

BI194M NEUTRON ACER TENDL-2021 LIBRARY; T=293.6K
Principal cross sections

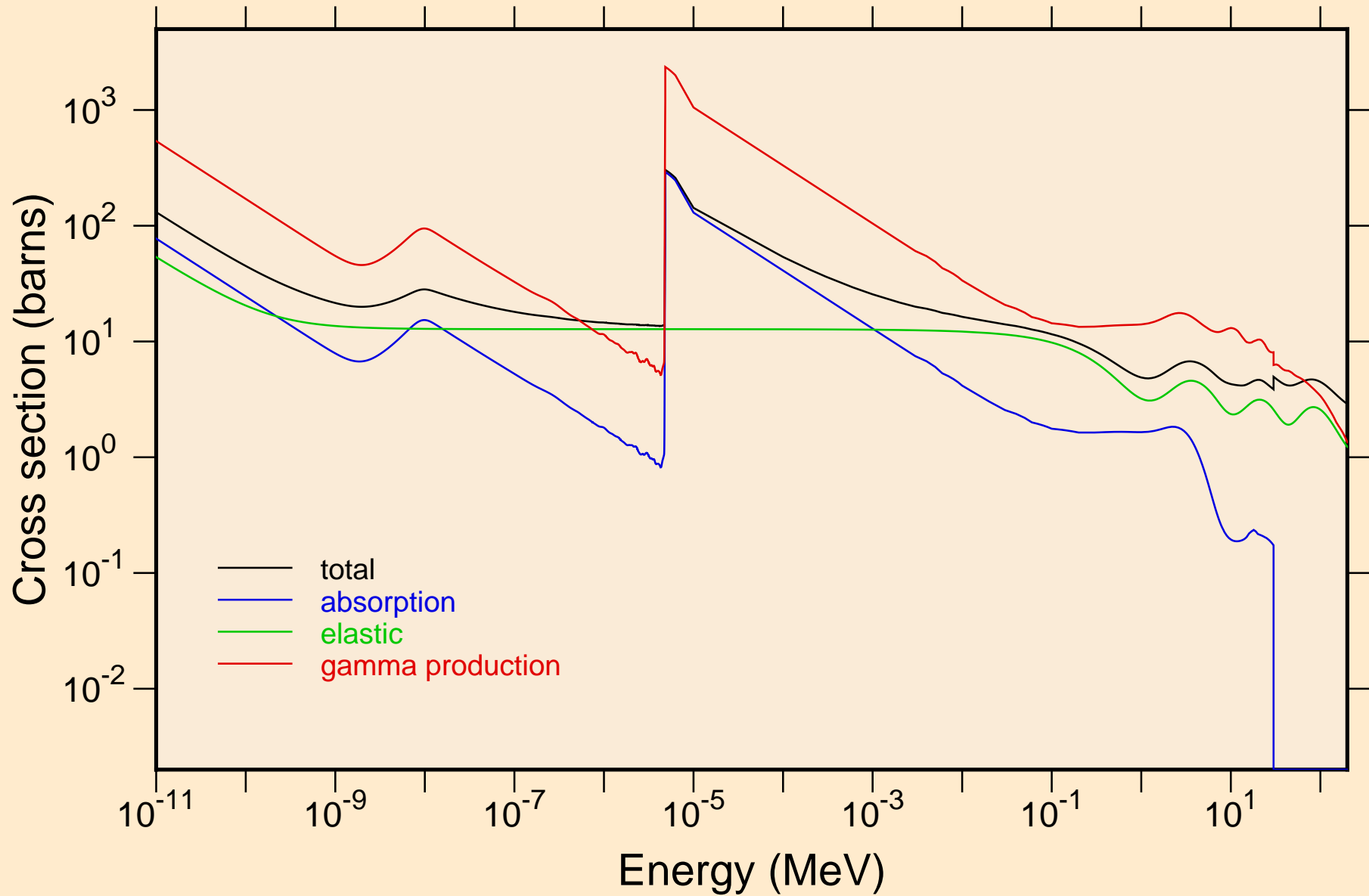

BI194M NEUTRON ACER TENDL-2021 LIBRARY; T=293.6K
resonance total cross section

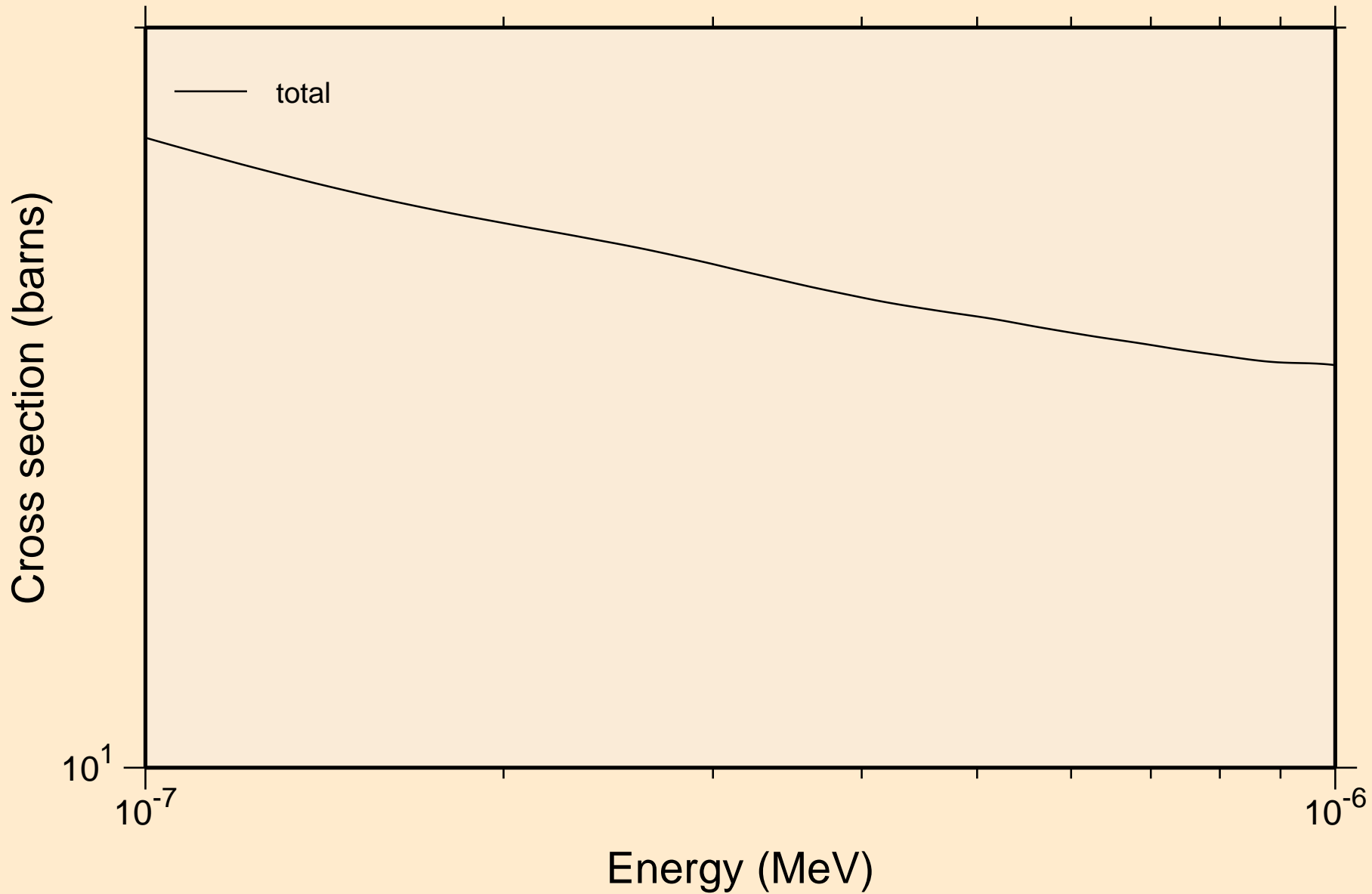

BI194M NEUTRON ACER TENDL-2021 LIBRARY; T=293.6K
resonance total cross section

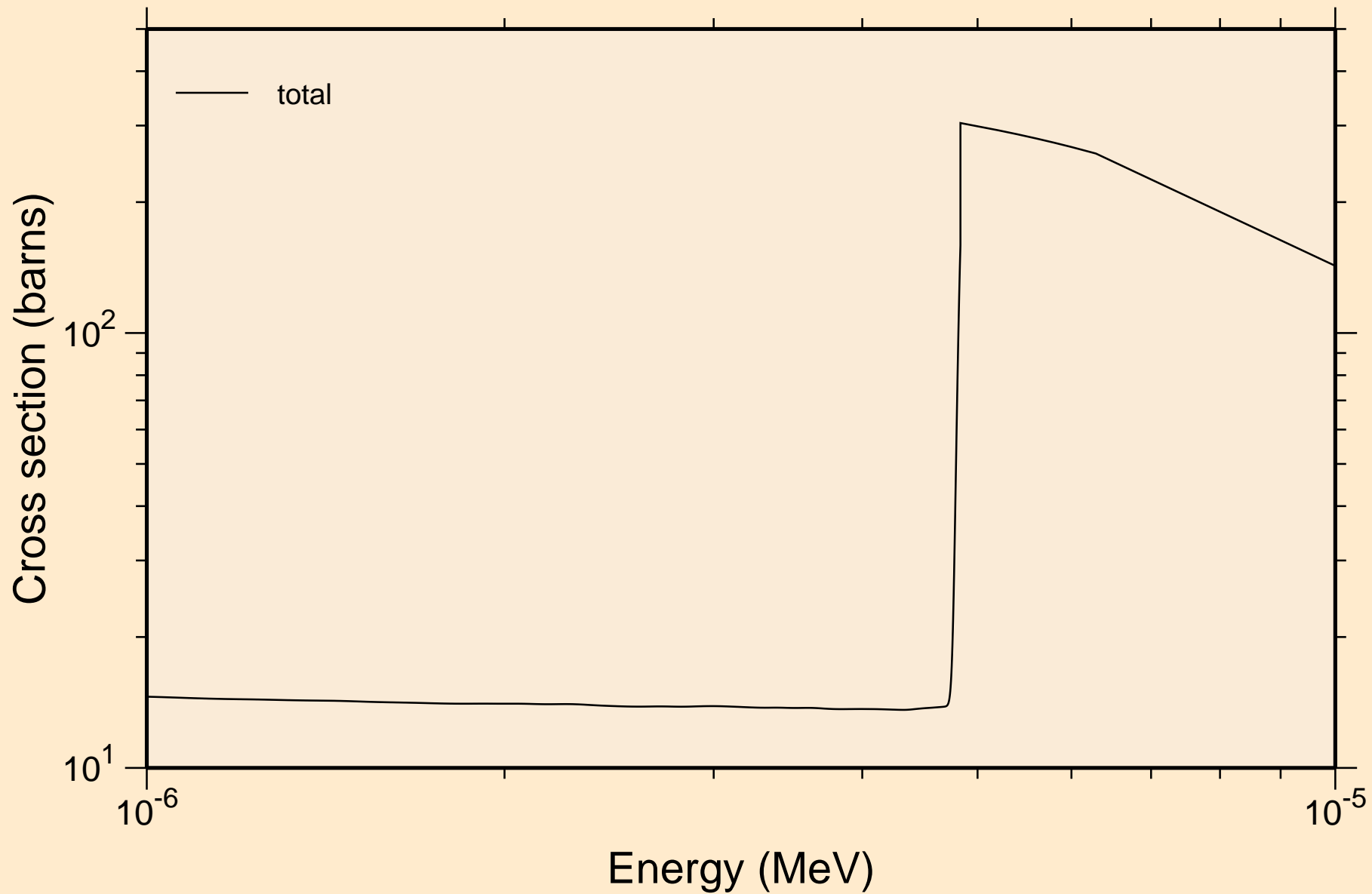

B¹⁹⁴M NEUTRON ACER TENDL-2021 LIBRARY; T=293.6K
resonance total cross section

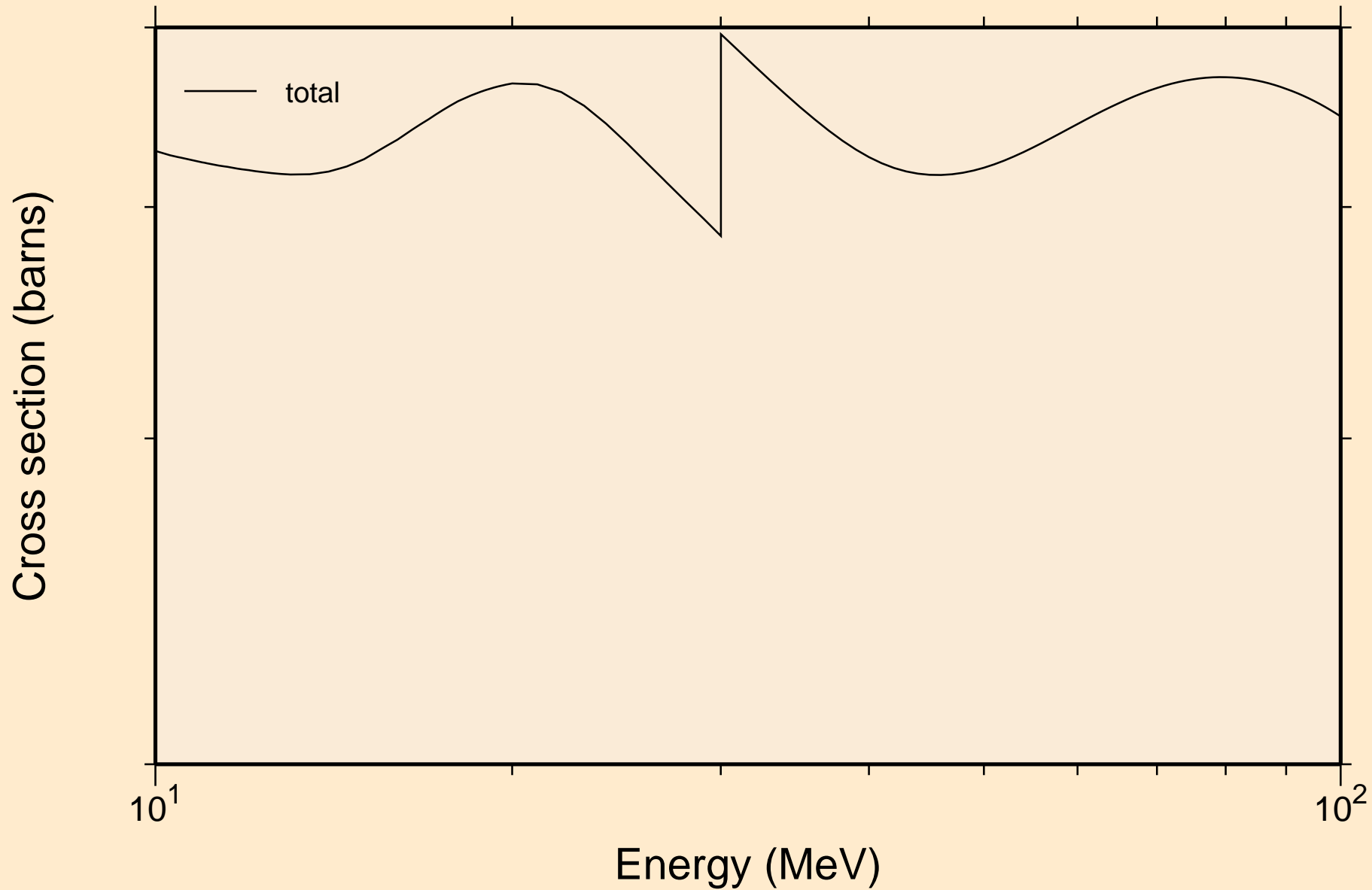

BI194M NEUTRON ACER TENDL-2021 LIBRARY; T=293.6K
resonance absorption cross sections

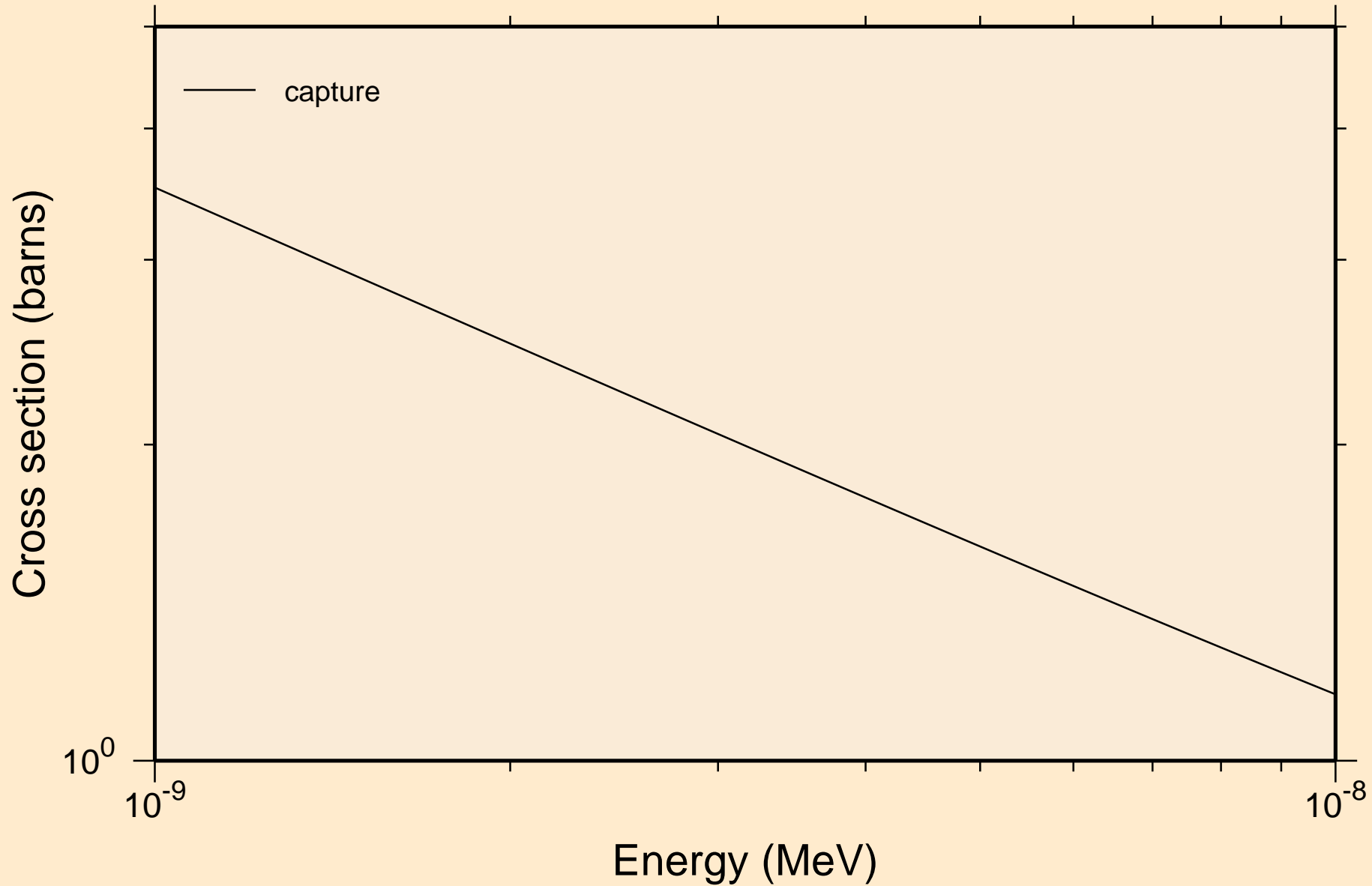

BI194M NEUTRON ACER TENDL-2021 LIBRARY; T=293.6K
resonance absorption cross sections

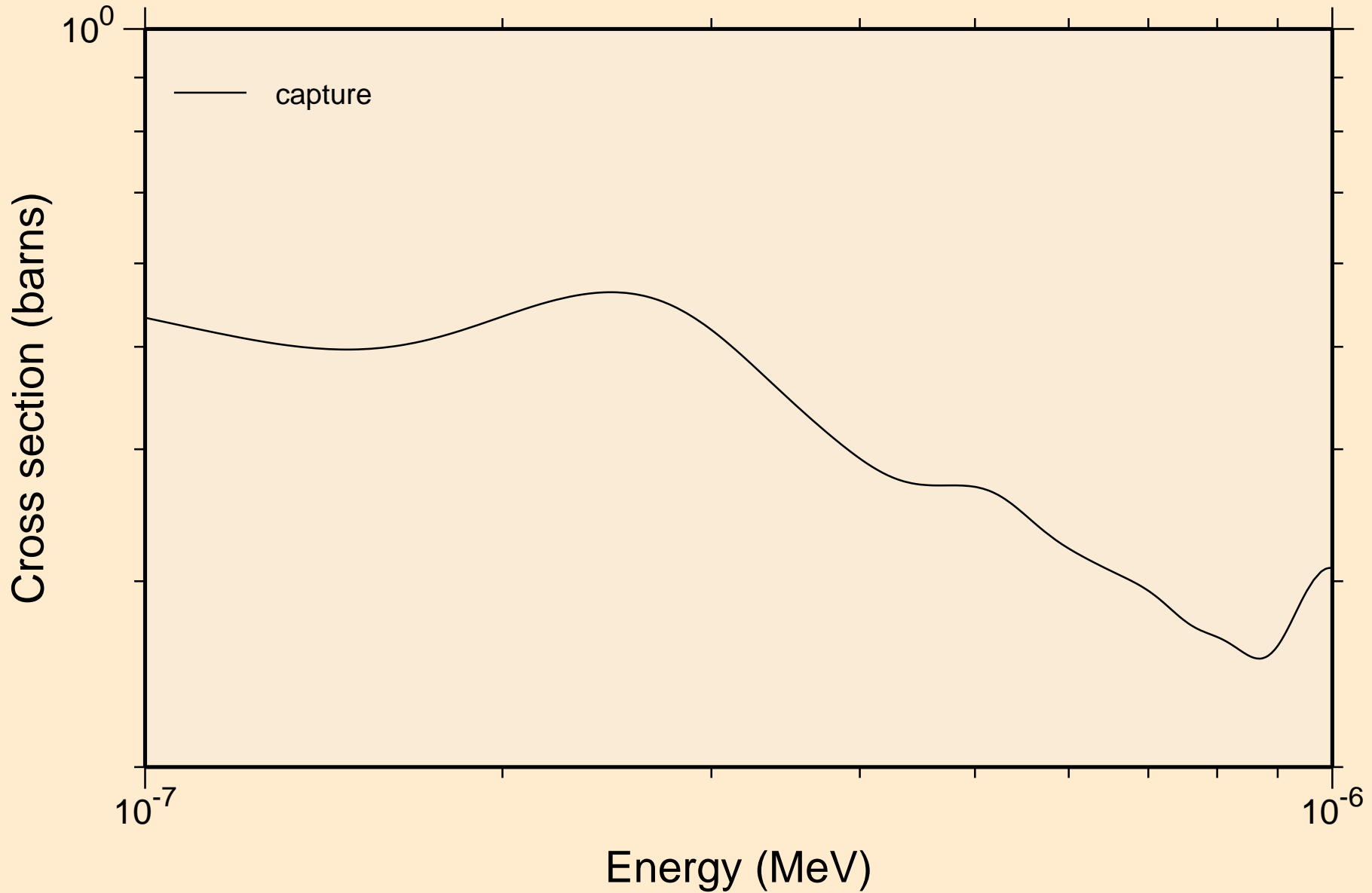

BI194M NEUTRON ACER TENDL-2021 LIBRARY; T=293.6K
resonance absorption cross sections

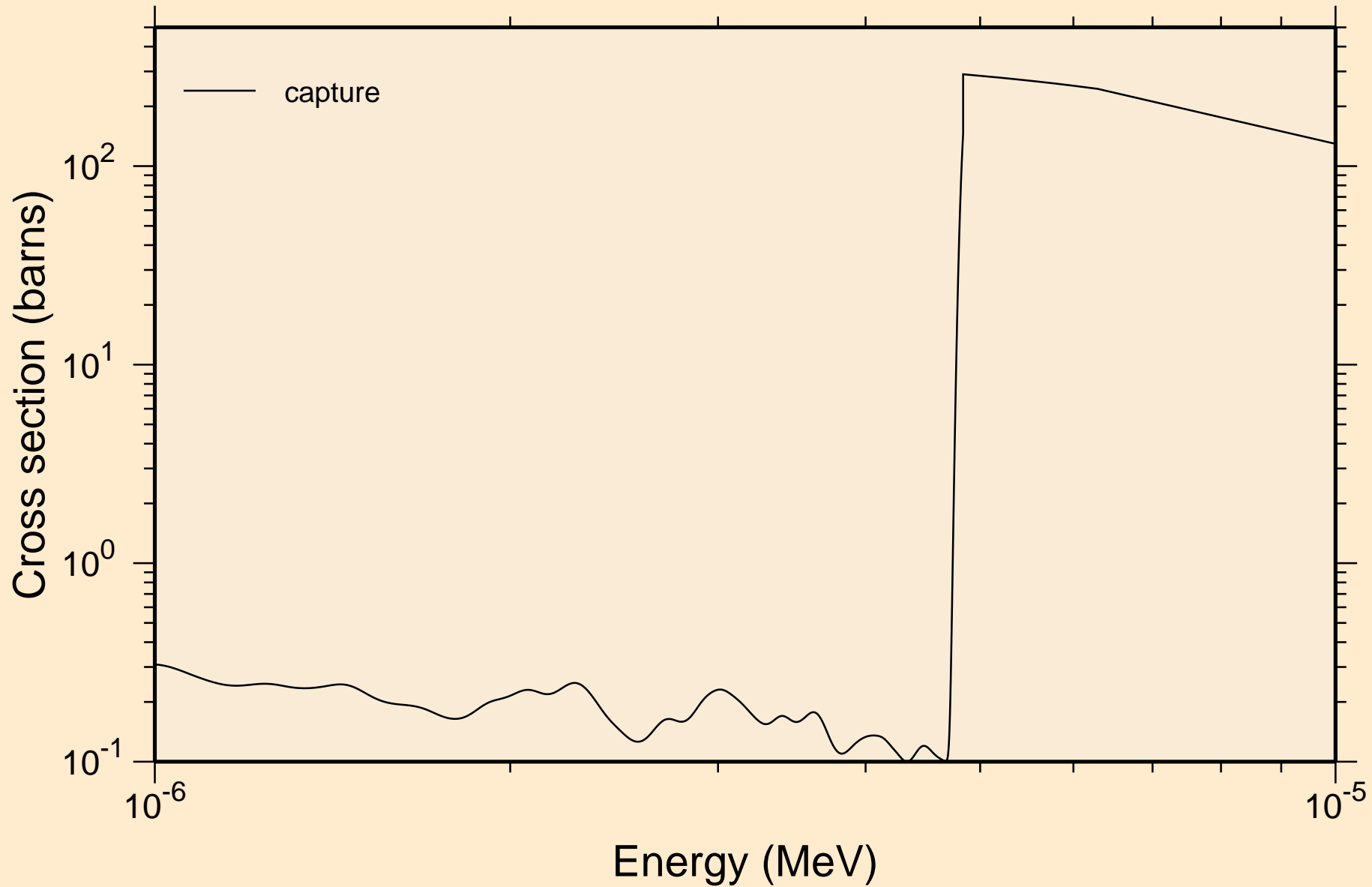

BI194M NEUTRON ACER TENDL-2021 LIBRARY; T=293.6K
resonance absorption cross sections

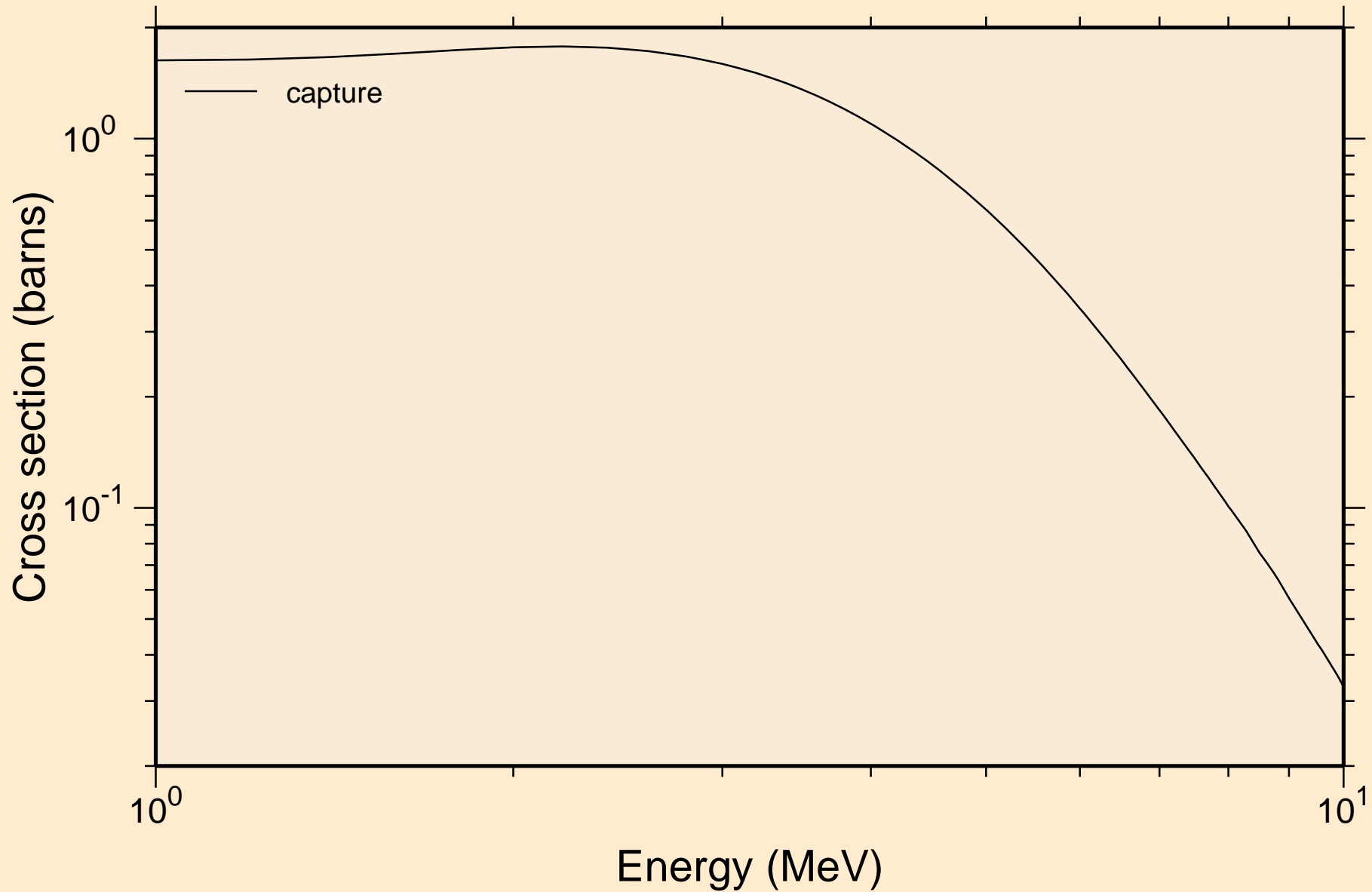

BI194M NEUTRON ACER TENDL-2021 LIBRARY; T=293.6K
Heating

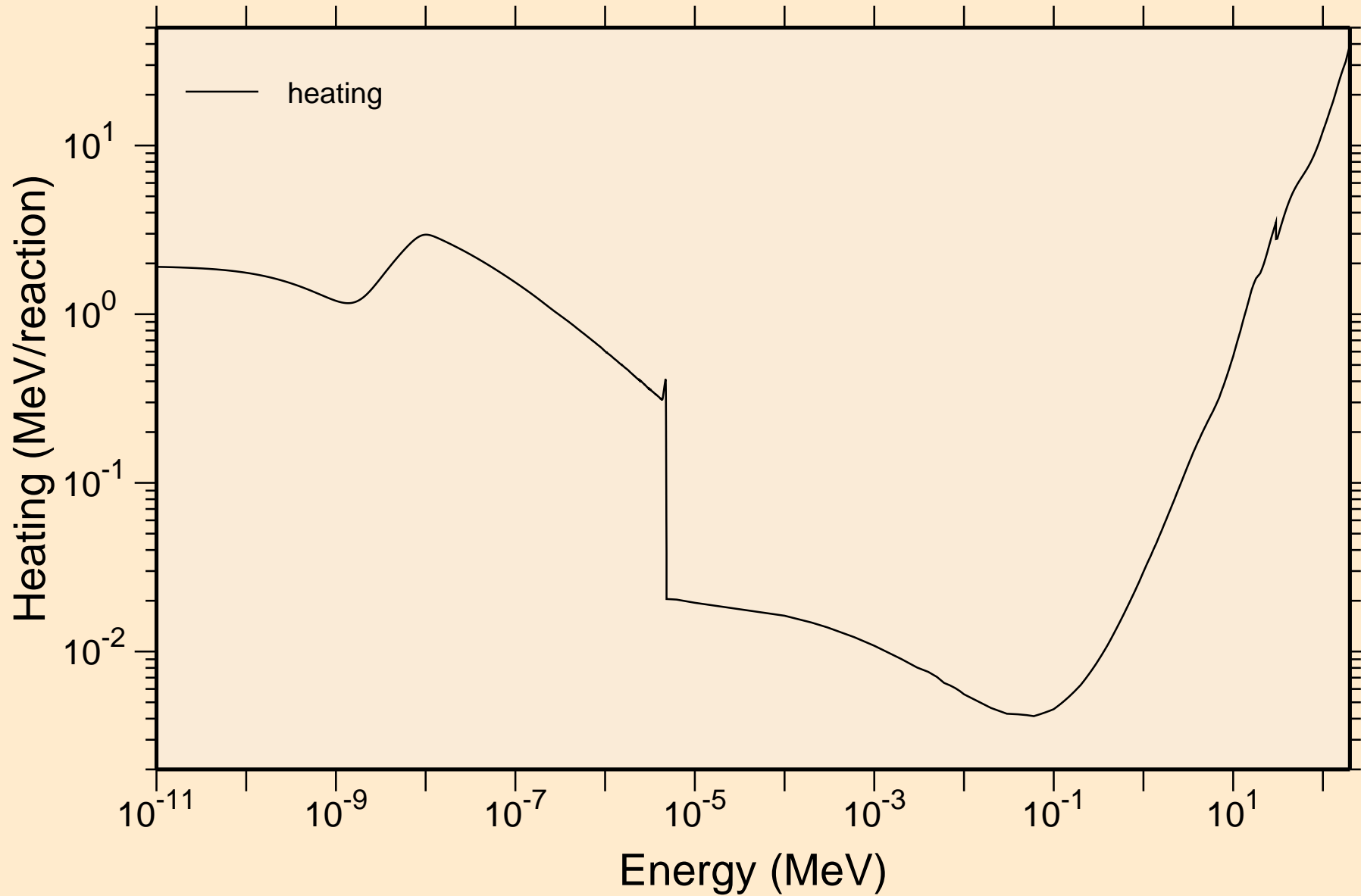

BI194M NEUTRON ACER TENDL-2021 LIBRARY; T=293.6K
Damage

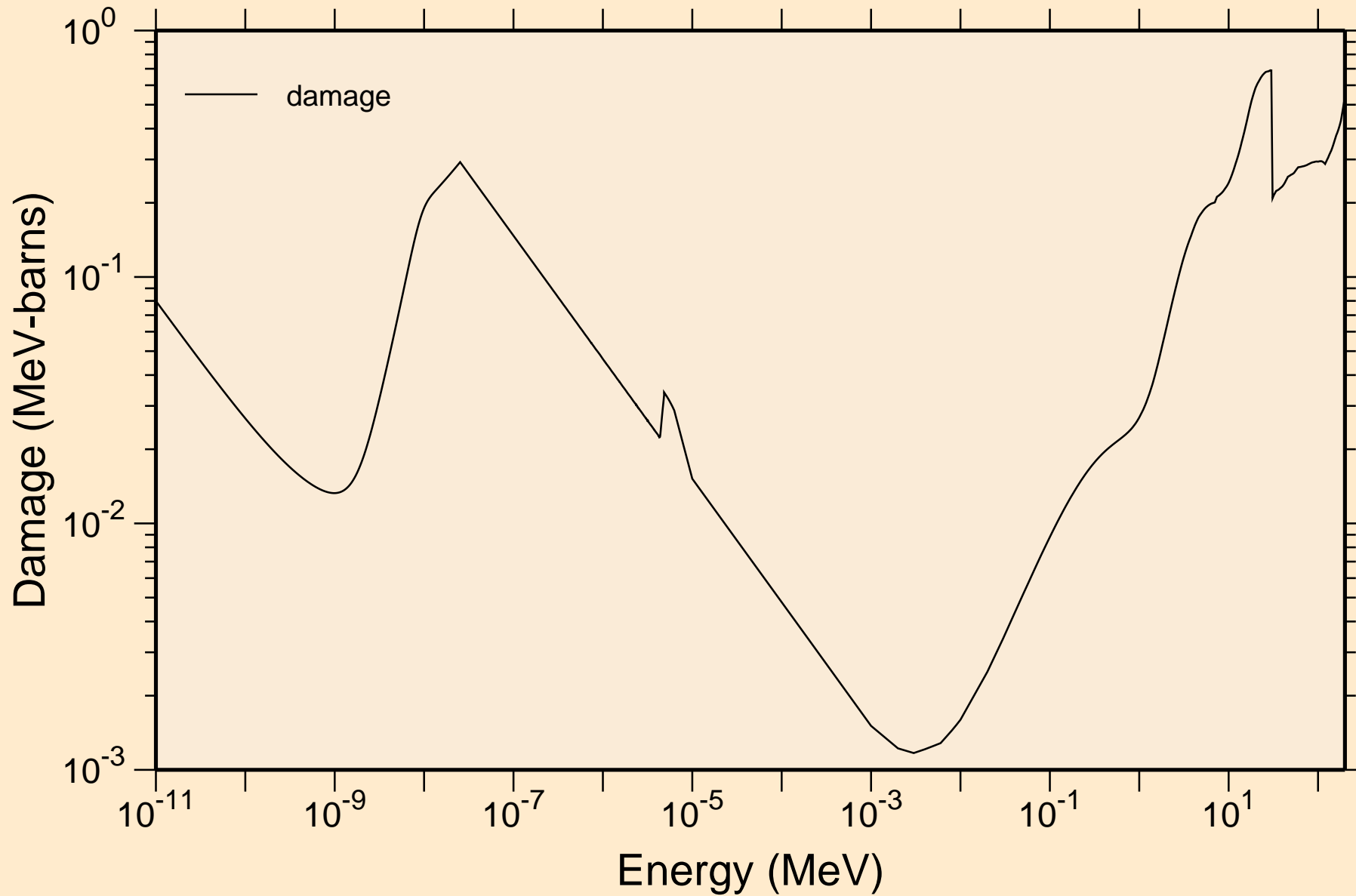

BI194M NEUTRON ACER TENDL-2021 LIBRARY; T=293.6K
Non-threshold reactions

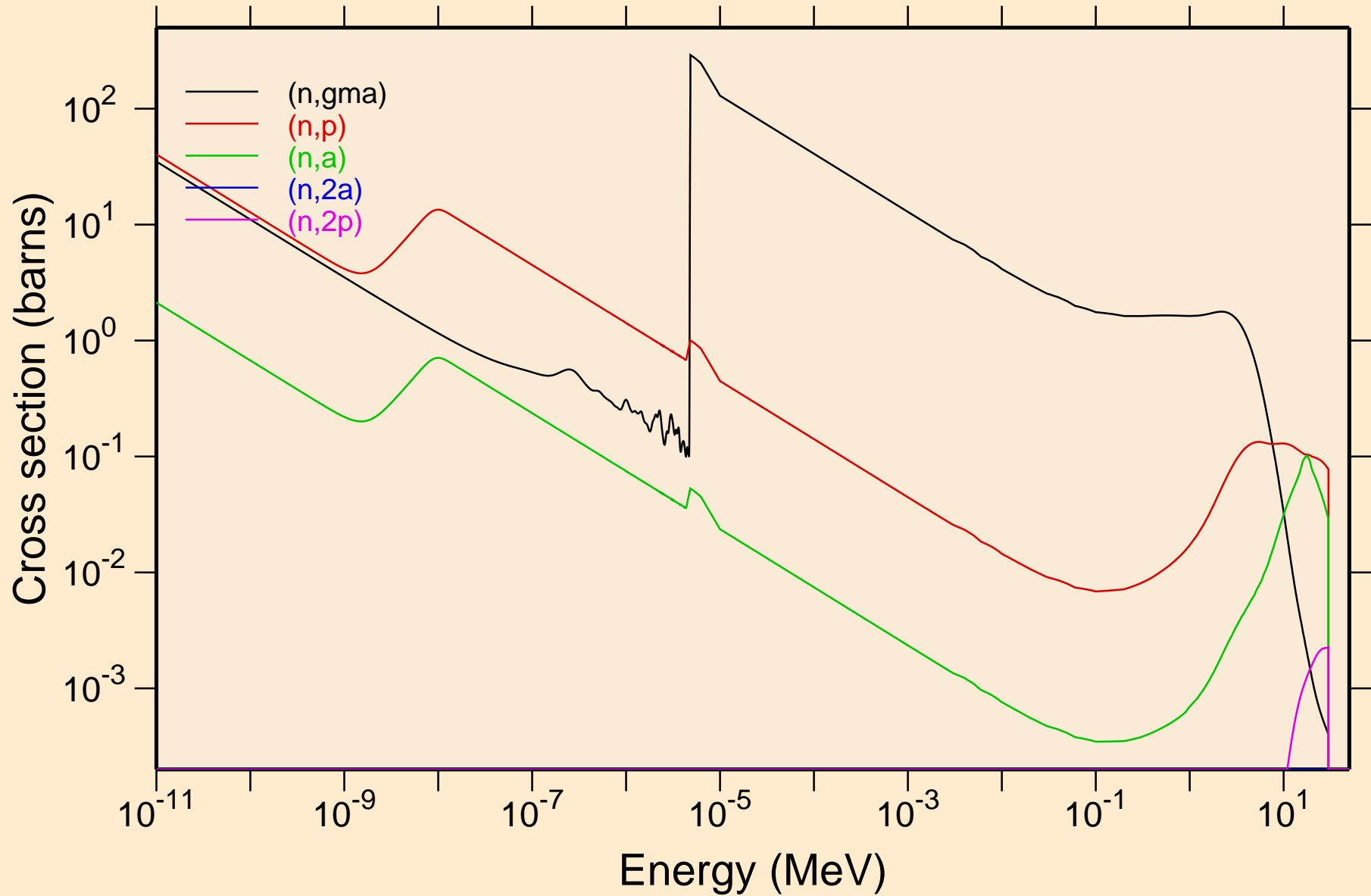

BI194M NEUTRON ACER TENDL-2021 LIBRARY; T=293.6K
Non-threshold reactions

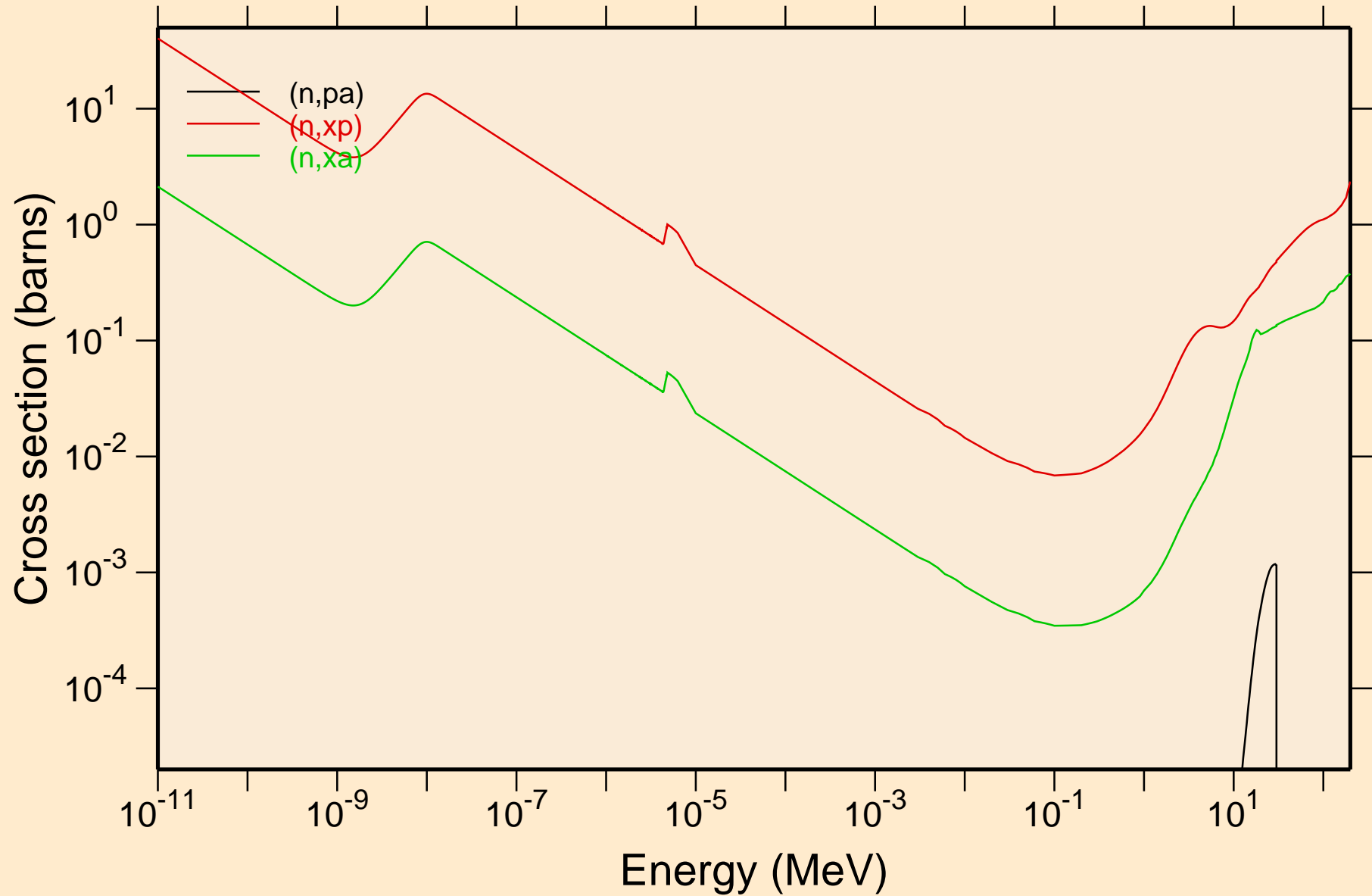

BI194M NEUTRON ACER TENDL-2021 LIBRARY; T=293.6K
Principal cross sections

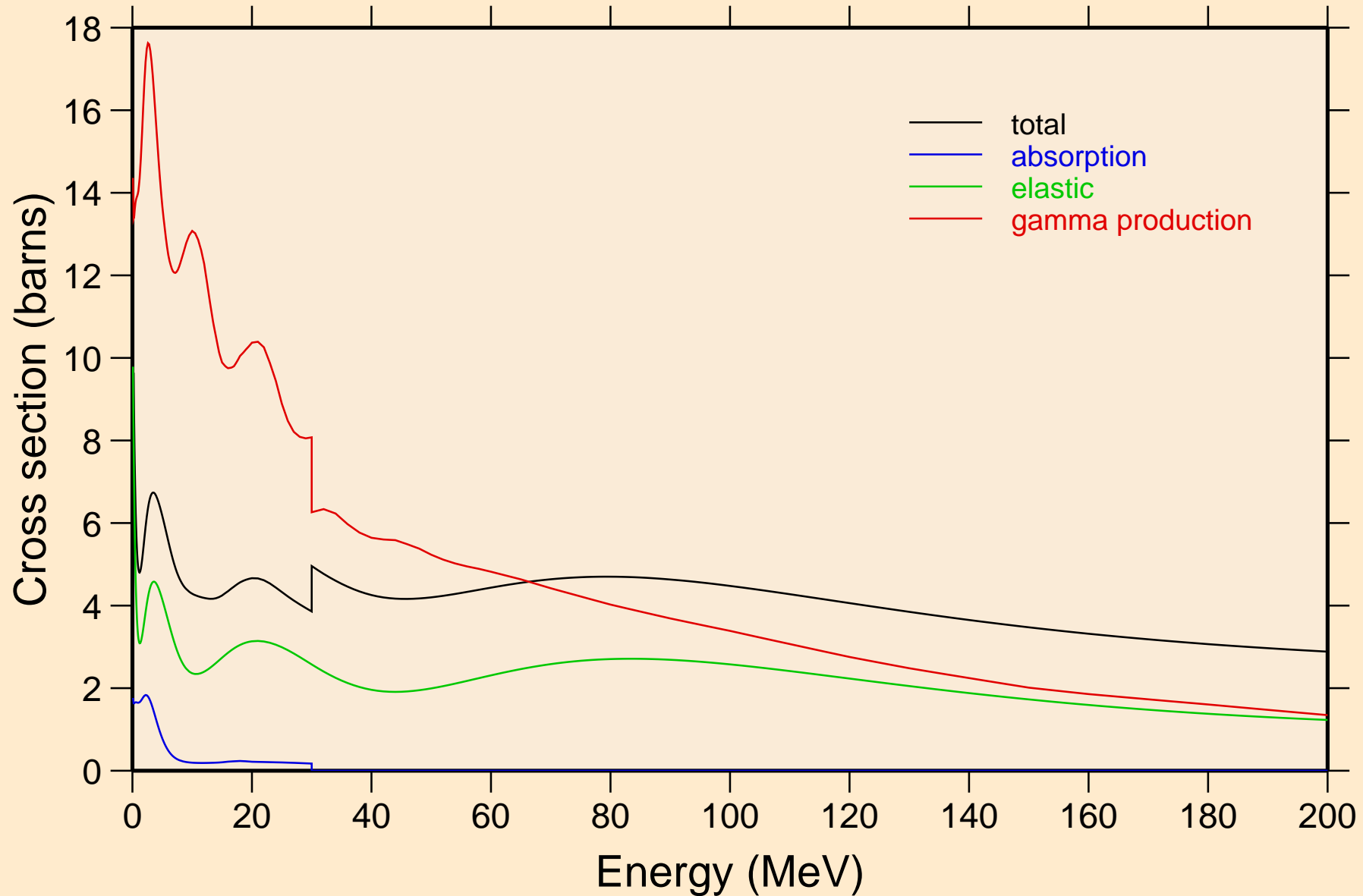

BI194M NEUTRON ACER TENDL-2021 LIBRARY; T=293.6K

Heating

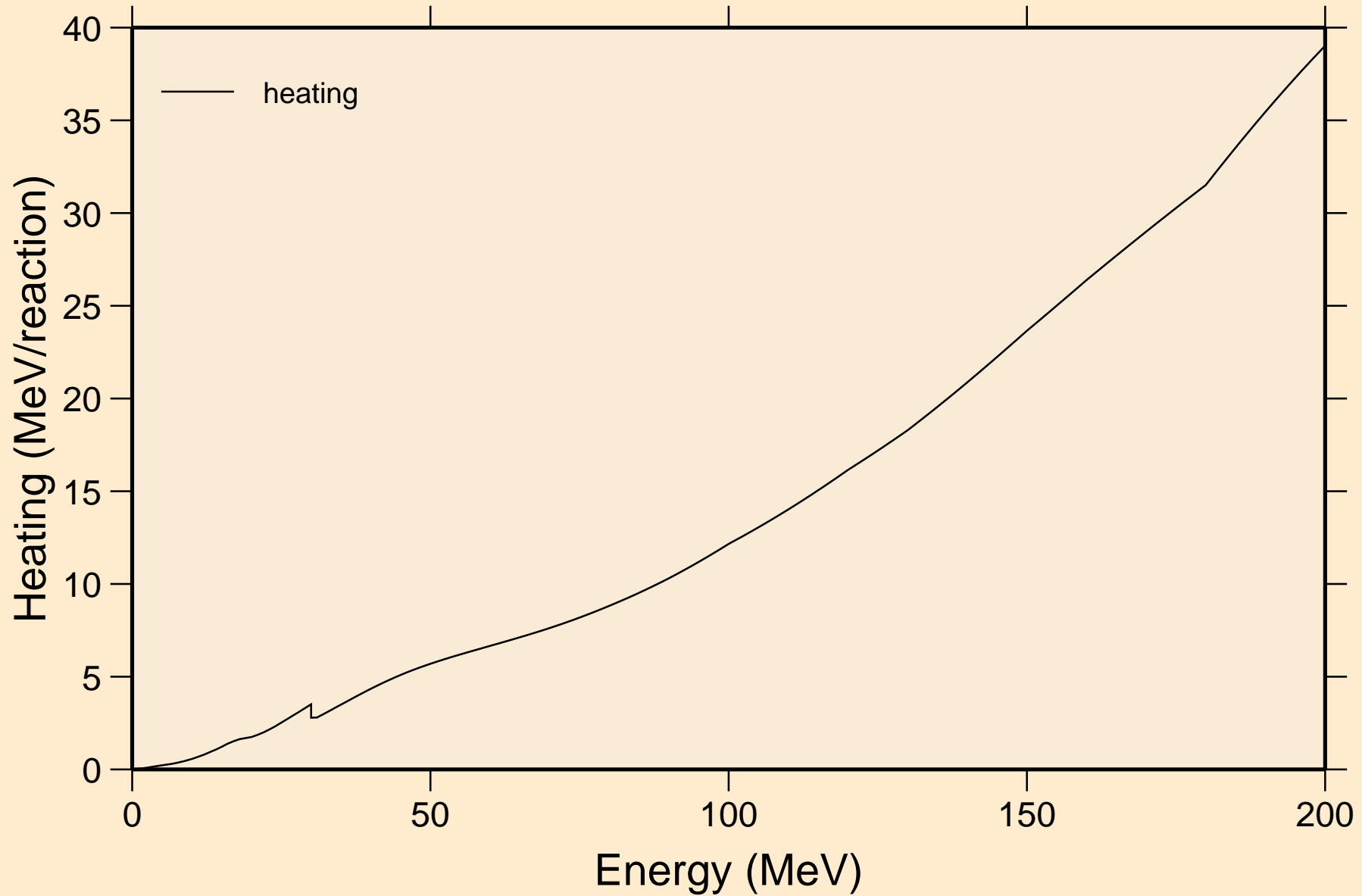

BI194M NEUTRON ACER TENDL-2021 LIBRARY; T=293.6K
Damage

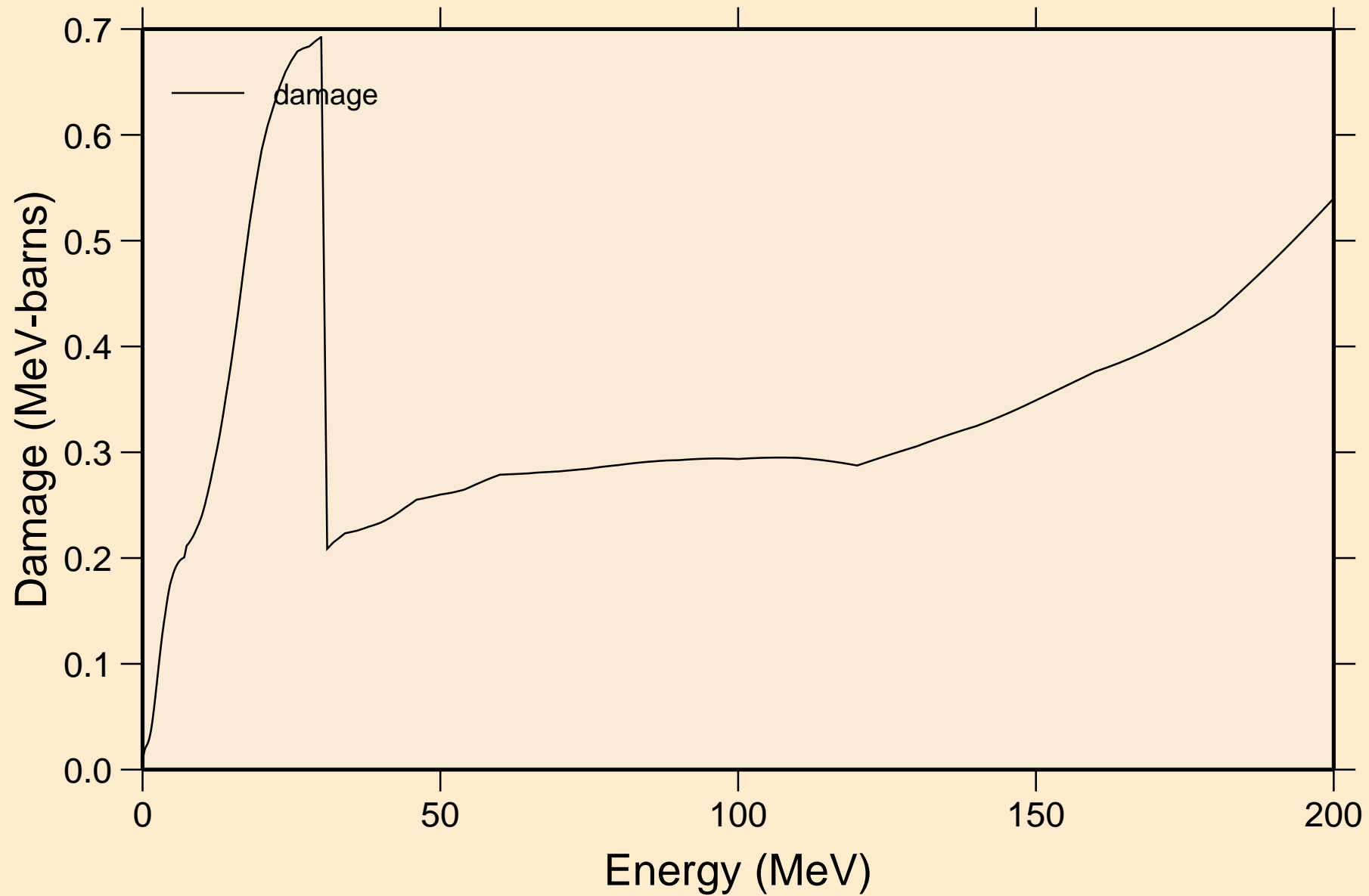

BI194M NEUTRON ACER TENDL-2021 LIBRARY; T=293.6K
Non-threshold reactions

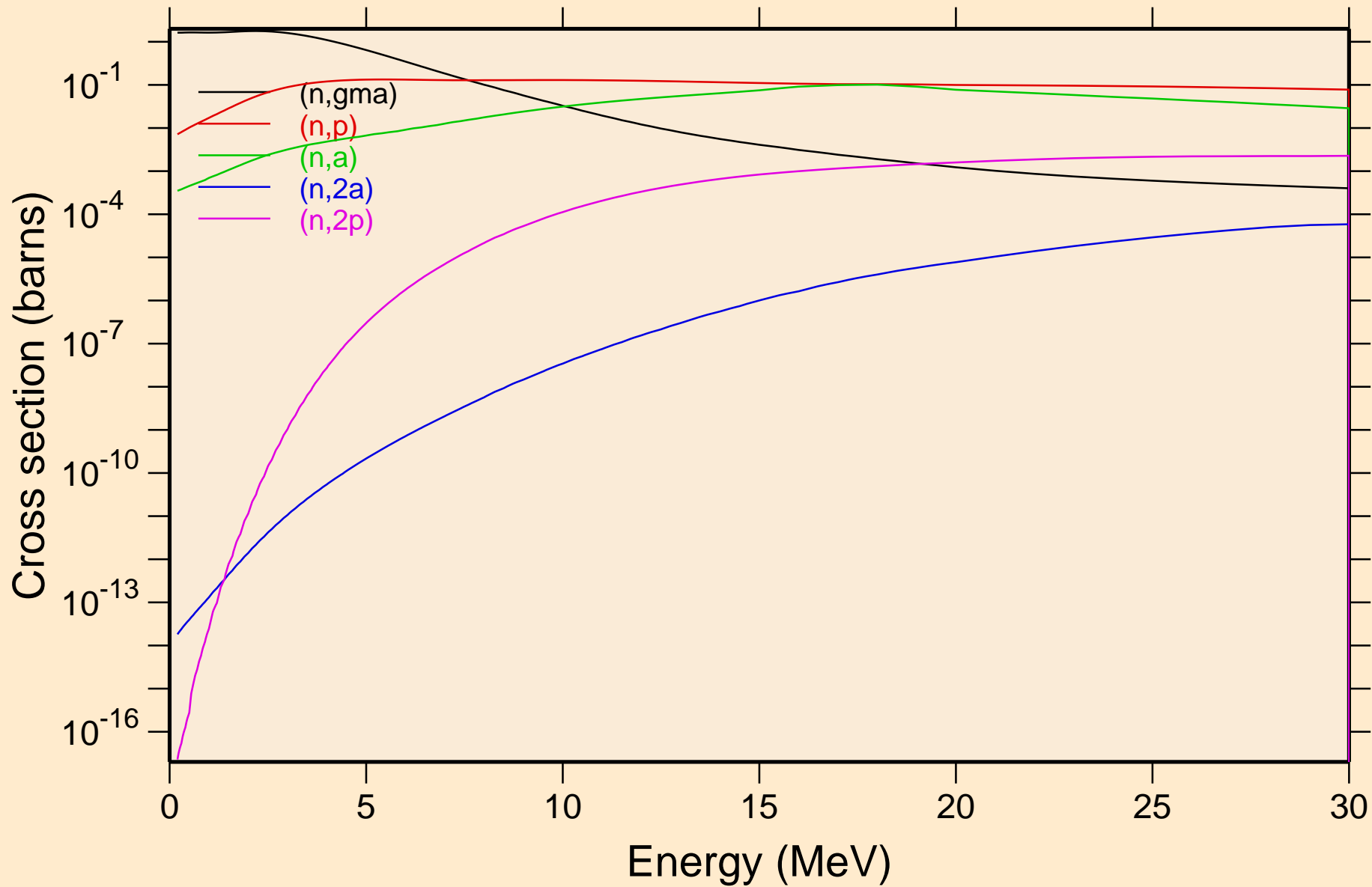

BI194M NEUTRON ACER TENDL-2021 LIBRARY; T=293.6K
Non-threshold reactions

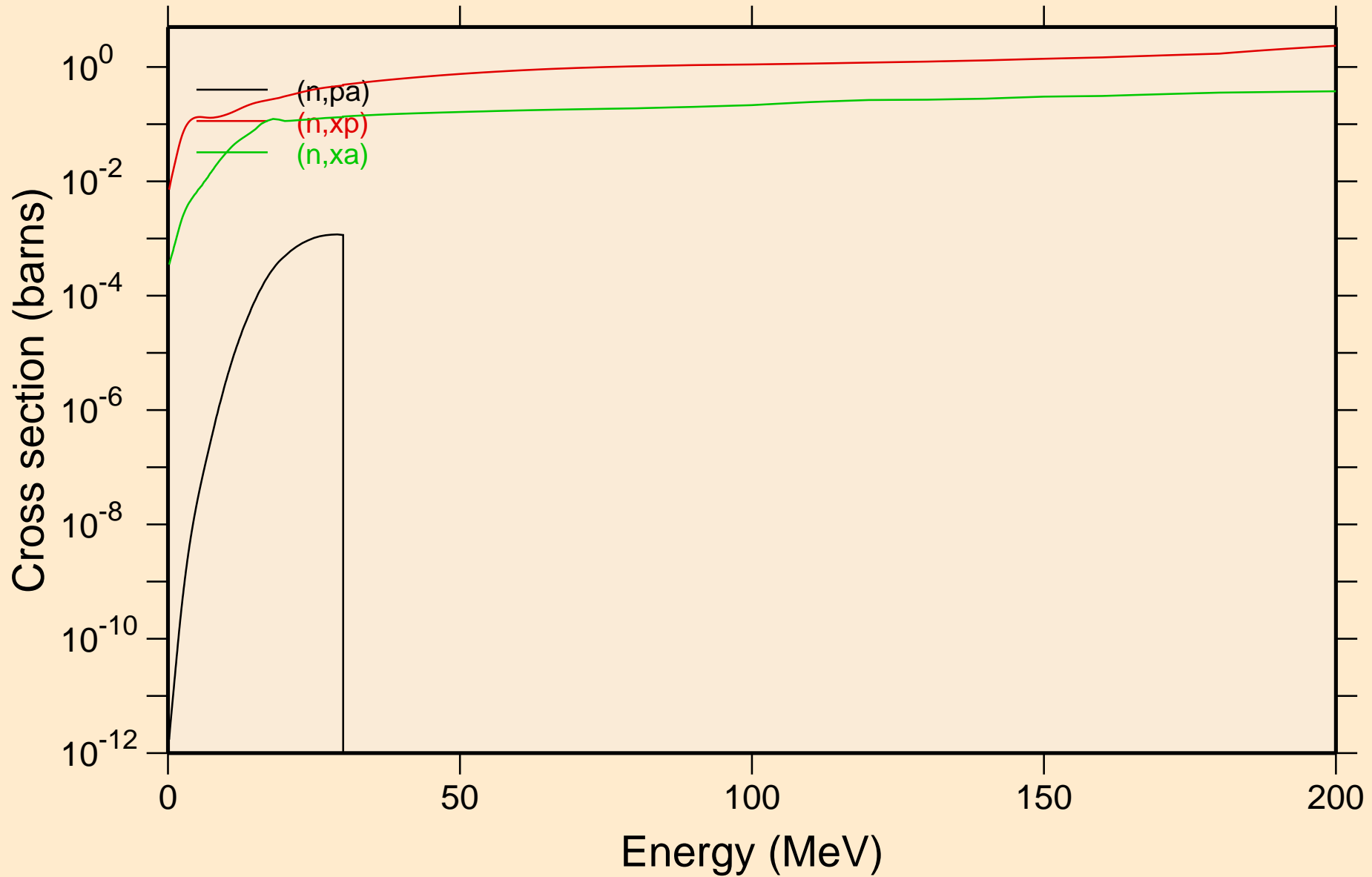

BI194M NEUTRON ACER TENDL-2021 LIBRARY; T=293.6K
Inelastic levels

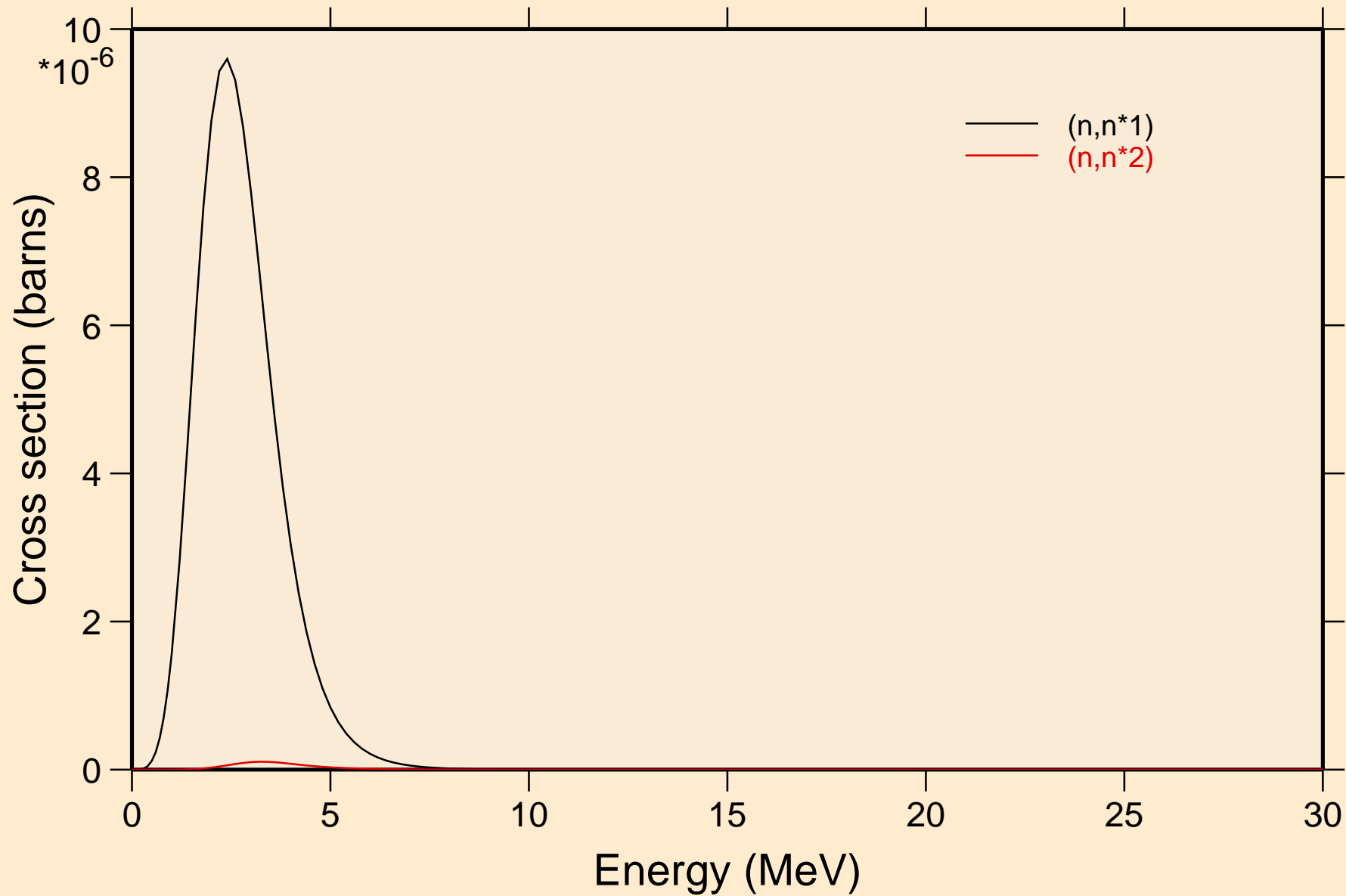

BI194M NEUTRON ACER TENDL-2021 LIBRARY; T=293.6K
Threshold reactions

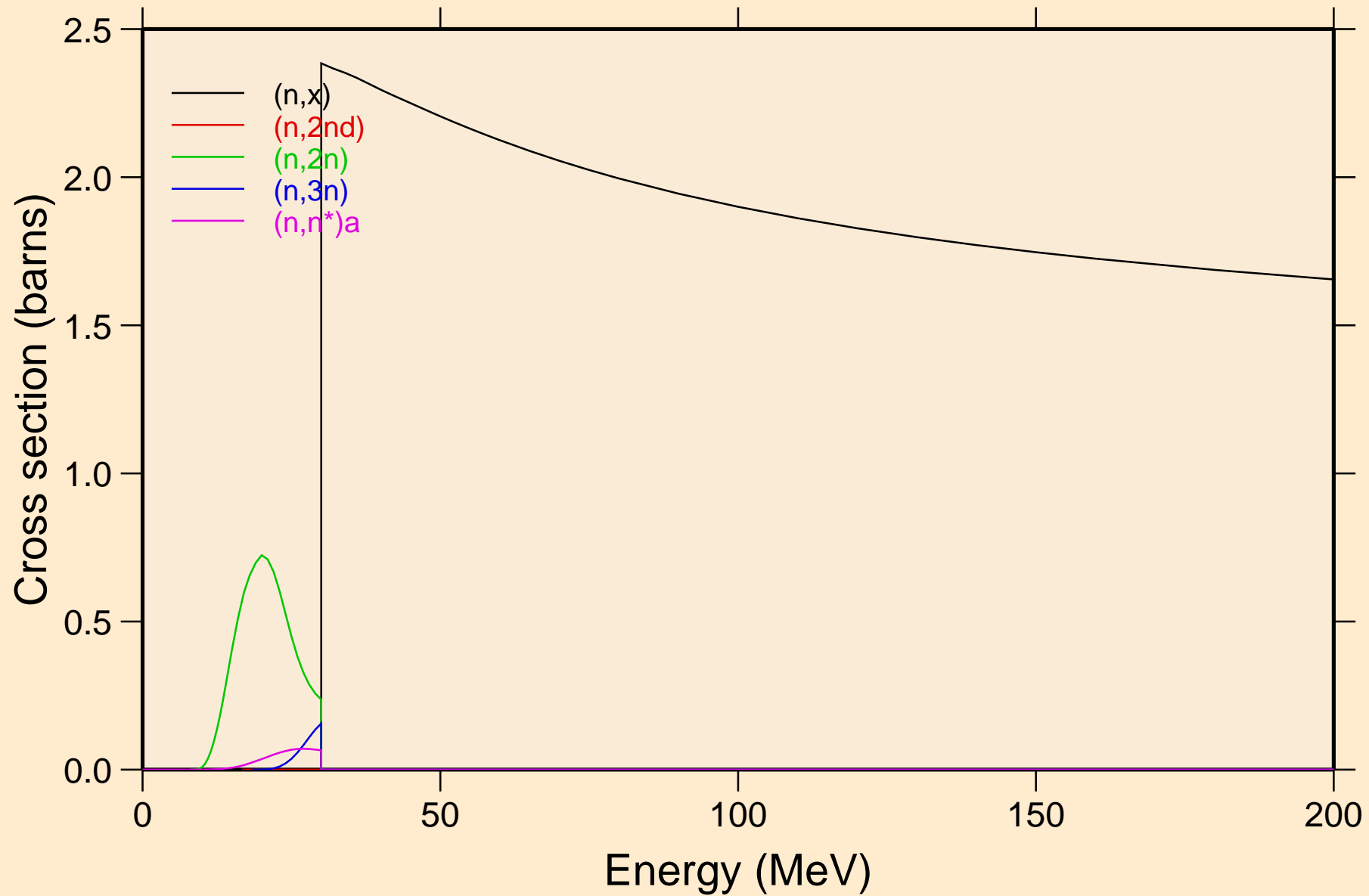

BI194M NEUTRON ACER TENDL-2021 LIBRARY; T=293.6K
Threshold reactions

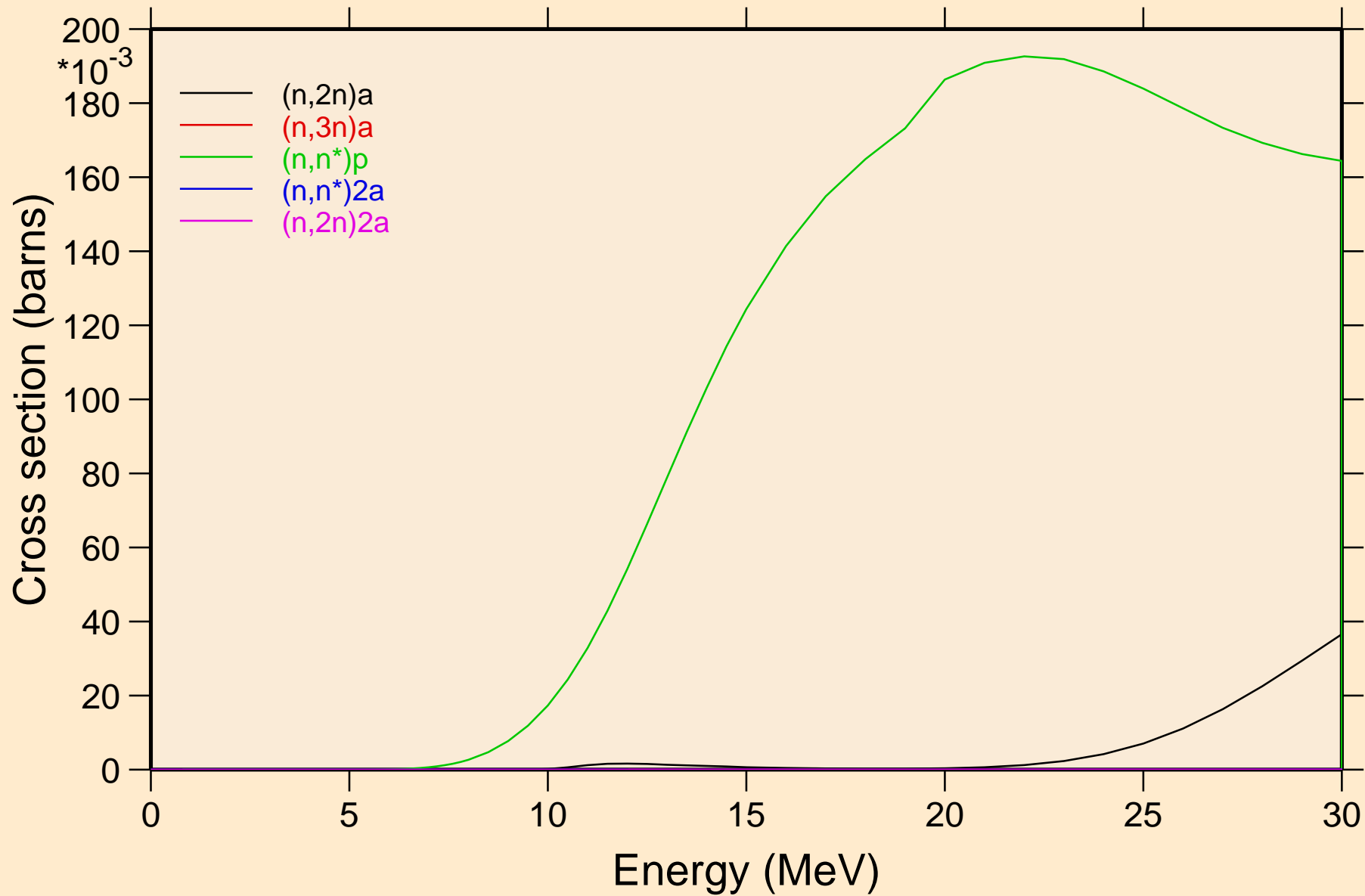

BI194M NEUTRON ACER TENDL-2021 LIBRARY; T=293.6K
Threshold reactions

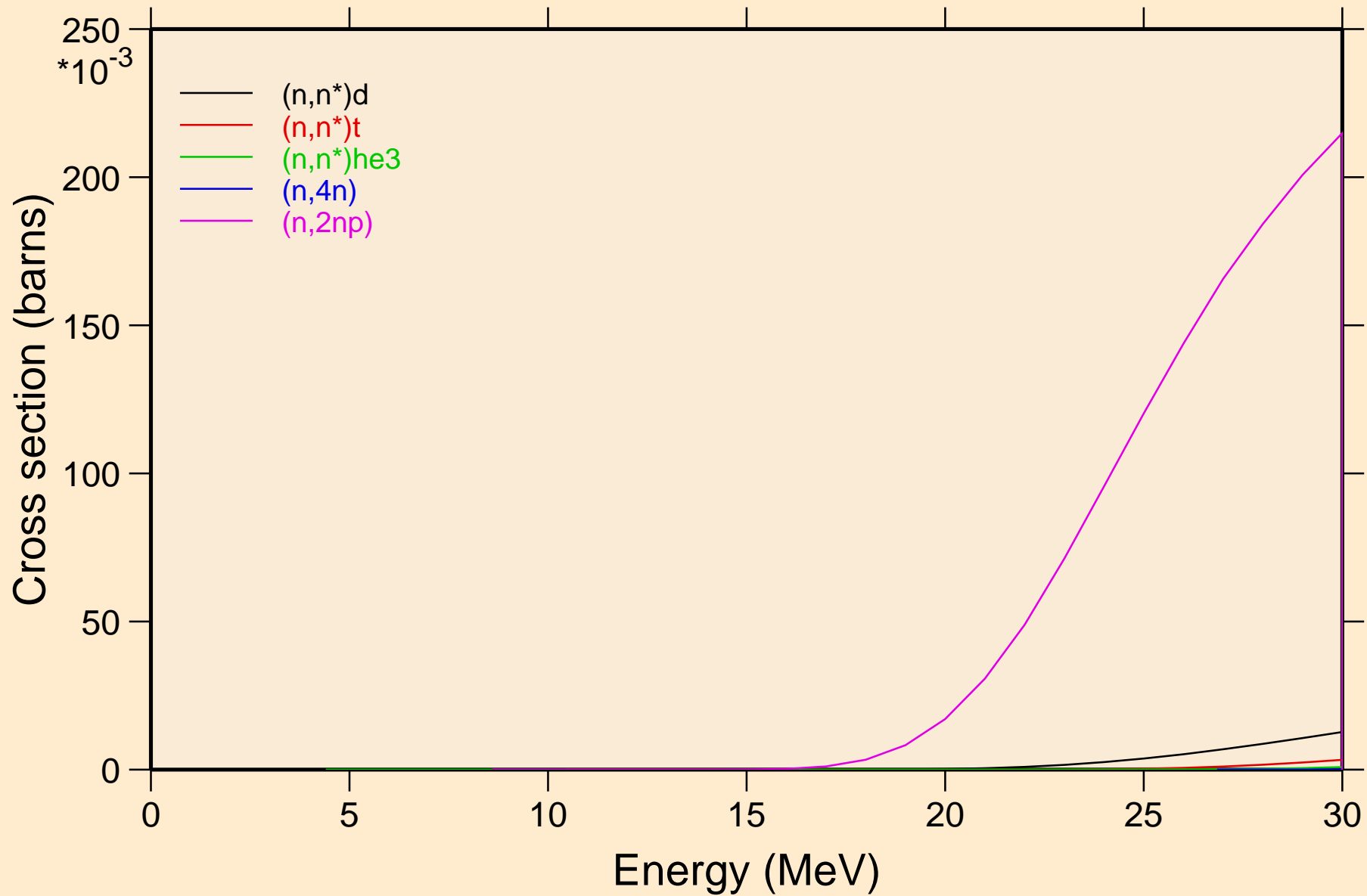

BI194M NEUTRON ACER TENDL-2021 LIBRARY; T=293.6K
Threshold reactions

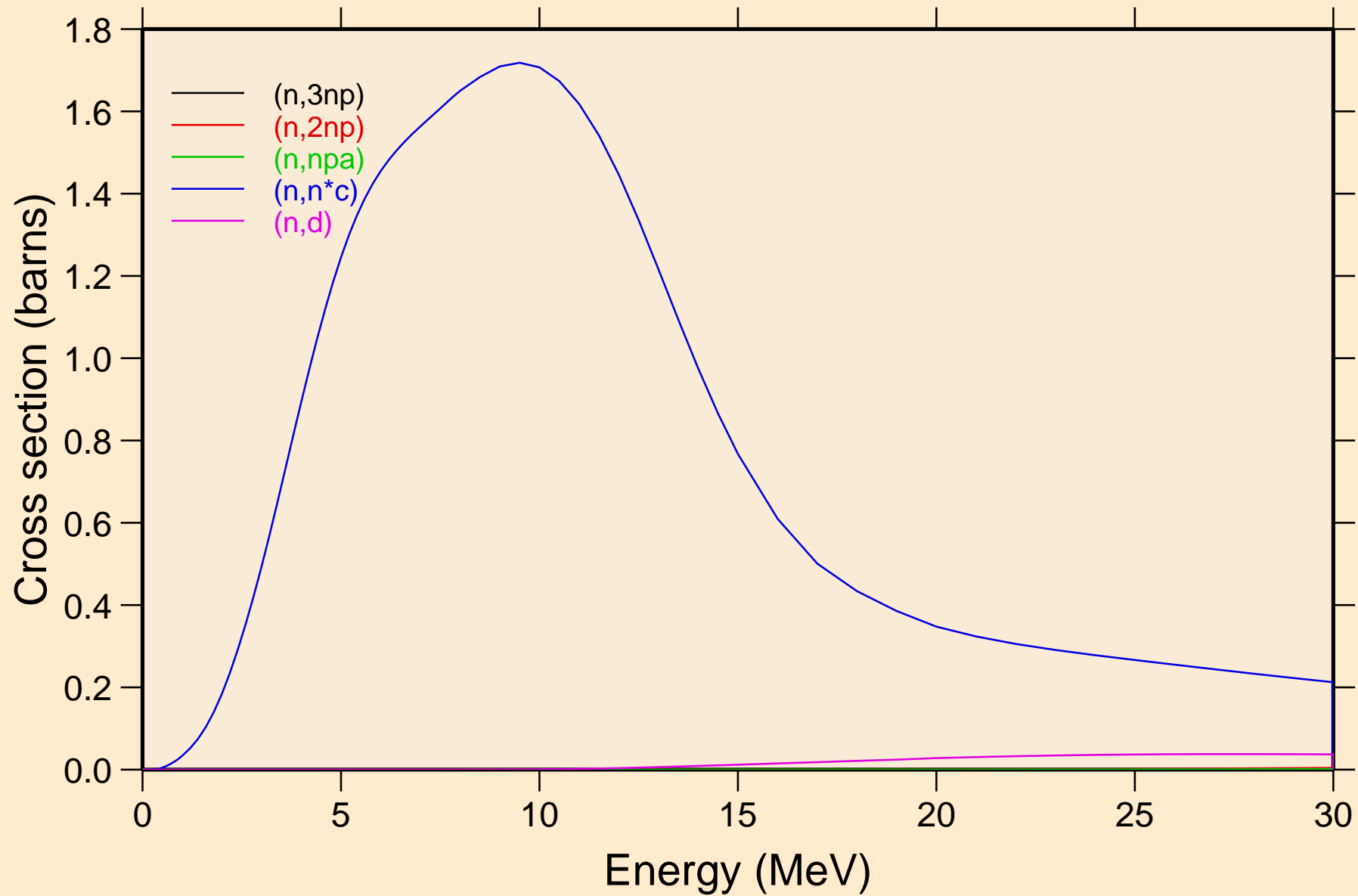

BI194M NEUTRON ACER TENDL-2021 LIBRARY; T=293.6K
Threshold reactions

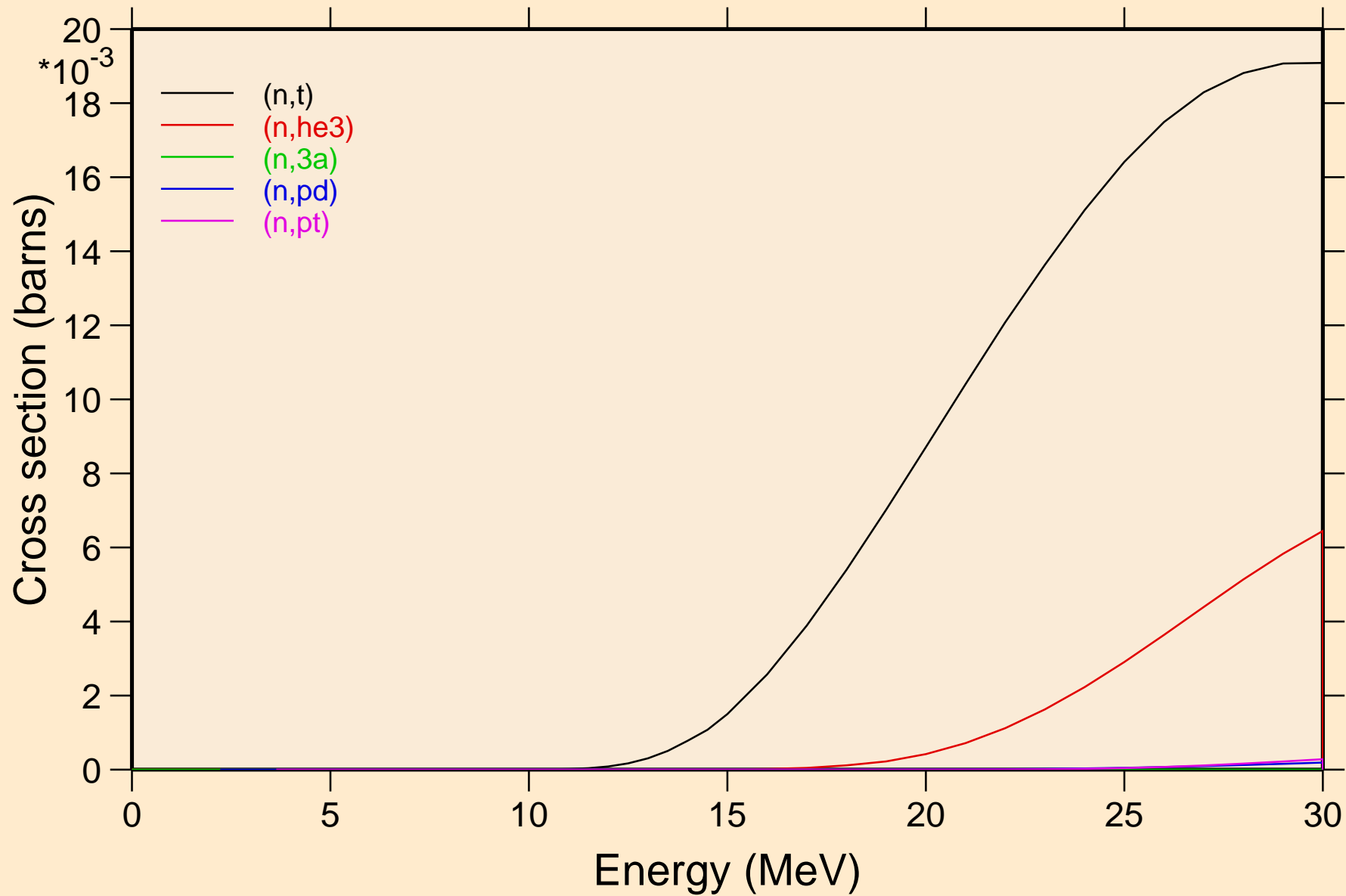

BI194M NEUTRON ACER TENDL-2021 LIBRARY; T=293.6K
Threshold reactions

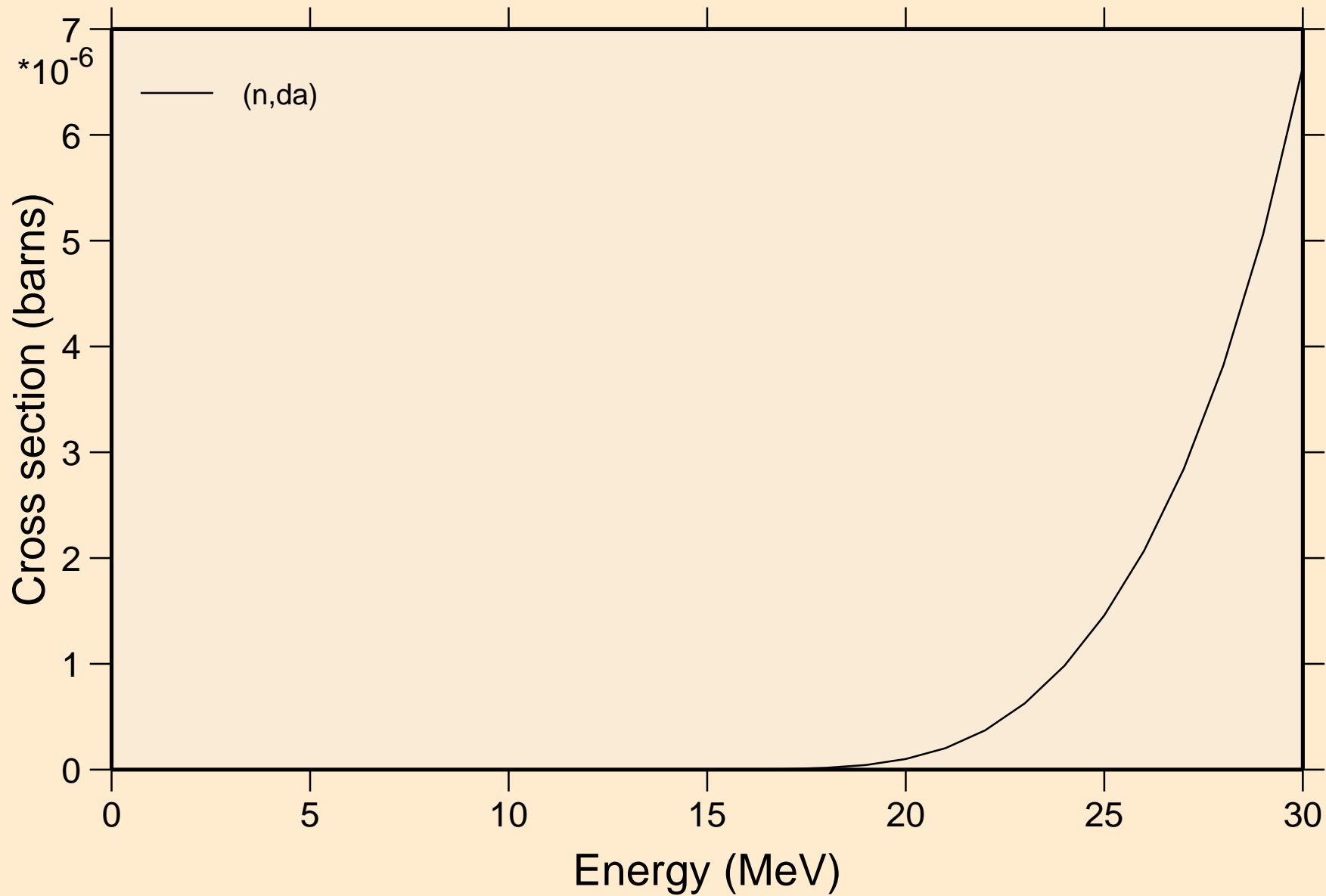

BI194M NEUTRON ACER TENDL-2021 LIBRARY; T=293.6K
Threshold reactions

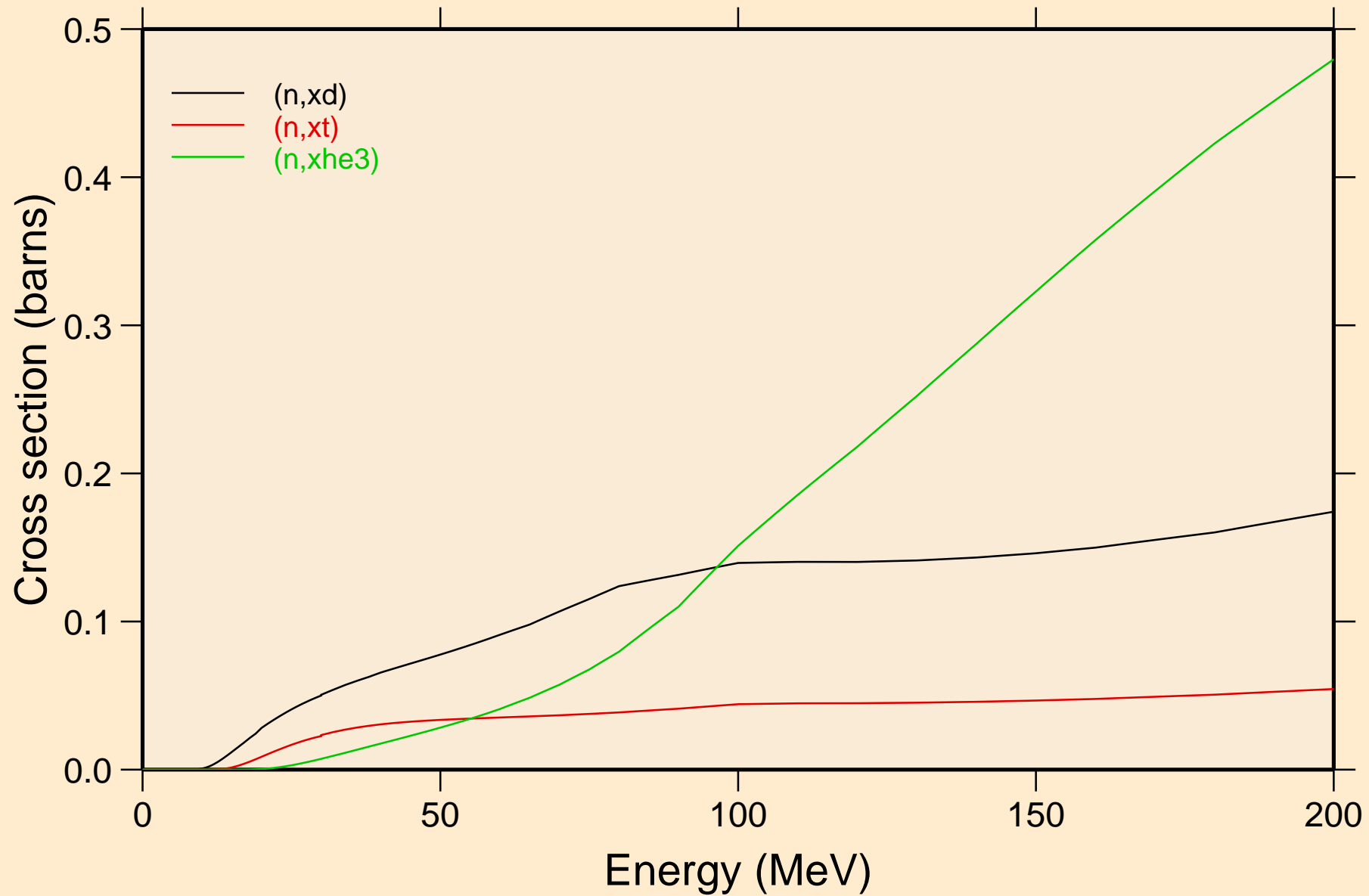

BI194M NEUTRON ACER TENDL-2021 LIBRARY; T=293.6K
angular distribution for elastic

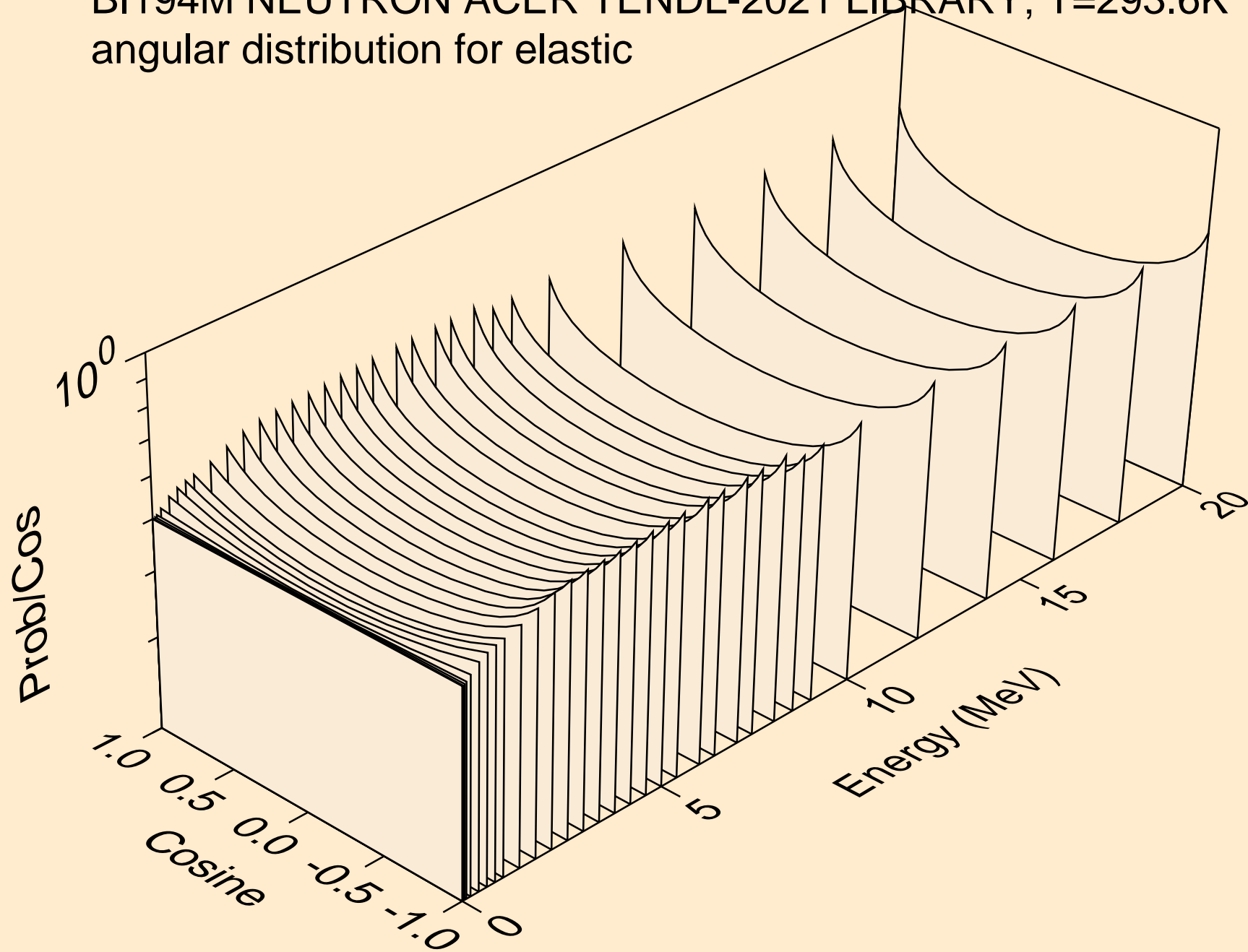

BI194M NEUTRON ACER TENDL-2021 LIBRARY; T=293.6K
angular distribution for elastic

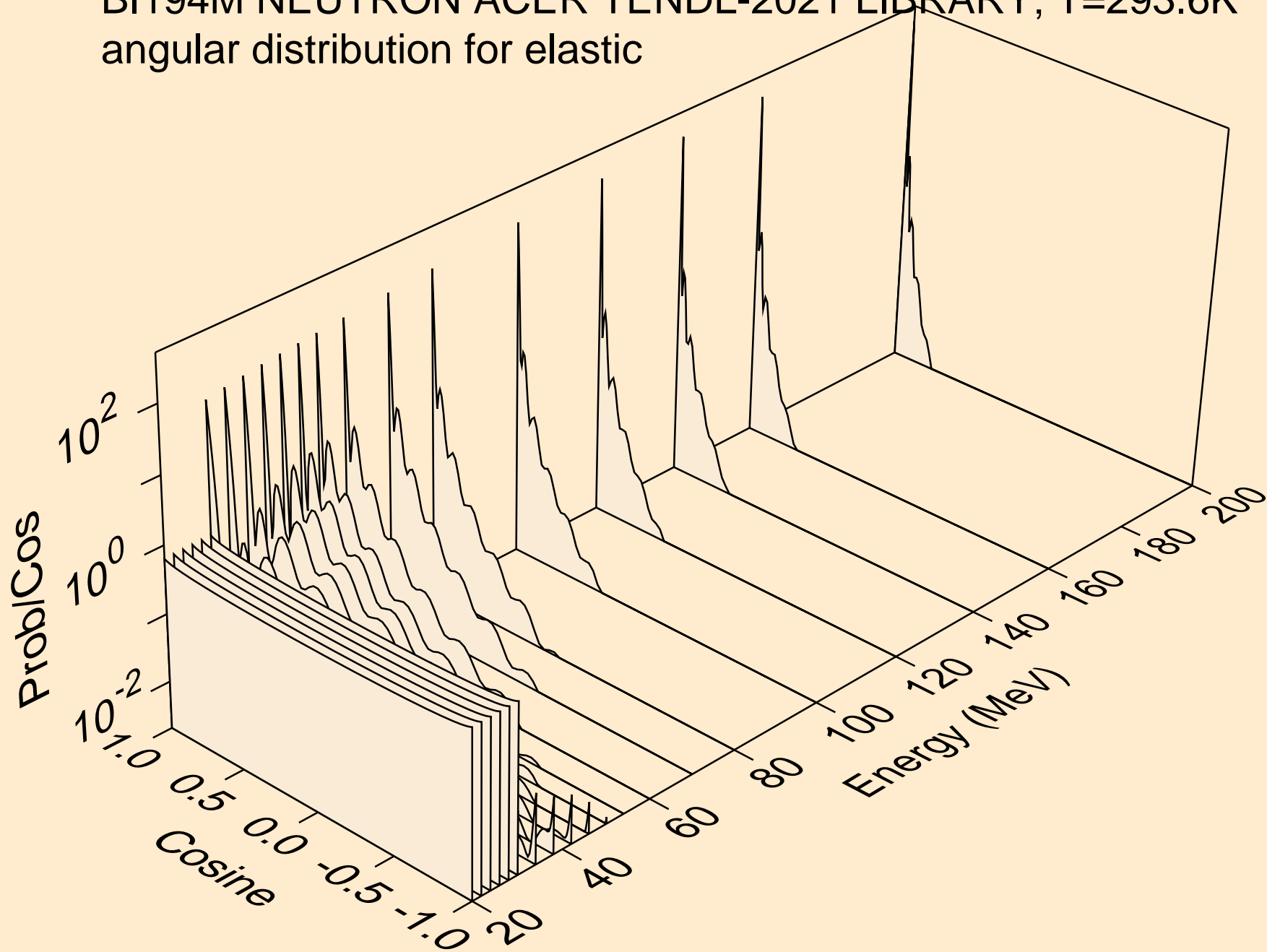

BI194M NEUTRON ACER TENDL-2021 LIBRARY; T=293.6K
angular distribution for (n,n*1)

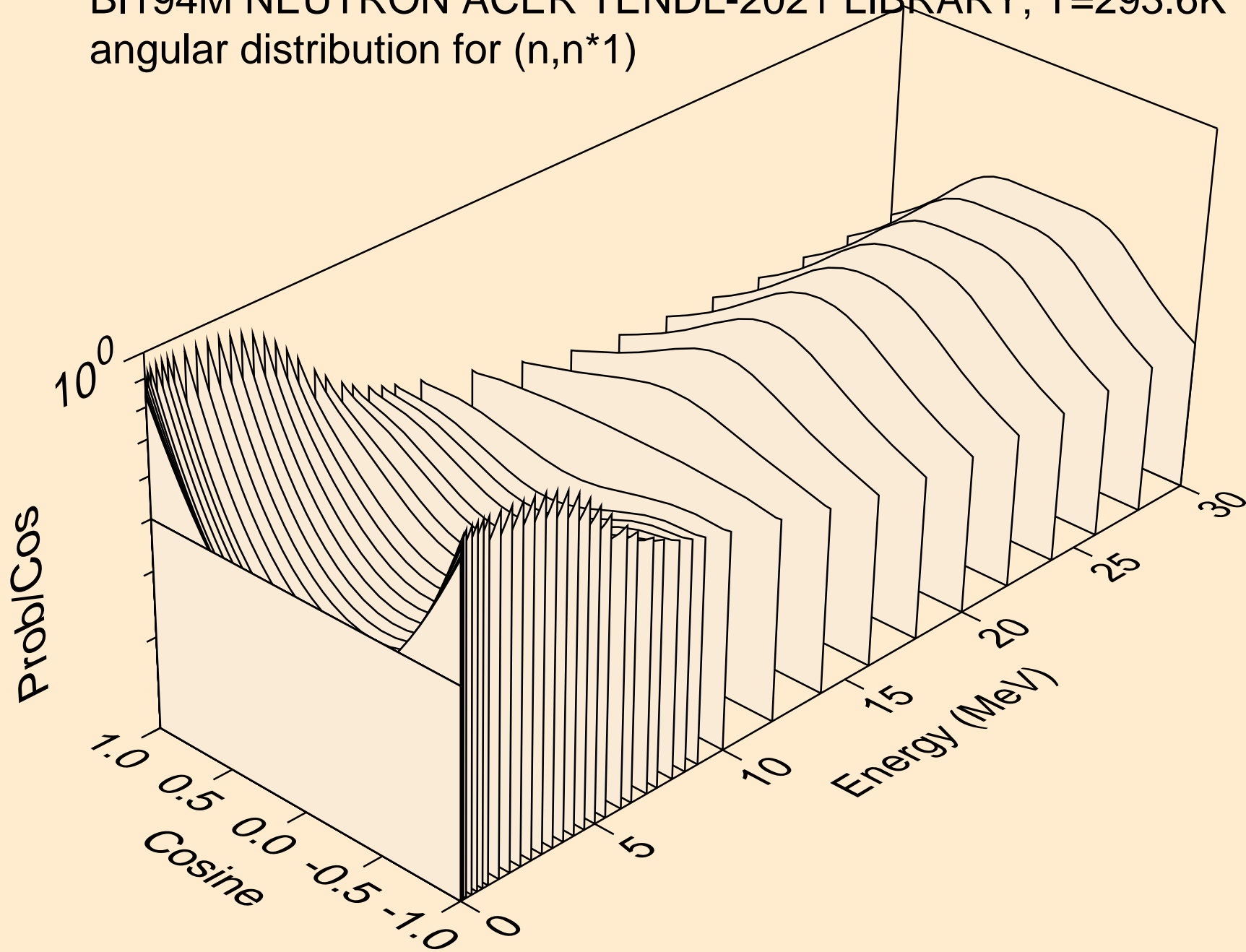

BI194M NEUTRON ACER TENDL-2021 LIBRARY; T=293.6K
angular distribution for (n,n*2)

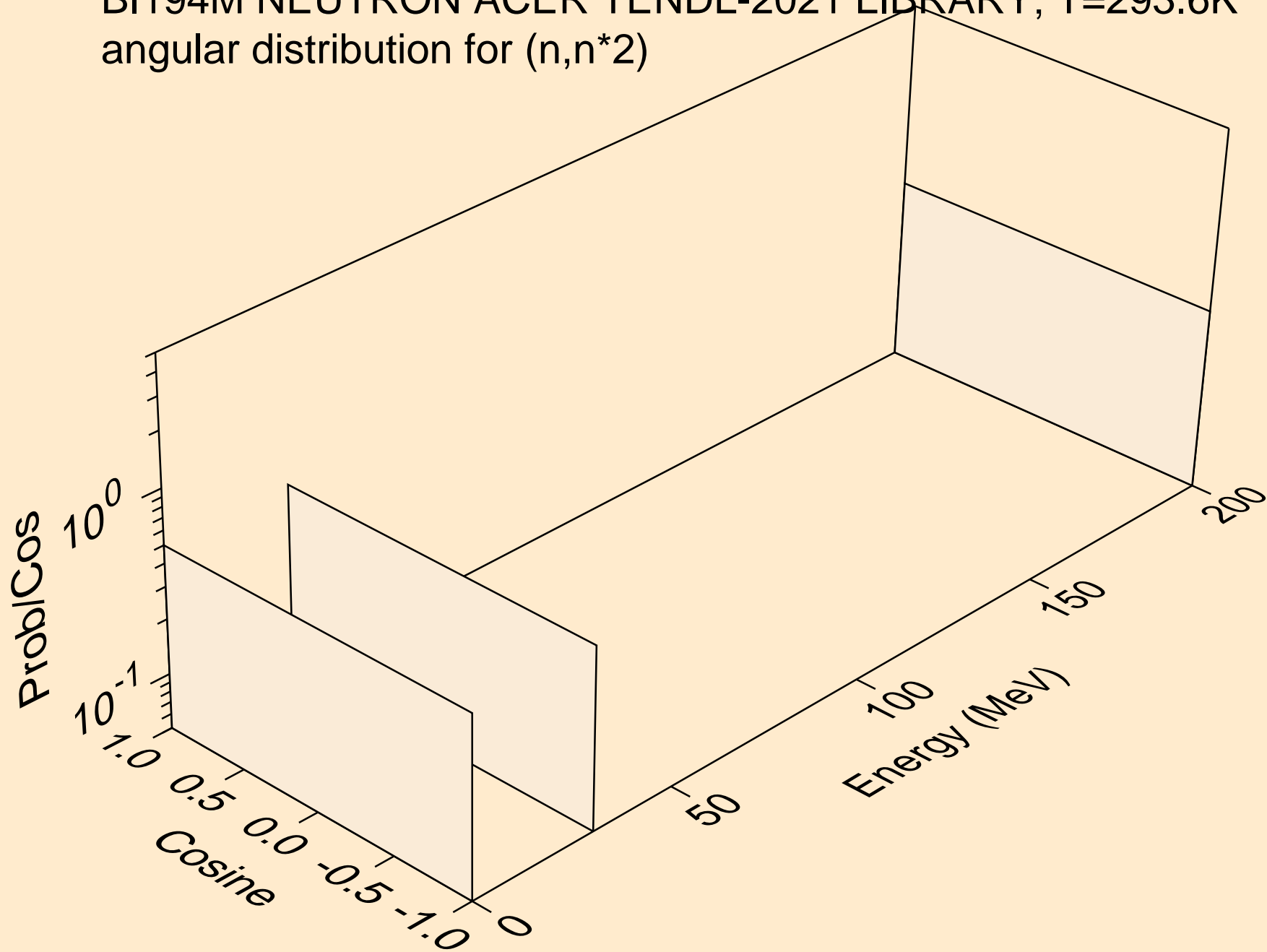

BI194M NEUTRON ACER TENDL-2021 LIBRARY; T=293.6K
Neutron emission for (n,x)

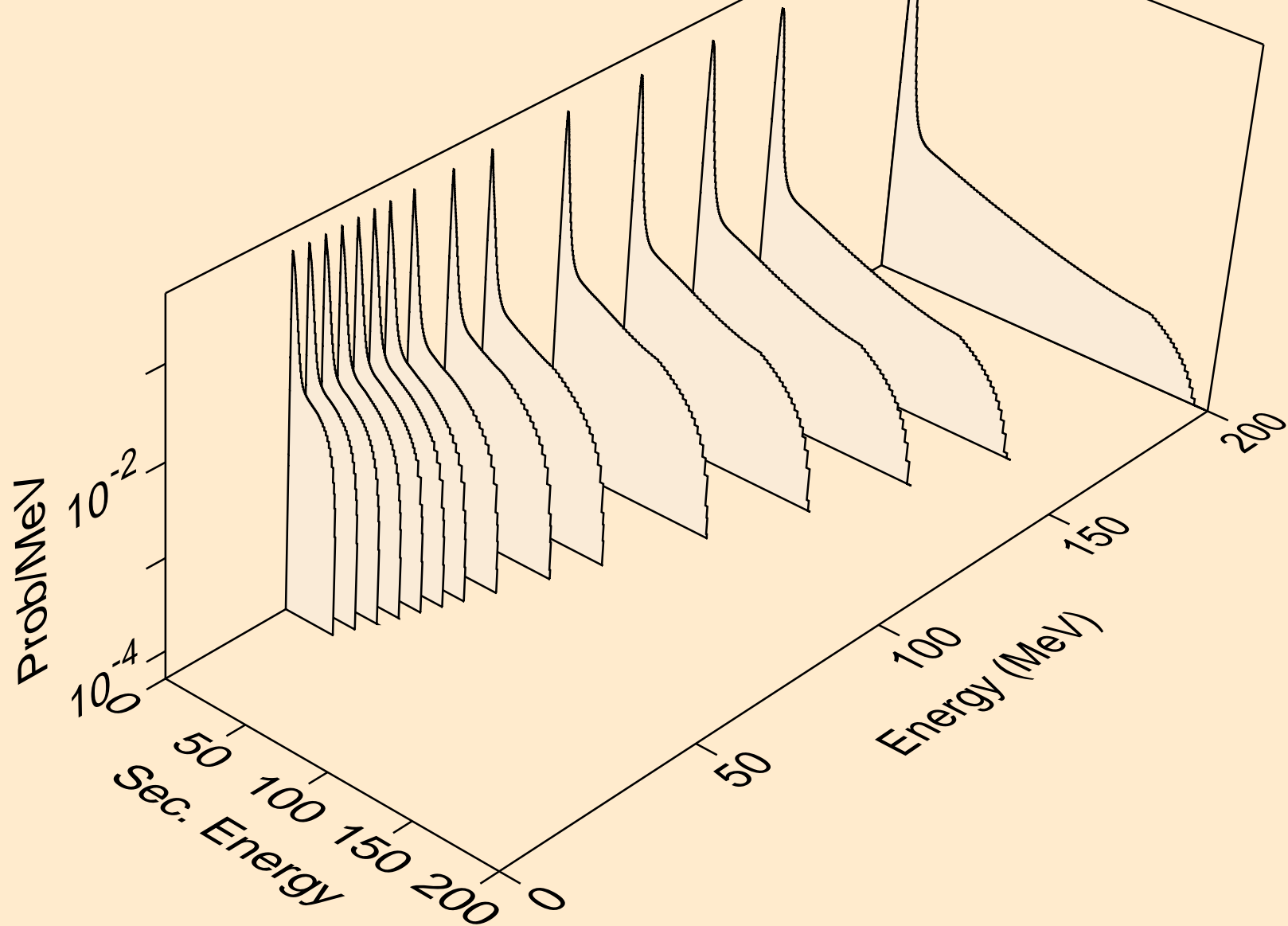

BI194M NEUTRON ACER TENDL-2021 LIBRARY; T=293.6K
Neutron emission for (n,2nd)

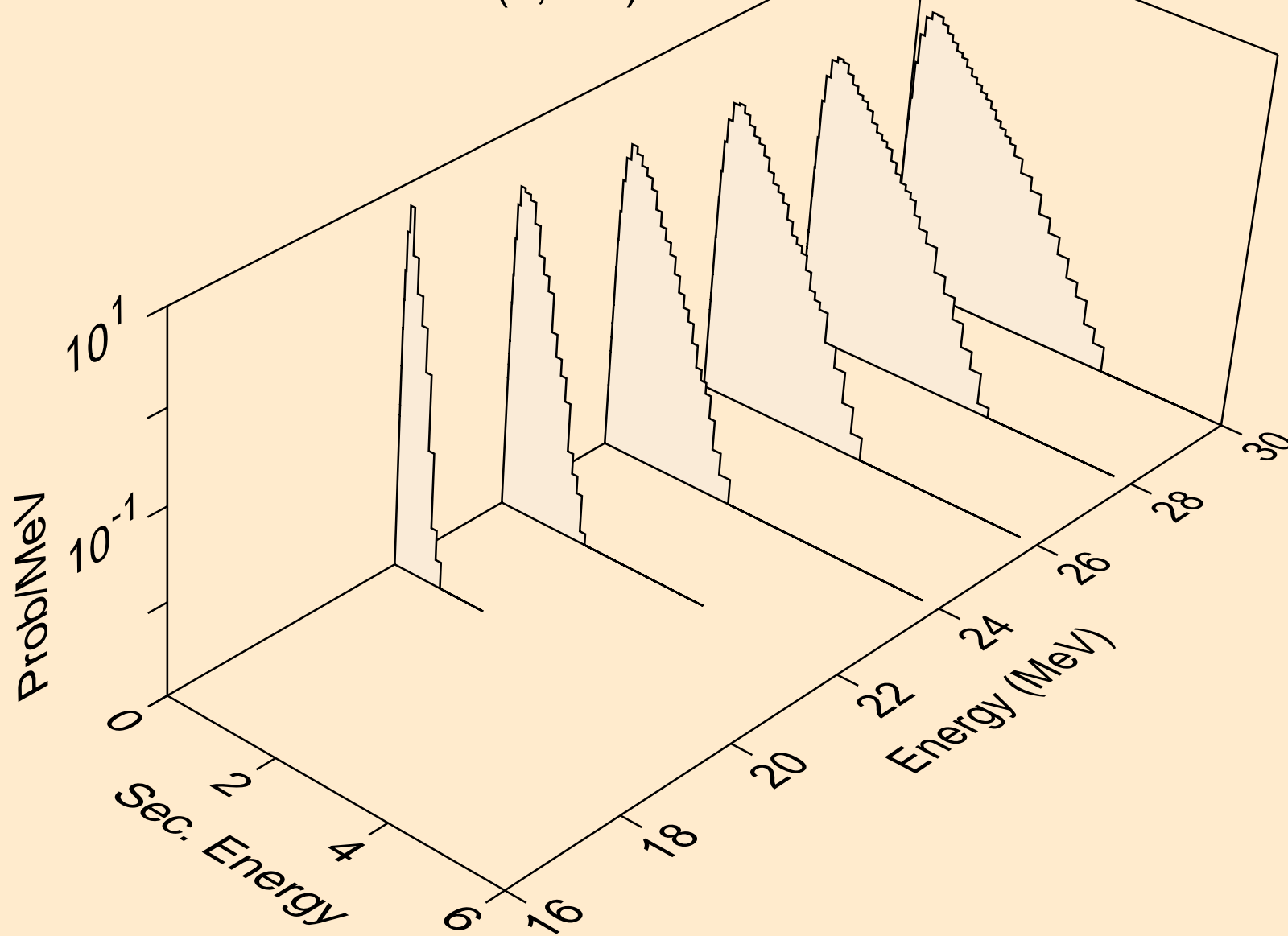

BI194M NEUTRON ACER TENDL-2021 LIBRARY; T=293.6K
Neutron emission for (n,2n)

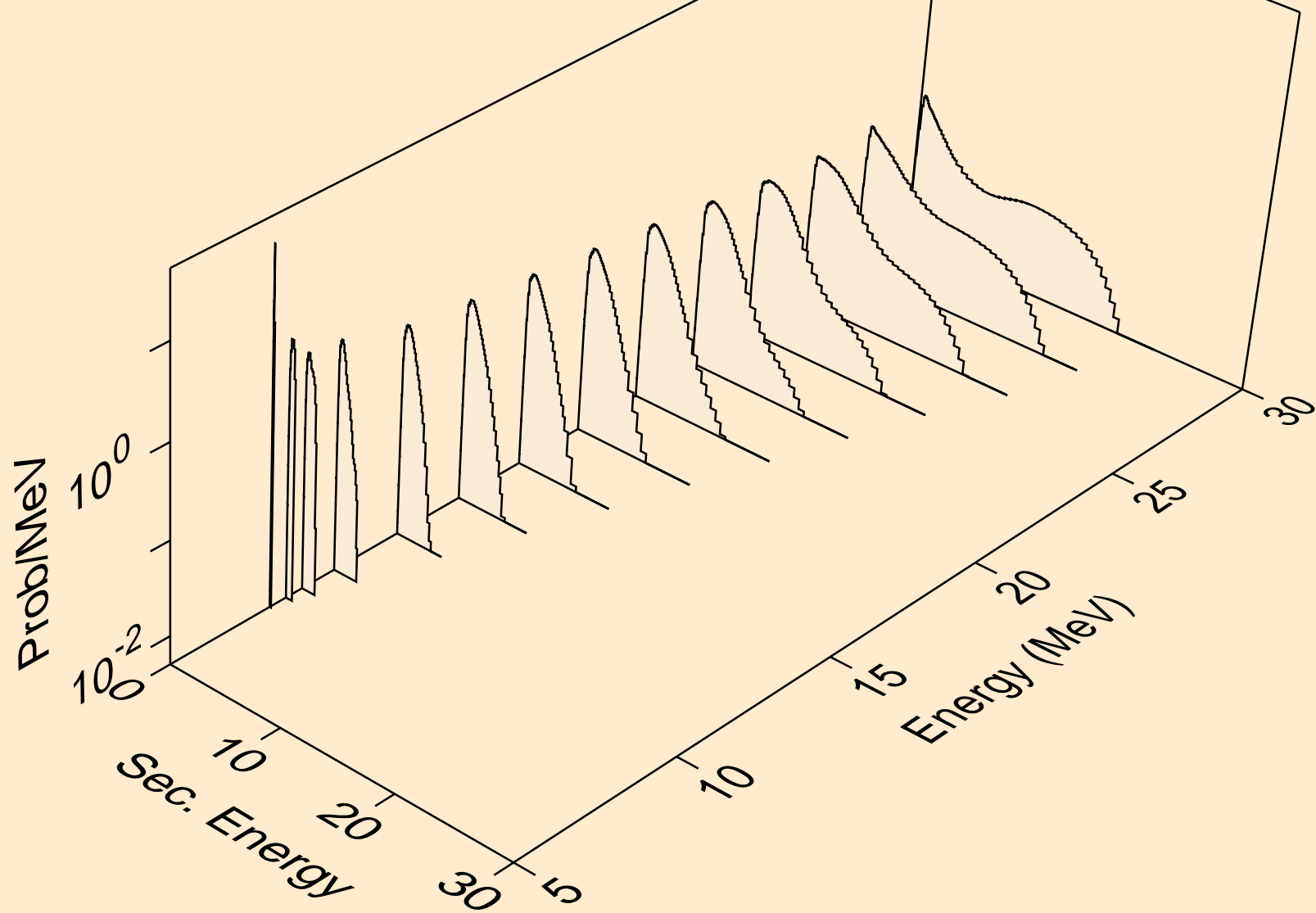

BI194M NEUTRON ACER TENDL-2021 LIBRARY; T=293.6K
Neutron emission for (n,3n)

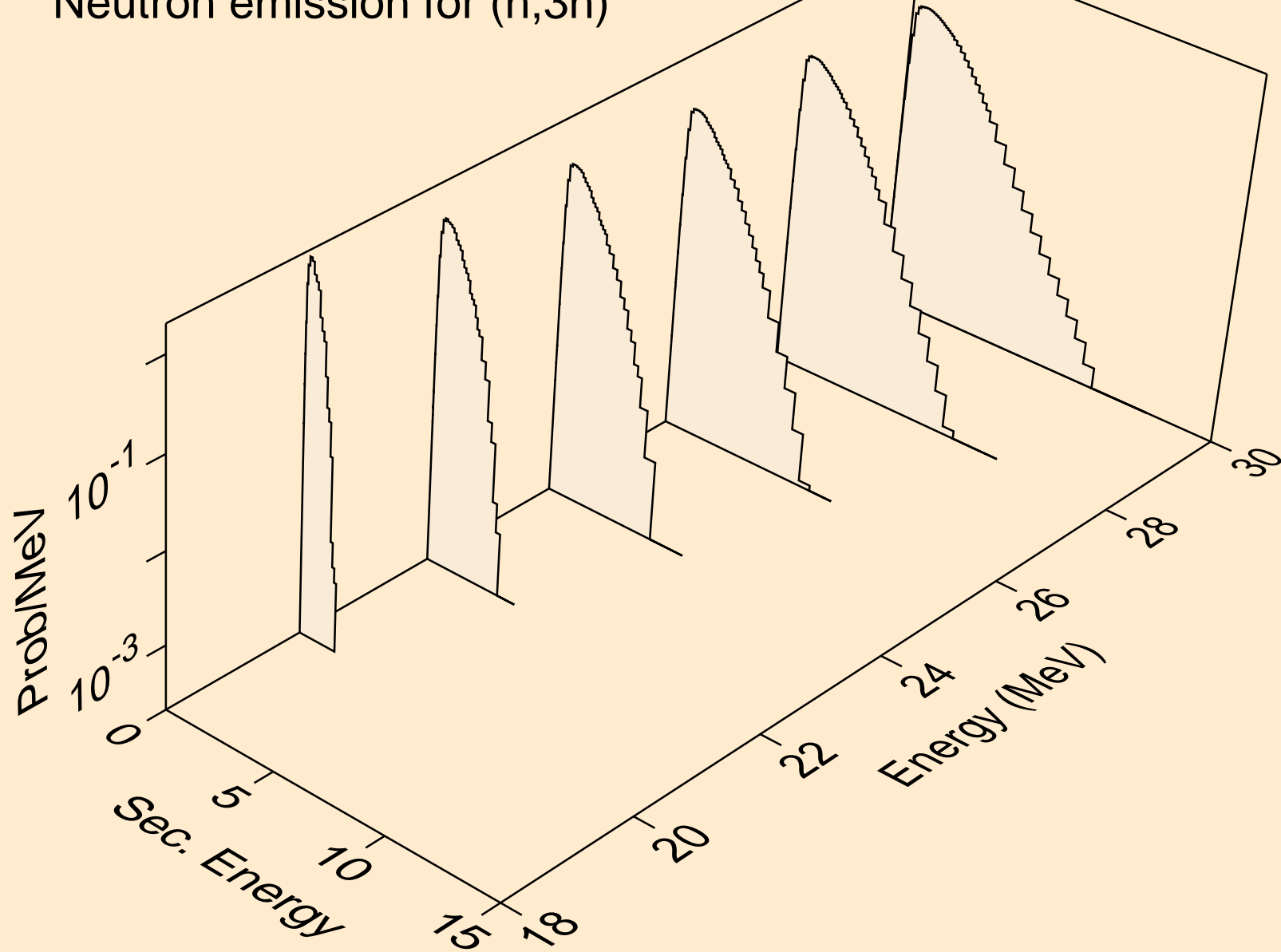

BI194M NEUTRON ACER TENDL-2021 LIBRARY; T=293.6K
Neutron emission for (n,n*)a

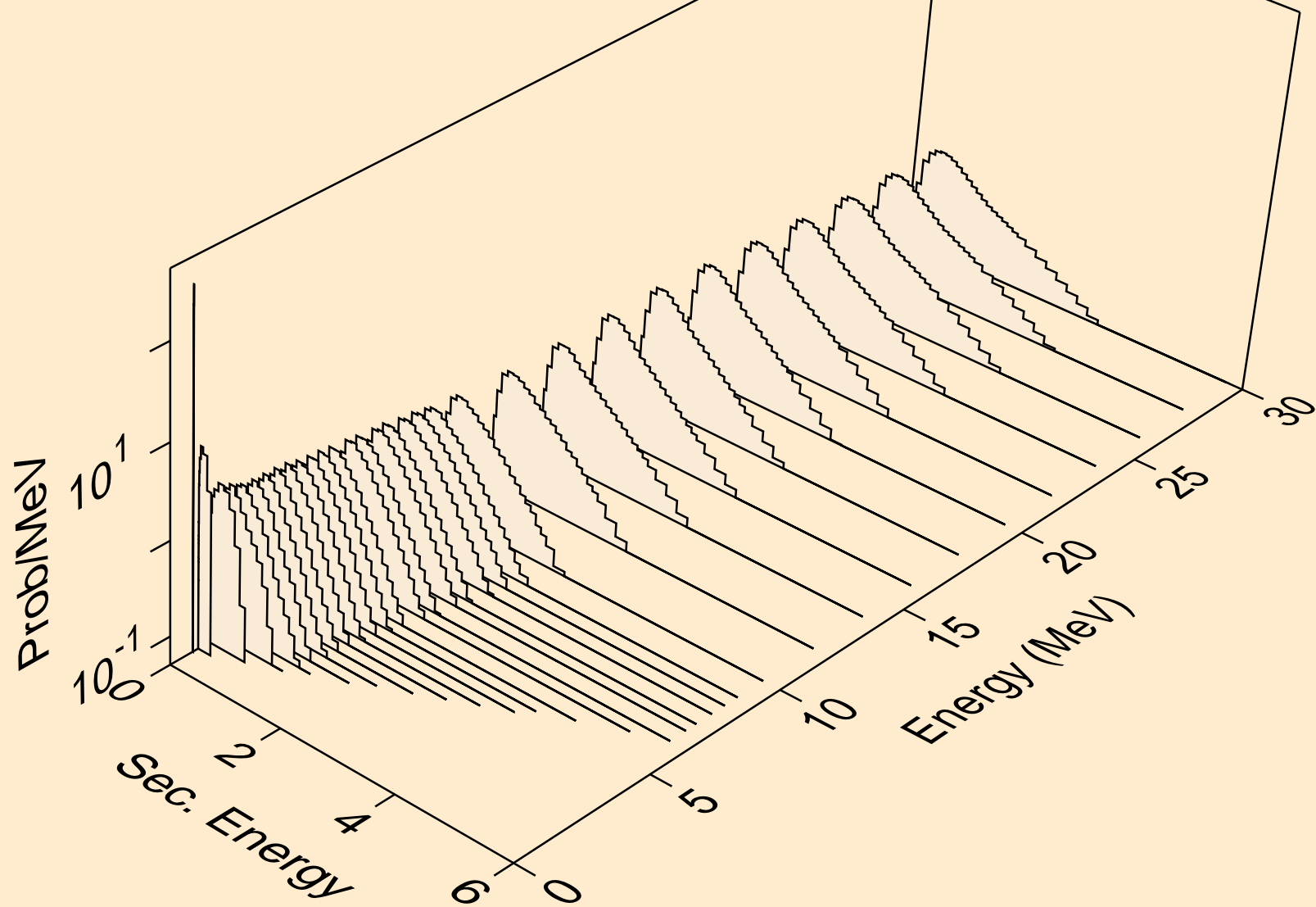

BI194M NEUTRON ACER TENDL-2021 LIBRARY; T=293.6K
Neutron emission for (n,2n)a

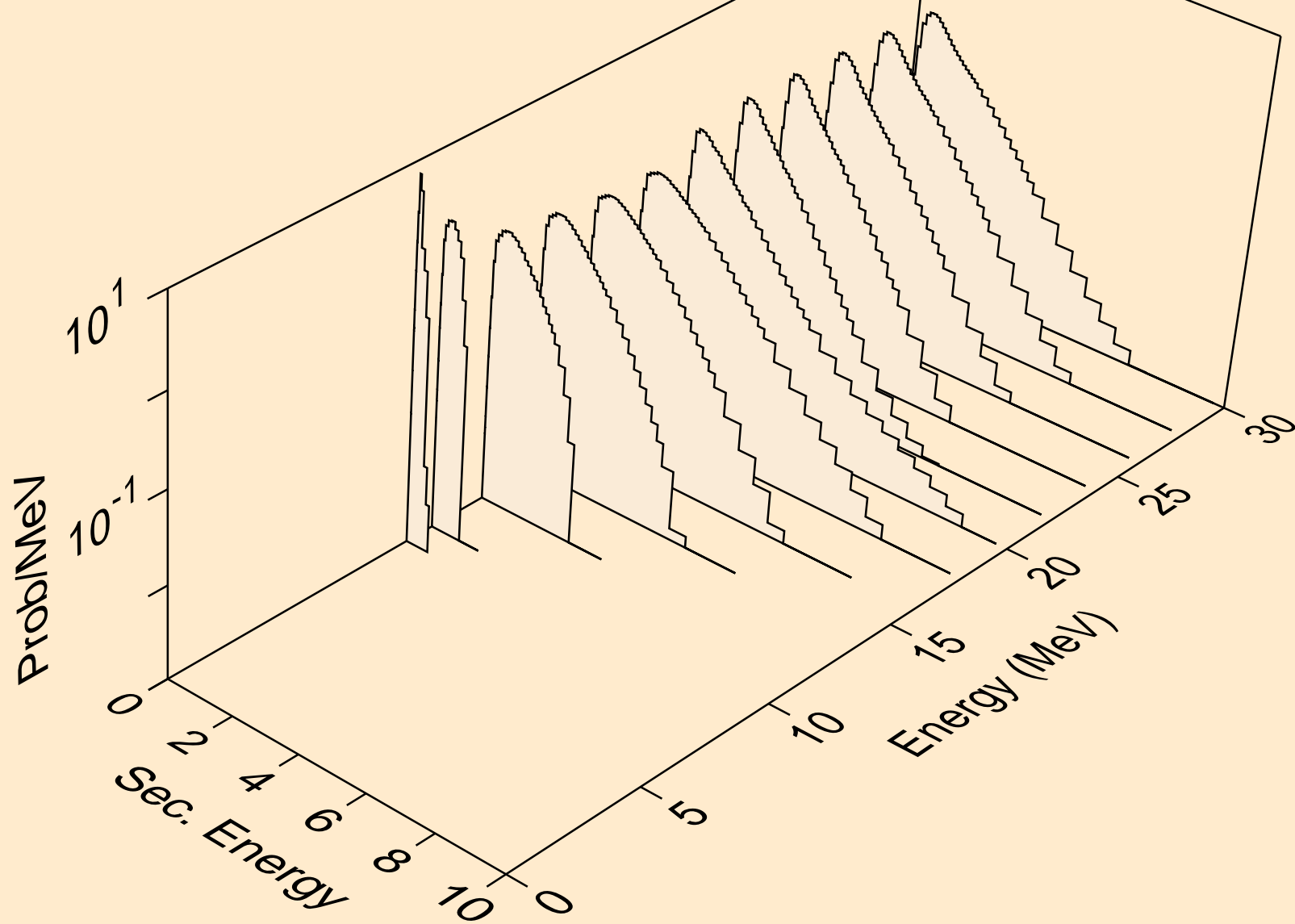

BI194M NEUTRON ACER TENDL-2021 LIBRARY; T=293.6K
Neutron emission for (n,3n)a

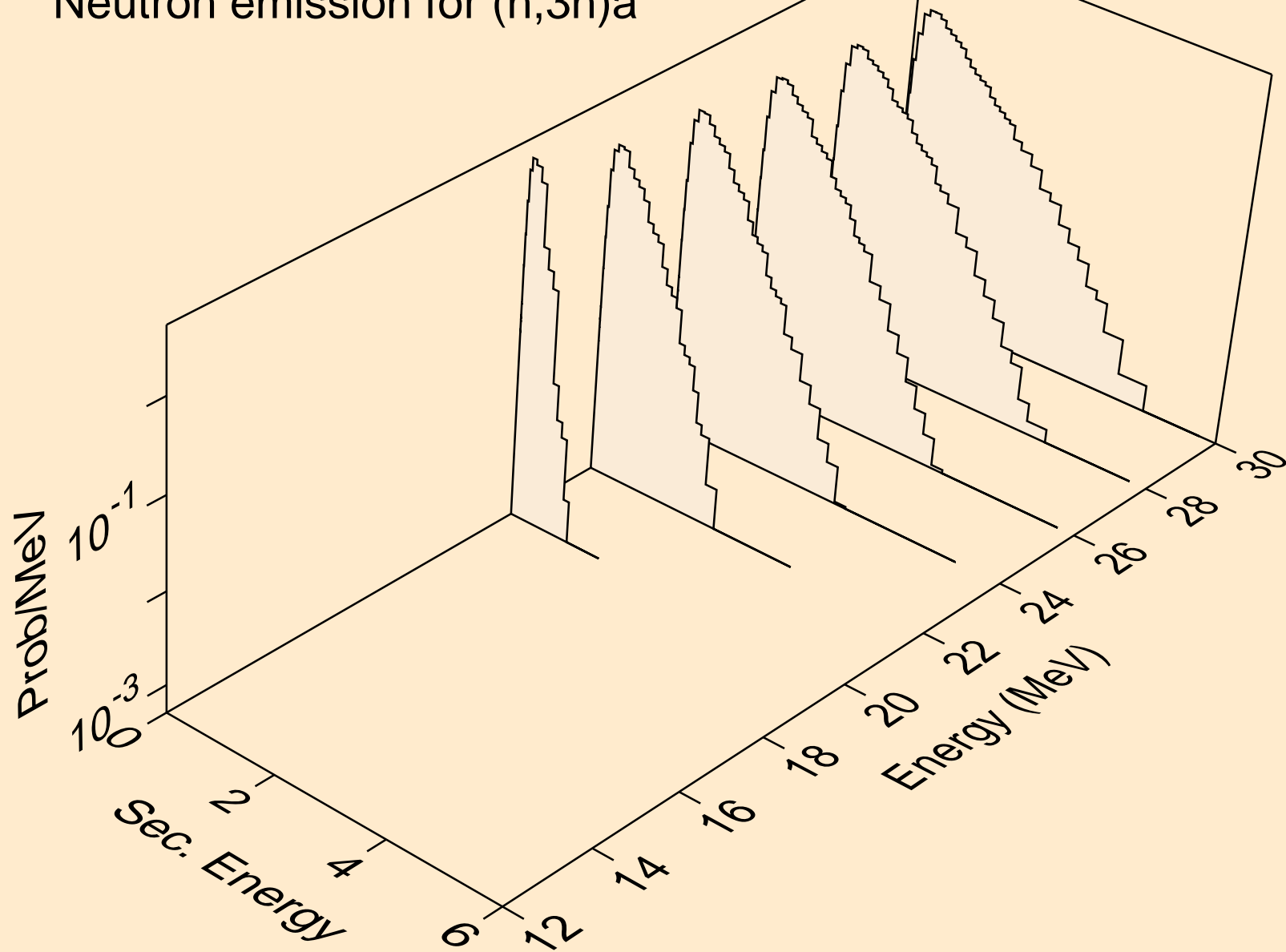

BI194M NEUTRON ACER TENDL-2021 LIBRARY; T=293.6K
Neutron emission for (n,n*)p

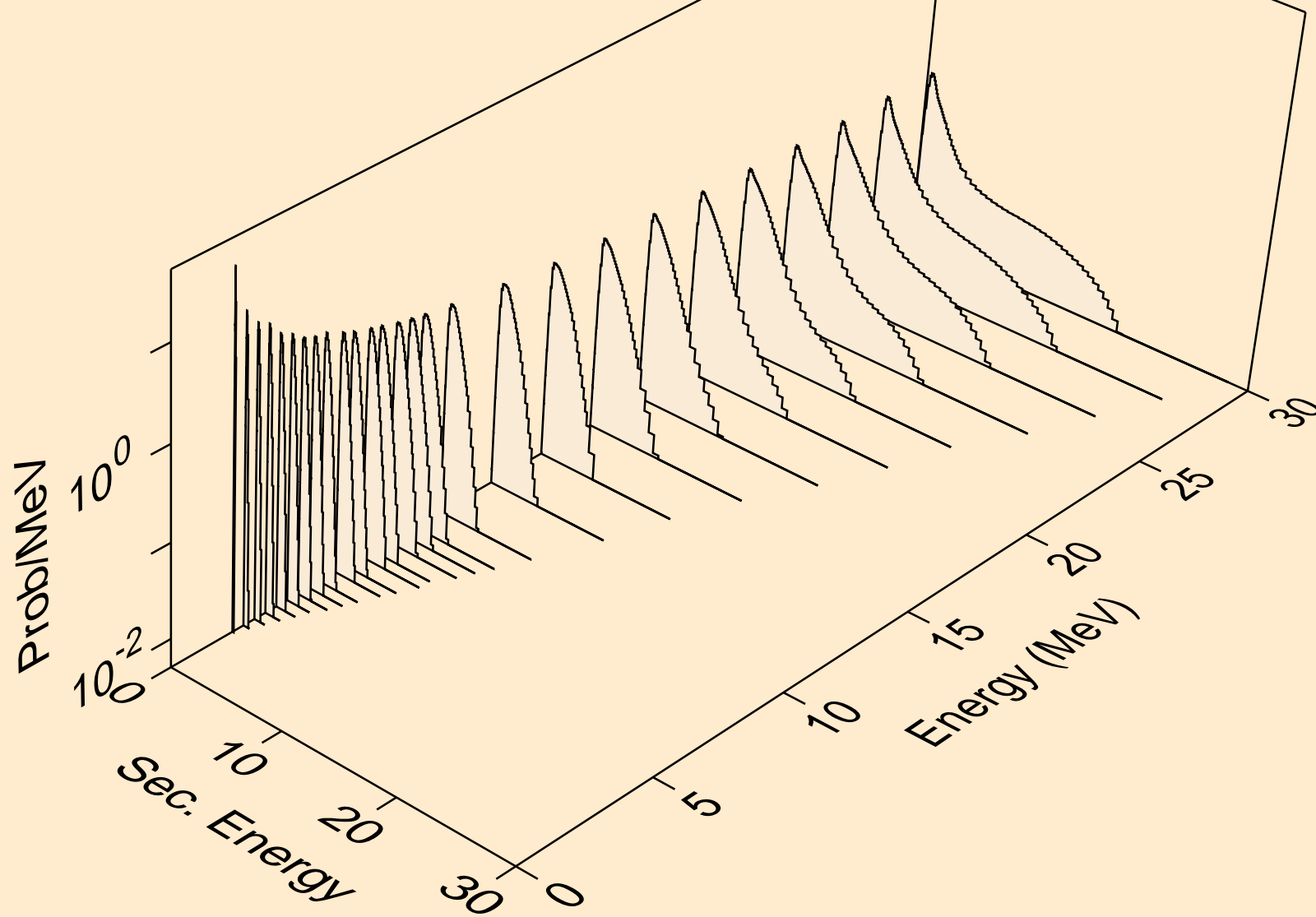

BI194M NEUTRON ACER TENDL-2021 LIBRARY; T=293.6K
Neutron emission for (n,n*)2a

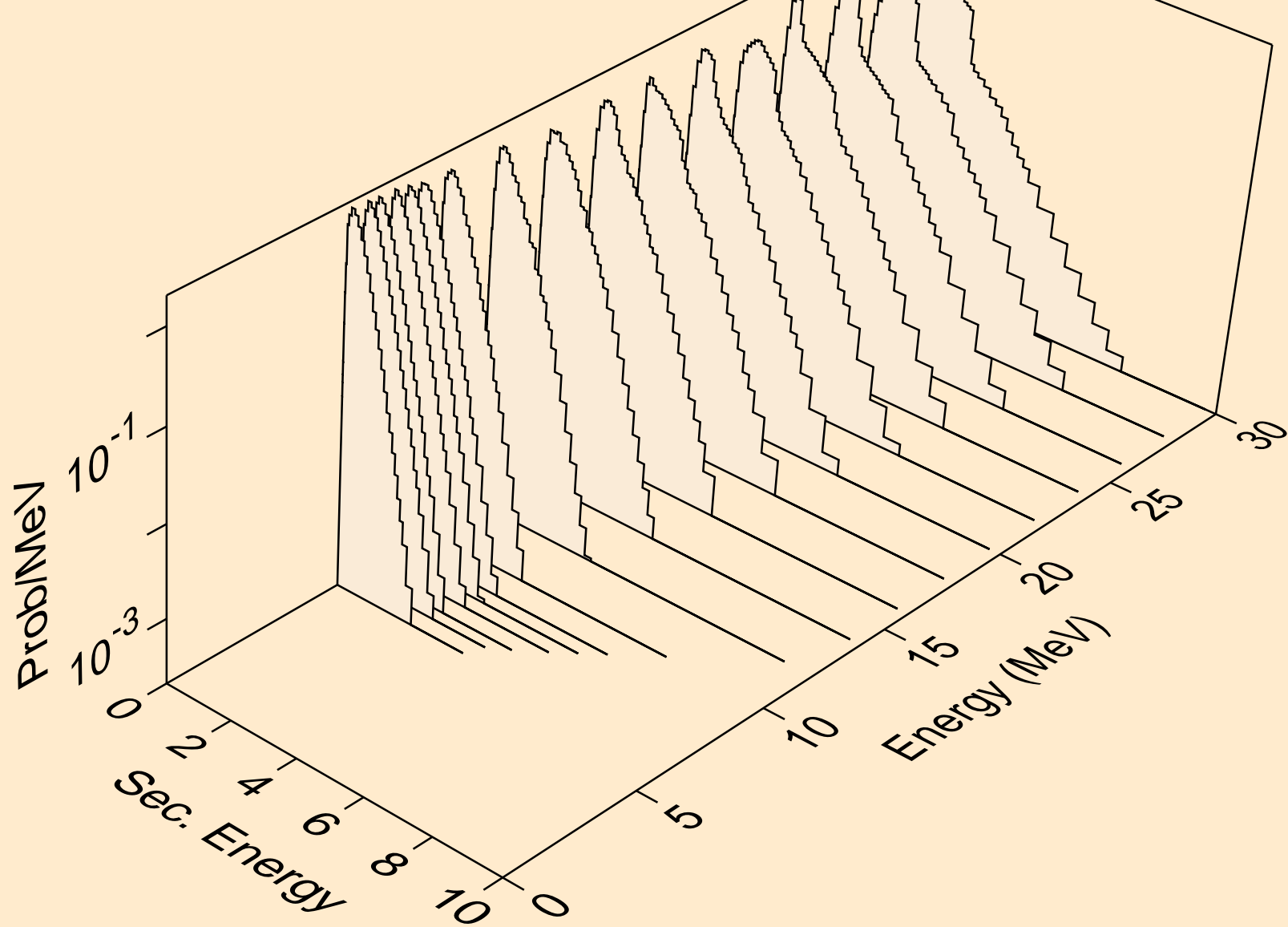

BI194M NEUTRON ACER TENDL-2021 LIBRARY; T=293.6K
Neutron emission for (n,2n)2a

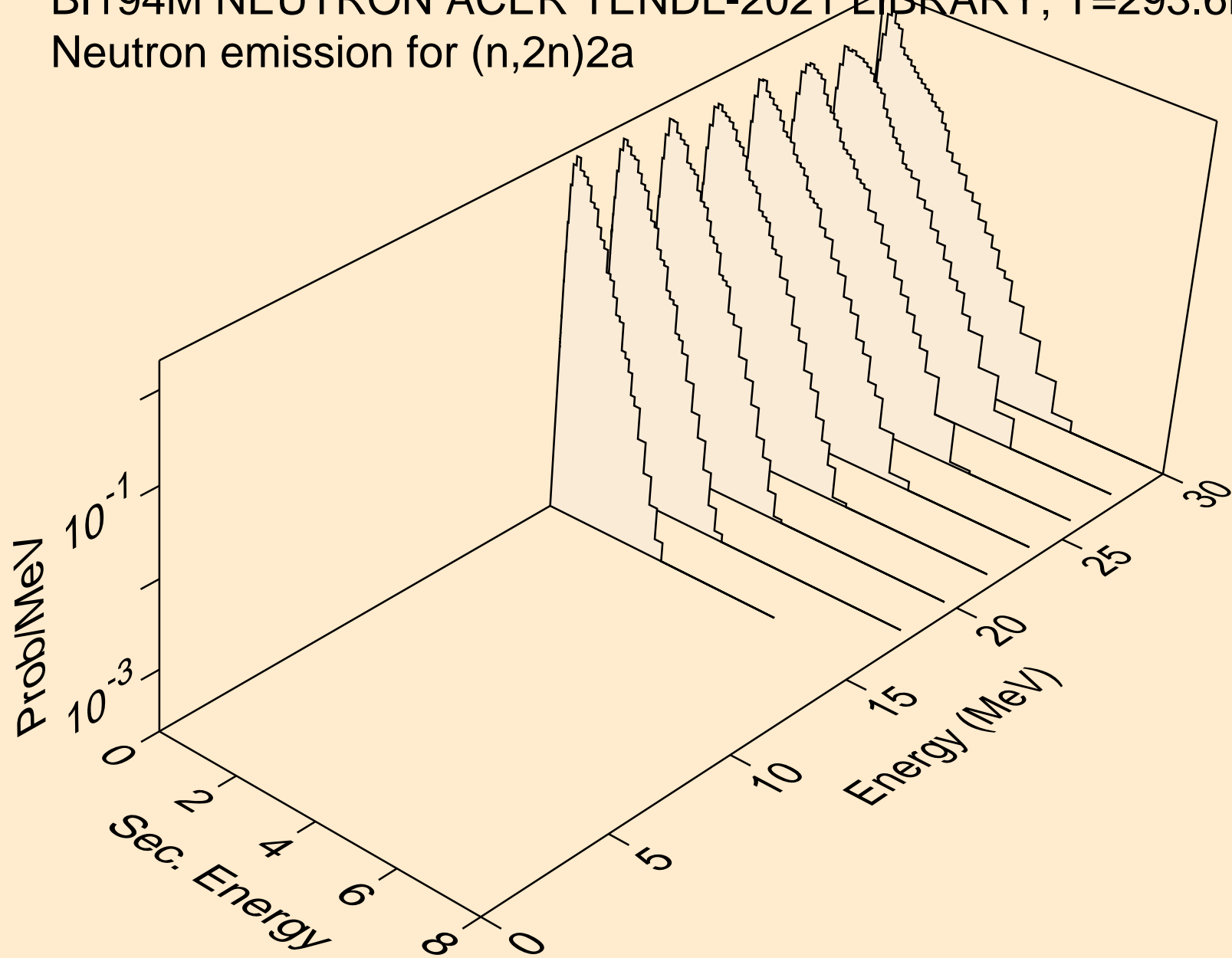

BI194M NEUTRON ACER TENDL-2021 LIBRARY; T=293.6K
Neutron emission for (n,n*)d

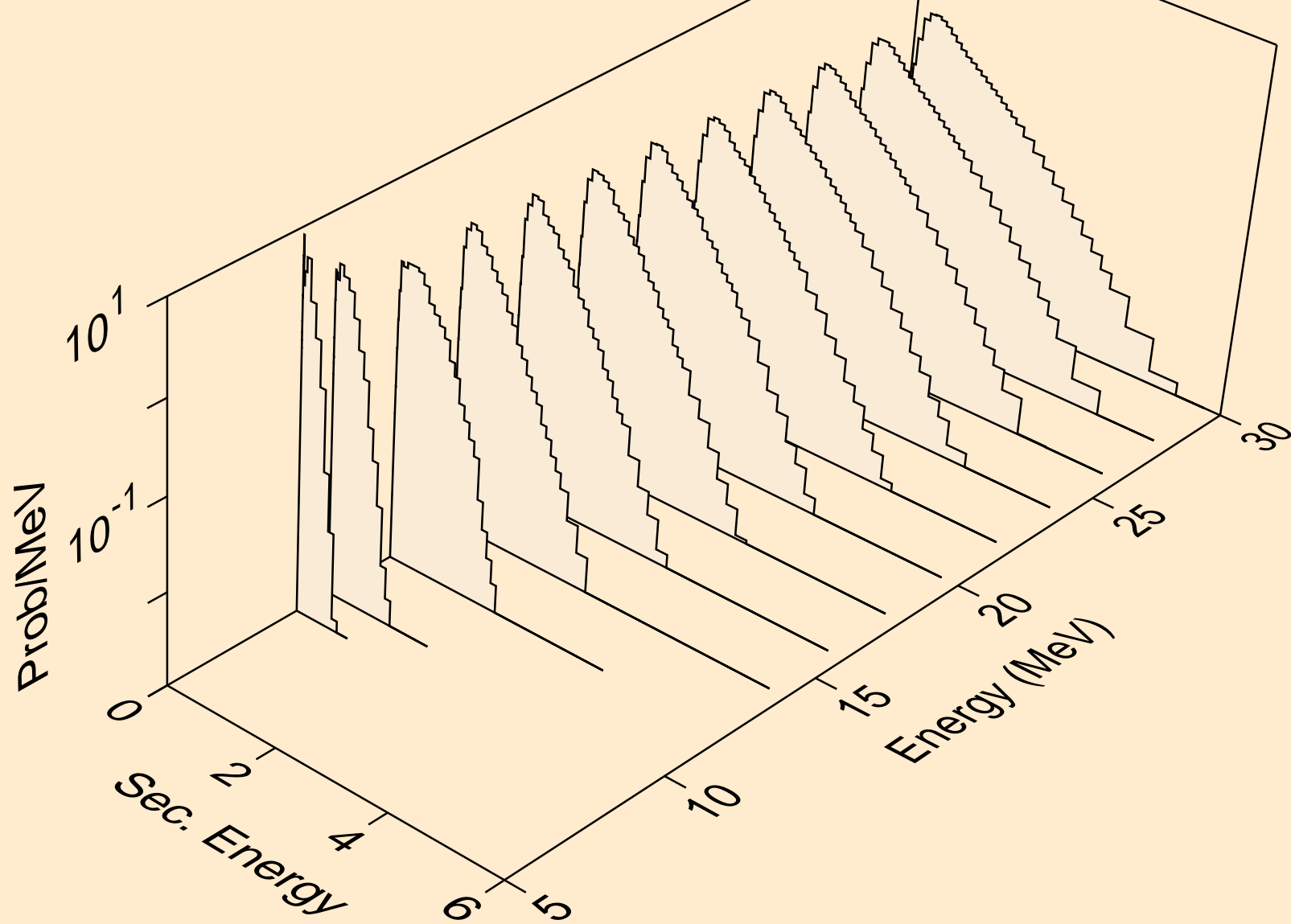

BI194M NEUTRON ACER TENDL-2021 LIBRARY; T=293.6K
Neutron emission for (n,n*)t

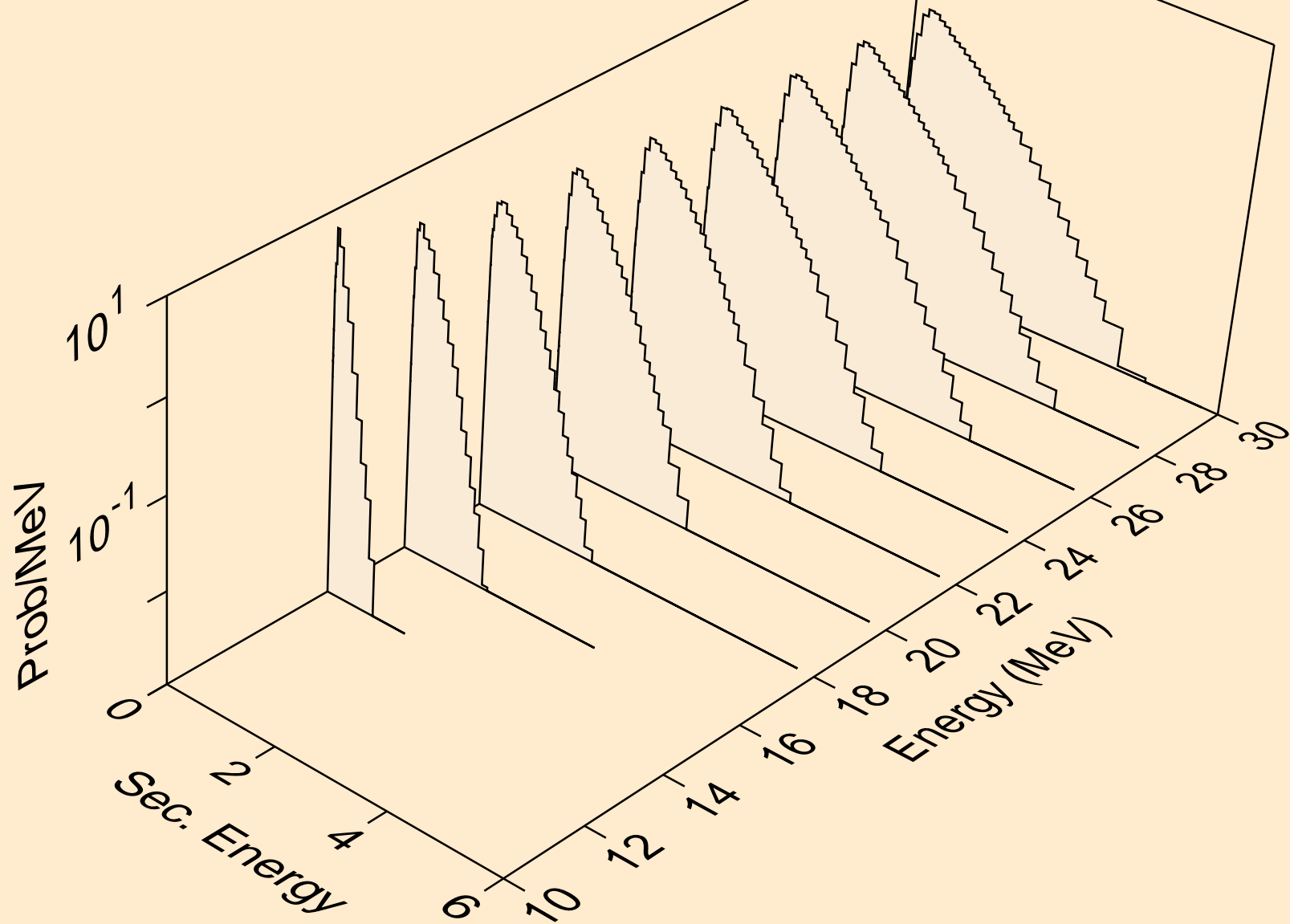

BI194M NEUTRON ACER TENDL-2021 LIBRARY; T=293.6K
Neutron emission for (n,n*)he3

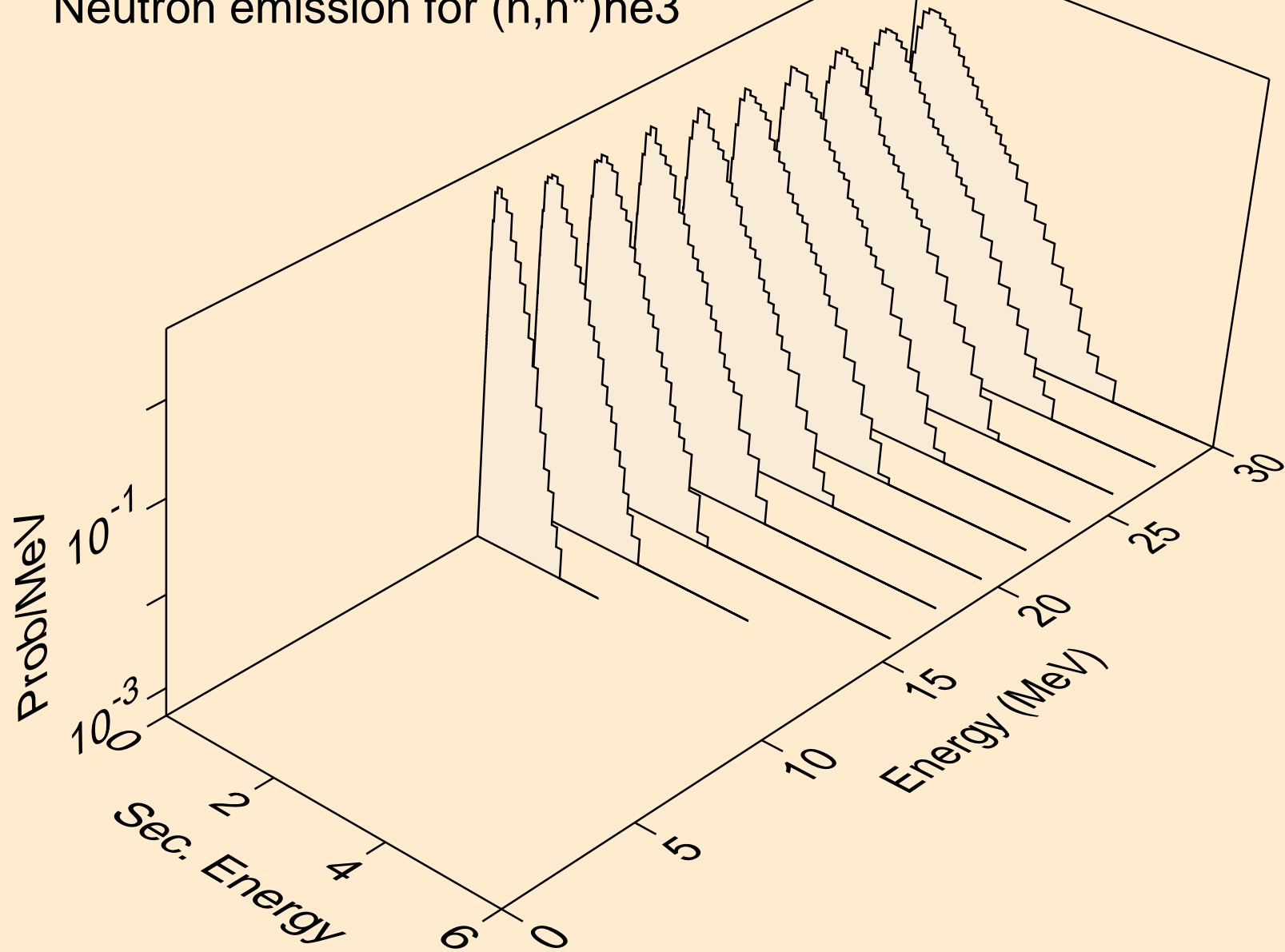

BI194M NEUTRON ACER TENDL-2021 LIBRARY; T=293.6K
Neutron emission for (n,4n)

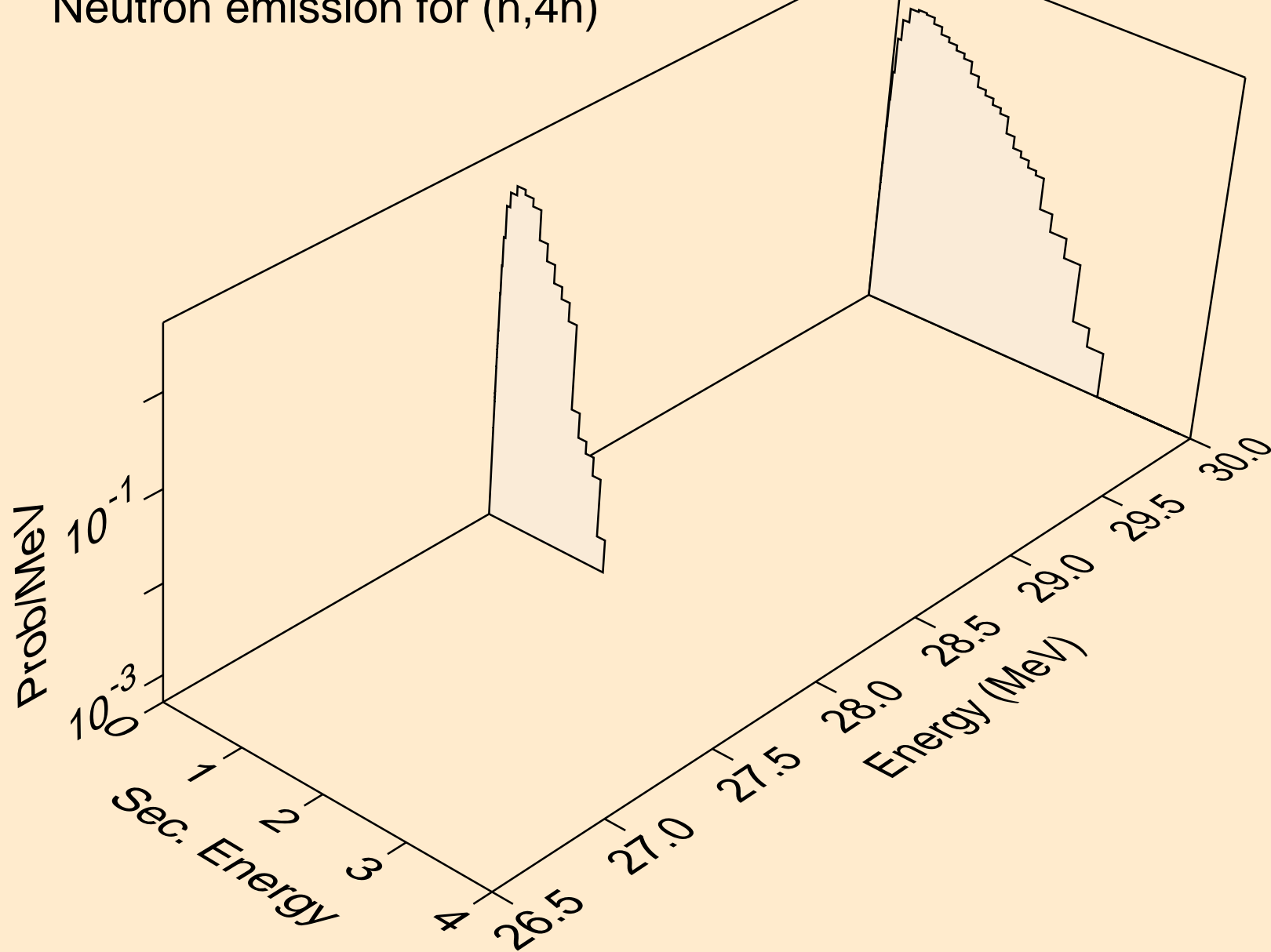

BI194M NEUTRON ACER TENDL-2021 LIBRARY; T=293.6K
Neutron emission for (n,2np)

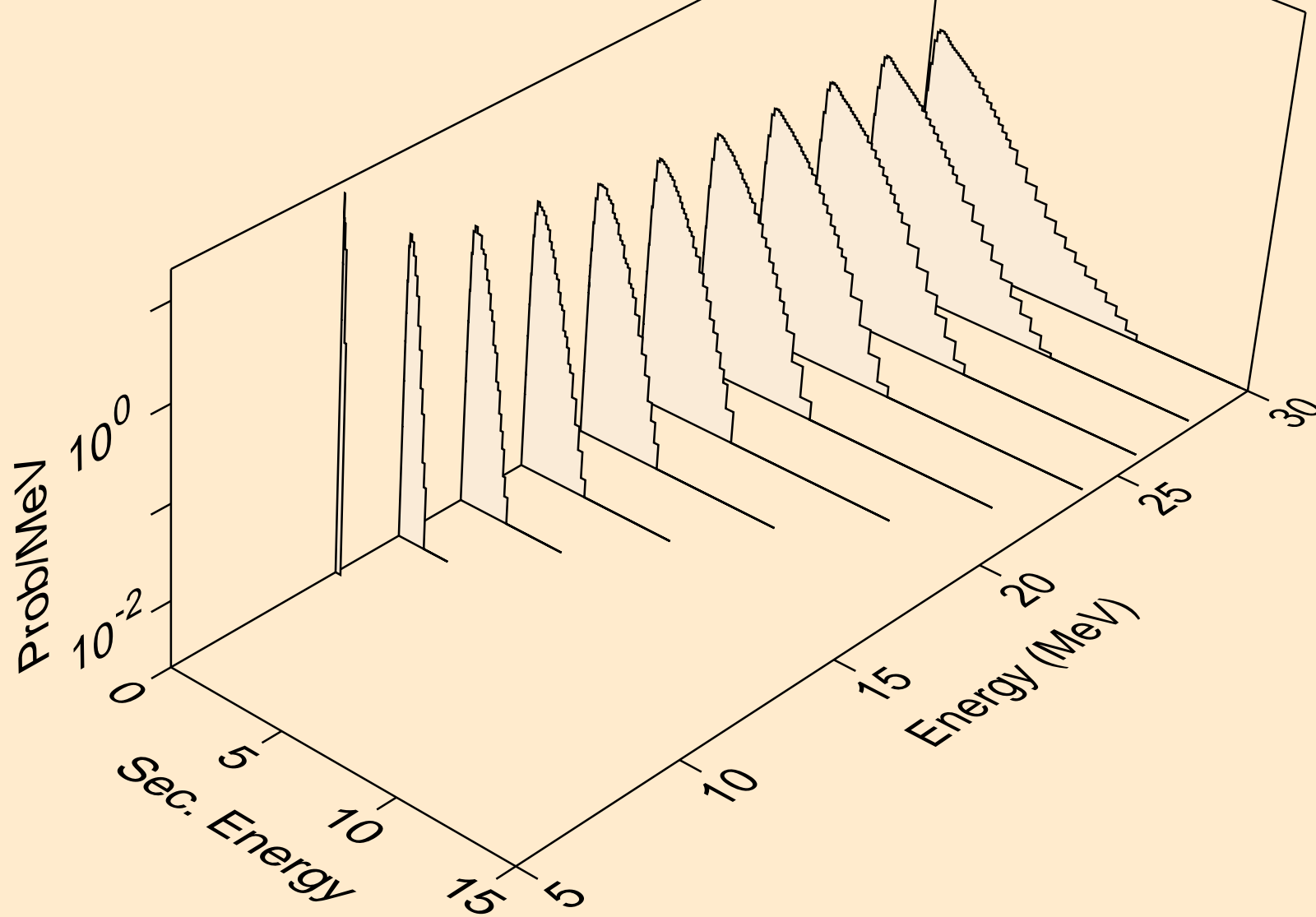

BI194M NEUTRON ACER TENDL-2021 LIBRARY; T=293.6K
Neutron emission for (n,3np)

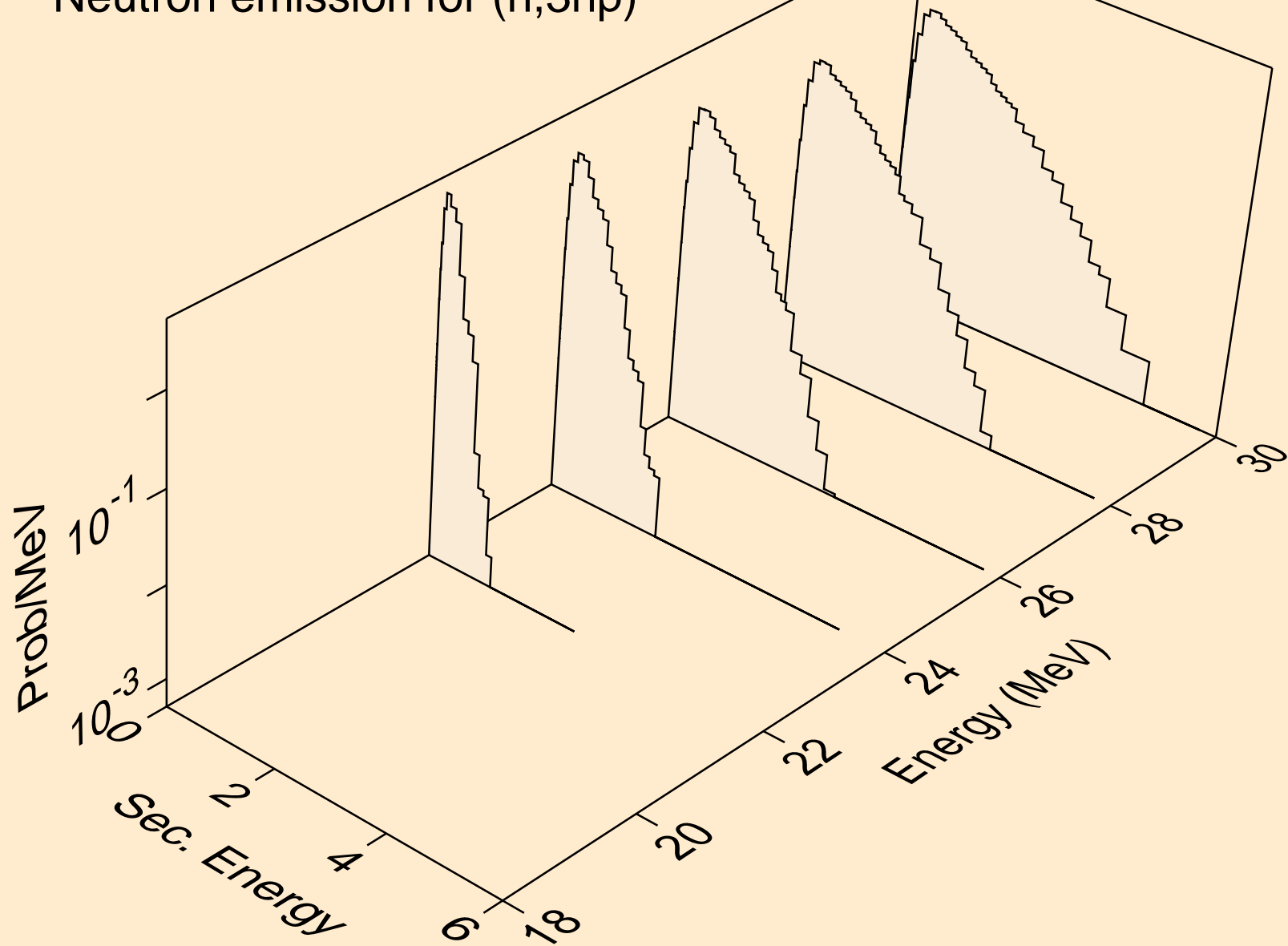

BI194M NEUTRON ACER TENDL-2021 LIBRARY; T=293.6K
Neutron emission for (n,2np)

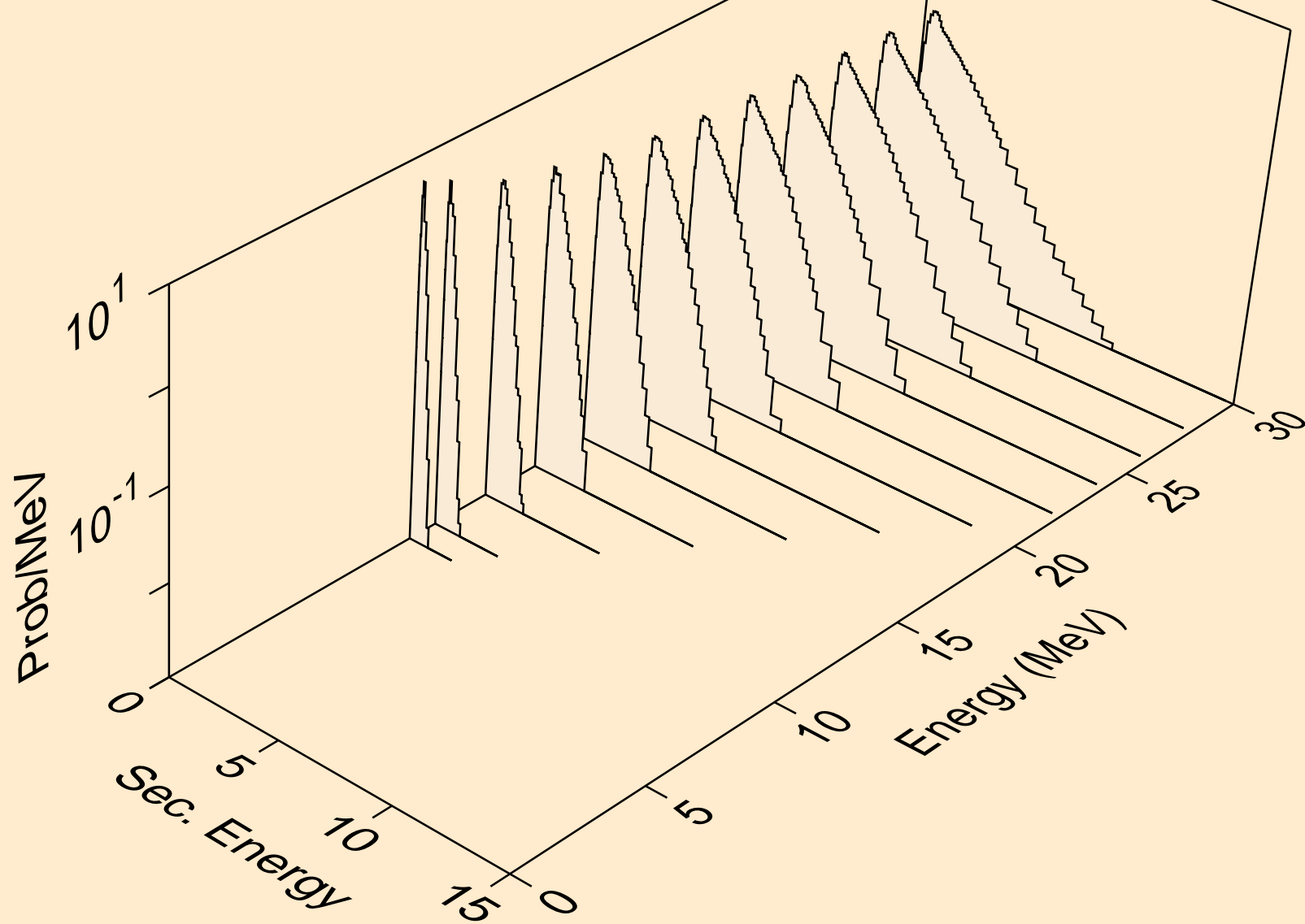

BI194M NEUTRON ACER TENDL-2021 LIBRARY; T=293.6K
Neutron emission for (n,npa)

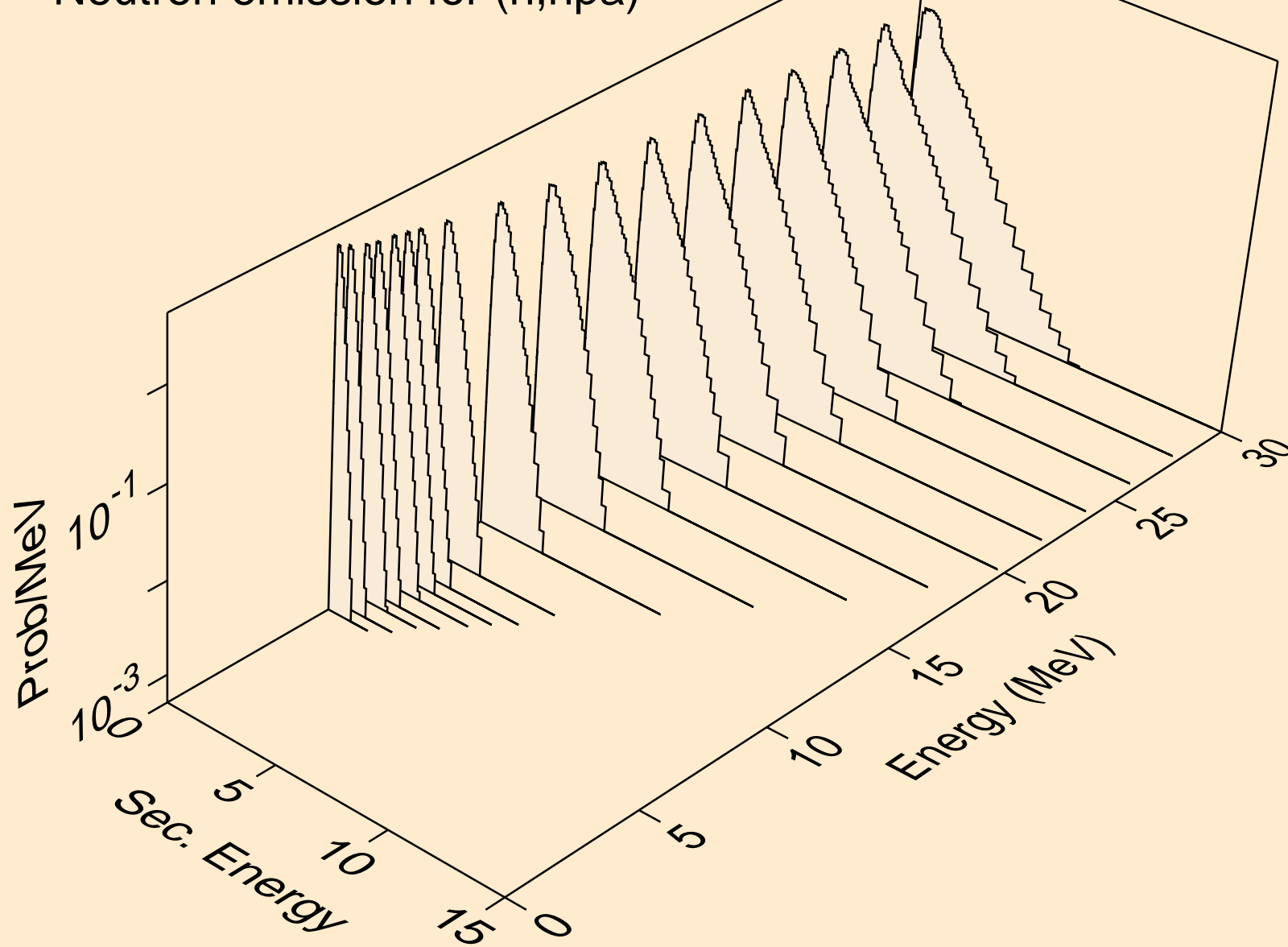

BI194M NEUTRON ACER TENDL-2021 LIBRARY; T=293.6K
Neutron emission for (n,n*c)

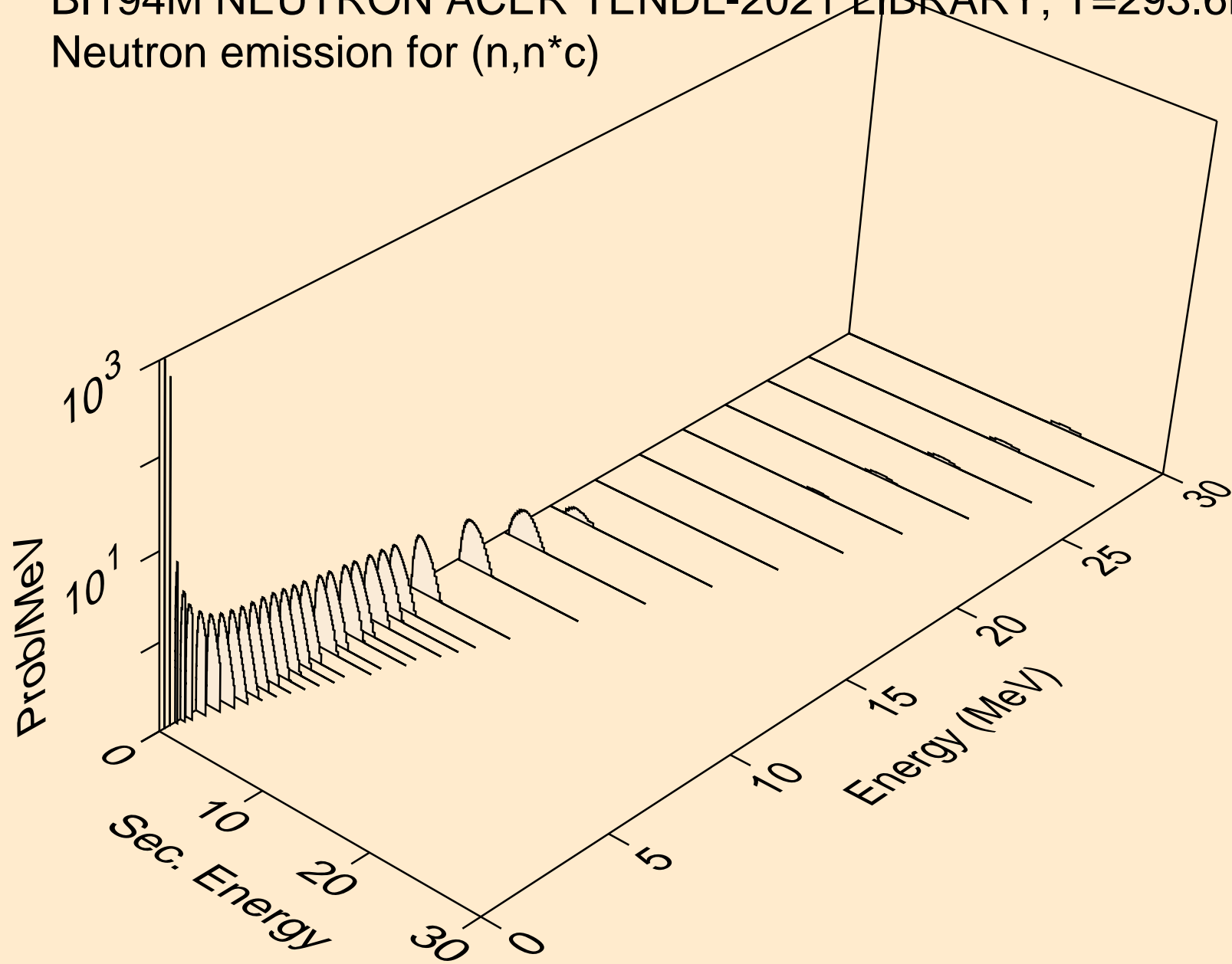

BI194M NEUTRON ACER TENDL-2021 LIBRARY; T=293.6K
Photon emission for (n,x)

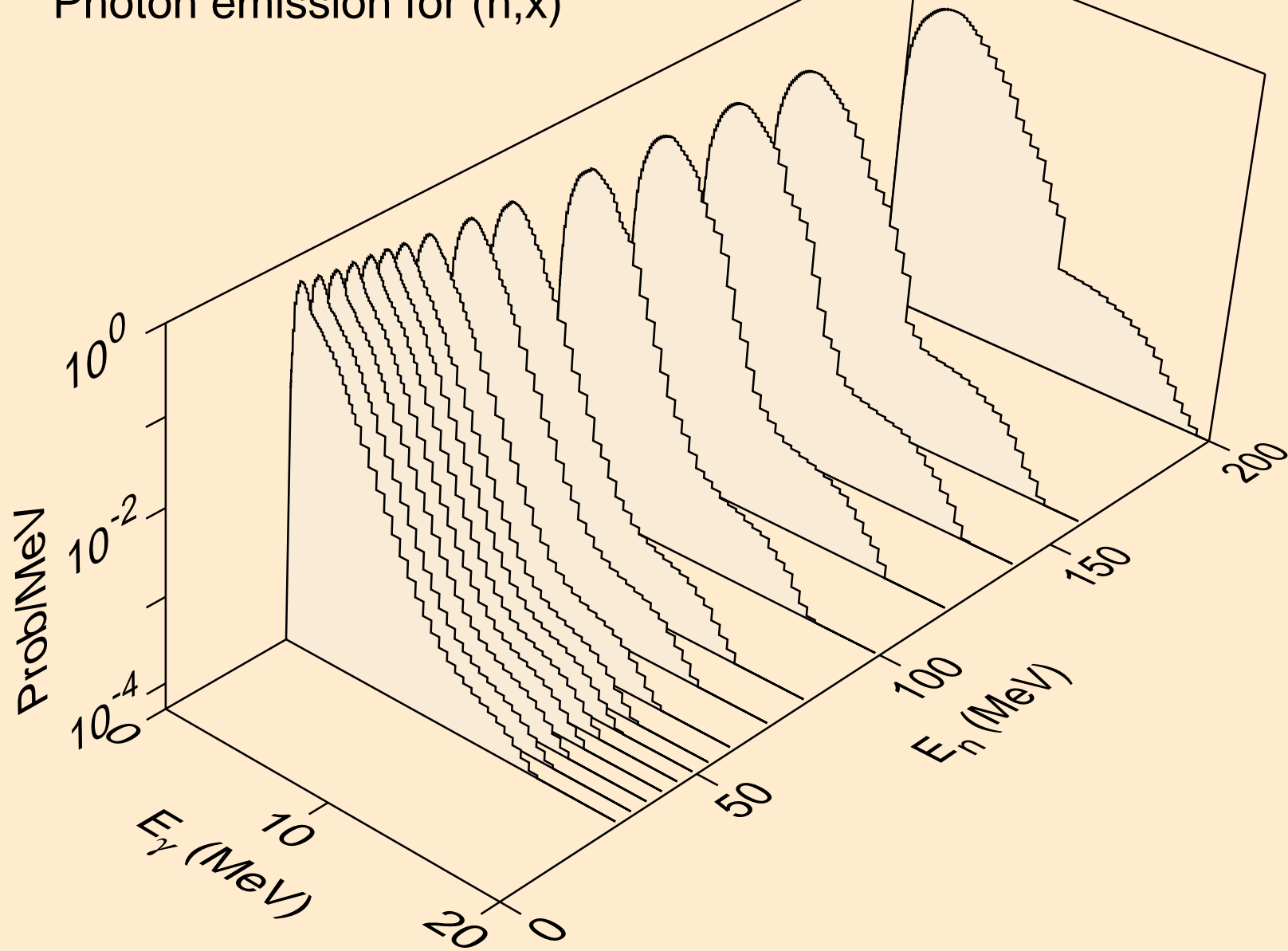

BI194M NEUTRON ACER TENDL-2021 LIBRARY; T=293.6K
Photon emission for (n,2nd)

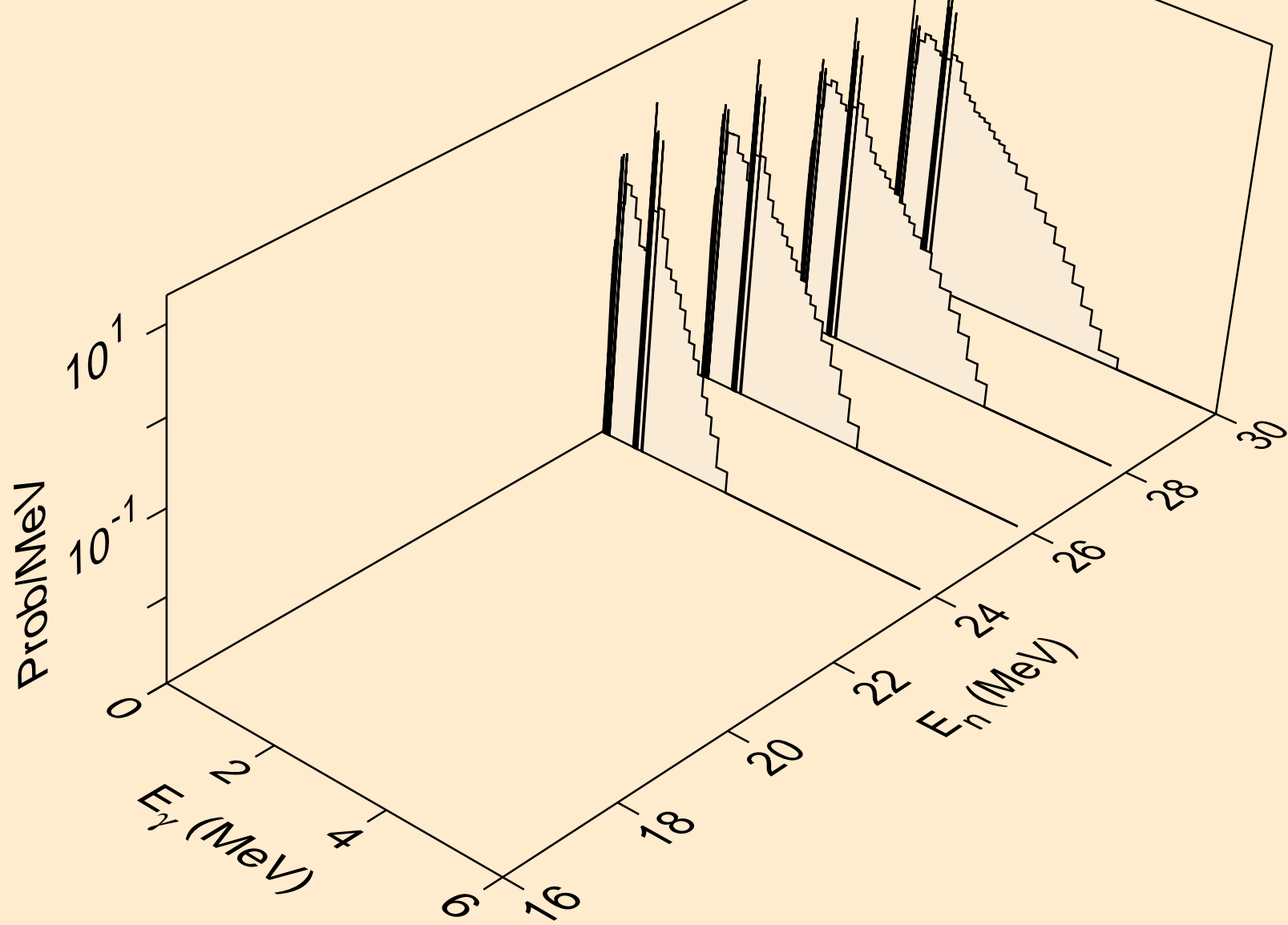

BI194M NEUTRON ACER TENDL-2021 LIBRARY; T=293.6K
Photon emission for (n,2n)

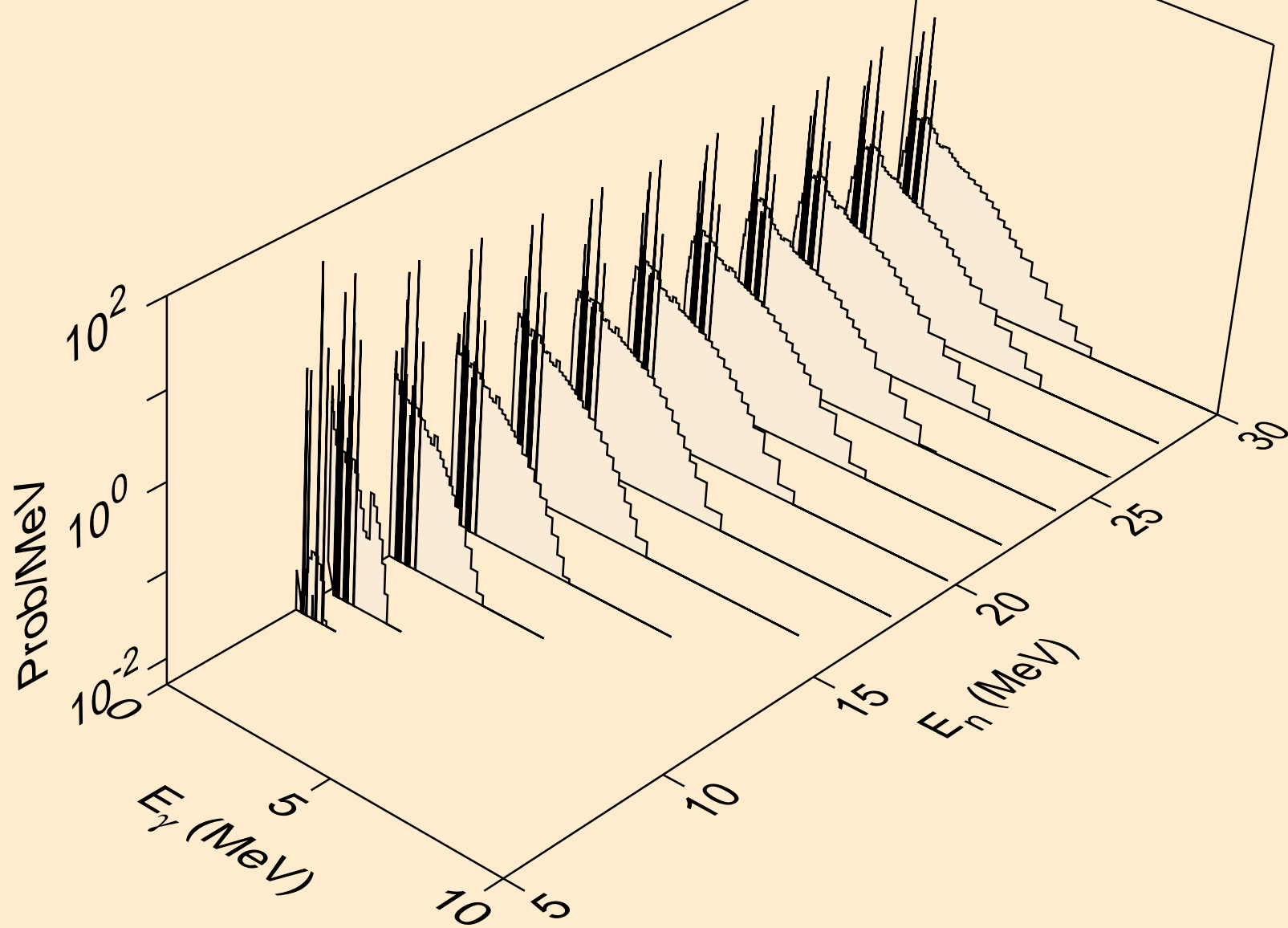

BI194M NEUTRON ACER TENDL-2021 LIBRARY; T=293.6K
Photon emission for (n,3n)

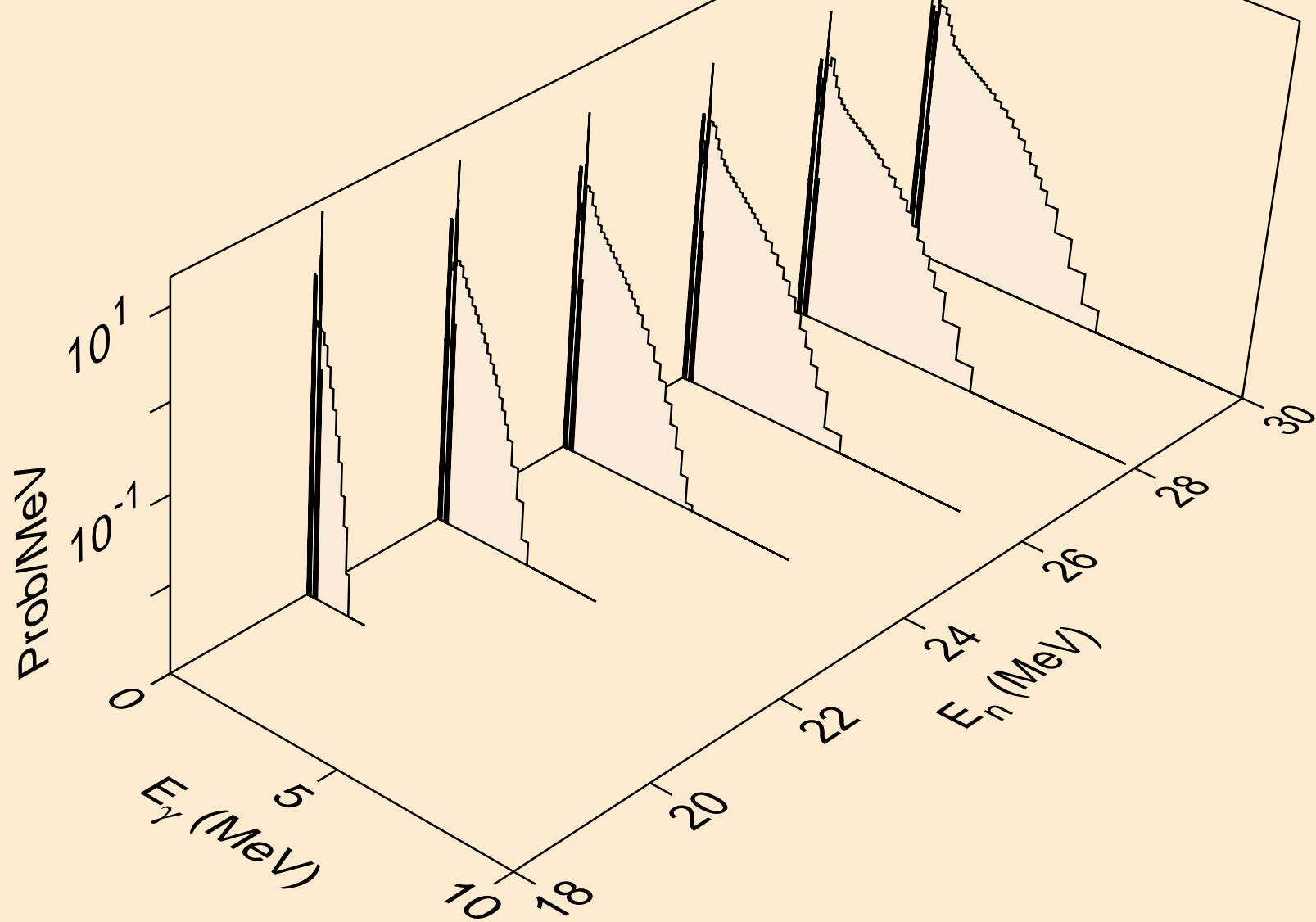

BI194M NEUTRON ACER TENDL-2021 LIBRARY; T=293.6K
Photon emission for (n,n*)a

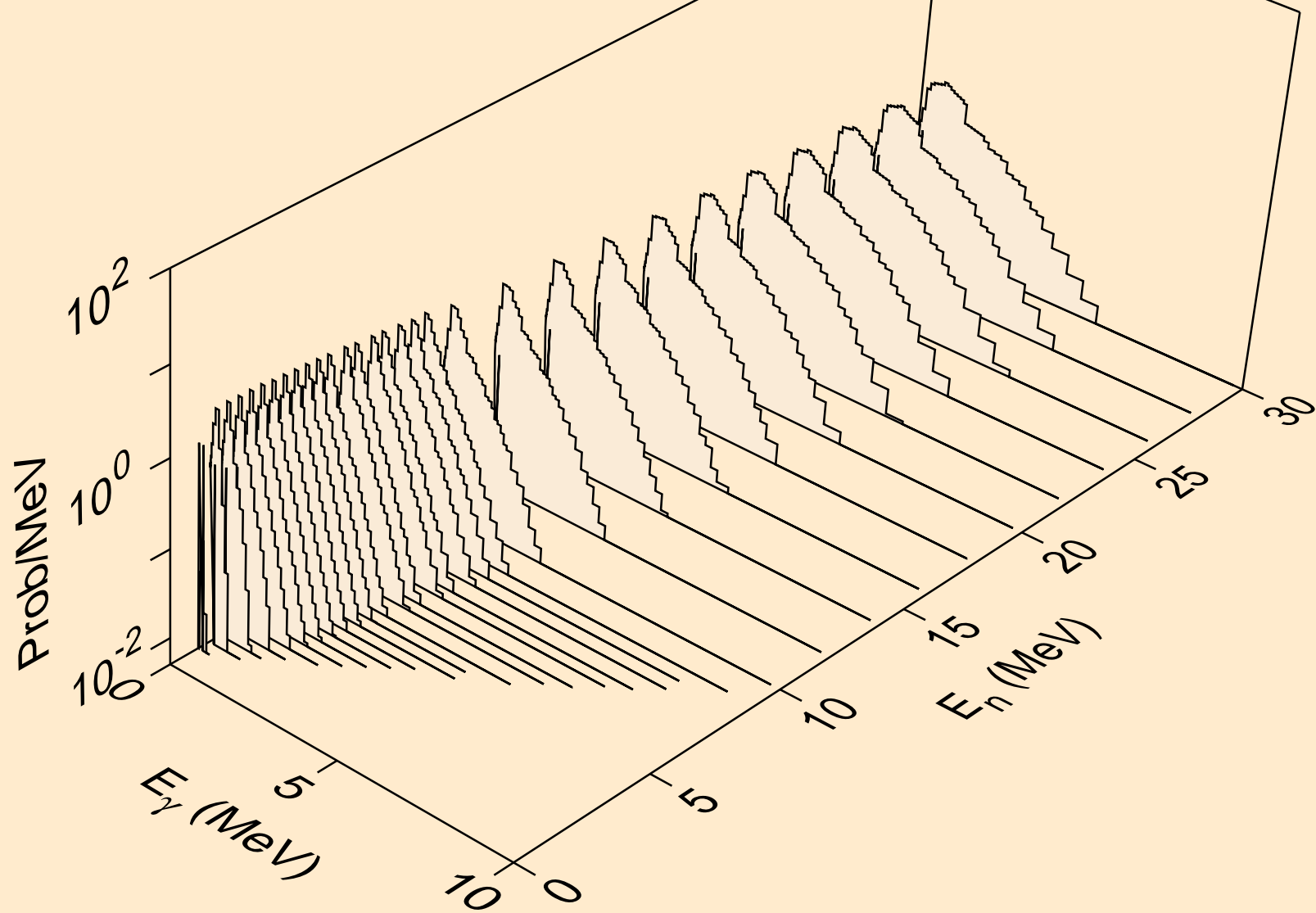

BI194M NEUTRON ACER TENDL-2021 LIBRARY; T=293.6K
Photon emission for (n,2n)a

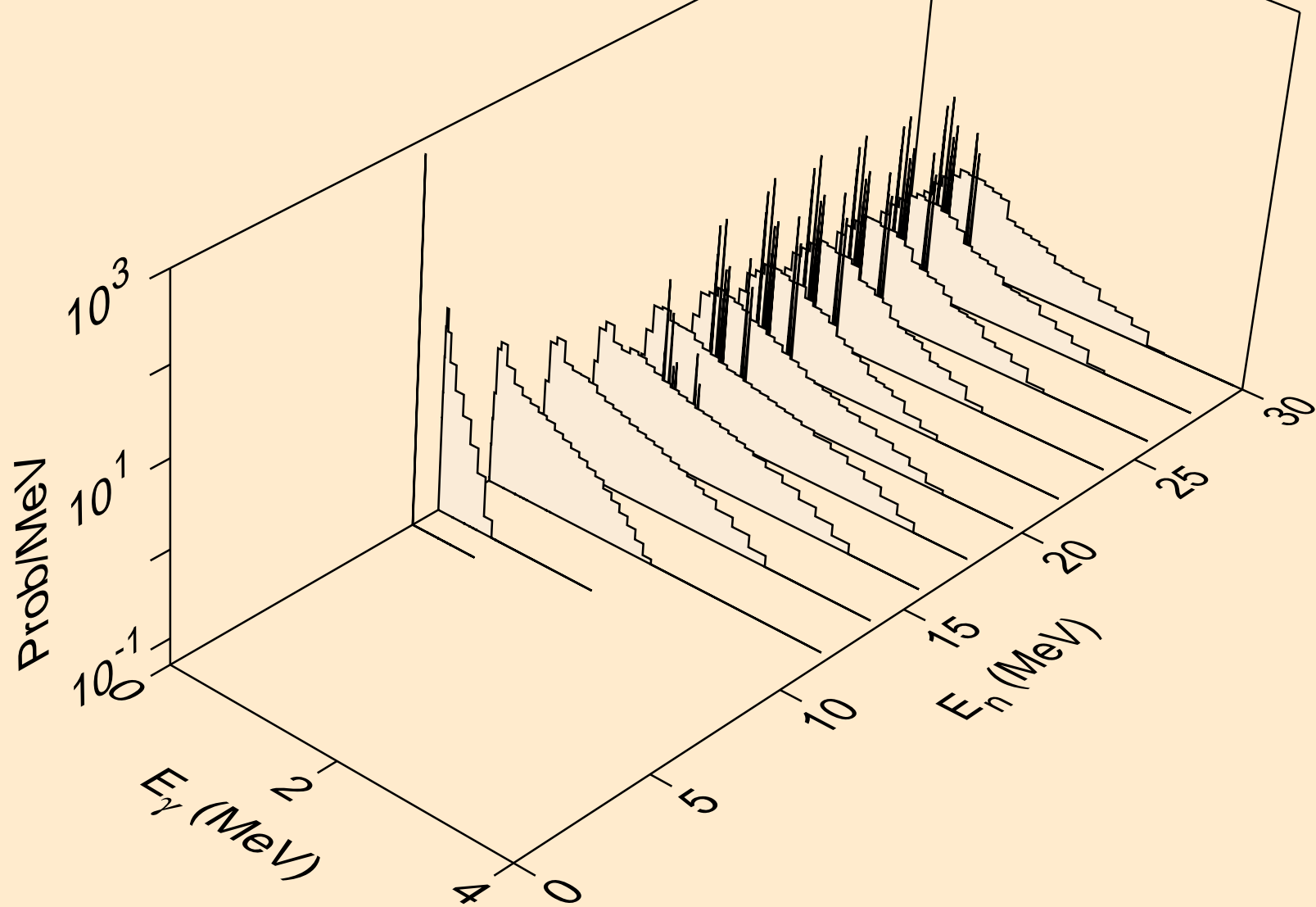

BI194M NEUTRON ACER TENDL-2021 LIBRARY; T=293.6K
Photon emission for (n,3n)a

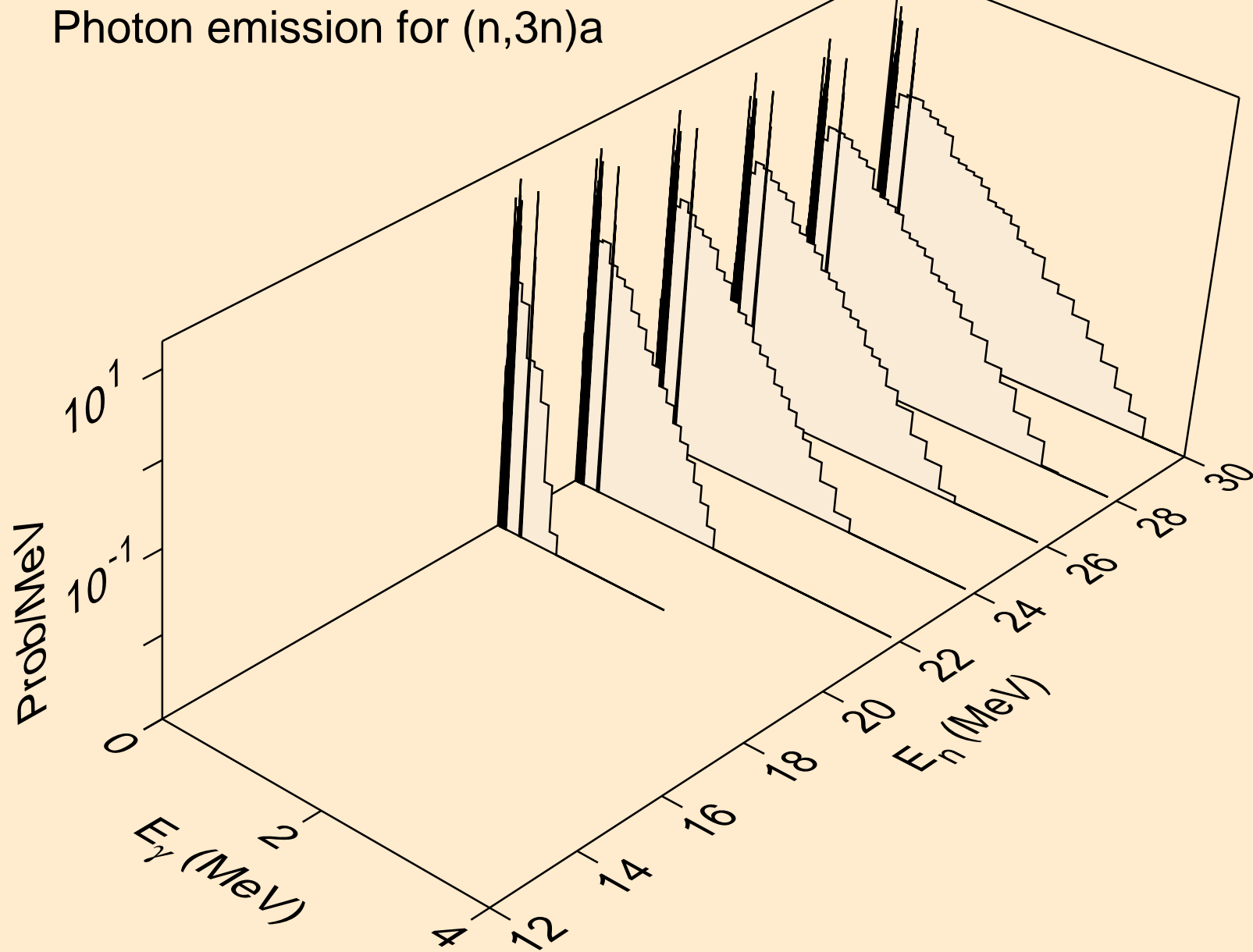

BI194M NEUTRON ACER TENDL-2021 LIBRARY; T=293.6K
Photon emission for (n,n*)p

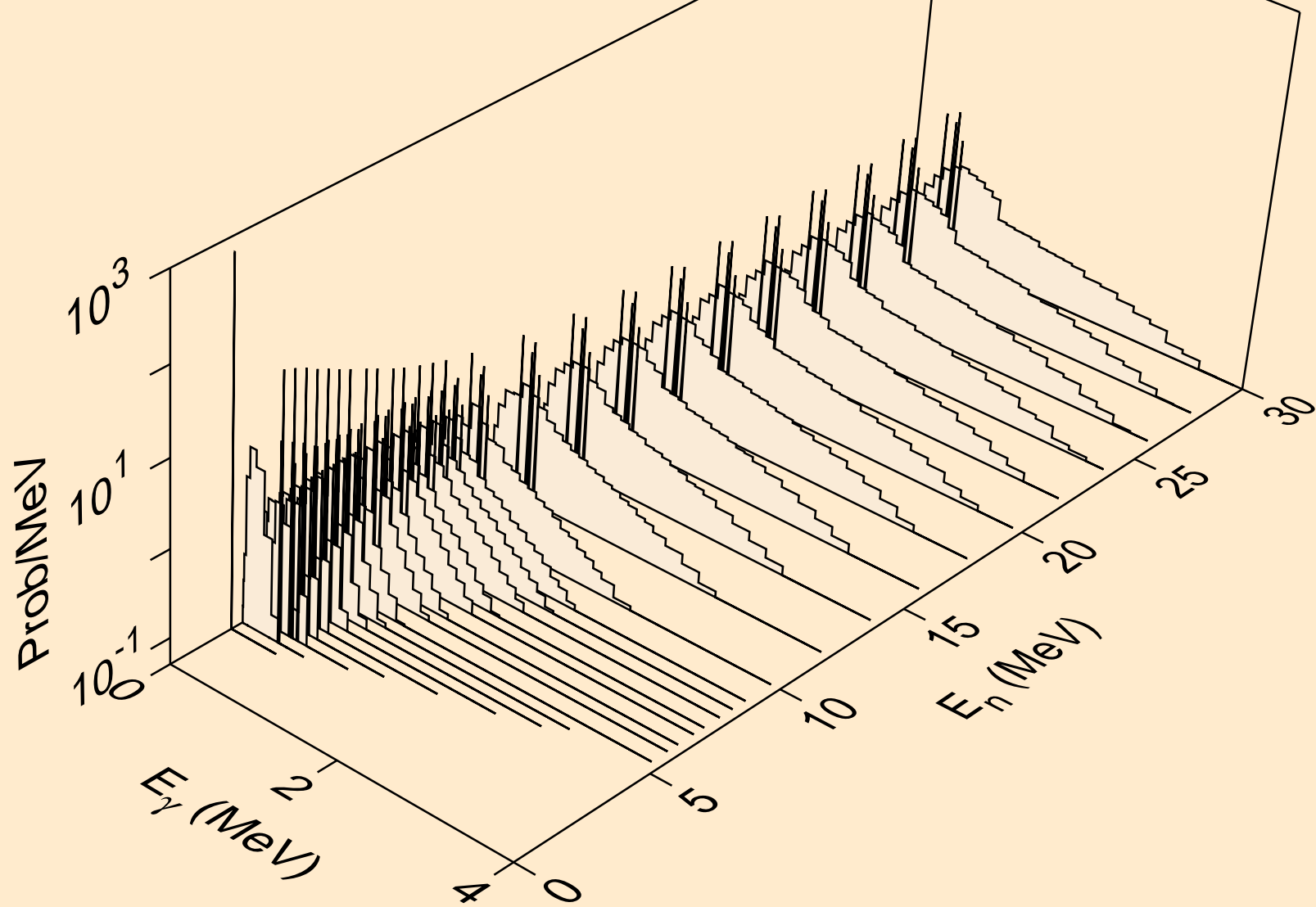

BI194M NEUTRON ACER TENDL-2021 LIBRARY; T=293.6K
Photon emission for (n,n*)2a

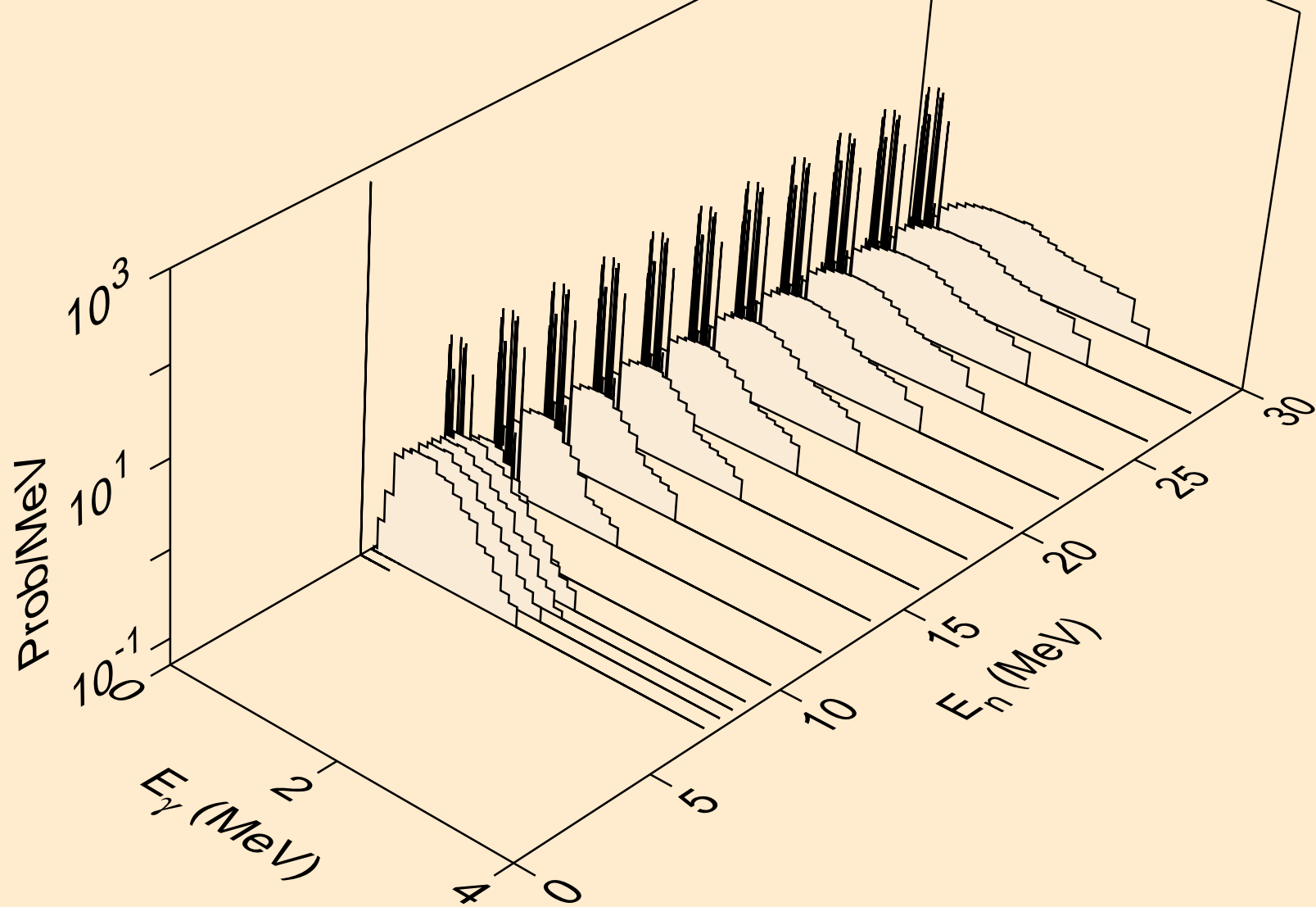

BI194M NEUTRON ACER TENDL-2021 LIBRARY; T=293.6K
Photon emission for (n,2n)2a

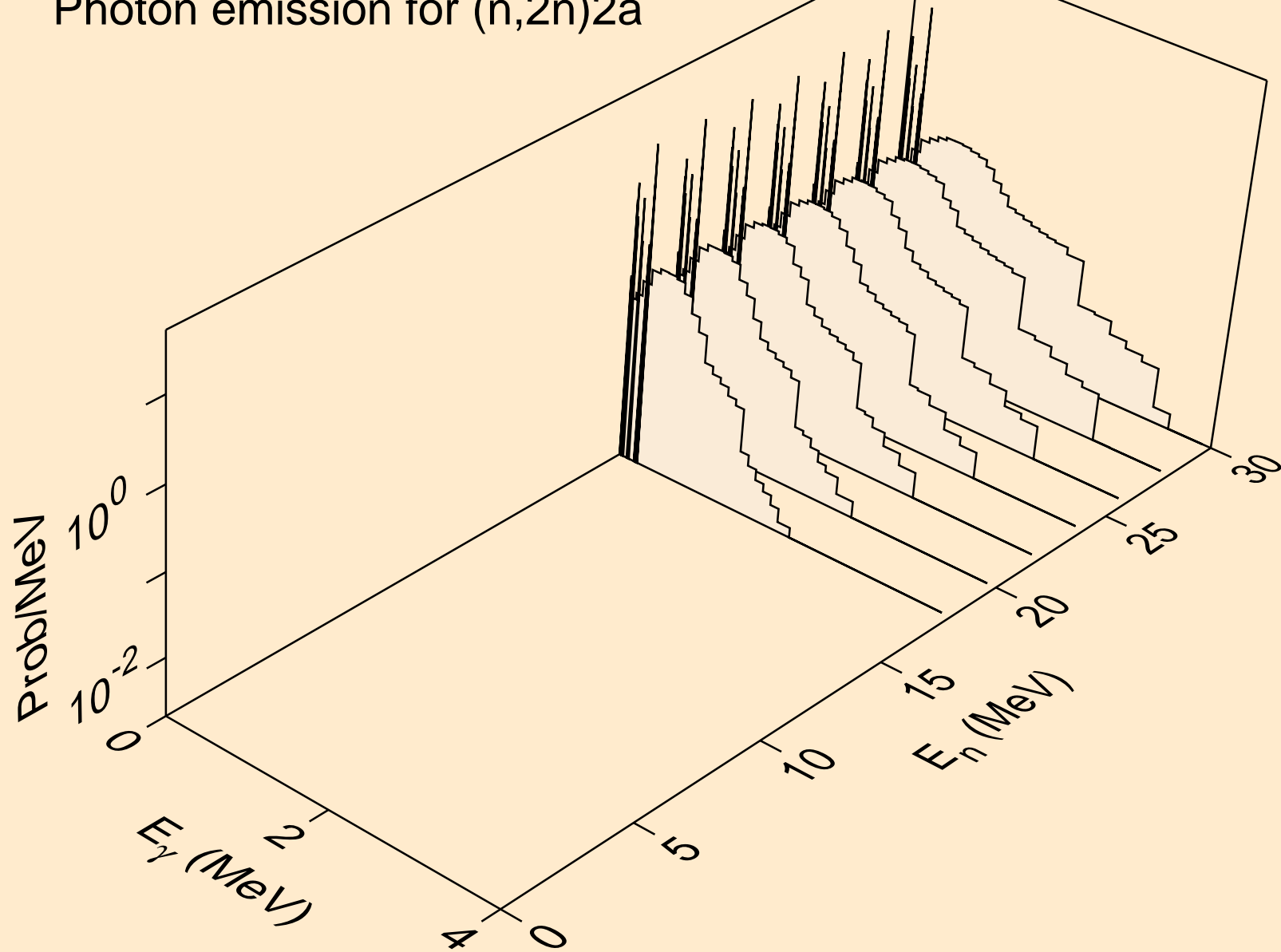

BI194M NEUTRON ACER TENDL-2021 LIBRARY; T=293.6K
Photon emission for (n,n*)d

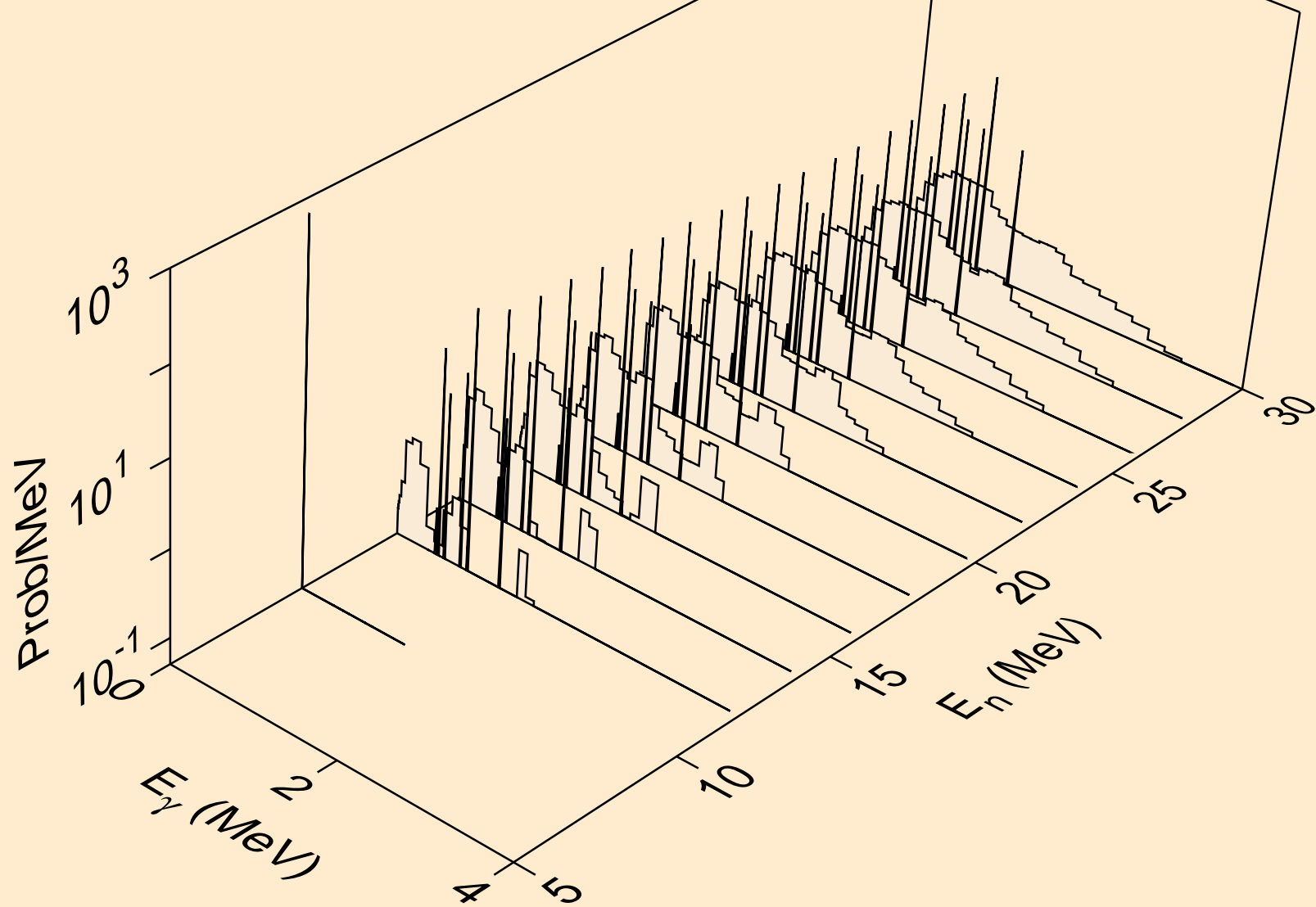

BI194M NEUTRON ACER TENDL-2021 LIBRARY; T=293.6K
Photon emission for (n,n*)t

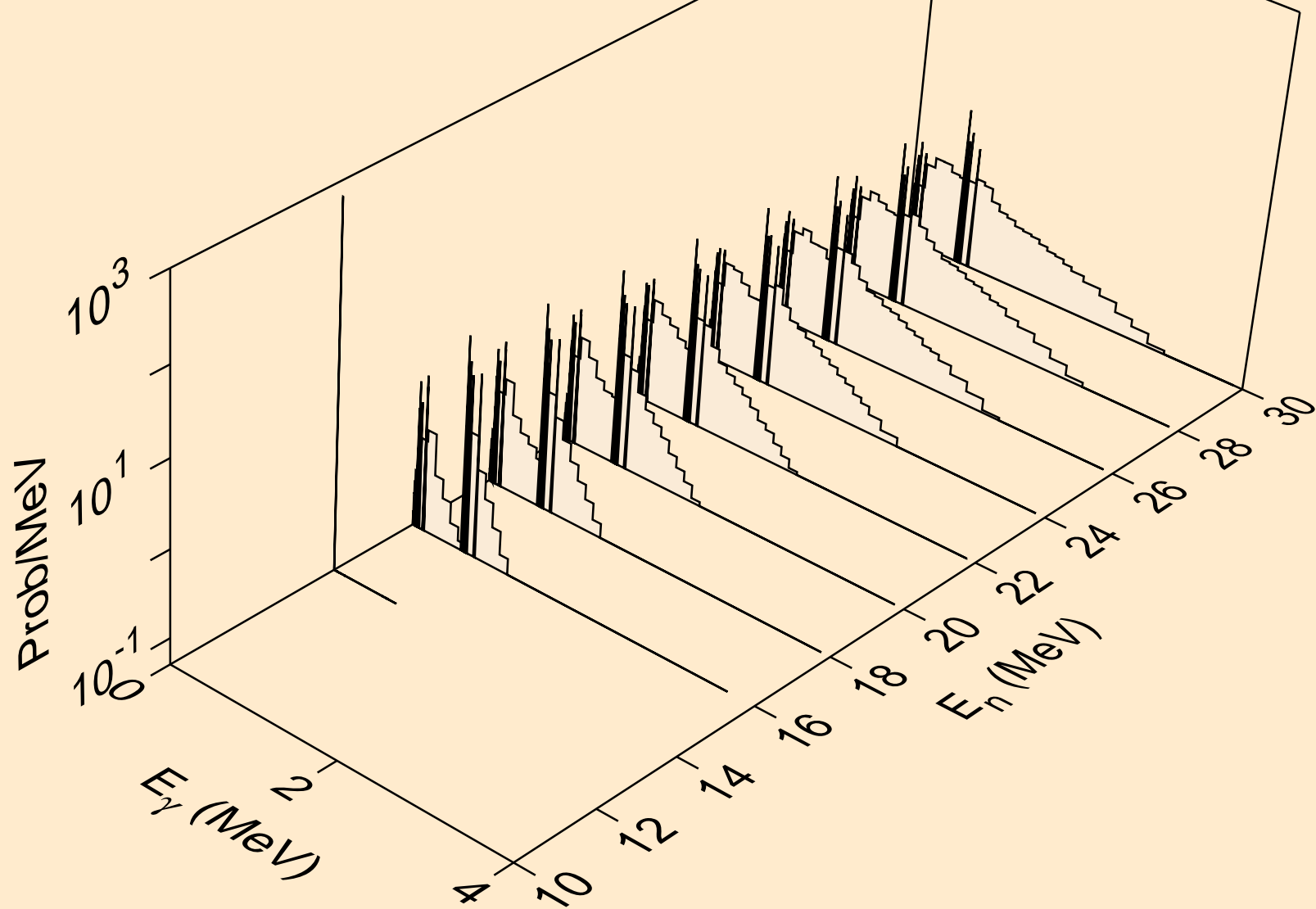

BI194M NEUTRON ACER TENDL-2021 LIBRARY; T=293.6K
Photon emission for (n,n*)he3

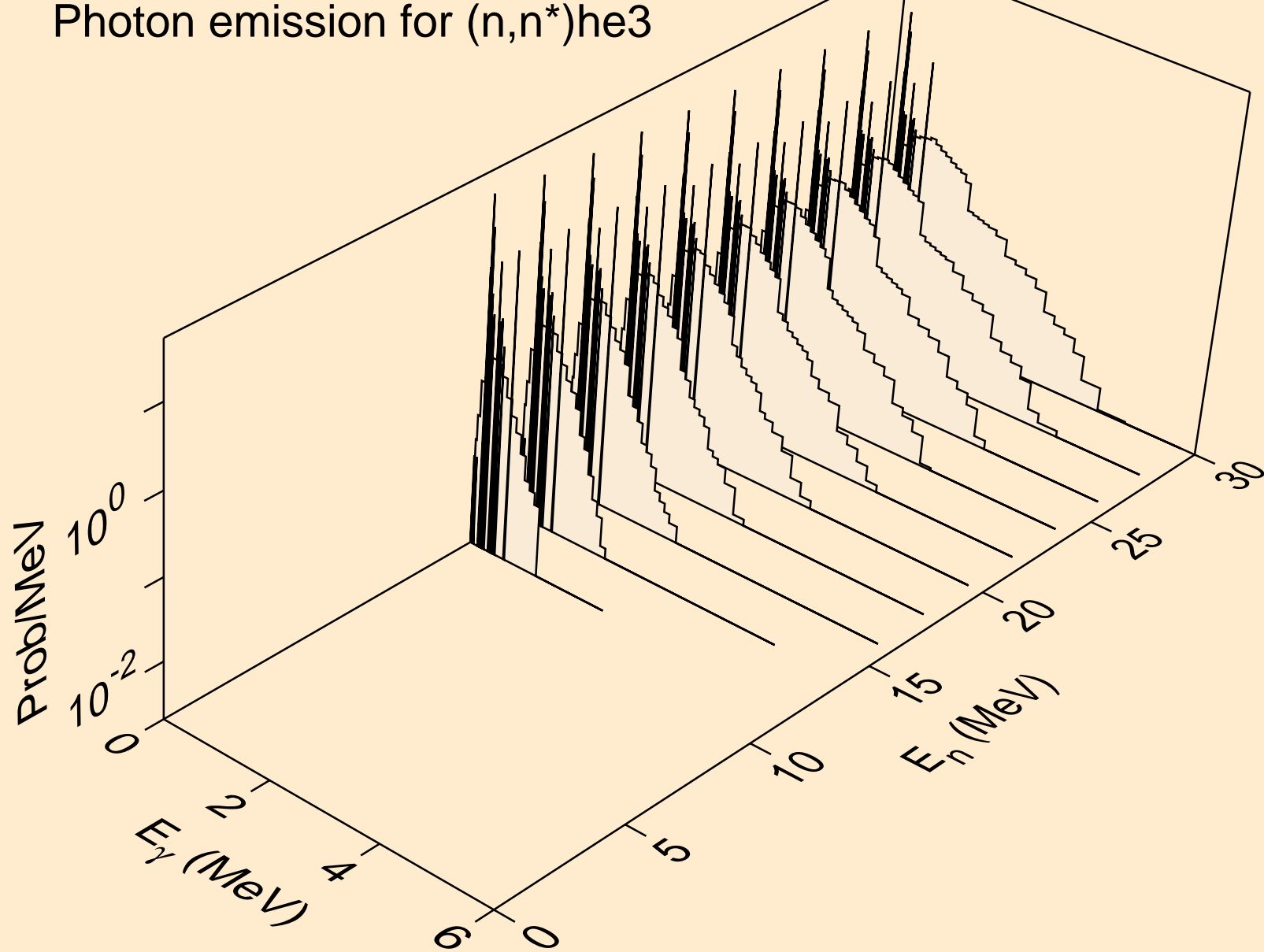

BI194M NEUTRON ACER TENDL-2021 LIBRARY; T=293.6K
Photon emission for (n,4n)

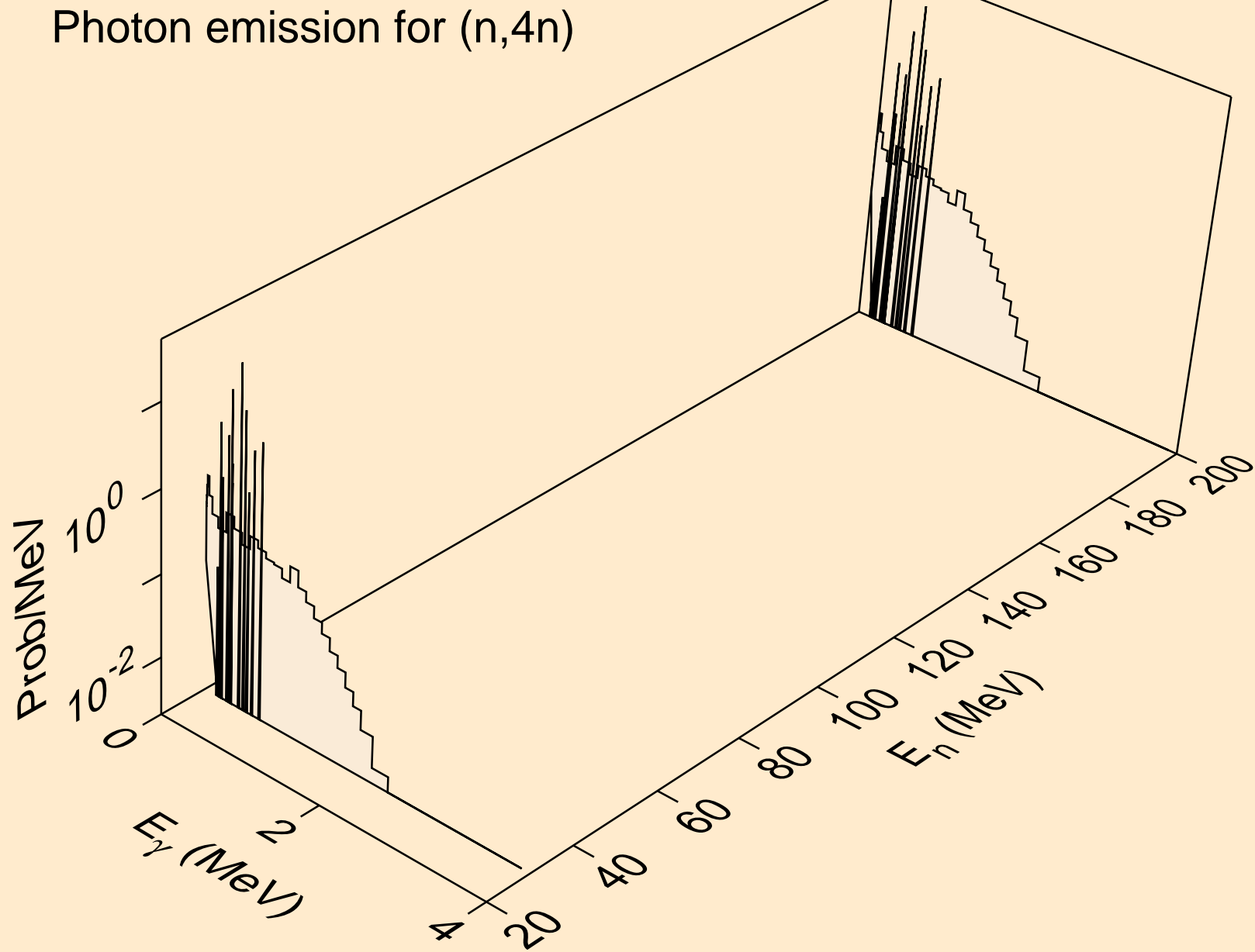

BI194M NEUTRON ACER TENDL-2021 LIBRARY; T=293.6K
Photon emission for (n,2np)

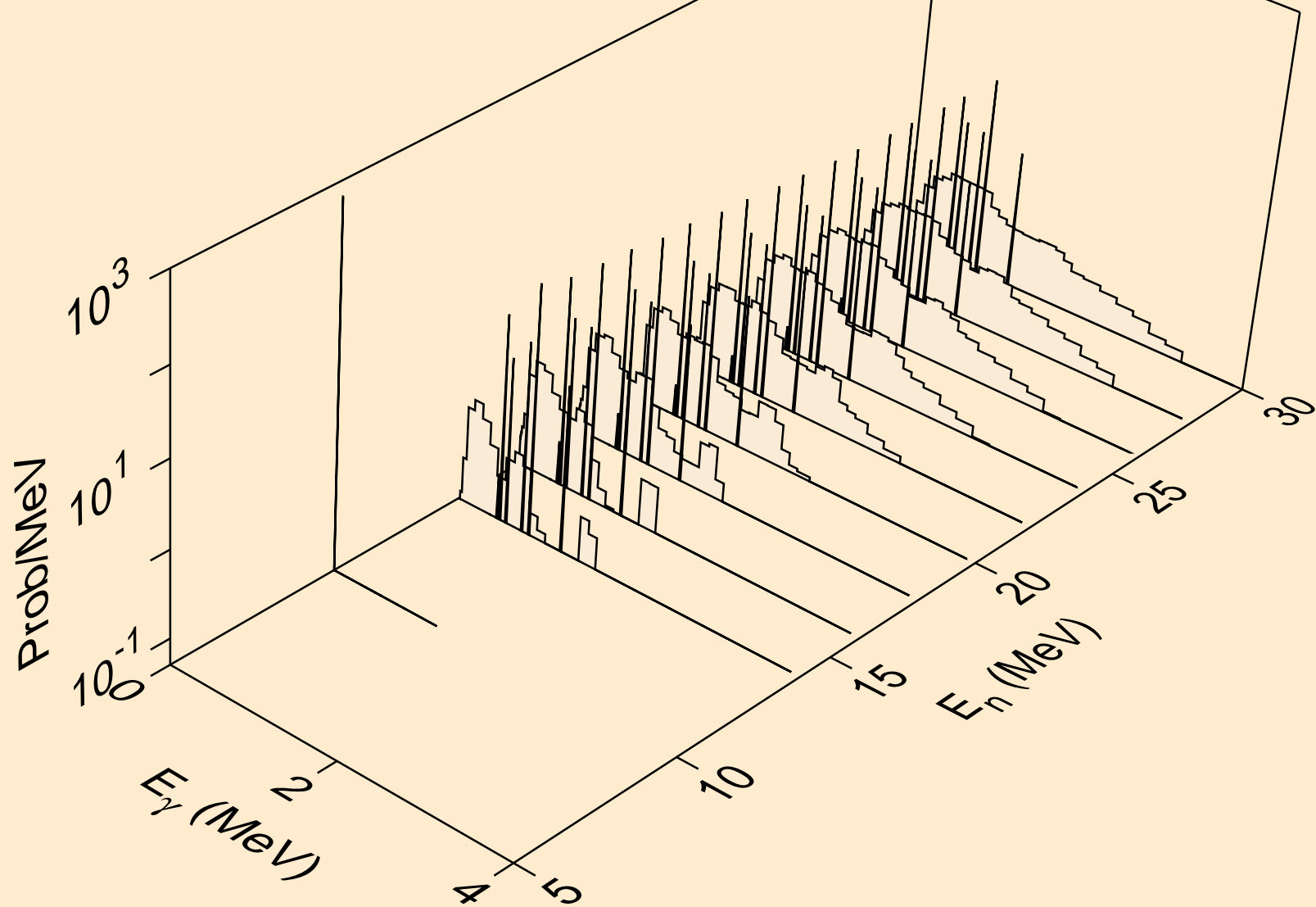

BI194M NEUTRON ACER TENDL-2021 LIBRARY; T=293.6K
Photon emission for (n,3np)

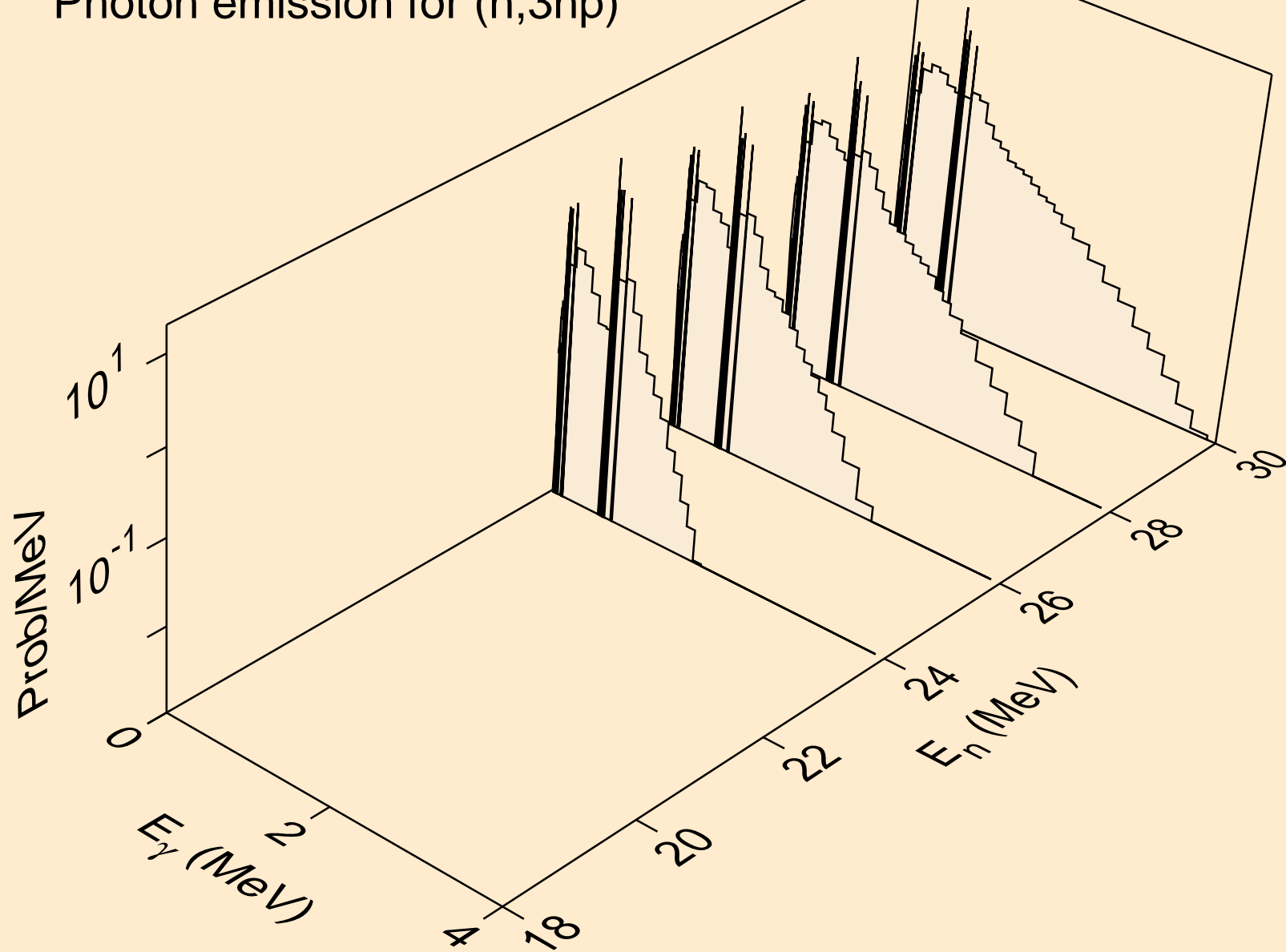

BI194M NEUTRON ACER TENDL-2021 LIBRARY; T=293.6K
Photon emission for (n,2np)

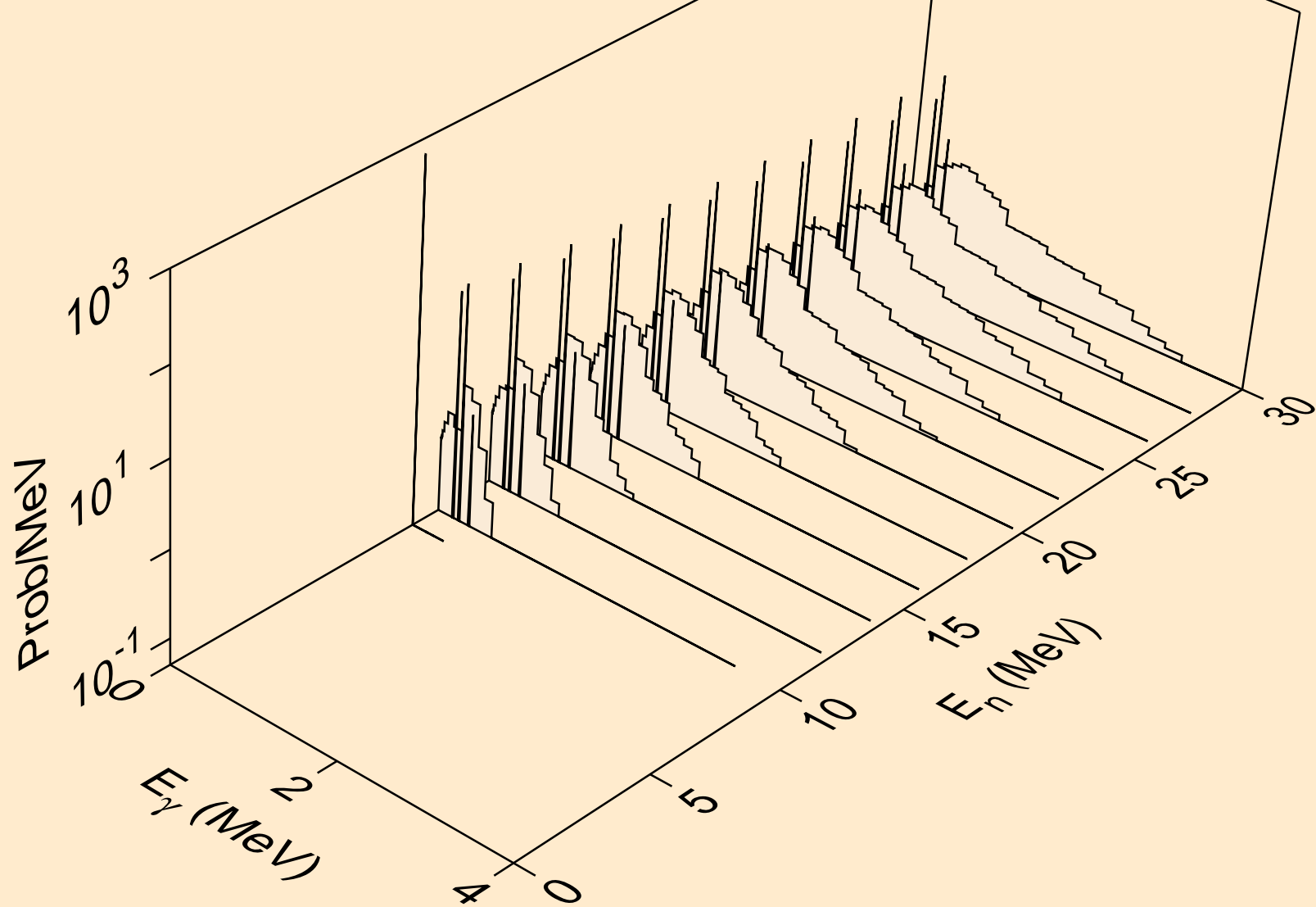

BI194M NEUTRON ACER TENDL-2021 LIBRARY; T=293.6K
Photon emission for (n,npa)

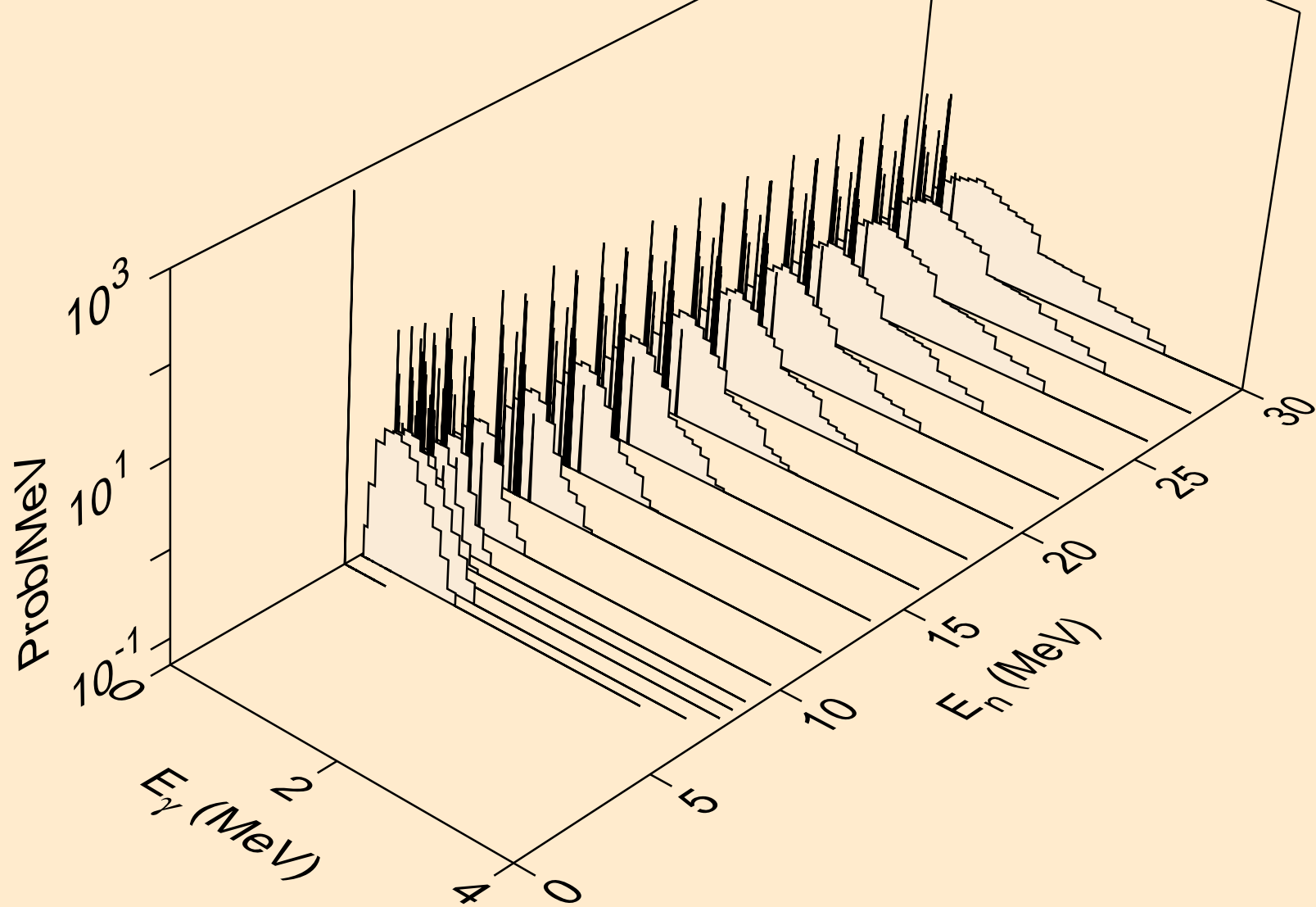

BI194M NEUTRON ACER TENDL-2021 LIBRARY; T=293.6K
Photon emission for (n,n*1)

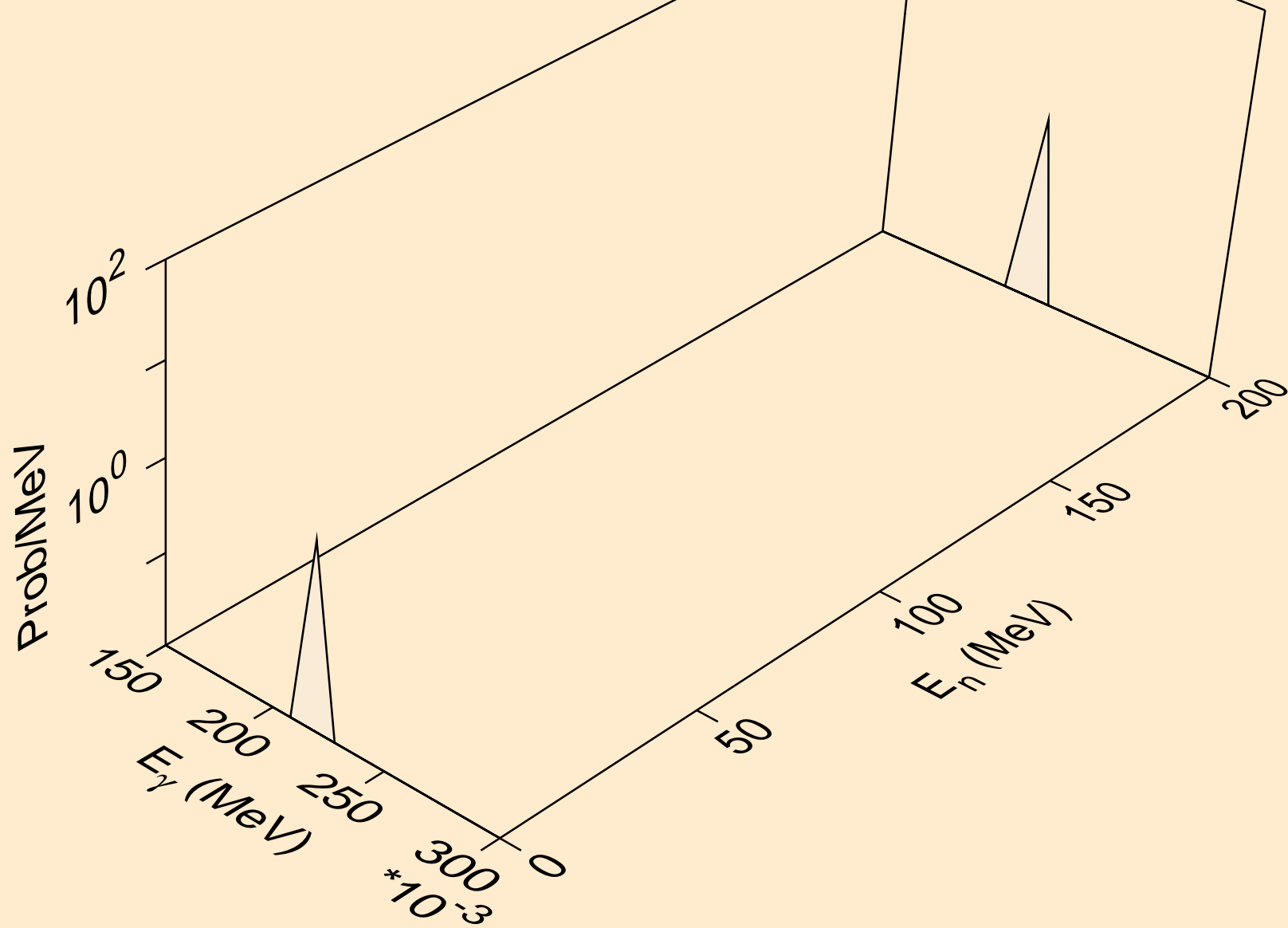

BI194M NEUTRON ACER TENDL-2021 LIBRARY; T=293.6K
Photon emission for (n,n*c)

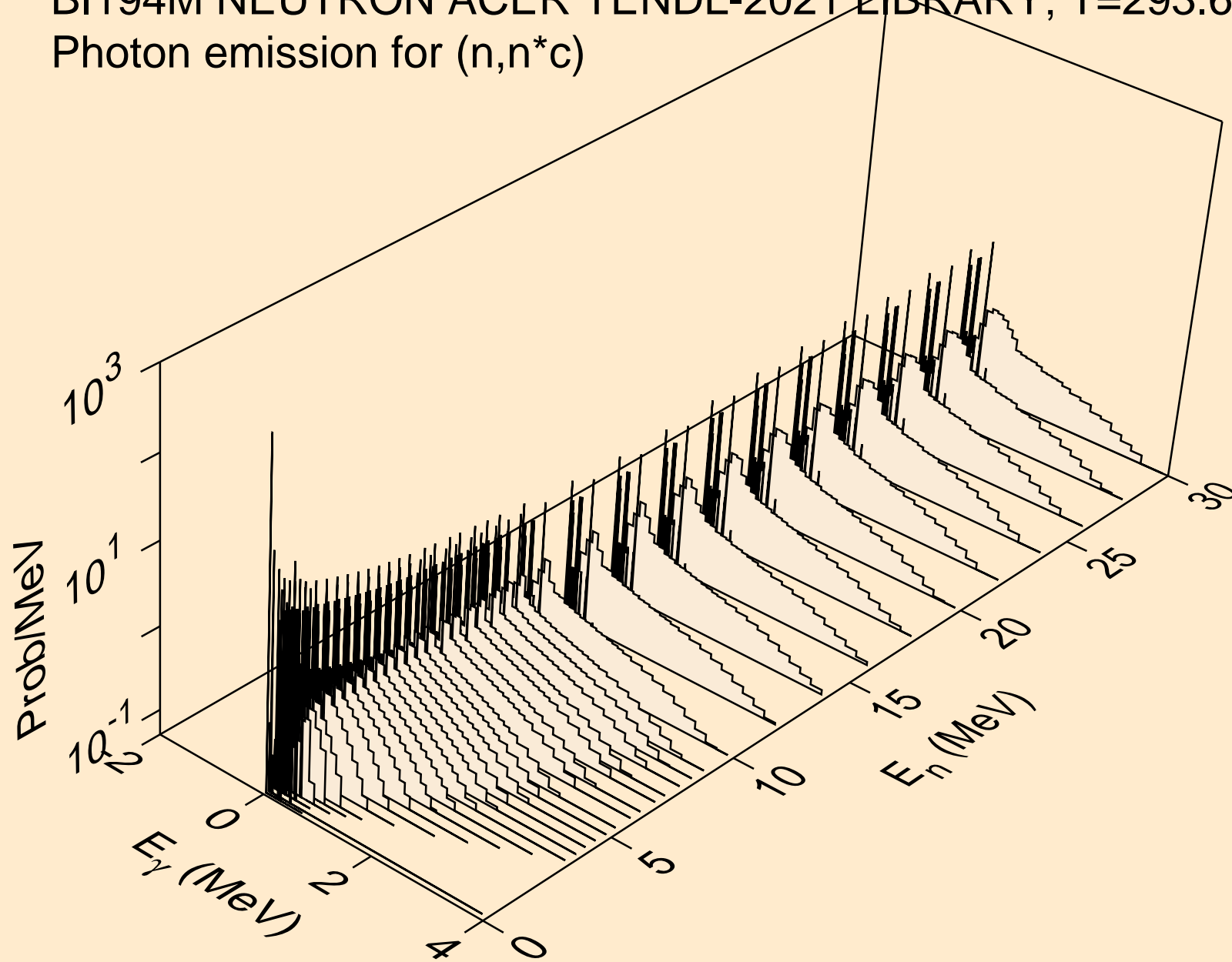

BI194M NEUTRON ACER TENDL-2021 LIBRARY; T=293.6K
Photon emission for (n,gma)

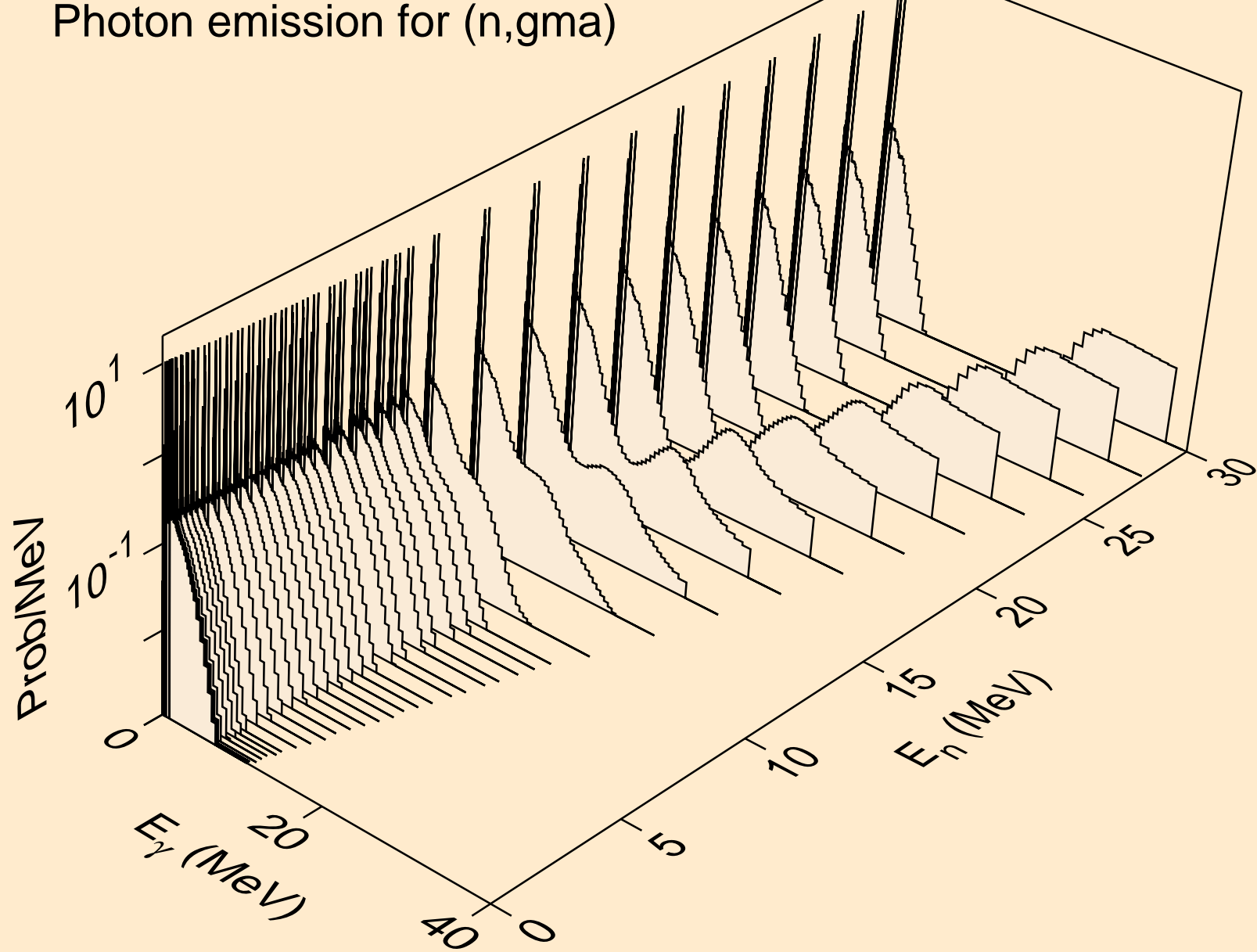

BI194M NEUTRON ACER TENDL-2021 LIBRARY; T=293.6K
Photon emission for (n,p)

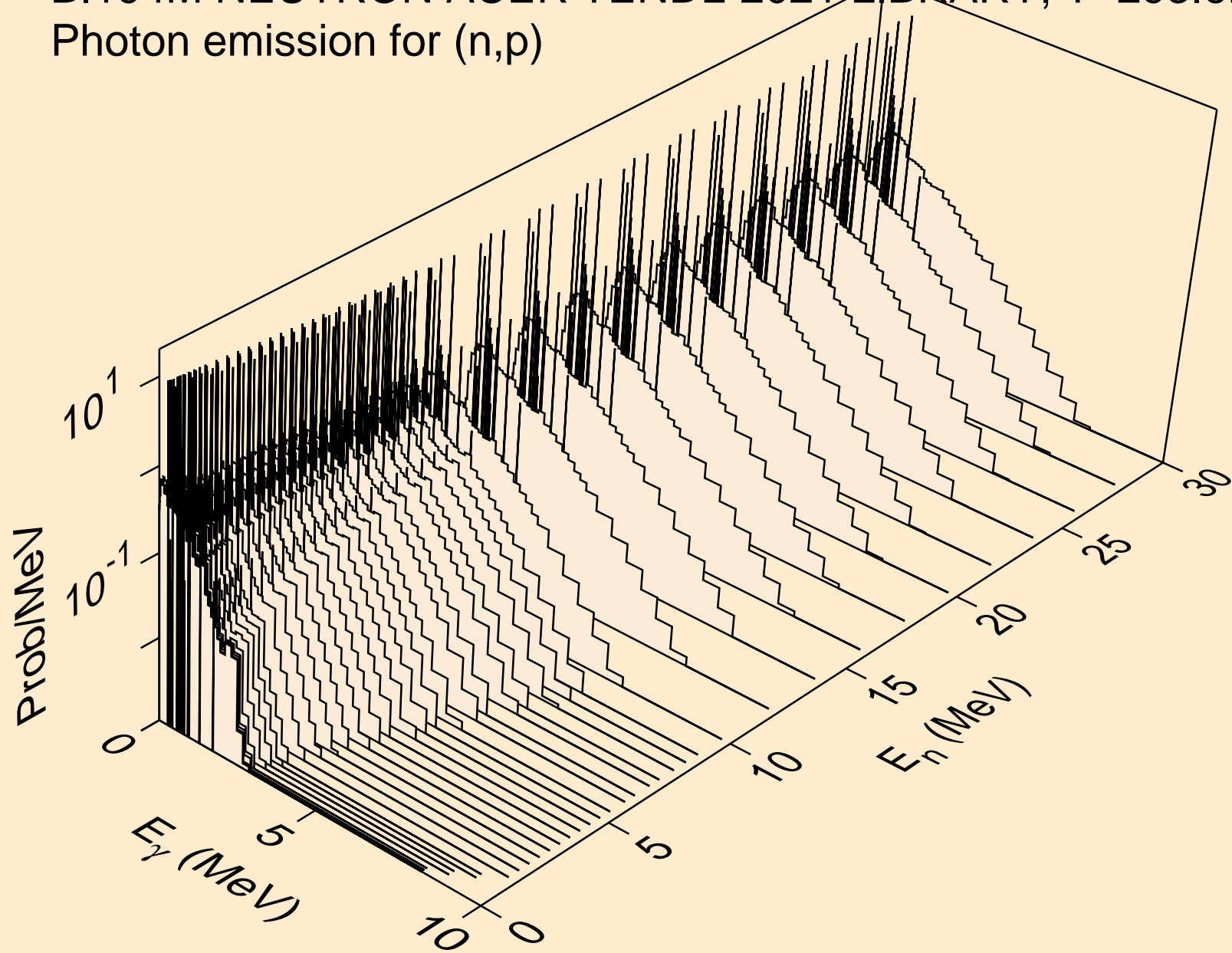

BI194M NEUTRON ACER TENDL-2021 LIBRARY; T=293.6K
Photon emission for (n,d)

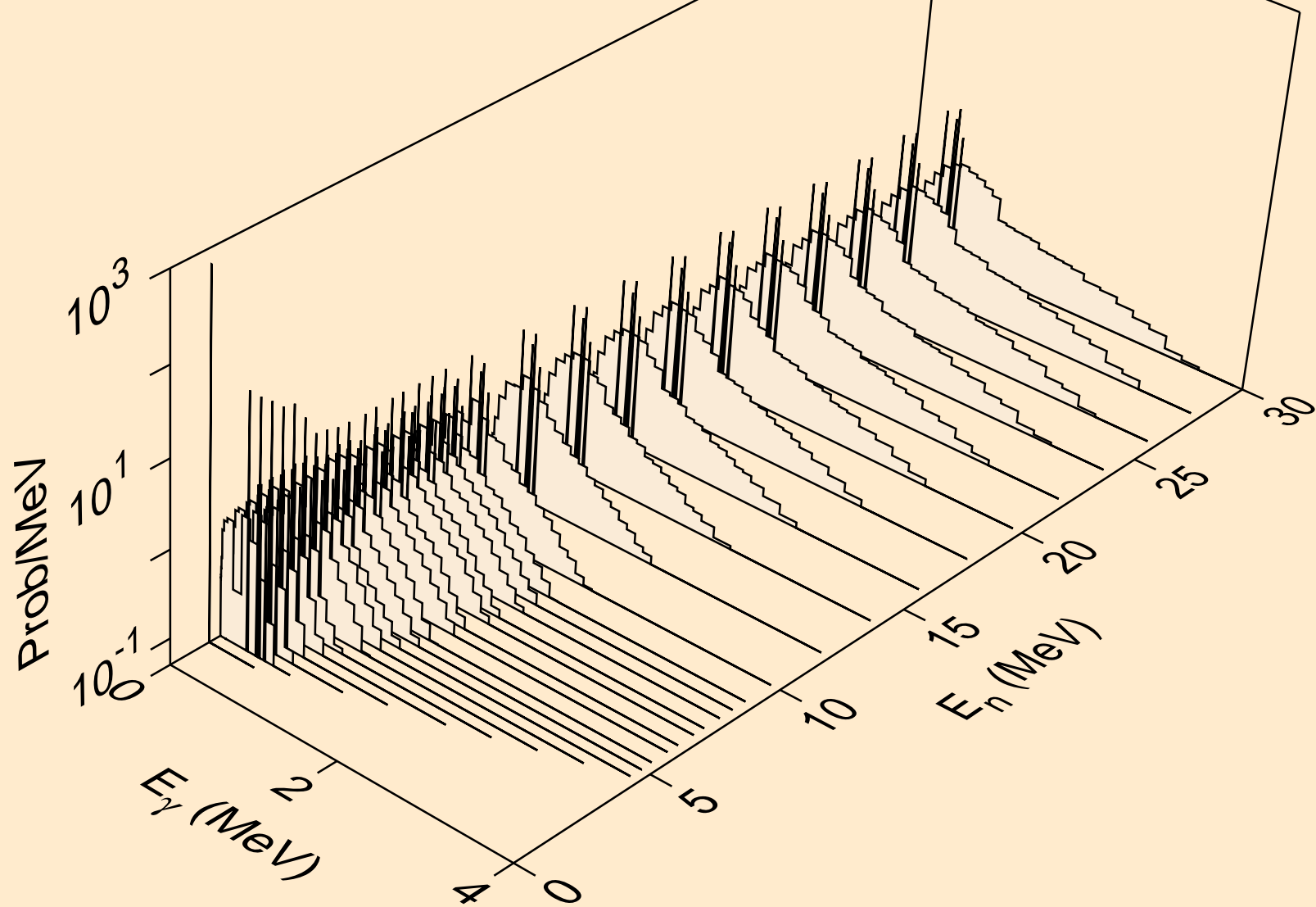

BI194M NEUTRON ACER TENDL-2021 LIBRARY; T=293.6K
Photon emission for (n,t)

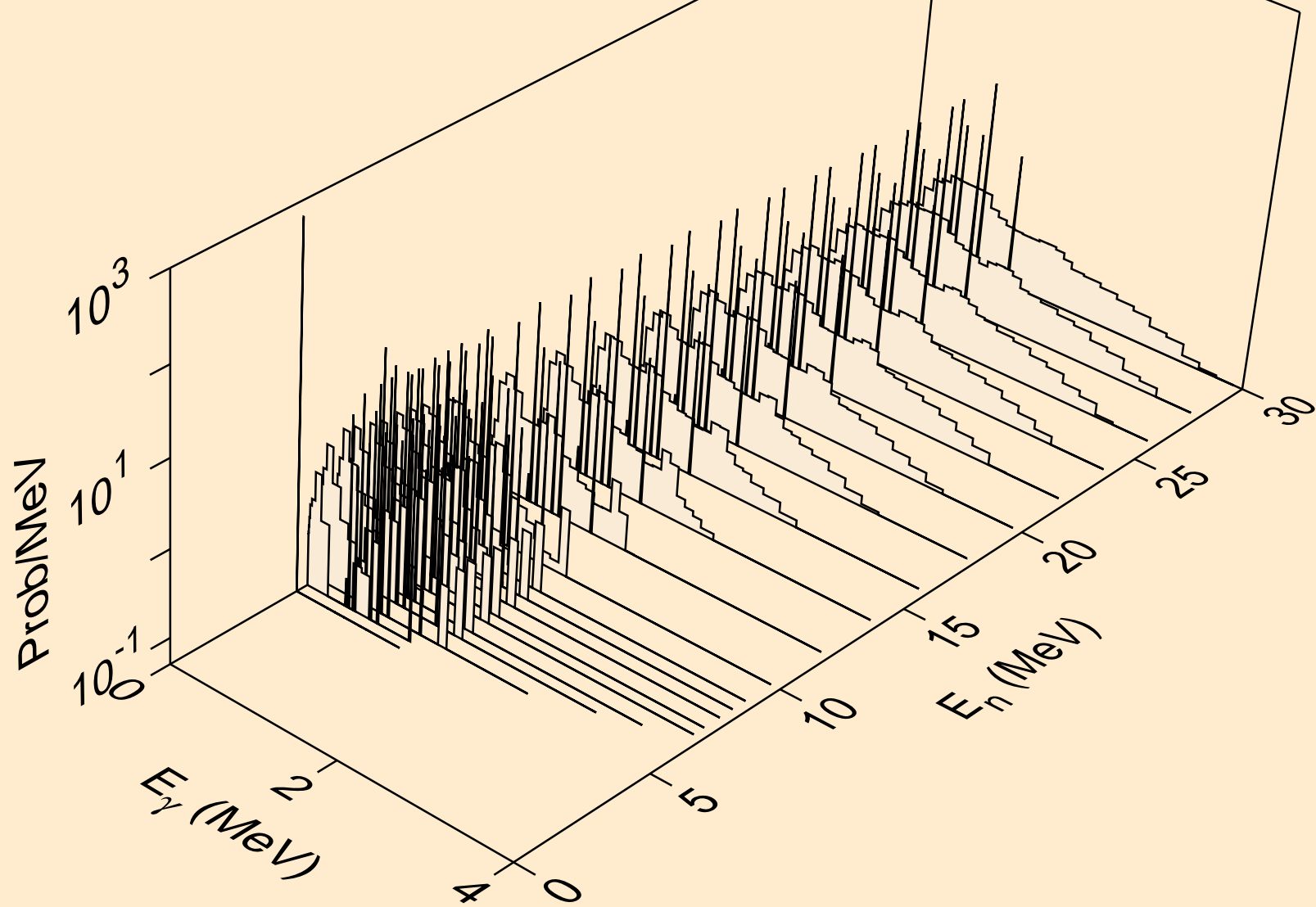

BI194M NEUTRON ACER TENDL-2021 LIBRARY; T=293.6K
Photon emission for (n,he3)

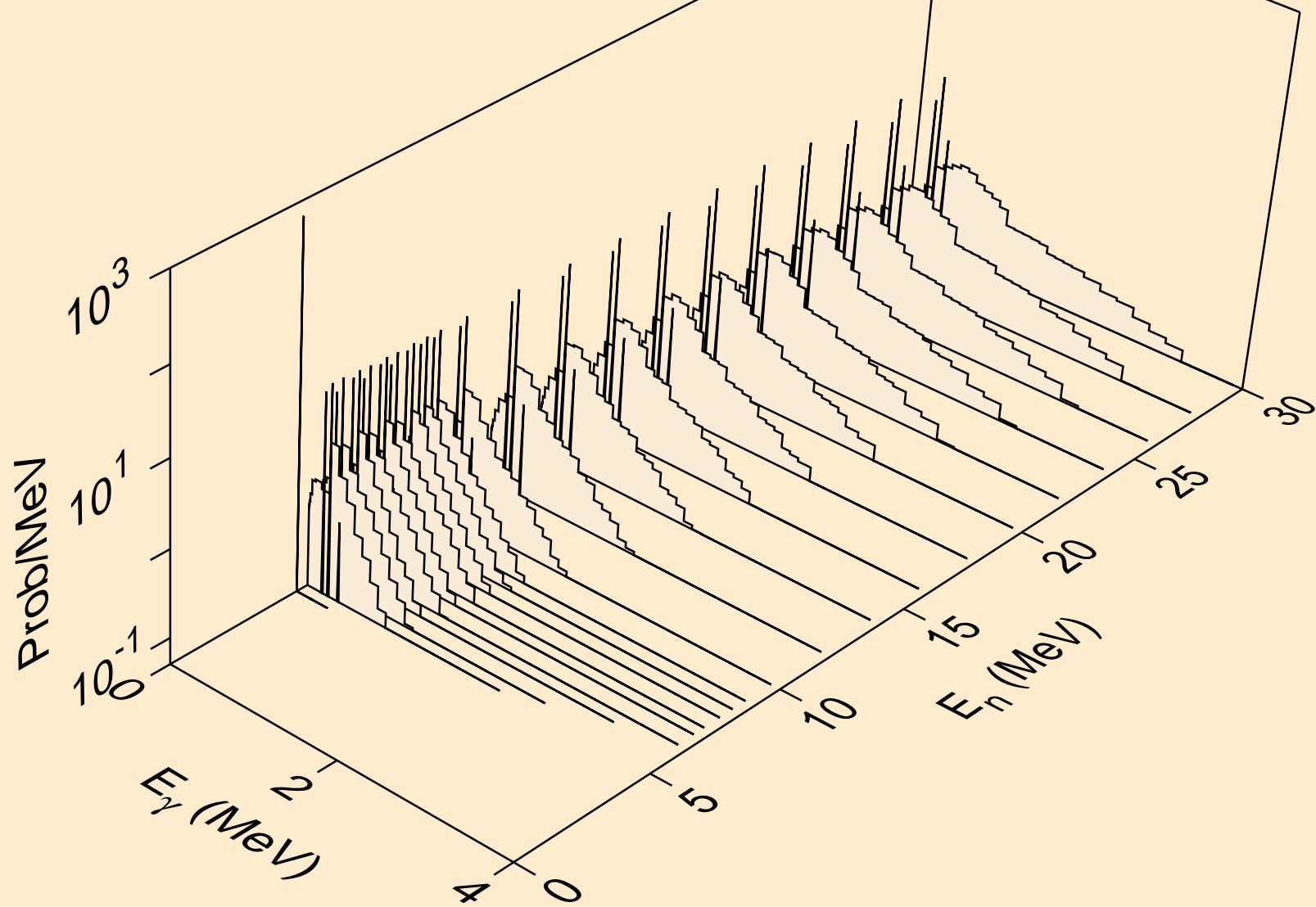

BI194M NEUTRON ACER TENDL-2021 LIBRARY; T=293.6K
Photon emission for (n,a)

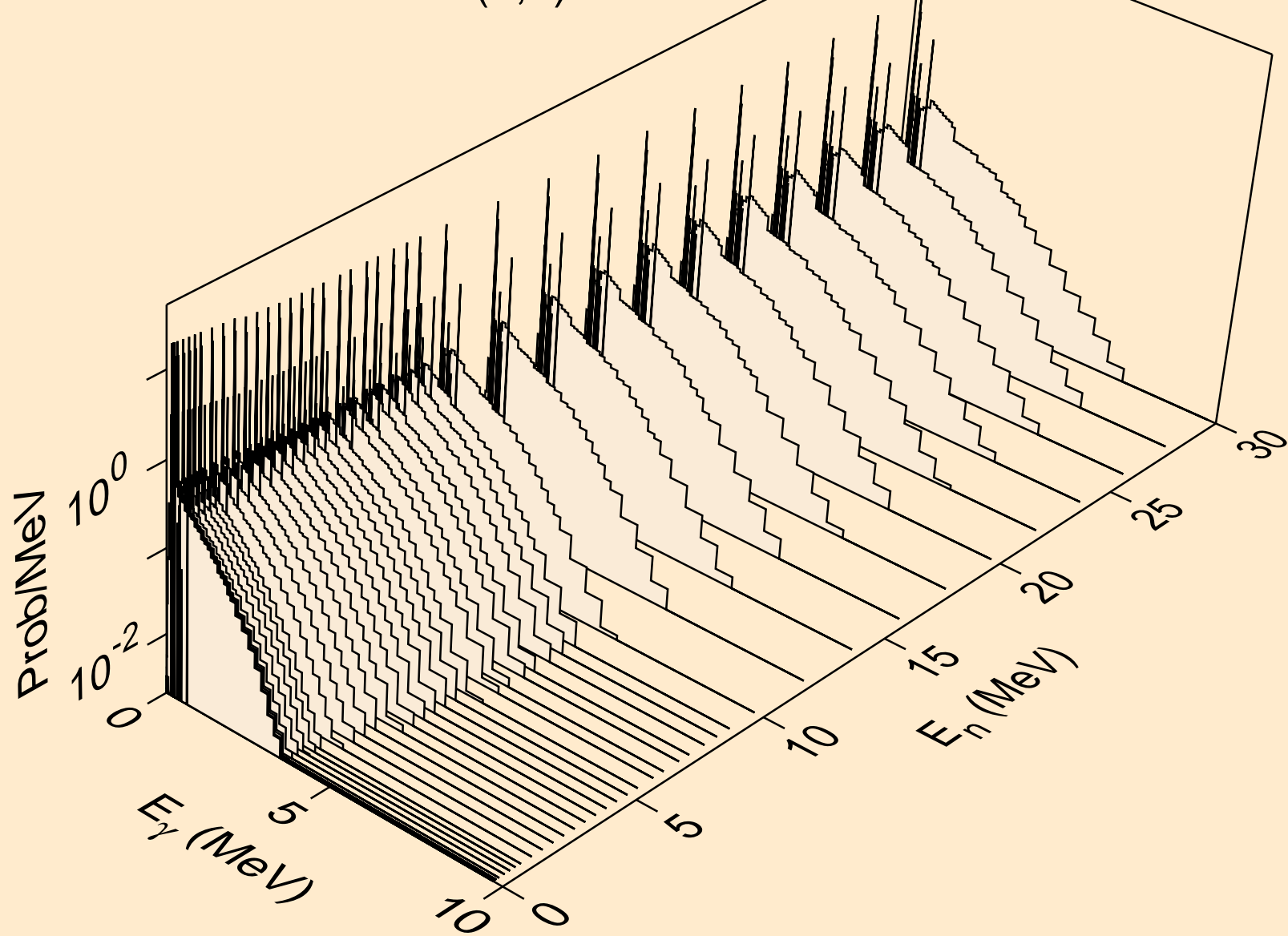

BI194M NEUTRON ACER TENDL-2021 LIBRARY; T=293.6K
Photon emission for (n,2a)

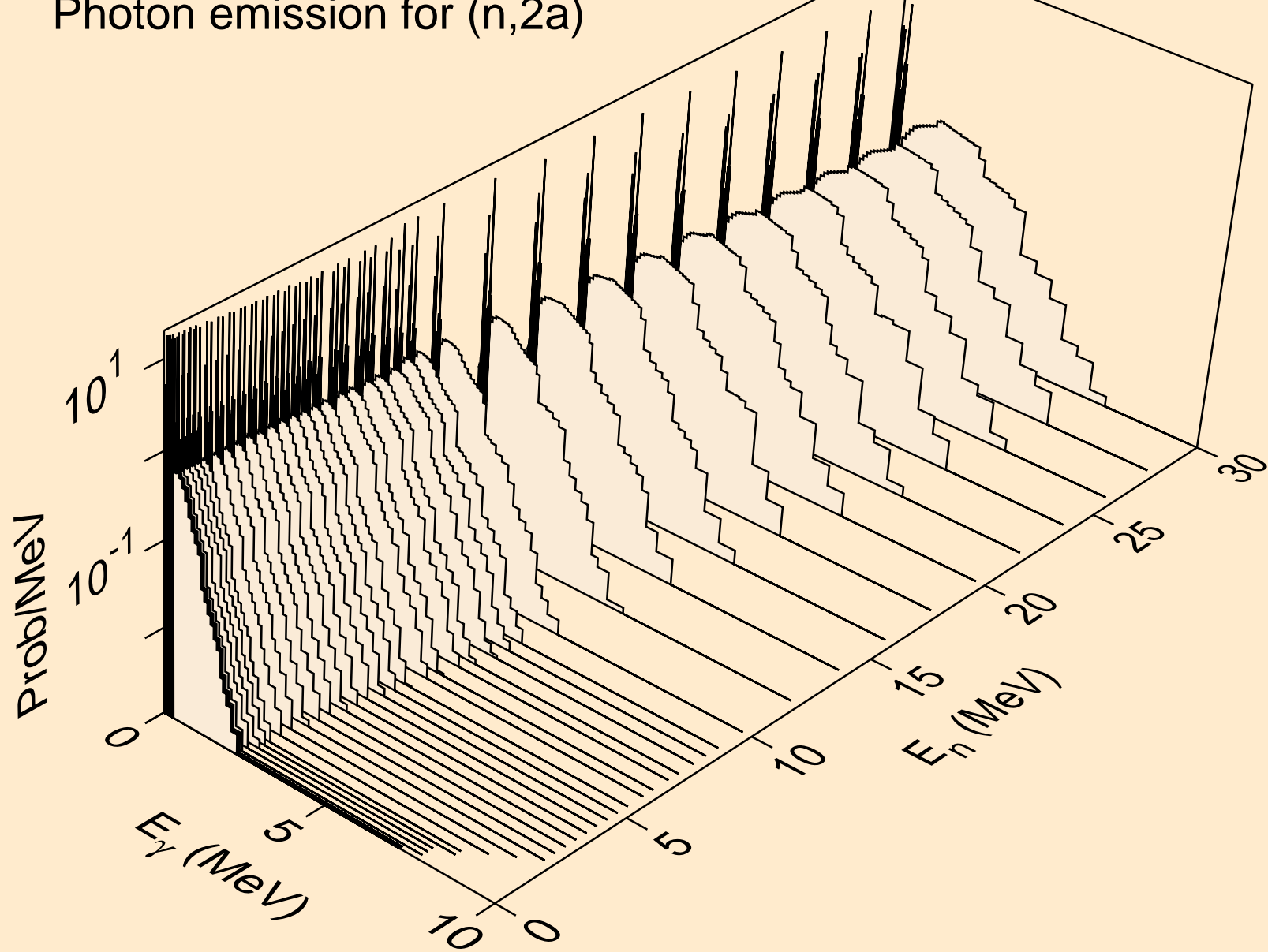

BI194M NEUTRON ACER TENDL-2021 LIBRARY; T=293.6K
Photon emission for (n,3a)

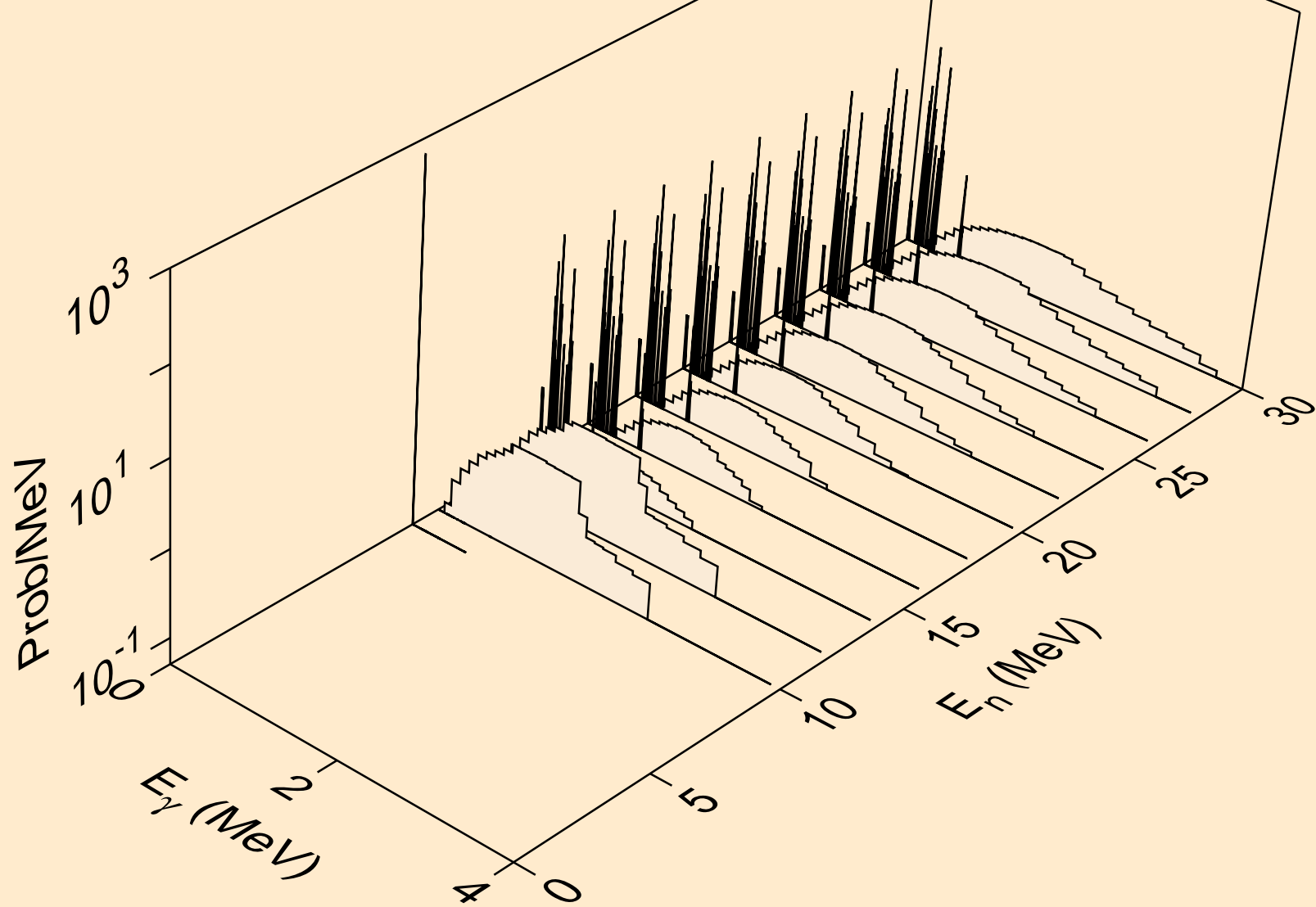

BI194M NEUTRON ACER TENDL-2021 LIBRARY; T=293.6K
Photon emission for (n,2p)

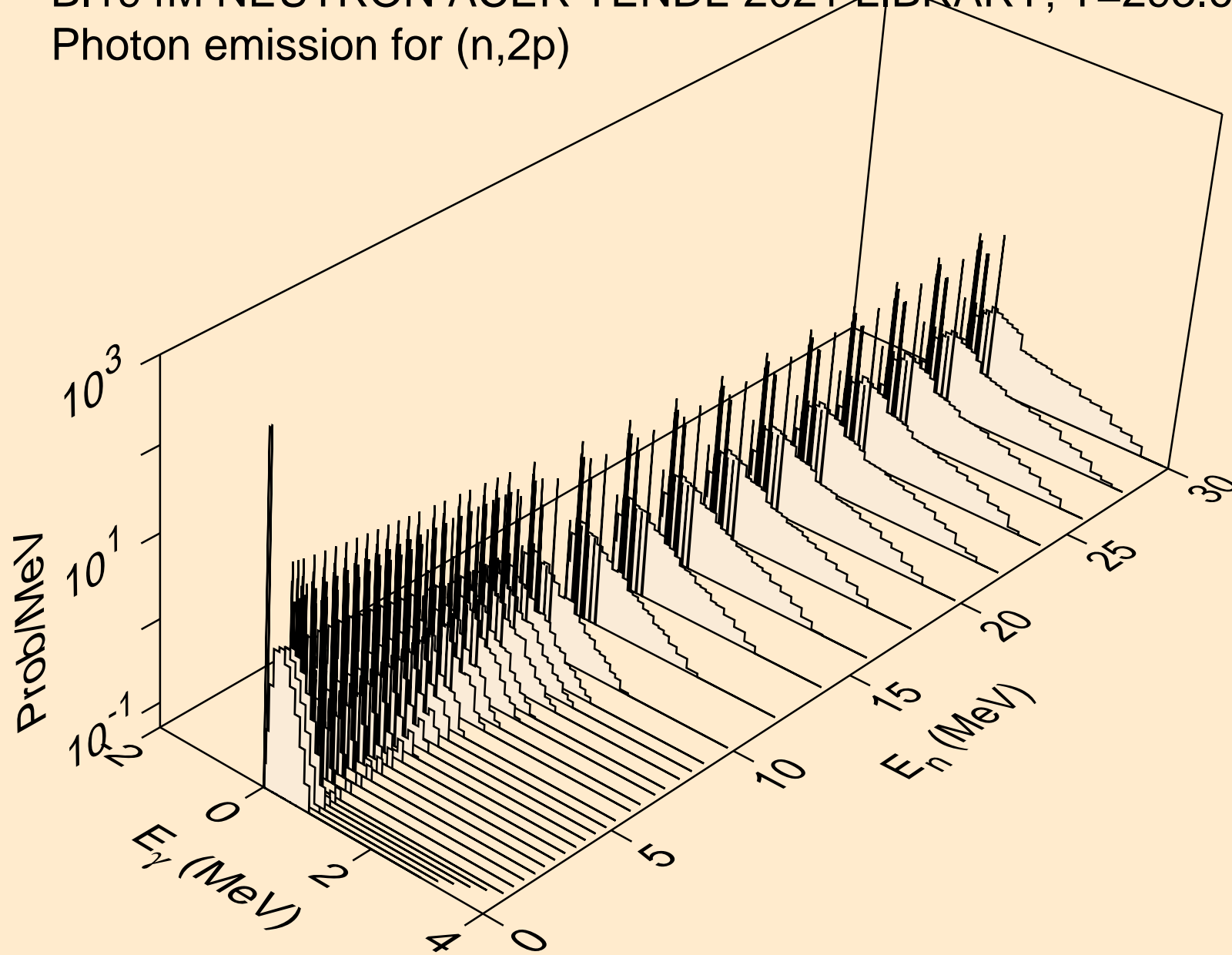

BI194M NEUTRON ACER TENDL-2021 LIBRARY; T=293.6K
Photon emission for (n,p α)

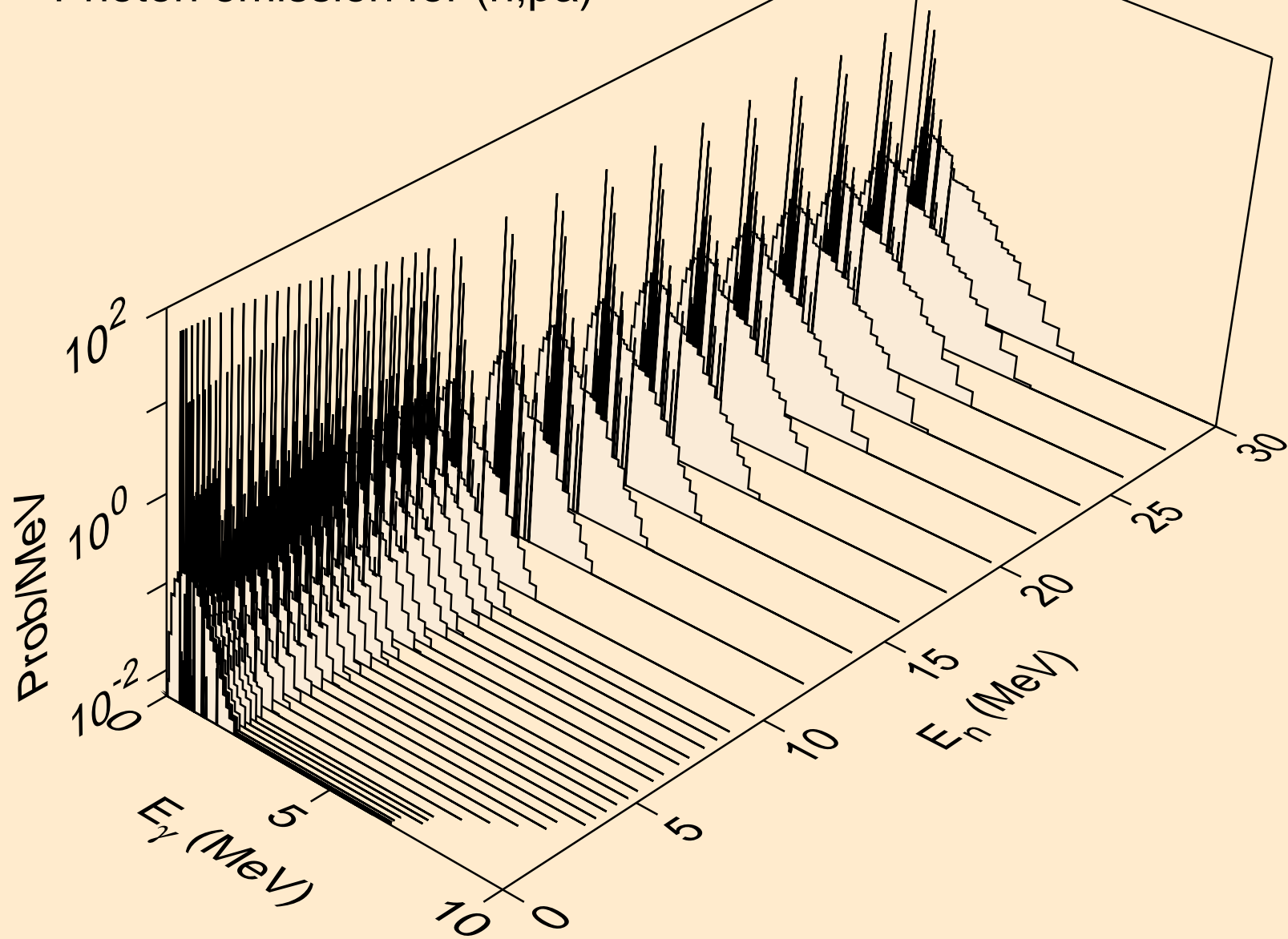

BI194M NEUTRON ACER TENDL-2021 LIBRARY; T=293.6K
Photon emission for (n,pd)

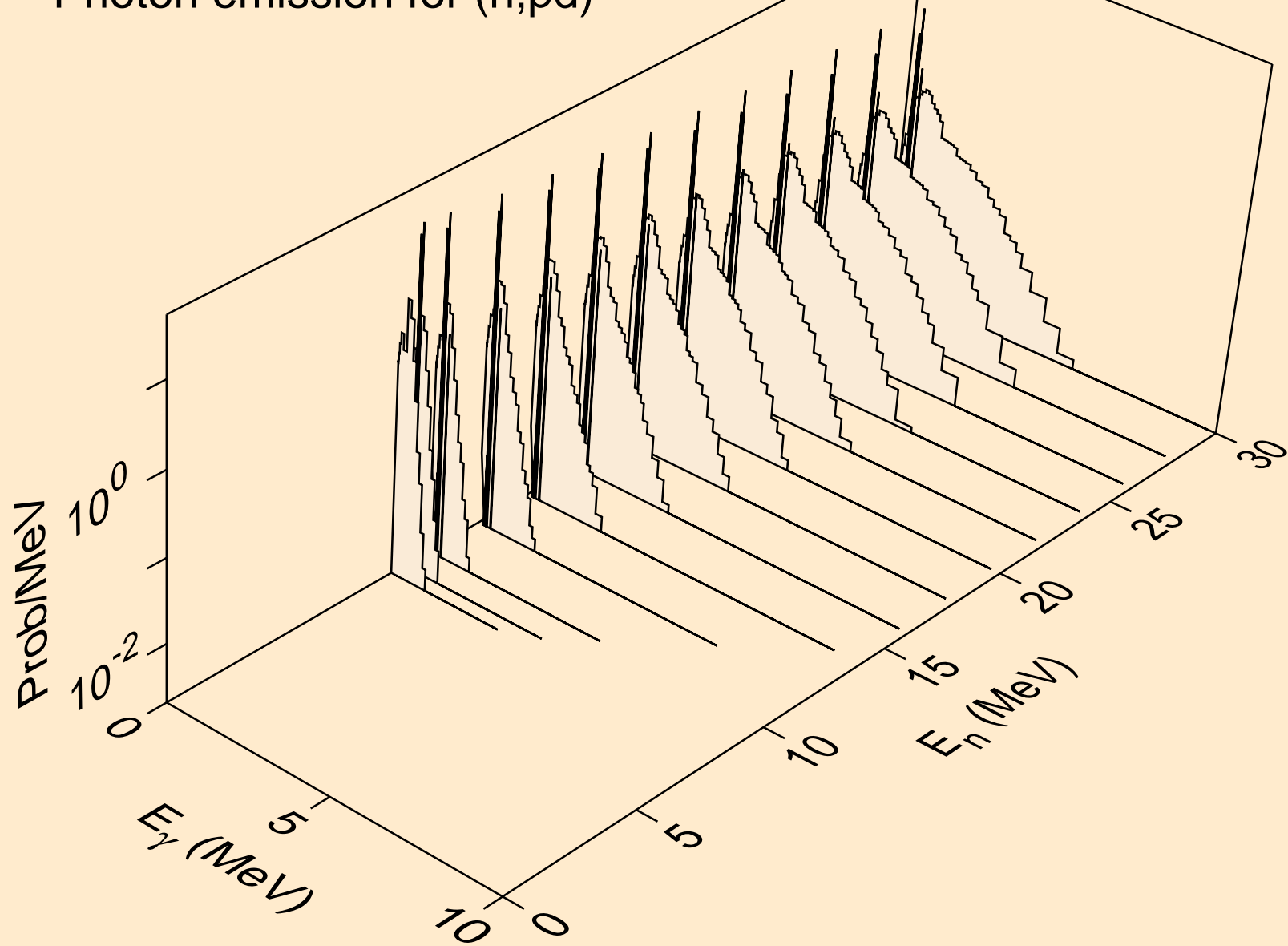

BI194M NEUTRON ACER TENDL-2021 LIBRARY; T=293.6K
Photon emission for (n,pt)

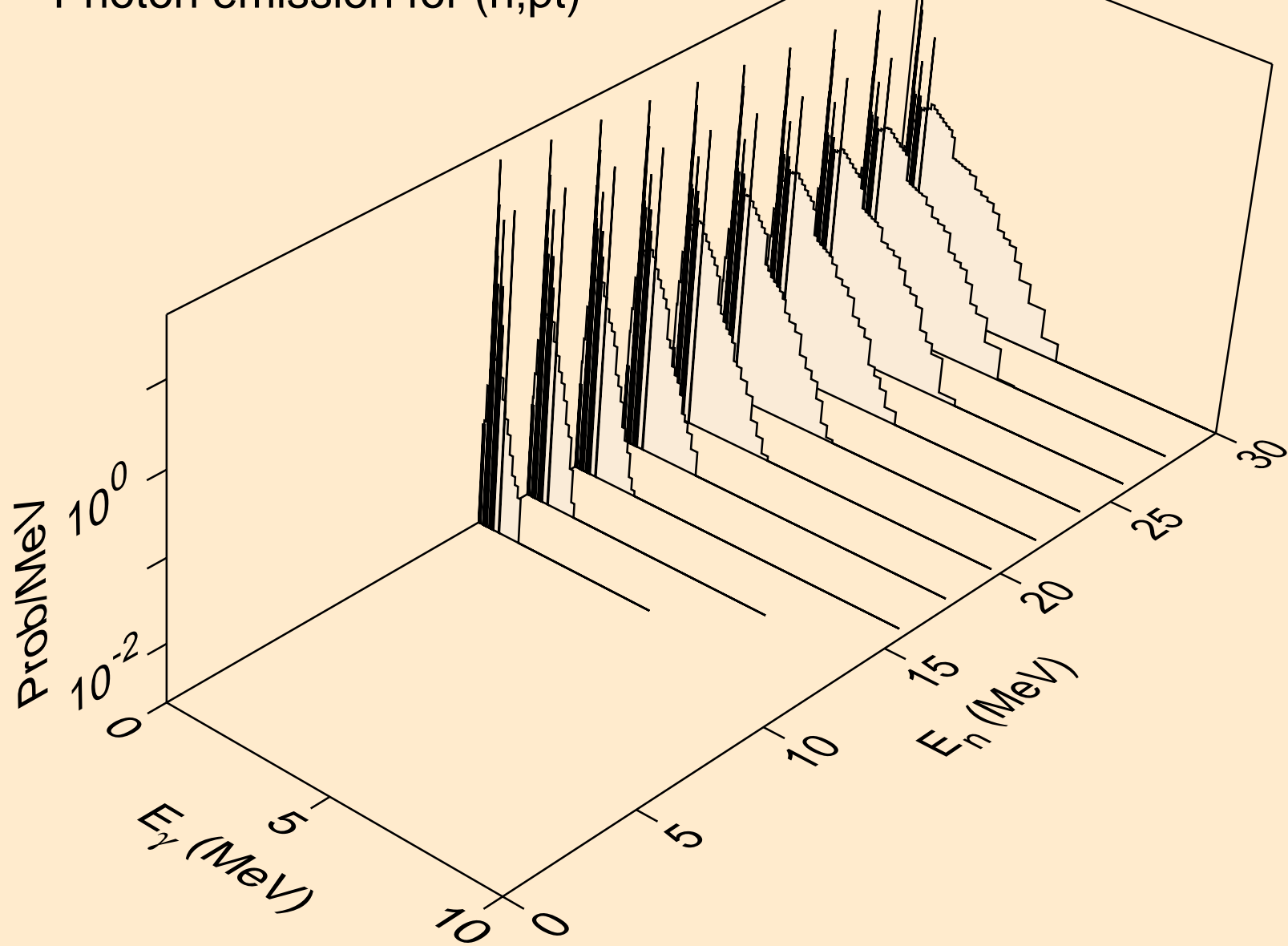

BI194M NEUTRON ACER TENDL-2021 LIBRARY; T=293.6K
Photon emission for (n,da)

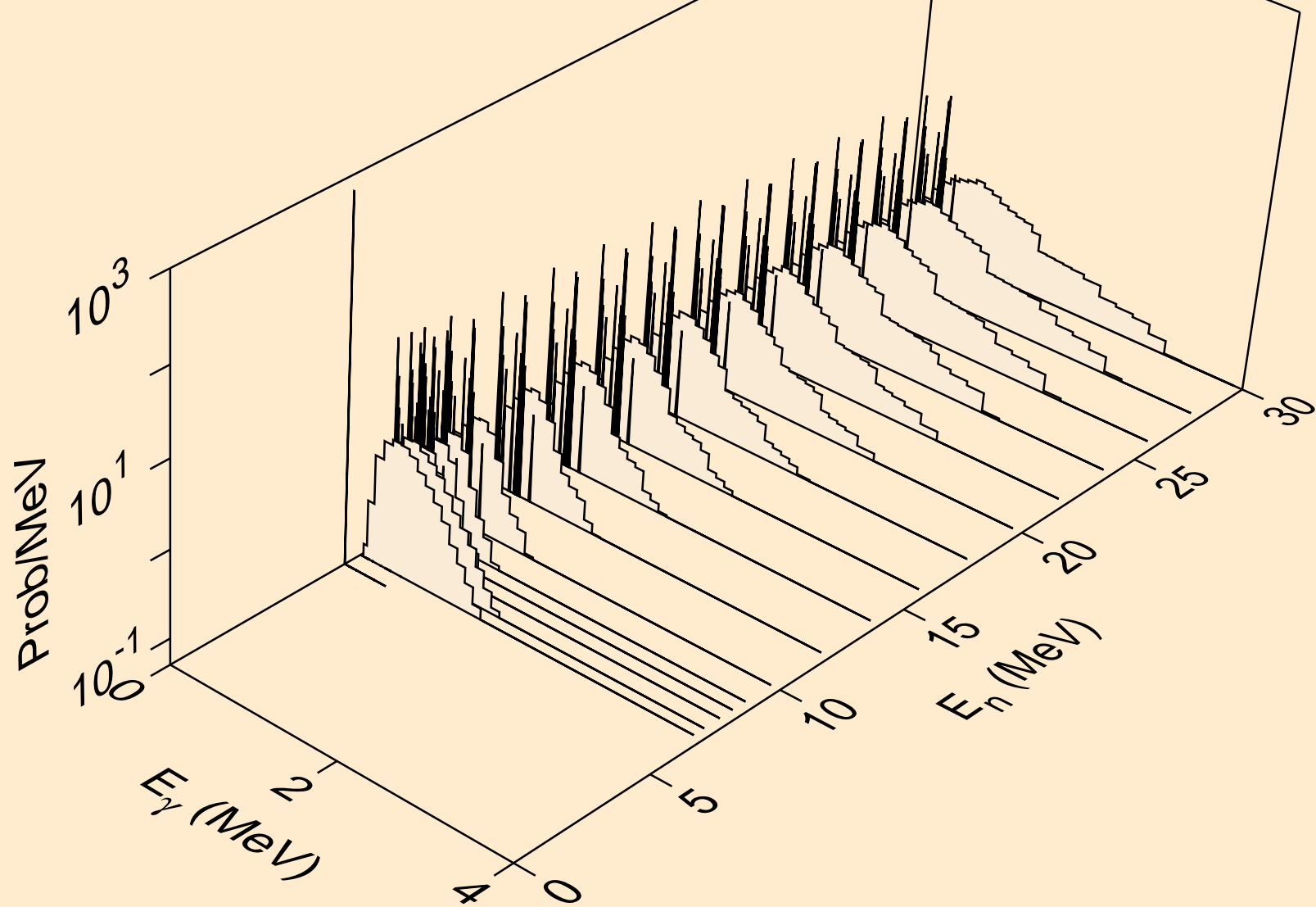

BI194M NEUTRON ACER TENDL-2021 LIBRARY; T=293.6K
thermal capture photon spectrum

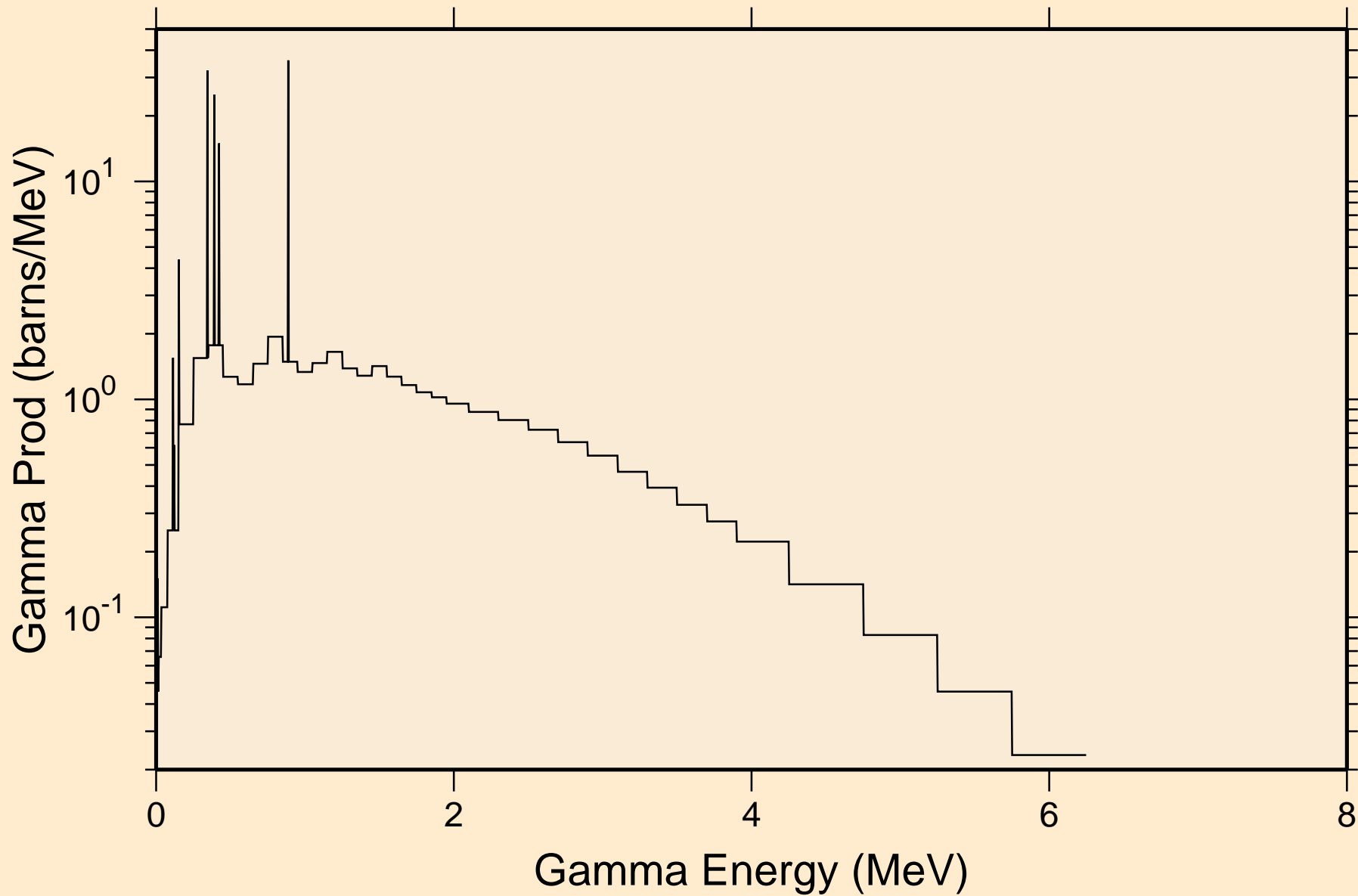

BI194M NEUTRON ACER TENDL-2021 LIBRARY; T=293.6K
14 MeV photon spectrum

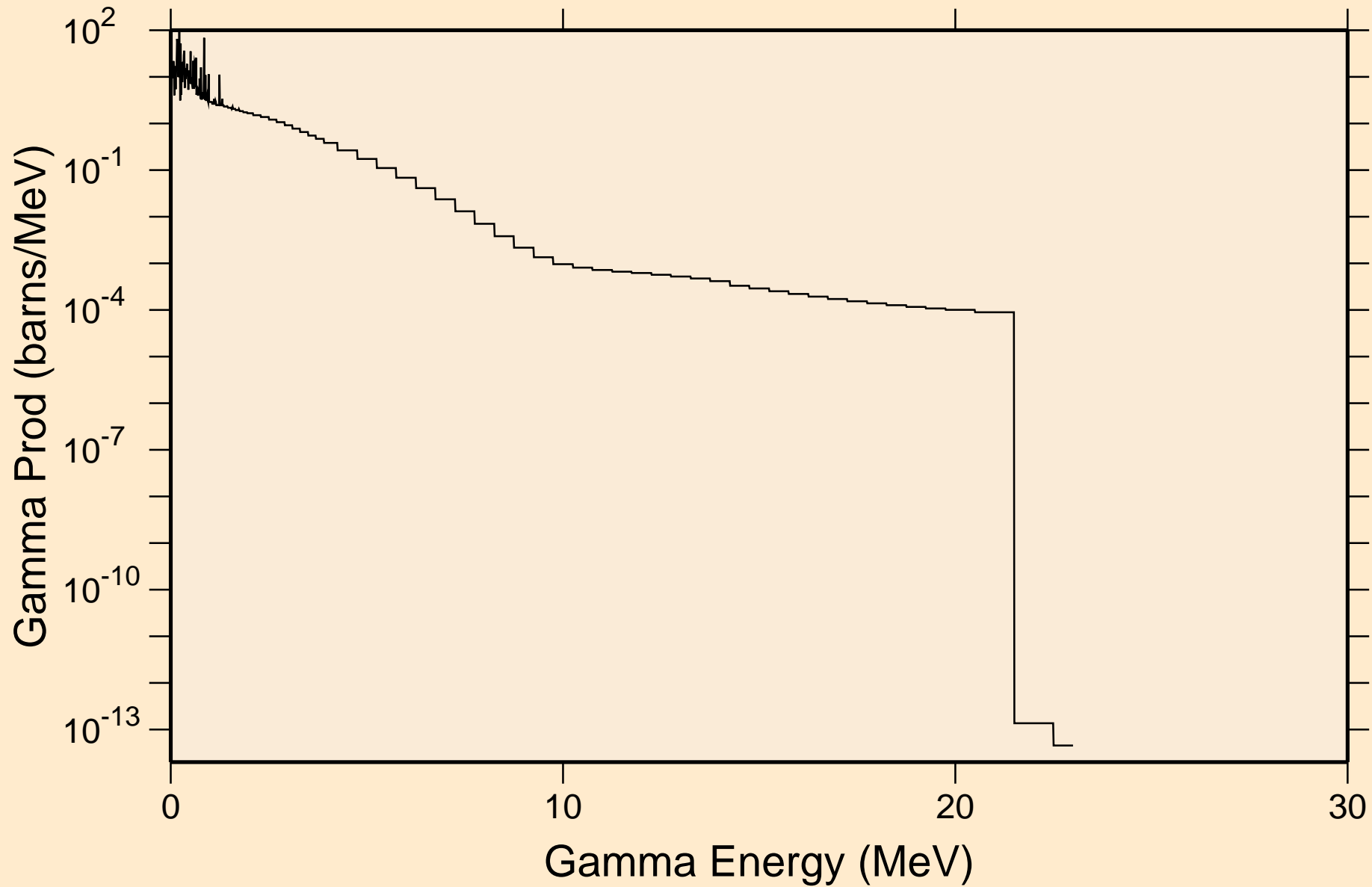

BI194M NEUTRON ACER TENDL-2021 LIBRARY; T=293.6K
Particle heating contributions

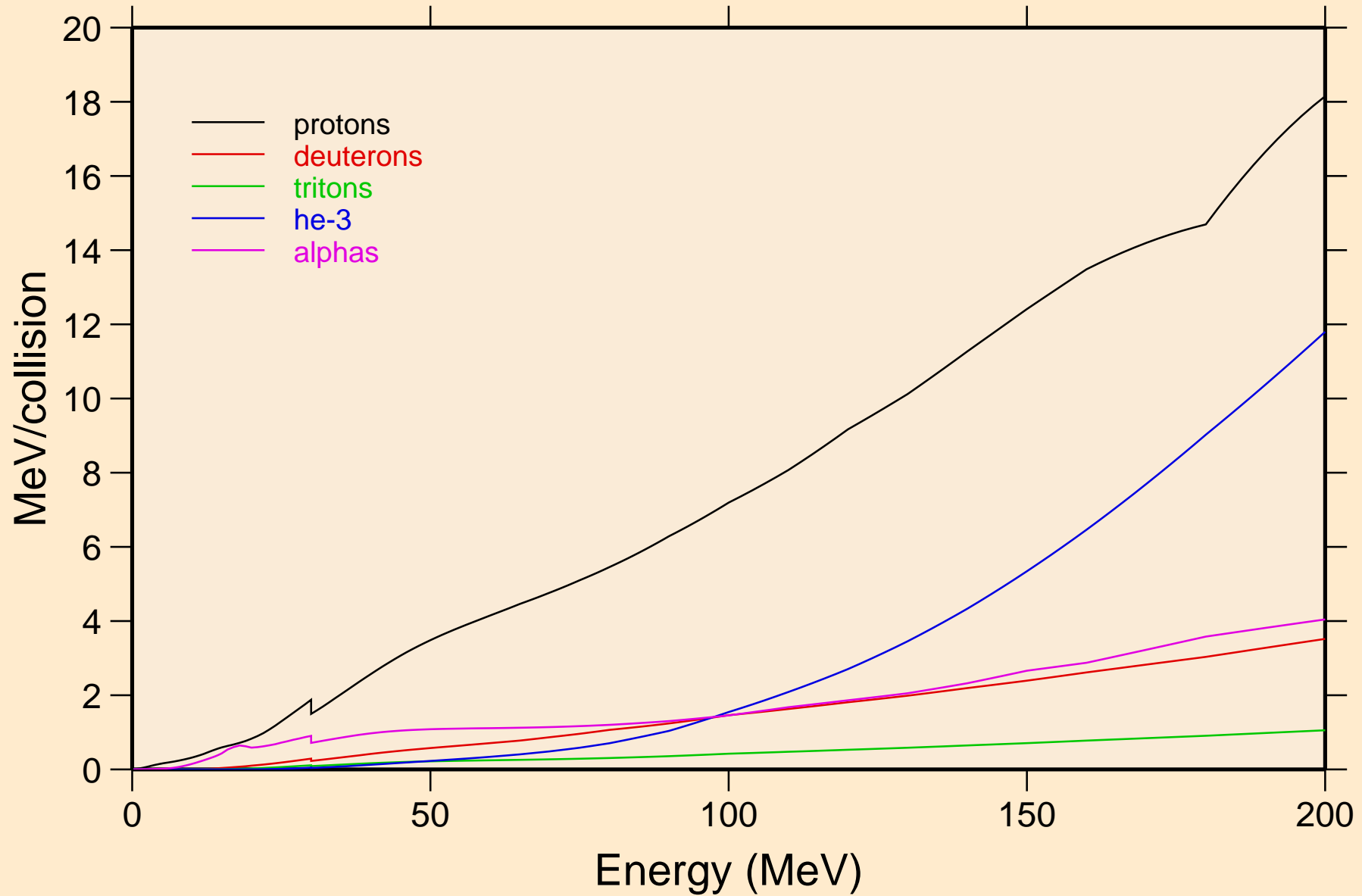

BI194M NEUTRON ACER TENDL-2021 LIBRARY; T=293.6K
Recoil Heating

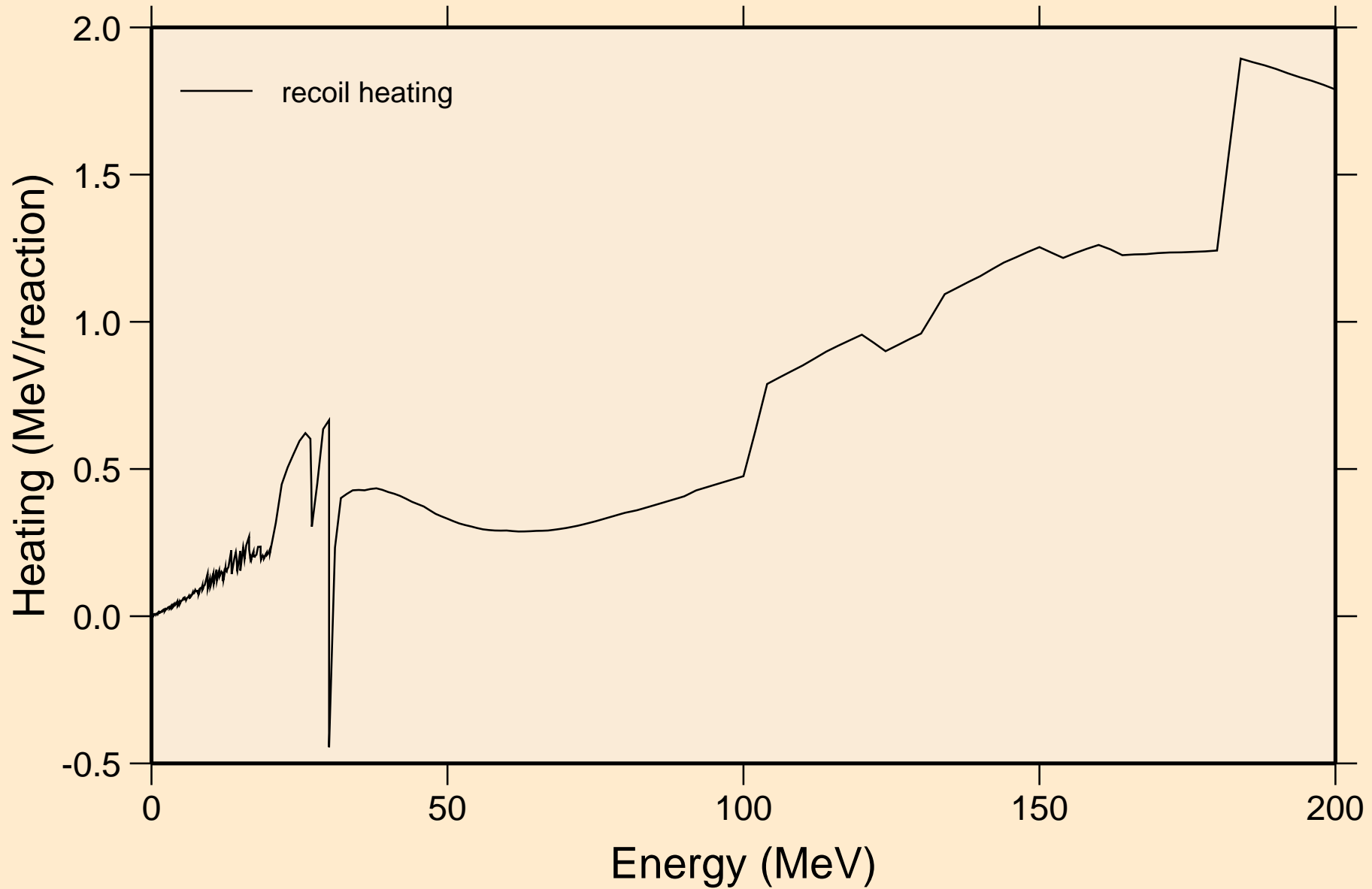

BI194M NEUTRON ACER TENDL-2021 LIBRARY; T=293.6K
Particle production cross sections

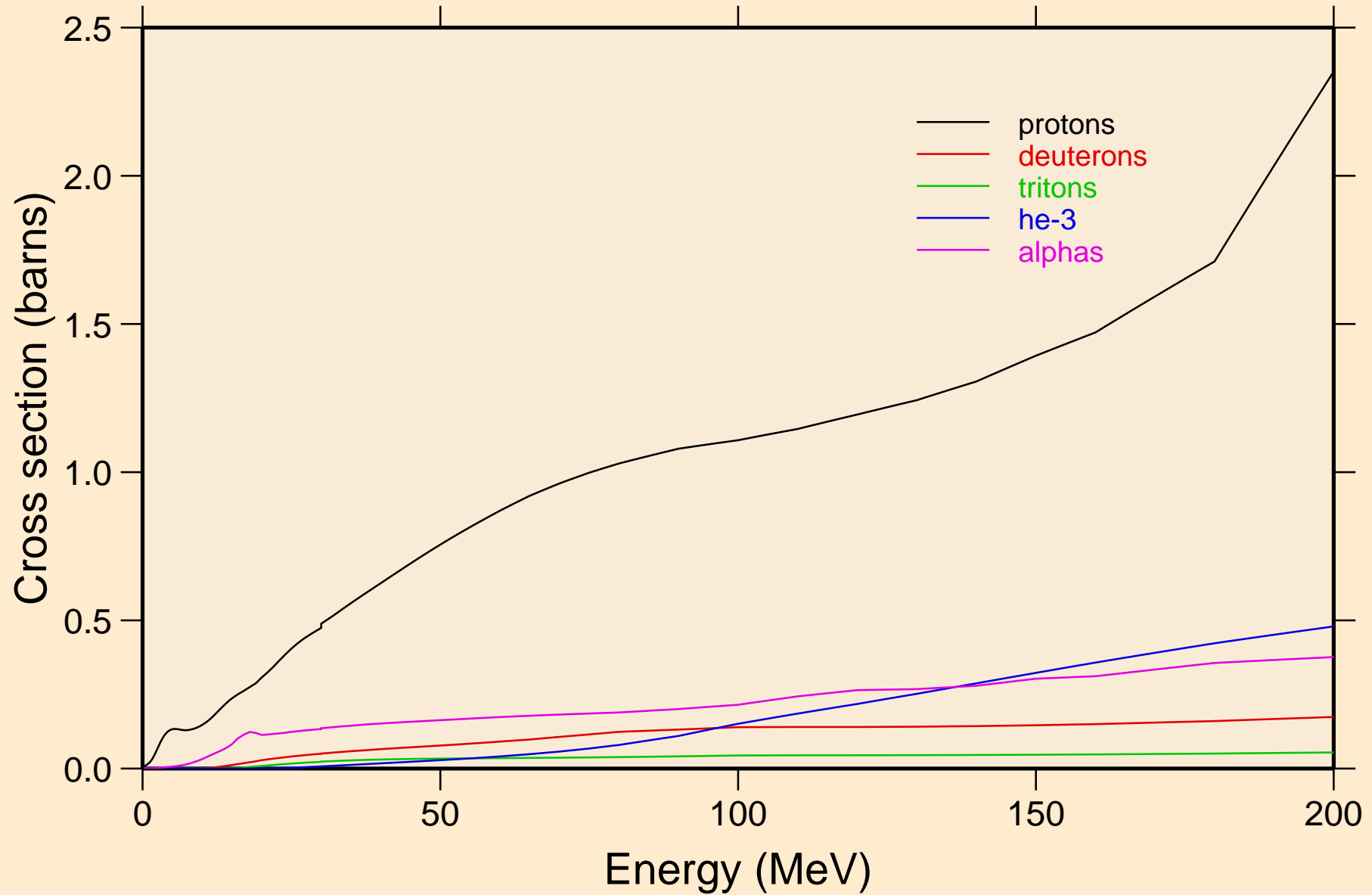

BI194M NEUTRON ACER TENDL-2021 LIBRARY; T=293.6K
protons from (n,x)

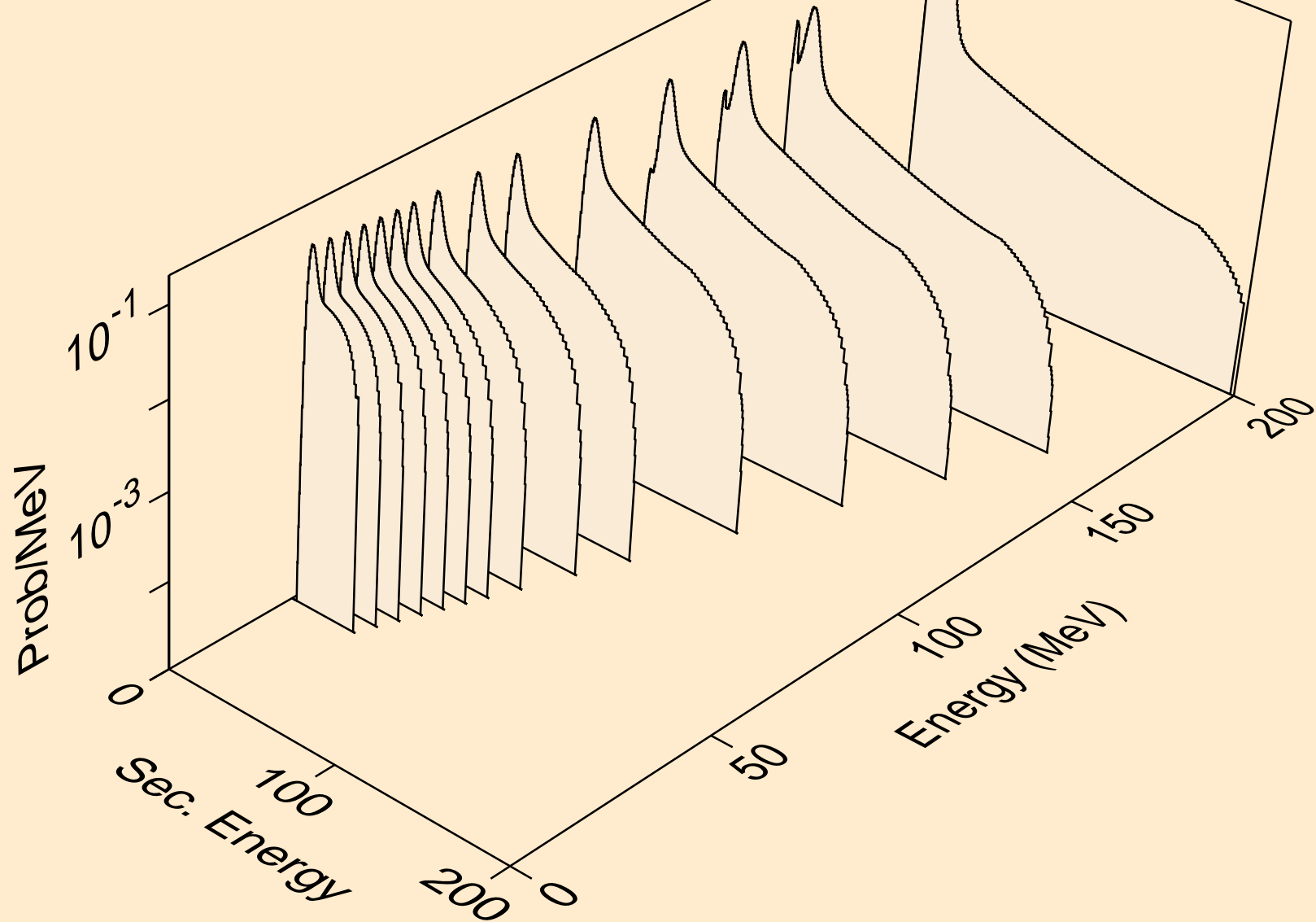

BI194M NEUTRON ACER TENDL-2021 LIBRARY; T=293.6K
protons from (n,n*)p

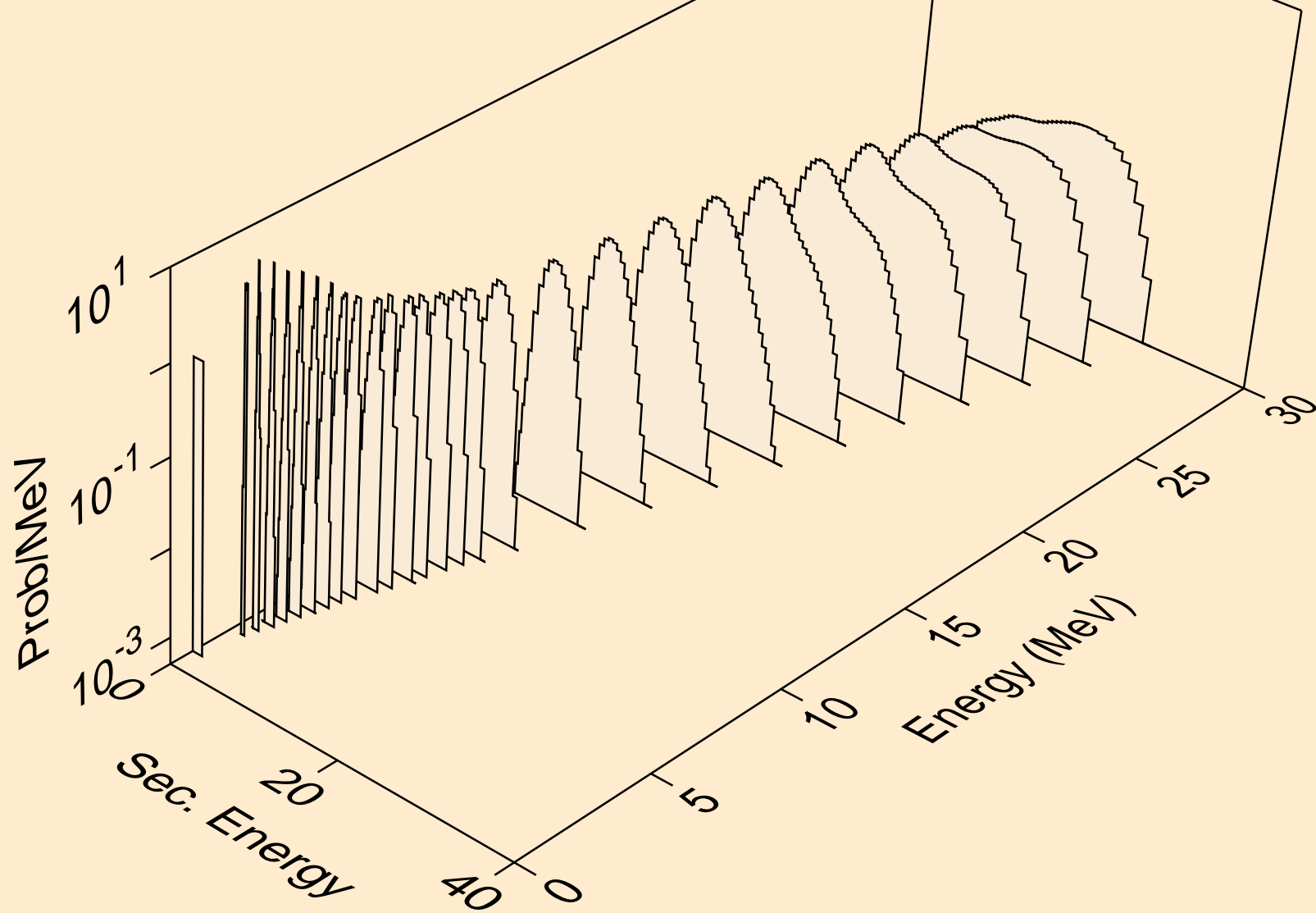

BI194M NEUTRON ACER TENDL-2021 LIBRARY; T=293.6K
protons from (n,2np)

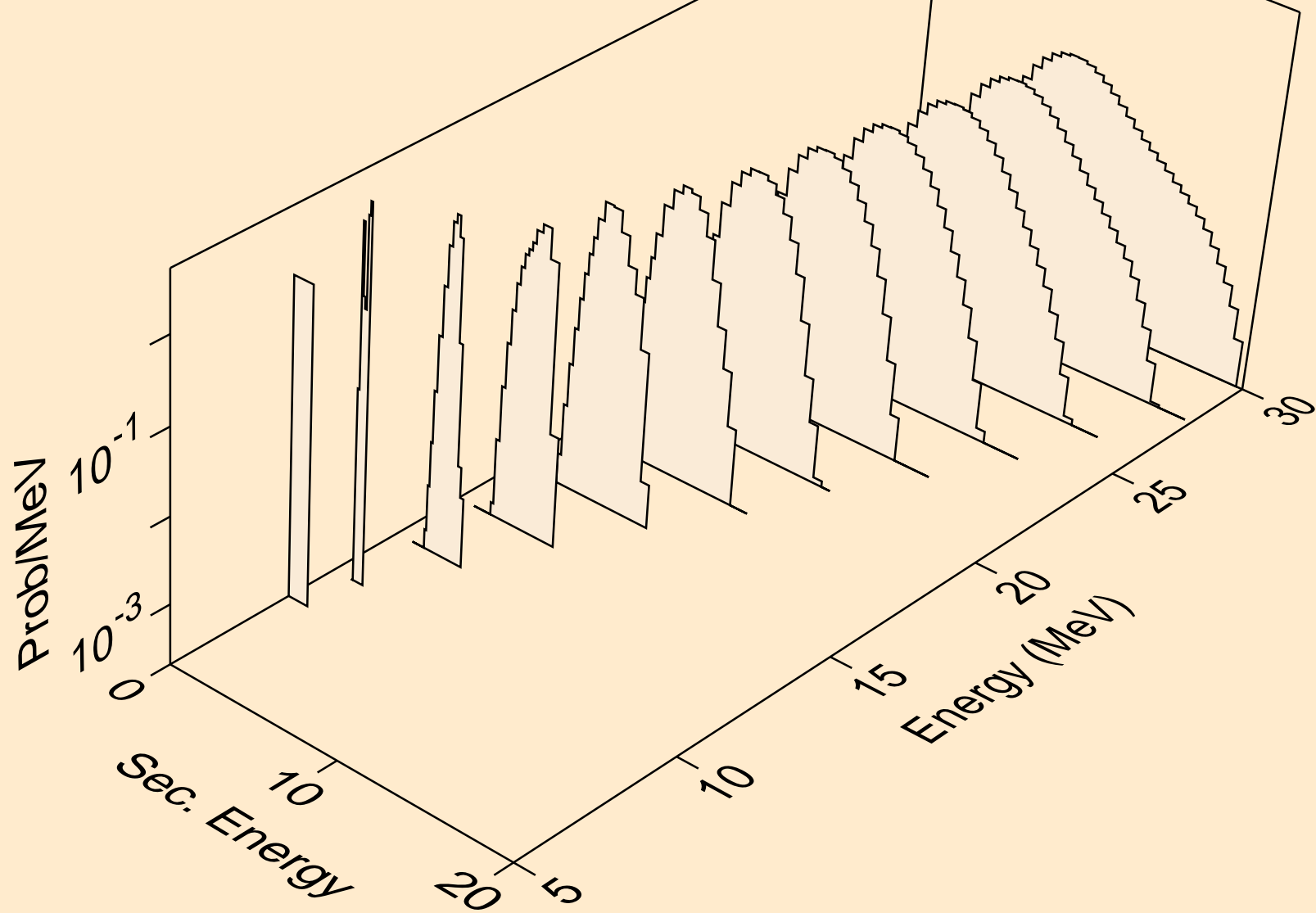

BI194M NEUTRON ACER TENDL-2021 LIBRARY; T=293.6K
protons from (n,3np)

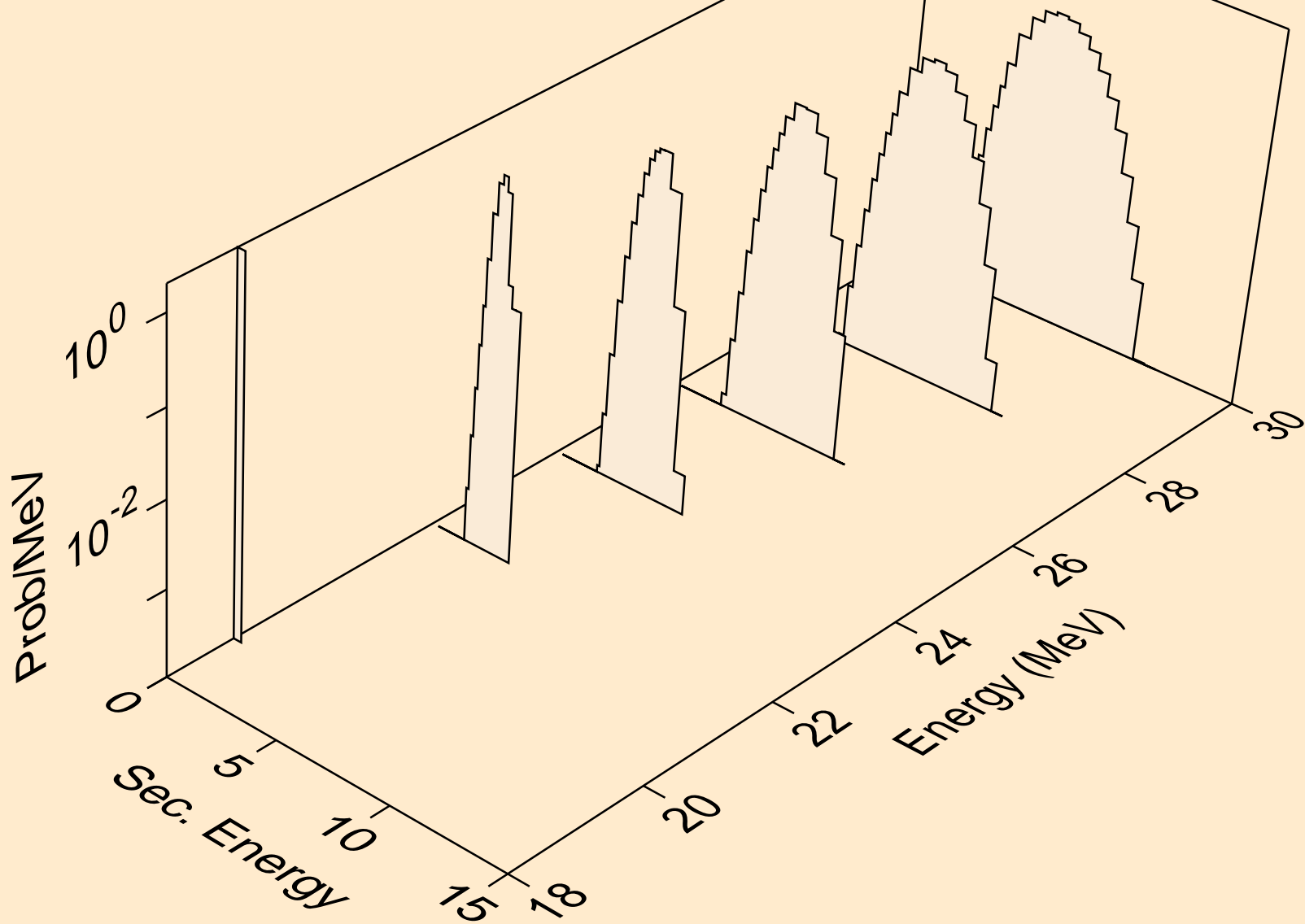

BI194M NEUTRON ACER TENDL-2021 LIBRARY; T=293.6K
protons from (n,2np)

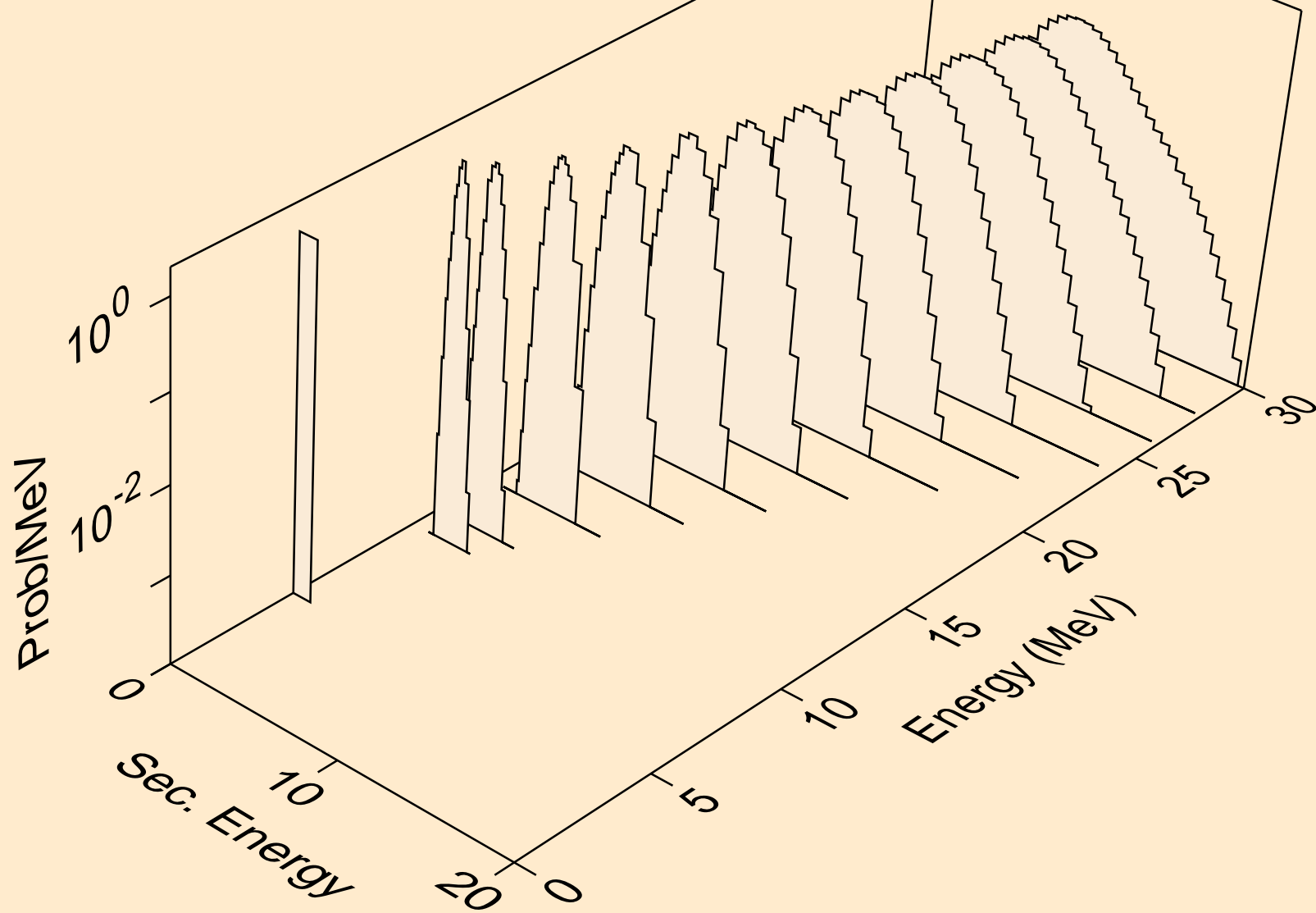

BI194M NEUTRON ACER TENDL-2021 LIBRARY; T=293.6K
protons from (n,npa)

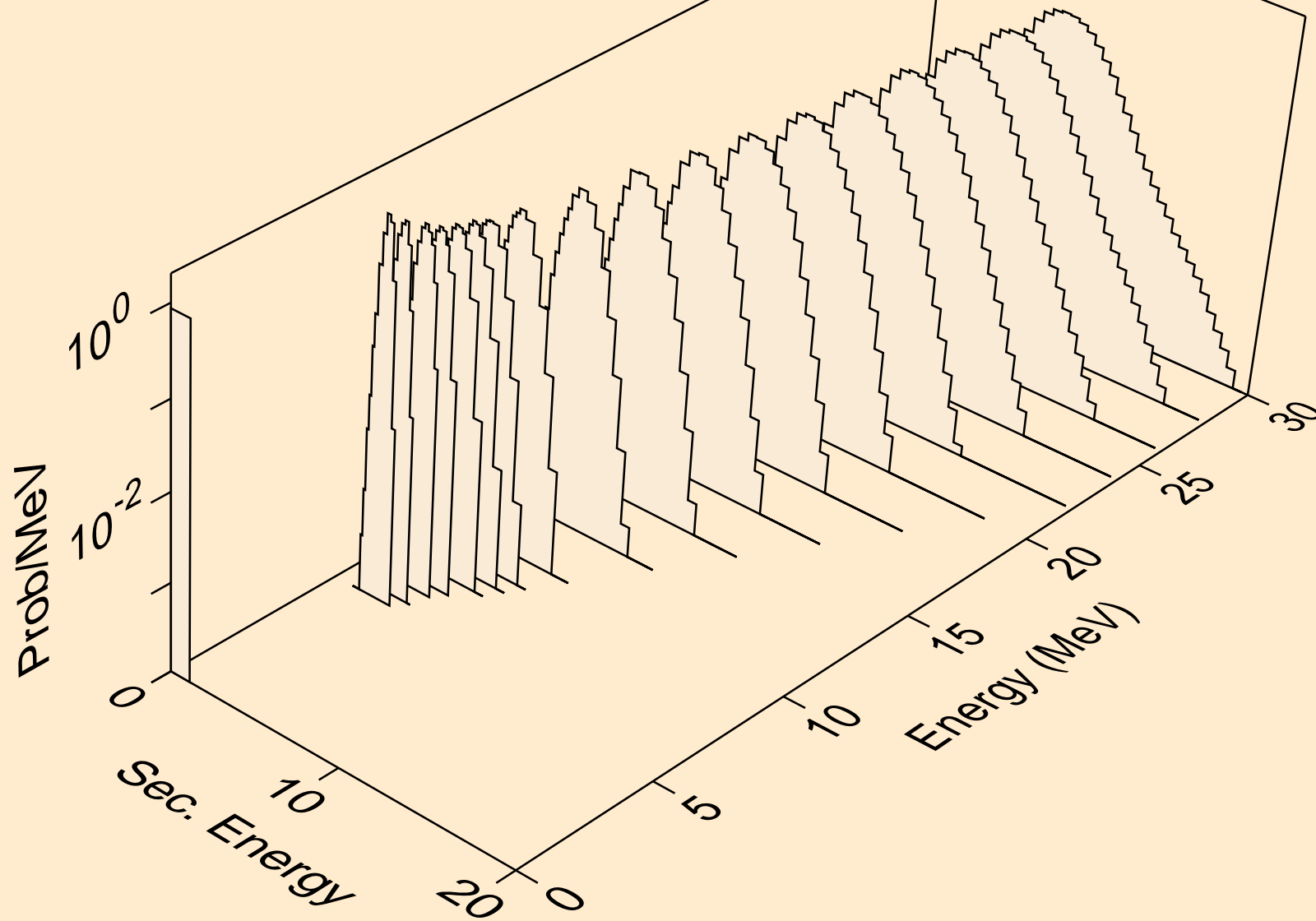

BI194M NEUTRON ACER TENDL-2021 LIBRARY; T=293.6K
protons from (n,p)

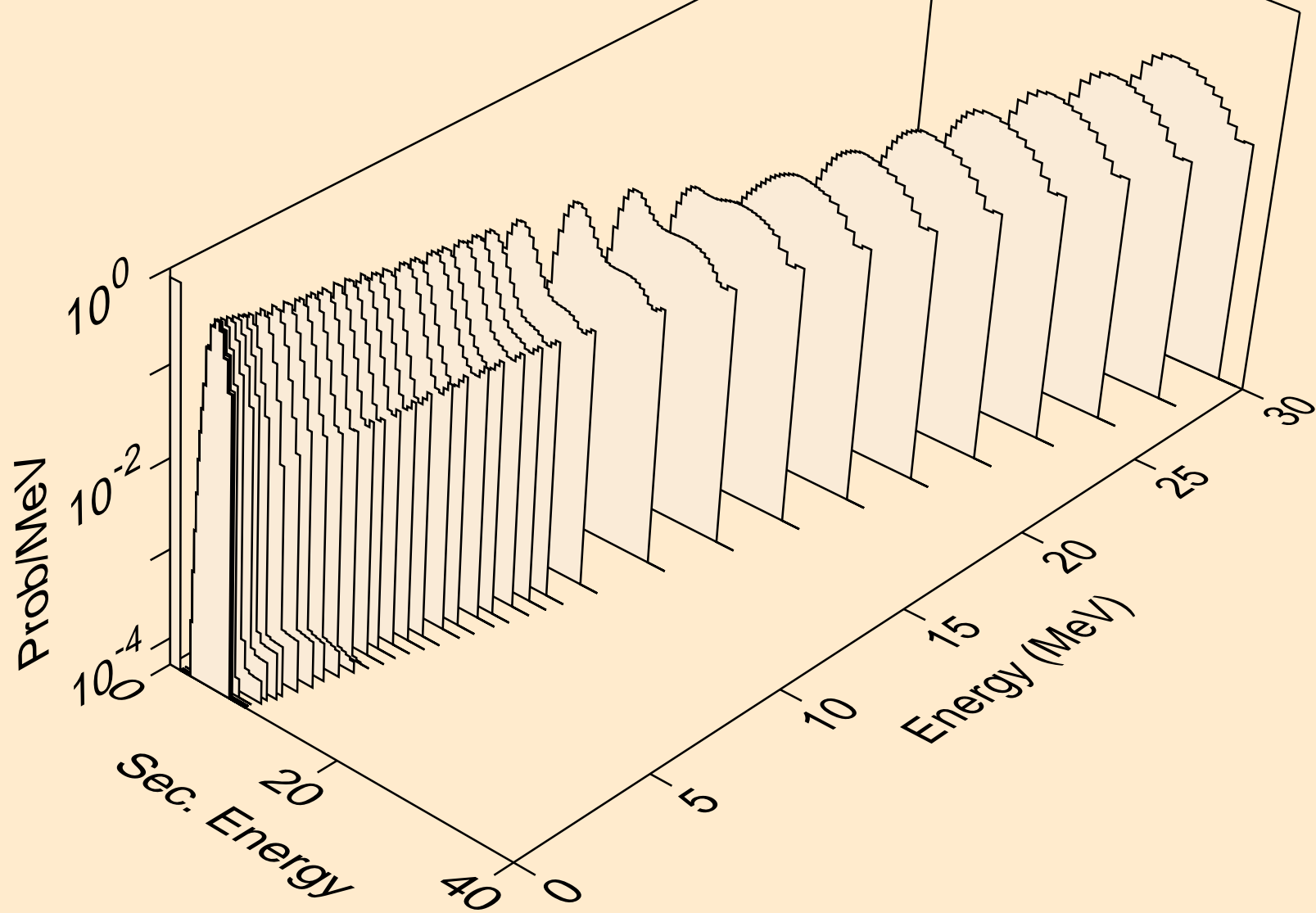

BI194M NEUTRON ACER TENDL-2021 LIBRARY; T=293.6K
protons from (n,2p)

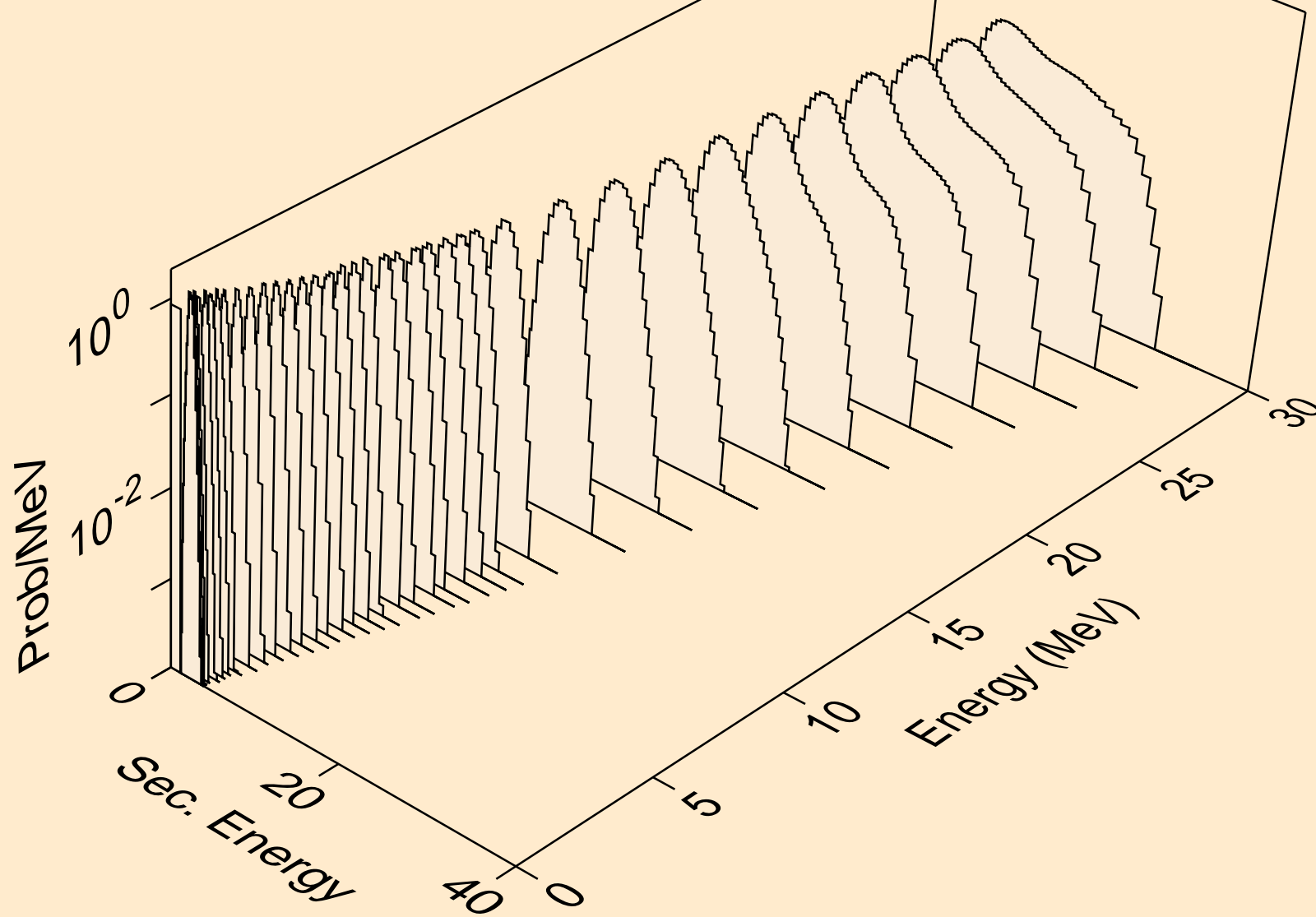

BI194M NEUTRON ACER TENDL-2021 LIBRARY; T=293.6K
protons from (n,p)

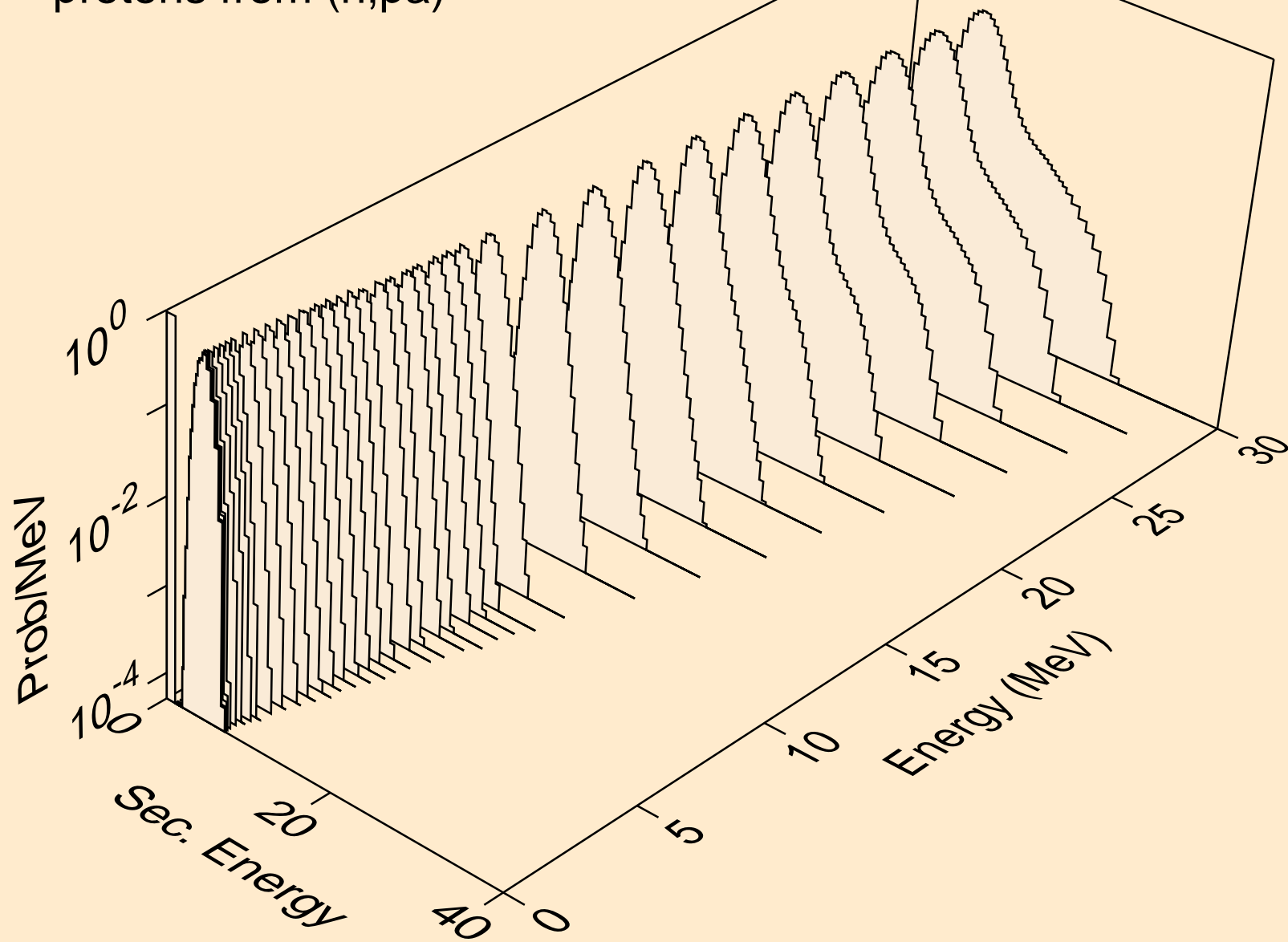

BI194M NEUTRON ACER TENDL-2021 LIBRARY; T=293.6K
protons from (n,pd)

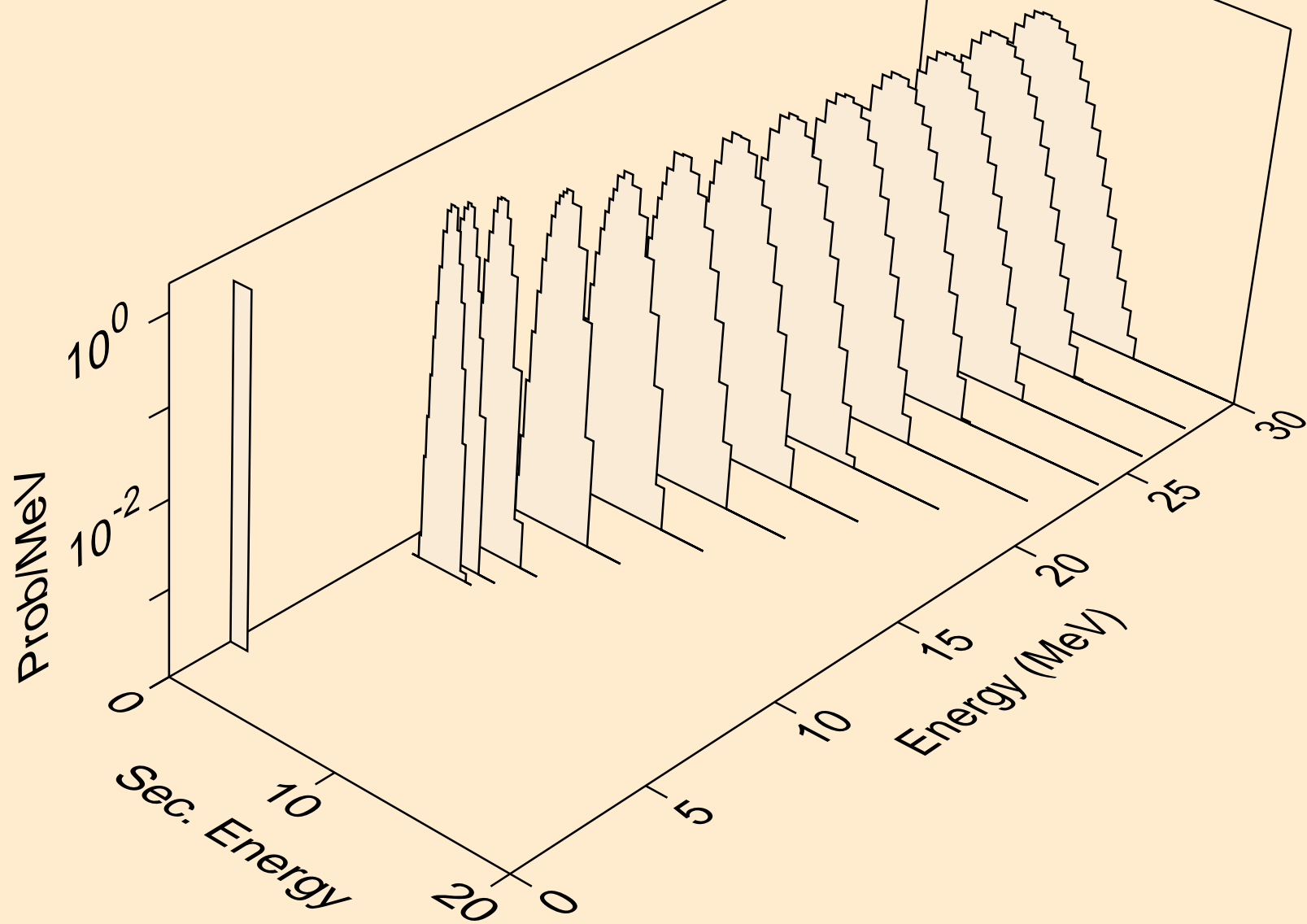

BI194M NEUTRON ACER TENDL-2021 LIBRARY; T=293.6K
protons from (n,pt)

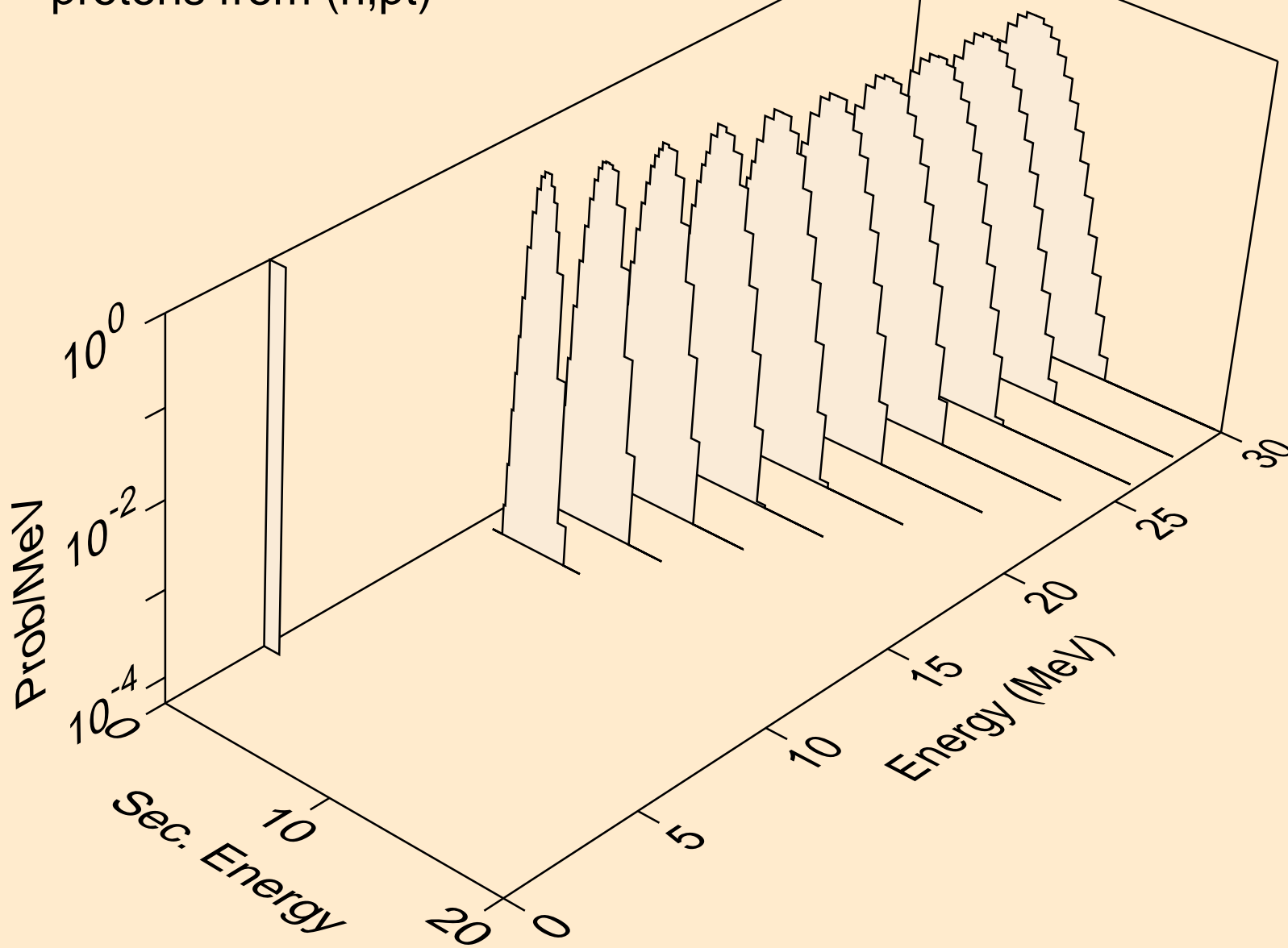

BI194M NEUTRON ACER TENDL-2021 LIBRARY; T=293.6K
deuterons from (n,x)

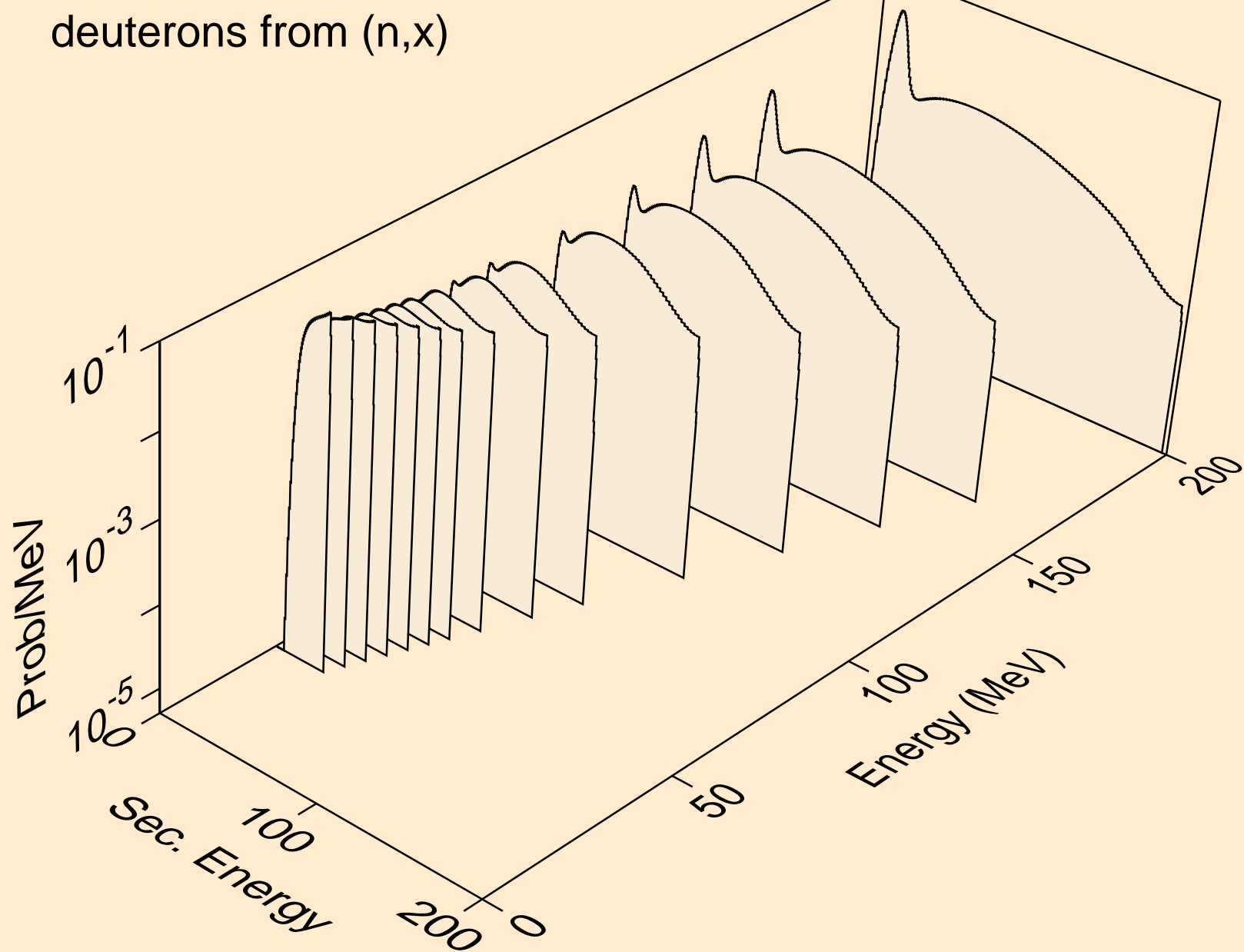

BI194M NEUTRON ACER TENDL-2021 LIBRARY; T=293.6K
deuterons from (n,2nd)

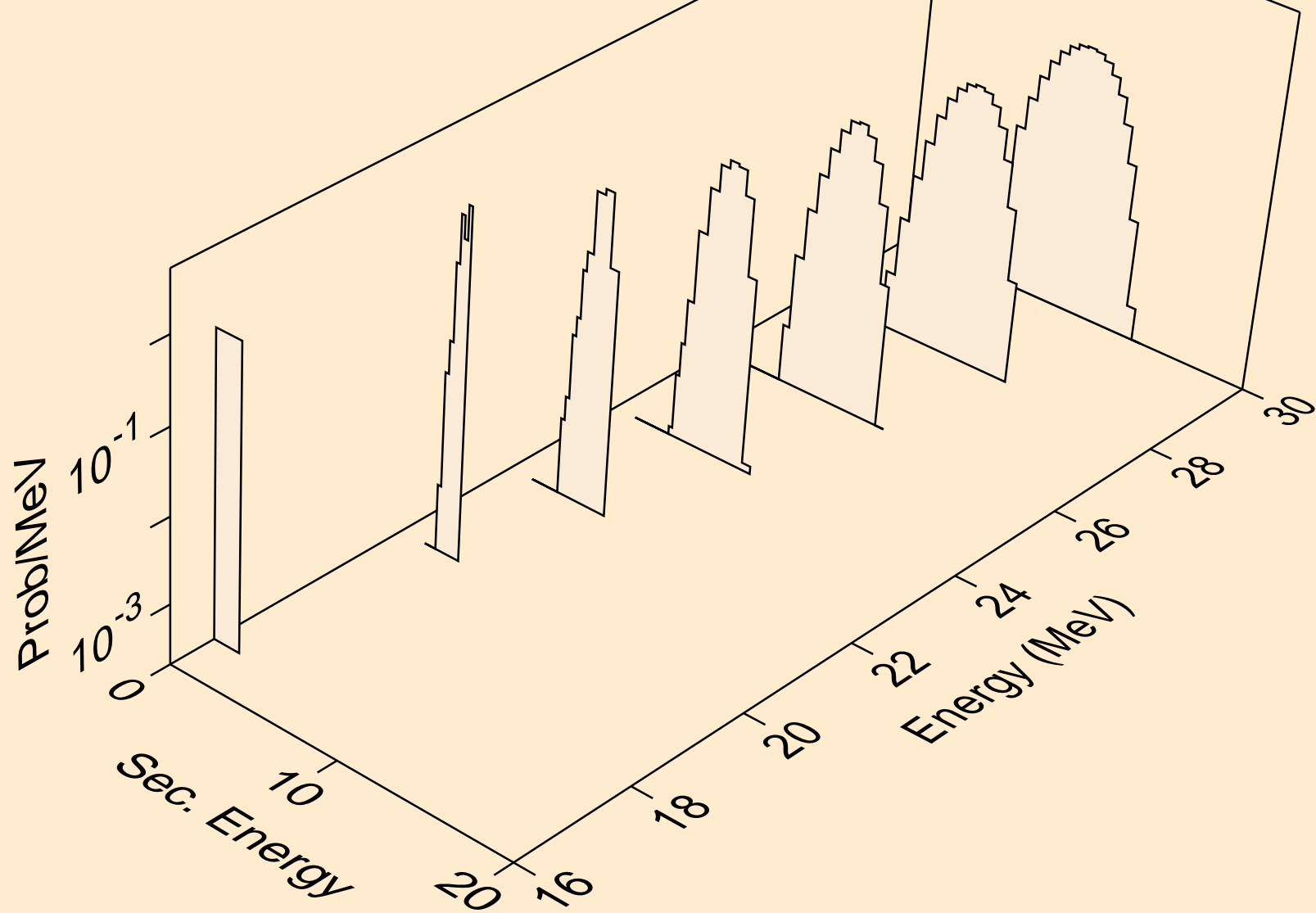

BI194M NEUTRON ACER TENDL-2021 LIBRARY; T=293.6K
deuterons from (n,n*)d

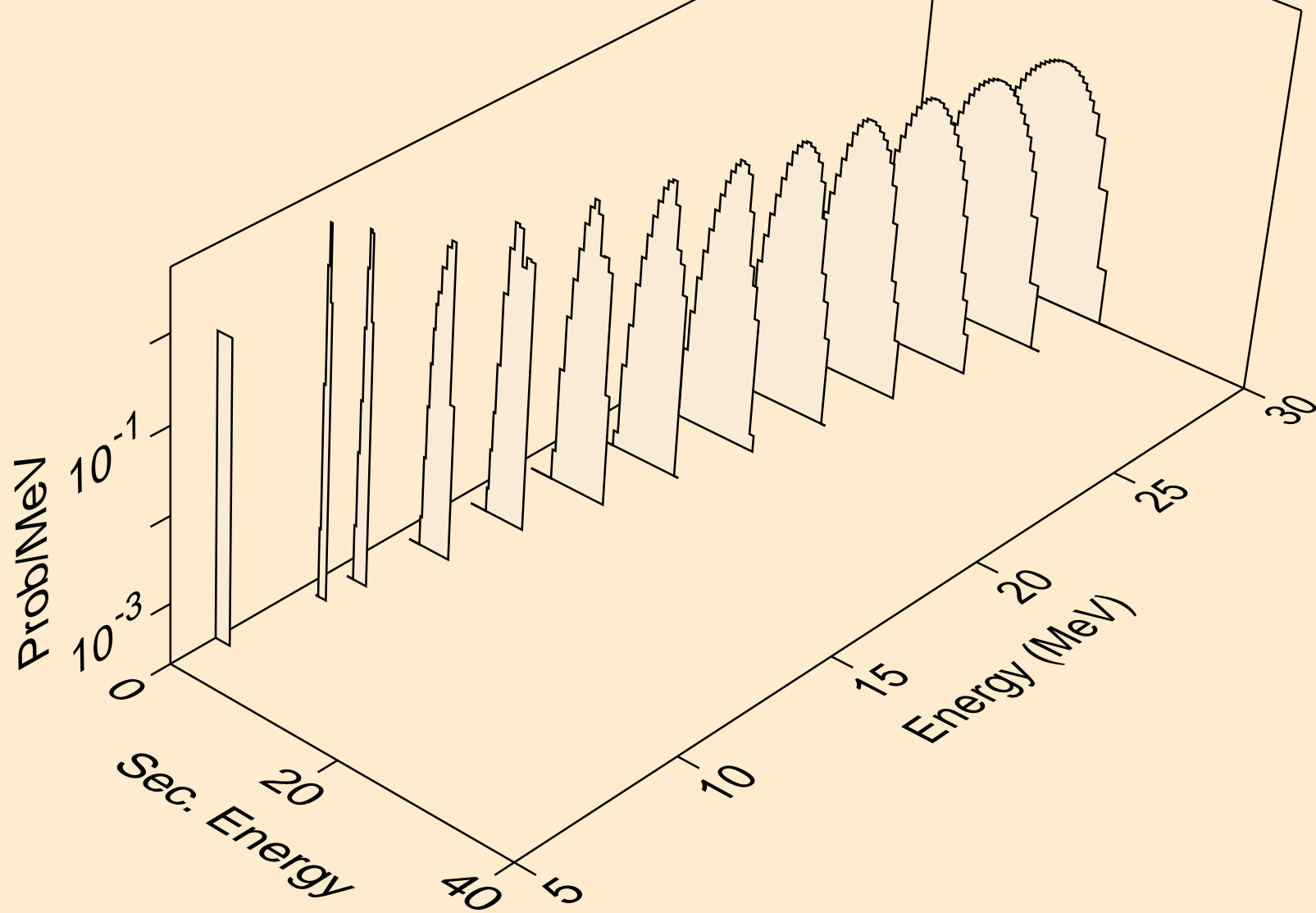

BI194M NEUTRON ACER TENDL-2021 LIBRARY; T=293.6K
deuterons from (n,d)

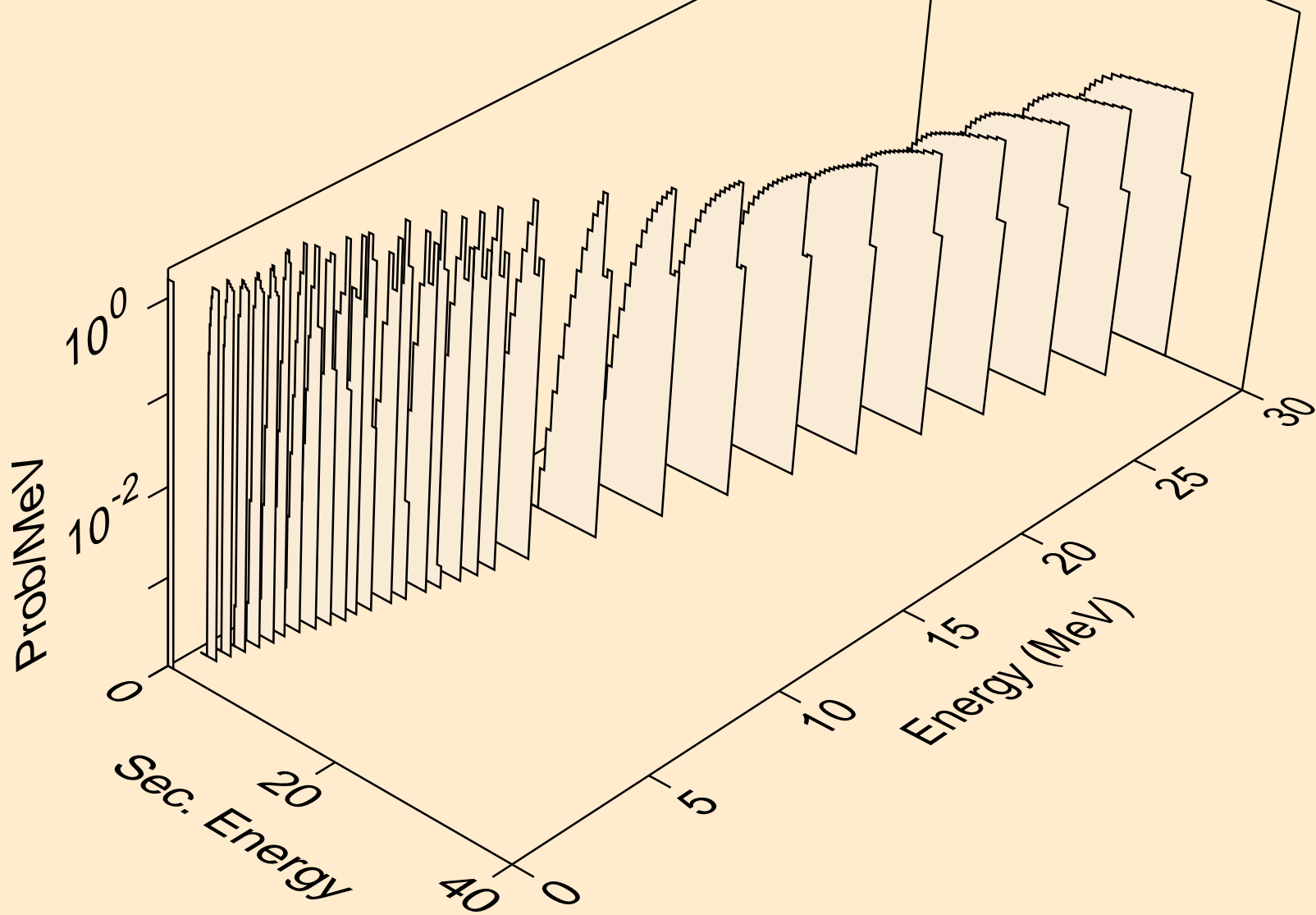

BI194M NEUTRON ACER TENDL-2021 LIBRARY; T=293.6K
deuterons from (n,pd)

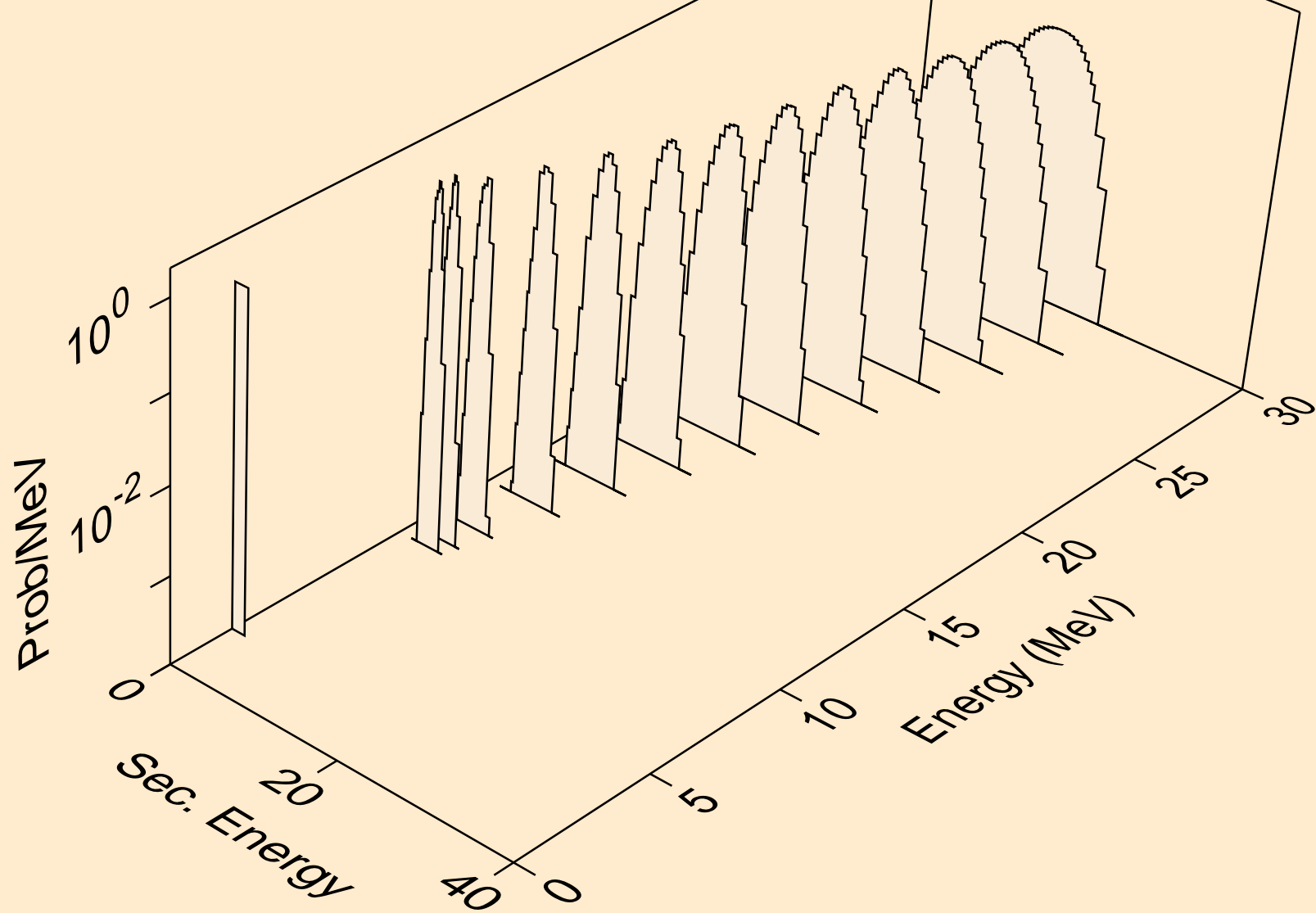

BI194M NEUTRON ACER TENDL-2021 LIBRARY; T=293.6K
deuterons from (n,da)

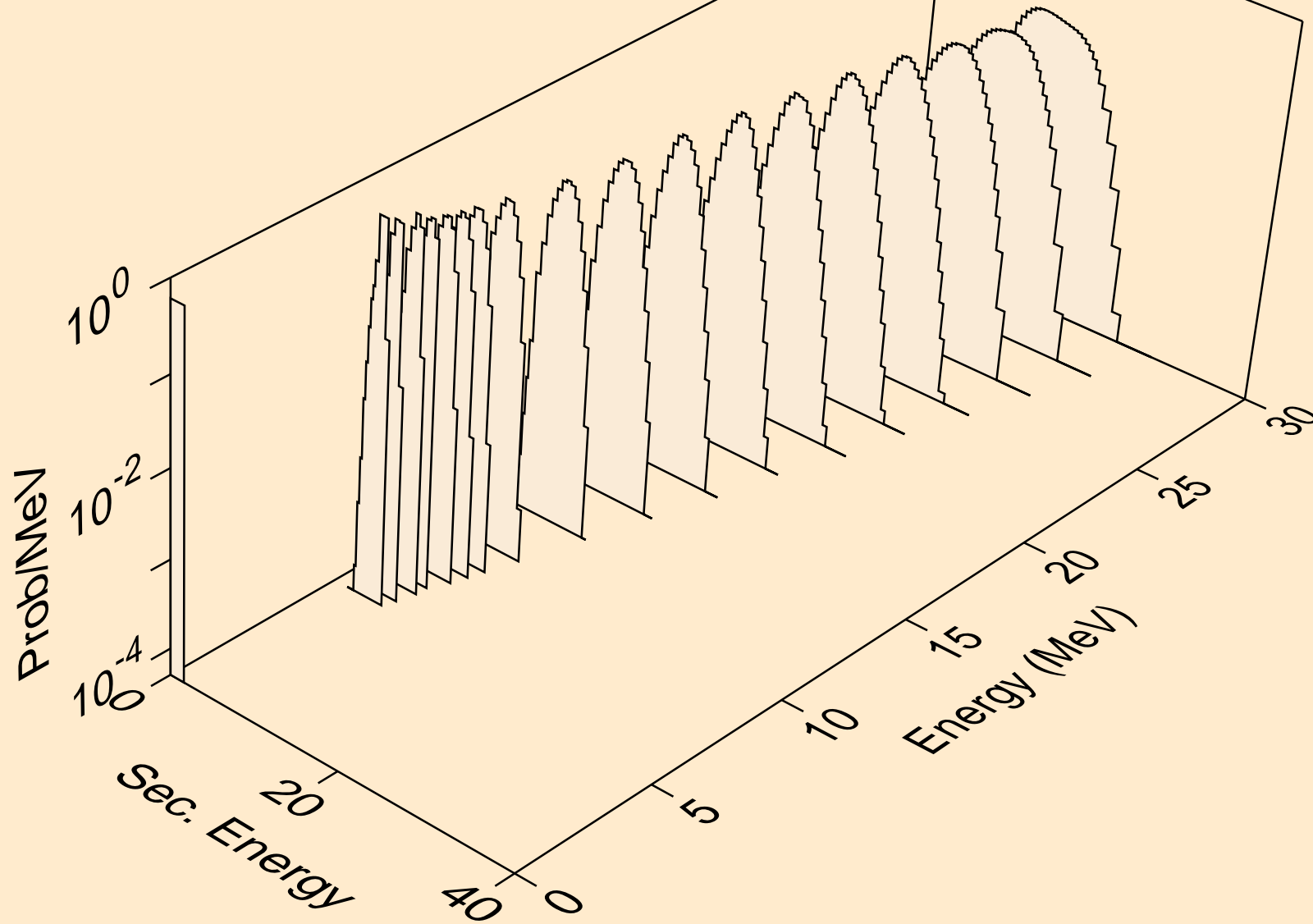

BI194M NEUTRON ACER TENDL-2021 LIBRARY; T=293.6K
tritons from (n,x)

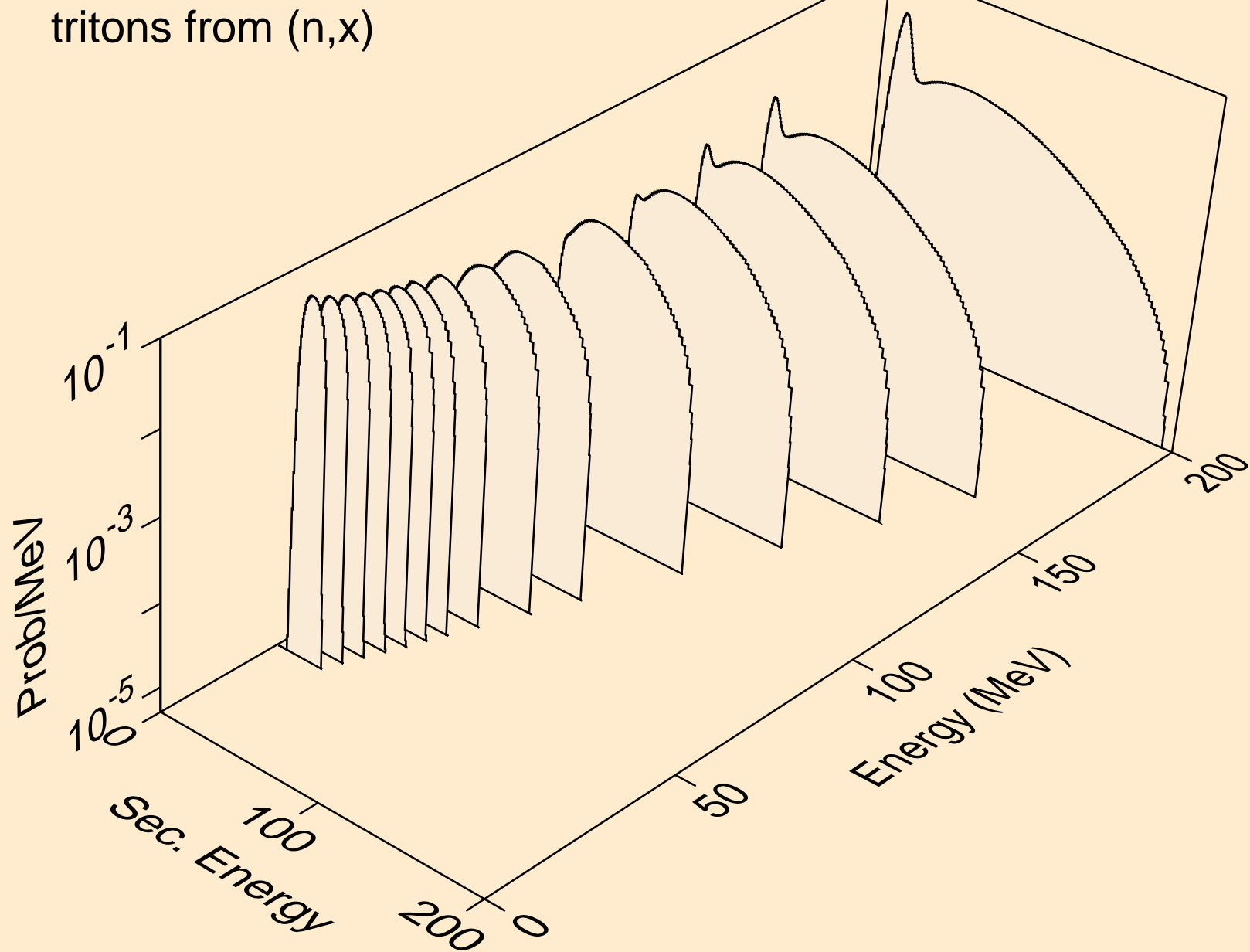

BI194M NEUTRON ACER TENDL-2021 LIBRARY; T=293.6K
tritons from (n,n*)t

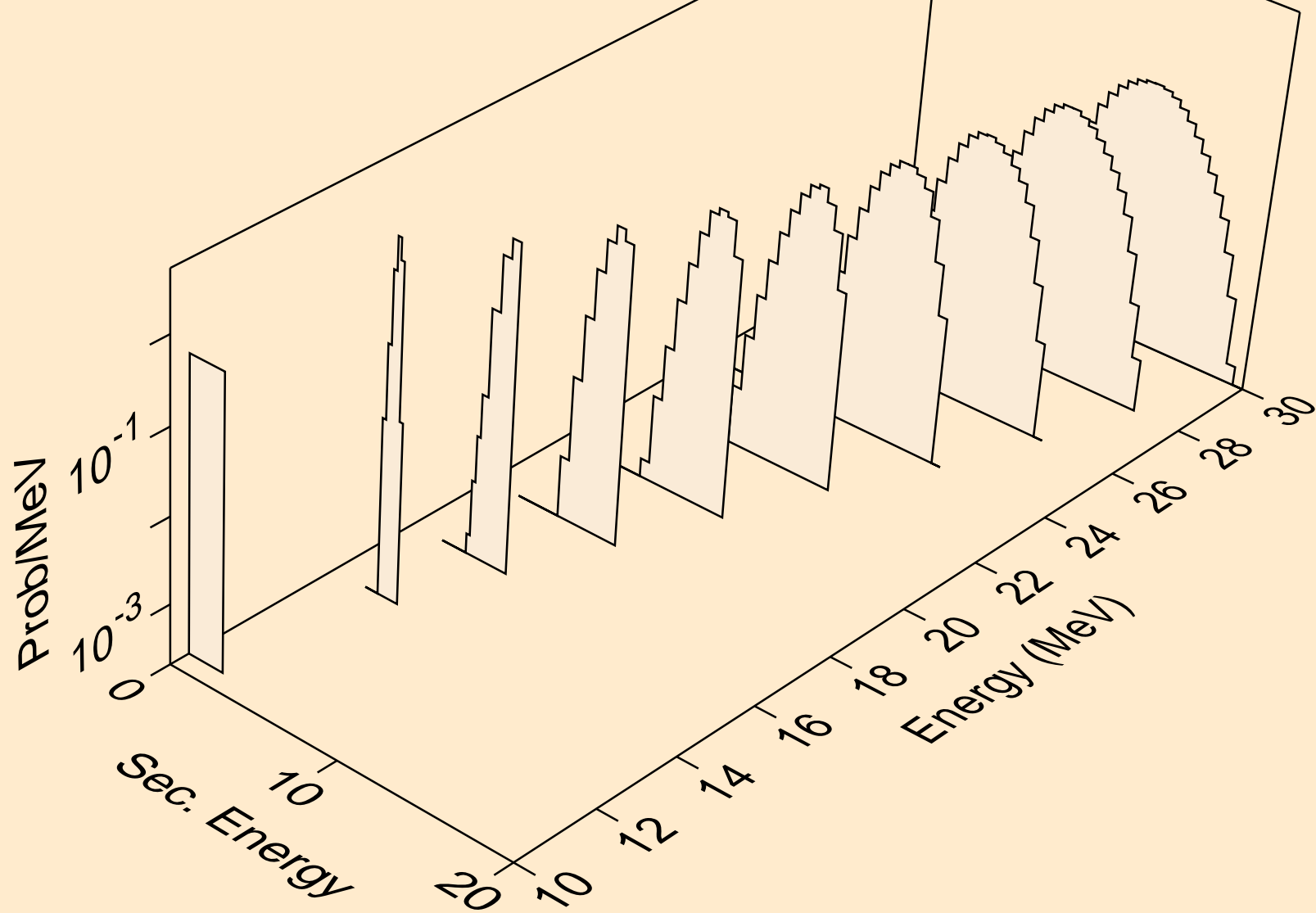

BI194M NEUTRON ACER TENDL-2021 LIBRARY; T=293.6K
tritons from (n,t)

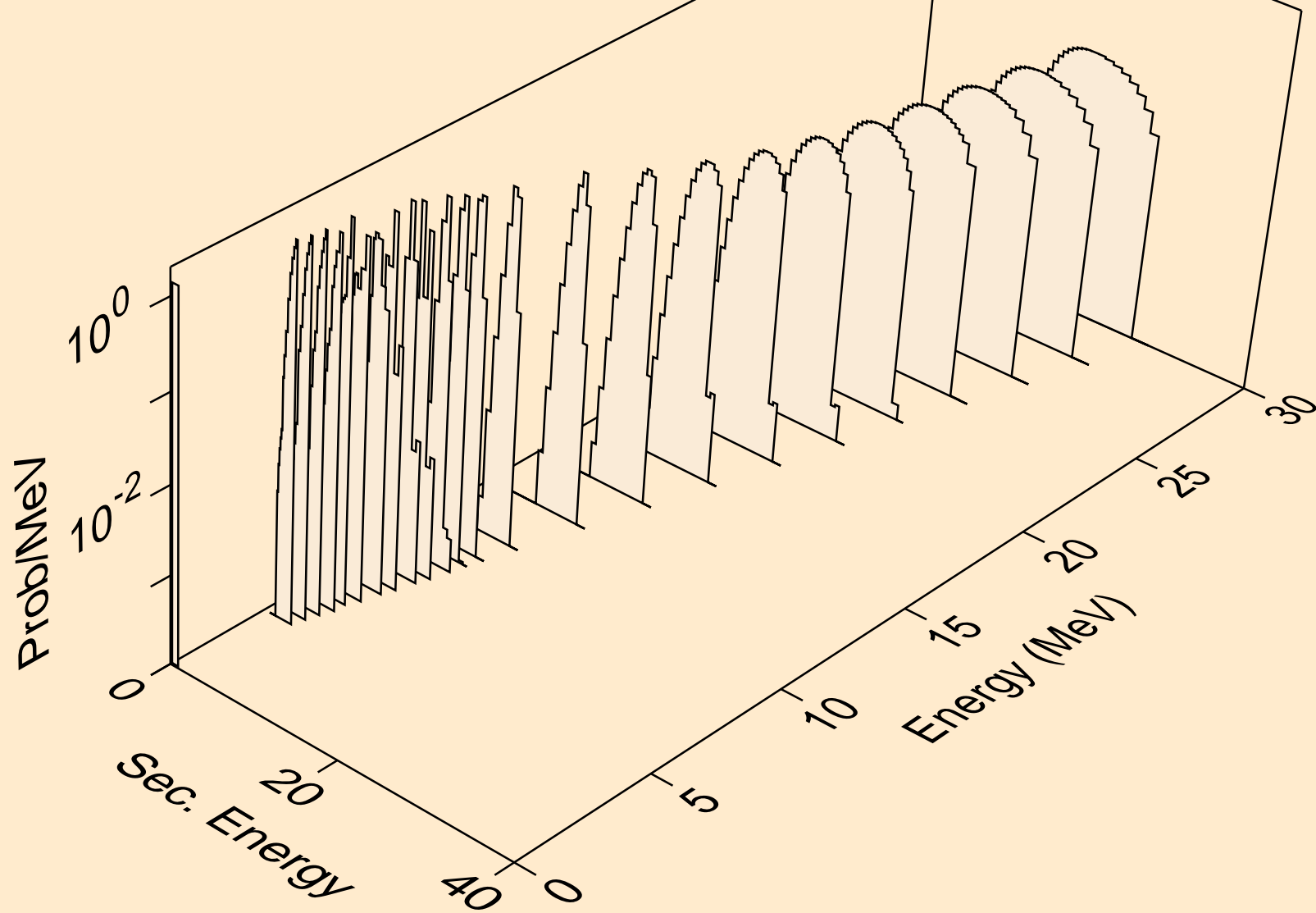

BI194M NEUTRON ACER TENDL-2021 LIBRARY; T=293.6K
tritons from (n,pt)

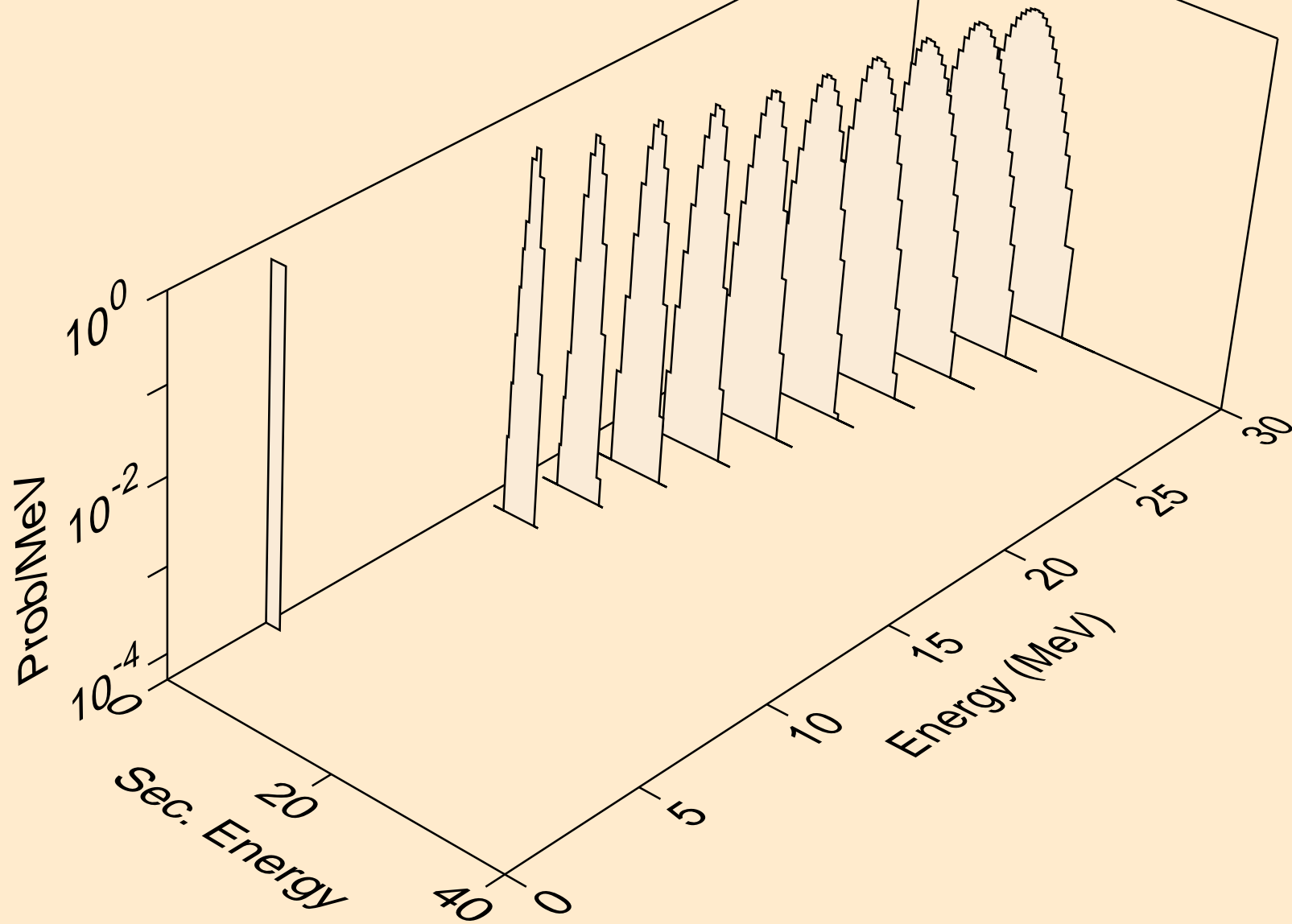

BI194M NEUTRON ACER TENDL-2021 LIBRARY; T=293.6K
he3s from (n,x)

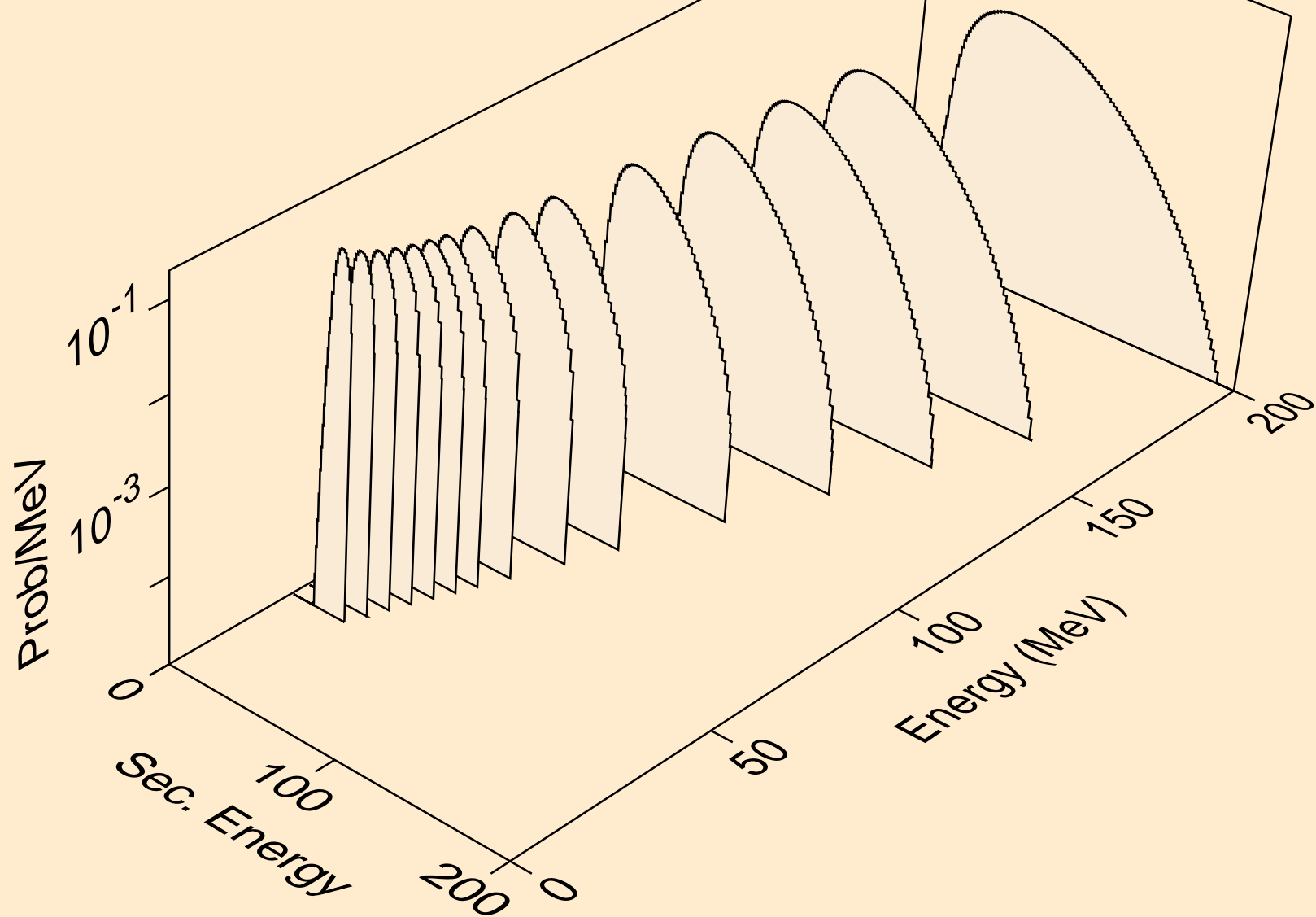

BI194M NEUTRON ACER TENDL-2021 LIBRARY; T=293.6K
he3s from (n,n*)he3

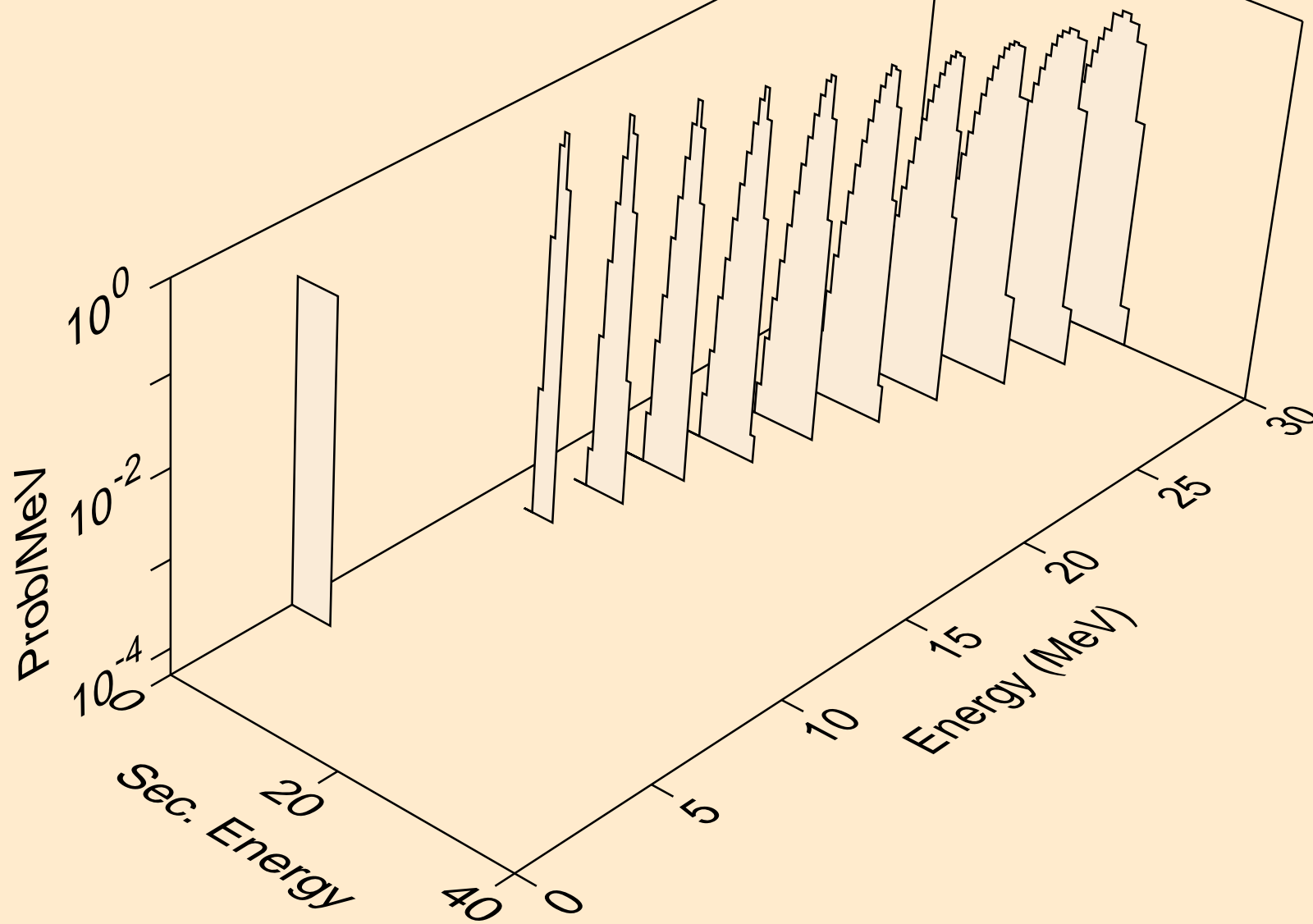

BI194M NEUTRON ACER TENDL-2021 LIBRARY; T=293.6K
he3s from (n,he3)

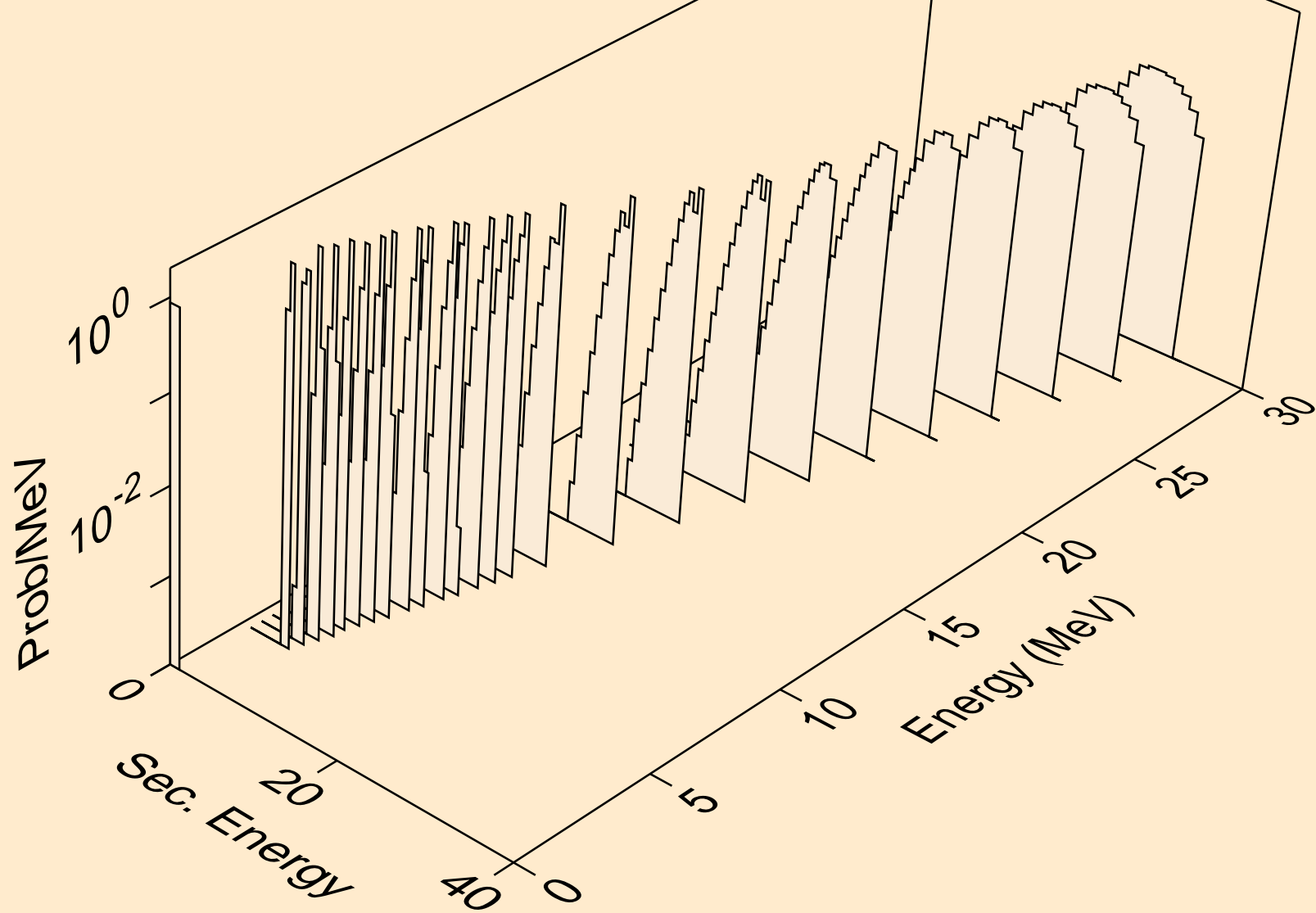

BI194M NEUTRON ACER TENDL-2021 LIBRARY; T=293.6K
alphas from (n,x)

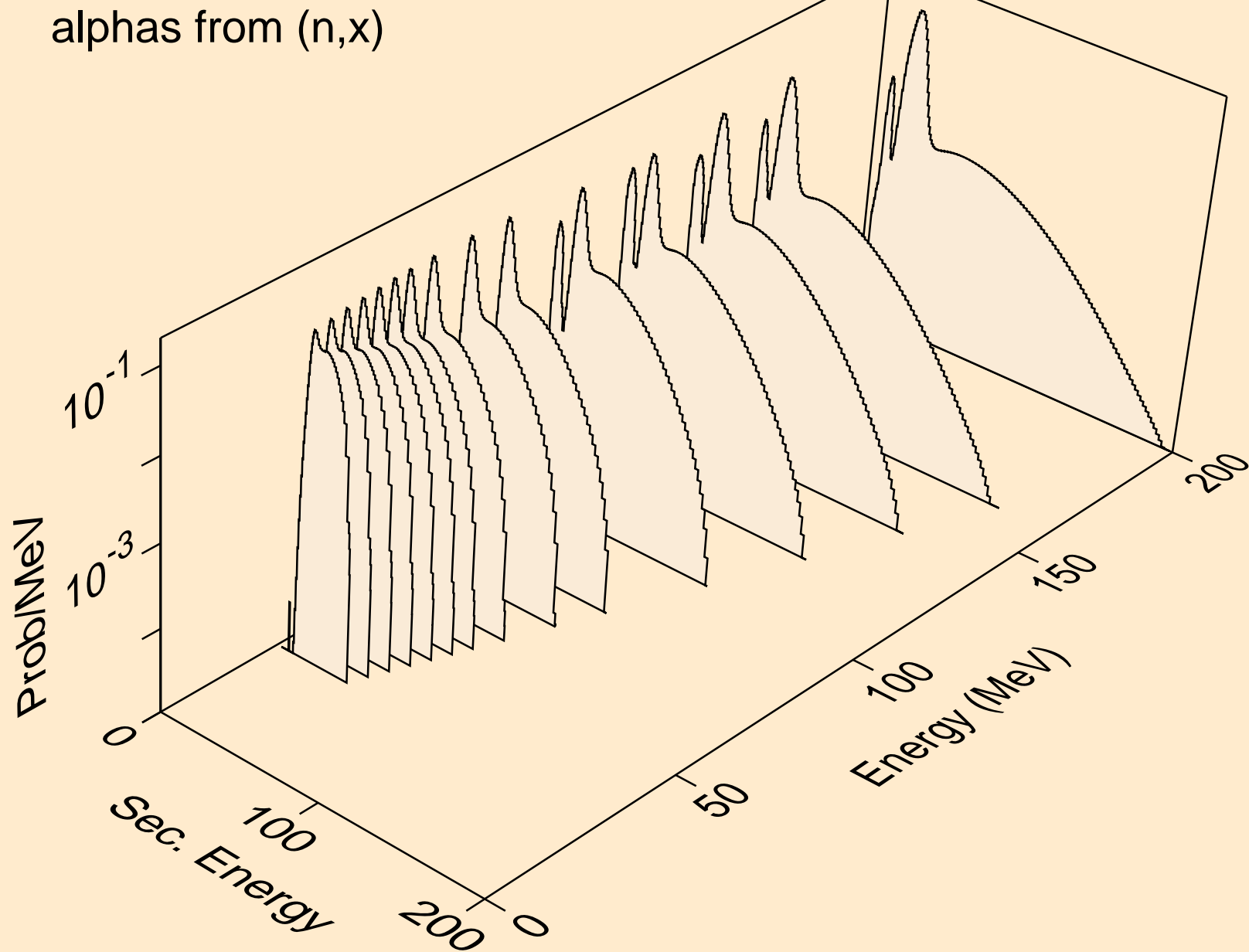

BI194M NEUTRON ACER TENDL-2021 LIBRARY; T=293.6K
alphas from (n,n*)a

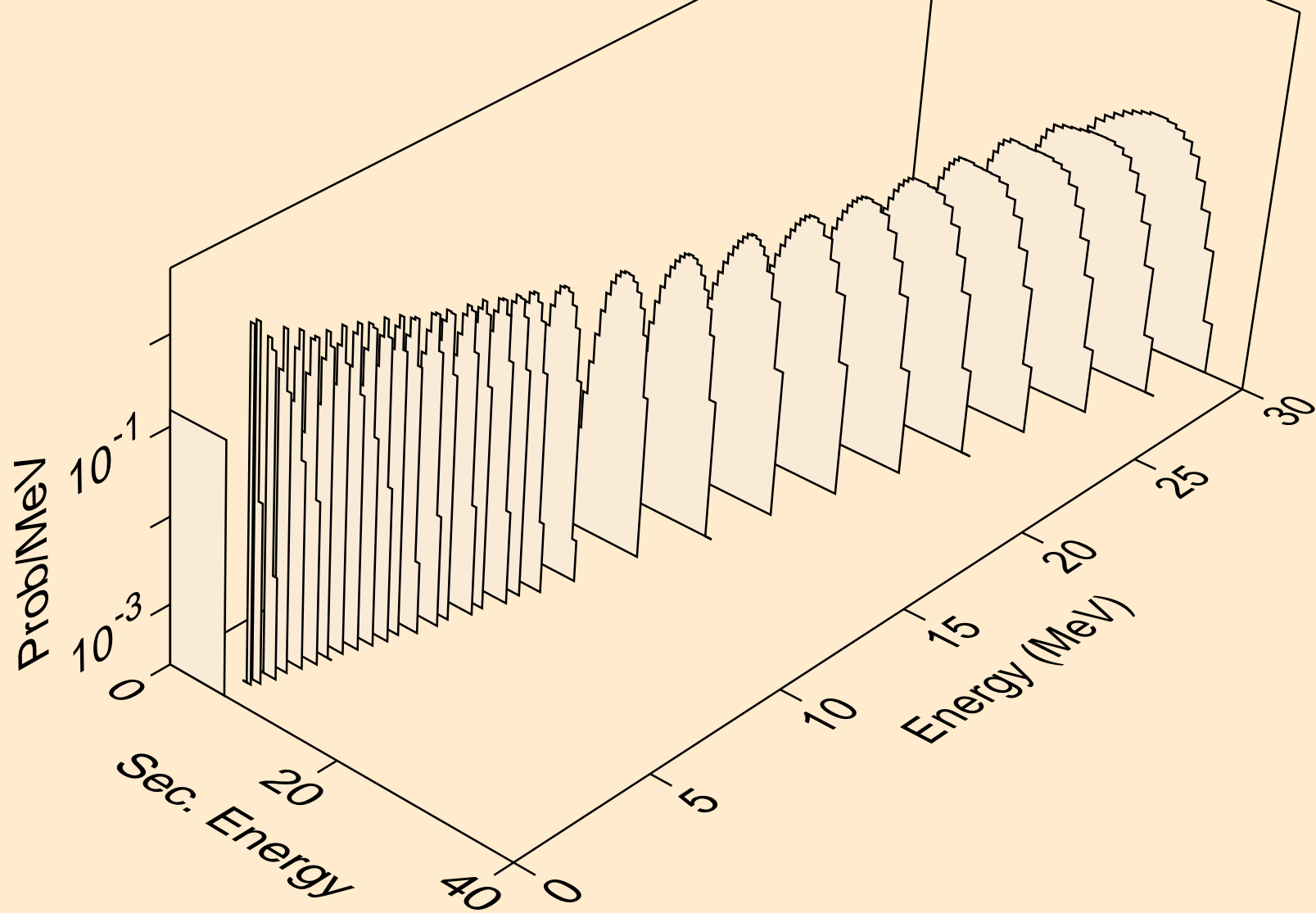

BI194M NEUTRON ACER TENDL-2021 LIBRARY; T=293.6K
alphas from (n,2n)a

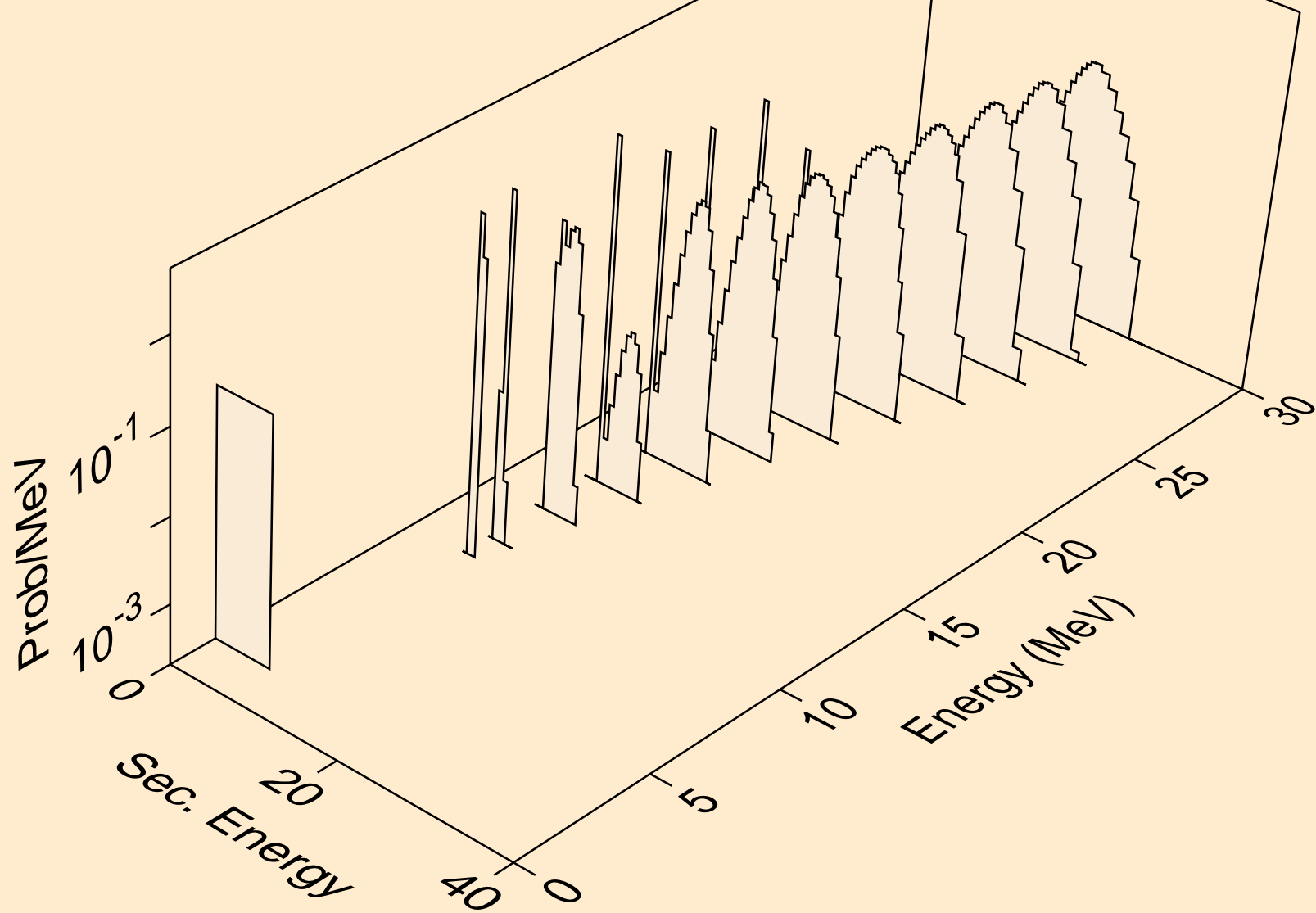

BI194M NEUTRON ACER TENDL-2021 LIBRARY; T=293.6K
alphas from (n,3n)a

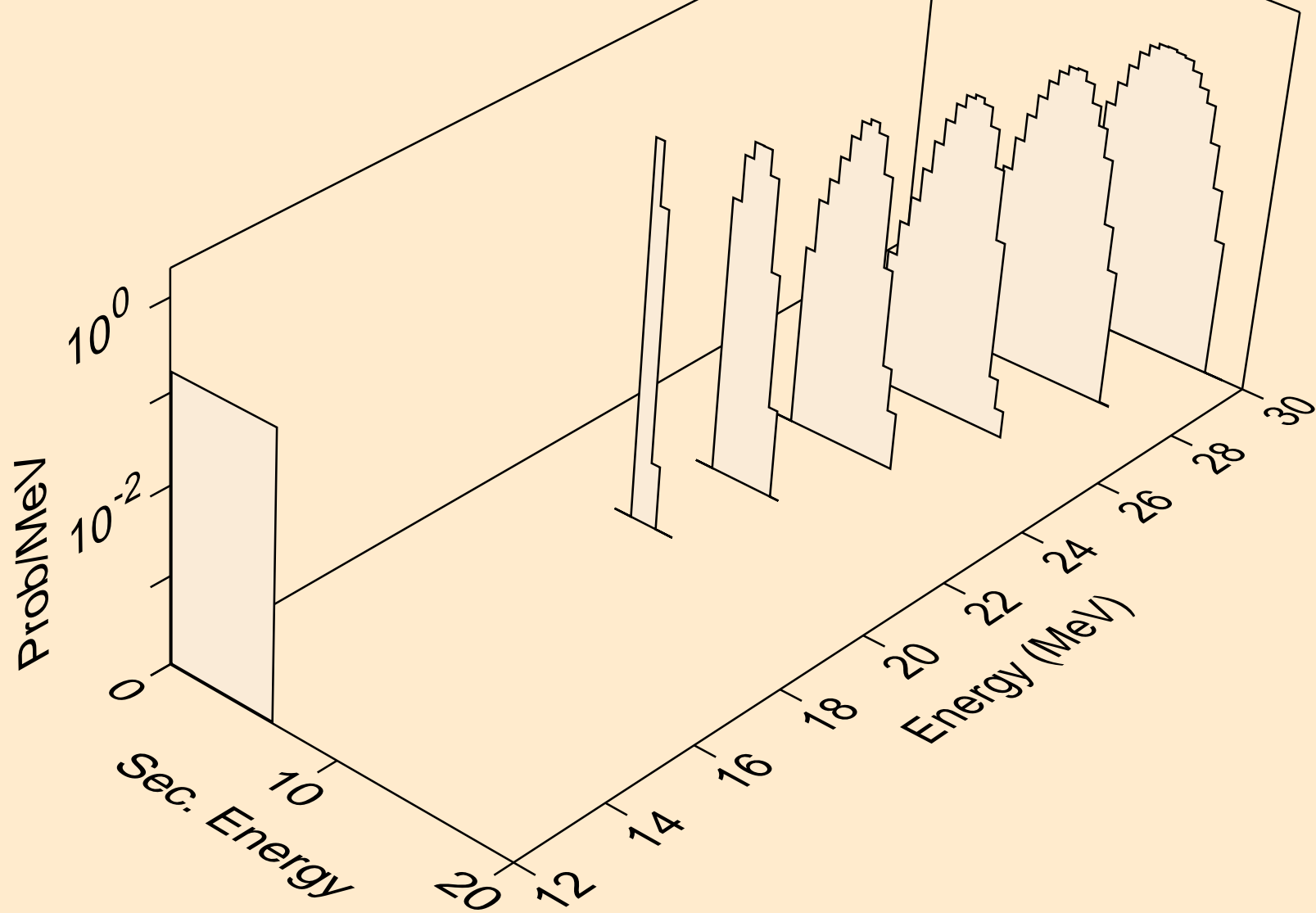

BI194M NEUTRON ACER TENDL-2021 LIBRARY; T=293.6K
alphas from (n,n*)2a

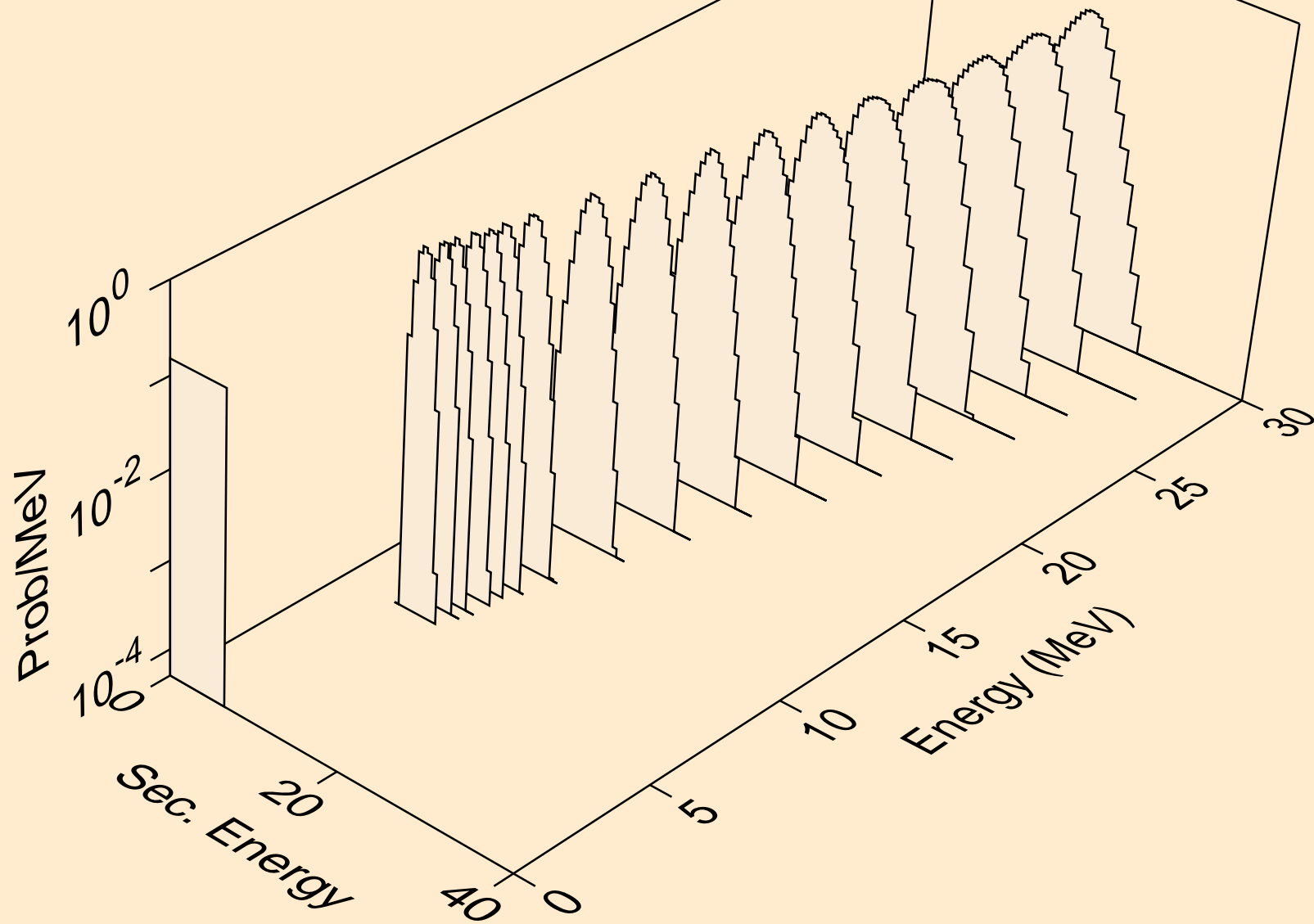

BI194M NEUTRON ACER TENDL-2021 LIBRARY; T=293.6K
alphas from (n,2n)2a

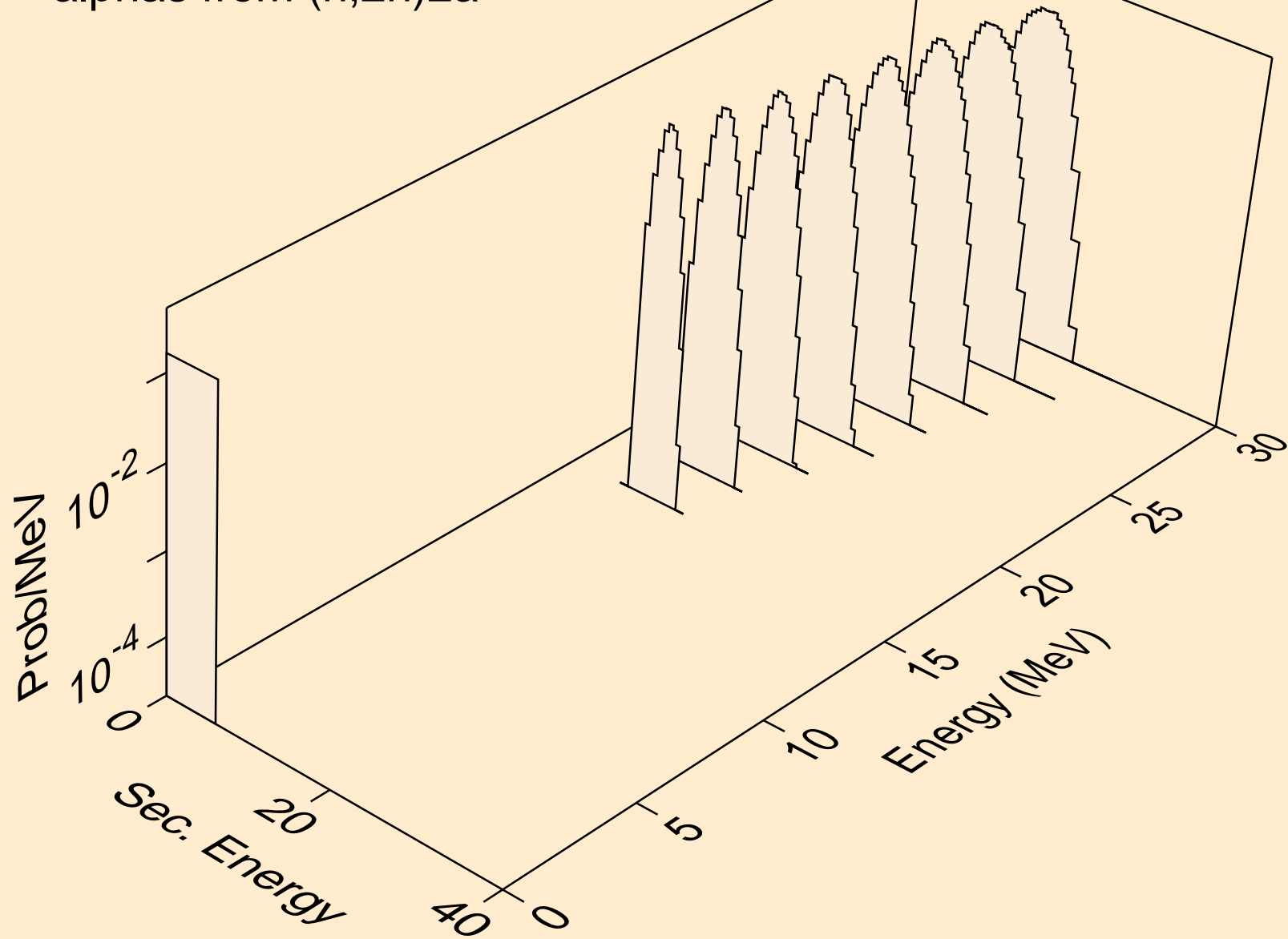

BI194M NEUTRON ACER TENDL-2021 LIBRARY; T=293.6K
alphas from (n,npa)

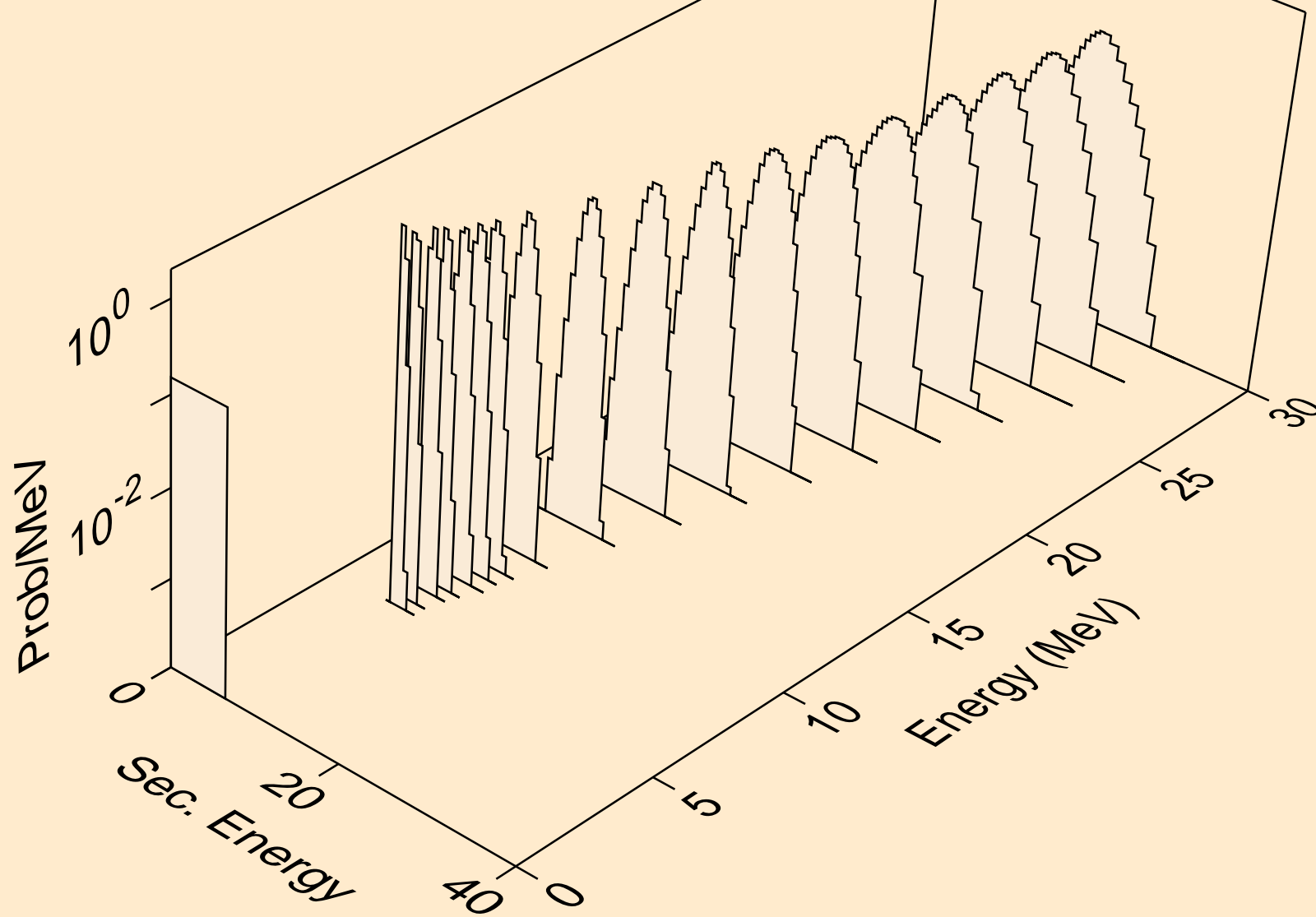

BI194M NEUTRON ACER TENDL-2021 LIBRARY; T=293.6K
alphas from (n,a)

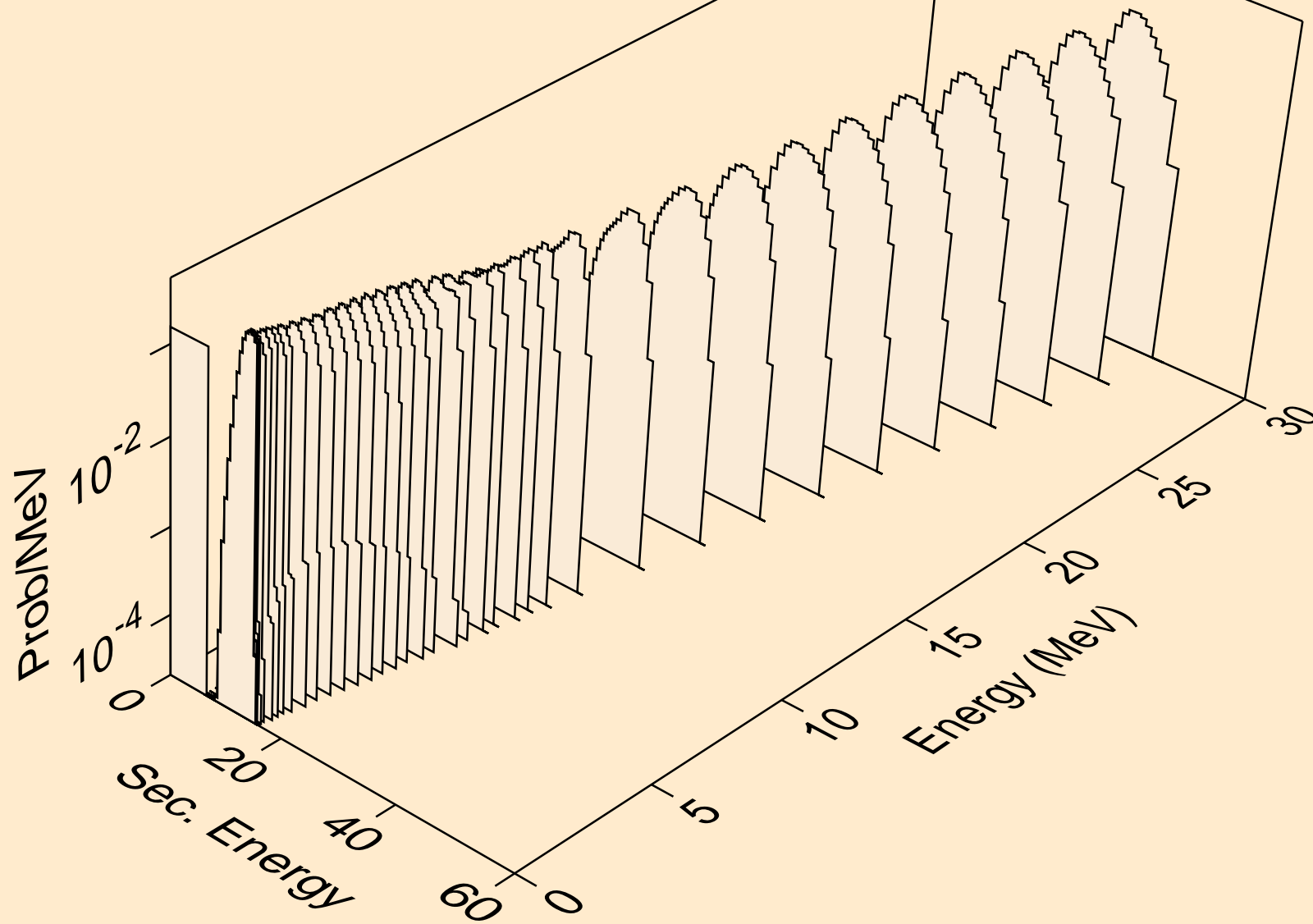

BI194M NEUTRON ACER TENDL-2021 LIBRARY; T=293.6K
alphas from (n,2a)

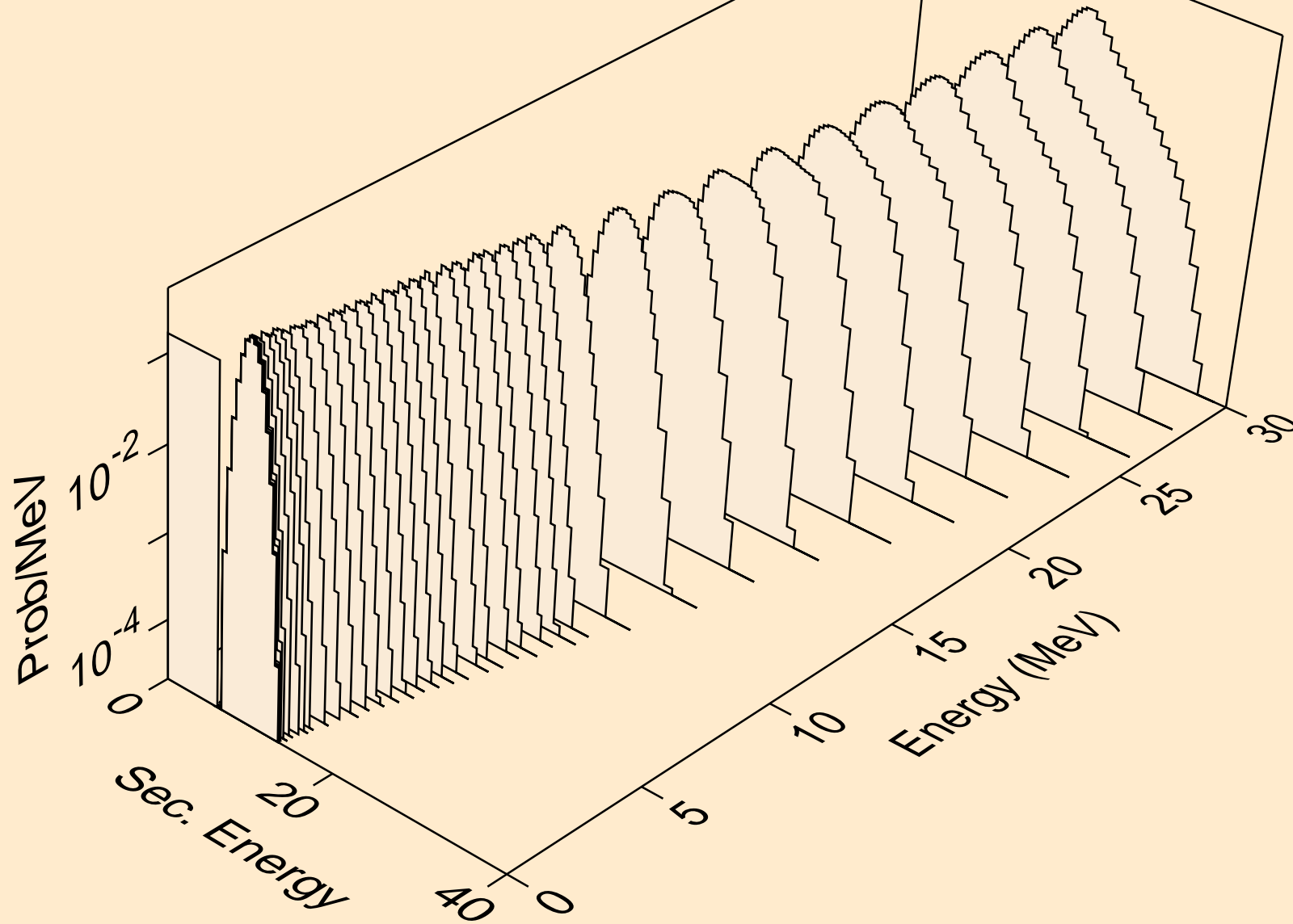

BI194M NEUTRON ACER TENDL-2021 LIBRARY; T=293.6K
alphas from (n,3a)

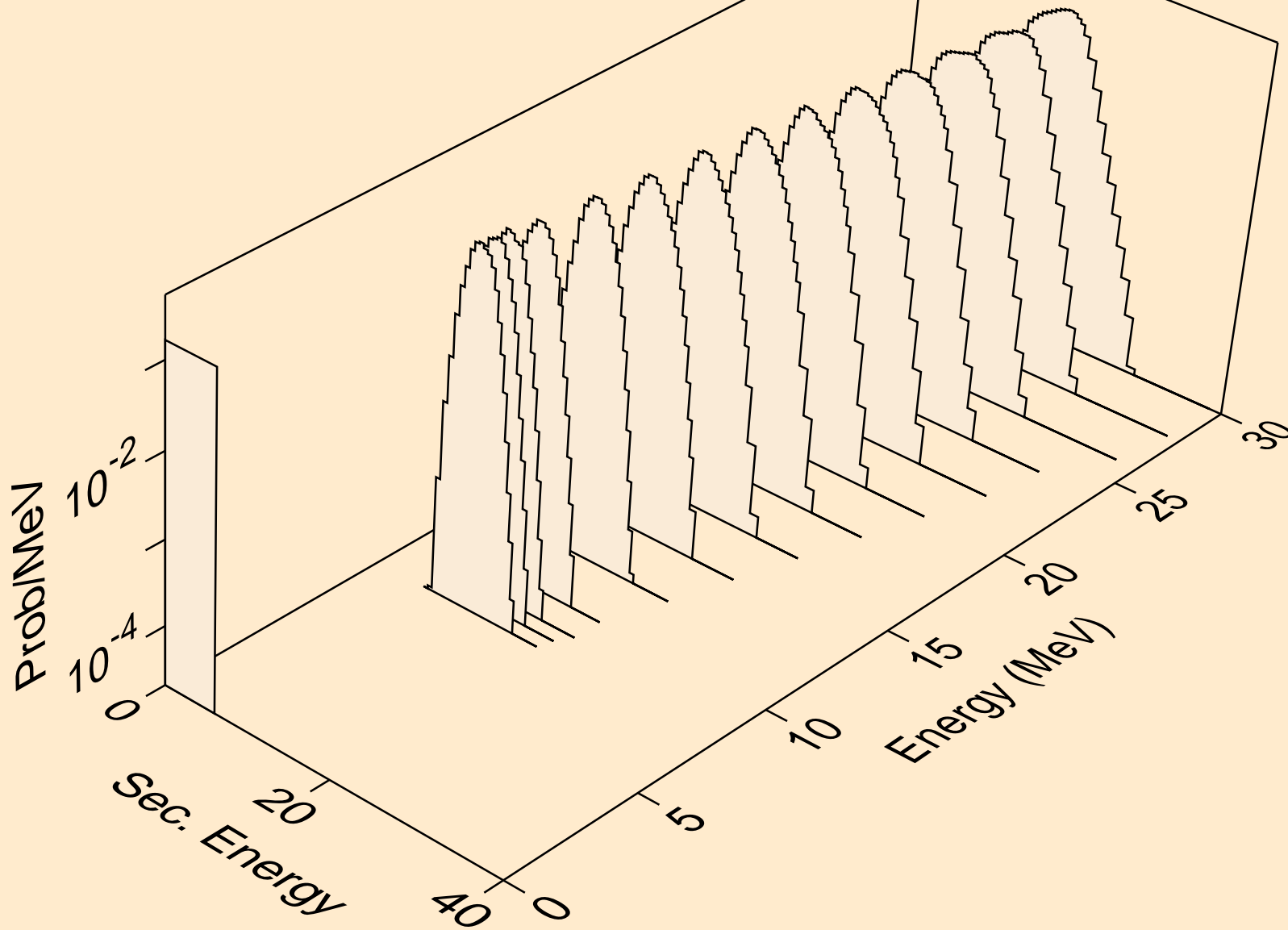

BI194M NEUTRON ACER TENDL-2021 LIBRARY; T=293.6K
alphas from (n,pa)

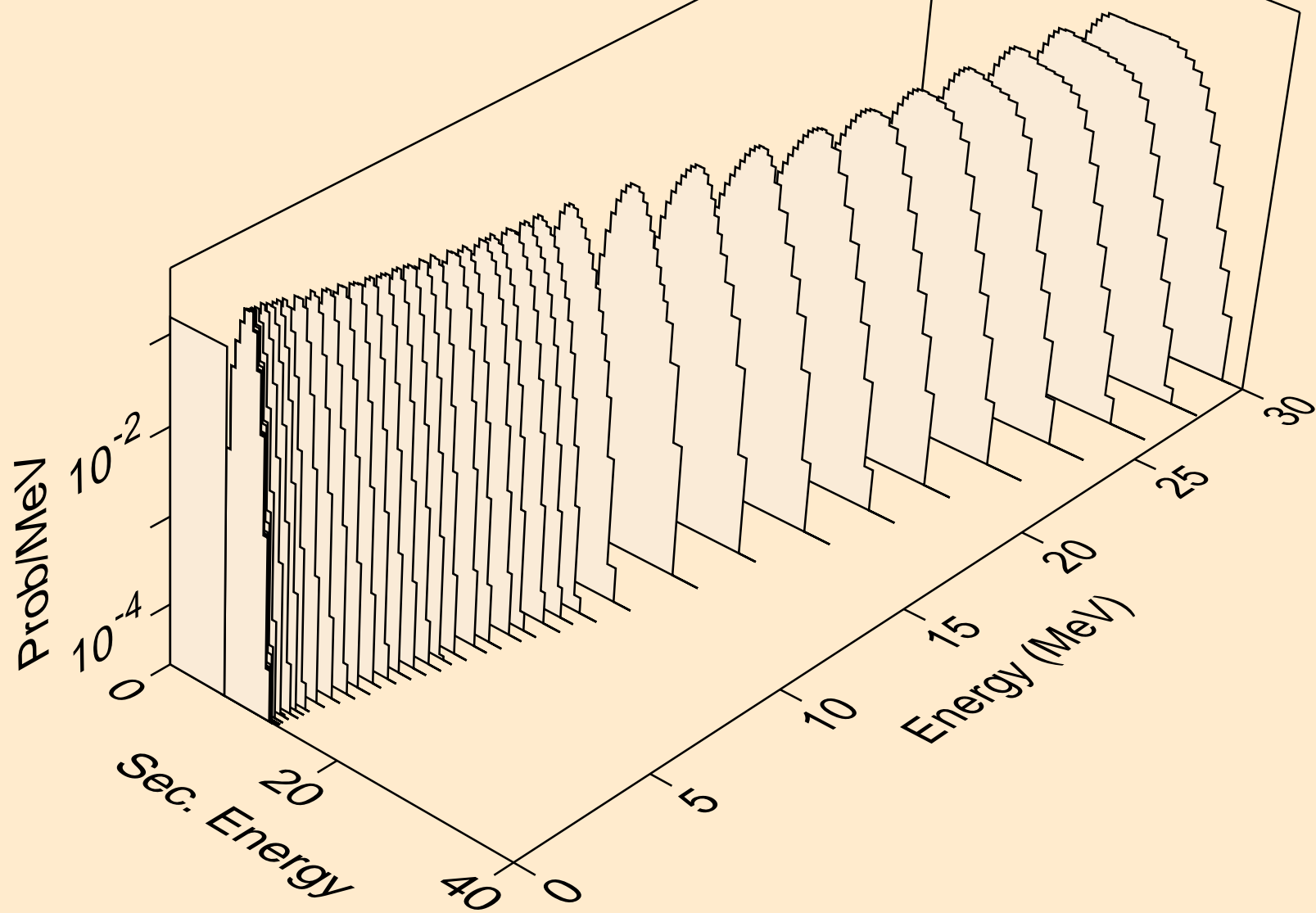

BI194M NEUTRON ACER TENDL-2021 LIBRARY; T=293.6K
alphas from (n,da)

