

BI199M NEUTRON ACER TENDL-2021 LIBRARY; T=293.6K  
Principal cross sections

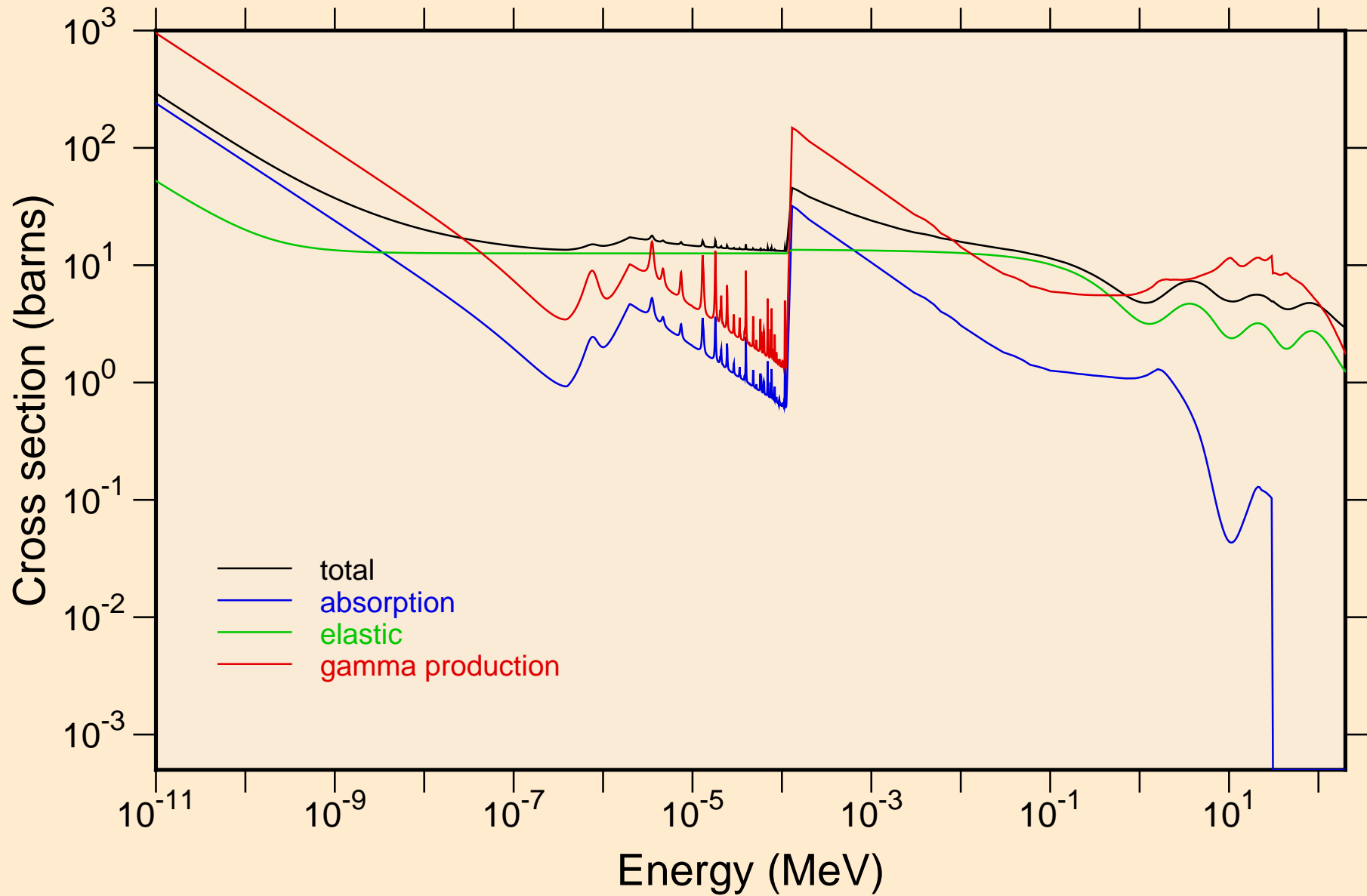

BI199M NEUTRON ACER TENDL-2021 LIBRARY; T=293.6K  
resonance total cross section

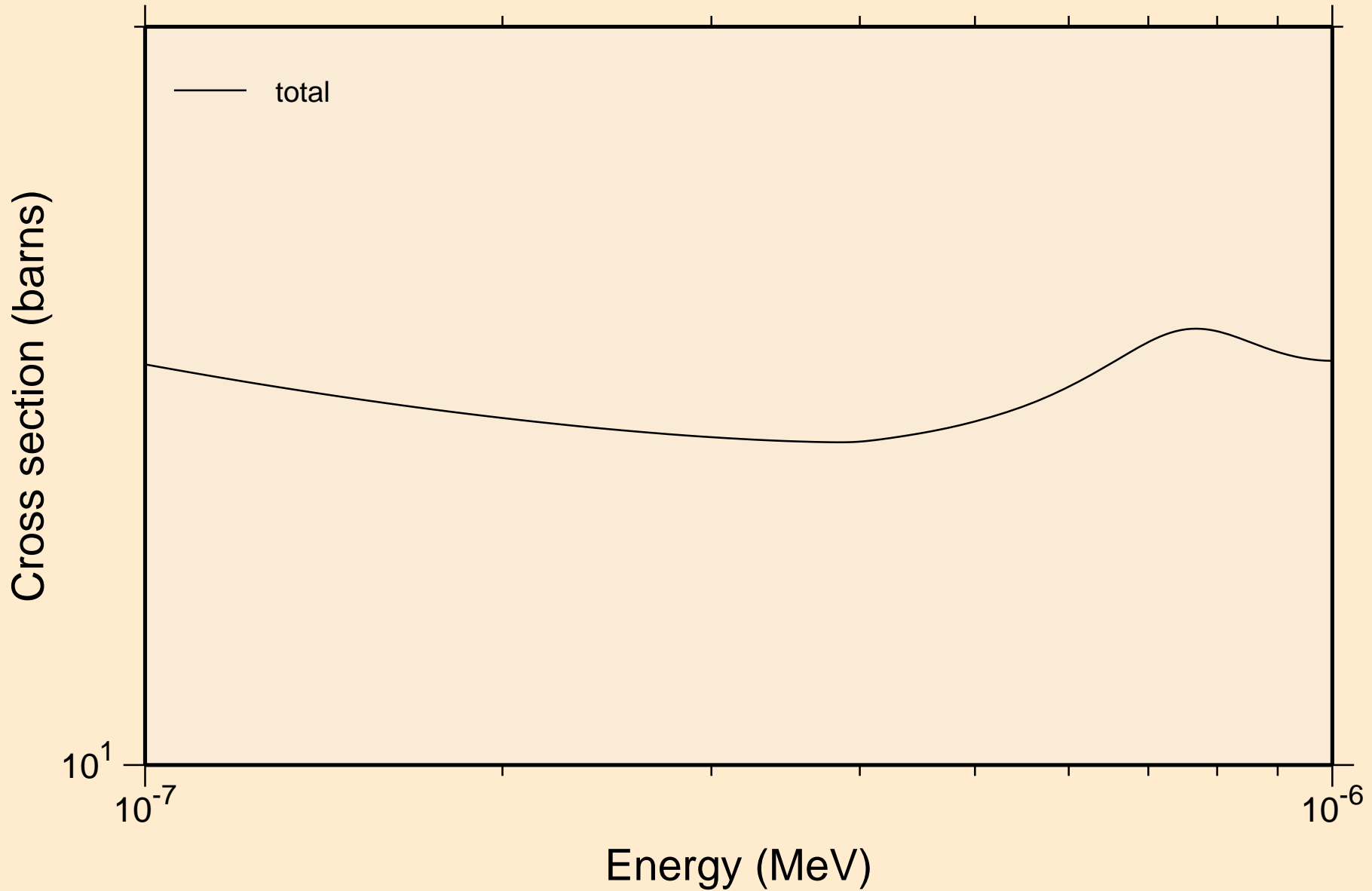

BI199M NEUTRON ACER TENDL-2021 LIBRARY; T=293.6K  
resonance total cross section

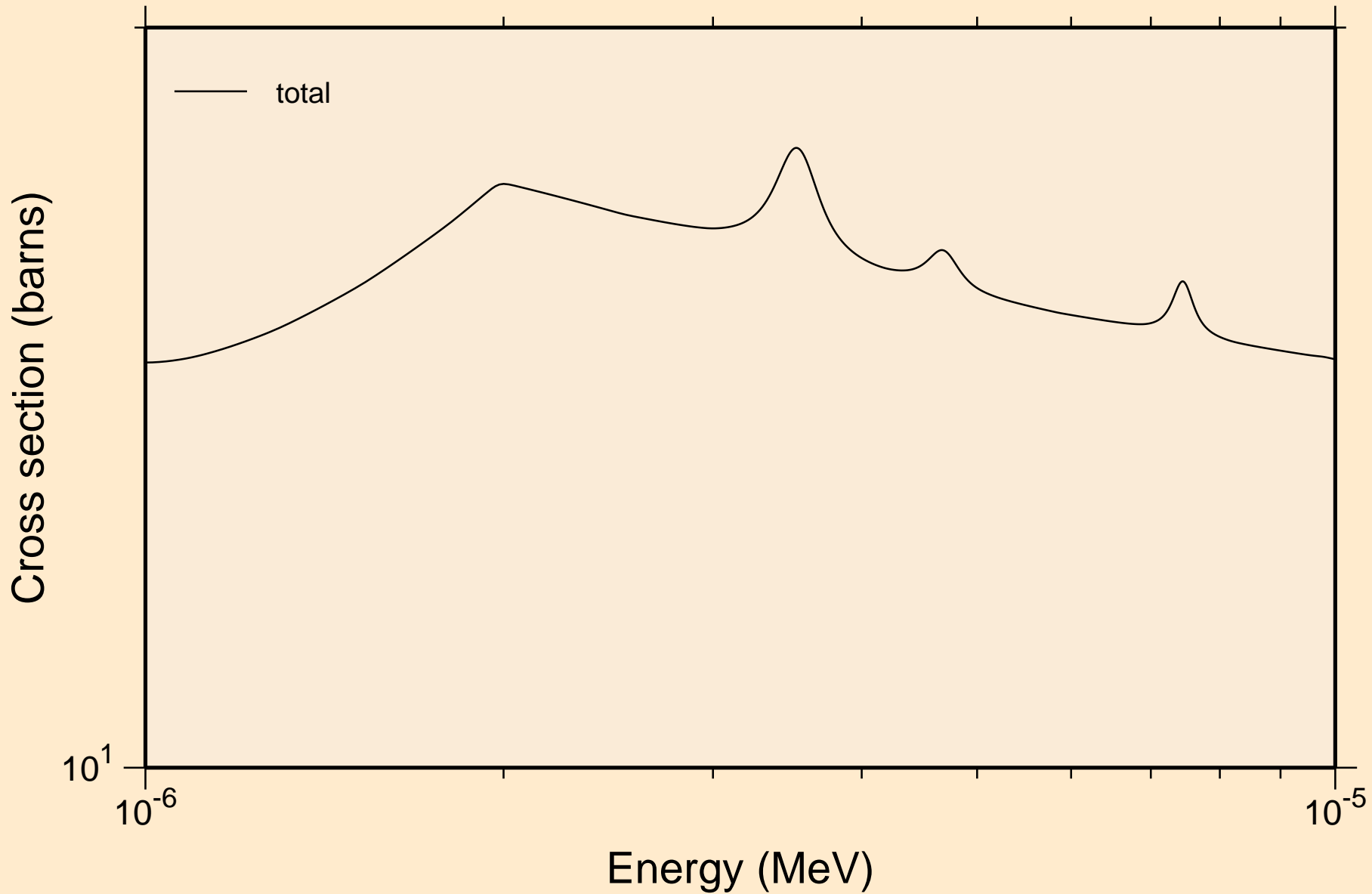

BI199M NEUTRON ACER TENDL-2021 LIBRARY; T=293.6K  
resonance total cross section

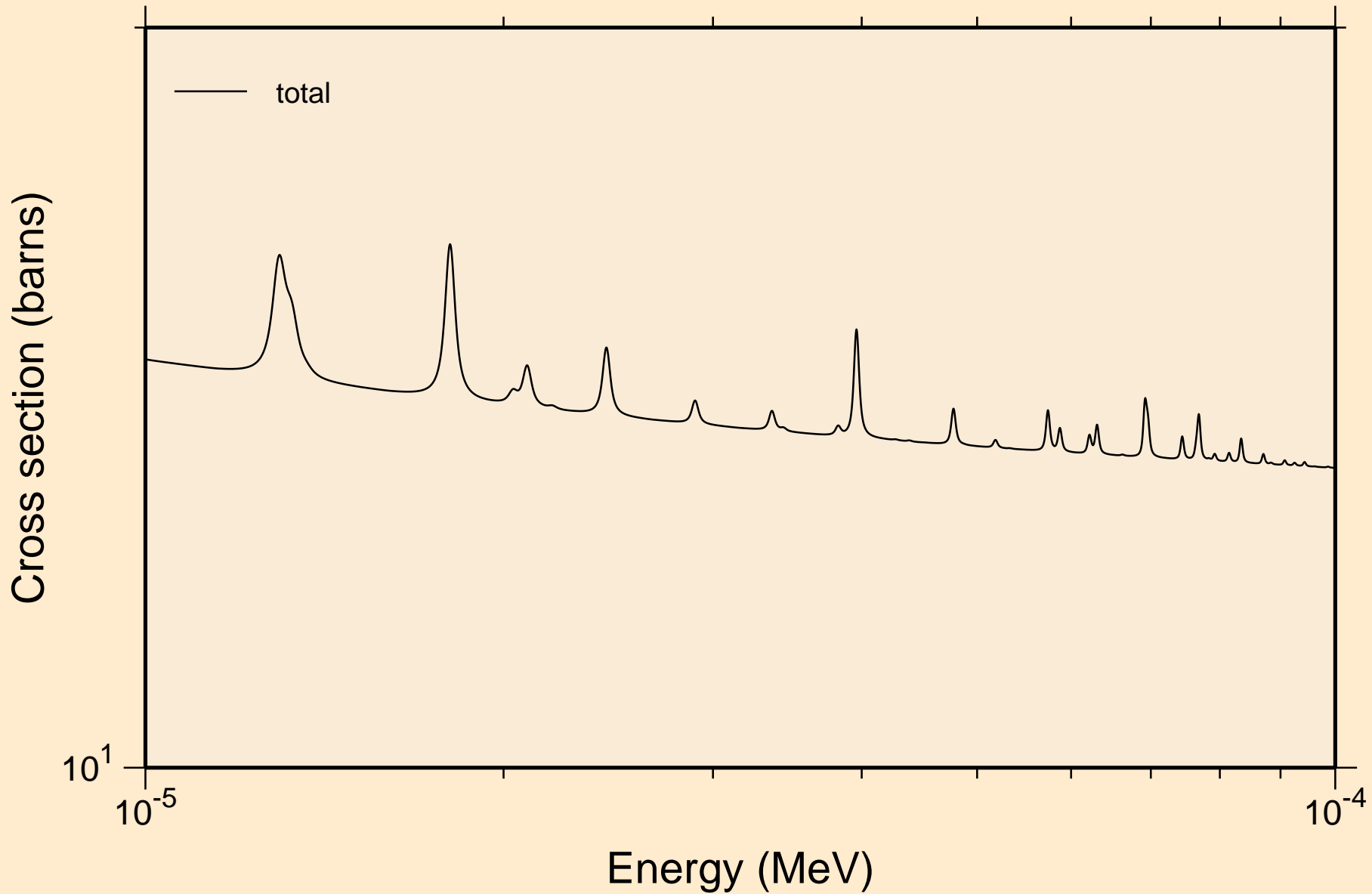

BI199M NEUTRON ACER TENDL-2021 LIBRARY; T=293.6K  
resonance total cross section

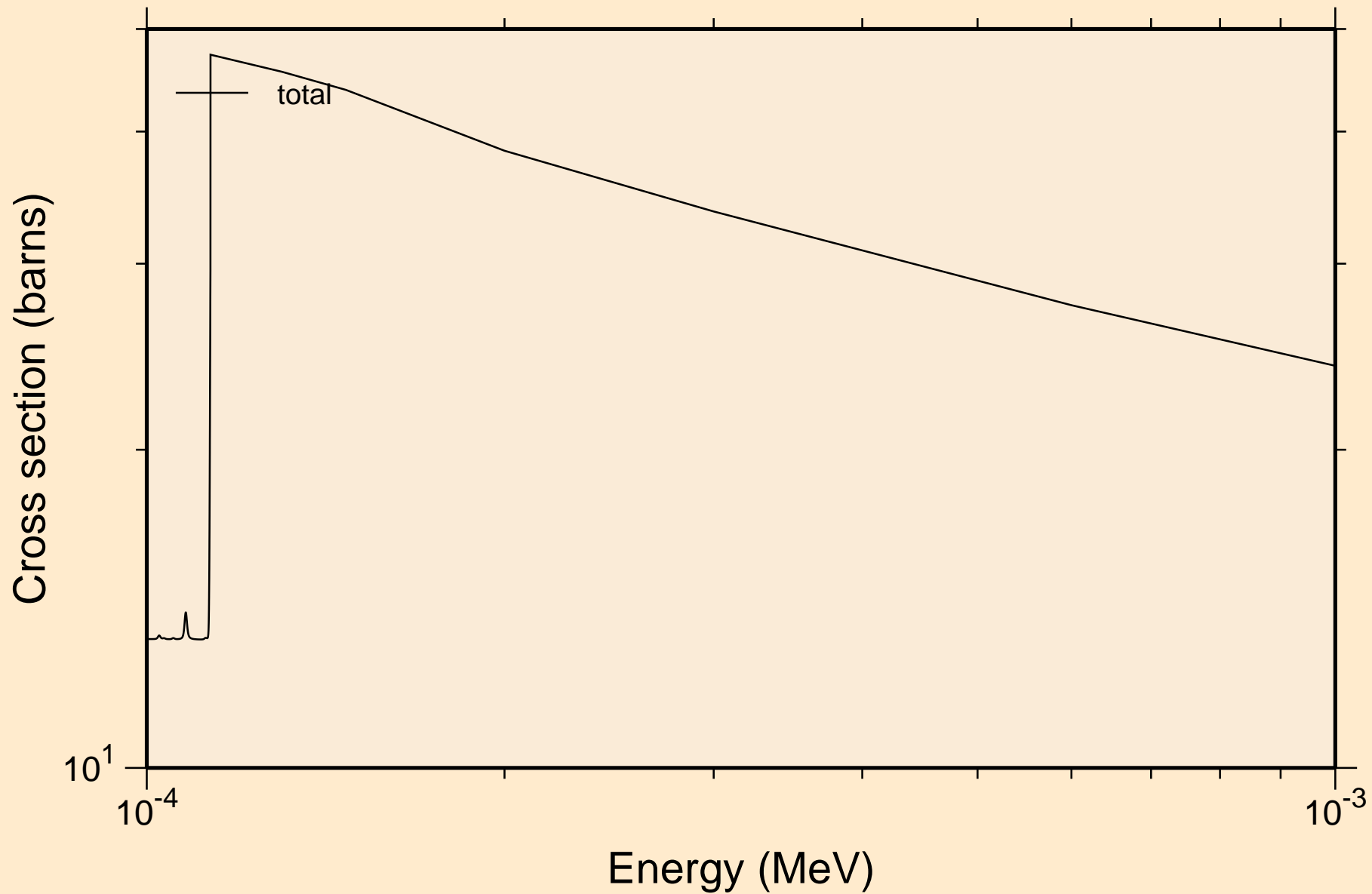

BI199M NEUTRON ACER TENDL-2021 LIBRARY; T=293.6K  
resonance total cross section

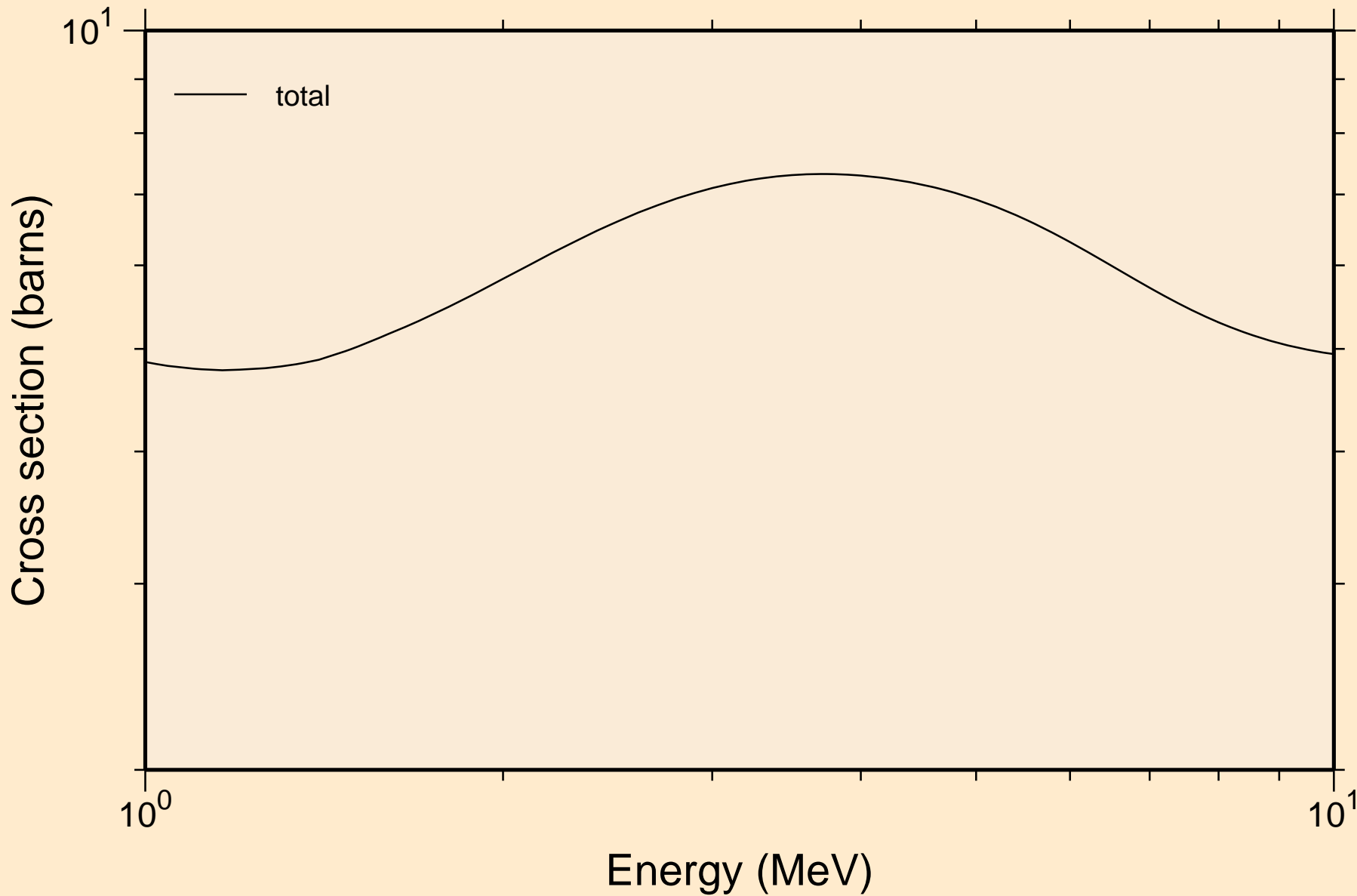

BI199M NEUTRON ACER TENDL-2021 LIBRARY; T=293.6K  
resonance absorption cross sections

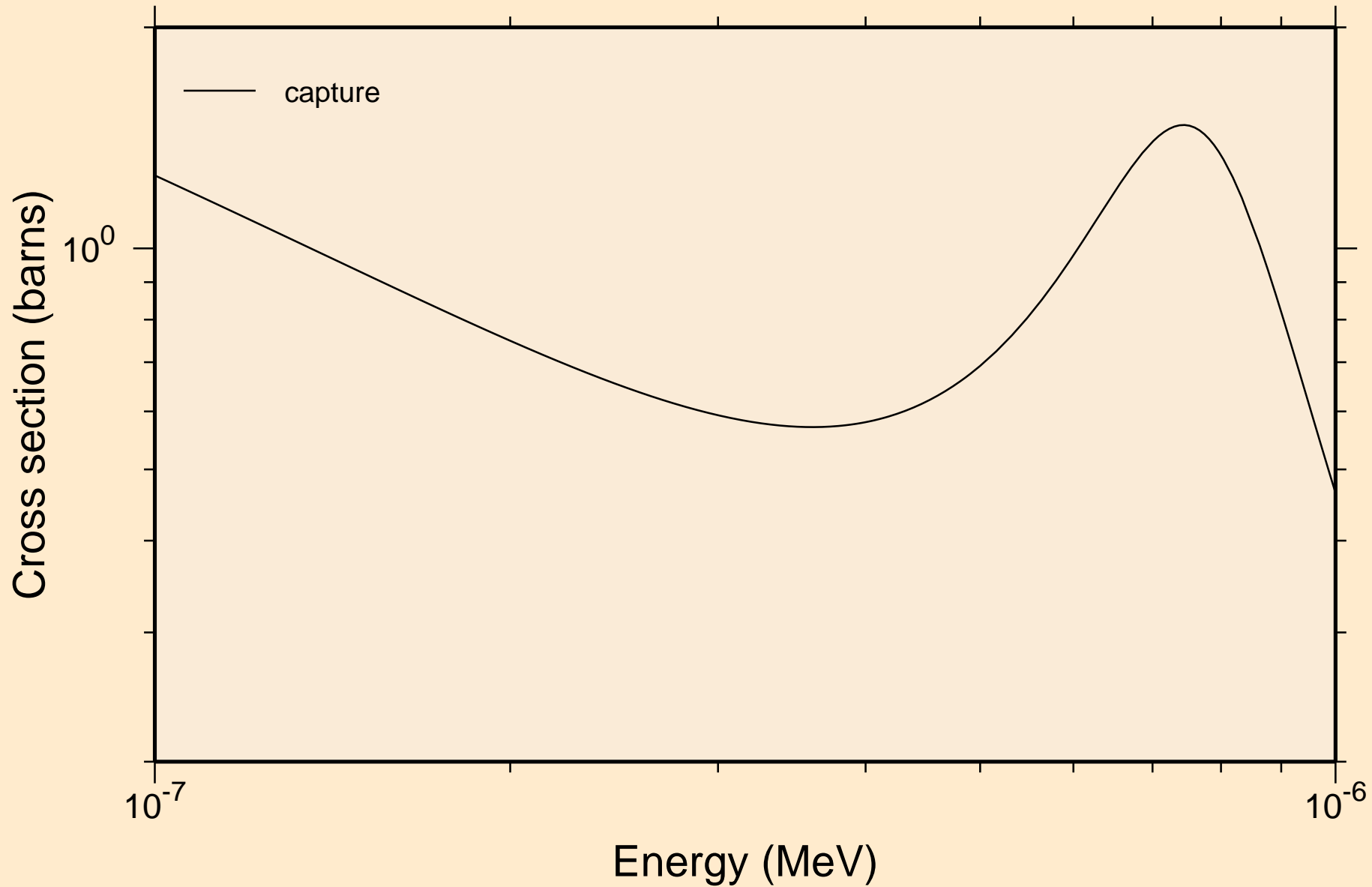

BI199M NEUTRON ACER TENDL-2021 LIBRARY; T=293.6K  
resonance absorption cross sections

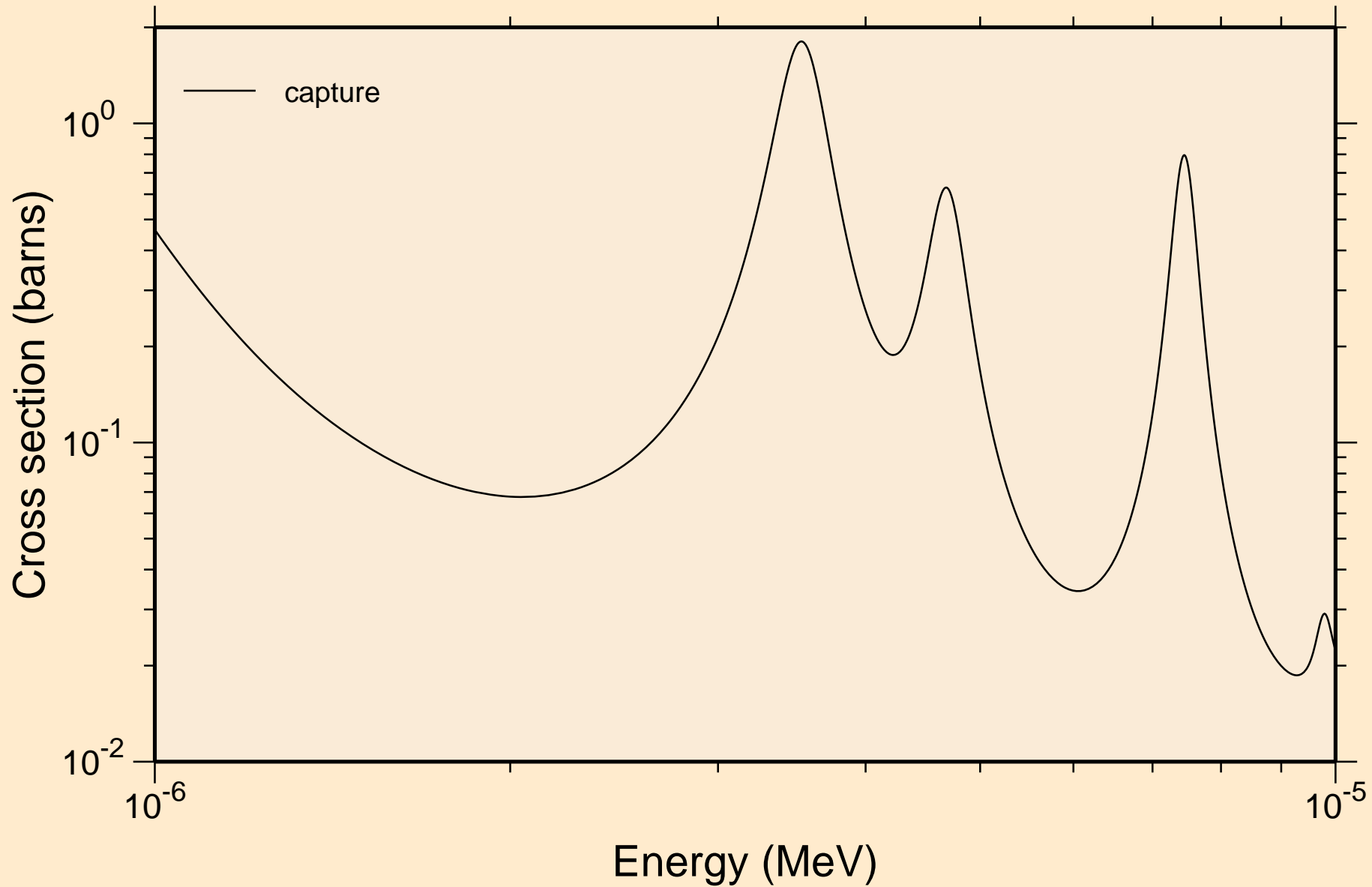



BI199M NEUTRON ACER TENDL-2021 LIBRARY; T=293.6K  
resonance absorption cross sections

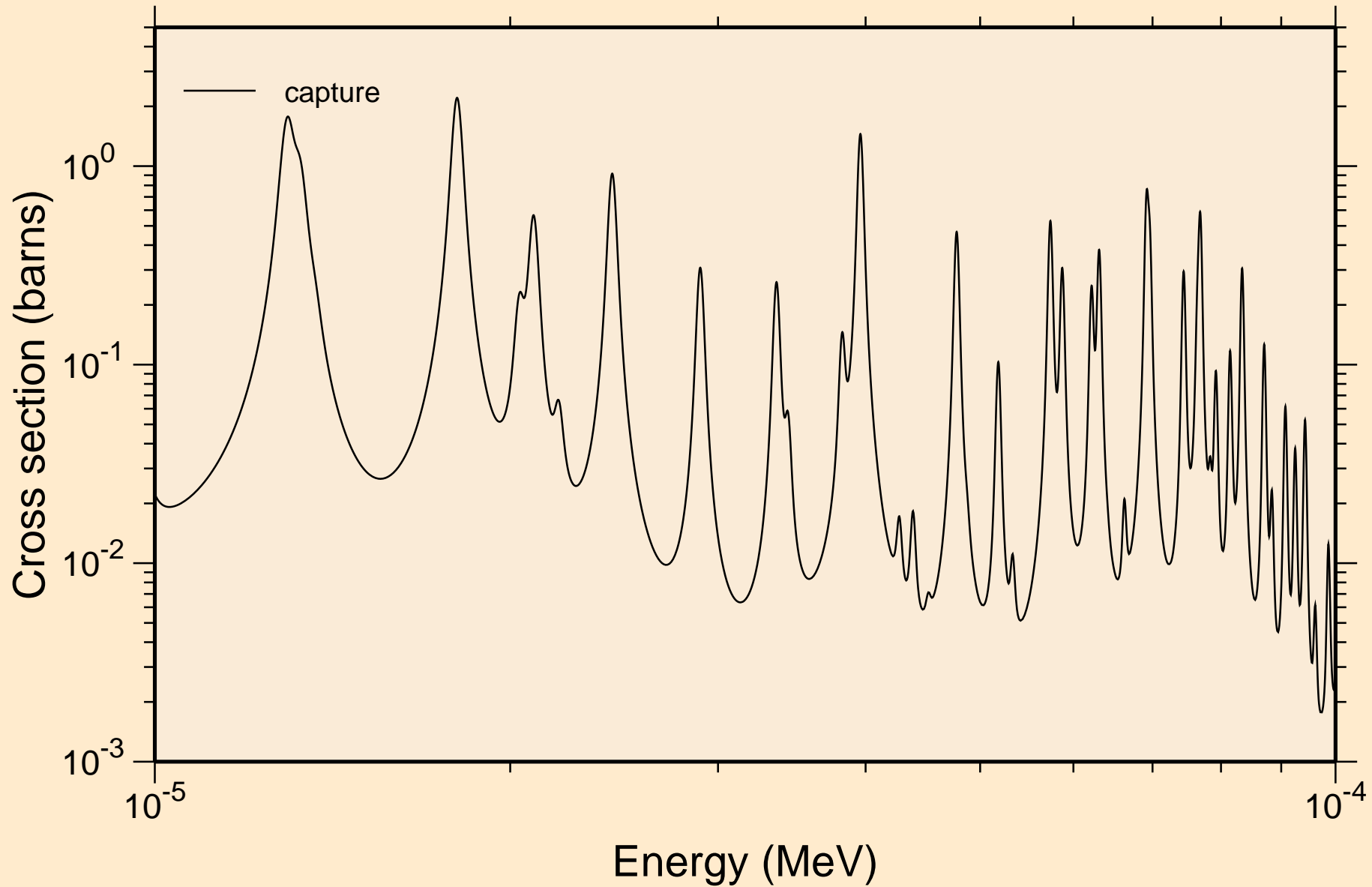

BI199M NEUTRON ACER TENDL-2021 LIBRARY; T=293.6K  
resonance absorption cross sections

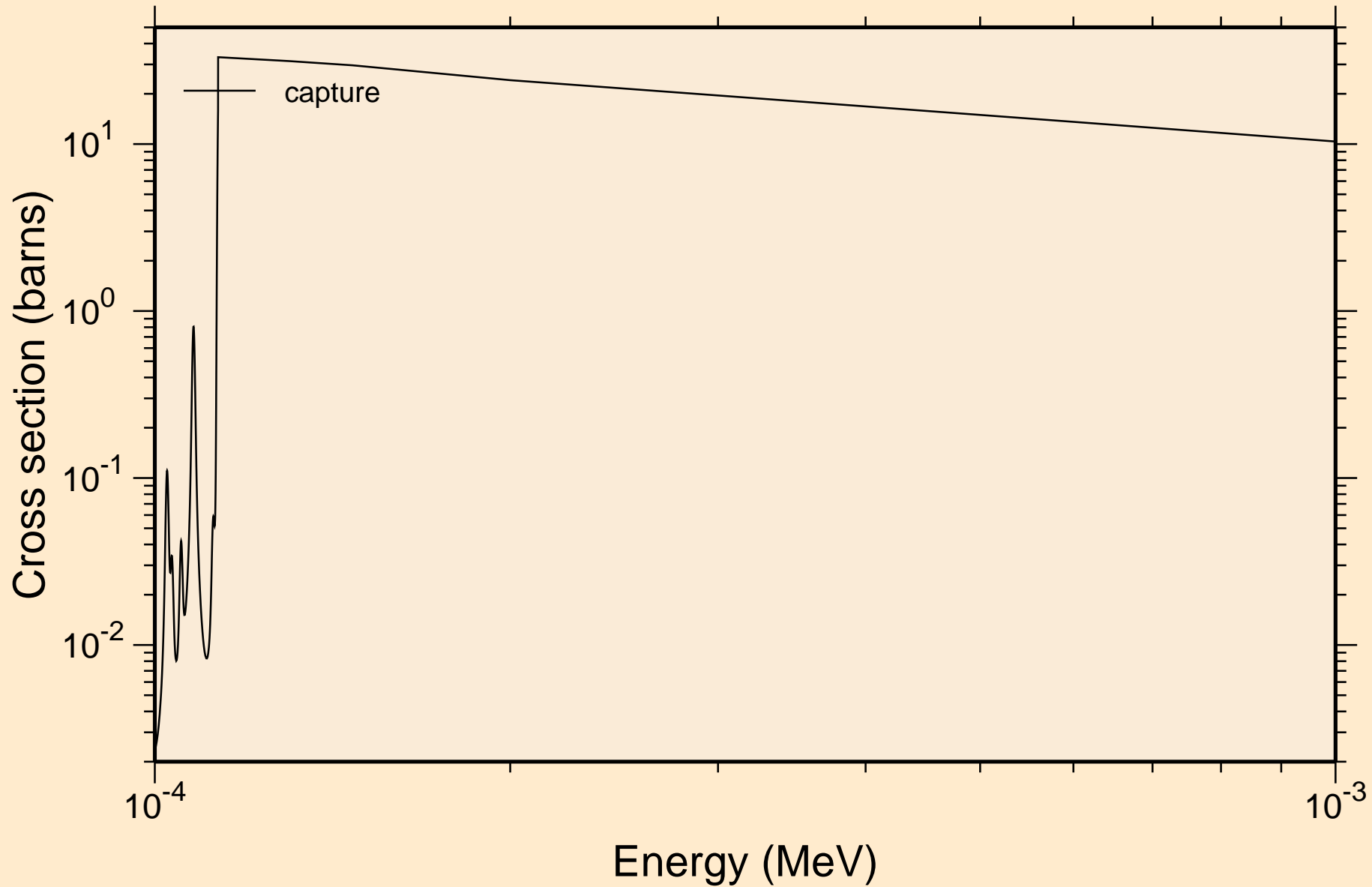

BI199M NEUTRON ACER TENDL-2021 LIBRARY; T=293.6K  
resonance absorption cross sections

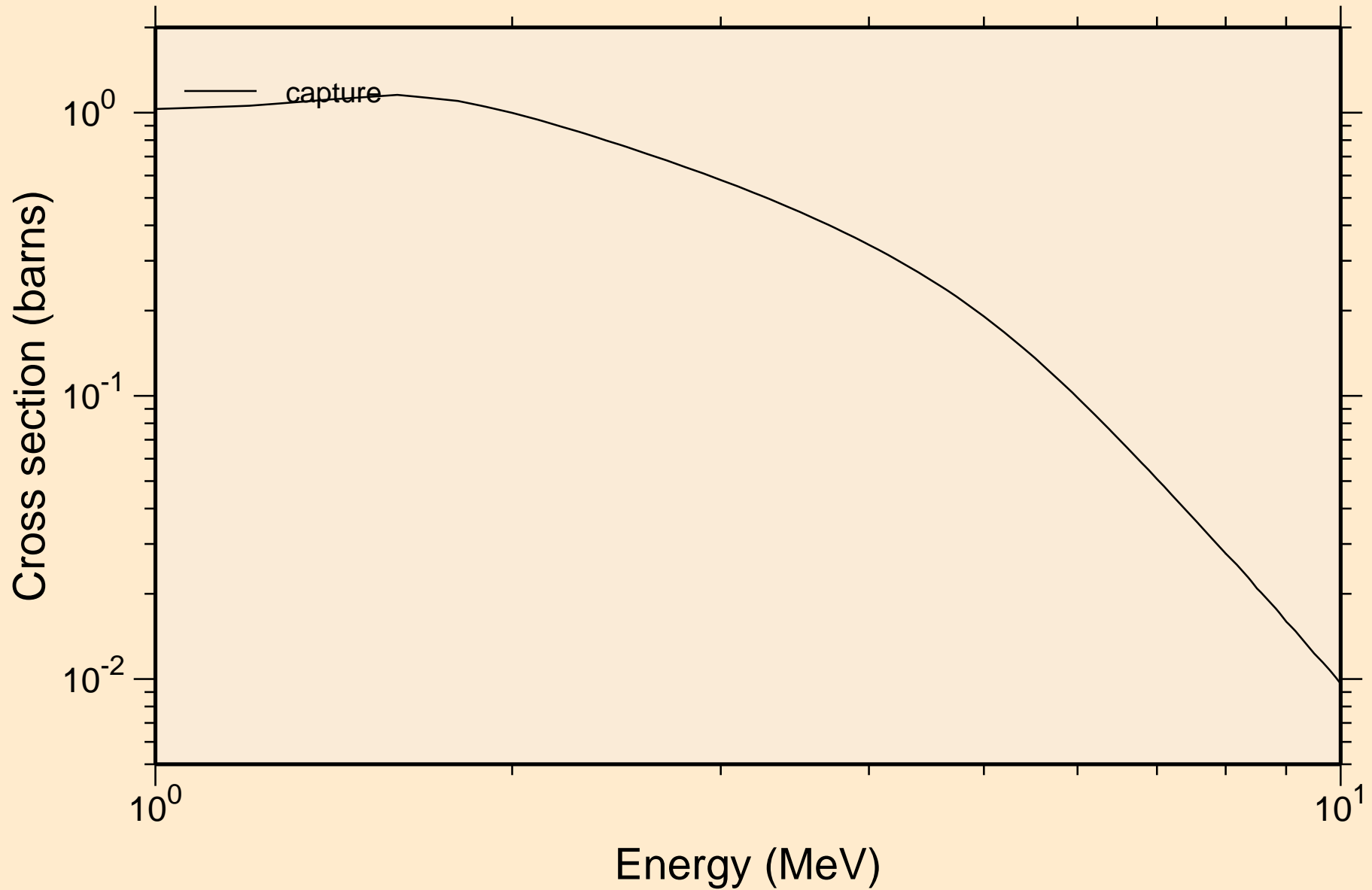

BI199M NEUTRON ACER TENDL-2021 LIBRARY; T=293.6K  
Heating

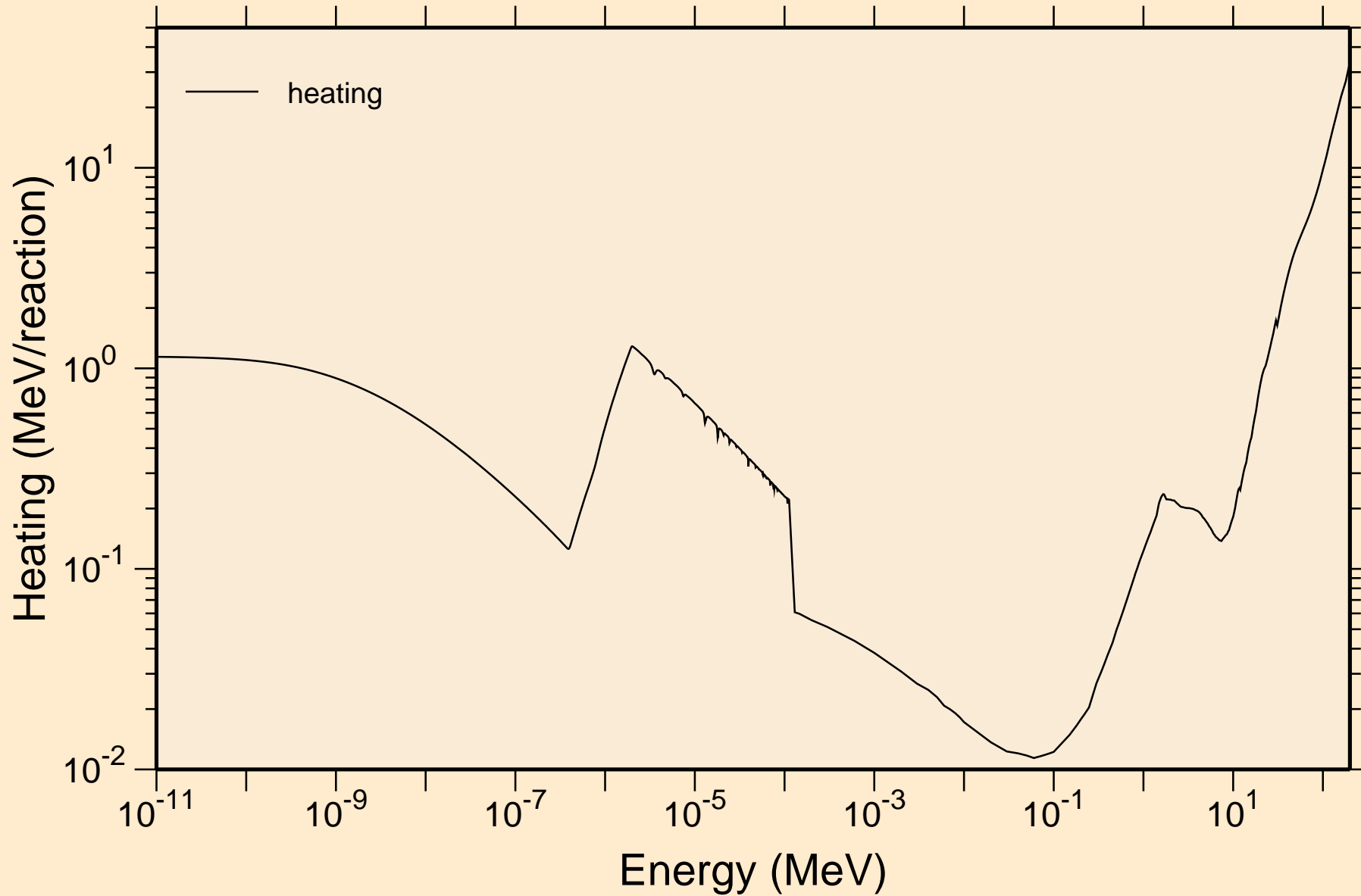

BI199M NEUTRON ACER TENDL-2021 LIBRARY; T=293.6K  
Damage

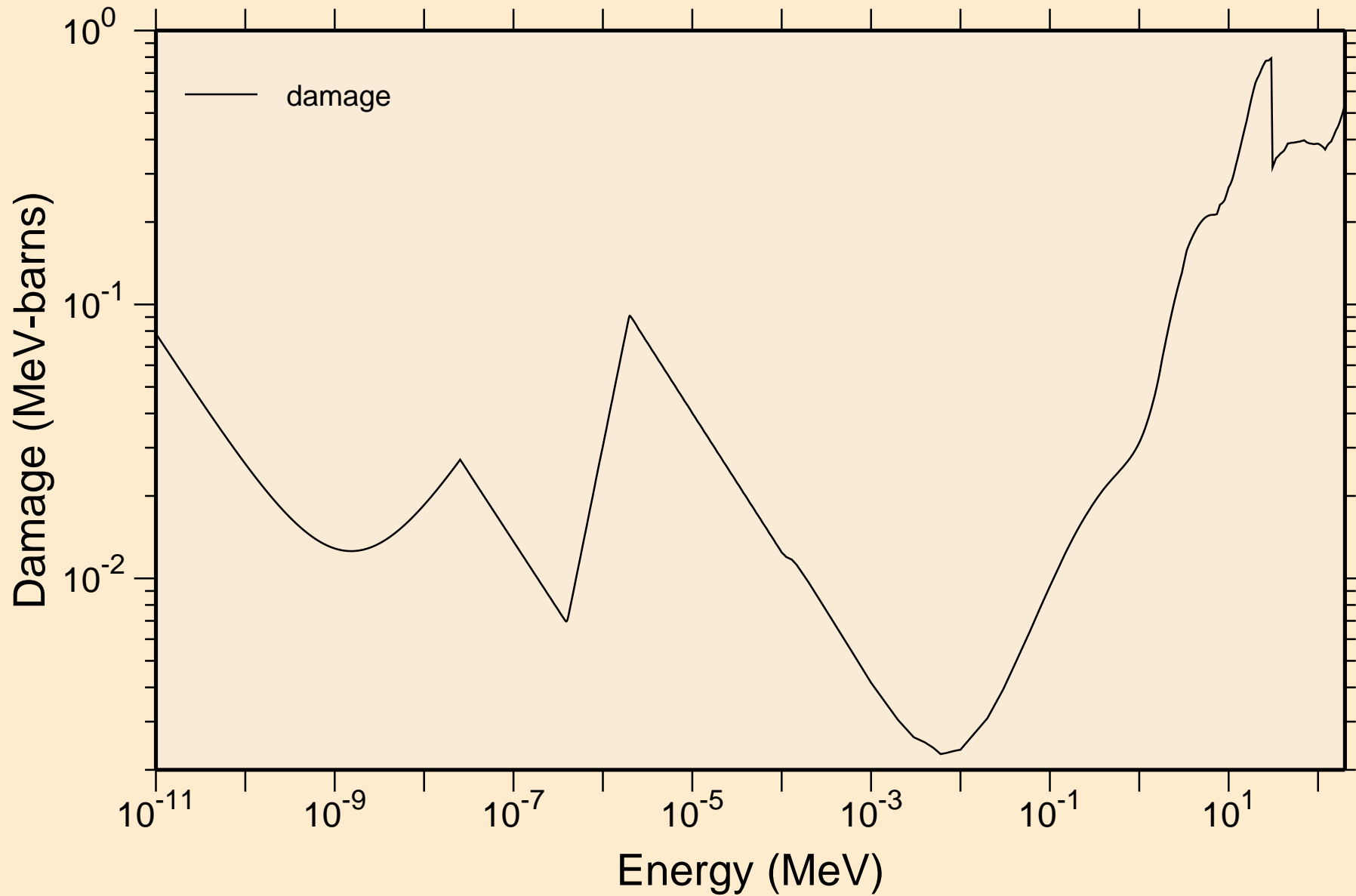

BI199M NEUTRON ACER TENDL-2021 LIBRARY; T=293.6K  
Non-threshold reactions

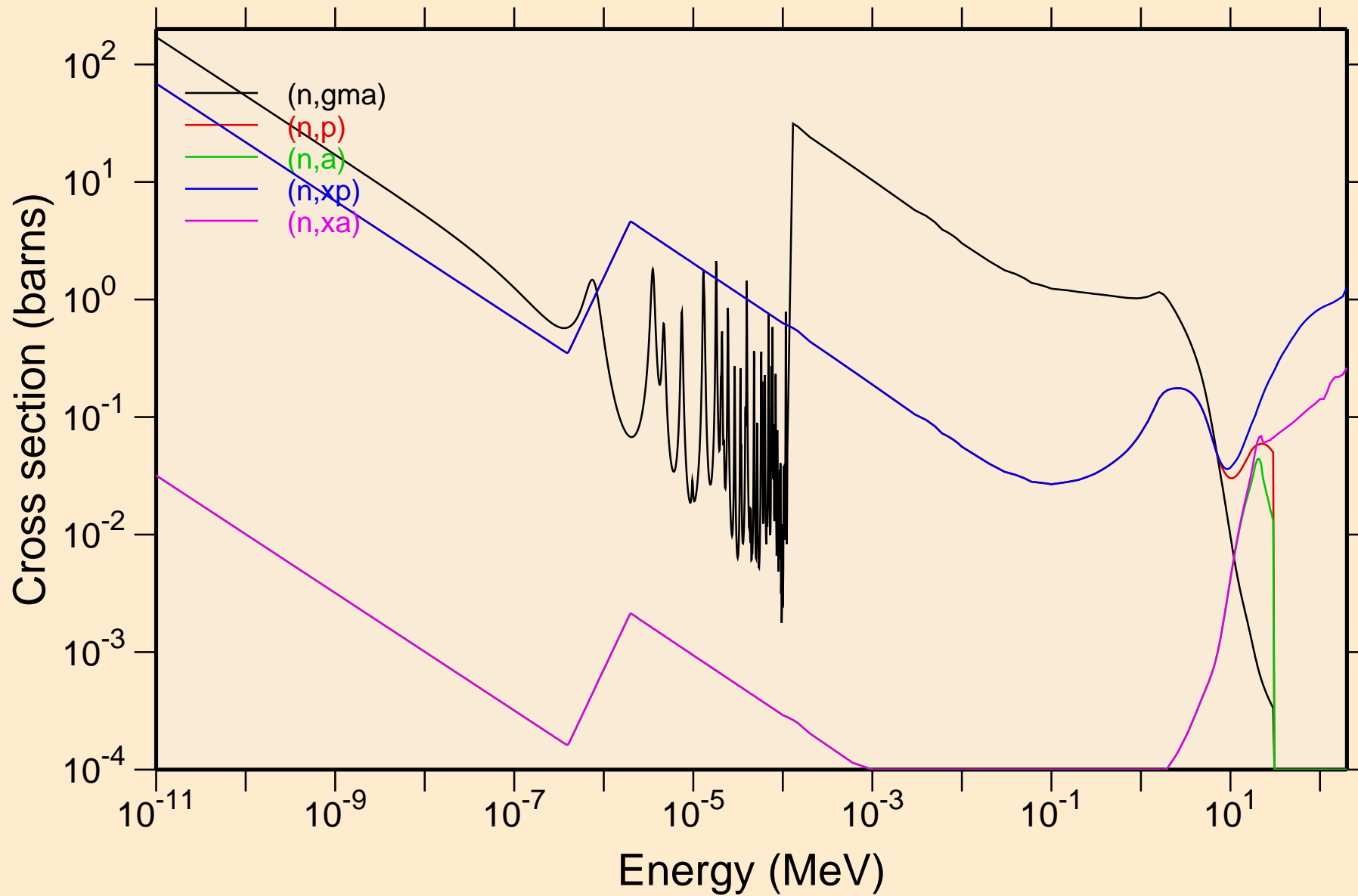

BI199M NEUTRON ACER TENDL-2021 LIBRARY; T=293.6K  
Principal cross sections

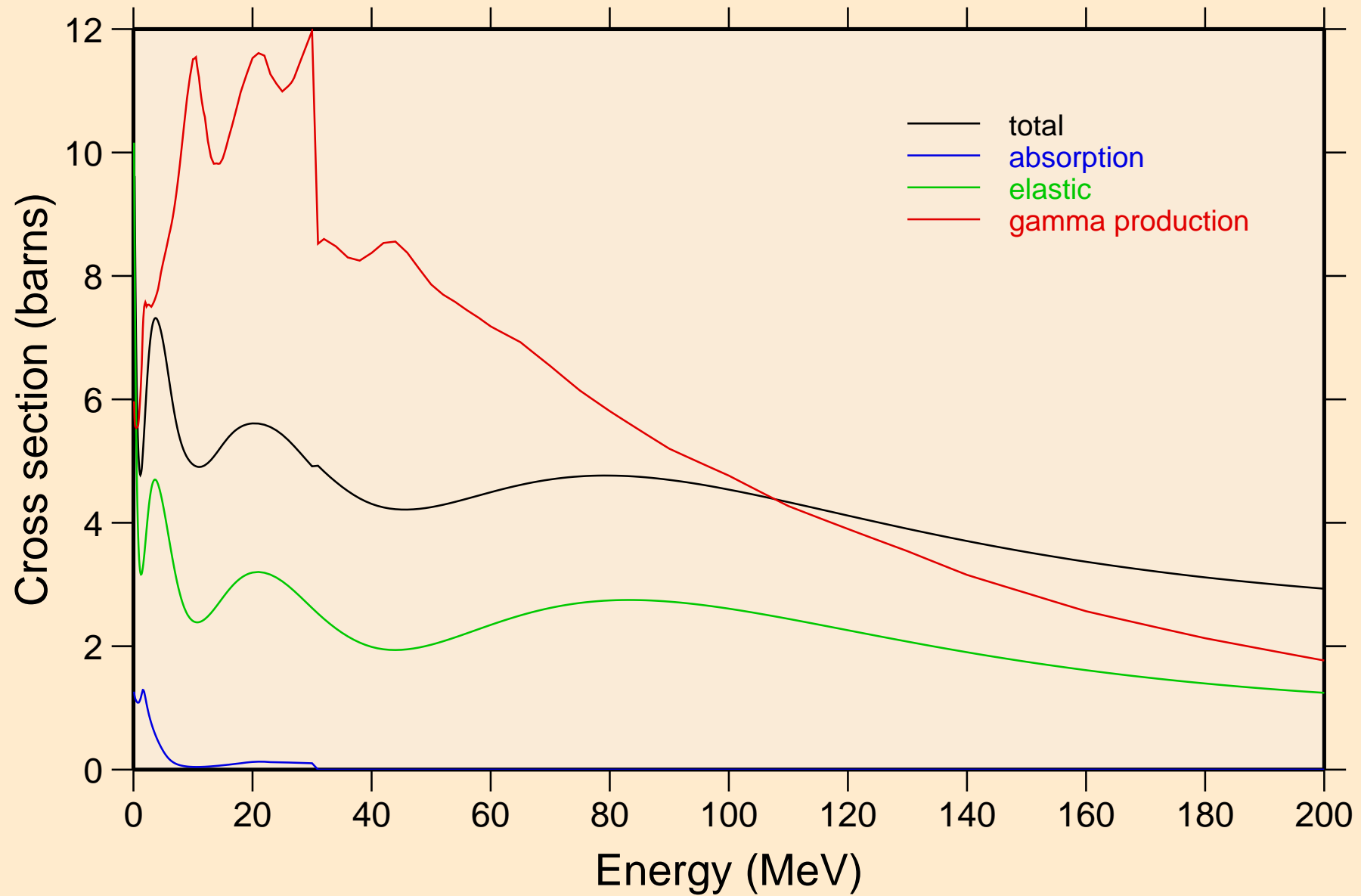

BI199M NEUTRON ACER TENDL-2021 LIBRARY; T=293.6K  
Heating

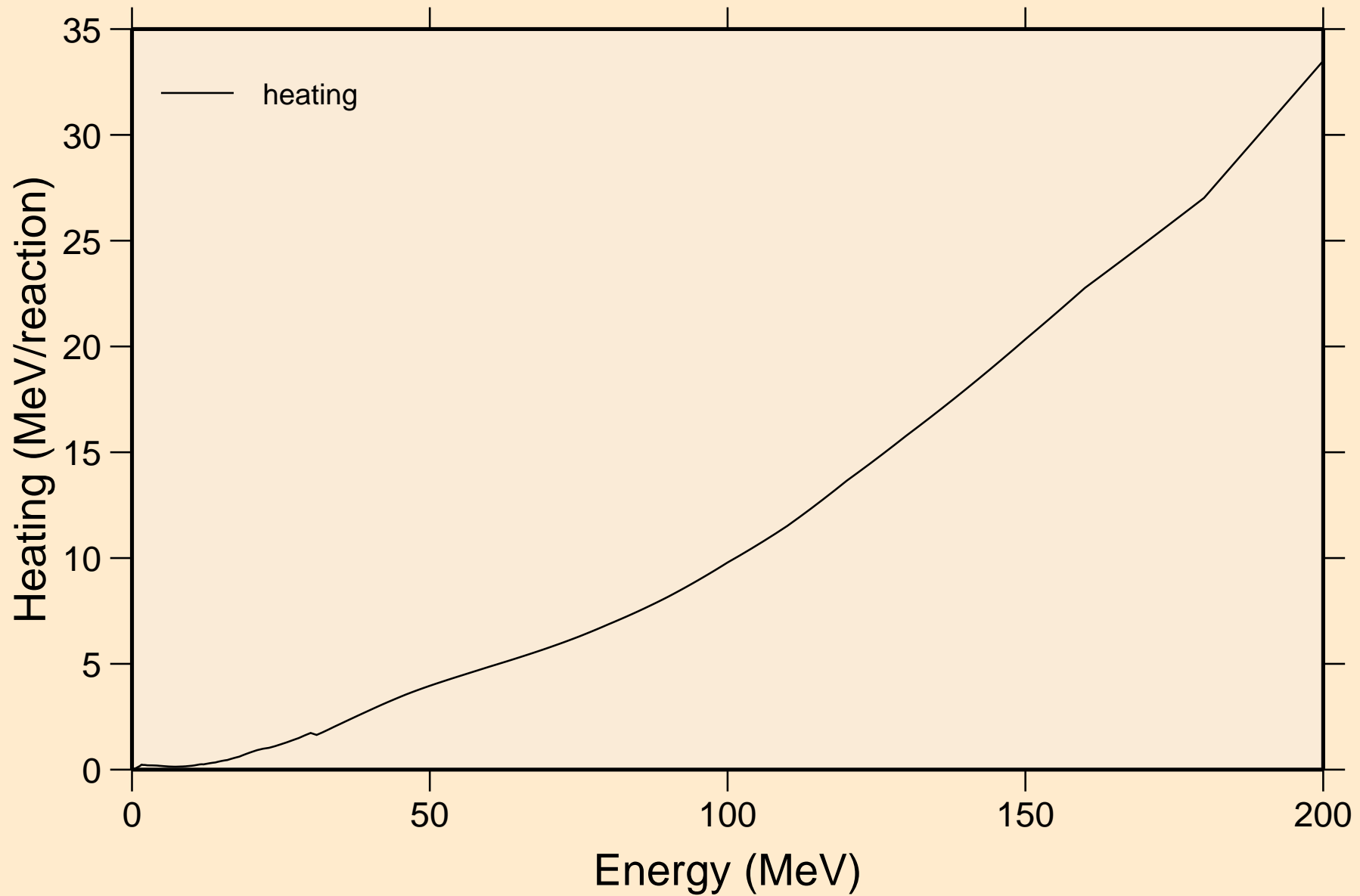



BI199M NEUTRON ACER TENDL-2021 LIBRARY; T=293.6K  
Damage

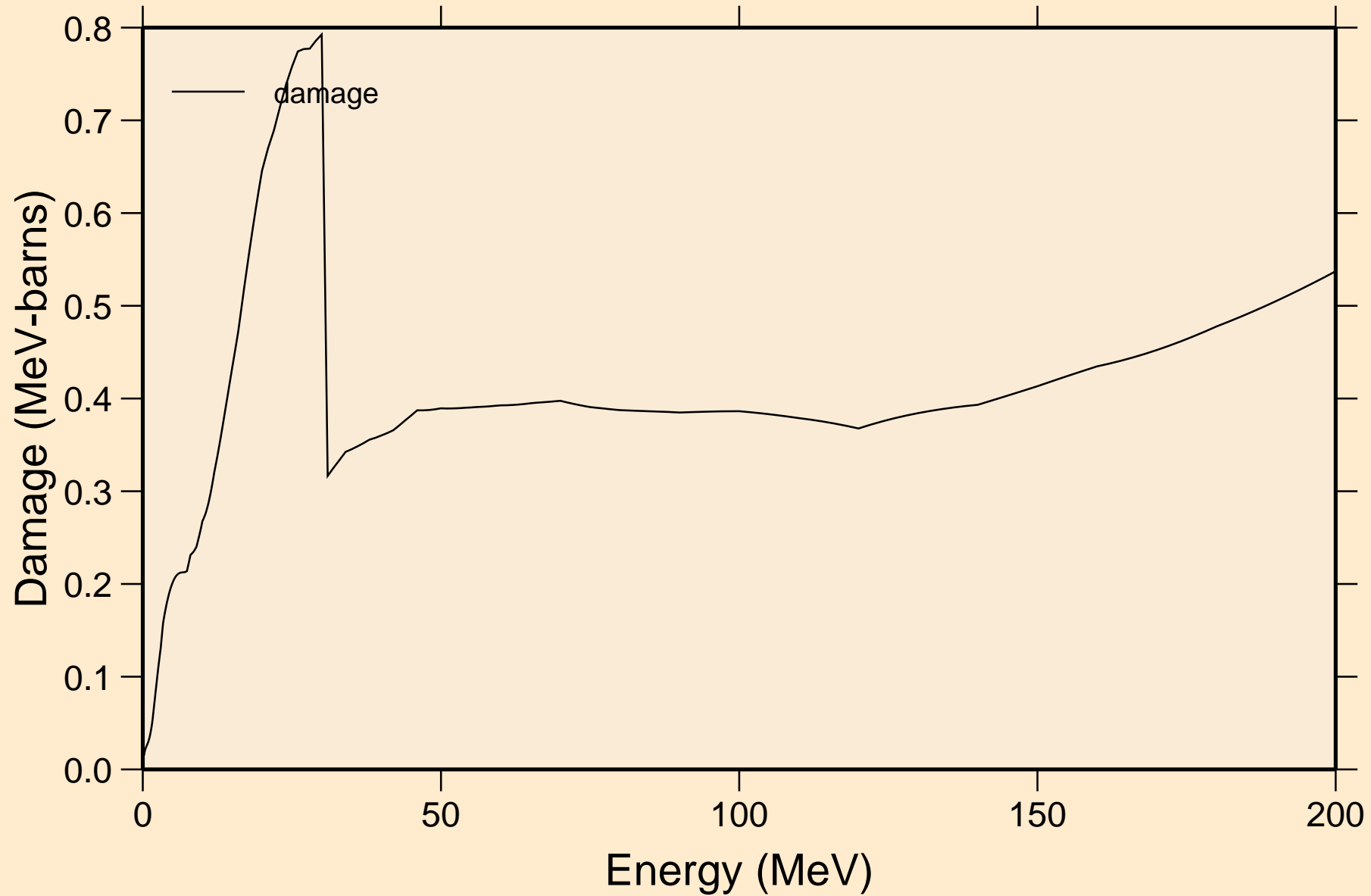

BI199M NEUTRON ACER TENDL-2021 LIBRARY; T=293.6K  
Non-threshold reactions

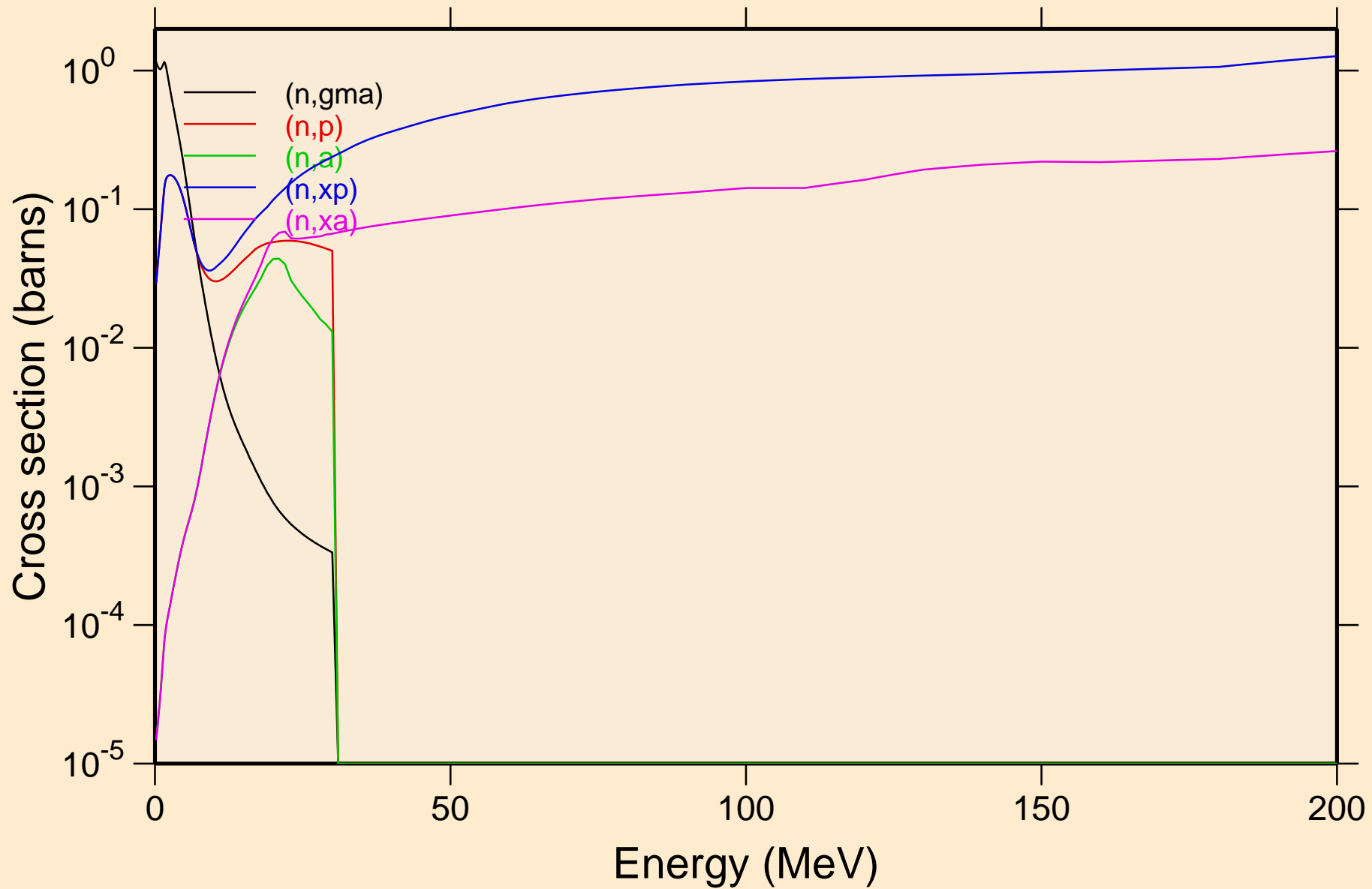

BI199M NEUTRON ACER TENDL-2021 LIBRARY; T=293.6K  
Inelastic levels

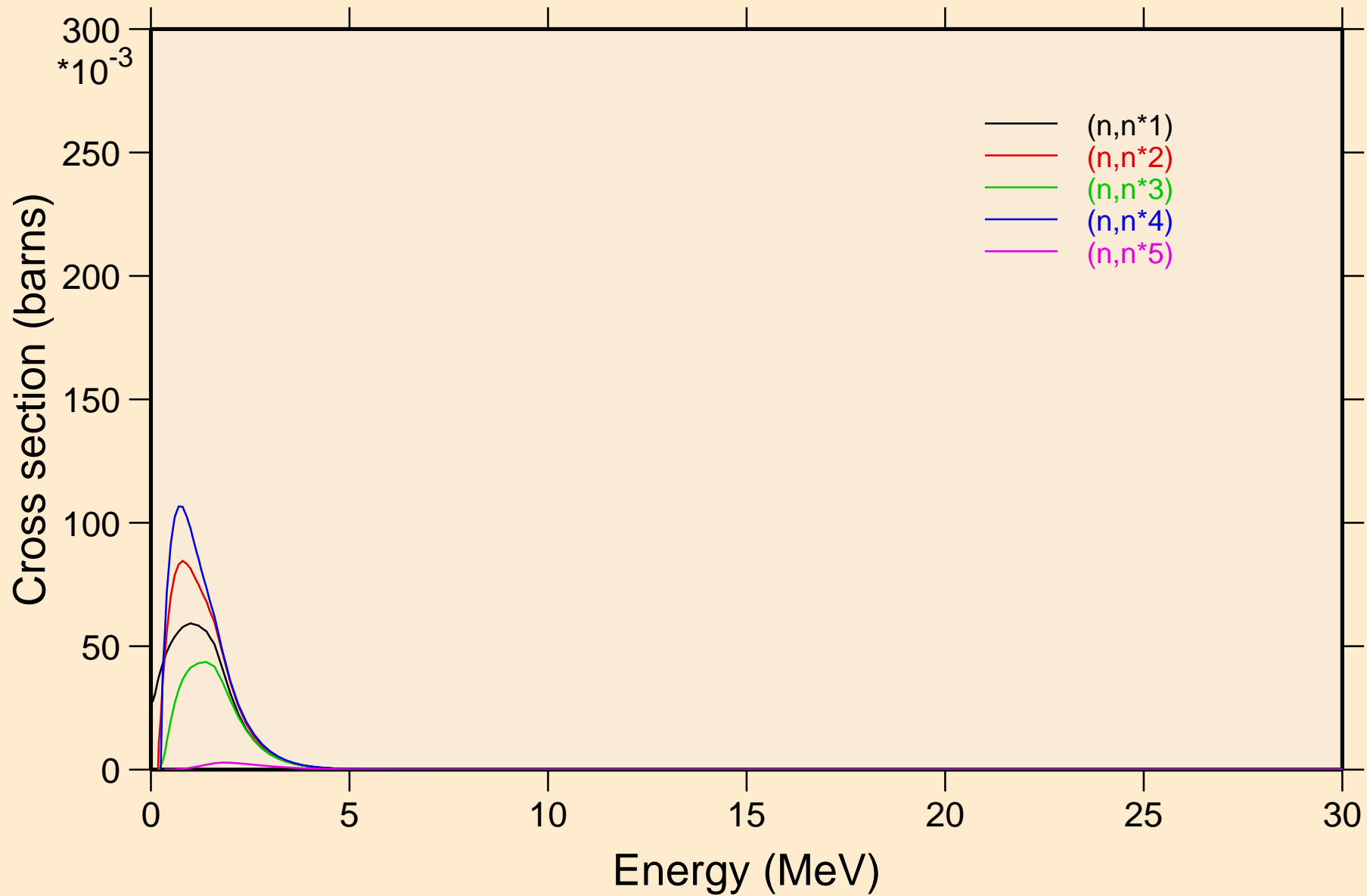

BI199M NEUTRON ACER TENDL-2021 LIBRARY; T=293.6K  
Inelastic levels

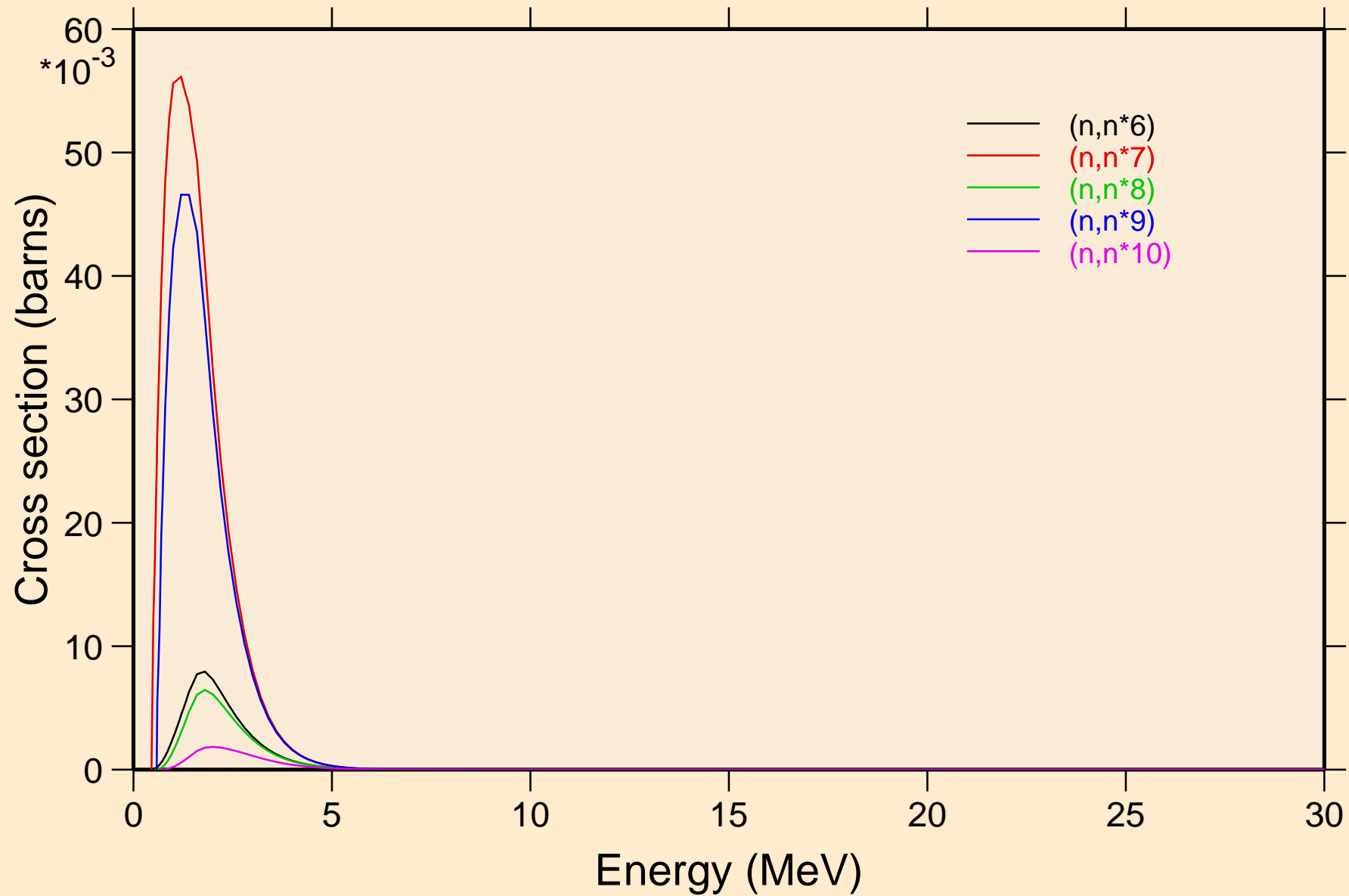

BI199M NEUTRON ACER TENDL-2021 LIBRARY; T=293.6K  
Inelastic levels

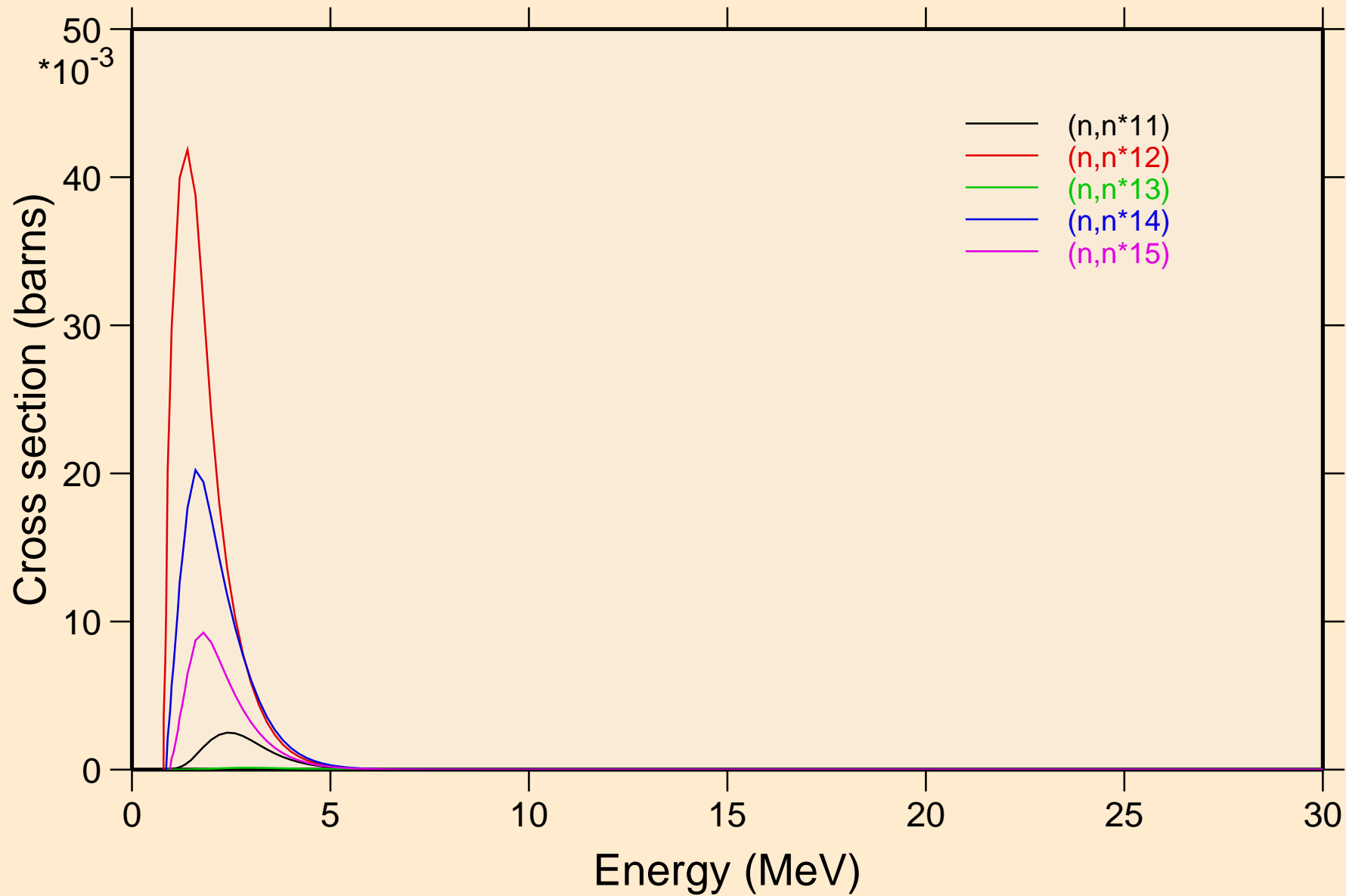

BI199M NEUTRON ACER TENDL-2021 LIBRARY; T=293.6K  
Inelastic levels

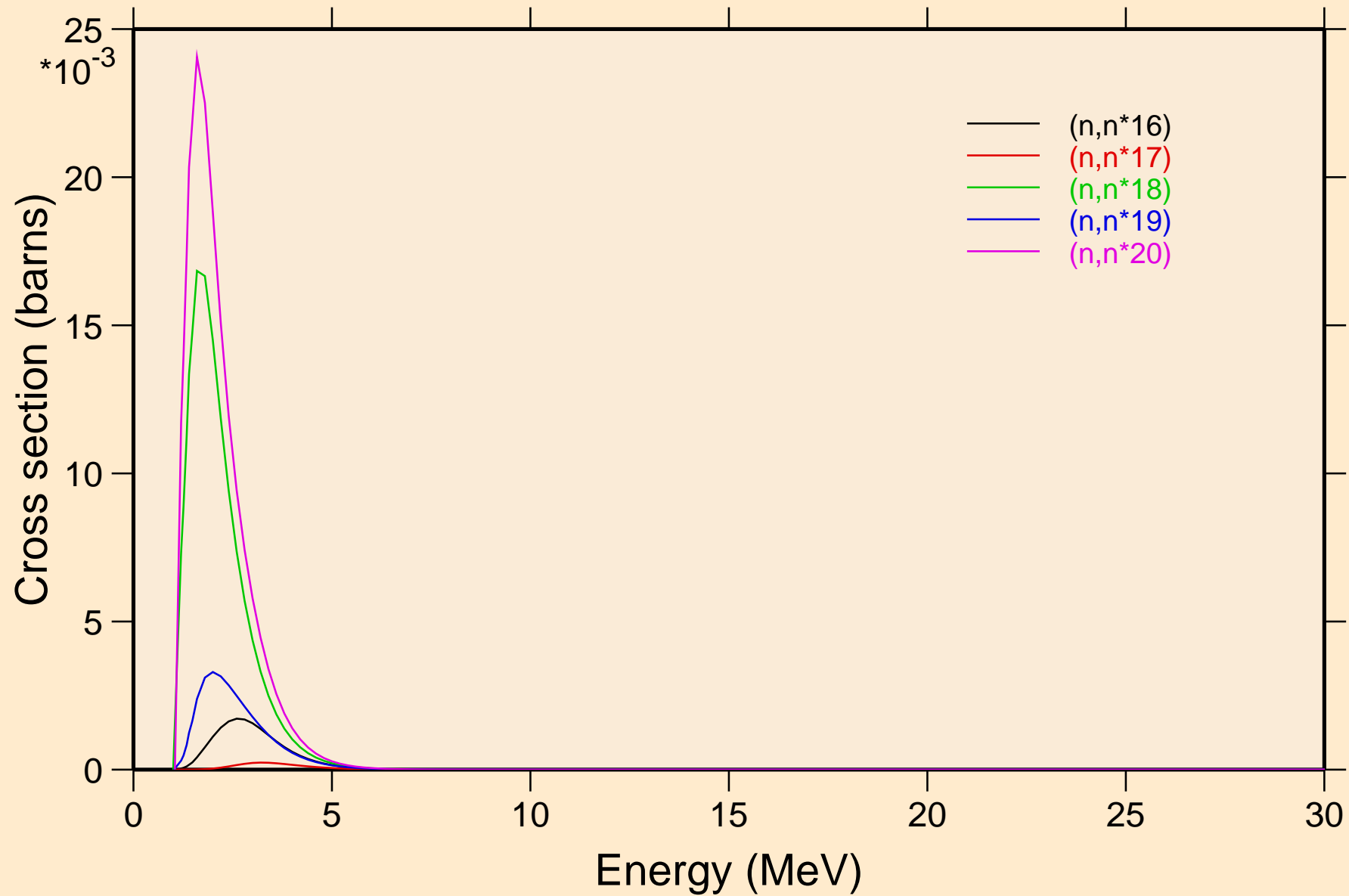

BI199M NEUTRON ACER TENDL-2021 LIBRARY; T=293.6K  
Inelastic levels

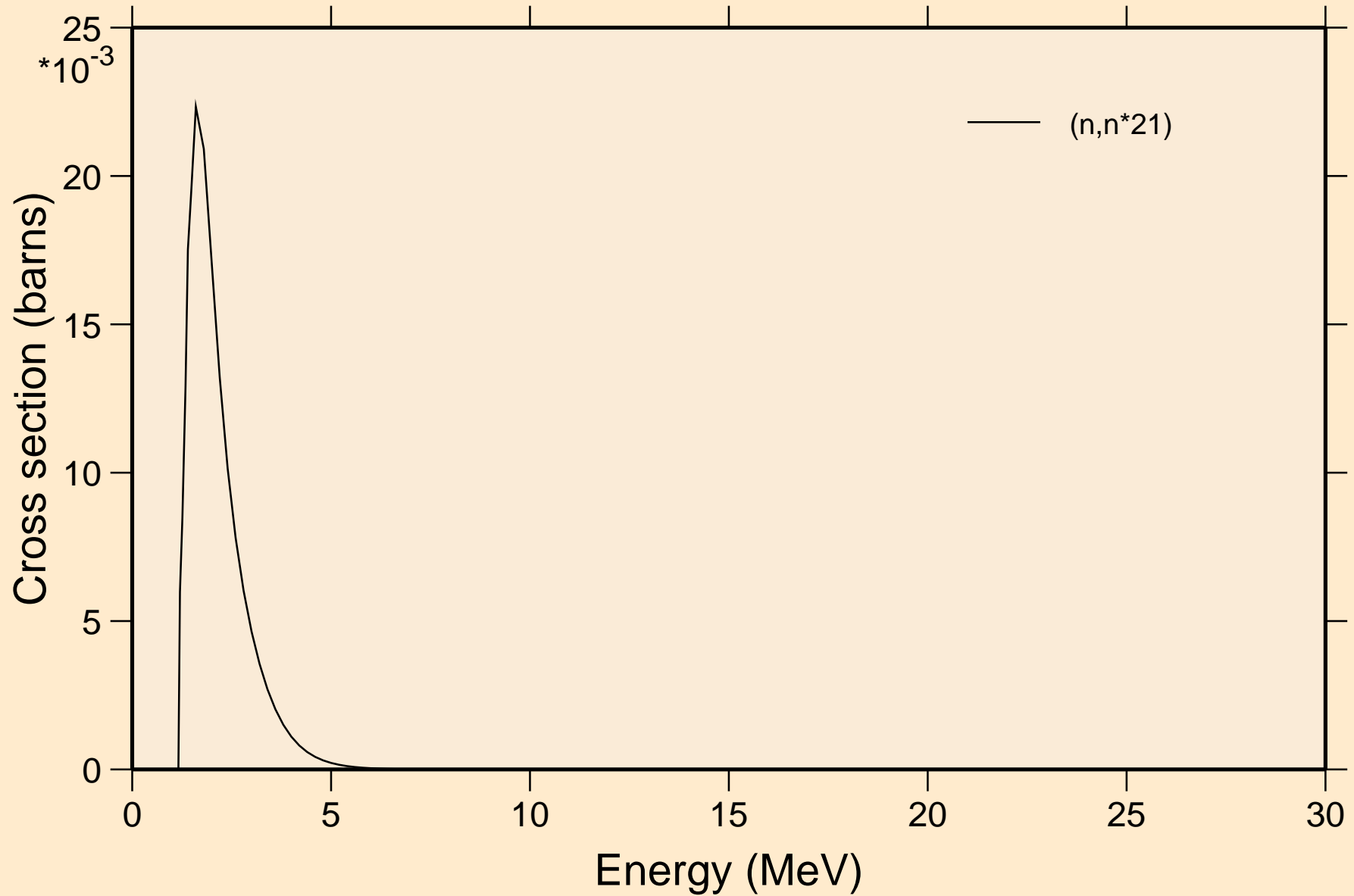

BI199M NEUTRON ACER TENDL-2021 LIBRARY; T=293.6K  
Threshold reactions

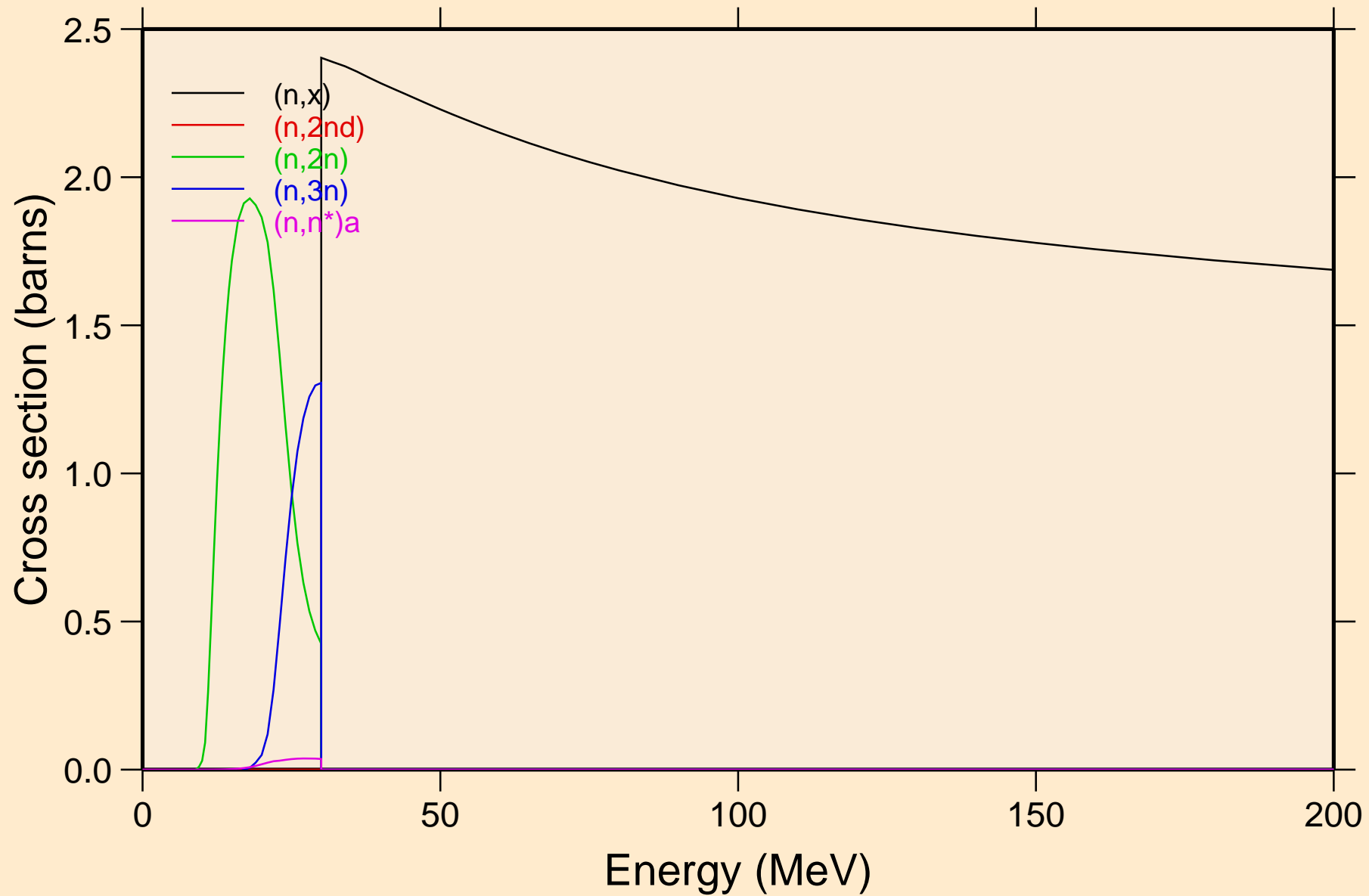



BI199M NEUTRON ACER TENDL-2021 LIBRARY; T=293.6K  
Threshold reactions

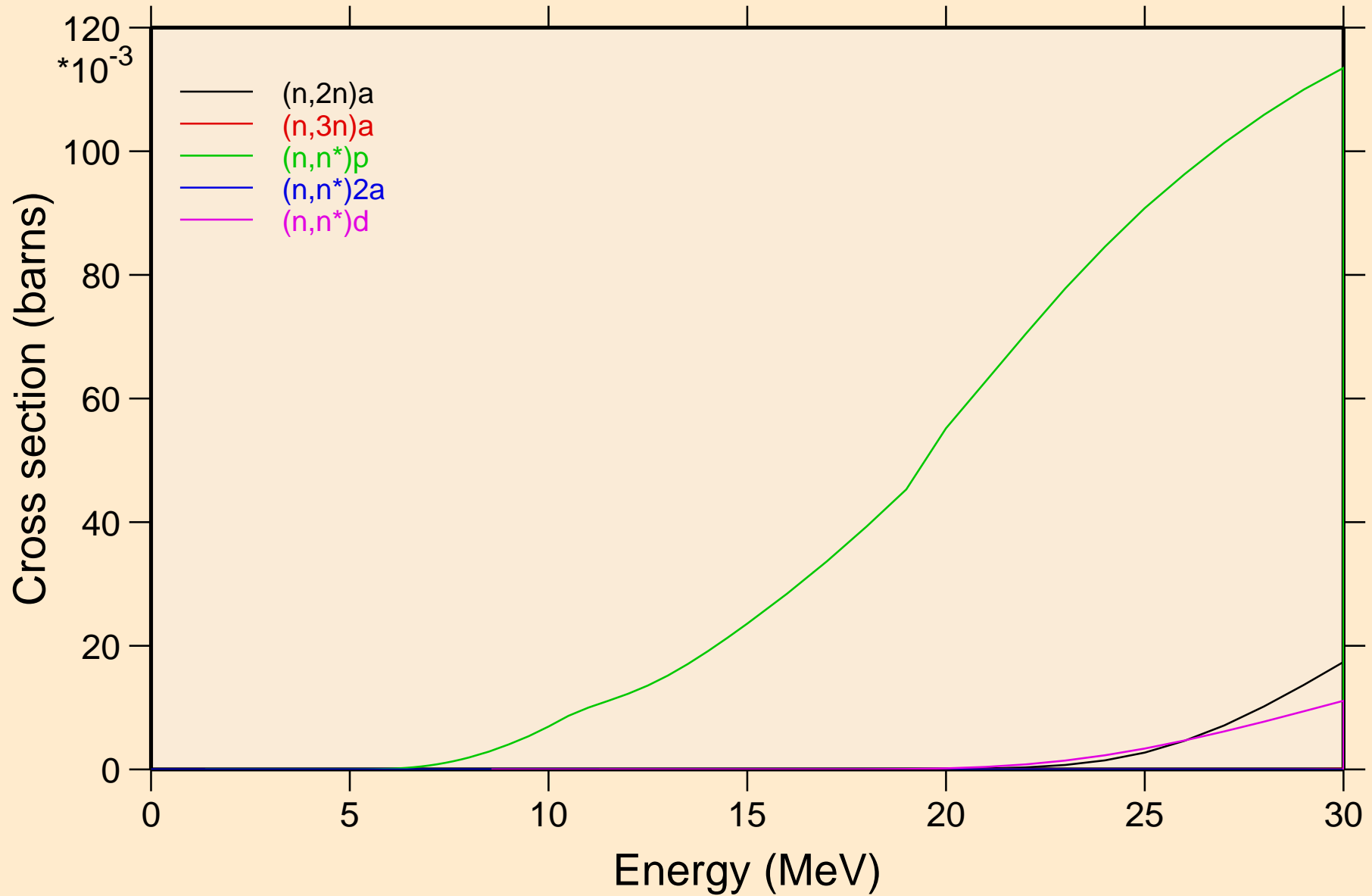

BI199M NEUTRON ACER TENDL-2021 LIBRARY; T=293.6K  
Threshold reactions

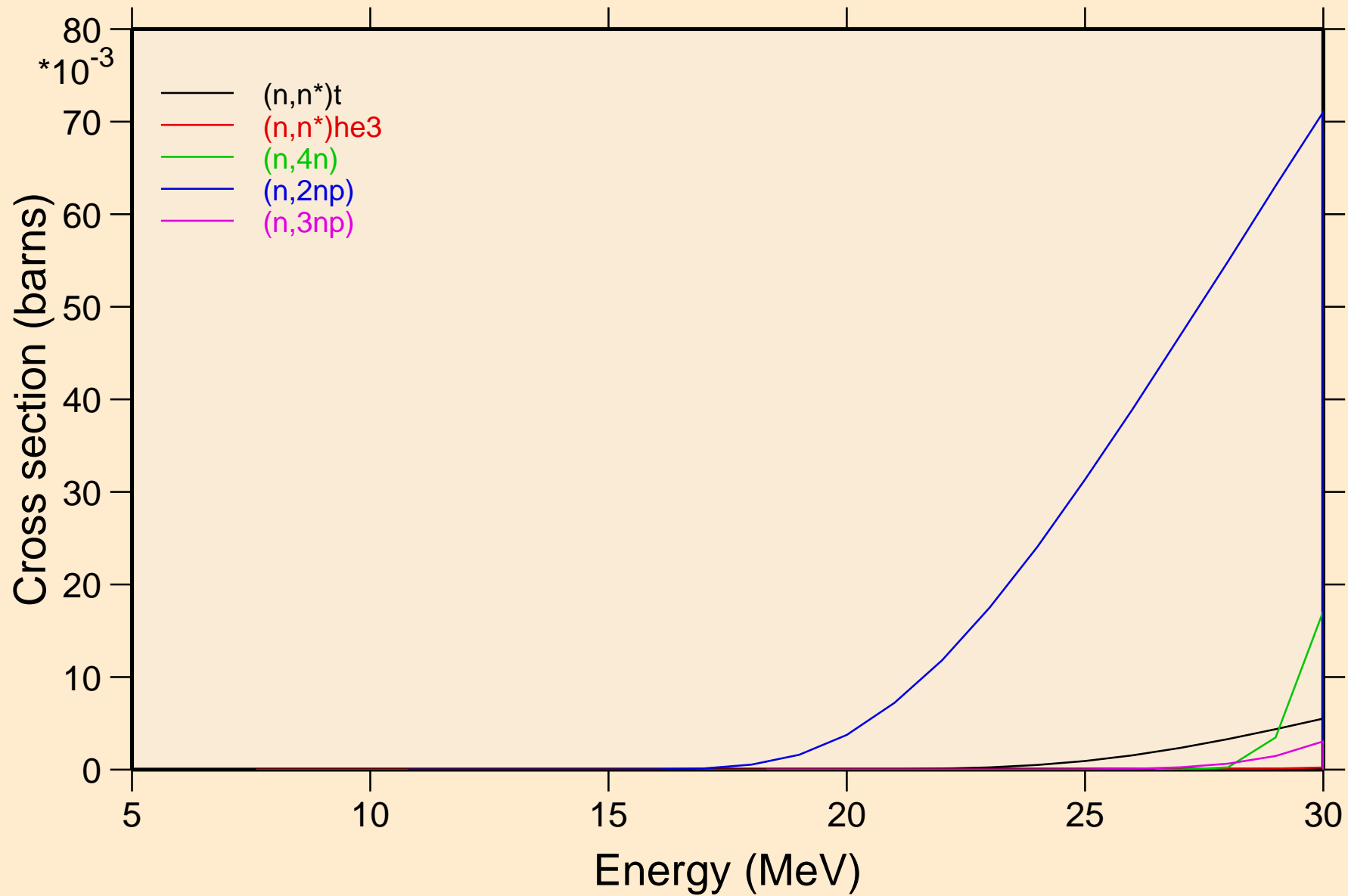

BI199M NEUTRON ACER TENDL-2021 LIBRARY; T=293.6K  
Threshold reactions

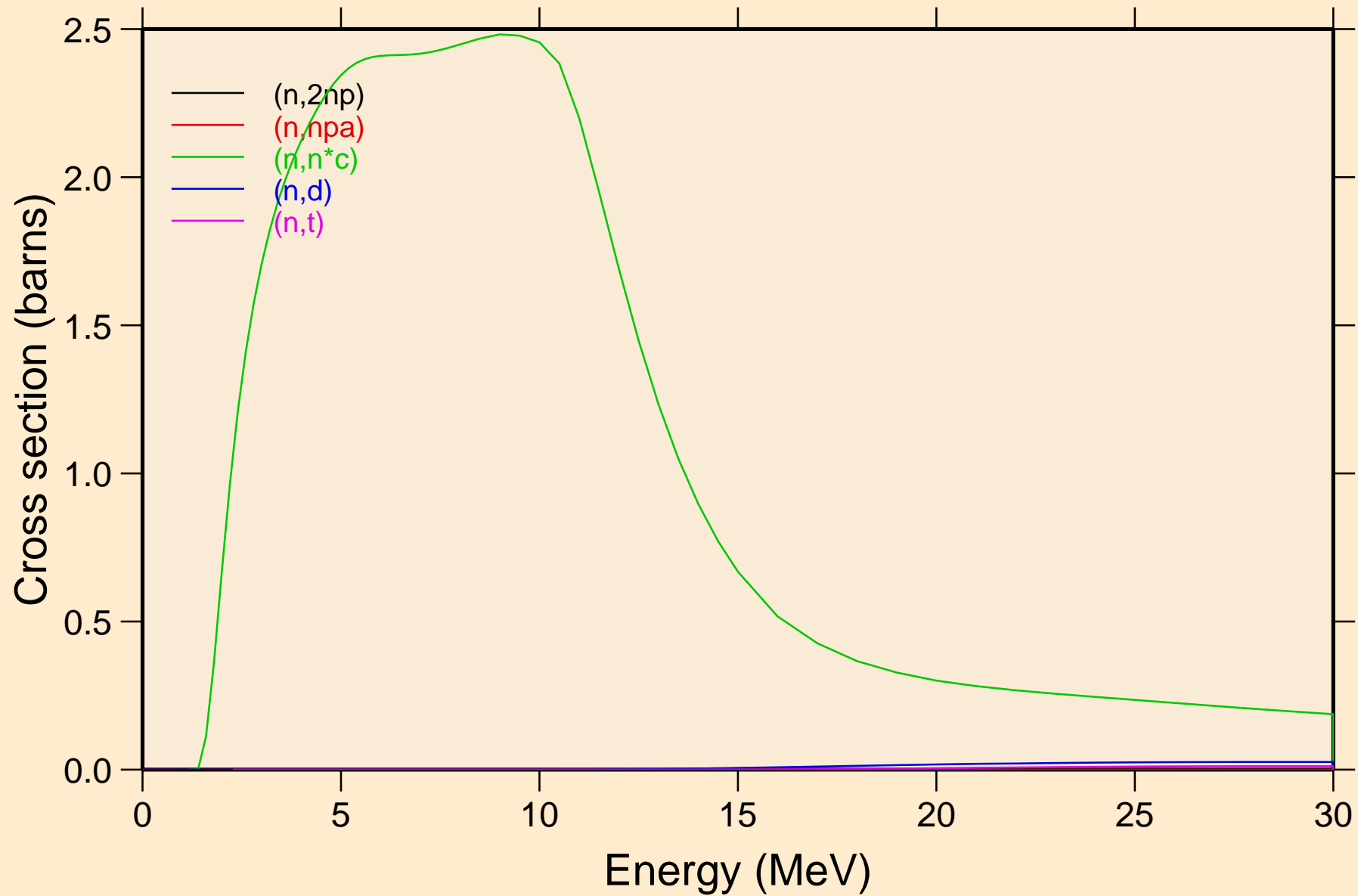

BI199M NEUTRON ACER TENDL-2021 LIBRARY; T=293.6K  
Threshold reactions

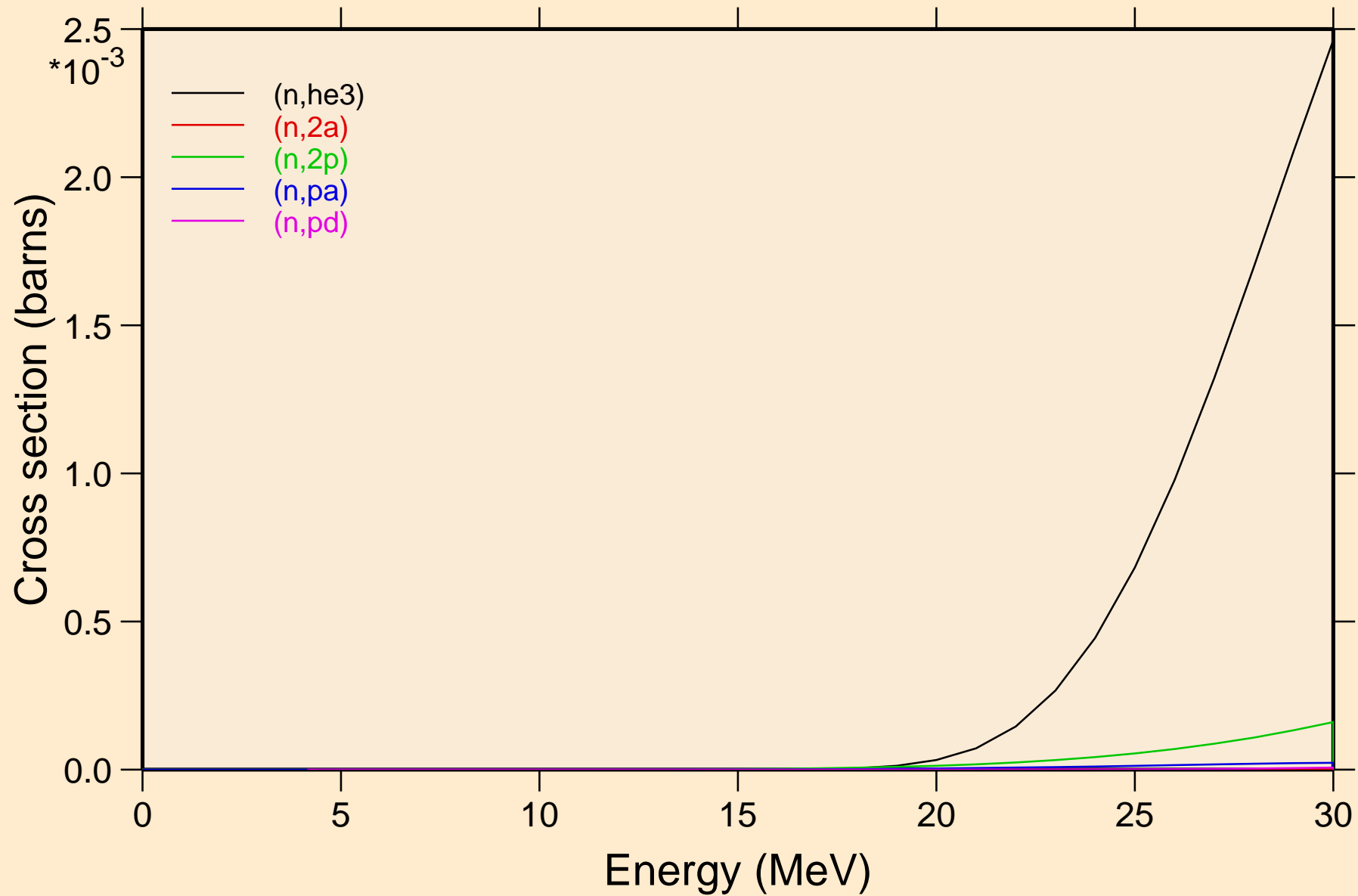

BI199M NEUTRON ACER TENDL-2021 LIBRARY; T=293.6K  
Threshold reactions

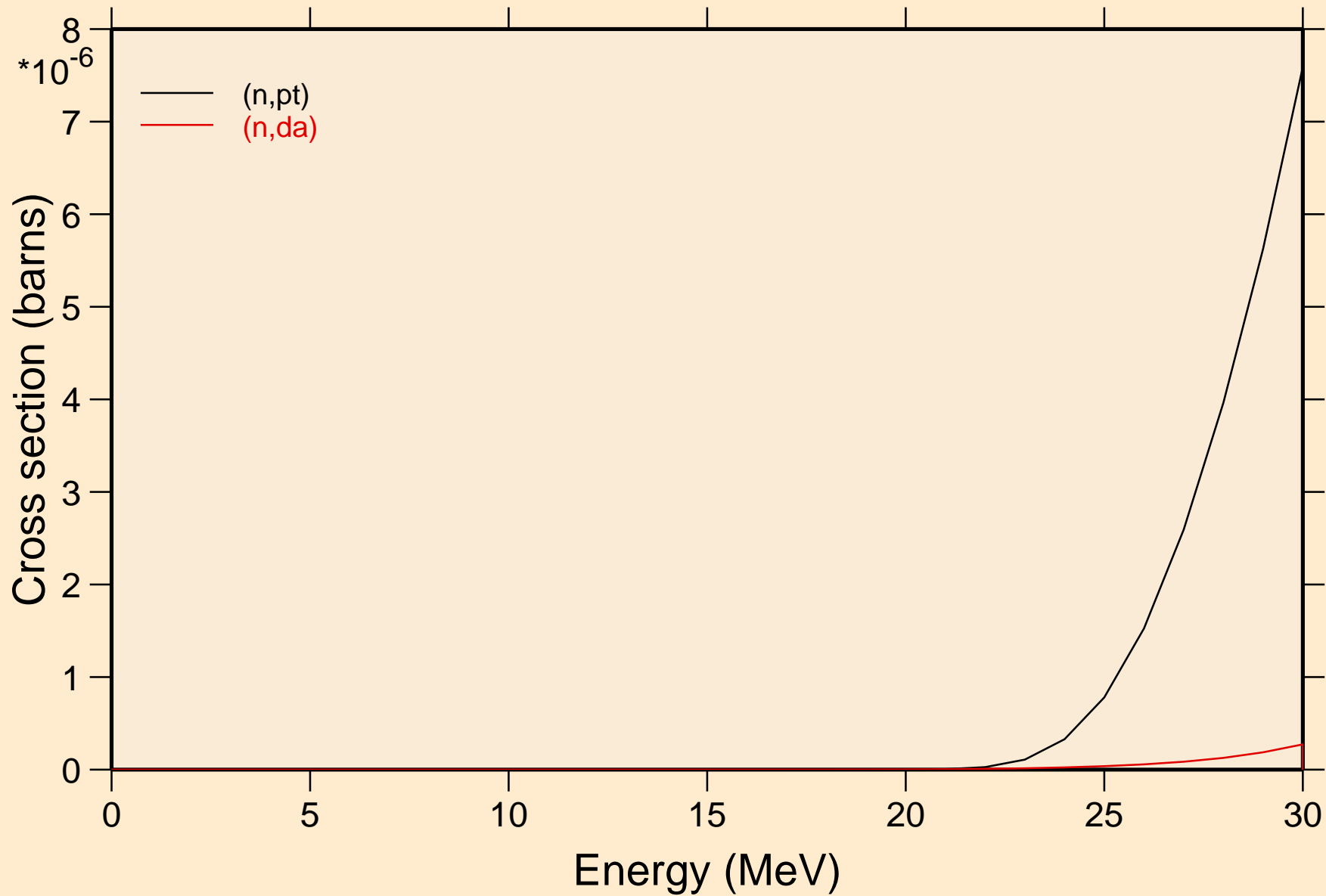

BI199M NEUTRON ACER TENDL-2021 LIBRARY; T=293.6K  
Threshold reactions

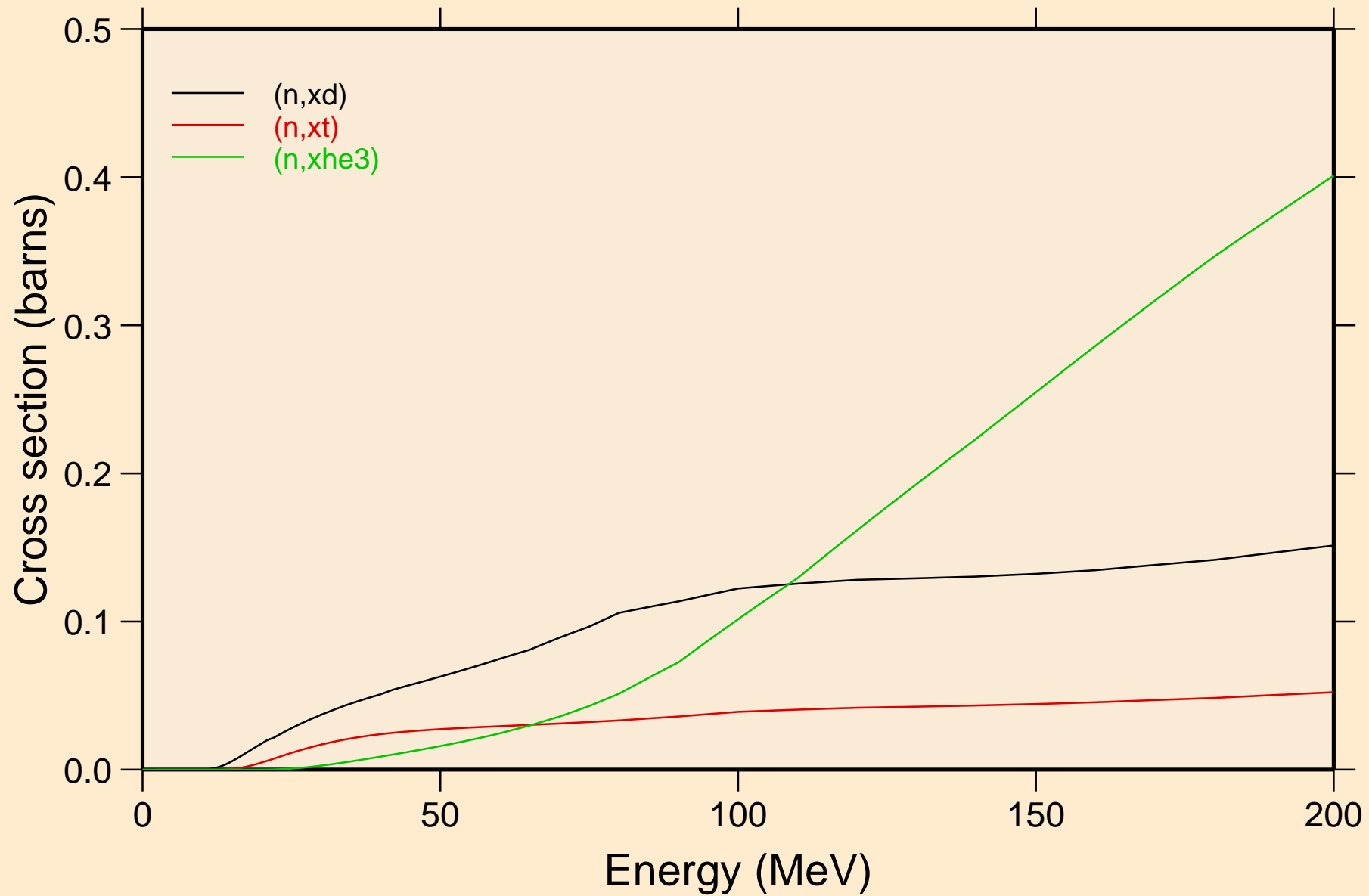

BI199M NEUTRON ACER TENDL-2021 LIBRARY; T=293.6K  
angular distribution for elastic

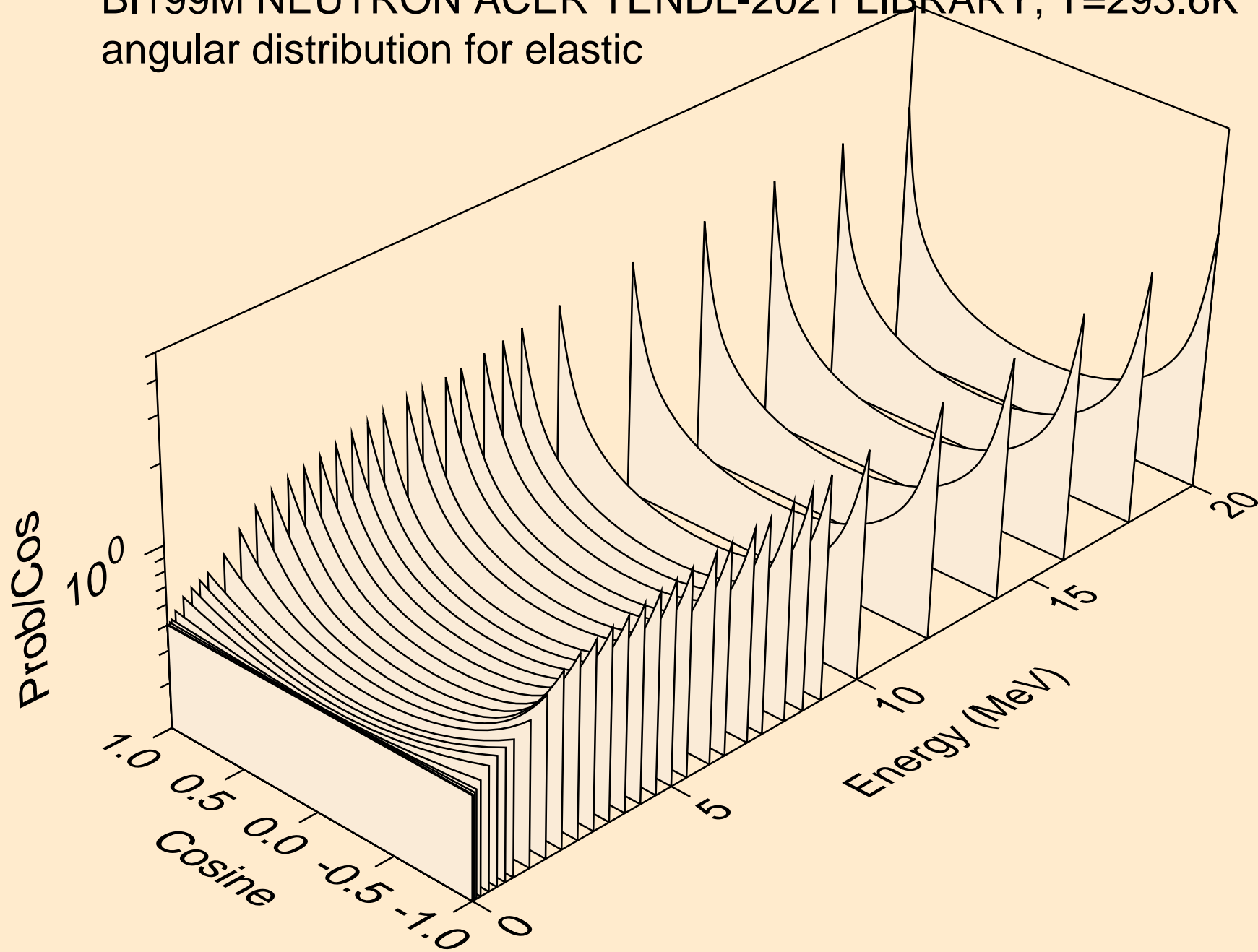

BI199M NEUTRON ACER TENDL-2021 LIBRARY; T=293.6K  
angular distribution for elastic

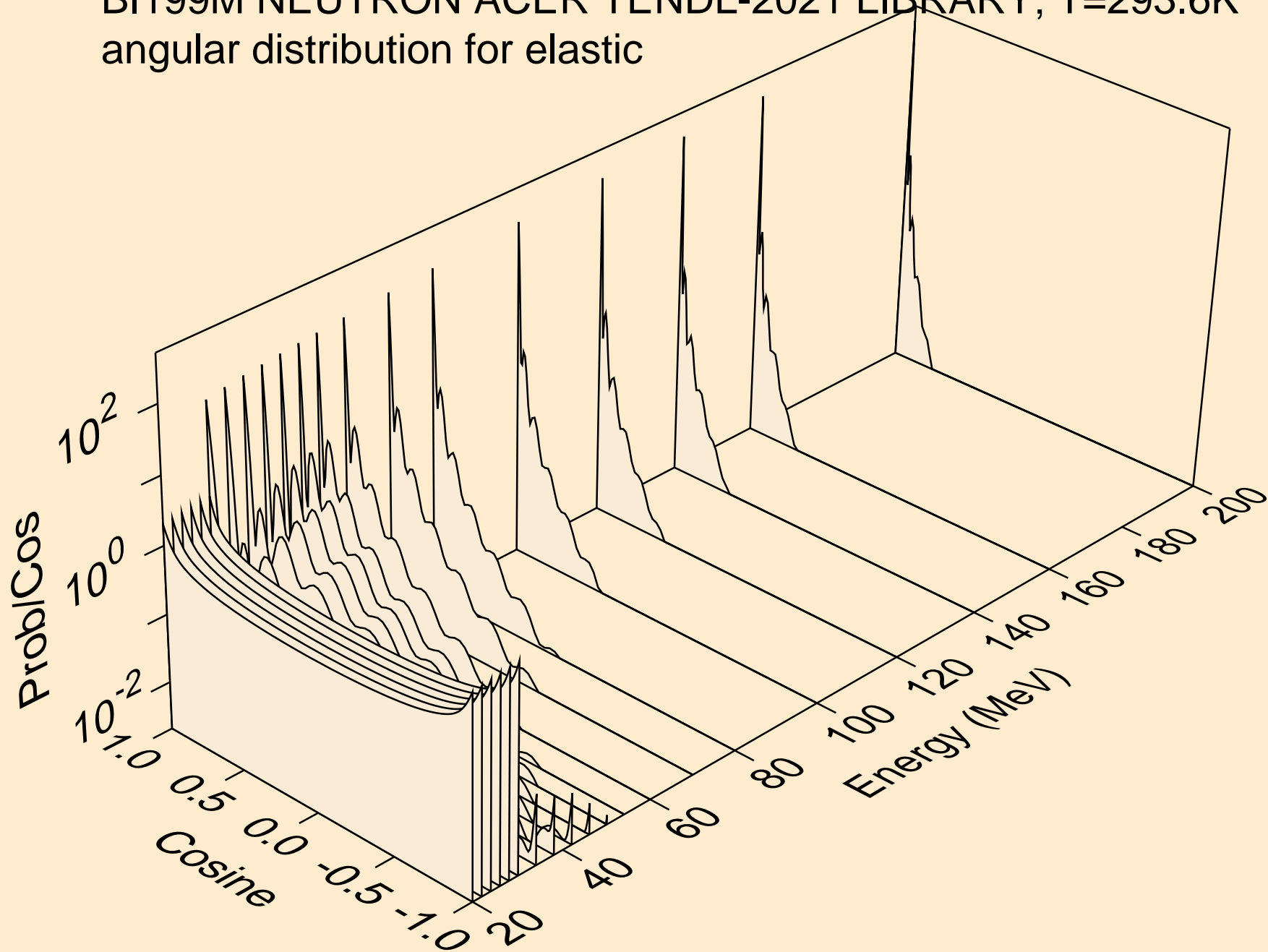



BI199M NEUTRON ACER TENDL-2021 LIBRARY; T=293.6K  
angular distribution for (n,n\*1)

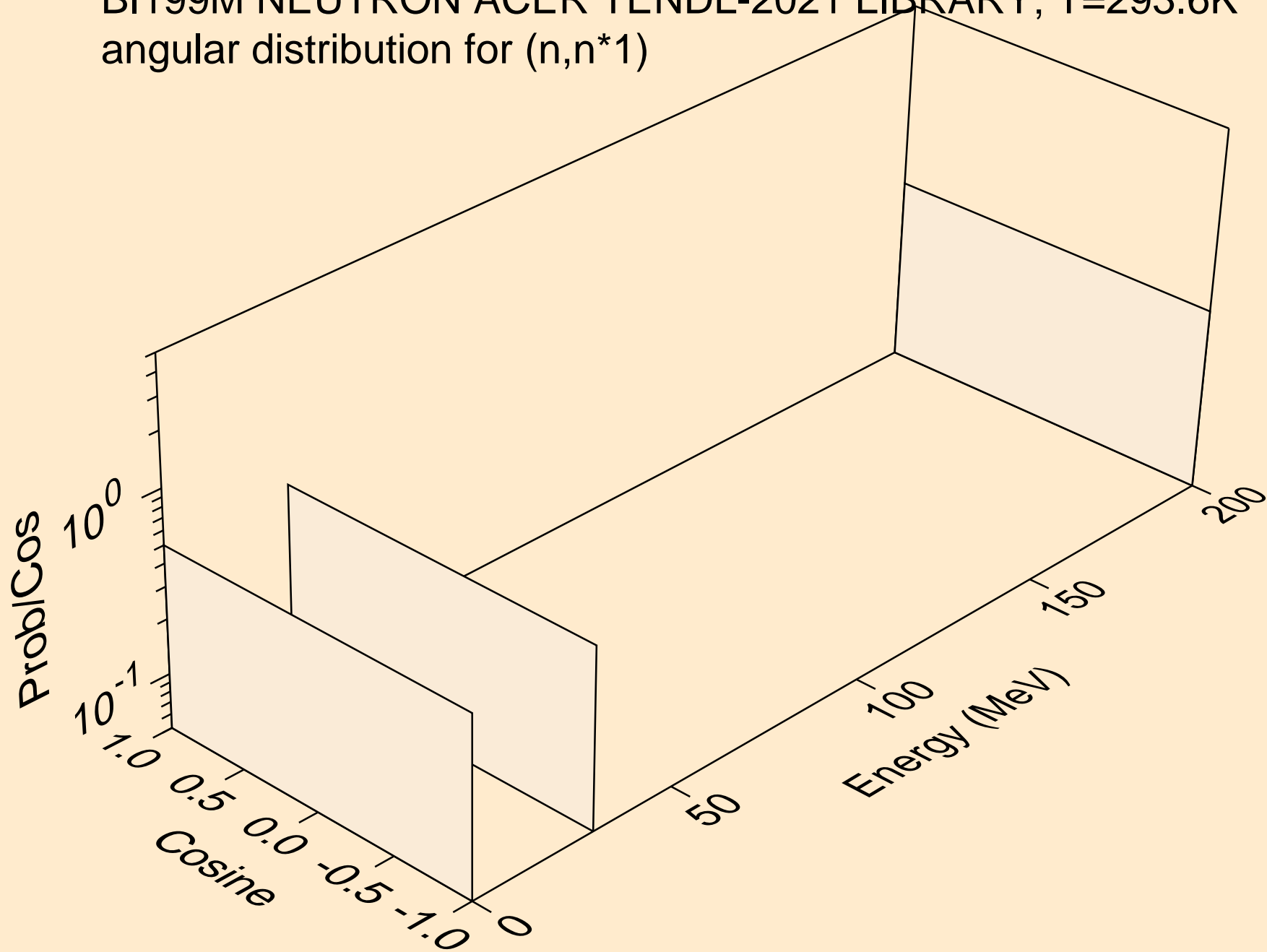

BI199M NEUTRON ACER TENDL-2021 LIBRARY; T=293.6K  
angular distribution for (n,n\*2)

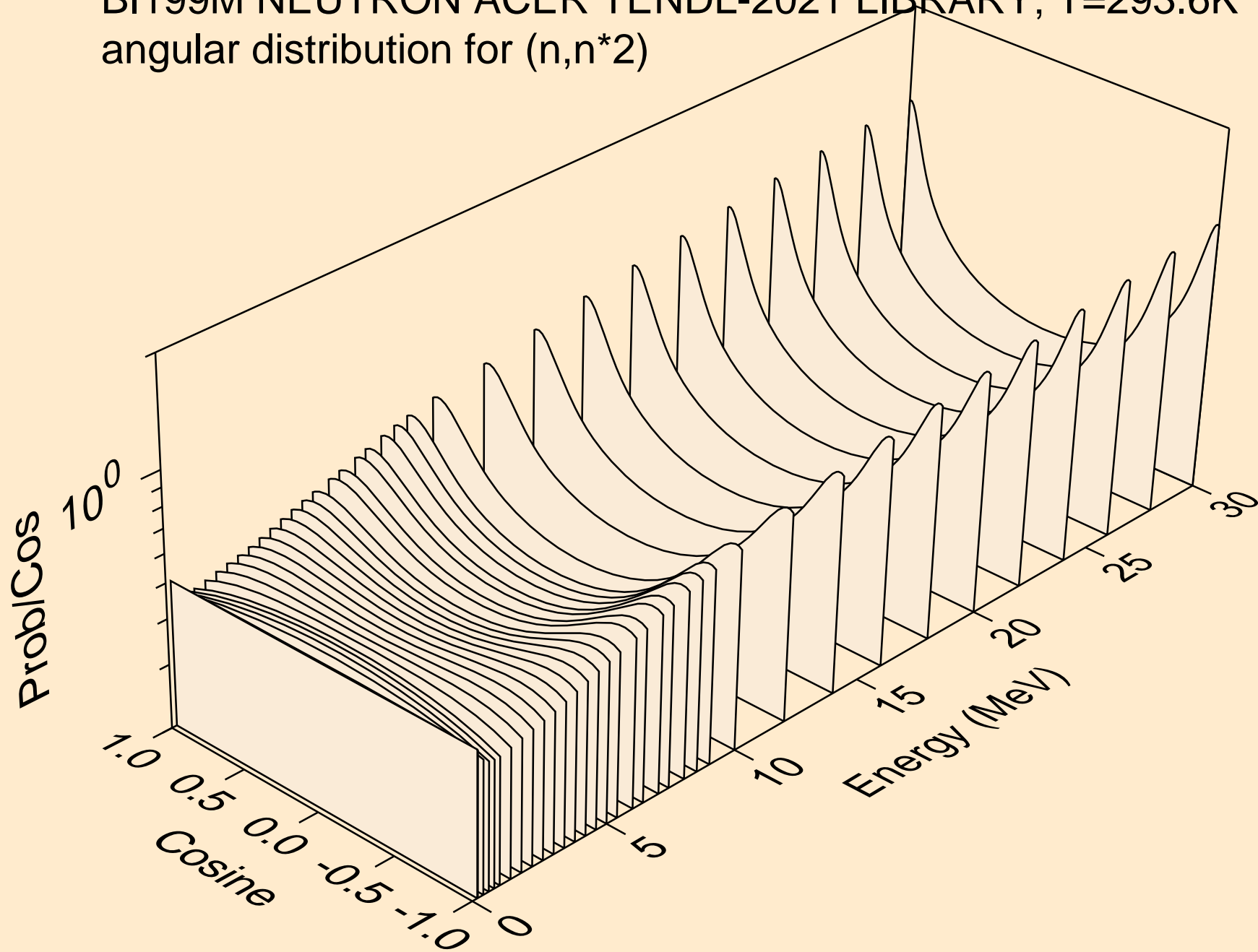

BI199M NEUTRON ACER TENDL-2021 LIBRARY; T=293.6K  
angular distribution for (n,n\*3)

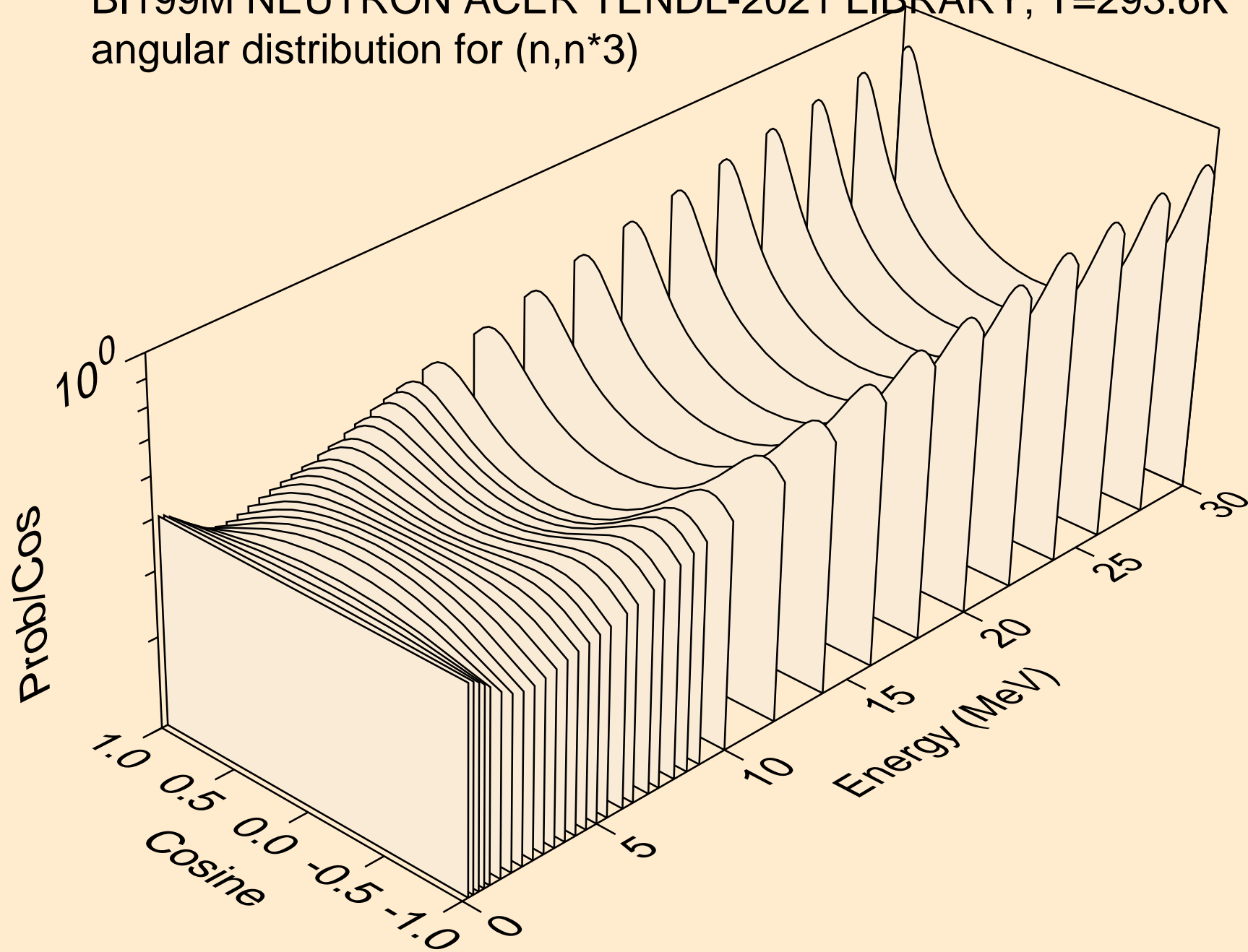

BI199M NEUTRON ACER TENDL-2021 LIBRARY; T=293.6K  
angular distribution for (n,n\*4)

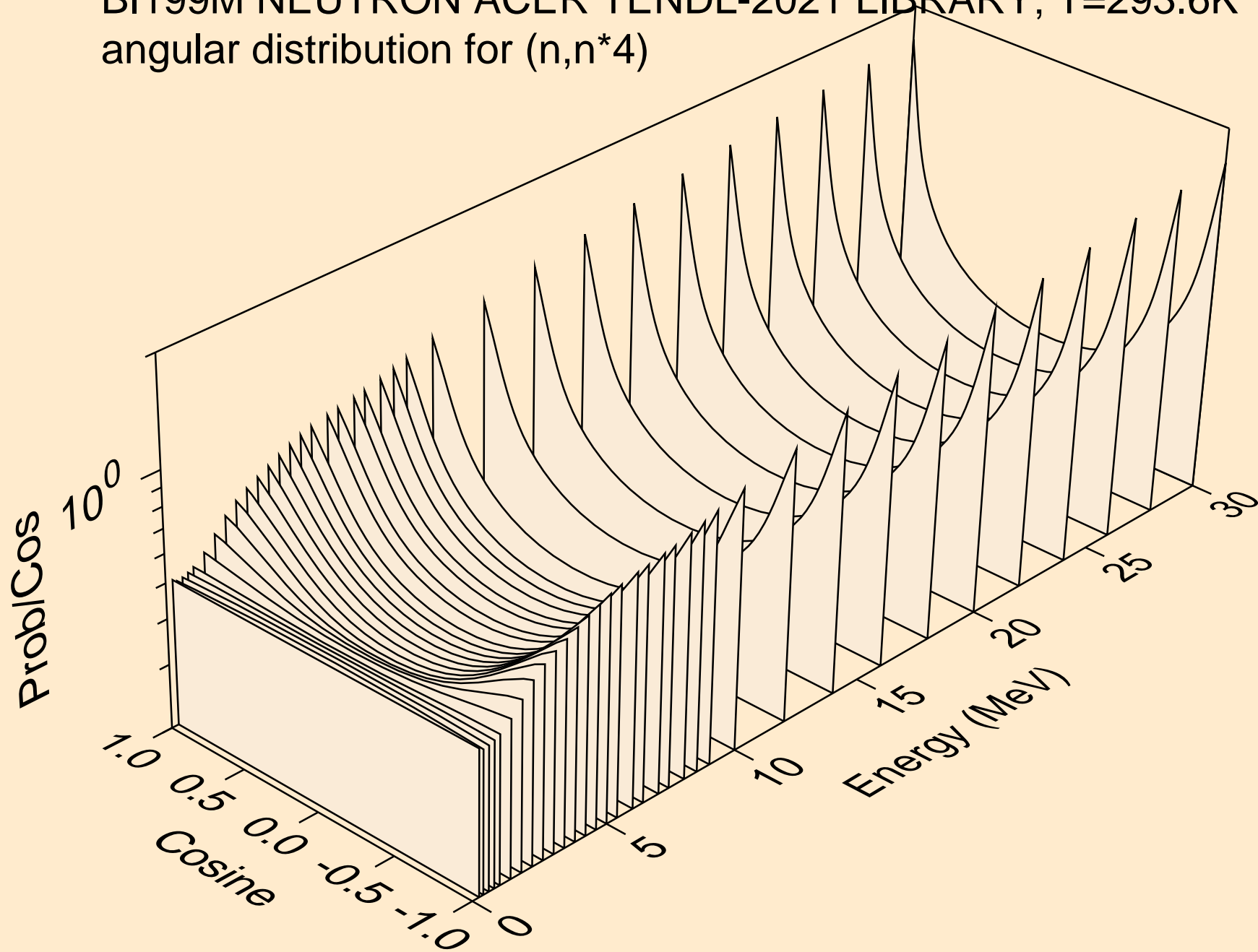

BI199M NEUTRON ACER TENDL-2021 LIBRARY; T=293.6K  
angular distribution for (n,n\*5)

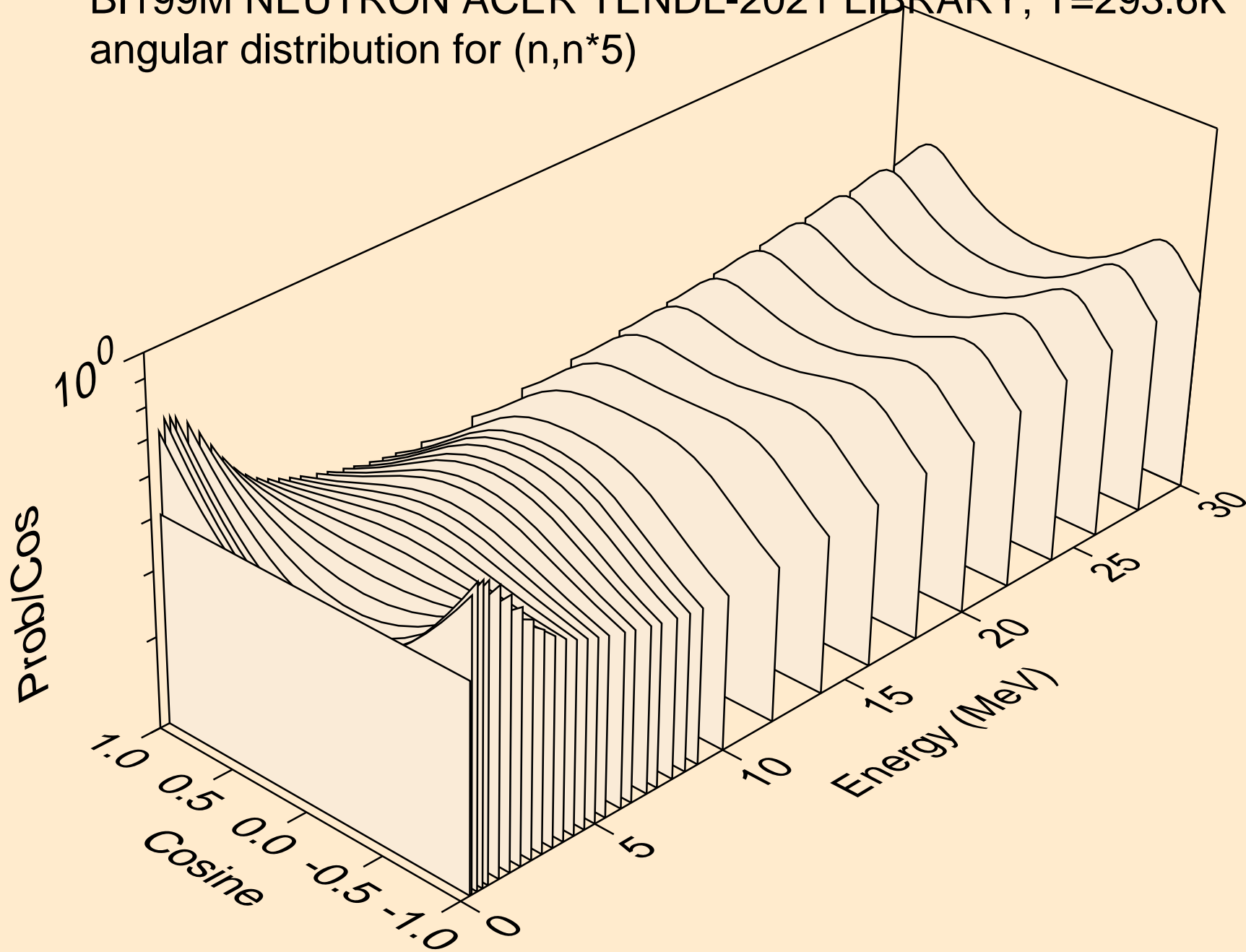

BI199M NEUTRON ACER TENDL-2021 LIBRARY; T=293.6K  
angular distribution for (n,n\*6)

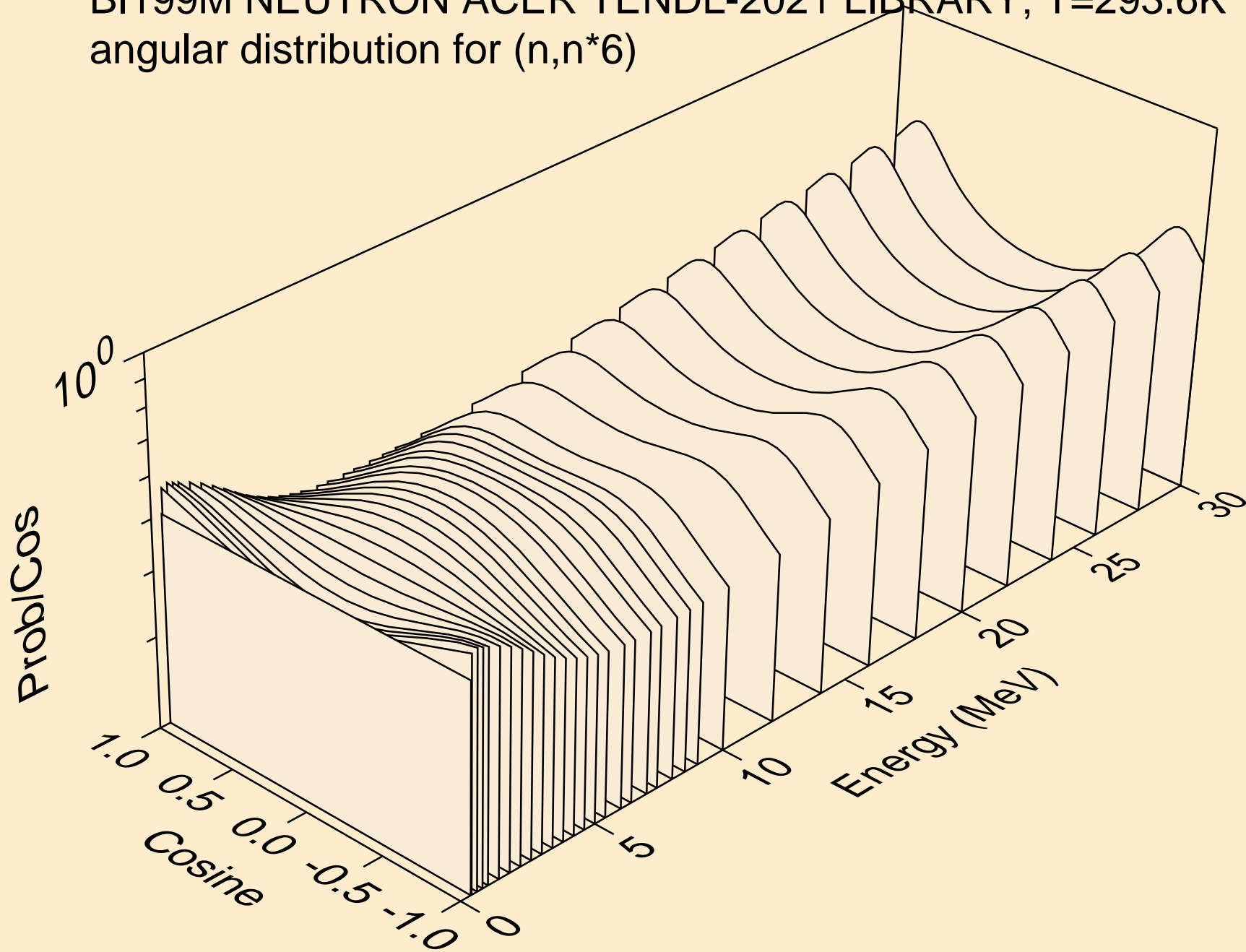

BI199M NEUTRON ACER TENDL-2021 LIBRARY; T=293.6K  
angular distribution for (n,n\*7)

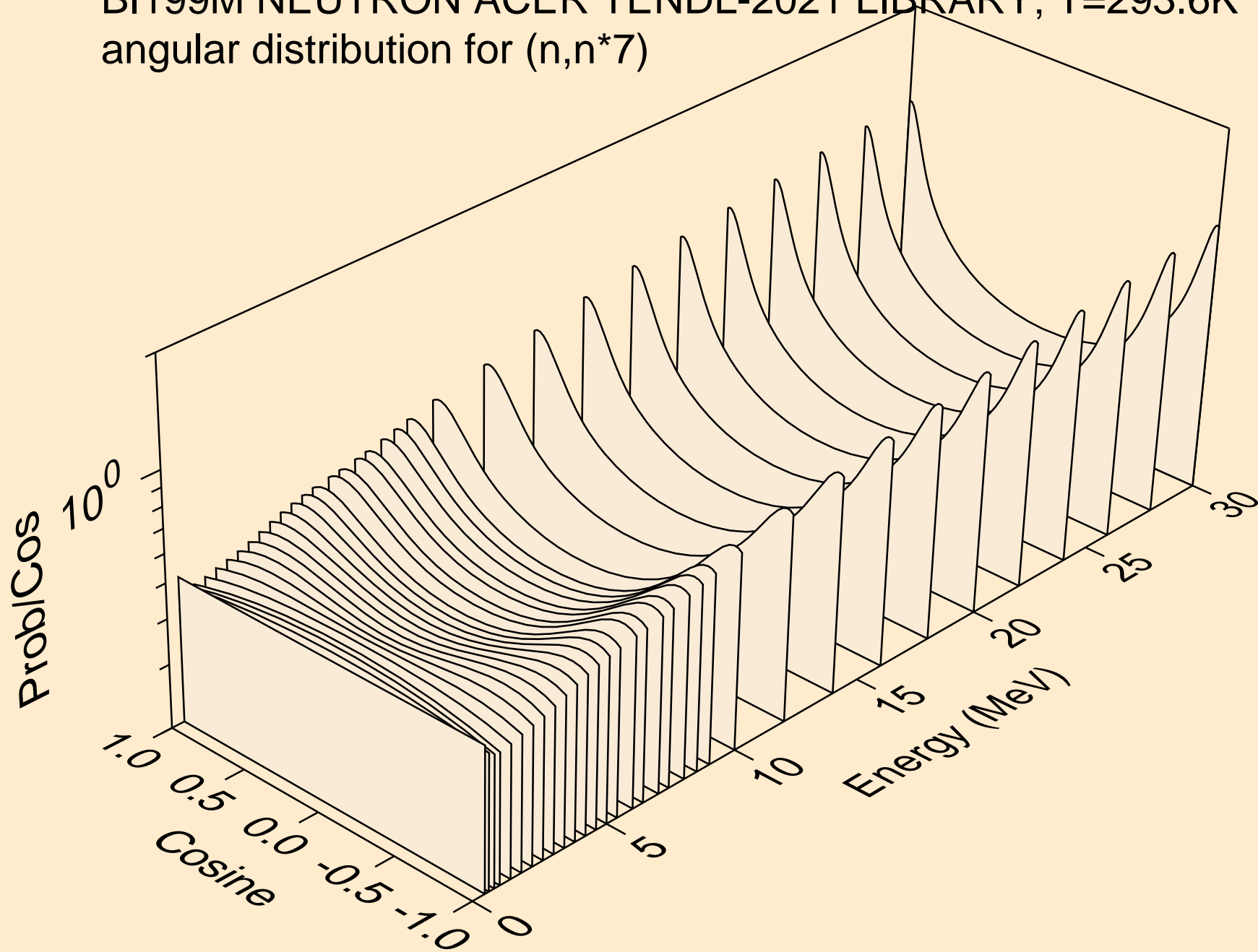

BI199M NEUTRON ACER TENDL-2021 LIBRARY; T=293.6K  
angular distribution for (n,n\*8)

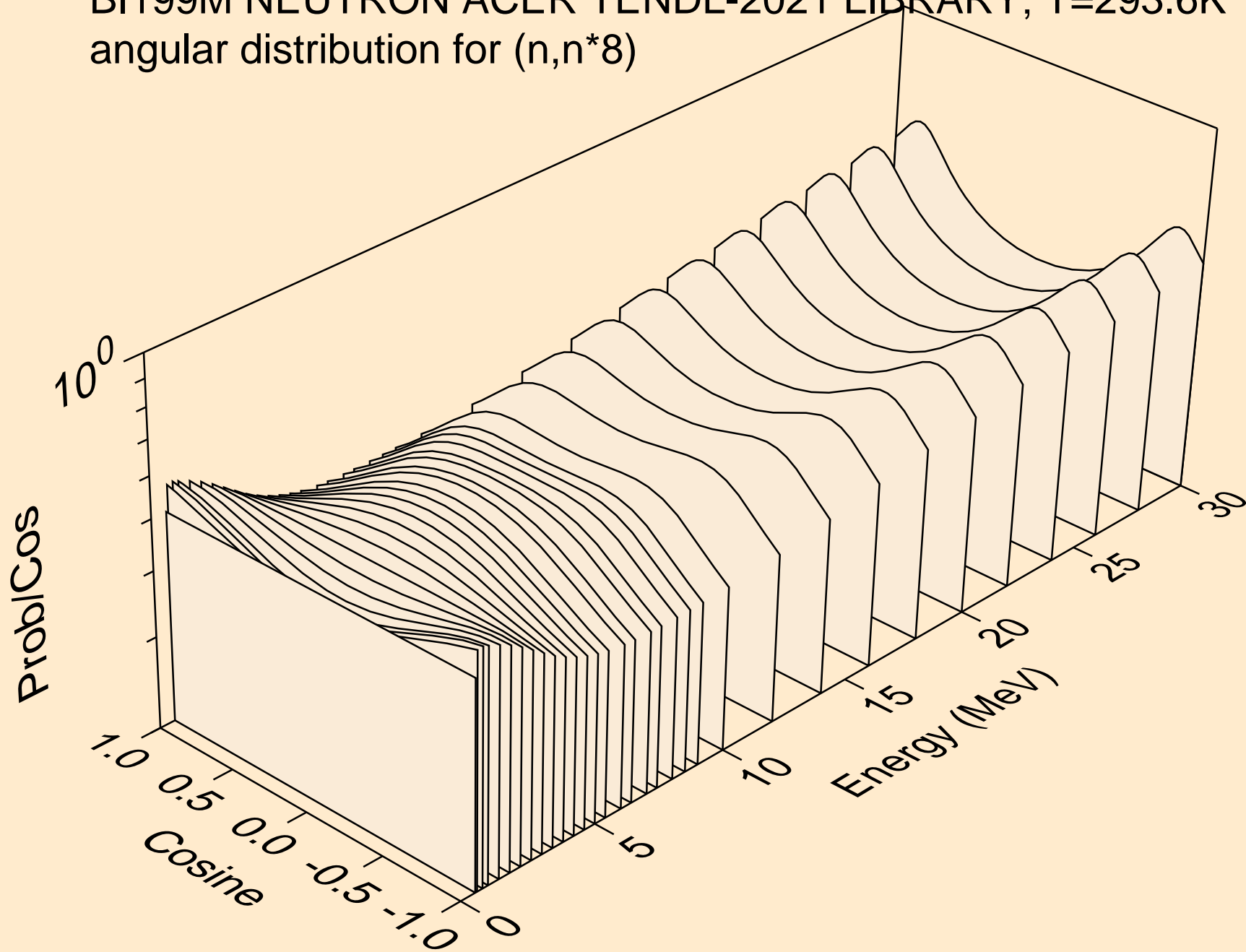



BI199M NEUTRON ACER TENDL-2021 LIBRARY; T=293.6K  
angular distribution for (n,n\*9)

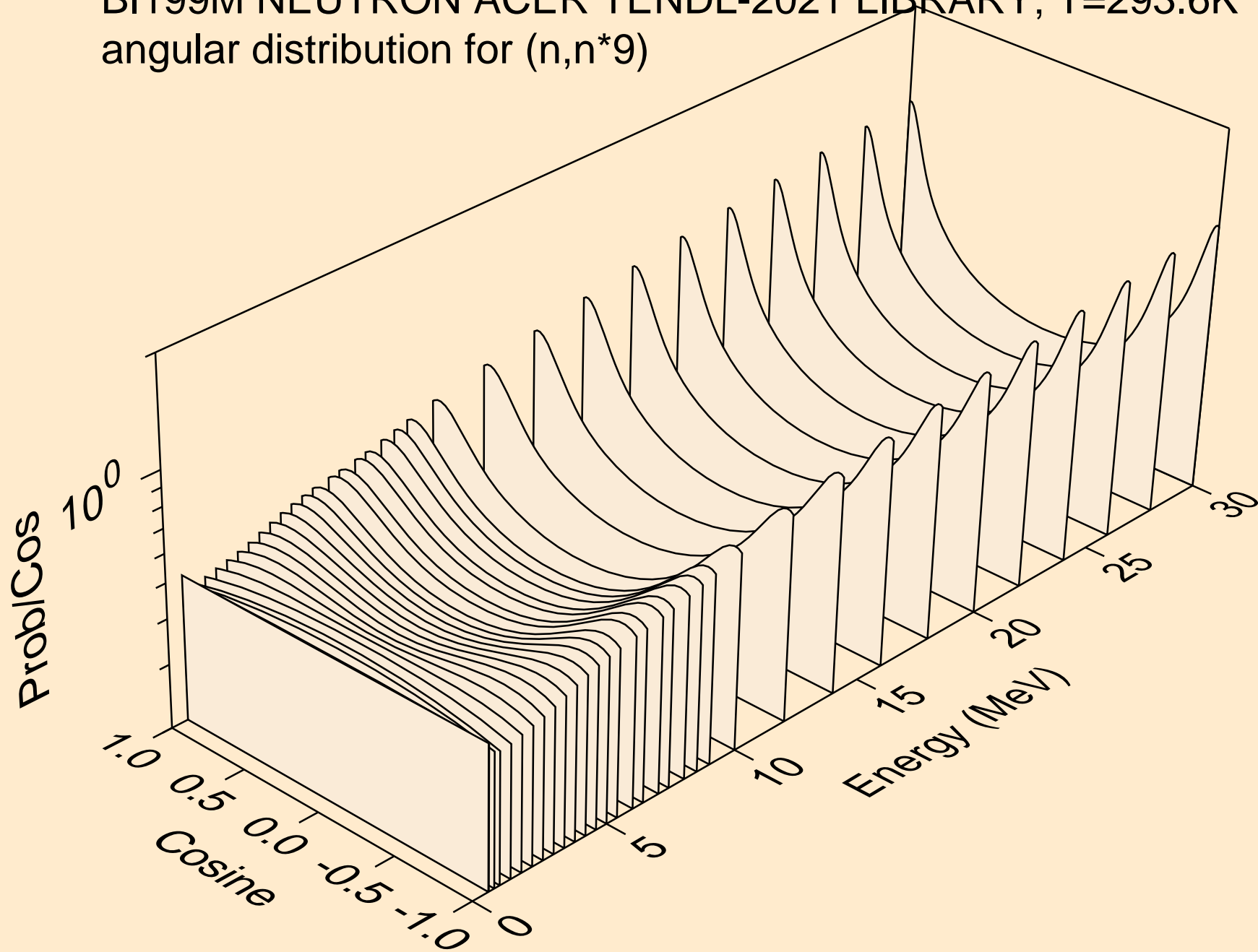

BI199M NEUTRON ACER TENDL-2021 LIBRARY; T=293.6K  
angular distribution for (n,n\*10)

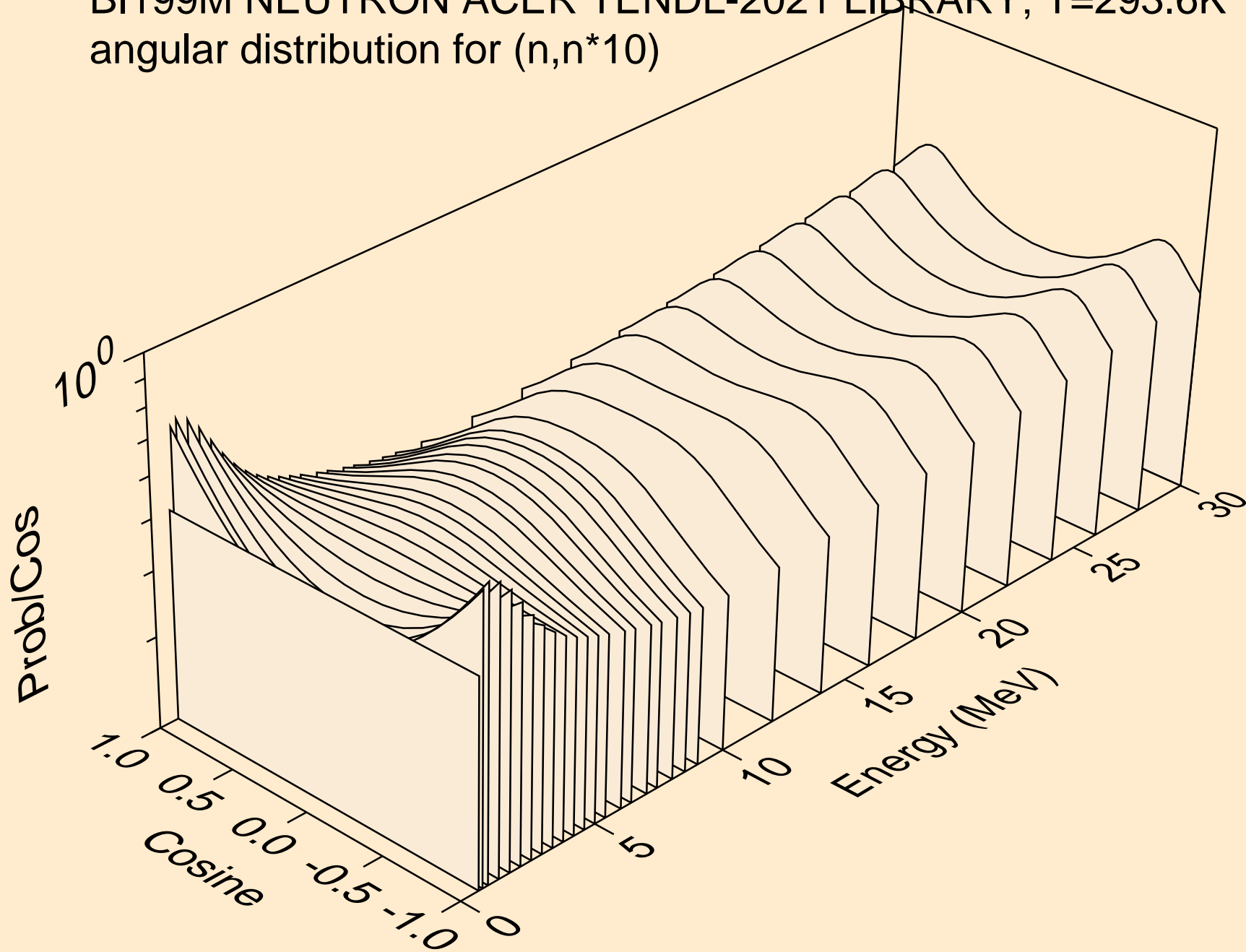

BI199M NEUTRON ACER TENDL-2021 LIBRARY; T=293.6K  
angular distribution for (n,n\*11)

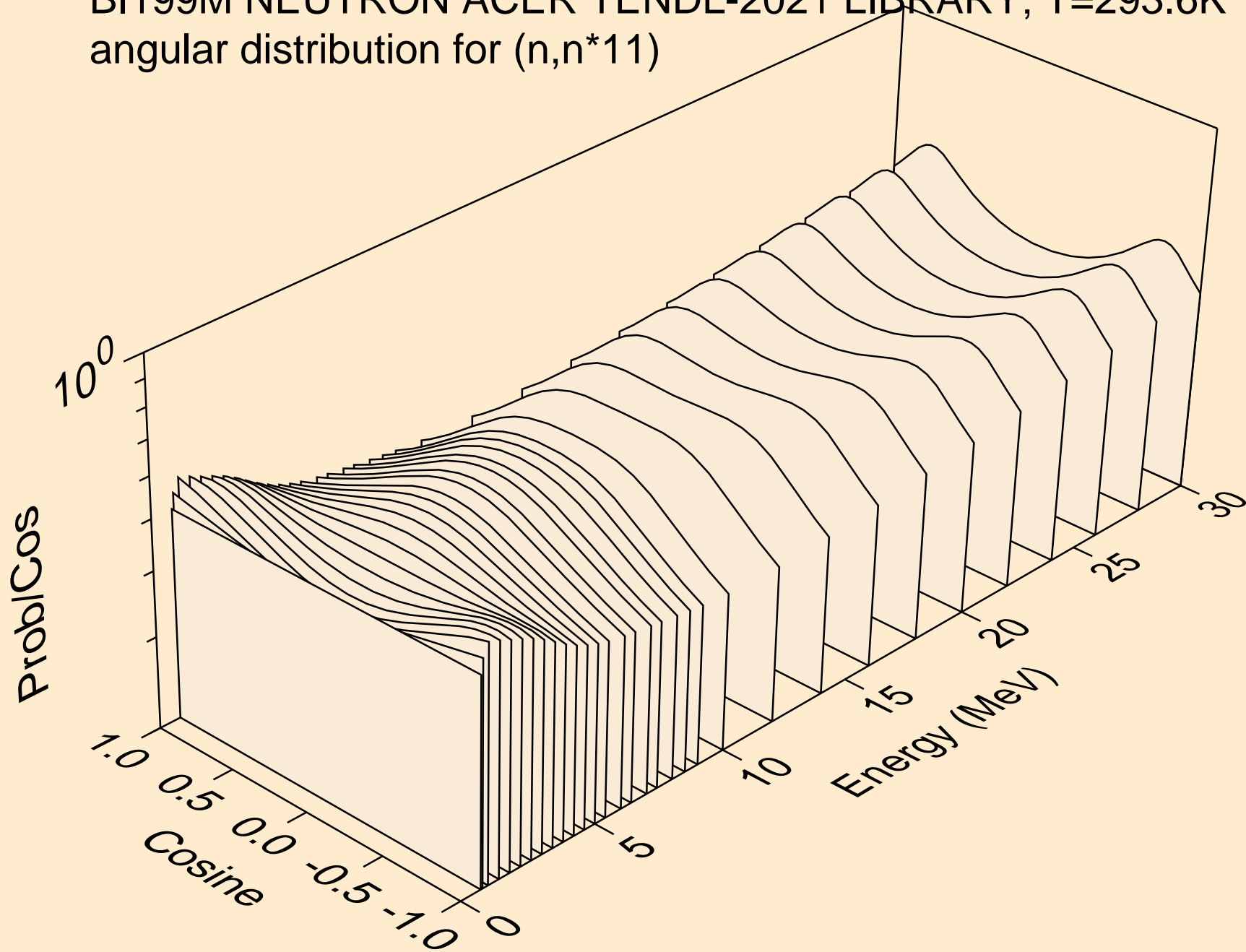

BI199M NEUTRON ACER TENDL-2021 LIBRARY; T=293.6K  
angular distribution for (n,n\*12)

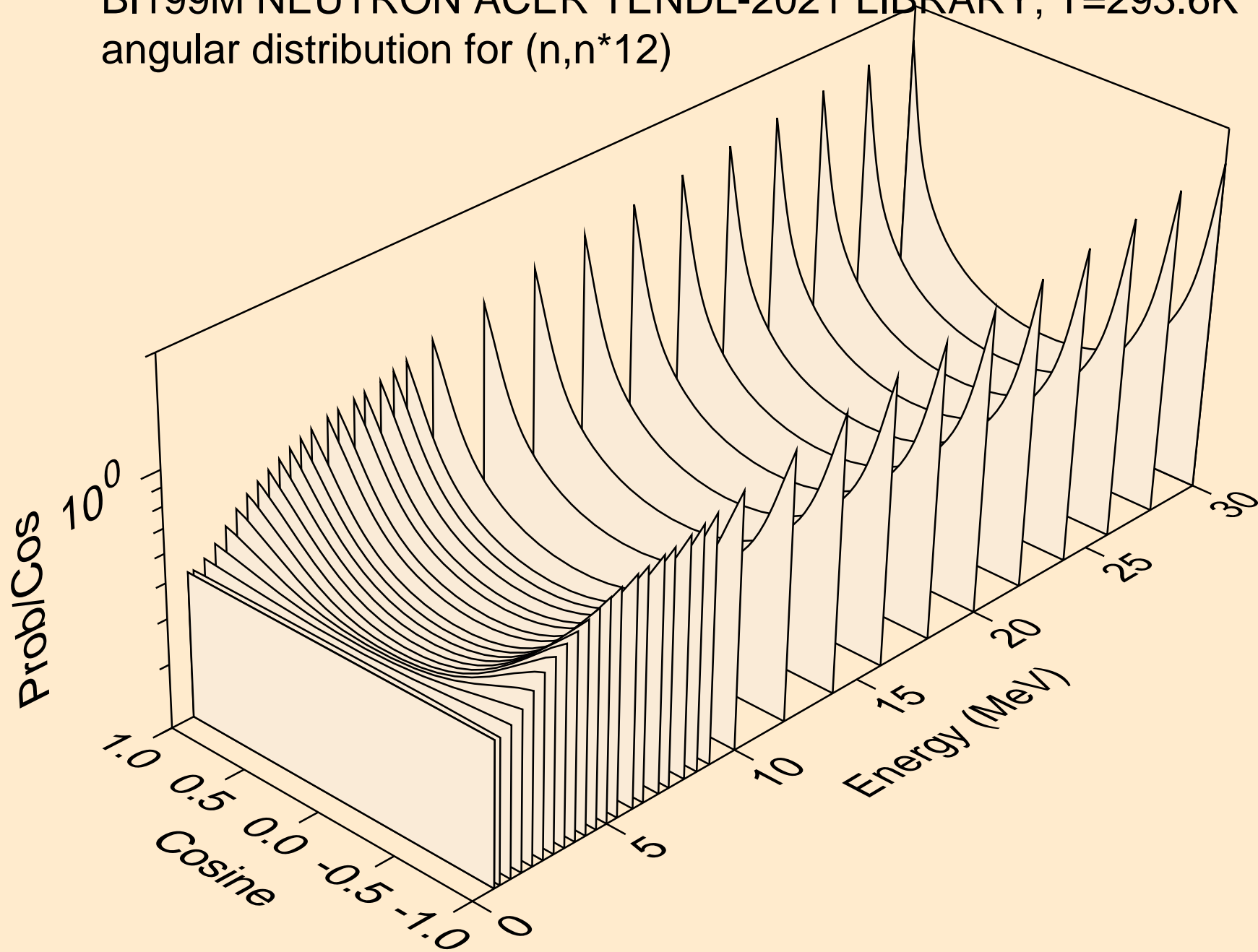

BI199M NEUTRON ACER TENDL-2021 LIBRARY; T=293.6K  
angular distribution for (n,n\*13)

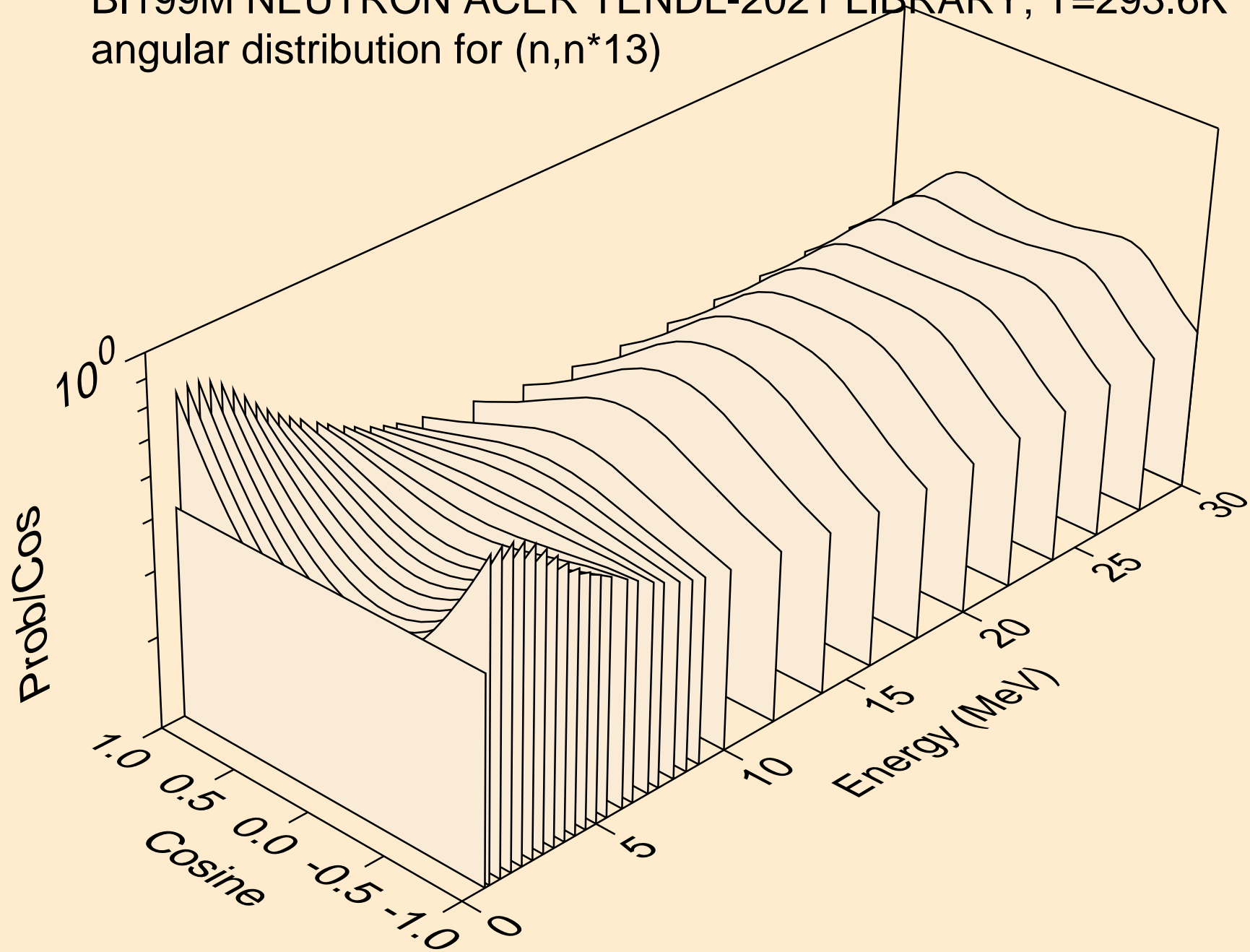

BI199M NEUTRON ACER TENDL-2021 LIBRARY; T=293.6K  
angular distribution for (n,n\*14)

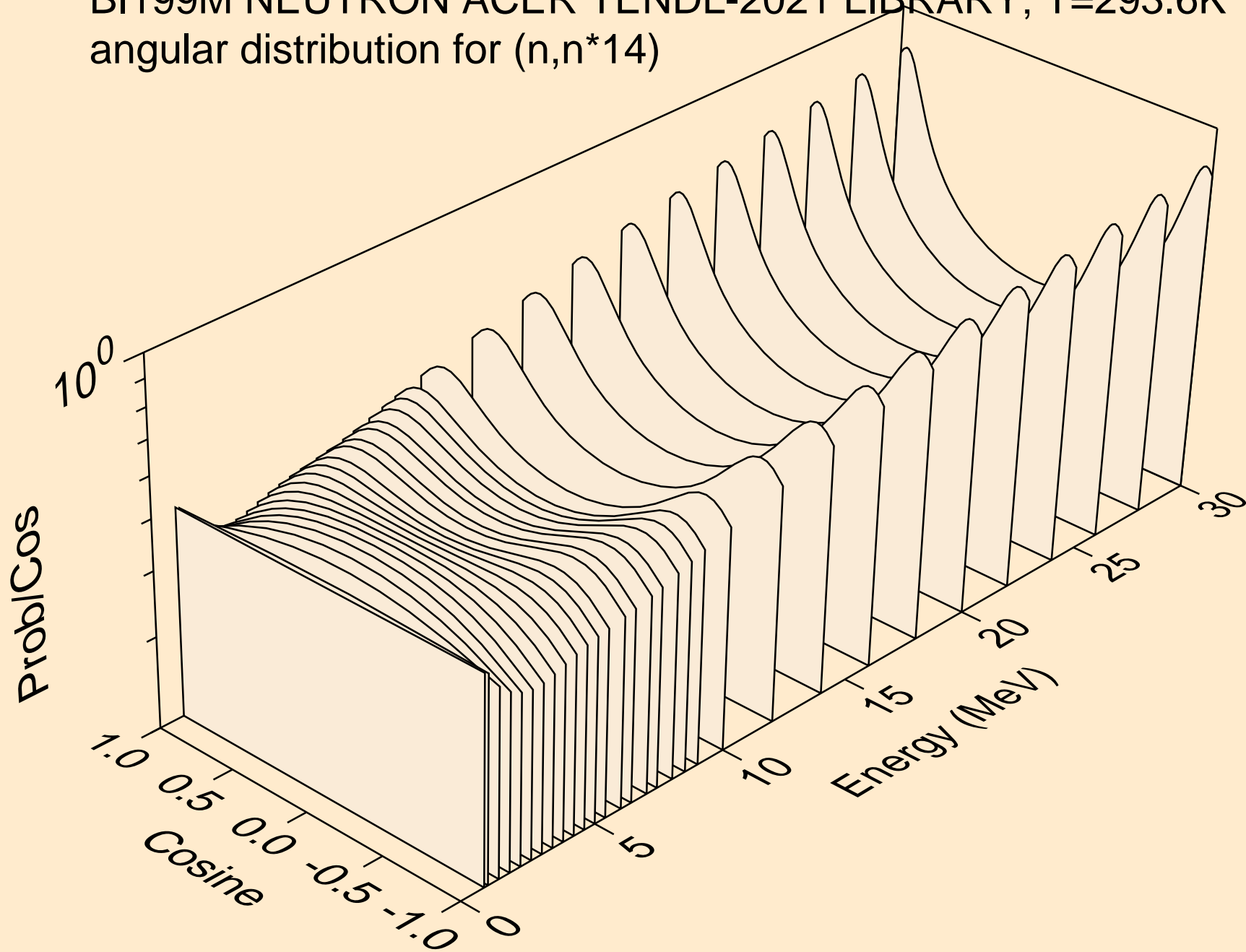

BI199M NEUTRON ACER TENDL-2021 LIBRARY; T=293.6K  
angular distribution for (n,n\*15)

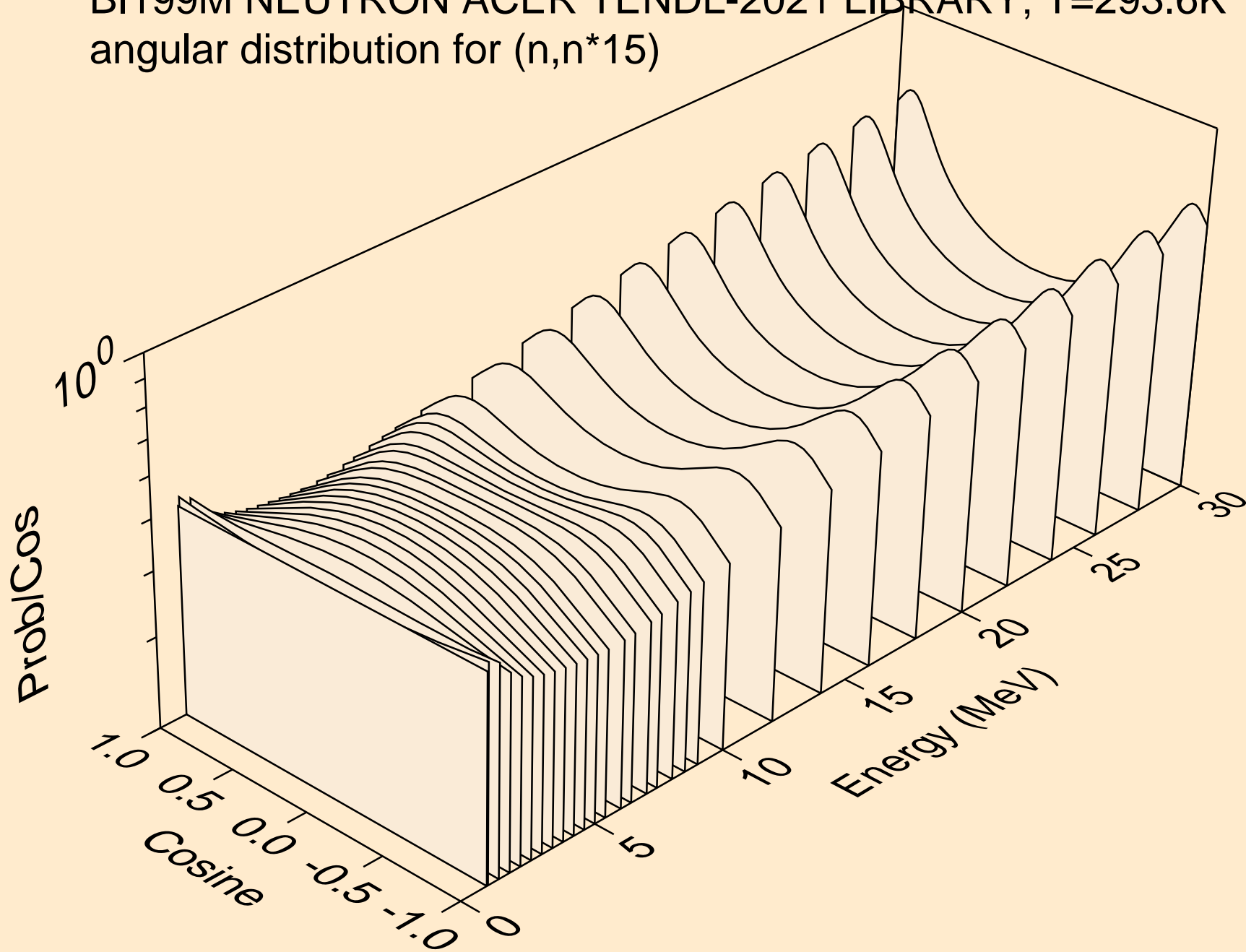

BI199M NEUTRON ACER TENDL-2021 LIBRARY; T=293.6K  
angular distribution for (n,n\*16)

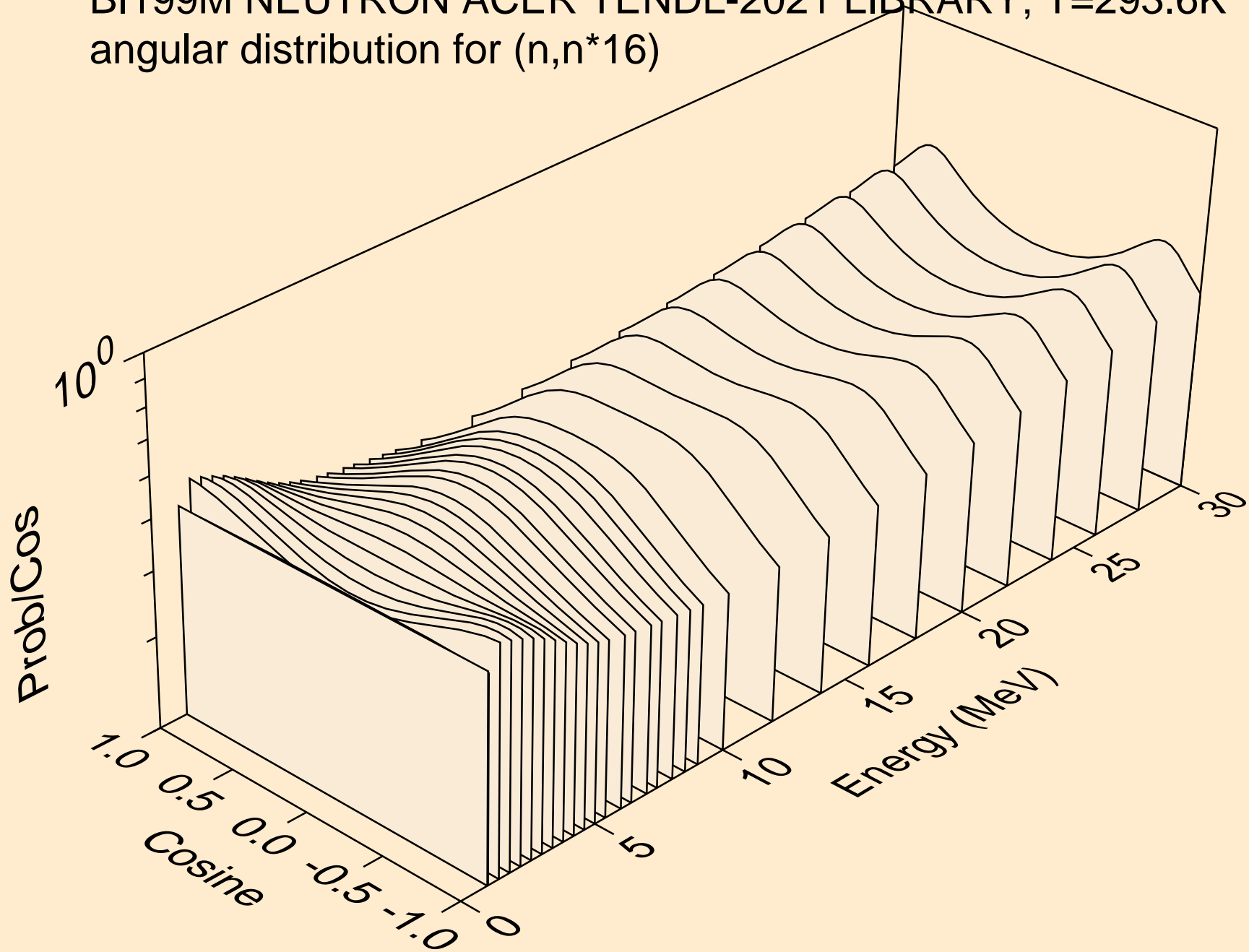



BI199M NEUTRON ACER TENDL-2021 LIBRARY; T=293.6K  
angular distribution for (n,n\*17)

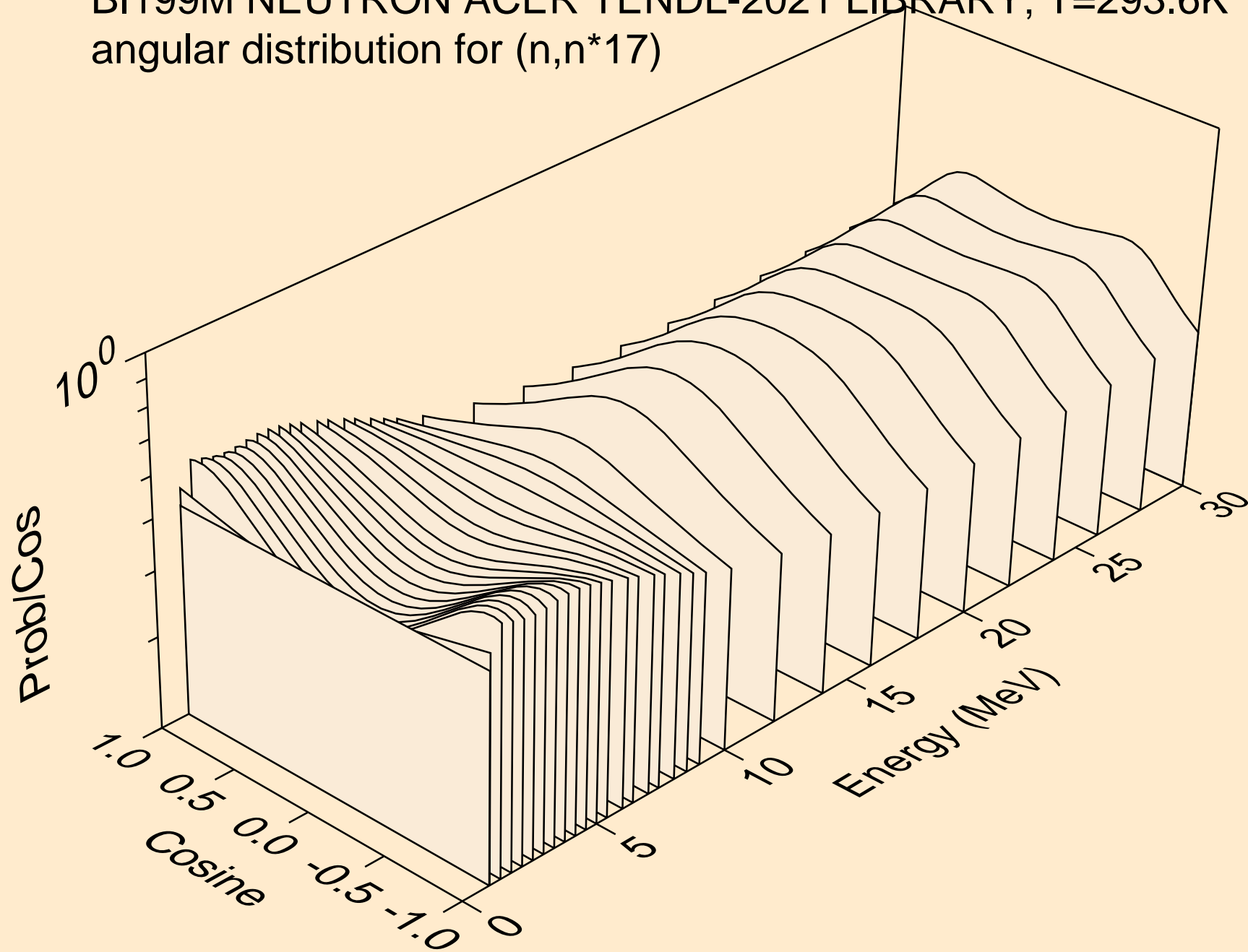

BI199M NEUTRON ACER TENDL-2021 LIBRARY; T=293.6K  
angular distribution for (n,n\*18)

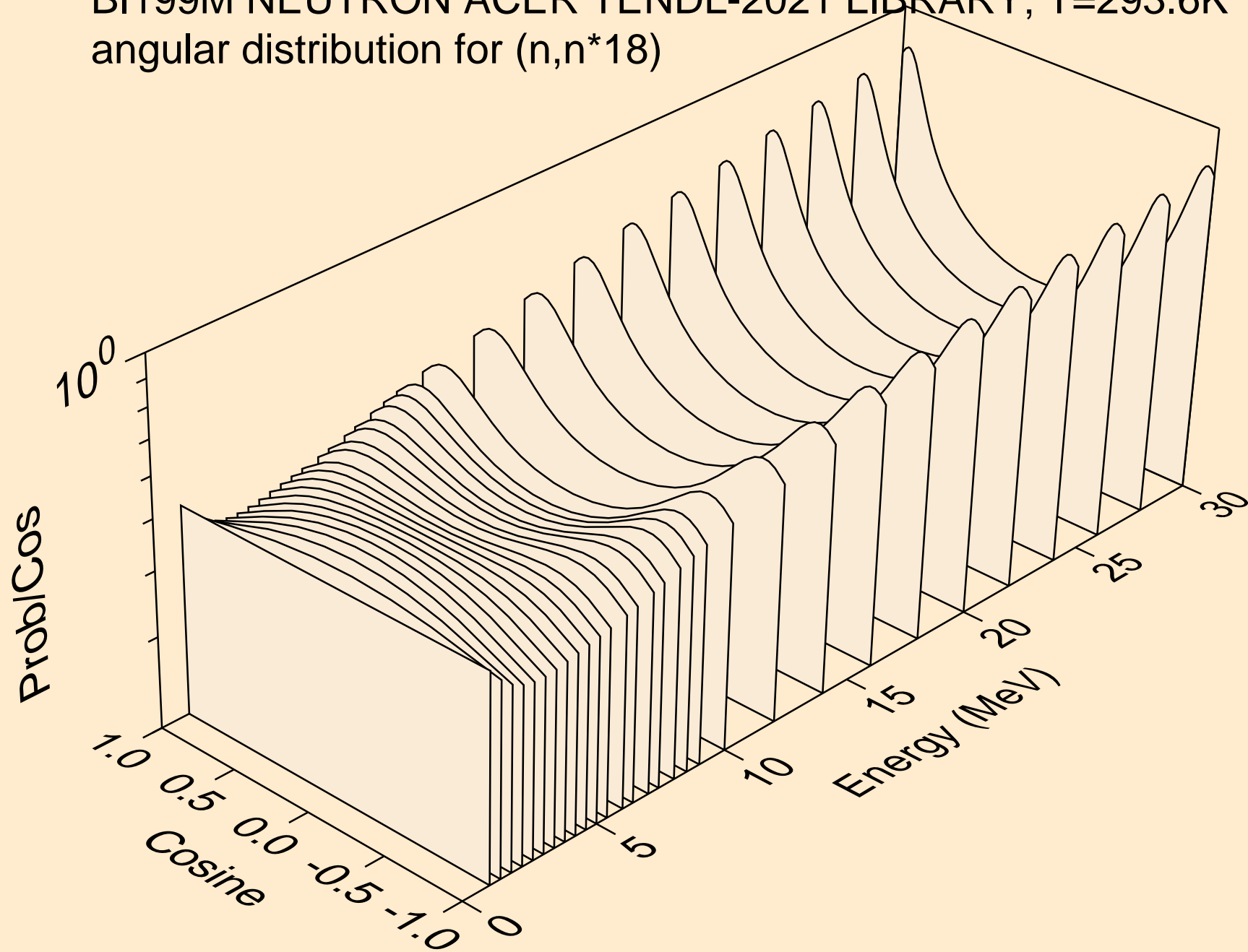

BI199M NEUTRON ACER TENDL-2021 LIBRARY; T=293.6K  
angular distribution for (n,n\*19)

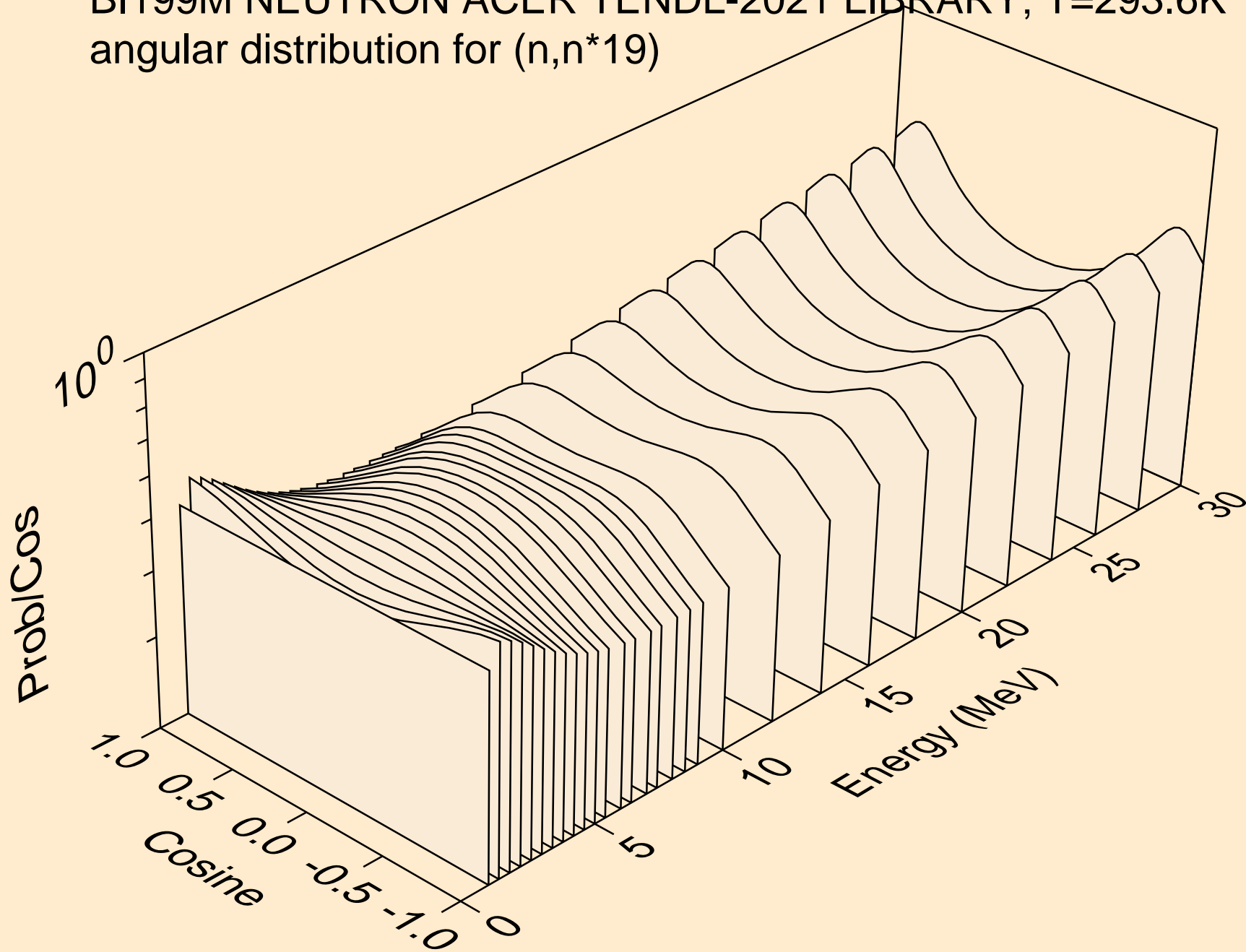

BI199M NEUTRON ACER TENDL-2021 LIBRARY; T=293.6K  
angular distribution for (n,n\*20)

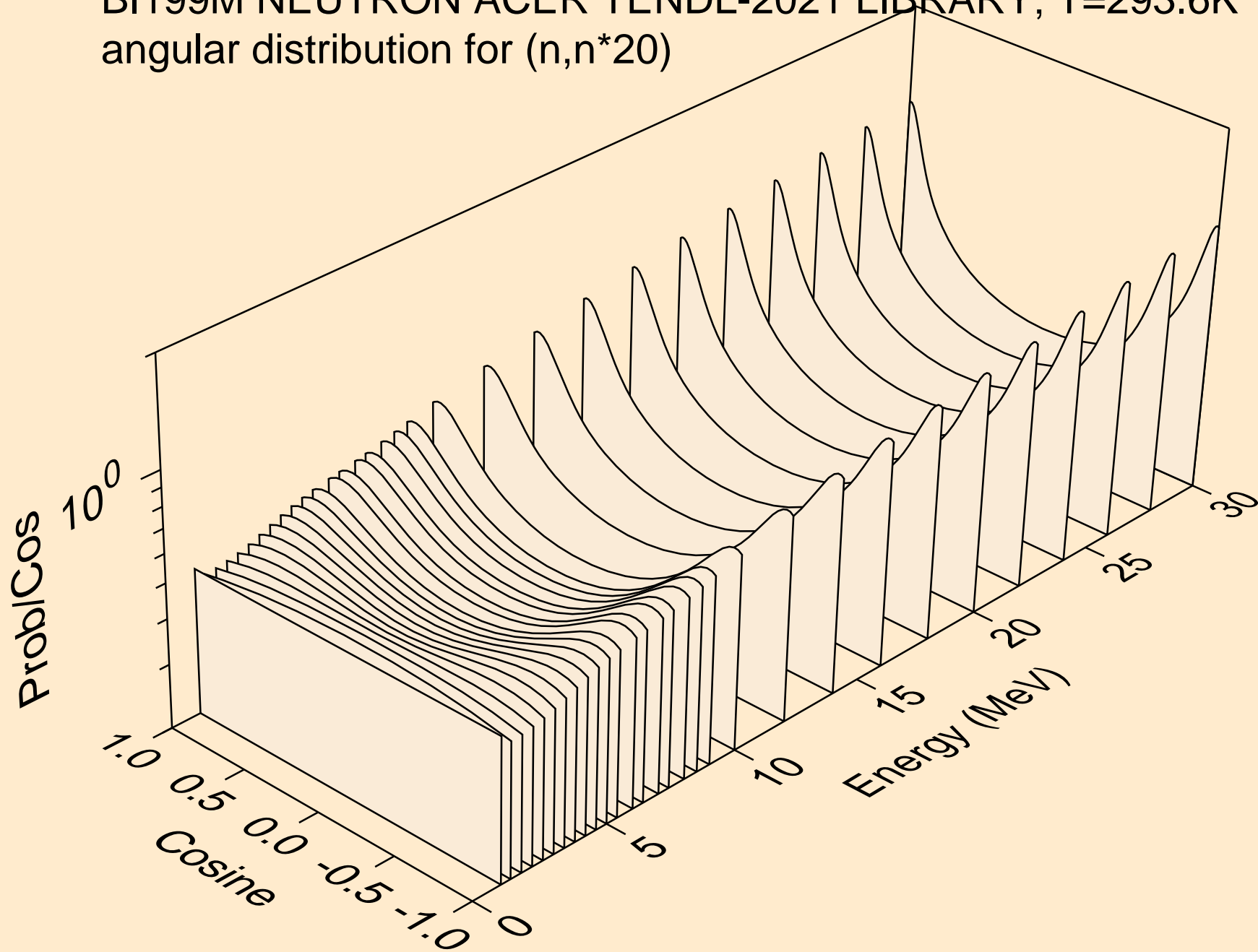

BI199M NEUTRON ACER TENDL-2021 LIBRARY; T=293.6K  
angular distribution for (n,n\*21)

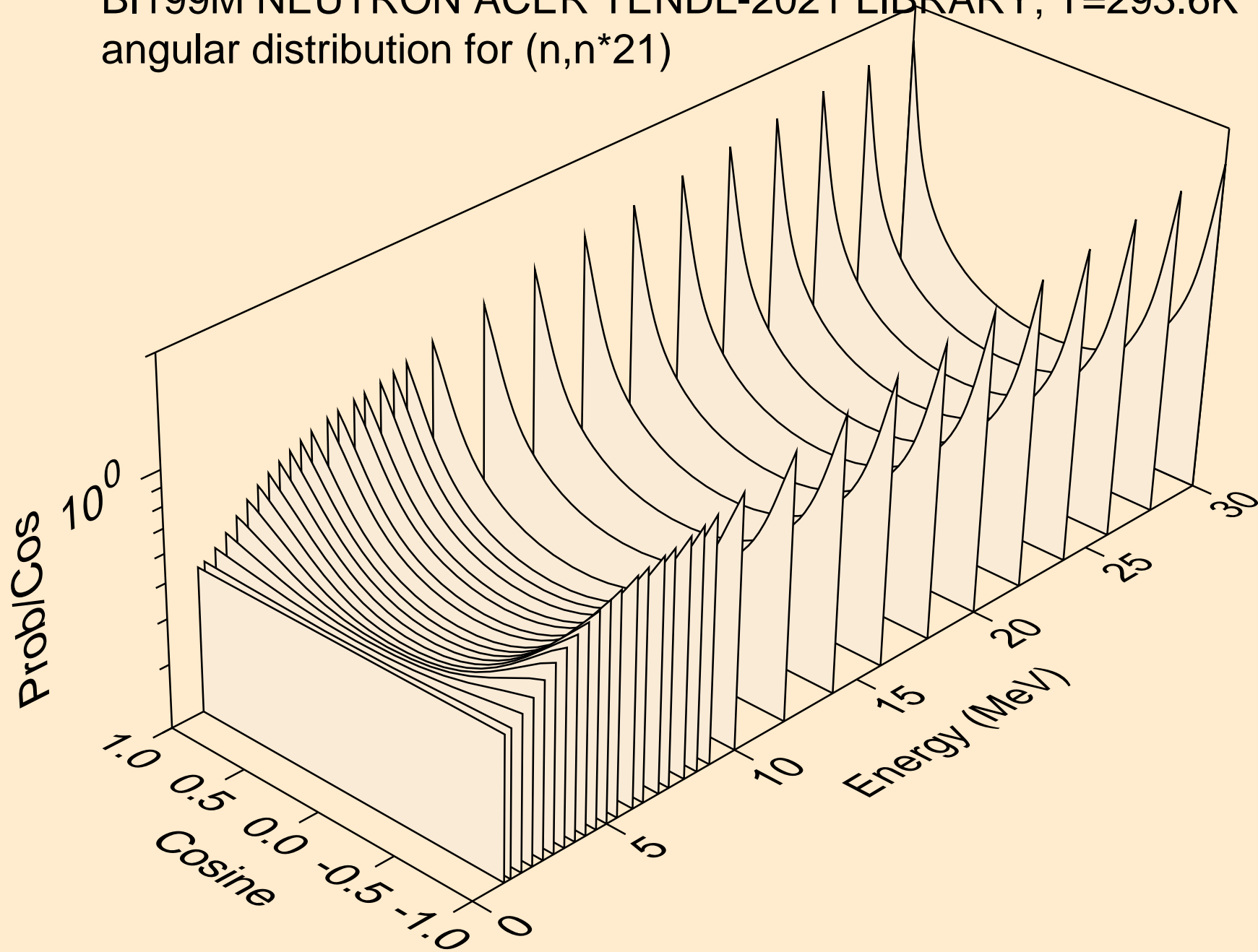

BI199M NEUTRON ACER TENDL-2021 LIBRARY; T=293.6K  
Neutron emission for (n,x)

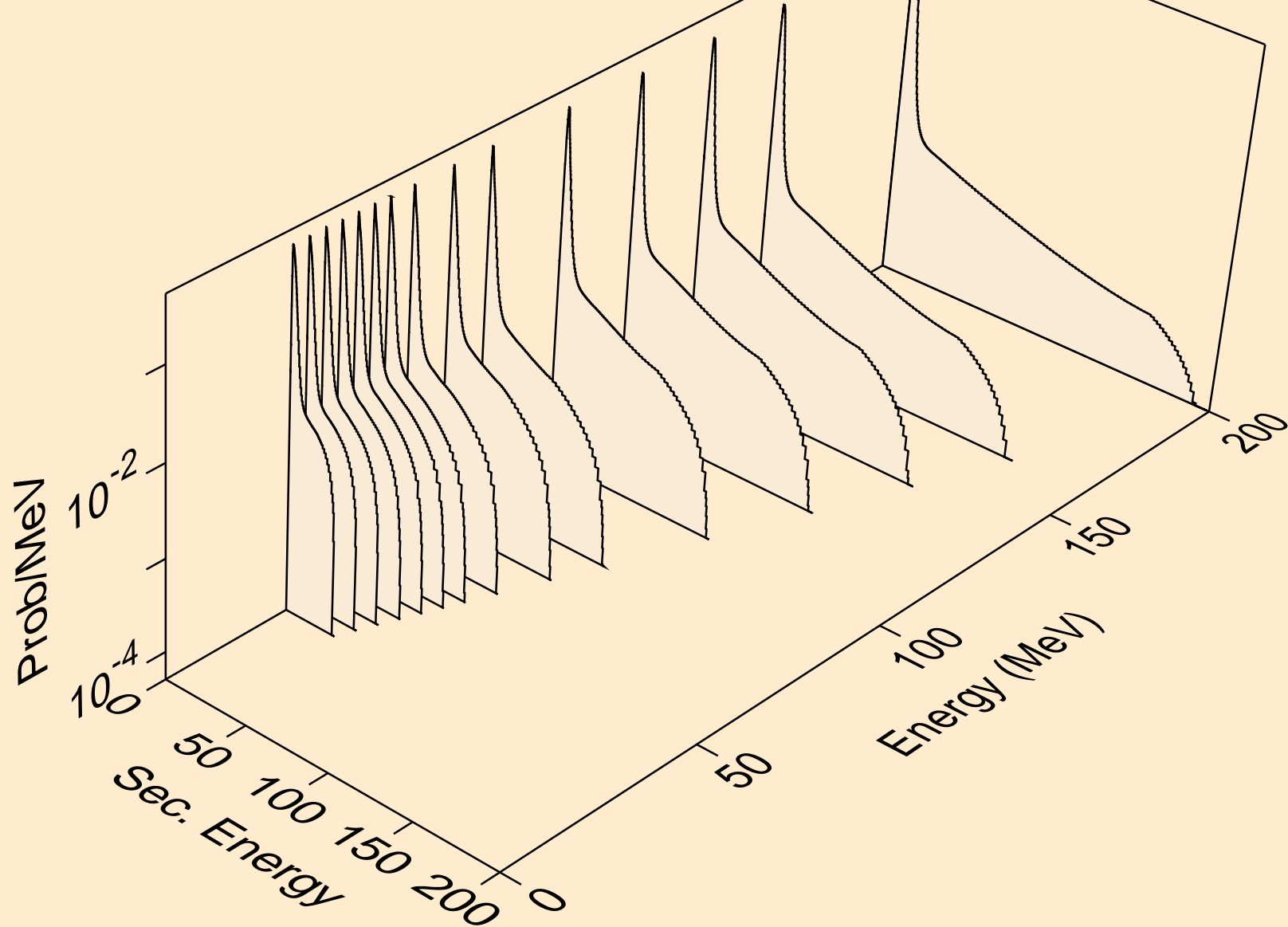

BI199M NEUTRON ACER TENDL-2021 LIBRARY; T=293.6K  
Neutron emission for (n,2nd)

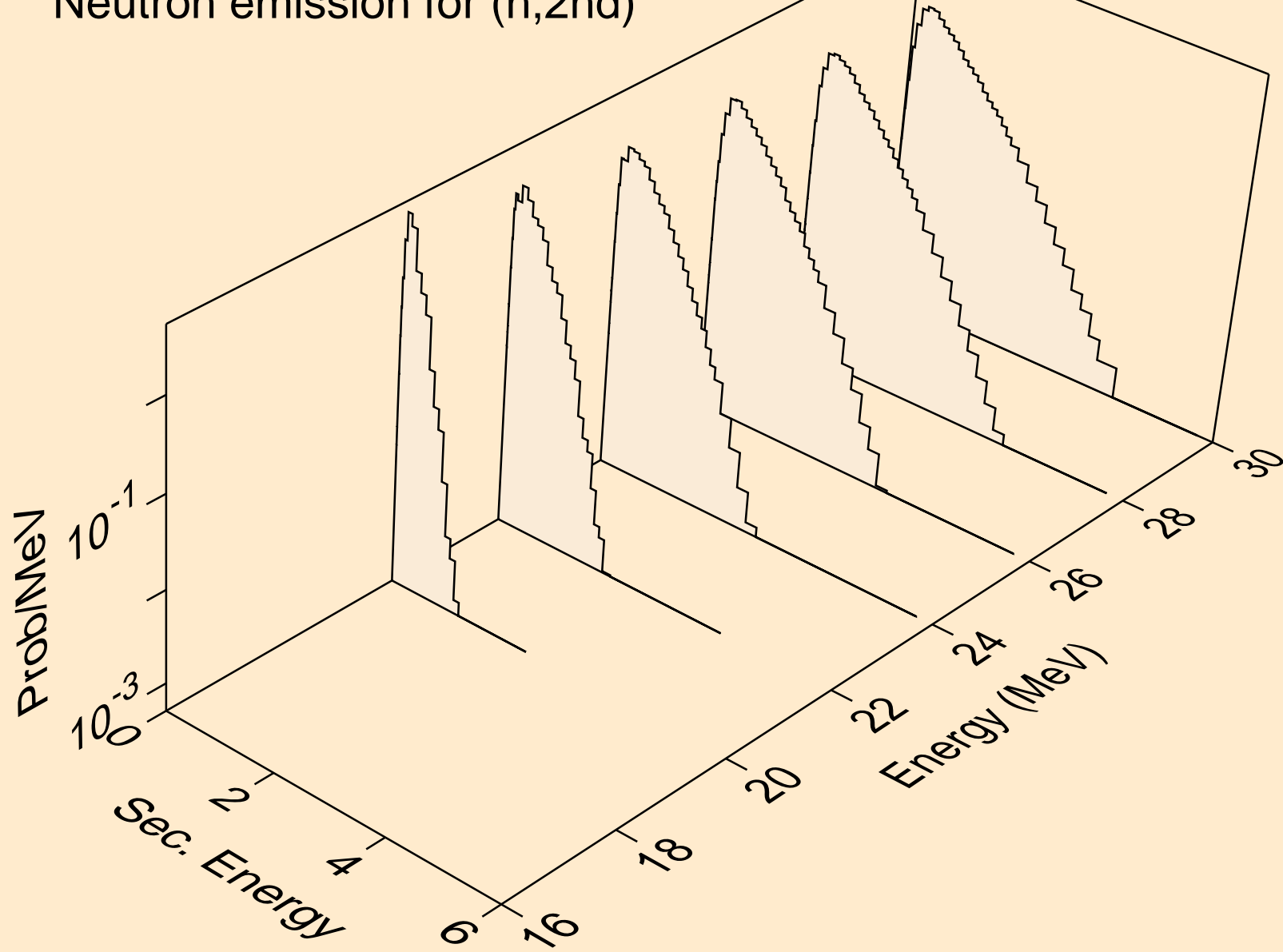

BI199M NEUTRON ACER TENDL-2021 LIBRARY; T=293.6K  
Neutron emission for (n,2n)

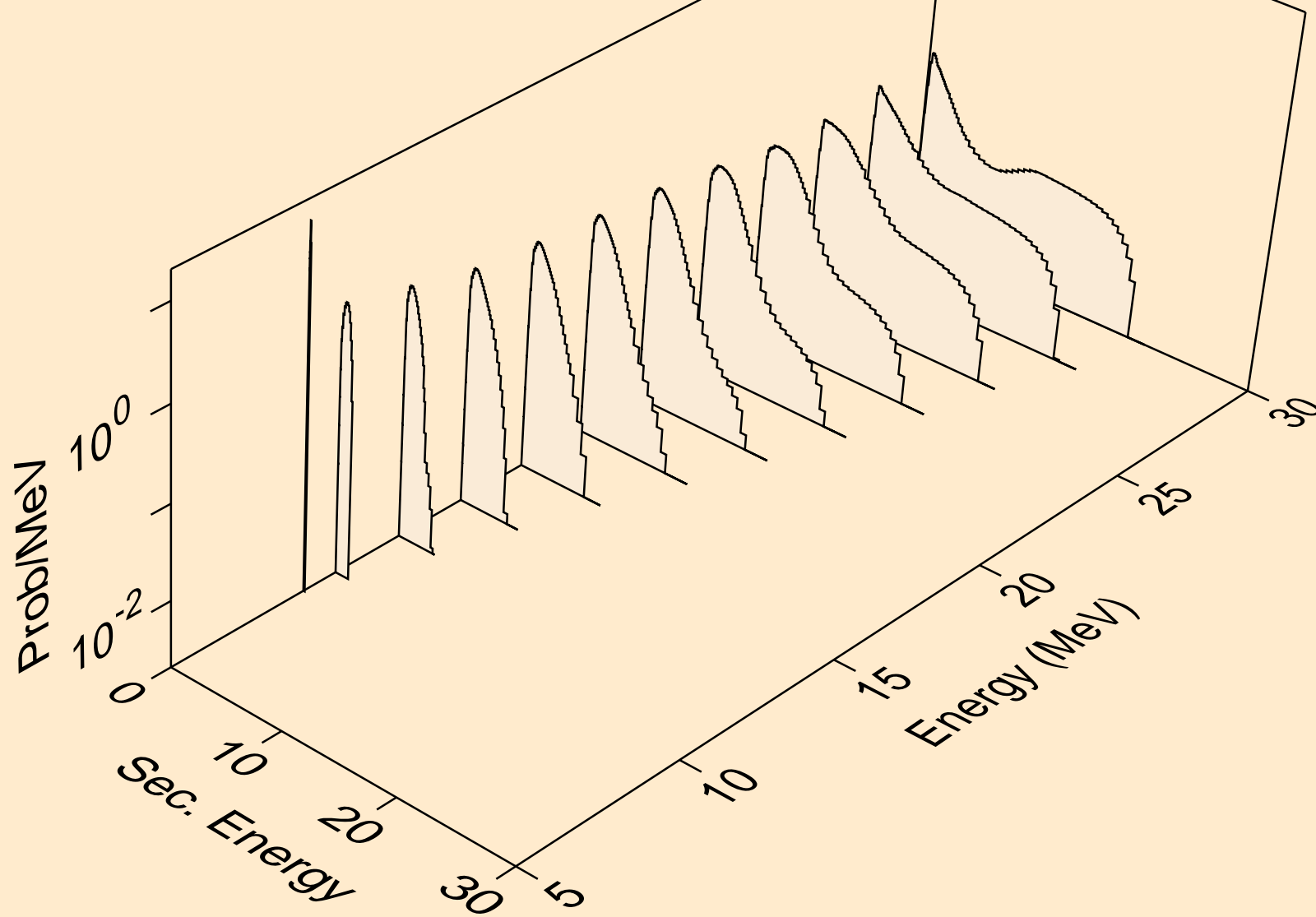



BI199M NEUTRON ACER TENDL-2021 LIBRARY; T=293.6K  
Neutron emission for (n,3n)

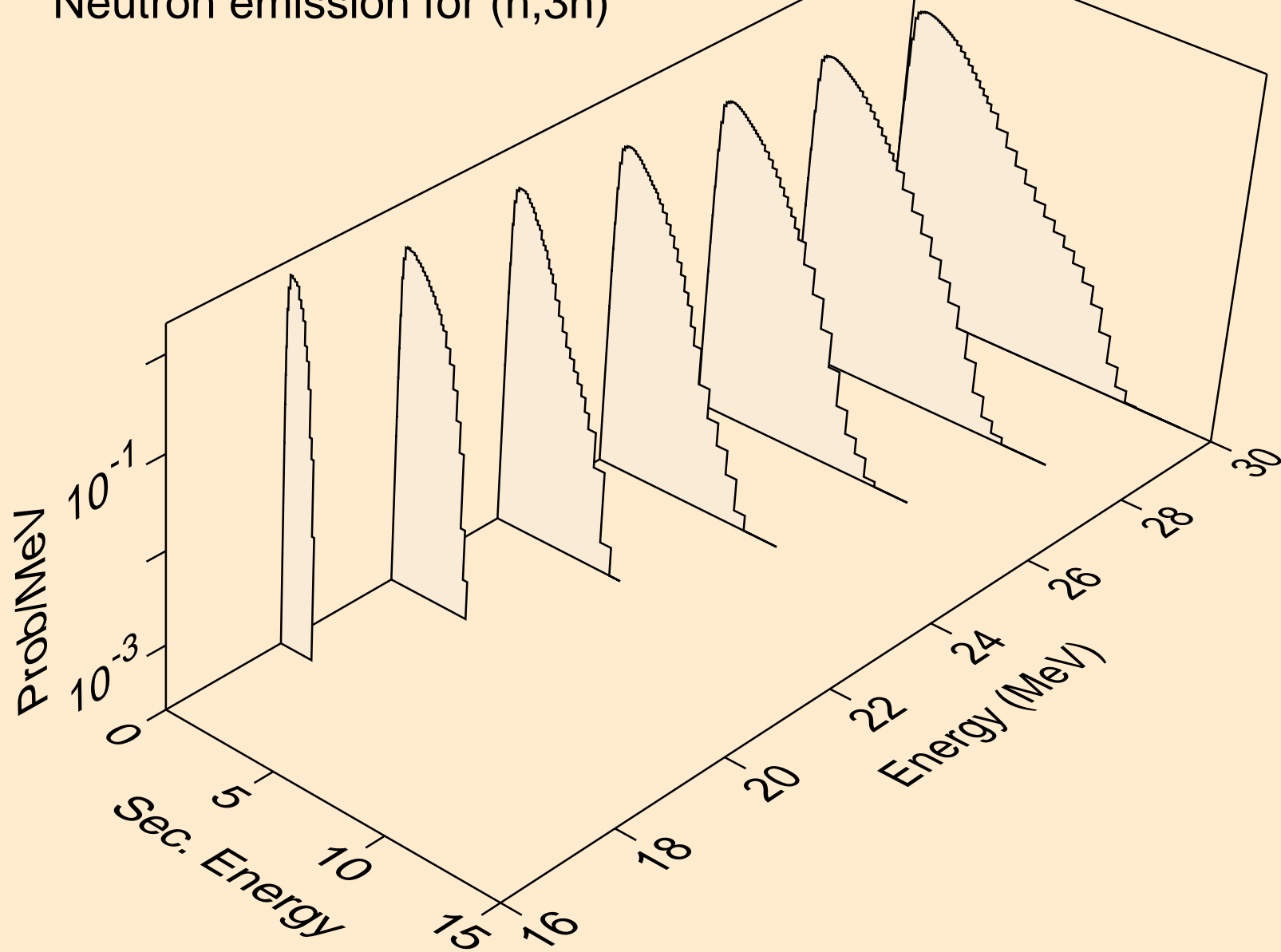

BI199M NEUTRON ACER TENDL-2021 LIBRARY; T=293.6K  
Neutron emission for (n,n\*)a

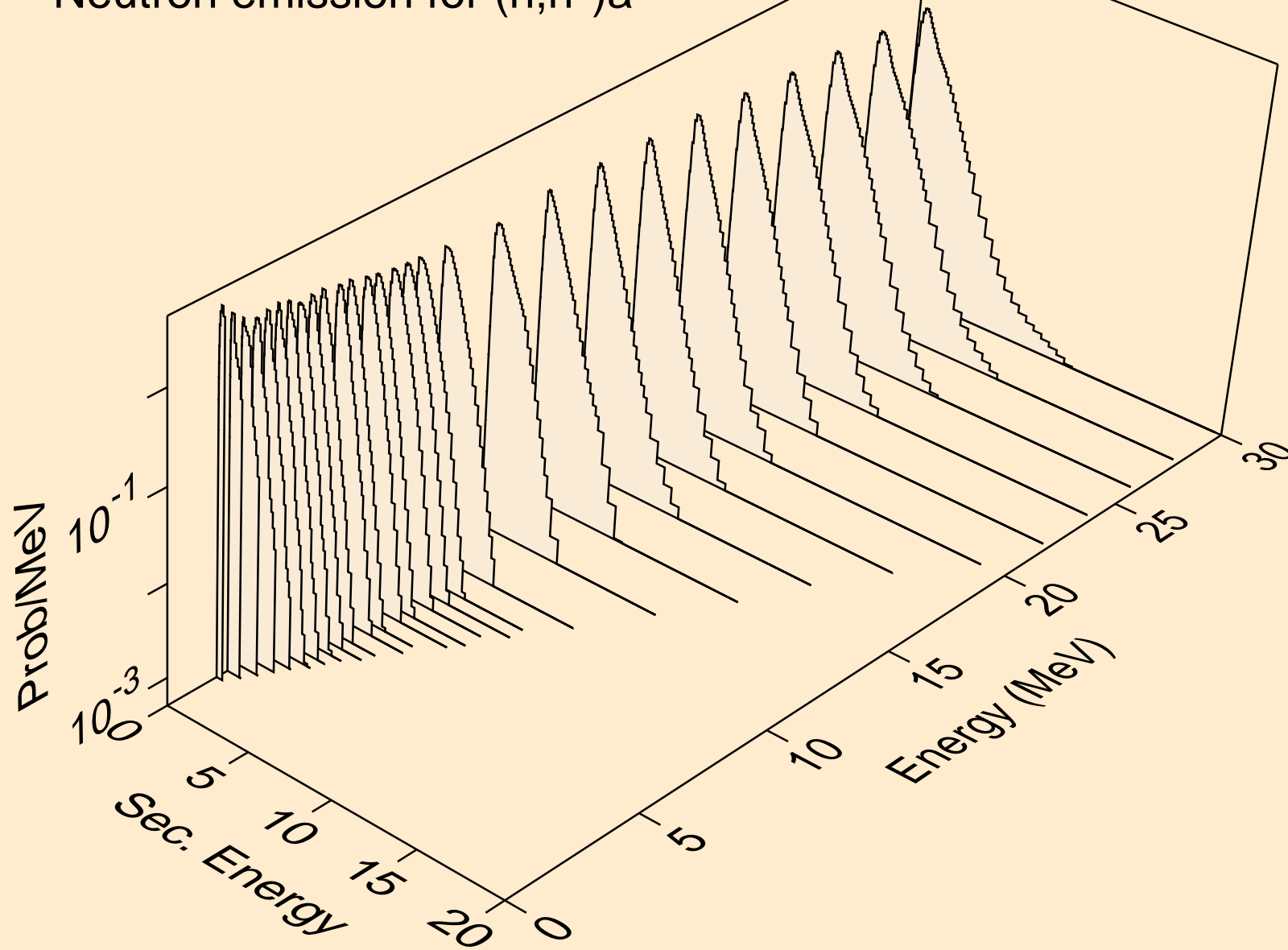

BI199M NEUTRON ACER TENDL-2021 LIBRARY; T=293.6K  
Neutron emission for (n,2n)<sub>a</sub>

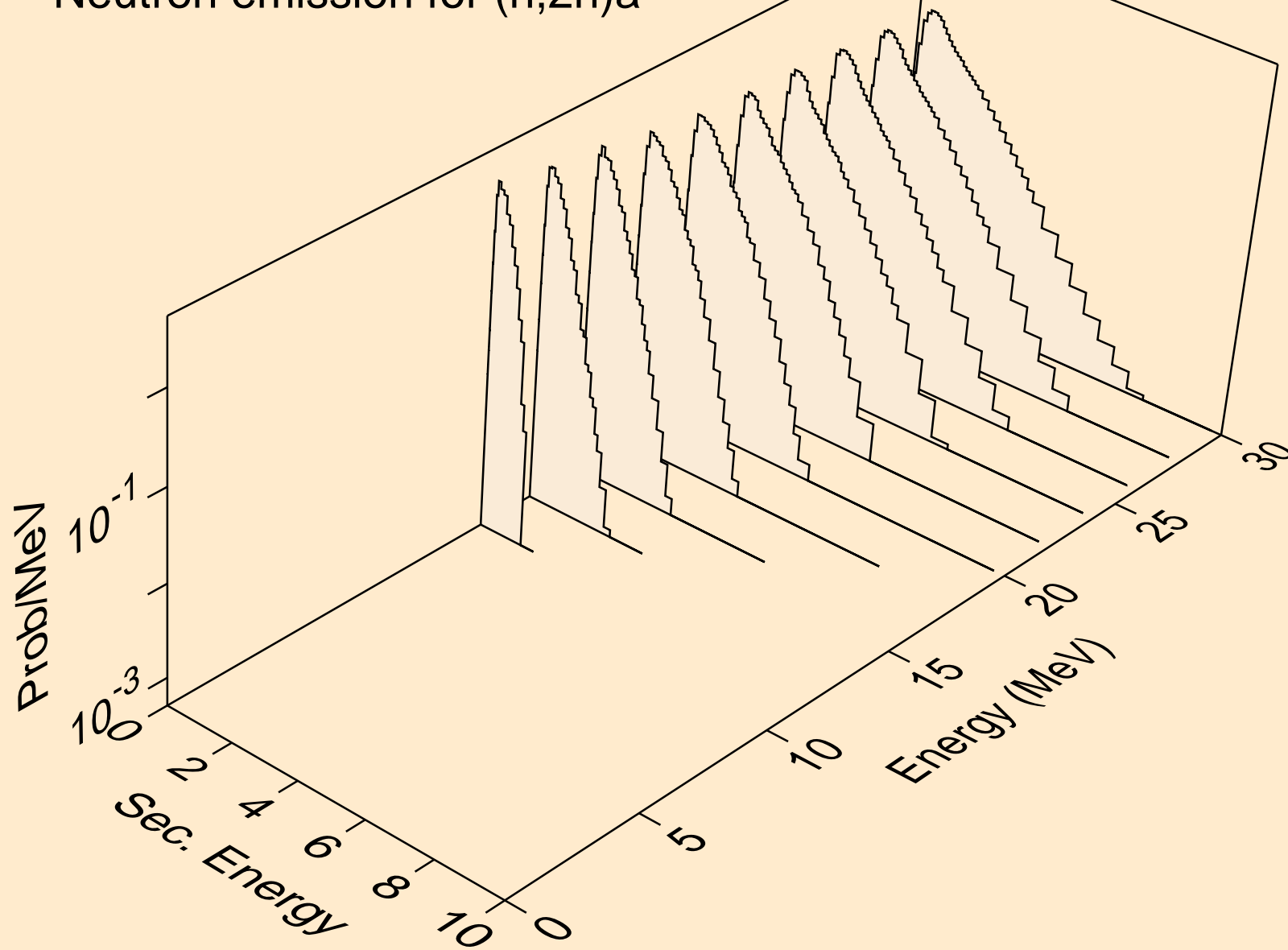

BI199M NEUTRON ACER TENDL-2021 LIBRARY; T=293.6K  
Neutron emission for (n,3n)a

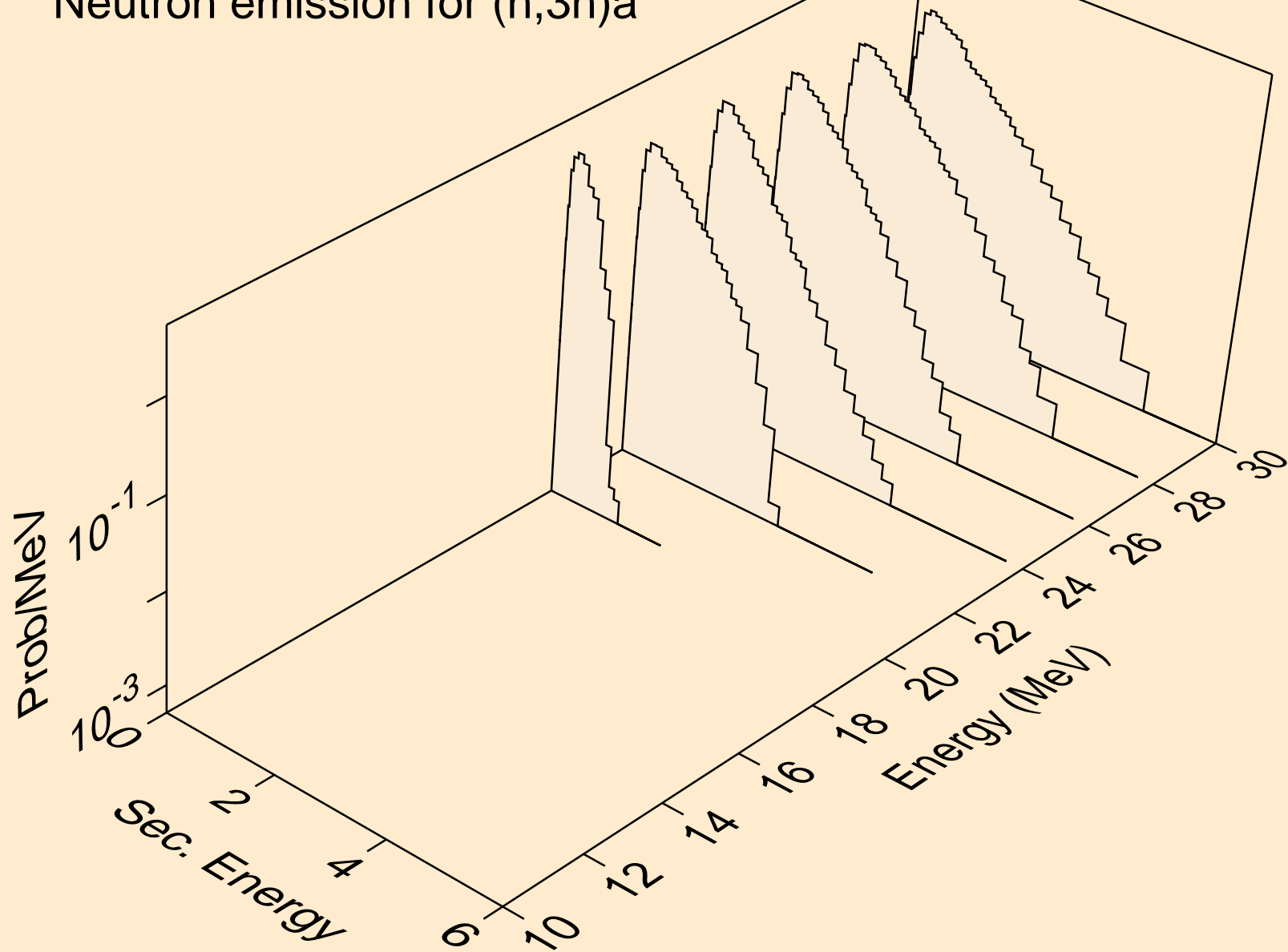

BI199M NEUTRON ACER TENDL-2021 LIBRARY; T=293.6K  
Neutron emission for (n,n\*)p

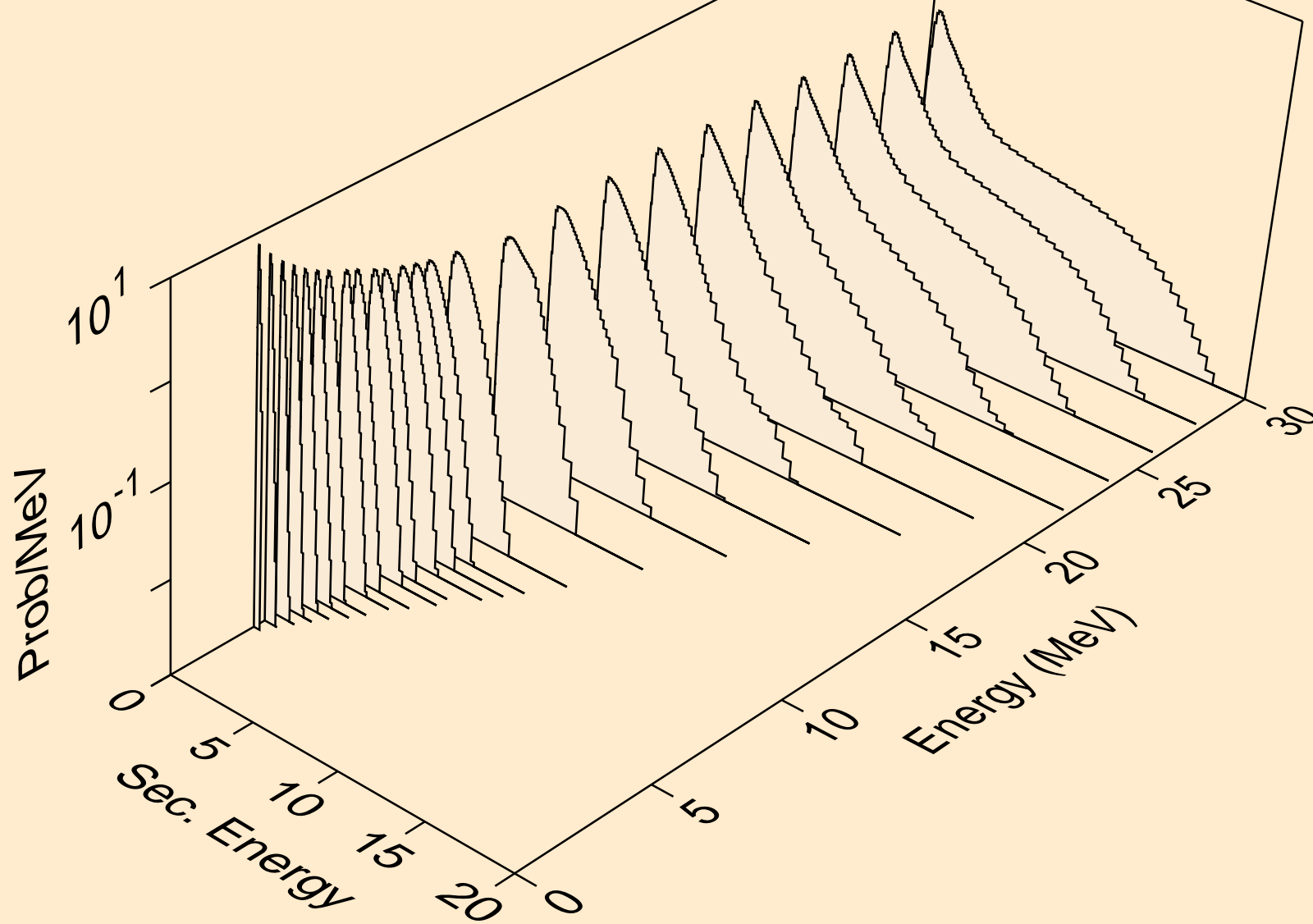

BI199M NEUTRON ACER TENDL-2021 LIBRARY; T=293.6K  
Neutron emission for (n,n\*)2a

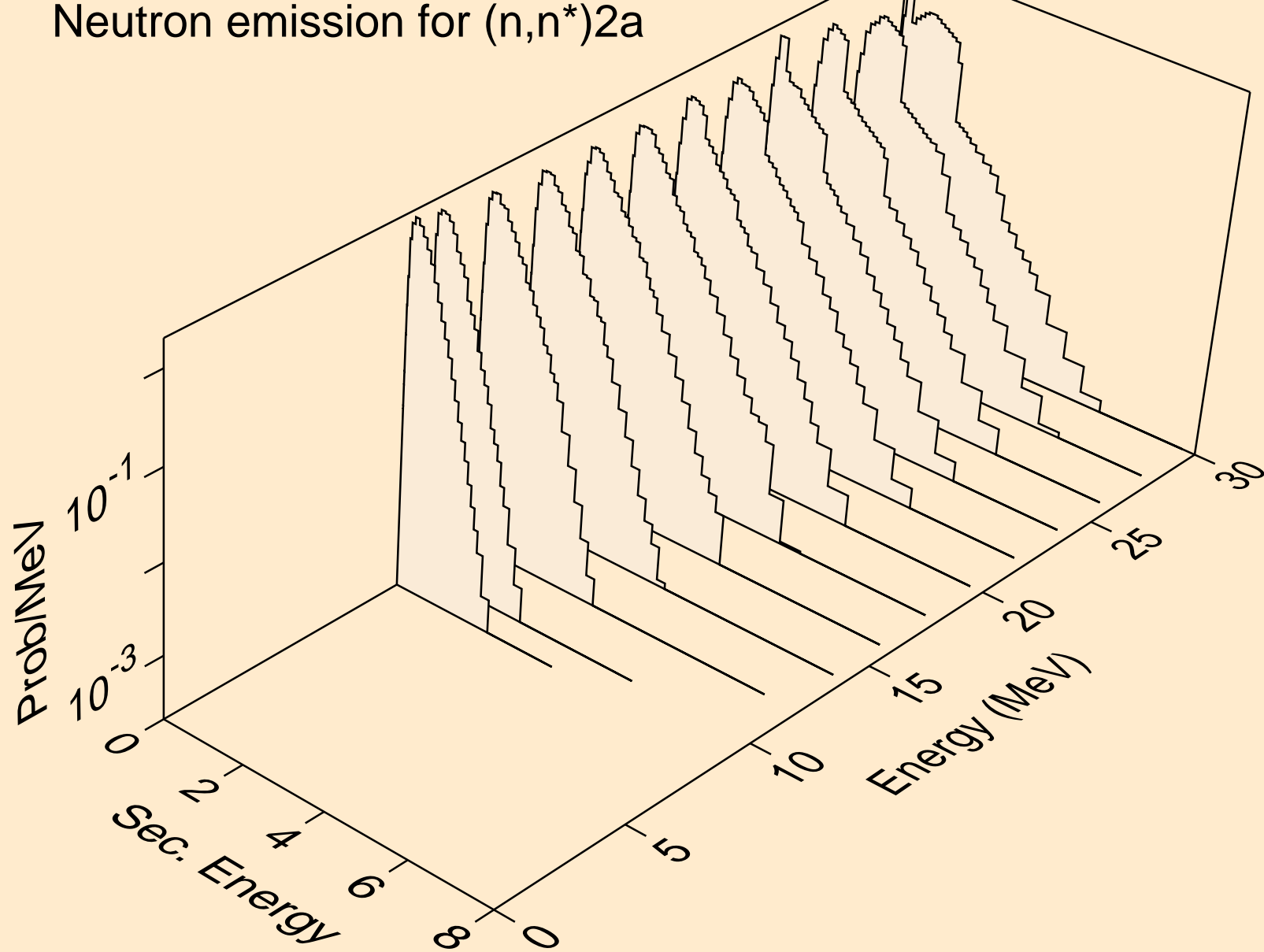

BI199M NEUTRON ACER TENDL-2021 LIBRARY; T=293.6K  
Neutron emission for (n,n\*)d

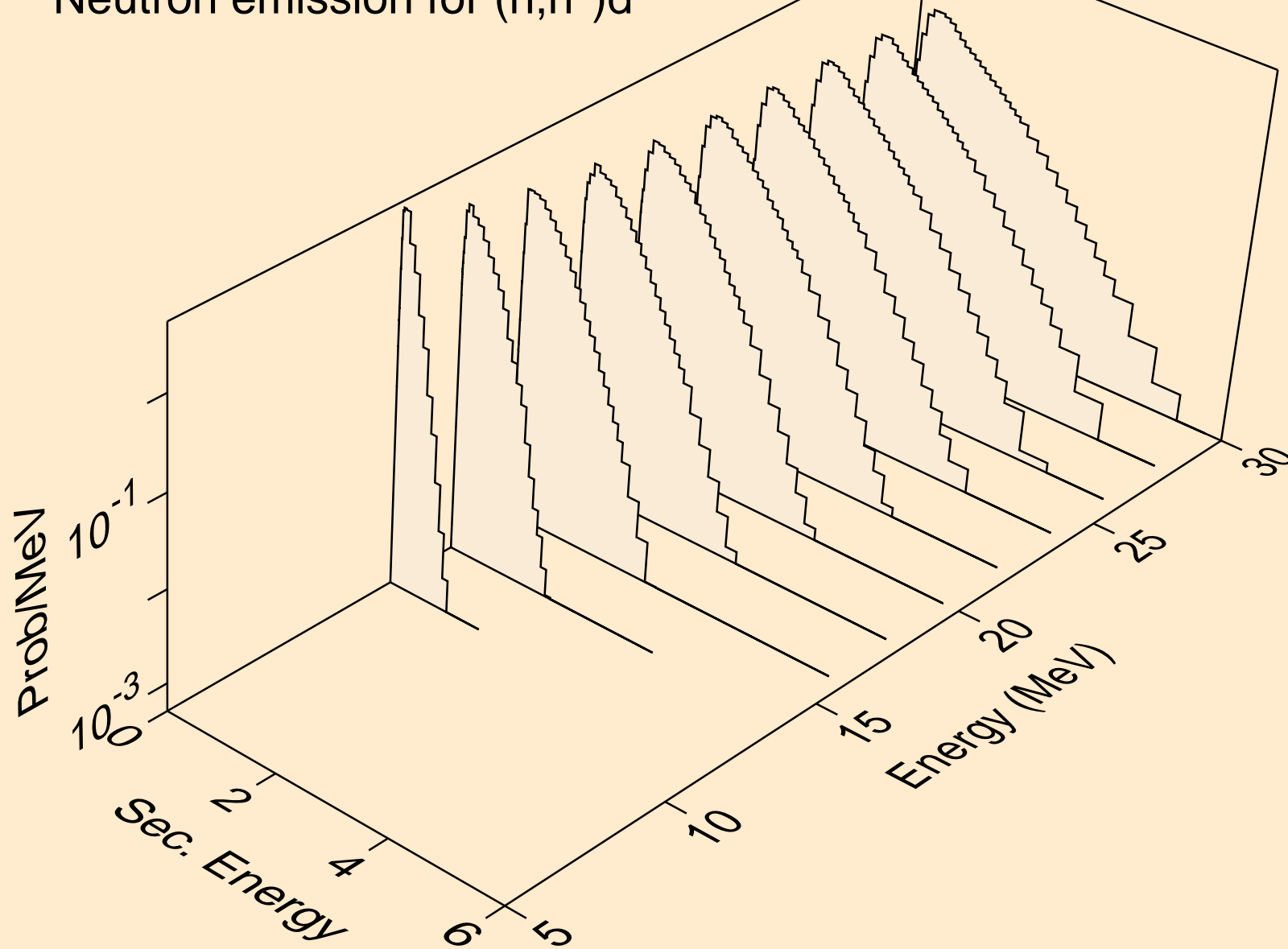

BI199M NEUTRON ACER TENDL-2021 LIBRARY; T=293.6K  
Neutron emission for (n,n\*)t

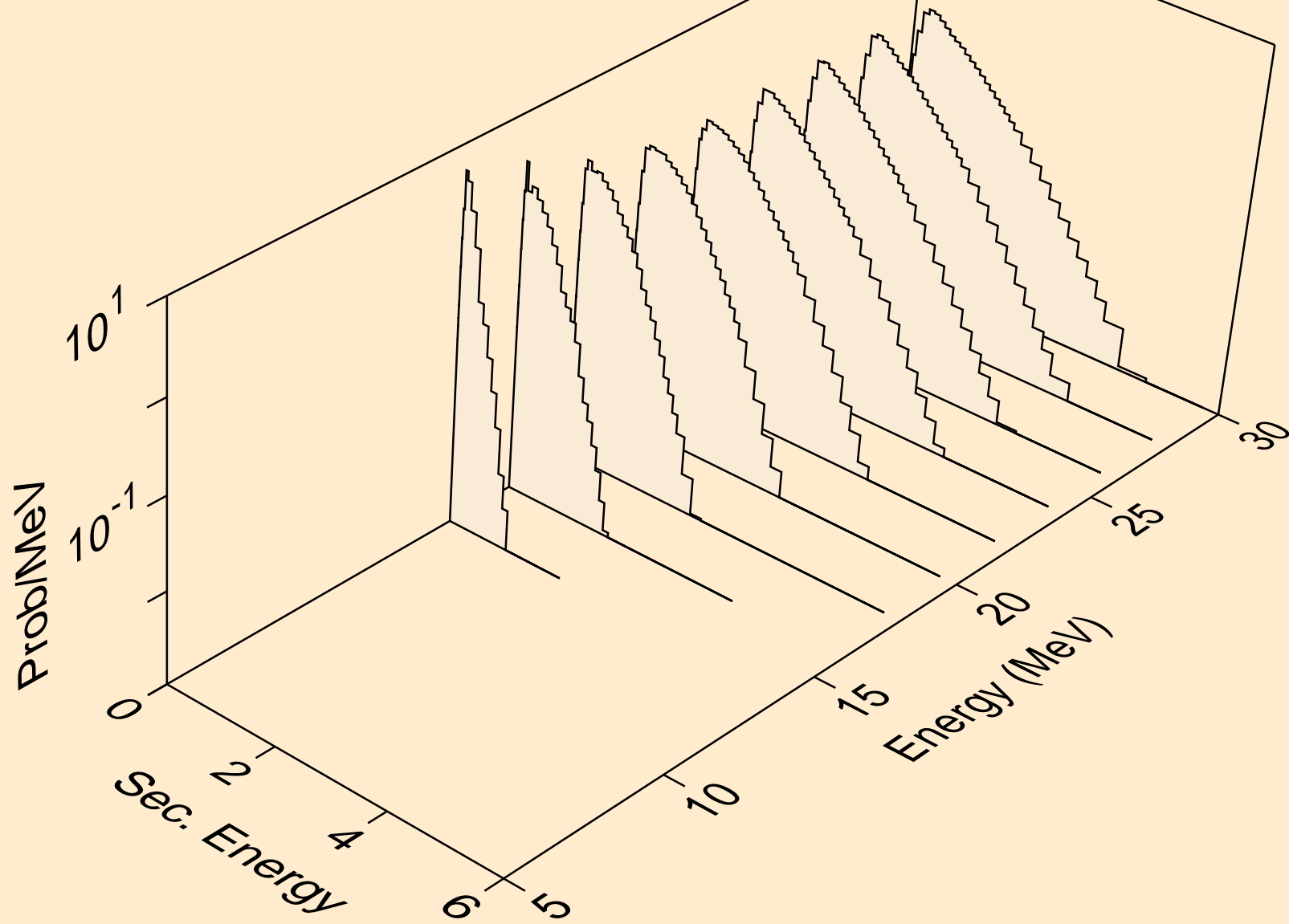



BI199M NEUTRON ACER TENDL-2021 LIBRARY; T=293.6K  
Neutron emission for (n,n\*)he3

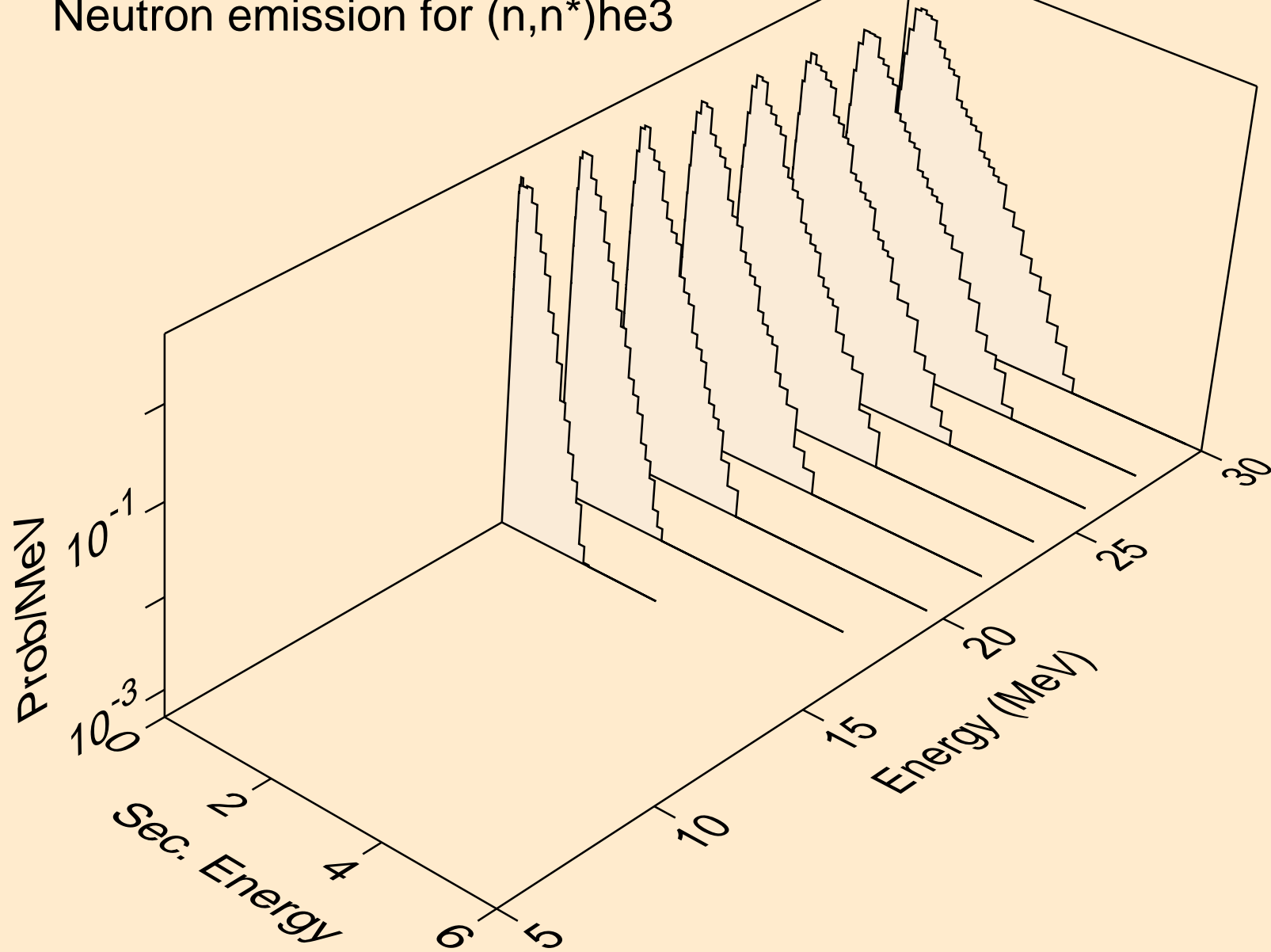

BI199M NEUTRON ACER TENDL-2021 LIBRARY; T=293.6K  
Neutron emission for (n,4n)

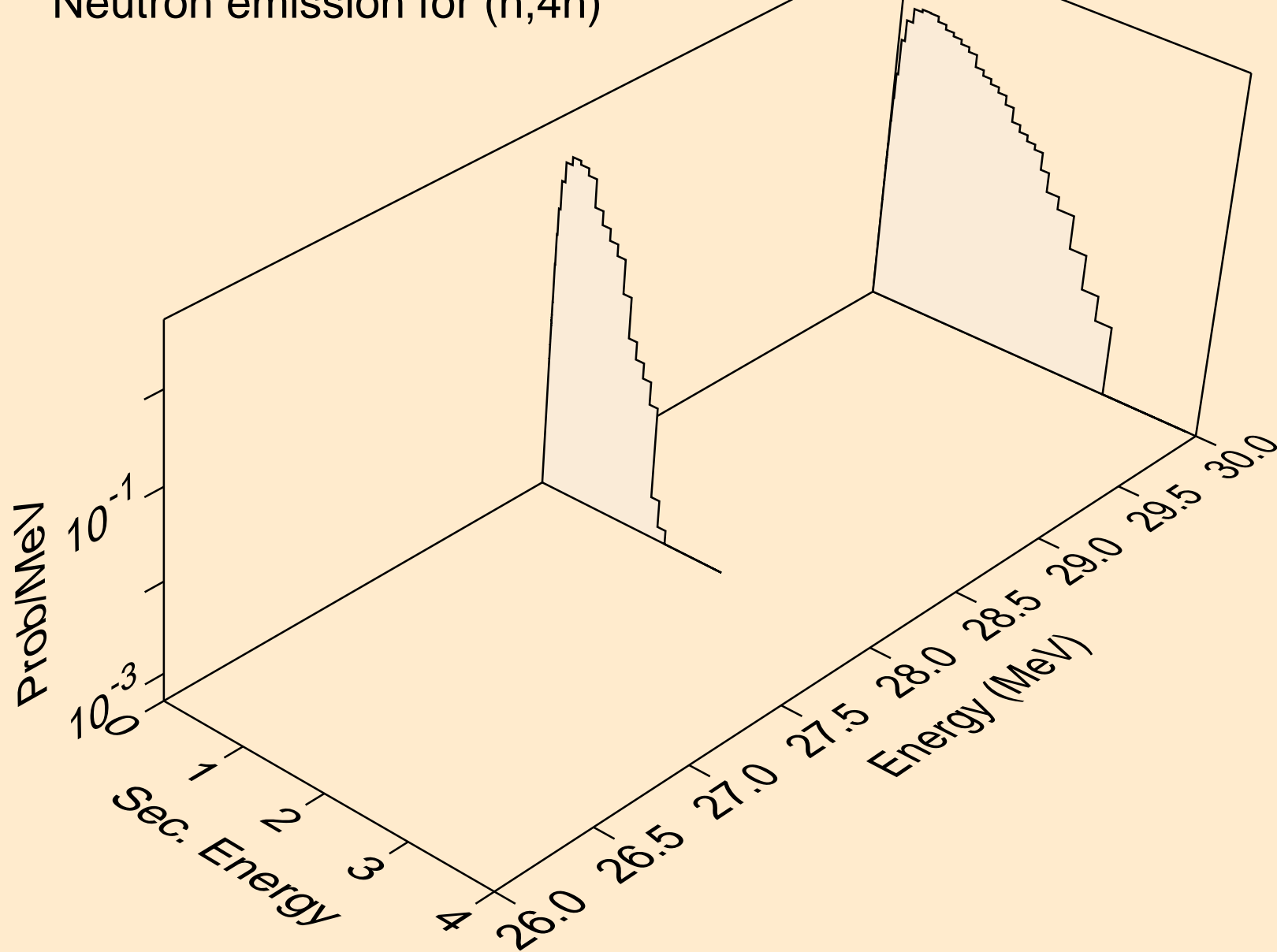

BI199M NEUTRON ACER TENDL-2021 LIBRARY; T=293.6K  
Neutron emission for (n,2np)

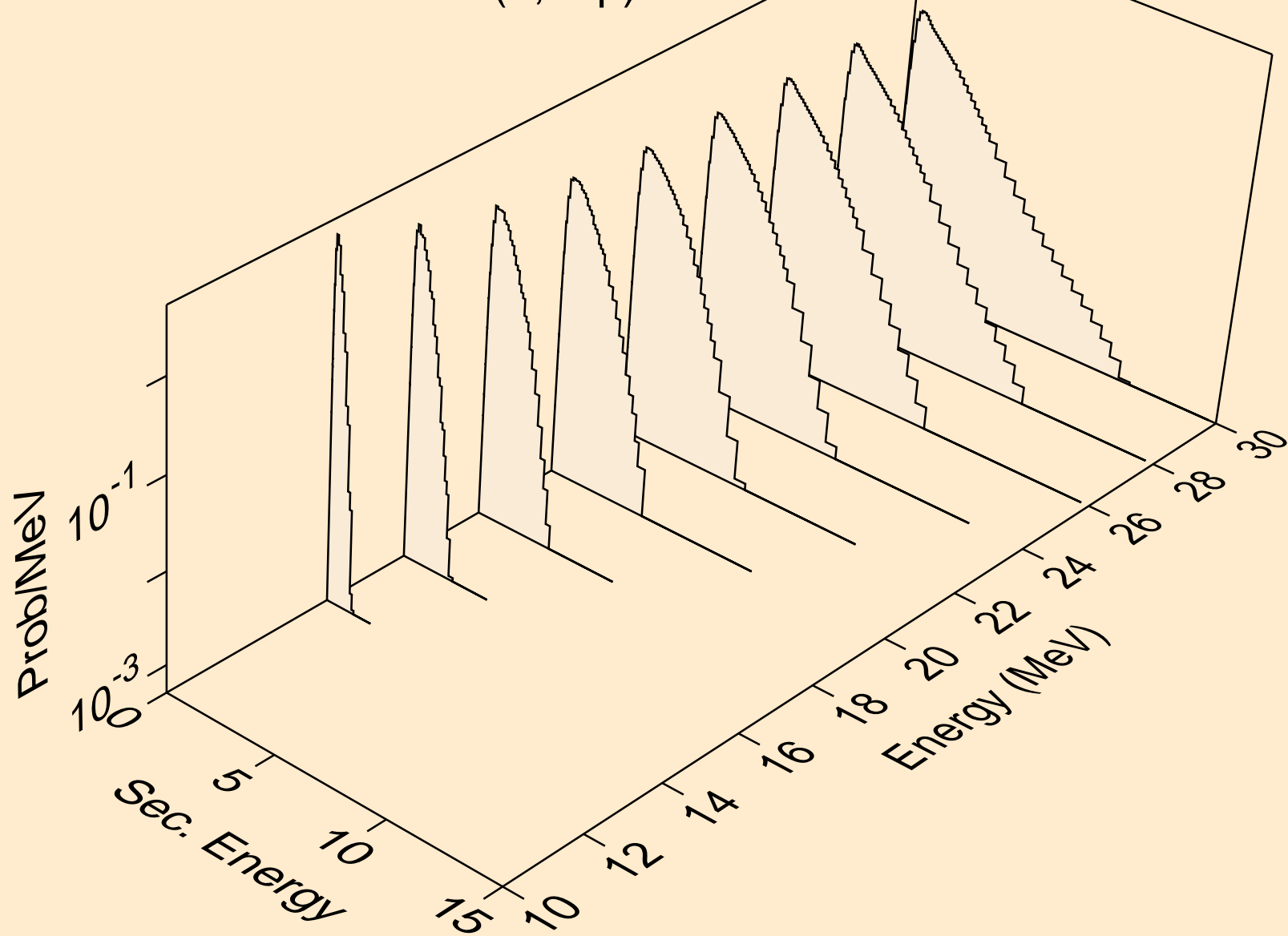

BI199M NEUTRON ACER TENDL-2021 LIBRARY; T=293.6K  
Neutron emission for (n,3np)

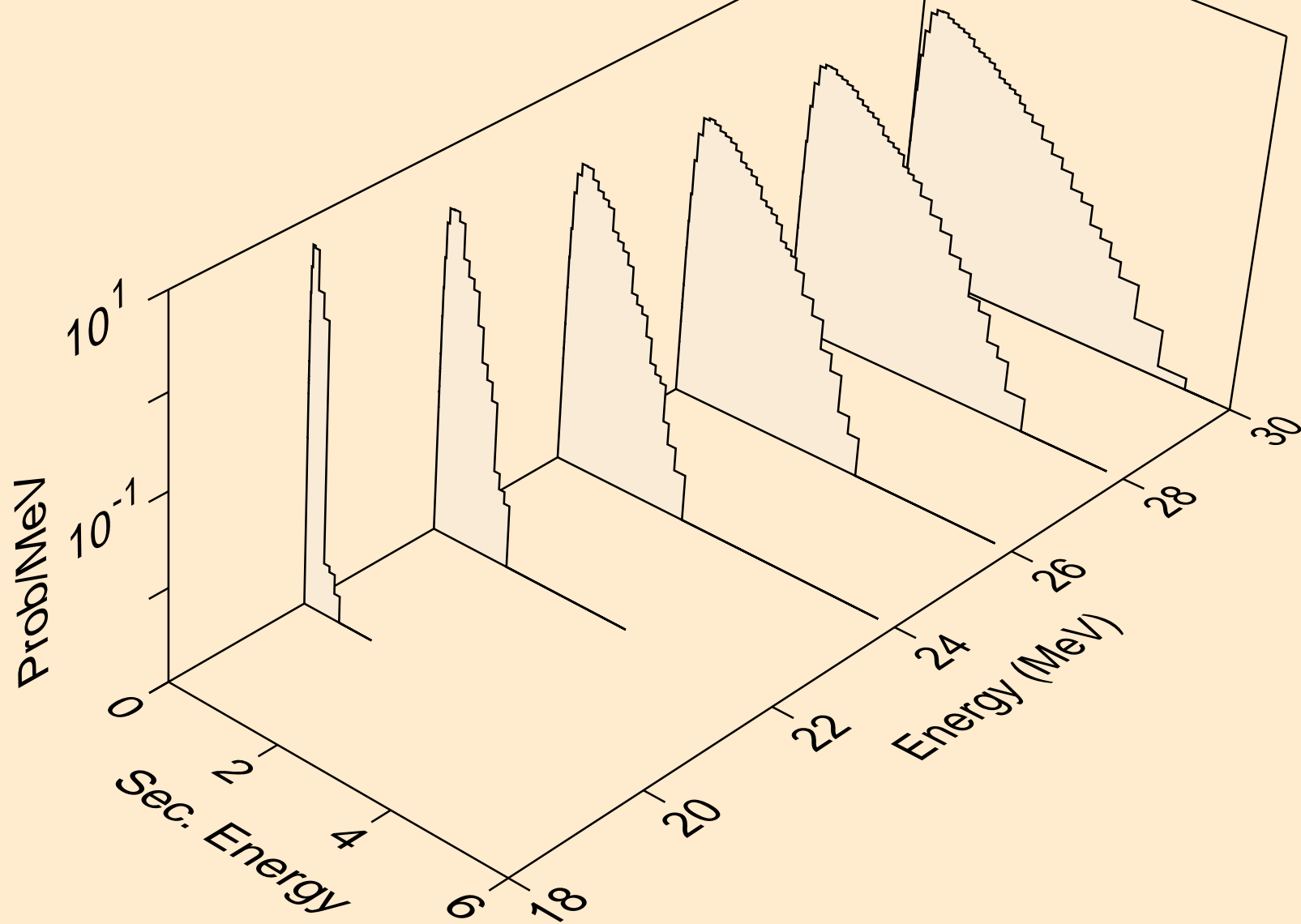

BI199M NEUTRON ACER TENDL-2021 LIBRARY; T=293.6K  
Neutron emission for (n,2np)

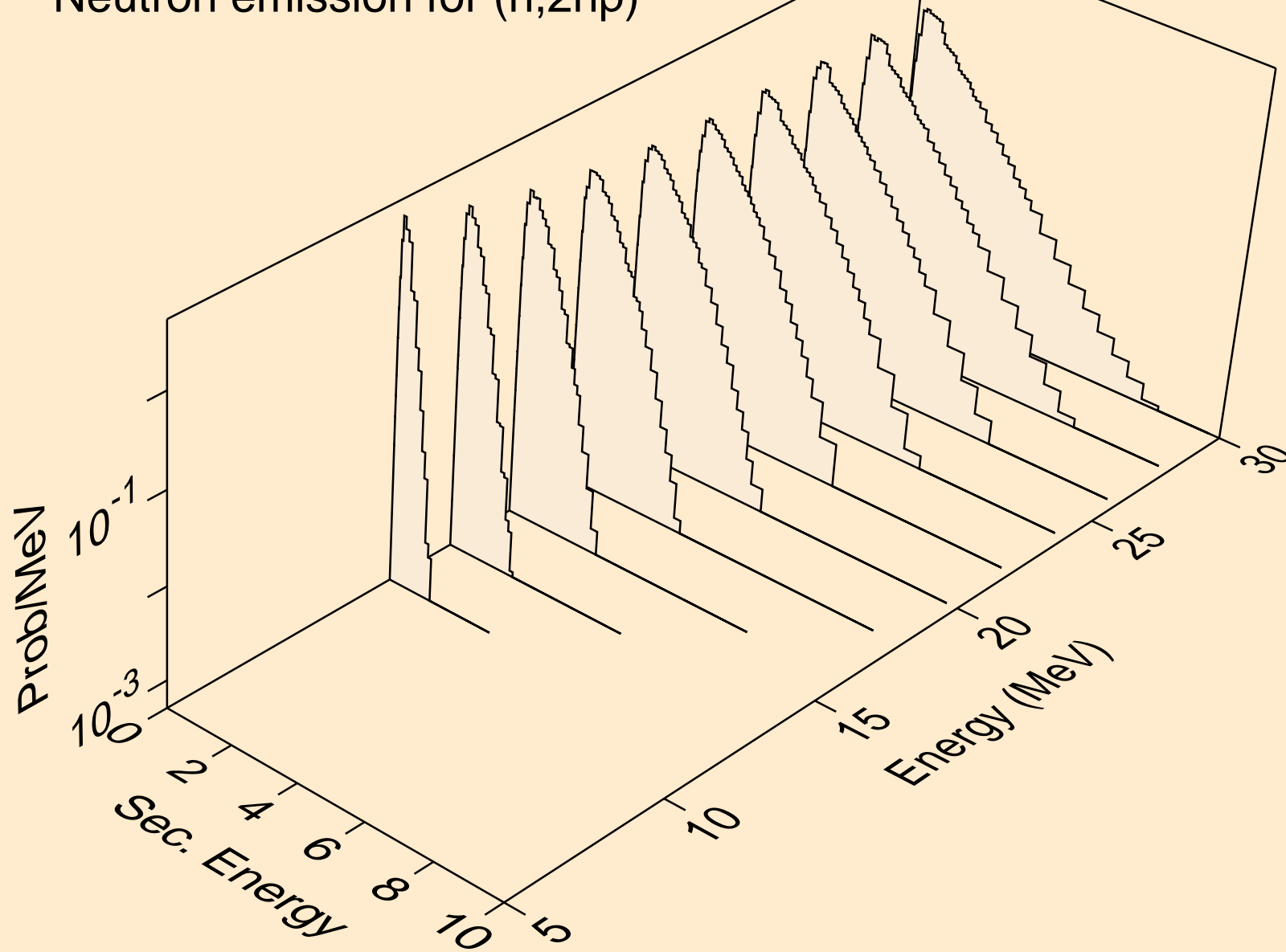

BI199M NEUTRON ACER TENDL-2021 LIBRARY; T=293.6K  
Neutron emission for (n,npa)

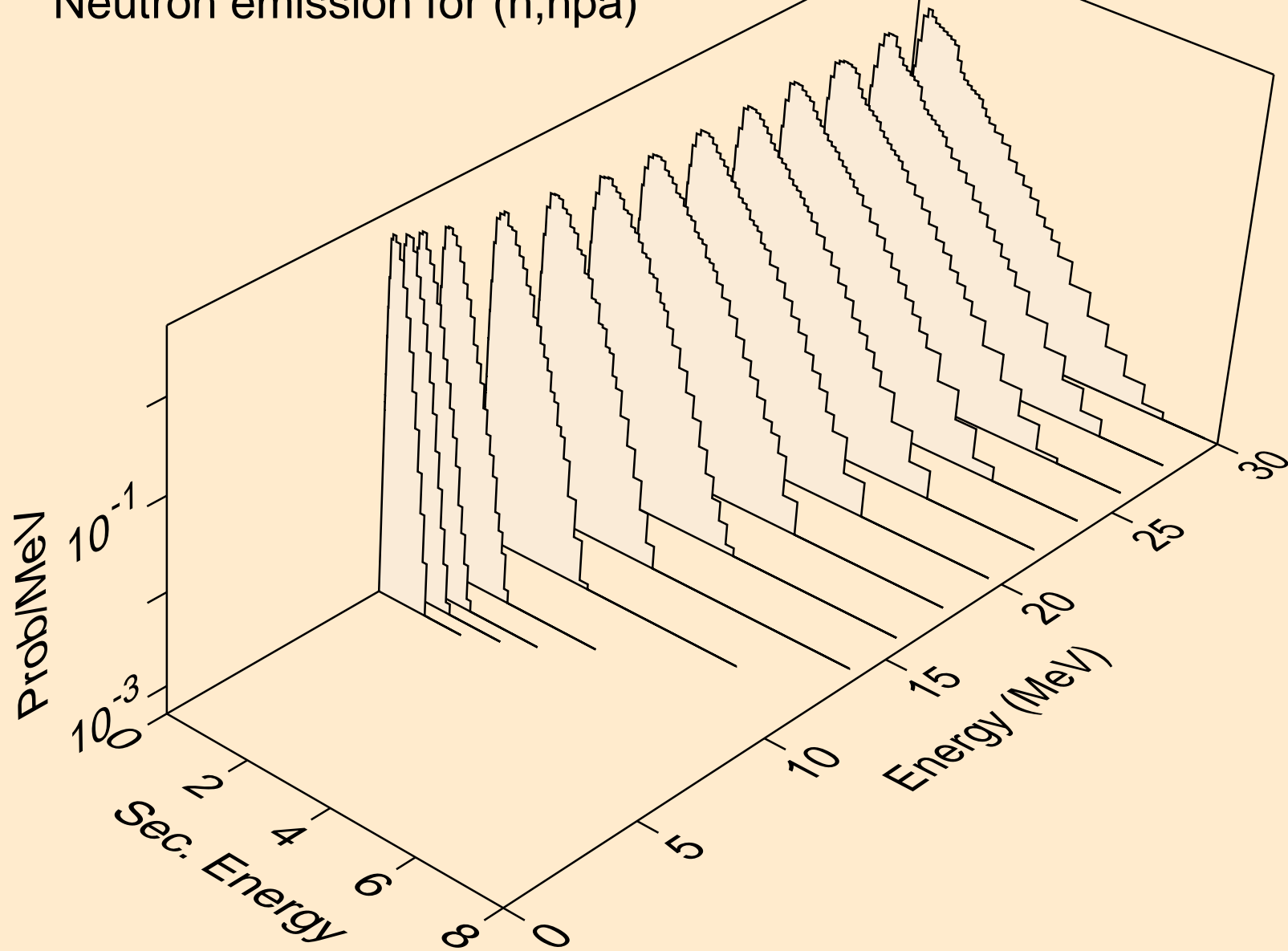

BI199M NEUTRON ACER TENDL-2021 LIBRARY; T=293.6K  
Neutron emission for (n,n\*c)

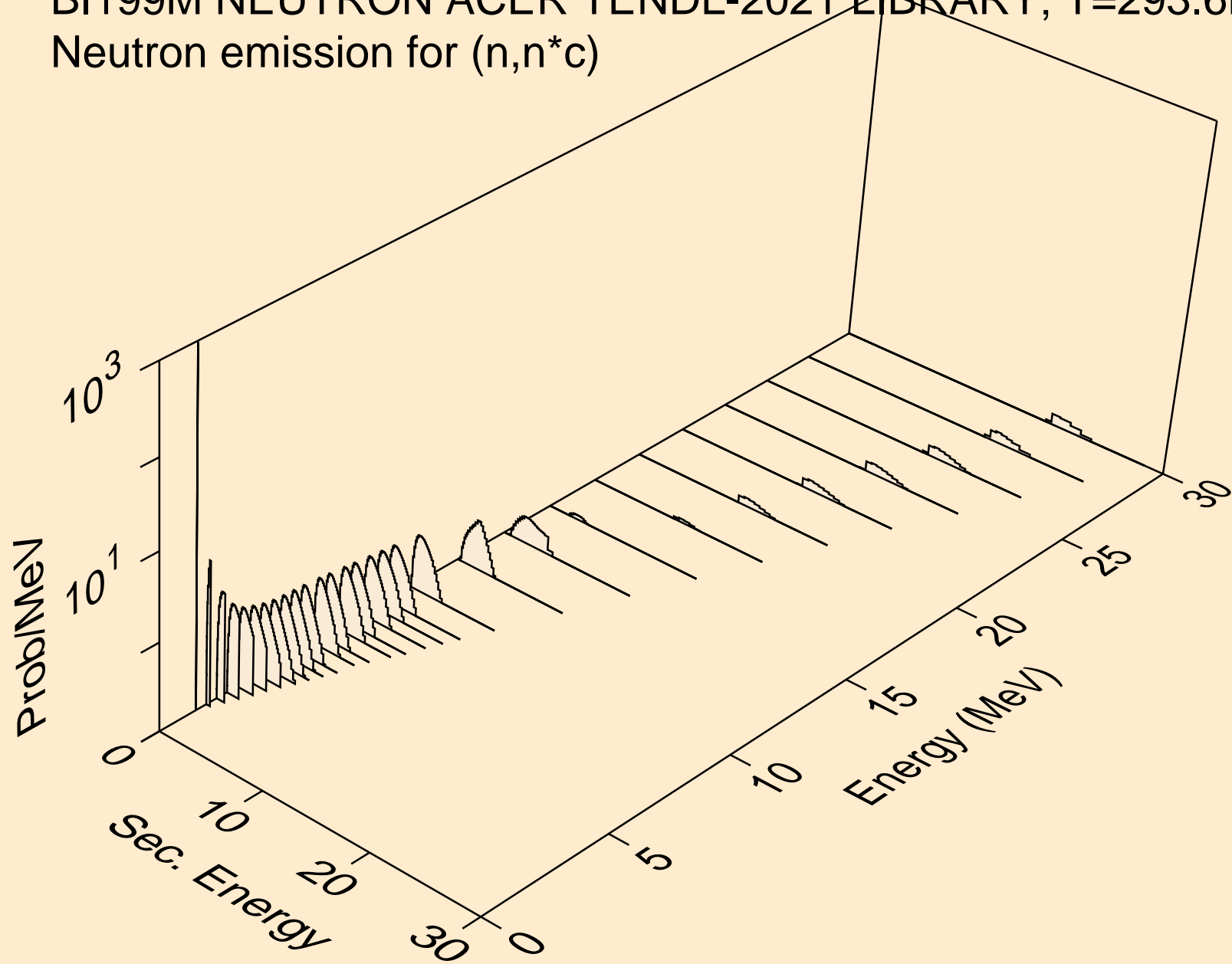

BI199M NEUTRON ACER TENDL-2021 LIBRARY; T=293.6K  
Photon emission for (n,x)

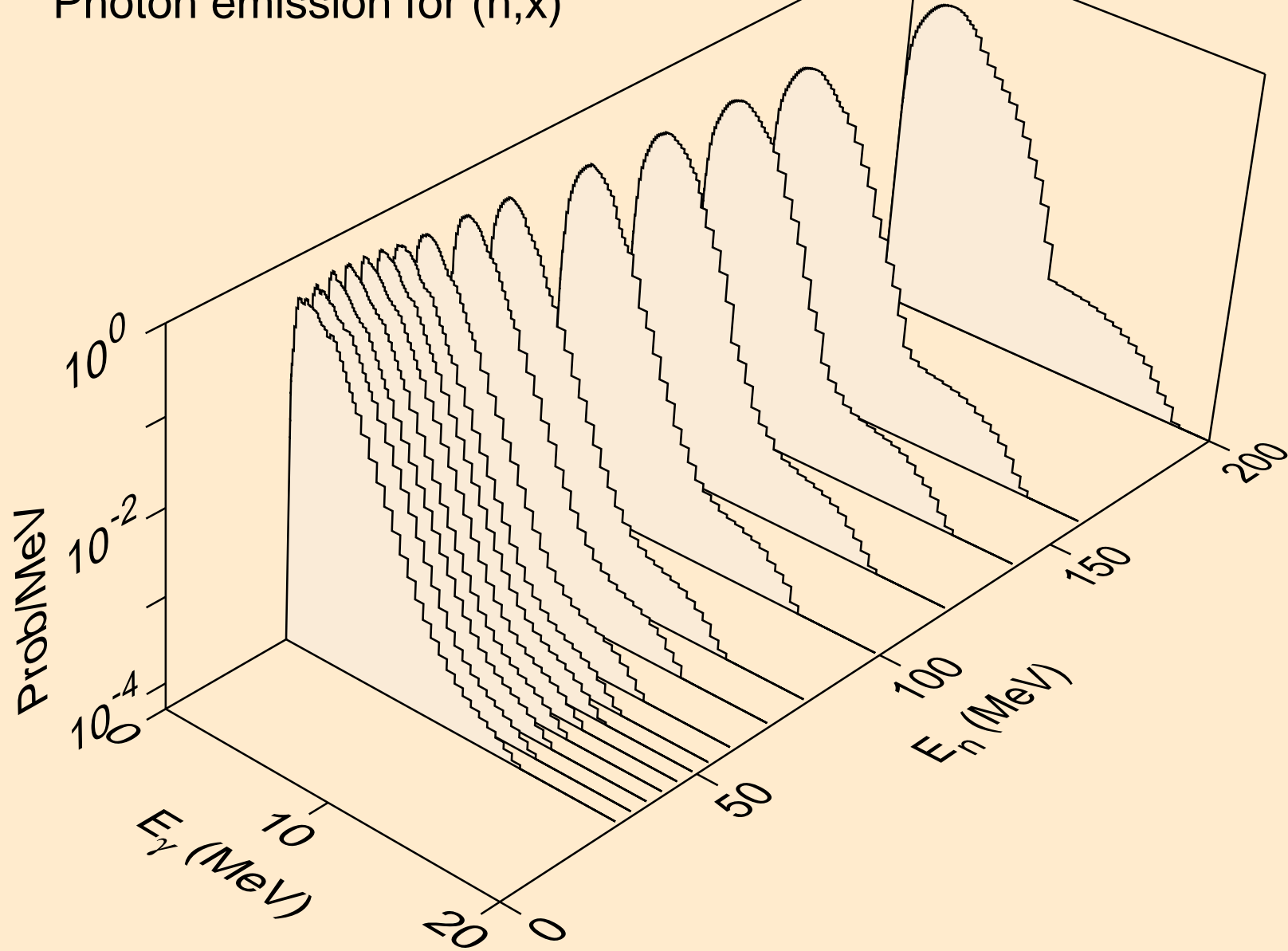



BI199M NEUTRON ACER TENDL-2021 LIBRARY; T=293.6K  
Photon emission for (n,2nd)

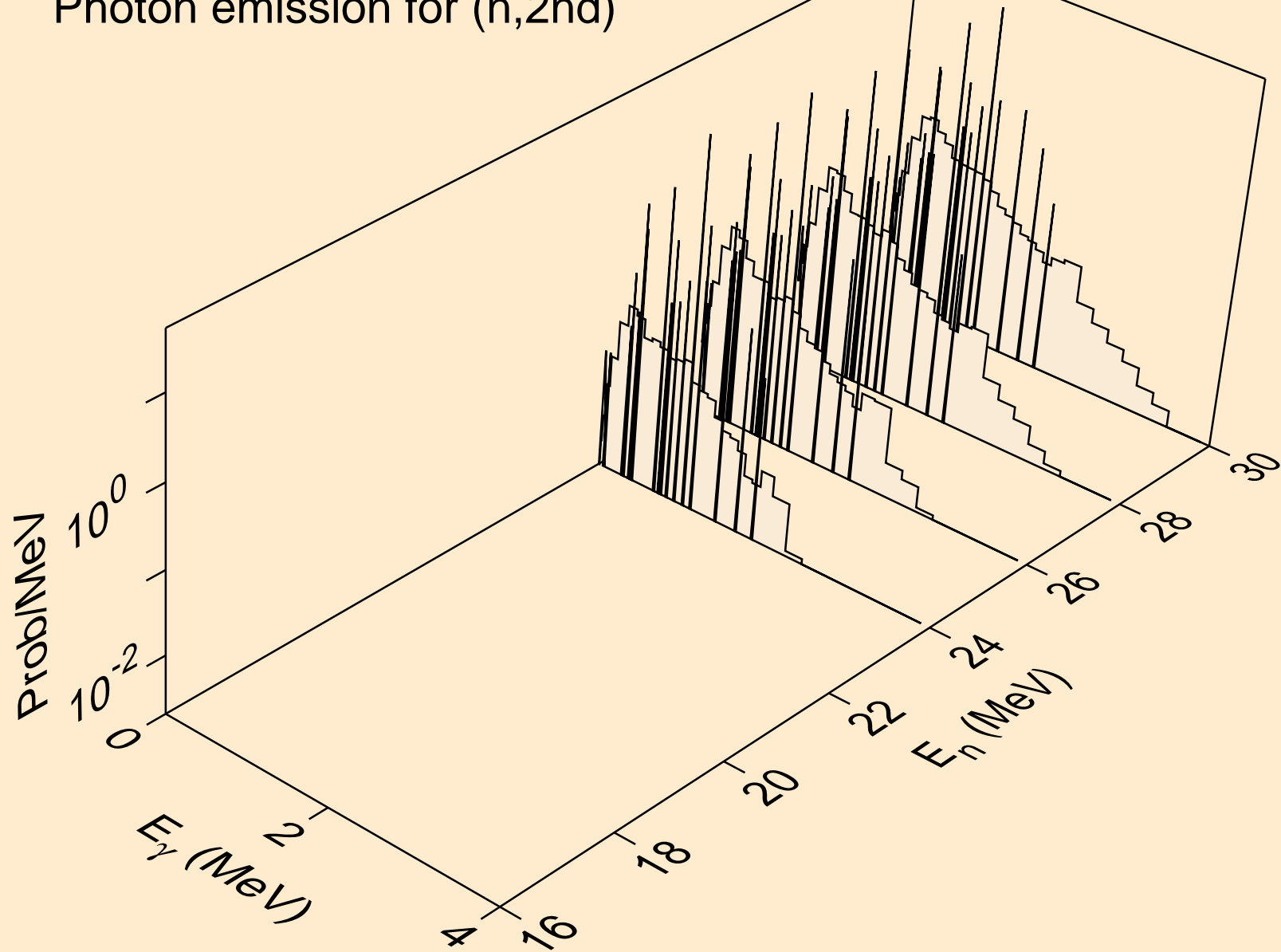

BI199M NEUTRON ACER TENDL-2021 LIBRARY; T=293.6K  
Photon emission for (n,2n)

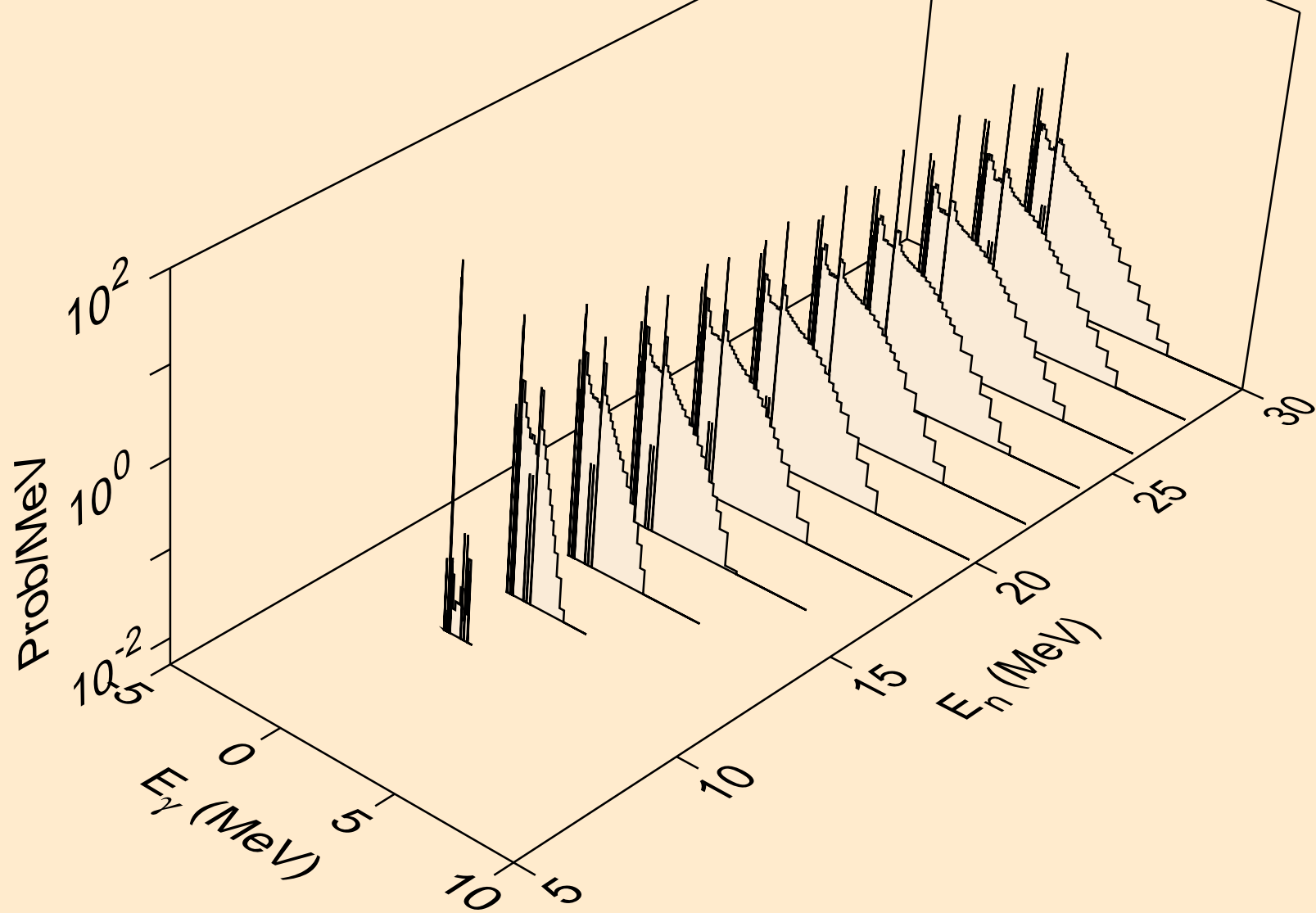

BI199M NEUTRON ACER TENDL-2021 LIBRARY; T=293.6K  
Photon emission for (n,3n)

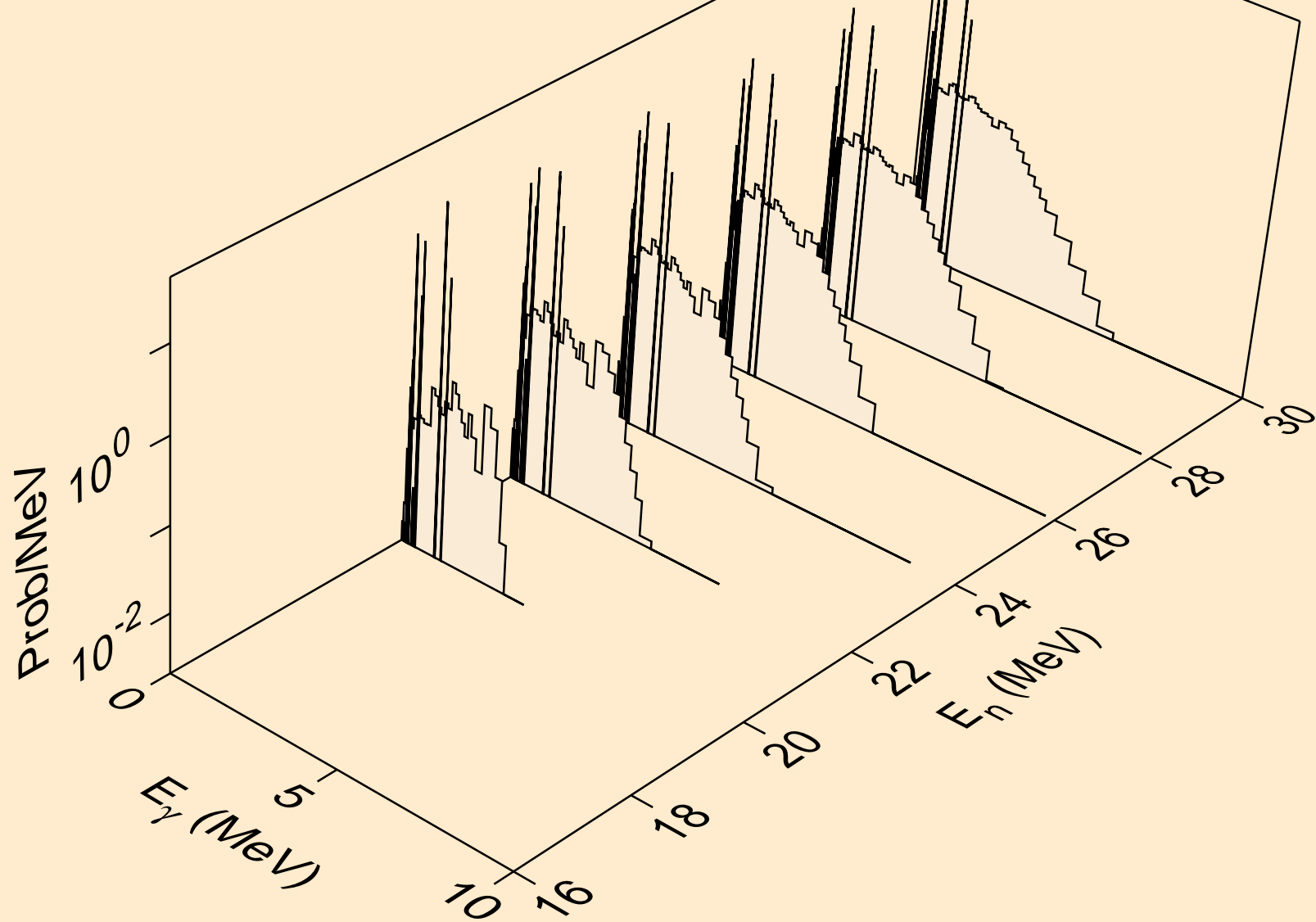

BI199M NEUTRON ACER TENDL-2021 LIBRARY; T=293.6K  
Photon emission for (n,n\*)a

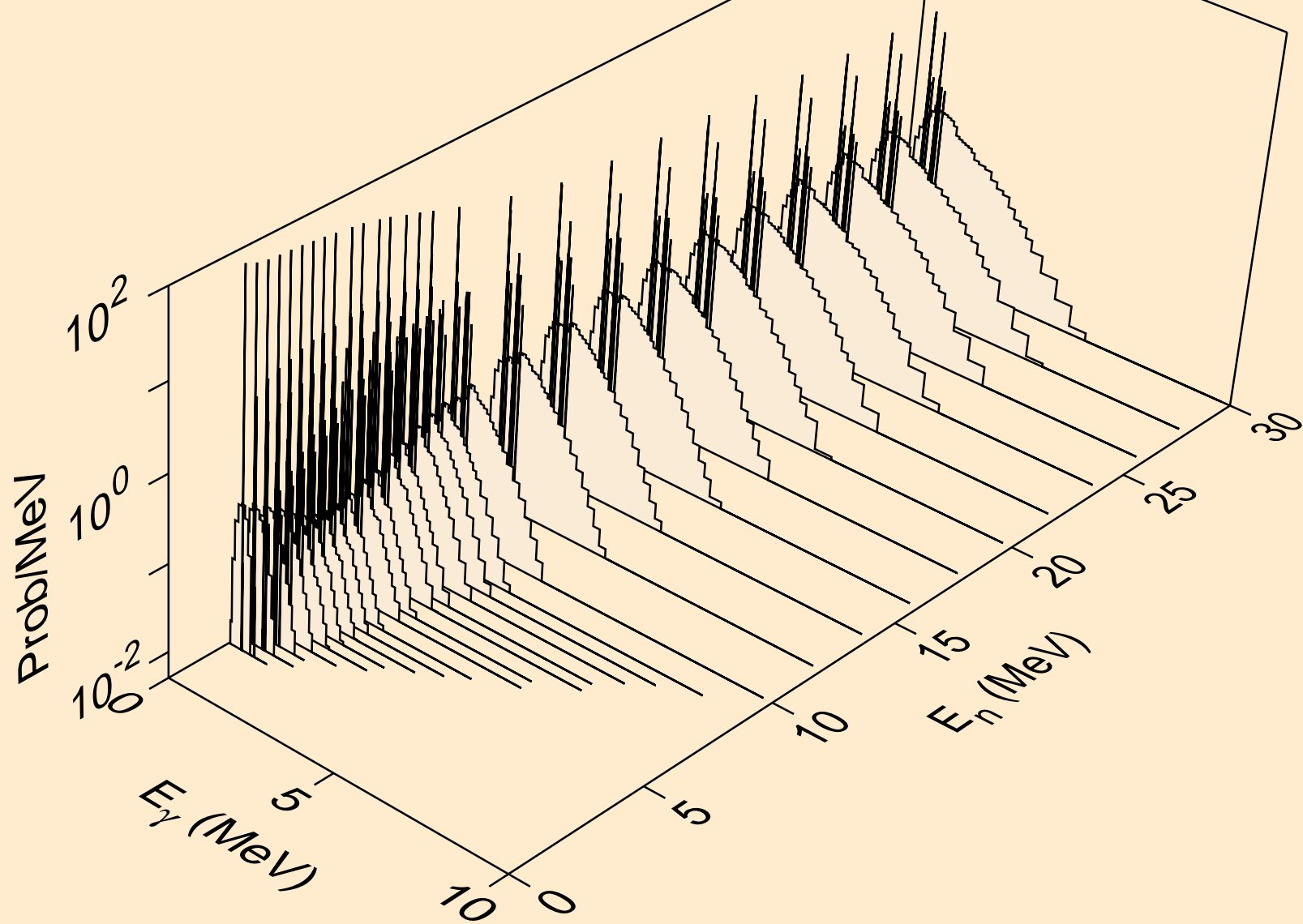

BI199M NEUTRON ACER TENDL-2021 LIBRARY; T=293.6K  
Photon emission for (n,2n)a

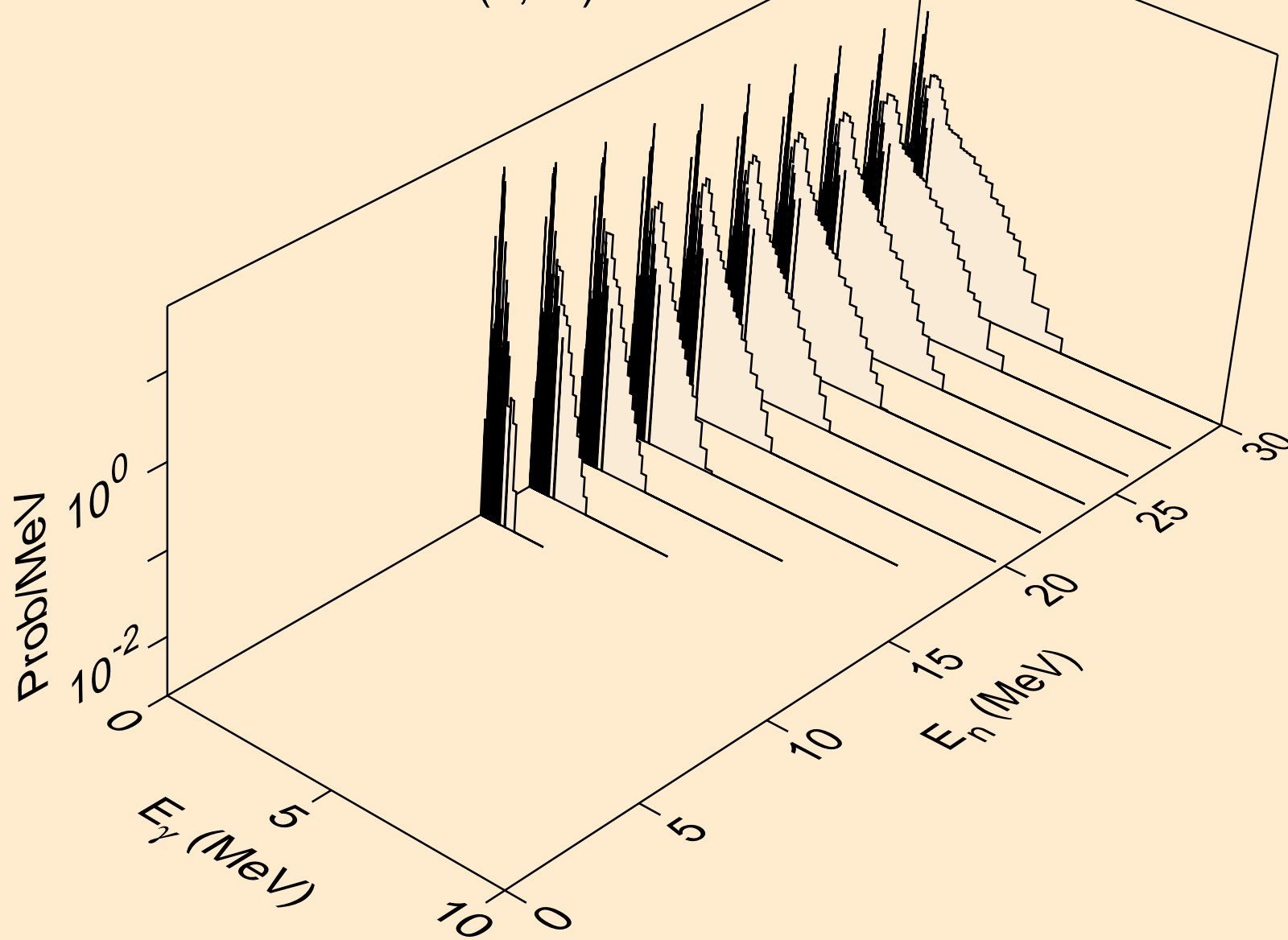

BI199M NEUTRON ACER TENDL-2021 LIBRARY; T=293.6K  
Photon emission for (n,3n)a

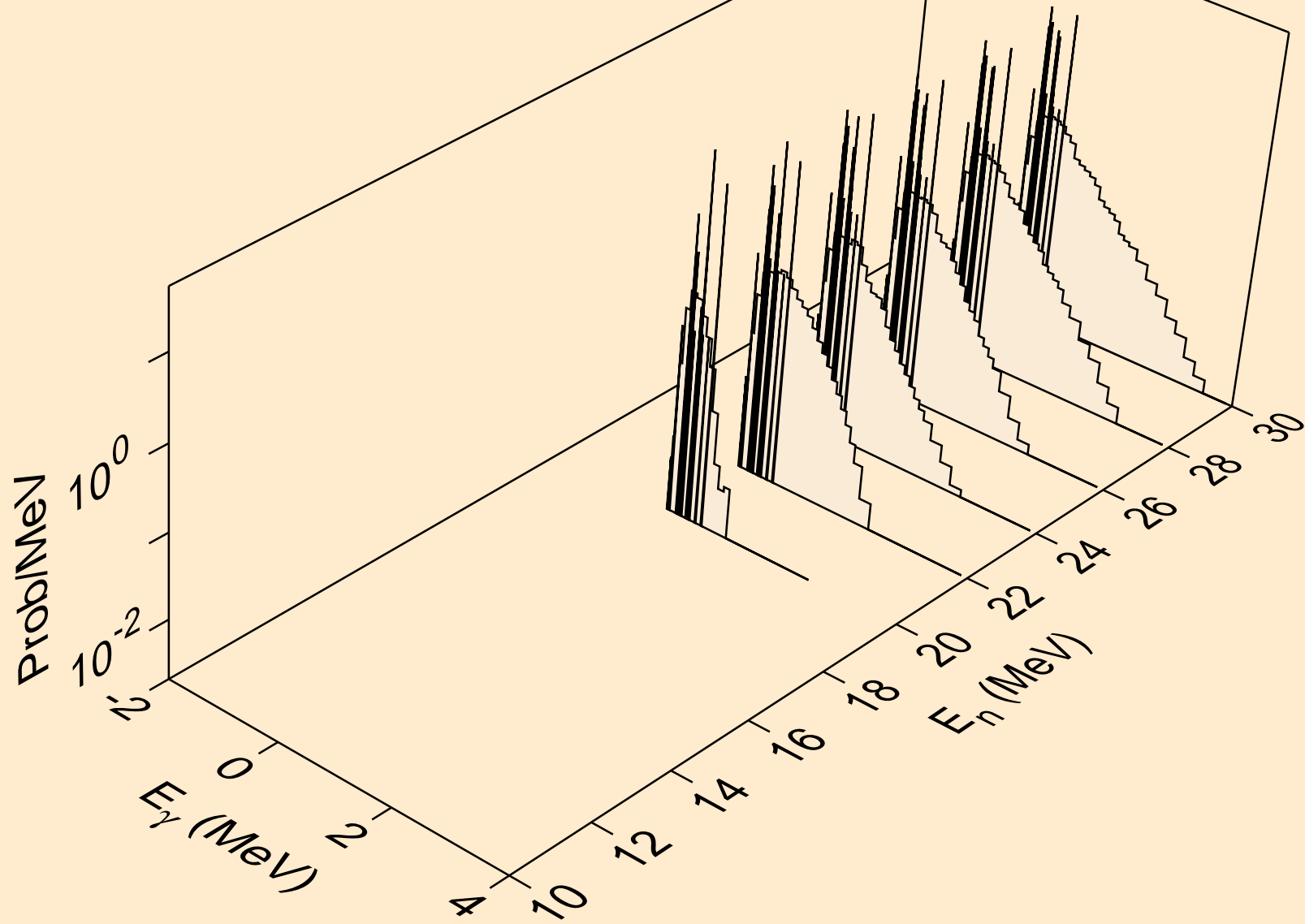

BI199M NEUTRON ACER TENDL-2021 LIBRARY; T=293.6K  
Photon emission for (n,n\*)p

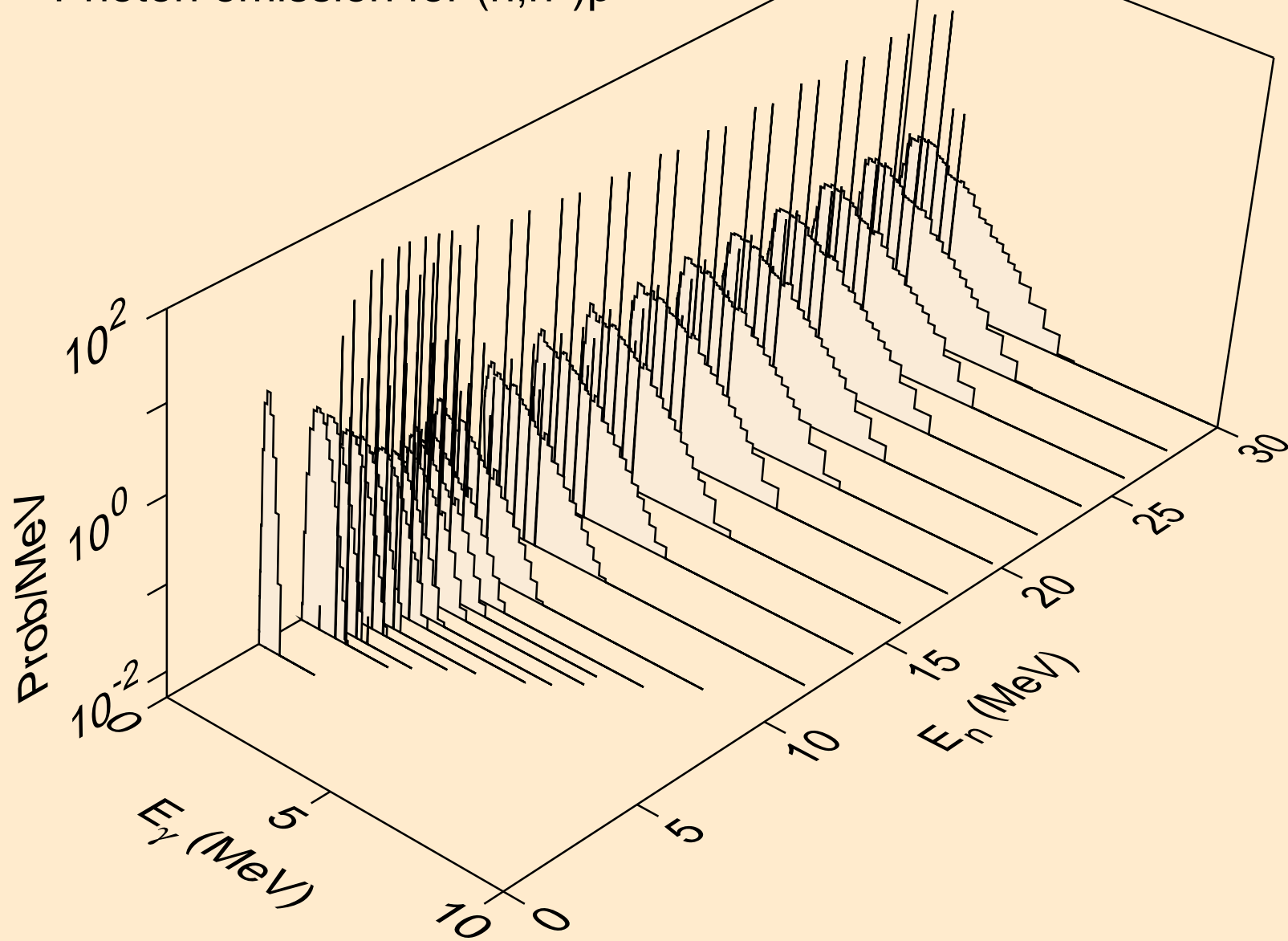

BI199M NEUTRON ACER TENDL-2021 LIBRARY; T=293.6K  
Photon emission for (n,n\*)2a

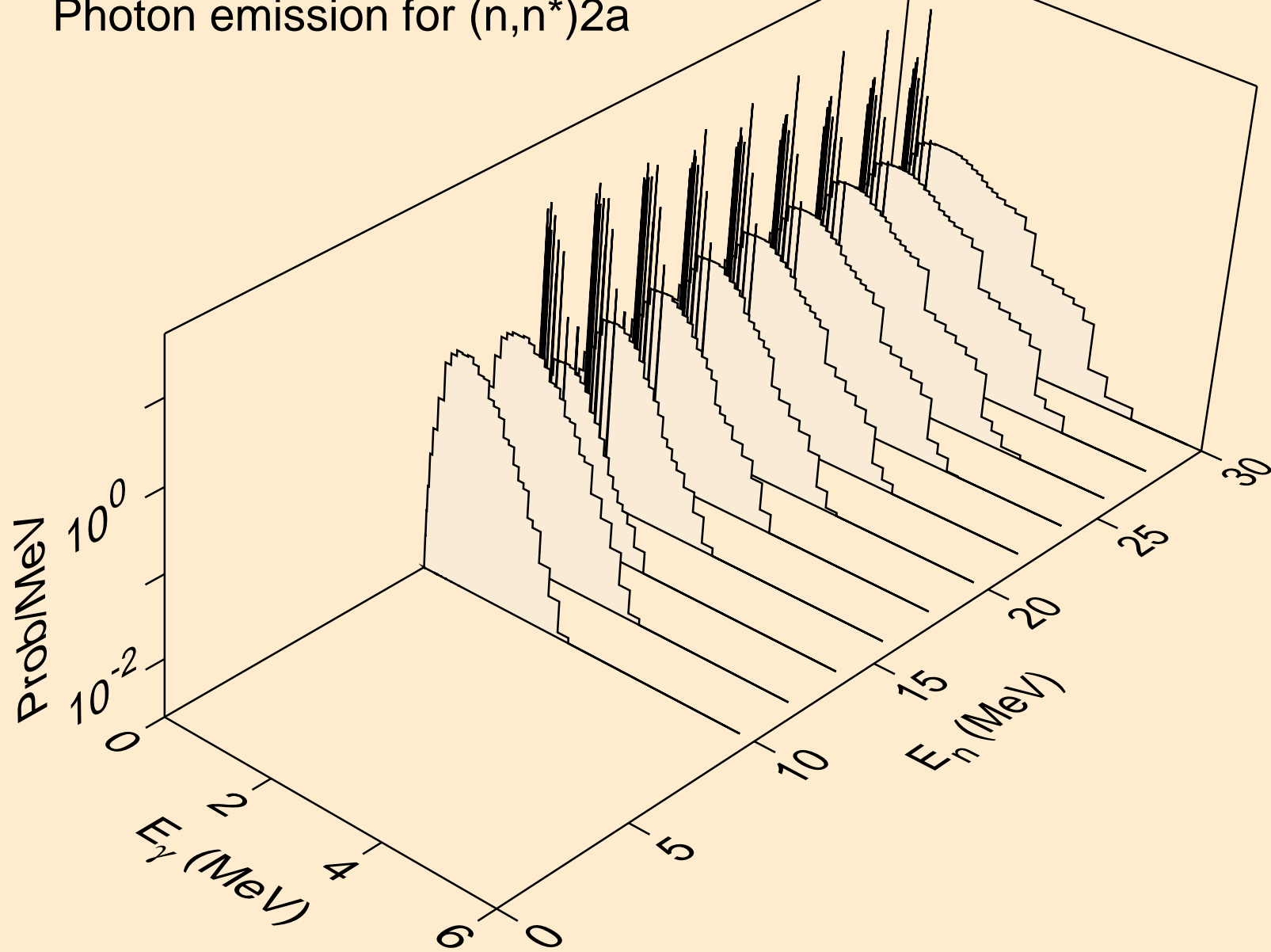



BI199M NEUTRON ACER TENDL-2021 LIBRARY; T=293.6K  
Photon emission for (n,n\*)d

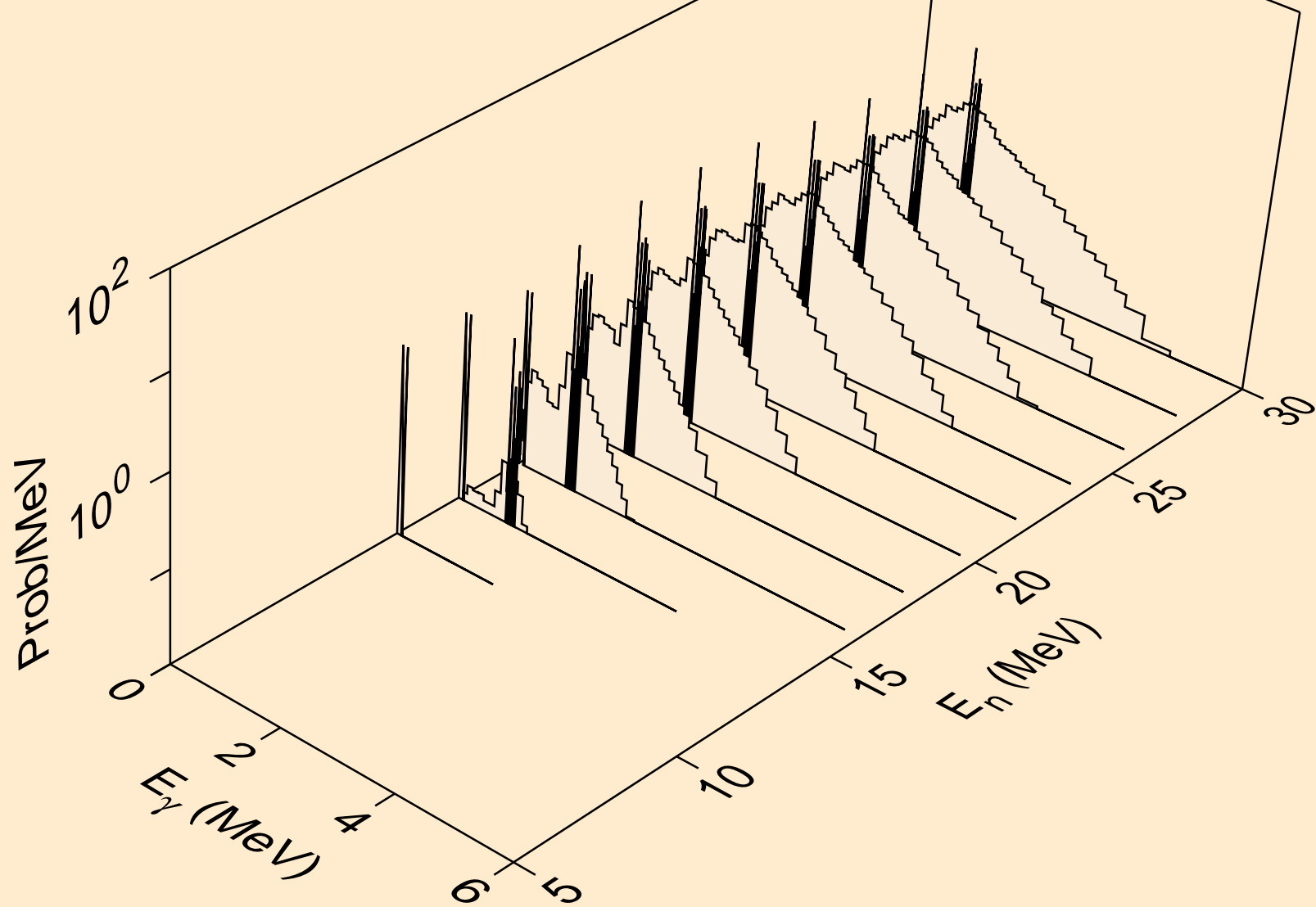

BI199M NEUTRON ACER TENDL-2021 LIBRARY; T=293.6K  
Photon emission for (n,n\*)t

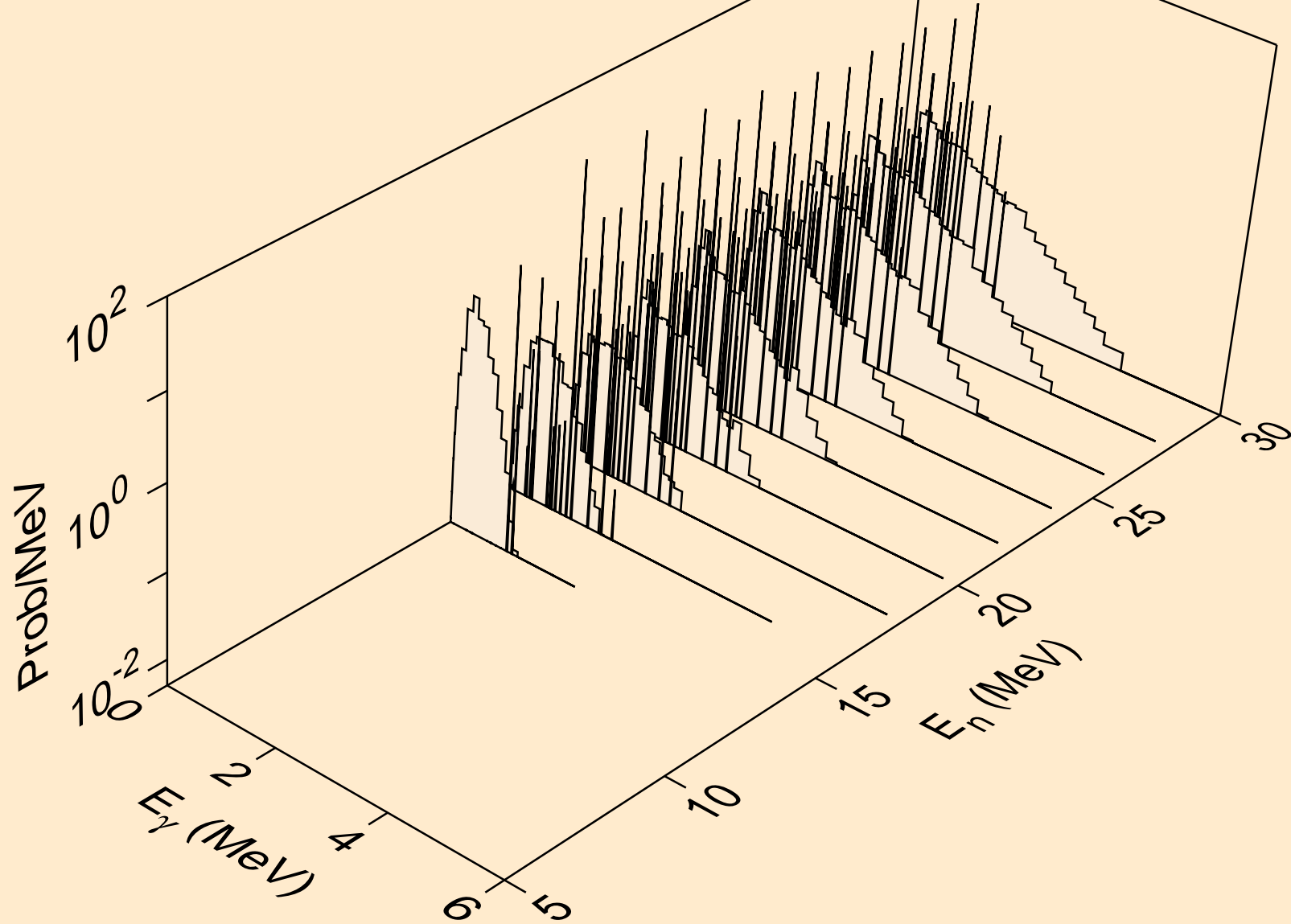

BI199M NEUTRON ACER TENDL-2021 LIBRARY; T=293.6K  
Photon emission for (n,n\*)he3

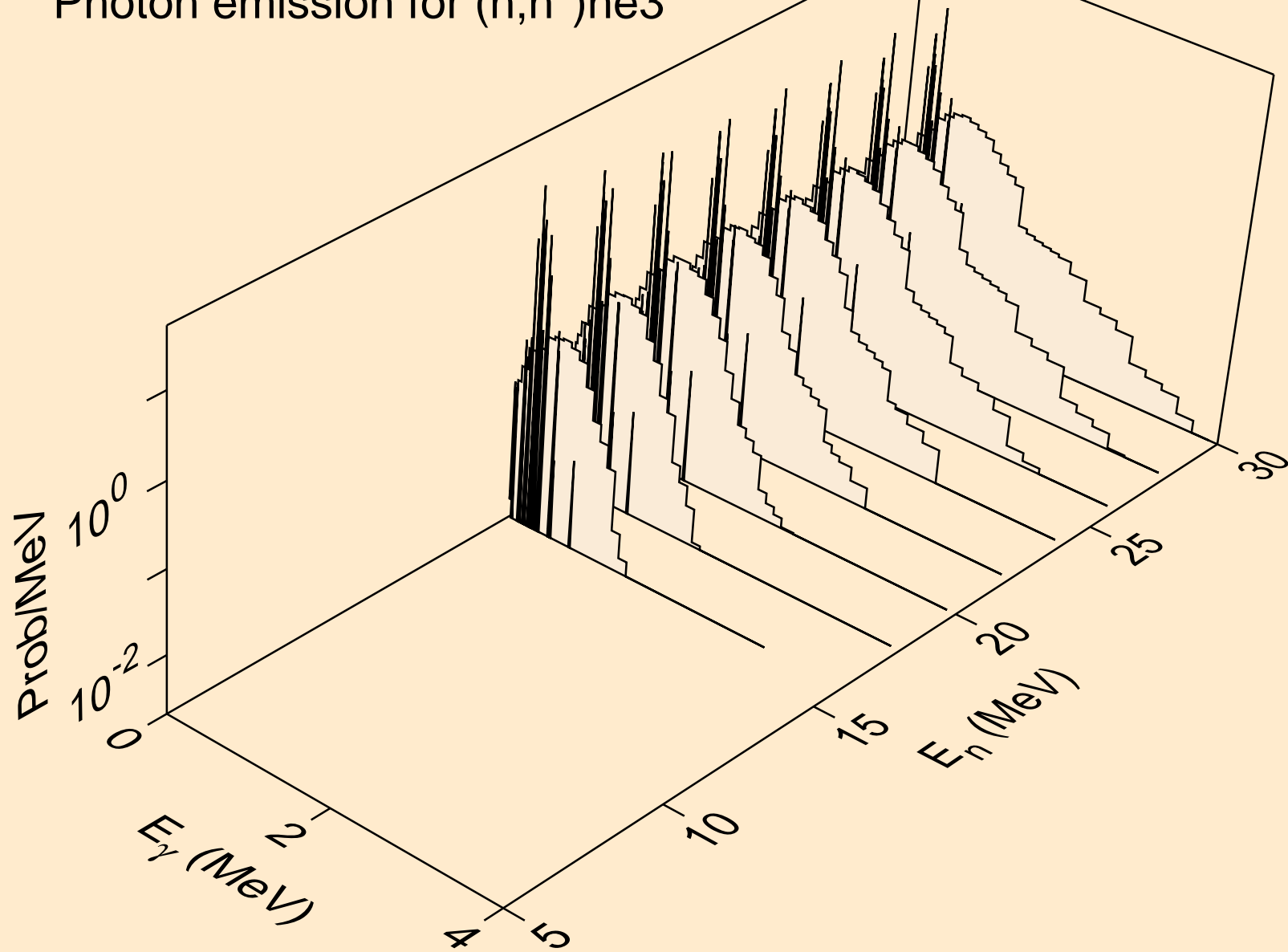

BI199M NEUTRON ACER TENDL-2021 LIBRARY; T=293.6K  
Photon emission for (n,4n)

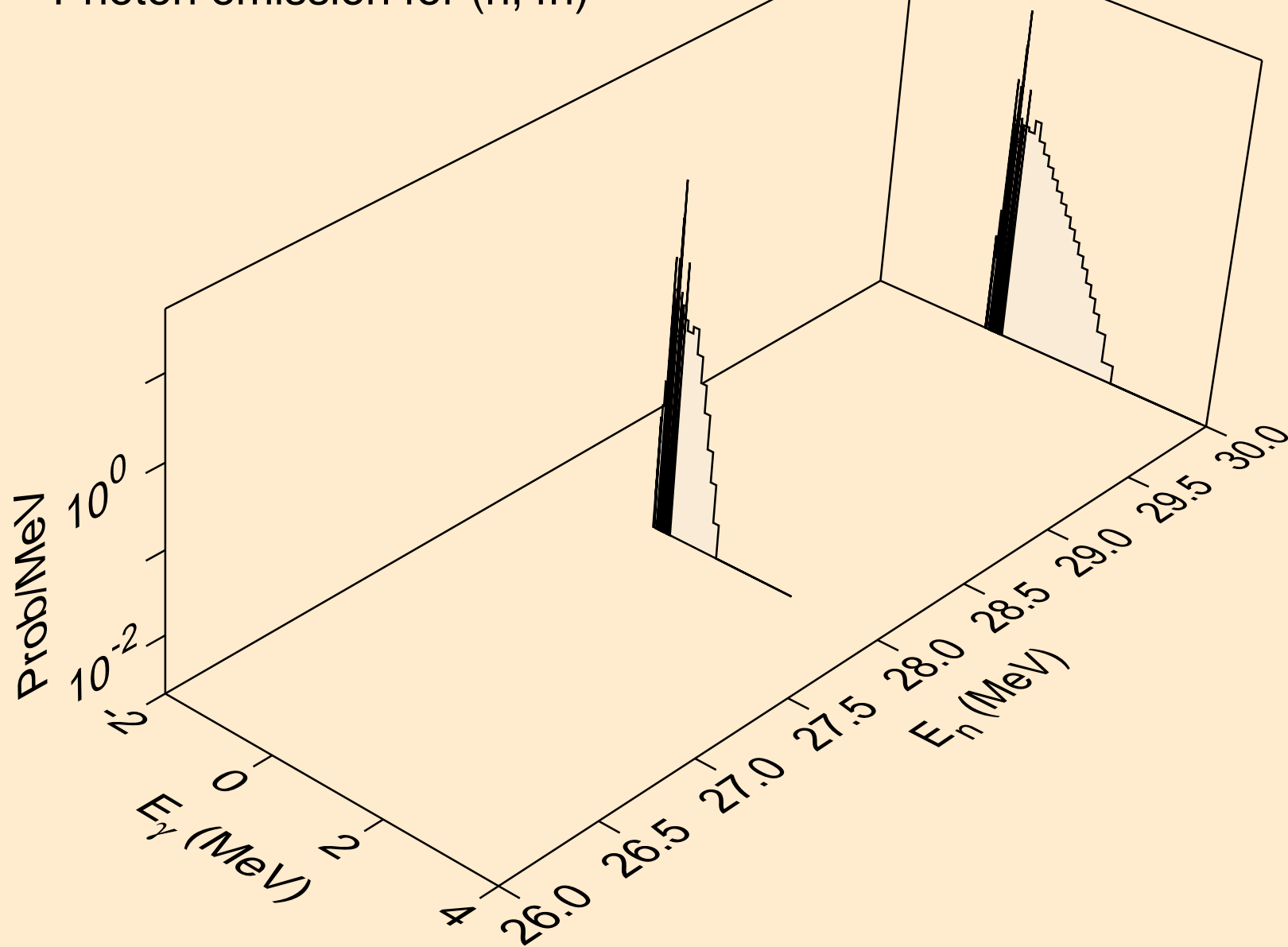

BI199M NEUTRON ACER TENDL-2021 LIBRARY; T=293.6K  
Photon emission for (n,2np)

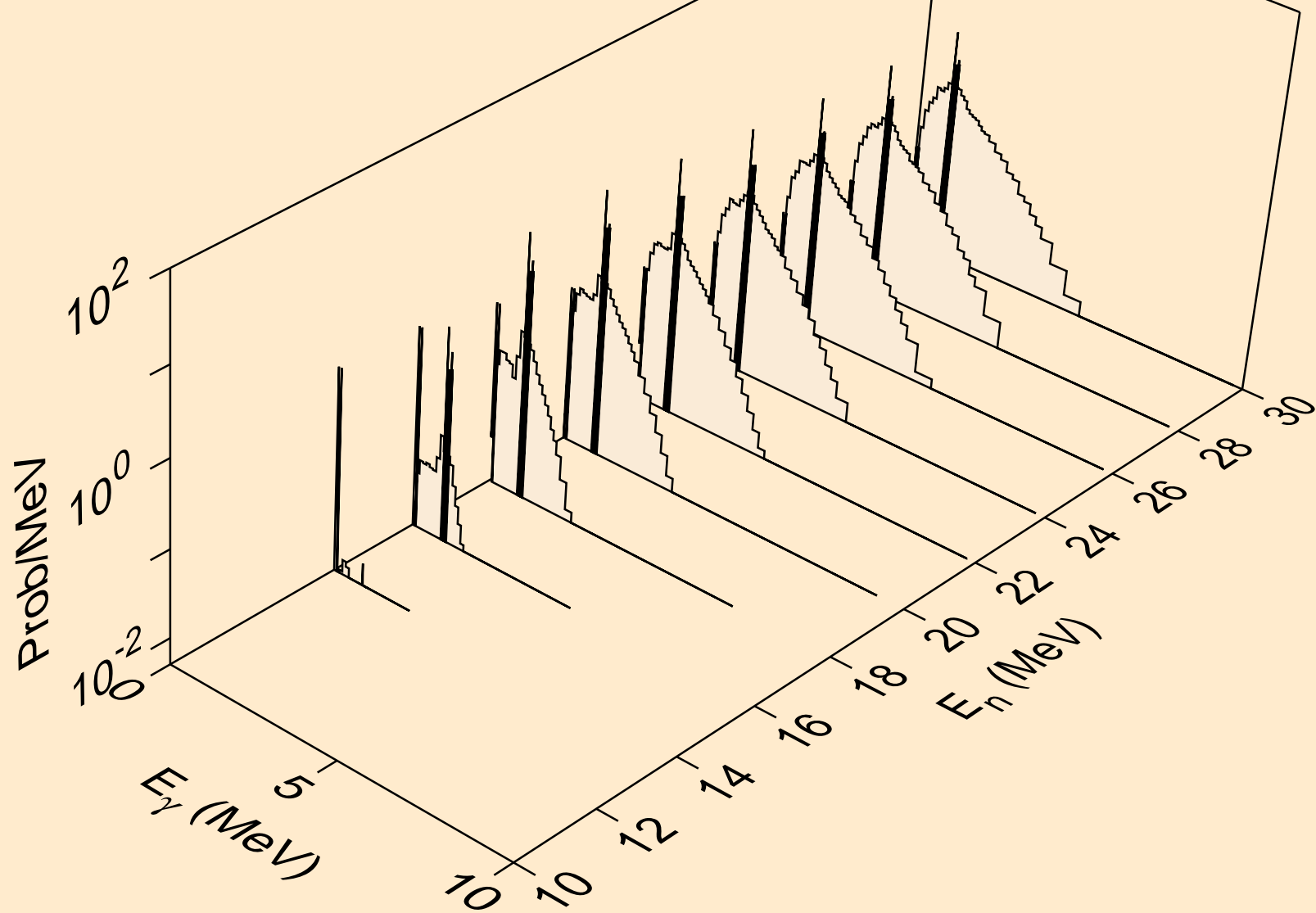

BI199M NEUTRON ACER TENDL-2021 LIBRARY; T=293.6K  
Photon emission for (n,3np)

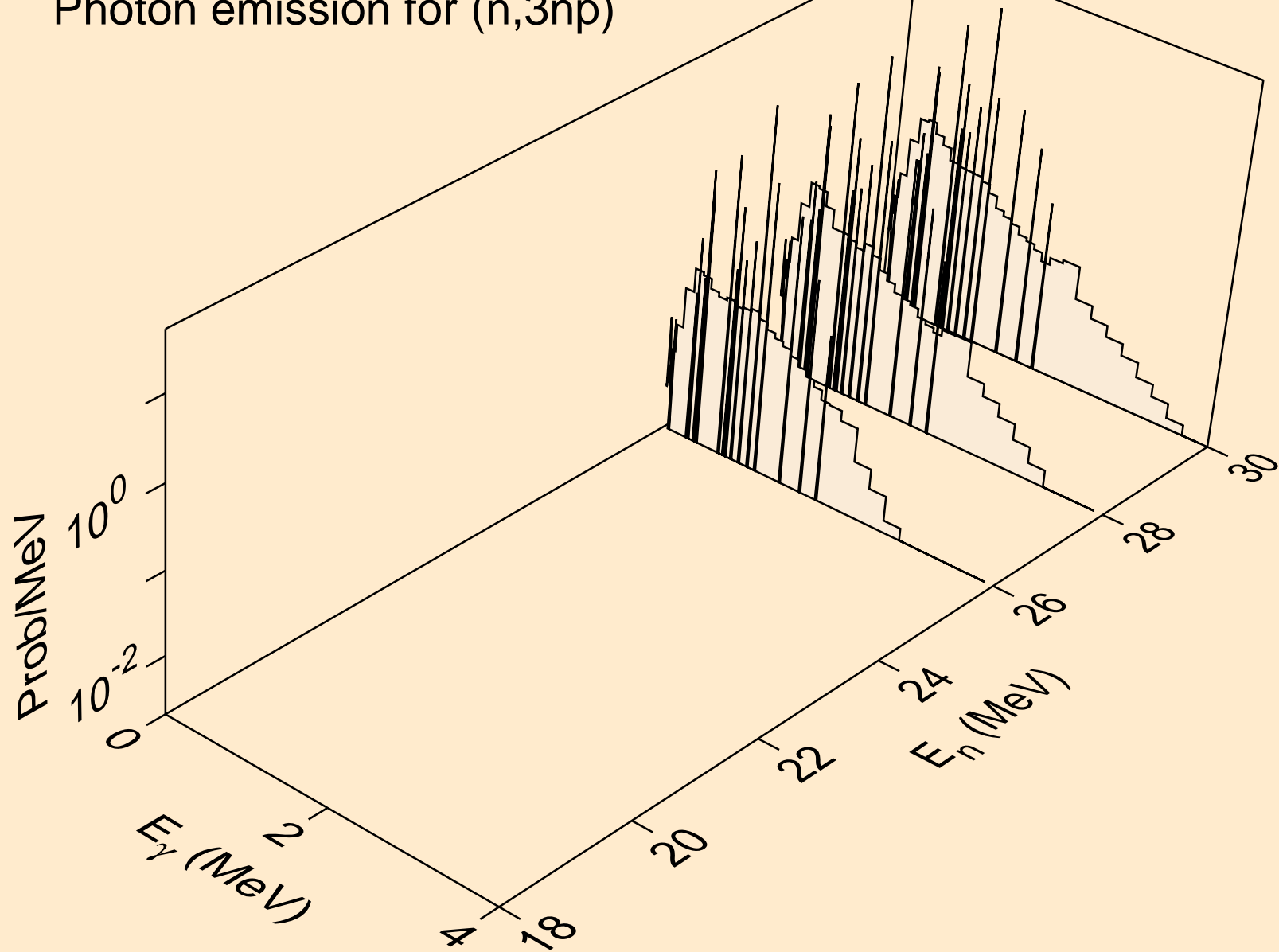

BI199M NEUTRON ACER TENDL-2021 LIBRARY; T=293.6K  
Photon emission for (n,2np)

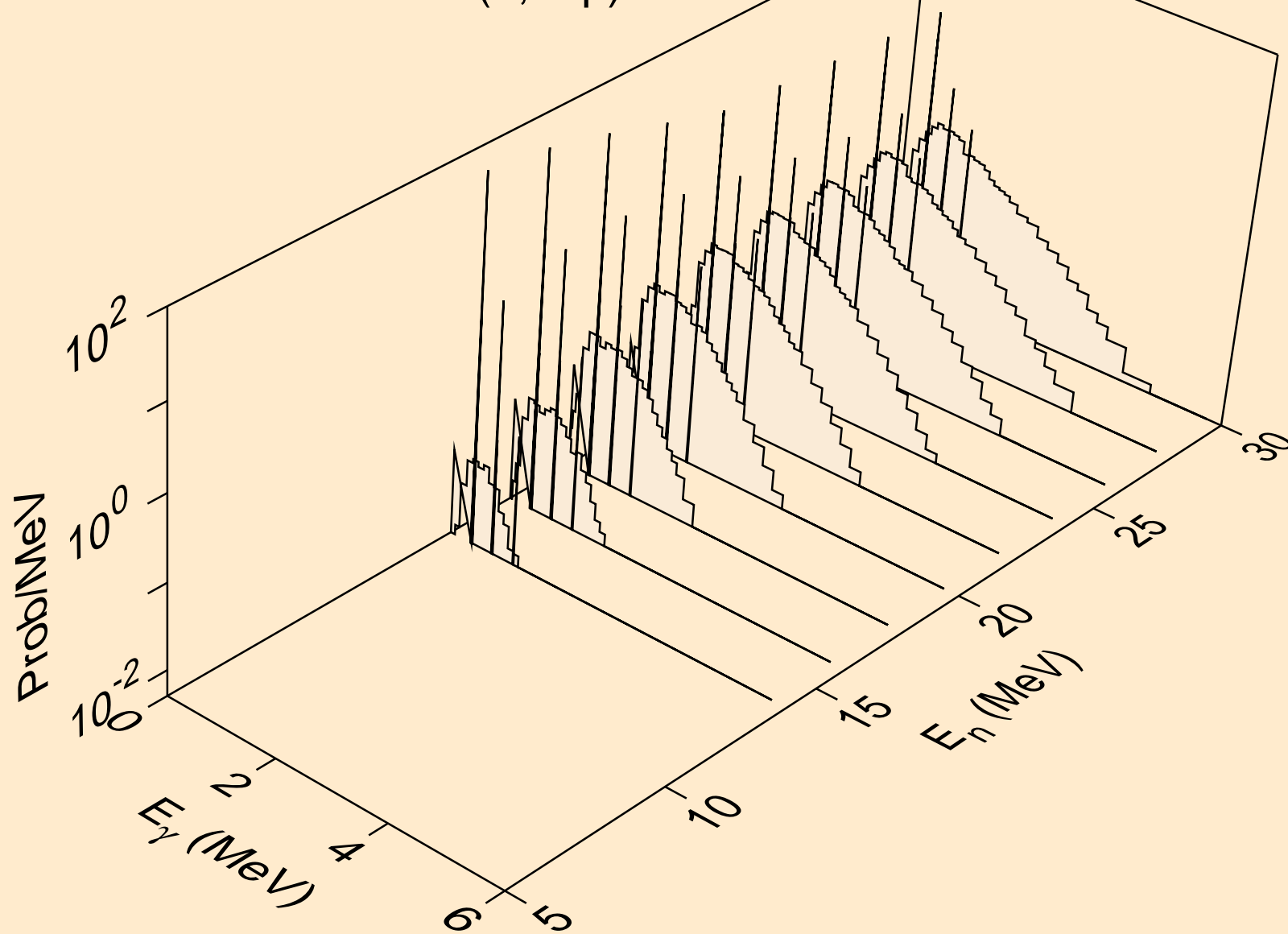

BI199M NEUTRON ACER TENDL-2021 LIBRARY; T=293.6K  
Photon emission for (n,npa)

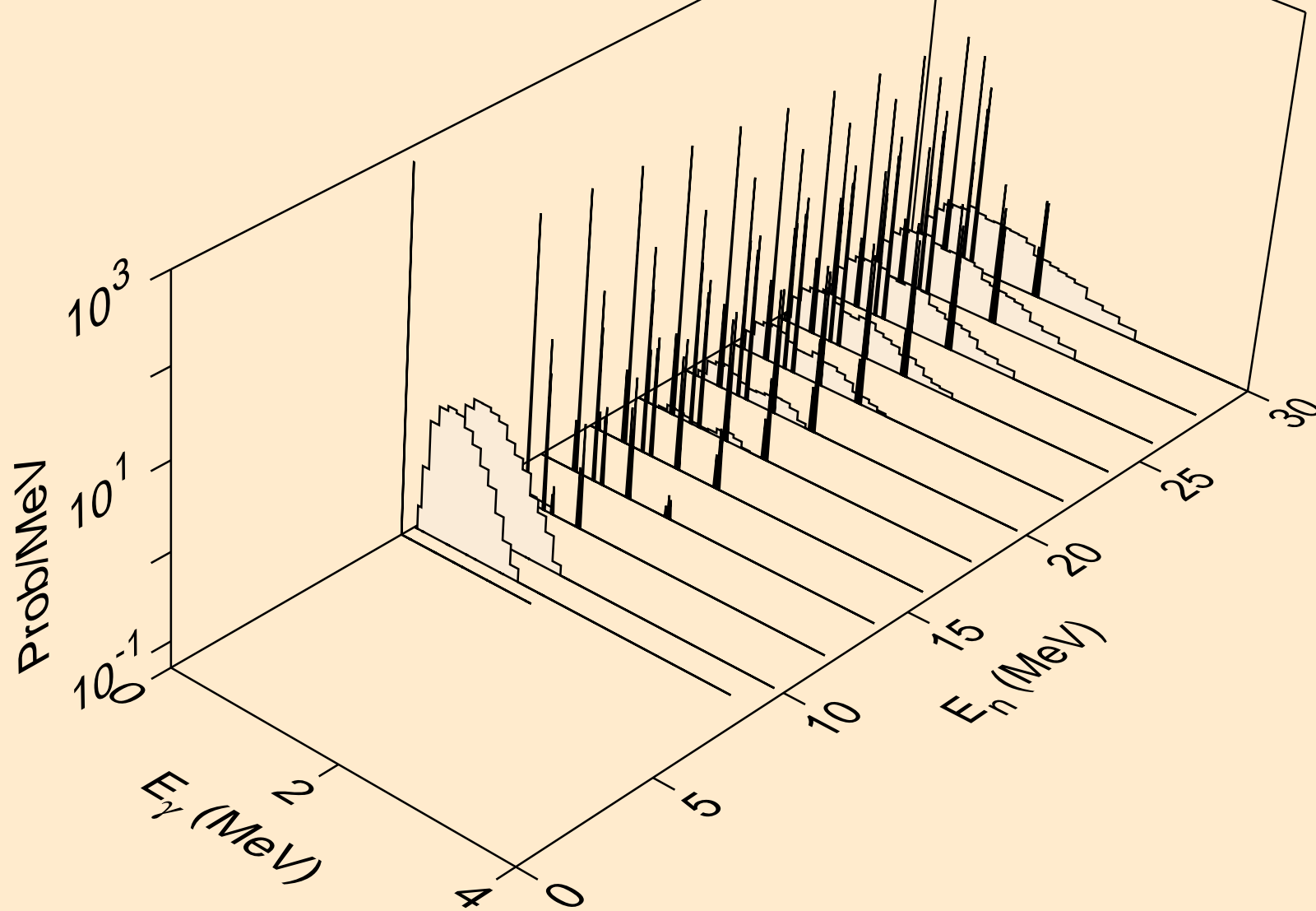



BI199M NEUTRON ACER TENDL-2021 LIBRARY; T=293.6K  
Photon emission for (n,n\*2)

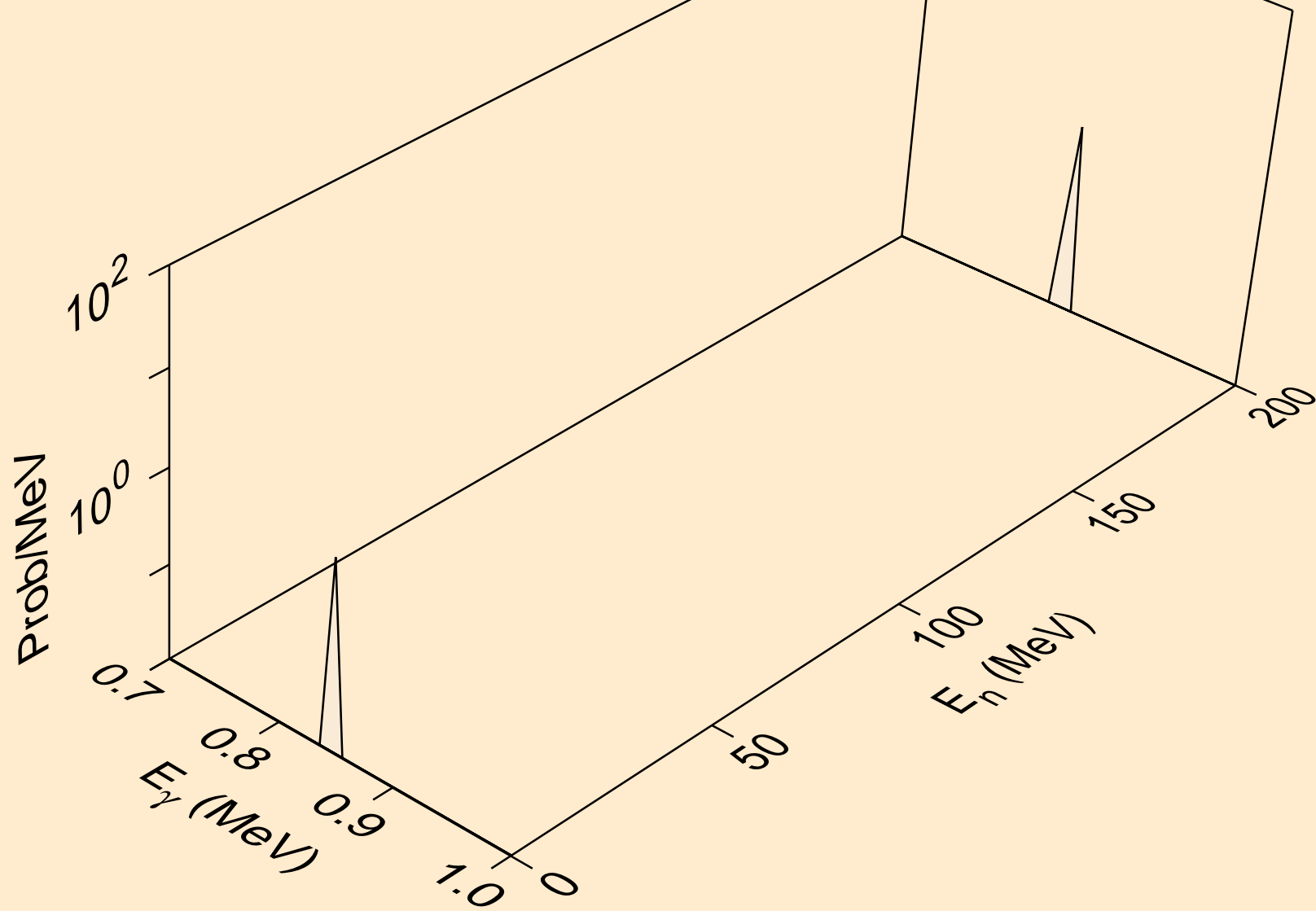

BI199M NEUTRON ACER TENDL-2021 LIBRARY; T=293.6K  
Photon emission for (n,n\*3)

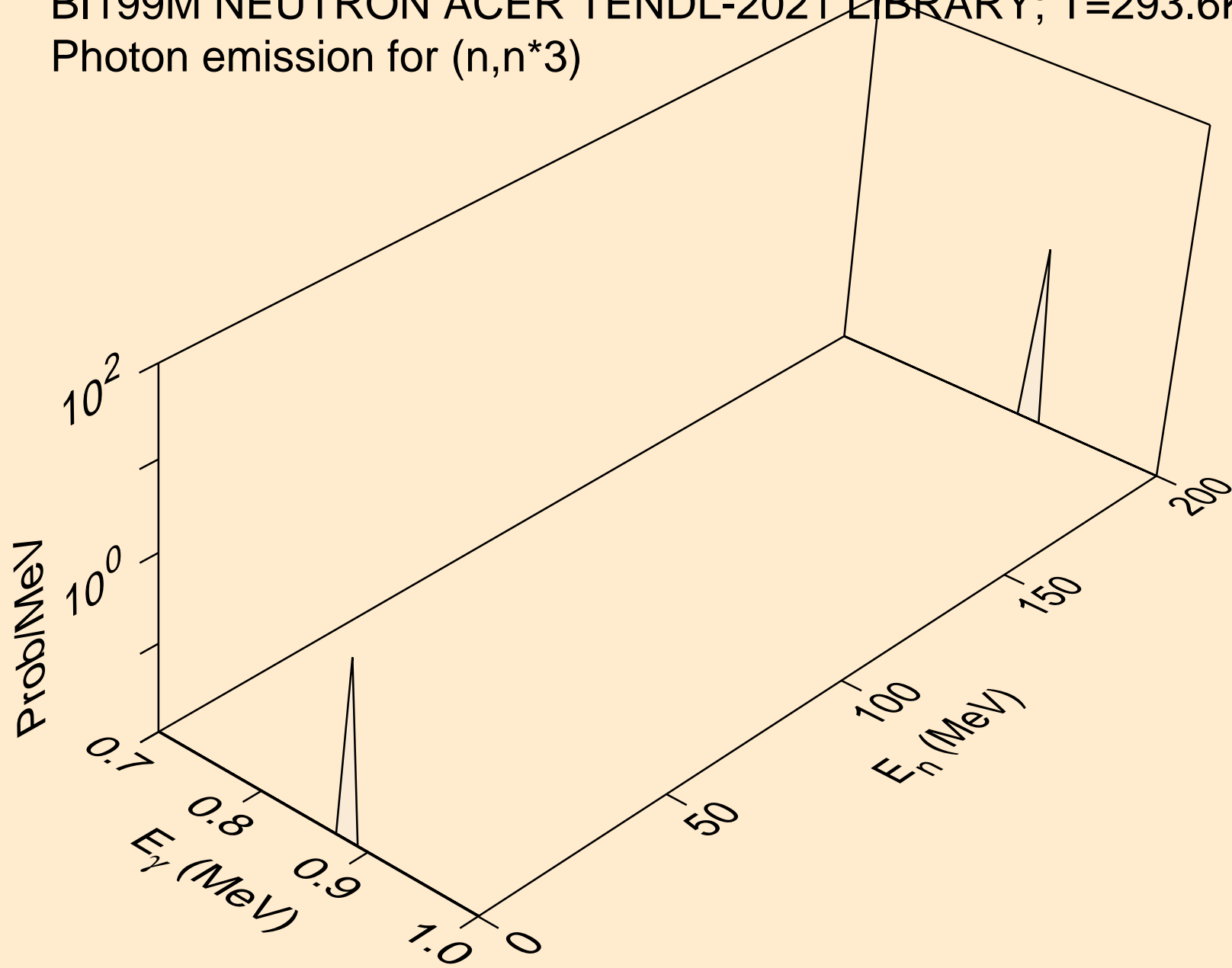

BI199M NEUTRON ACER TENDL-2021 LIBRARY; T=293.6K  
Photon emission for (n,n\*4)

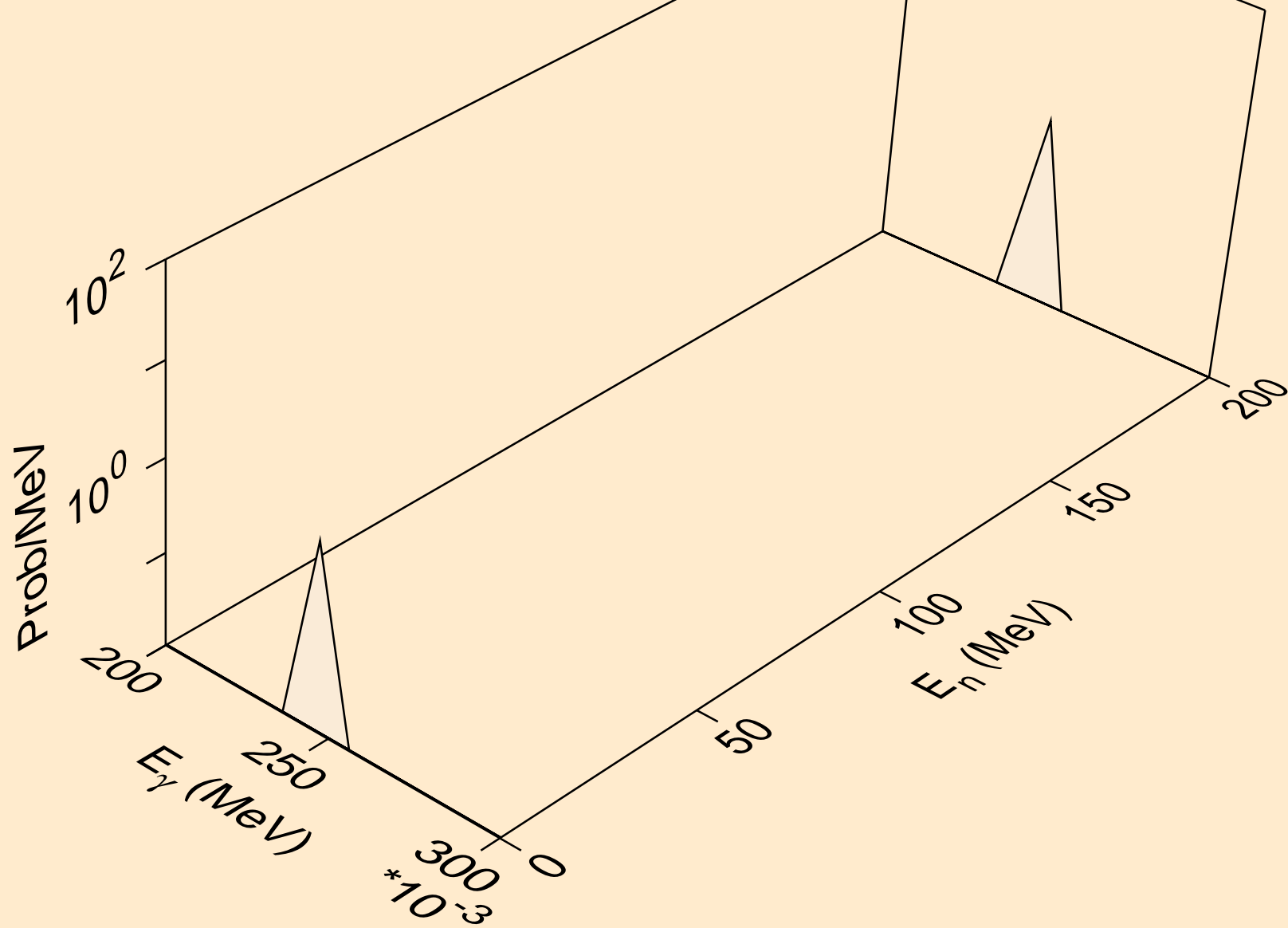

BI199M NEUTRON ACER TENDL-2021 LIBRARY; T=293.6K  
Photon emission for (n,n\*5)

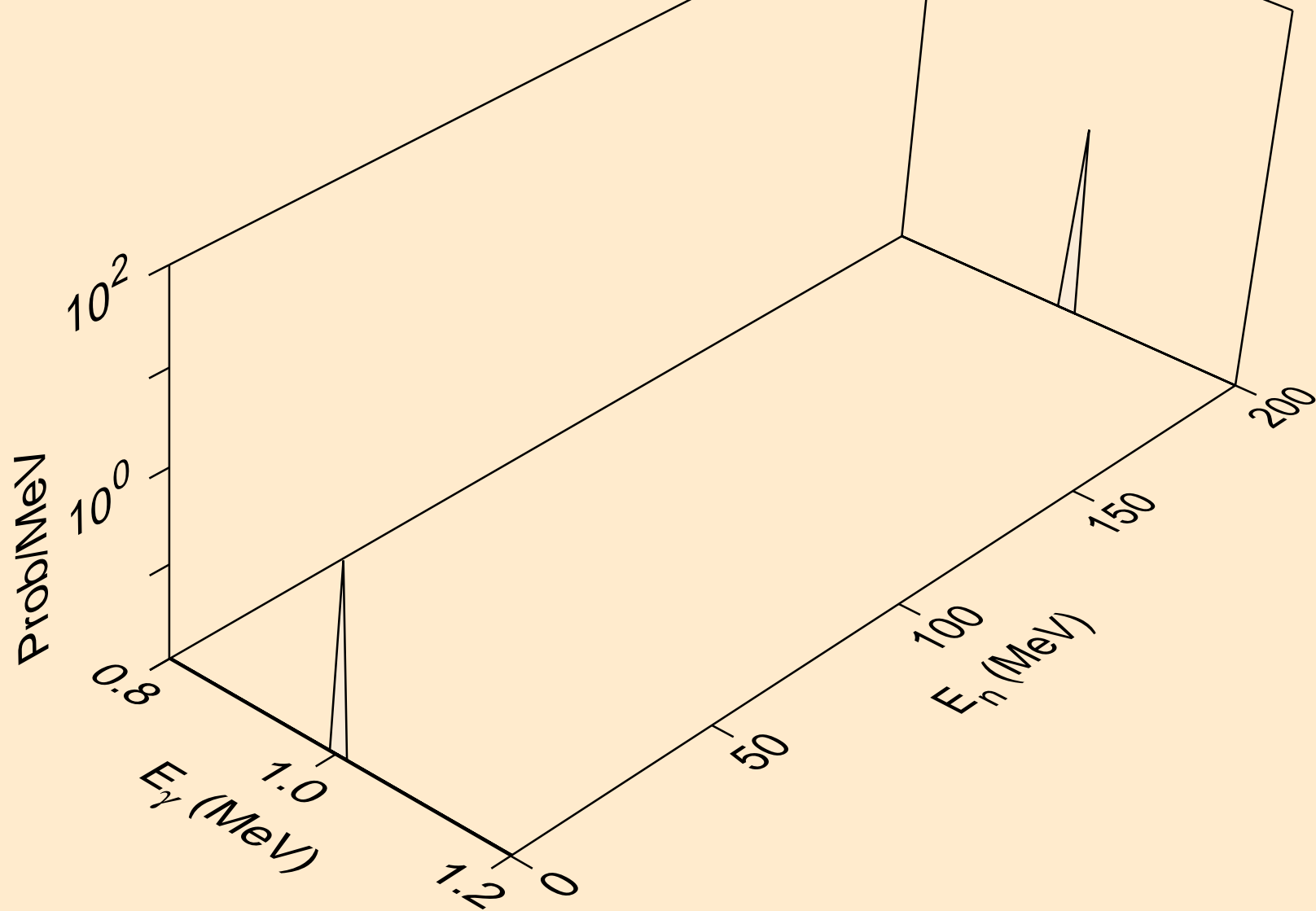

BI199M NEUTRON ACER TENDL-2021 LIBRARY; T=293.6K  
Photon emission for (n,n\*6)

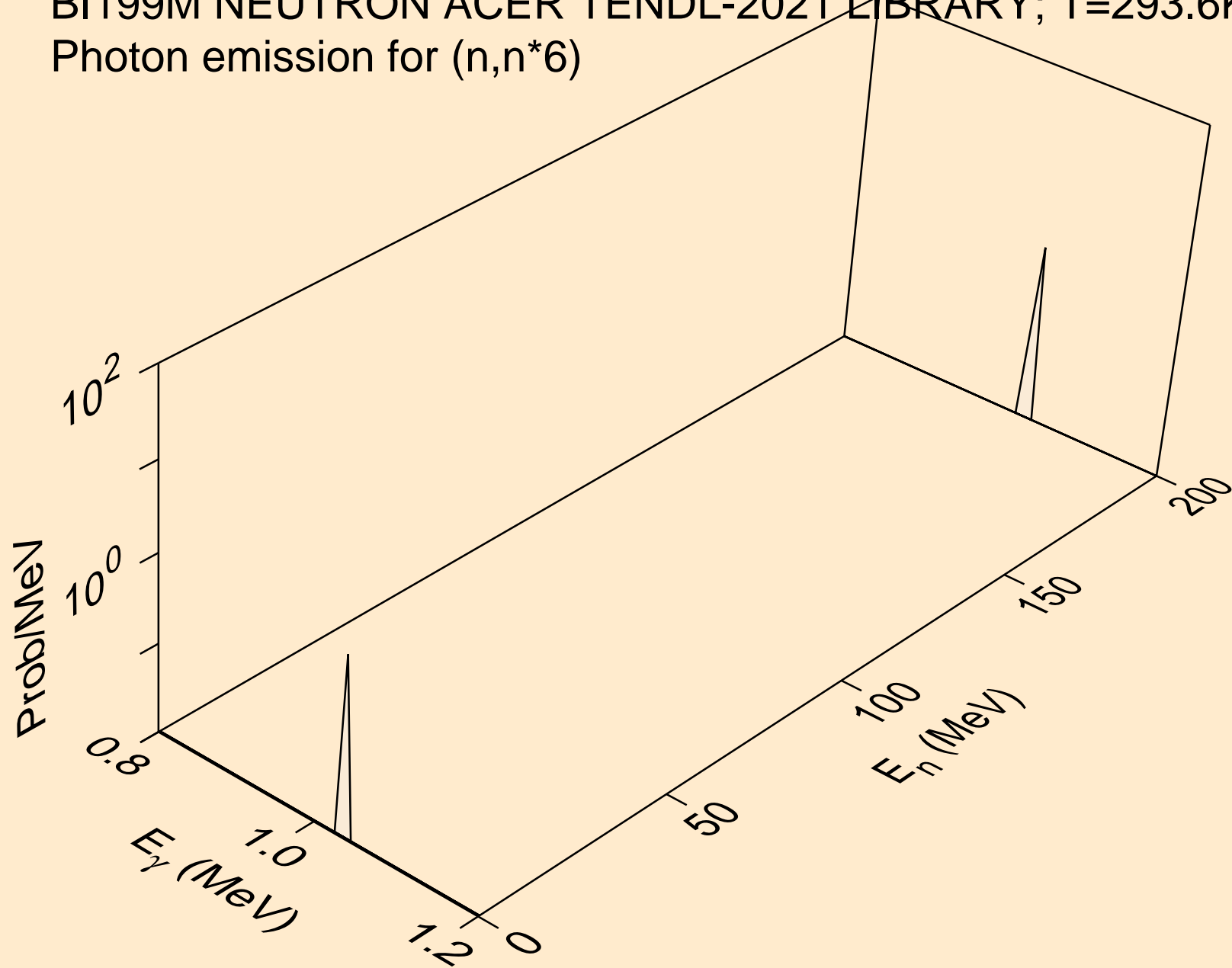

BI199M NEUTRON ACER TENDL-2021 LIBRARY; T=293.6K  
Photon emission for (n,n\*7)

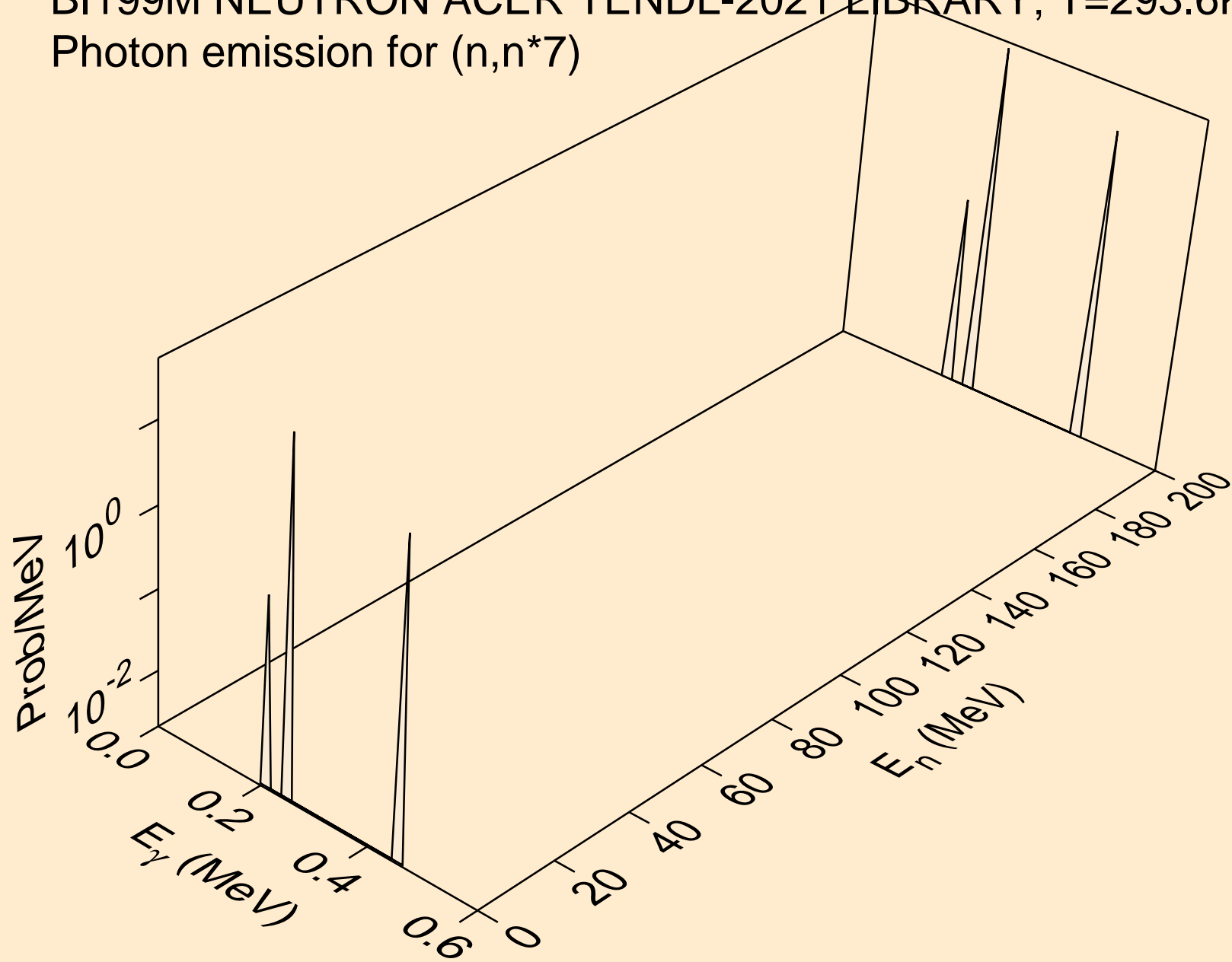

BI199M NEUTRON ACER TENDL-2021 LIBRARY; T=293.6K  
Photon emission for (n,n\*8)

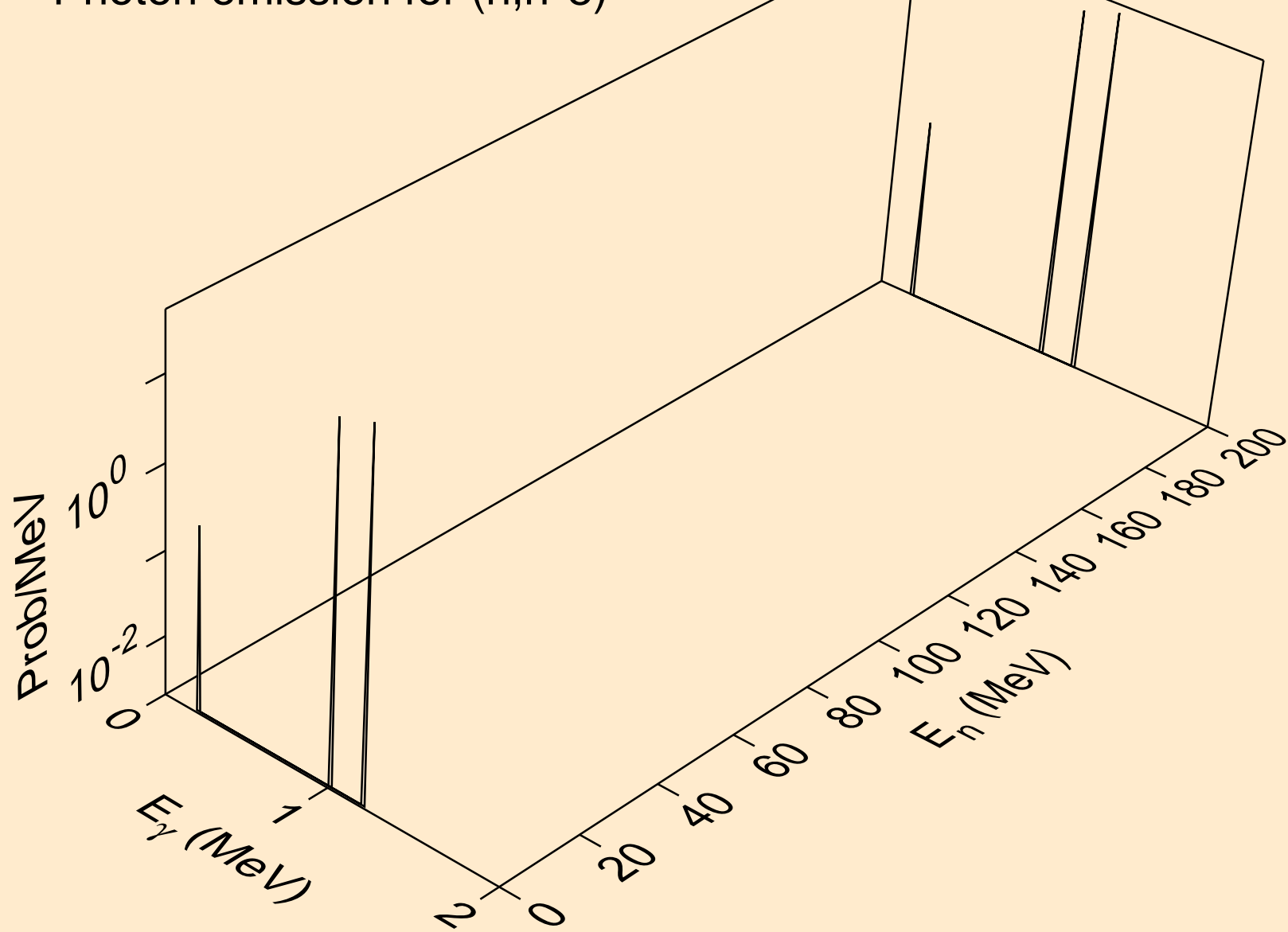

BI199M NEUTRON ACER TENDL-2021 LIBRARY; T=293.6K  
Photon emission for (n,n\*9)

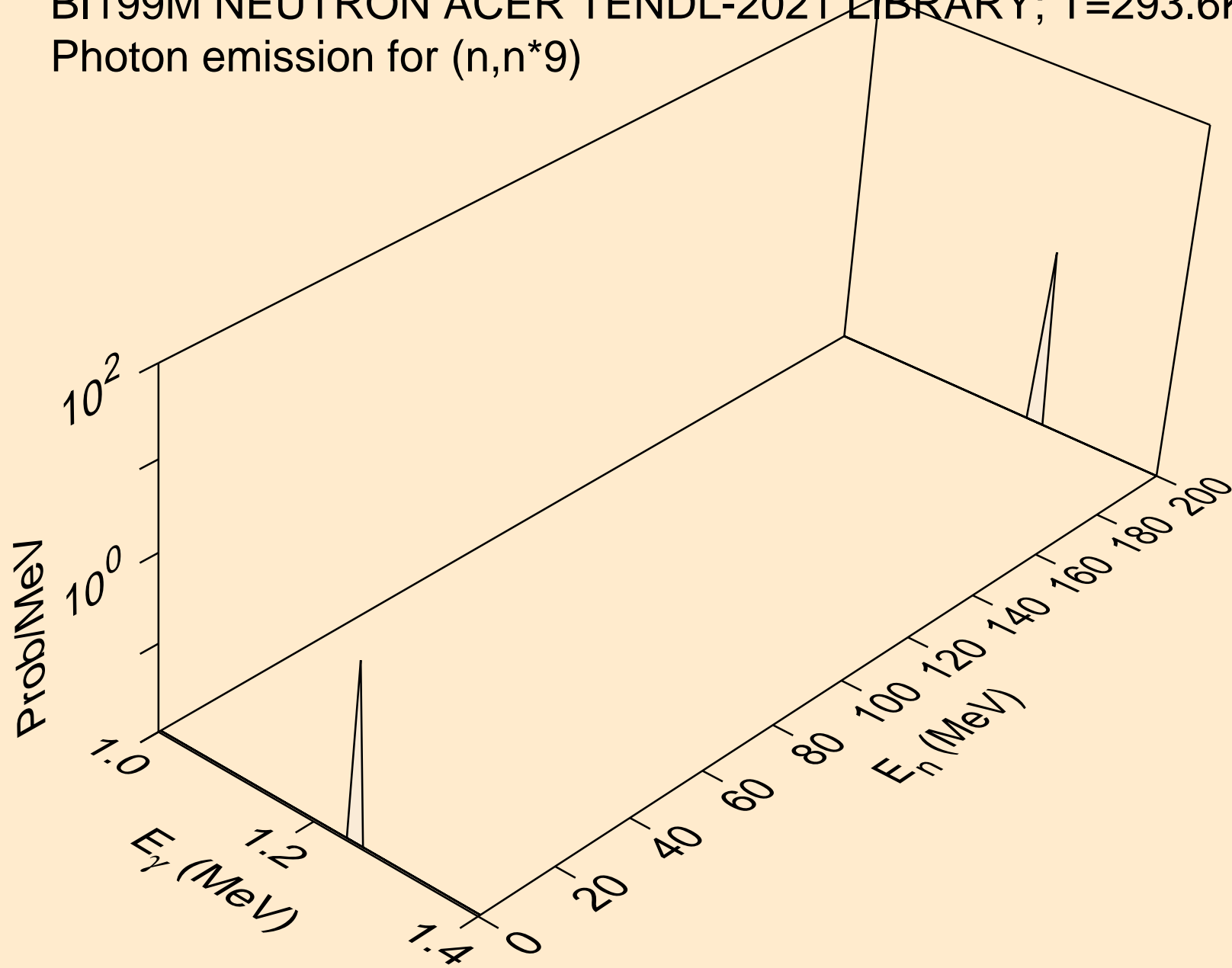



BI199M NEUTRON ACER TENDL-2021 LIBRARY; T=293.6K  
Photon emission for (n,n\*10)

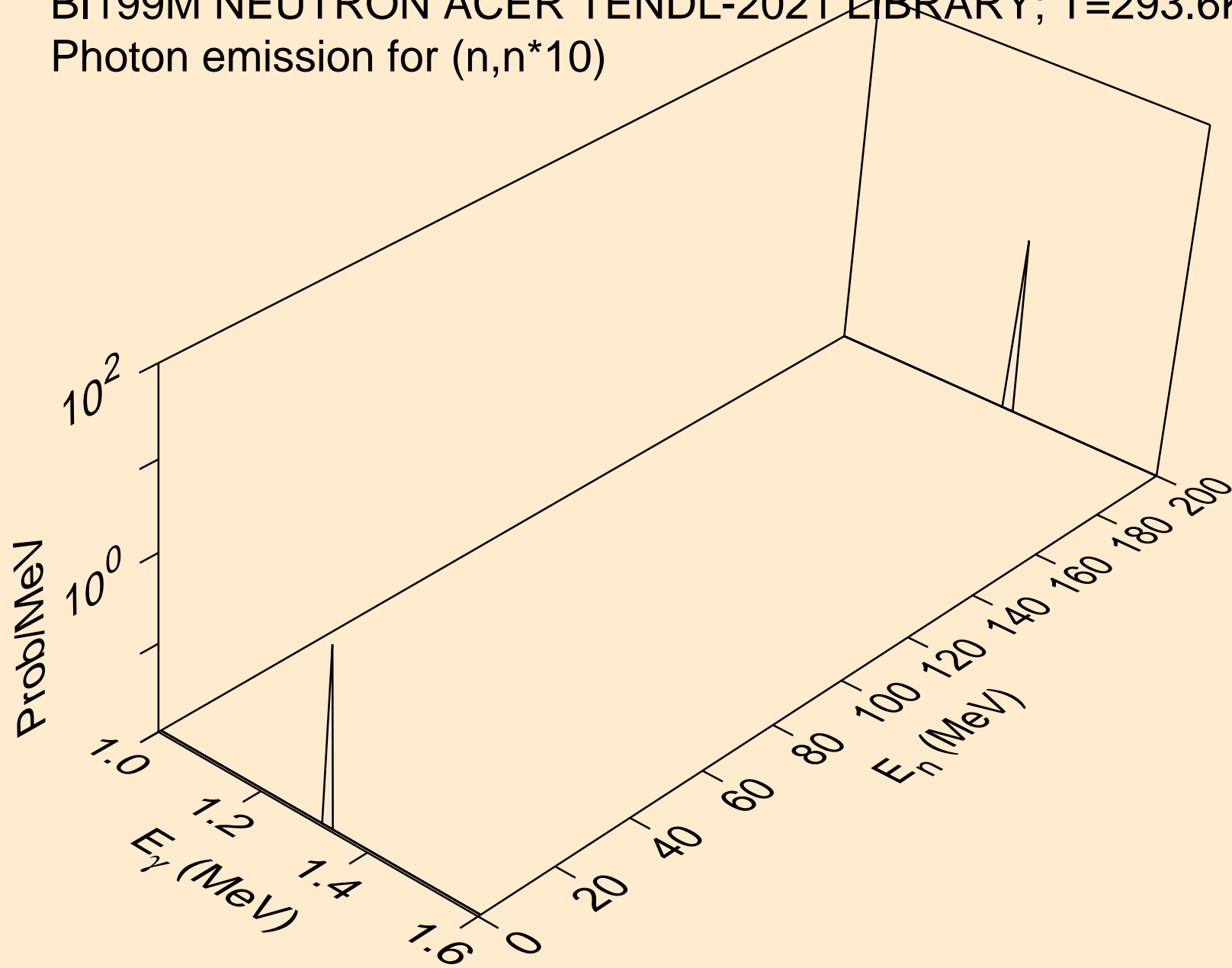

BI199M NEUTRON ACER TENDL-2021 LIBRARY; T=293.6K  
Photon emission for (n,n\*11)

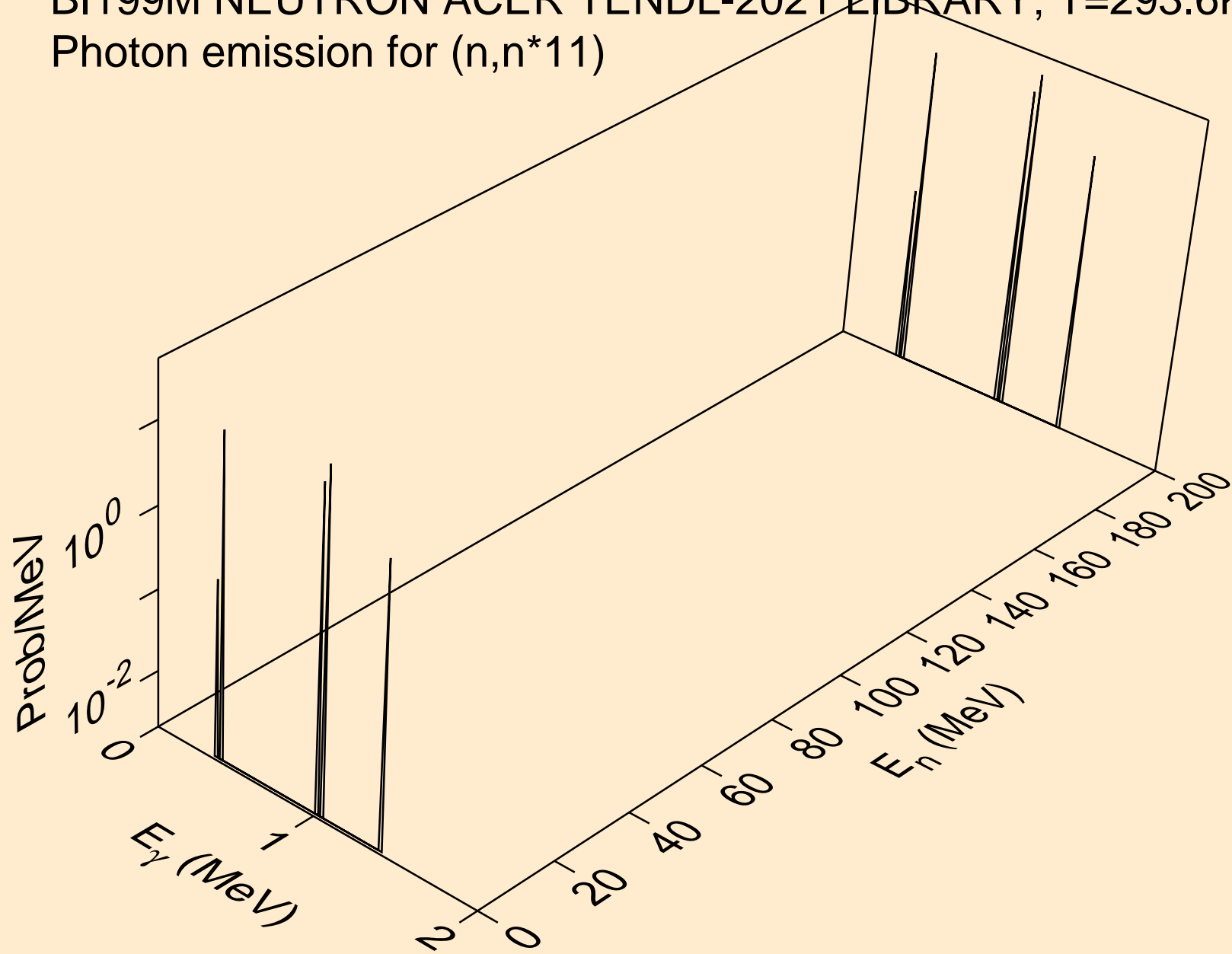

BI199M NEUTRON ACER TENDL-2021 LIBRARY; T=293.6K  
Photon emission for (n,n\*12)

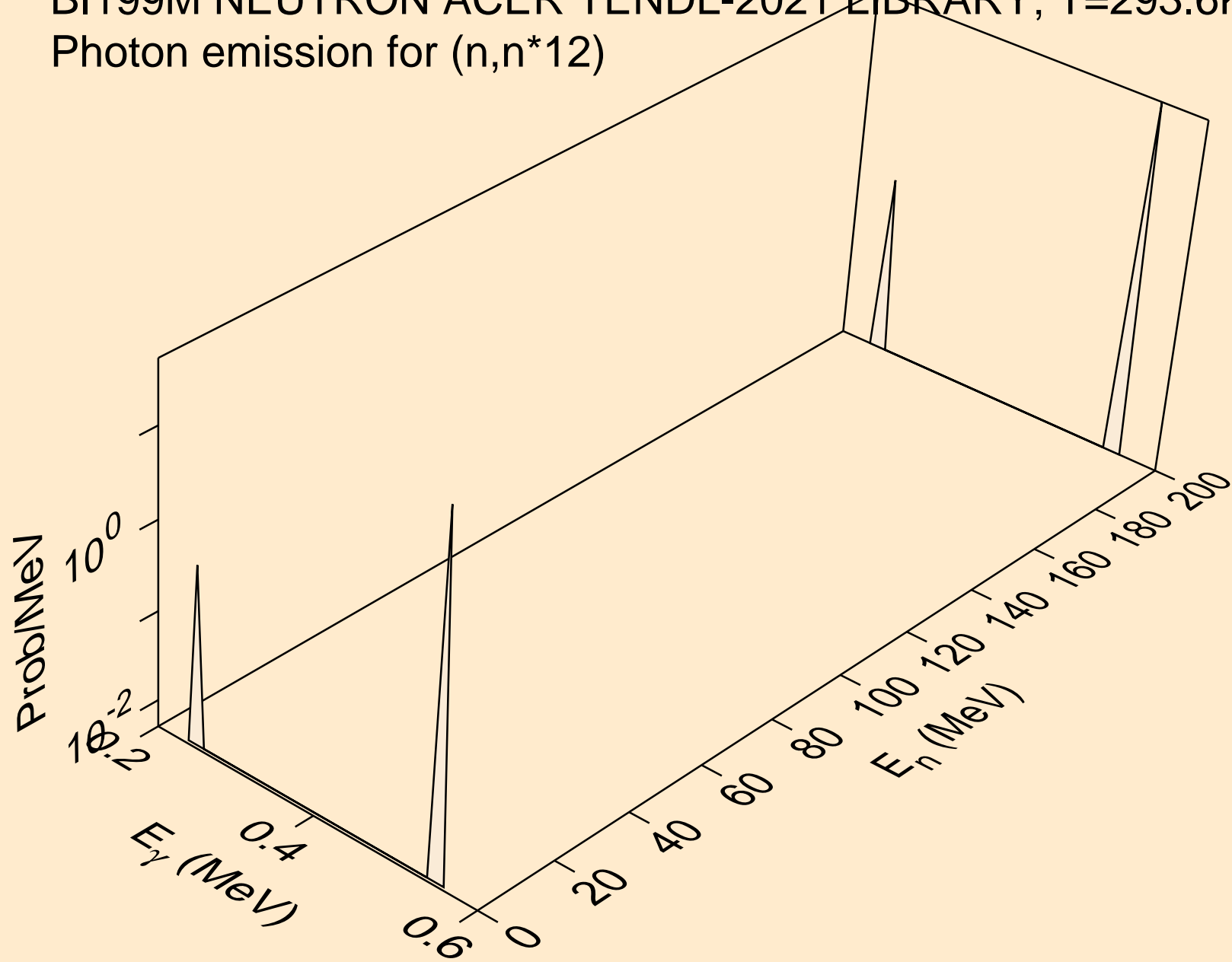

BI199M NEUTRON ACER TENDL-2021 LIBRARY; T=293.6K  
Photon emission for (n,n\*13)

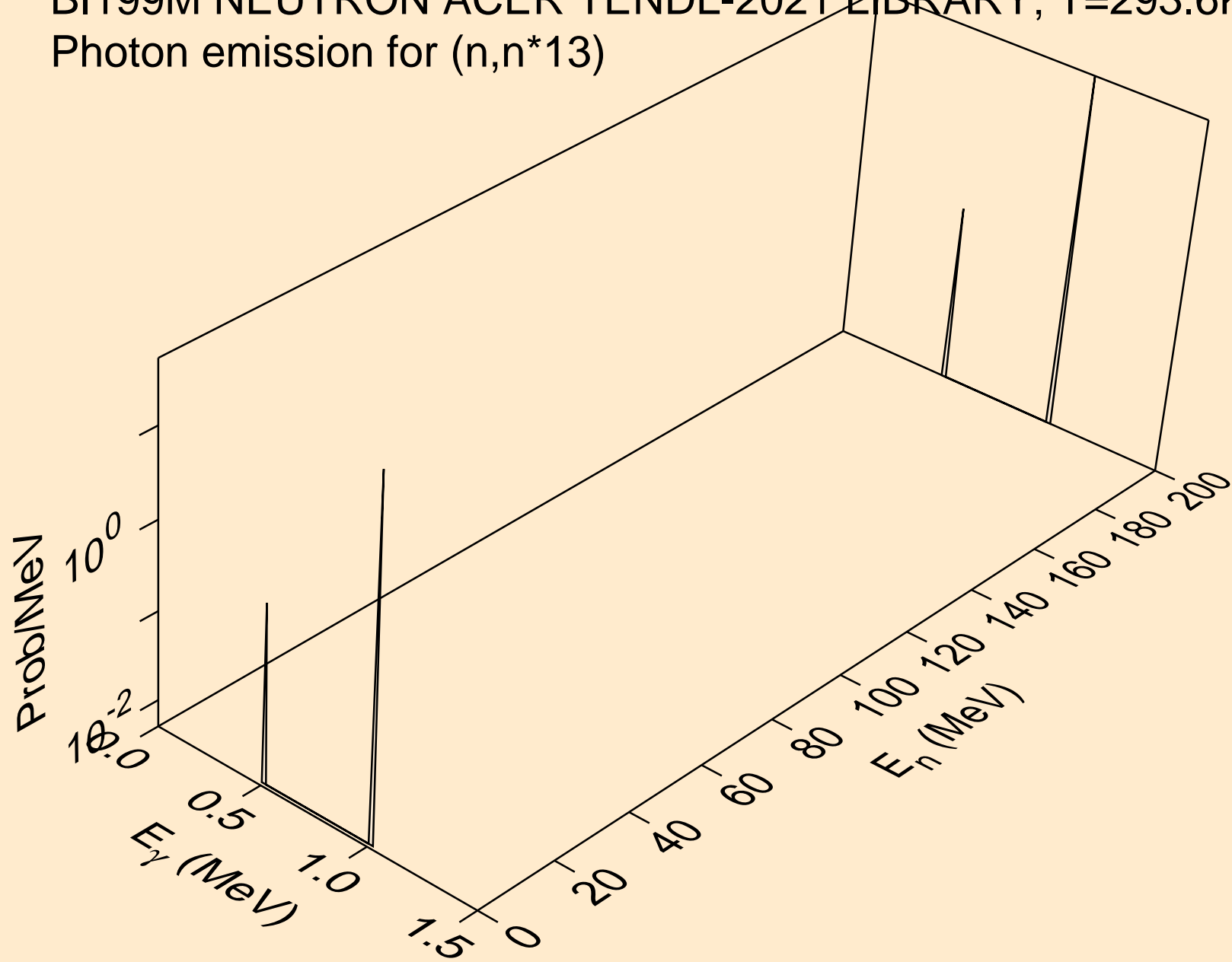

BI199M NEUTRON ACER TENDL-2021 LIBRARY; T=293.6K  
Photon emission for (n,n\*14)

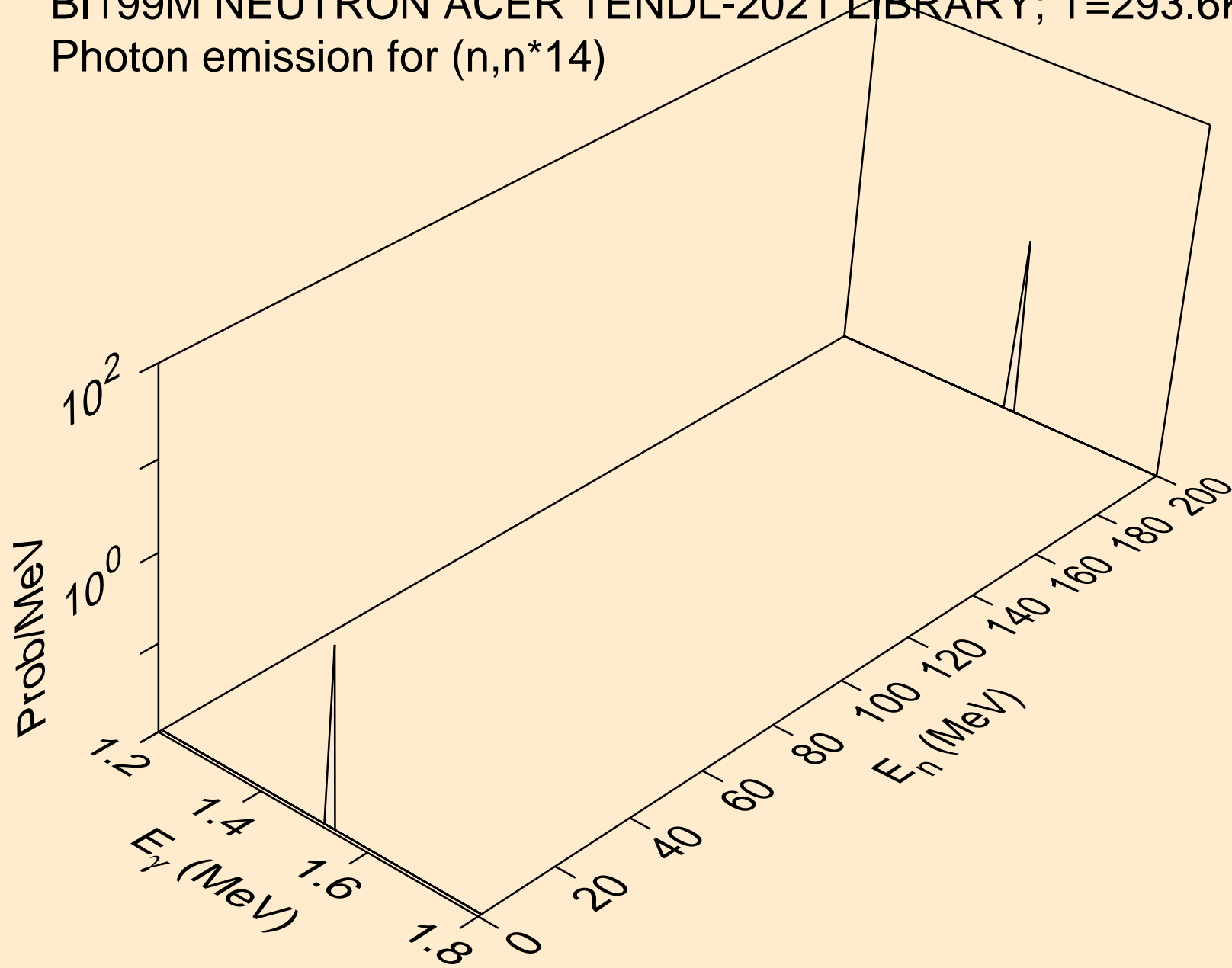

BI199M NEUTRON ACER TENDL-2021 LIBRARY; T=293.6K  
Photon emission for (n,n\*15)

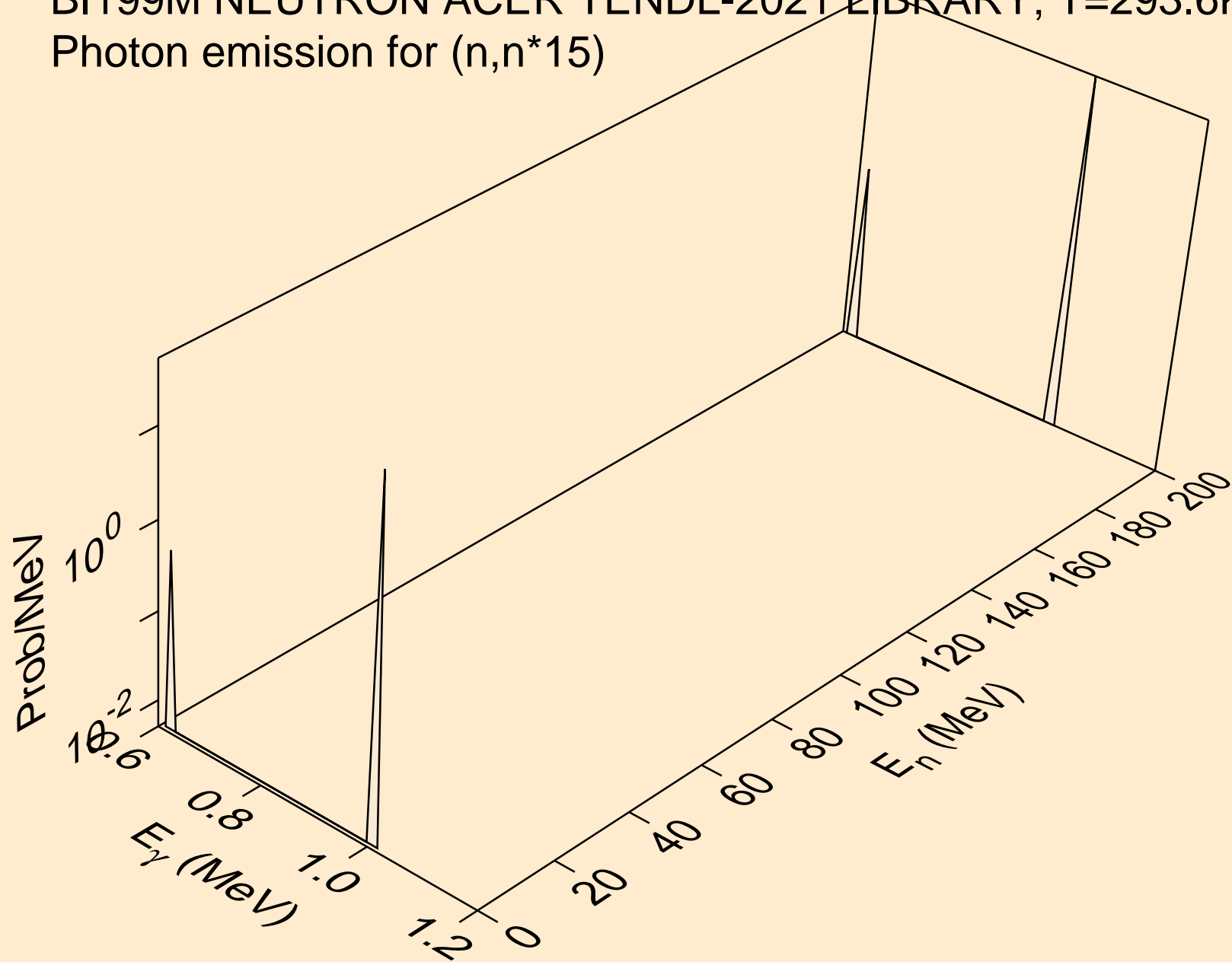

BI199M NEUTRON ACER TENDL-2021 LIBRARY; T=293.6K  
Photon emission for (n,n\*16)

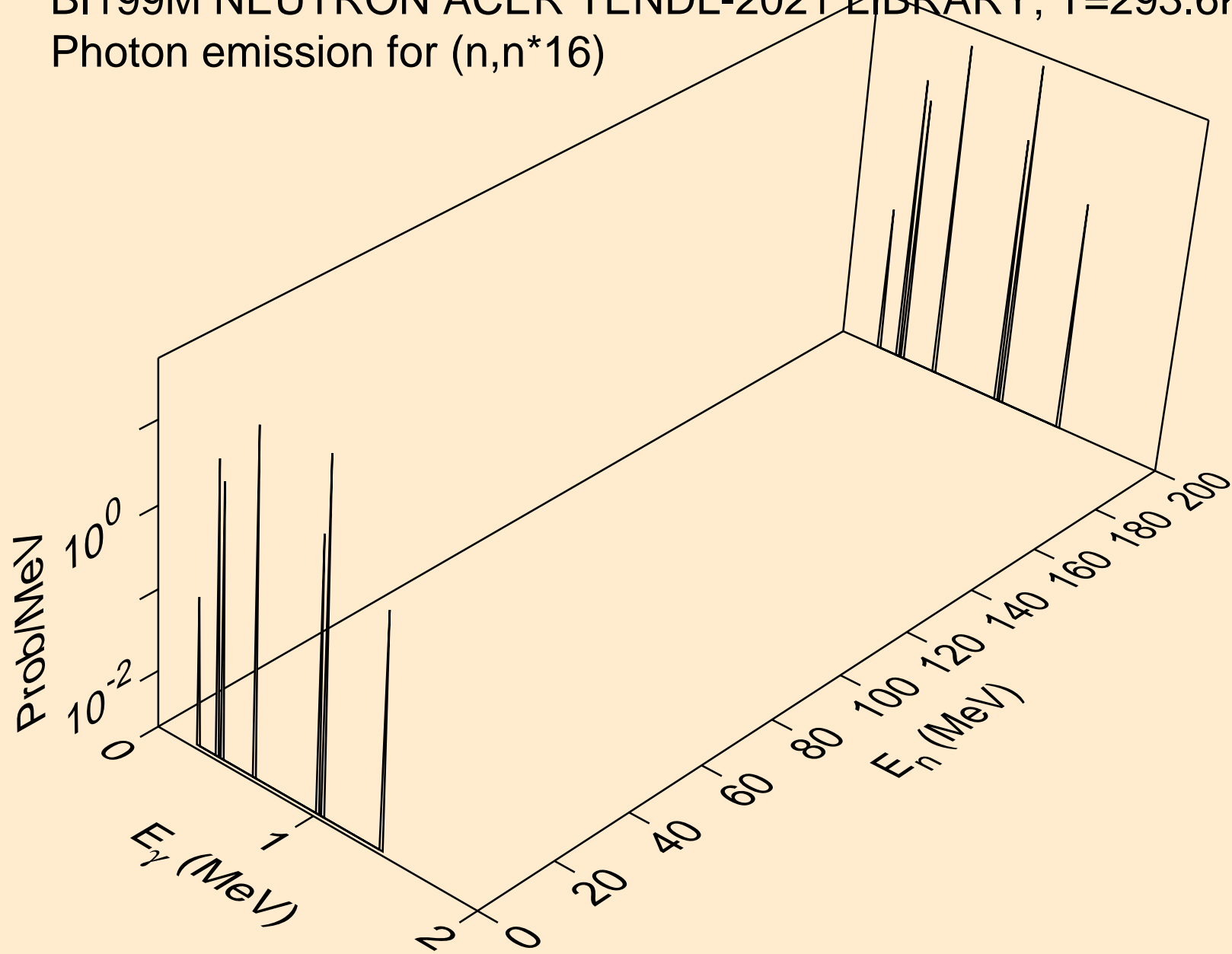

BI199M NEUTRON ACER TENDL-2021 LIBRARY; T=293.6K  
Photon emission for (n,n\*17)

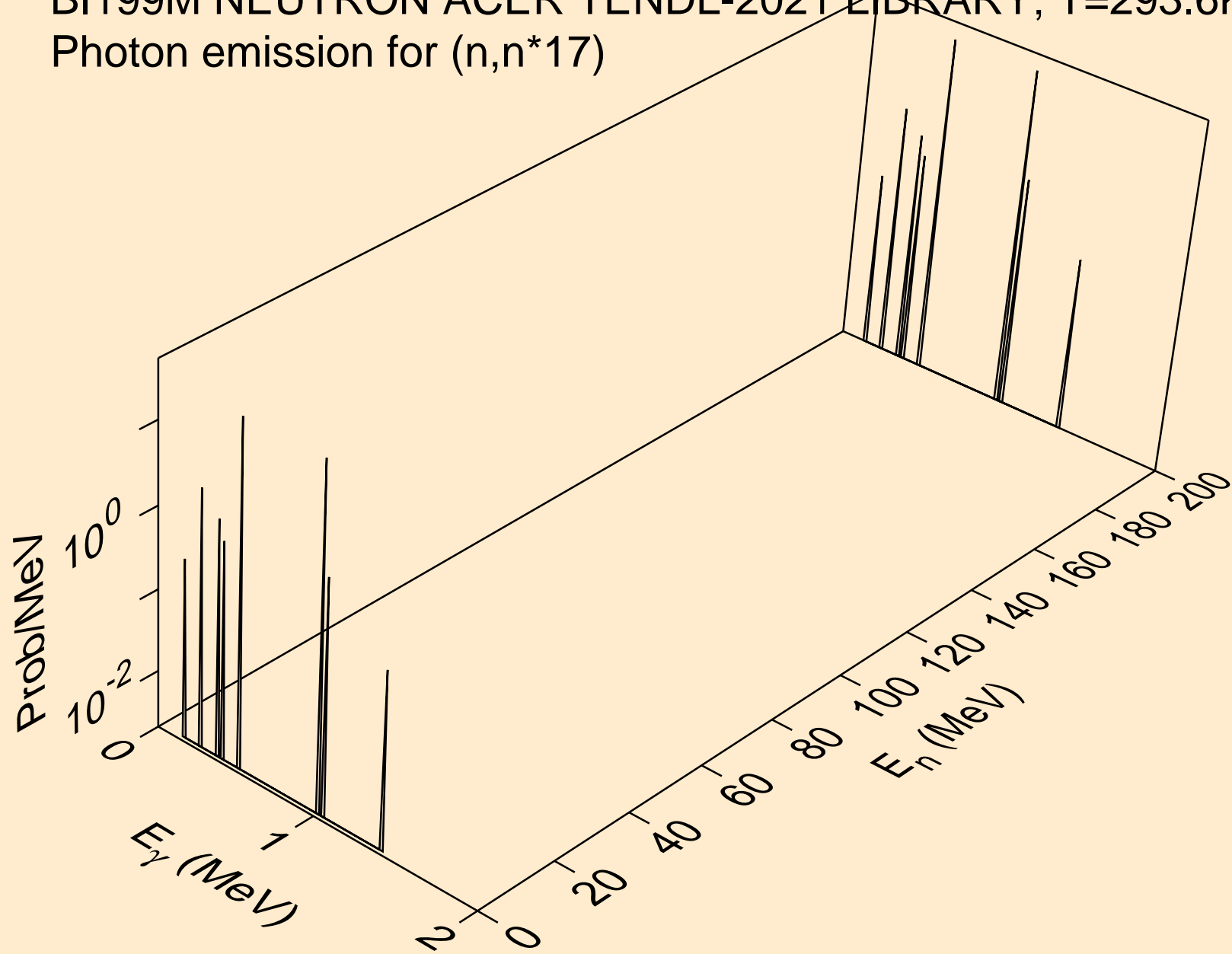



BI199M NEUTRON ACER TENDL-2021 LIBRARY; T=293.6K  
Photon emission for (n,n\*18)

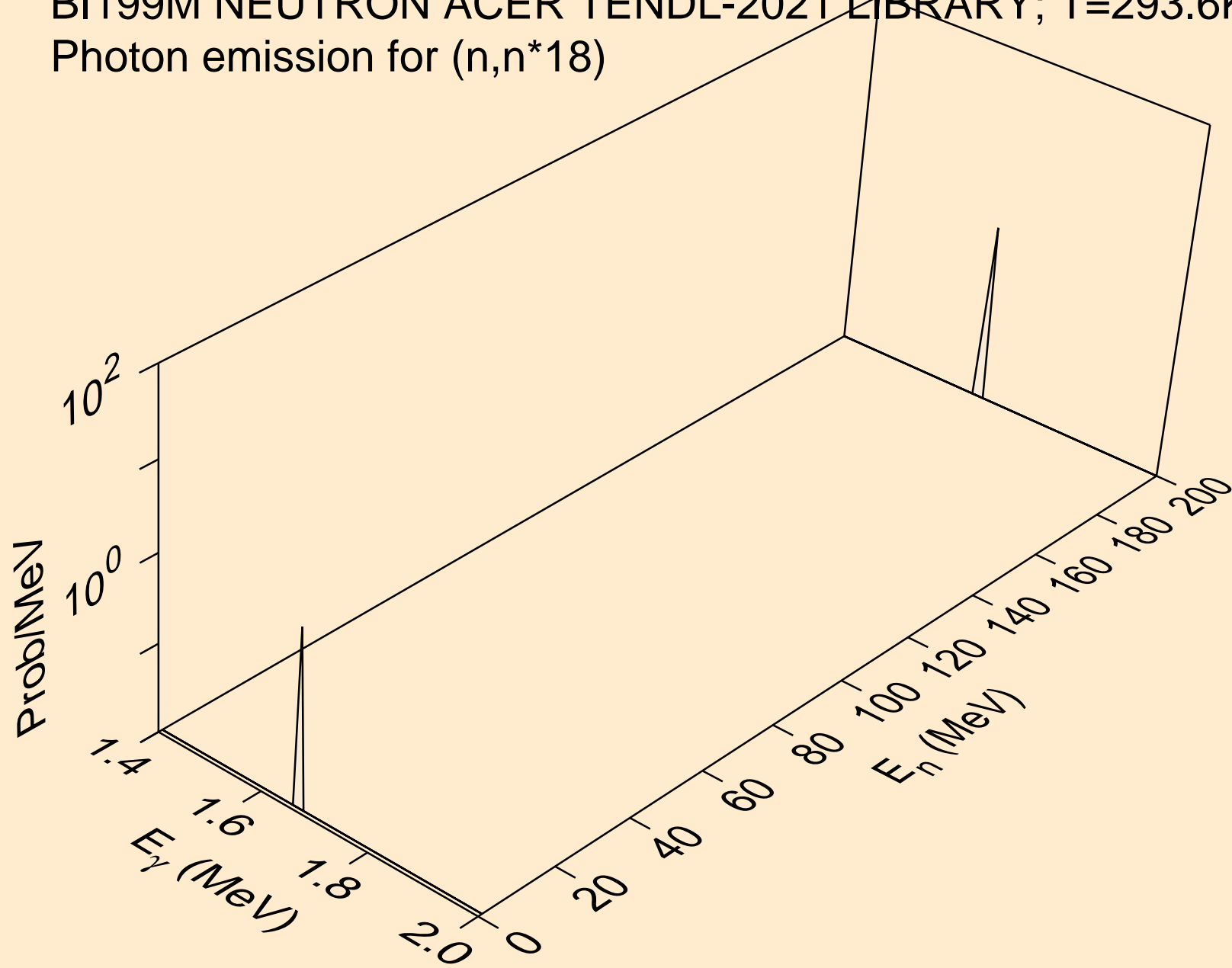

BI199M NEUTRON ACER TENDL-2021 LIBRARY; T=293.6K  
Photon emission for (n,n\*19)

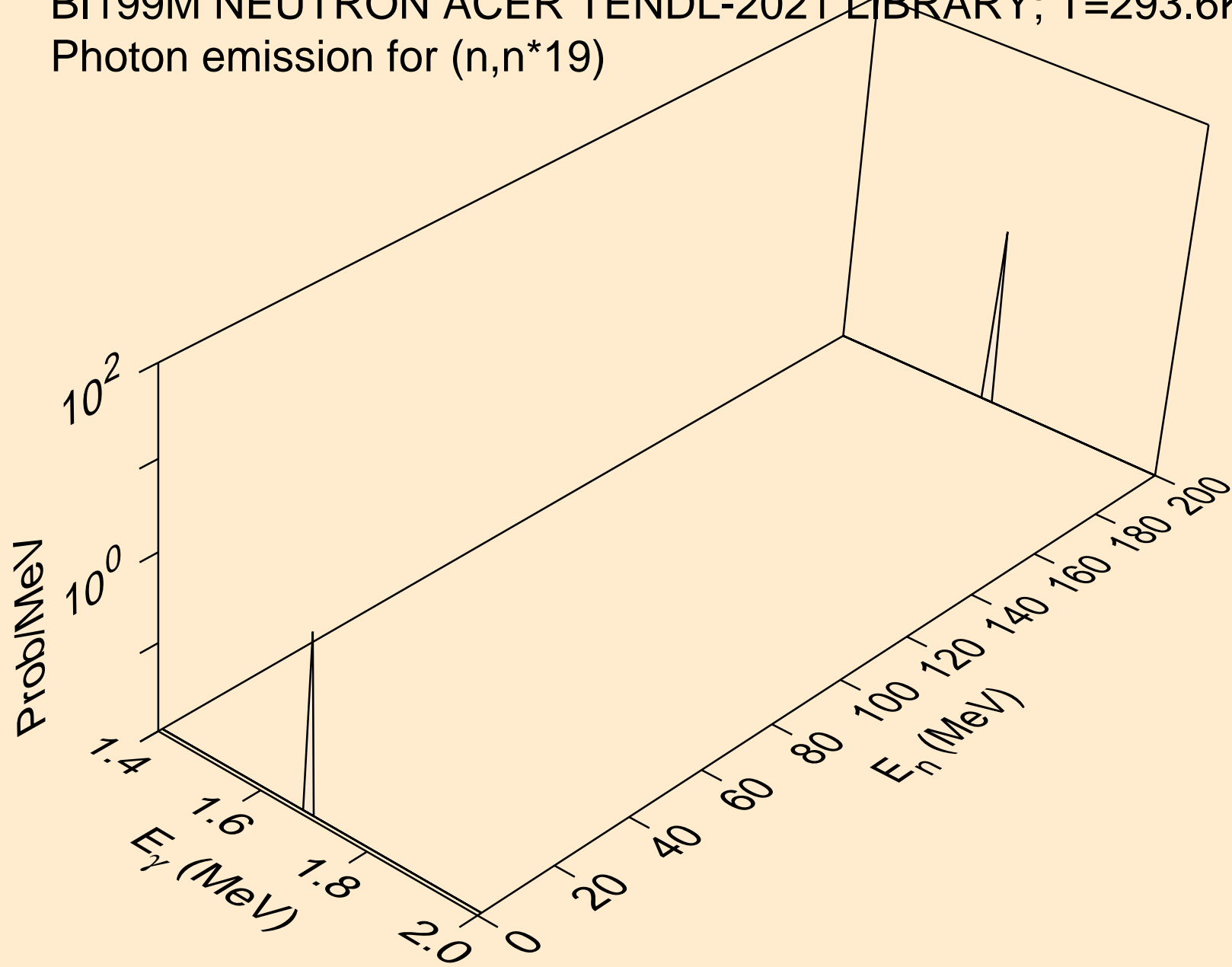

BI199M NEUTRON ACER TENDL-2021 LIBRARY; T=293.6K  
Photon emission for (n,n\*20)

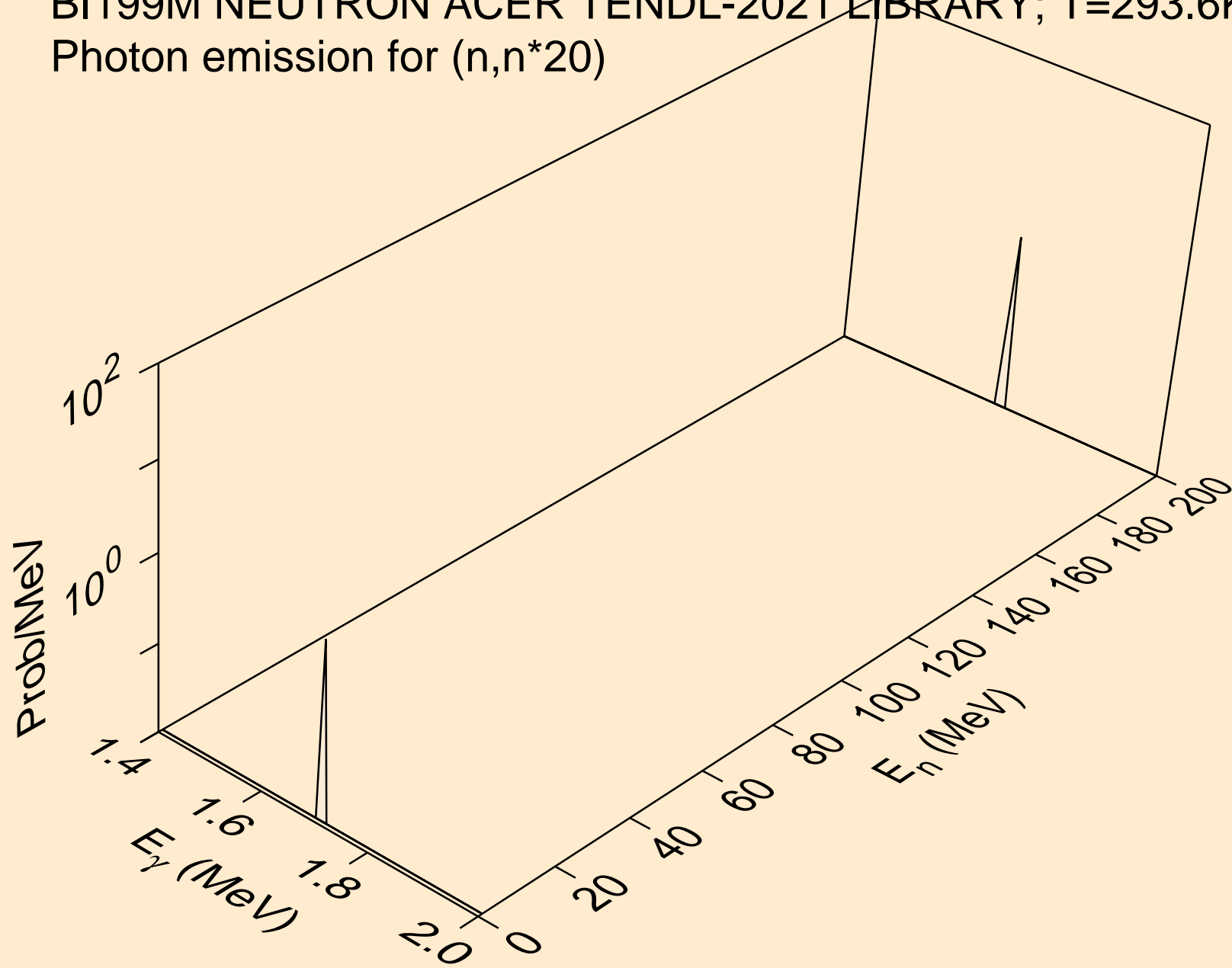

BI199M NEUTRON ACER TENDL-2021 LIBRARY; T=293.6K  
Photon emission for (n,n\*21)

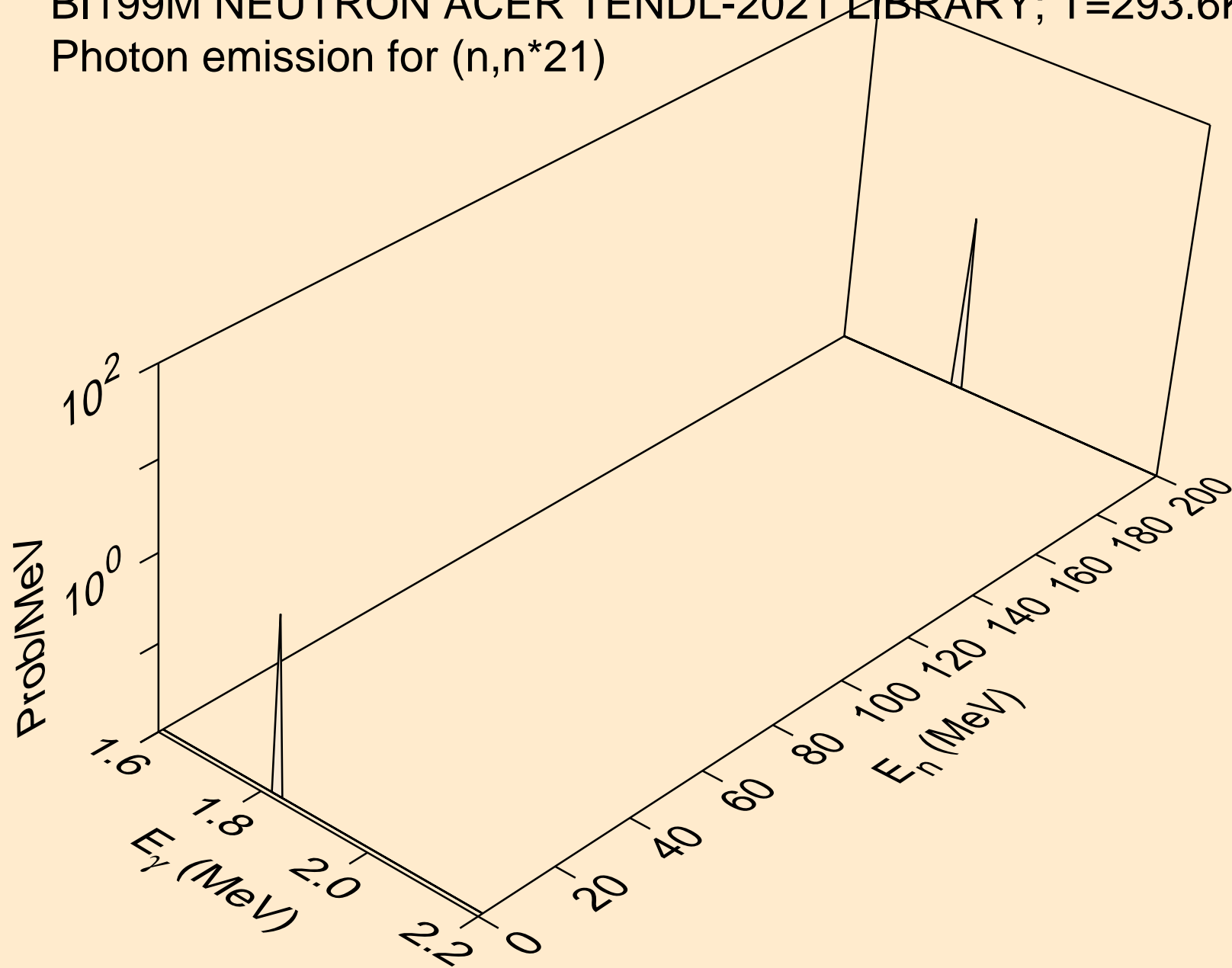

BI199M NEUTRON ACER TENDL-2021 LIBRARY; T=293.6K  
Photon emission for (n,n\*c)

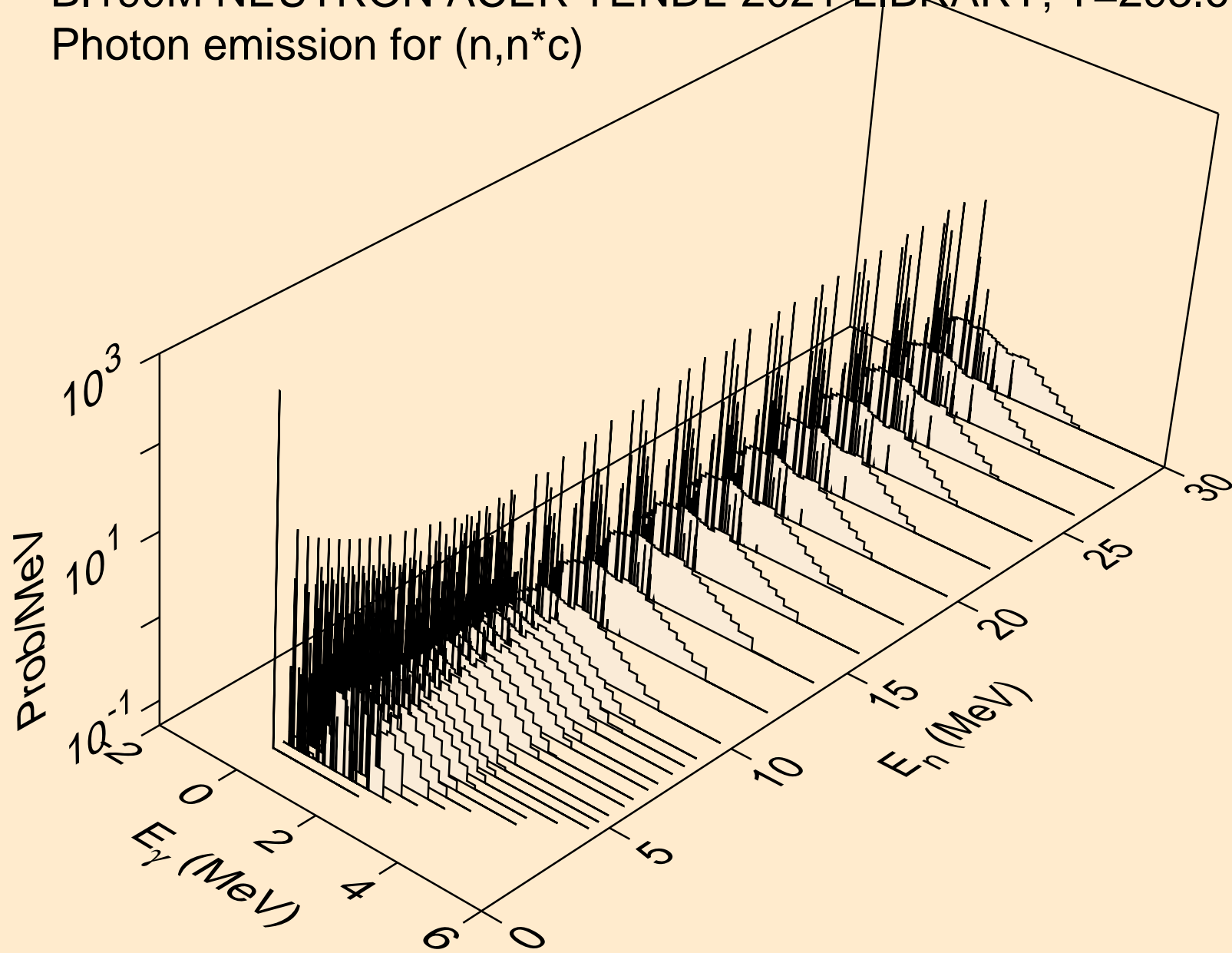

BI199M NEUTRON ACER TENDL-2021 LIBRARY; T=293.6K  
Photon emission for (n,gma)

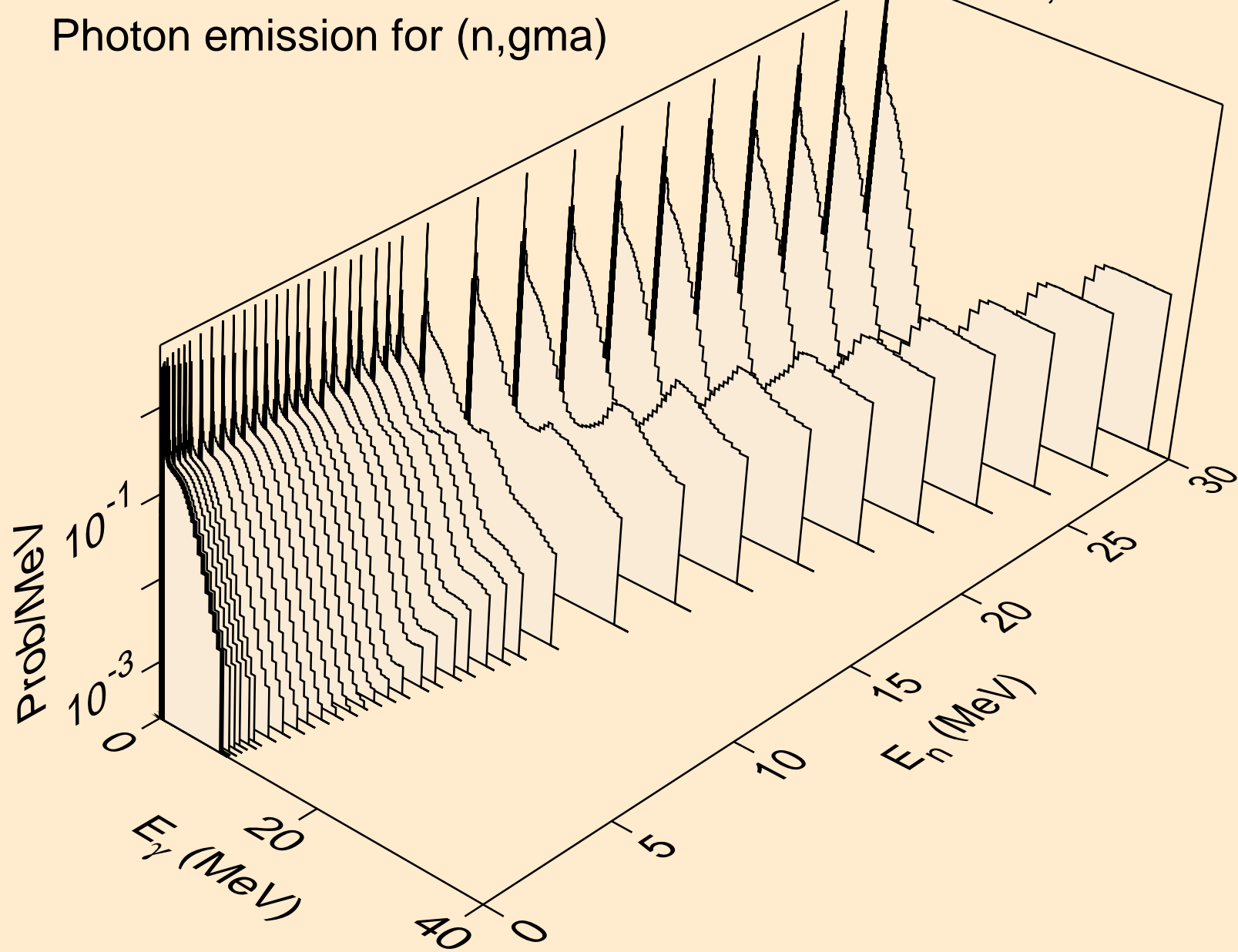

BI199M NEUTRON ACER TENDL-2021 LIBRARY; T=293.6K  
Photon emission for (n,p)

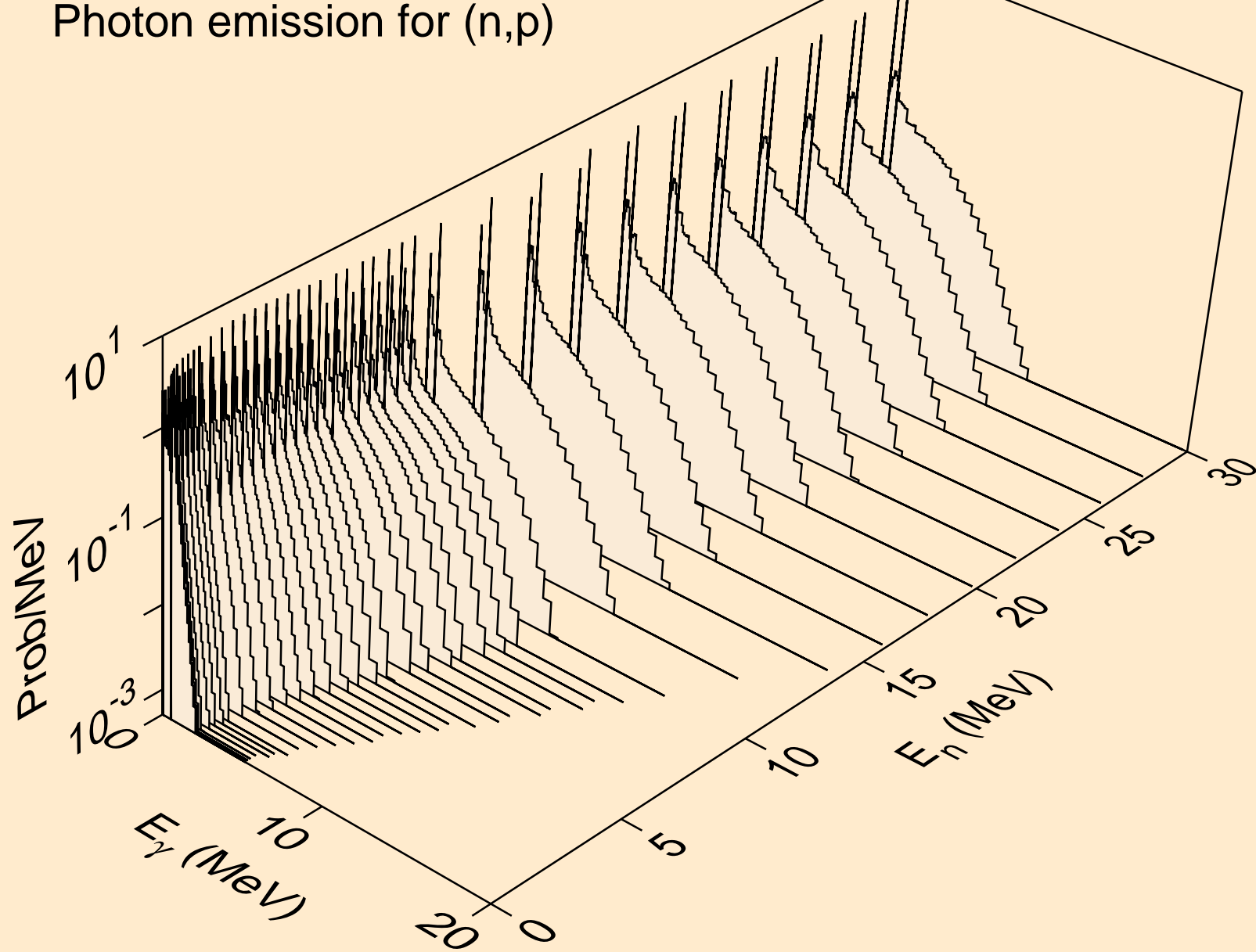

BI199M NEUTRON ACER TENDL-2021 LIBRARY; T=293.6K  
Photon emission for (n,d)

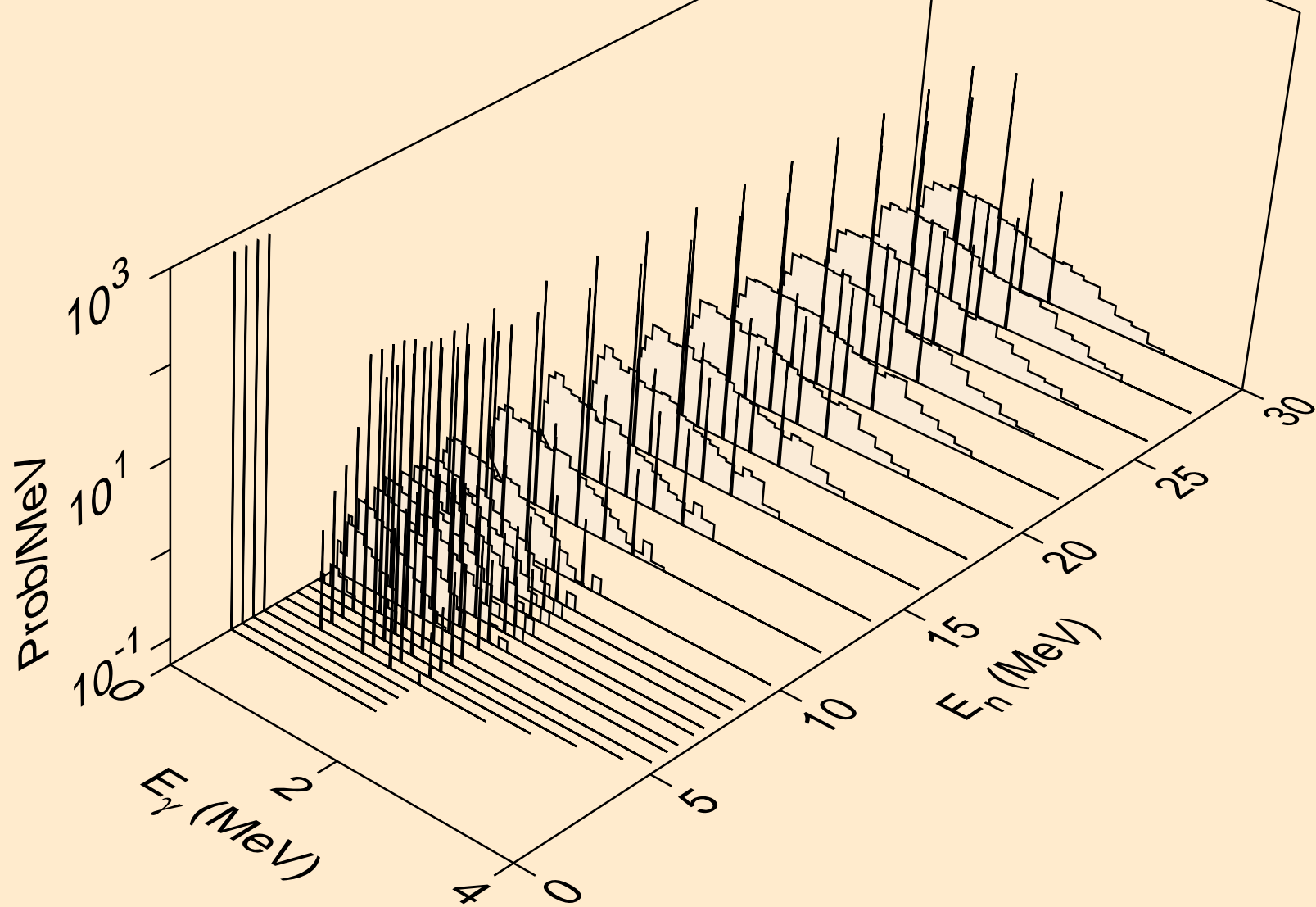



BI199M NEUTRON ACER TENDL-2021 LIBRARY; T=293.6K  
Photon emission for (n,t)

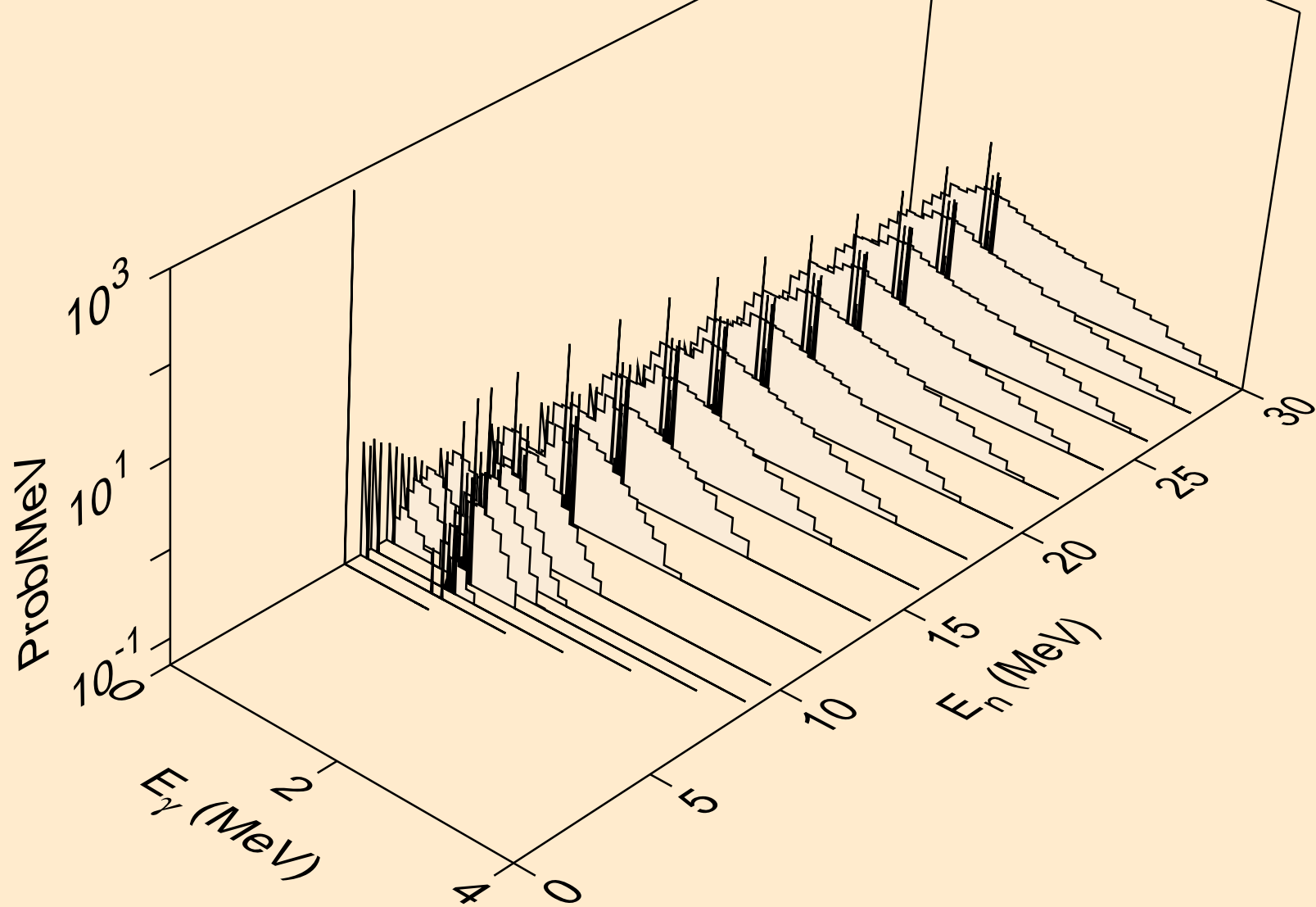

BI199M NEUTRON ACER TENDL-2021 LIBRARY; T=293.6K  
Photon emission for (n,he3)

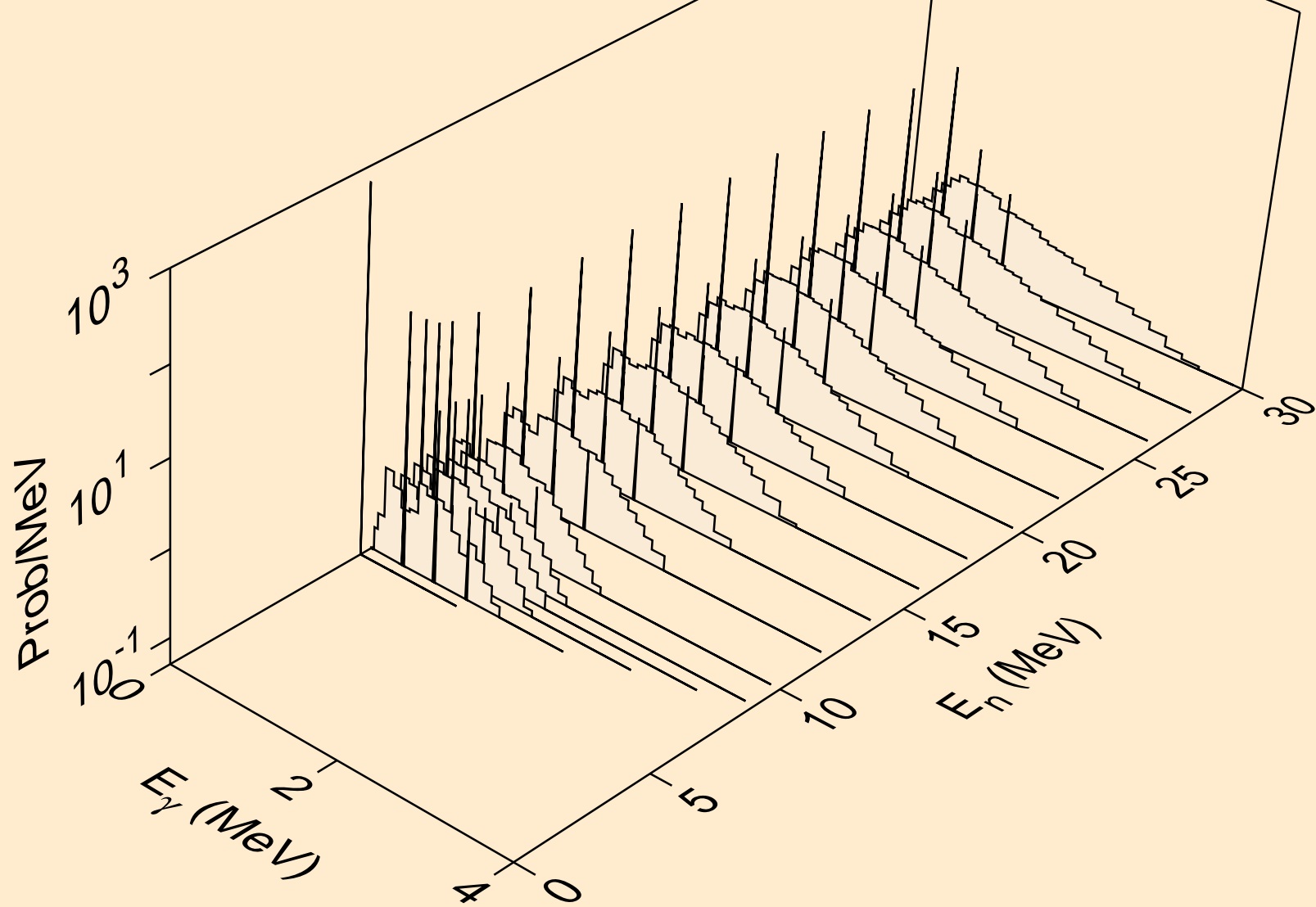

BI199M NEUTRON ACER TENDL-2021 LIBRARY; T=293.6K  
Photon emission for (n,a)

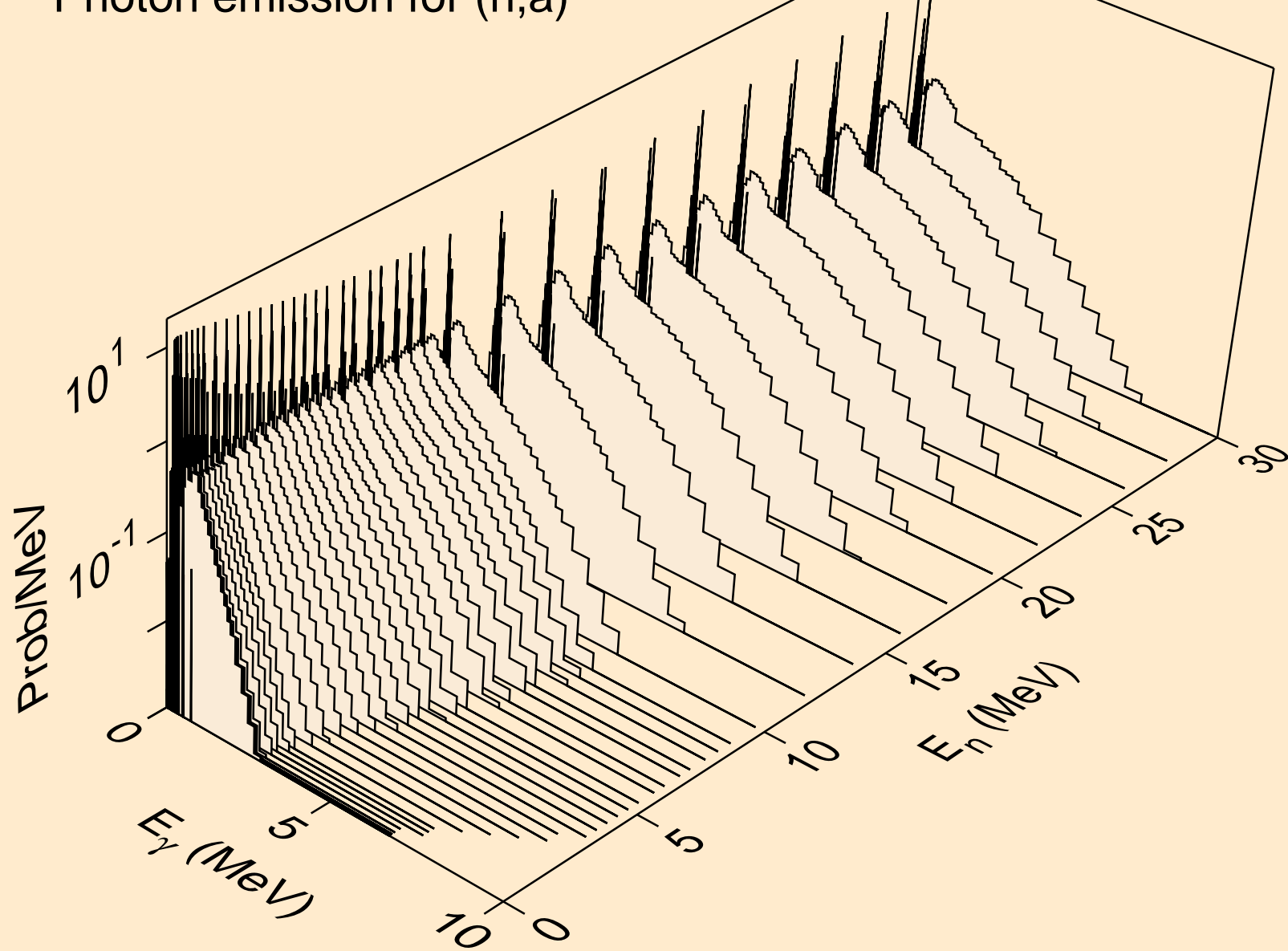

BI199M NEUTRON ACER TENDL-2021 LIBRARY; T=293.6K  
Photon emission for (n,2a)

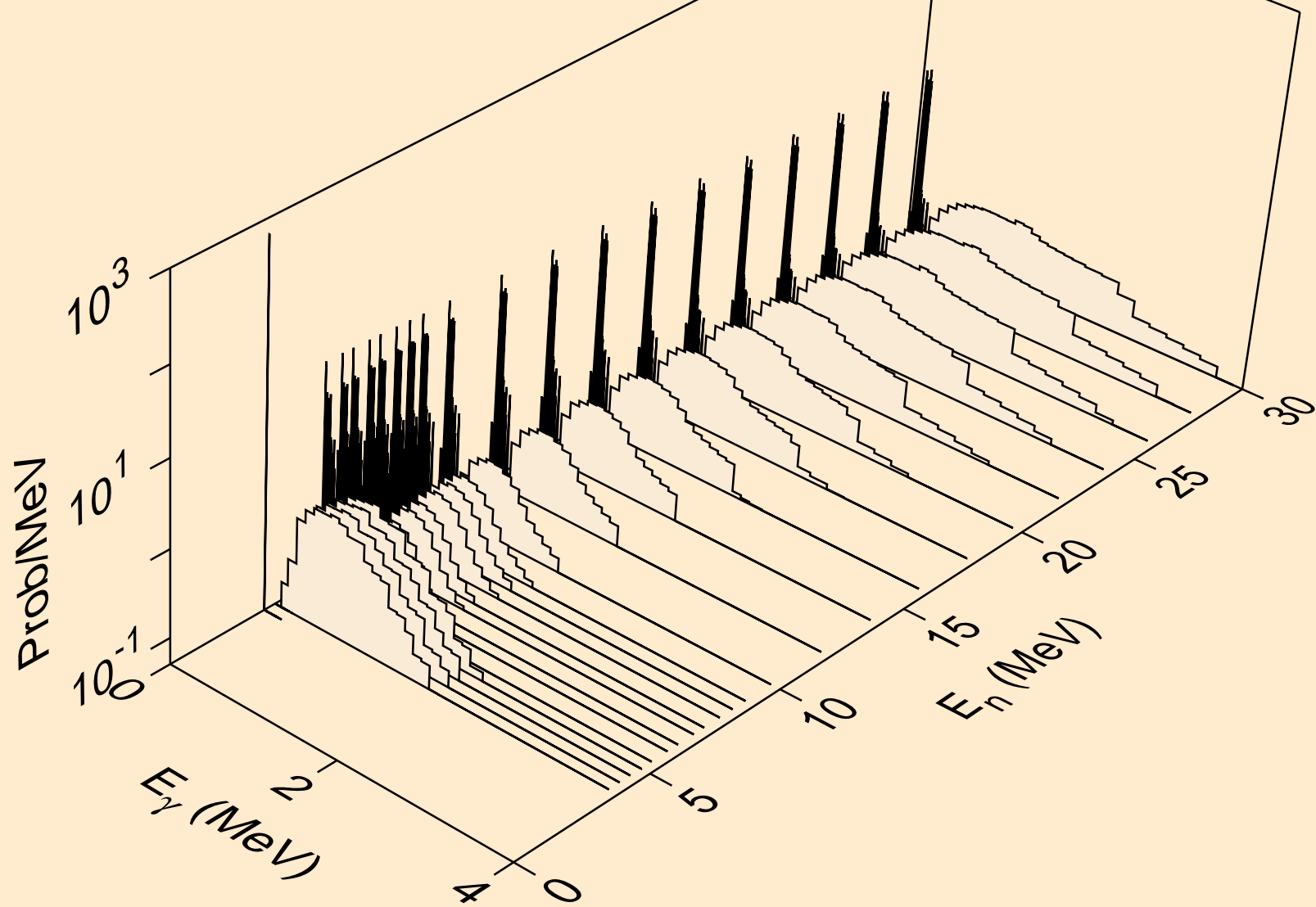

BI199M NEUTRON ACER TENDL-2021 LIBRARY; T=293.6K  
Photon emission for (n,2p)

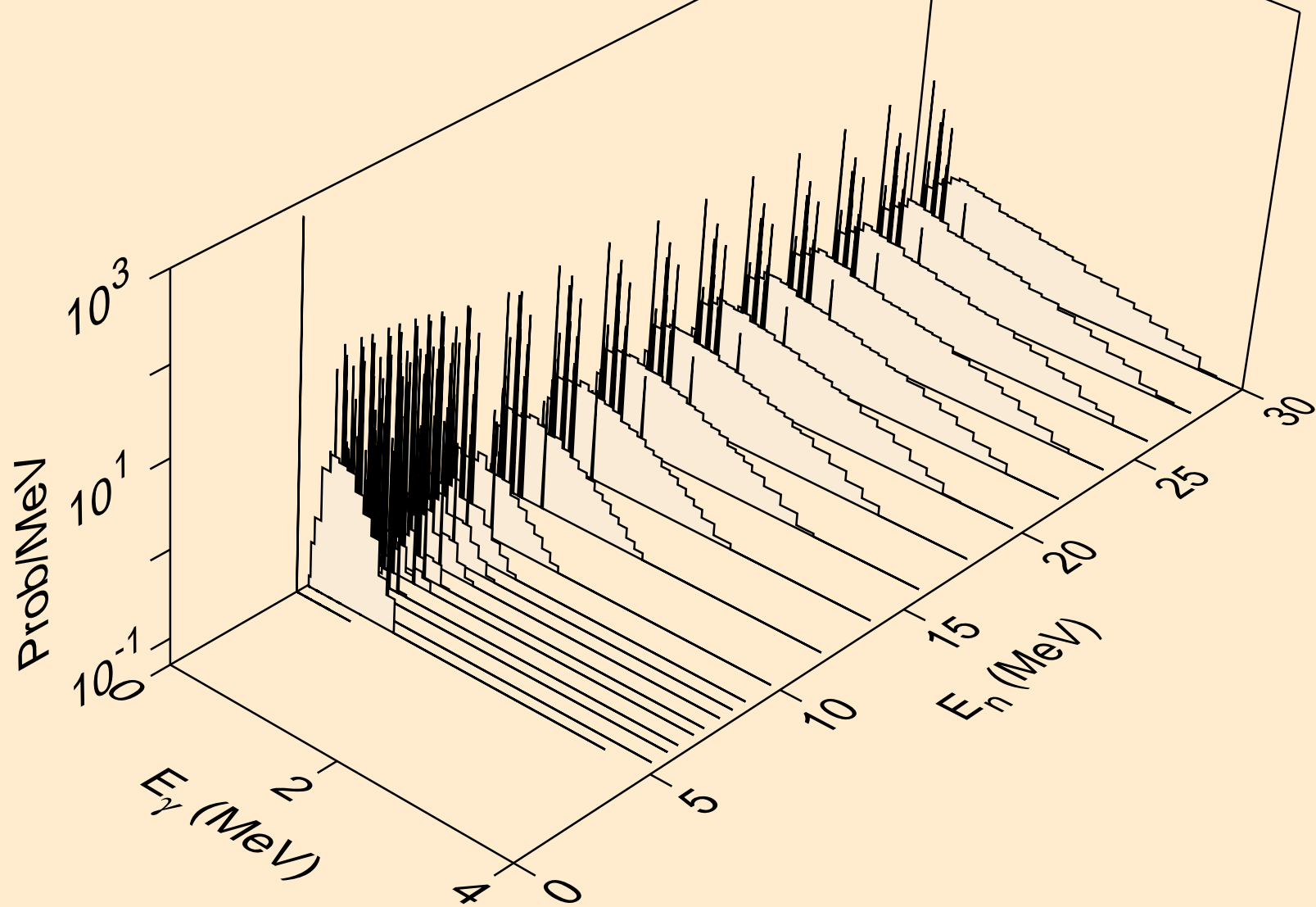

BI199M NEUTRON ACER TENDL-2021 LIBRARY; T=293.6K  
Photon emission for (n,p $\alpha$ )

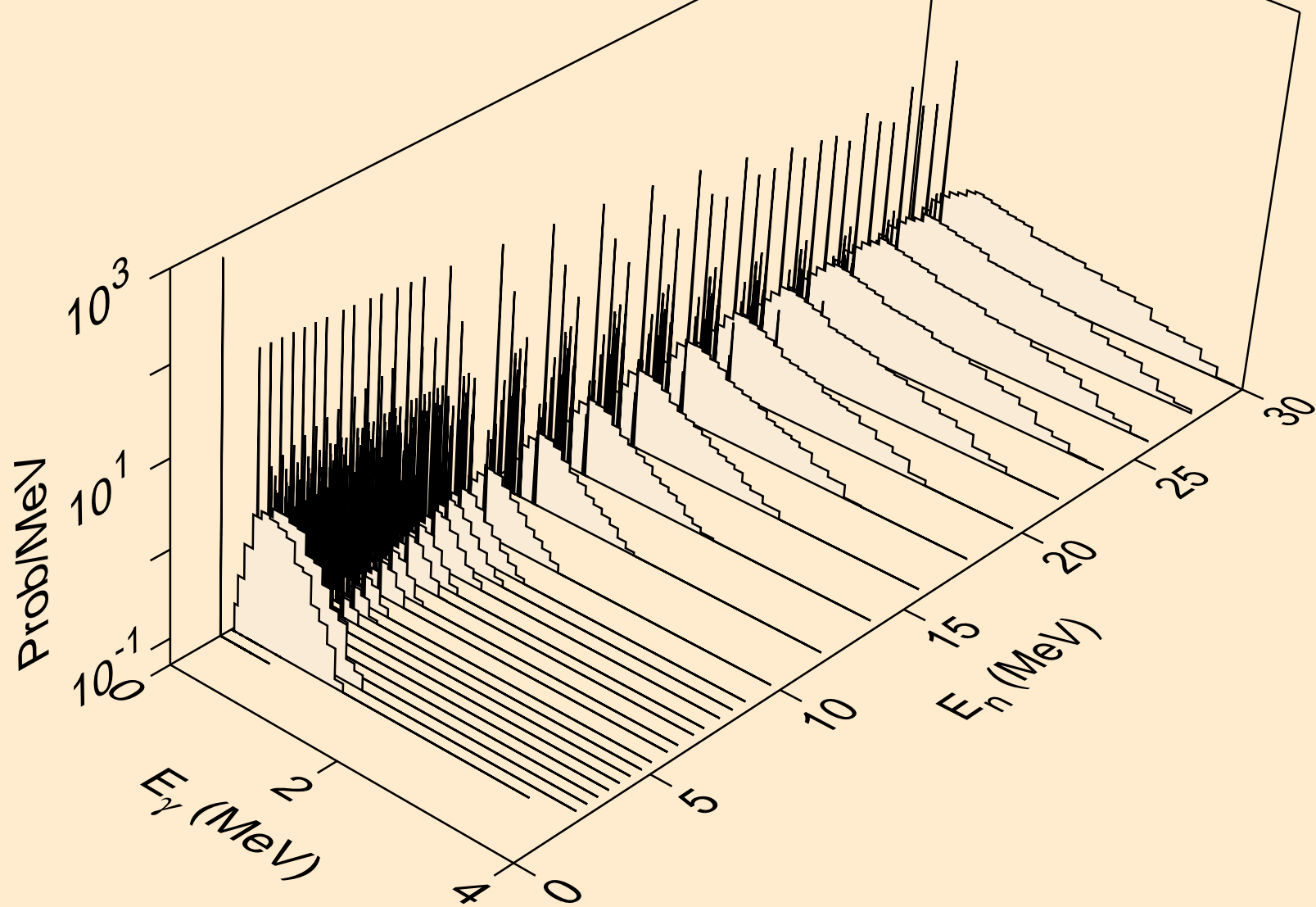

BI199M NEUTRON ACER TENDL-2021 LIBRARY; T=293.6K  
Photon emission for (n,pd)

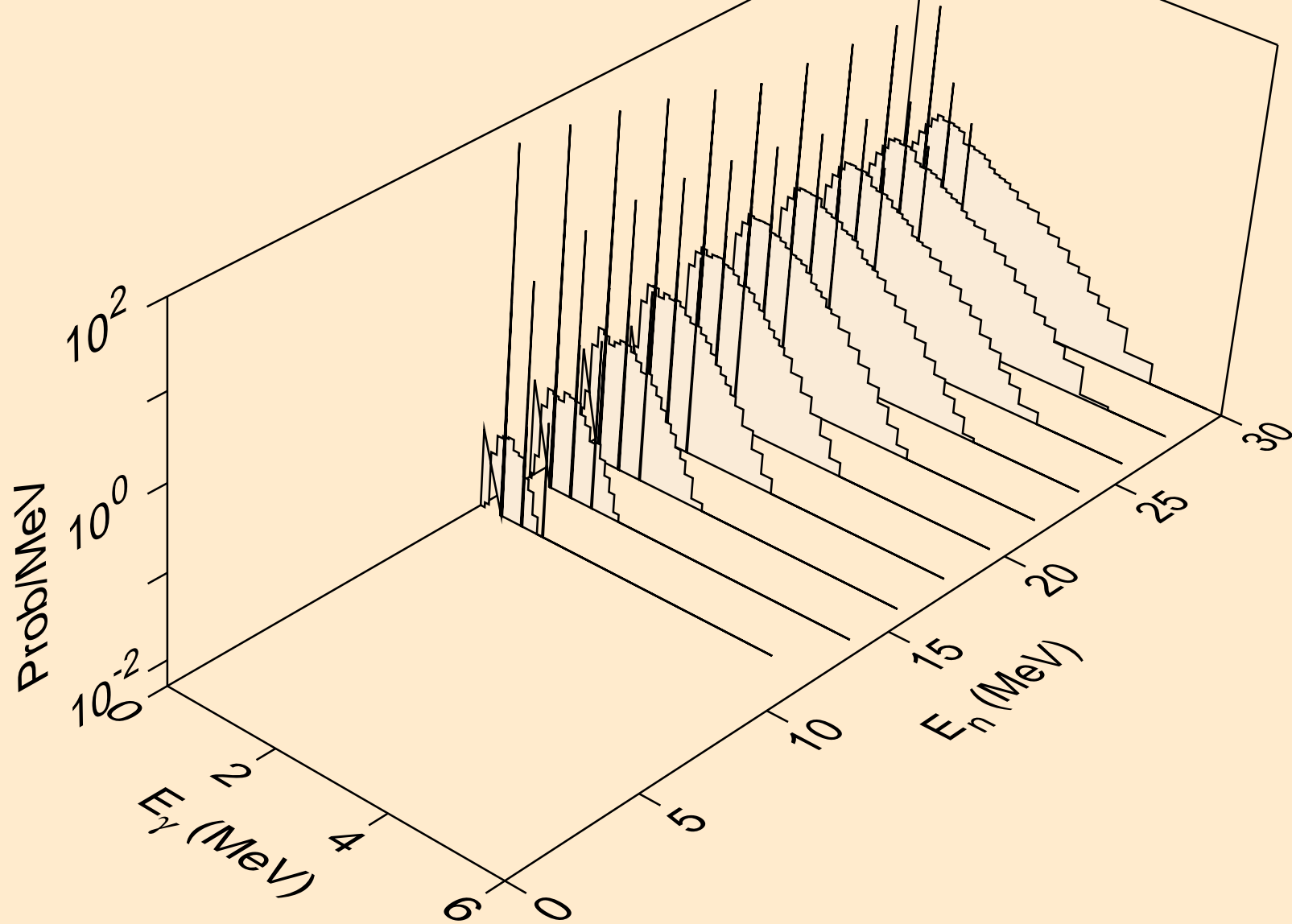

BI199M NEUTRON ACER TENDL-2021 LIBRARY; T=293.6K  
Photon emission for (n,pt)

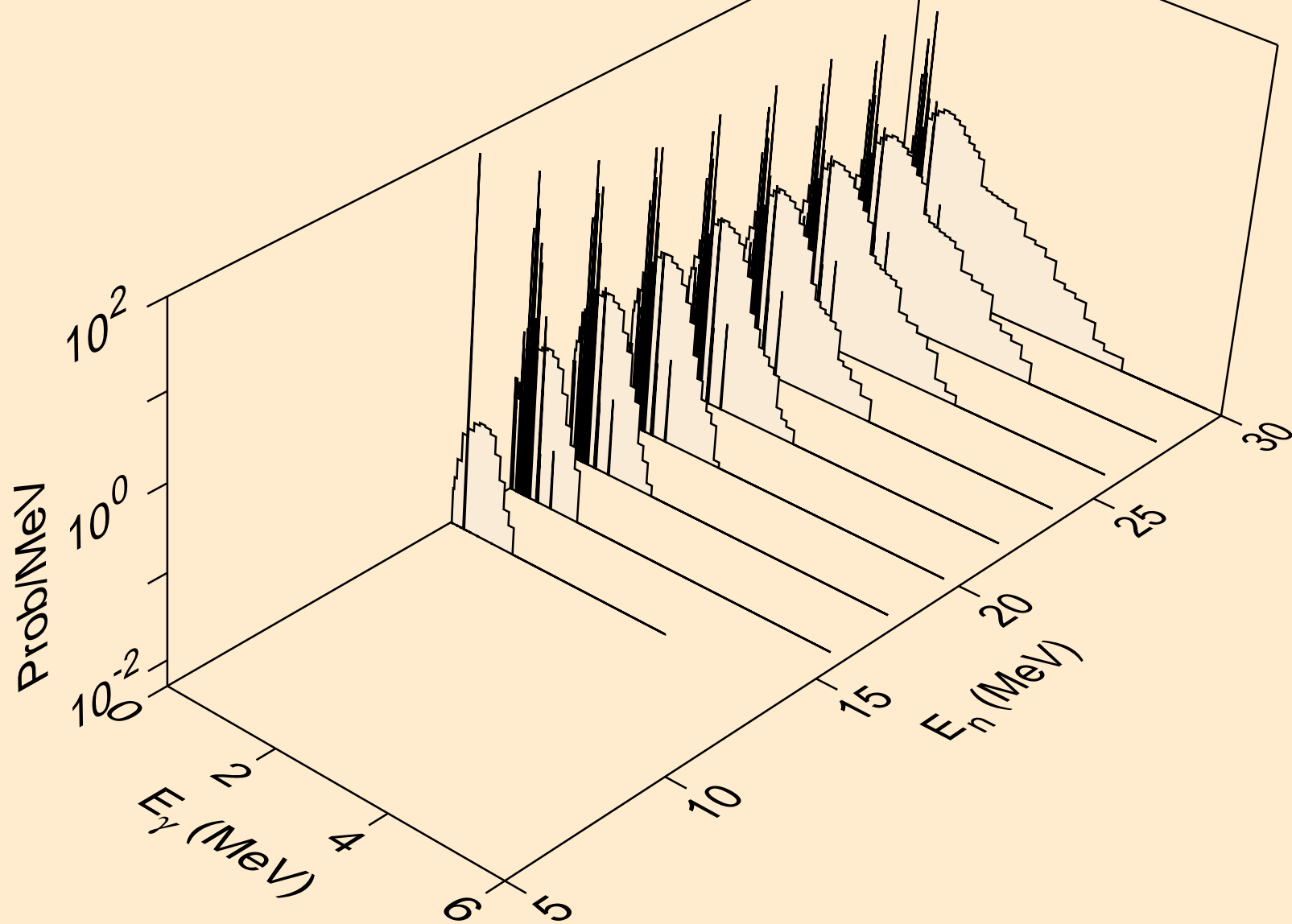



BI199M NEUTRON ACER TENDL-2021 LIBRARY; T=293.6K  
Photon emission for (n,da)

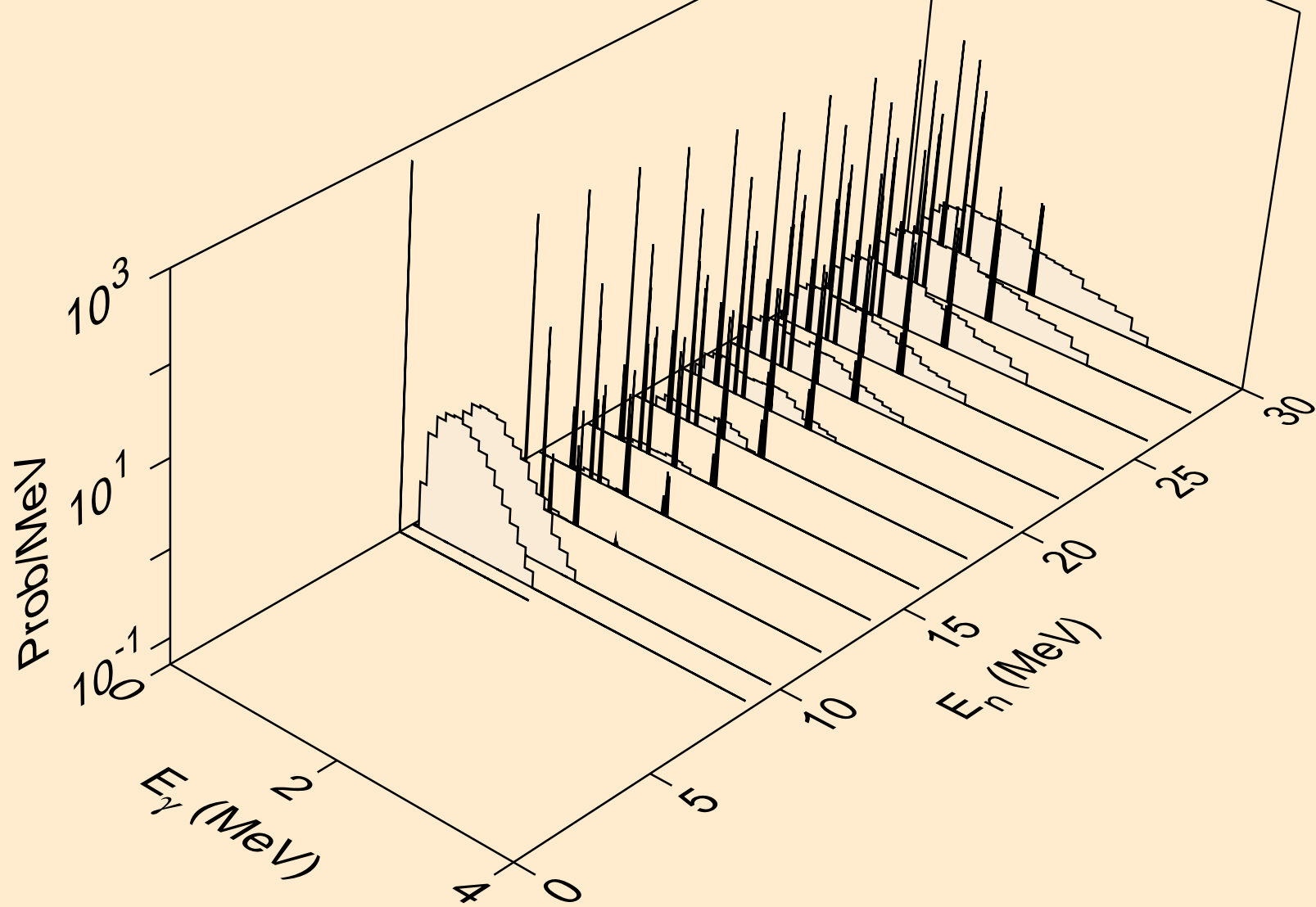

BI199M NEUTRON ACER TENDL-2021 LIBRARY; T=293.6K  
thermal capture photon spectrum

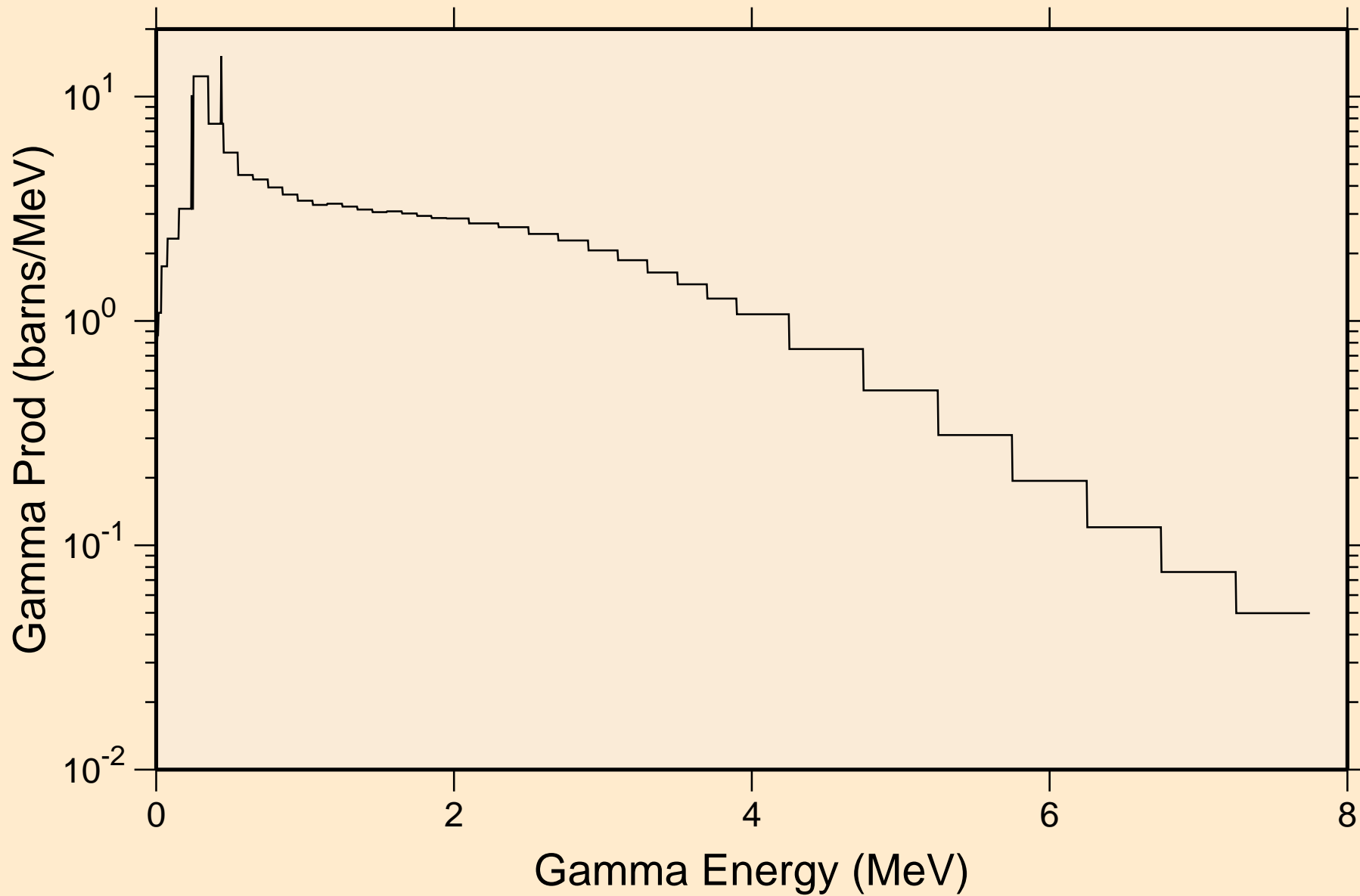

BI199M NEUTRON ACER TENDL-2021 LIBRARY; T=293.6K  
14 MeV photon spectrum

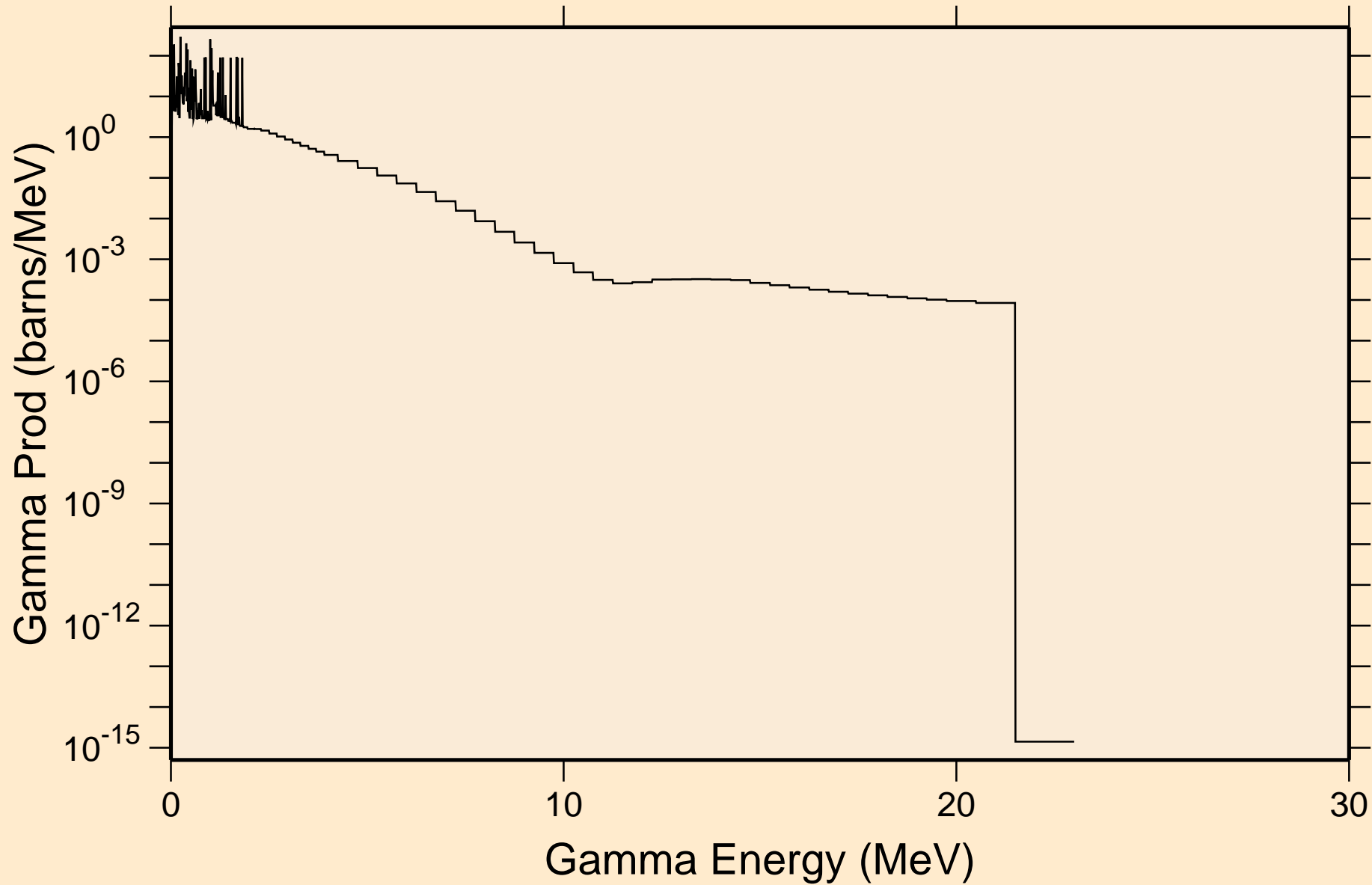

BI199M NEUTRON ACER TENDL-2021 LIBRARY; T=293.6K  
Particle heating contributions

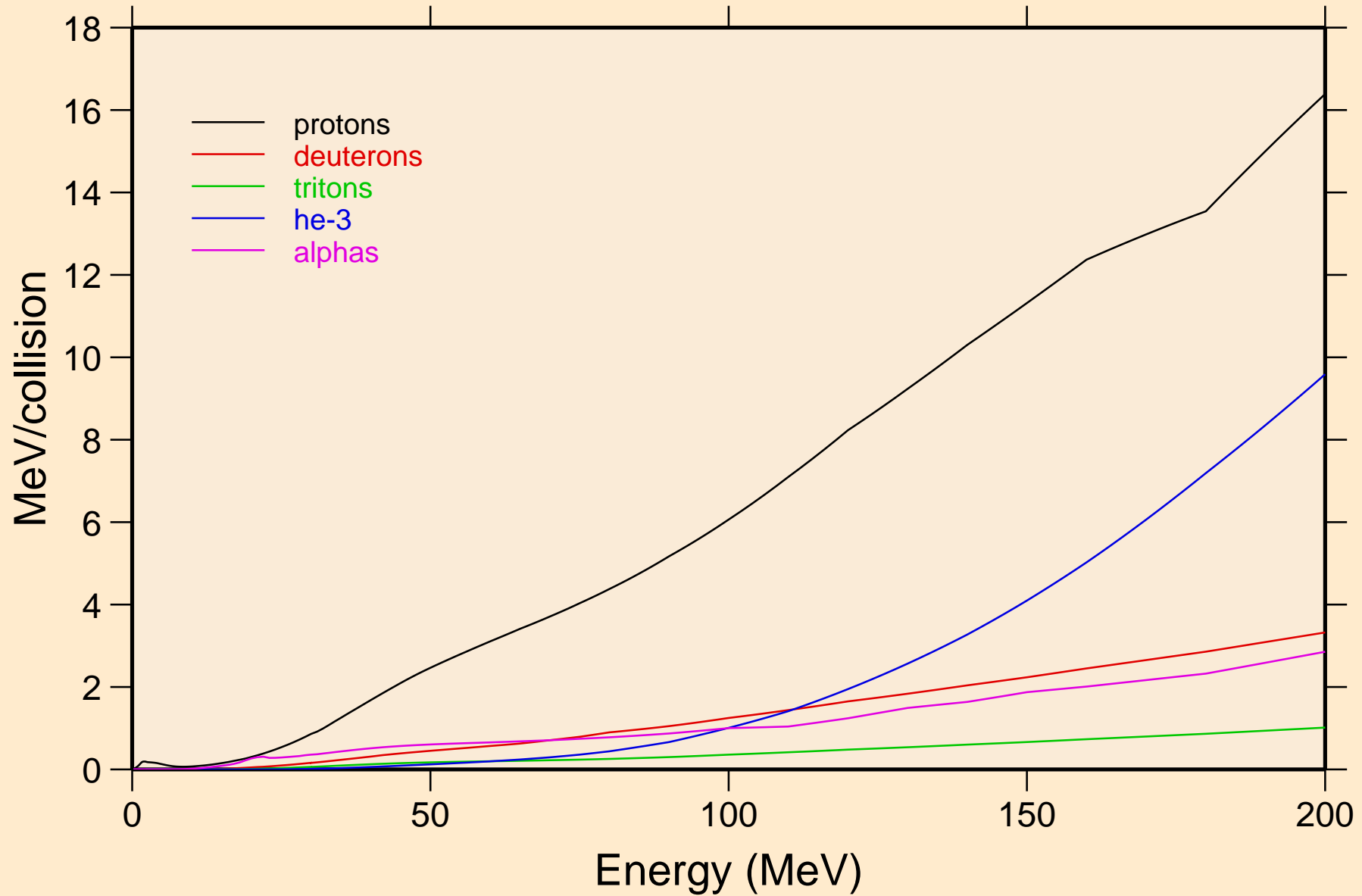

BI199M NEUTRON ACER TENDL-2021 LIBRARY; T=293.6K  
Recoil Heating

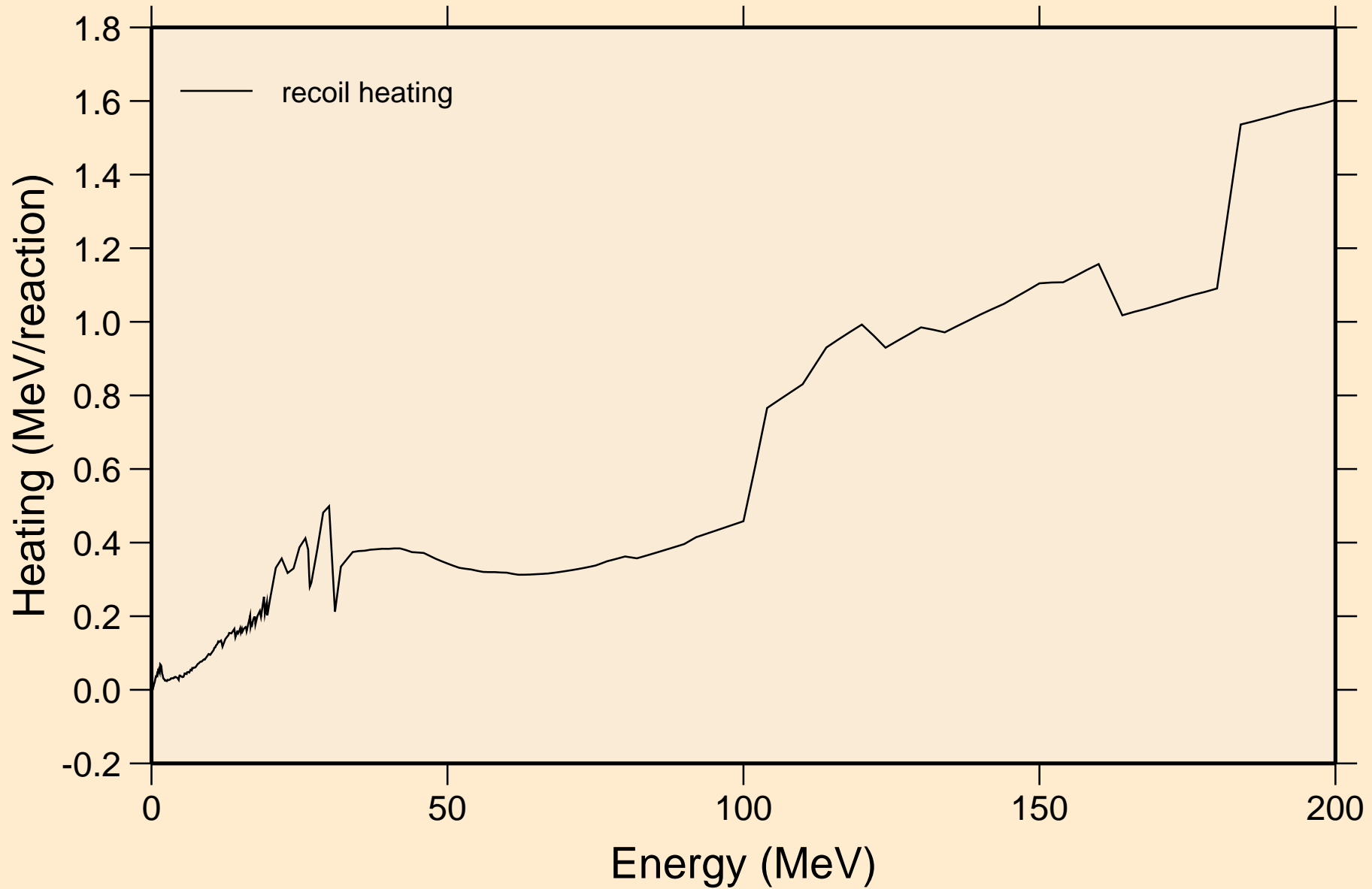

BI199M NEUTRON ACER TENDL-2021 LIBRARY; T=293.6K  
Particle production cross sections

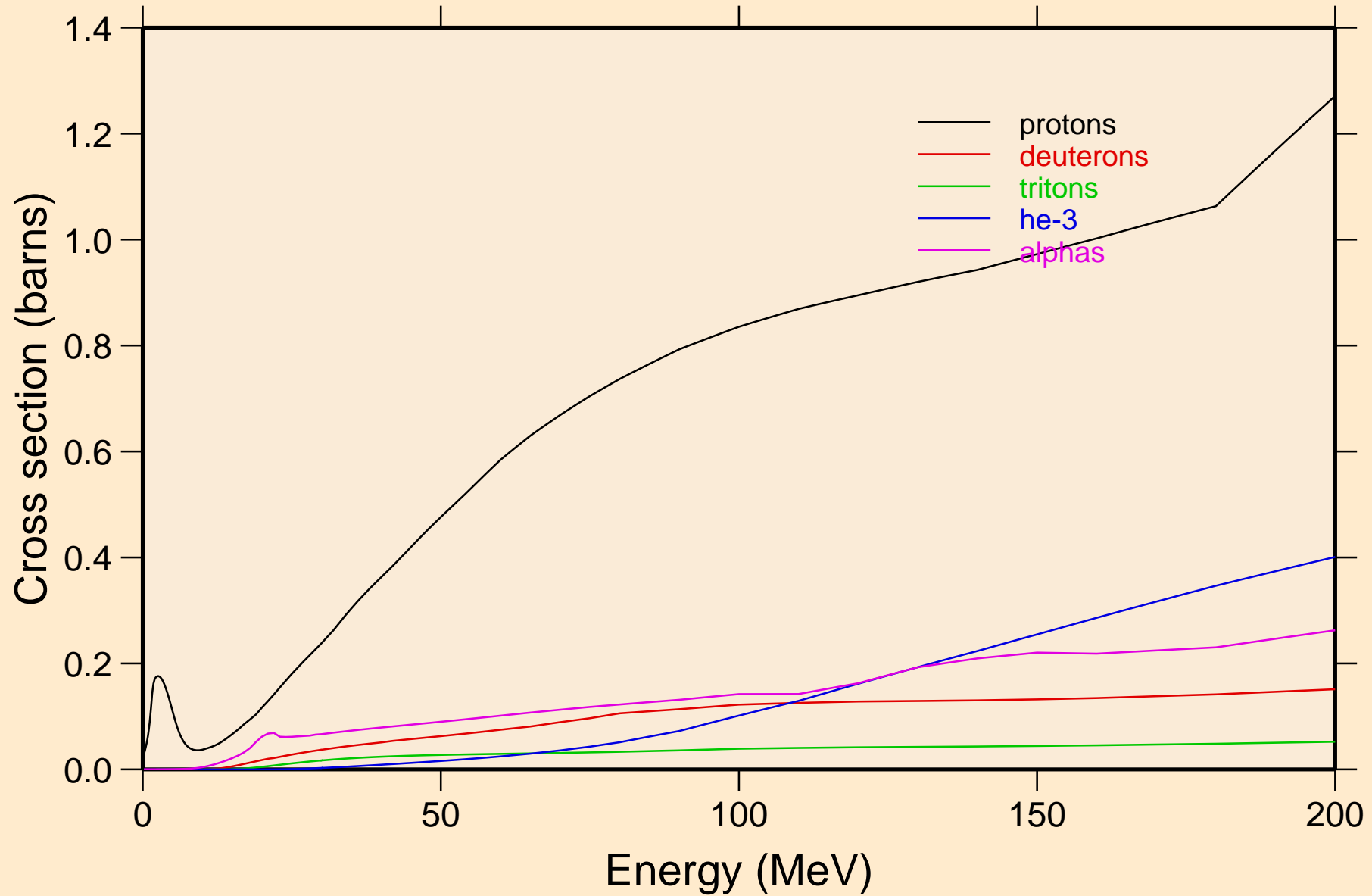

BI199M NEUTRON ACER TENDL-2021 LIBRARY; T=293.6K  
protons from (n,x)

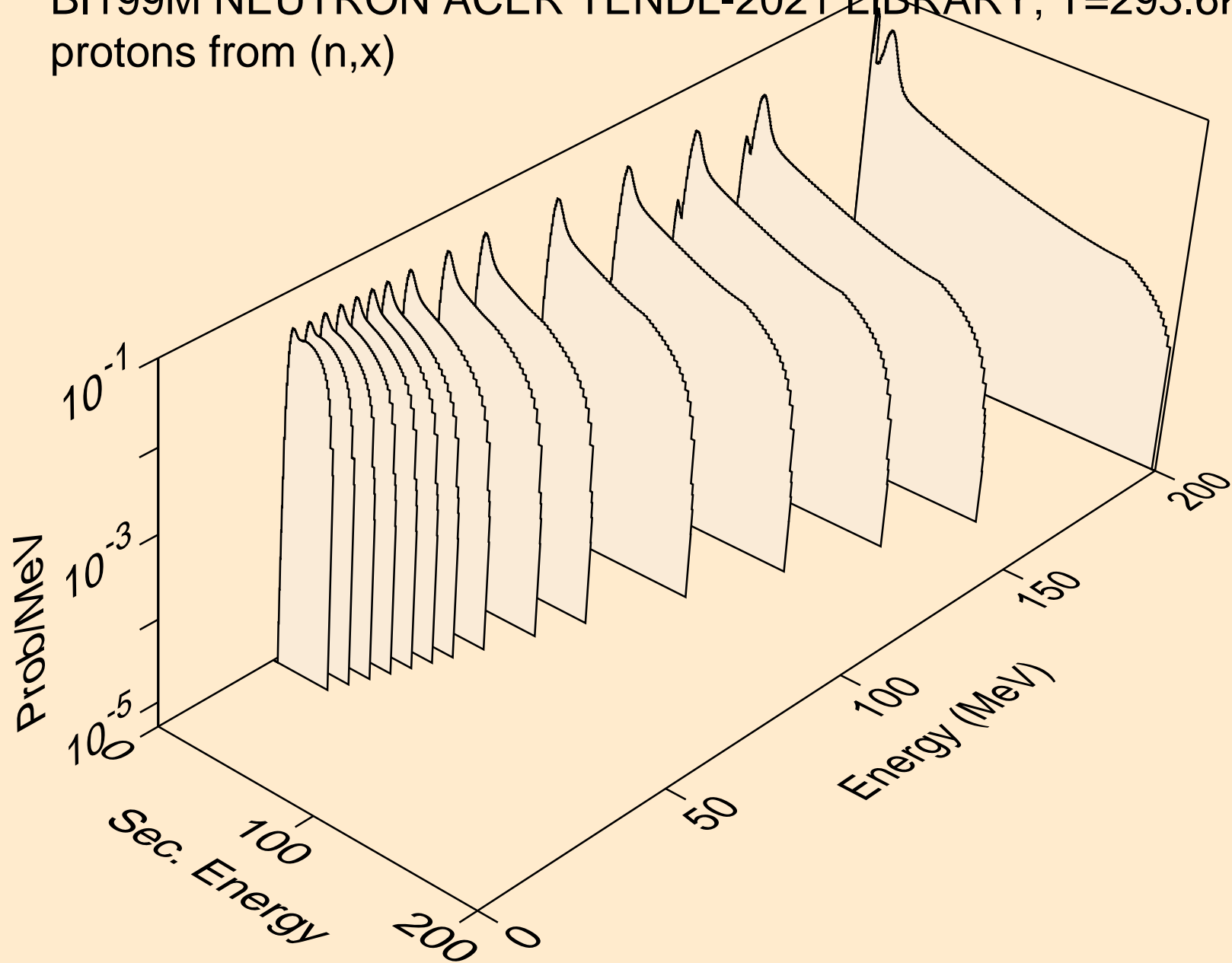

BI199M NEUTRON ACER TENDL-2021 LIBRARY; T=293.6K  
protons from (n,n\*)p

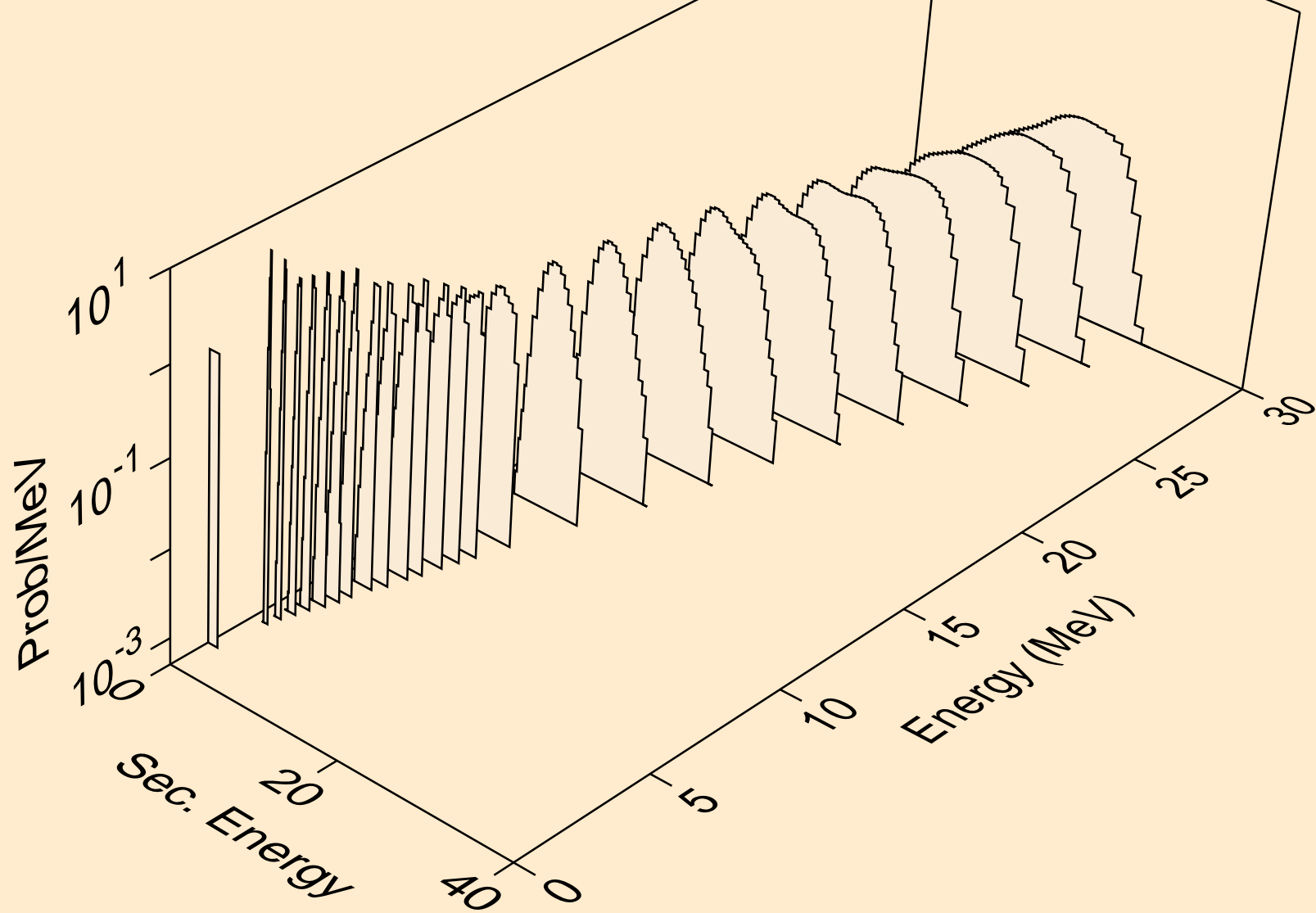



BI199M NEUTRON ACER TENDL-2021 LIBRARY; T=293.6K  
protons from (n,2np)

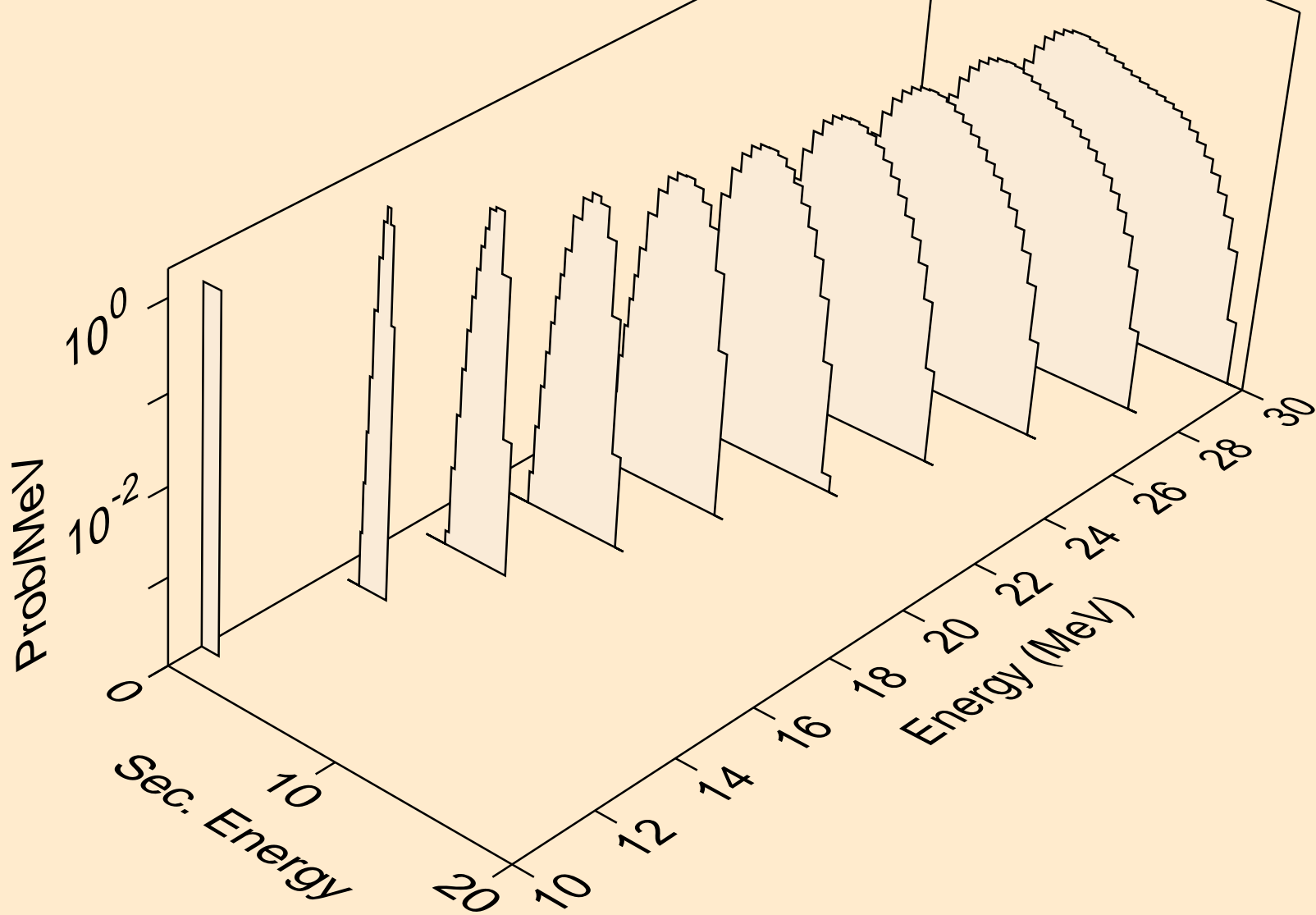

BI199M NEUTRON ACER TENDL-2021 LIBRARY; T=293.6K  
protons from (n,3np)

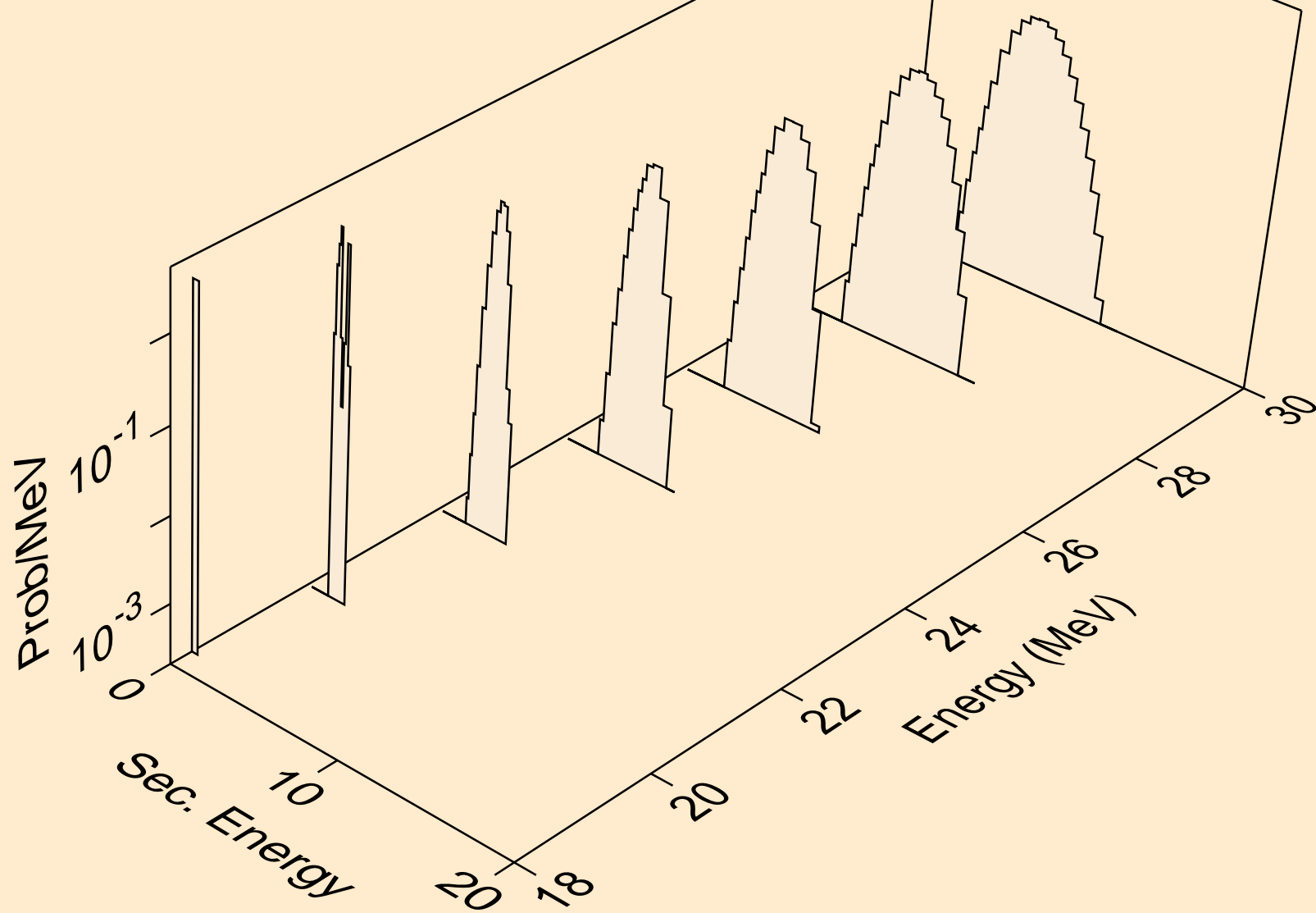

BI199M NEUTRON ACER TENDL-2021 LIBRARY; T=293.6K  
protons from (n,2np)

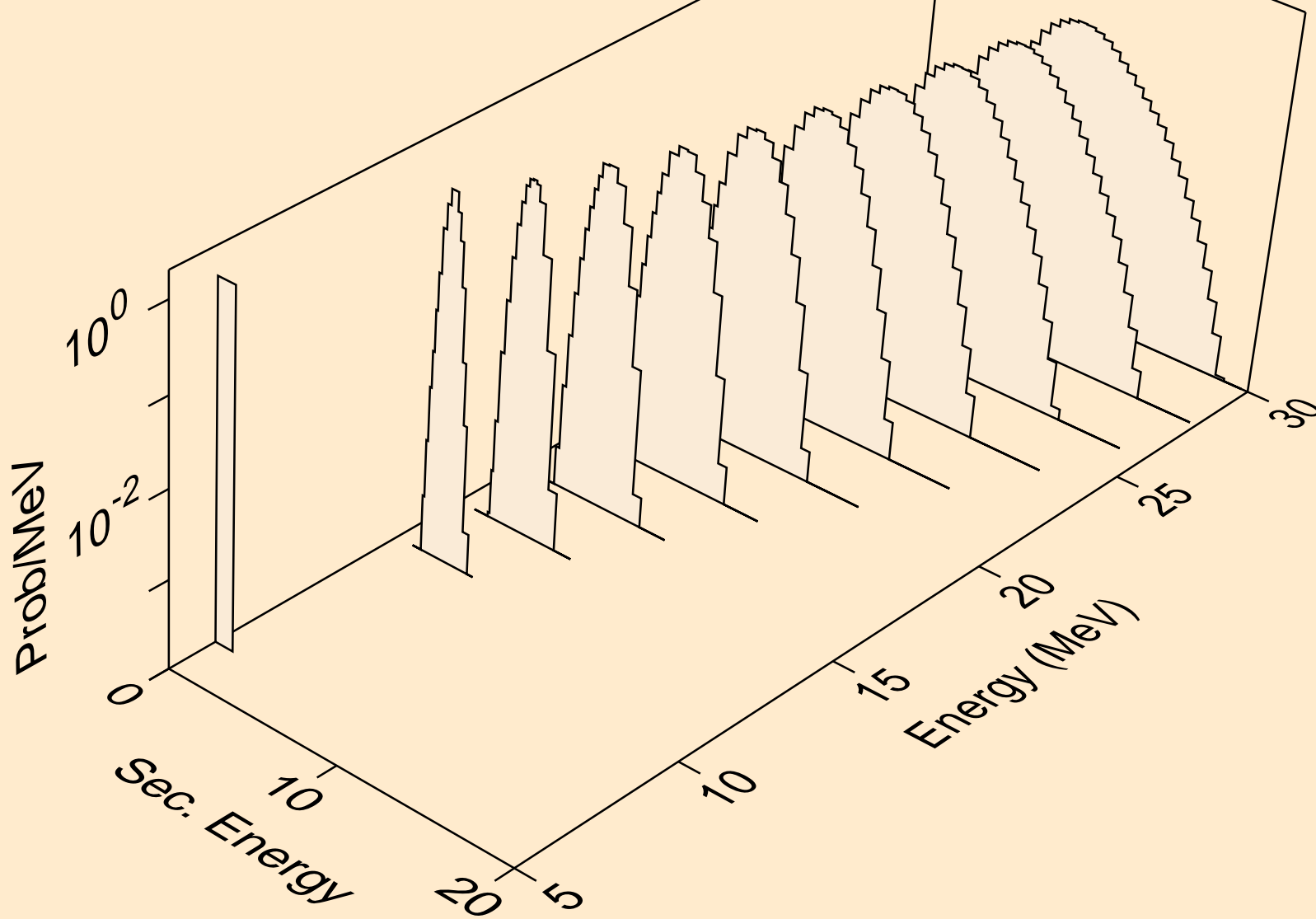

BI199M NEUTRON ACER TENDL-2021 LIBRARY; T=293.6K  
protons from (n,npa)

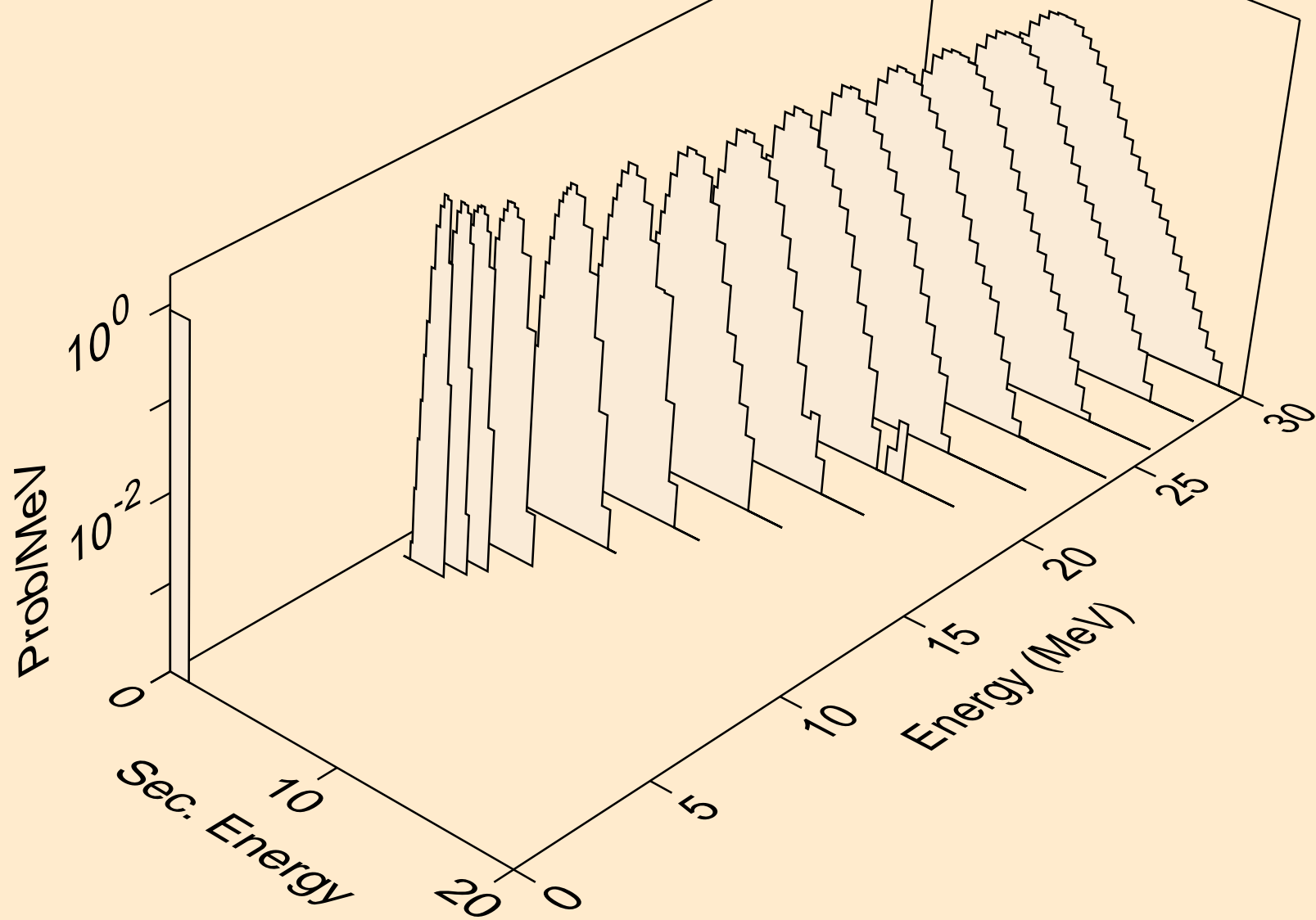

BI199M NEUTRON ACER TENDL-2021 LIBRARY; T=293.6K  
protons from (n,p)

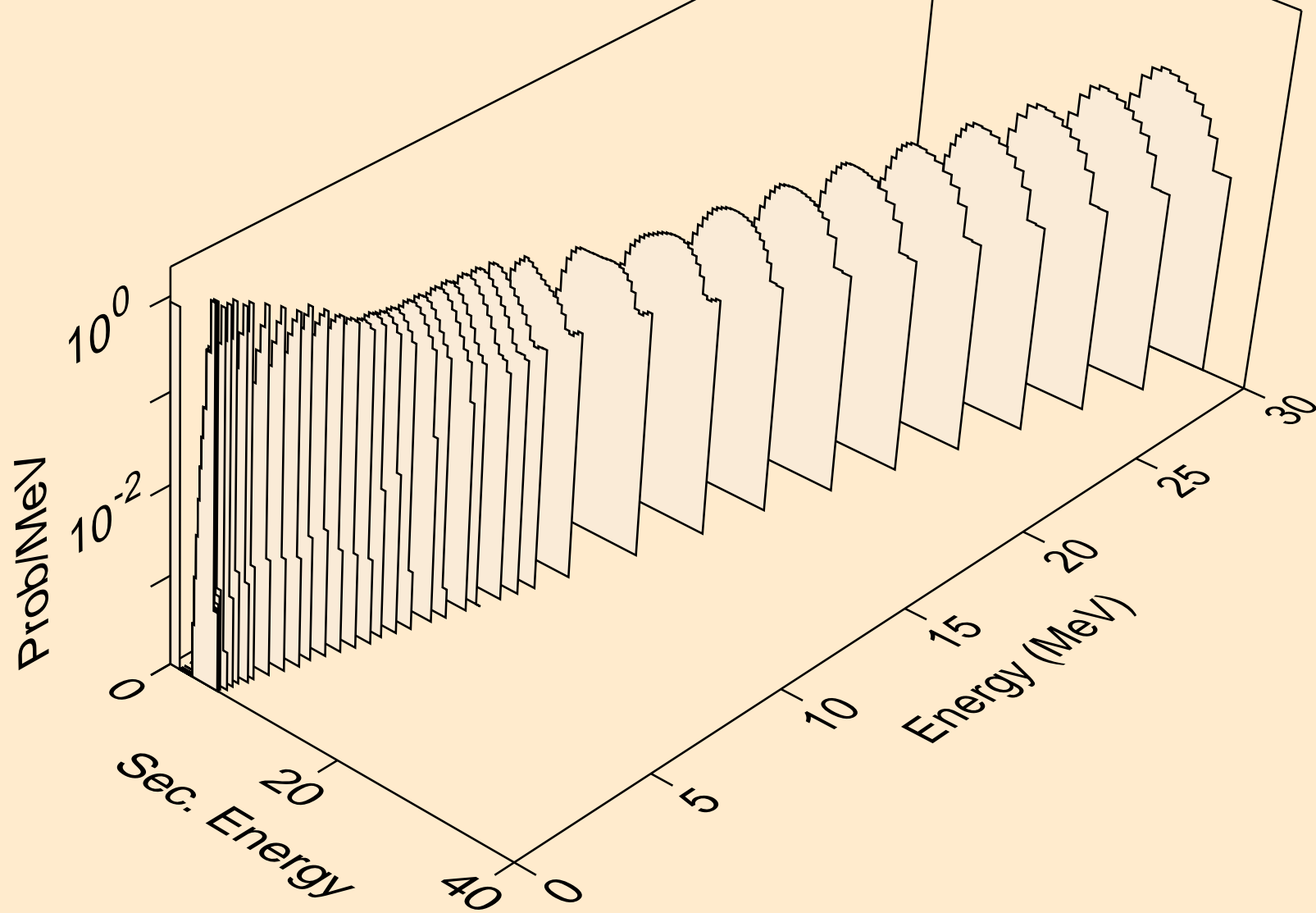

BI199M NEUTRON ACER TENDL-2021 LIBRARY; T=293.6K  
protons from (n,2p)

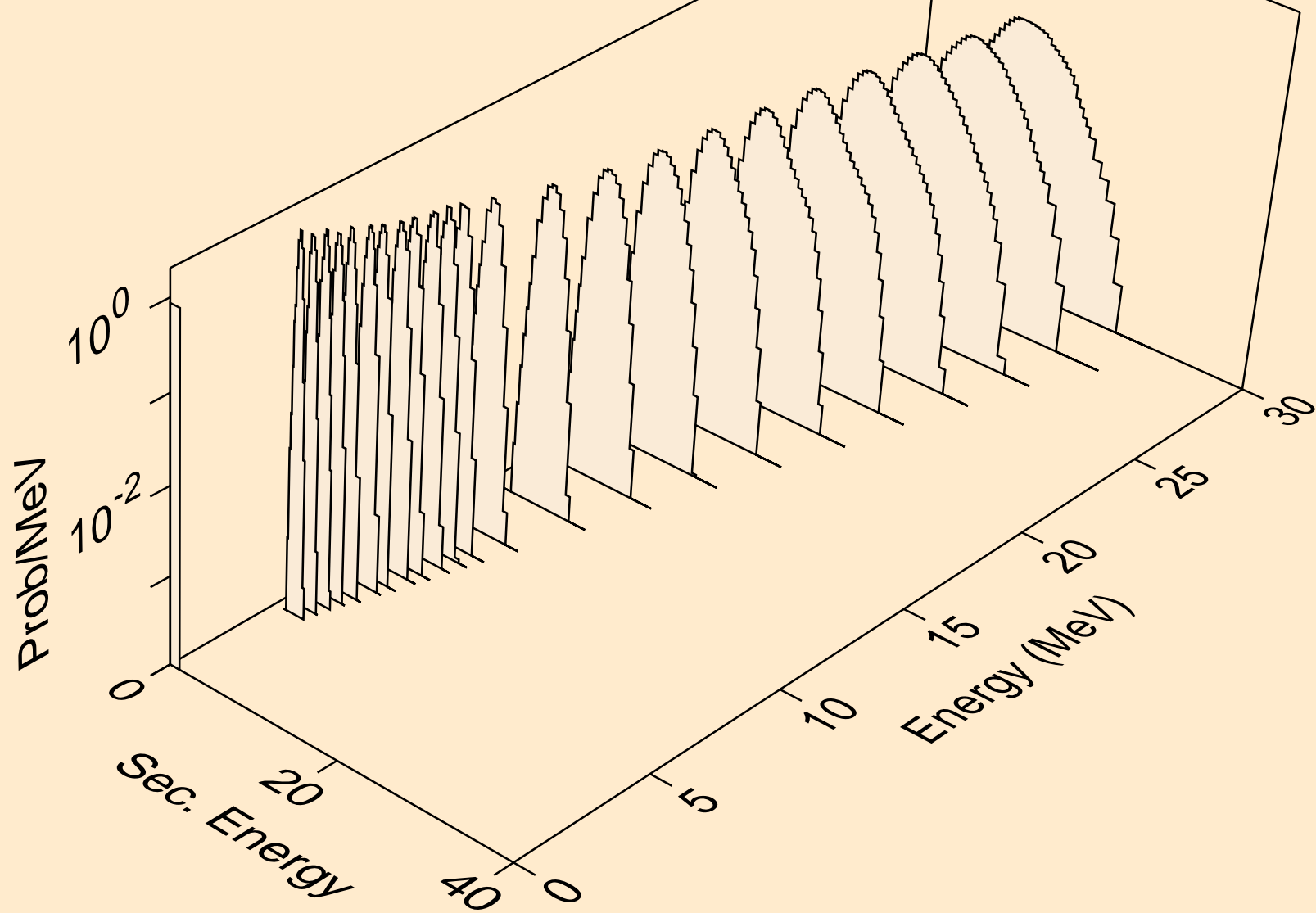

BI199M NEUTRON ACER TENDL-2021 LIBRARY; T=293.6K  
protons from (n,p)

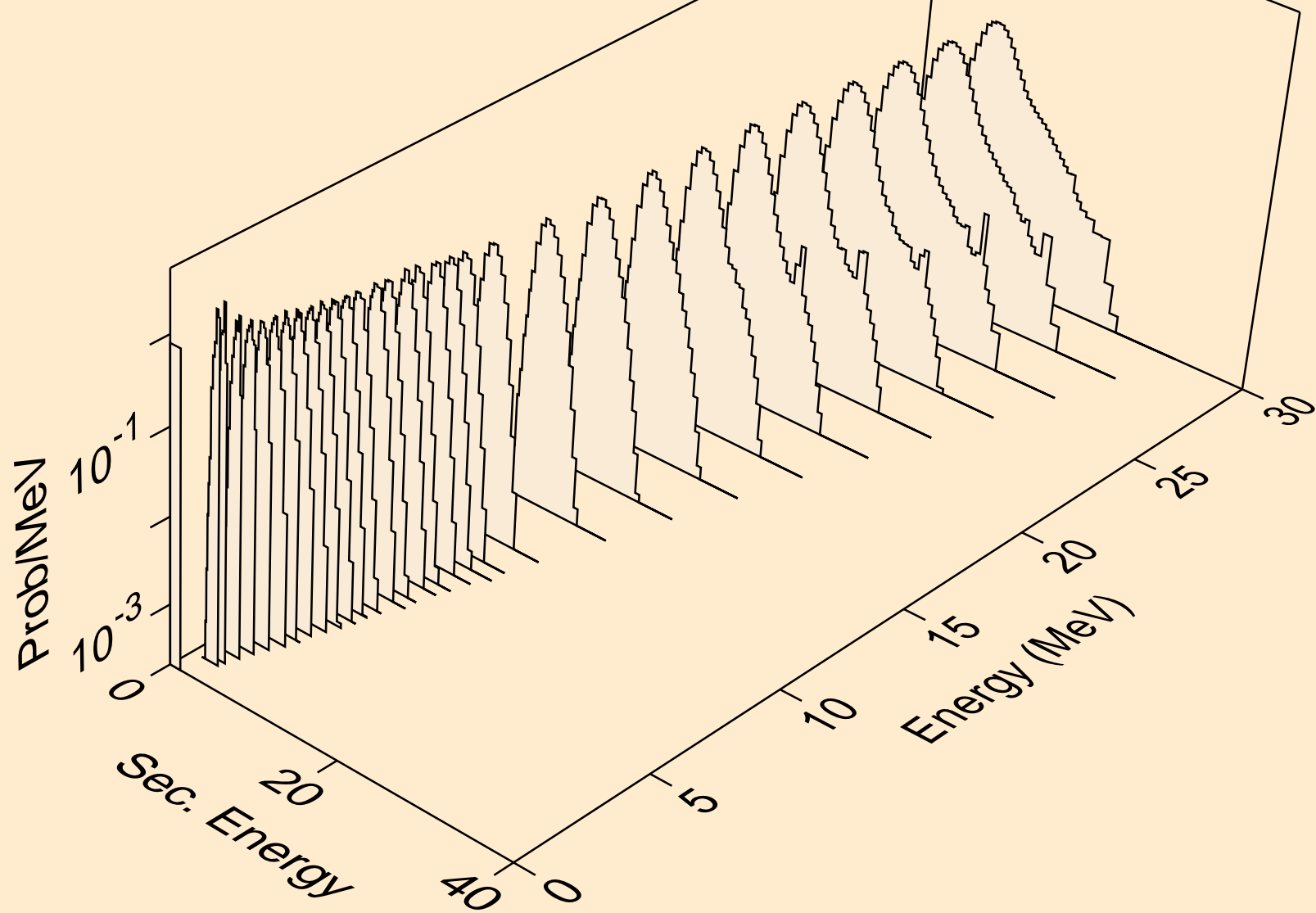

BI199M NEUTRON ACER TENDL-2021 LIBRARY; T=293.6K  
protons from (n,pd)

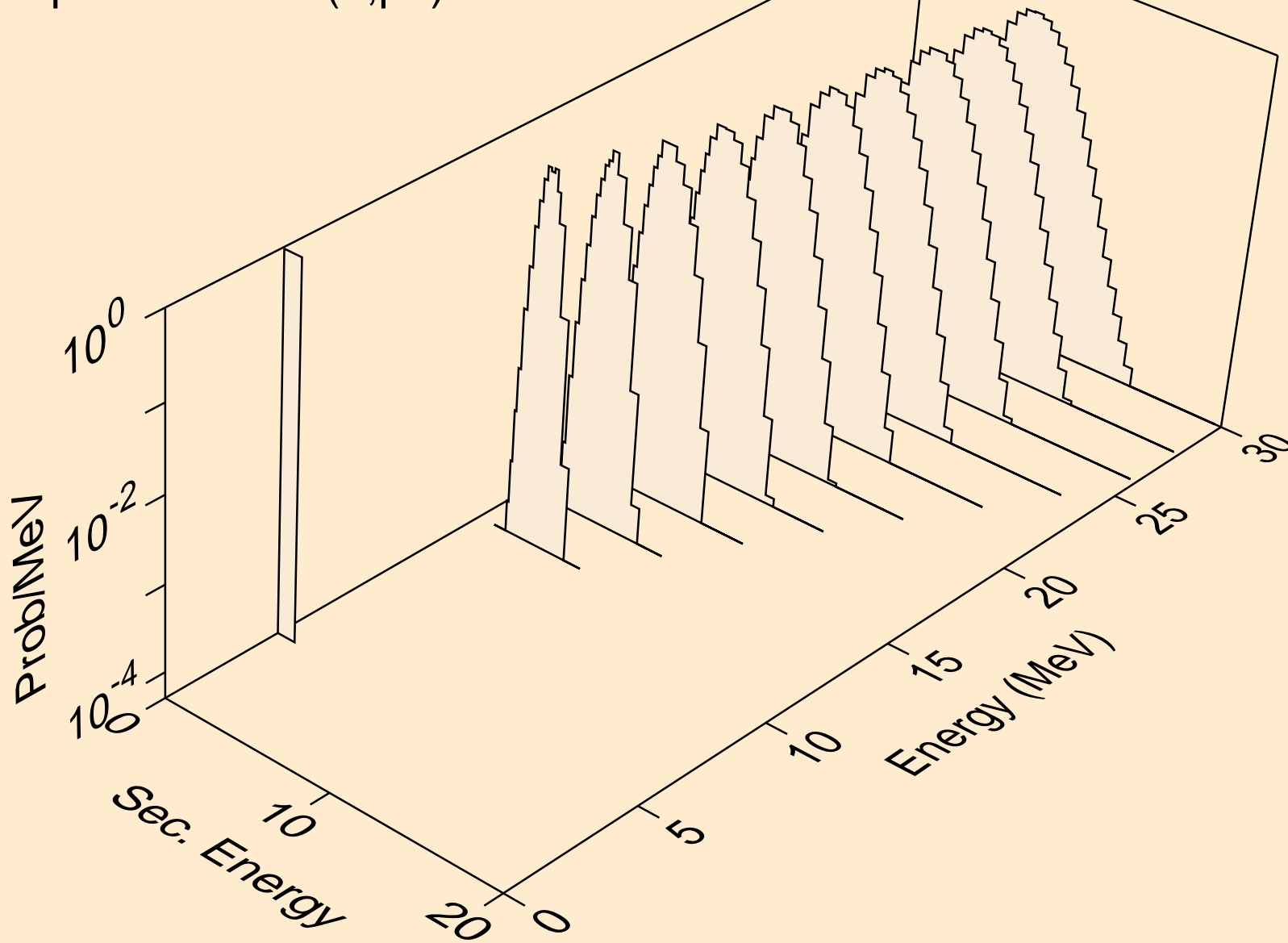



BI199M NEUTRON ACER TENDL-2021 LIBRARY; T=293.6K  
protons from (n,pt)

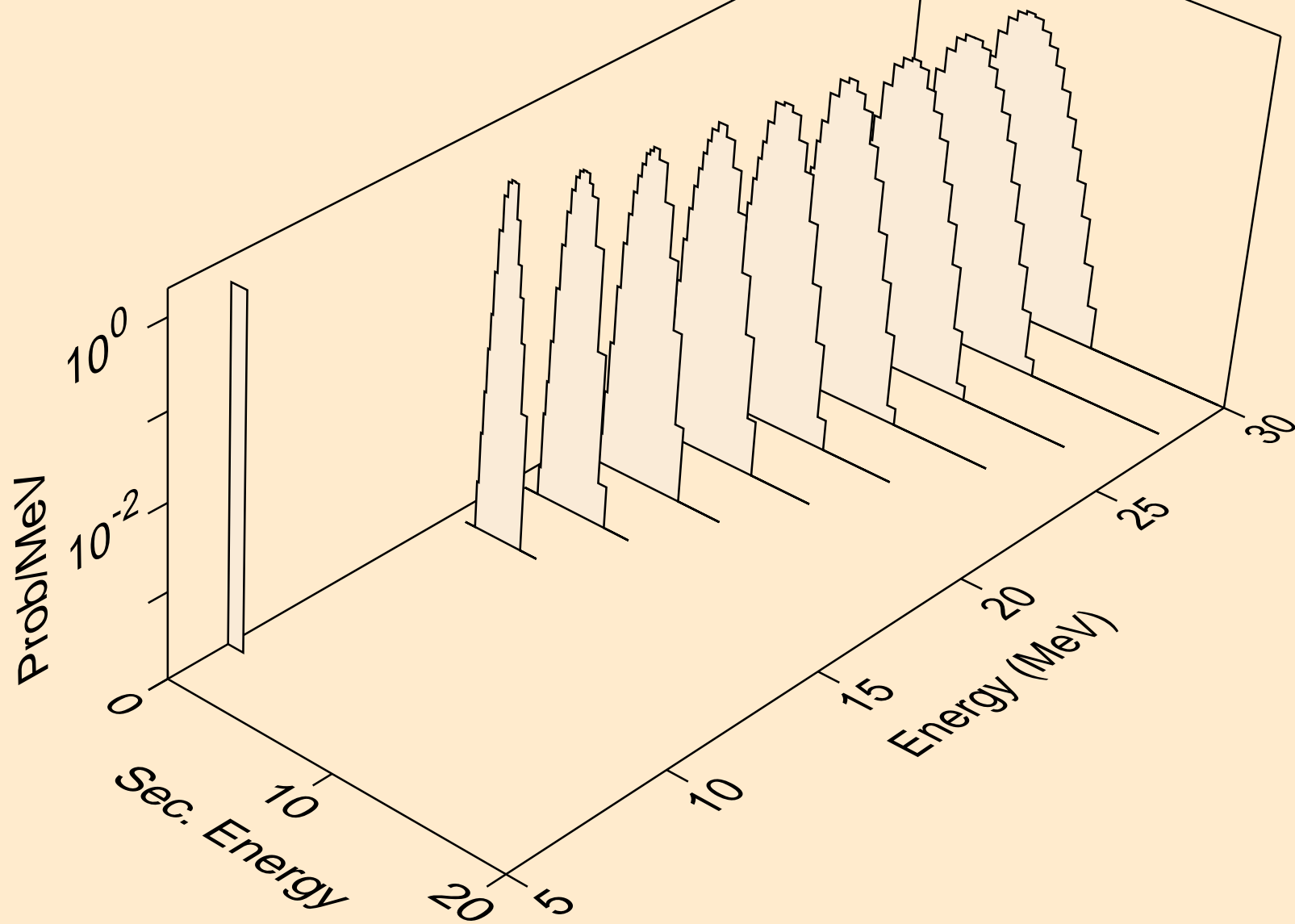

BI199M NEUTRON ACER TENDL-2021 LIBRARY; T=293.6K  
deuterons from (n,x)

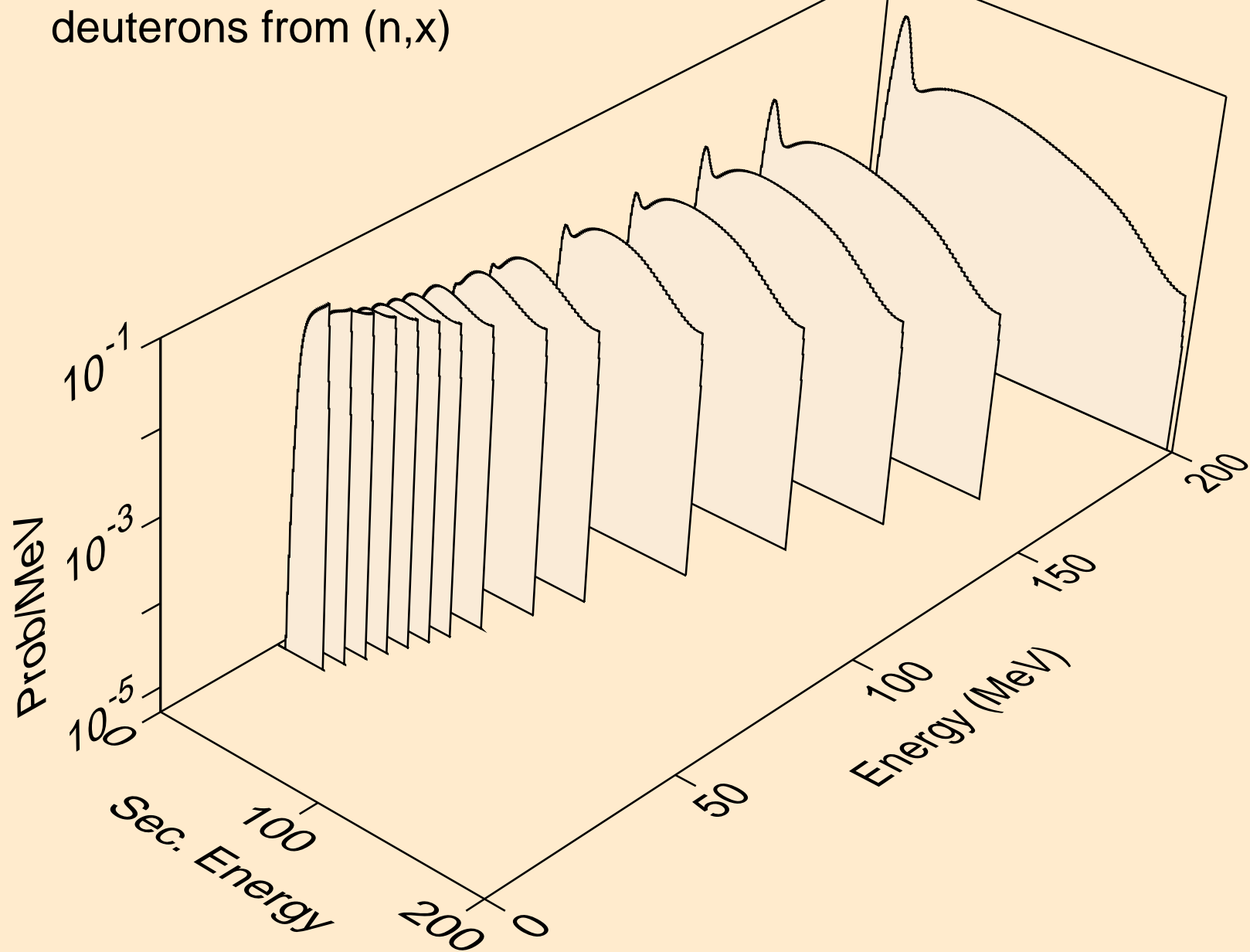

BI199M NEUTRON ACER TENDL-2021 LIBRARY; T=293.6K  
deuterons from (n,2nd)

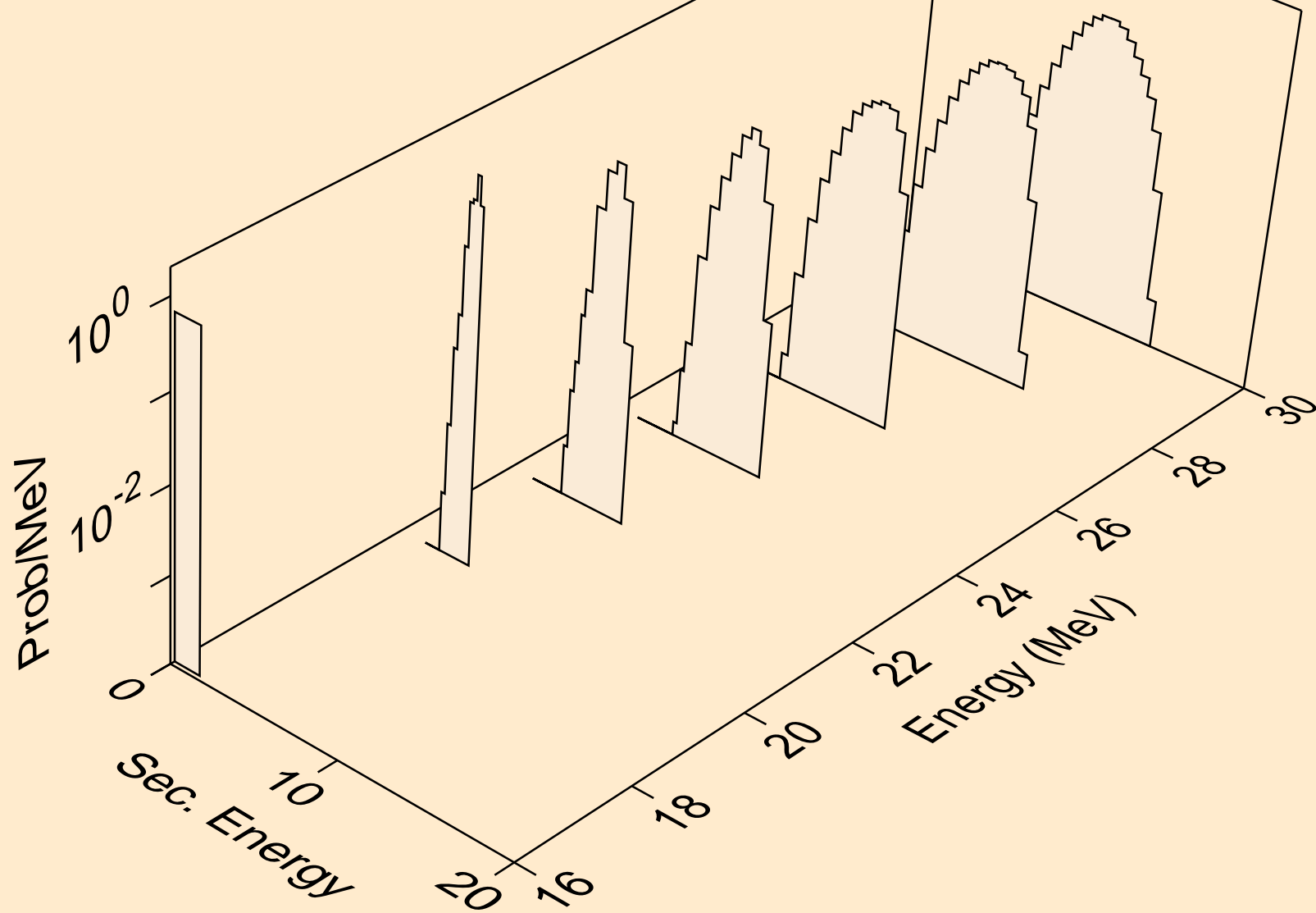

BI199M NEUTRON ACER TENDL-2021 LIBRARY; T=293.6K  
deuterons from (n,n\*)d

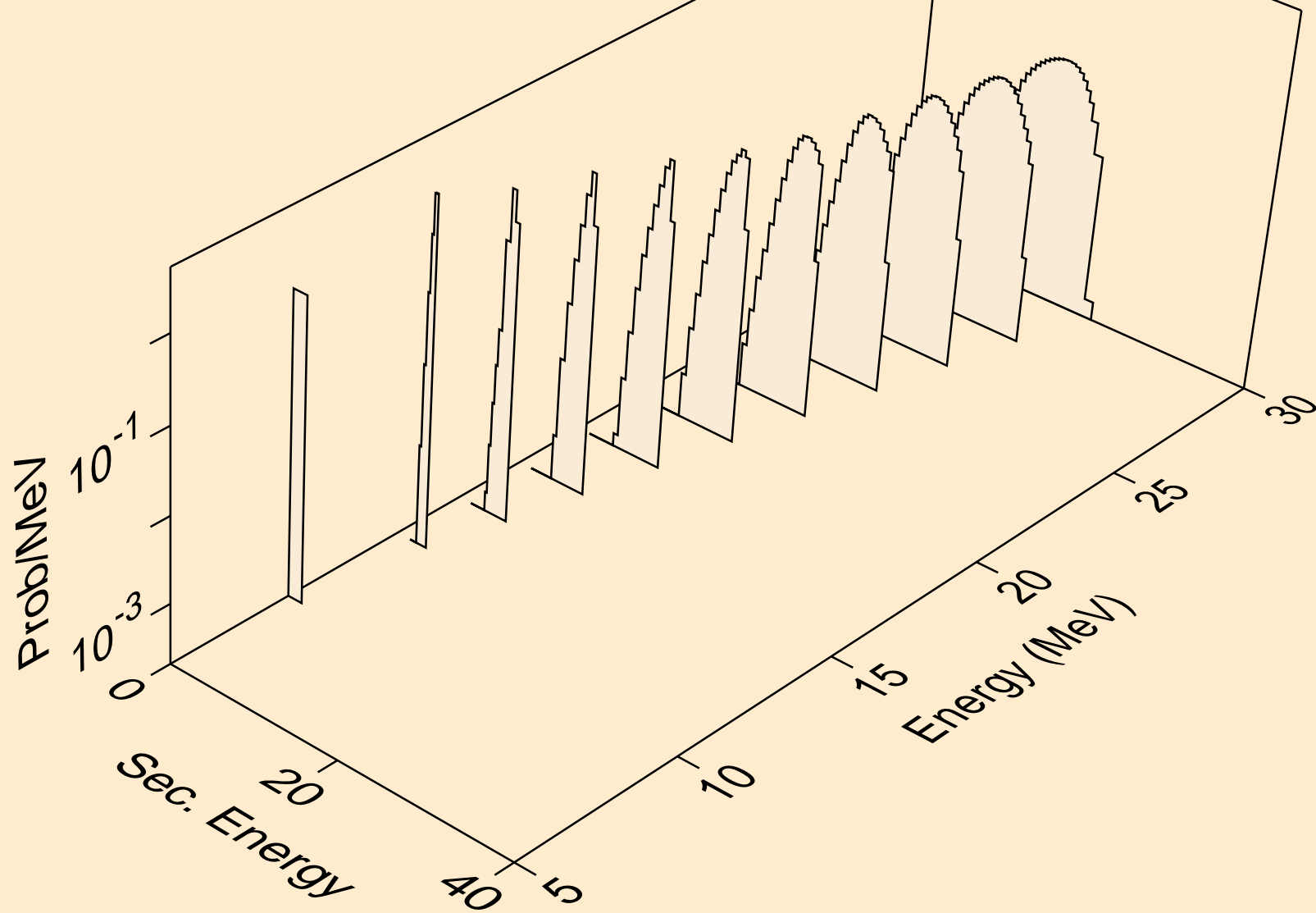

BI199M NEUTRON ACER TENDL-2021 LIBRARY; T=293.6K  
deuterons from (n,d)

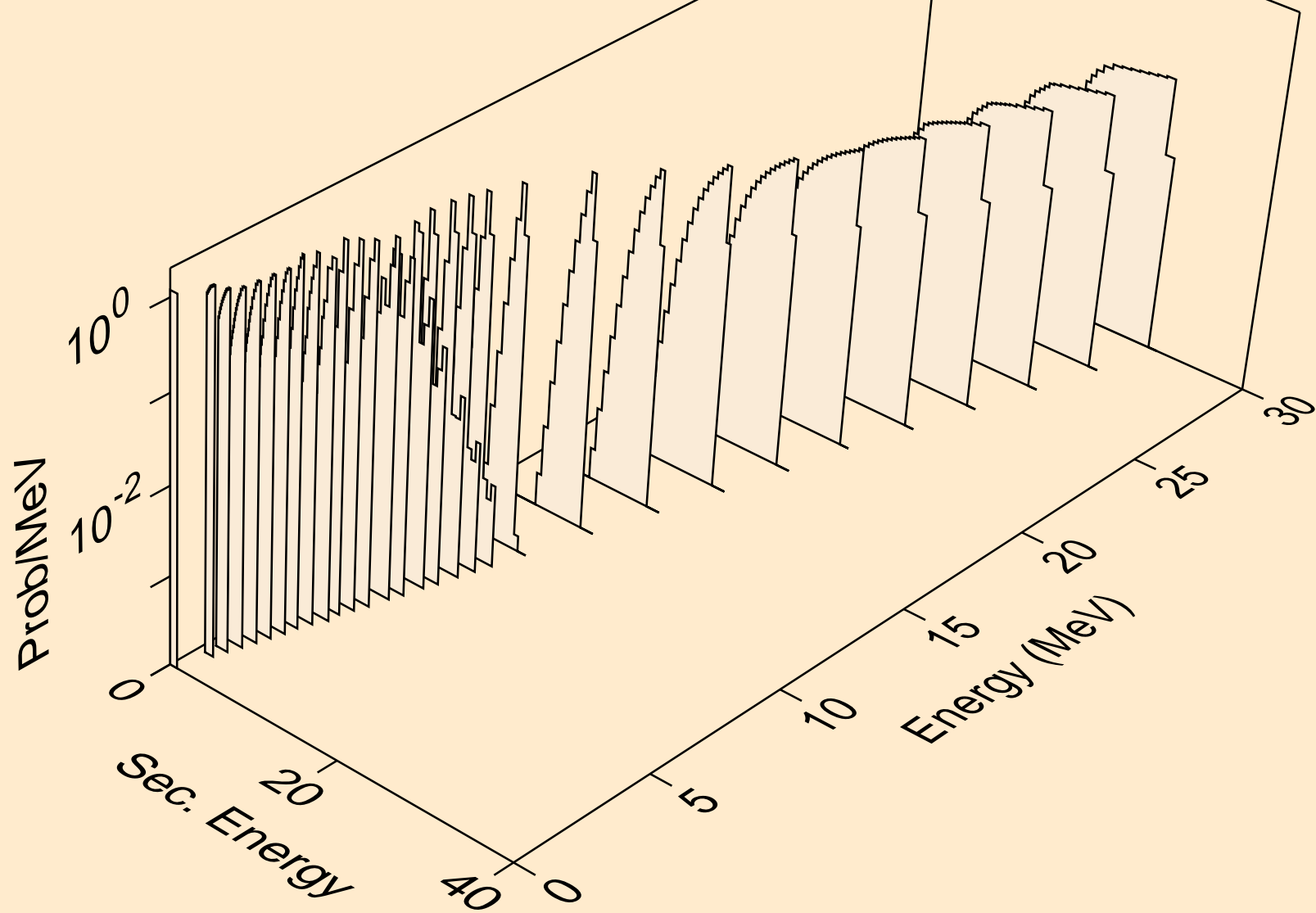

BI199M NEUTRON ACER TENDL-2021 LIBRARY; T=293.6K  
deuterons from (n,pd)

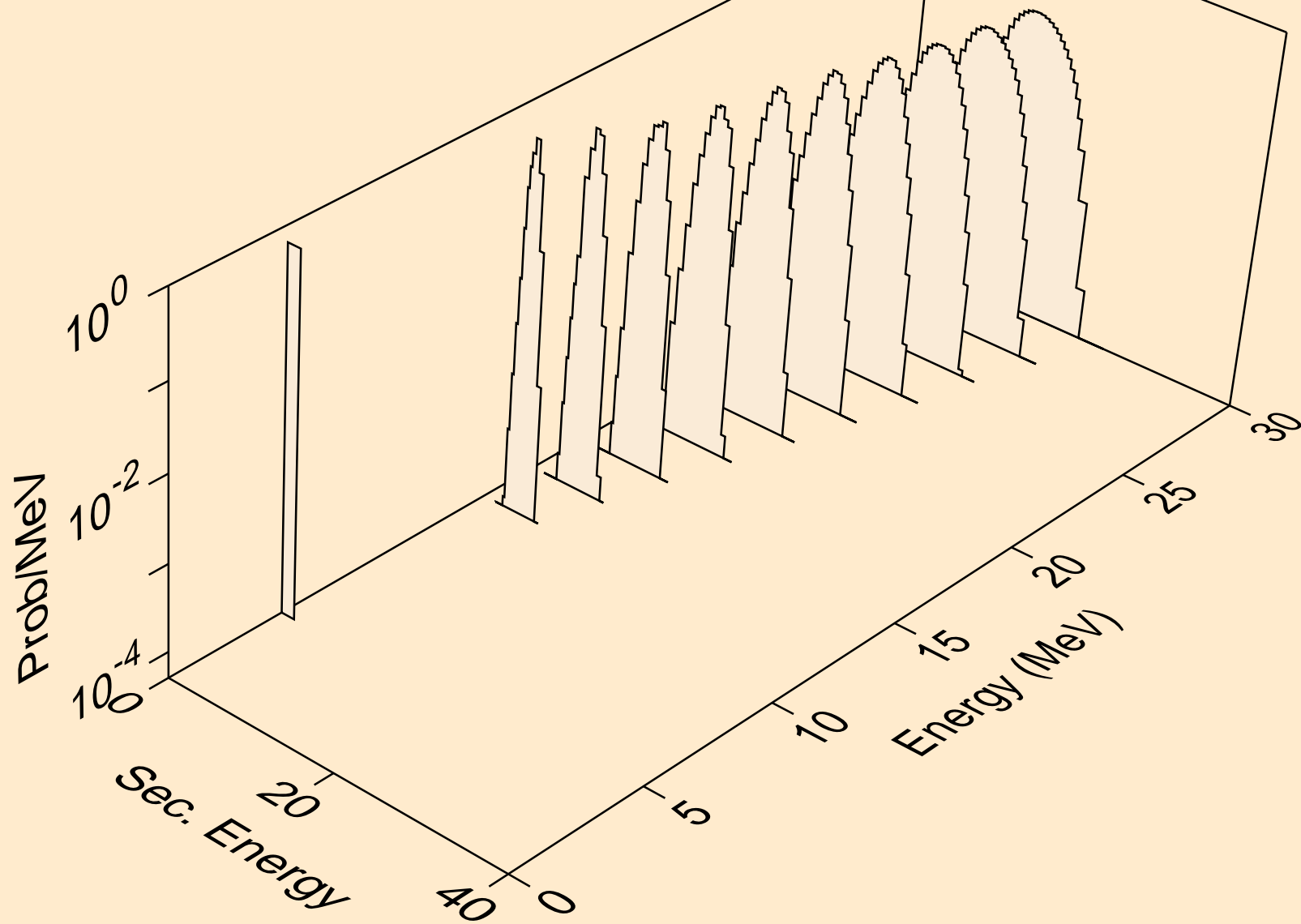

BI199M NEUTRON ACER TENDL-2021 LIBRARY; T=293.6K  
deuterons from (n,da)

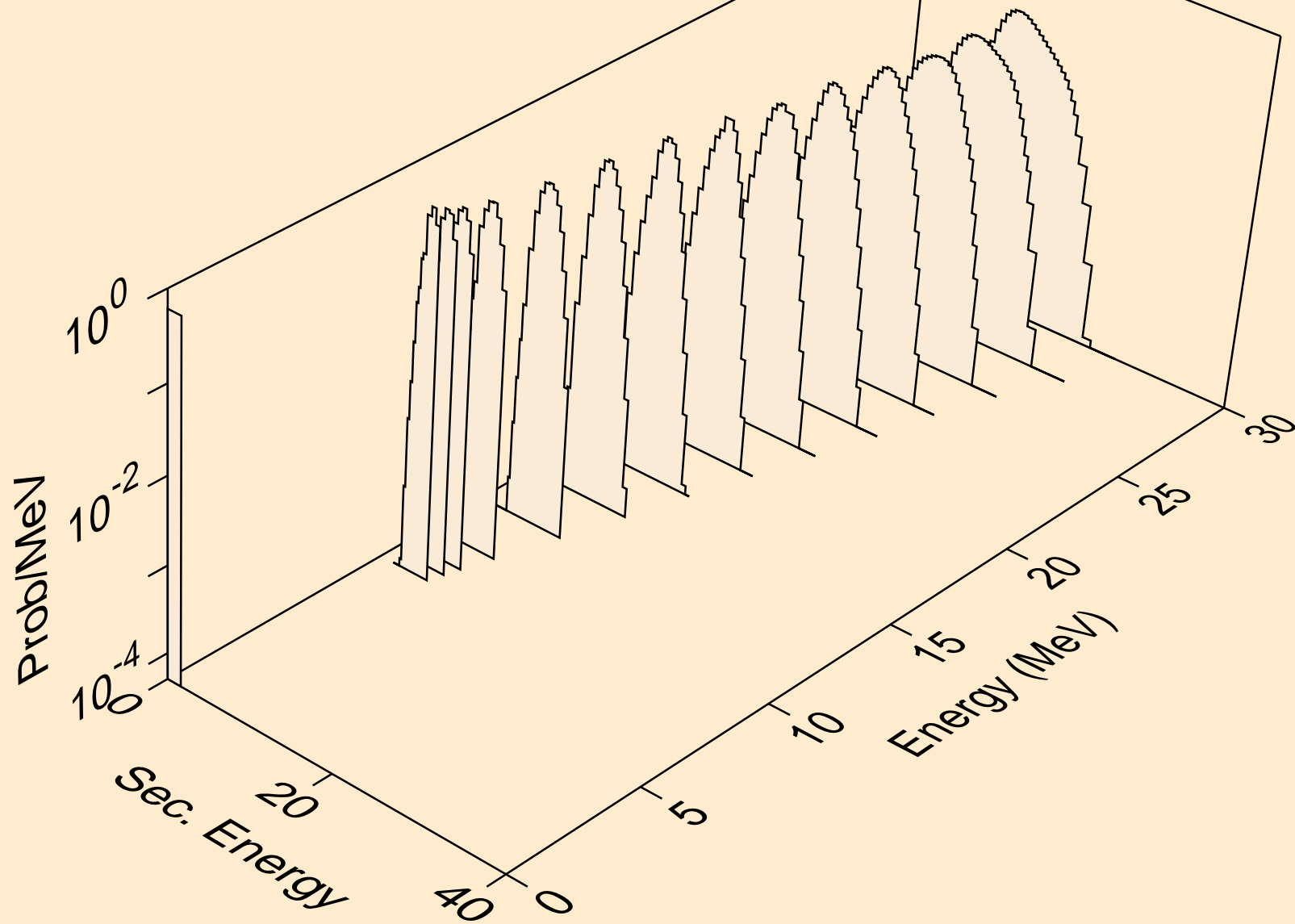

BI199M NEUTRON ACER TENDL-2021 LIBRARY; T=293.6K  
tritons from (n,x)

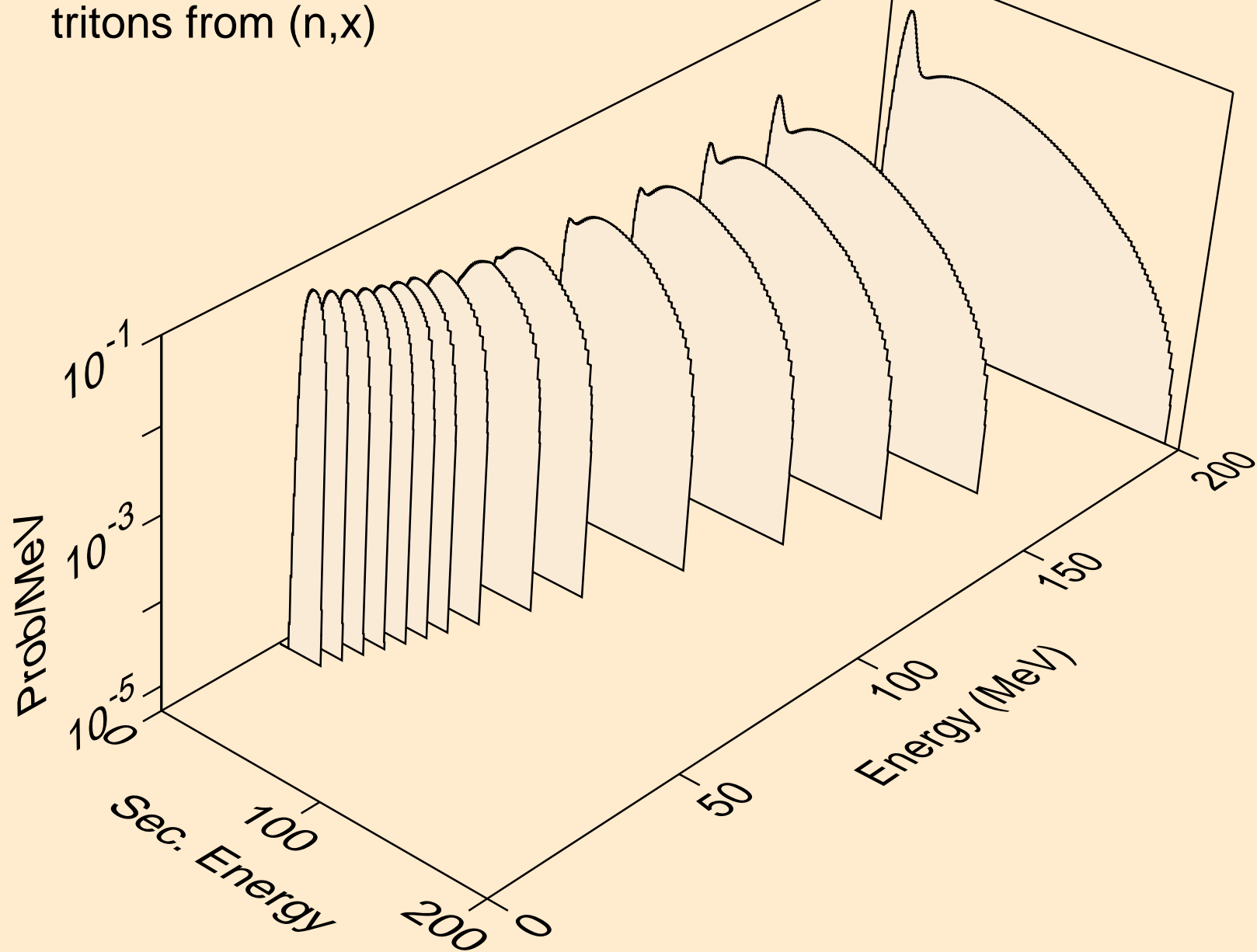



BI199M NEUTRON ACER TENDL-2021 LIBRARY; T=293.6K  
tritons from (n,n\*)t

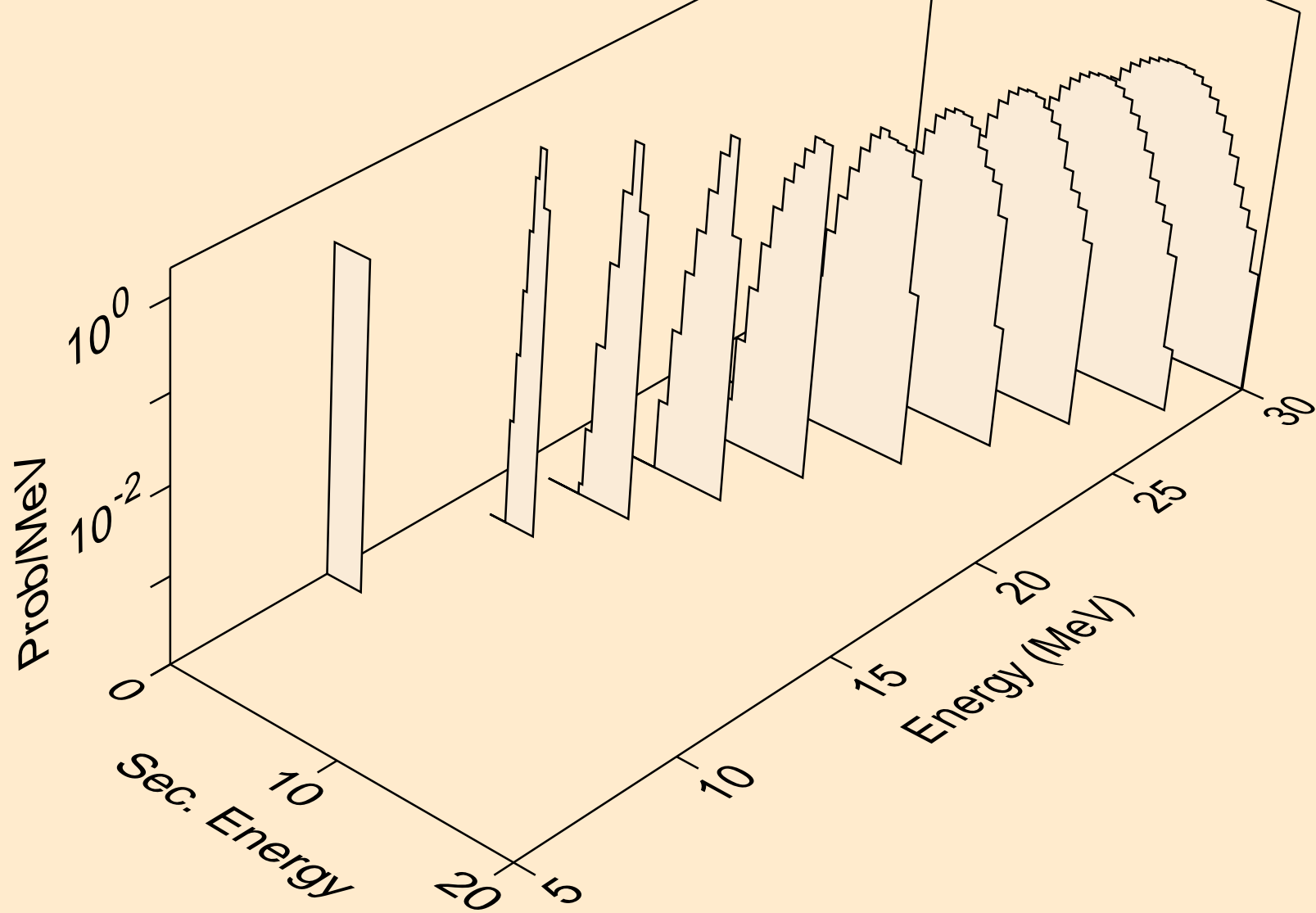

BI199M NEUTRON ACER TENDL-2021 LIBRARY; T=293.6K  
tritons from (n,t)

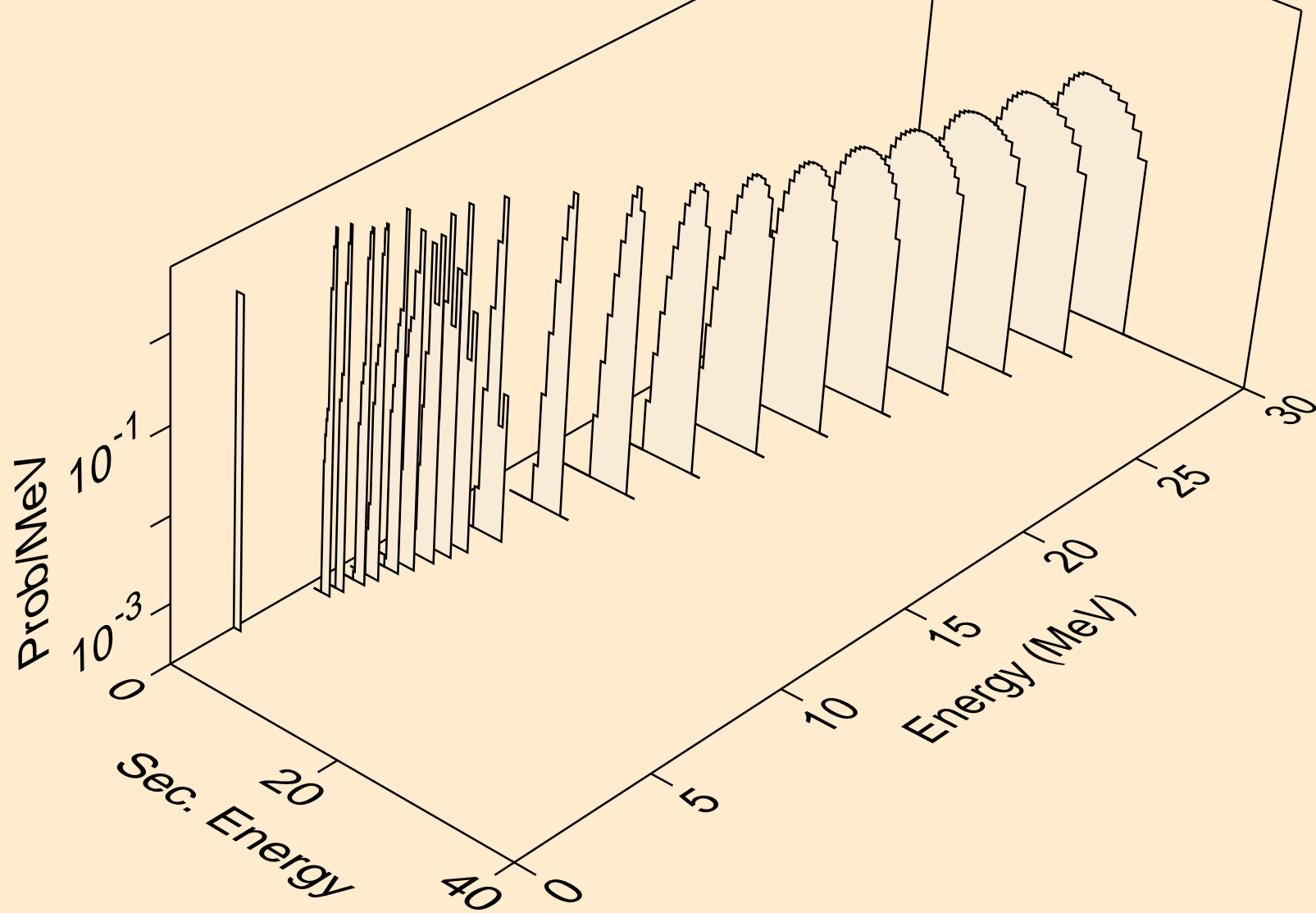

BI199M NEUTRON ACER TENDL-2021 LIBRARY; T=293.6K  
tritons from (n,pt)

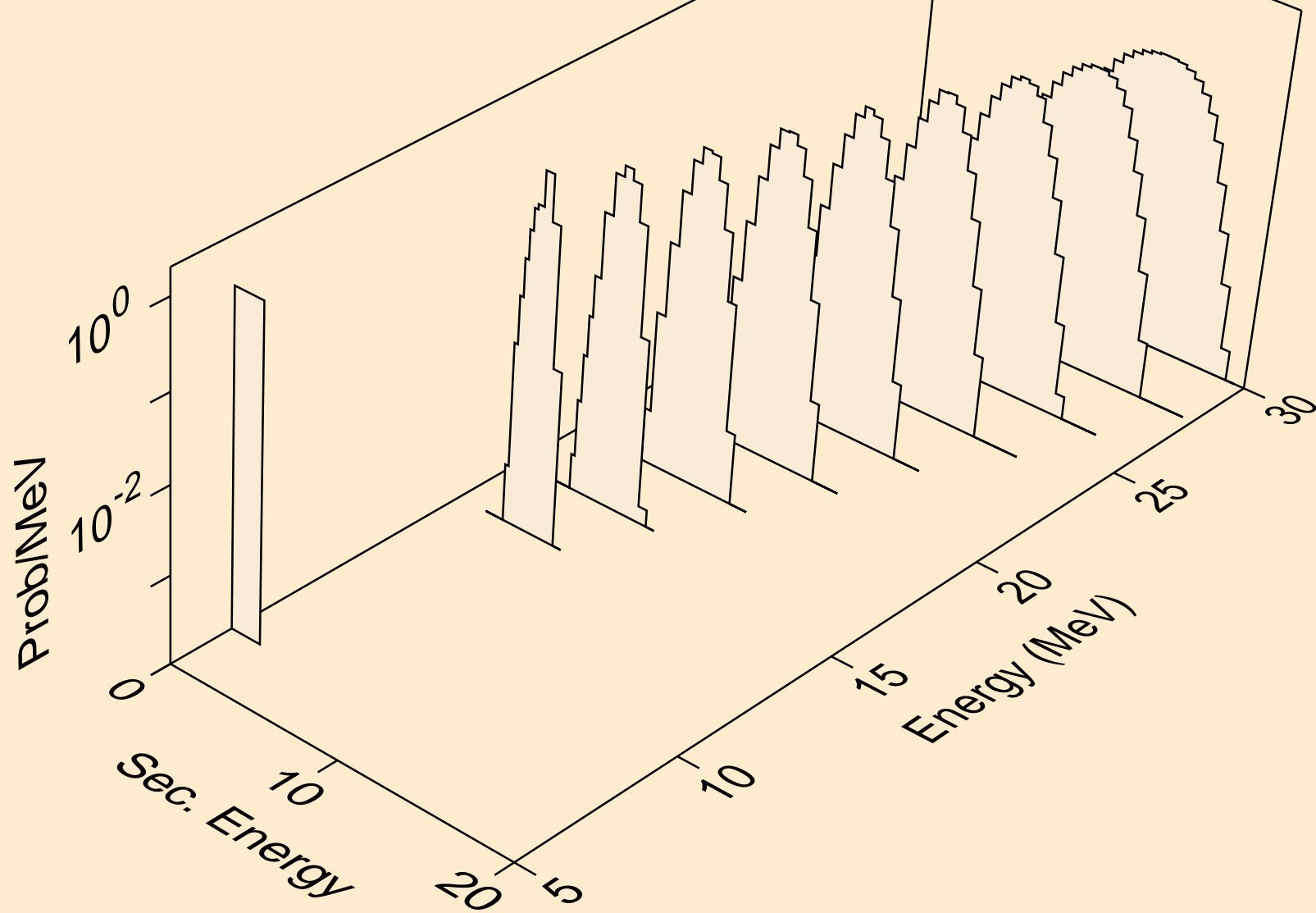

BI199M NEUTRON ACER TENDL-2021 LIBRARY; T=293.6K  
he3s from (n,x)

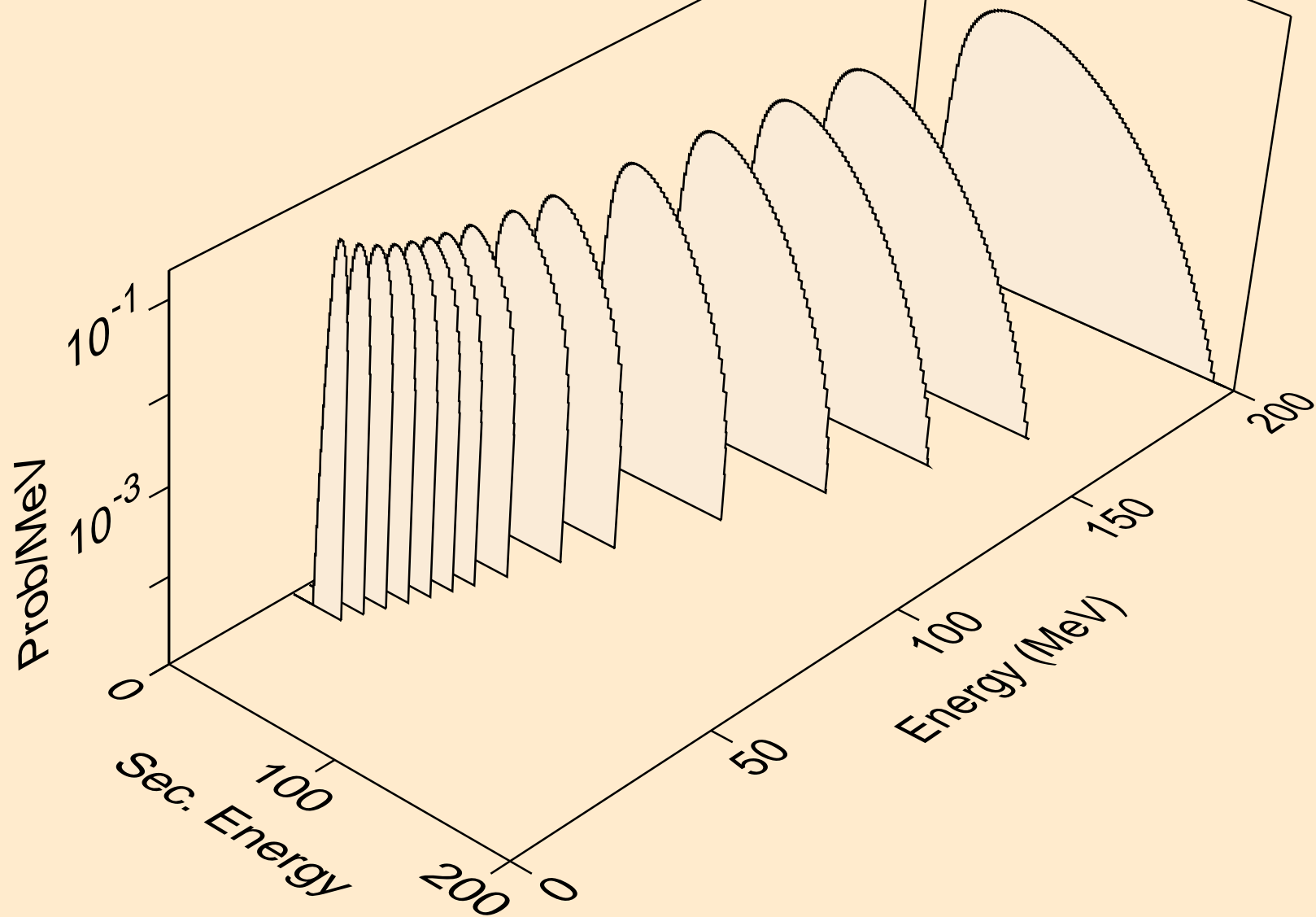

BI199M NEUTRON ACER TENDL-2021 LIBRARY; T=293.6K  
he3s from (n,n\*)he3

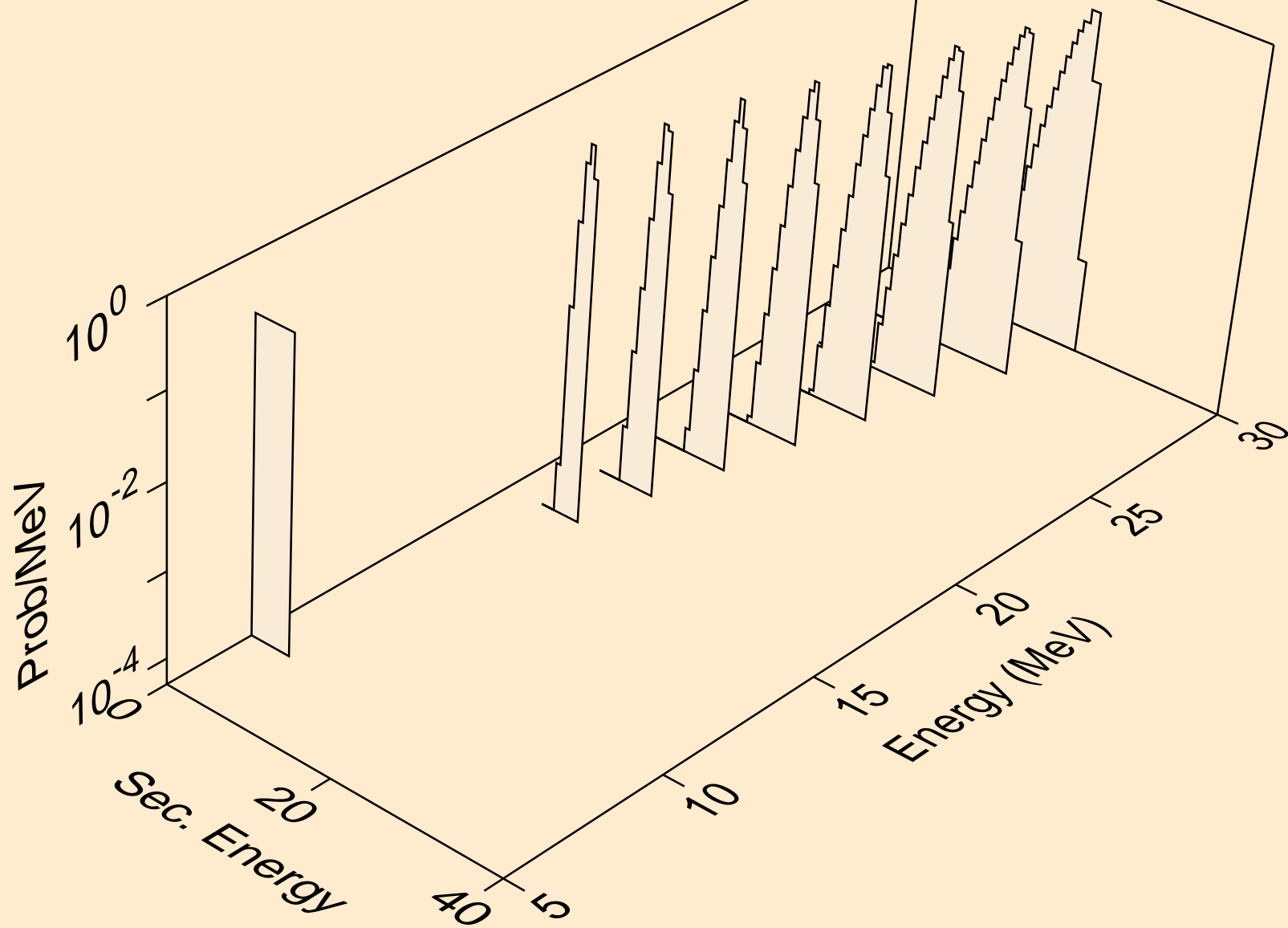

BI199M NEUTRON ACER TENDL-2021 LIBRARY; T=293.6K  
he3s from (n,he3)

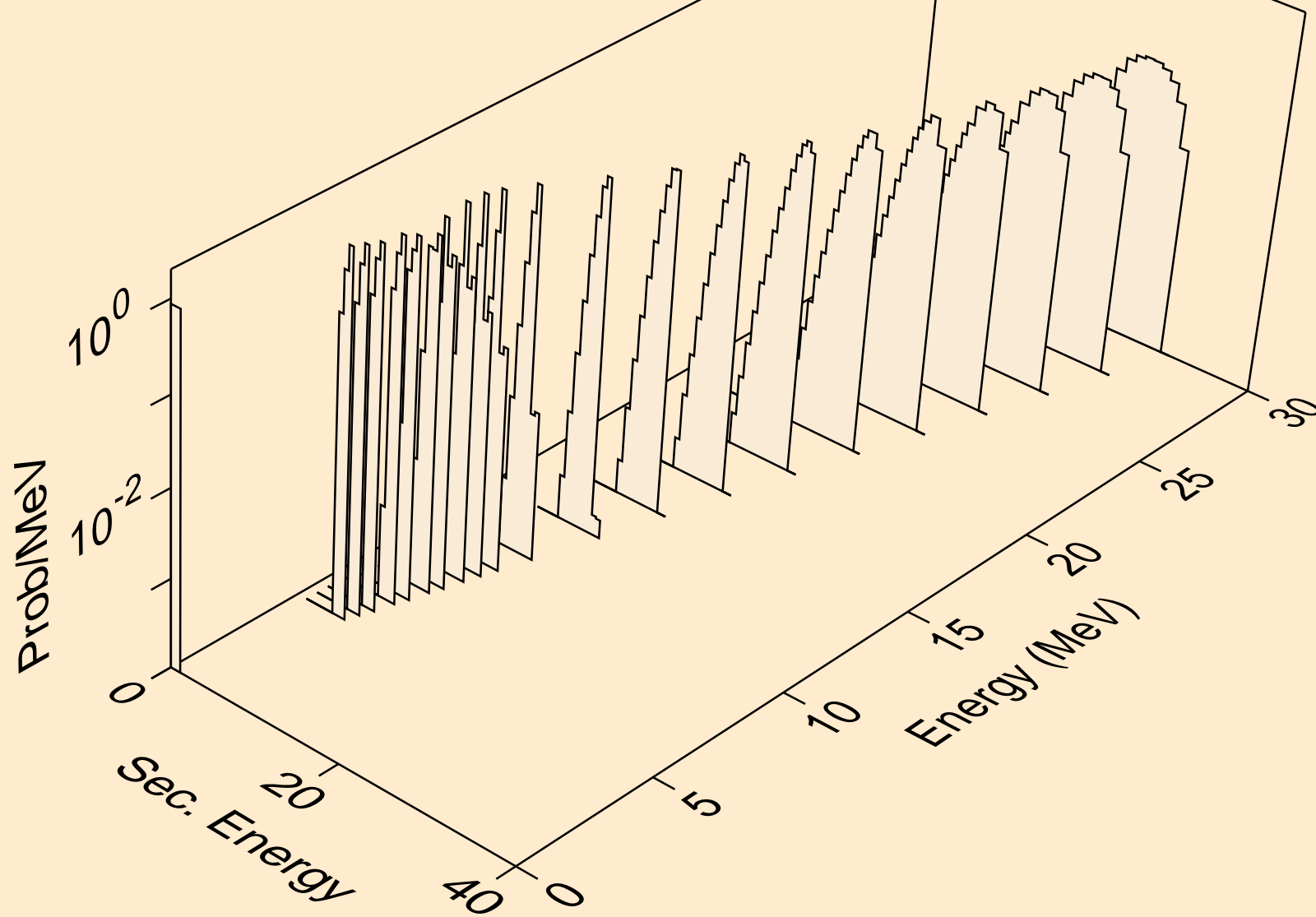

BI199M NEUTRON ACER TENDL-2021 LIBRARY; T=293.6K  
alphas from (n,x)

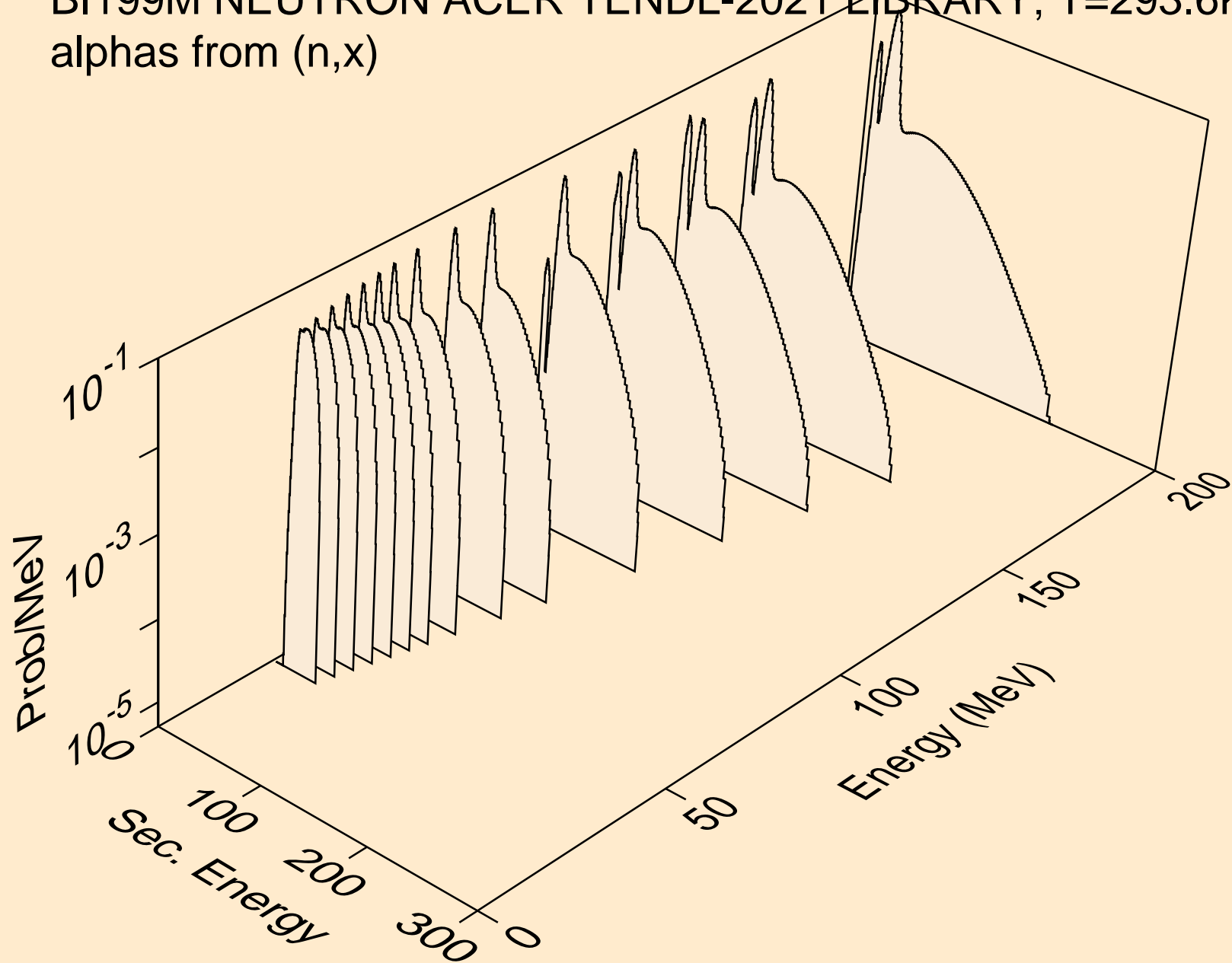

BI199M NEUTRON ACER TENDL-2021 LIBRARY; T=293.6K  
alphas from (n,n\*)a

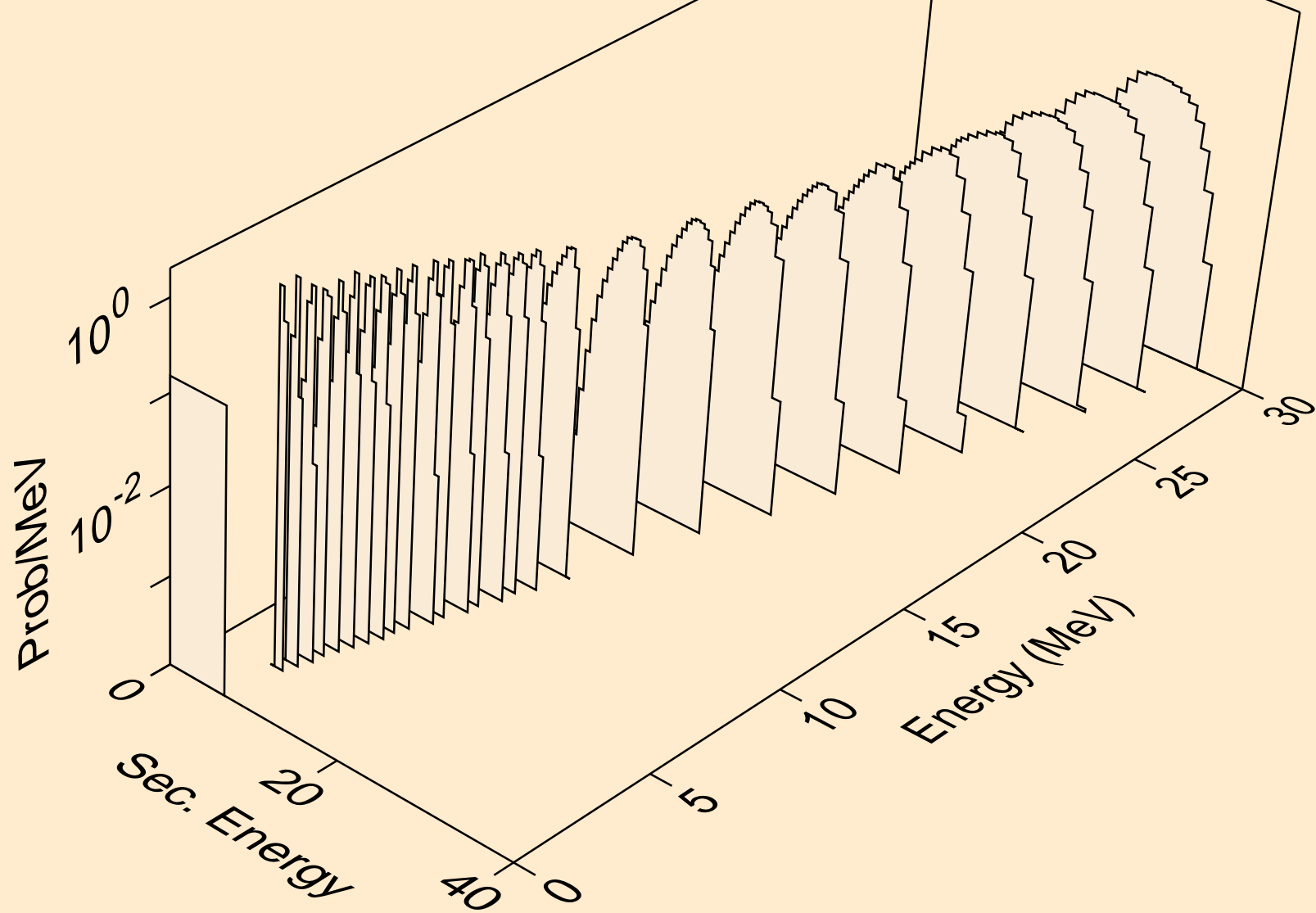



BI199M NEUTRON ACER TENDL-2021 LIBRARY; T=293.6K  
alphas from (n,2n)a

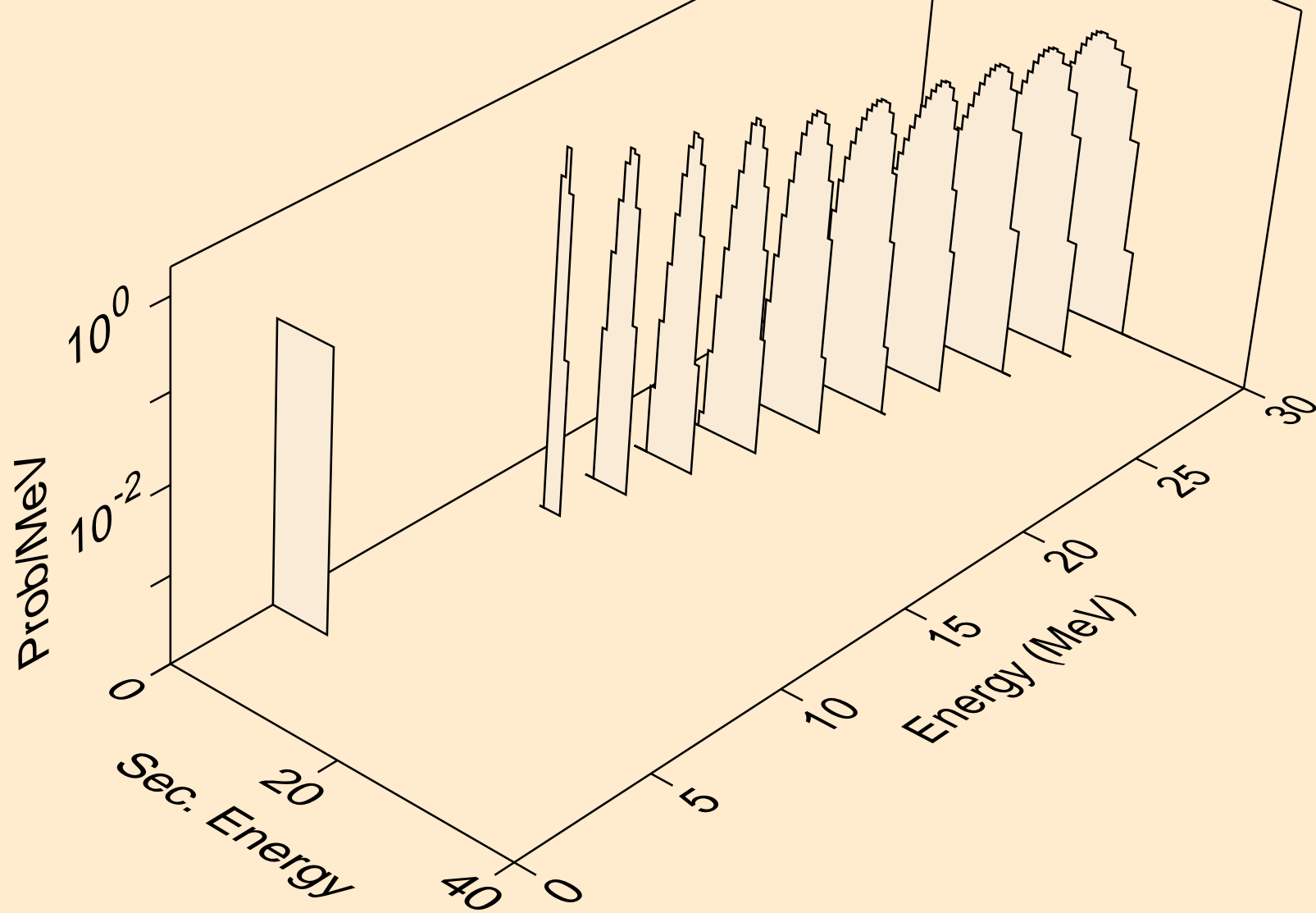

BI199M NEUTRON ACER TENDL-2021 LIBRARY; T=293.6K  
alphas from (n,3n)a

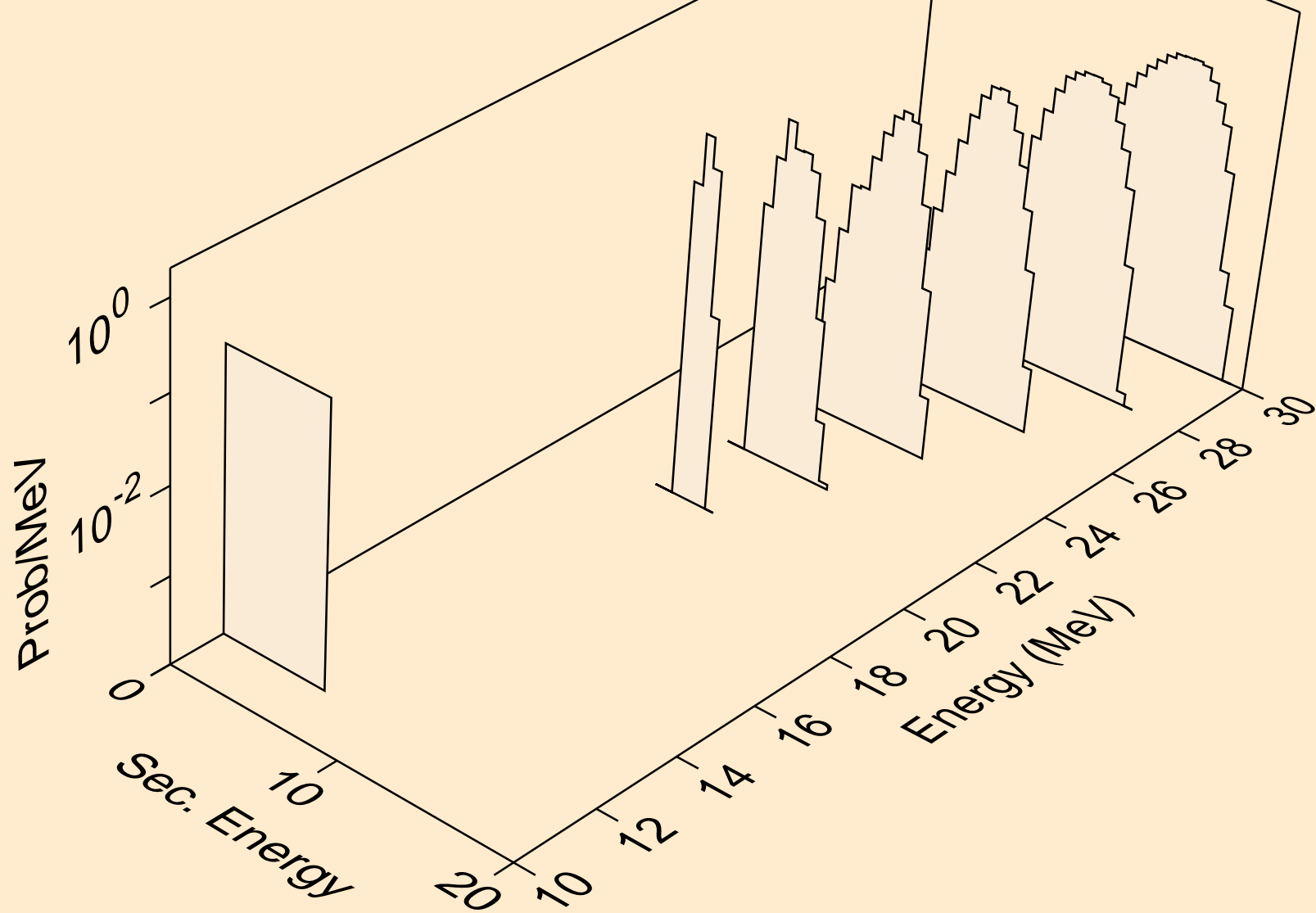

BI199M NEUTRON ACER TENDL-2021 LIBRARY; T=293.6K  
alphas from (n,n\*)2a

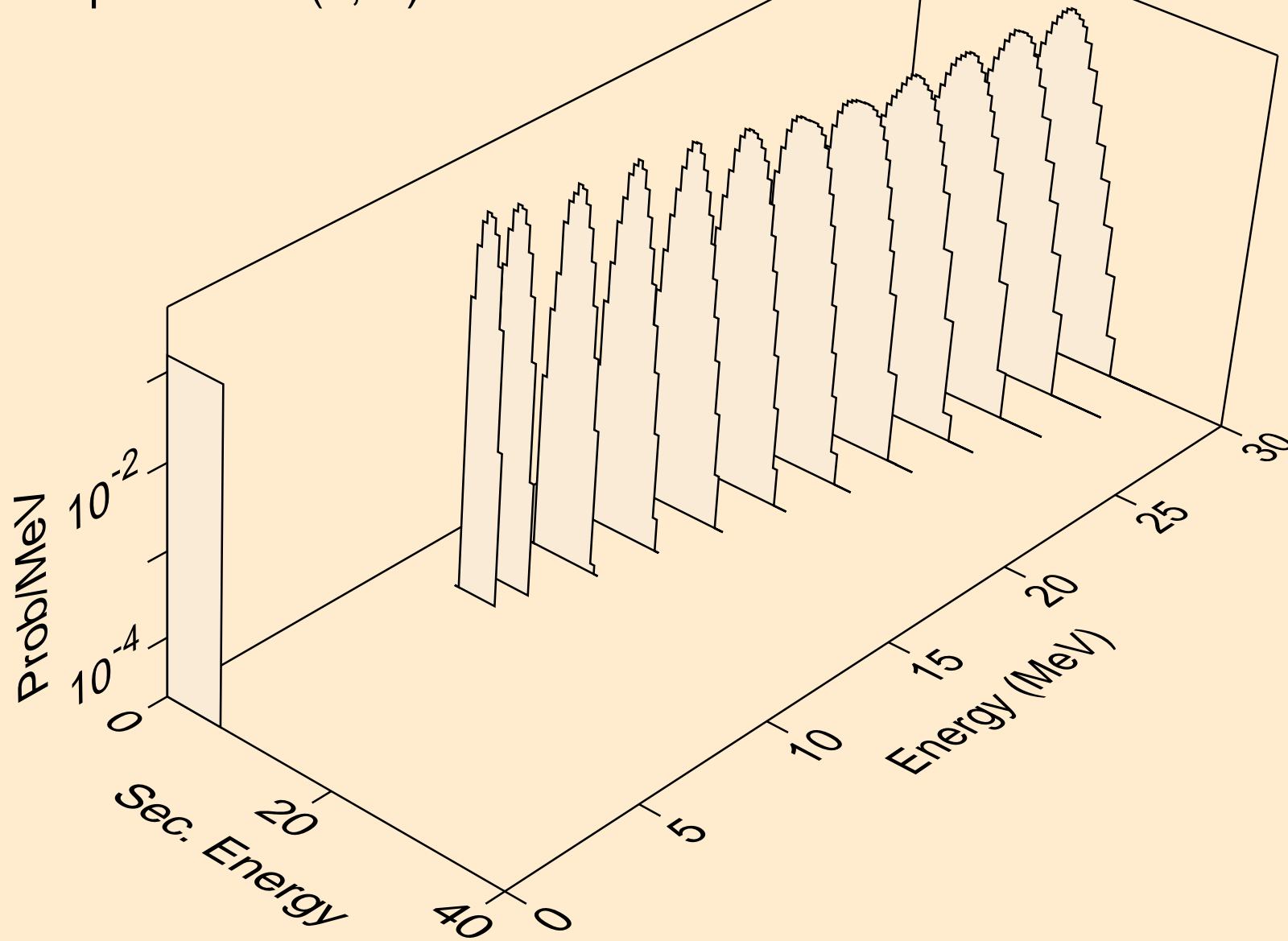

BI199M NEUTRON ACER TENDL-2021 LIBRARY; T=293.6K  
alphas from (n,npa)

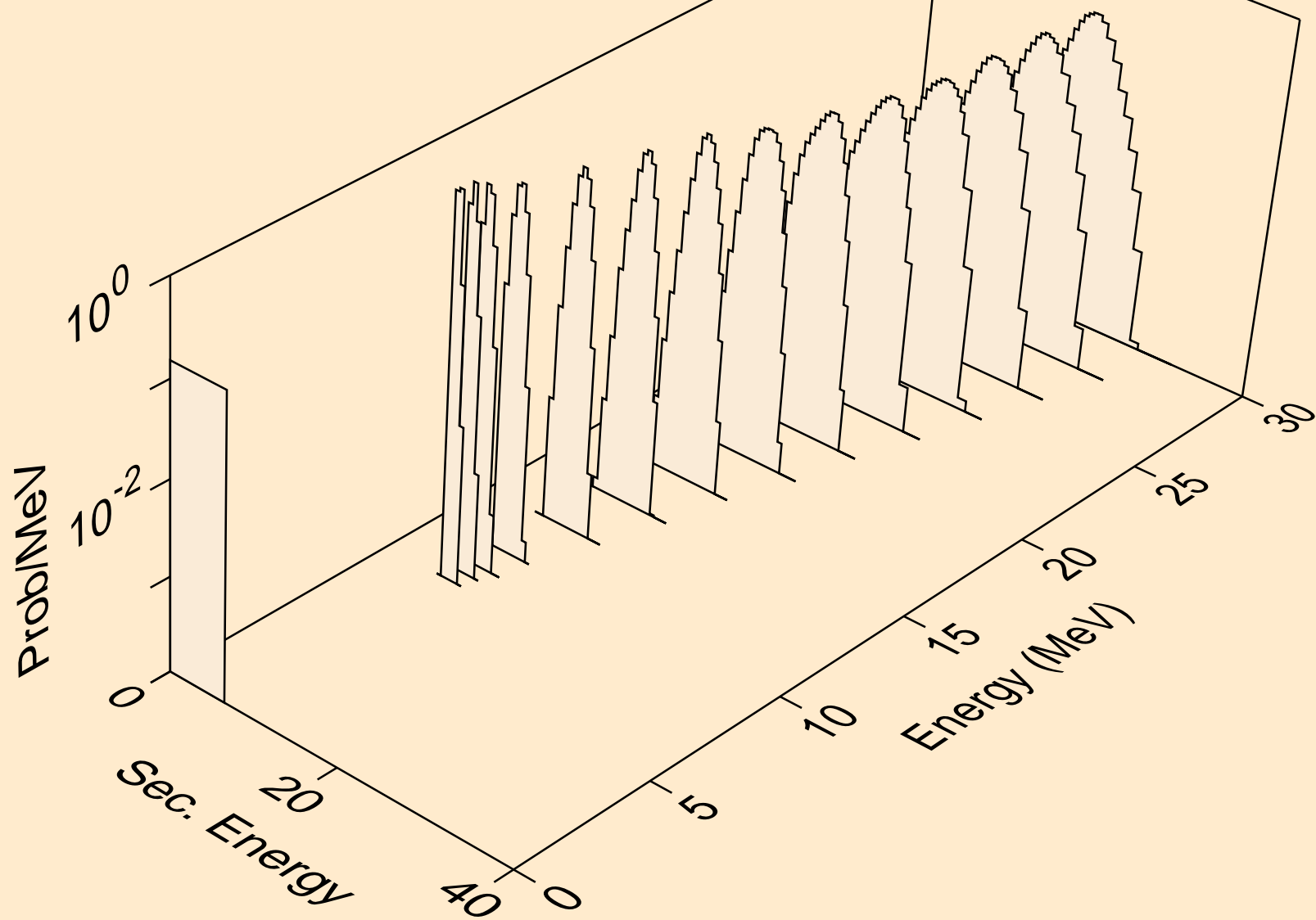

BI199M NEUTRON ACER TENDL-2021 LIBRARY; T=293.6K  
alphas from (n,a)

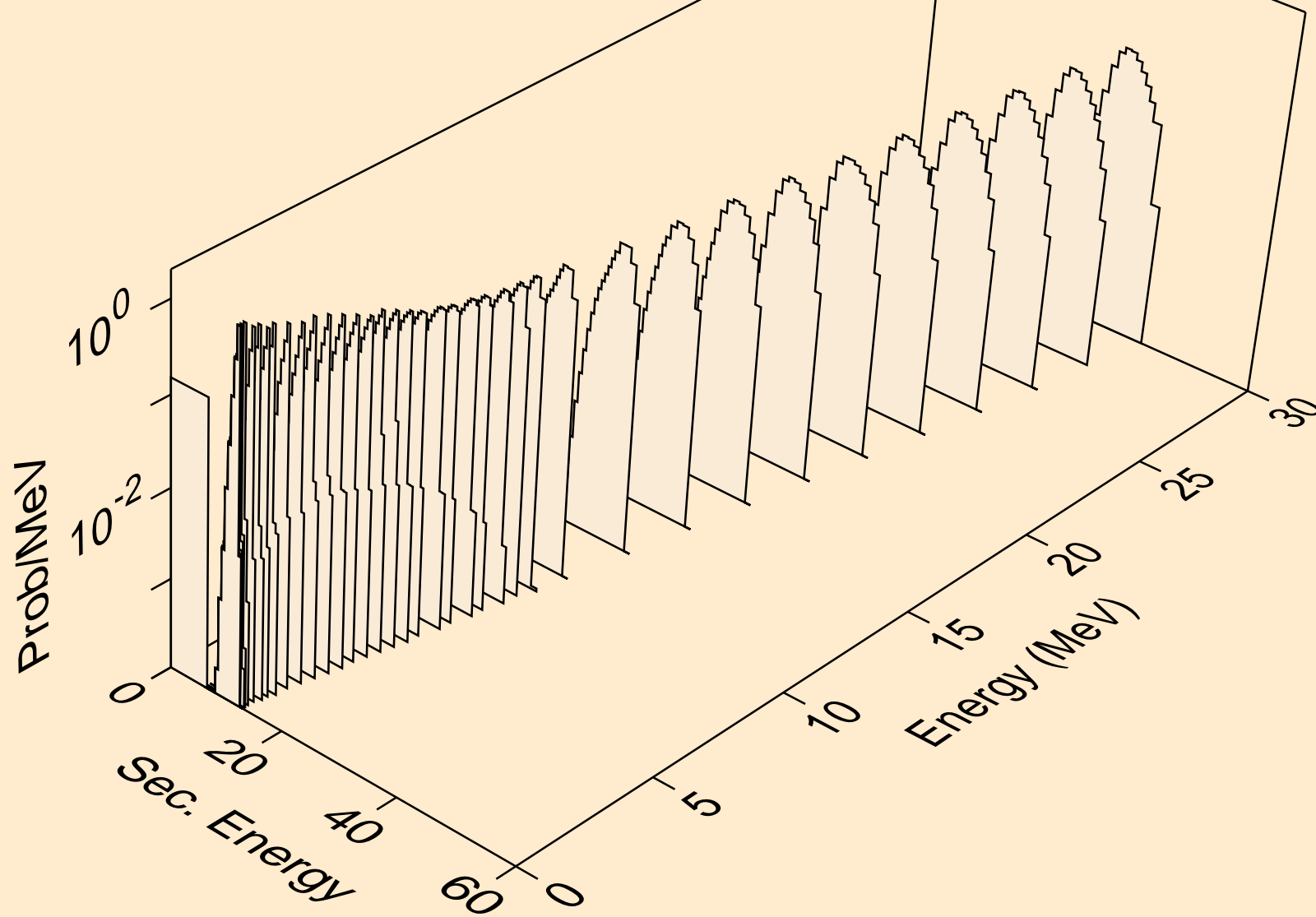

BI199M NEUTRON ACER TENDL-2021 LIBRARY; T=293.6K  
alphas from (n,2a)

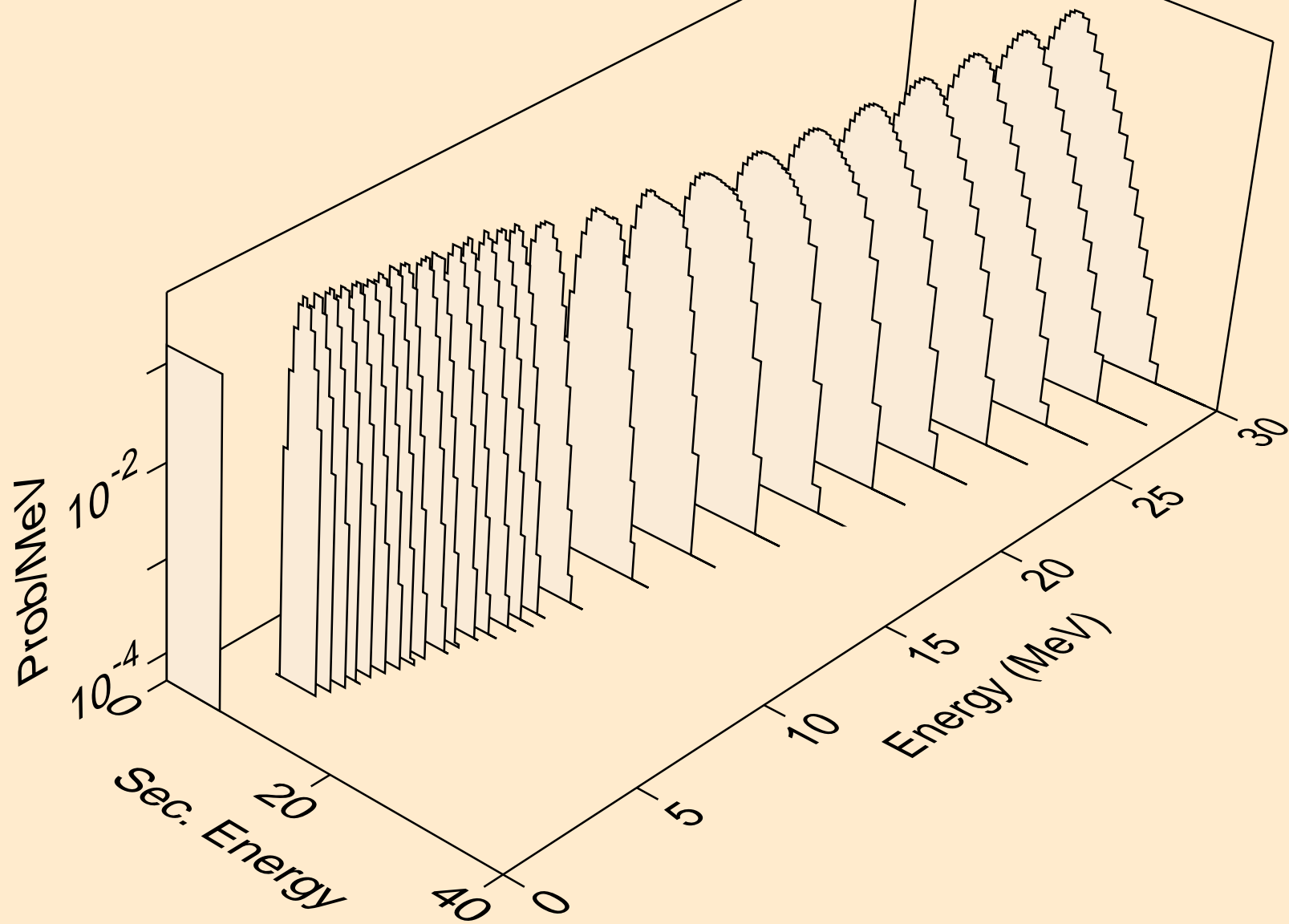

BI199M NEUTRON ACER TENDL-2021 LIBRARY; T=293.6K  
alphas from (n,pa)

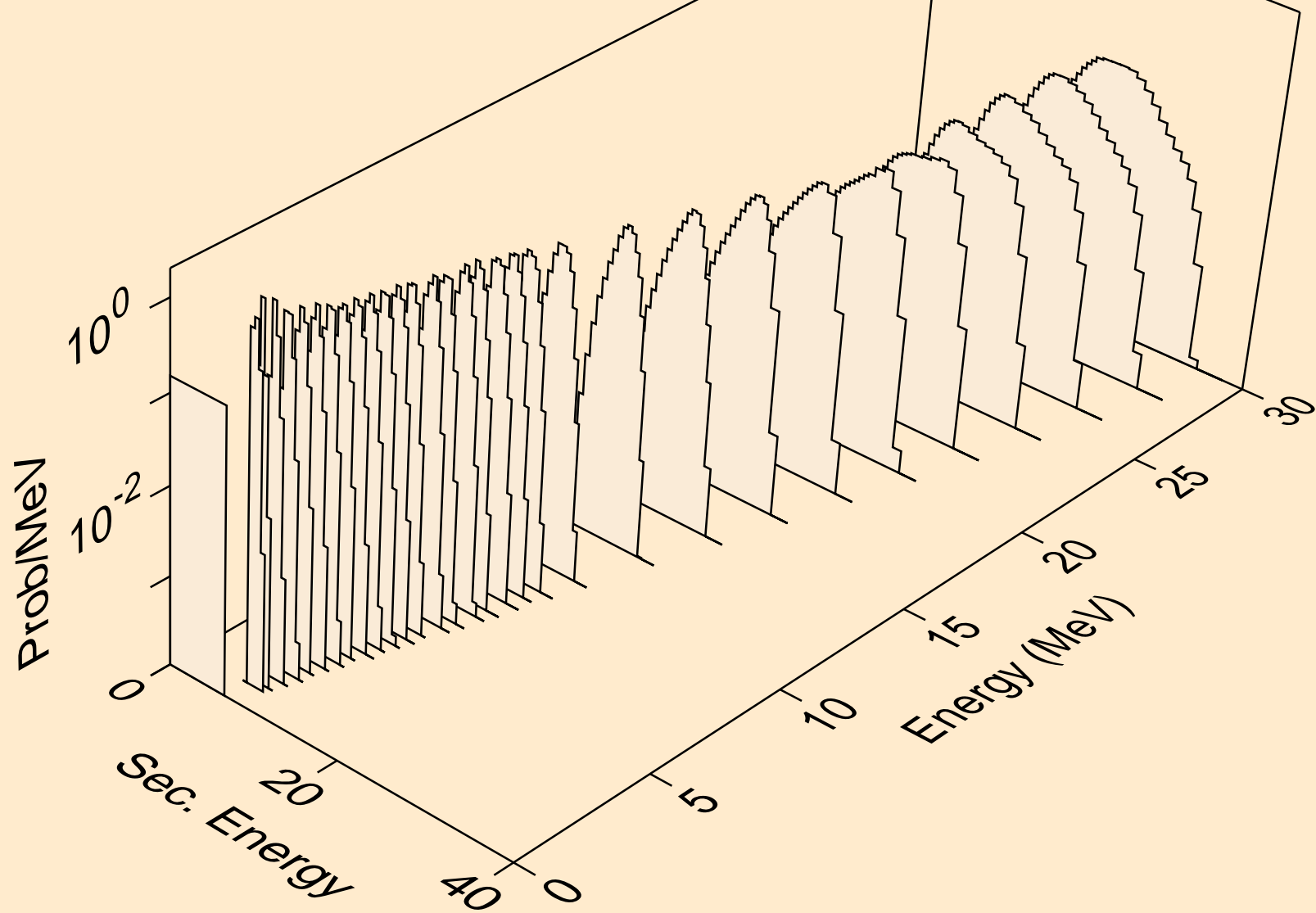

BI199M NEUTRON ACER TENDL-2021 LIBRARY; T=293.6K  
alphas from (n,da)

