

BI204 NEUTRON ACER TENDL-2021 LIBRARY; T=293.6K  
Principal cross sections

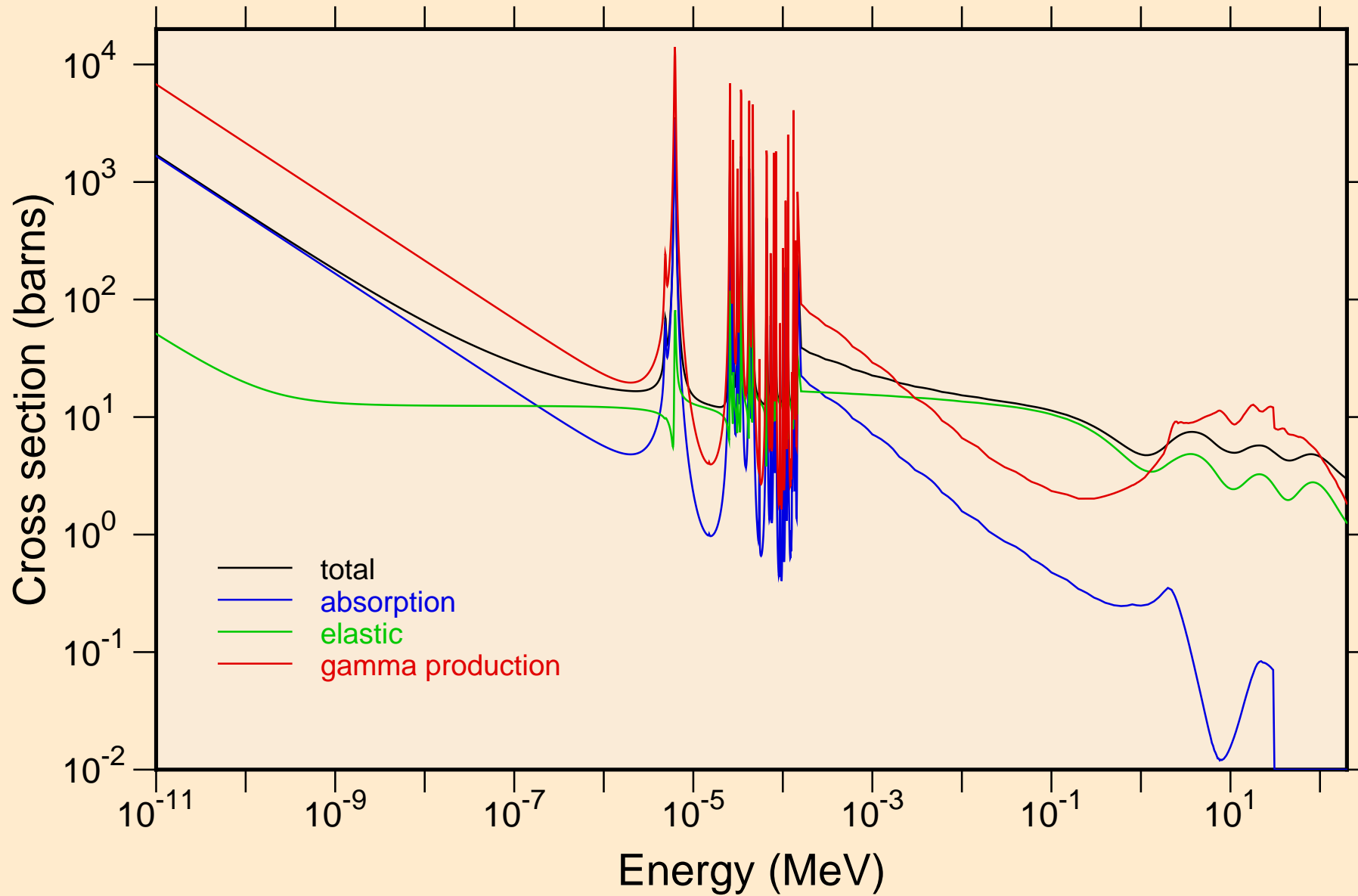

BI204 NEUTRON ACER TENDL-2021 LIBRARY; T=293.6K  
resonance total cross section

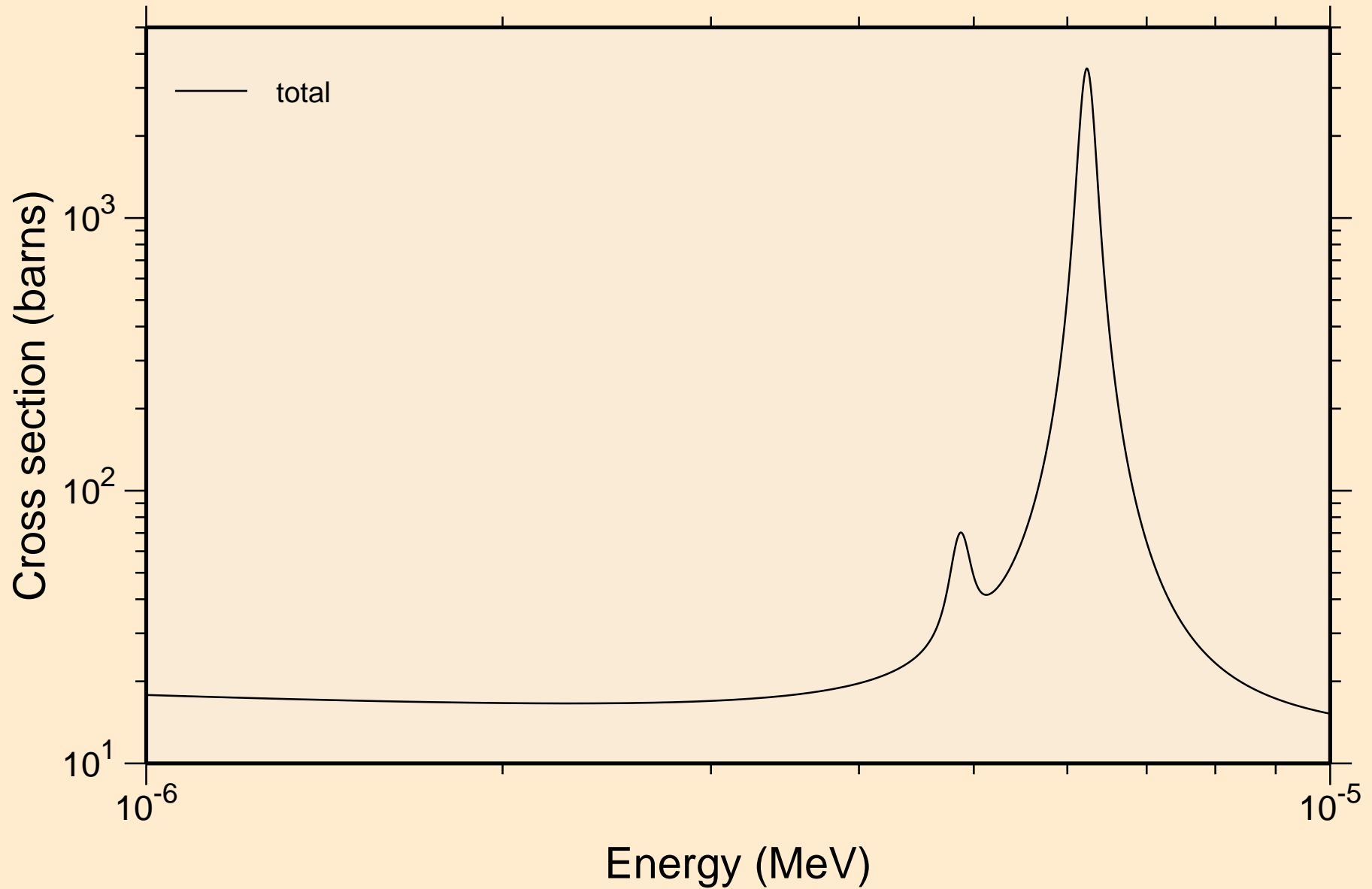

BI204 NEUTRON ACER TENDL-2021 LIBRARY; T=293.6K  
resonance total cross section

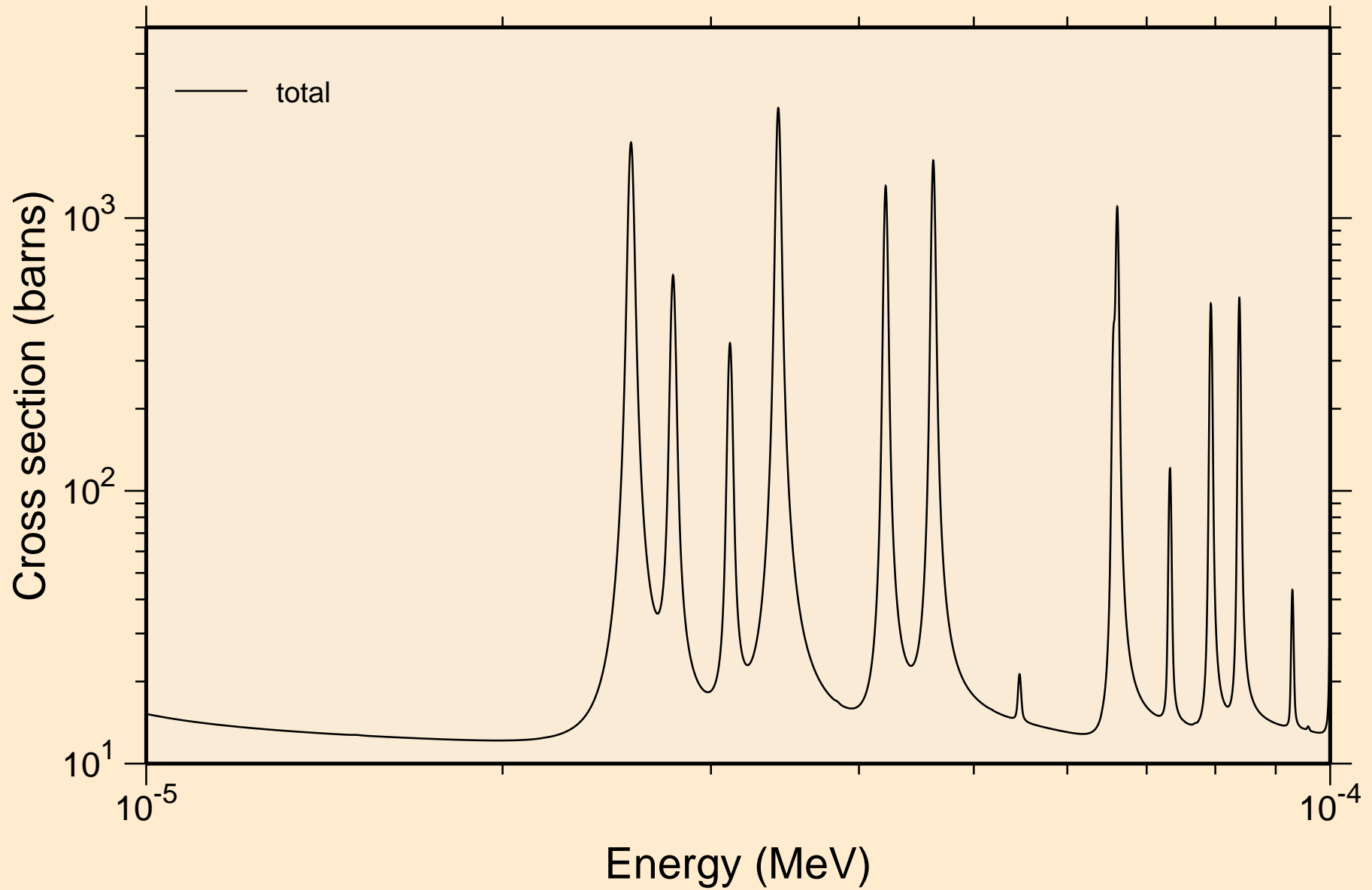

BI204 NEUTRON ACER TENDL-2021 LIBRARY; T=293.6K  
resonance total cross section

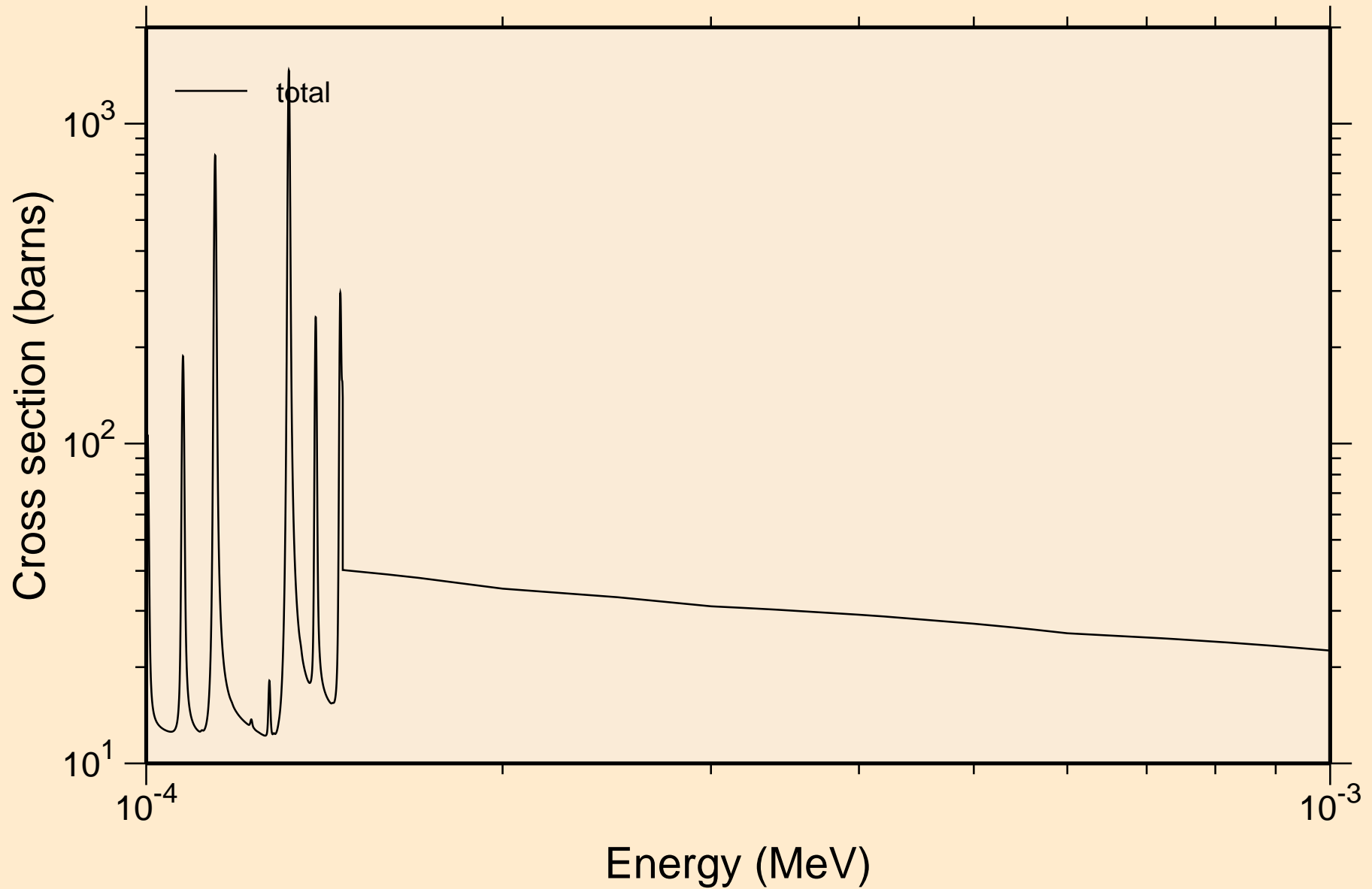

BI204 NEUTRON ACER TENDL-2021 LIBRARY; T=293.6K  
resonance total cross section

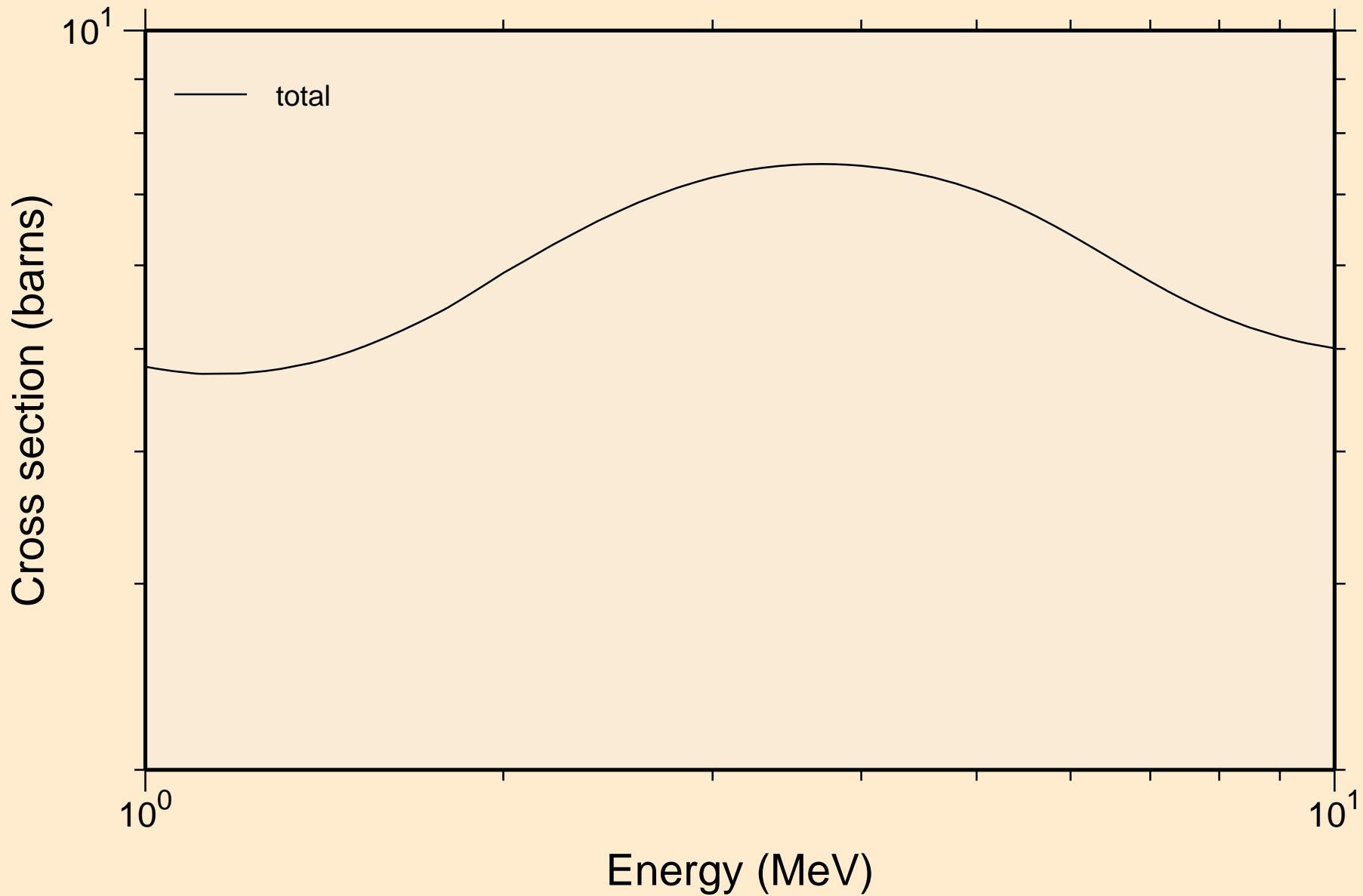

BI204 NEUTRON ACER TENDL-2021 LIBRARY; T=293.6K  
resonance absorption cross sections

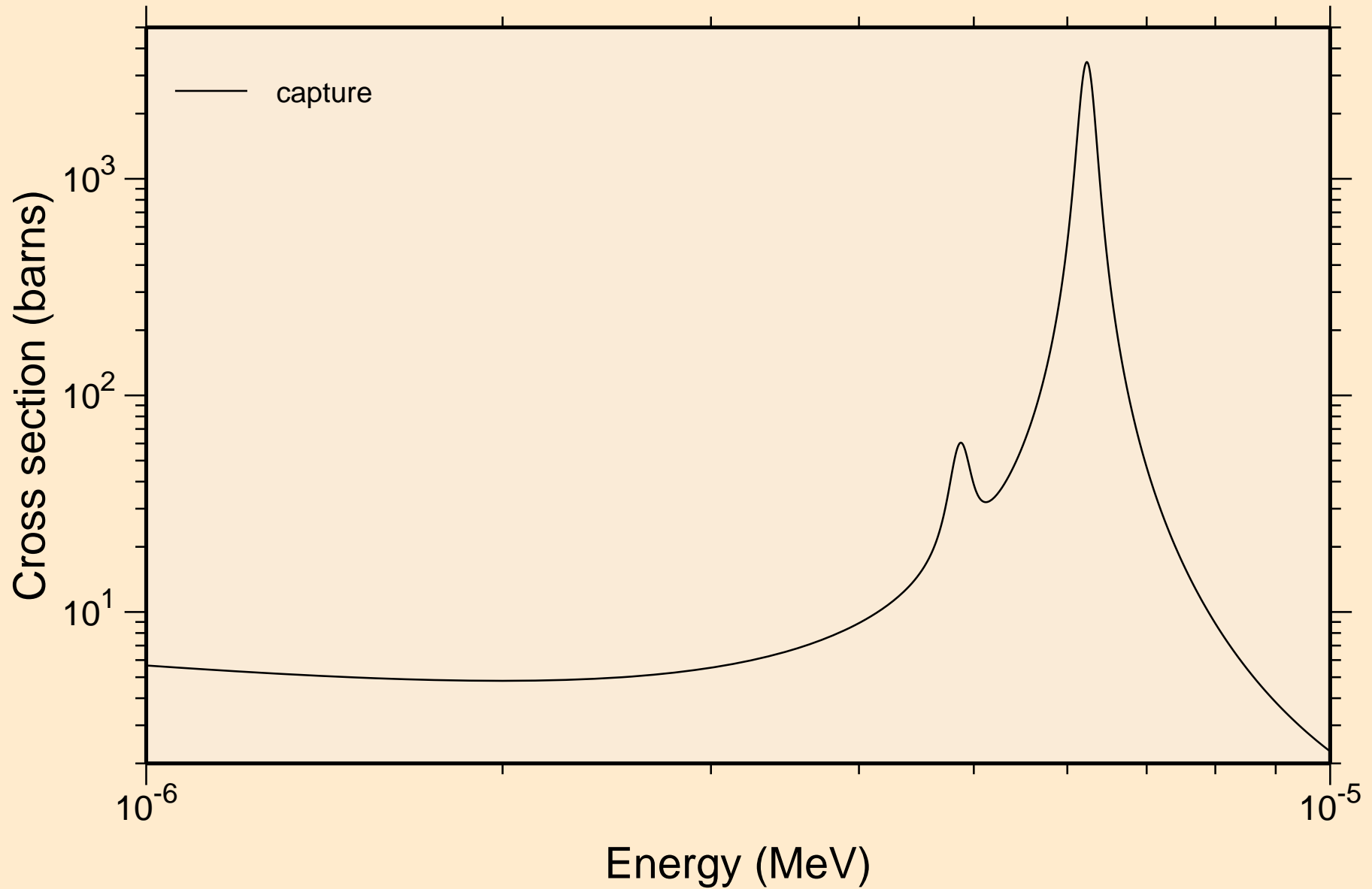

BI204 NEUTRON ACER TENDL-2021 LIBRARY; T=293.6K  
resonance absorption cross sections

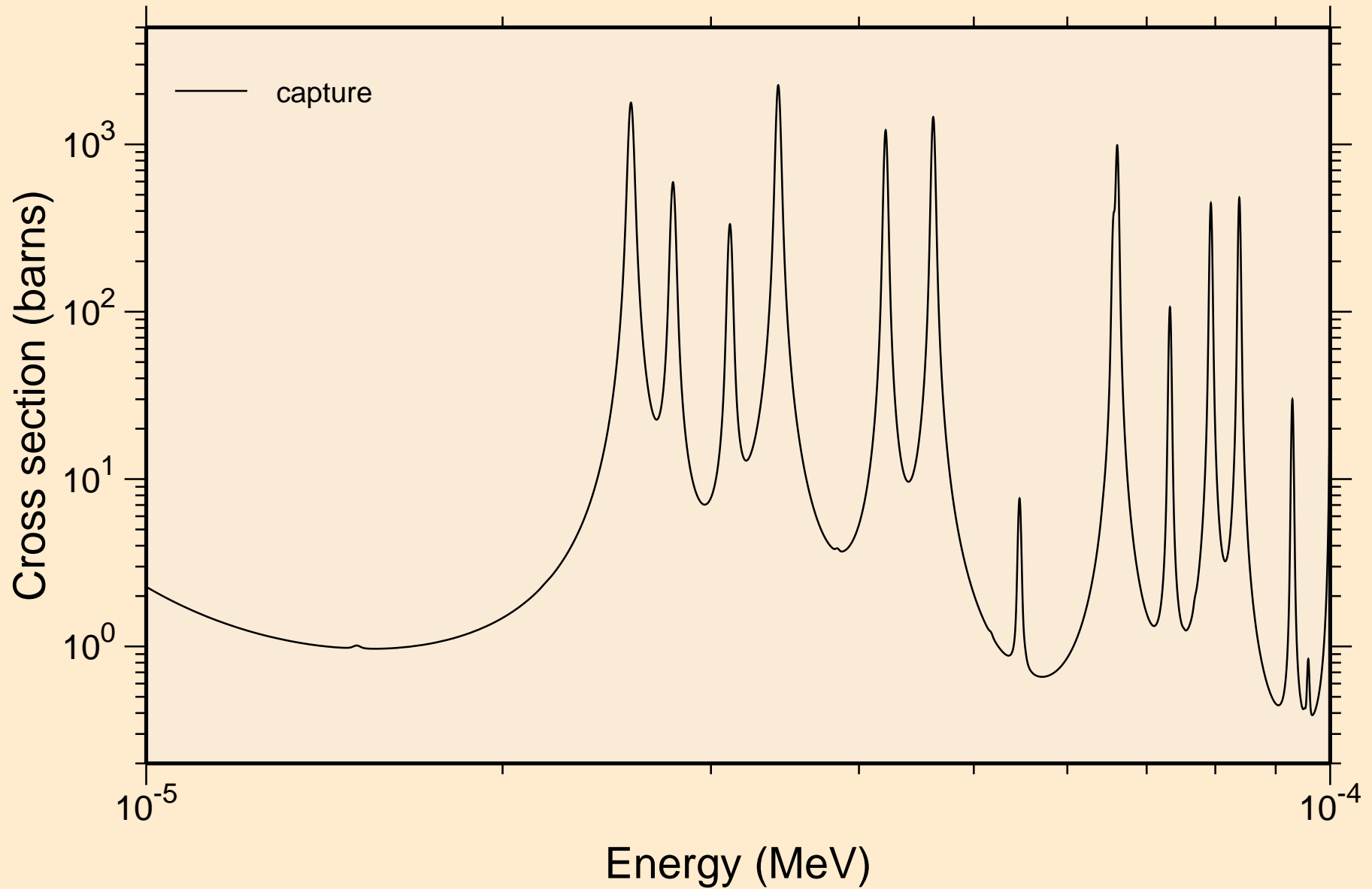

BI204 NEUTRON ACER TENDL-2021 LIBRARY; T=293.6K  
resonance absorption cross sections

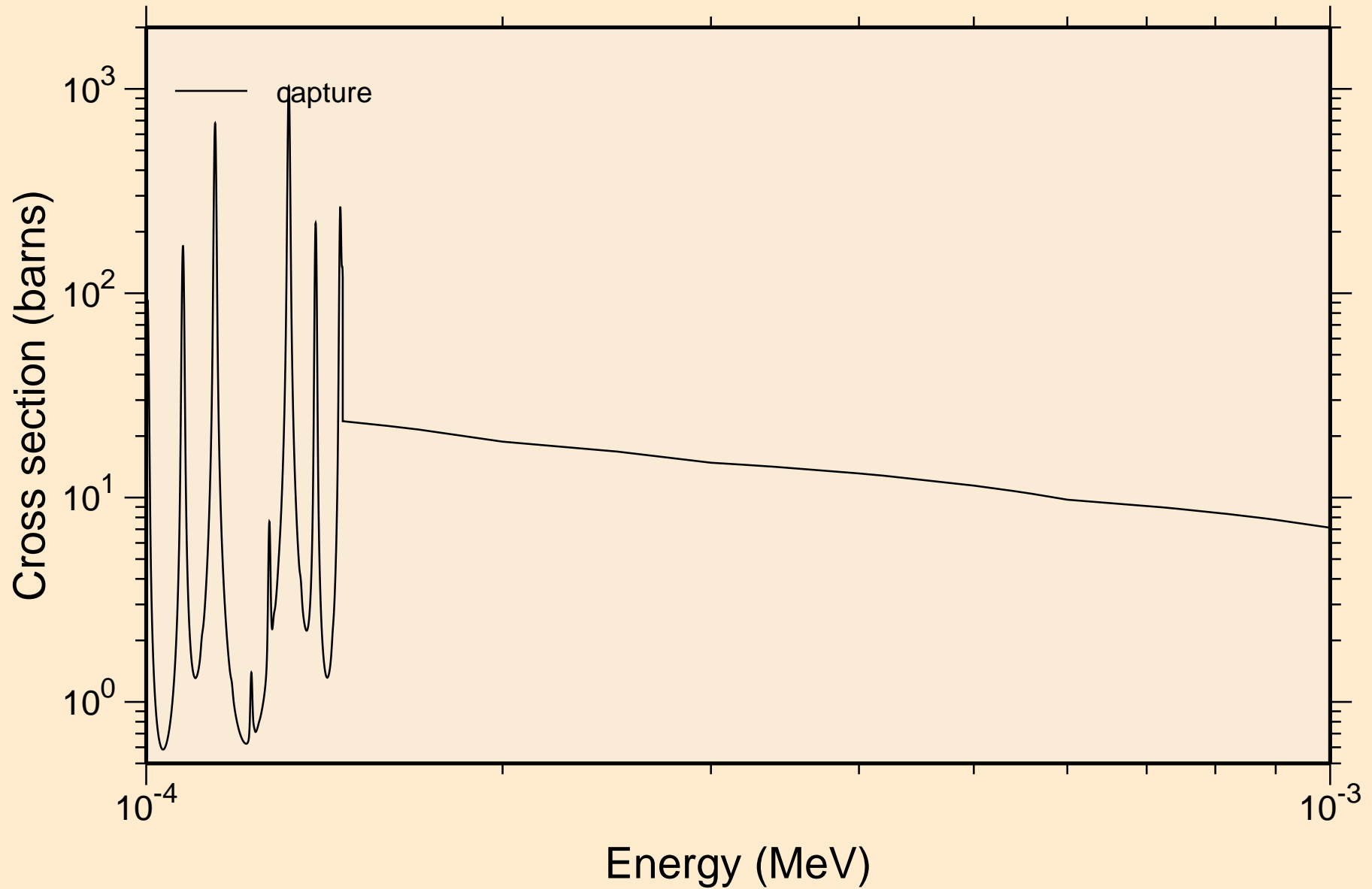



BI204 NEUTRON ACER TENDL-2021 LIBRARY; T=293.6K  
resonance absorption cross sections

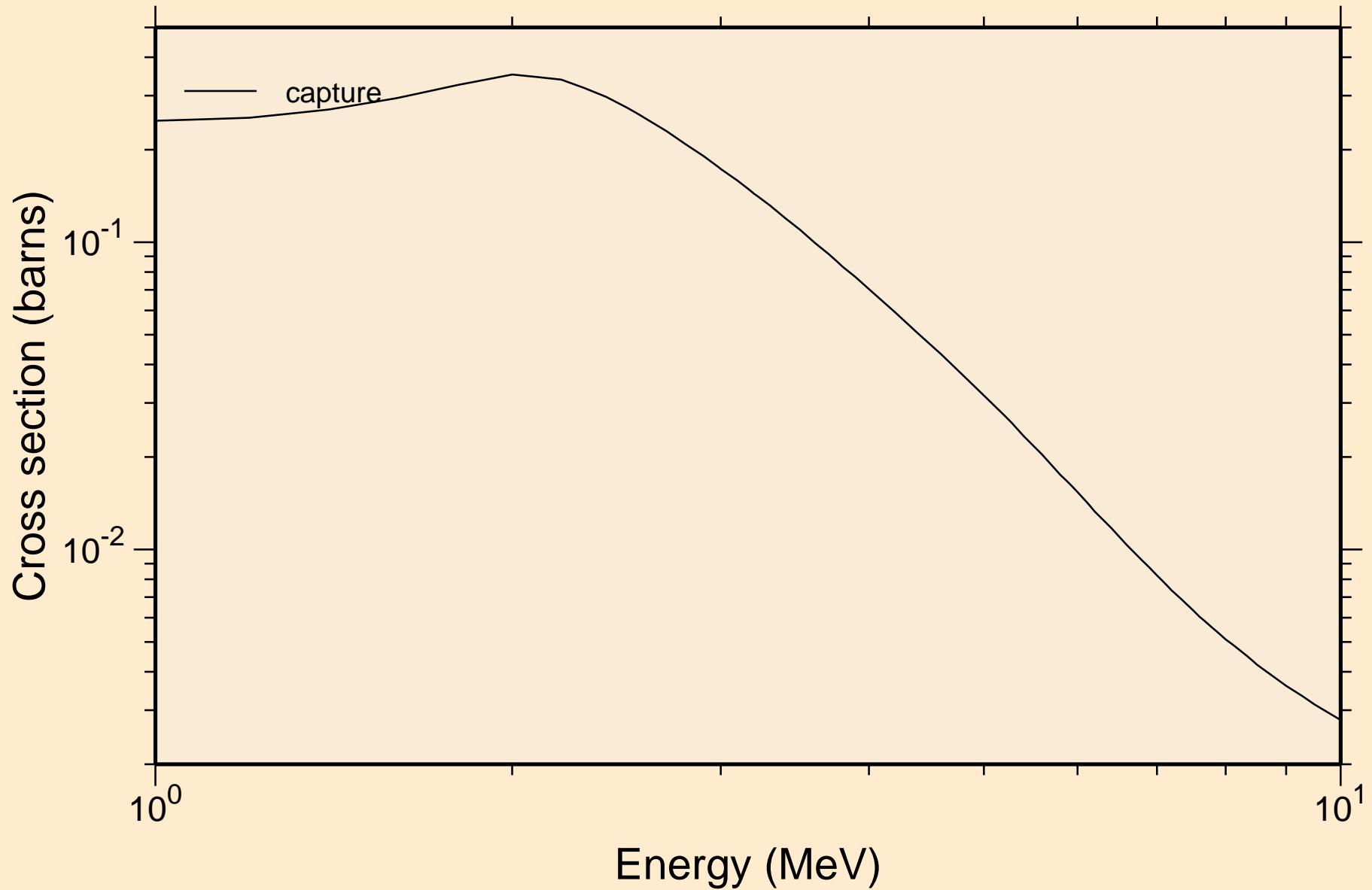

BI204 NEUTRON ACER TENDL-2021 LIBRARY; T=293.6K  
Heating

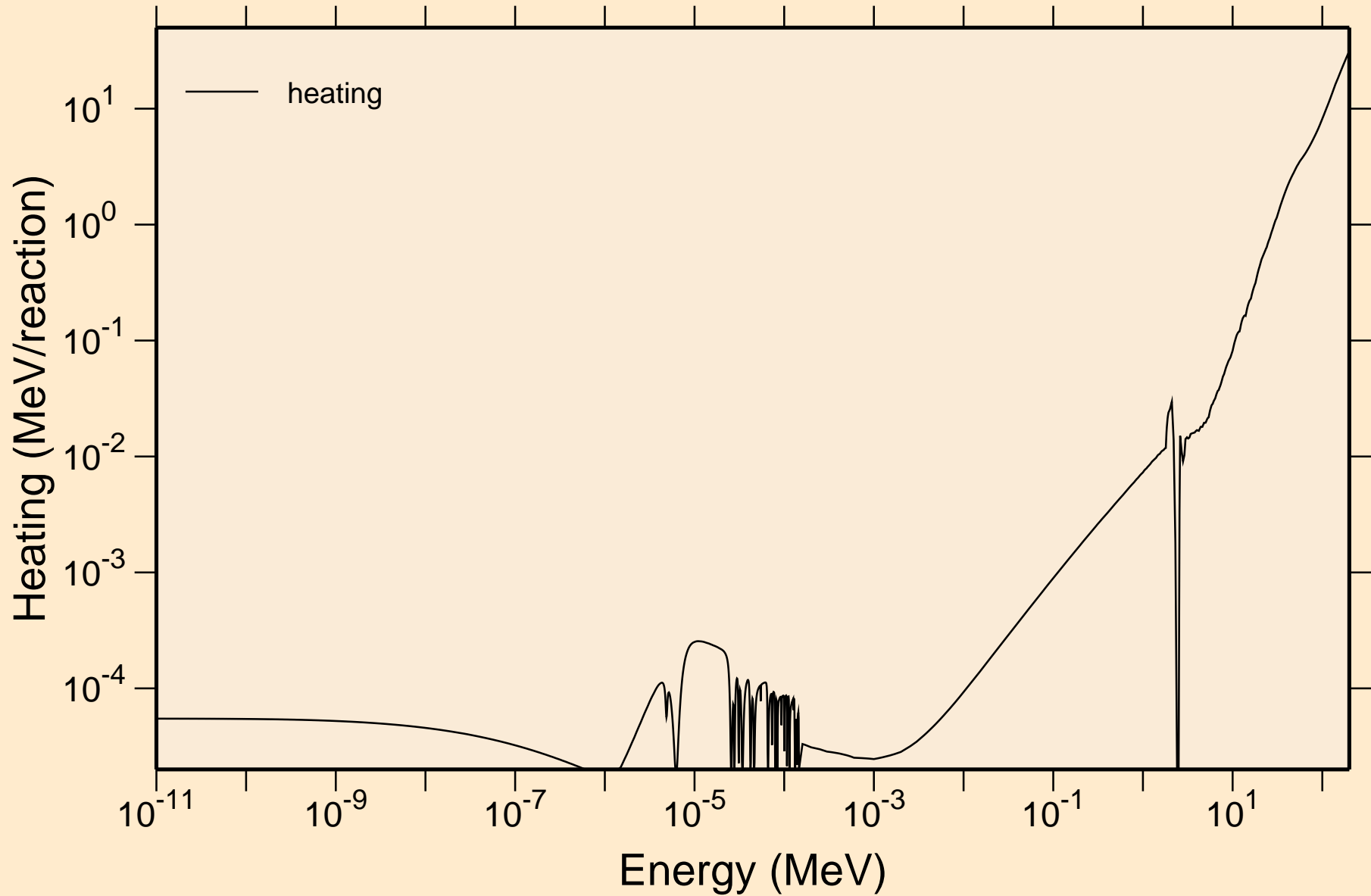

BI204 NEUTRON ACER TENDL-2021 LIBRARY; T=293.6K  
Damage

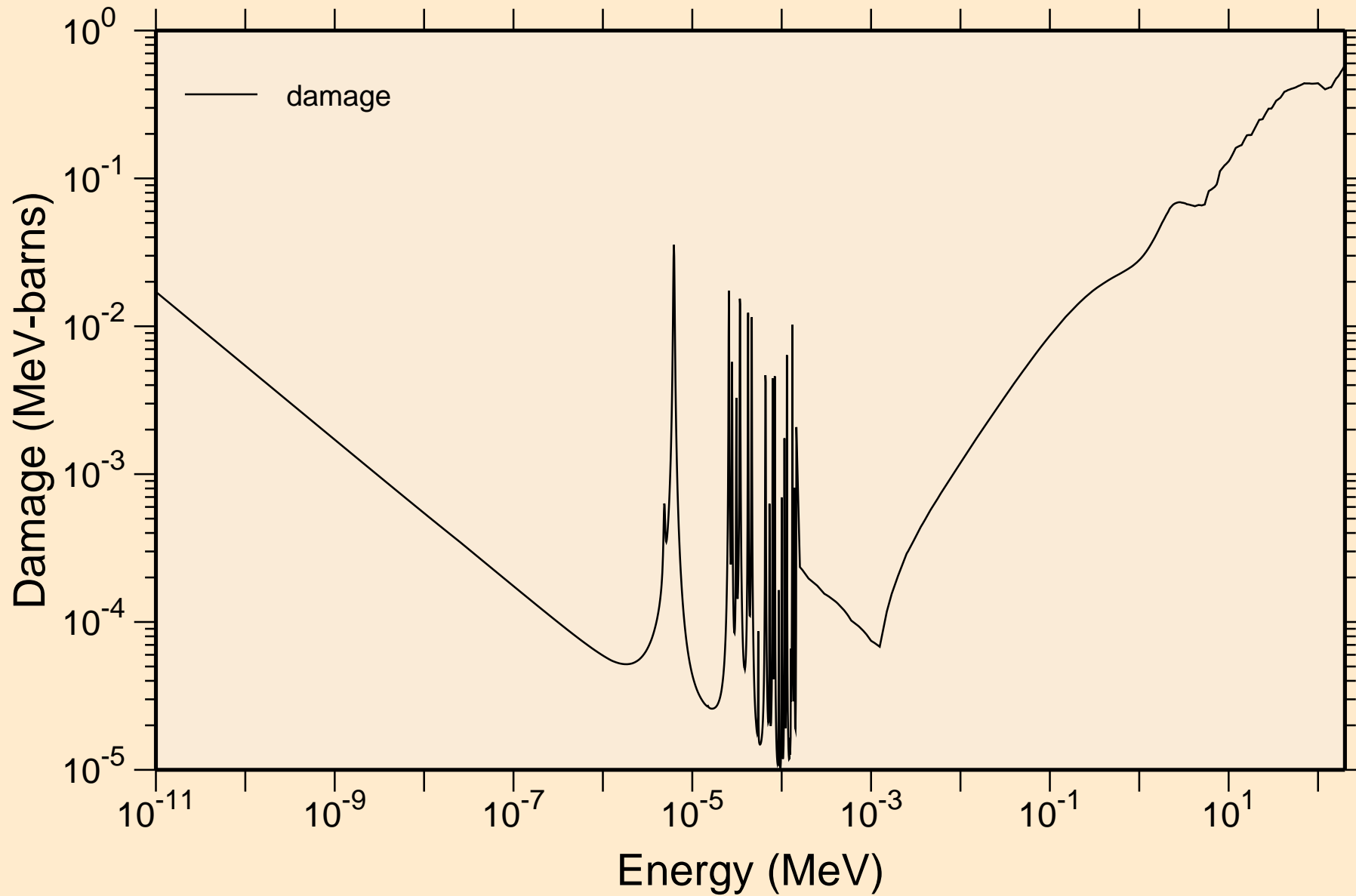

BI204 NEUTRON ACER TENDL-2021 LIBRARY; T=293.6K  
Non-threshold reactions

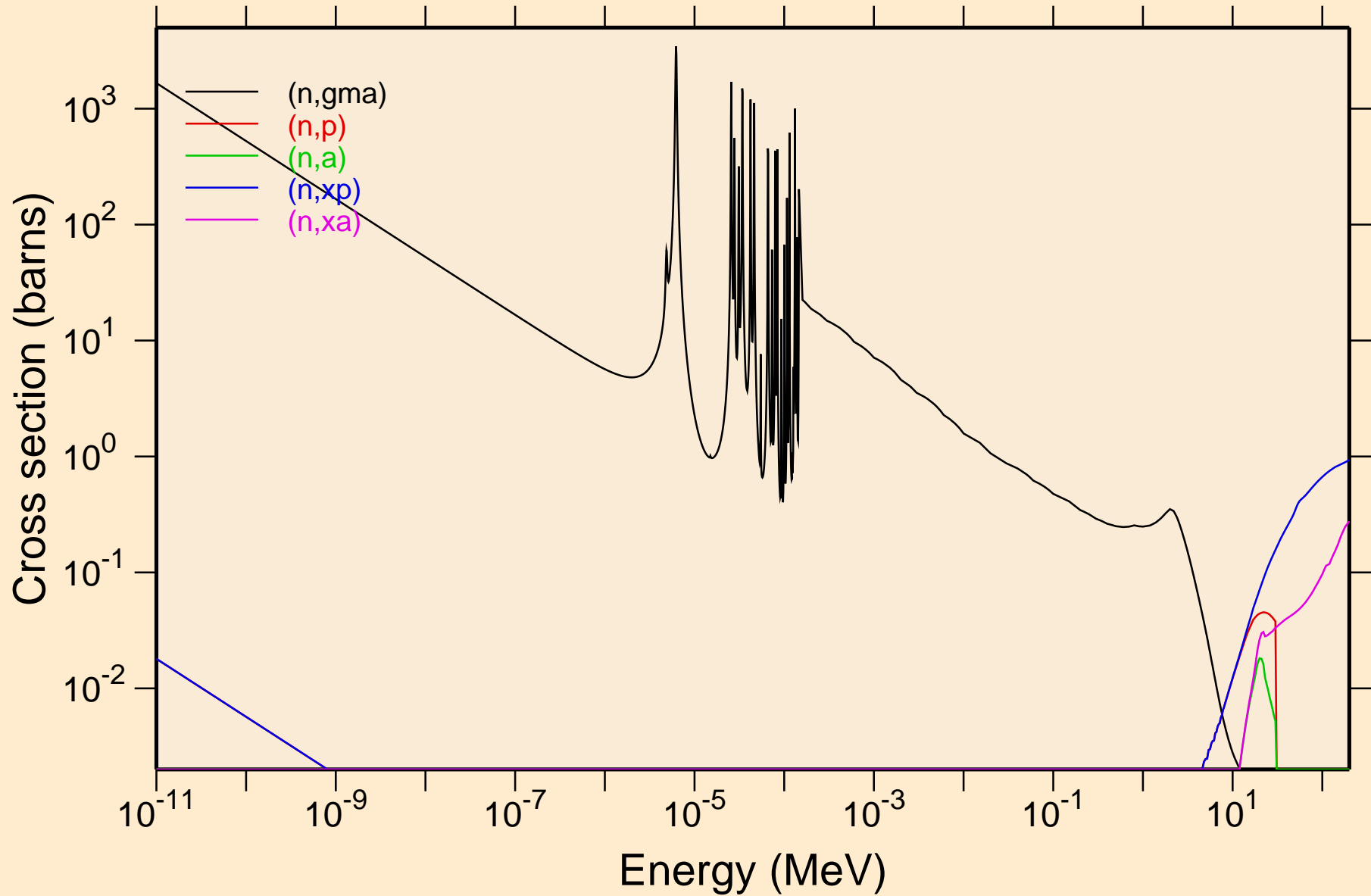

BI204 NEUTRON ACER TENDL-2021 LIBRARY; T=293.6K  
Principal cross sections

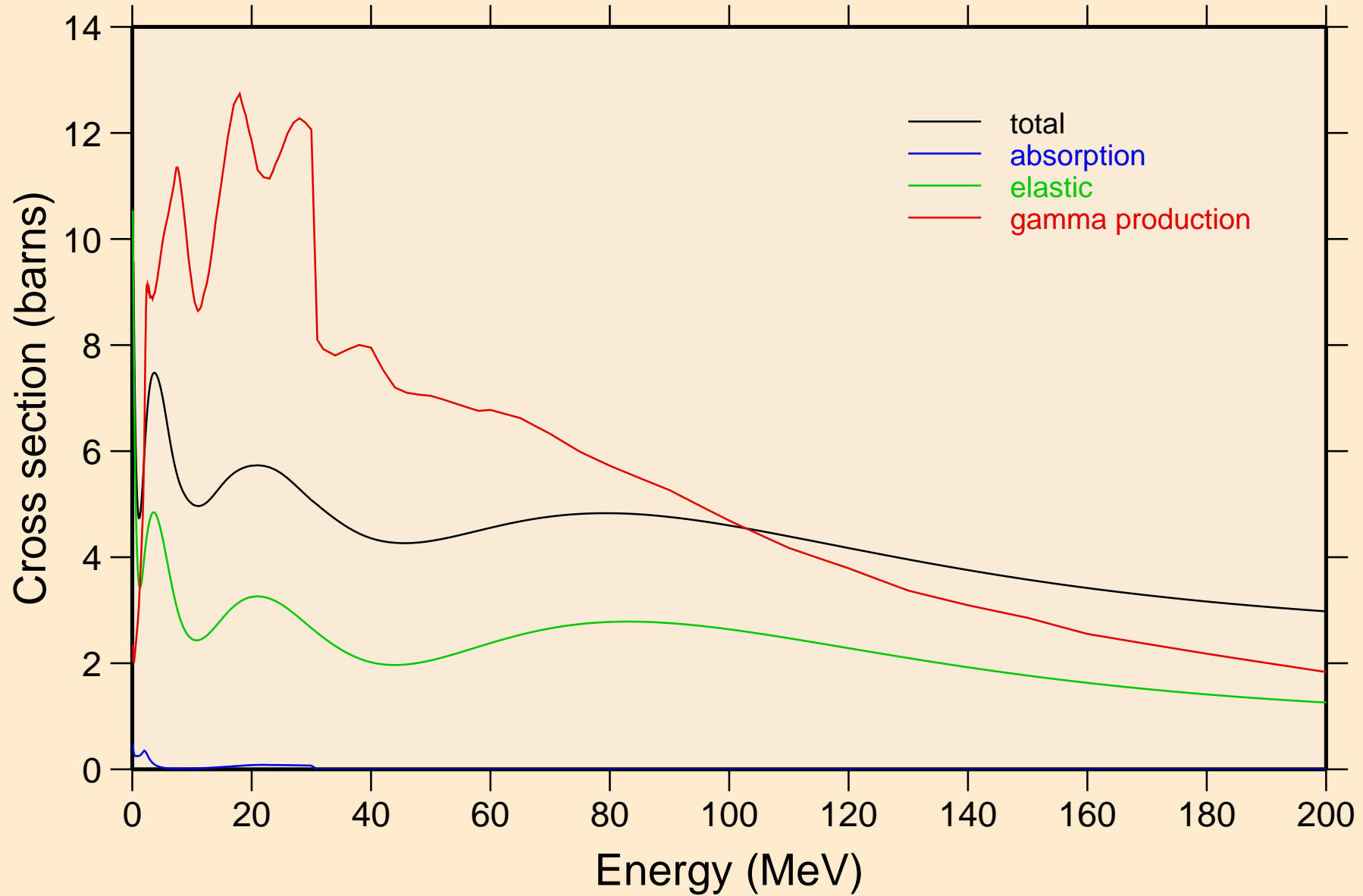

BI204 NEUTRON ACER TENDL-2021 LIBRARY; T=293.6K

Heating

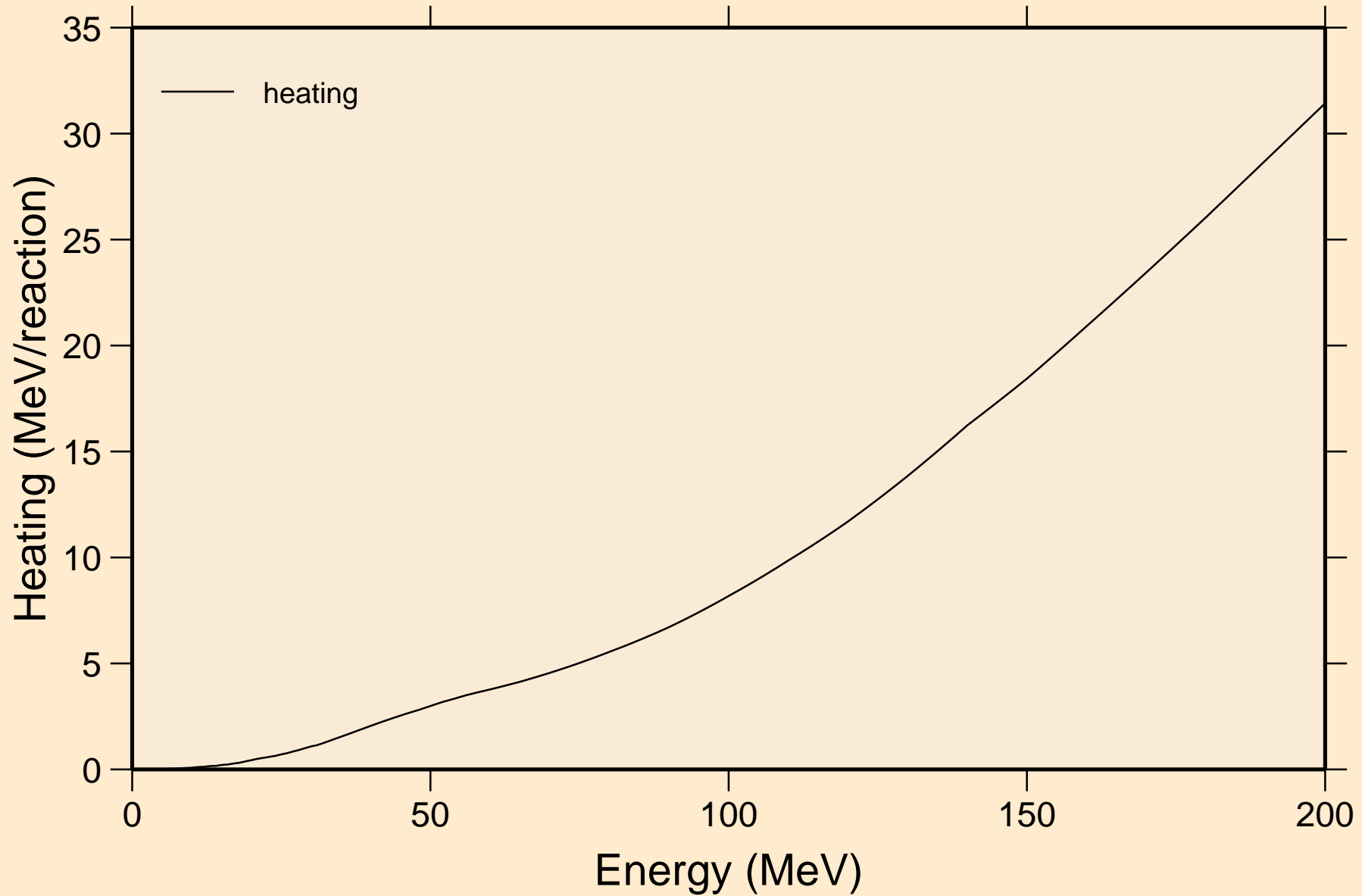

BI204 NEUTRON ACER TENDL-2021 LIBRARY; T=293.6K  
Damage

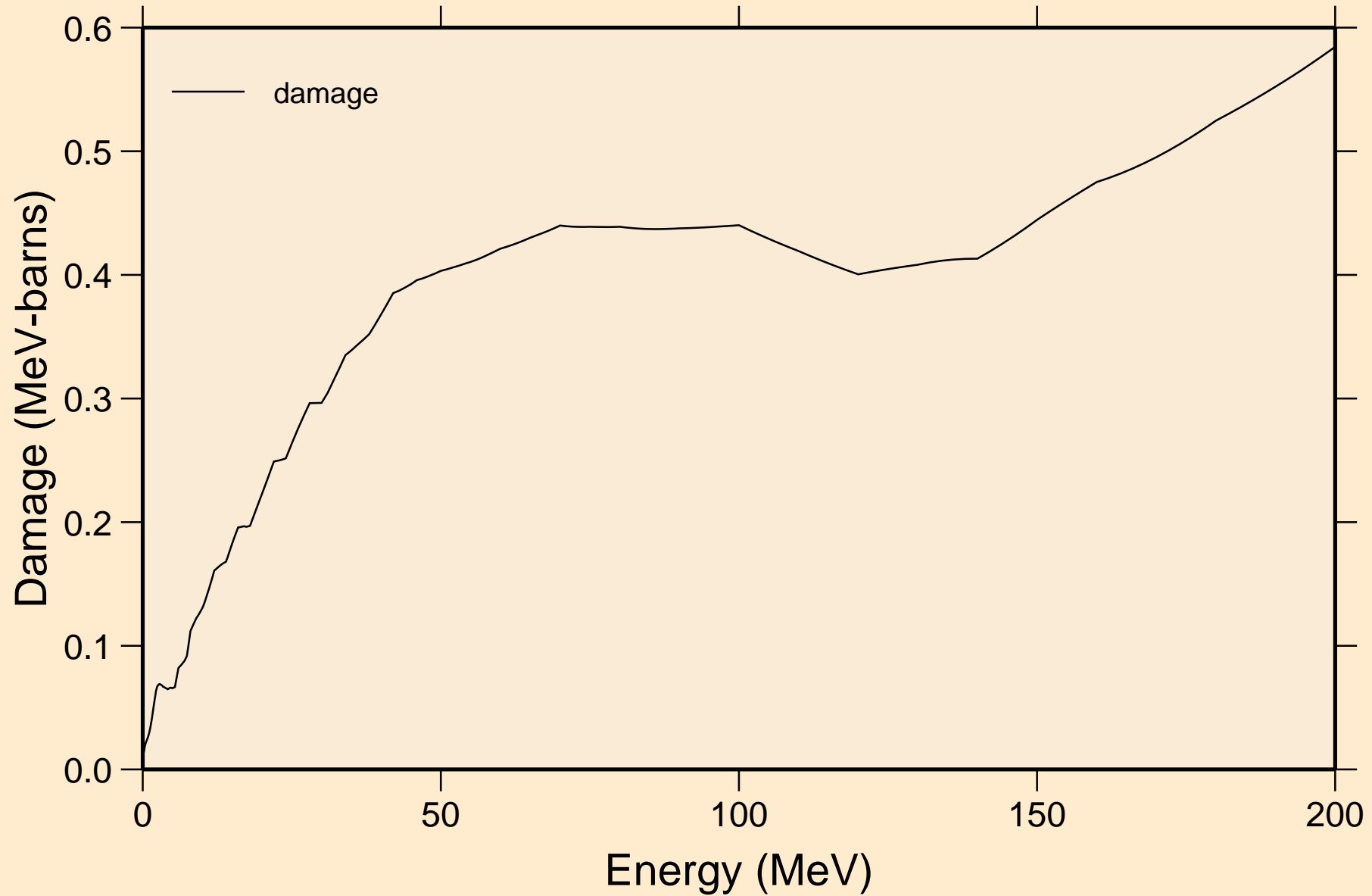

BI204 NEUTRON ACER TENDL-2021 LIBRARY; T=293.6K  
Non-threshold reactions

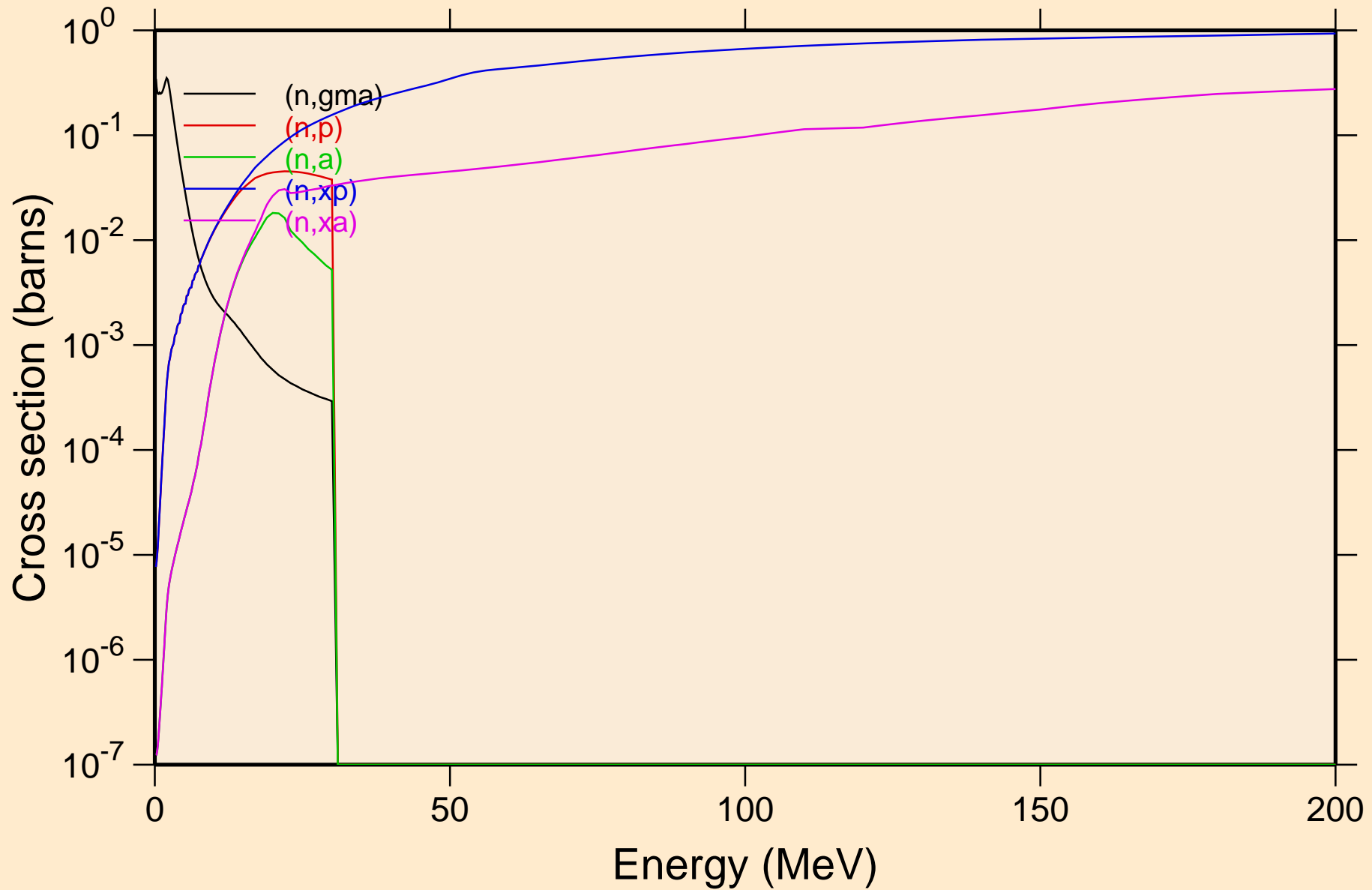



BI204 NEUTRON ACER TENDL-2021 LIBRARY; T=293.6K  
Inelastic levels

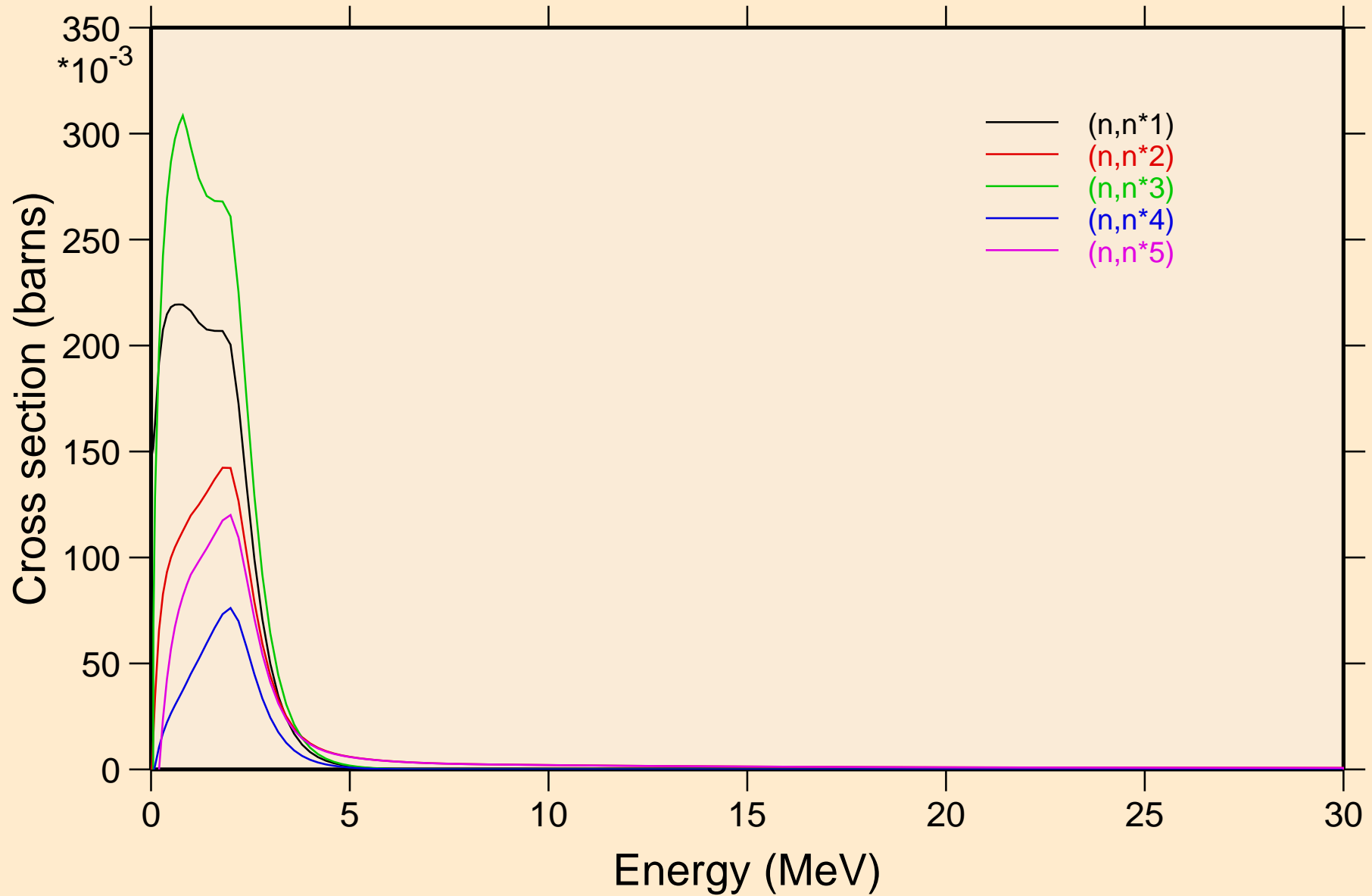

BI204 NEUTRON ACER TENDL-2021 LIBRARY; T=293.6K  
Inelastic levels

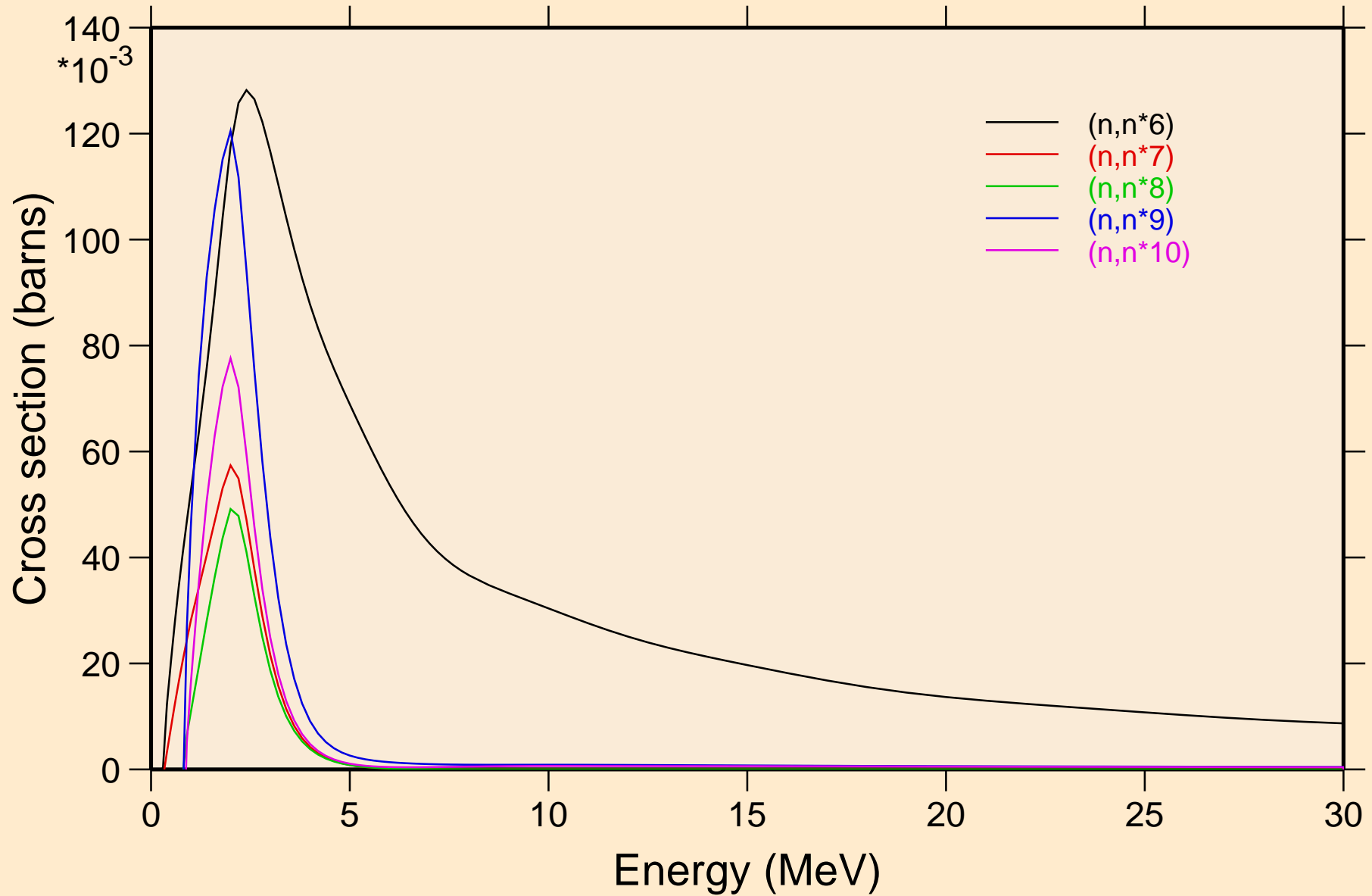

BI204 NEUTRON ACER TENDL-2021 LIBRARY; T=293.6K  
Inelastic levels

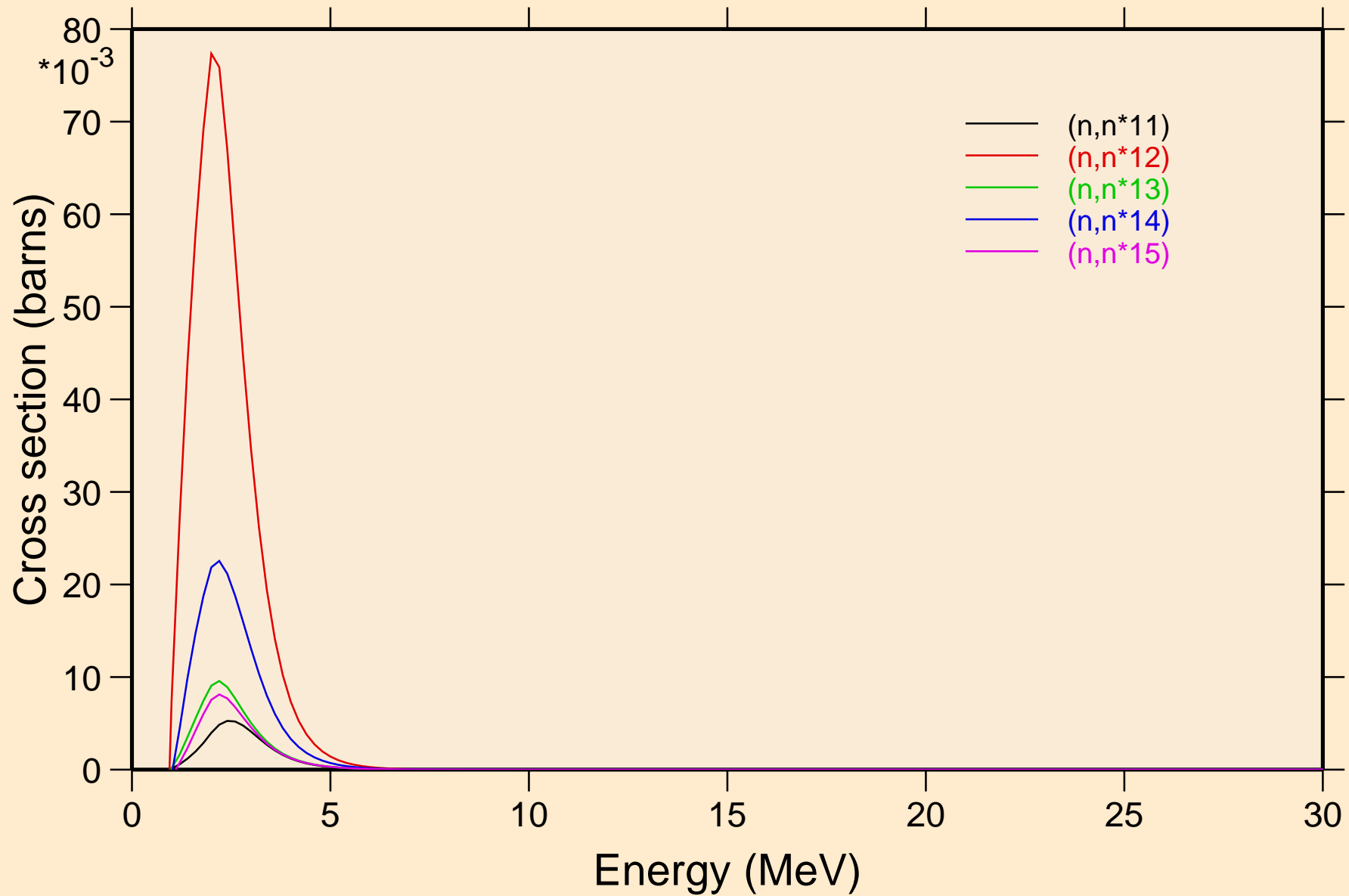

BI204 NEUTRON ACER TENDL-2021 LIBRARY; T=293.6K  
Inelastic levels

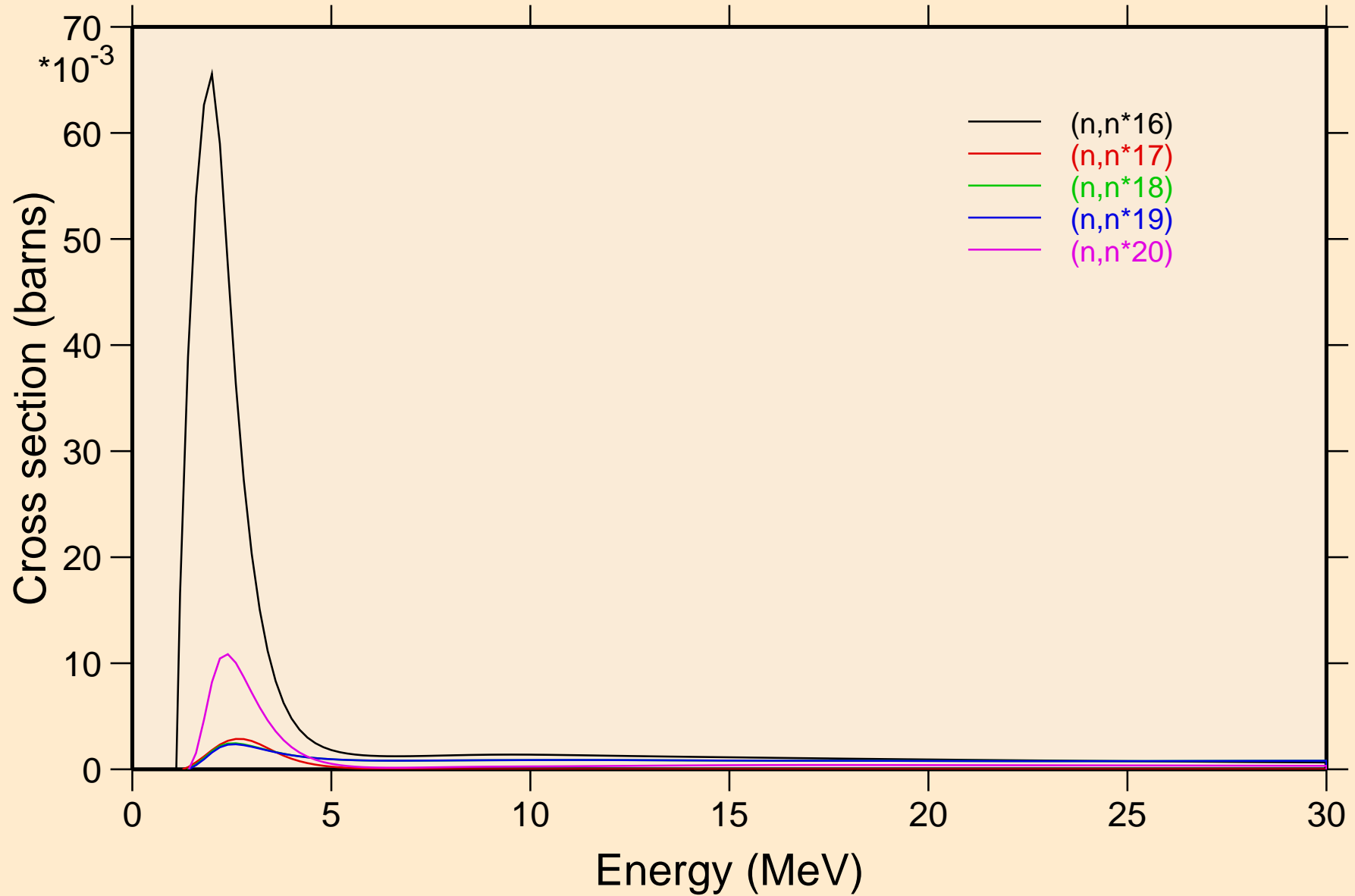

BI204 NEUTRON ACER TENDL-2021 LIBRARY; T=293.6K  
Inelastic levels

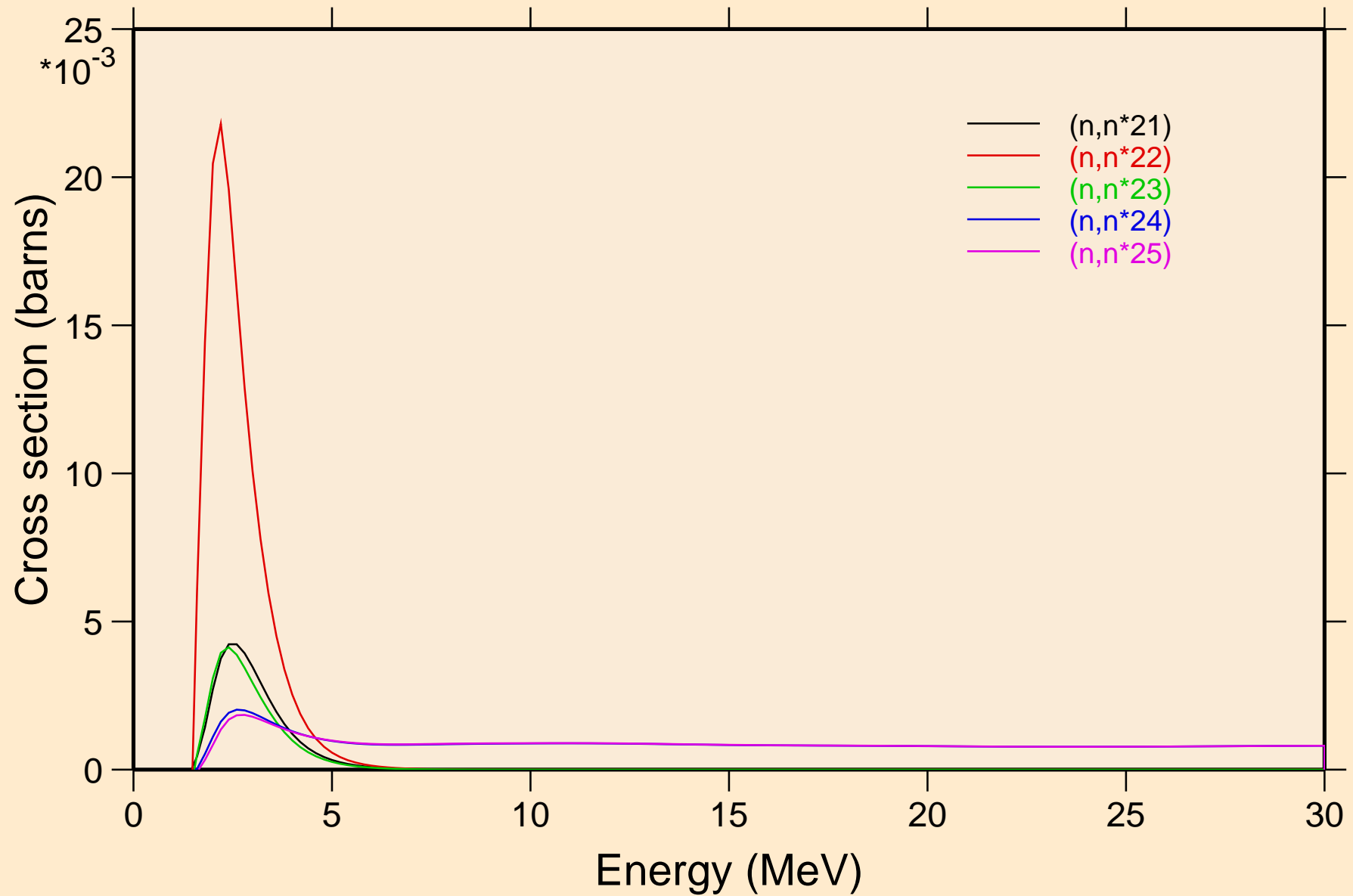

BI204 NEUTRON ACER TENDL-2021 LIBRARY; T=293.6K  
Inelastic levels

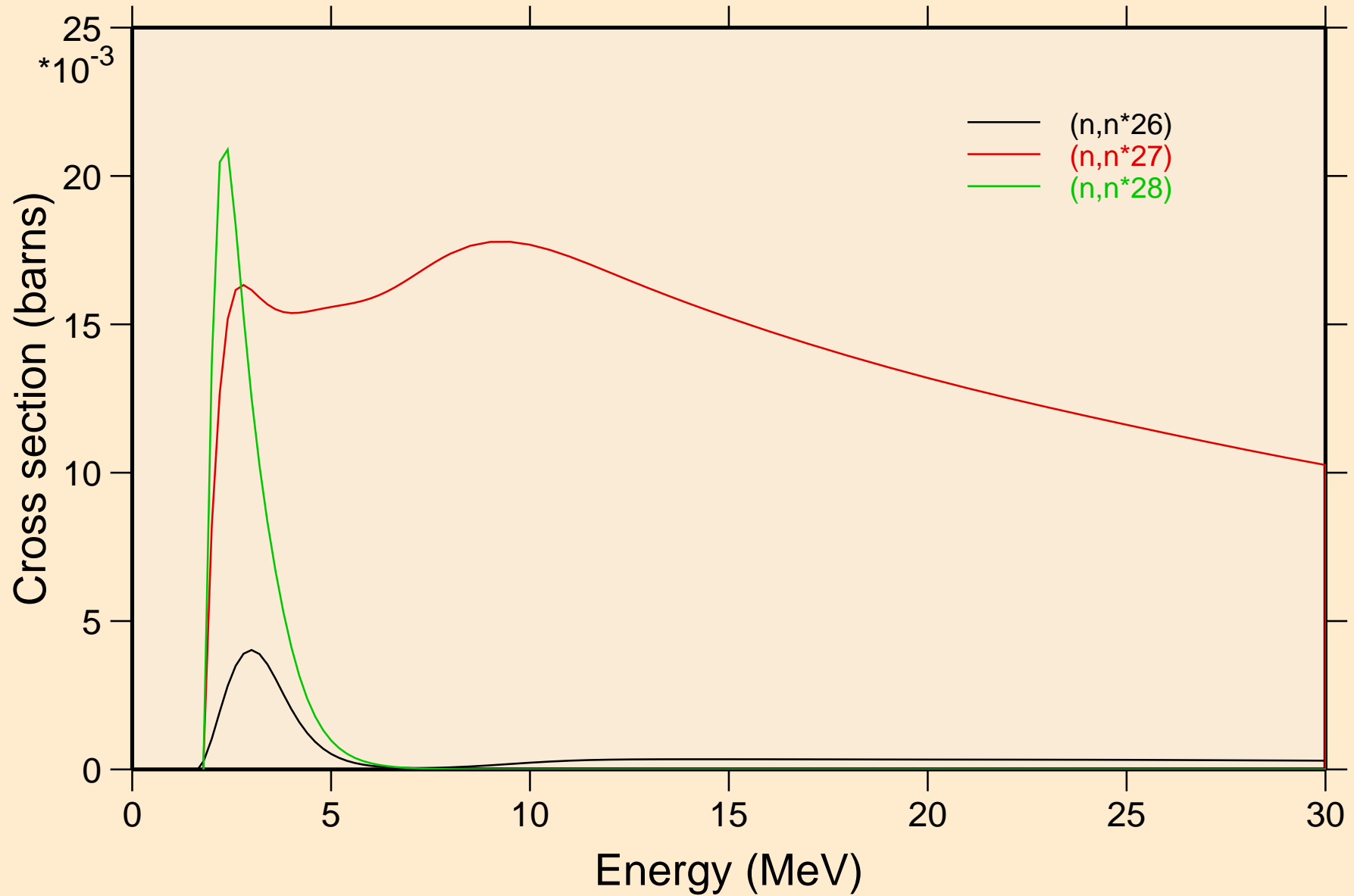

BI204 NEUTRON ACER TENDL-2021 LIBRARY; T=293.6K  
Threshold reactions

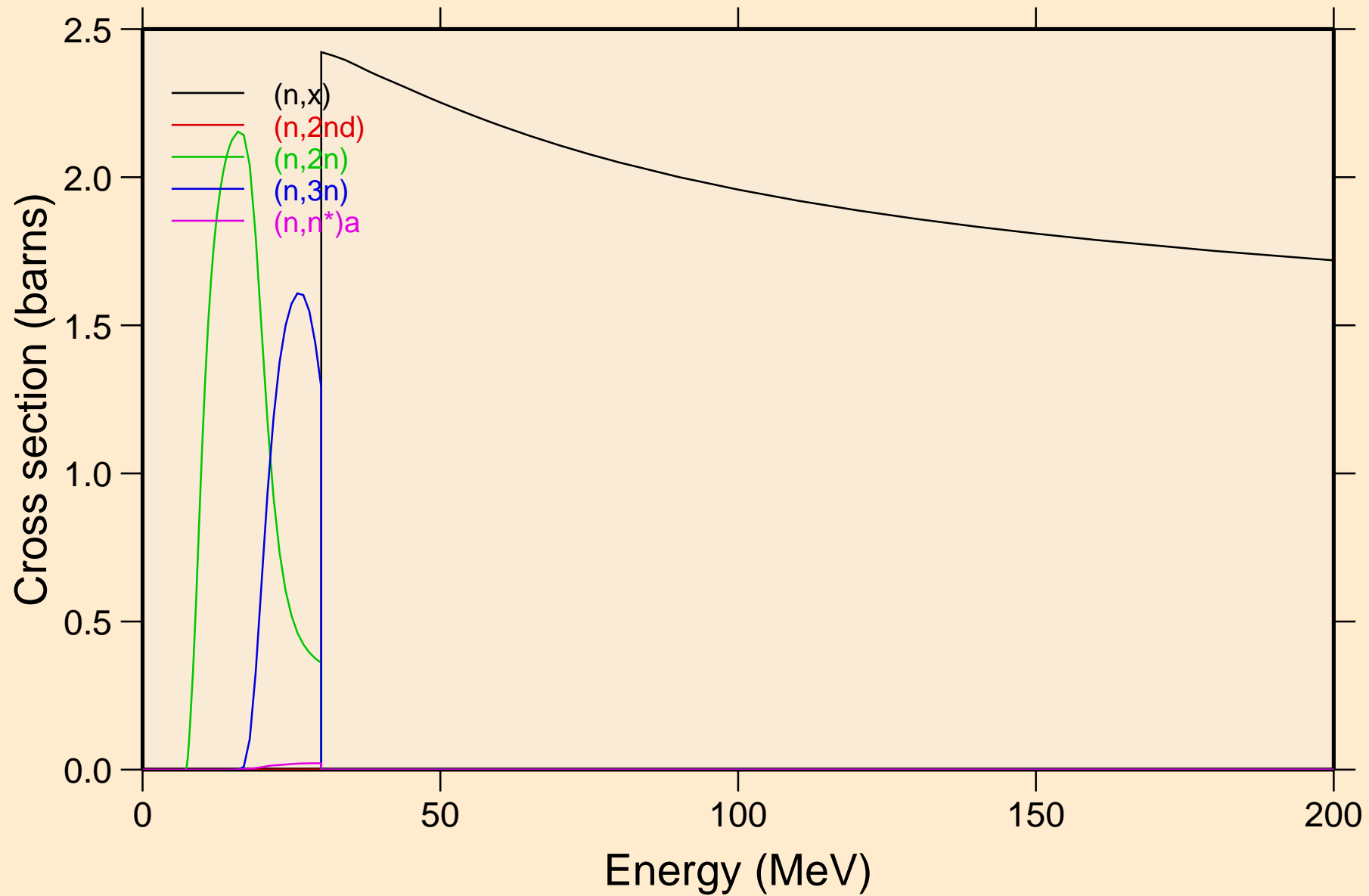

BI204 NEUTRON ACER TENDL-2021 LIBRARY; T=293.6K  
Threshold reactions

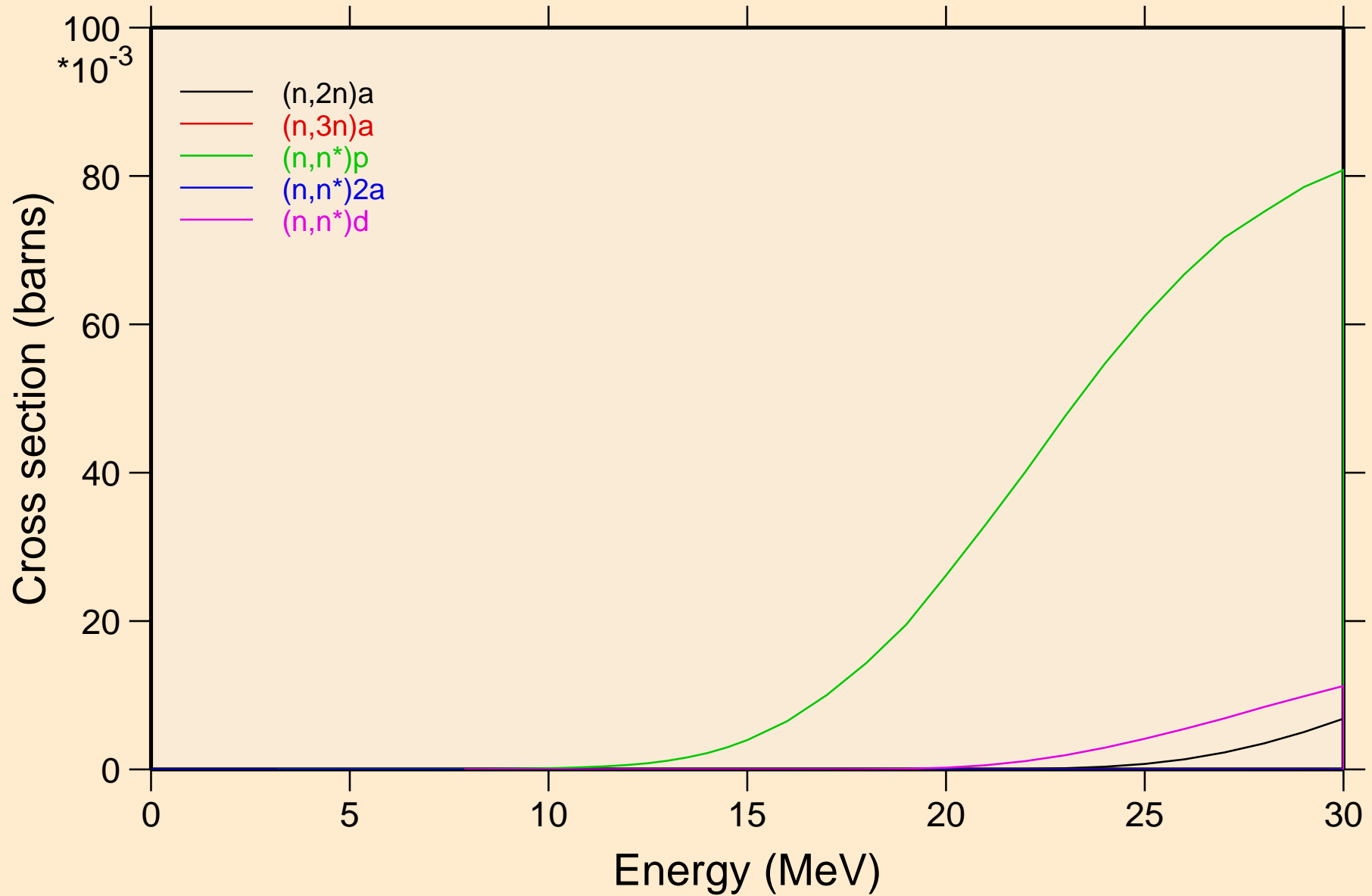



BI204 NEUTRON ACER TENDL-2021 LIBRARY; T=293.6K  
Threshold reactions

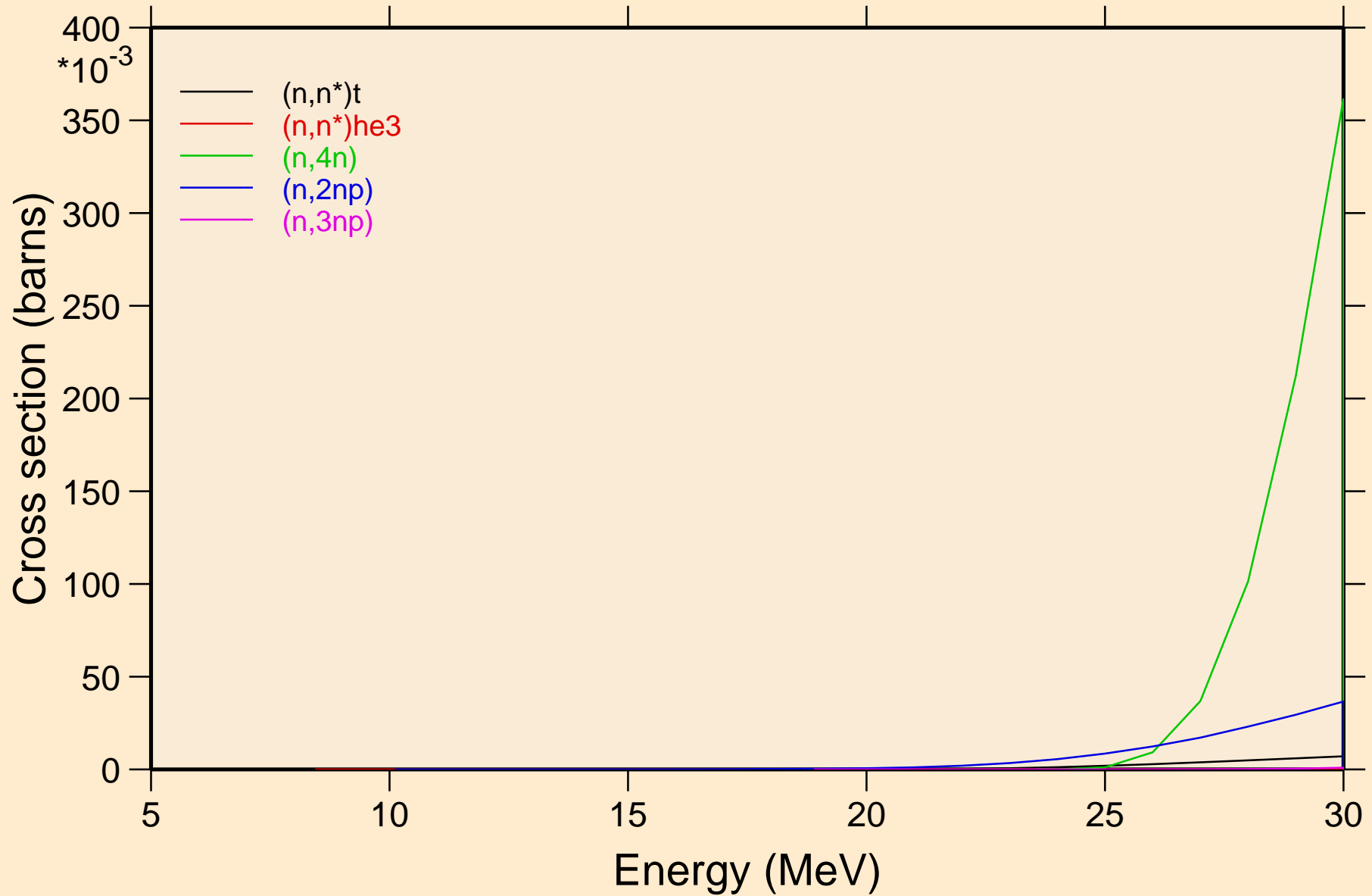

BI204 NEUTRON ACER TENDL-2021 LIBRARY; T=293.6K  
Threshold reactions

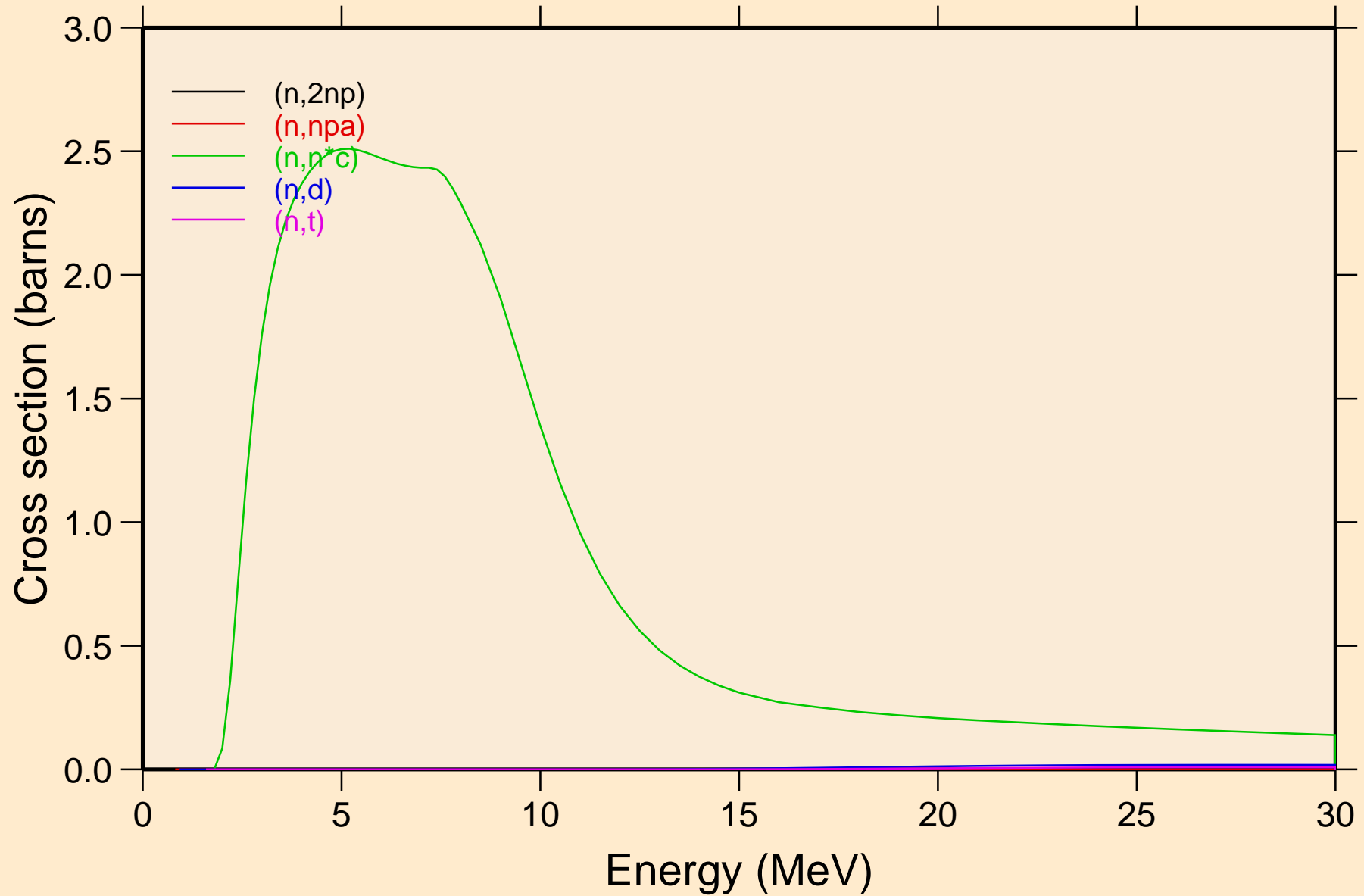

BI204 NEUTRON ACER TENDL-2021 LIBRARY; T=293.6K  
Threshold reactions

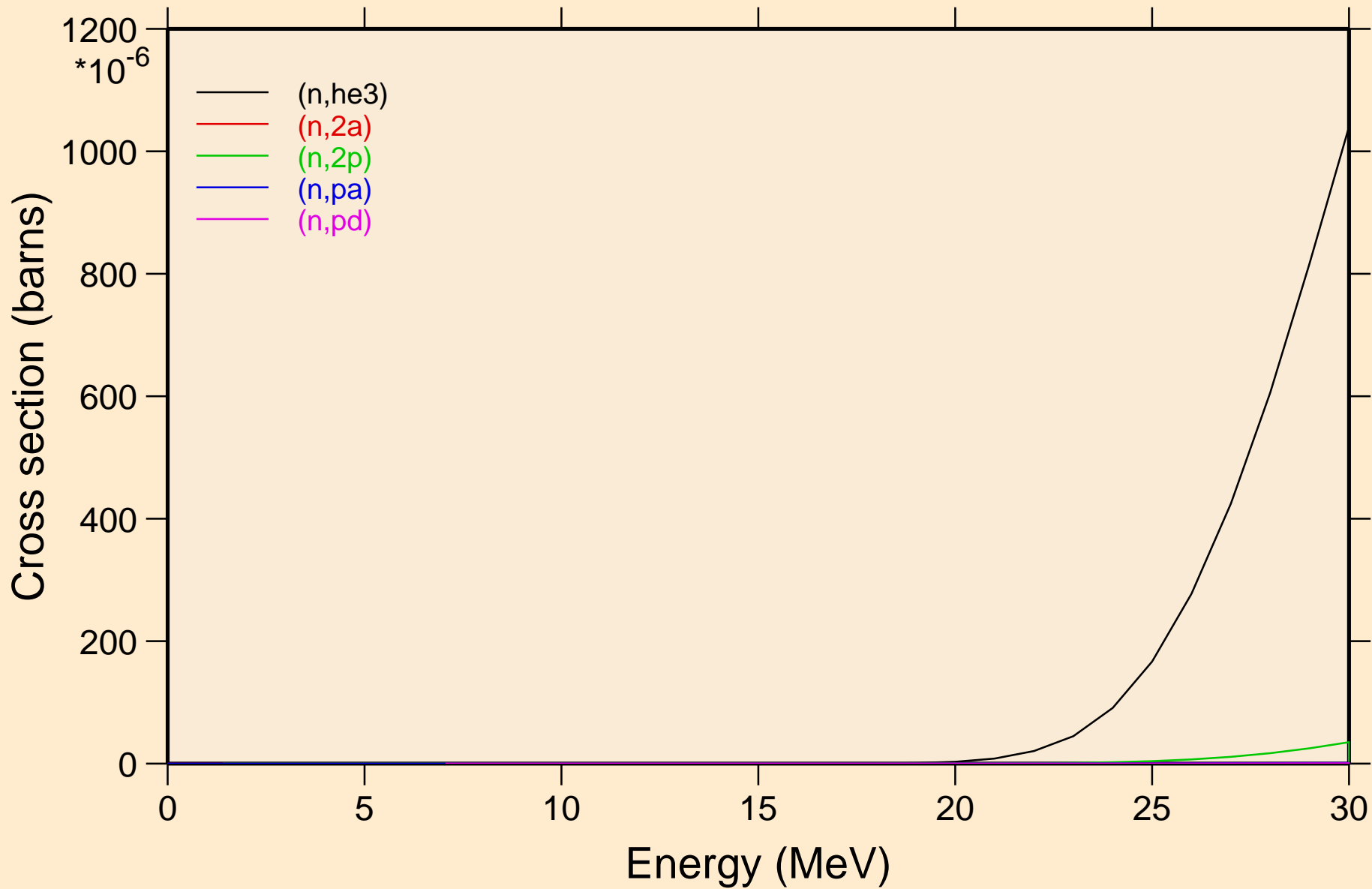

BI204 NEUTRON ACER TENDL-2021 LIBRARY; T=293.6K  
Threshold reactions

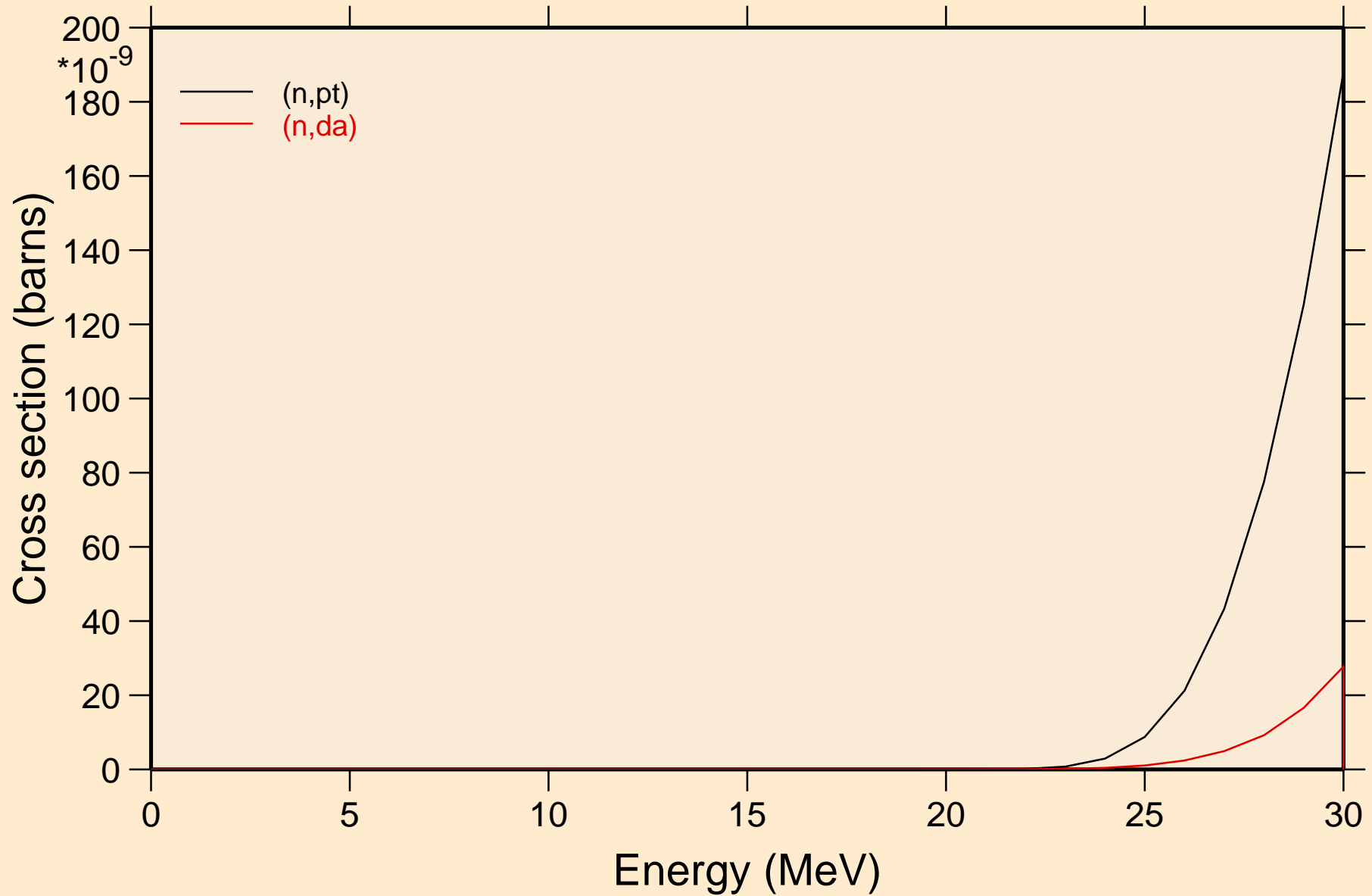

BI204 NEUTRON ACER TENDL-2021 LIBRARY; T=293.6K  
Threshold reactions

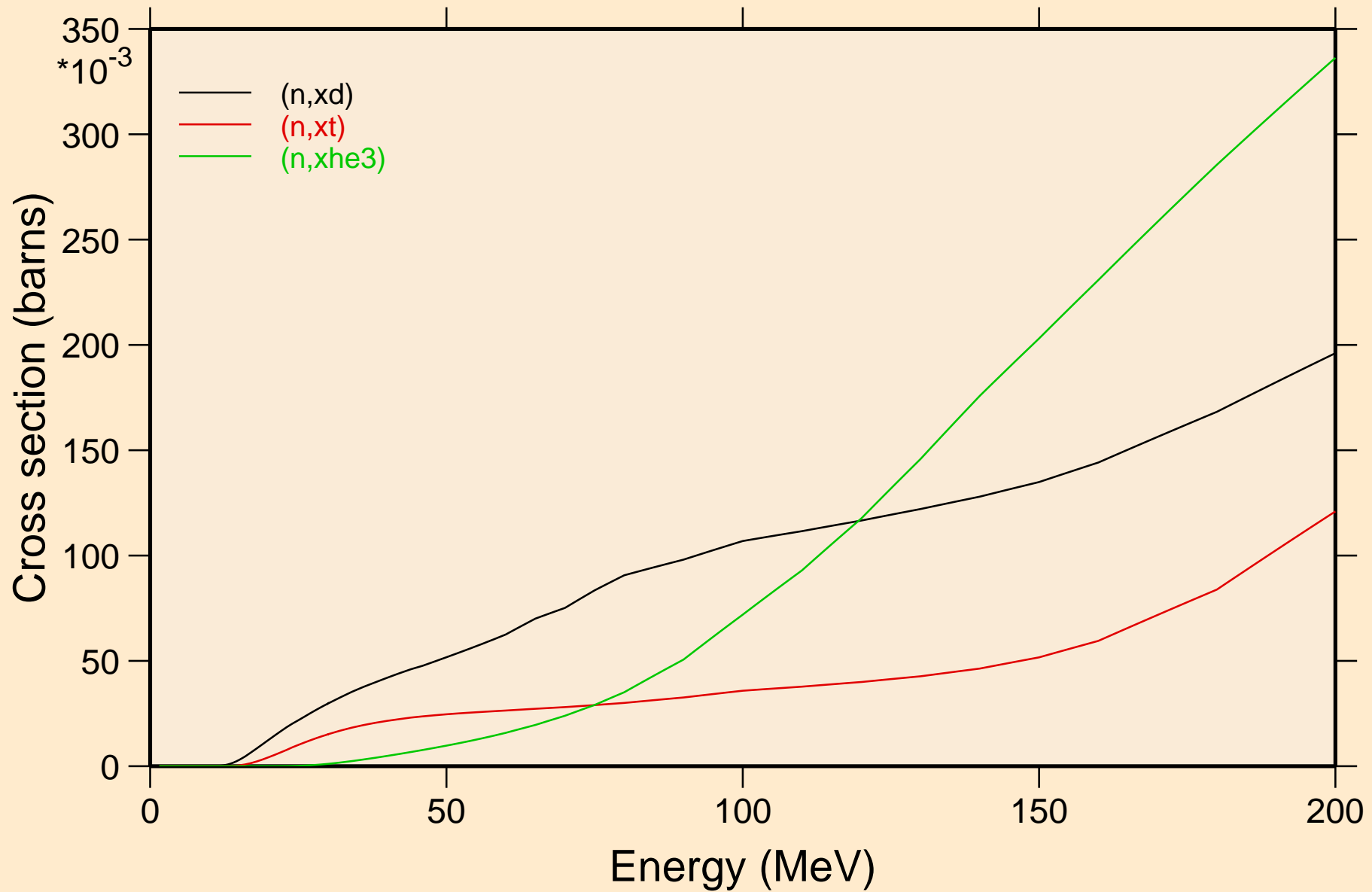

BI204 NEUTRON ACER TENDL-2021 LIBRARY; T=293.6K  
angular distribution for elastic

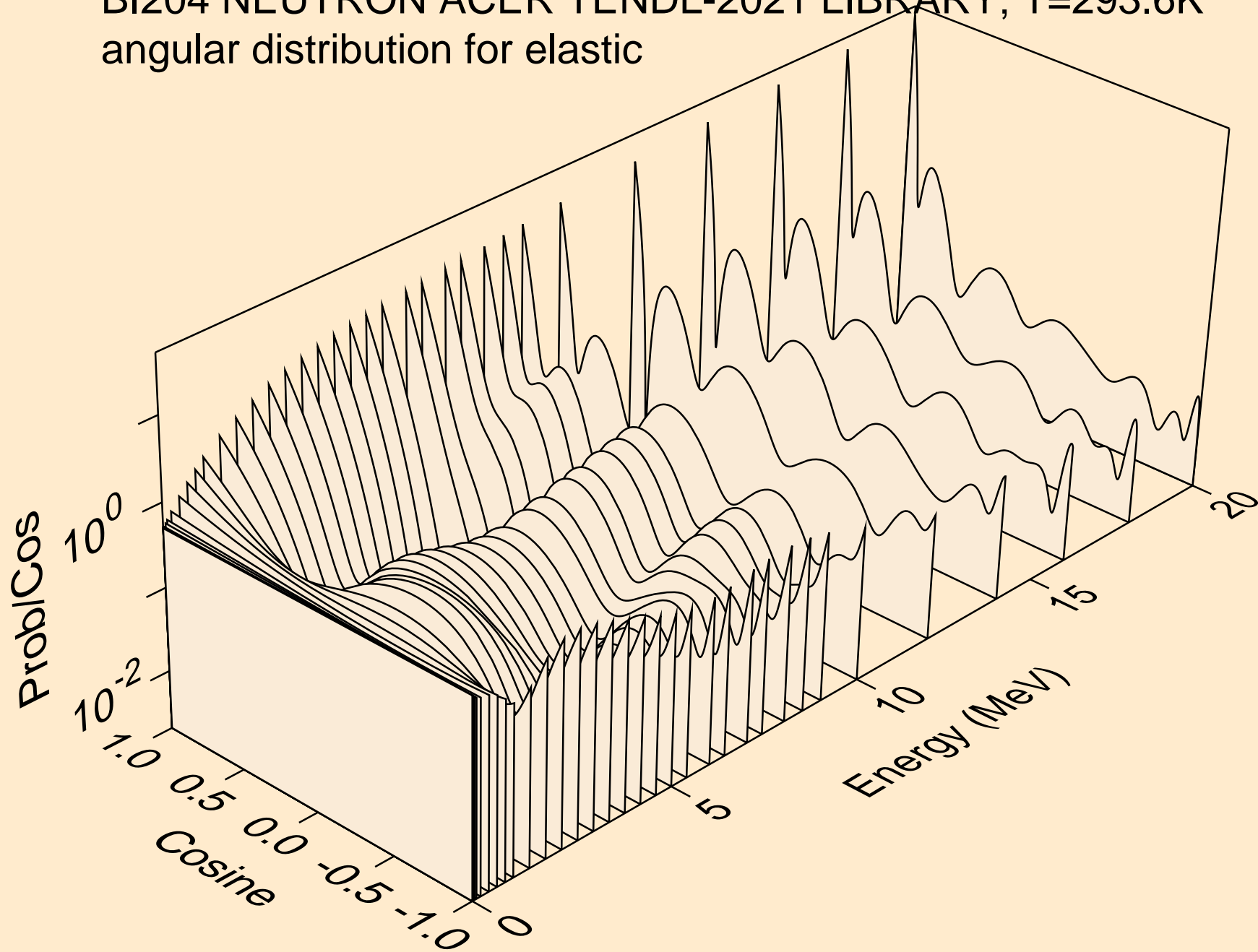

BI204 NEUTRON ACER TENDL-2021 LIBRARY; T=293.6K  
angular distribution for elastic

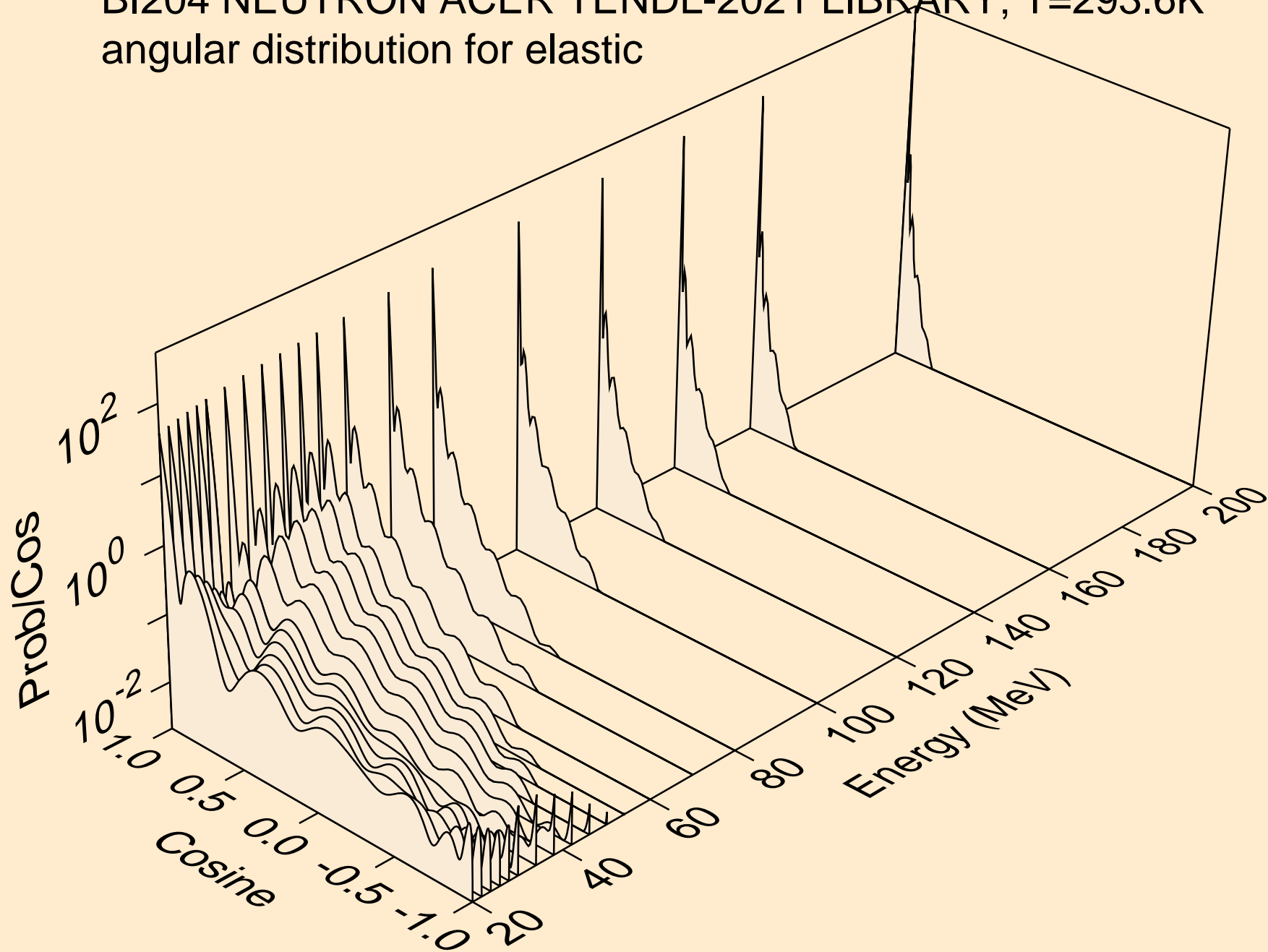

BI204 NEUTRON ACER TENDL-2021 LIBRARY; T=293.6K  
angular distribution for (n,n\*1)

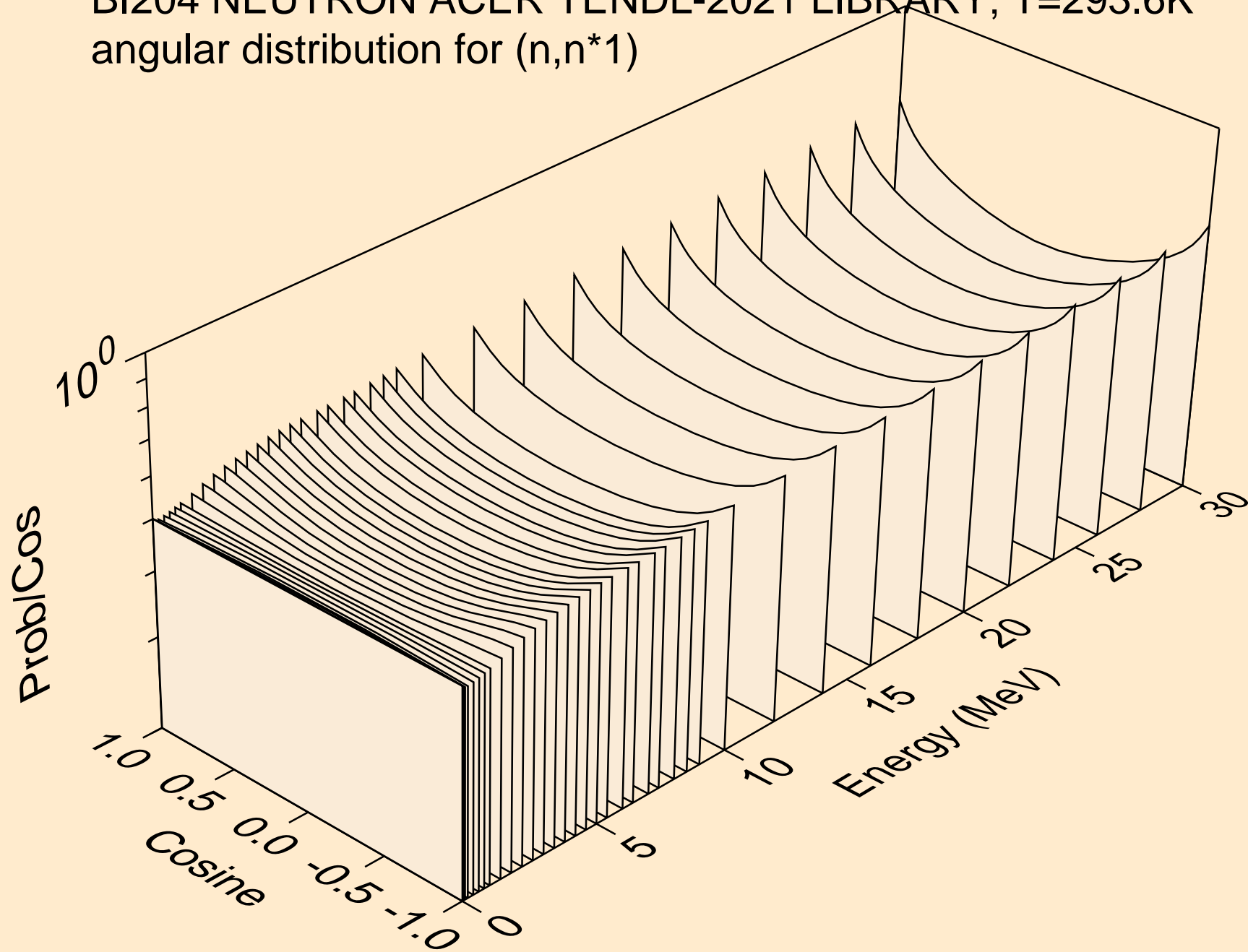



BI204 NEUTRON ACER TENDL-2021 LIBRARY; T=293.6K  
angular distribution for (n,n\*2)

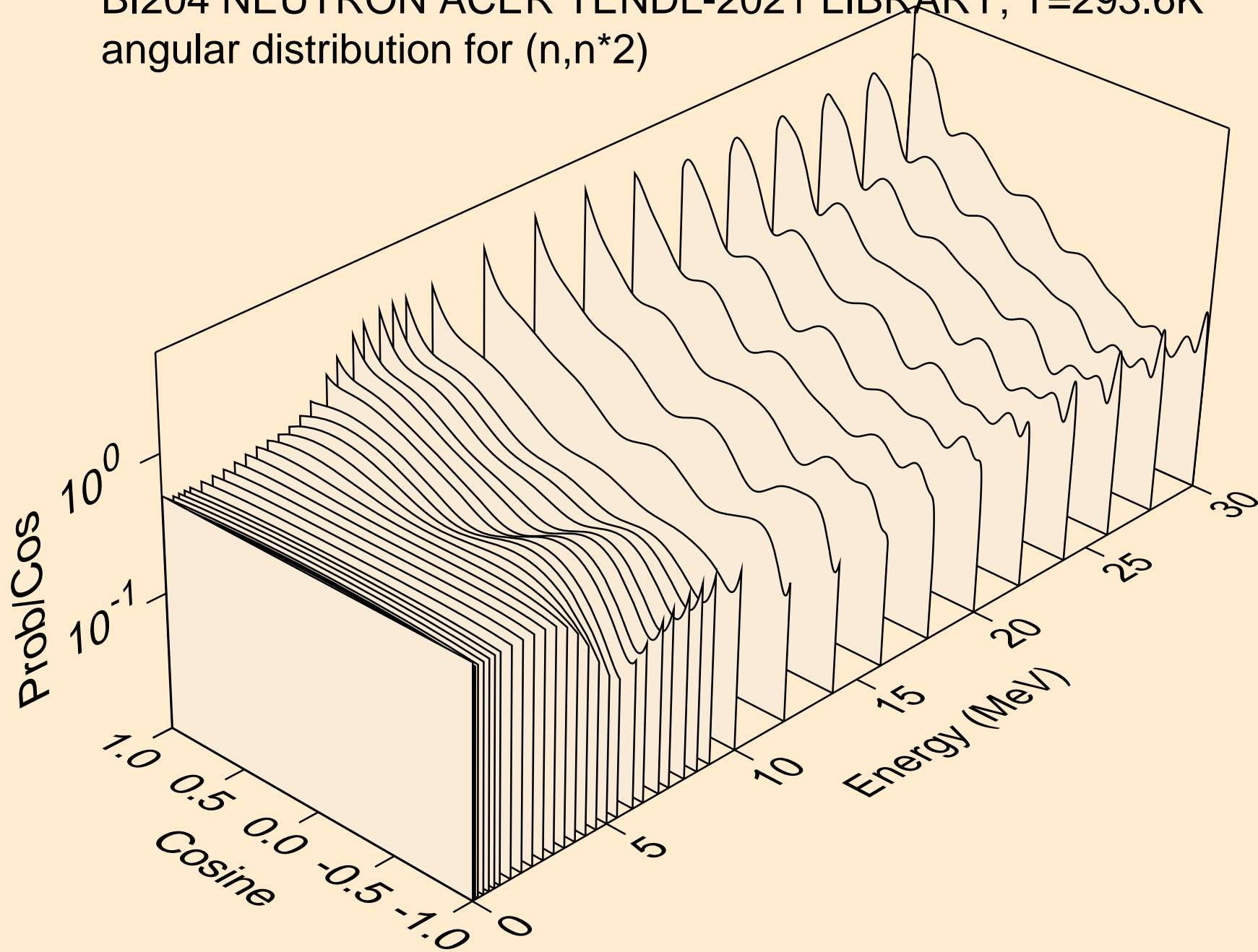

BI204 NEUTRON ACER TENDL-2021 LIBRARY; T=293.6K  
angular distribution for (n,n\*3)

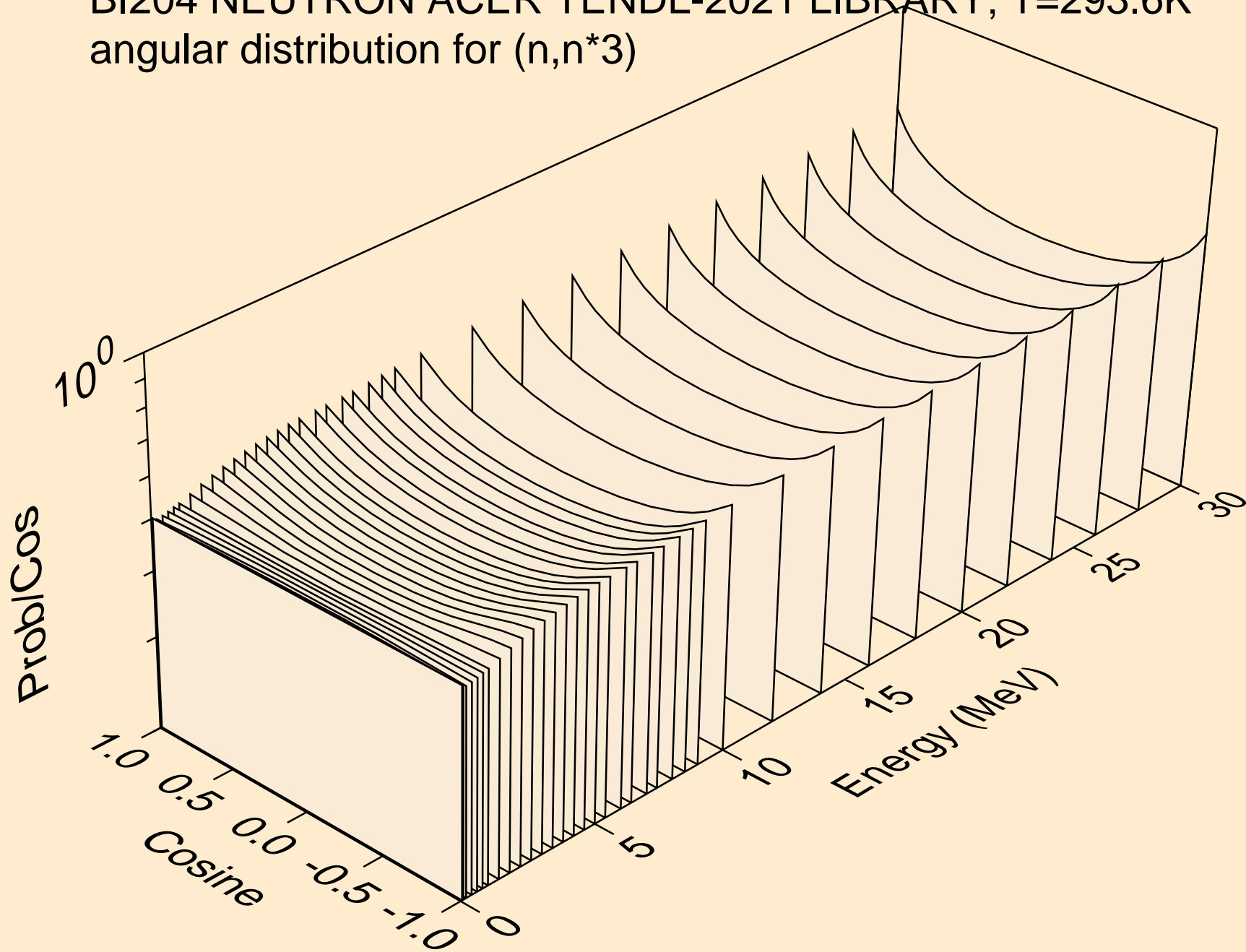

BI204 NEUTRON ACER TENDL-2021 LIBRARY; T=293.6K  
angular distribution for (n,n\*4)

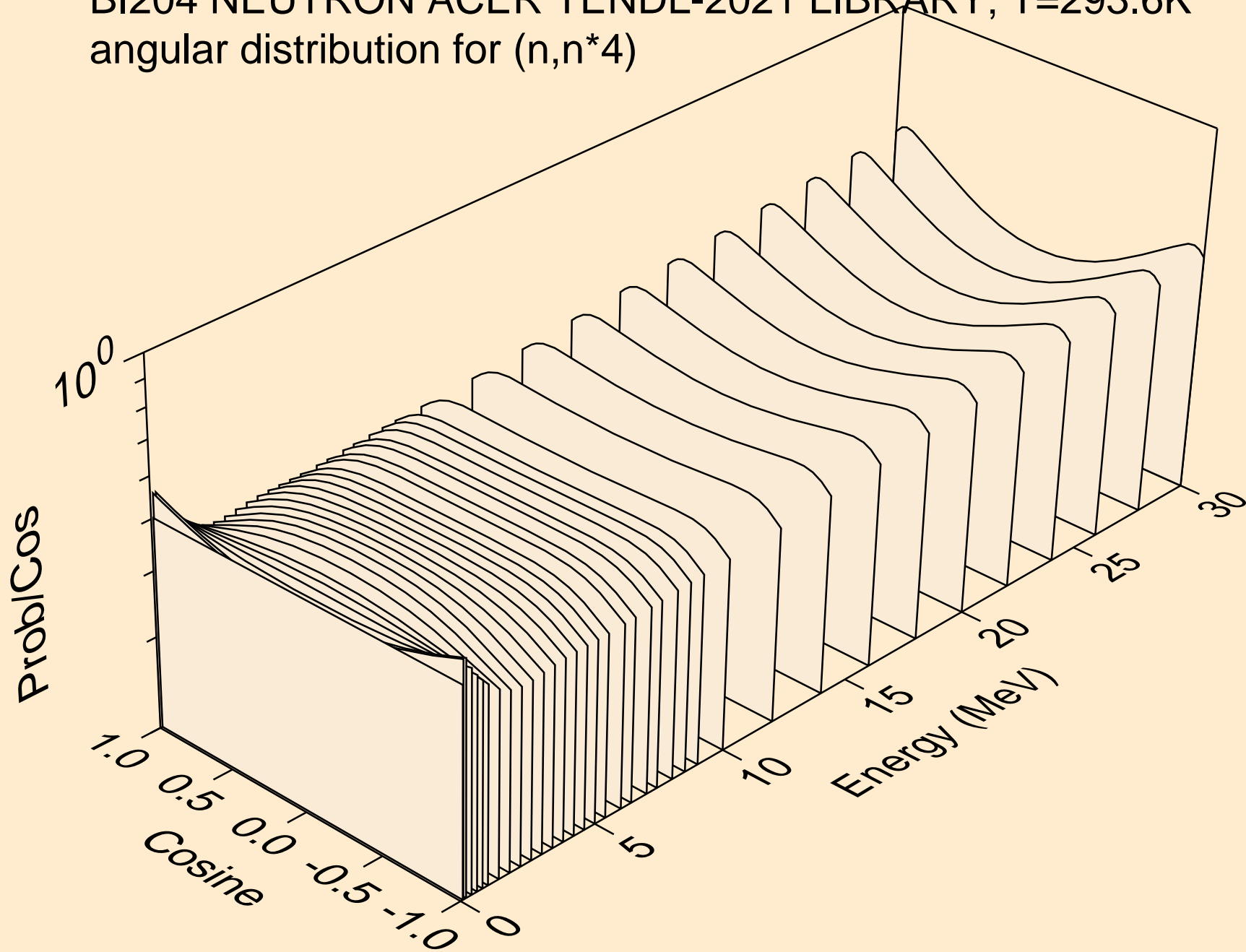

BI204 NEUTRON ACER TENDL-2021 LIBRARY; T=293.6K  
angular distribution for (n,n\*5)

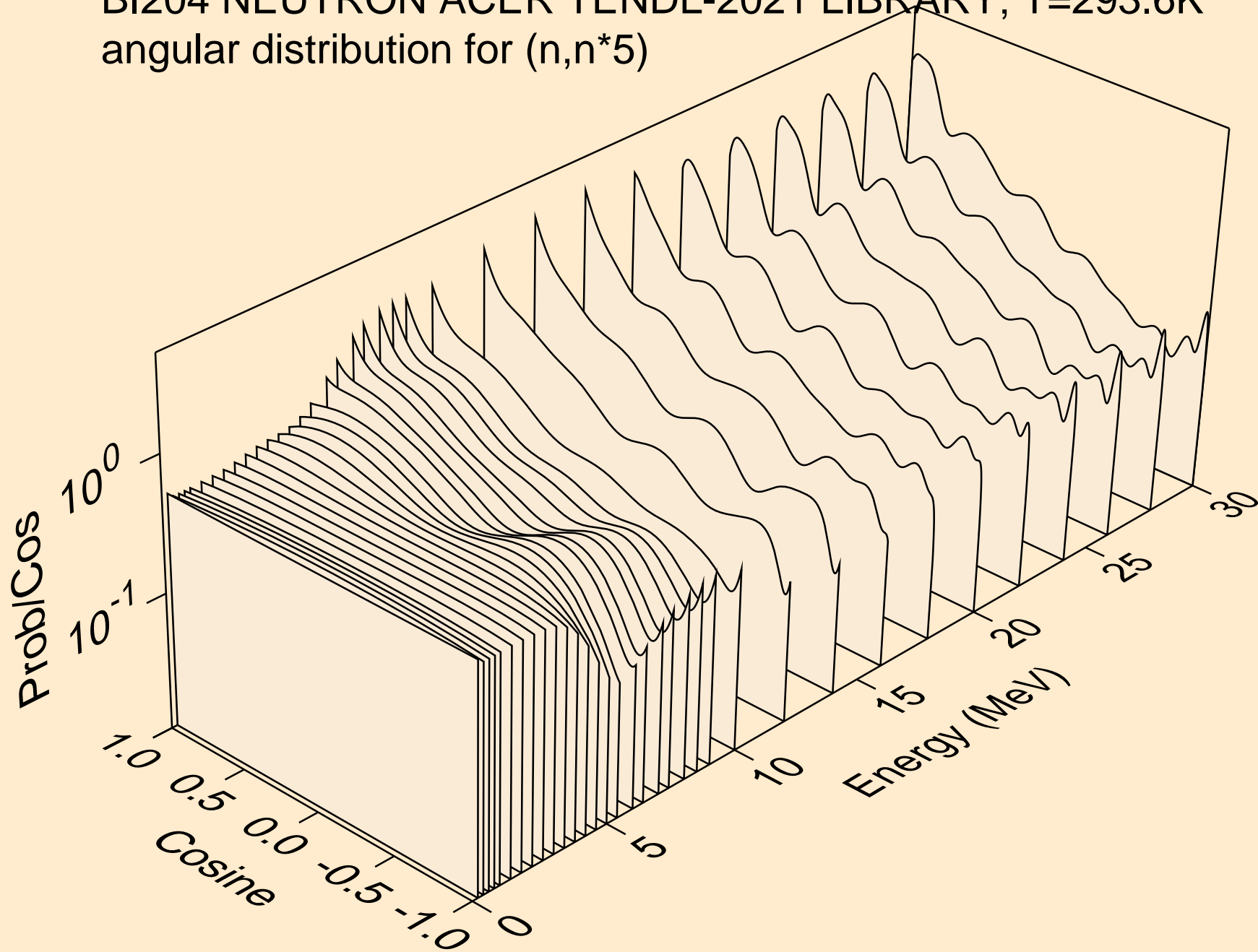

BI204 NEUTRON ACER TENDL-2021 LIBRARY; T=293.6K  
angular distribution for (n,n\*6)

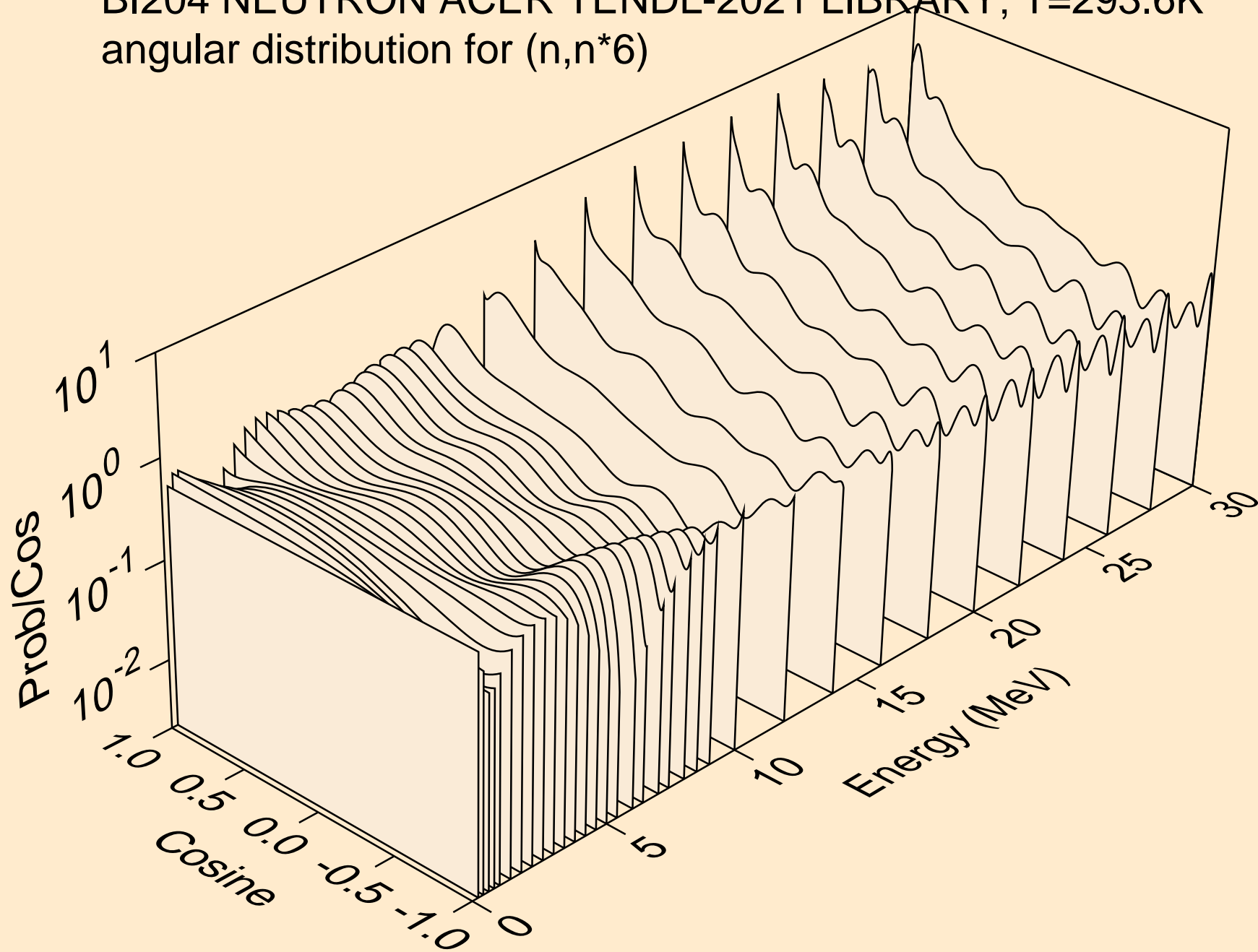

BI204 NEUTRON ACER TENDL-2021 LIBRARY; T=293.6K  
angular distribution for (n,n\*7)

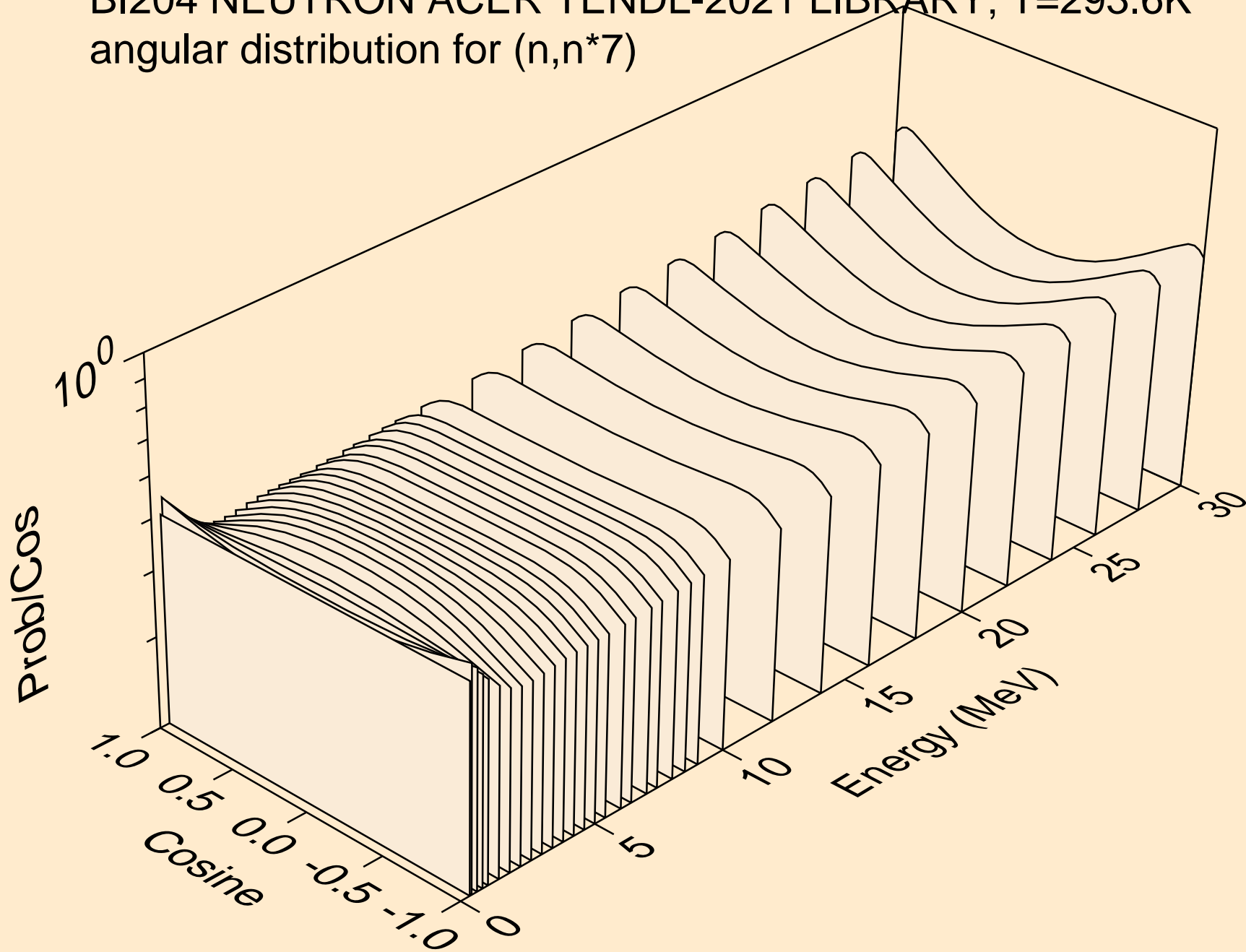

BI204 NEUTRON ACER TENDL-2021 LIBRARY; T=293.6K  
angular distribution for (n,n\*8)

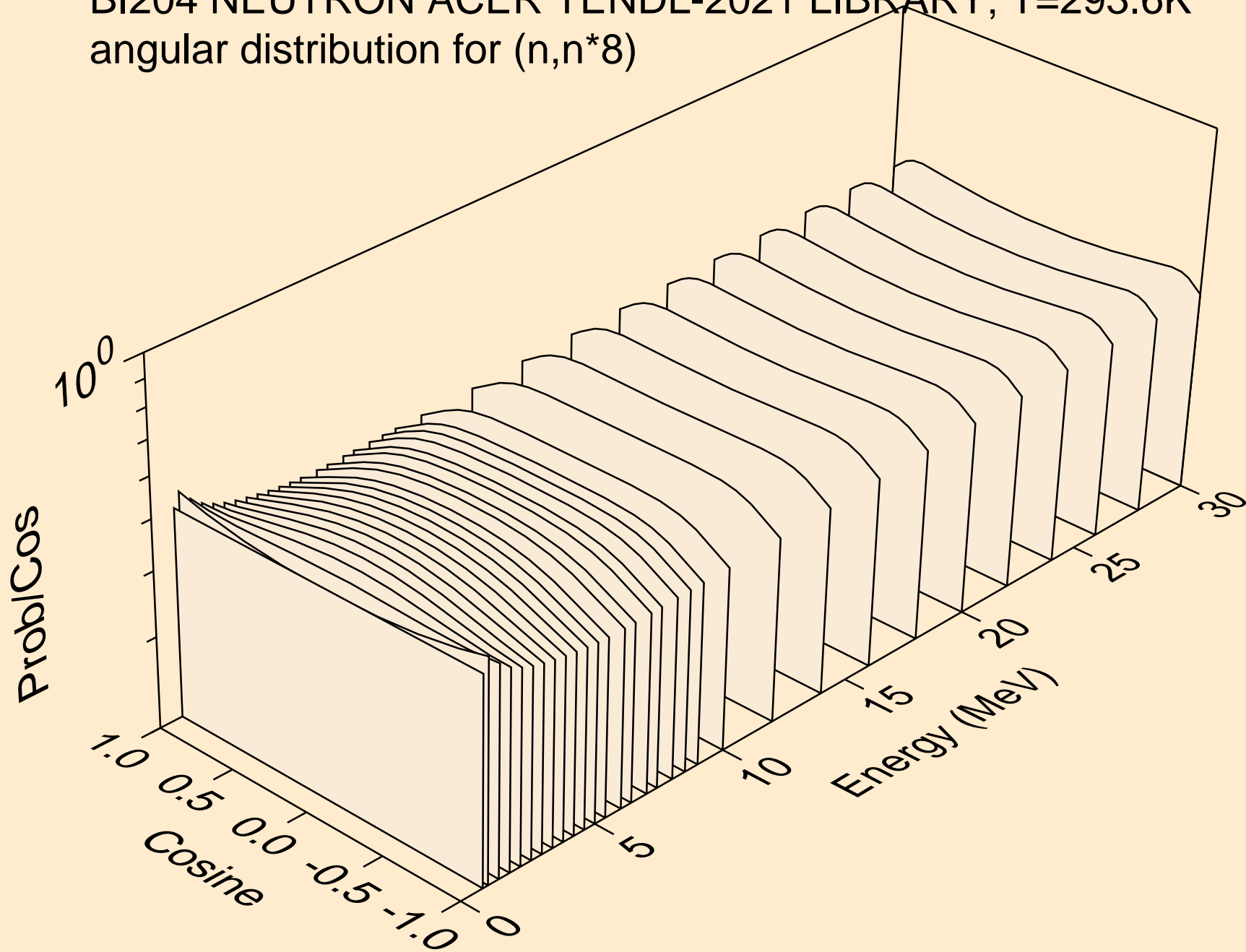

BI204 NEUTRON ACER TENDL-2021 LIBRARY; T=293.6K  
angular distribution for (n,n\*9)

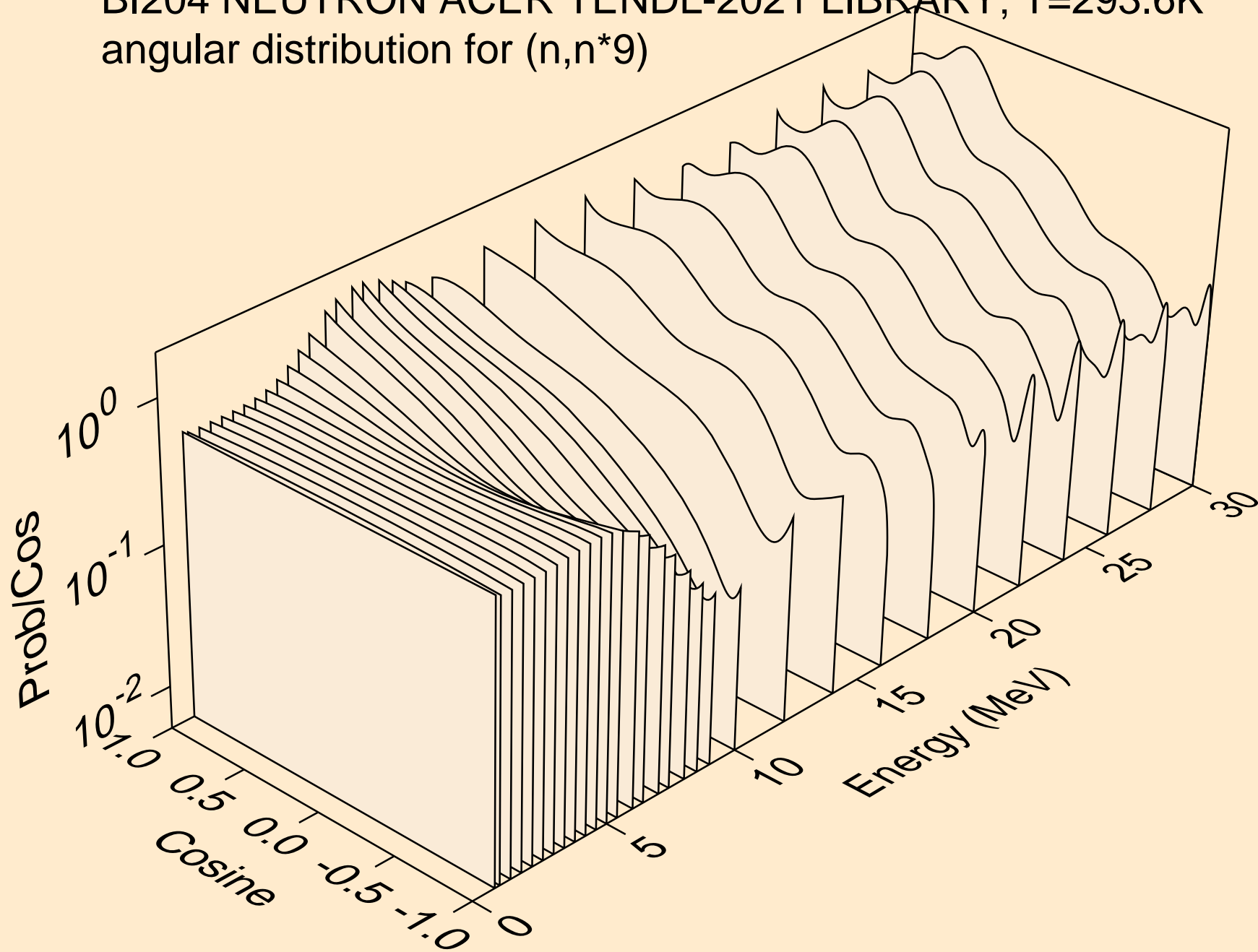



BI204 NEUTRON ACER TENDL-2021 LIBRARY; T=293.6K  
angular distribution for (n,n\*10)

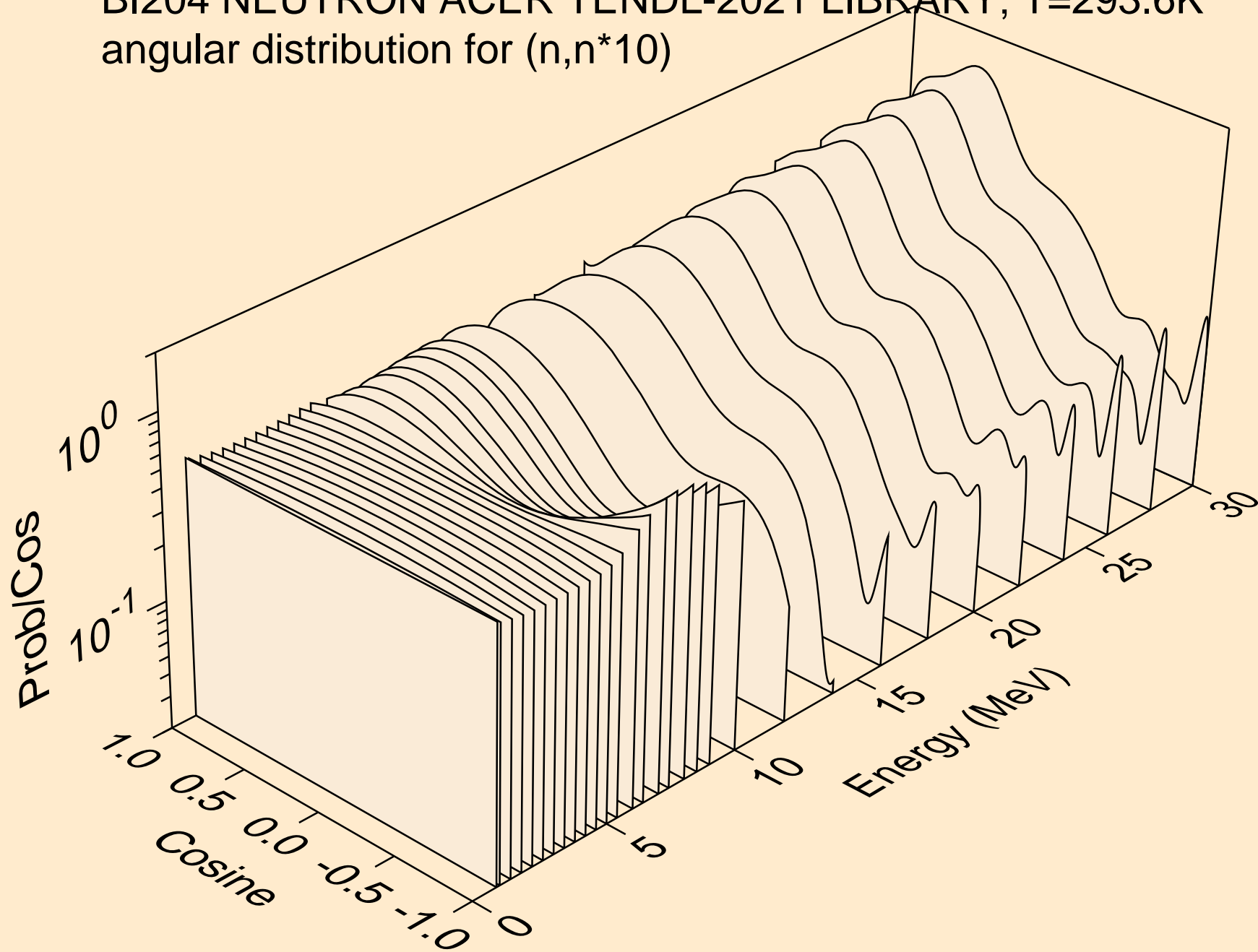

BI204 NEUTRON ACER TENDL-2021 LIBRARY; T=293.6K  
angular distribution for (n,n\*11)

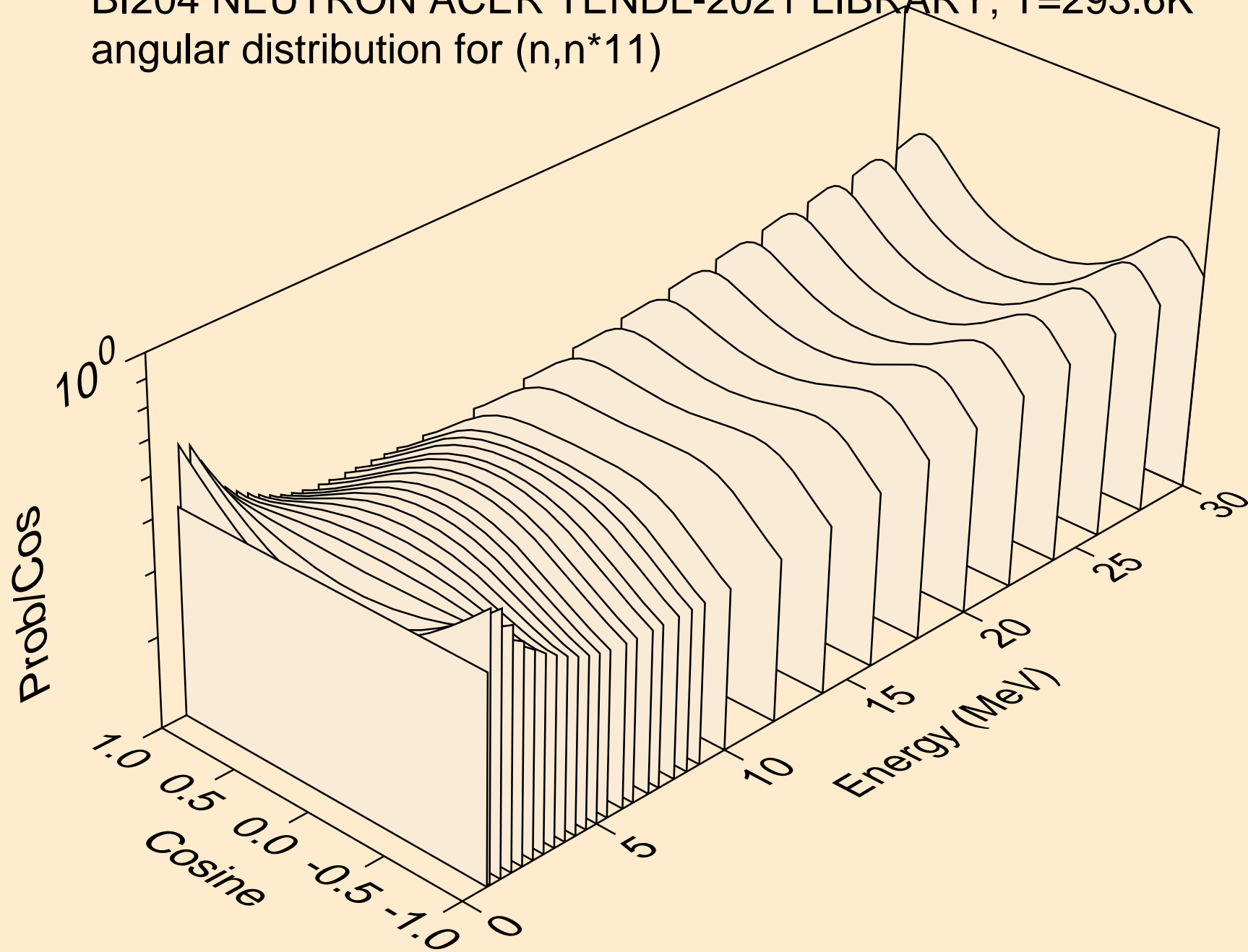

BI204 NEUTRON ACER TENDL-2021 LIBRARY; T=293.6K  
angular distribution for (n,n\*12)

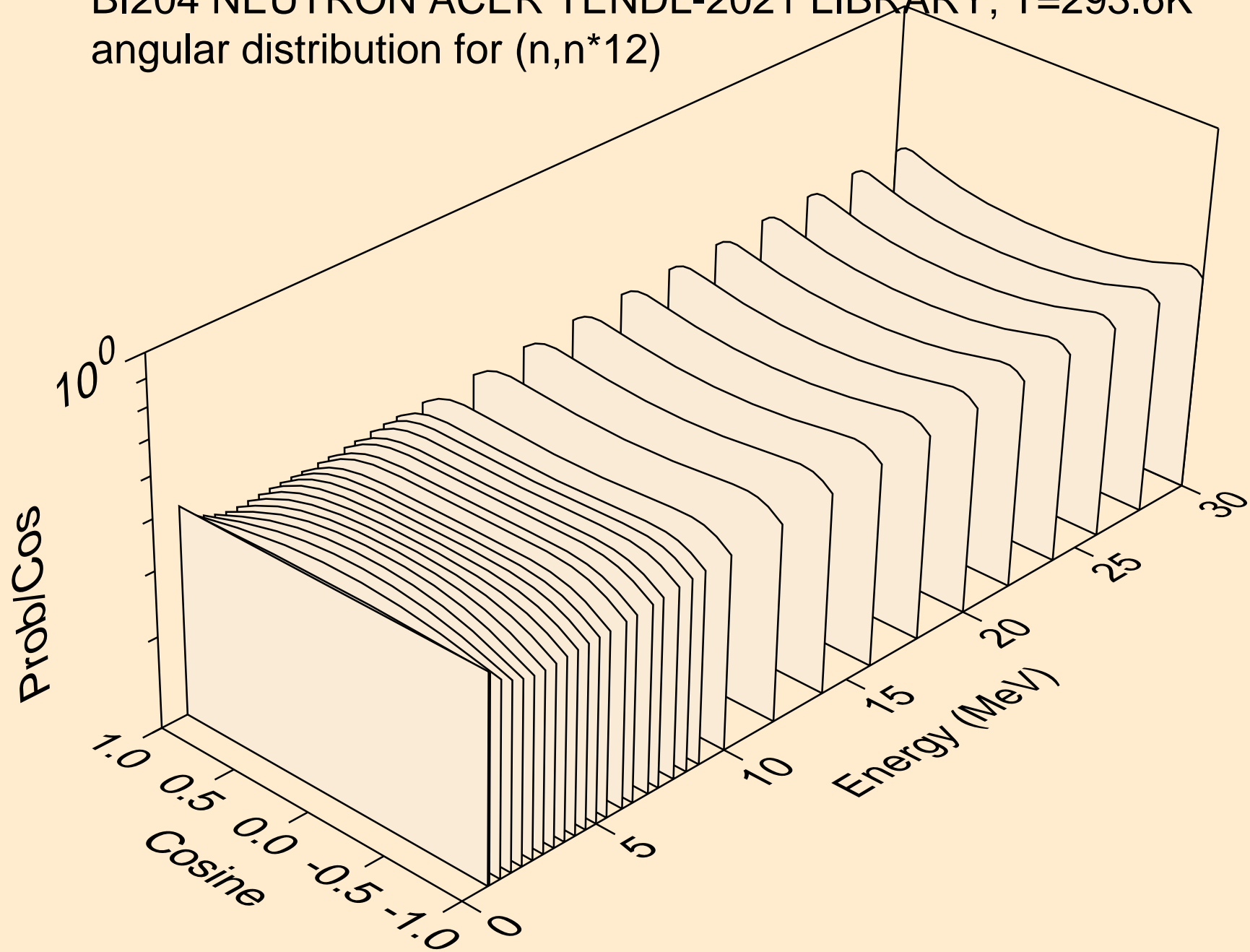

BI204 NEUTRON ACER TENDL-2021 LIBRARY; T=293.6K  
angular distribution for (n,n\*13)

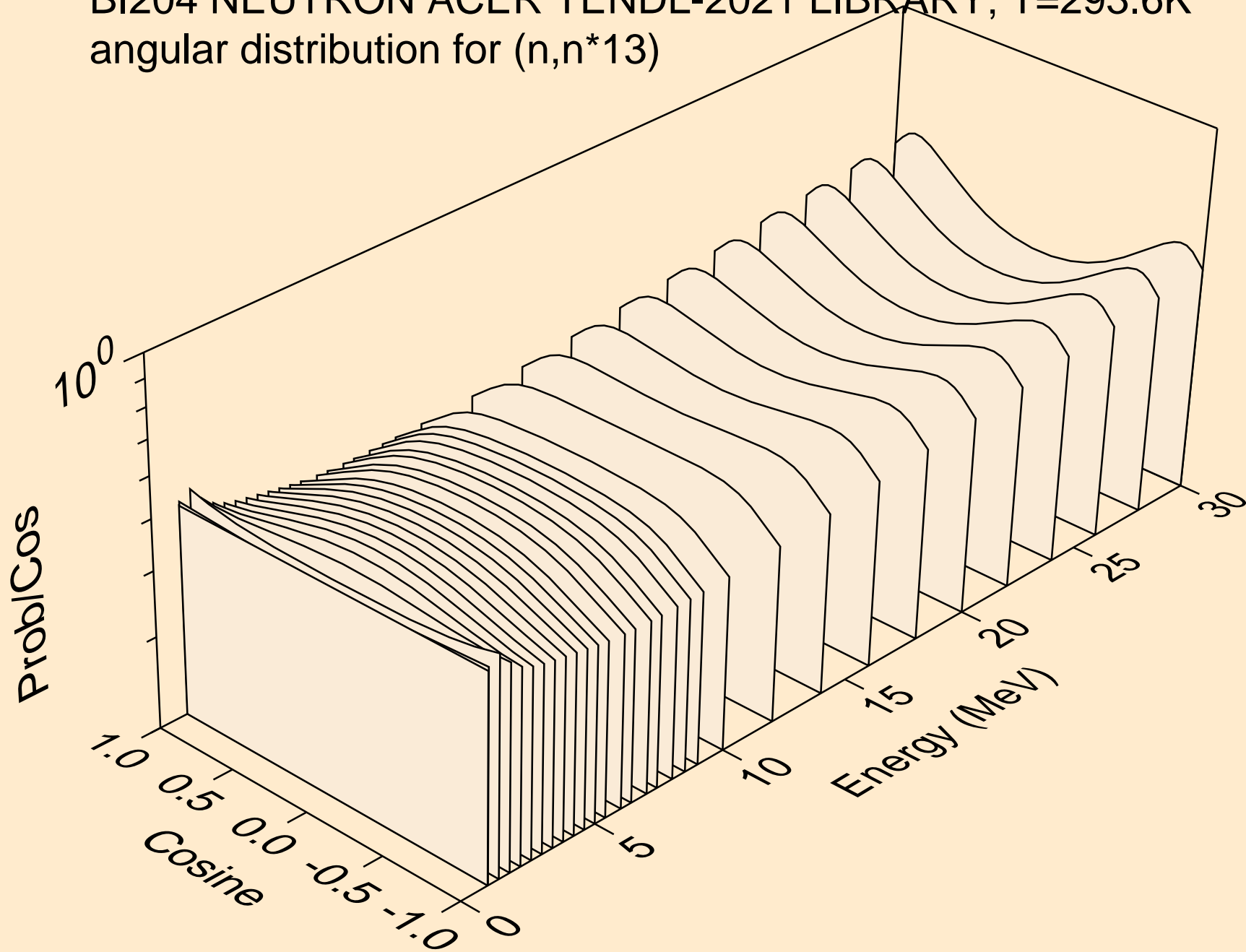

BI204 NEUTRON ACER TENDL-2021 LIBRARY; T=293.6K  
angular distribution for (n,n\*14)

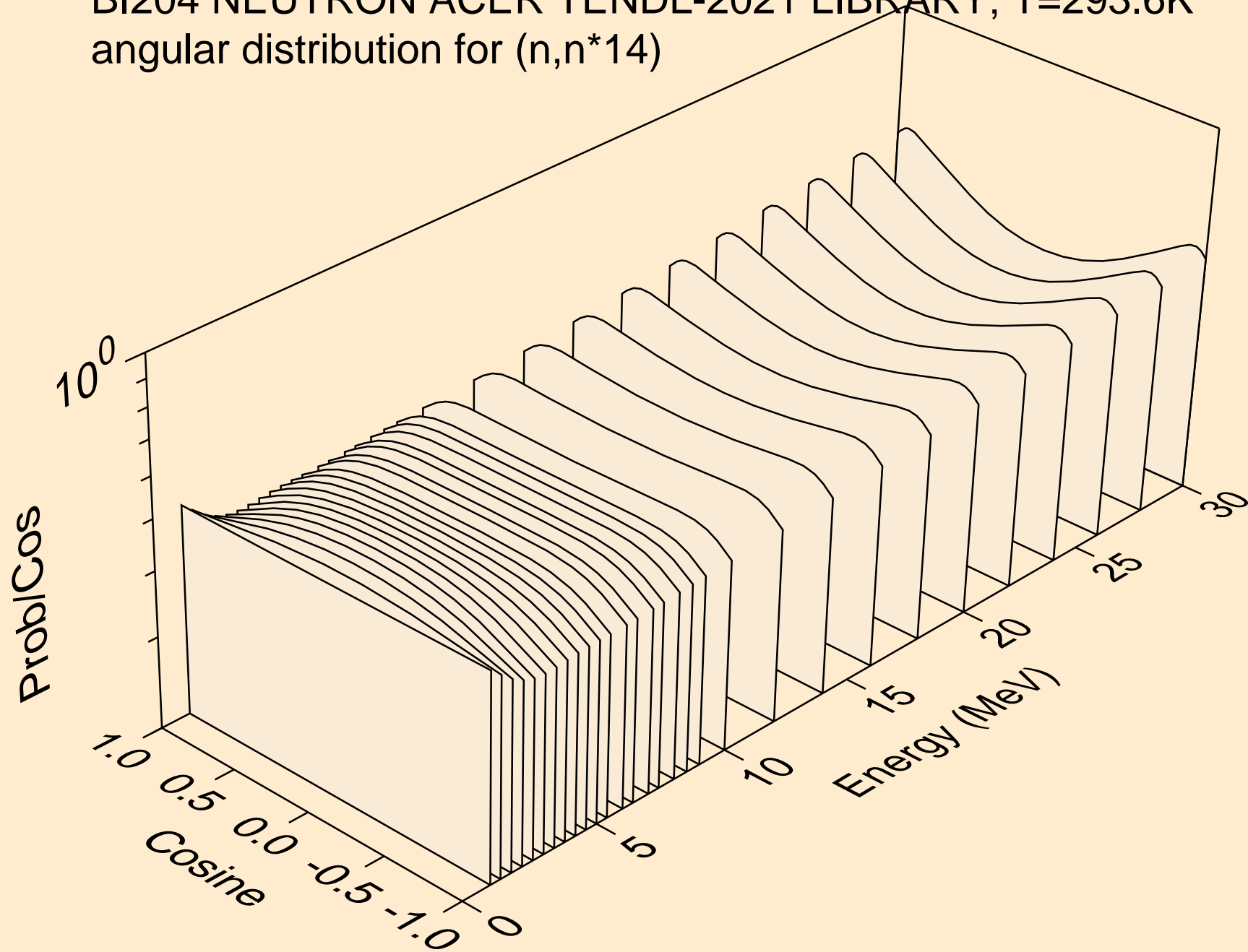

BI204 NEUTRON ACER TENDL-2021 LIBRARY; T=293.6K  
angular distribution for (n,n\*15)

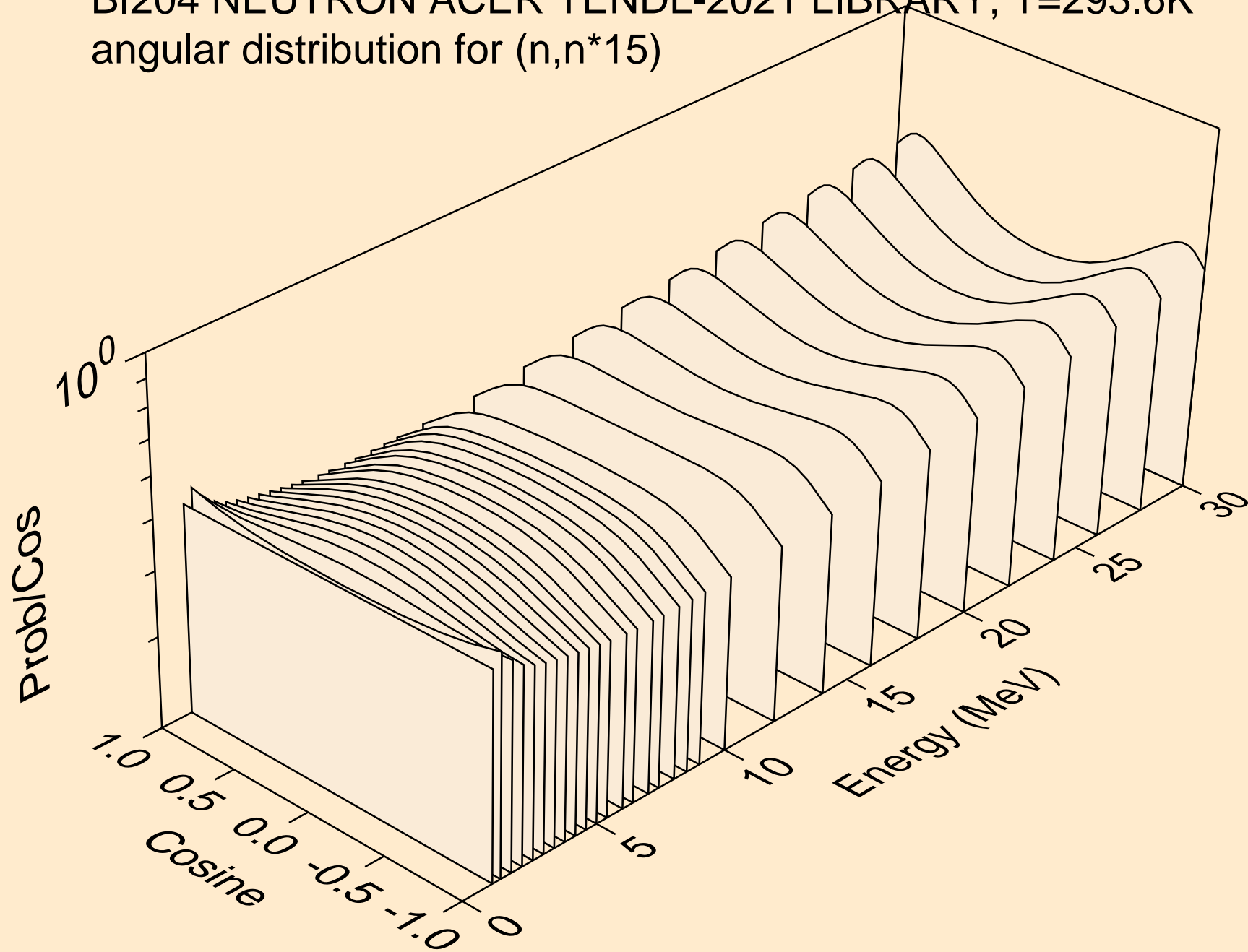

BI204 NEUTRON ACER TENDL-2021 LIBRARY; T=293.6K  
angular distribution for (n,n\*16)

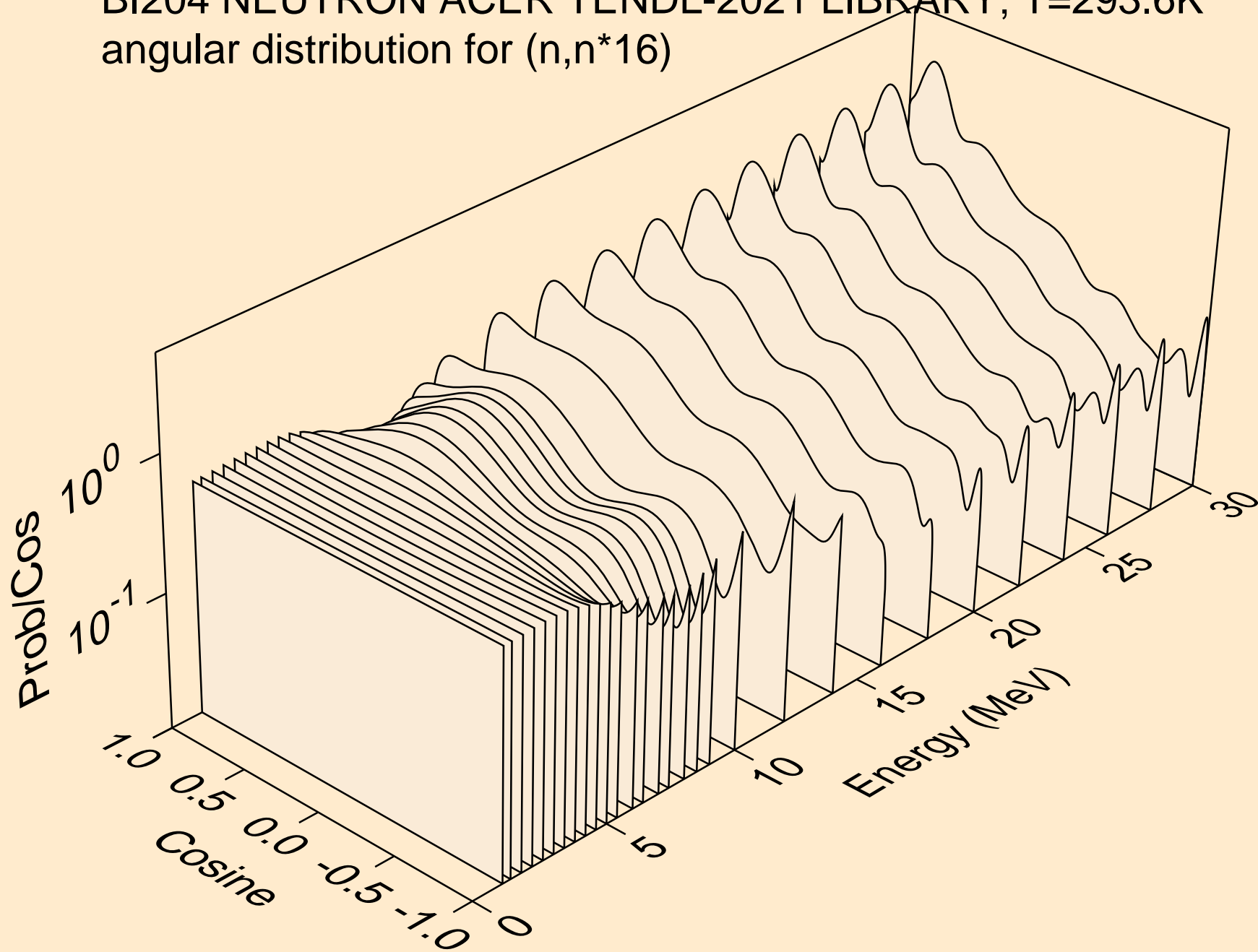

BI204 NEUTRON ACER TENDL-2021 LIBRARY; T=293.6K  
angular distribution for (n,n\*17)

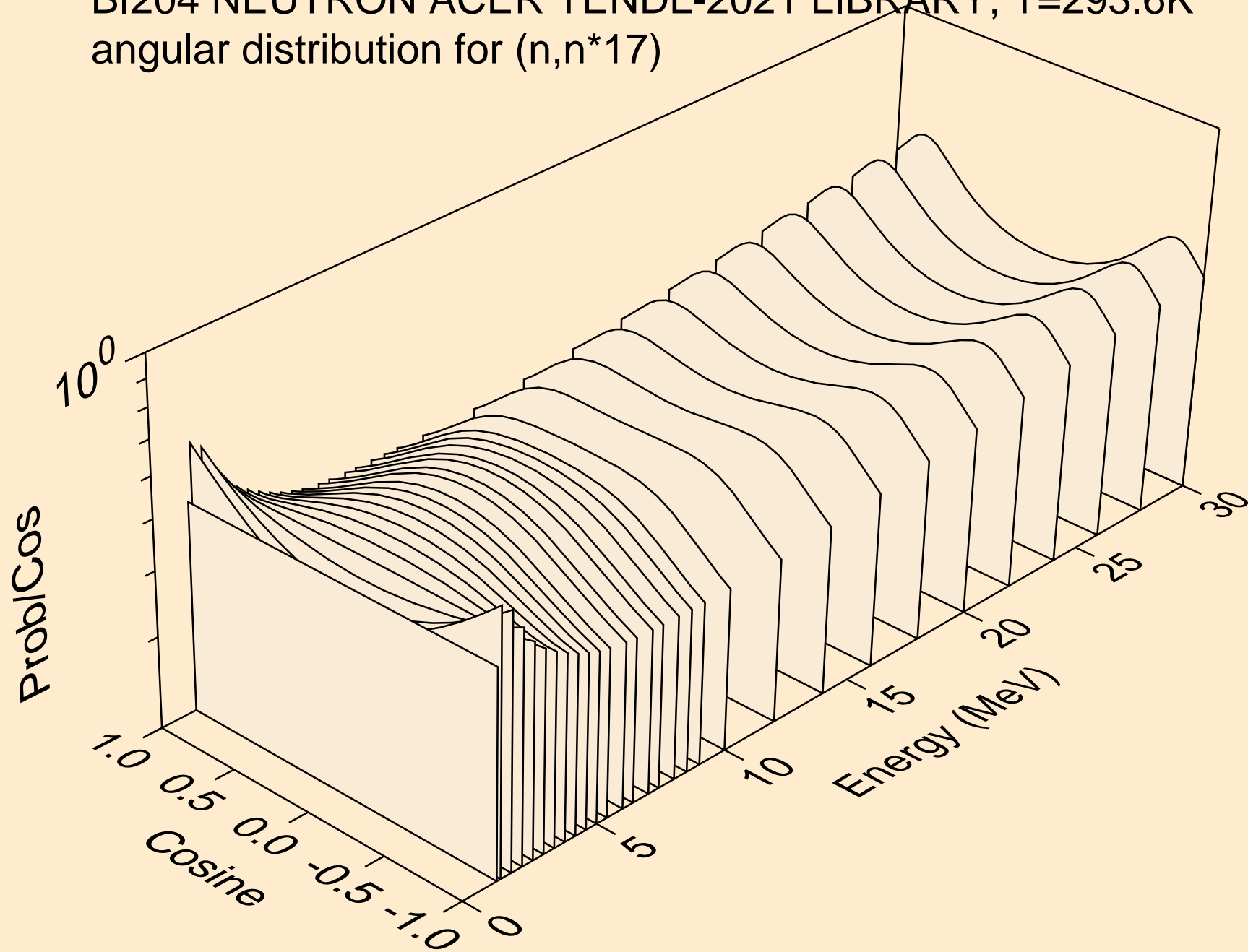



BI204 NEUTRON ACER TENDL-2021 LIBRARY; T=293.6K  
angular distribution for (n,n\*18)

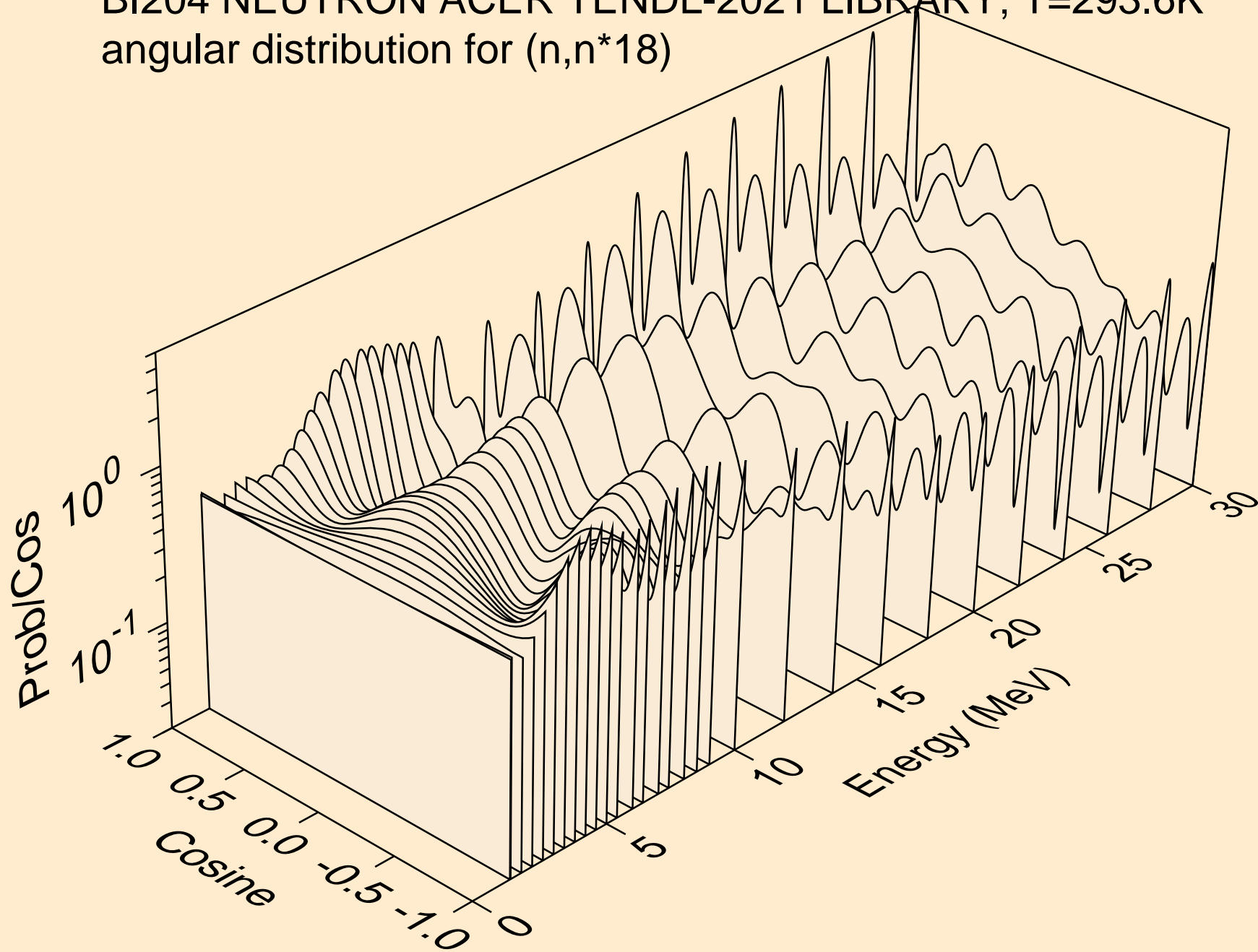

BI204 NEUTRON ACER TENDL-2021 LIBRARY; T=293.6K  
angular distribution for (n,n\*19)

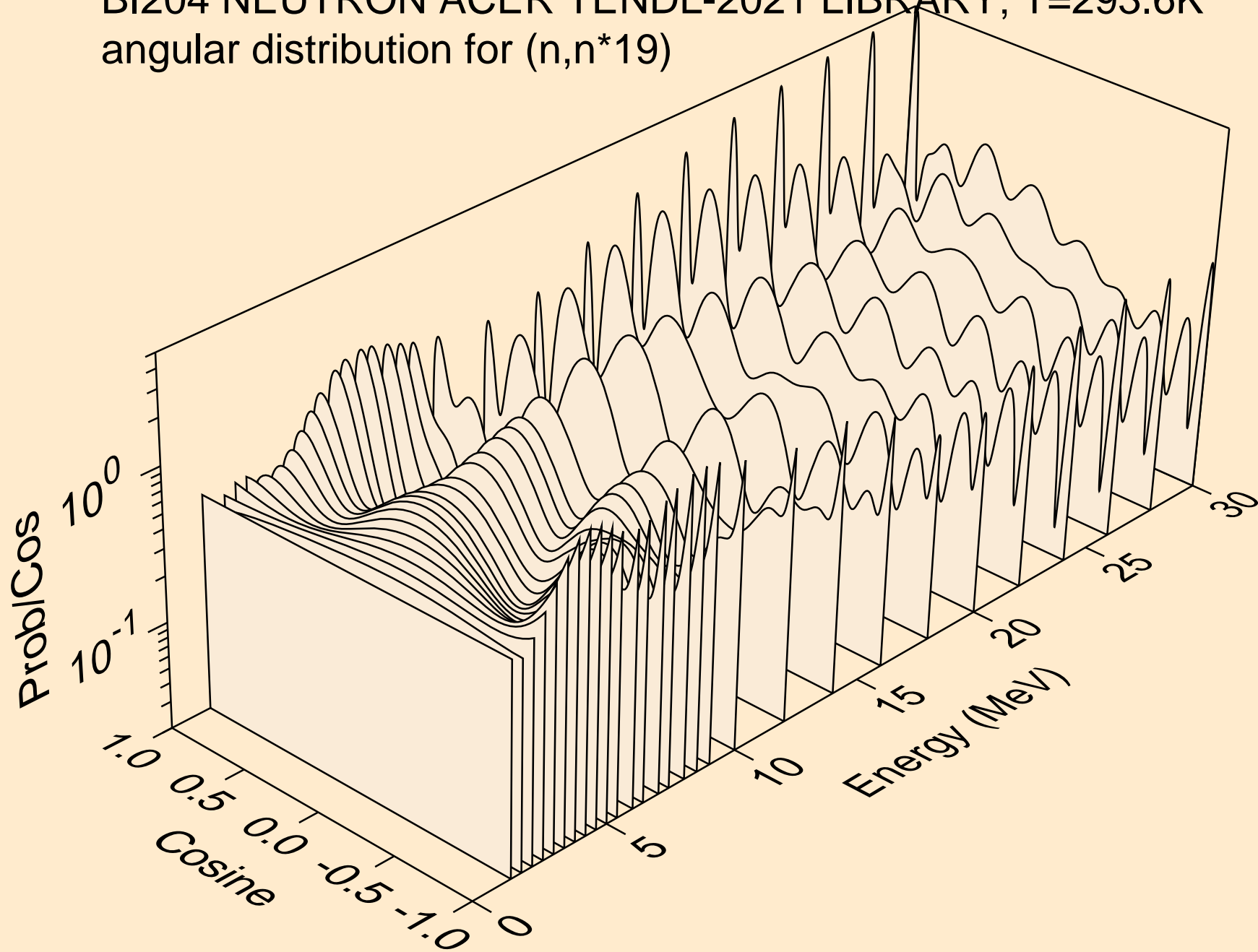

BI204 NEUTRON ACER TENDL-2021 LIBRARY; T=293.6K  
angular distribution for (n,n\*20)

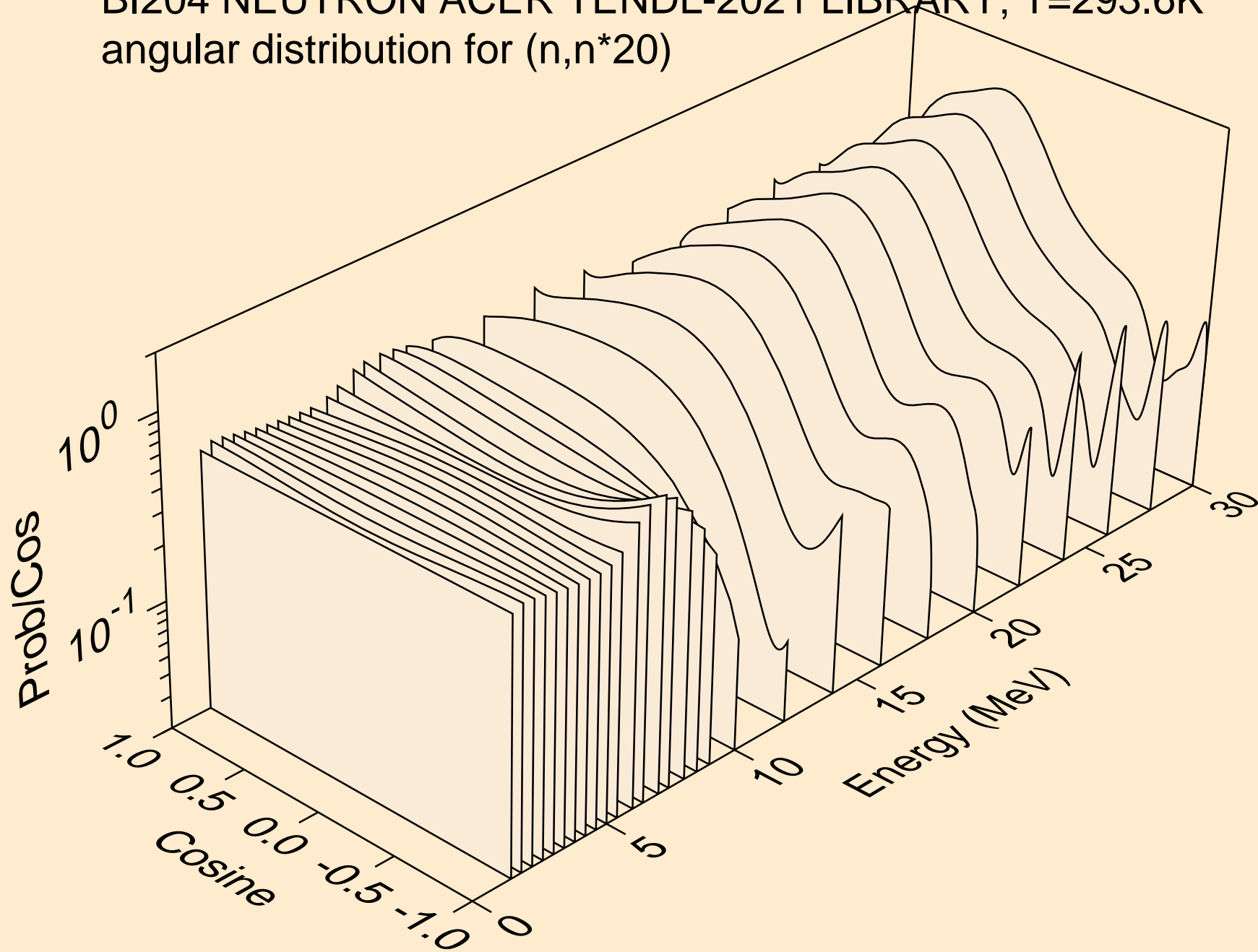

BI204 NEUTRON ACER TENDL-2021 LIBRARY; T=293.6K  
angular distribution for (n,n\*21)

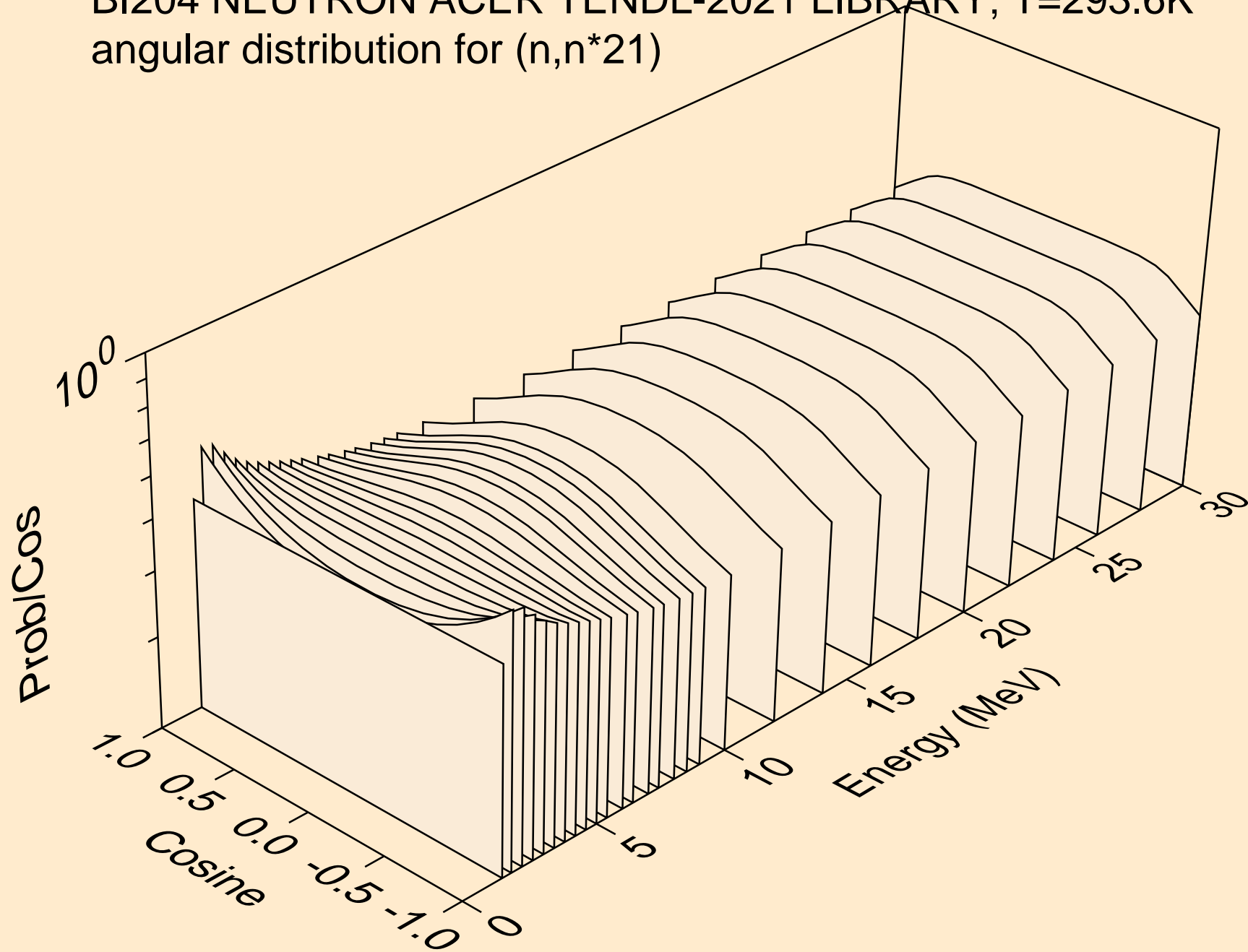

BI204 NEUTRON ACER TENDL-2021 LIBRARY; T=293.6K  
angular distribution for (n,n\*22)

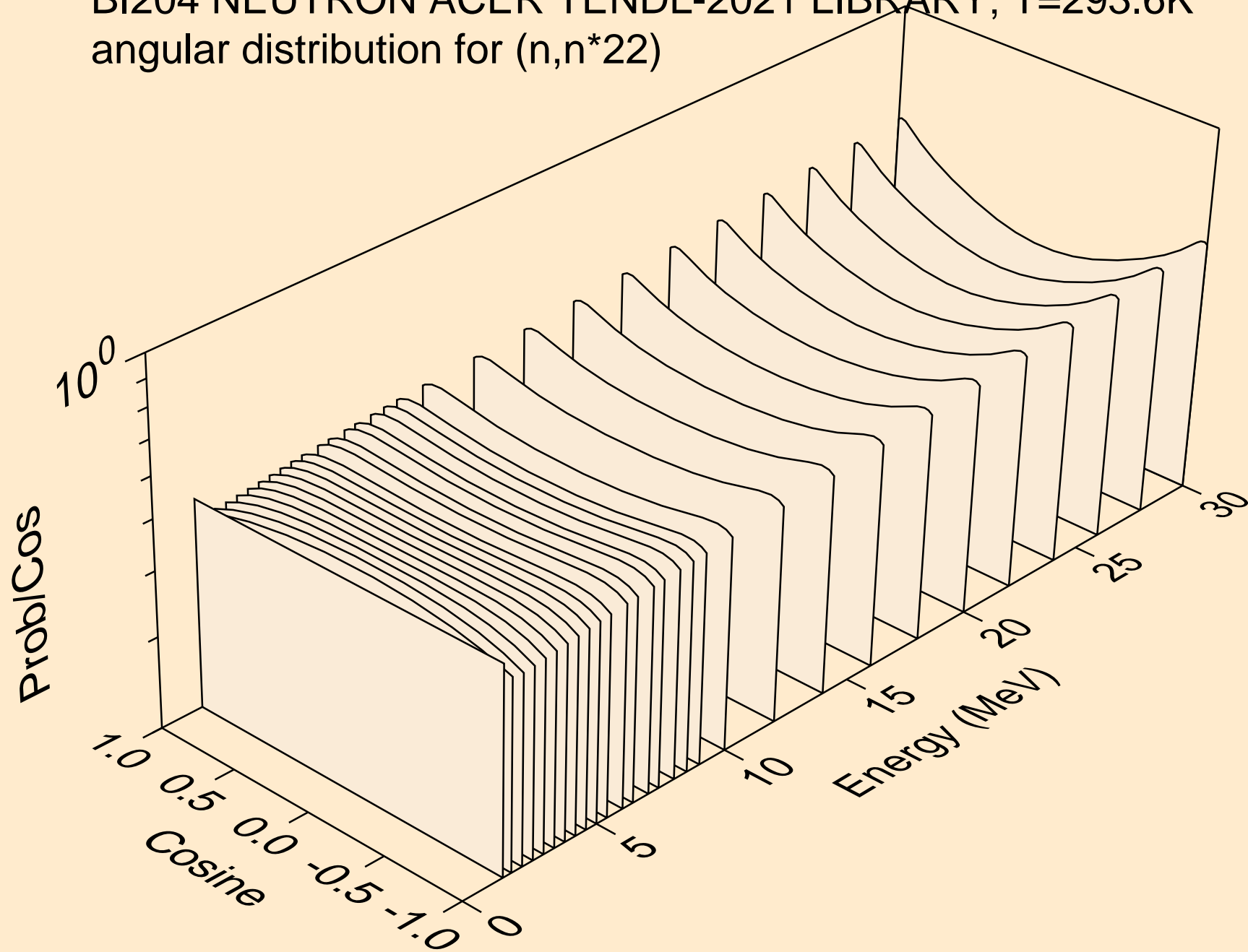

BI204 NEUTRON ACER TENDL-2021 LIBRARY; T=293.6K  
angular distribution for (n,n\*23)

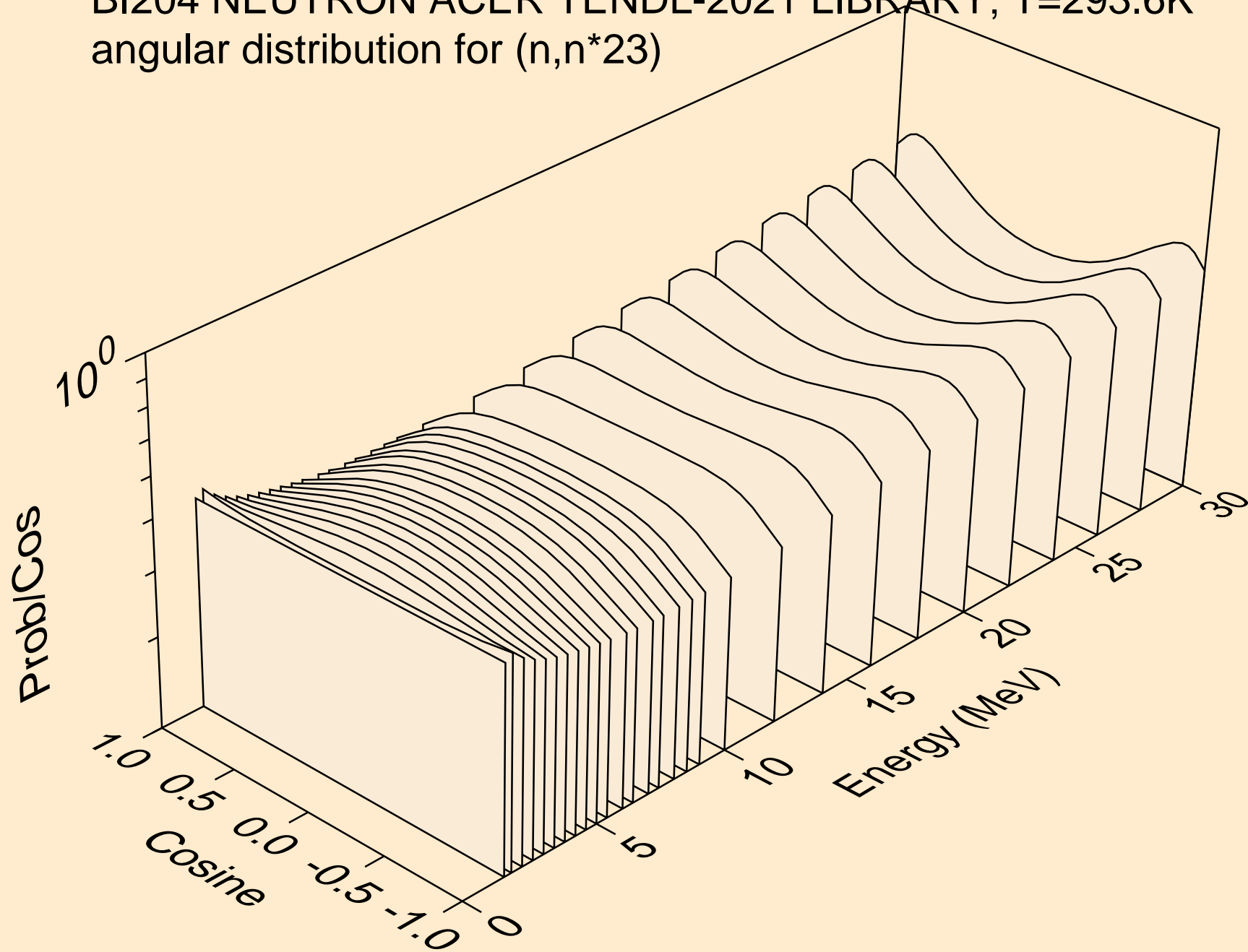

BI204 NEUTRON ACER TENDL-2021 LIBRARY; T=293.6K  
angular distribution for (n,n\*24)

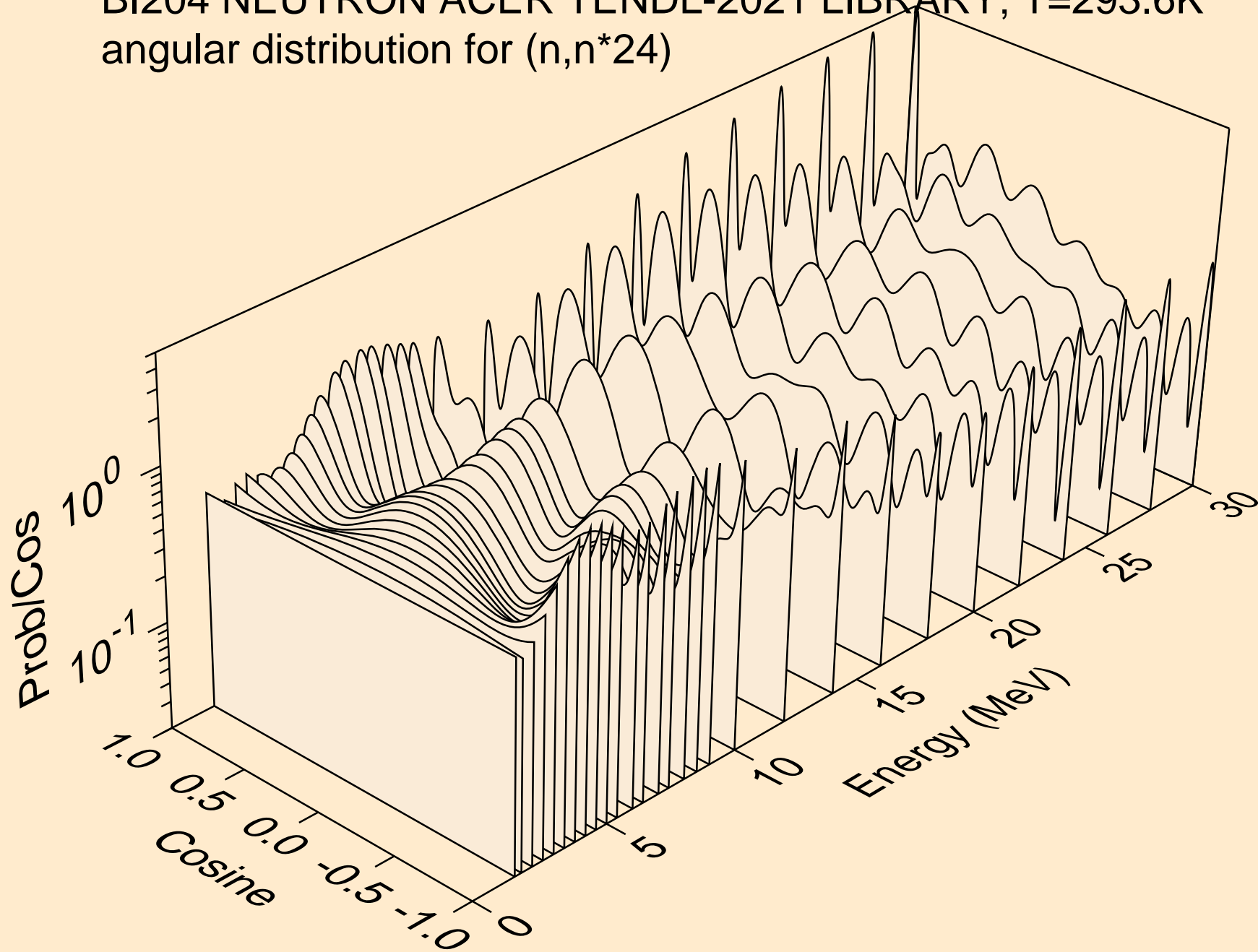

BI204 NEUTRON ACER TENDL-2021 LIBRARY; T=293.6K  
angular distribution for (n,n\*25)

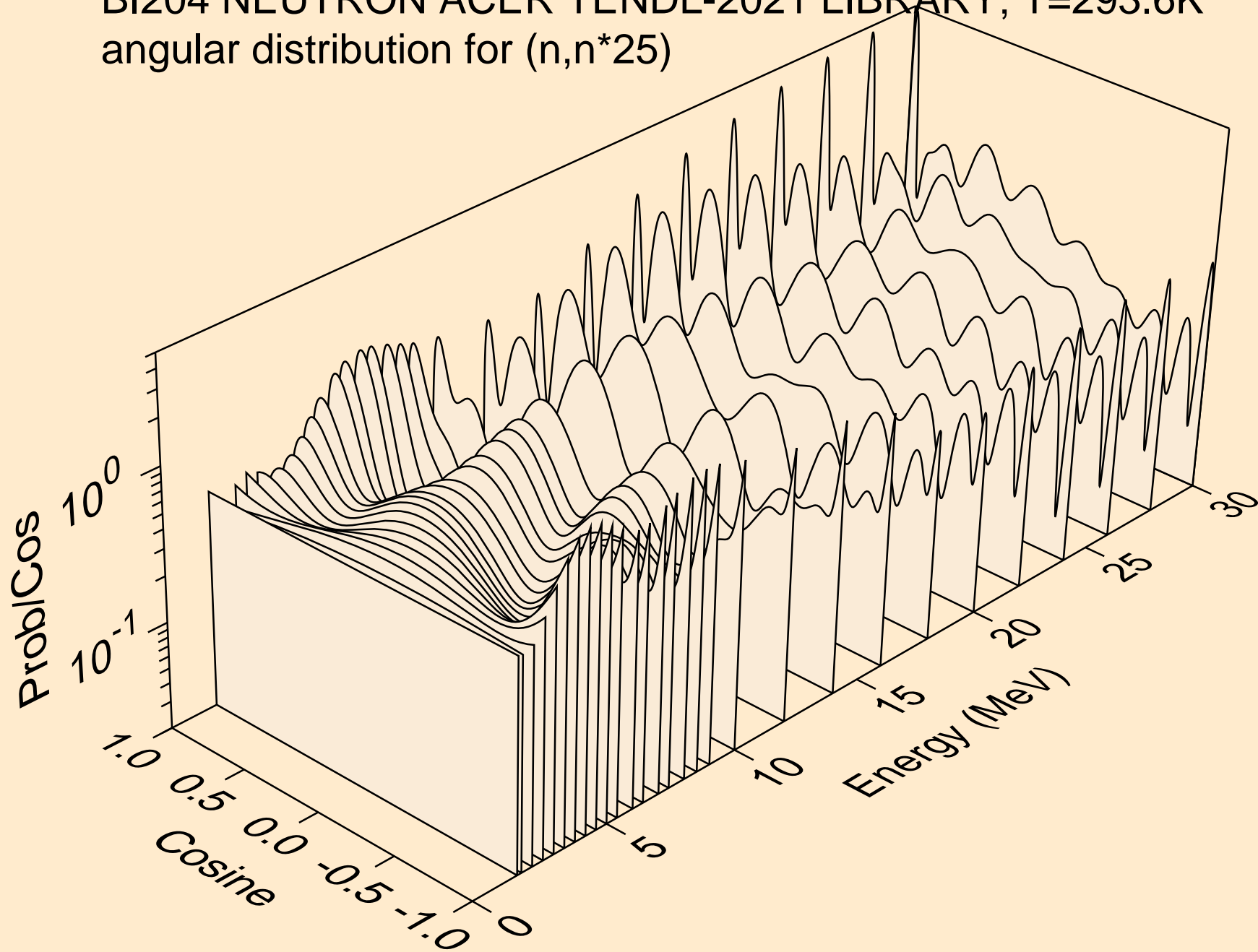



BI204 NEUTRON ACER TENDL-2021 LIBRARY; T=293.6K  
angular distribution for (n,n\*26)

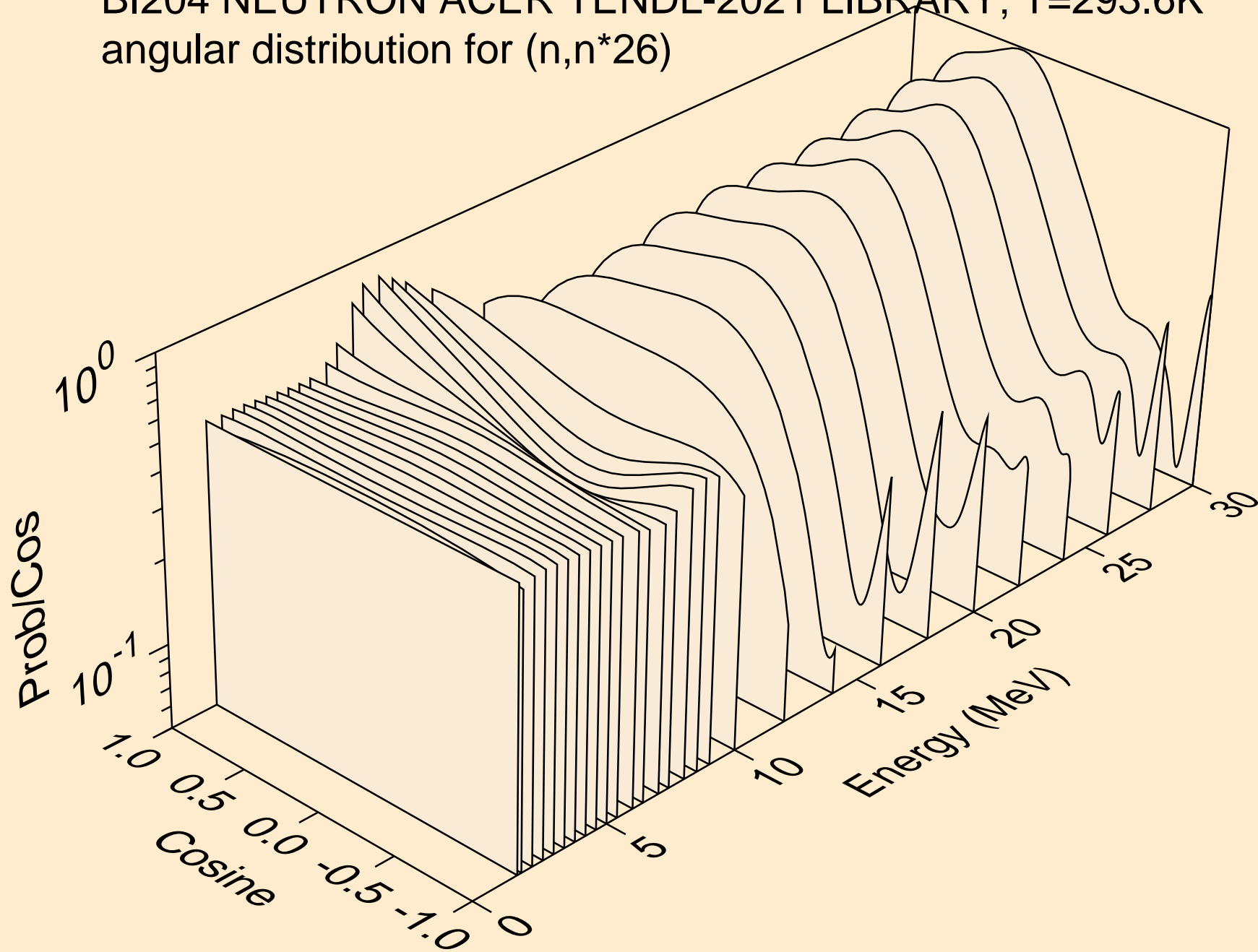

BI204 NEUTRON ACER TENDL-2021 LIBRARY; T=293.6K  
angular distribution for (n,n\*27)

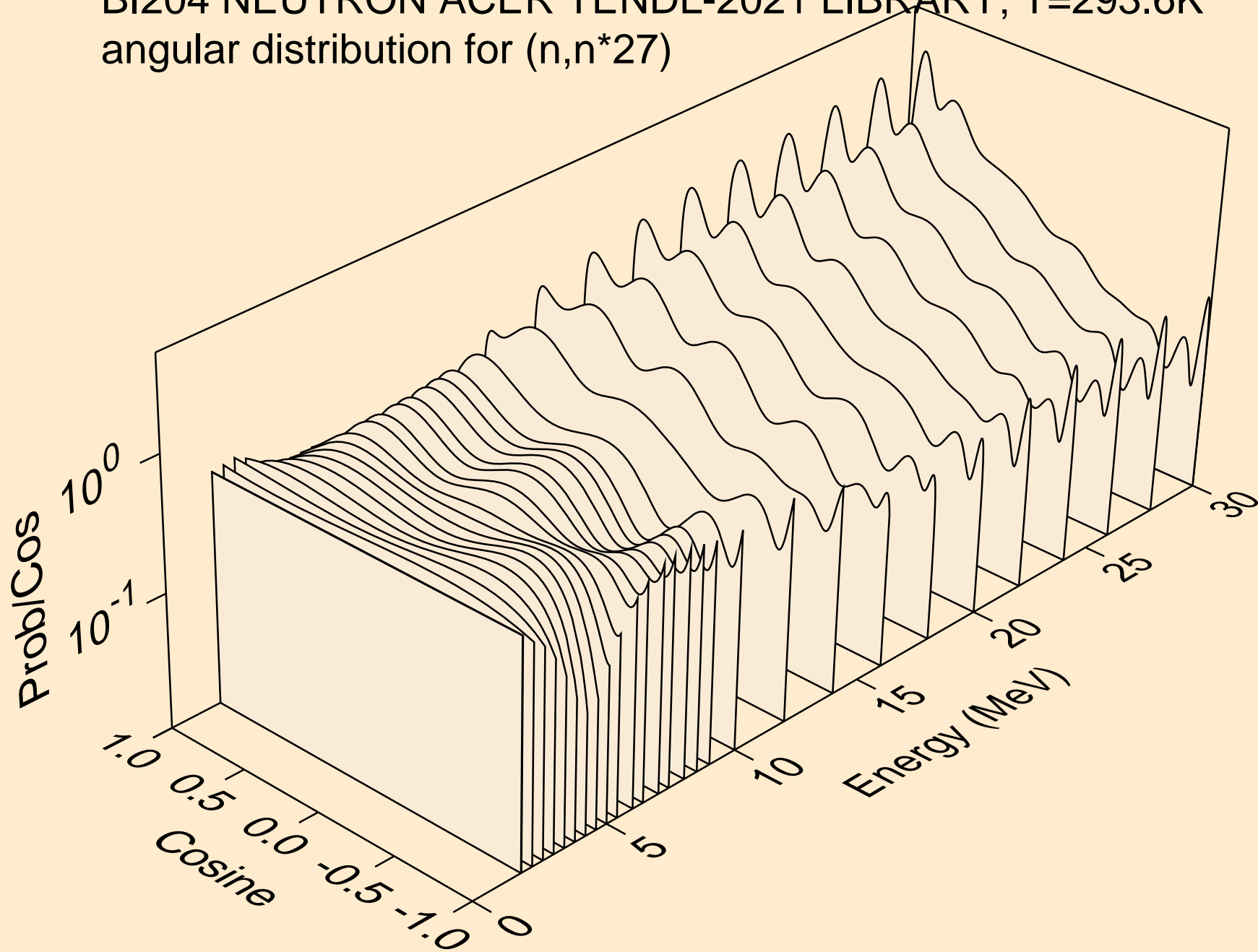

BI204 NEUTRON ACER TENDL-2021 LIBRARY; T=293.6K  
angular distribution for (n,n\*28)

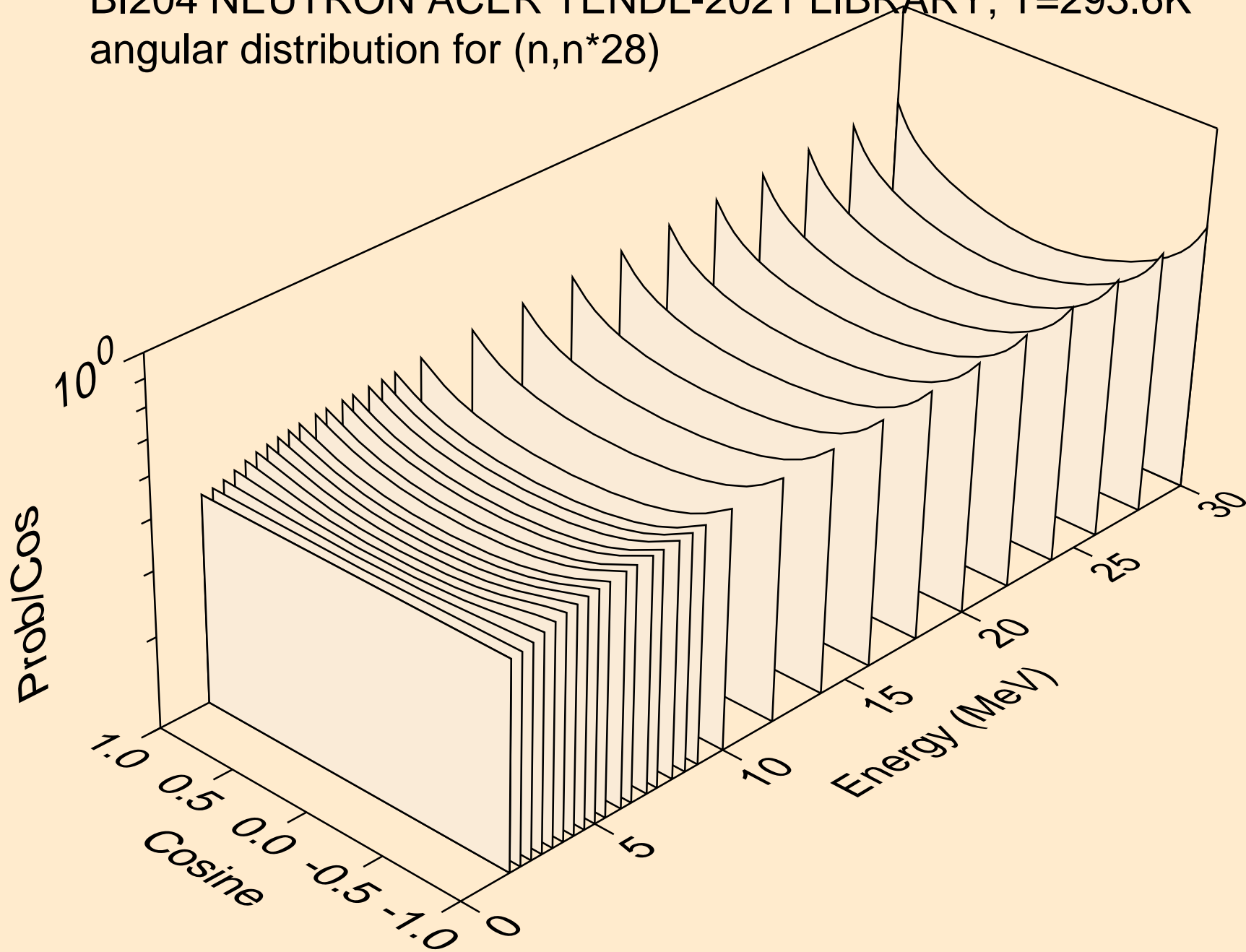

BI204 NEUTRON ACER TENDL-2021 LIBRARY; T=293.6K  
Neutron emission for (n,x)

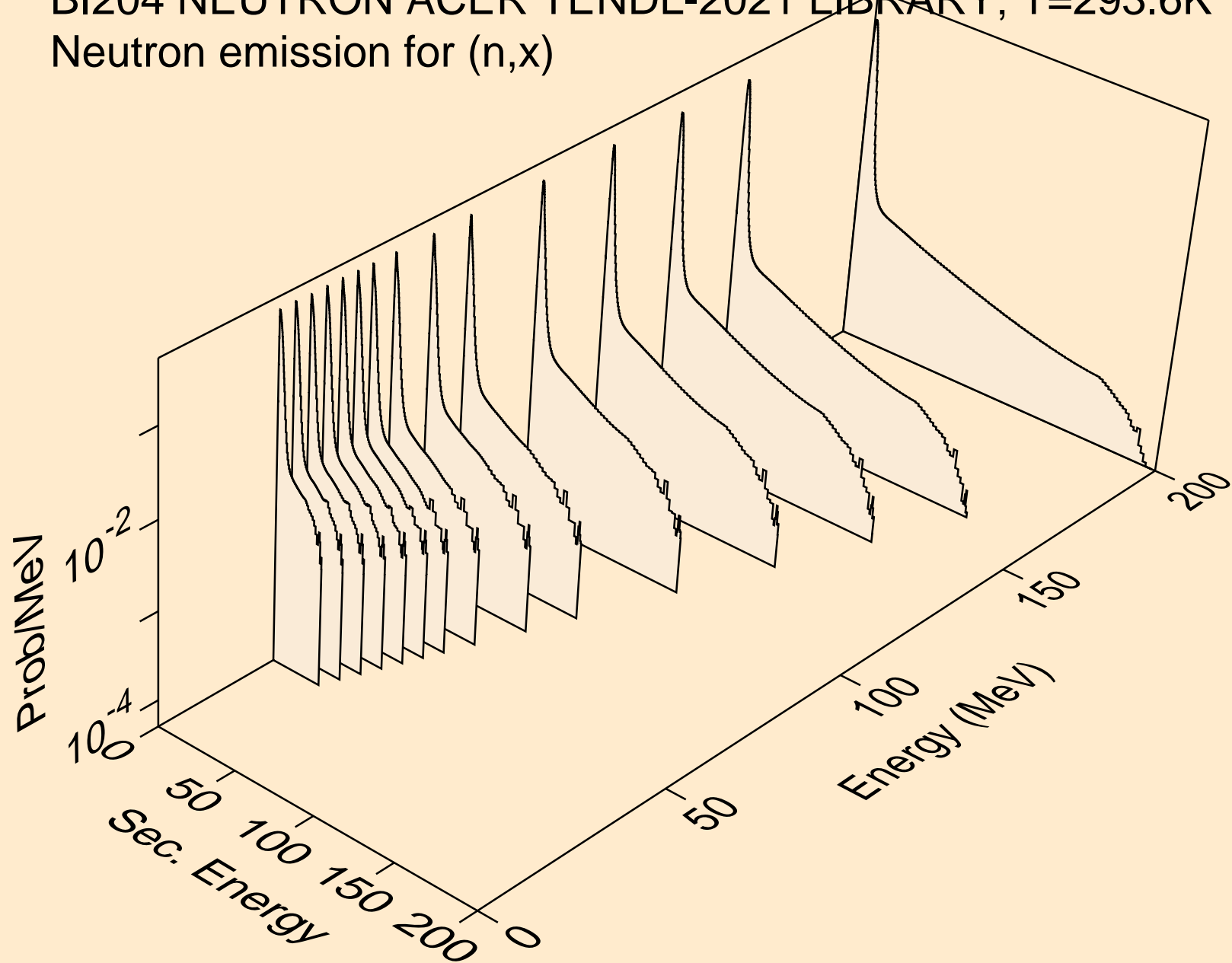

BI204 NEUTRON ACER TENDL-2021 LIBRARY; T=293.6K  
Neutron emission for (n,2nd)

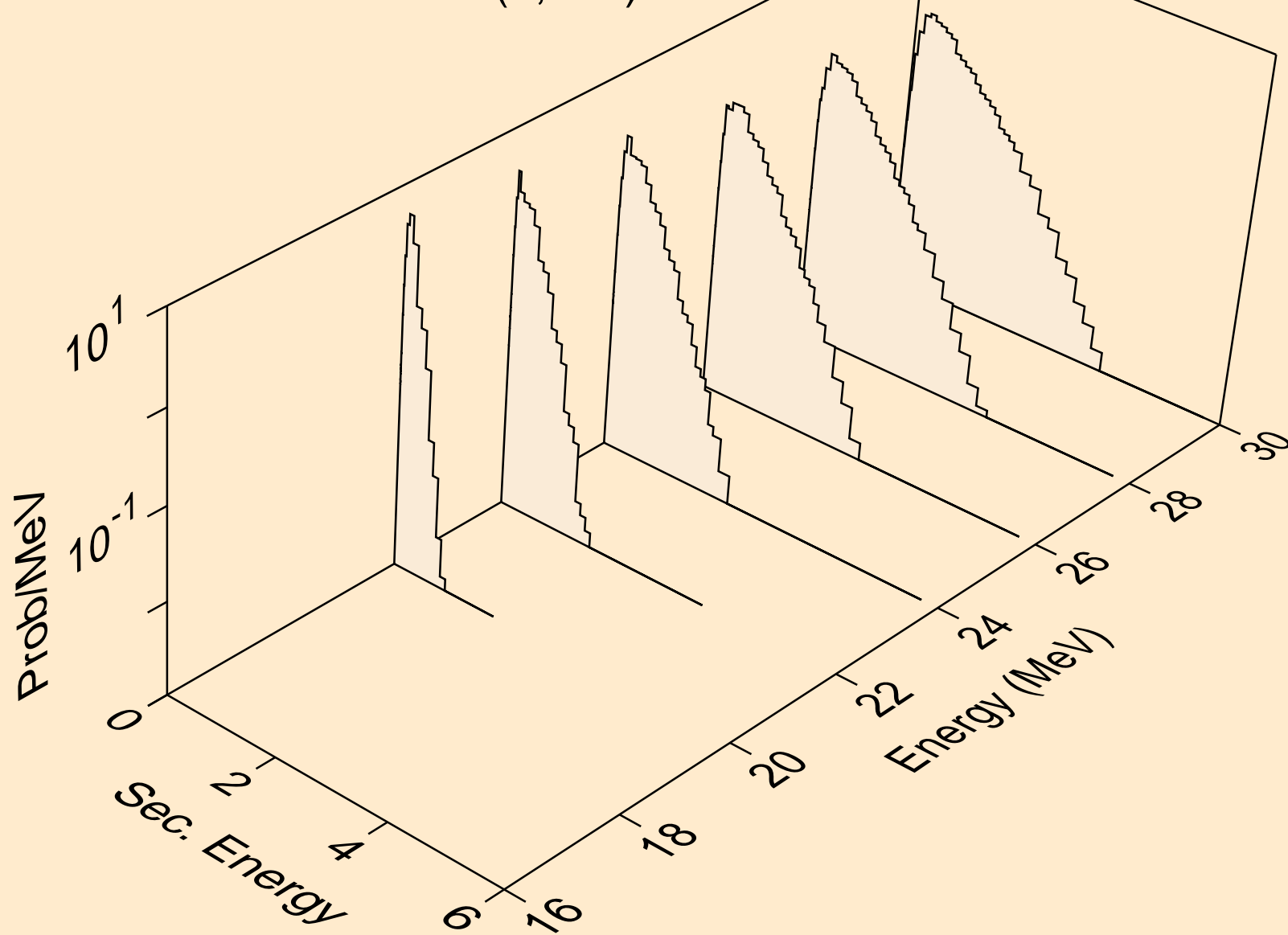

BI204 NEUTRON ACER TENDL-2021 LIBRARY; T=293.6K  
Neutron emission for (n,2n)

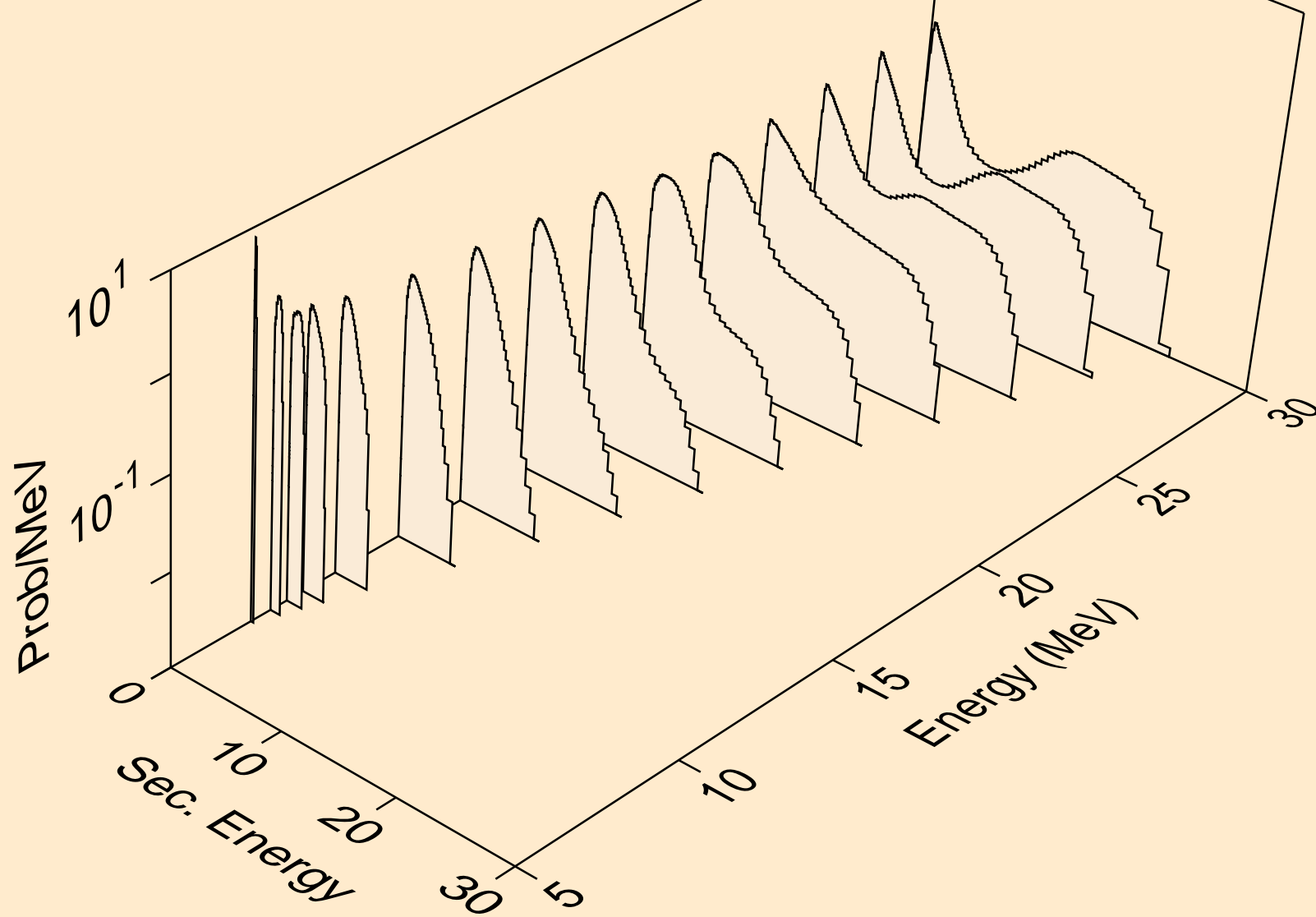

BI204 NEUTRON ACER TENDL-2021 LIBRARY; T=293.6K  
Neutron emission for (n,3n)

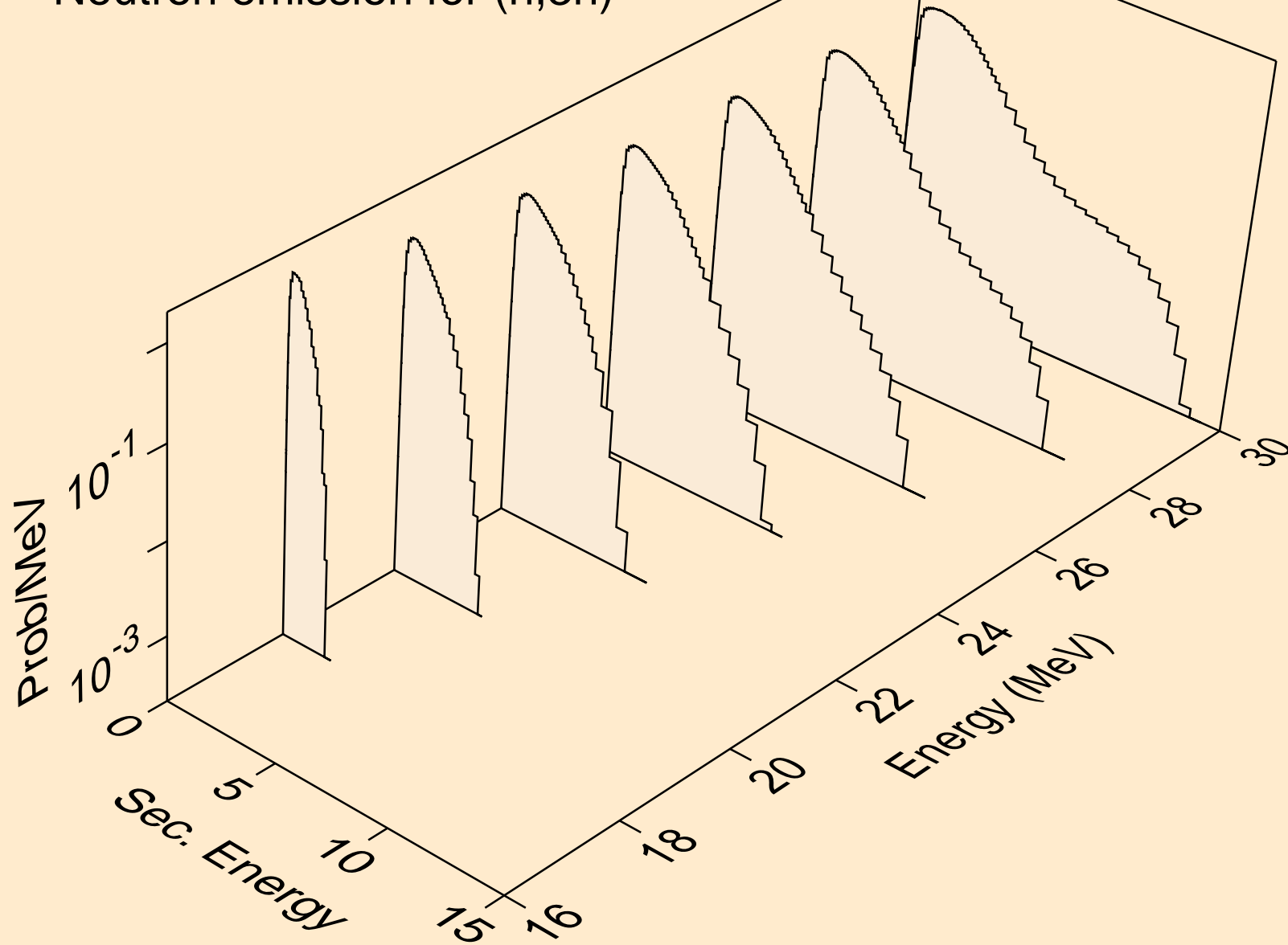

BI204 NEUTRON ACER TENDL-2021 LIBRARY; T=293.6K  
Neutron emission for (n,n\*)a

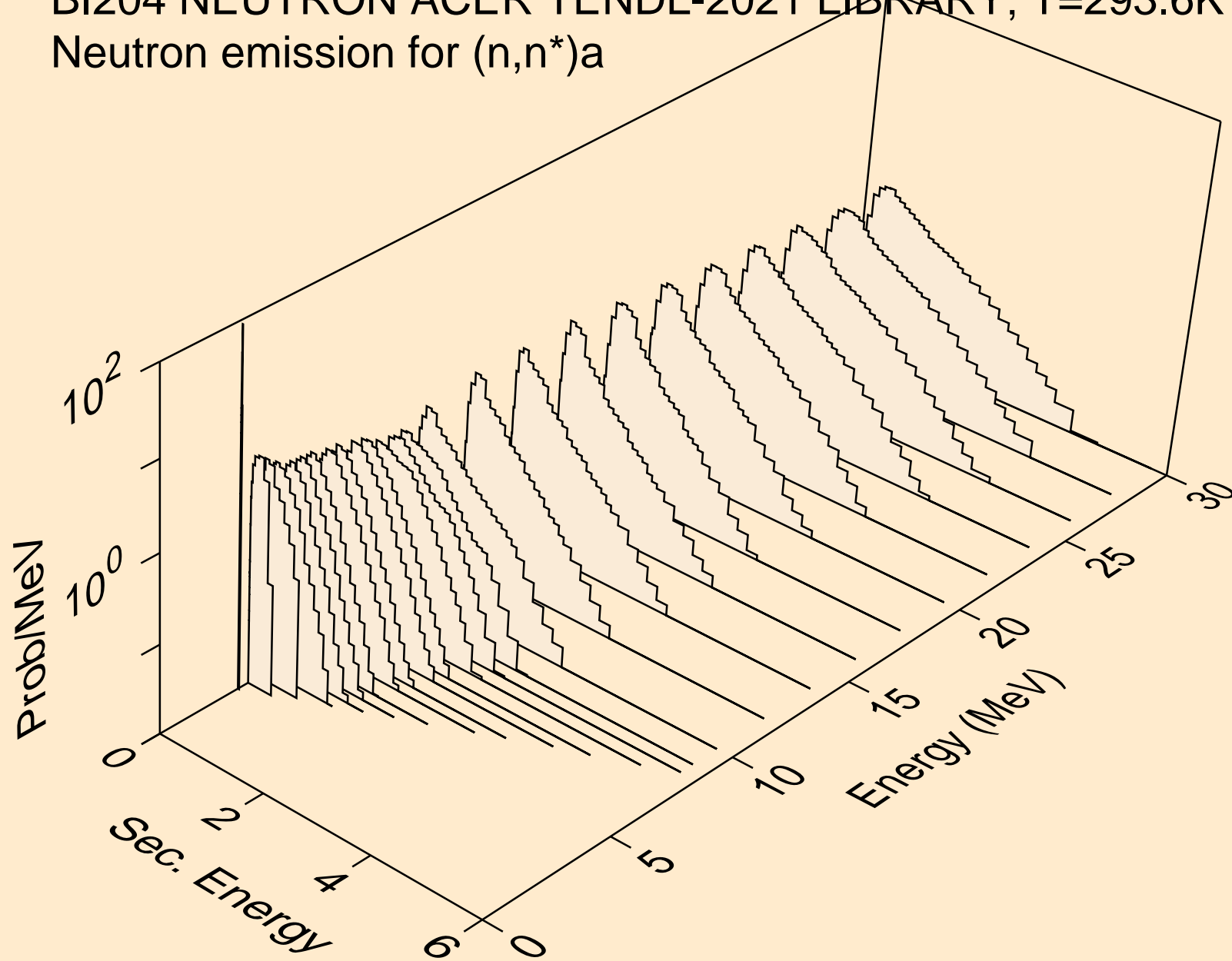



BI204 NEUTRON ACER TENDL-2021 LIBRARY; T=293.6K  
Neutron emission for (n,2n)a

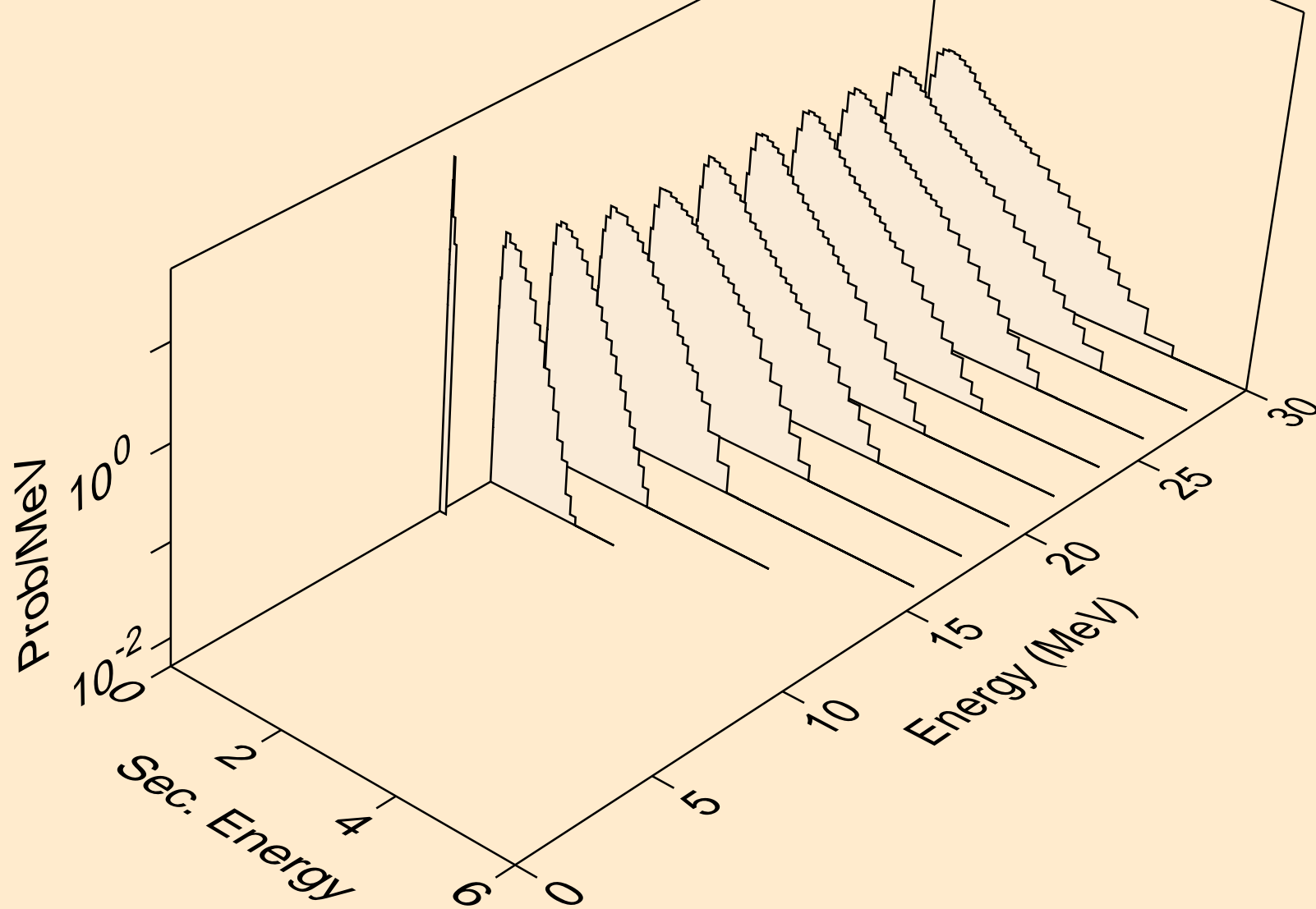

BI204 NEUTRON ACER TENDL-2021 LIBRARY; T=293.6K  
Neutron emission for (n,3n)a

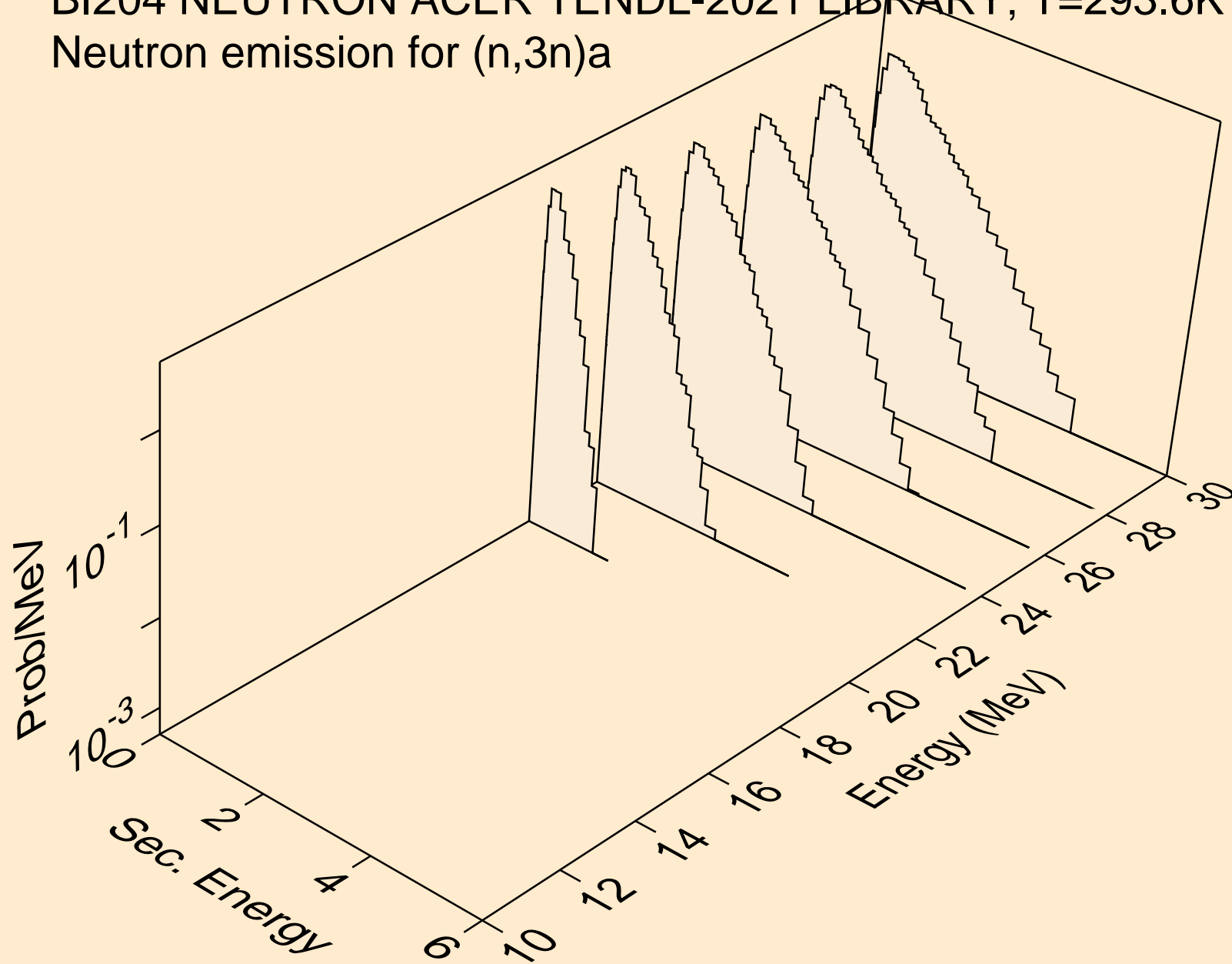

BI204 NEUTRON ACER TENDL-2021 LIBRARY; T=293.6K  
Neutron emission for (n,n\*)p

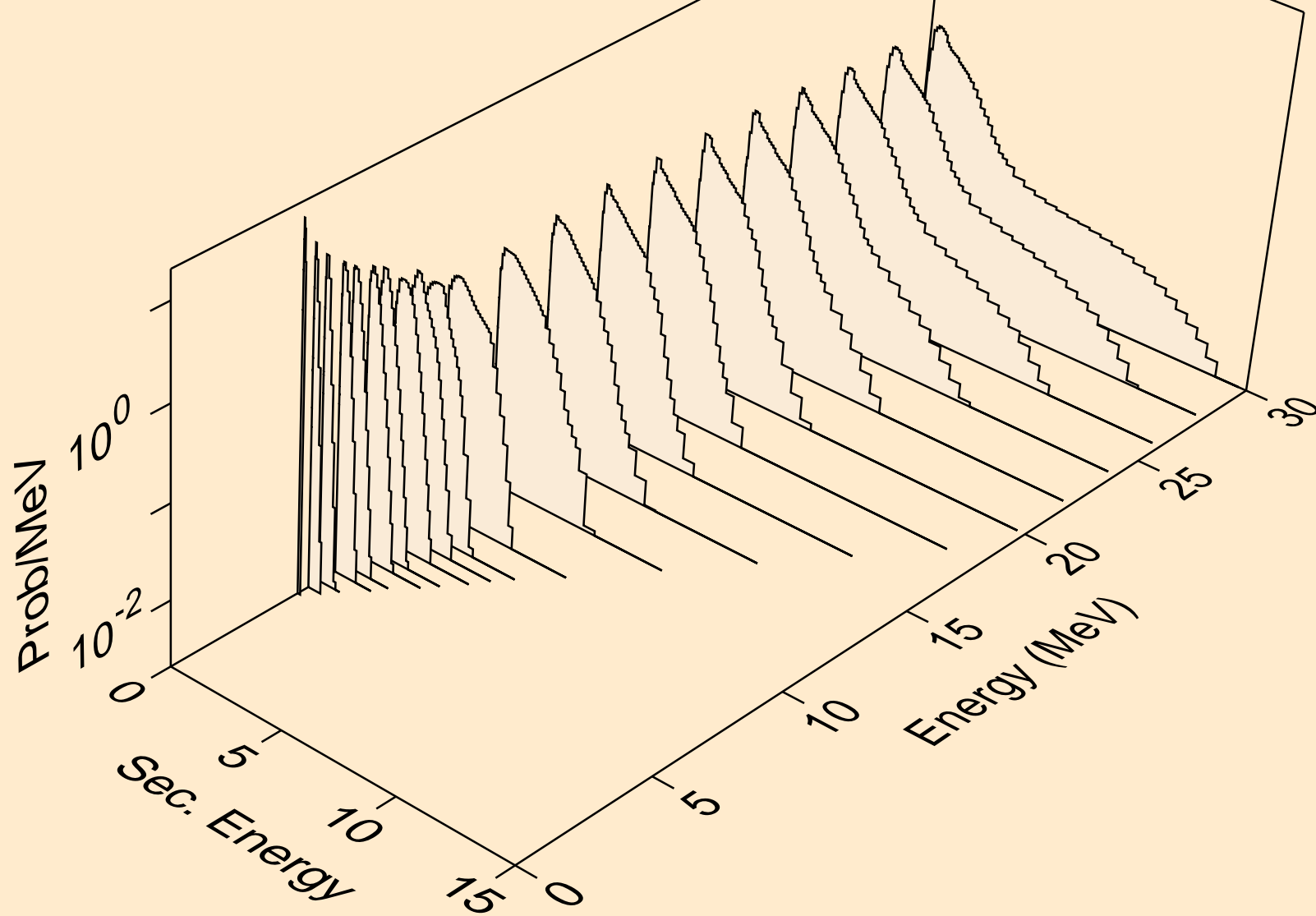

BI204 NEUTRON ACER TENDL-2021 LIBRARY; T=293.6K  
Neutron emission for (n,n\*)2a

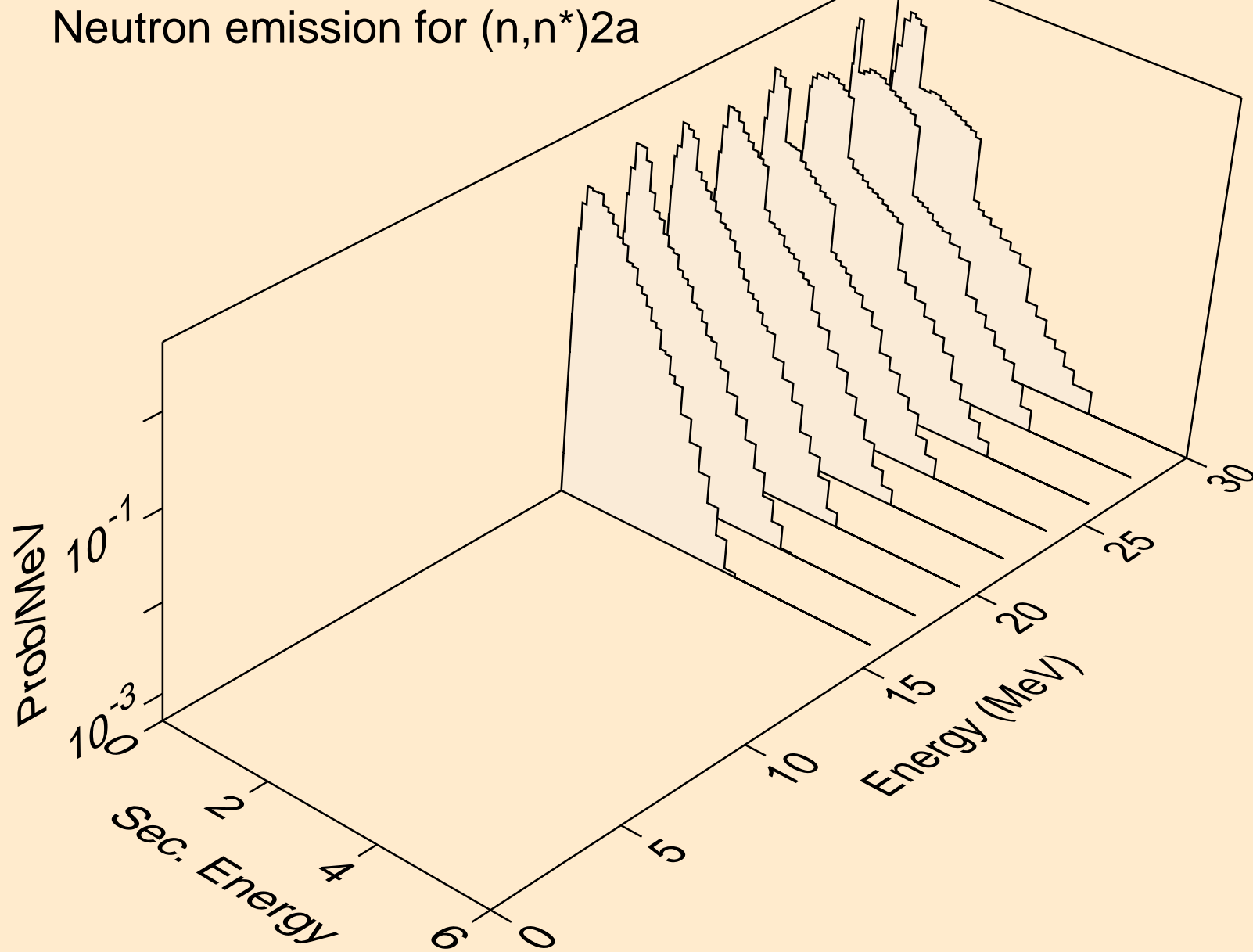

BI204 NEUTRON ACER TENDL-2021 LIBRARY; T=293.6K  
Neutron emission for (n,n\*)d

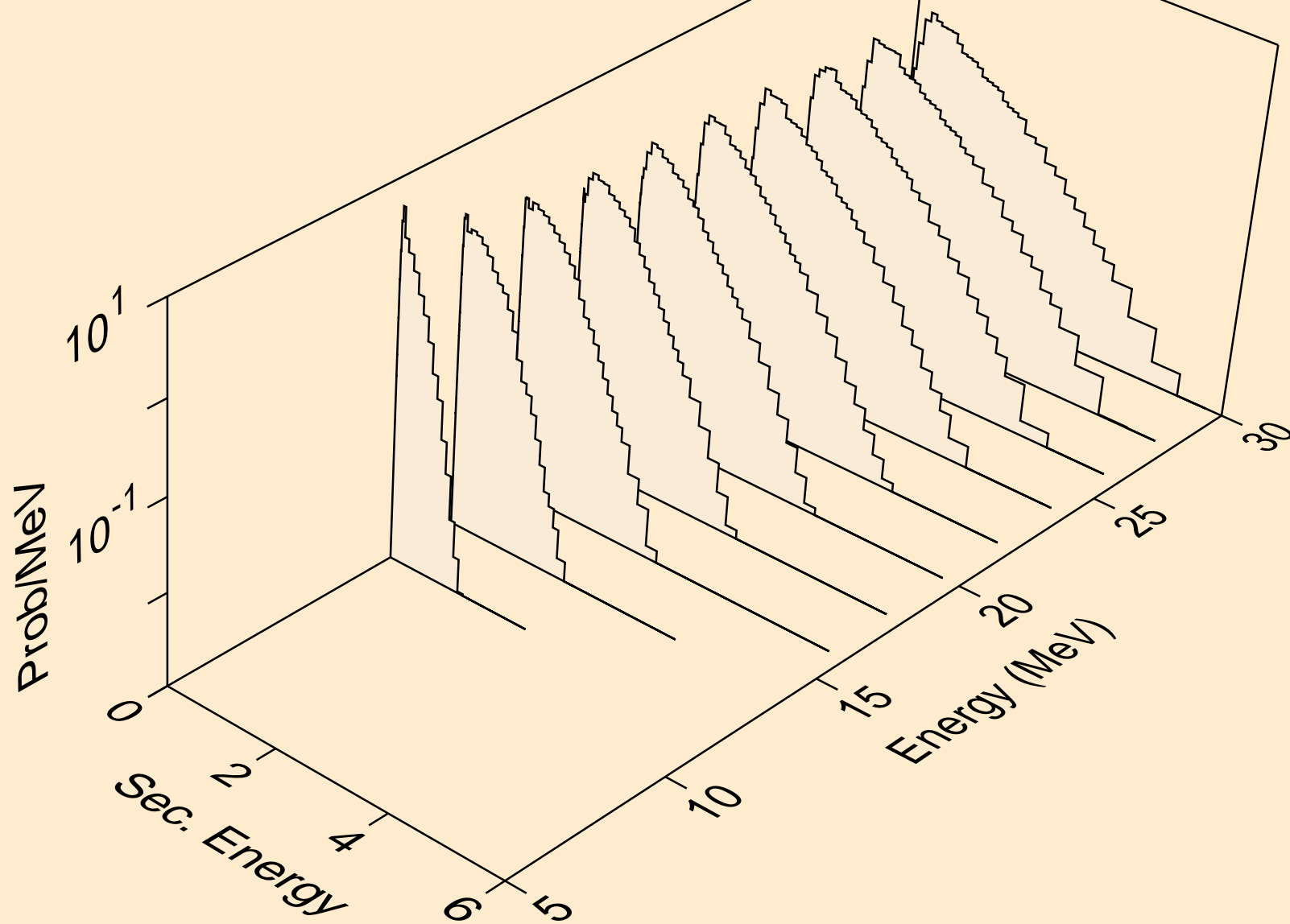

BI204 NEUTRON ACER TENDL-2021 LIBRARY; T=293.6K  
Neutron emission for (n,n\*)t

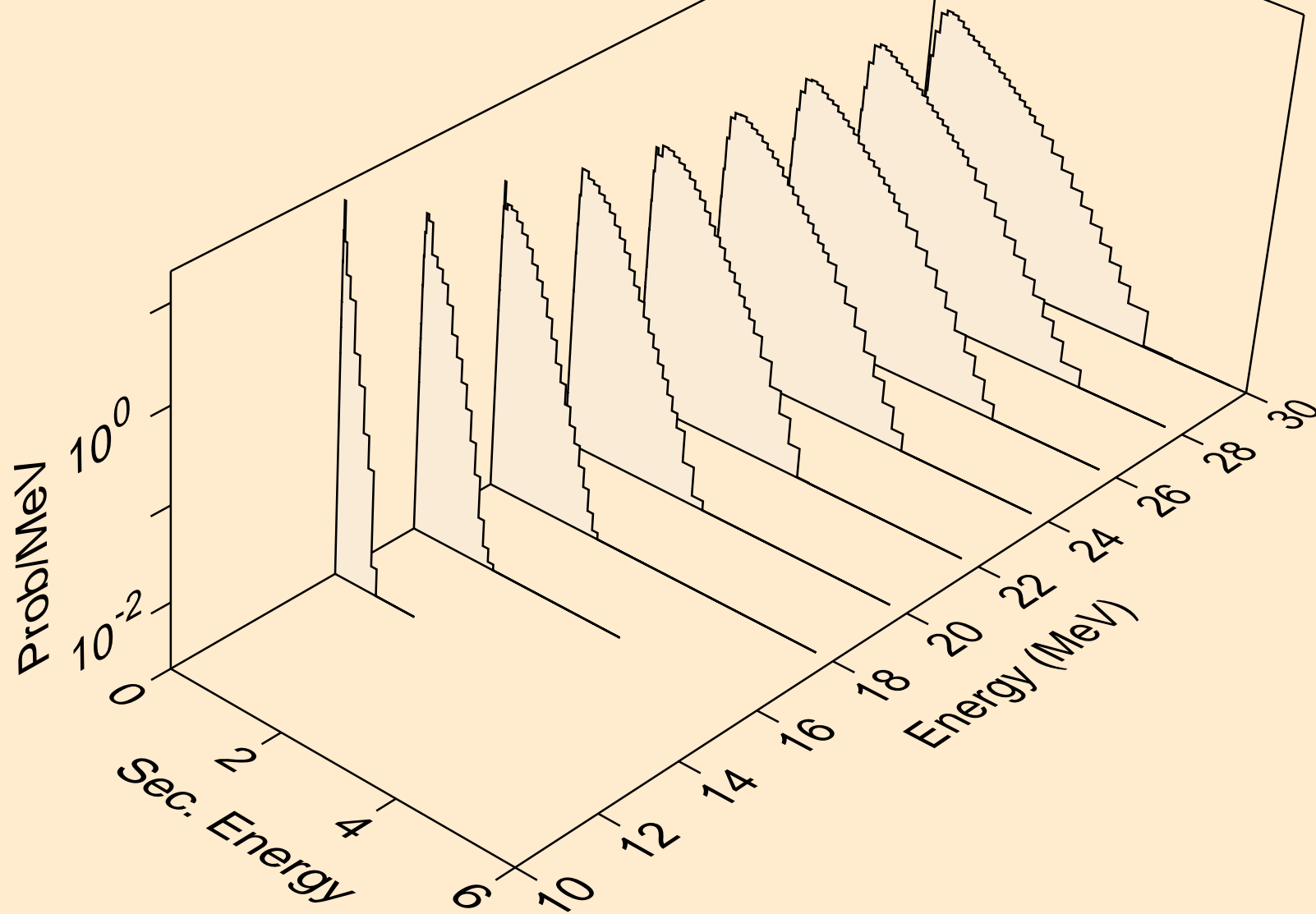

BI204 NEUTRON ACER TENDL-2021 LIBRARY; T=293.6K  
Neutron emission for (n,n\*)he3

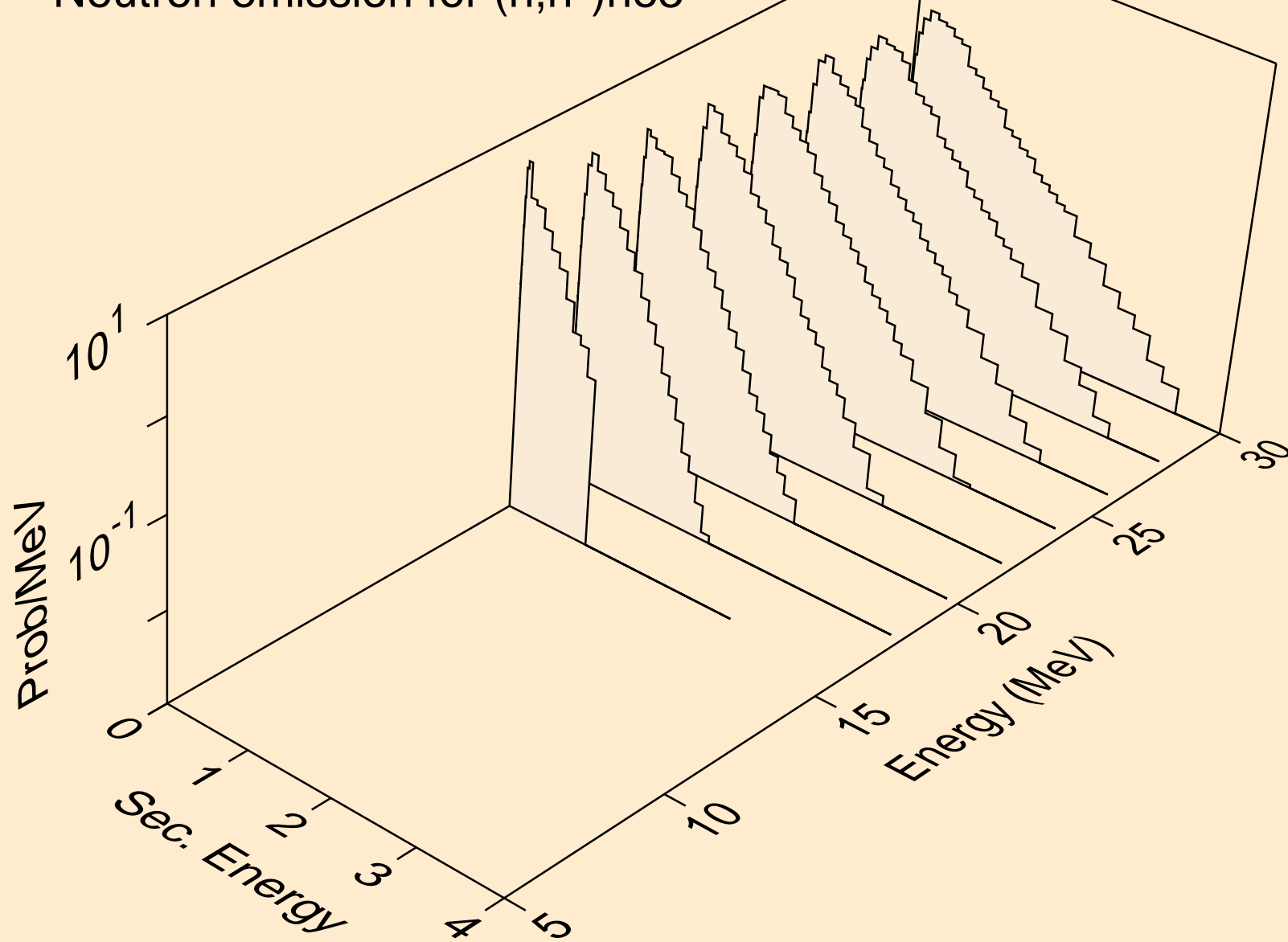

BI204 NEUTRON ACER TENDL-2021 LIBRARY; T=293.6K  
Neutron emission for (n,4n)

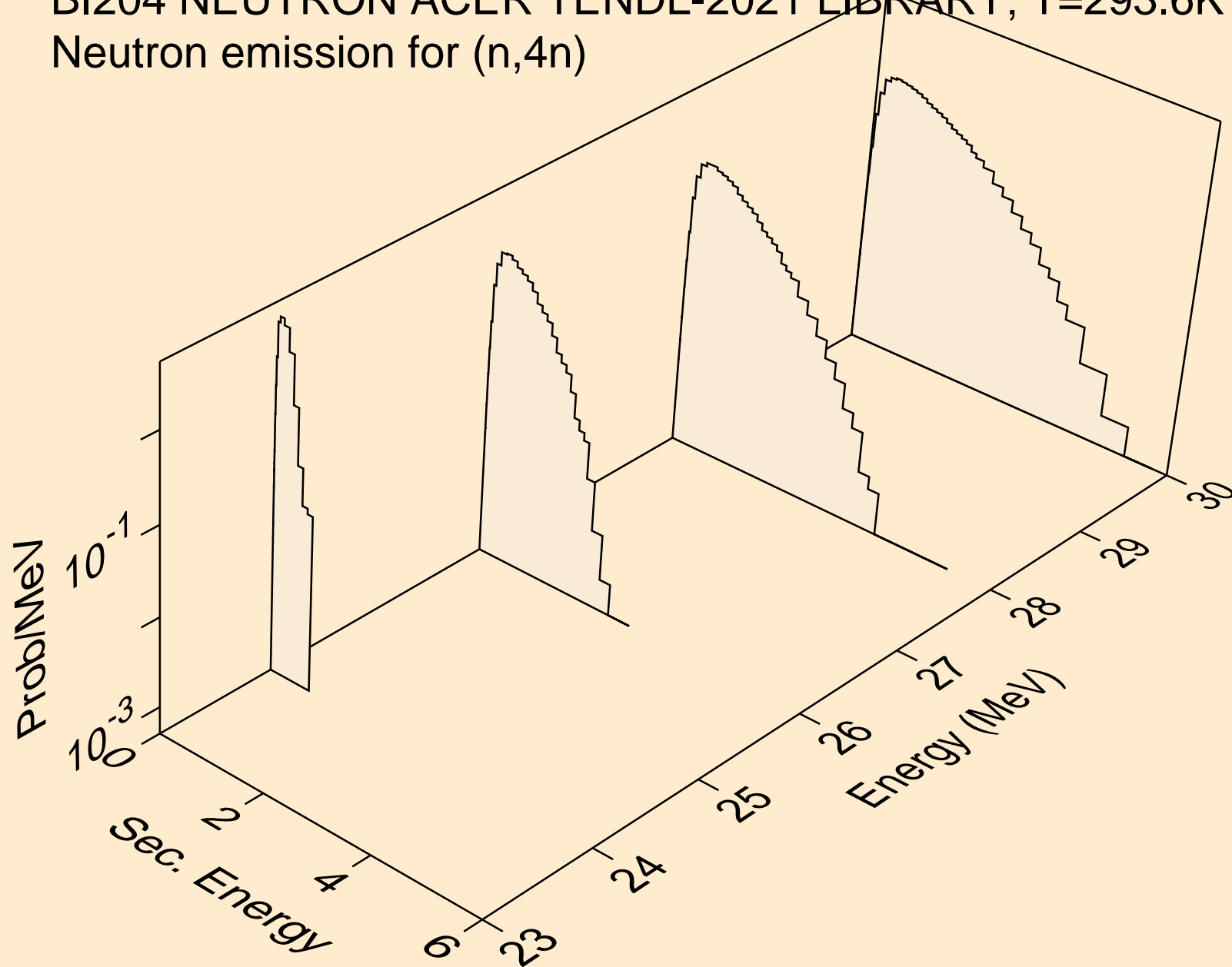



BI204 NEUTRON ACER TENDL-2021 LIBRARY; T=293.6K  
Neutron emission for (n,2np)

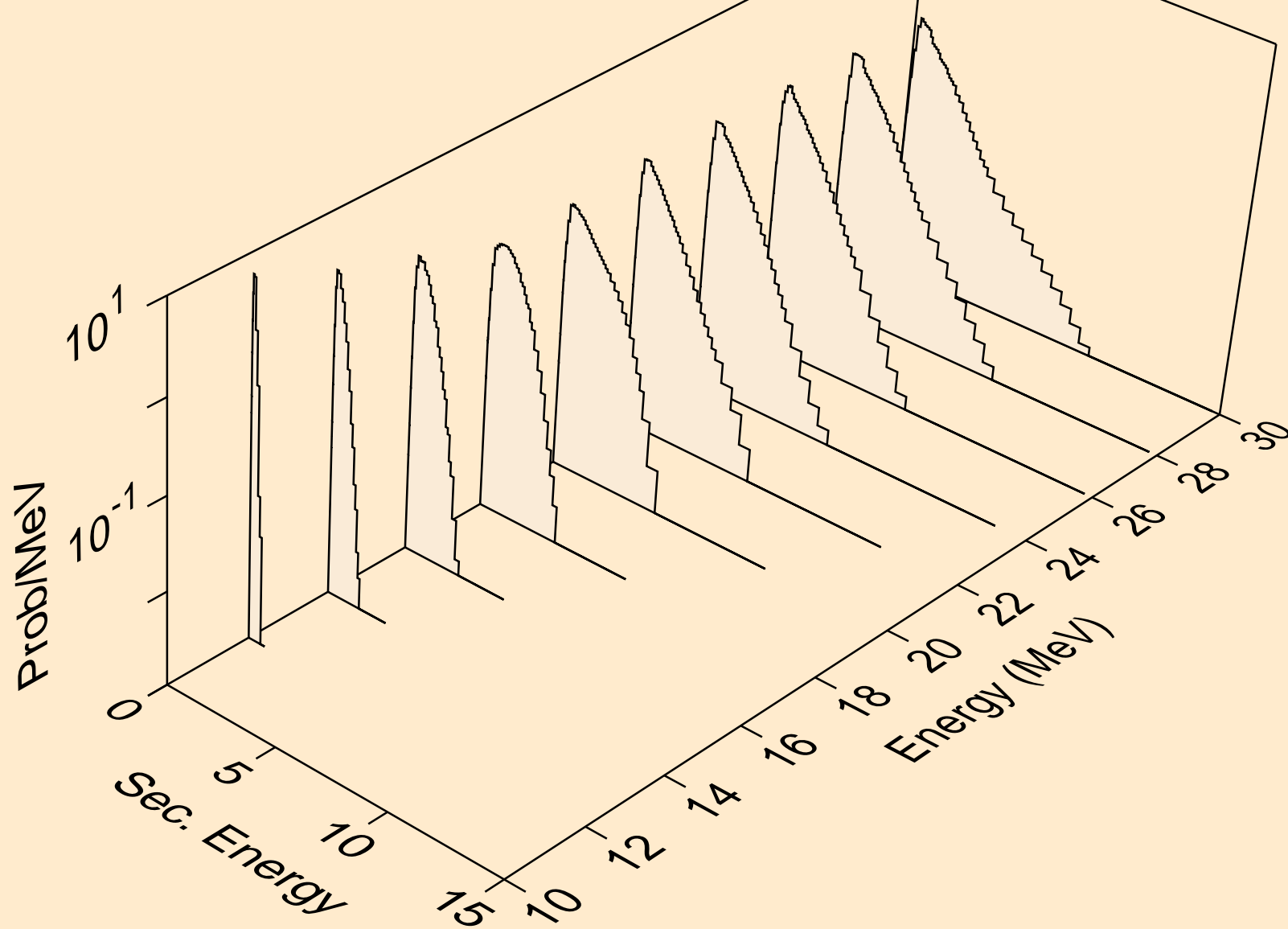

BI204 NEUTRON ACER TENDL-2021 LIBRARY; T=293.6K  
Neutron emission for (n,3np)

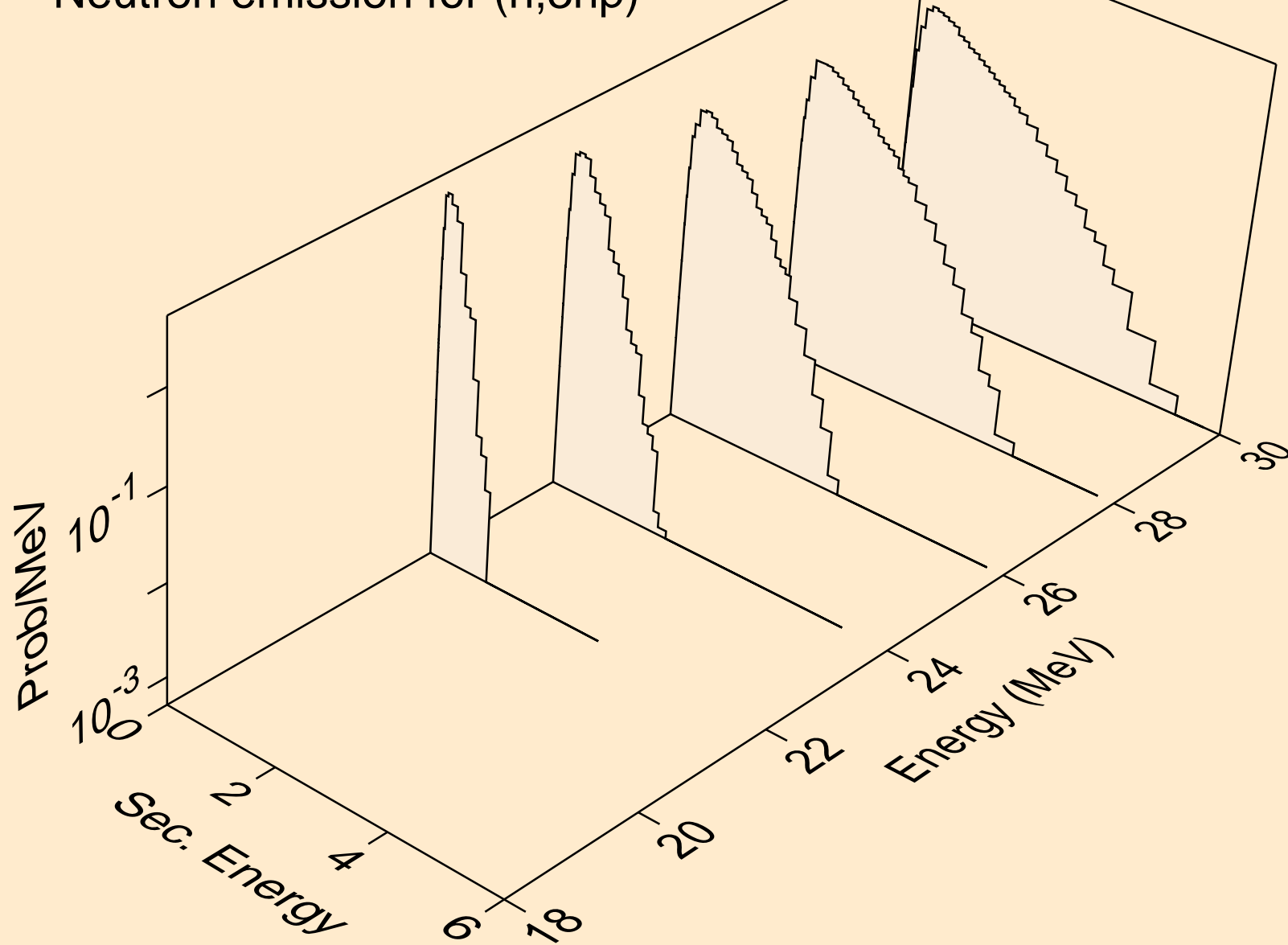

BI204 NEUTRON ACER TENDL-2021 LIBRARY; T=293.6K  
Neutron emission for (n,2np)

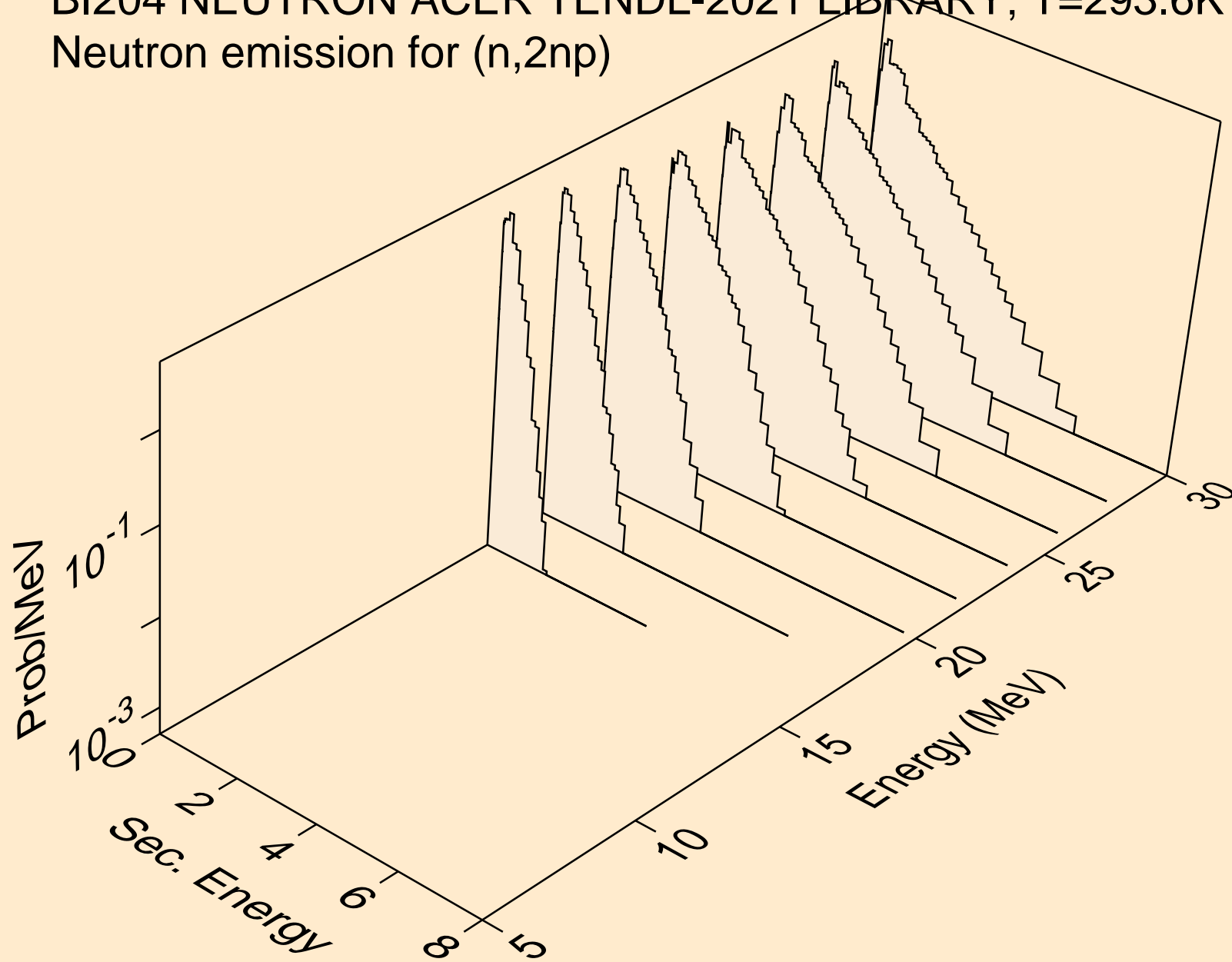

BI204 NEUTRON ACER TENDL-2021 LIBRARY; T=293.6K  
Neutron emission for (n,npa)

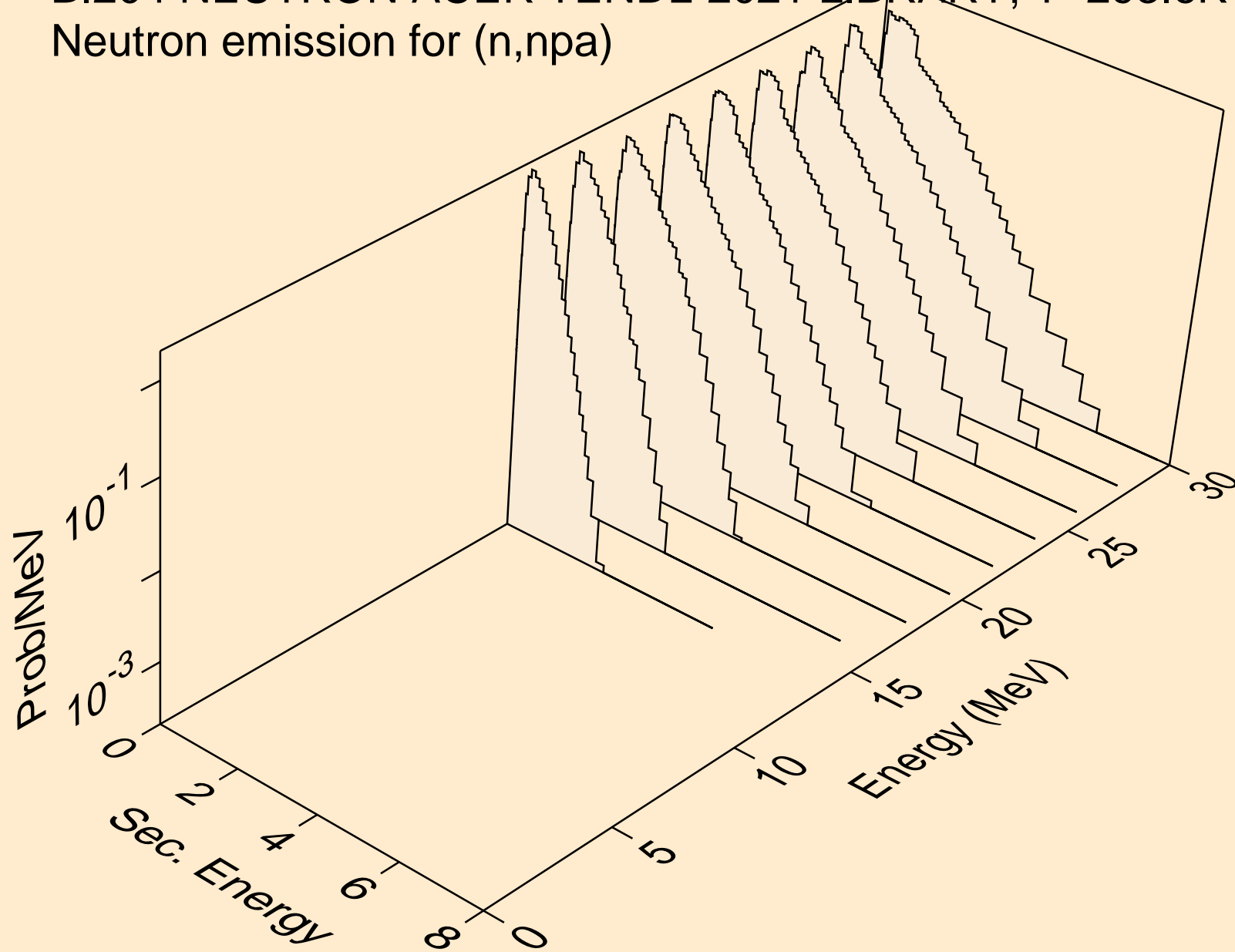

BI204 NEUTRON ACER TENDL-2021 LIBRARY; T=293.6K  
Neutron emission for (n,n\*c)

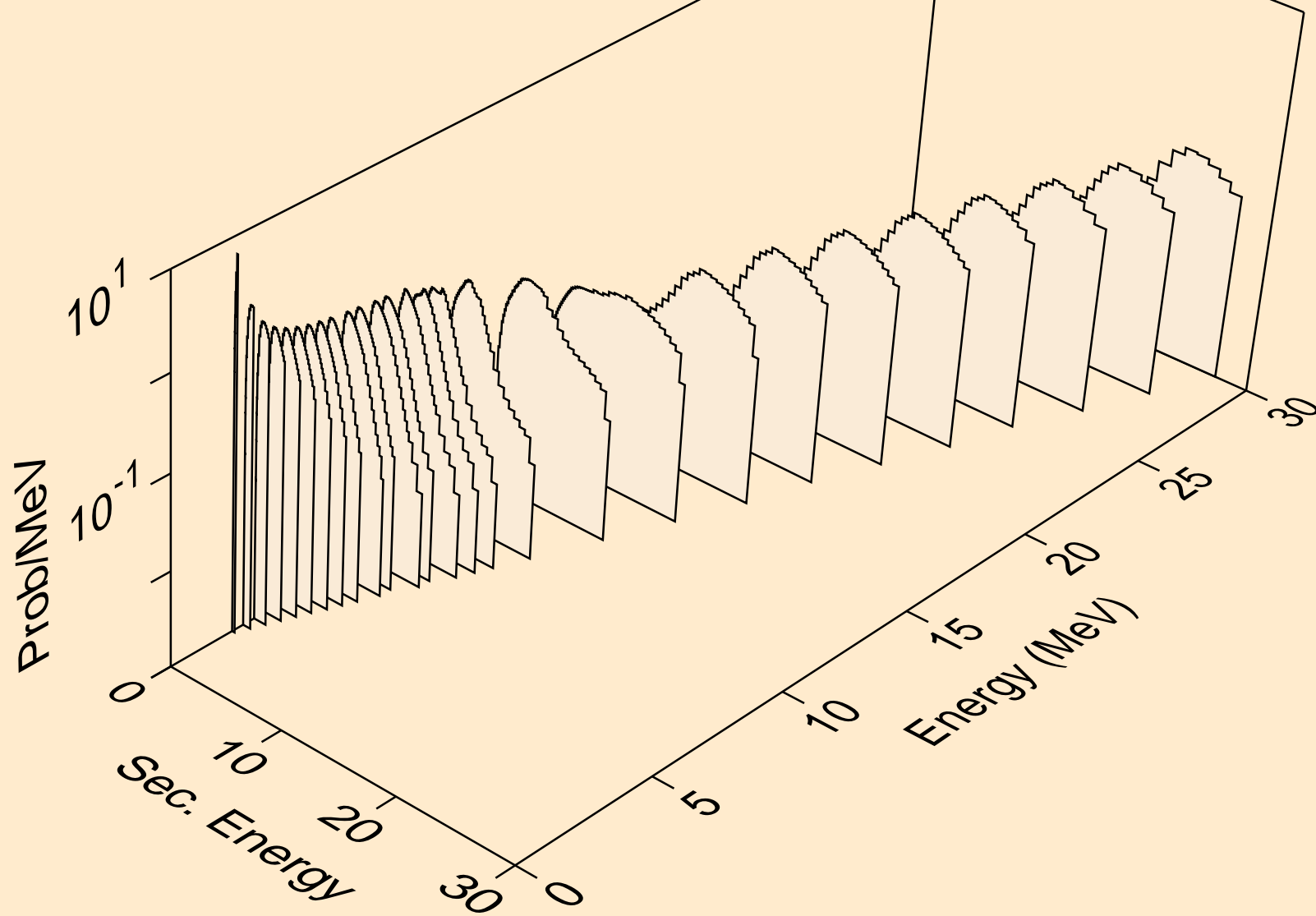

BI204 NEUTRON ACER TENDL-2021 LIBRARY; T=293.6K  
Photon emission for (n,x)

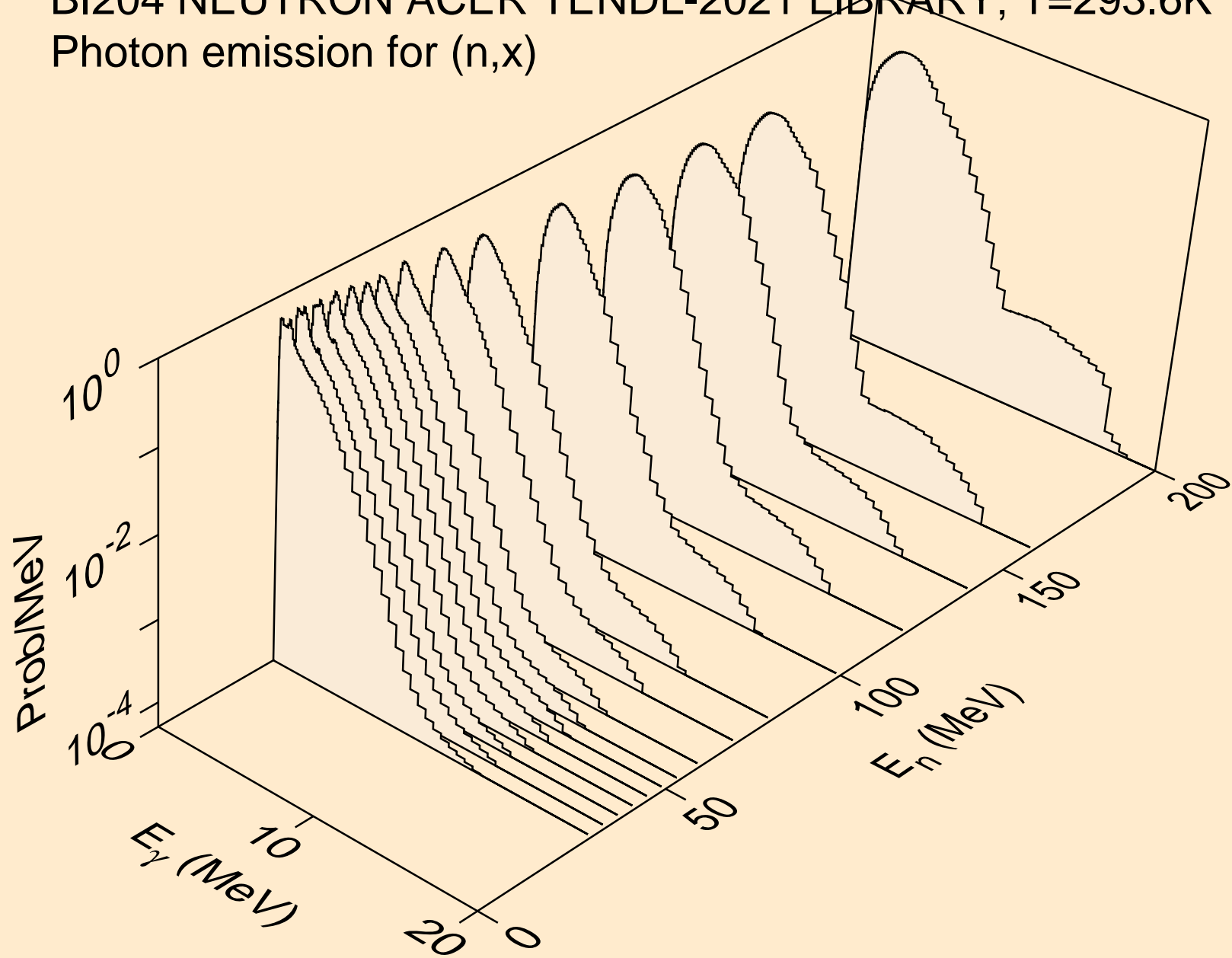

BI204 NEUTRON ACER TENDL-2021 LIBRARY; T=293.6K  
Photon emission for (n,2nd)

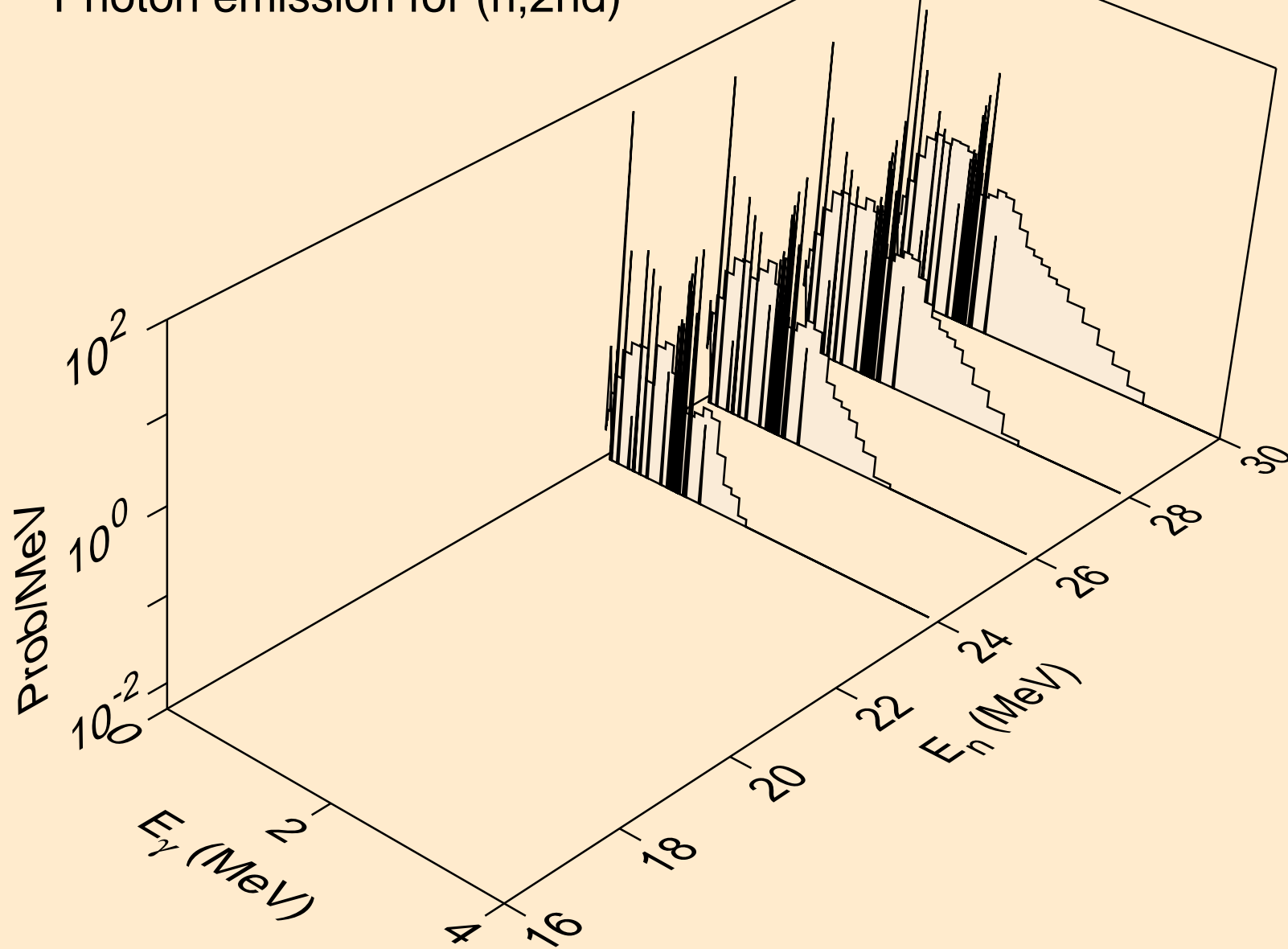

BI204 NEUTRON ACER TENDL-2021 LIBRARY; T=293.6K  
Photon emission for (n,2n)

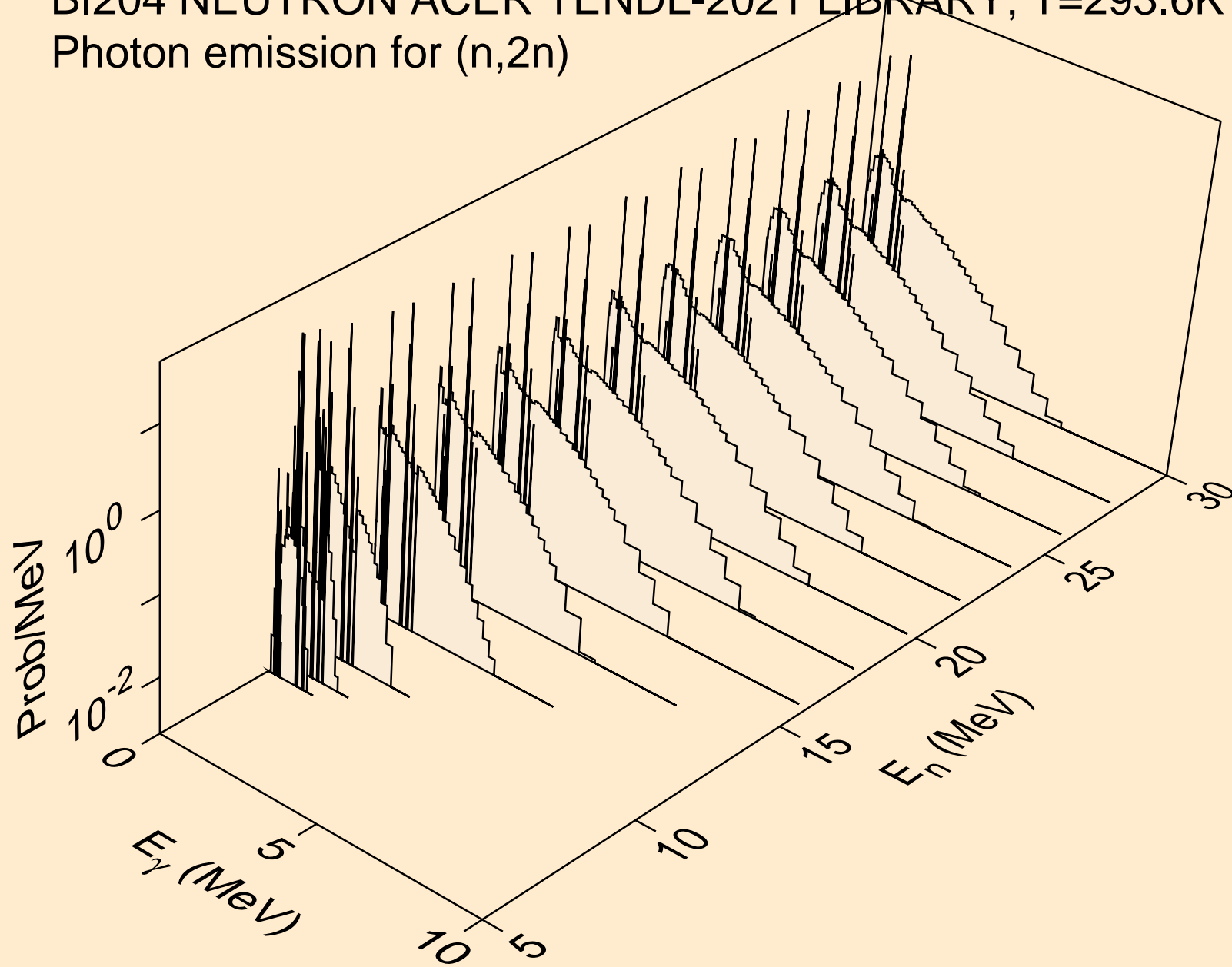



BI204 NEUTRON ACER TENDL-2021 LIBRARY; T=293.6K  
Photon emission for (n,3n)

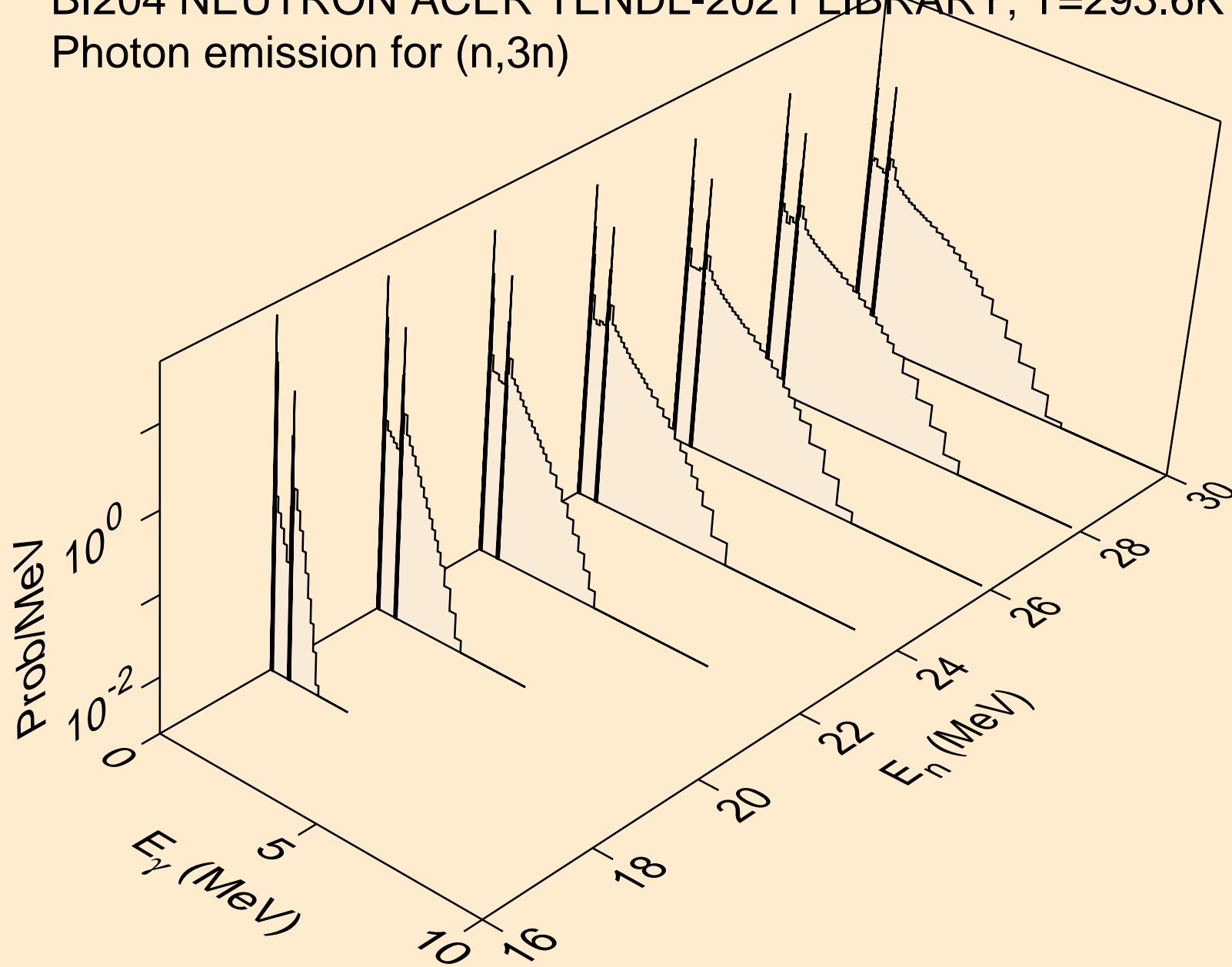

BI204 NEUTRON ACER TENDL-2021 LIBRARY; T=293.6K  
Photon emission for (n,n\*)a

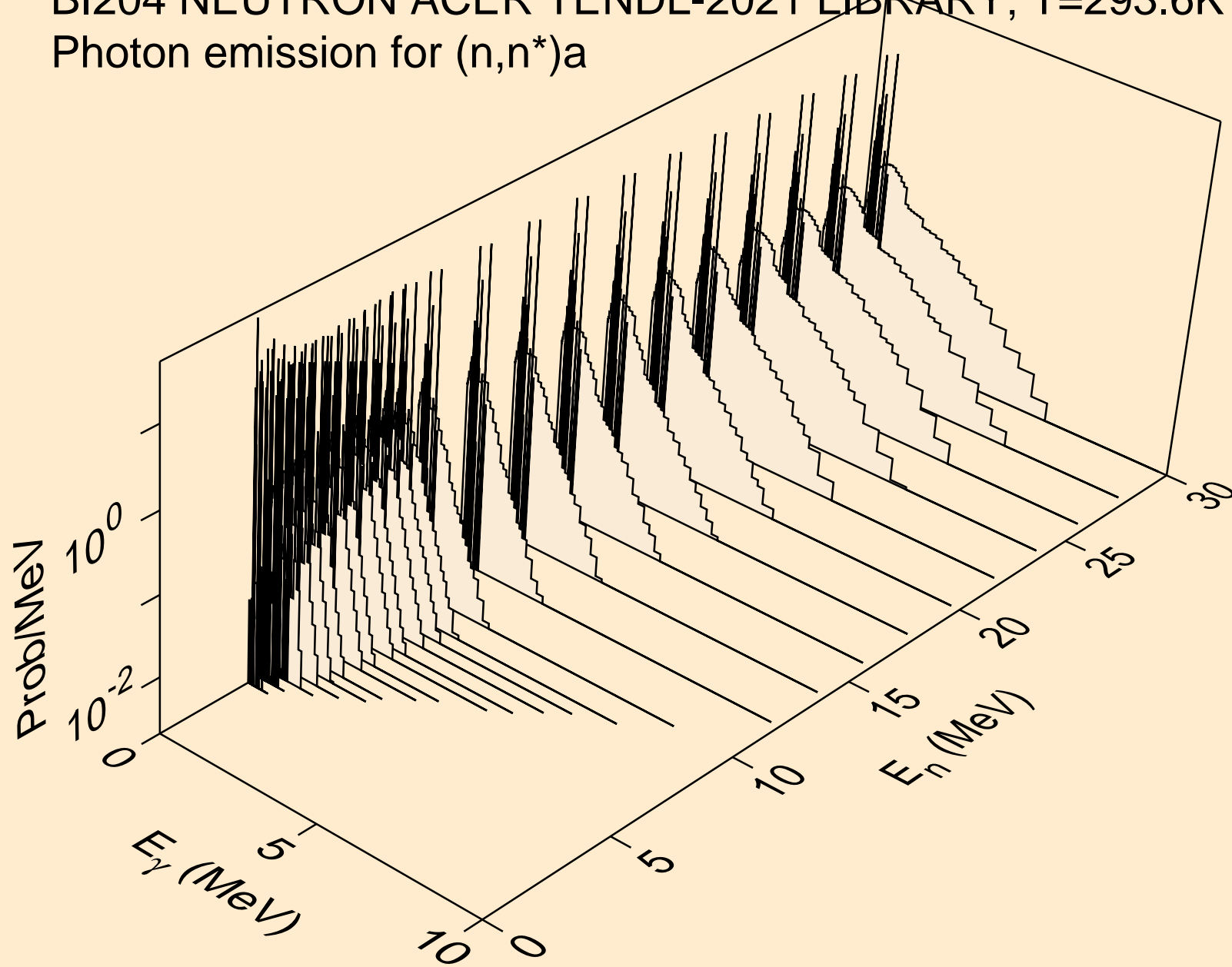

BI204 NEUTRON ACER TENDL-2021 LIBRARY; T=293.6K  
Photon emission for (n,2n)a

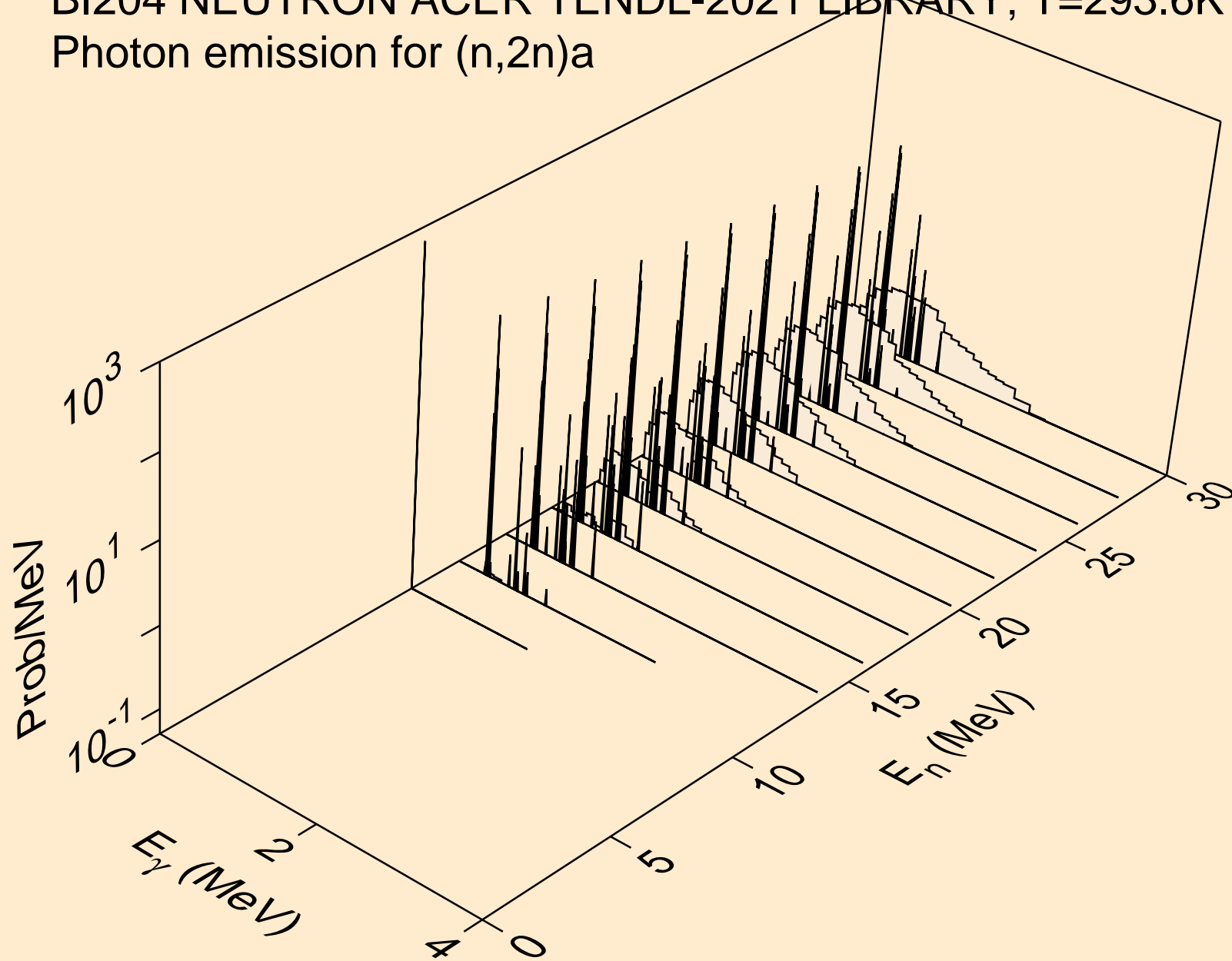

BI204 NEUTRON ACER TENDL-2021 LIBRARY; T=293.6K  
Photon emission for (n,3n)a

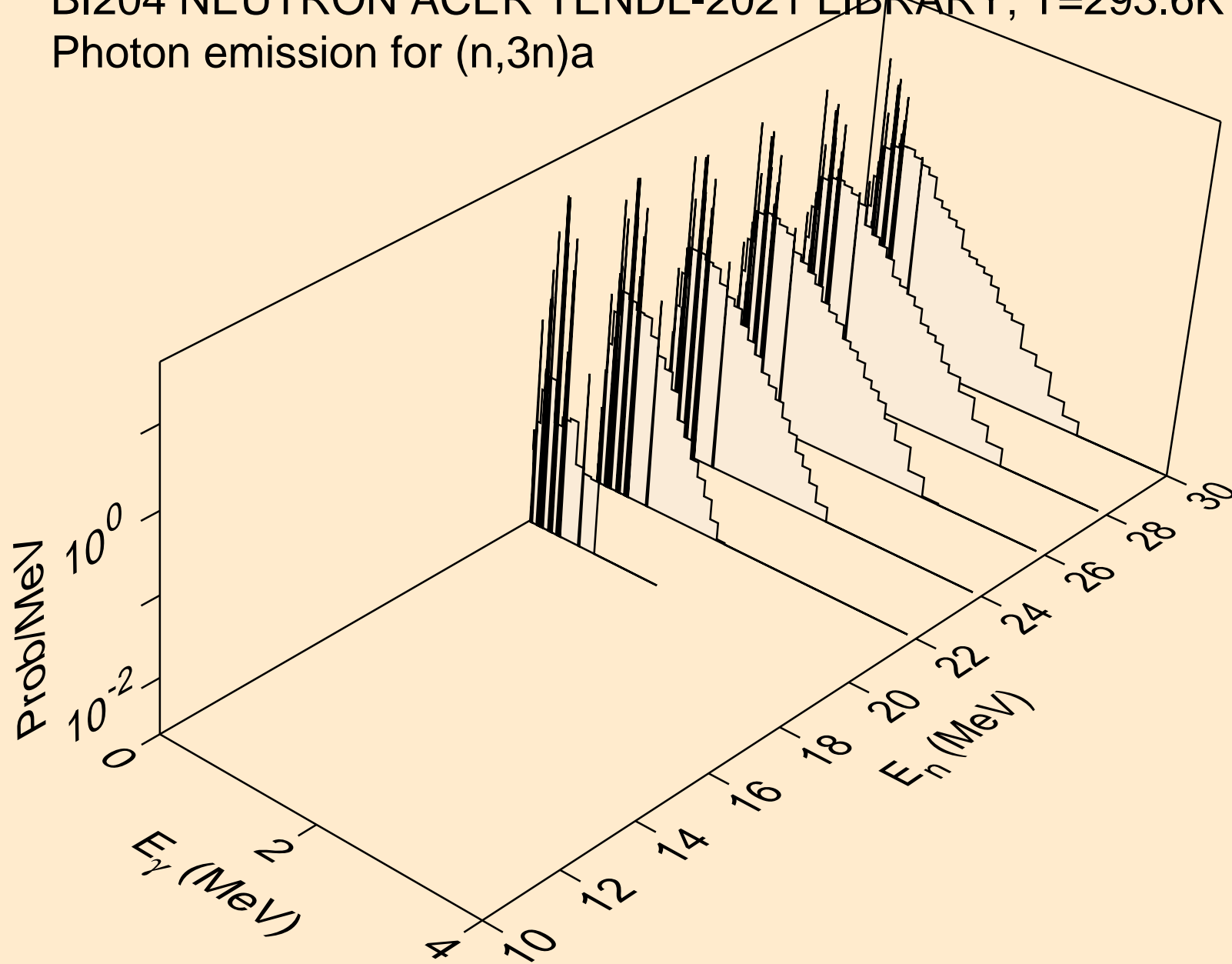

BI204 NEUTRON ACER TENDL-2021 LIBRARY; T=293.6K  
Photon emission for (n,n\*)p

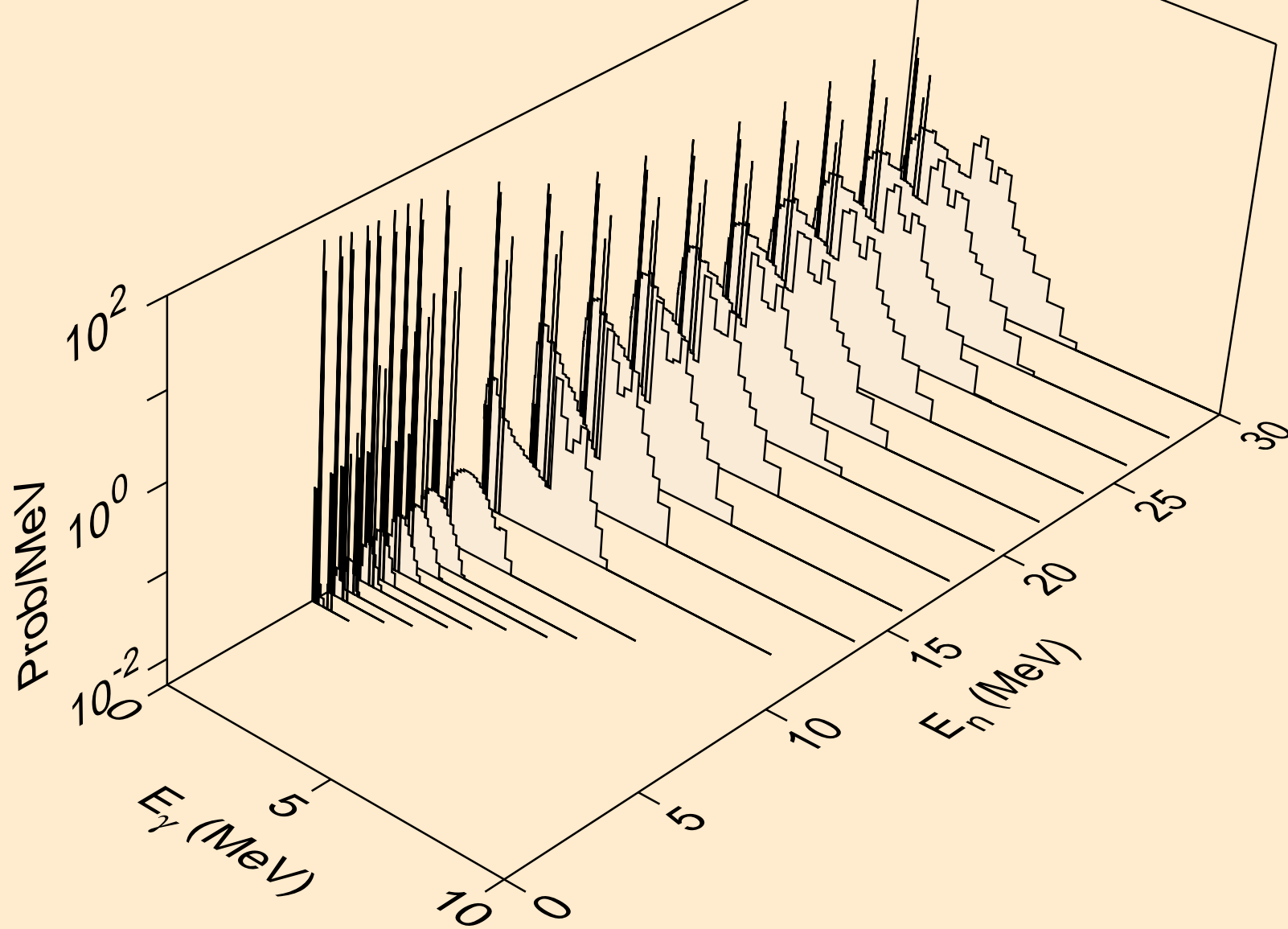

BI204 NEUTRON ACER TENDL-2021 LIBRARY; T=293.6K  
Photon emission for (n,n\*)2a

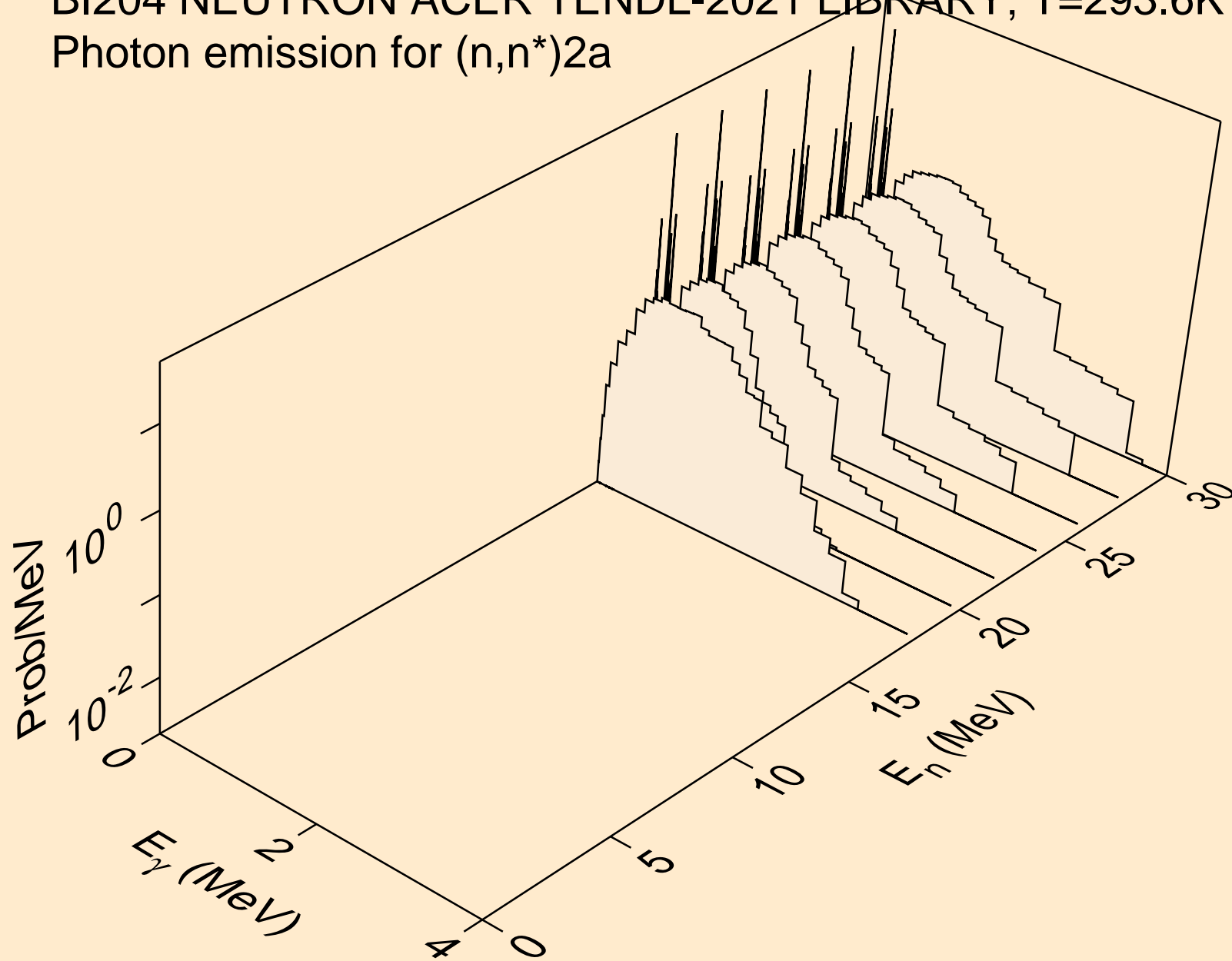

BI204 NEUTRON ACER TENDL-2021 LIBRARY; T=293.6K  
Photon emission for (n,n\*)d

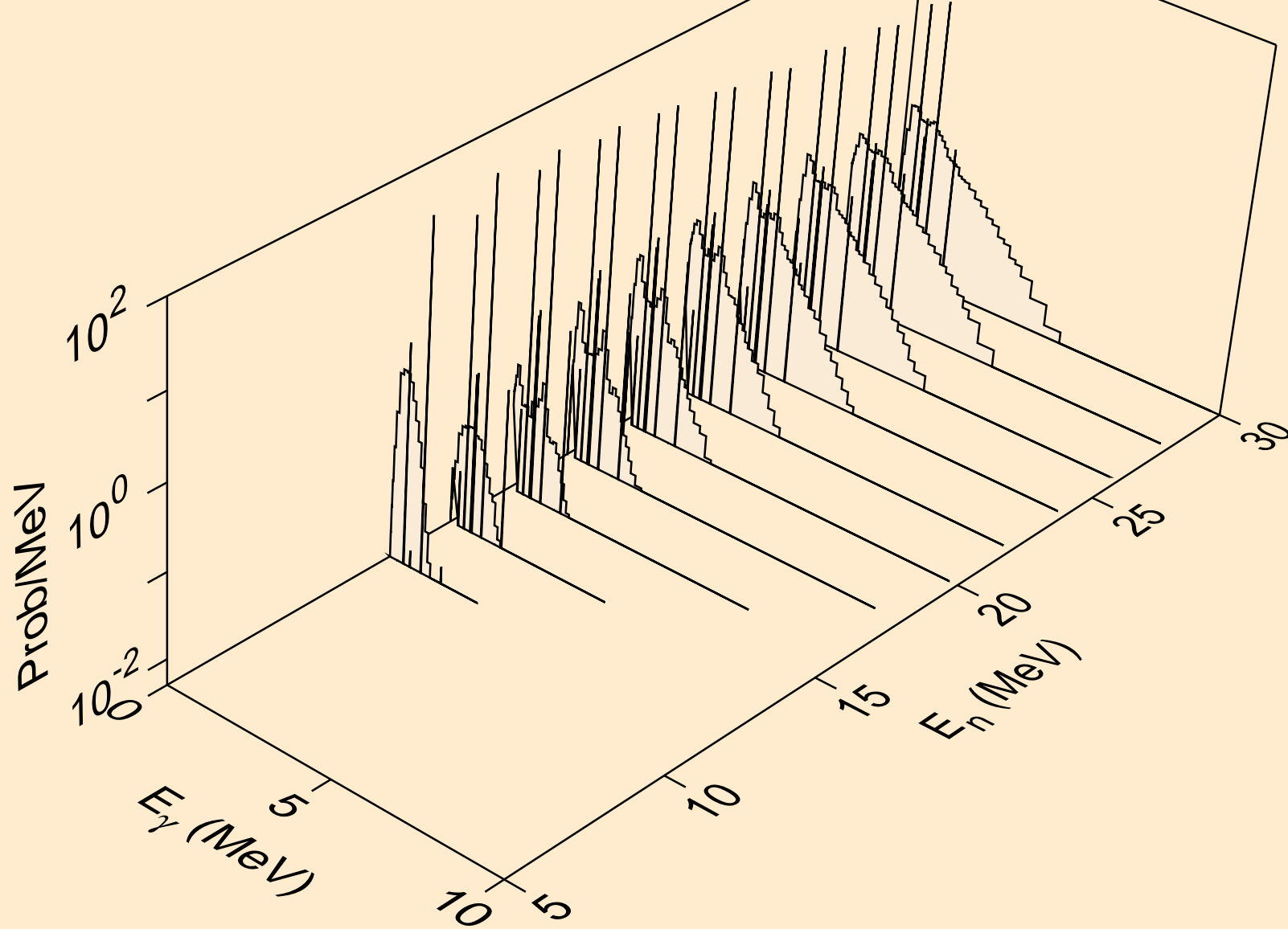

BI204 NEUTRON ACER TENDL-2021 LIBRARY; T=293.6K  
Photon emission for (n,n\*)t

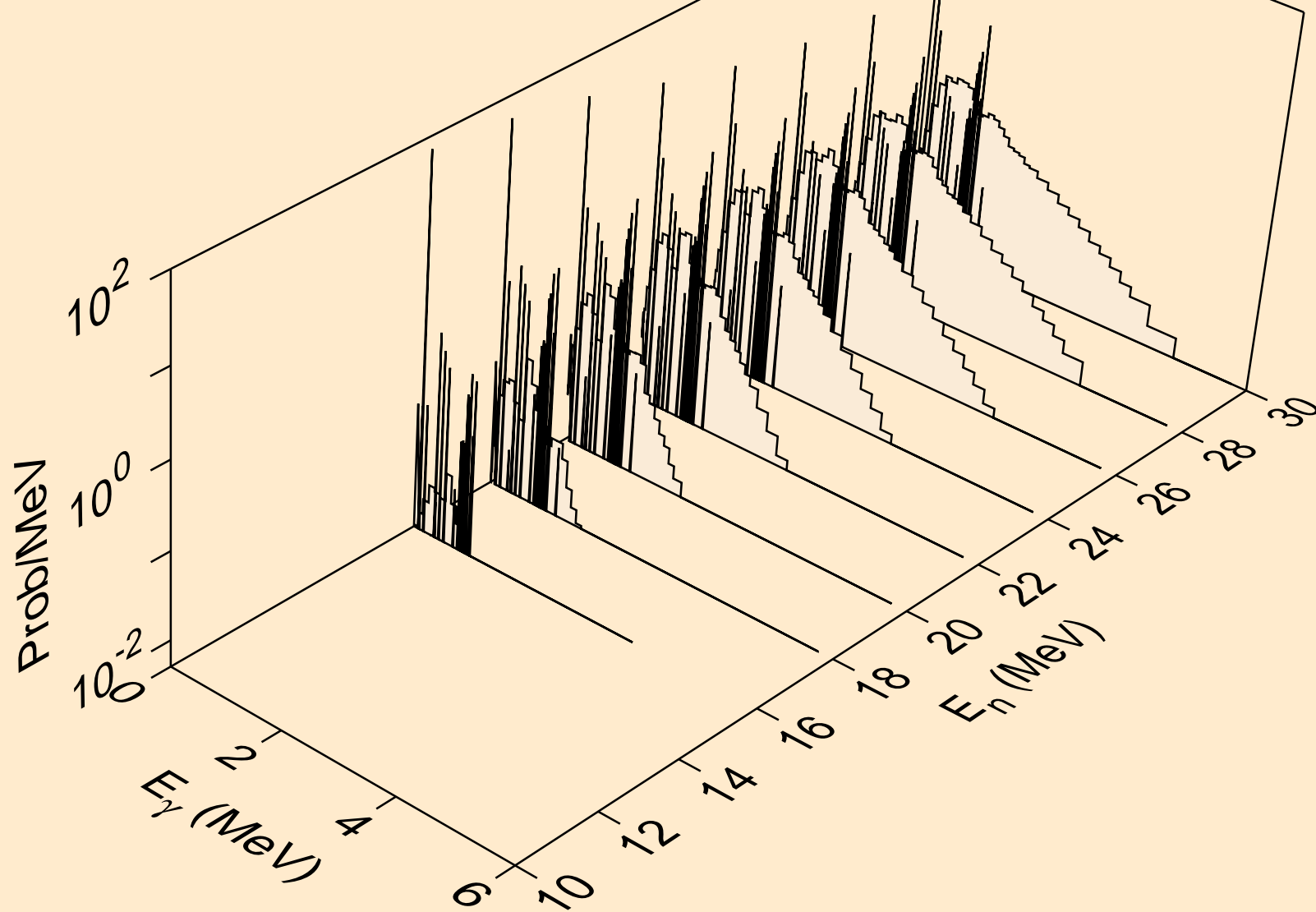



BI204 NEUTRON ACER TENDL-2021 LIBRARY; T=293.6K  
Photon emission for (n,n\*)he3

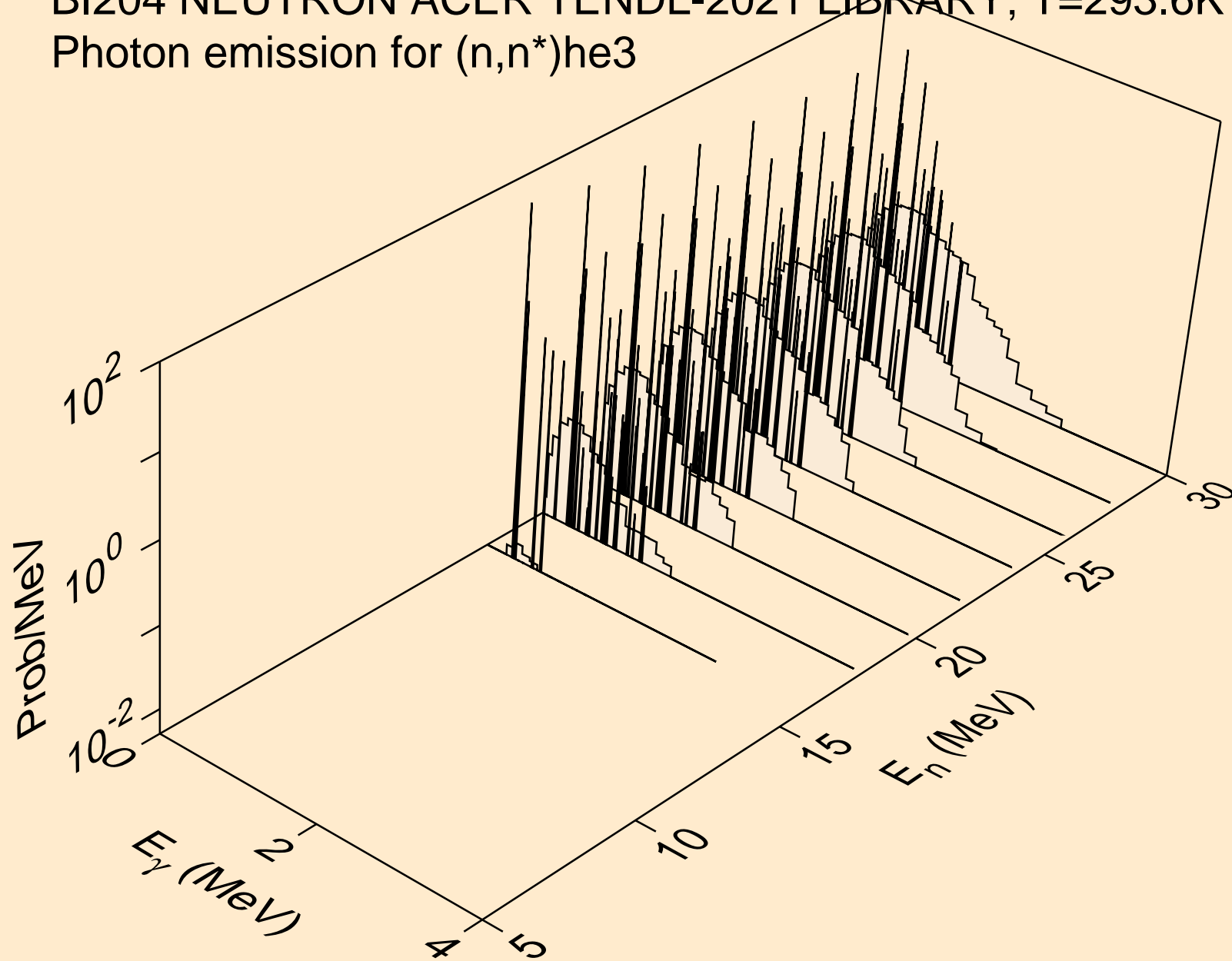

BI204 NEUTRON ACER TENDL-2021 LIBRARY; T=293.6K  
Photon emission for (n,4n)

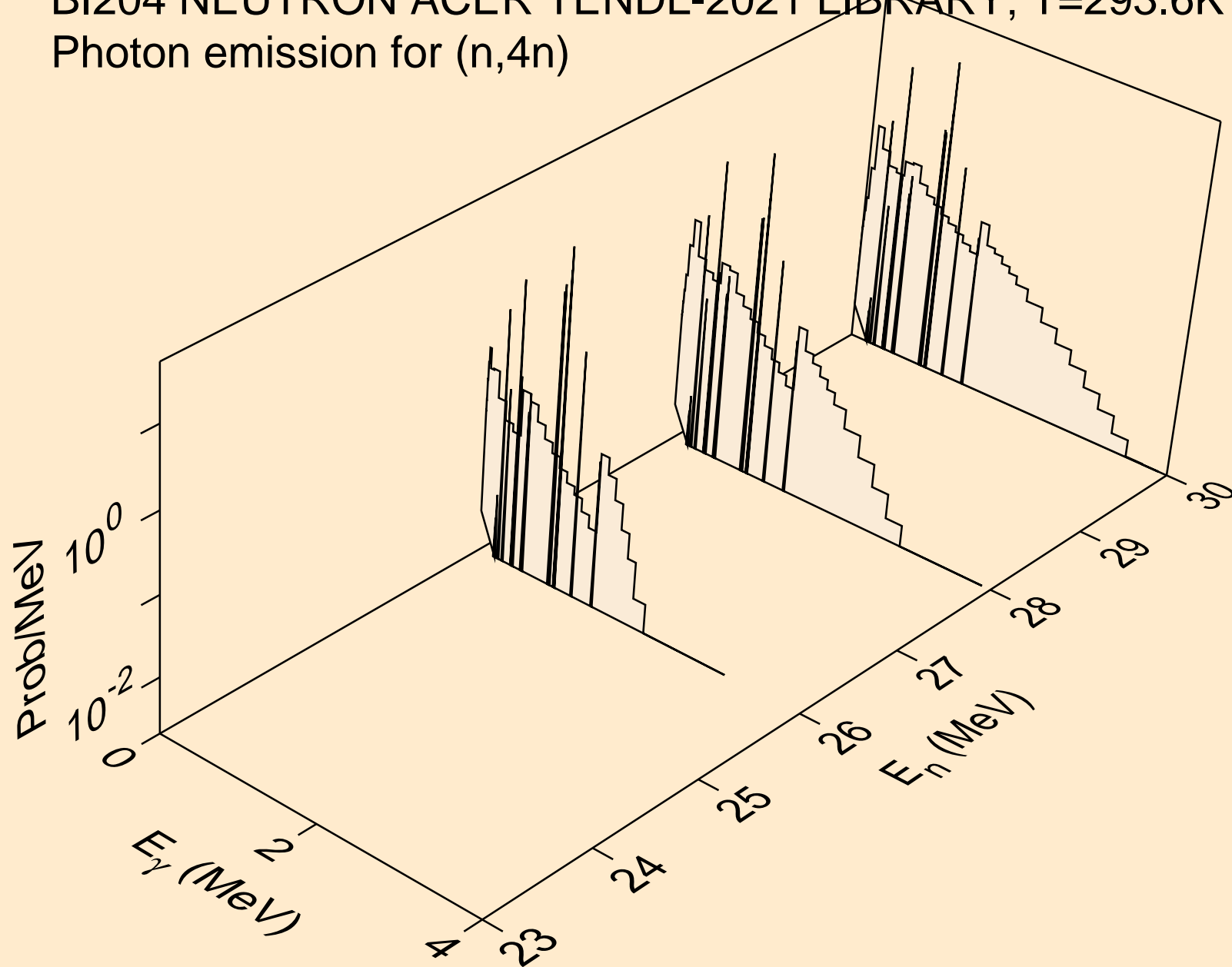

BI204 NEUTRON ACER TENDL-2021 LIBRARY; T=293.6K  
Photon emission for (n,2np)

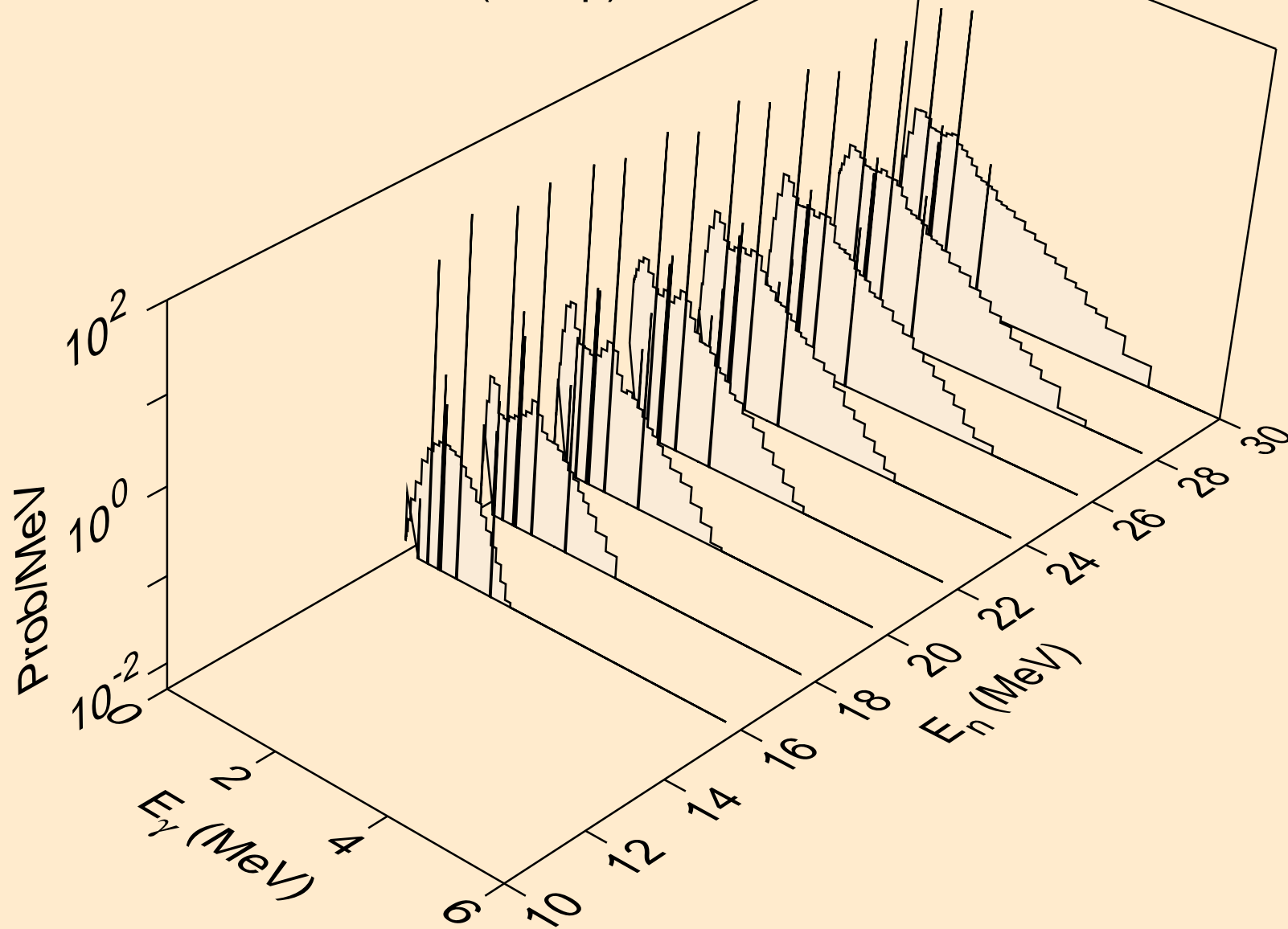

BI204 NEUTRON ACER TENDL-2021 LIBRARY; T=293.6K  
Photon emission for (n,3np)

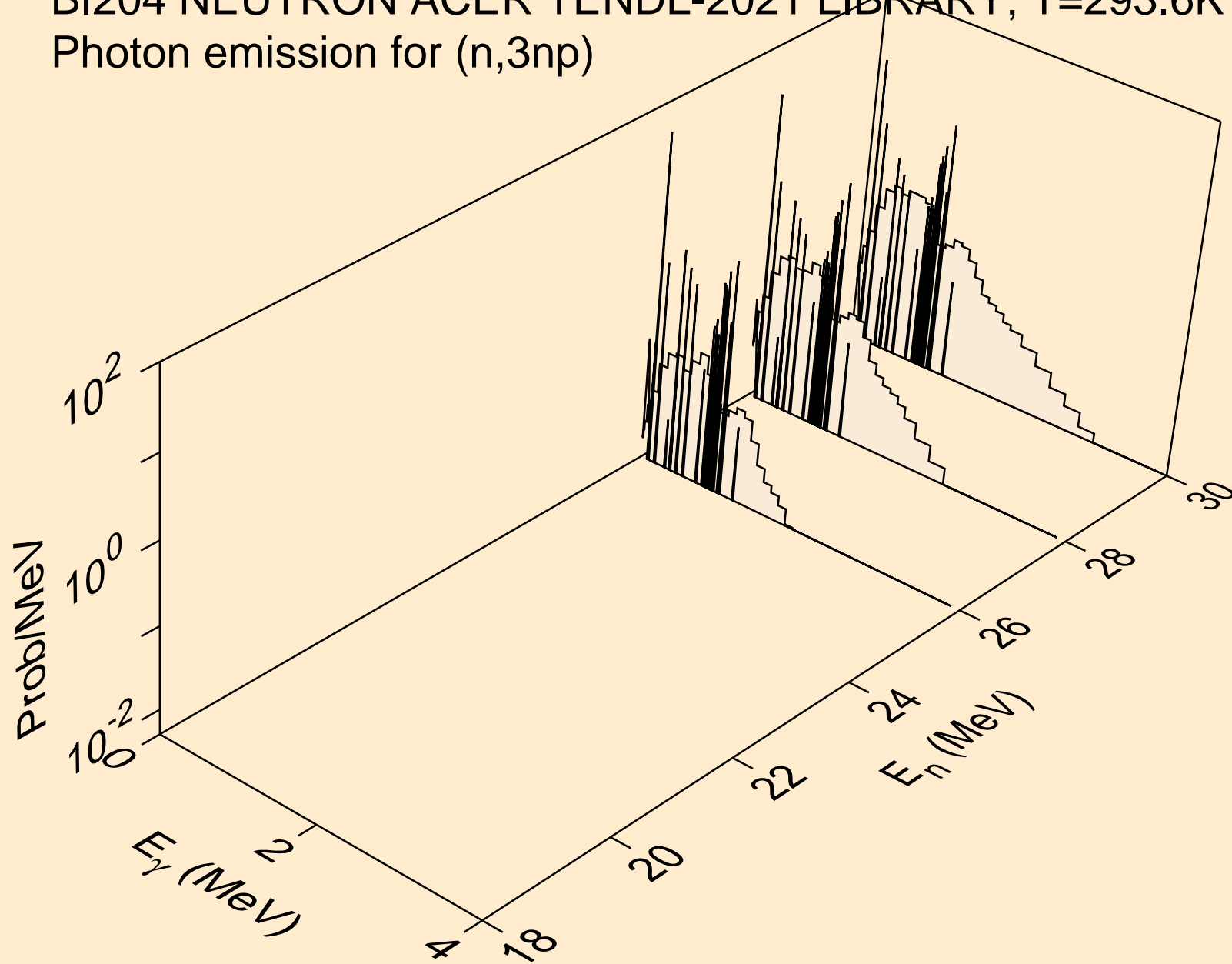

BI204 NEUTRON ACER TENDL-2021 LIBRARY; T=293.6K  
Photon emission for (n,2np)

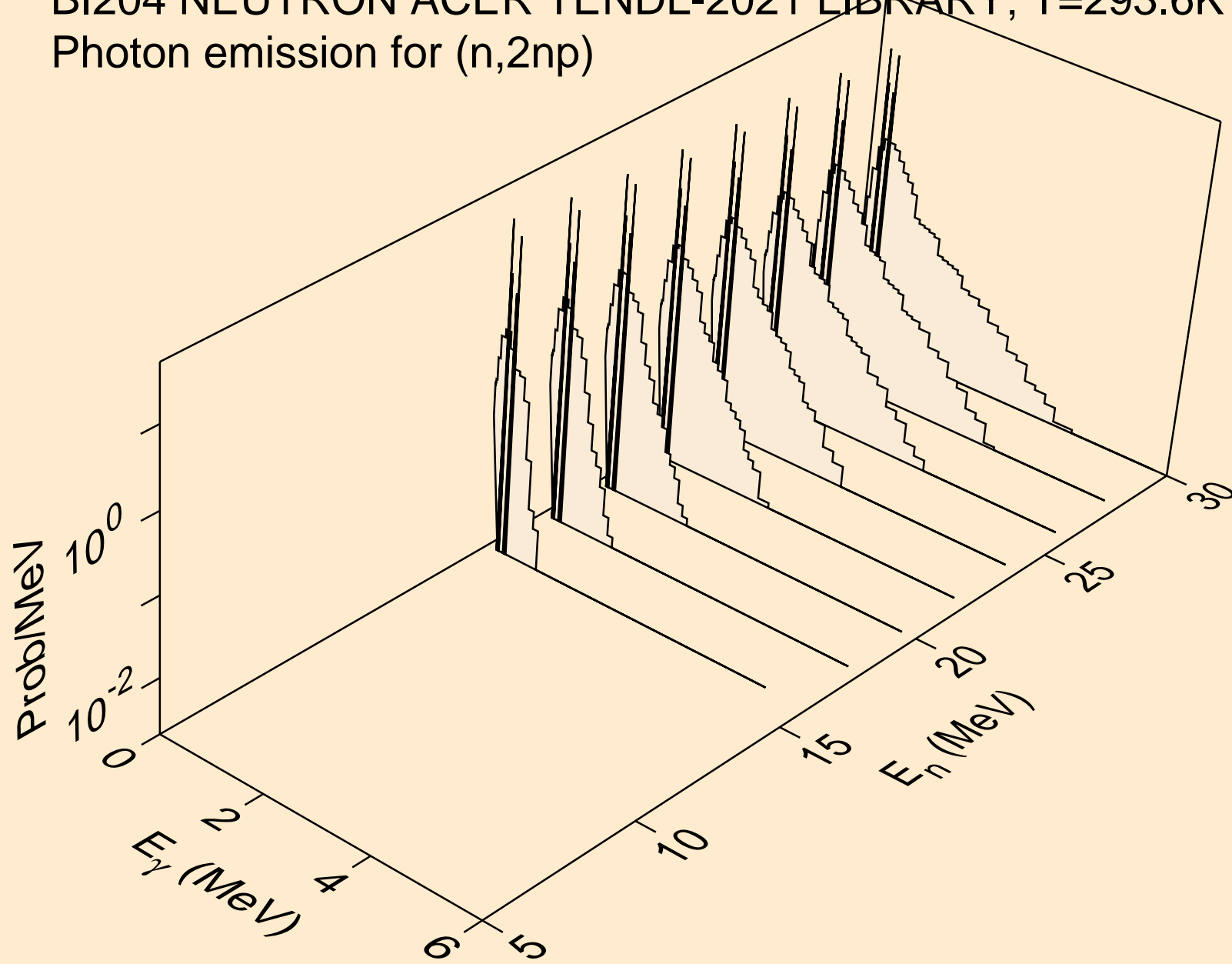

BI204 NEUTRON ACER TENDL-2021 LIBRARY; T=293.6K  
Photon emission for (n,npa)

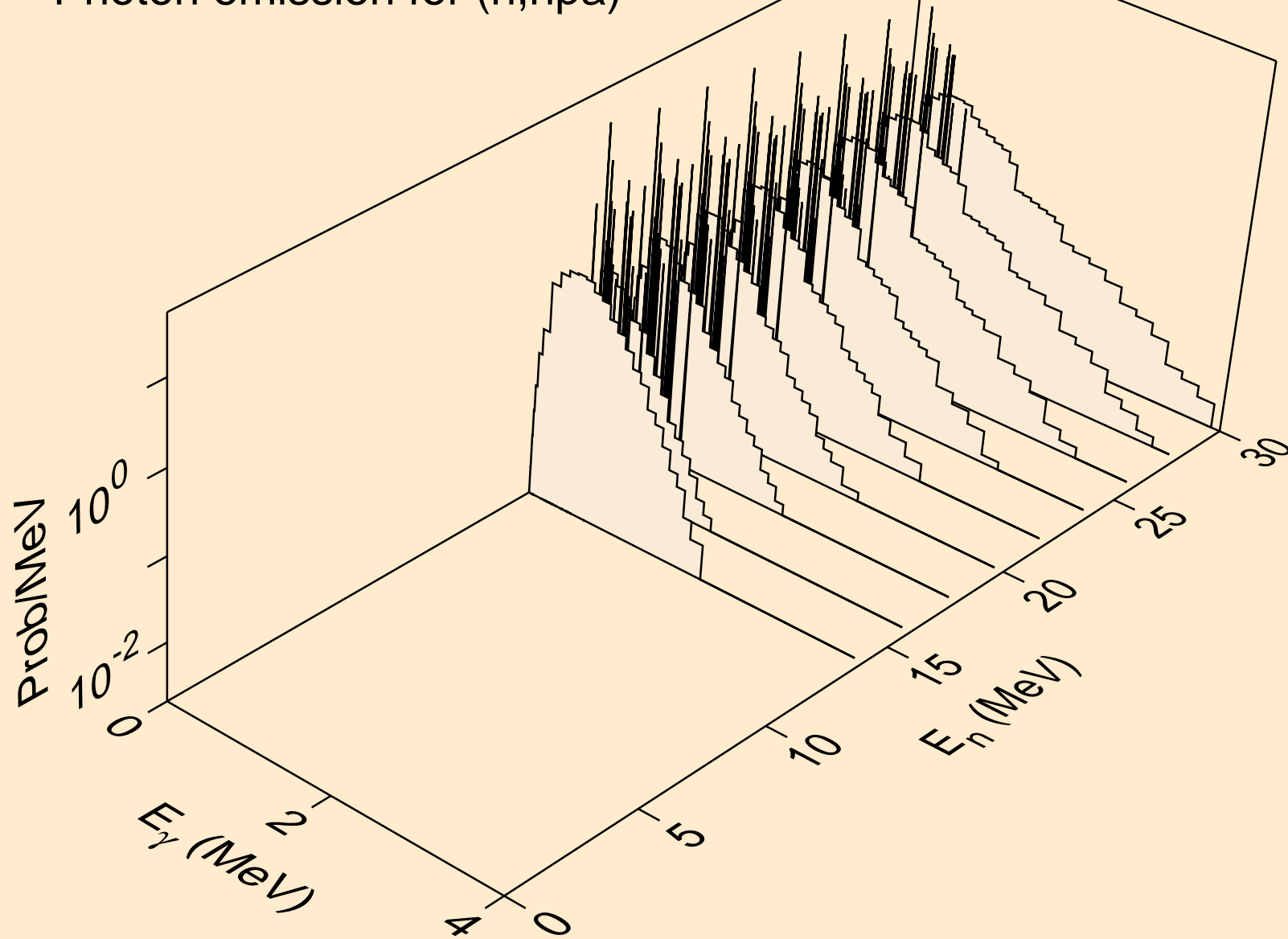

BI204 NEUTRON ACER TENDL-2021 LIBRARY; T=293.6K  
Photon emission for (n,n\*c)

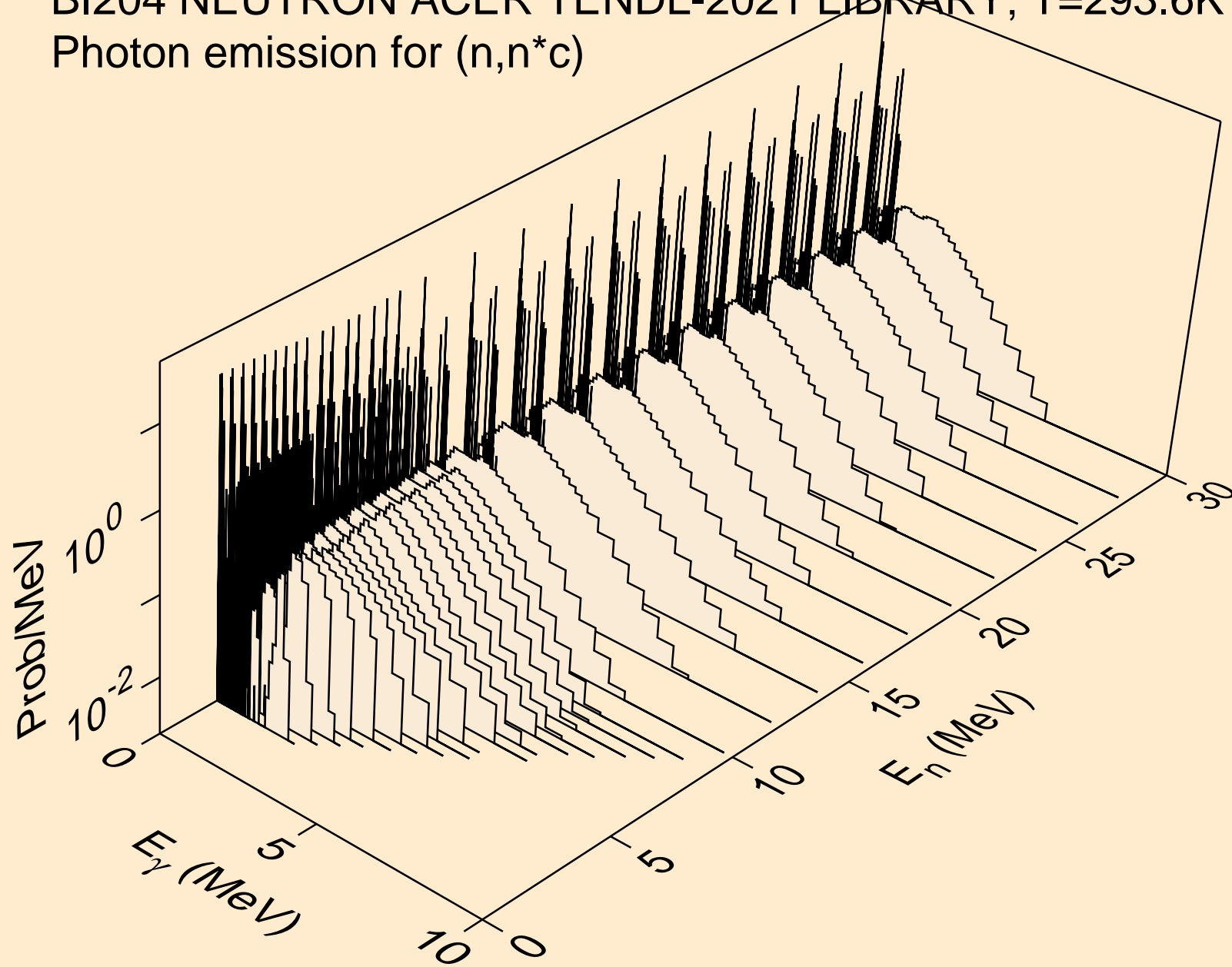

BI204 NEUTRON ACER TENDL-2021 LIBRARY; T=293.6K  
Photon emission for (n,gma)

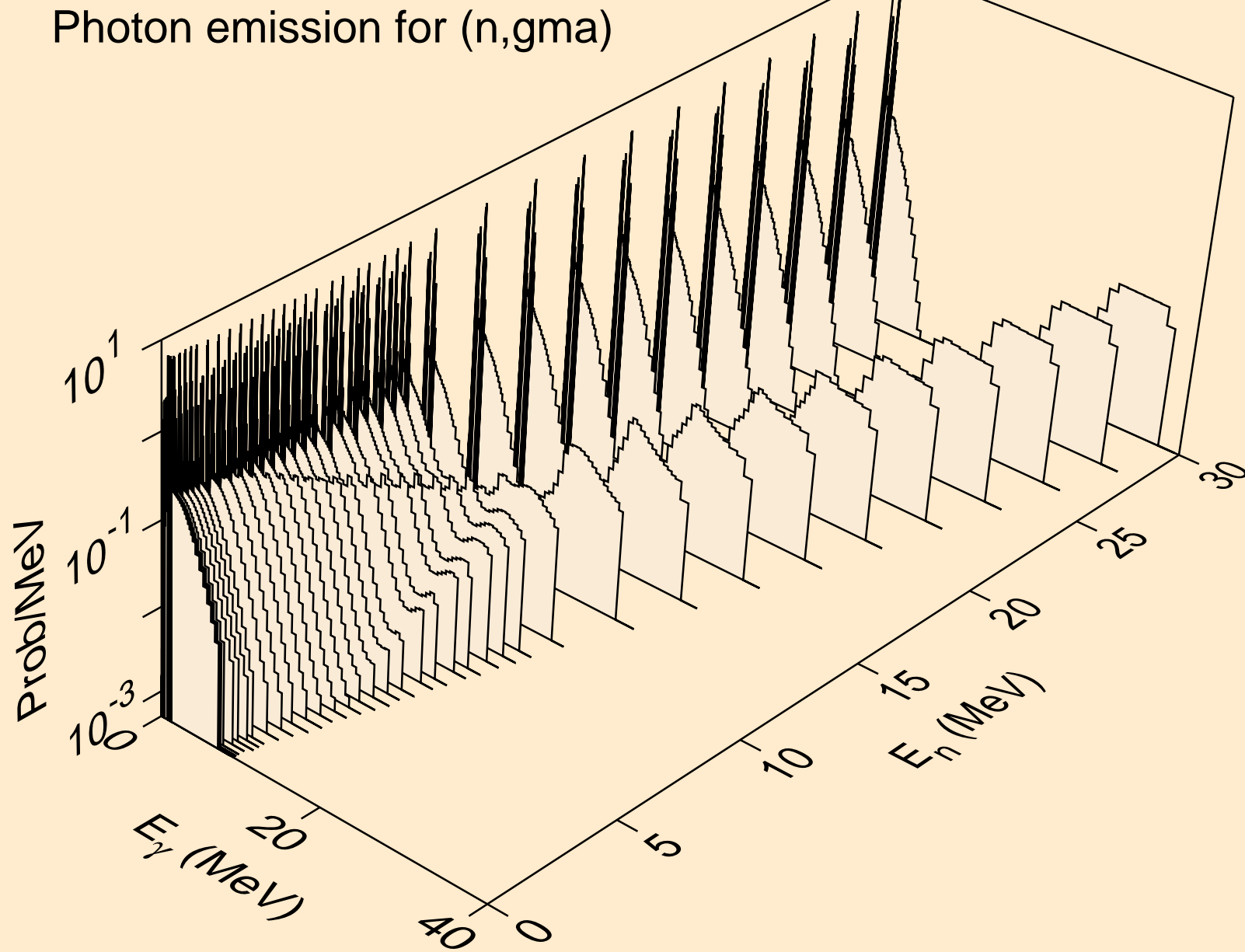



BI204 NEUTRON ACER TENDL-2021 LIBRARY; T=293.6K  
Photon emission for (n,p)

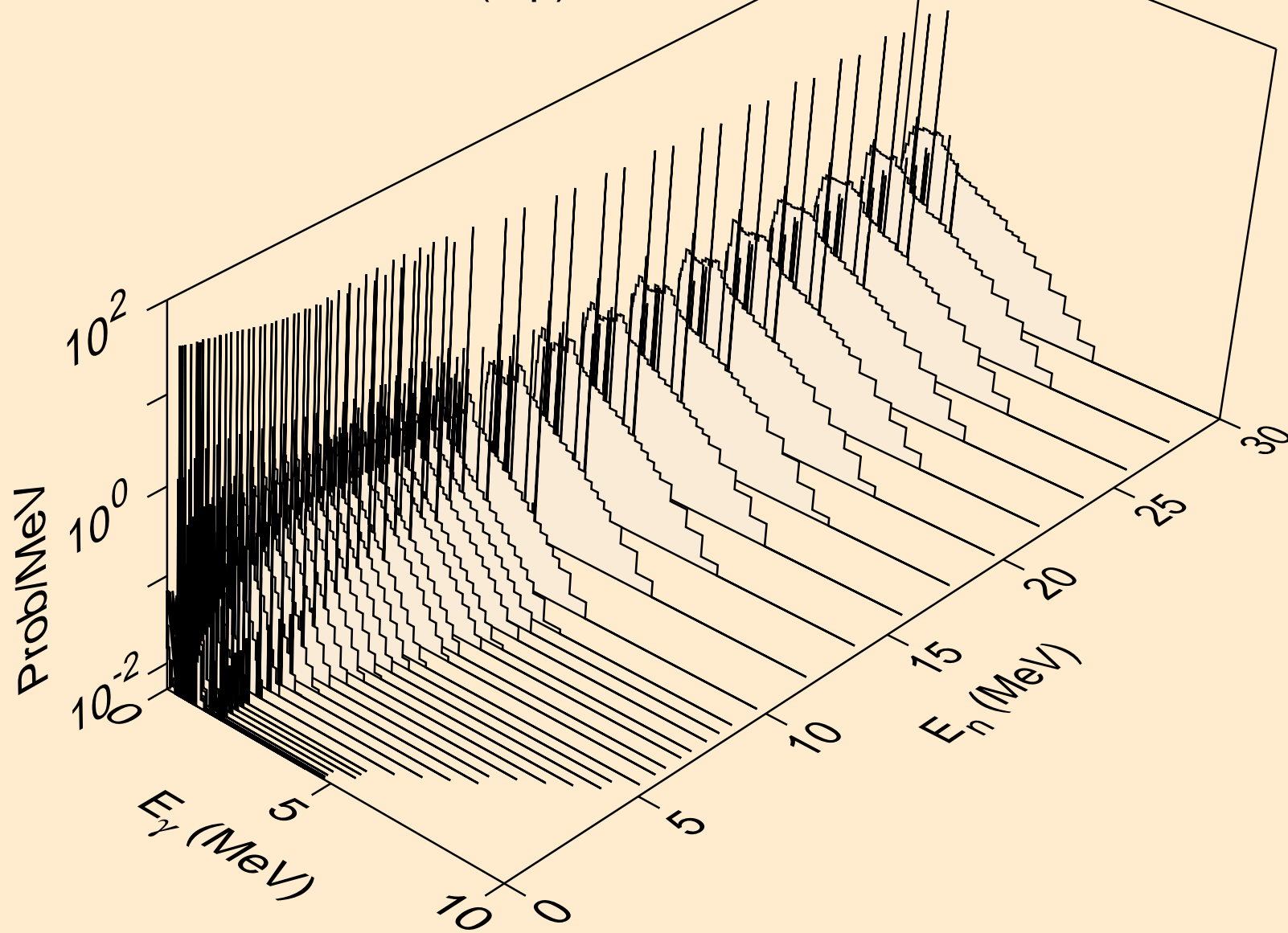

BI204 NEUTRON ACER TENDL-2021 LIBRARY; T=293.6K  
Photon emission for (n,d)

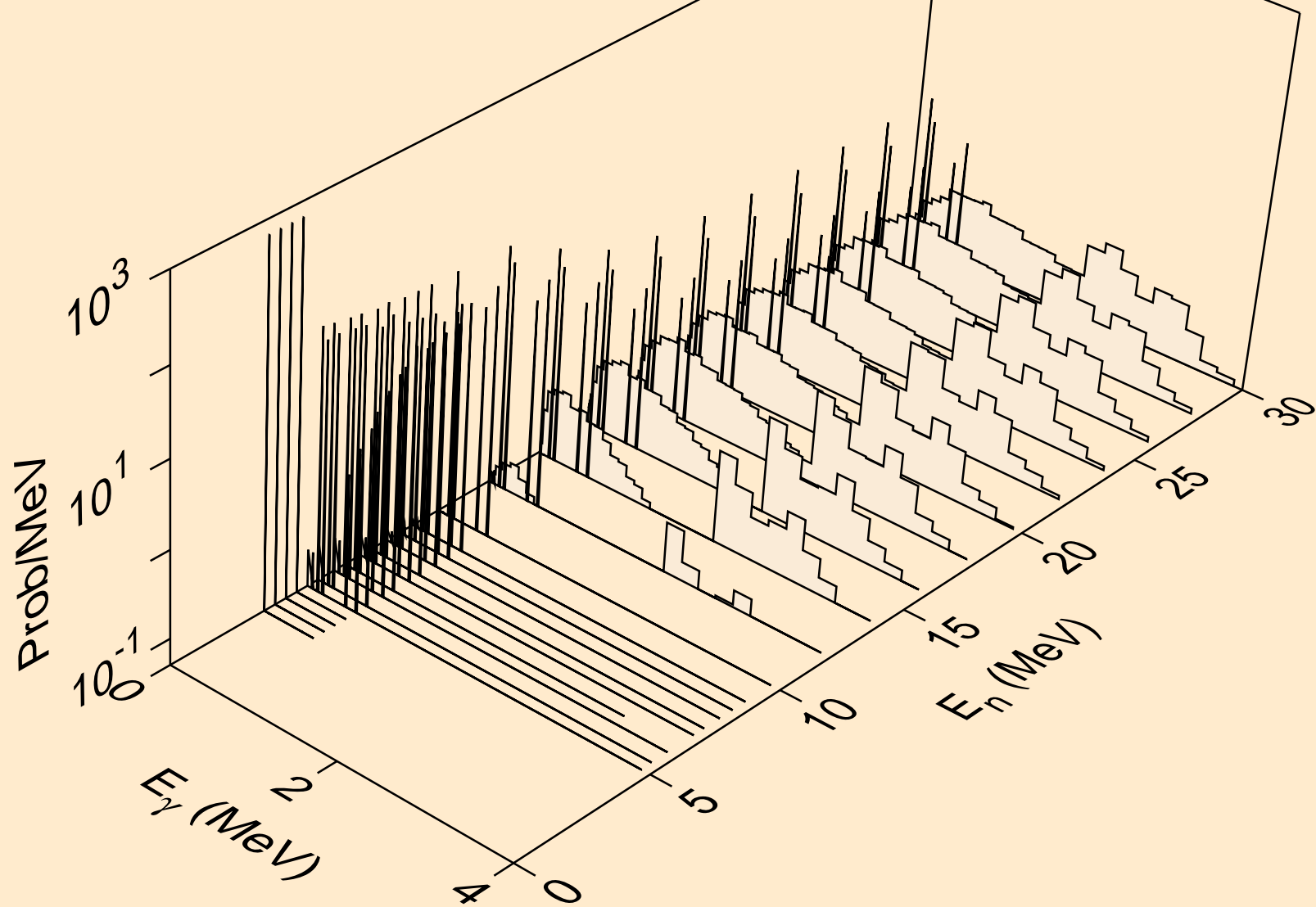

BI204 NEUTRON ACER TENDL-2021 LIBRARY; T=293.6K  
Photon emission for (n,t)

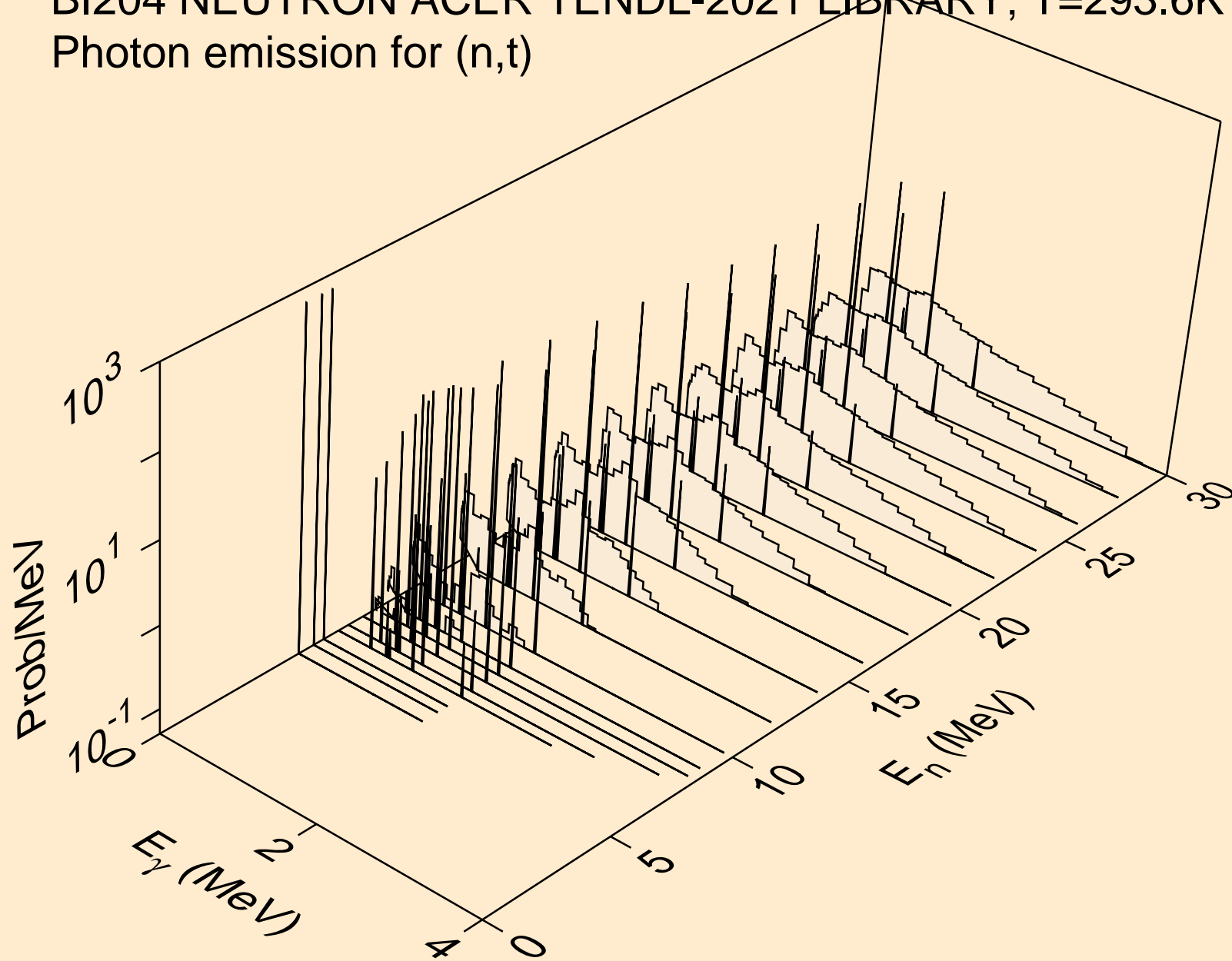

BI204 NEUTRON ACER TENDL-2021 LIBRARY; T=293.6K  
Photon emission for (n,he3)

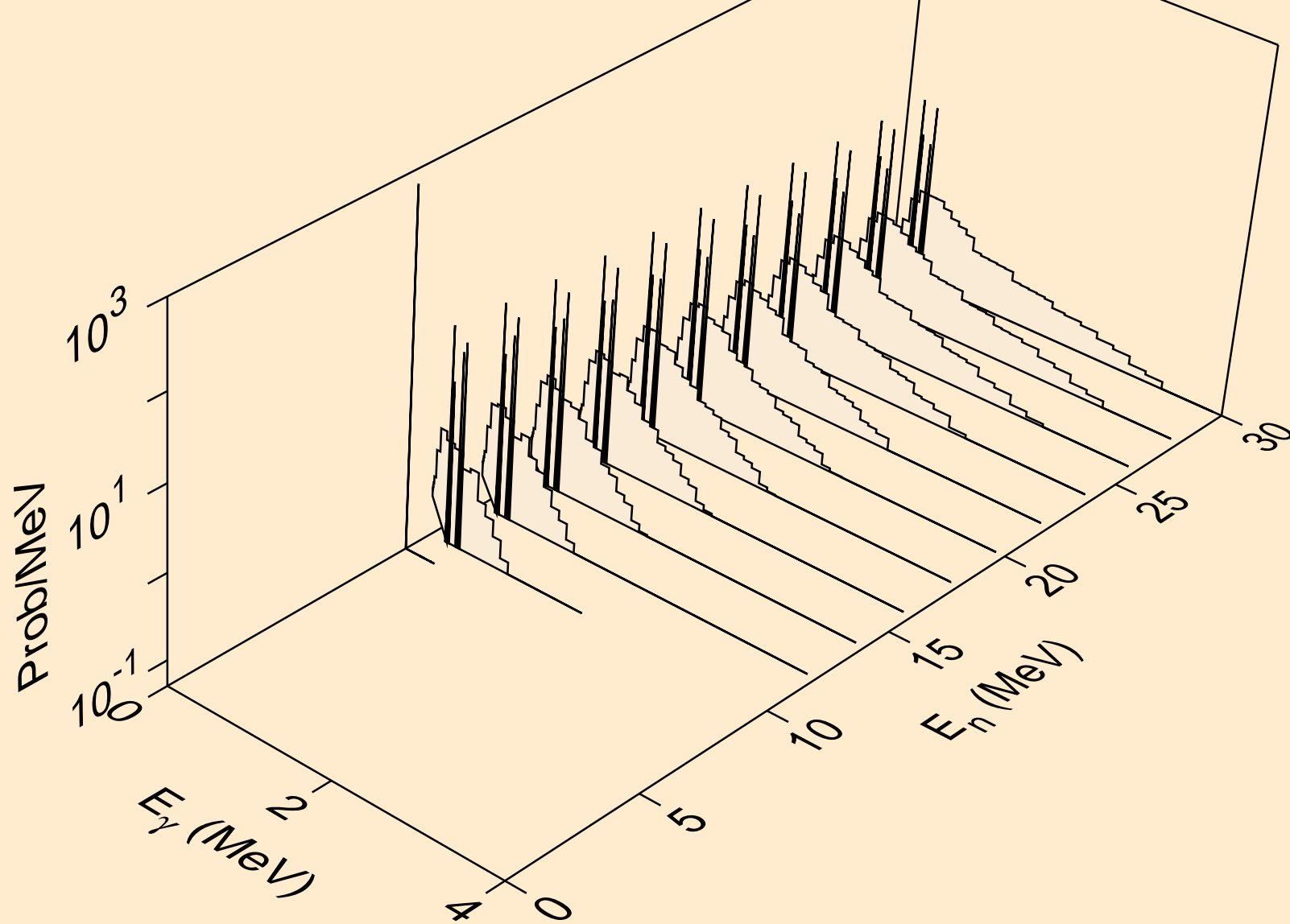

BI204 NEUTRON ACER TENDL-2021 LIBRARY; T=293.6K  
Photon emission for (n,a)

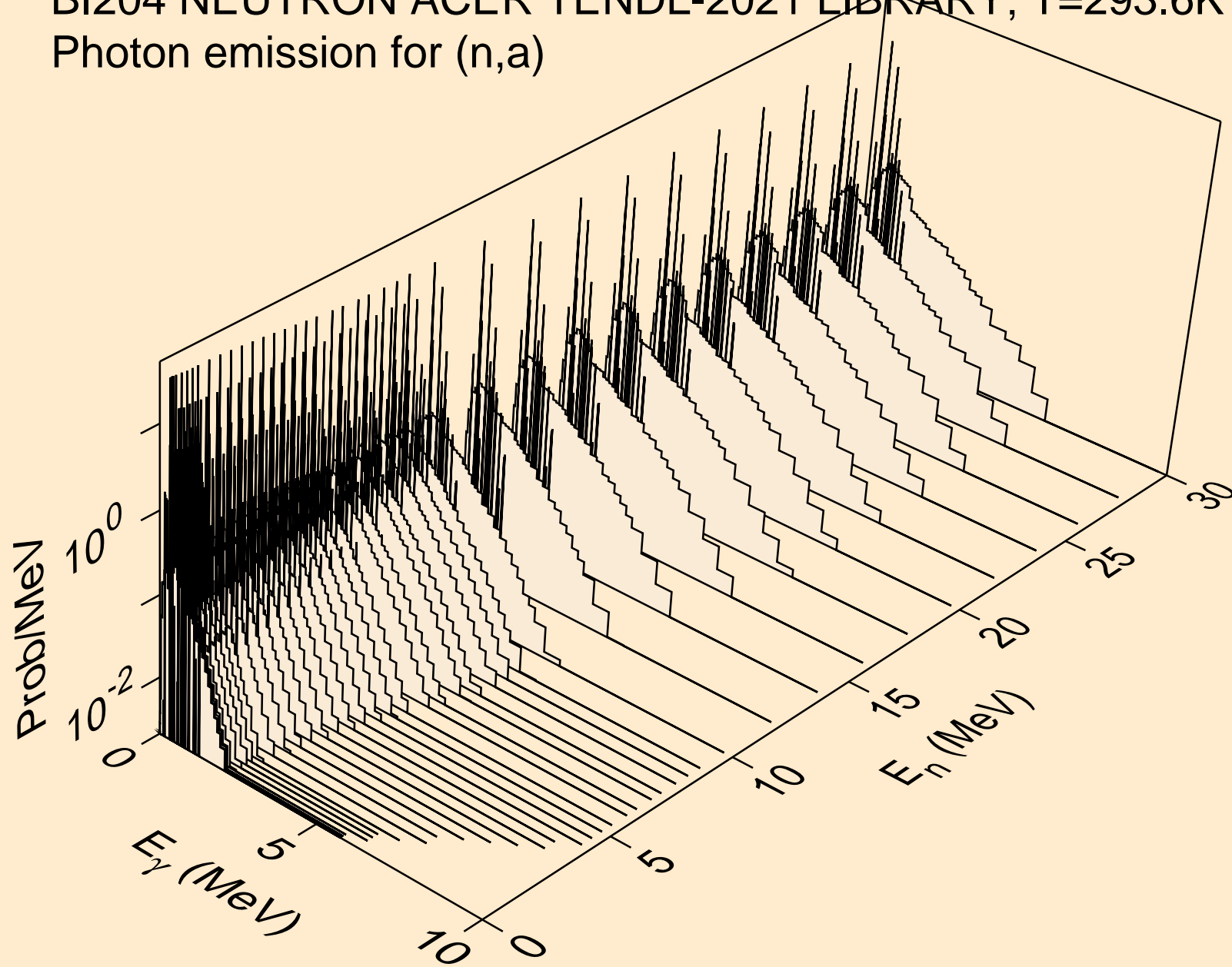

BI204 NEUTRON ACER TENDL-2021 LIBRARY; T=293.6K  
Photon emission for (n,2a)

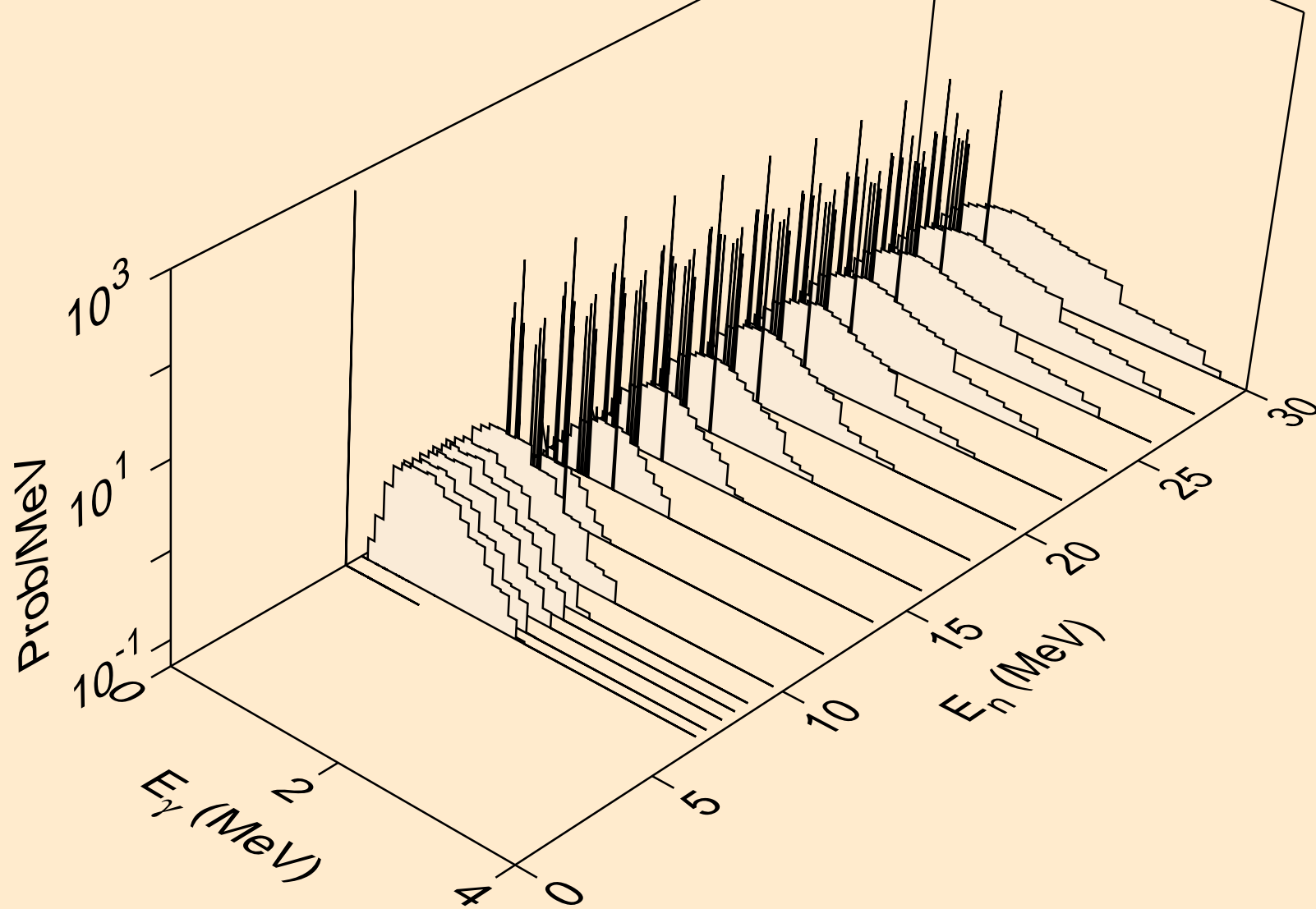

BI204 NEUTRON ACER TENDL-2021 LIBRARY; T=293.6K  
Photon emission for (n,2p)

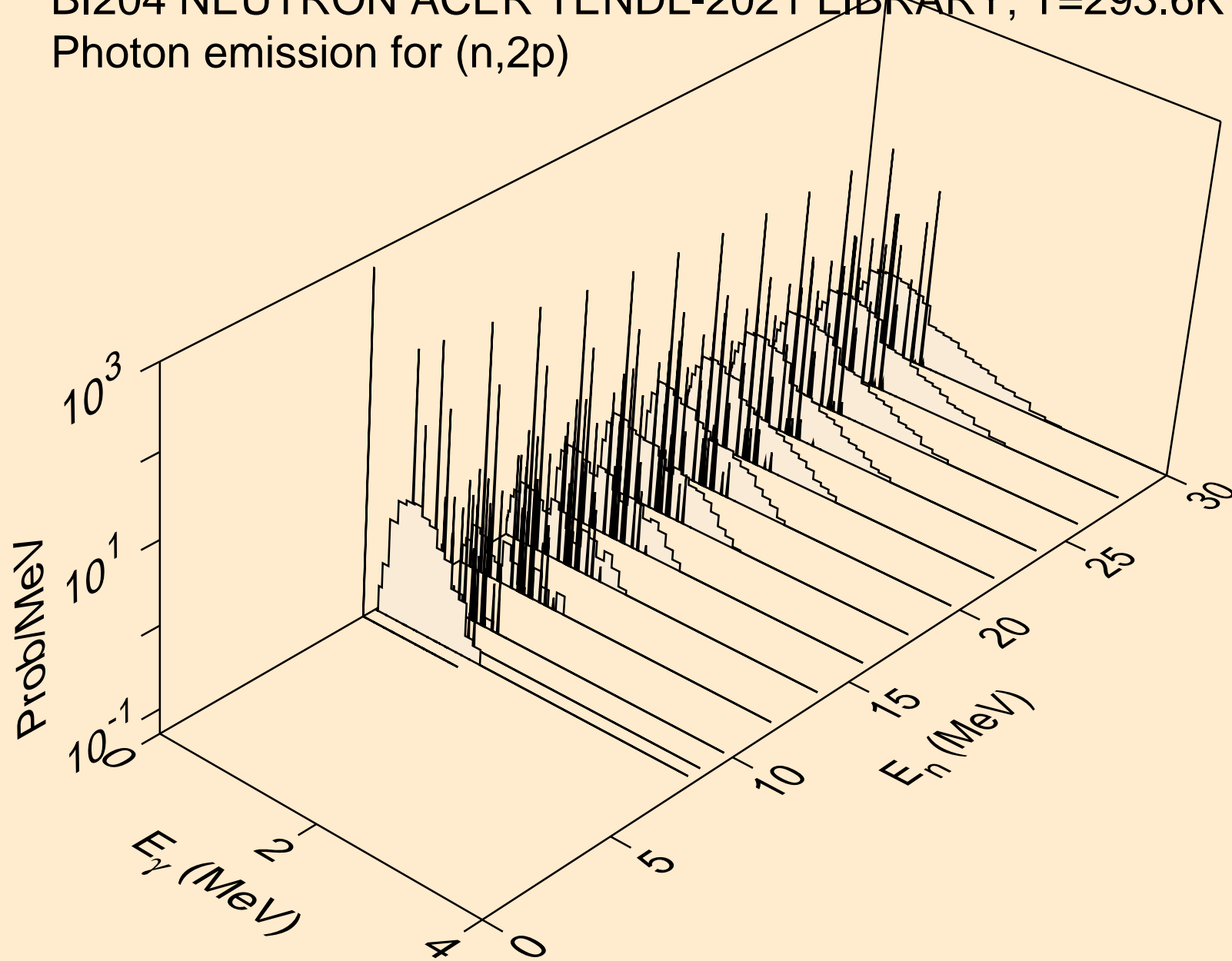

BI204 NEUTRON ACER TENDL-2021 LIBRARY; T=293.6K  
Photon emission for (n,p $\alpha$ )

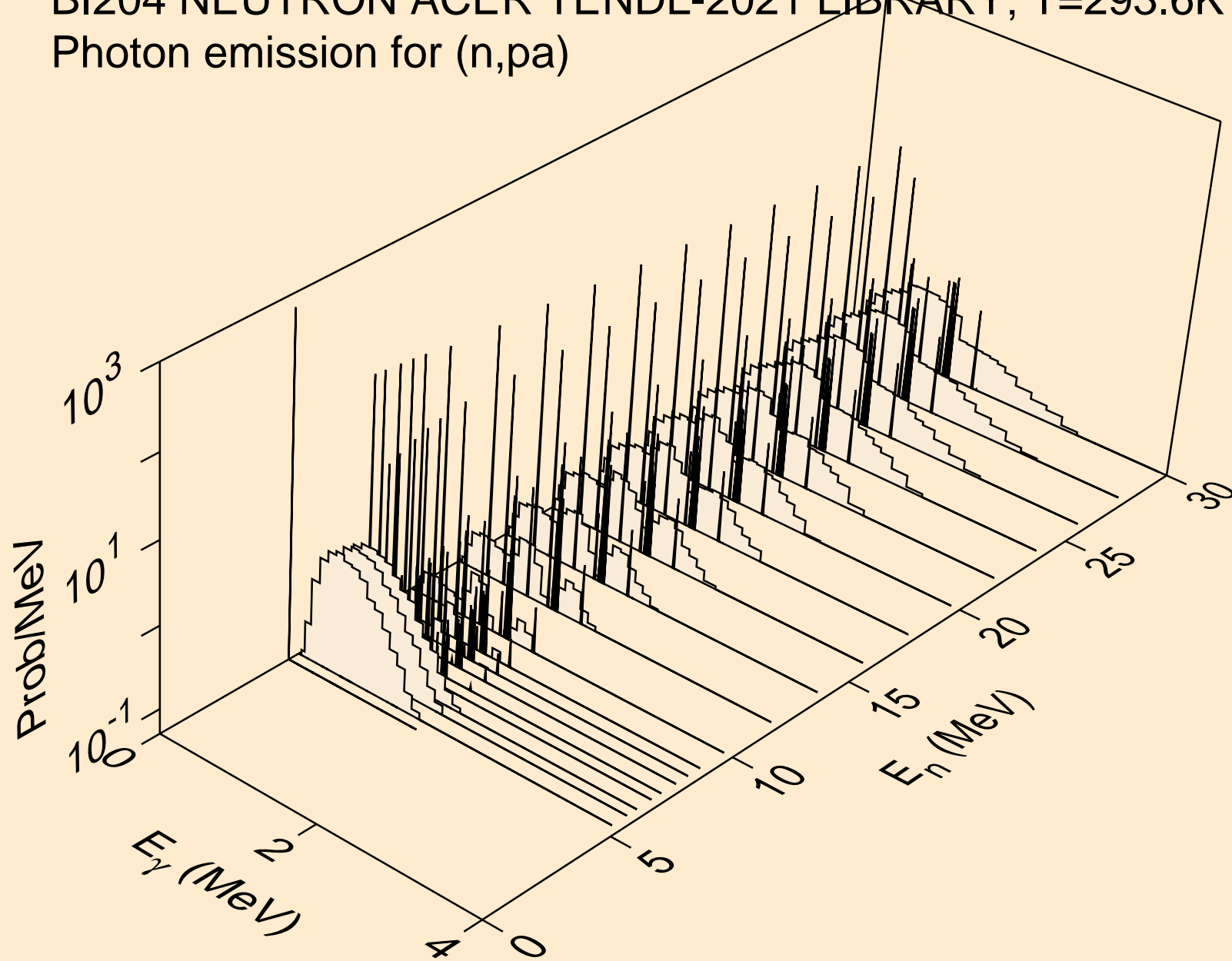



BI204 NEUTRON ACER TENDL-2021 LIBRARY; T=293.6K  
Photon emission for (n,pd)

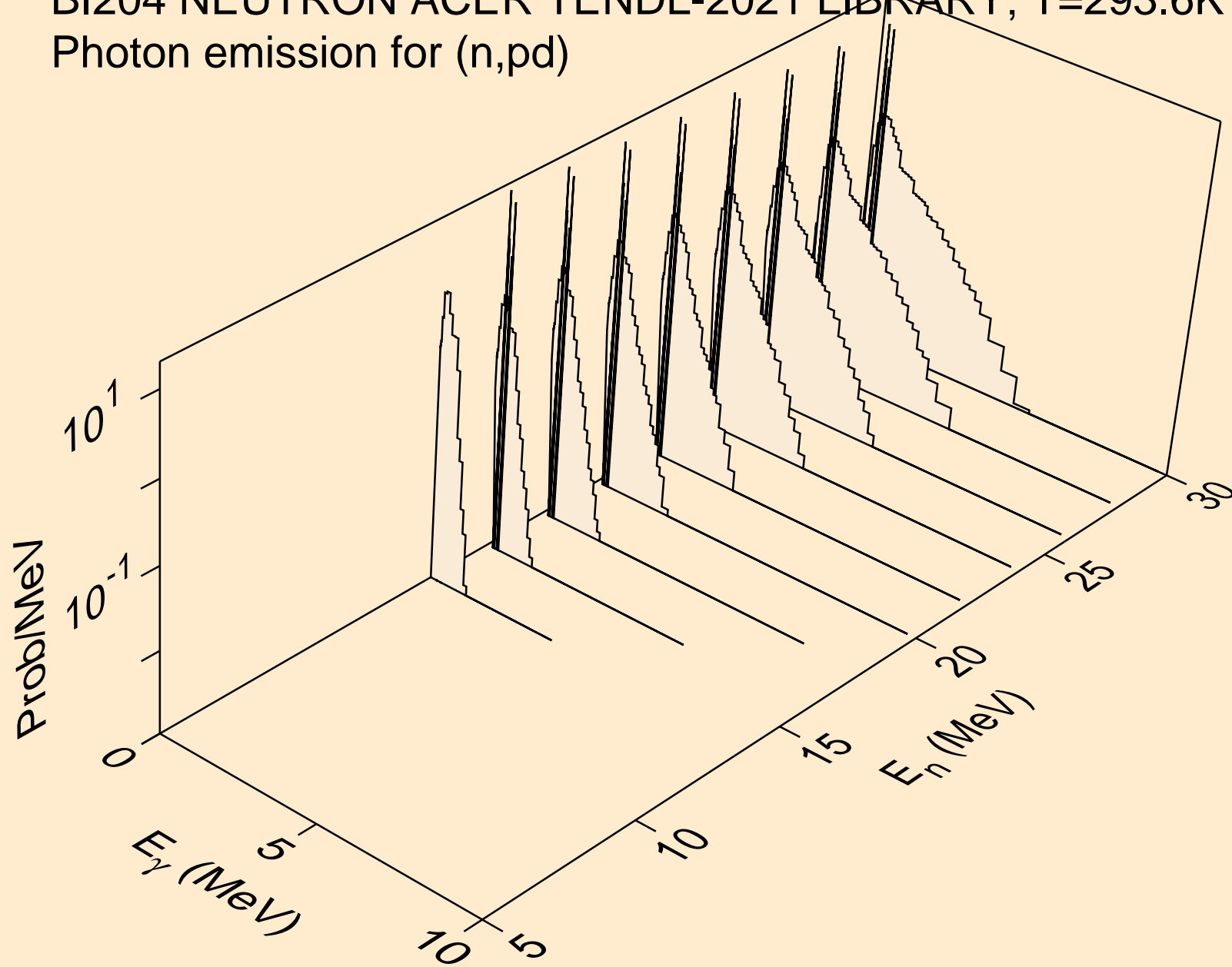

BI204 NEUTRON ACER TENDL-2021 LIBRARY; T=293.6K  
Photon emission for (n,pt)

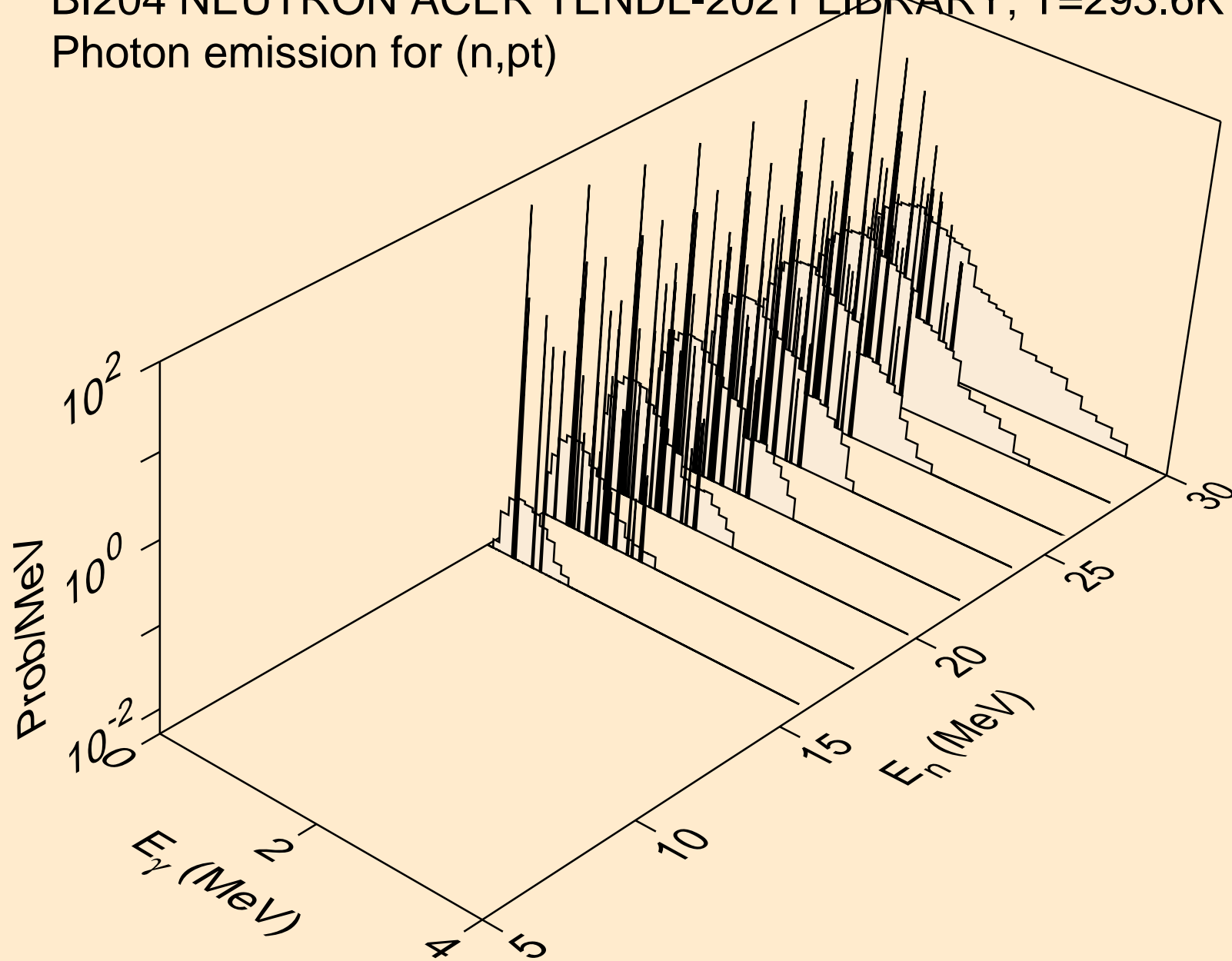

BI204 NEUTRON ACER TENDL-2021 LIBRARY; T=293.6K  
Photon emission for (n,da)

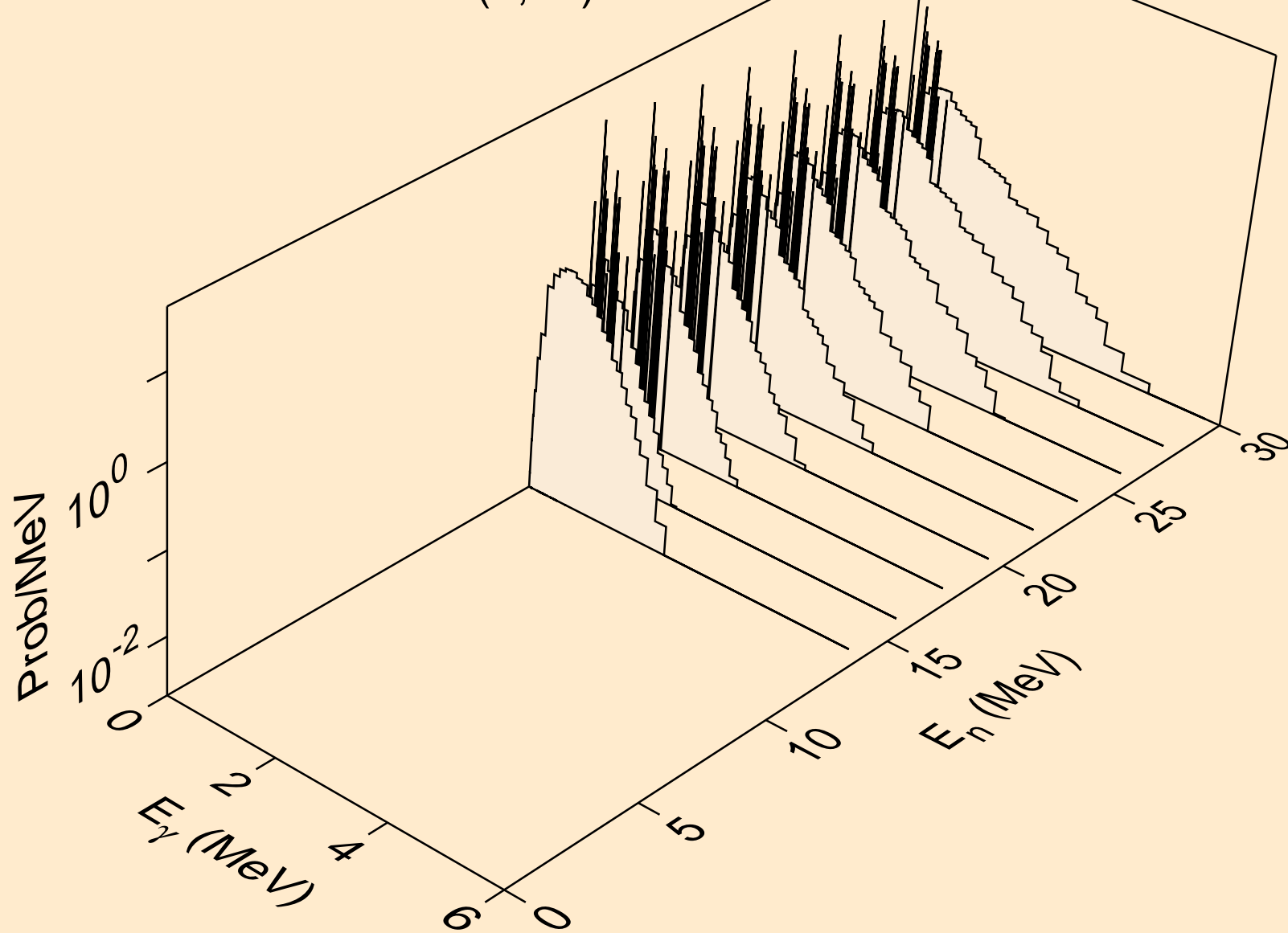

BI204 NEUTRON ACER TENDL-2021 LIBRARY; T=293.6K  
thermal capture photon spectrum

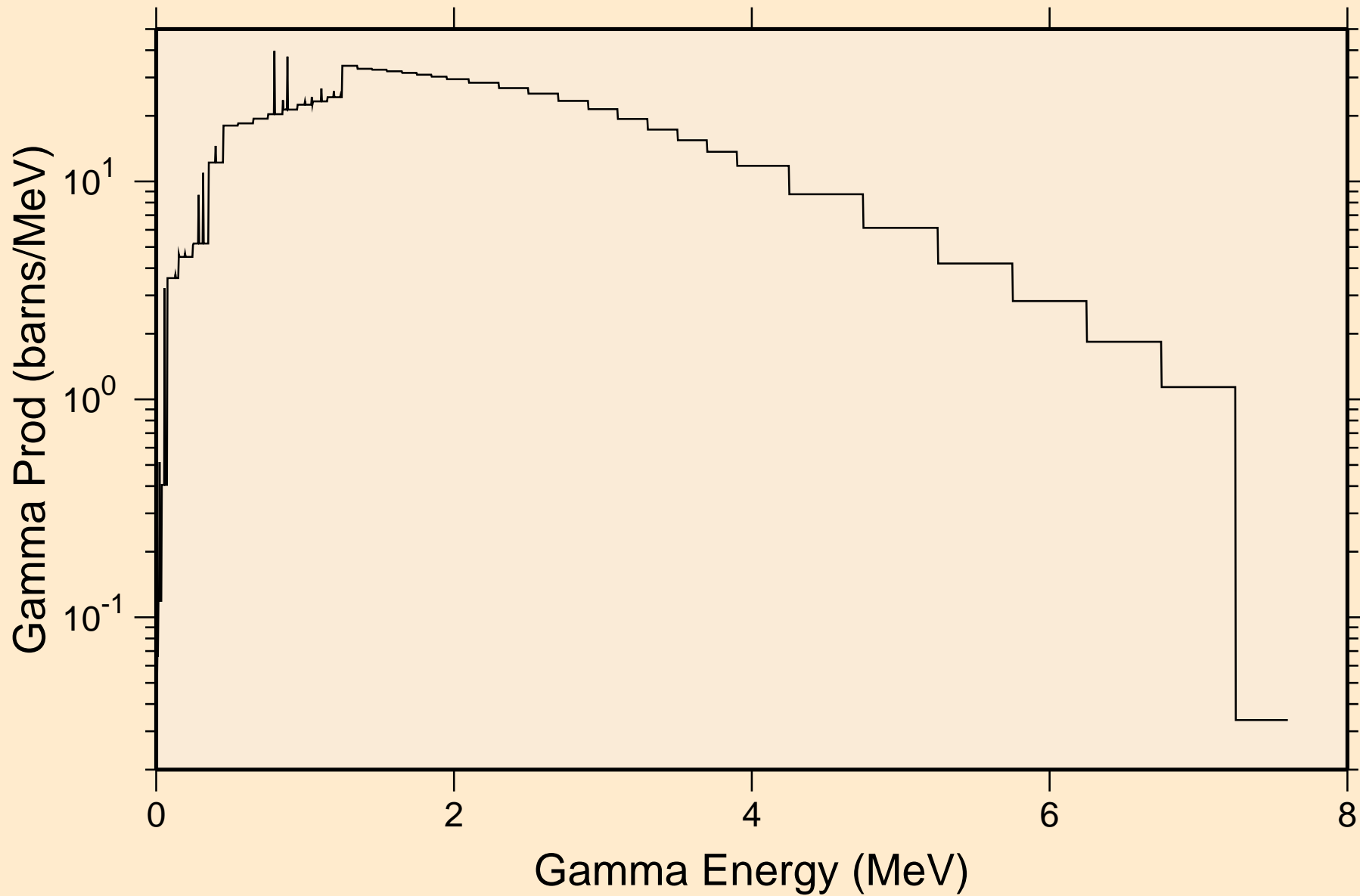

BI204 NEUTRON ACER TENDL-2021 LIBRARY; T=293.6K  
14 MeV photon spectrum

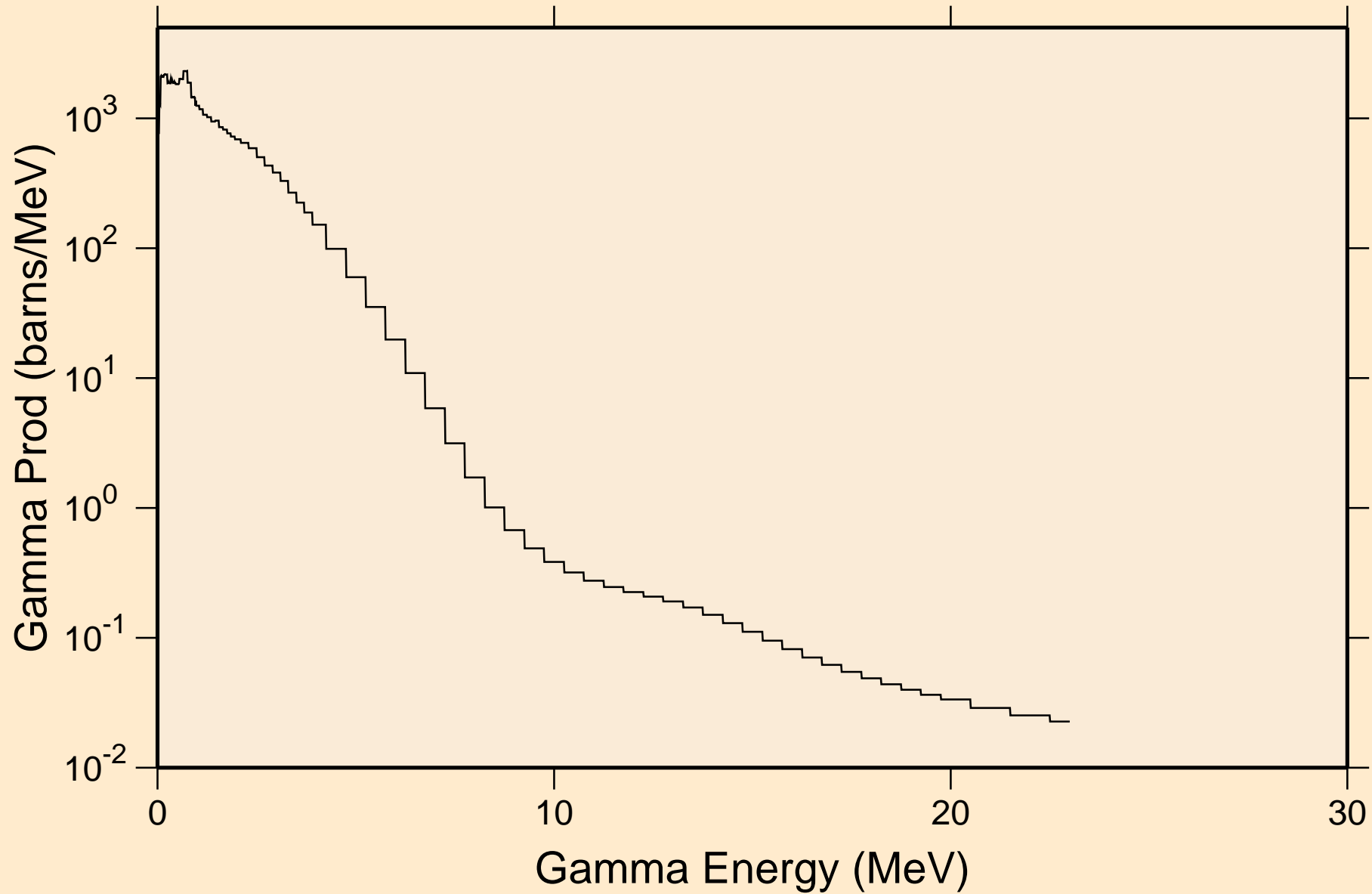

BI204 NEUTRON ACER TENDL-2021 LIBRARY; T=293.6K  
Particle heating contributions

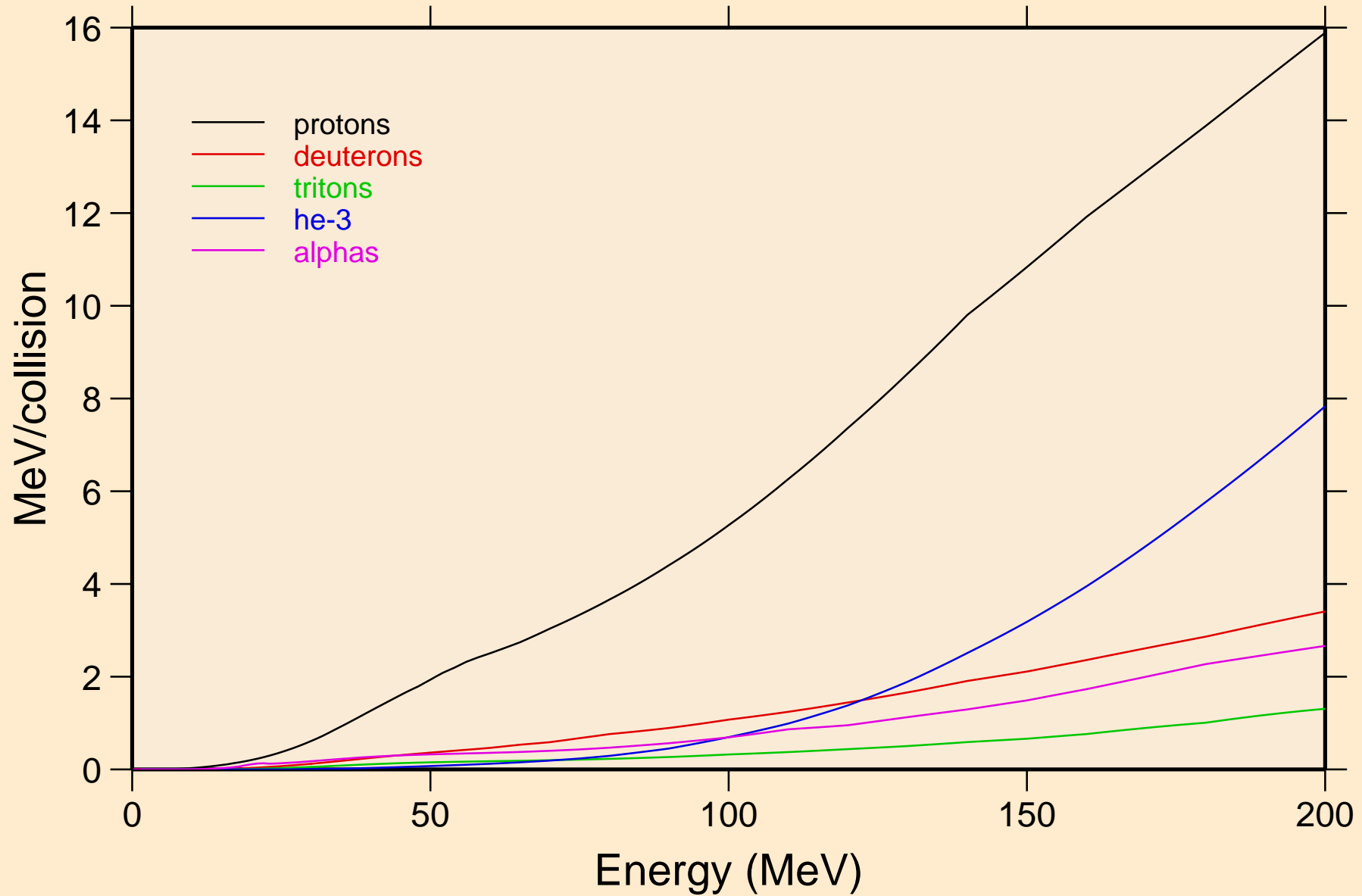

BI204 NEUTRON ACER TENDL-2021 LIBRARY; T=293.6K  
Recoil Heating

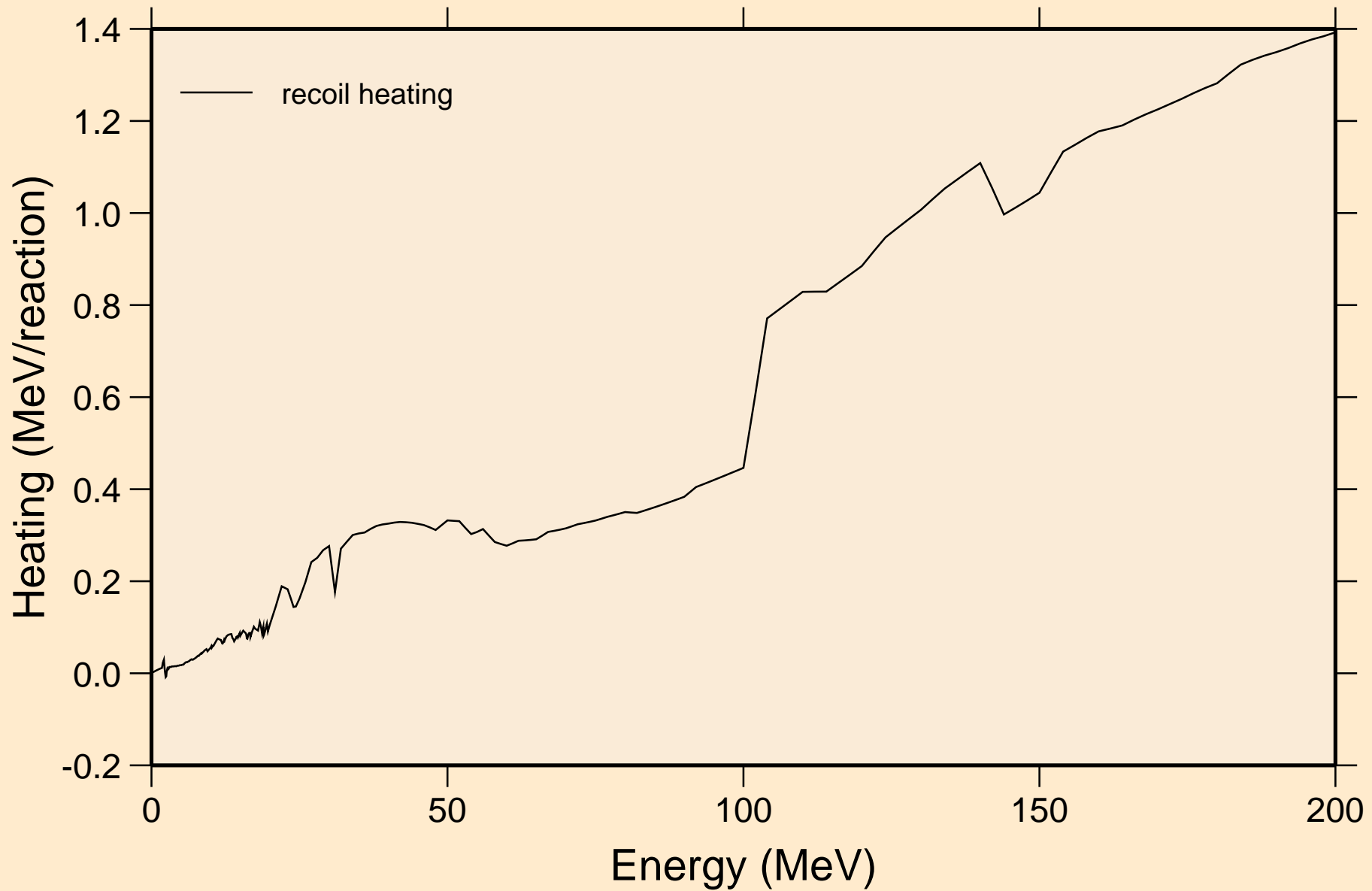

BI204 NEUTRON ACER TENDL-2021 LIBRARY; T=293.6K  
Particle production cross sections

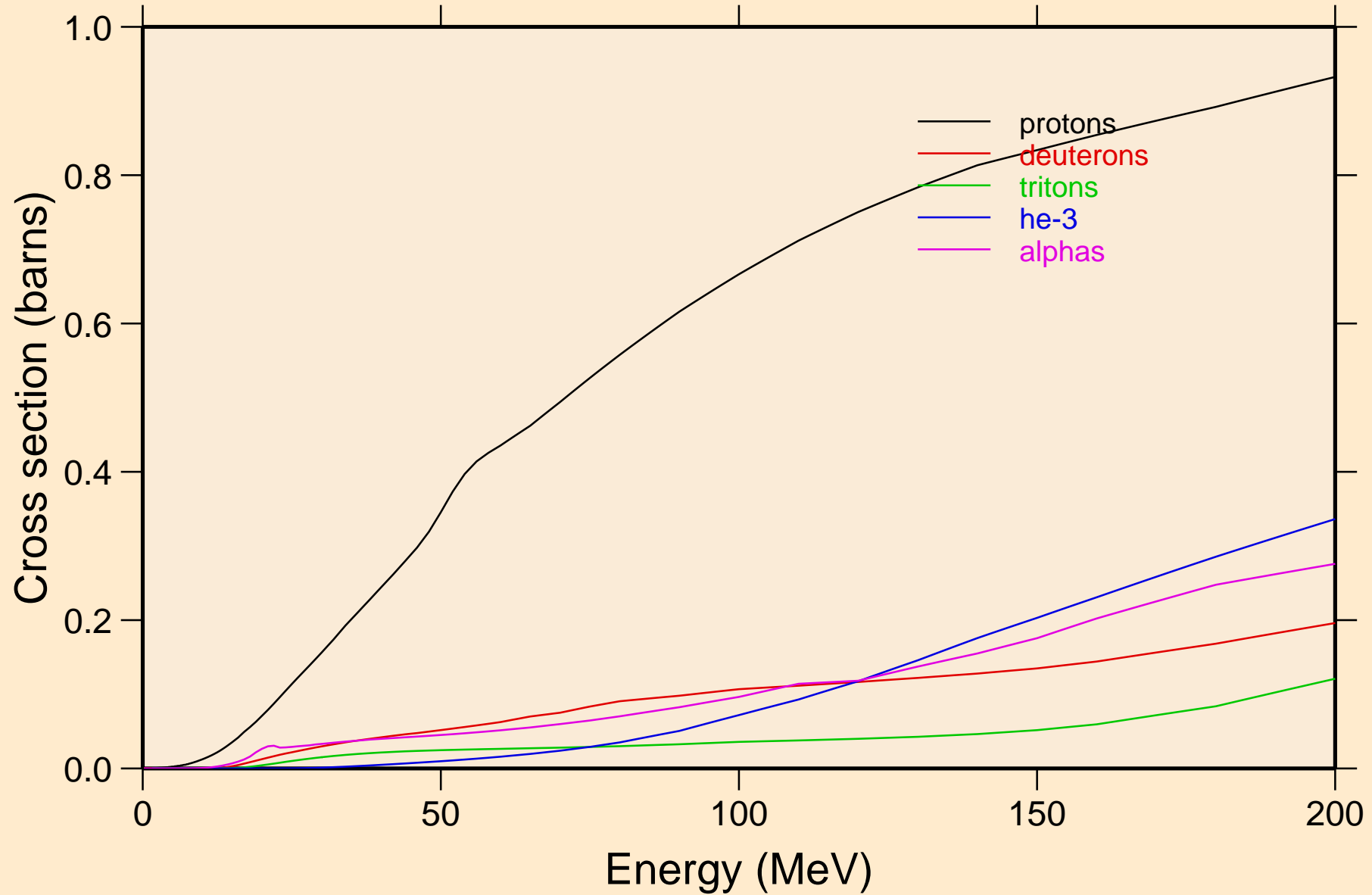



BI204 NEUTRON ACER TENDL-2021 LIBRARY; T=293.6K  
protons from (n,x)

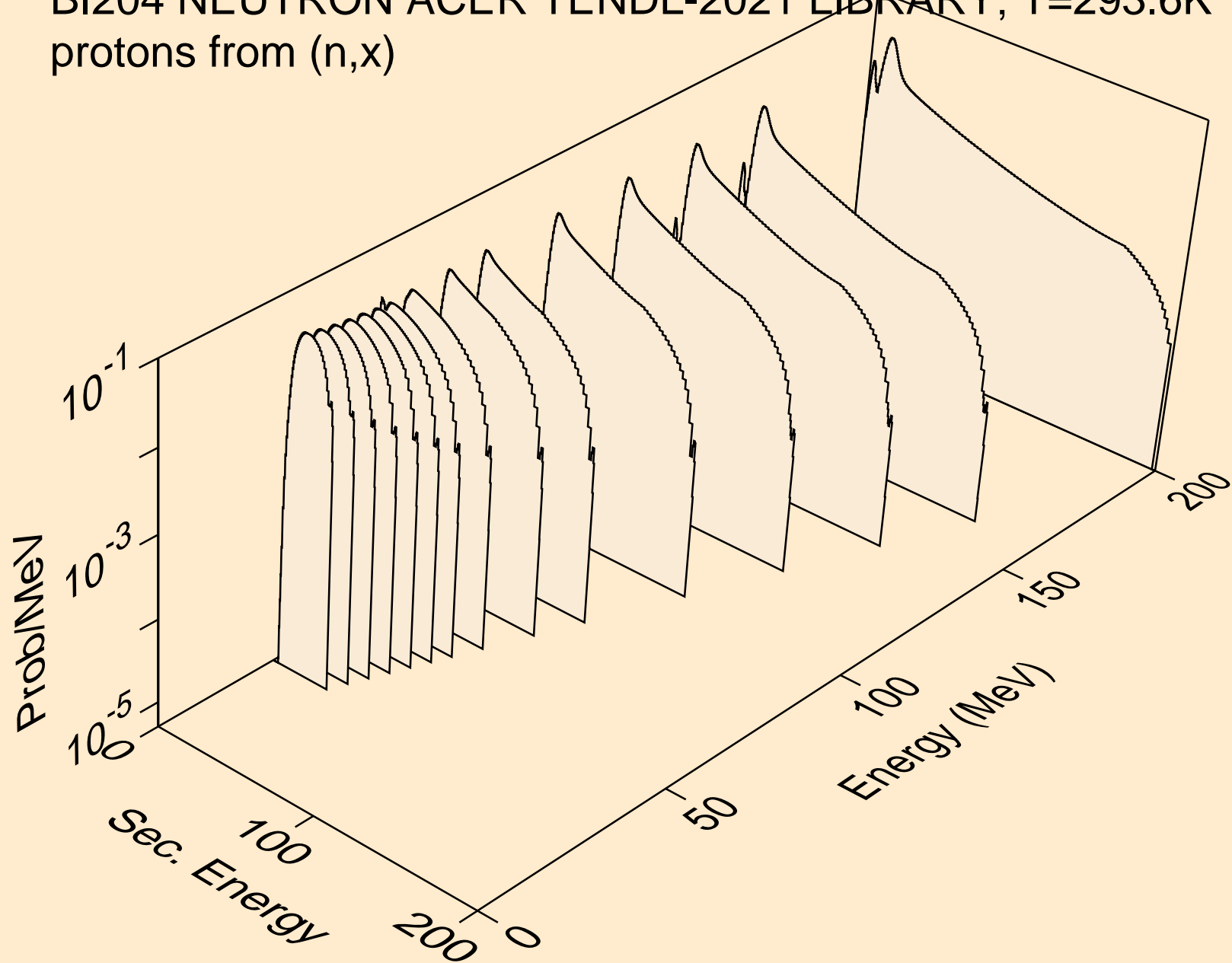

BI204 NEUTRON ACER TENDL-2021 LIBRARY; T=293.6K  
protons from (n,n\*)p

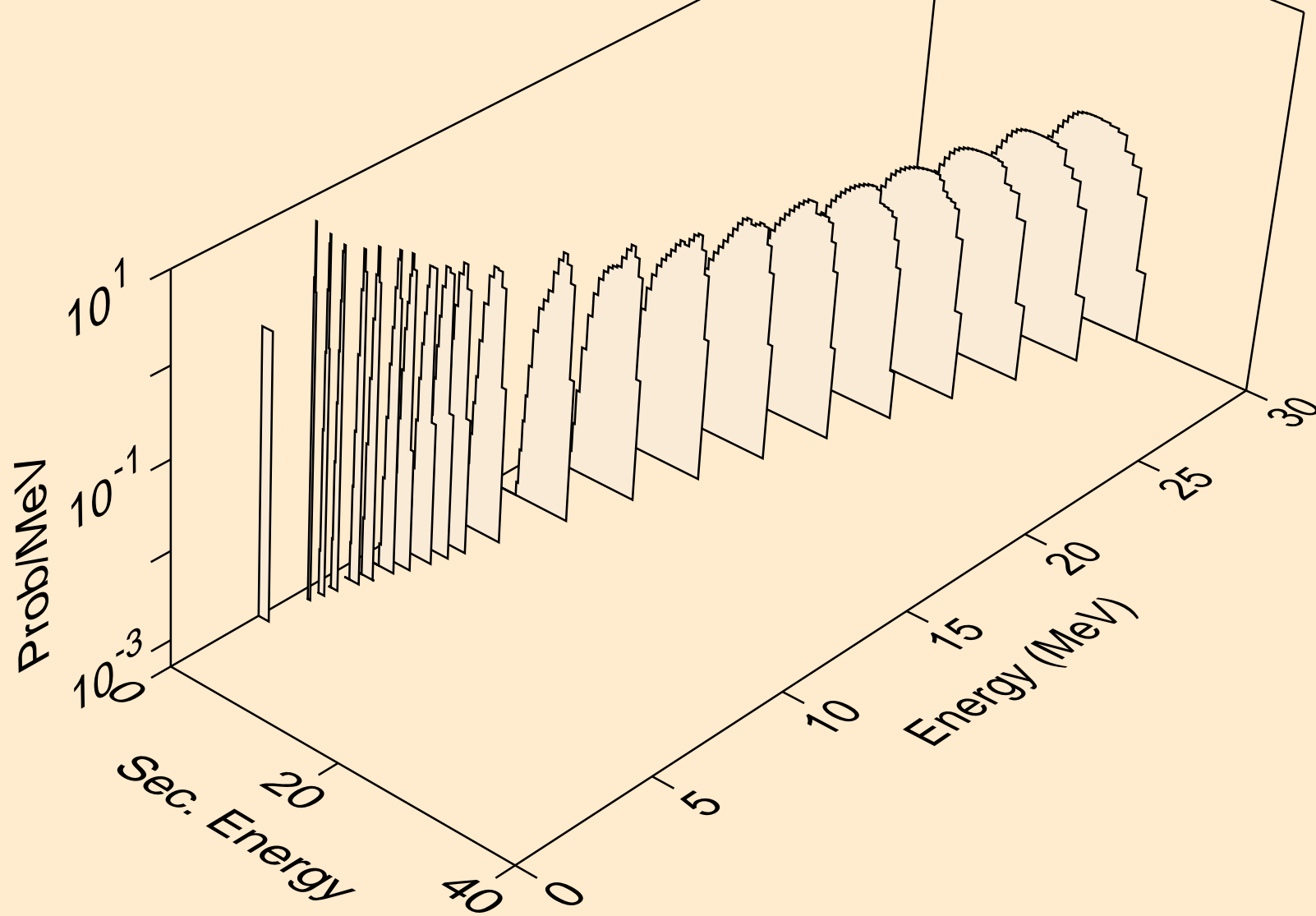

BI204 NEUTRON ACER TENDL-2021 LIBRARY; T=293.6K  
protons from (n,2np)

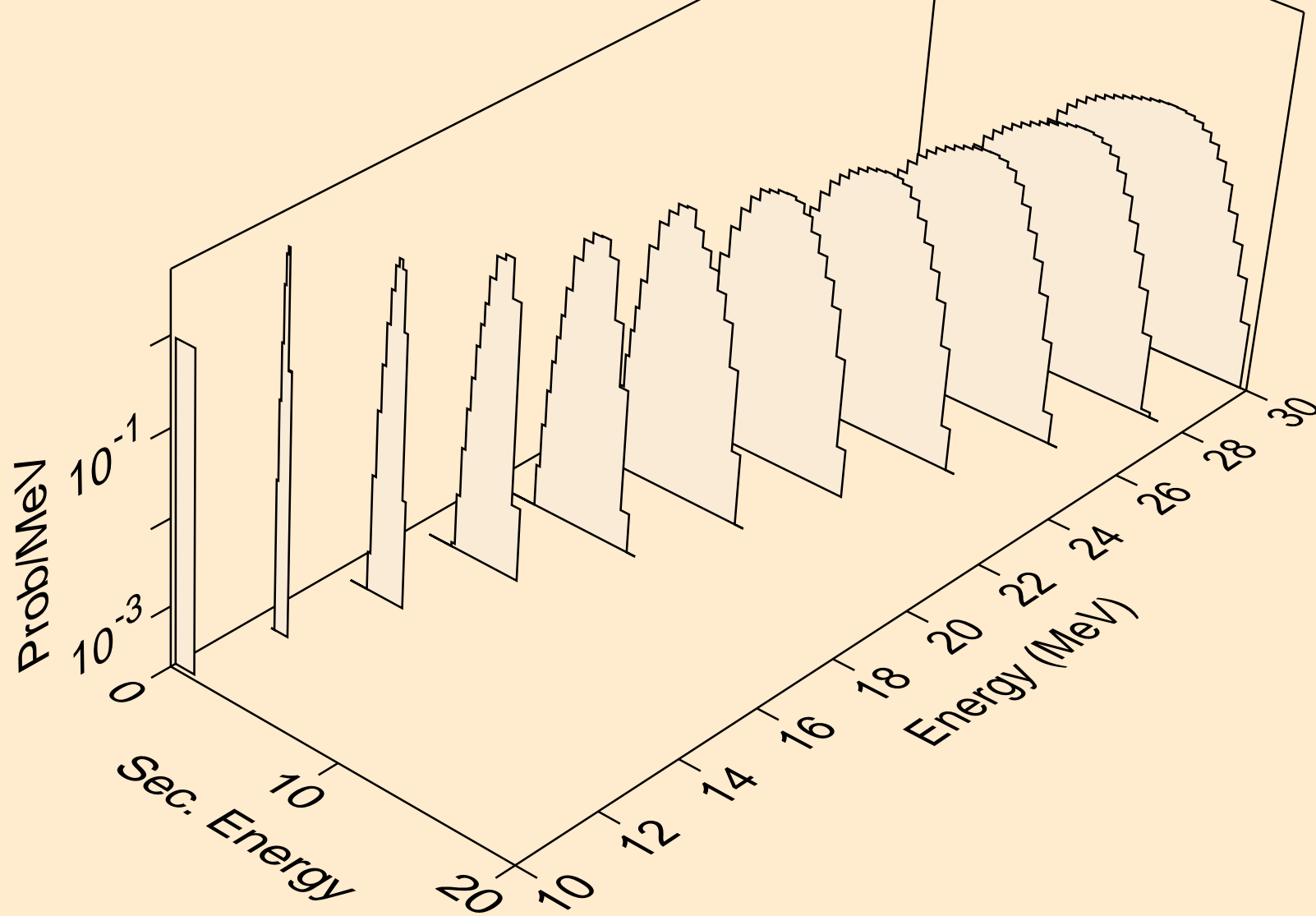

BI204 NEUTRON ACER TENDL-2021 LIBRARY; T=293.6K  
protons from (n,3np)

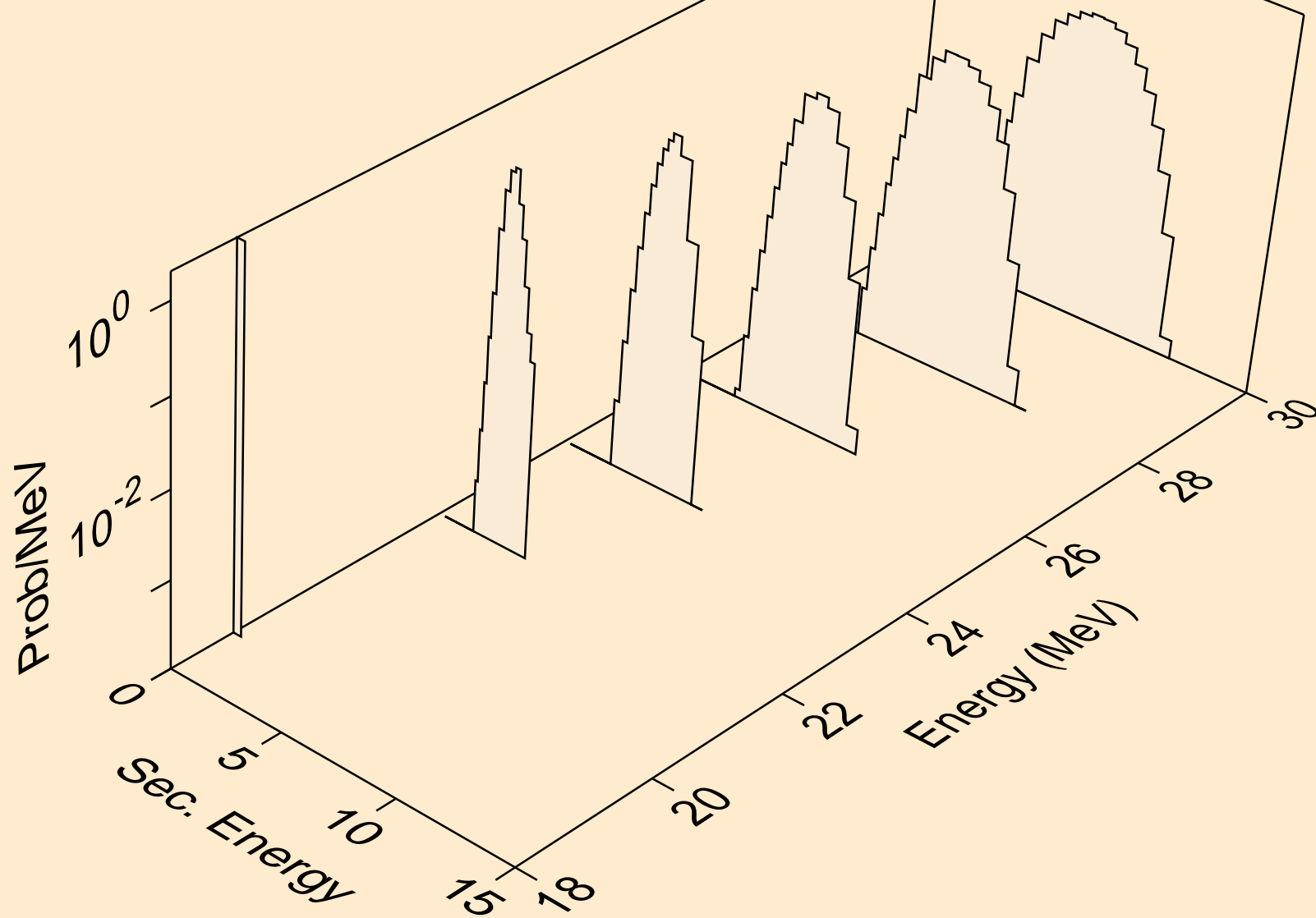

BI204 NEUTRON ACER TENDL-2021 LIBRARY; T=293.6K  
protons from (n,2np)

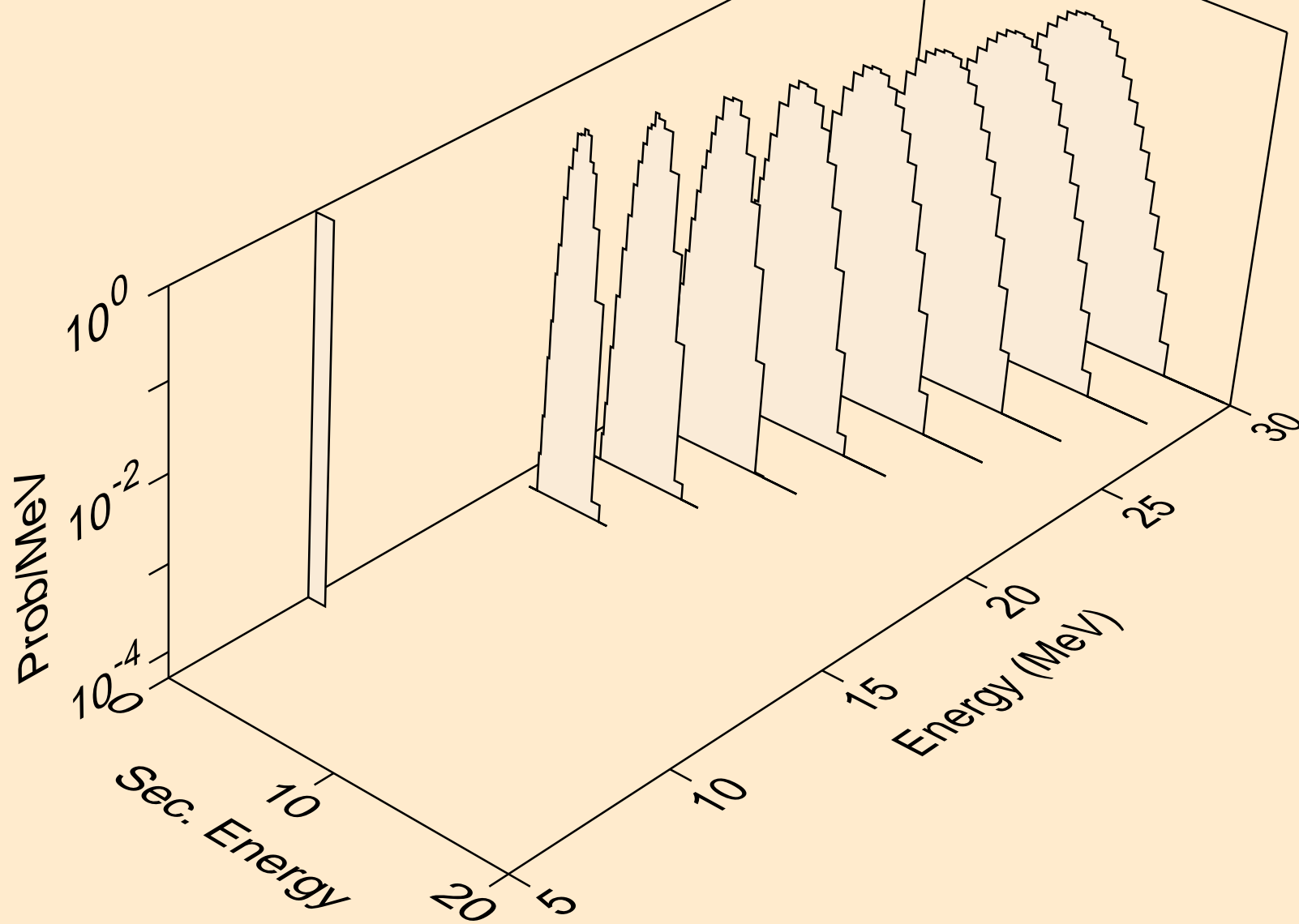

BI204 NEUTRON ACER TENDL-2021 LIBRARY; T=293.6K  
protons from (n,npa)

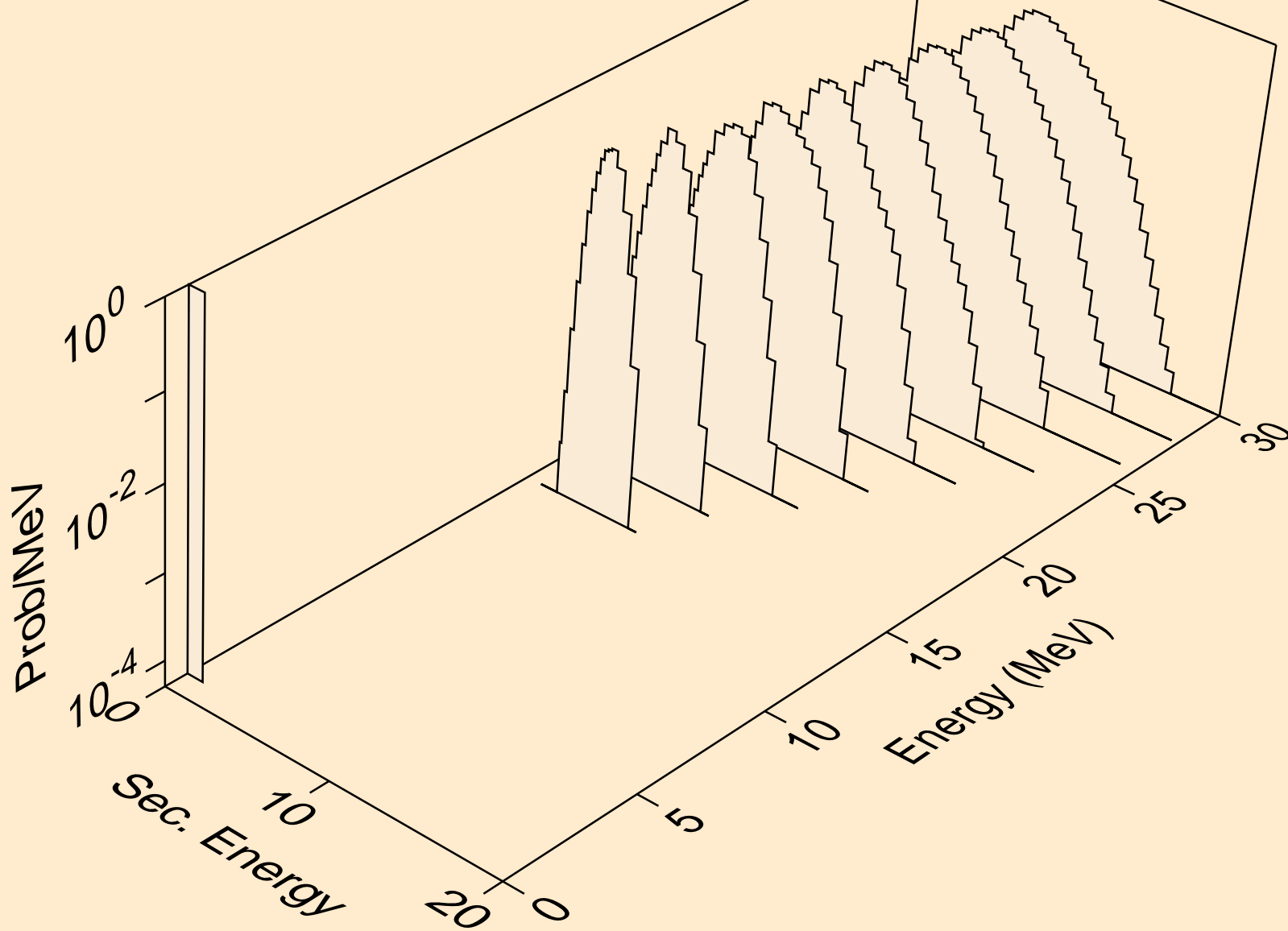

BI204 NEUTRON ACER TENDL-2021 LIBRARY; T=293.6K  
protons from (n,p)

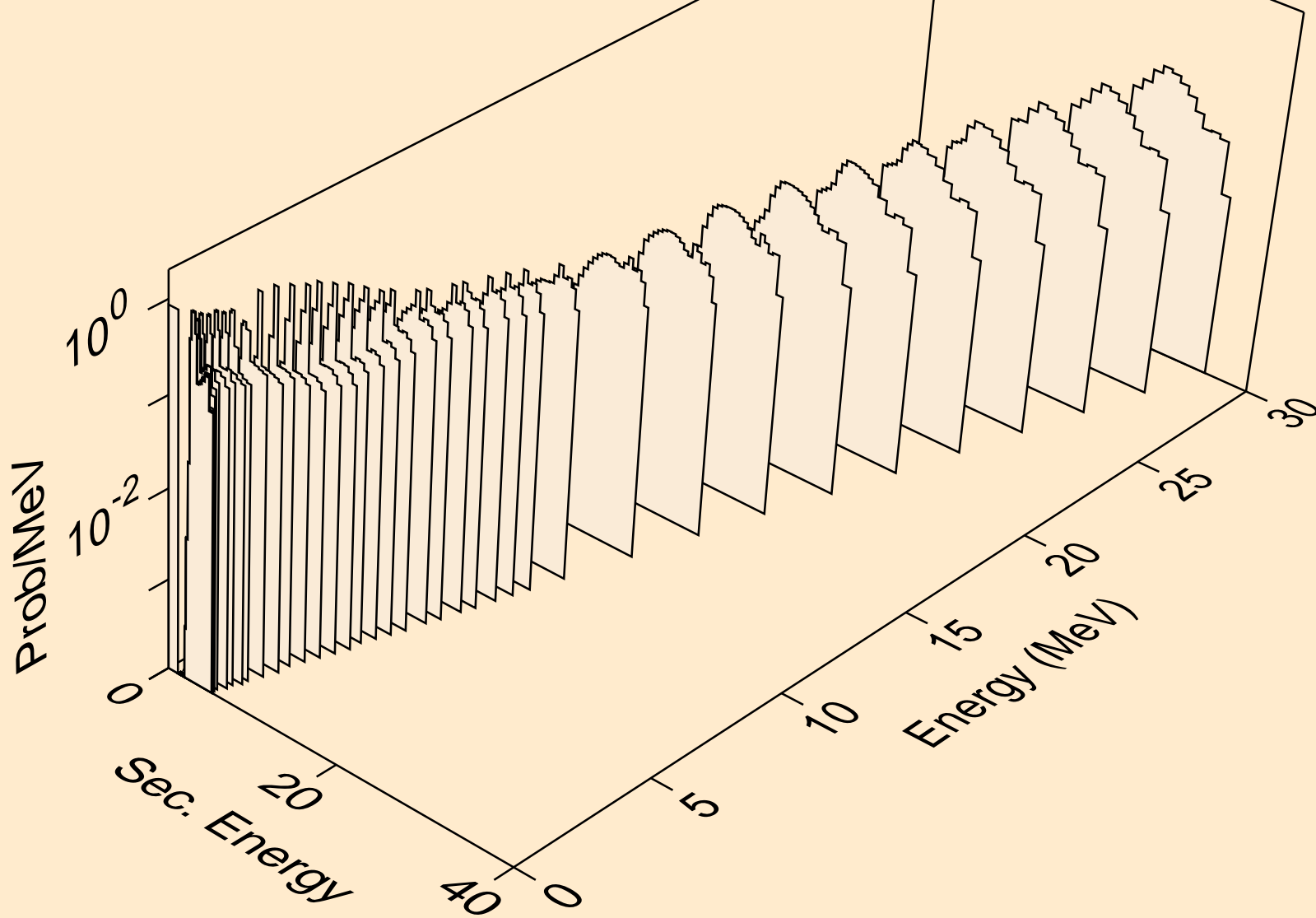

BI204 NEUTRON ACER TENDL-2021 LIBRARY; T=293.6K  
protons from (n,2p)

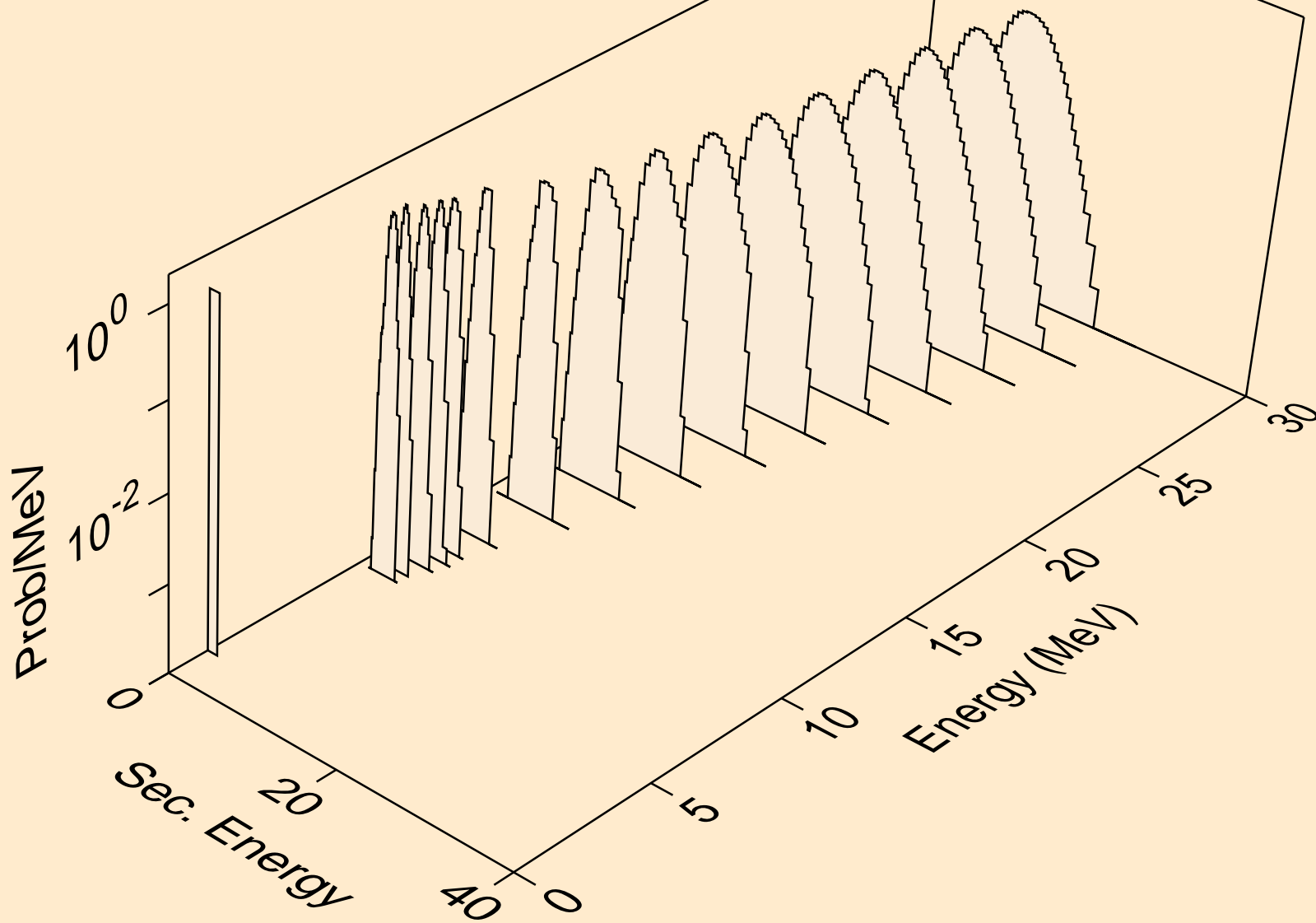



BI204 NEUTRON ACER TENDL-2021 LIBRARY; T=293.6K  
protons from (n,p)

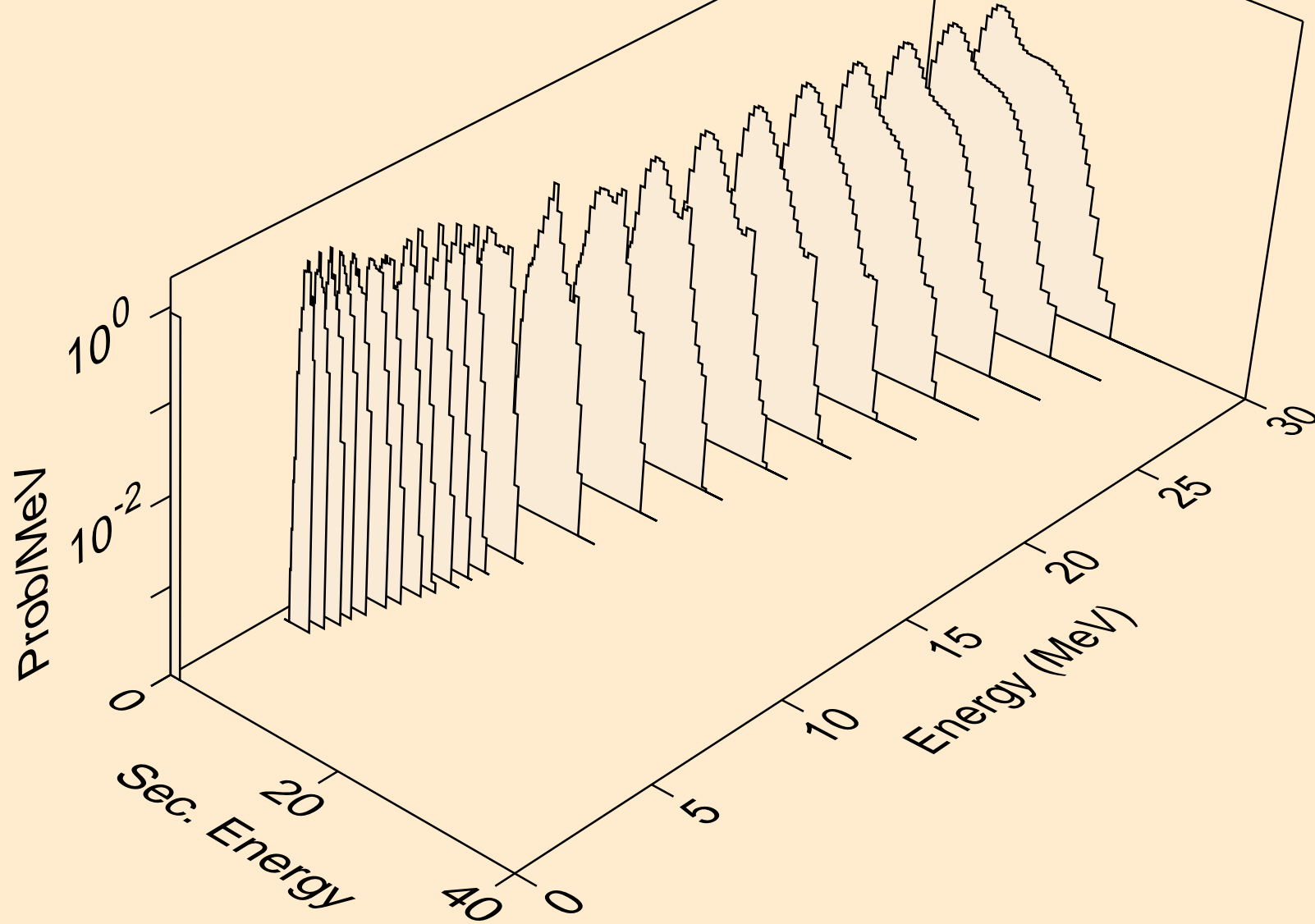

BI204 NEUTRON ACER TENDL-2021 LIBRARY; T=293.6K  
protons from (n,pd)

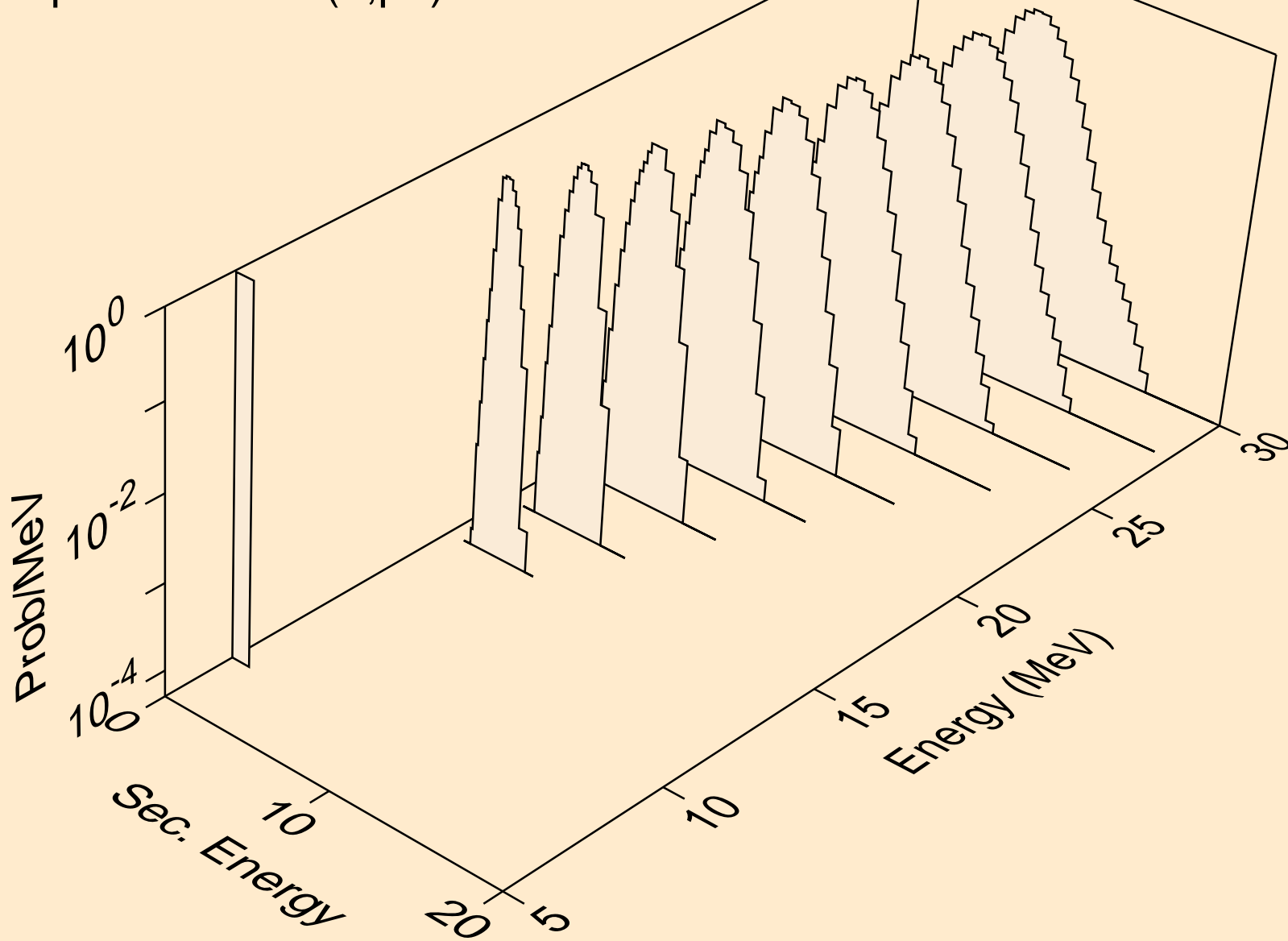

BI204 NEUTRON ACER TENDL-2021 LIBRARY; T=293.6K  
protons from (n,pt)

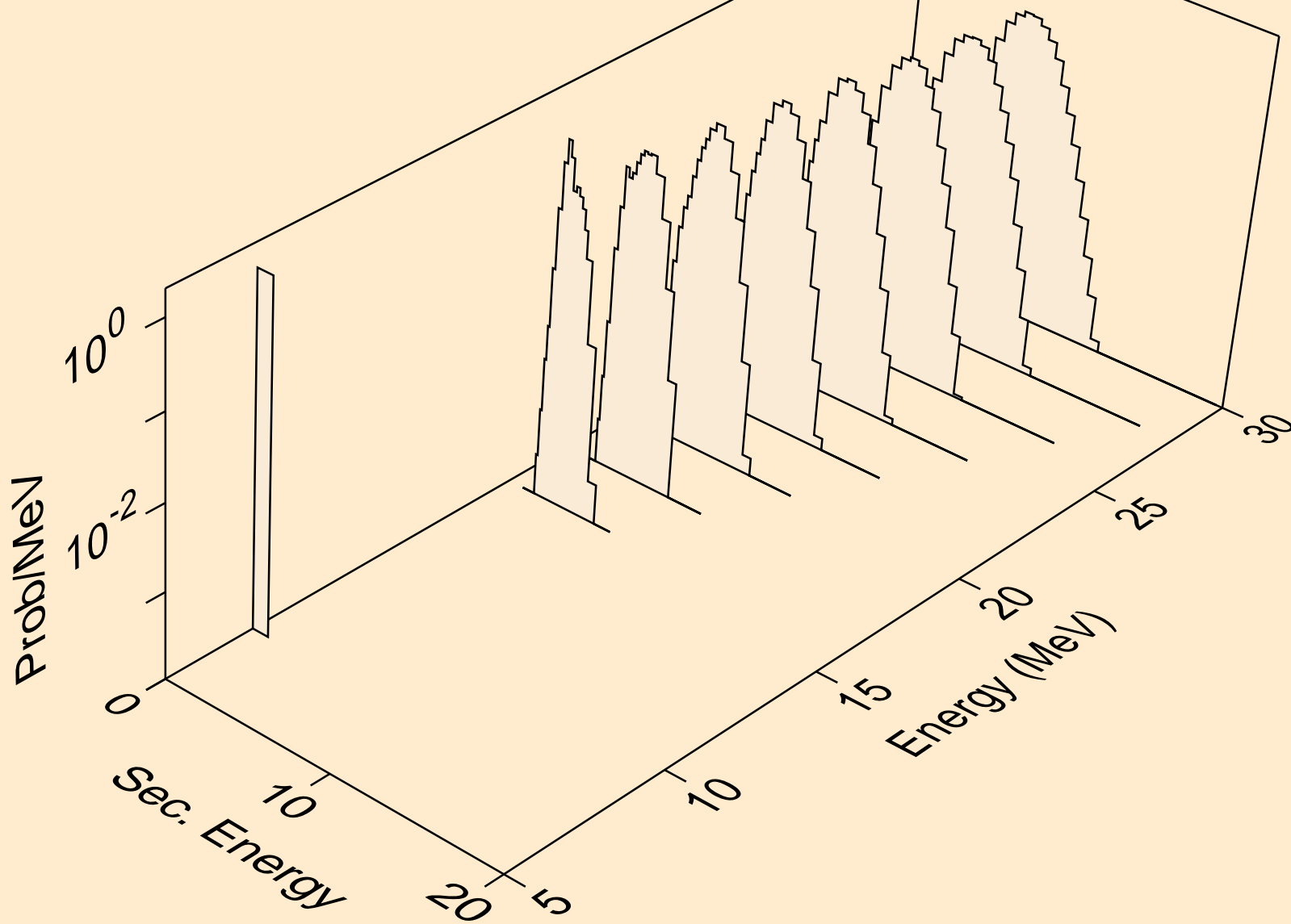

BI204 NEUTRON ACER TENDL-2021 LIBRARY; T=293.6K  
deuterons from (n,x)

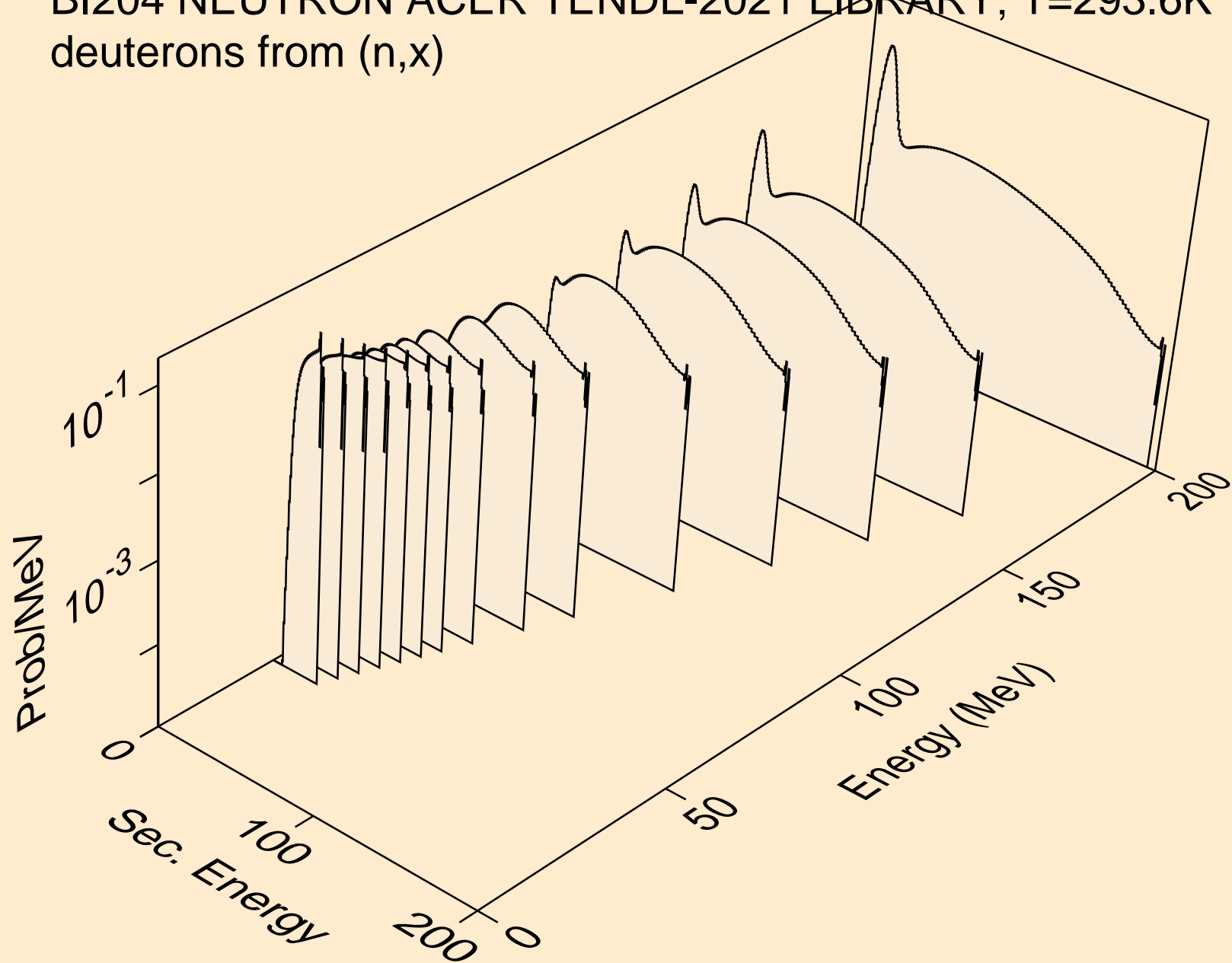

BI204 NEUTRON ACER TENDL-2021 LIBRARY; T=293.6K  
deuterons from (n,2nd)

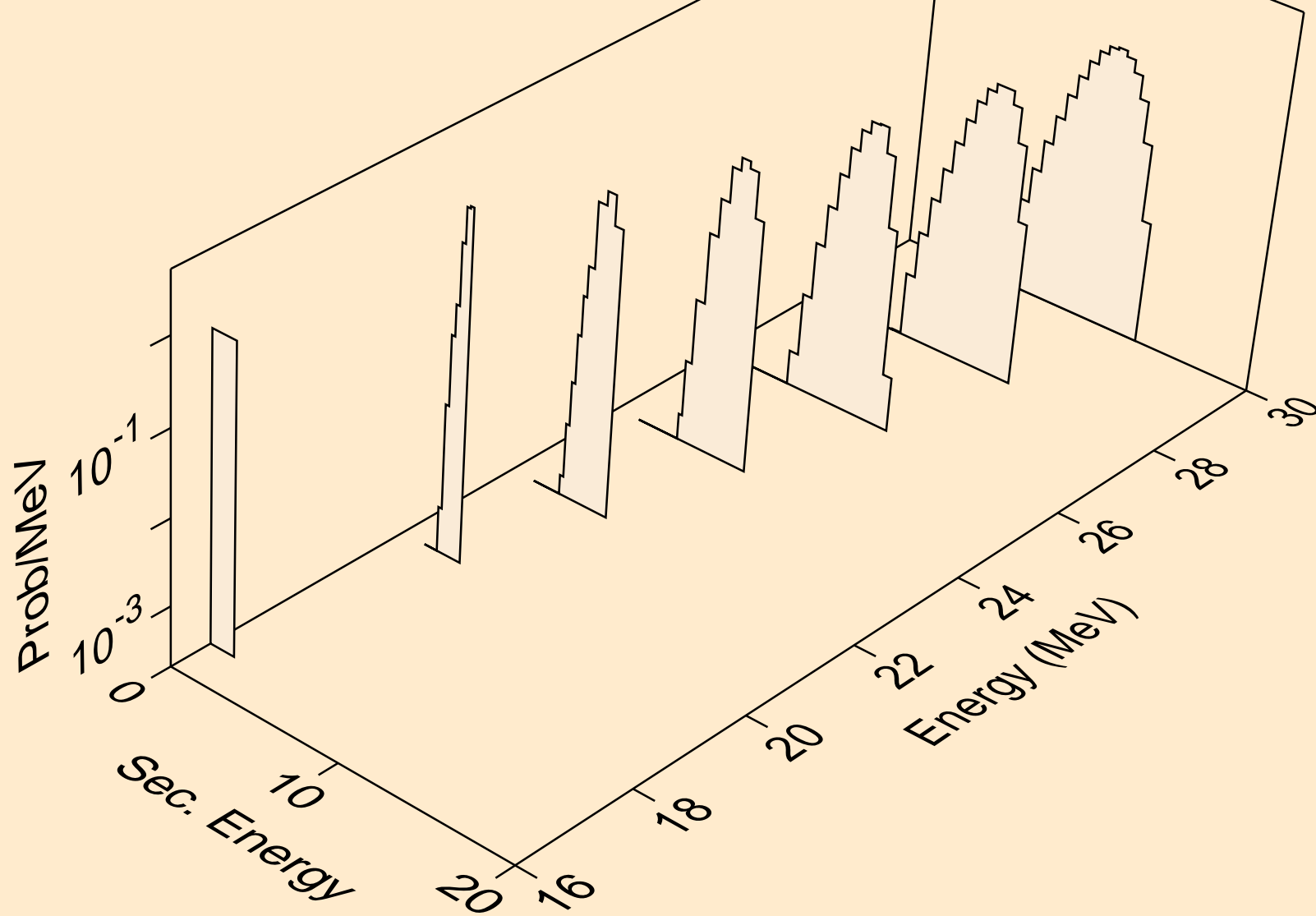

BI204 NEUTRON ACER TENDL-2021 LIBRARY; T=293.6K  
deuterons from (n,n\*)d

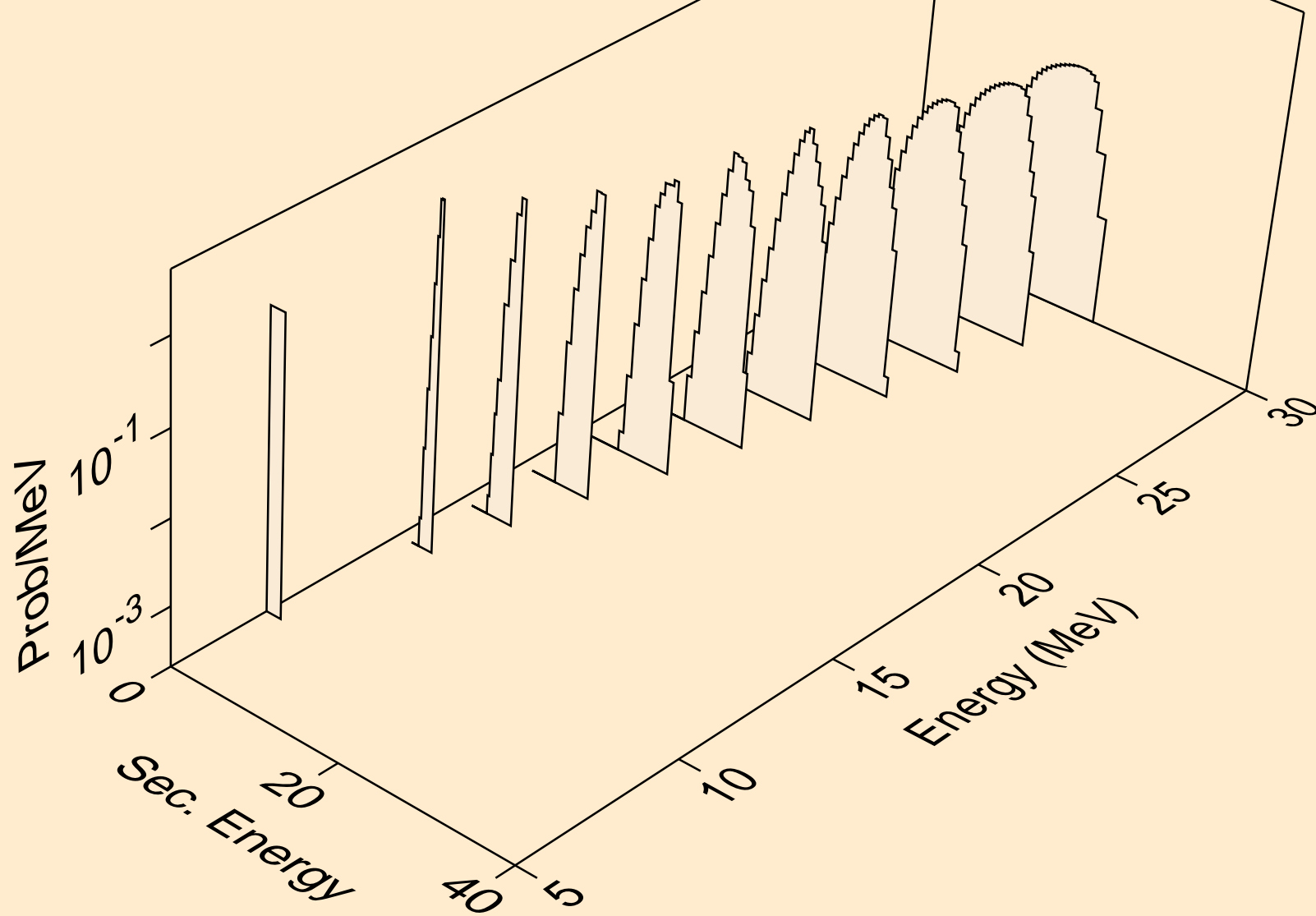

BI204 NEUTRON ACER TENDL-2021 LIBRARY; T=293.6K  
deuterons from (n,d)

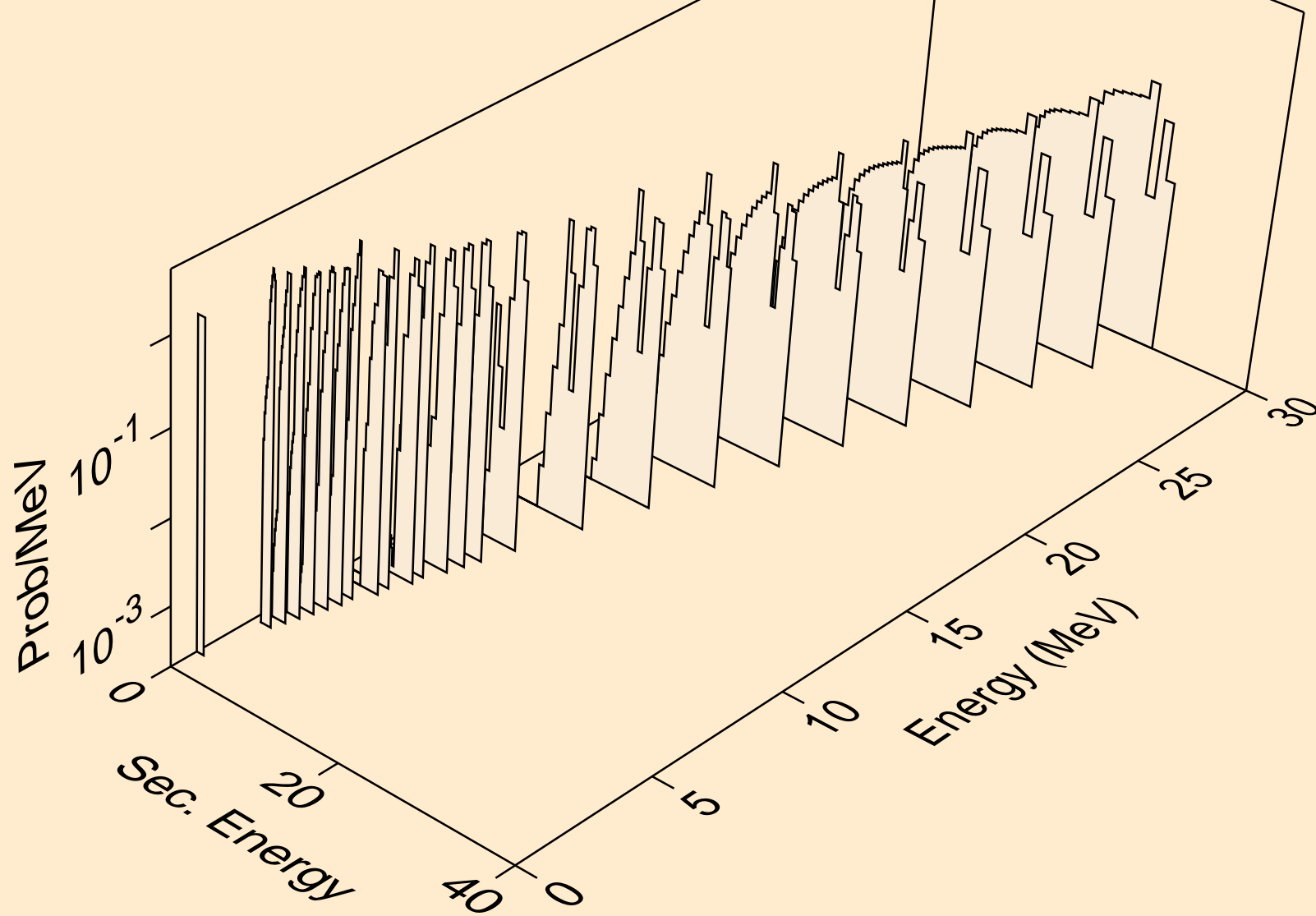

BI204 NEUTRON ACER TENDL-2021 LIBRARY; T=293.6K  
deuterons from (n,pd)

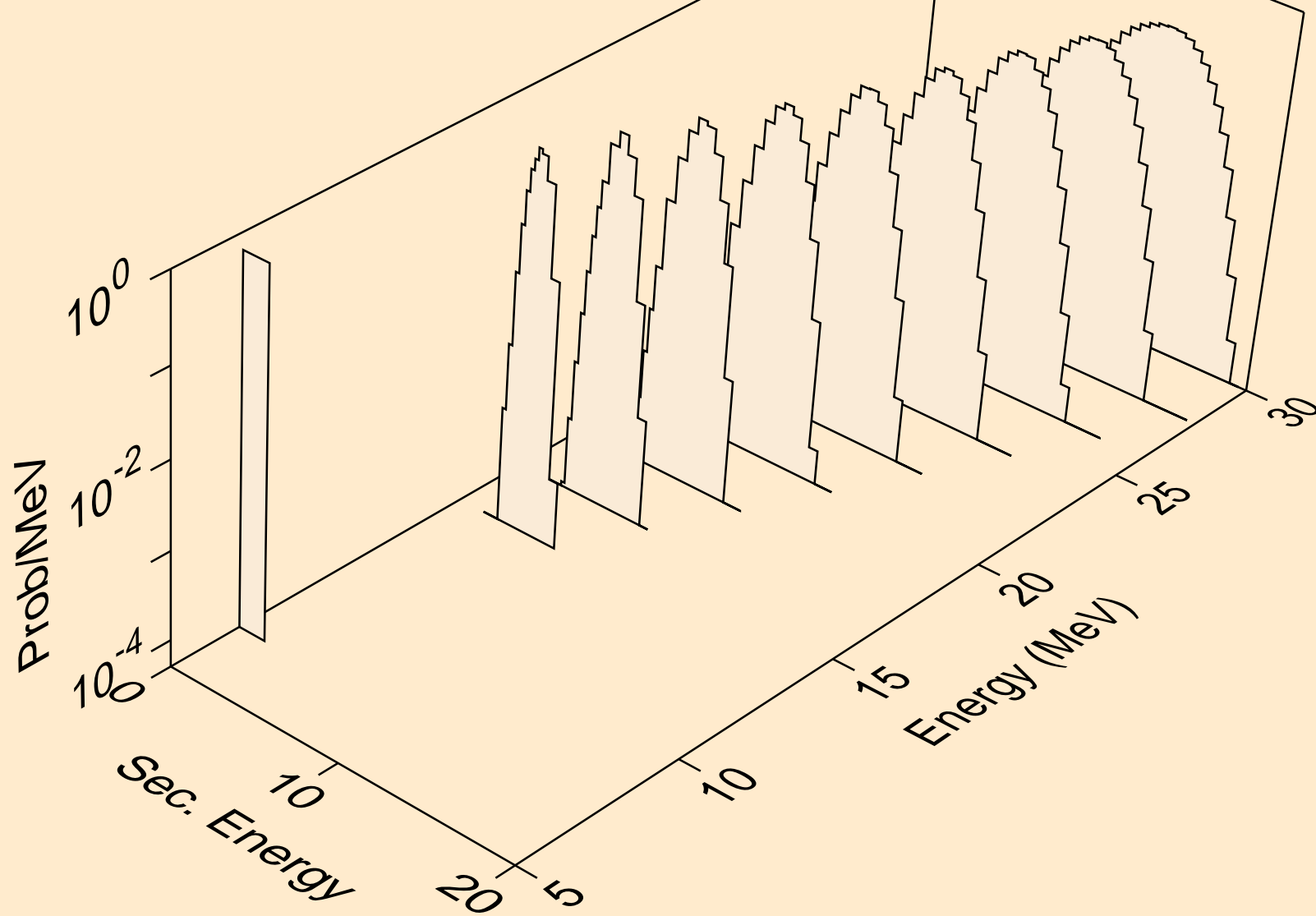



BI204 NEUTRON ACER TENDL-2021 LIBRARY; T=293.6K  
deuterons from (n,da)

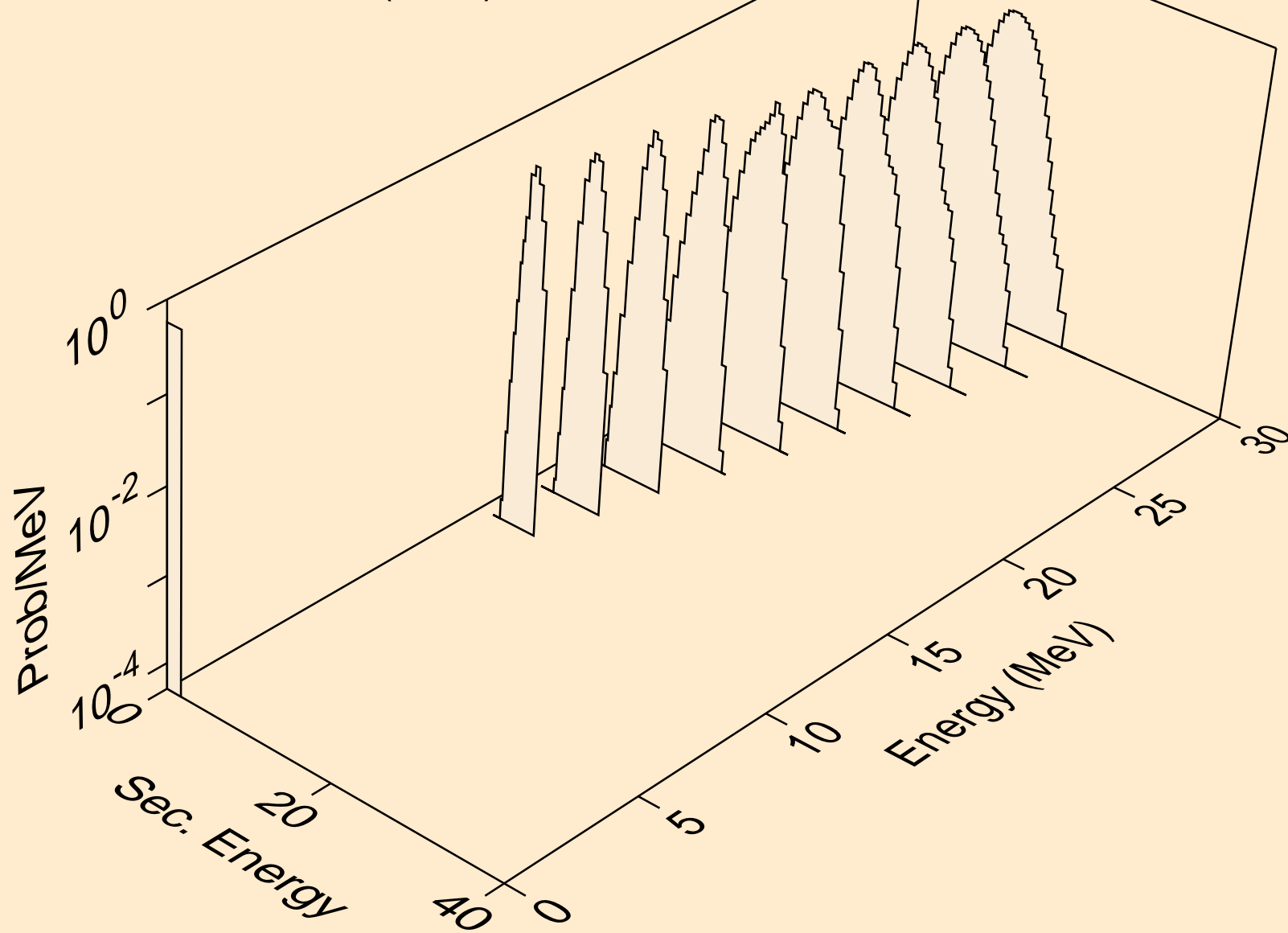

BI204 NEUTRON ACER TENDL-2021 LIBRARY; T=293.6K  
tritons from (n,x)

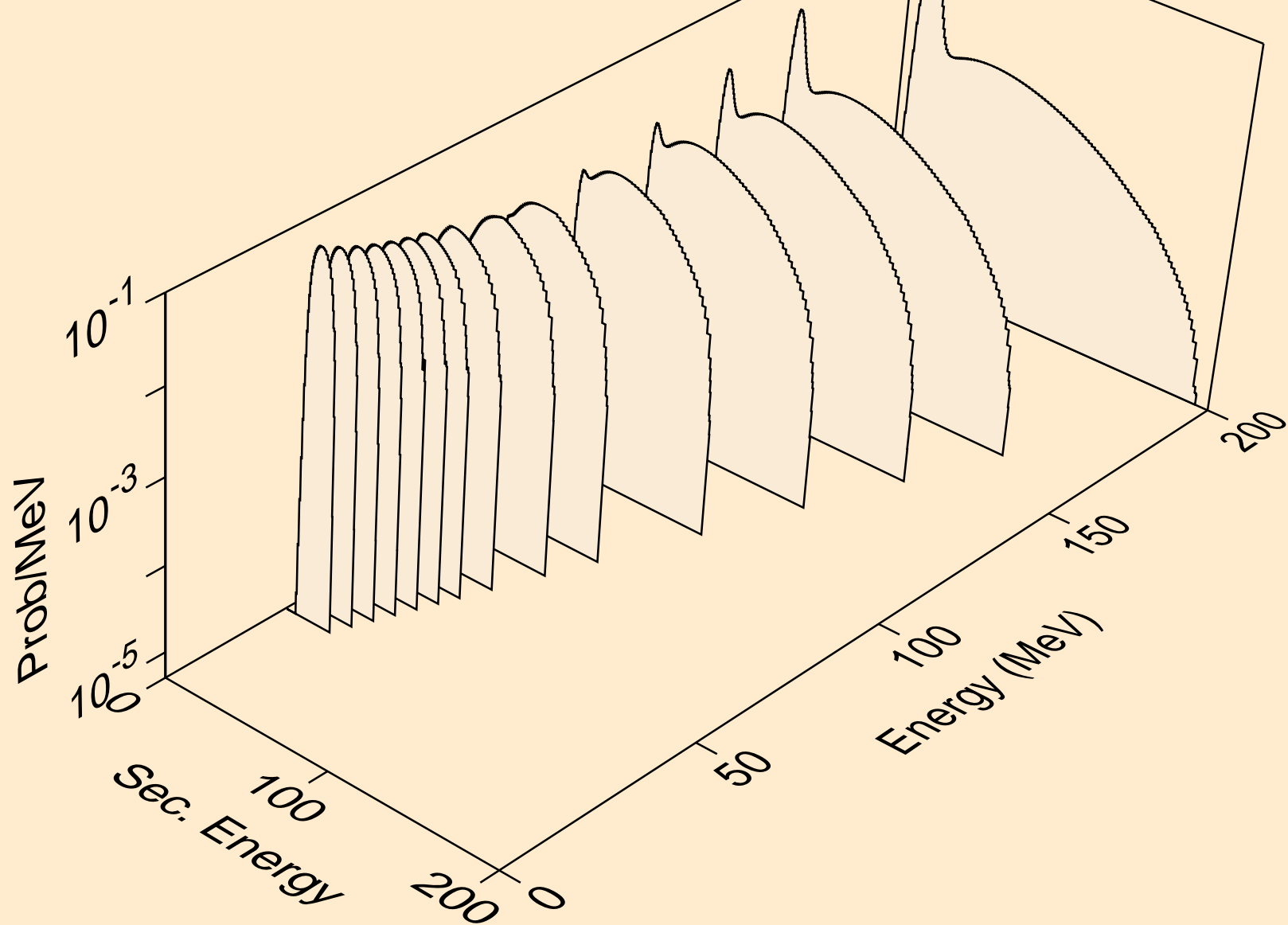

BI204 NEUTRON ACER TENDL-2021 LIBRARY; T=293.6K  
tritons from (n,n\*)t

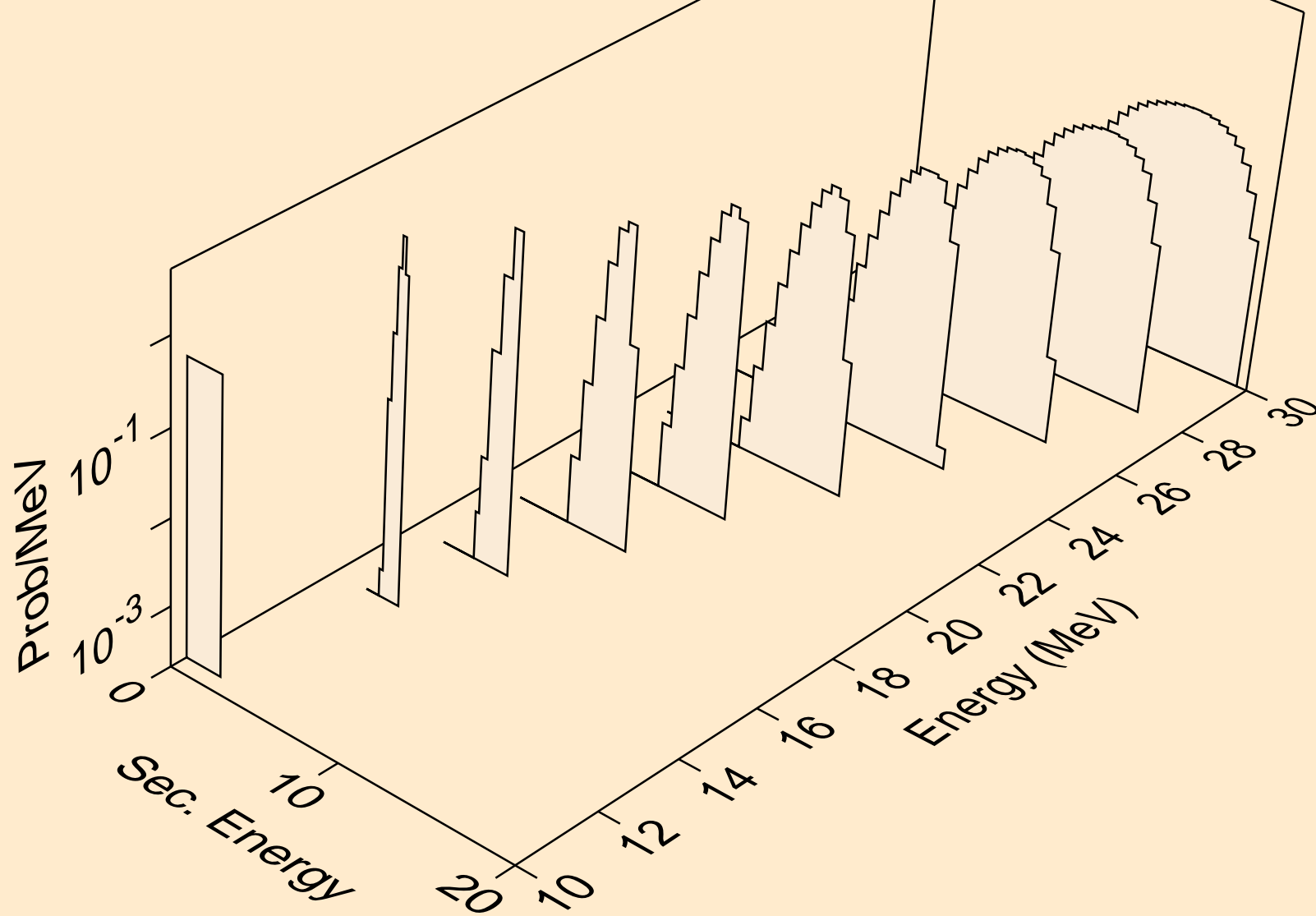

BI204 NEUTRON ACER TENDL-2021 LIBRARY; T=293.6K  
tritons from (n,t)

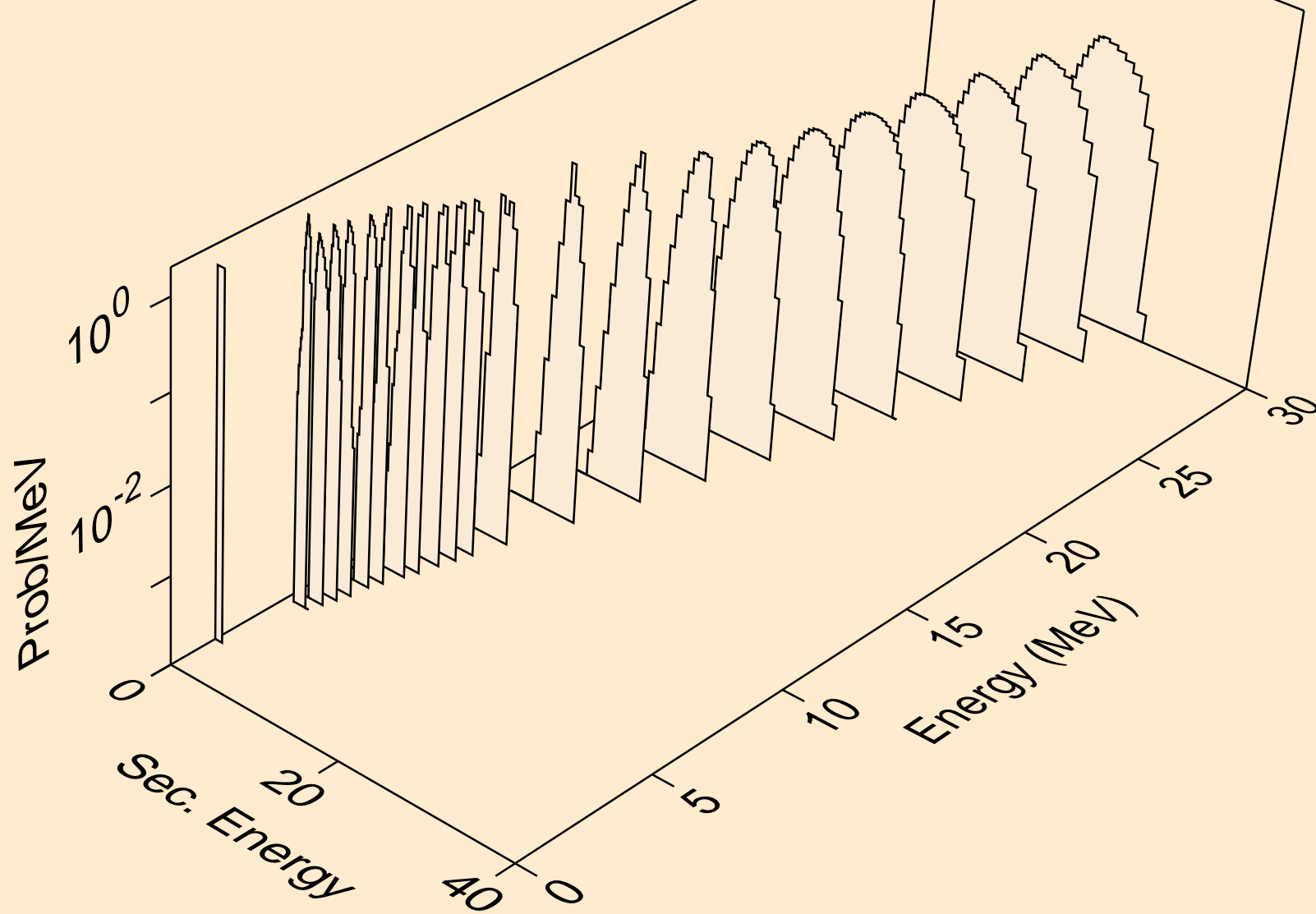

BI204 NEUTRON ACER TENDL-2021 LIBRARY; T=293.6K  
tritons from (n,pt)

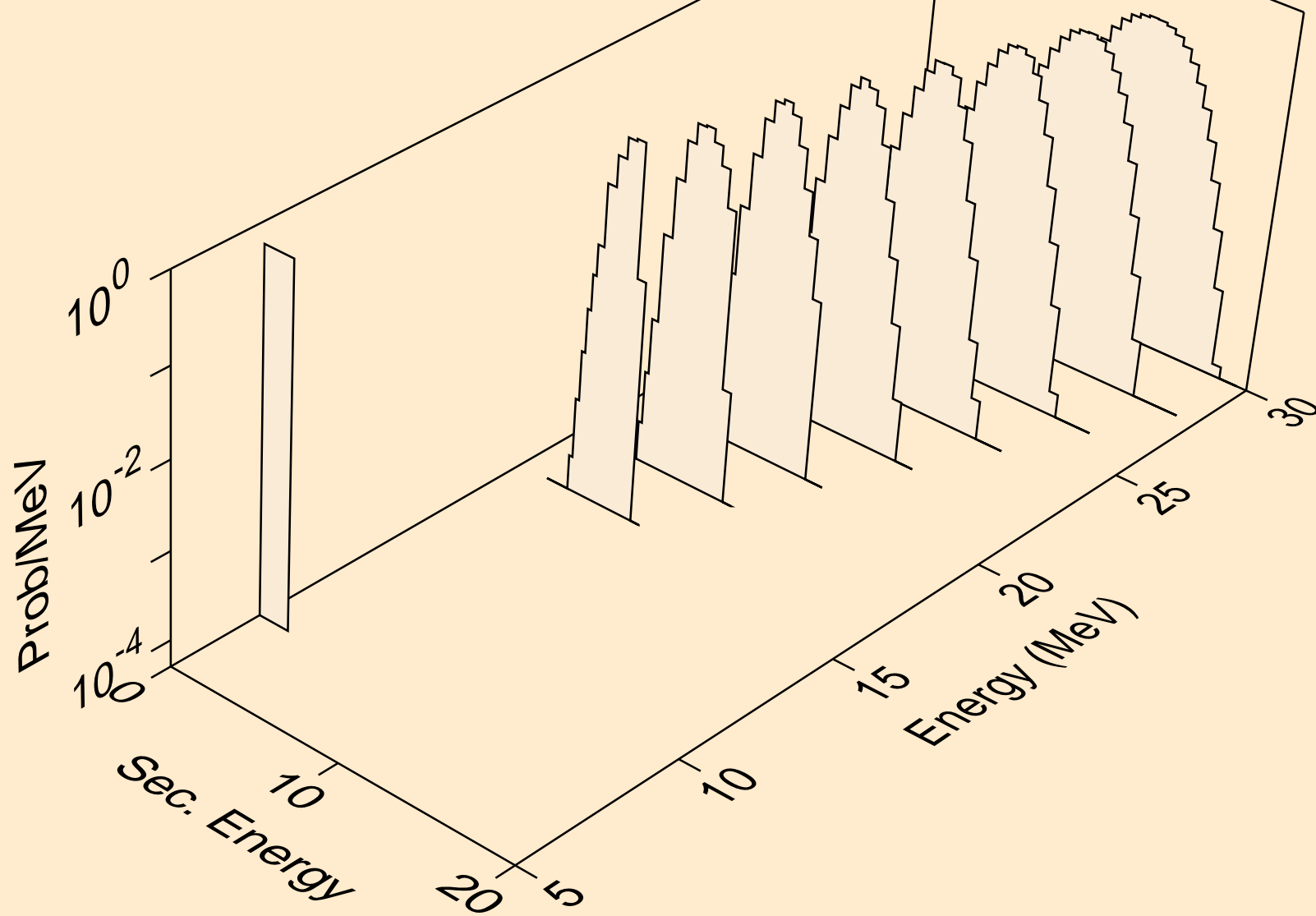

BI204 NEUTRON ACER TENDL-2021 LIBRARY; T=293.6K  
he3s from (n,x)

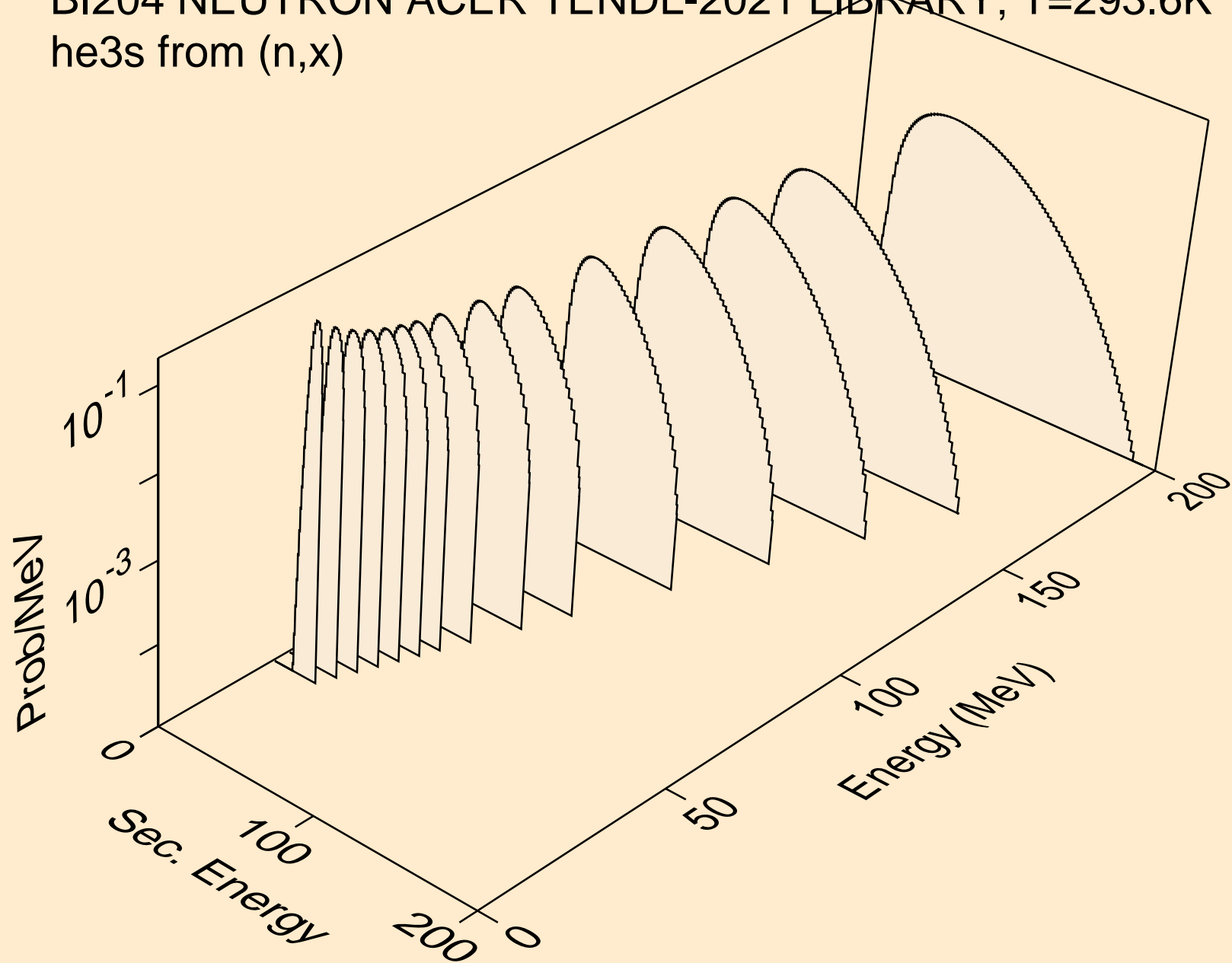

BI204 NEUTRON ACER TENDL-2021 LIBRARY; T=293.6K  
he3s from (n,n\*)he3

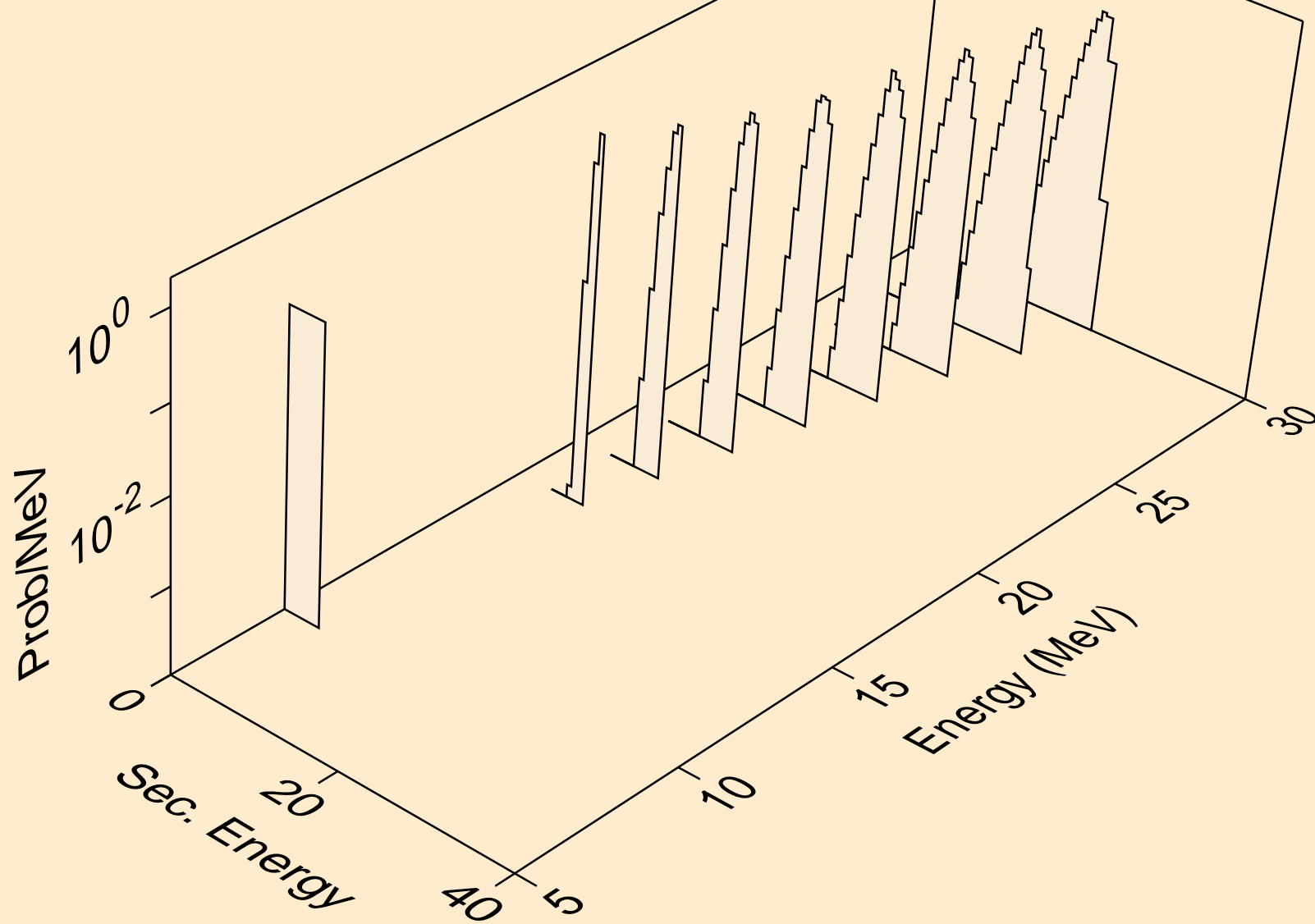

BI204 NEUTRON ACER TENDL-2021 LIBRARY; T=293.6K  
he3s from (n,he3)

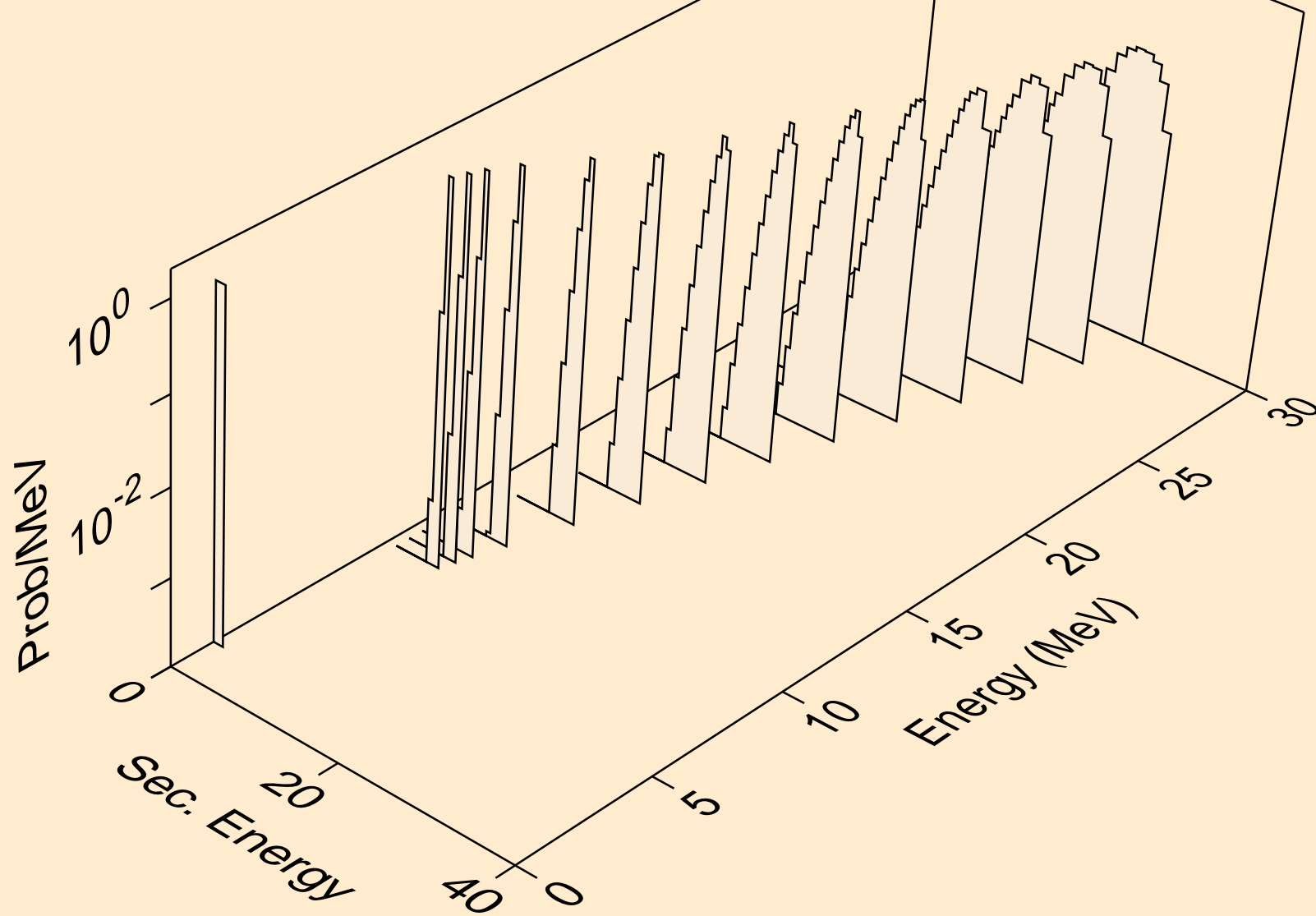



BI204 NEUTRON ACER TENDL-2021 LIBRARY; T=293.6K  
alphas from (n,x)

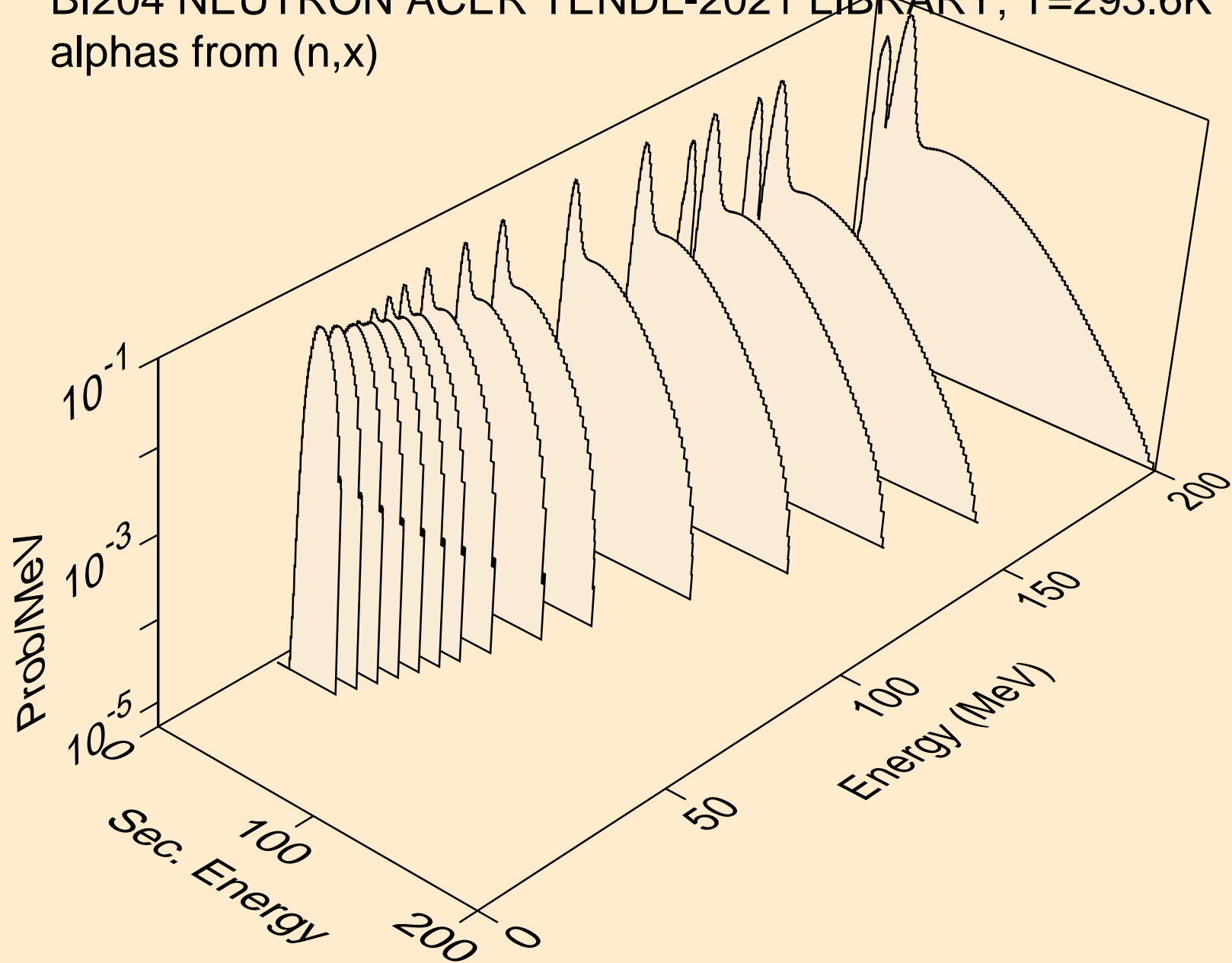

BI204 NEUTRON ACER TENDL-2021 LIBRARY; T=293.6K  
alphas from (n,n\*)a

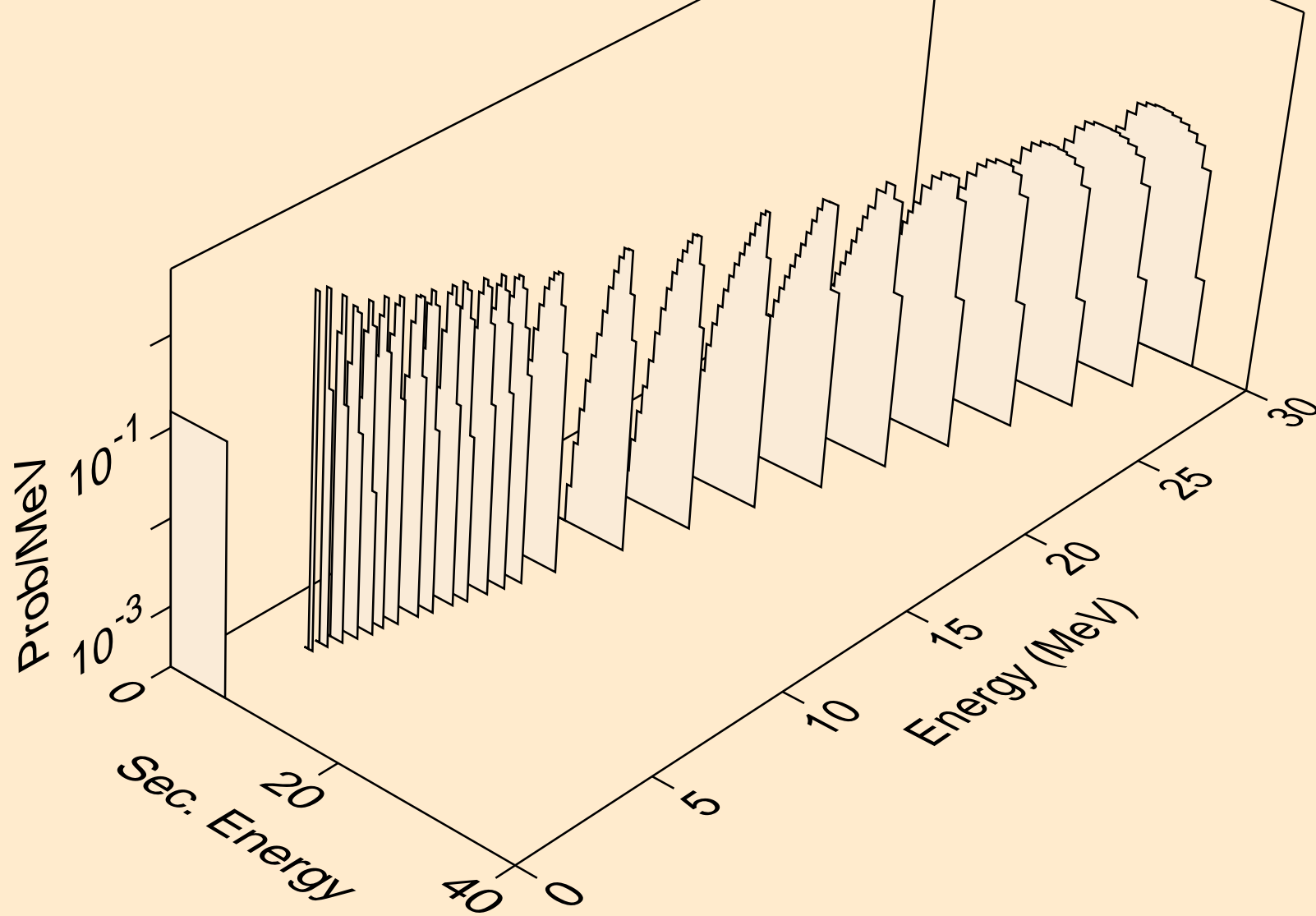

BI204 NEUTRON ACER TENDL-2021 LIBRARY; T=293.6K  
alphas from (n,2n)a

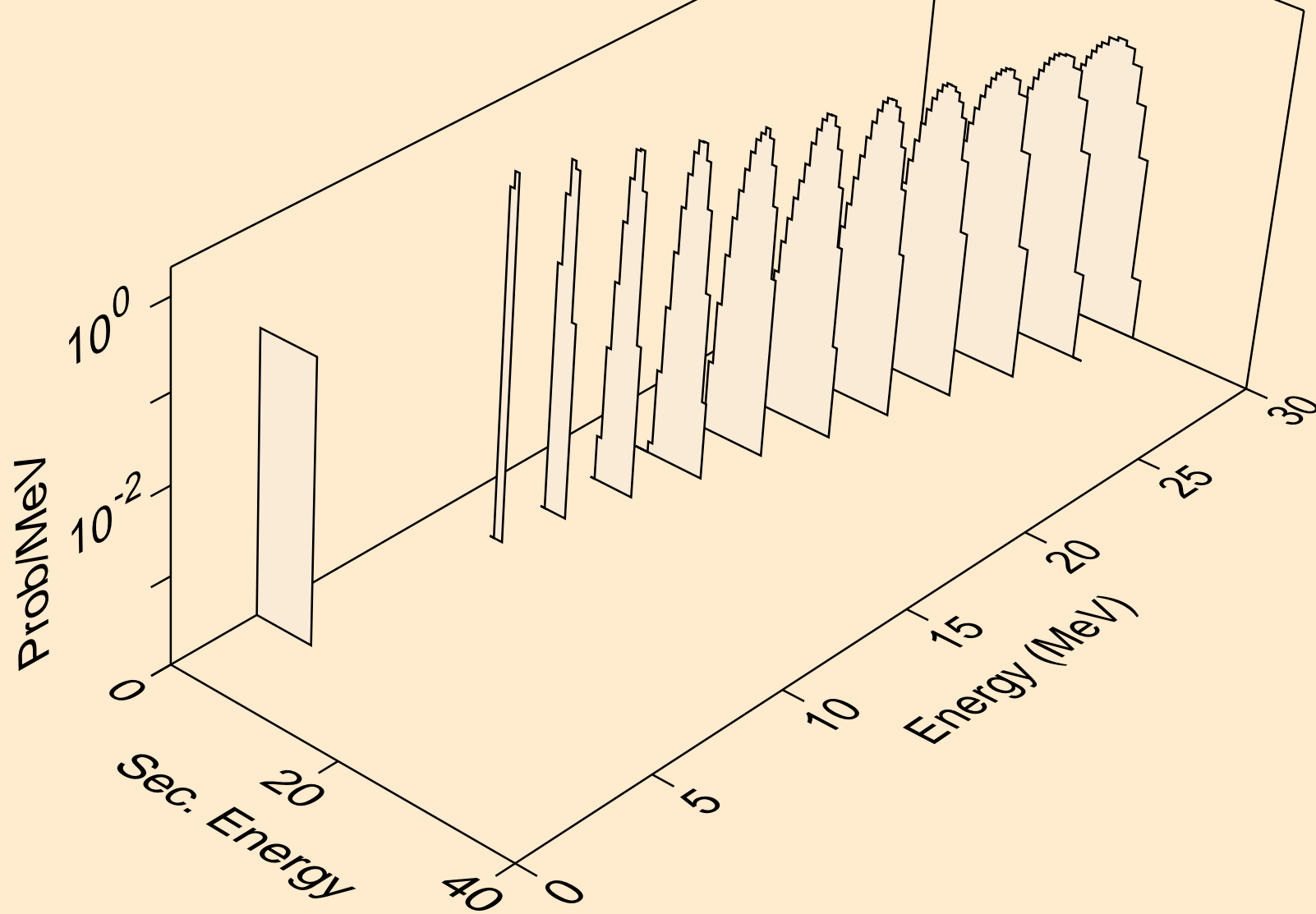

BI204 NEUTRON ACER TENDL-2021 LIBRARY; T=293.6K  
alphas from (n,3n)a

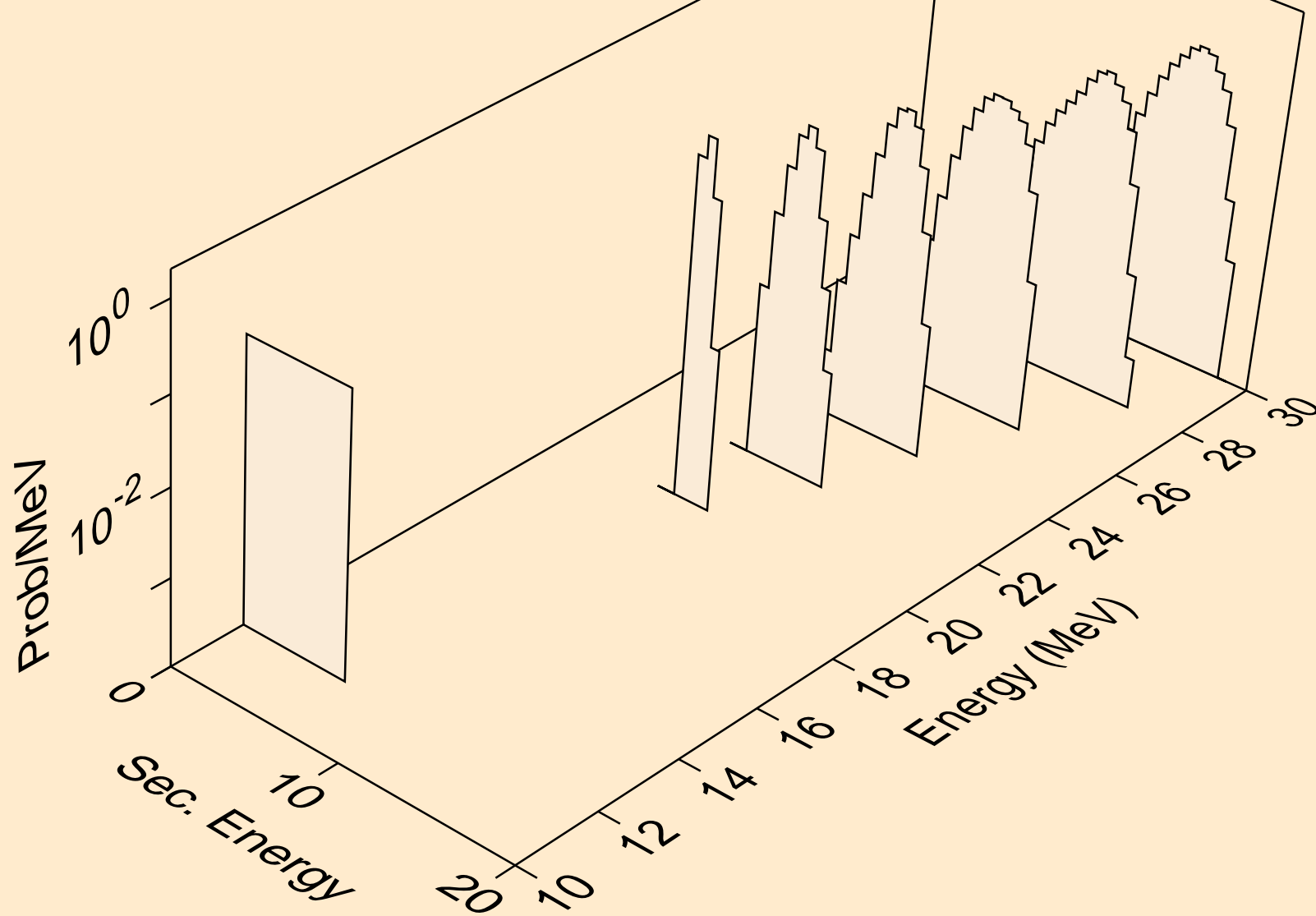

BI204 NEUTRON ACER TENDL-2021 LIBRARY; T=293.6K  
alphas from (n,n\*)2a

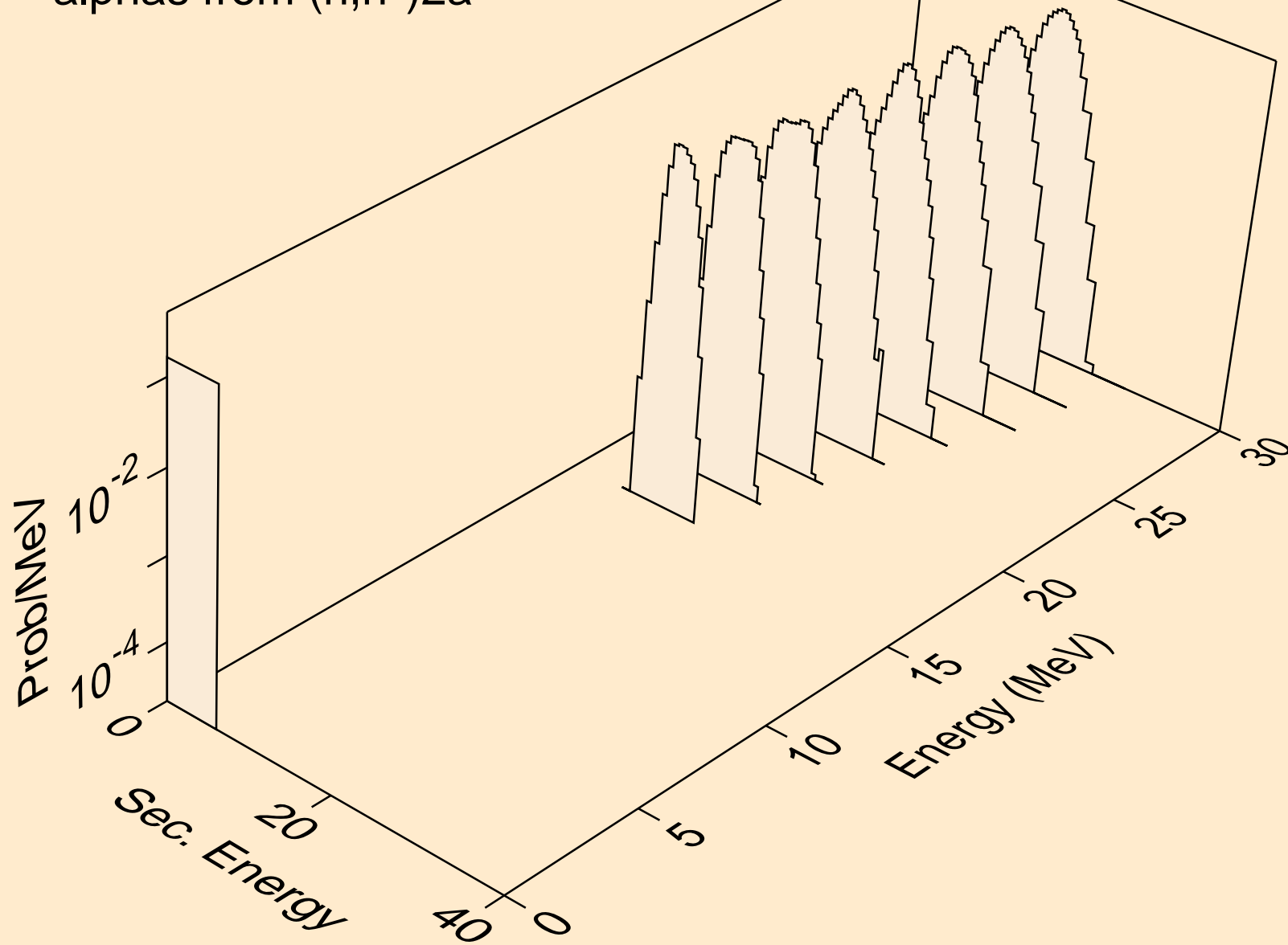

BI204 NEUTRON ACER TENDL-2021 LIBRARY; T=293.6K  
alphas from (n,npa)

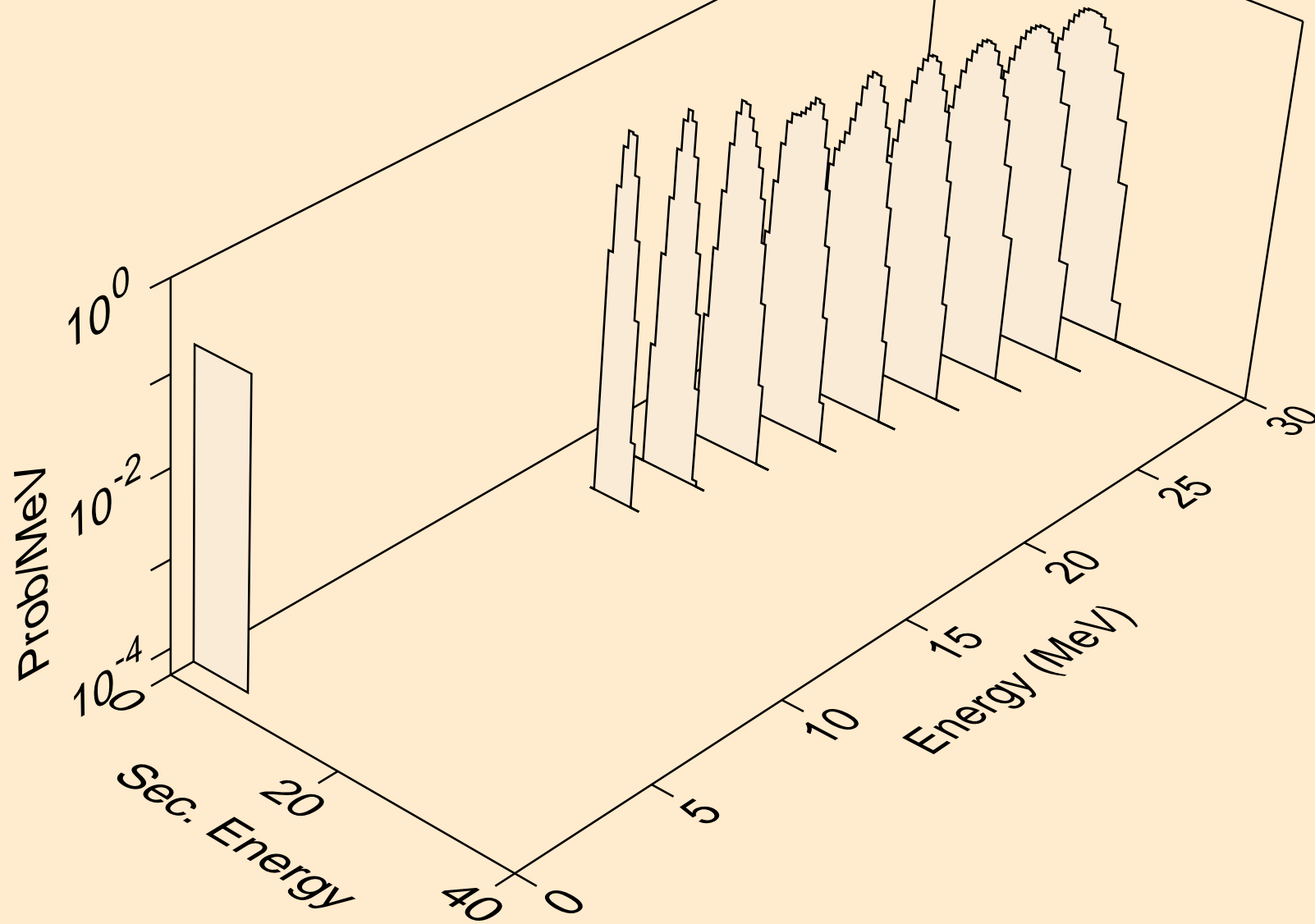

BI204 NEUTRON ACER TENDL-2021 LIBRARY; T=293.6K  
alphas from (n,a)

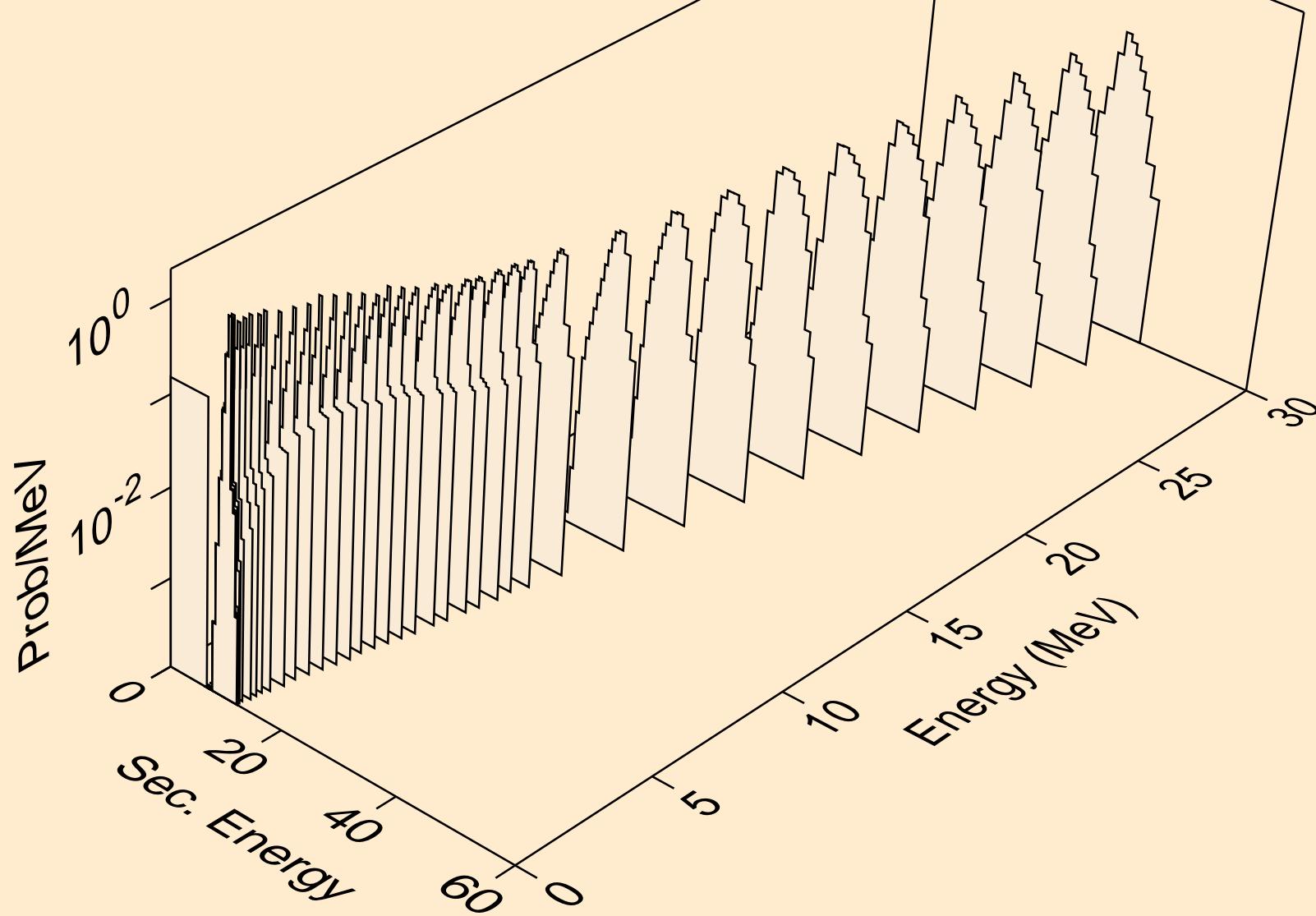

BI204 NEUTRON ACER TENDL-2021 LIBRARY; T=293.6K  
alphas from (n,2a)

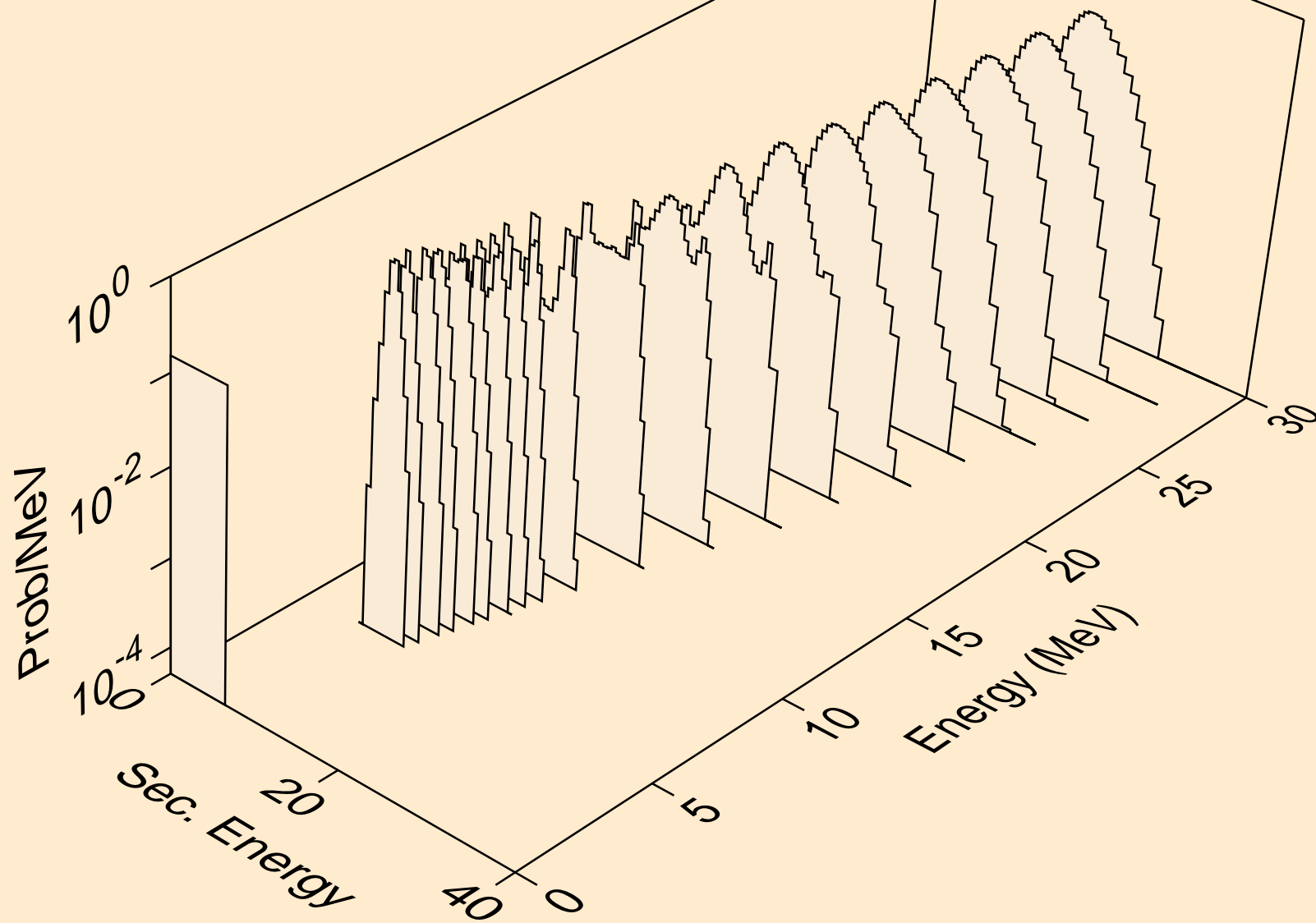



BI204 NEUTRON ACER TENDL-2021 LIBRARY; T=293.6K  
alphas from (n,pa)

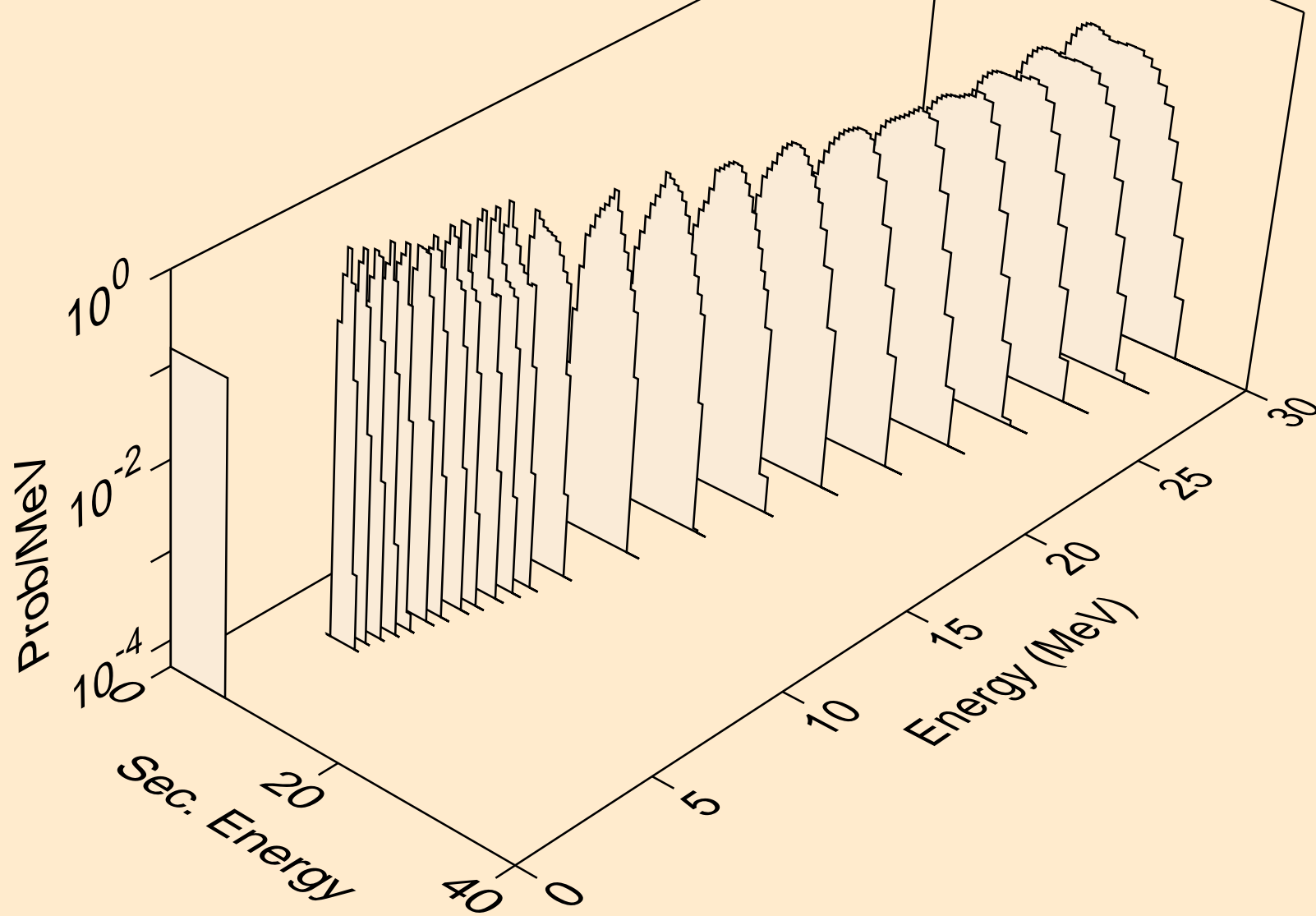

BI204 NEUTRON ACER TENDL-2021 LIBRARY; T=293.6K  
alphas from (n,da)

