

# BI216M NEUTRON ACER TENDL-2021 LIBRARY; T=293.6K

## Principal cross sections

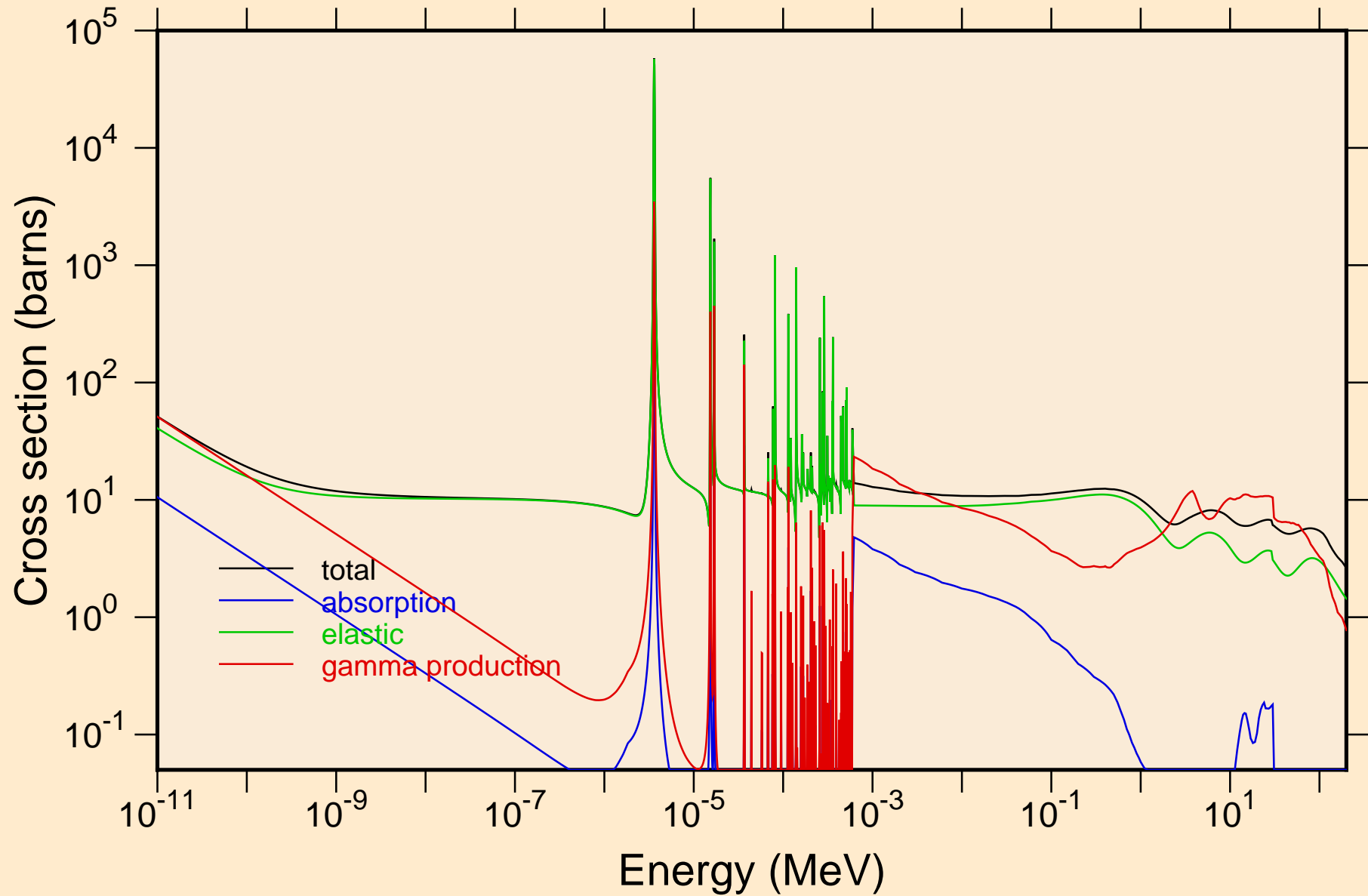

BI216M NEUTRON ACER TENDL-2021 LIBRARY; T=293.6K  
resonance total cross section

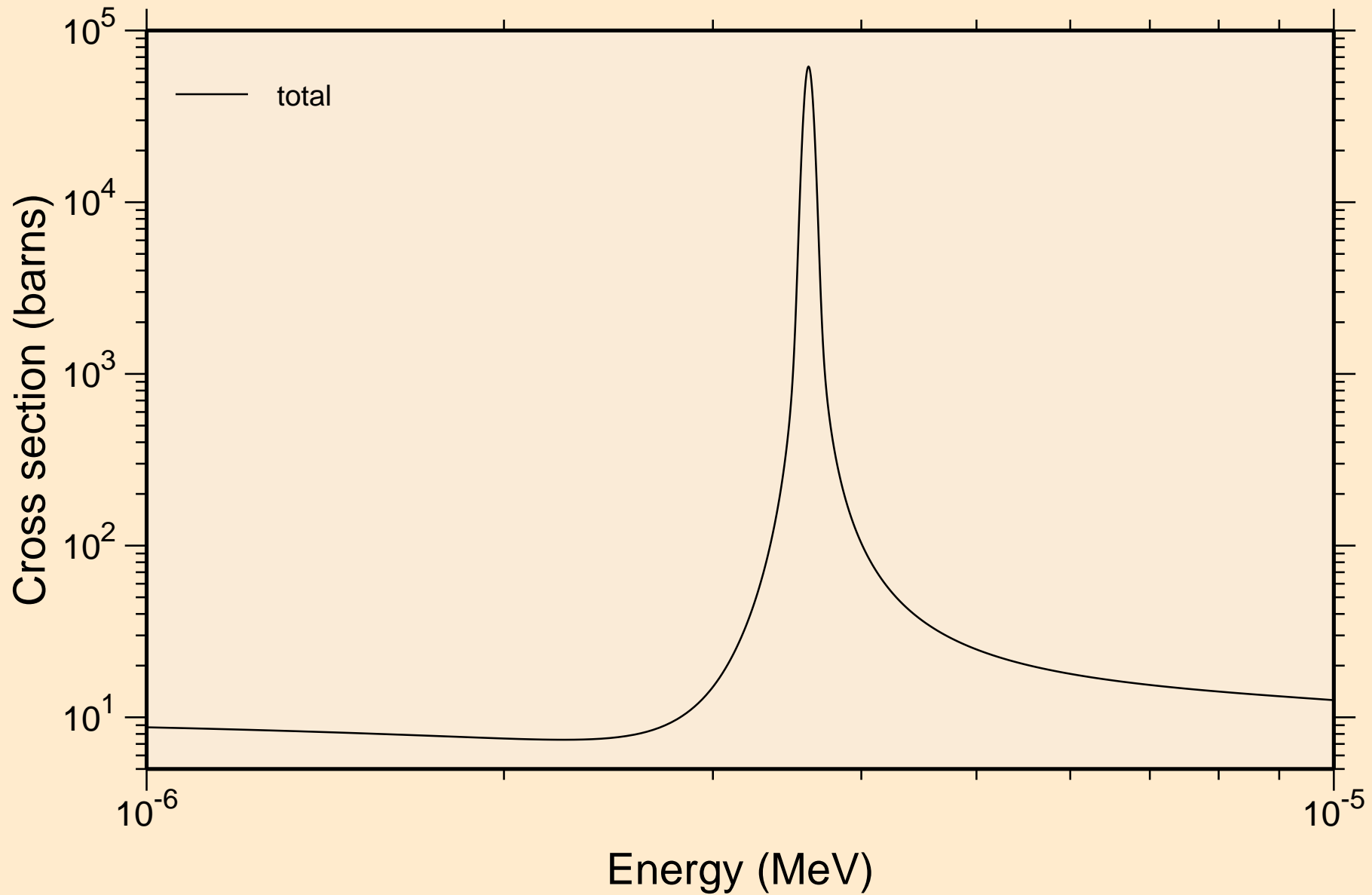

BI216M NEUTRON ACER TENDL-2021 LIBRARY; T=293.6K  
resonance total cross section

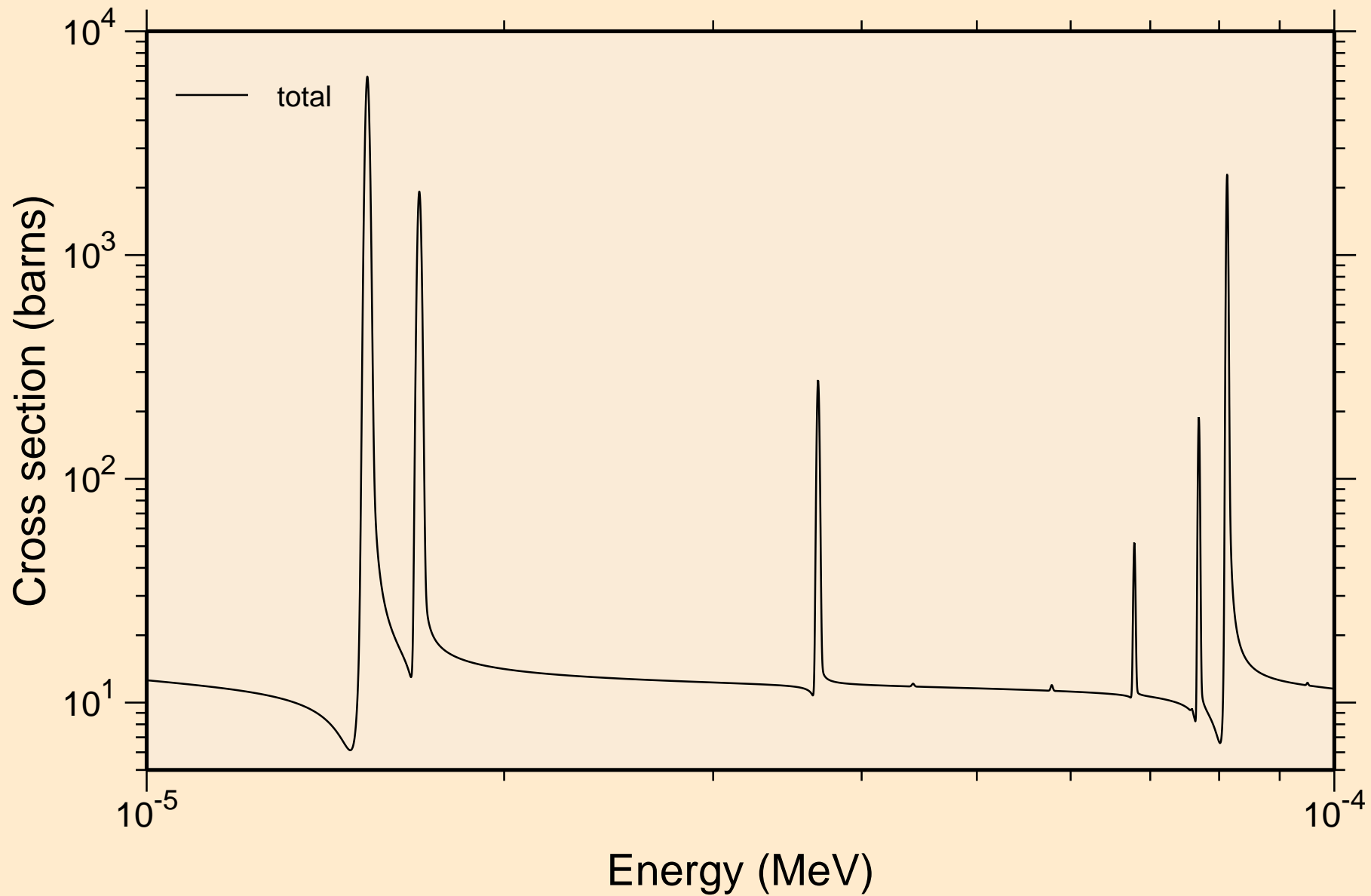

BI216M NEUTRON ACER TENDL-2021 LIBRARY; T=293.6K  
resonance total cross section

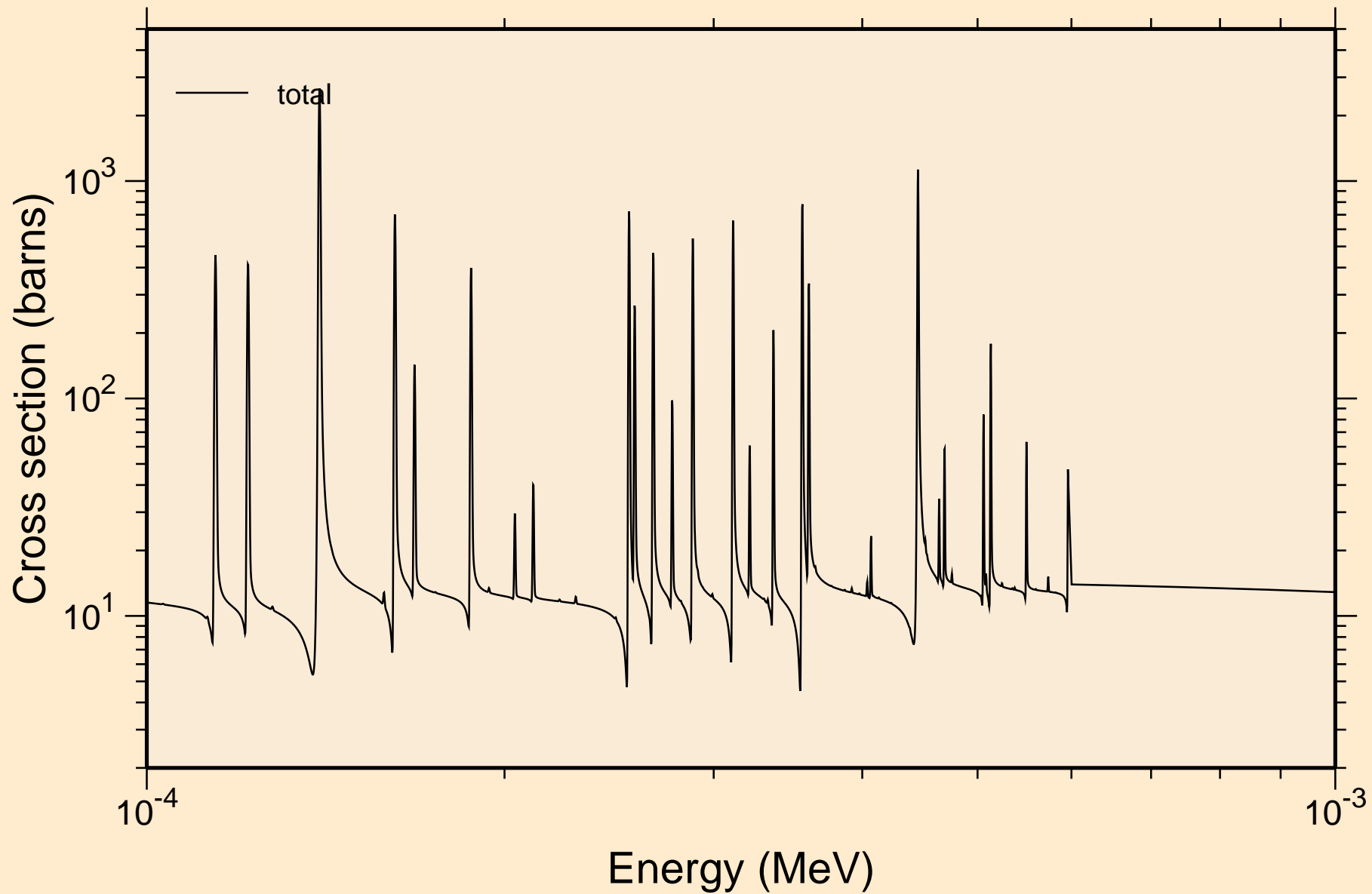

BI216M NEUTRON ACER TENDL-2021 LIBRARY; T=293.6K  
resonance total cross section

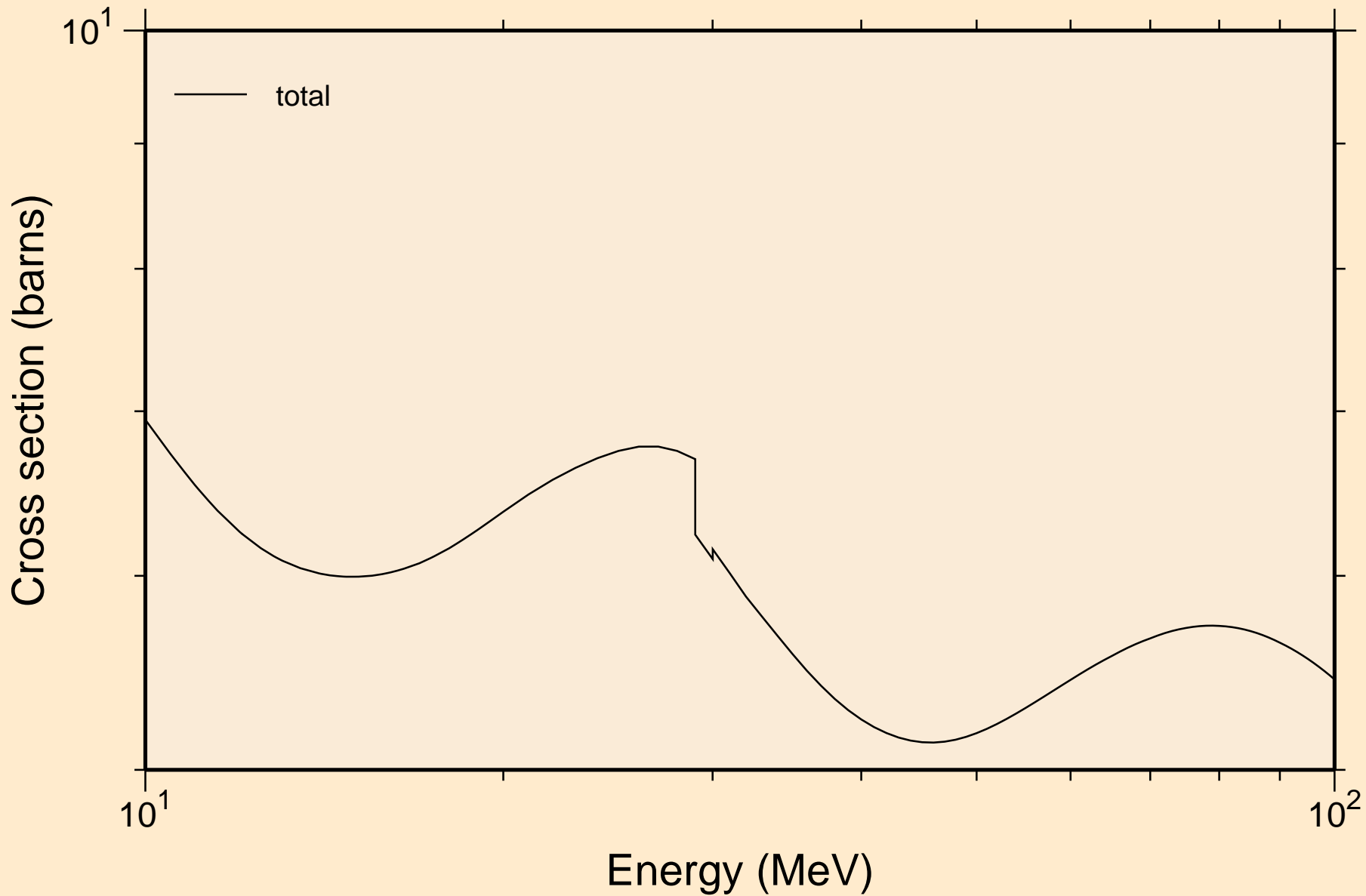

BI216M NEUTRON ACER TENDL-2021 LIBRARY; T=293.6K  
resonance absorption cross sections

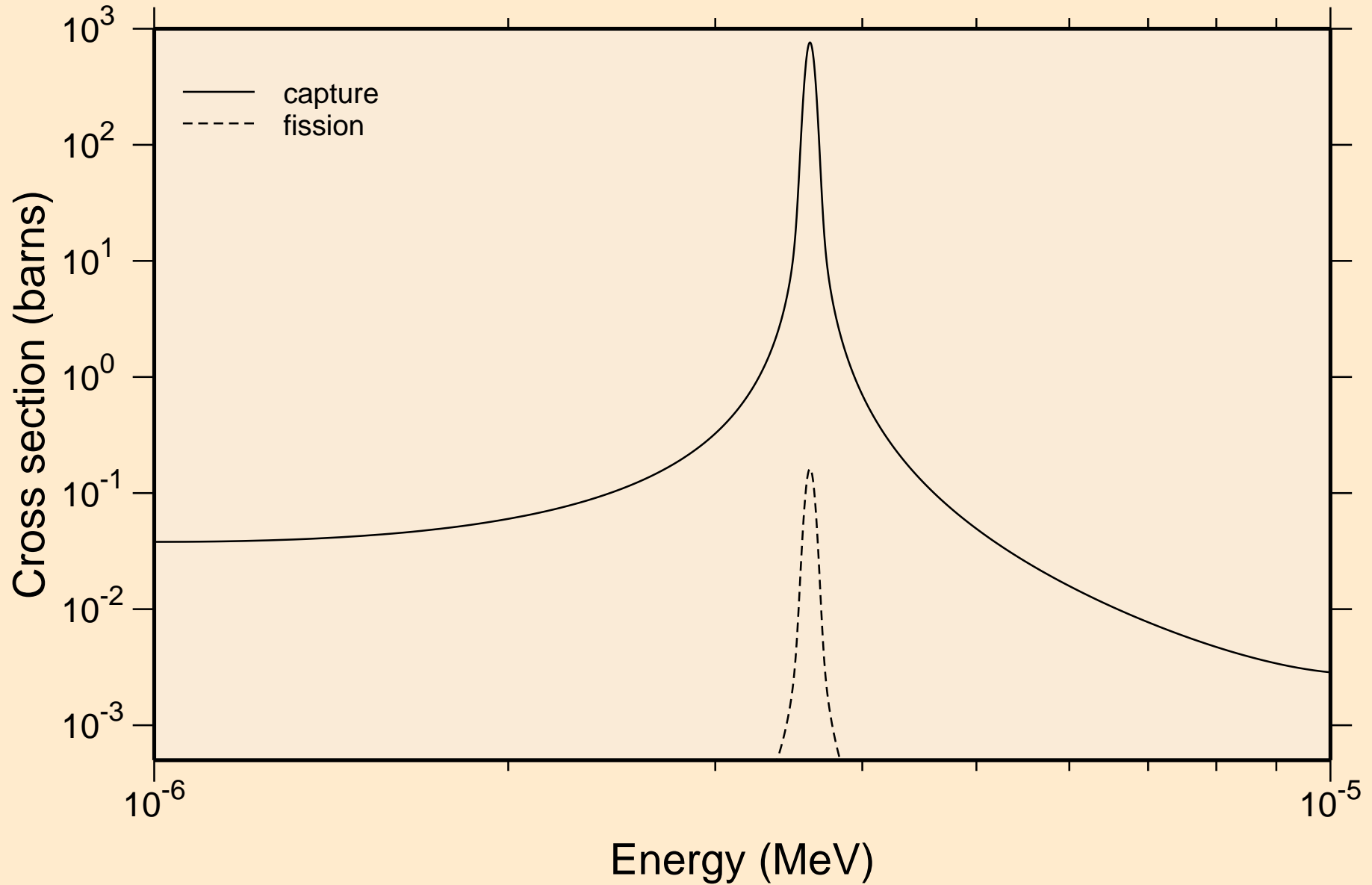

BI216M NEUTRON ACER TENDL-2021 LIBRARY; T=293.6K  
resonance absorption cross sections

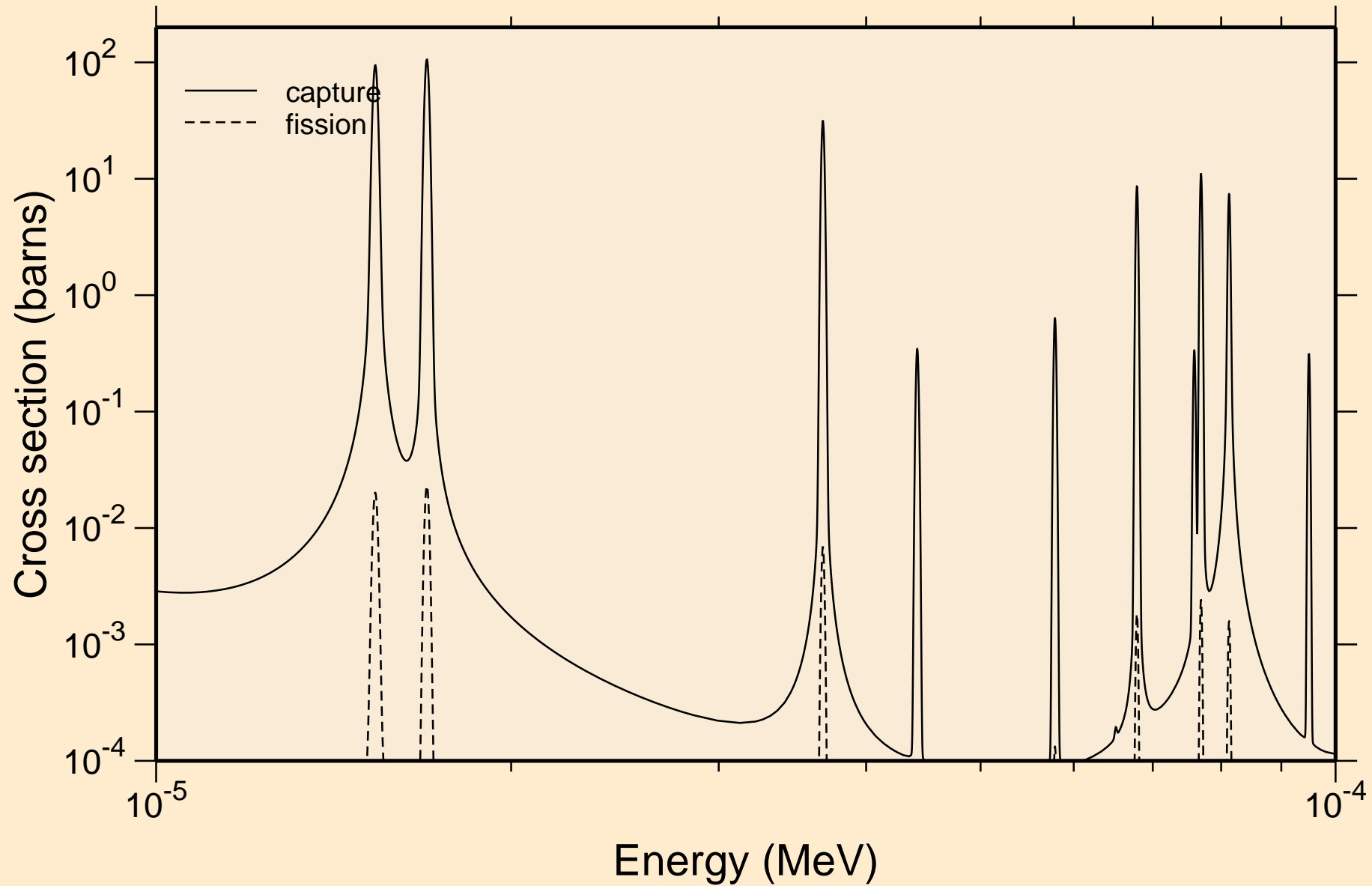

BI216M NEUTRON ACER TENDL-2021 LIBRARY; T=293.6K  
resonance absorption cross sections

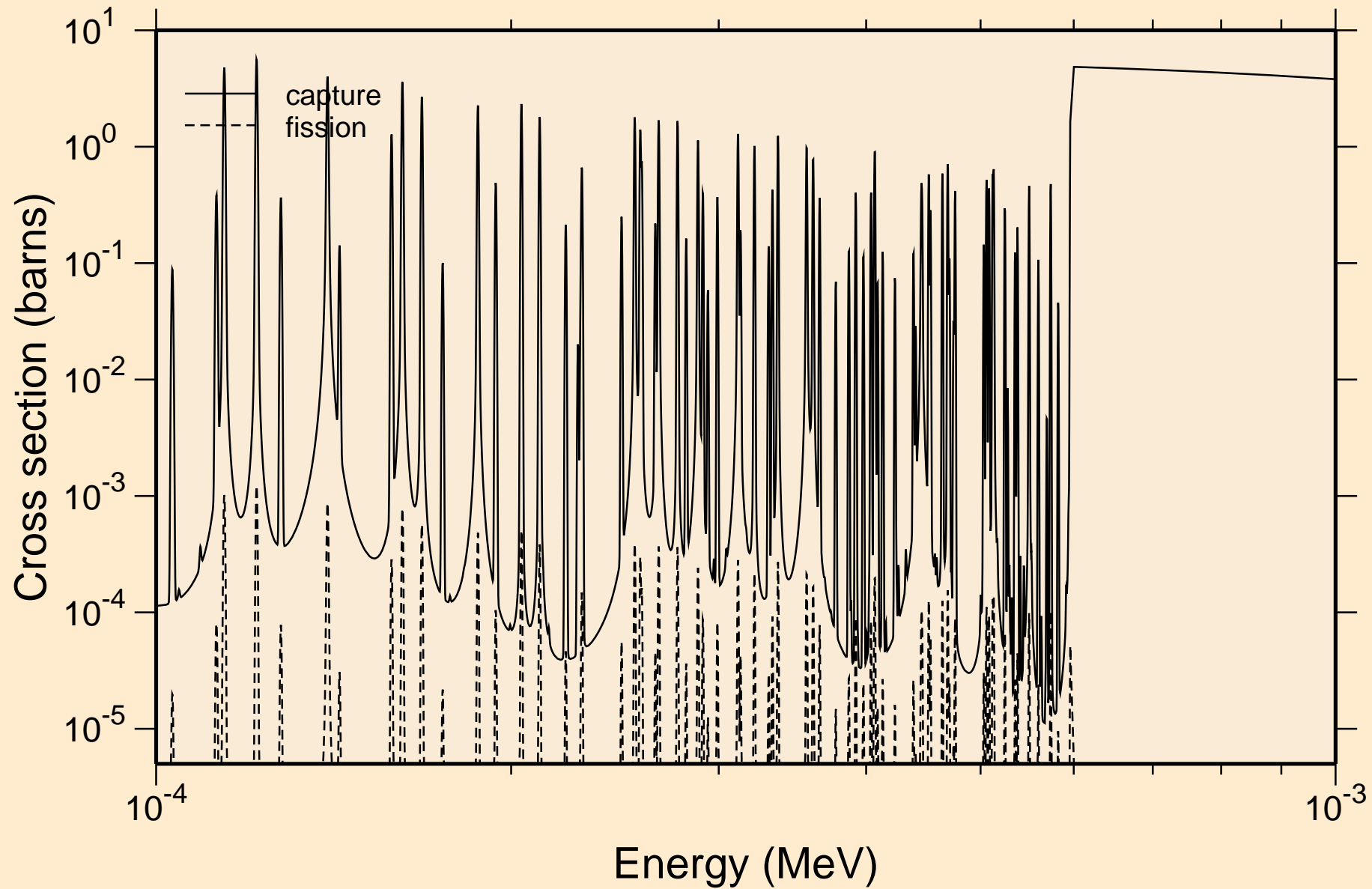



BI216M NEUTRON ACER TENDL-2021 LIBRARY; T=293.6K  
resonance absorption cross sections

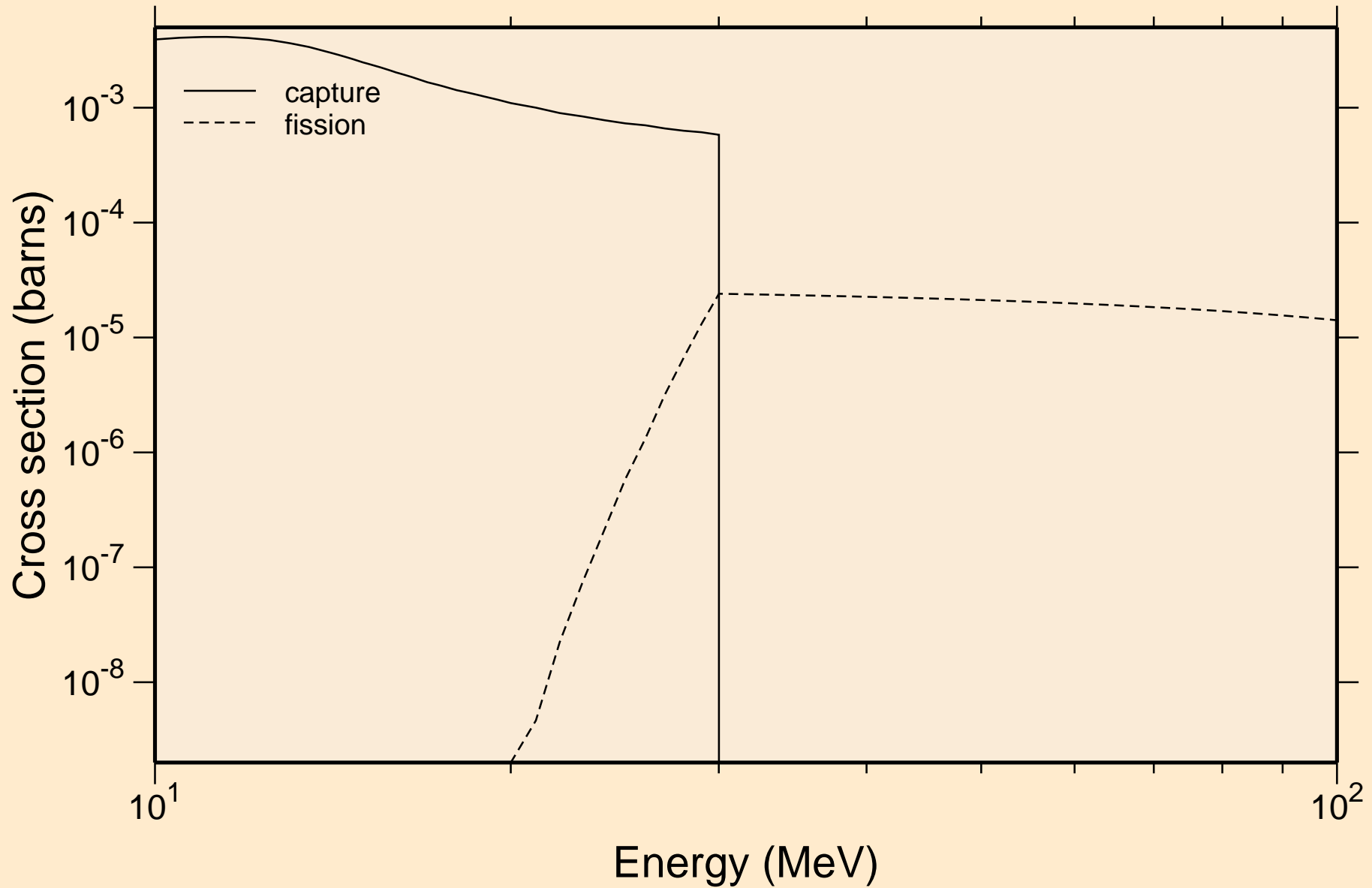

BI216M NEUTRON ACER TENDL-2021 LIBRARY; T=293.6K  
Heating

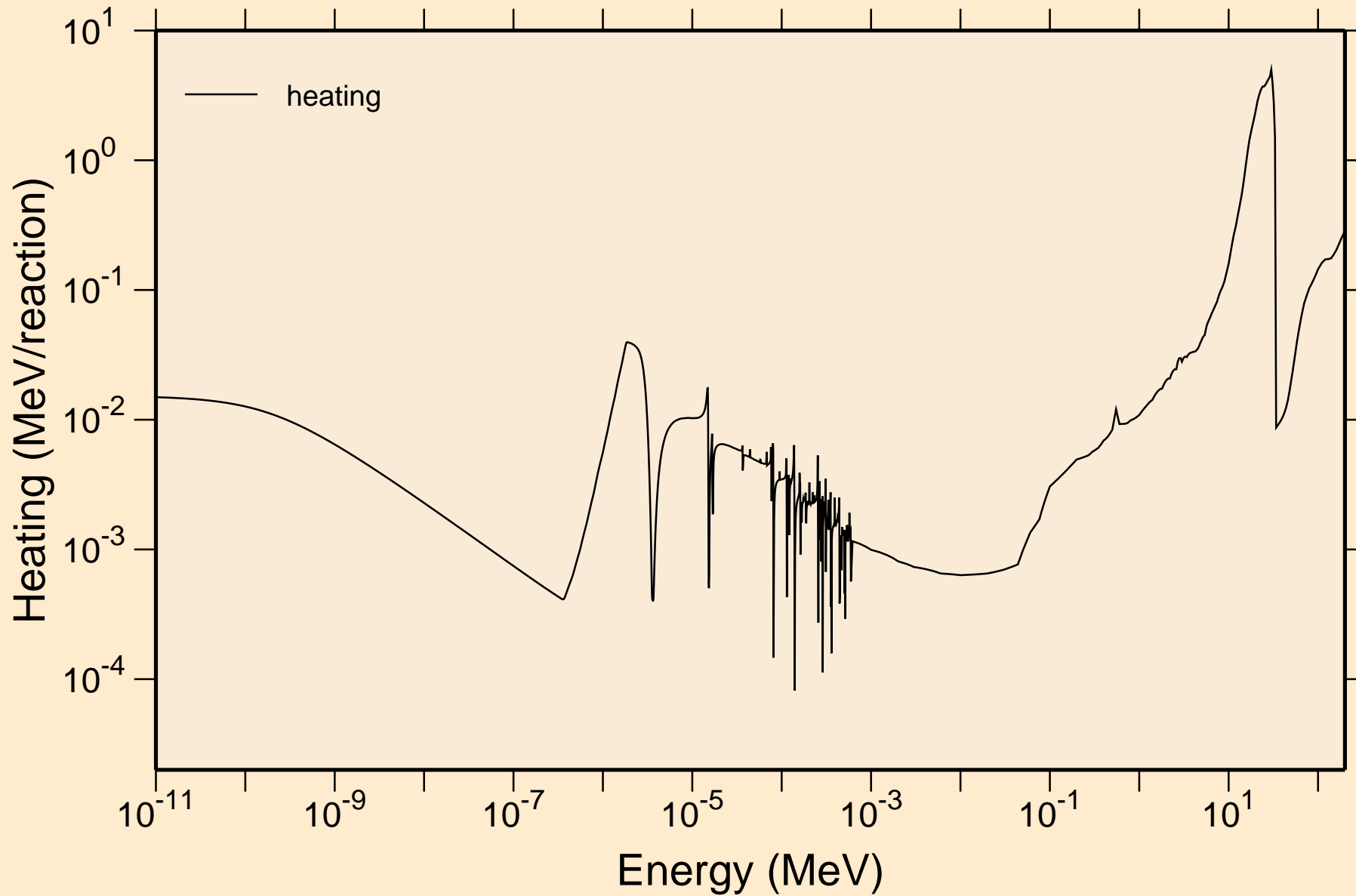

BI216M NEUTRON ACER TENDL-2021 LIBRARY; T=293.6K  
Damage

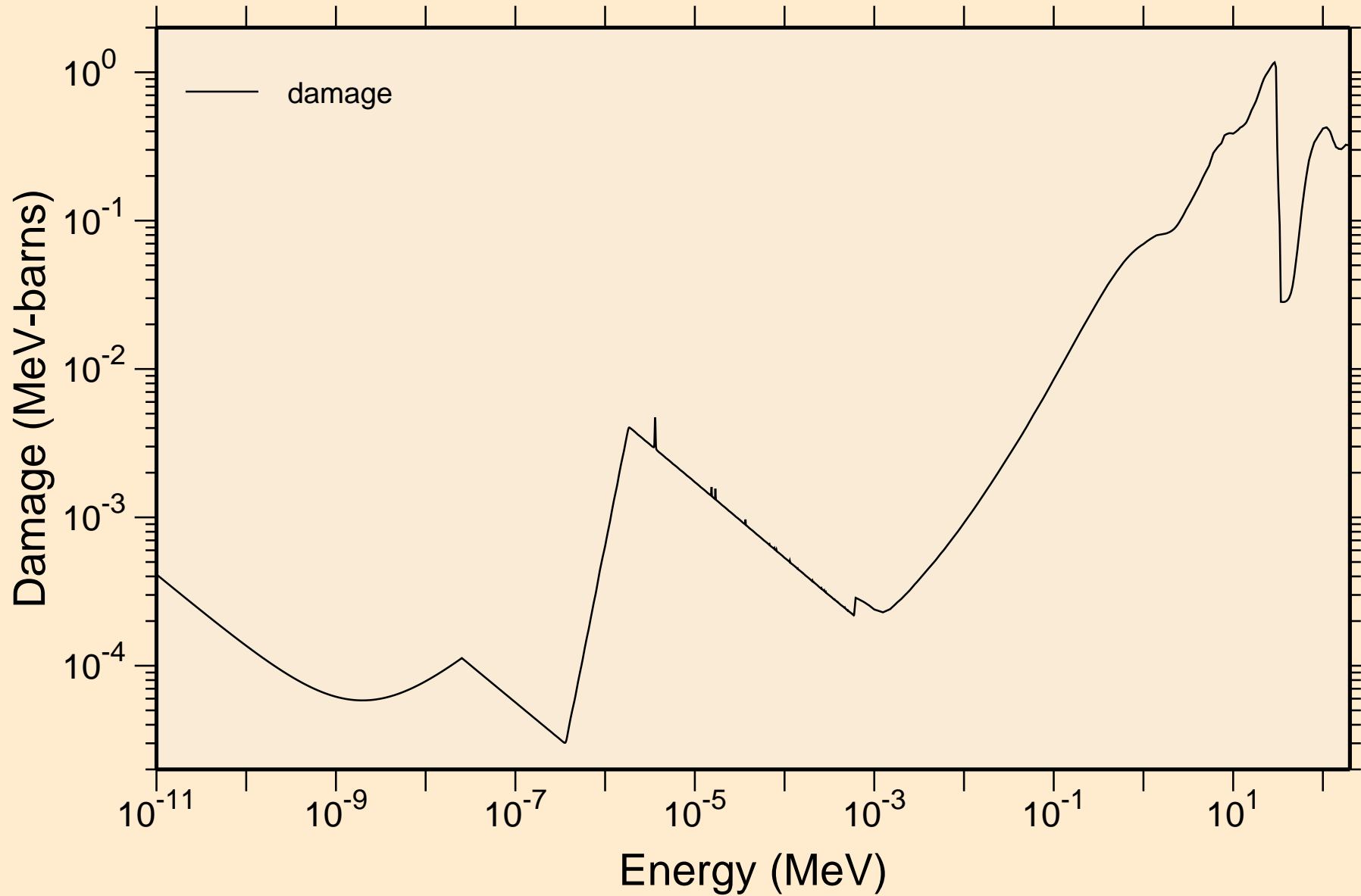

BI216M NEUTRON ACER TENDL-2021 LIBRARY; T=293.6K  
Non-threshold reactions

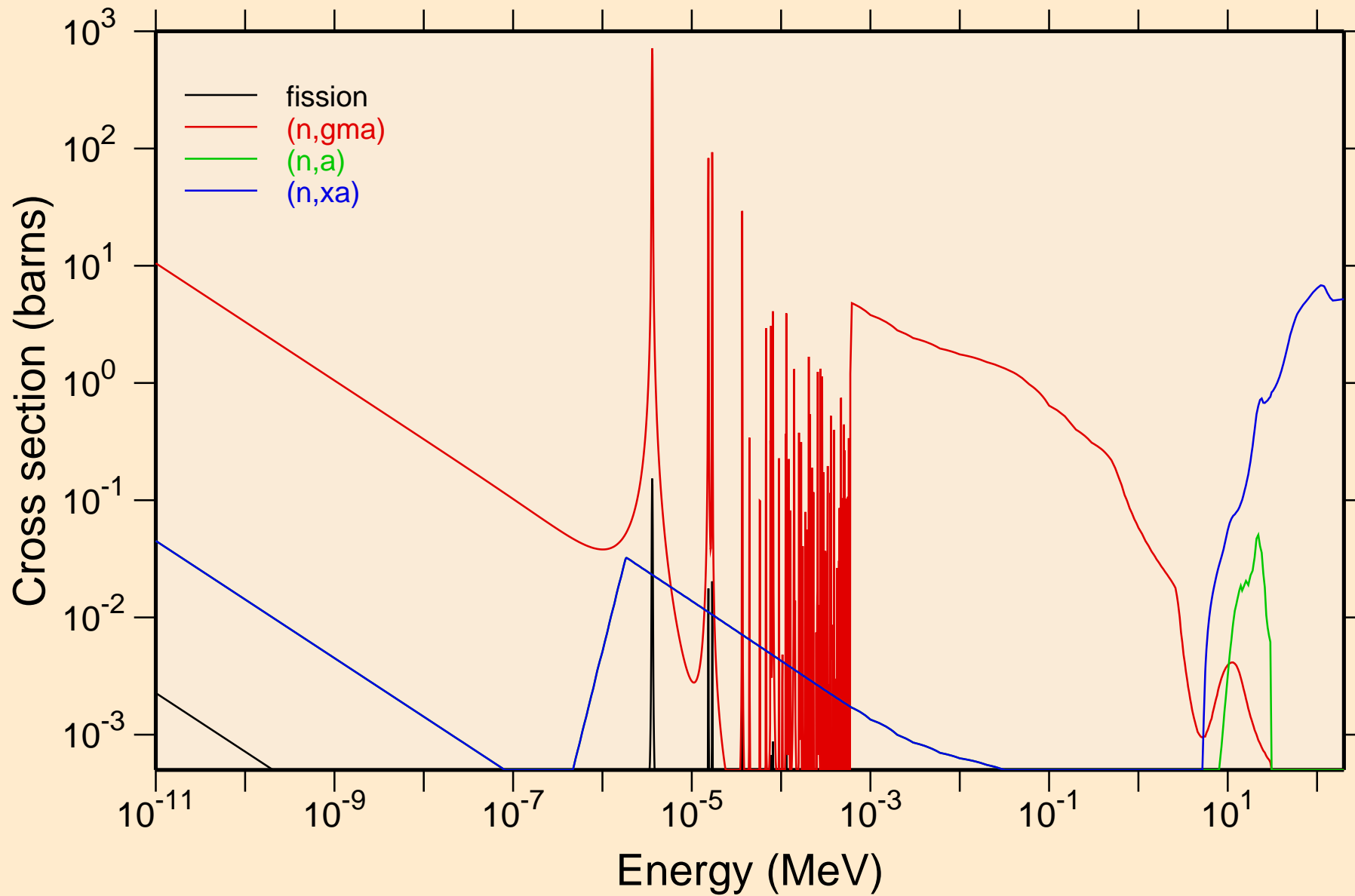

BI216M NEUTRON ACER TENDL-2021 LIBRARY; T=293.6K  
Principal cross sections

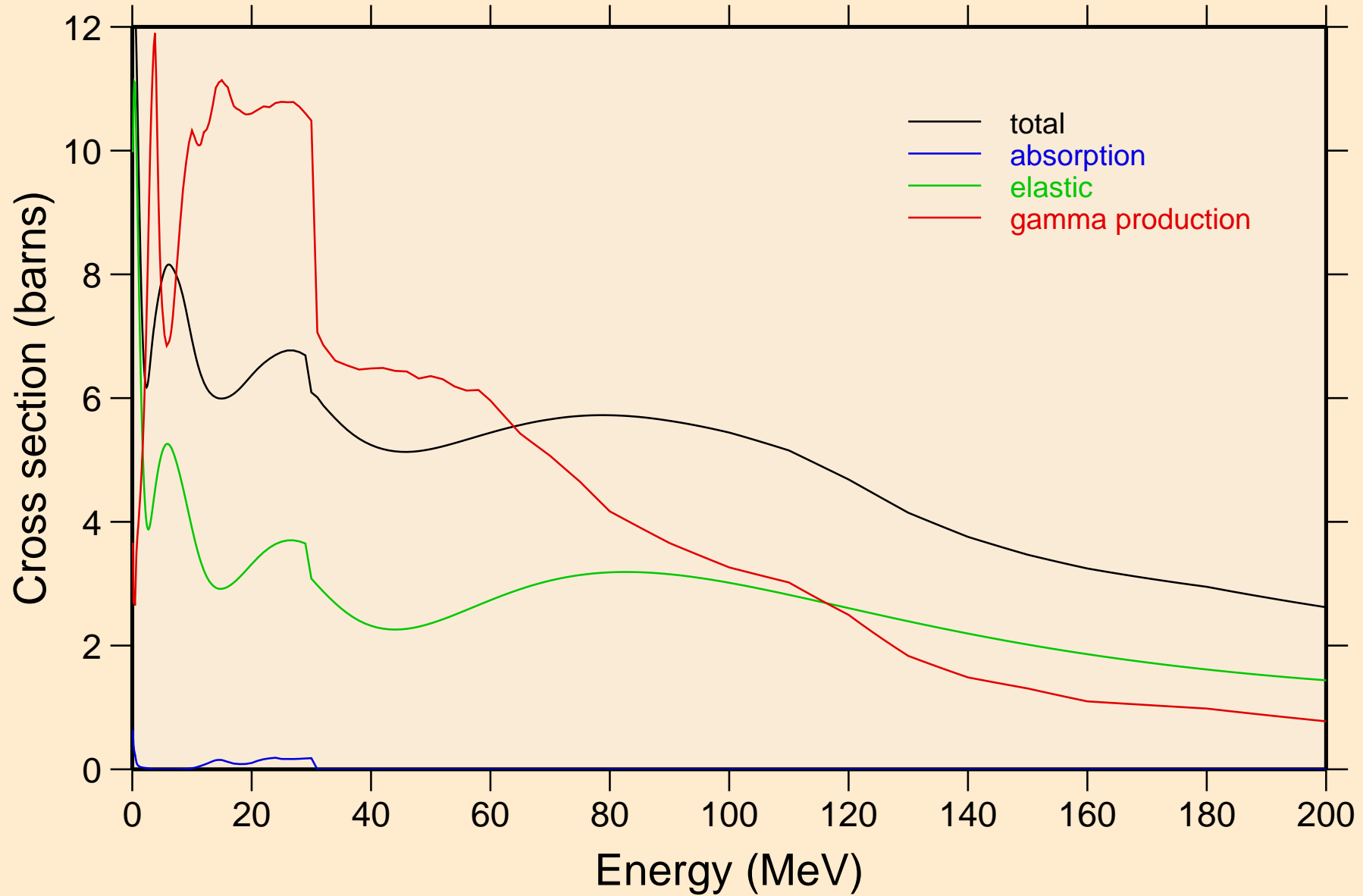

BI216M NEUTRON ACER TENDL-2021 LIBRARY; T=293.6K  
Heating

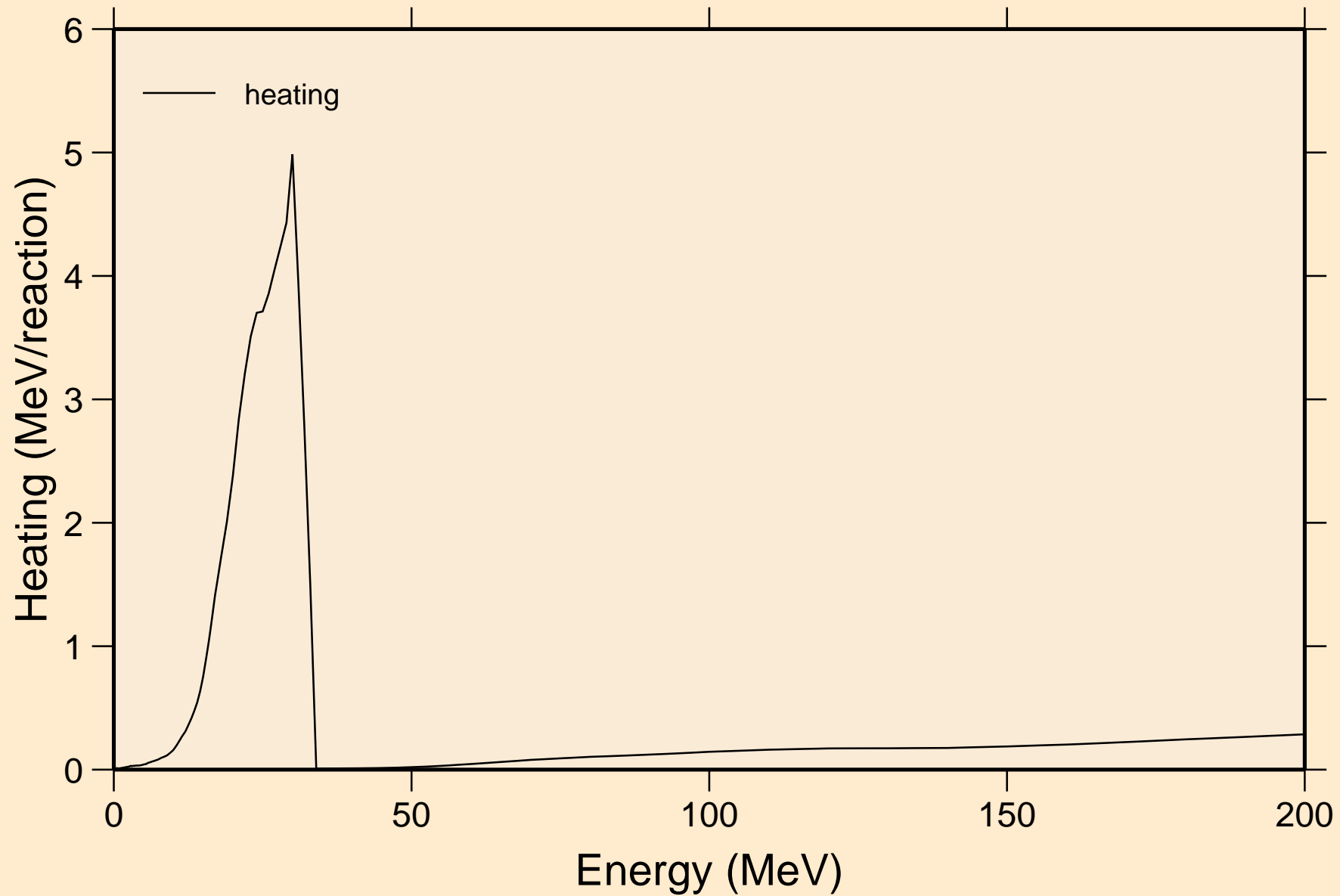

BI216M NEUTRON ACER TENDL-2021 LIBRARY; T=293.6K  
Damage

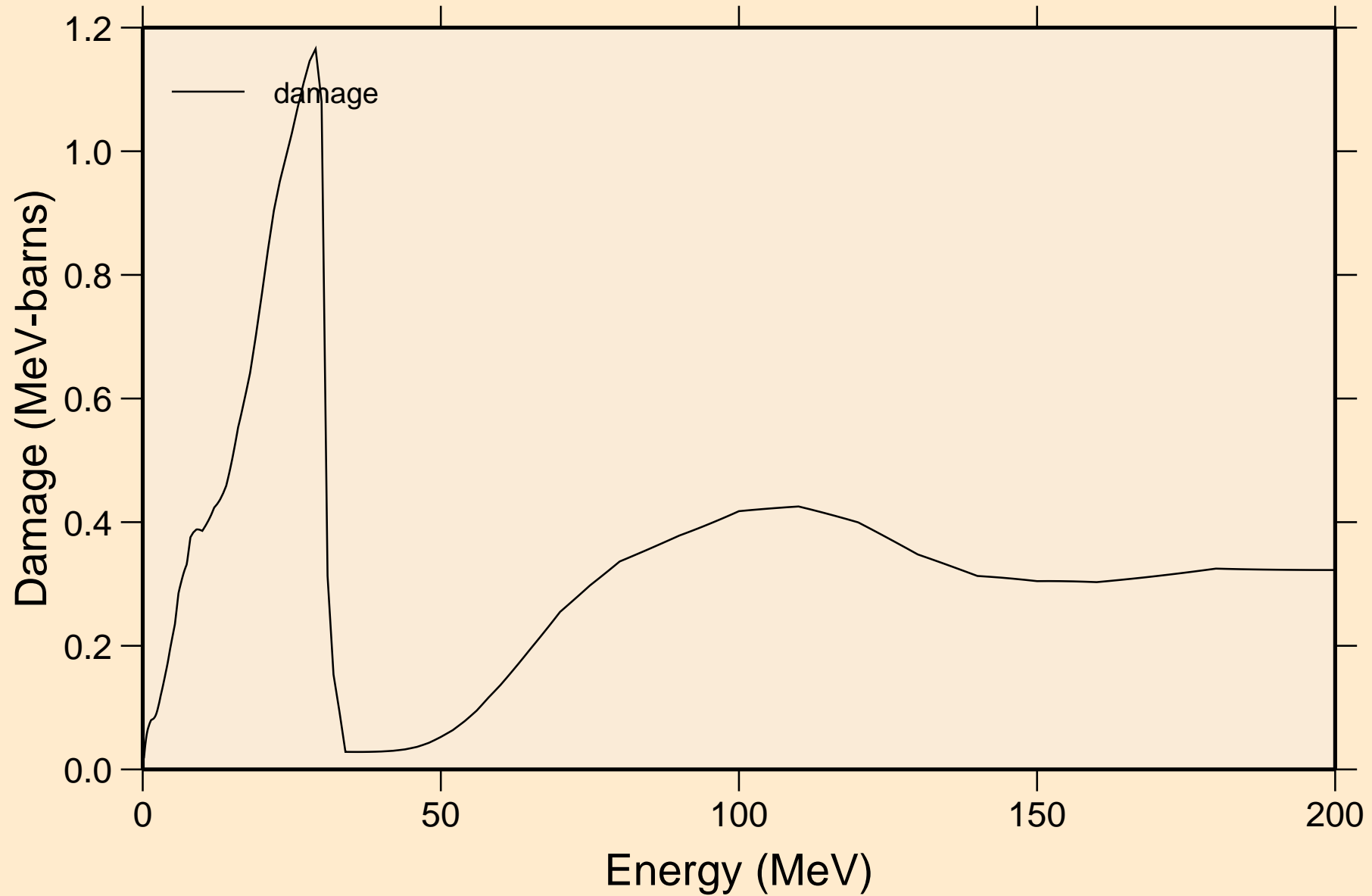

BI216M NEUTRON ACER TENDL-2021 LIBRARY; T=293.6K  
Non-threshold reactions

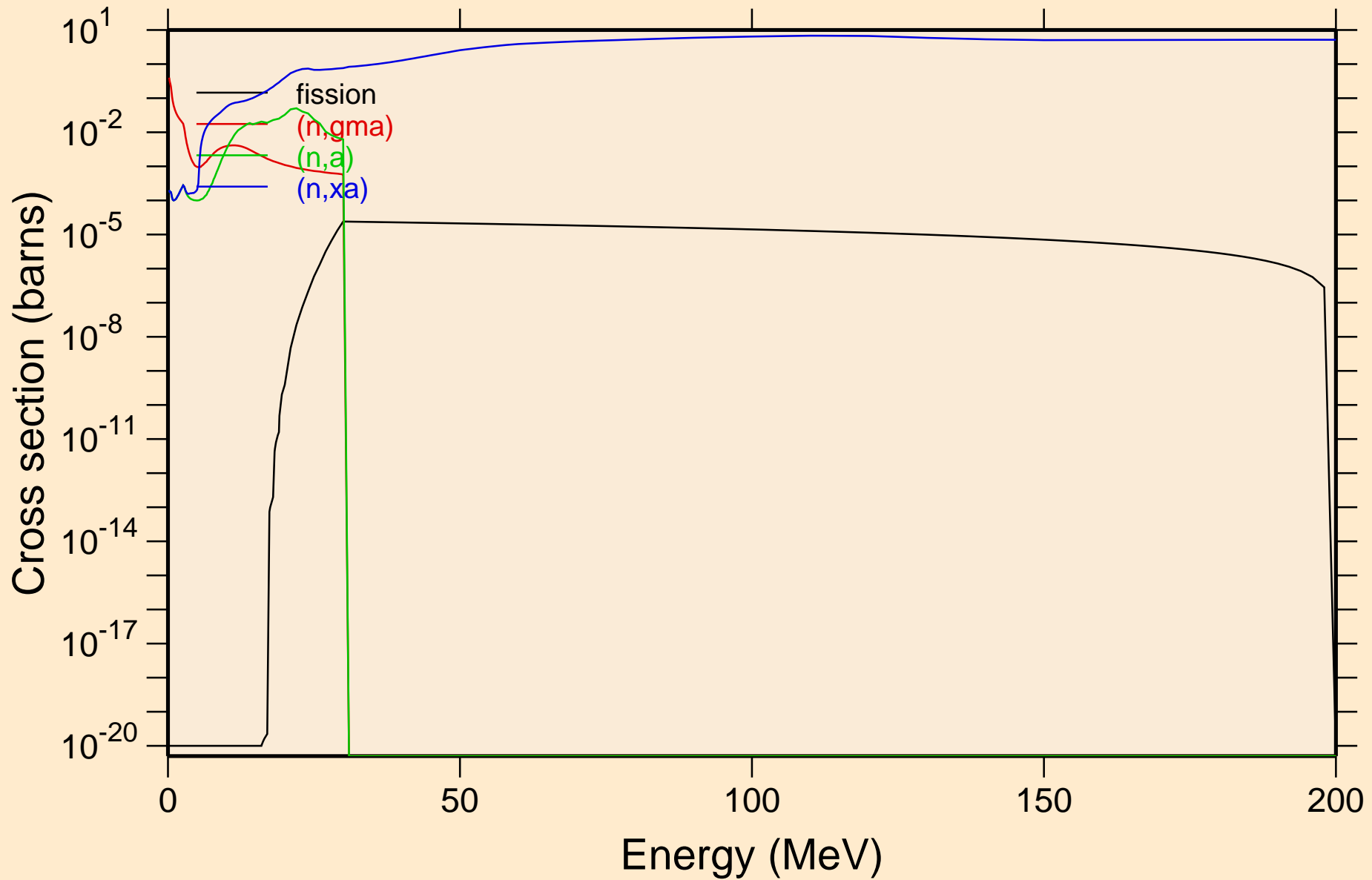



BI216M NEUTRON ACER TENDL-2021 LIBRARY; T=293.6K  
Inelastic levels

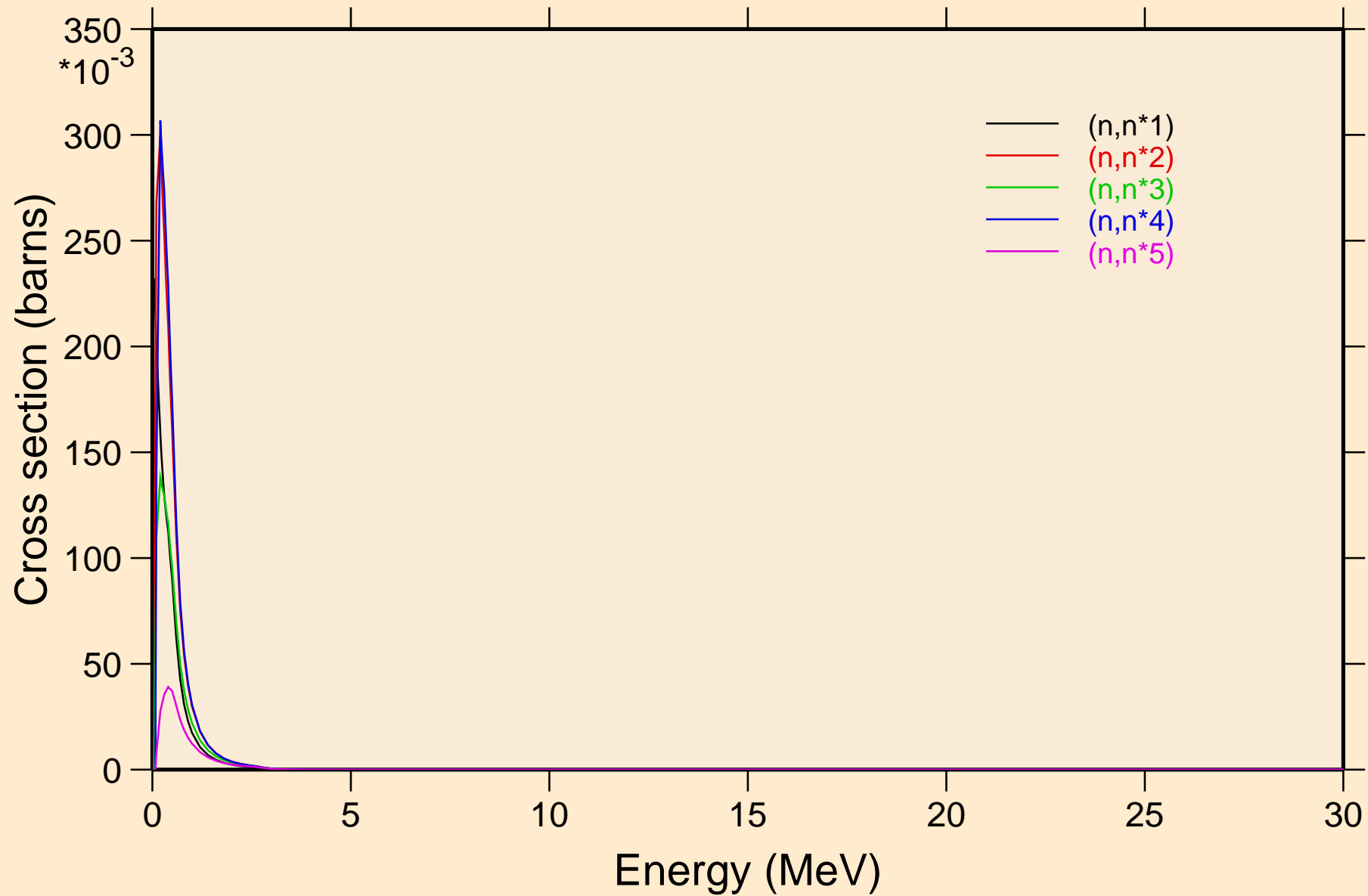

BI216M NEUTRON ACER TENDL-2021 LIBRARY; T=293.6K  
Inelastic levels

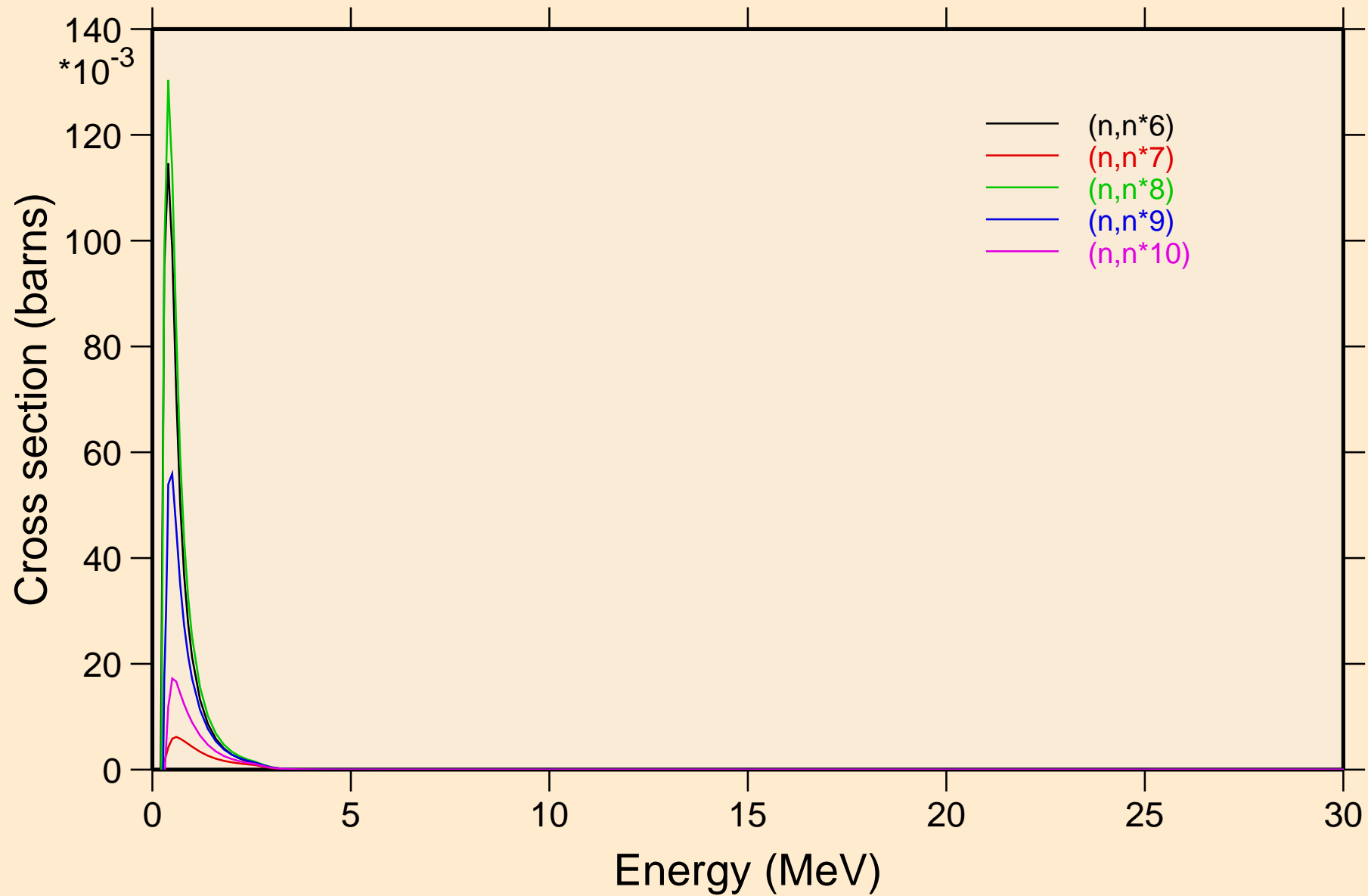

BI216M NEUTRON ACER TENDL-2021 LIBRARY; T=293.6K  
Inelastic levels

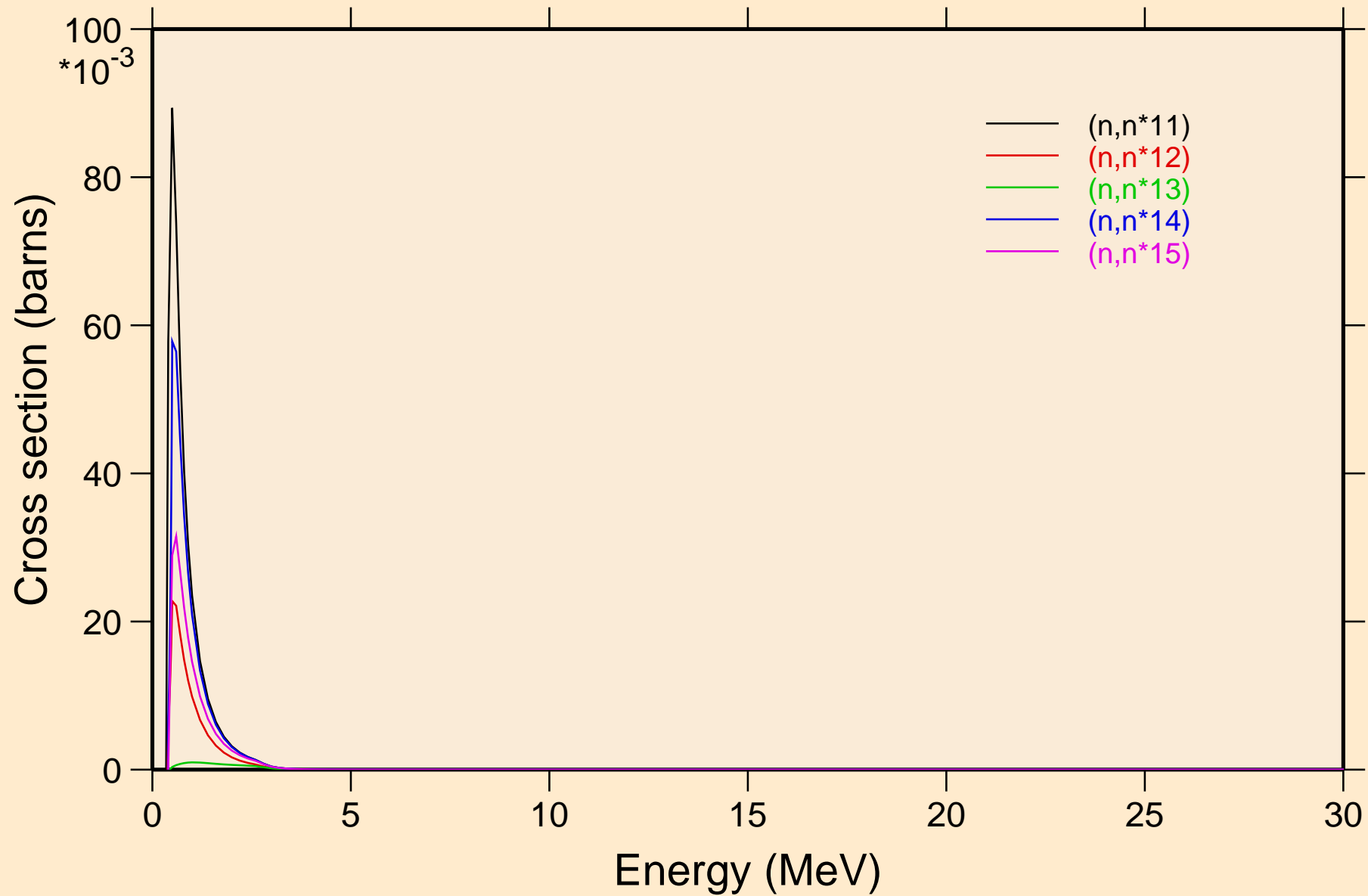

BI216M NEUTRON ACER TENDL-2021 LIBRARY; T=293.6K  
Inelastic levels

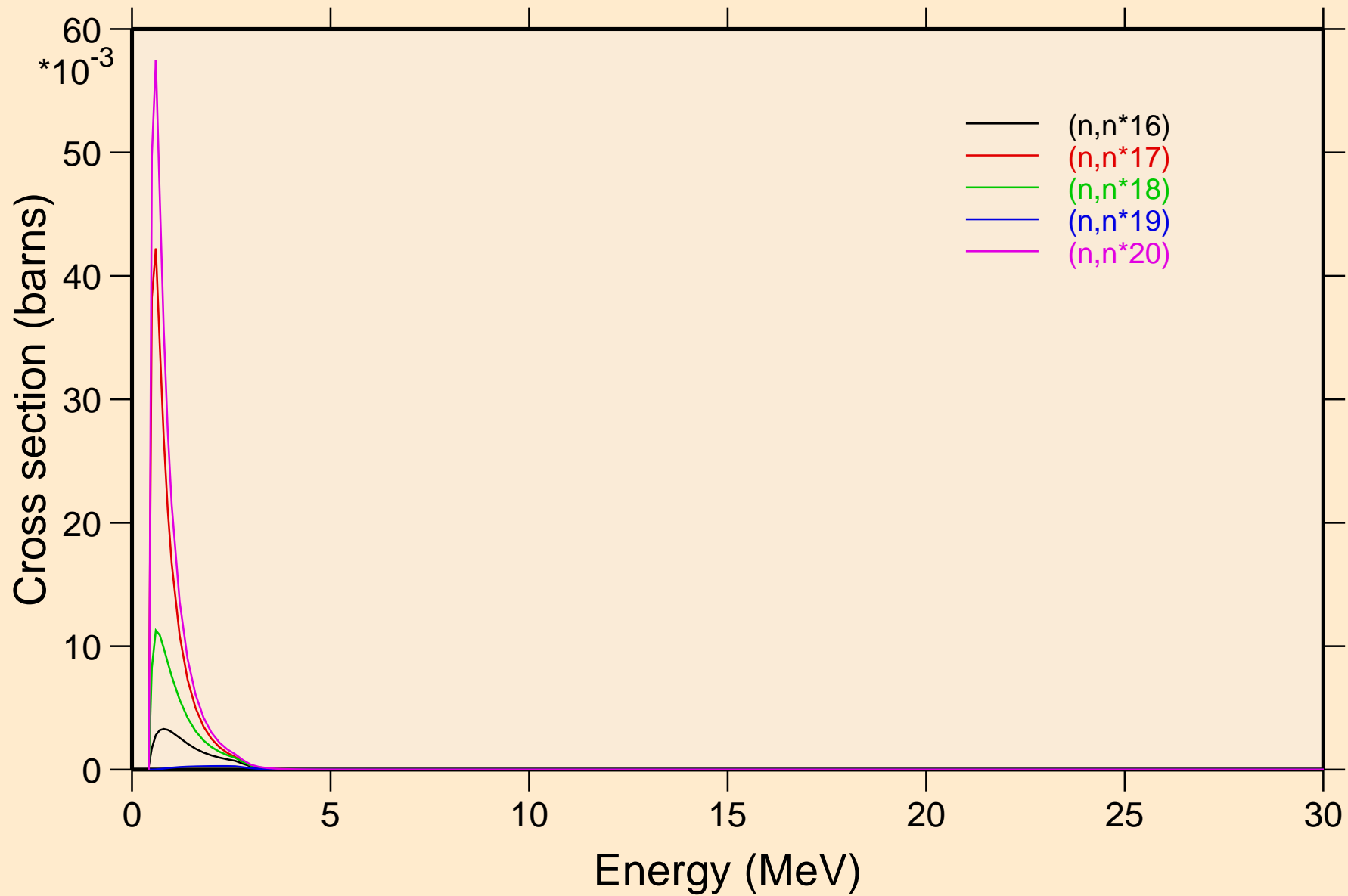

BI216M NEUTRON ACER TENDL-2021 LIBRARY; T=293.6K  
Inelastic levels

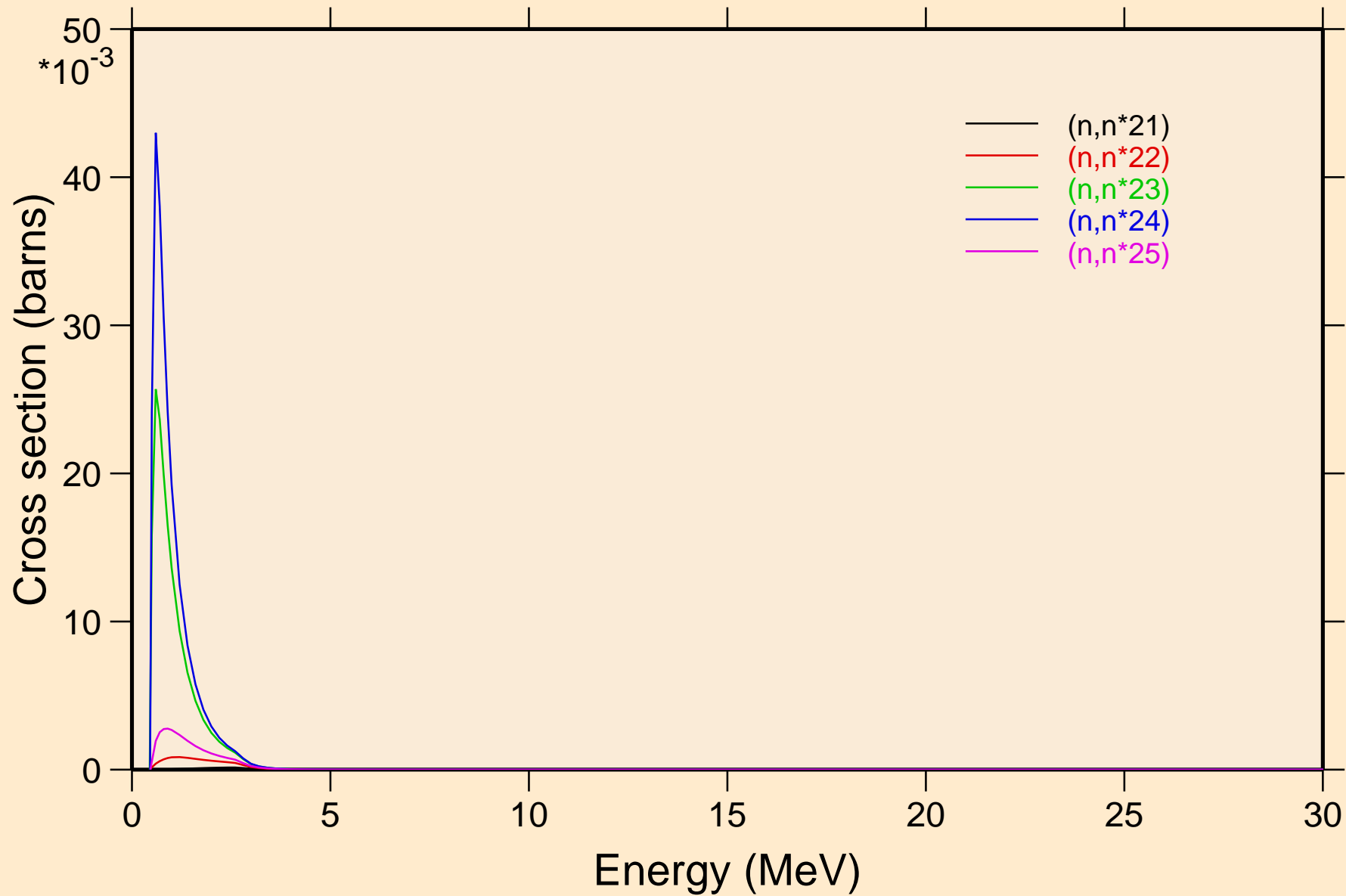

BI216M NEUTRON ACER TENDL-2021 LIBRARY; T=293.6K  
Inelastic levels

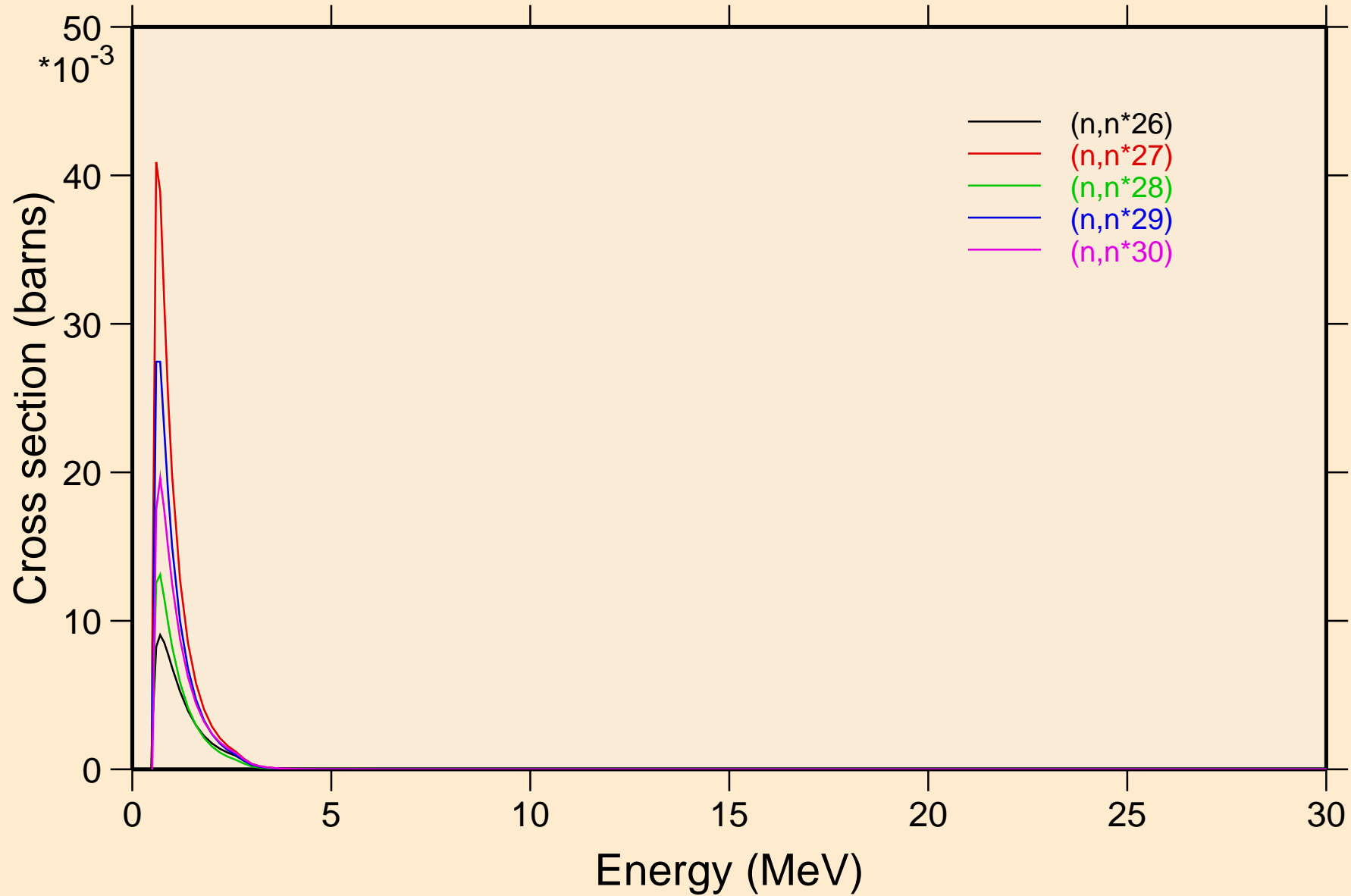

BI216M NEUTRON ACER TENDL-2021 LIBRARY; T=293.6K  
Threshold reactions

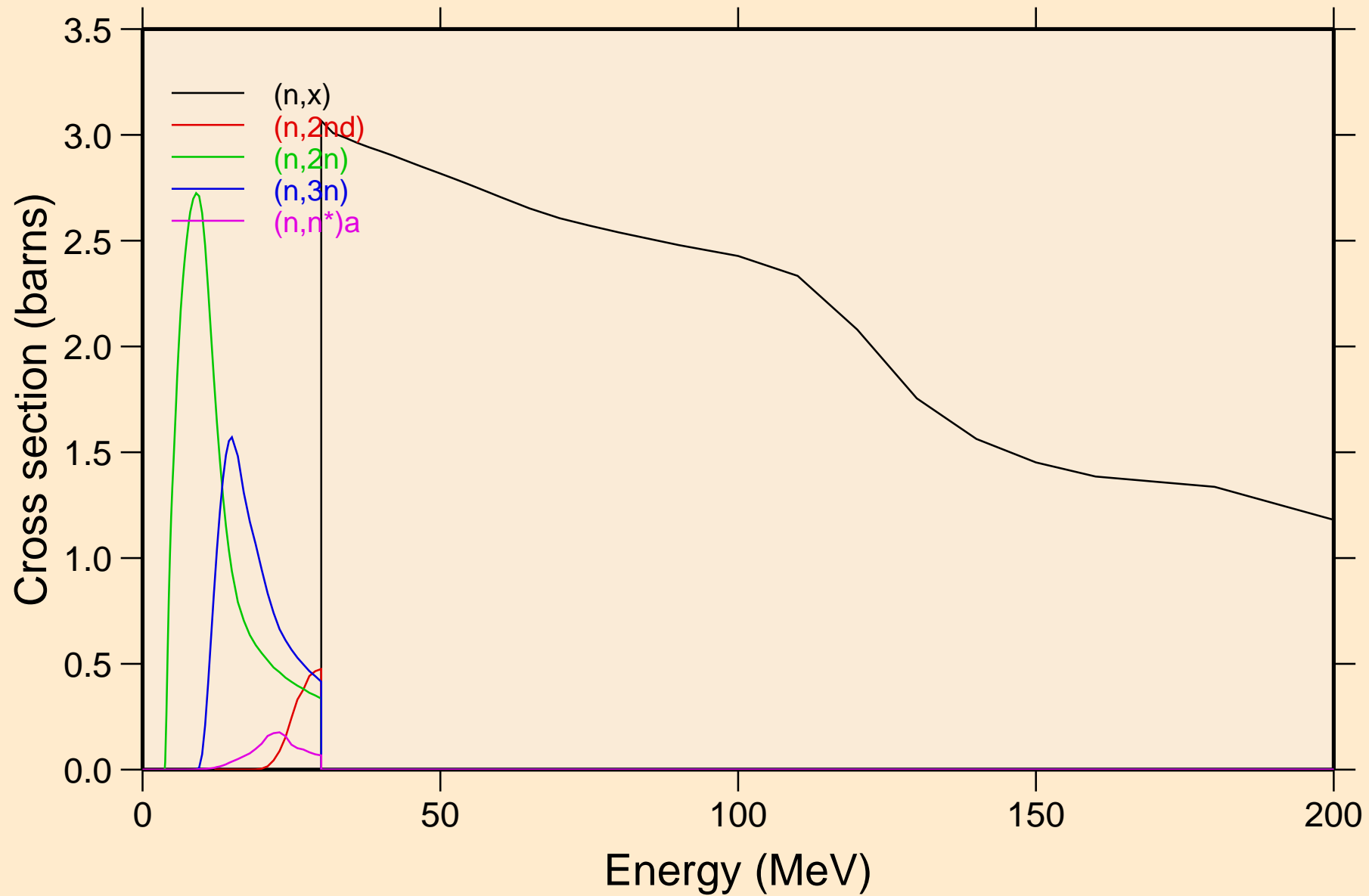

BI216M NEUTRON ACER TENDL-2021 LIBRARY; T=293.6K  
Threshold reactions

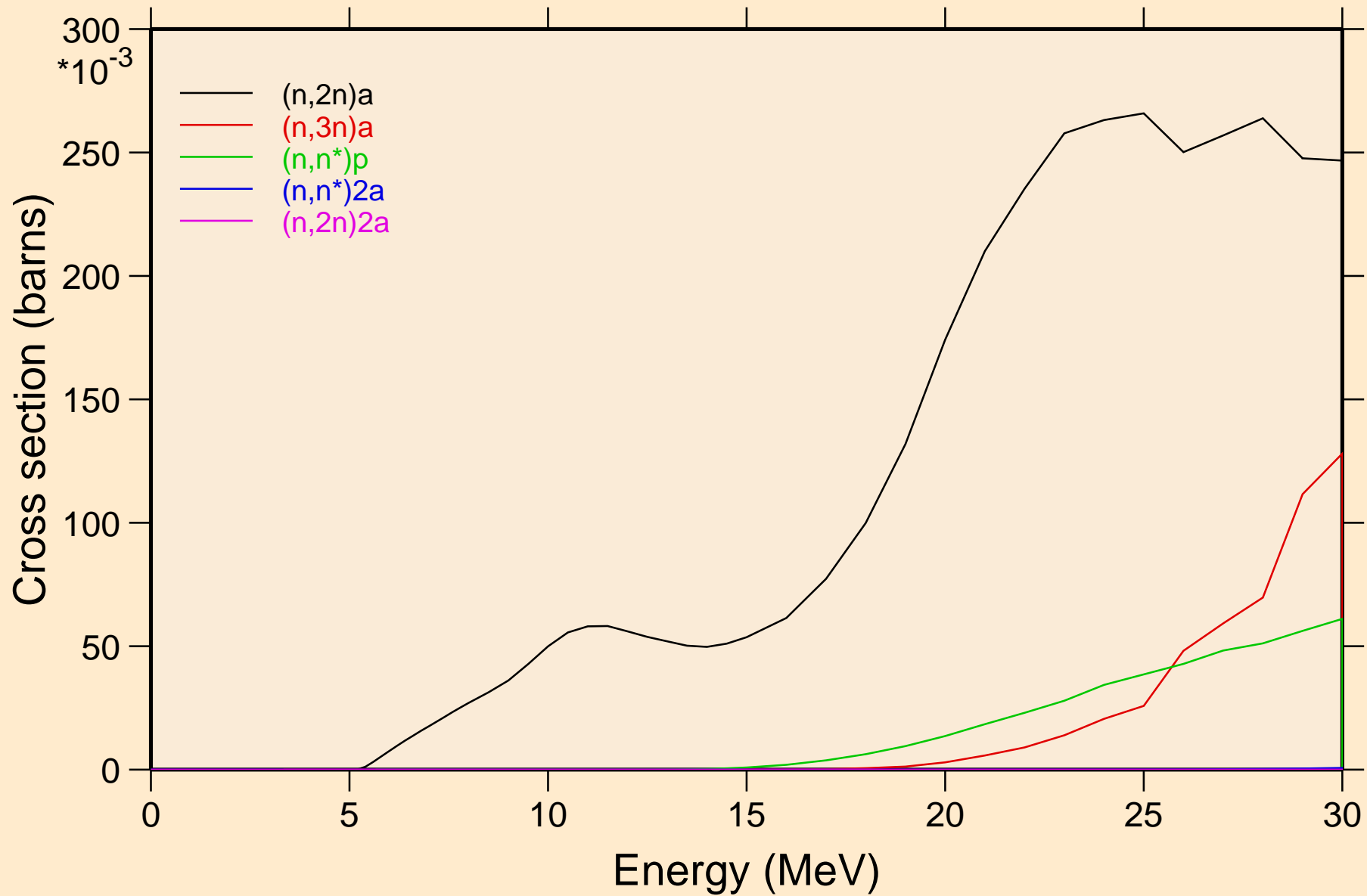



BI216M NEUTRON ACER TENDL-2021 LIBRARY; T=293.6K  
Threshold reactions

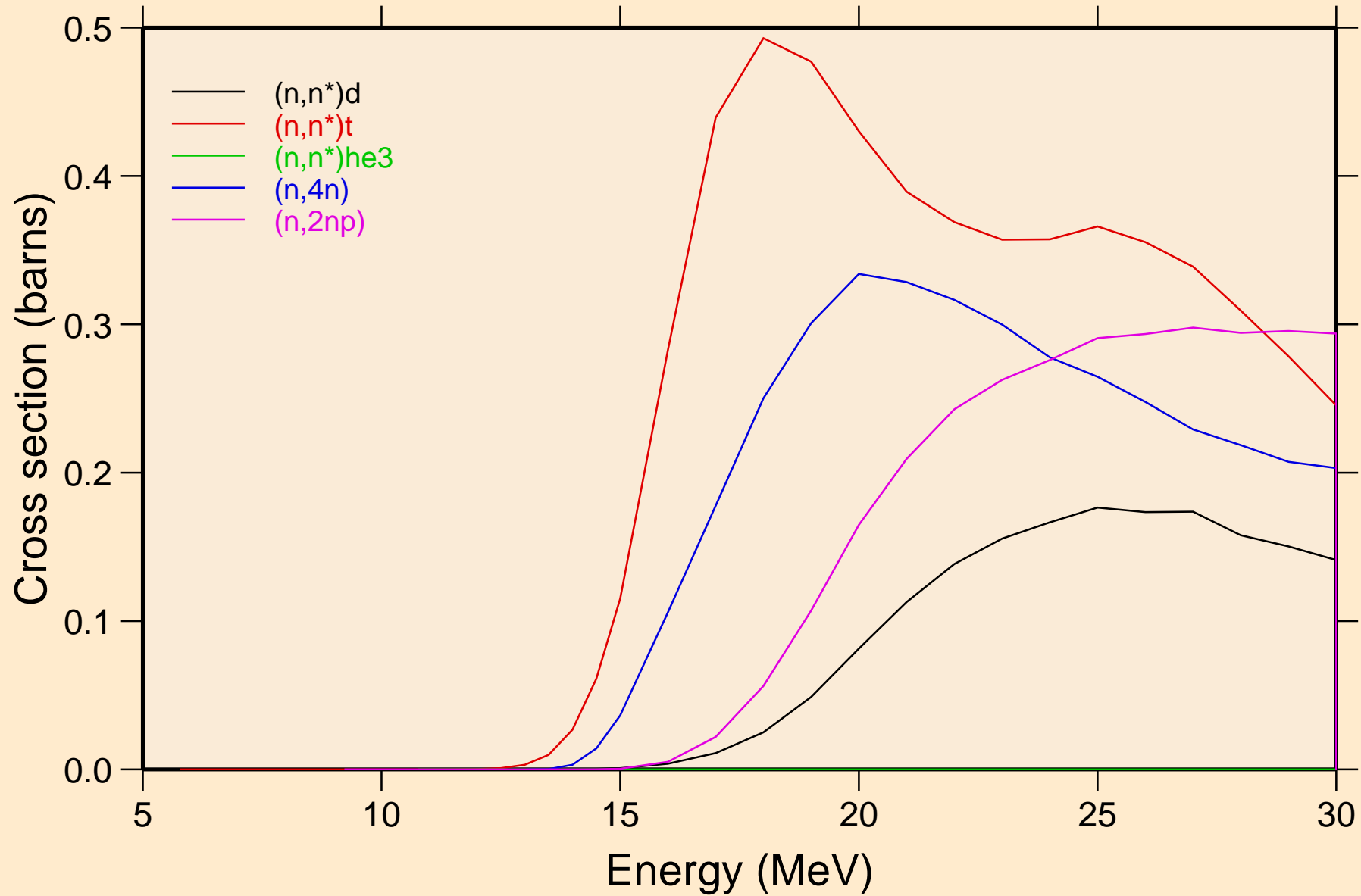

BI216M NEUTRON ACER TENDL-2021 LIBRARY; T=293.6K  
Threshold reactions

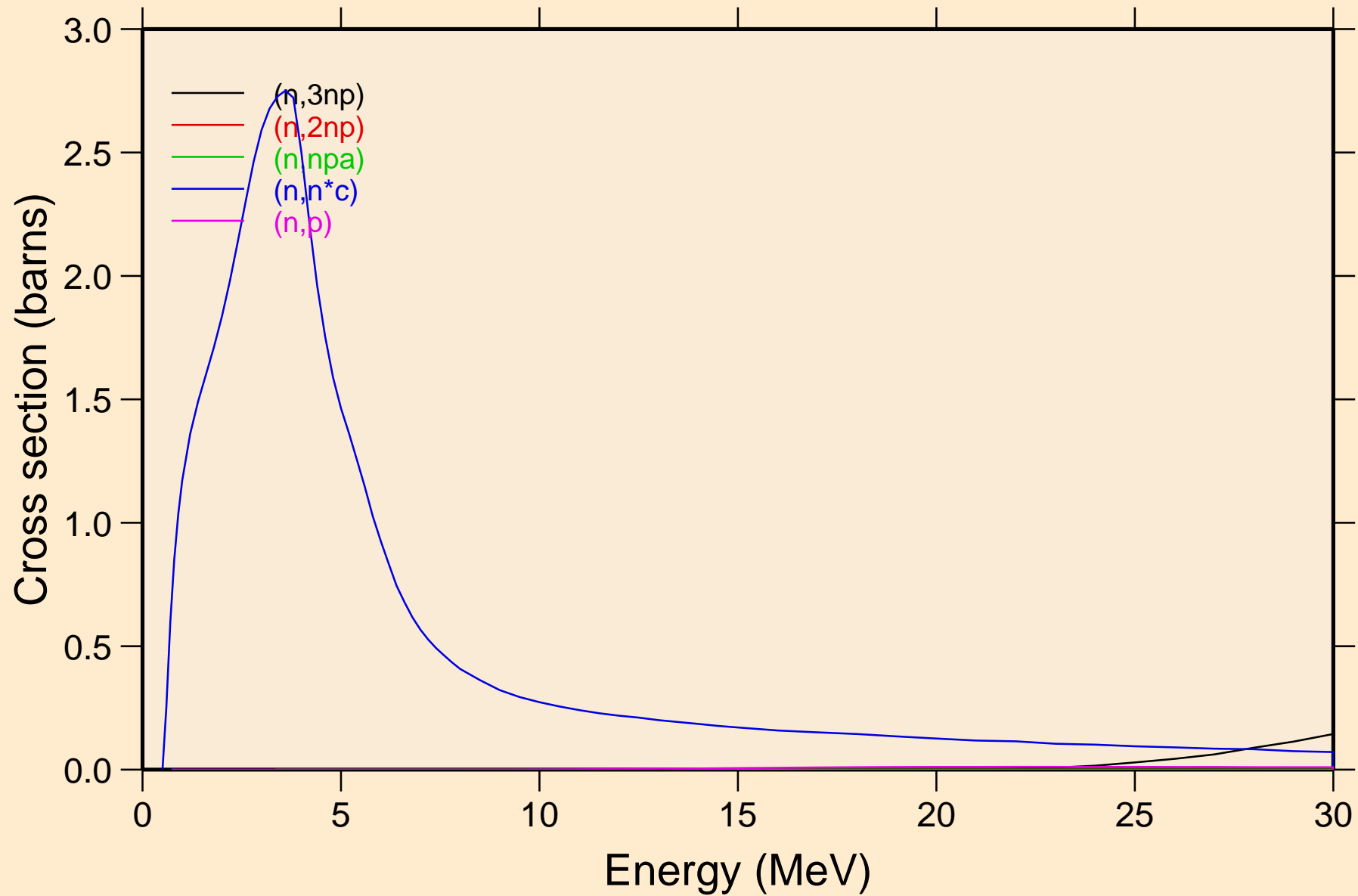

BI216M NEUTRON ACER TENDL-2021 LIBRARY; T=293.6K  
Threshold reactions

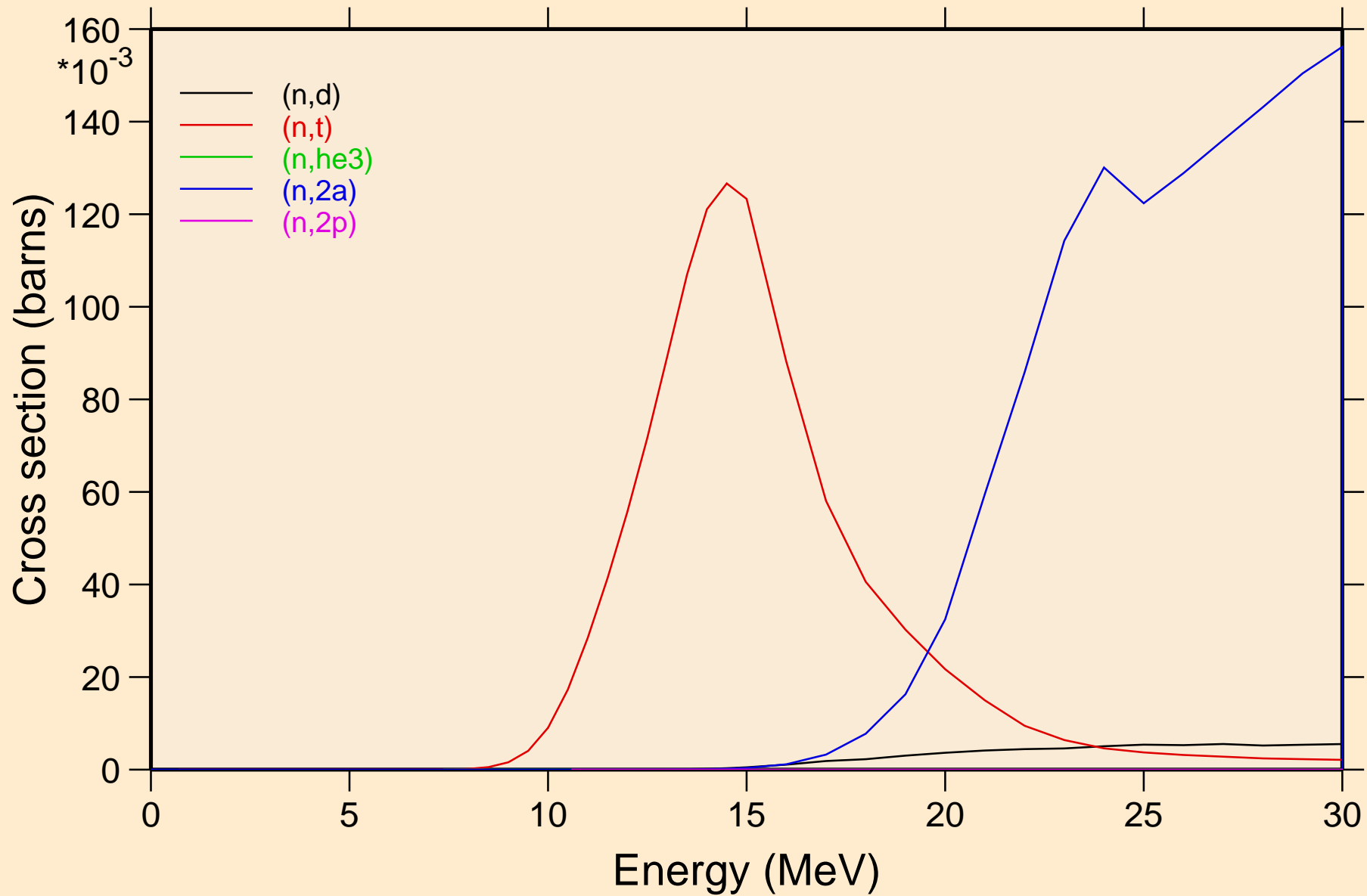

BI216M NEUTRON ACER TENDL-2021 LIBRARY; T=293.6K  
Threshold reactions

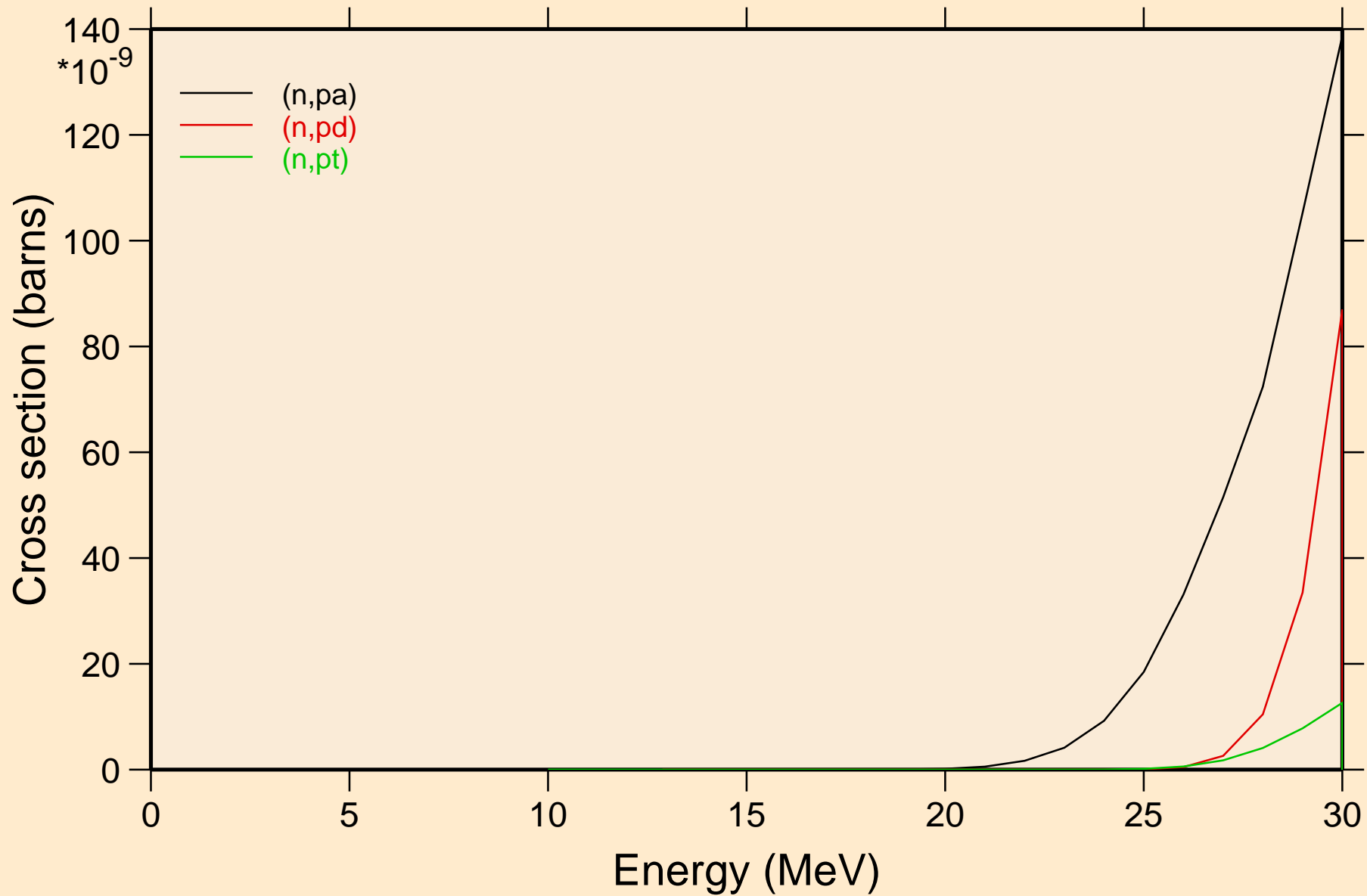

# BI216M NEUTRON ACER TENDL-2021 LIBRARY; T=293.6K

## Threshold reactions

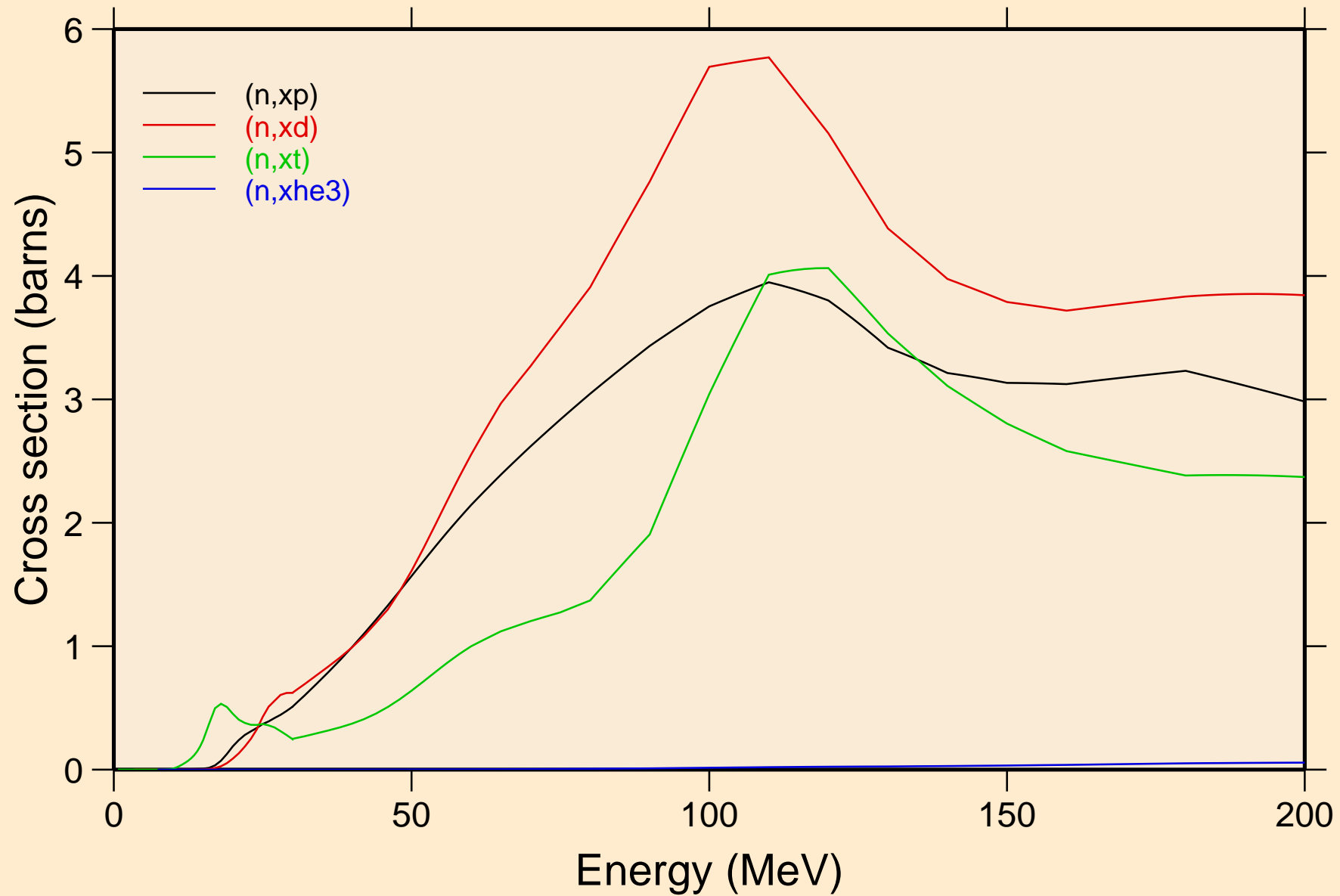

BI216M NEUTRON ACER TENDL-2021 LIBRARY; T=293.6K  
angular distribution for elastic

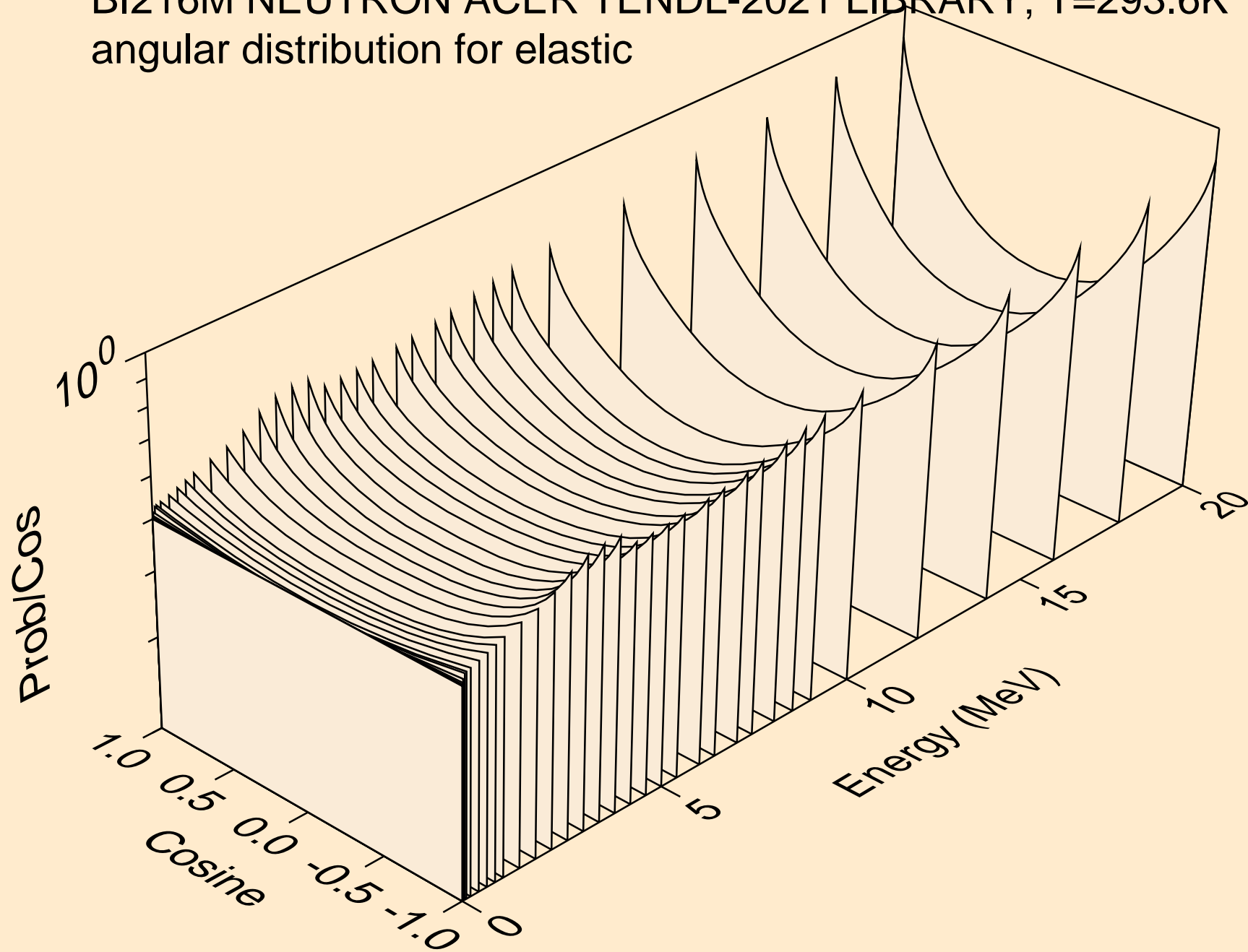

BI216M NEUTRON ACER TENDL-2021 LIBRARY; T=293.6K  
angular distribution for elastic

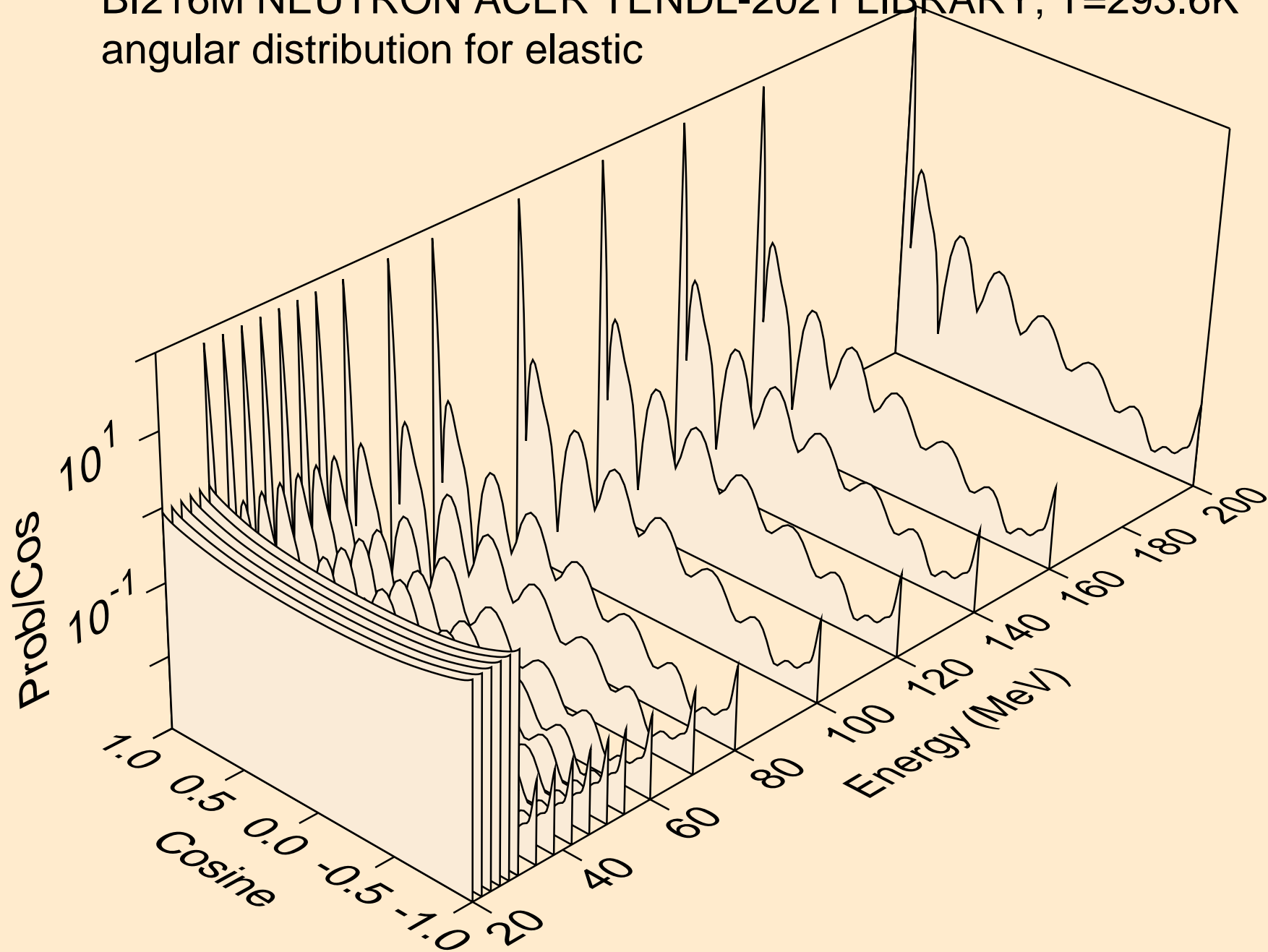

BI216M NEUTRON ACER TENDL-2021 LIBRARY; T=293.6K  
angular distribution for (n,n\*1)

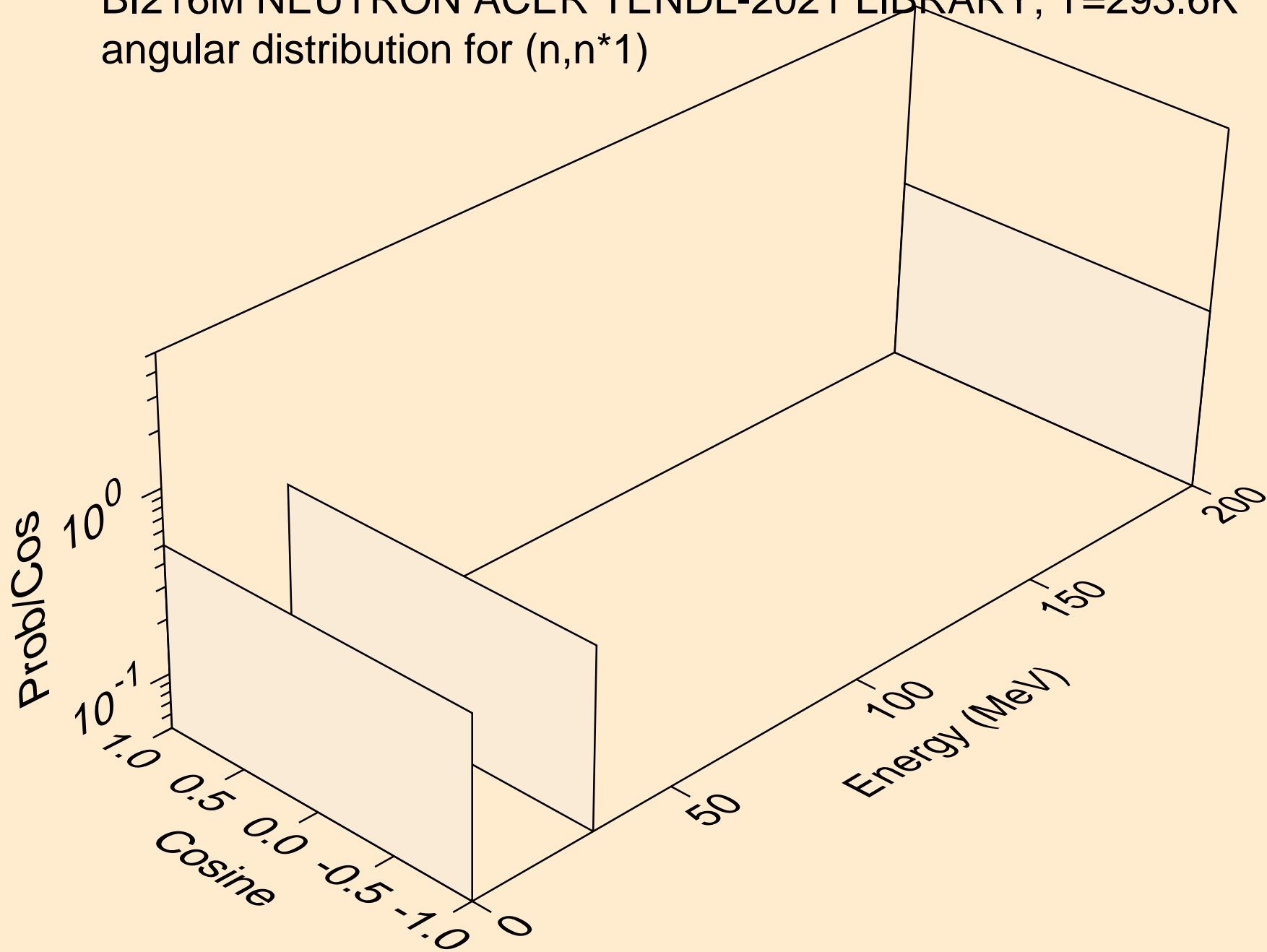



BI216M NEUTRON ACER TENDL-2021 LIBRARY; T=293.6K  
angular distribution for (n,n\*2)

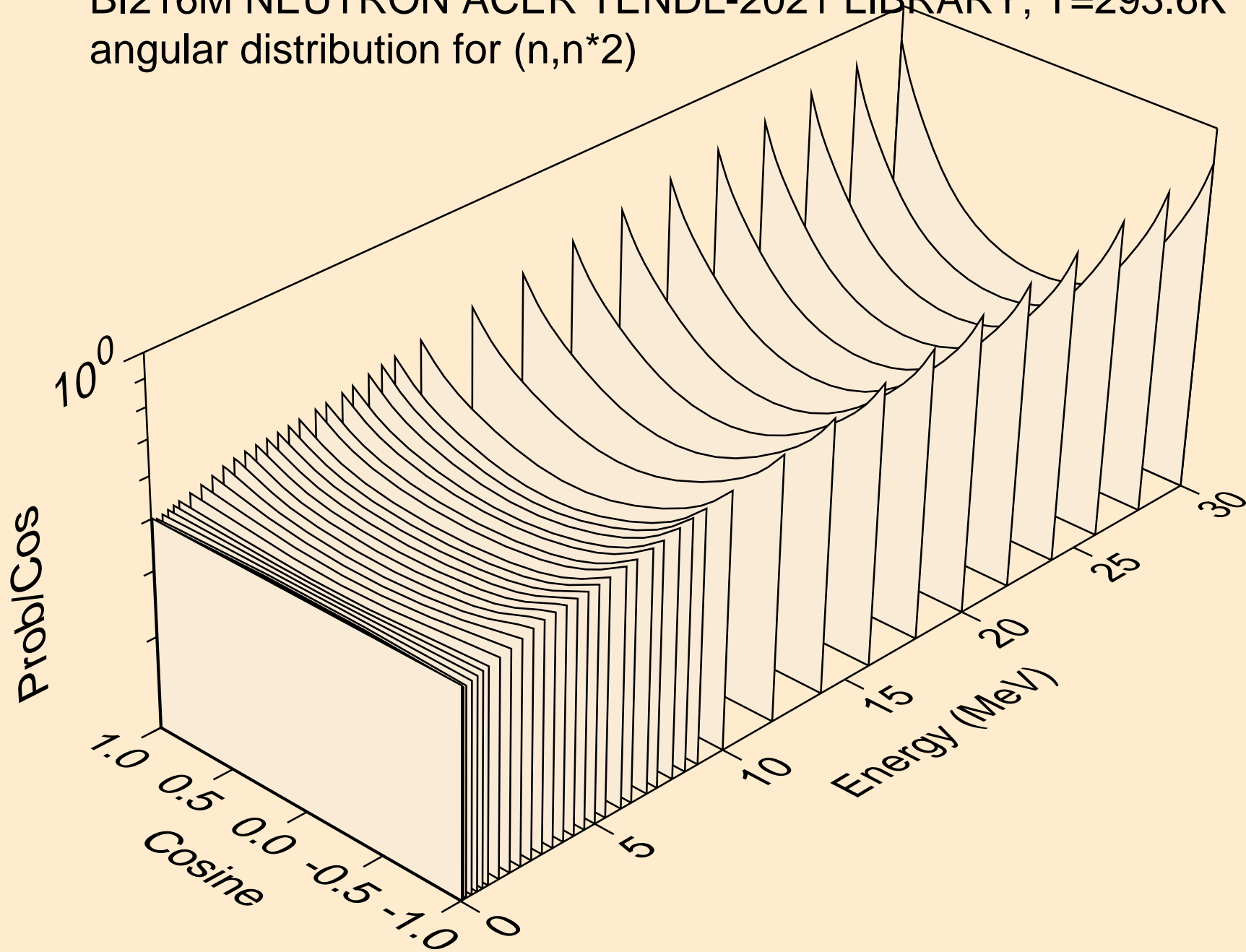

BI216M NEUTRON ACER TENDL-2021 LIBRARY; T=293.6K  
angular distribution for (n,n\*3)

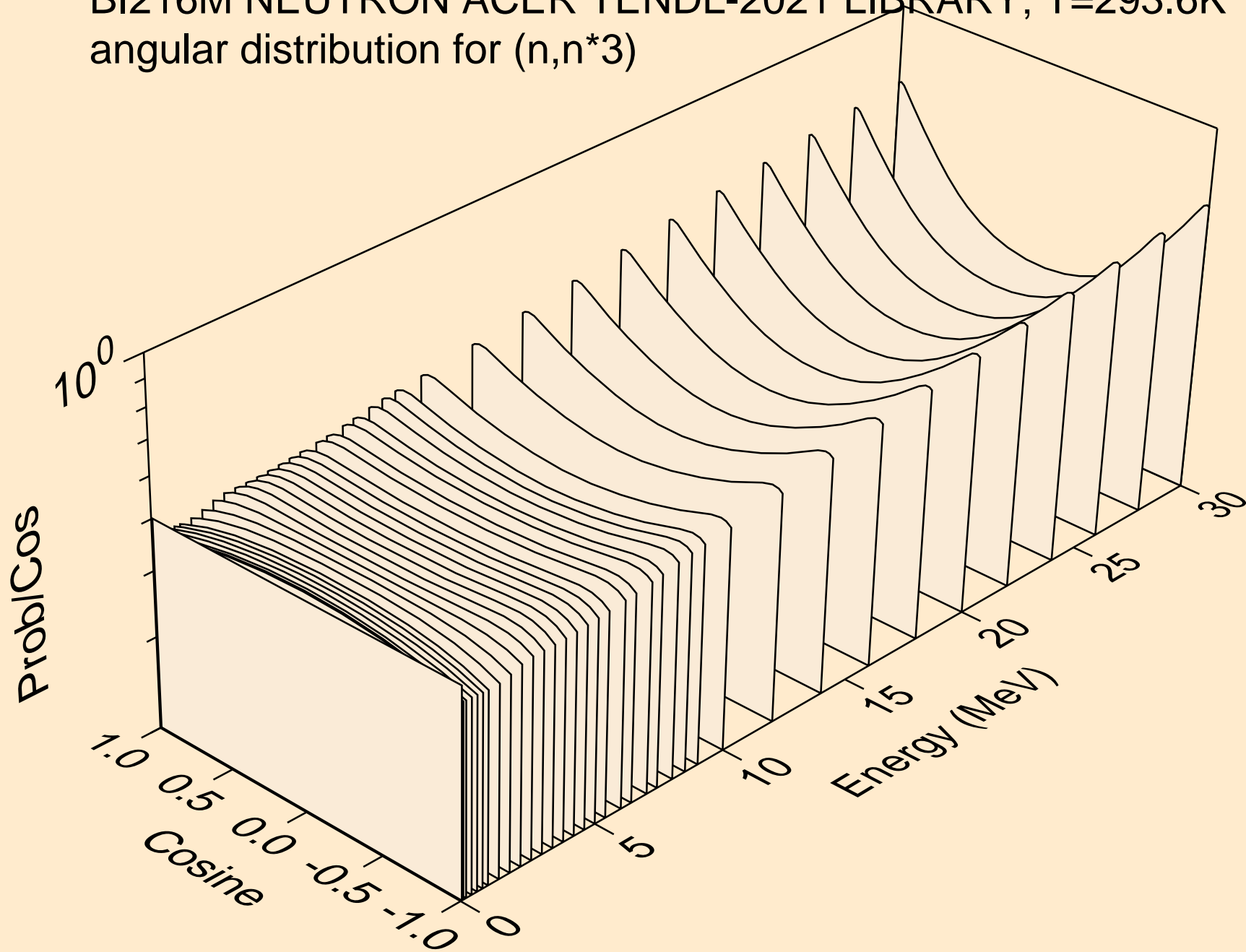

BI216M NEUTRON ACER TENDL-2021 LIBRARY; T=293.6K  
angular distribution for (n,n\*4)

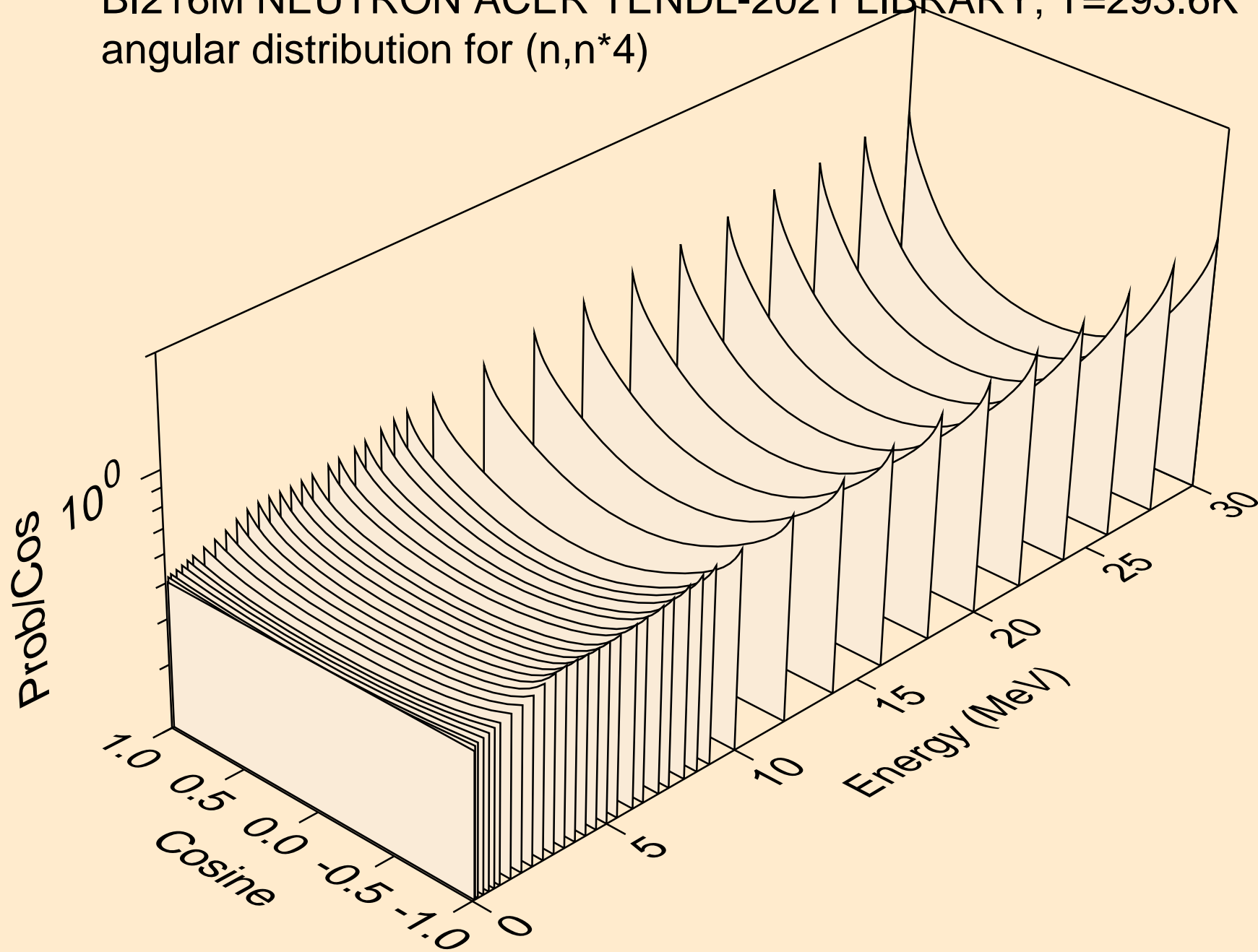

BI216M NEUTRON ACER TENDL-2021 LIBRARY; T=293.6K  
angular distribution for (n,n\*5)

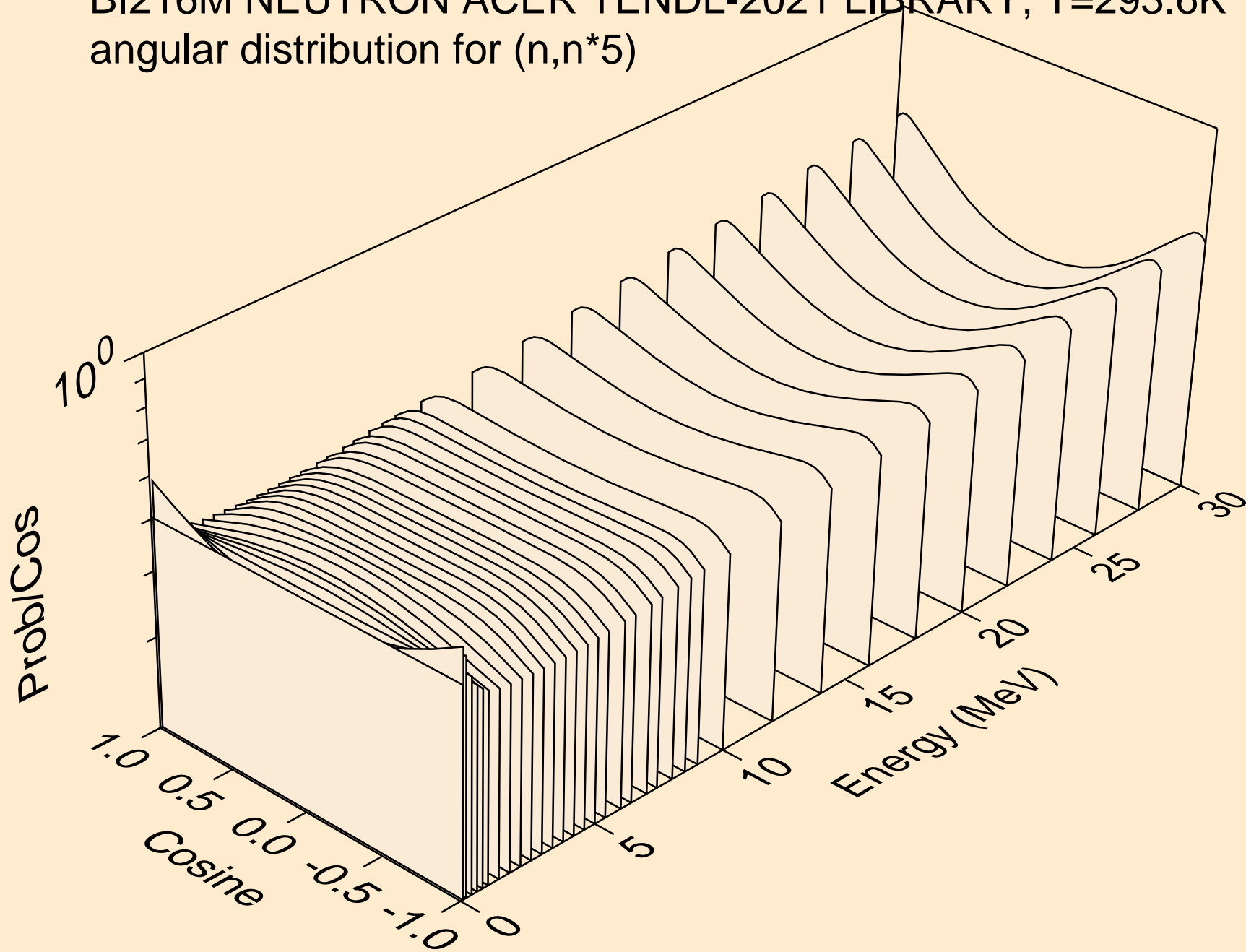

BI216M NEUTRON ACER TENDL-2021 LIBRARY; T=293.6K  
angular distribution for (n,n\*6)

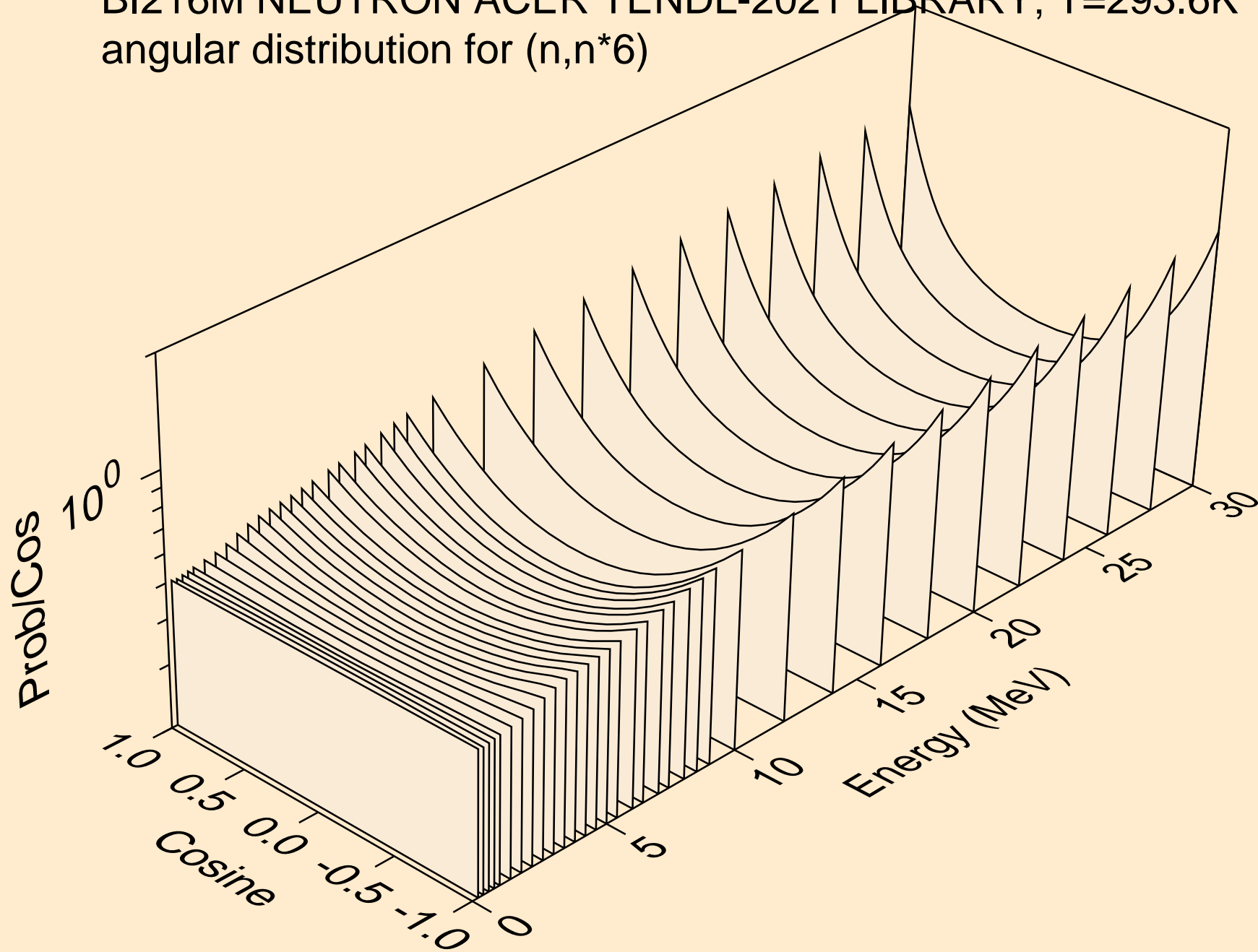

BI216M NEUTRON ACER TENDL-2021 LIBRARY; T=293.6K  
angular distribution for (n,n\*7)

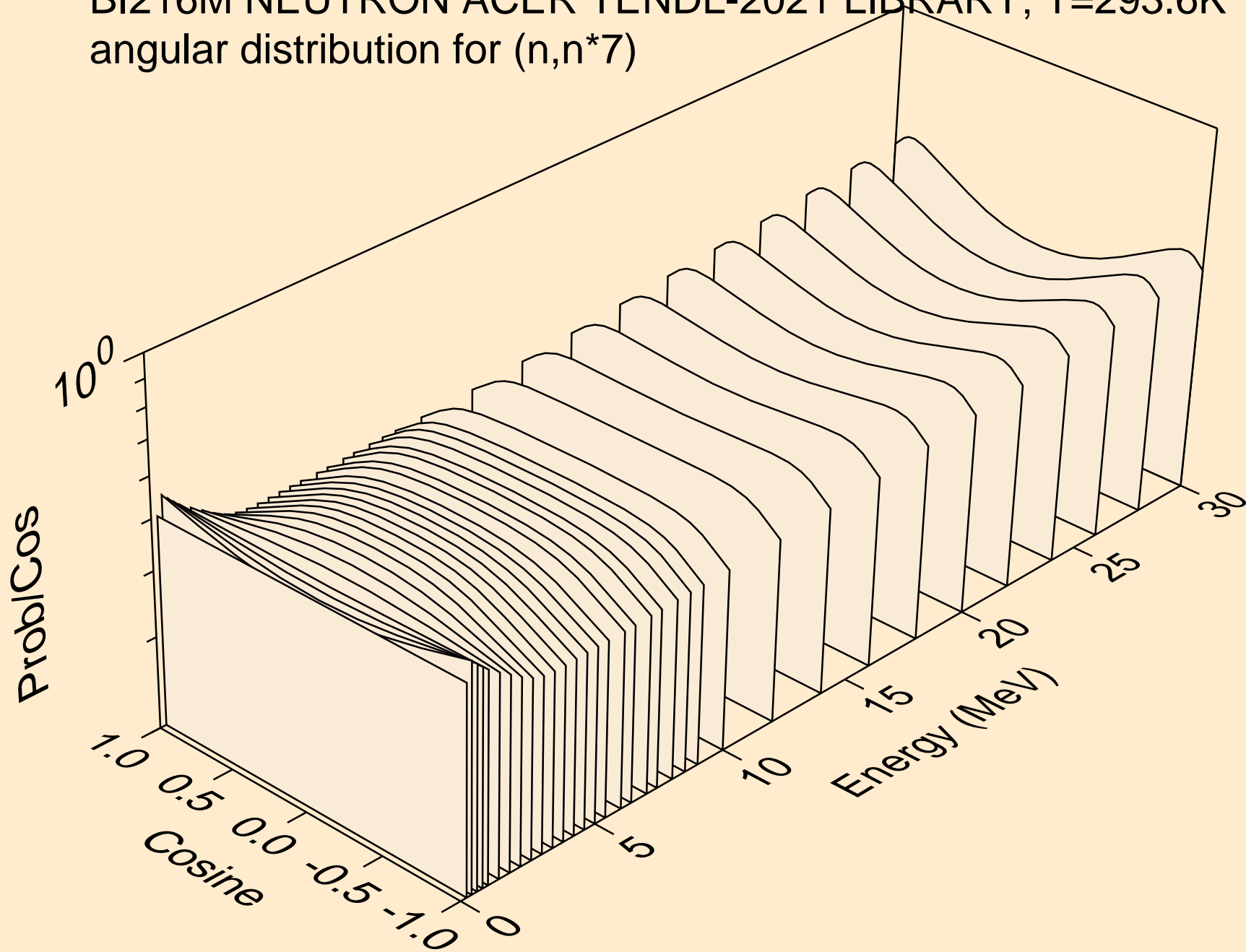

BI216M NEUTRON ACER TENDL-2021 LIBRARY; T=293.6K  
angular distribution for (n,n\*8)

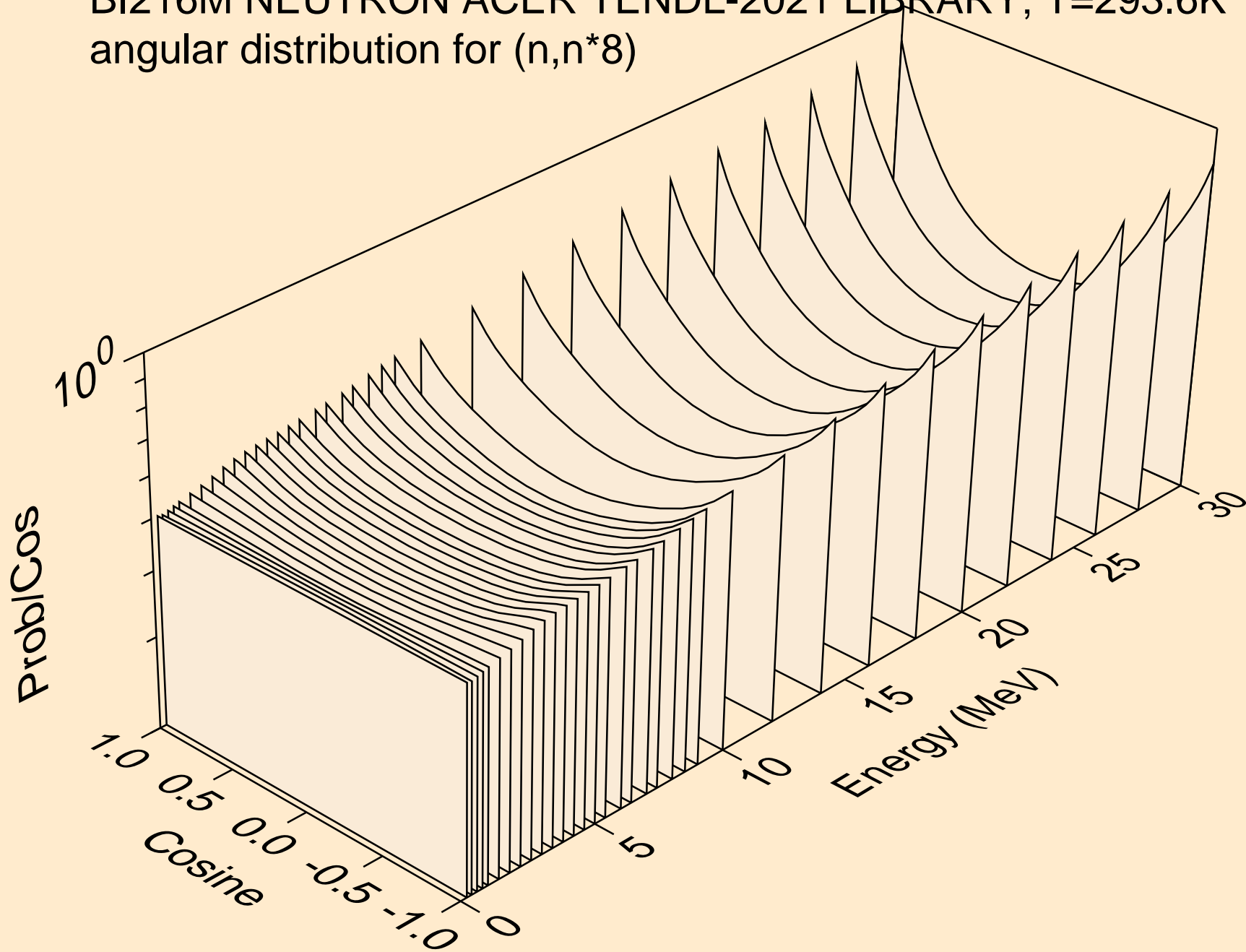

BI216M NEUTRON ACER TENDL-2021 LIBRARY; T=293.6K  
angular distribution for (n,n\*9)

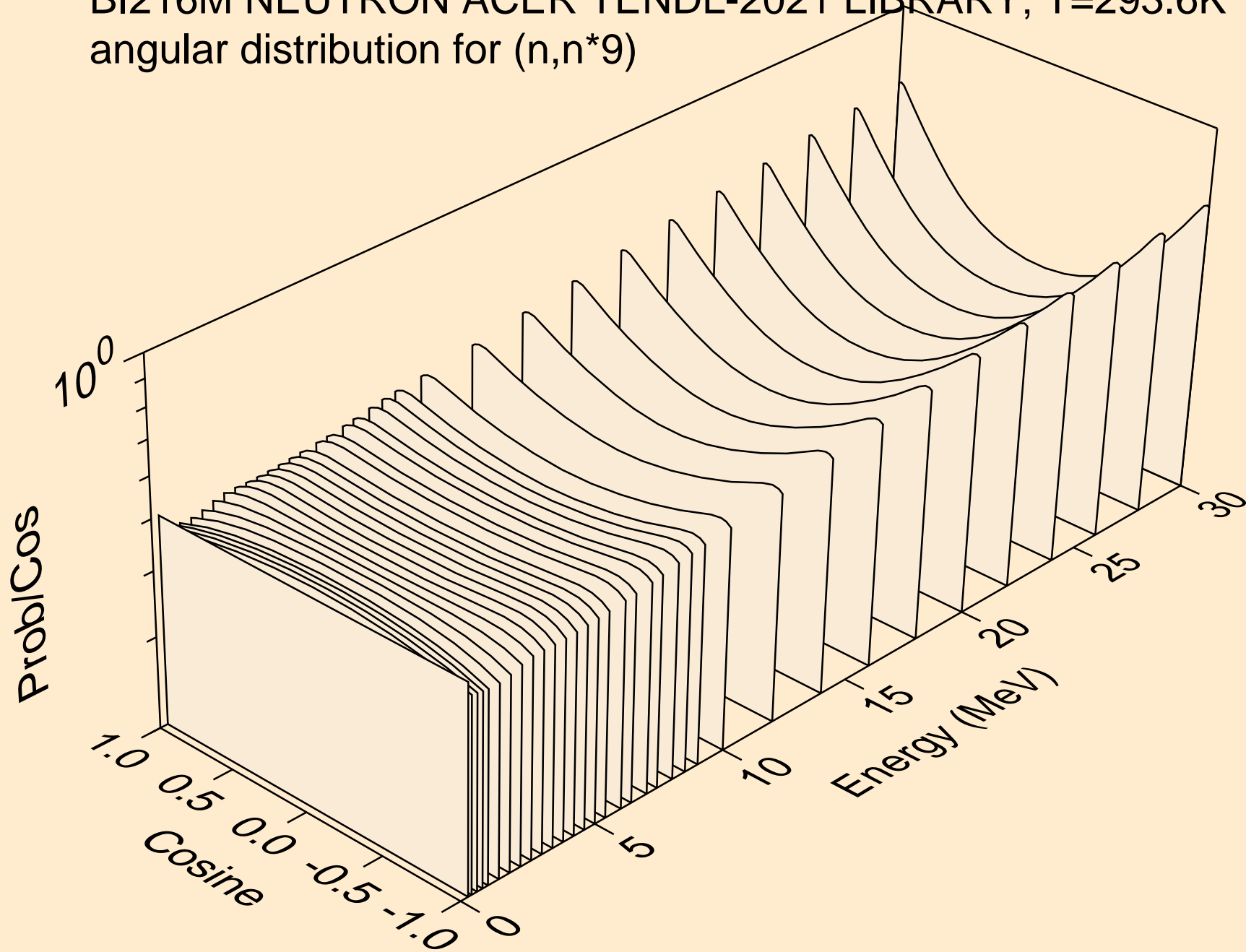



BI216M NEUTRON ACER TENDL-2021 LIBRARY; T=293.6K  
angular distribution for (n,n\*10)

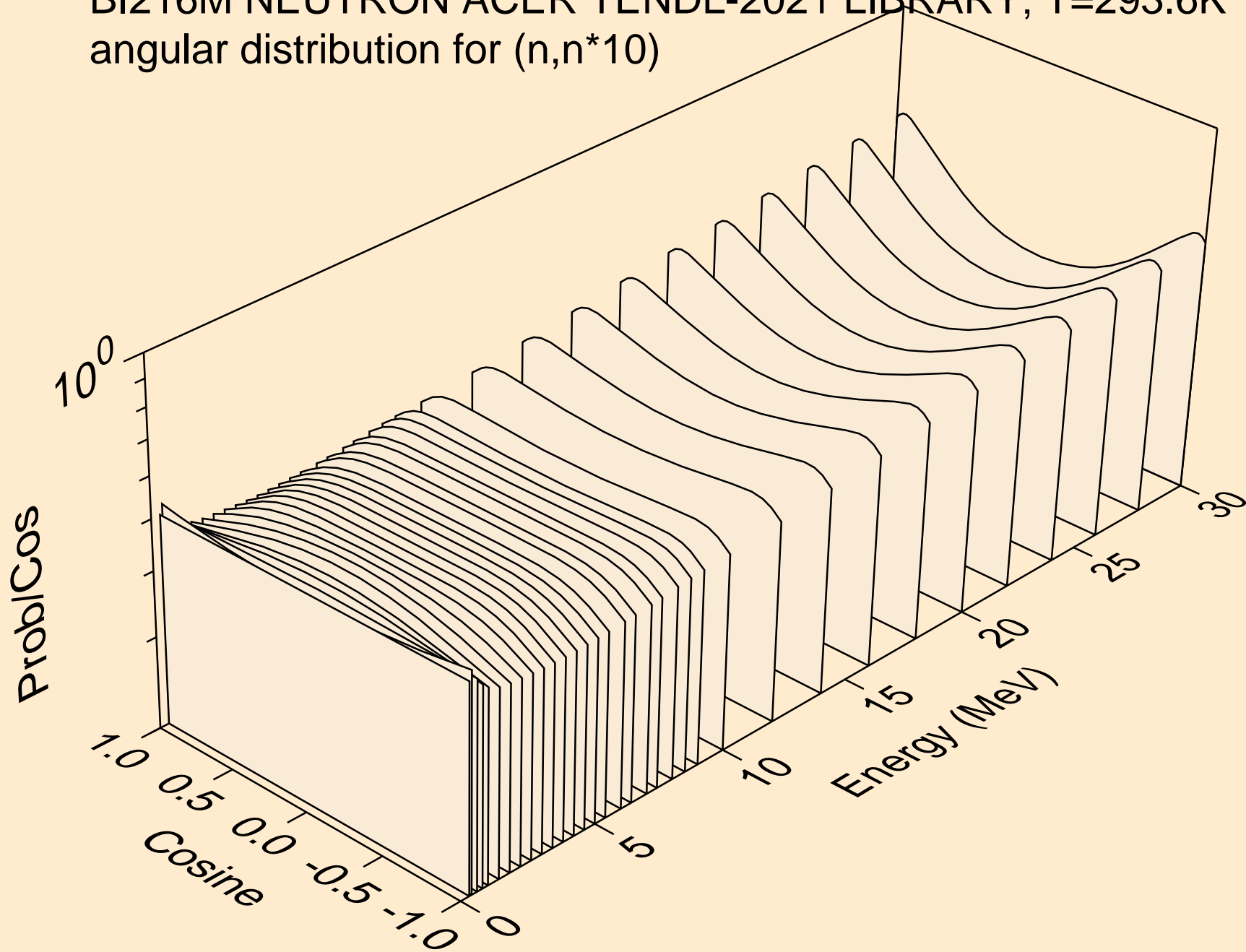

BI216M NEUTRON ACER TENDL-2021 LIBRARY; T=293.6K  
angular distribution for (n,n\*11)

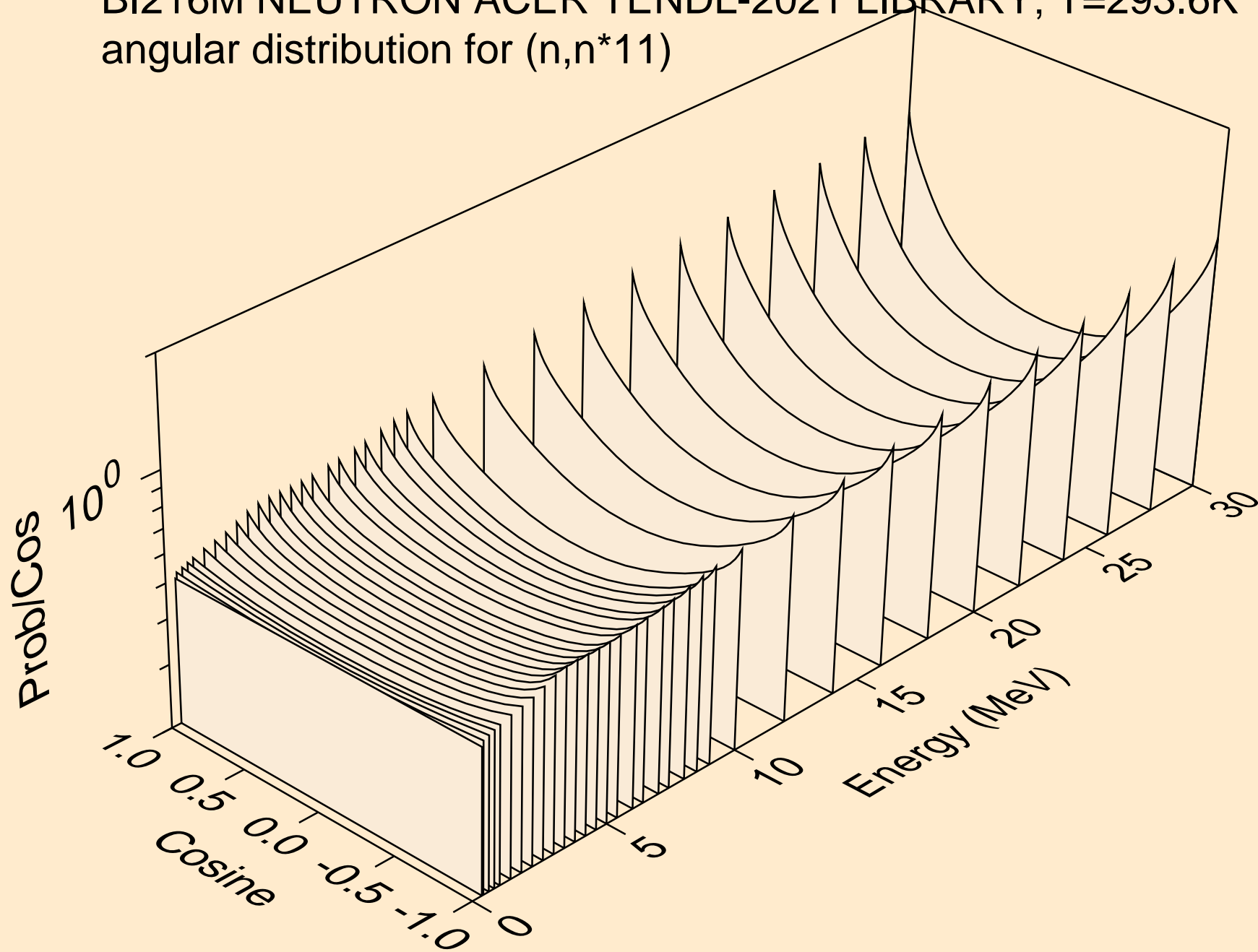

BI216M NEUTRON ACER TENDL-2021 LIBRARY; T=293.6K  
angular distribution for (n,n\*12)

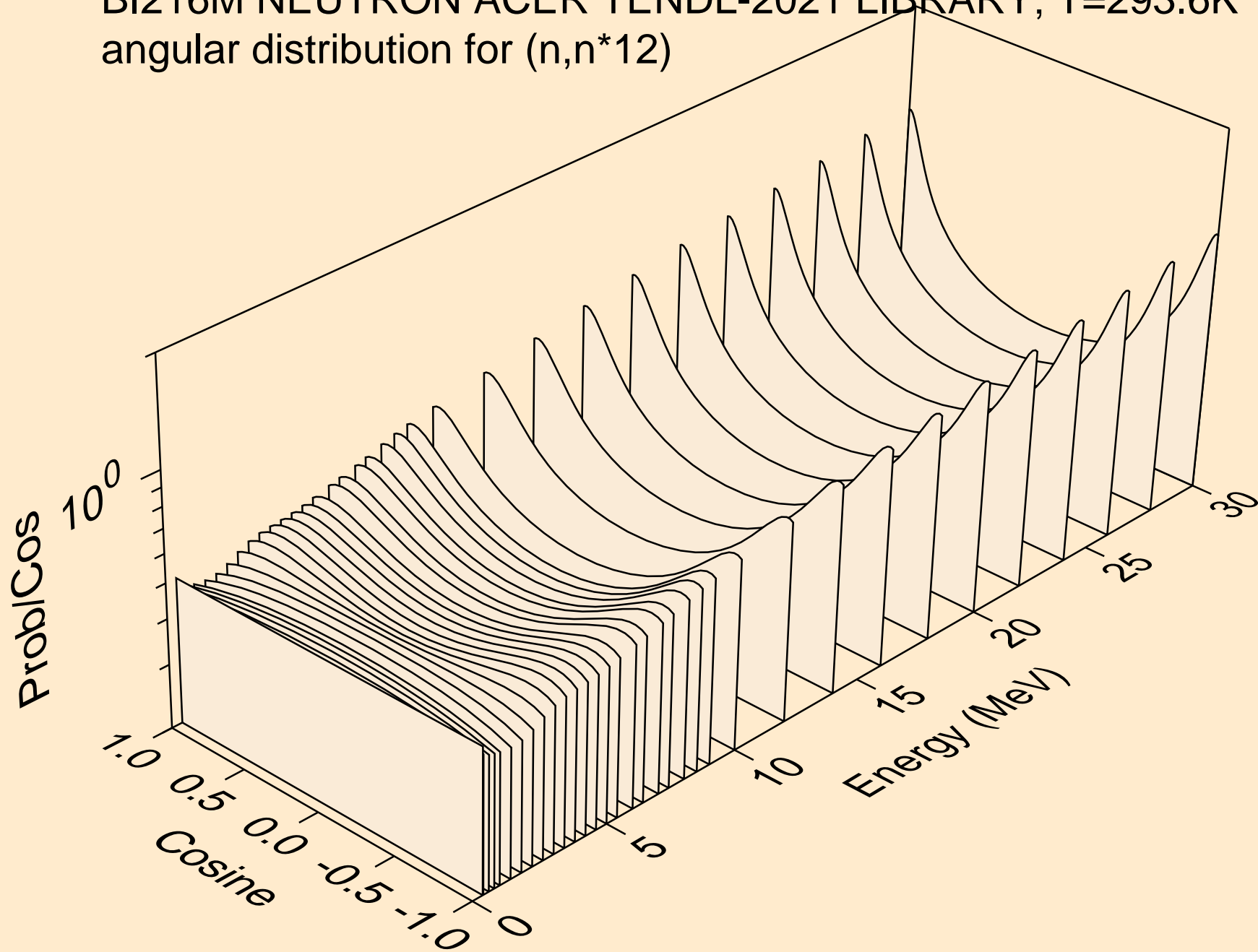

BI216M NEUTRON ACER TENDL-2021 LIBRARY; T=293.6K  
angular distribution for (n,n\*13)

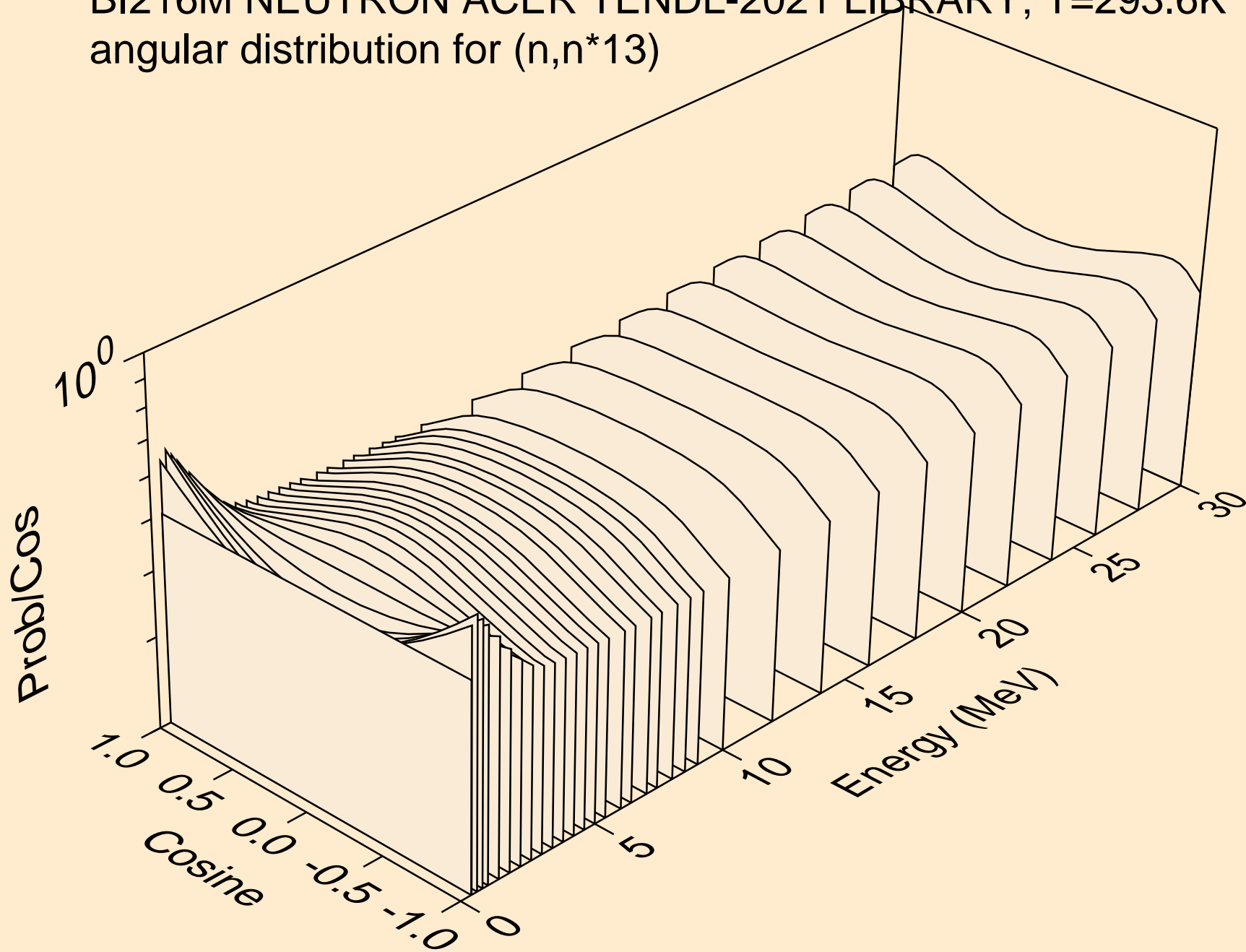

BI216M NEUTRON ACER TENDL-2021 LIBRARY; T=293.6K  
angular distribution for (n,n\*14)

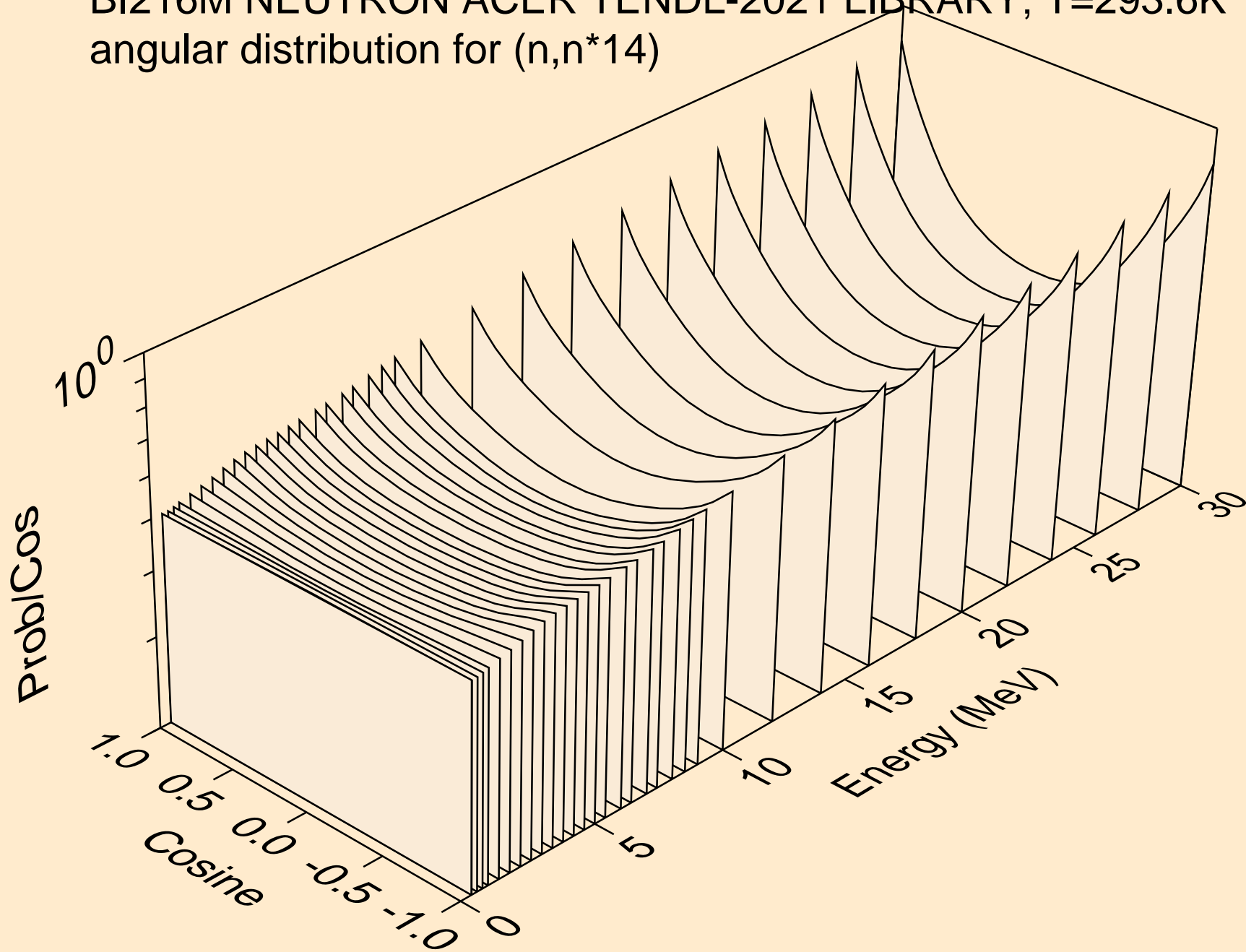

BI216M NEUTRON ACER TENDL-2021 LIBRARY; T=293.6K  
angular distribution for (n,n\*15)

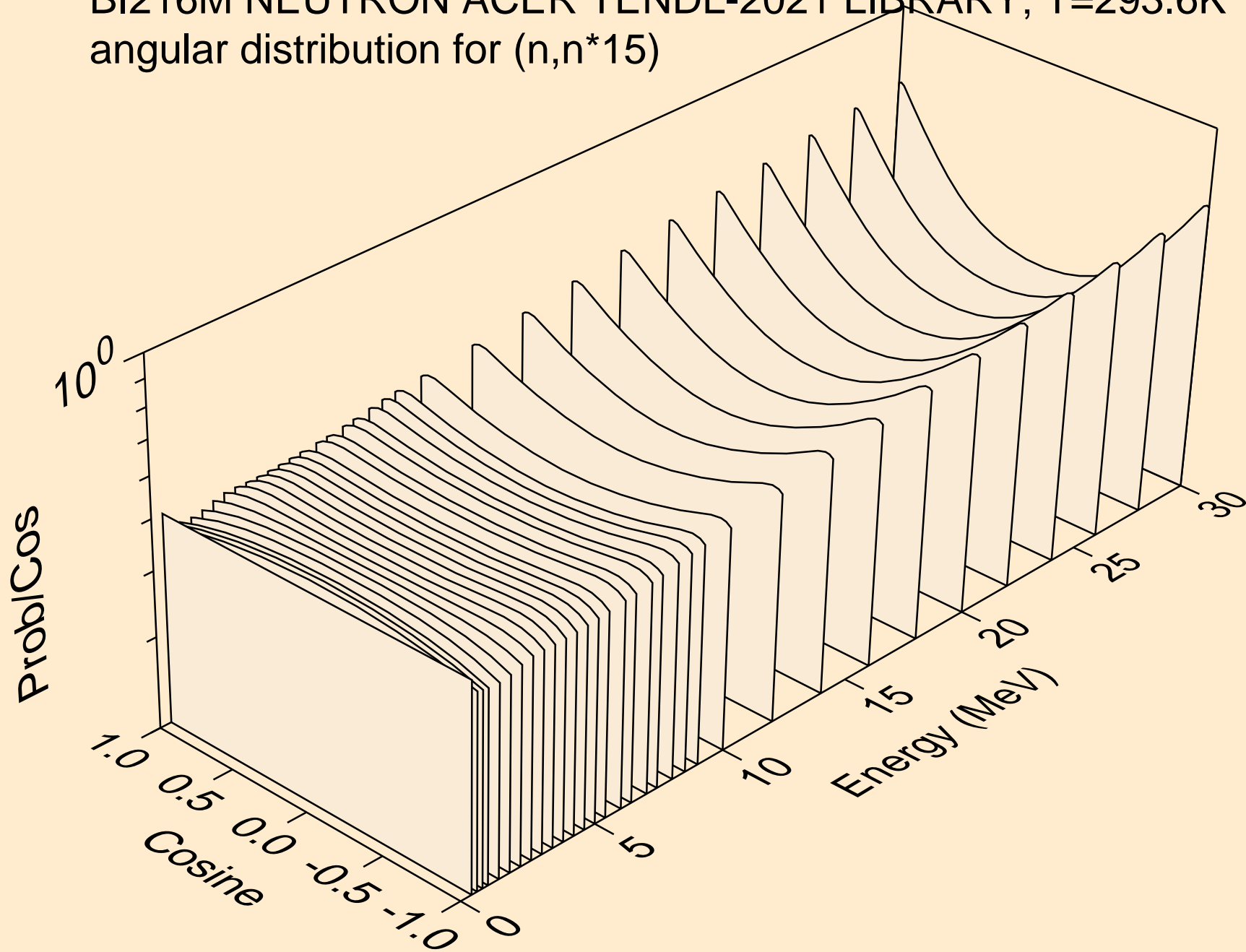

BI216M NEUTRON ACER TENDL-2021 LIBRARY; T=293.6K  
angular distribution for (n,n\*16)

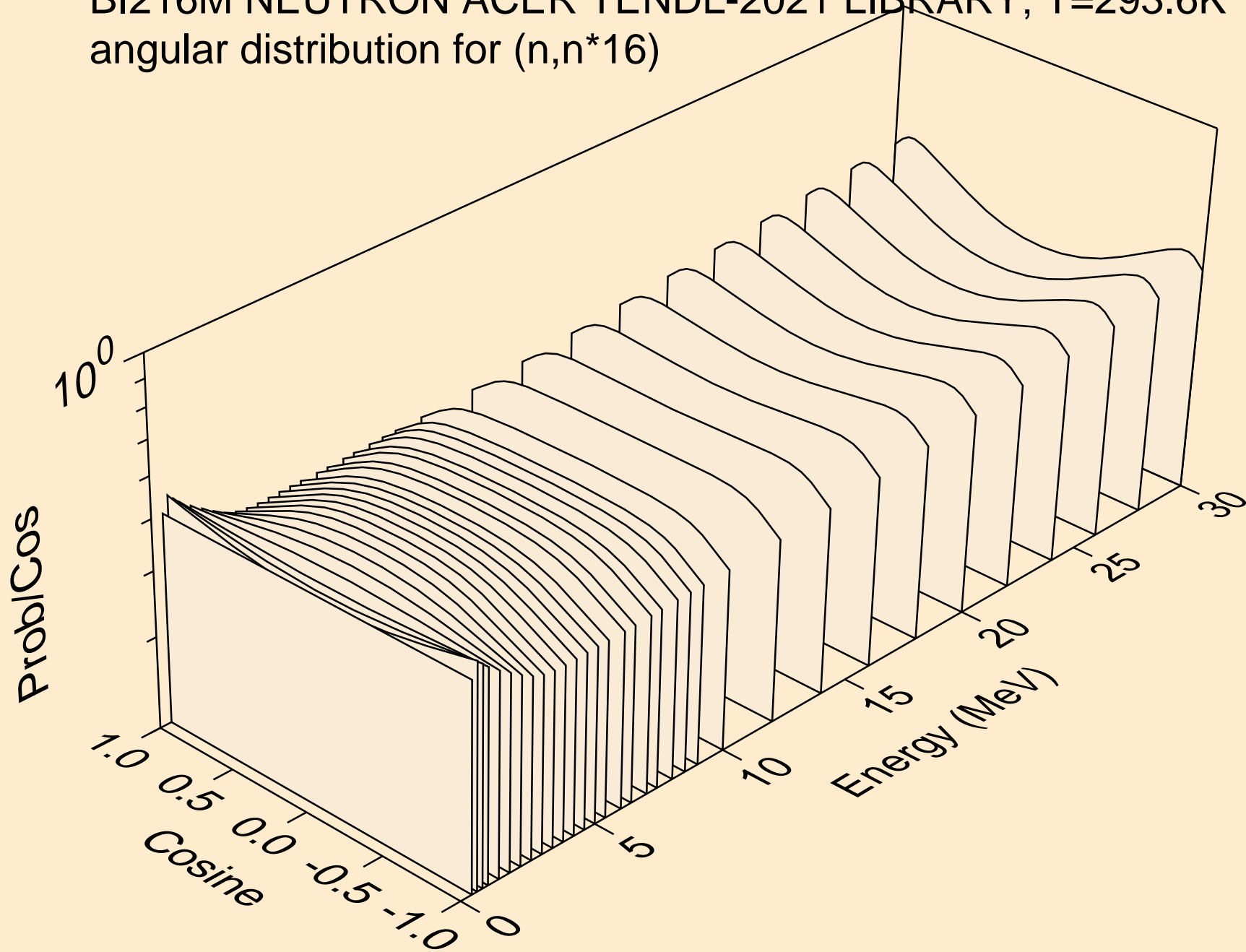

BI216M NEUTRON ACER TENDL-2021 LIBRARY; T=293.6K  
angular distribution for (n,n\*17)

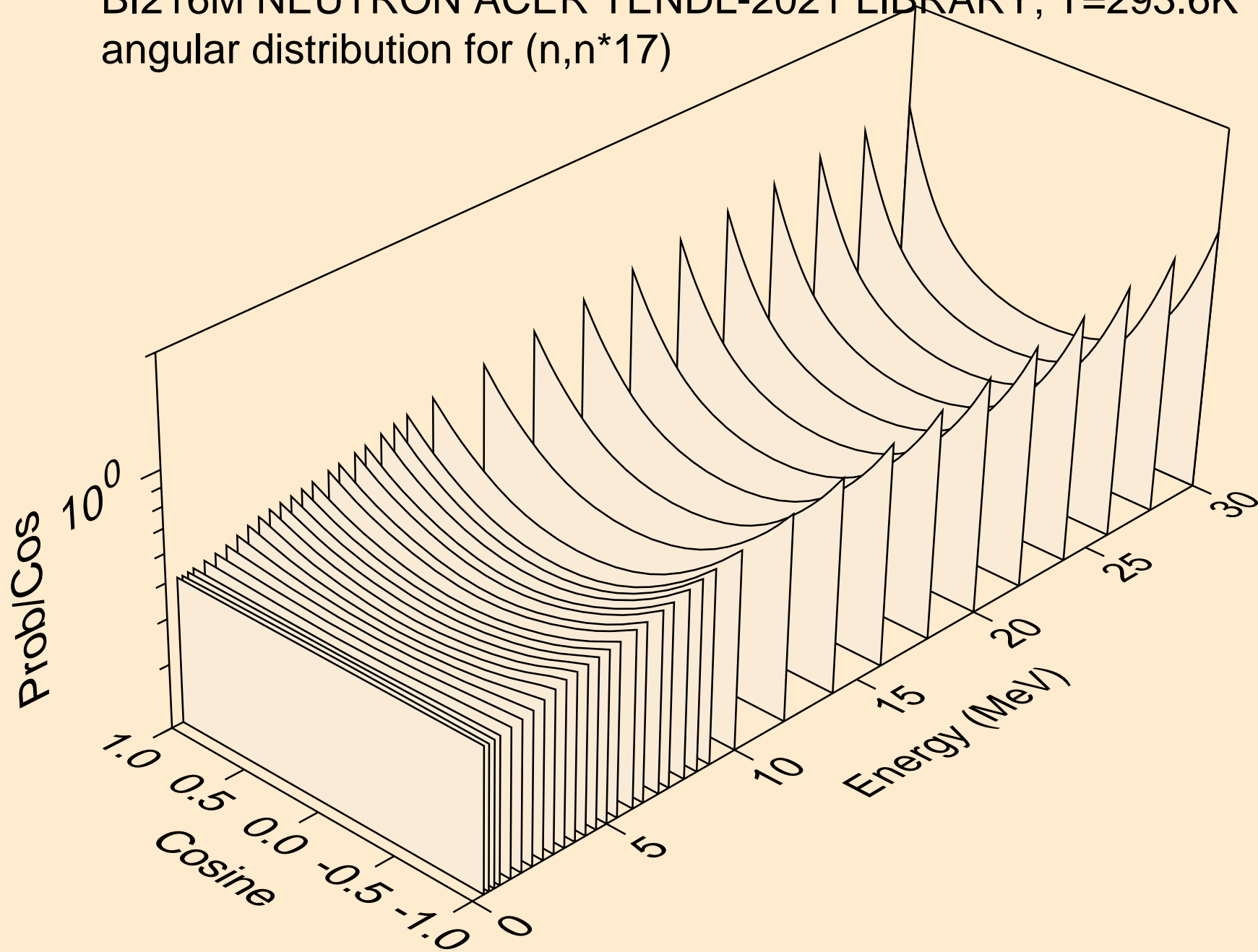



BI216M NEUTRON ACER TENDL-2021 LIBRARY; T=293.6K  
angular distribution for (n,n\*18)

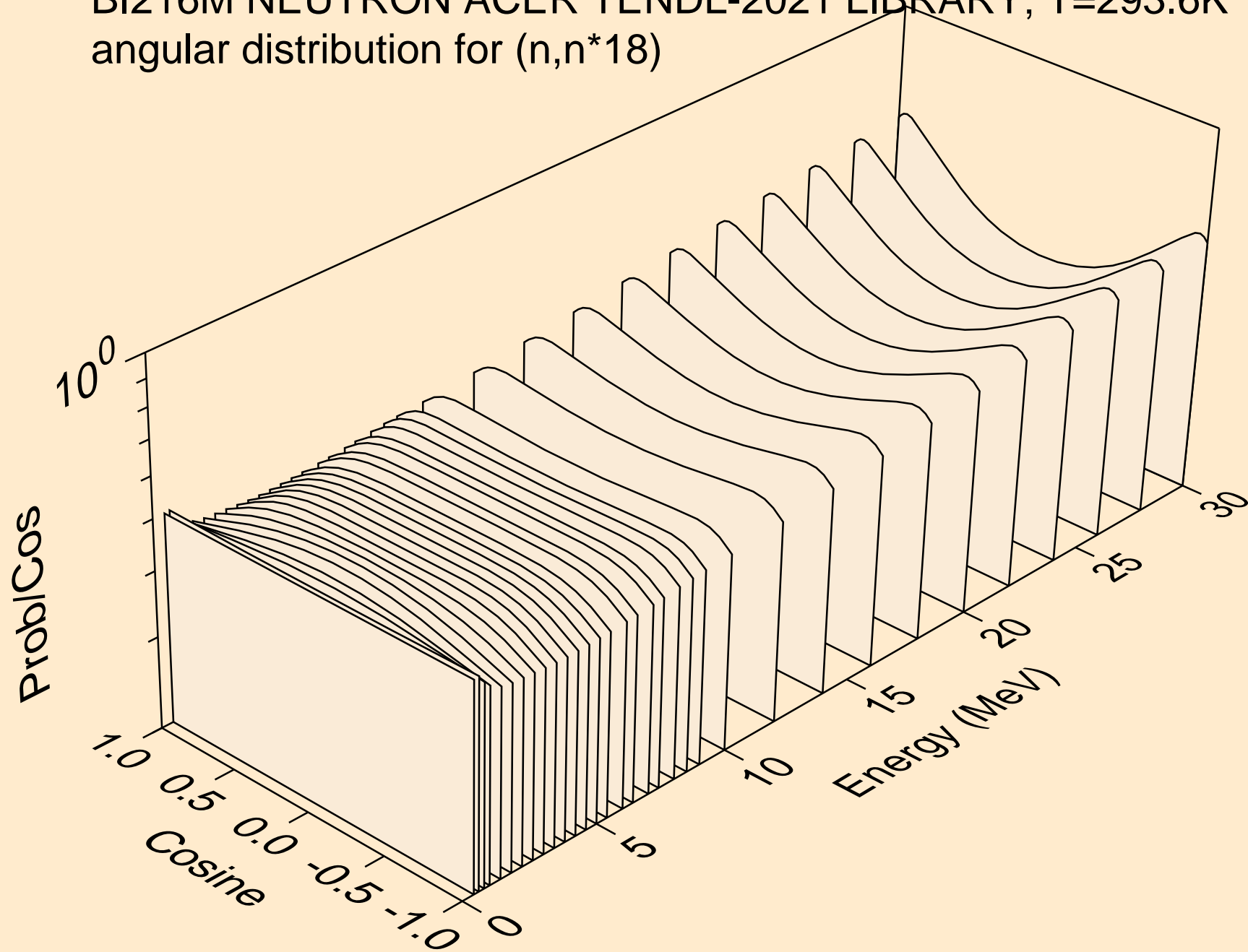

BI216M NEUTRON ACER TENDL-2021 LIBRARY; T=293.6K  
angular distribution for (n,n\*19)

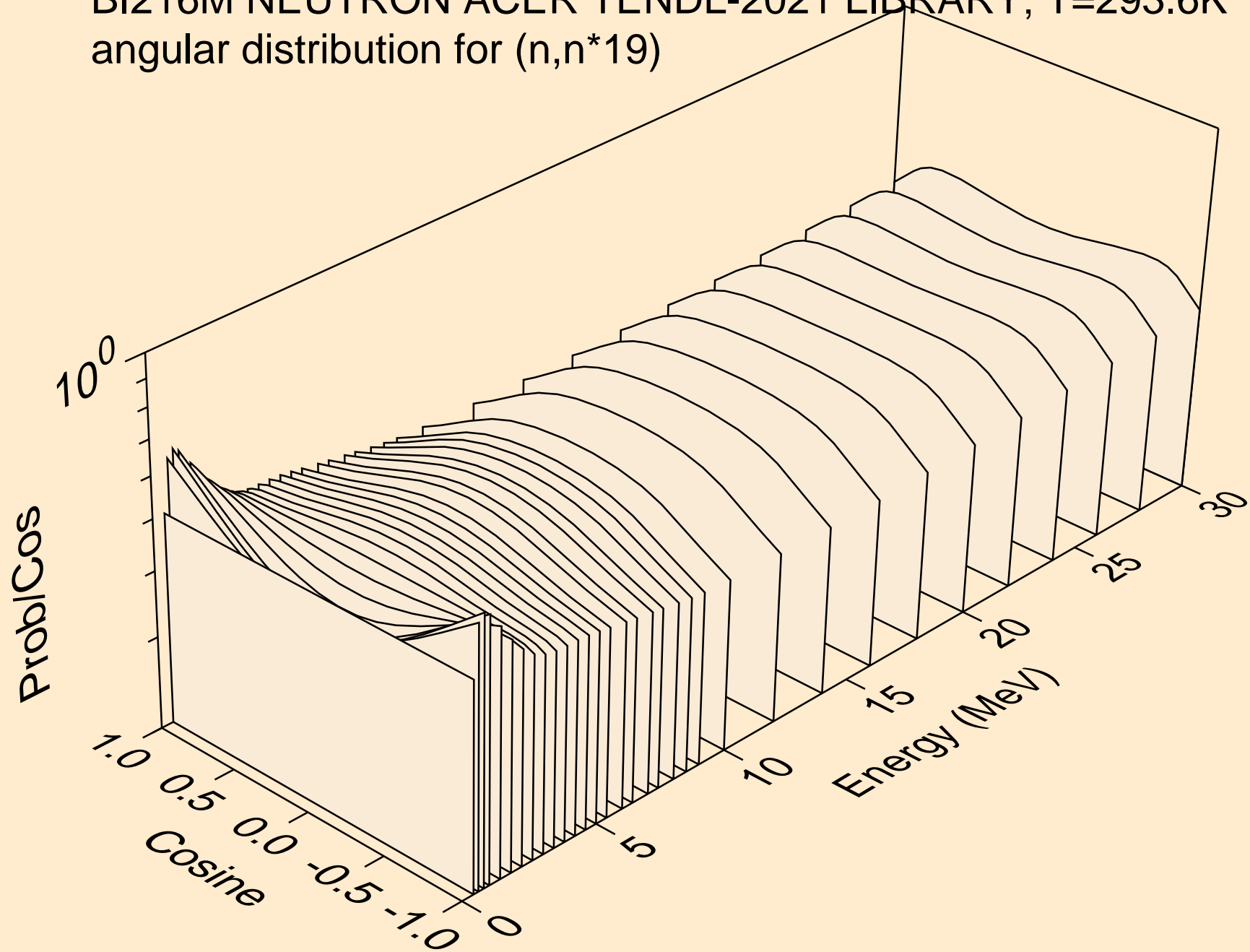

BI216M NEUTRON ACER TENDL-2021 LIBRARY; T=293.6K  
angular distribution for (n,n\*20)

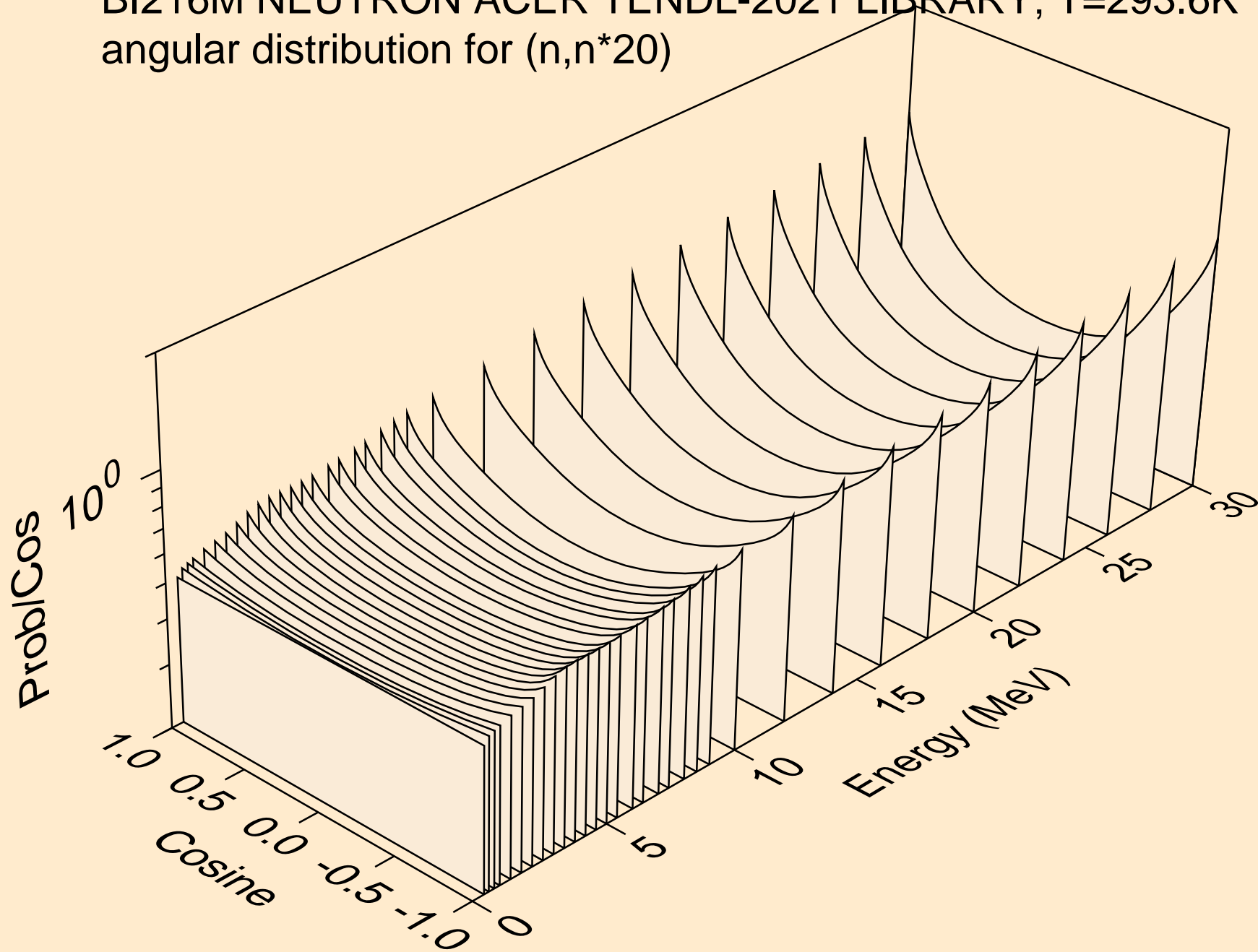

BI216M NEUTRON ACER TENDL-2021 LIBRARY; T=293.6K  
angular distribution for (n,n\*21)

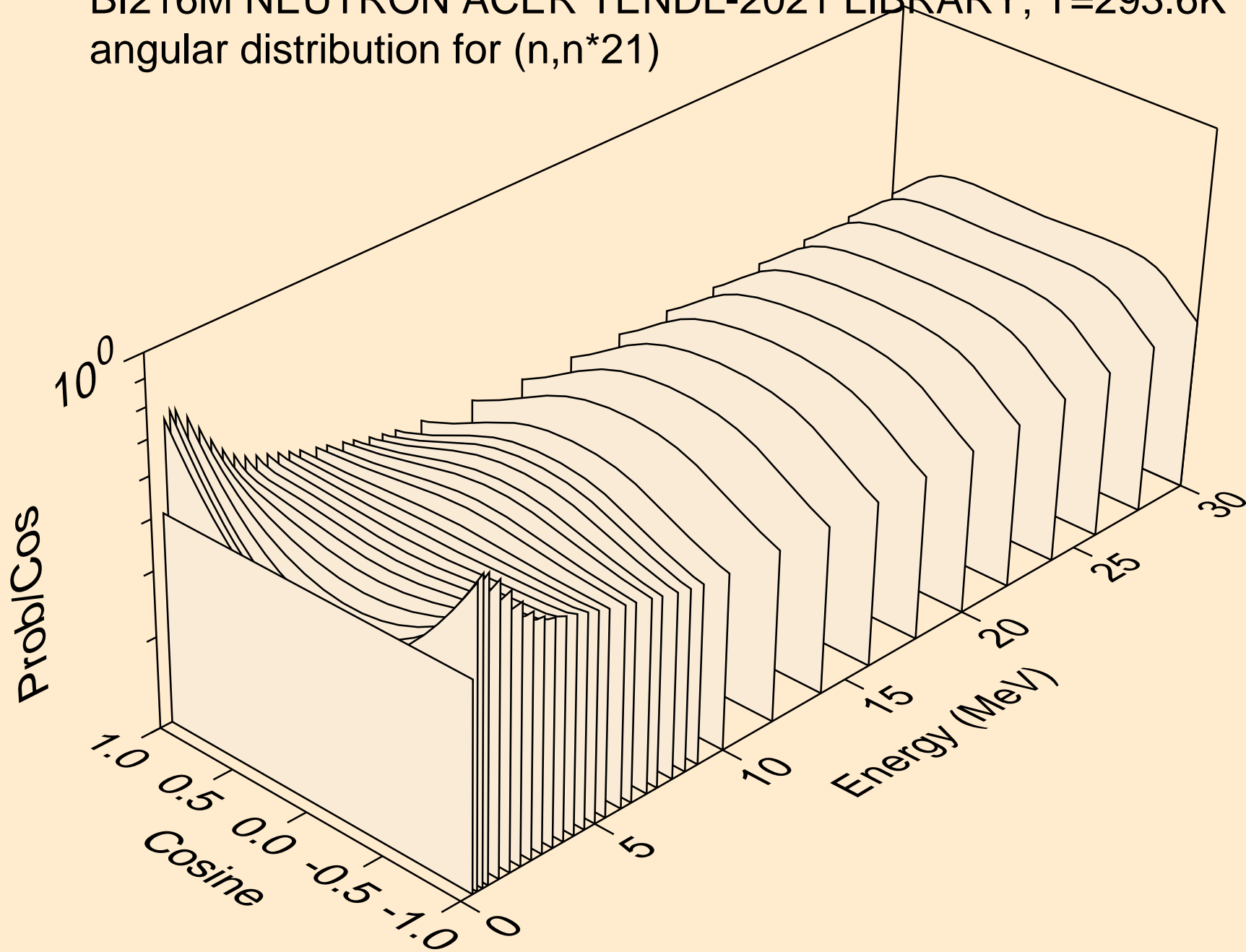

BI216M NEUTRON ACER TENDL-2021 LIBRARY; T=293.6K  
angular distribution for (n,n\*22)

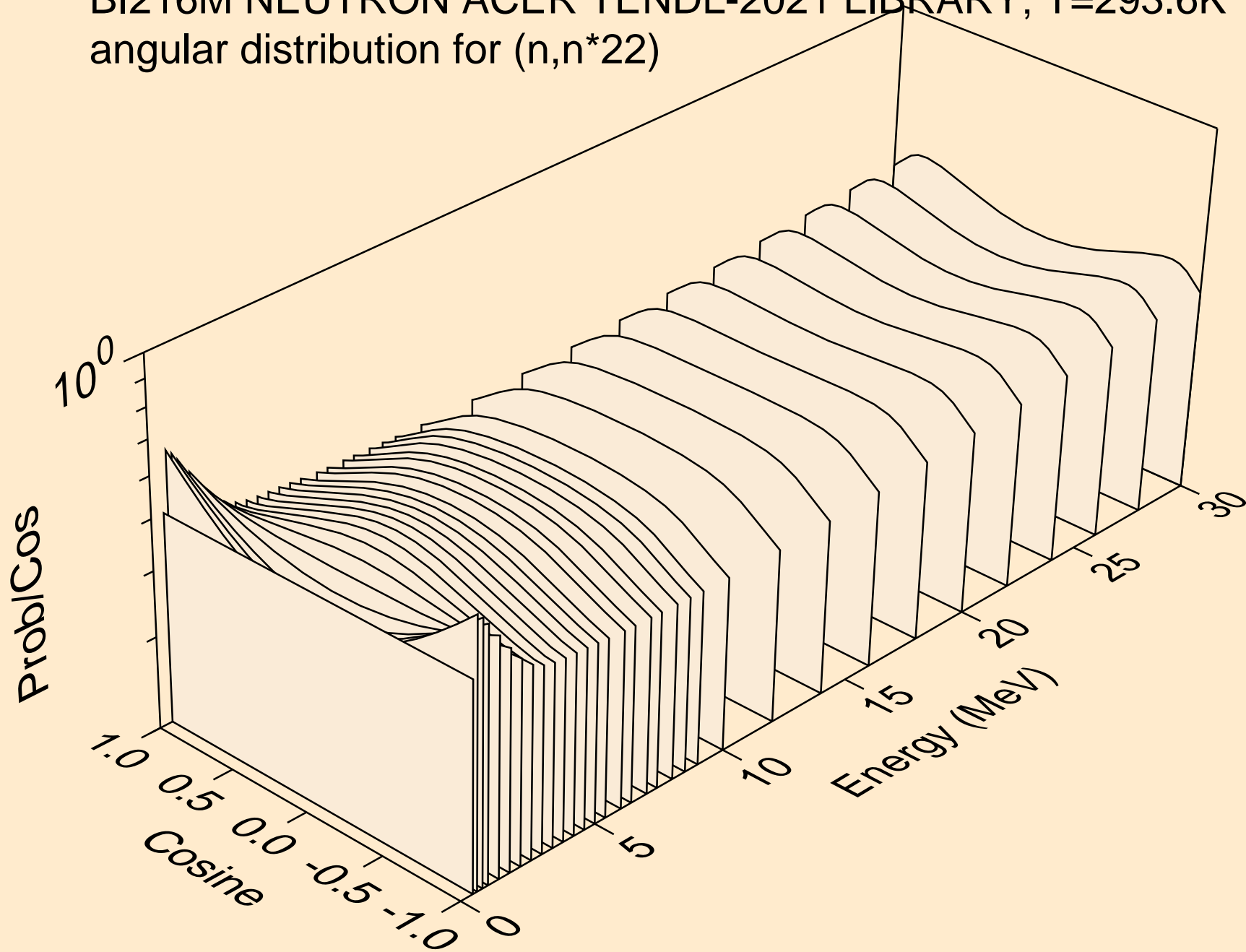

BI216M NEUTRON ACER TENDL-2021 LIBRARY; T=293.6K  
angular distribution for (n,n\*23)

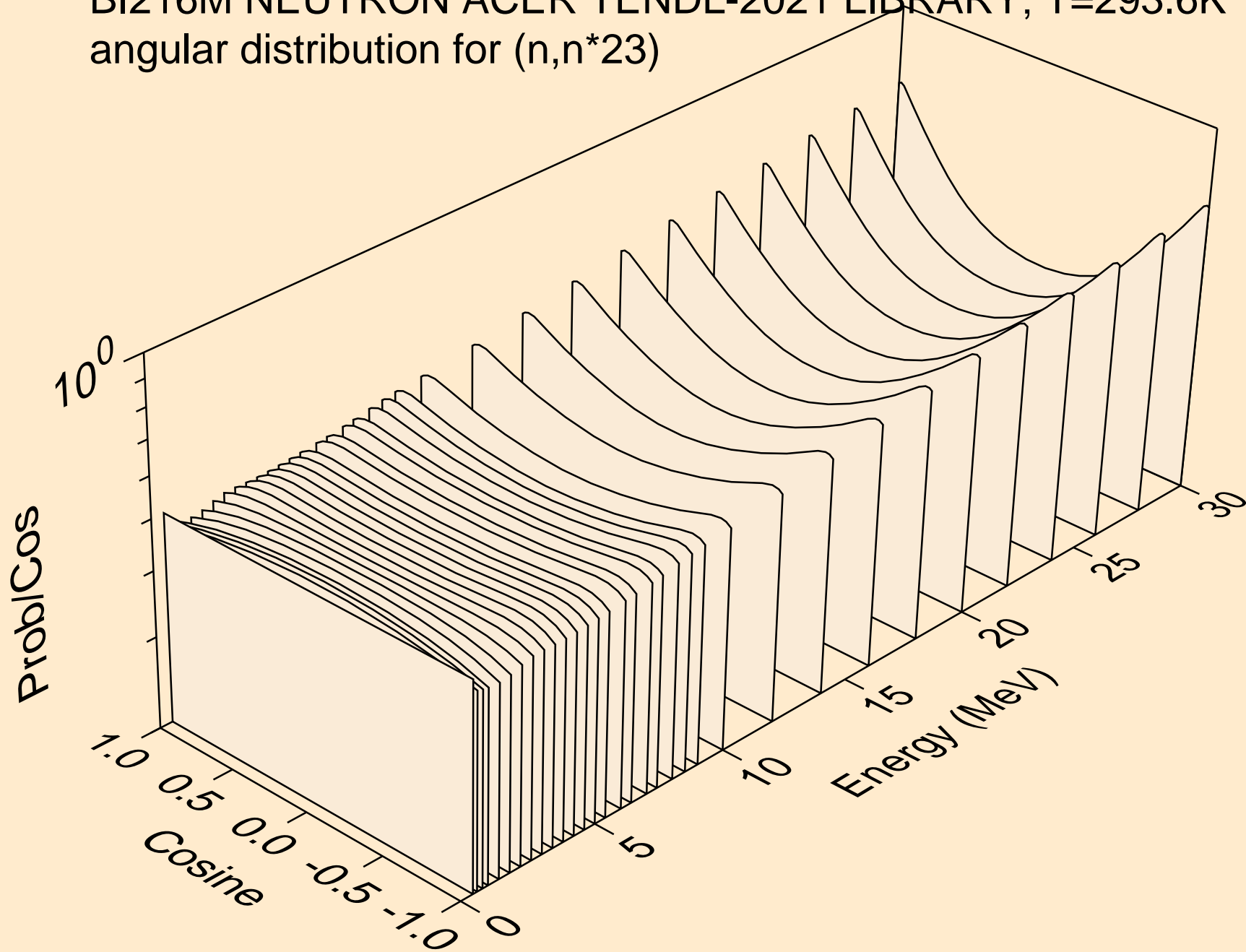

BI216M NEUTRON ACER TENDL-2021 LIBRARY; T=293.6K  
angular distribution for (n,n\*24)

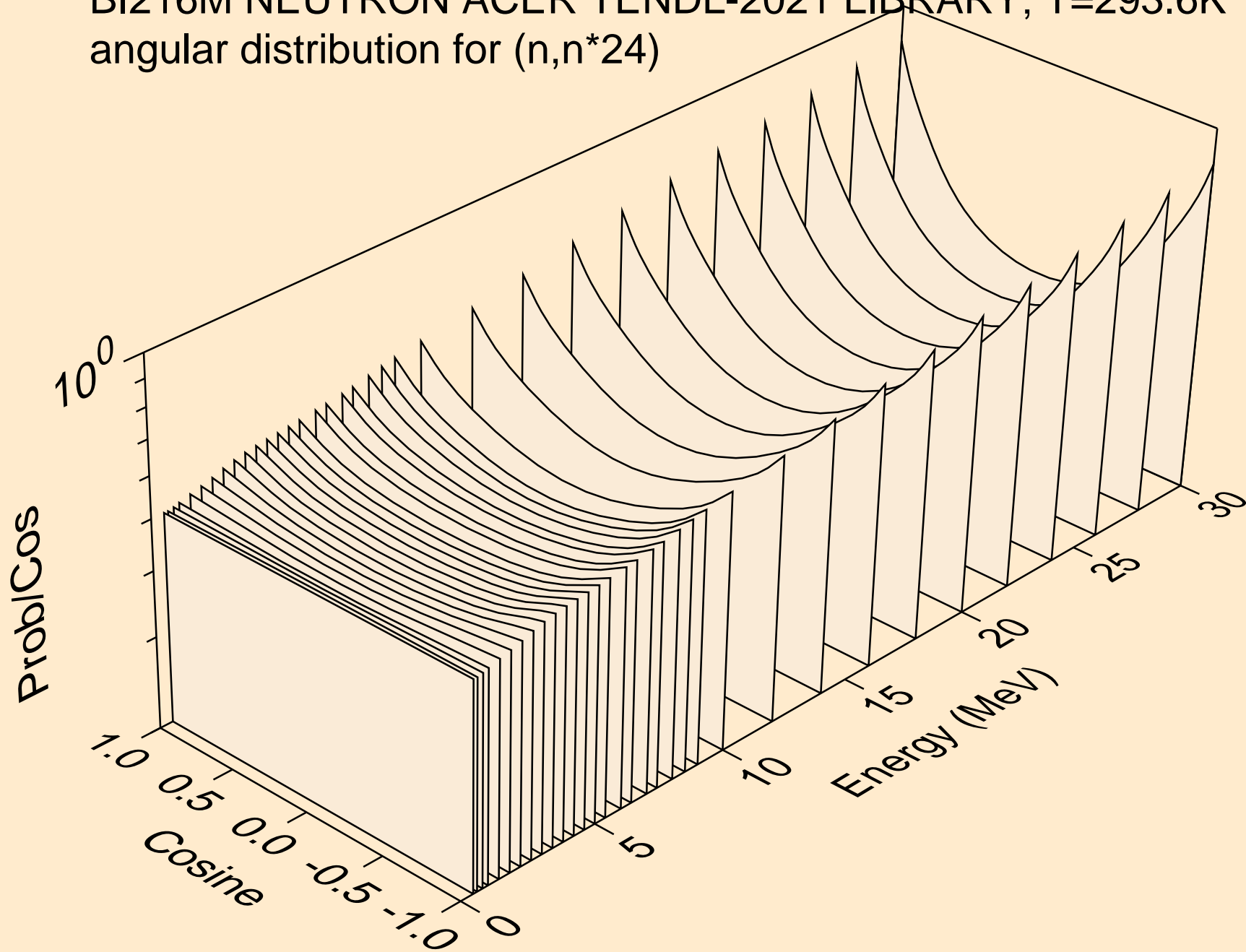

BI216M NEUTRON ACER TENDL-2021 LIBRARY; T=293.6K  
angular distribution for (n,n\*25)

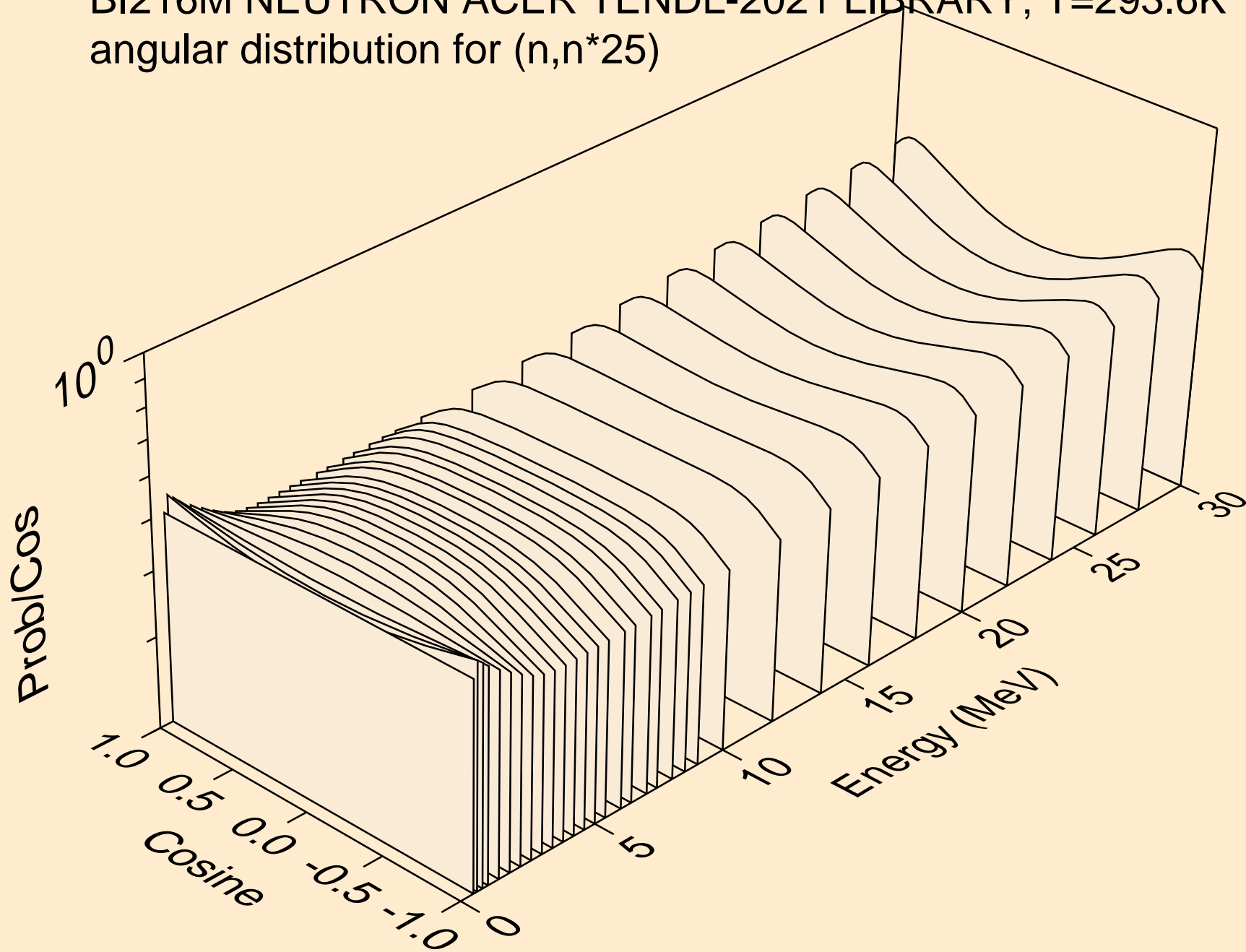



BI216M NEUTRON ACER TENDL-2021 LIBRARY; T=293.6K  
angular distribution for (n,n\*26)

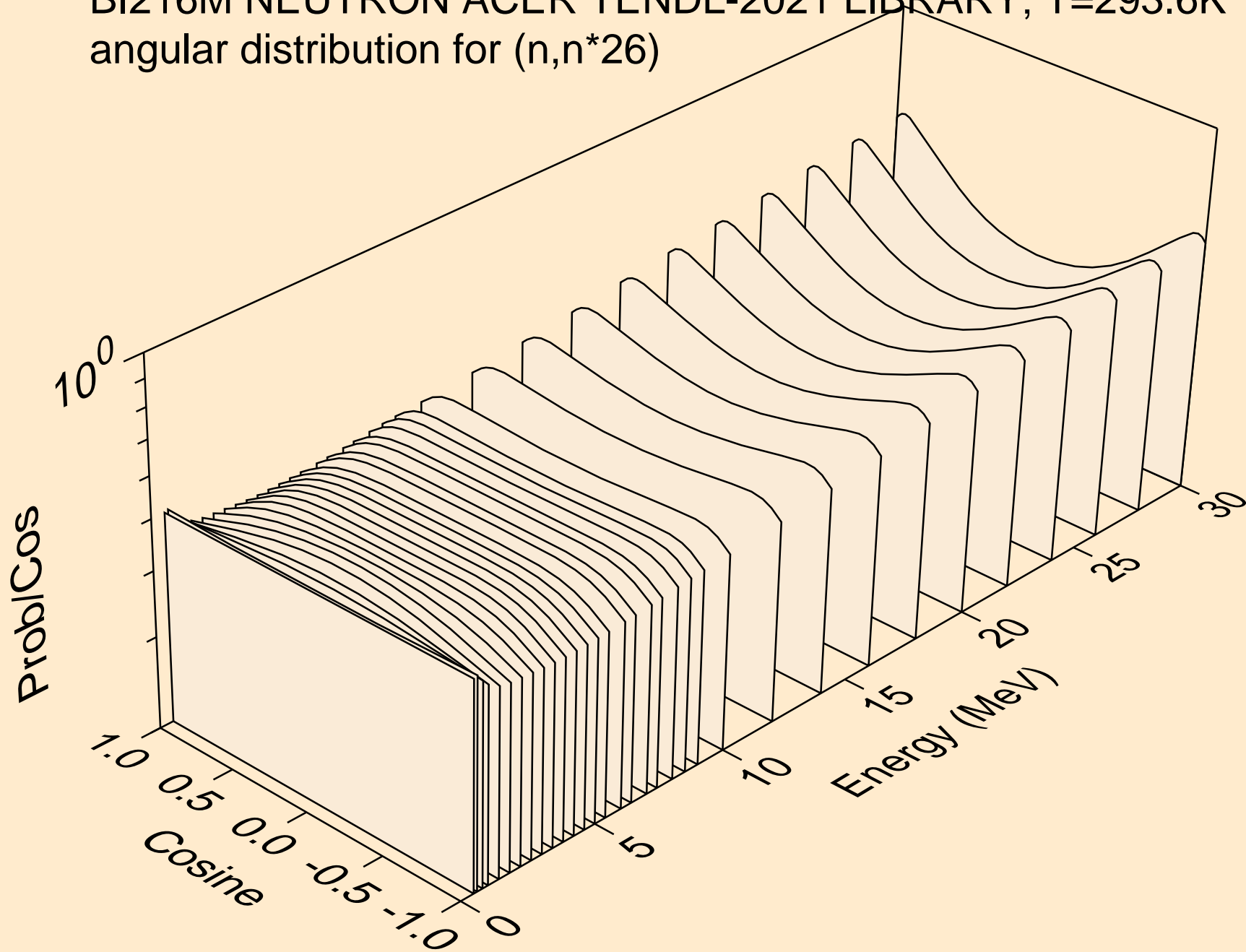

BI216M NEUTRON ACER TENDL-2021 LIBRARY; T=293.6K  
angular distribution for (n,n\*27)

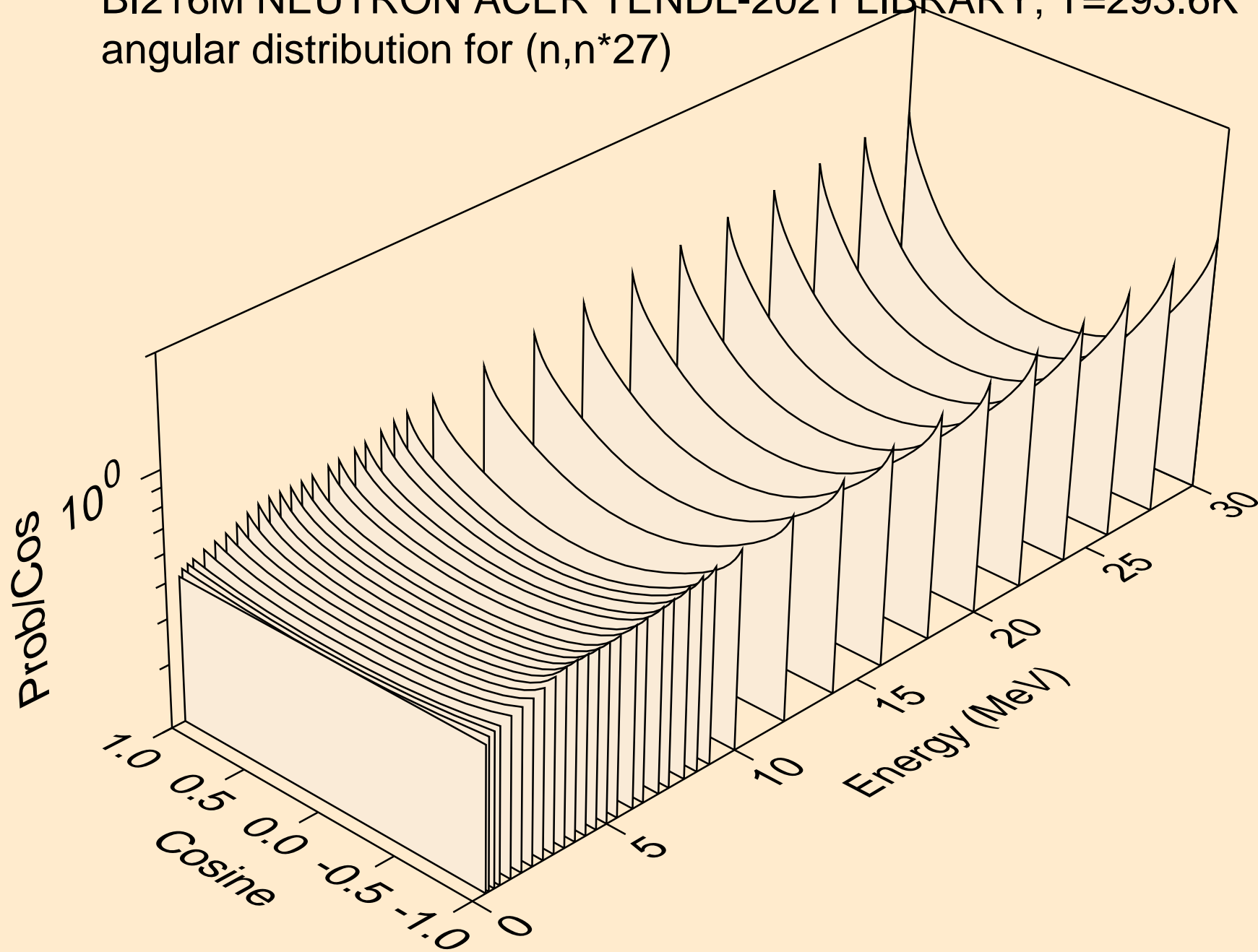

BI216M NEUTRON ACER TENDL-2021 LIBRARY; T=293.6K  
angular distribution for (n,n\*28)

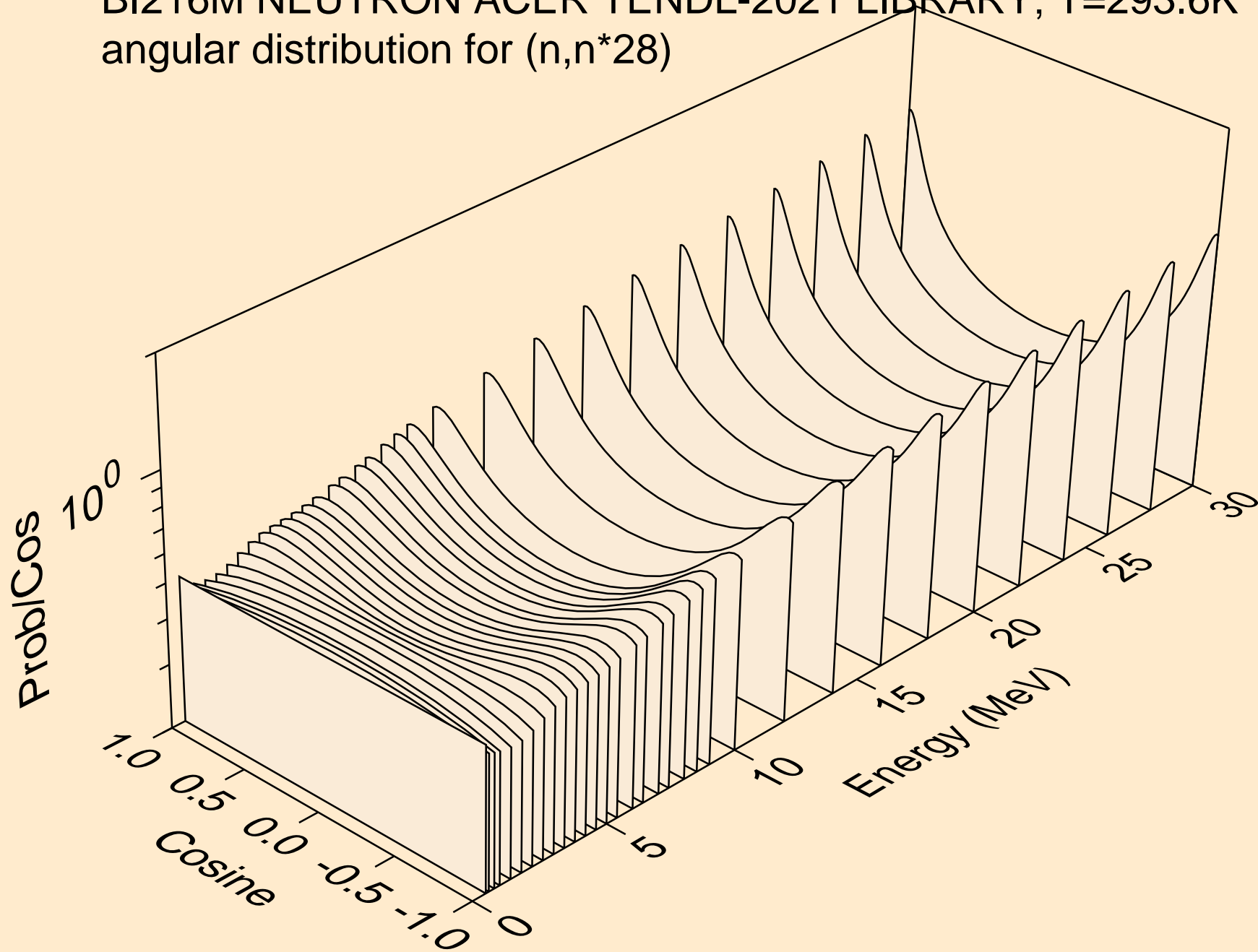

BI216M NEUTRON ACER TENDL-2021 LIBRARY; T=293.6K  
angular distribution for (n,n\*29)

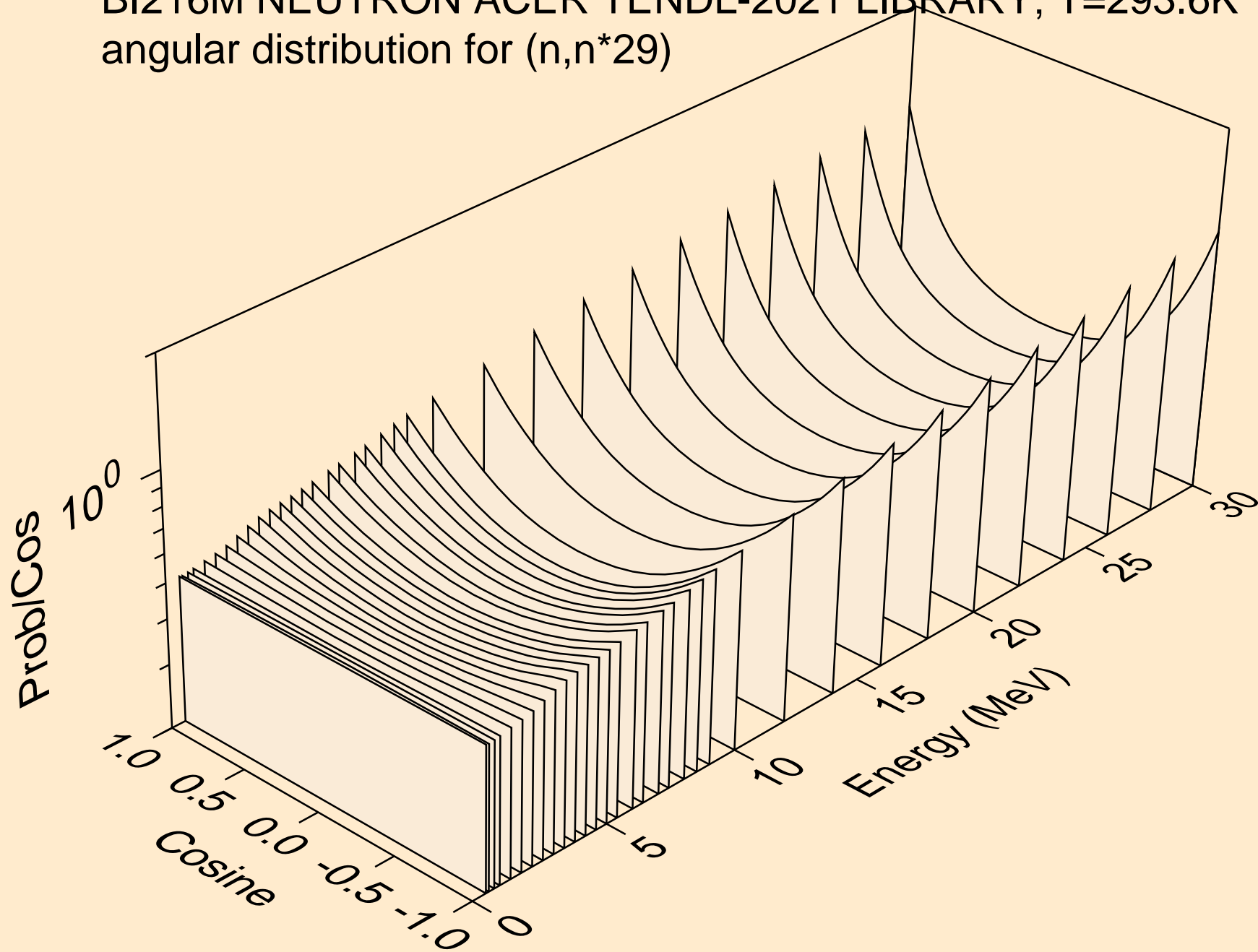

BI216M NEUTRON ACER TENDL-2021 LIBRARY; T=293.6K  
angular distribution for (n,n\*30)

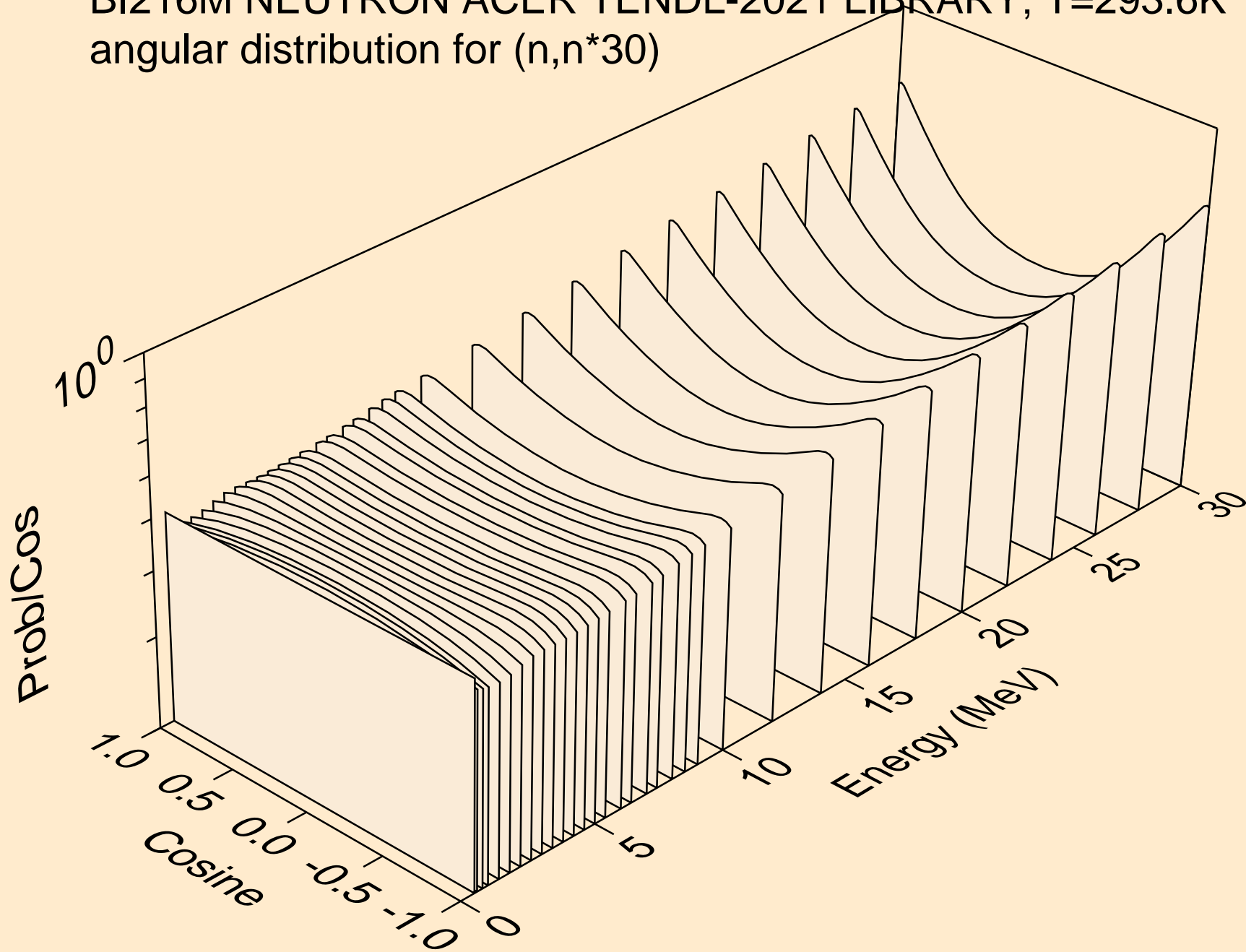

BI216M NEUTRON ACER TENDL-2021 LIBRARY; T=293.6K  
Total fission nubar

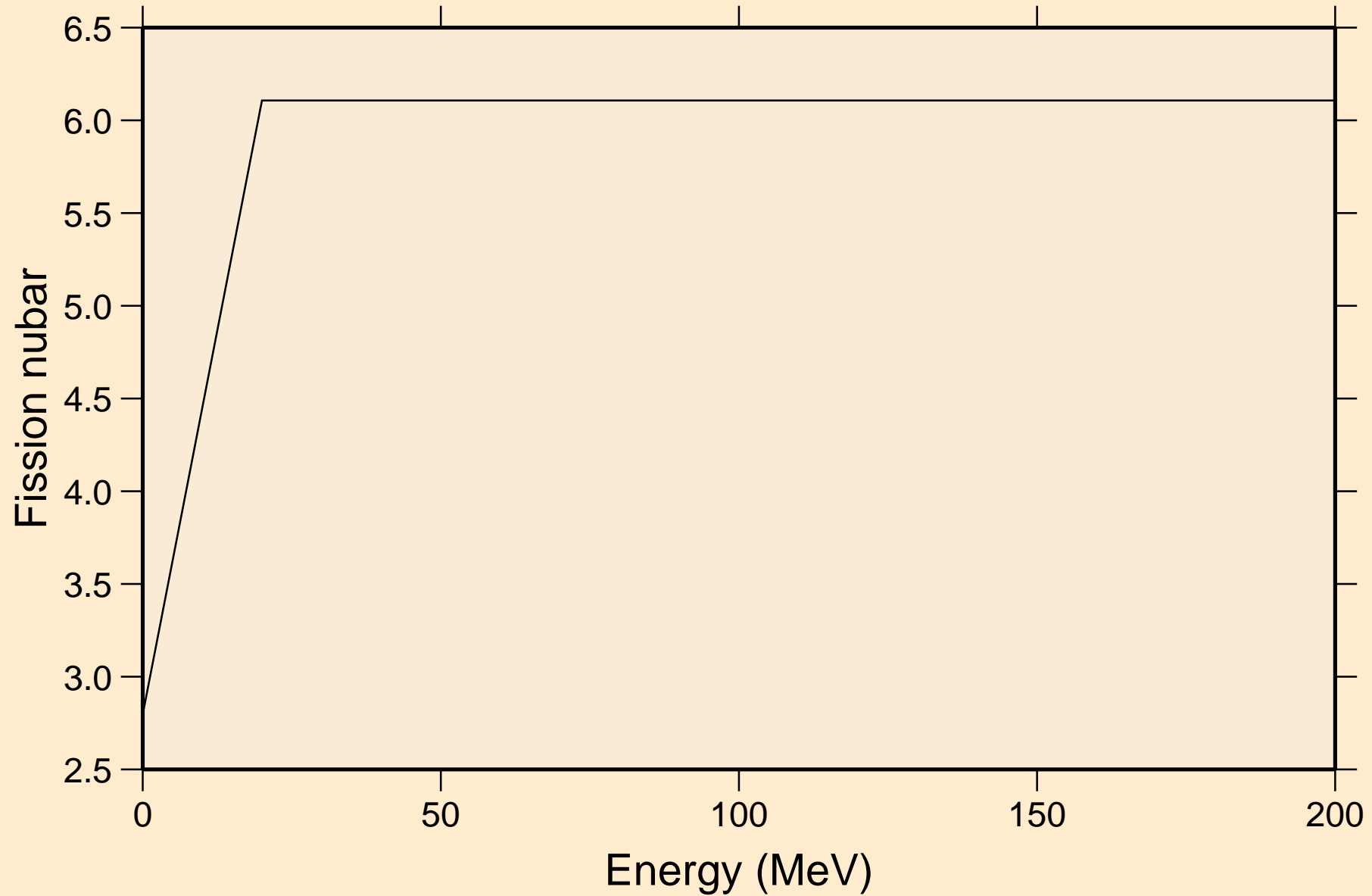

BI216M NEUTRON ACER TENDL-2021 LIBRARY; T=293.6K  
Neutron emission for (n,x)

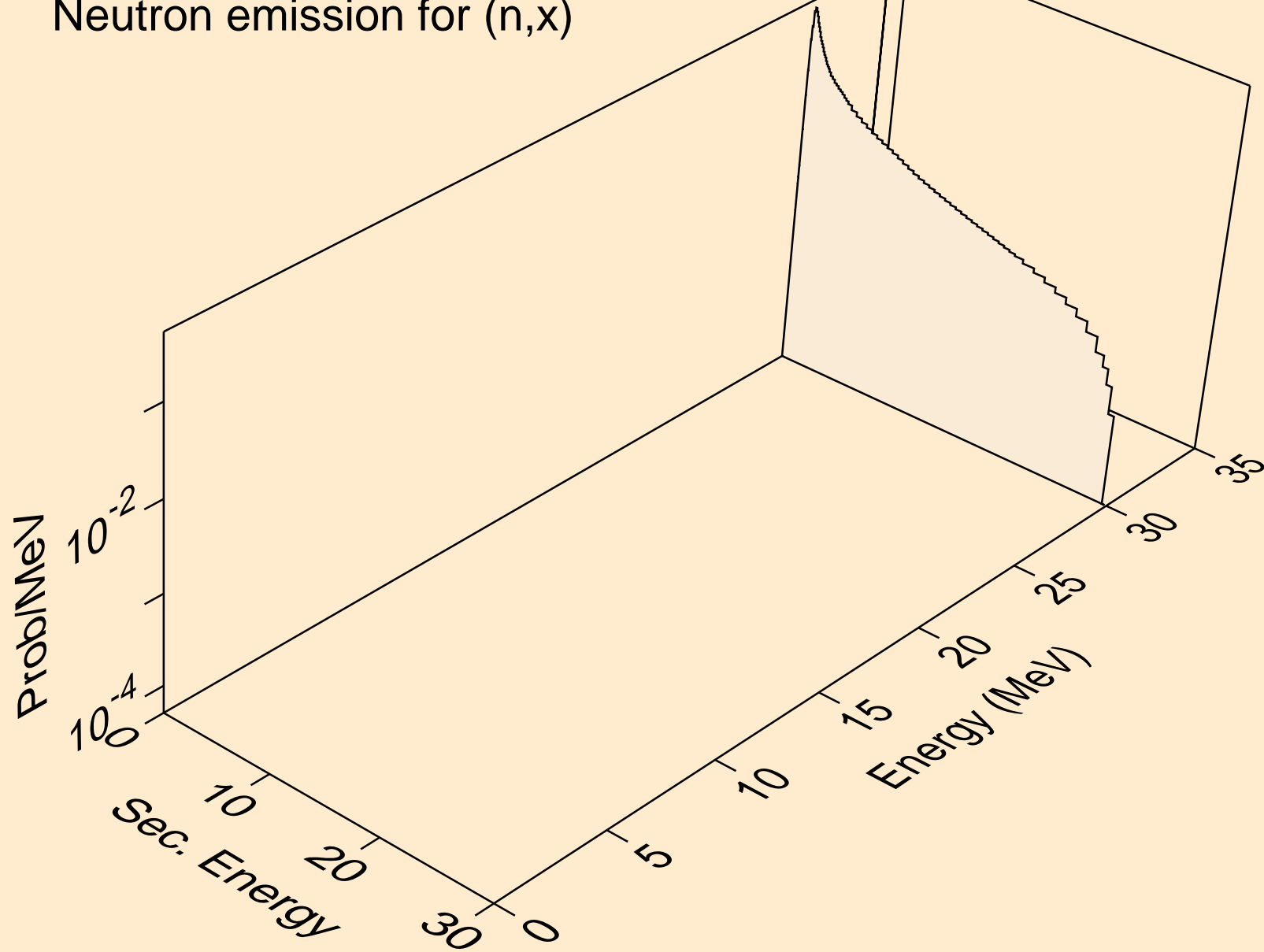

BI216M NEUTRON ACER TENDL-2021 LIBRARY; T=293.6K  
Neutron emission for (n,2nd)

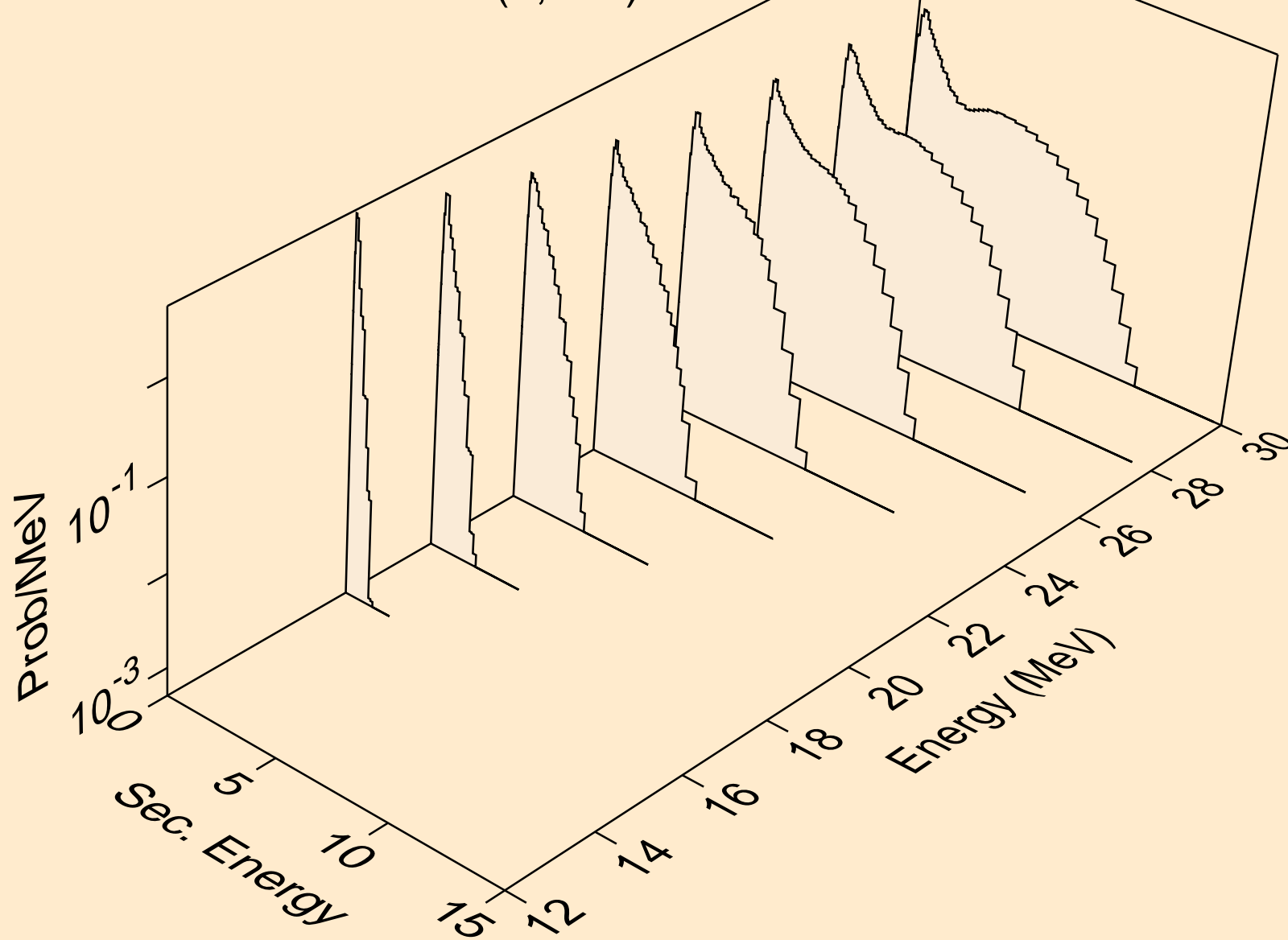



BI216M NEUTRON ACER TENDL-2021 LIBRARY; T=293.6K  
Neutron emission for (n,2n)

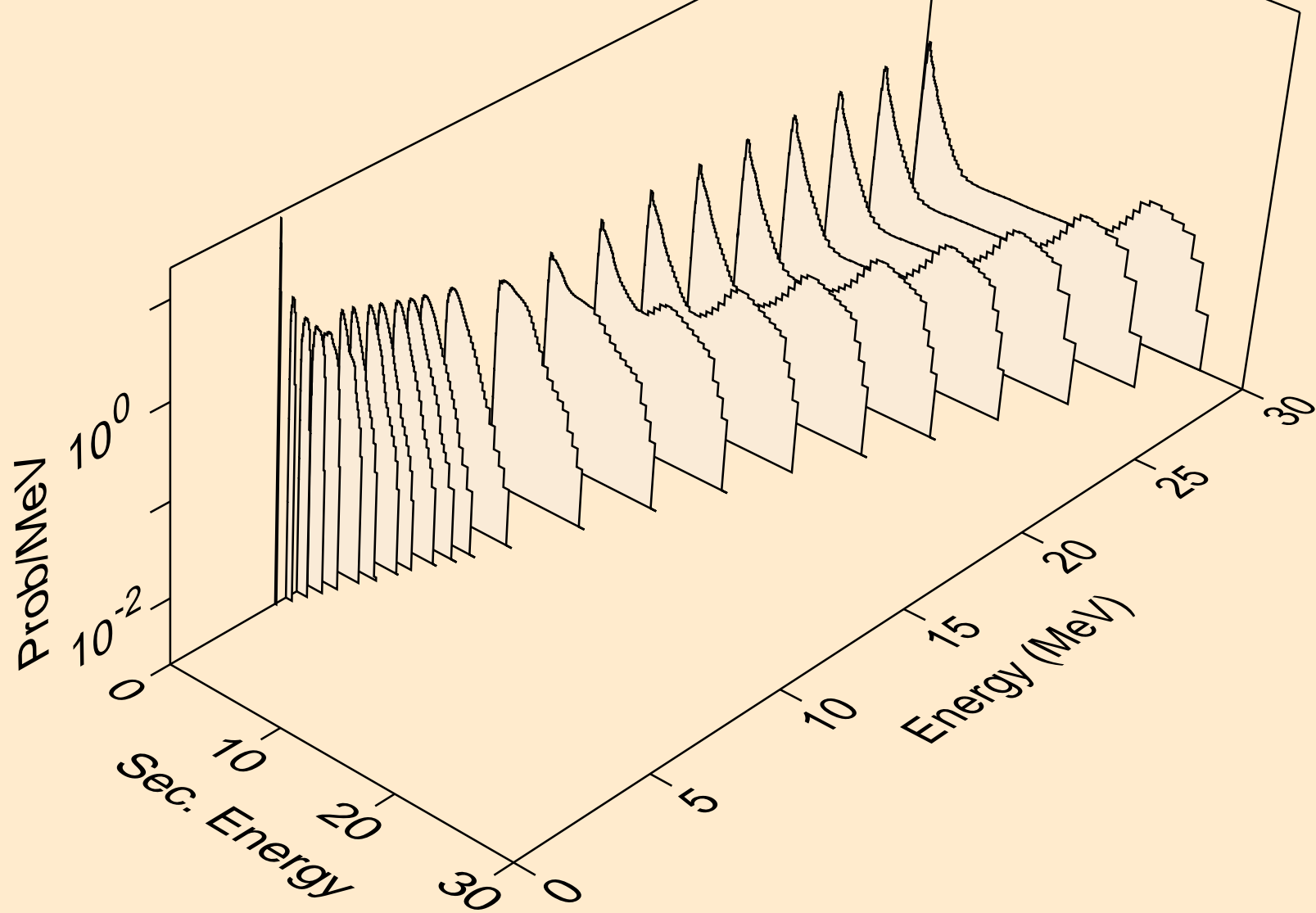

BI216M NEUTRON ACER TENDL-2021 LIBRARY; T=293.6K  
Neutron emission for (n,3n)

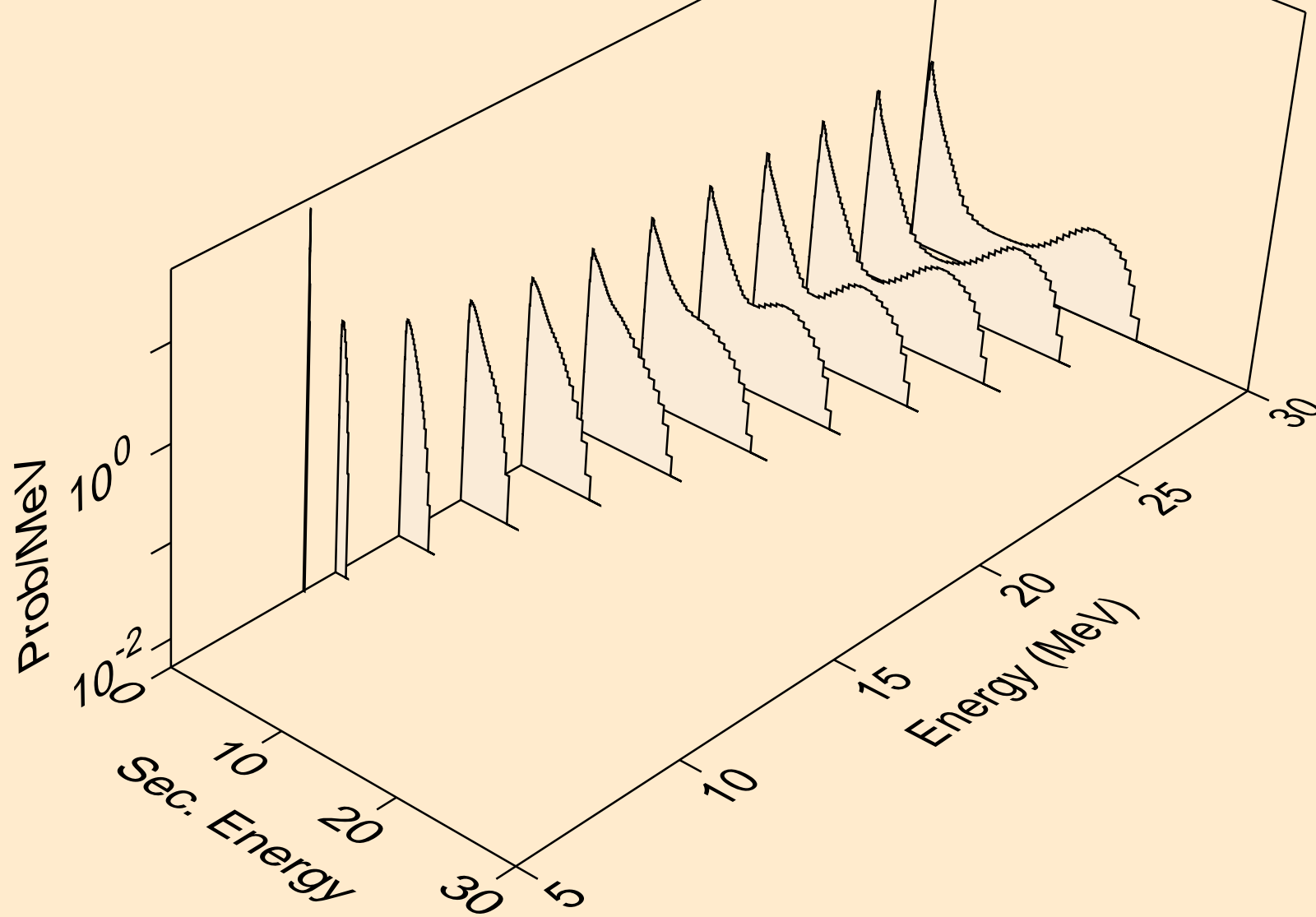

BI216M NEUTRON ACER TENDL-2021 LIBRARY; T=293.6K  
Neutron emission for fission

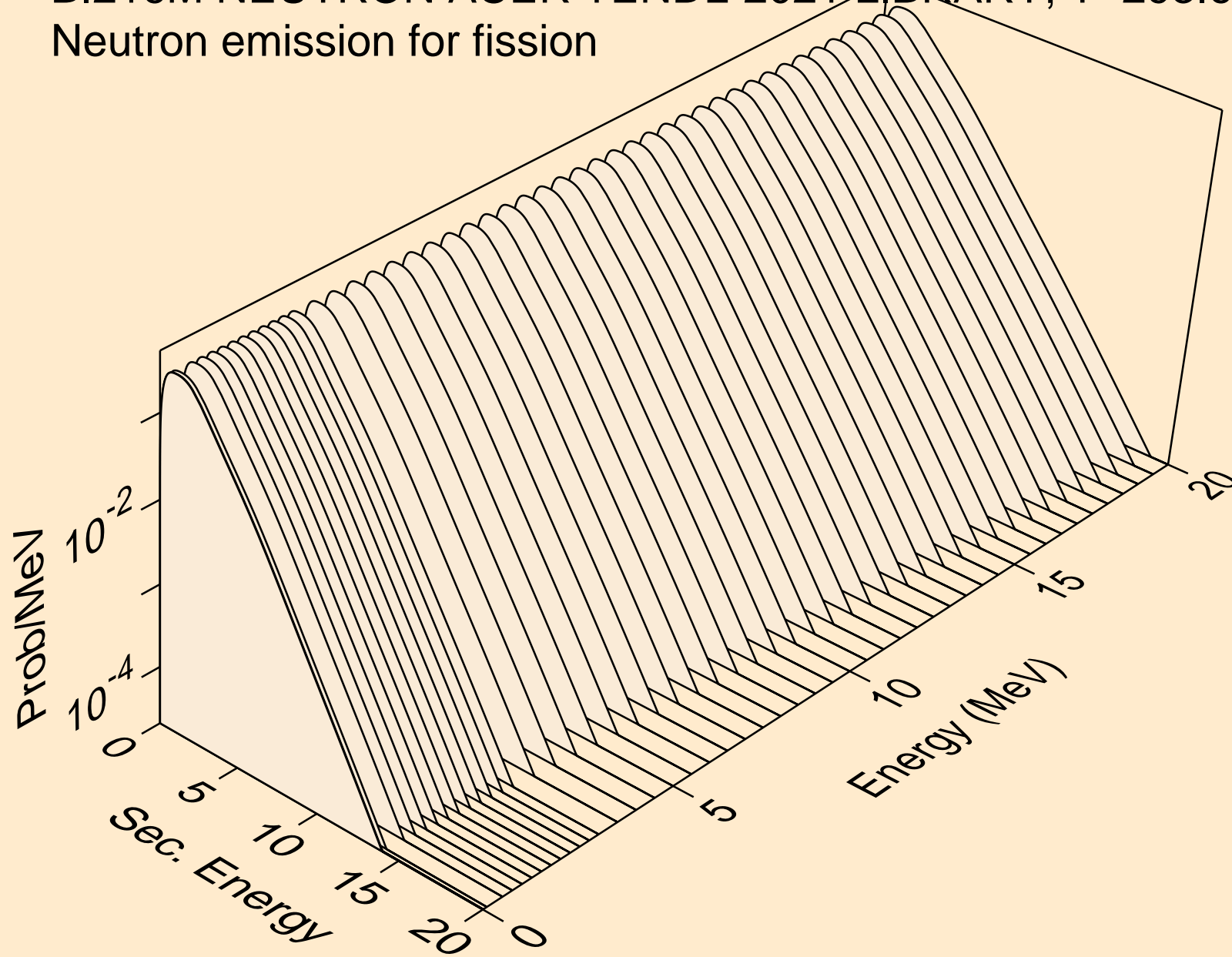

BI216M NEUTRON ACER TENDL-2021 LIBRARY; T=293.6K  
Neutron emission for (n,n\*)a

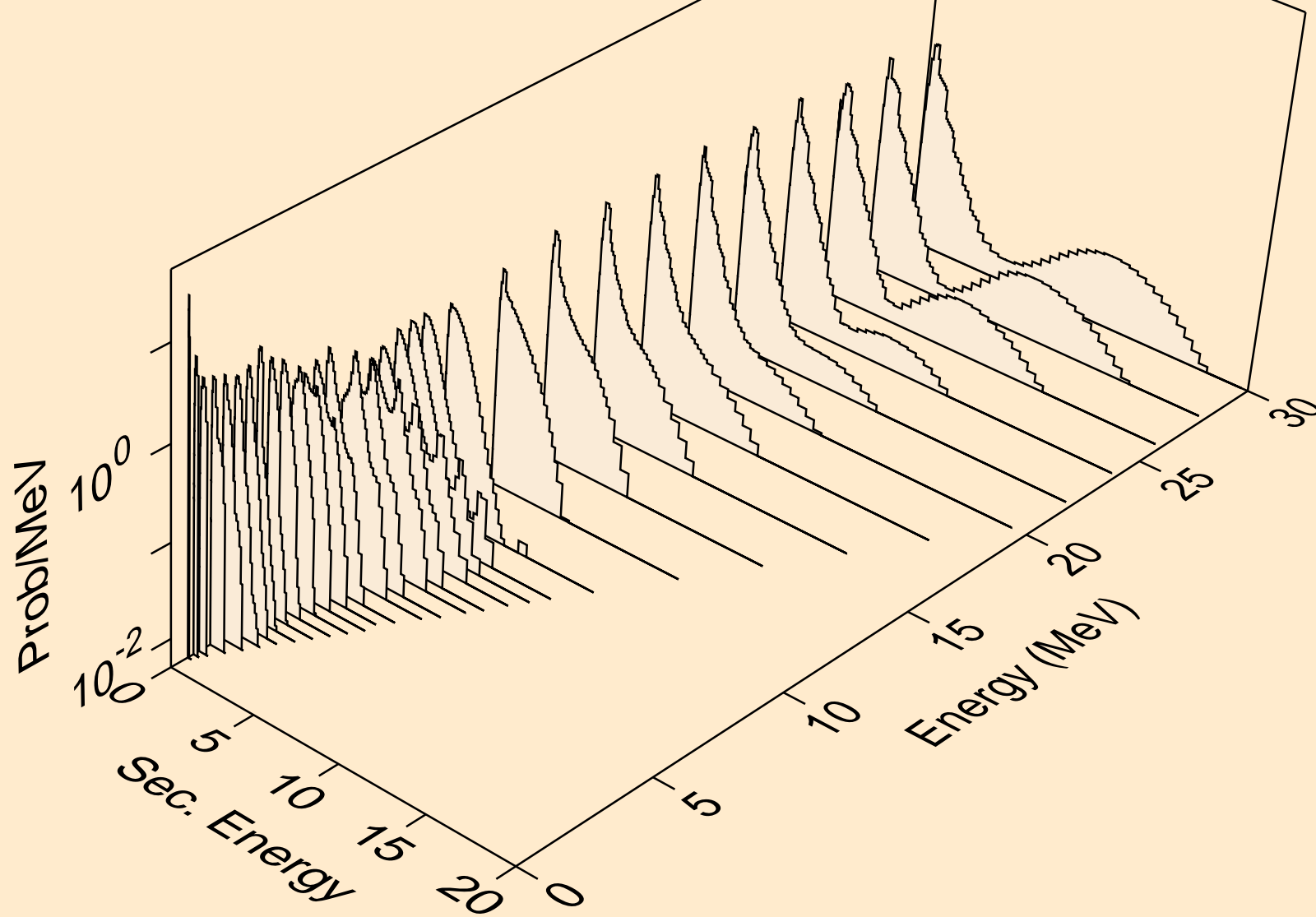

BI216M NEUTRON ACER TENDL-2021 LIBRARY; T=293.6K  
Neutron emission for (n,2n)a

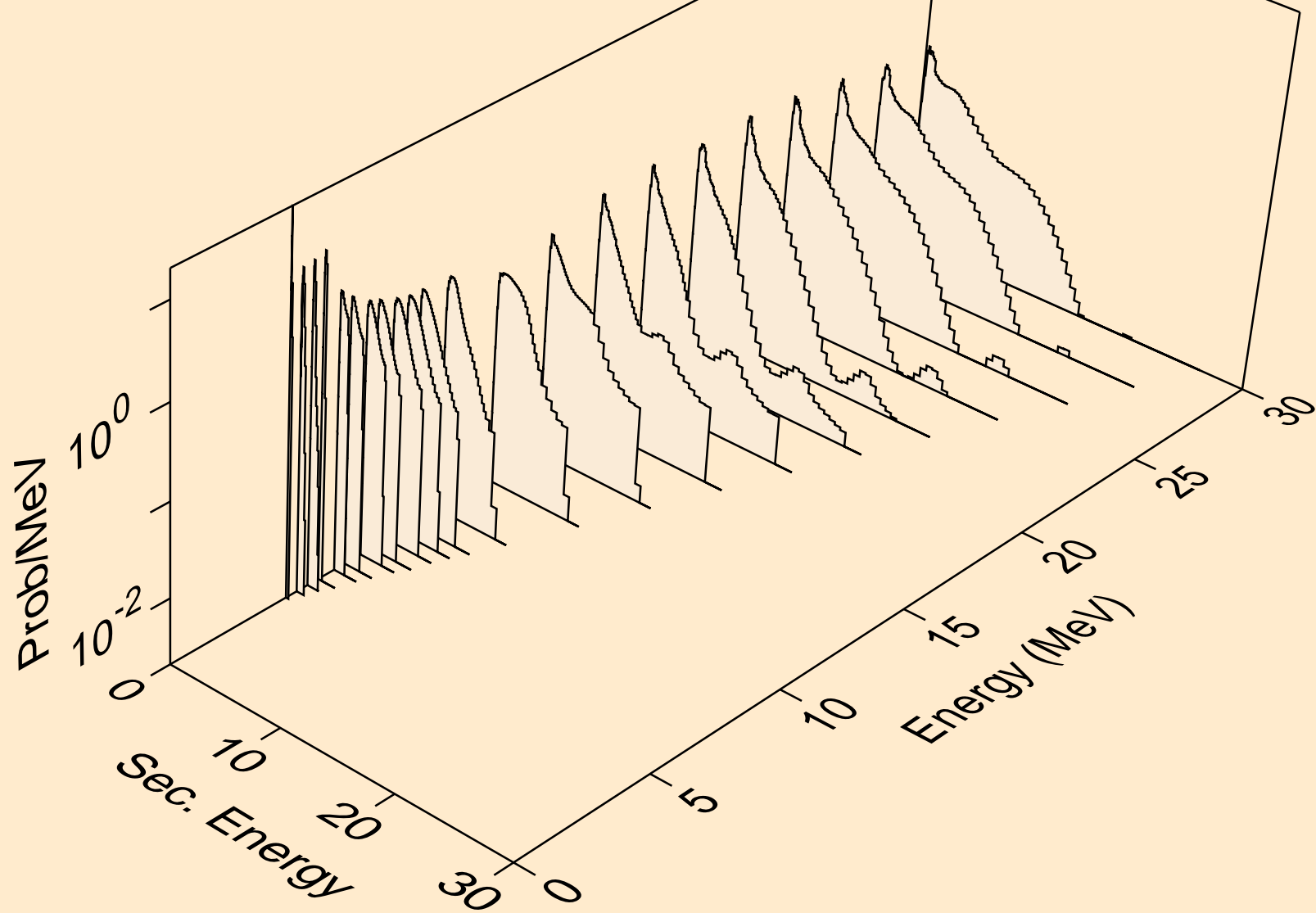

BI216M NEUTRON ACER TENDL-2021 LIBRARY; T=293.6K  
Neutron emission for (n,3n)a

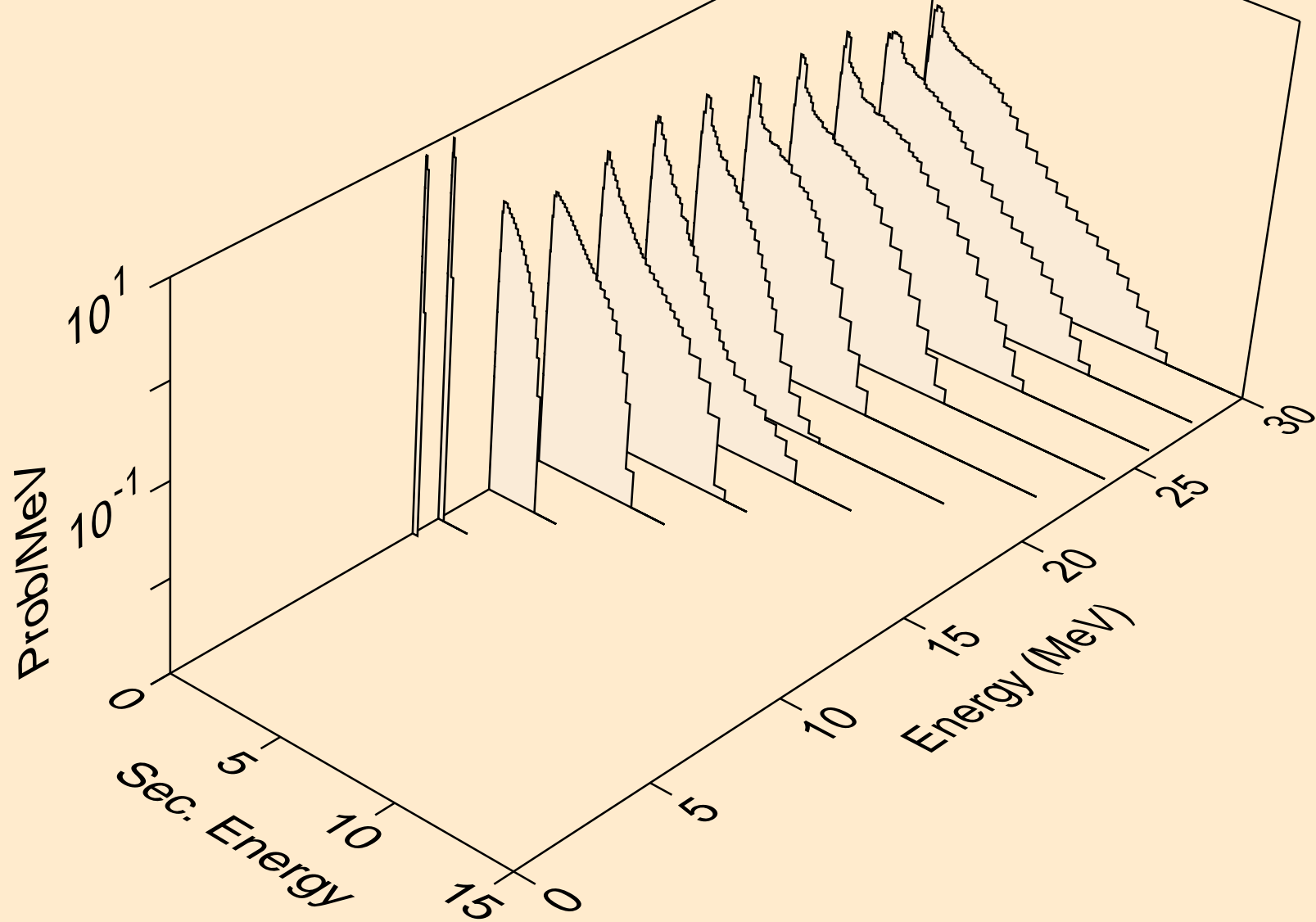

BI216M NEUTRON ACER TENDL-2021 LIBRARY; T=293.6K  
Neutron emission for (n,n\*)p

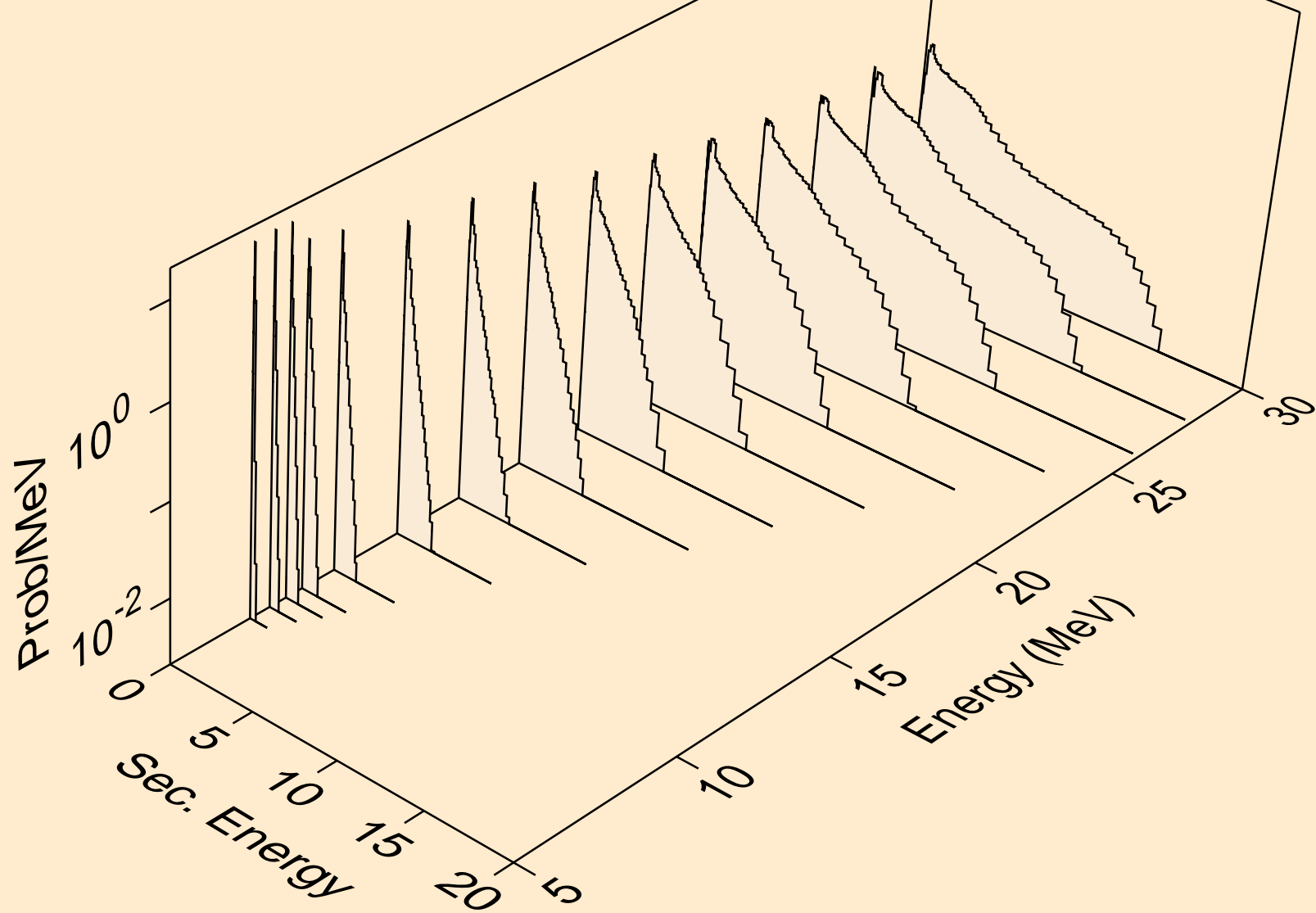

BI216M NEUTRON ACER TENDL-2021 LIBRARY; T=293.6K  
Neutron emission for (n,n\*)2a

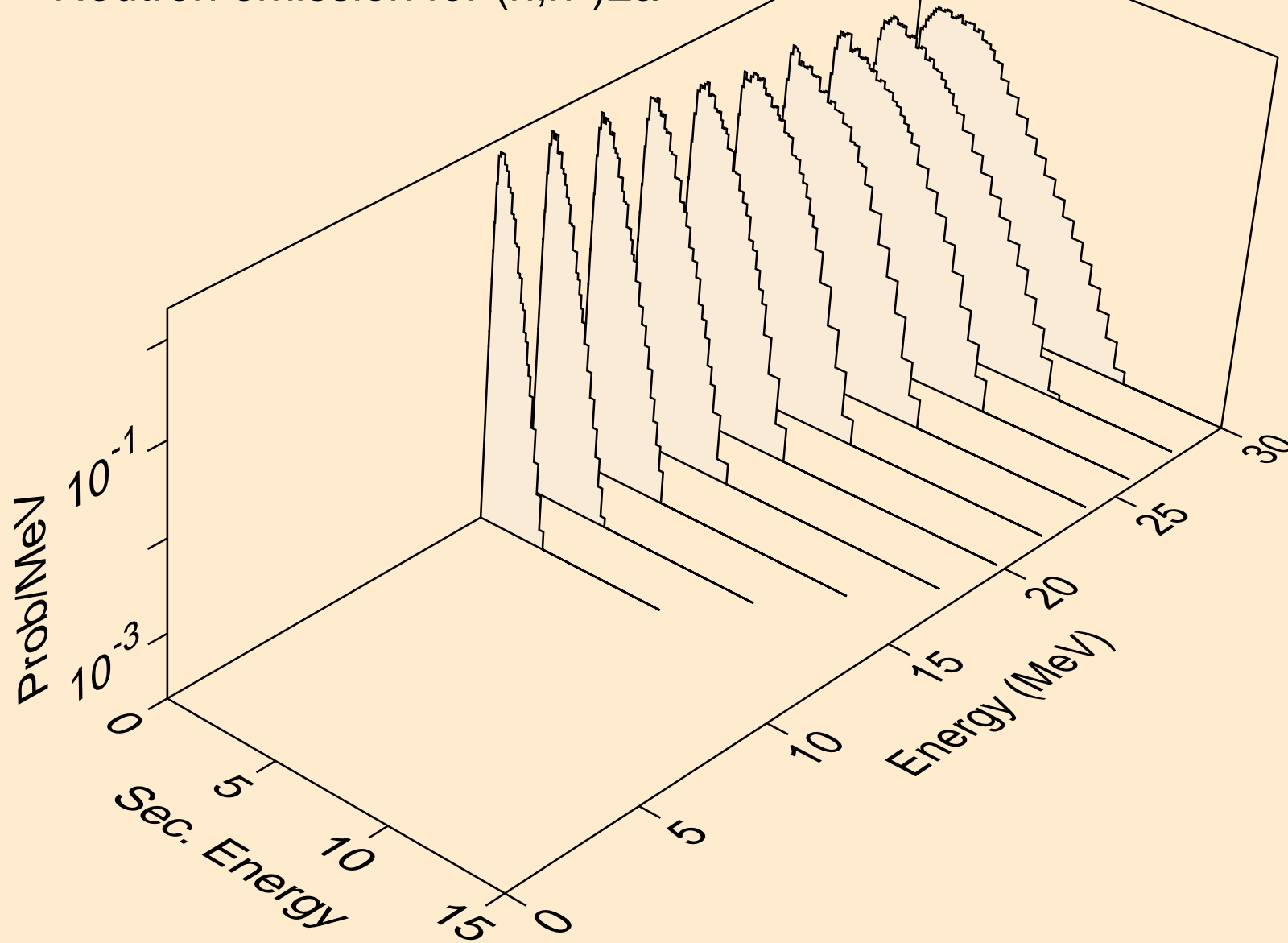



BI216M NEUTRON ACER TENDL-2021 LIBRARY; T=293.6K  
Neutron emission for (n,2n)2a

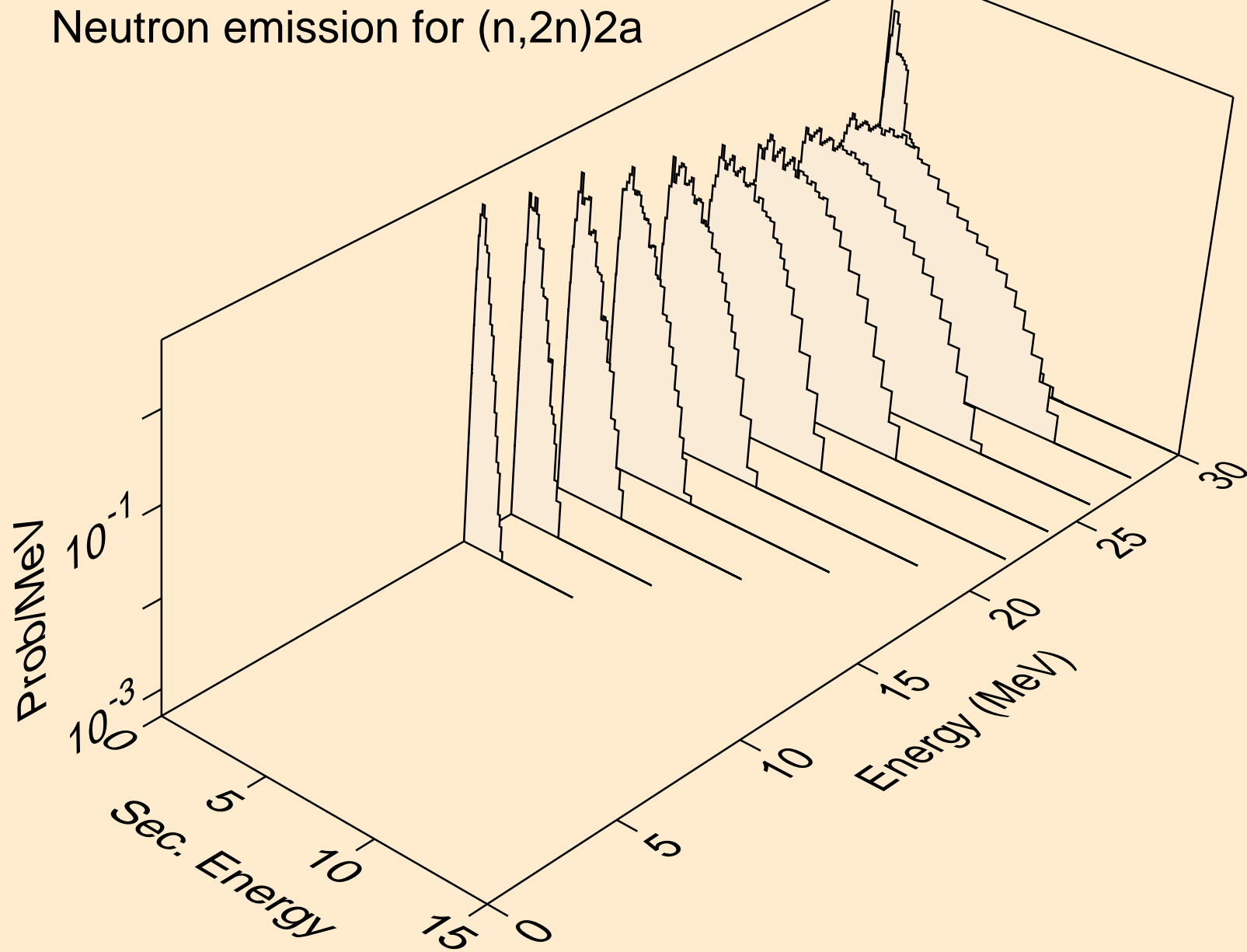

BI216M NEUTRON ACER TENDL-2021 LIBRARY; T=293.6K  
Neutron emission for (n,n\*)d

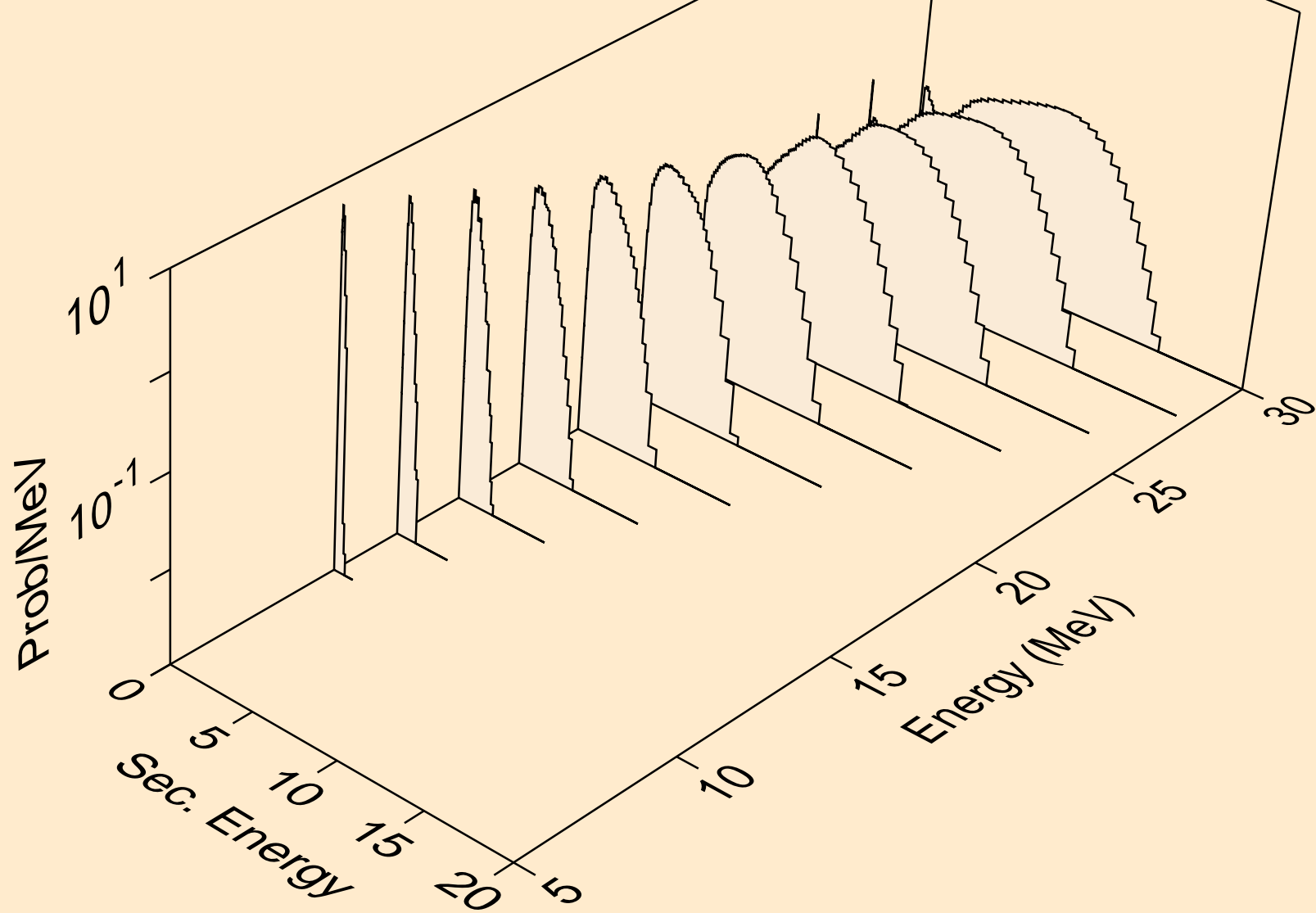

BI216M NEUTRON ACER TENDL-2021 LIBRARY; T=293.6K  
Neutron emission for (n,n\*)t

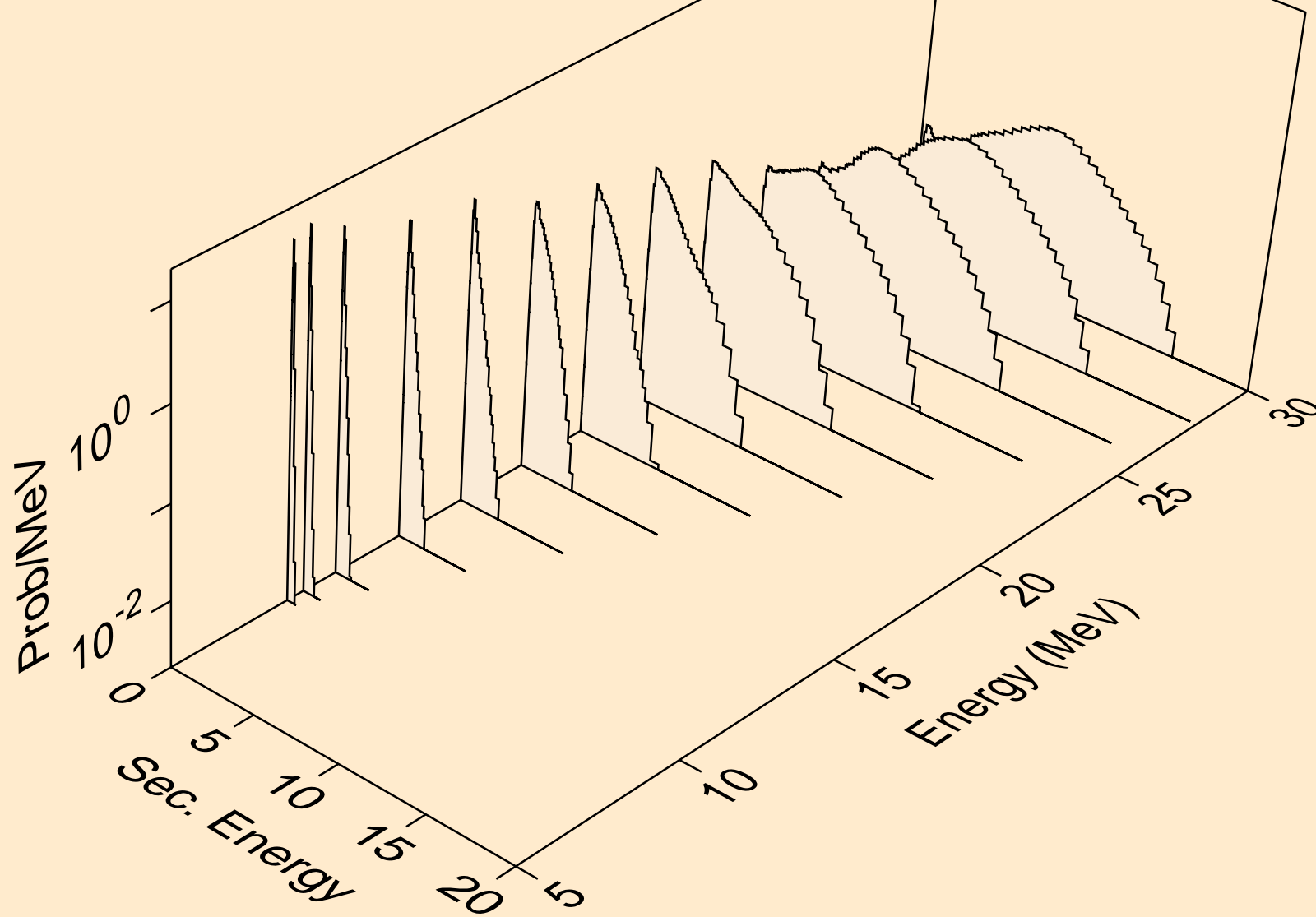

BI216M NEUTRON ACER TENDL-2021 LIBRARY; T=293.6K  
Neutron emission for (n,n\*)he3

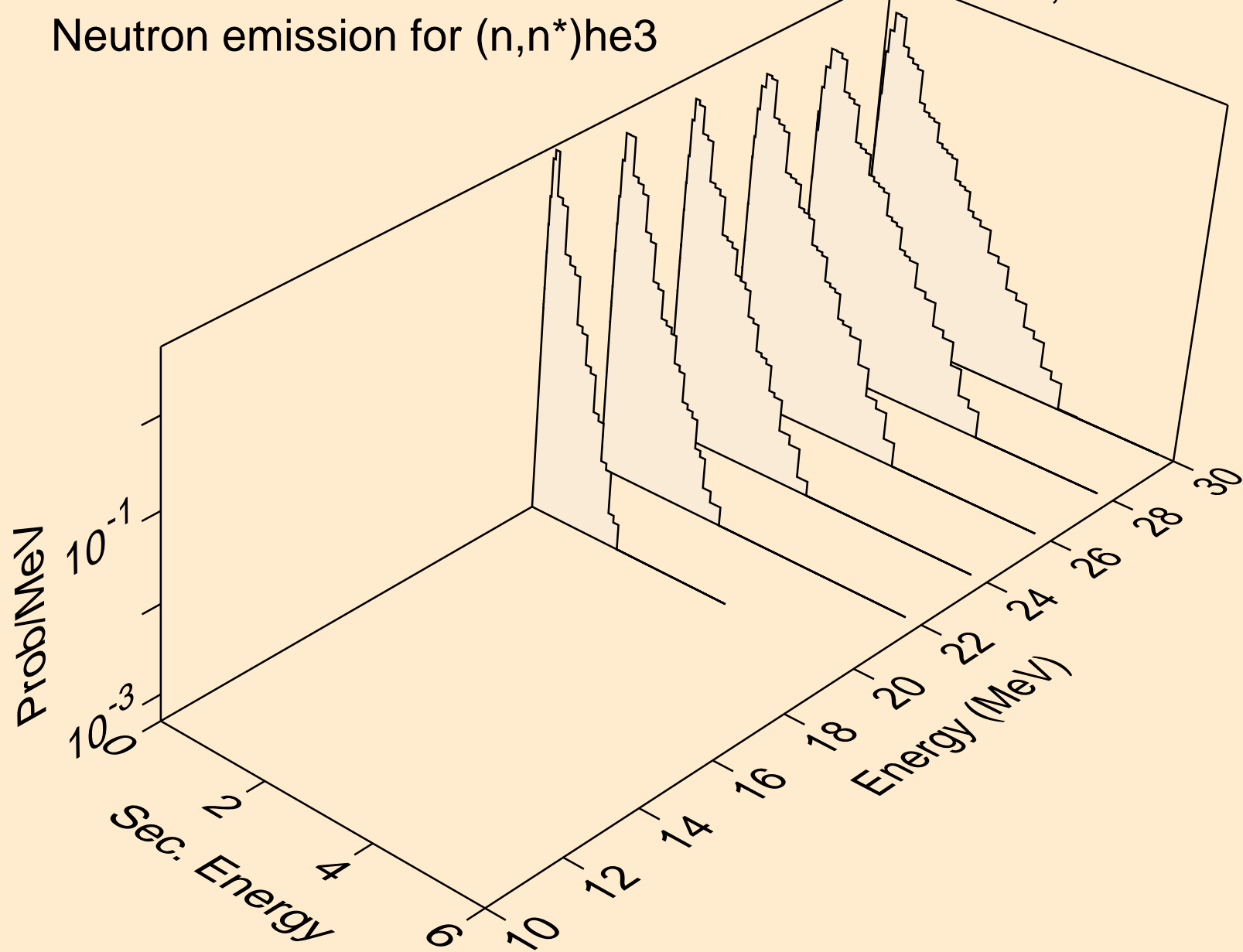

BI216M NEUTRON ACER TENDL-2021 LIBRARY; T=293.6K  
Neutron emission for (n,4n)

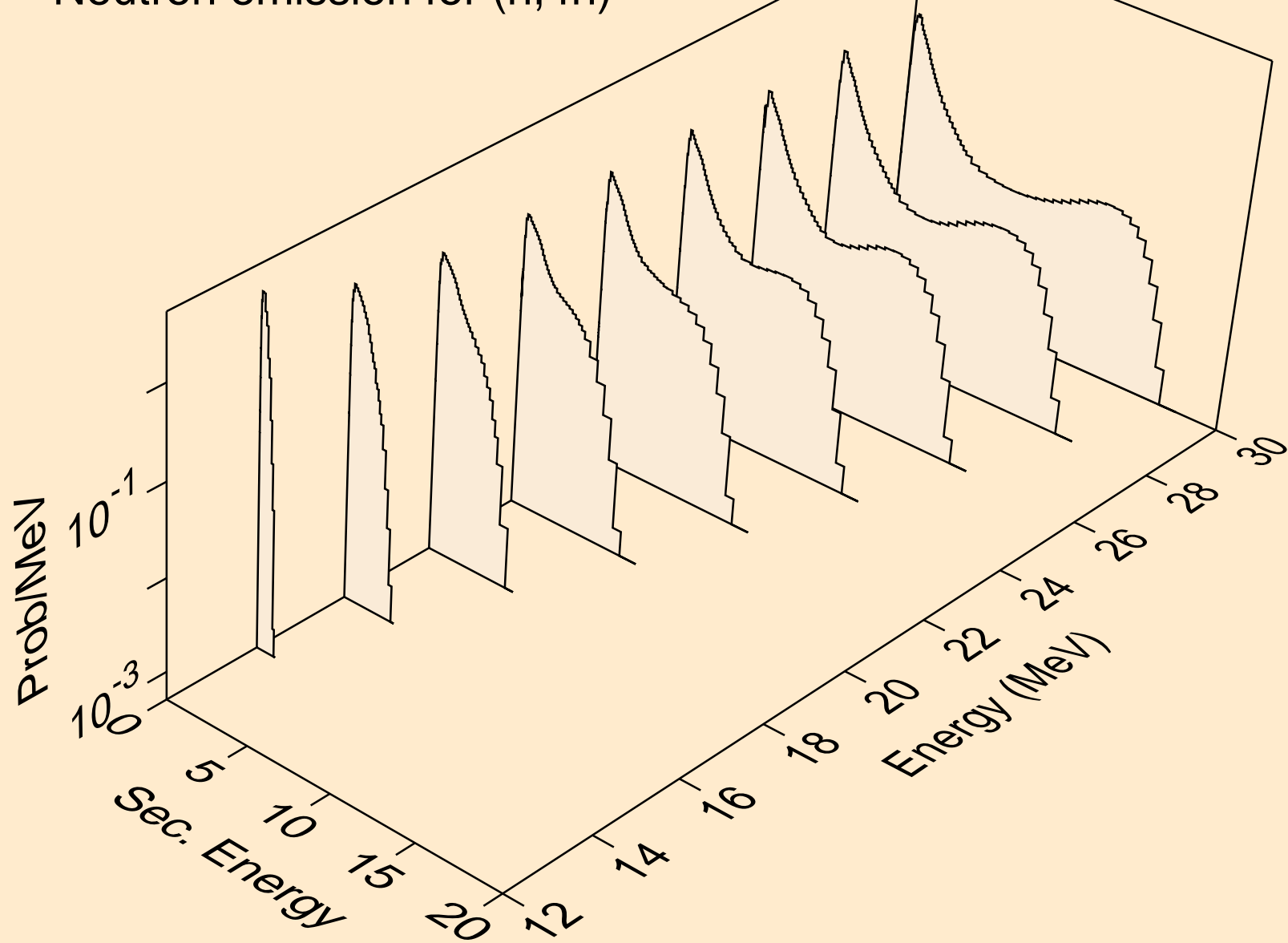

BI216M NEUTRON ACER TENDL-2021 LIBRARY; T=293.6K  
Neutron emission for (n,2np)

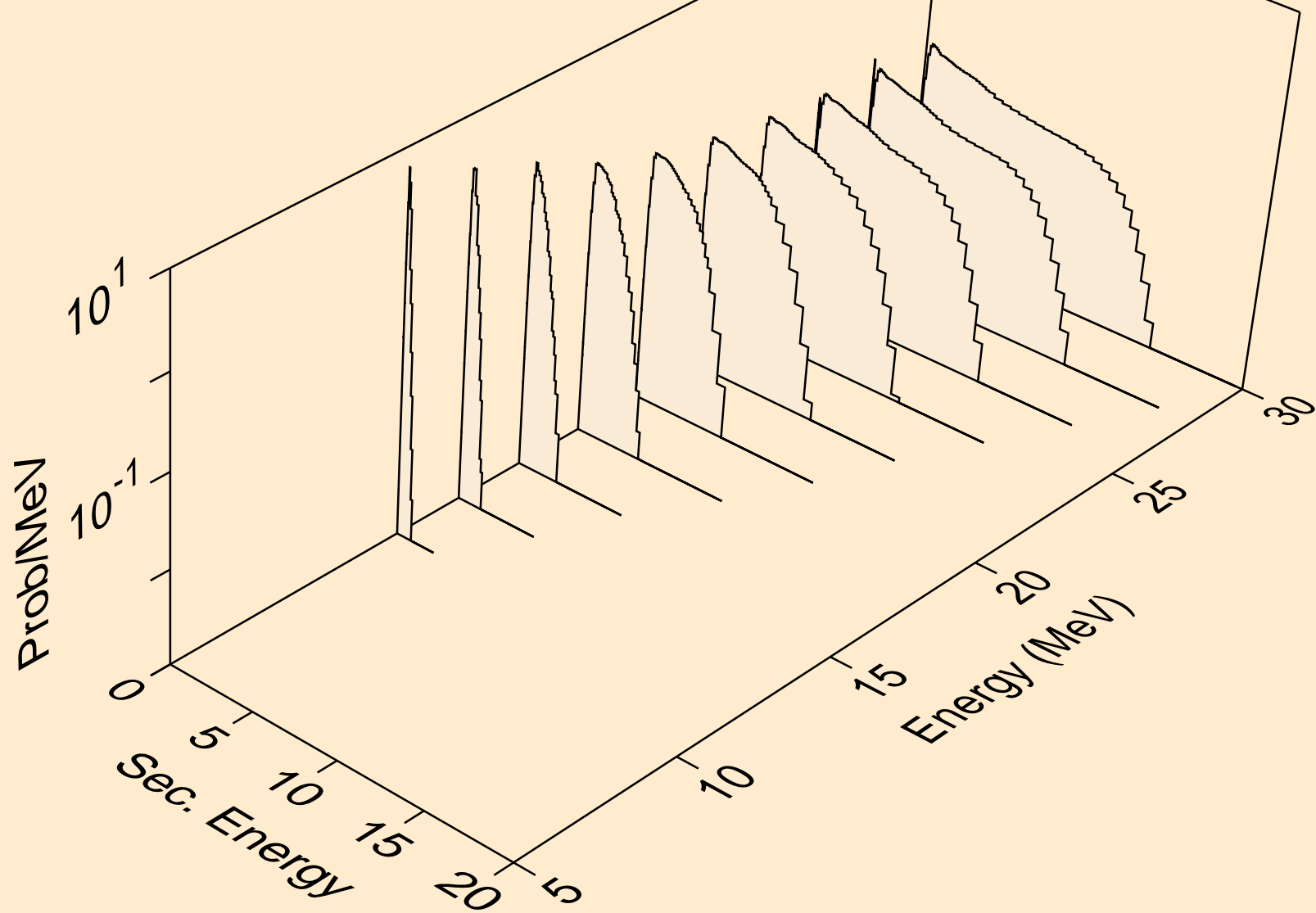

BI216M NEUTRON ACER TENDL-2021 LIBRARY; T=293.6K  
Neutron emission for (n,3np)

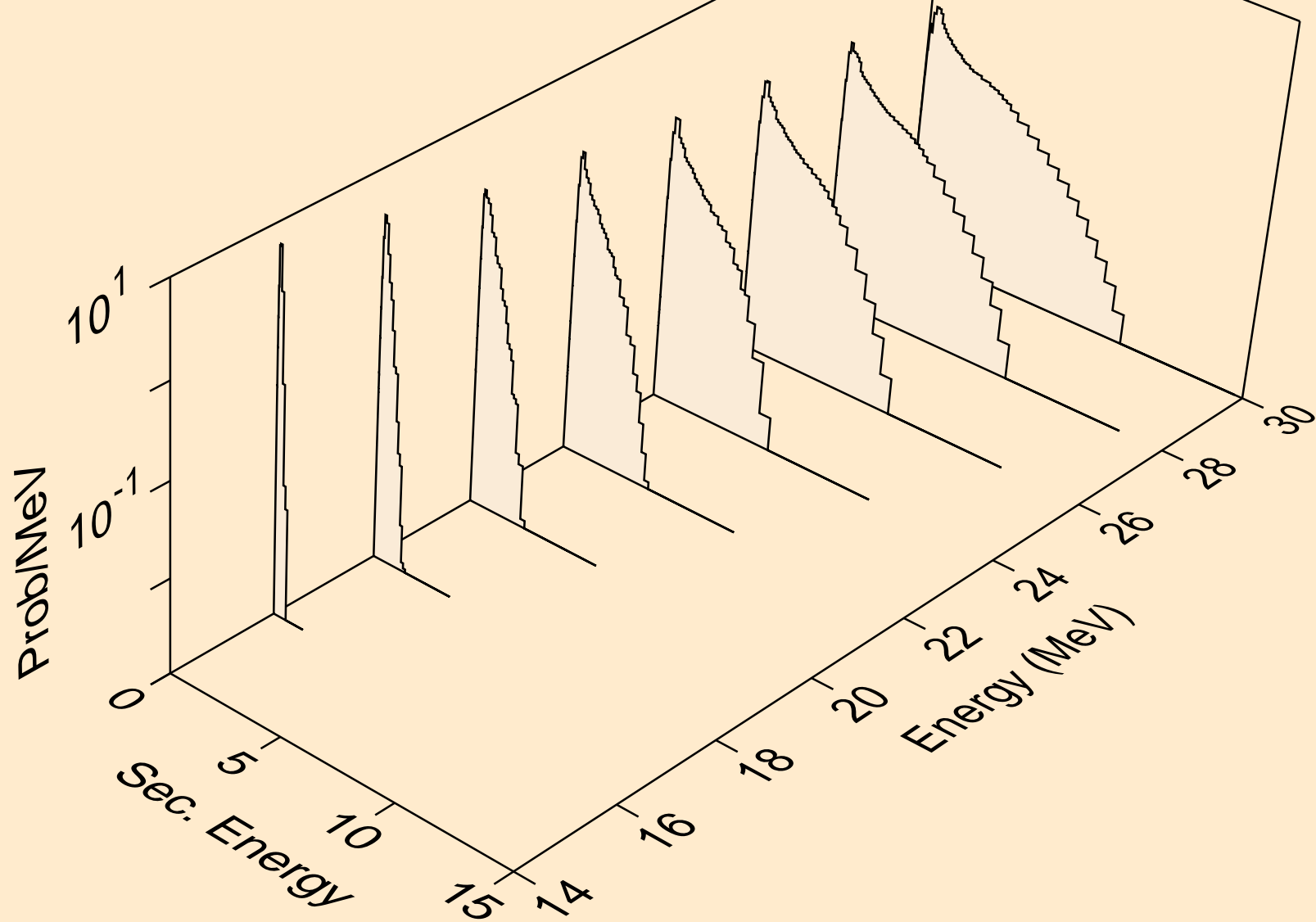

BI216M NEUTRON ACER TENDL-2021 LIBRARY; T=293.6K  
Neutron emission for (n,2np)

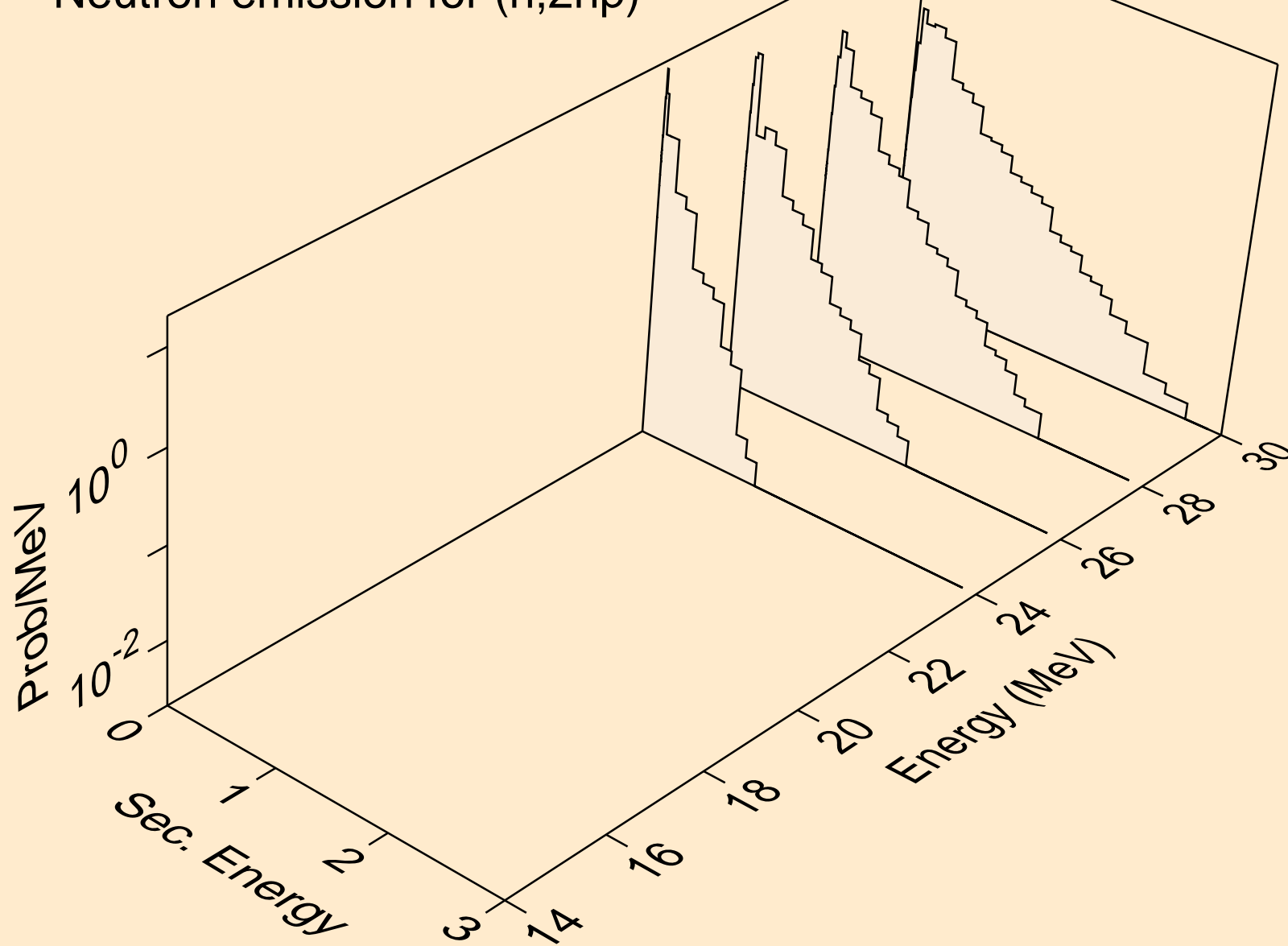



BI216M NEUTRON ACER TENDL-2021 LIBRARY; T=293.6K  
Neutron emission for (n,npa)

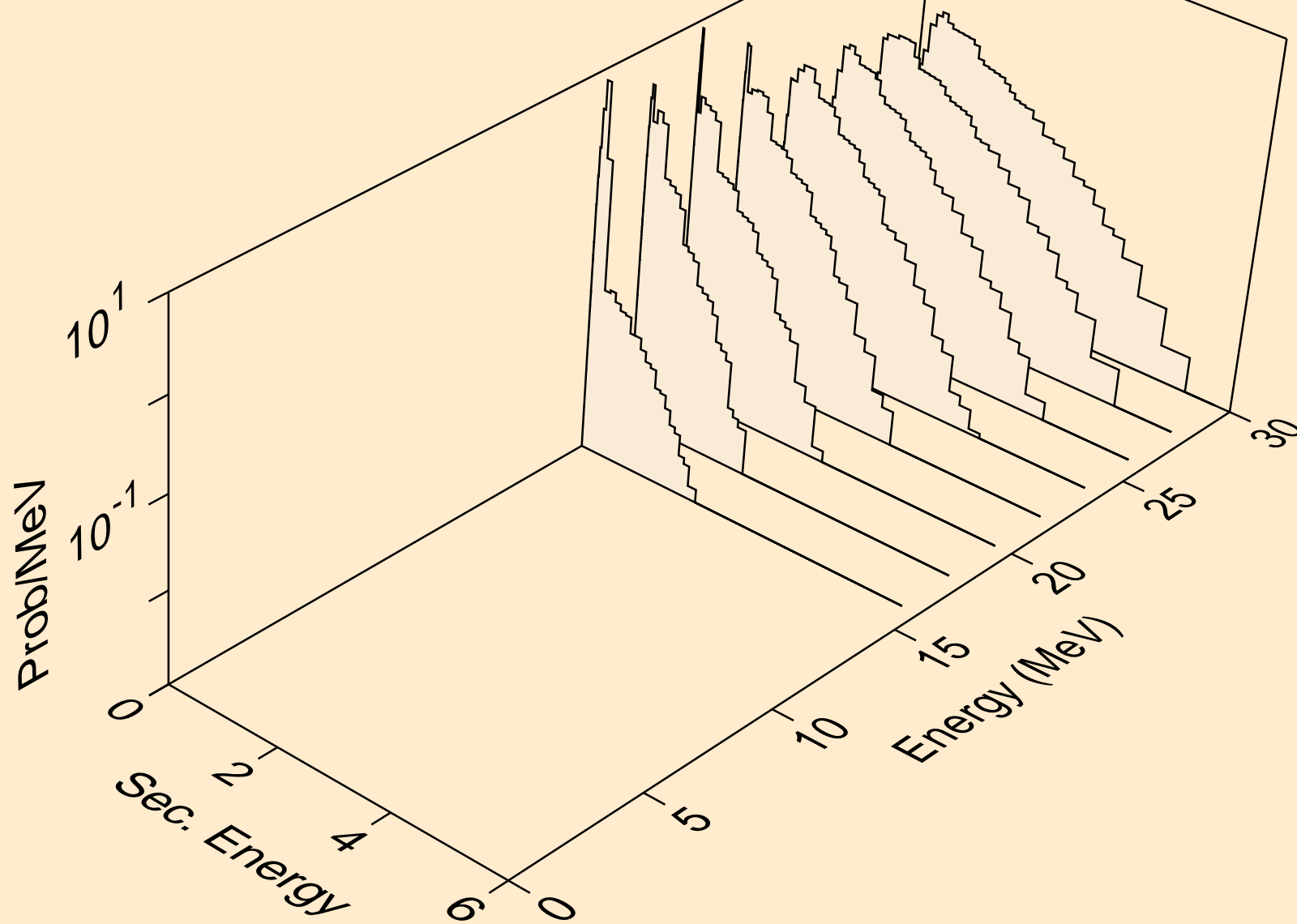

BI216M NEUTRON ACER TENDL-2021 LIBRARY; T=293.6K  
Neutron emission for (n,n\*c)

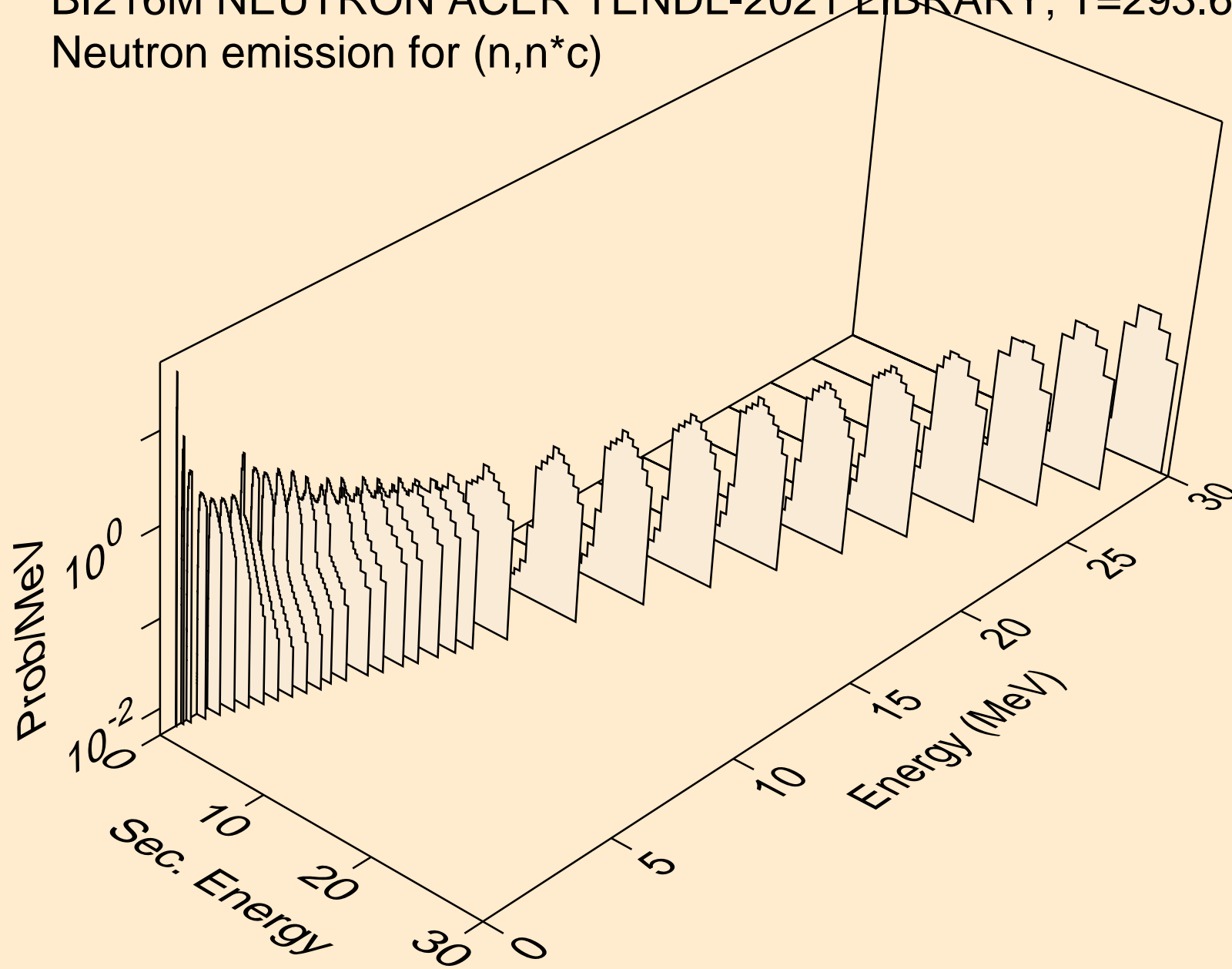

# BI216M NEUTRON ACER TENDL-2021 LIBRARY; T=293.6K

## Delayed nubar

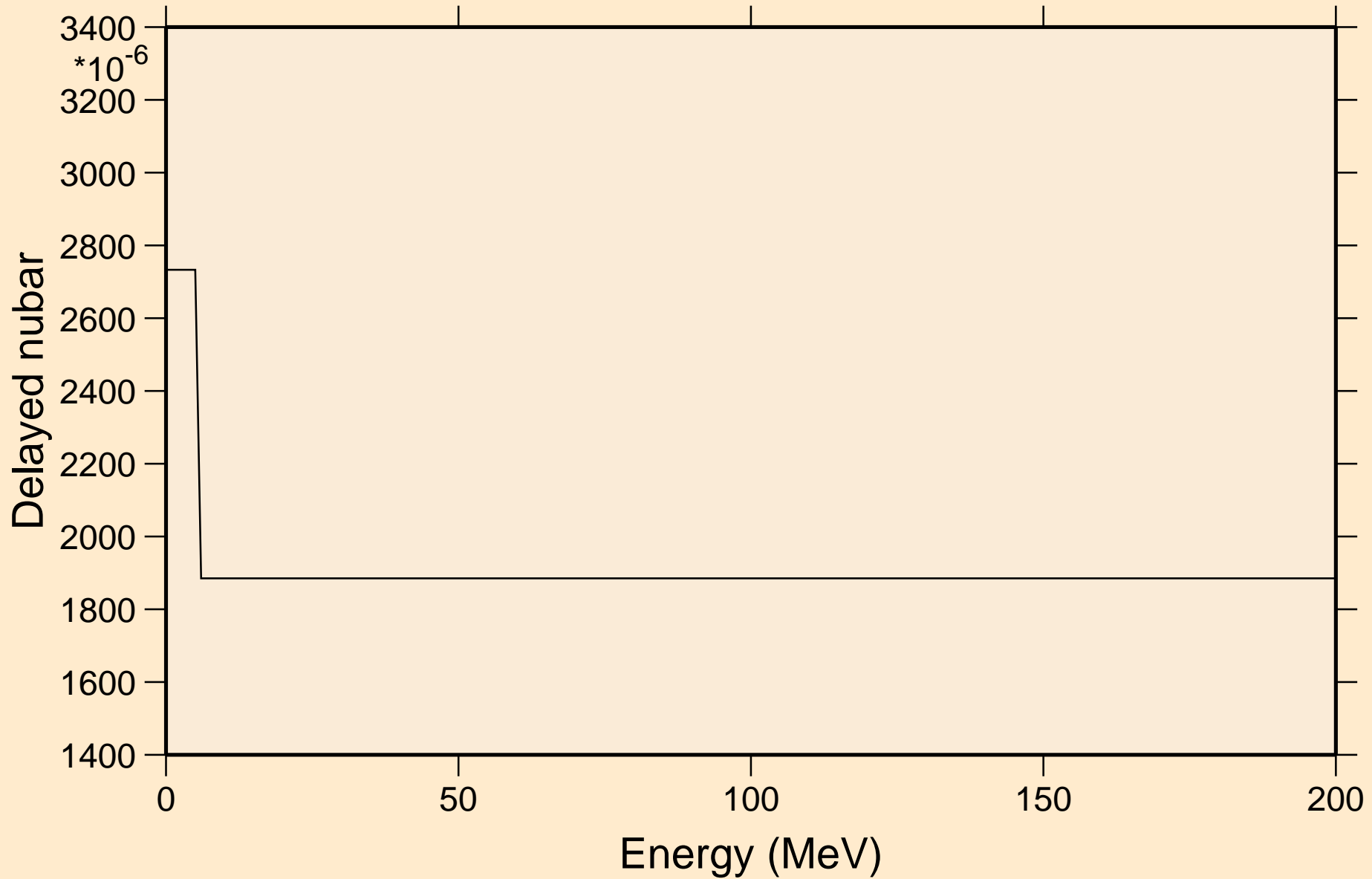

BI216M NEUTRON ACER TENDL-2021 LIBRARY; T=293.6K  
Delayed neutron spectra

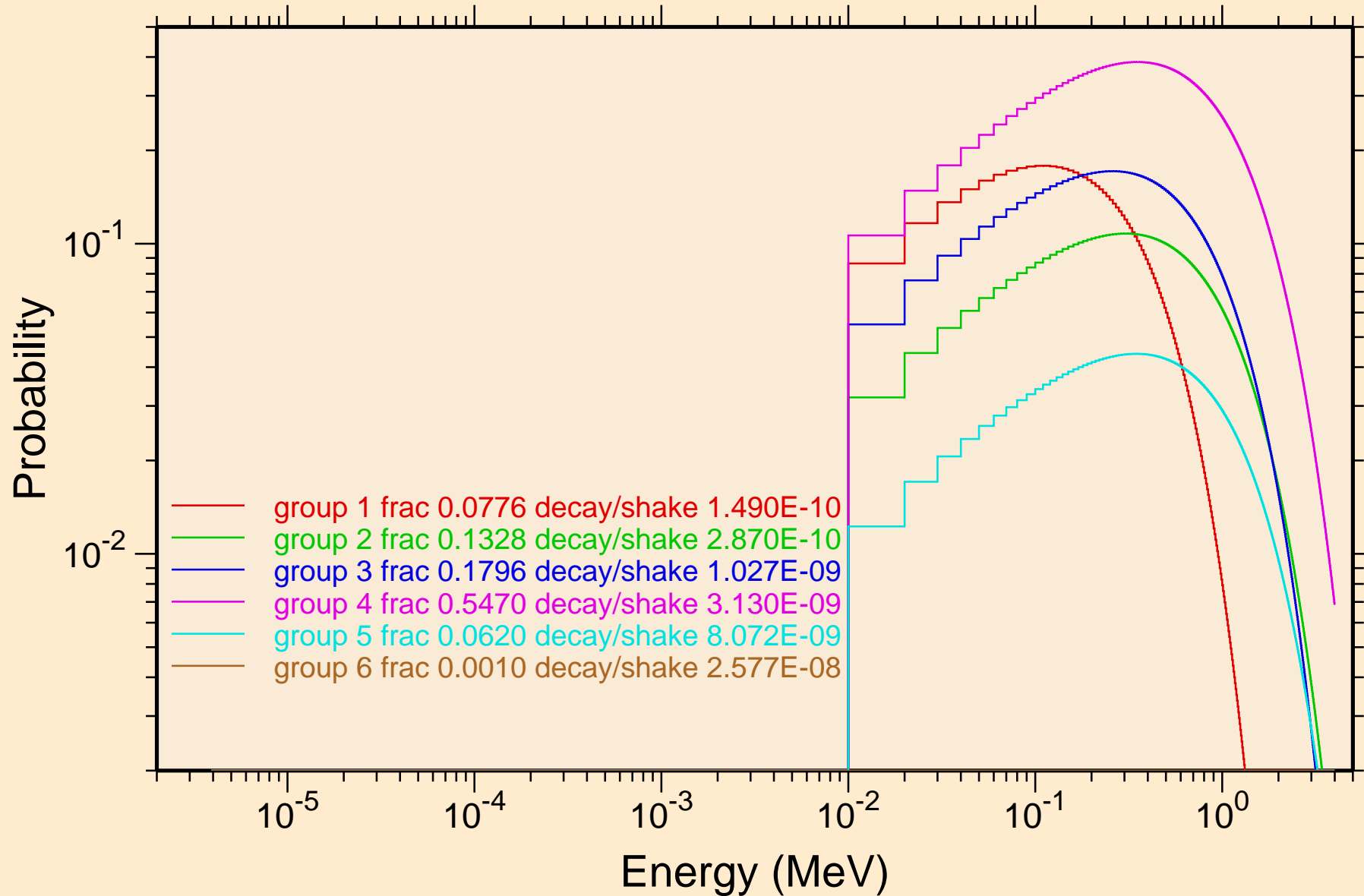

BI216M NEUTRON ACER TENDL-2021 LIBRARY; T=293.6K  
Photon emission for (n,x)

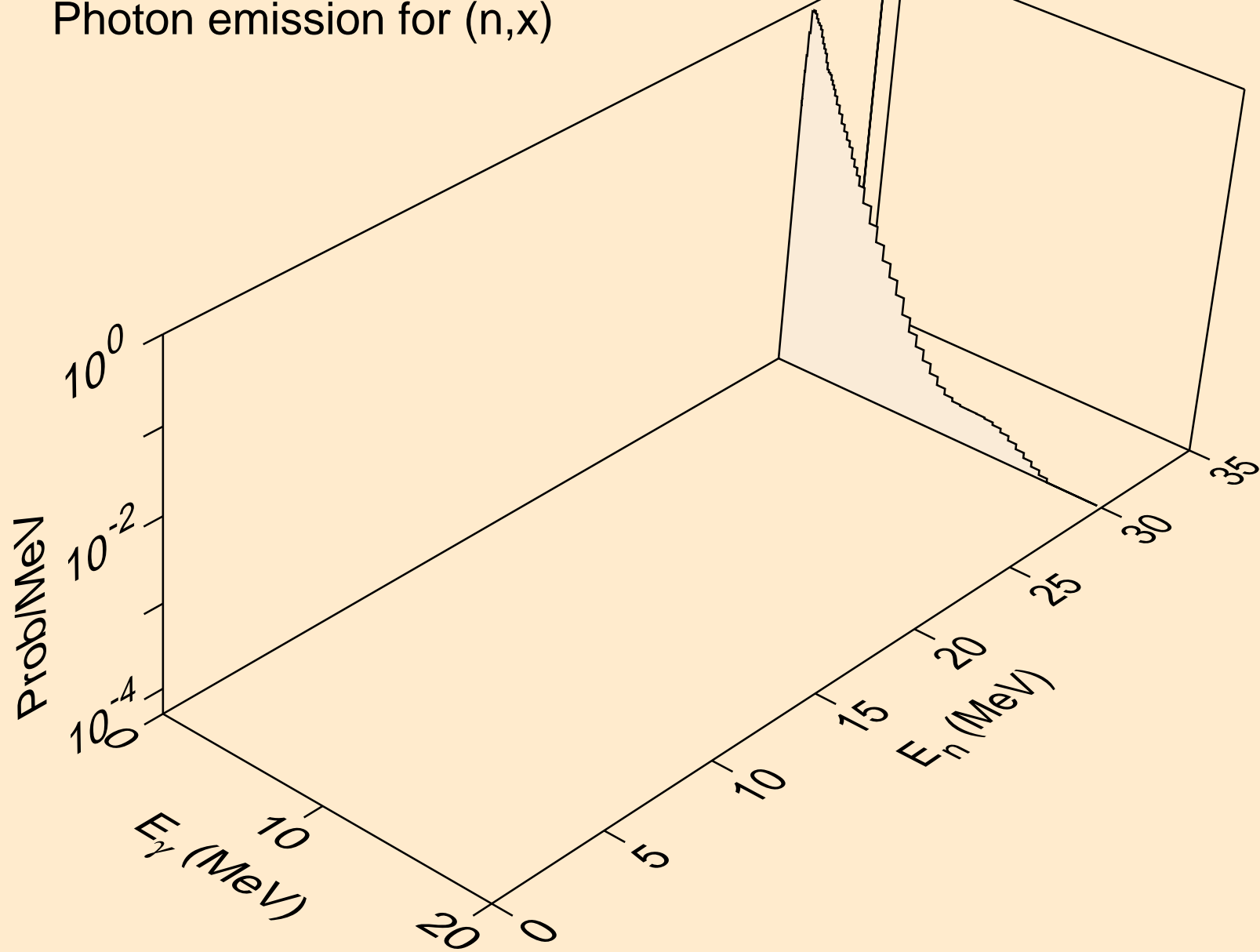

BI216M NEUTRON ACER TENDL-2021 LIBRARY; T=293.6K  
Photon emission for (n,2nd)

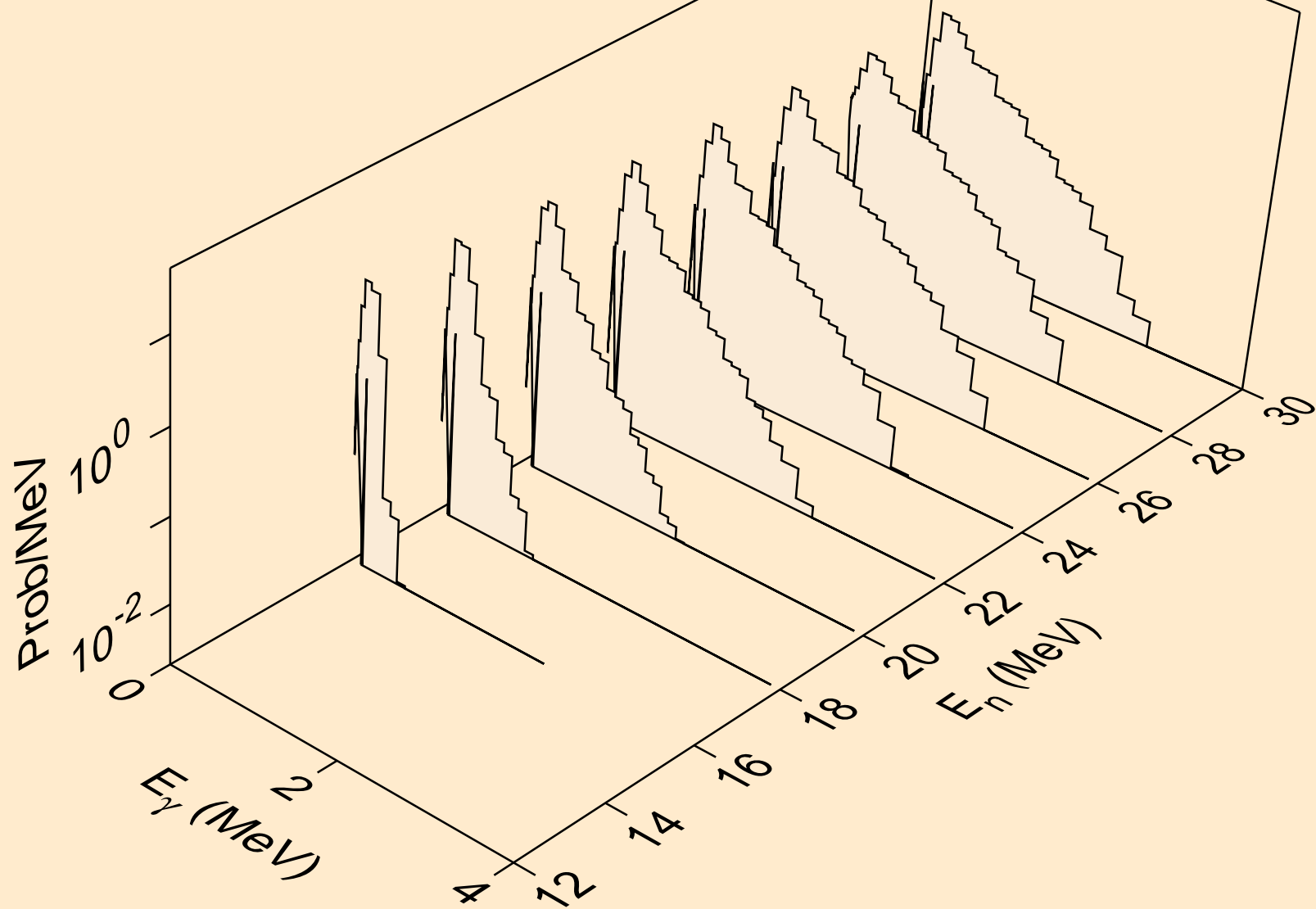

BI216M NEUTRON ACER TENDL-2021 LIBRARY; T=293.6K  
Photon emission for (n,2n)

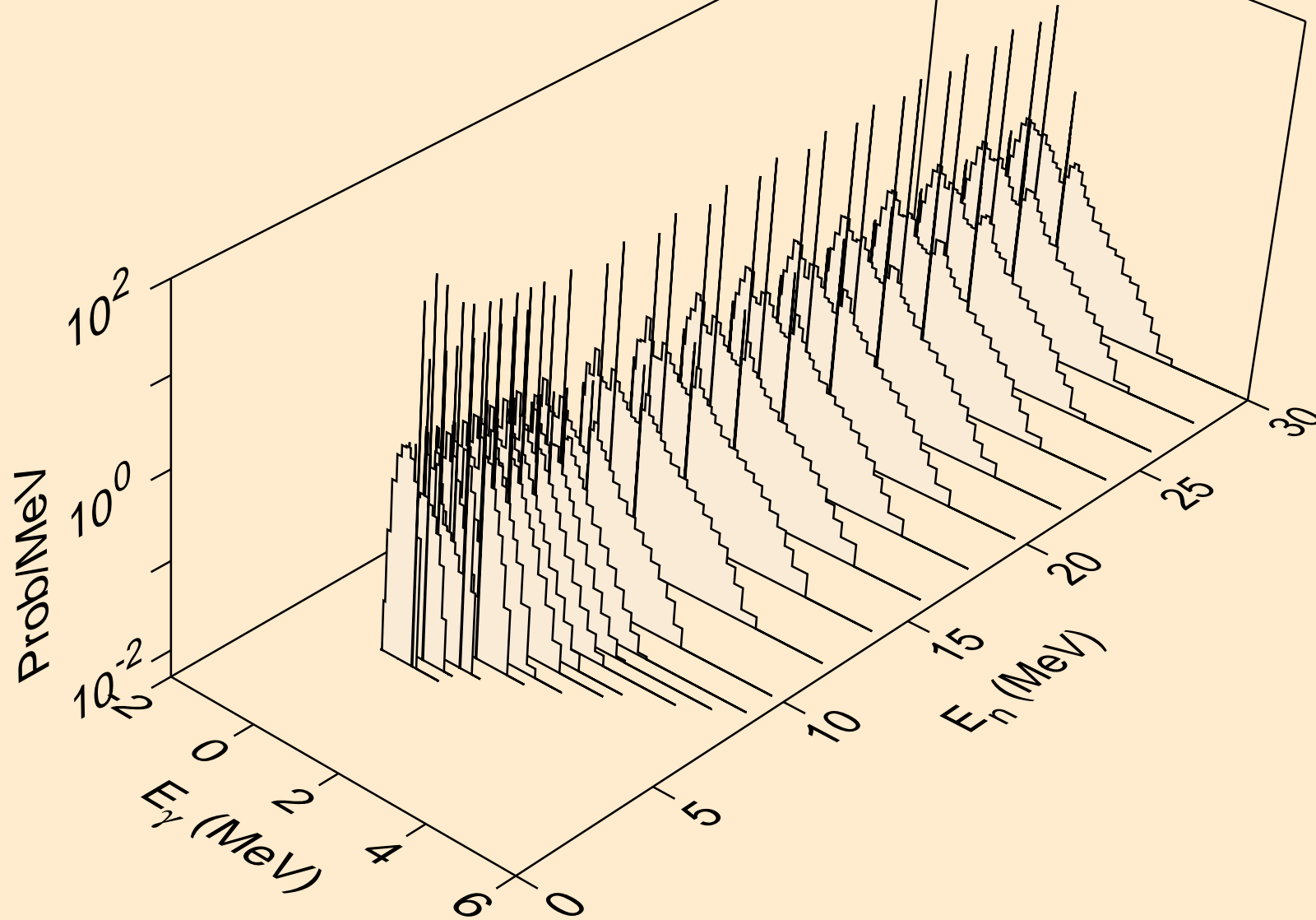

BI216M NEUTRON ACER TENDL-2021 LIBRARY; T=293.6K  
Photon emission for (n,3n)

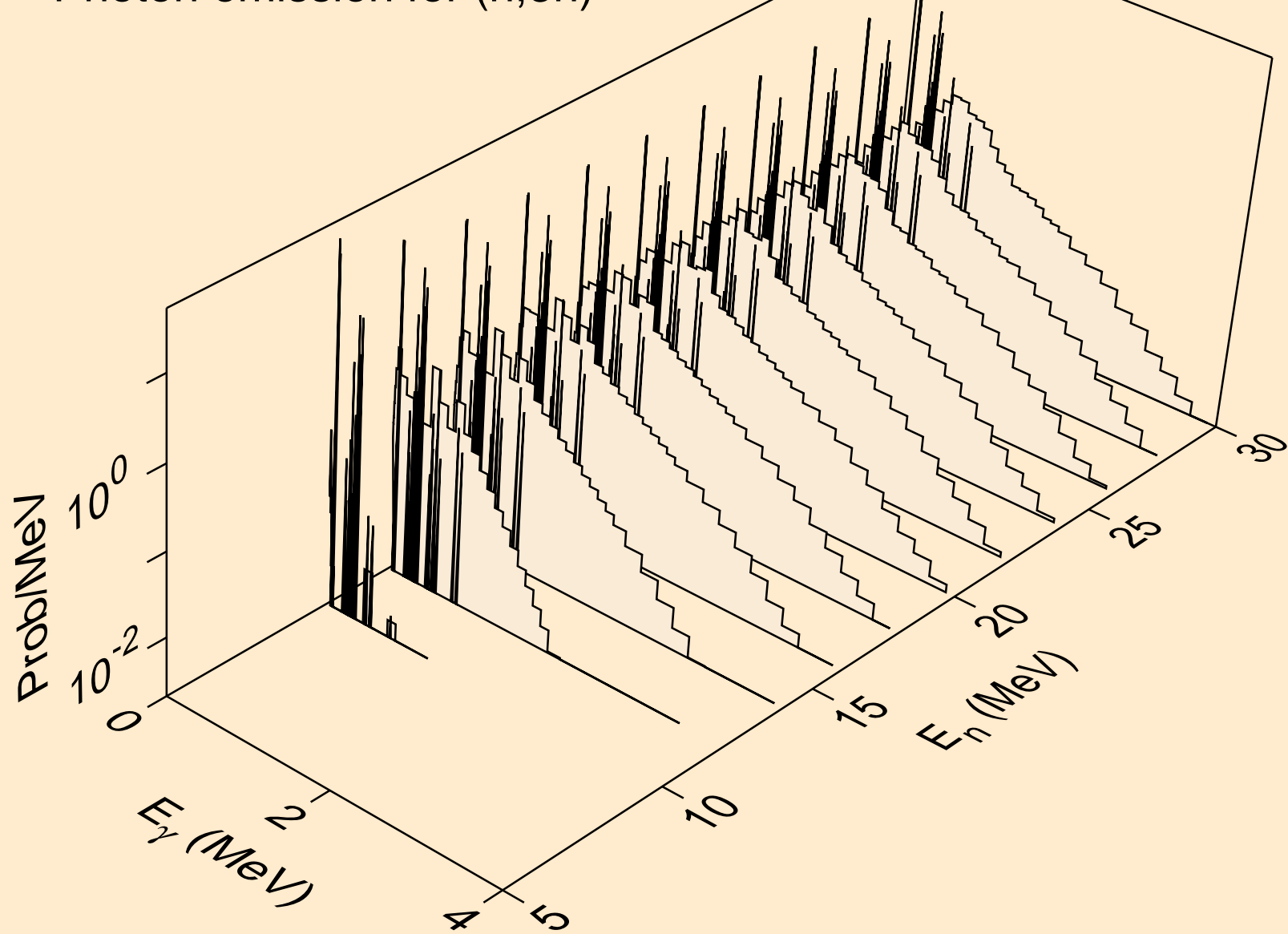



BI216M NEUTRON ACER TENDL-2021 LIBRARY; T=293.6K  
Photon emission for (n,n\*)a

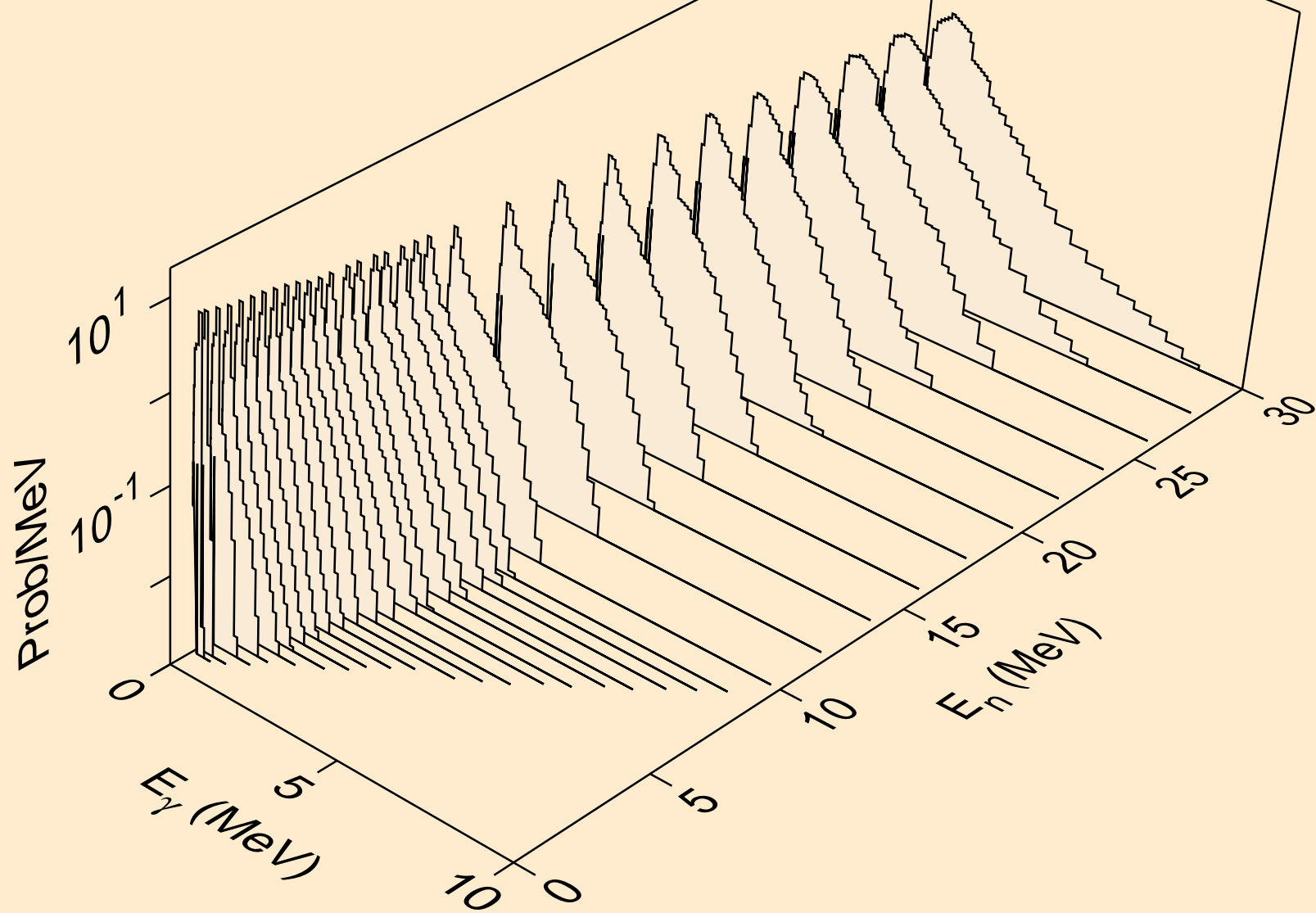

BI216M NEUTRON ACER TENDL-2021 LIBRARY; T=293.6K  
Photon emission for (n,2n)a

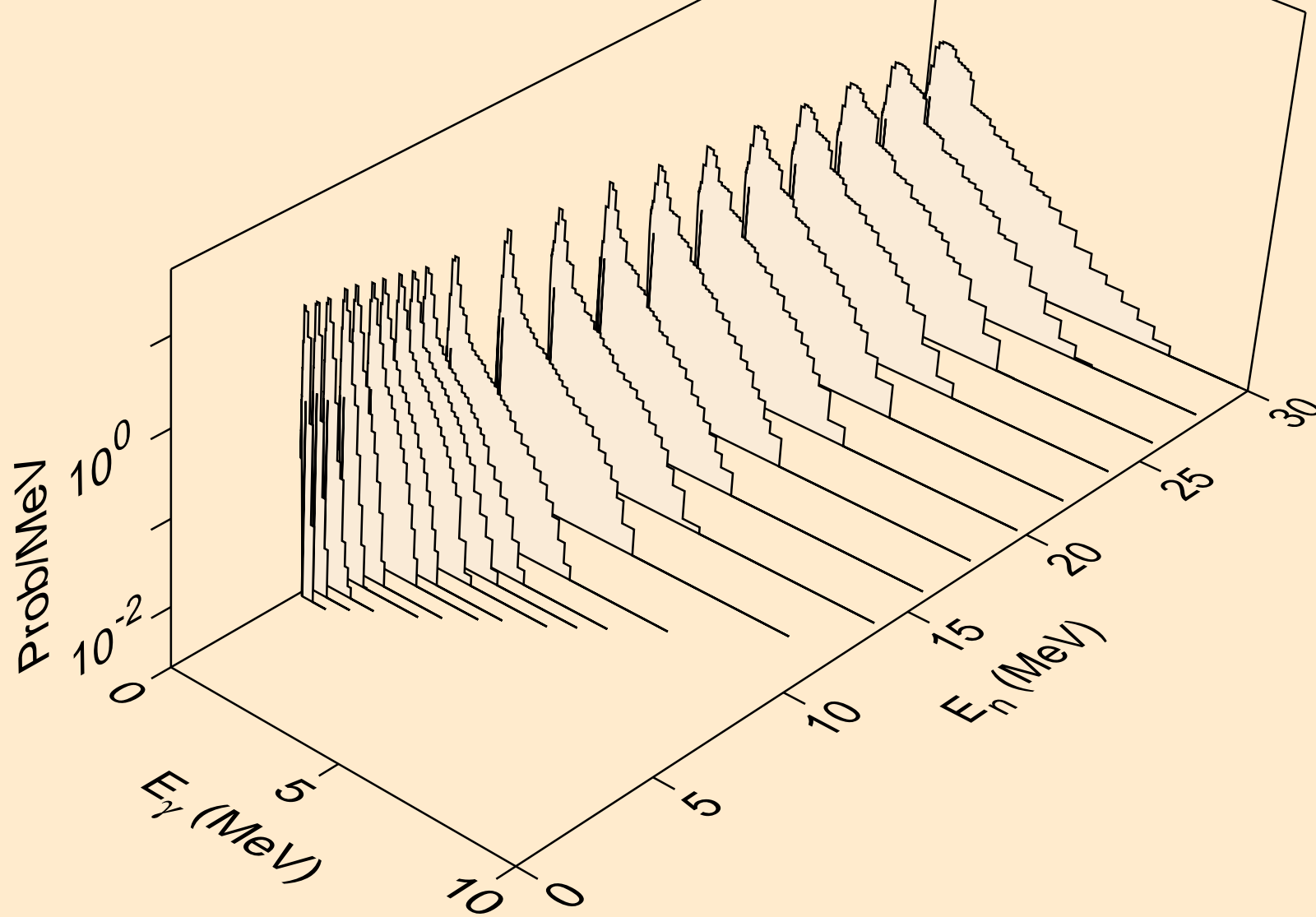

BI216M NEUTRON ACER TENDL-2021 LIBRARY; T=293.6K  
Photon emission for (n,3n)a

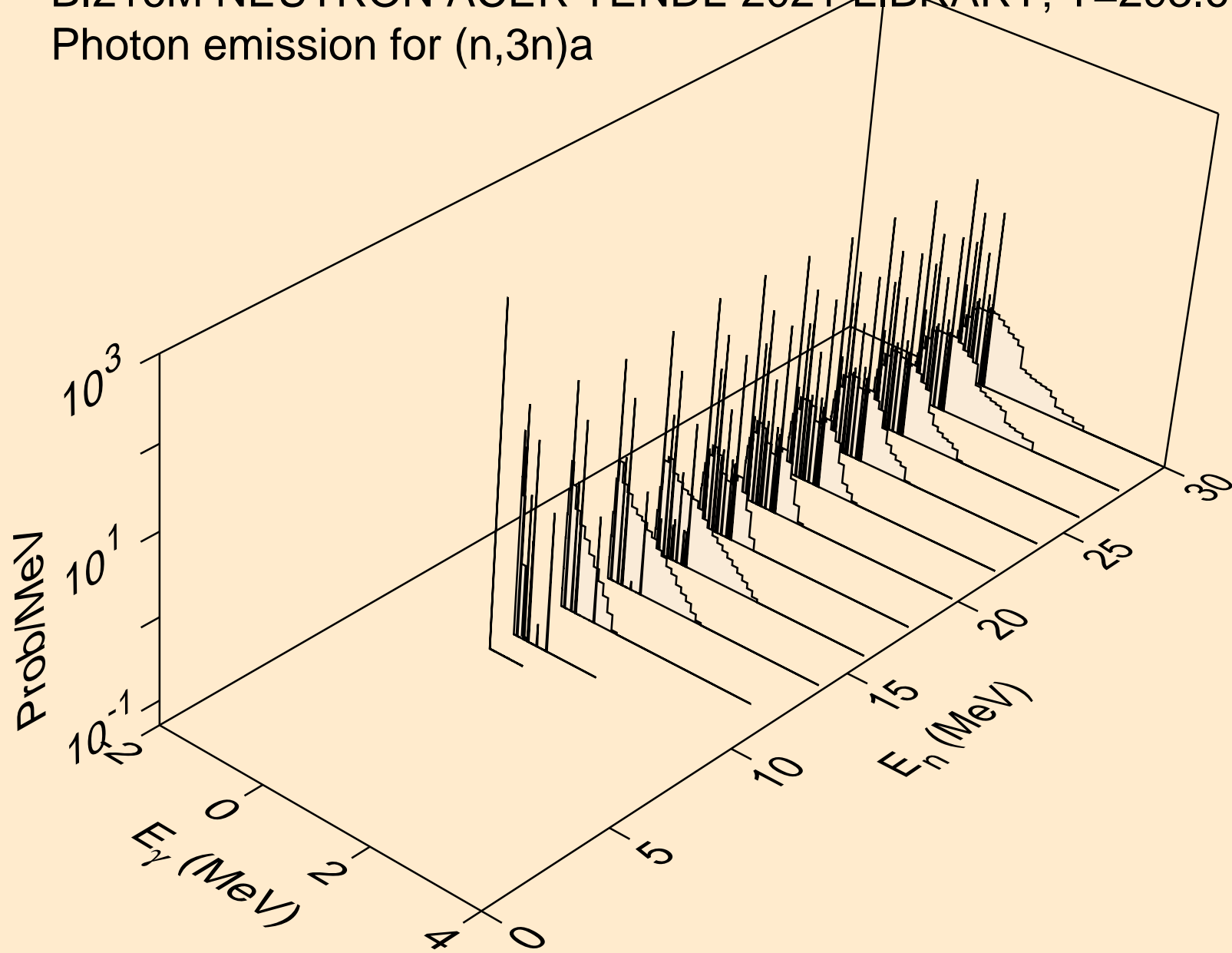

BI216M NEUTRON ACER TENDL-2021 LIBRARY; T=293.6K  
Photon emission for (n,n\*)p

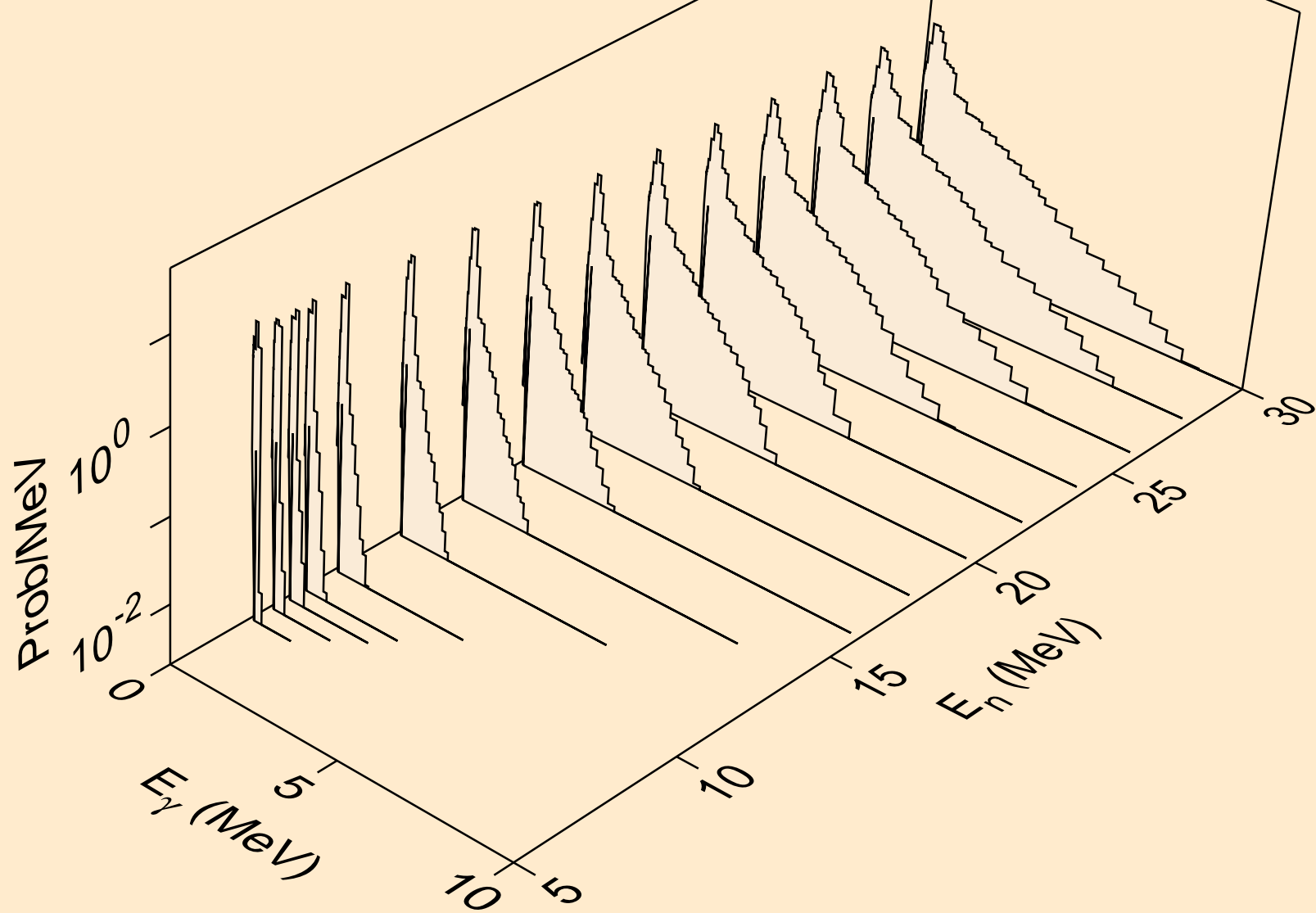

BI216M NEUTRON ACER TENDL-2021 LIBRARY; T=293.6K  
Photon emission for (n,n\*)2a

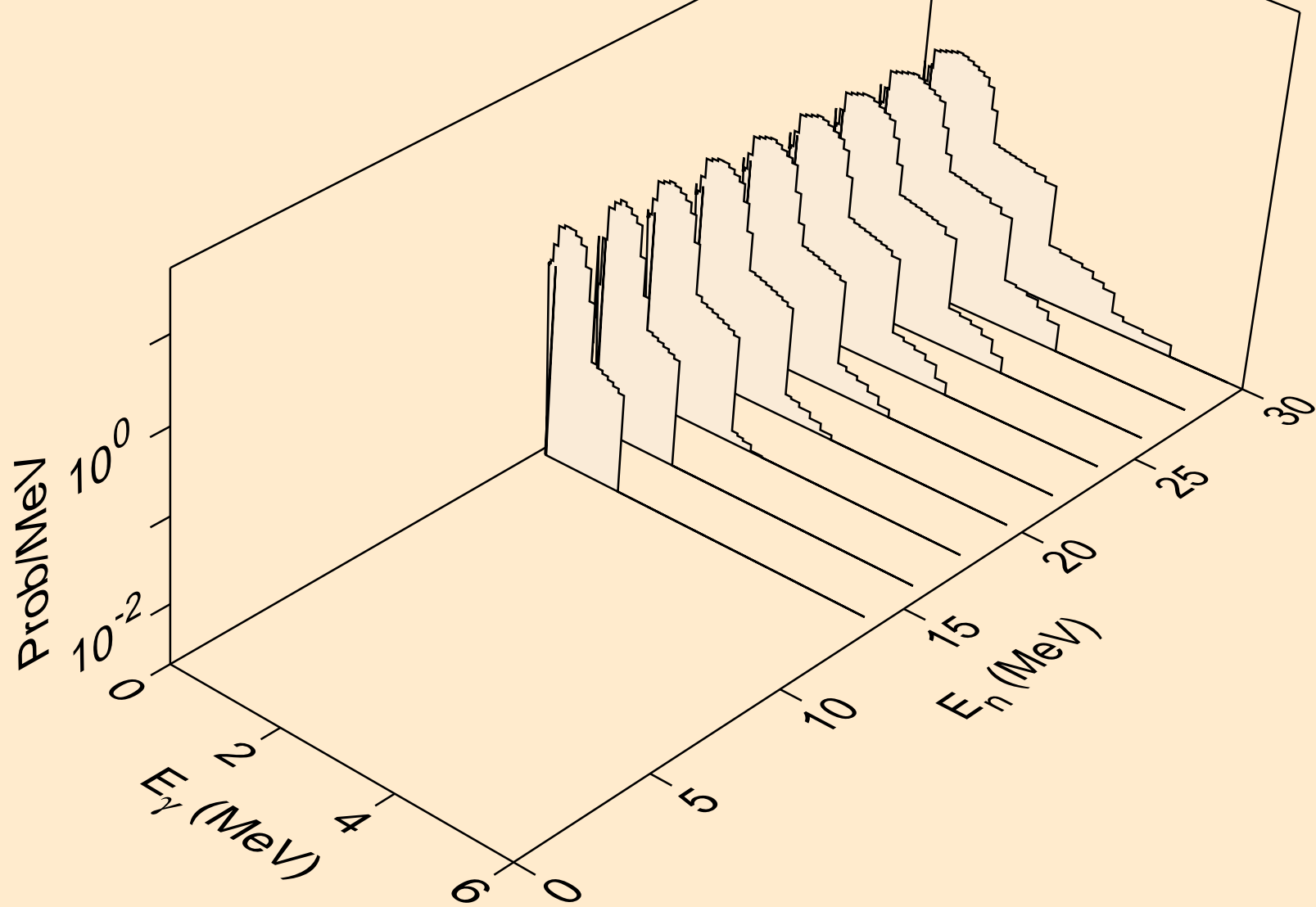

BI216M NEUTRON ACER TENDL-2021 LIBRARY; T=293.6K  
Photon emission for (n,2n)2a

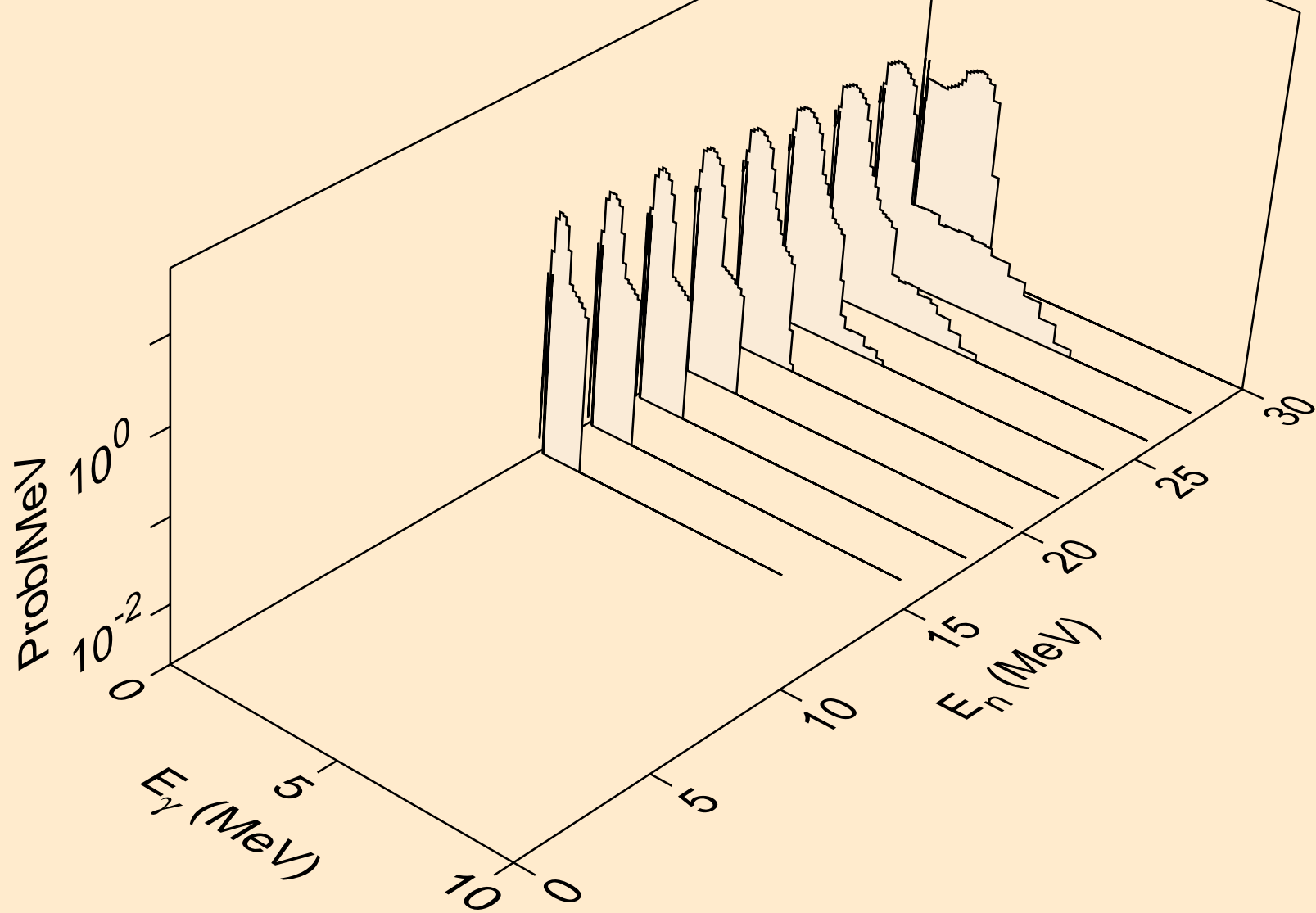

BI216M NEUTRON ACER TENDL-2021 LIBRARY; T=293.6K  
Photon emission for (n,n\*)d

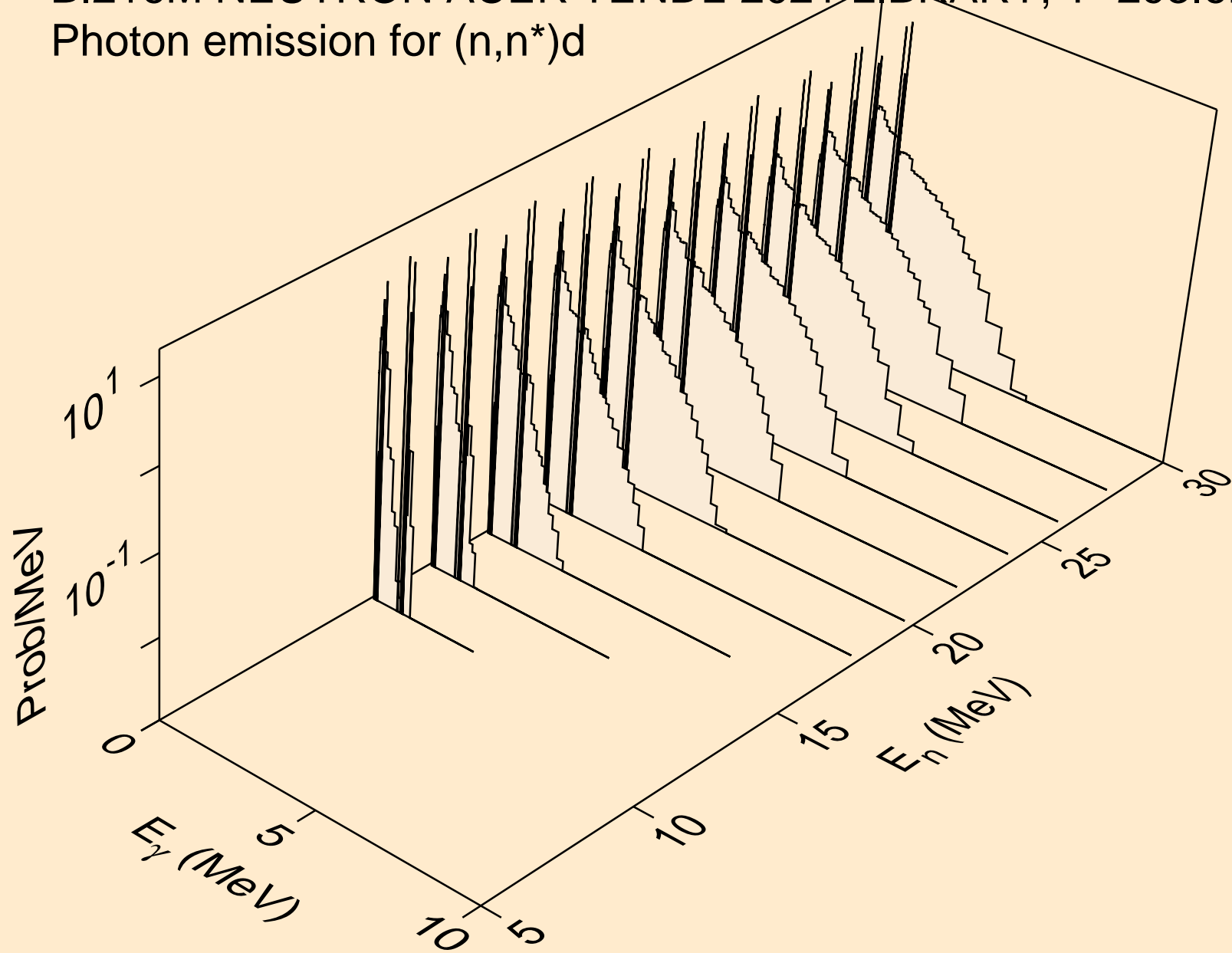

BI216M NEUTRON ACER TENDL-2021 LIBRARY; T=293.6K  
Photon emission for (n,n\*)t

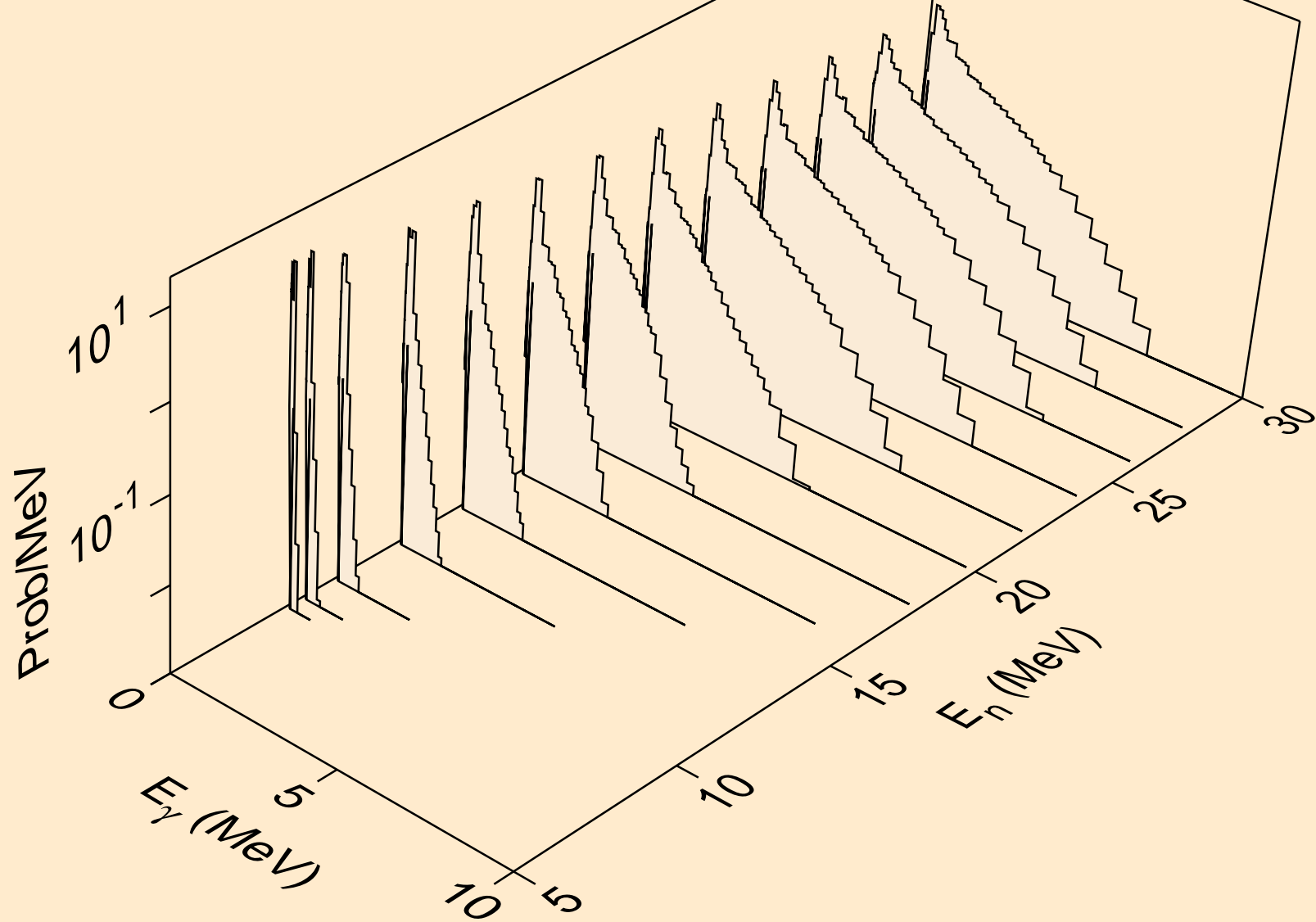



BI216M NEUTRON ACER TENDL-2021 LIBRARY; T=293.6K  
Photon emission for (n,n\*)he3

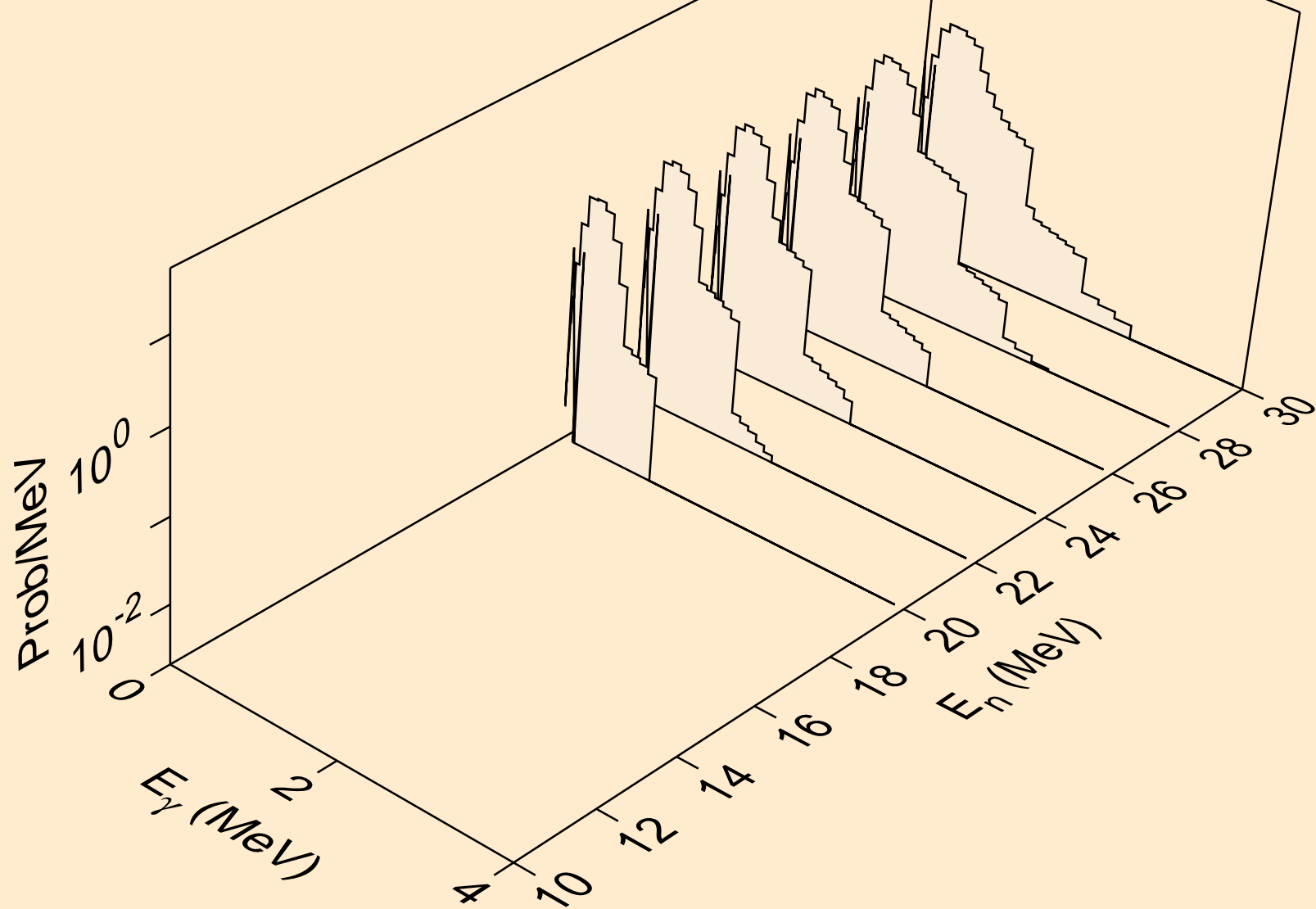

BI216M NEUTRON ACER TENDL-2021 LIBRARY; T=293.6K  
Photon emission for (n,4n)

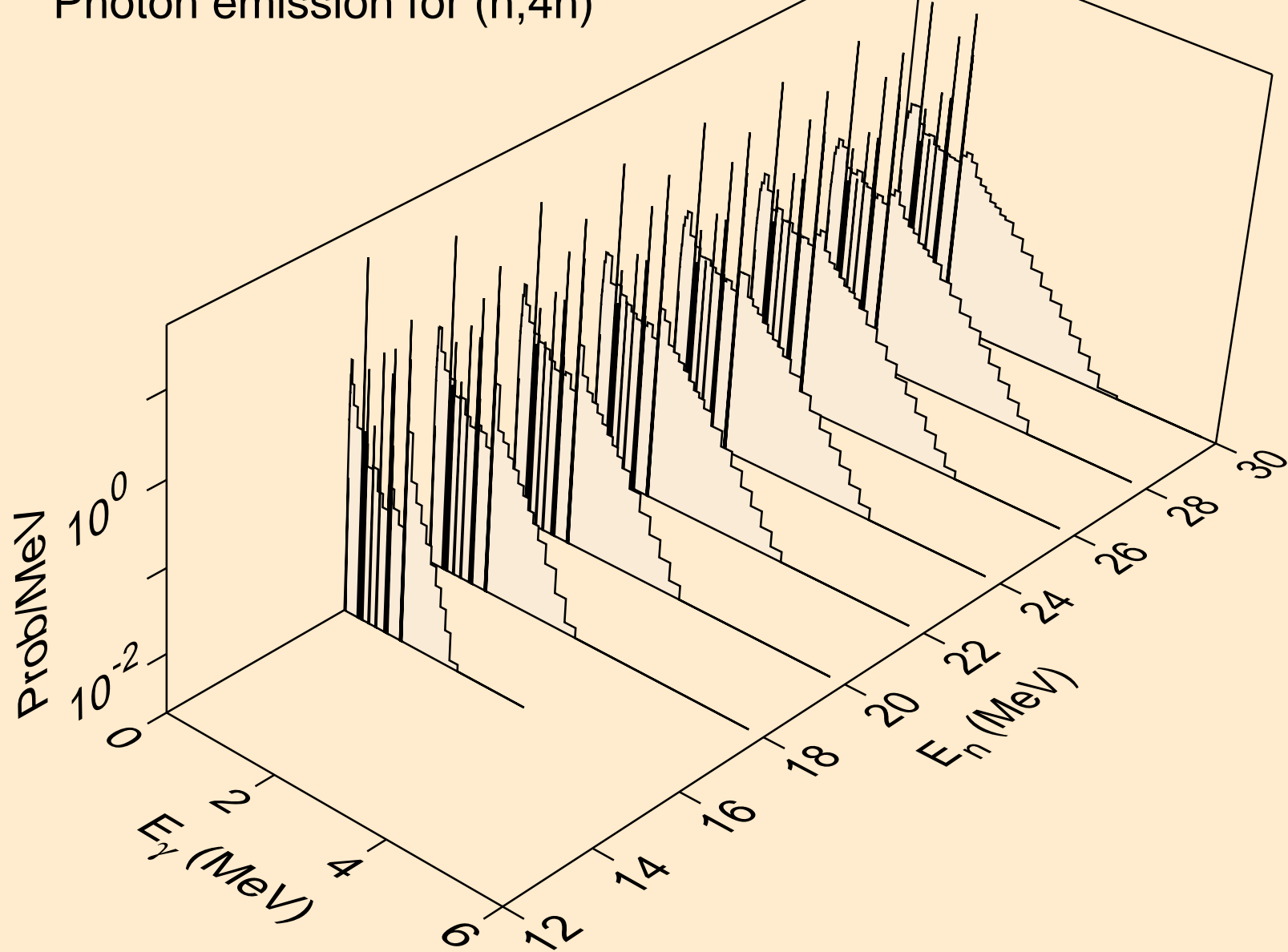

BI216M NEUTRON ACER TENDL-2021 LIBRARY; T=293.6K  
Photon emission for (n,2np)

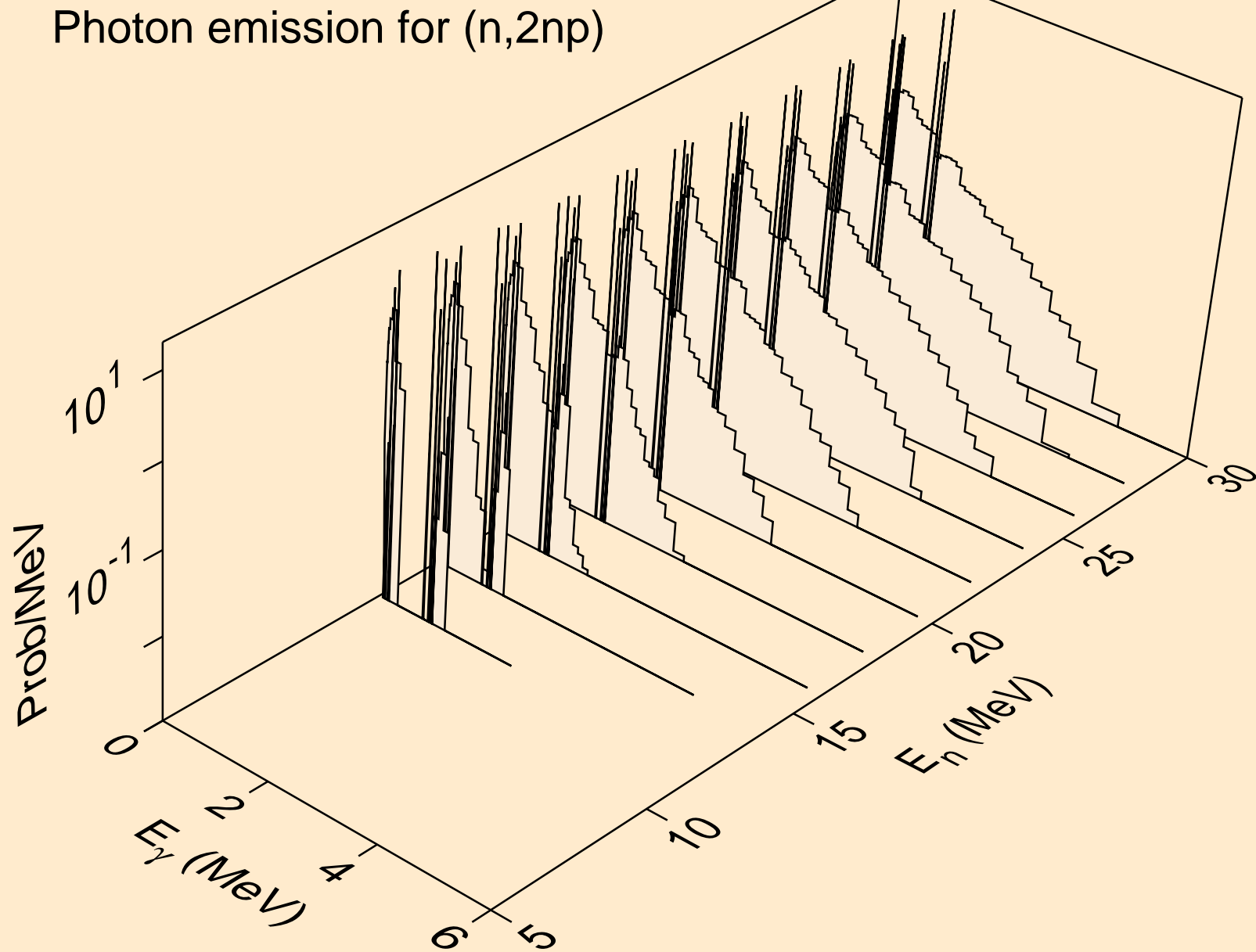

BI216M NEUTRON ACER TENDL-2021 LIBRARY; T=293.6K  
Photon emission for (n,3np)

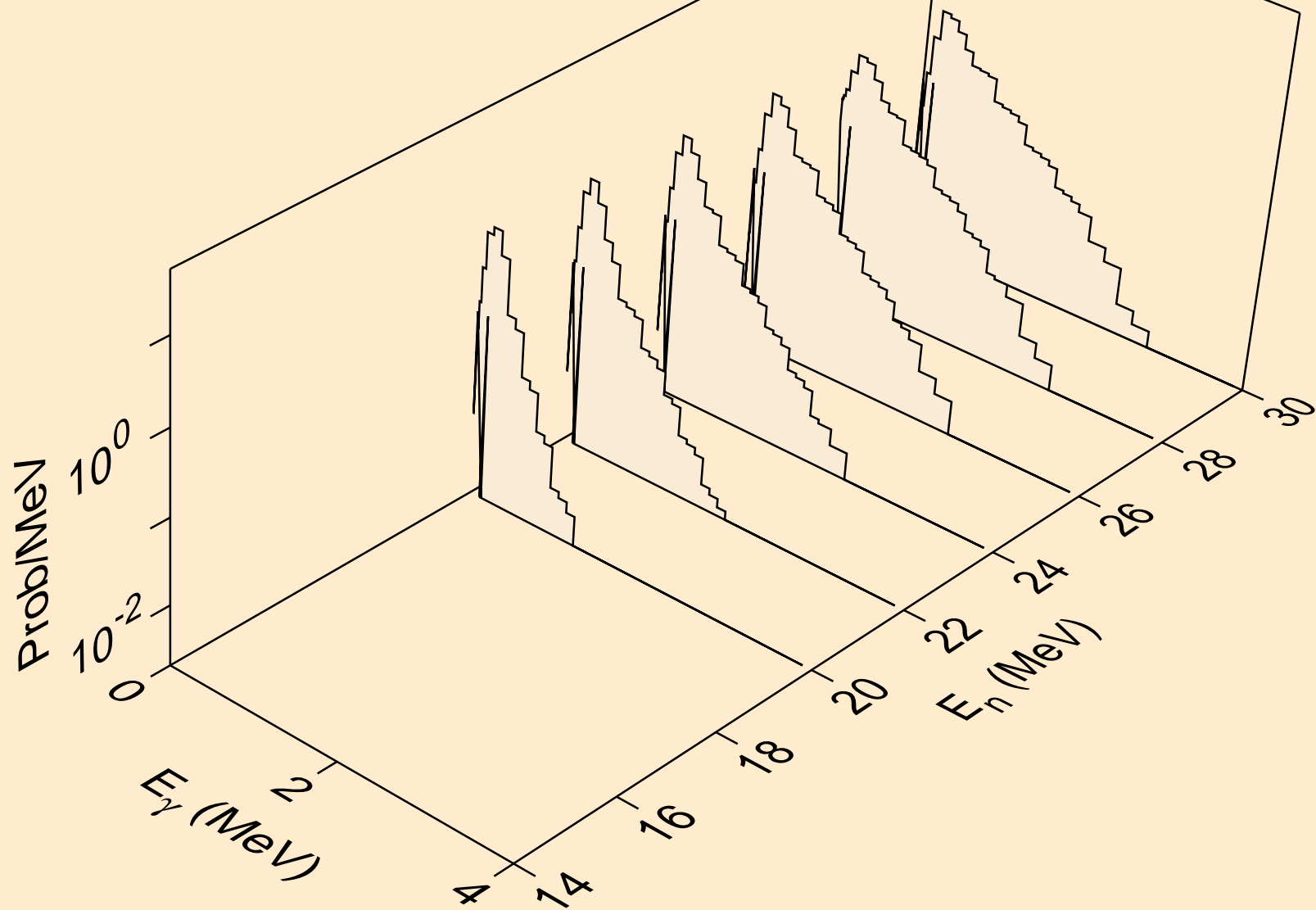

BI216M NEUTRON ACER TENDL-2021 LIBRARY; T=293.6K  
Photon emission for (n,2np)

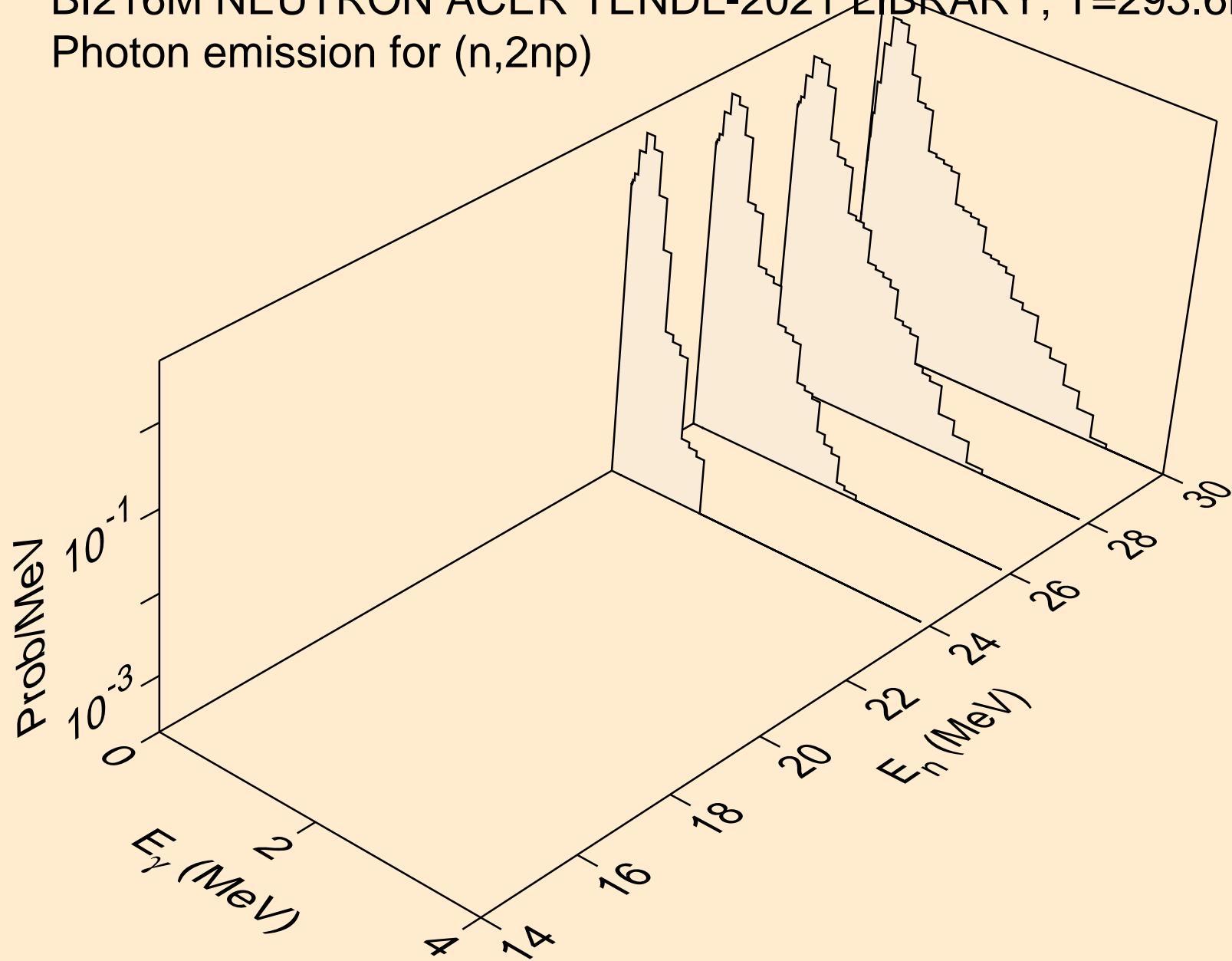

BI216M NEUTRON ACER TENDL-2021 LIBRARY; T=293.6K  
Photon emission for (n,npa)

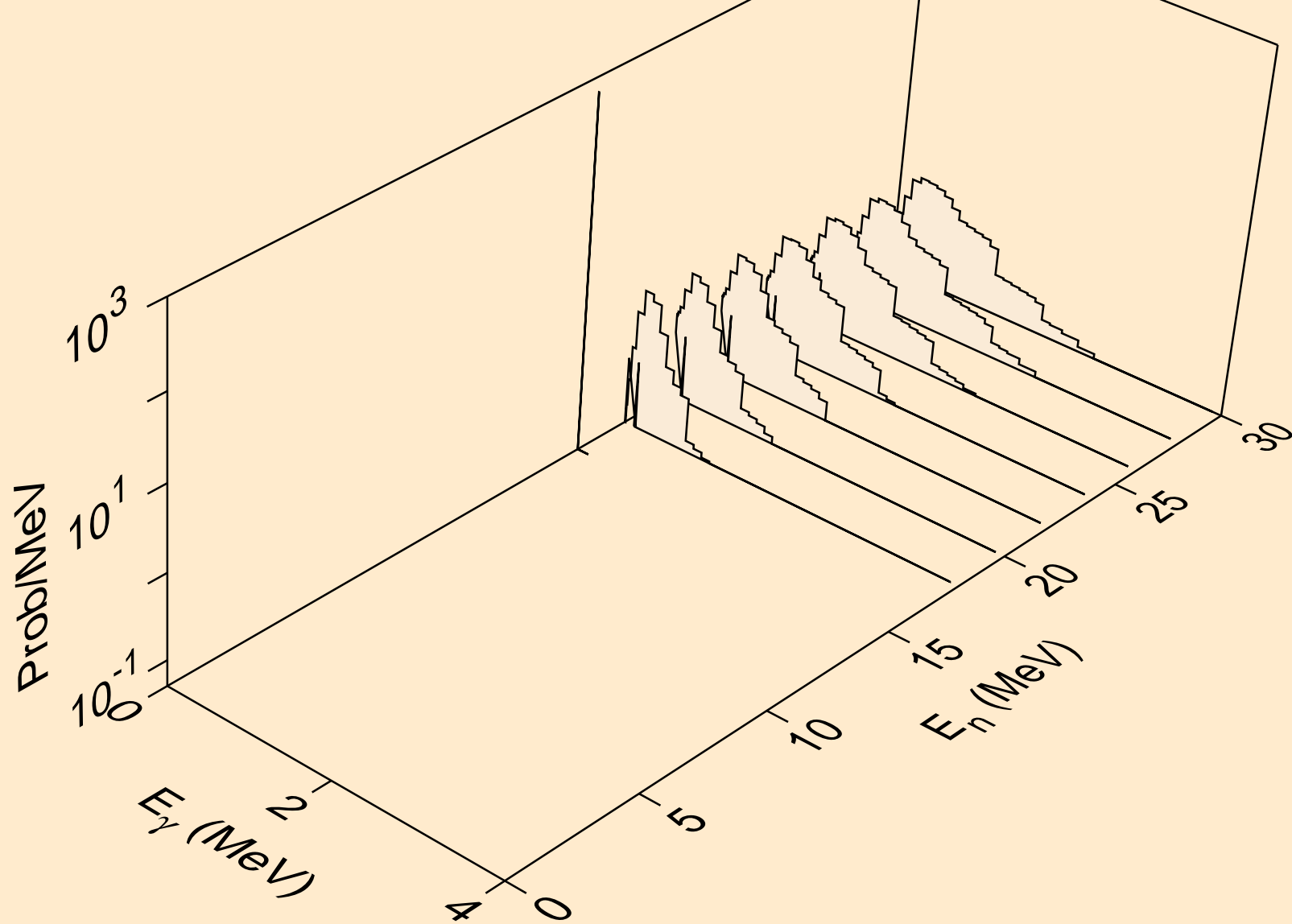

BI216M NEUTRON ACER TENDL-2021 LIBRARY; T=293.6K  
Photon emission for (n,n\*2)

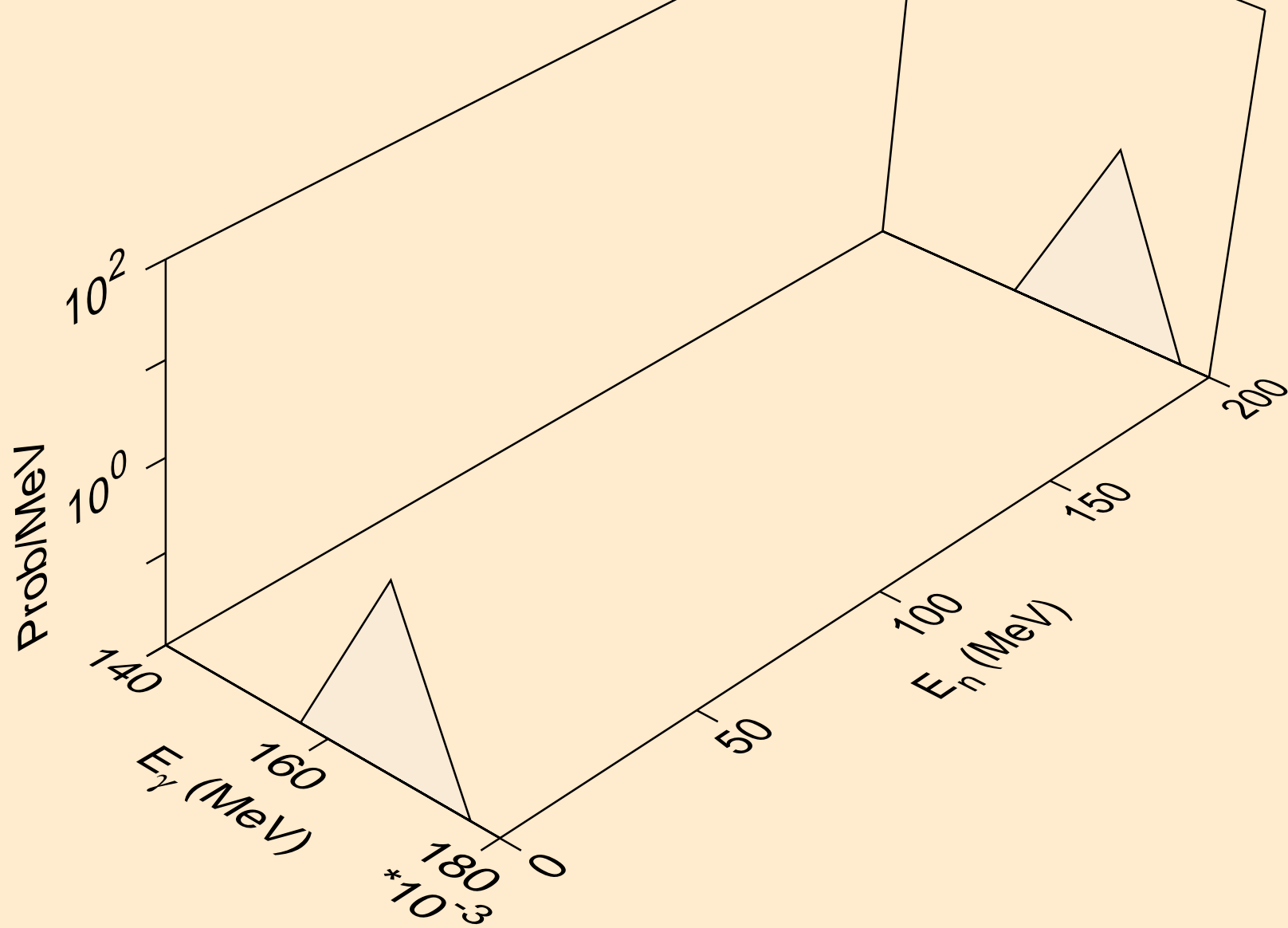

BI216M NEUTRON ACER TENDL-2021 LIBRARY; T=293.6K  
Photon emission for (n,n\*3)

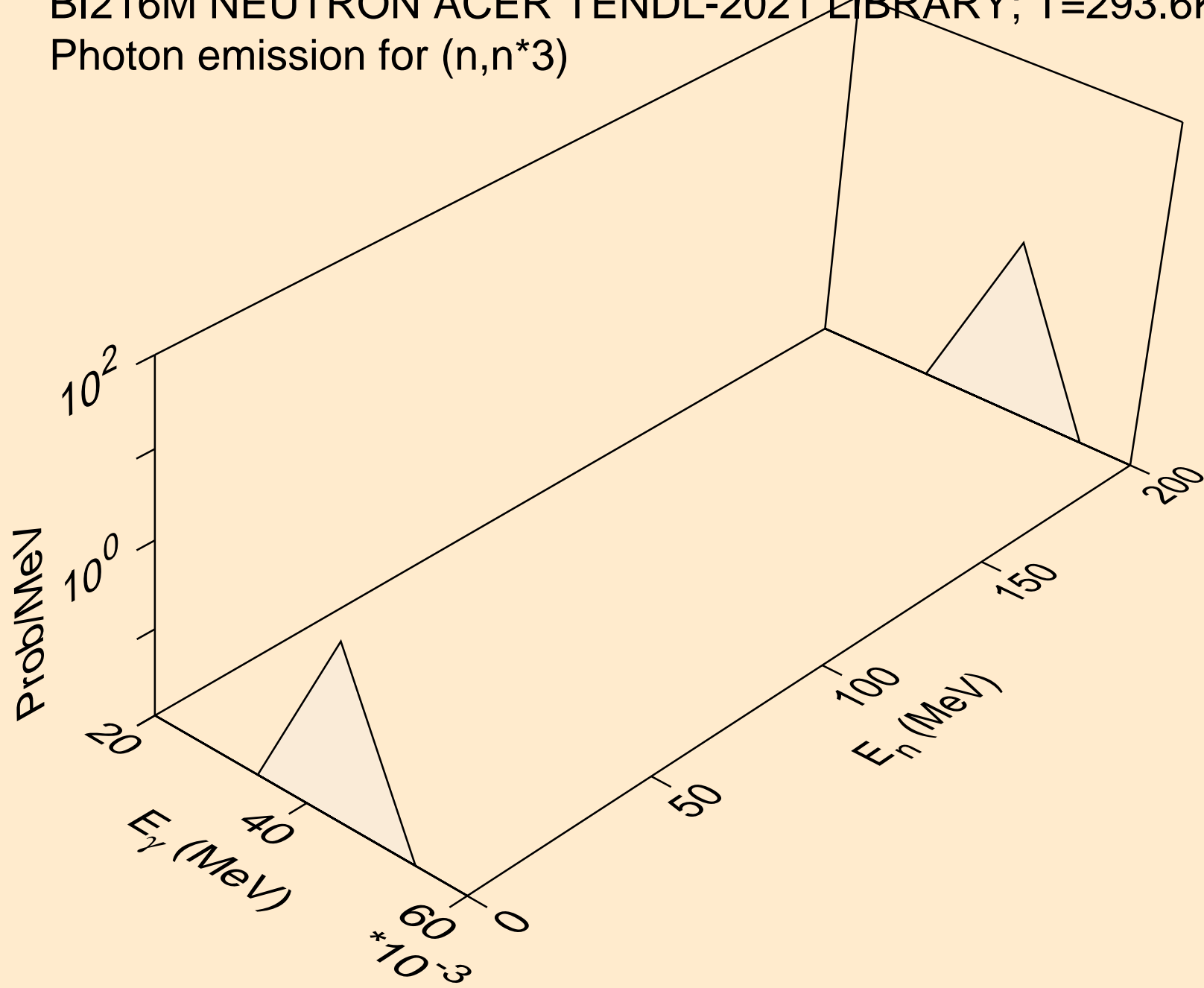



BI216M NEUTRON ACER TENDL-2021 LIBRARY; T=293.6K  
Photon emission for (n,n\*4)

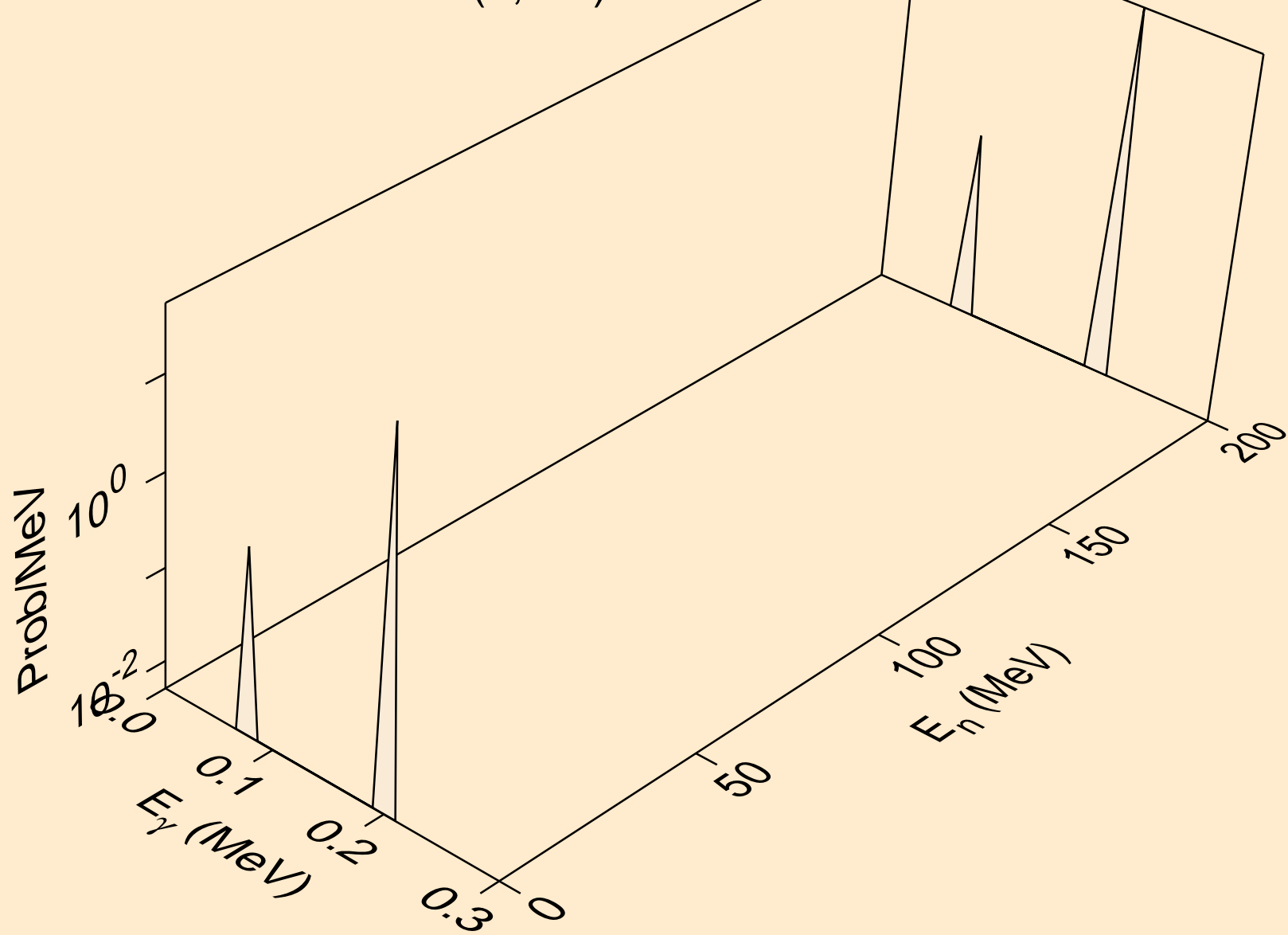

BI216M NEUTRON ACER TENDL-2021 LIBRARY; T=293.6K  
Photon emission for (n,n\*5)

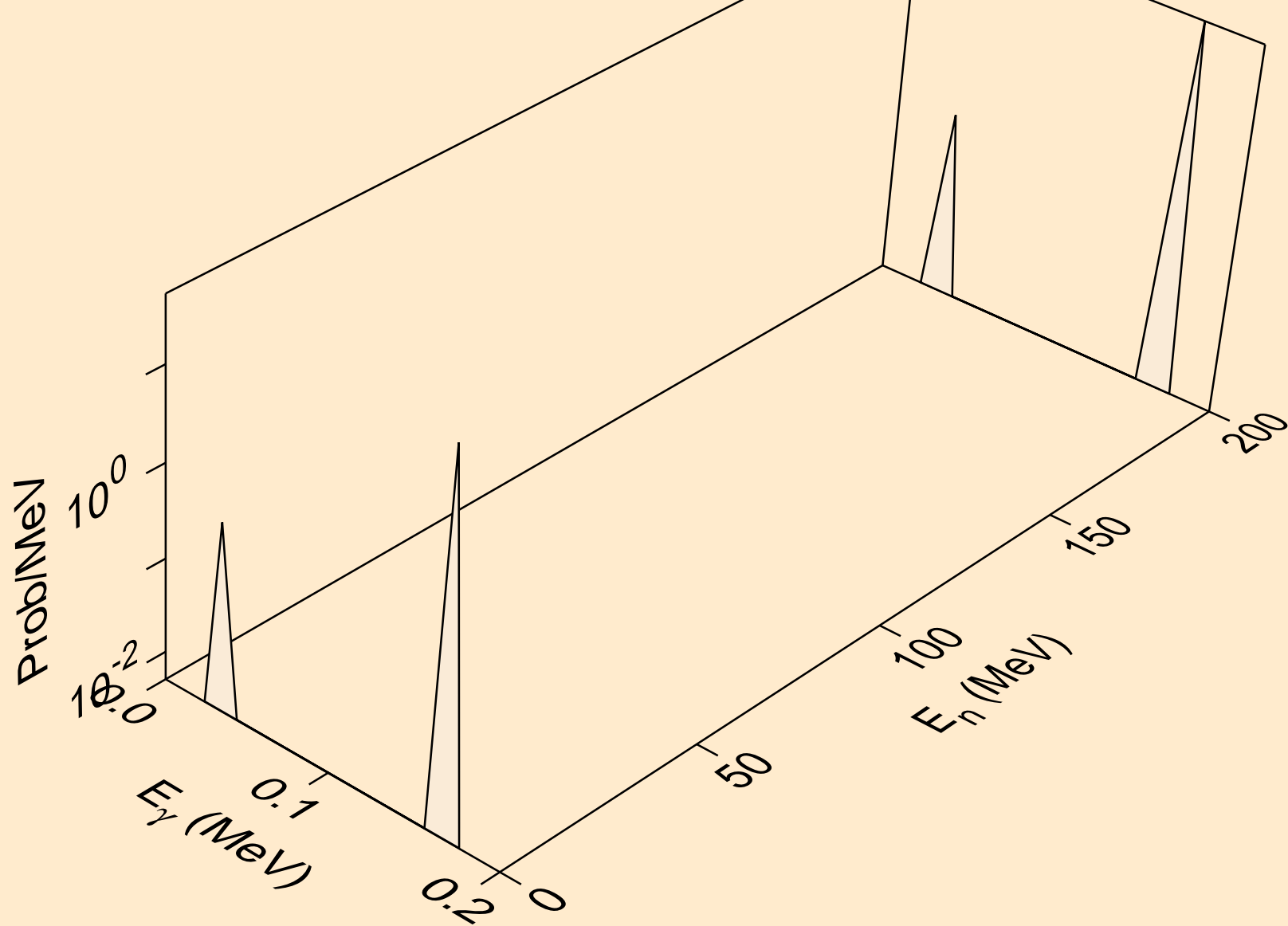

BI216M NEUTRON ACER TENDL-2021 LIBRARY; T=293.6K  
Photon emission for (n,n\*6)

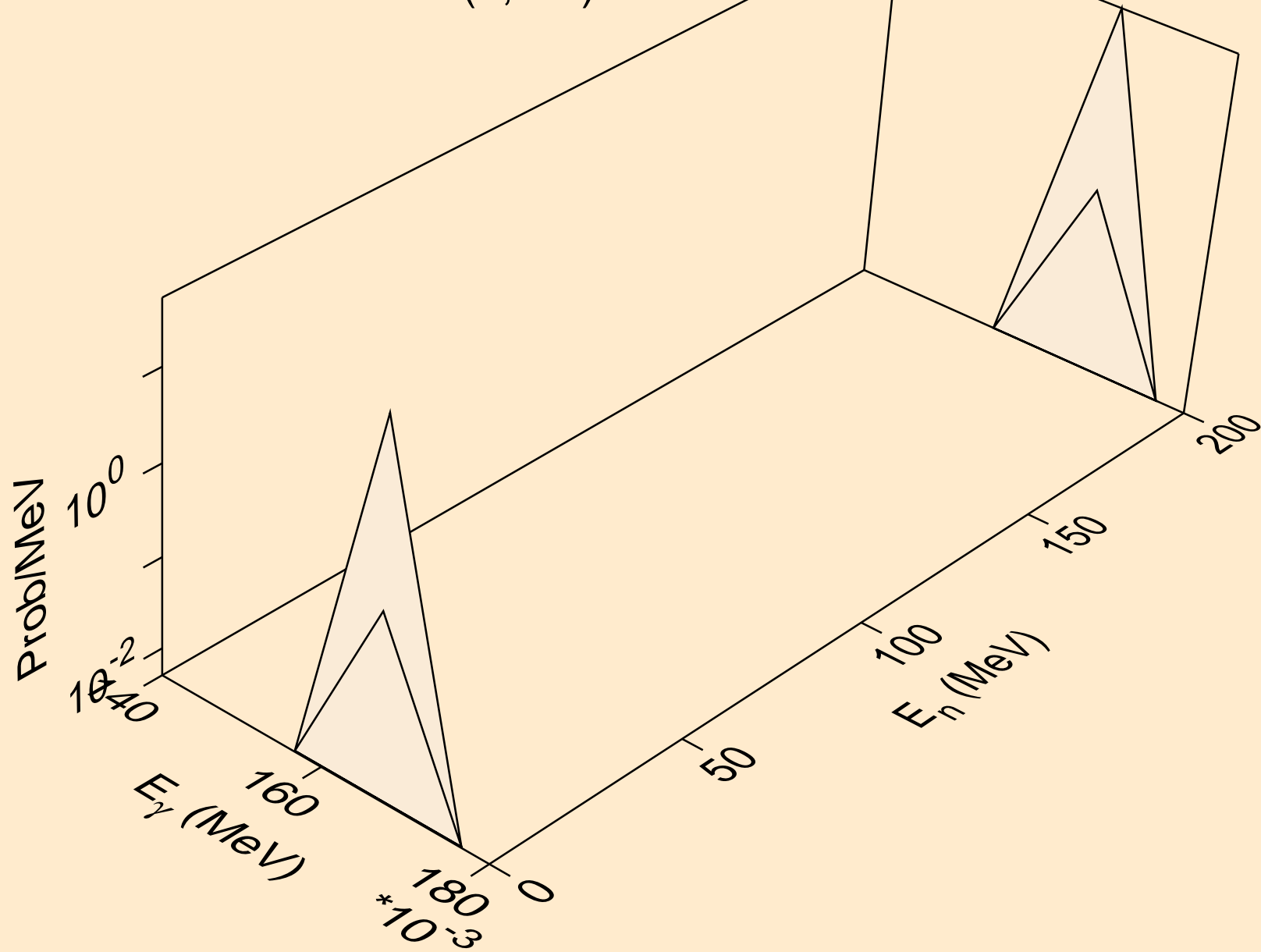

BI216M NEUTRON ACER TENDL-2021 LIBRARY; T=293.6K  
Photon emission for (n,n\*7)

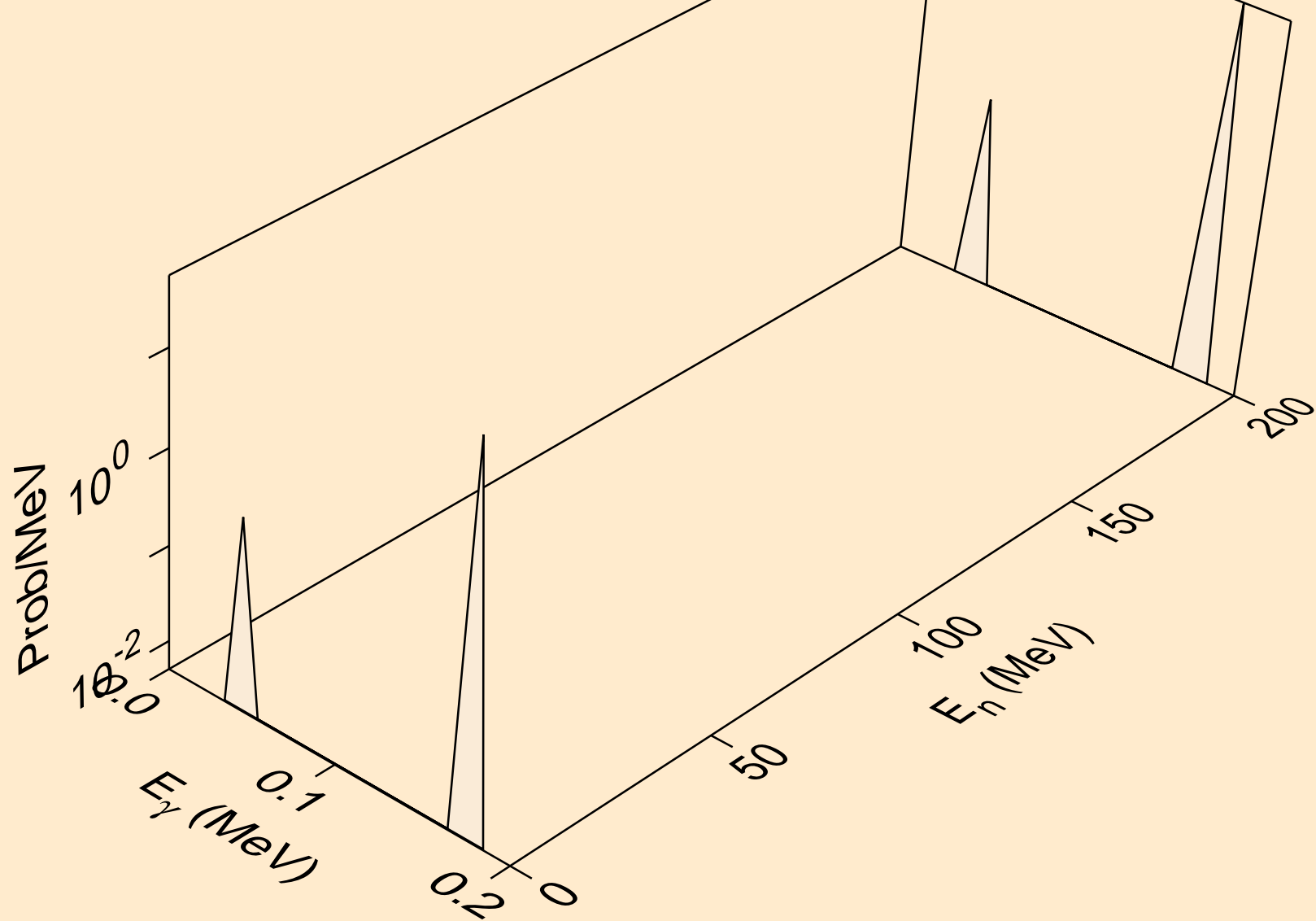

BI216M NEUTRON ACER TENDL-2021 LIBRARY; T=293.6K  
Photon emission for (n,n\*8)

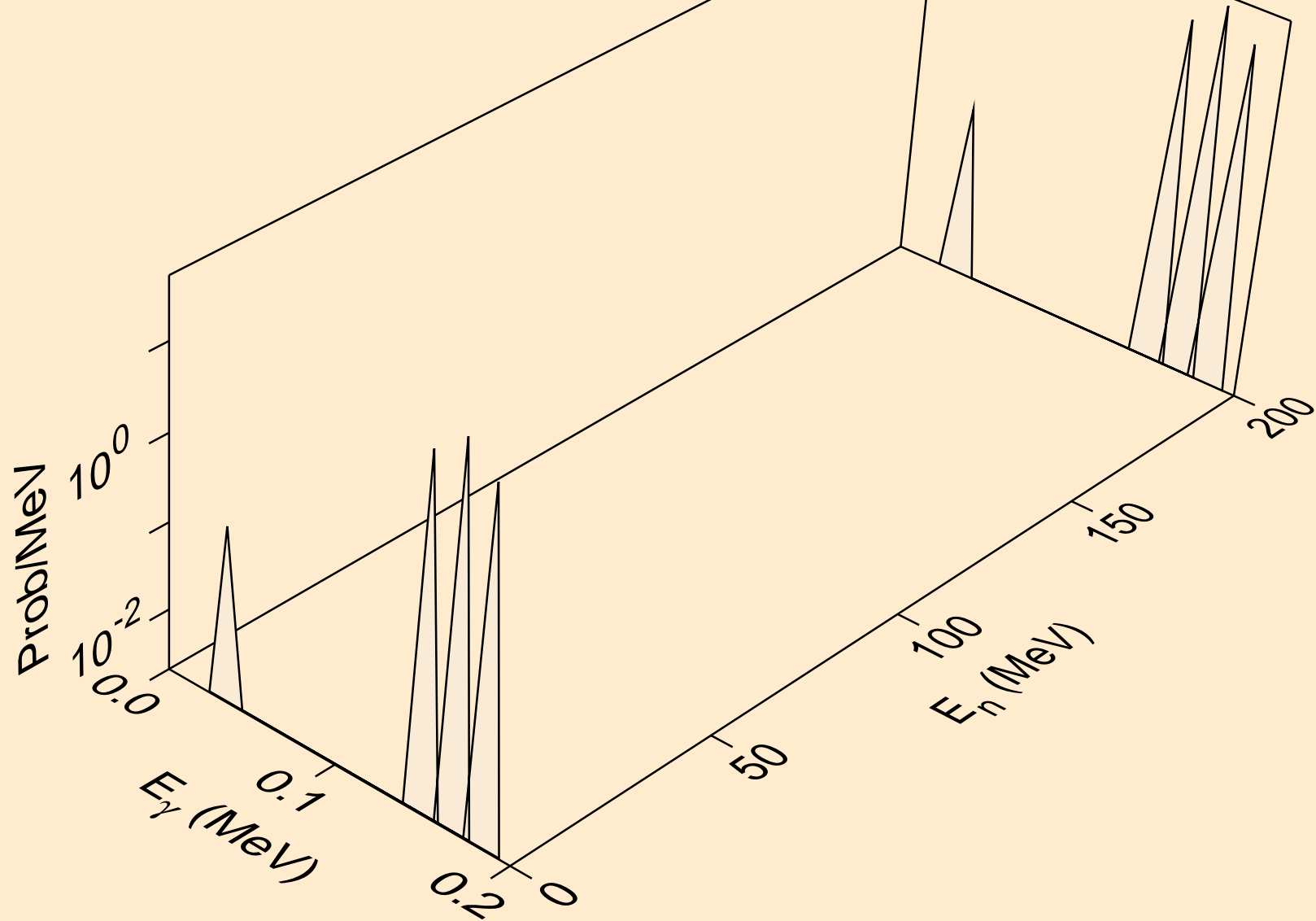

BI216M NEUTRON ACER TENDL-2021 LIBRARY; T=293.6K  
Photon emission for (n,n\*9)

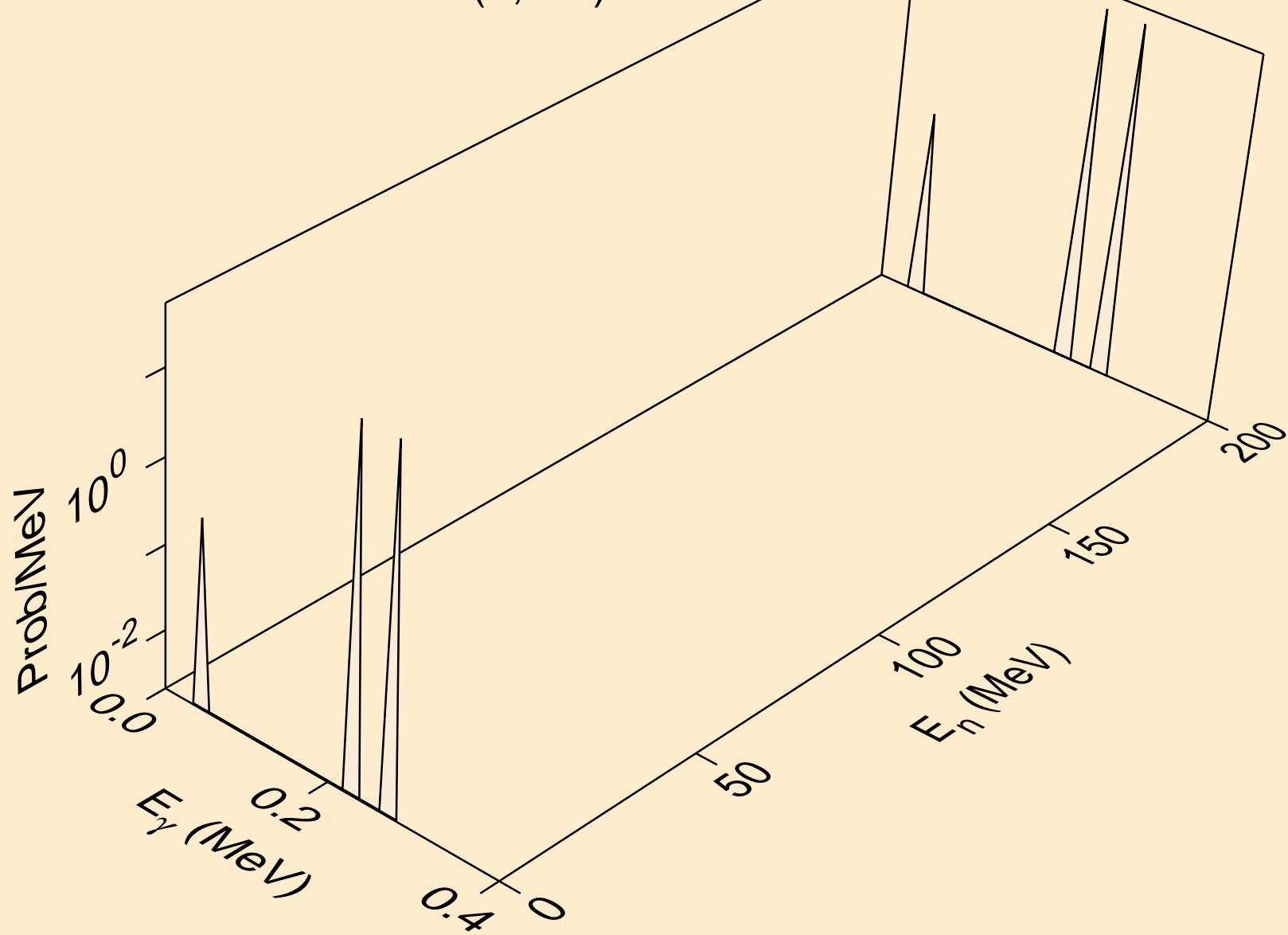

BI216M NEUTRON ACER TENDL-2021 LIBRARY; T=293.6K  
Photon emission for (n,n\*10)

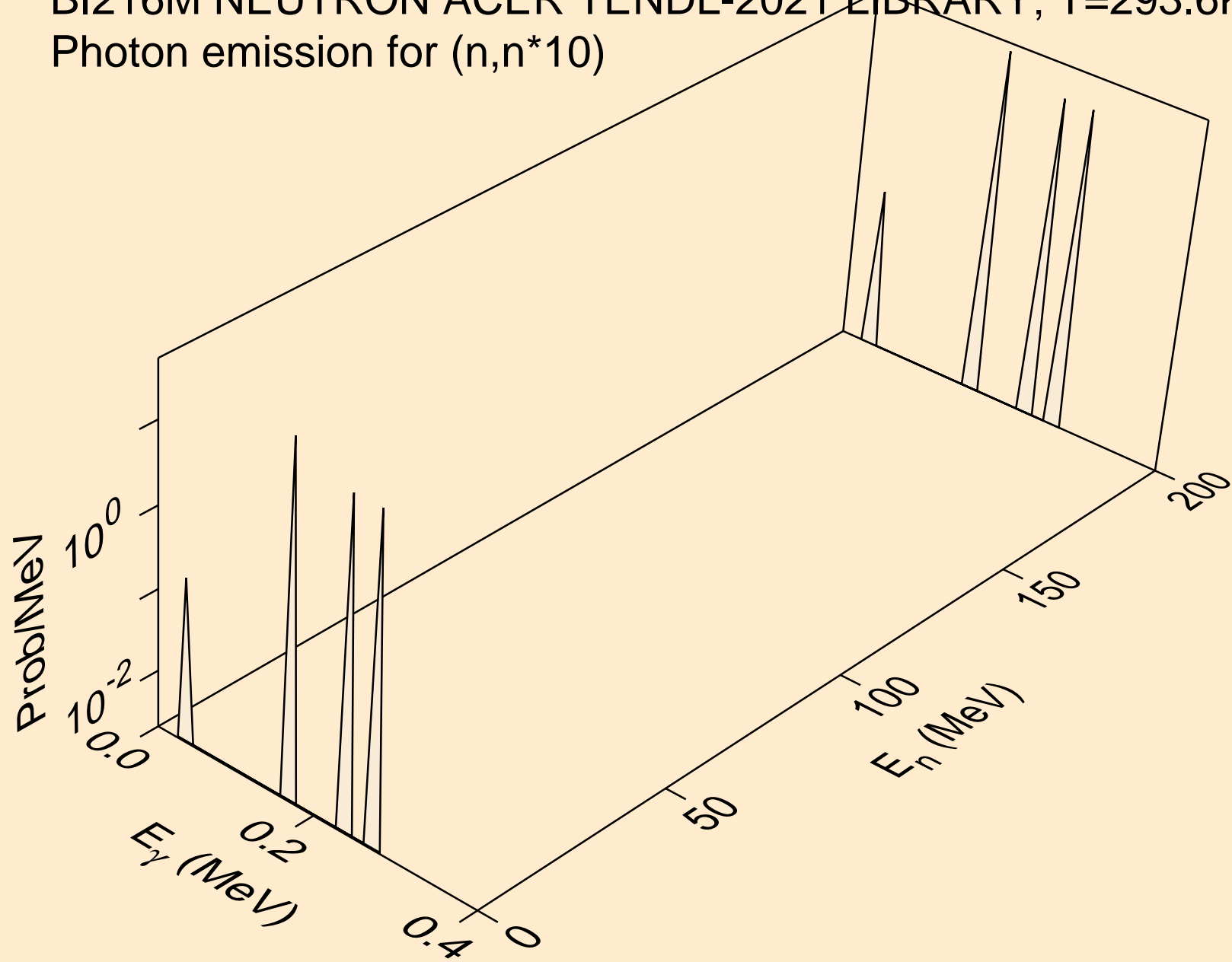

BI216M NEUTRON ACER TENDL-2021 LIBRARY; T=293.6K  
Photon emission for (n,n\*11)

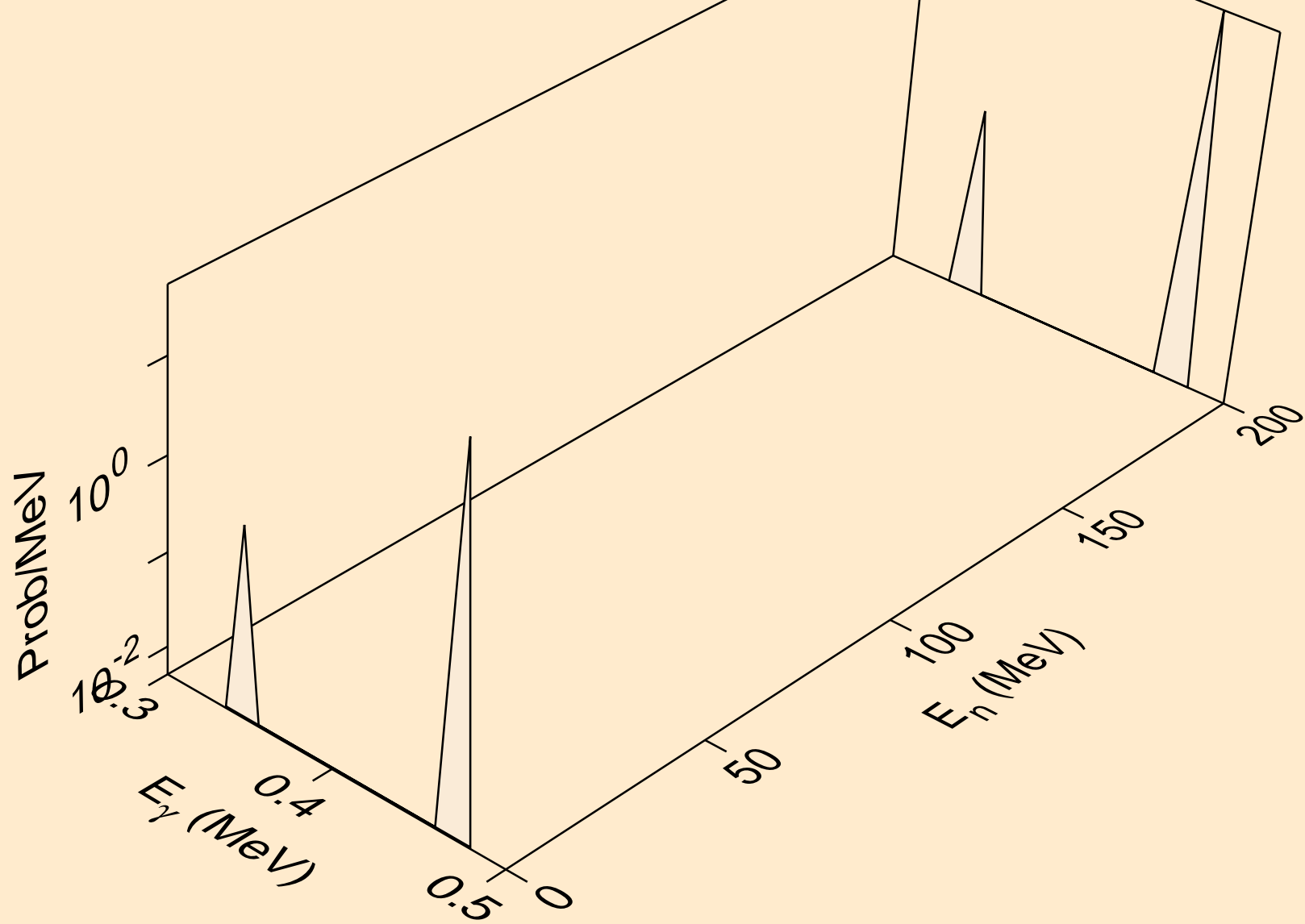



BI216M NEUTRON ACER TENDL-2021 LIBRARY; T=293.6K  
Photon emission for (n,n\*12)

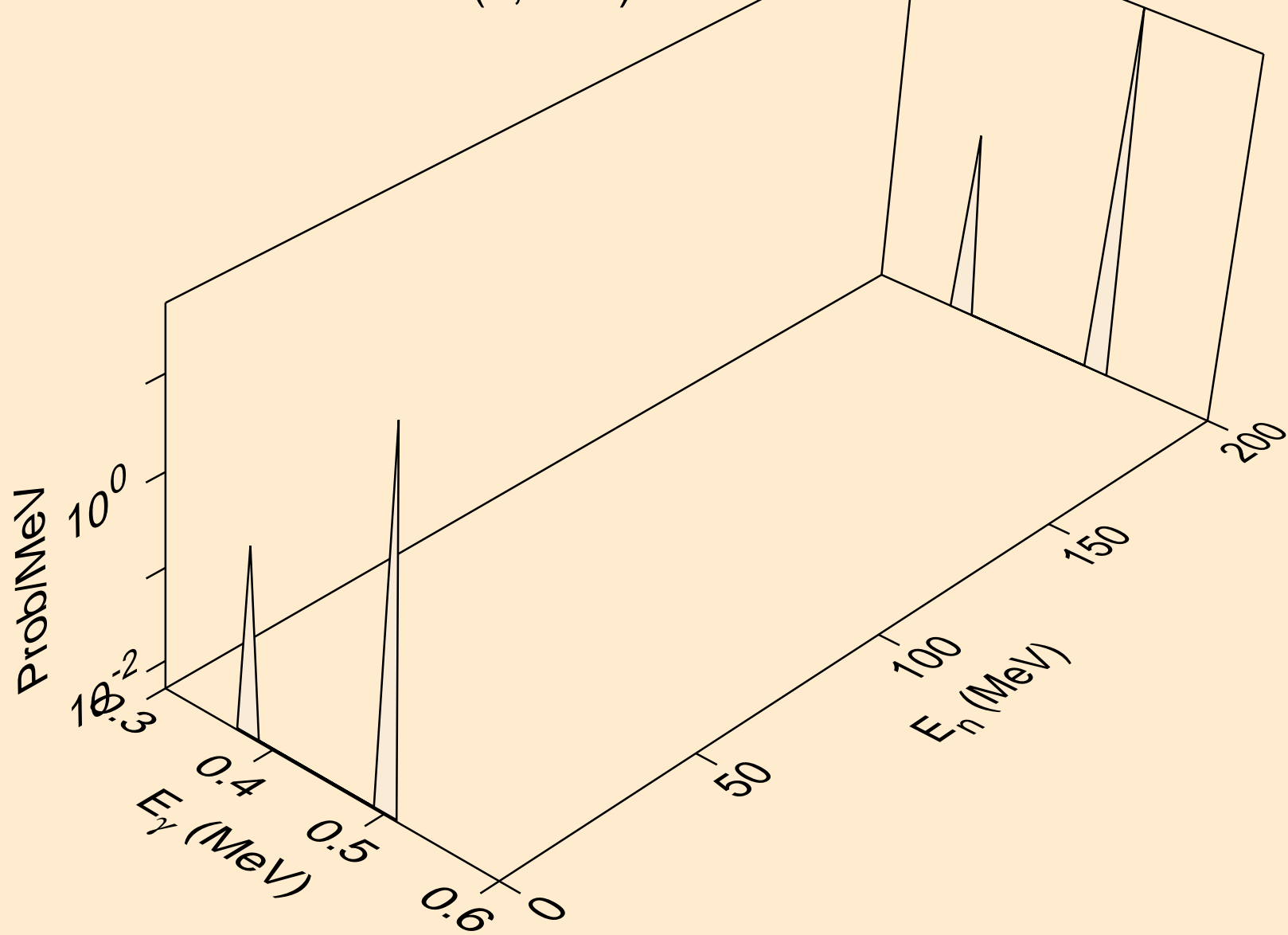

BI216M NEUTRON ACER TENDL-2021 LIBRARY; T=293.6K  
Photon emission for (n,n\*13)

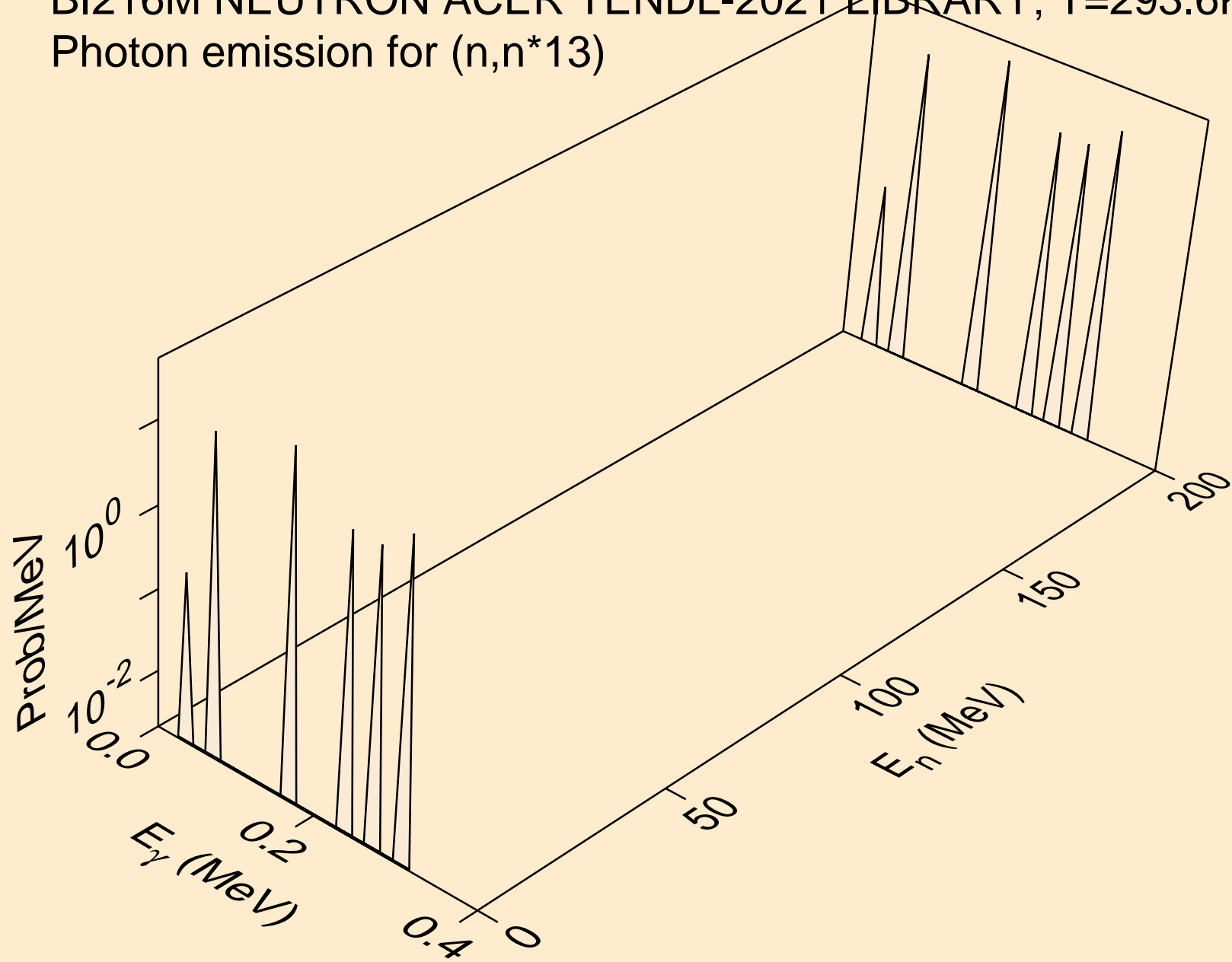

BI216M NEUTRON ACER TENDL-2021 LIBRARY; T=293.6K  
Photon emission for (n,n\*14)

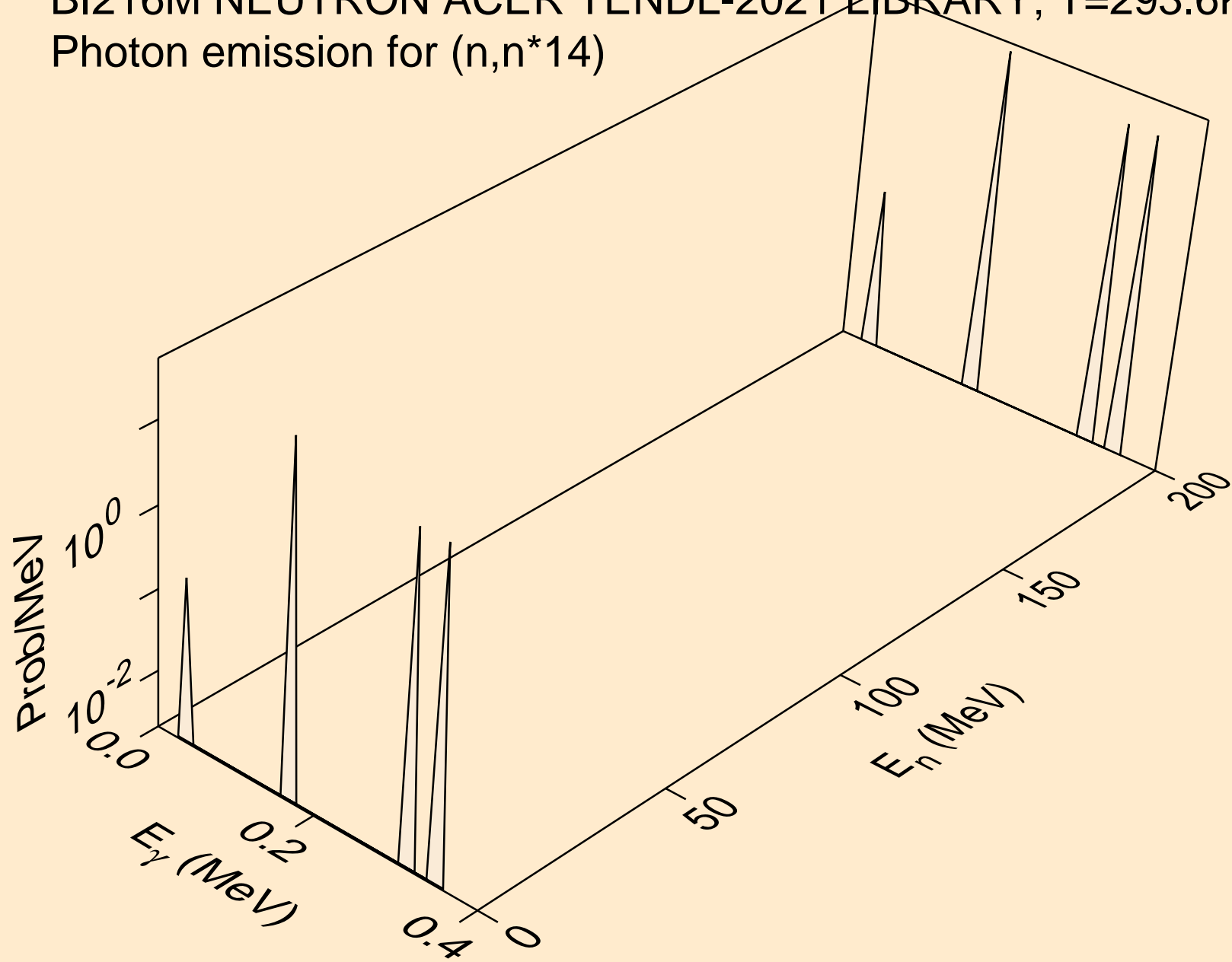

BI216M NEUTRON ACER TENDL-2021 LIBRARY; T=293.6K  
Photon emission for (n,n\*15)

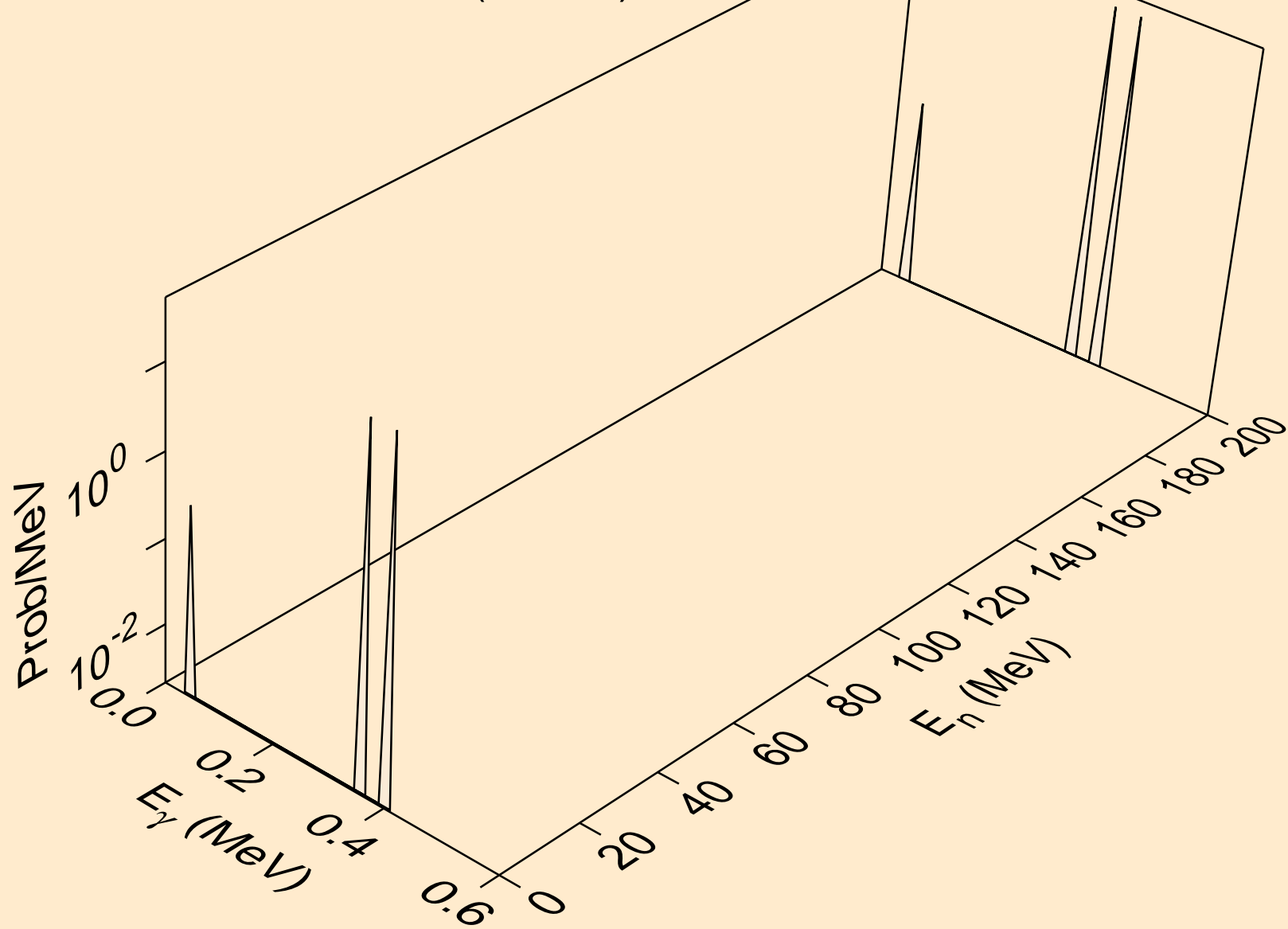

BI216M NEUTRON ACER TENDL-2021 LIBRARY; T=293.6K  
Photon emission for (n,n\*16)

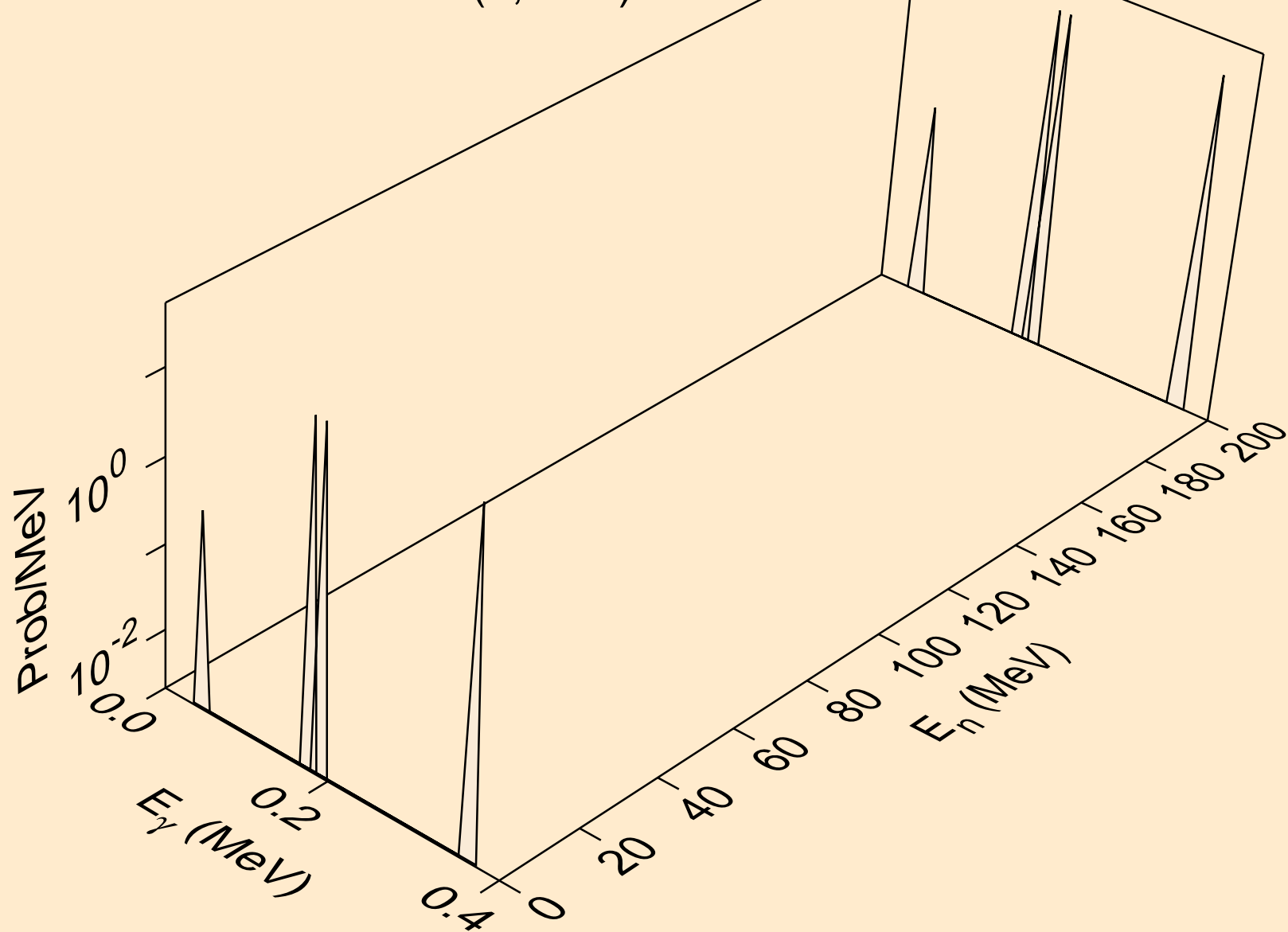

BI216M NEUTRON ACER TENDL-2021 LIBRARY; T=293.6K  
Photon emission for (n,n\*17)

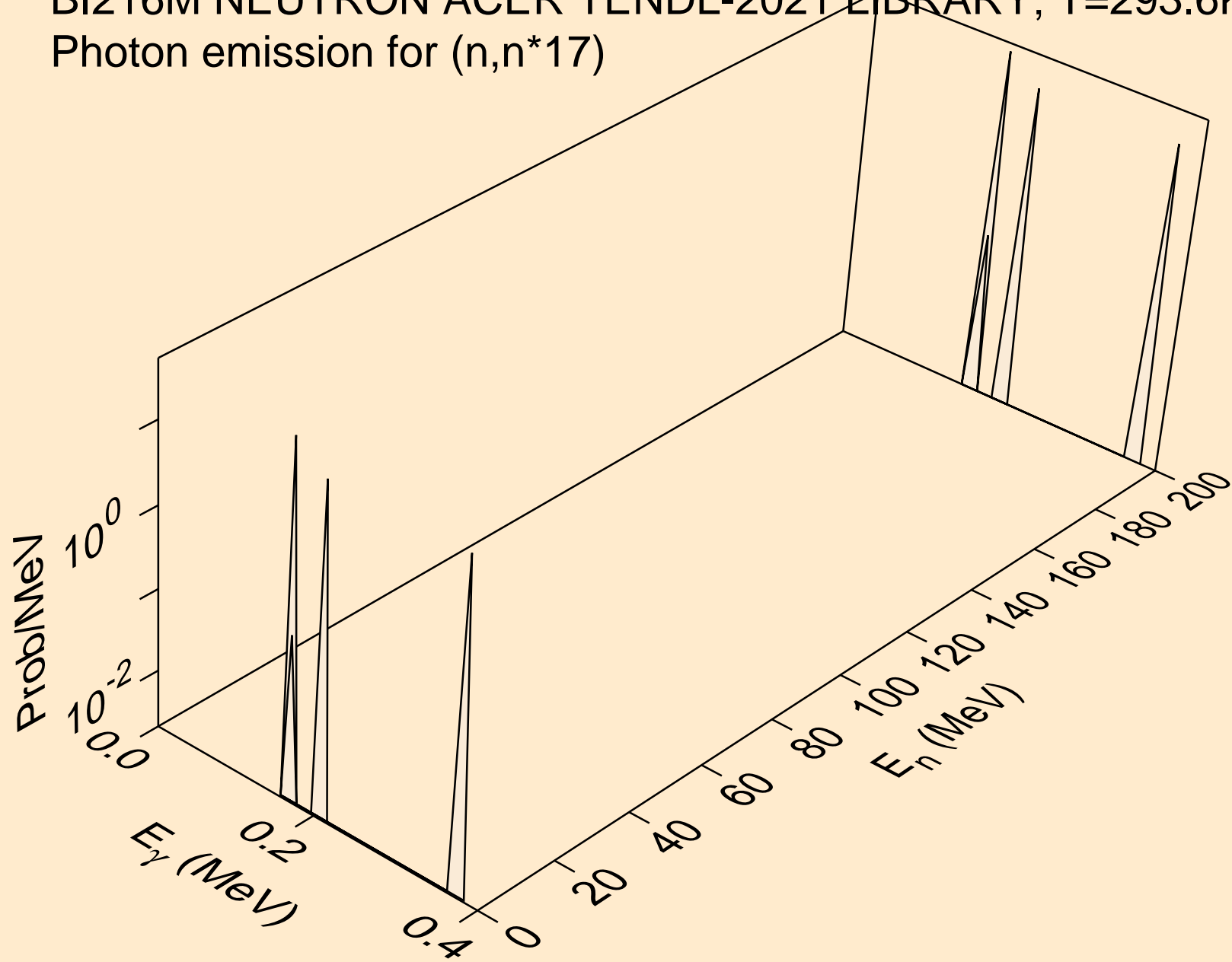

BI216M NEUTRON ACER TENDL-2021 LIBRARY; T=293.6K  
Photon emission for (n,n\*18)

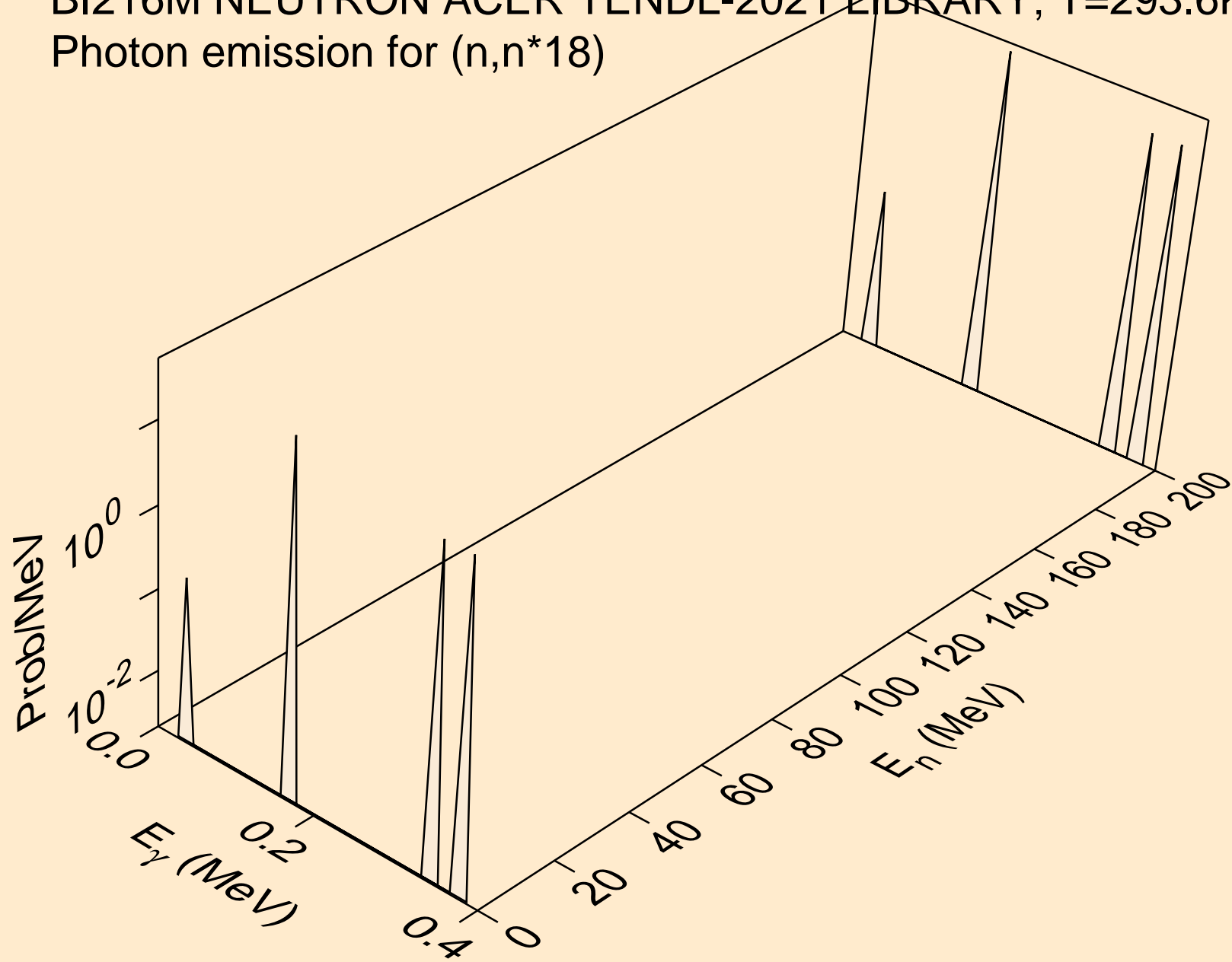

BI216M NEUTRON ACER TENDL-2021 LIBRARY; T=293.6K  
Photon emission for (n,n\*19)

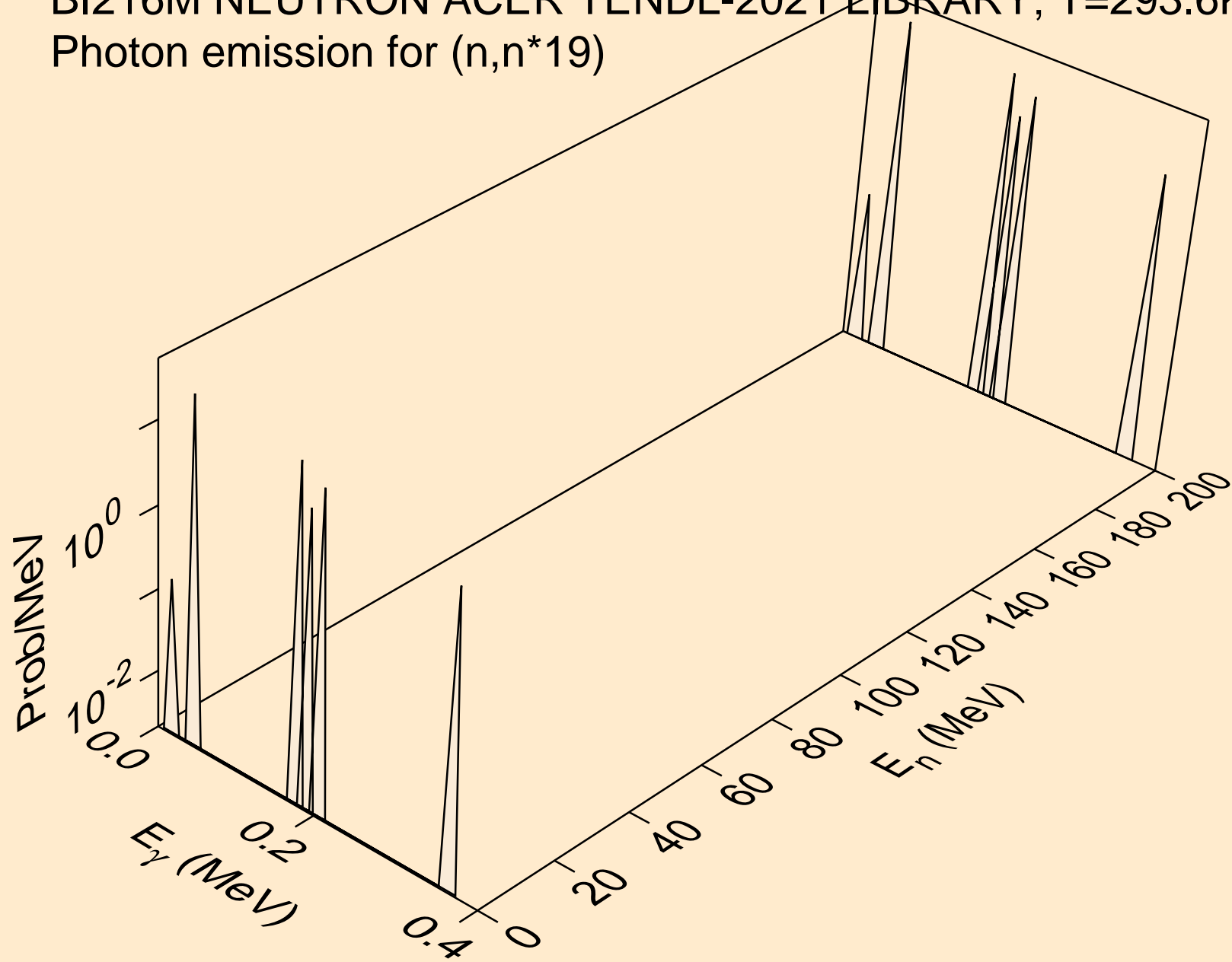



BI216M NEUTRON ACER TENDL-2021 LIBRARY; T=293.6K  
Photon emission for (n,n\*20)

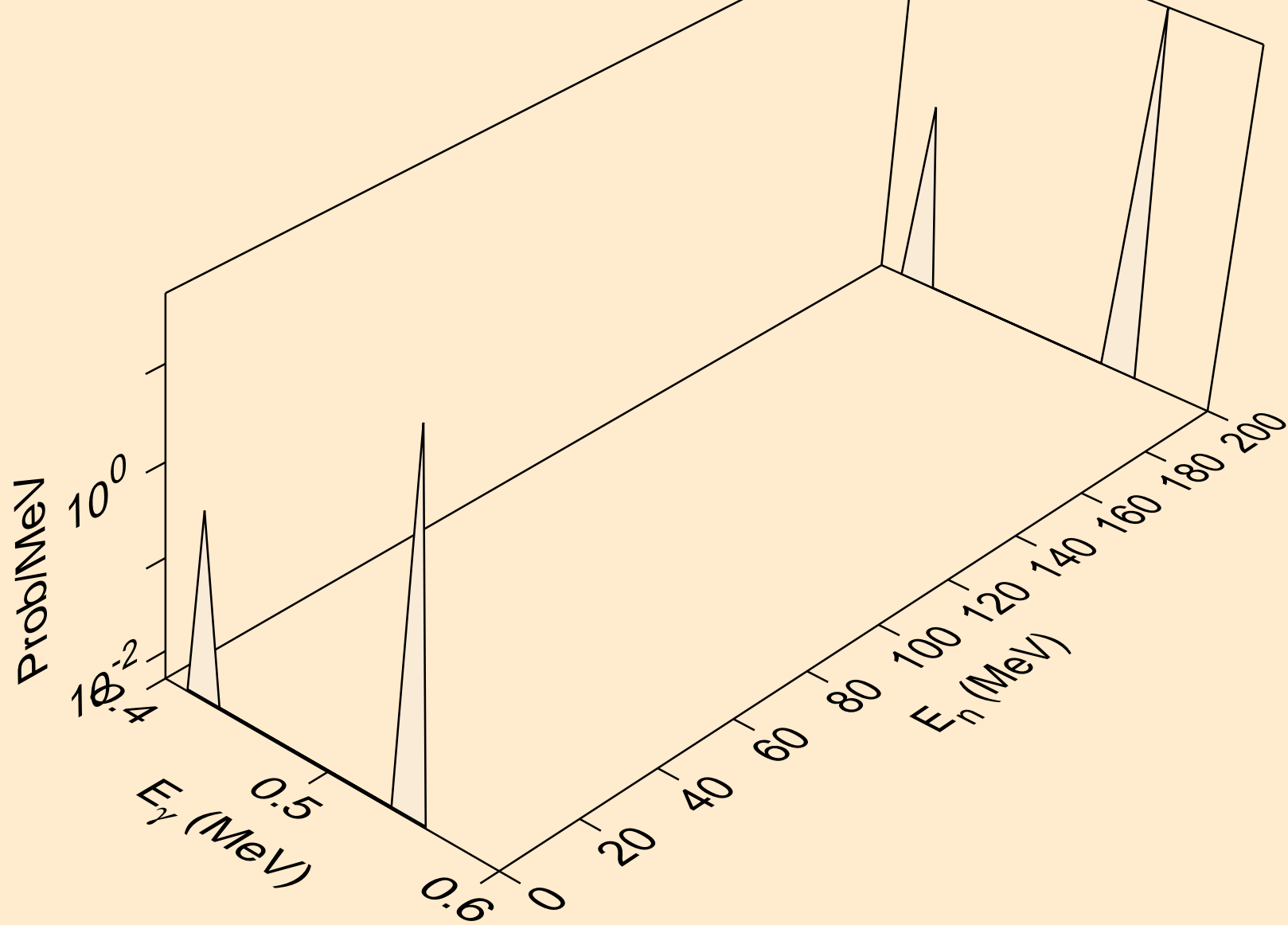

BI216M NEUTRON ACER TENDL-2021 LIBRARY; T=293.6K  
Photon emission for (n,n\*21)

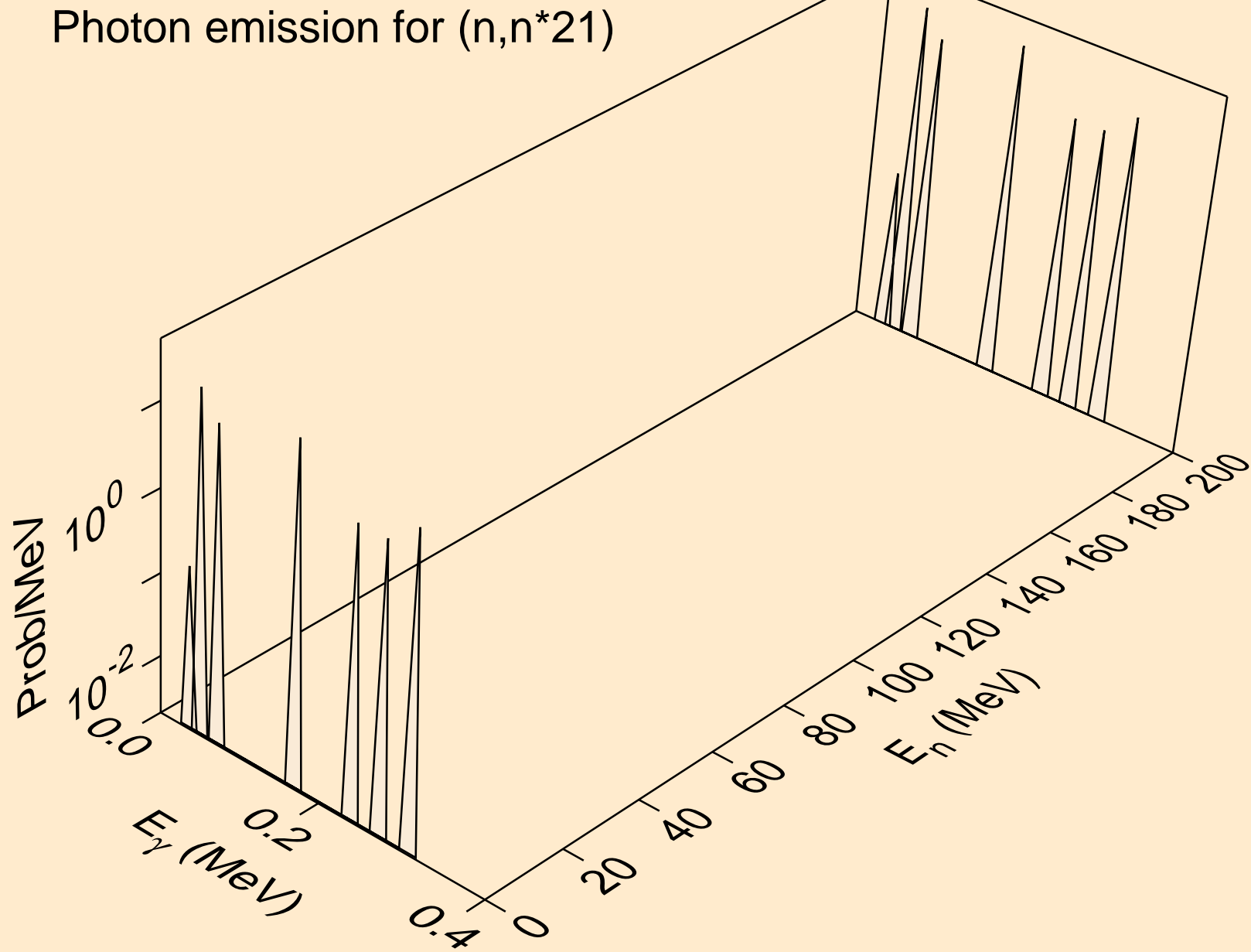

BI216M NEUTRON ACER TENDL-2021 LIBRARY; T=293.6K  
Photon emission for (n,n\*22)

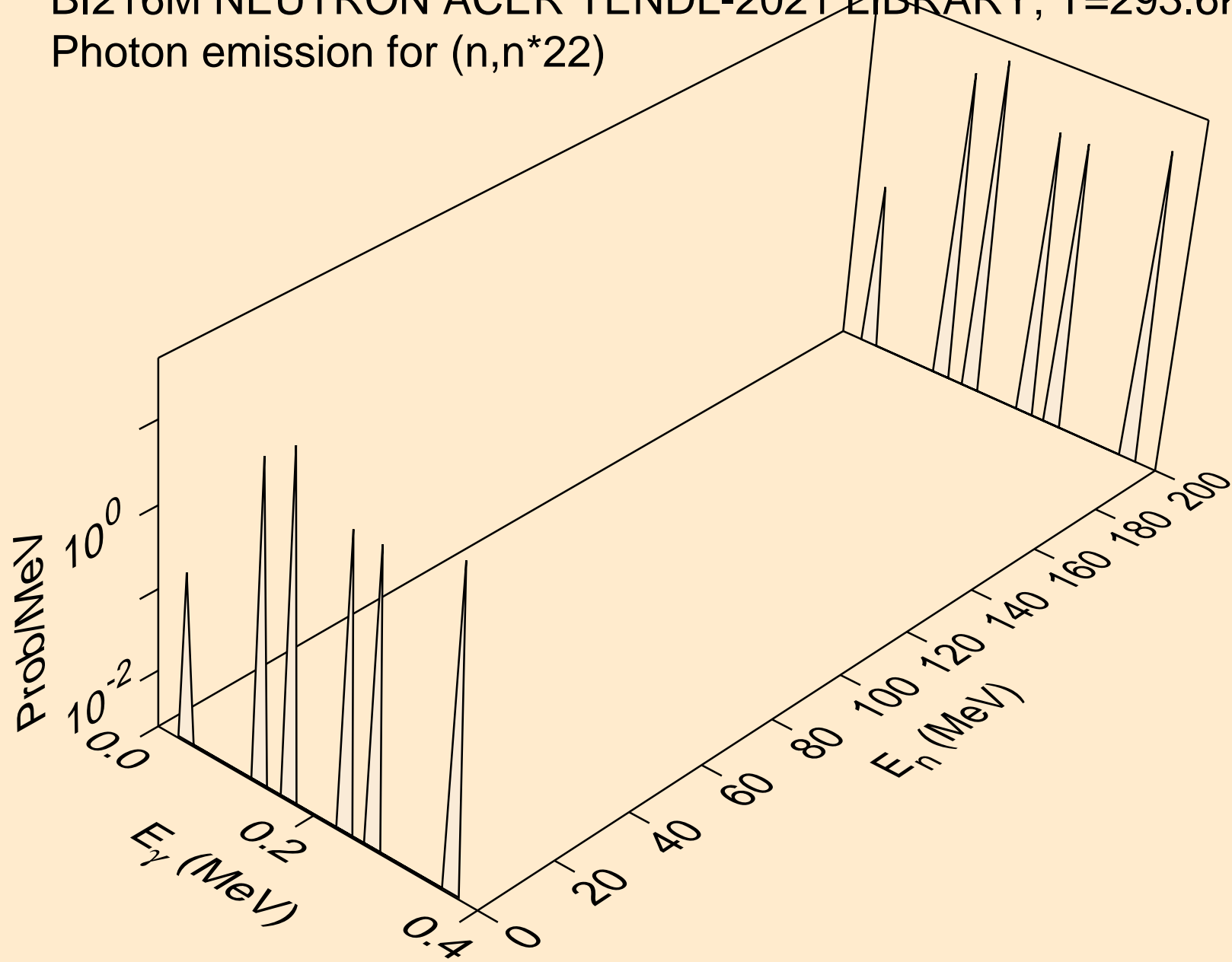

BI216M NEUTRON ACER TENDL-2021 LIBRARY; T=293.6K  
Photon emission for (n,n\*23)

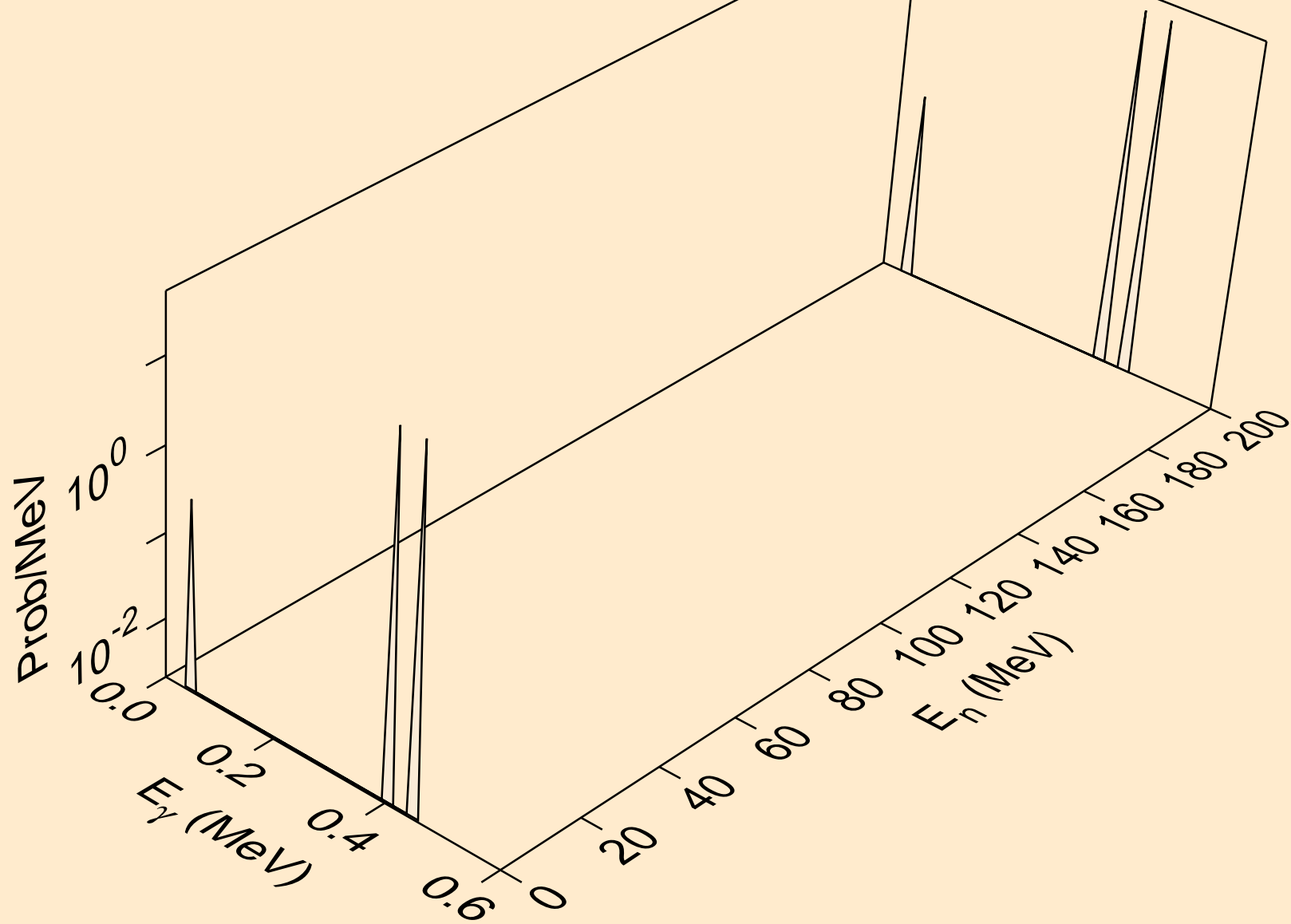

BI216M NEUTRON ACER TENDL-2021 LIBRARY; T=293.6K  
Photon emission for (n,n\*24)

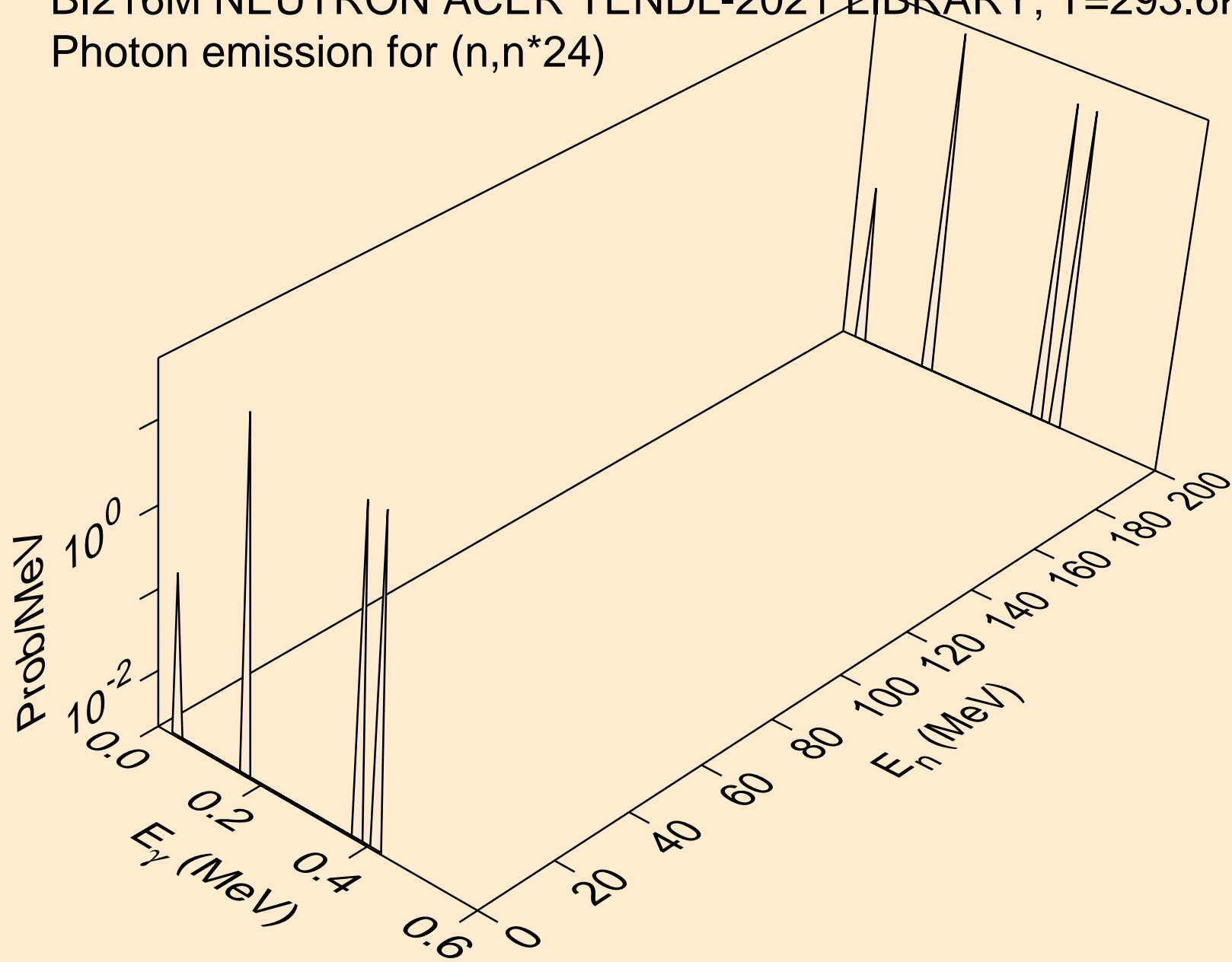

BI216M NEUTRON ACER TENDL-2021 LIBRARY; T=293.6K  
Photon emission for (n,n\*25)

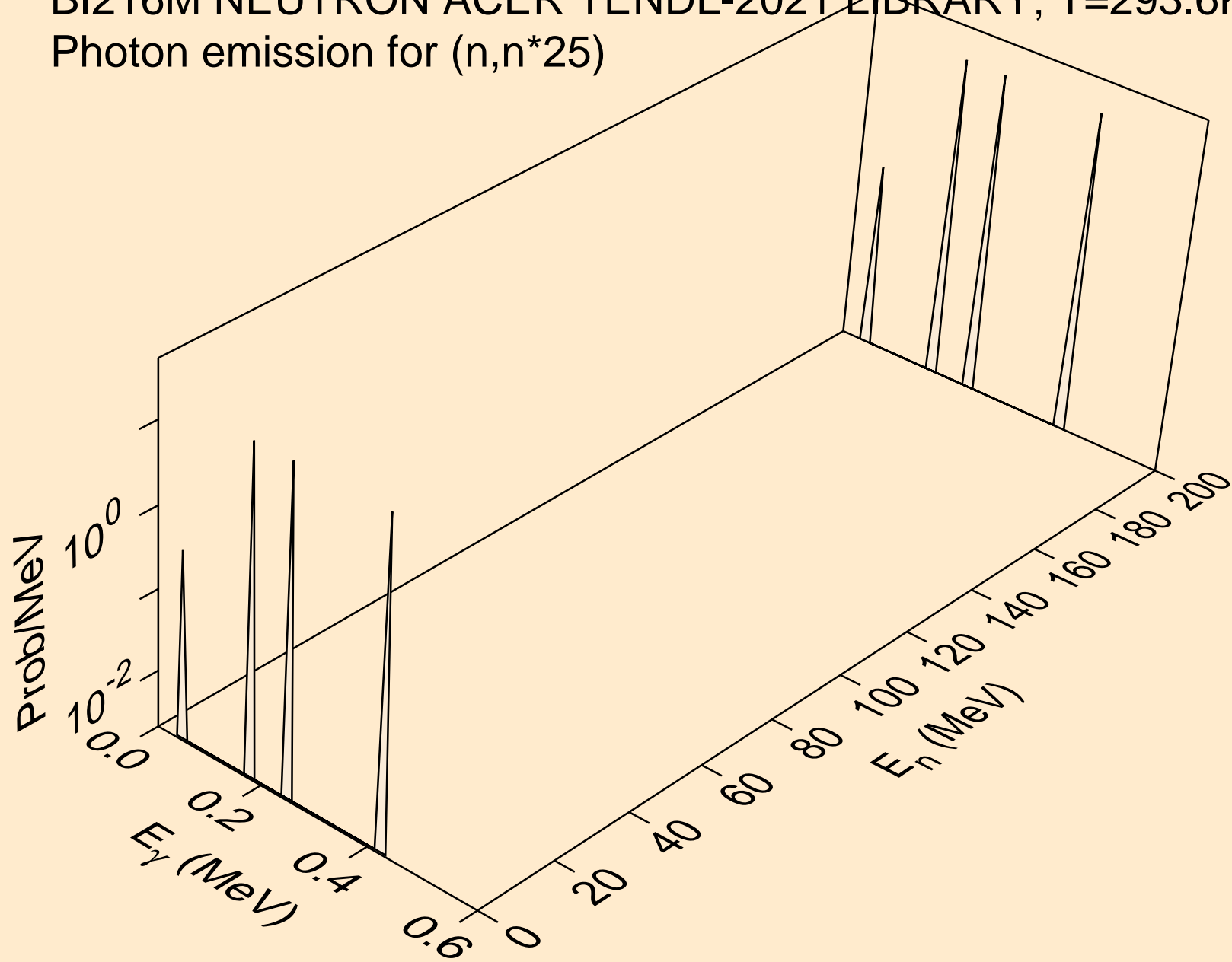

BI216M NEUTRON ACER TENDL-2021 LIBRARY; T=293.6K  
Photon emission for (n,n\*26)

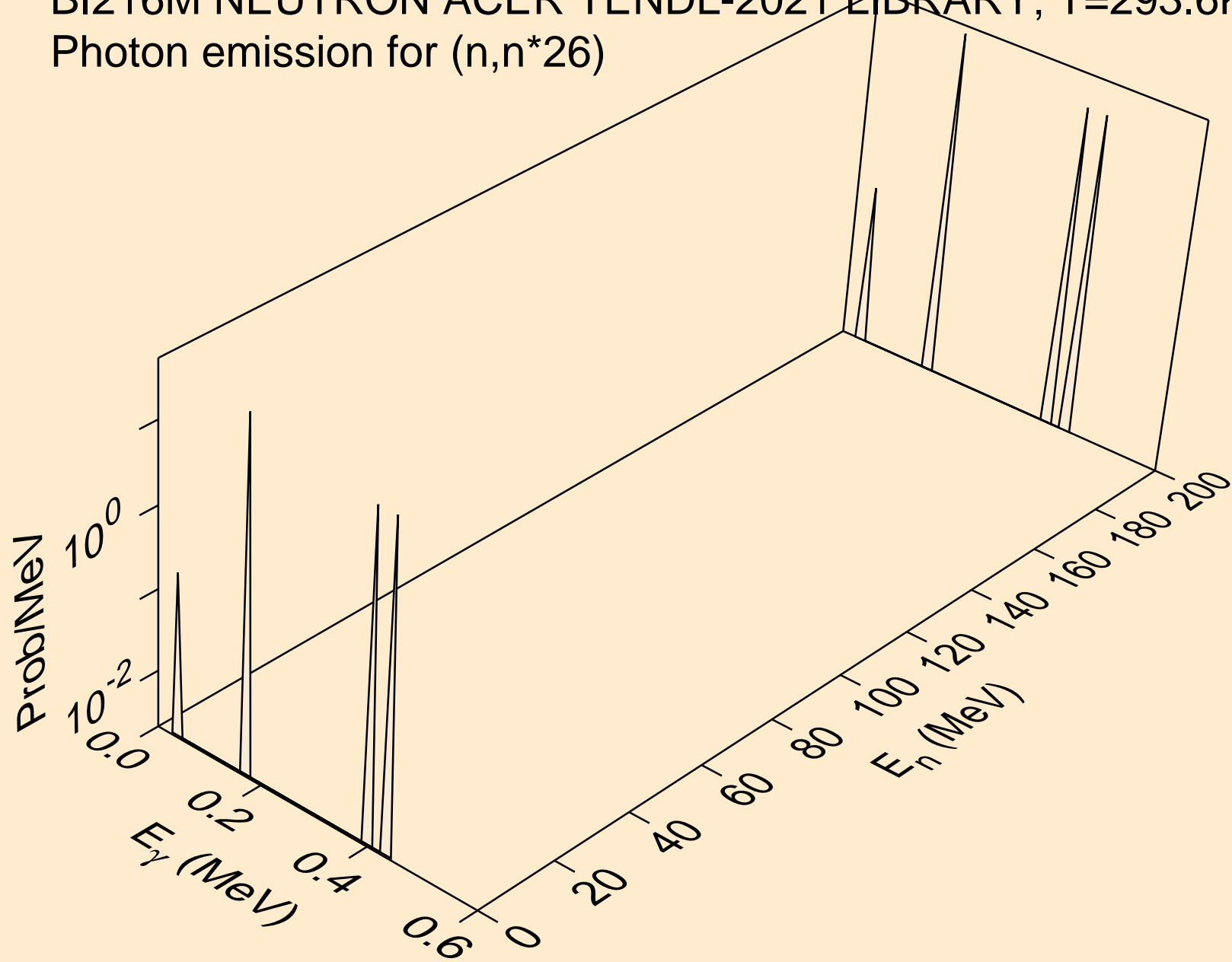

BI216M NEUTRON ACER TENDL-2021 LIBRARY; T=293.6K  
Photon emission for (n,n\*27)

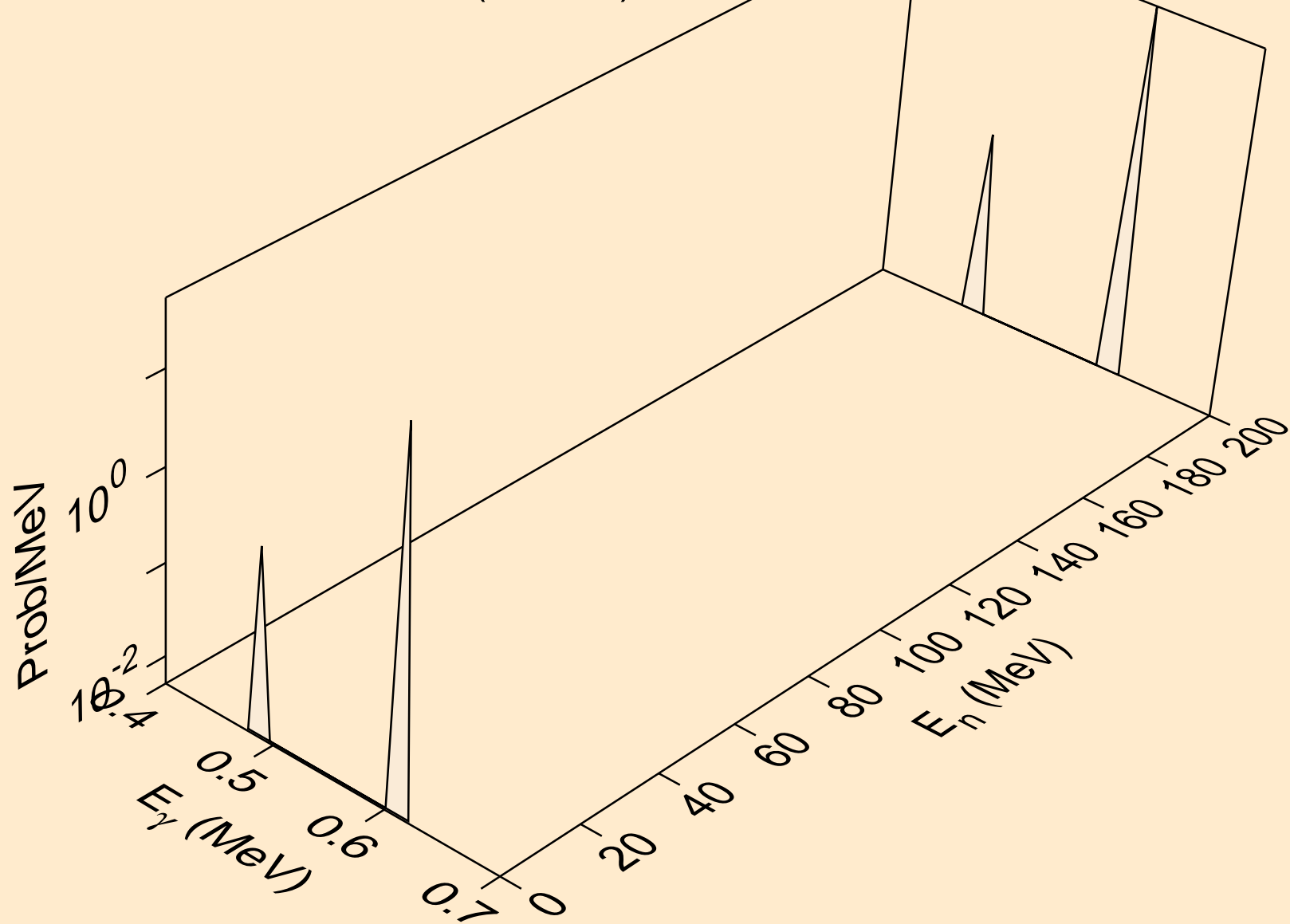



BI216M NEUTRON ACER TENDL-2021 LIBRARY; T=293.6K  
Photon emission for (n,n\*28)

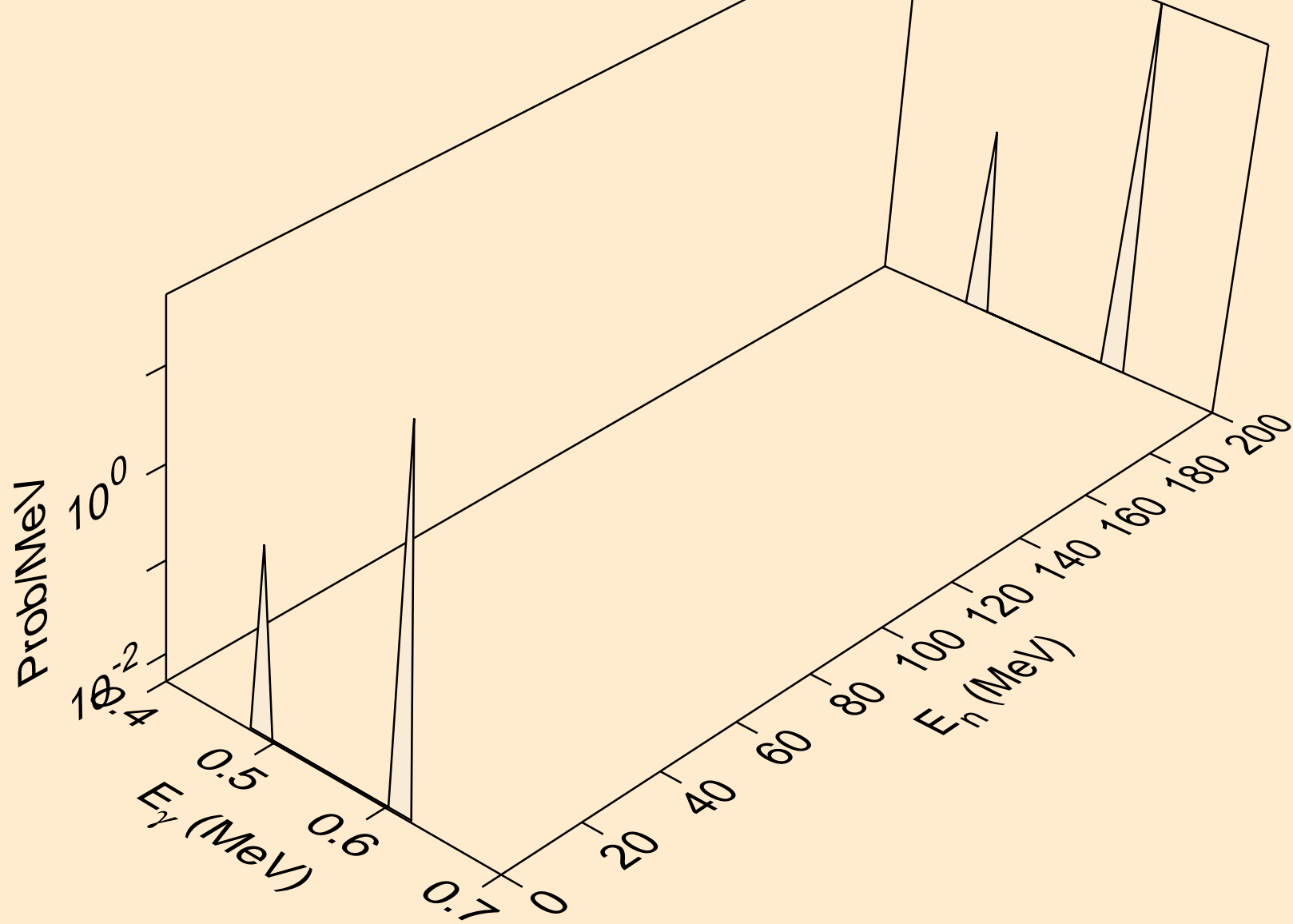

BI216M NEUTRON ACER TENDL-2021 LIBRARY; T=293.6K  
Photon emission for (n,n\*29)

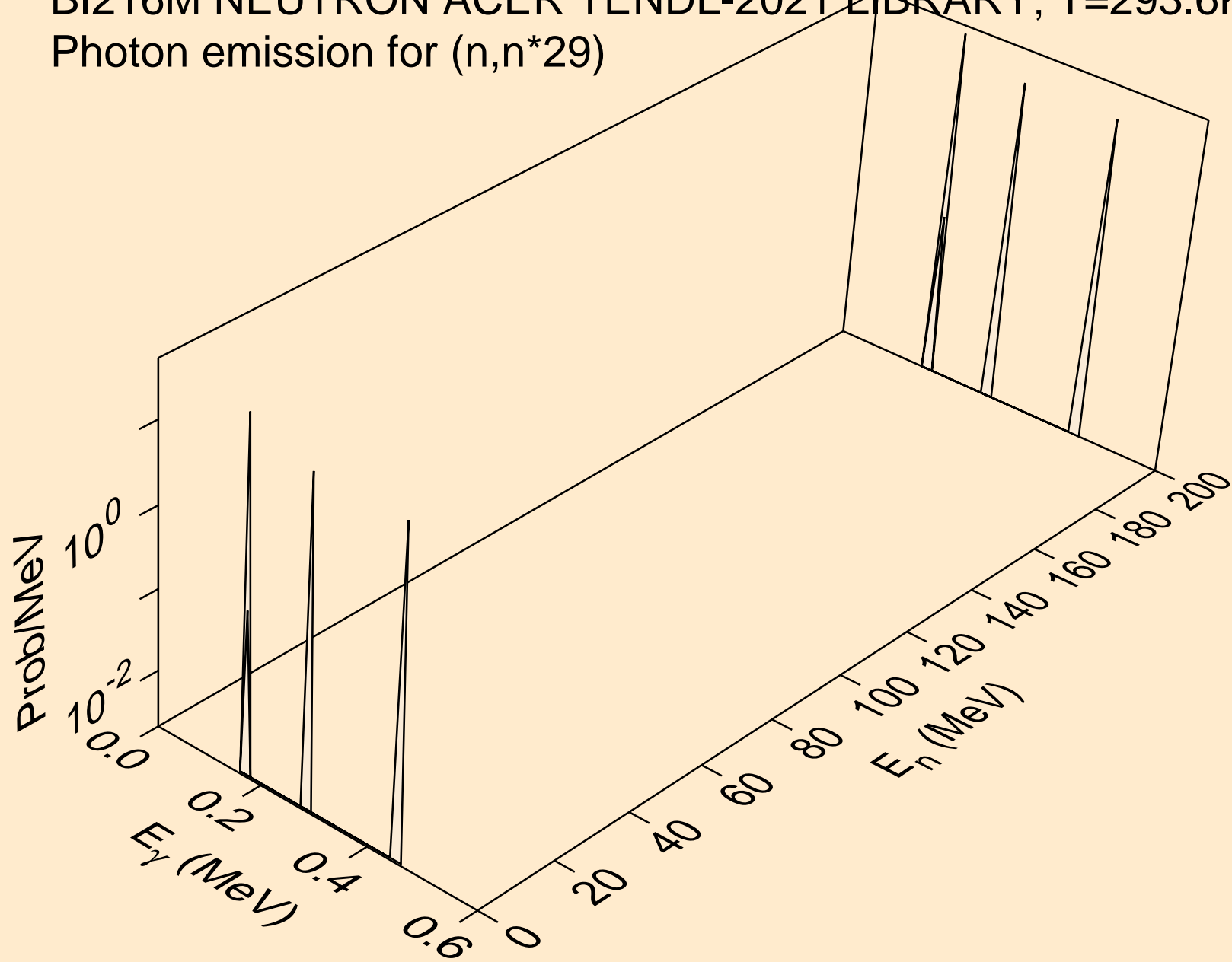

BI216M NEUTRON ACER TENDL-2021 LIBRARY; T=293.6K  
Photon emission for (n,n\*30)

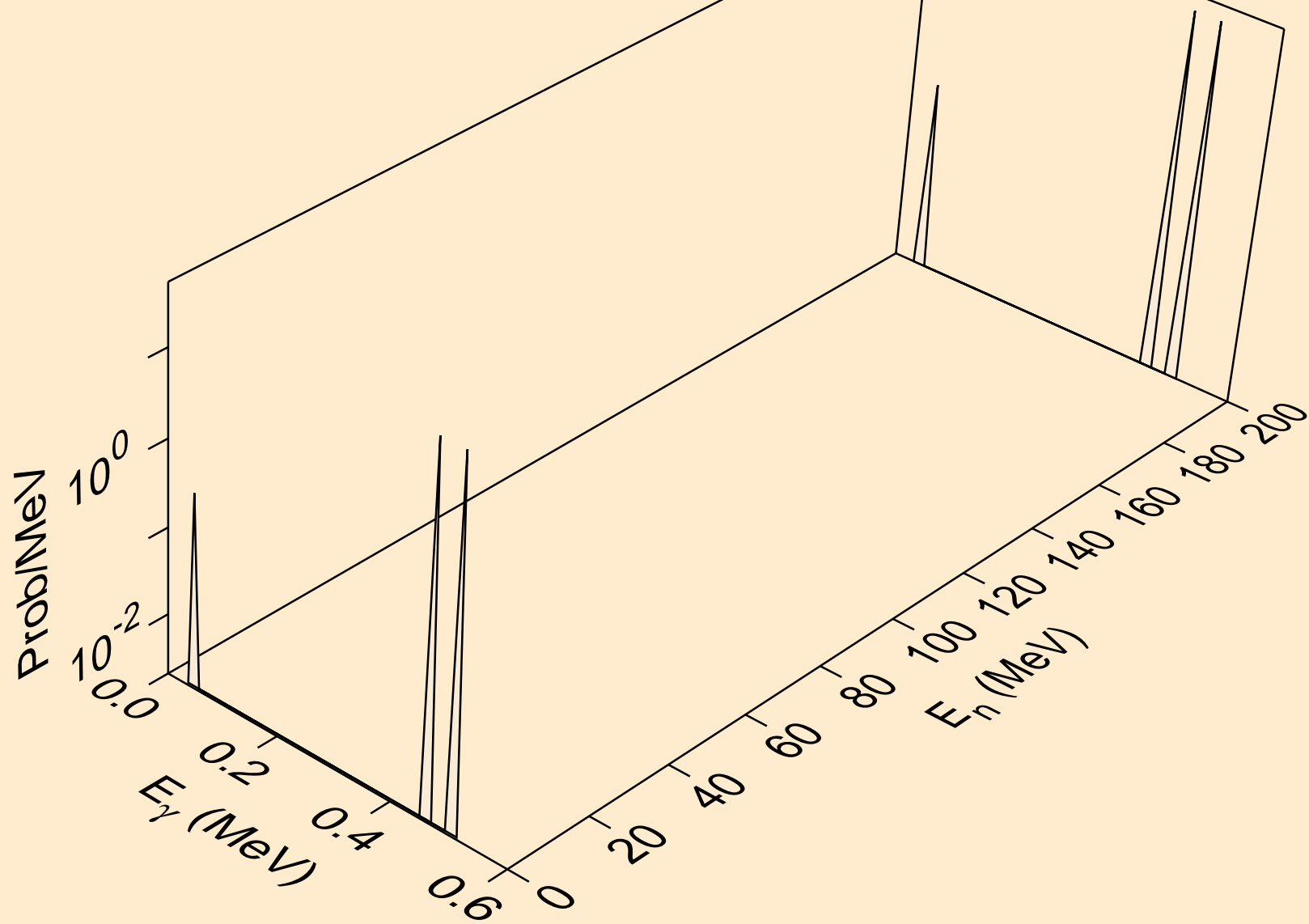

BI216M NEUTRON ACER TENDL-2021 LIBRARY; T=293.6K  
Photon emission for (n,n\*c)

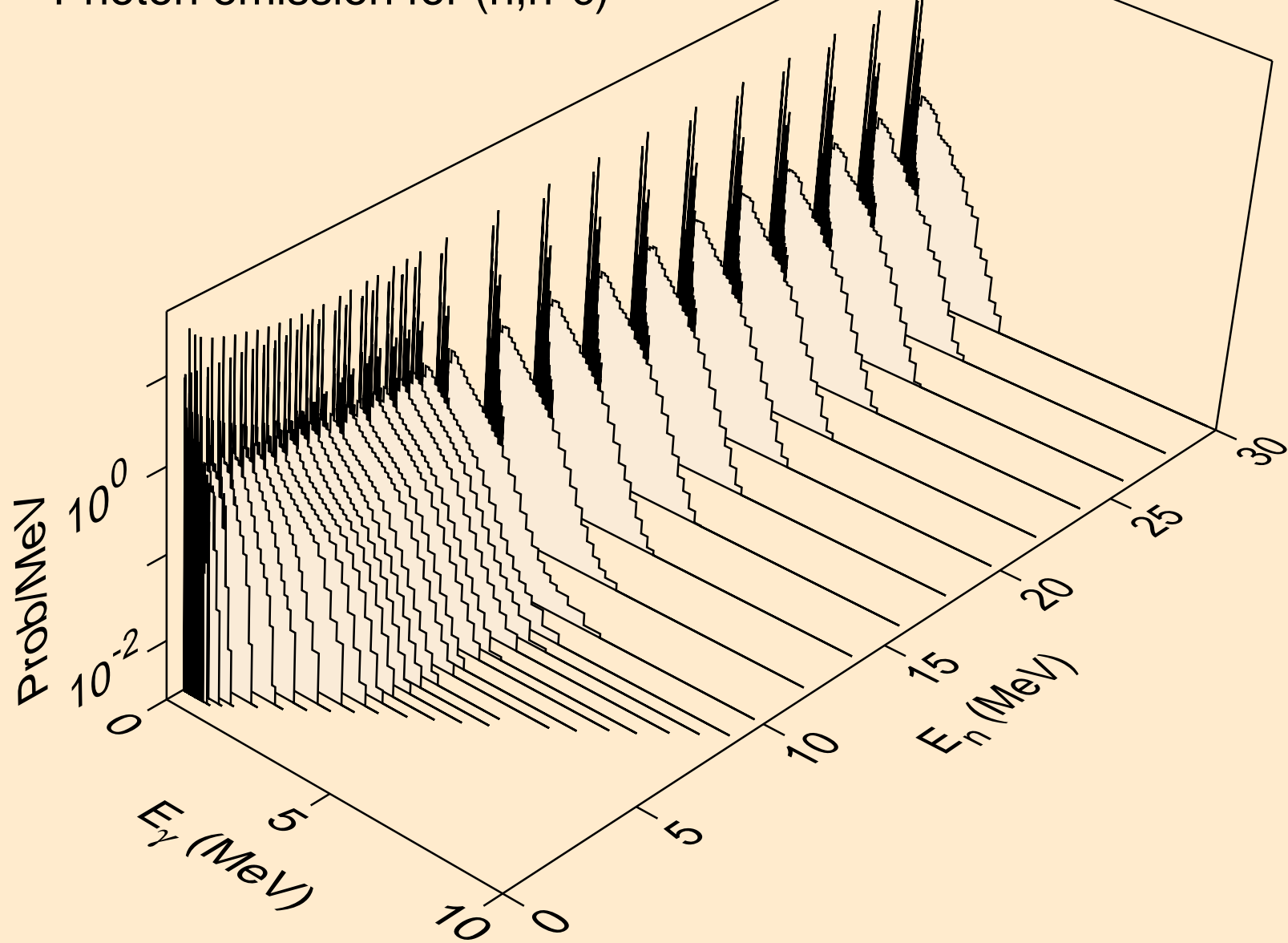

BI216M NEUTRON ACER TENDL-2021 LIBRARY; T=293.6K  
Photon emission for (n,gma)

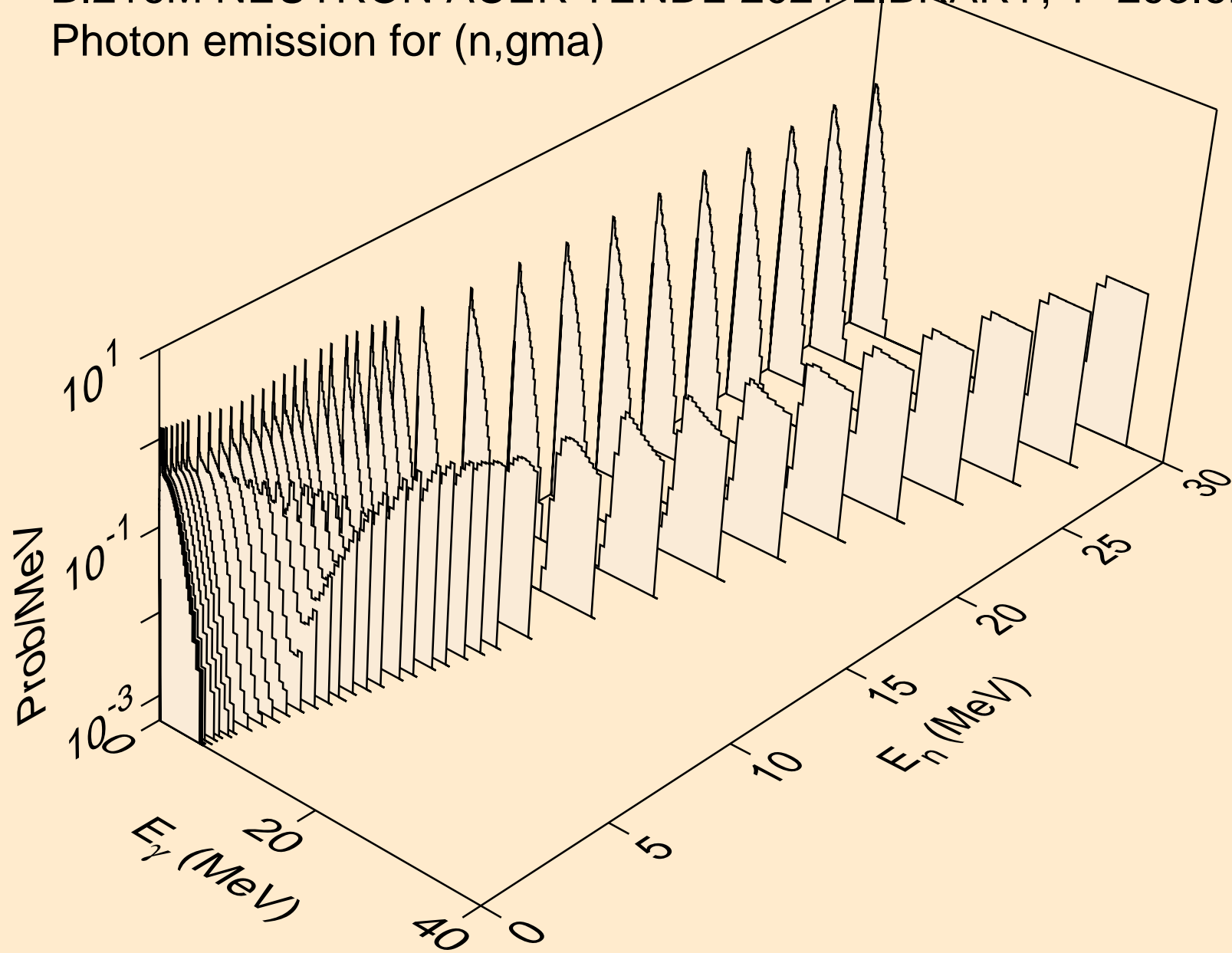

BI216M NEUTRON ACER TENDL-2021 LIBRARY; T=293.6K  
Photon emission for (n,p)

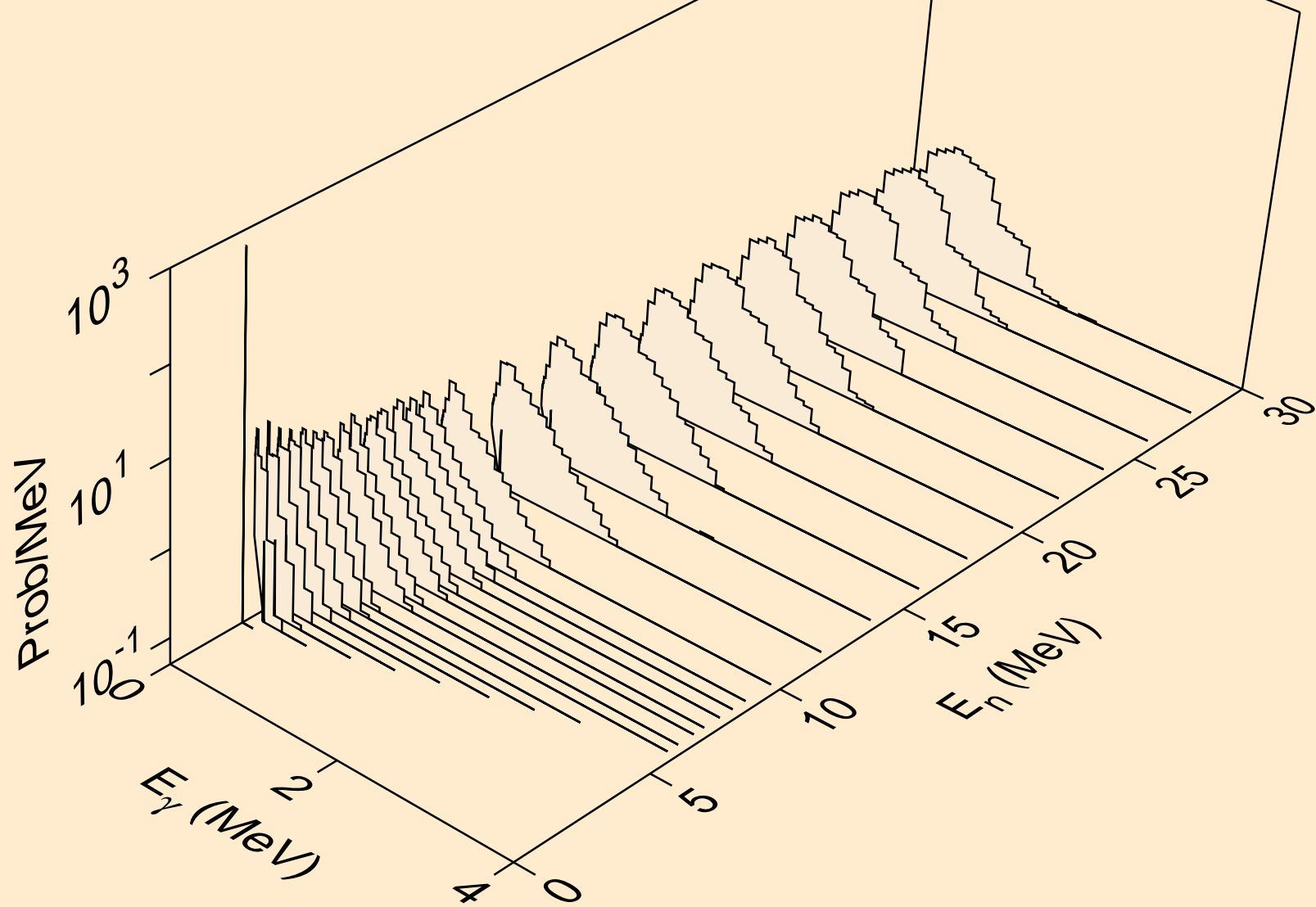

BI216M NEUTRON ACER TENDL-2021 LIBRARY; T=293.6K  
Photon emission for (n,d)

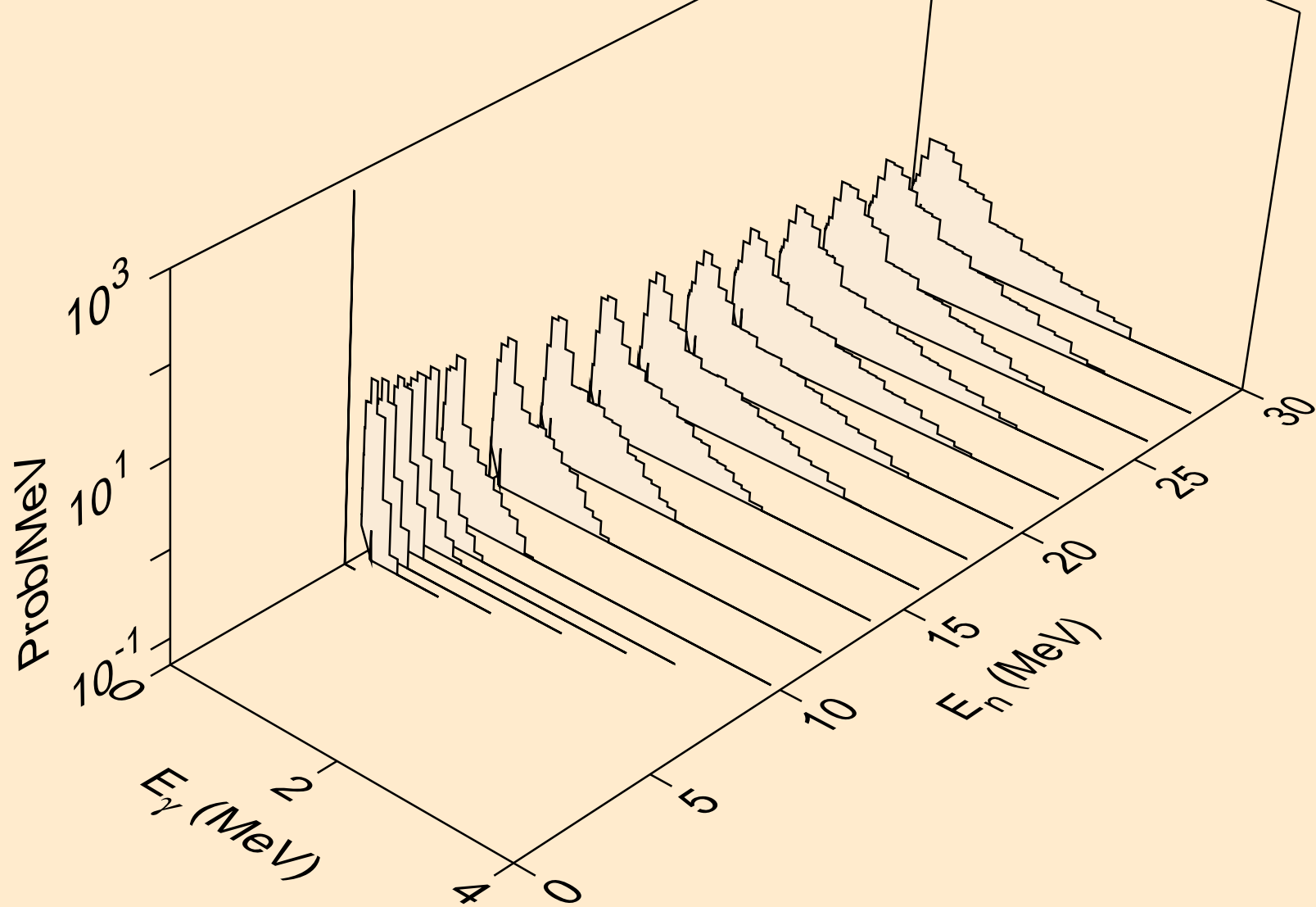

BI216M NEUTRON ACER TENDL-2021 LIBRARY; T=293.6K  
Photon emission for (n,t)

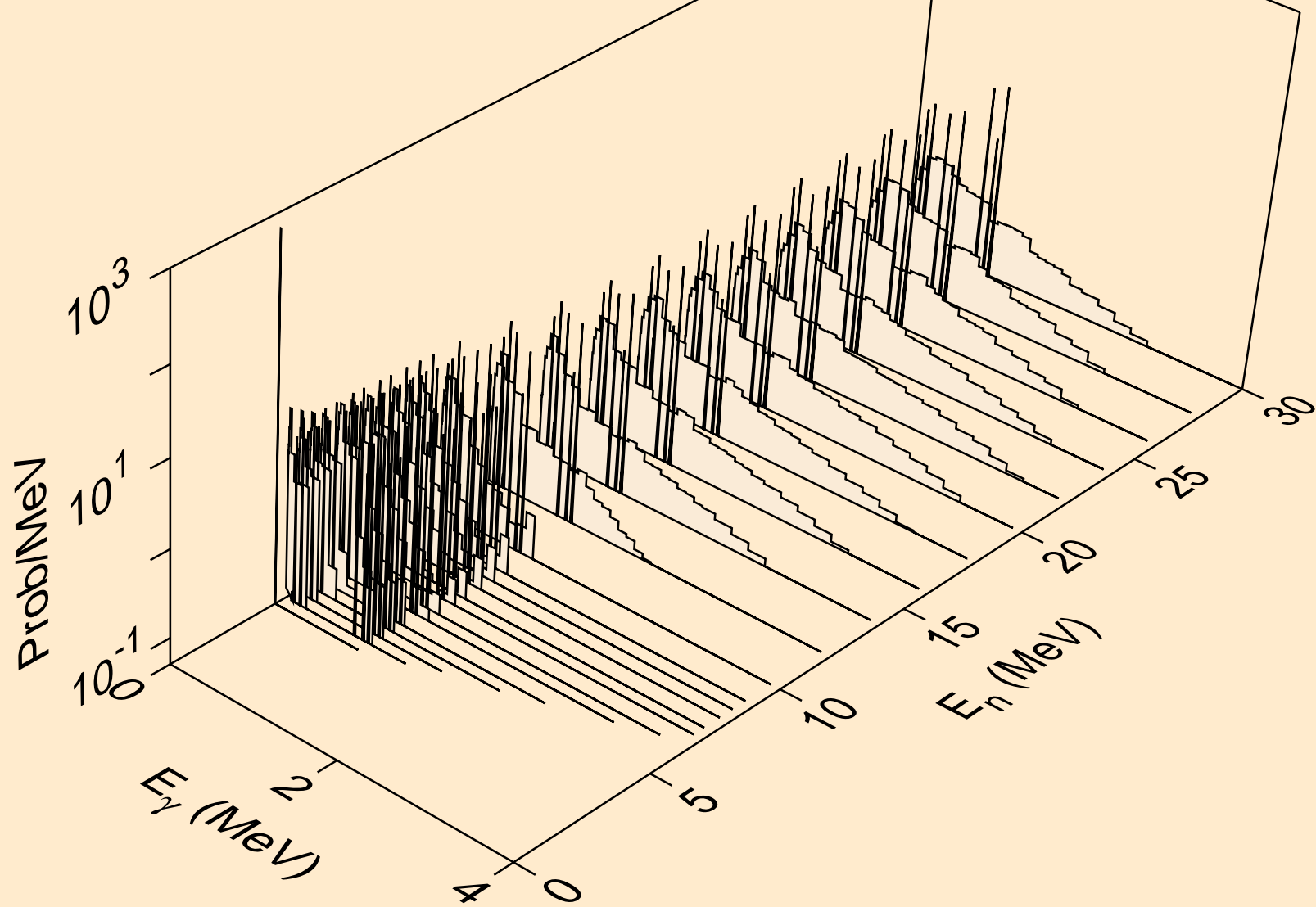



BI216M NEUTRON ACER TENDL-2021 LIBRARY; T=293.6K  
Photon emission for (n,he3)

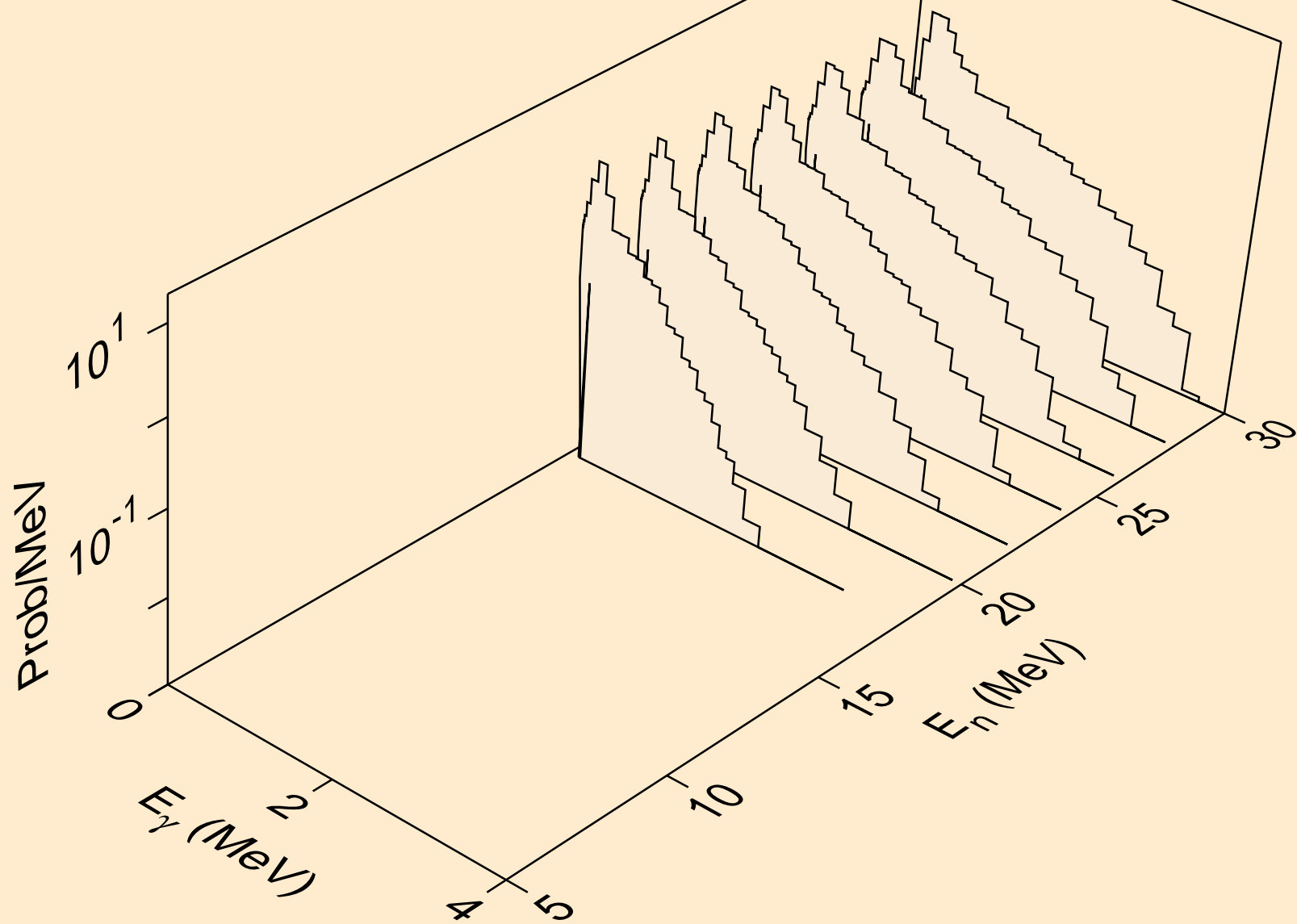

BI216M NEUTRON ACER TENDL-2021 LIBRARY; T=293.6K  
Photon emission for (n,a)

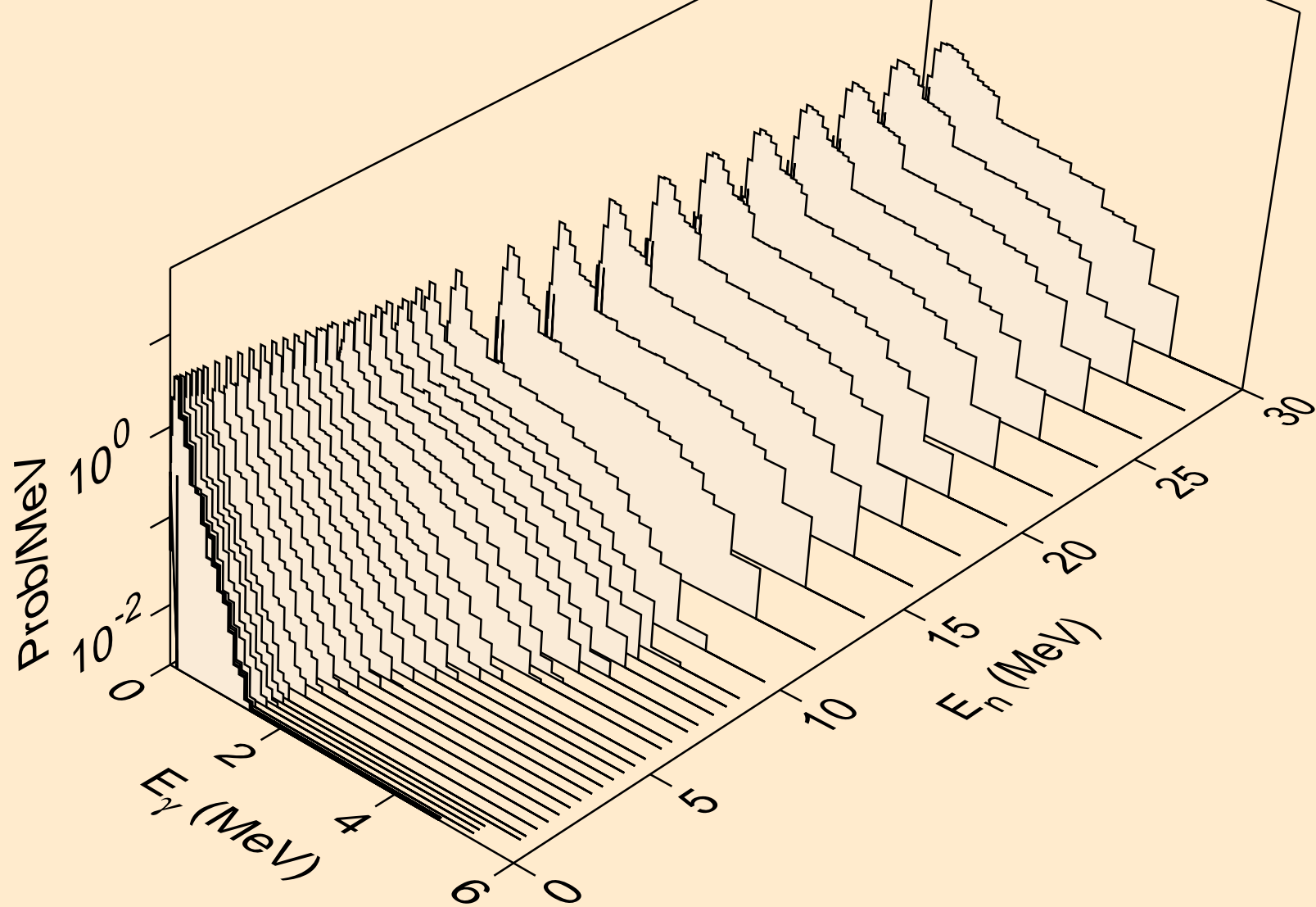

BI216M NEUTRON ACER TENDL-2021 LIBRARY; T=293.6K  
Photon emission for (n,2a)

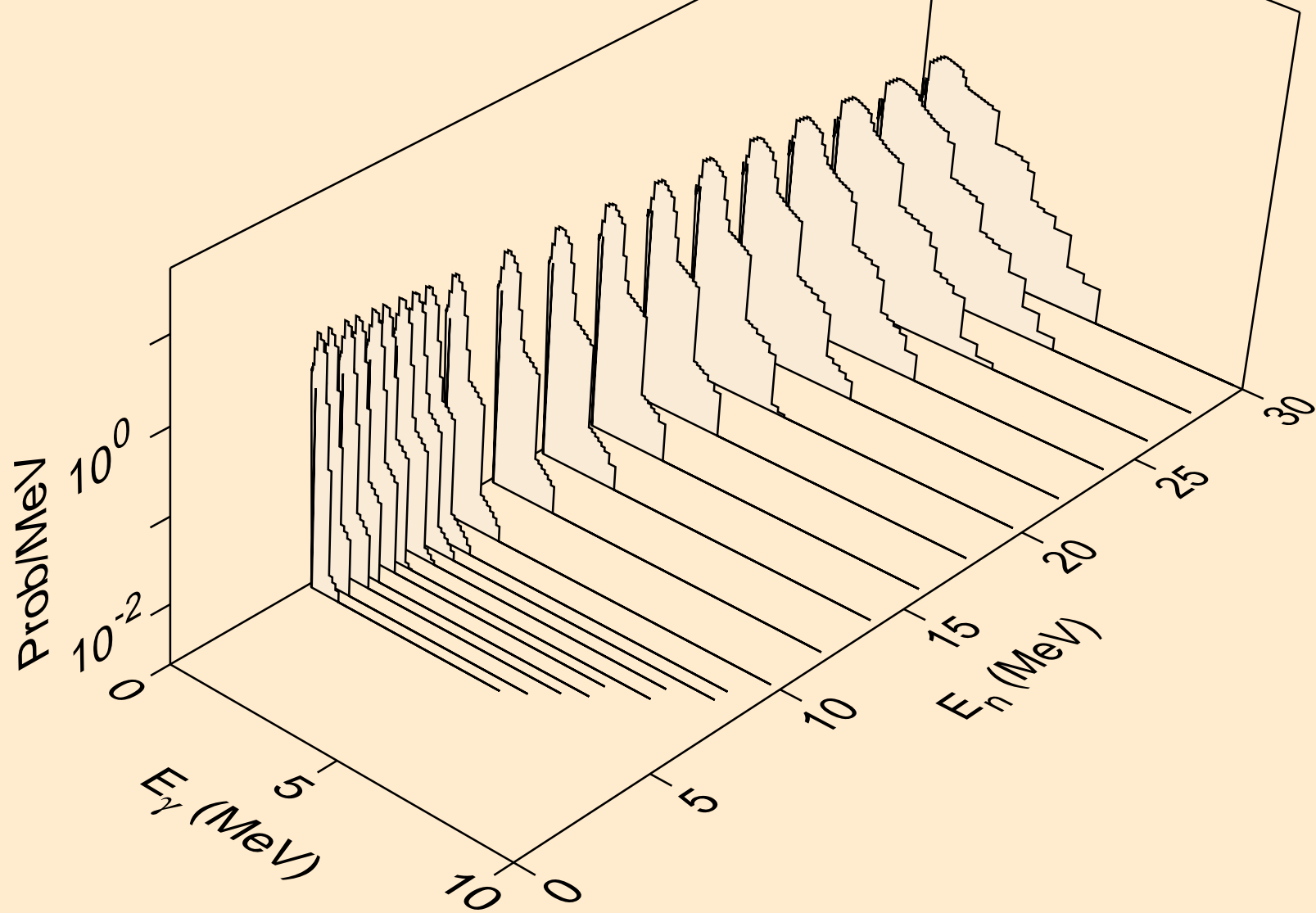

BI216M NEUTRON ACER TENDL-2021 LIBRARY; T=293.6K  
Photon emission for (n,2p)

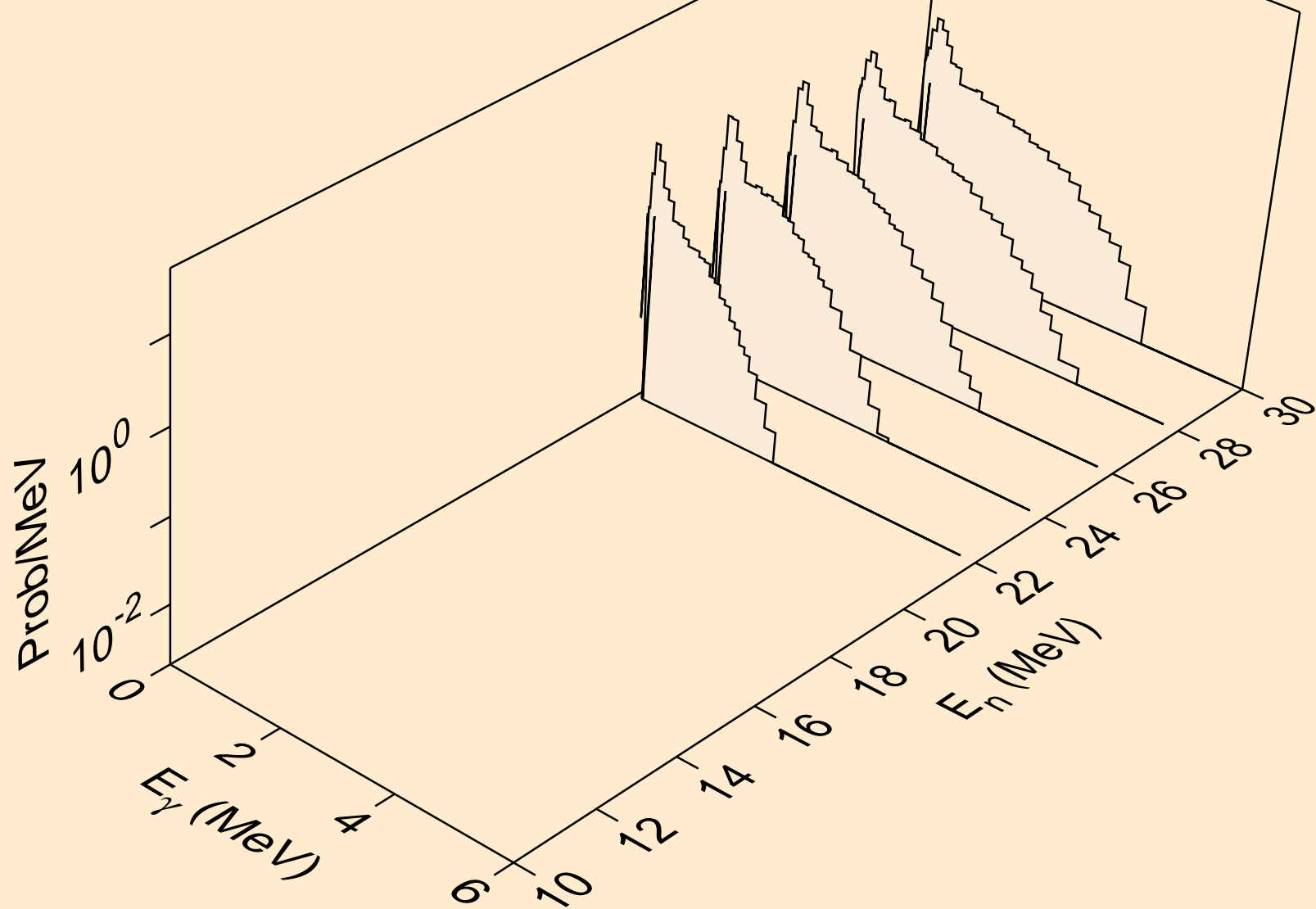

BI216M NEUTRON ACER TENDL-2021 LIBRARY; T=293.6K  
Photon emission for (n,p $\alpha$ )

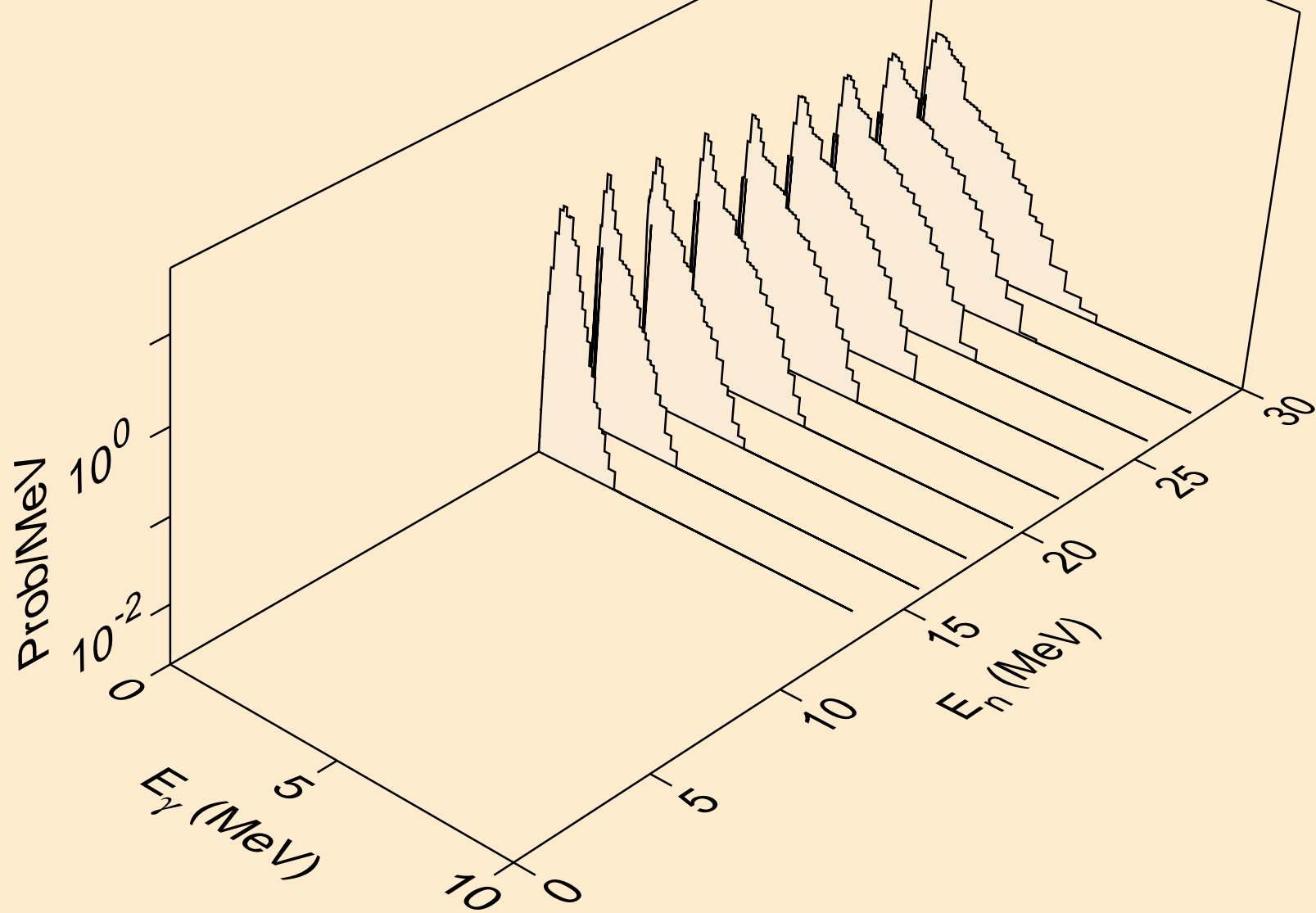

BI216M NEUTRON ACER TENDL-2021 LIBRARY; T=293.6K  
Photon emission for (n,pd)

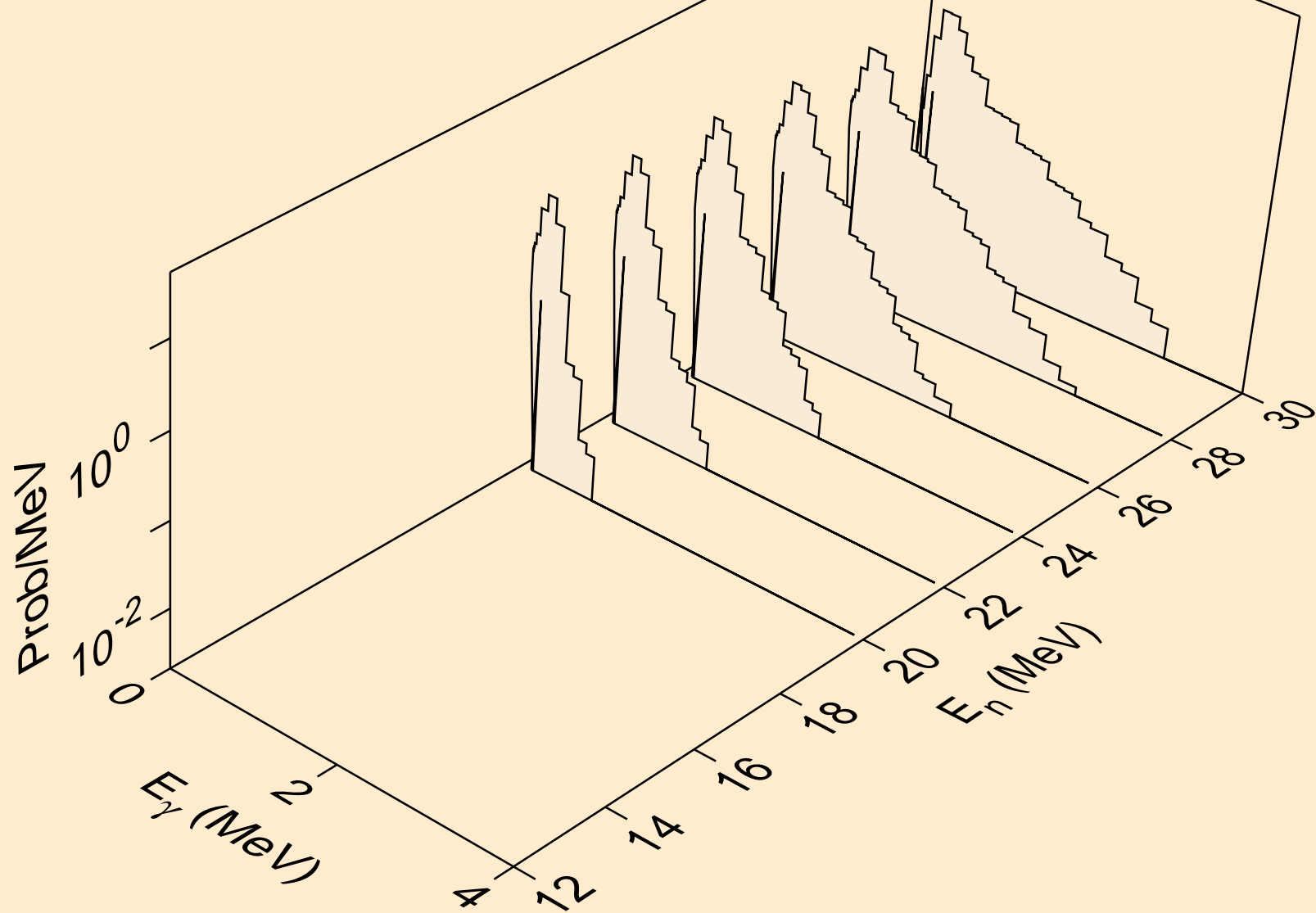

BI216M NEUTRON ACER TENDL-2021 LIBRARY; T=293.6K  
Photon emission for (n,pt)

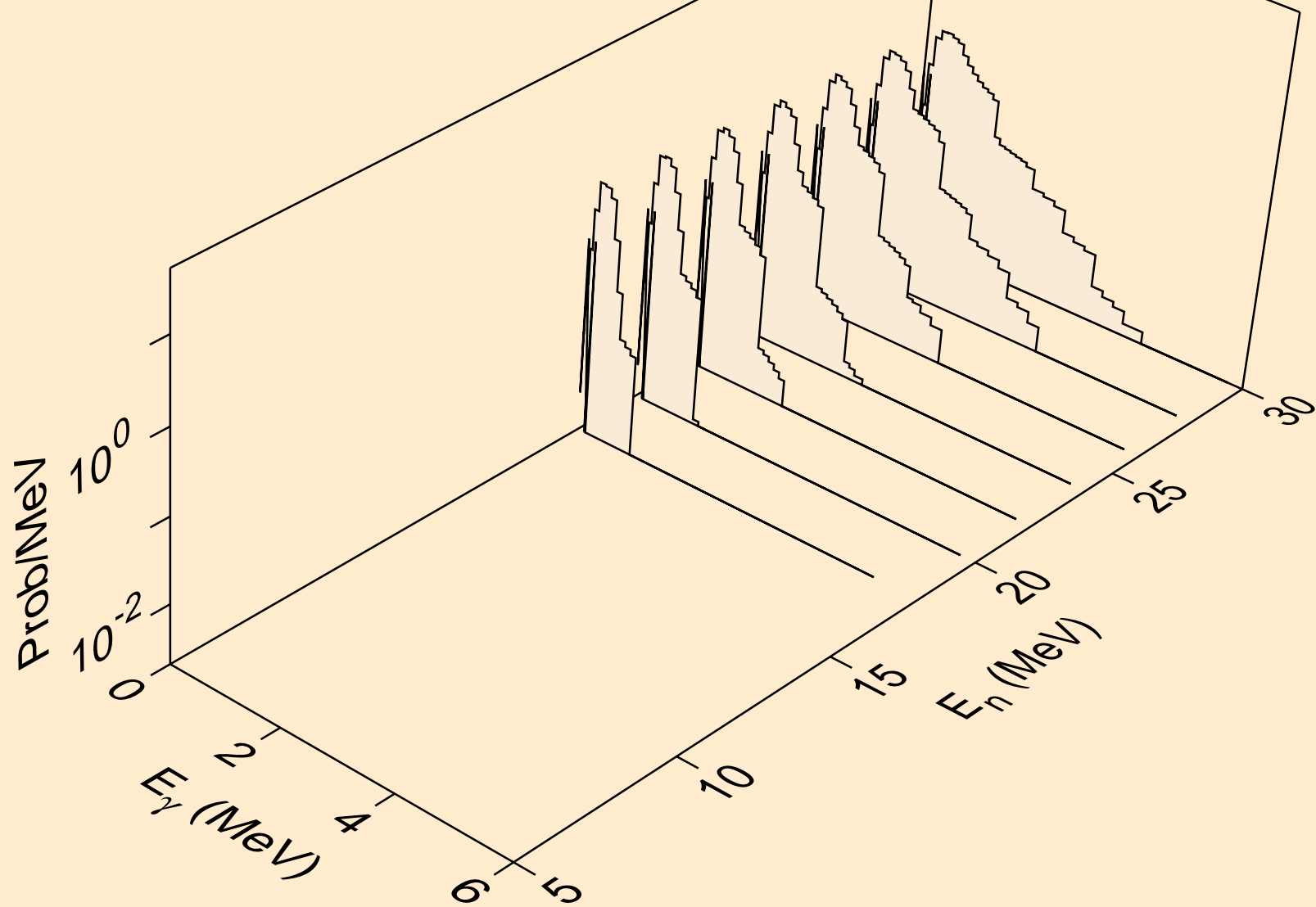

BI216M NEUTRON ACER TENDL-2021 LIBRARY; T=293.6K  
thermal capture photon spectrum

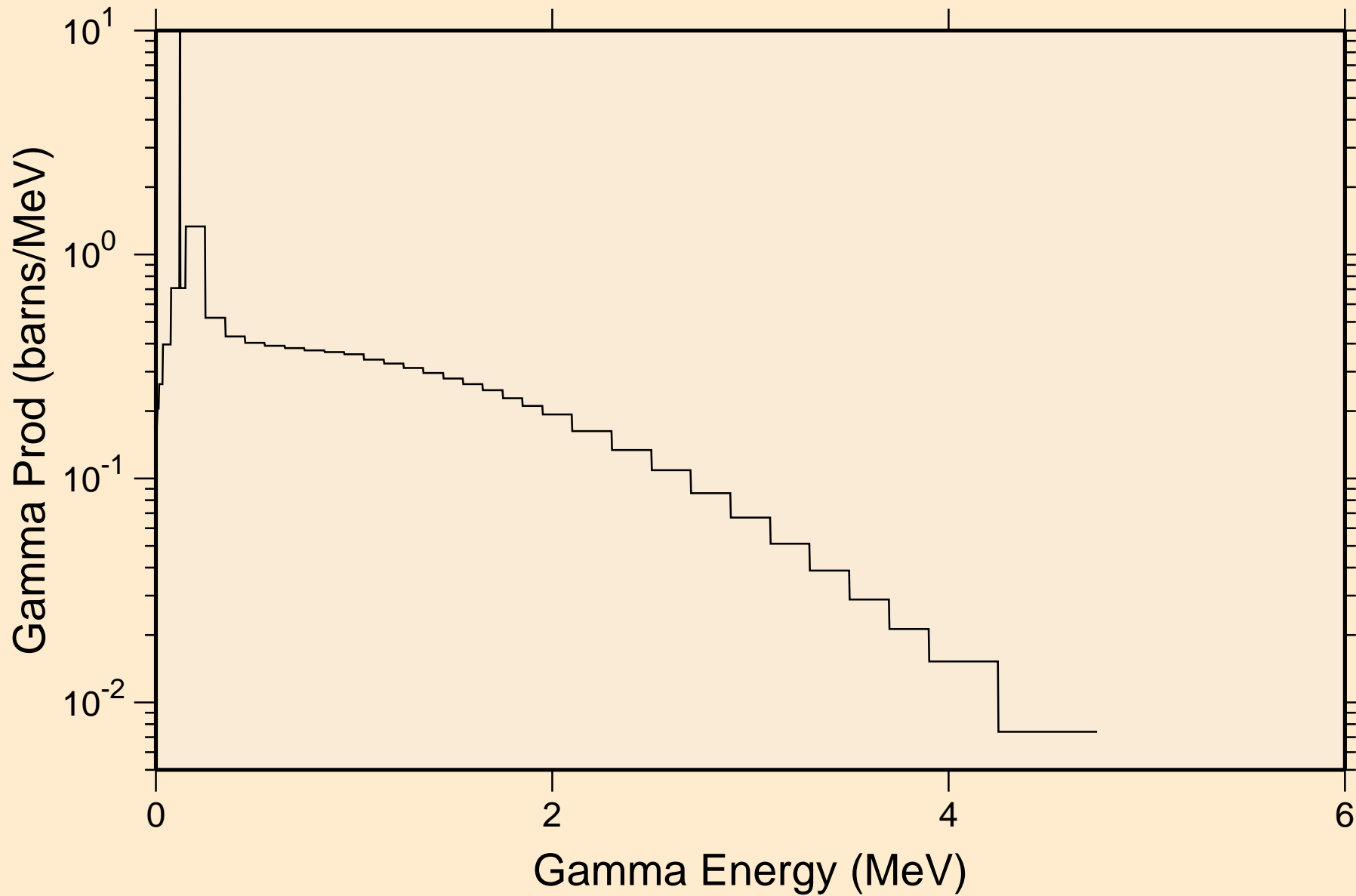



BI216M NEUTRON ACER TENDL-2021 LIBRARY; T=293.6K  
14 MeV photon spectrum

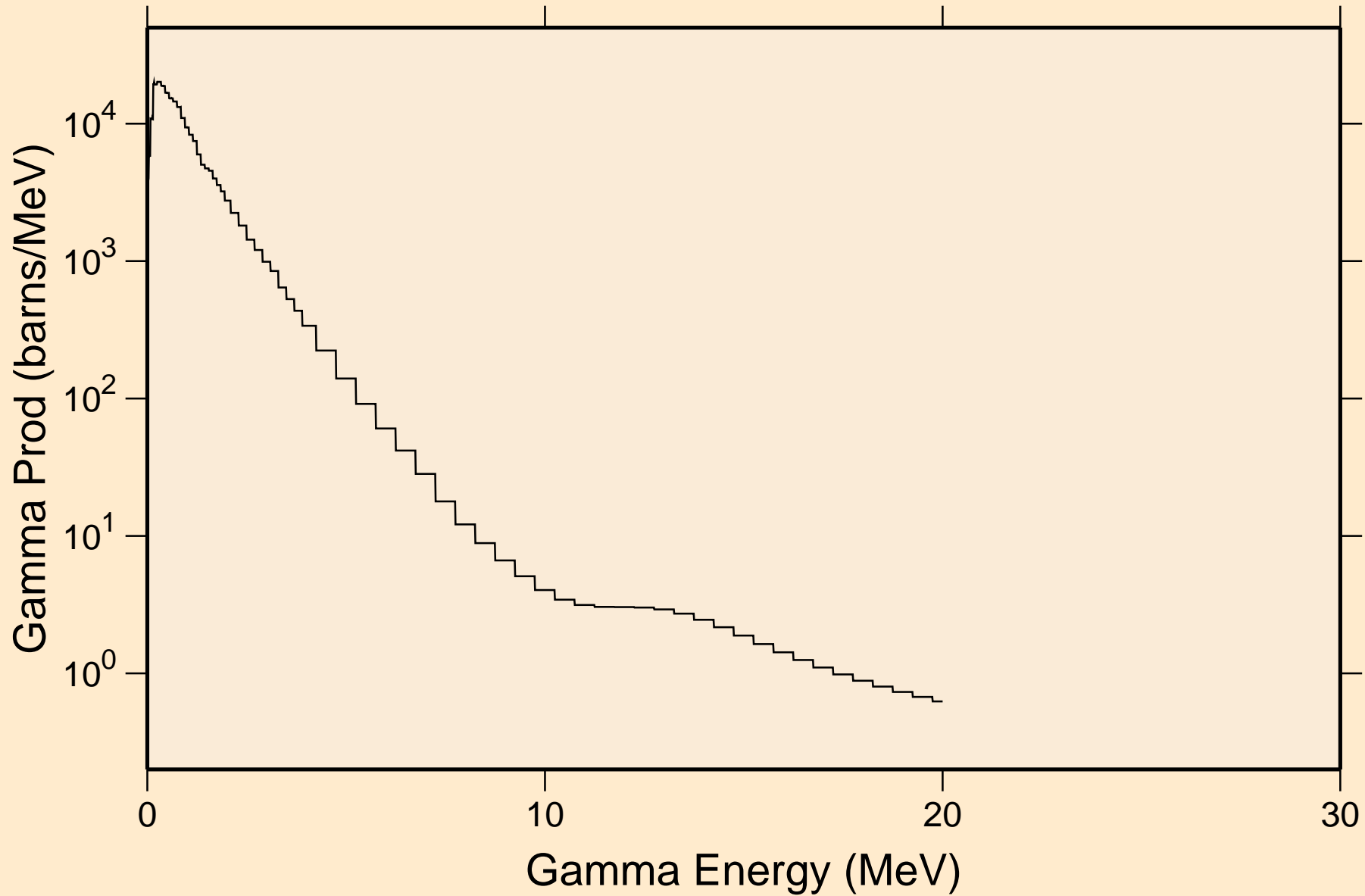

BI216M NEUTRON ACER TENDL-2021 LIBRARY; T=293.6K  
Particle heating contributions

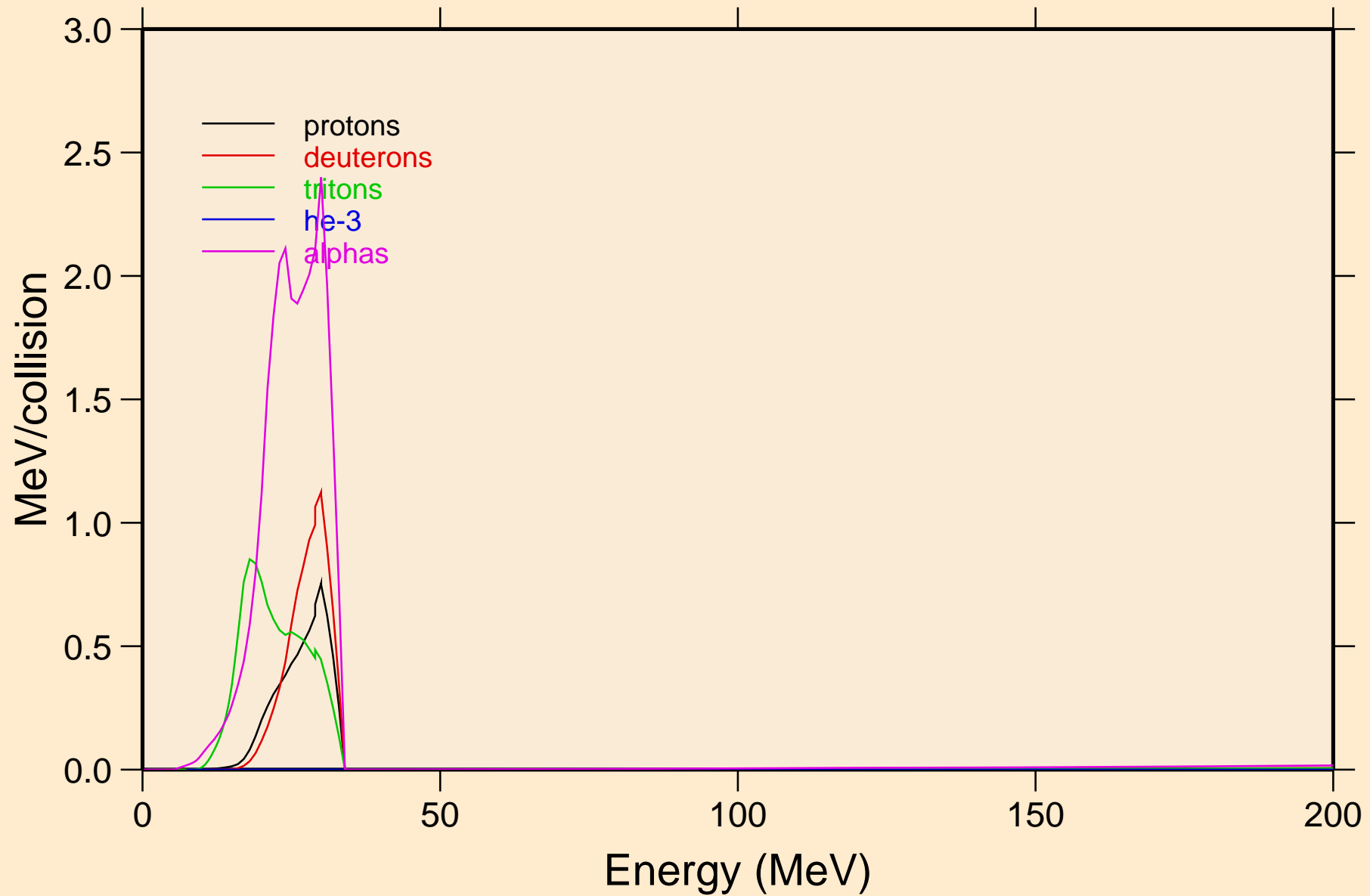

BI216M NEUTRON ACER TENDL-2021 LIBRARY; T=293.6K  
Recoil Heating

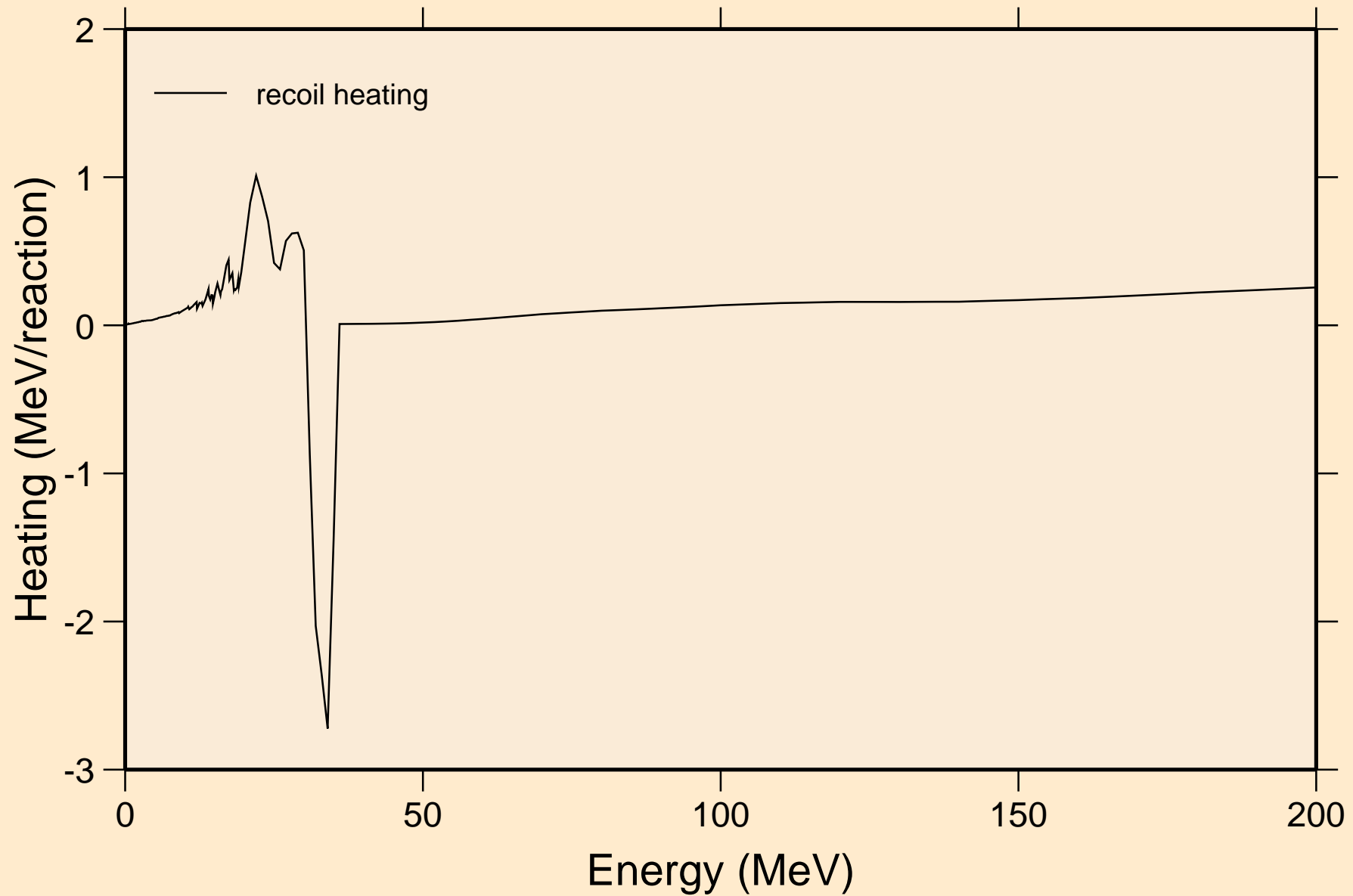

BI216M NEUTRON ACER TENDL-2021 LIBRARY; T=293.6K  
Particle production cross sections

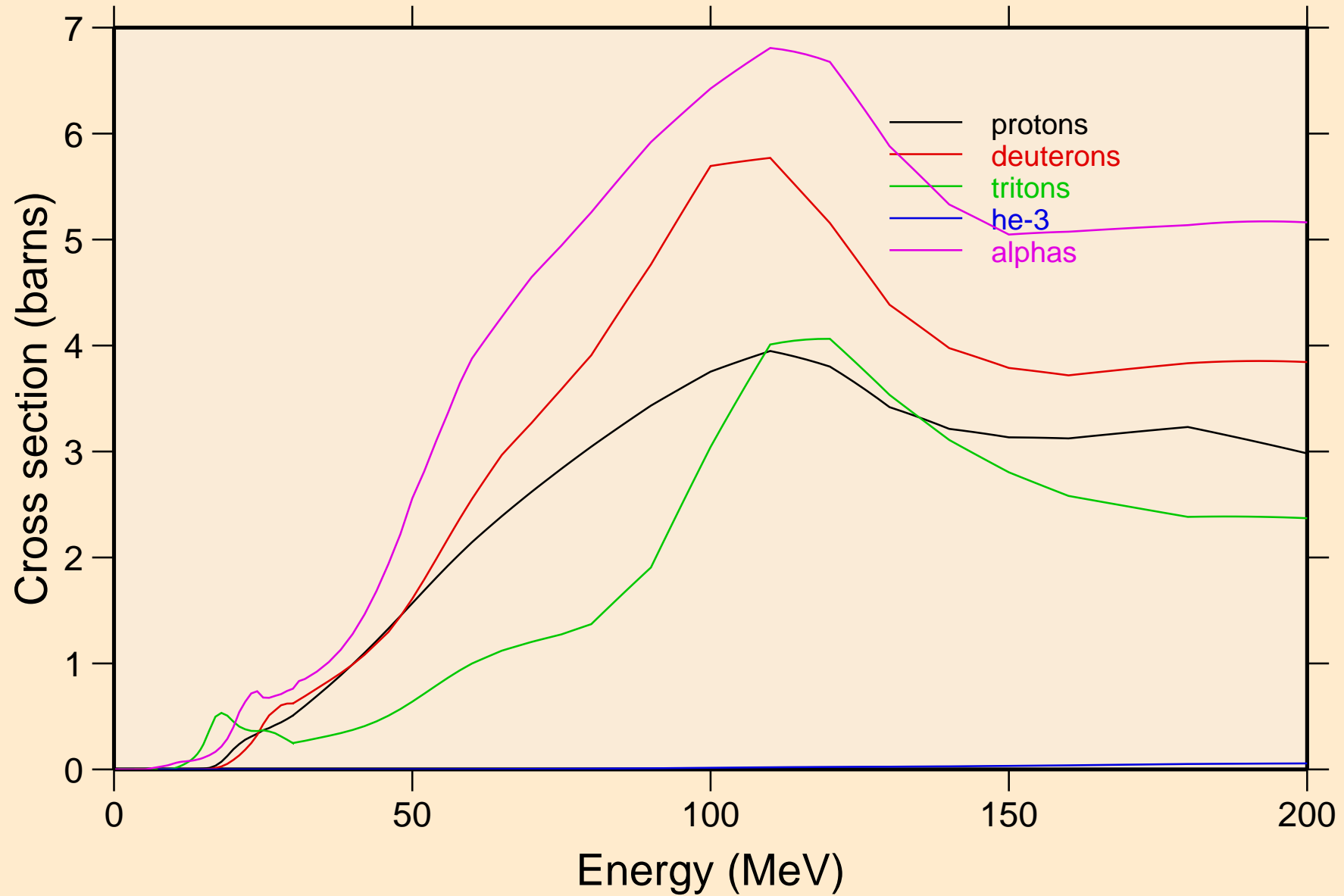

BI216M NEUTRON ACER TENDL-2021 LIBRARY; T=293.6K  
protons from (n,x)

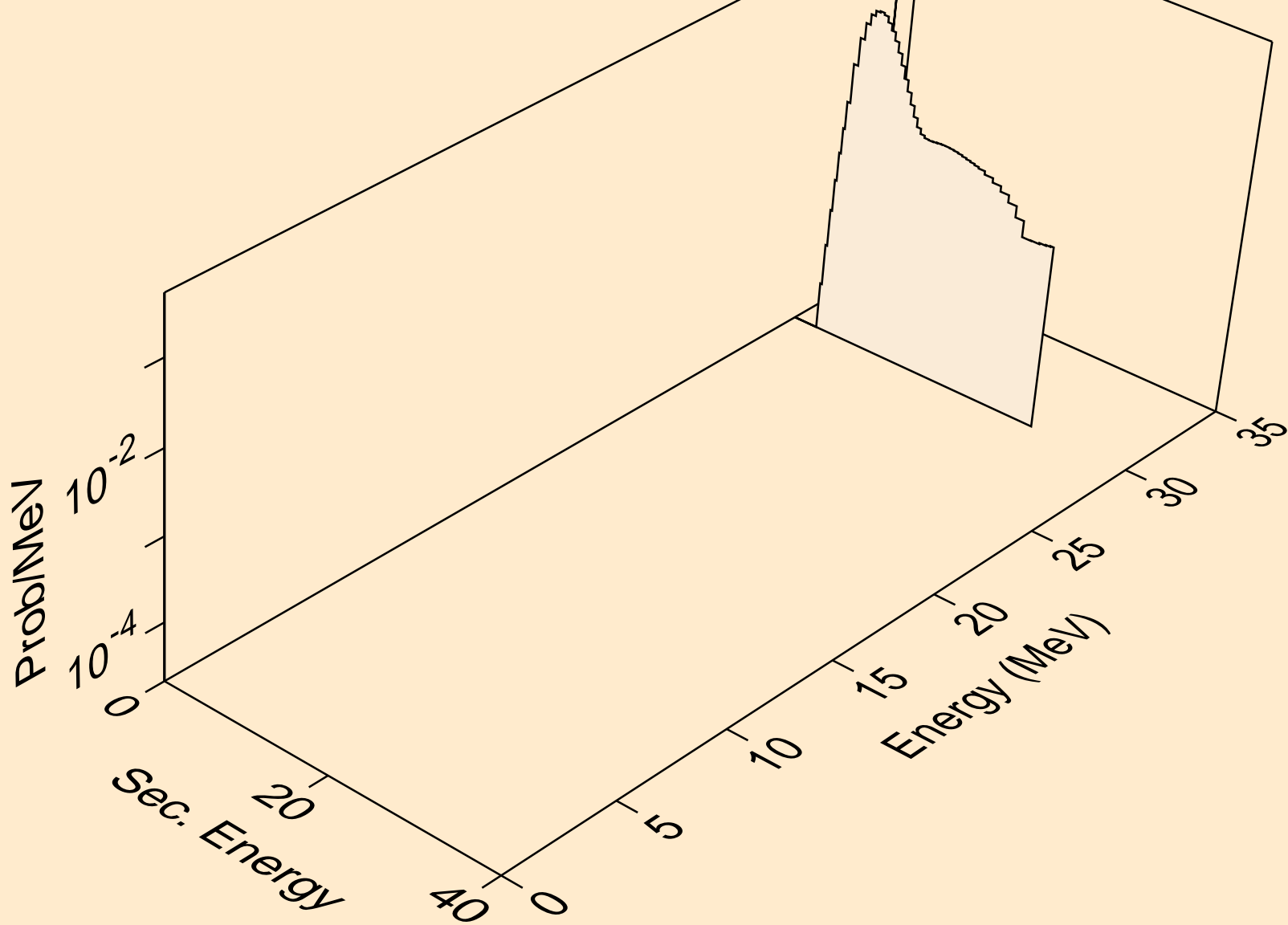

BI216M NEUTRON ACER TENDL-2021 LIBRARY; T=293.6K  
protons from (n,n\*)p

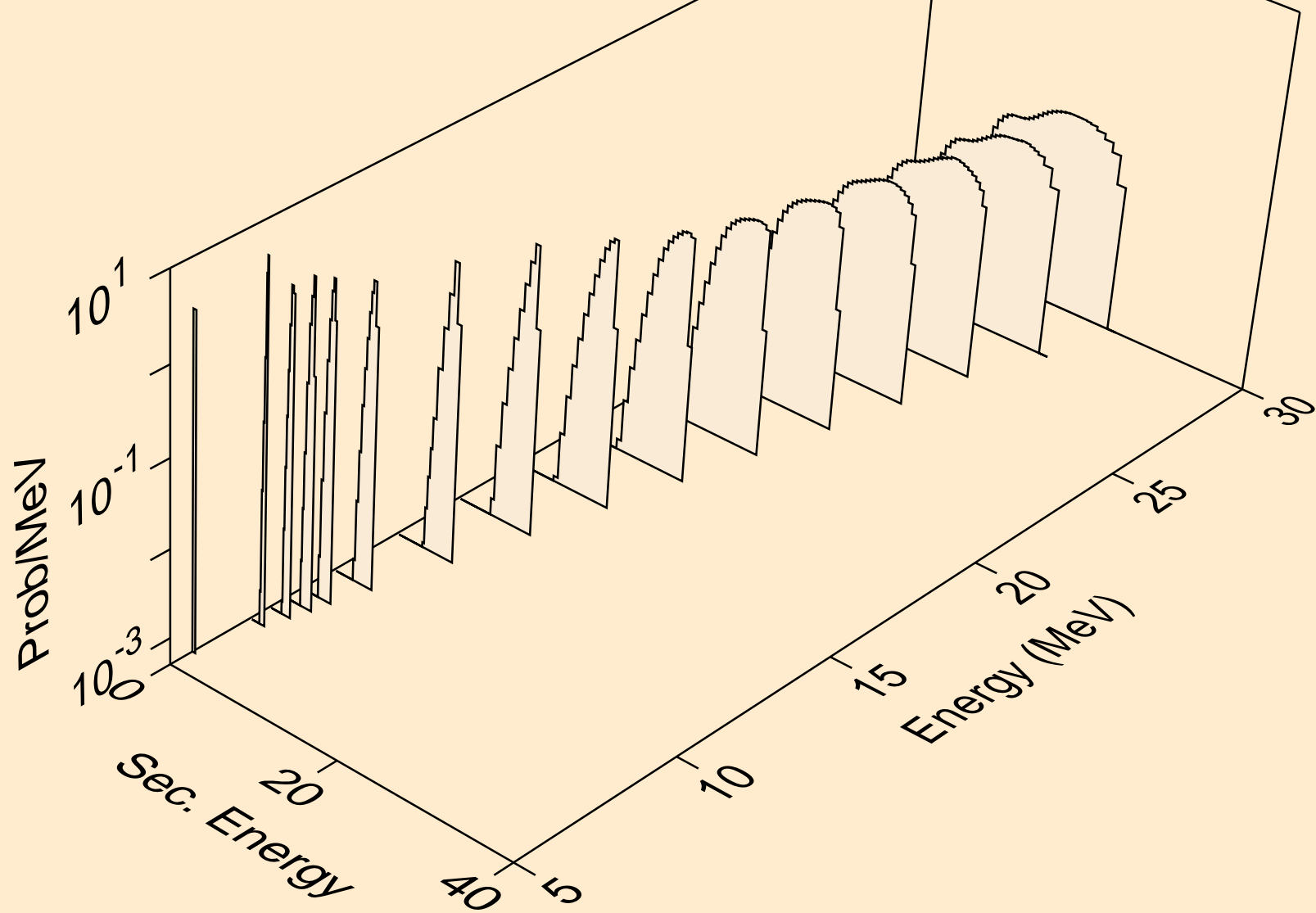

BI216M NEUTRON ACER TENDL-2021 LIBRARY; T=293.6K  
protons from (n,2np)

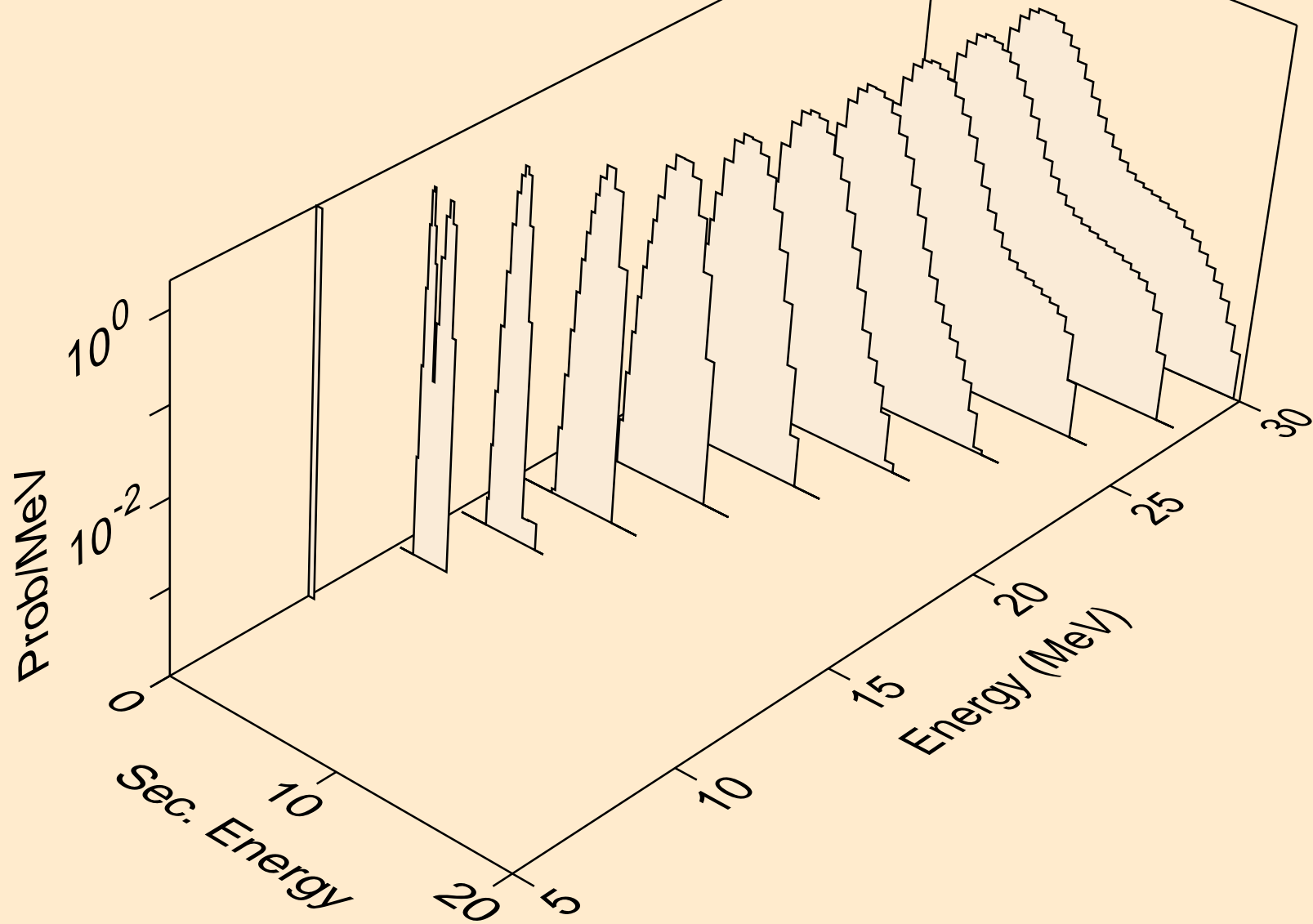

BI216M NEUTRON ACER TENDL-2021 LIBRARY; T=293.6K  
protons from (n,3np)

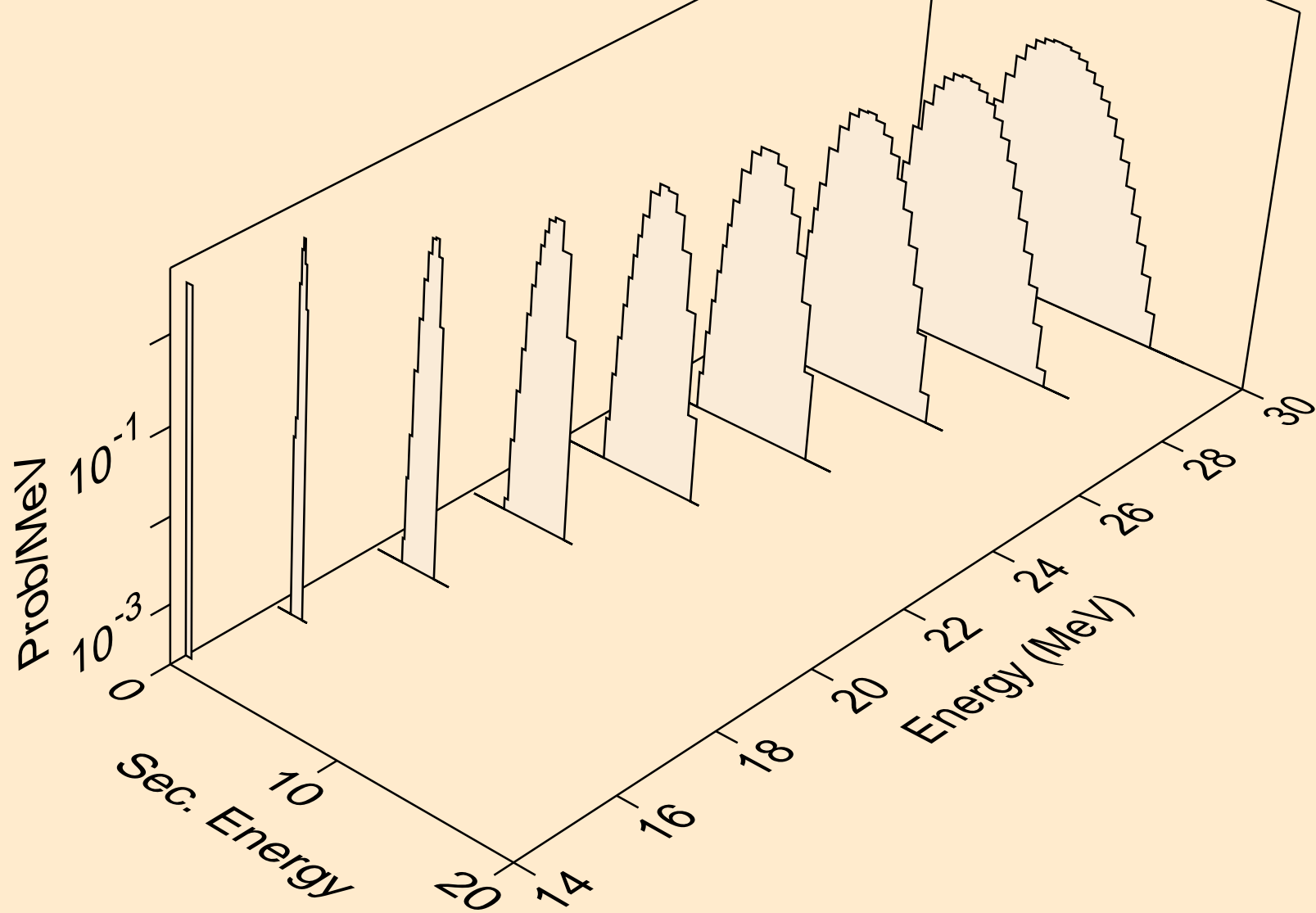



BI216M NEUTRON ACER TENDL-2021 LIBRARY; T=293.6K  
protons from (n,2np)

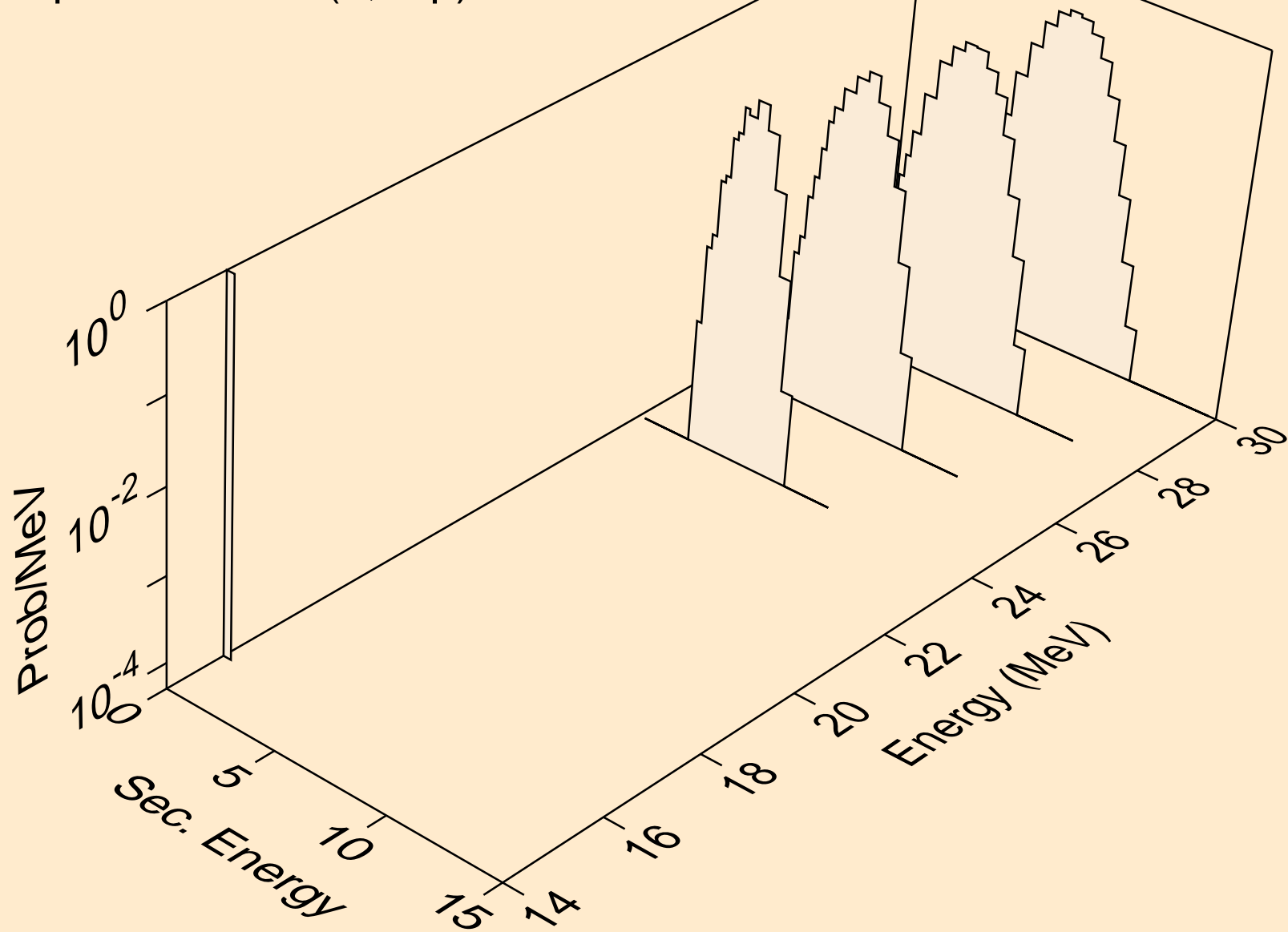

BI216M NEUTRON ACER TENDL-2021 LIBRARY; T=293.6K  
protons from (n,npa)

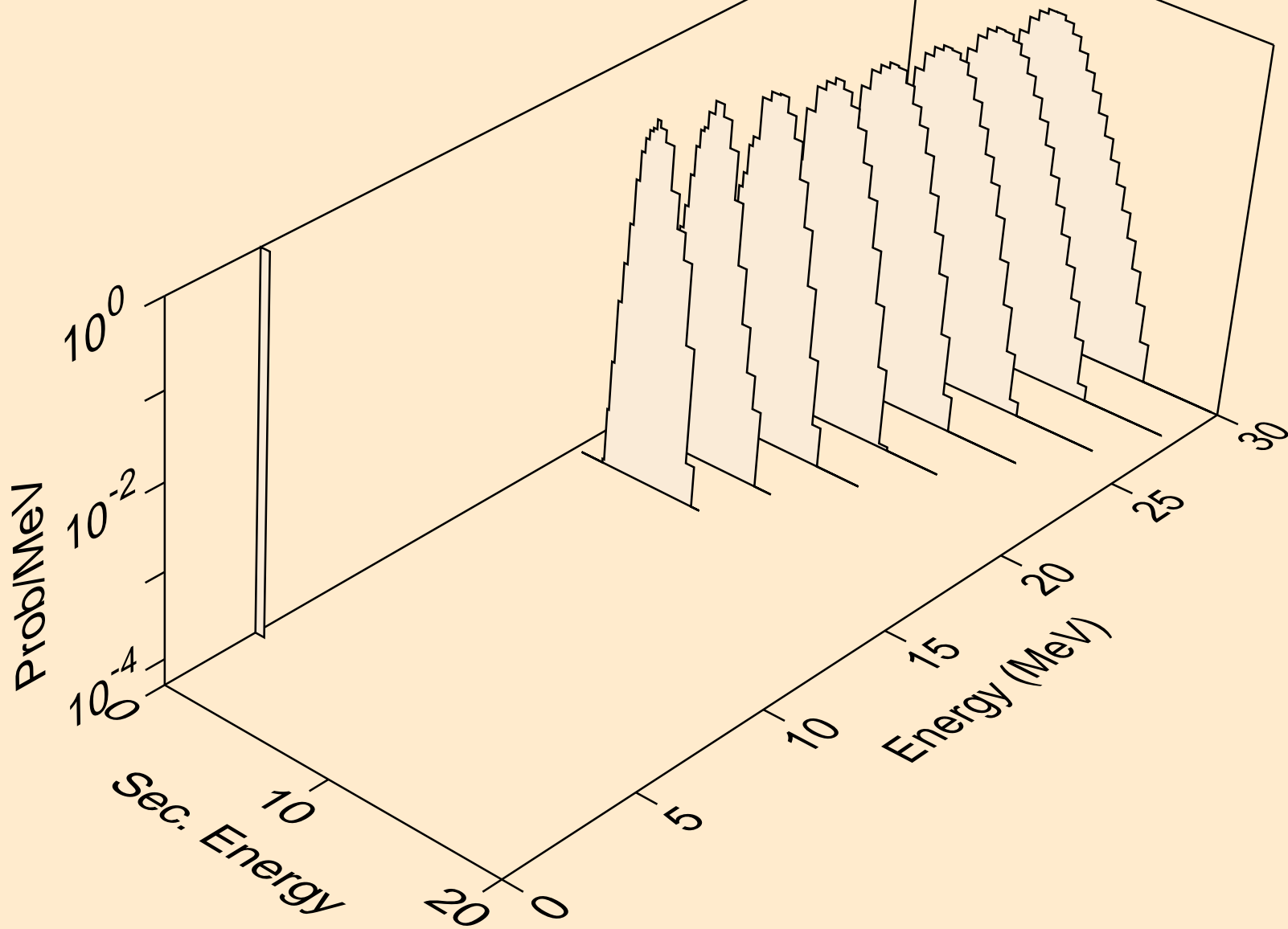

BI216M NEUTRON ACER TENDL-2021 LIBRARY; T=293.6K  
protons from (n,p)

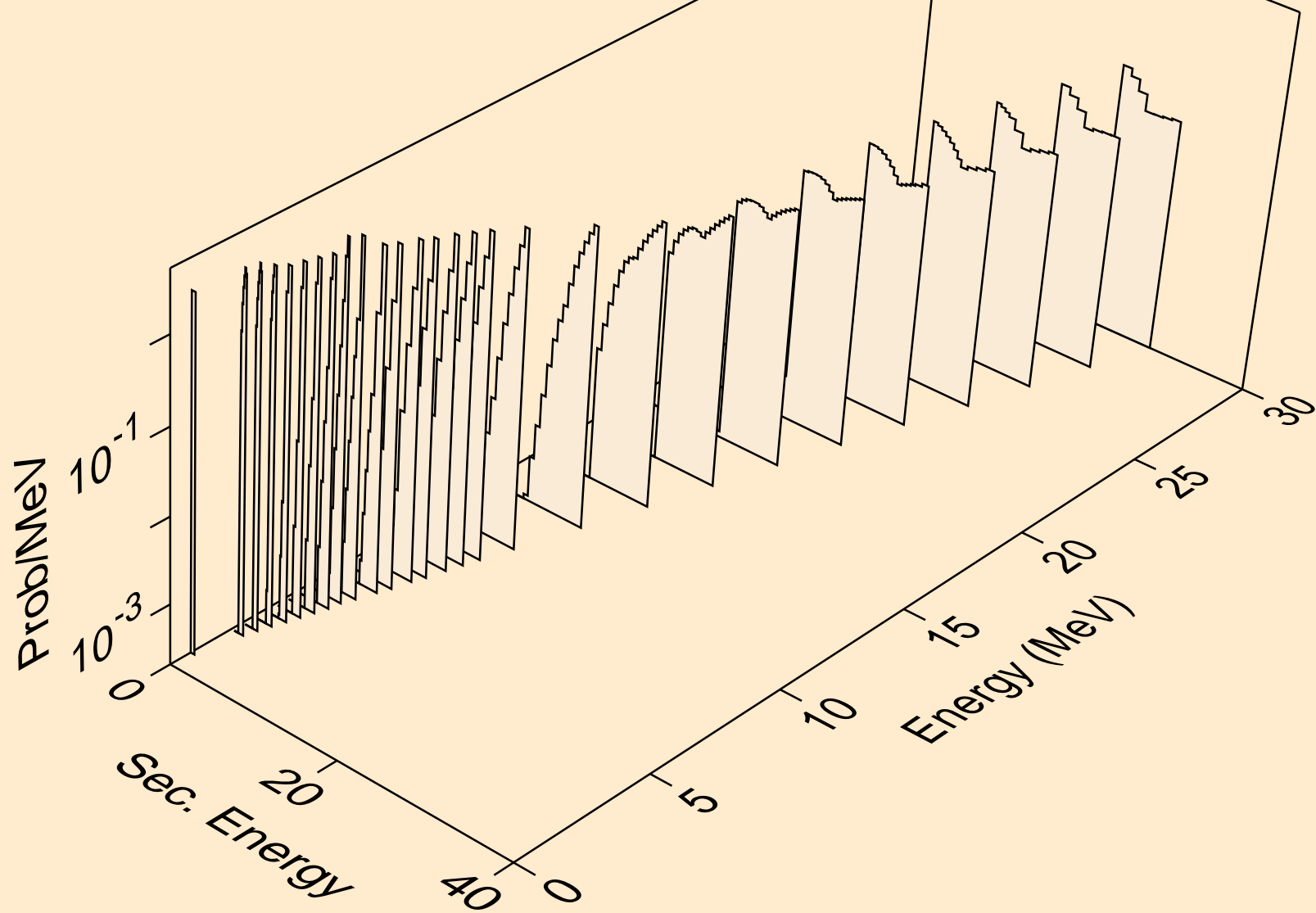

BI216M NEUTRON ACER TENDL-2021 LIBRARY; T=293.6K  
protons from (n,2p)

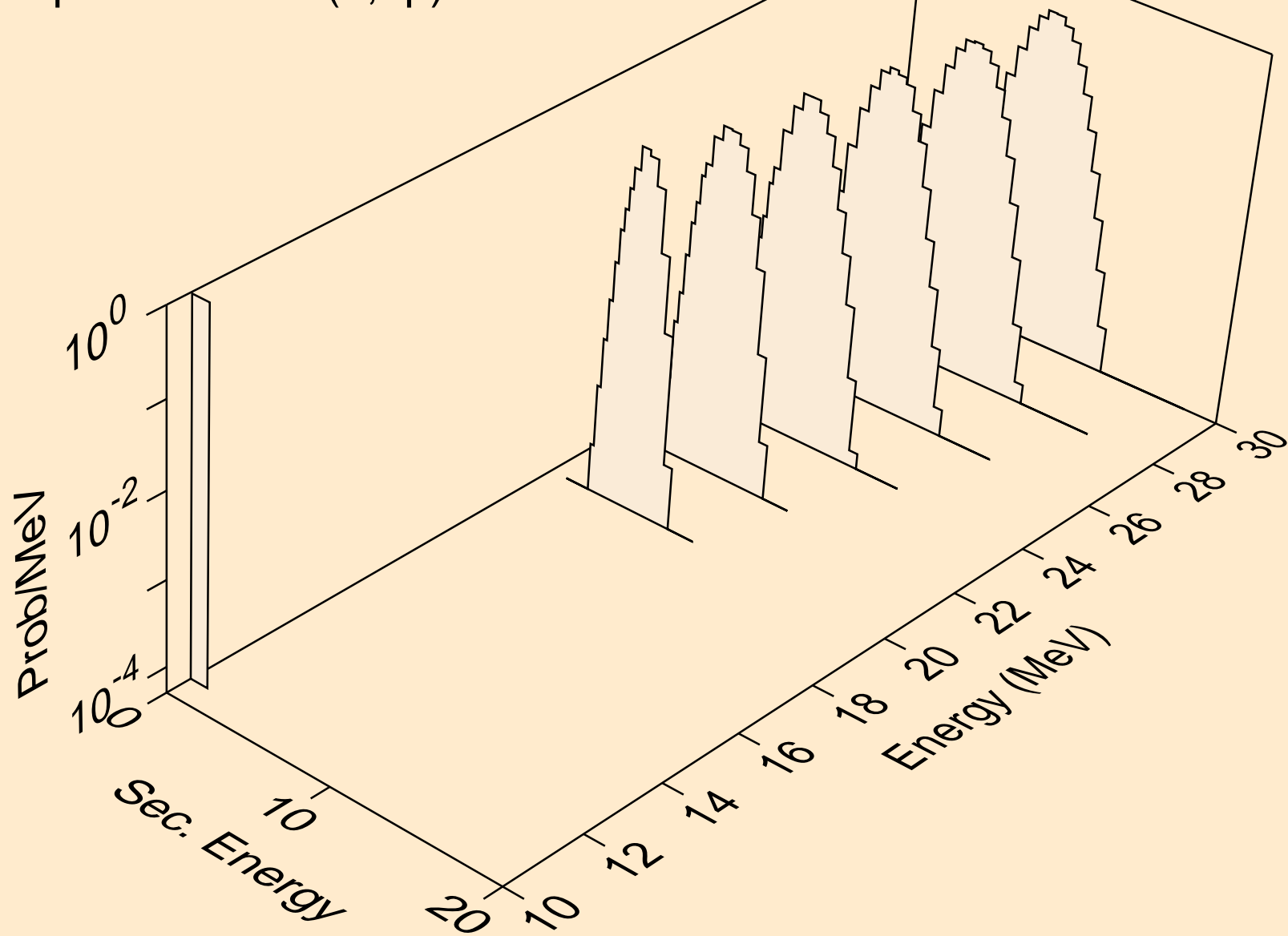

BI216M NEUTRON ACER TENDL-2021 LIBRARY; T=293.6K  
protons from (n,p)

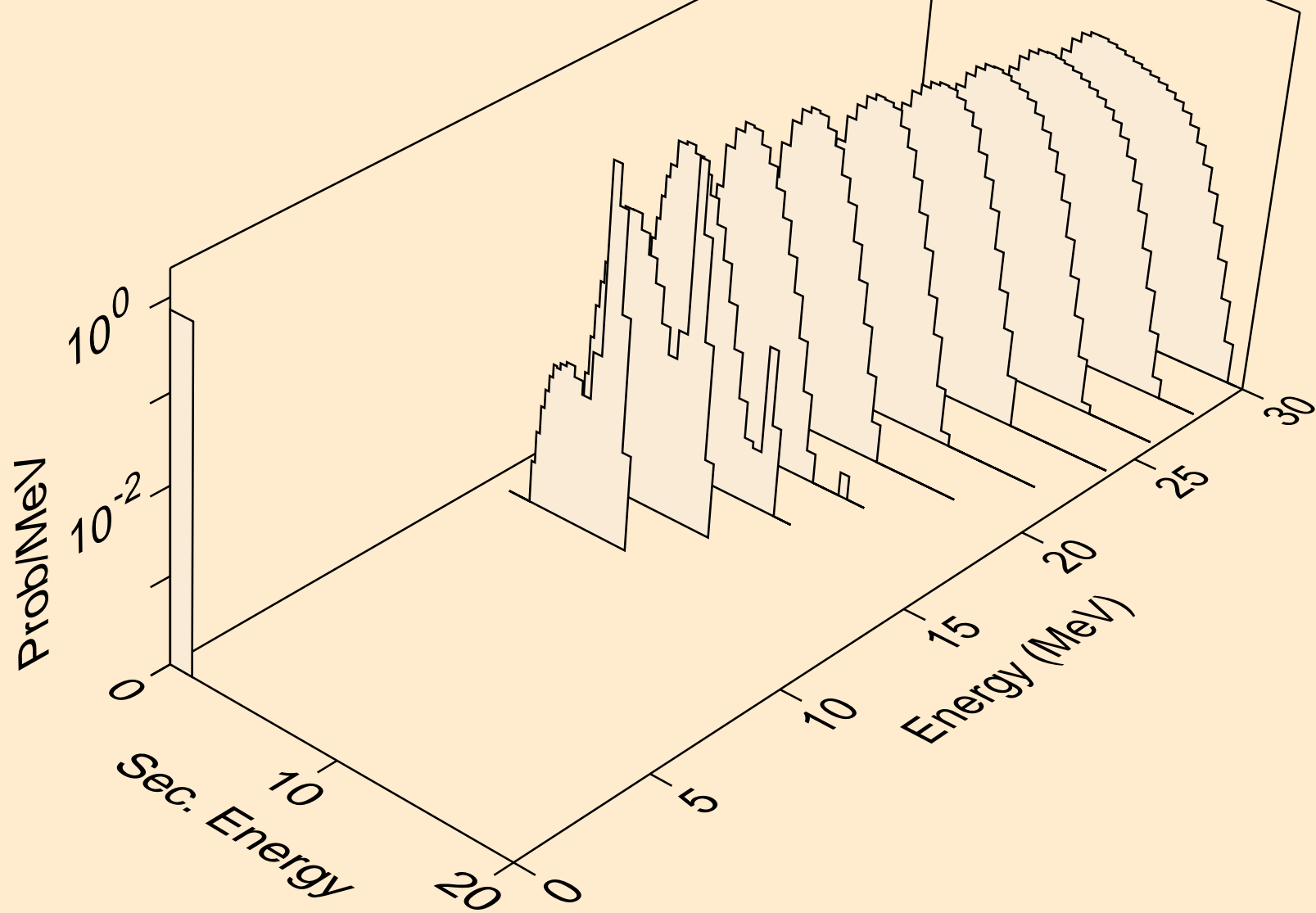

BI216M NEUTRON ACER TENDL-2021 LIBRARY; T=293.6K  
protons from (n,pd)

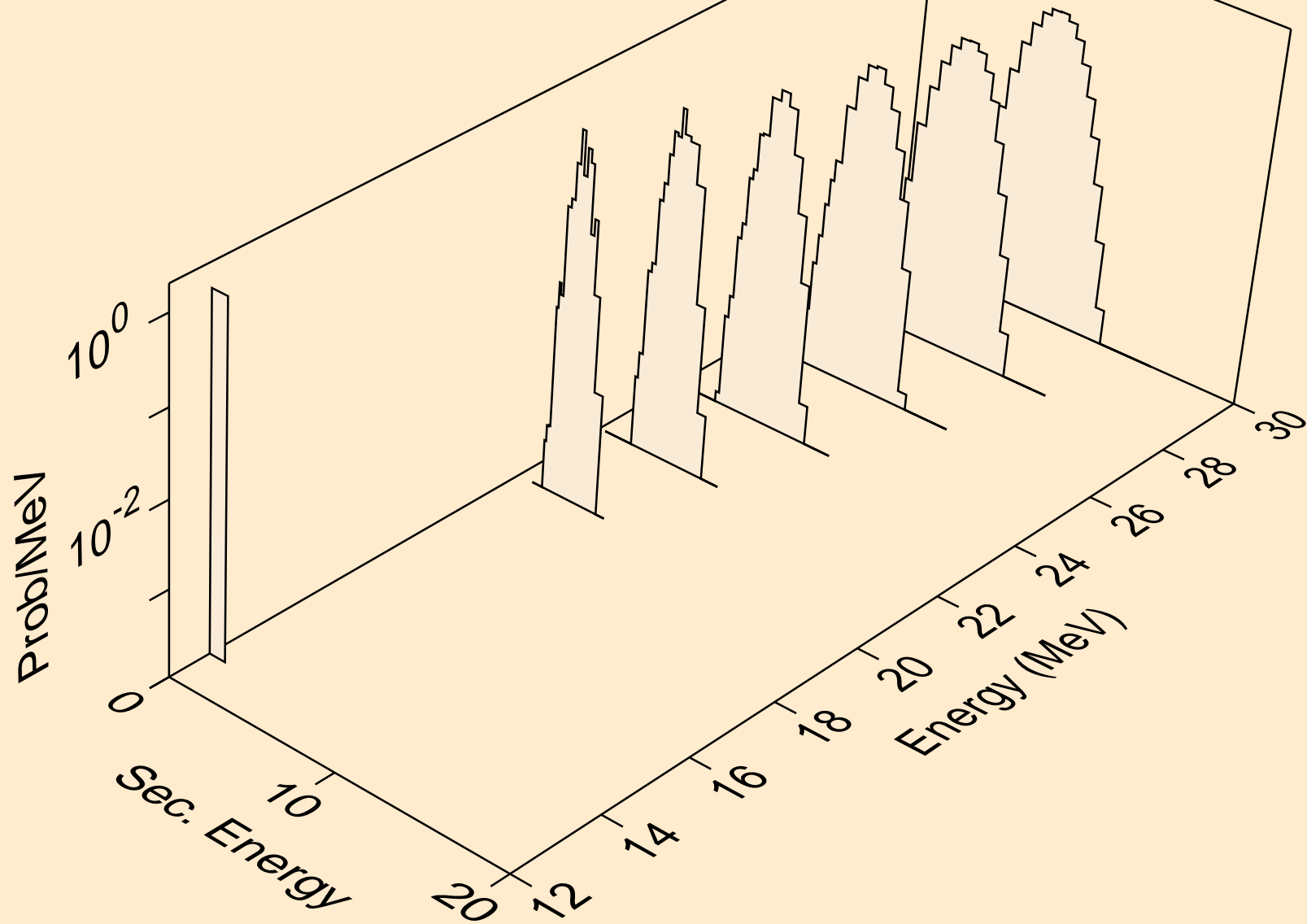

BI216M NEUTRON ACER TENDL-2021 LIBRARY; T=293.6K  
protons from (n,pt)

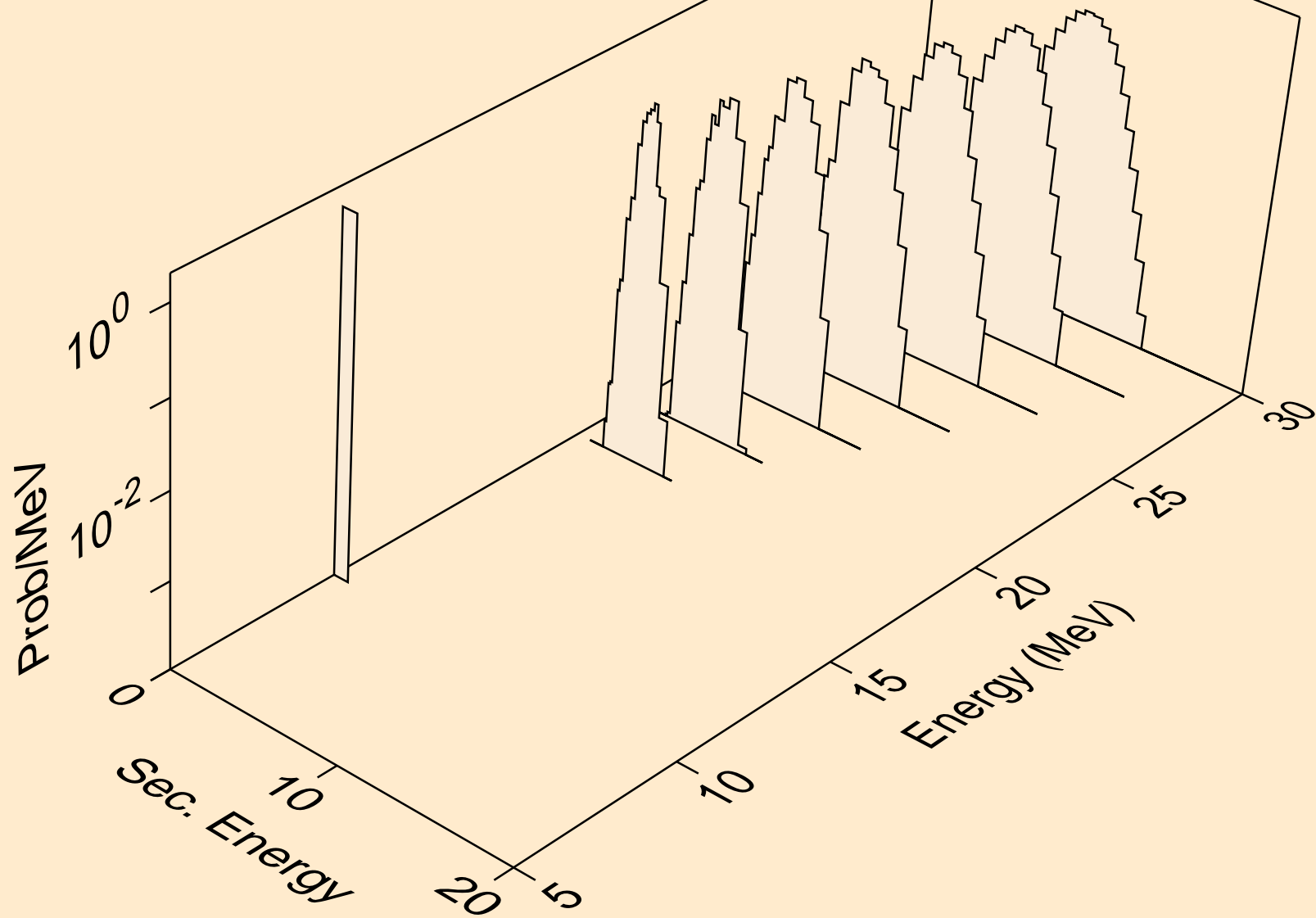

BI216M NEUTRON ACER TENDL-2021 LIBRARY; T=293.6K  
deuterons from (n,x)

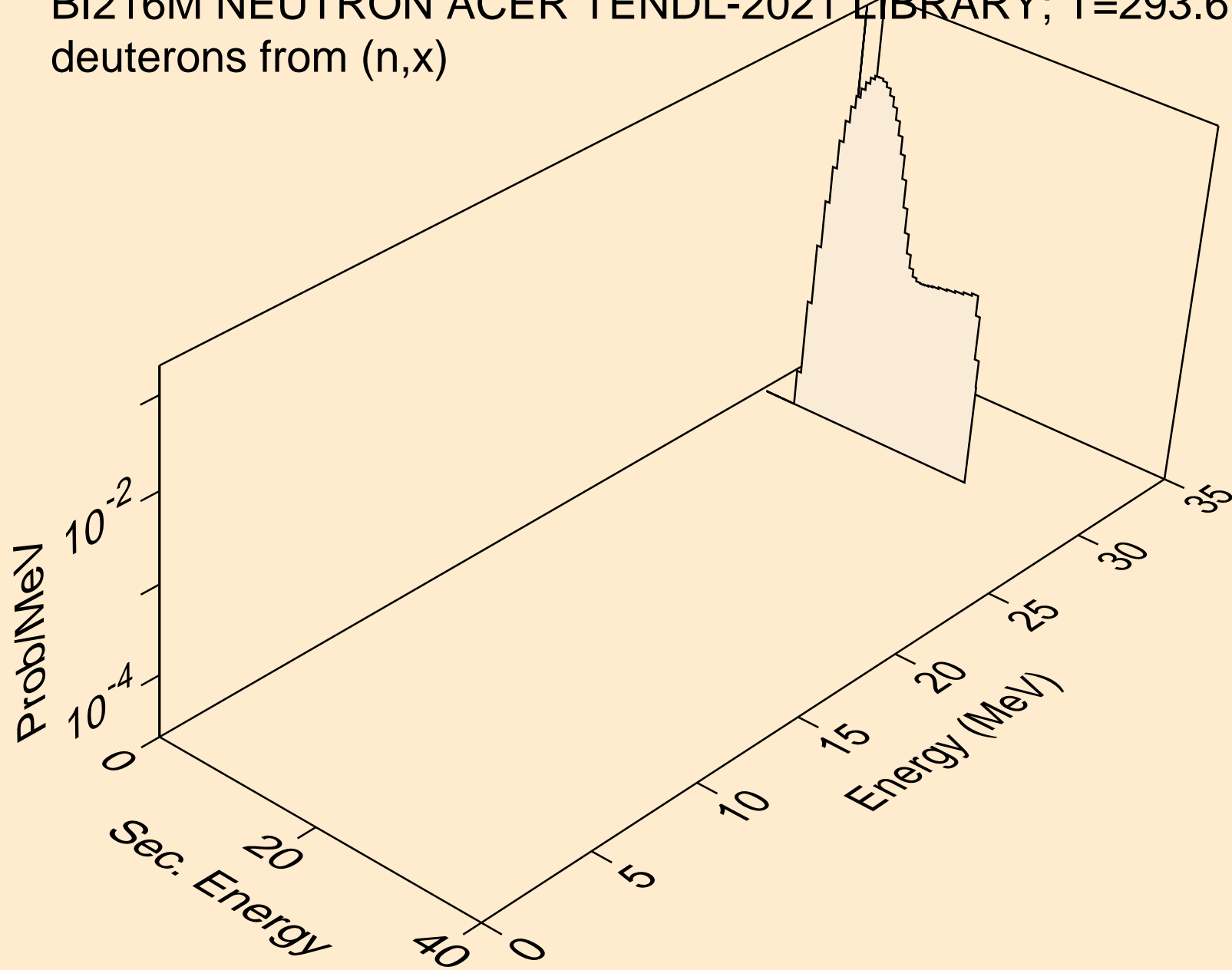



BI216M NEUTRON ACER TENDL-2021 LIBRARY; T=293.6K  
deuterons from (n,2nd)

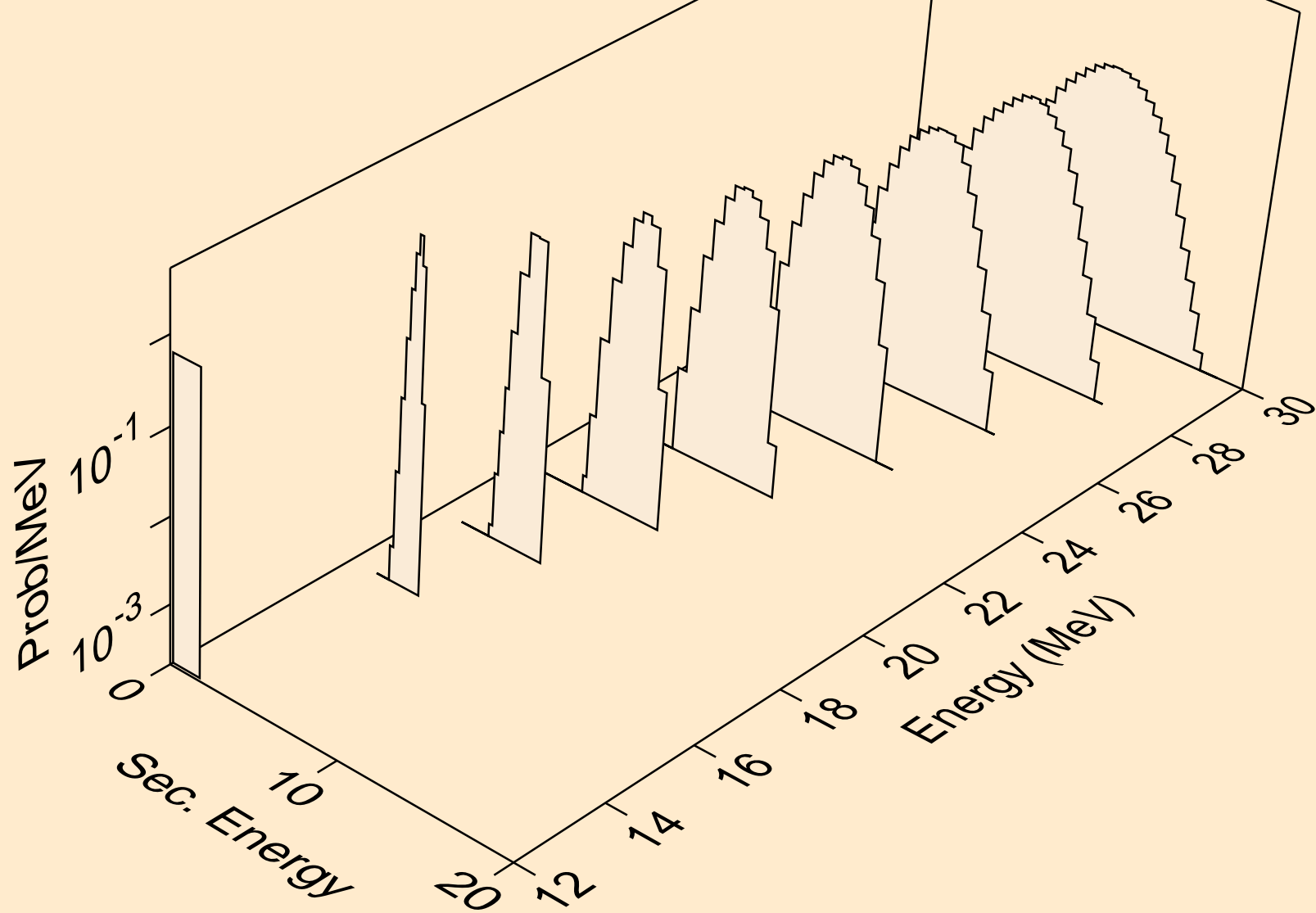

BI216M NEUTRON ACER TENDL-2021 LIBRARY; T=293.6K  
deuterons from (n,n\*)d

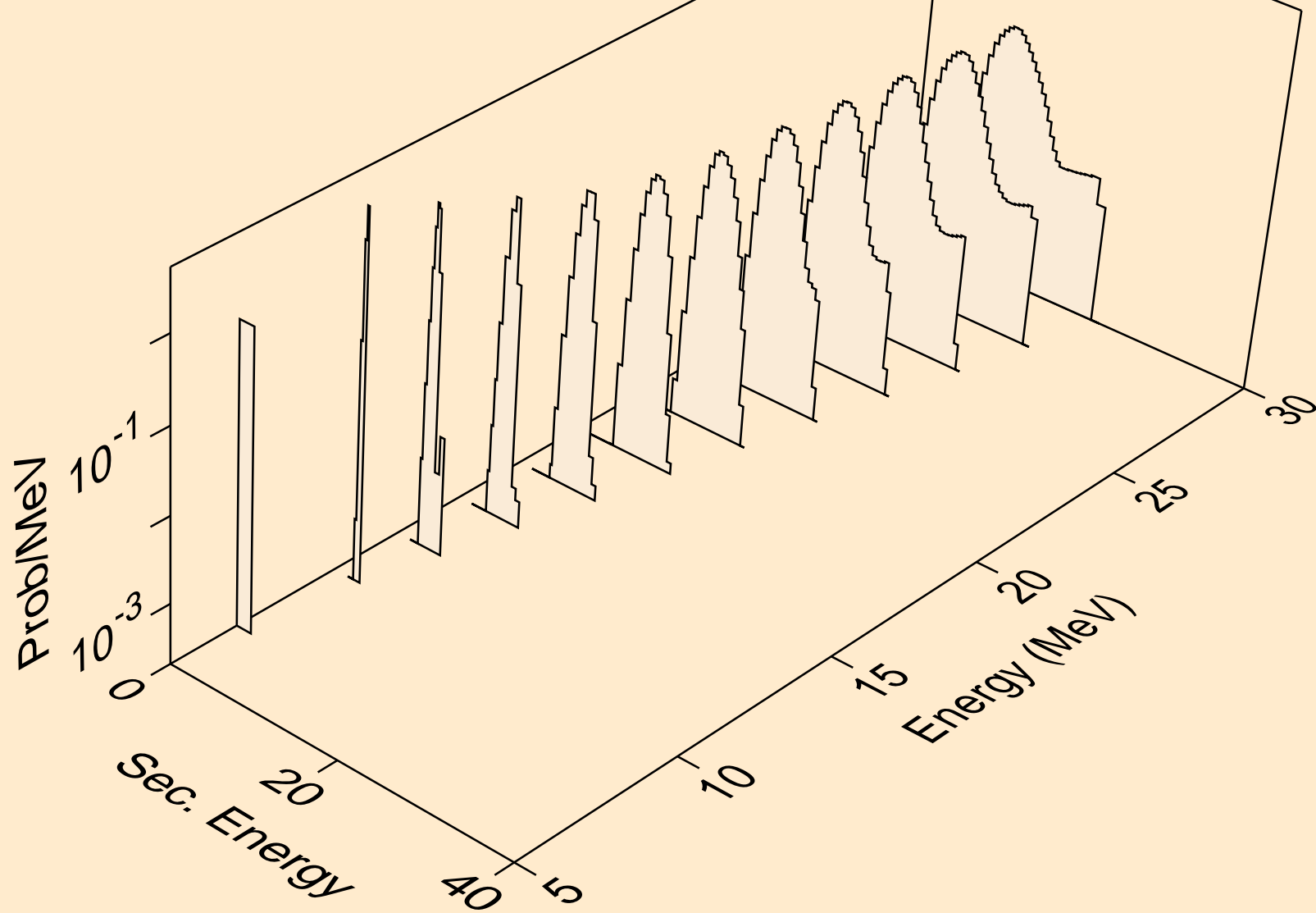

BI216M NEUTRON ACER TENDL-2021 LIBRARY; T=293.6K  
deuterons from (n,d)

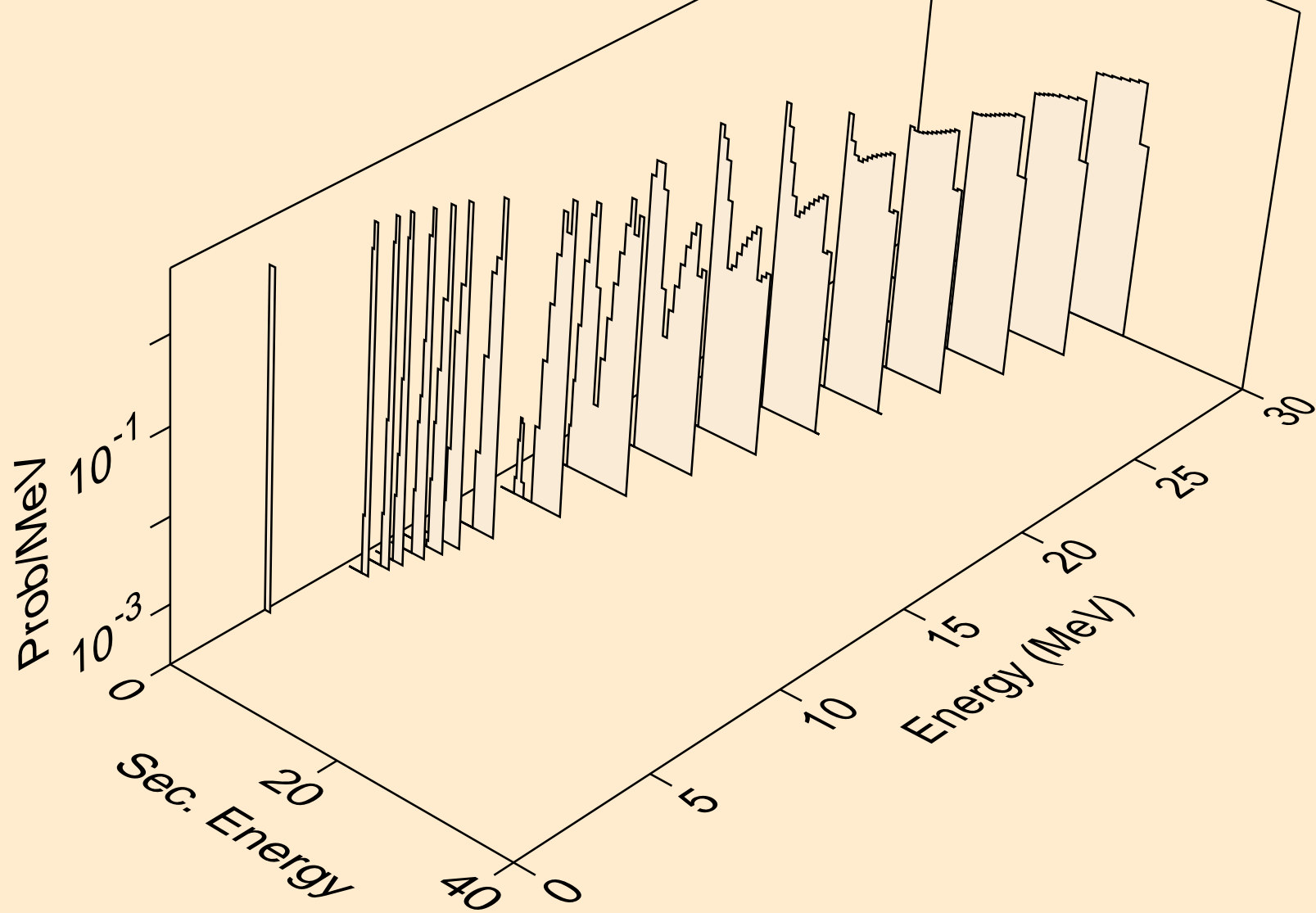

BI216M NEUTRON ACER TENDL-2021 LIBRARY; T=293.6K  
deuterons from (n,pd)

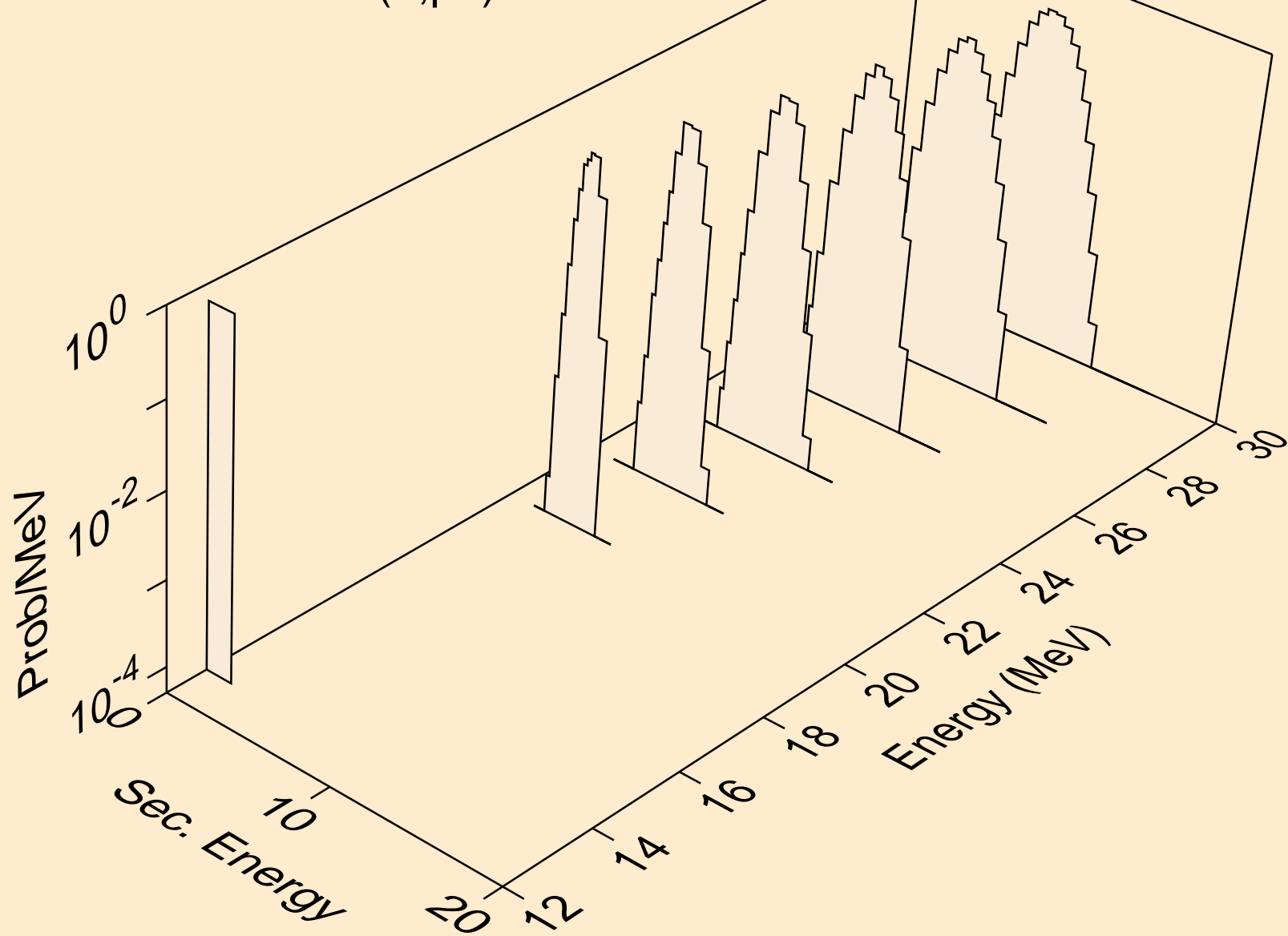

BI216M NEUTRON ACER TENDL-2021 LIBRARY; T=293.6K  
tritons from (n,x)

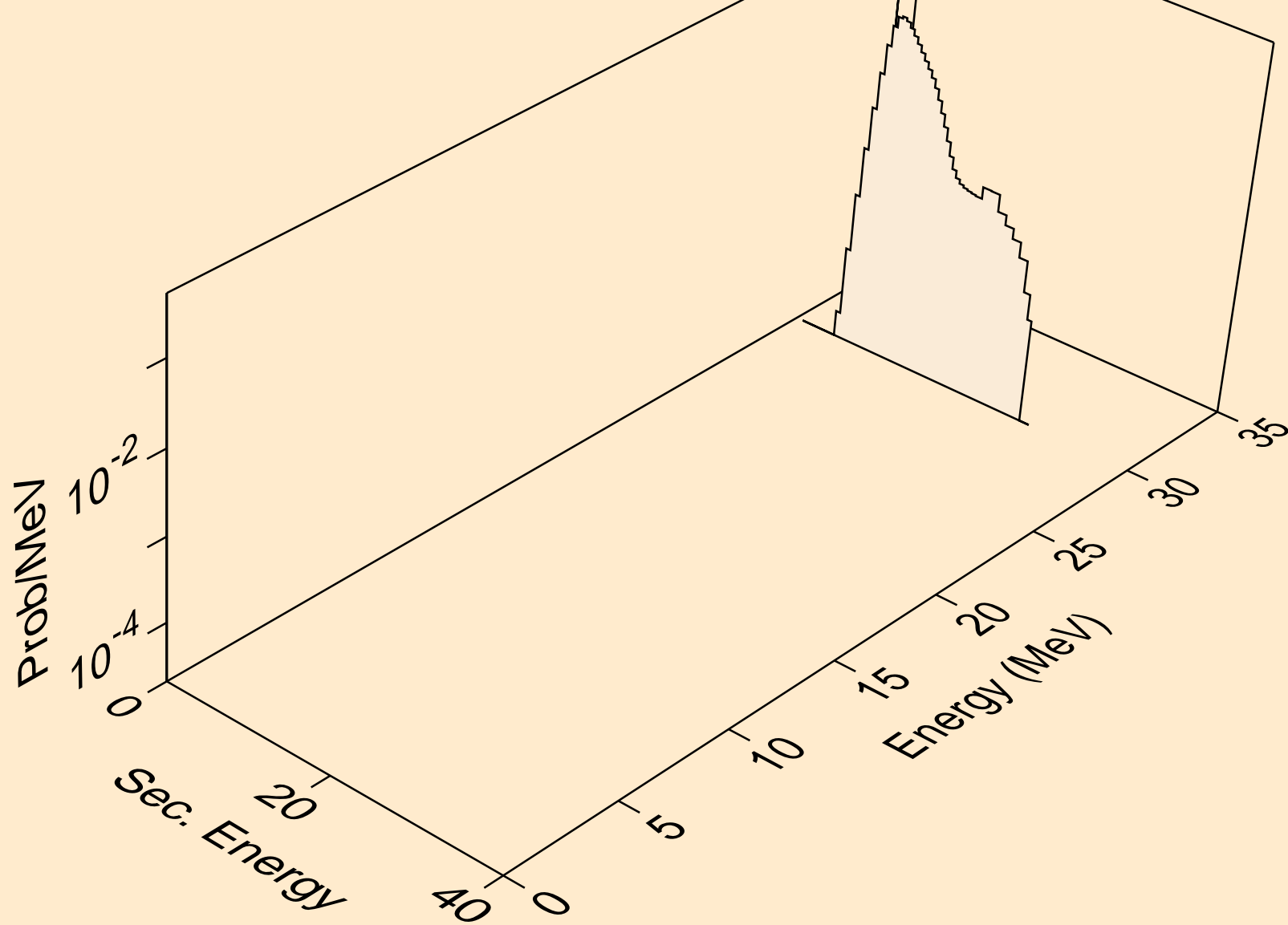

BI216M NEUTRON ACER TENDL-2021 LIBRARY; T=293.6K  
tritons from (n,n\*)t

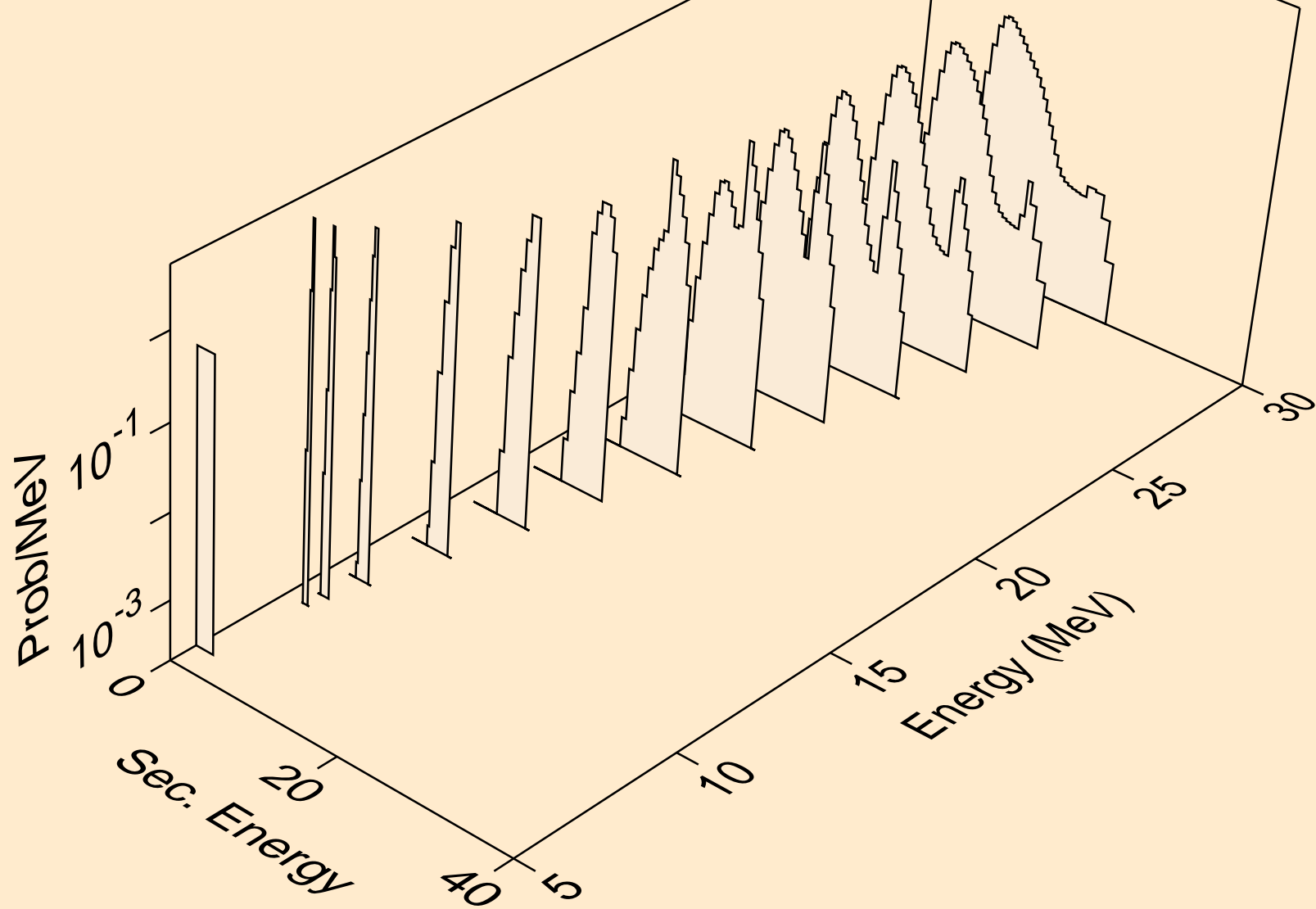

BI216M NEUTRON ACER TENDL-2021 LIBRARY; T=293.6K  
tritons from (n,t)

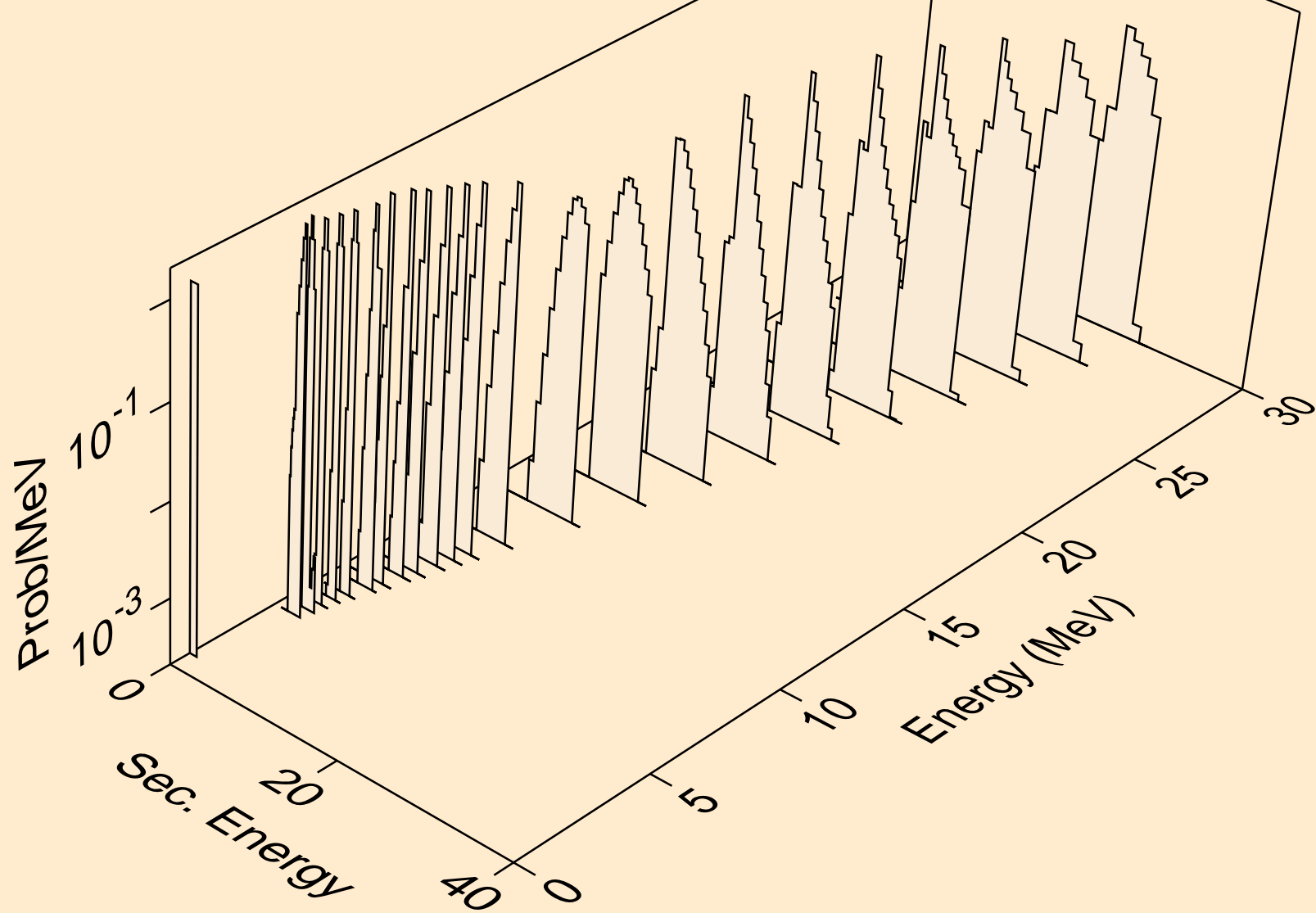

BI216M NEUTRON ACER TENDL-2021 LIBRARY; T=293.6K  
tritons from (n,pt)

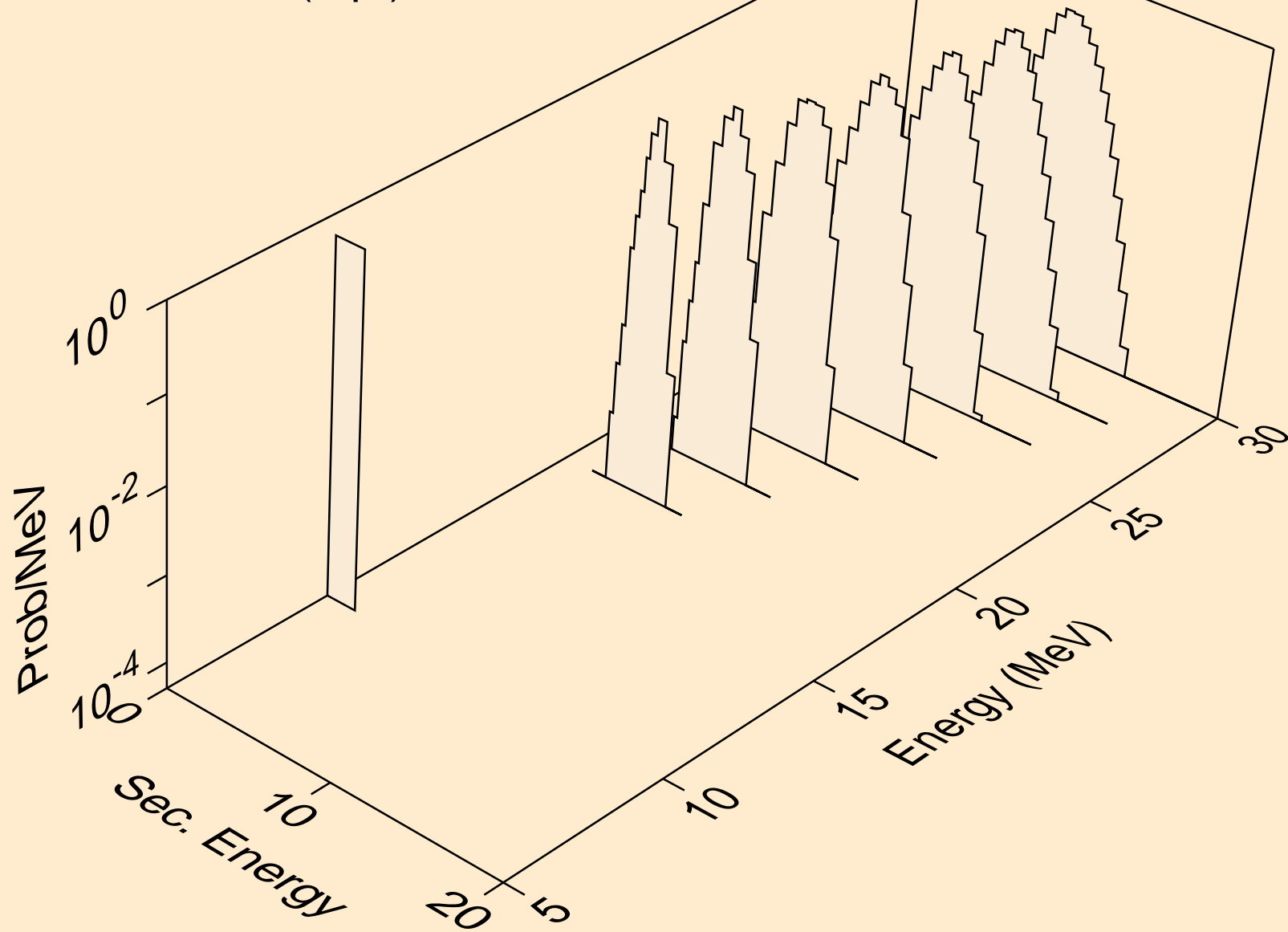



BI216M NEUTRON ACER TENDL-2021 LIBRARY; T=293.6K  
he3s from (n,x)

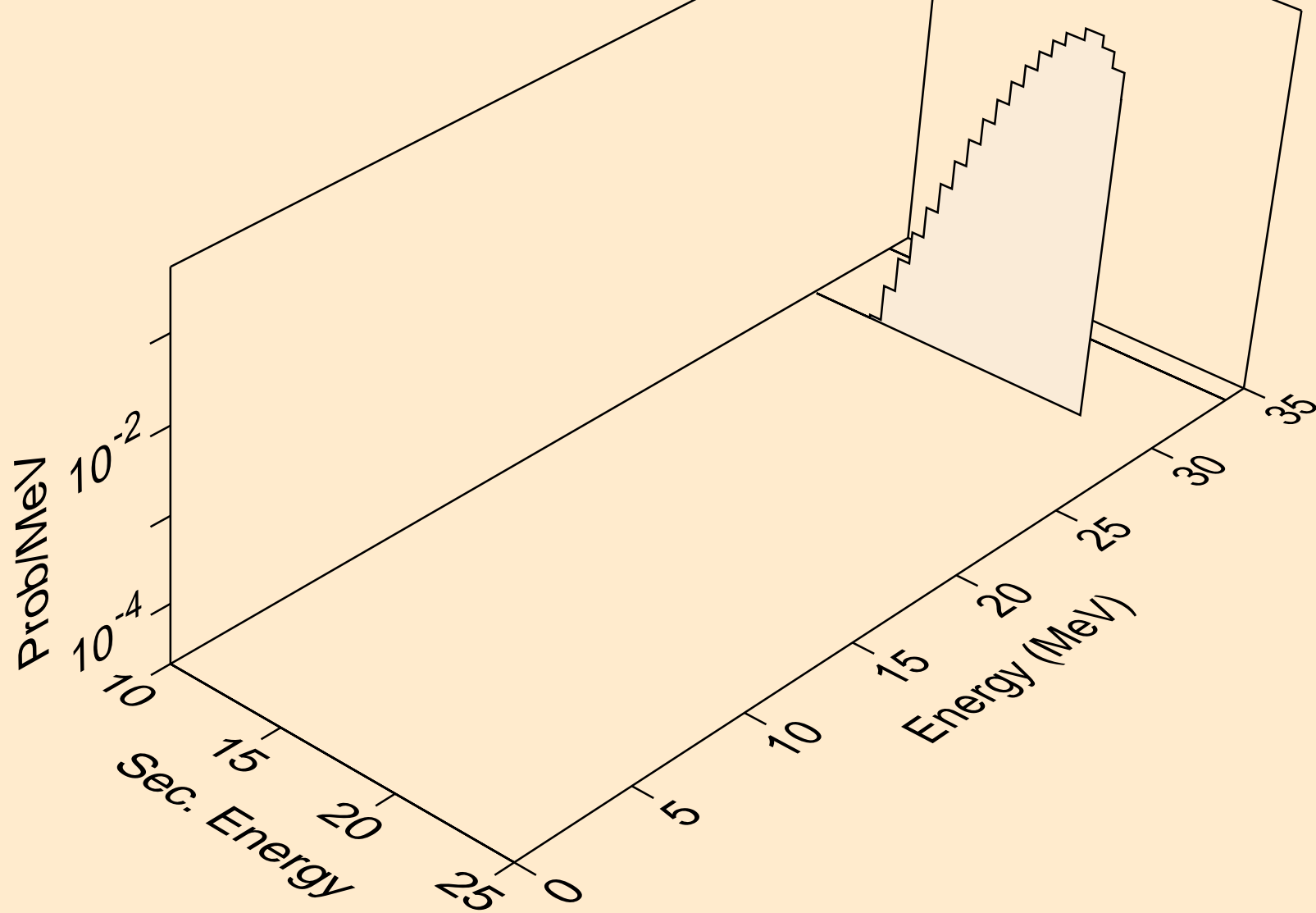

BI216M NEUTRON ACER TENDL-2021 LIBRARY; T=293.6K  
he3s from (n,n\*)he3

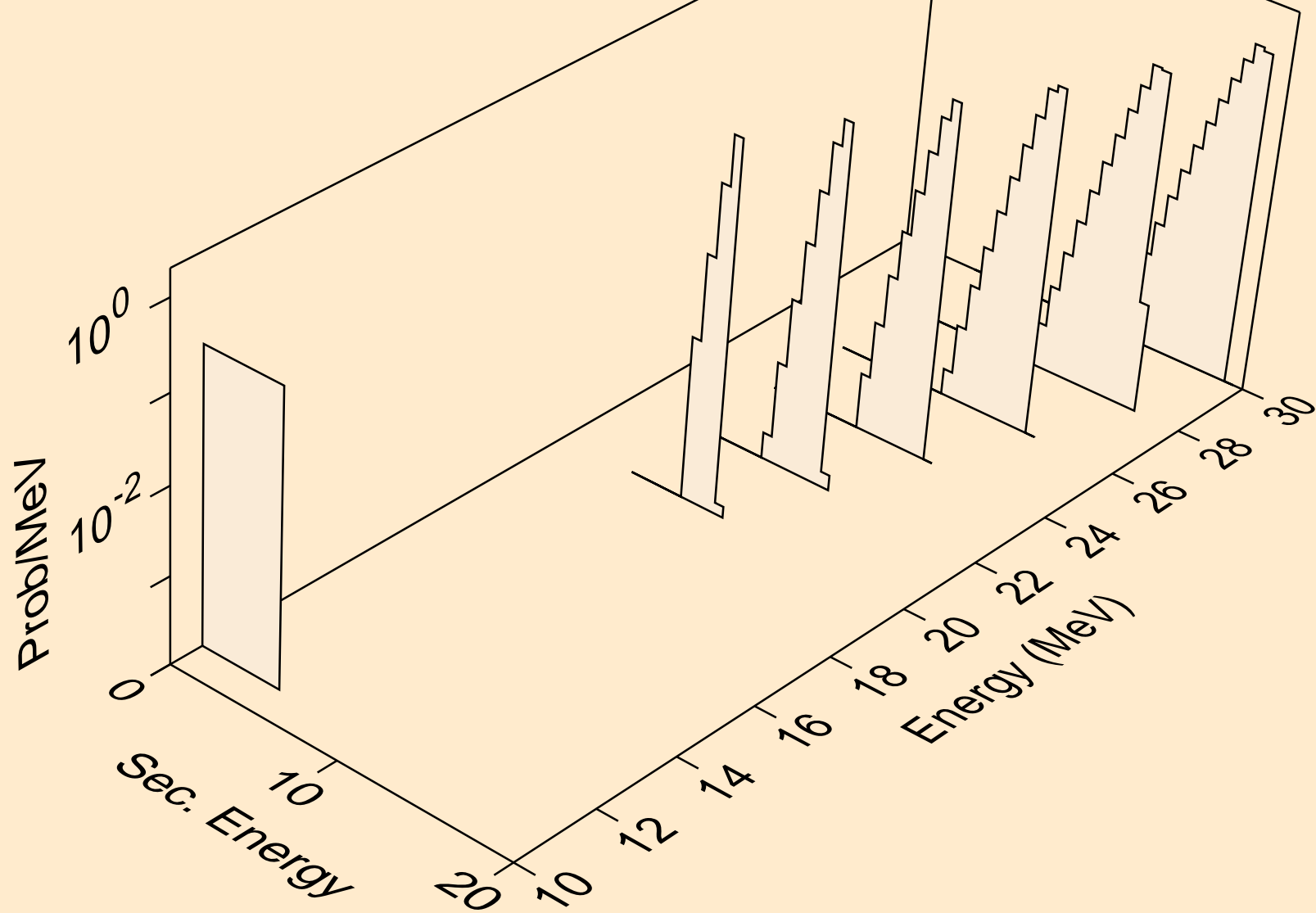

BI216M NEUTRON ACER TENDL-2021 LIBRARY; T=293.6K  
he3s from (n,he3)

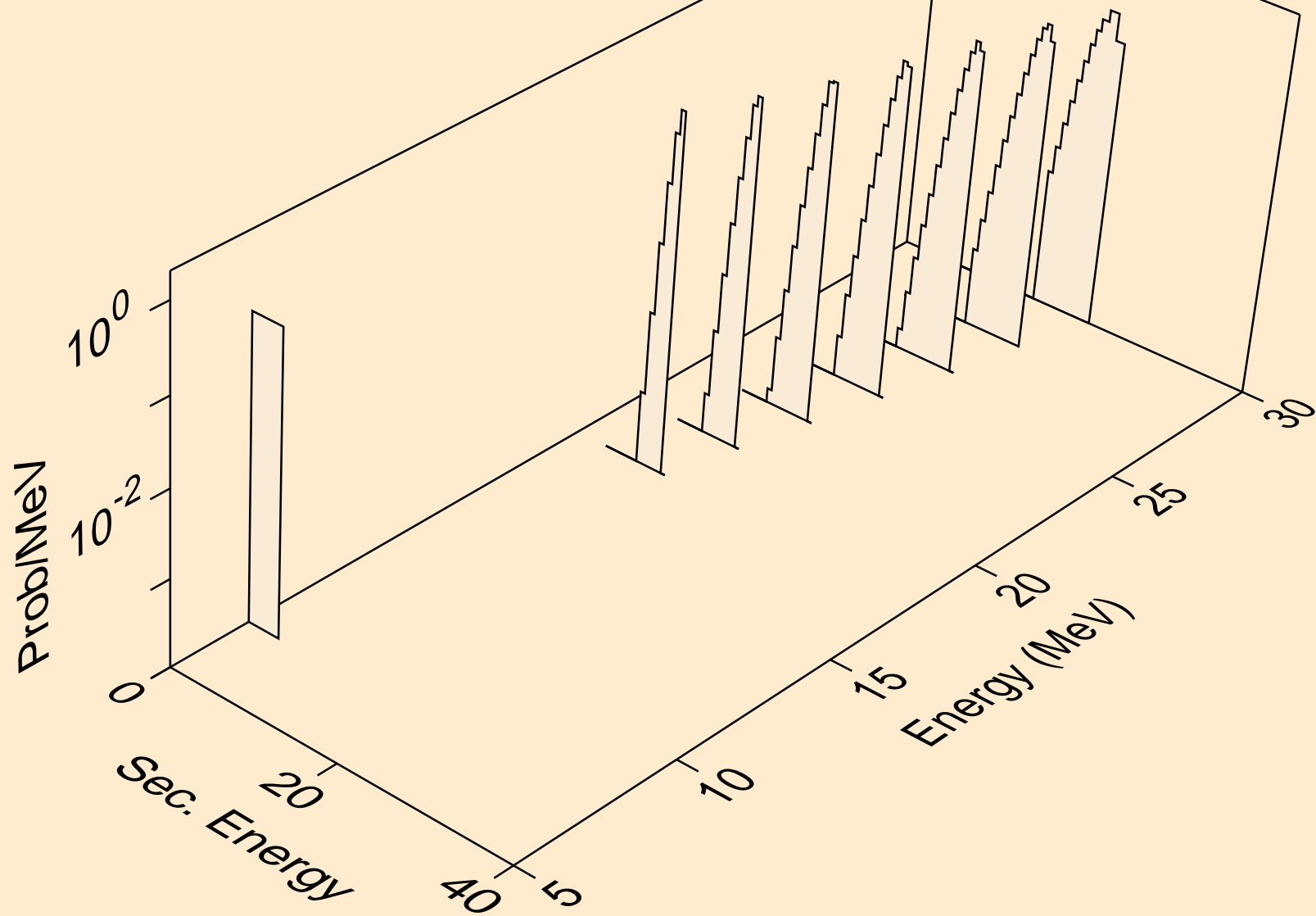

BI216M NEUTRON ACER TENDL-2021 LIBRARY; T=293.6K  
alphas from (n,x)

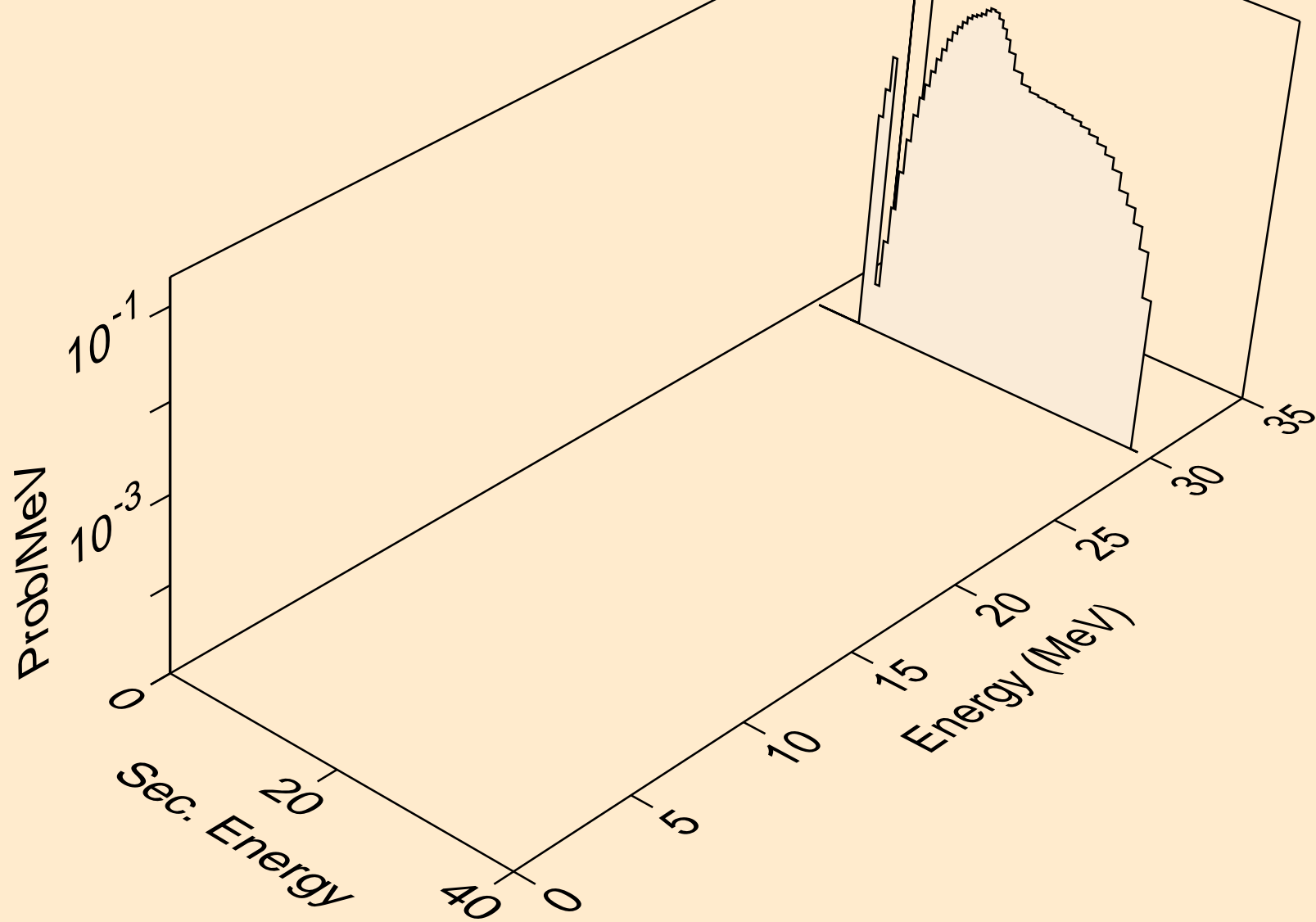

BI216M NEUTRON ACER TENDL-2021 LIBRARY; T=293.6K  
alphas from (n,n\*)a

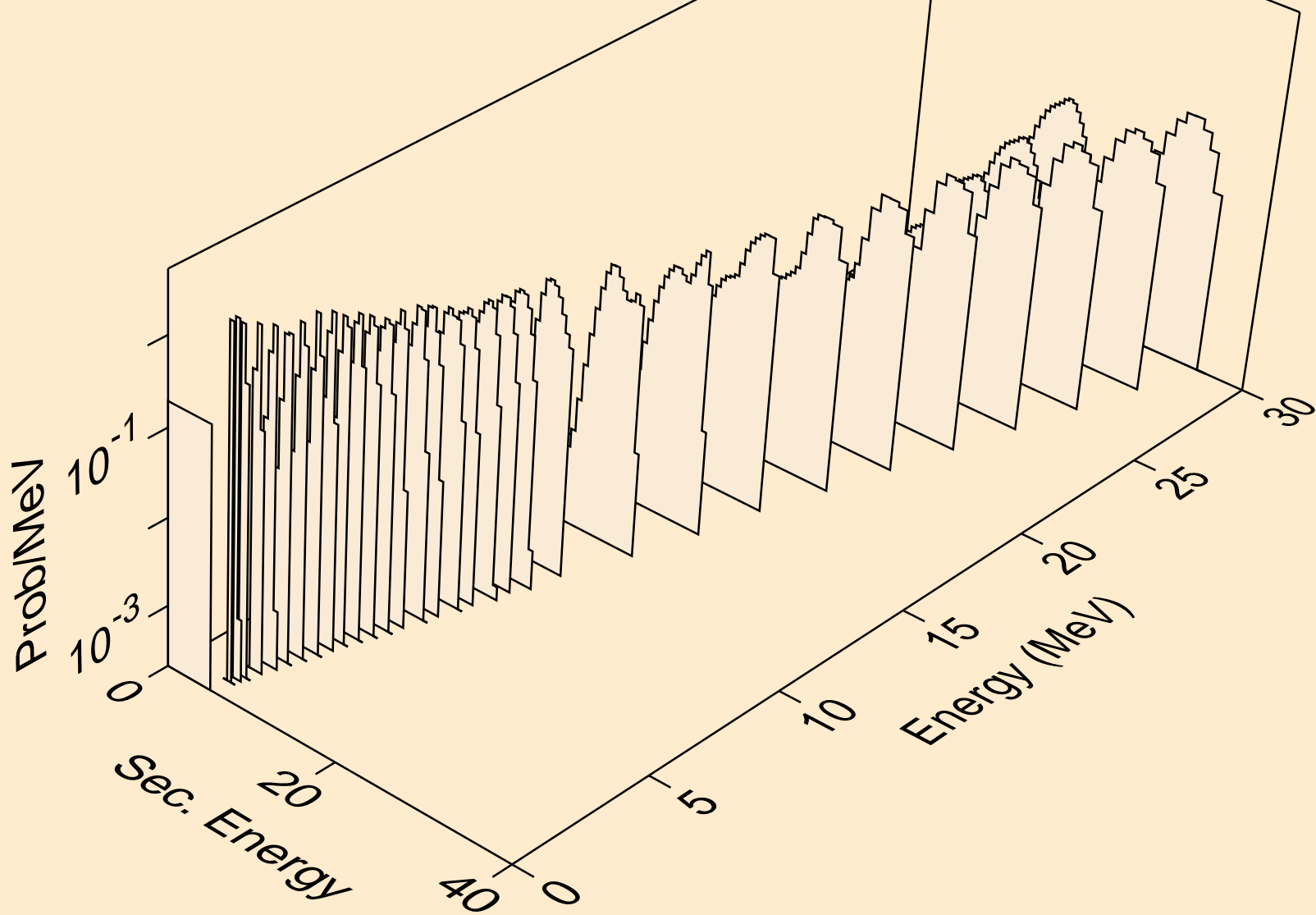

BI216M NEUTRON ACER TENDL-2021 LIBRARY; T=293.6K  
alphas from (n,2n)a

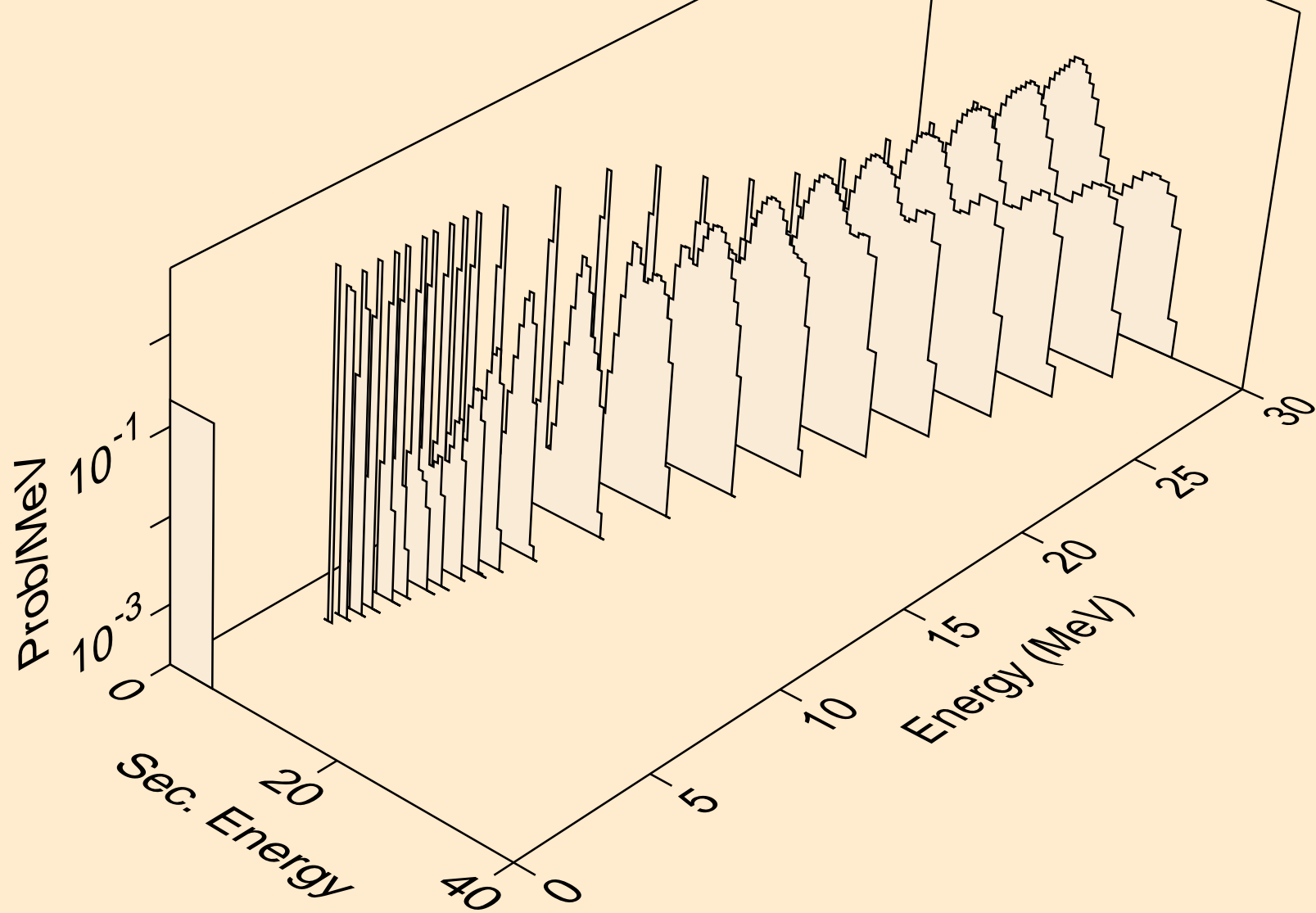

BI216M NEUTRON ACER TENDL-2021 LIBRARY; T=293.6K  
alphas from (n,3n)a

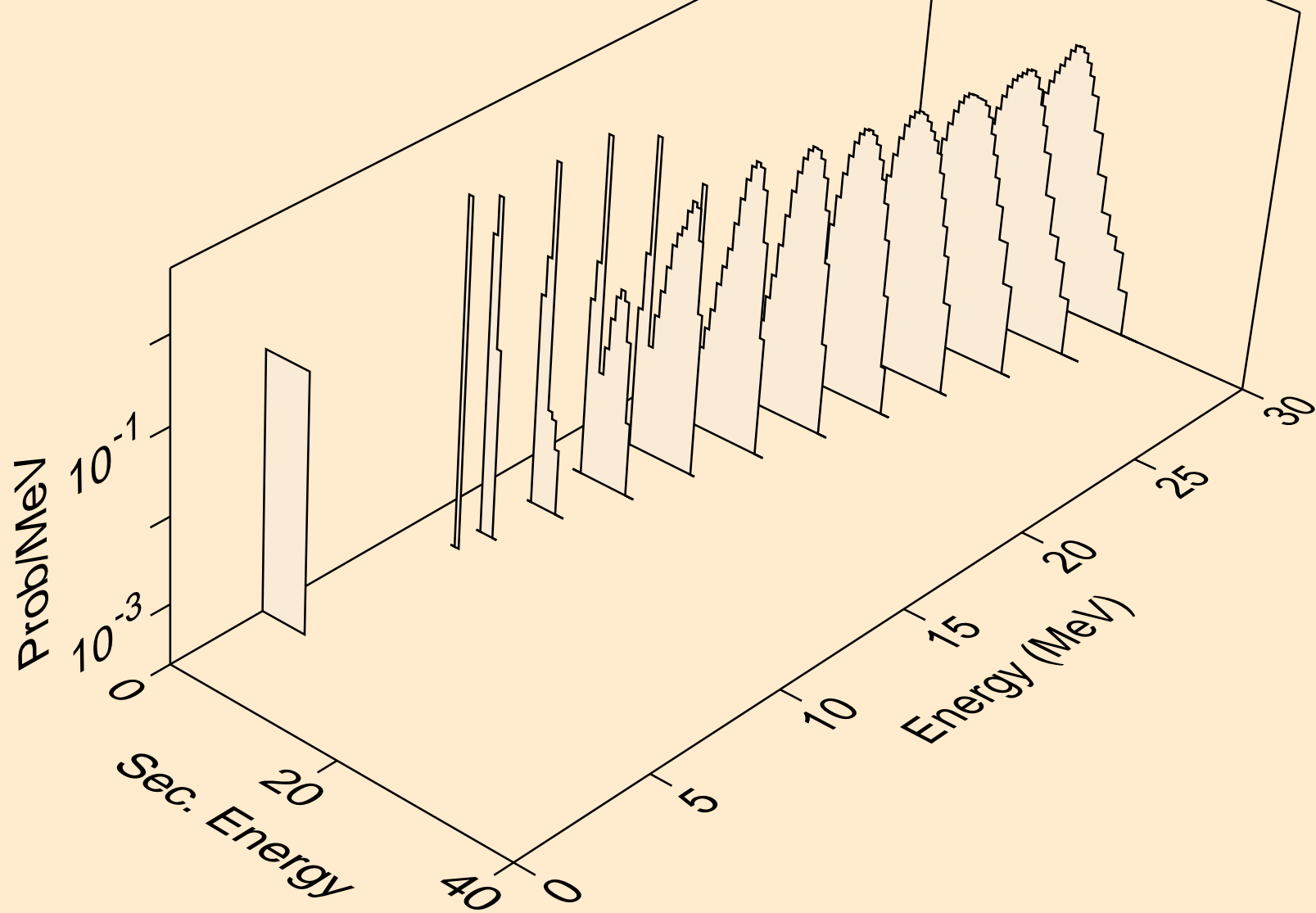

BI216M NEUTRON ACER TENDL-2021 LIBRARY; T=293.6K  
alphas from (n,n\*)2a

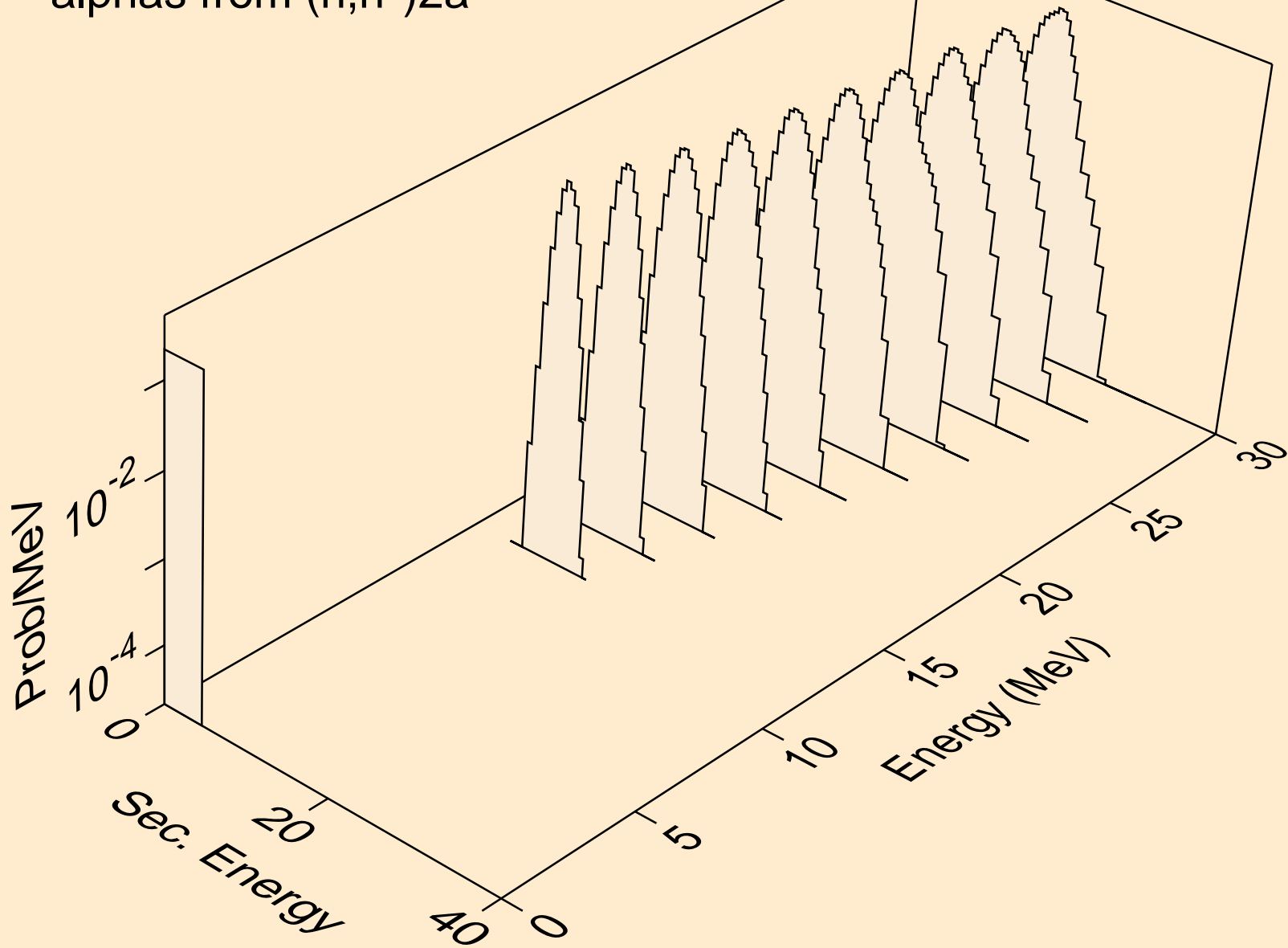



BI216M NEUTRON ACER TENDL-2021 LIBRARY; T=293.6K  
alphas from (n,2n)2a

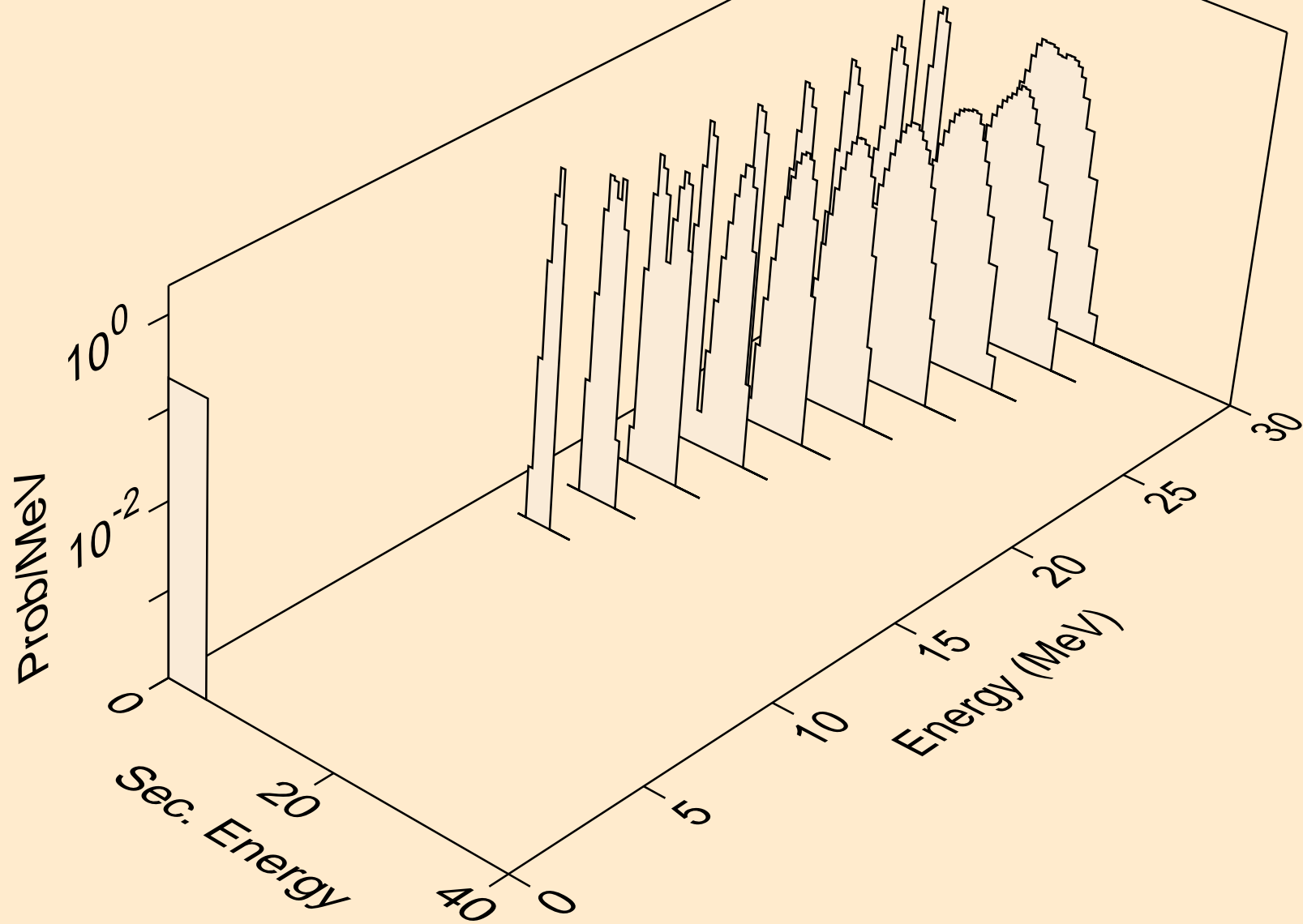

BI216M NEUTRON ACER TENDL-2021 LIBRARY; T=293.6K  
alphas from (n,npa)

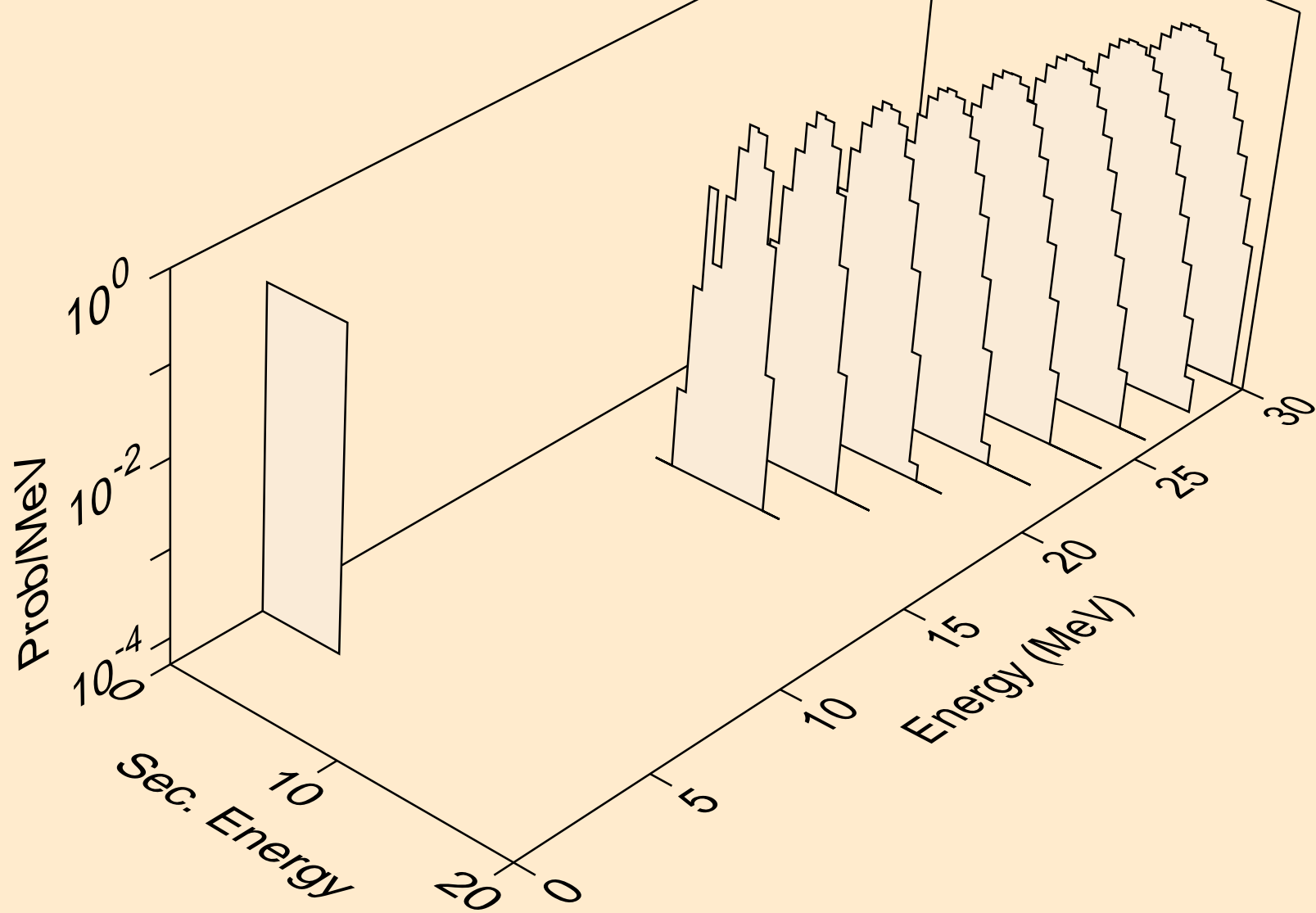

BI216M NEUTRON ACER TENDL-2021 LIBRARY; T=293.6K  
alphas from (n,a)

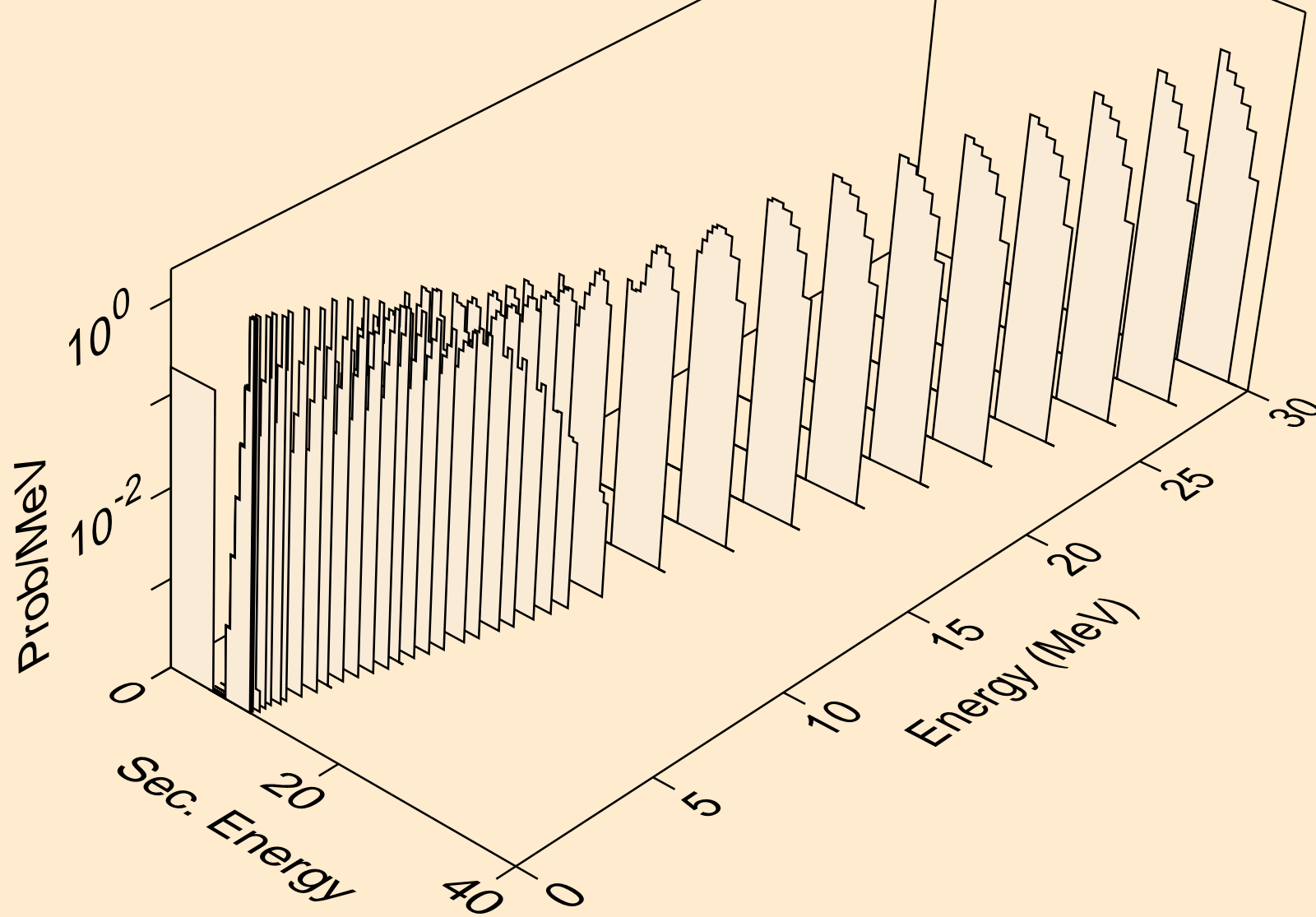

BI216M NEUTRON ACER TENDL-2021 LIBRARY; T=293.6K  
alphas from (n,2a)

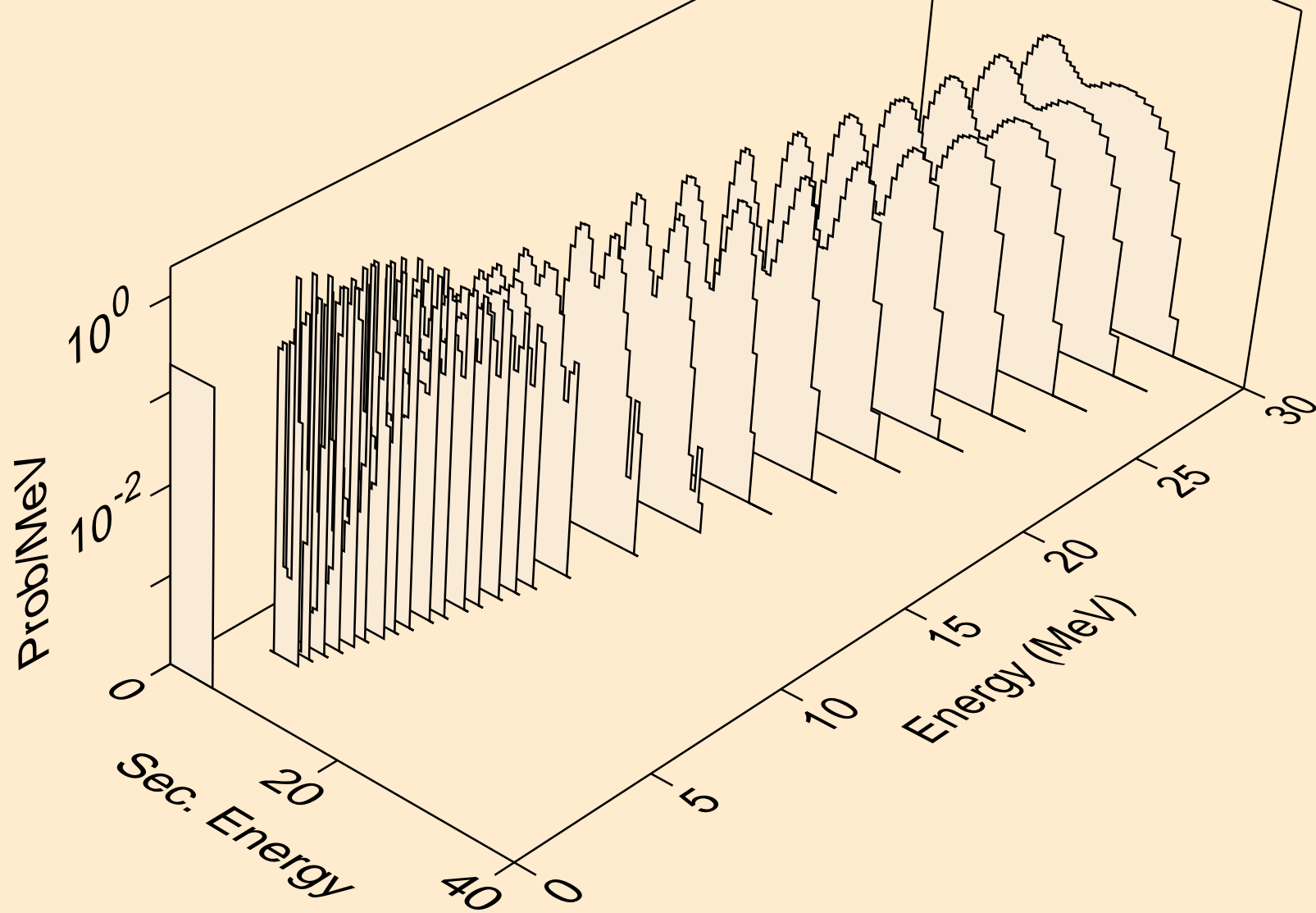

BI216M NEUTRON ACER TENDL-2021 LIBRARY; T=293.6K  
alphas from (n,pa)

