

BK238 NEUTRON ACER TENDL-2021 LIBRARY; T=293.6K

Principal cross sections

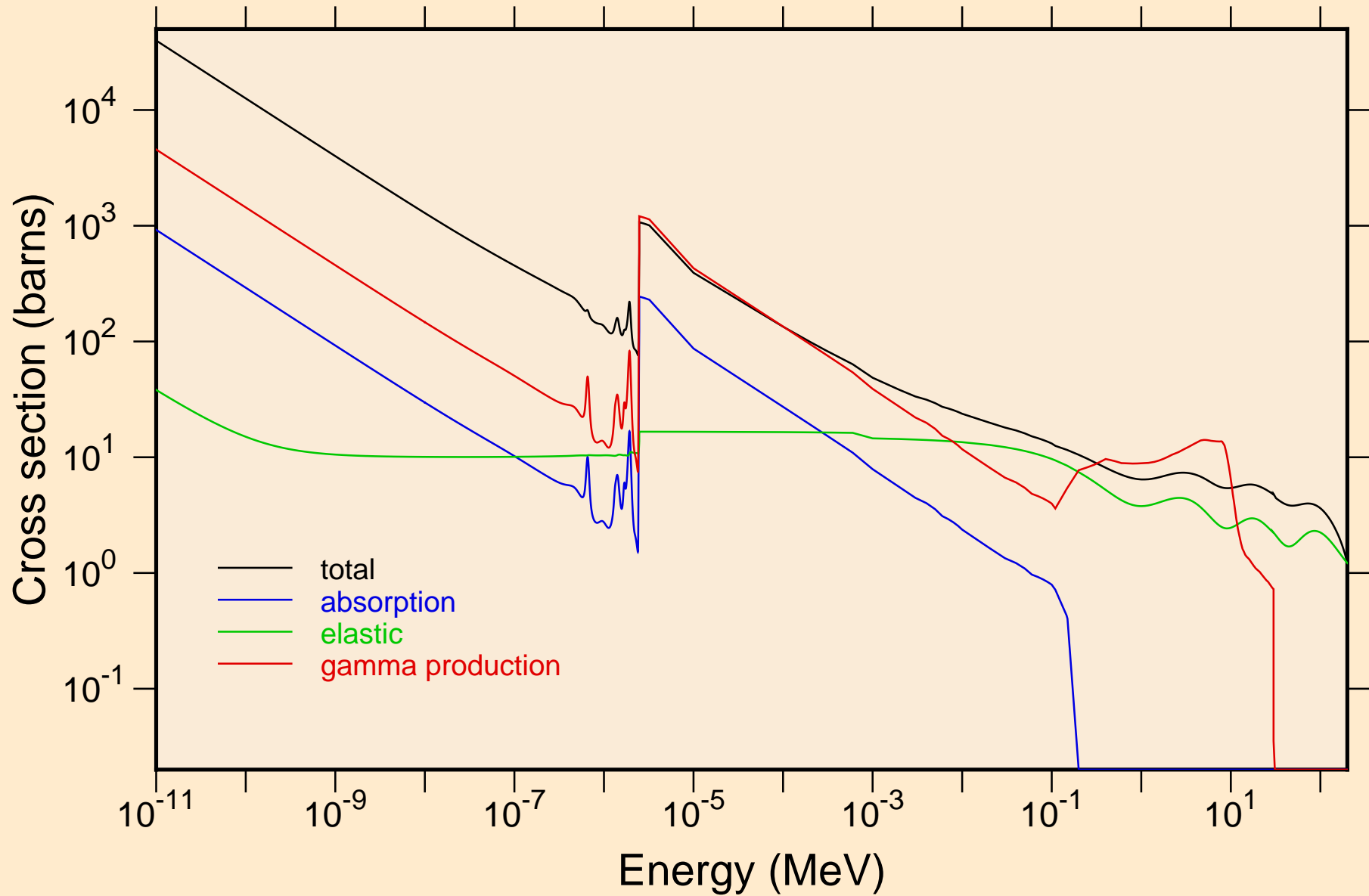

BK238 NEUTRON ACER TENDL-2021 LIBRARY; T=293.6K
Heating

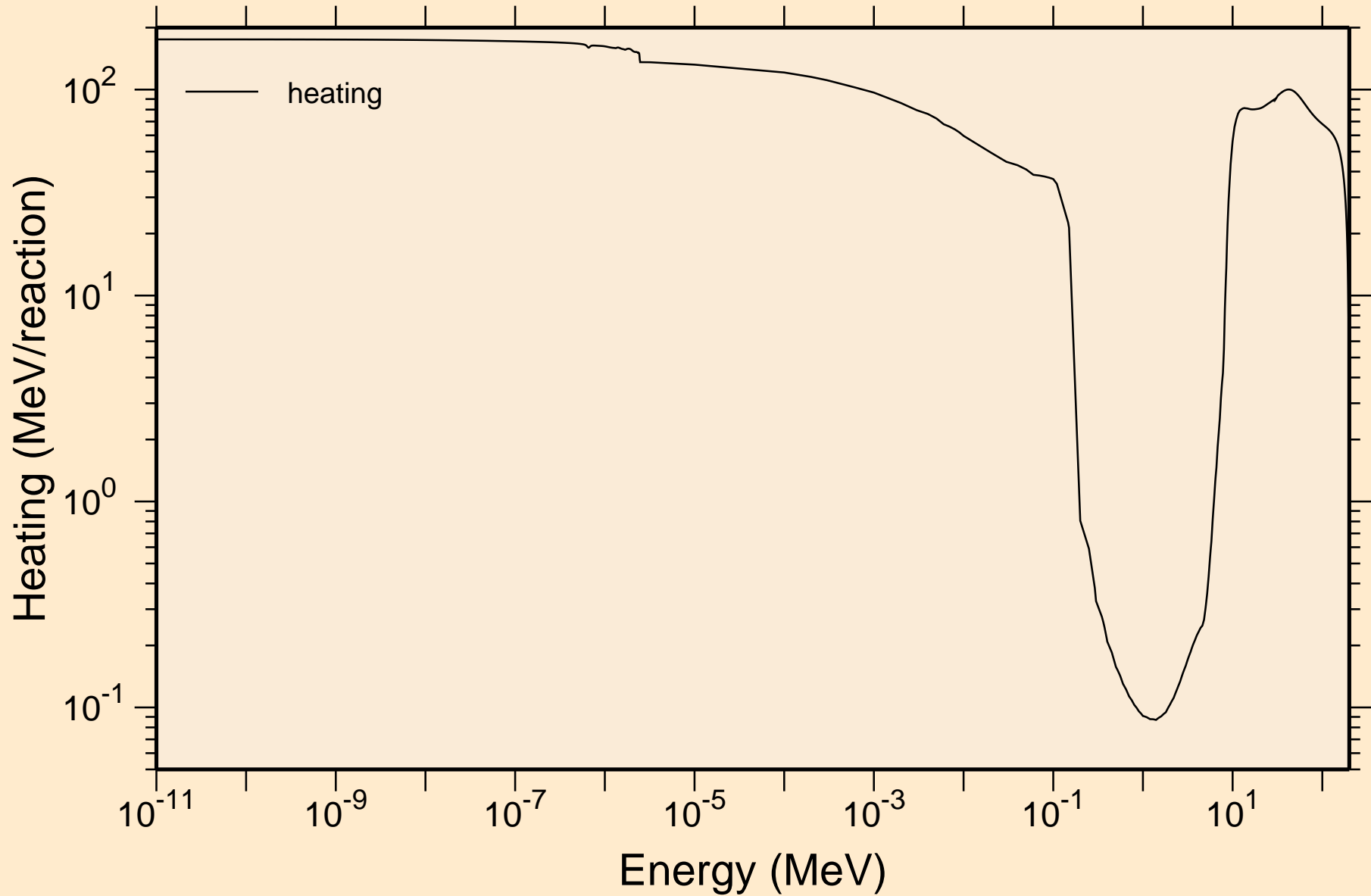

BK238 NEUTRON ACER TENDL-2021 LIBRARY; T=293.6K
Damage

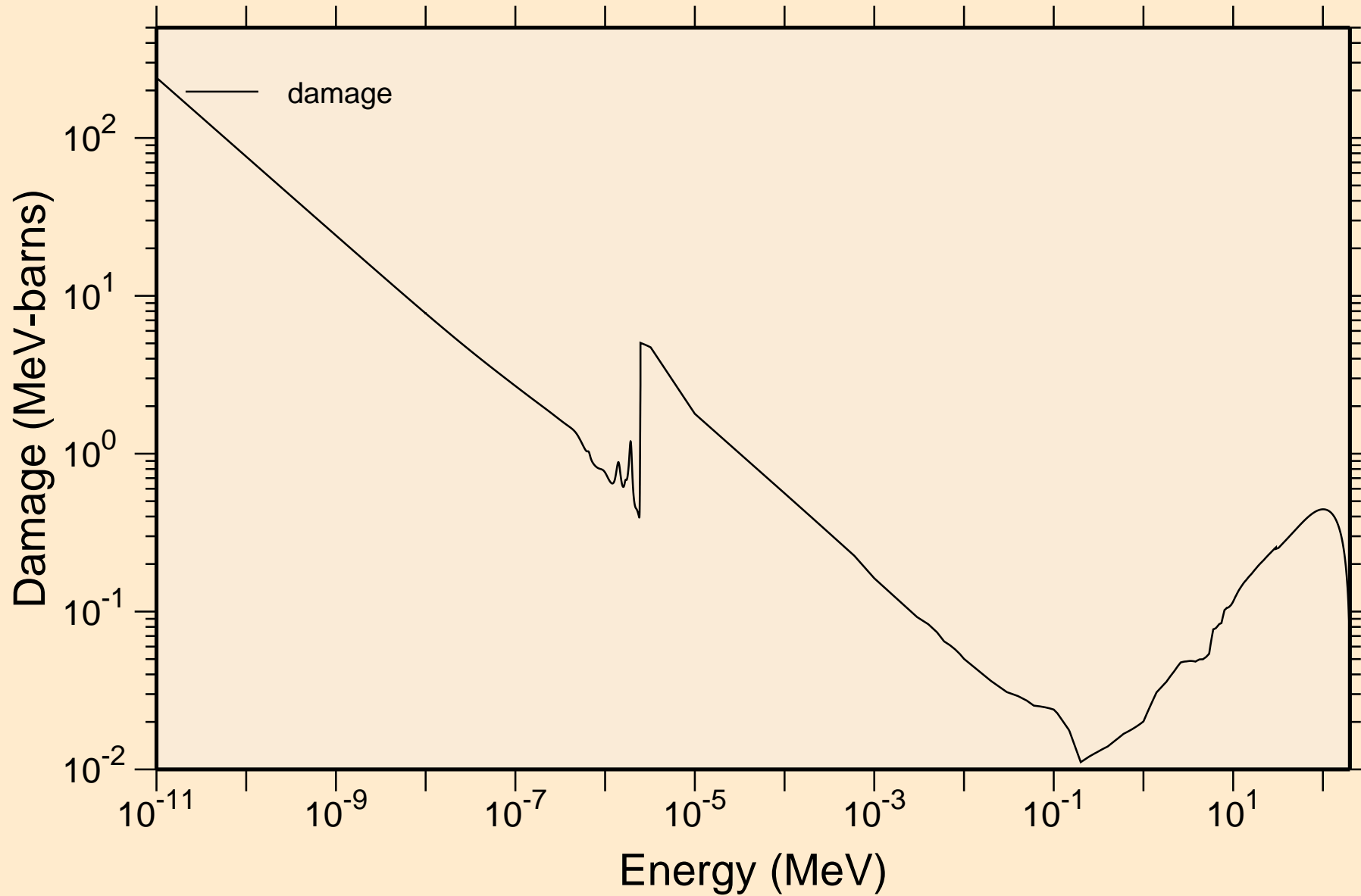

BK238 NEUTRON ACER TENDL-2021 LIBRARY; T=293.6K

Non-threshold reactions

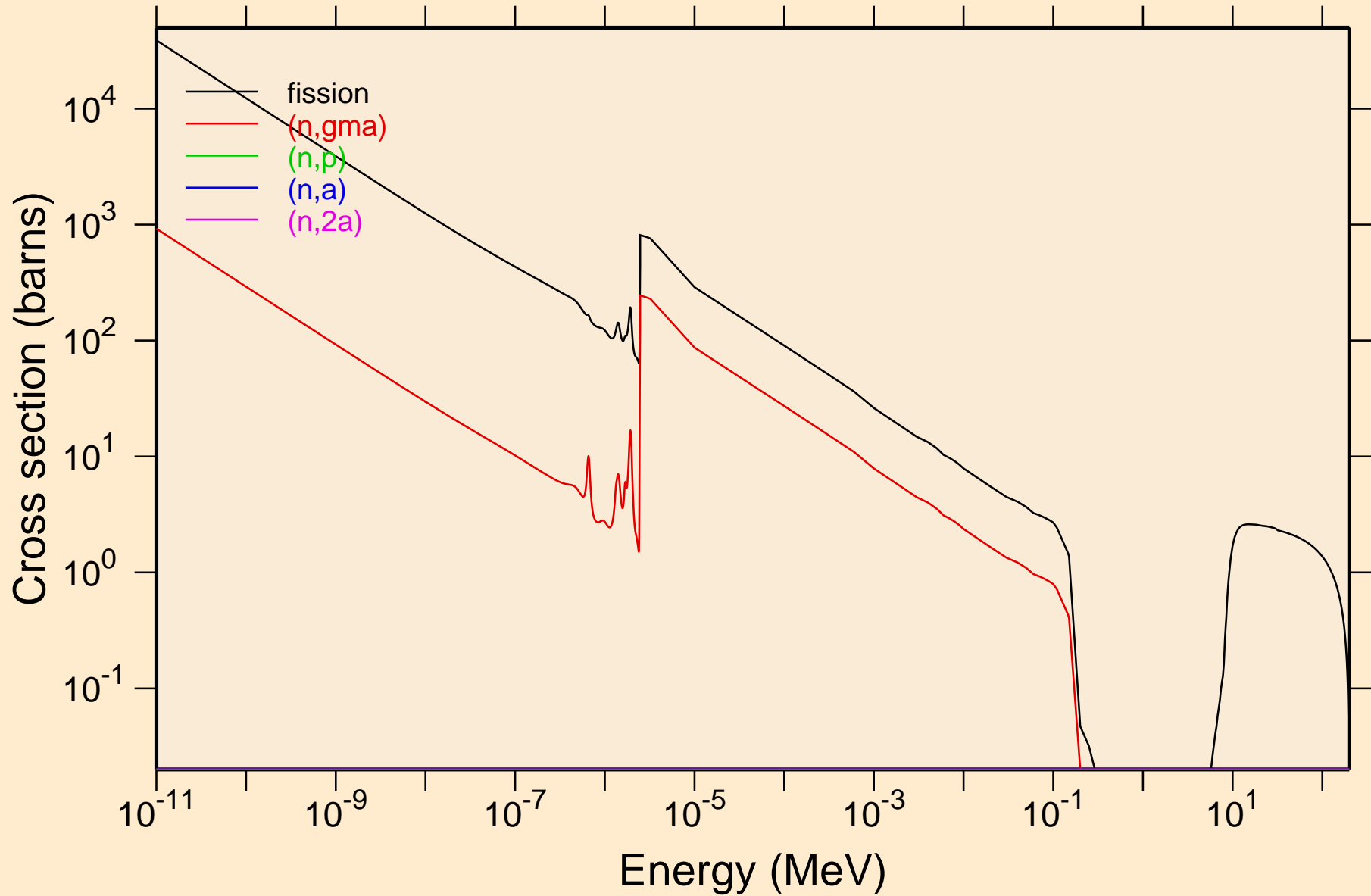

BK238 NEUTRON ACER TENDL-2021 LIBRARY; T=293.6K
Non-threshold reactions

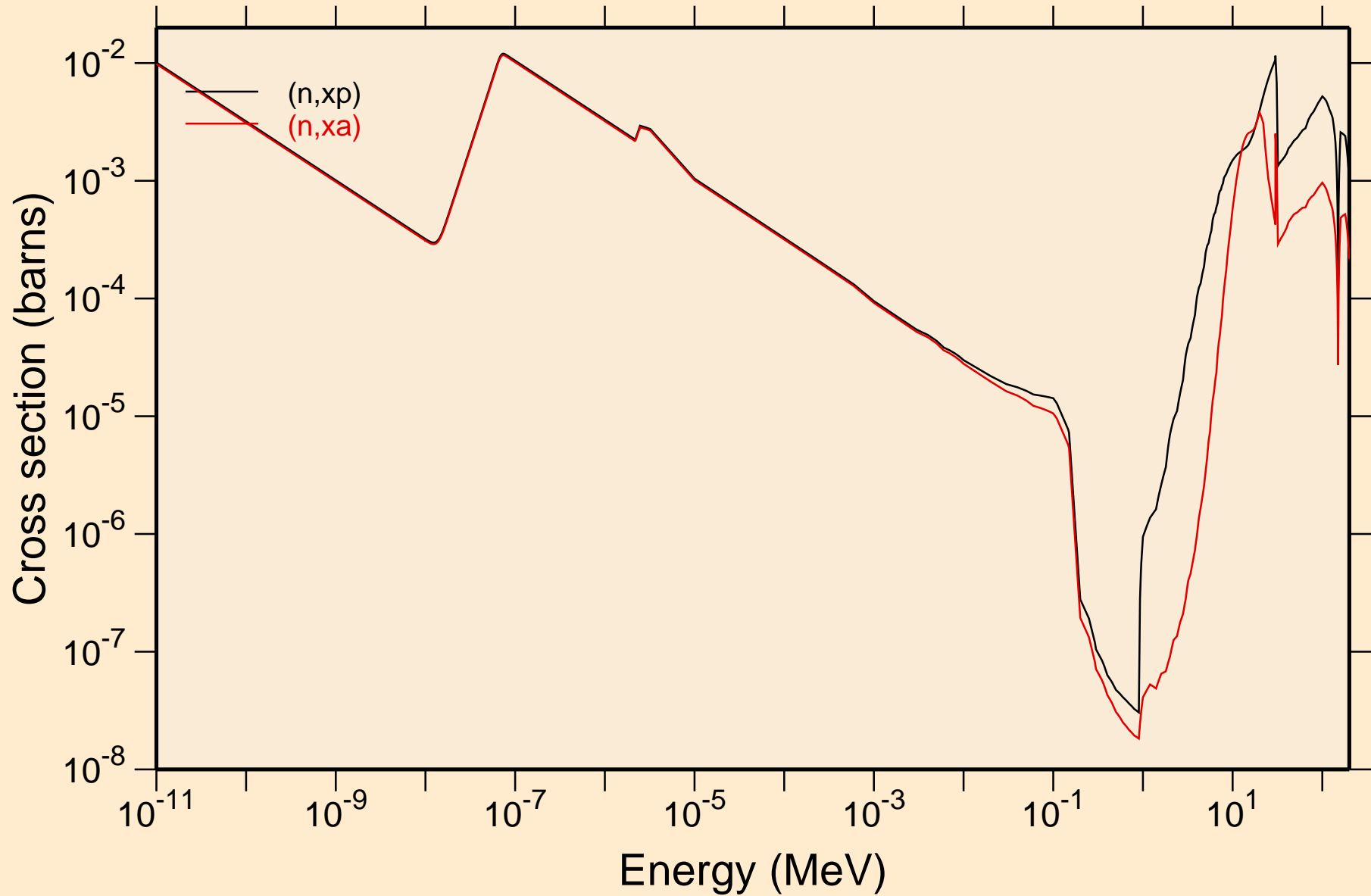

BK238 NEUTRON ACER TENDL-2021 LIBRARY; T=293.6K
Principal cross sections

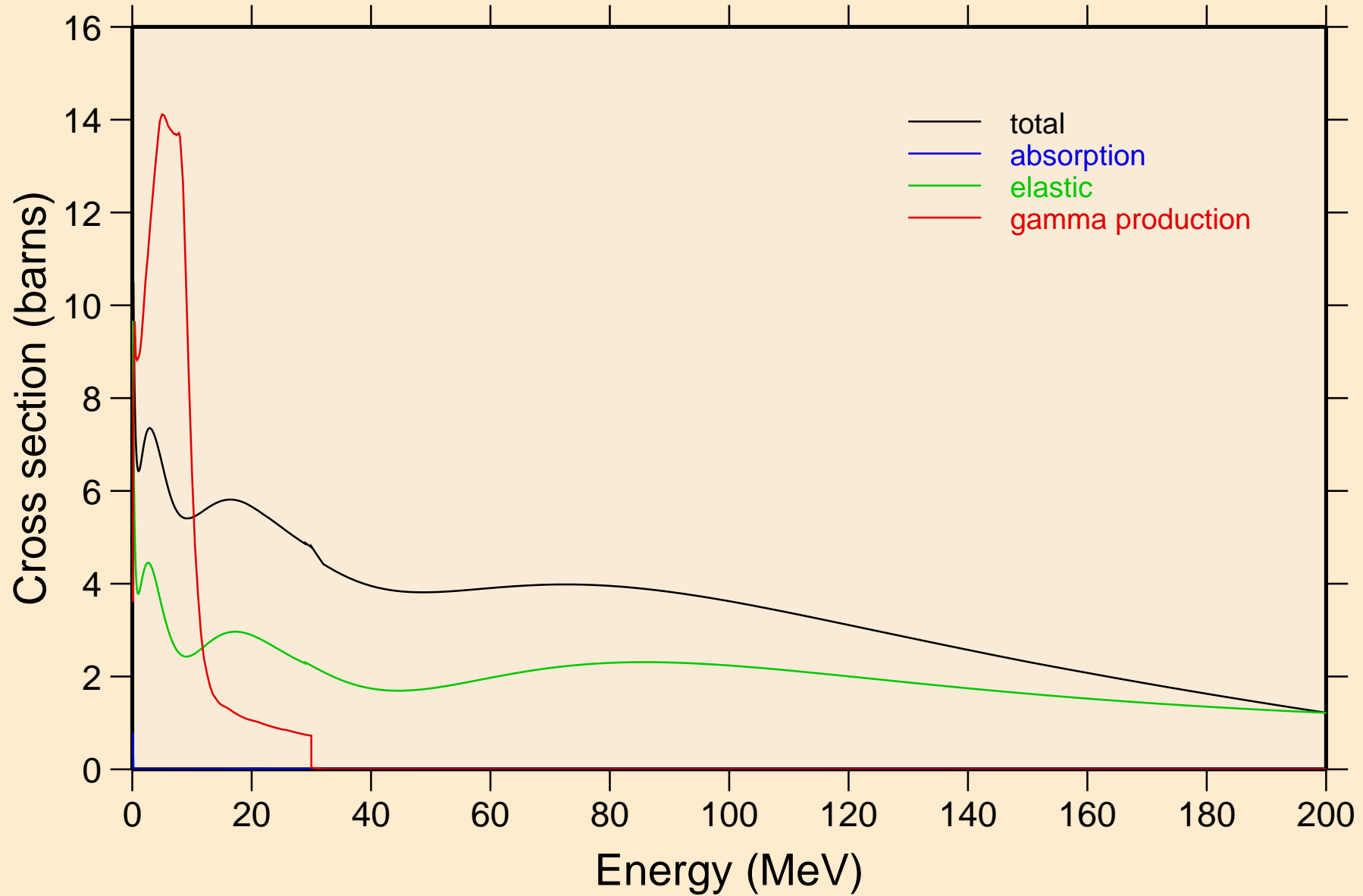

BK238 NEUTRON ACER TENDL-2021 LIBRARY; T=293.6K
Heating

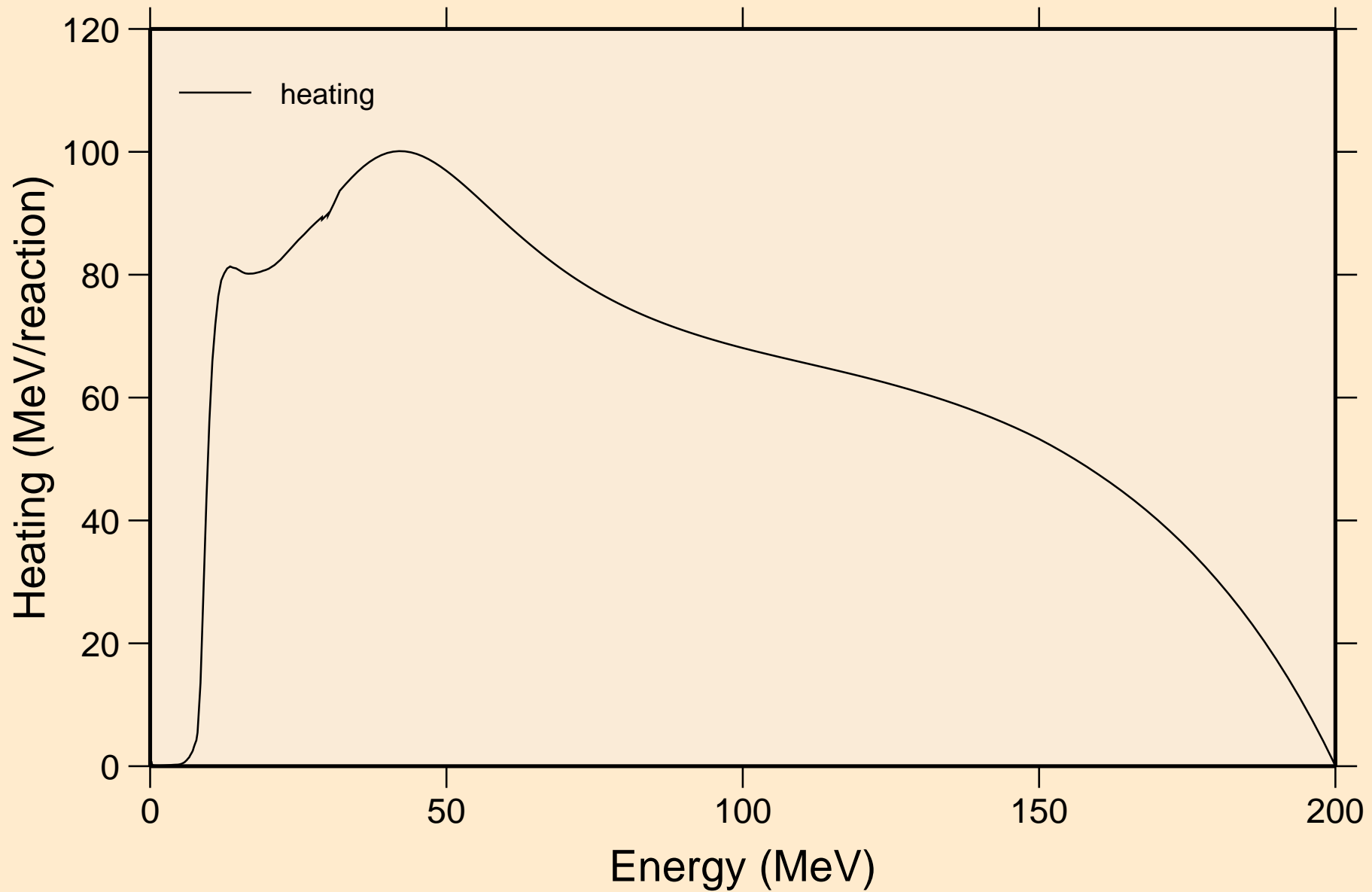

BK238 NEUTRON ACER TENDL-2021 LIBRARY; T=293.6K
Damage

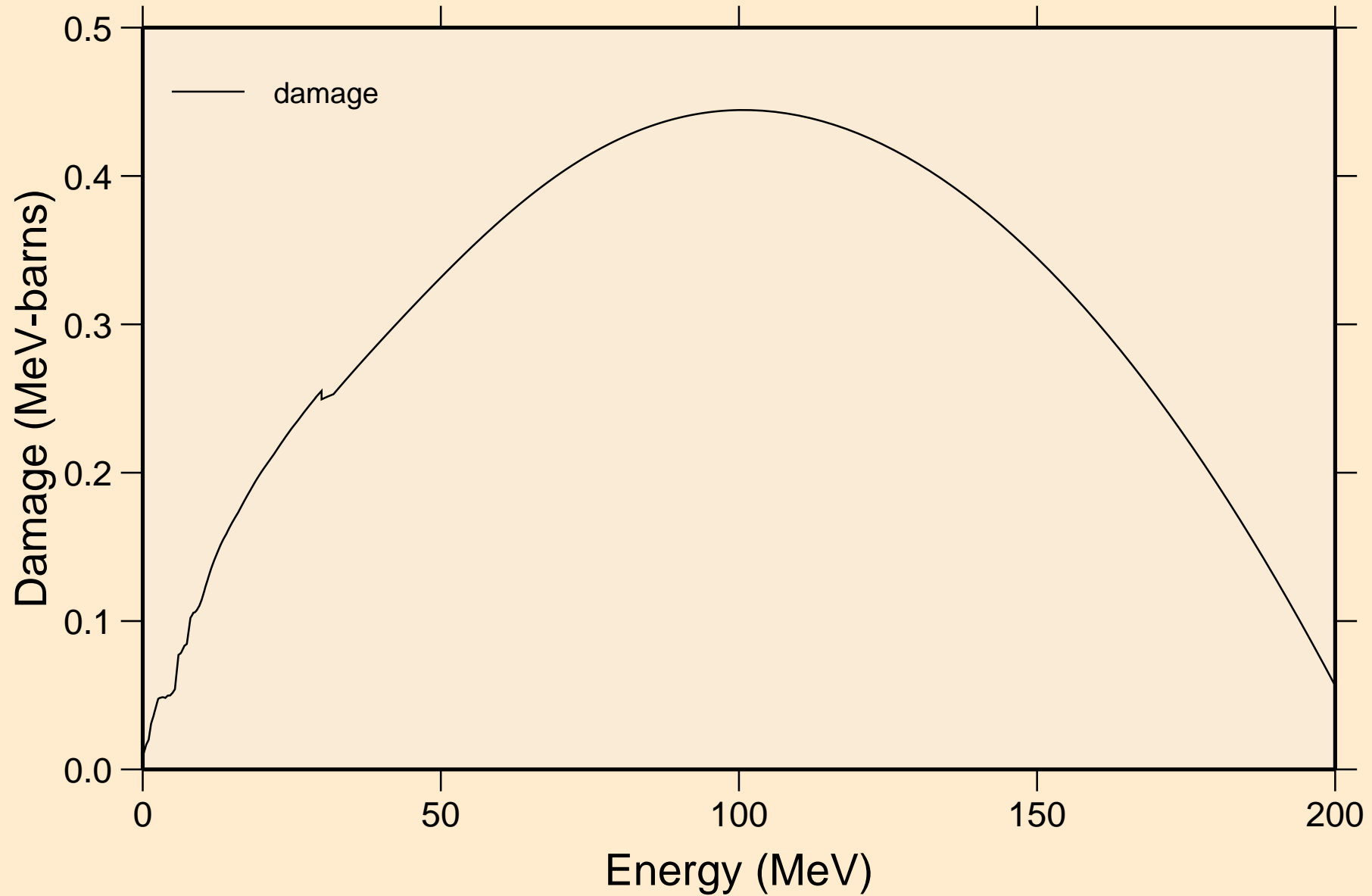

BK238 NEUTRON ACER TENDL-2021 LIBRARY; T=293.6K
Non-threshold reactions

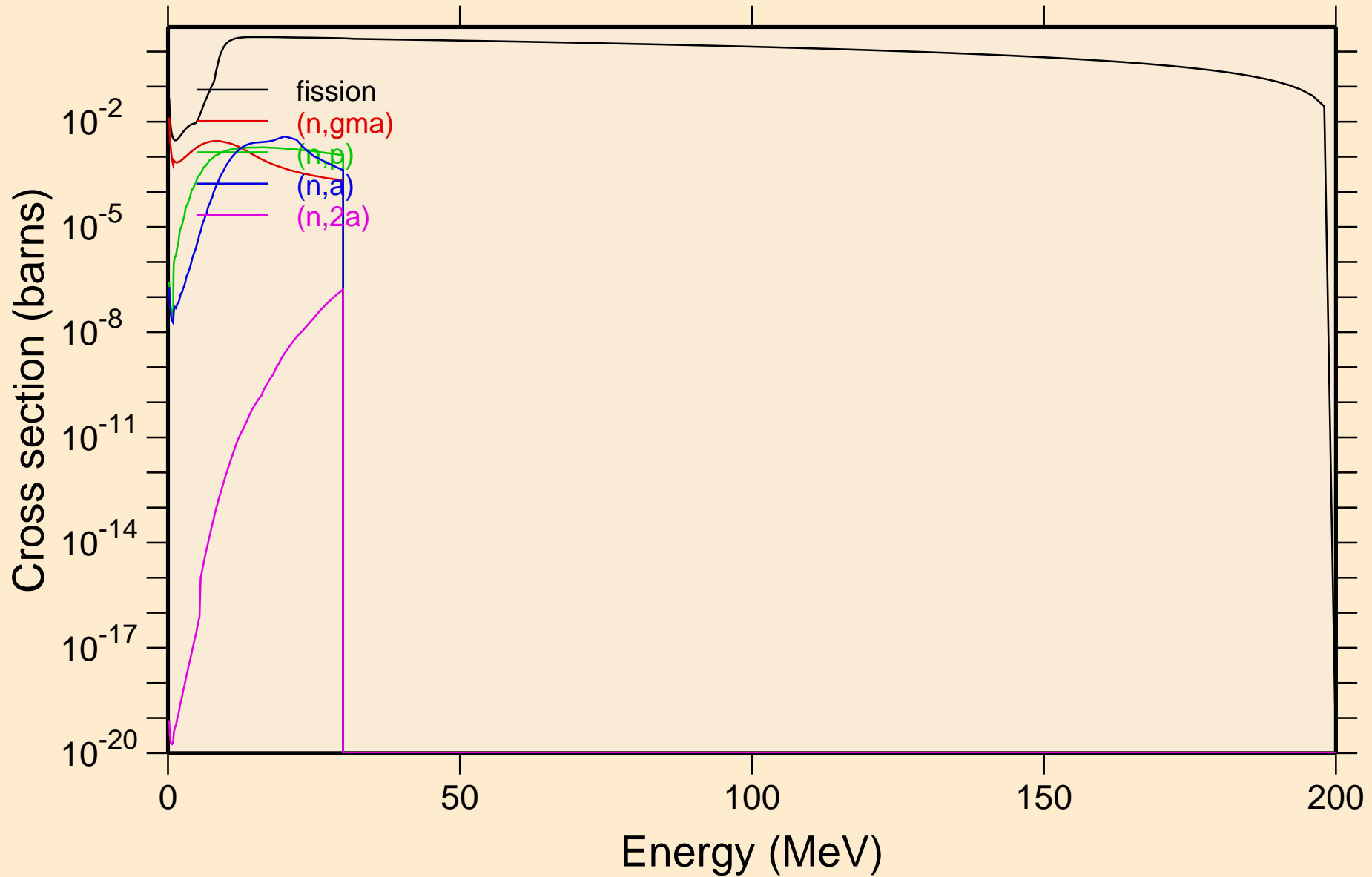

BK238 NEUTRON ACER TENDL-2021 LIBRARY; T=293.6K
Non-threshold reactions

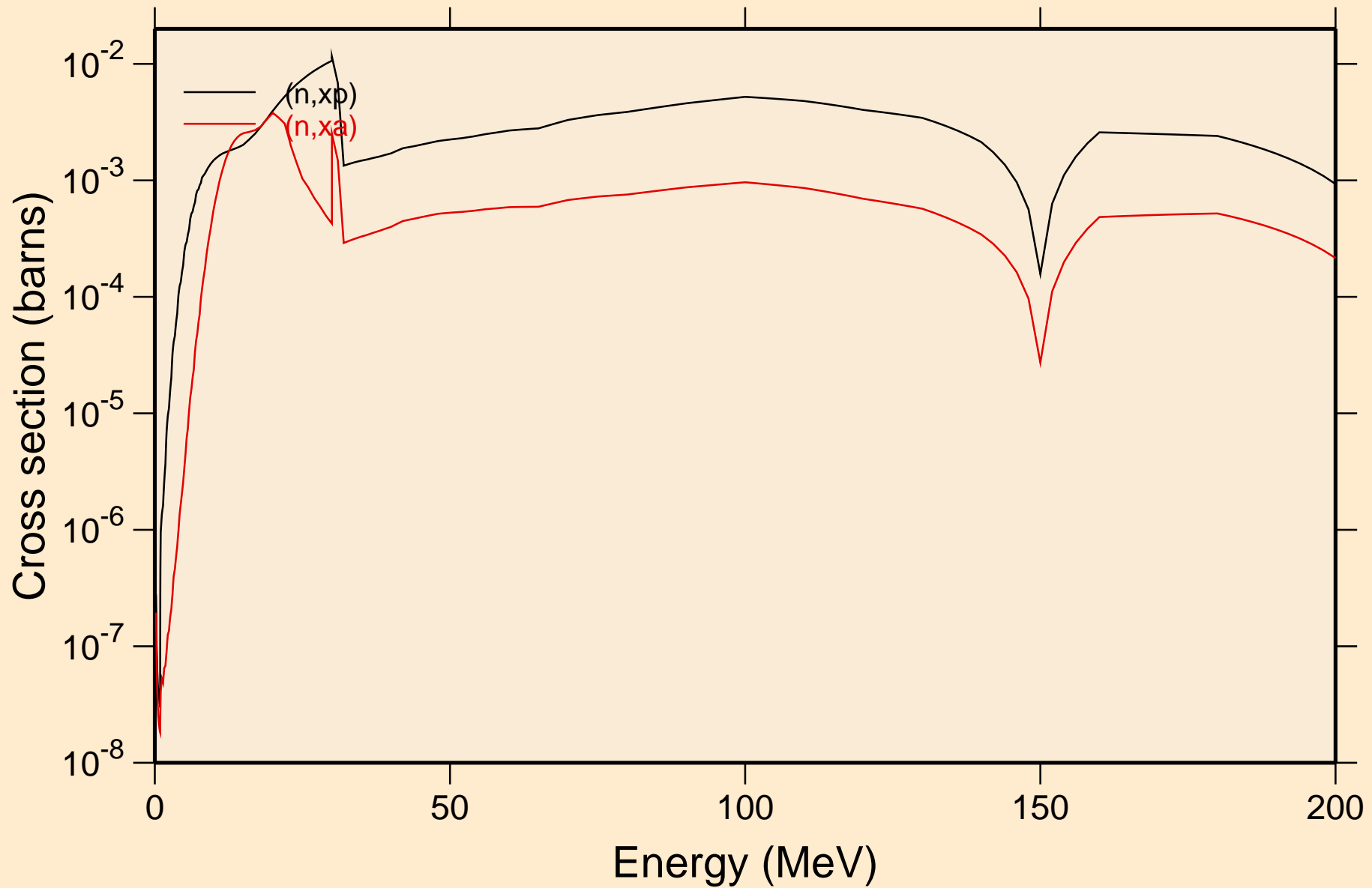

BK238 NEUTRON ACER TENDL-2021 LIBRARY; T=293.6K
Inelastic levels

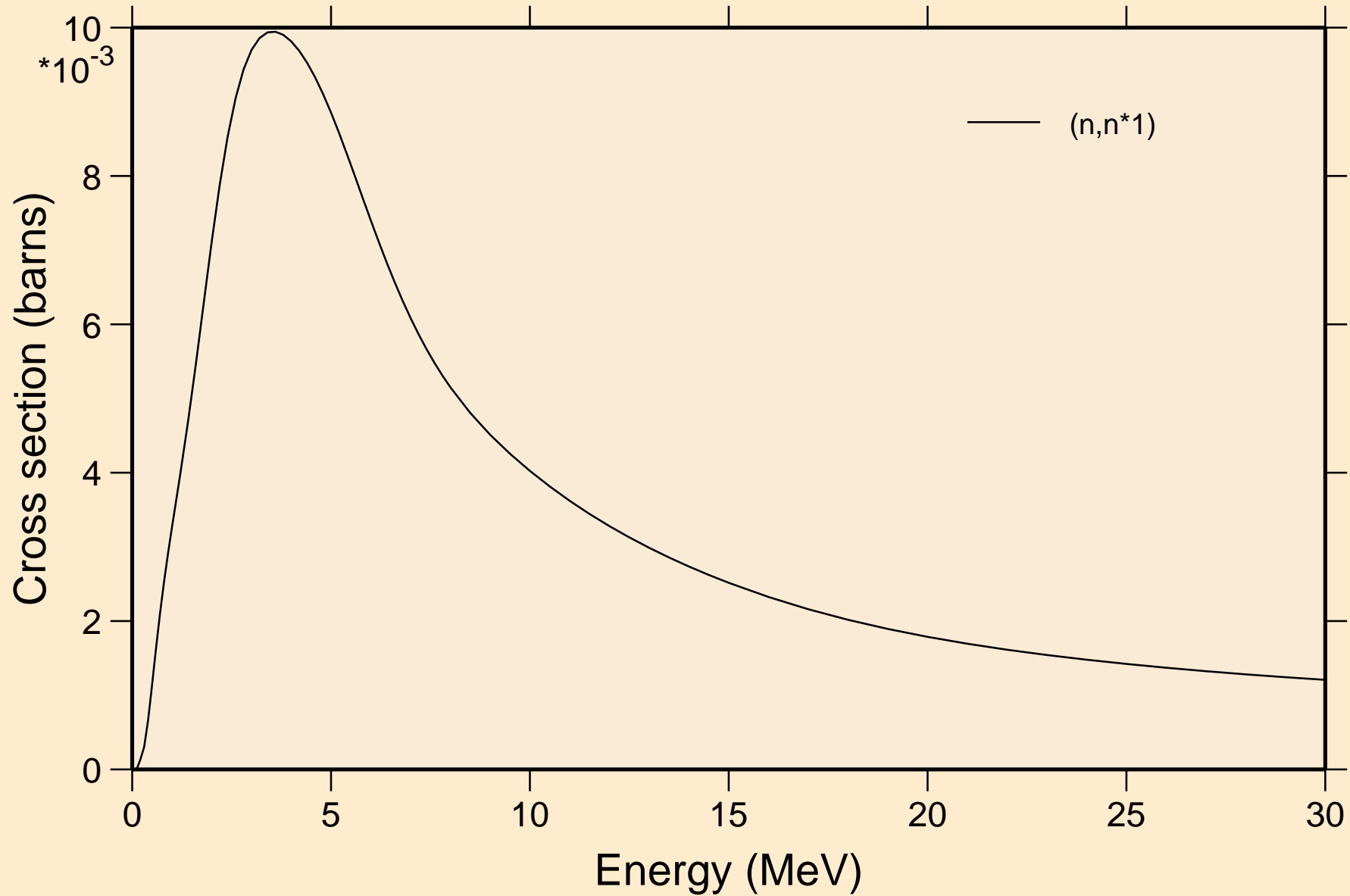

BK238 NEUTRON ACER TENDL-2021 LIBRARY; T=293.6K

Threshold reactions

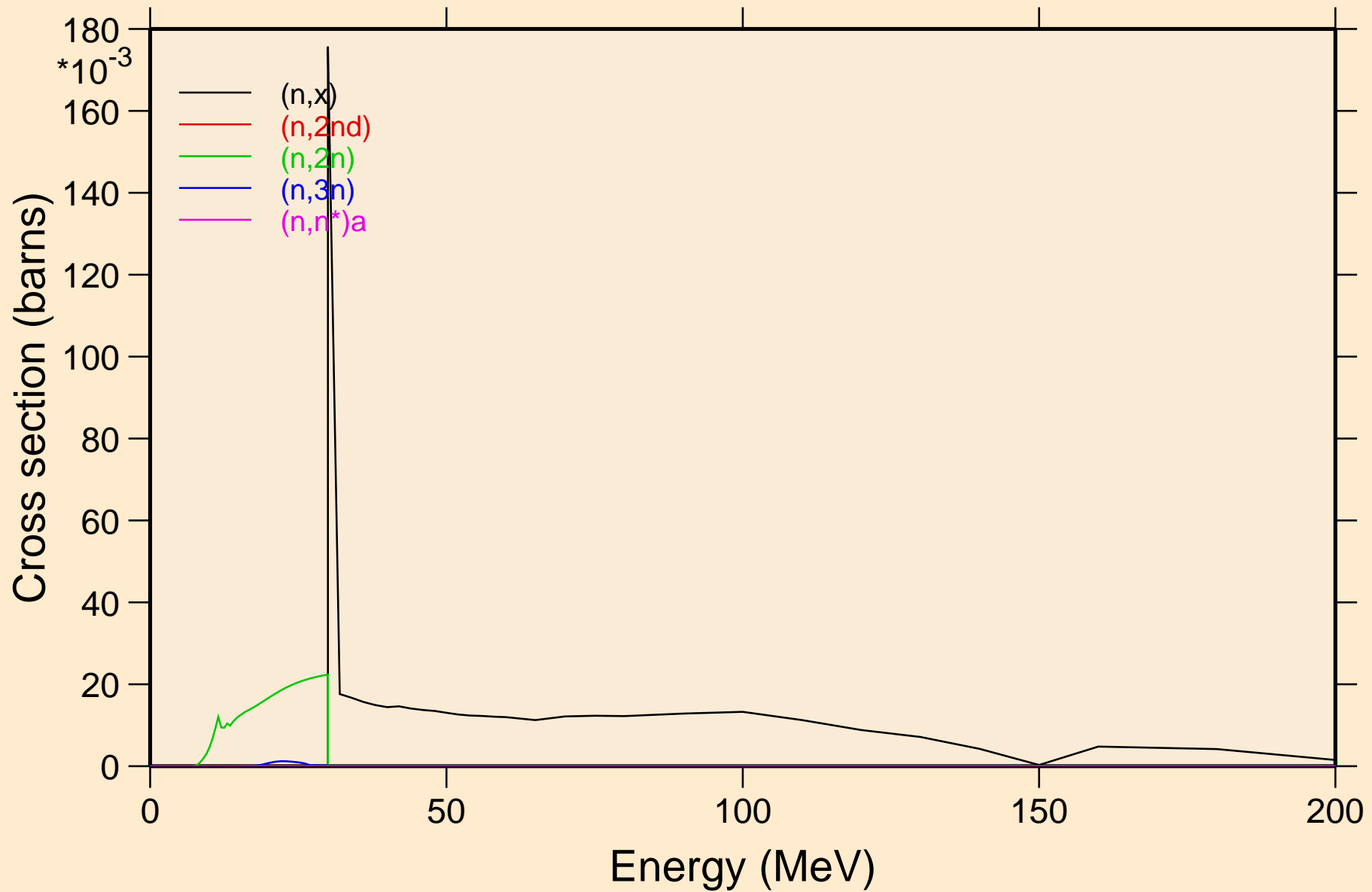

BK238 NEUTRON ACER TENDL-2021 LIBRARY; T=293.6K
Threshold reactions

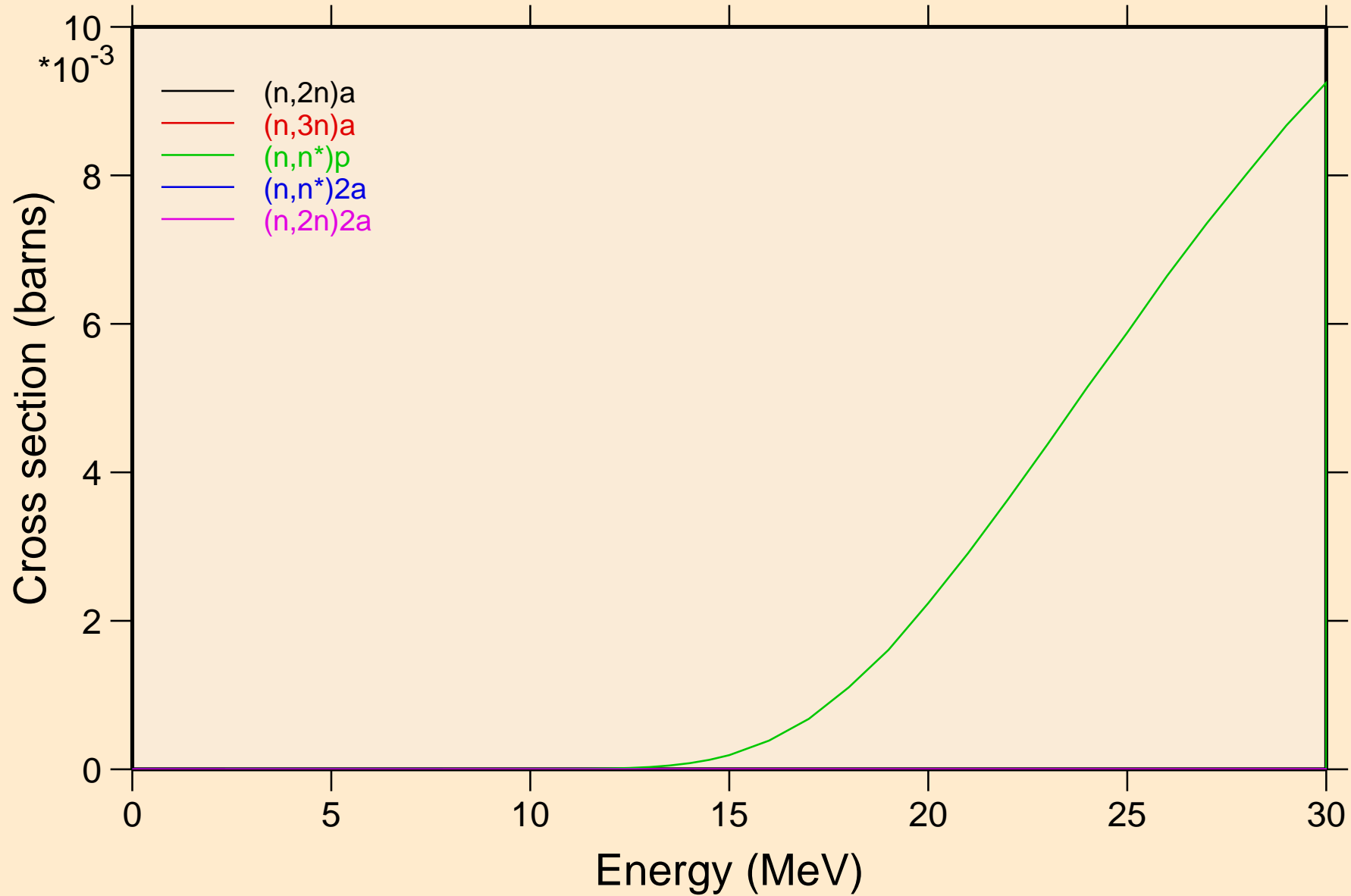

BK238 NEUTRON ACER TENDL-2021 LIBRARY; T=293.6K
Threshold reactions

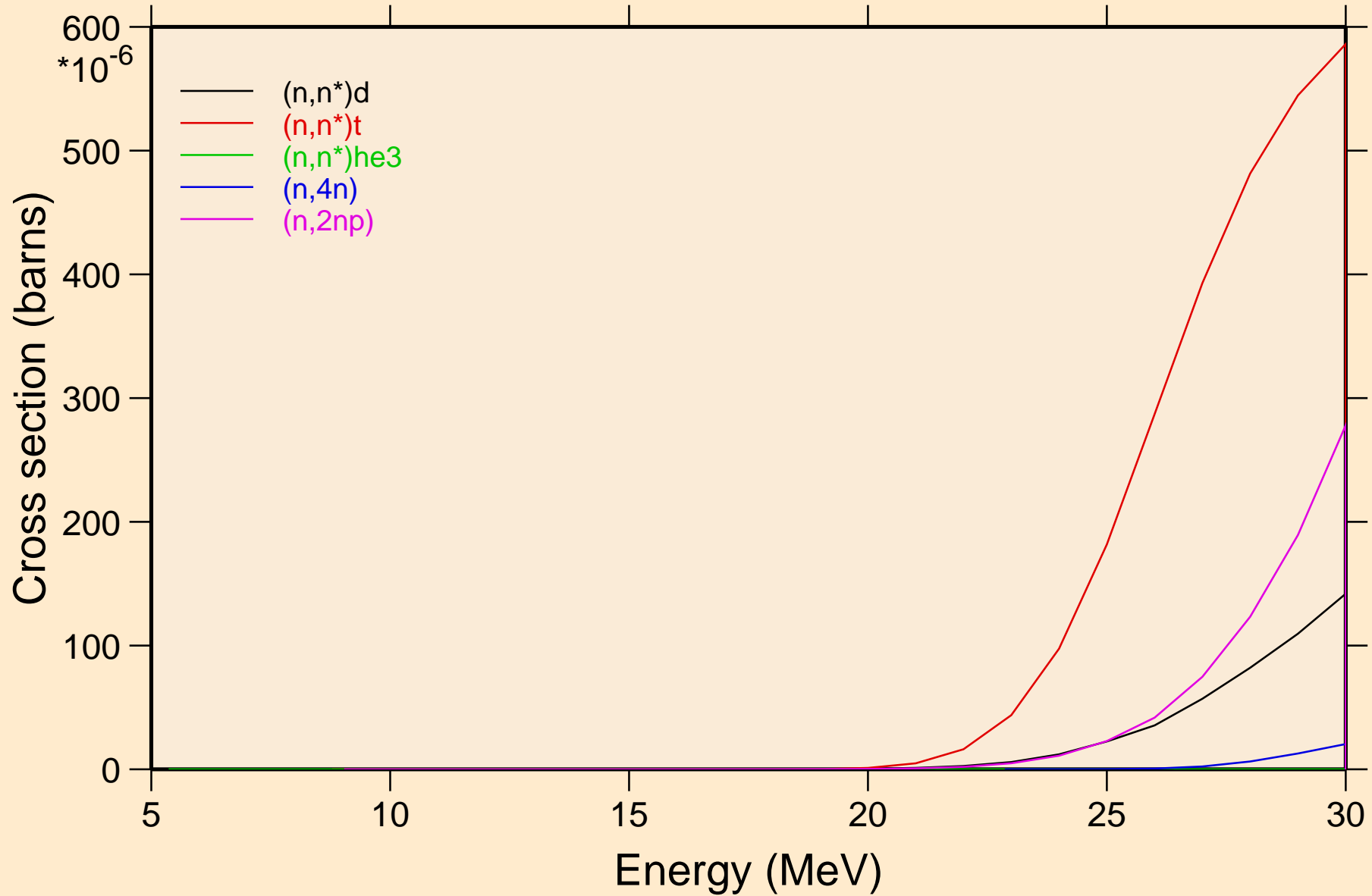

BK238 NEUTRON ACER TENDL-2021 LIBRARY; T=293.6K

Threshold reactions

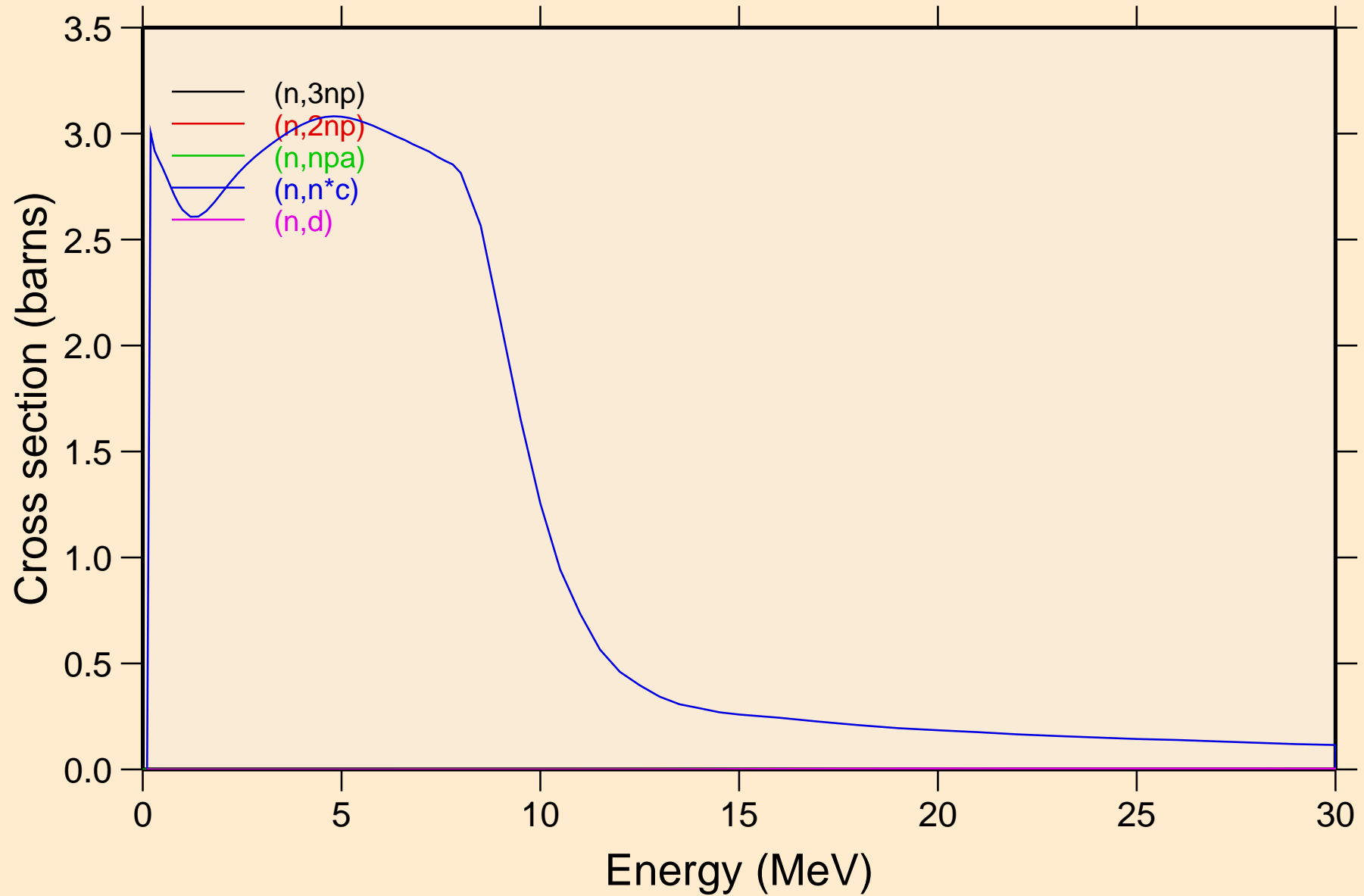

BK238 NEUTRON ACER TENDL-2021 LIBRARY; T=293.6K
Threshold reactions

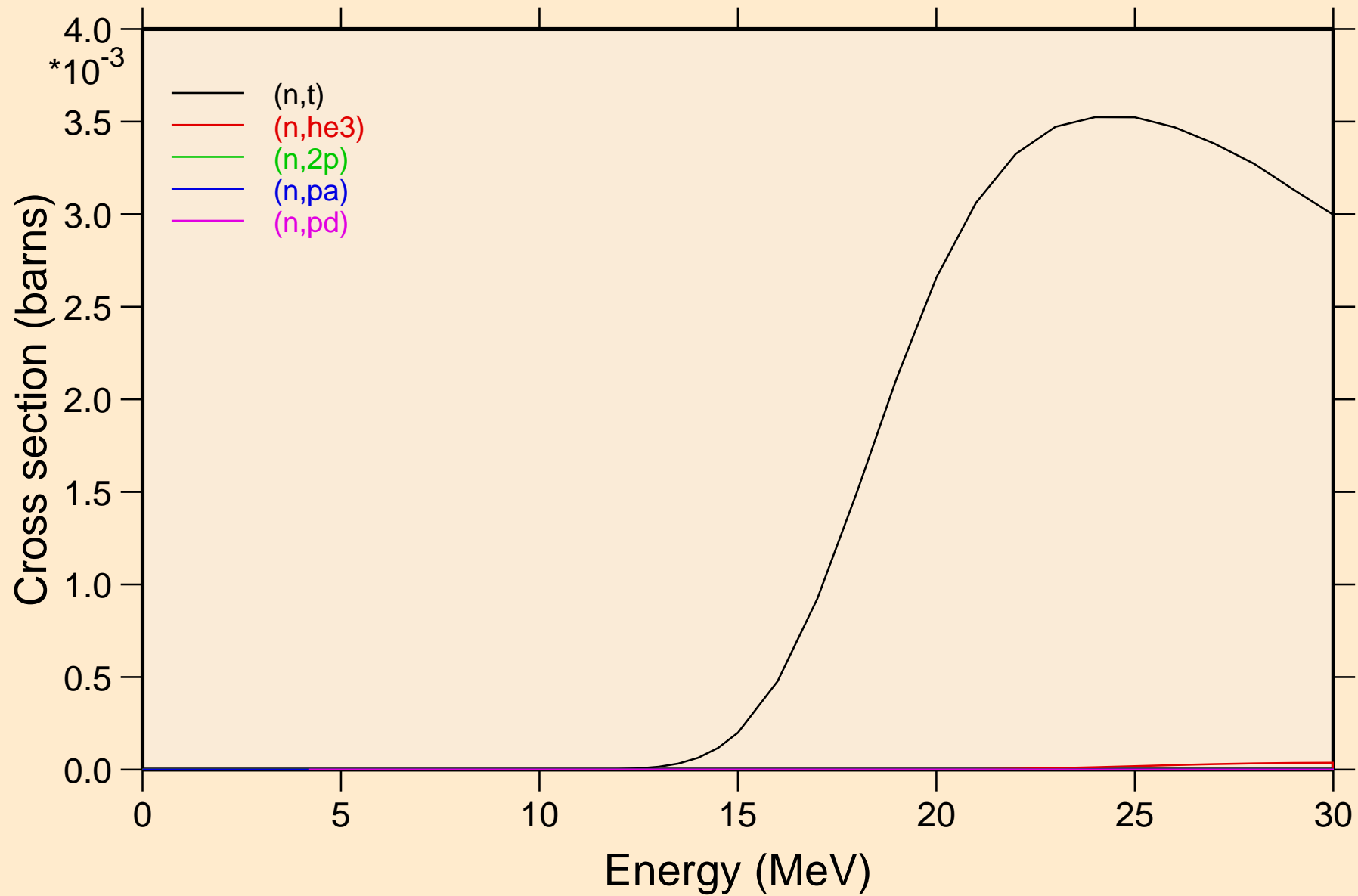

BK238 NEUTRON ACER TENDL-2021 LIBRARY; T=293.6K
Threshold reactions

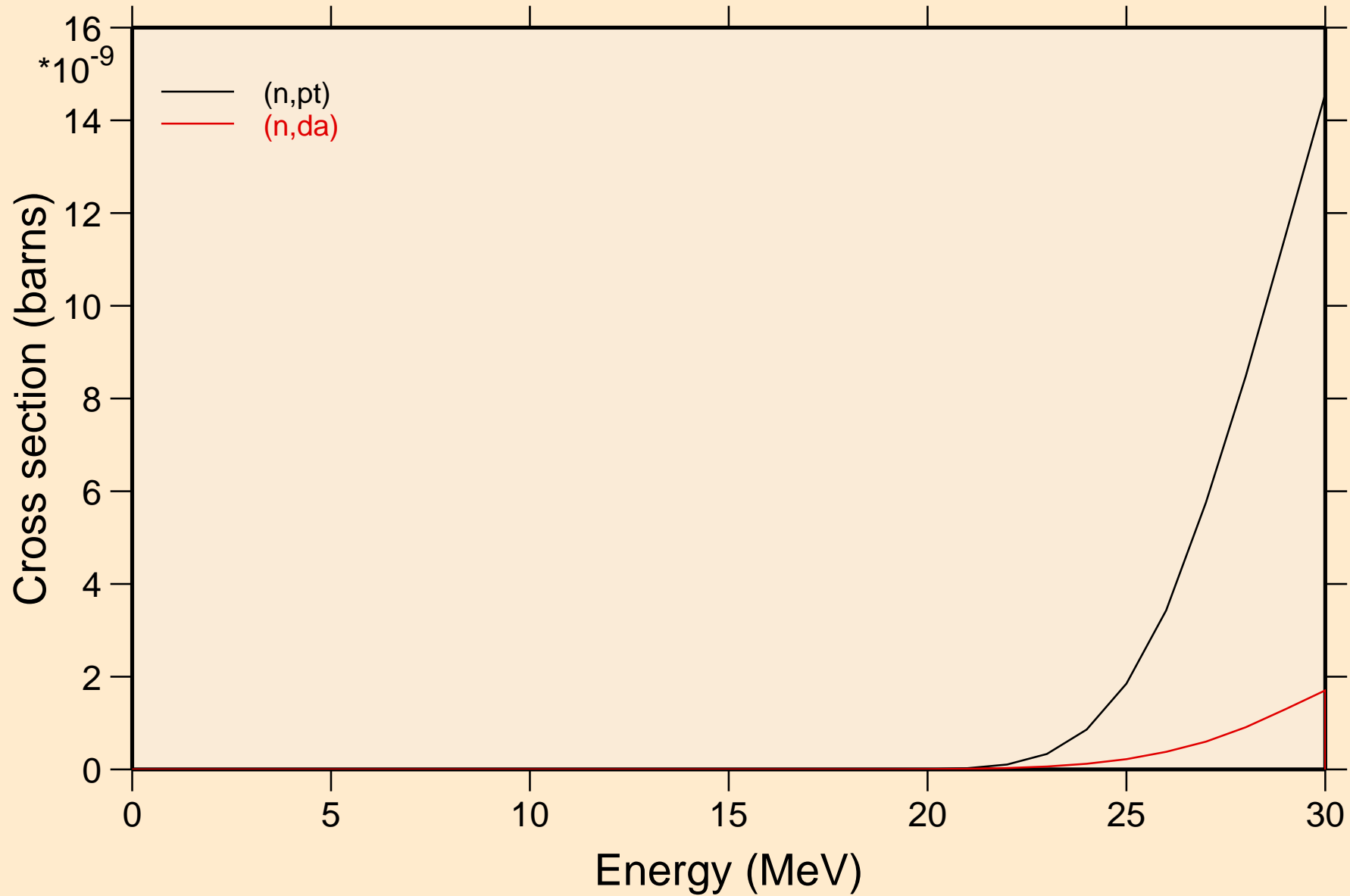

BK238 NEUTRON ACER TENDL-2021 LIBRARY; T=293.6K
Threshold reactions

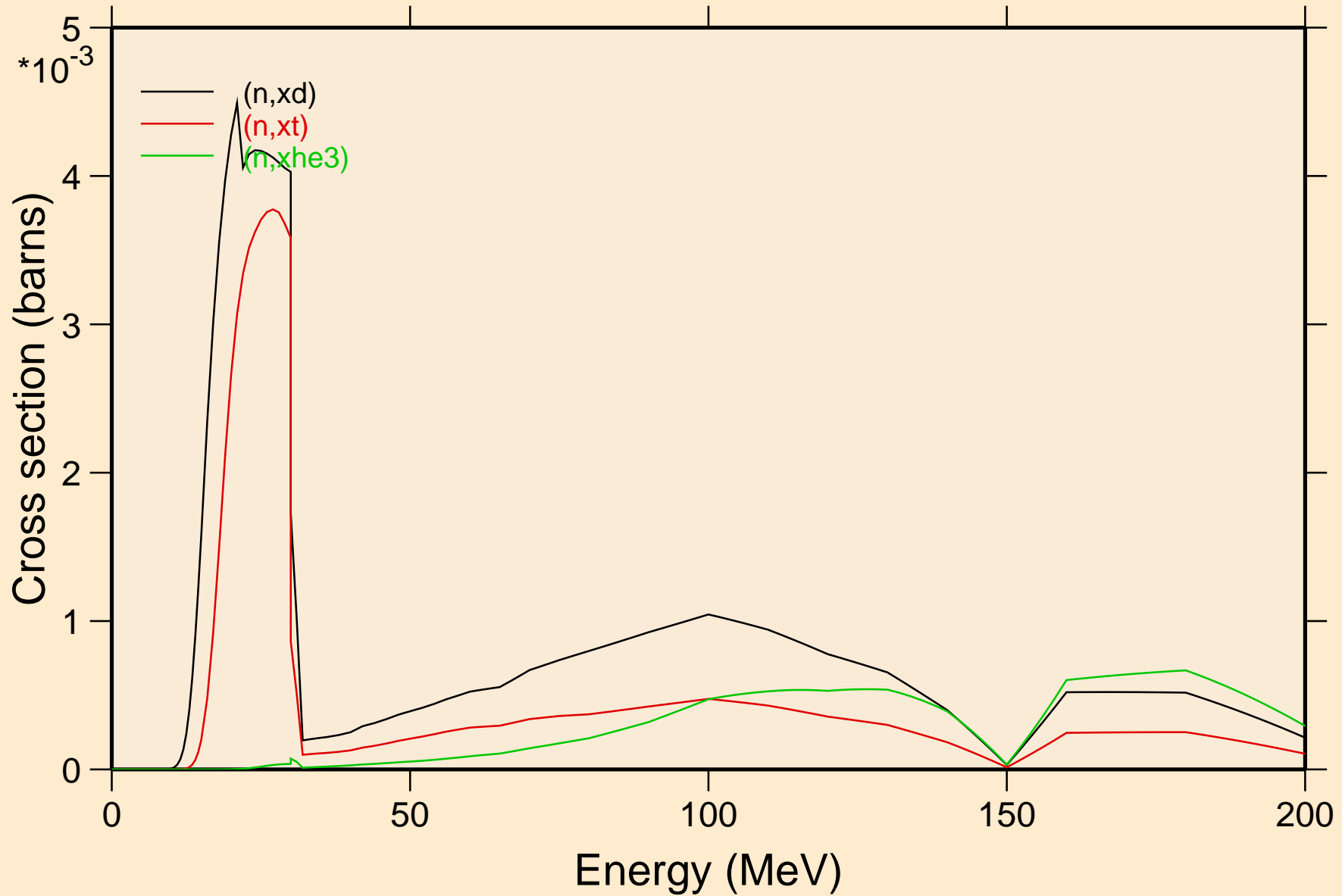

BK238 NEUTRON ACER TENDL-2021 LIBRARY; T=293.6K
angular distribution for elastic

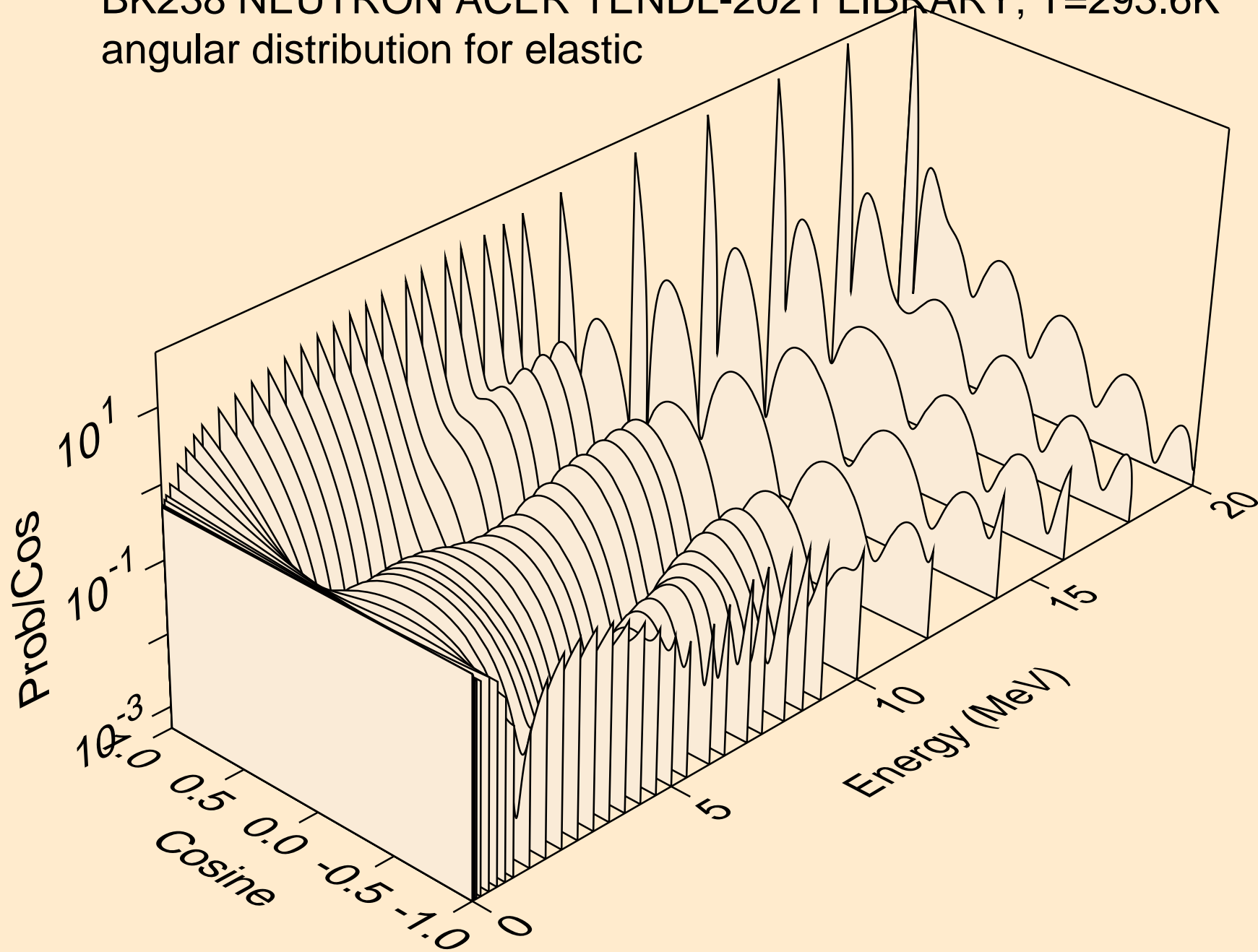

BK238 NEUTRON ACER TENDL-2021 LIBRARY; T=293.6K
angular distribution for elastic

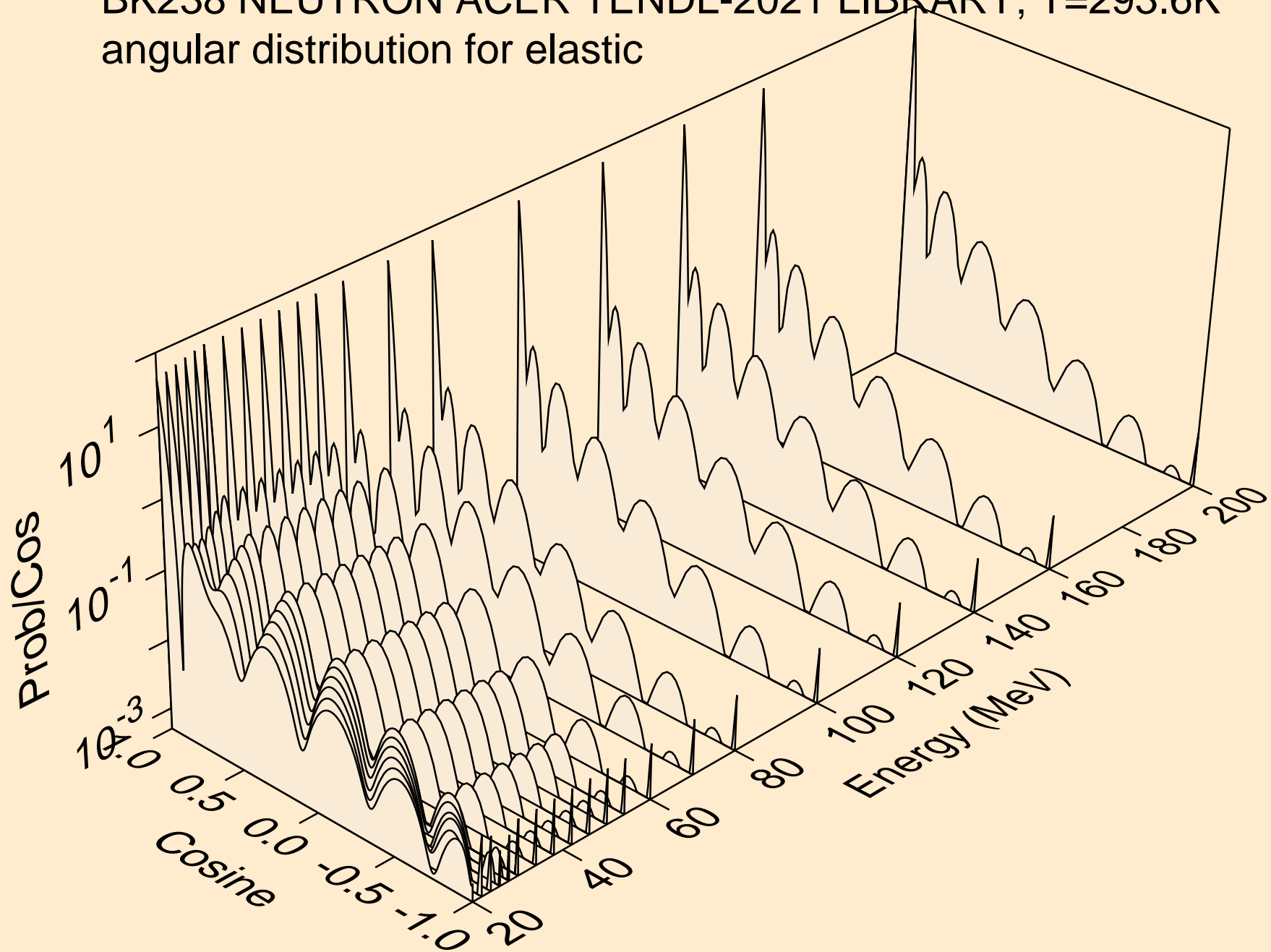

BK238 NEUTRON ACER TENDL-2021 LIBRARY; T=293.6K
angular distribution for (n,n*1)

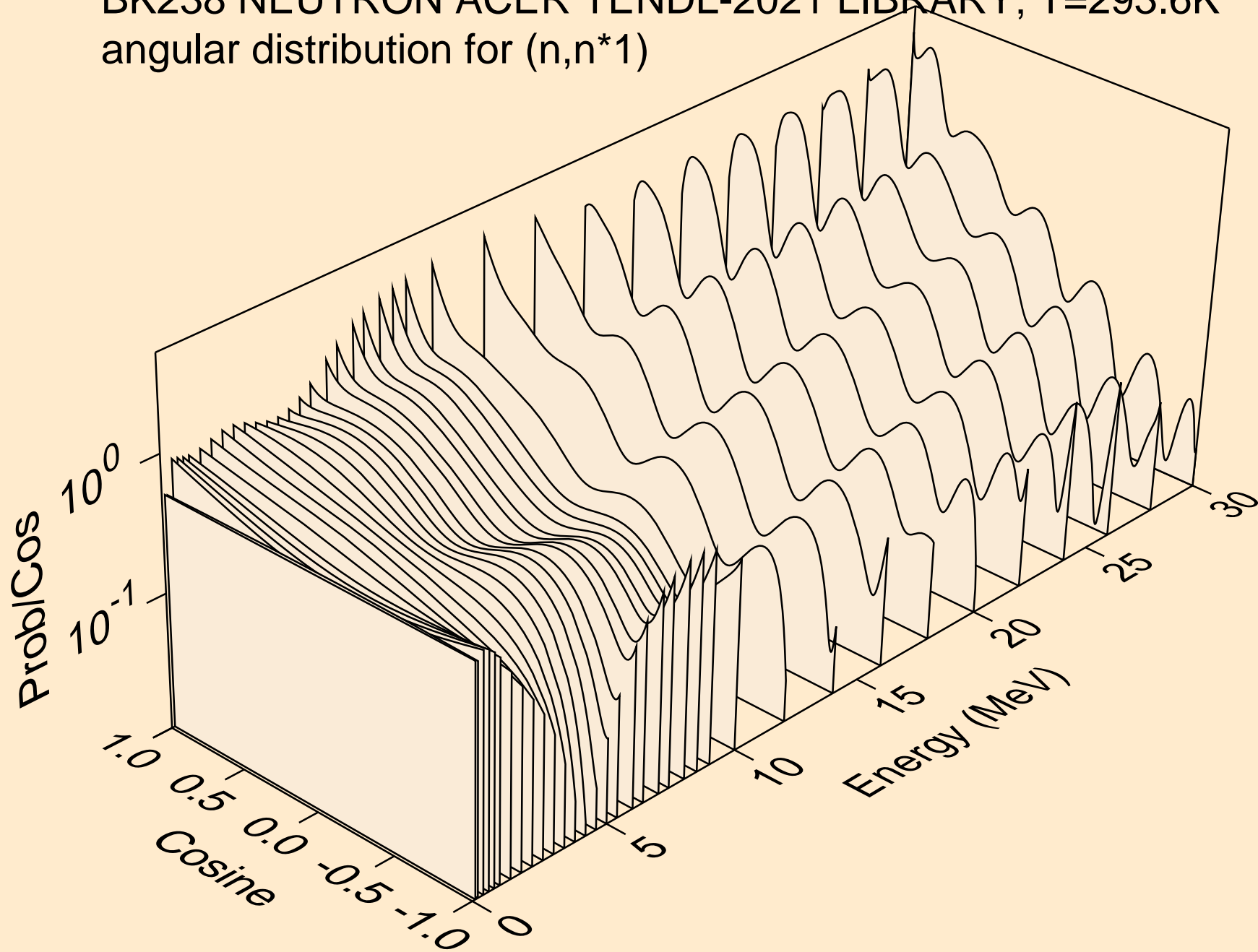

BK238 NEUTRON ACER TENDL-2021 LIBRARY; T=293.6K
Total fission nubar

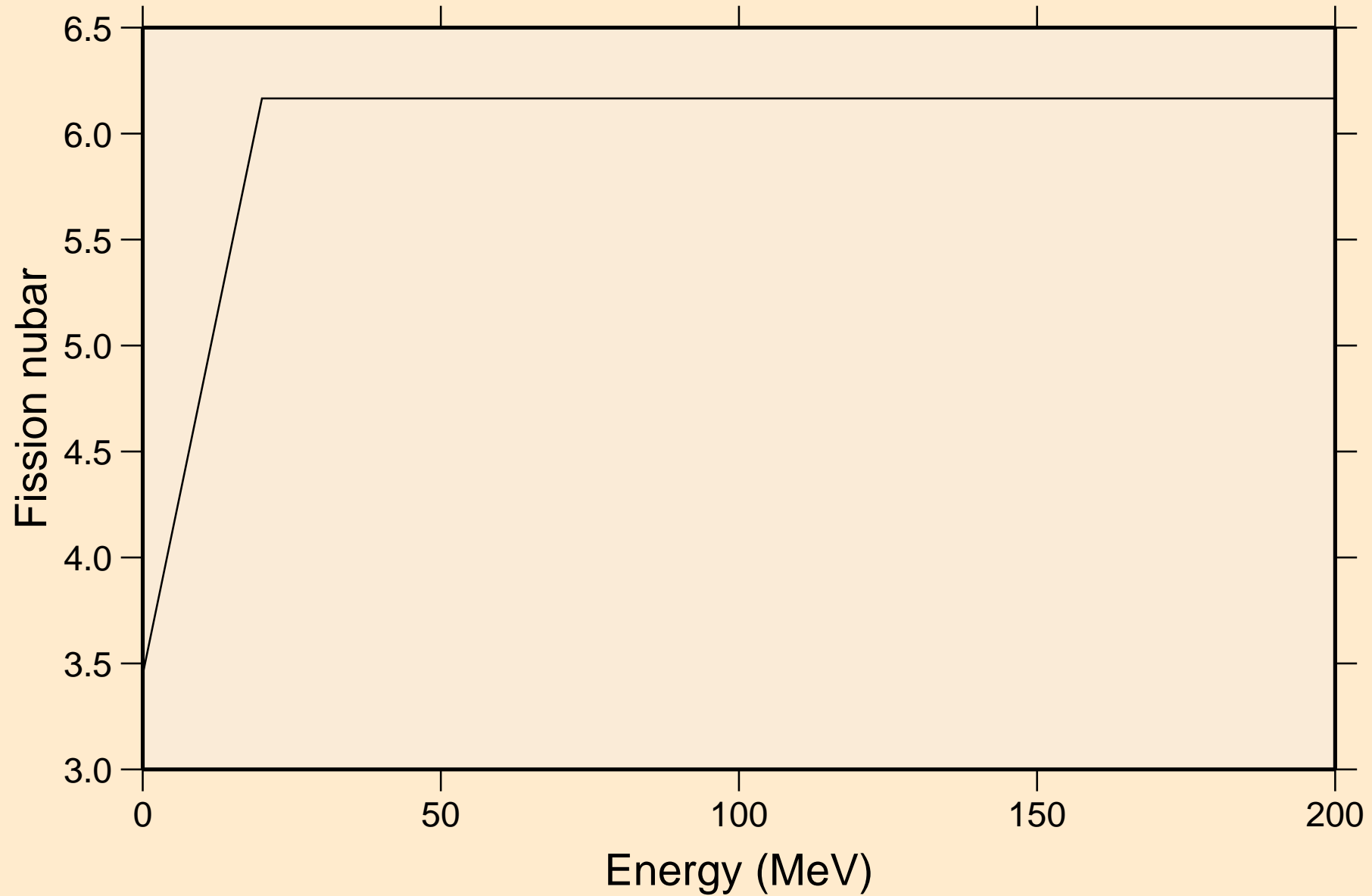

BK238 NEUTRON ACER TENDL-2021 LIBRARY; T=293.6K
Neutron emission for (n,x)

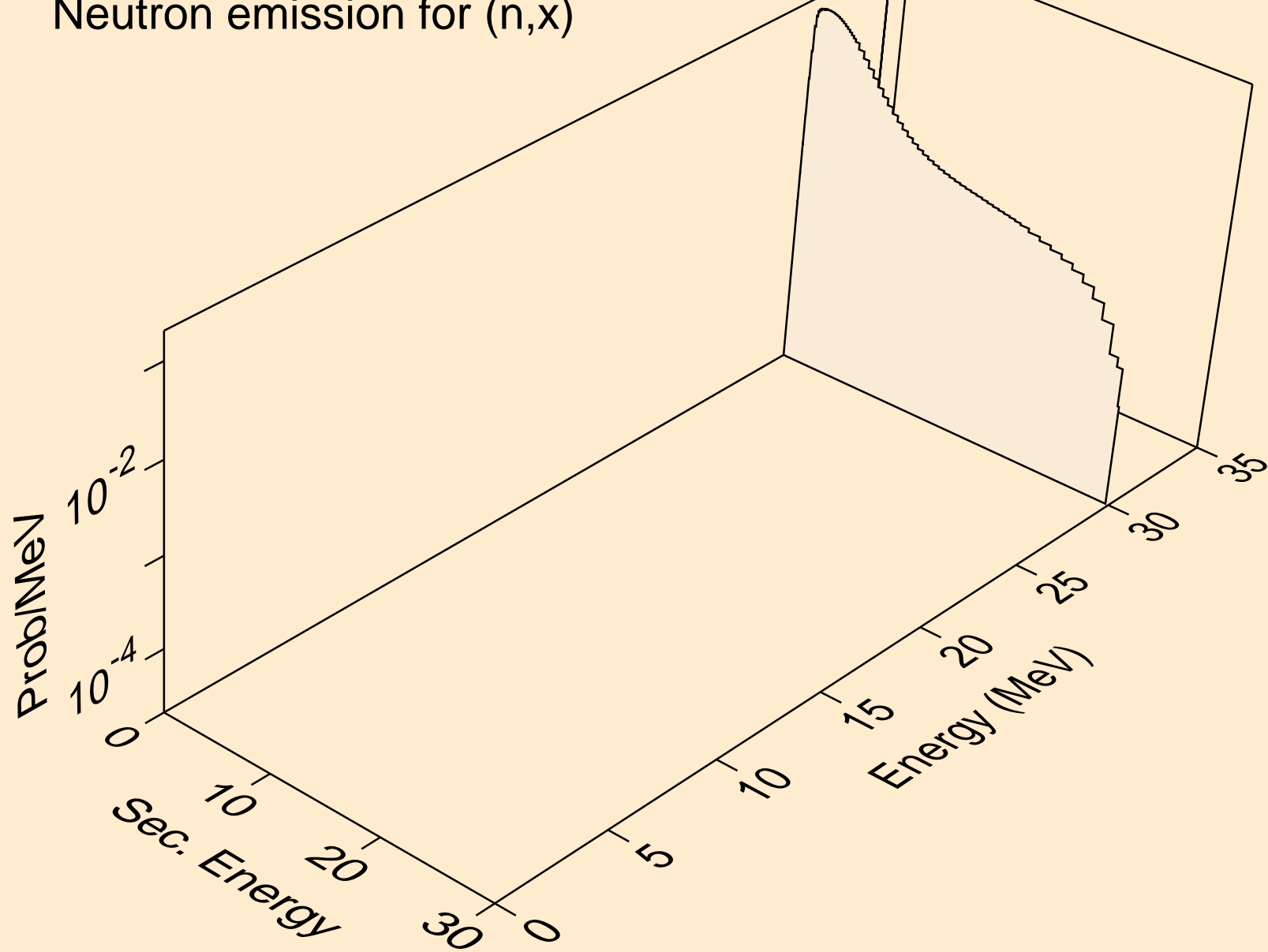

BK238 NEUTRON ACER TENDL-2021 LIBRARY; T=293.6K
Neutron emission for (n,2nd)

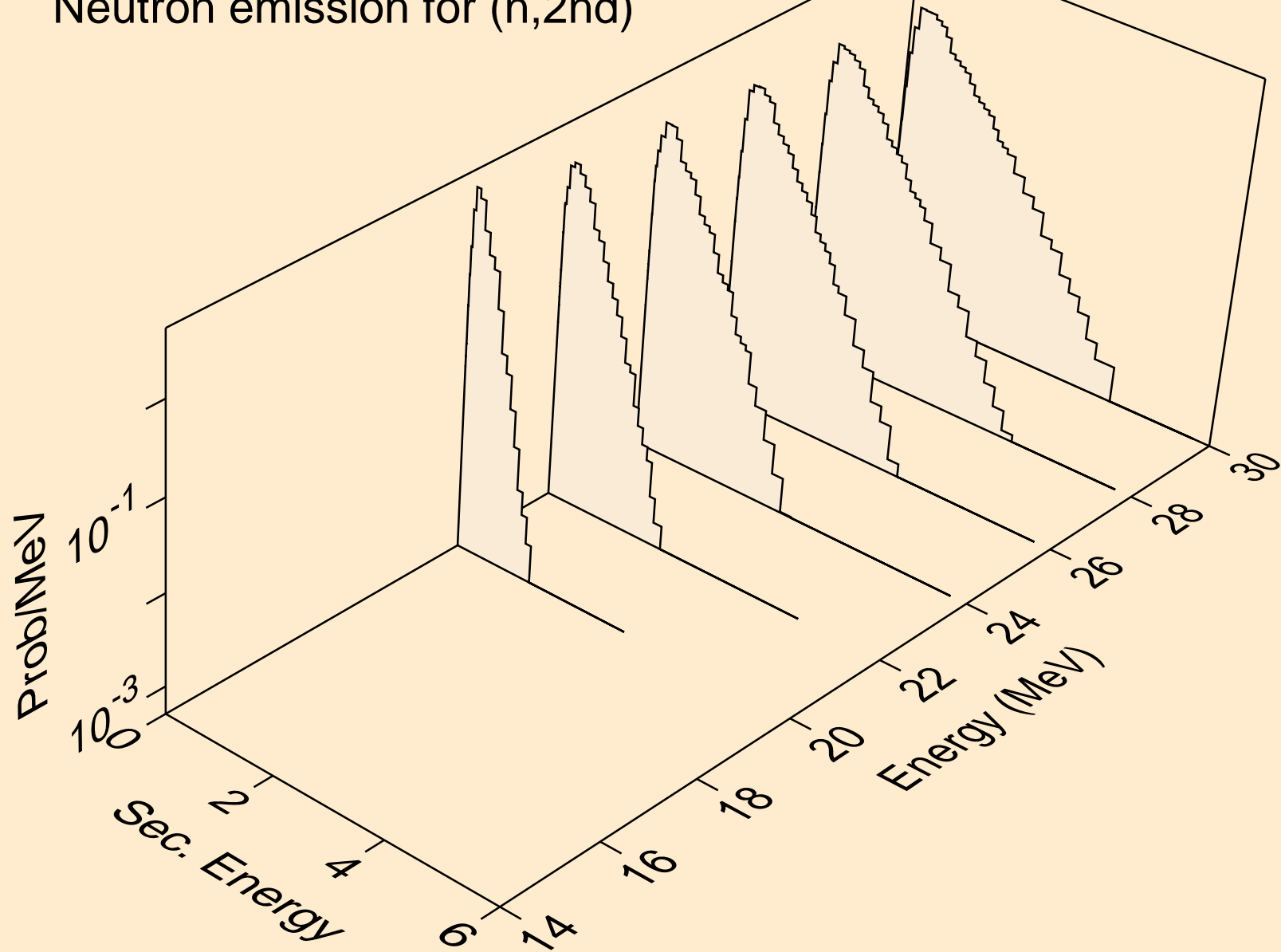

BK238 NEUTRON ACER TENDL-2021 LIBRARY; T=293.6K
Neutron emission for (n,2n)

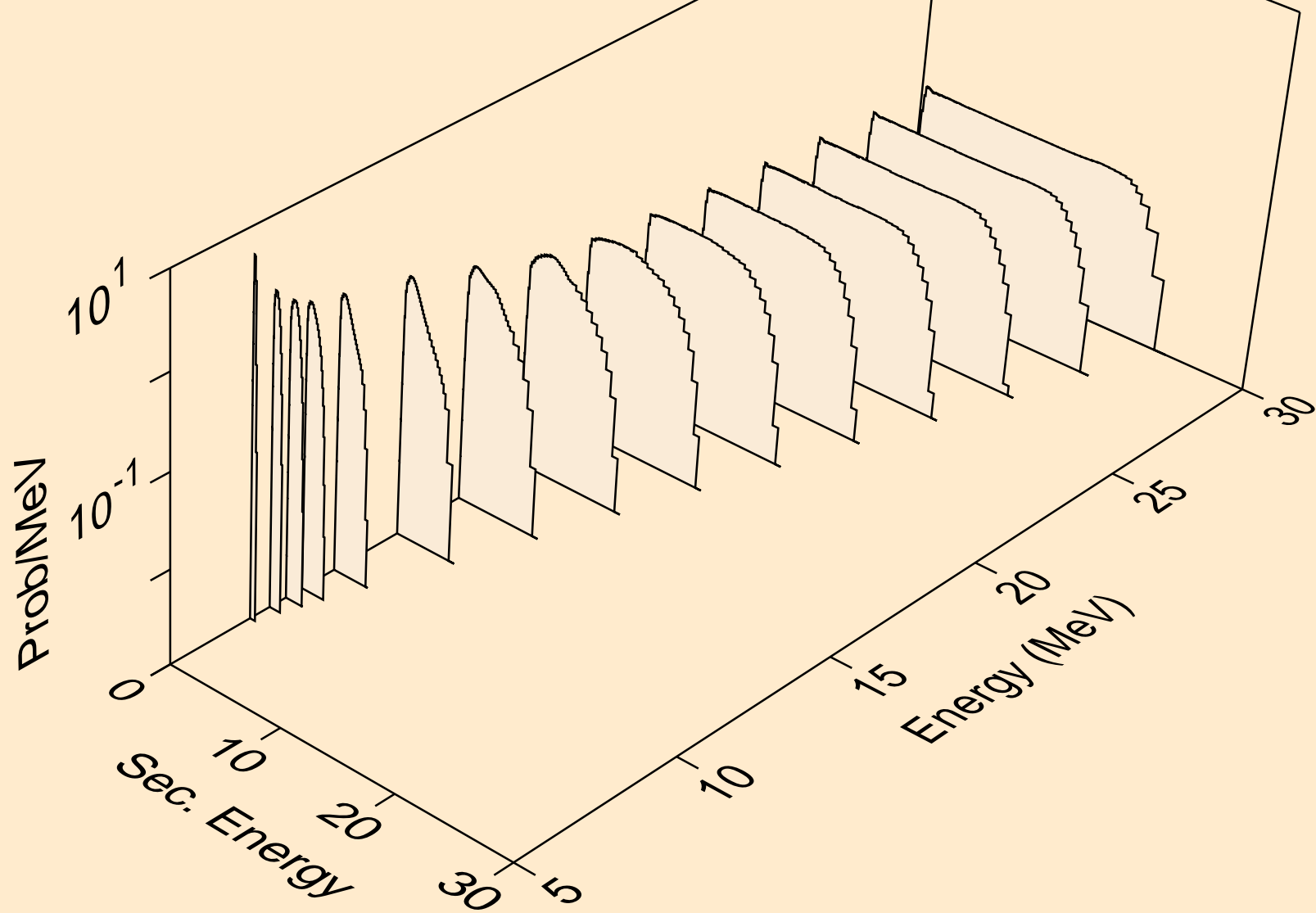

BK238 NEUTRON ACER TENDL-2021 LIBRARY; T=293.6K
Neutron emission for (n,3n)

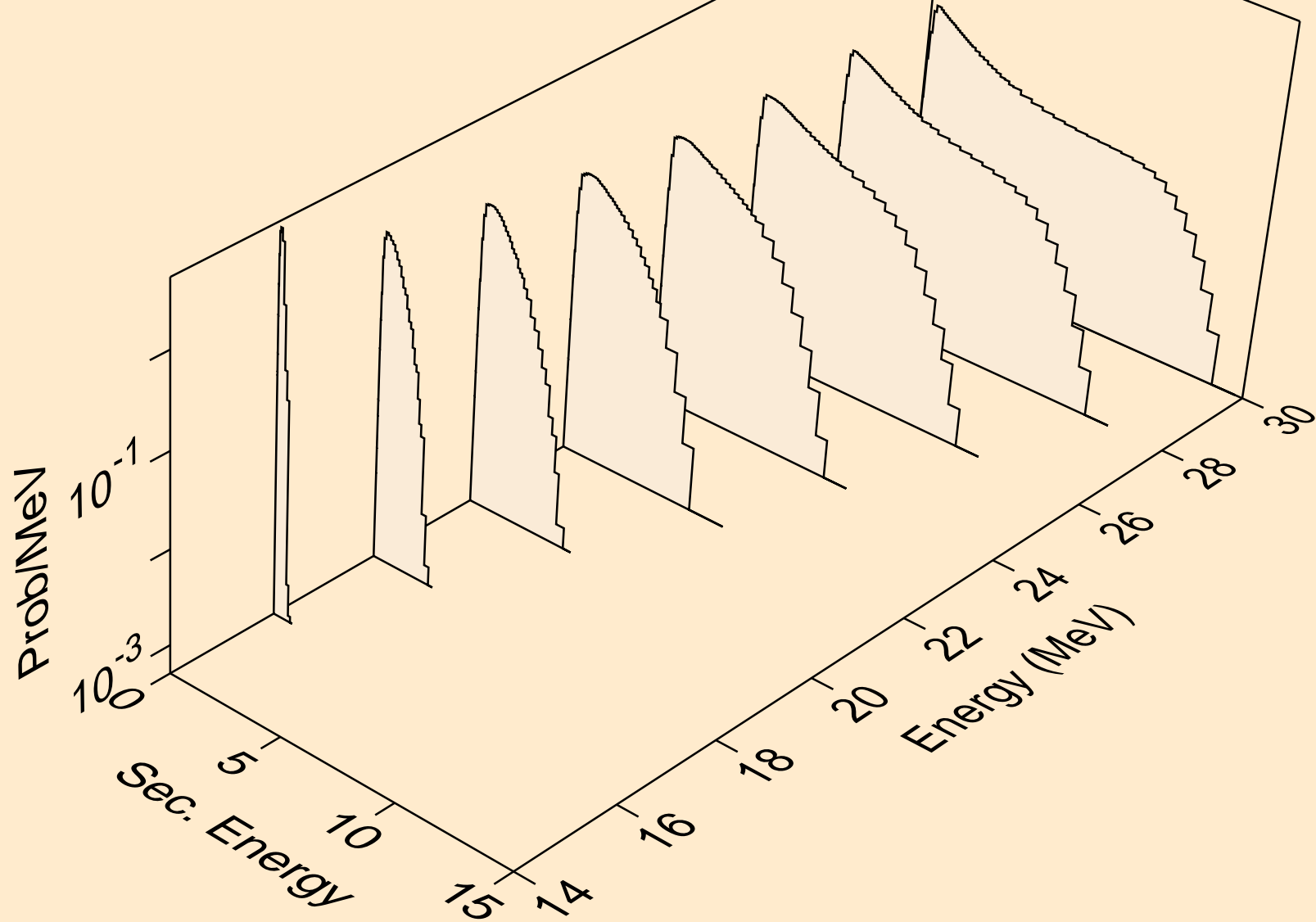

BK238 NEUTRON ACER TENDL-2021 LIBRARY; T=293.6K
Neutron emission for fission

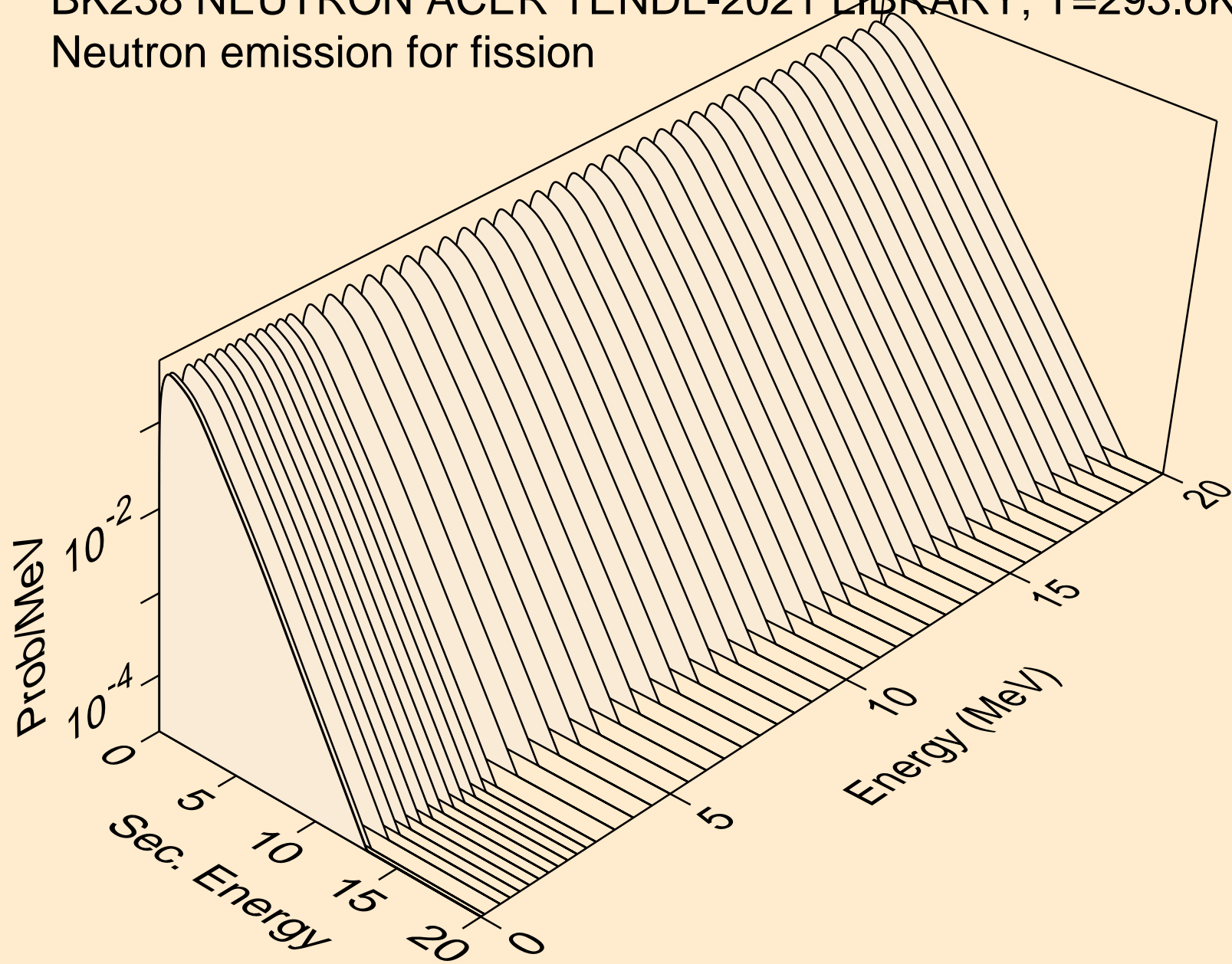

BK238 NEUTRON ACER TENDL-2021 LIBRARY; T=293.6K
Neutron emission for (n,n*)a

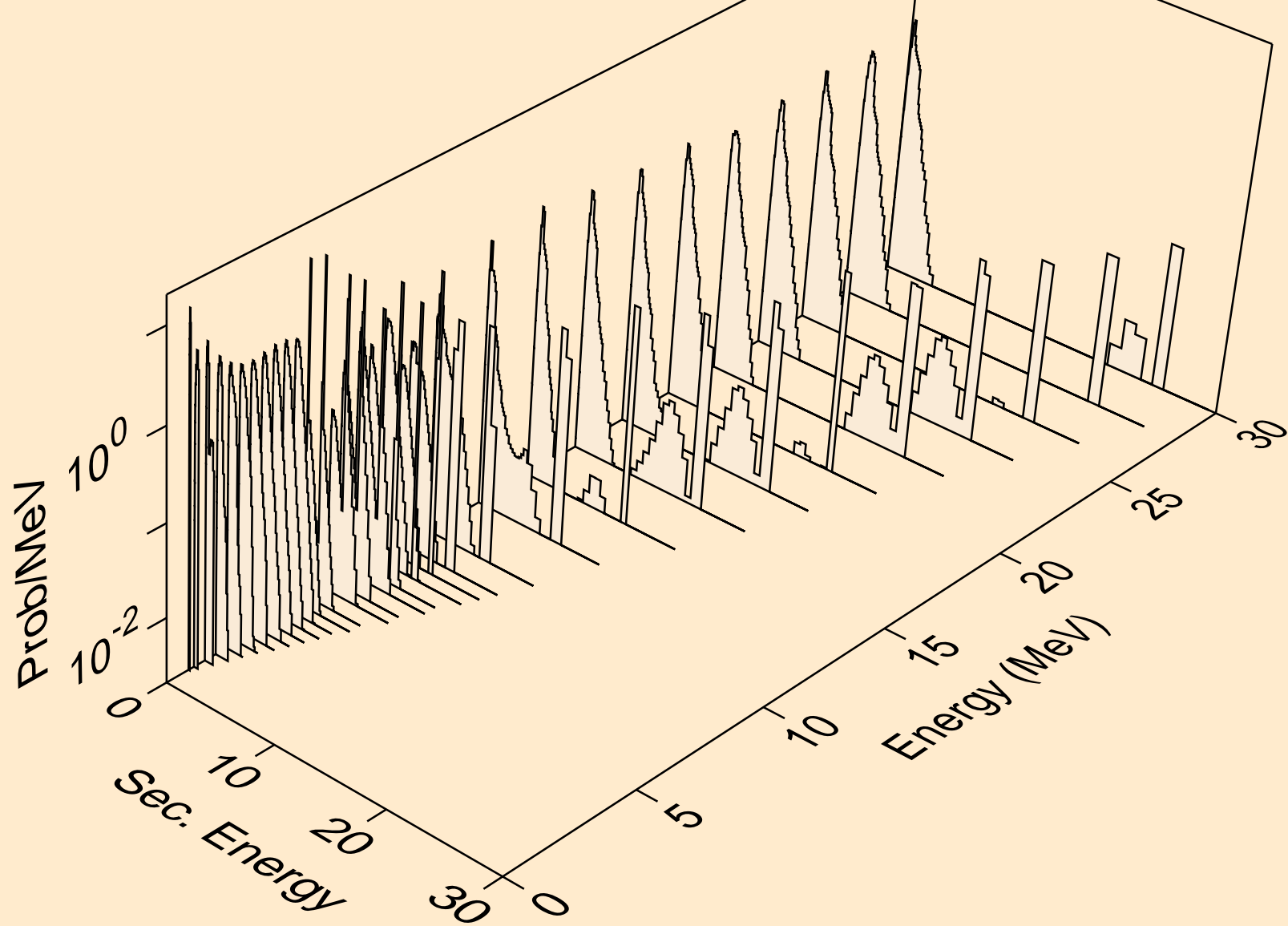

BK238 NEUTRON ACER TENDL-2021 LIBRARY; T=293.6K
Neutron emission for (n,2n)a

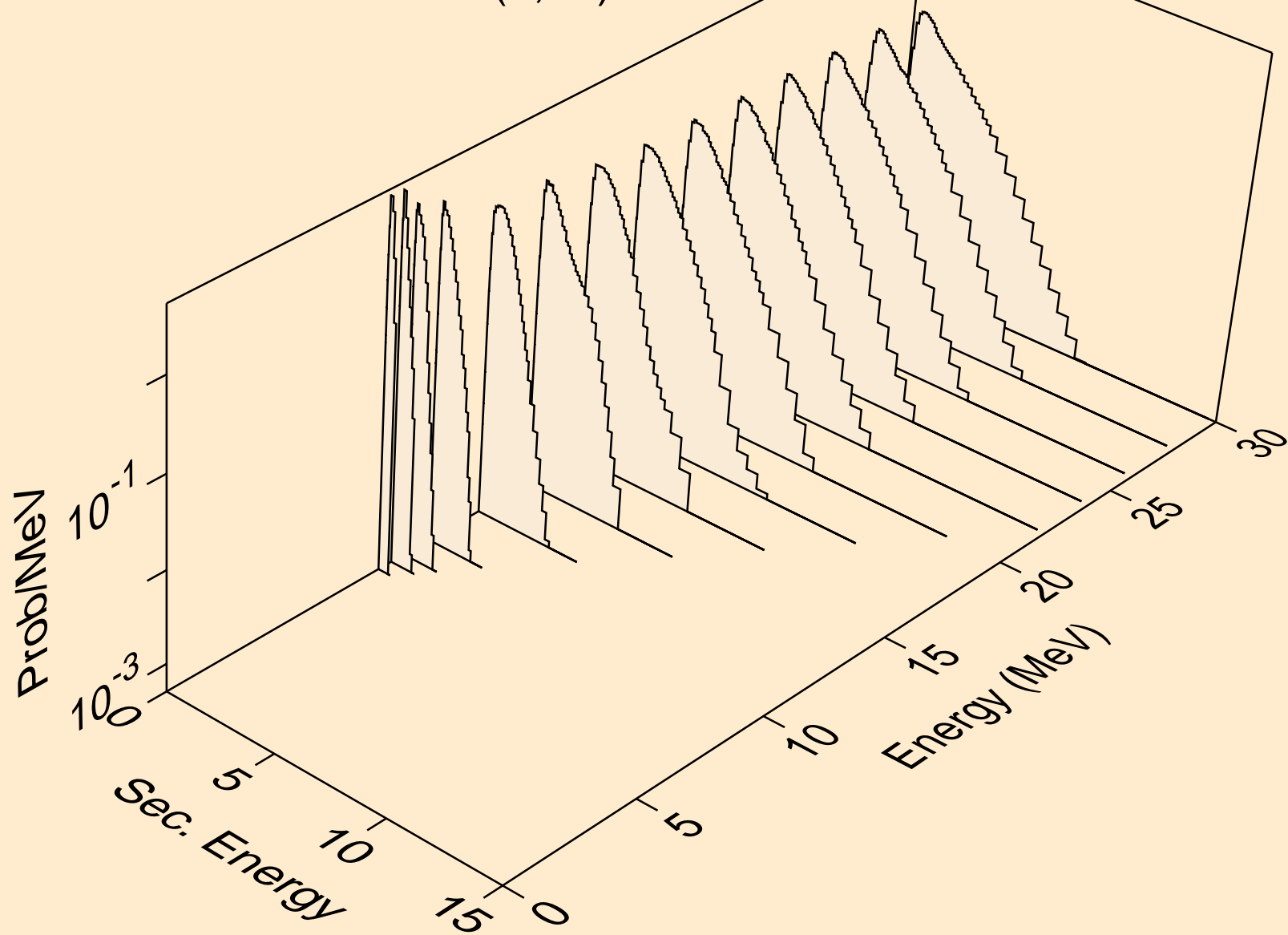

BK238 NEUTRON ACER TENDL-2021 LIBRARY; T=293.6K
Neutron emission for (n,3n)a

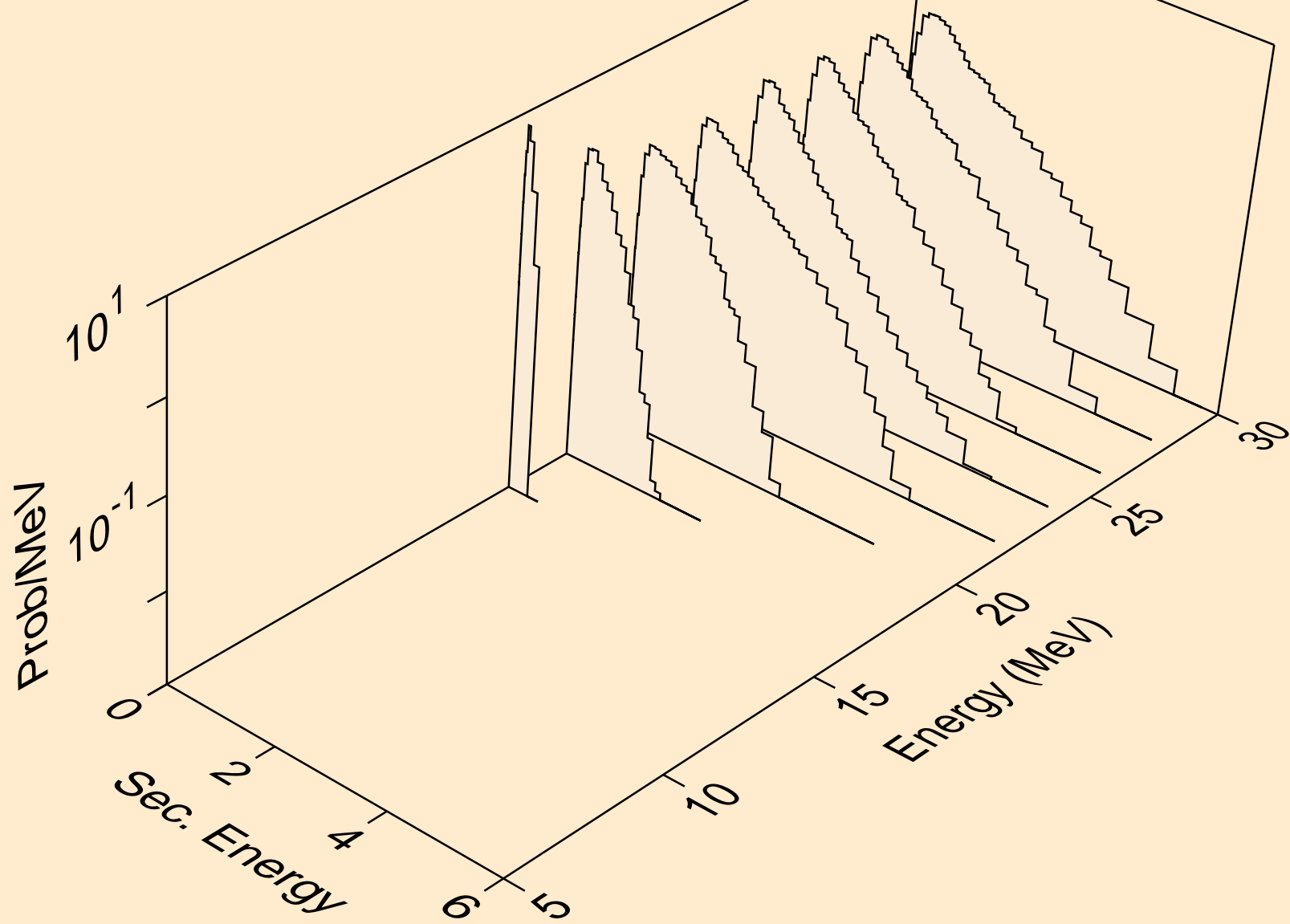

BK238 NEUTRON ACER TENDL-2021 LIBRARY; T=293.6K
Neutron emission for (n,n*)p

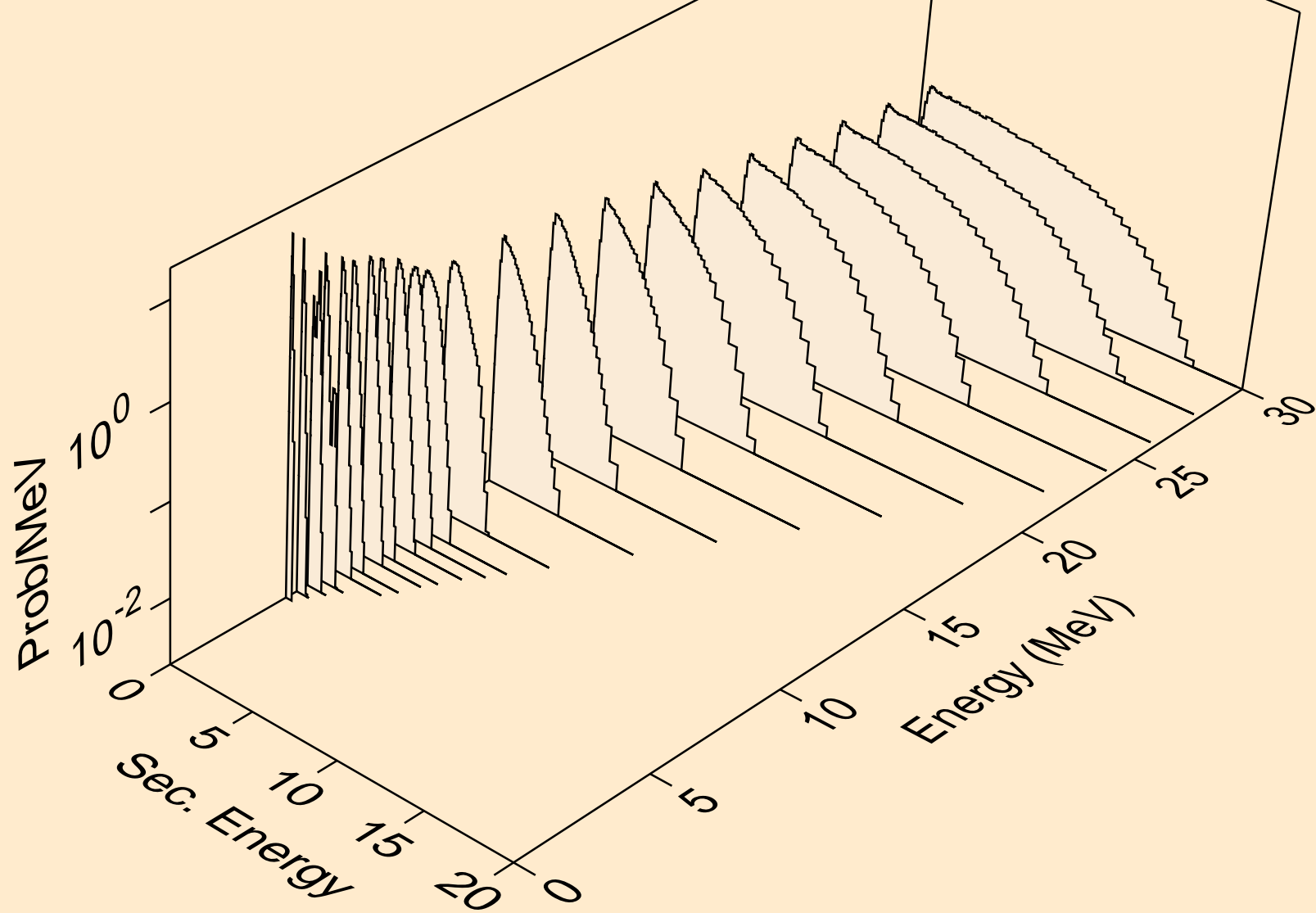

BK238 NEUTRON ACER TENDL-2021 LIBRARY; T=293.6K
Neutron emission for (n,n*)2a

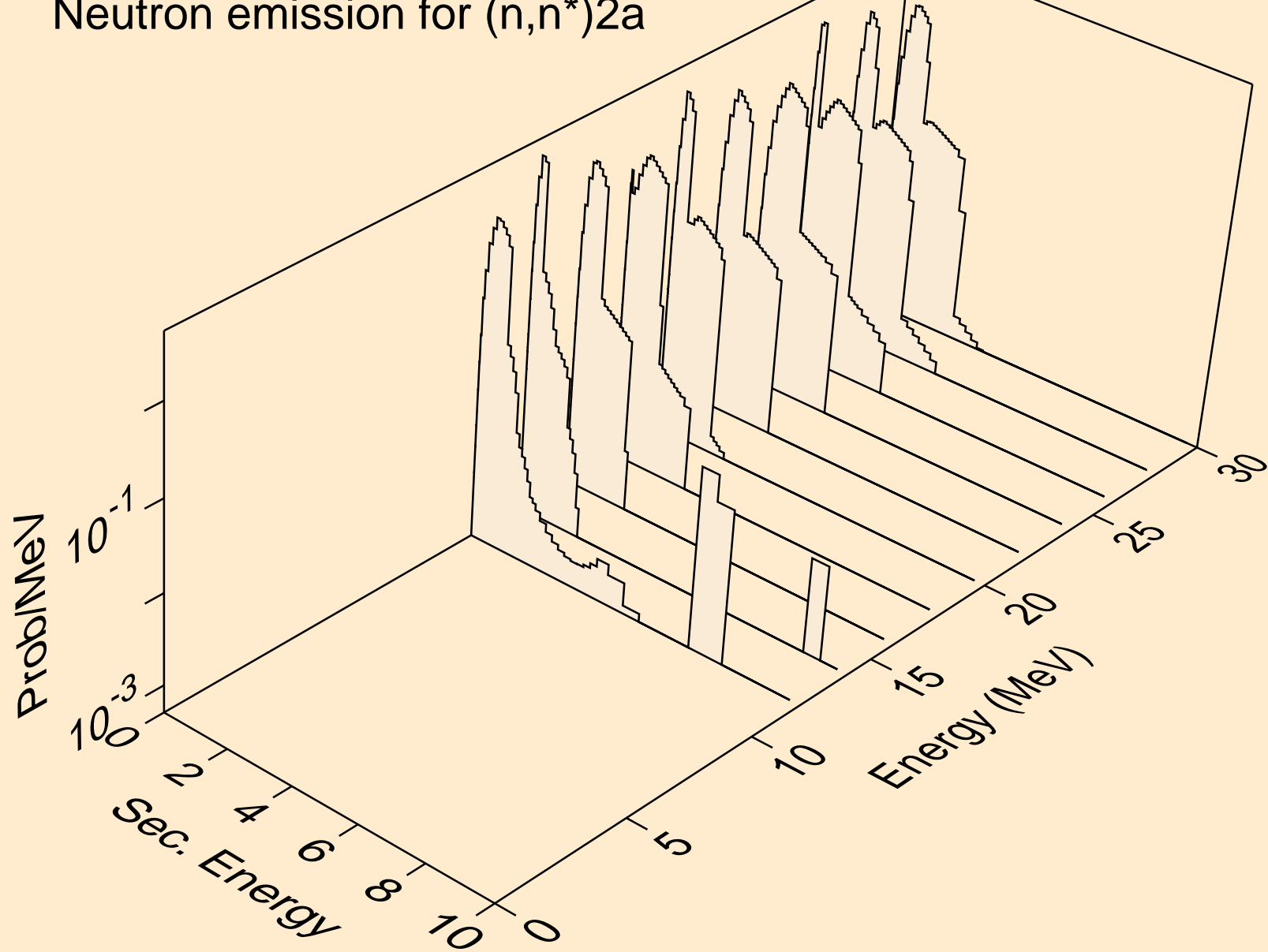

BK238 NEUTRON ACER TENDL-2021 LIBRARY; T=293.6K
Neutron emission for (n,2n)2a

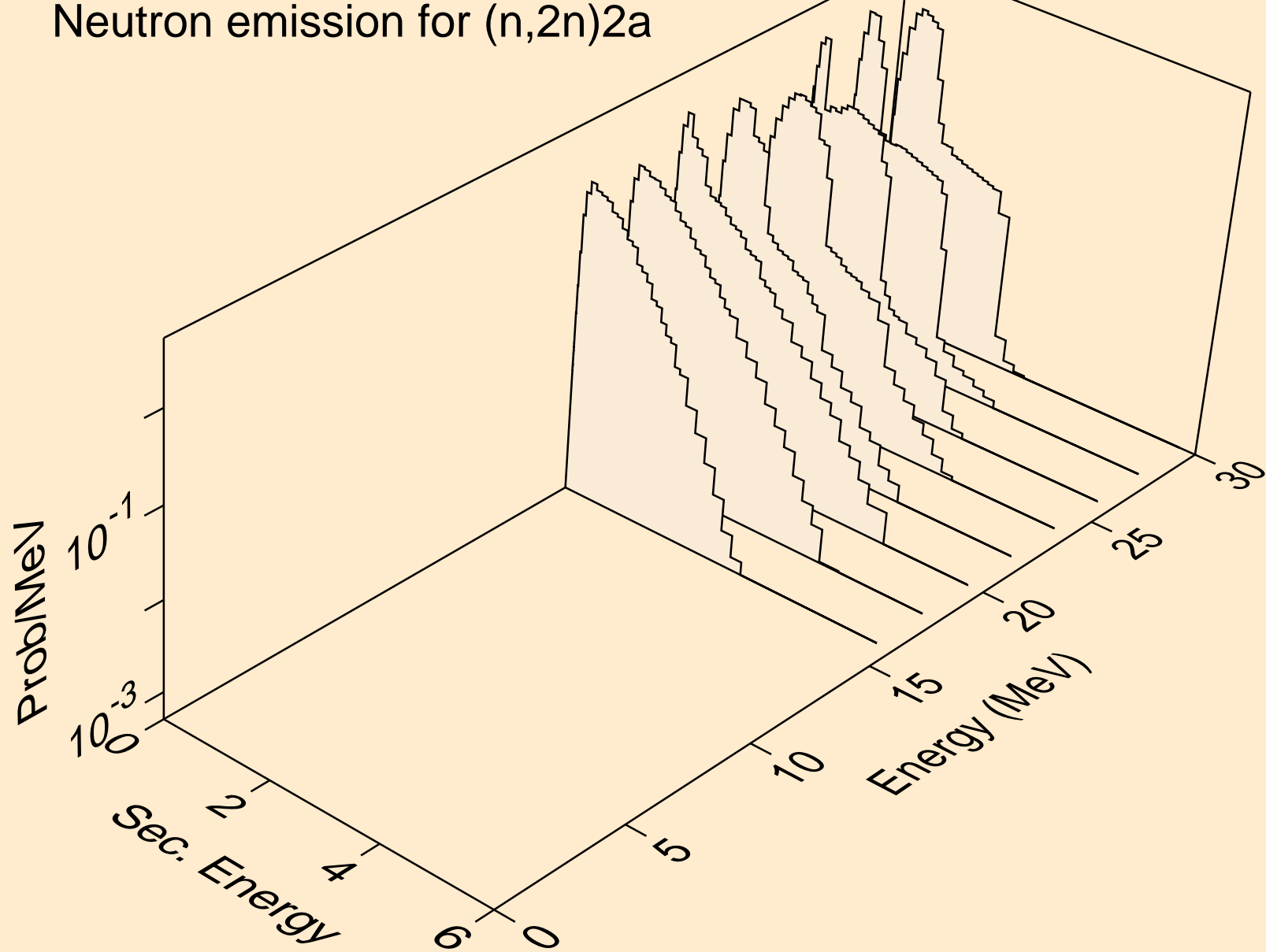

BK238 NEUTRON ACER TENDL-2021 LIBRARY; T=293.6K
Neutron emission for (n,n*)d

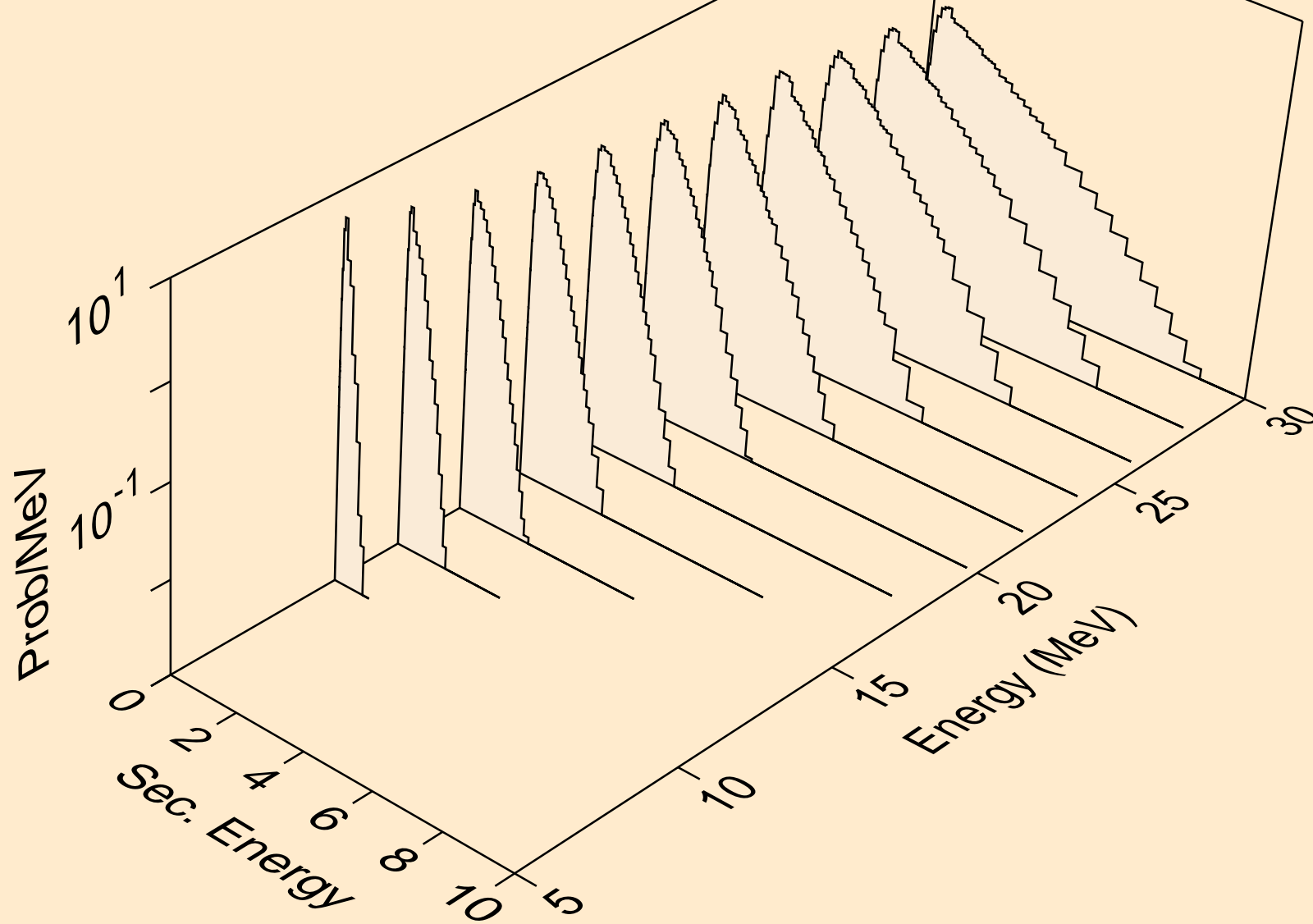

BK238 NEUTRON ACER TENDL-2021 LIBRARY; T=293.6K
Neutron emission for (n,n*)t

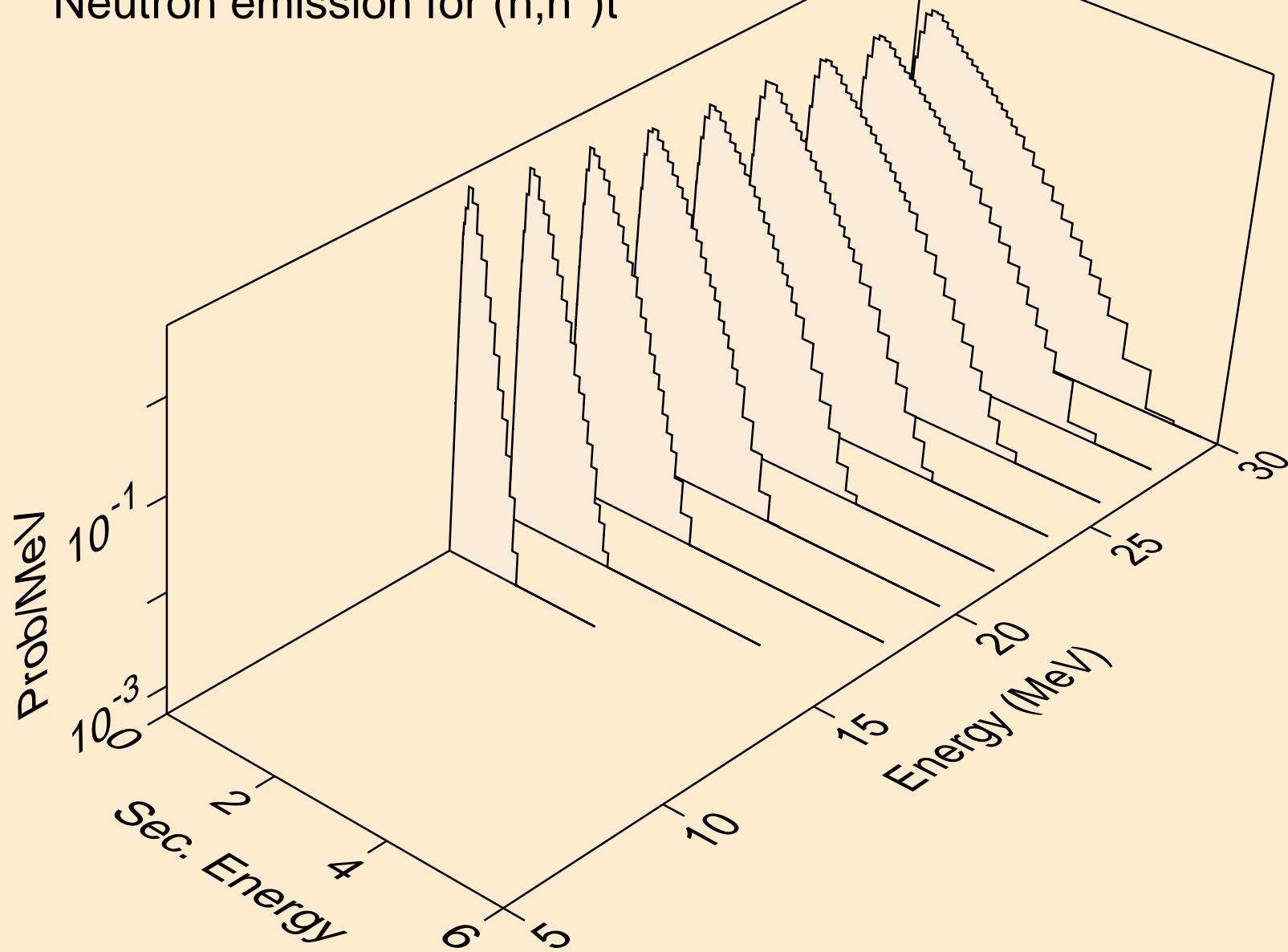

BK238 NEUTRON ACER TENDL-2021 LIBRARY; T=293.6K
Neutron emission for (n,n*)he3

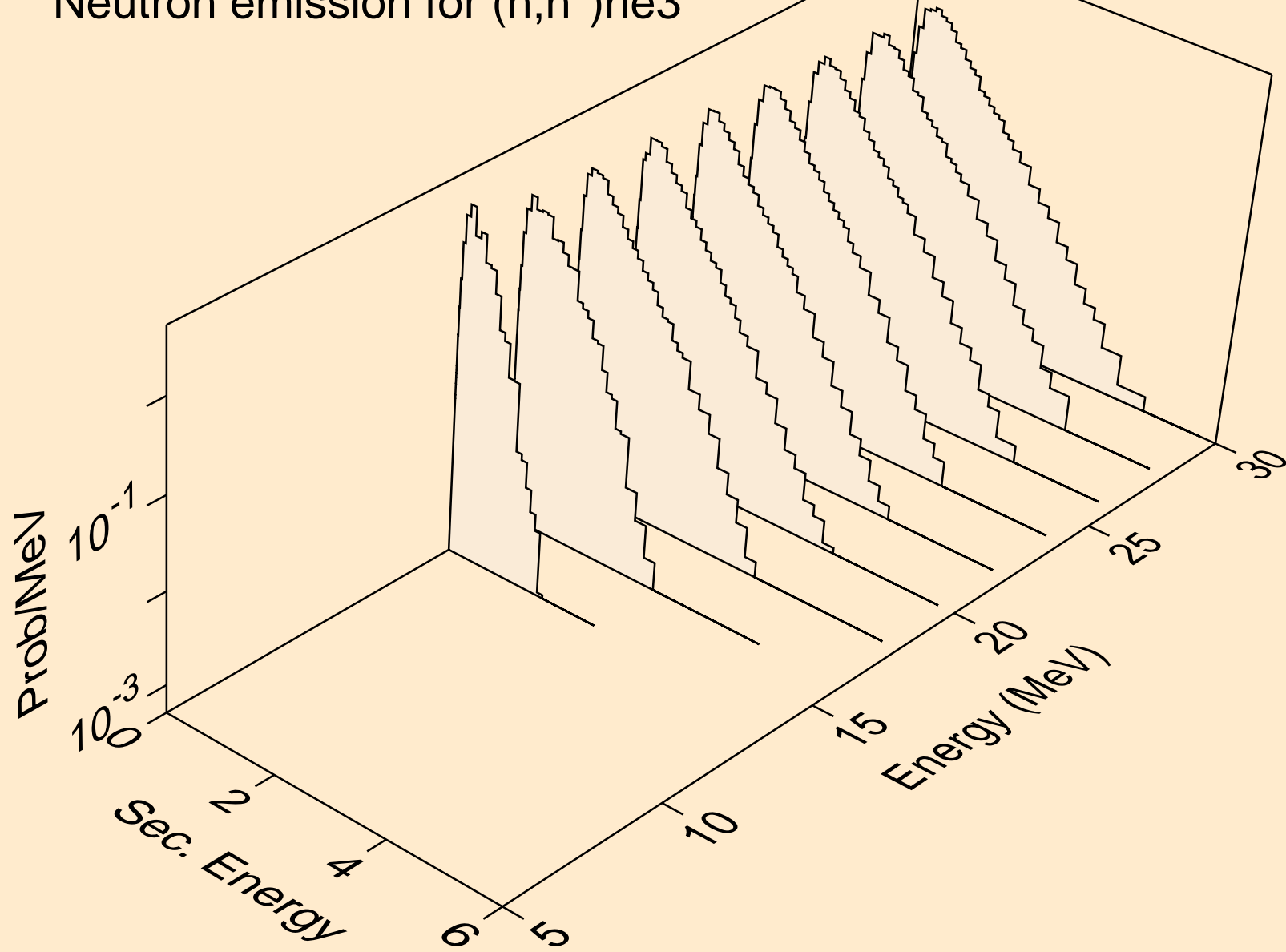

BK238 NEUTRON ACER TENDL-2021 LIBRARY; T=293.6K
Neutron emission for (n,4n)

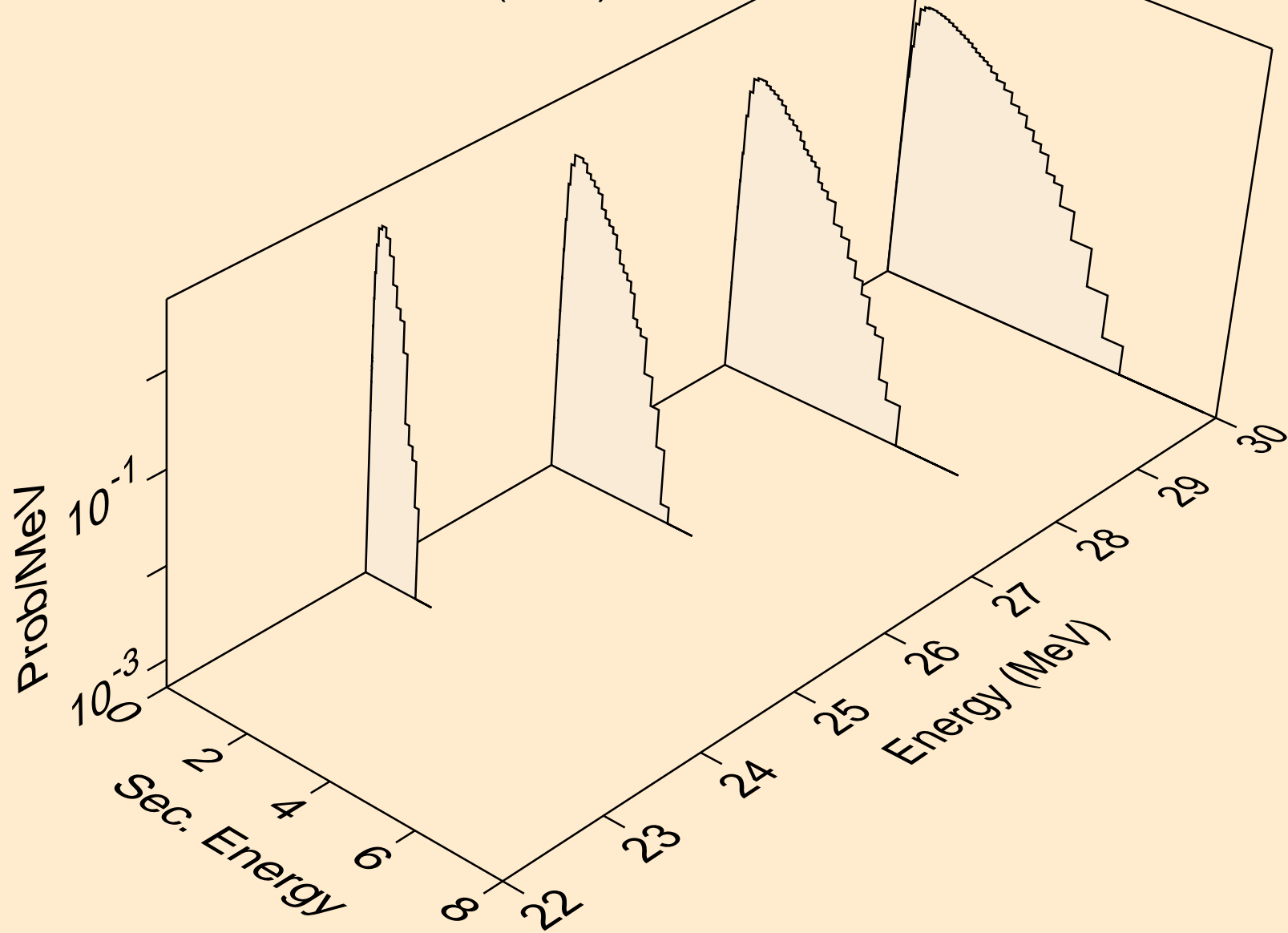

BK238 NEUTRON ACER TENDL-2021 LIBRARY; T=293.6K
Neutron emission for (n,2np)

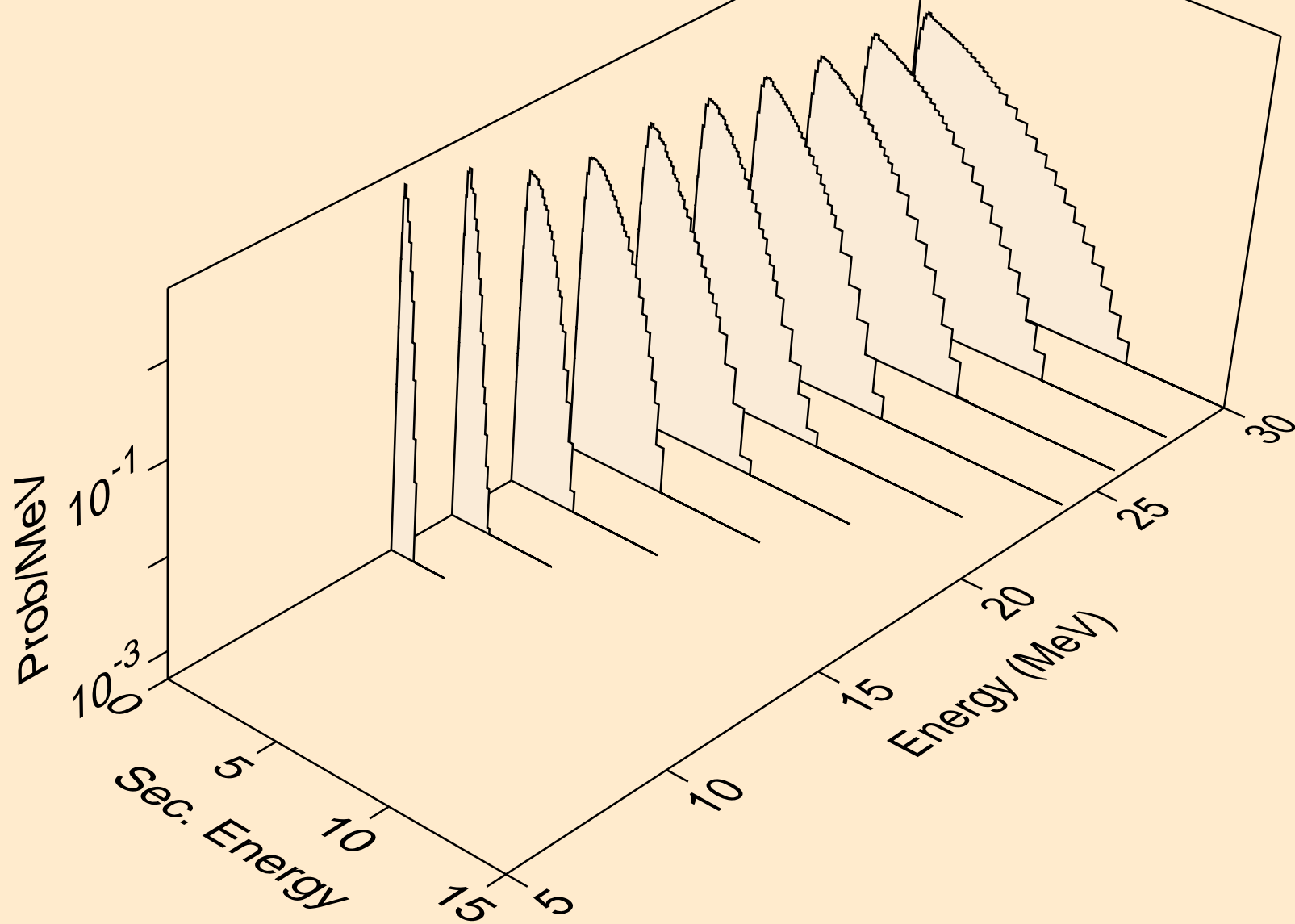

BK238 NEUTRON ACER TENDL-2021 LIBRARY; T=293.6K
Neutron emission for (n,3np)

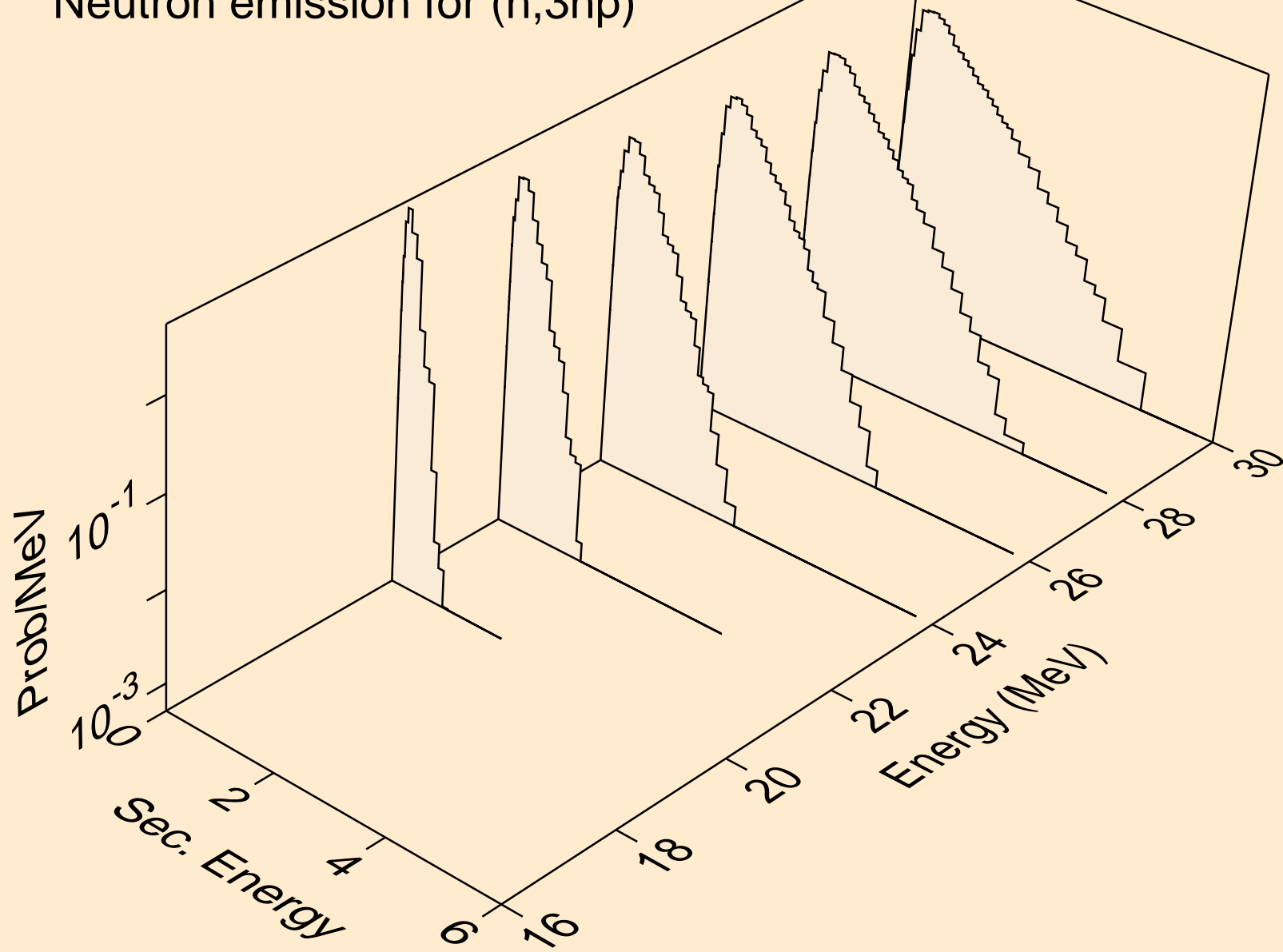

BK238 NEUTRON ACER TENDL-2021 LIBRARY; T=293.6K
Neutron emission for (n,2np)

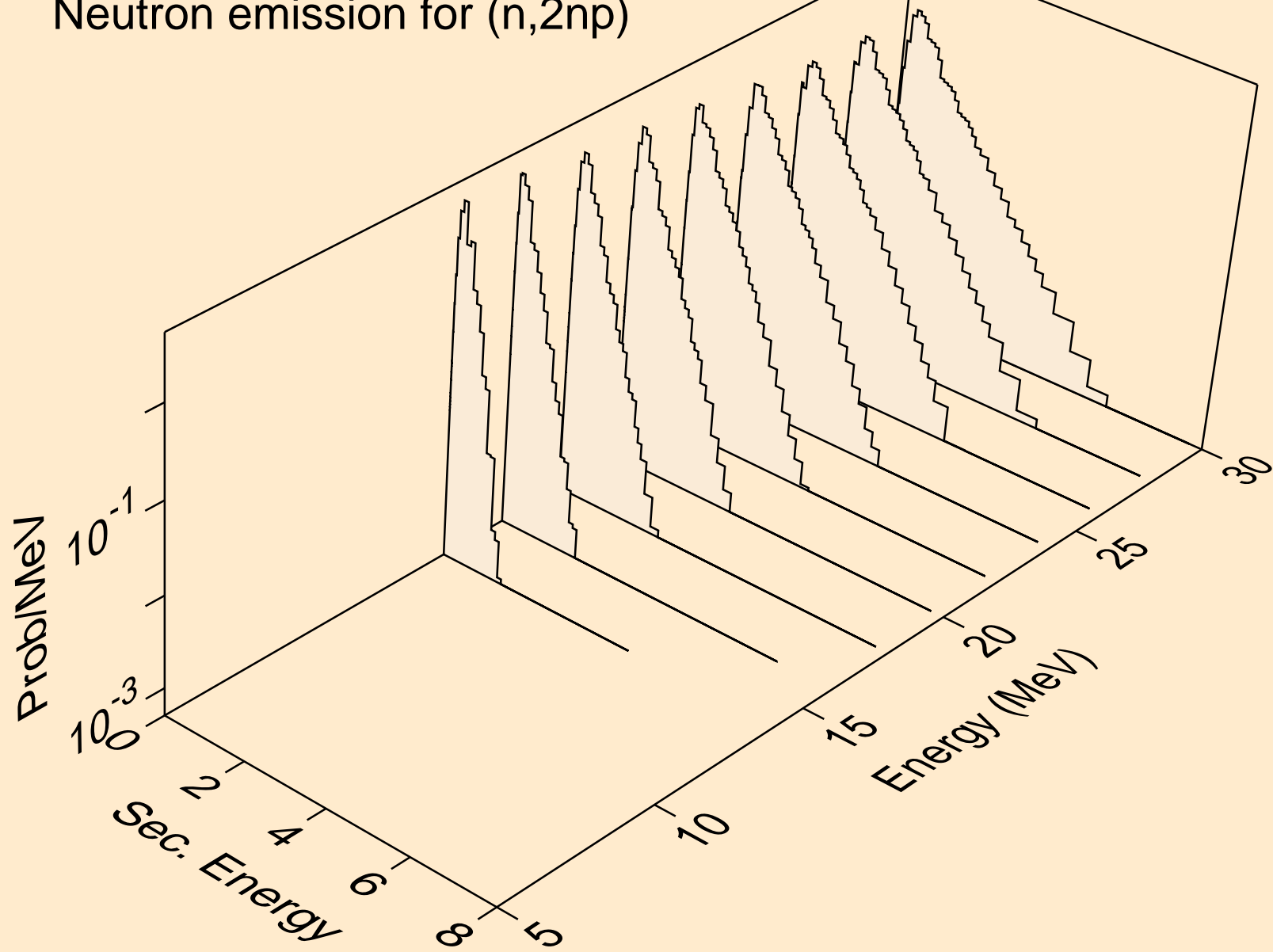

BK238 NEUTRON ACER TENDL-2021 LIBRARY; T=293.6K
Neutron emission for (n,npa)

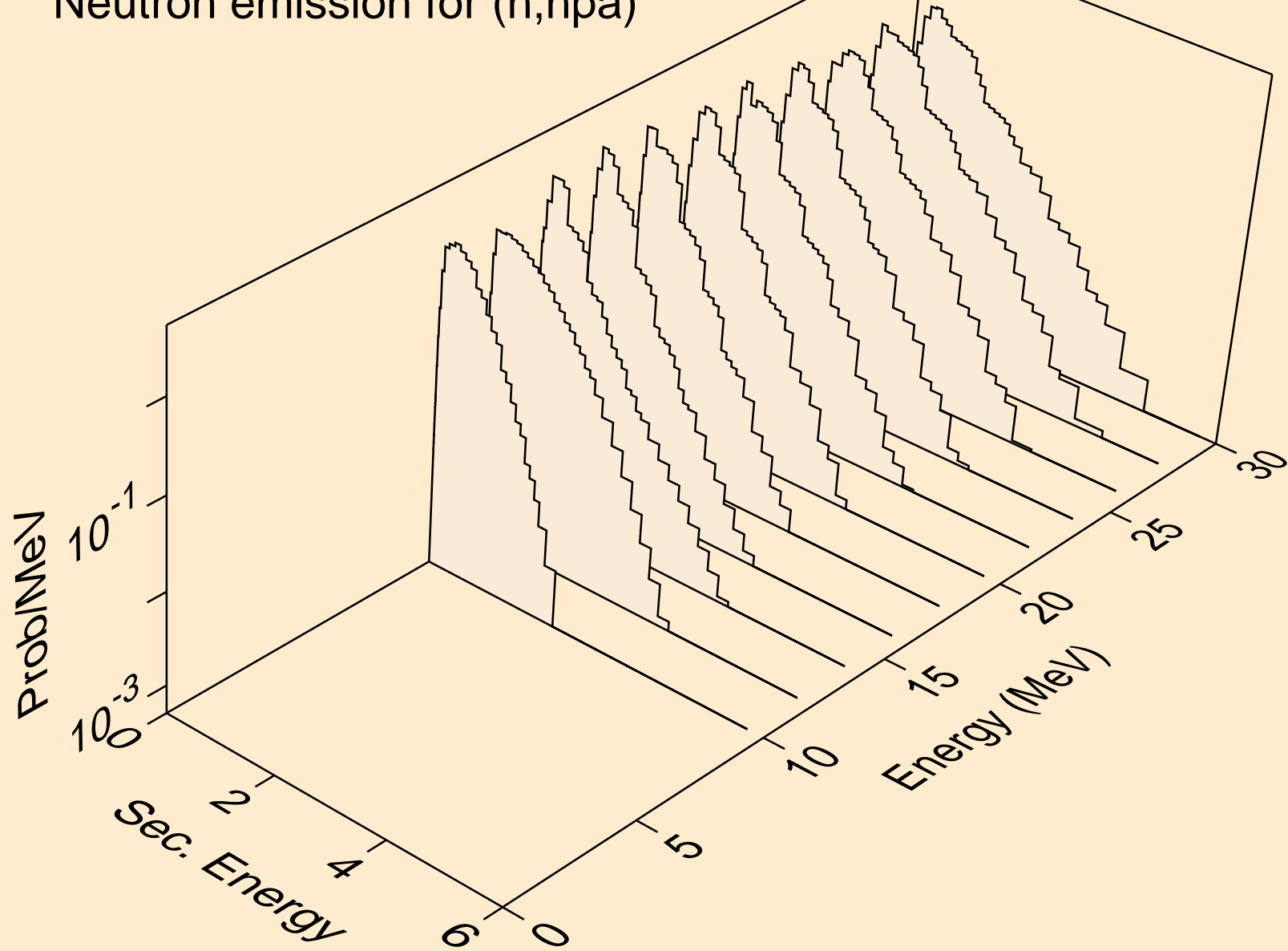

BK238 NEUTRON ACER TENDL-2021 LIBRARY; T=293.6K
Neutron emission for (n,n*c)

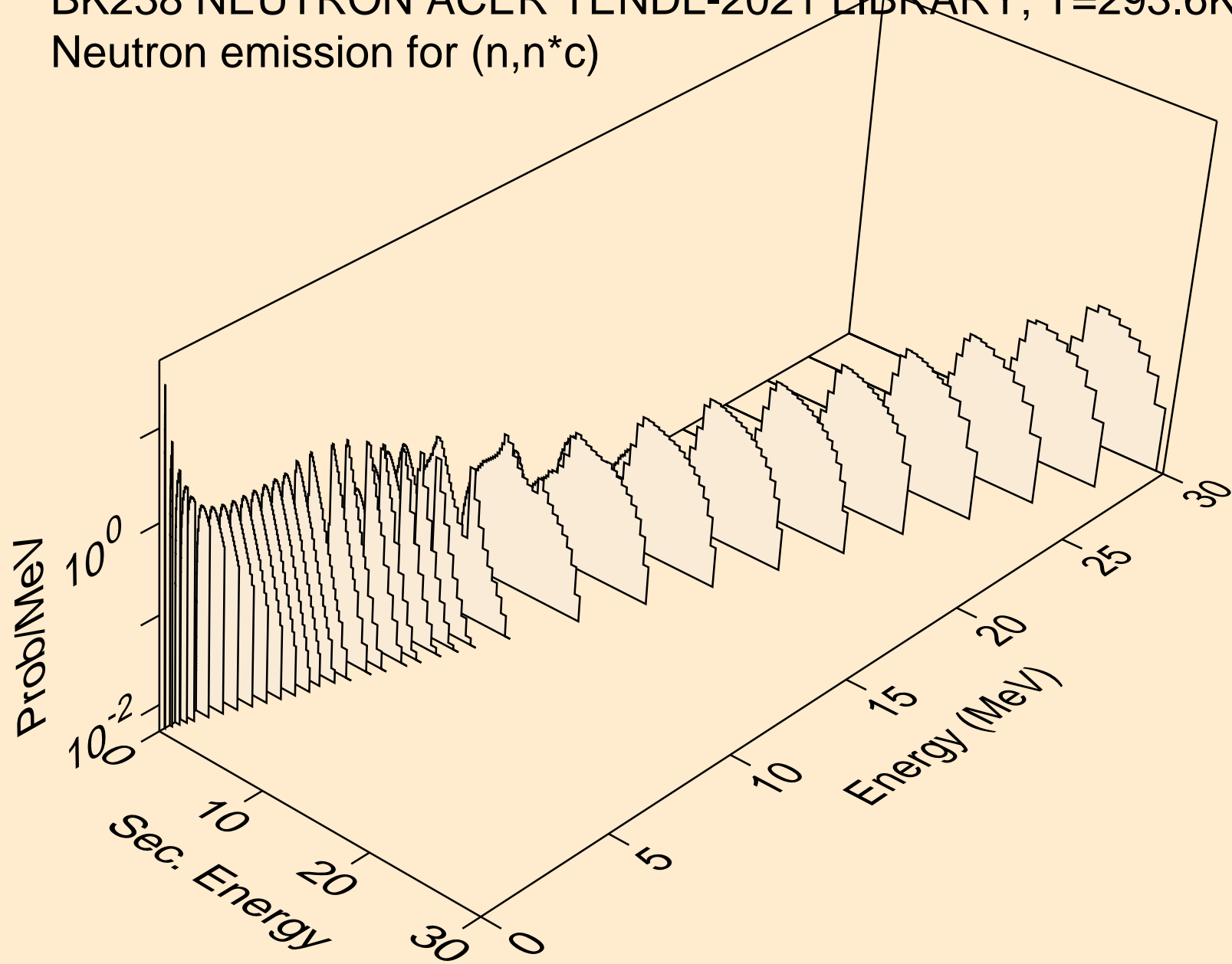

BK238 NEUTRON ACER TENDL-2021 LIBRARY; T=293.6K
Delayed nubar

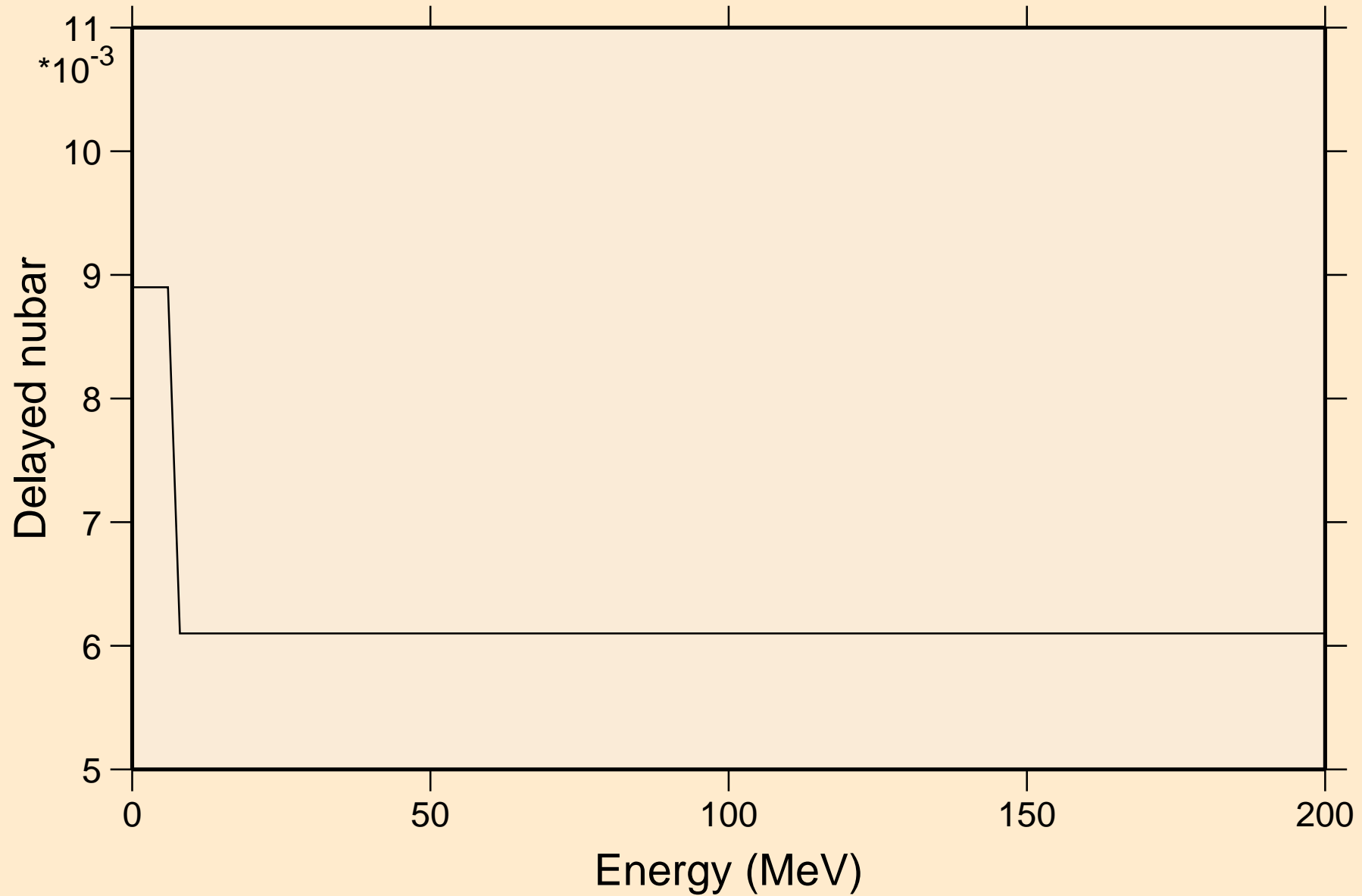

BK238 NEUTRON ACER TENDL-2021 LIBRARY; T=293.6K

Delayed neutron spectra

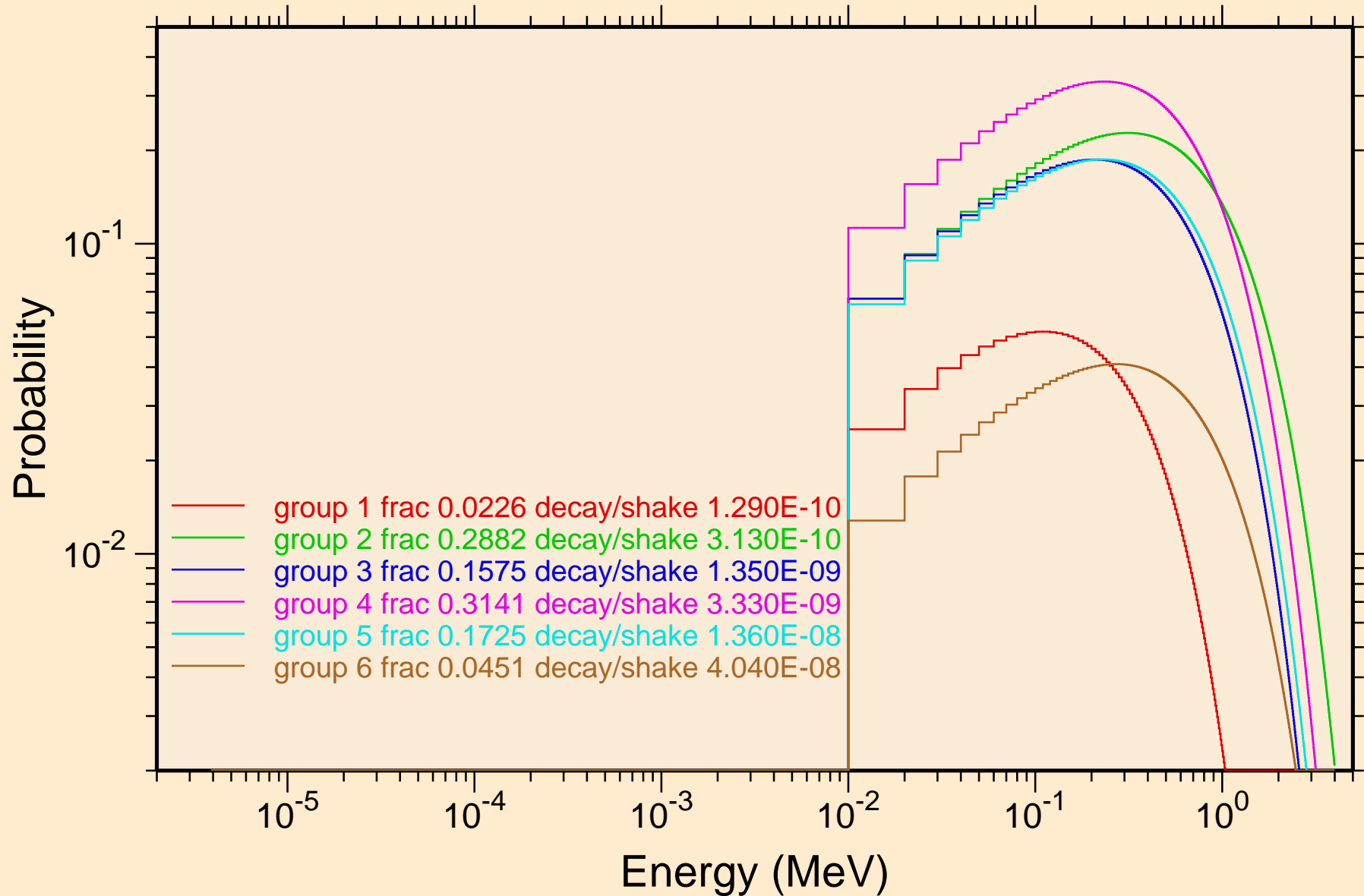

BK238 NEUTRON ACER TENDL-2021 LIBRARY; T=293.6K
Photon emission for (n,x)

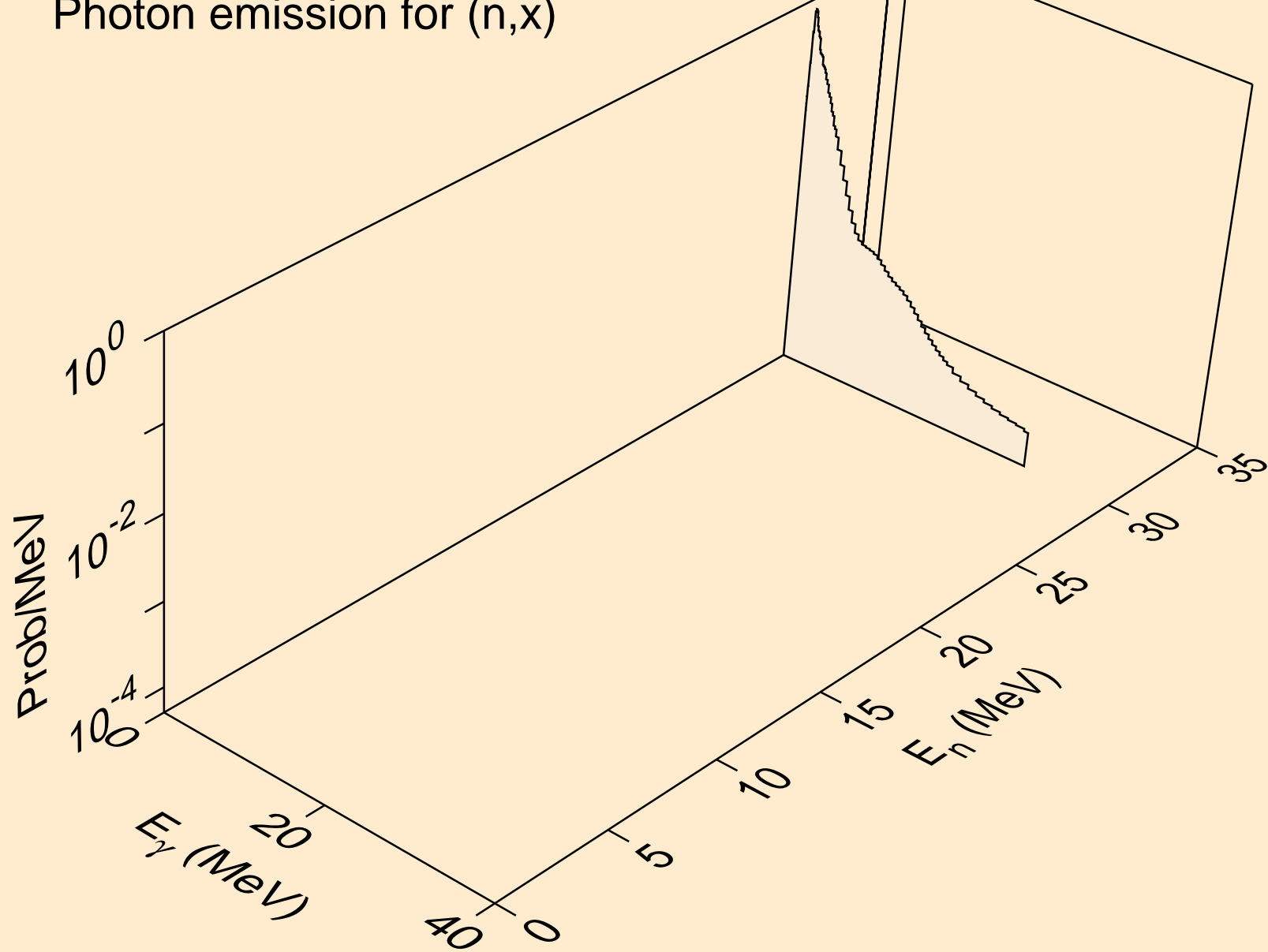

BK238 NEUTRON ACER TENDL-2021 LIBRARY; T=293.6K
Photon emission for (n,2nd)

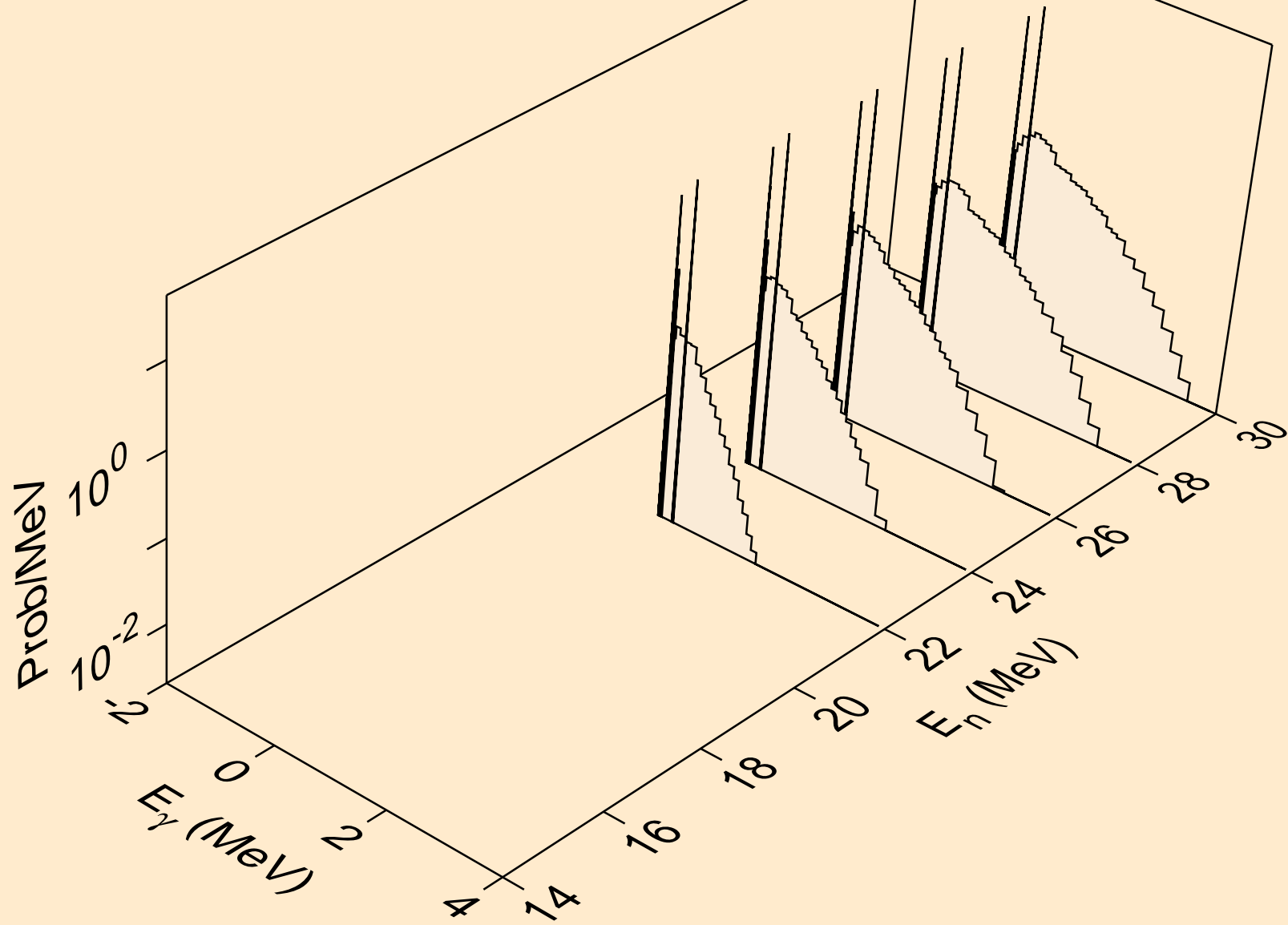

BK238 NEUTRON ACER TENDL-2021 LIBRARY; T=293.6K
Photon emission for (n,2n)

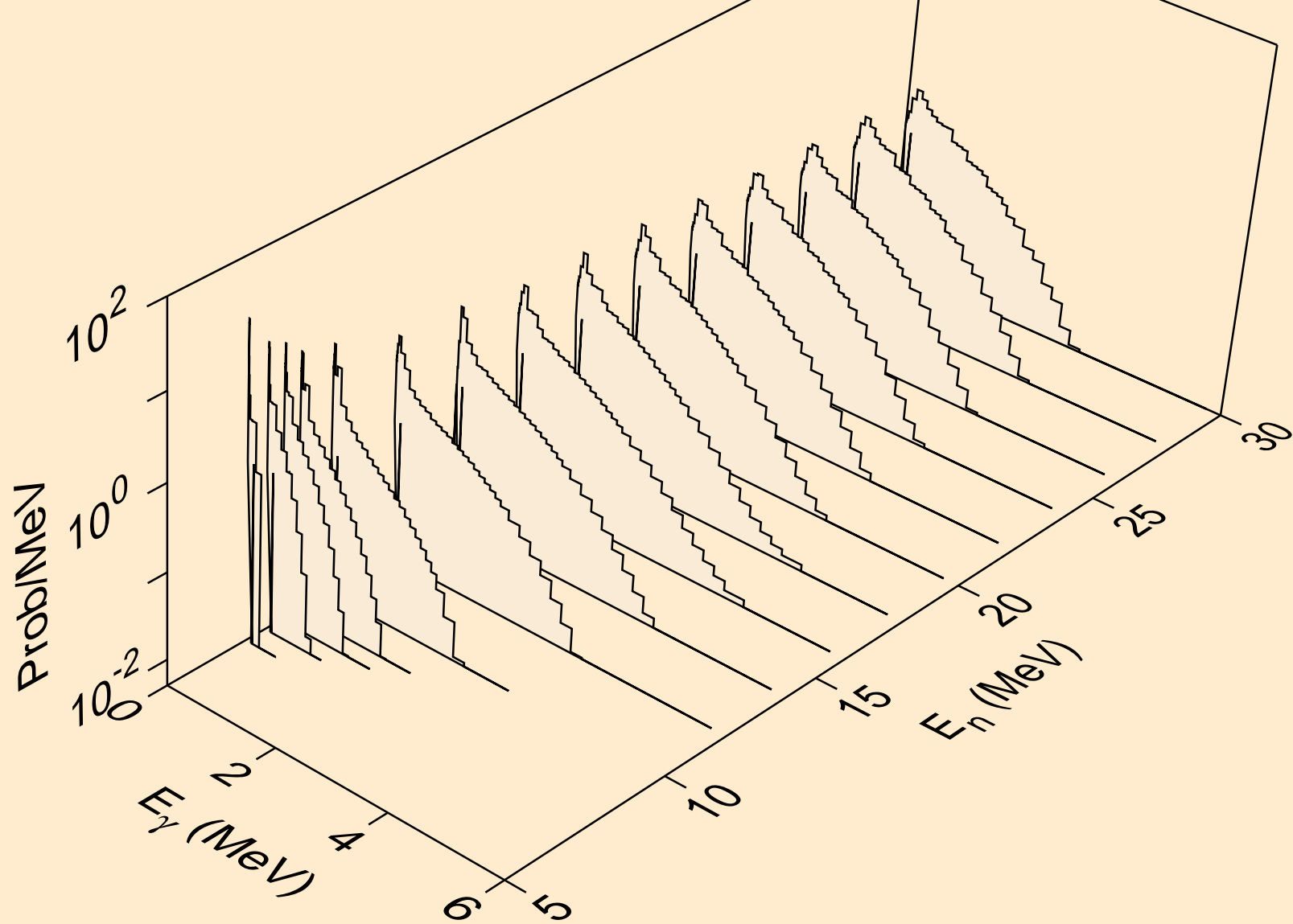

BK238 NEUTRON ACER TENDL-2021 LIBRARY; T=293.6K
Photon emission for (n,3n)

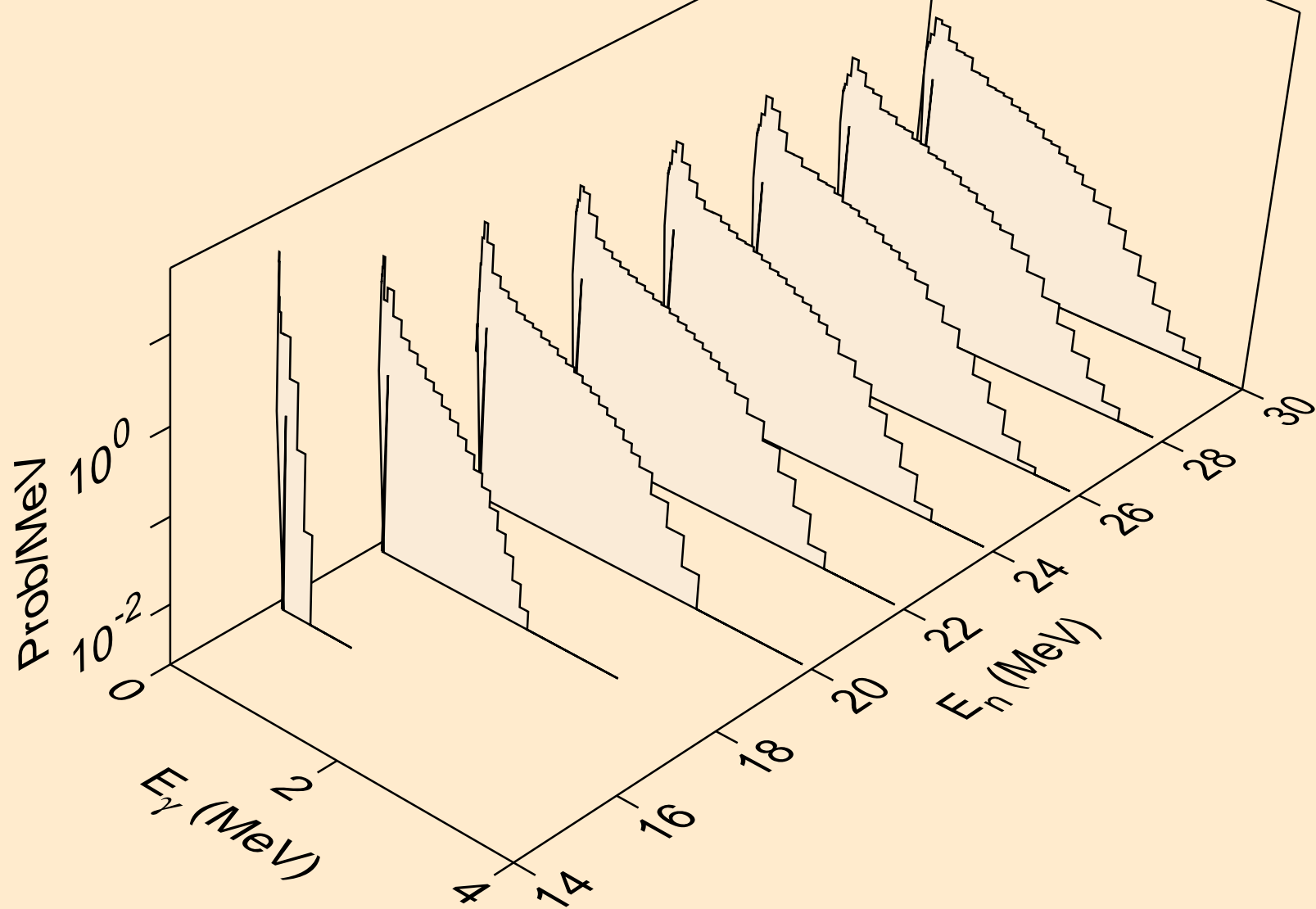

BK238 NEUTRON ACER TENDL-2021 LIBRARY; T=293.6K
Photon emission for (n,n*)a

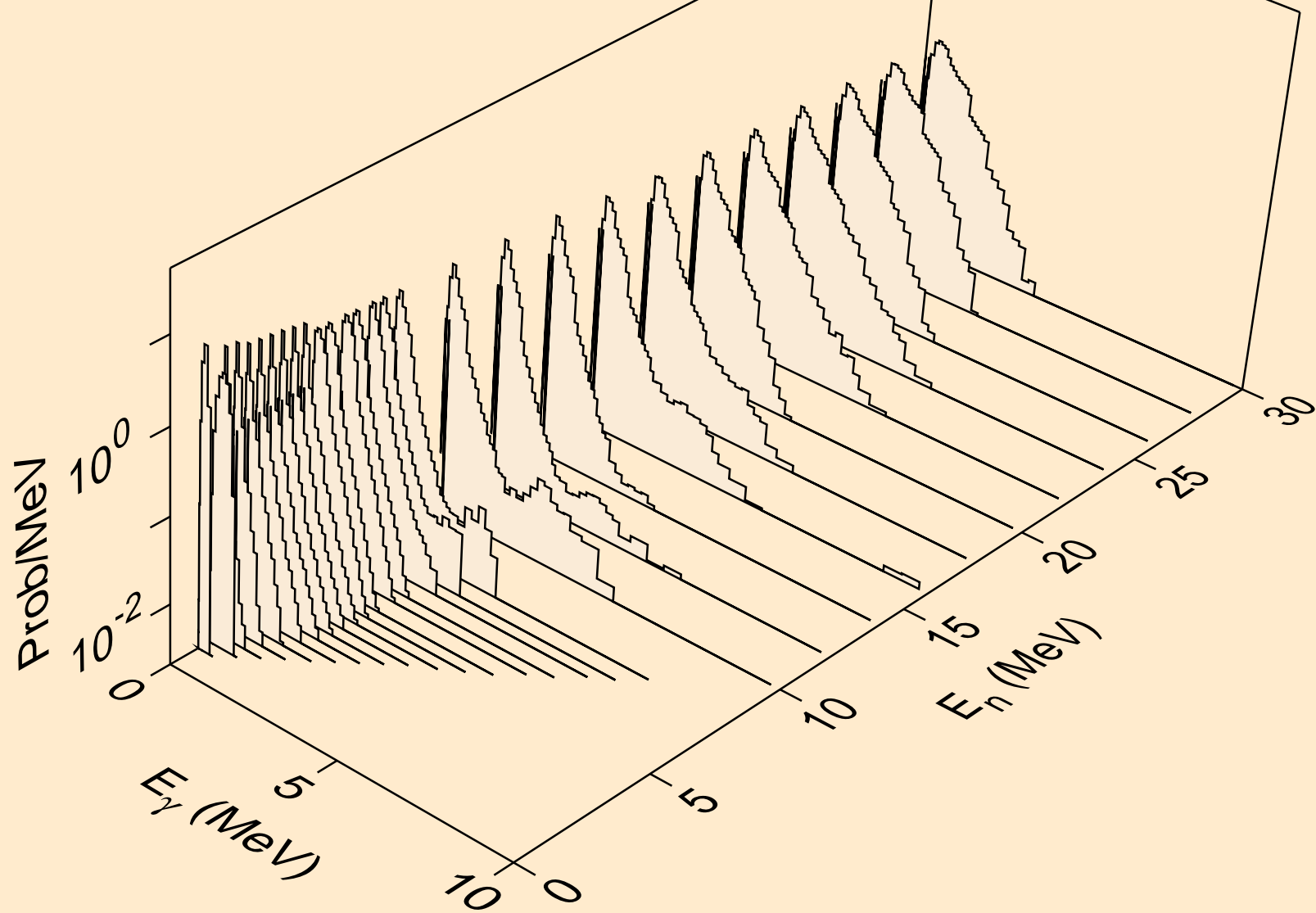

BK238 NEUTRON ACER TENDL-2021 LIBRARY; T=293.6K
Photon emission for (n,2n)a

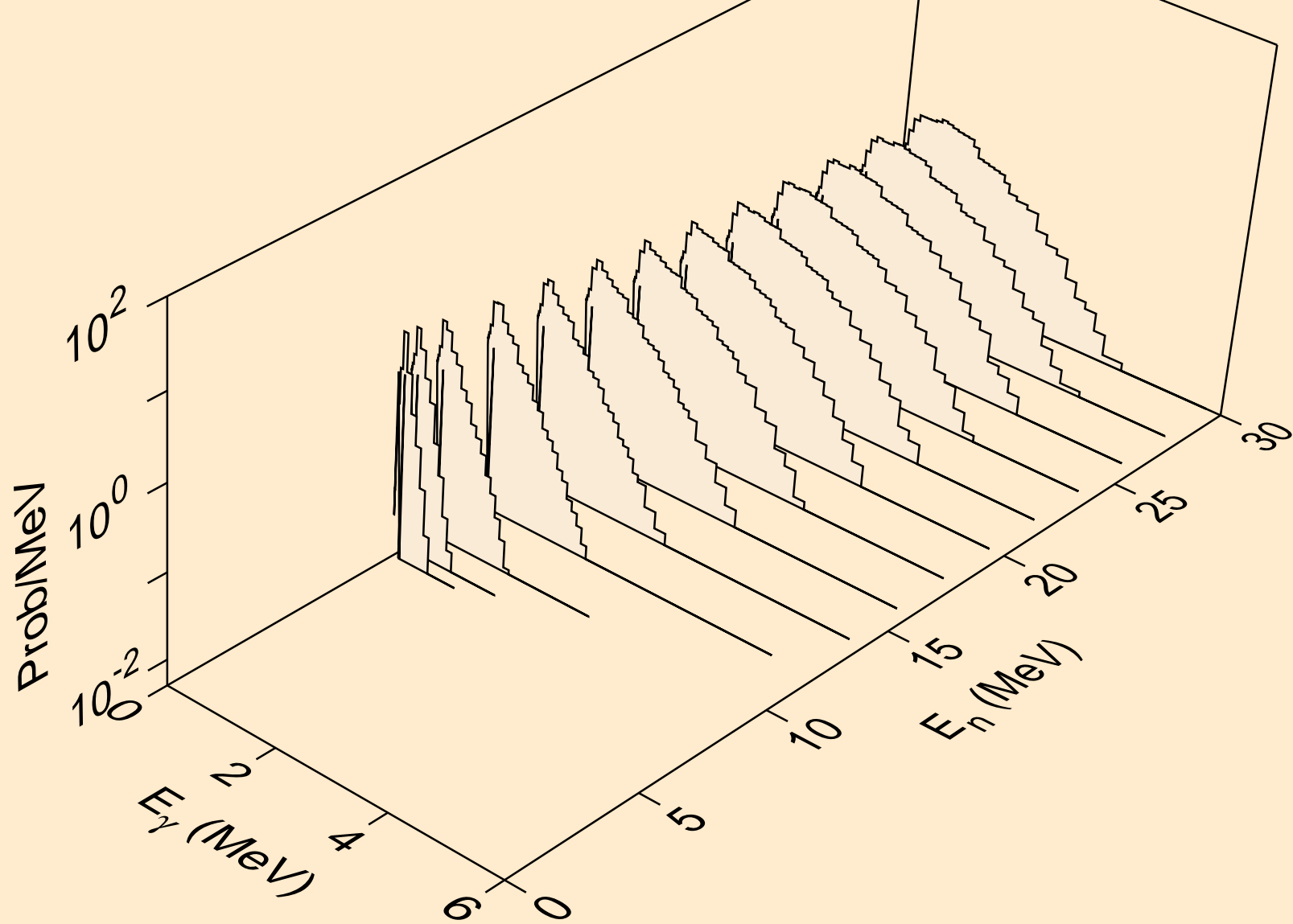

BK238 NEUTRON ACER TENDL-2021 LIBRARY; T=293.6K
Photon emission for (n,3n)a

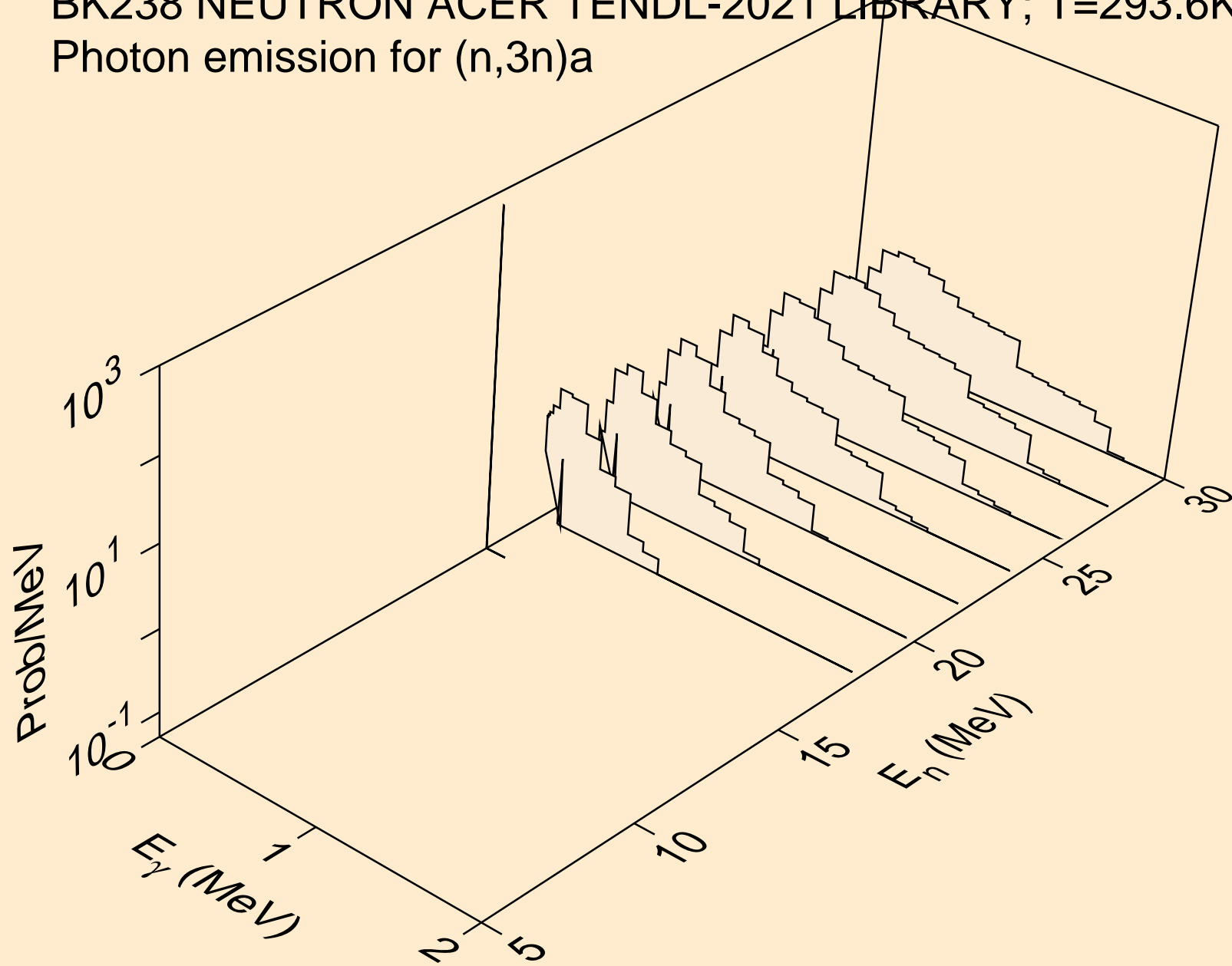

BK238 NEUTRON ACER TENDL-2021 LIBRARY; T=293.6K
Photon emission for (n,n*)p

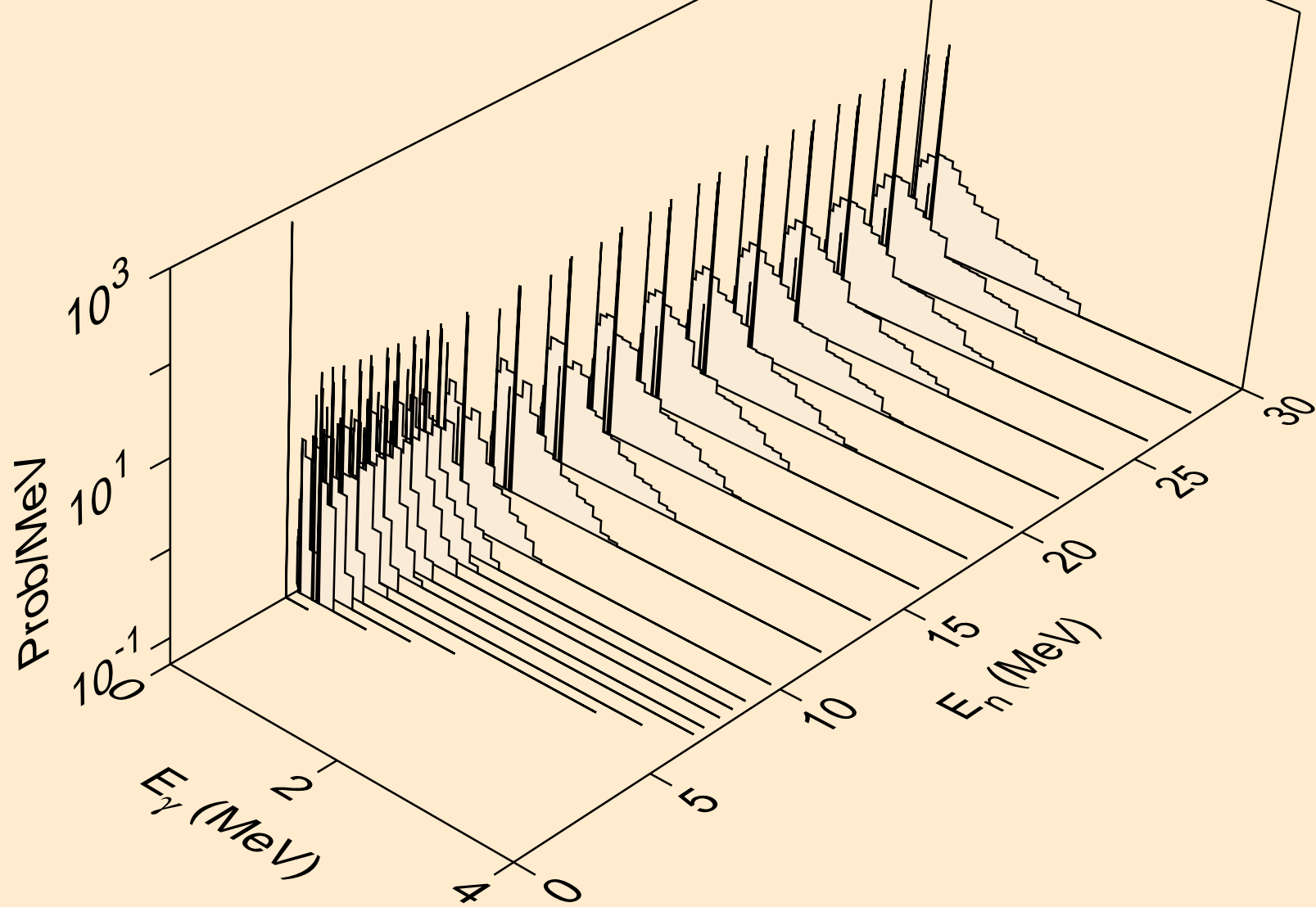

BK238 NEUTRON ACER TENDL-2021 LIBRARY; T=293.6K
Photon emission for (n,n*)2a

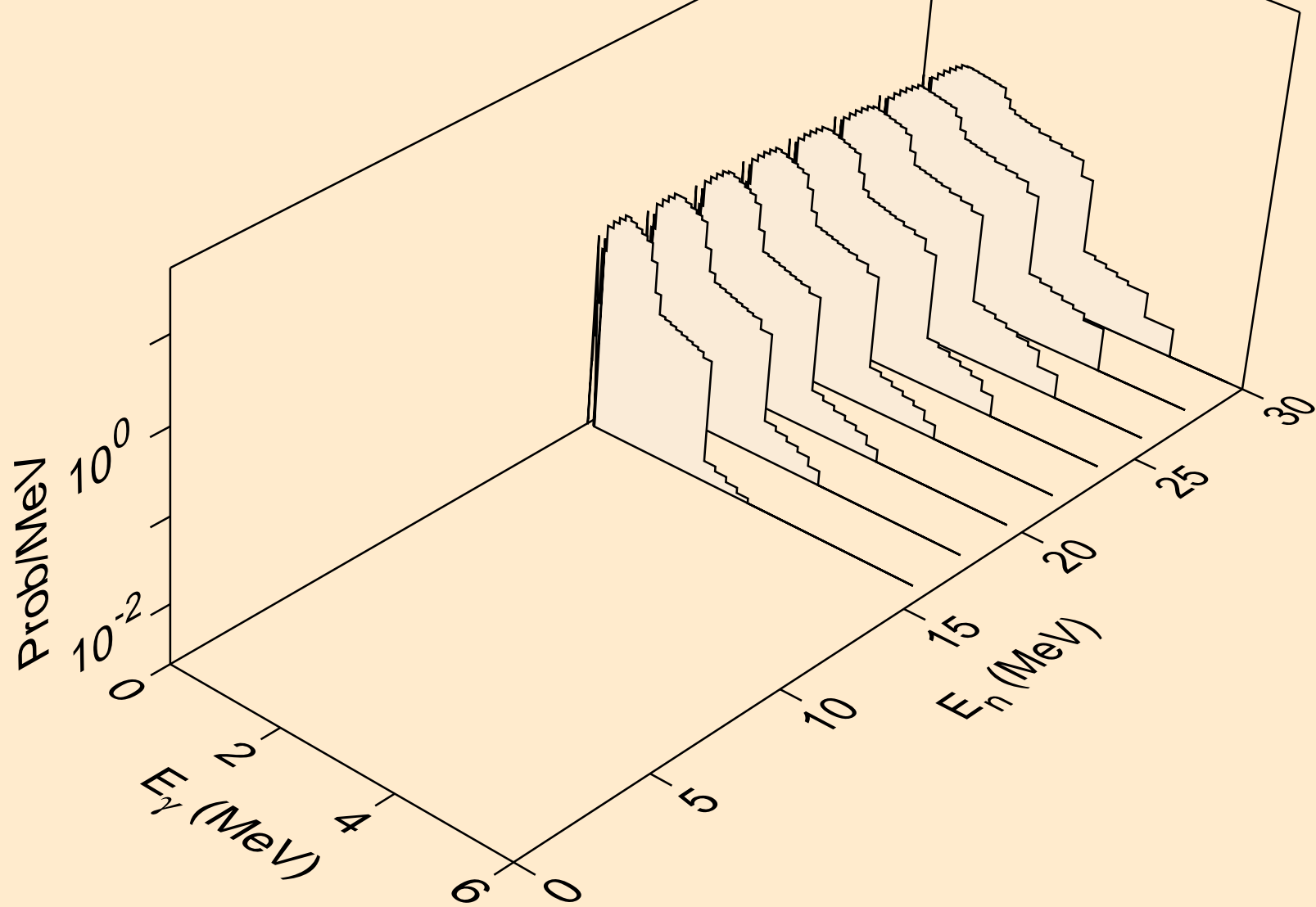

BK238 NEUTRON ACER TENDL-2021 LIBRARY; T=293.6K
Photon emission for (n,2n)2a

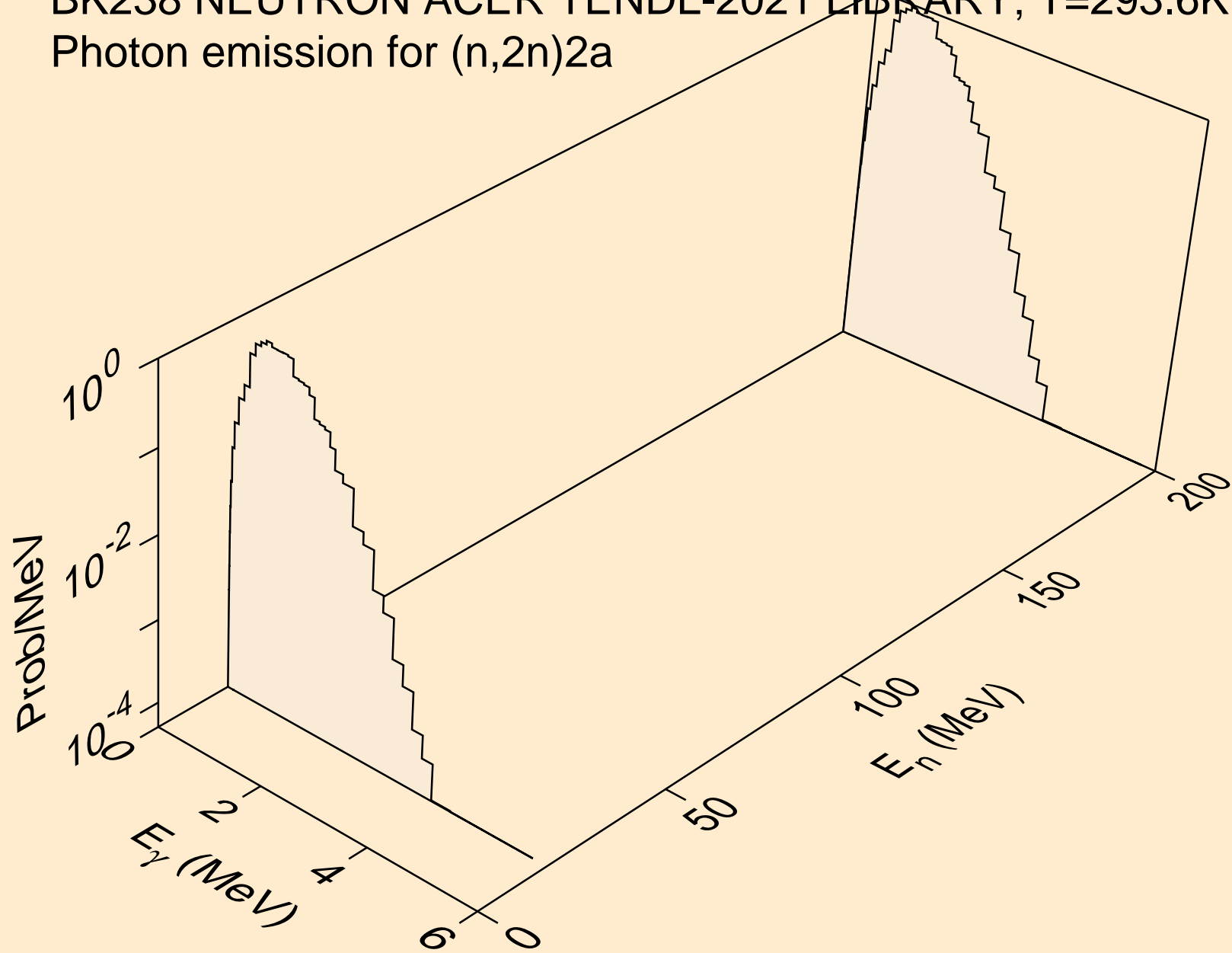

BK238 NEUTRON ACER TENDL-2021 LIBRARY; T=293.6K
Photon emission for (n,n*)d

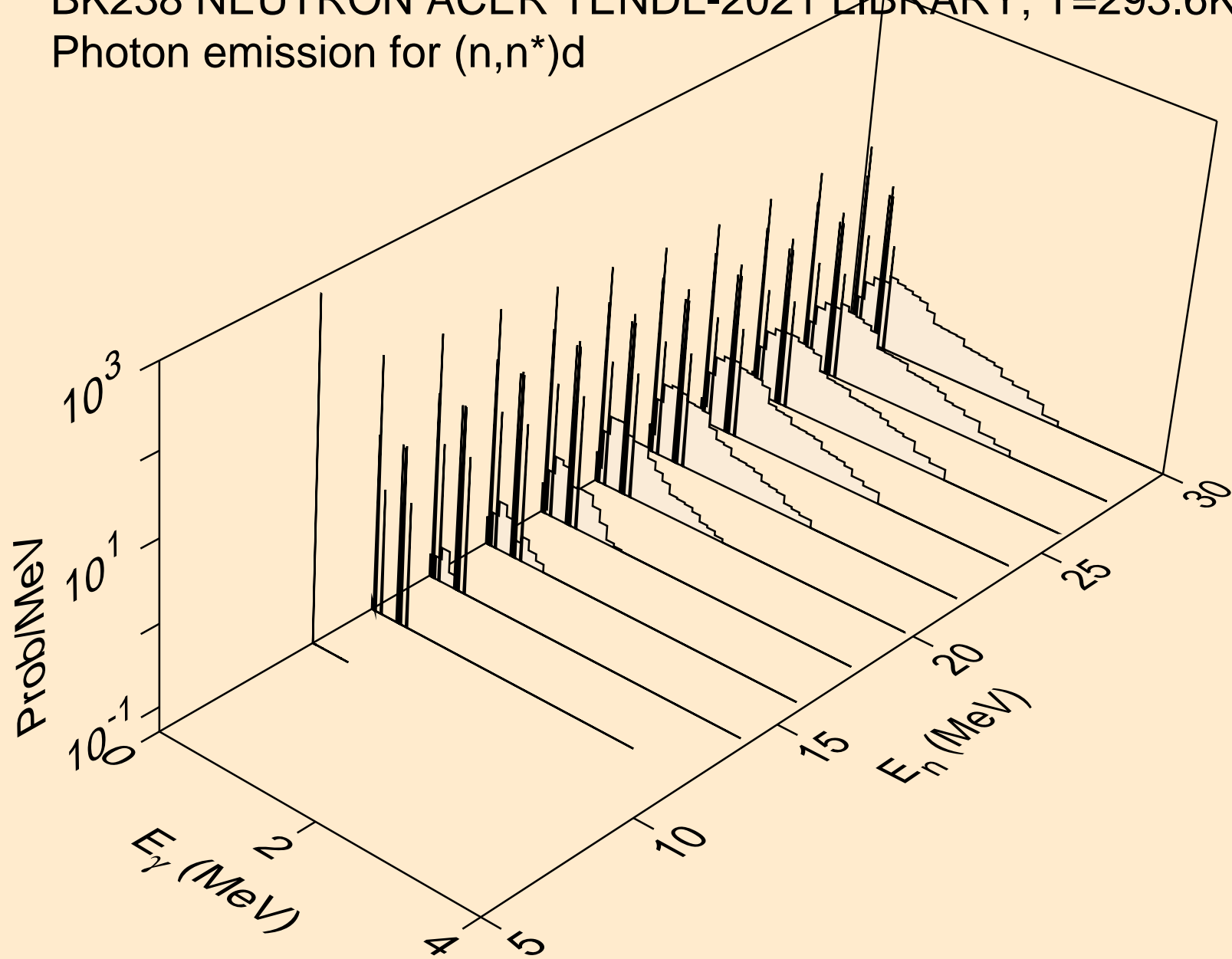

BK238 NEUTRON ACER TENDL-2021 LIBRARY; T=293.6K
Photon emission for (n,n*)t

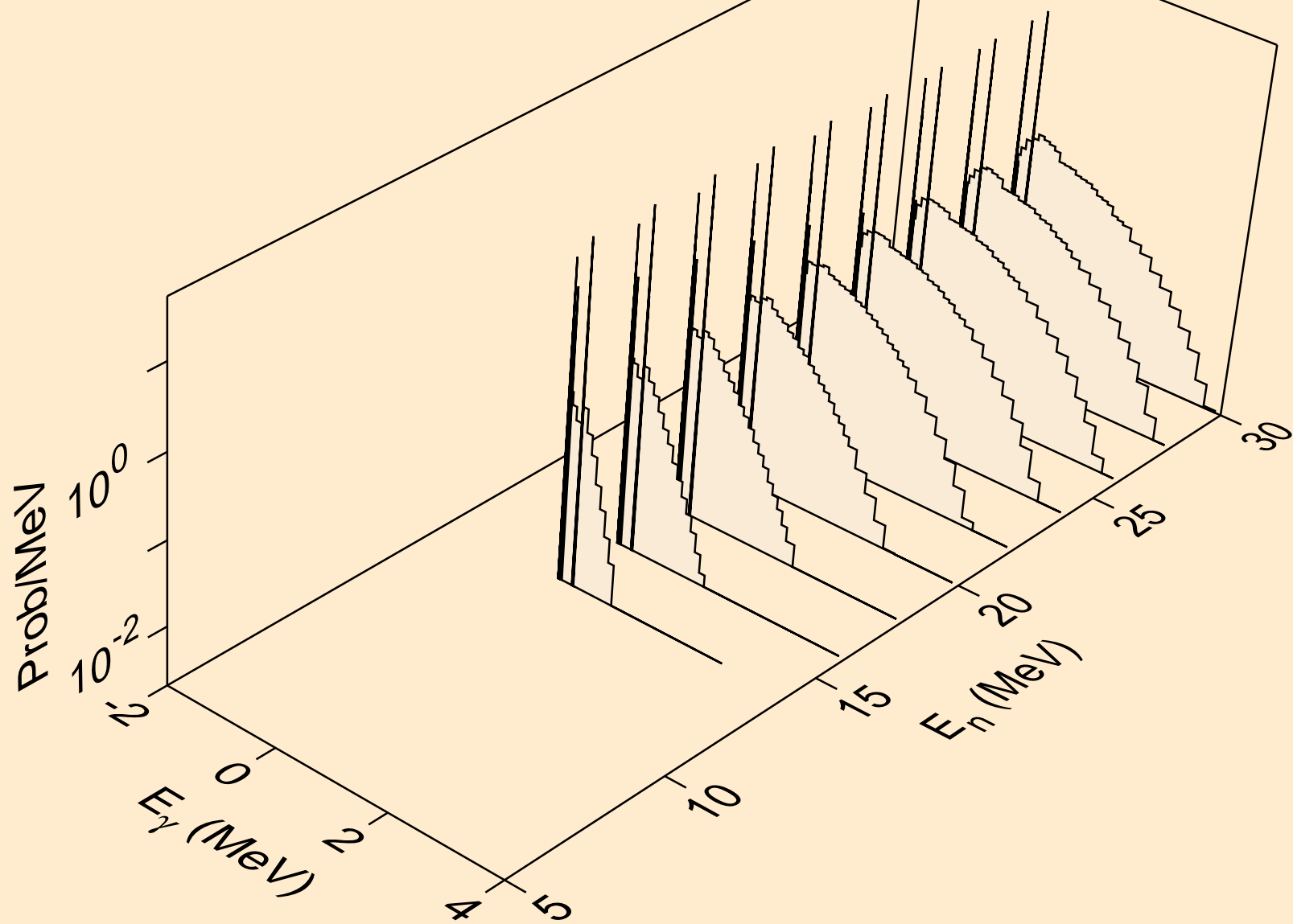

BK238 NEUTRON ACER TENDL-2021 LIBRARY; T=293.6K
Photon emission for (n,n*)he3

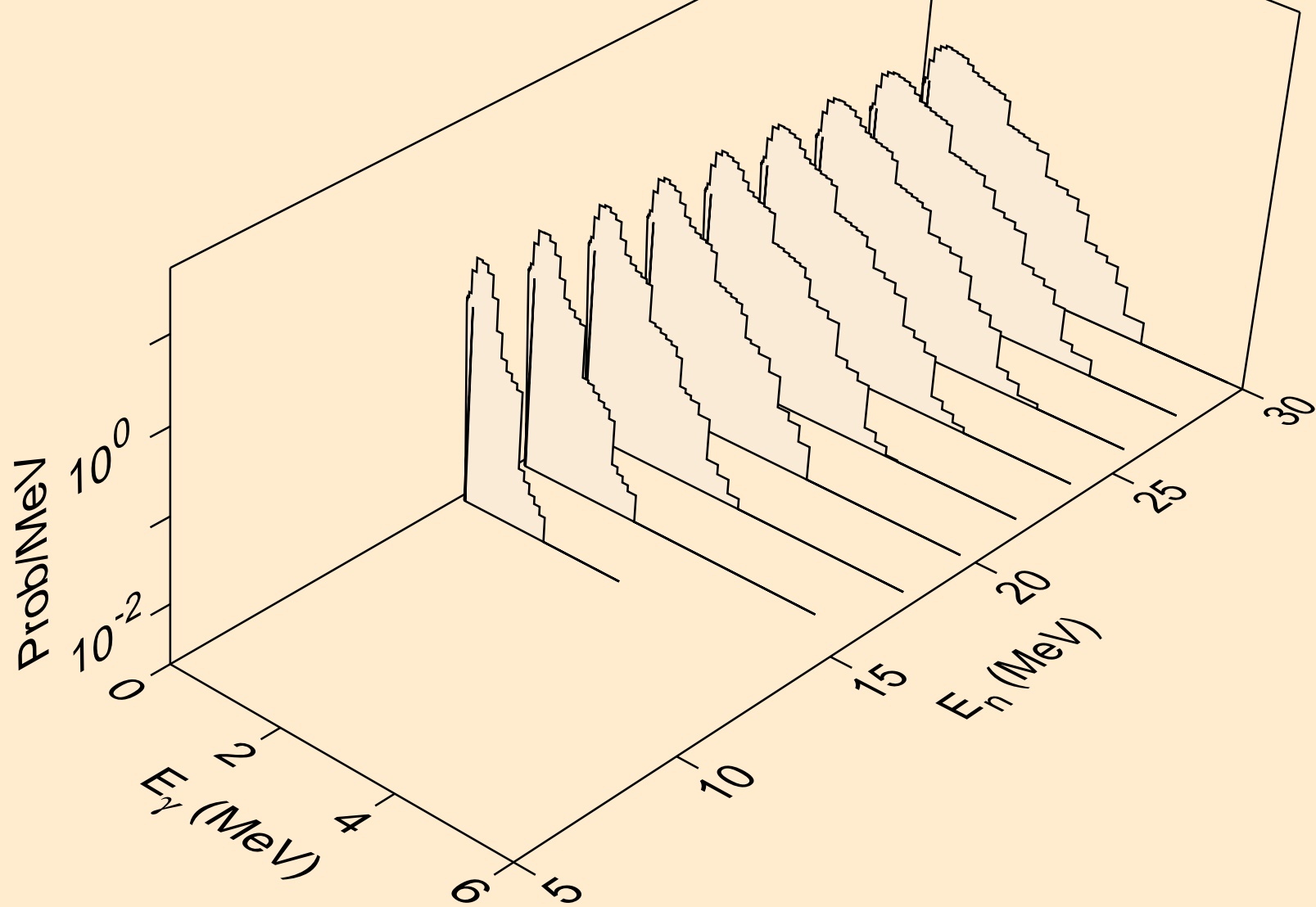

BK238 NEUTRON ACER TENDL-2021 LIBRARY; T=293.6K
Photon emission for (n,4n)

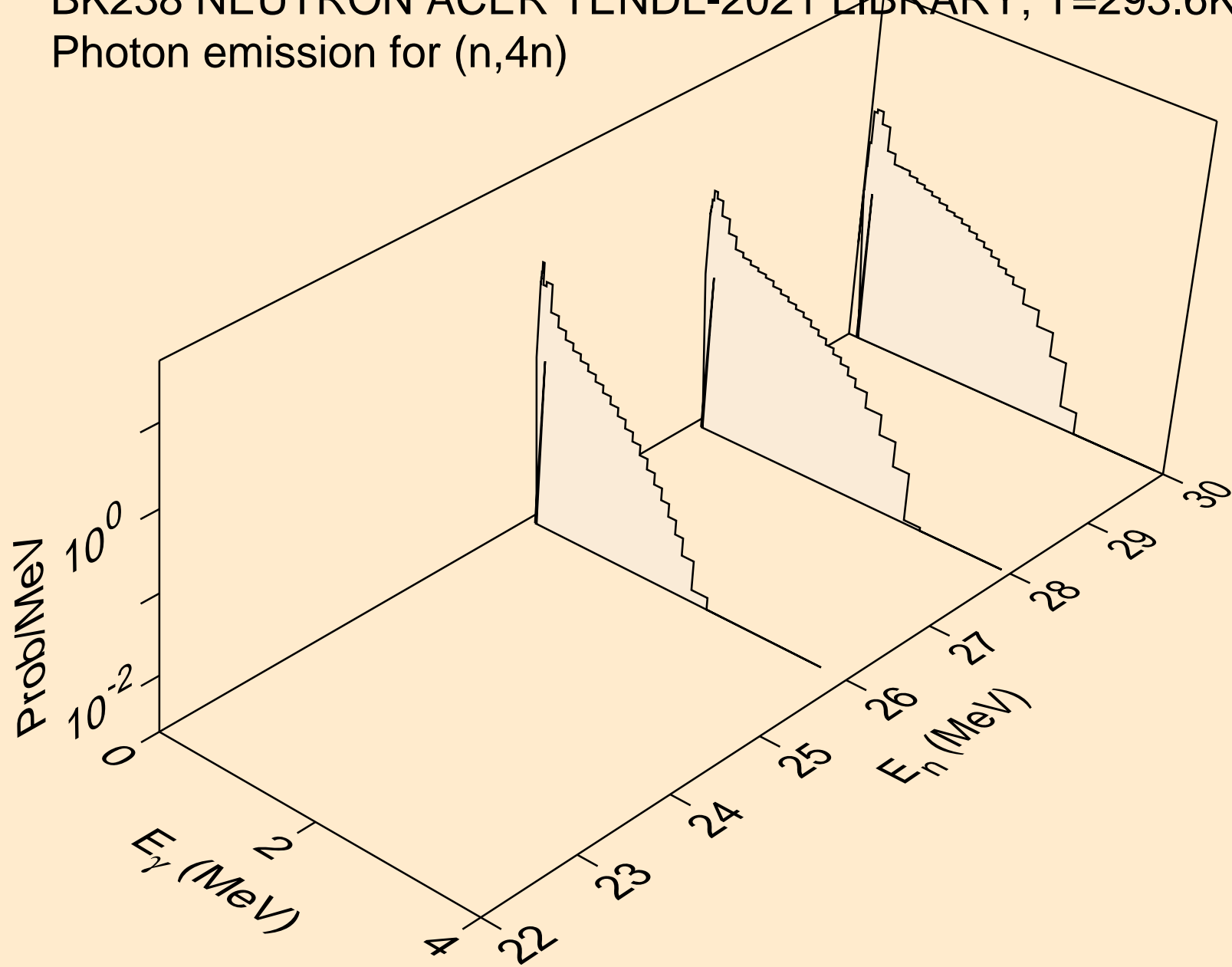

BK238 NEUTRON ACER TENDL-2021 LIBRARY; T=293.6K
Photon emission for (n,2np)

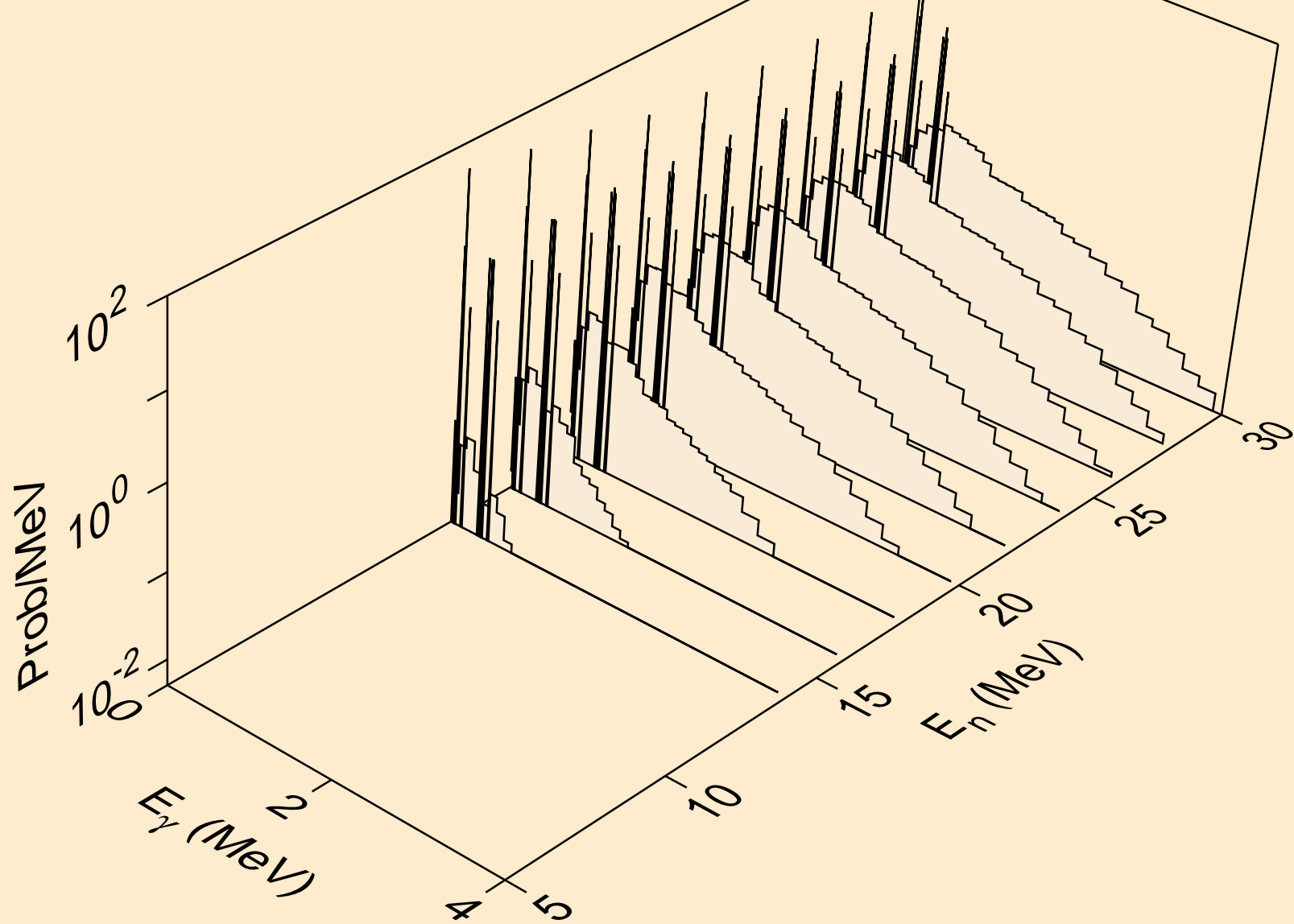

BK238 NEUTRON ACER TENDL-2021 LIBRARY; T=293.6K
Photon emission for (n,3np)

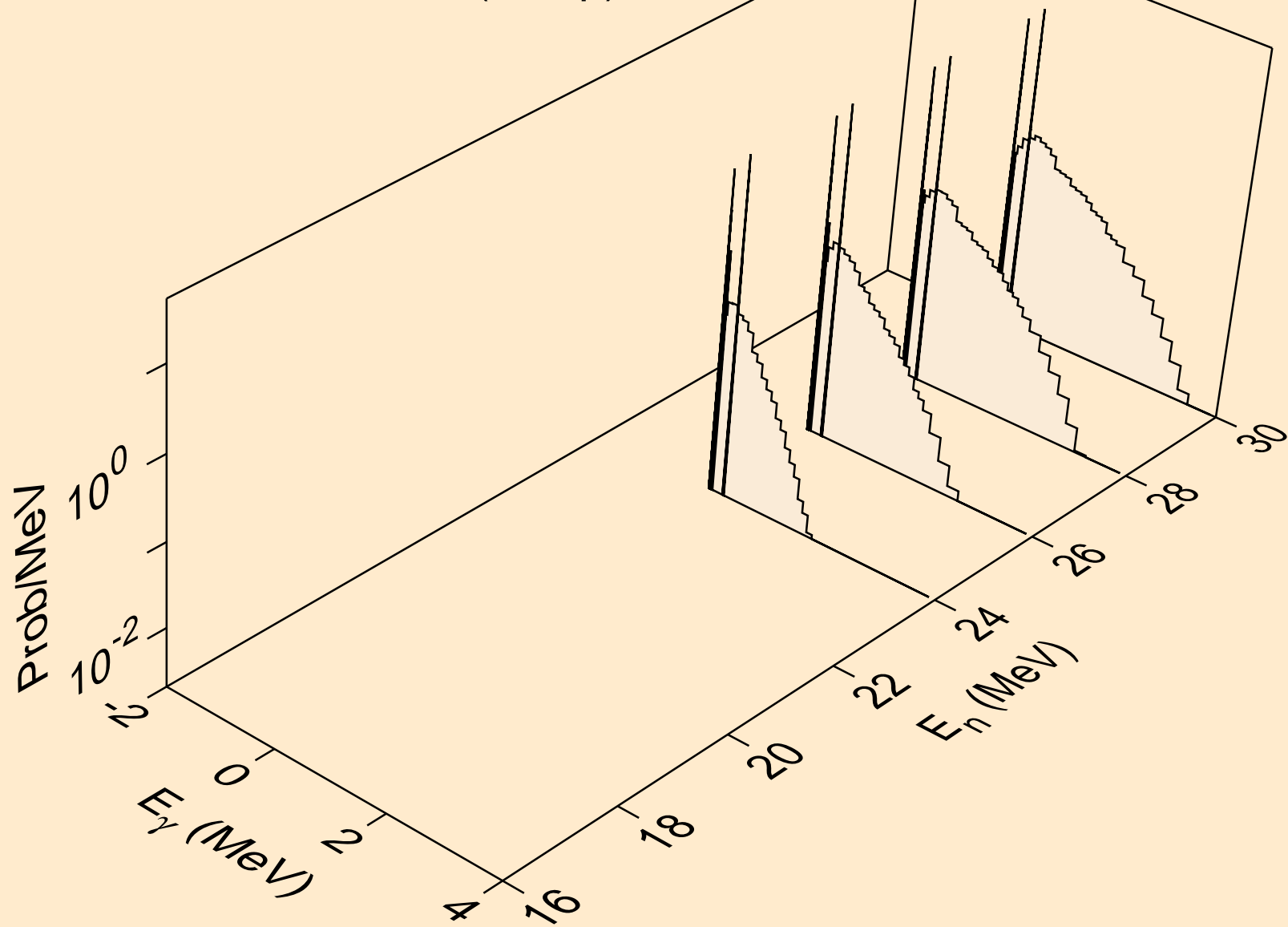

BK238 NEUTRON ACER TENDL-2021 LIBRARY; T=293.6K
Photon emission for (n,2np)

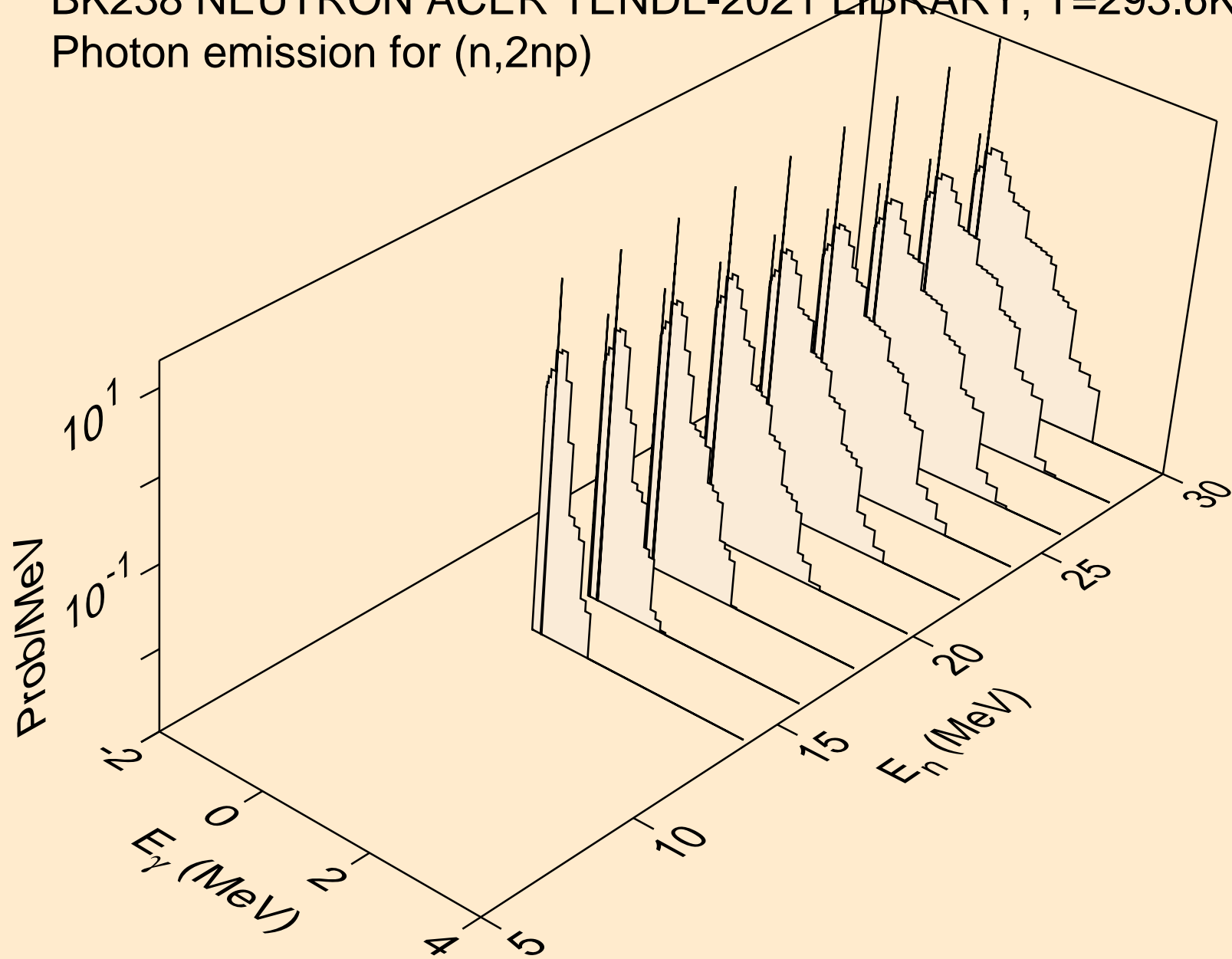

BK238 NEUTRON ACER TENDL-2021 LIBRARY; T=293.6K
Photon emission for (n,npa)

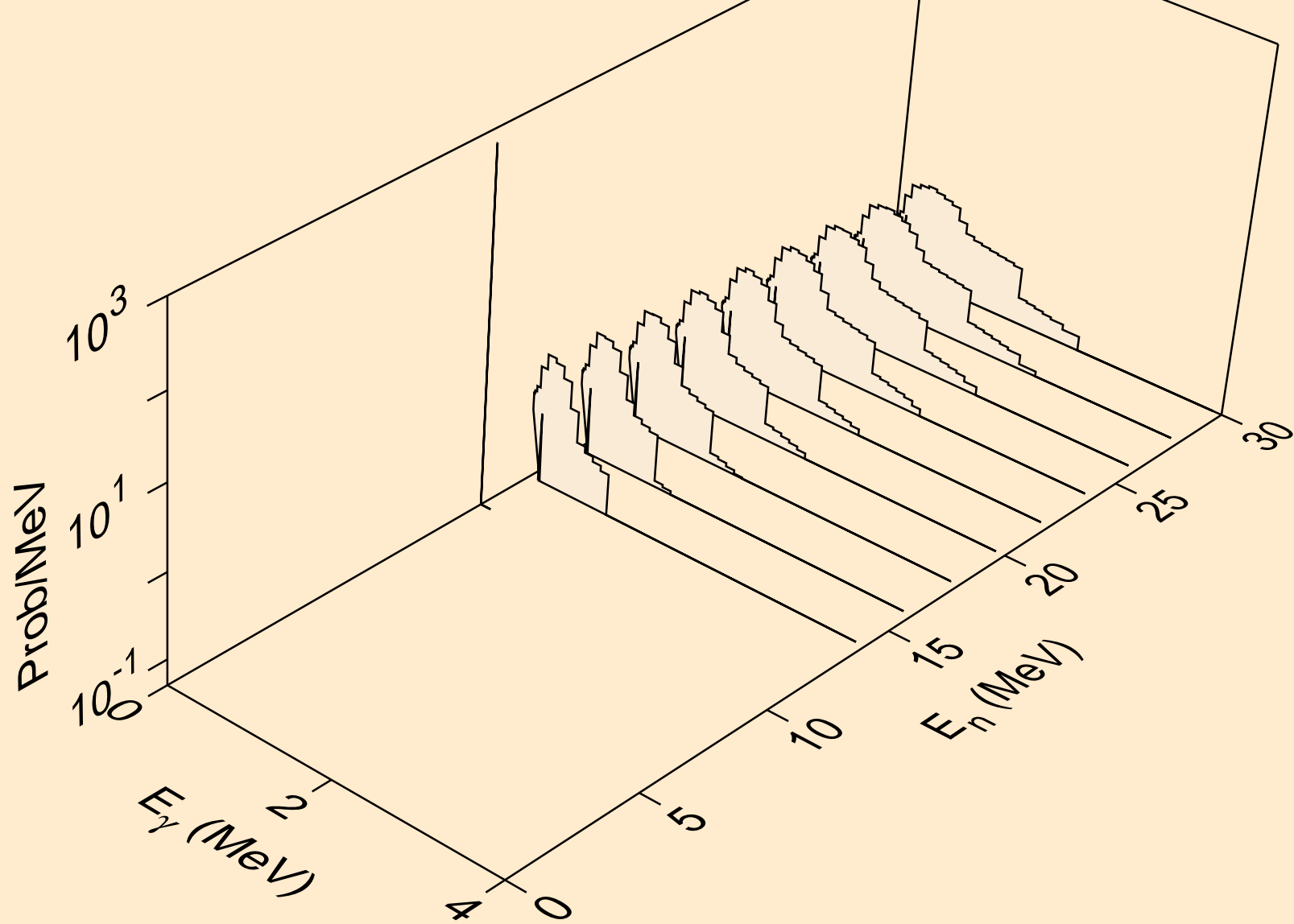

BK238 NEUTRON ACER TENDL-2021 LIBRARY; T=293.6K
Photon emission for (n,n*c)

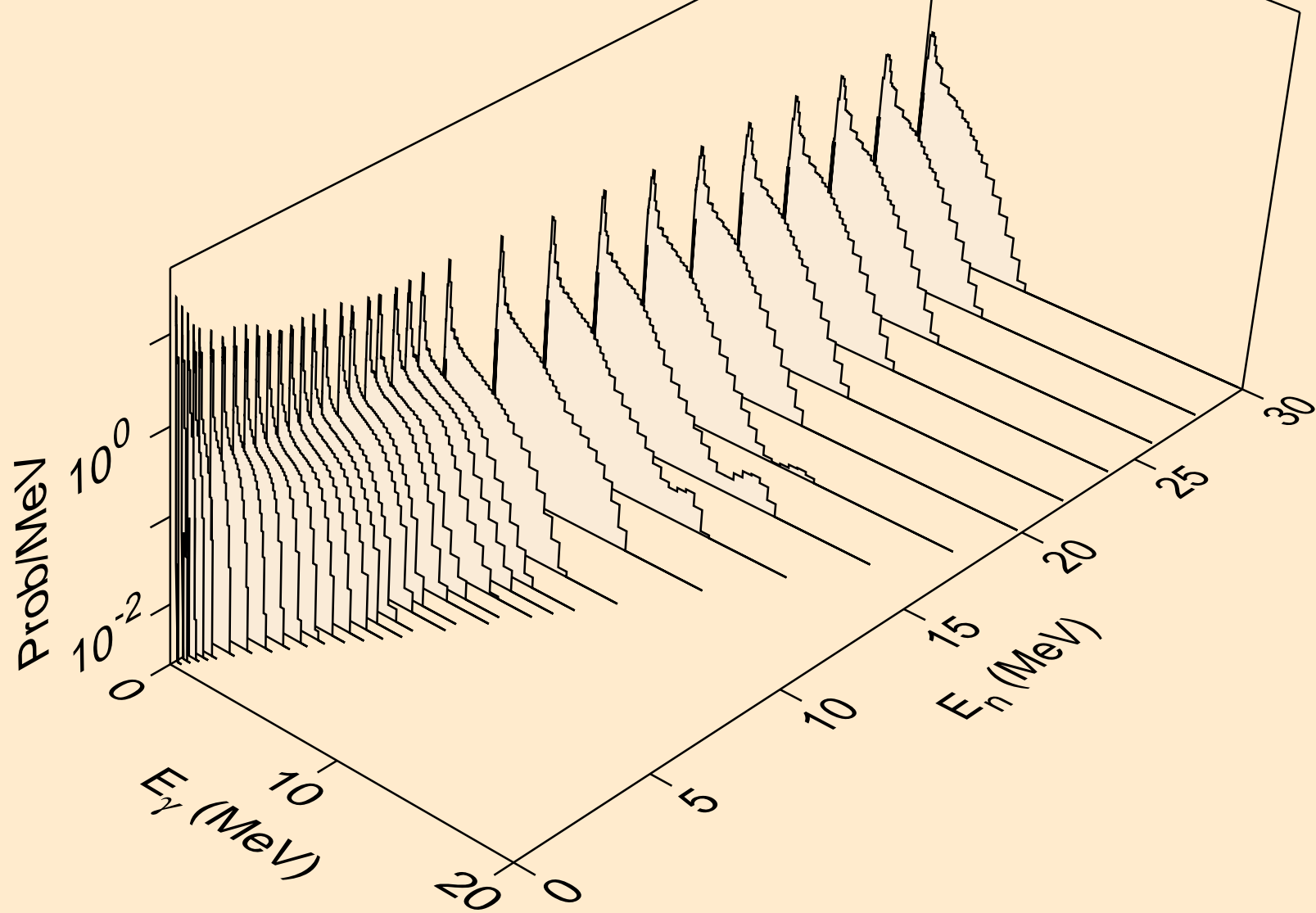

BK238 NEUTRON ACER TENDL-2021 LIBRARY; T=293.6K
Photon emission for (n,gma)

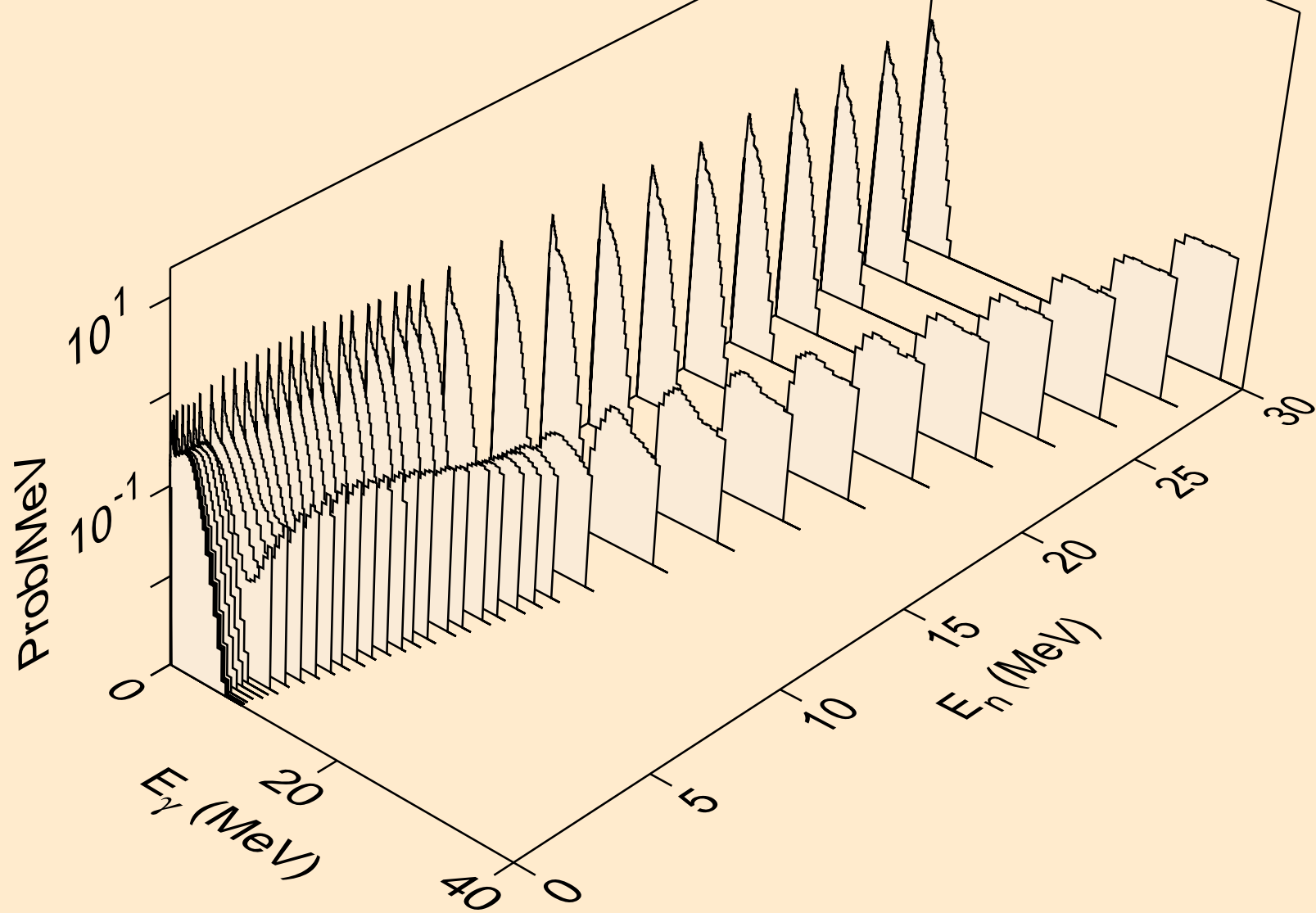

BK238 NEUTRON ACER TENDL-2021 LIBRARY; T=293.6K
Photon emission for (n,p)

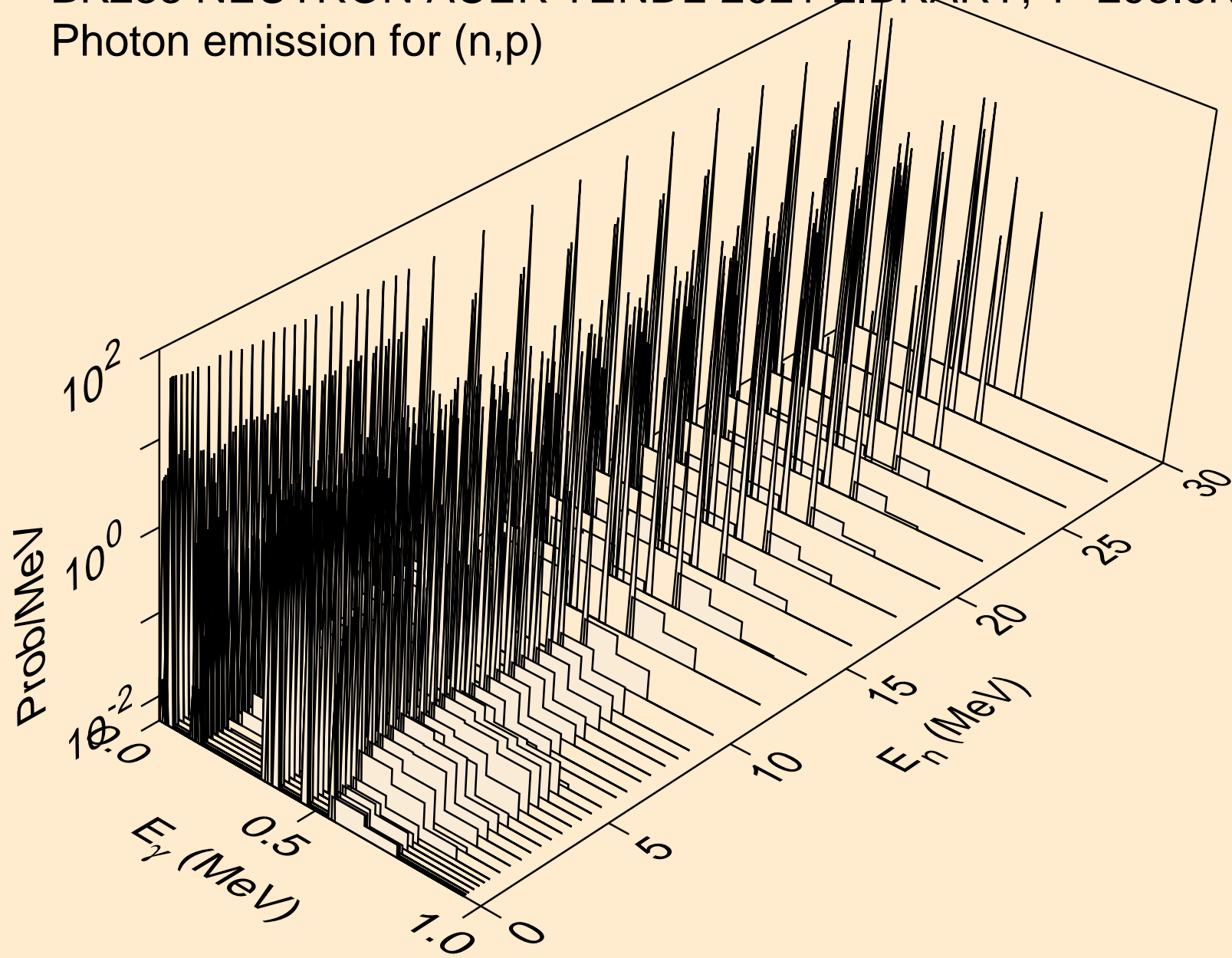

BK238 NEUTRON ACER TENDL-2021 LIBRARY; T=293.6K
Photon emission for (n,d)

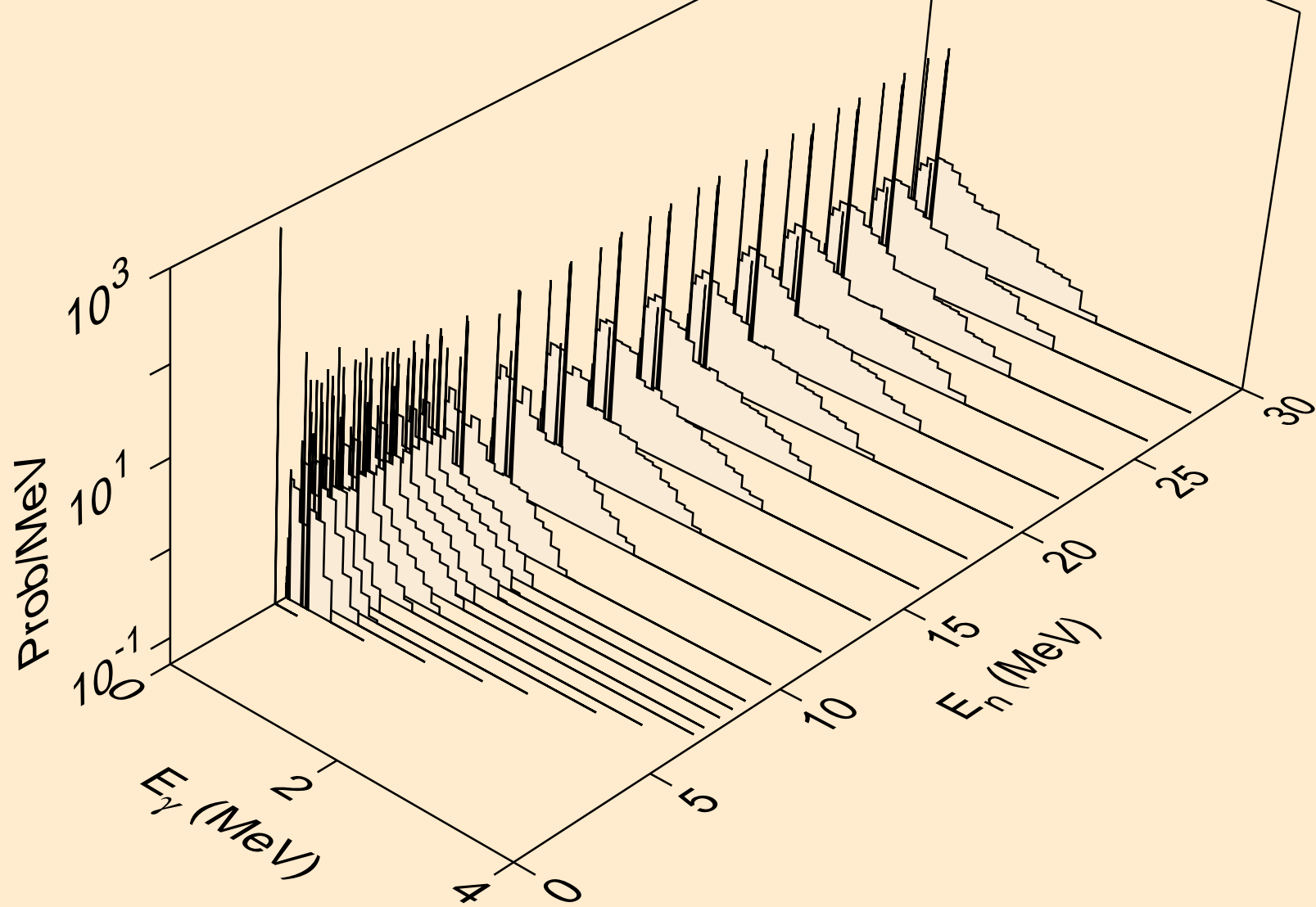

BK238 NEUTRON ACER TENDL-2021 LIBRARY; T=293.6K
Photon emission for (n,t)

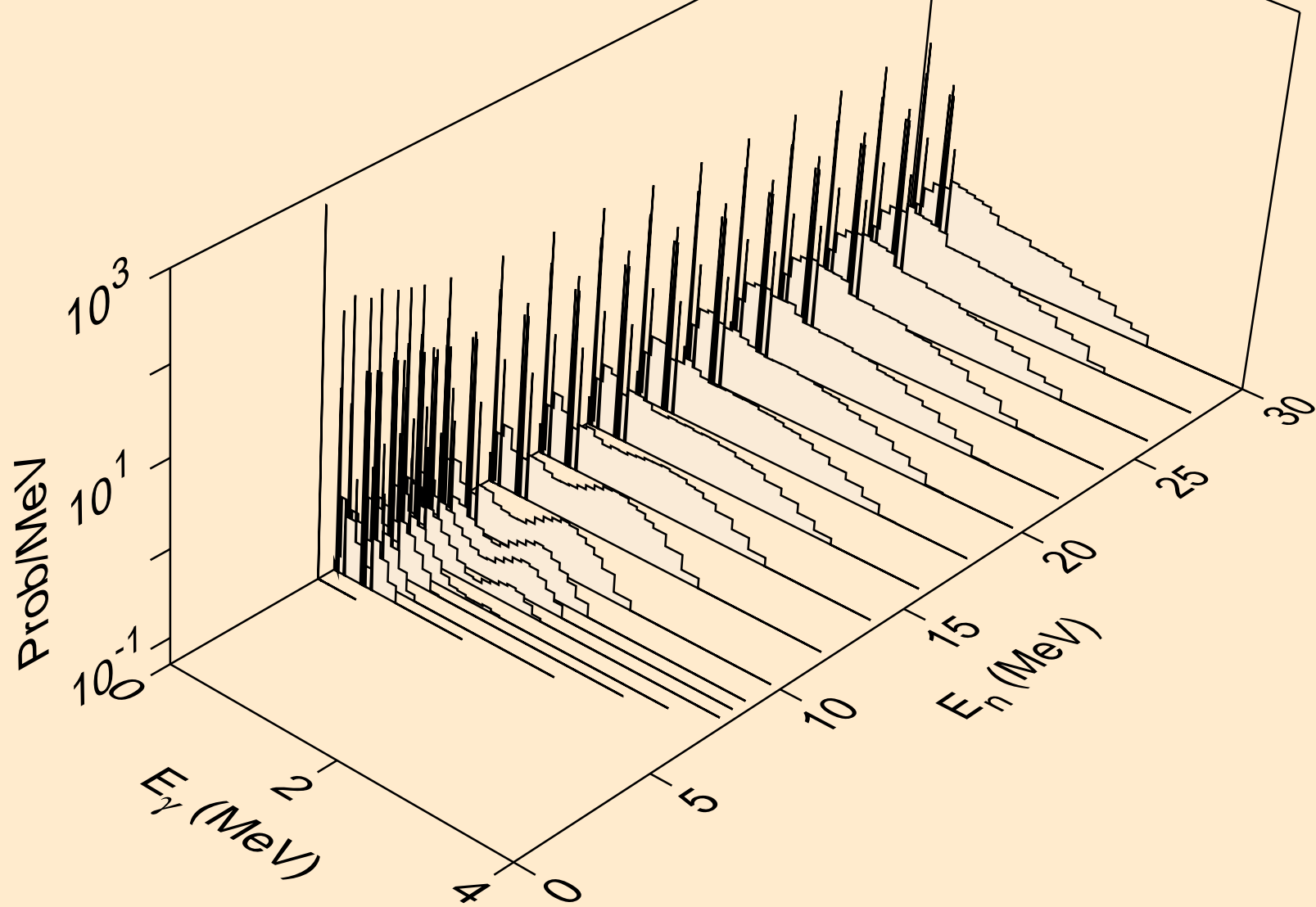

BK238 NEUTRON ACER TENDL-2021 LIBRARY; T=293.6K
Photon emission for (n,he3)

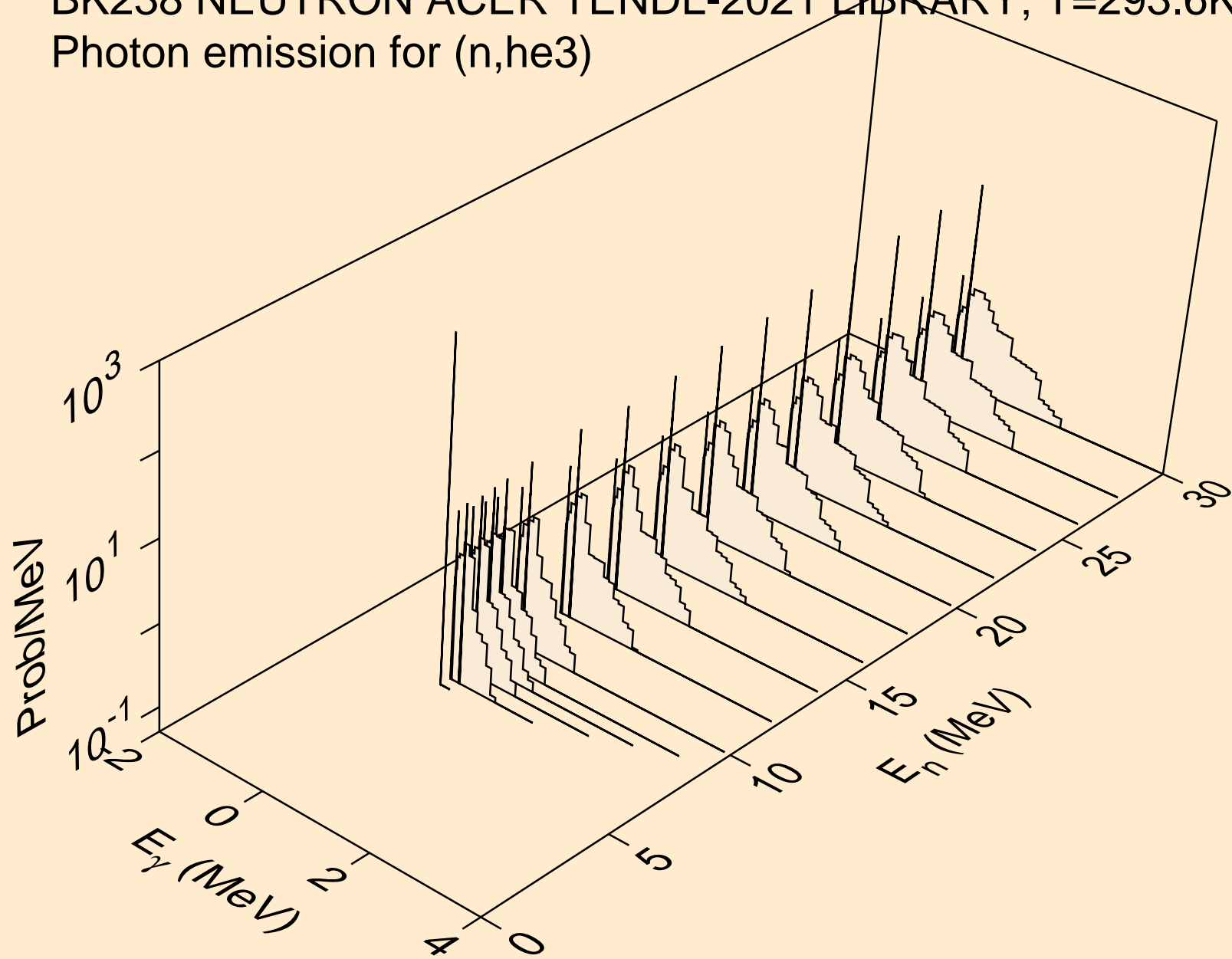

BK238 NEUTRON ACER TENDL-2021 LIBRARY; T=293.6K
Photon emission for (n,a)

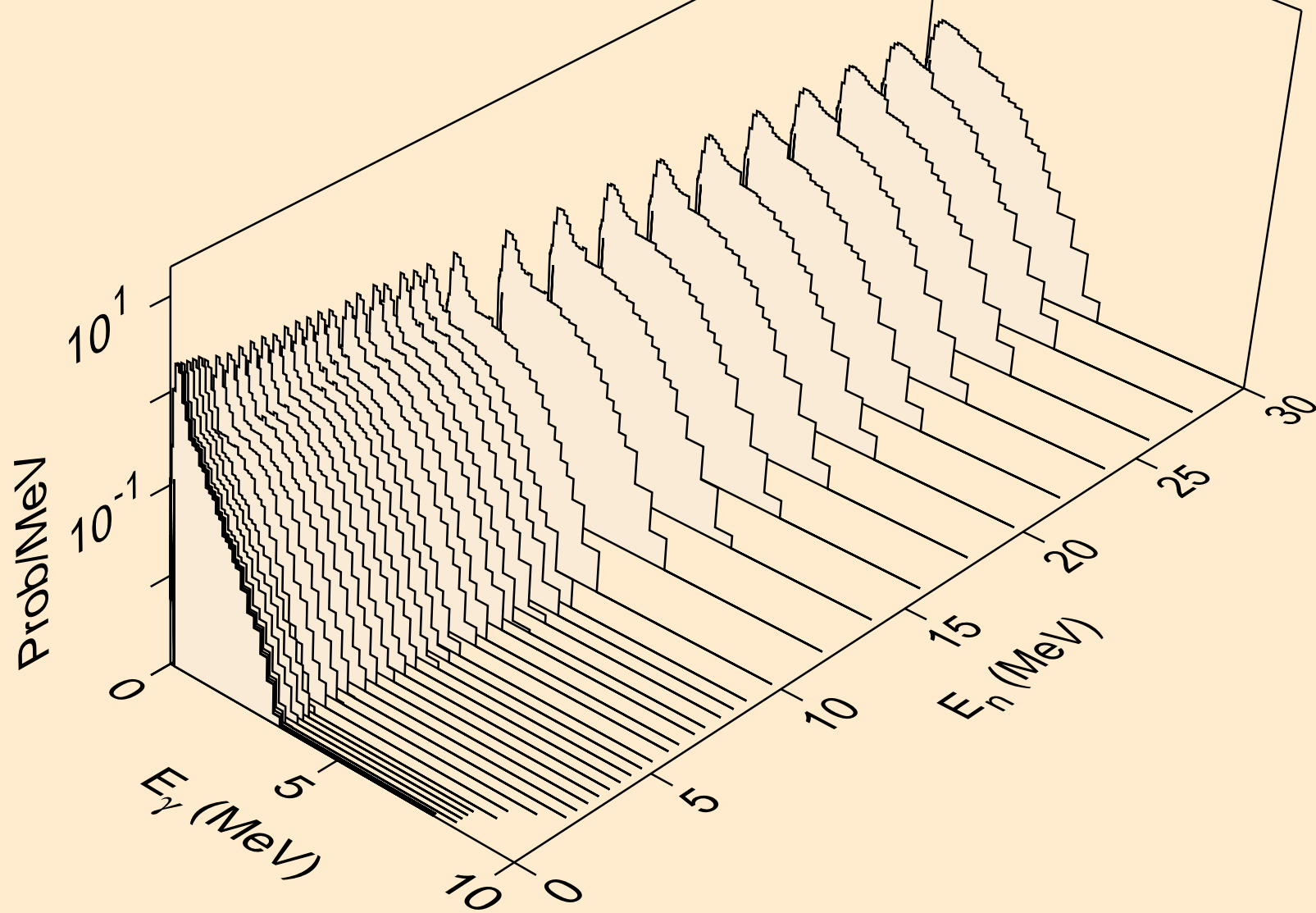

BK238 NEUTRON ACER TENDL-2021 LIBRARY; T=293.6K
Photon emission for (n,2a)

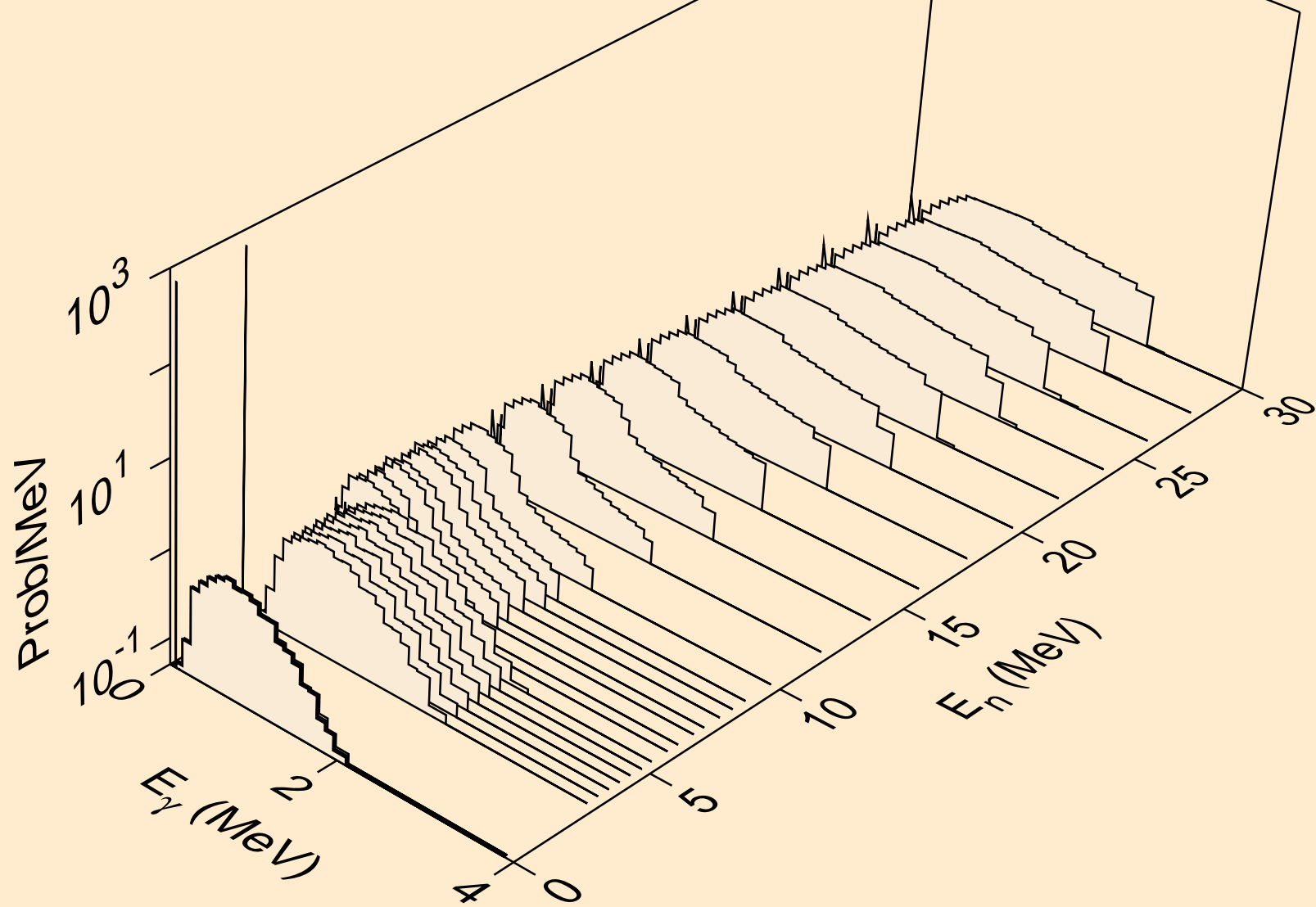

BK238 NEUTRON ACER TENDL-2021 LIBRARY; T=293.6K
Photon emission for (n,2p)

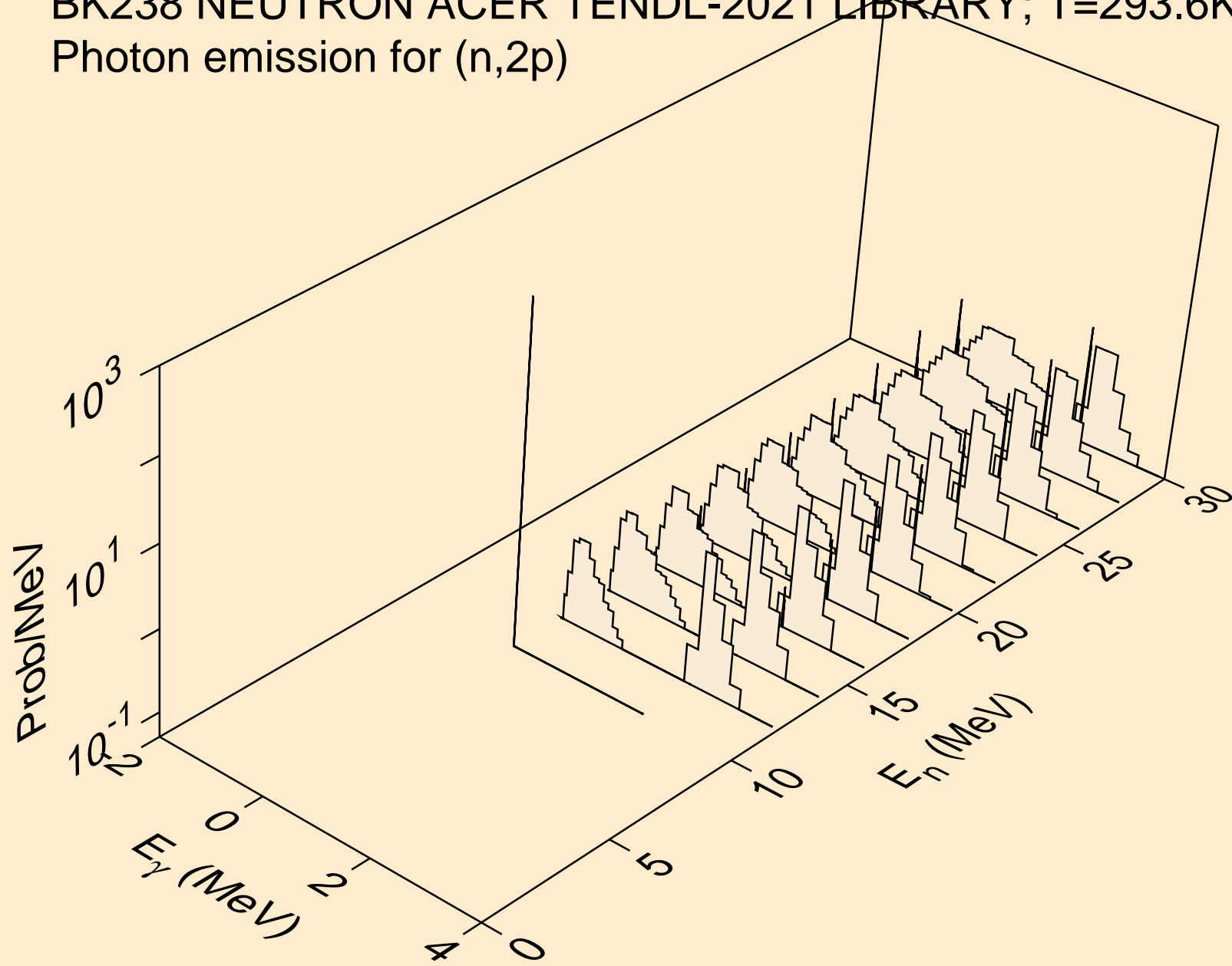

BK238 NEUTRON ACER TENDL-2021 LIBRARY; T=293.6K
Photon emission for (n,p α)

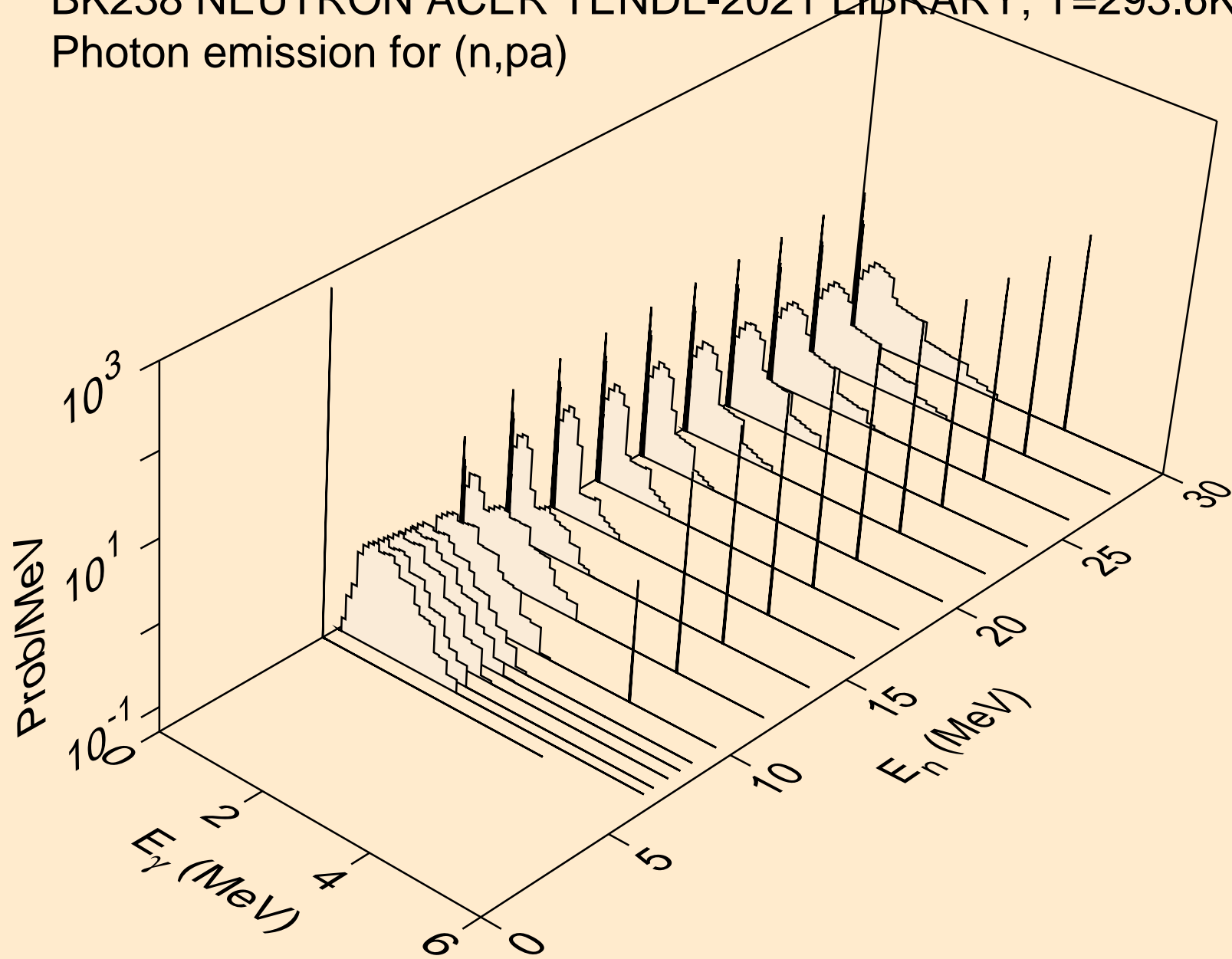

BK238 NEUTRON ACER TENDL-2021 LIBRARY; T=293.6K
Photon emission for (n,pd)

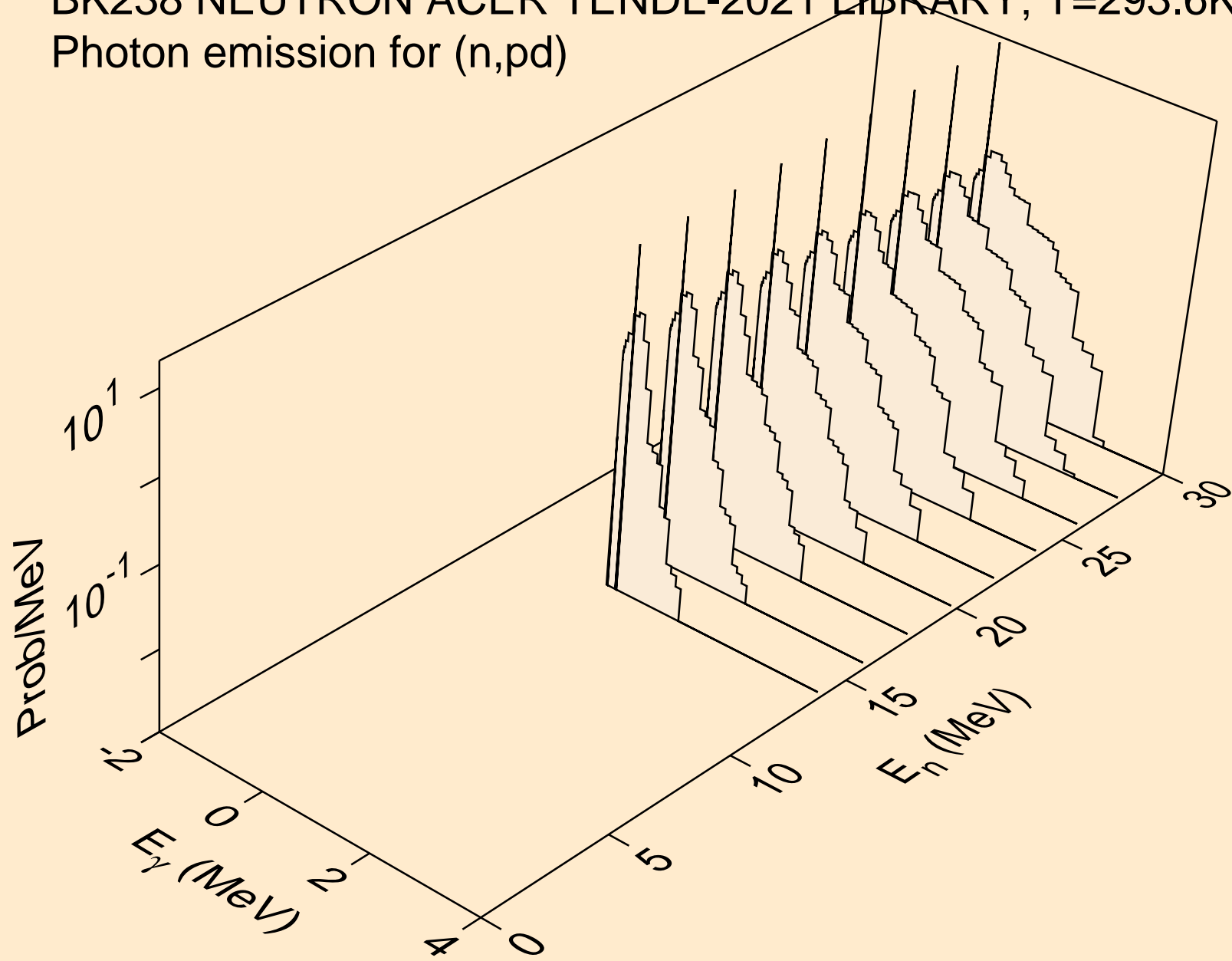

BK238 NEUTRON ACER TENDL-2021 LIBRARY; T=293.6K
Photon emission for (n,pt)

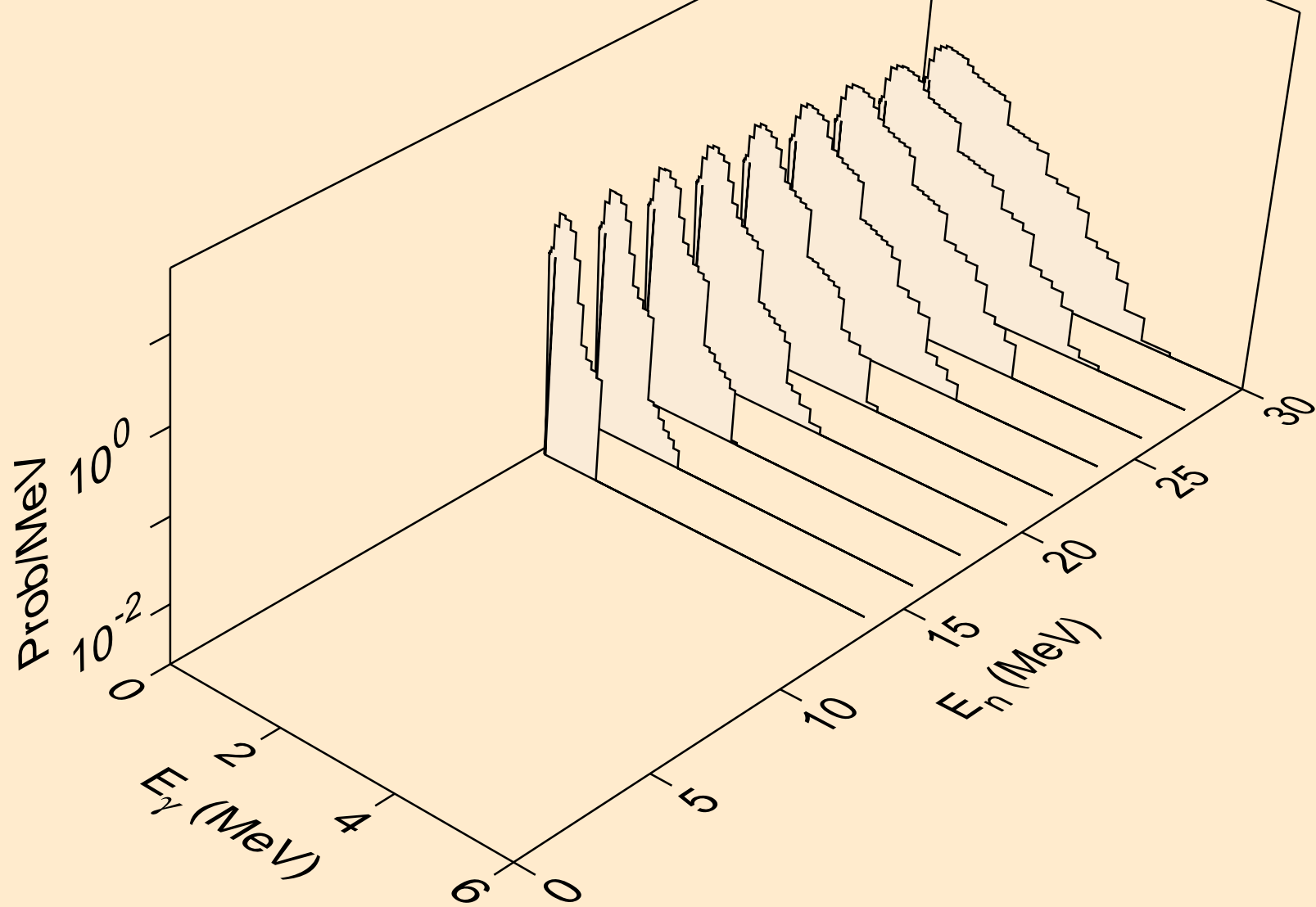

BK238 NEUTRON ACER TENDL-2021 LIBRARY; T=293.6K
Photon emission for (n,da)

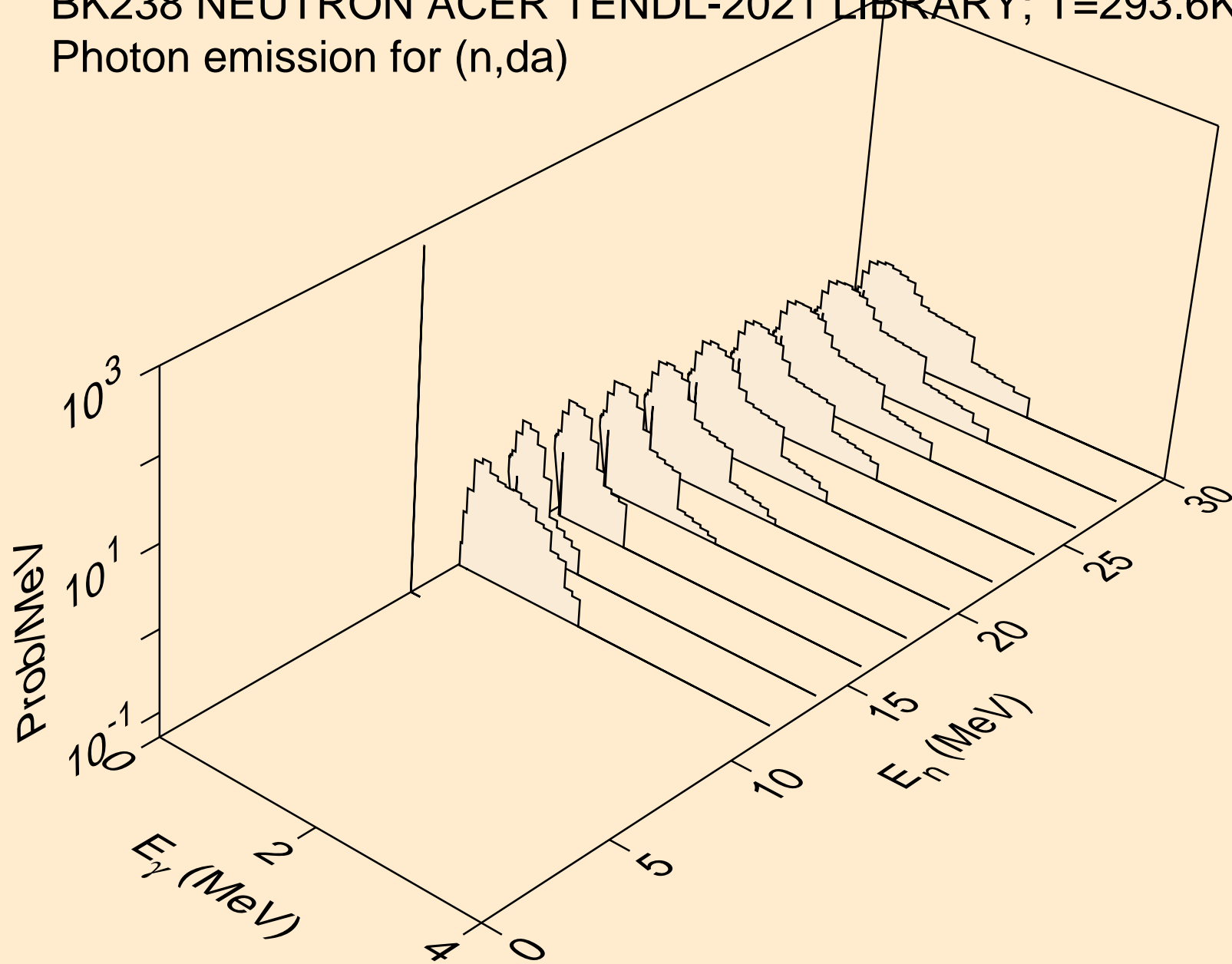

BK238 NEUTRON ACER TENDL-2021 LIBRARY; T=293.6K
thermal capture photon spectrum

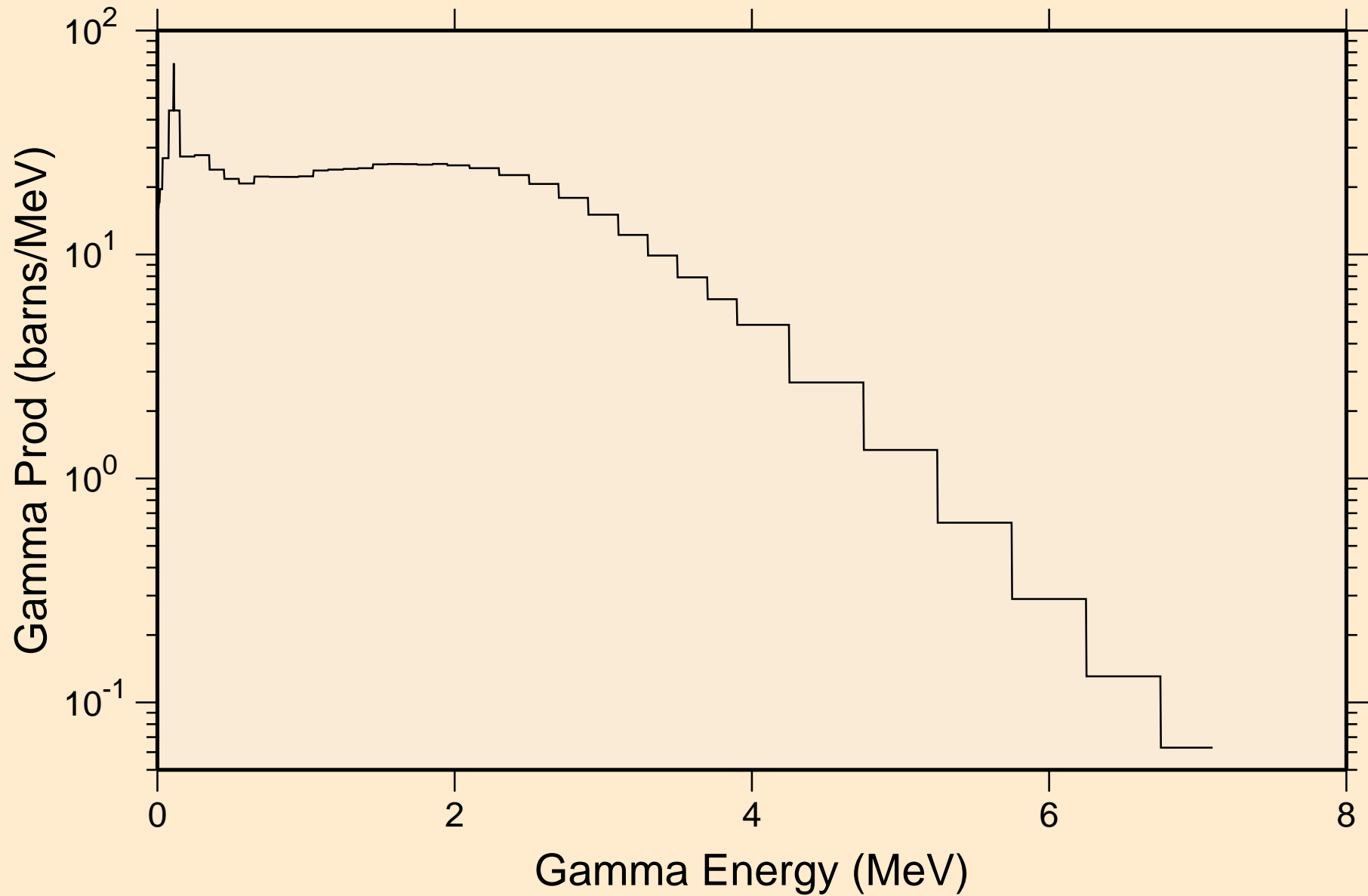

BK238 NEUTRON ACER TENDL-2021 LIBRARY; T=293.6K
14 MeV photon spectrum

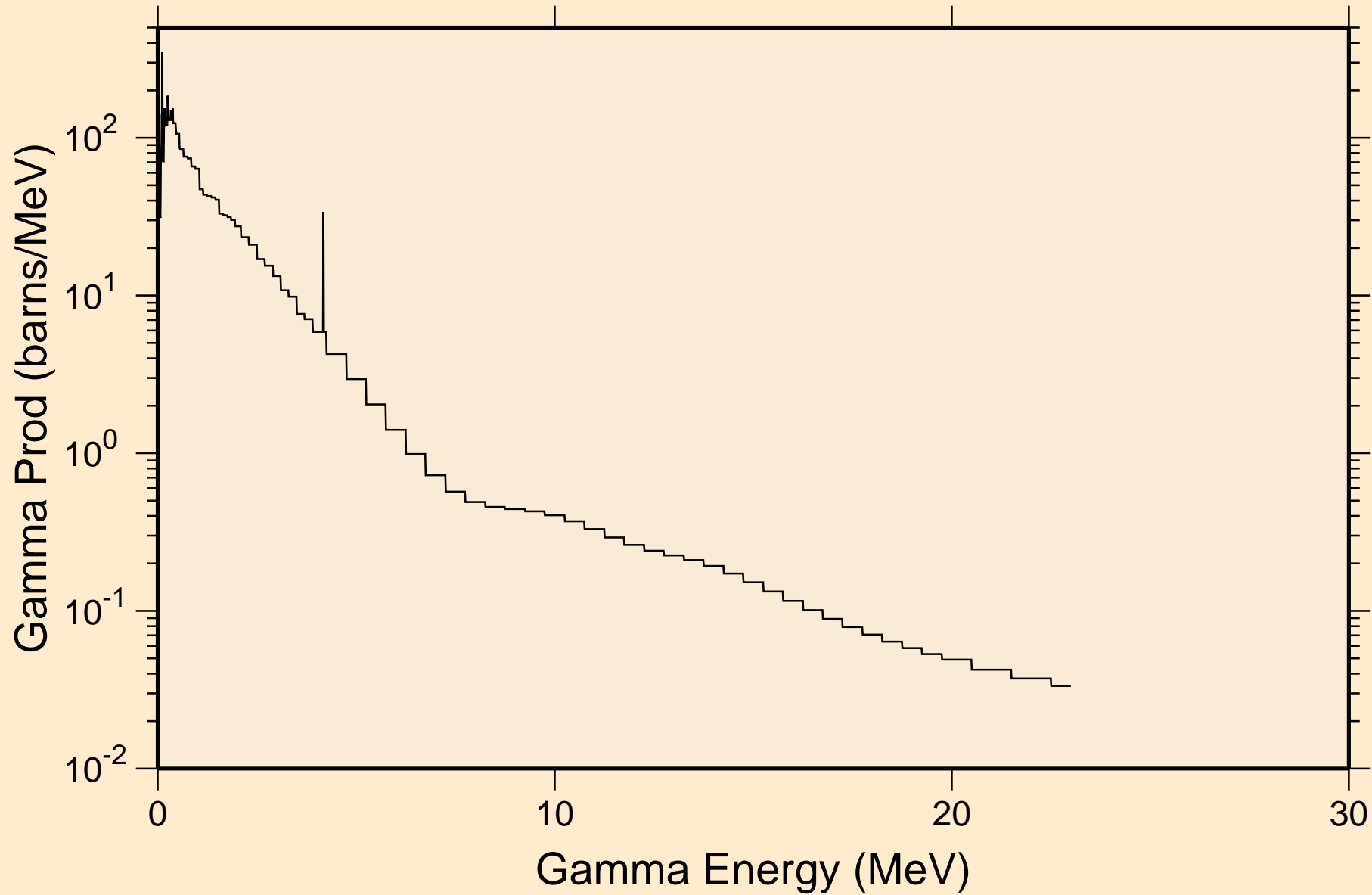

BK238 NEUTRON ACER TENDL-2021 LIBRARY; T=293.6K
Particle heating contributions

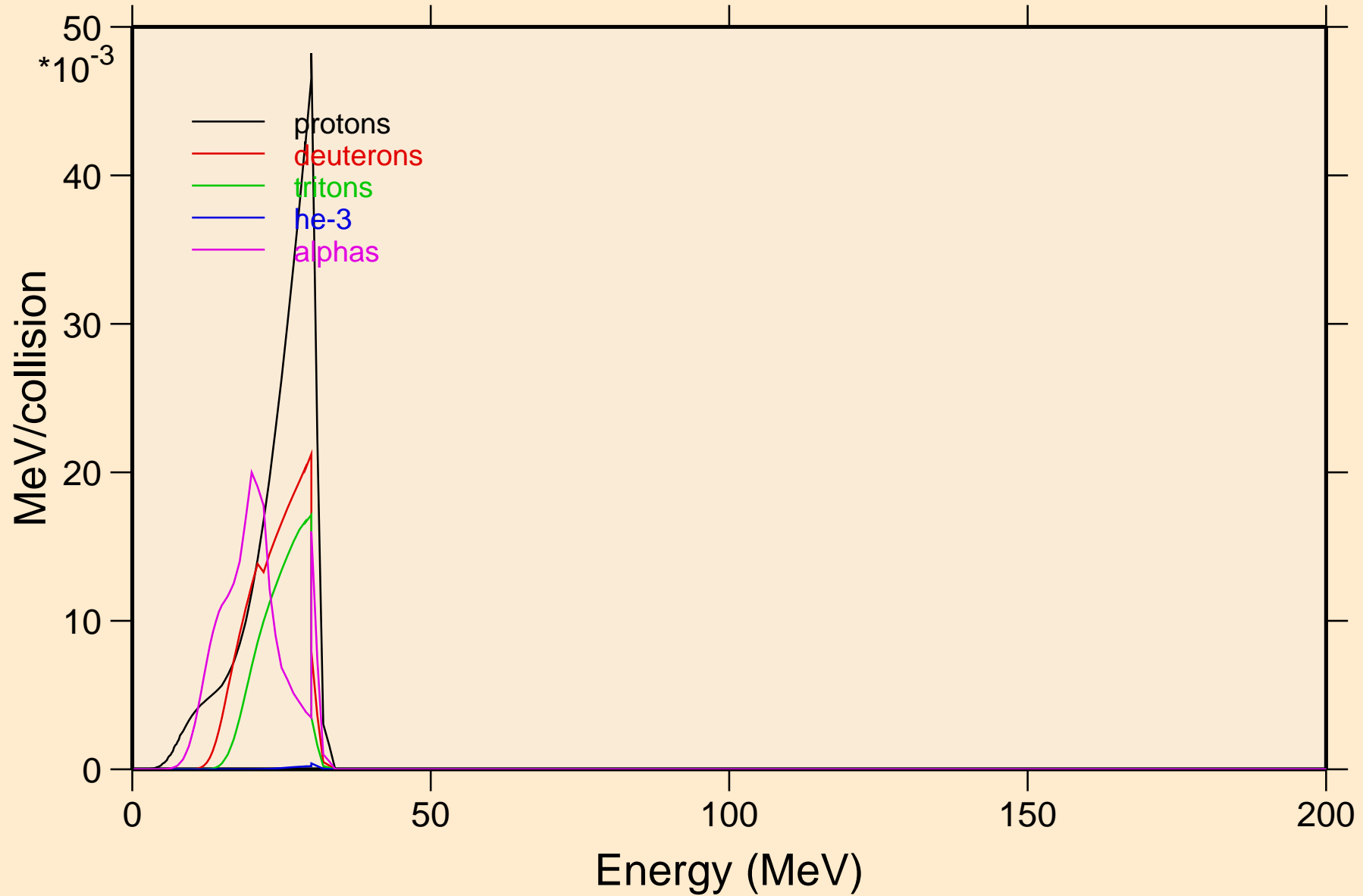

BK238 NEUTRON ACER TENDL-2021 LIBRARY; T=293.6K
Recoil Heating

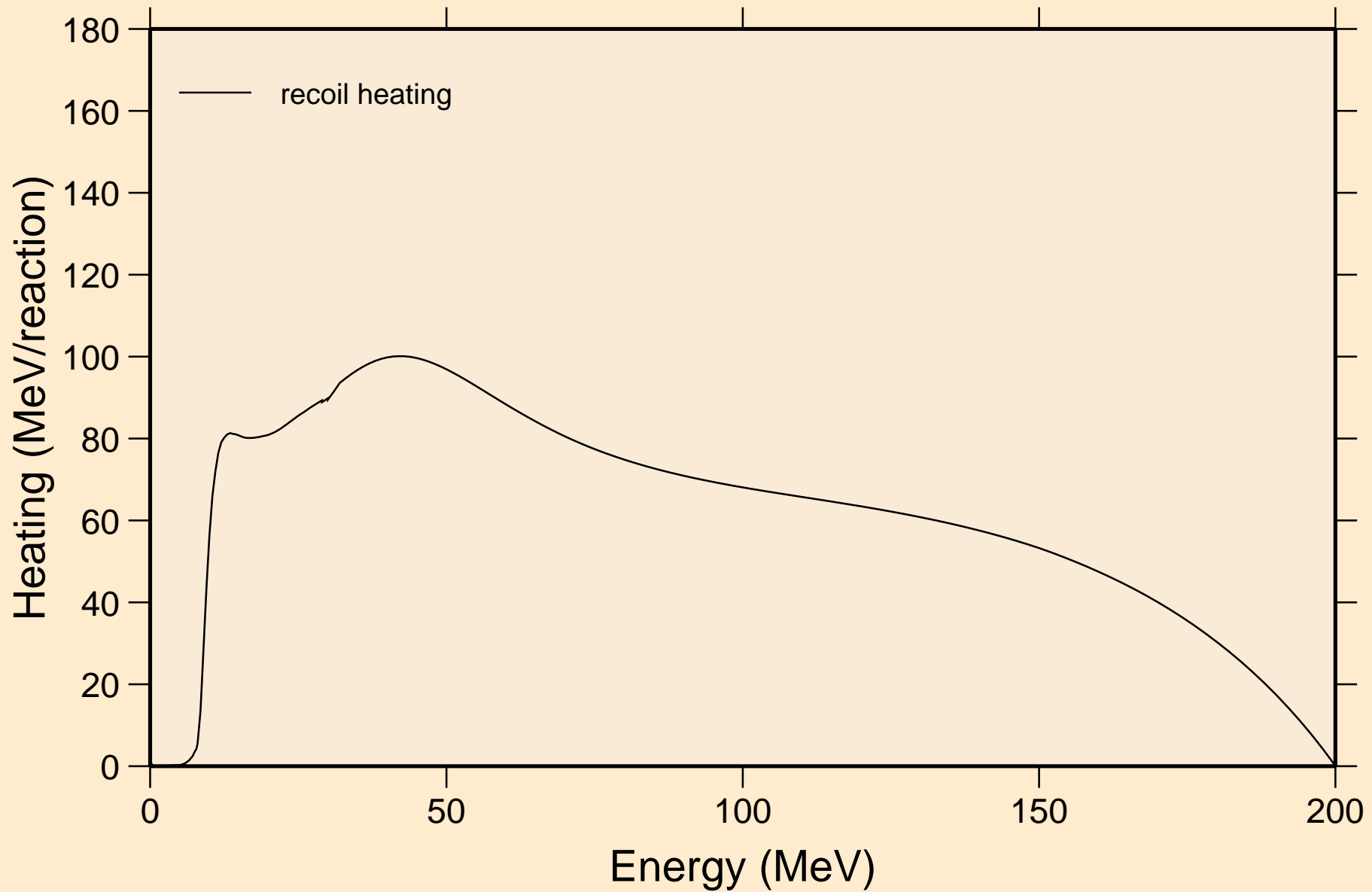

BK238 NEUTRON ACER TENDL-2021 LIBRARY; T=293.6K
Particle production cross sections

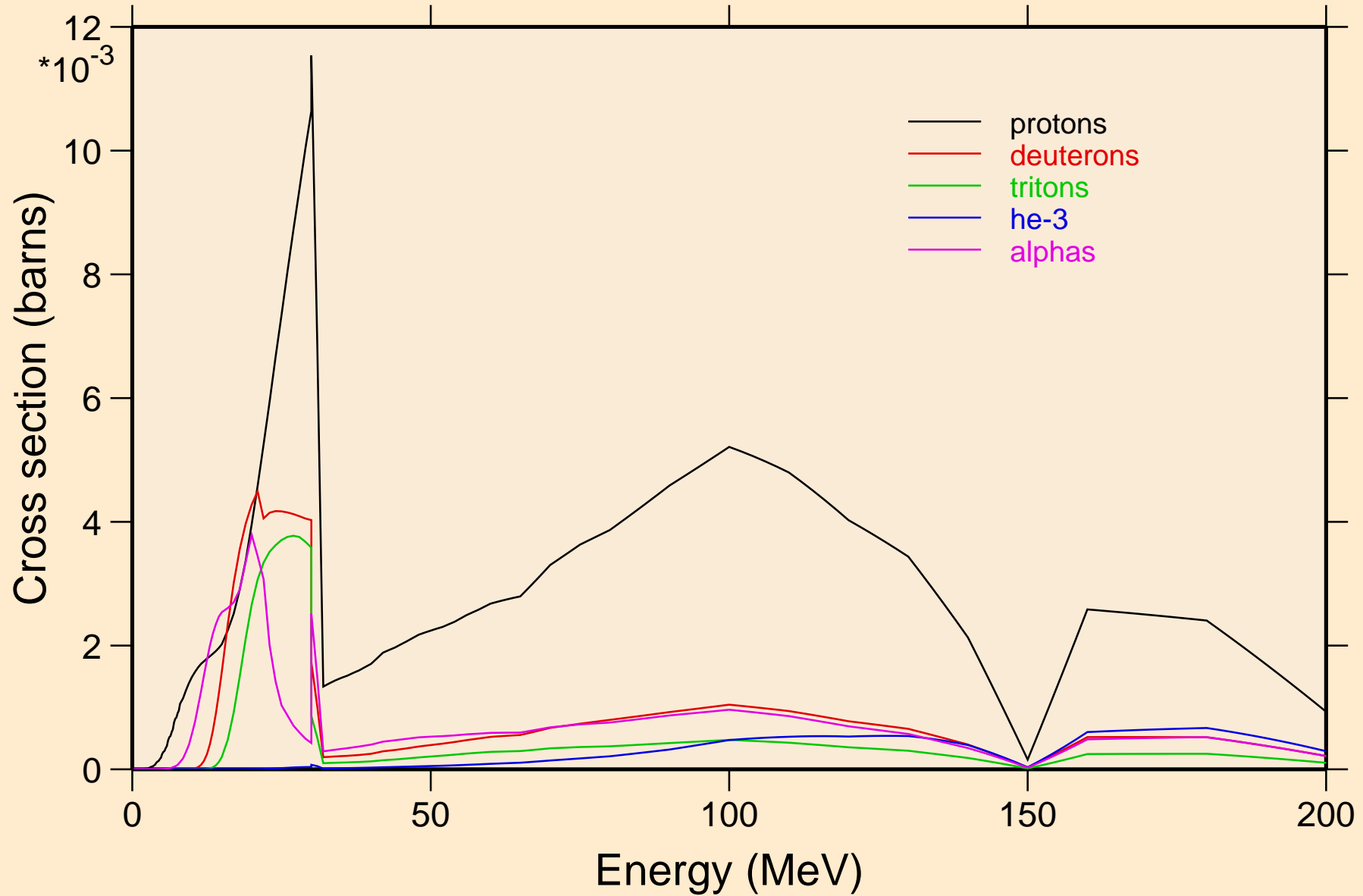

BK238 NEUTRON ACER TENDL-2021 LIBRARY; T=293.6K
protons from (n,x)

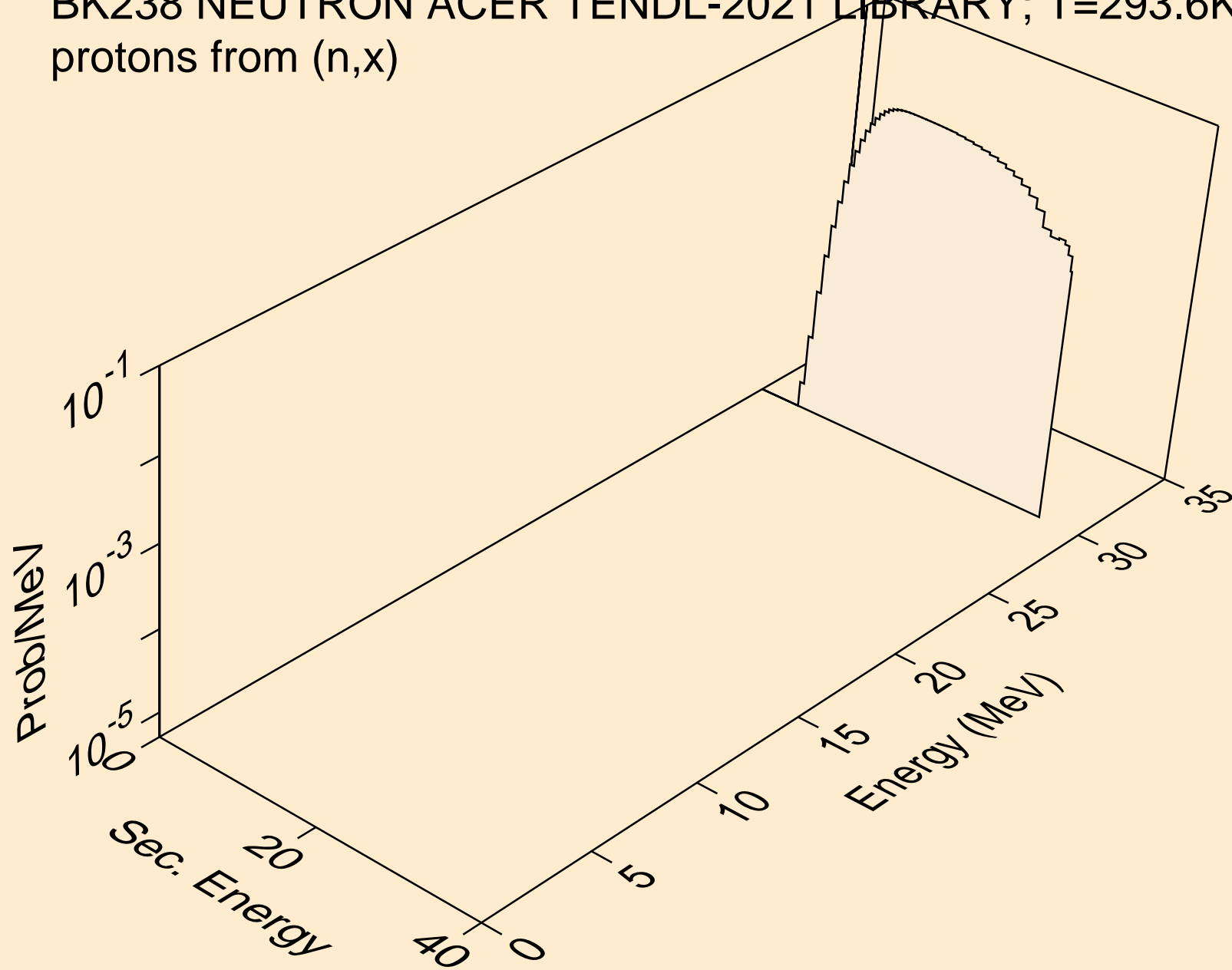

BK238 NEUTRON ACER TENDL-2021 LIBRARY; T=293.6K
protons from (n,n*)p

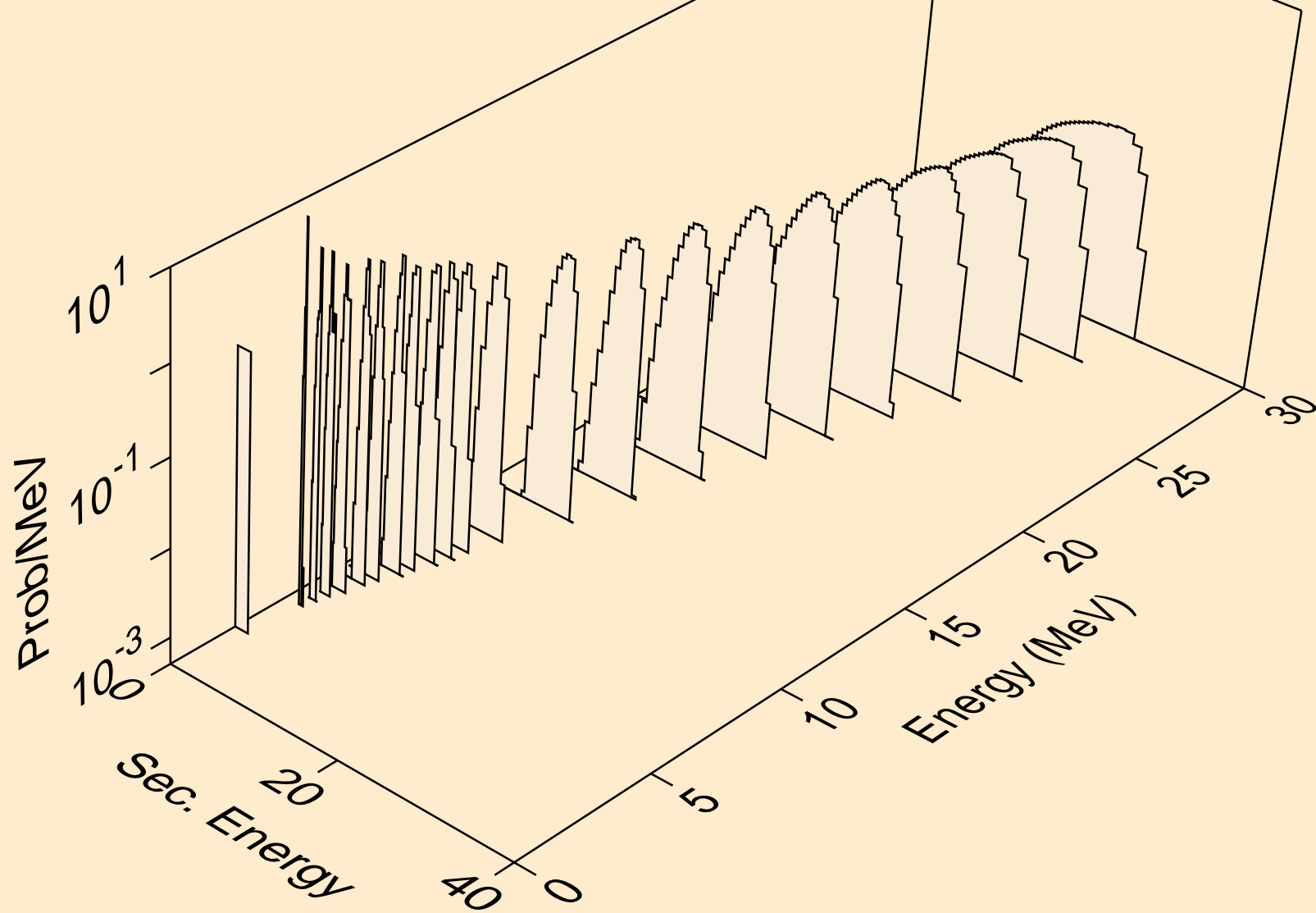

BK238 NEUTRON ACER TENDL-2021 LIBRARY; T=293.6K
protons from (n,2np)

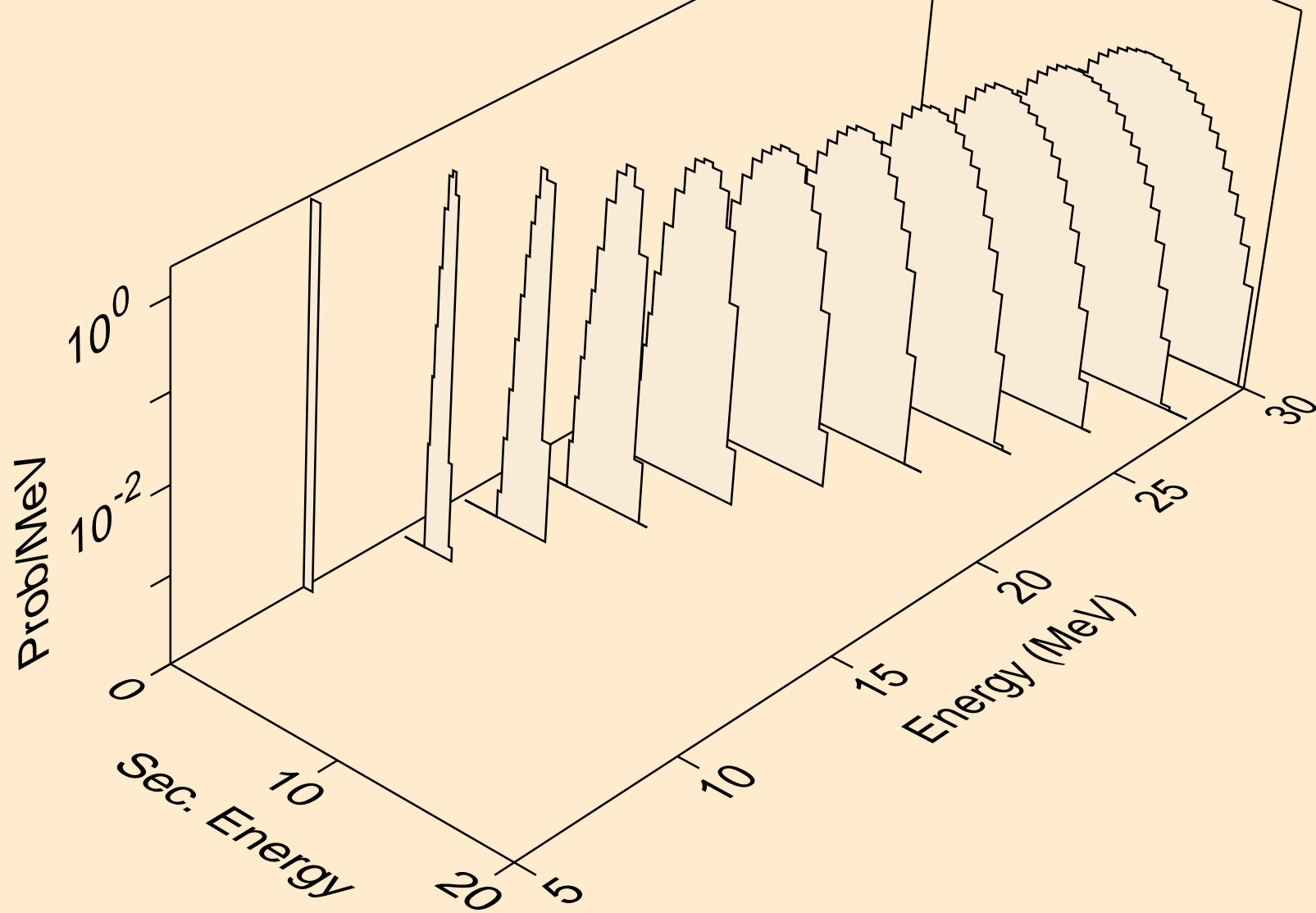

BK238 NEUTRON ACER TENDL-2021 LIBRARY; T=293.6K
protons from (n,3np)

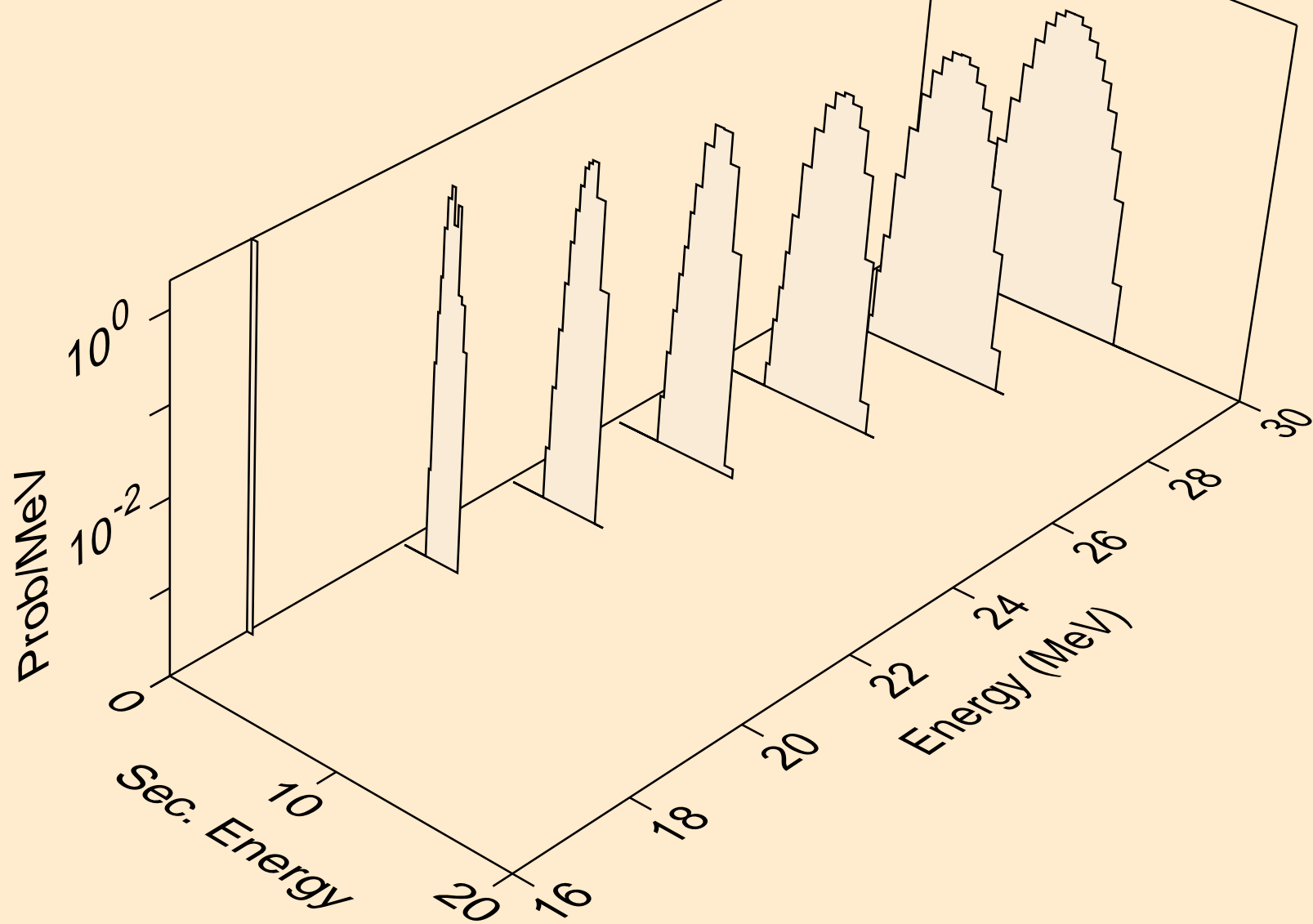

BK238 NEUTRON ACER TENDL-2021 LIBRARY; T=293.6K
protons from (n,2np)

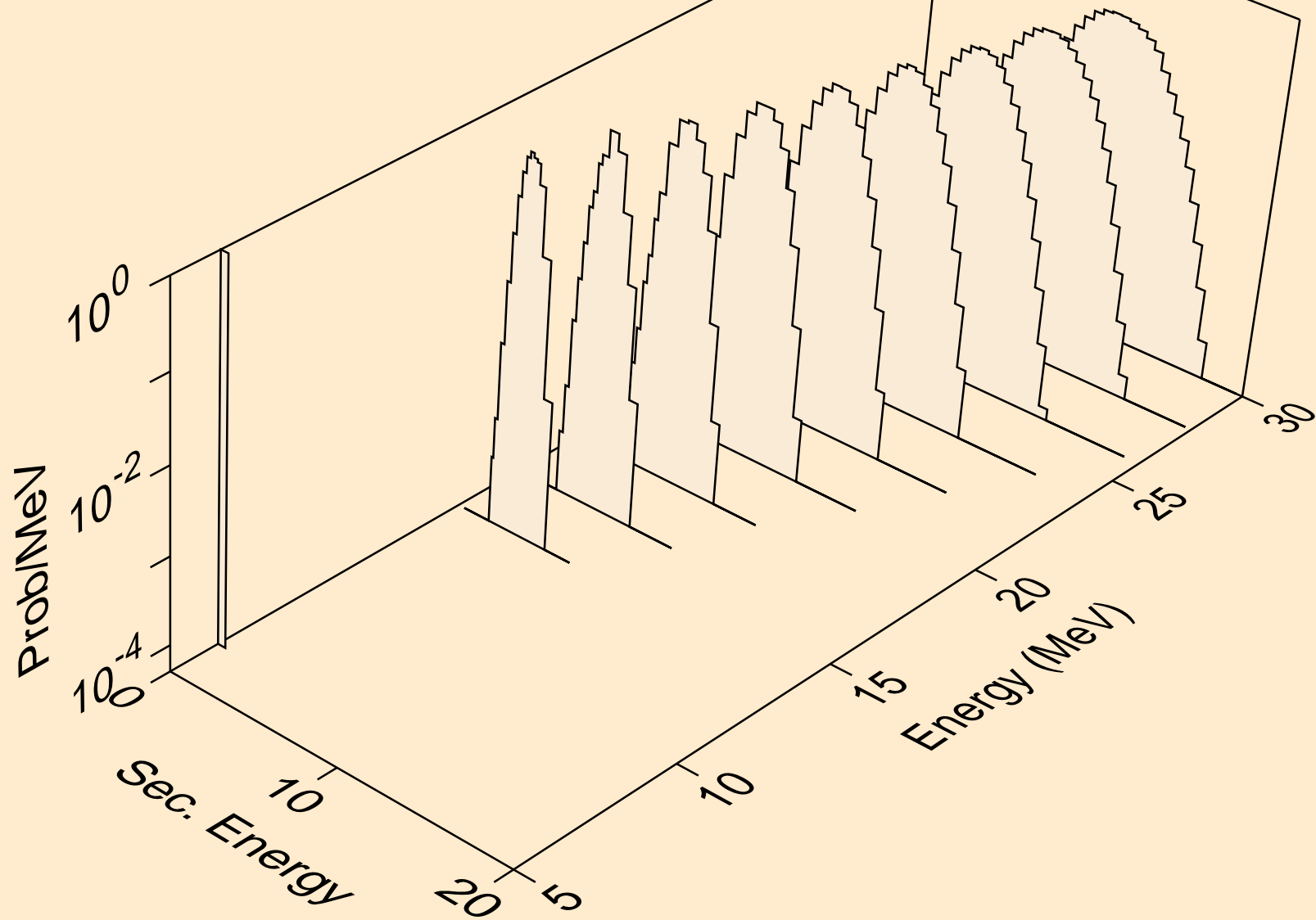

BK238 NEUTRON ACER TENDL-2021 LIBRARY; T=293.6K
protons from (n,npa)

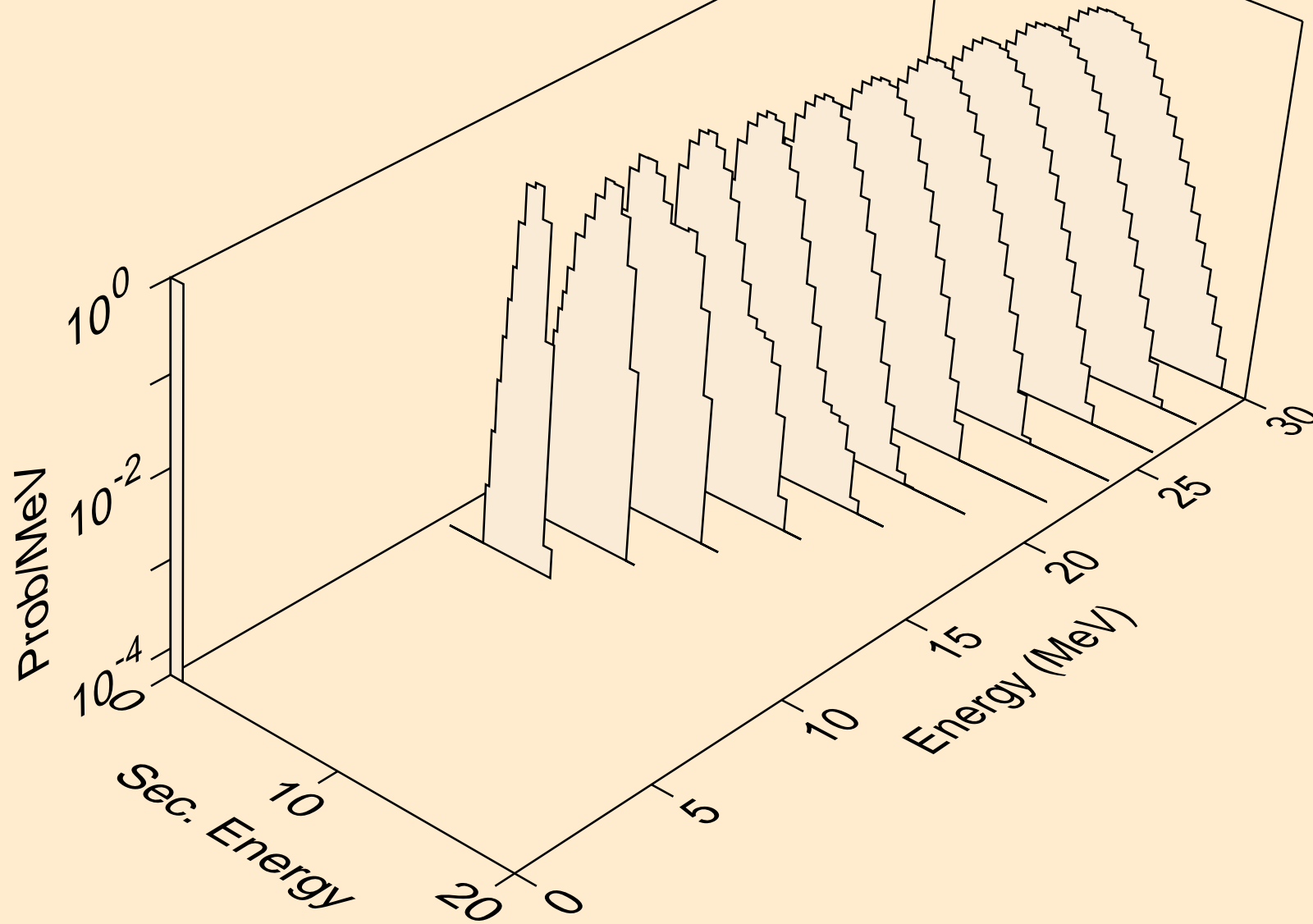

BK238 NEUTRON ACER TENDL-2021 LIBRARY; T=293.6K
protons from (n,p)

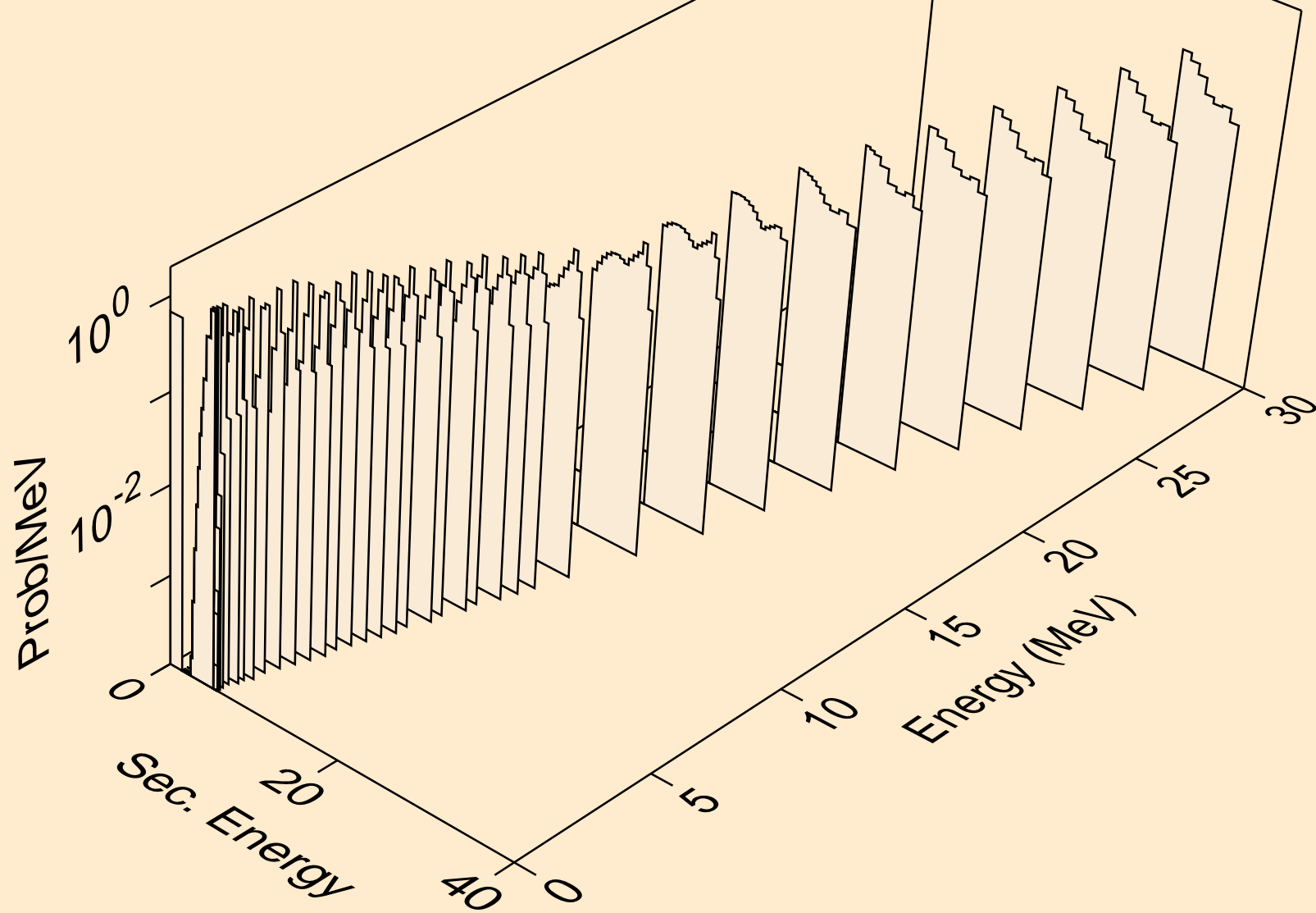

BK238 NEUTRON ACER TENDL-2021 LIBRARY; T=293.6K
protons from (n,2p)

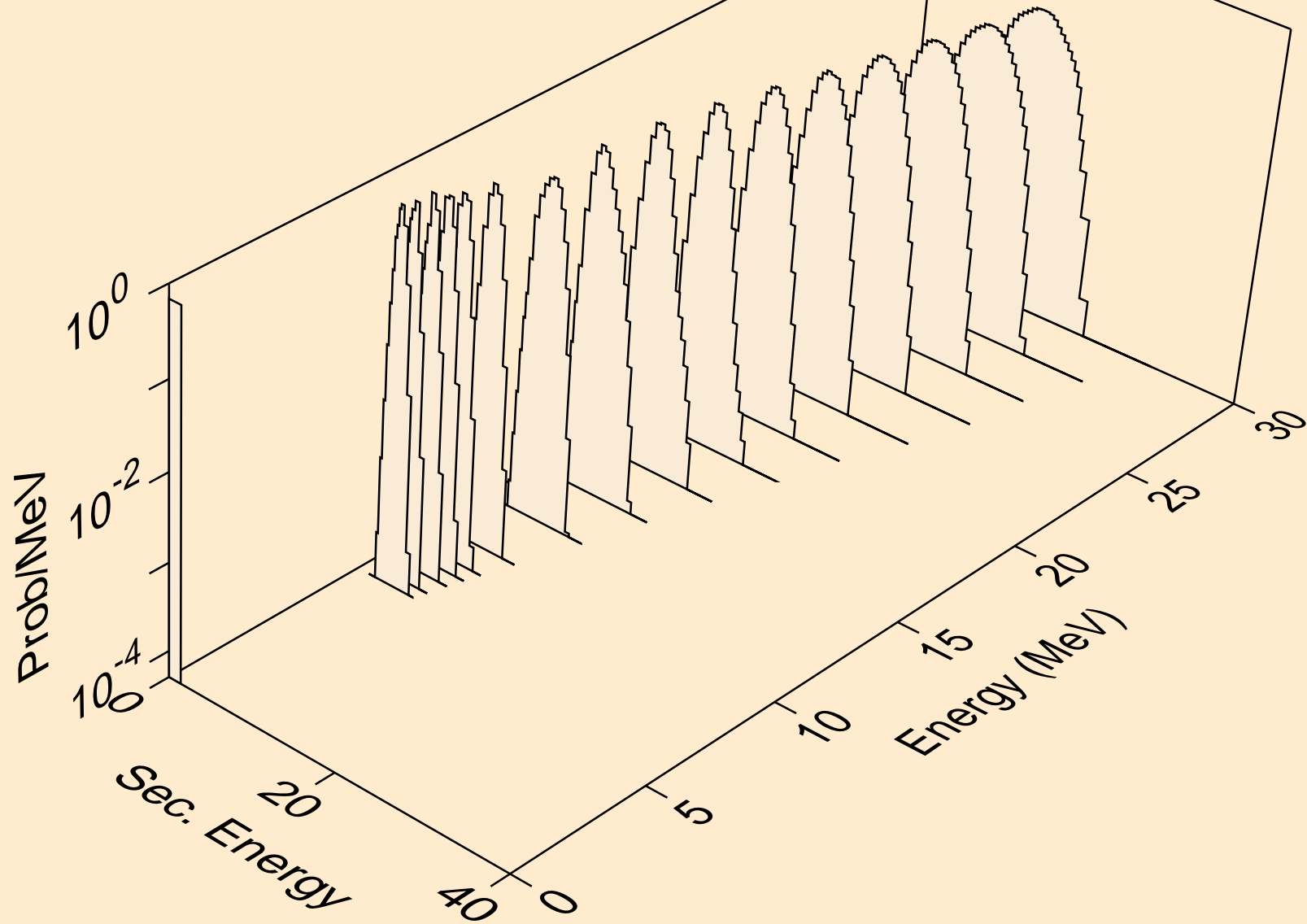

BK238 NEUTRON ACER TENDL-2021 LIBRARY; T=293.6K
protons from (n,p)

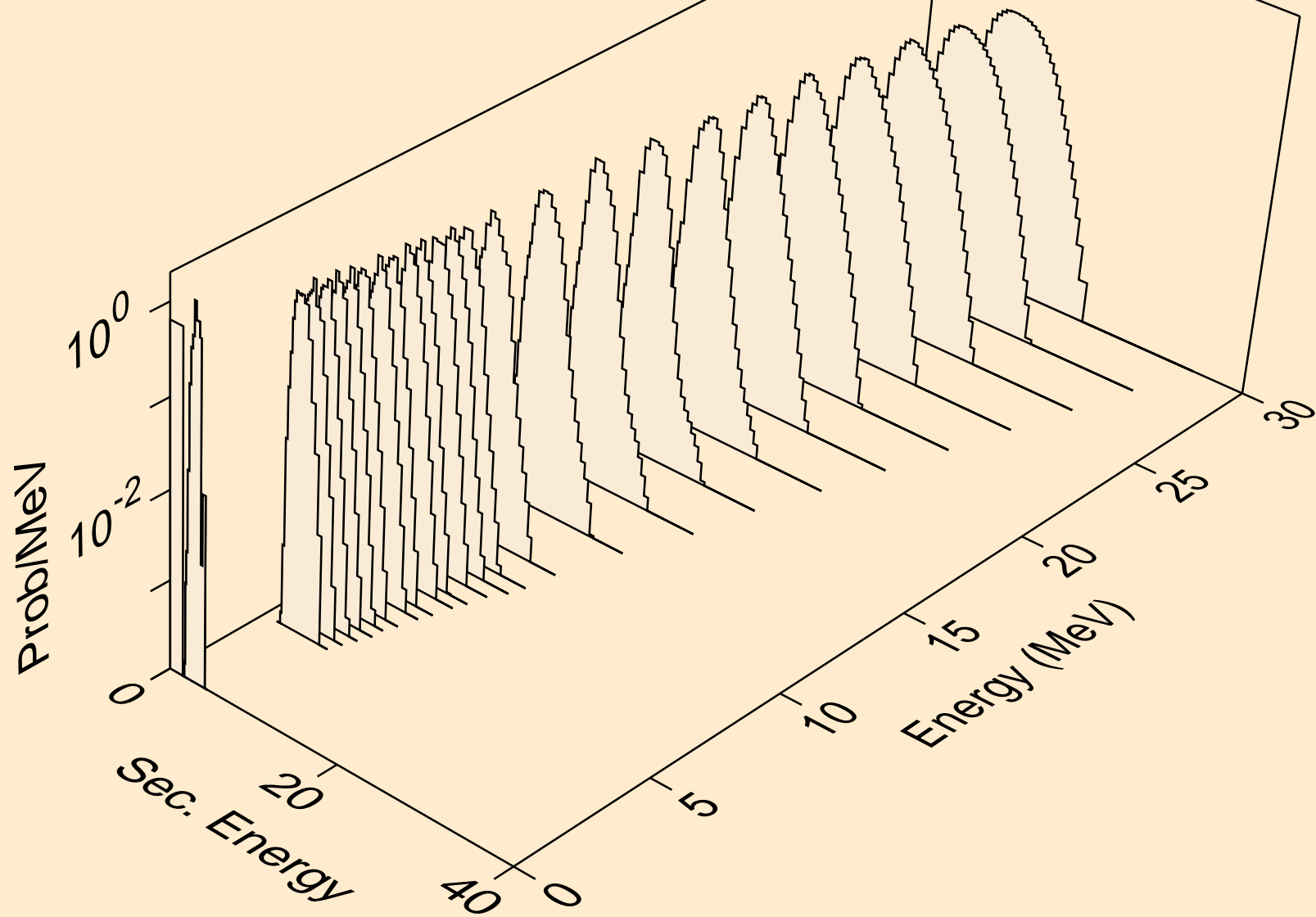

BK238 NEUTRON ACER TENDL-2021 LIBRARY; T=293.6K
protons from (n,pd)

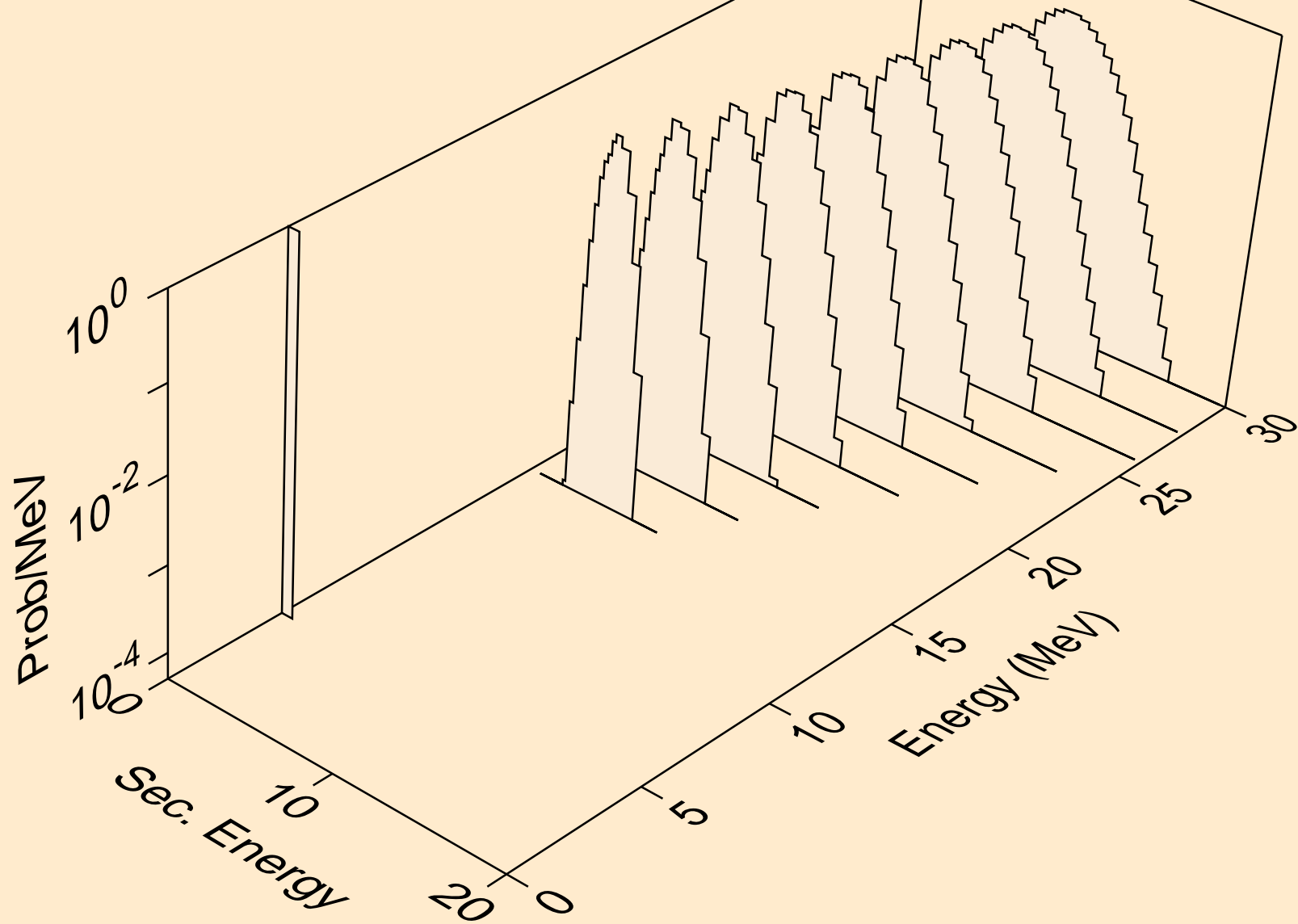

BK238 NEUTRON ACER TENDL-2021 LIBRARY; T=293.6K
protons from (n,pt)

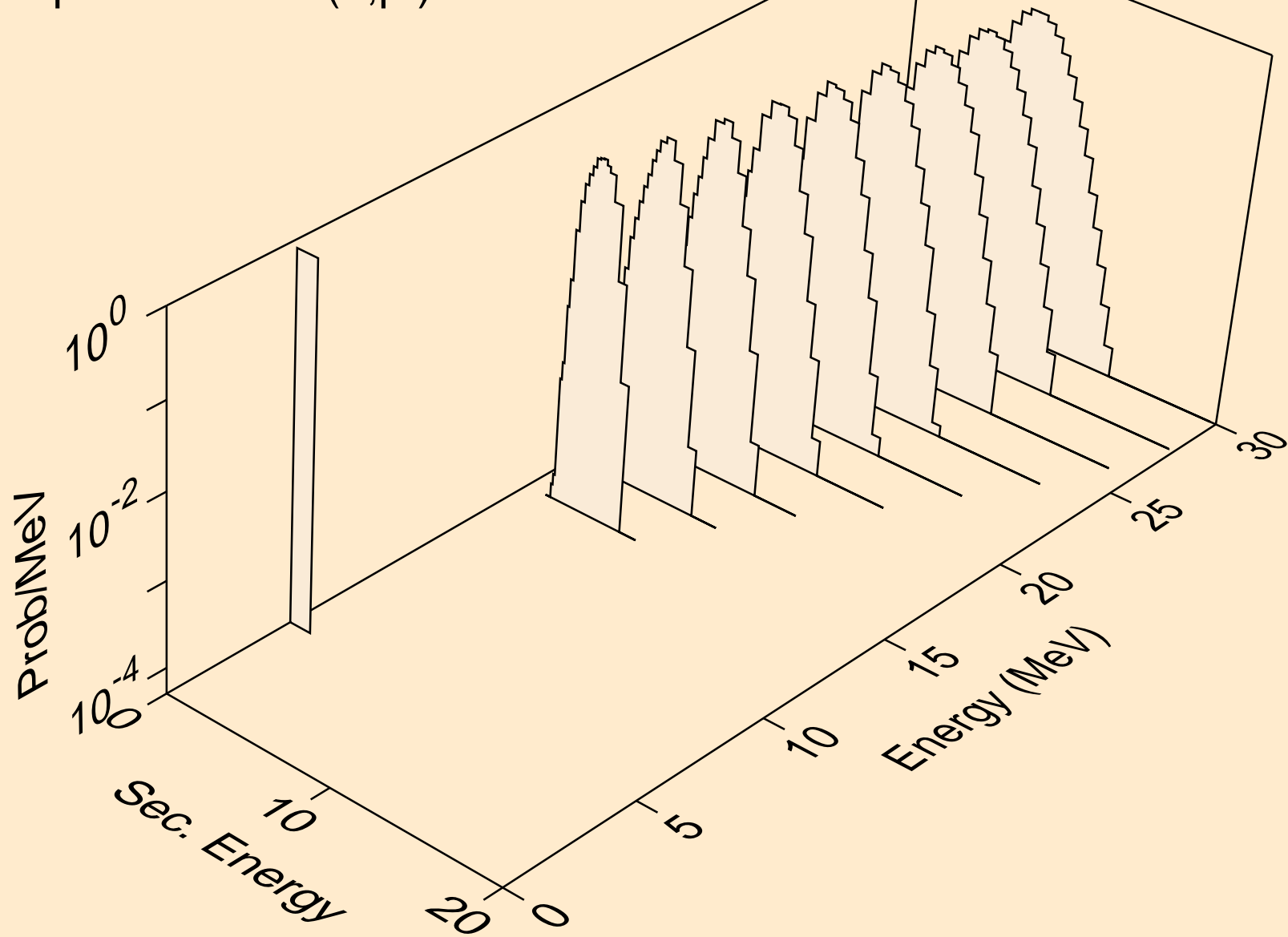

BK238 NEUTRON ACER TENDL-2021 LIBRARY; T=293.6K
deuterons from (n,x)

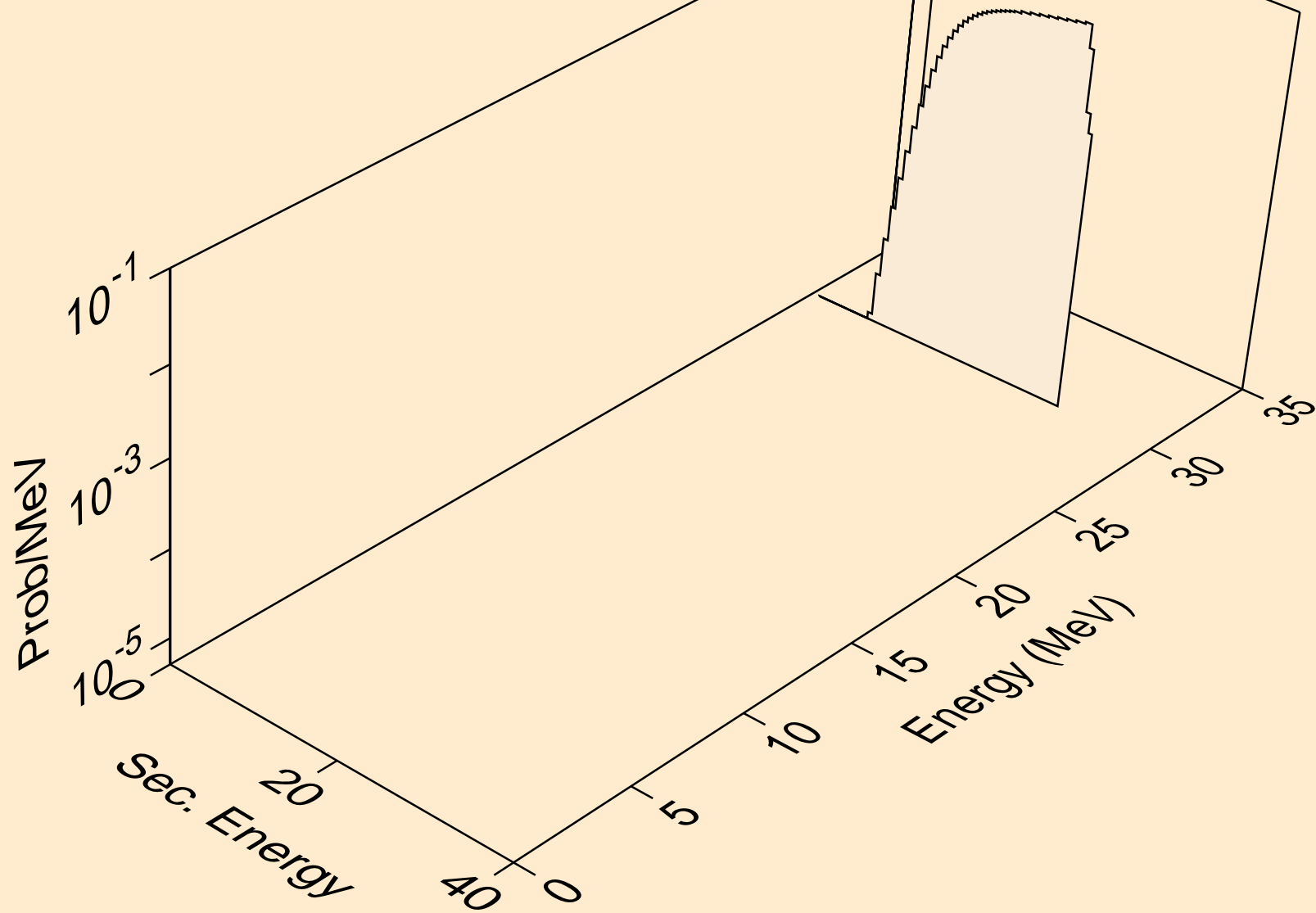

BK238 NEUTRON ACER TENDL-2021 LIBRARY; T=293.6K
deuterons from (n,2nd)

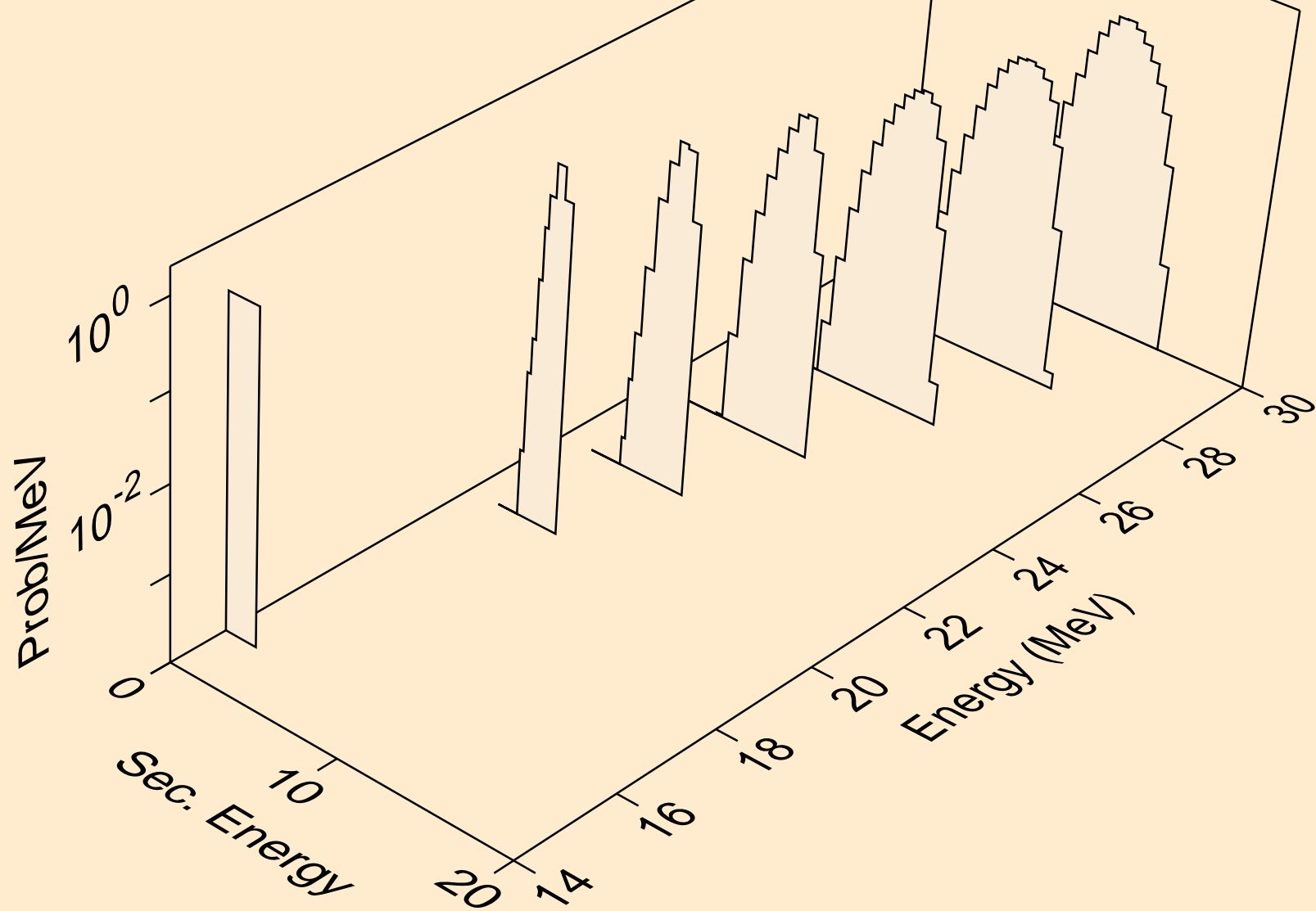

BK238 NEUTRON ACER TENDL-2021 LIBRARY; T=293.6K
deuterons from (n,n*)d

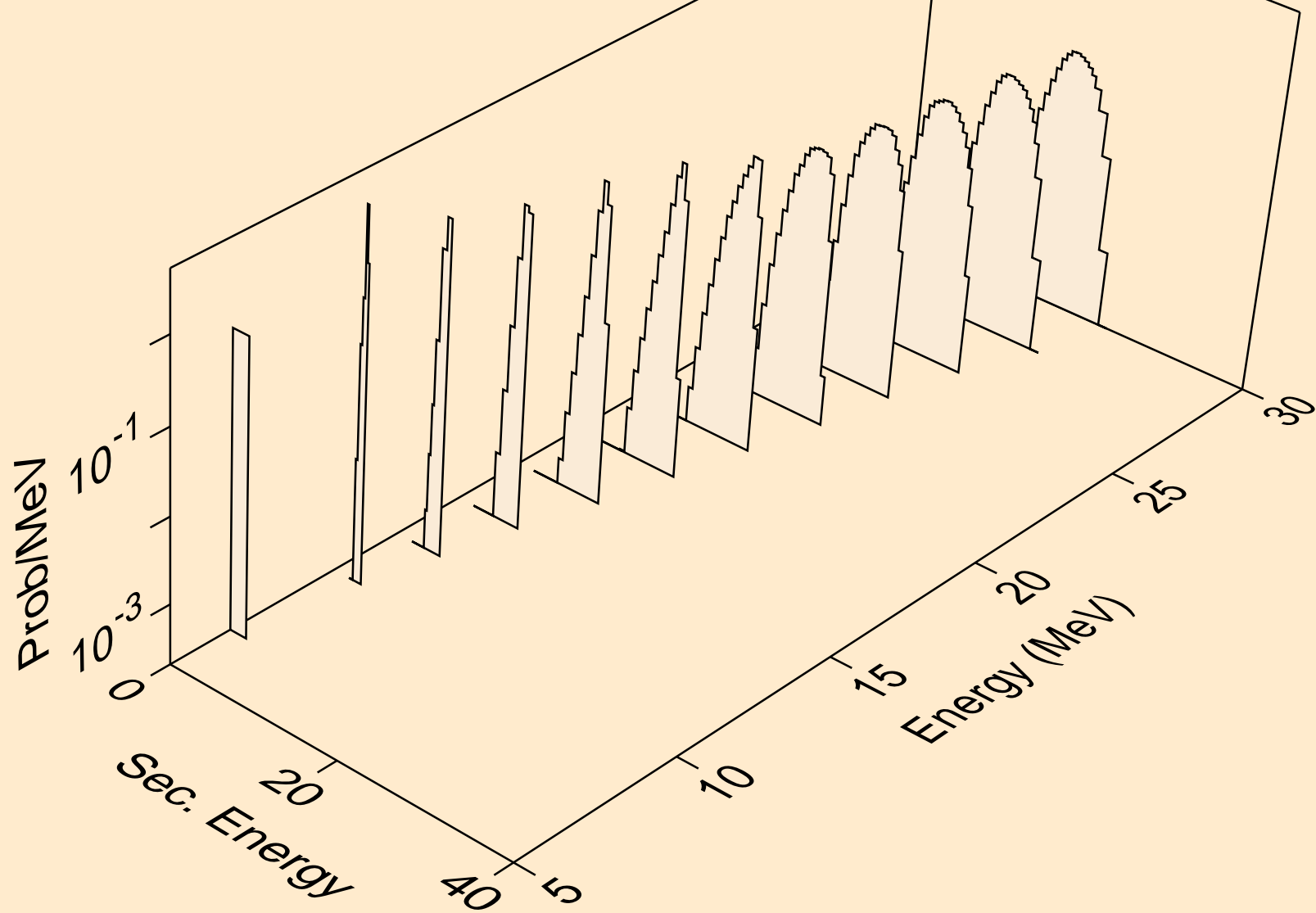

BK238 NEUTRON ACER TENDL-2021 LIBRARY; T=293.6K
deuterons from (n,d)

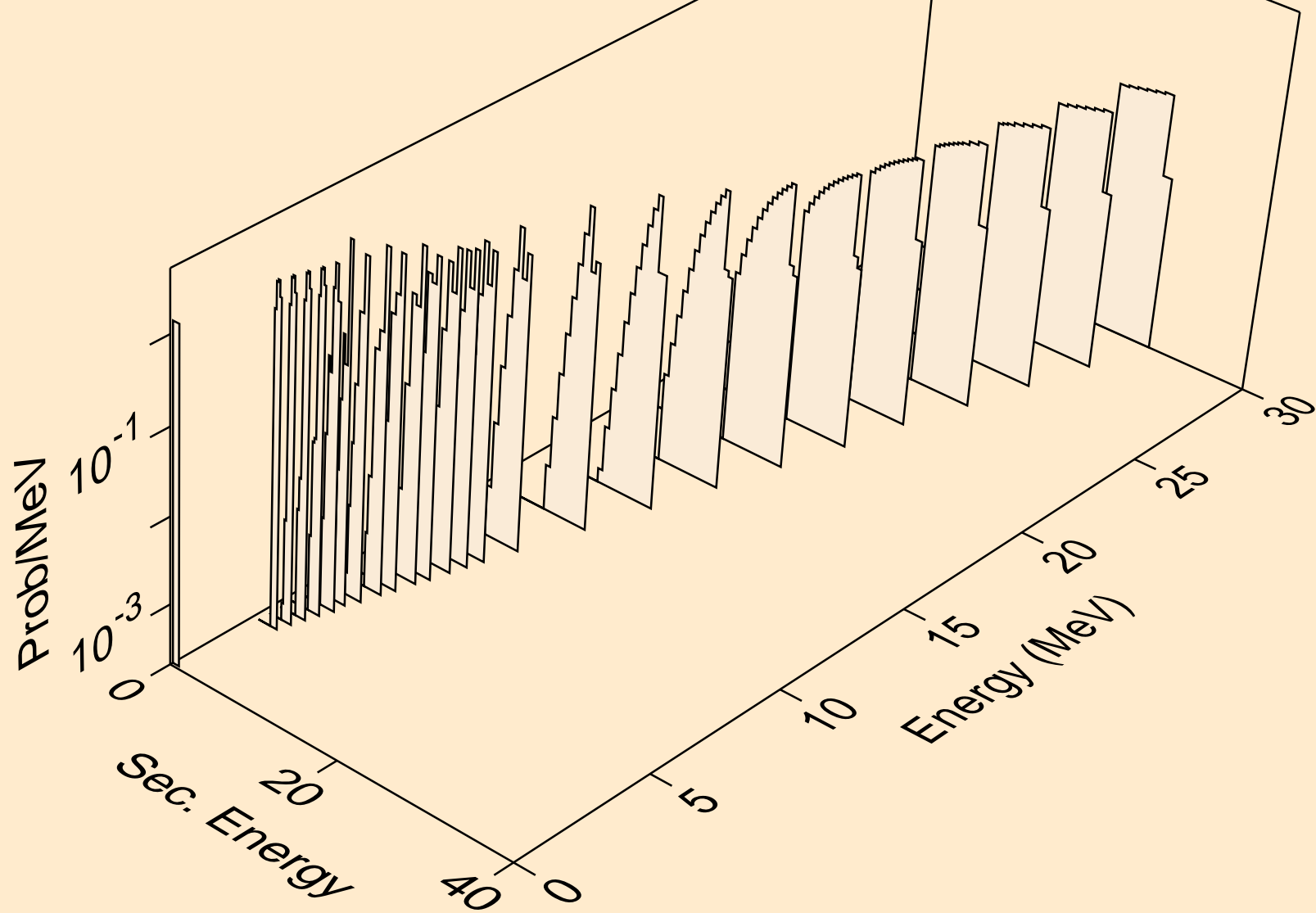

BK238 NEUTRON ACER TENDL-2021 LIBRARY; T=293.6K
deuterons from (n,pd)

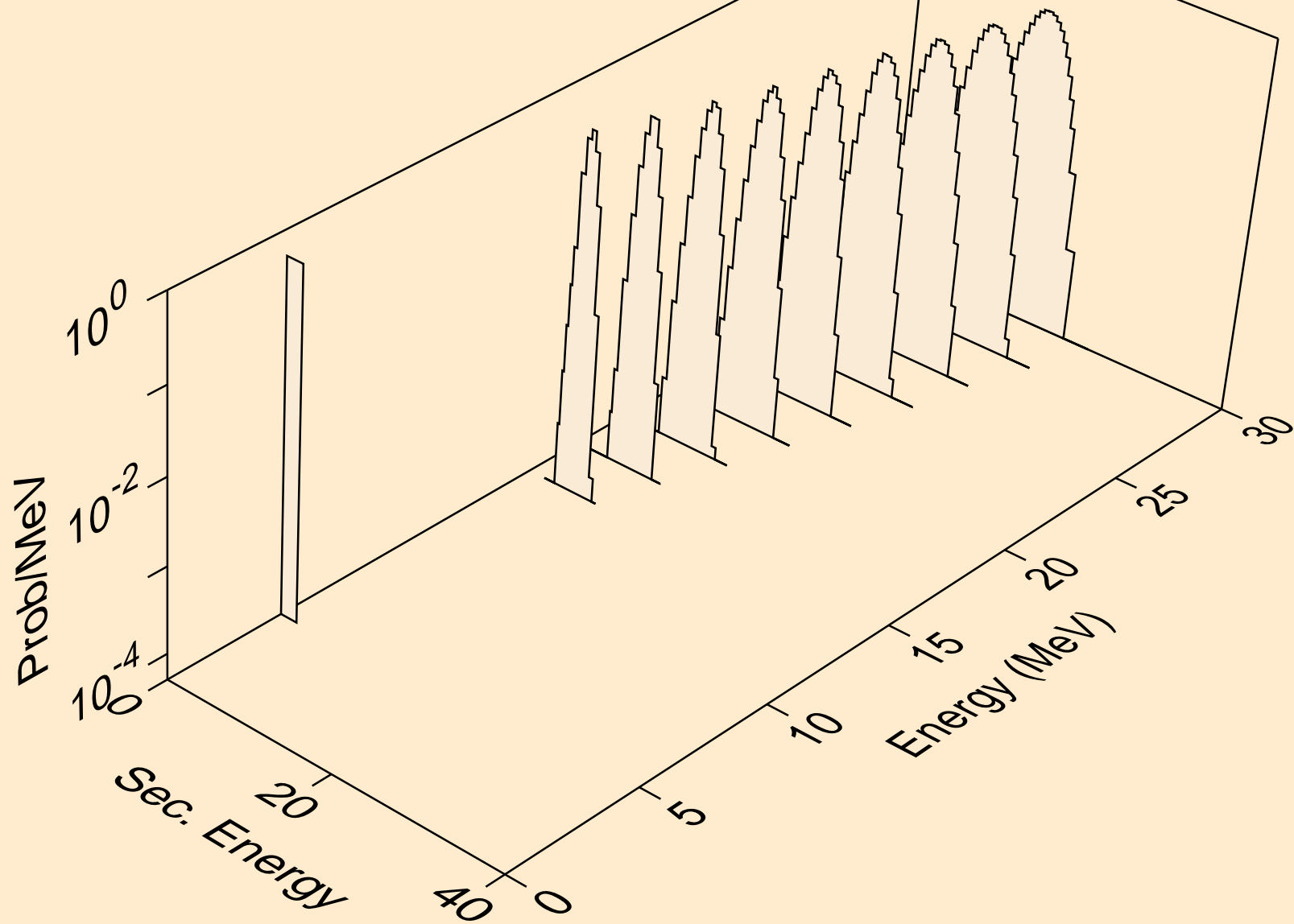

BK238 NEUTRON ACER TENDL-2021 LIBRARY; T=293.6K
deuterons from (n,da)

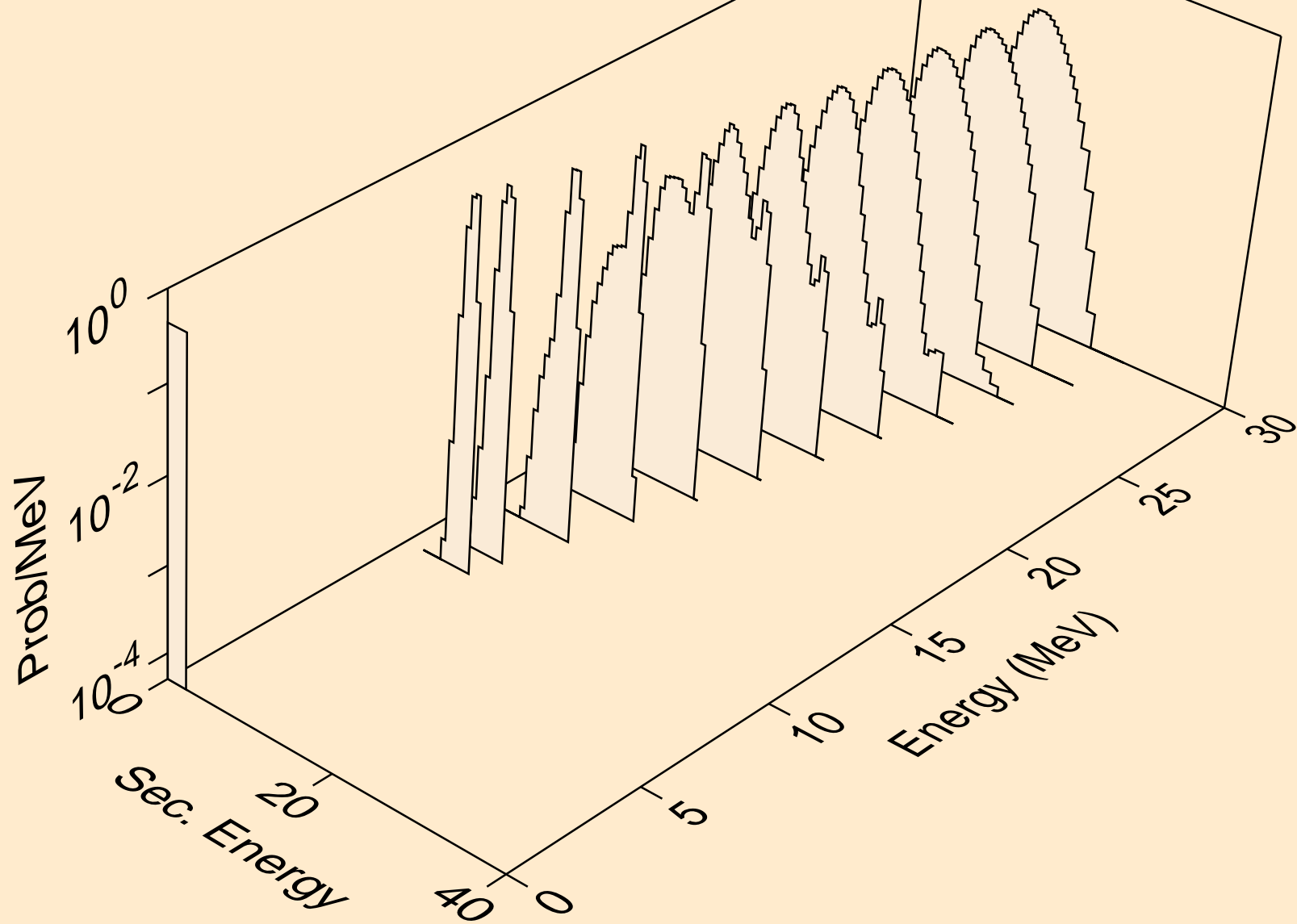

BK238 NEUTRON ACER TENDL-2021 LIBRARY; T=293.6K
tritons from (n,x)

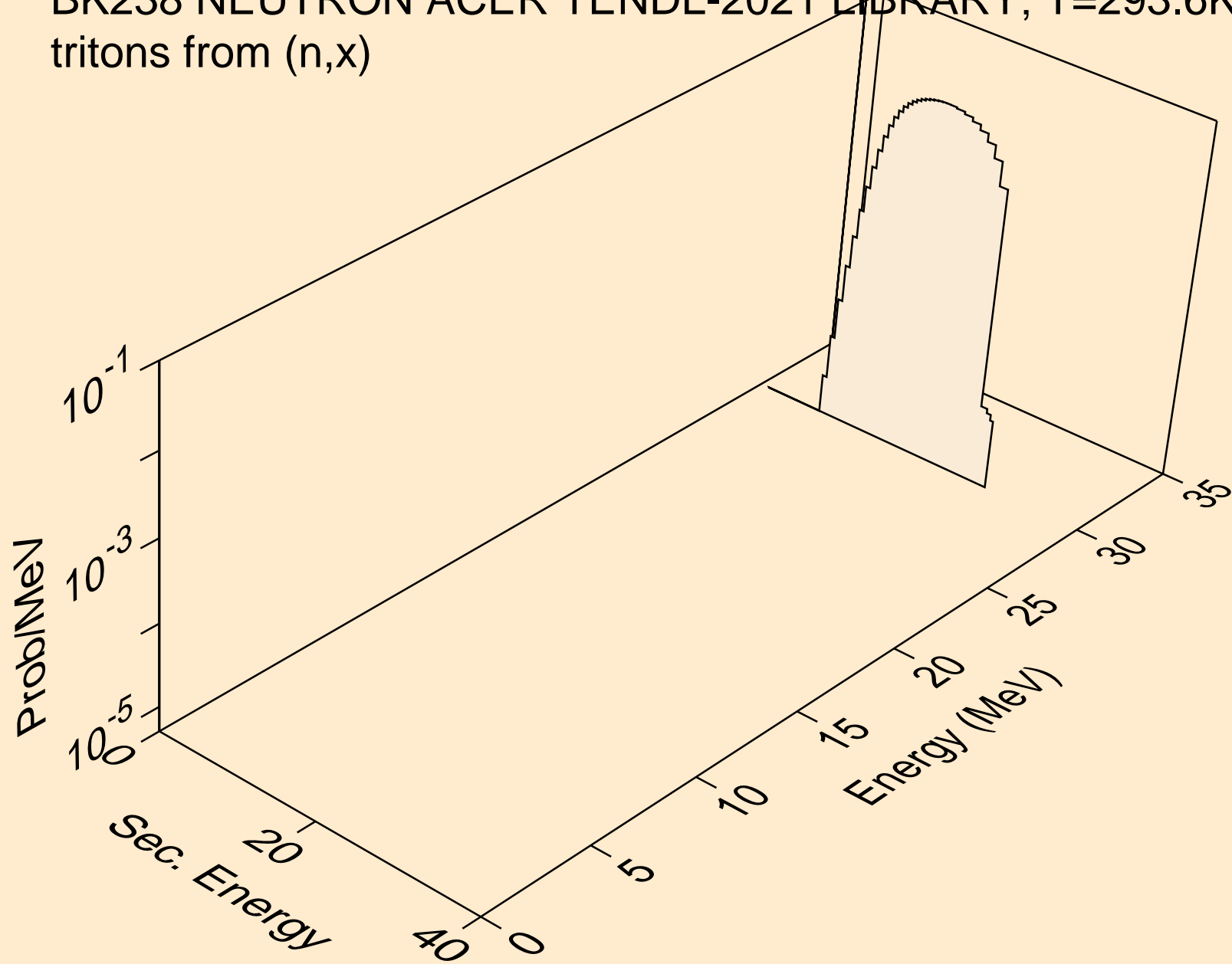

BK238 NEUTRON ACER TENDL-2021 LIBRARY; T=293.6K
tritons from (n,n*)t

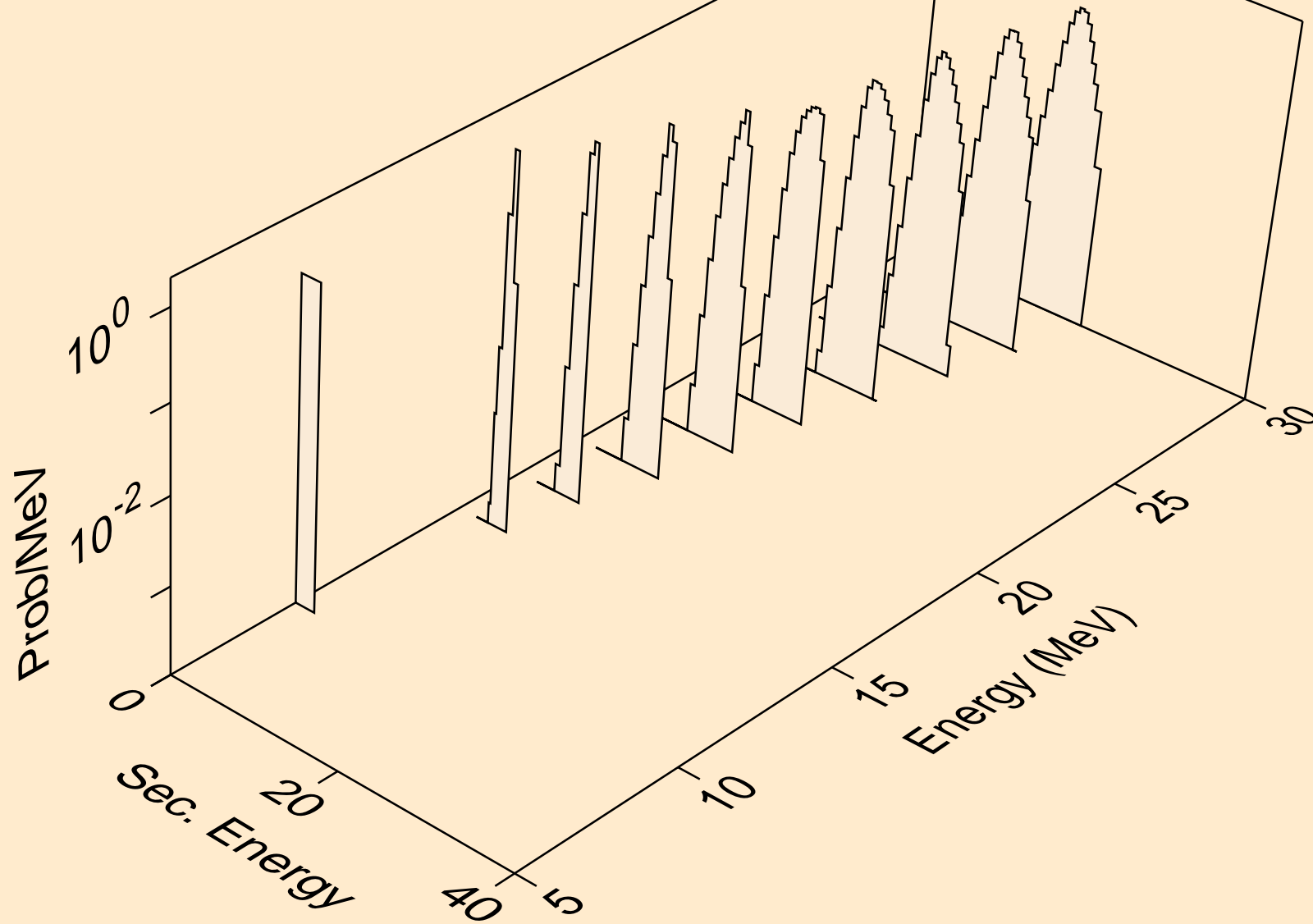

BK238 NEUTRON ACER TENDL-2021 LIBRARY; T=293.6K
tritons from (n,t)

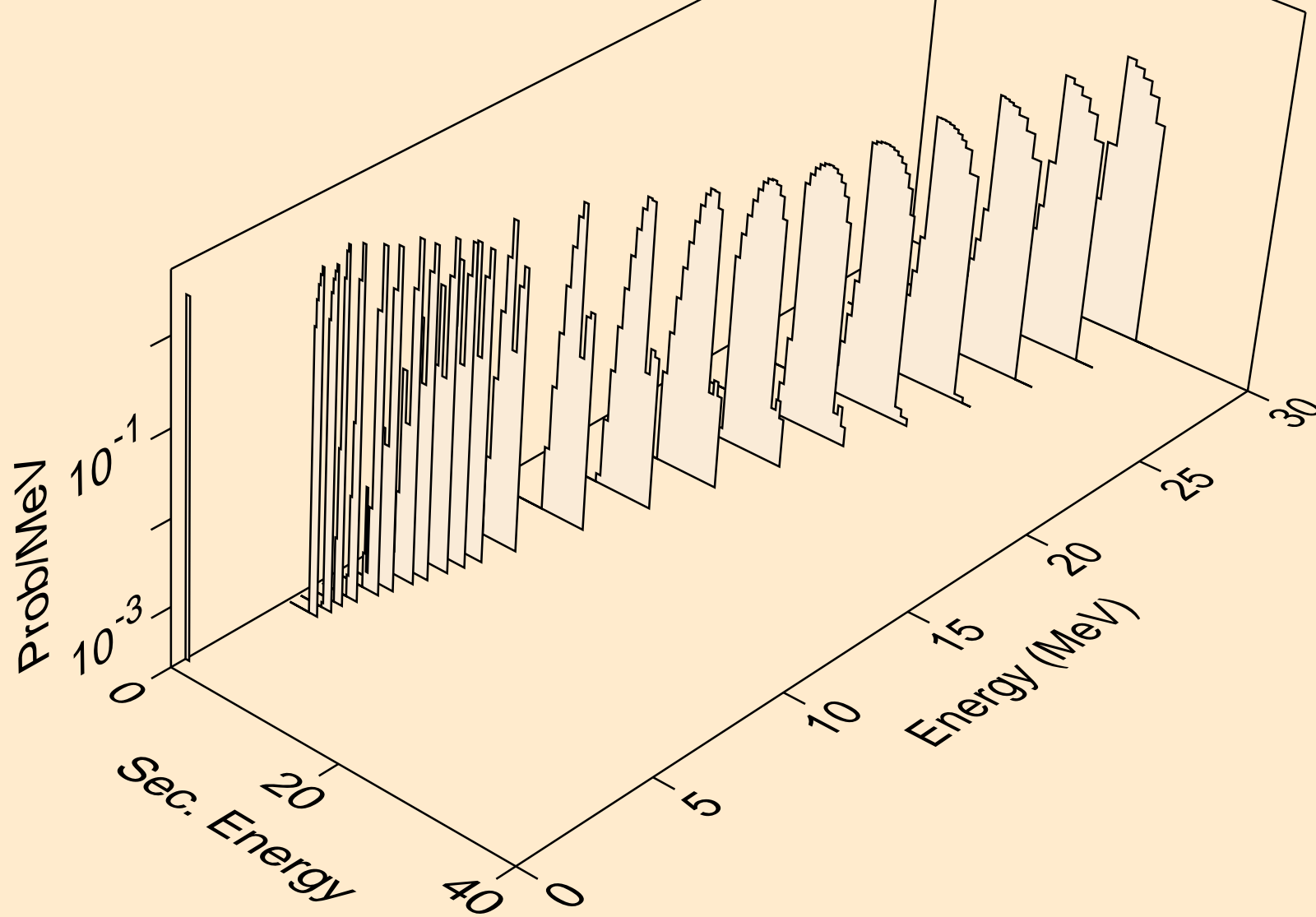

BK238 NEUTRON ACER TENDL-2021 LIBRARY; T=293.6K
tritons from (n,pt)

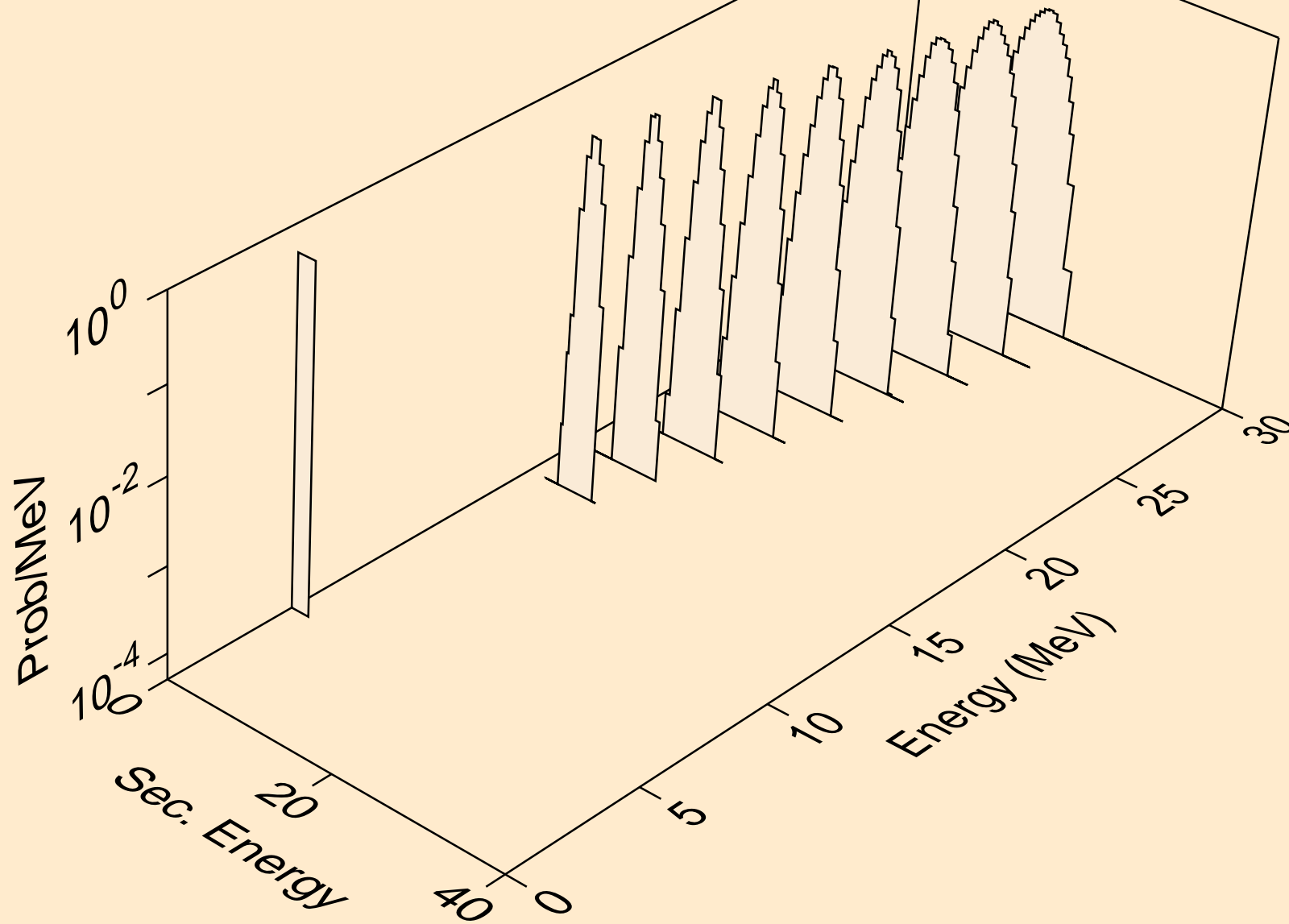

BK238 NEUTRON ACER TENDL-2021 LIBRARY; T=293.6K
he3s from (n,x)

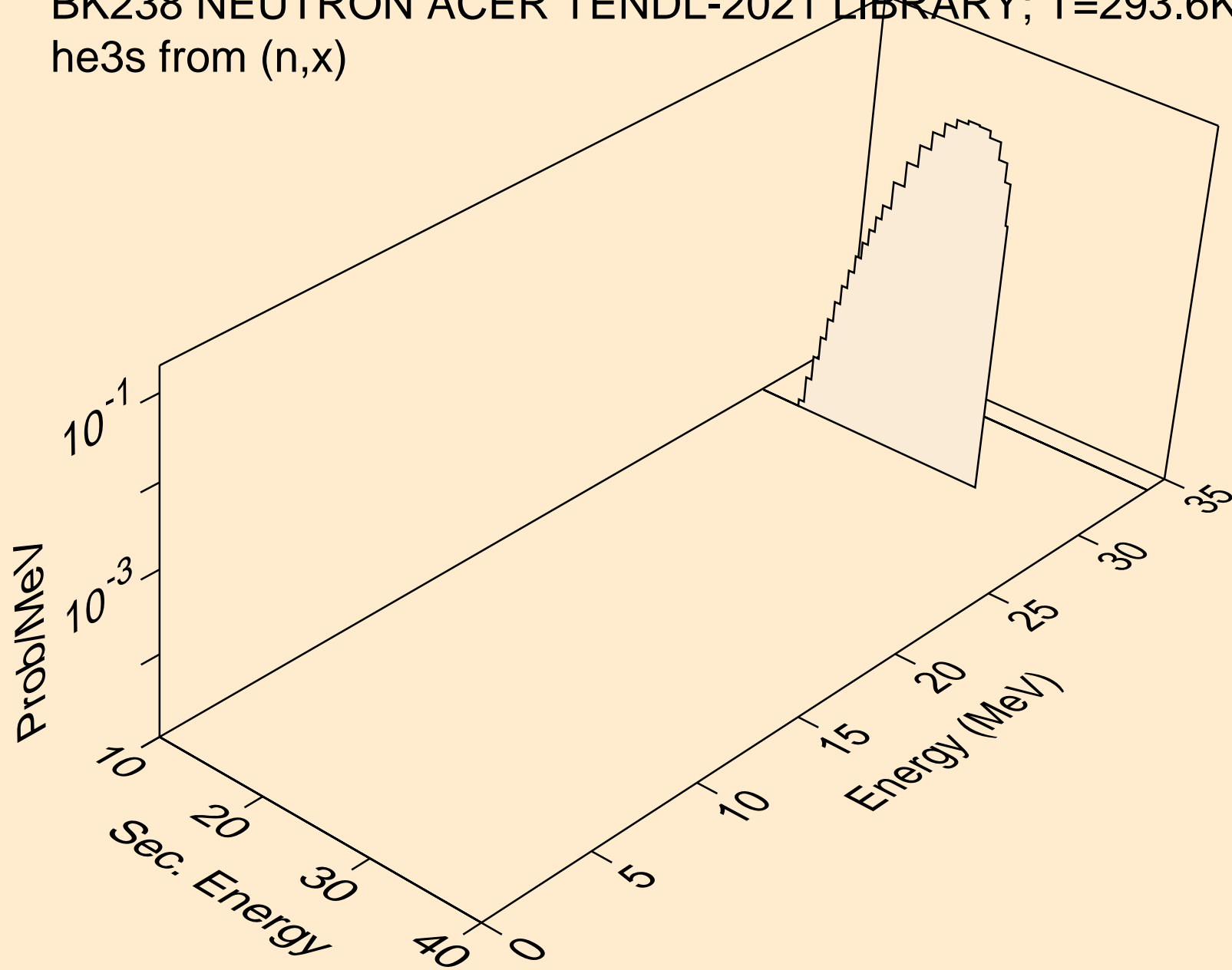

BK238 NEUTRON ACER TENDL-2021 LIBRARY; T=293.6K
he3s from (n,n*)he3

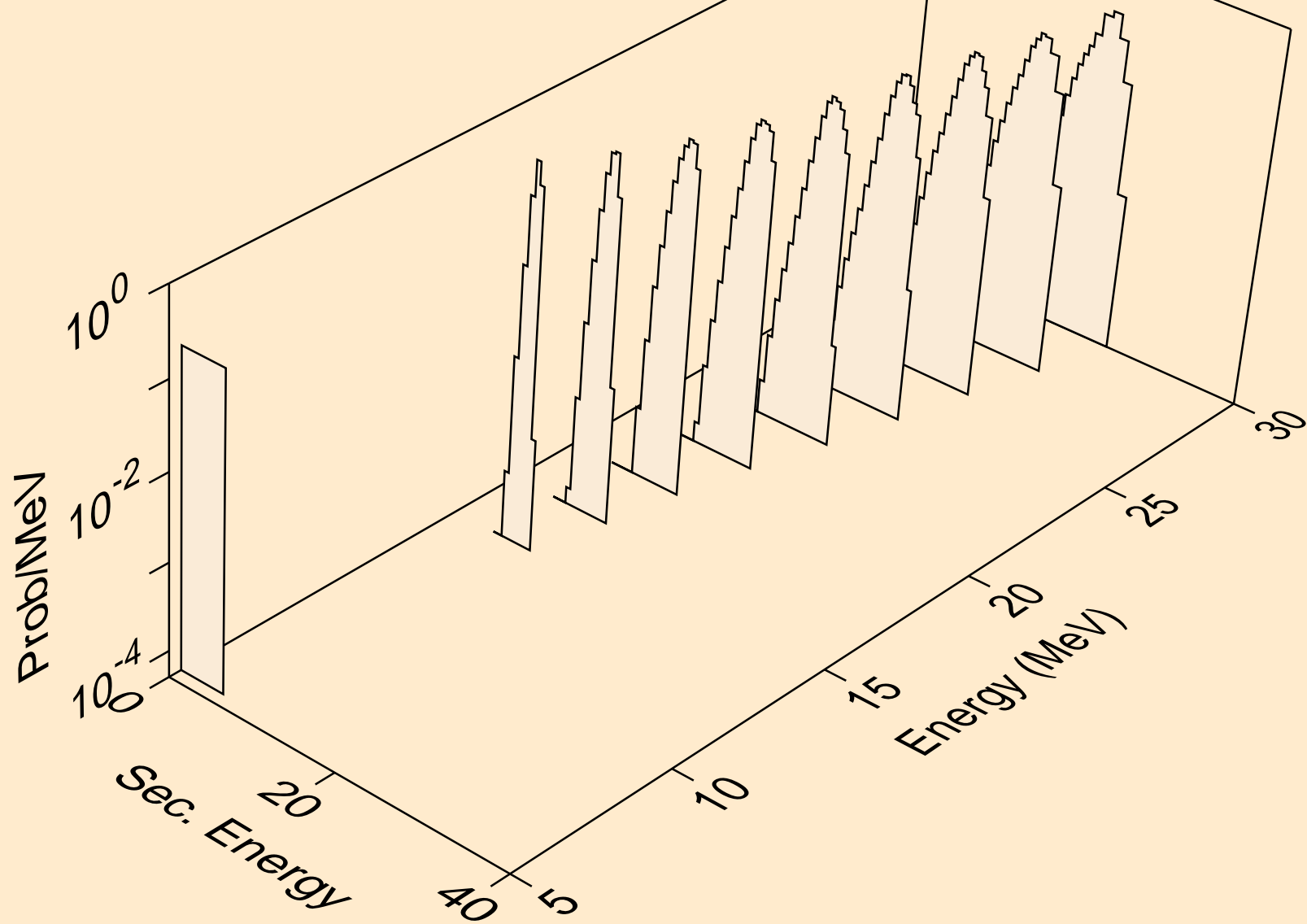

BK238 NEUTRON ACER TENDL-2021 LIBRARY; T=293.6K
he3s from (n,he3)

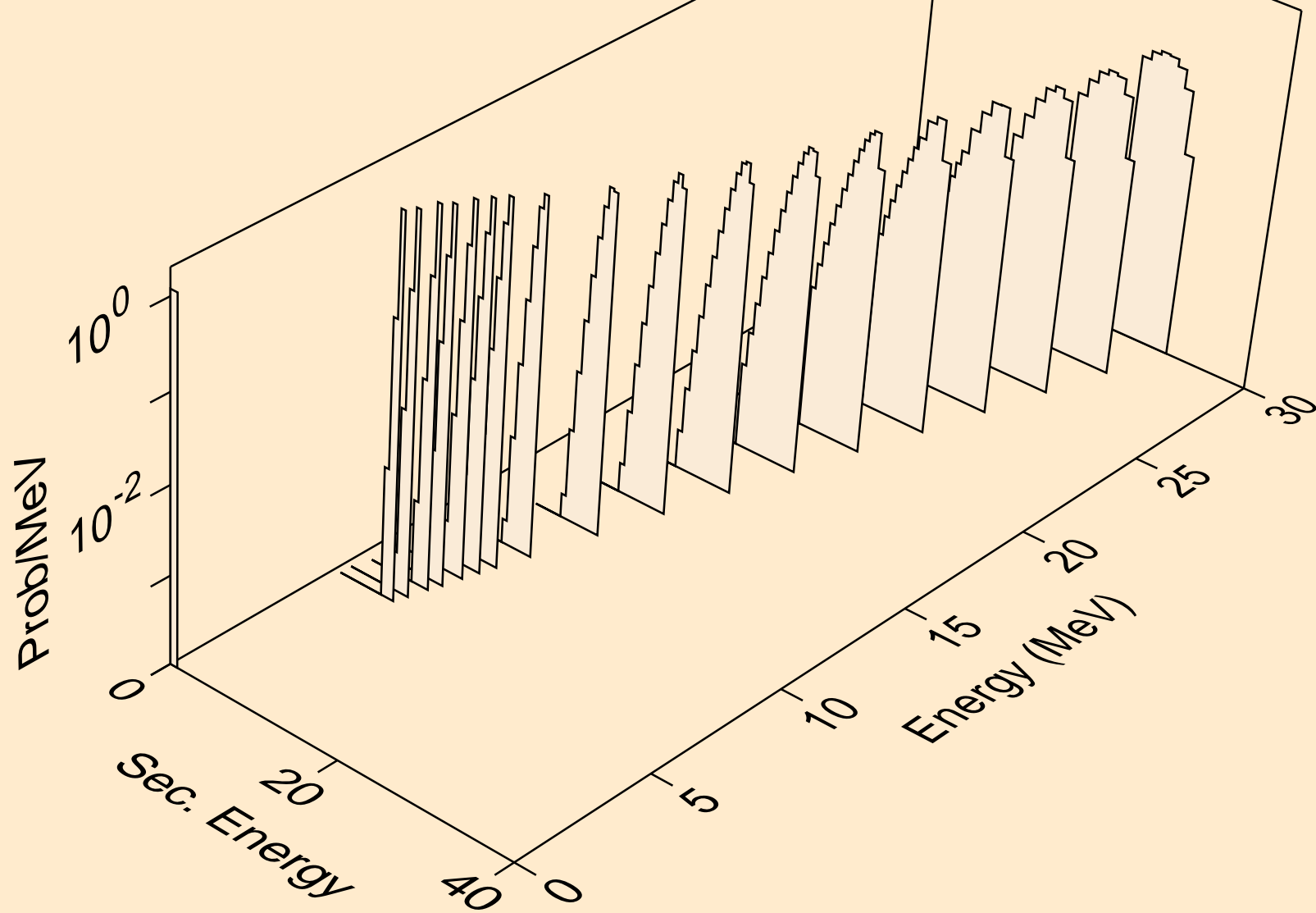

BK238 NEUTRON ACER TENDL-2021 LIBRARY; T=293.6K
alphas from (n,x)

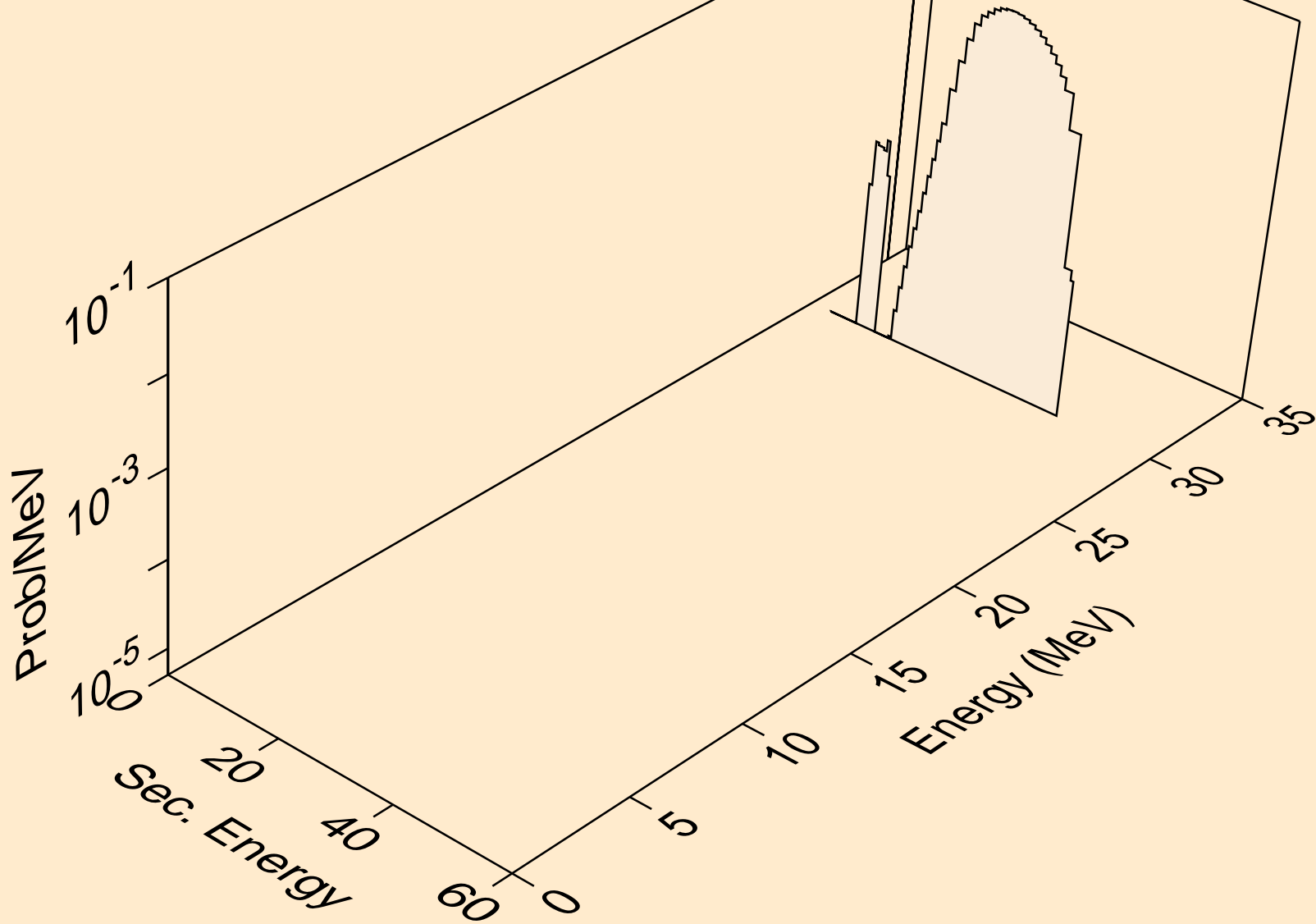

BK238 NEUTRON ACER TENDL-2021 LIBRARY; T=293.6K
alphas from (n,n*)a

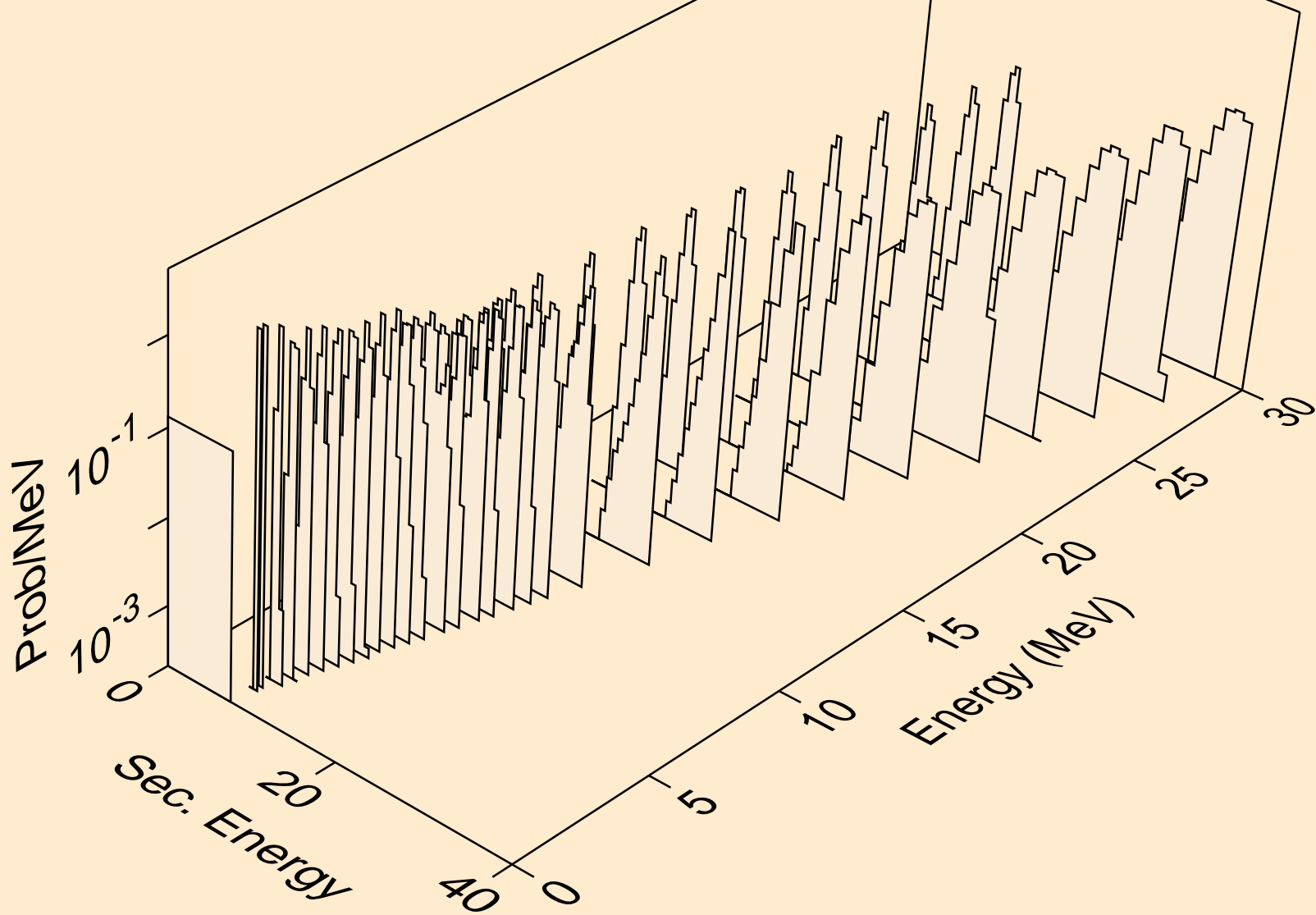

BK238 NEUTRON ACER TENDL-2021 LIBRARY; T=293.6K
alphas from (n,2n)a

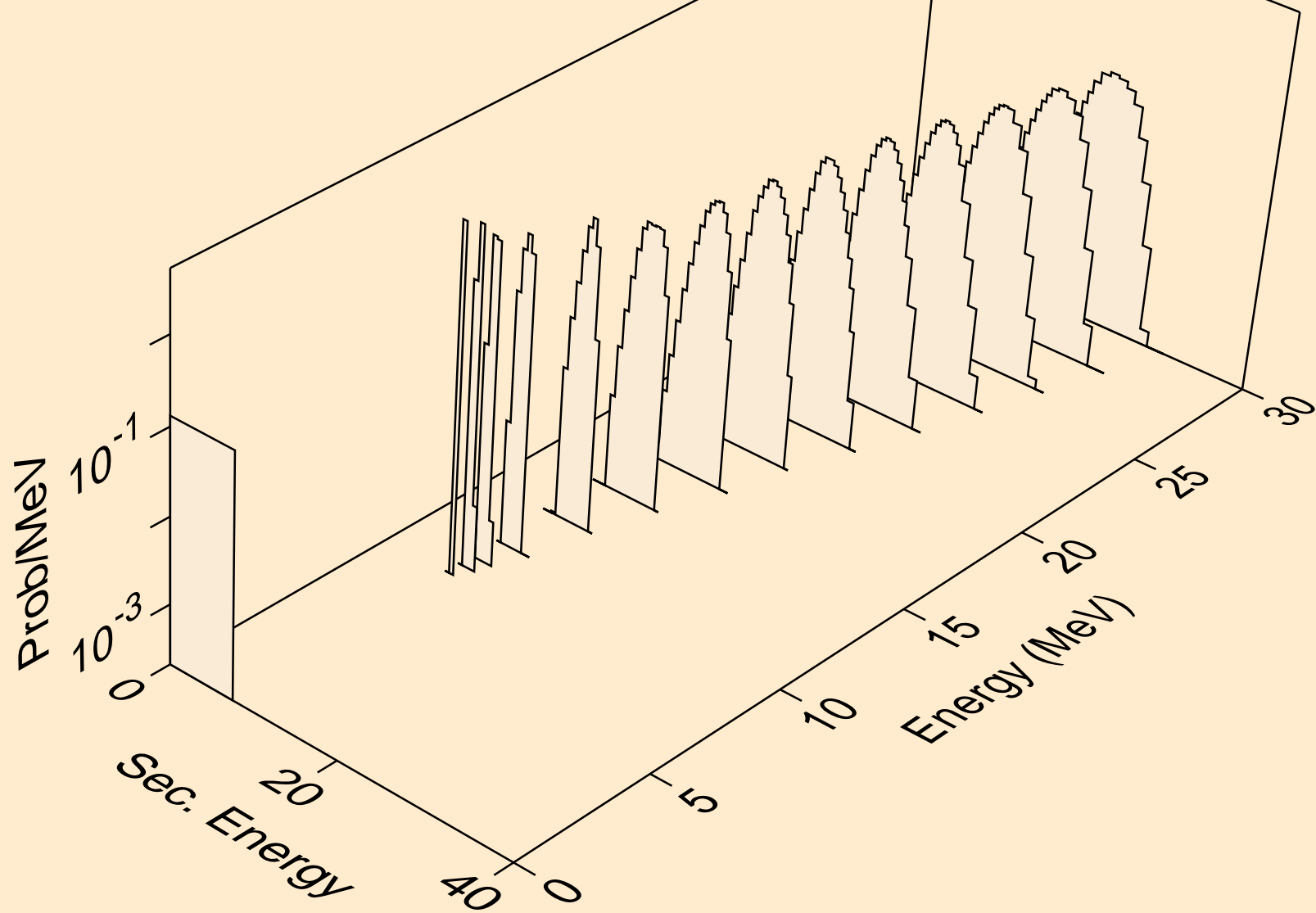

BK238 NEUTRON ACER TENDL-2021 LIBRARY; T=293.6K
alphas from (n,3n)a

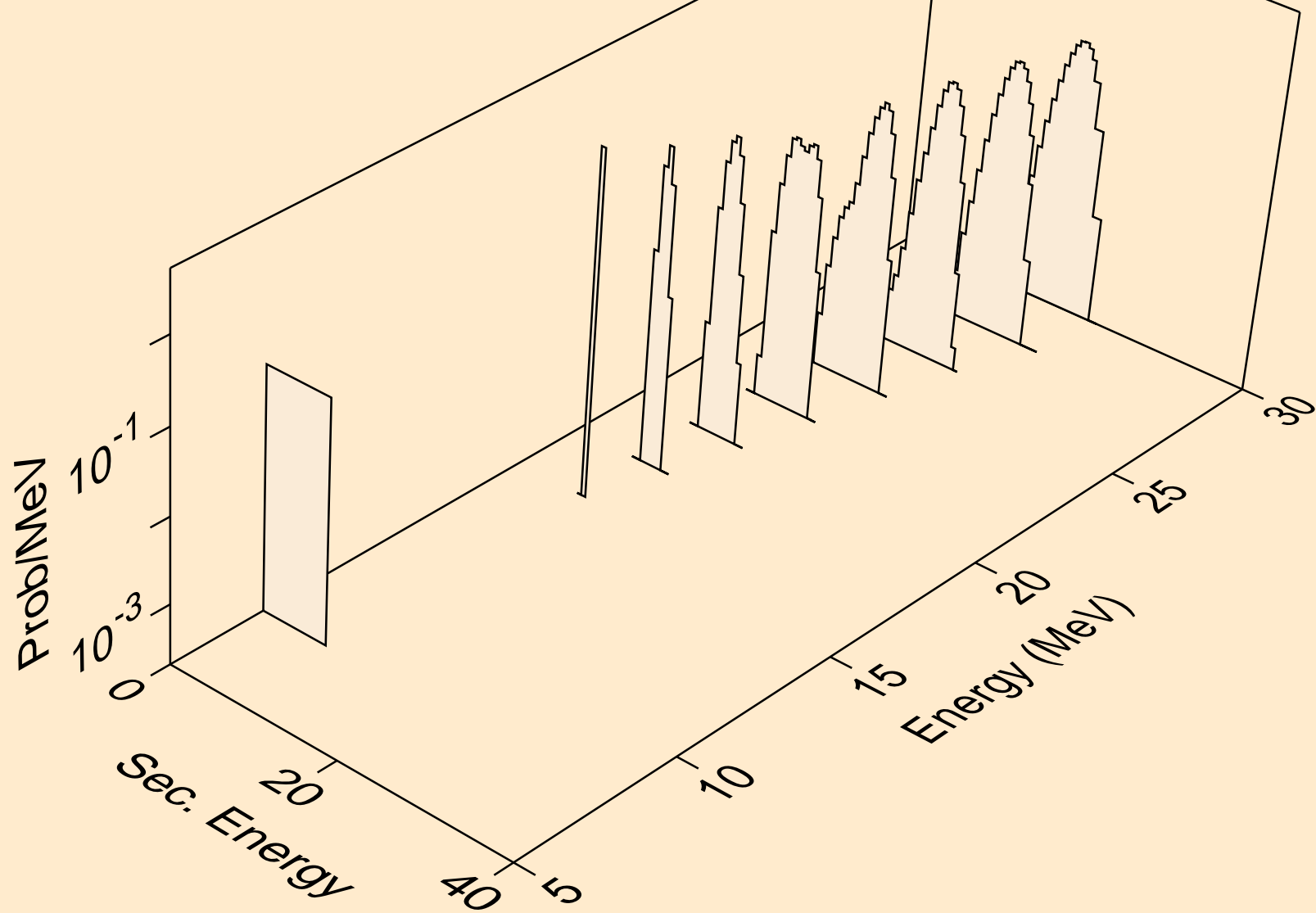

BK238 NEUTRON ACER TENDL-2021 LIBRARY; T=293.6K
alphas from (n,n*)2a

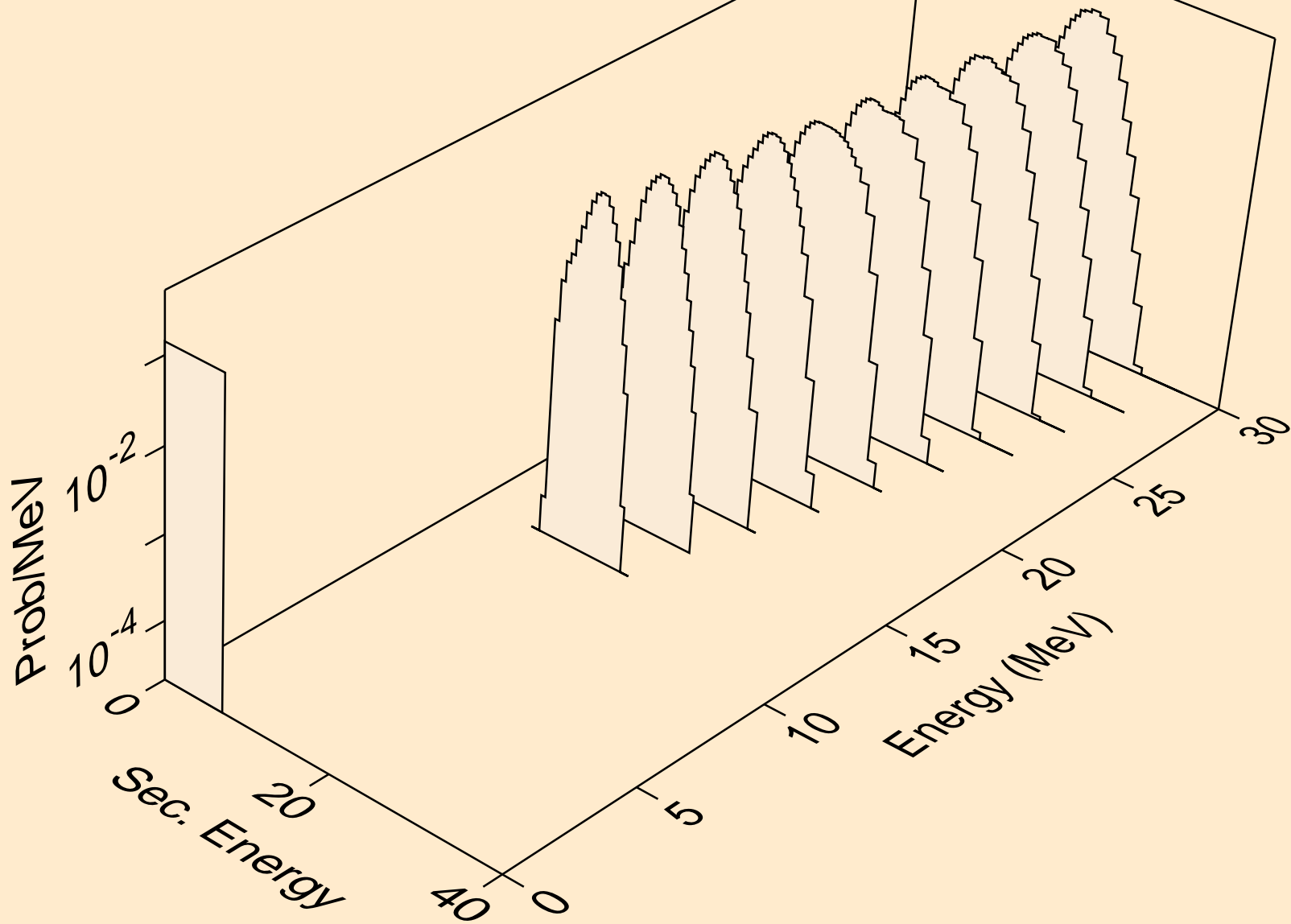

BK238 NEUTRON ACER TENDL-2021 LIBRARY; T=293.6K
alphas from (n,2n)2a

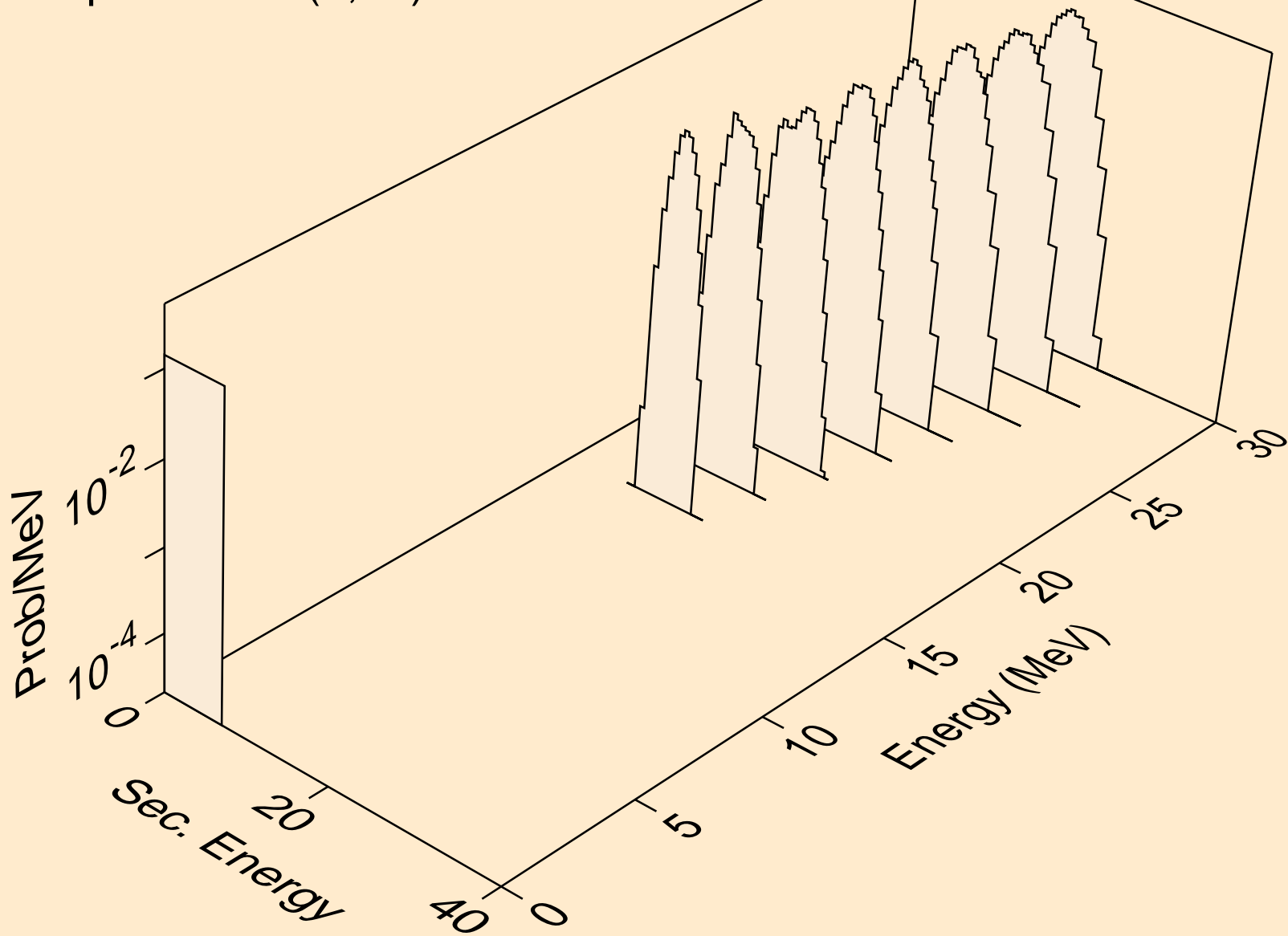

BK238 NEUTRON ACER TENDL-2021 LIBRARY; T=293.6K
alphas from (n,npa)

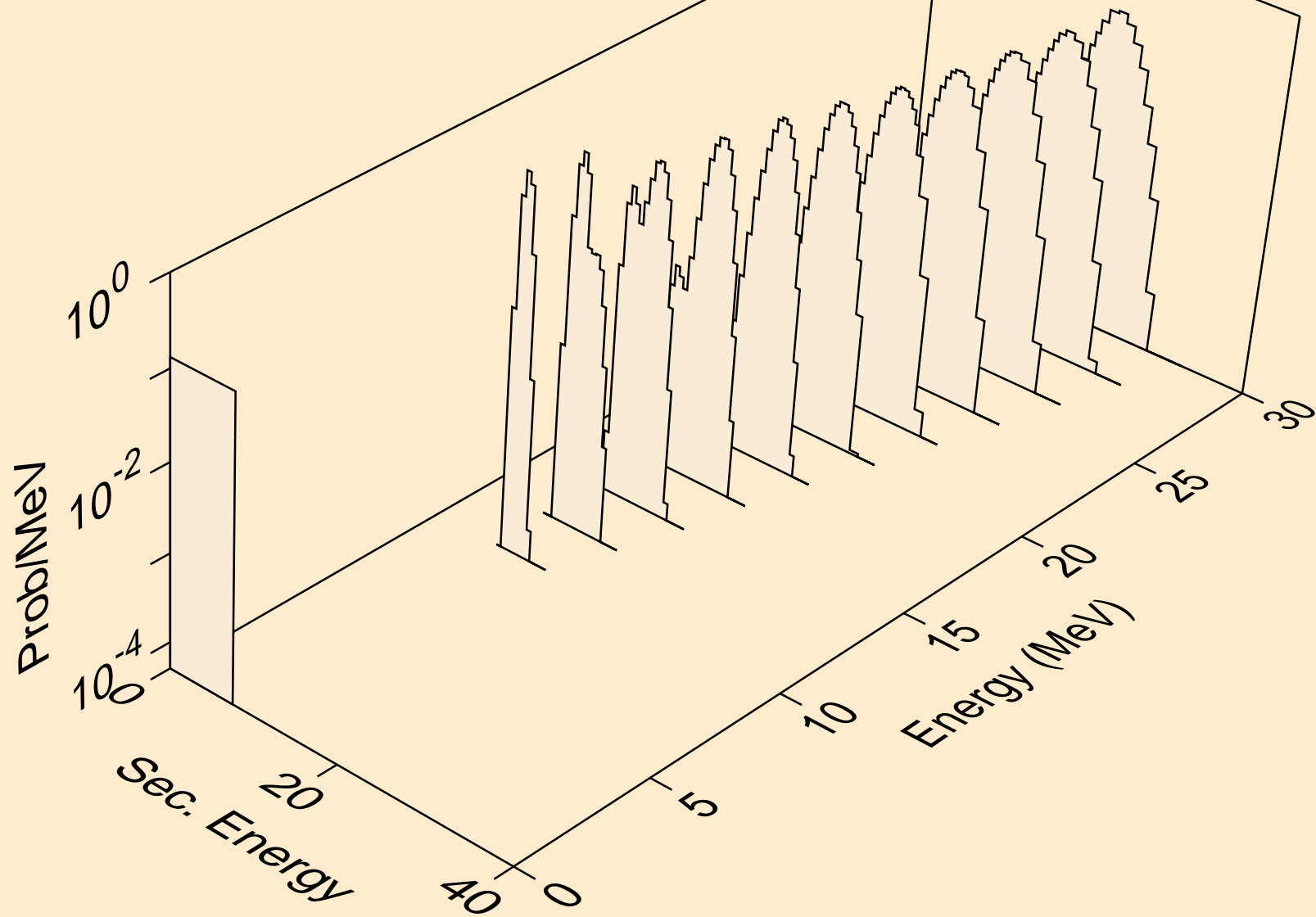

BK238 NEUTRON ACER TENDL-2021 LIBRARY; T=293.6K
alphas from (n,a)

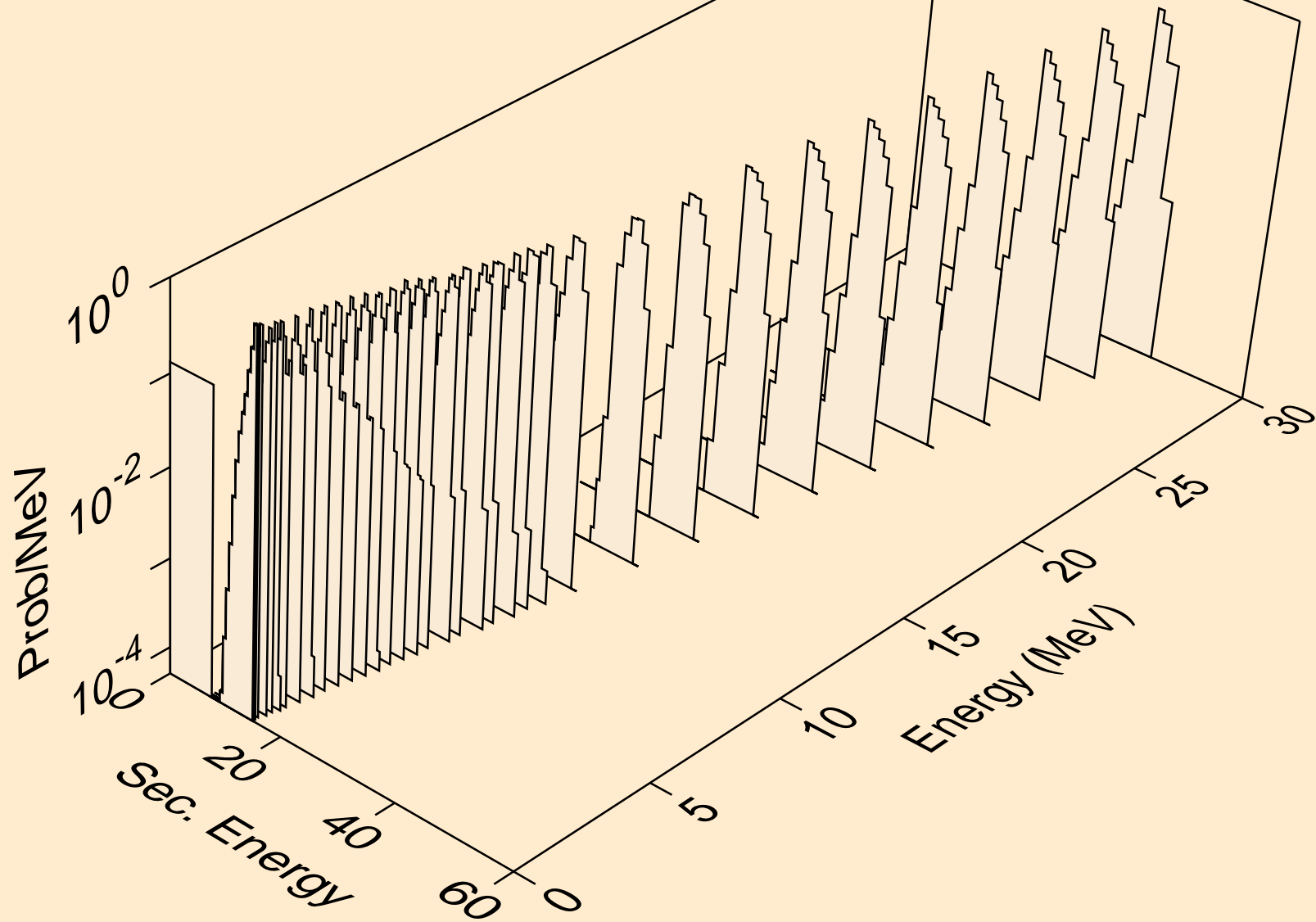

BK238 NEUTRON ACER TENDL-2021 LIBRARY; T=293.6K
alphas from (n,2a)

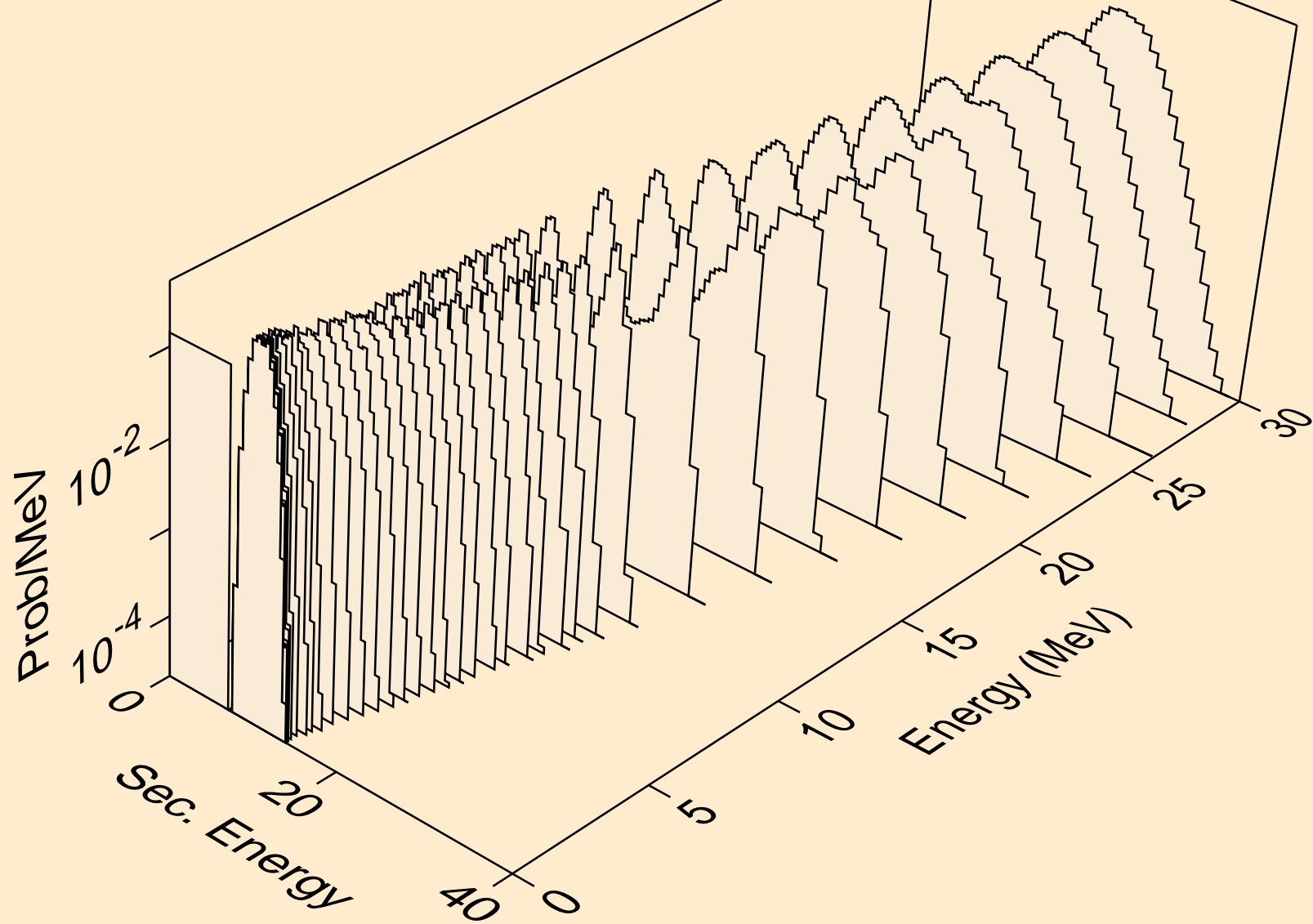

BK238 NEUTRON ACER TENDL-2021 LIBRARY; T=293.6K
alphas from (n,pa)

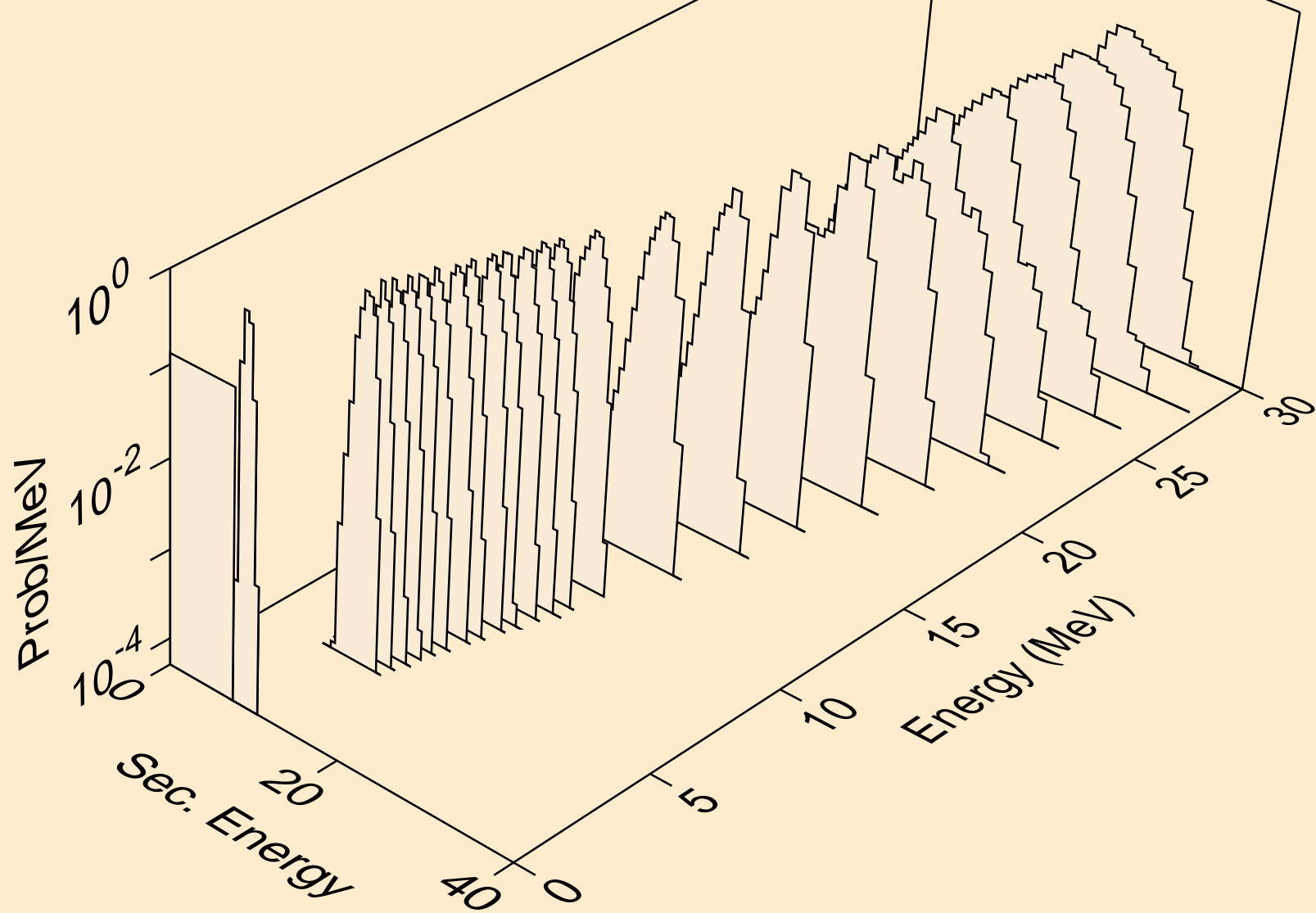

BK238 NEUTRON ACER TENDL-2021 LIBRARY; T=293.6K
alphas from (n,da)

