

BR072M NEUTRON ACER TENDL-2021 LIBRARY; T=293.6K
Principal cross sections

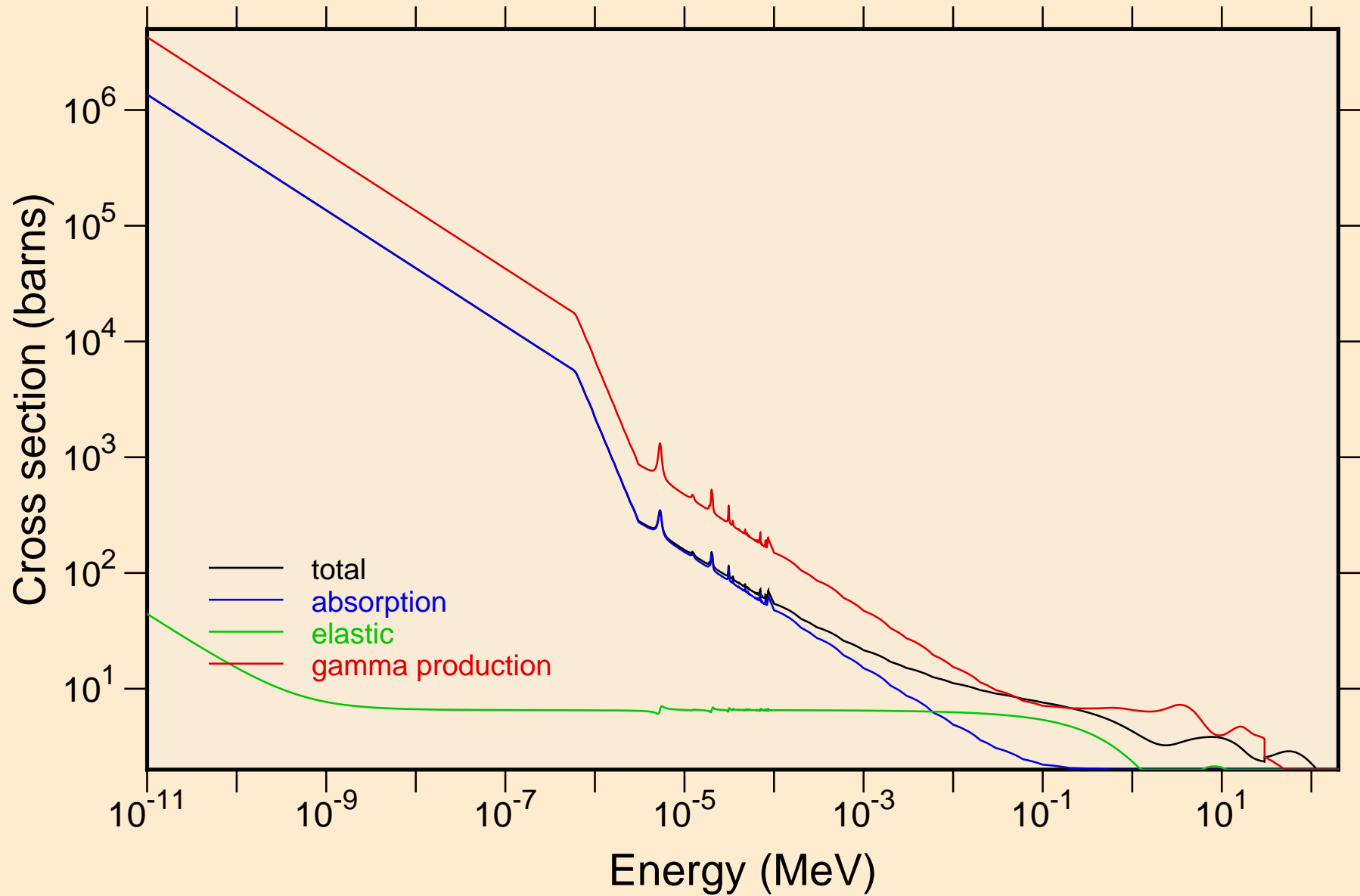

BR072M NEUTRON ACER TENDL-2021 LIBRARY; T=293.6K
resonance total cross section

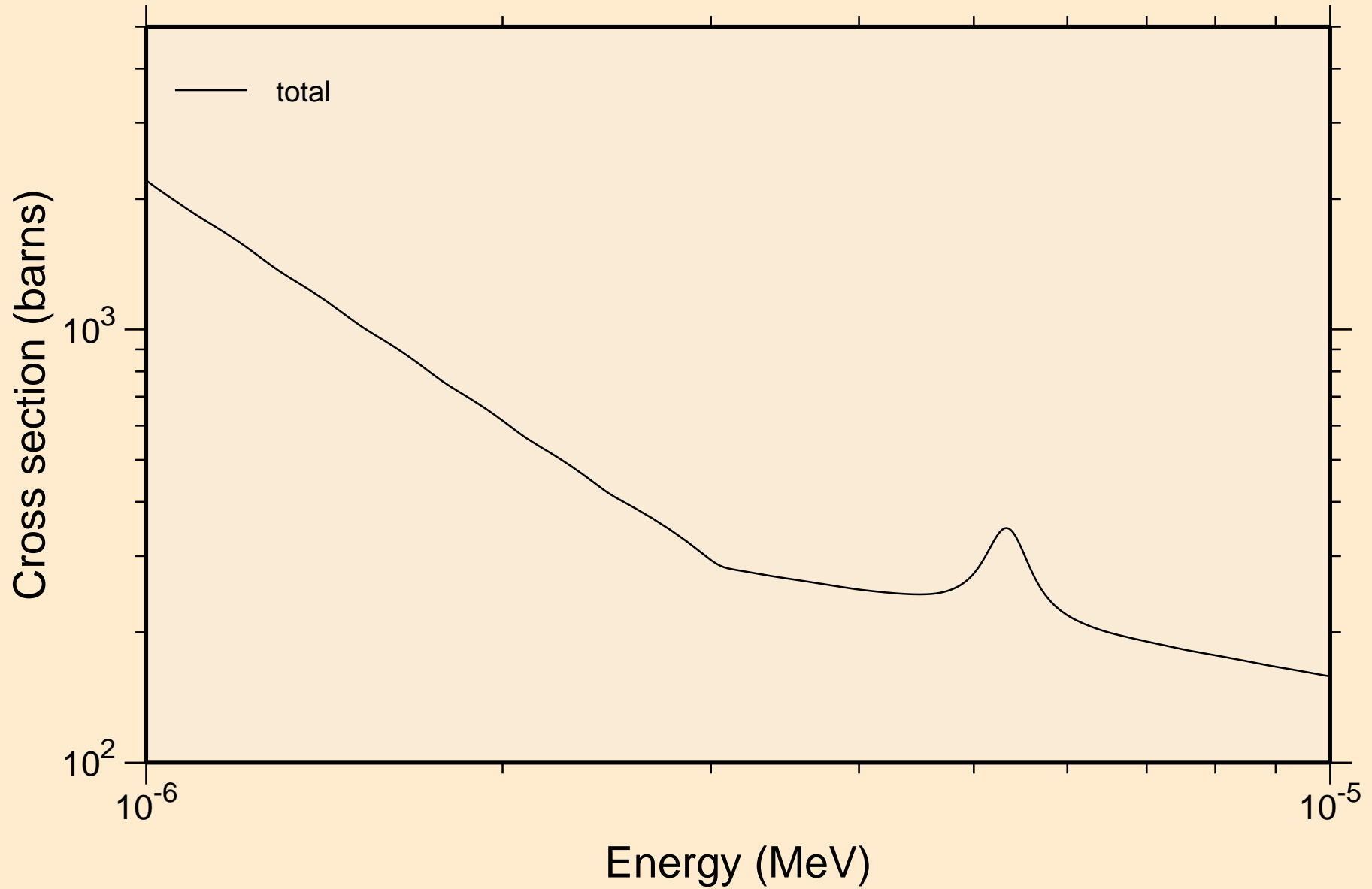

BR072M NEUTRON ACER TENDL-2021 LIBRARY; T=293.6K
resonance total cross section

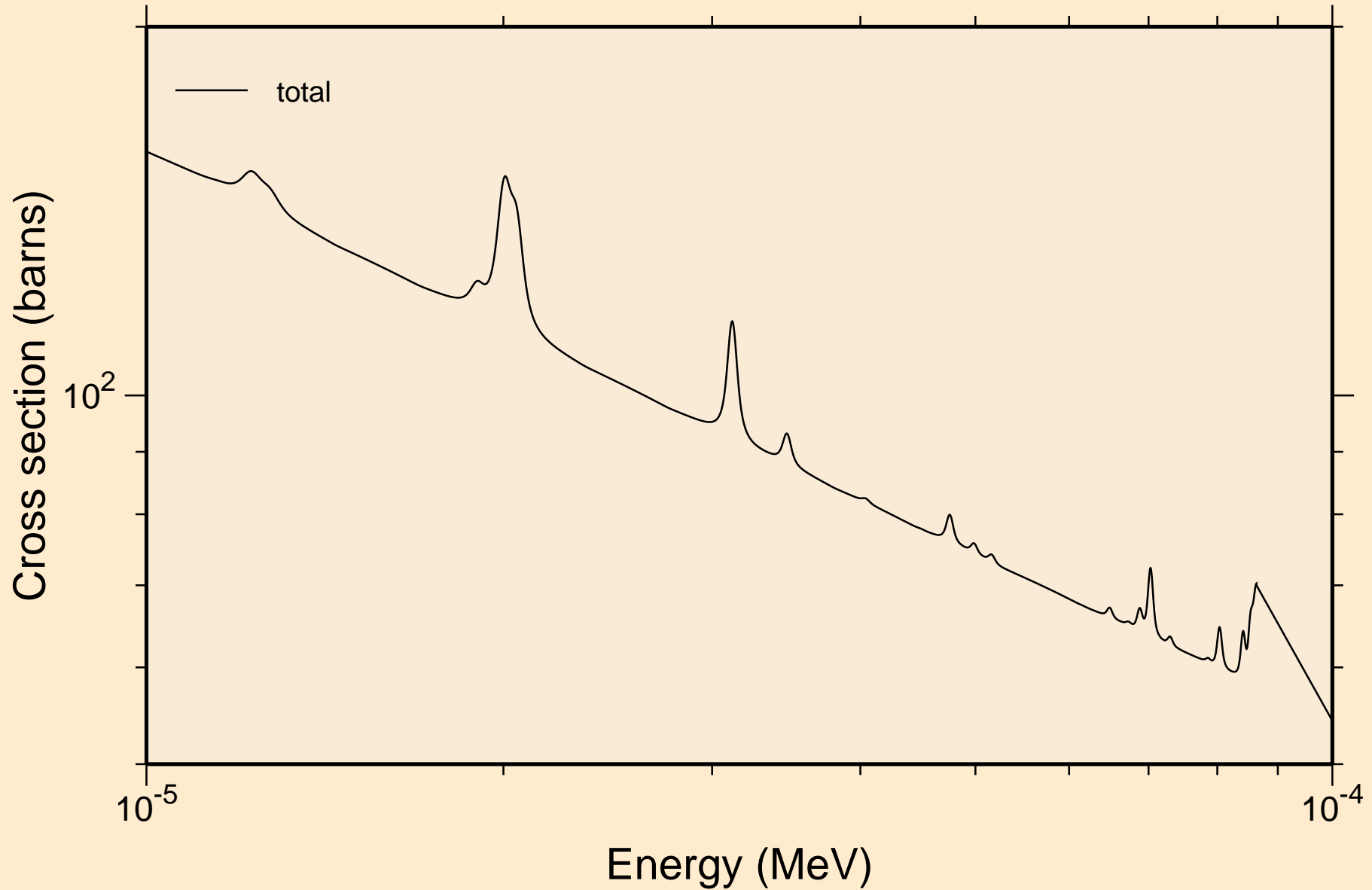

B̄R072M NEUTRON ACER TENDL-2021 LIBRARY; T=293.6K
resonance total cross section

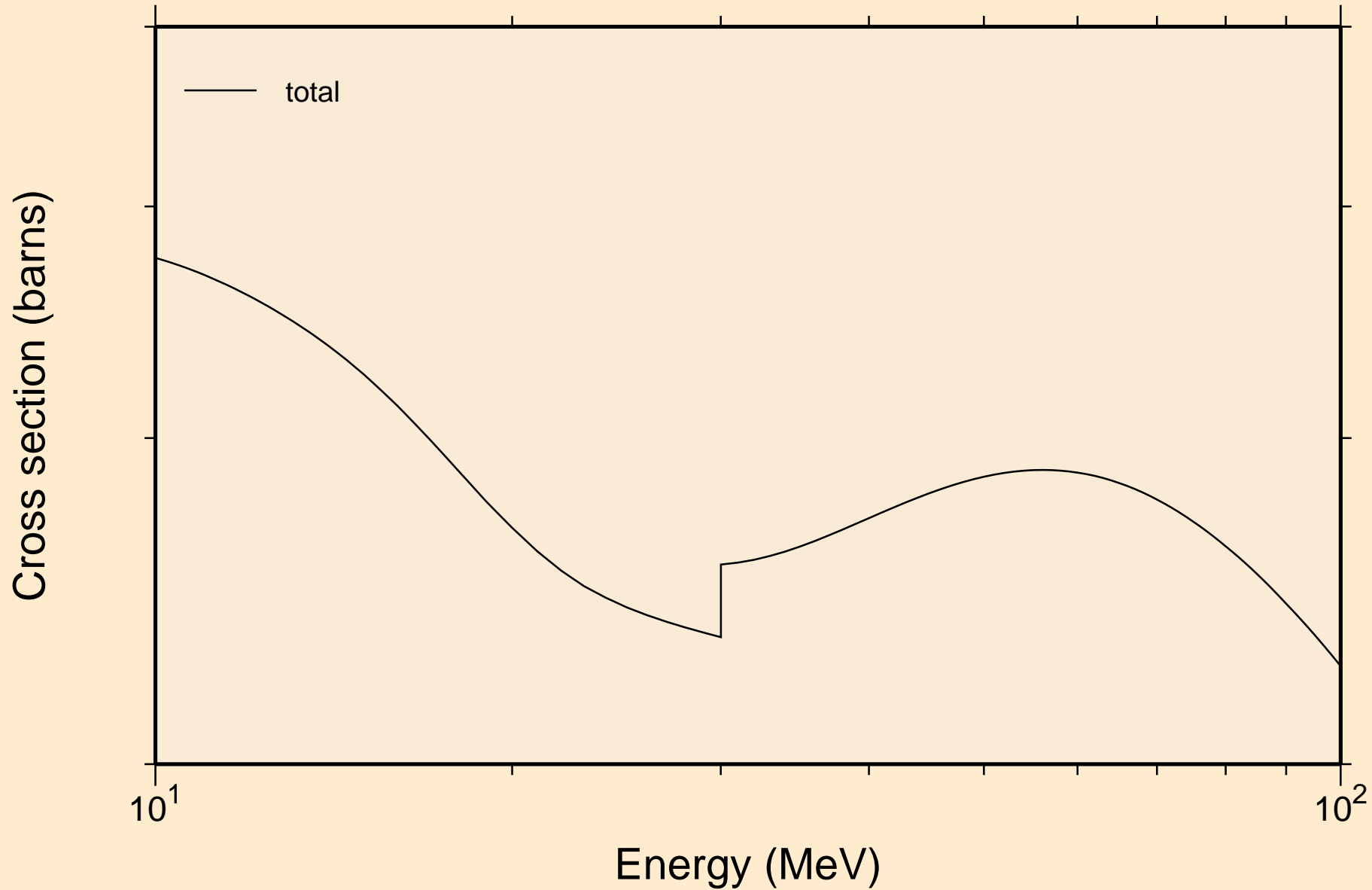

BR072M NEUTRON ACER TENDL-2021 LIBRARY; T=293.6K
resonance absorption cross sections

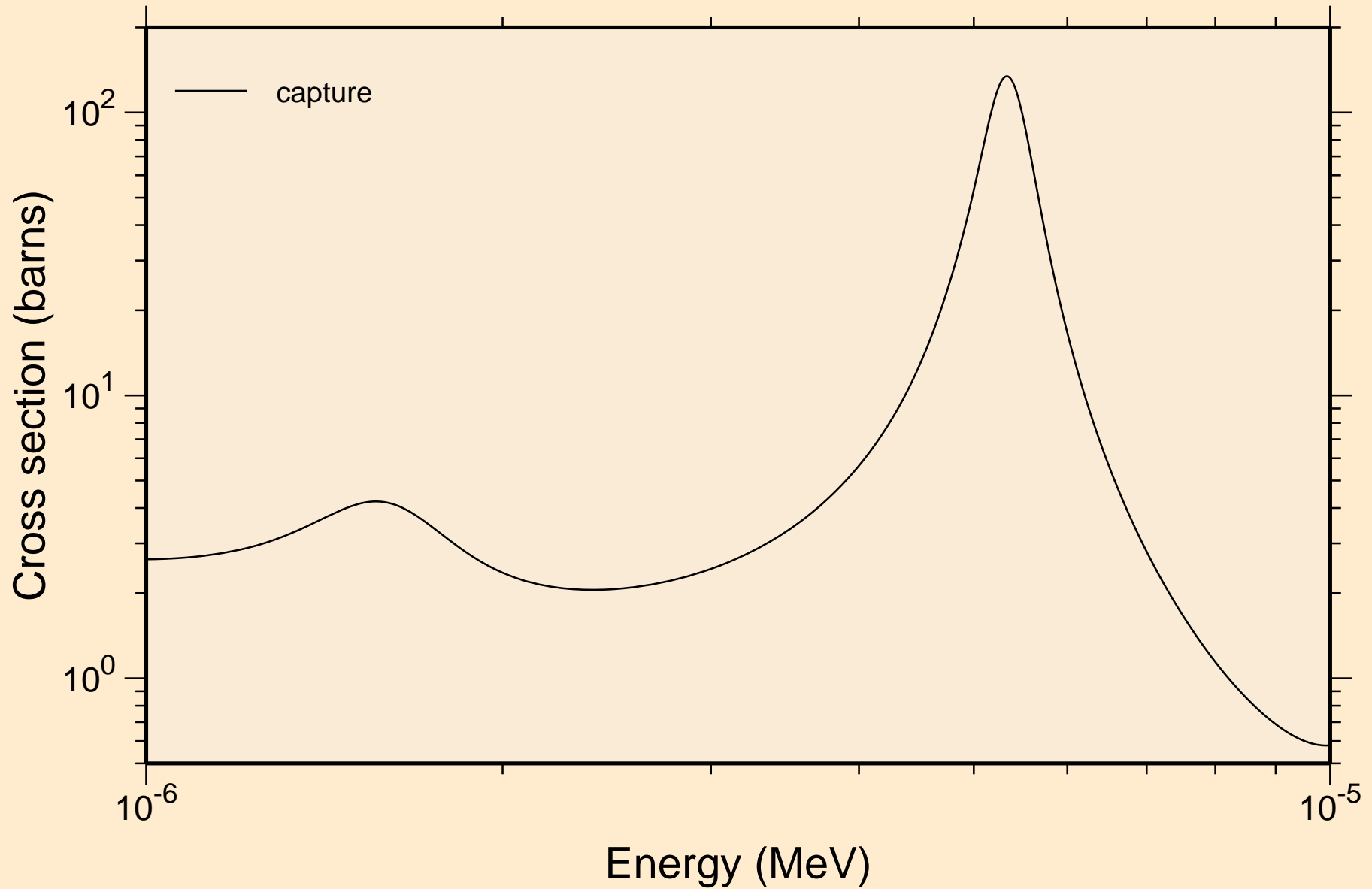

BR072M NEUTRON ACER TENDL-2021 LIBRARY; T=293.6K
resonance absorption cross sections

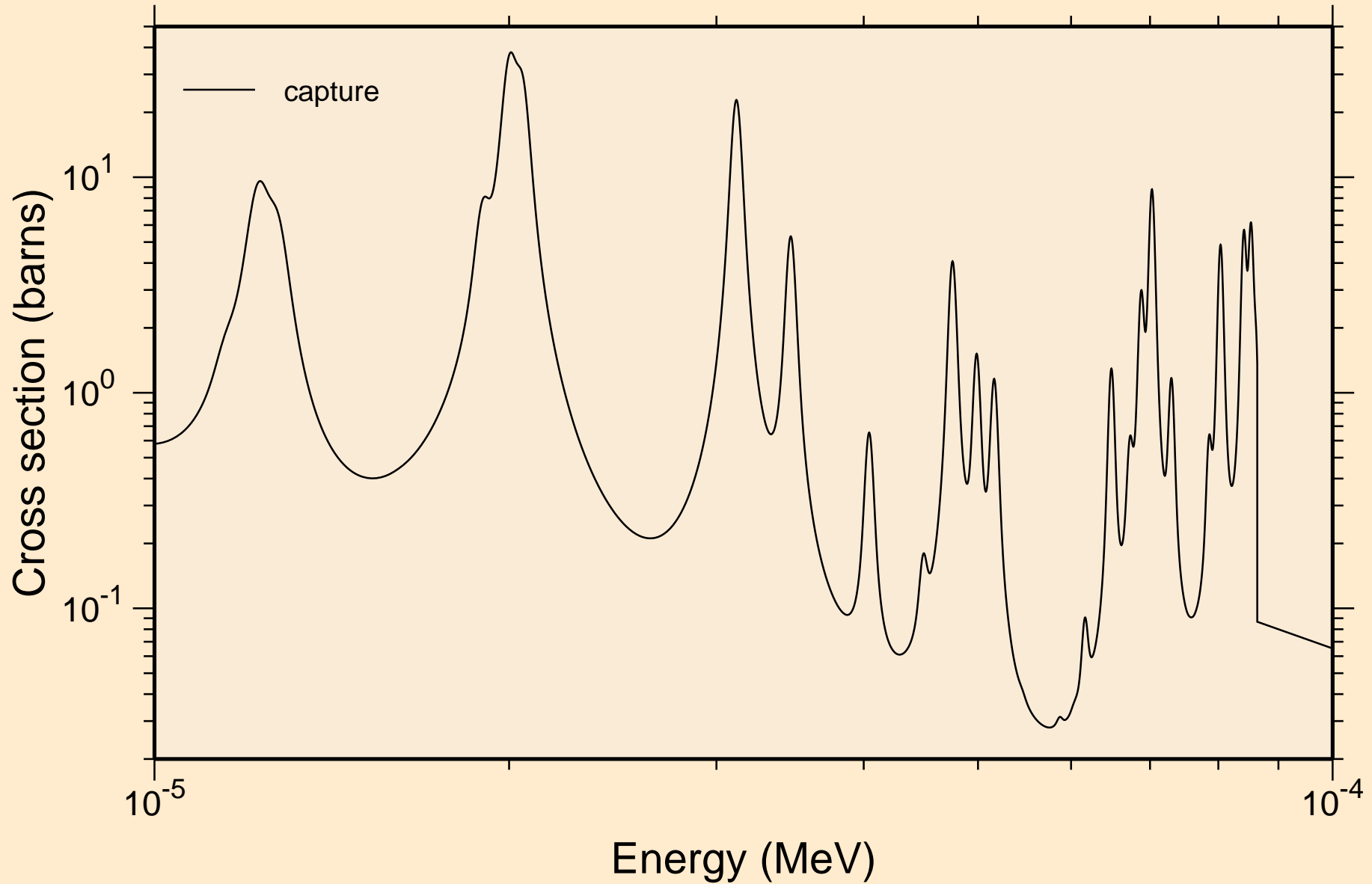

BR072M NEUTRON ACER TENDL-2021 LIBRARY; T=293.6K
resonance absorption cross sections

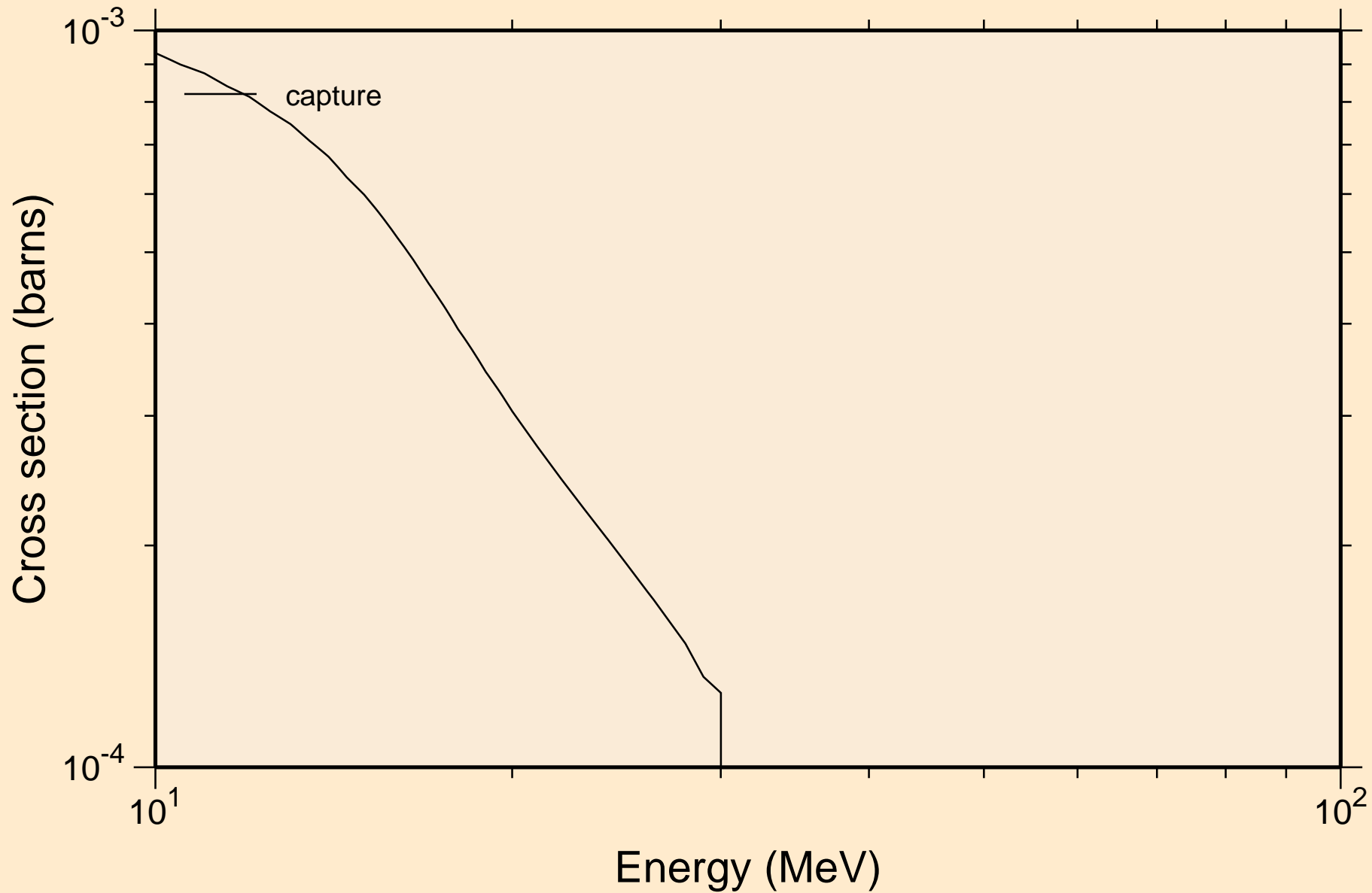

BR072M NEUTRON ACER TENDL-2021 LIBRARY; T=293.6K
Heating

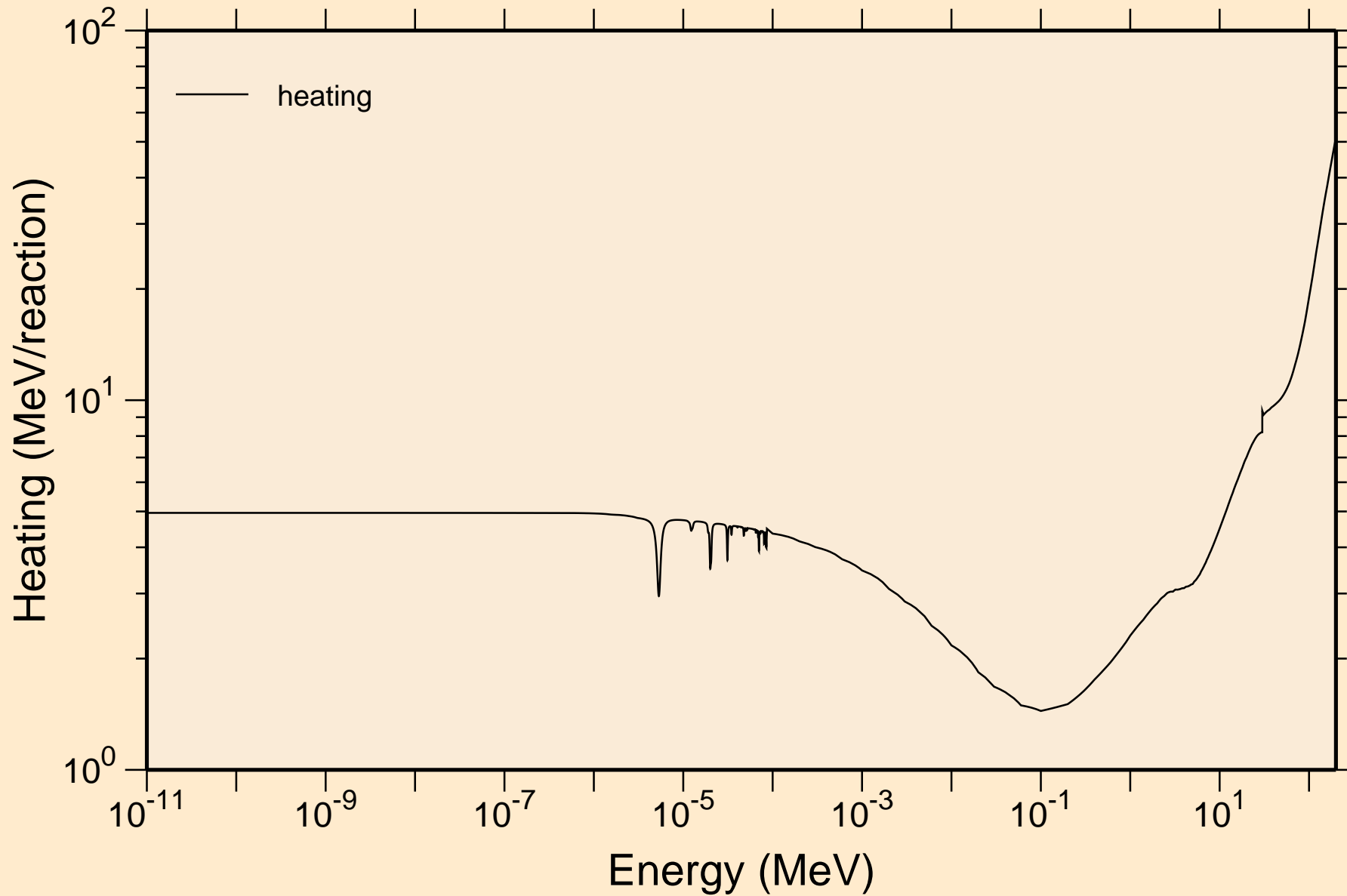

BR072M NEUTRON ACER TENDL-2021 LIBRARY; T=293.6K
Damage

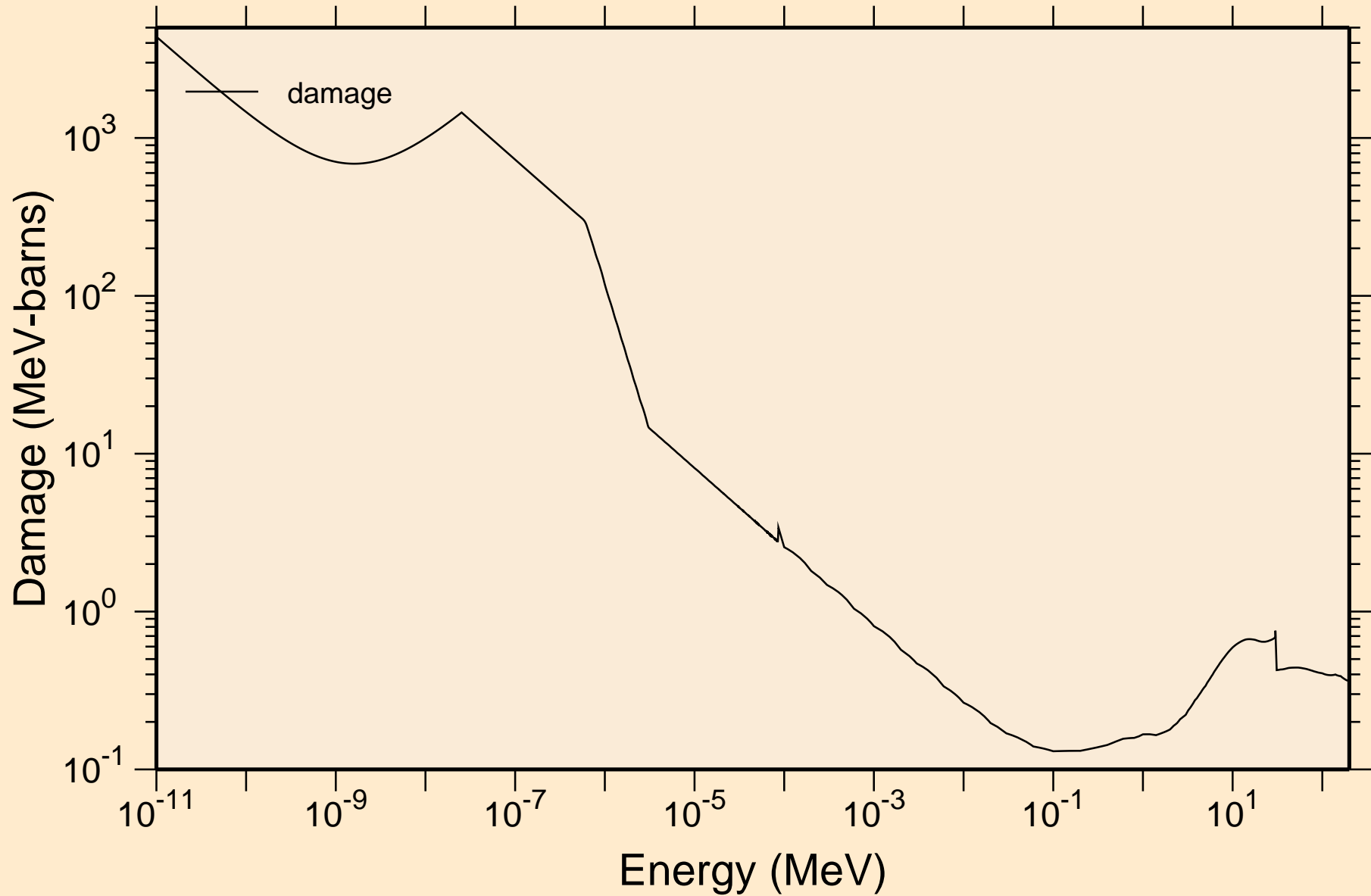

BR072M NEUTRON ACER TENDL-2021 LIBRARY; T=293.6K
Non-threshold reactions

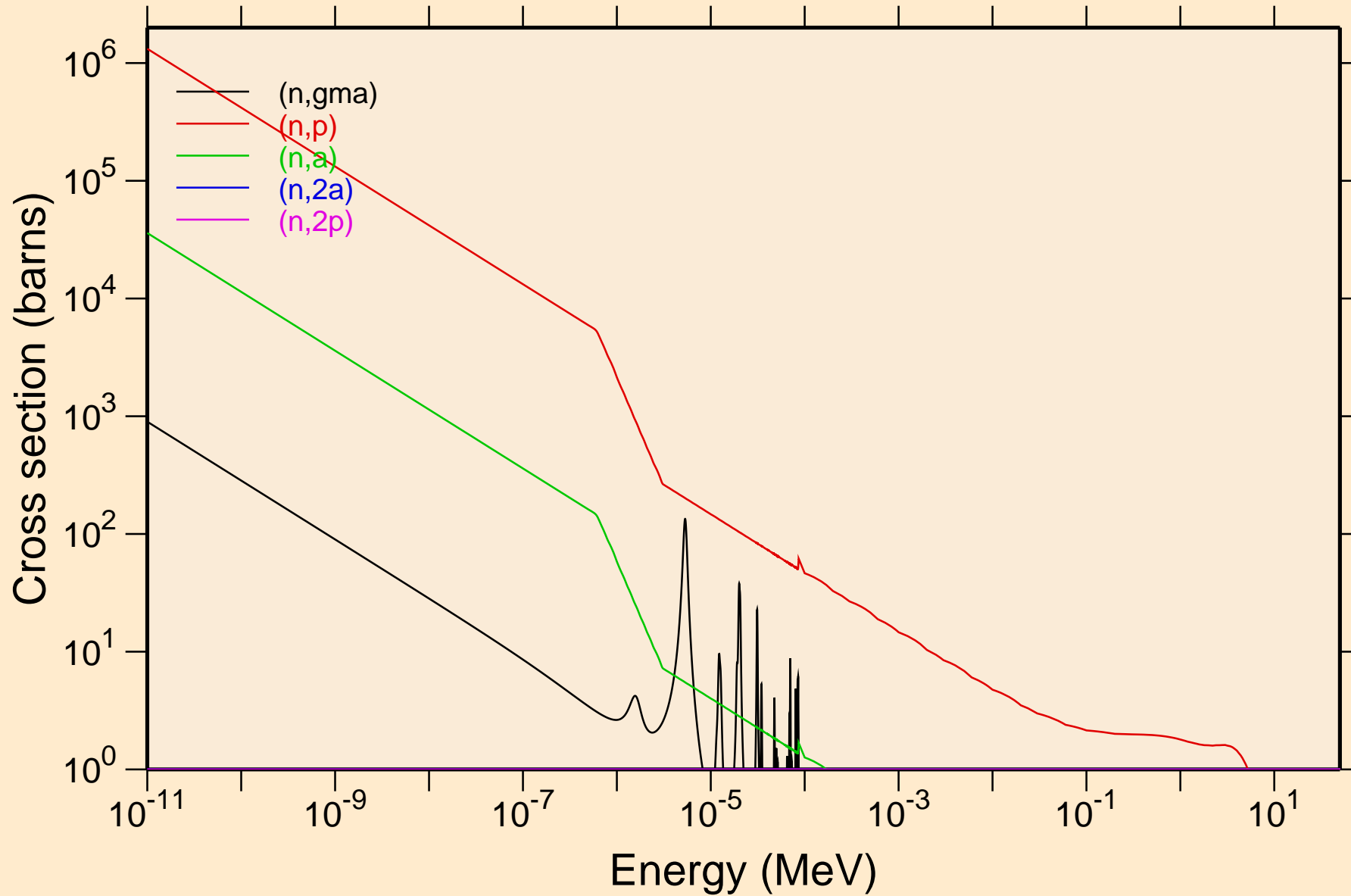

BR072M NEUTRON ACER TENDL-2021 LIBRARY; T=293.6K
Non-threshold reactions

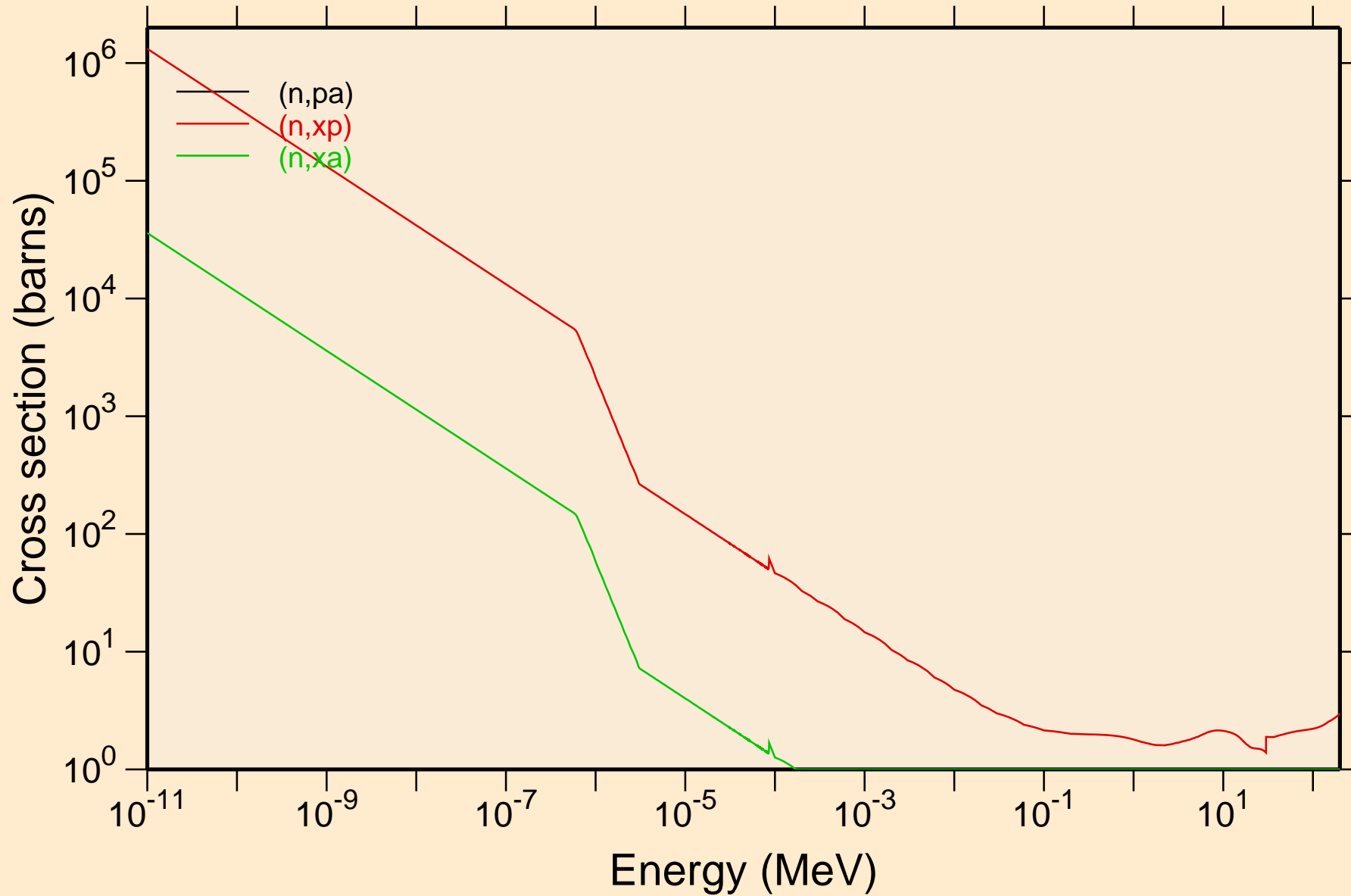

BR072M NEUTRON ACER TENDL-2021 LIBRARY; T=293.6K
Principal cross sections

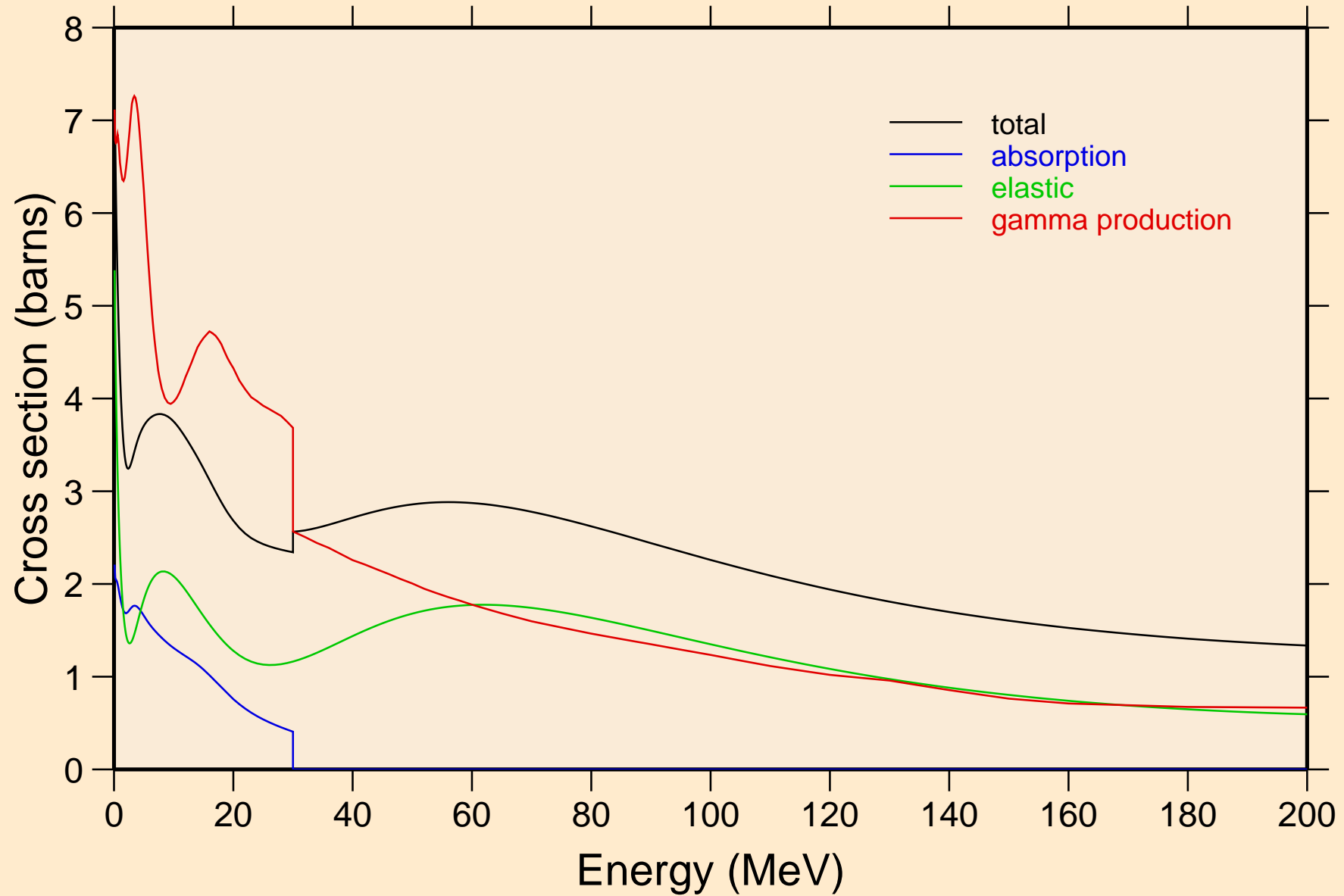

BR072M NEUTRON ACER TENDL-2021 LIBRARY; T=293.6K
Heating

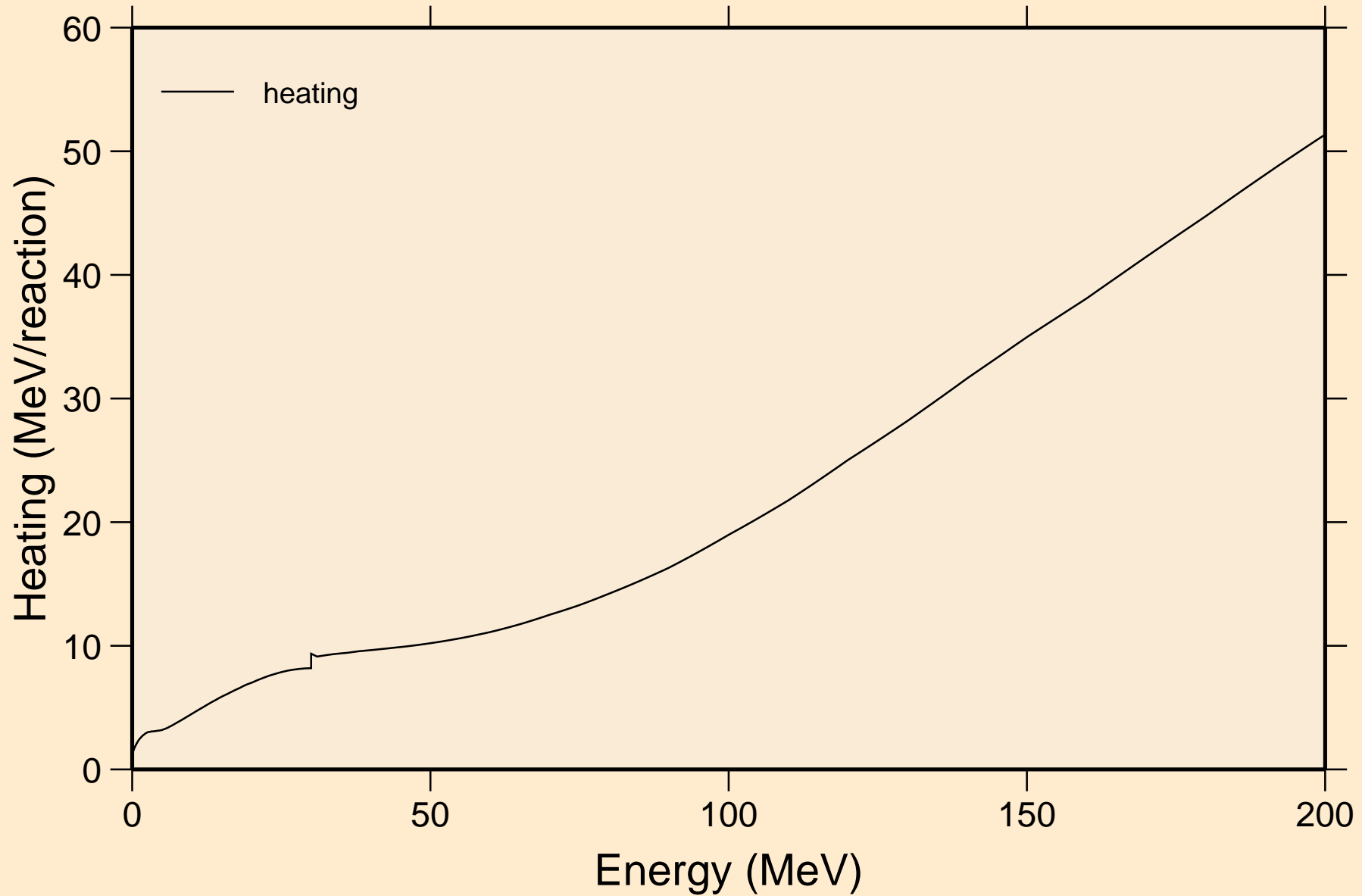

BR072M NEUTRON ACER TENDL-2021 LIBRARY; T=293.6K
Damage

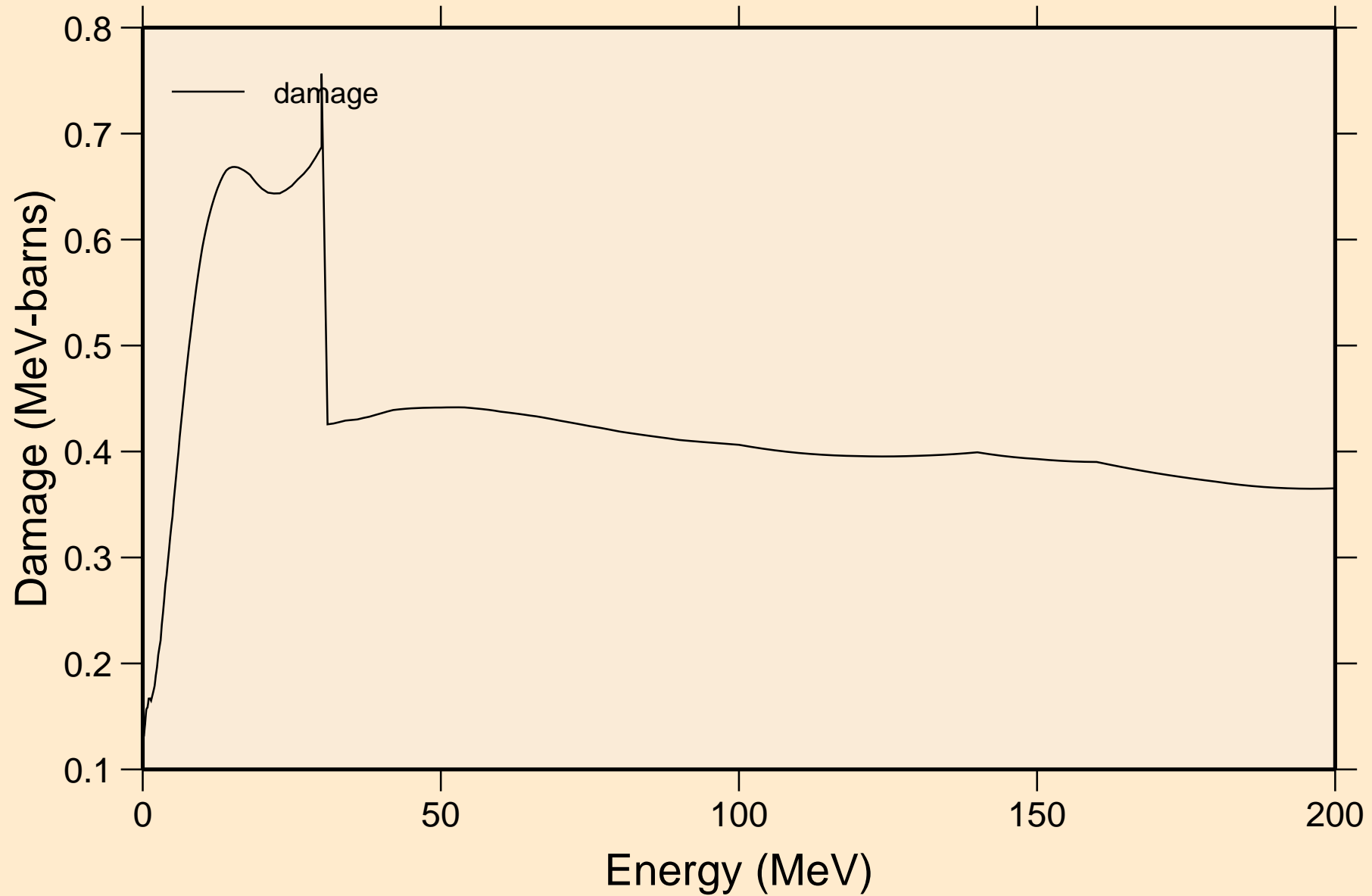

BR072M NEUTRON ACER TENDL-2021 LIBRARY; T=293.6K
Non-threshold reactions

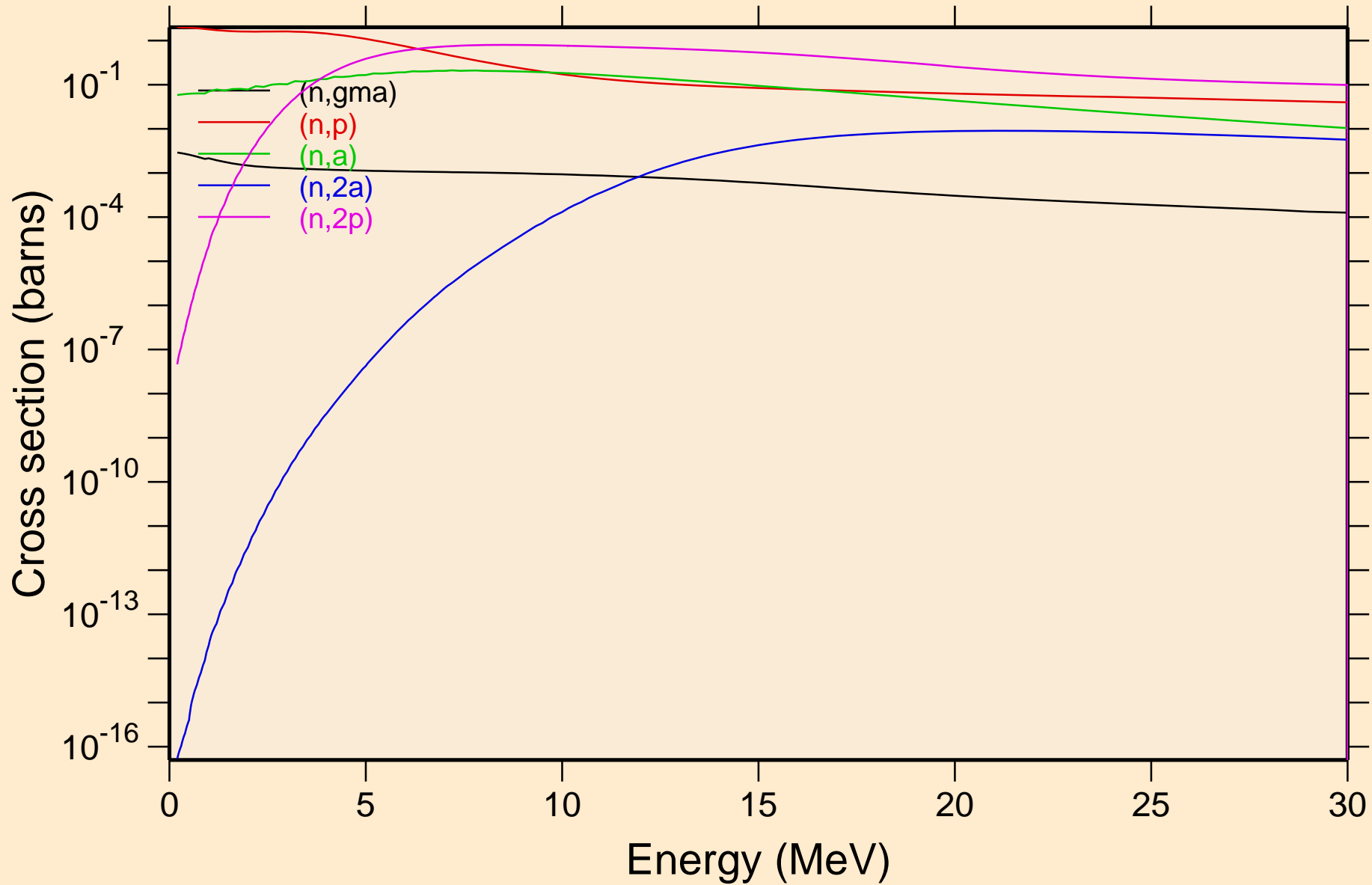

BR072M NEUTRON ACER TENDL-2021 LIBRARY; T=293.6K
Non-threshold reactions

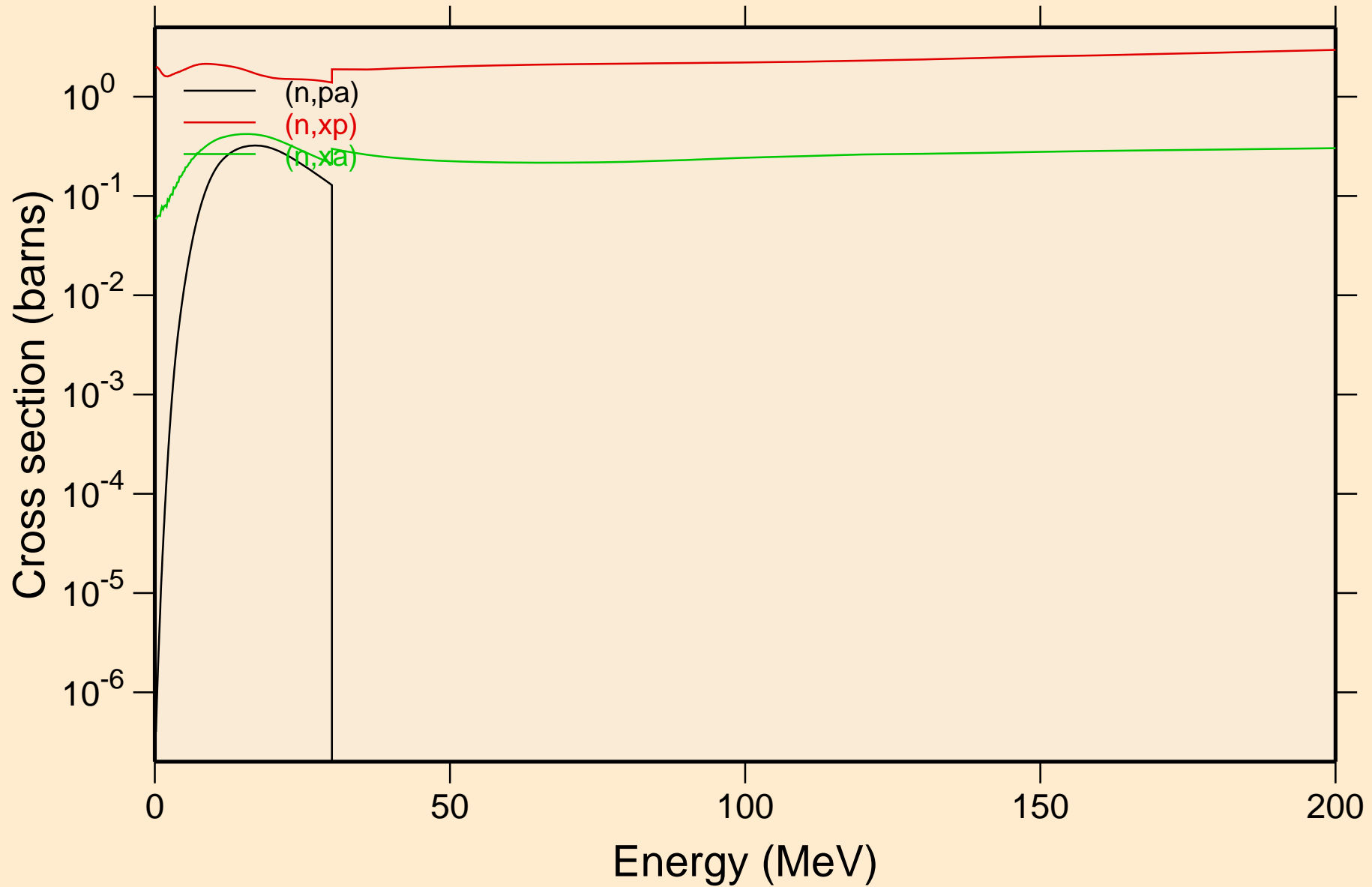

BR072M NEUTRON ACER TENDL-2021 LIBRARY; T=293.6K
Inelastic levels

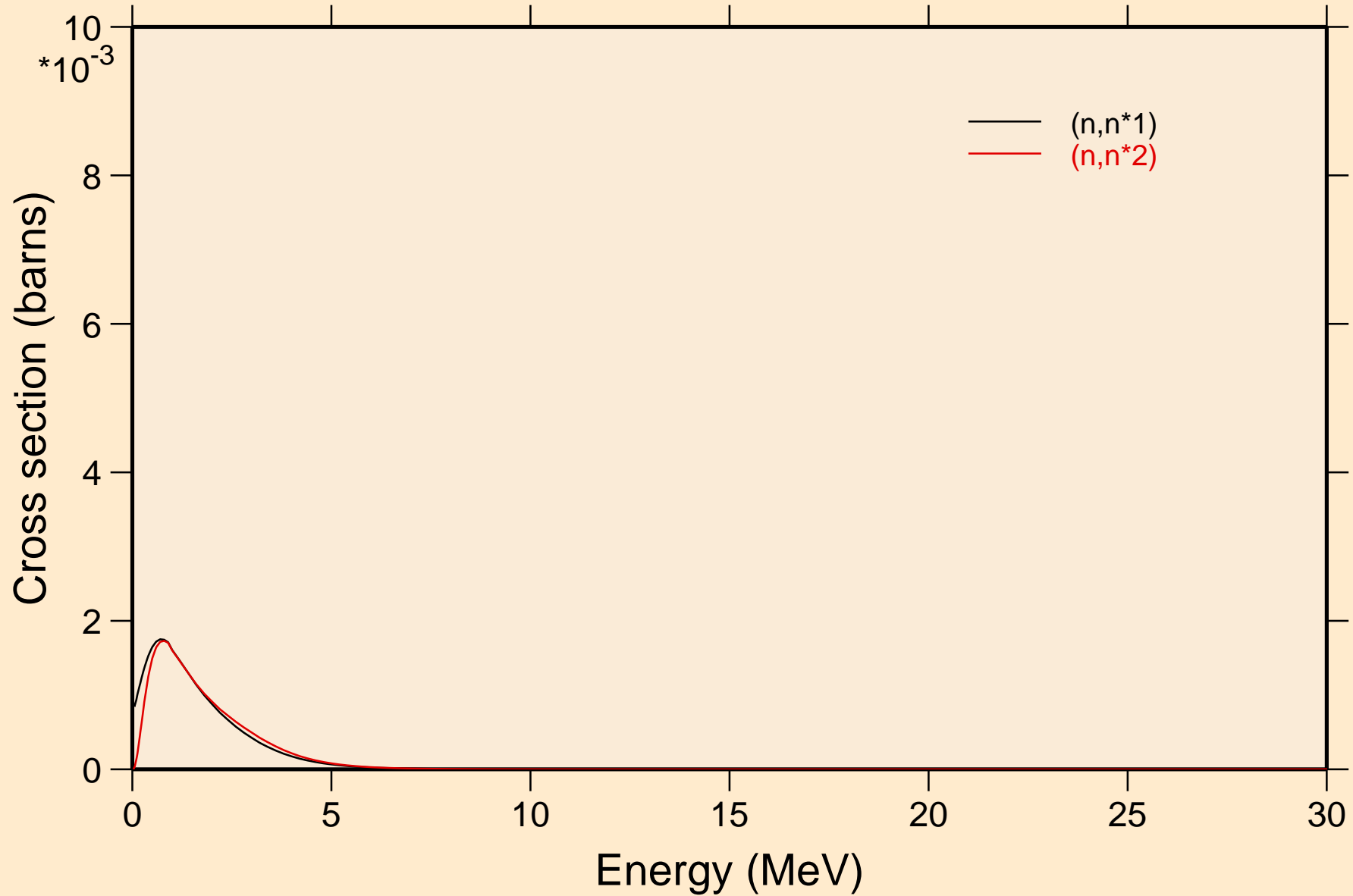

BR072M NEUTRON ACER TENDL-2021 LIBRARY; T=293.6K
Threshold reactions

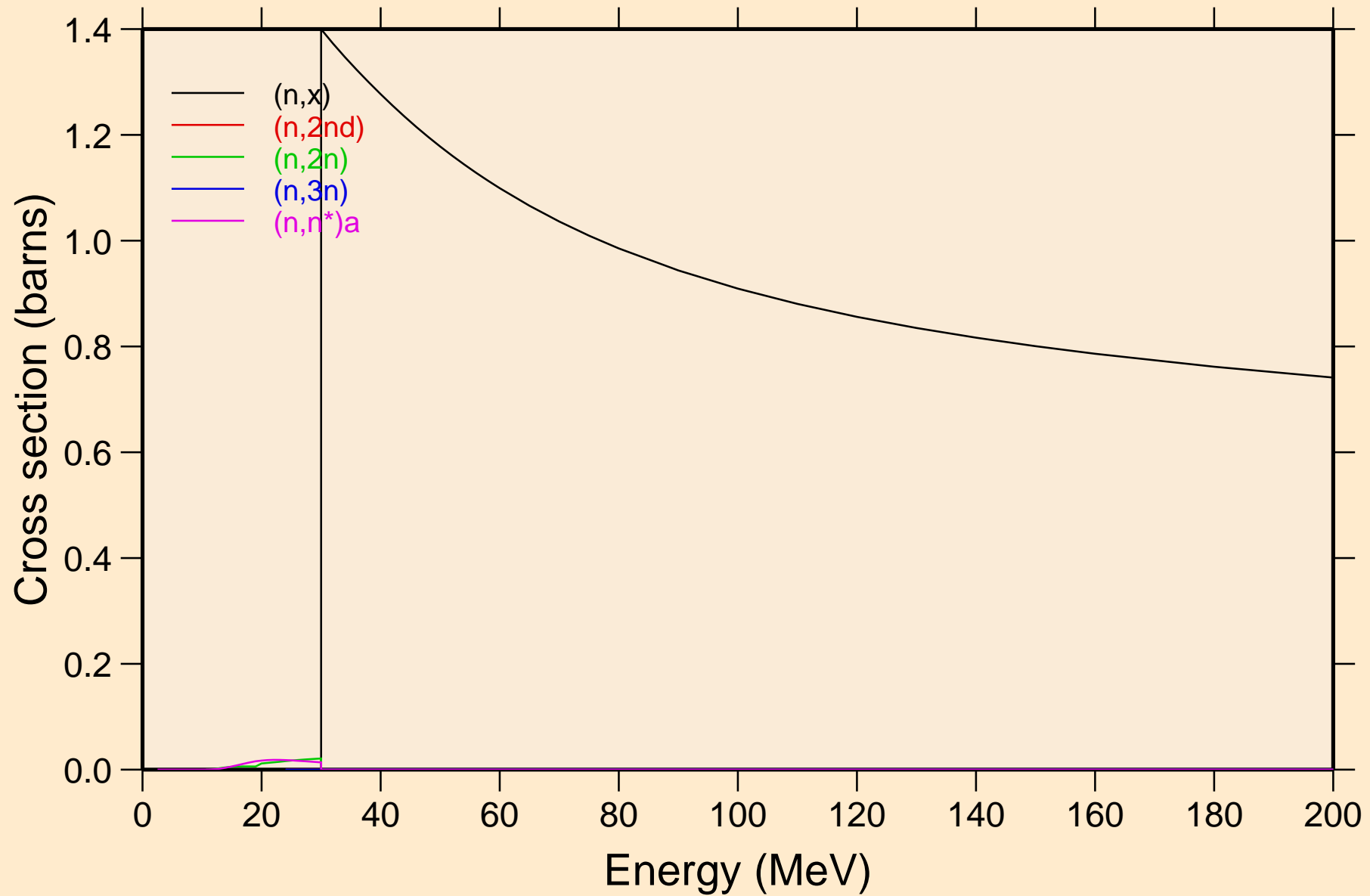

BR072M NEUTRON ACER TENDL-2021 LIBRARY; T=293.6K
Threshold reactions

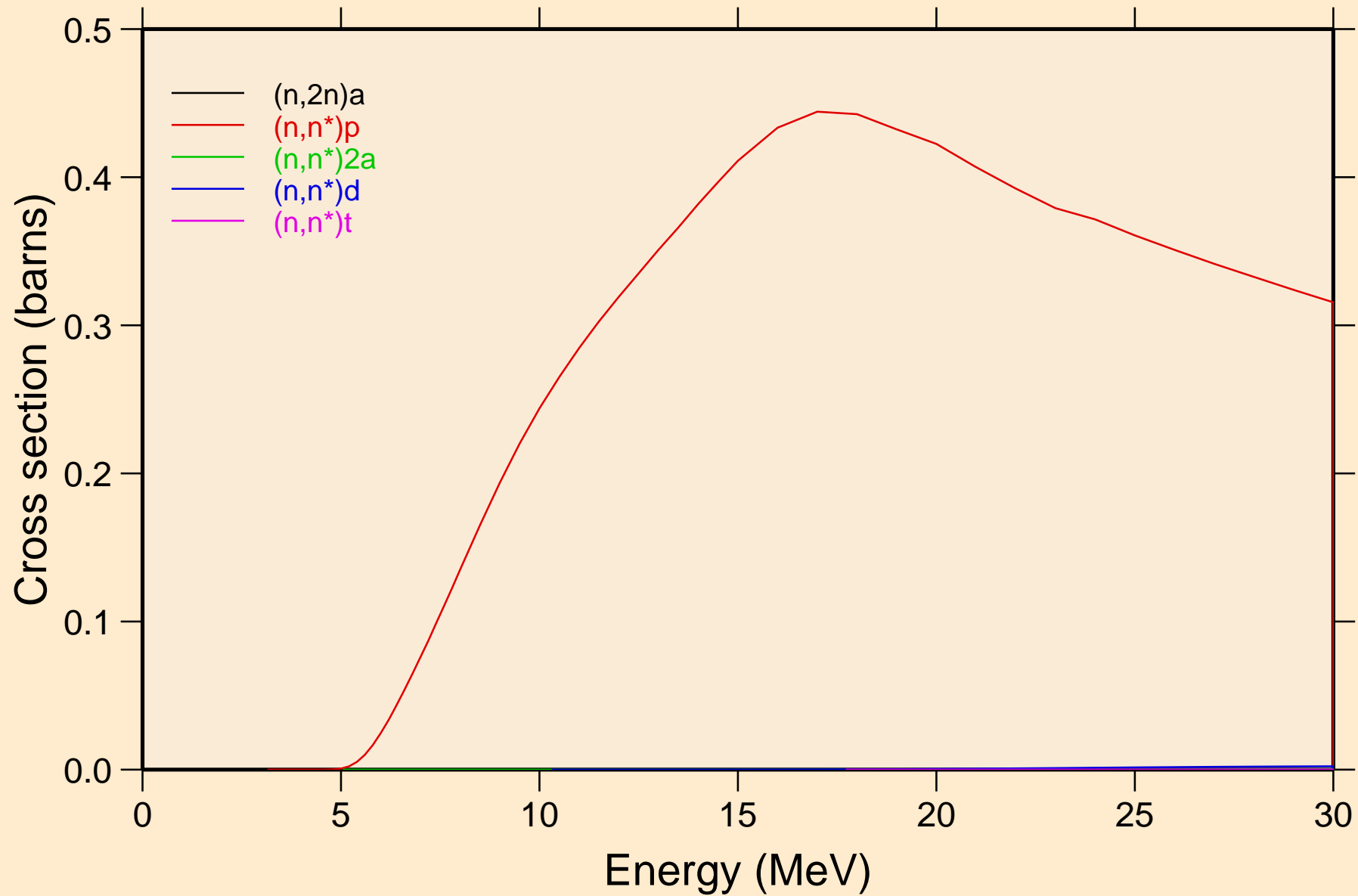

BR072M NEUTRON ACER TENDL-2021 LIBRARY; T=293.6K
Threshold reactions

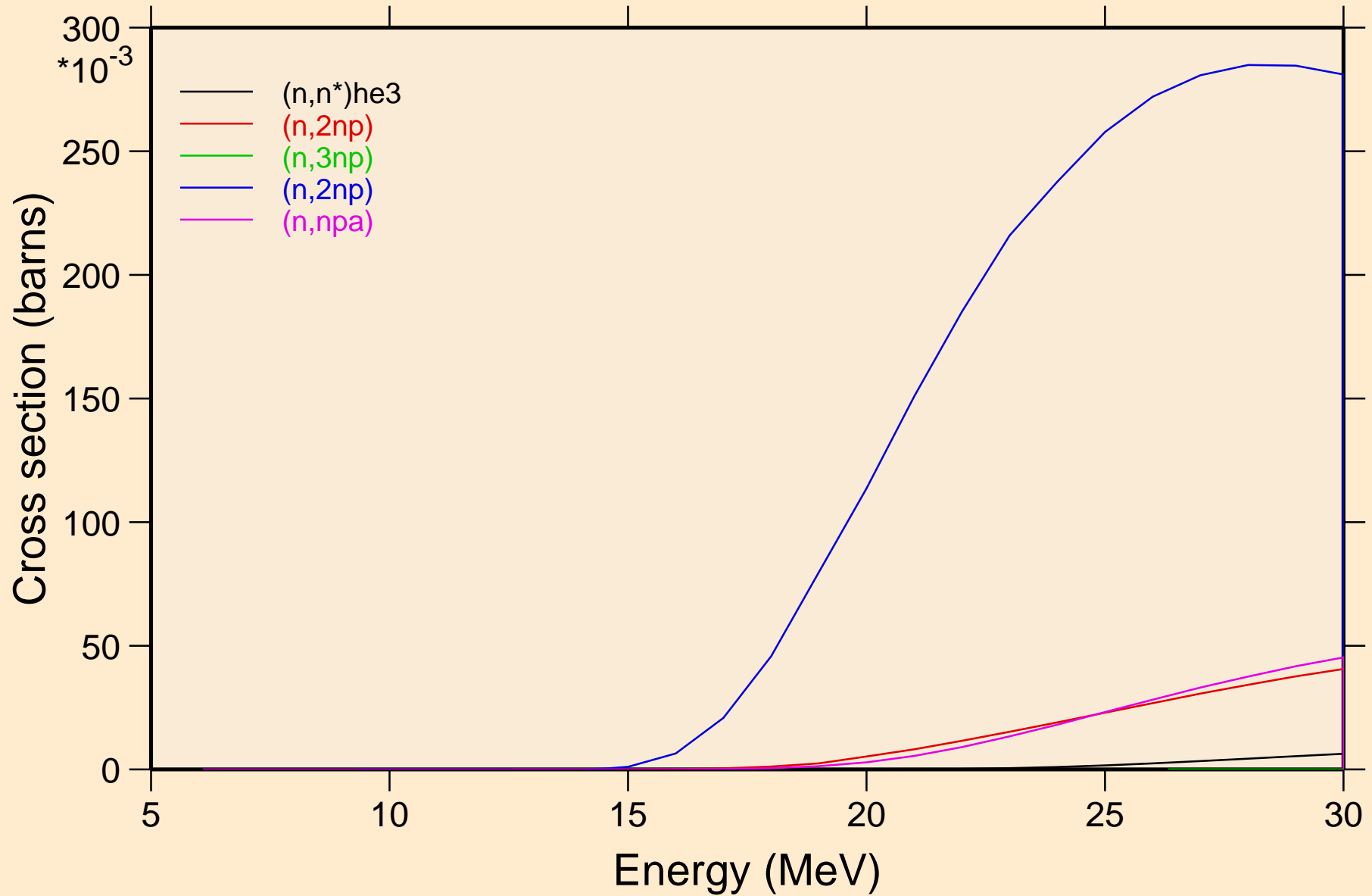

BR072M NEUTRON ACER TENDL-2021 LIBRARY; T=293.6K
Threshold reactions

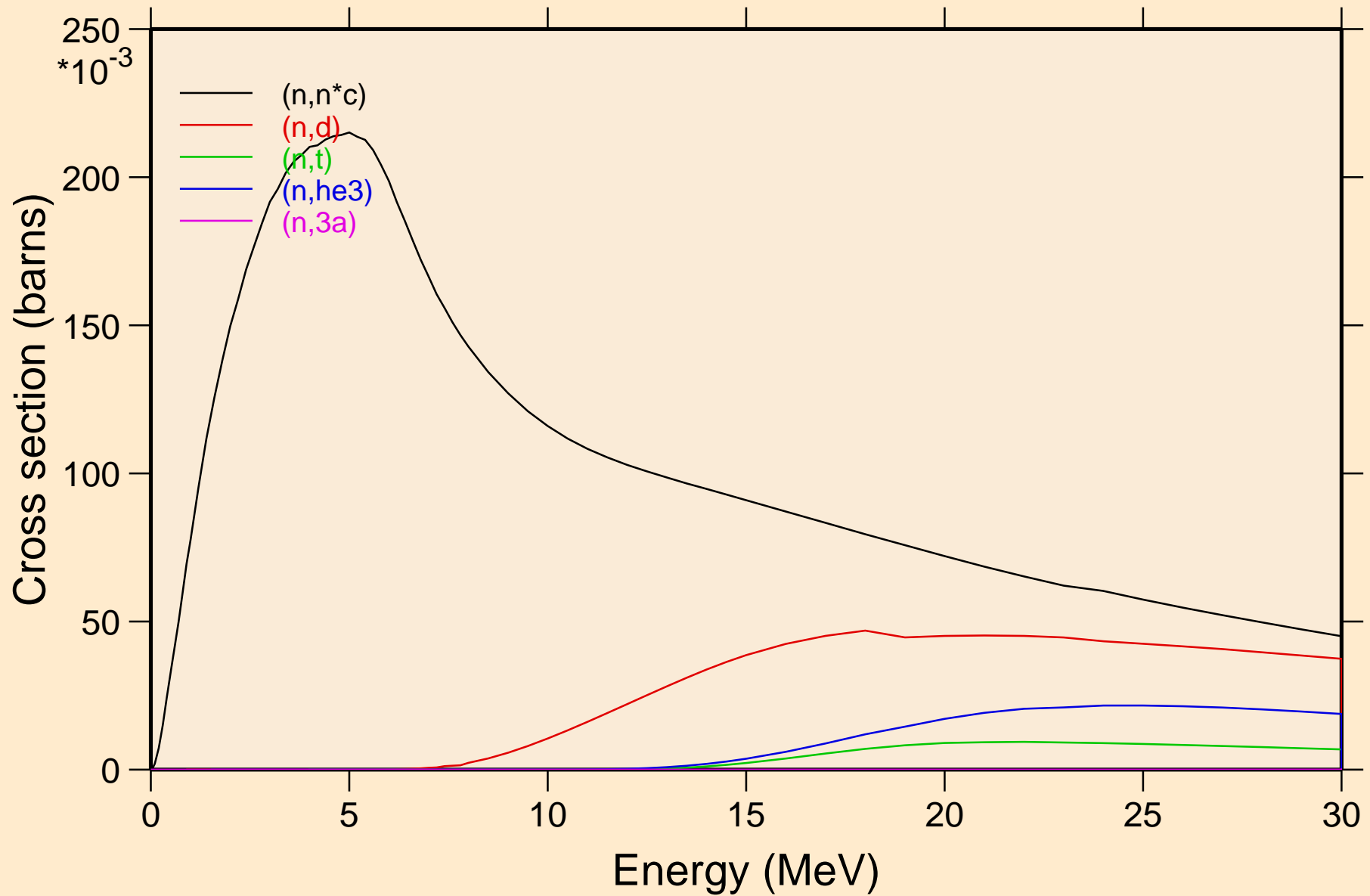

BR072M NEUTRON ACER TENDL-2021 LIBRARY; T=293.6K
Threshold reactions

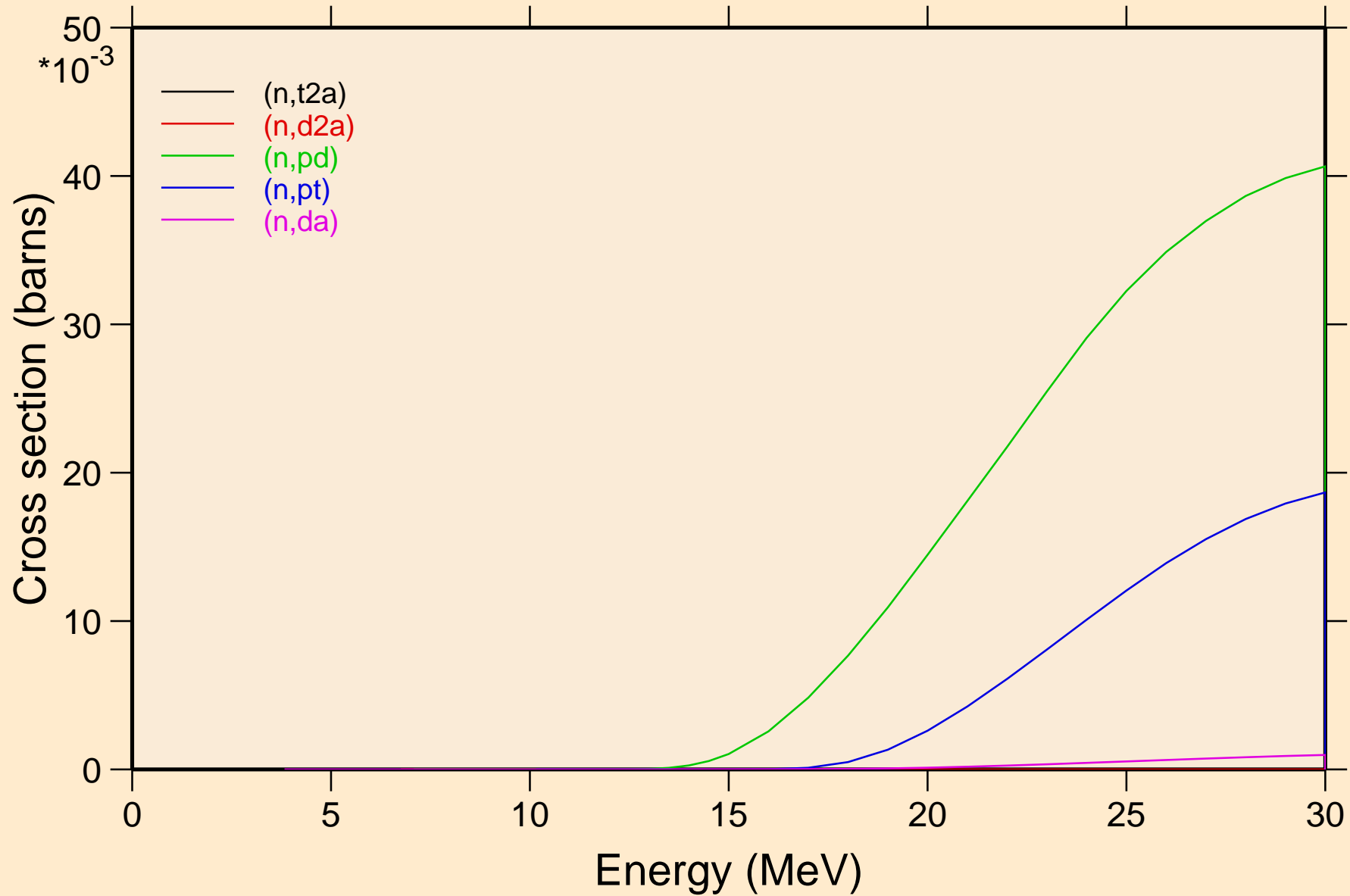

BR072M NEUTRON ACER TENDL-2021 LIBRARY; T=293.6K
Threshold reactions

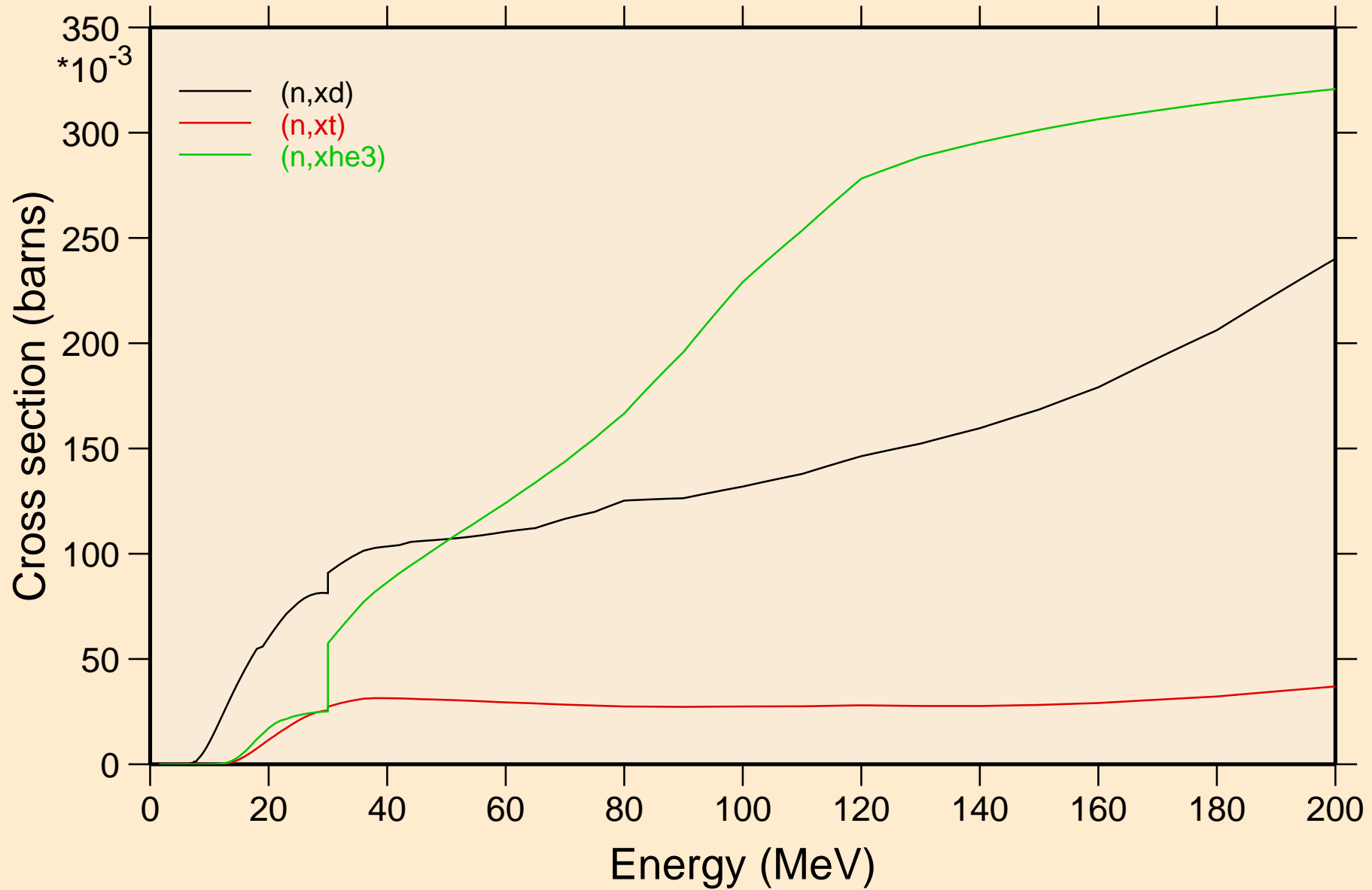

BR072M NEUTRON ACER TENDL-2021 LIBRARY; T=293.6K
angular distribution for elastic

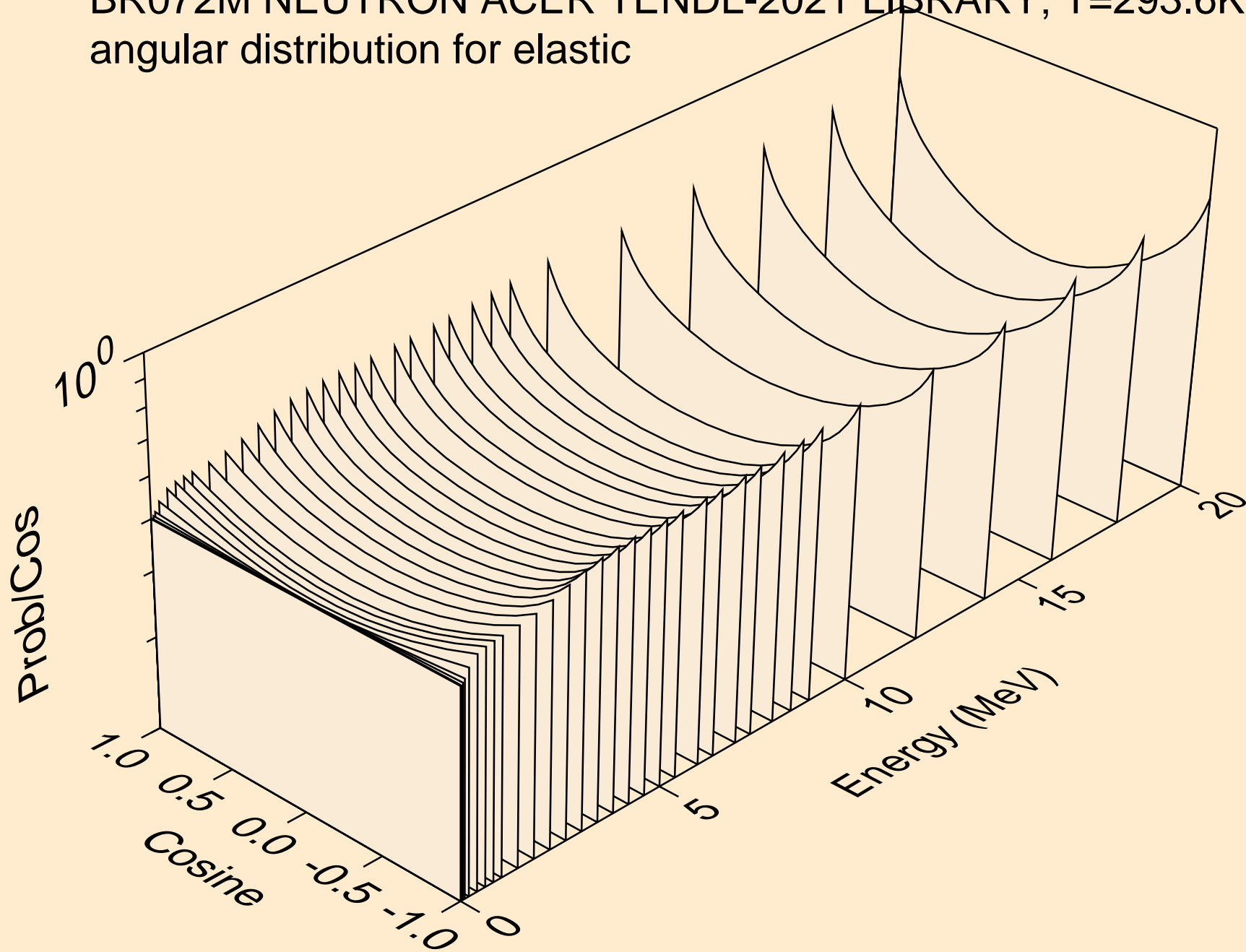

BR072M NEUTRON ACER TENDL-2021 LIBRARY; T=293.6K
angular distribution for elastic

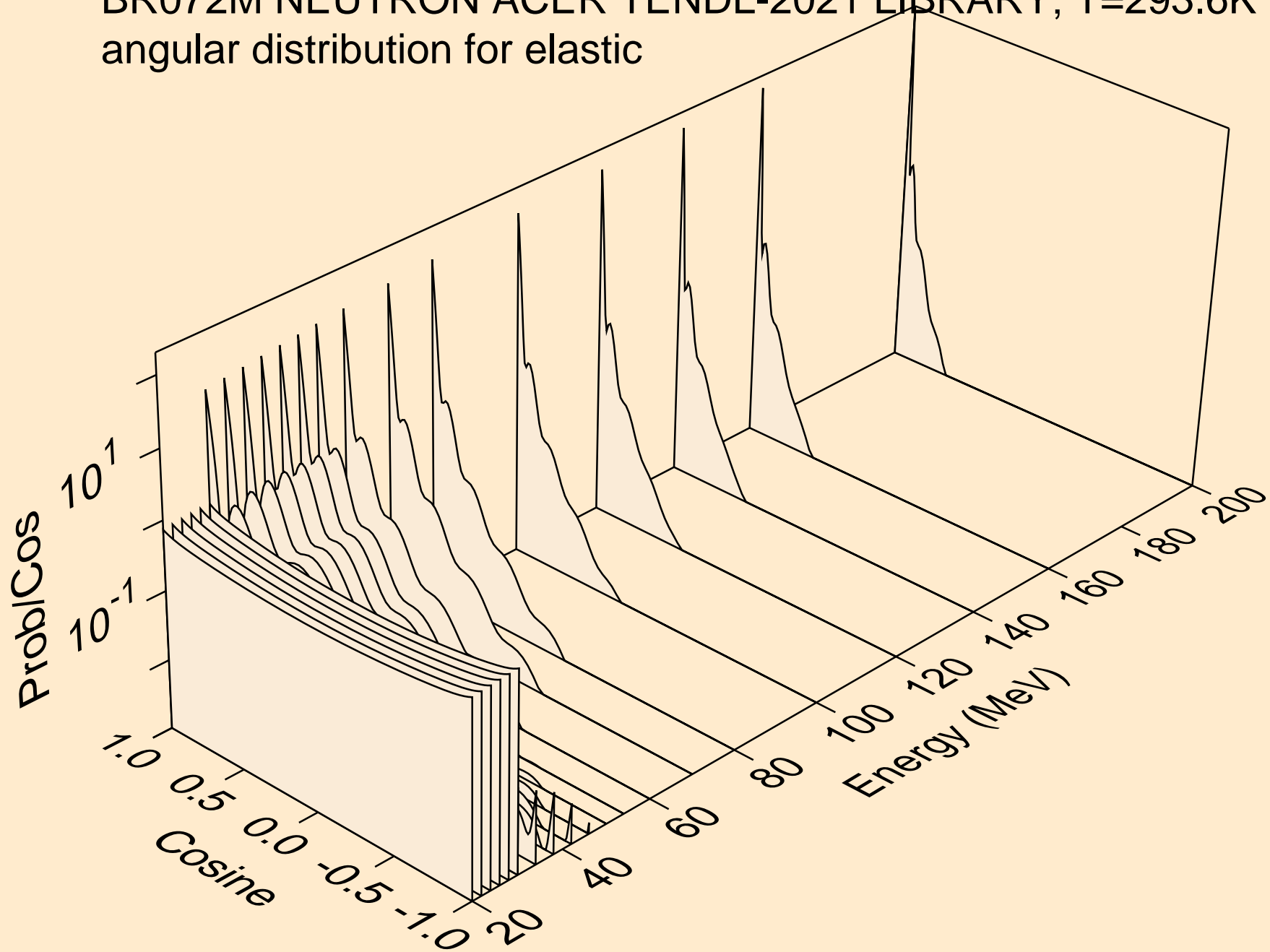

BR072M NEUTRON ACER TENDL-2021 LIBRARY; T=293.6K
angular distribution for (n,n*1)

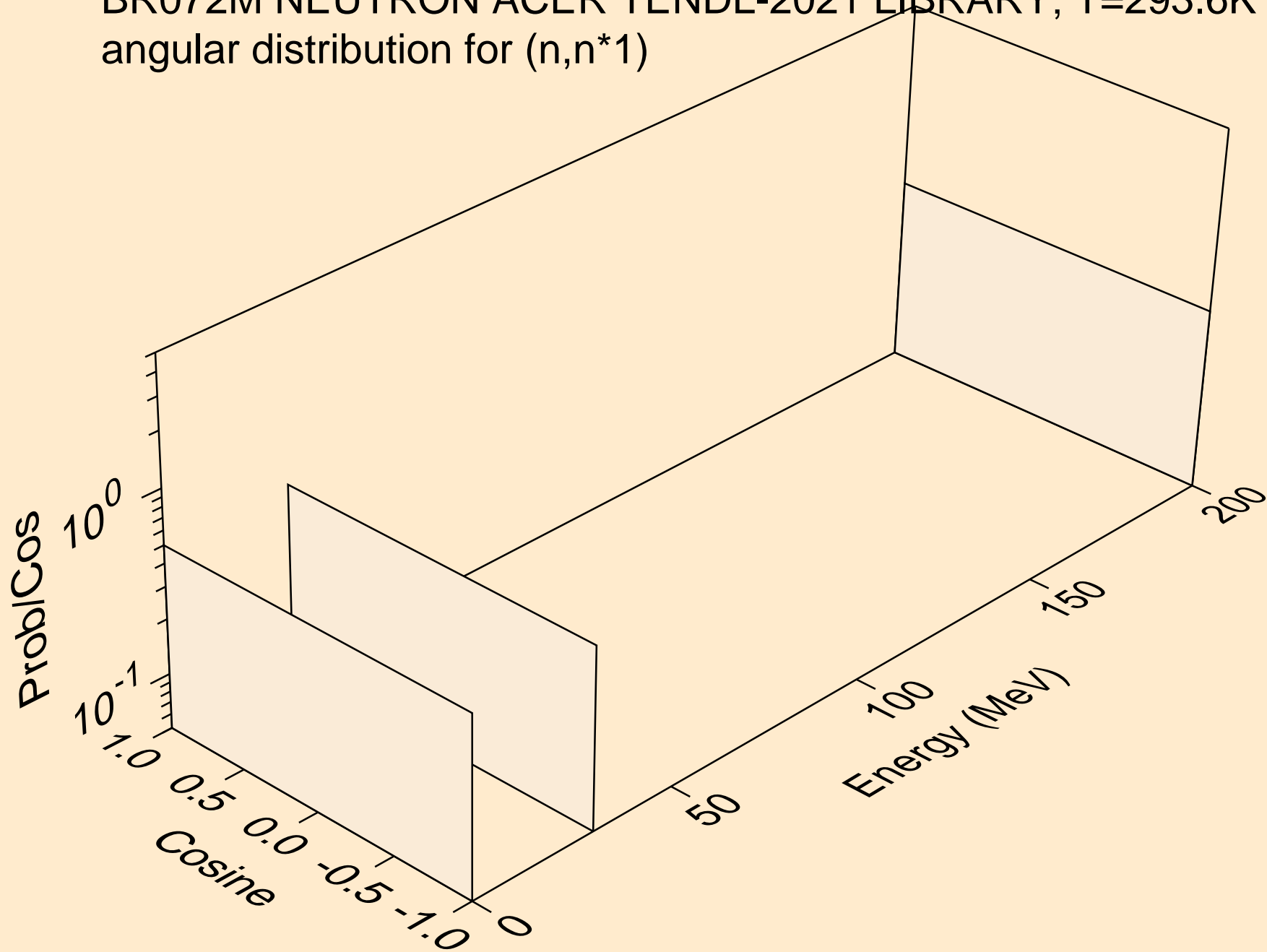

BR072M NEUTRON ACER TENDL-2021 LIBRARY; T=293.6K
angular distribution for (n,n*2)

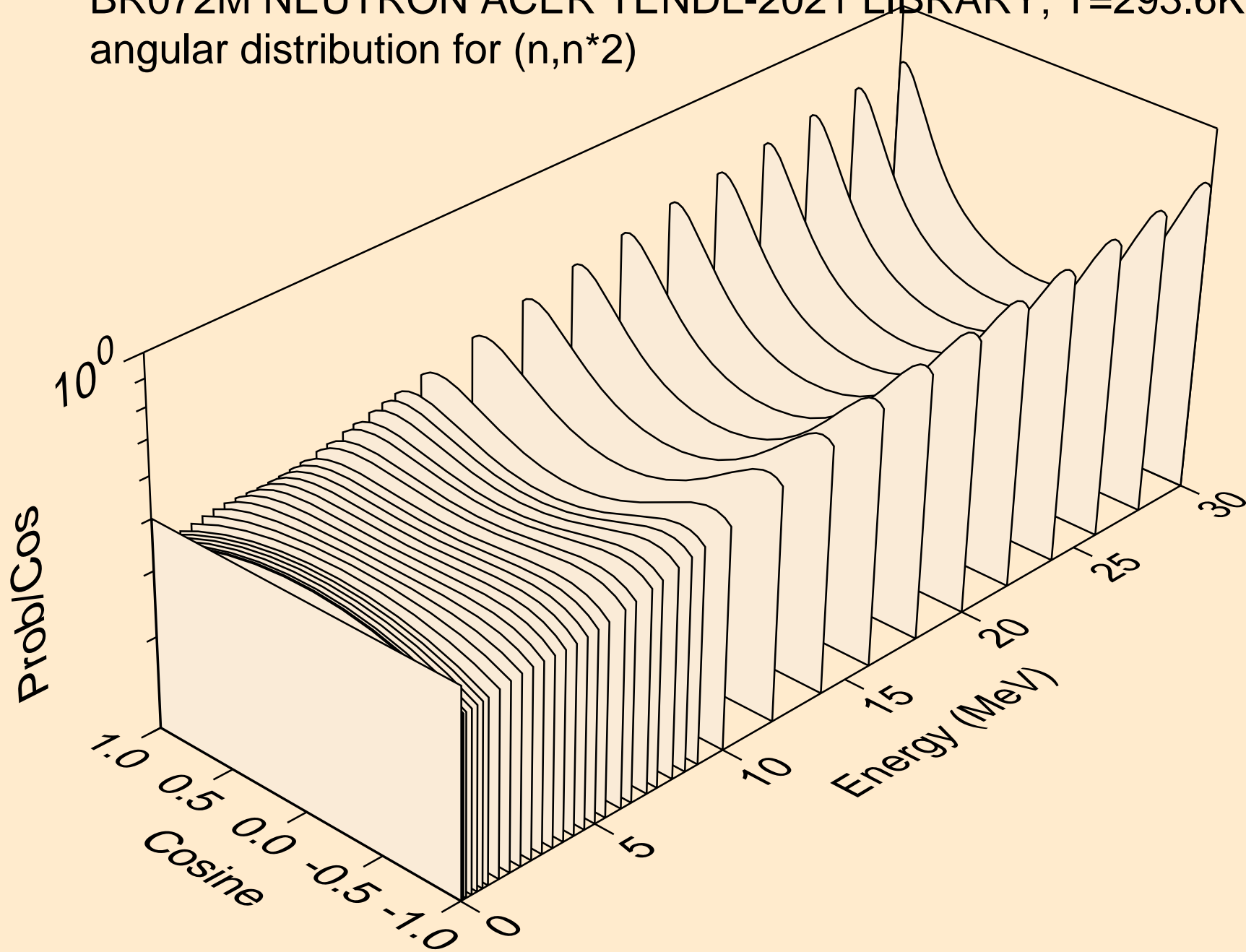

BR072M NEUTRON ACER TENDL-2021 LIBRARY; T=293.6K
Neutron emission for (n,x)

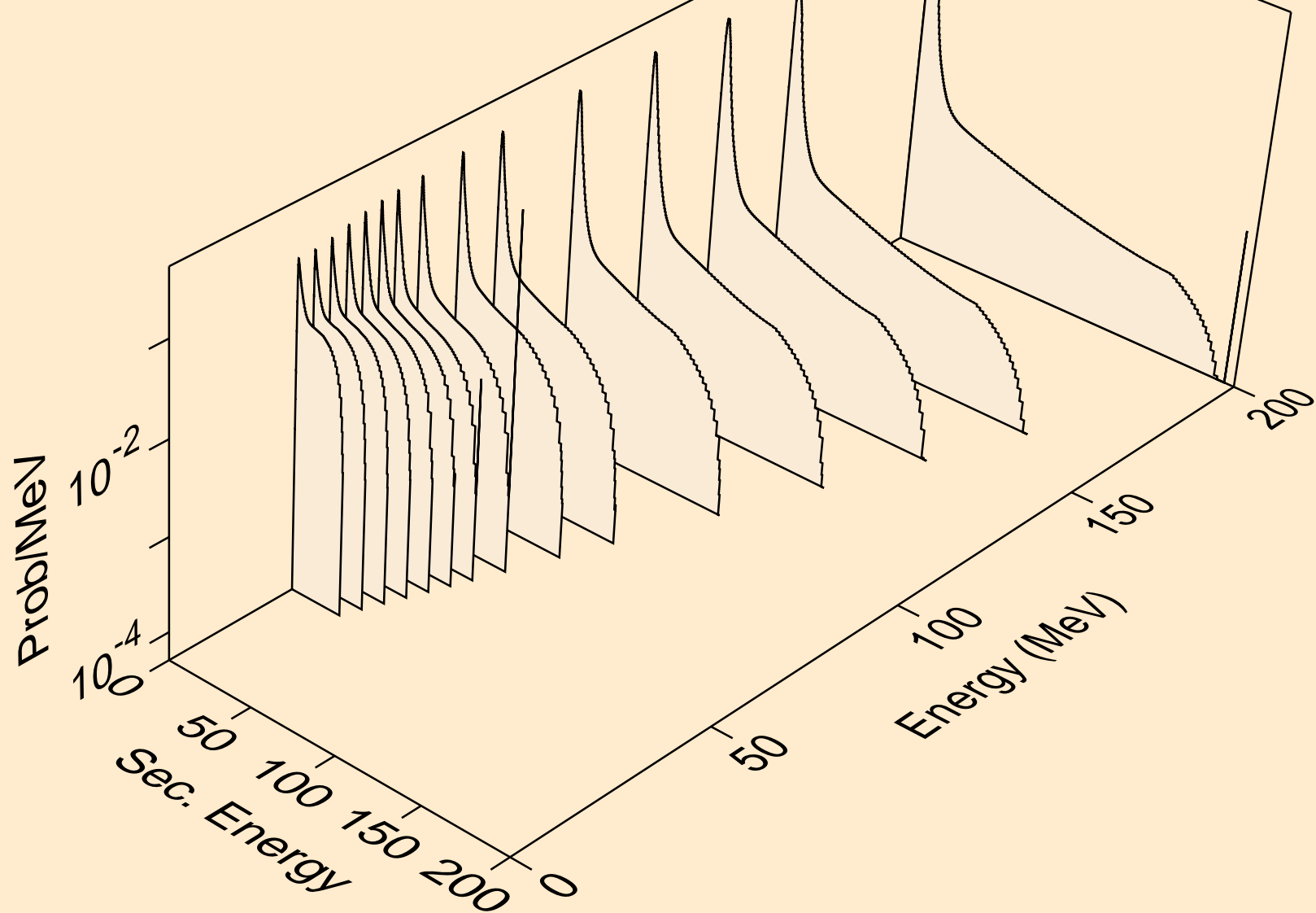

BR072M NEUTRON ACER TENDL-2021 LIBRARY; T=293.6K
Neutron emission for (n,2nd)

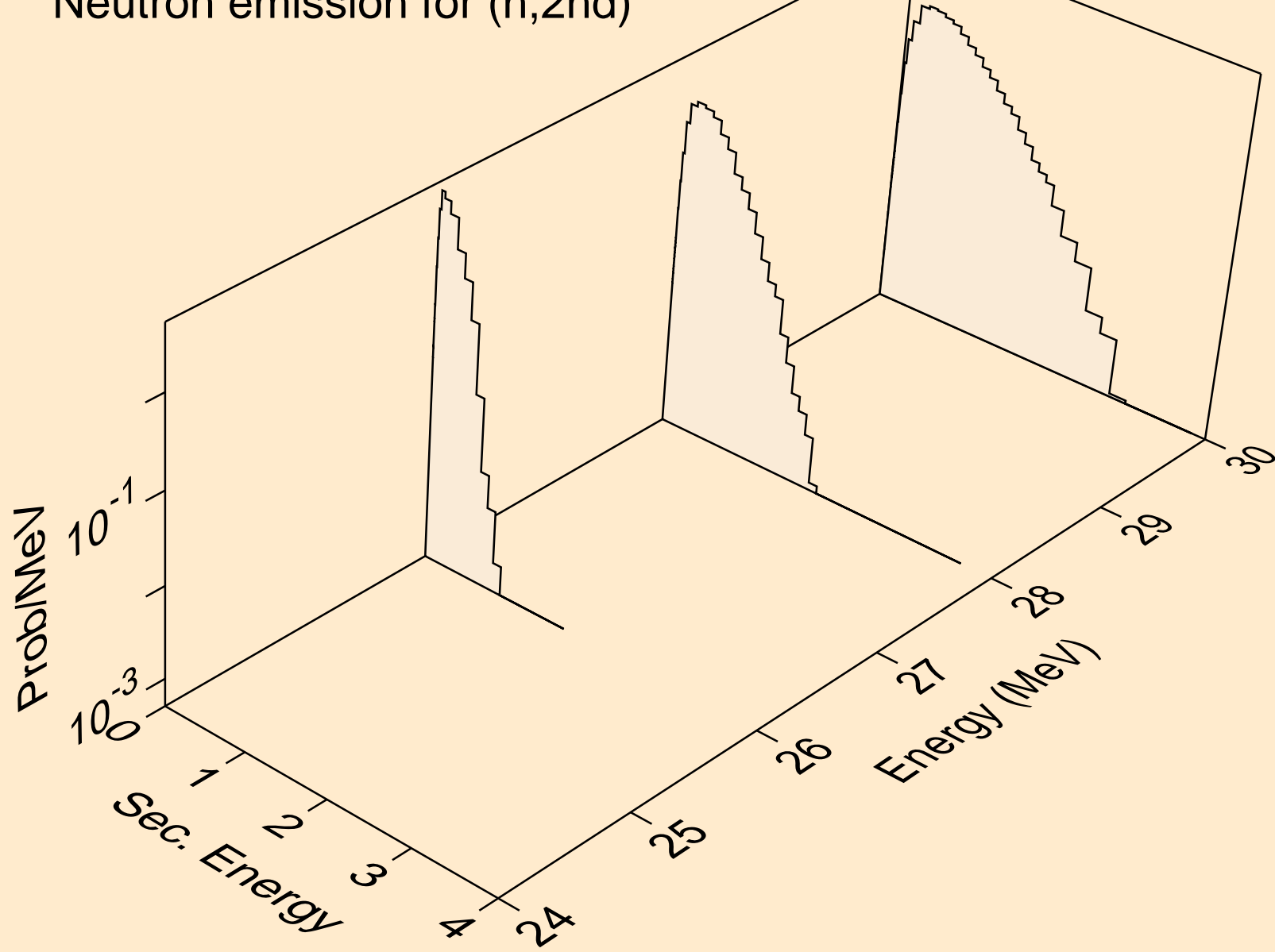

BR072M NEUTRON ACER TENDL-2021 LIBRARY; T=293.6K
Neutron emission for (n,2n)

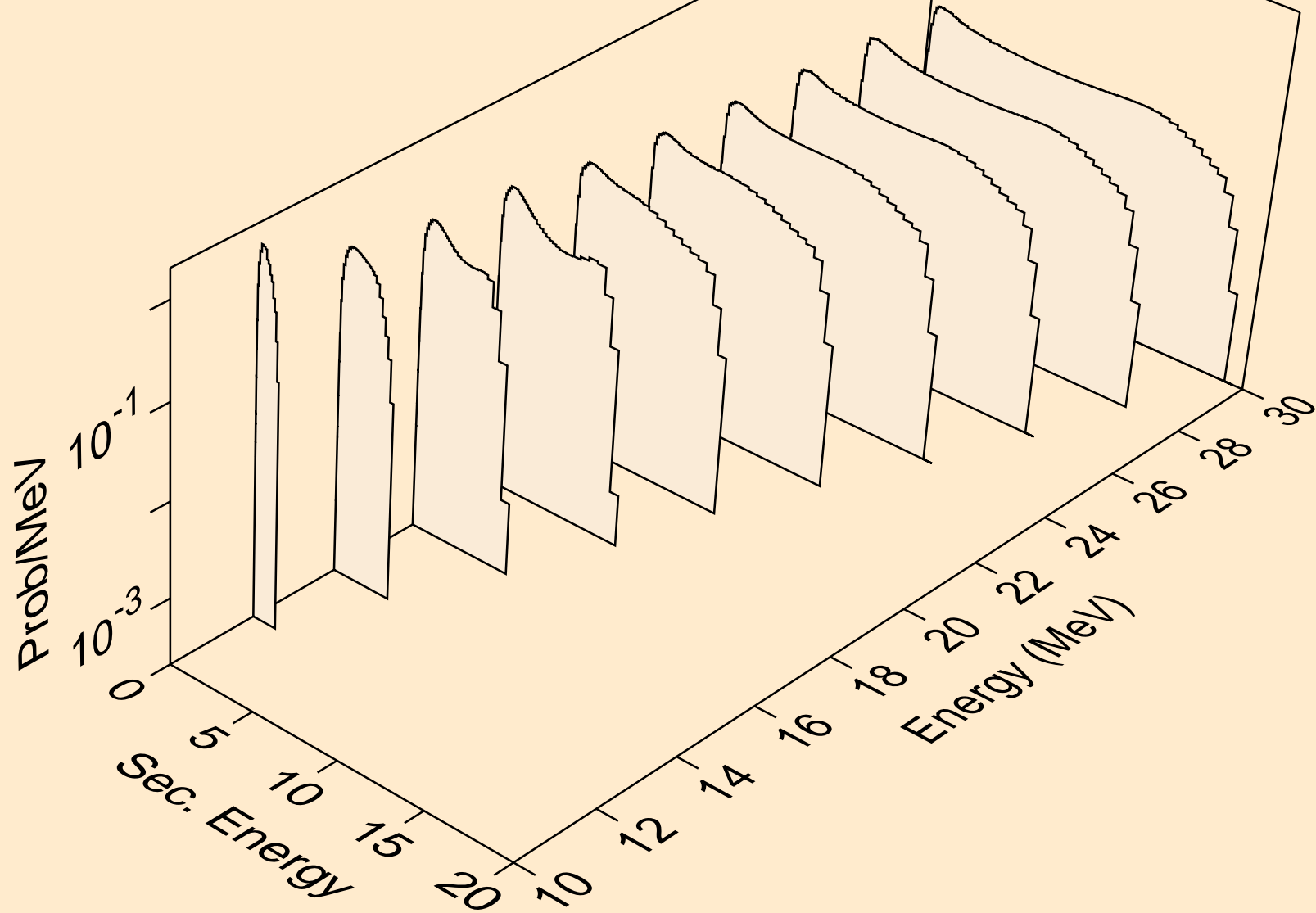

BR072M NEUTRON ACER TENDL-2021 LIBRARY; T=293.6K
Neutron emission for (n,3n)

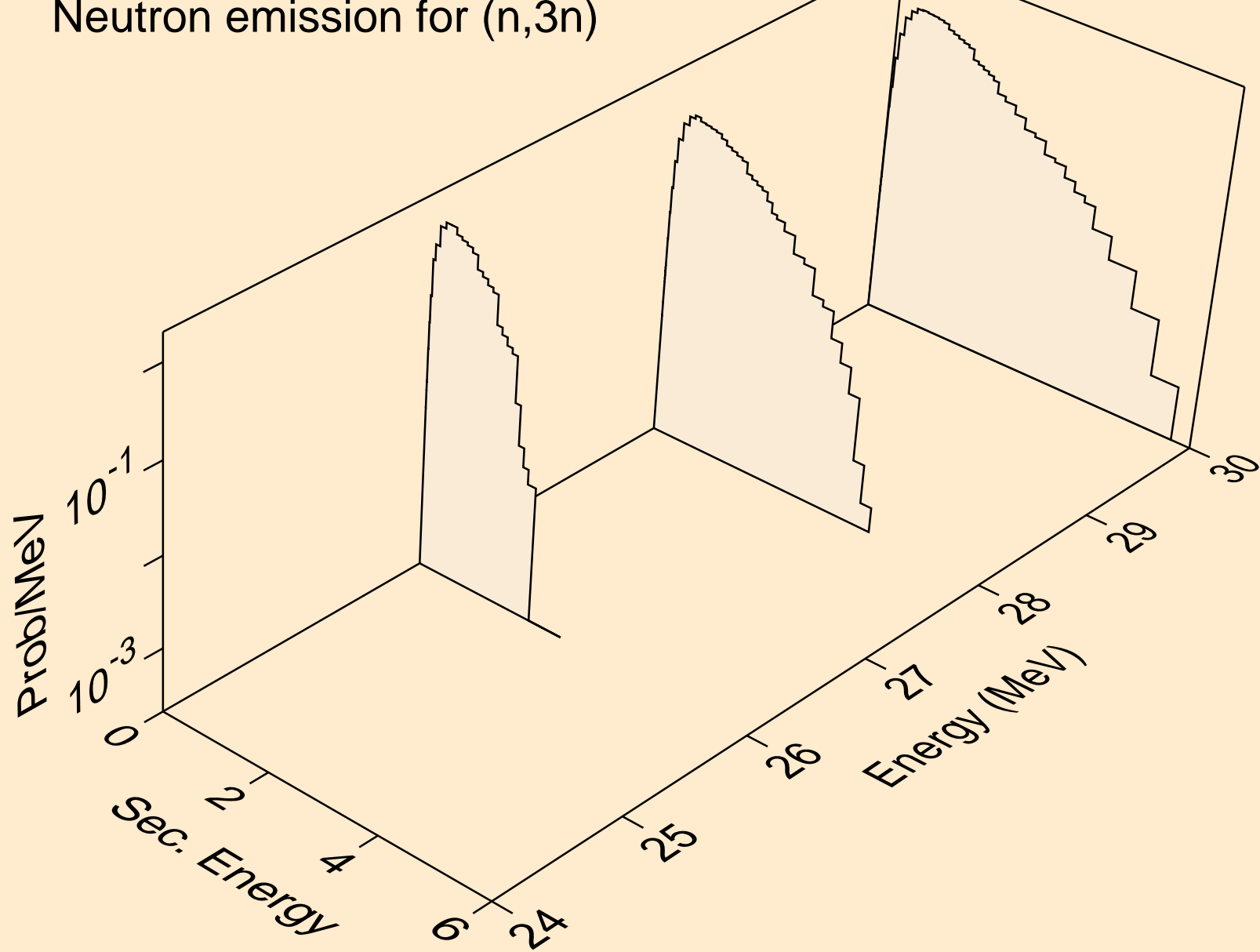

BR072M NEUTRON ACER TENDL-2021 LIBRARY; T=293.6K
Neutron emission for (n,n*)a

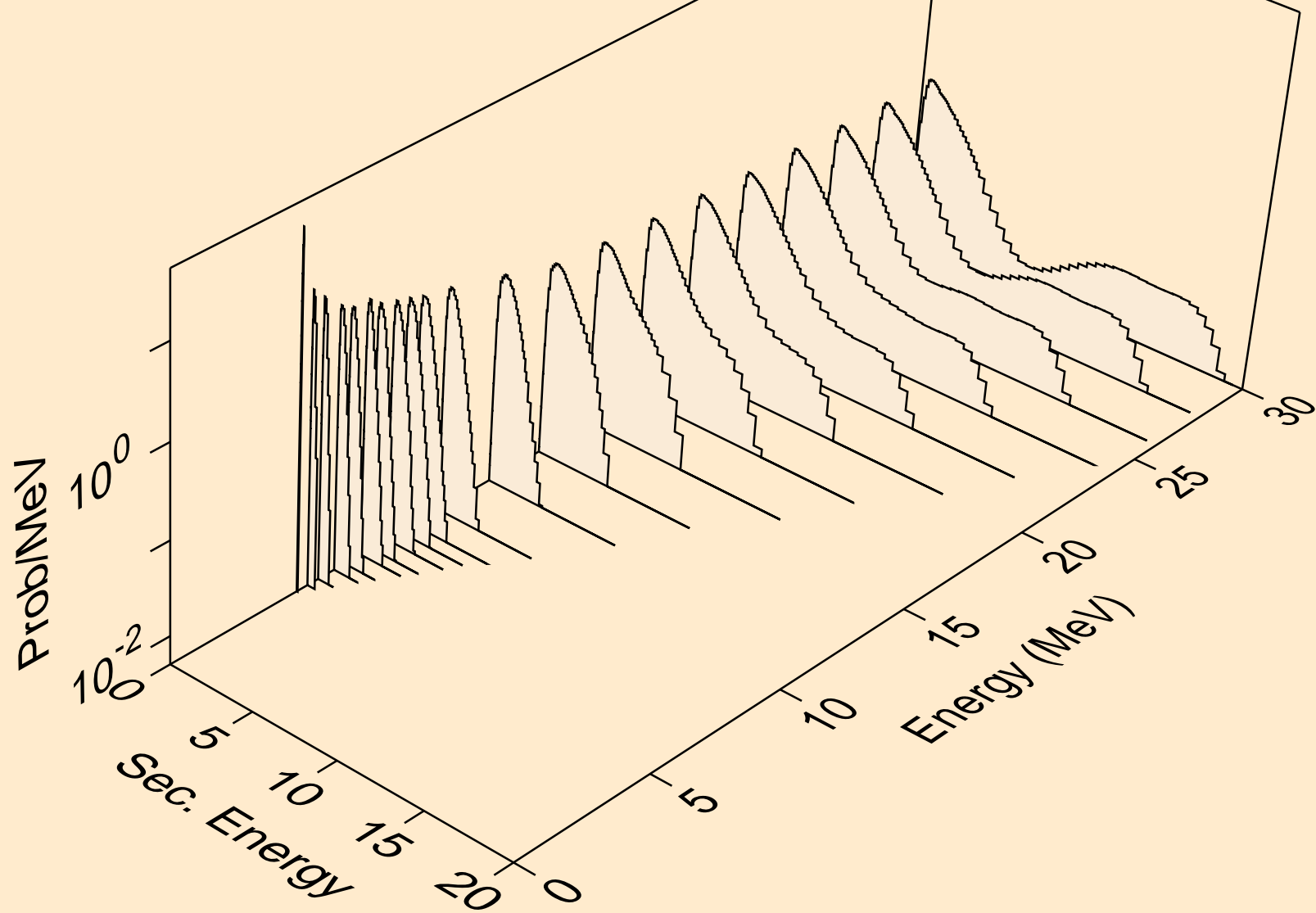

BR072M NEUTRON ACER TENDL-2021 LIBRARY; T=293.6K
Neutron emission for (n,2n)a

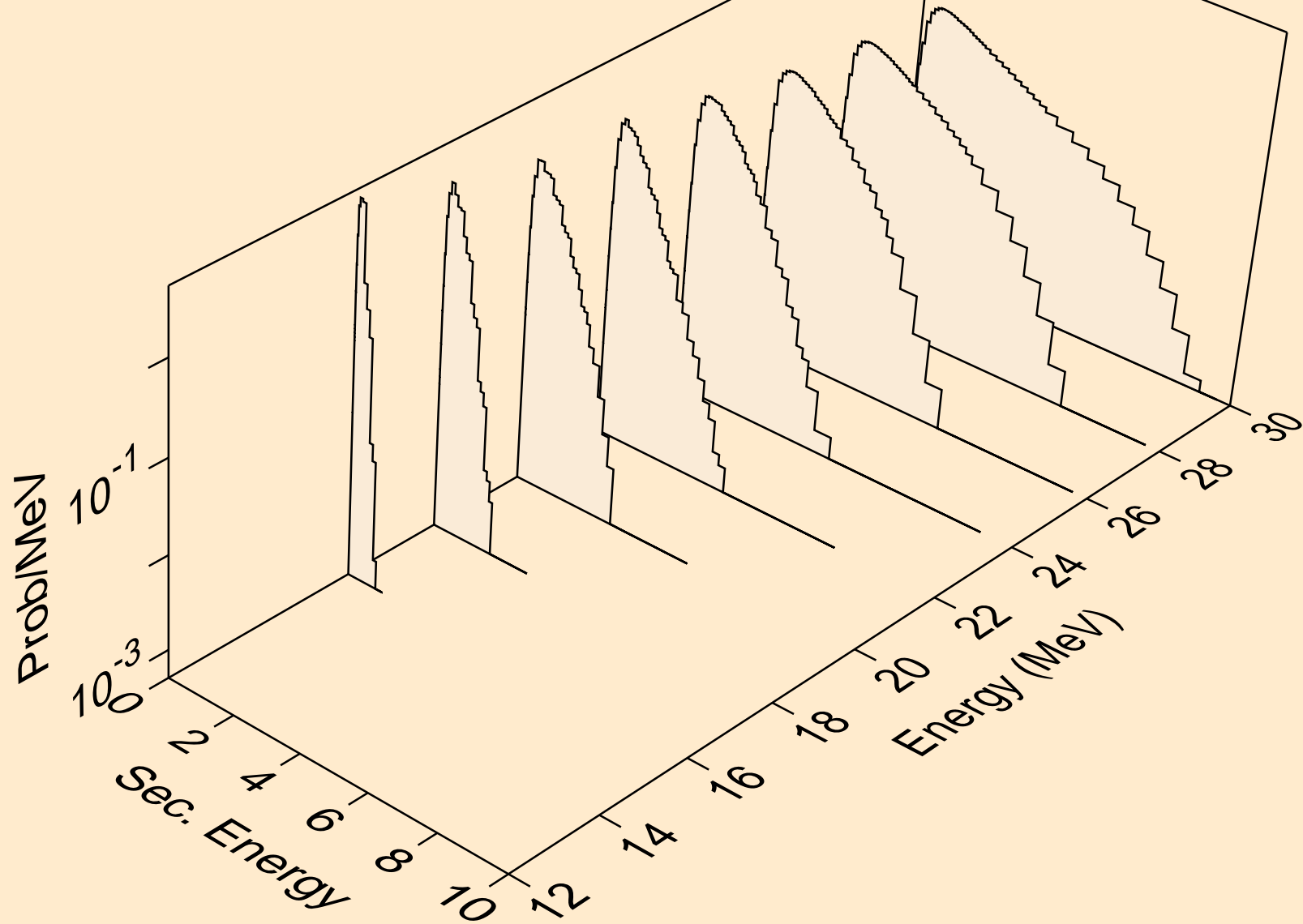

BR072M NEUTRON ACER TENDL-2021 LIBRARY; T=293.6K
Neutron emission for (n,n*)p

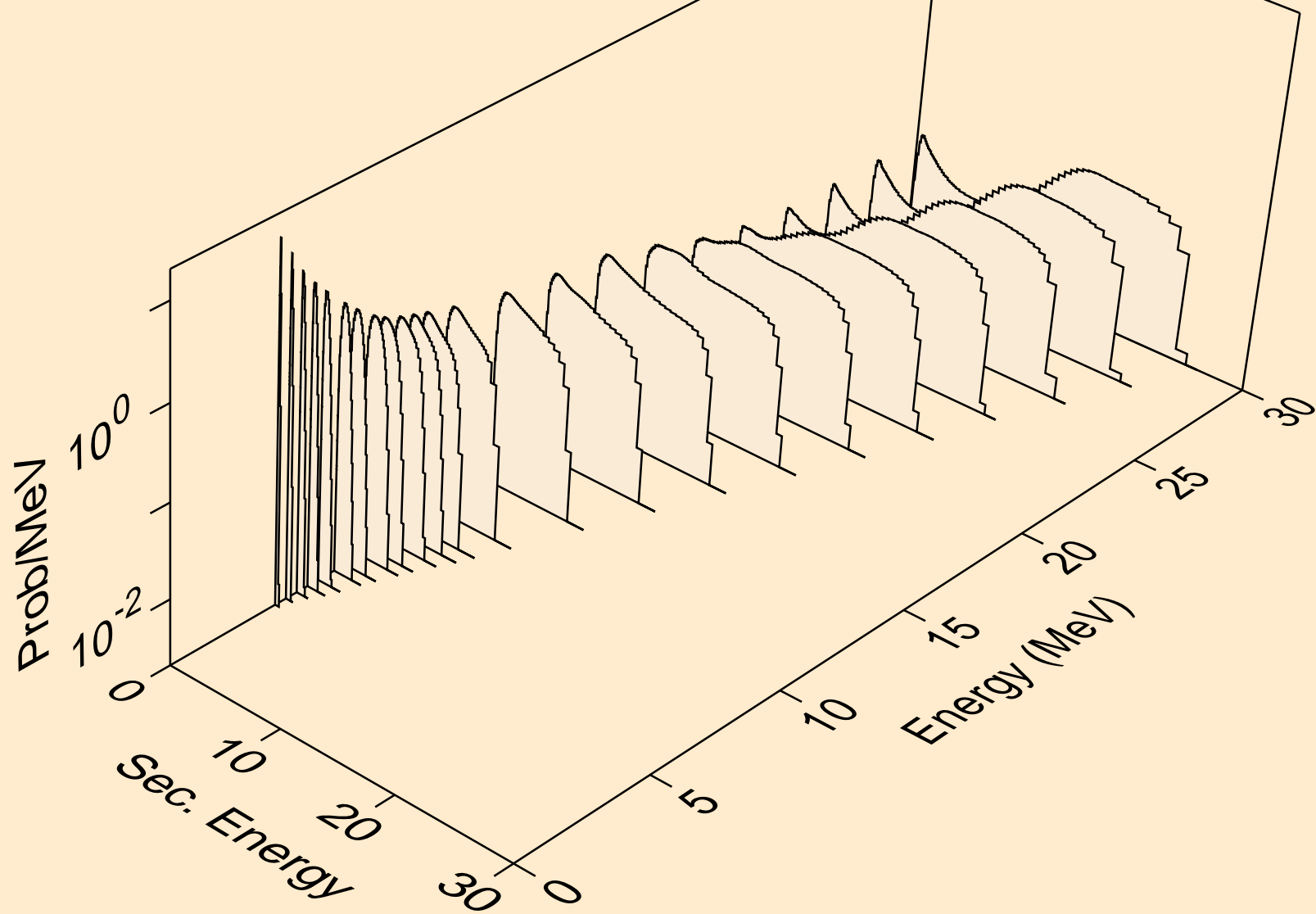

BR072M NEUTRON ACER TENDL-2021 LIBRARY; T=293.6K
Neutron emission for (n,n*)2a

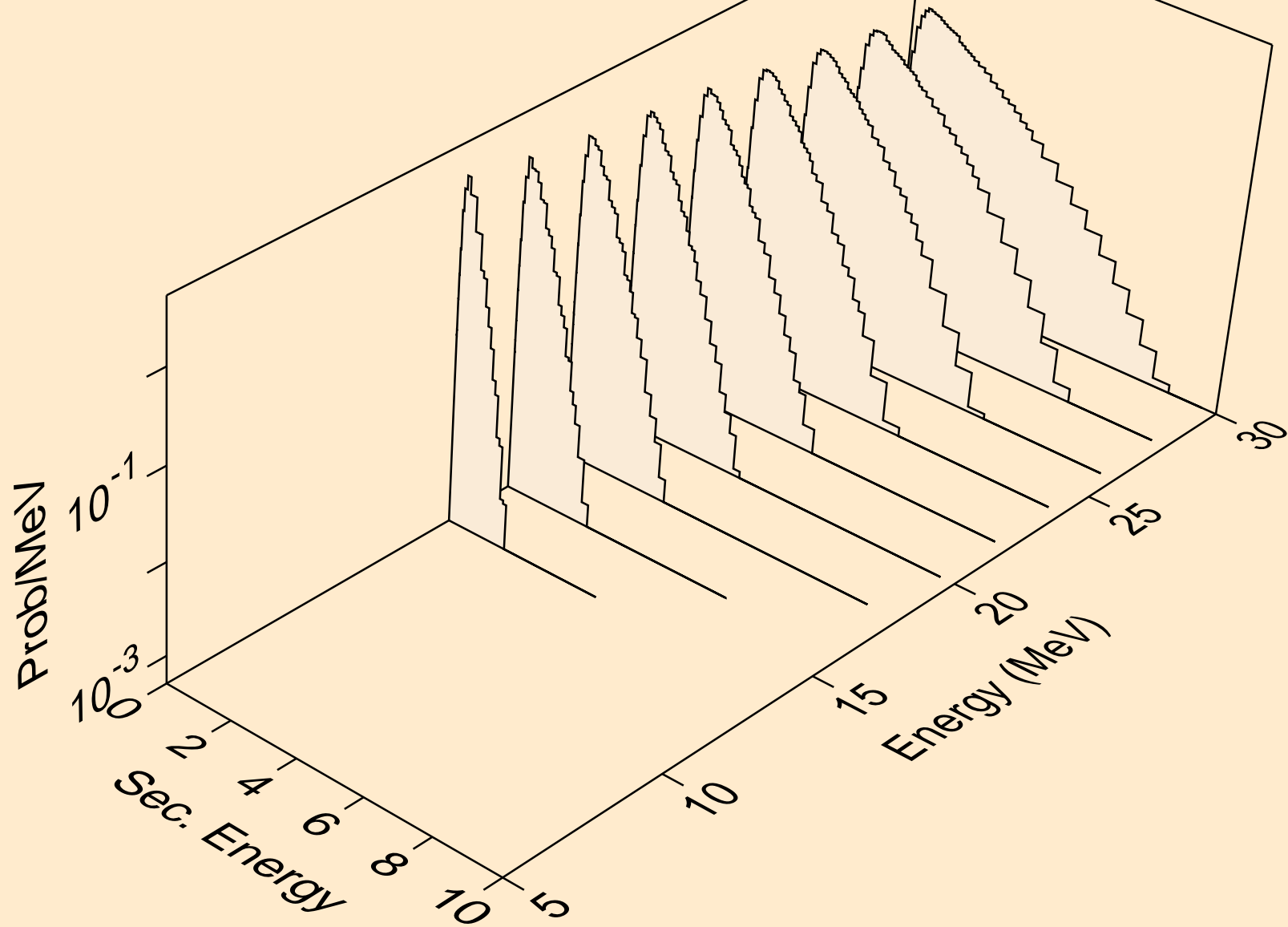

BR072M NEUTRON ACER TENDL-2021 LIBRARY; T=293.6K
Neutron emission for (n,n*)d

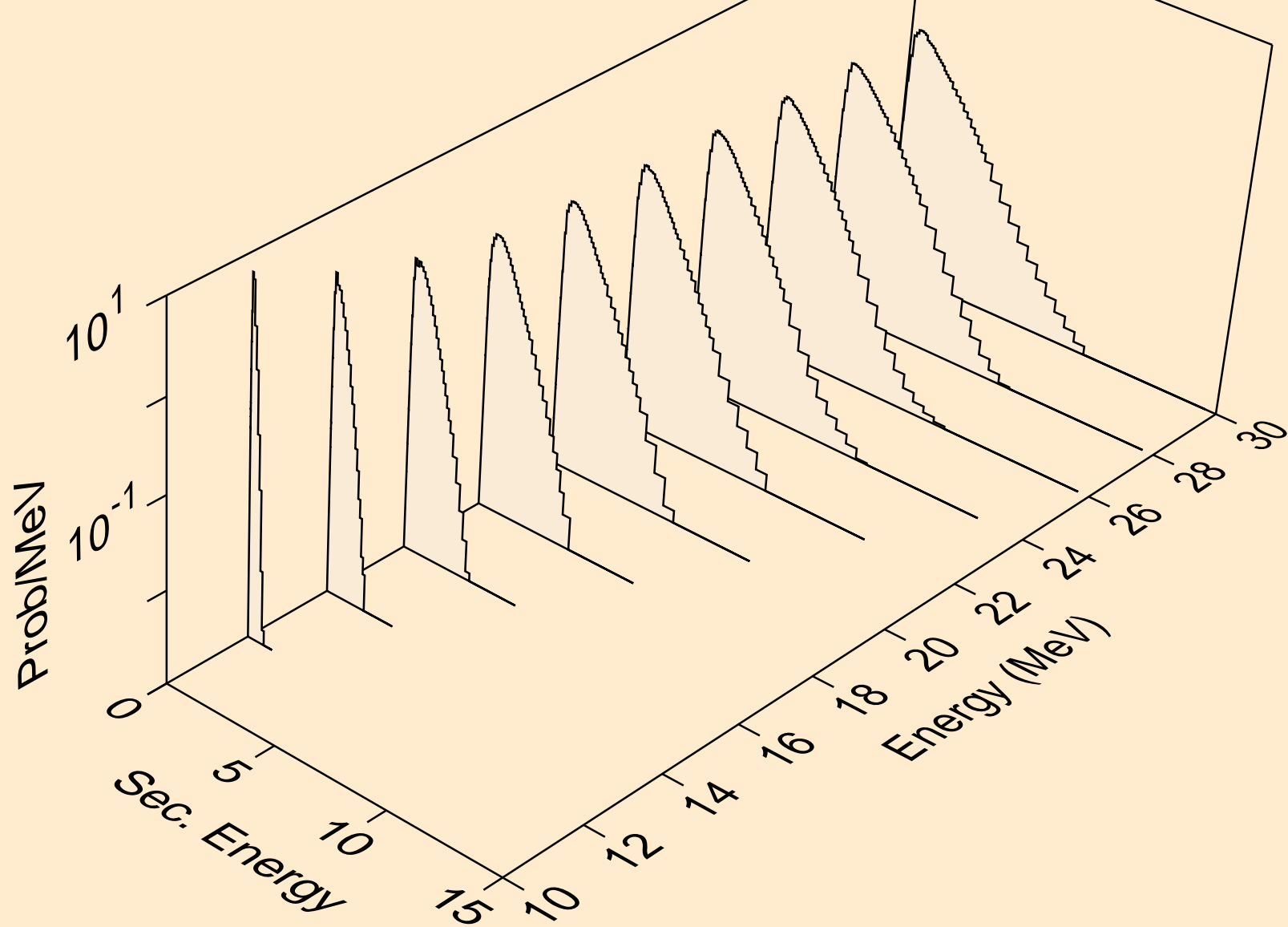

BR072M NEUTRON ACER TENDL-2021 LIBRARY; T=293.6K
Neutron emission for (n,n*)t

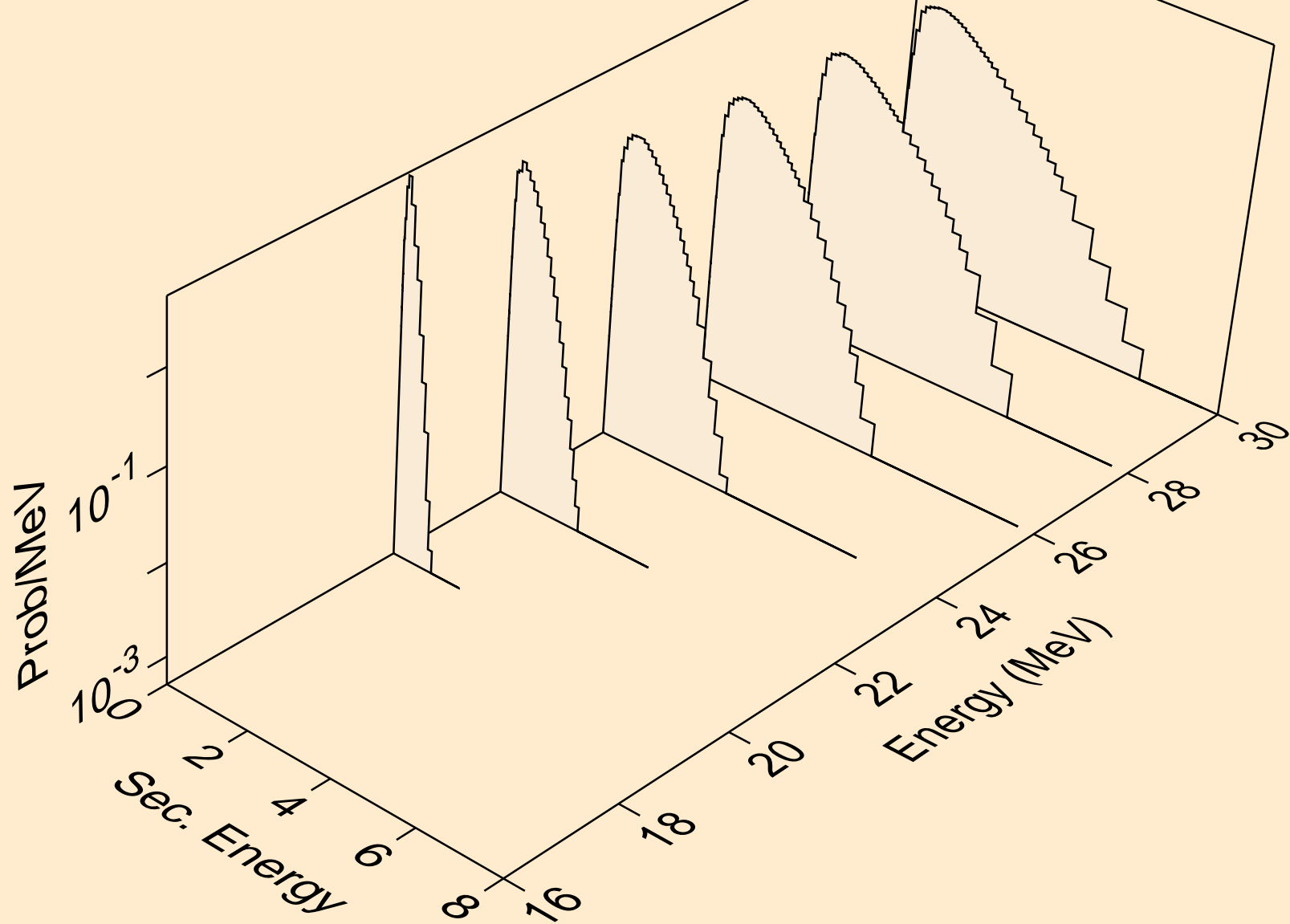

BR072M NEUTRON ACER TENDL-2021 LIBRARY; T=293.6K
Neutron emission for (n,n*)he3

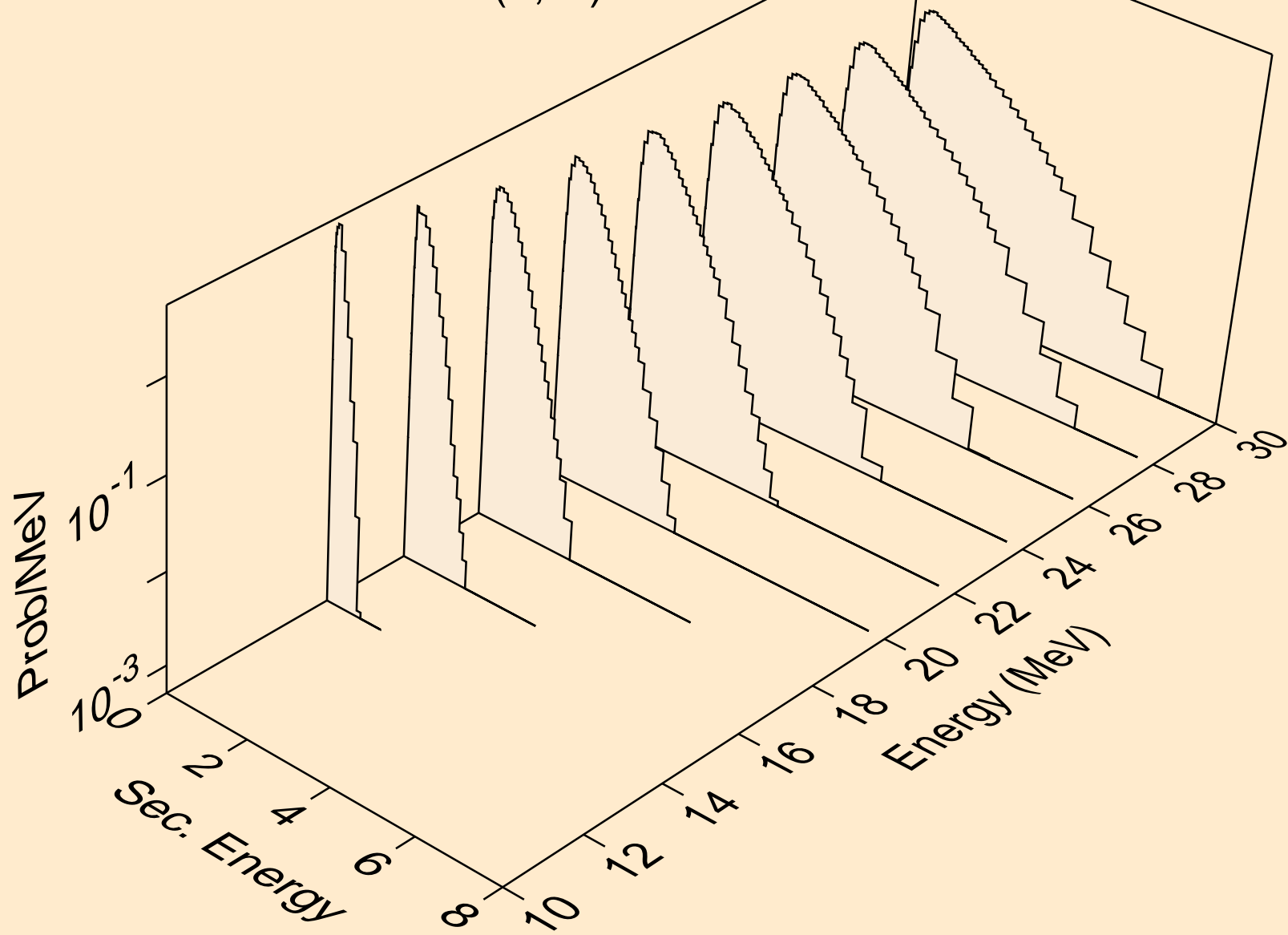

BR072M NEUTRON ACER TENDL-2021 LIBRARY; T=293.6K
Neutron emission for (n,2np)

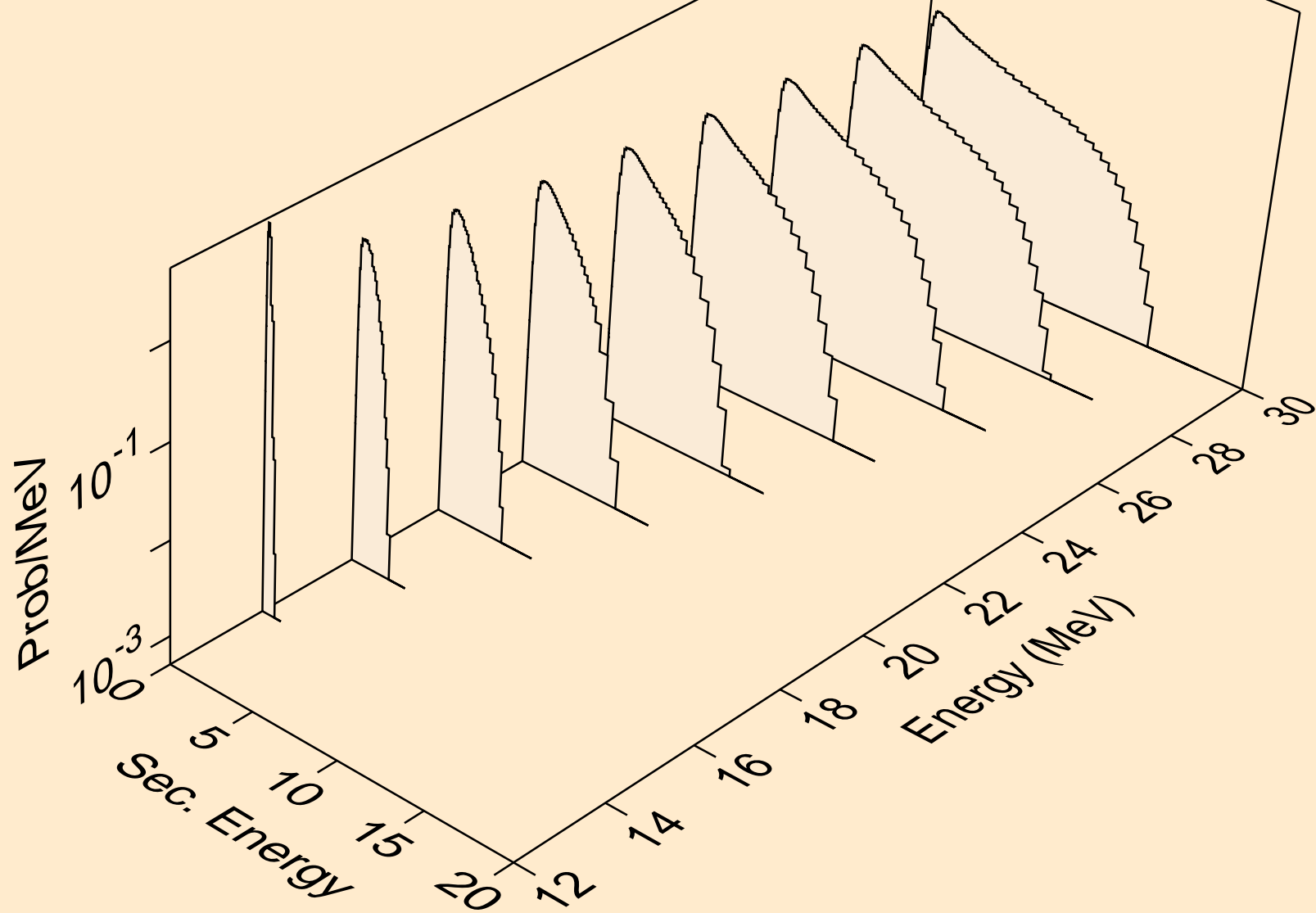

BR072M NEUTRON ACER TENDL-2021 LIBRARY; T=293.6K
Neutron emission for (n,3np)

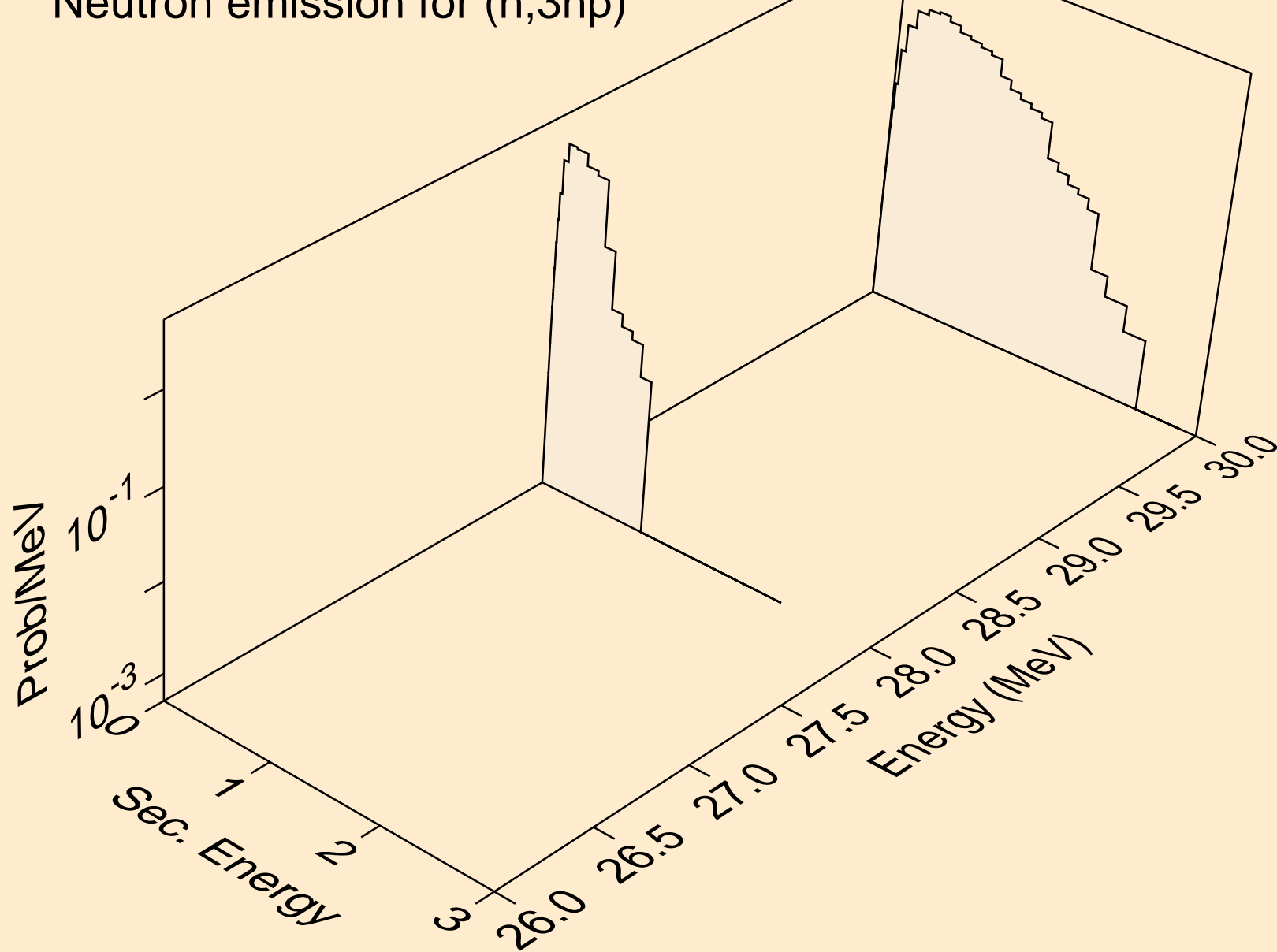

BR072M NEUTRON ACER TENDL-2021 LIBRARY; T=293.6K
Neutron emission for (n,2np)

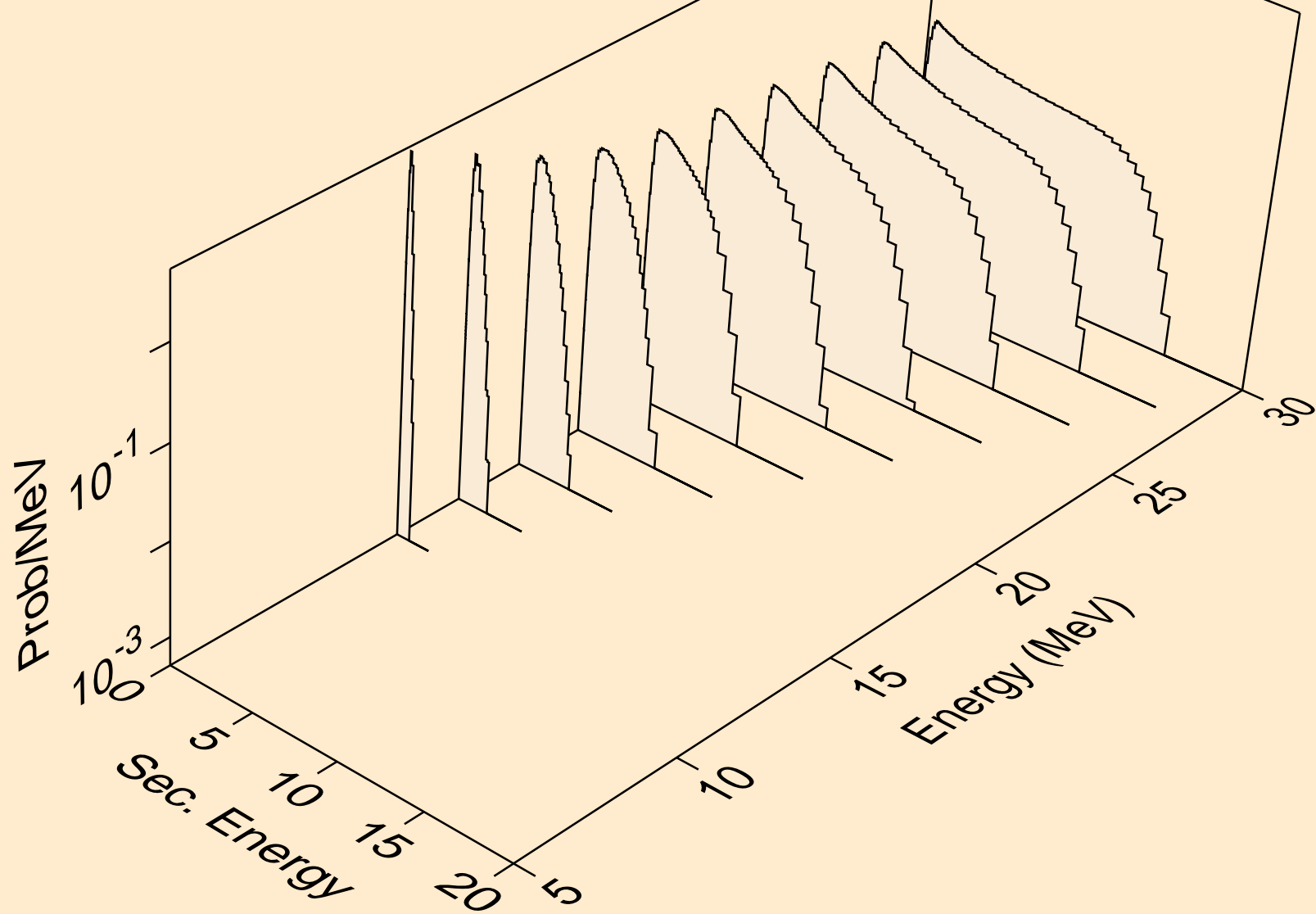

BR072M NEUTRON ACER TENDL-2021 LIBRARY; T=293.6K
Neutron emission for (n,npa)

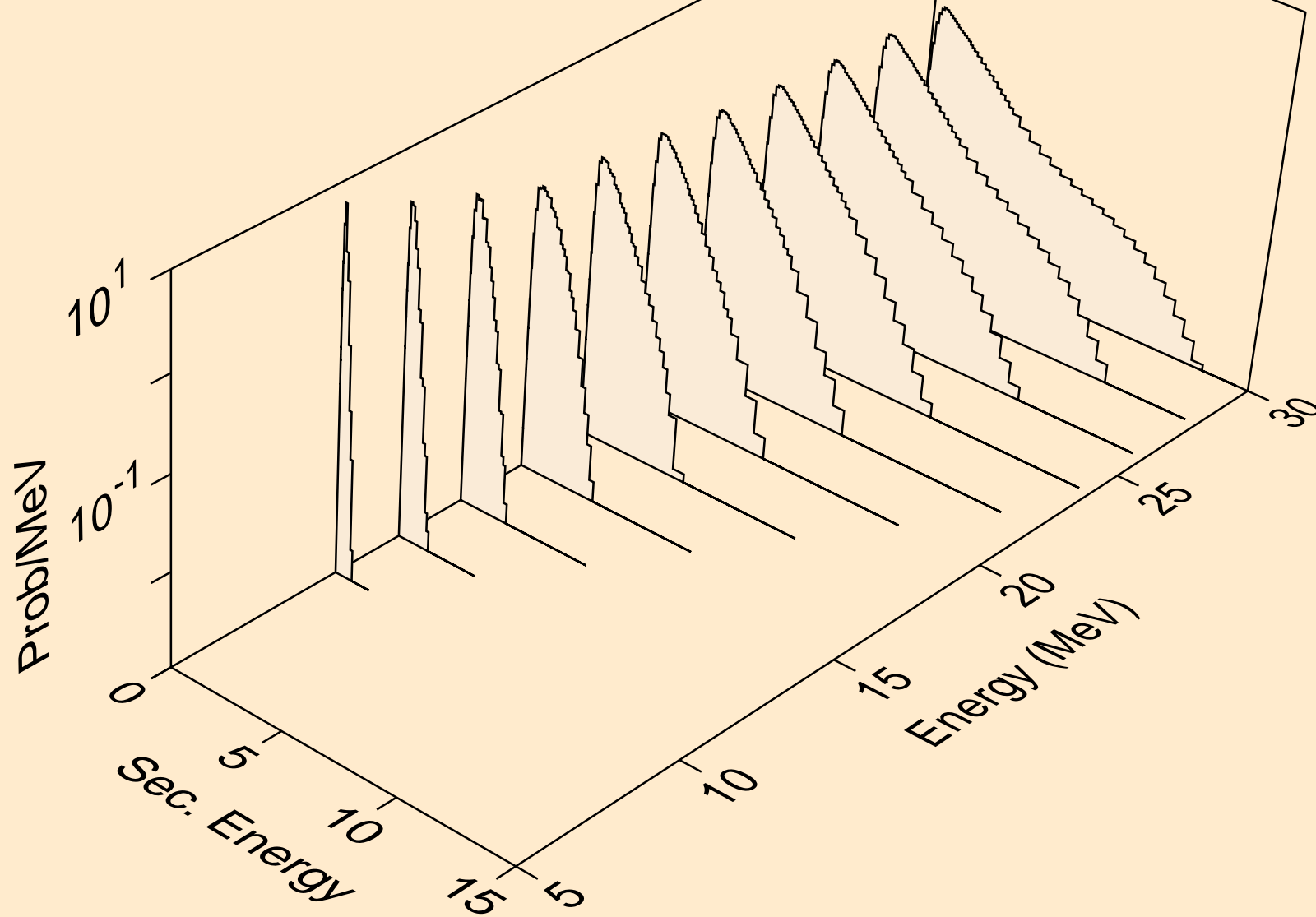

BR072M NEUTRON ACER TENDL-2021 LIBRARY; T=293.6K
Neutron emission for (n,n*c)

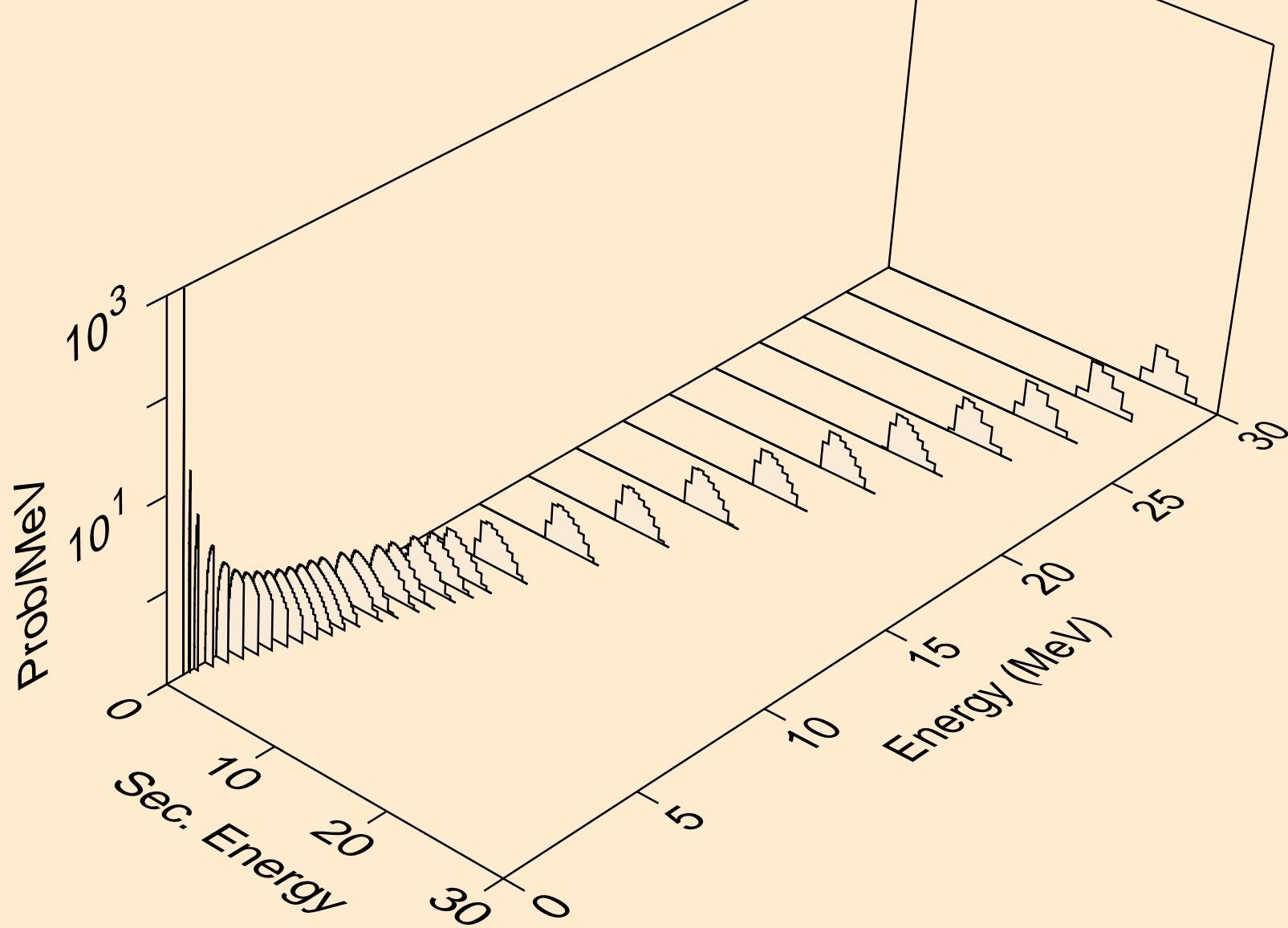

BR072M NEUTRON ACER TENDL-2021 LIBRARY; T=293.6K
Photon emission for (n,x)

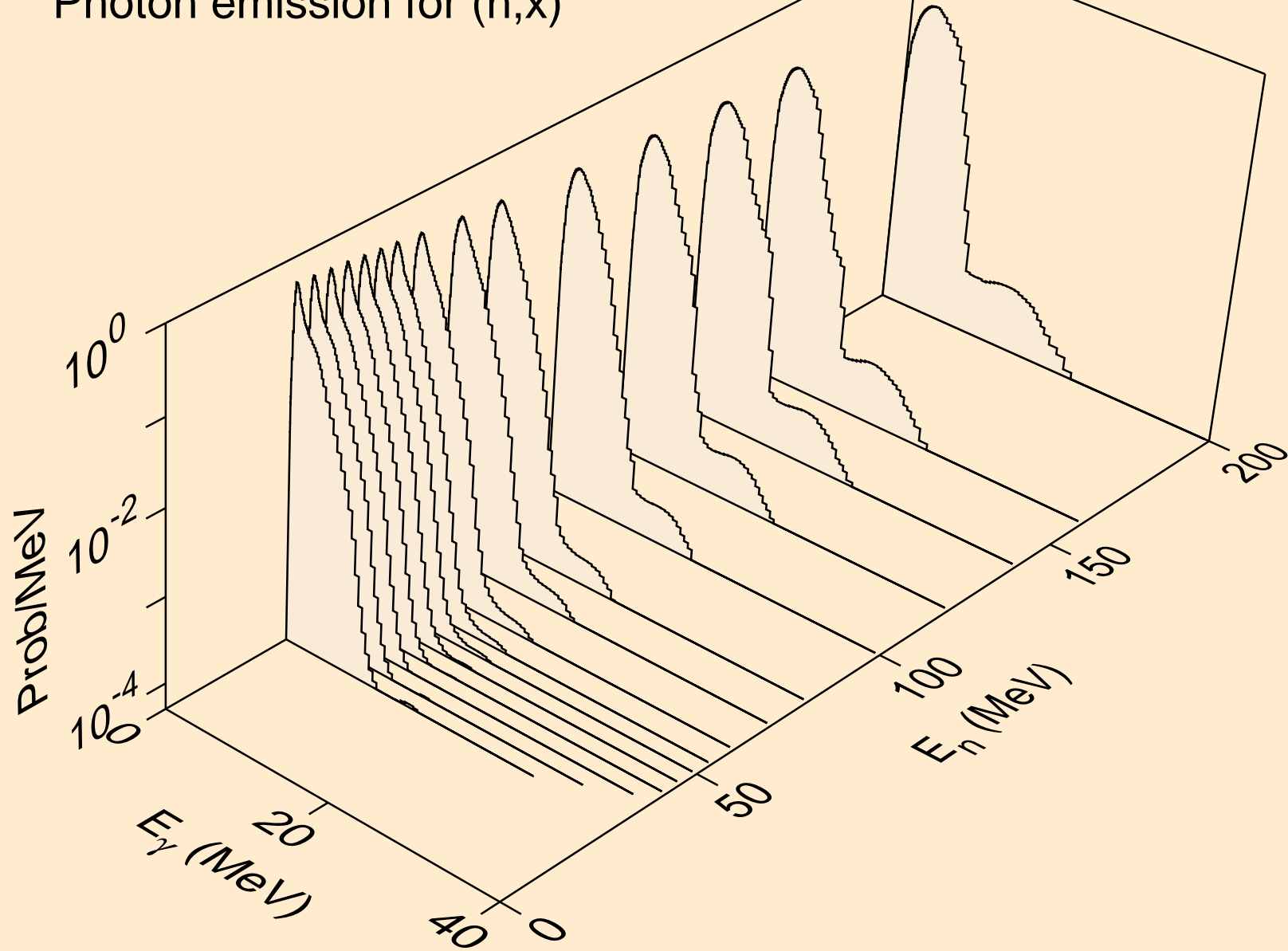

BR072M NEUTRON ACER TENDL-2021 LIBRARY; T=293.6K
Photon emission for (n,2nd)

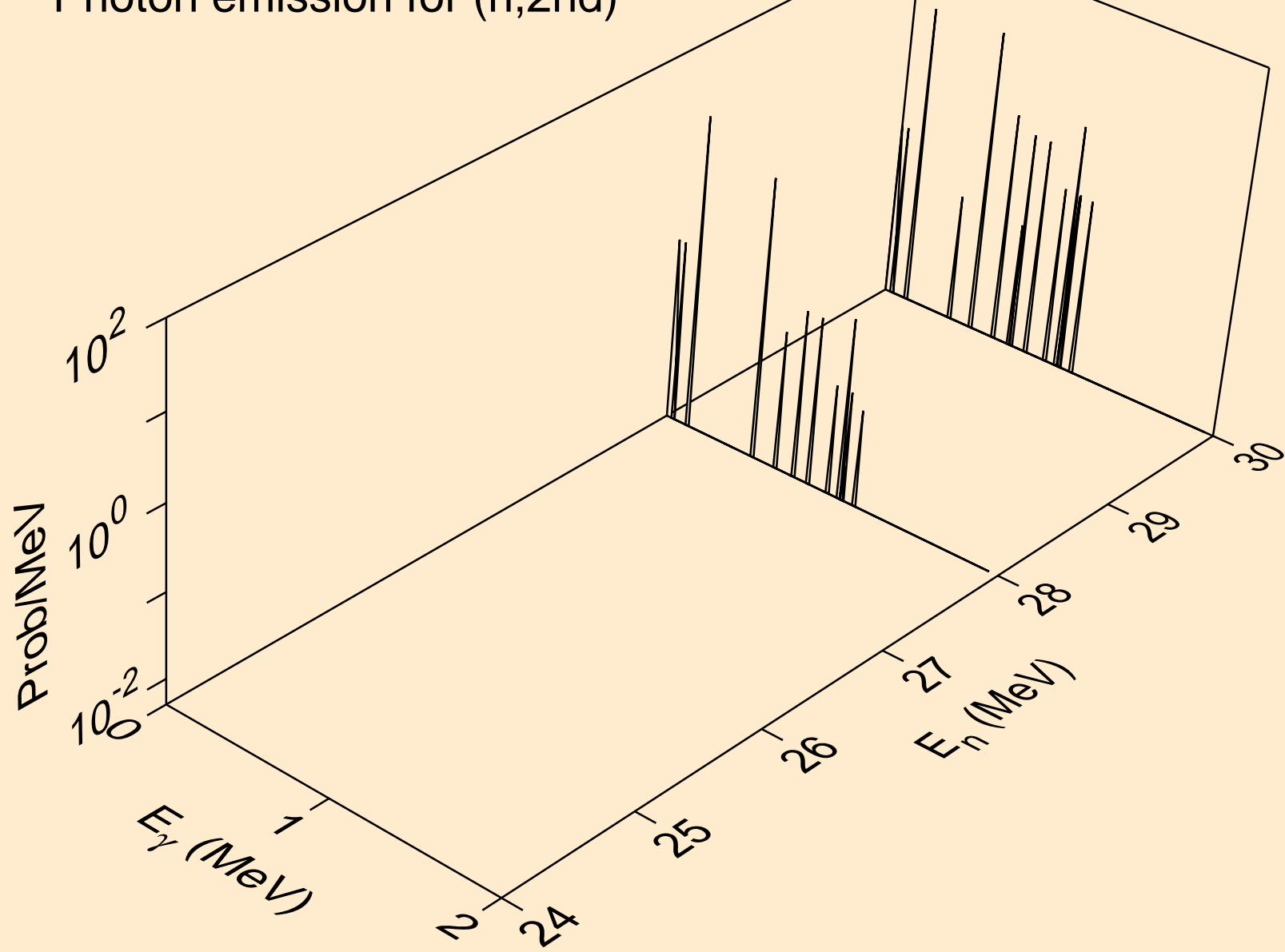

BR072M NEUTRON ACER TENDL-2021 LIBRARY; T=293.6K
Photon emission for (n,2n)

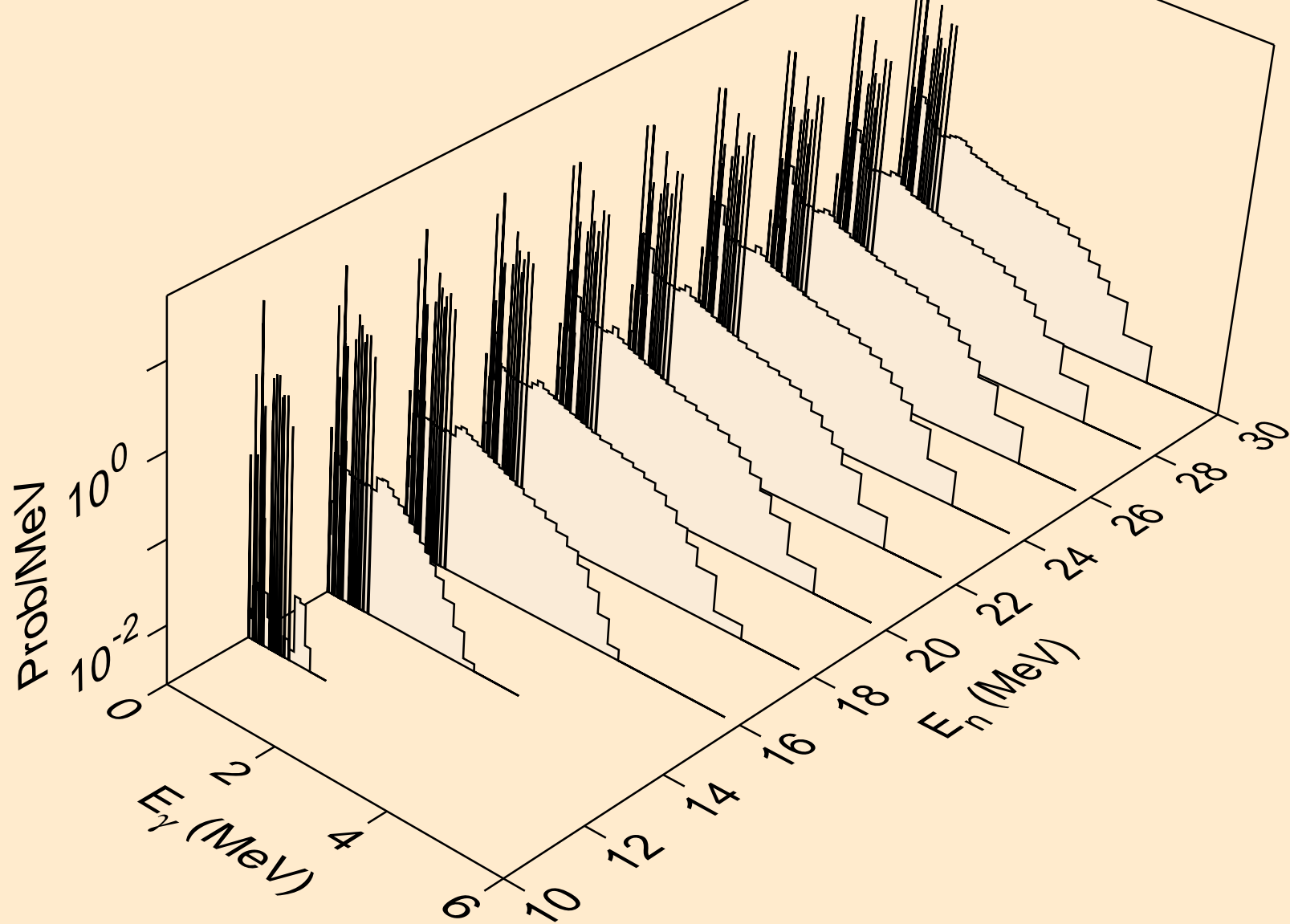

BR072M NEUTRON ACER TENDL-2021 LIBRARY; T=293.6K
Photon emission for (n,3n)

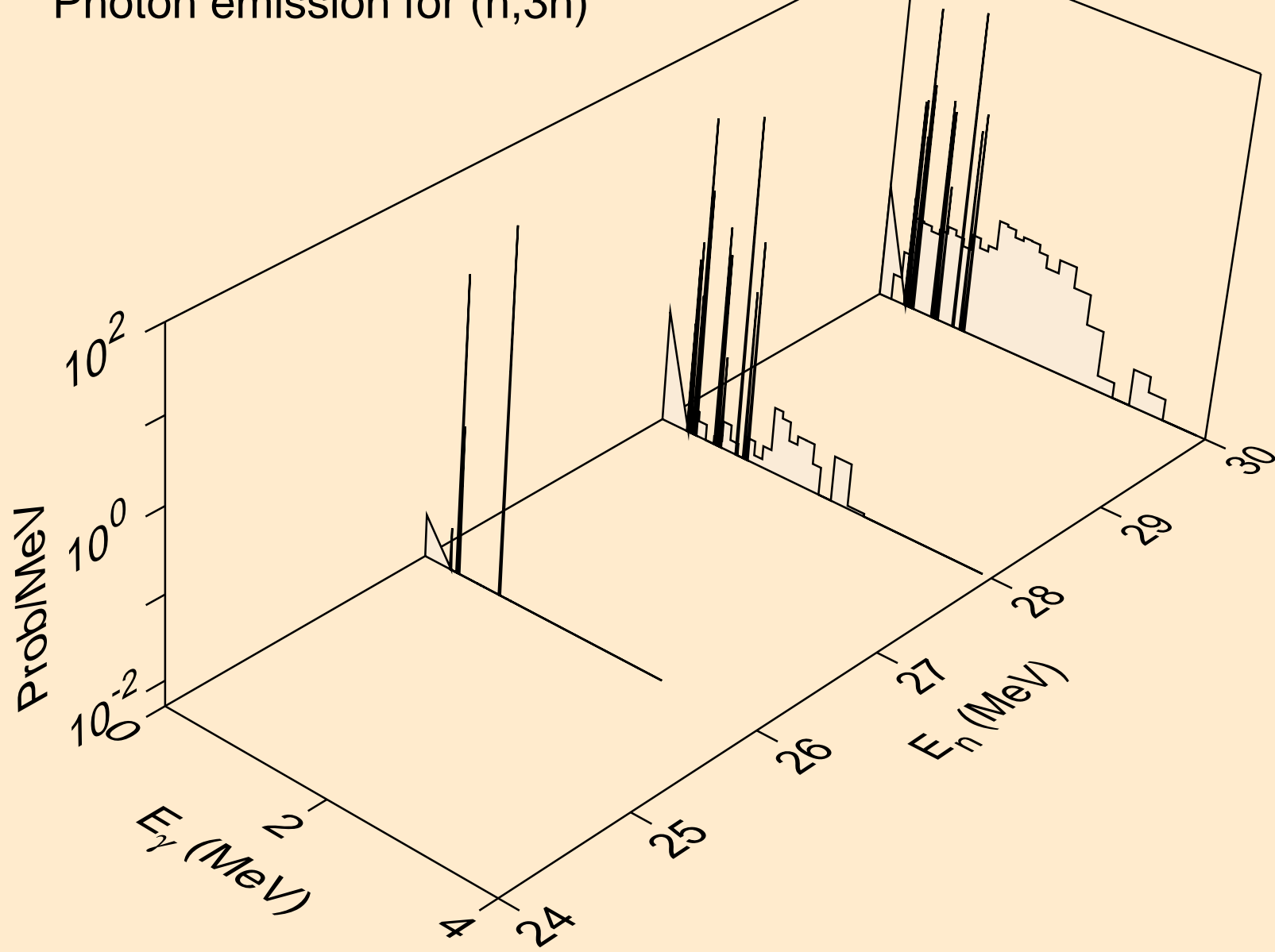

BR072M NEUTRON ACER TENDL-2021 LIBRARY; T=293.6K
Photon emission for (n,n*)a

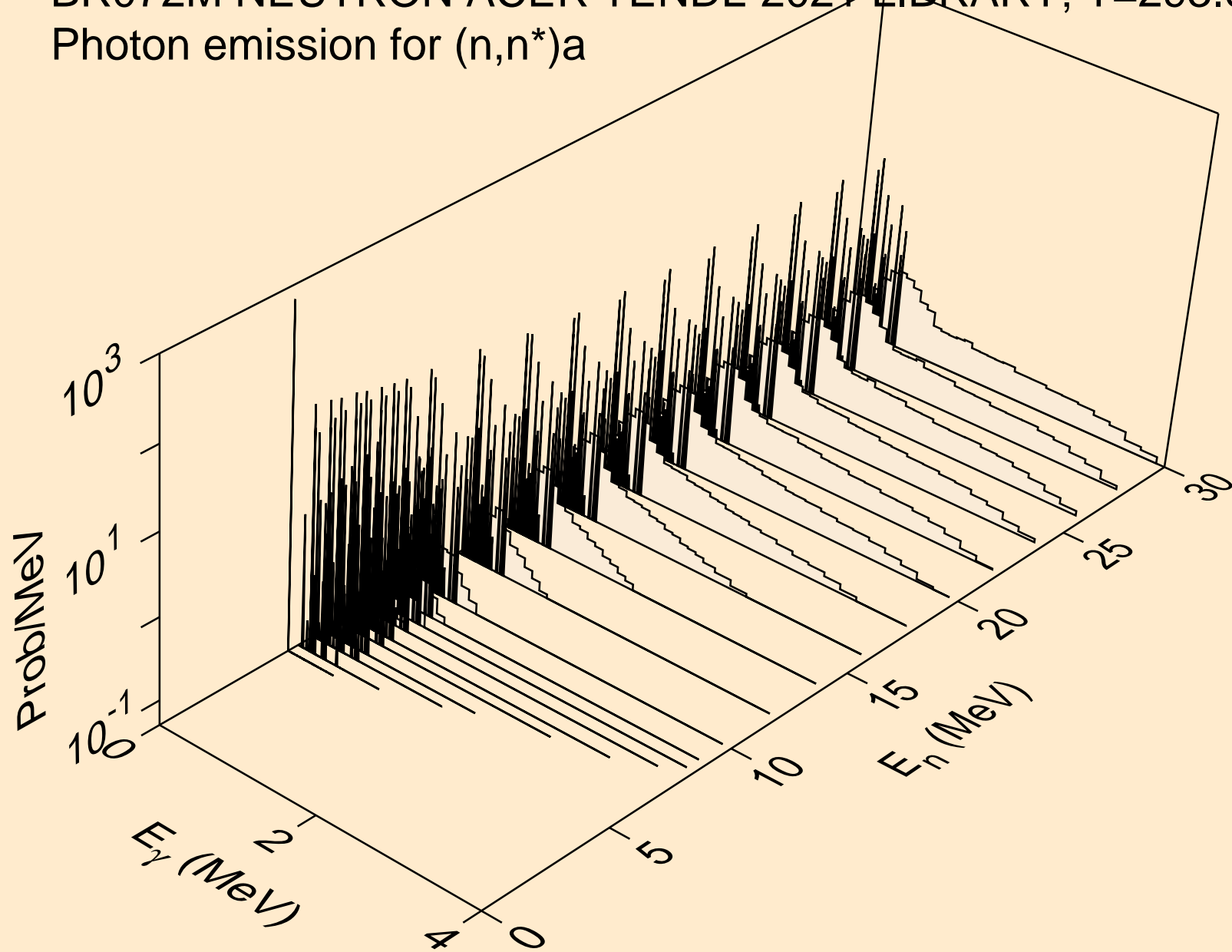

BR072M NEUTRON ACER TENDL-2021 LIBRARY; T=293.6K
Photon emission for (n,2n)a

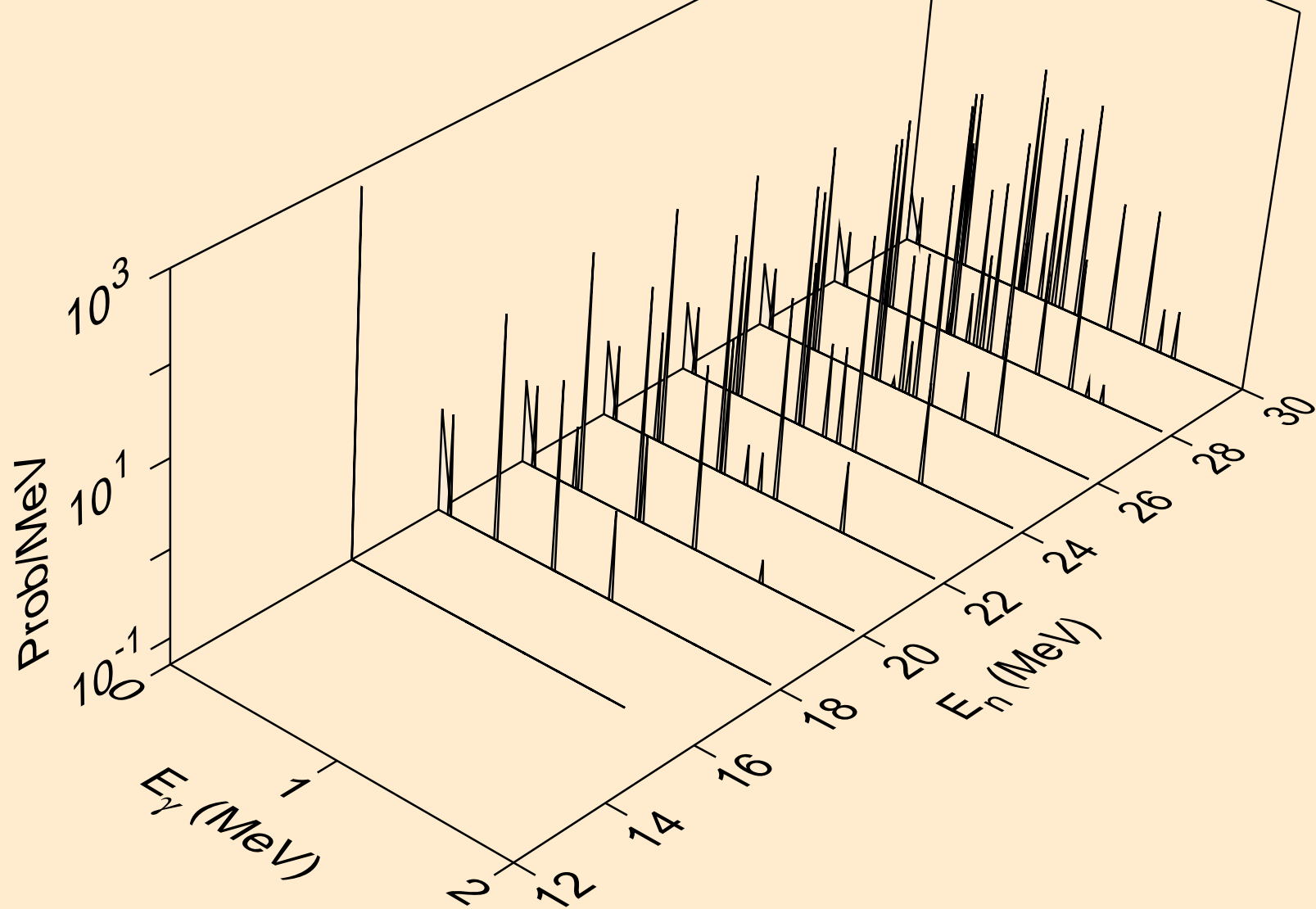

BR072M NEUTRON ACER TENDL-2021 LIBRARY; T=293.6K
Photon emission for (n,n*)p

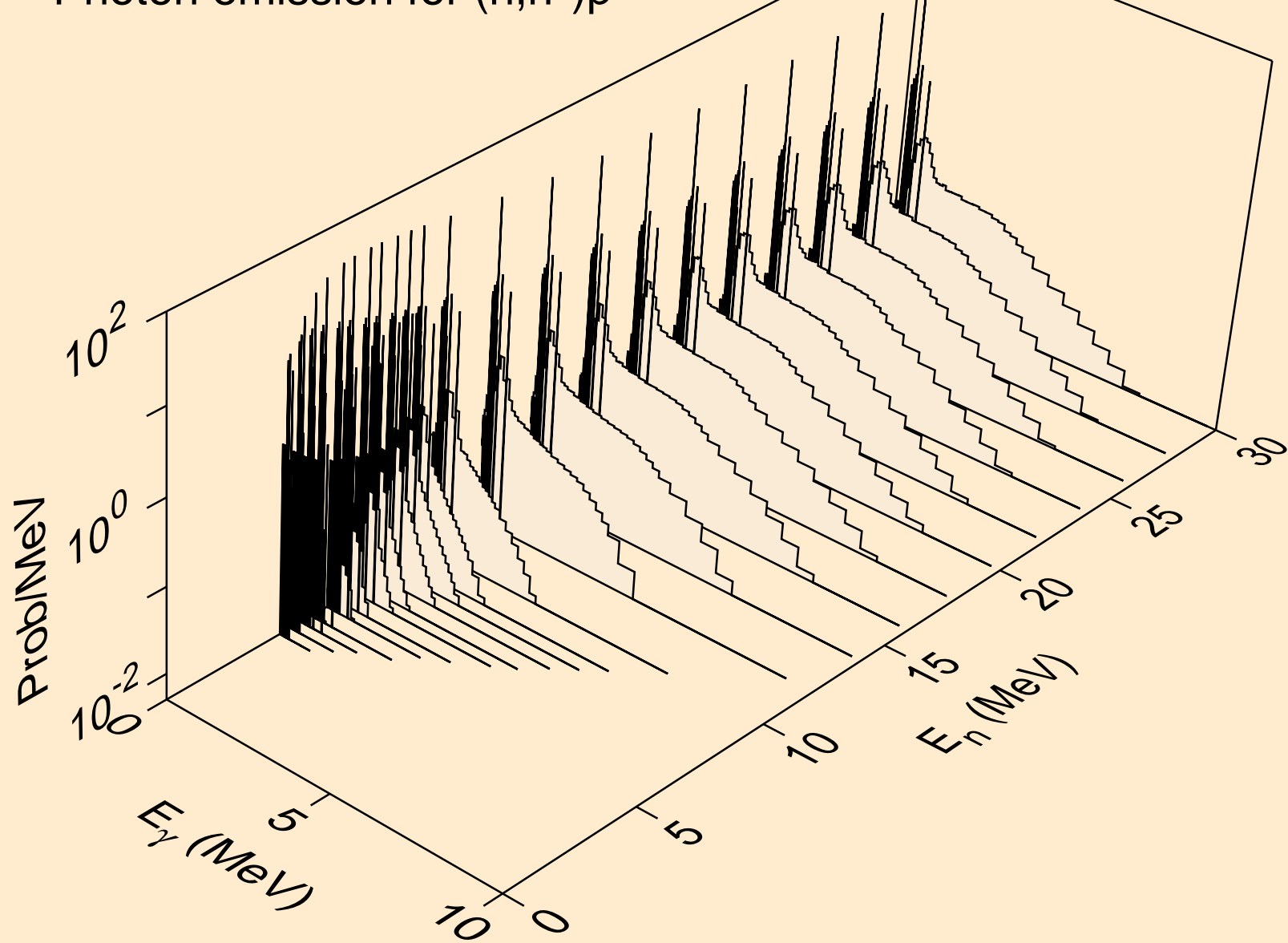

BR072M NEUTRON ACER TENDL-2021 LIBRARY; T=293.6K
Photon emission for (n,n*)2a

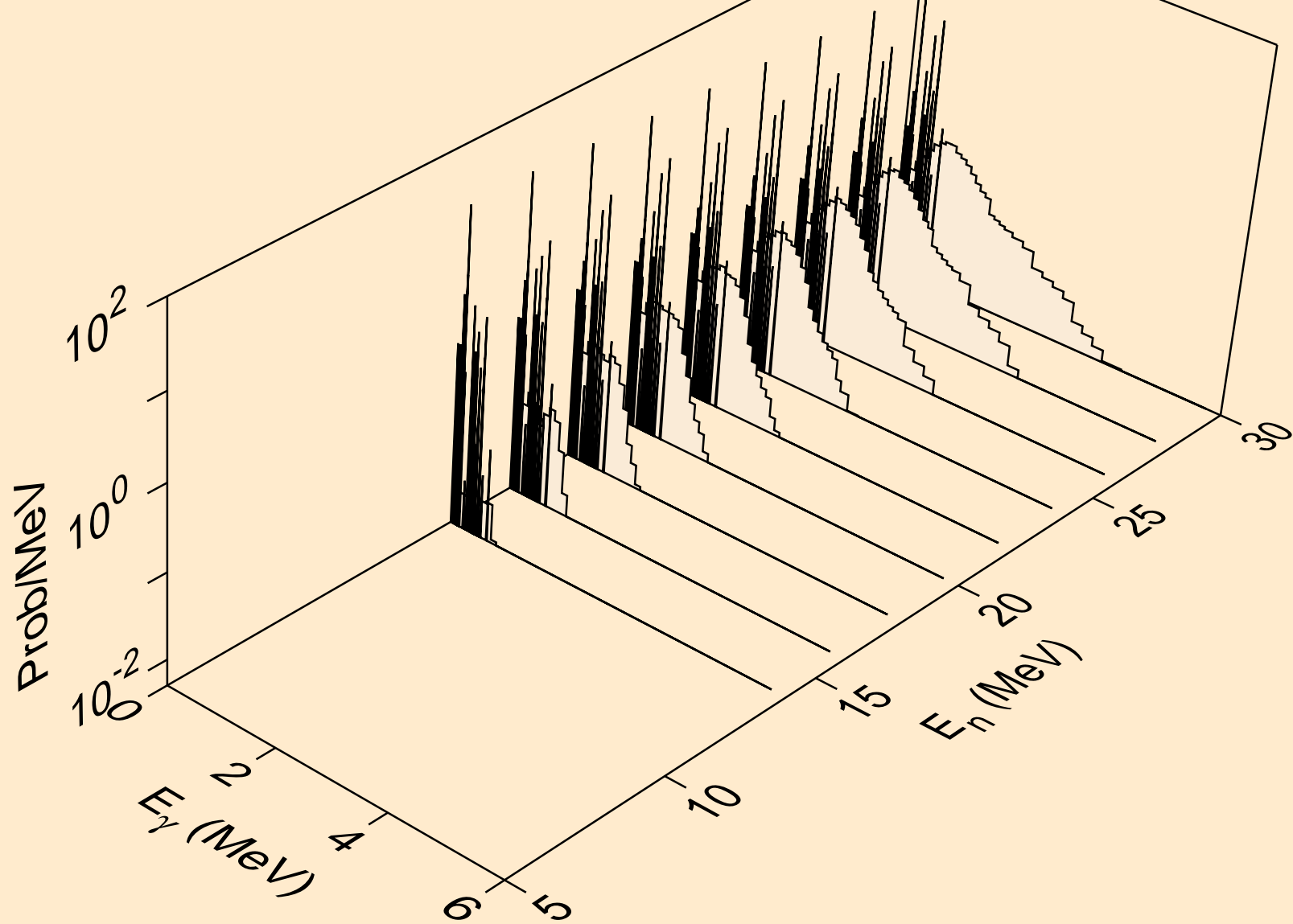

BR072M NEUTRON ACER TENDL-2021 LIBRARY; T=293.6K
Photon emission for (n,n*)d

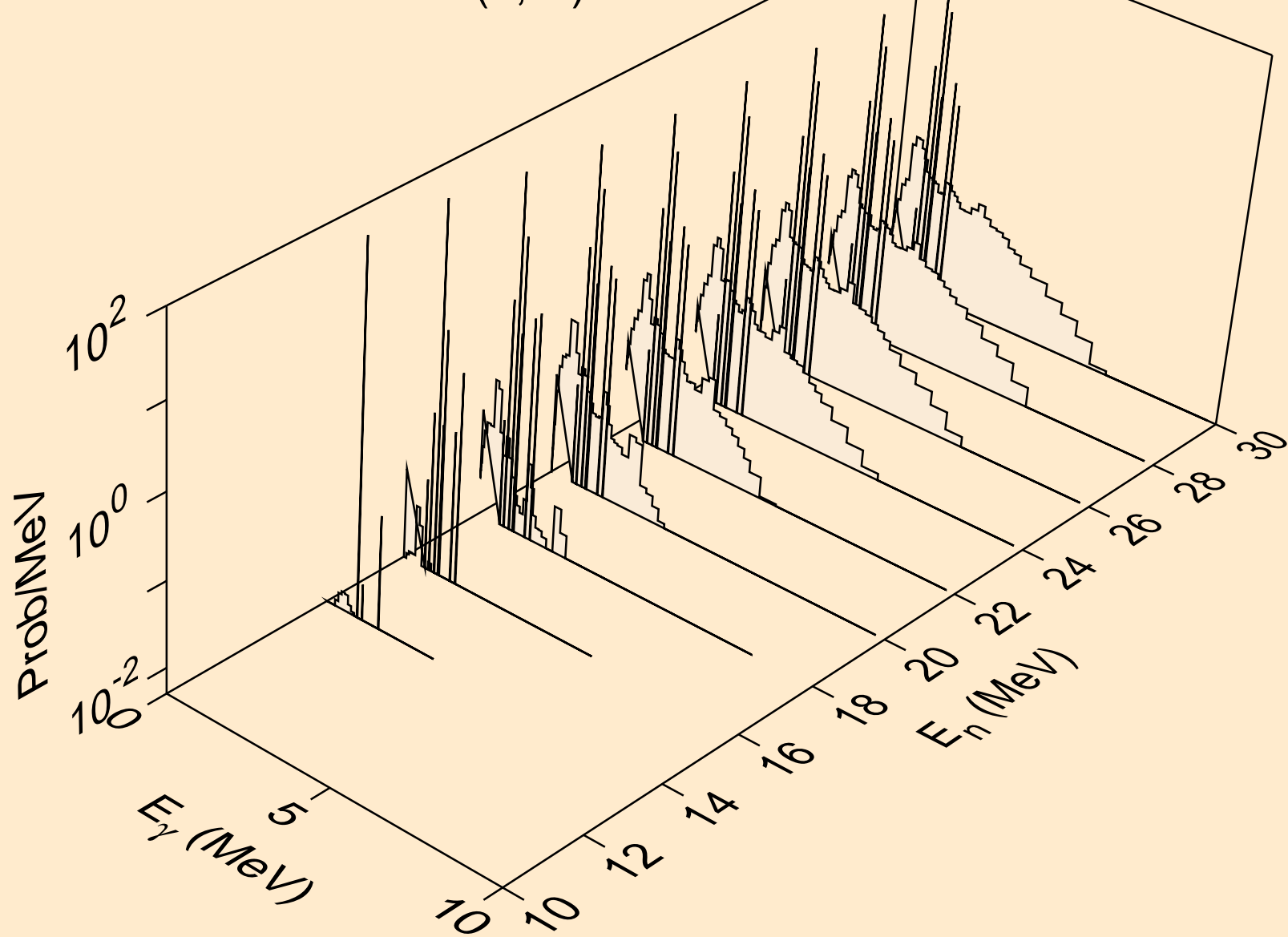

BR072M NEUTRON ACER TENDL-2021 LIBRARY; T=293.6K
Photon emission for (n,n*)t

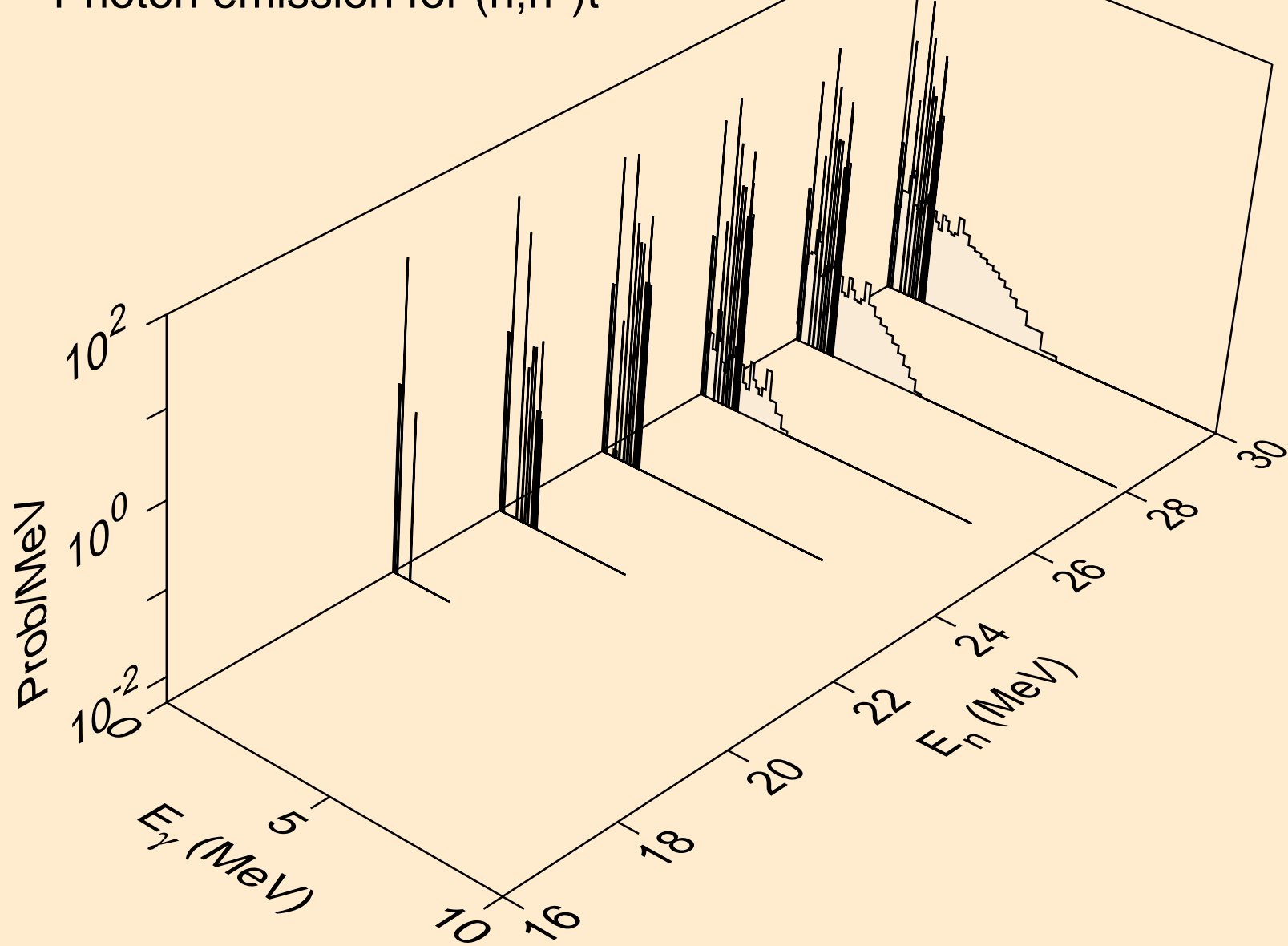

BR072M NEUTRON ACER TENDL-2021 LIBRARY; T=293.6K
Photon emission for (n,n*)he3

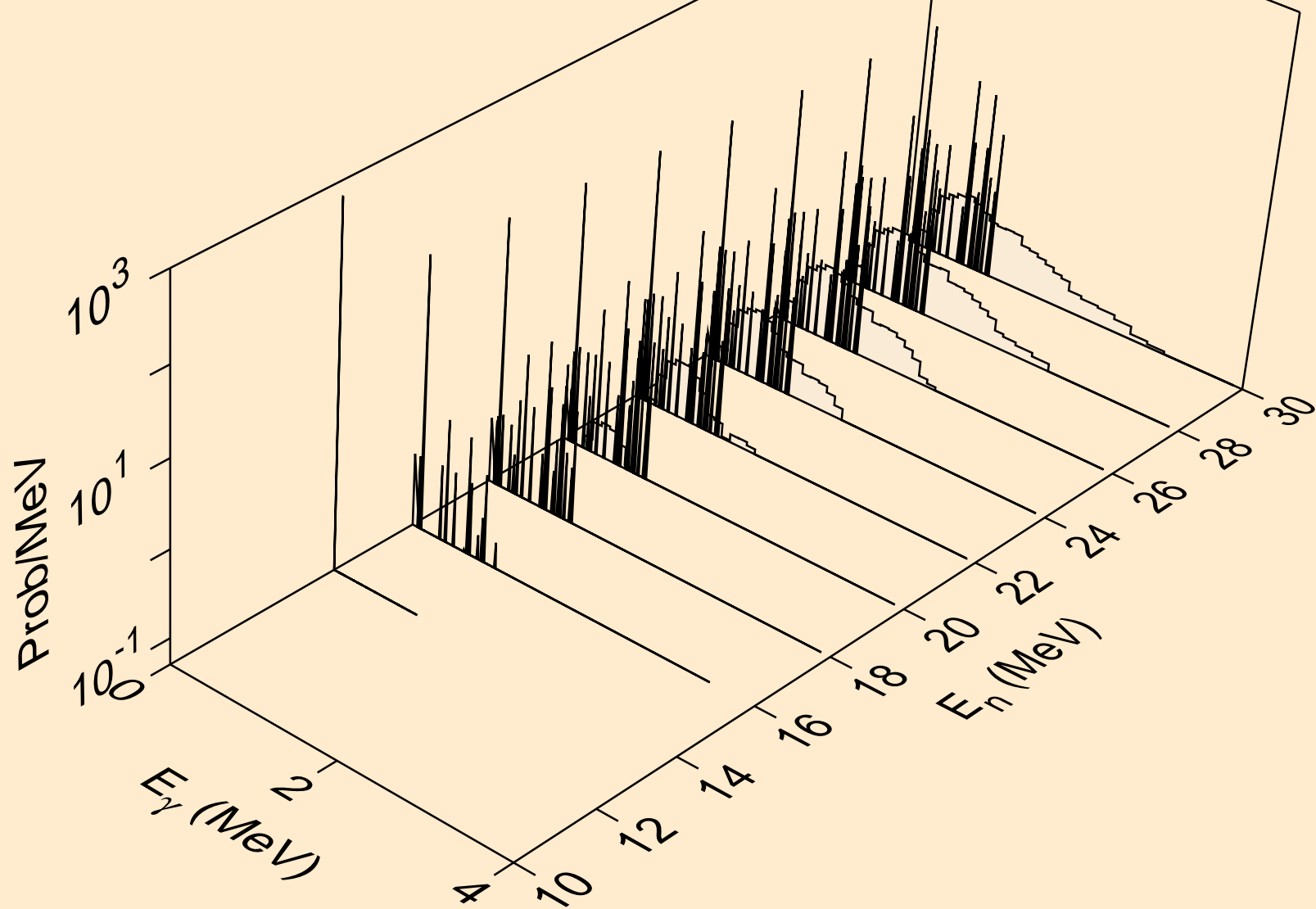

BR072M NEUTRON ACER TENDL-2021 LIBRARY; T=293.6K
Photon emission for (n,2np)

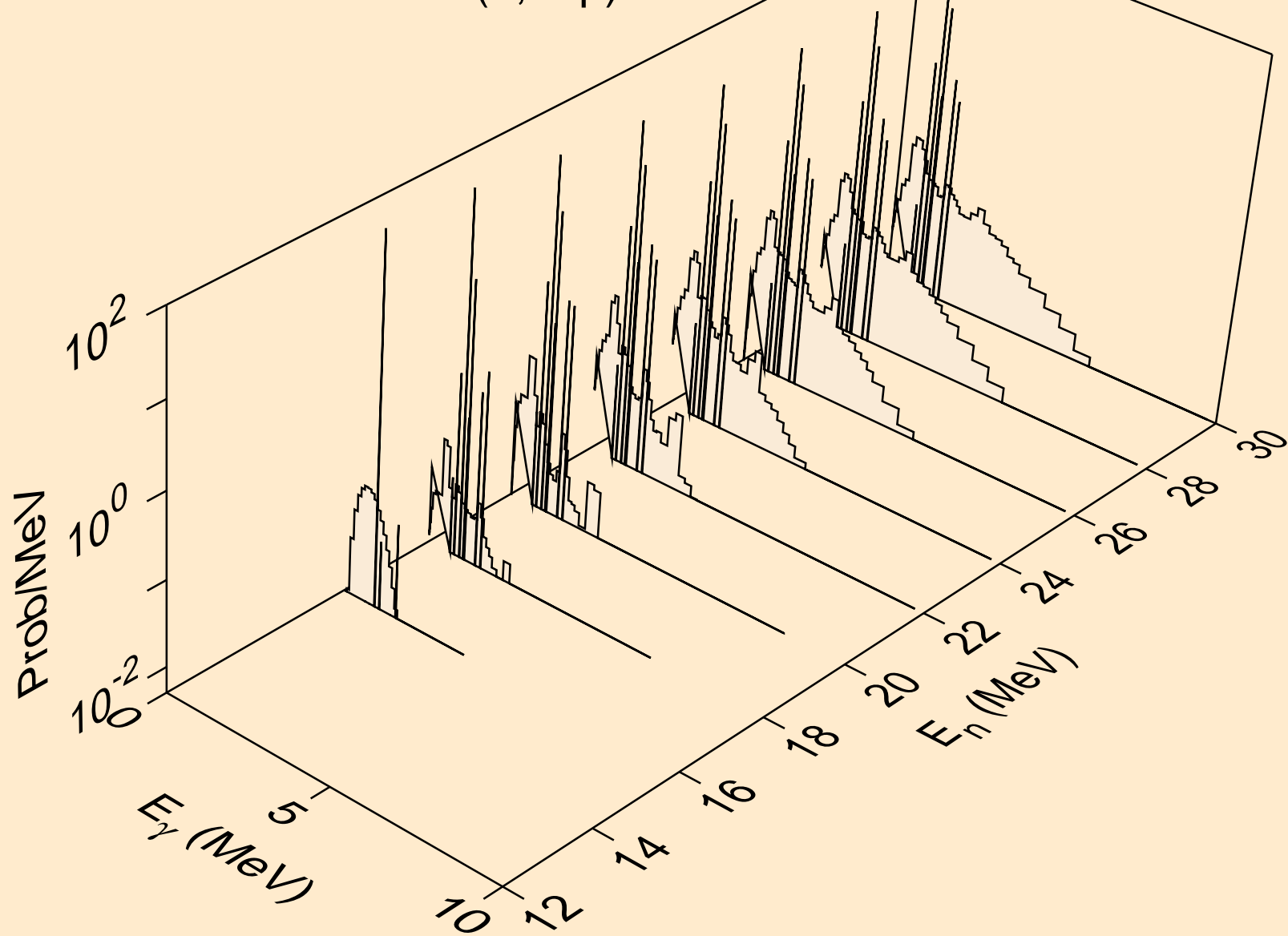

BR072M NEUTRON ACER TENDL-2021 LIBRARY; T=293.6K
Photon emission for (n,3np)

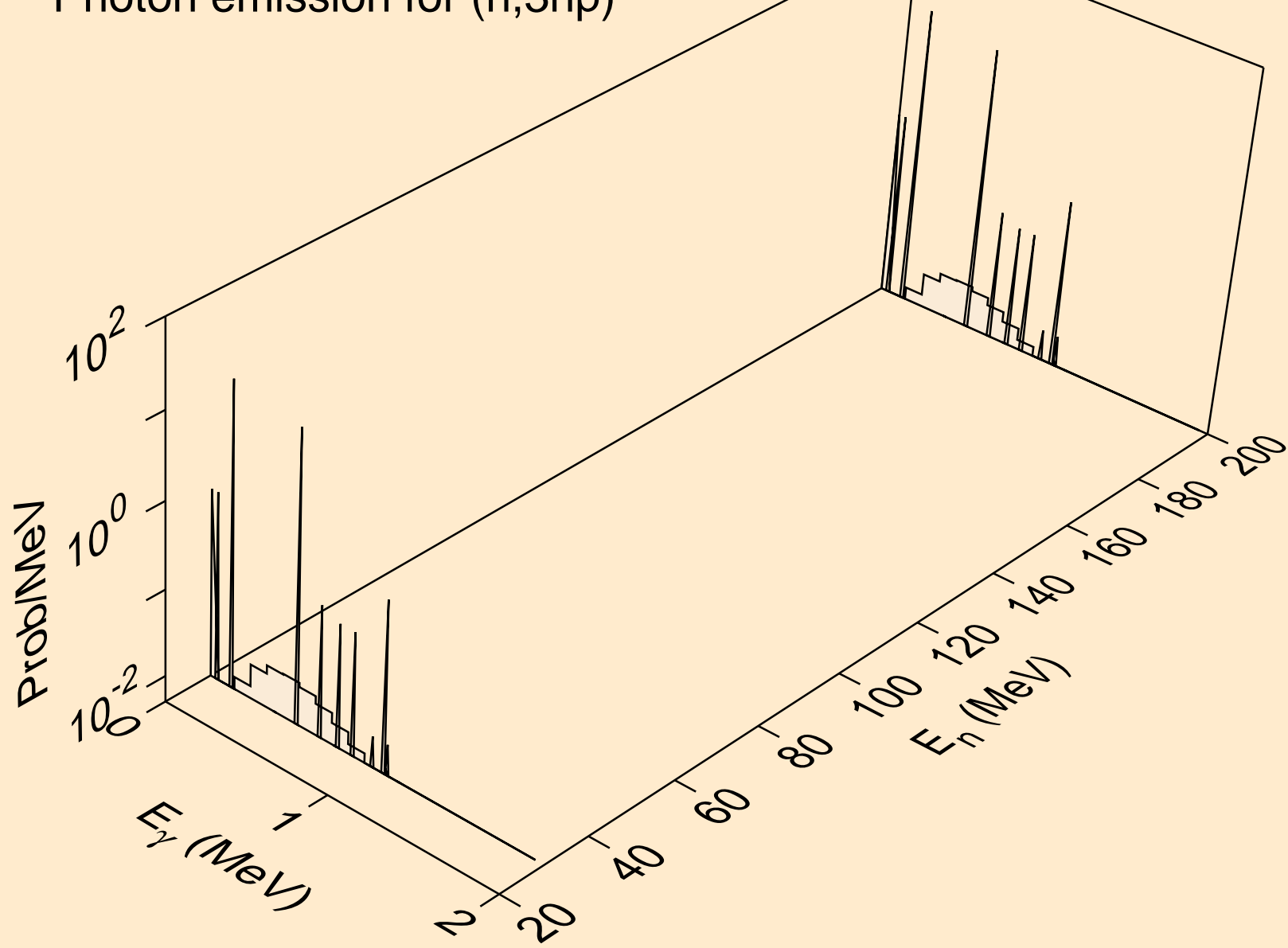

BR072M NEUTRON ACER TENDL-2021 LIBRARY; T=293.6K
Photon emission for (n,2np)

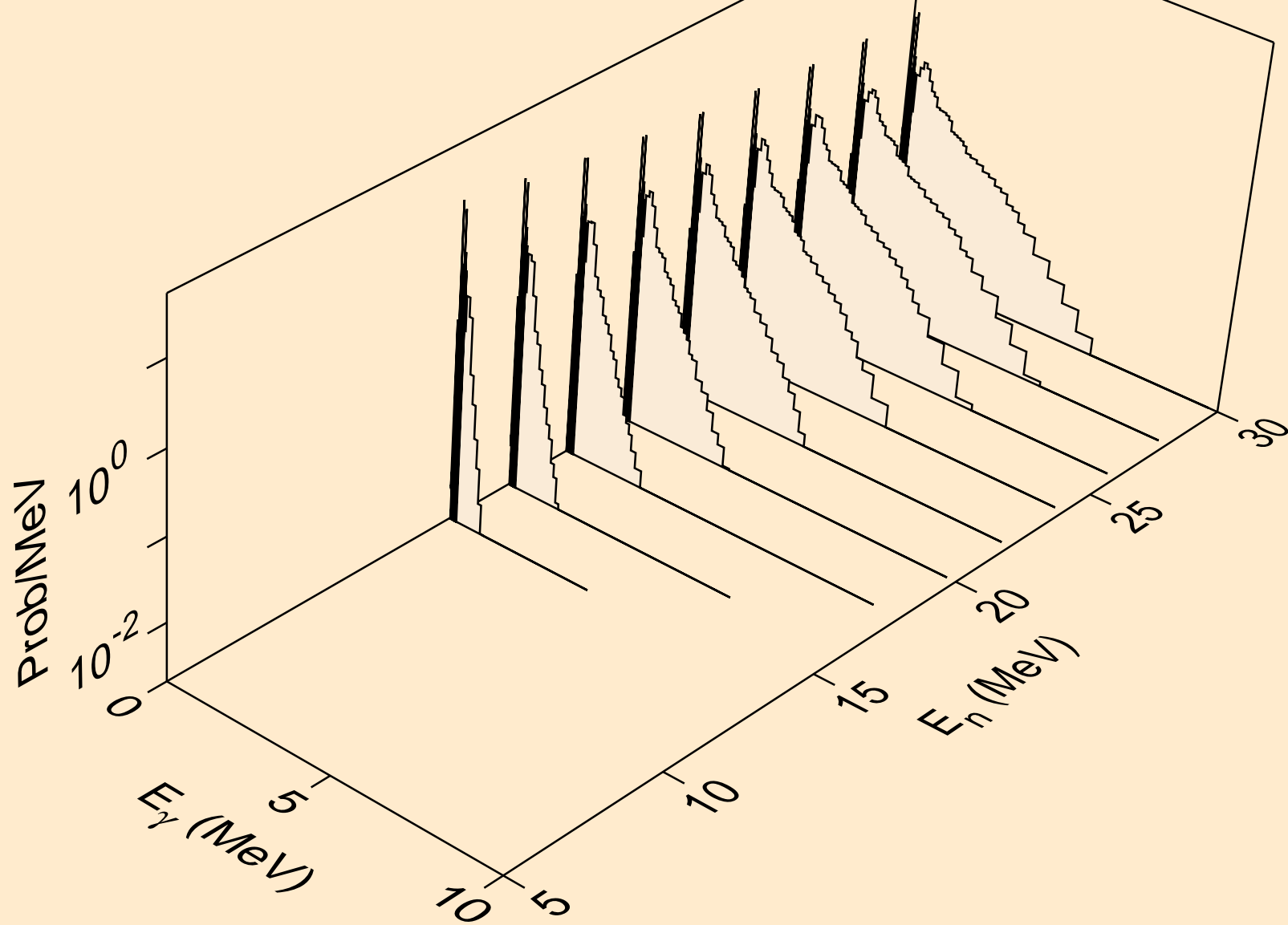

BR072M NEUTRON ACER TENDL-2021 LIBRARY; T=293.6K
Photon emission for (n,npa)

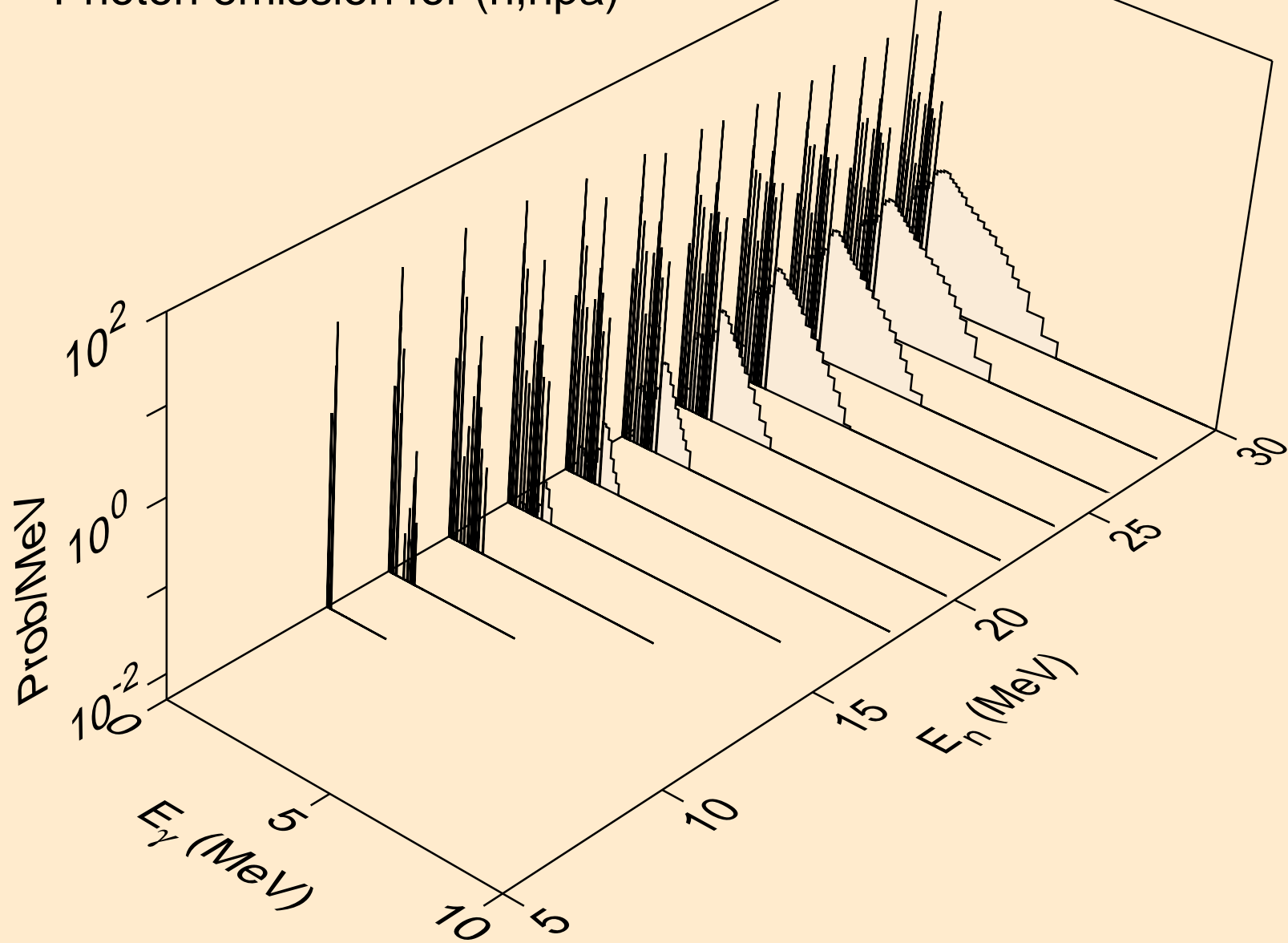

BR072M NEUTRON ACER TENDL-2021 LIBRARY; T=293.6K
Photon emission for (n,n*2)

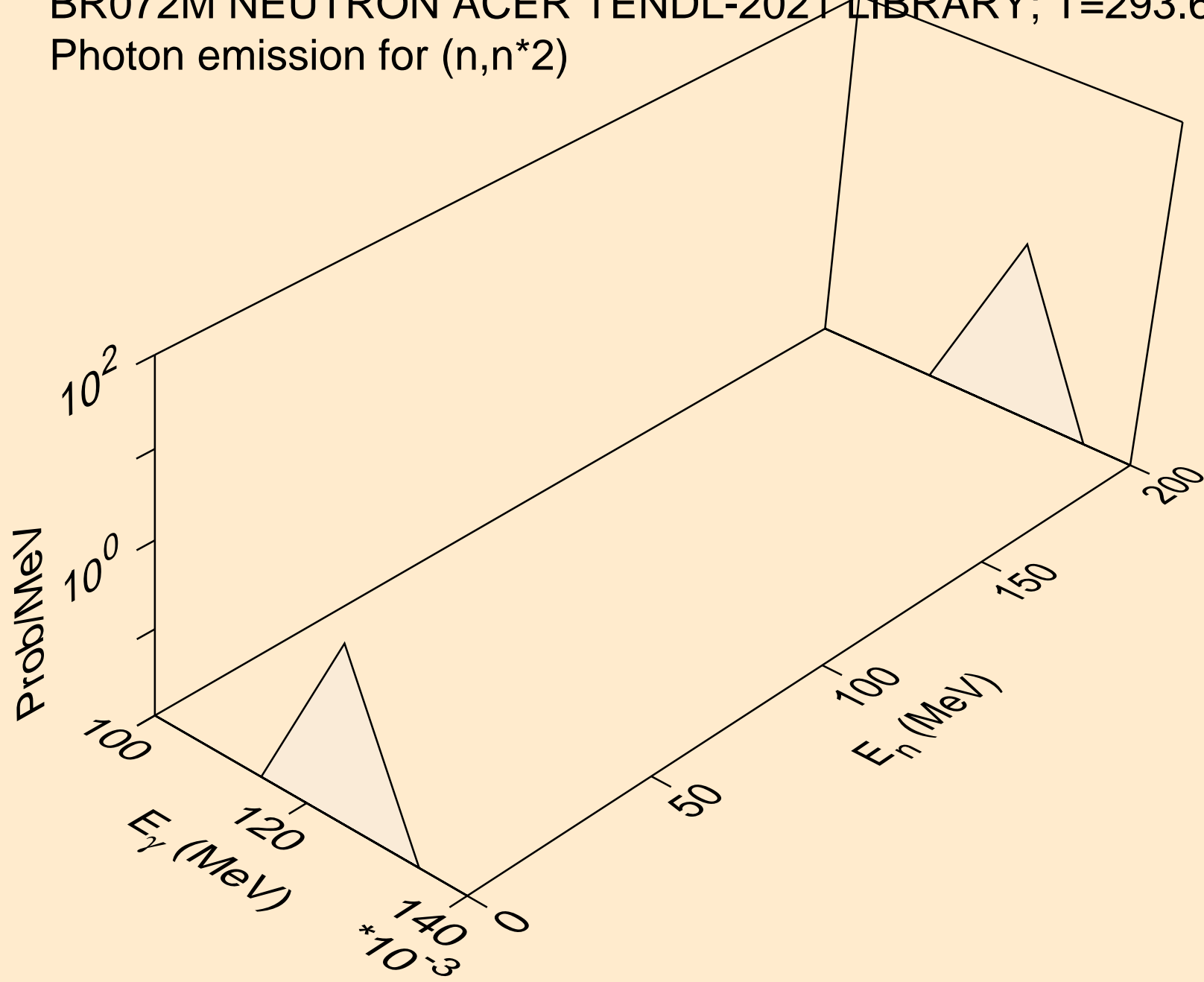

BR072M NEUTRON ACER TENDL-2021 LIBRARY; T=293.6K
Photon emission for (n,n*c)

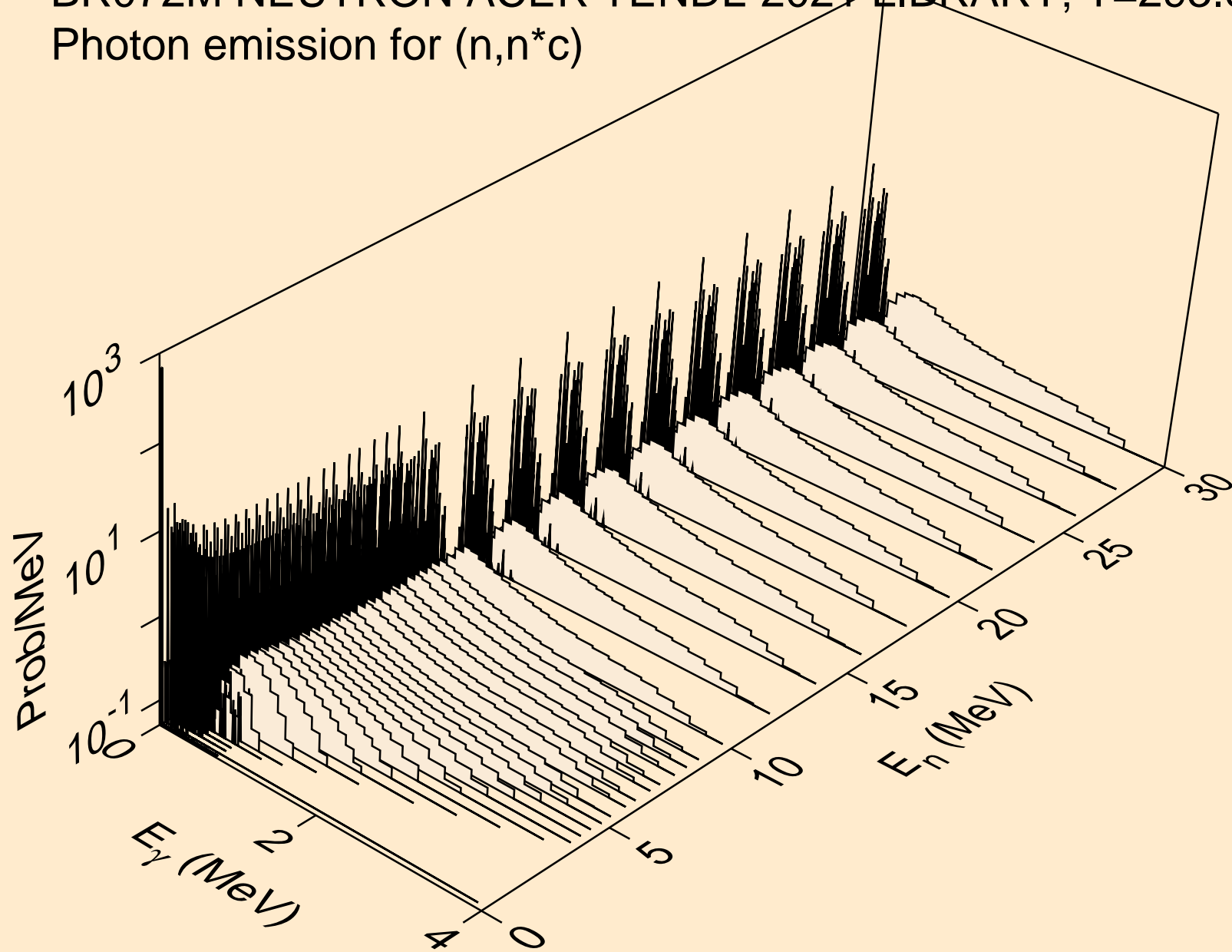

BR072M NEUTRON ACER TENDL-2021 LIBRARY; T=293.6K
Photon emission for (n,gma)

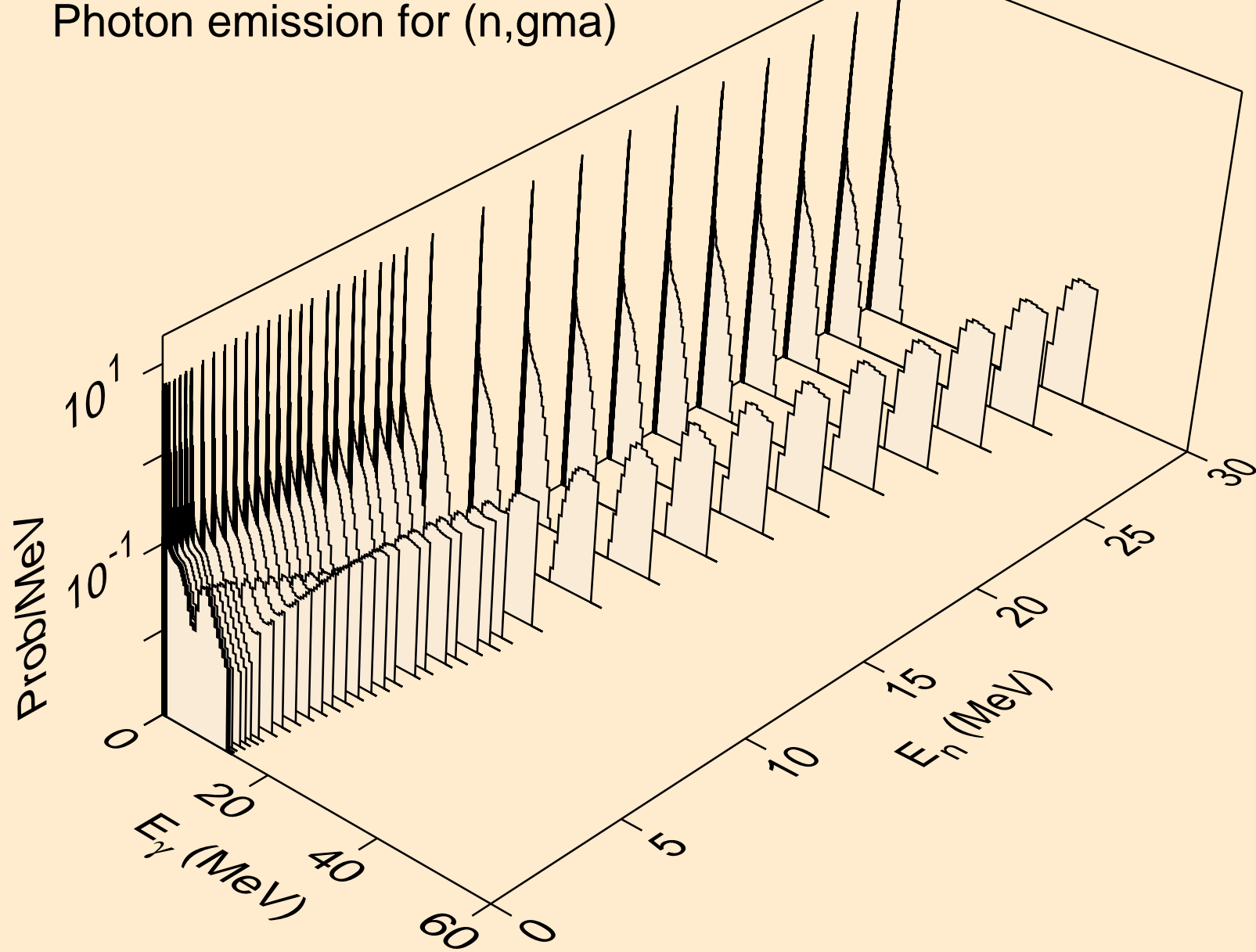

BR072M NEUTRON ACER TENDL-2021 LIBRARY; T=293.6K
Photon emission for (n,p)

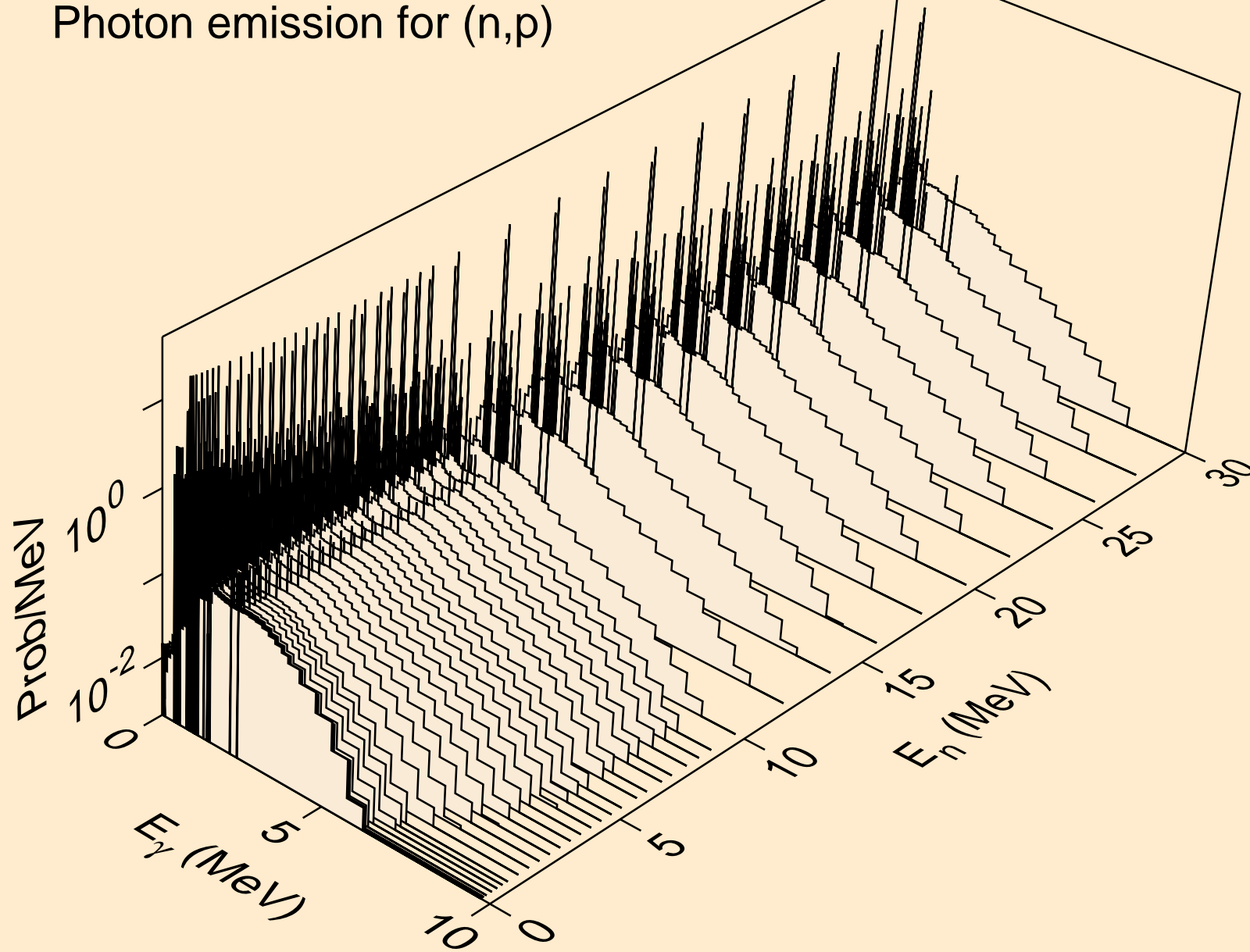

BR072M NEUTRON ACER TENDL-2021 LIBRARY; T=293.6K
Photon emission for (n,d)

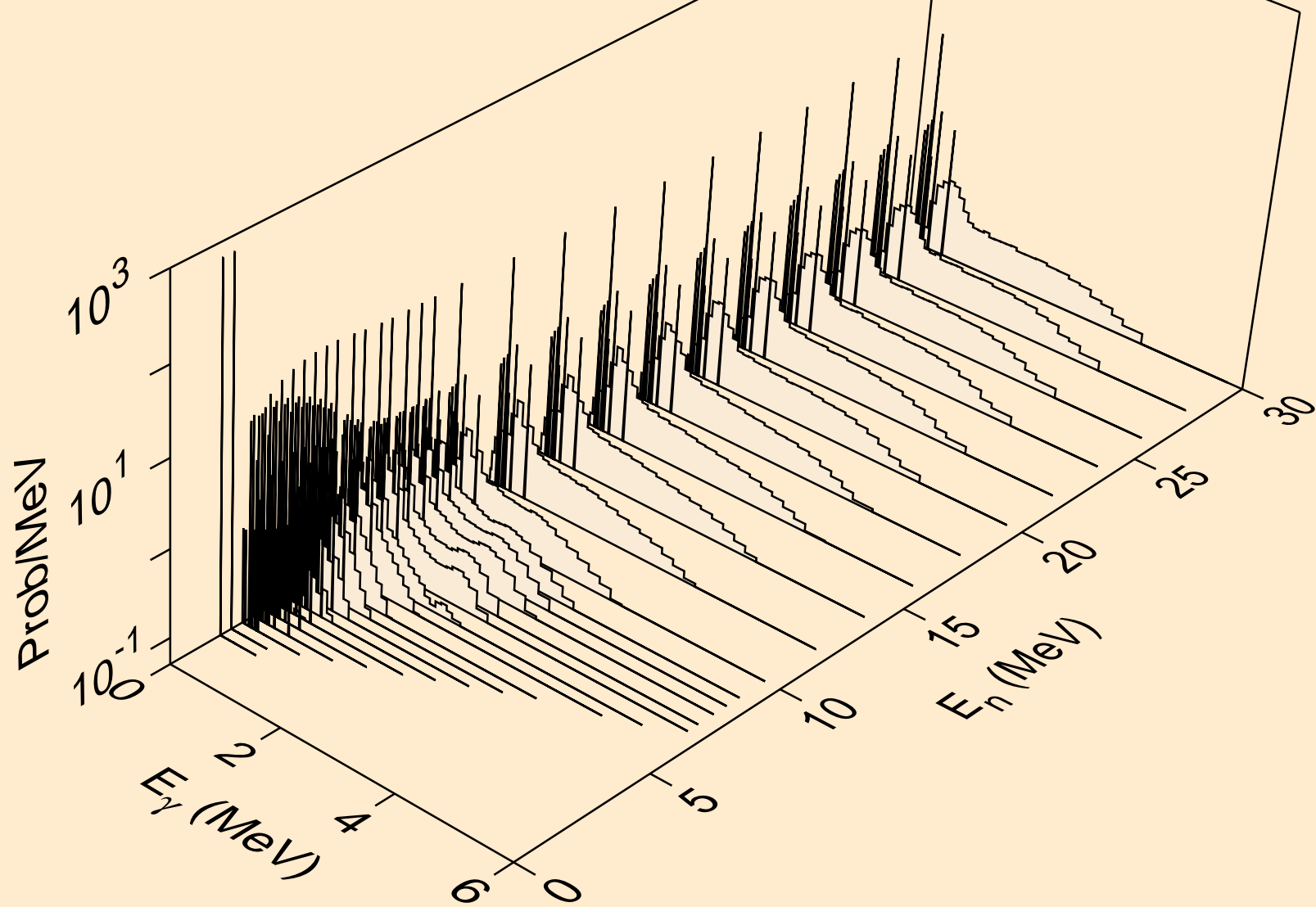

BR072M NEUTRON ACER TENDL-2021 LIBRARY; T=293.6K
Photon emission for (n,t)

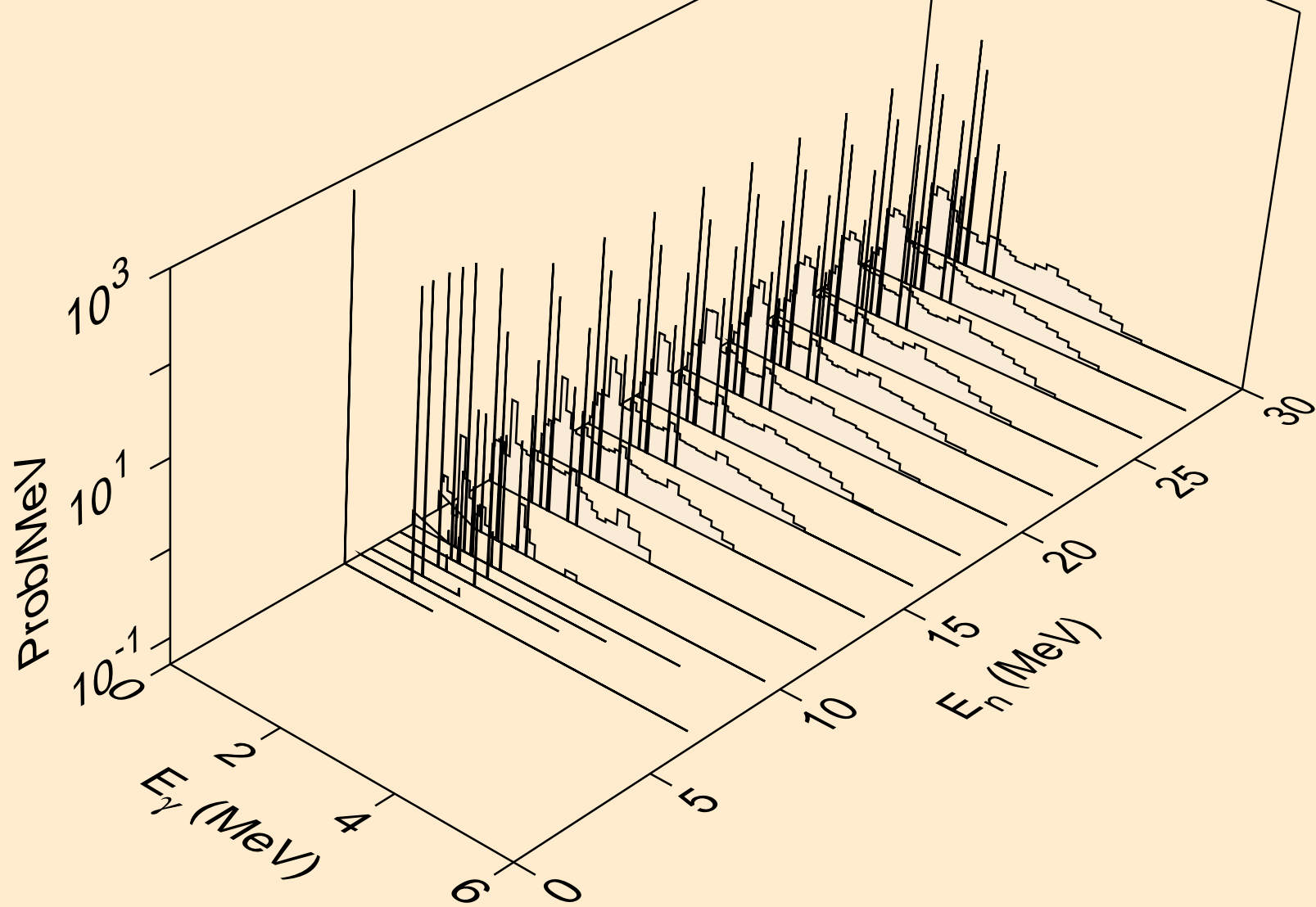

BR072M NEUTRON ACER TENDL-2021 LIBRARY; T=293.6K
Photon emission for (n,he3)

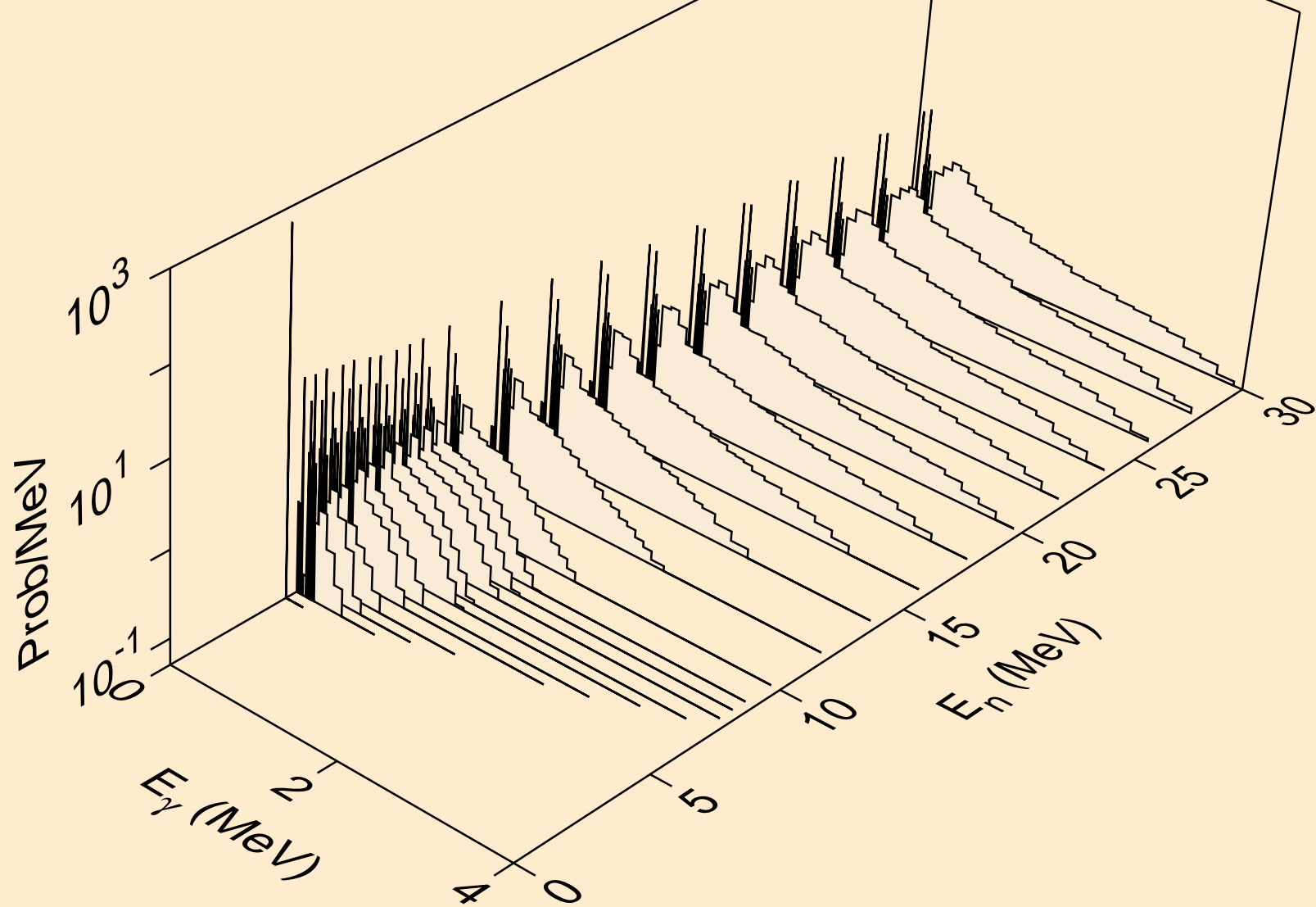

BR072M NEUTRON ACER TENDL-2021 LIBRARY; T=293.6K
Photon emission for (n,a)

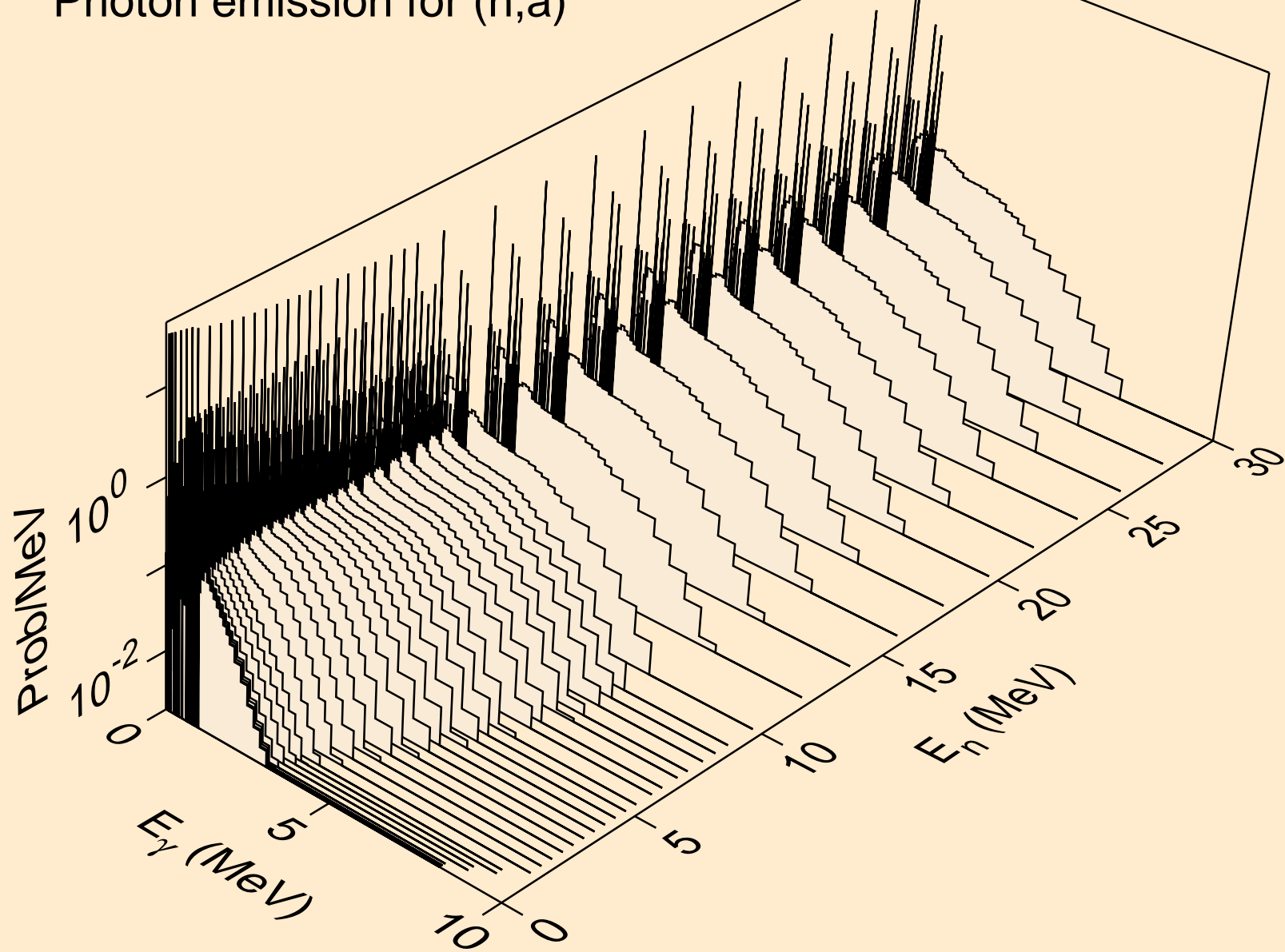

BR072M NEUTRON ACER TENDL-2021 LIBRARY; T=293.6K
Photon emission for (n,2a)

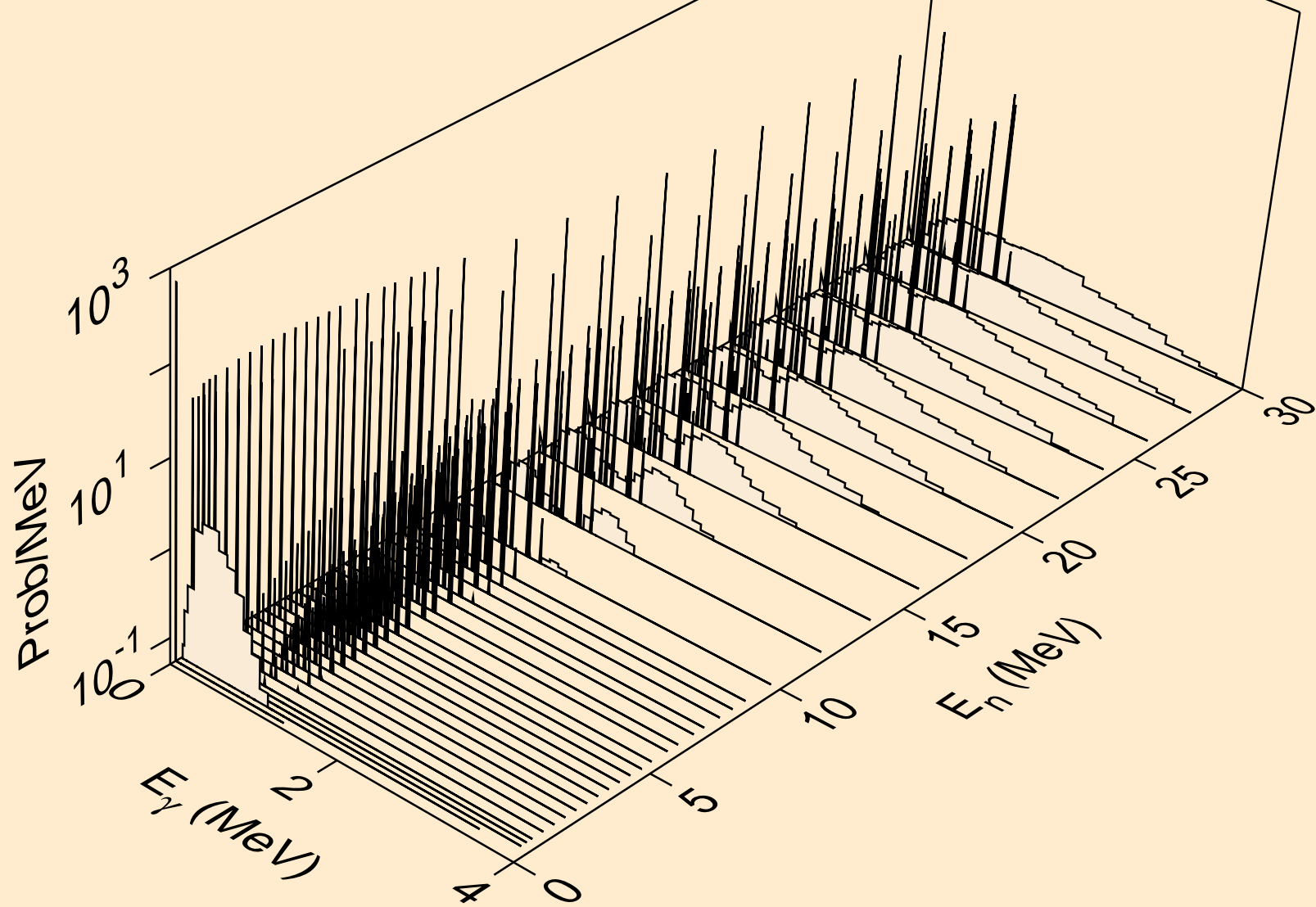

BR072M NEUTRON ACER TENDL-2021 LIBRARY; T=293.6K
Photon emission for (n,3a)

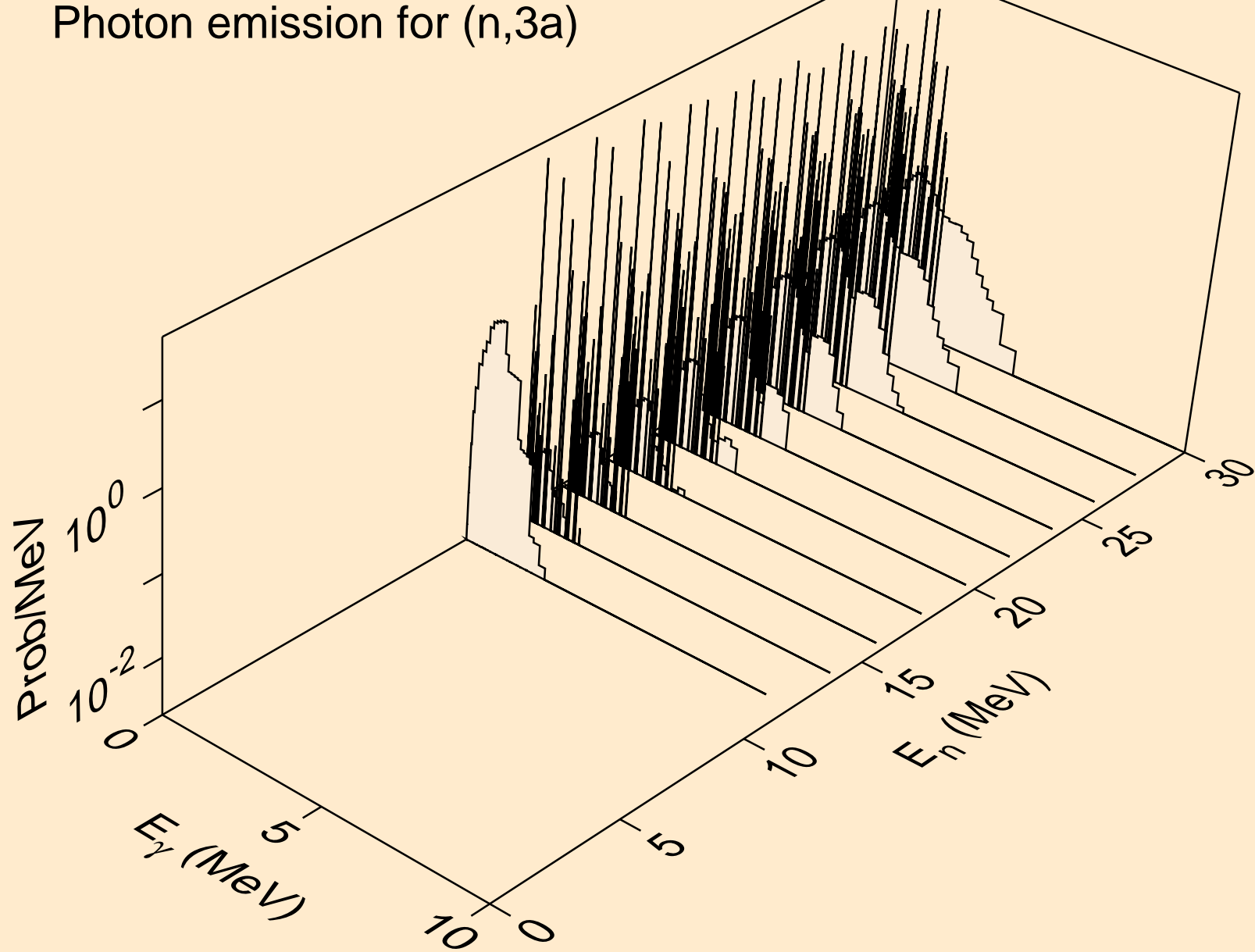

BR072M NEUTRON ACER TENDL-2021 LIBRARY; T=293.6K
Photon emission for (n,2p)

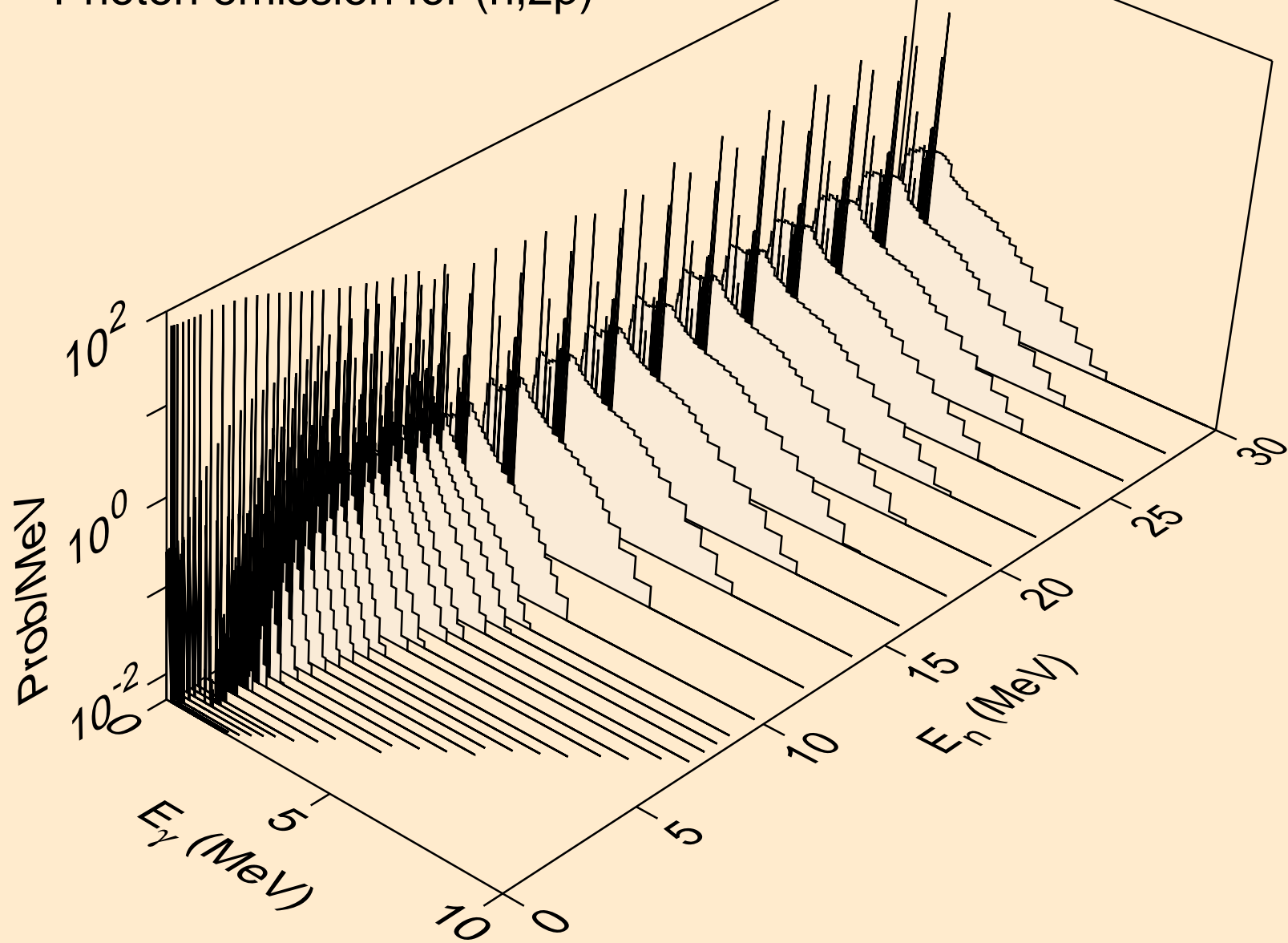

BR072M NEUTRON ACER TENDL-2021 LIBRARY; T=293.6K
Photon emission for (n,p α)

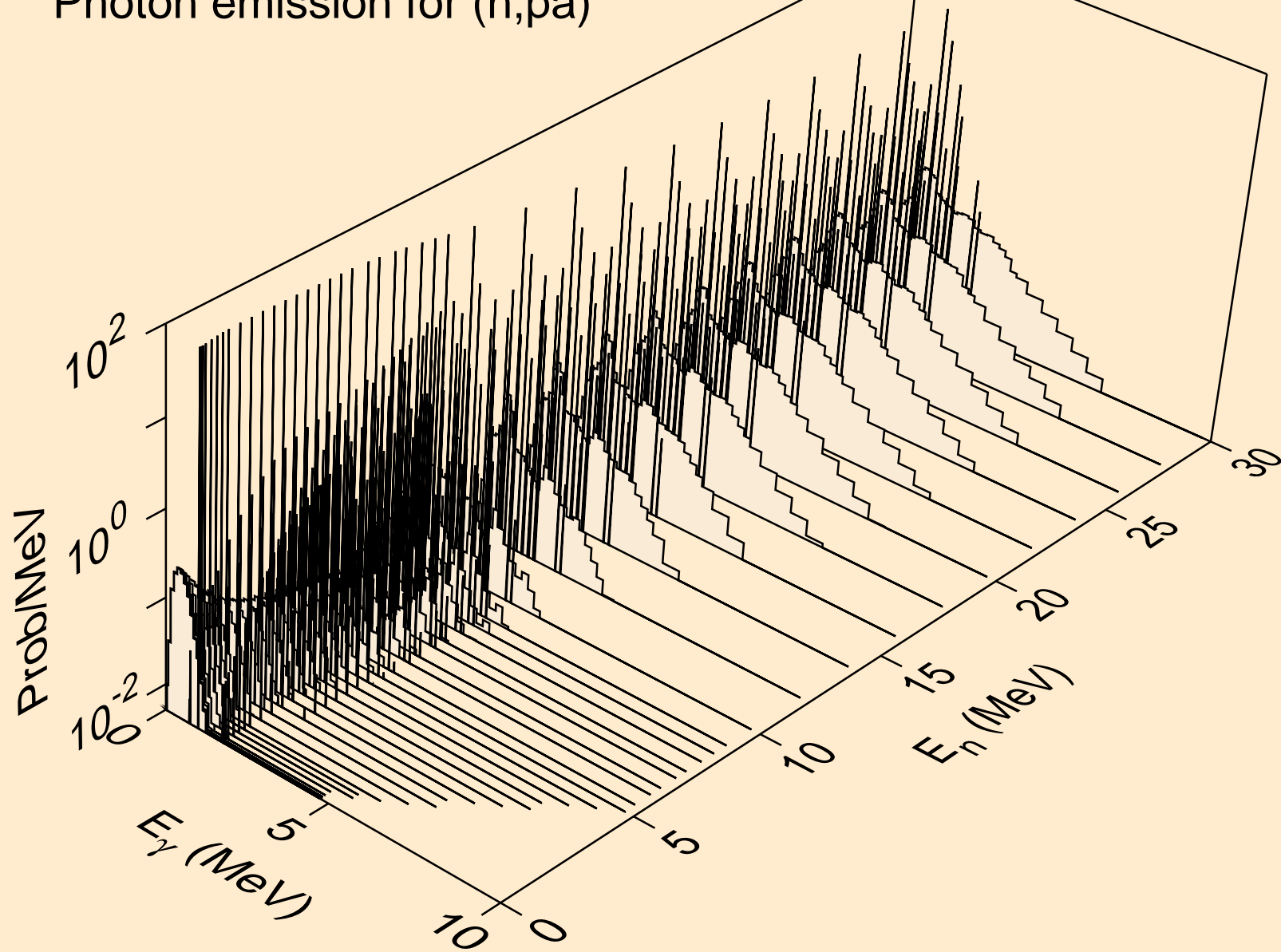

BR072M NEUTRON ACER TENDL-2021 LIBRARY; T=293.6K
Photon emission for (n,t2a)

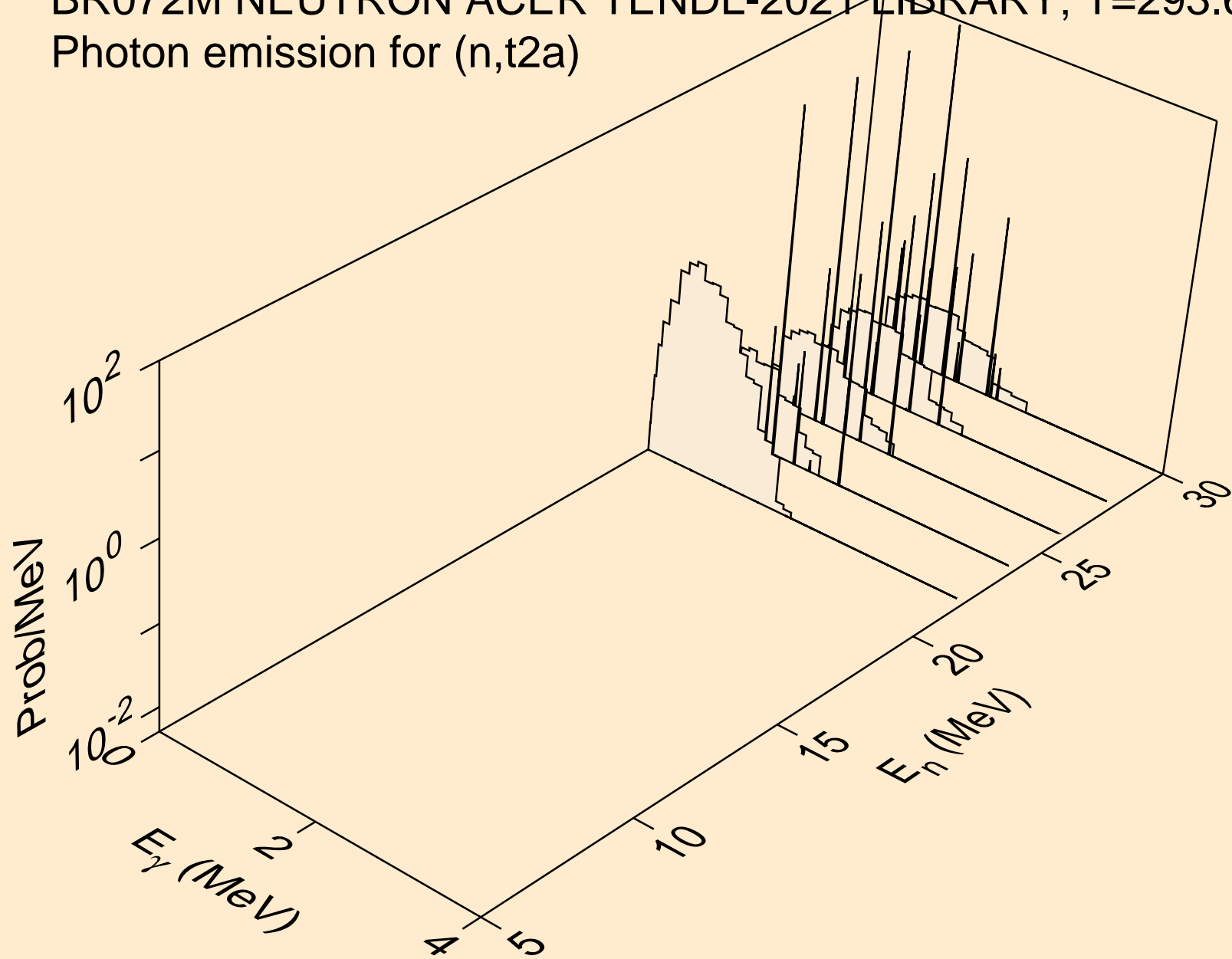

BR072M NEUTRON ACER TENDL-2021 LIBRARY; T=293.6K
Photon emission for (n,d2a)

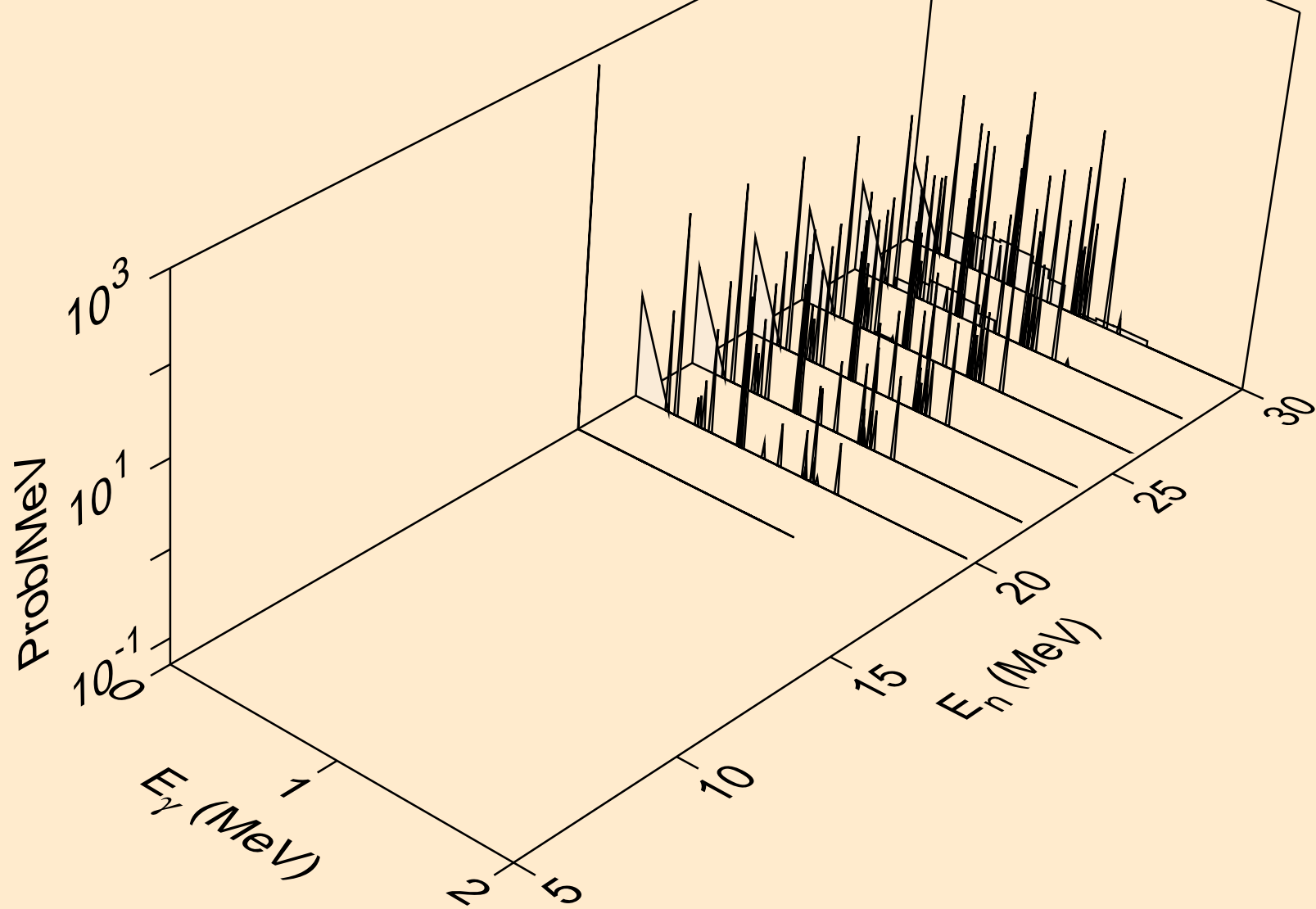

BR072M NEUTRON ACER TENDL-2021 LIBRARY; T=293.6K
Photon emission for (n,pd)

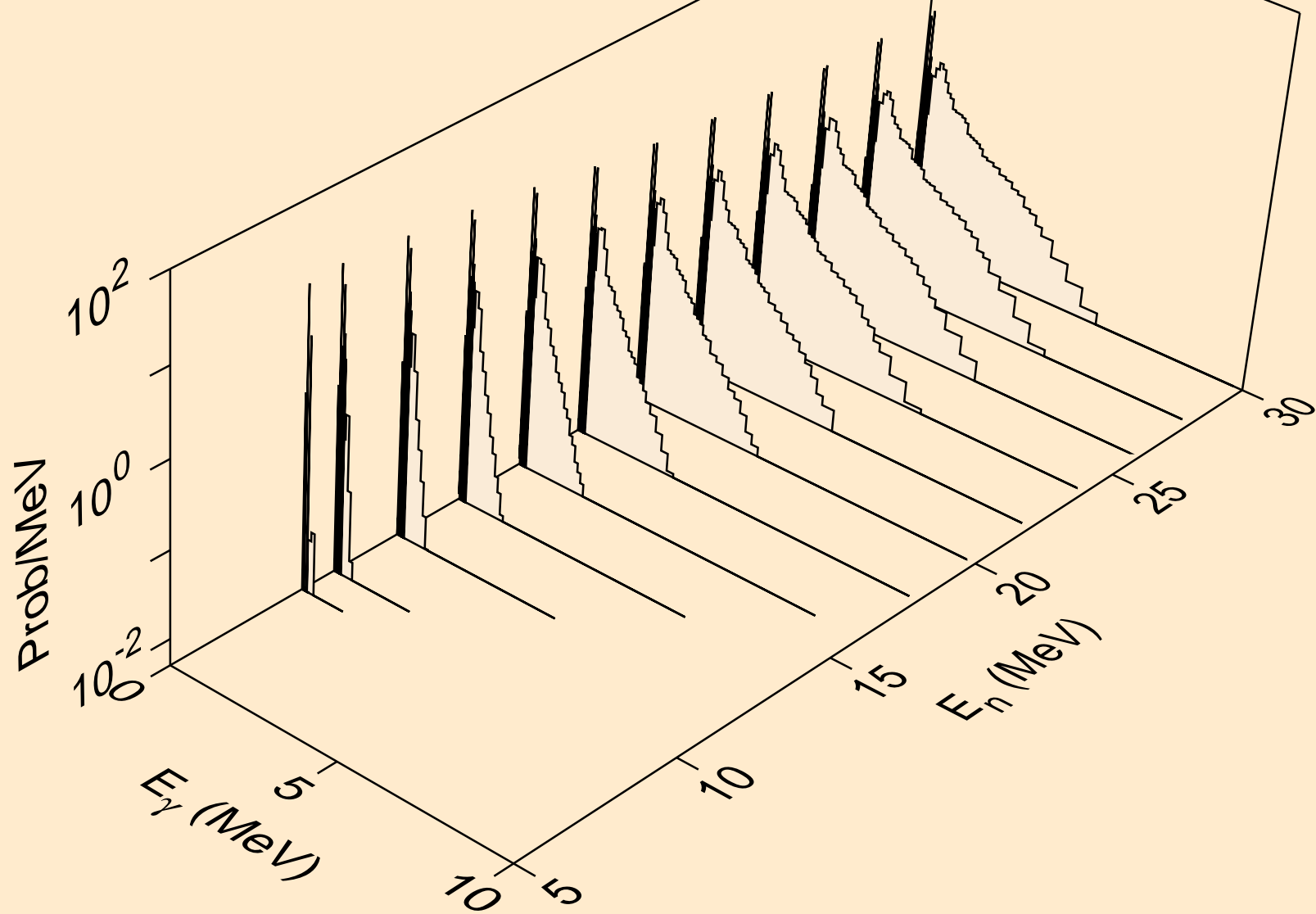

BR072M NEUTRON ACER TENDL-2021 LIBRARY; T=293.6K
Photon emission for (n,pt)

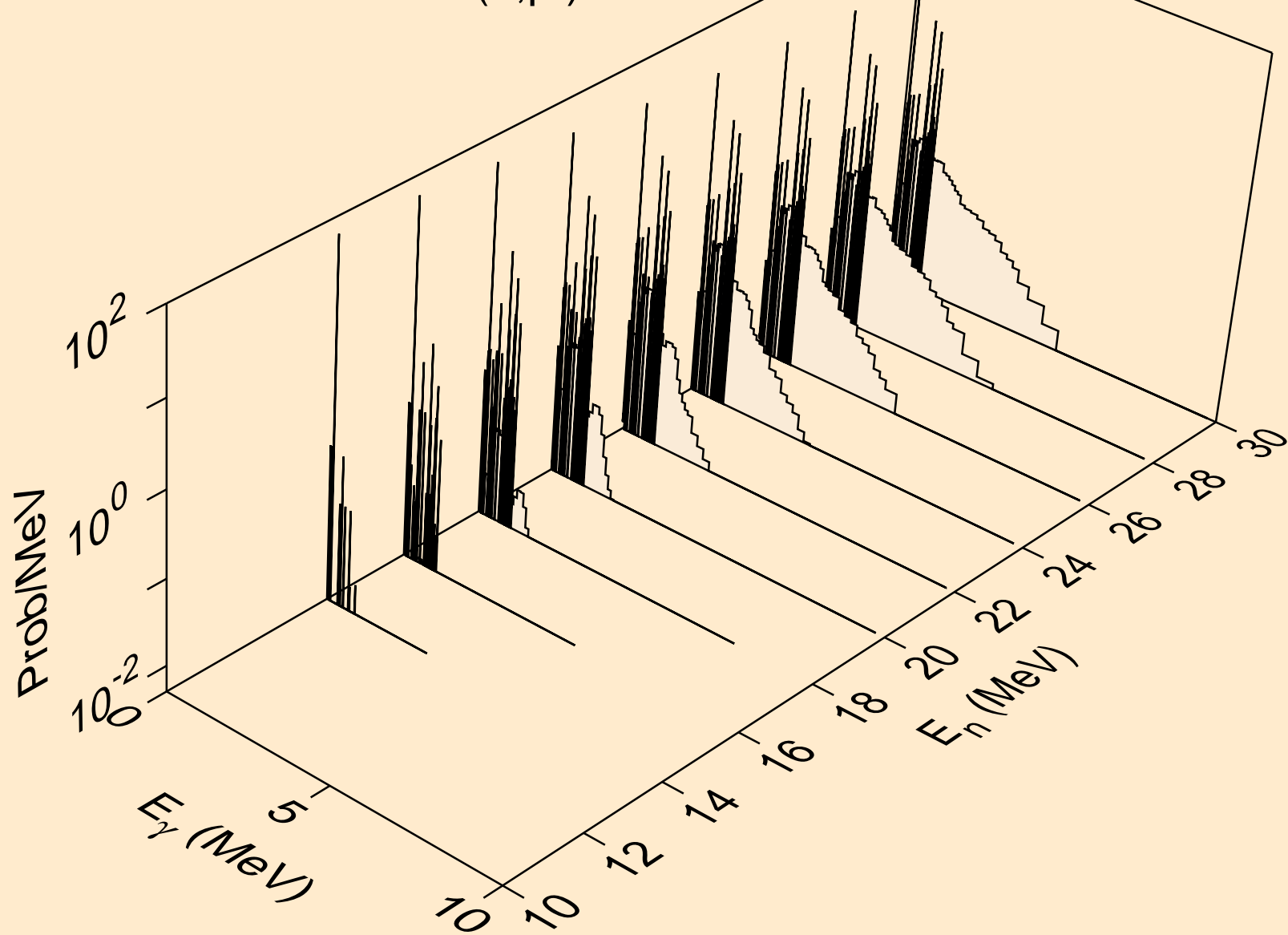

BR072M NEUTRON ACER TENDL-2021 LIBRARY; T=293.6K
Photon emission for (n,da)

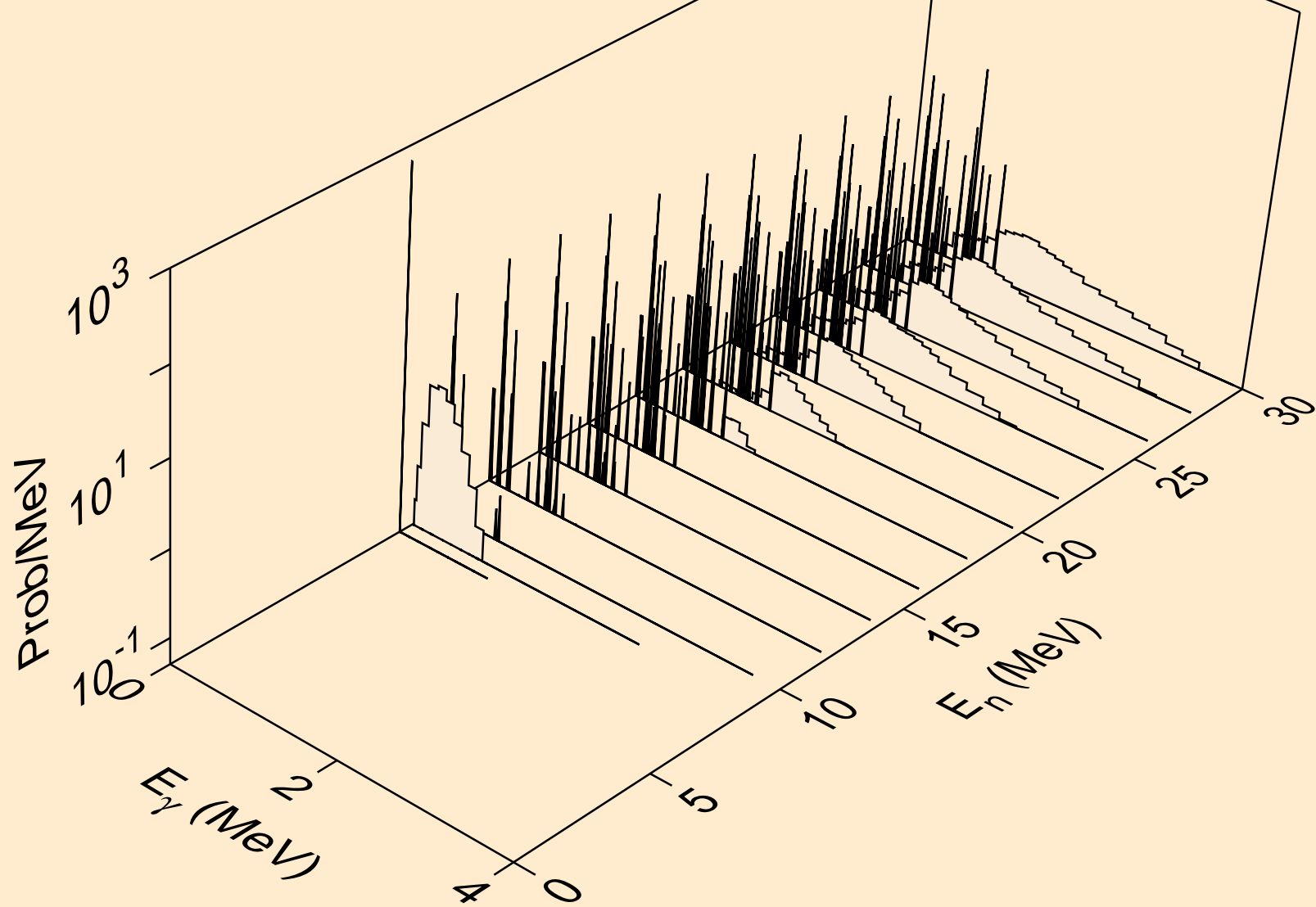

BR072M NEUTRON ACER TENDL-2021 LIBRARY; T=293.6K
thermal capture photon spectrum

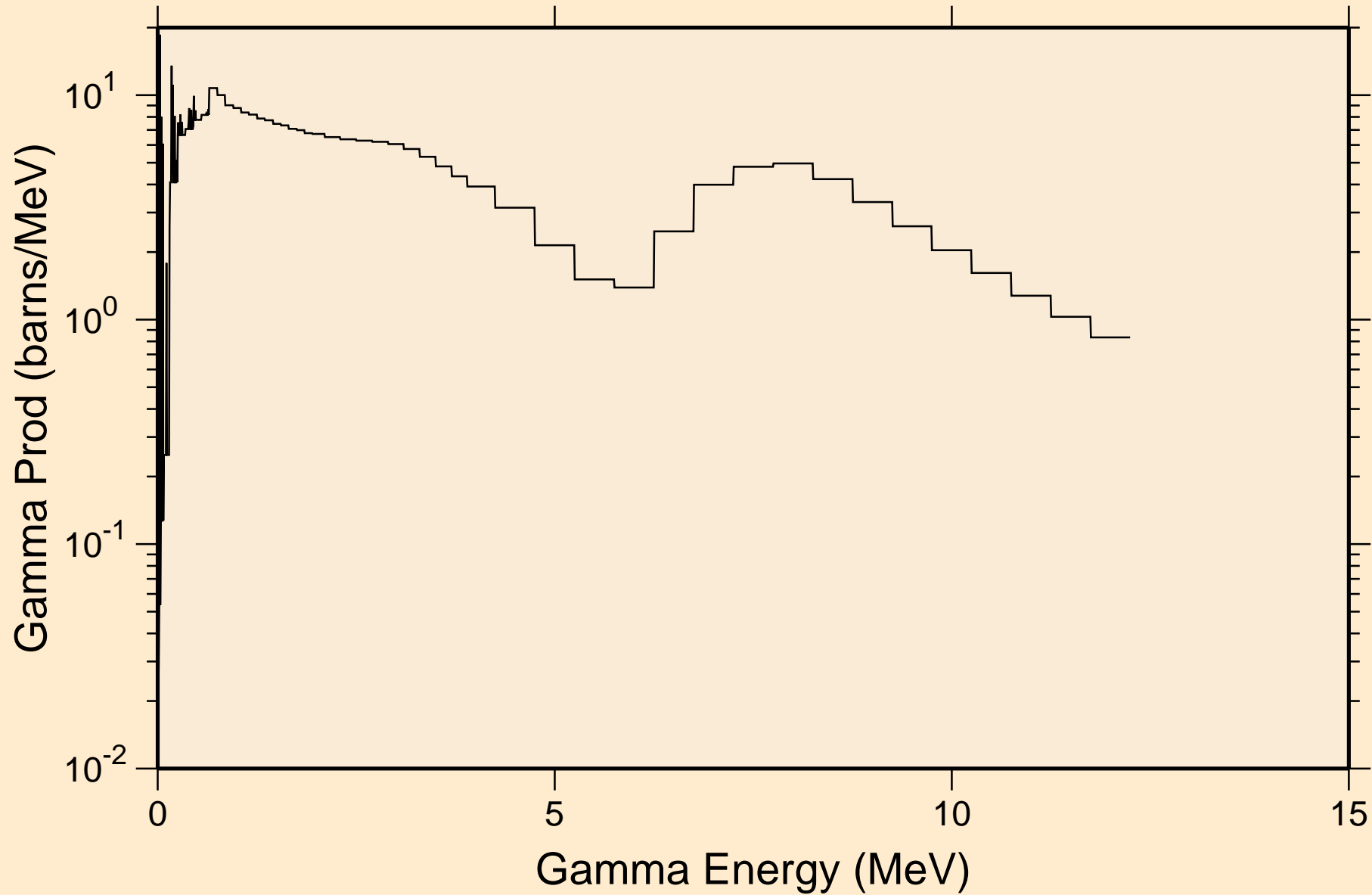

BR072M NEUTRON ACER TENDL-2021 LIBRARY; T=293.6K
14 MeV photon spectrum

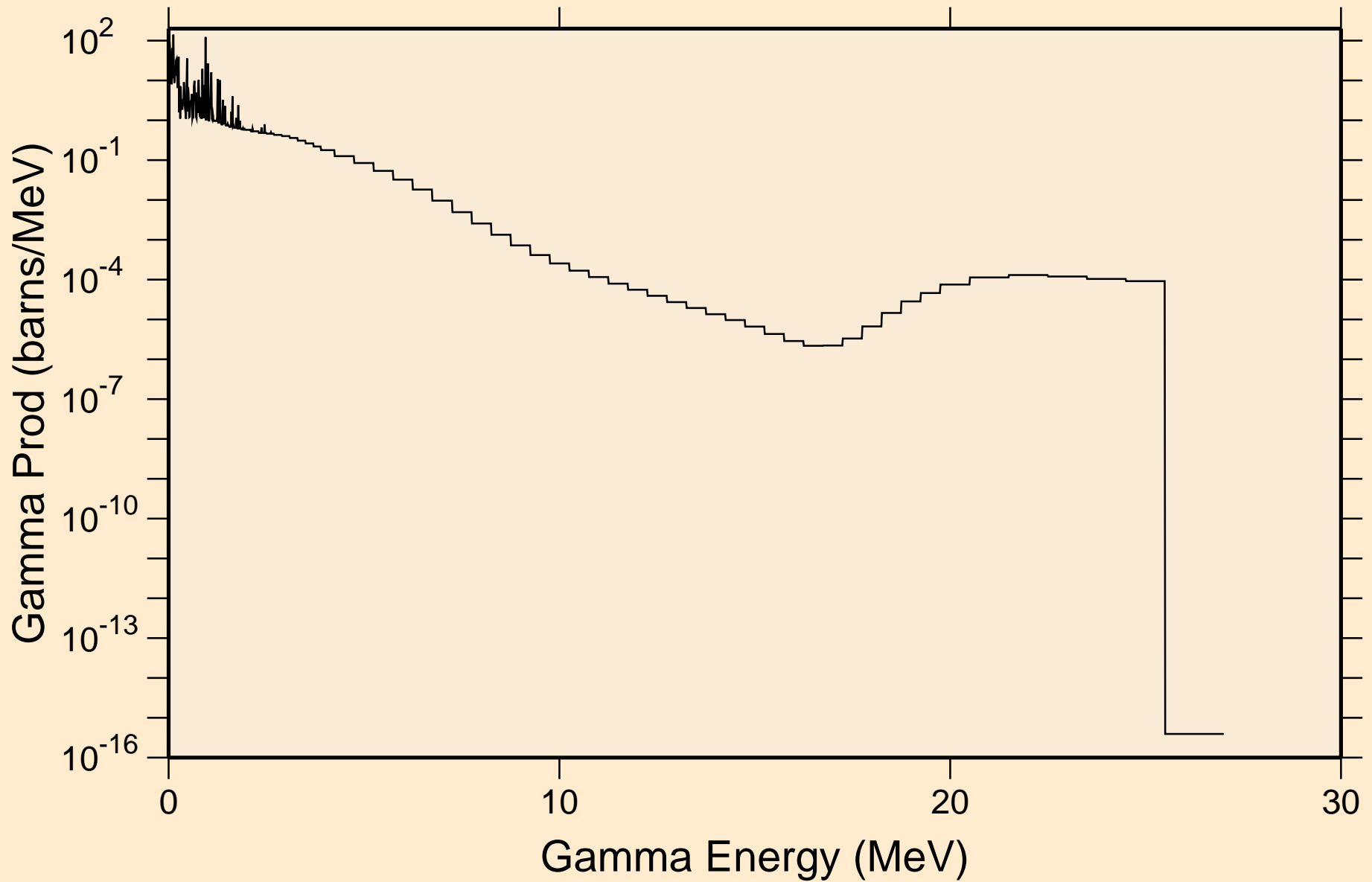

BR072M NEUTRON ACER TENDL-2021 LIBRARY; T=293.6K
Particle heating contributions

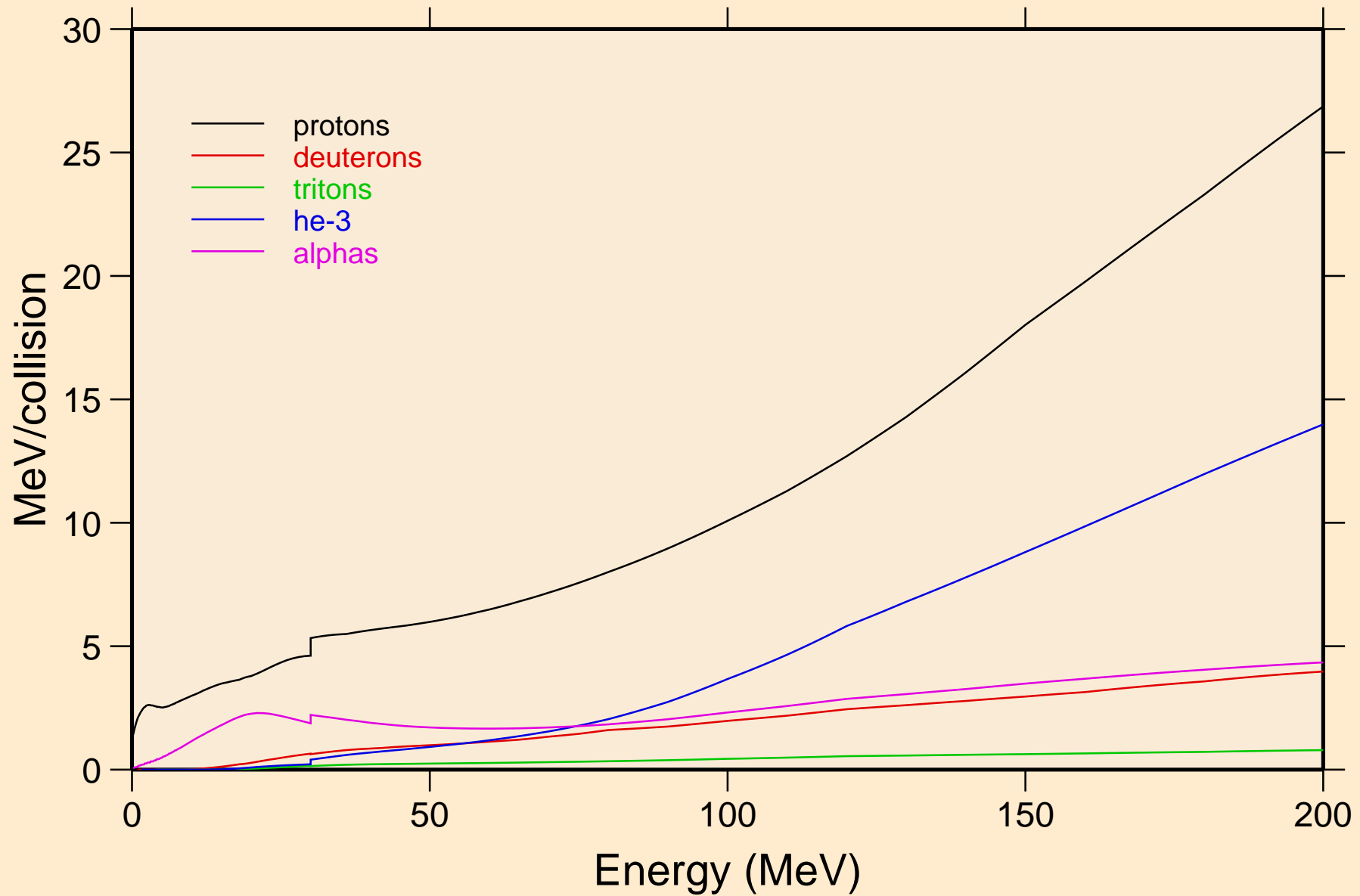

BR072M NEUTRON ACER TENDL-2021 LIBRARY; T=293.6K
Recoil Heating

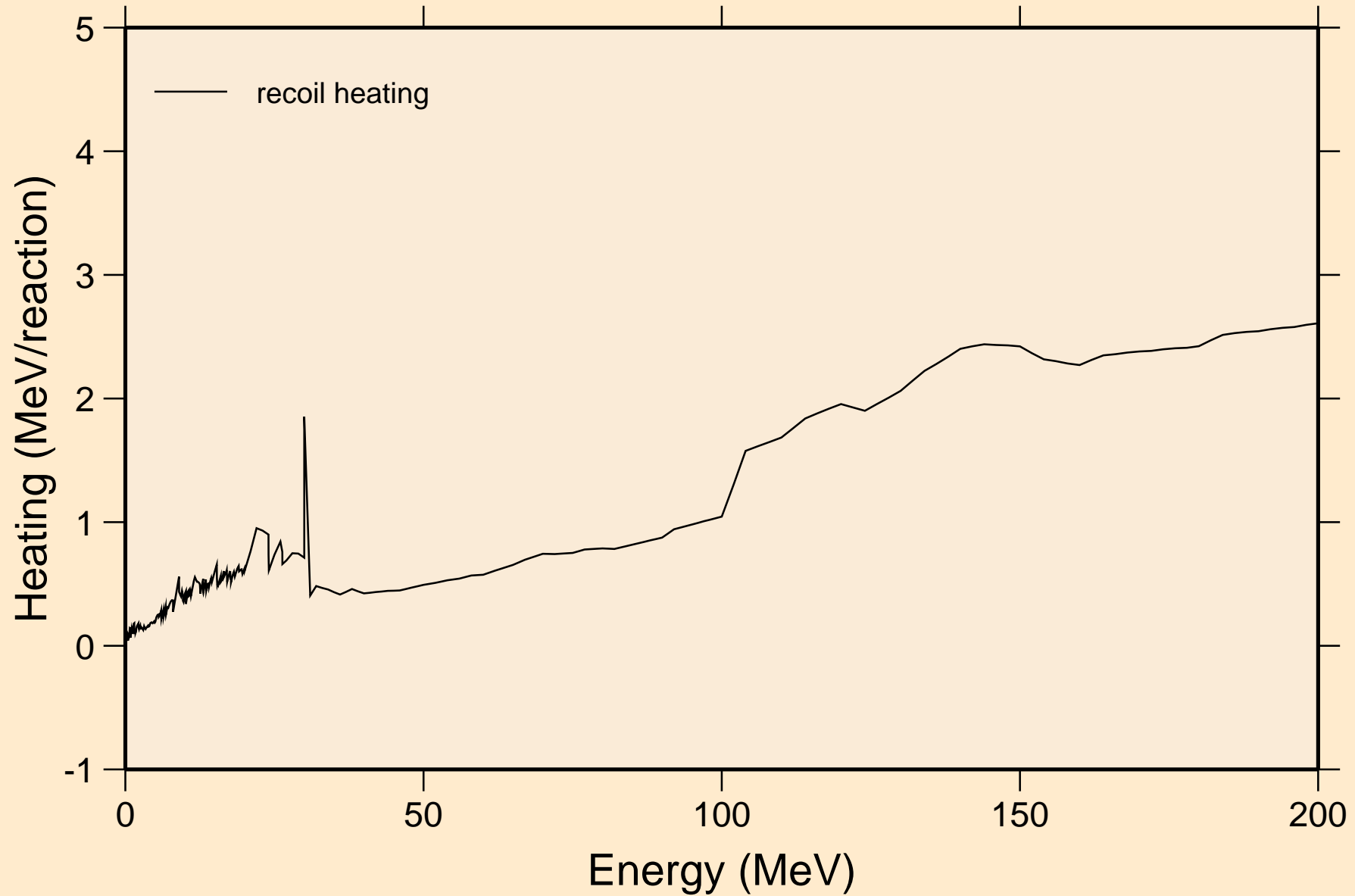

BR072M NEUTRON ACER TENDL-2021 LIBRARY; T=293.6K
Particle production cross sections

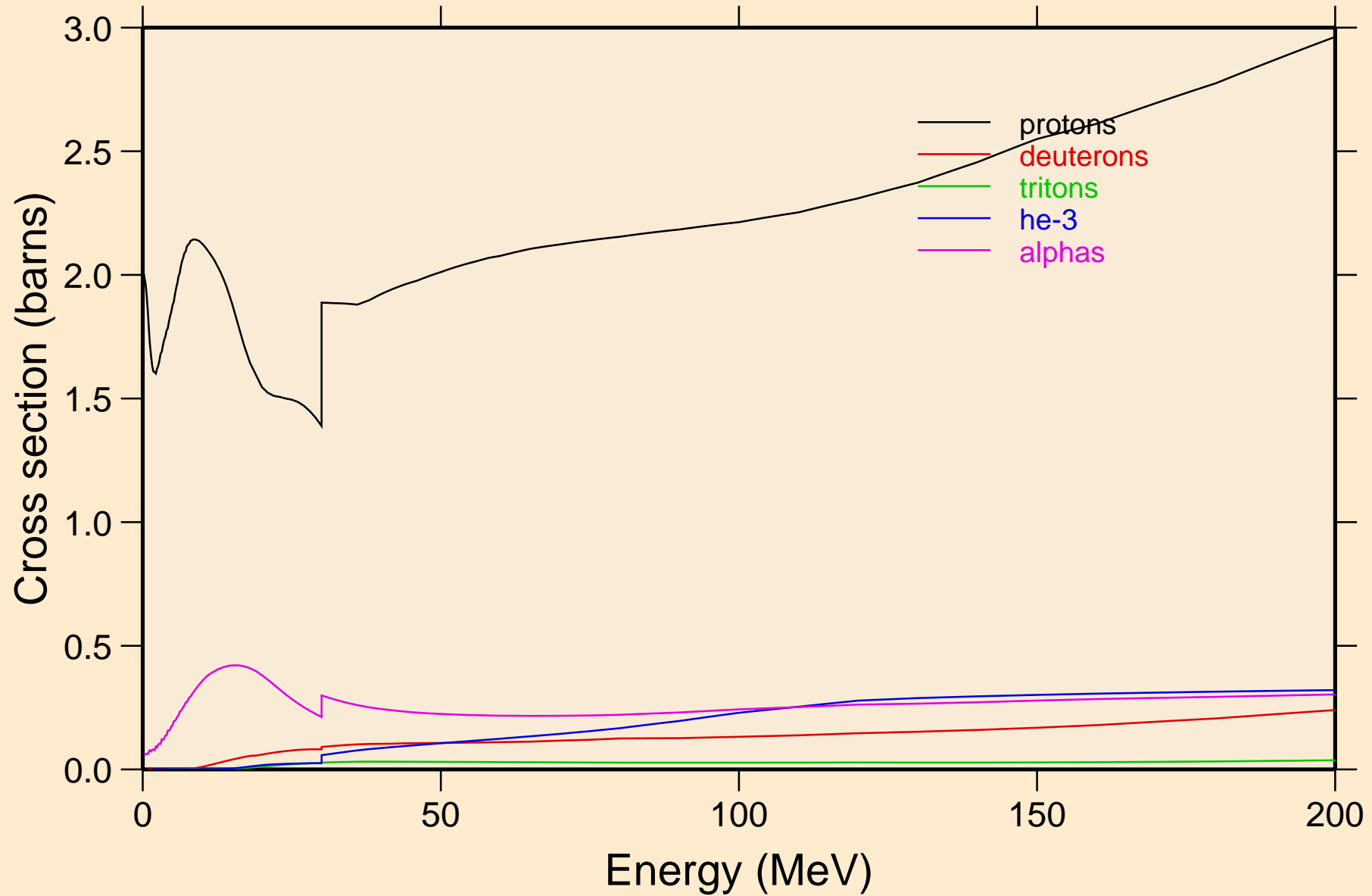

BR072M NEUTRON ACER TENDL-2021 LIBRARY; T=293.6K
protons from (n,x)

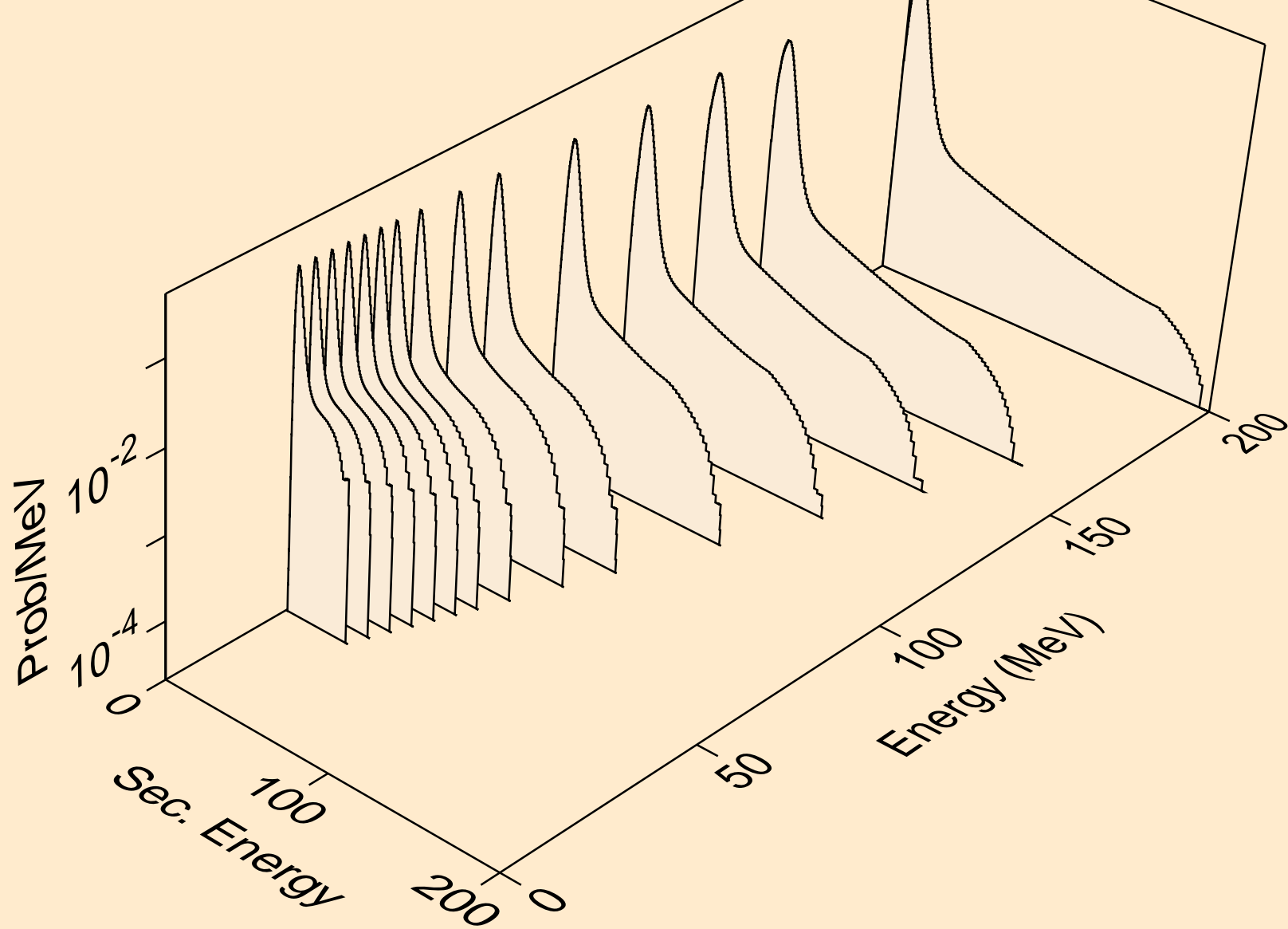

BR072M NEUTRON ACER TENDL-2021 LIBRARY; T=293.6K
protons from (n,n*)p

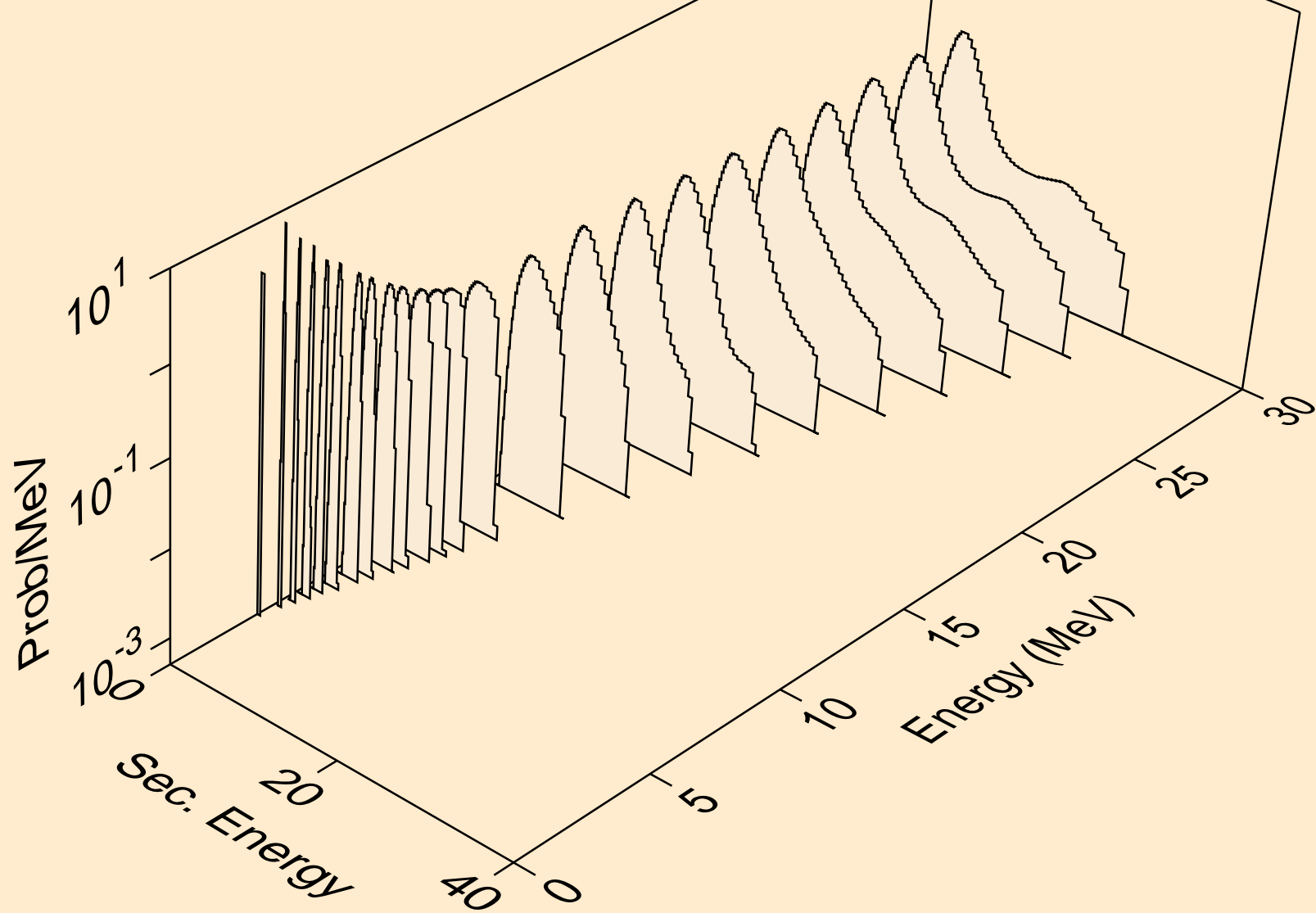

BR072M NEUTRON ACER TENDL-2021 LIBRARY; T=293.6K
protons from (n,2np)

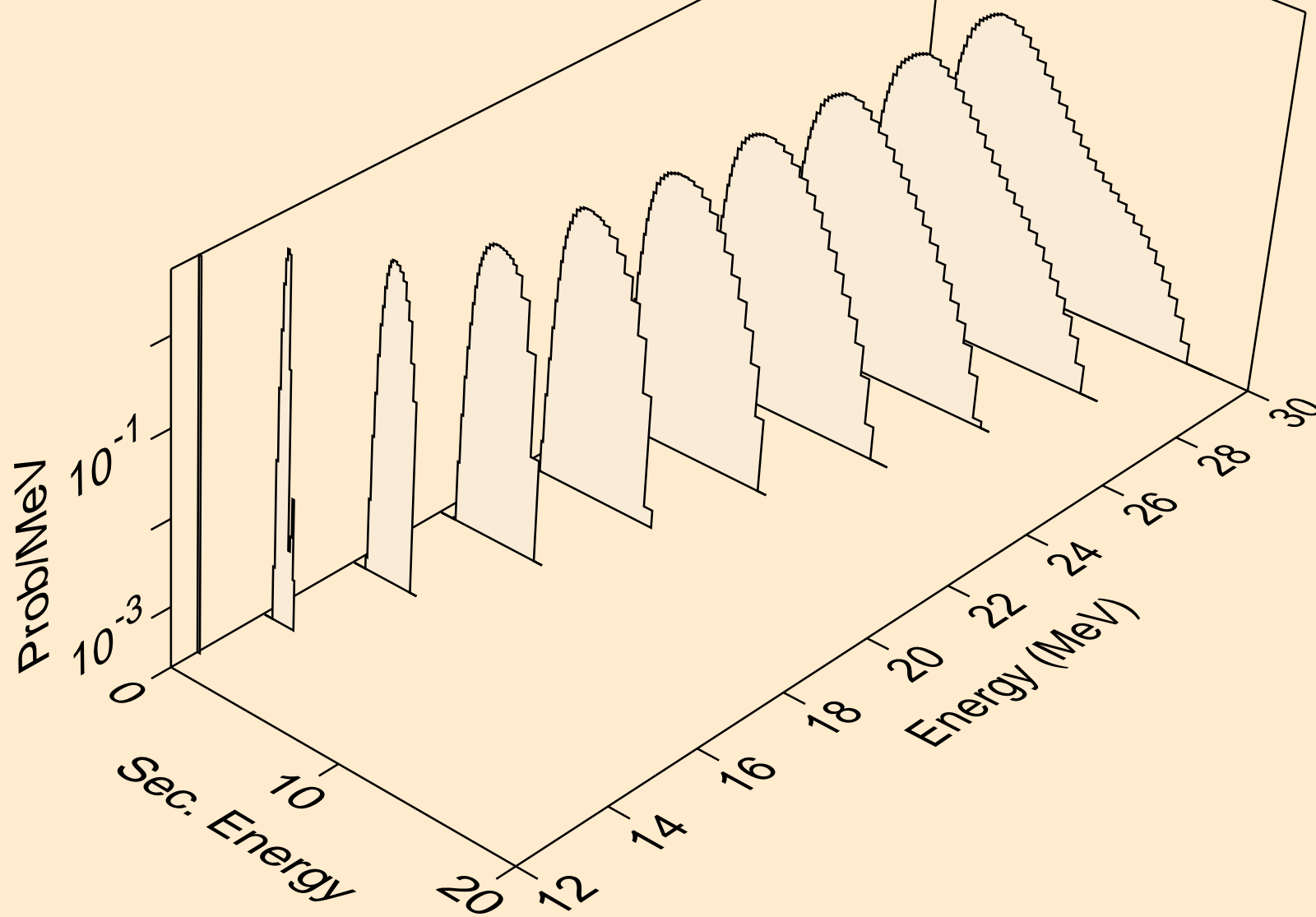

BR072M NEUTRON ACER TENDL-2021 LIBRARY; T=293.6K
protons from (n,3np)

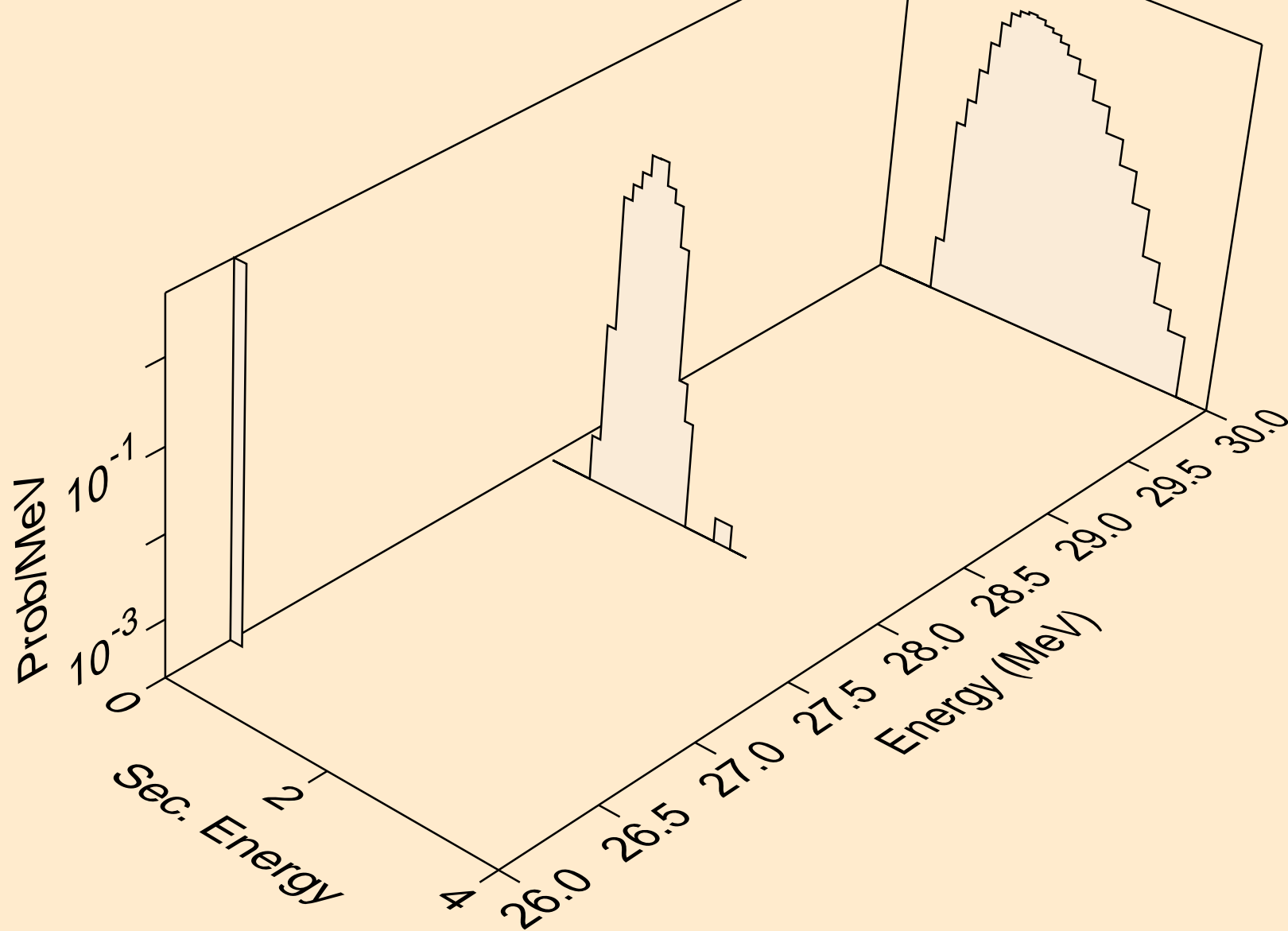

BR072M NEUTRON ACER TENDL-2021 LIBRARY; T=293.6K
protons from (n,2np)

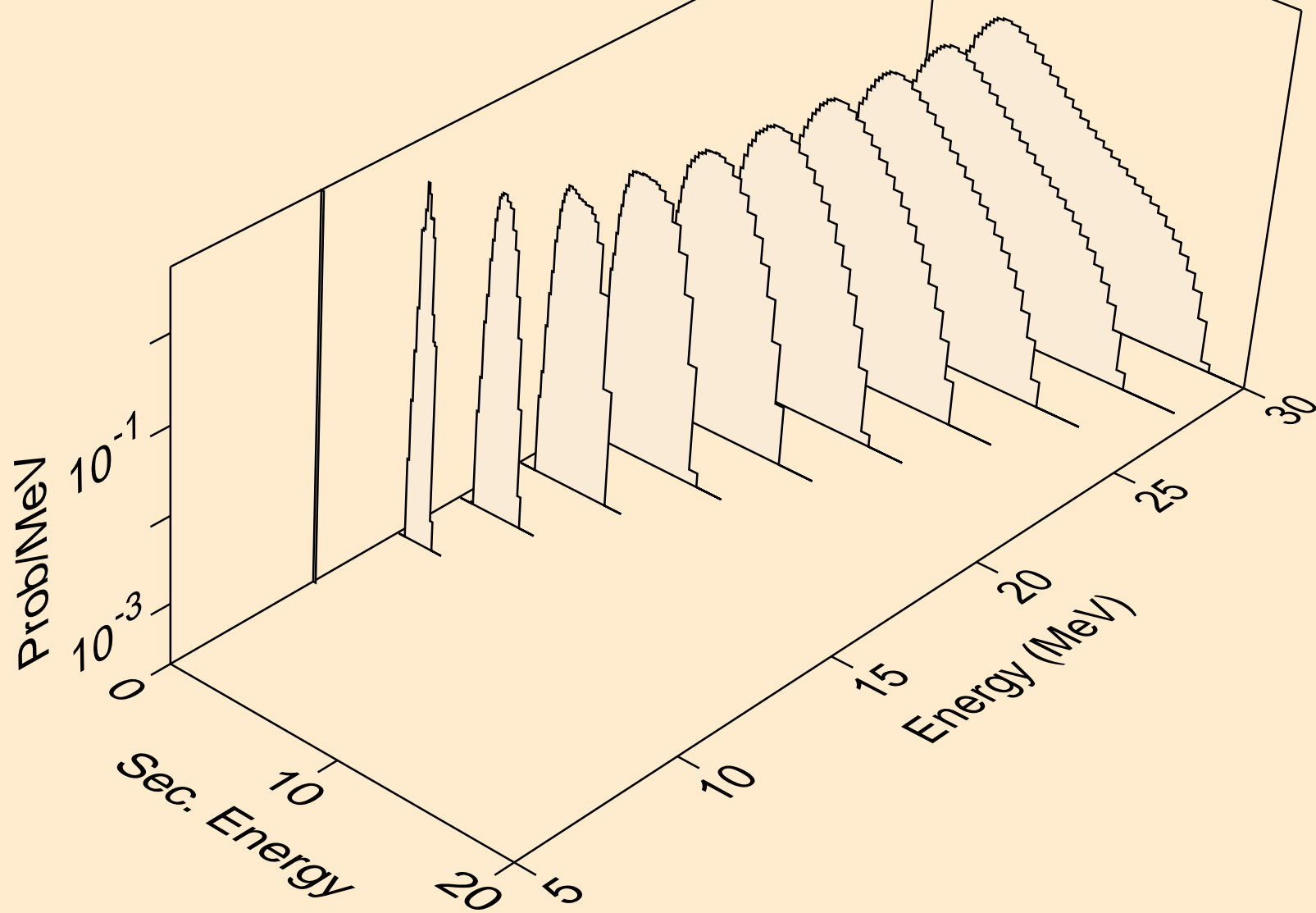

BR072M NEUTRON ACER TENDL-2021 LIBRARY; T=293.6K
protons from (n,npa)

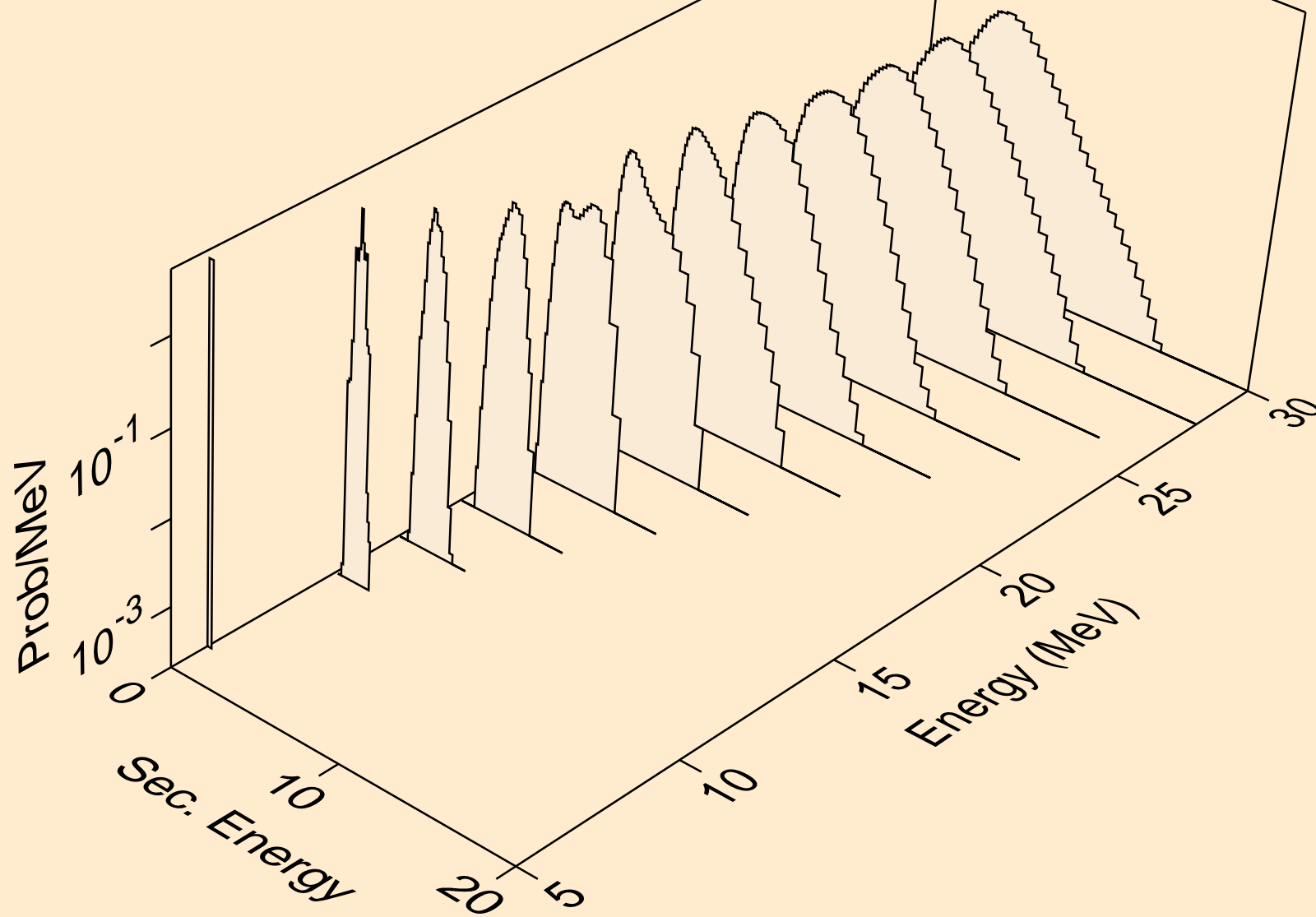

BR072M NEUTRON ACER TENDL-2021 LIBRARY; T=293.6K
protons from (n,p)

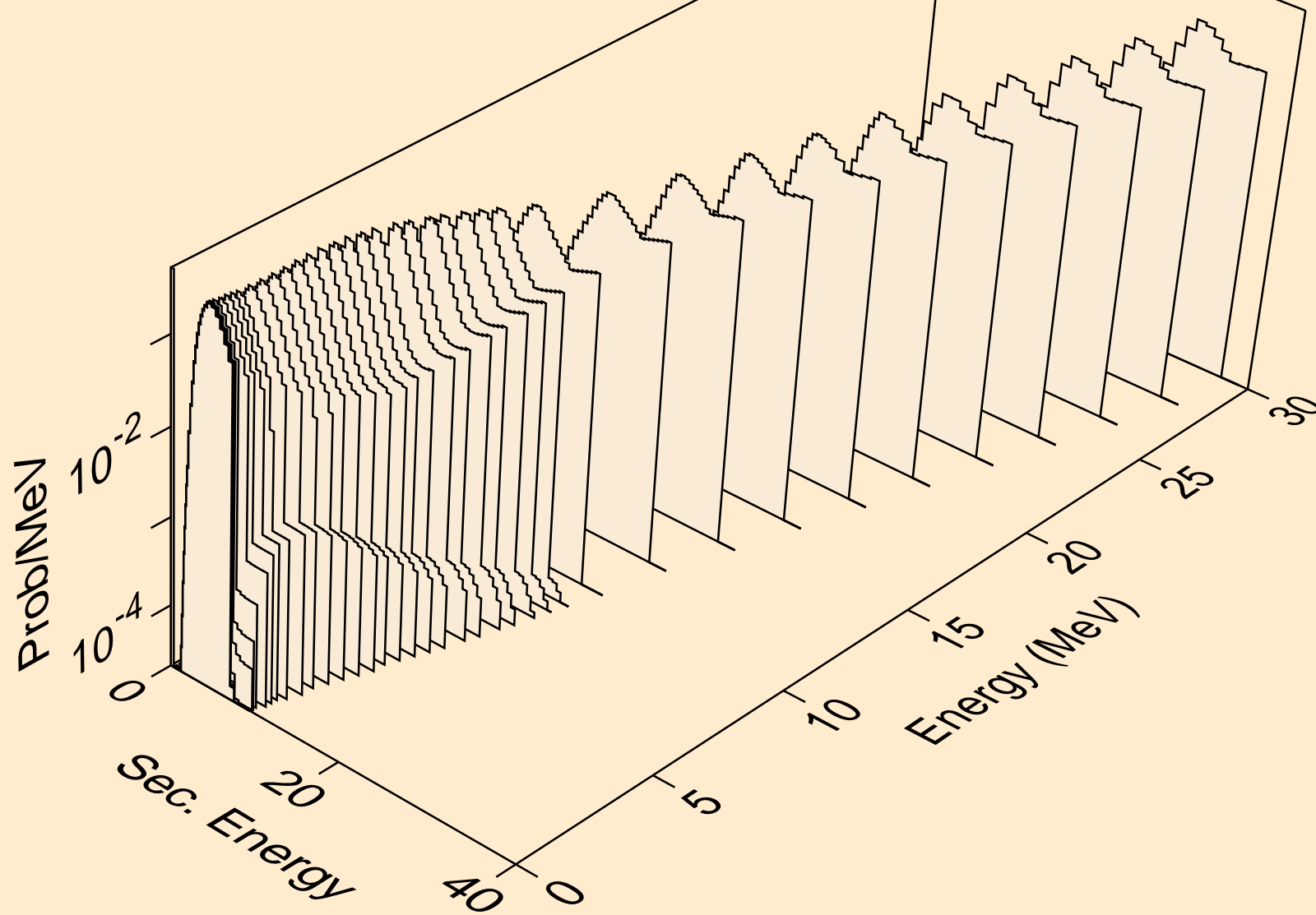

BR072M NEUTRON ACER TENDL-2021 LIBRARY; T=293.6K
protons from (n,2p)

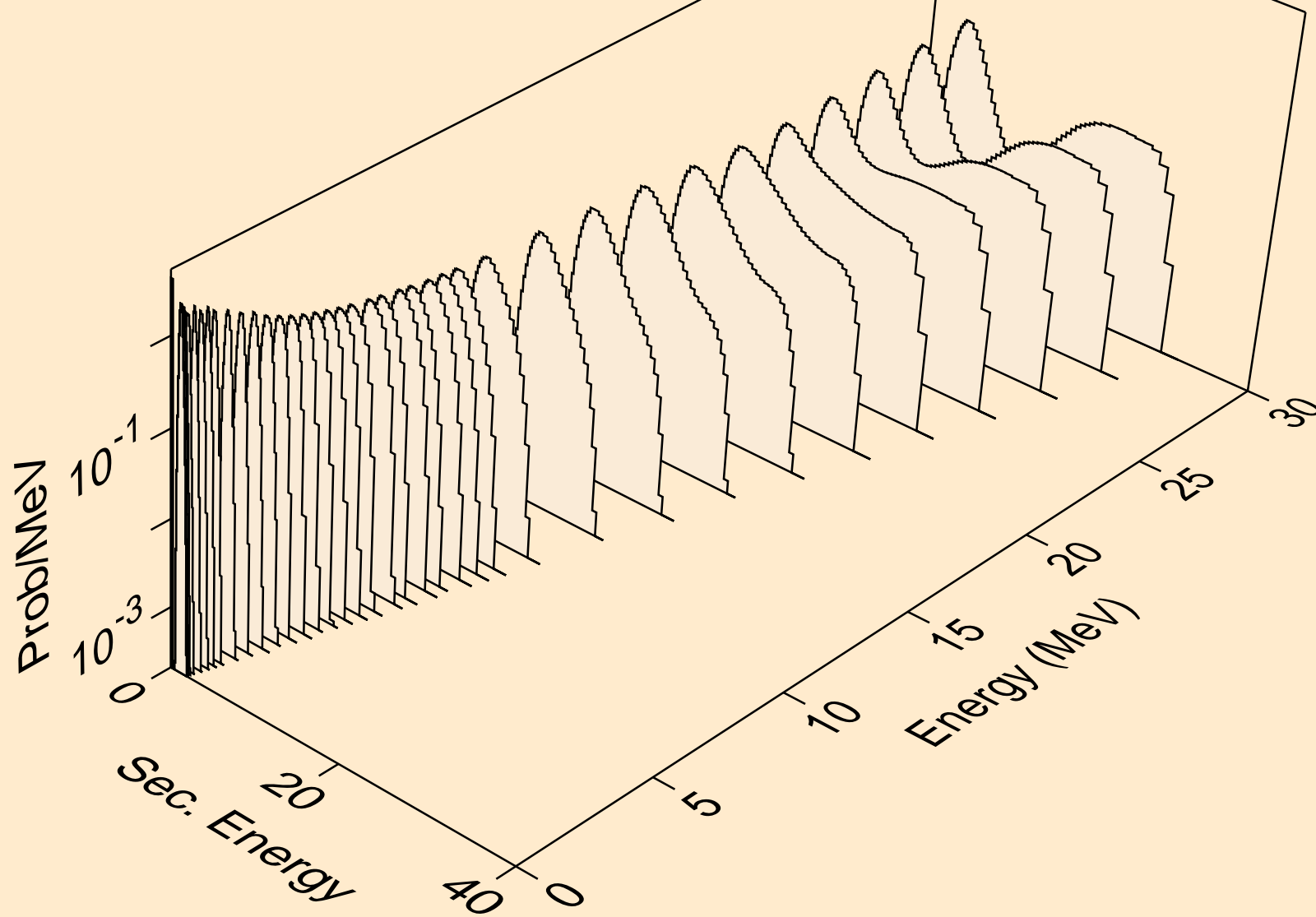

BR072M NEUTRON ACER TENDL-2021 LIBRARY; T=293.6K
protons from (n,p)

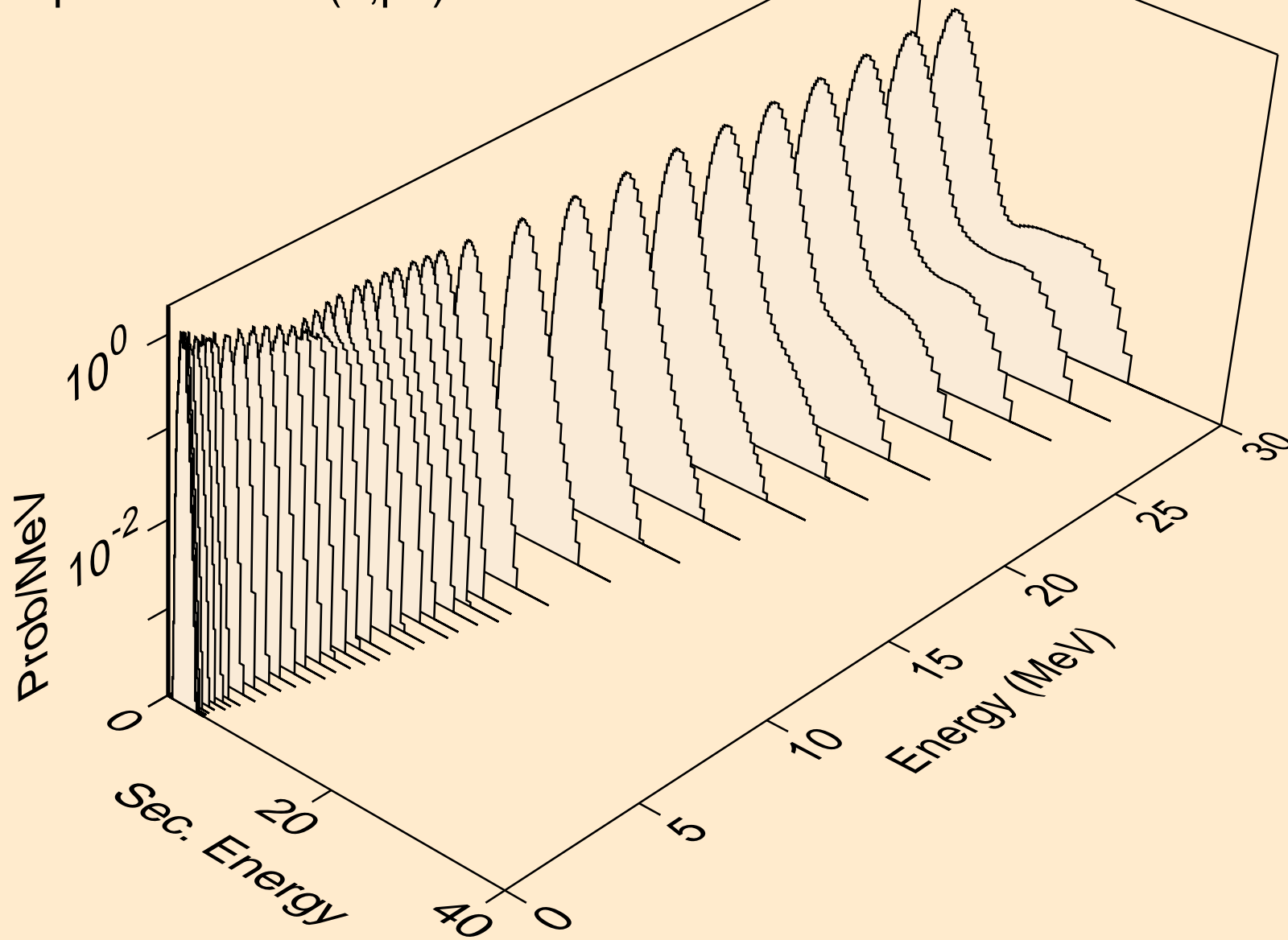

BR072M NEUTRON ACER TENDL-2021 LIBRARY; T=293.6K
protons from (n,pd)

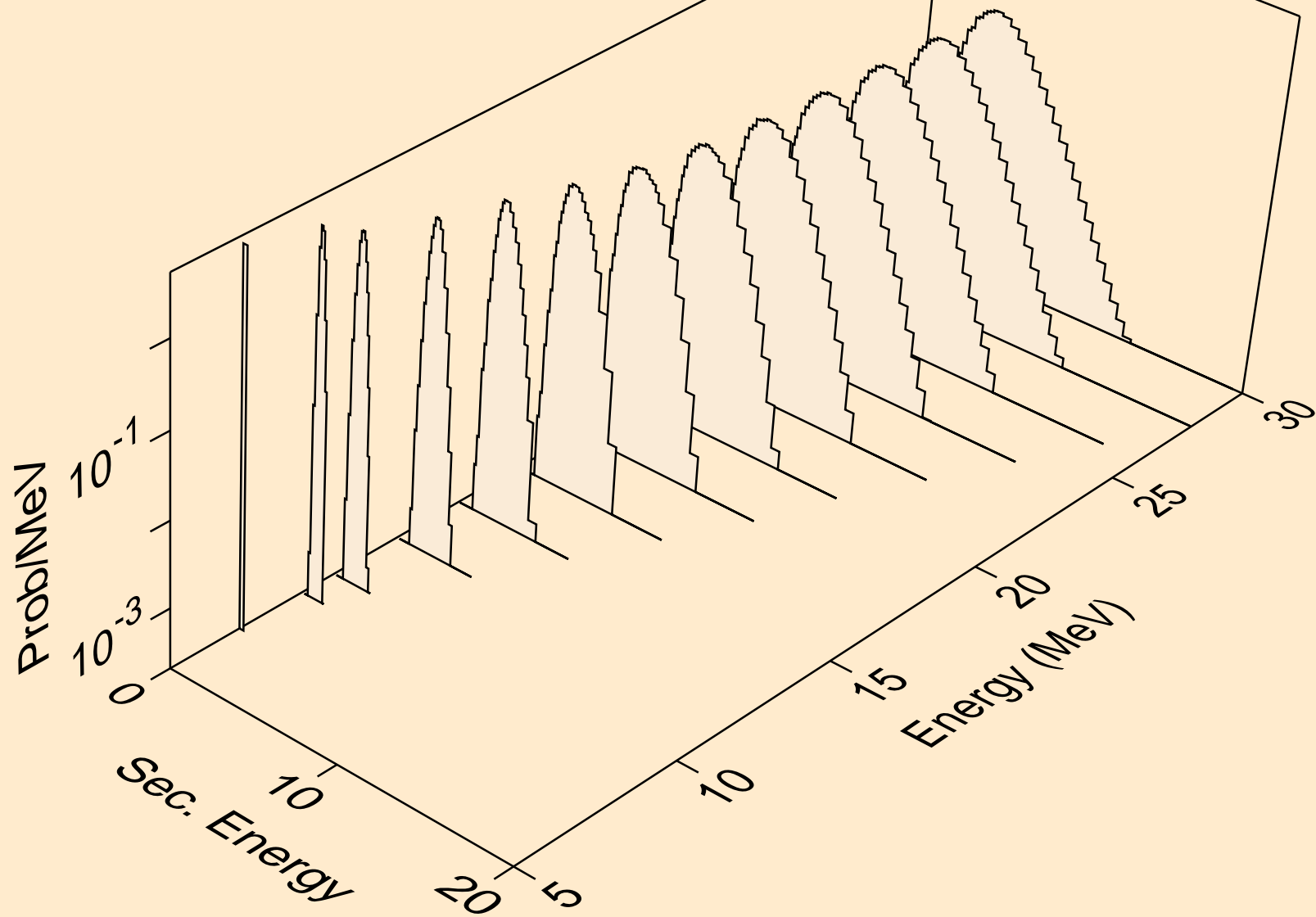

BR072M NEUTRON ACER TENDL-2021 LIBRARY; T=293.6K
protons from (n,pt)

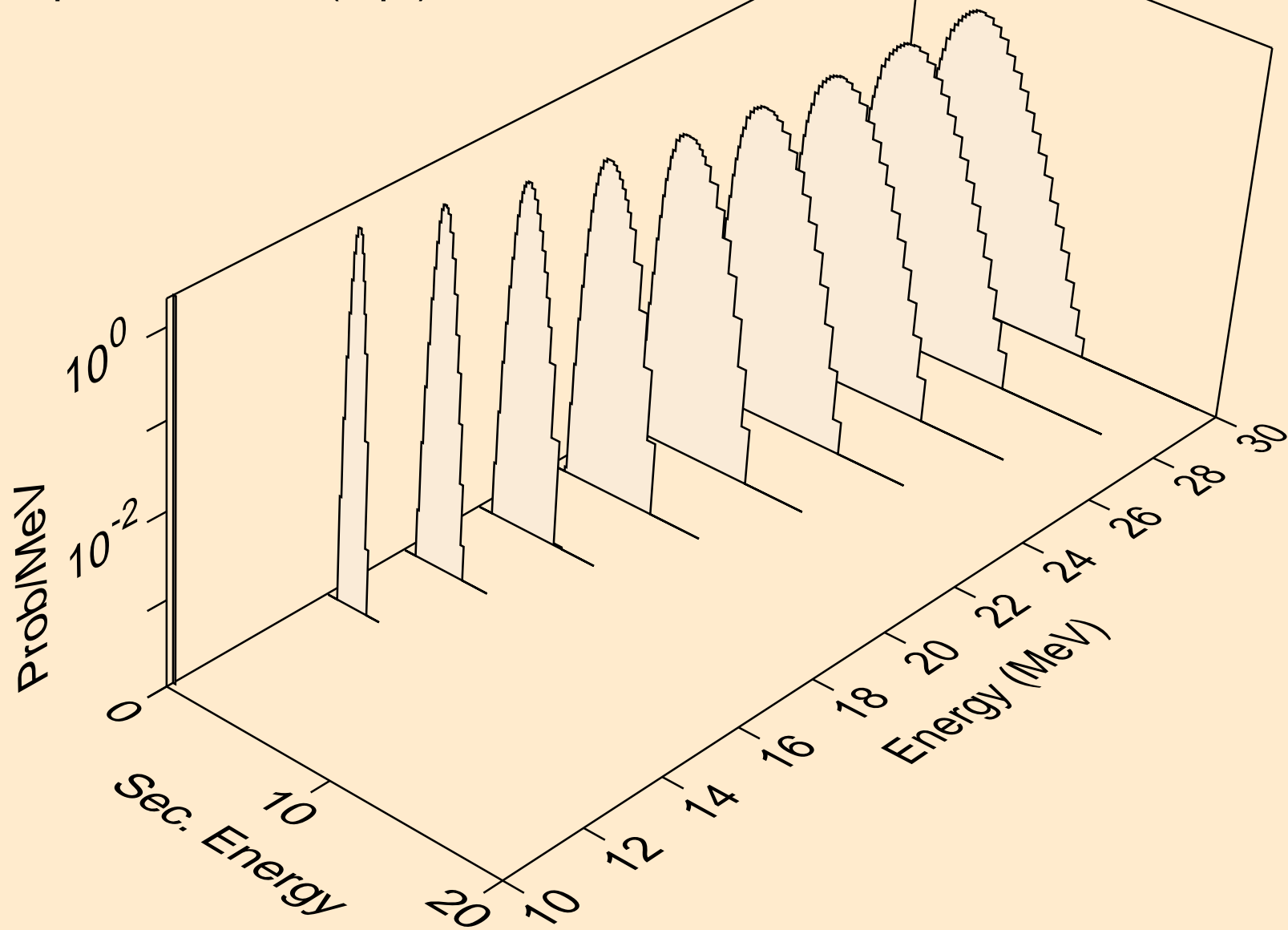

BR072M NEUTRON ACER TENDL-2021 LIBRARY; T=293.6K
deuterons from (n,x)

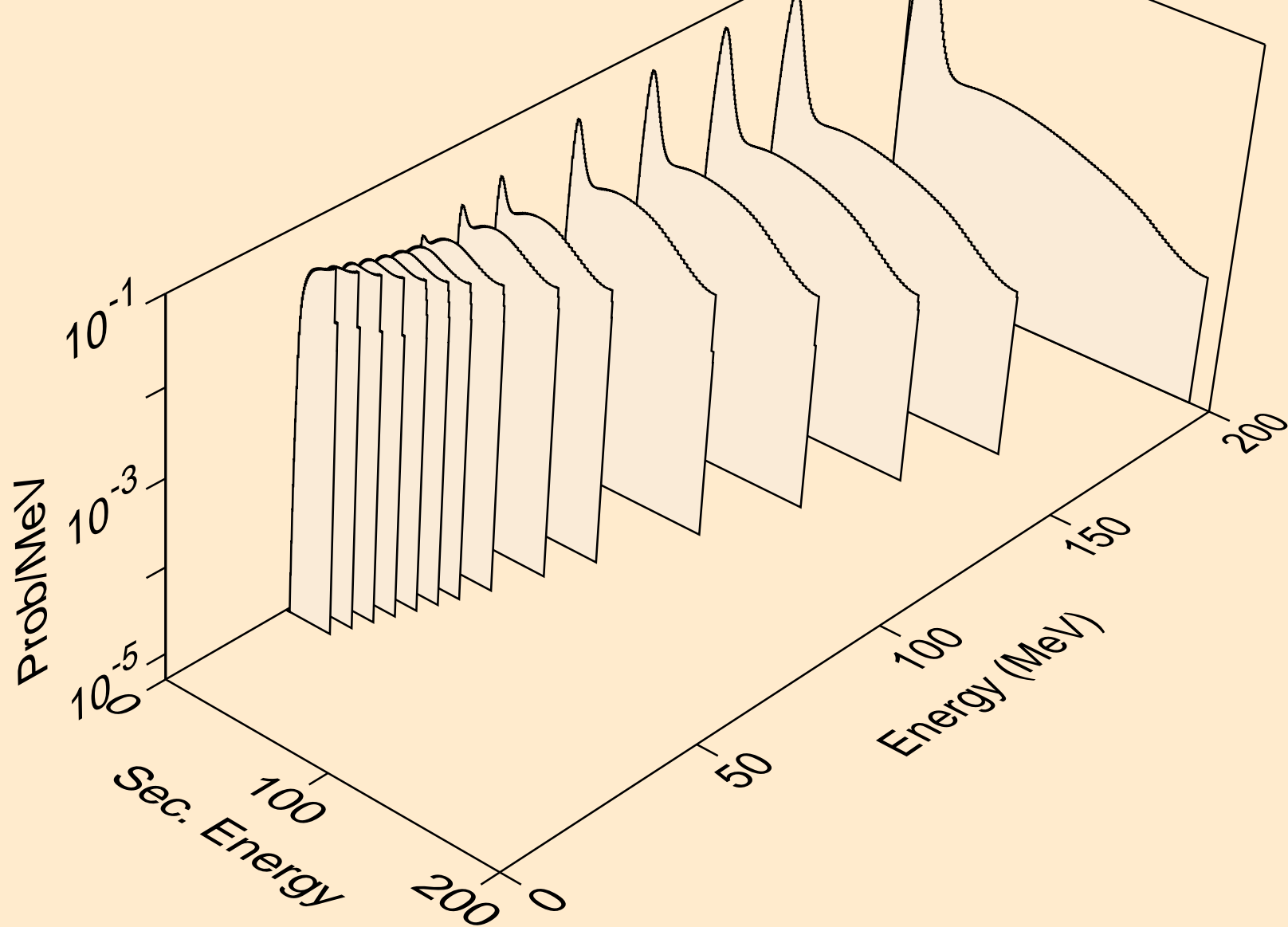

BR072M NEUTRON ACER TENDL-2021 LIBRARY; T=293.6K
deuterons from (n,2nd)

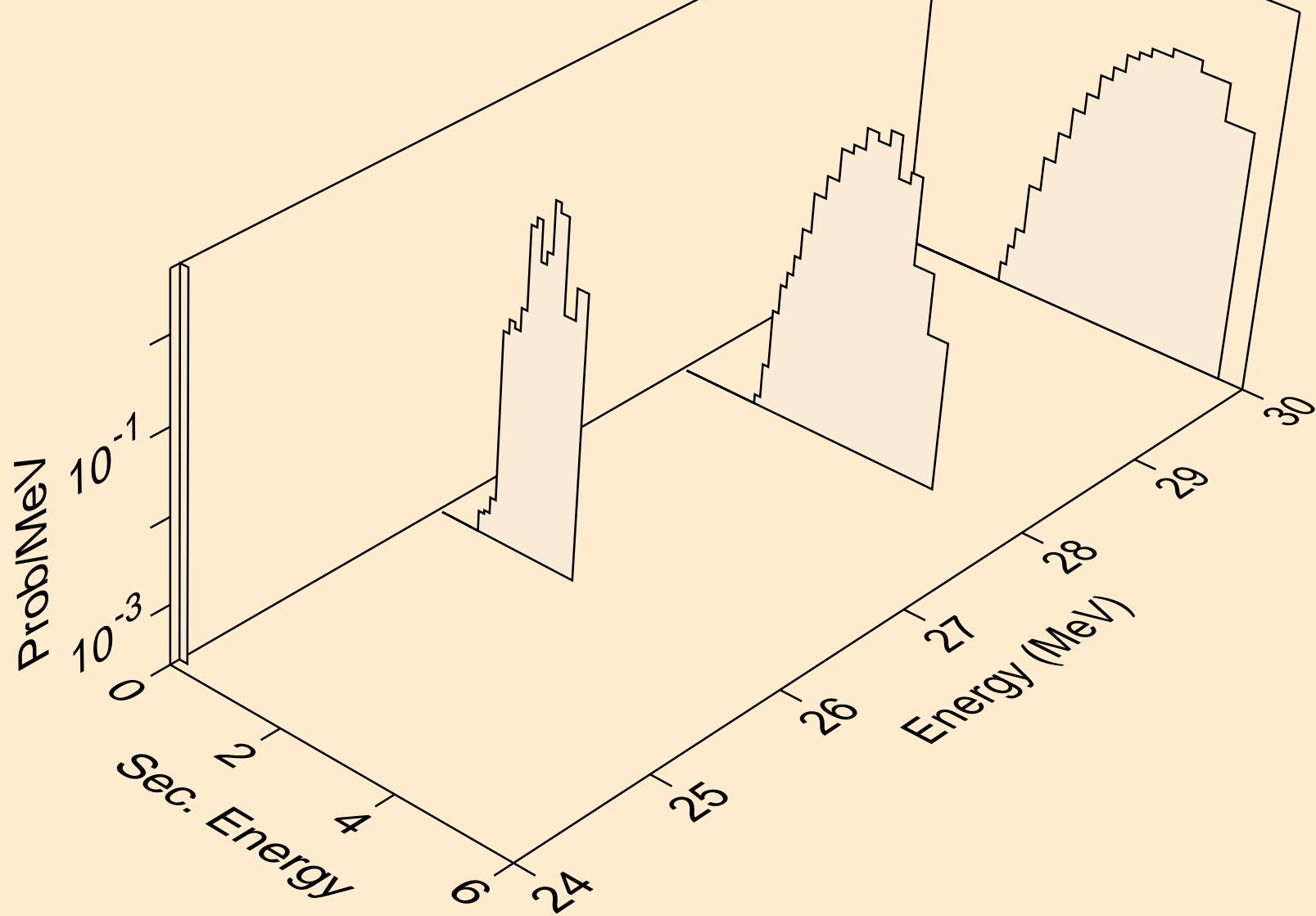

BR072M NEUTRON ACER TENDL-2021 LIBRARY; T=293.6K
deuterons from (n,n*)d

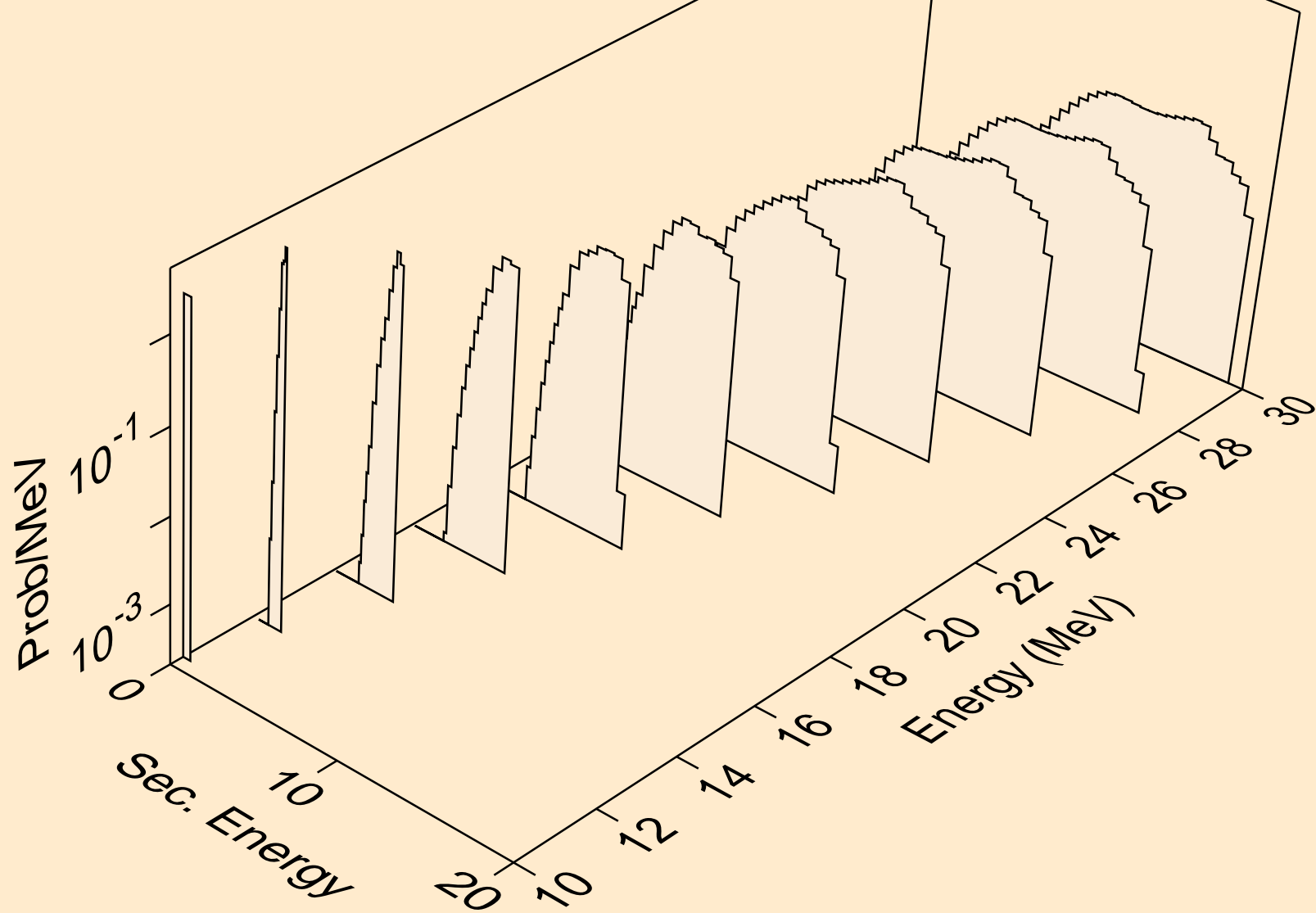

BR072M NEUTRON ACER TENDL-2021 LIBRARY; T=293.6K
deuterons from (n,d)

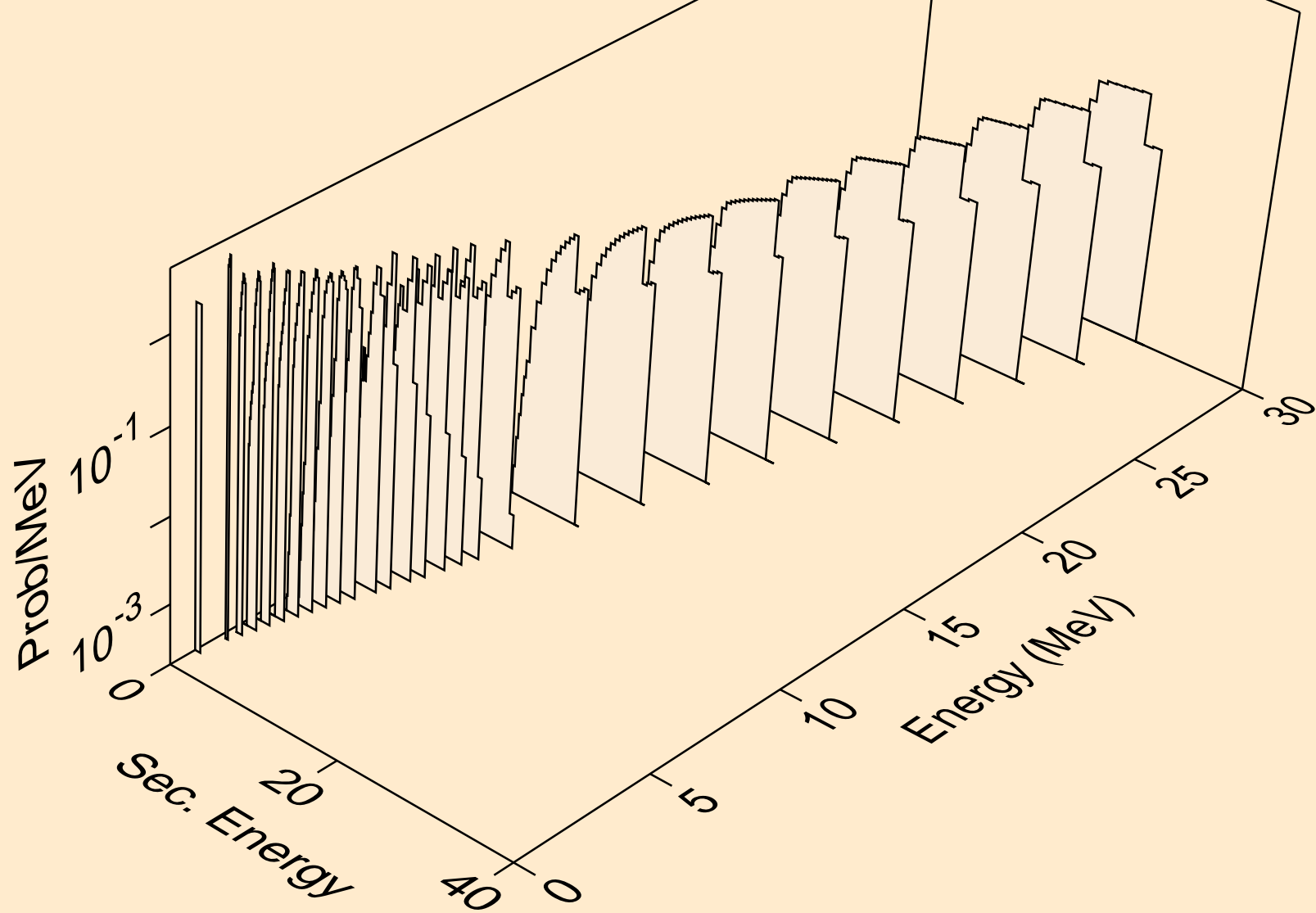

BR072M NEUTRON ACER TENDL-2021 LIBRARY; T=293.6K
deuterons from (n,d2a)

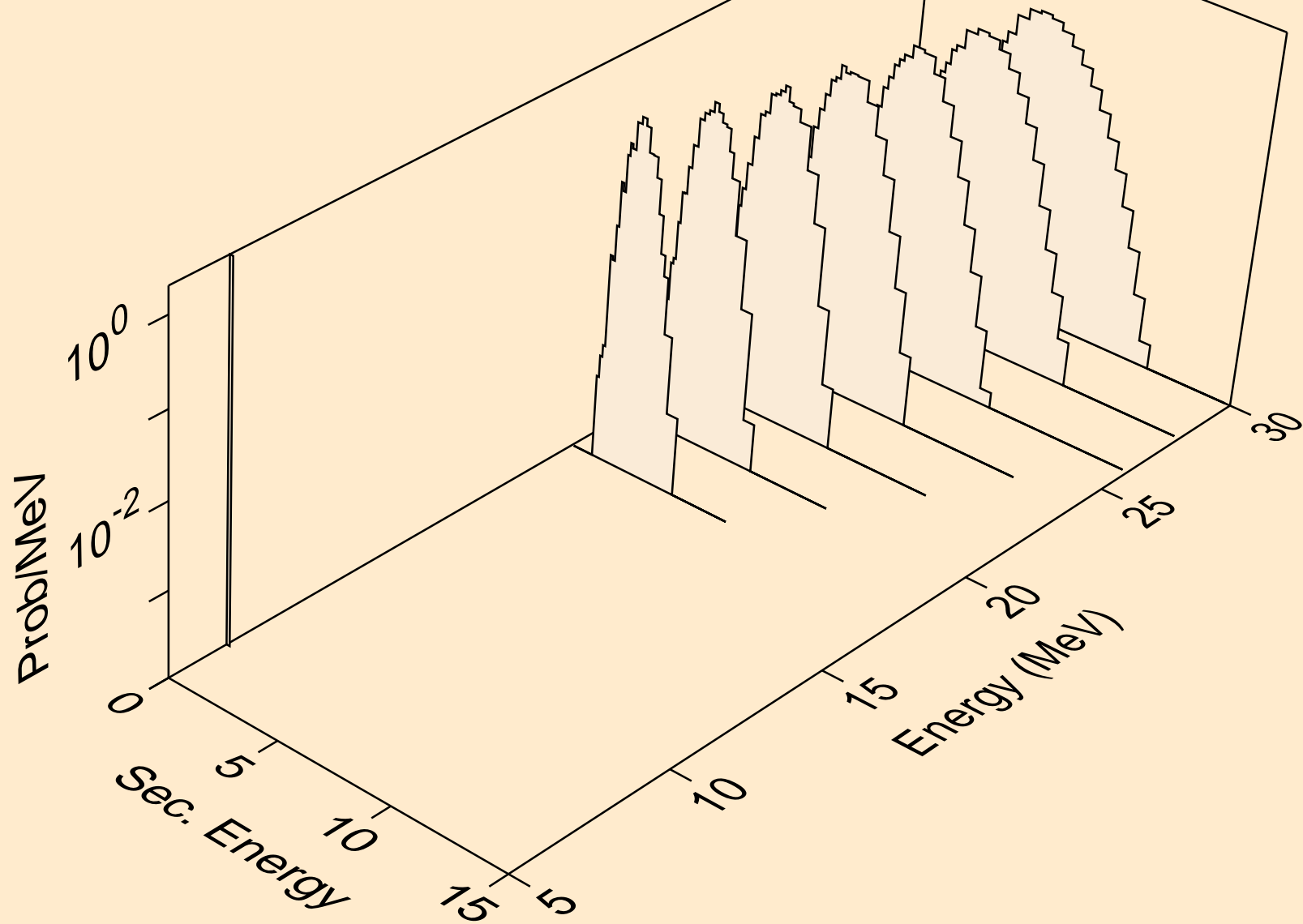

BR072M NEUTRON ACER TENDL-2021 LIBRARY; T=293.6K
deuterons from (n,pd)

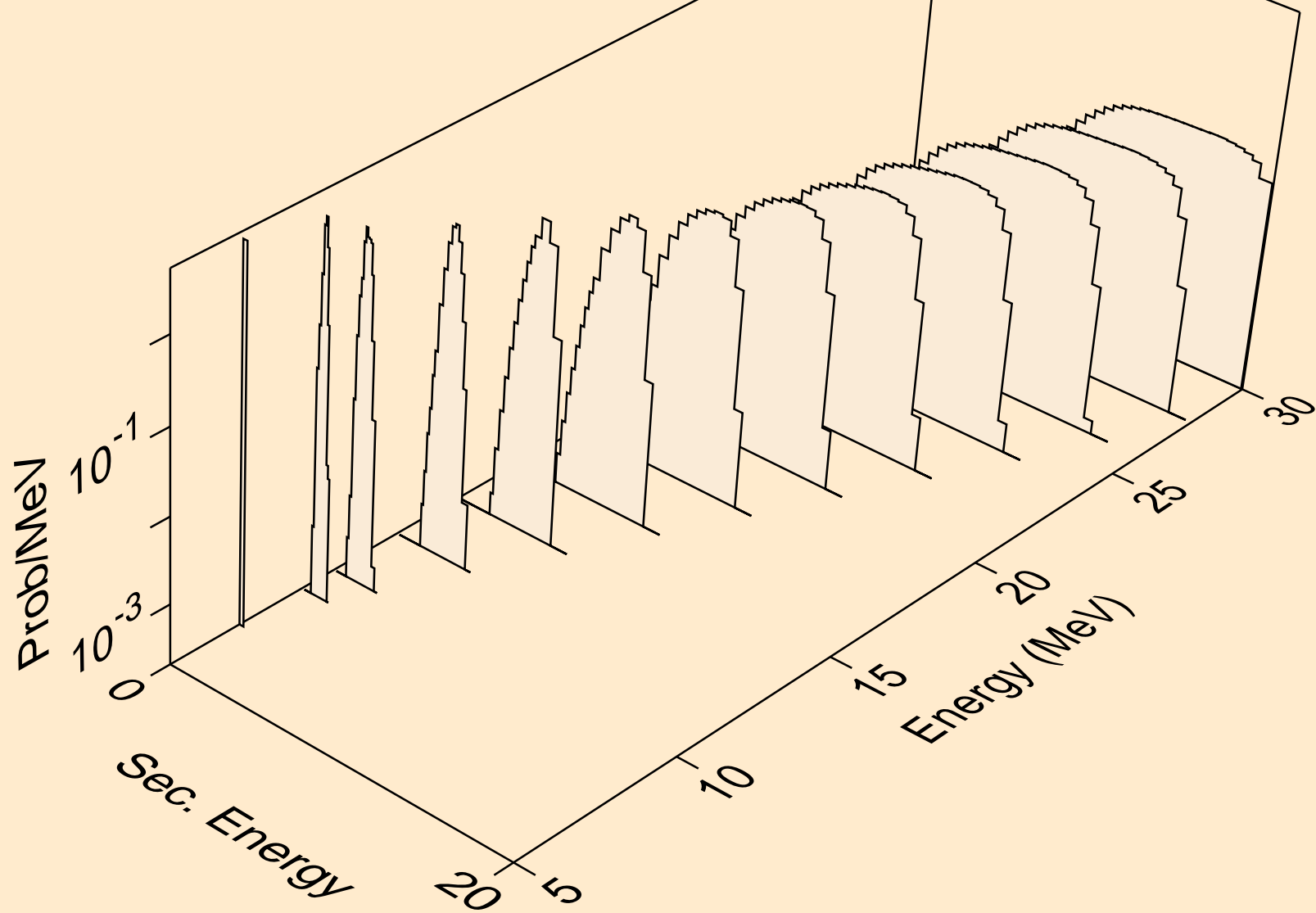

BR072M NEUTRON ACER TENDL-2021 LIBRARY; T=293.6K
deuterons from (n,da)

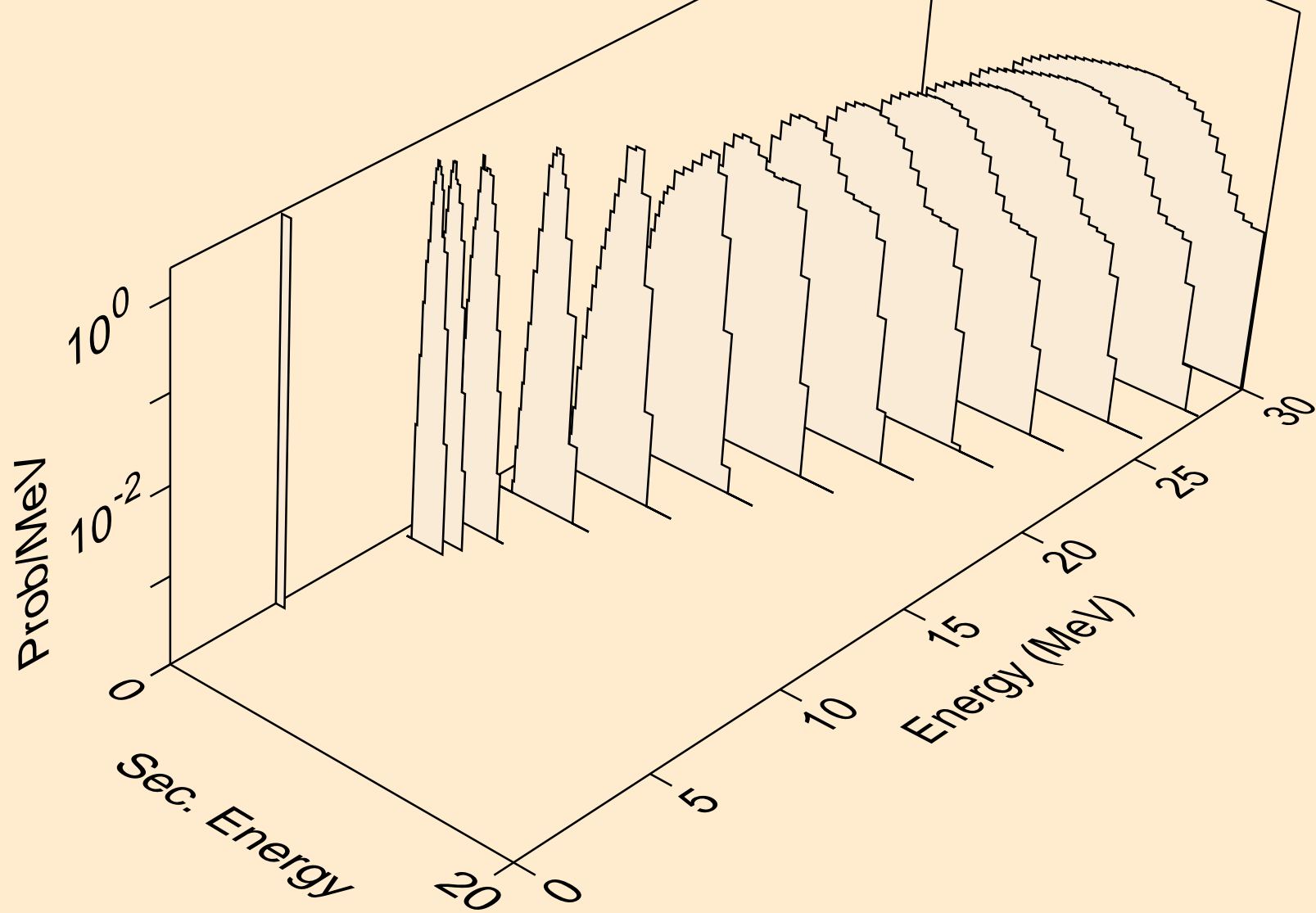

BR072M NEUTRON ACER TENDL-2021 LIBRARY; T=293.6K
tritons from (n,x)

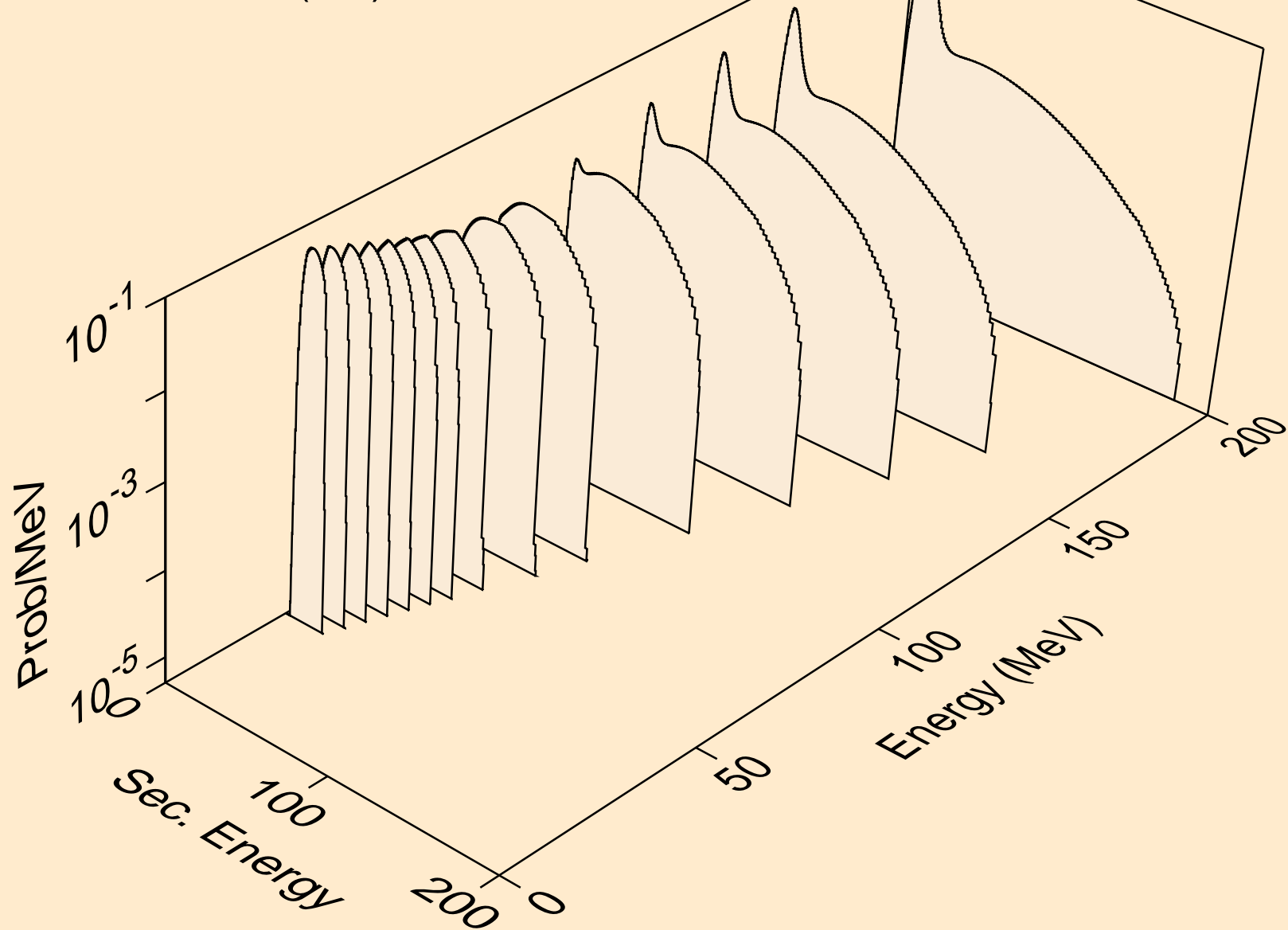

BR072M NEUTRON ACER TENDL-2021 LIBRARY; T=293.6K
tritons from (n,n*)t

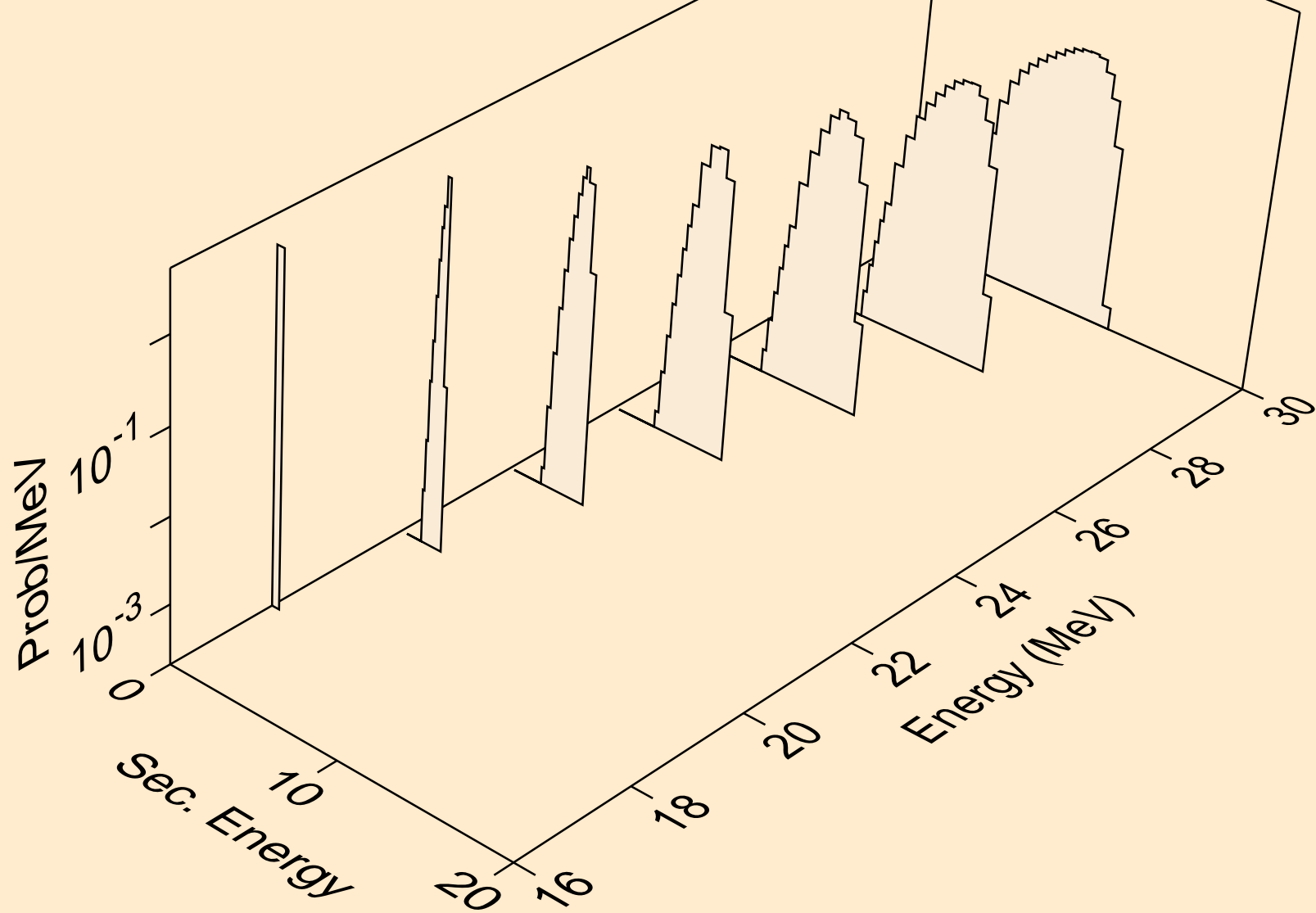

BR072M NEUTRON ACER TENDL-2021 LIBRARY; T=293.6K
tritons from (n,t)

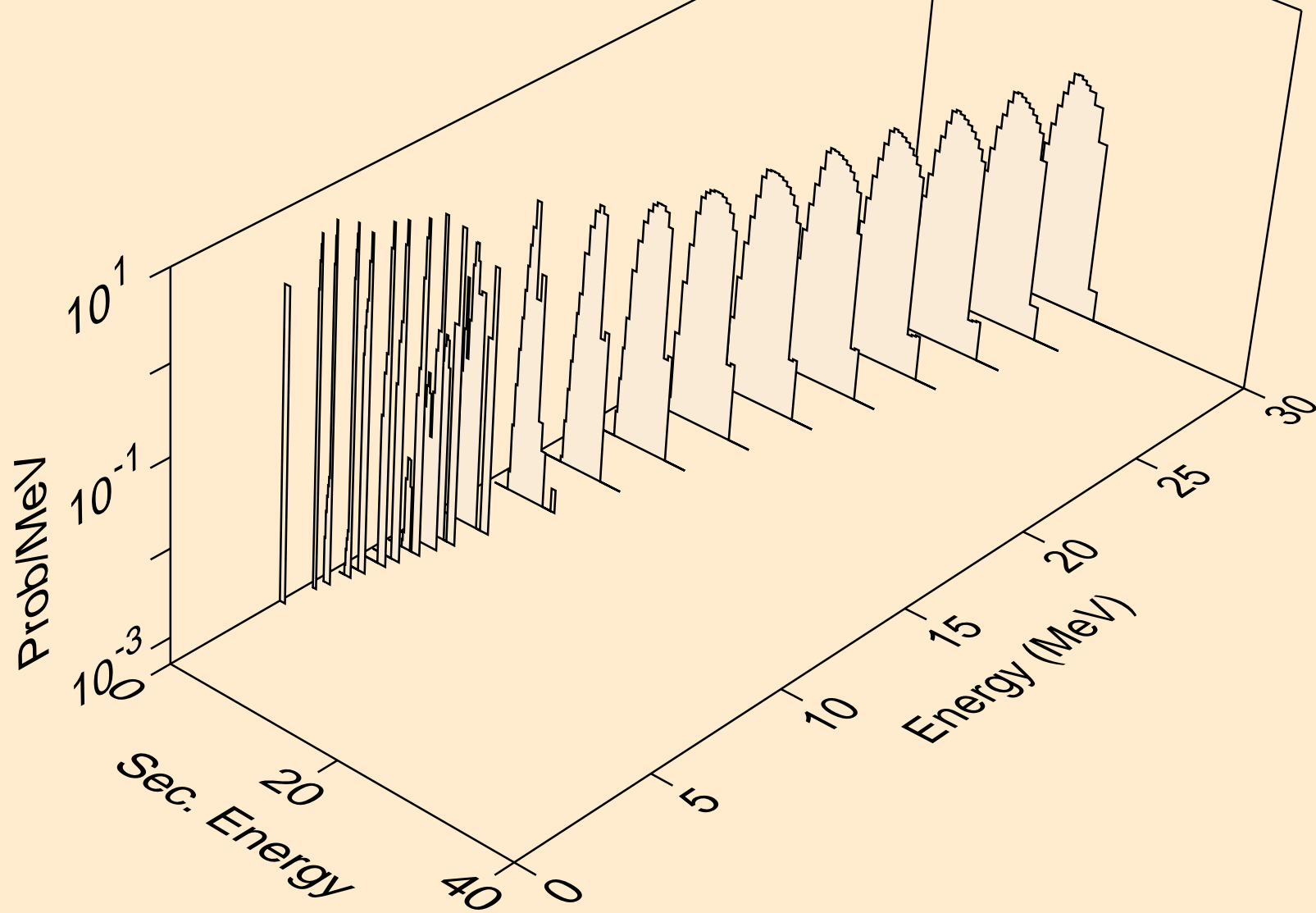

BR072M NEUTRON ACER TENDL-2021 LIBRARY; T=293.6K
tritons from (n,t2a)

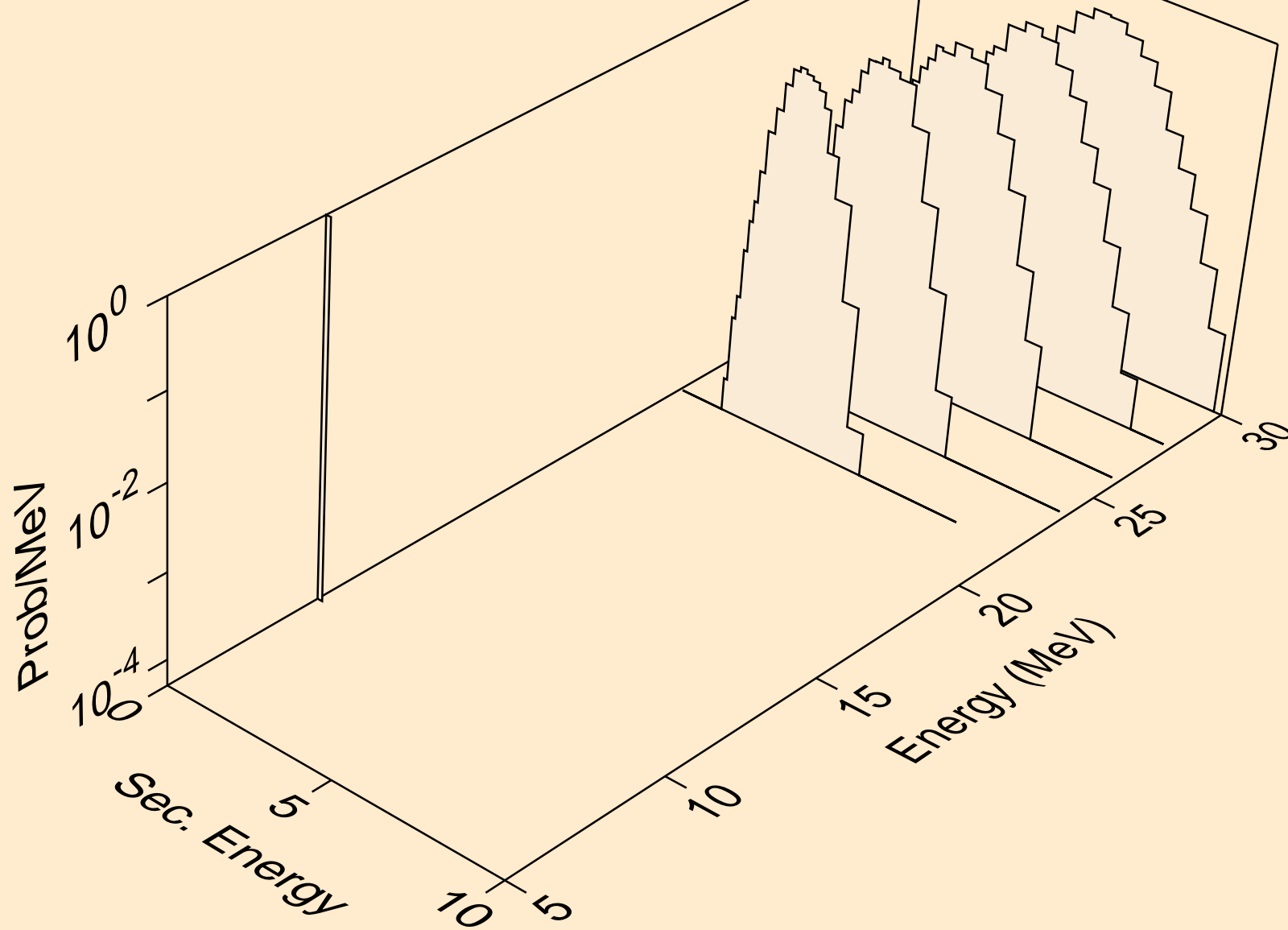

BR072M NEUTRON ACER TENDL-2021 LIBRARY; T=293.6K
tritons from (n,pt)

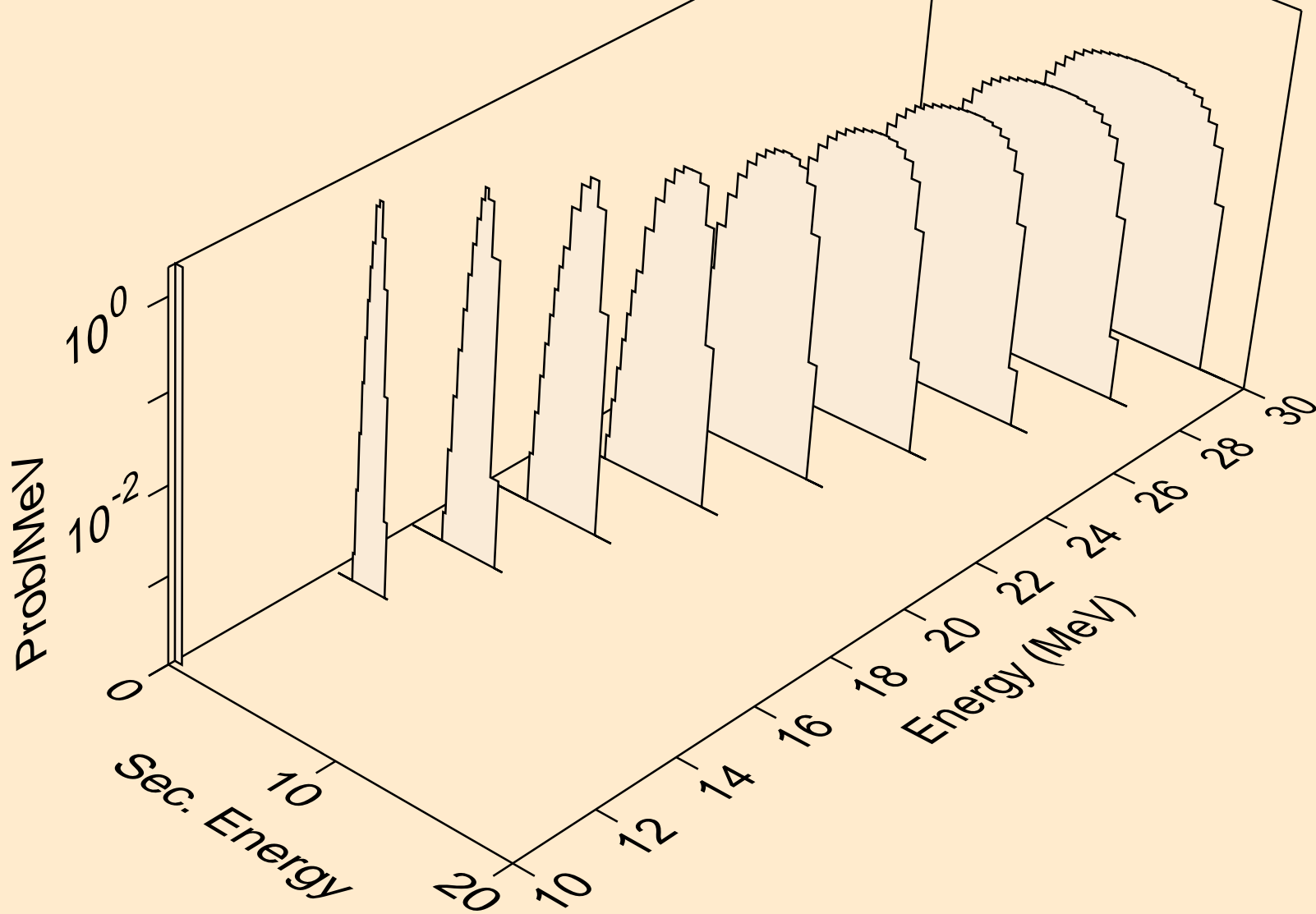

BR072M NEUTRON ACER TENDL-2021 LIBRARY; T=293.6K
he3s from (n,x)

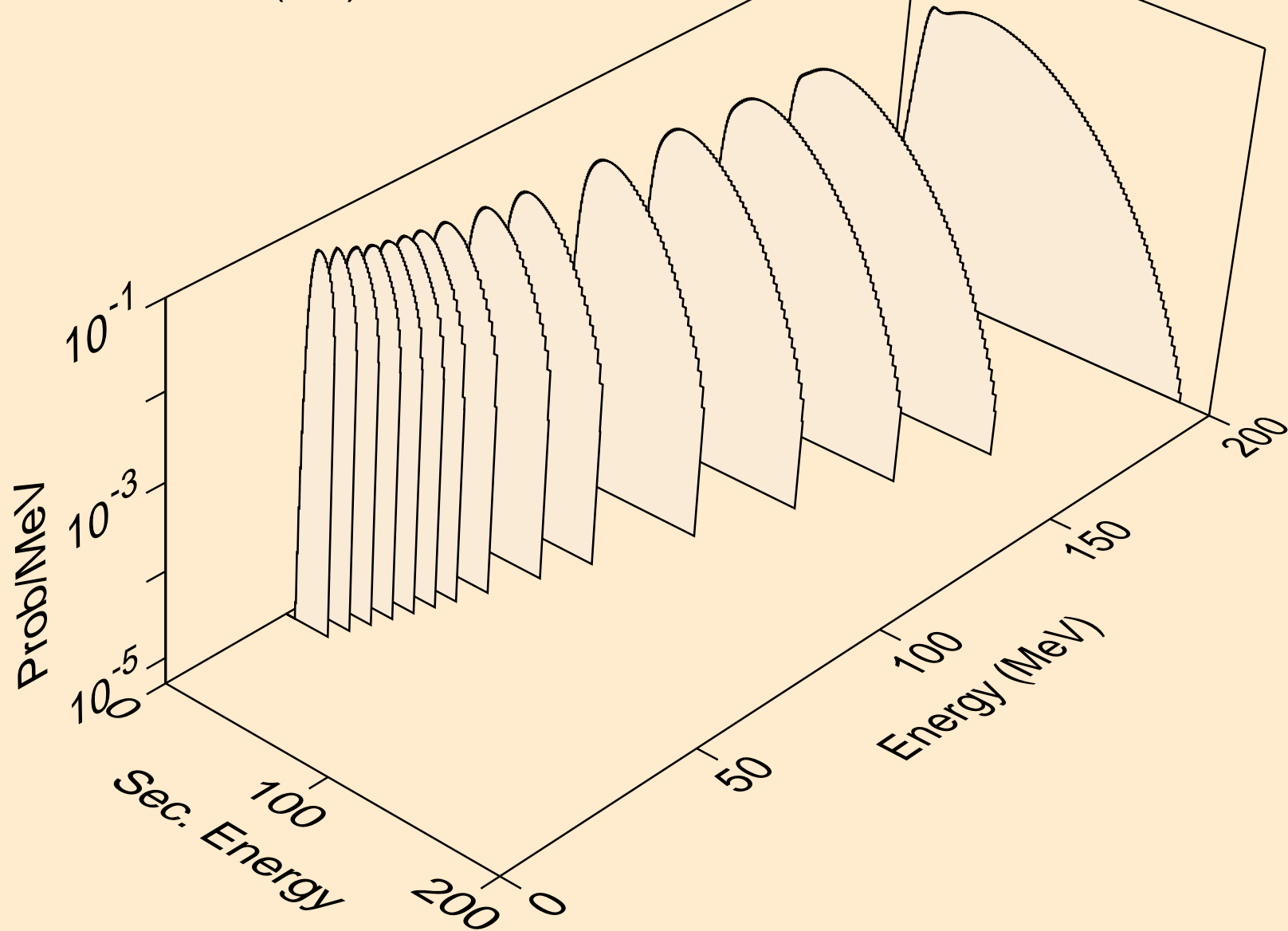

BR072M NEUTRON ACER TENDL-2021 LIBRARY; T=293.6K
he3s from (n,n*)he3

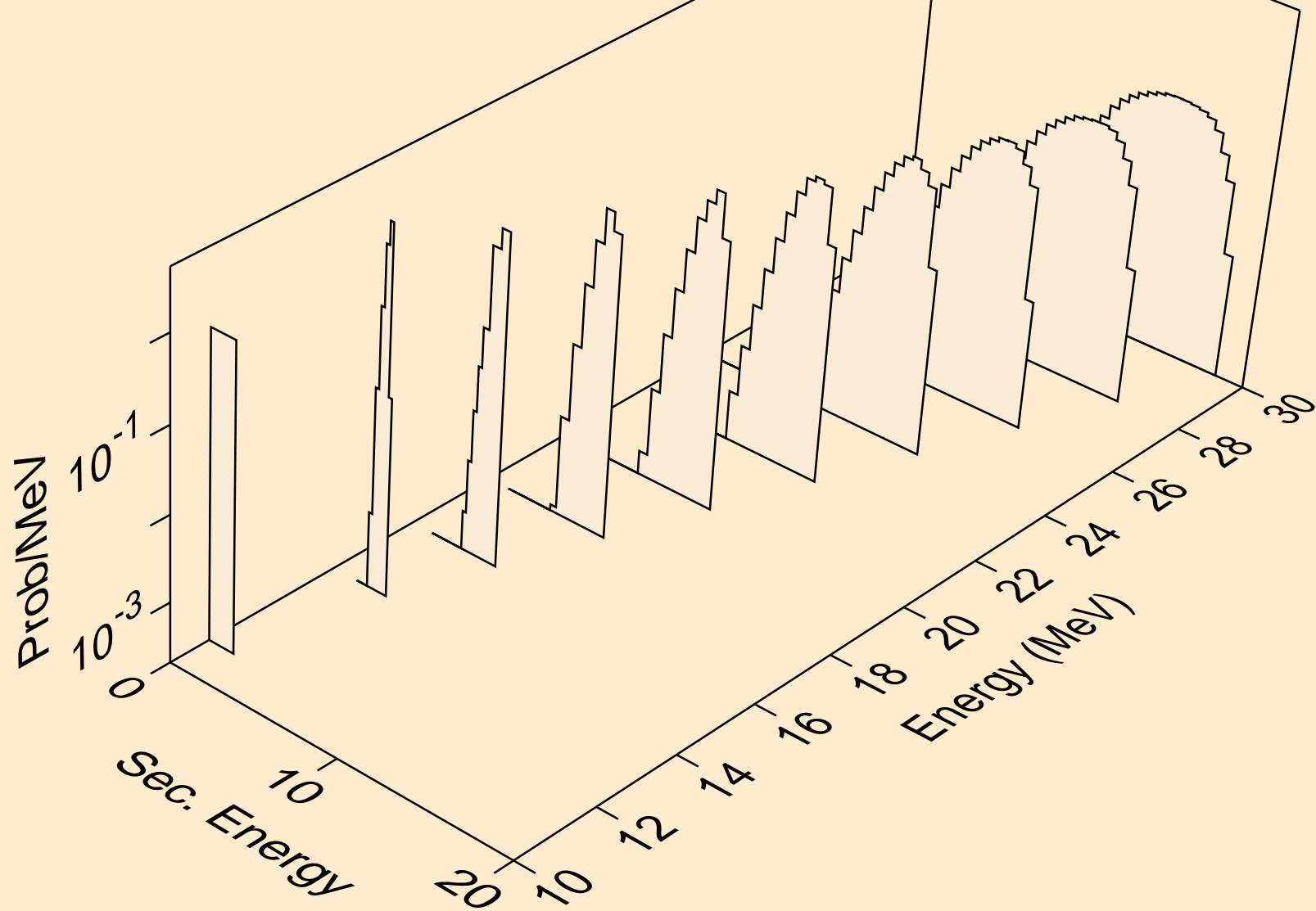

BR072M NEUTRON ACER TENDL-2021 LIBRARY; T=293.6K
he3s from (n,he3)

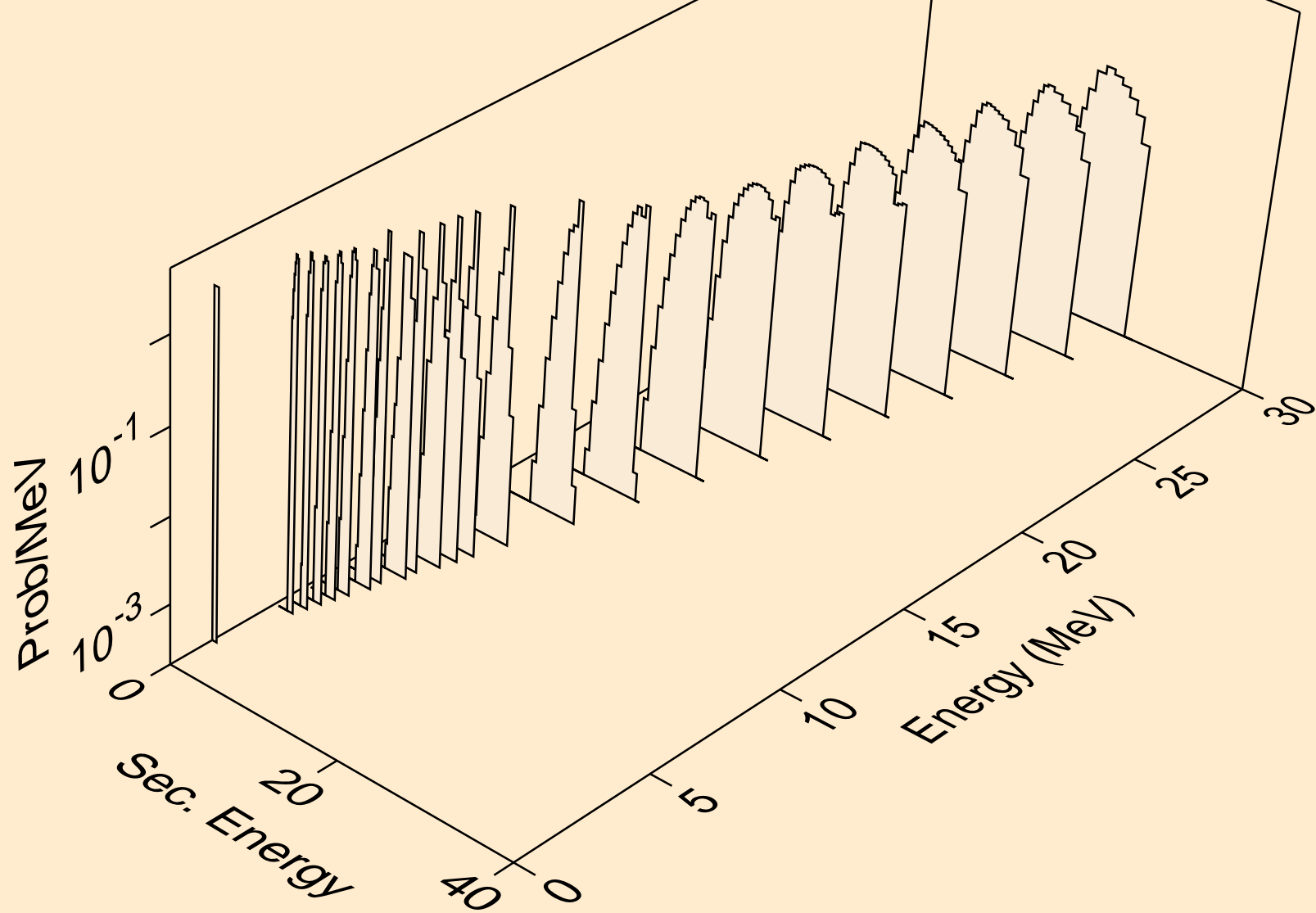

BR072M NEUTRON ACER TENDL-2021 LIBRARY; T=293.6K
alphas from (n,x)

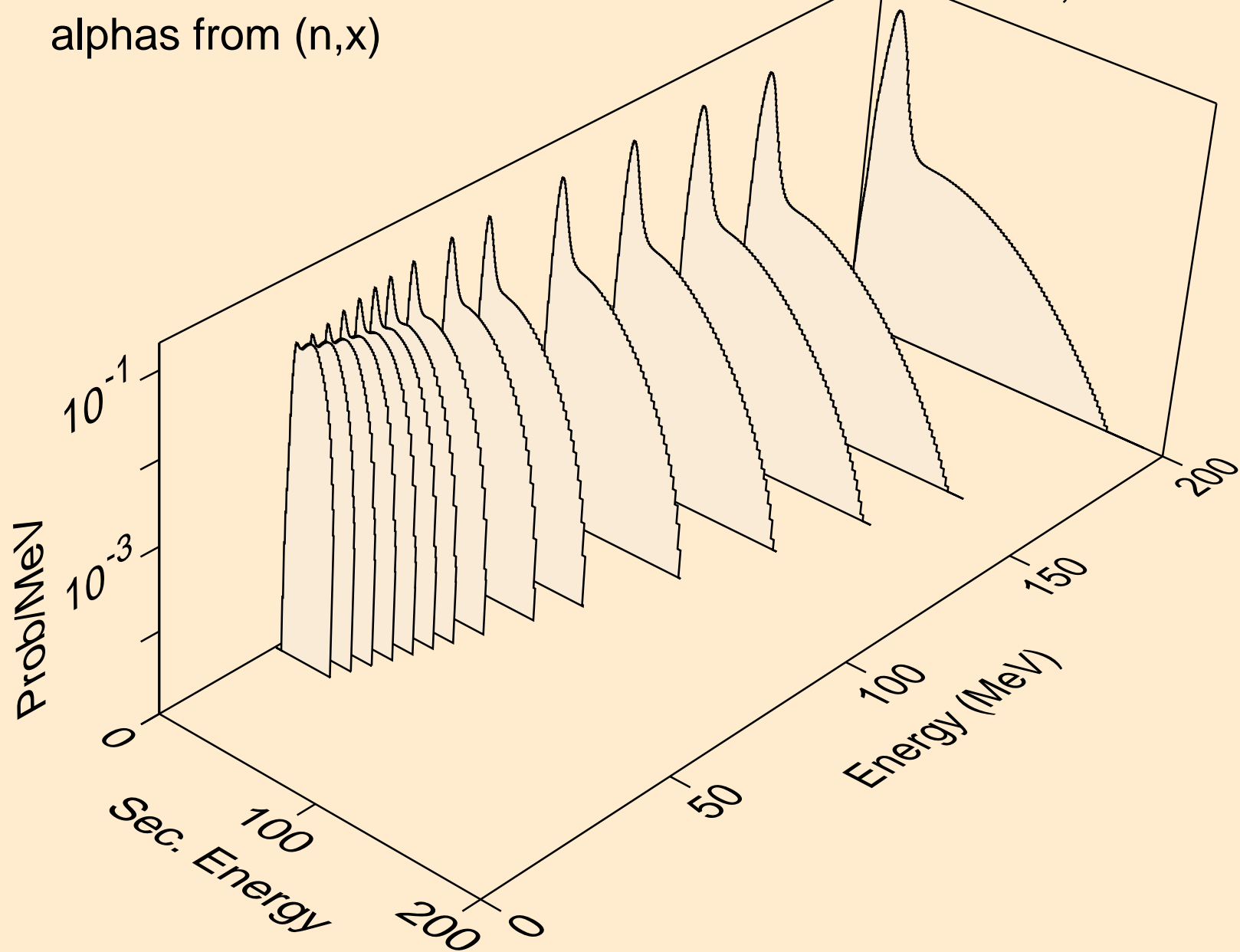

BR072M NEUTRON ACER TENDL-2021 LIBRARY; T=293.6K
alphas from (n,n*)a

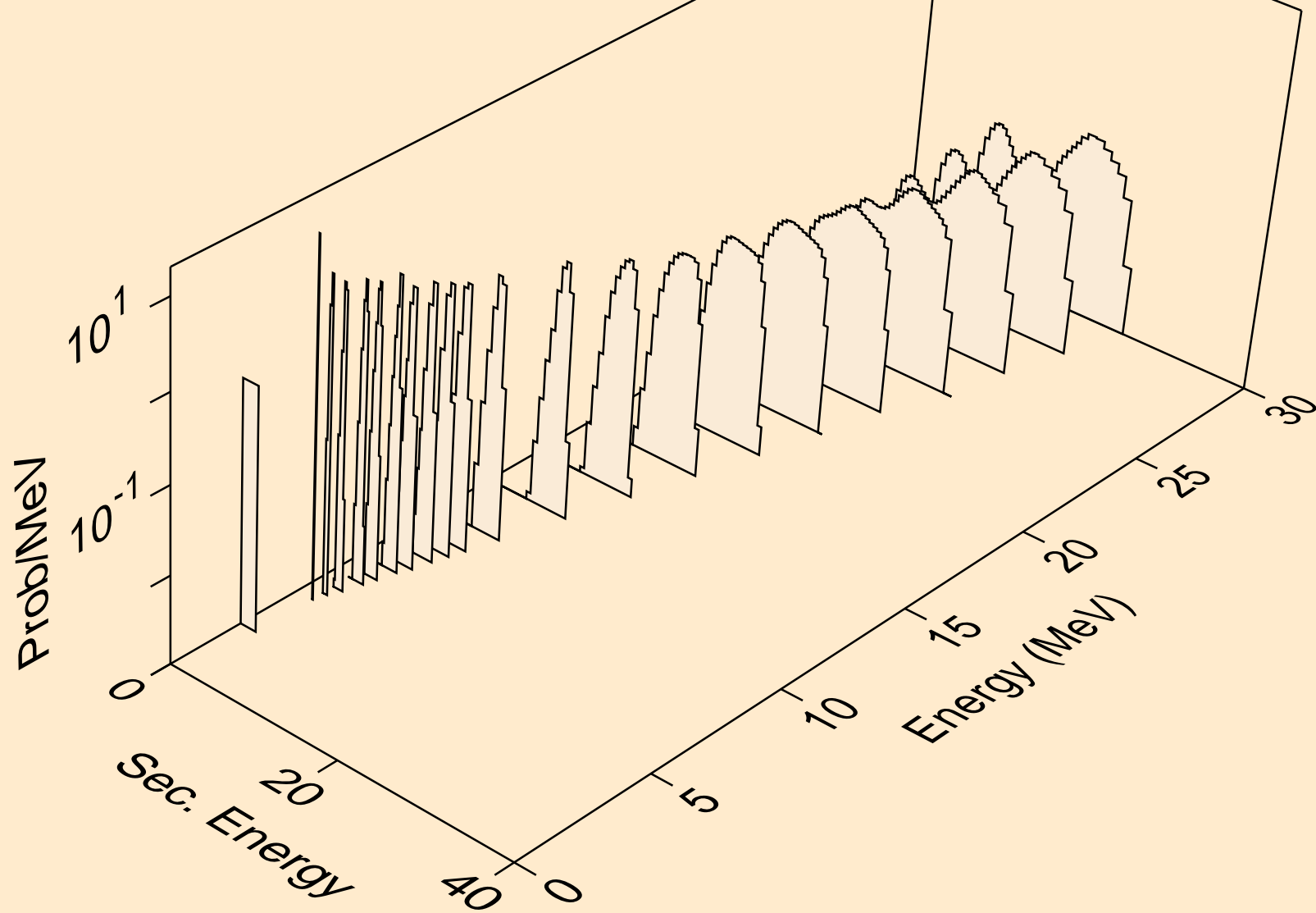

BR072M NEUTRON ACER TENDL-2021 LIBRARY; T=293.6K
alphas from (n,2n)a

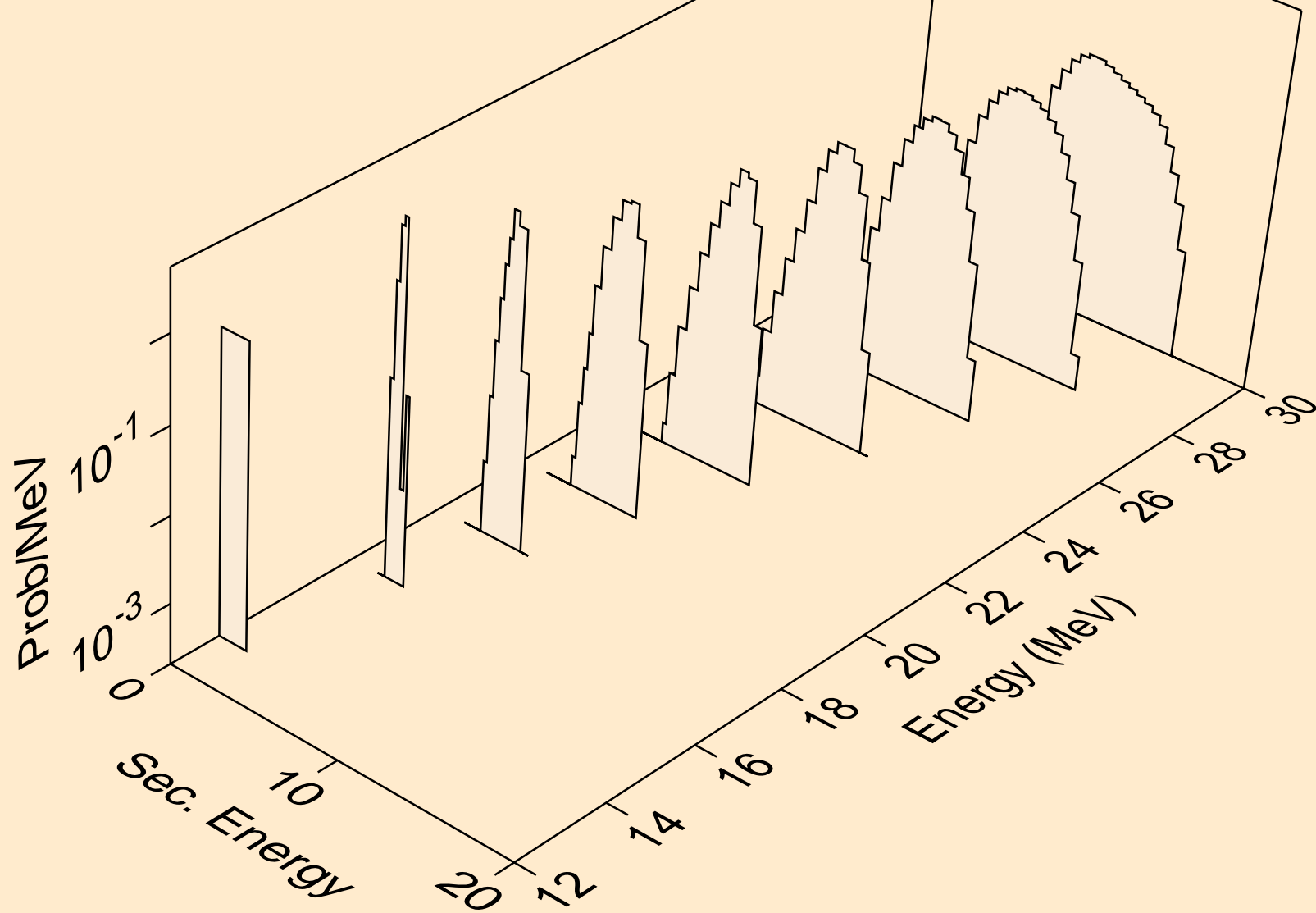

BR072M NEUTRON ACER TENDL-2021 LIBRARY; T=293.6K
alphas from (n,n*)2a

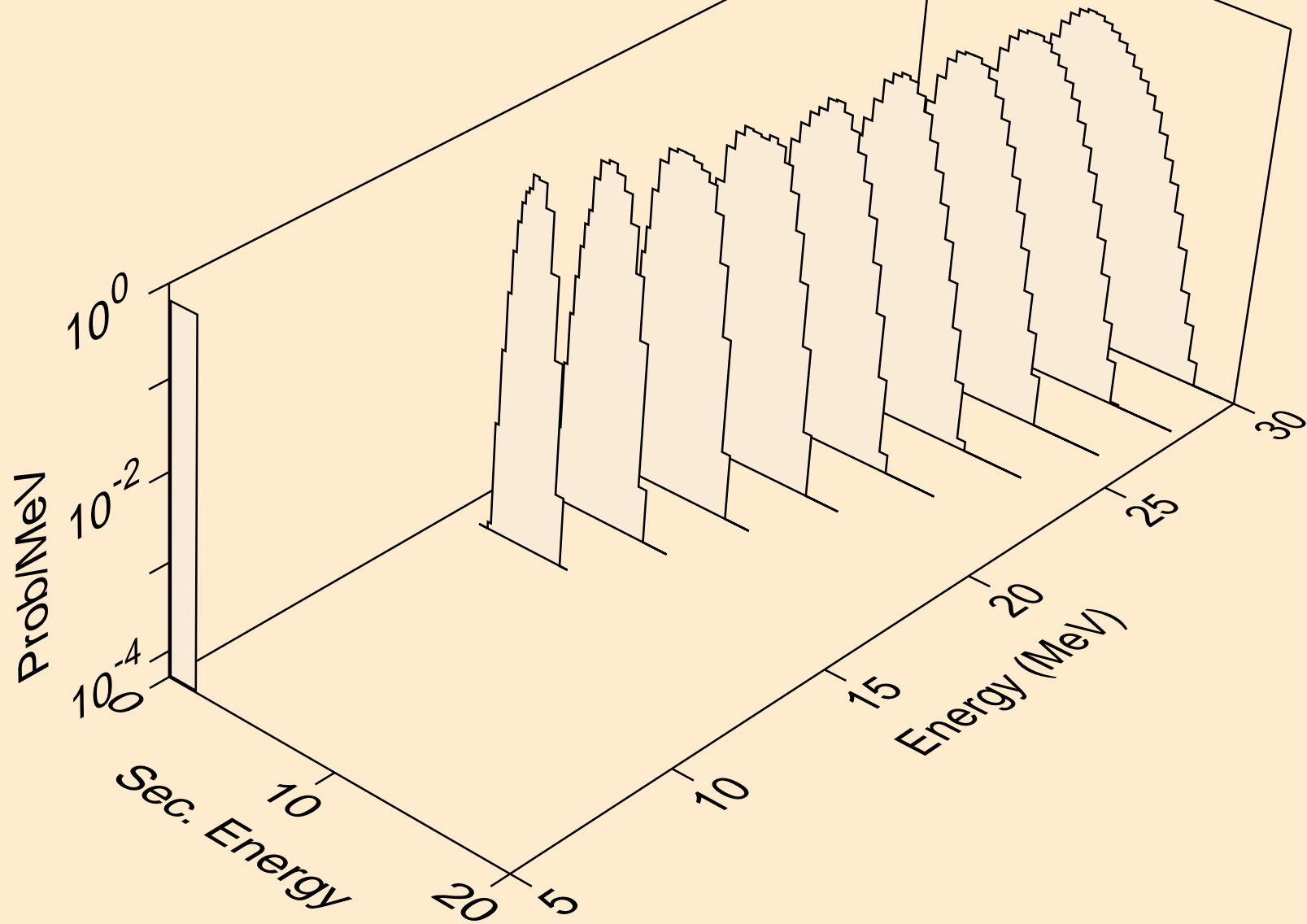

BR072M NEUTRON ACER TENDL-2021 LIBRARY; T=293.6K
alphas from (n,npa)

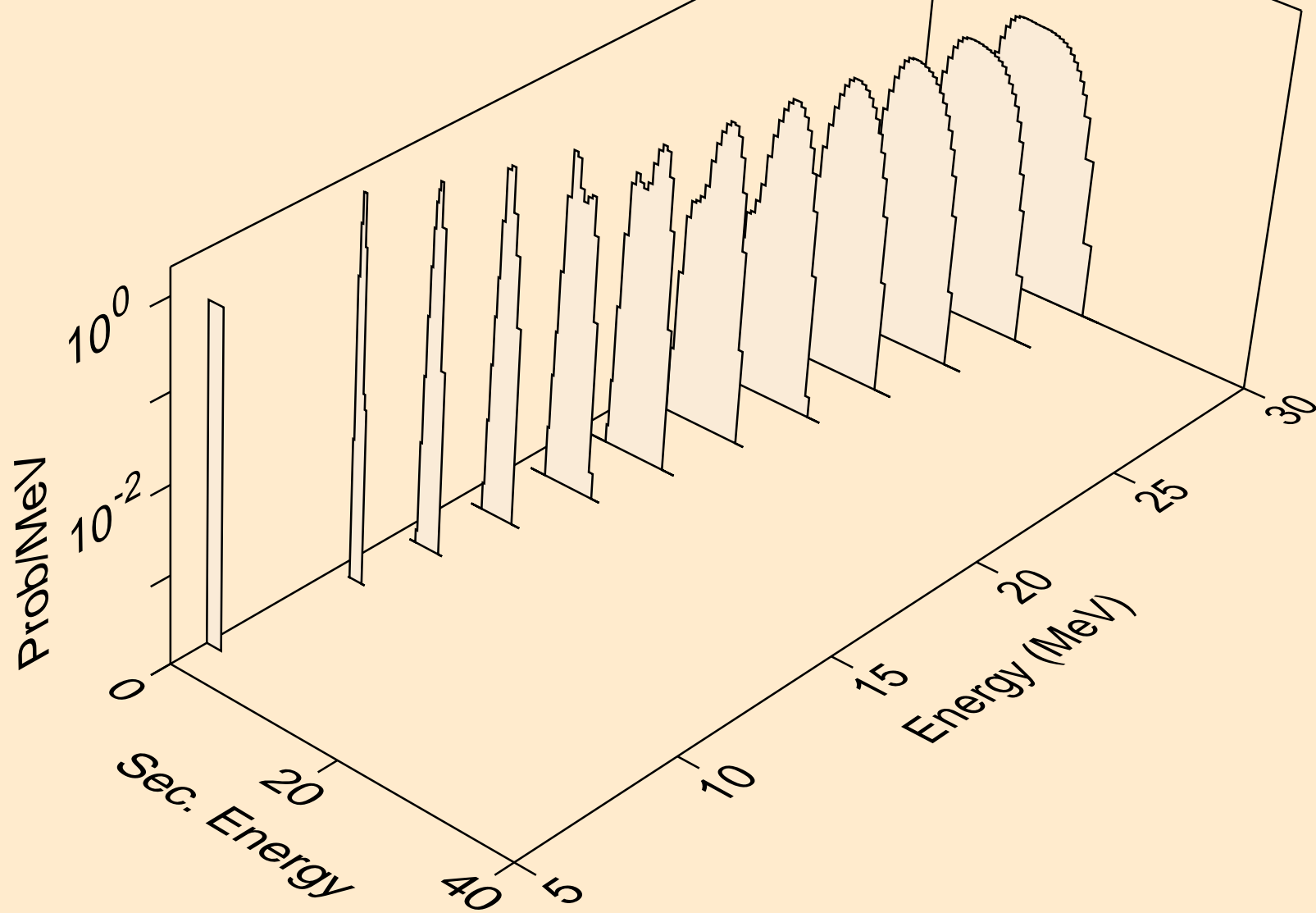

BR072M NEUTRON ACER TENDL-2021 LIBRARY; T=293.6K
alphas from (n,a)

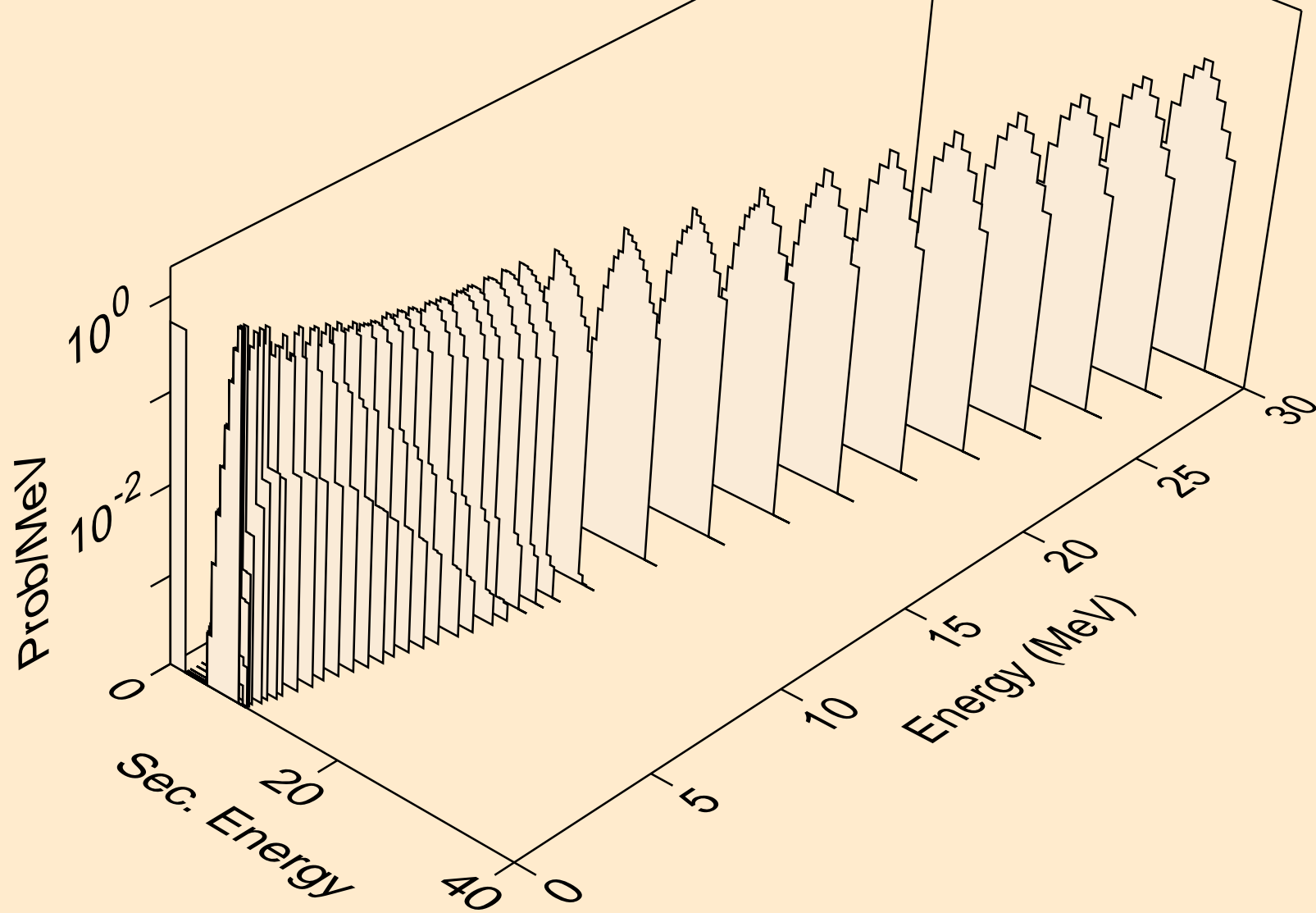

BR072M NEUTRON ACER TENDL-2021 LIBRARY; T=293.6K
alphas from (n,2a)

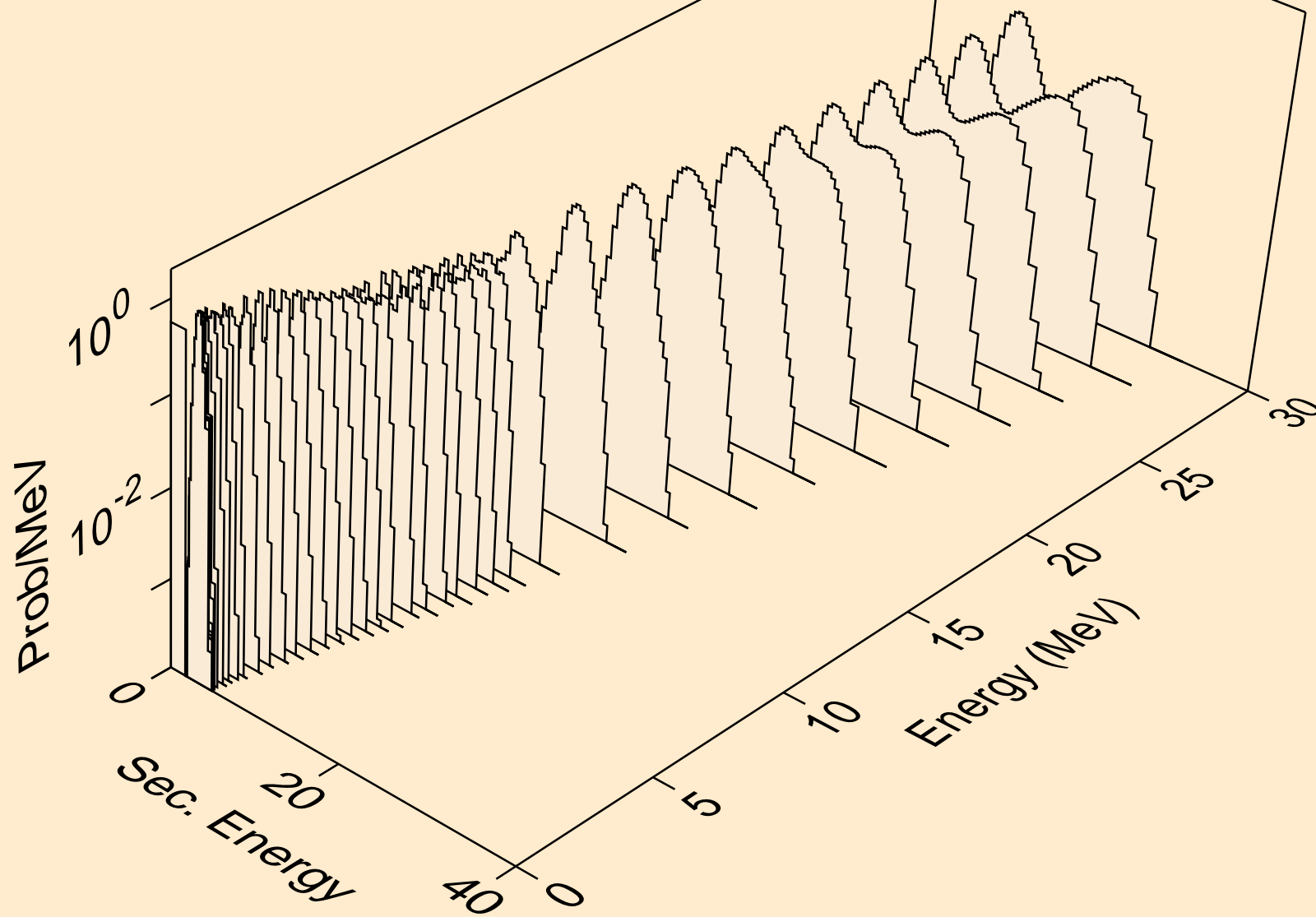

BR072M NEUTRON ACER TENDL-2021 LIBRARY; T=293.6K
alphas from (n,3a)

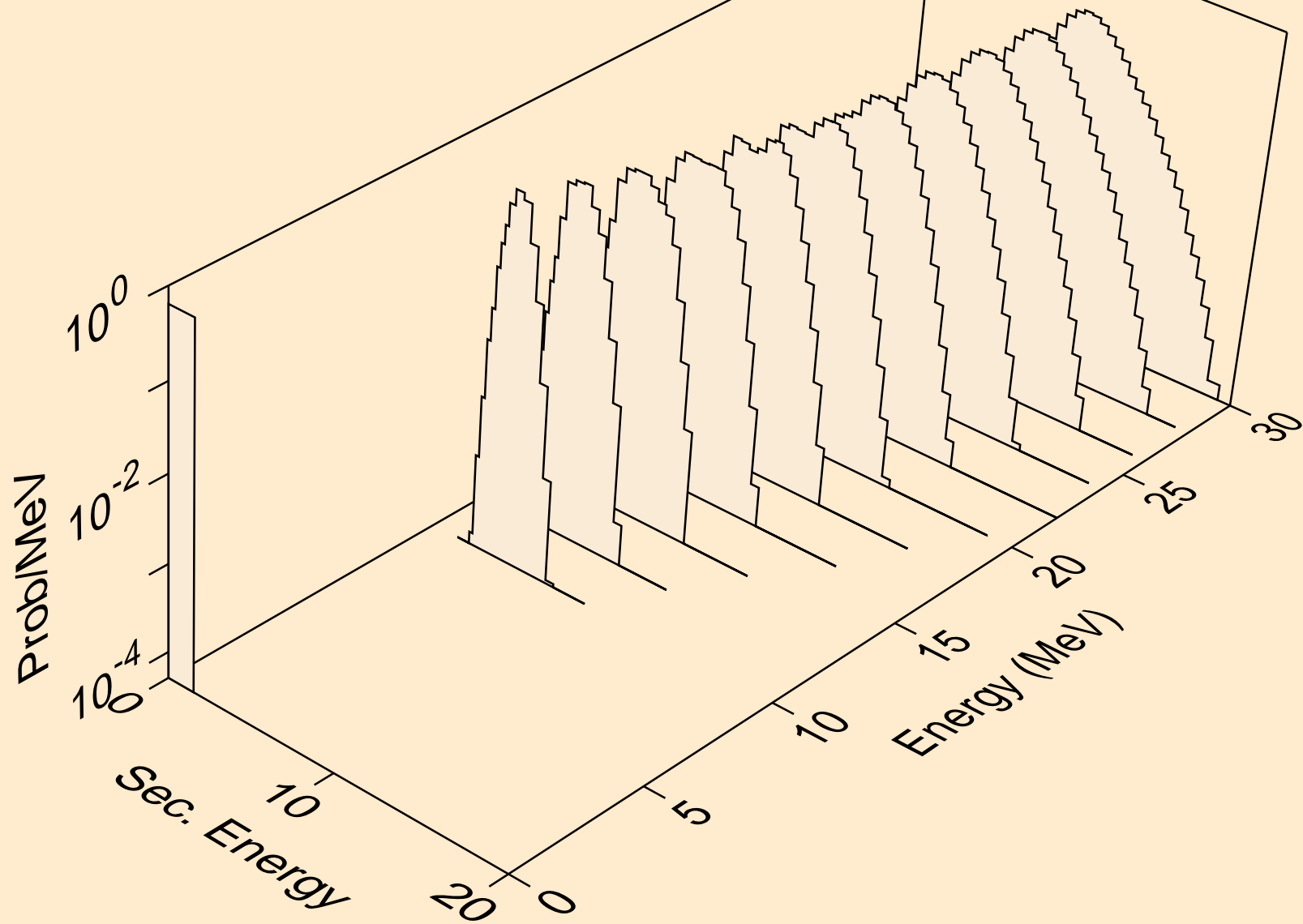

BR072M NEUTRON ACER TENDL-2021 LIBRARY; T=293.6K
alphas from (n,pa)

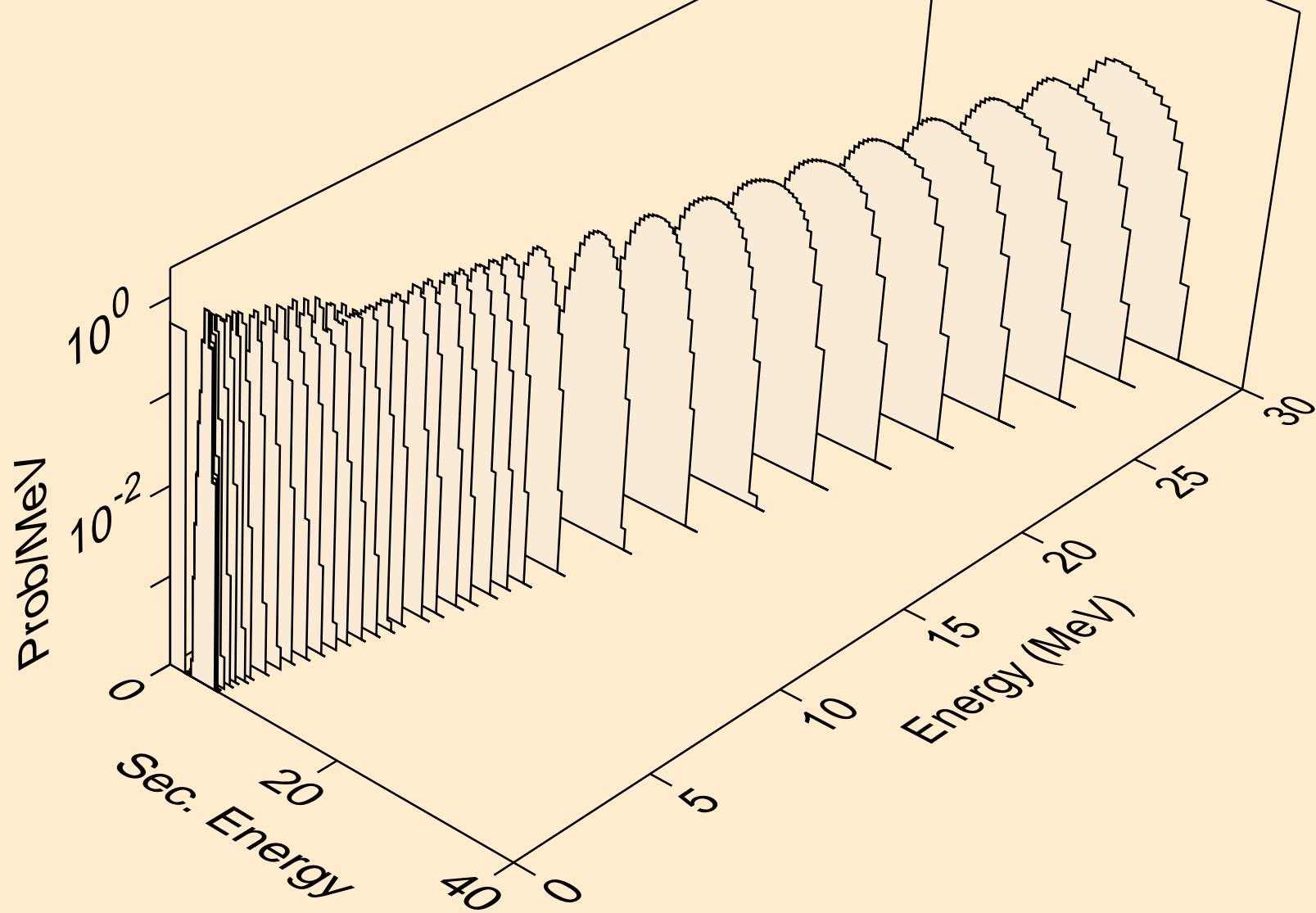

BR072M NEUTRON ACER TENDL-2021 LIBRARY; T=293.6K
alphas from (n,t2a)

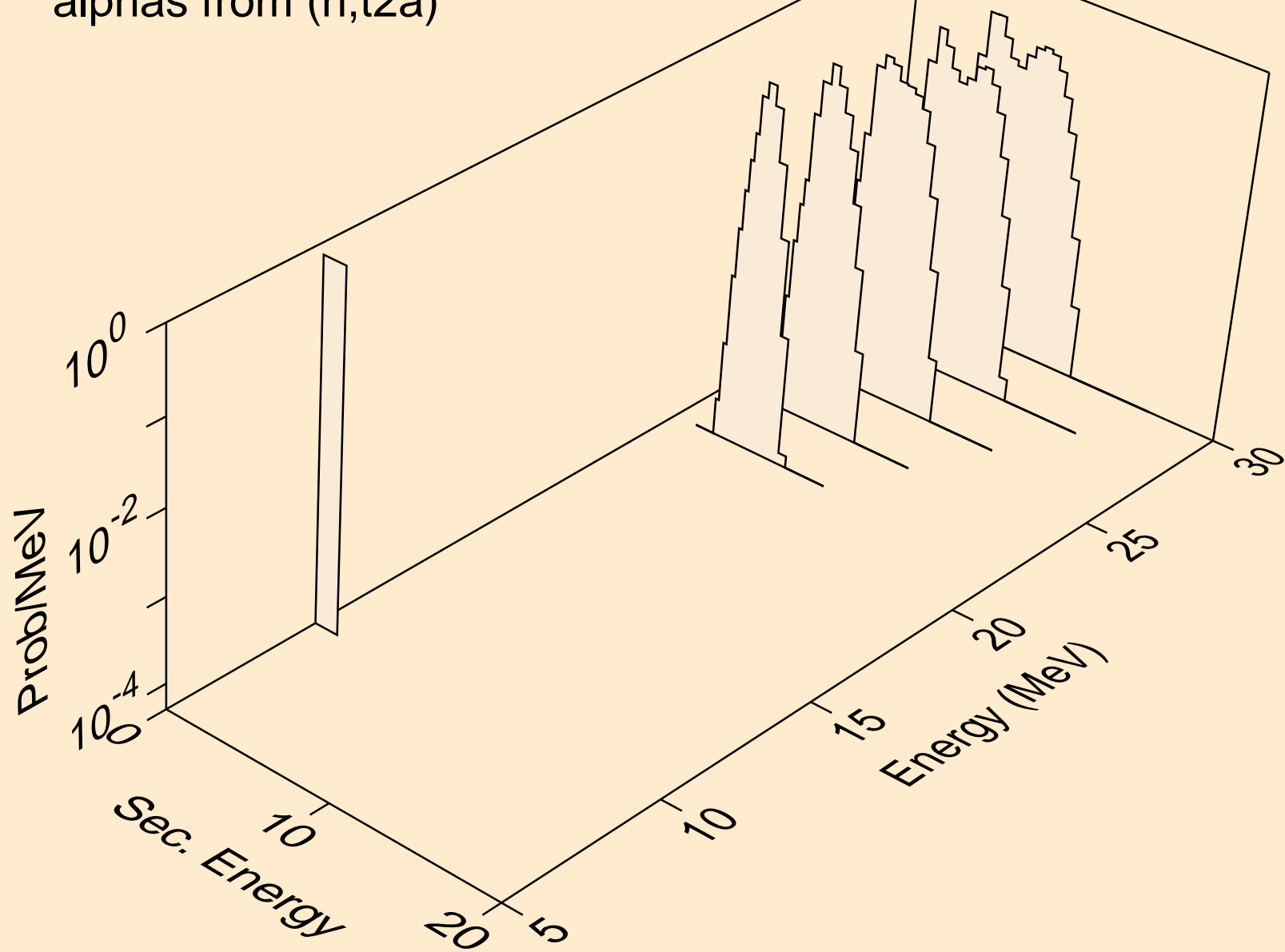

BR072M NEUTRON ACER TENDL-2021 LIBRARY; T=293.6K
alphas from (n,d2a)

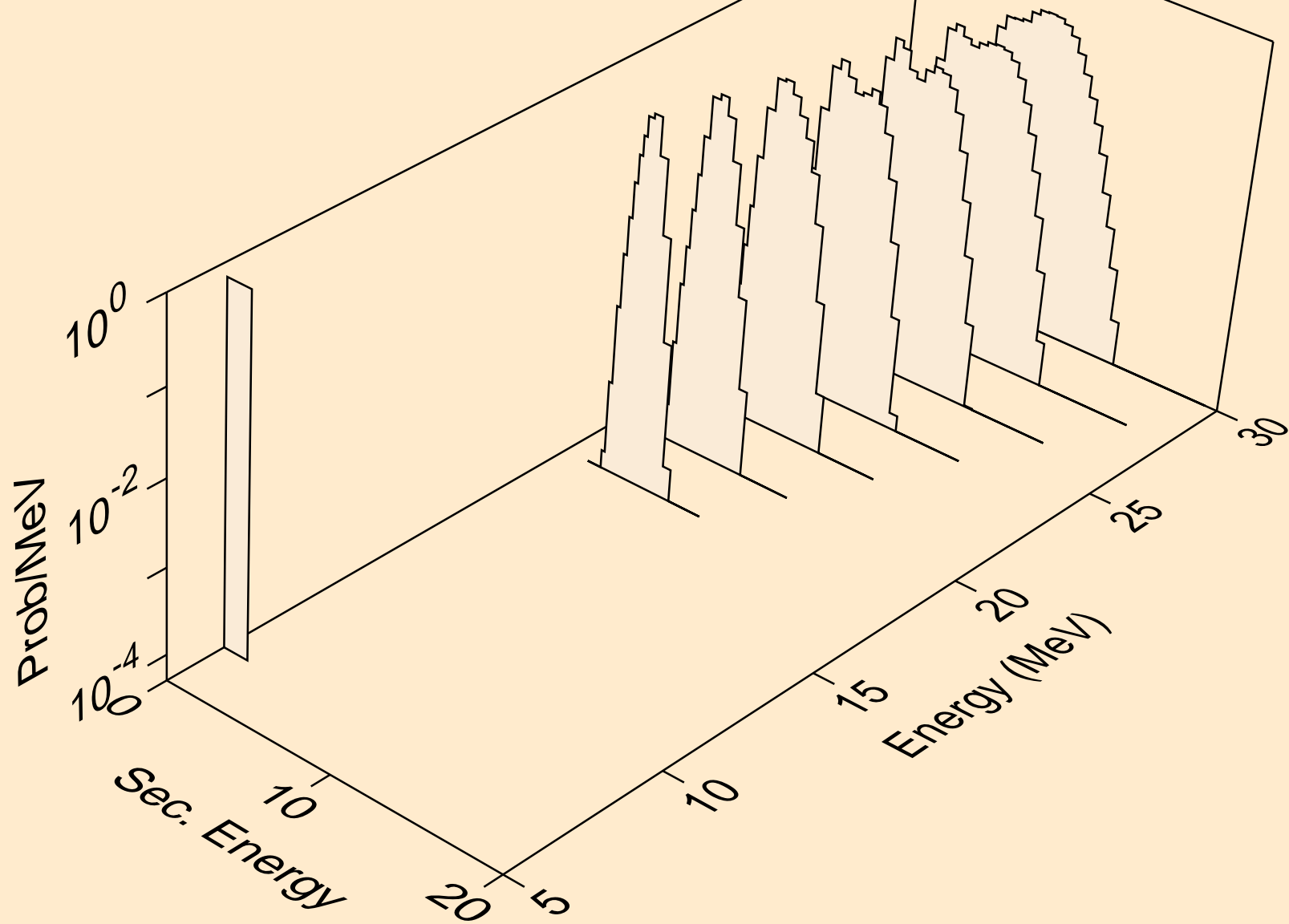

BR072M NEUTRON ACER TENDL-2021 LIBRARY; T=293.6K
alphas from (n,da)

