

BR081 NEUTRON ACER TENDL-2021 LIBRARY; T=293.6K
Principal cross sections

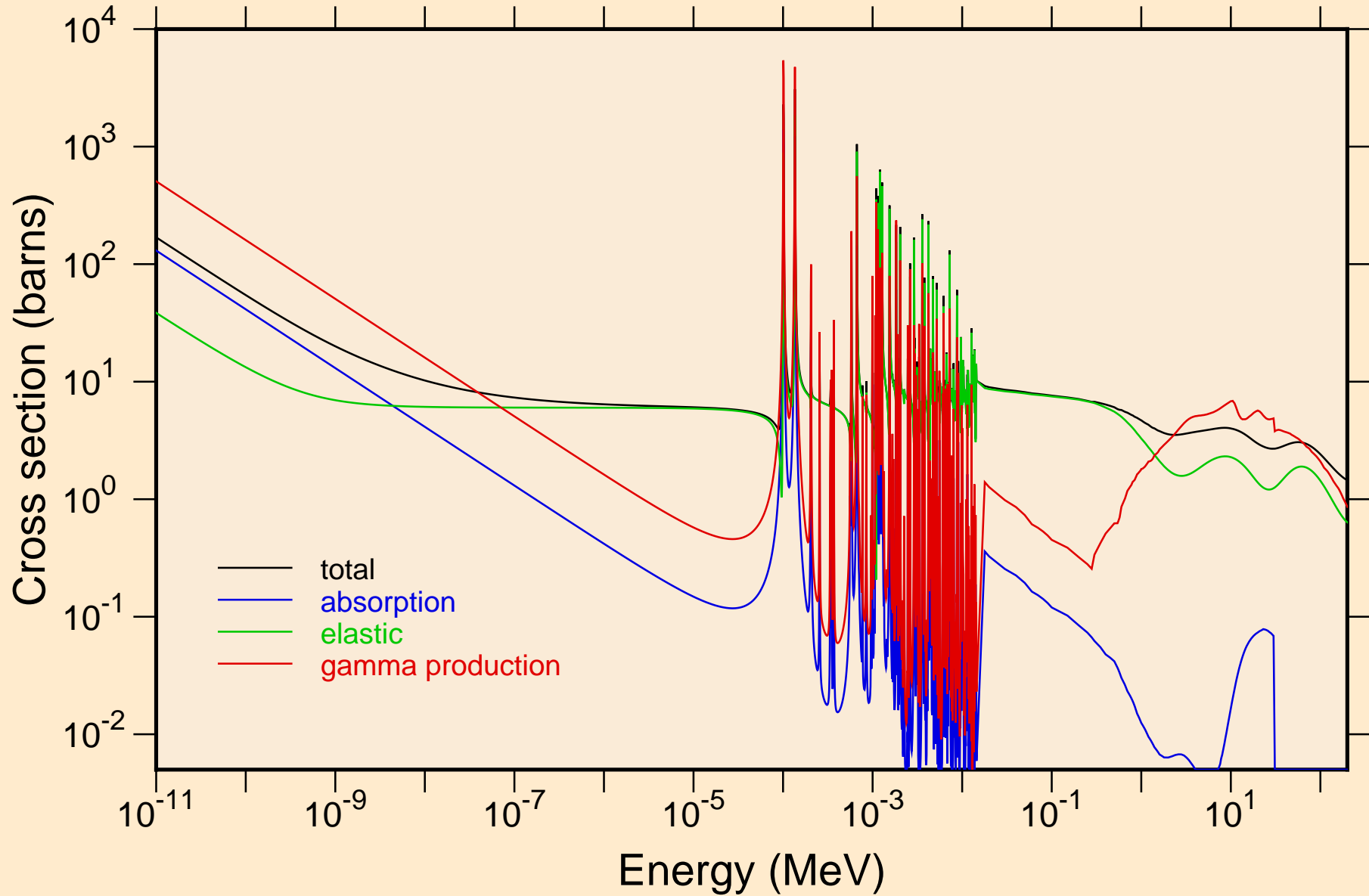

BR081 NEUTRON ACER TENDL-2021 LIBRARY; T=293.6K
resonance total cross section

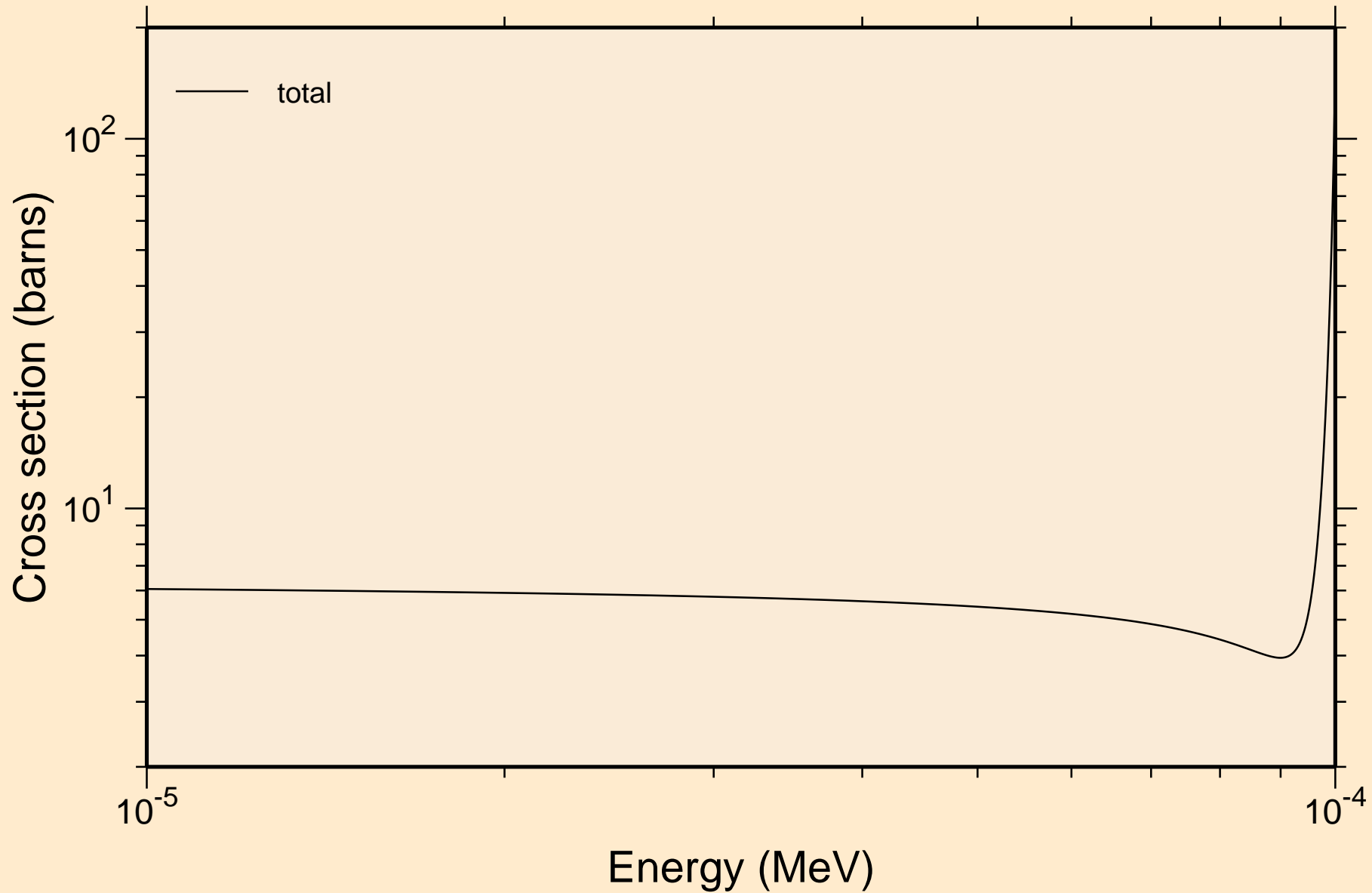

BR081 NEUTRON ACER TENDL-2021 LIBRARY; T=293.6K
resonance total cross section

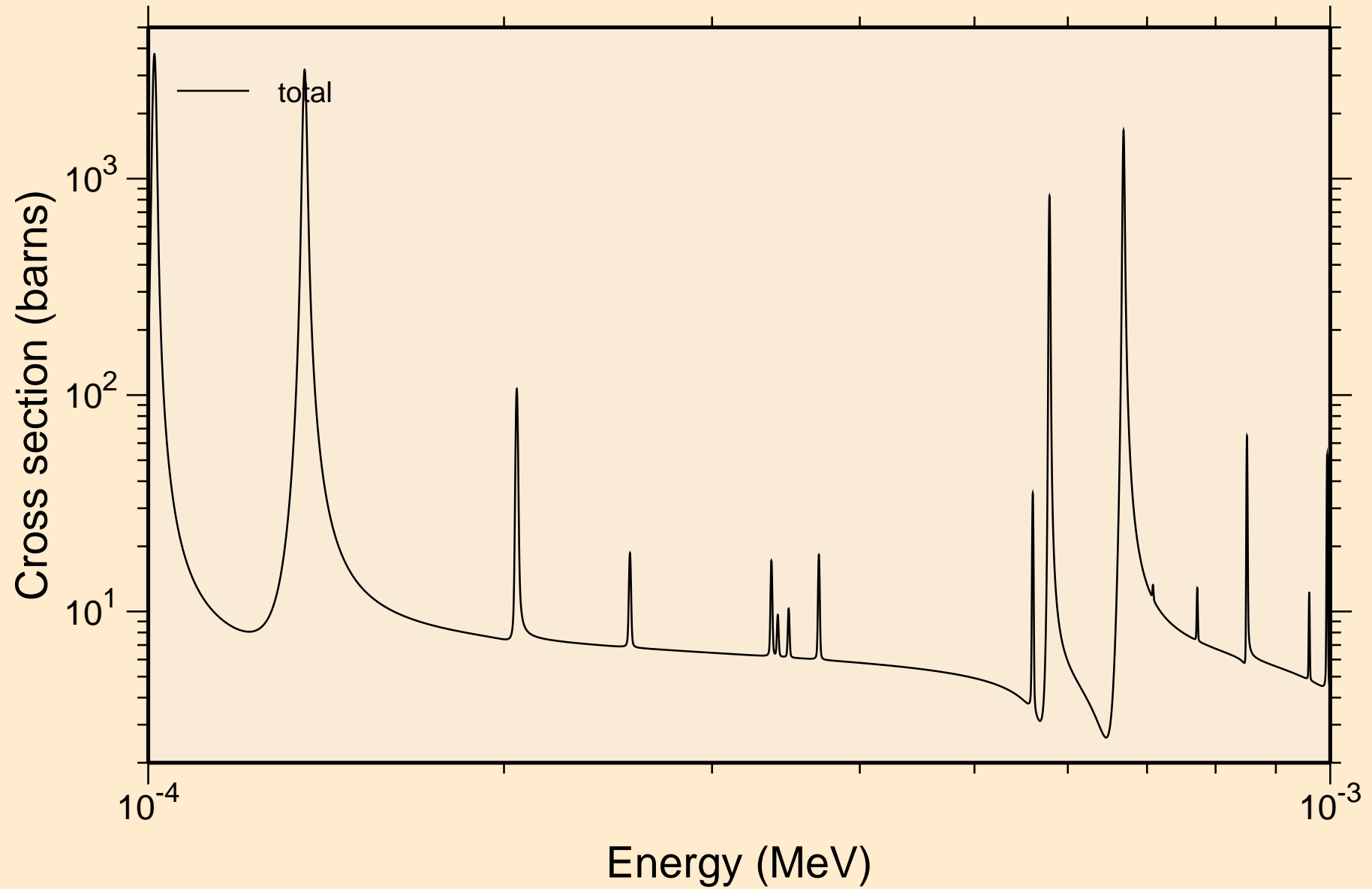

BR081 NEUTRON ACER TENDL-2021 LIBRARY; T=293.6K
resonance total cross section

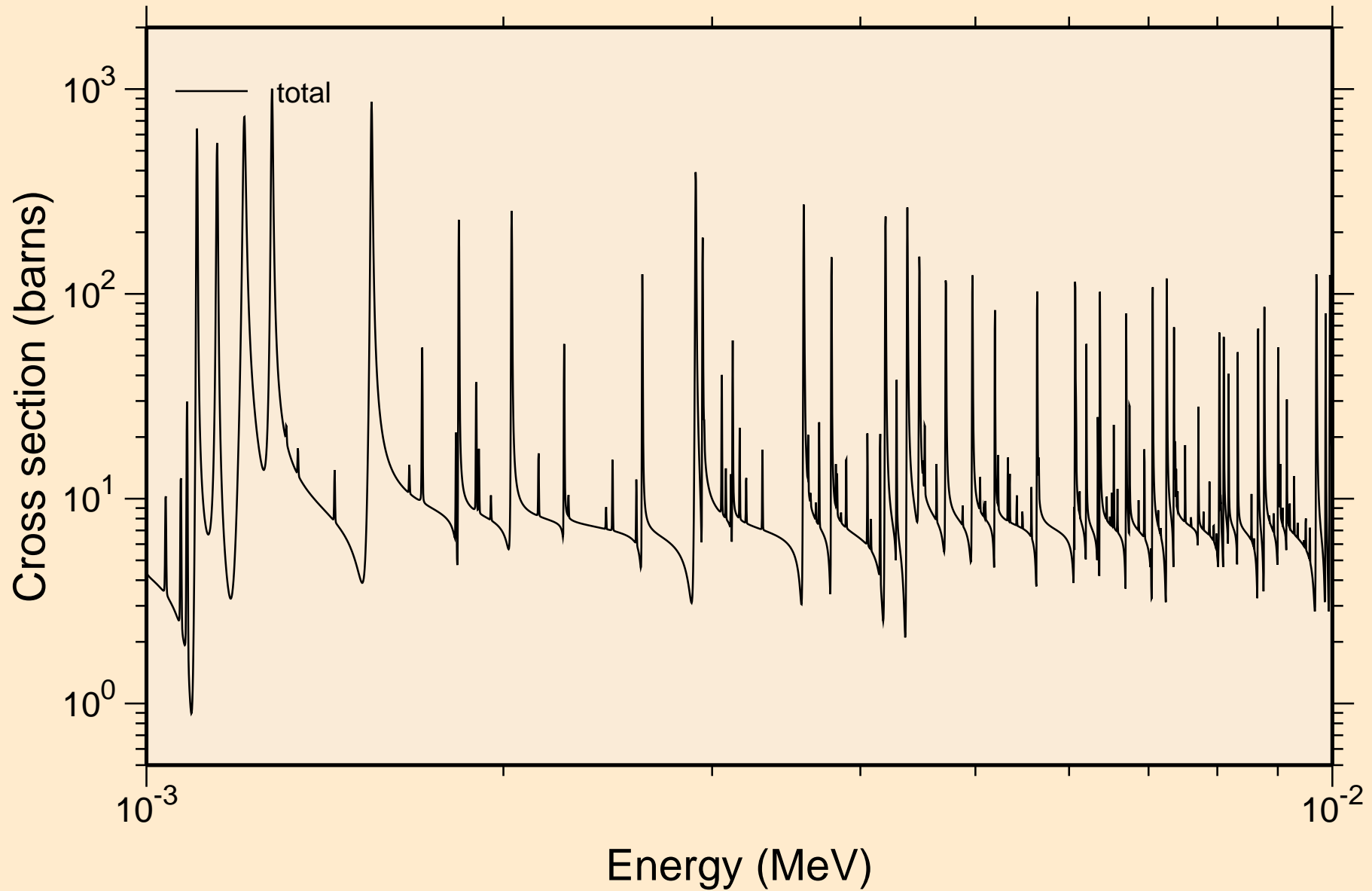

BR081 NEUTRON ACER TENDL-2021 LIBRARY; T=293.6K
resonance total cross section

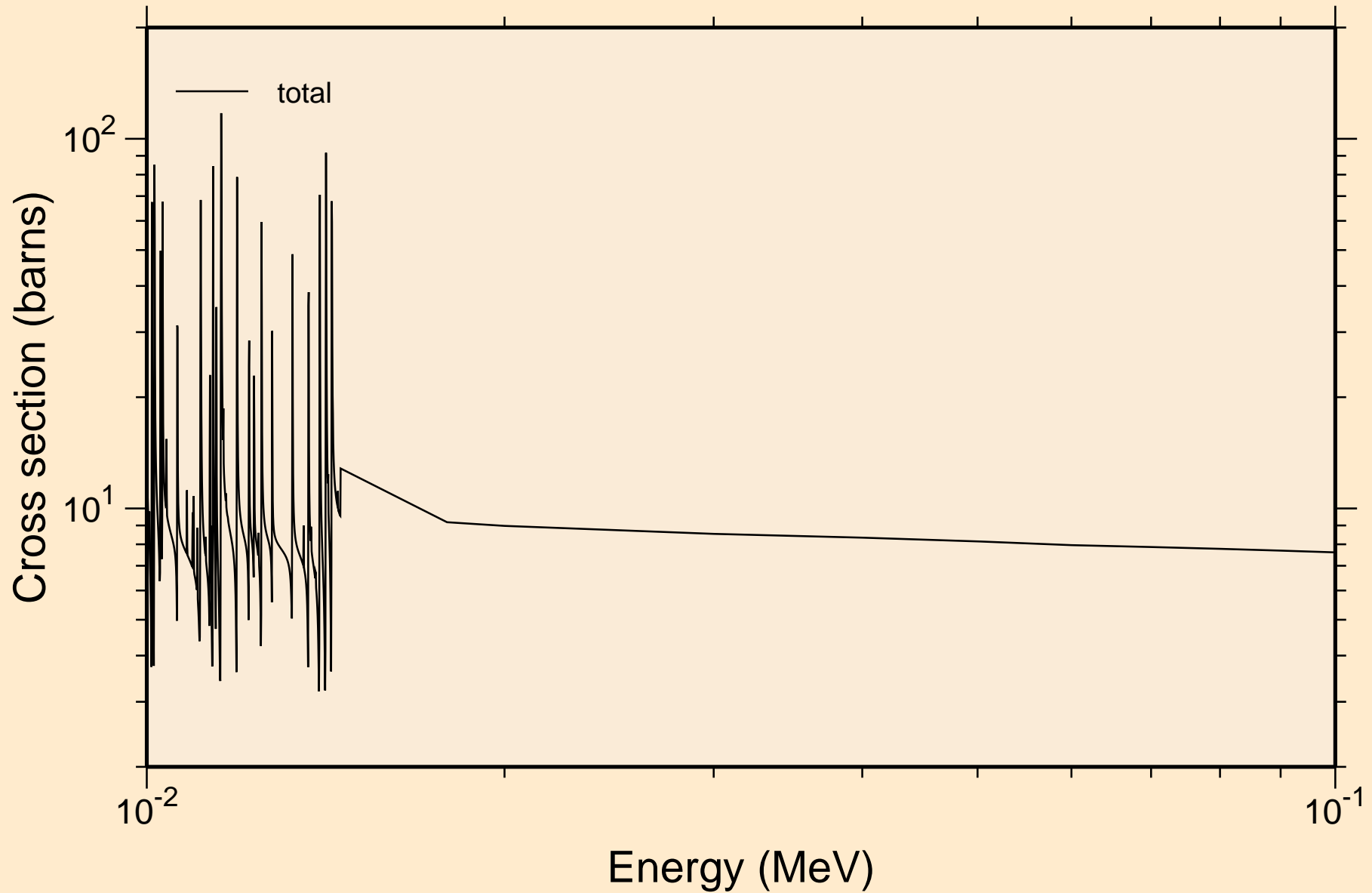

BR081 NEUTRON ACER TENDL-2021 LIBRARY; T=293.6K
resonance total cross section

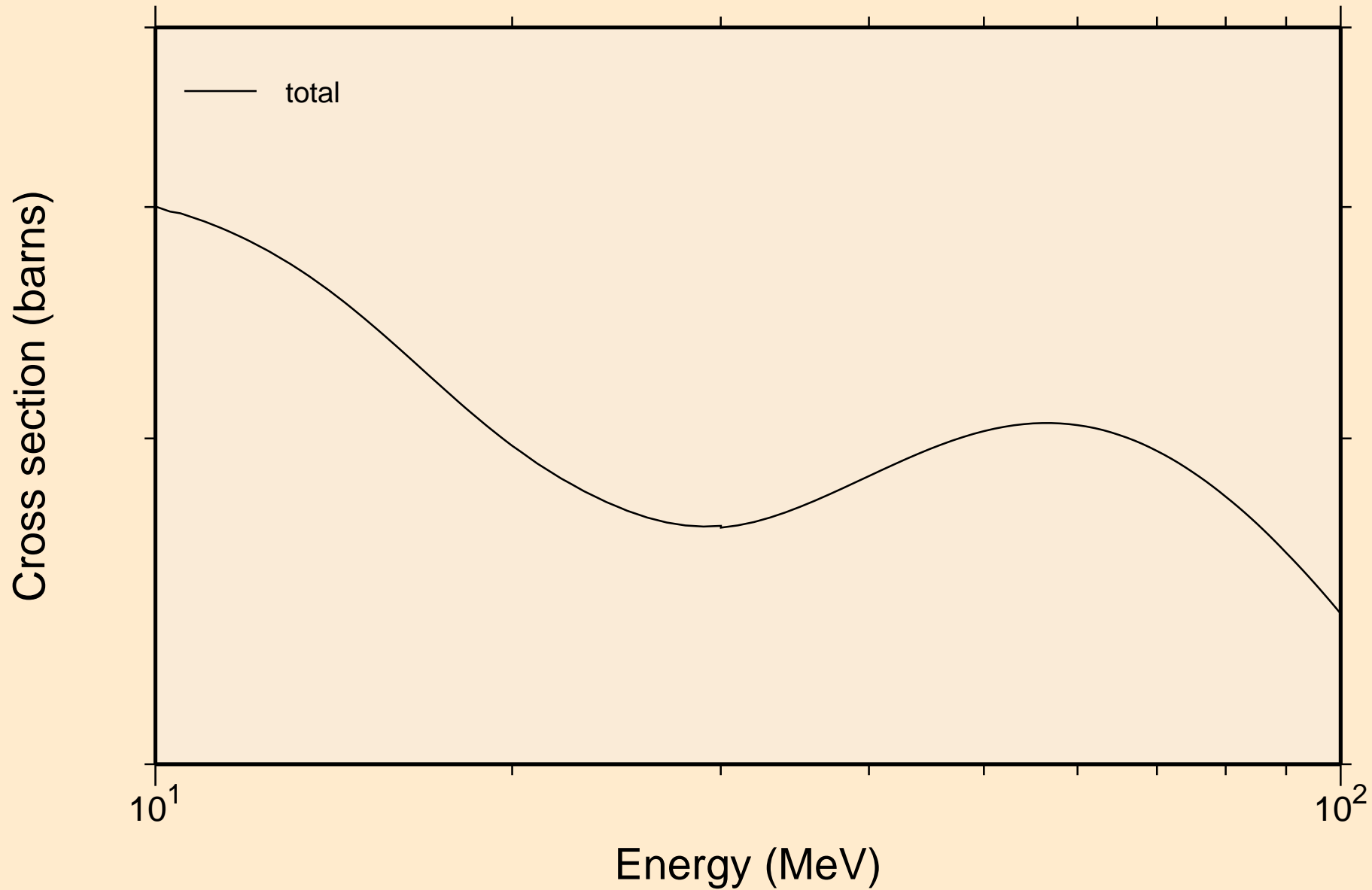

BR081 NEUTRON ACER TENDL-2021 LIBRARY; T=293.6K
resonance absorption cross sections

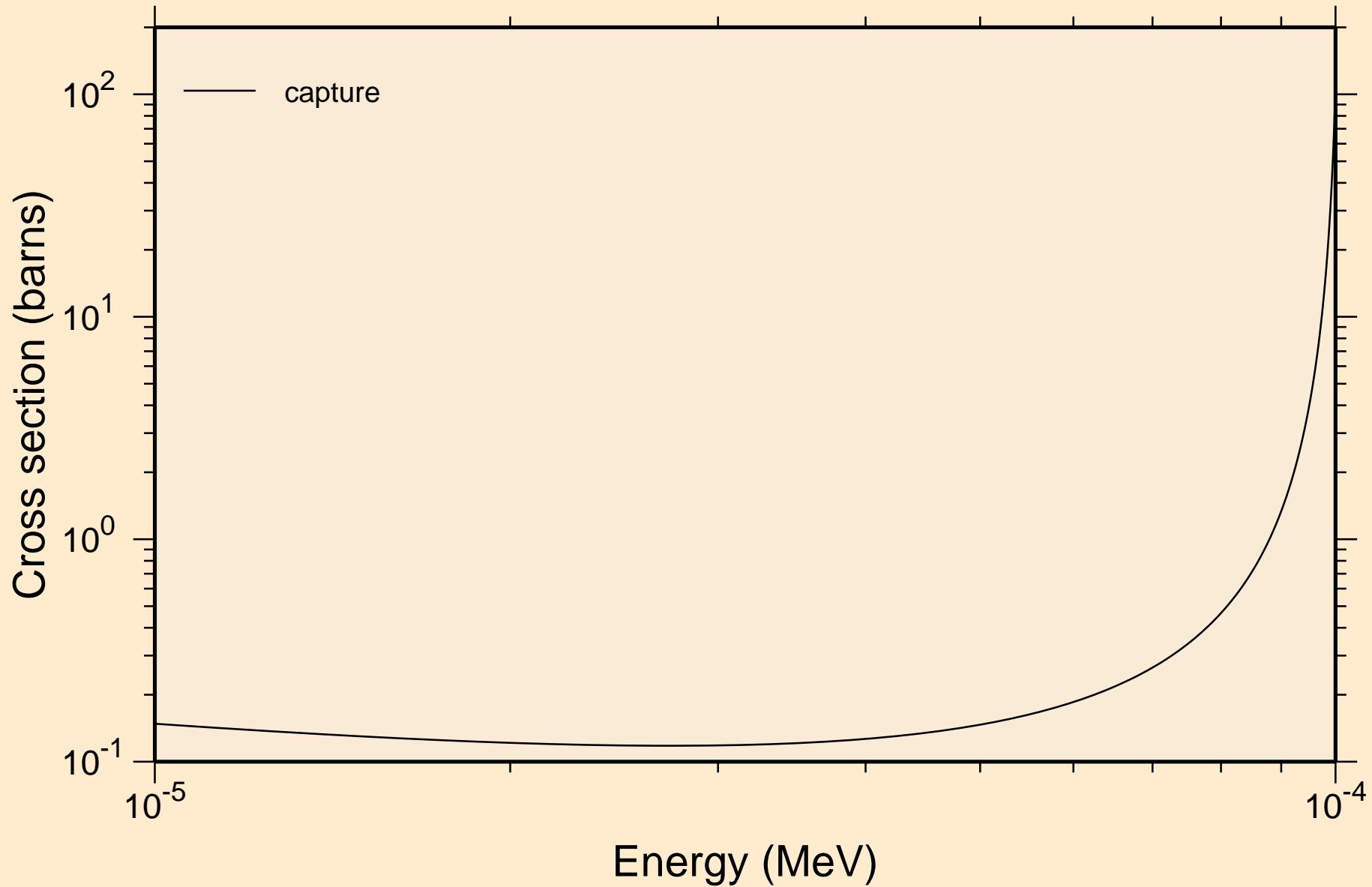

BR081 NEUTRON ACER TENDL-2021 LIBRARY; T=293.6K
resonance absorption cross sections

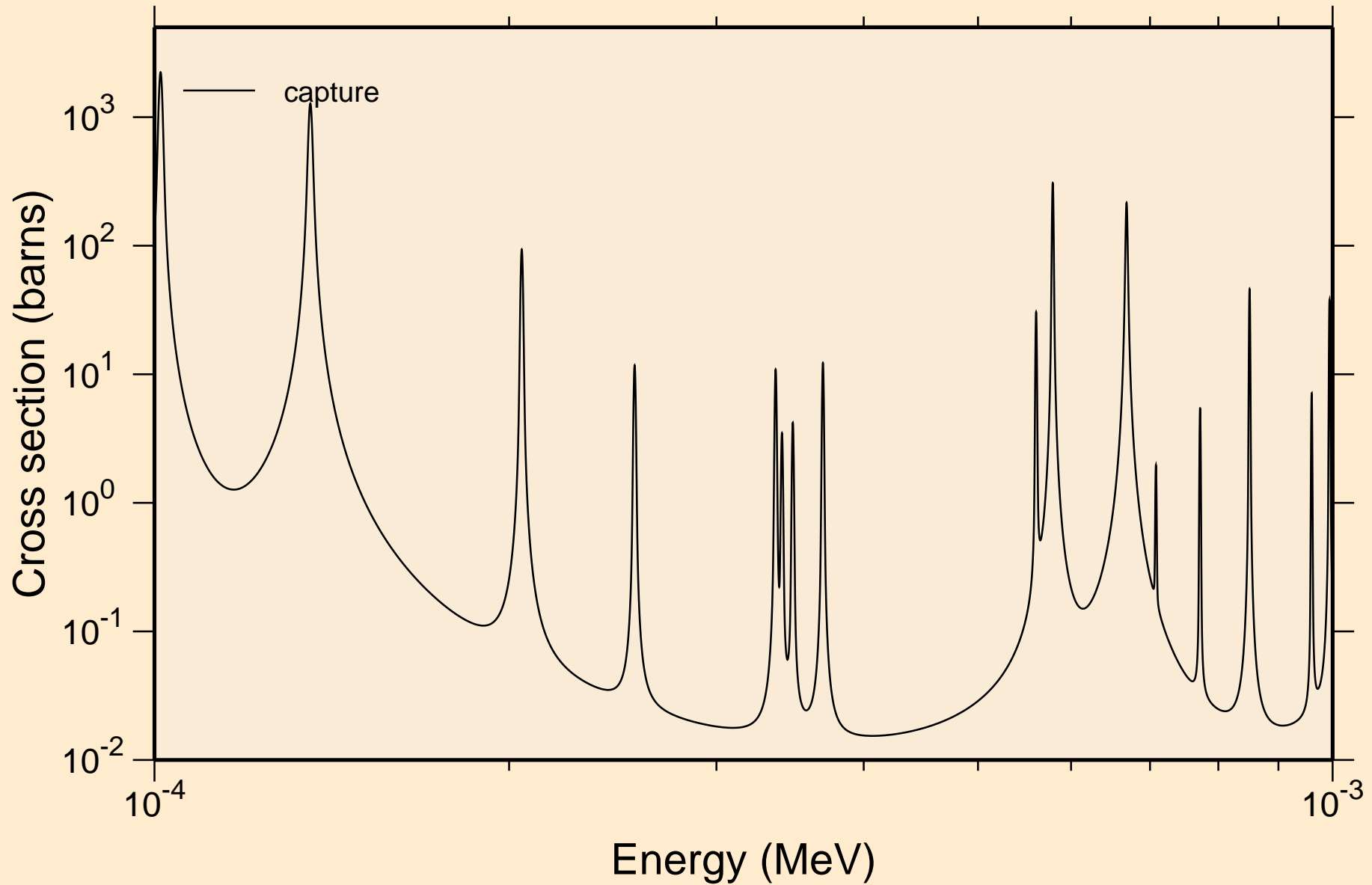

BR081 NEUTRON ACER TENDL-2021 LIBRARY; T=293.6K
resonance absorption cross sections

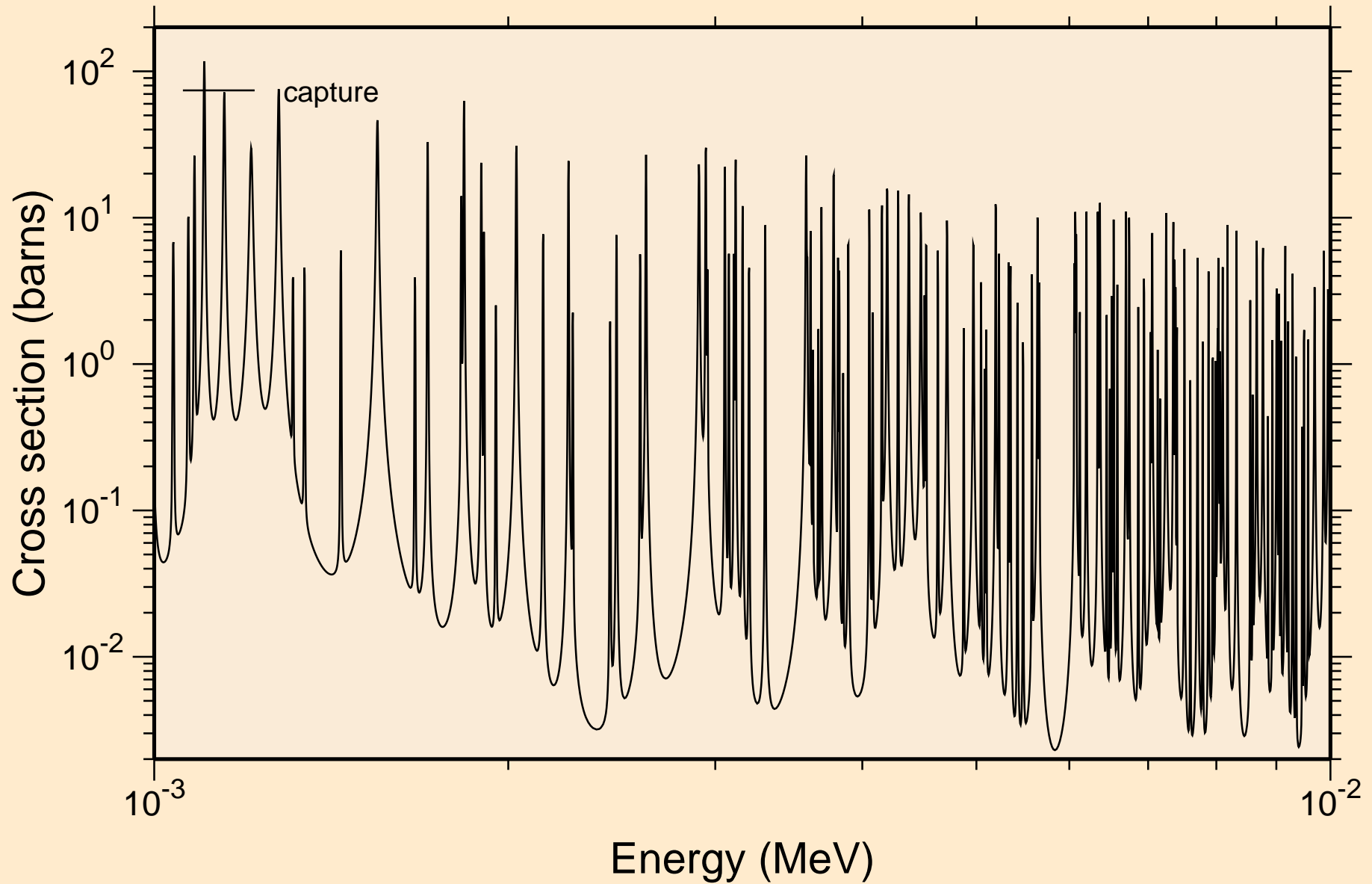

BR081 NEUTRON ACER TENDL-2021 LIBRARY; T=293.6K
resonance absorption cross sections

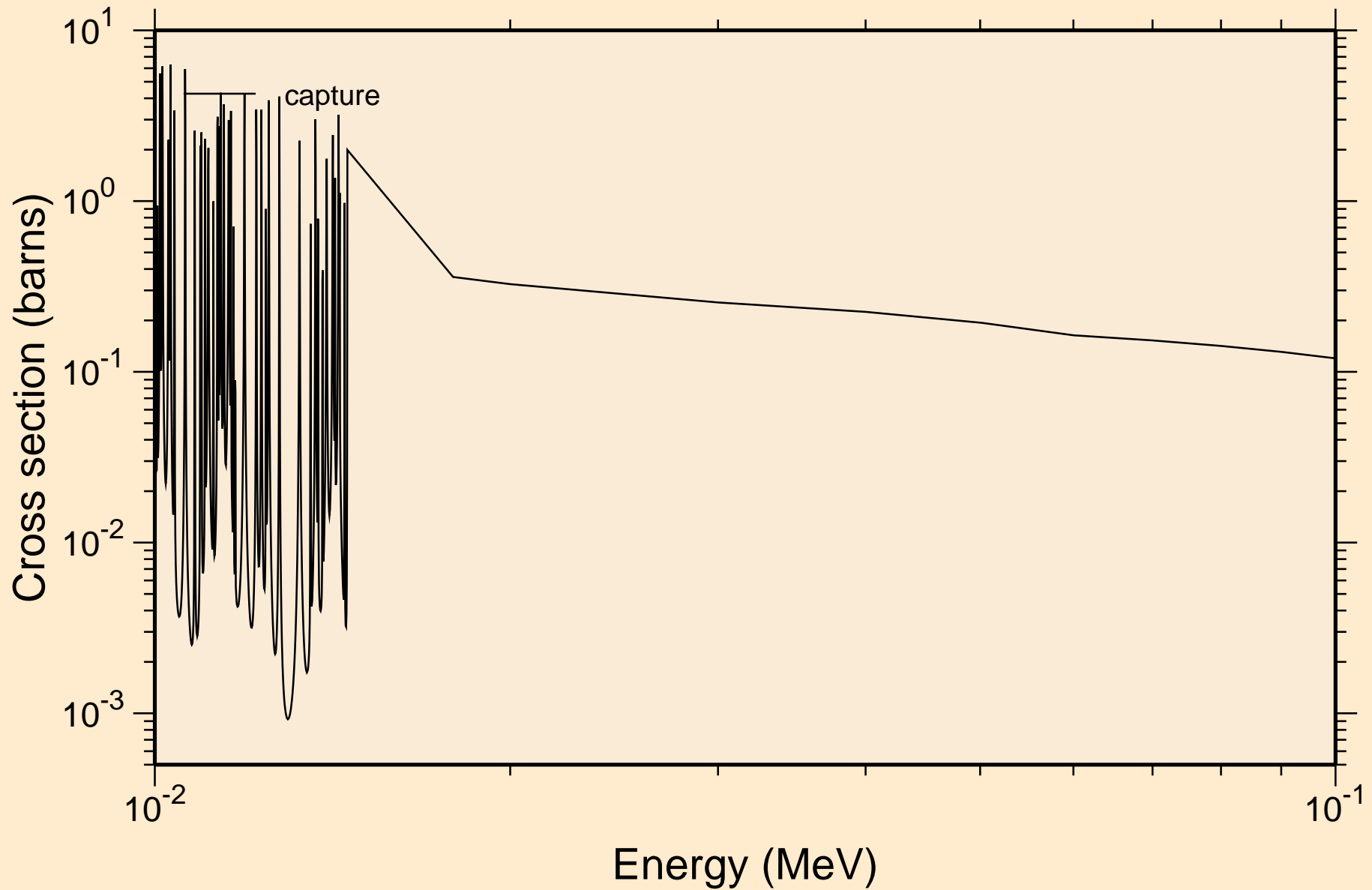

BR081 NEUTRON ACER TENDL-2021 LIBRARY; T=293.6K
resonance absorption cross sections

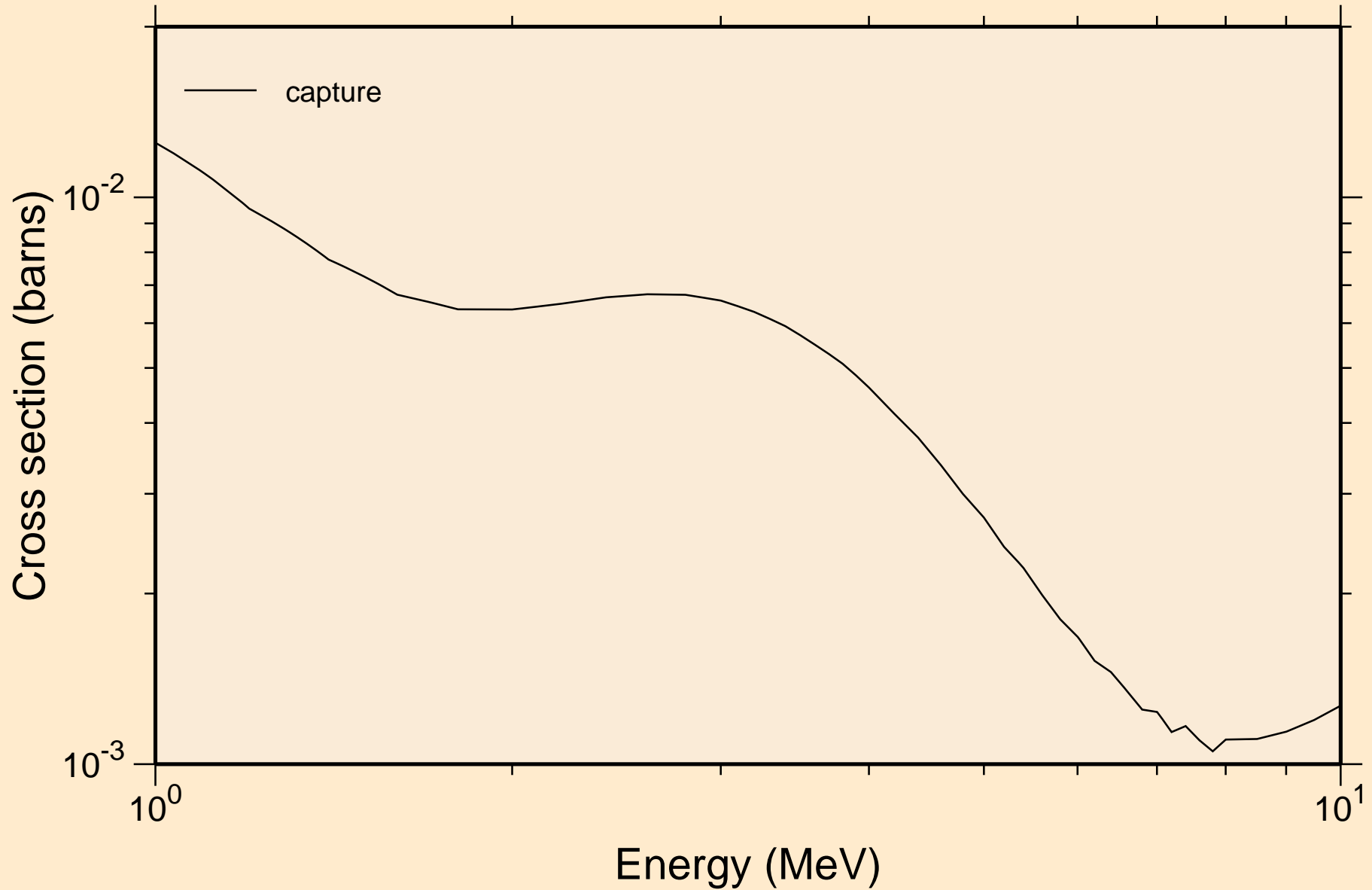

BR081 NEUTRON ACER TENDL-2021 LIBRARY; T=293.6K
Heating

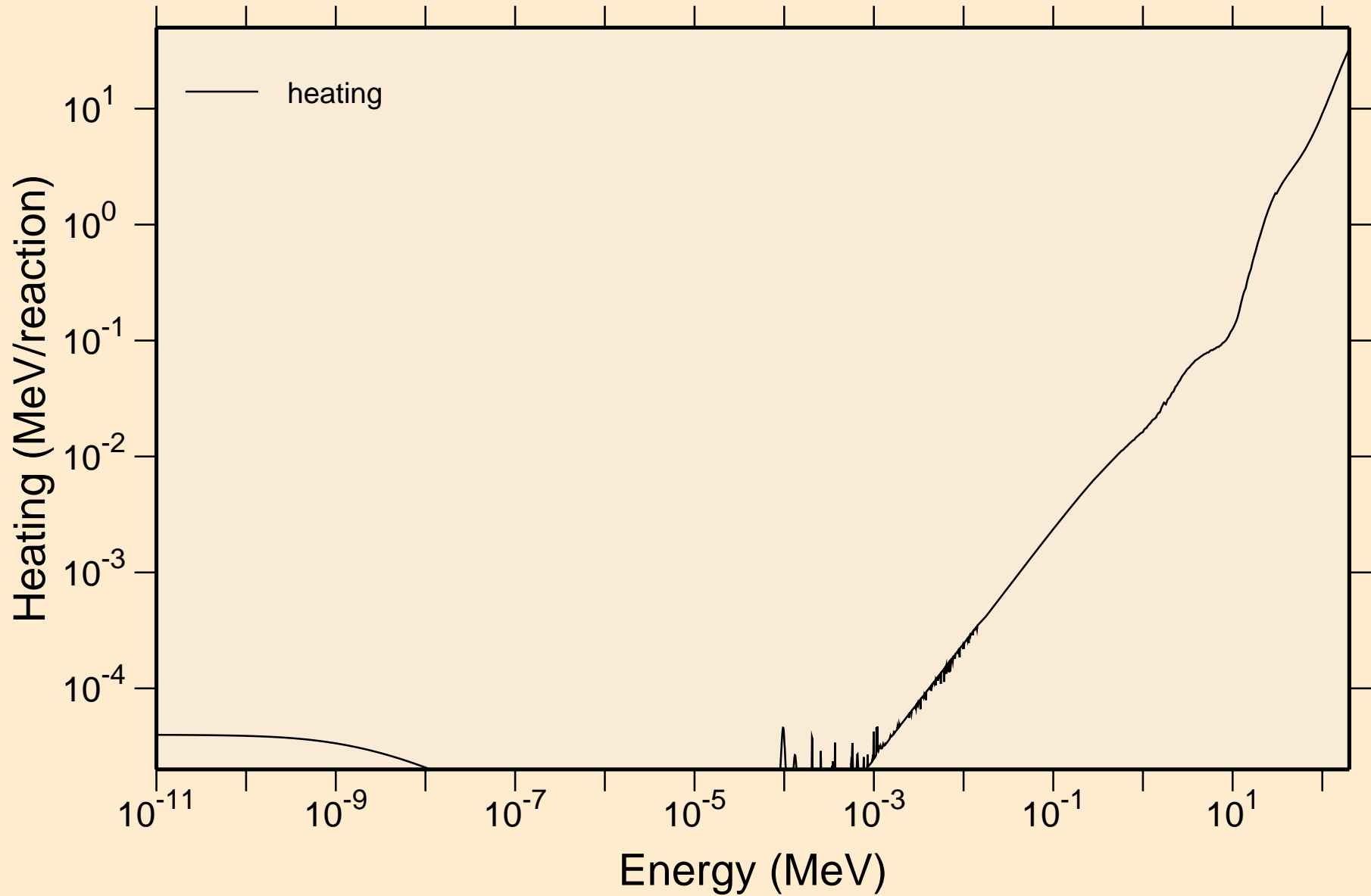

BR081 NEUTRON ACER TENDL-2021 LIBRARY; T=293.6K
Damage

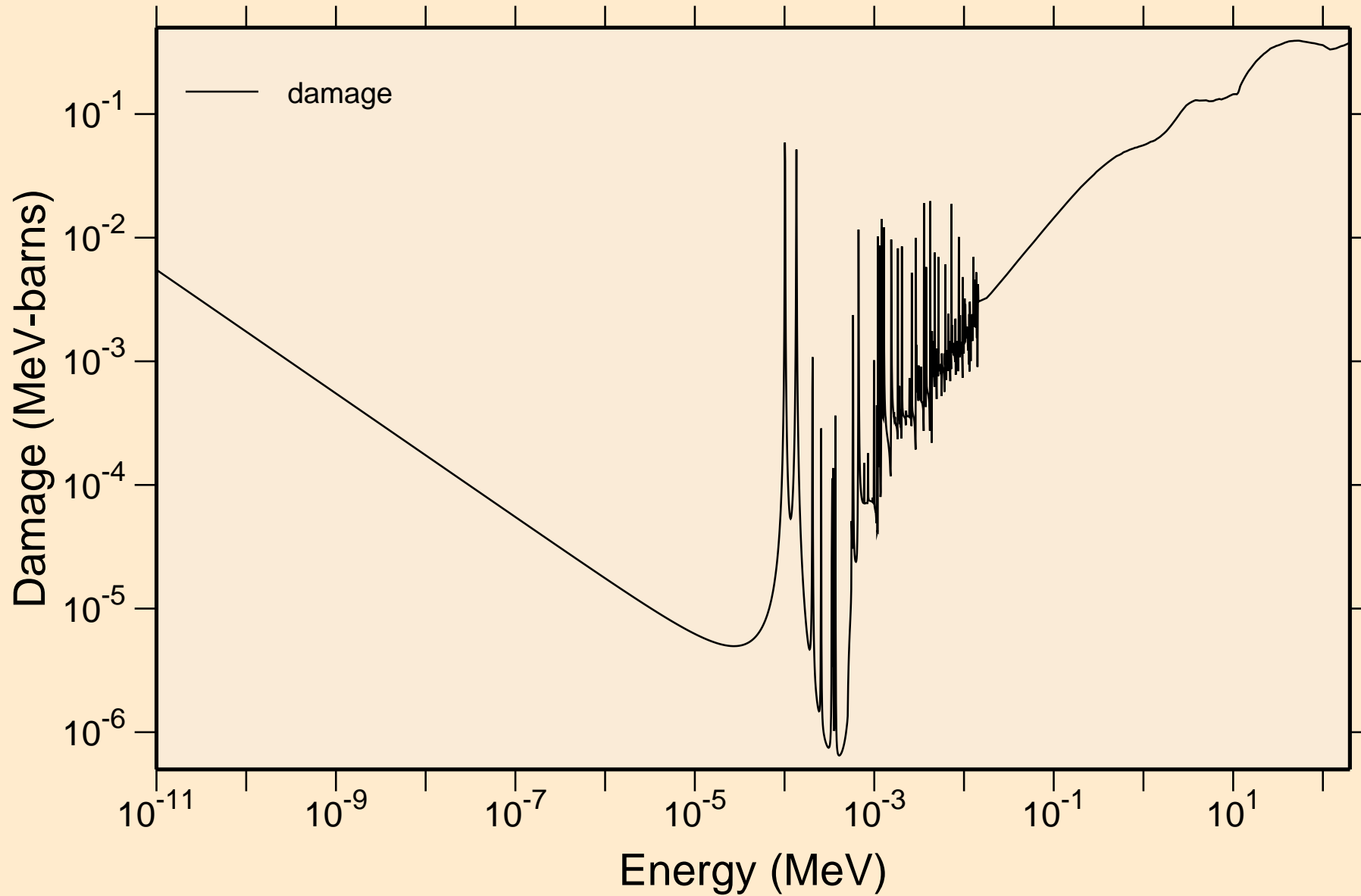

BR081 NEUTRON ACER TENDL-2021 LIBRARY; T=293.6K
Non-threshold reactions

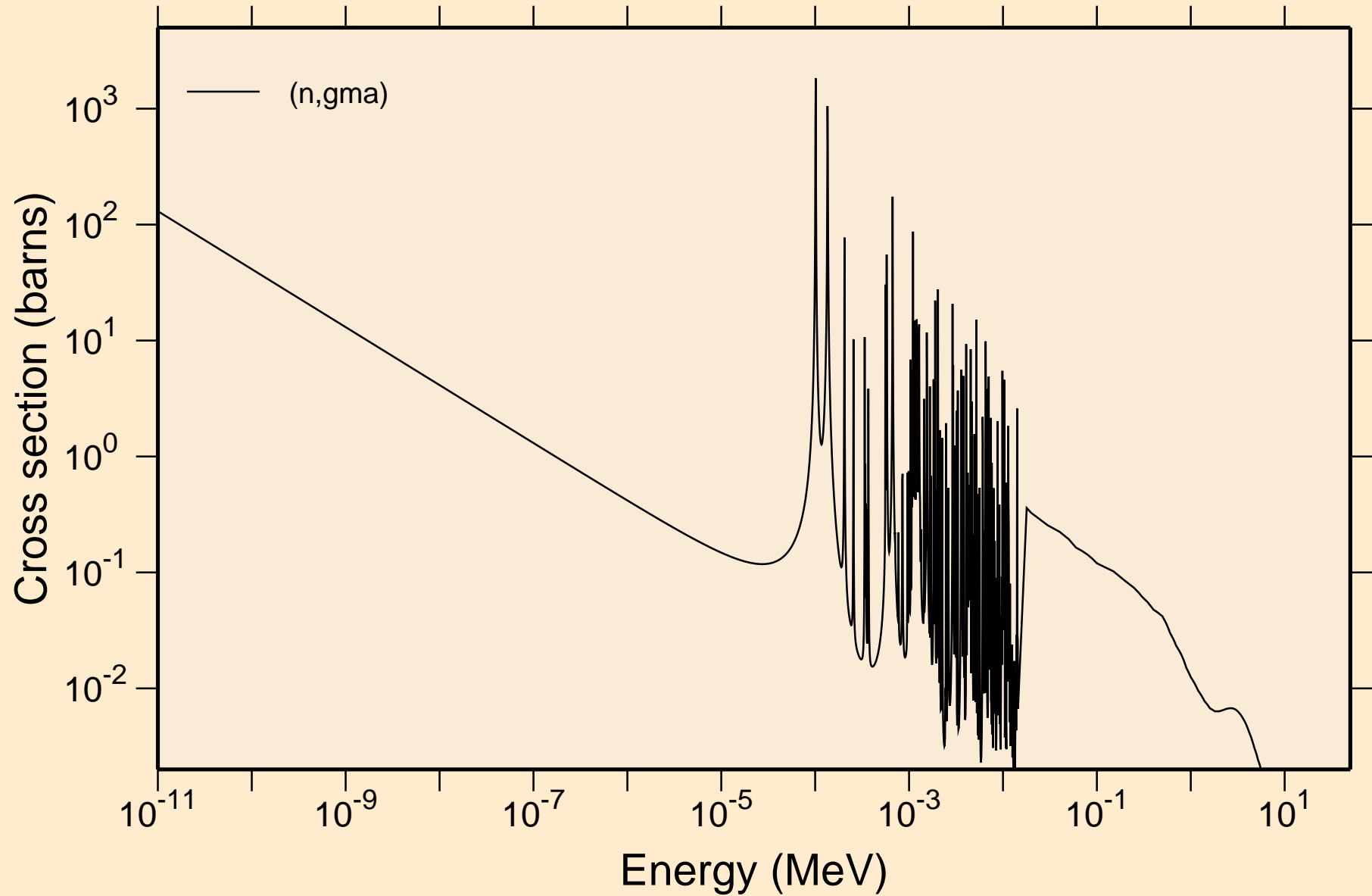

BR081 NEUTRON ACER TENDL-2021 LIBRARY; T=293.6K
Principal cross sections

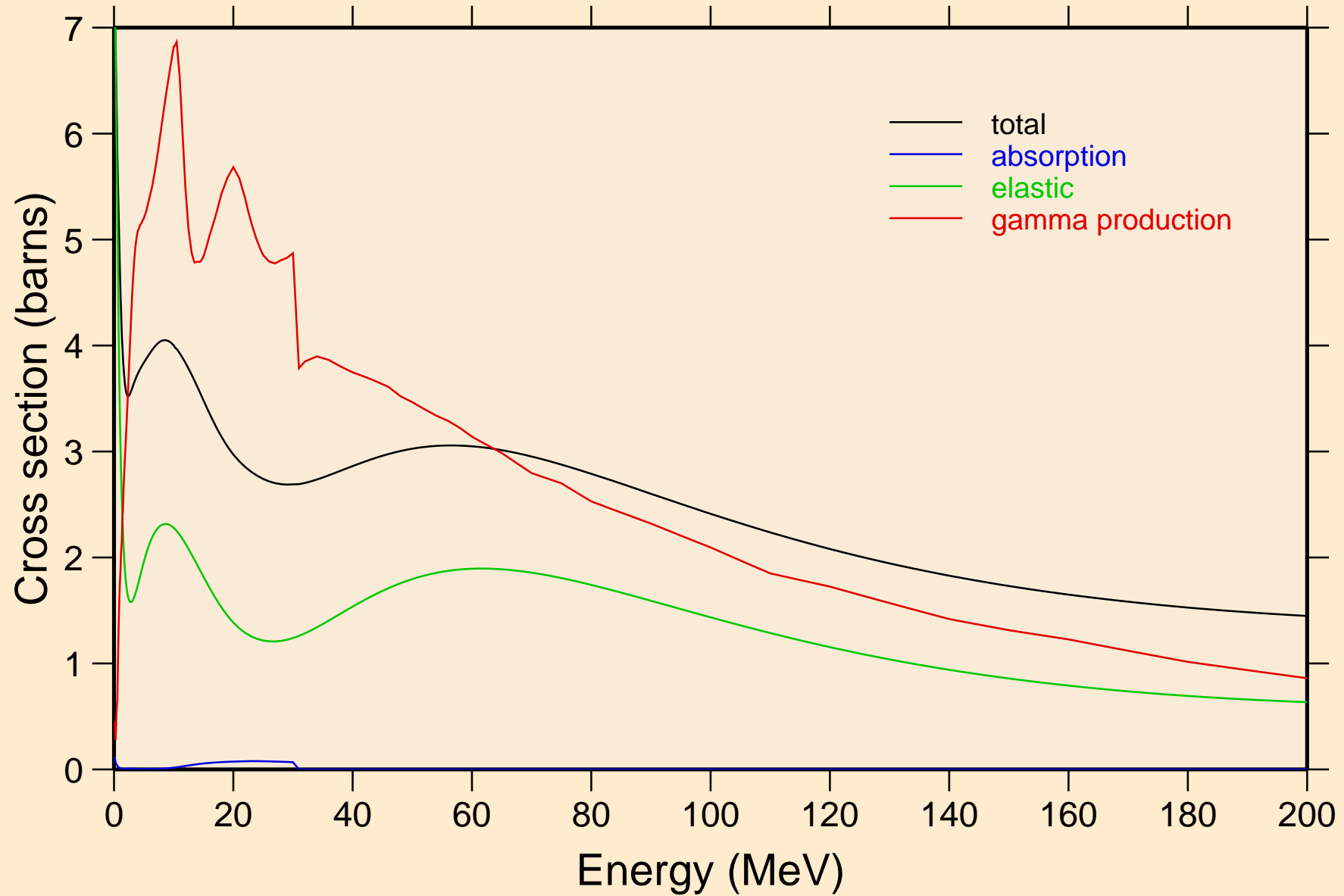

BR081 NEUTRON ACER TENDL-2021 LIBRARY; T=293.6K
Heating

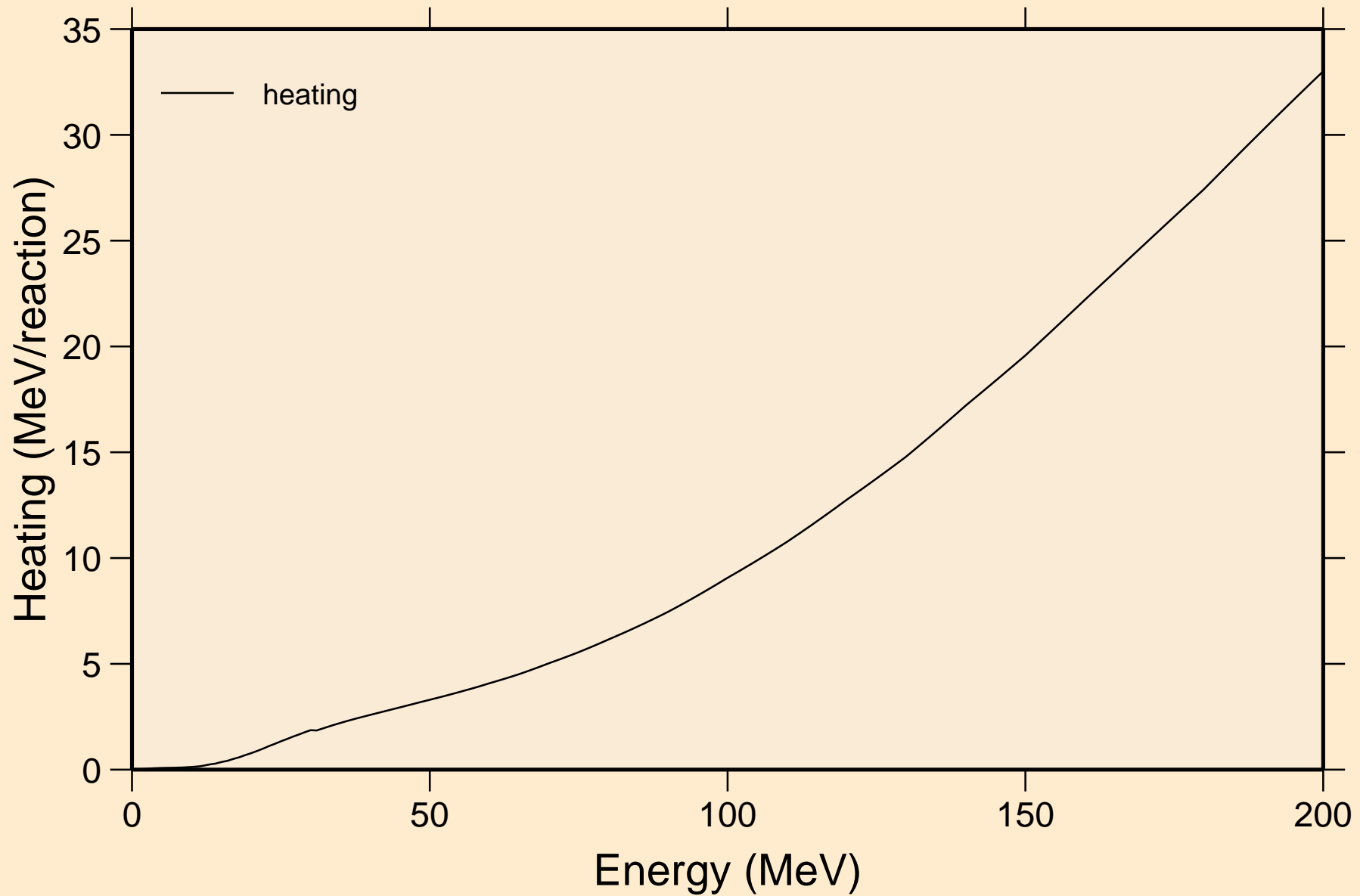

BR081 NEUTRON ACER TENDL-2021 LIBRARY; T=293.6K
Damage

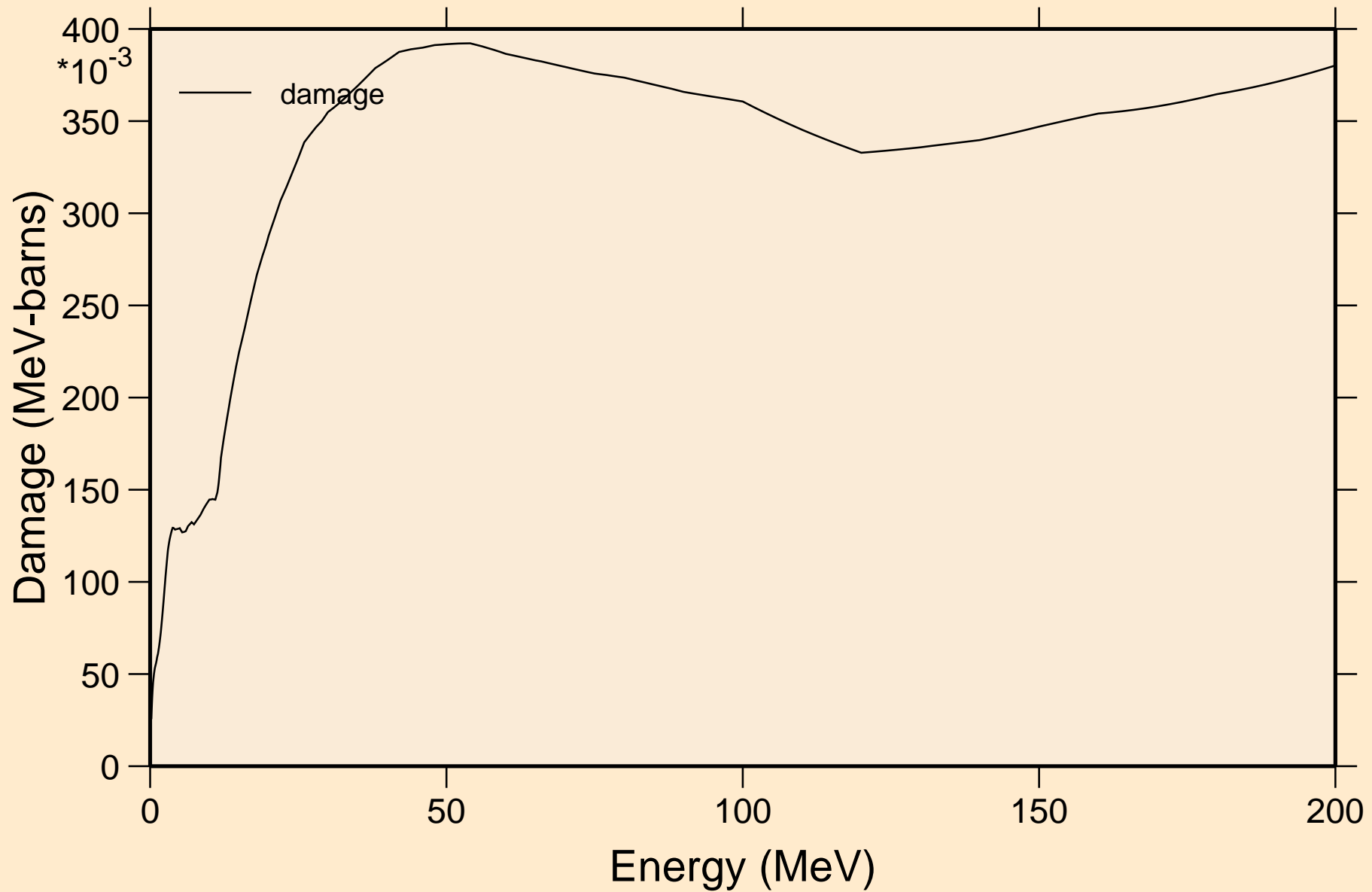

BR081 NEUTRON ACER TENDL-2021 LIBRARY; T=293.6K
Non-threshold reactions

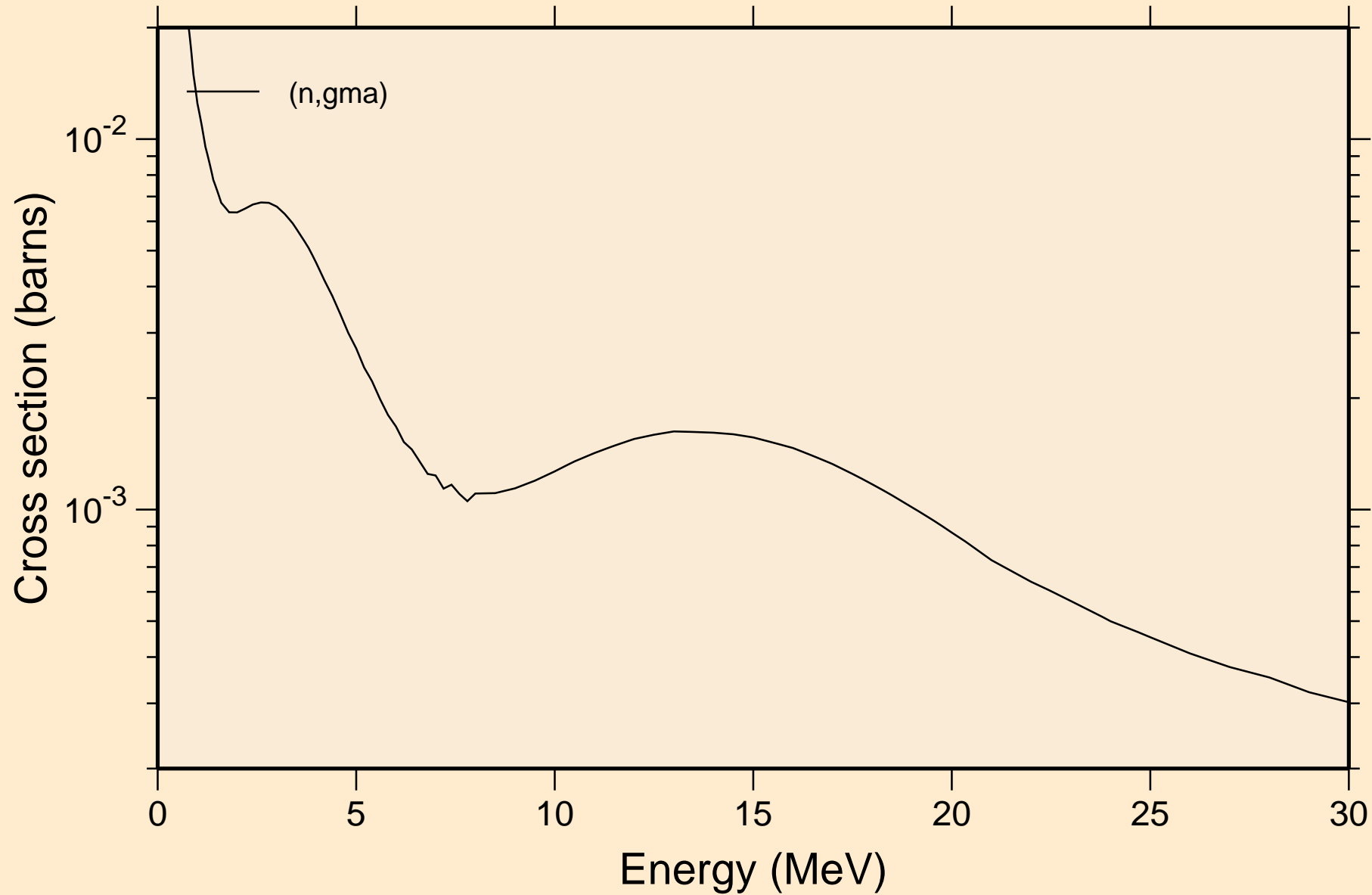

BR081 NEUTRON ACER TENDL-2021 LIBRARY; T=293.6K
Inelastic levels

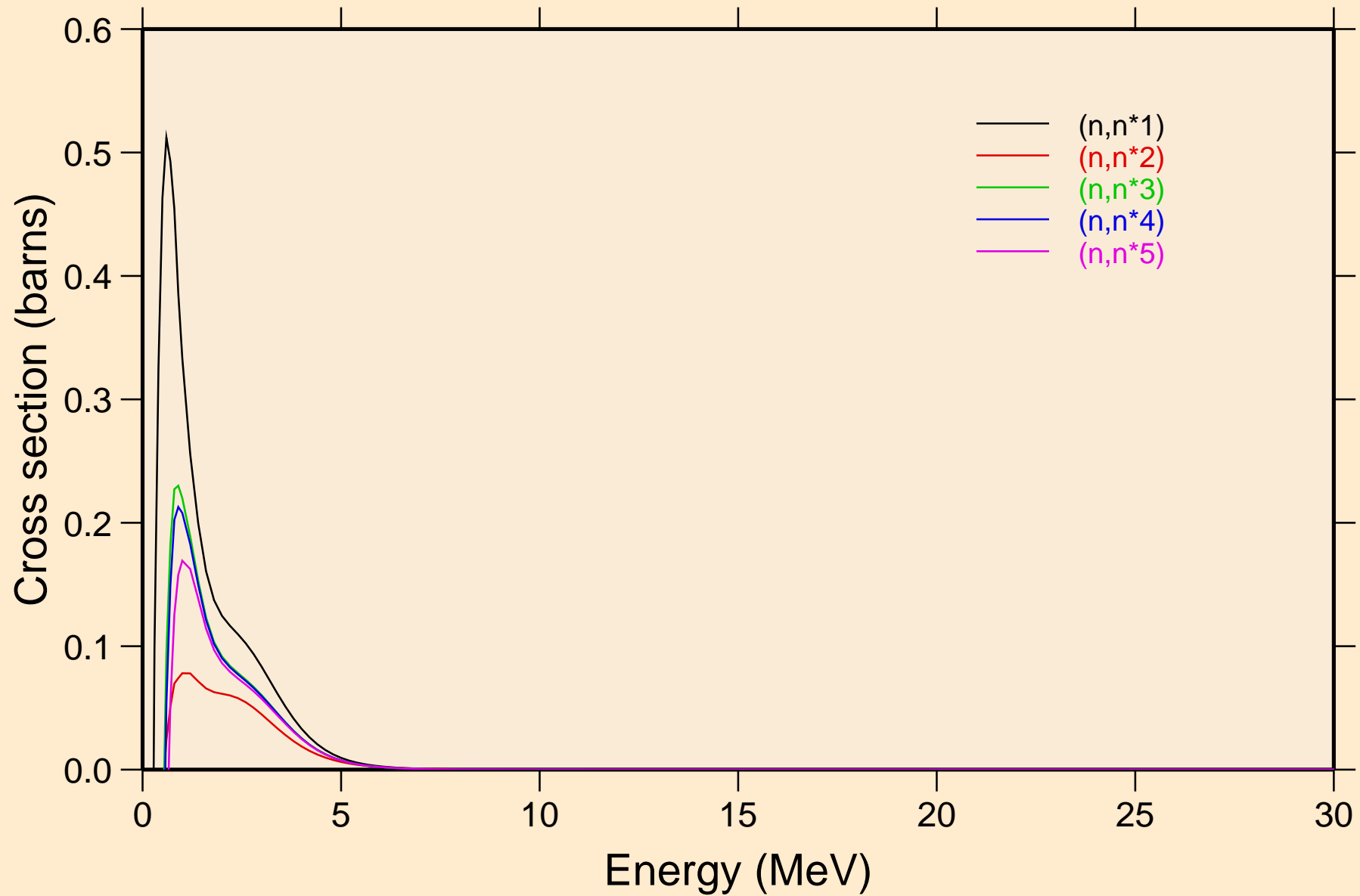

BR081 NEUTRON ACER TENDL-2021 LIBRARY; T=293.6K
Inelastic levels

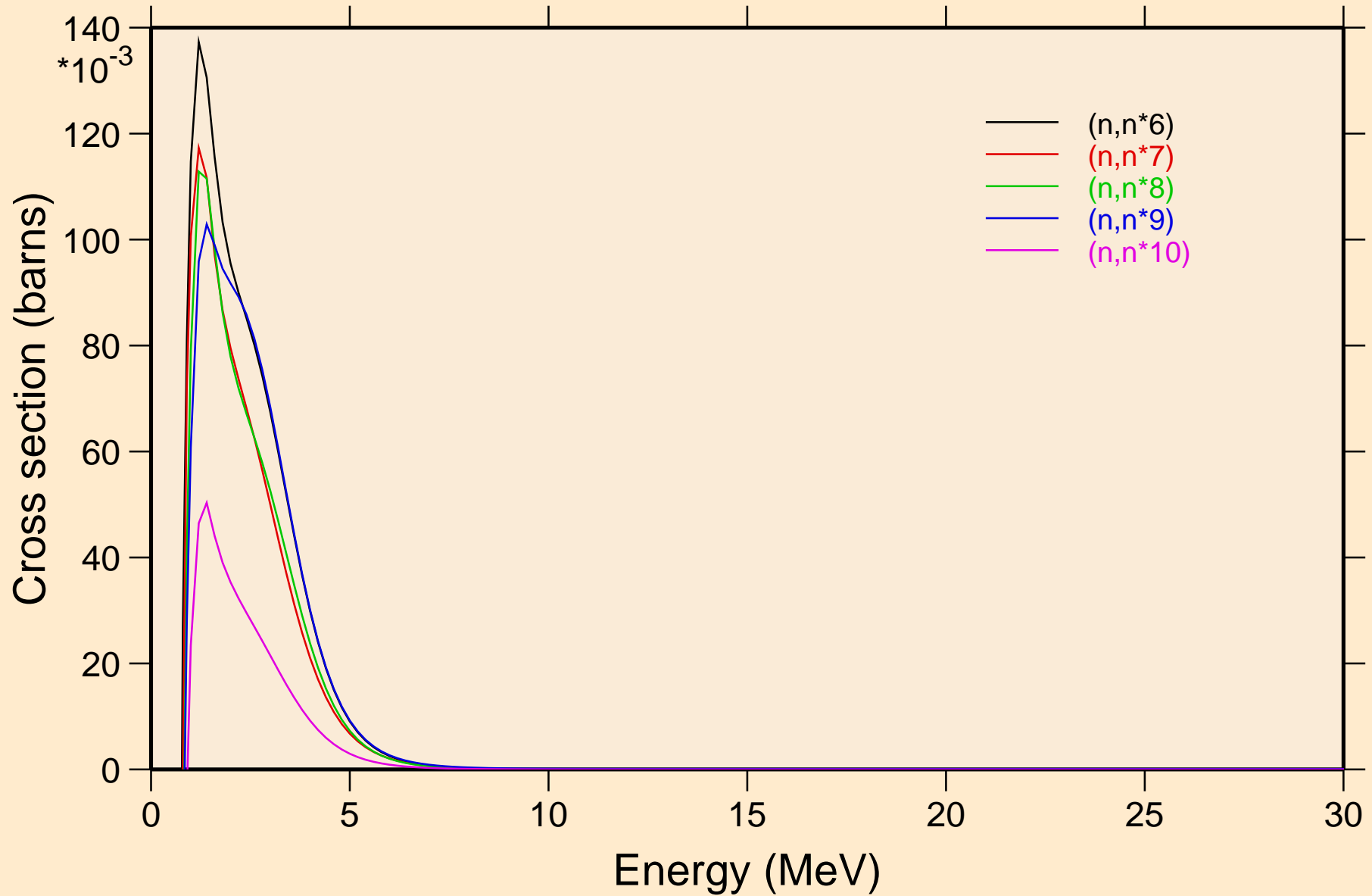

BR081 NEUTRON ACER TENDL-2021 LIBRARY; T=293.6K
Inelastic levels

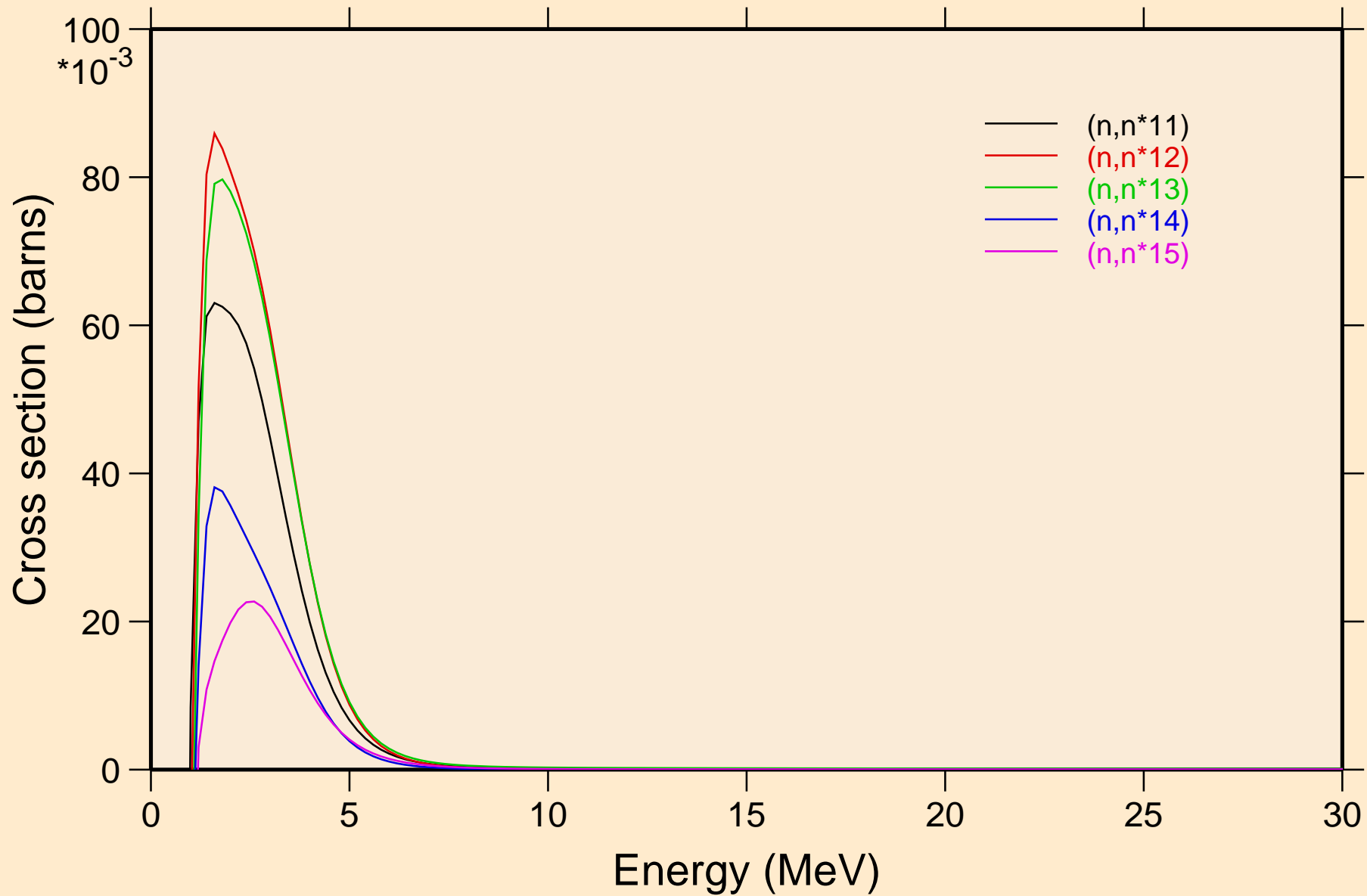

BR081 NEUTRON ACER TENDL-2021 LIBRARY; T=293.6K
Inelastic levels

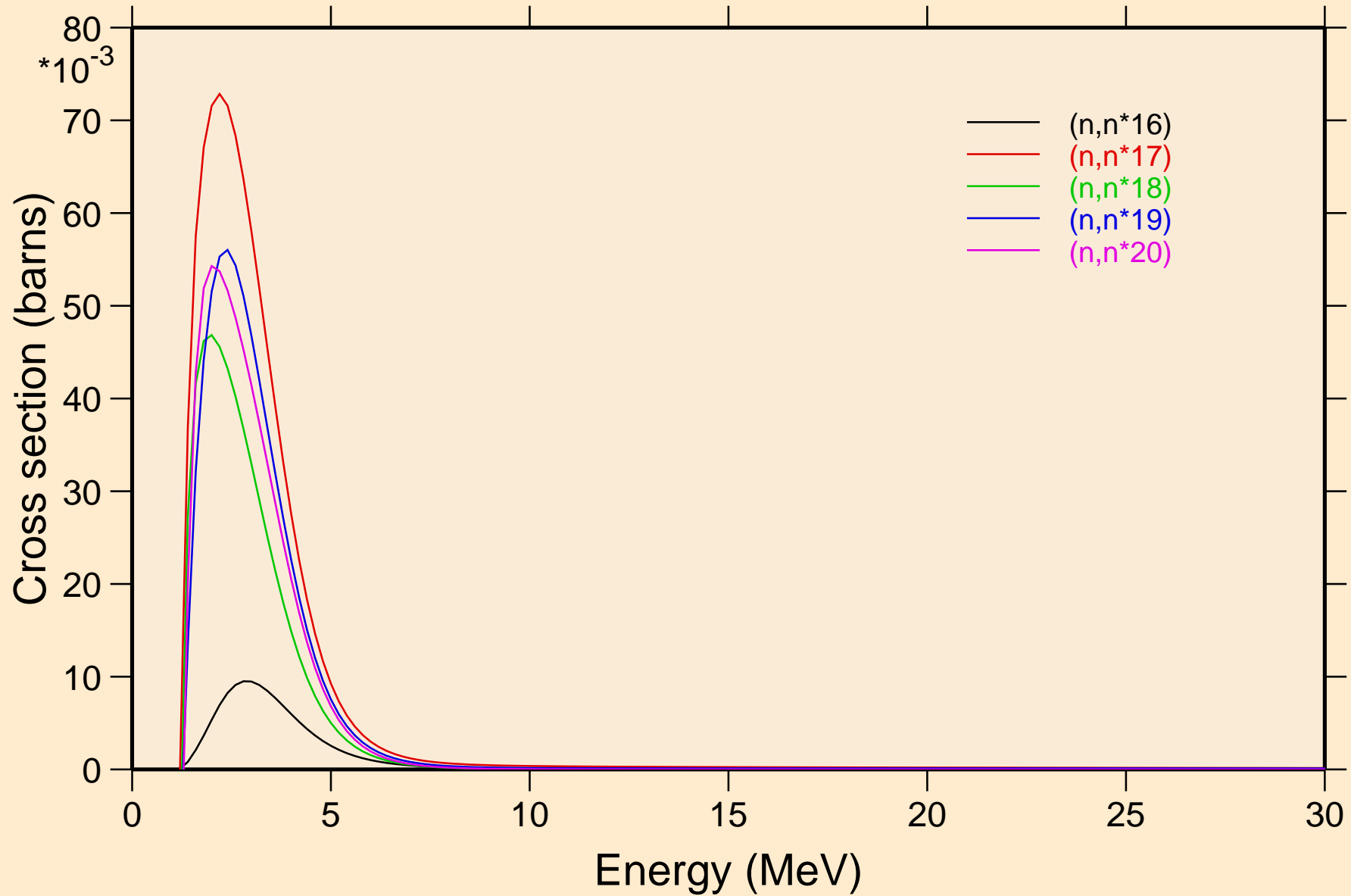

BR081 NEUTRON ACER TENDL-2021 LIBRARY; T=293.6K
Inelastic levels

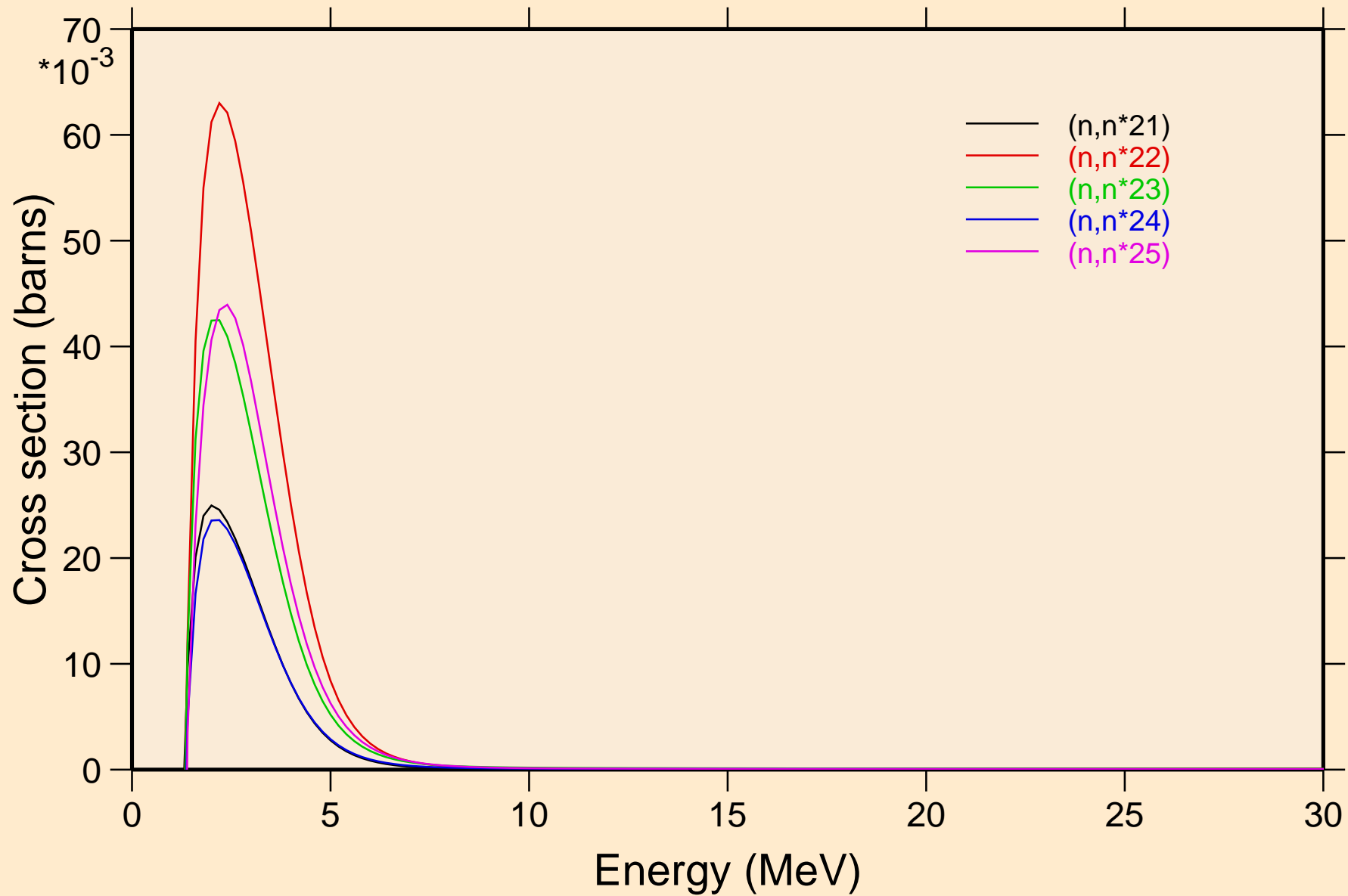

BR081 NEUTRON ACER TENDL-2021 LIBRARY; T=293.6K
Inelastic levels

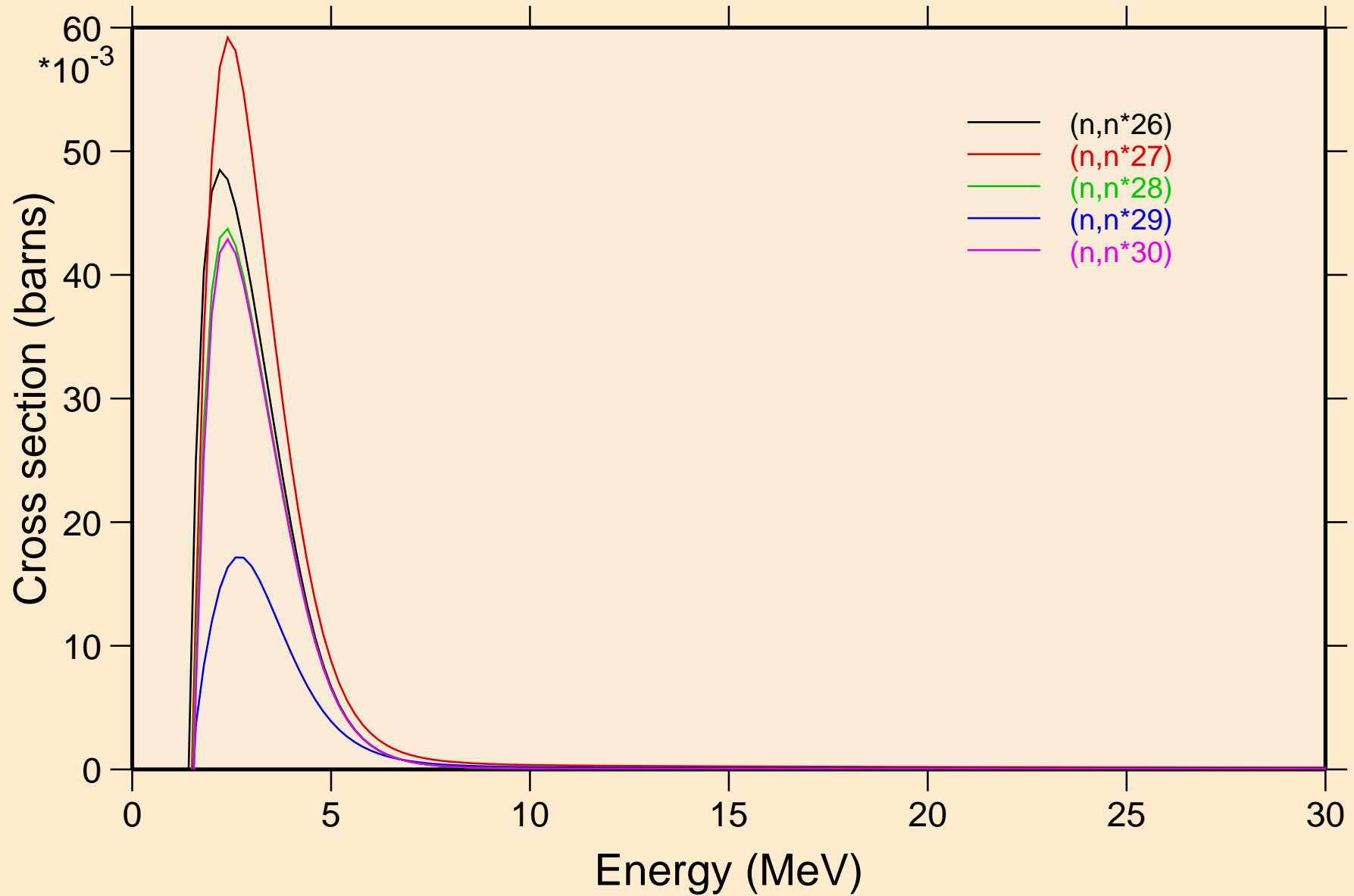

BR081 NEUTRON ACER TENDL-2021 LIBRARY; T=293.6K
Threshold reactions

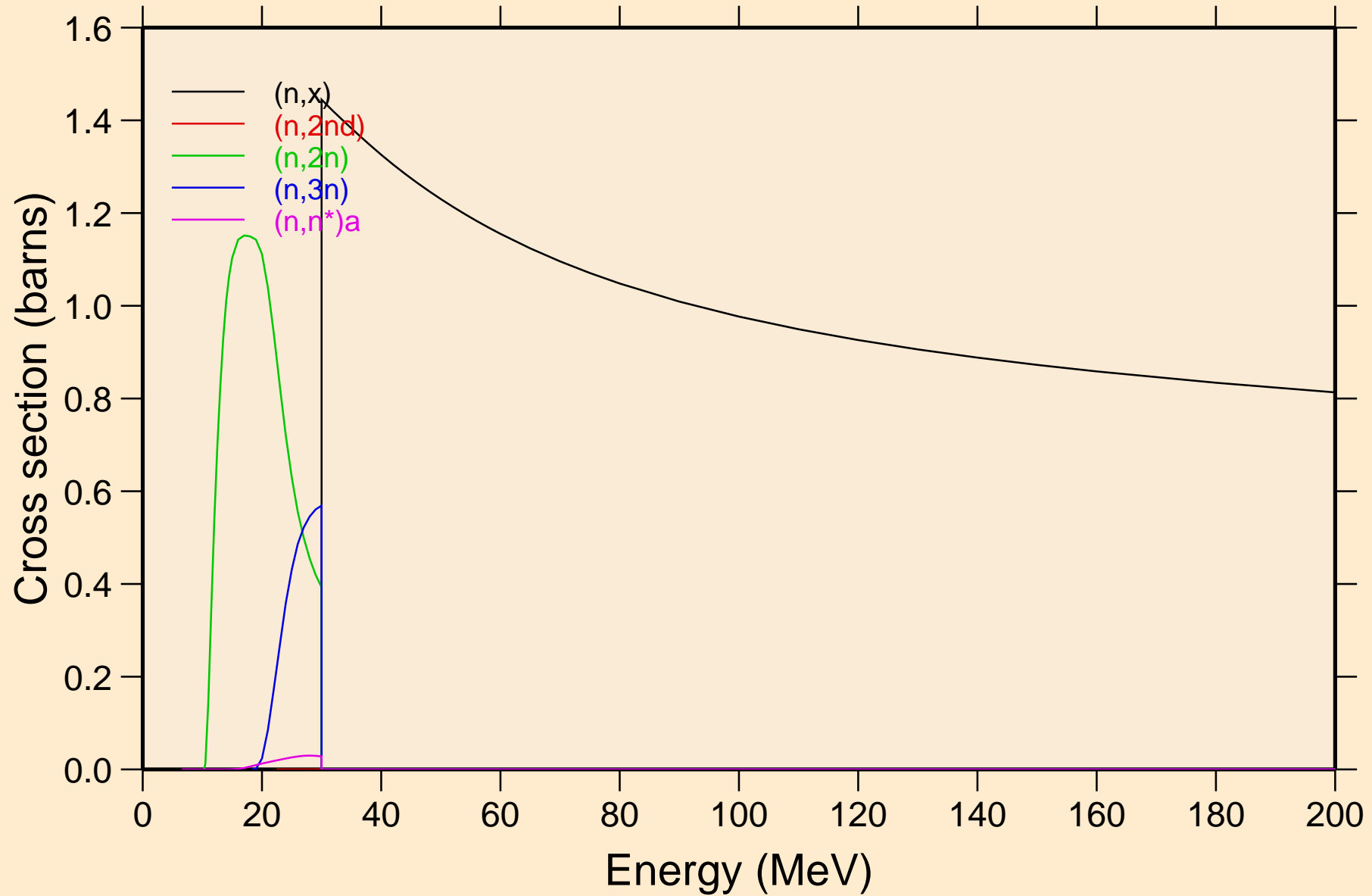

BR081 NEUTRON ACER TENDL-2021 LIBRARY; T=293.6K
Threshold reactions

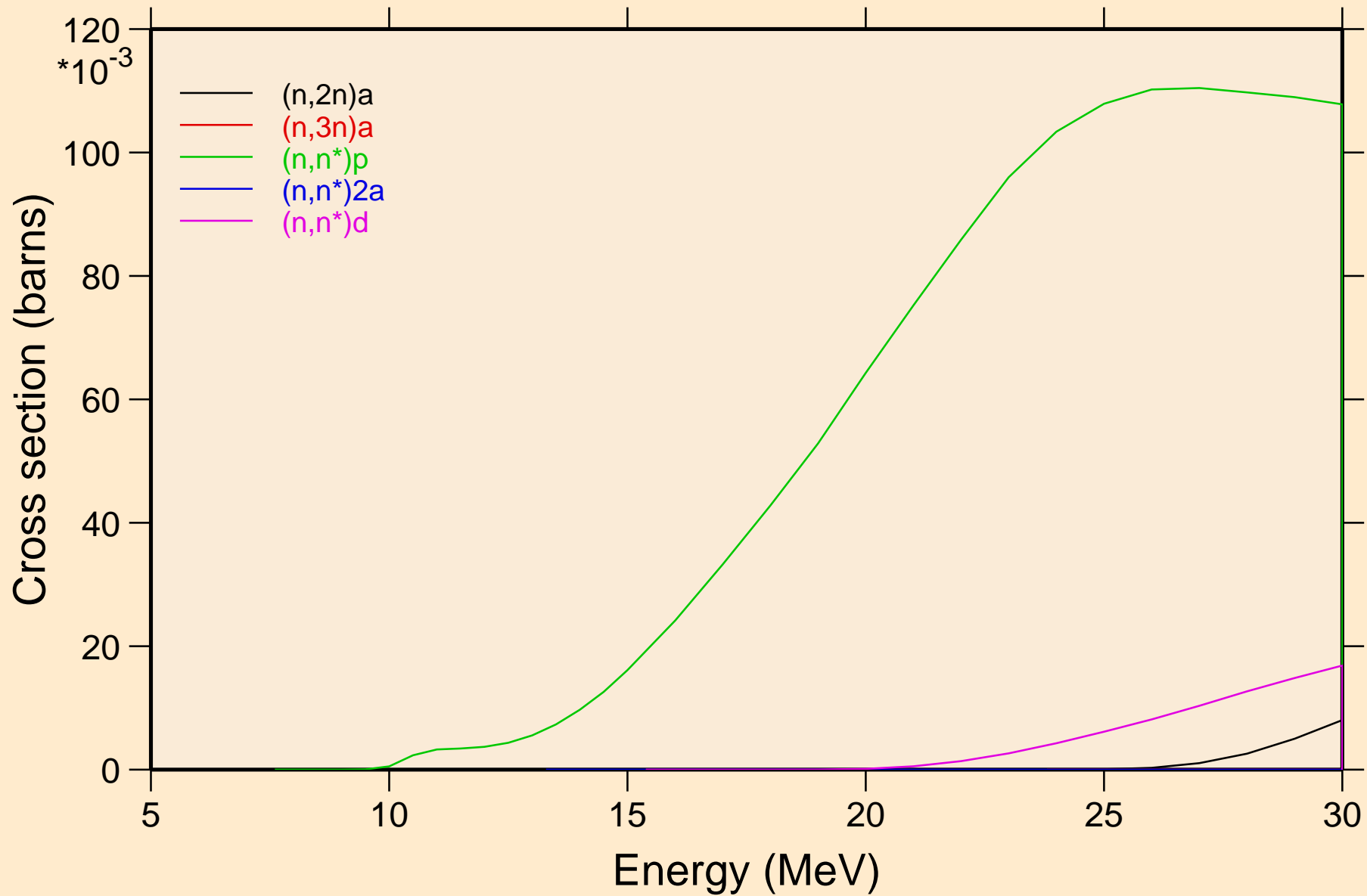

BR081 NEUTRON ACER TENDL-2021 LIBRARY; T=293.6K
Threshold reactions

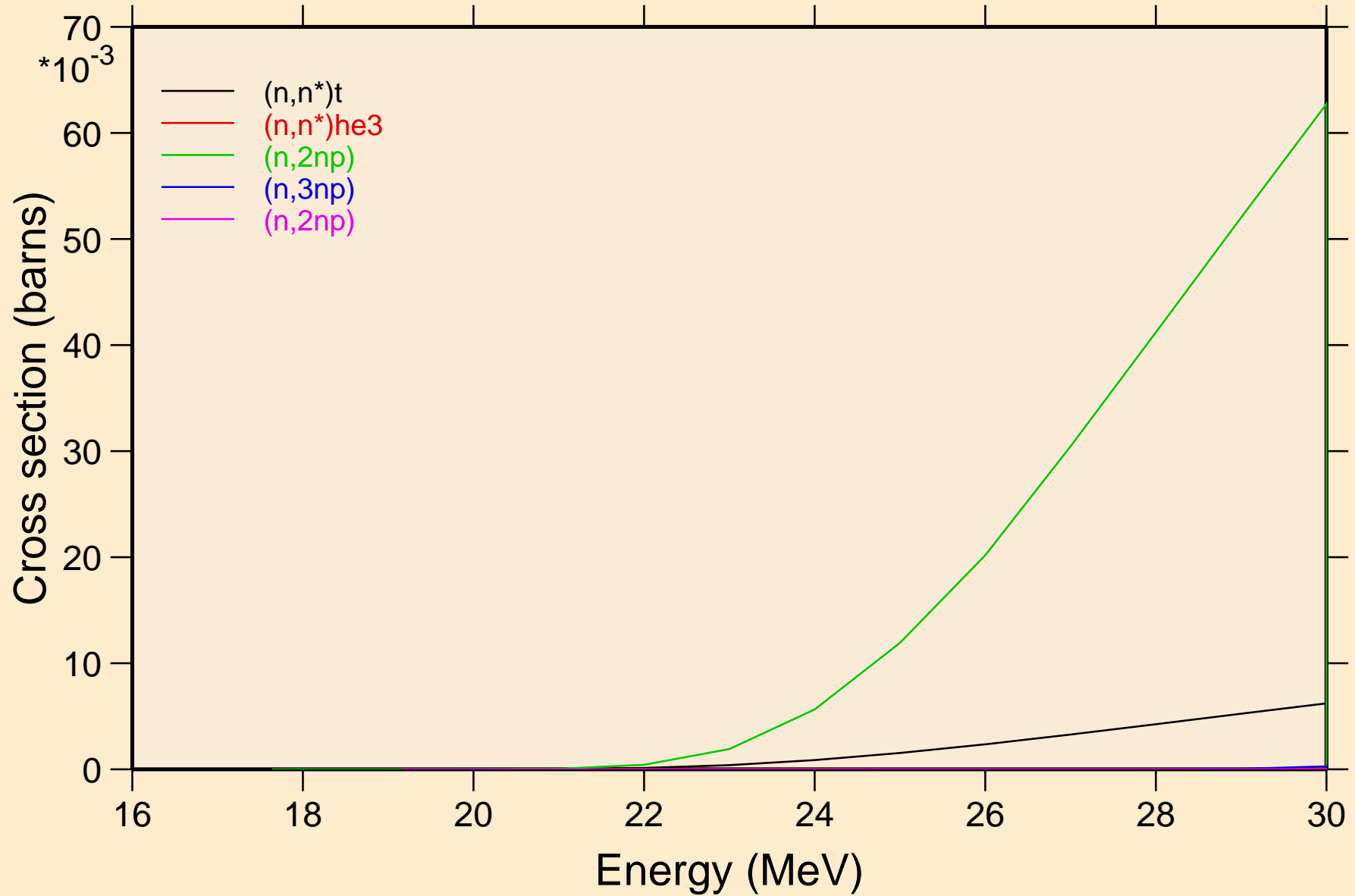

BR081 NEUTRON ACER TENDL-2021 LIBRARY; T=293.6K
Threshold reactions

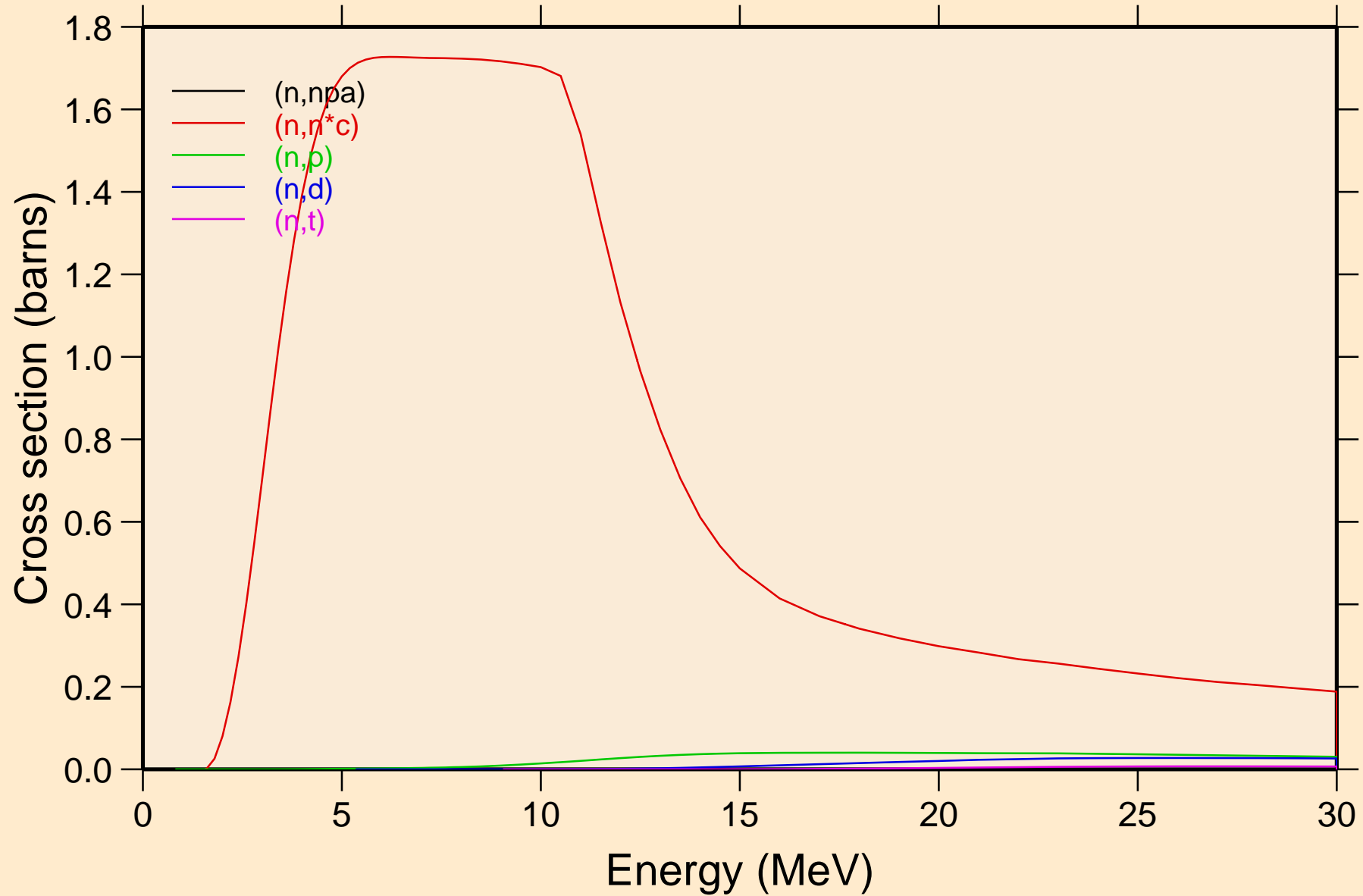

BR081 NEUTRON ACER TENDL-2021 LIBRARY; T=293.6K
Threshold reactions

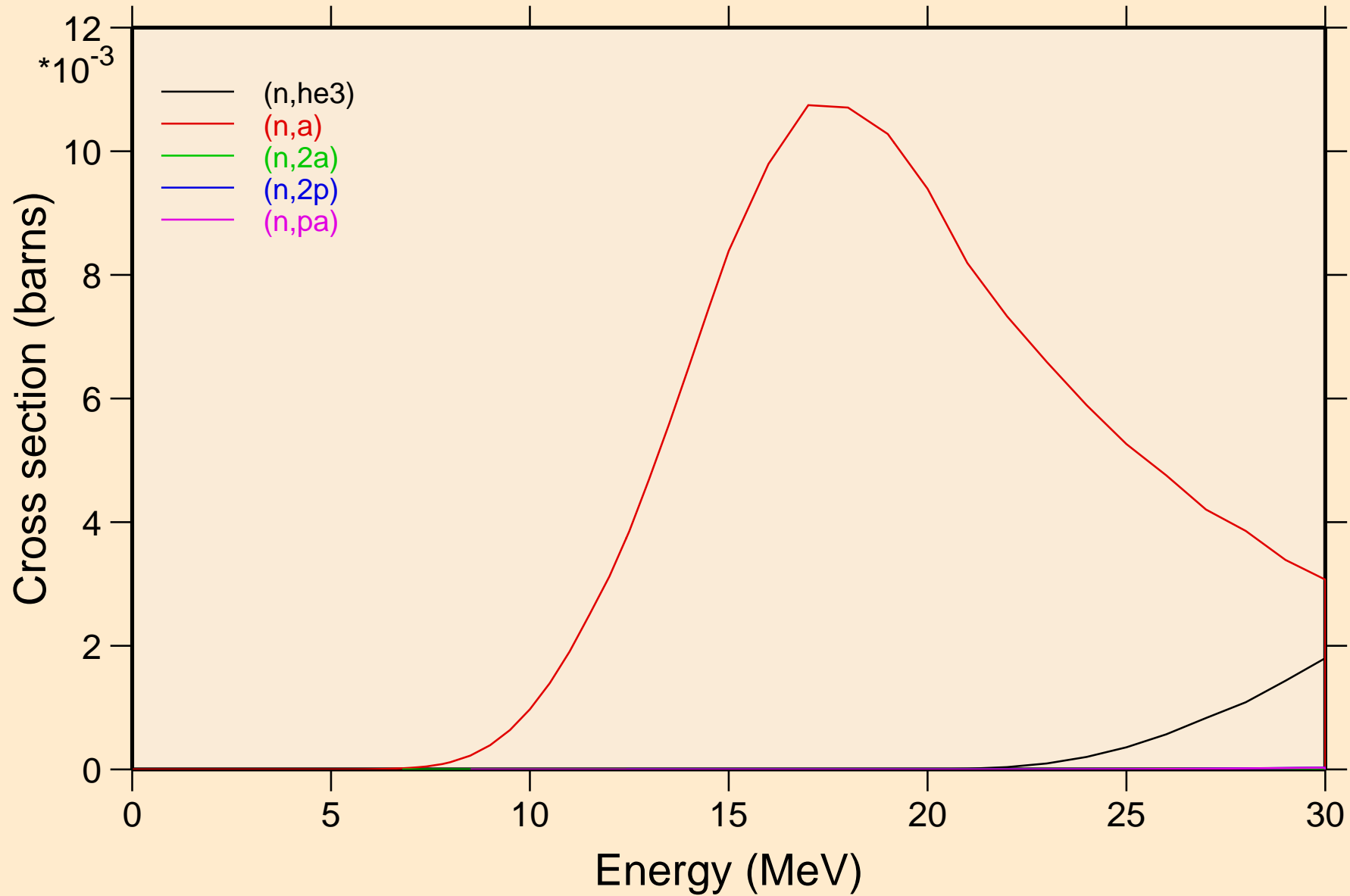

BR081 NEUTRON ACER TENDL-2021 LIBRARY; T=293.6K
Threshold reactions

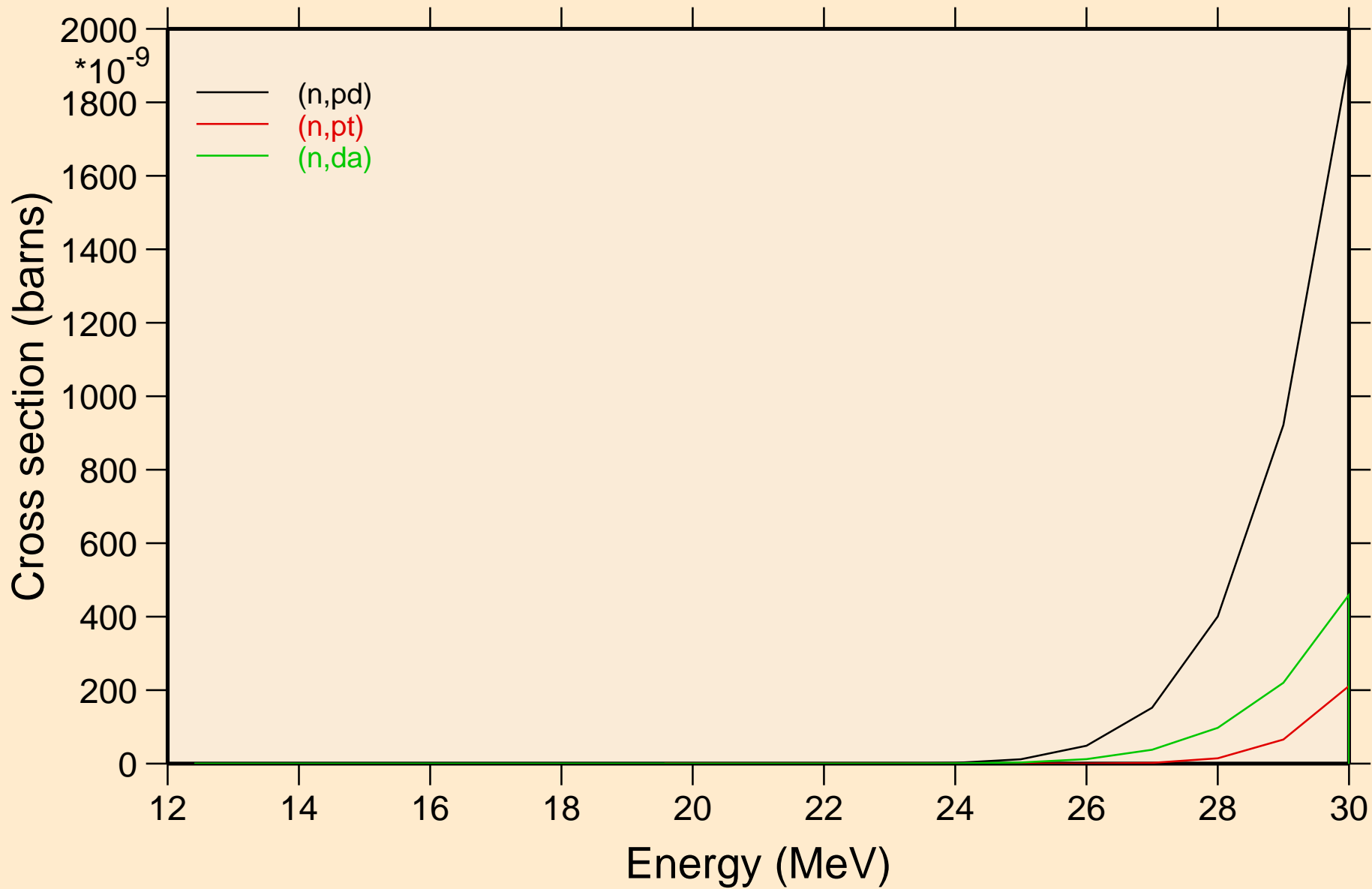

BR081 NEUTRON ACER TENDL-2021 LIBRARY; T=293.6K
Threshold reactions

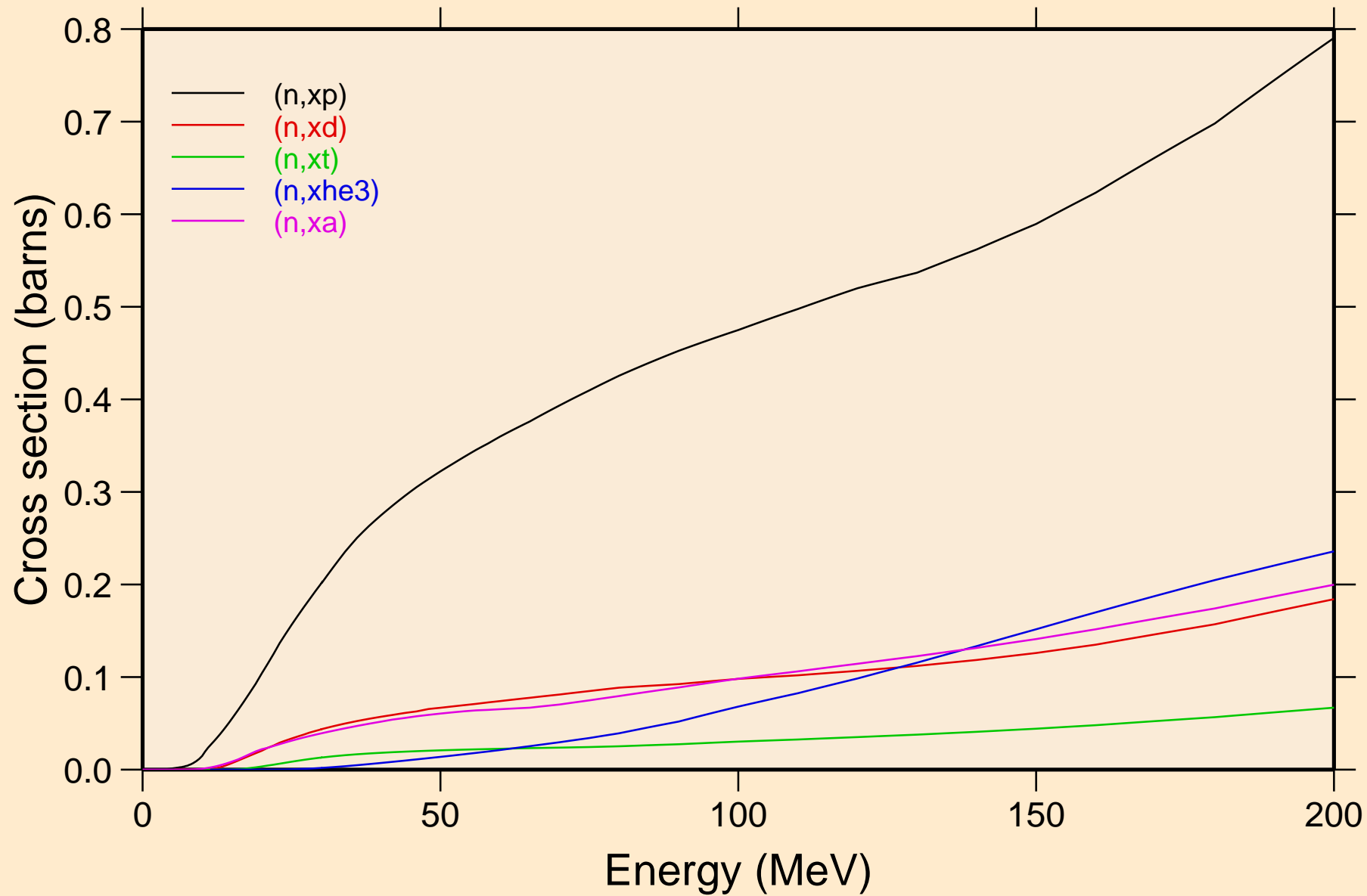

BR081 NEUTRON ACER TENDL-2021 LIBRARY; T=293.6K
angular distribution for elastic

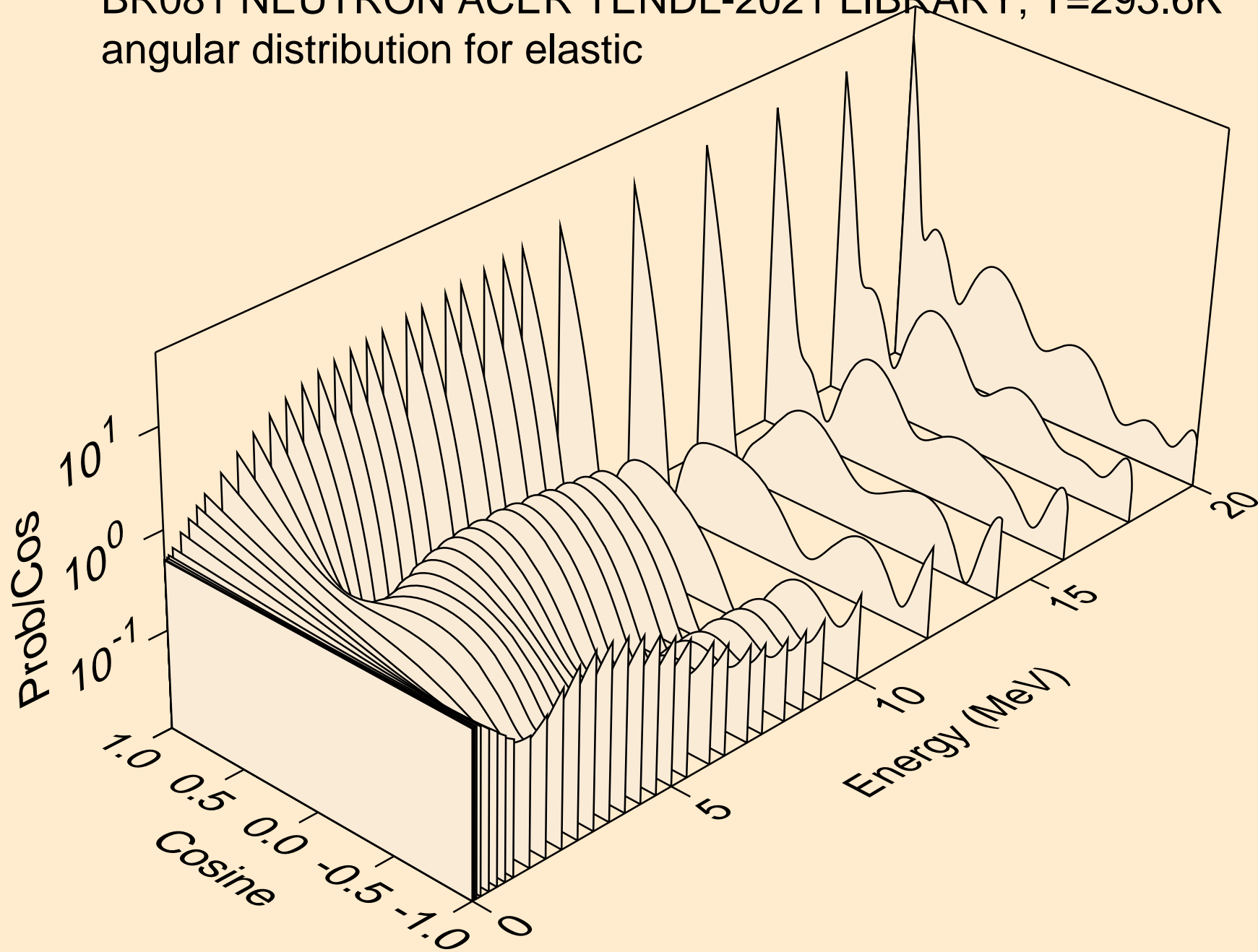

BR081 NEUTRON ACER TENDL-2021 LIBRARY; T=293.6K
angular distribution for elastic

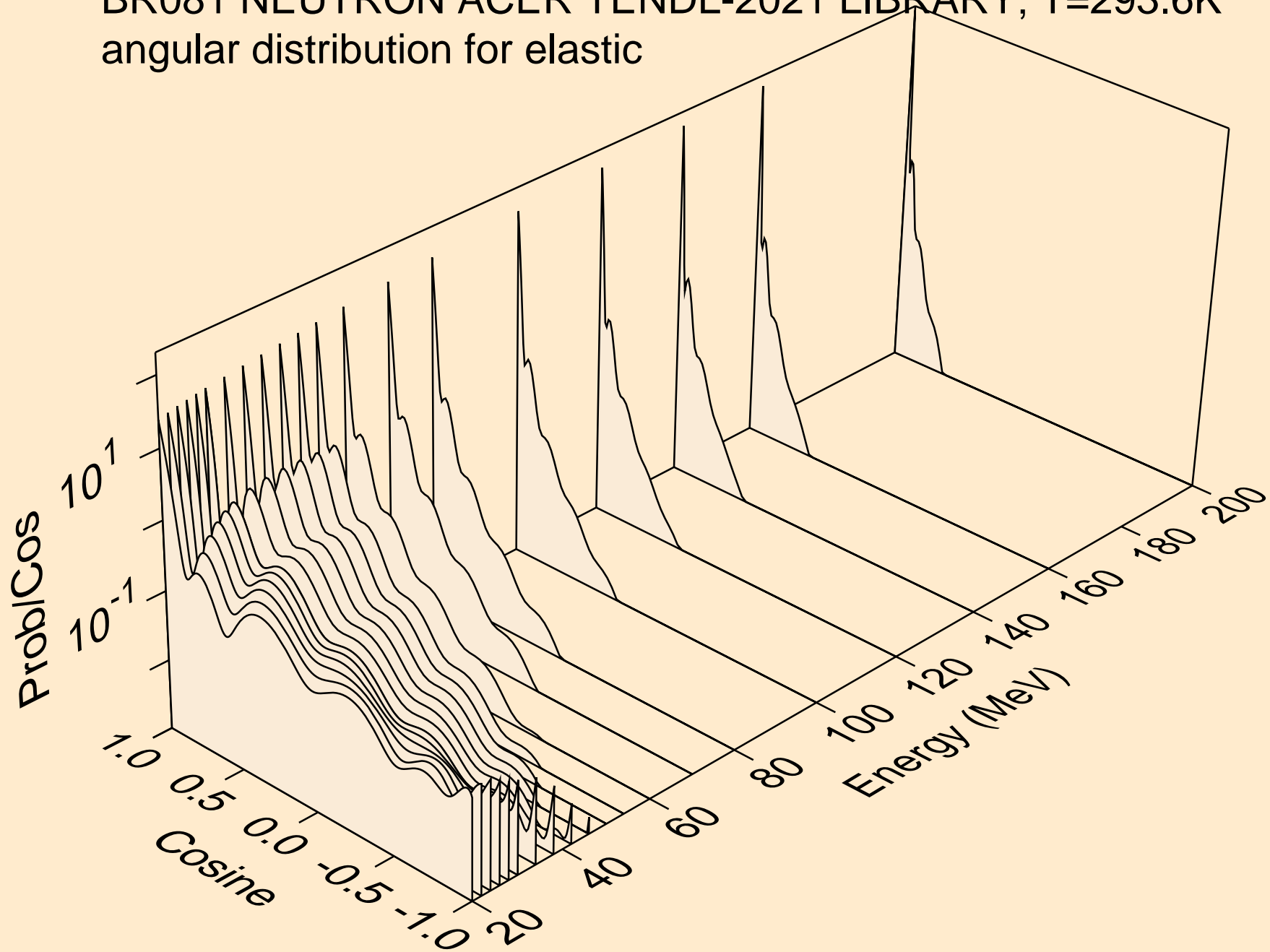

BR081 NEUTRON ACER TENDL-2021 LIBRARY; T=293.6K
angular distribution for (n,n*1)

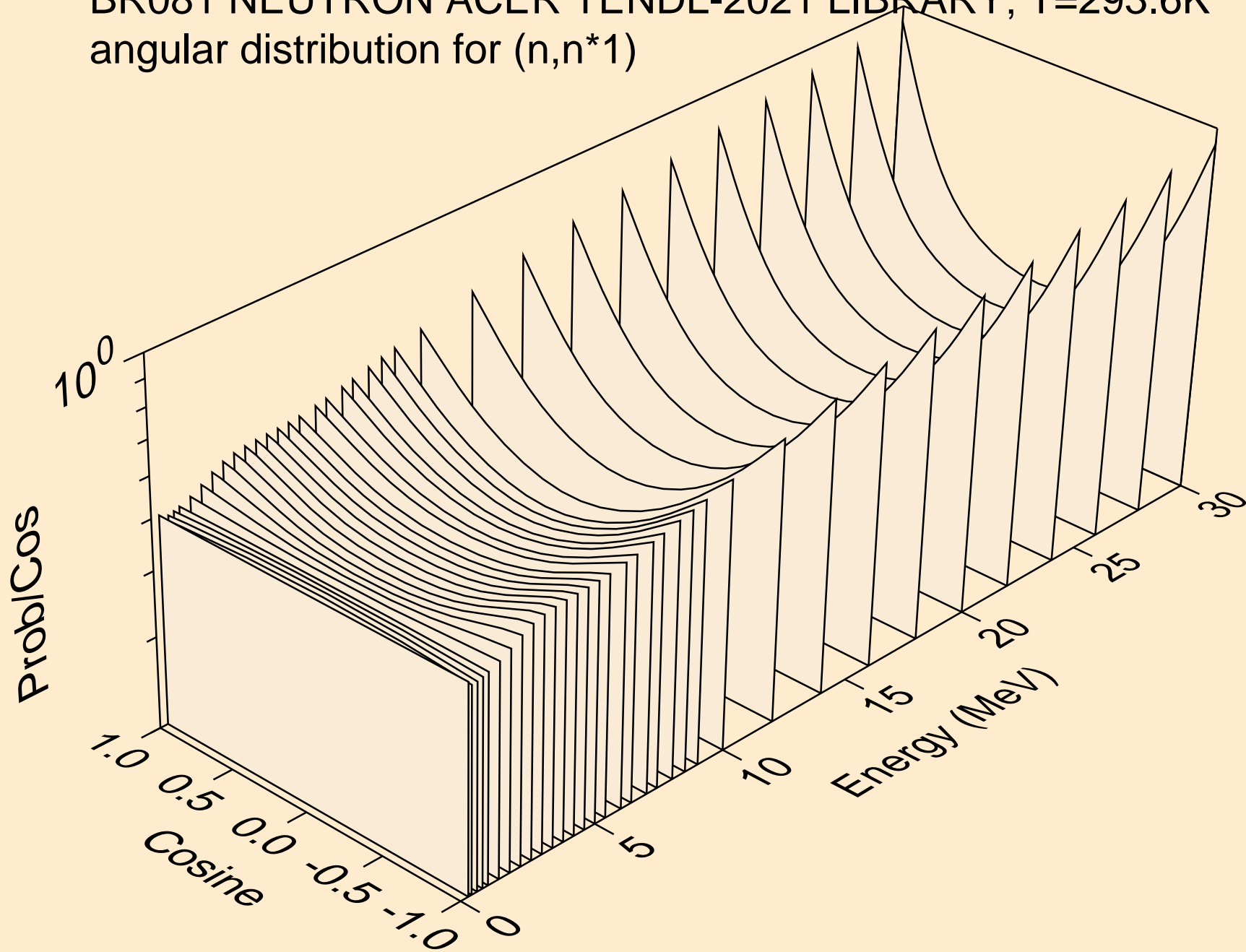

BR081 NEUTRON ACER TENDL-2021 LIBRARY; T=293.6K
angular distribution for (n,n*2)

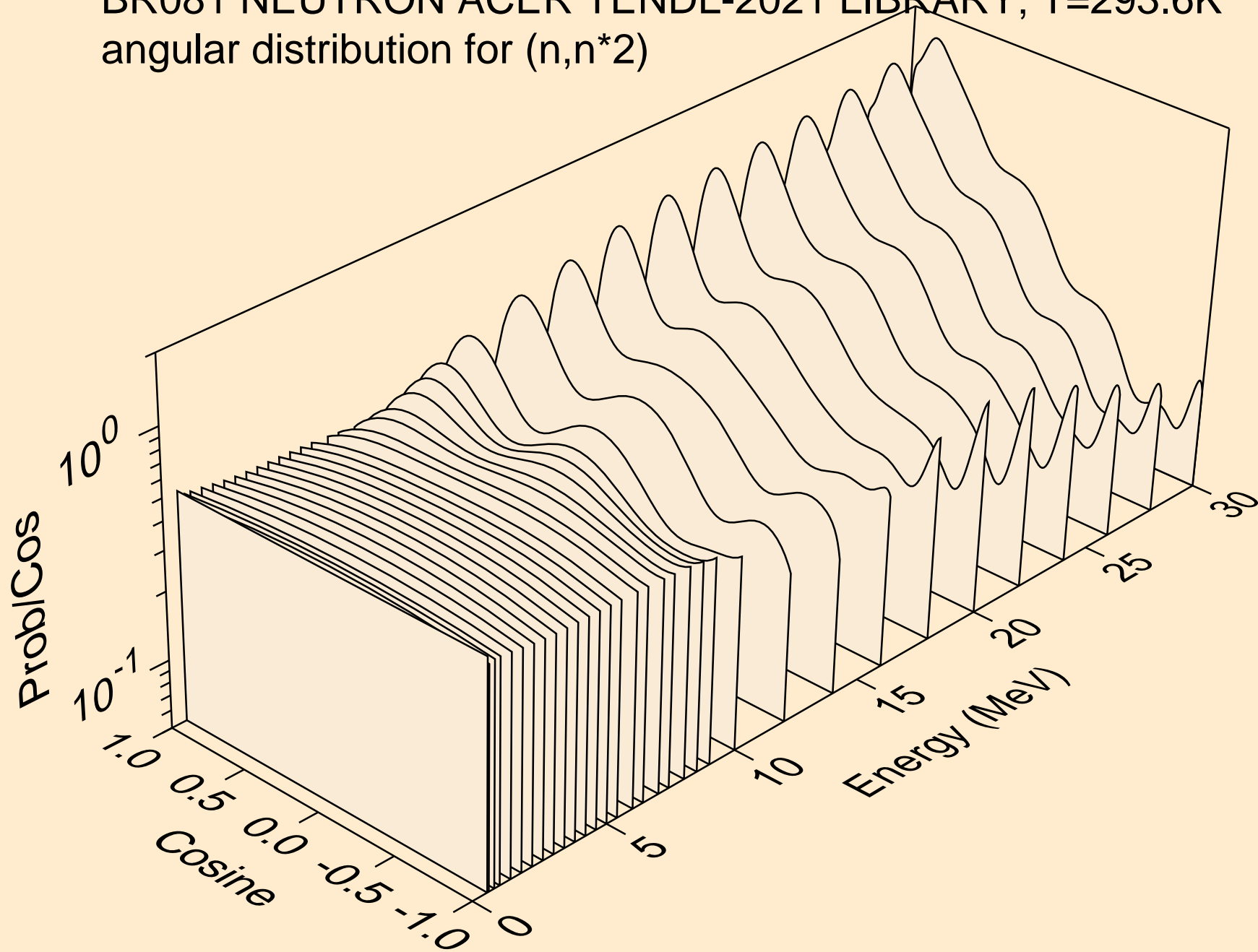

BR081 NEUTRON ACER TENDL-2021 LIBRARY; T=293.6K
angular distribution for (n,n*3)

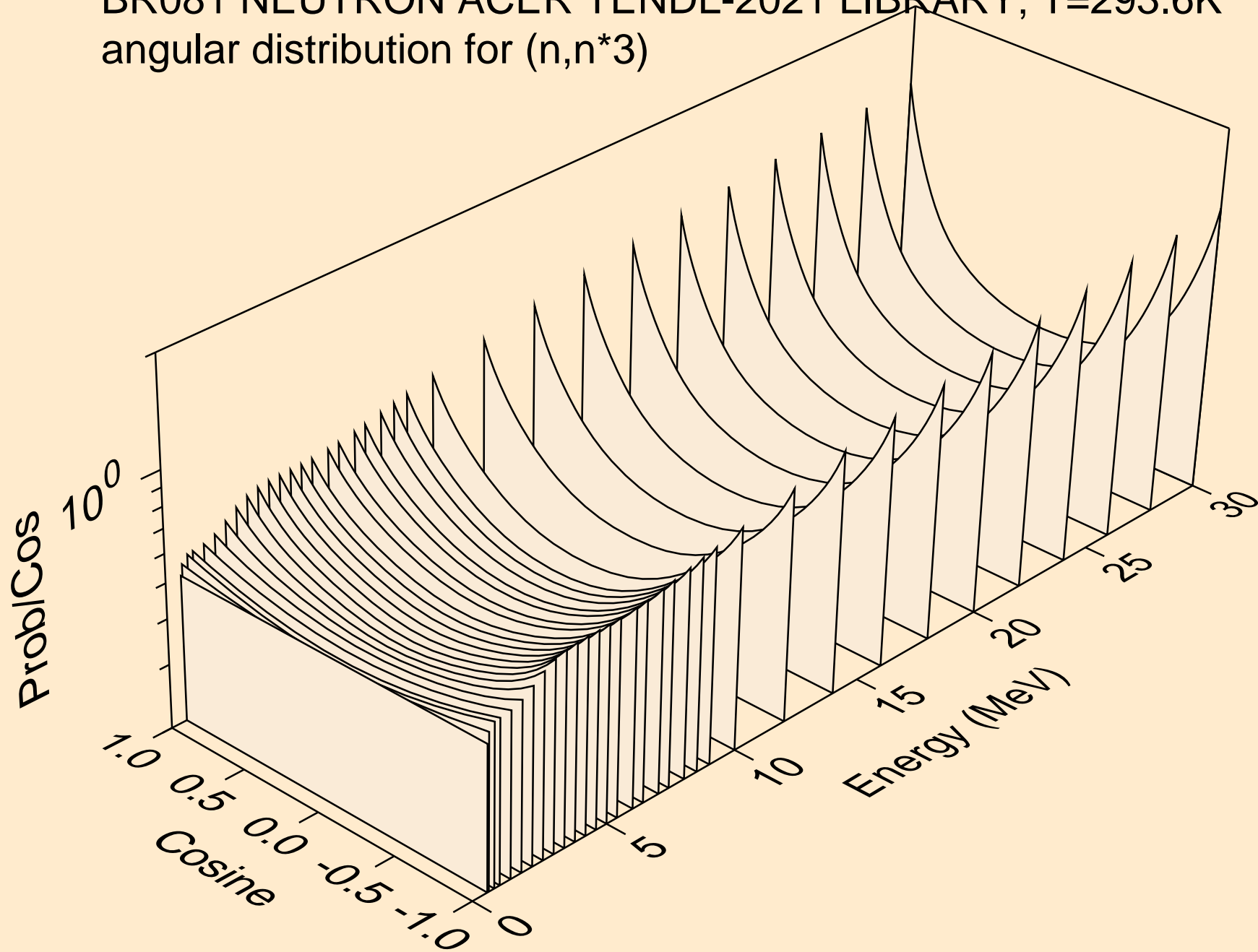

BR081 NEUTRON ACER TENDL-2021 LIBRARY; T=293.6K
angular distribution for (n,n*4)

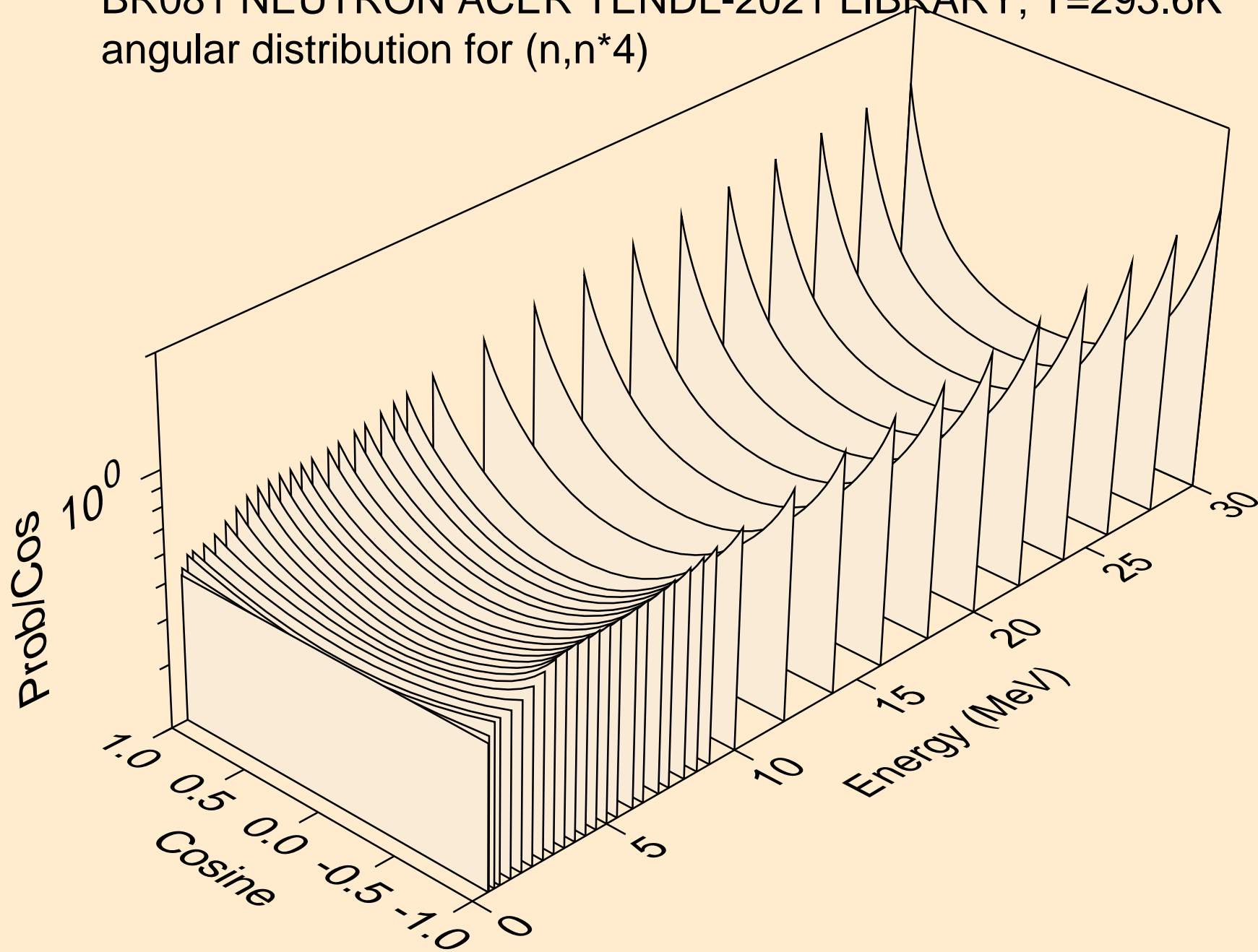

BR081 NEUTRON ACER TENDL-2021 LIBRARY; T=293.6K
angular distribution for (n,n*5)

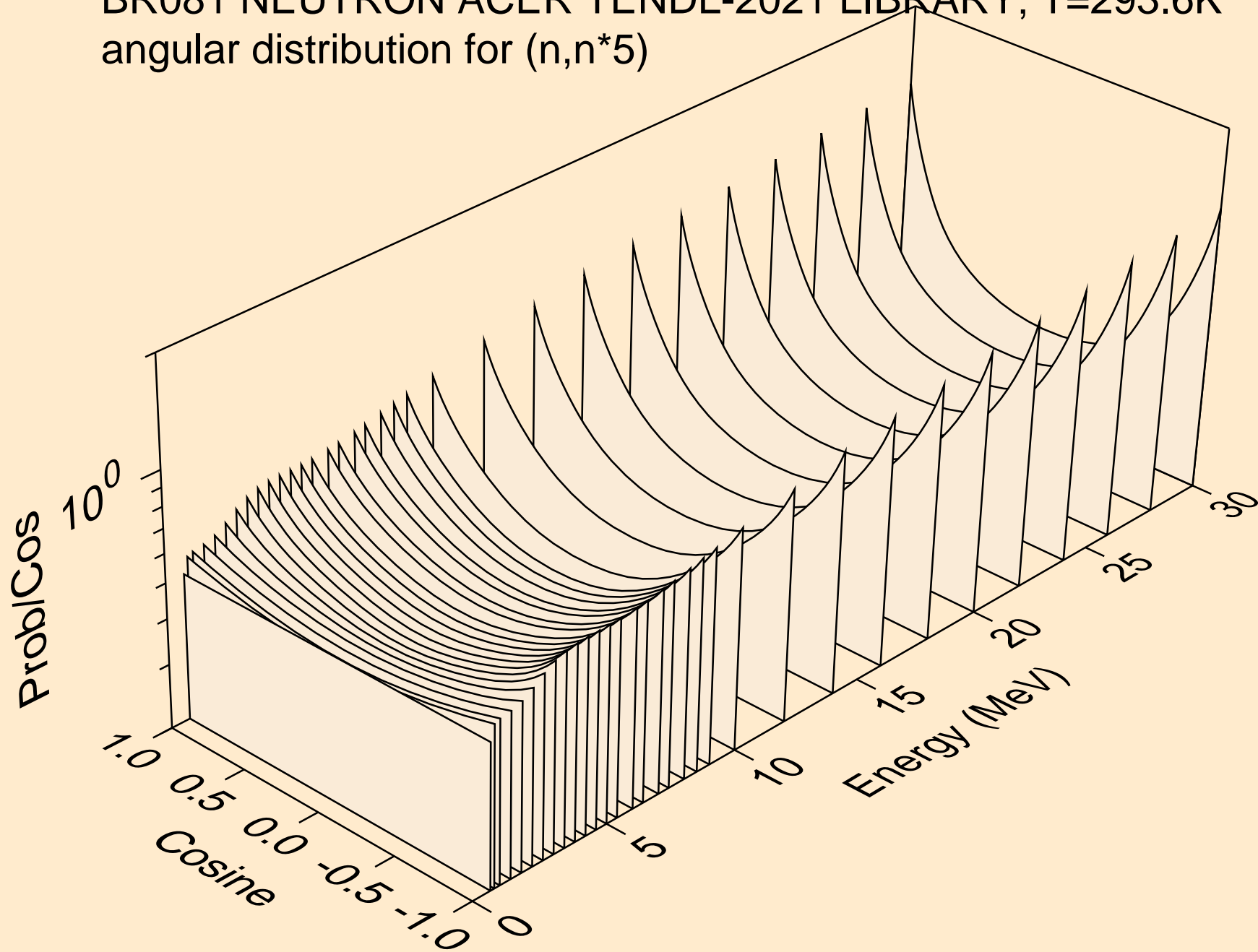

BR081 NEUTRON ACER TENDL-2021 LIBRARY; T=293.6K
angular distribution for (n,n*6)

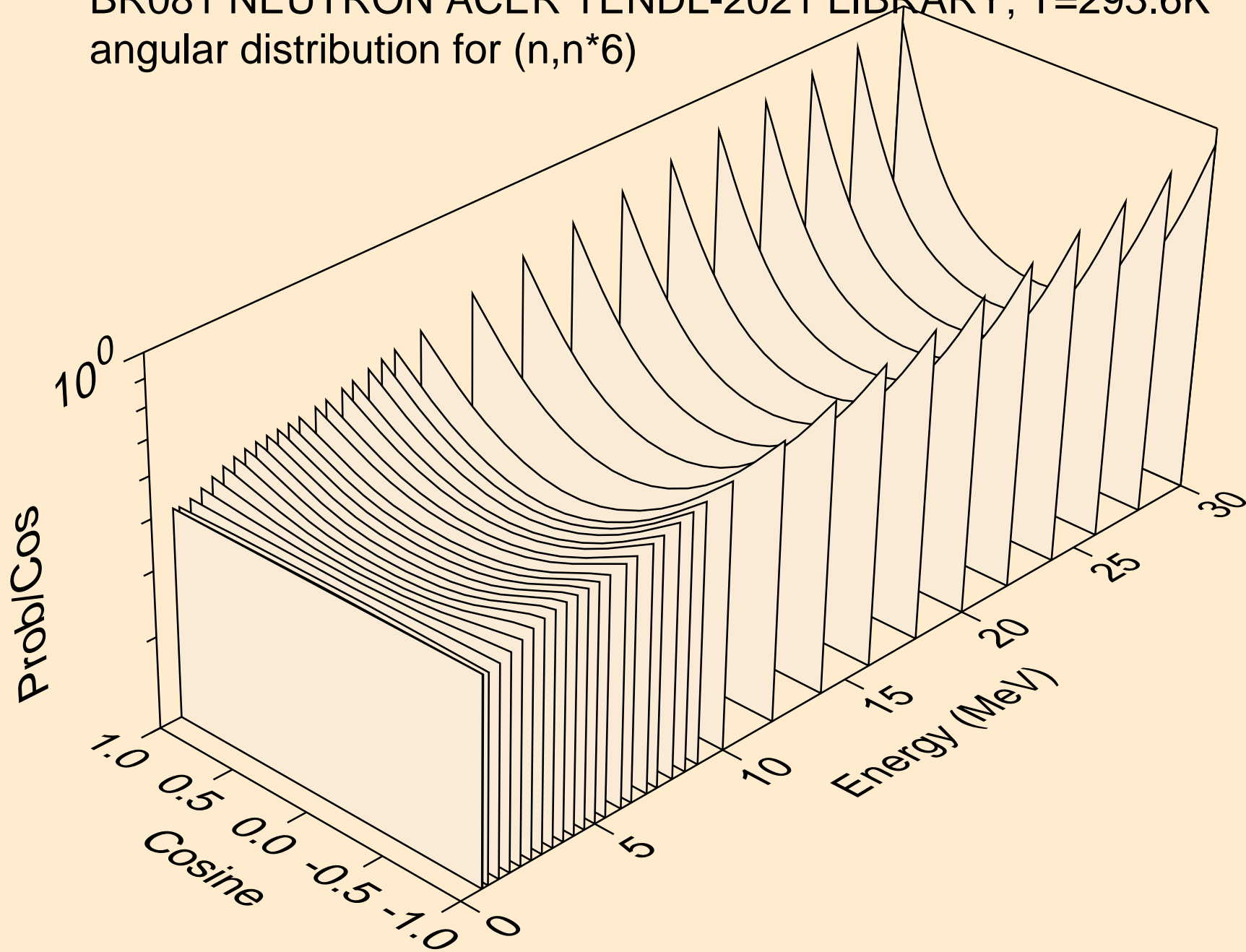

BR081 NEUTRON ACER TENDL-2021 LIBRARY; T=293.6K
angular distribution for (n,n*7)

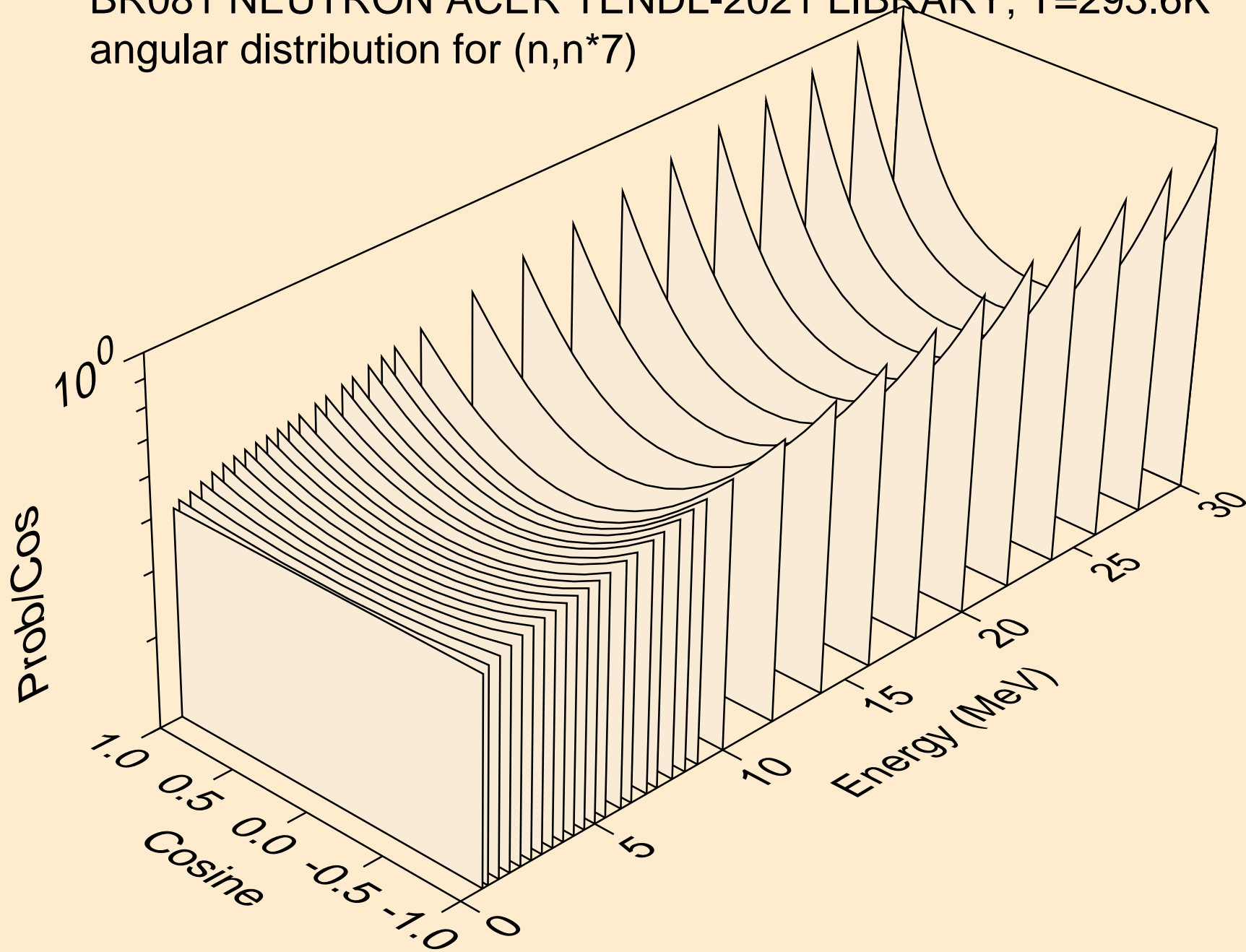

BR081 NEUTRON ACER TENDL-2021 LIBRARY; T=293.6K
angular distribution for (n,n*8)

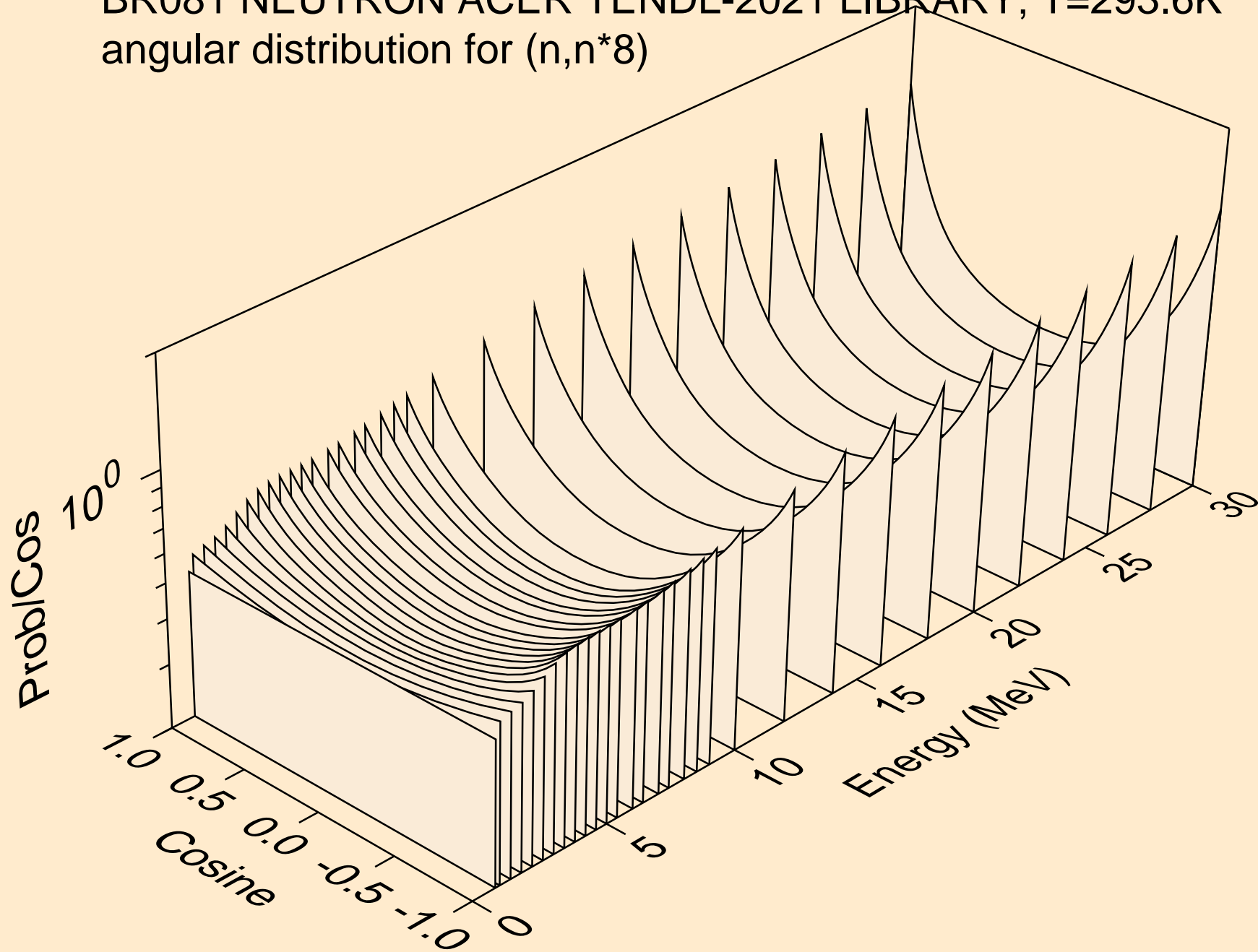

BR081 NEUTRON ACER TENDL-2021 LIBRARY; T=293.6K
angular distribution for (n,n*9)

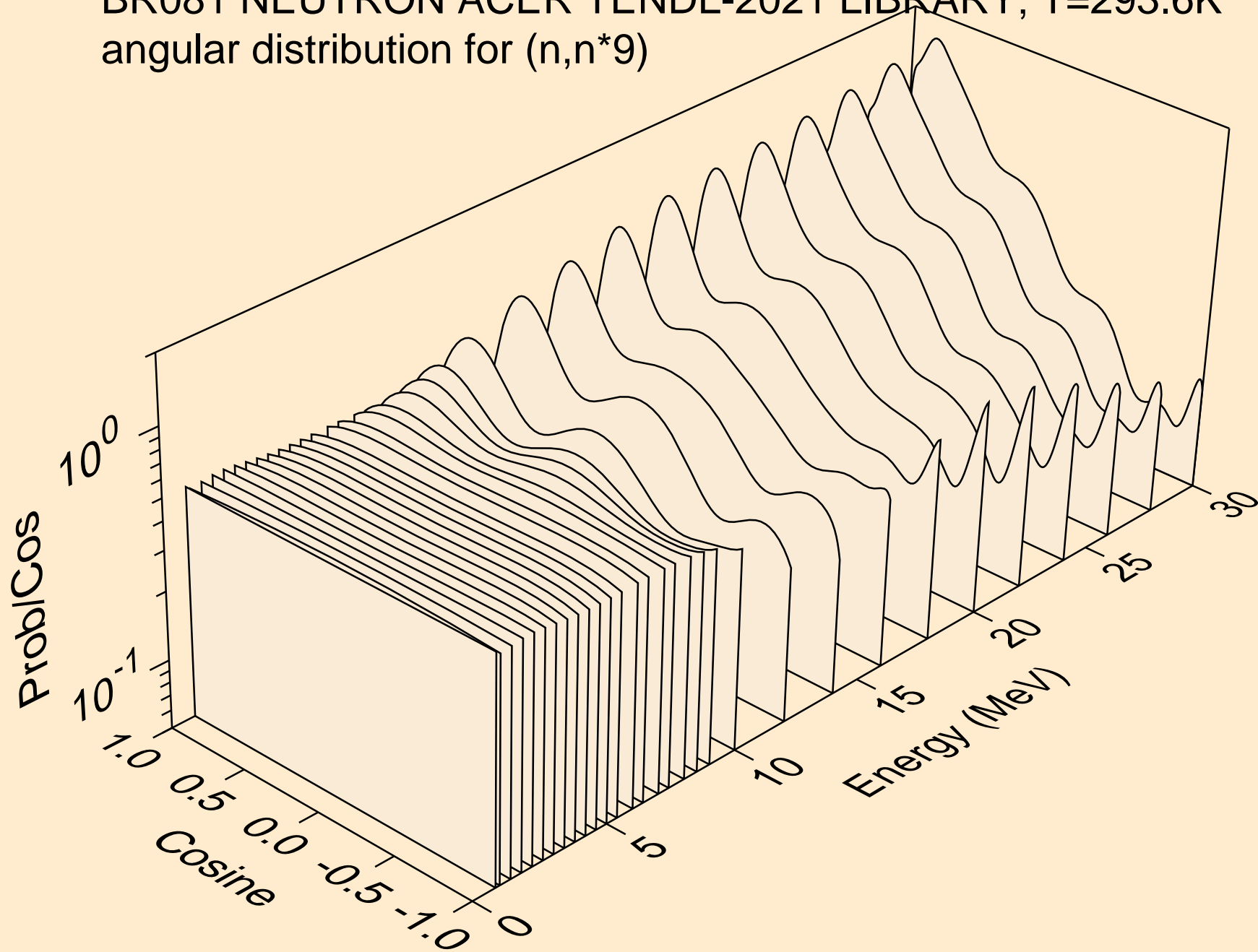

BR081 NEUTRON ACER TENDL-2021 LIBRARY; T=293.6K
angular distribution for (n,n*10)

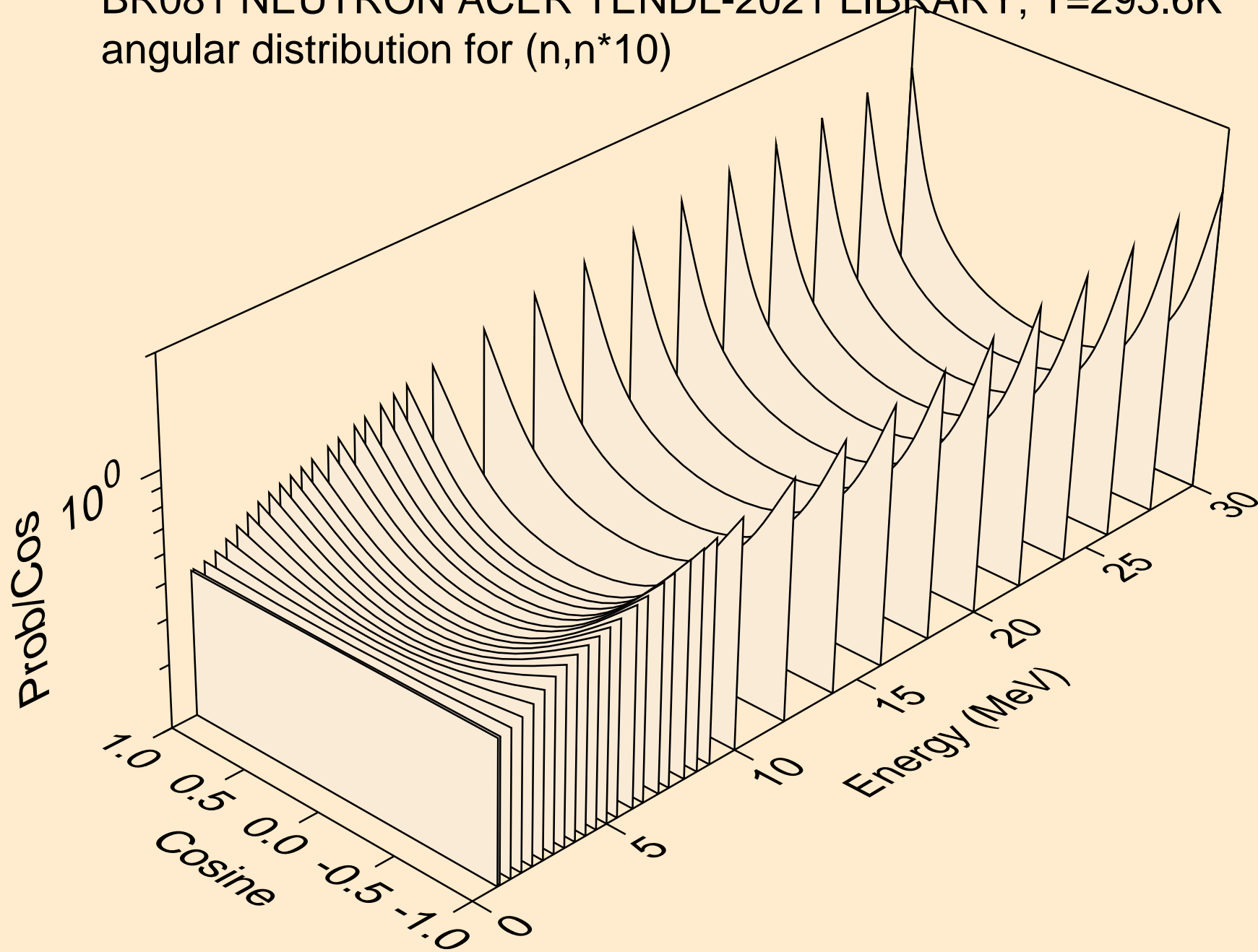

BR081 NEUTRON ACER TENDL-2021 LIBRARY; T=293.6K
angular distribution for (n,n*11)

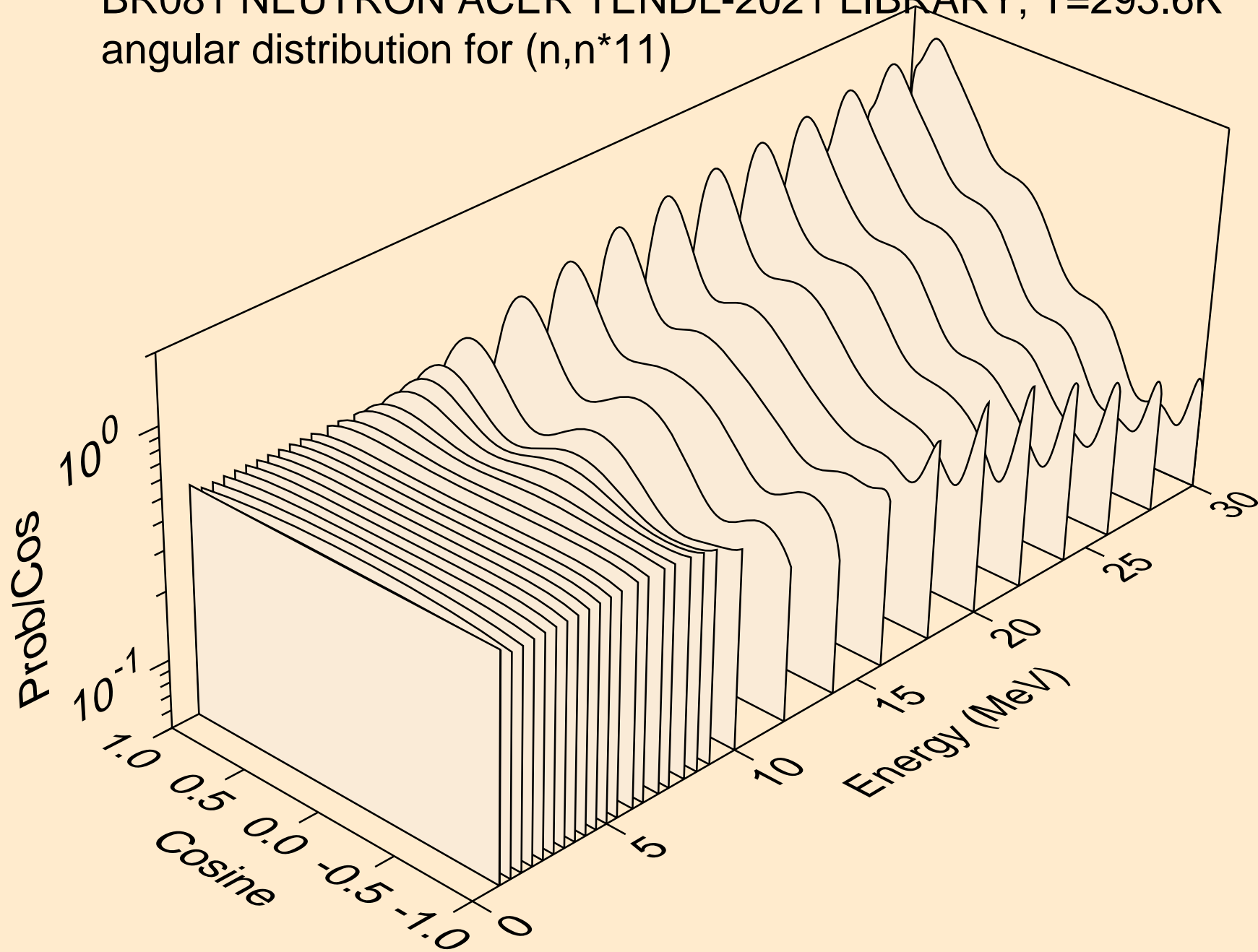

BR081 NEUTRON ACER TENDL-2021 LIBRARY; T=293.6K
angular distribution for (n,n*12)

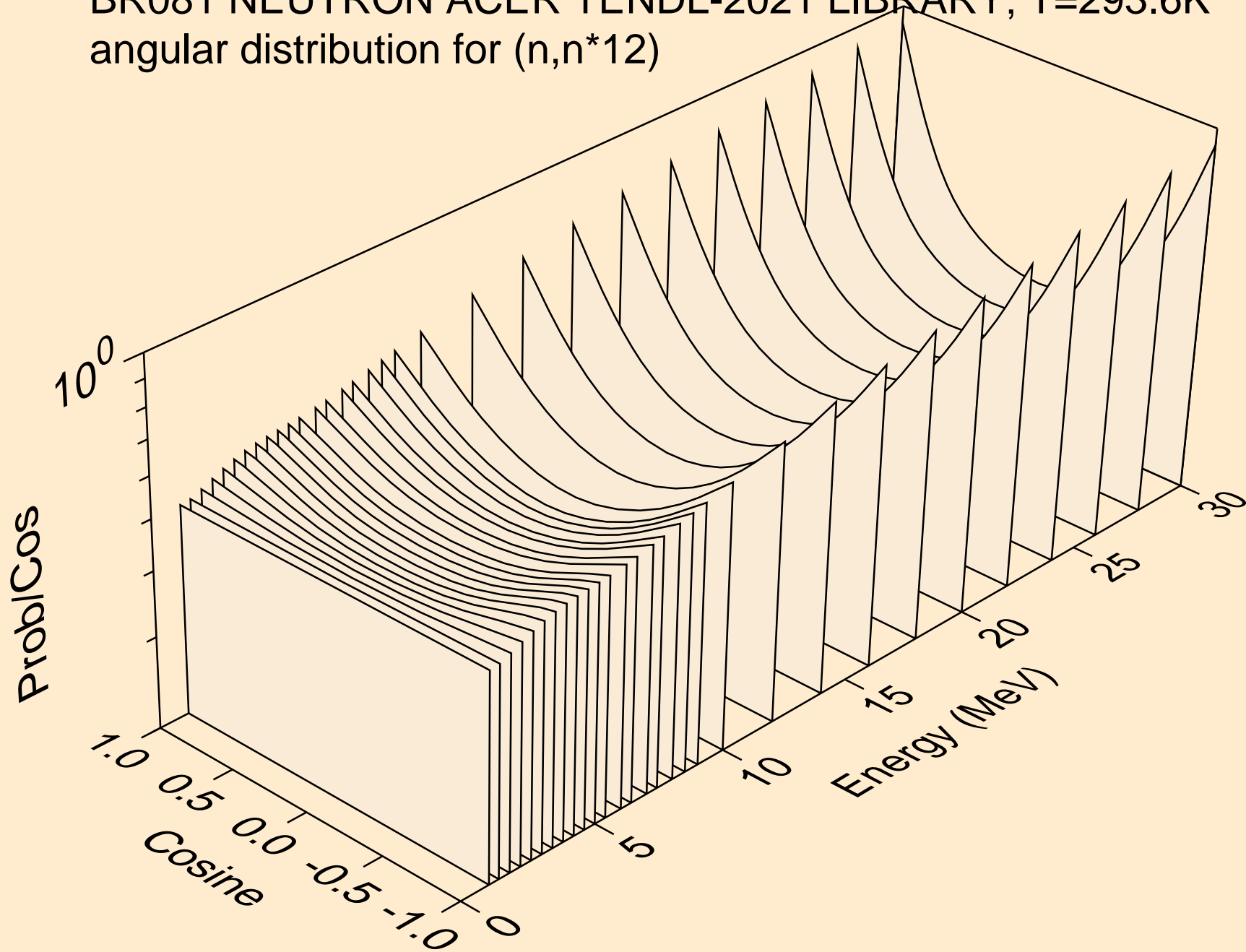

BR081 NEUTRON ACER TENDL-2021 LIBRARY; T=293.6K
angular distribution for (n,n*13)

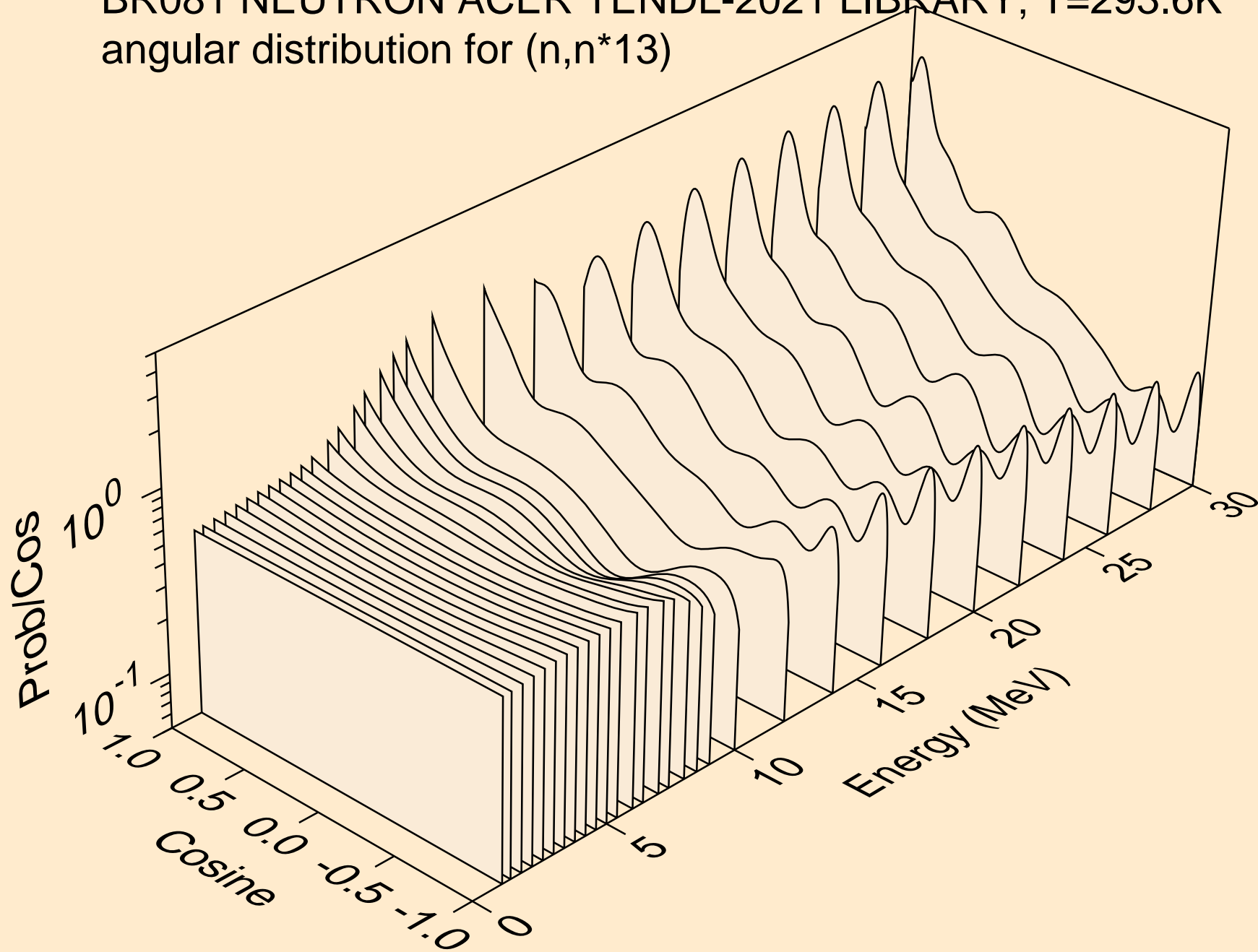

BR081 NEUTRON ACER TENDL-2021 LIBRARY; T=293.6K
angular distribution for (n,n*14)

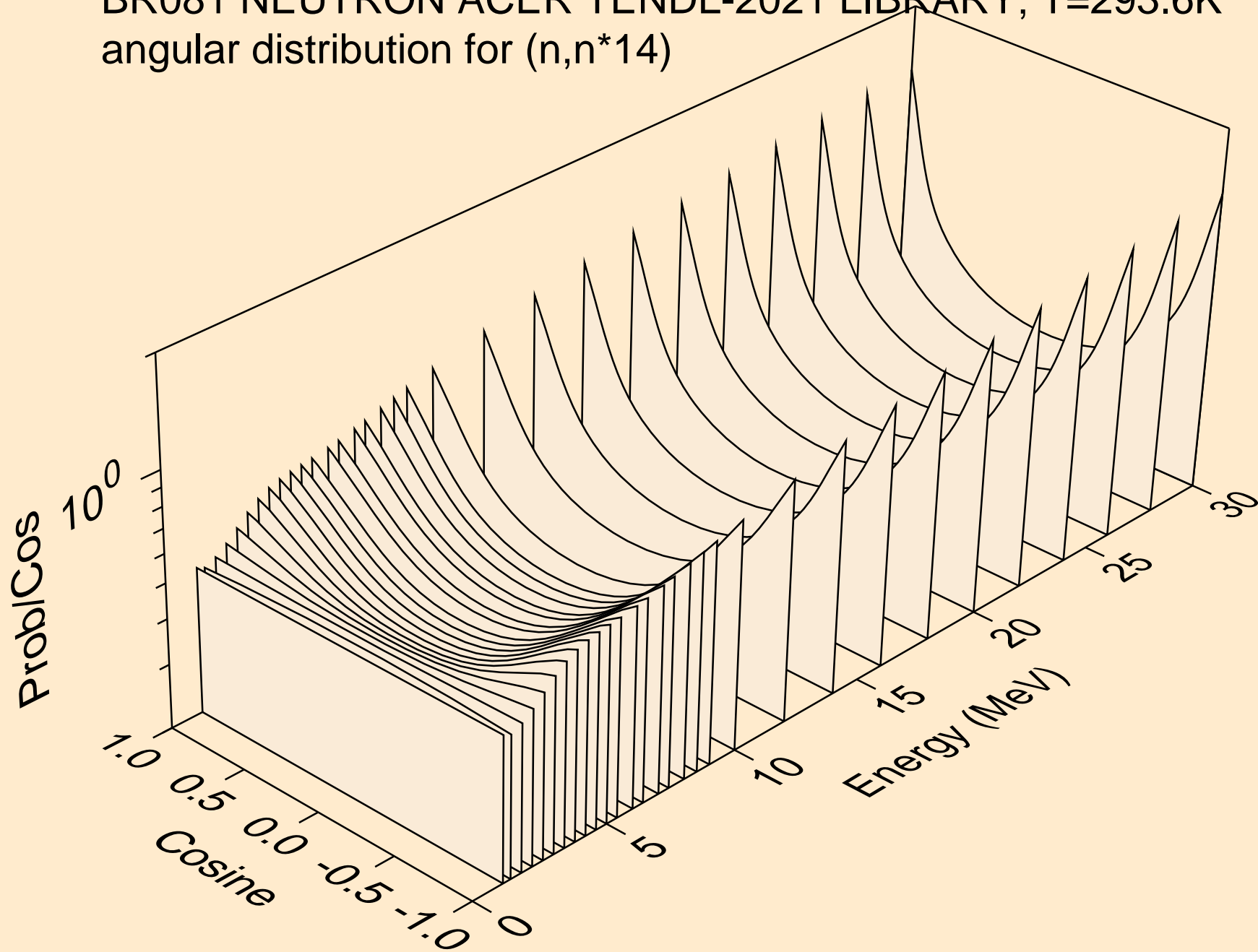

BR081 NEUTRON ACER TENDL-2021 LIBRARY; T=293.6K
angular distribution for (n,n*15)

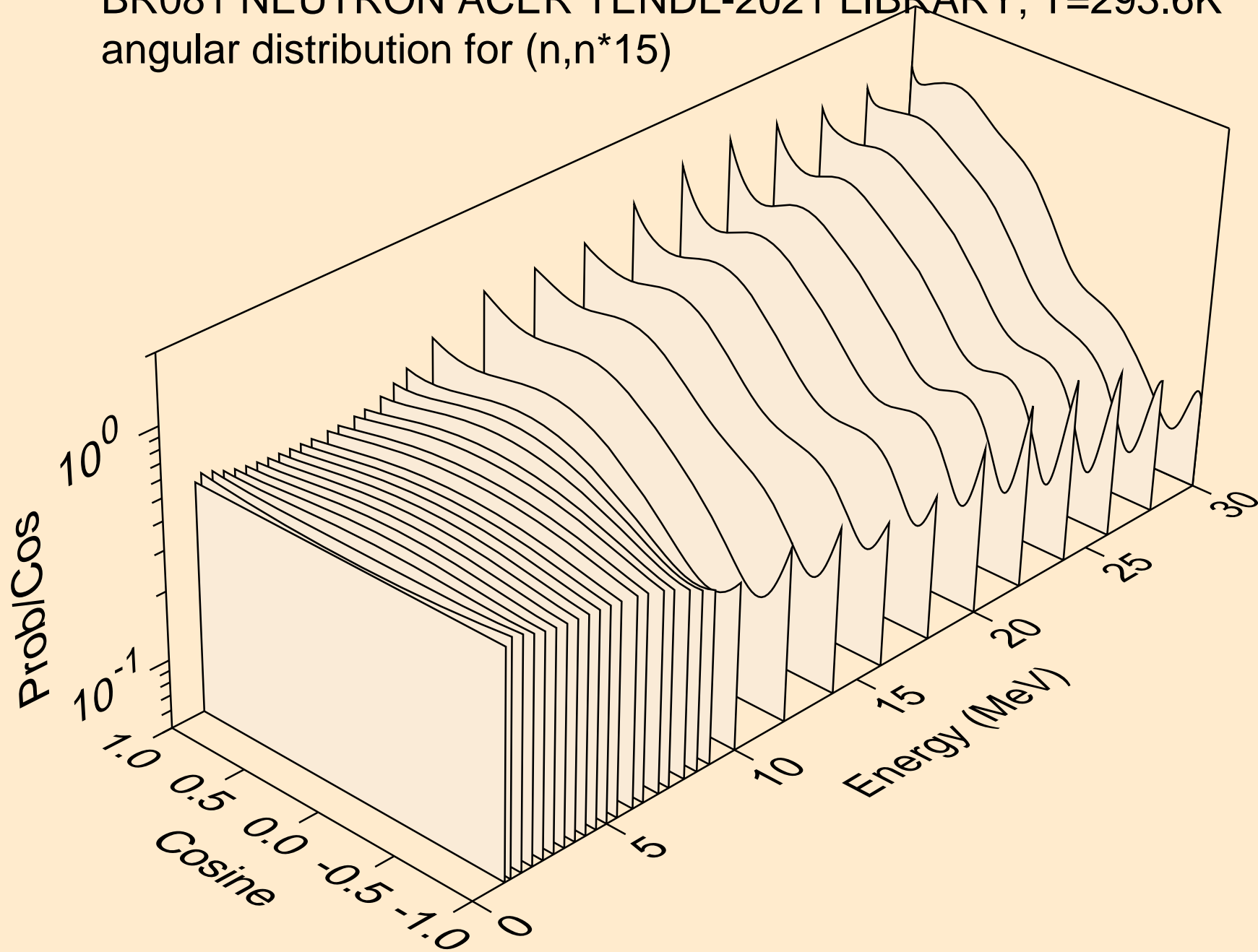

BR081 NEUTRON ACER TENDL-2021 LIBRARY; T=293.6K
angular distribution for (n,n*16)

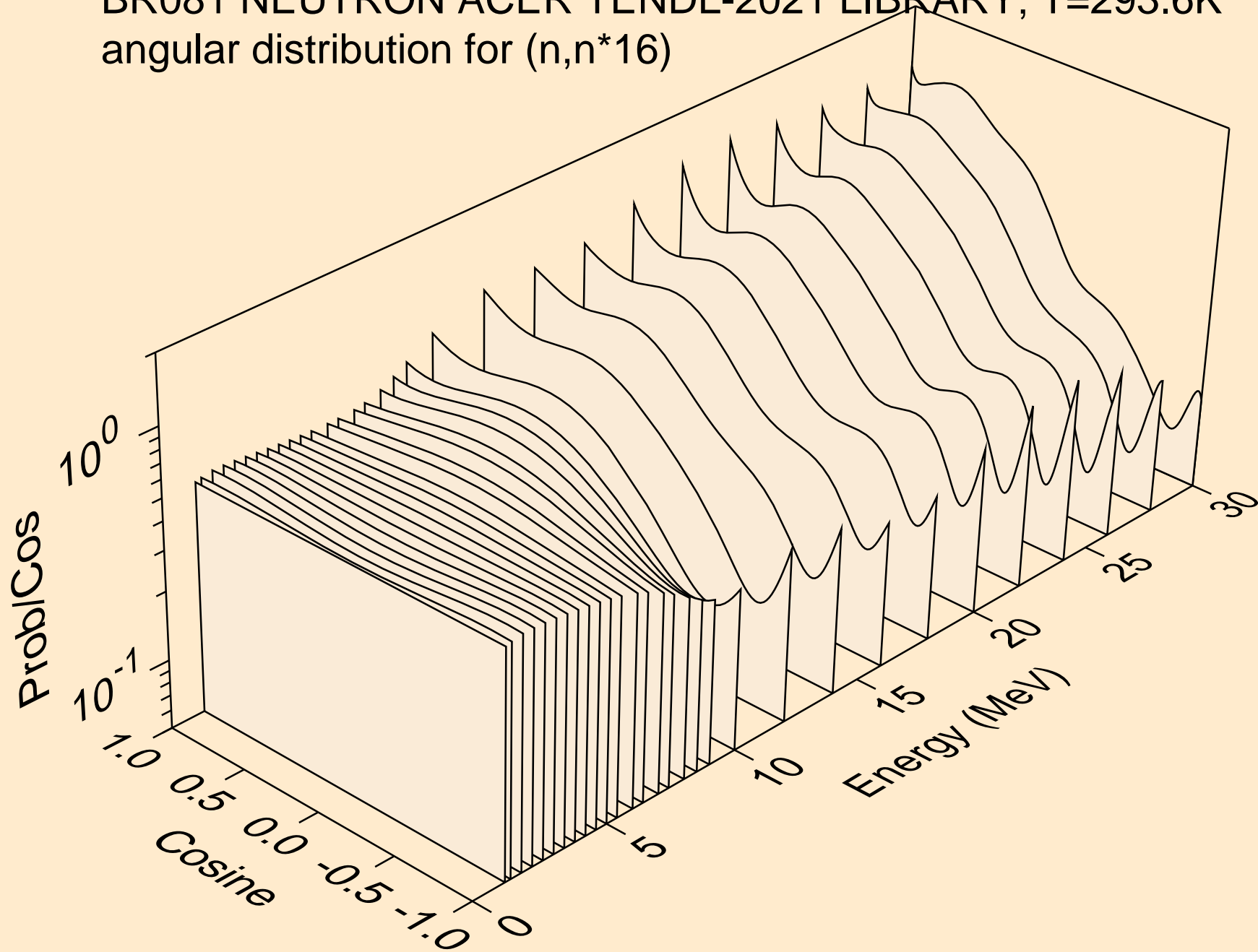

BR081 NEUTRON ACER TENDL-2021 LIBRARY; T=293.6K
angular distribution for (n,n*17)

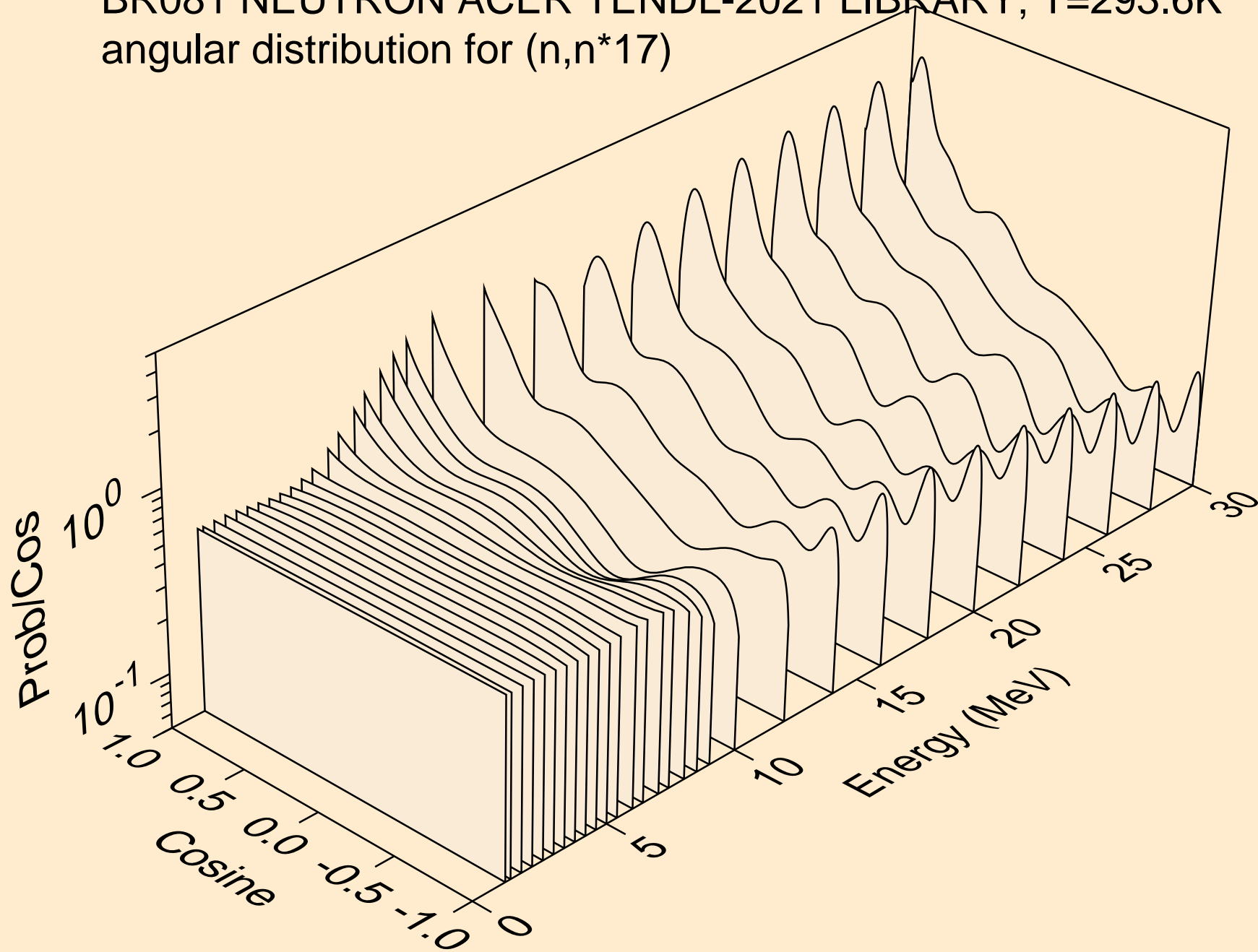

BR081 NEUTRON ACER TENDL-2021 LIBRARY; T=293.6K
angular distribution for (n,n*18)

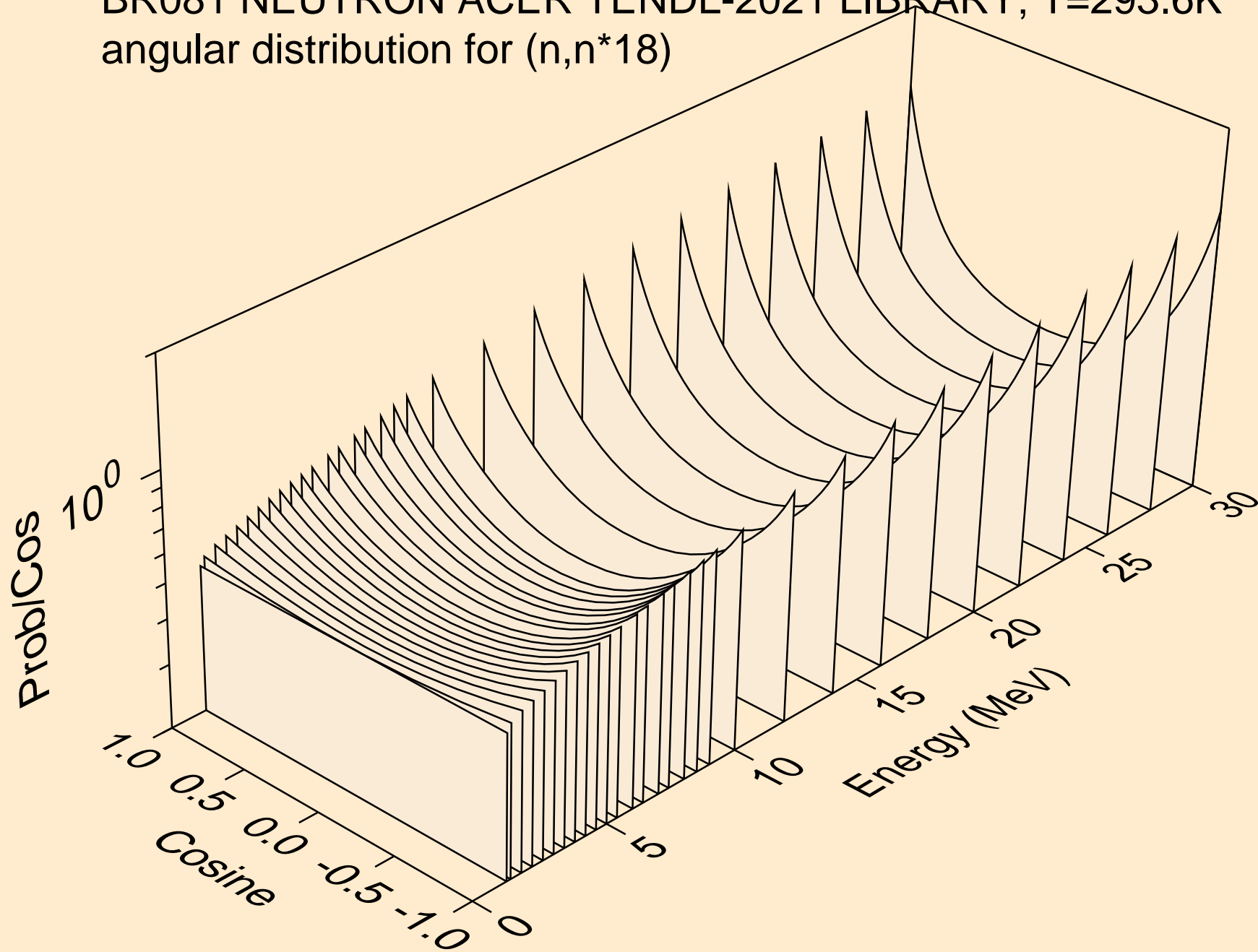

BR081 NEUTRON ACER TENDL-2021 LIBRARY; T=293.6K
angular distribution for (n,n*19)

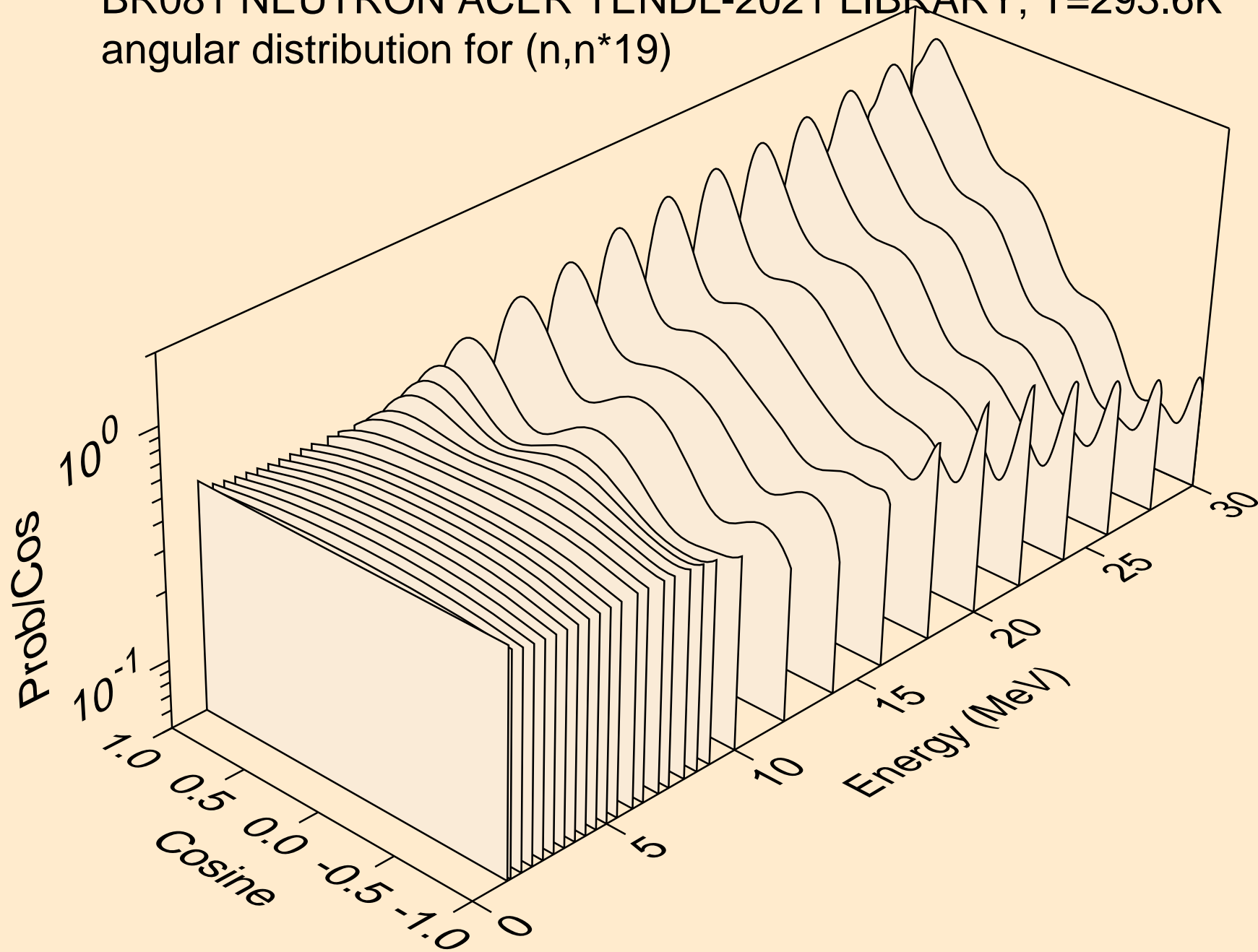

BR081 NEUTRON ACER TENDL-2021 LIBRARY; T=293.6K
angular distribution for (n,n*20)

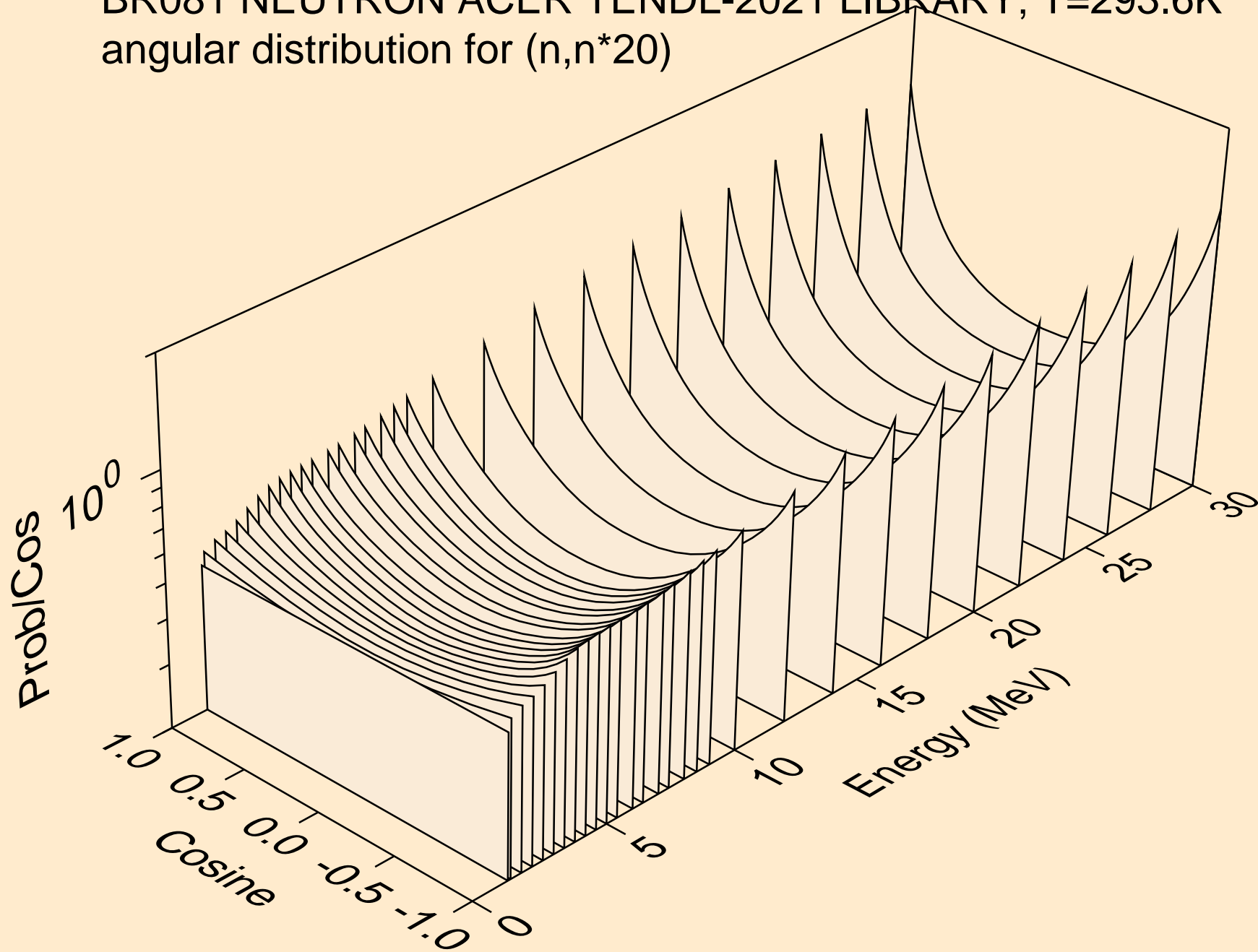

BR081 NEUTRON ACER TENDL-2021 LIBRARY; T=293.6K
angular distribution for (n,n*21)

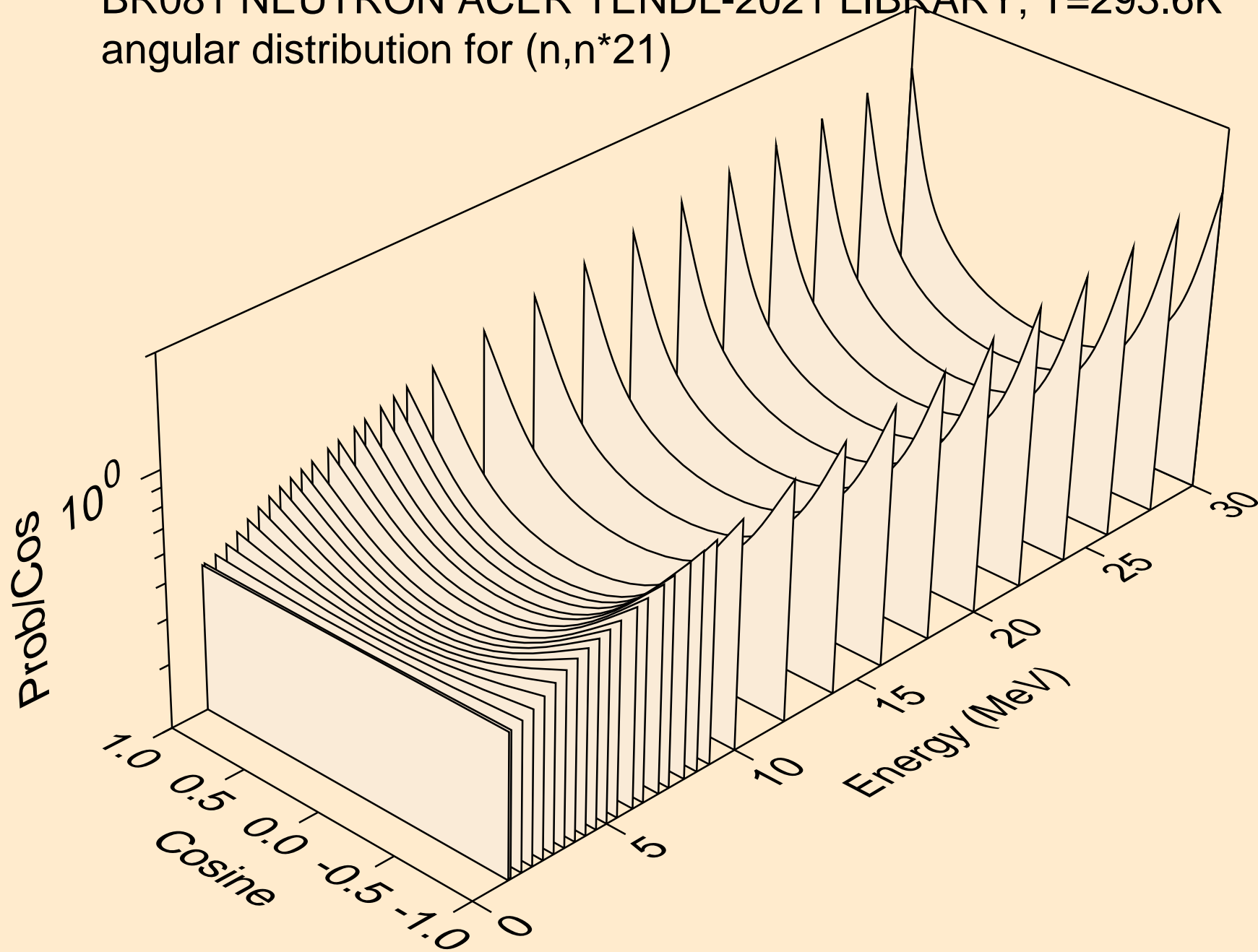

BR081 NEUTRON ACER TENDL-2021 LIBRARY; T=293.6K
angular distribution for (n,n*22)

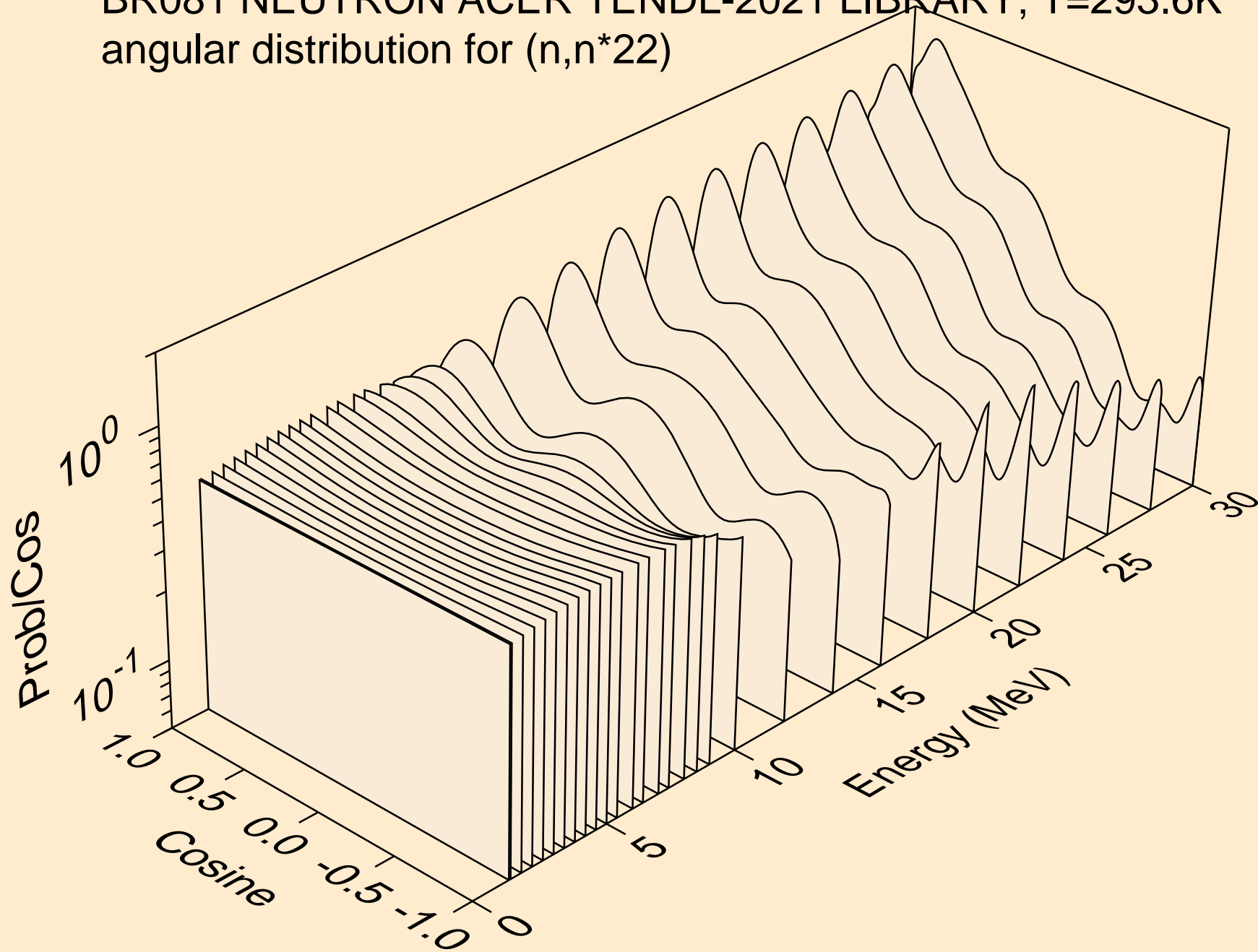

BR081 NEUTRON ACER TENDL-2021 LIBRARY; T=293.6K
angular distribution for (n,n*23)

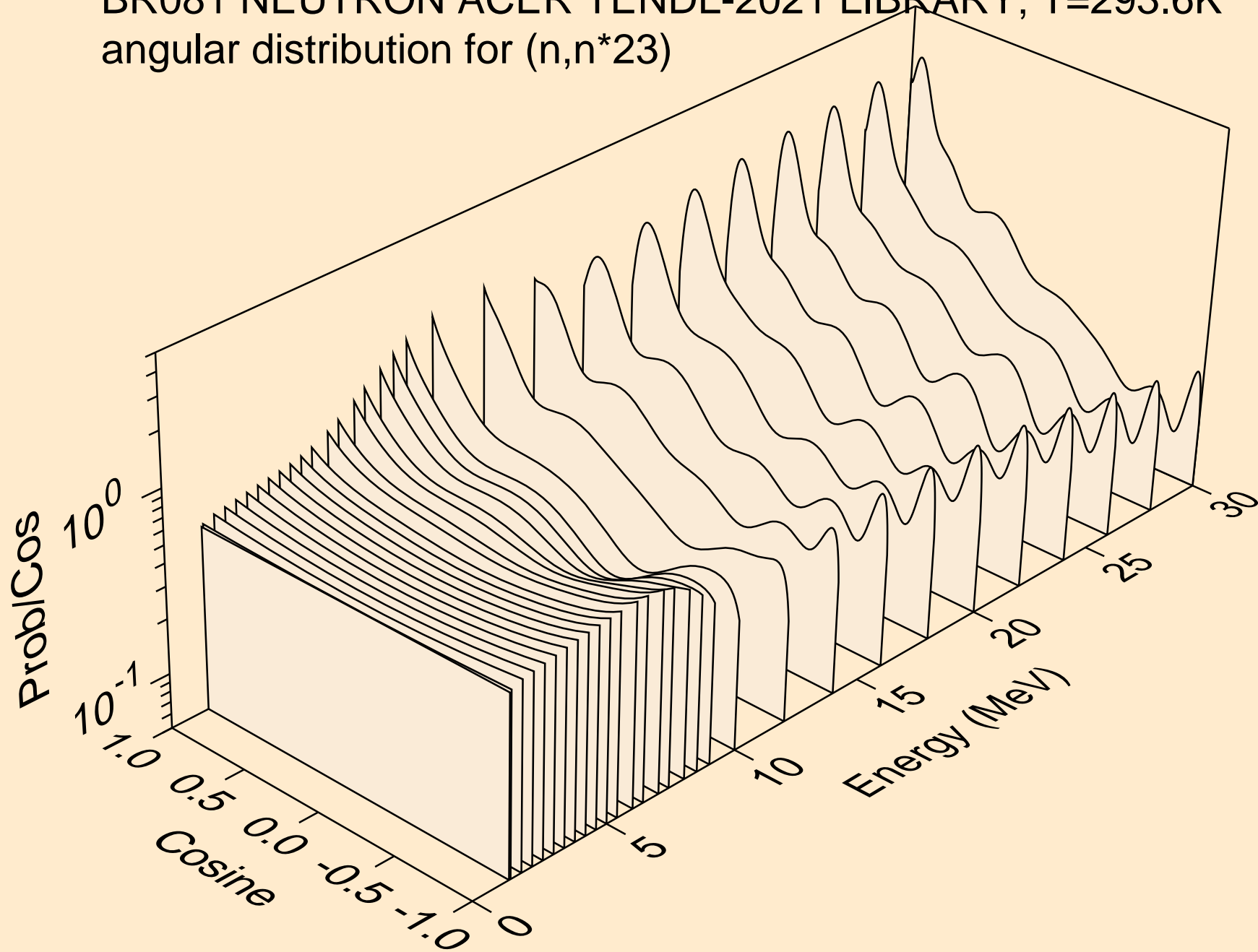

BR081 NEUTRON ACER TENDL-2021 LIBRARY; T=293.6K
angular distribution for (n,n*24)

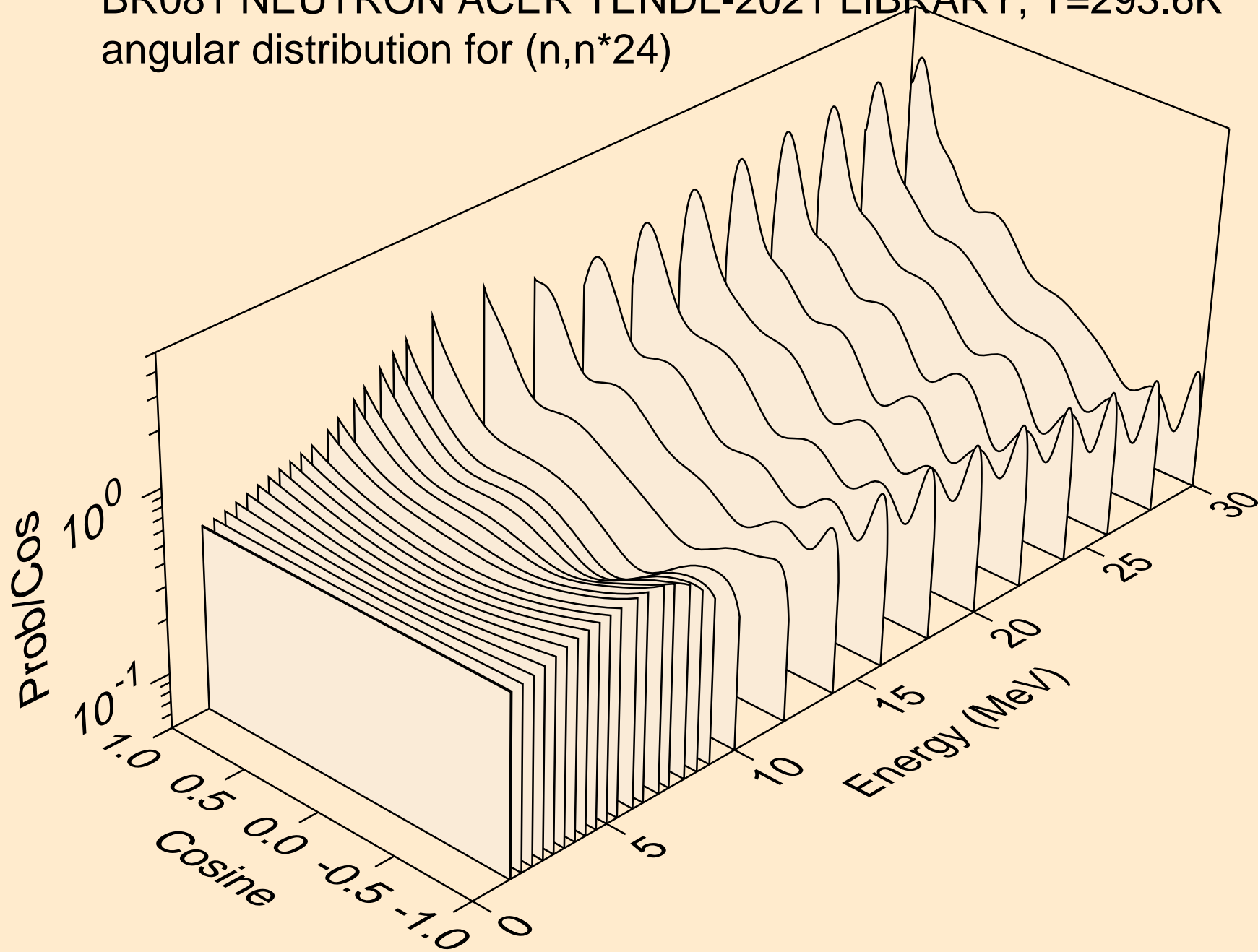

BR081 NEUTRON ACER TENDL-2021 LIBRARY; T=293.6K
angular distribution for (n,n*25)

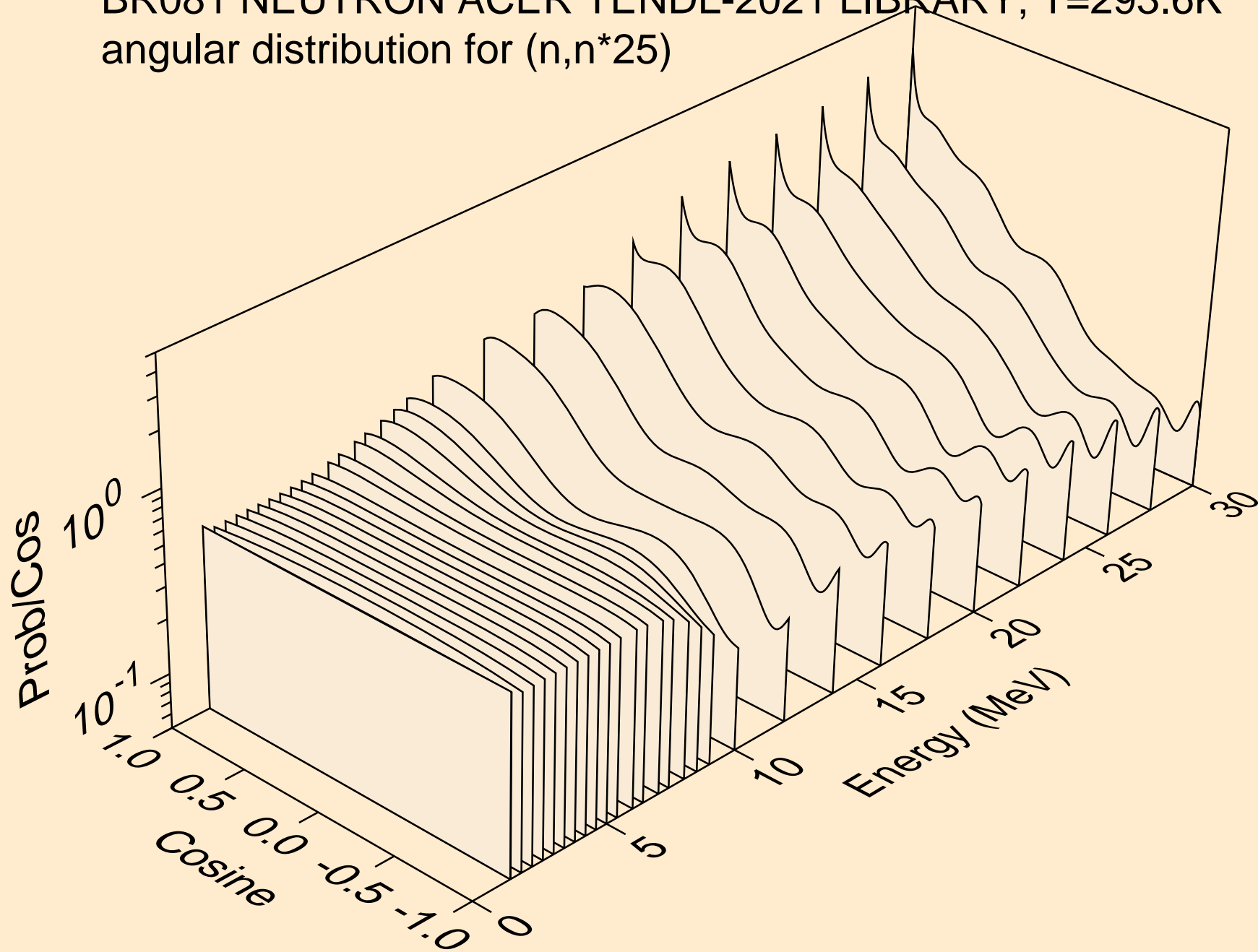

BR081 NEUTRON ACER TENDL-2021 LIBRARY; T=293.6K
angular distribution for (n,n*26)

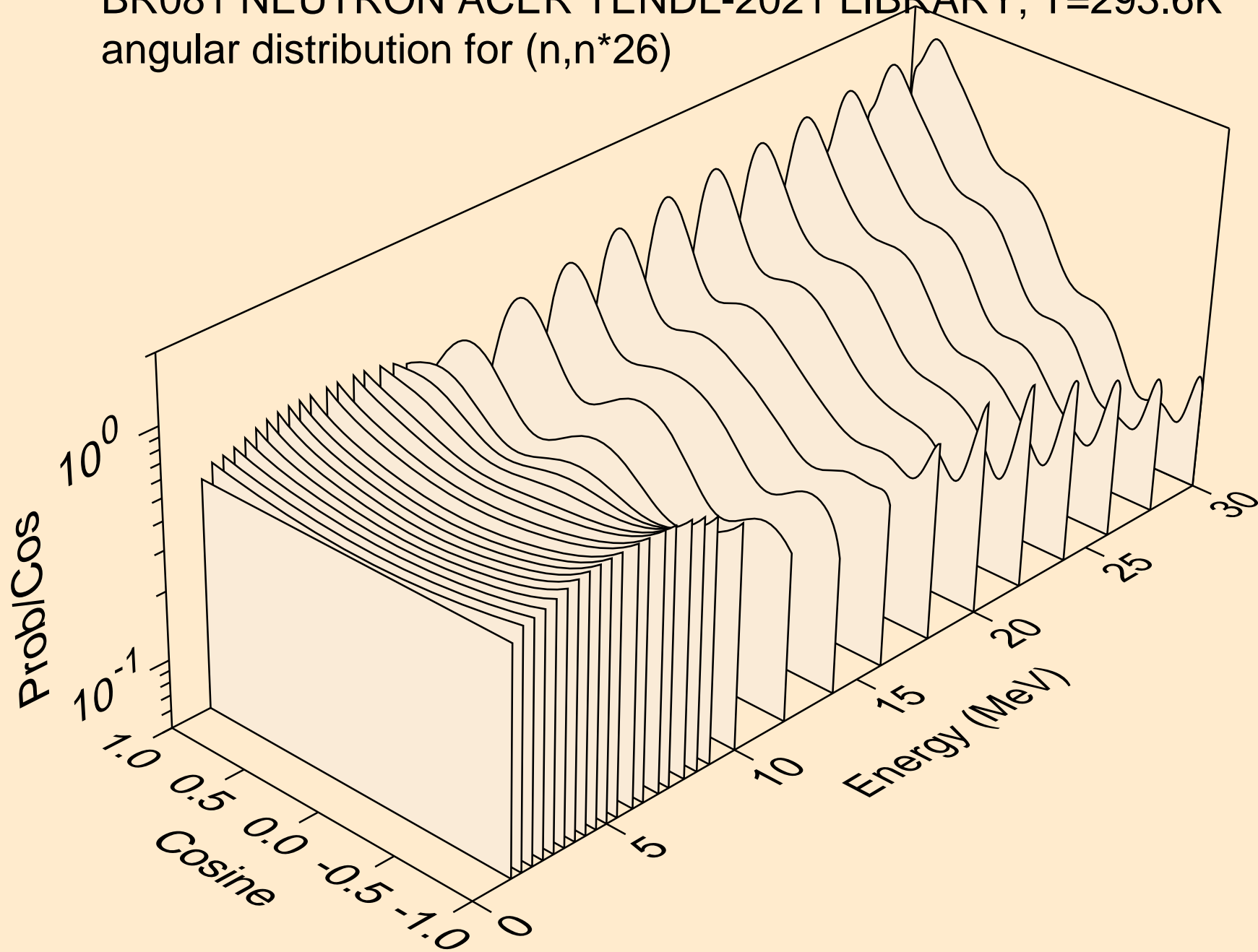

BR081 NEUTRON ACER TENDL-2021 LIBRARY; T=293.6K
angular distribution for (n,n*27)

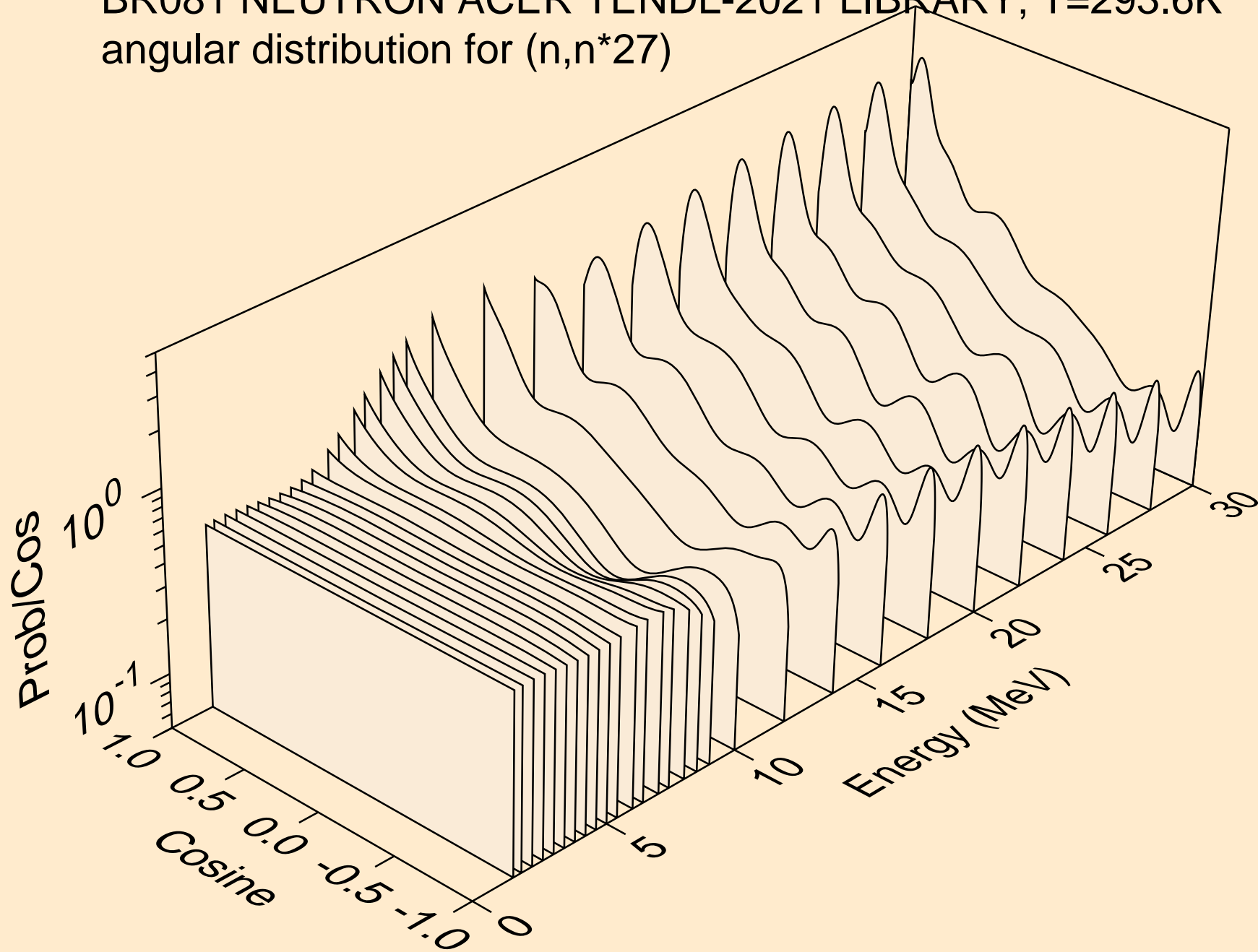

BR081 NEUTRON ACER TENDL-2021 LIBRARY; T=293.6K
angular distribution for (n,n*28)

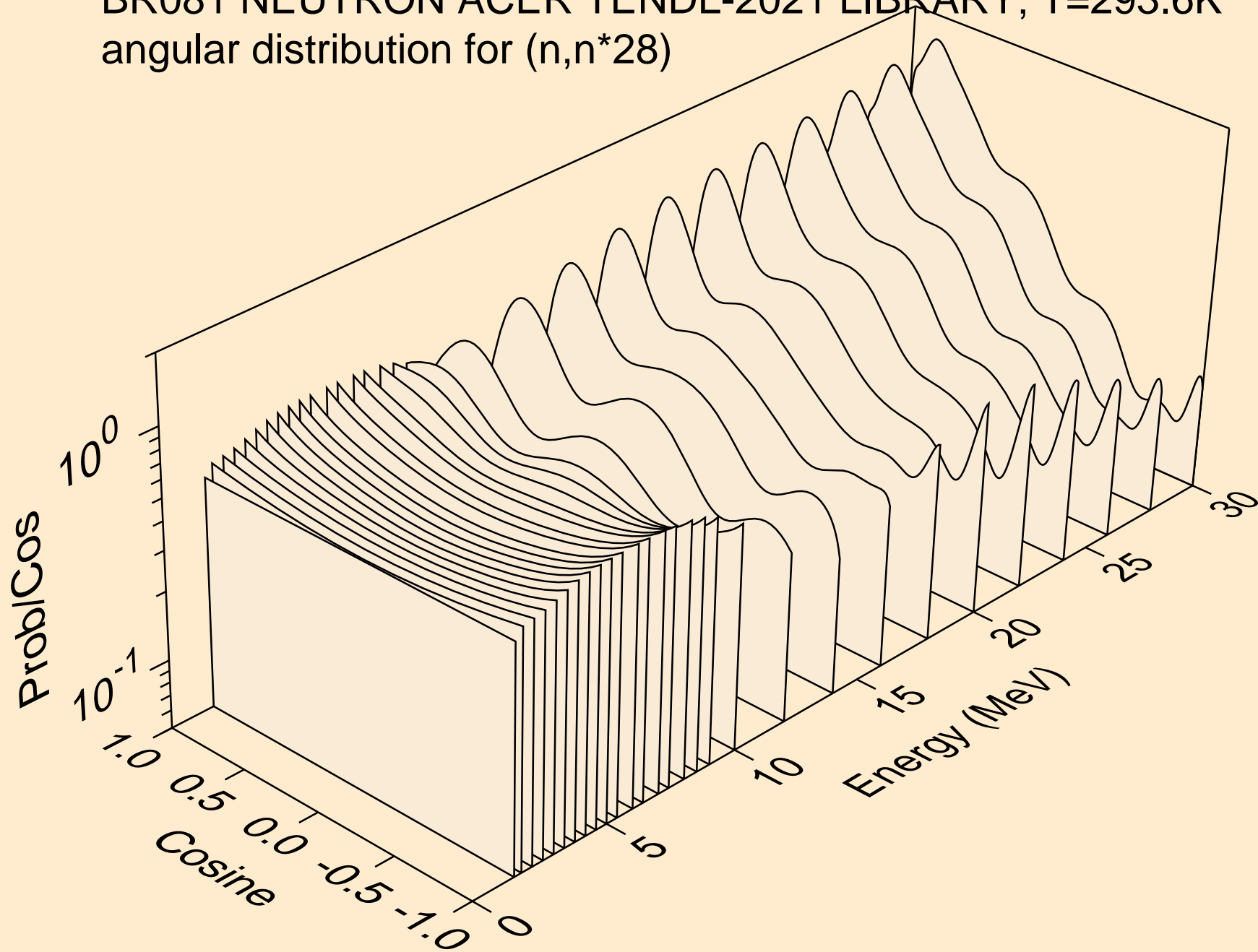

BR081 NEUTRON ACER TENDL-2021 LIBRARY; T=293.6K
angular distribution for (n,n*29)

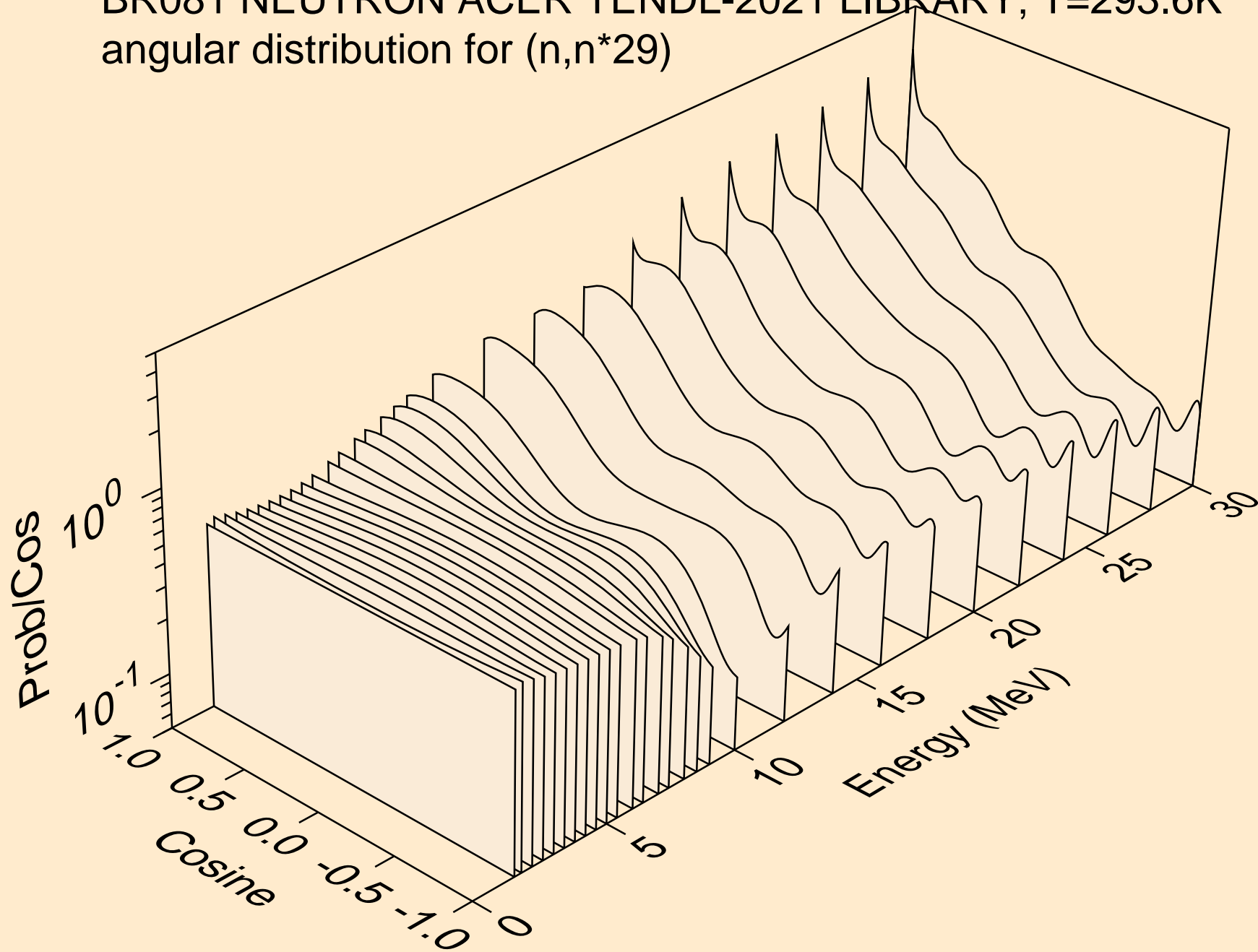

BR081 NEUTRON ACER TENDL-2021 LIBRARY; T=293.6K
angular distribution for (n,n*30)

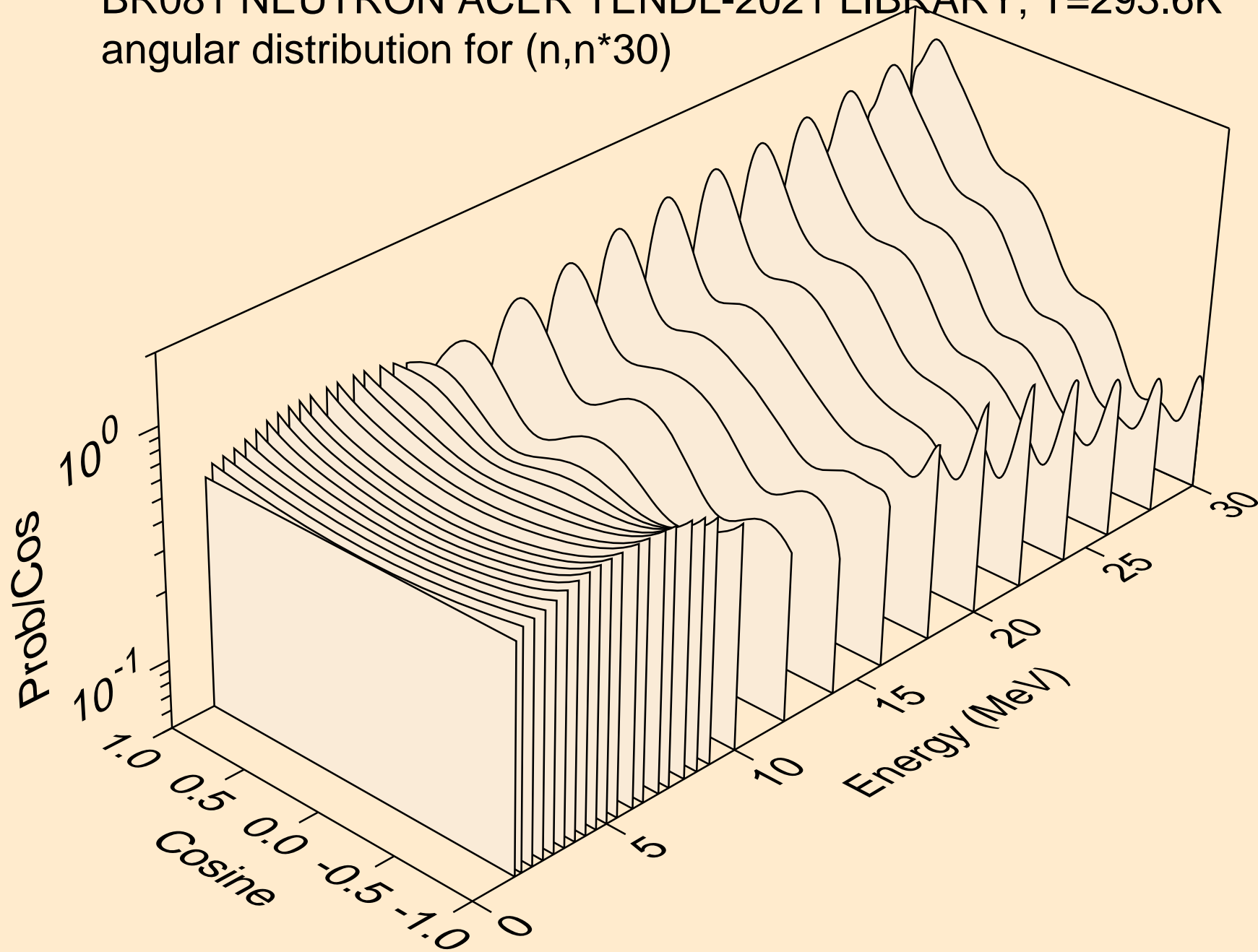

BR081 NEUTRON ACER TENDL-2021 LIBRARY; T=293.6K
Neutron emission for (n,x)

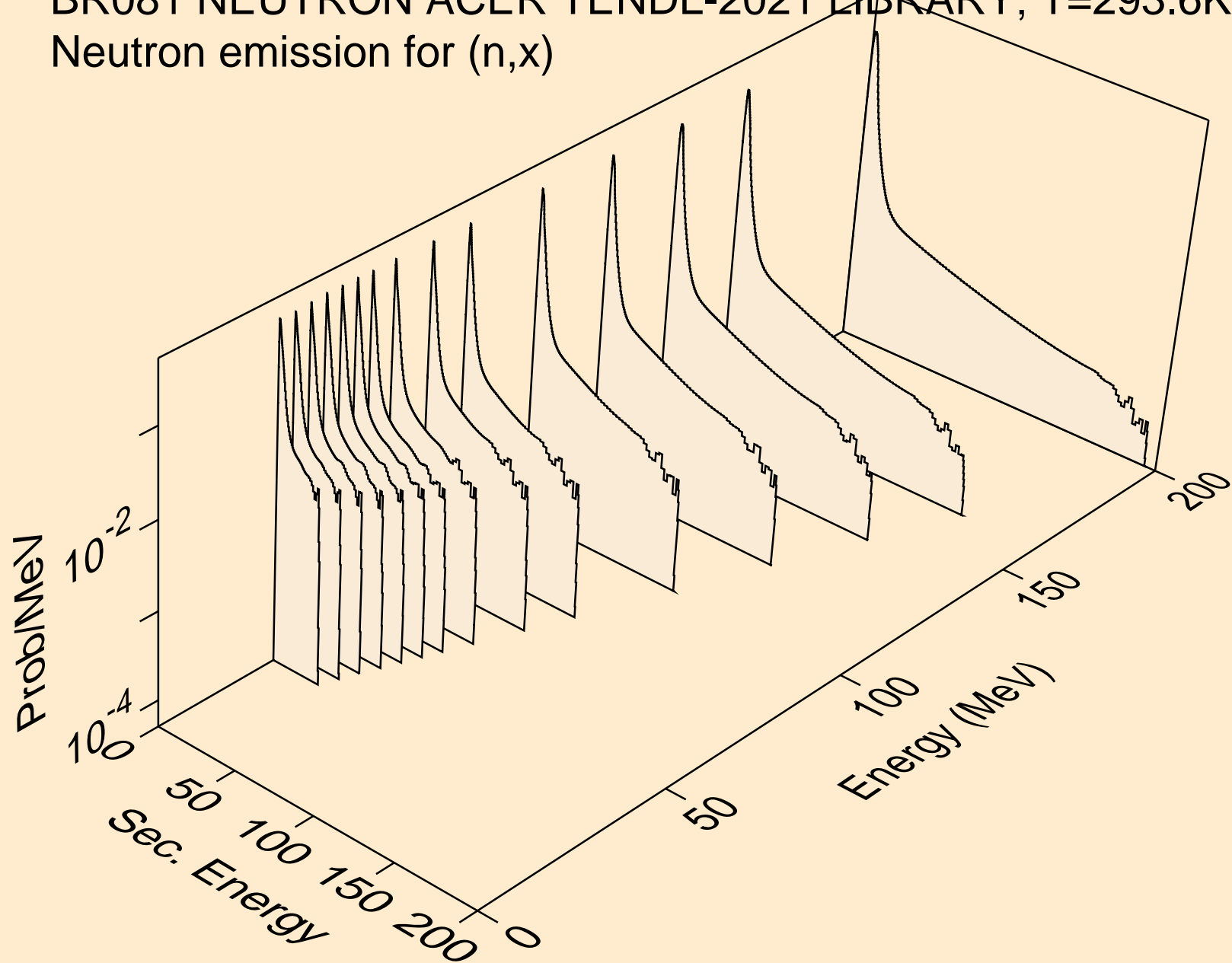

BR081 NEUTRON ACER TENDL-2021 LIBRARY; T=293.6K
Neutron emission for (n,2nd)

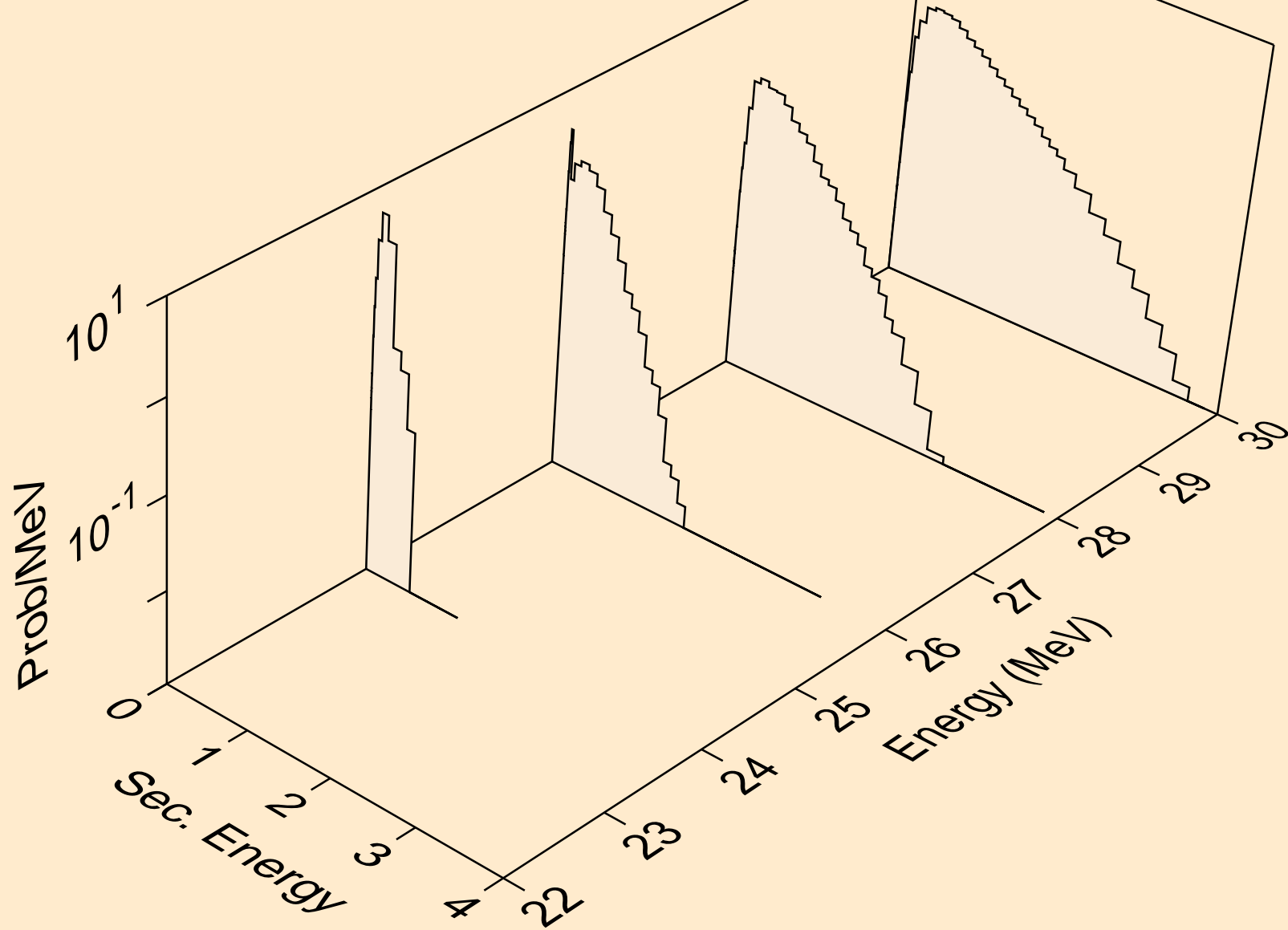

BR081 NEUTRON ACER TENDL-2021 LIBRARY; T=293.6K
Neutron emission for (n,2n)

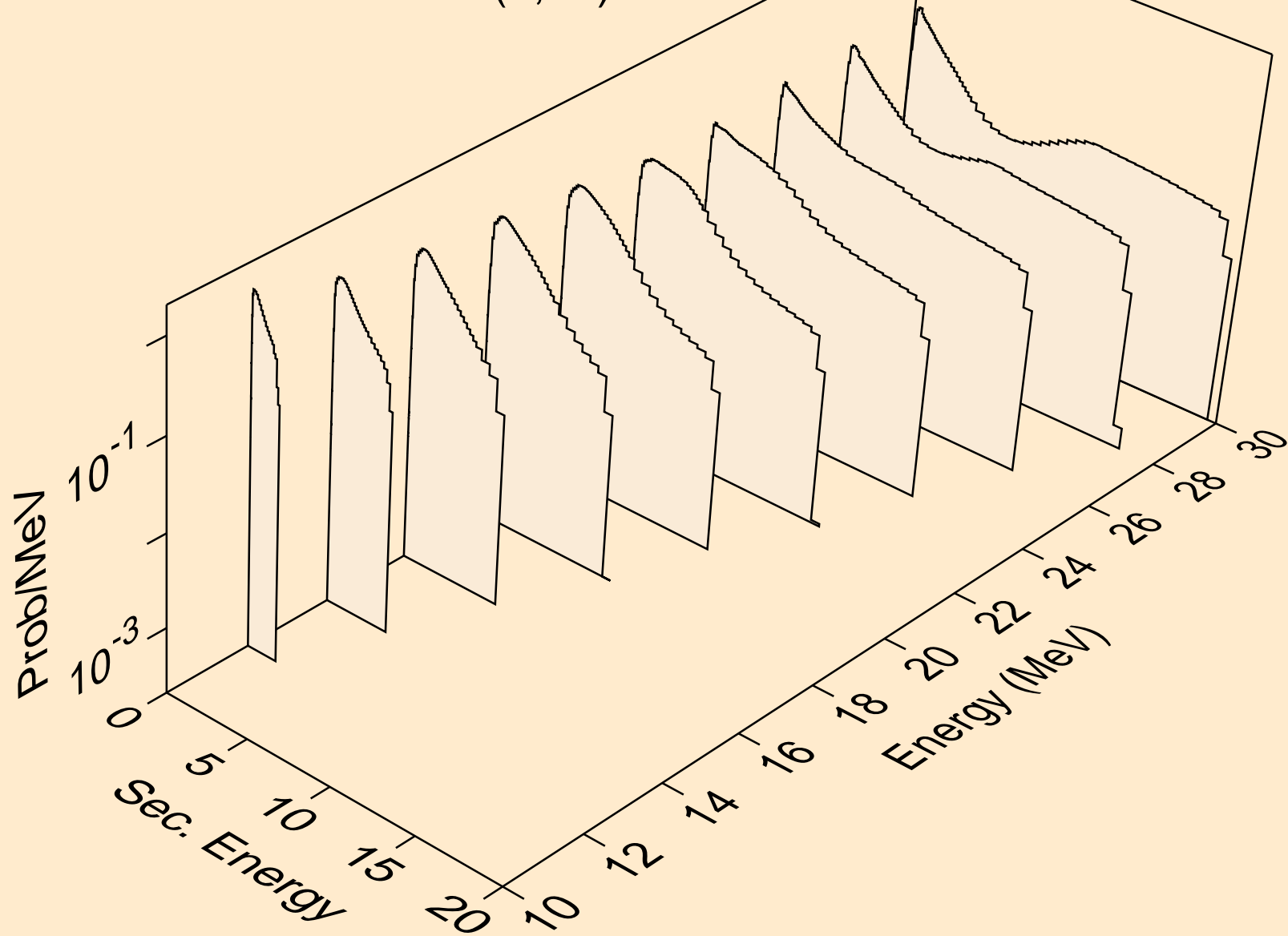

BR081 NEUTRON ACER TENDL-2021 LIBRARY; T=293.6K
Neutron emission for (n,3n)

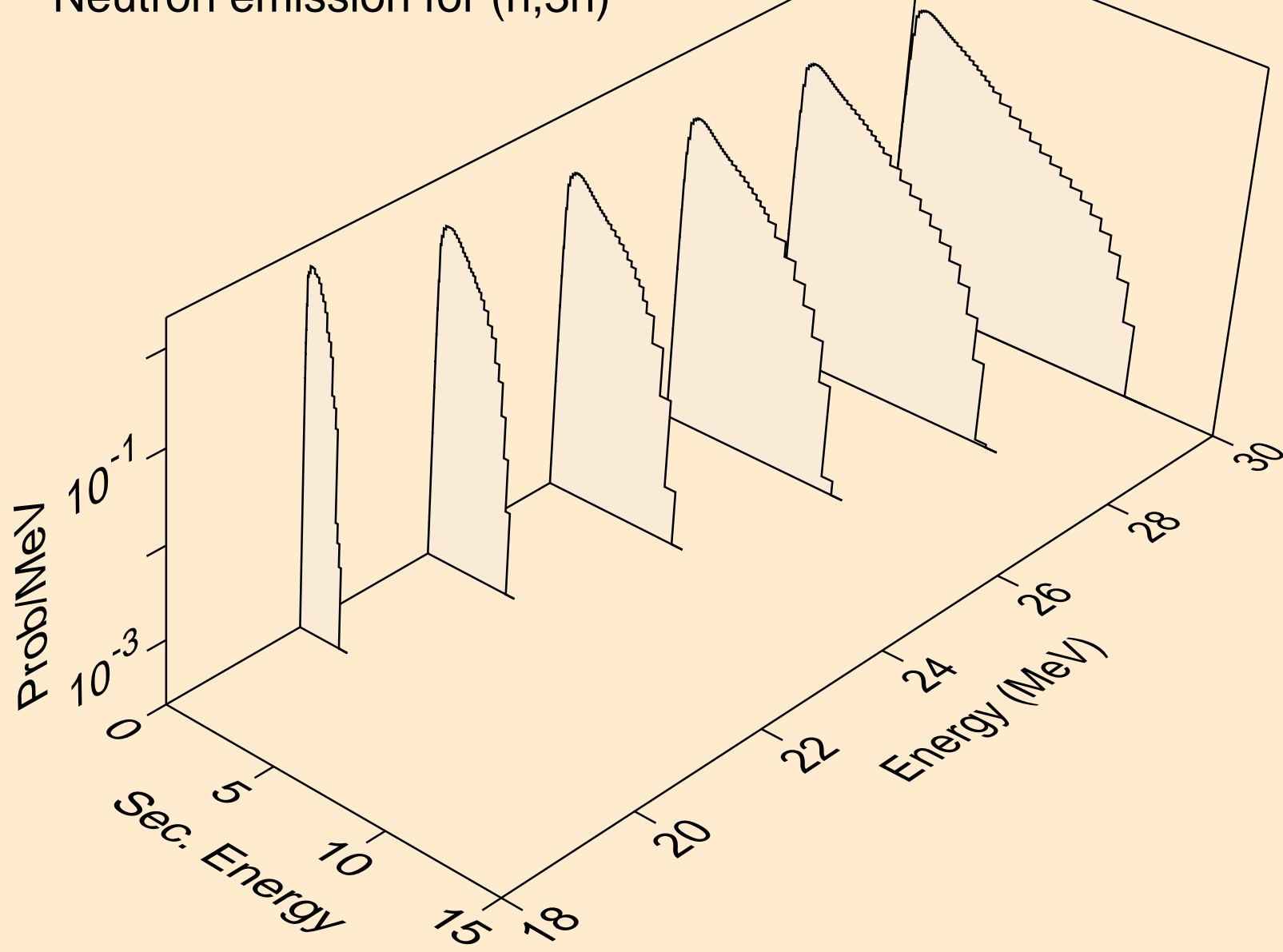

BR081 NEUTRON ACER TENDL-2021 LIBRARY; T=293.6K
Neutron emission for (n,n*)a

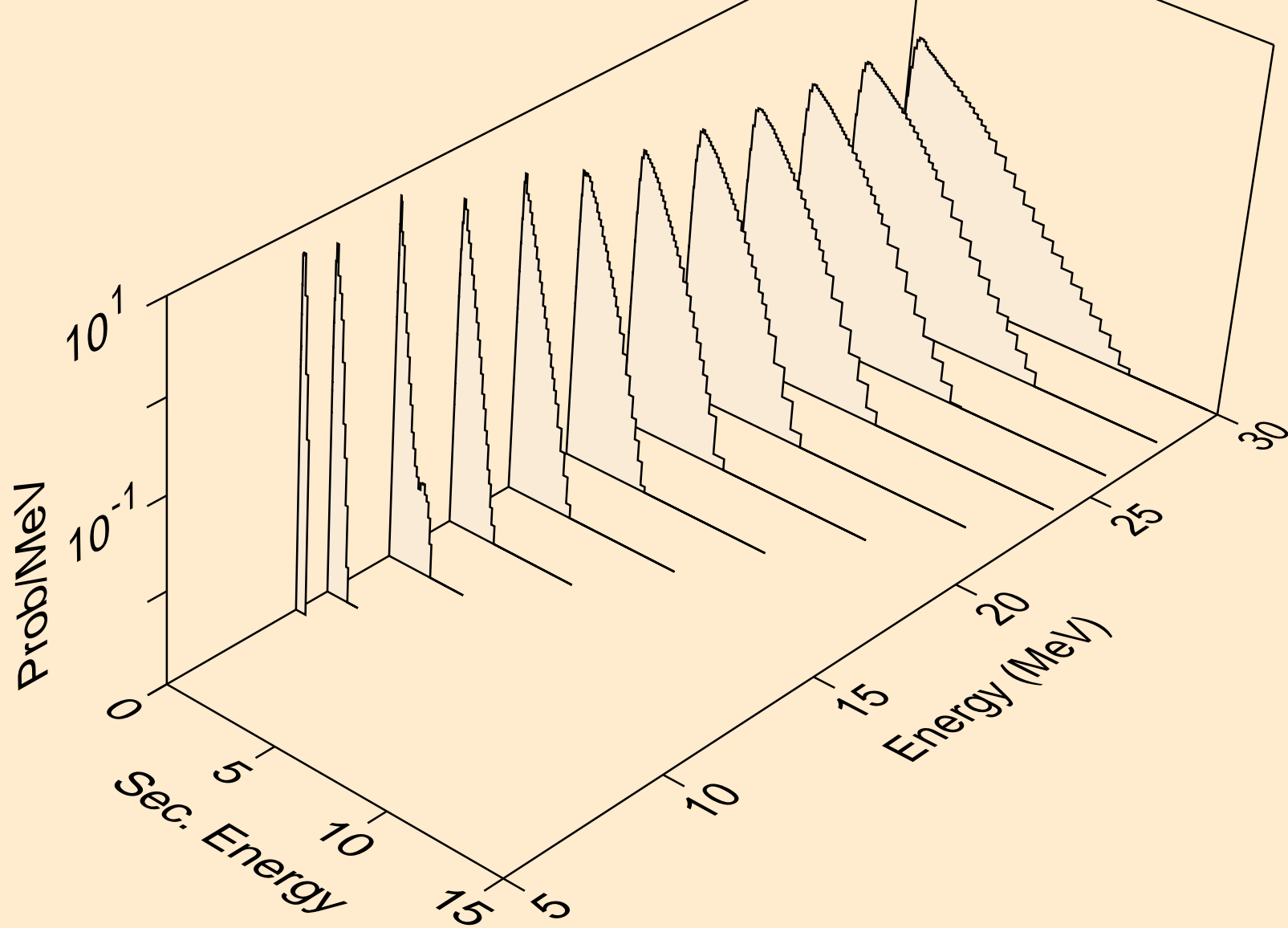

BR081 NEUTRON ACER TENDL-2021 LIBRARY; T=293.6K
Neutron emission for (n,2n)a

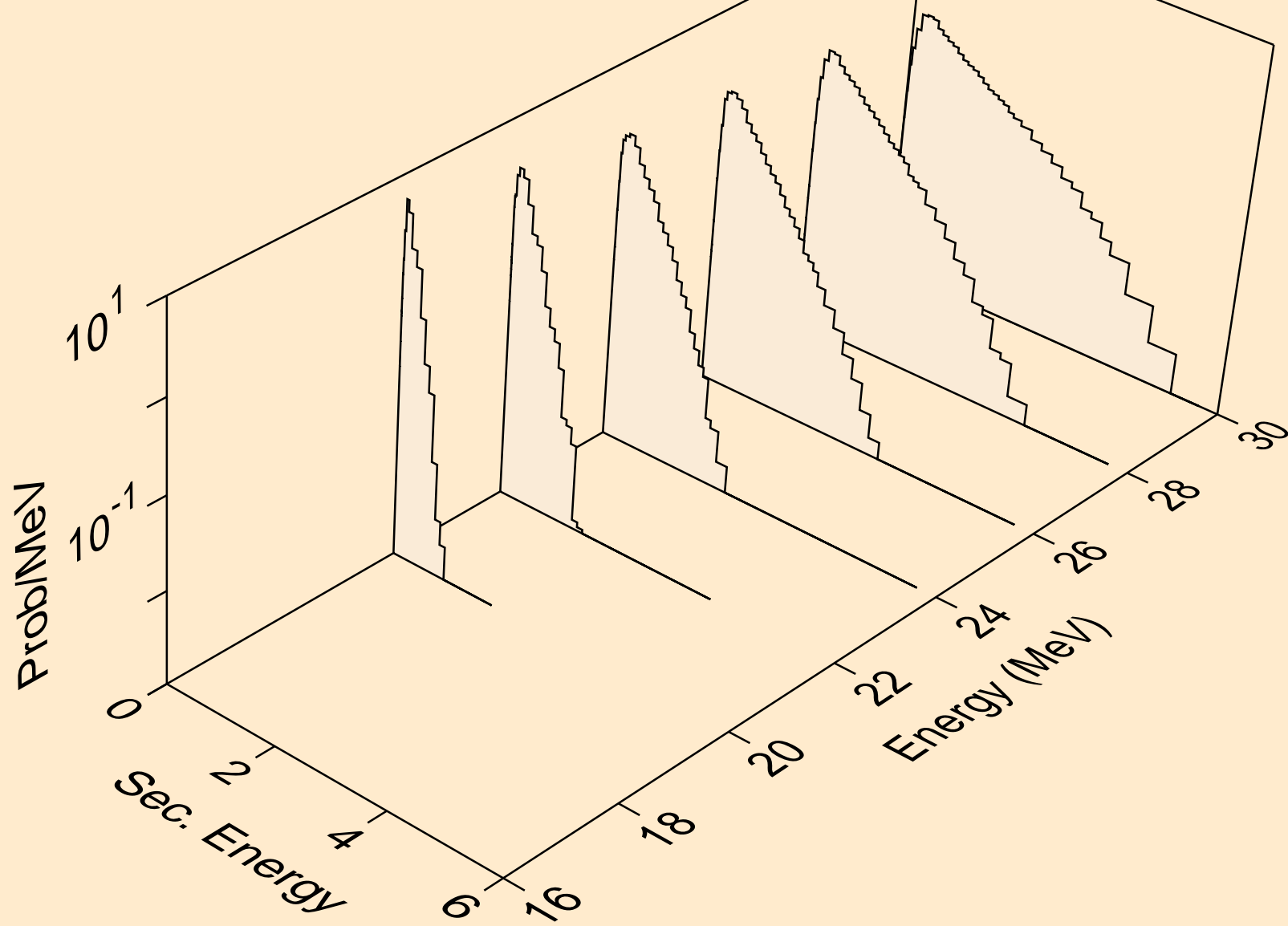

BR081 NEUTRON ACER TENDL-2021 LIBRARY; T=293.6K
Neutron emission for (n,3n)a

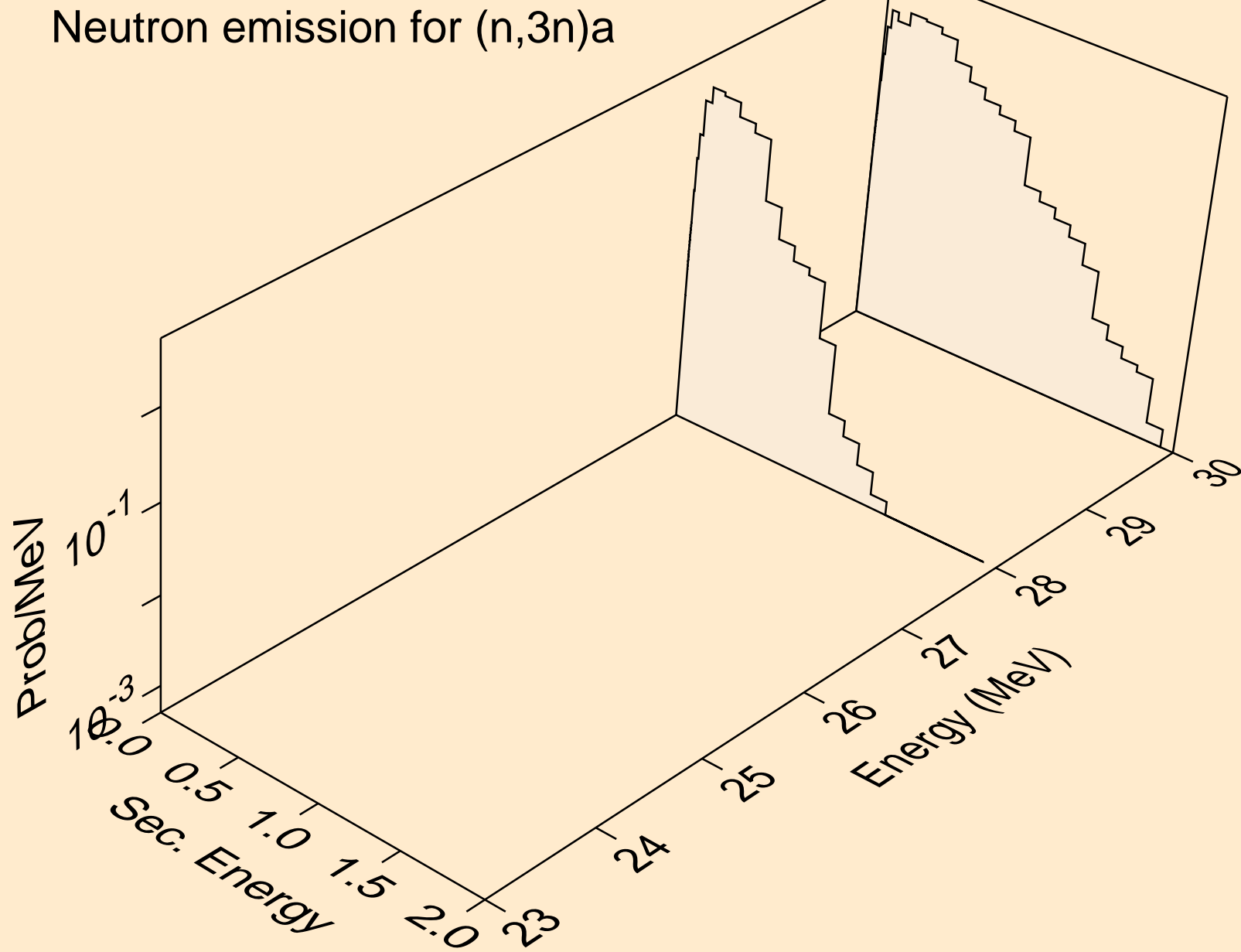

BR081 NEUTRON ACER TENDL-2021 LIBRARY; T=293.6K
Neutron emission for (n,n*)p

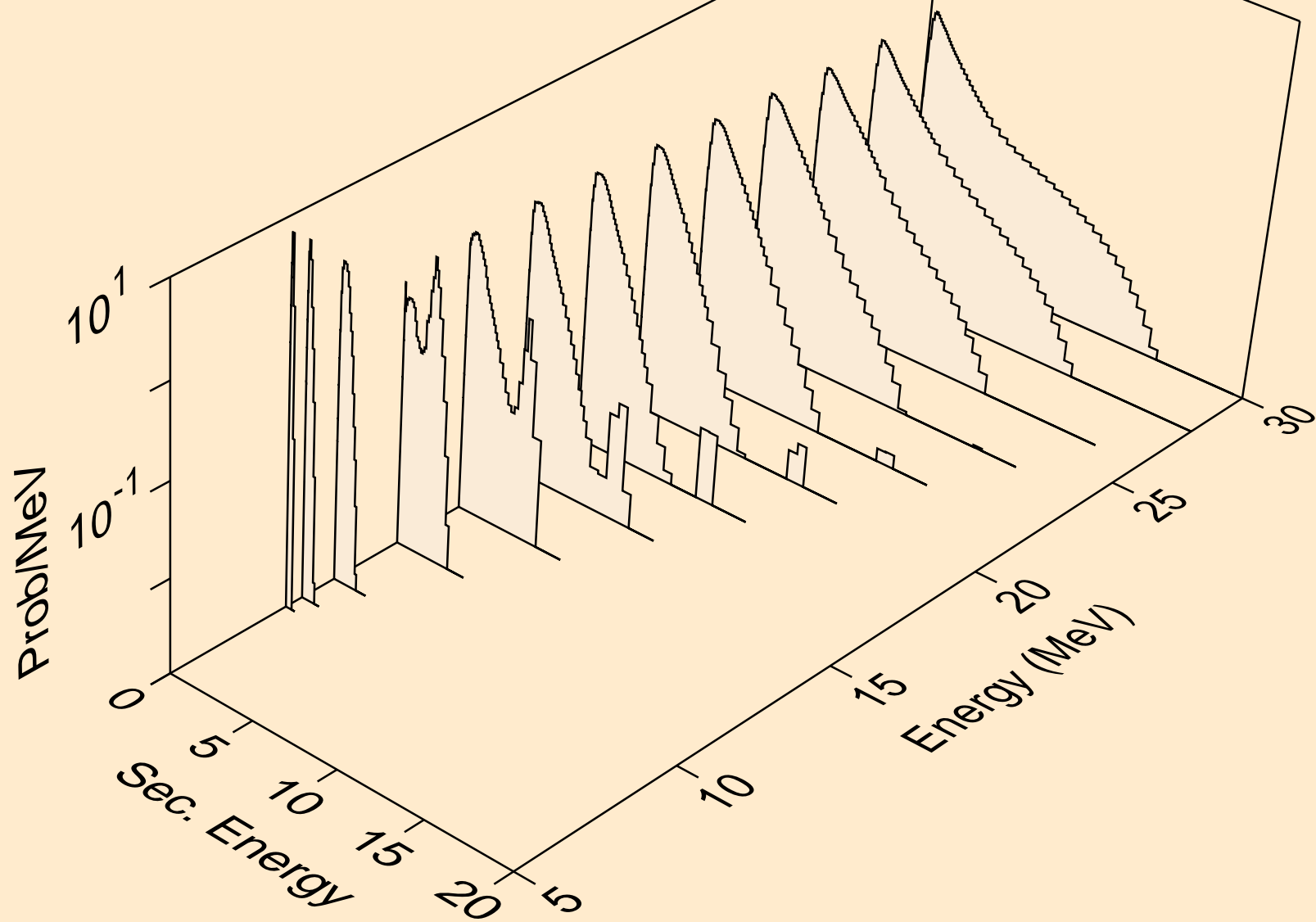

BR081 NEUTRON ACER TENDL-2021 LIBRARY; T=293.6K
Neutron emission for (n,n*)2a

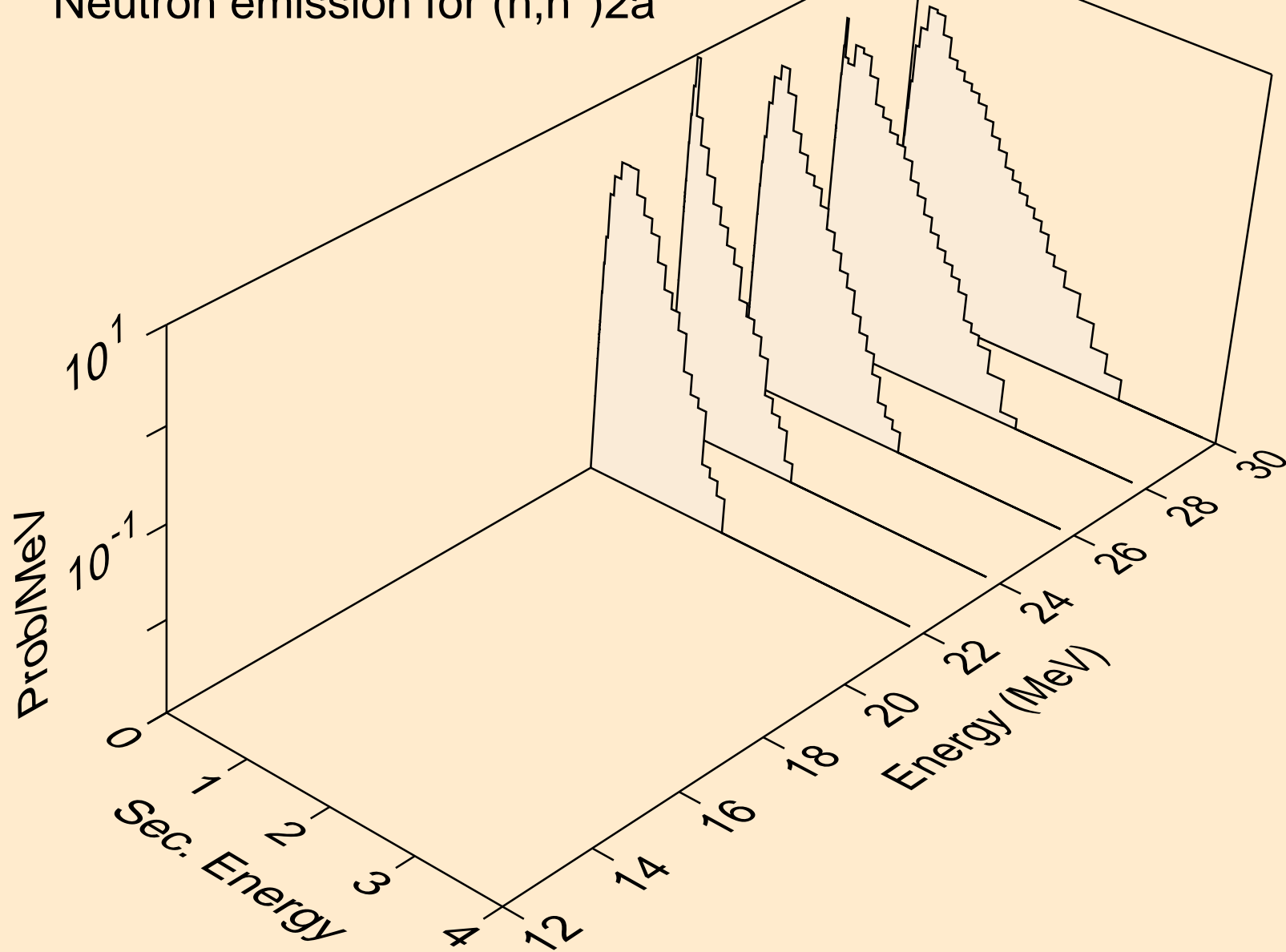

BR081 NEUTRON ACER TENDL-2021 LIBRARY; T=293.6K
Neutron emission for (n,n*)d

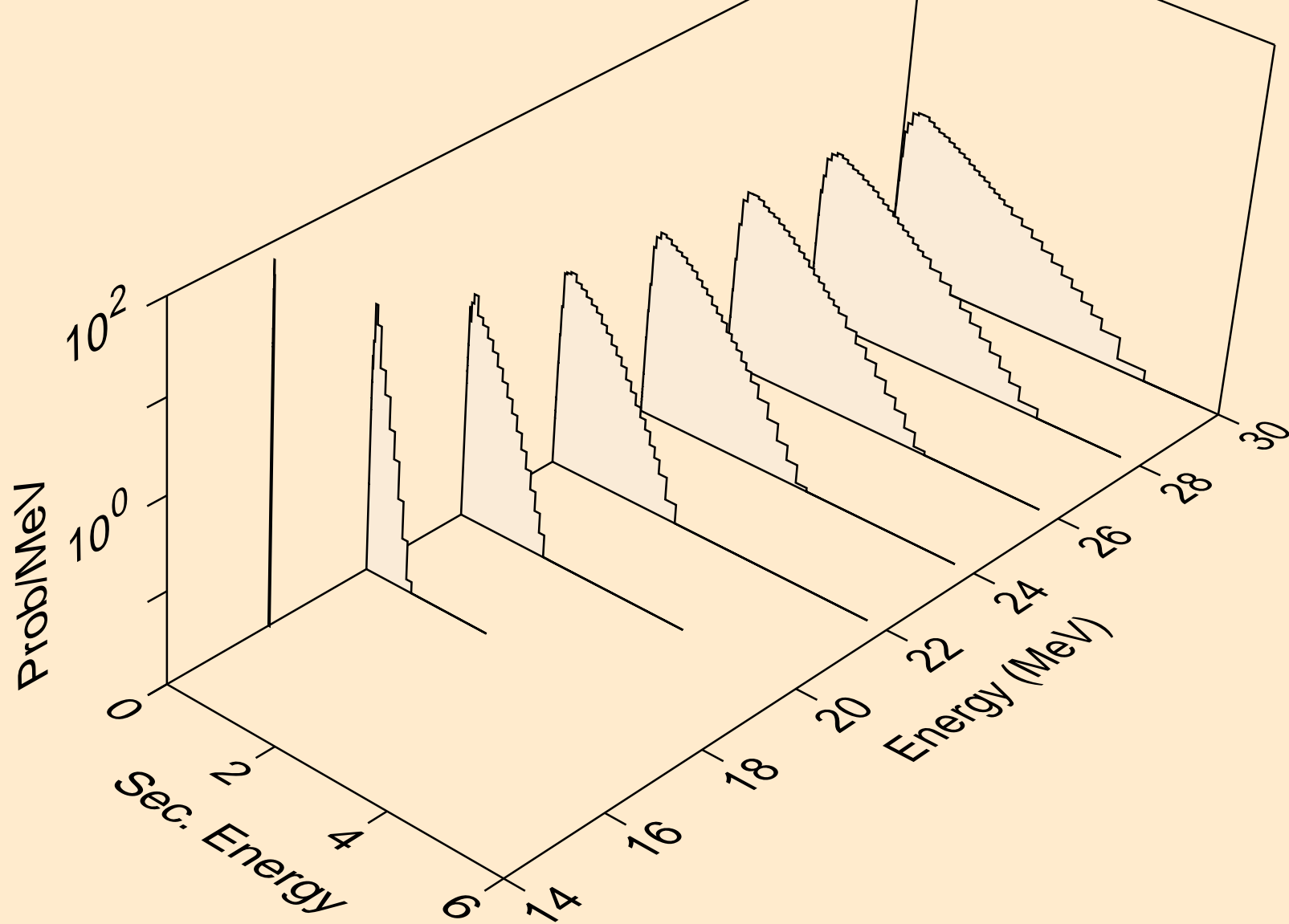

BR081 NEUTRON ACER TENDL-2021 LIBRARY; T=293.6K
Neutron emission for (n,n*)t

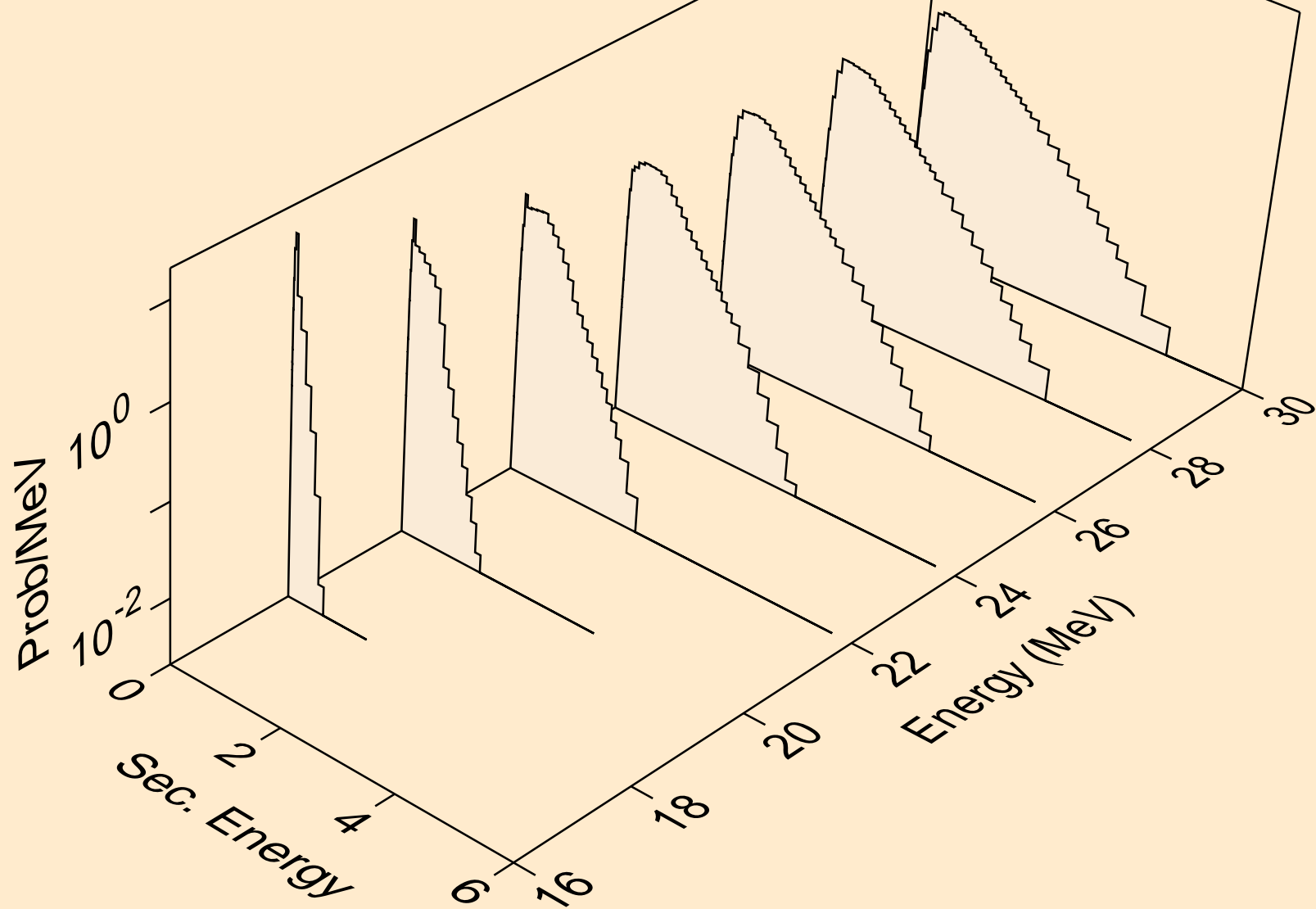

BR081 NEUTRON ACER TENDL-2021 LIBRARY; T=293.6K
Neutron emission for (n,n*)he3

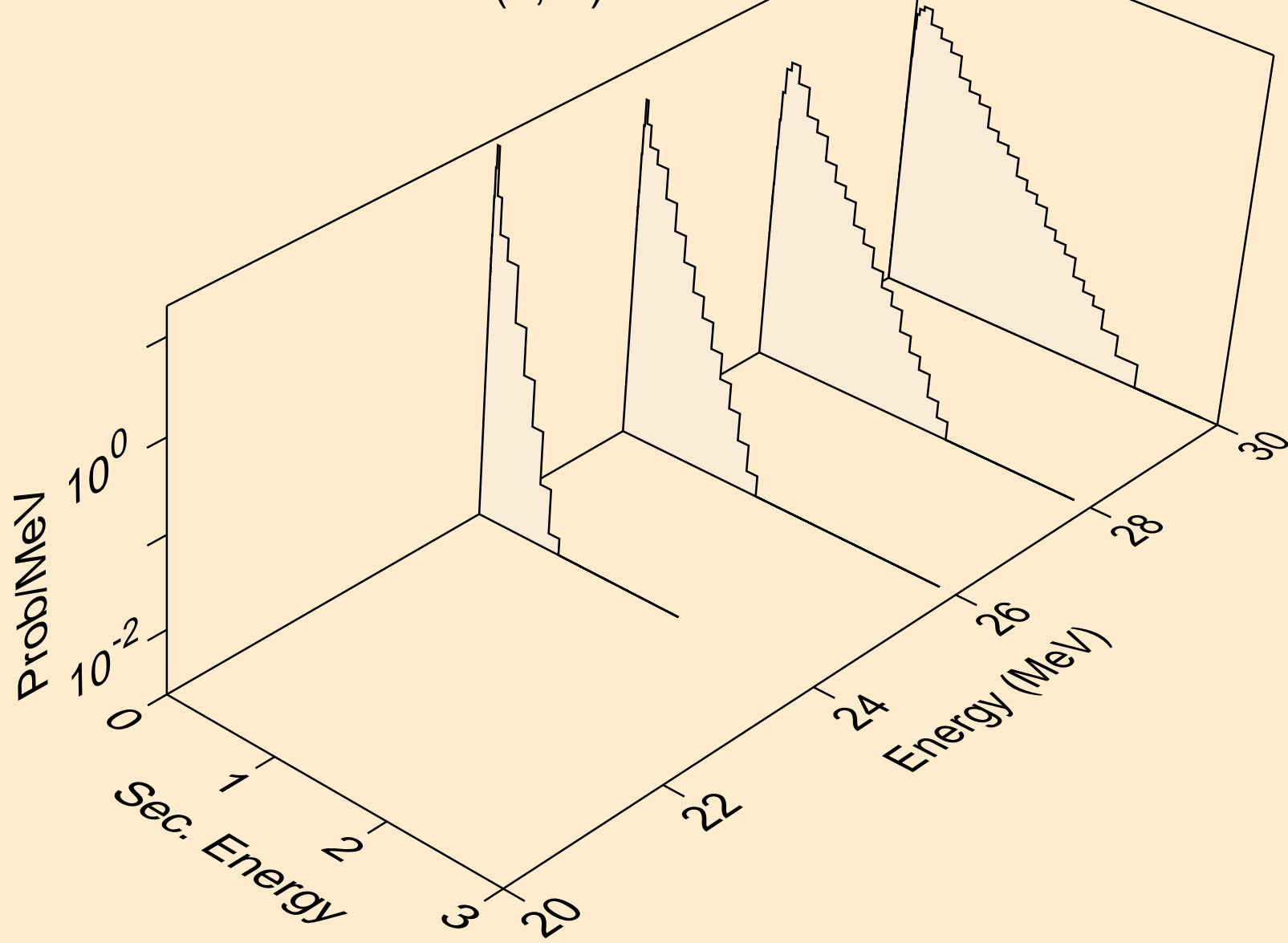

BR081 NEUTRON ACER TENDL-2021 LIBRARY; T=293.6K
Neutron emission for (n,2np)

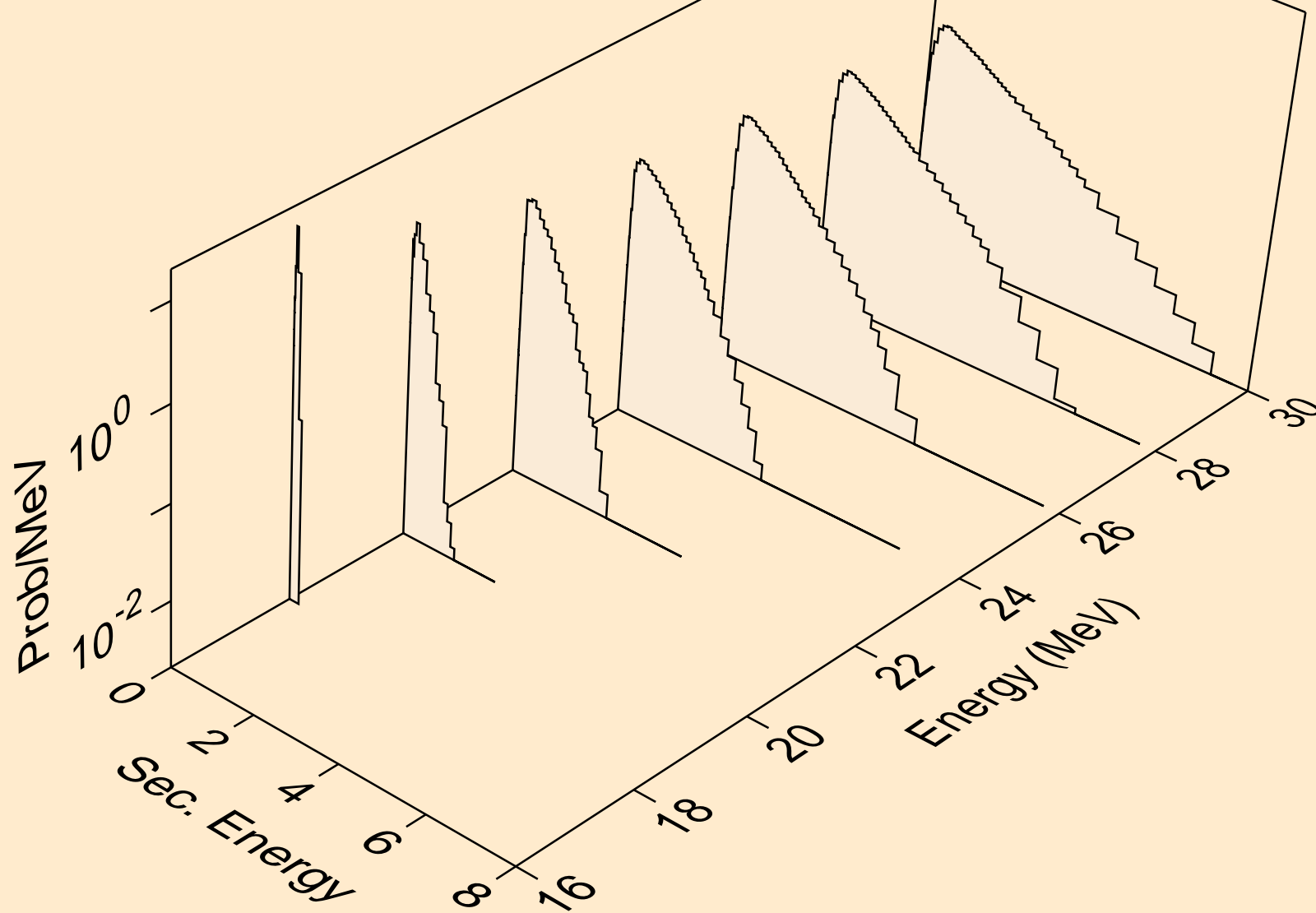

BR081 NEUTRON ACER TENDL-2021 LIBRARY; T=293.6K
Neutron emission for (n,3np)

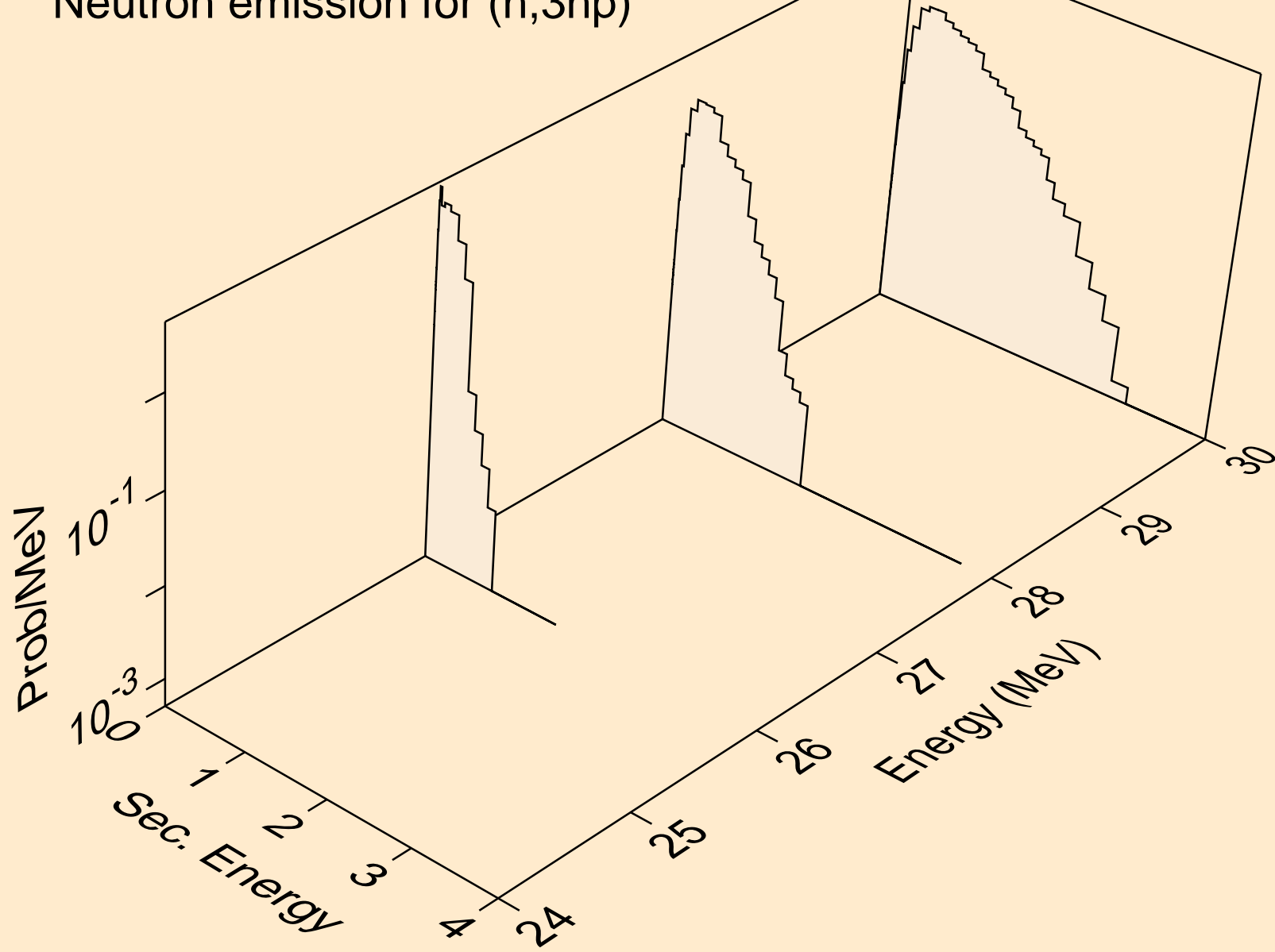

BR081 NEUTRON ACER TENDL-2021 LIBRARY; T=293.6K
Neutron emission for (n,2np)

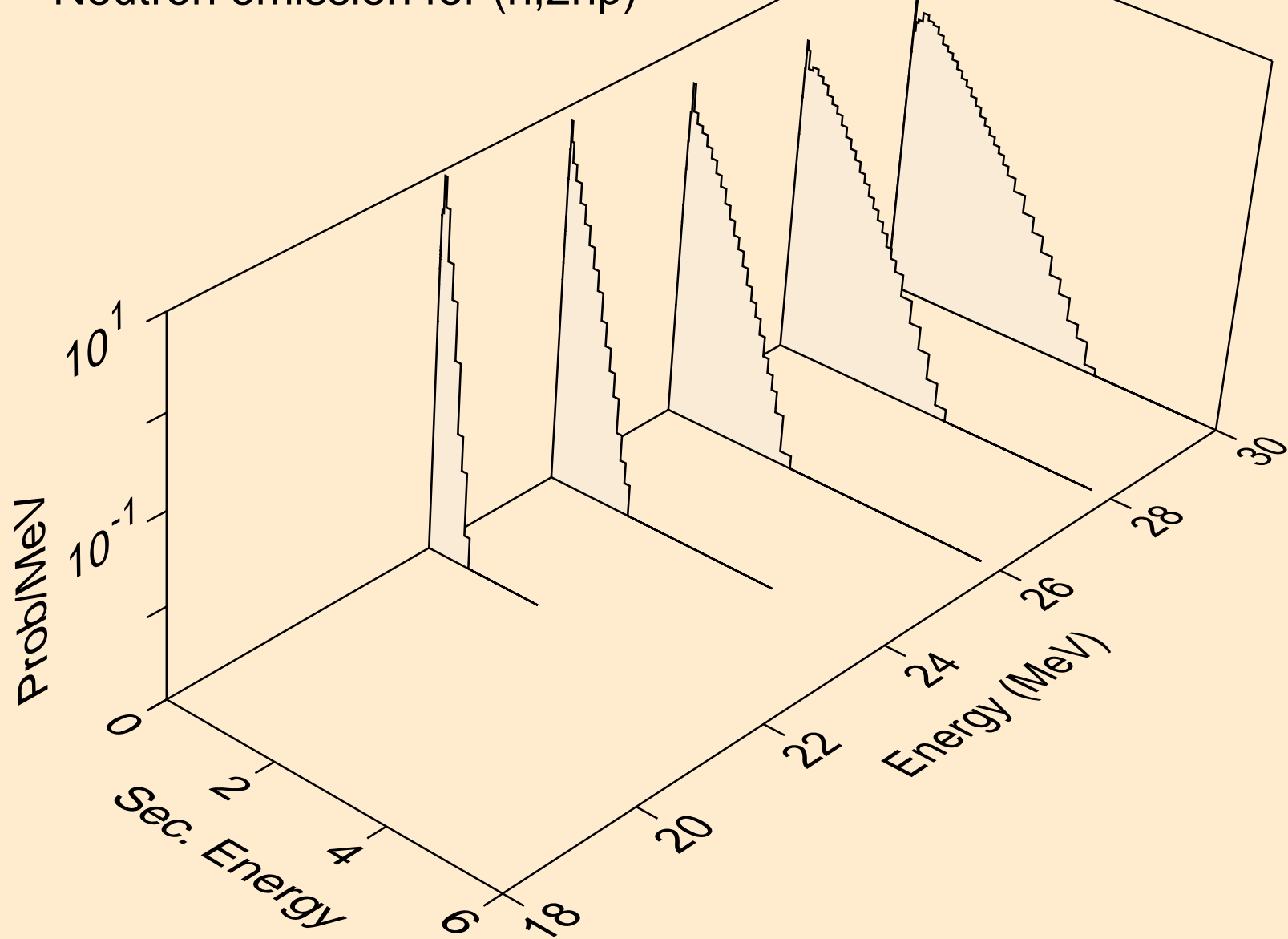

BR081 NEUTRON ACER TENDL-2021 LIBRARY; T=293.6K
Neutron emission for (n,npa)

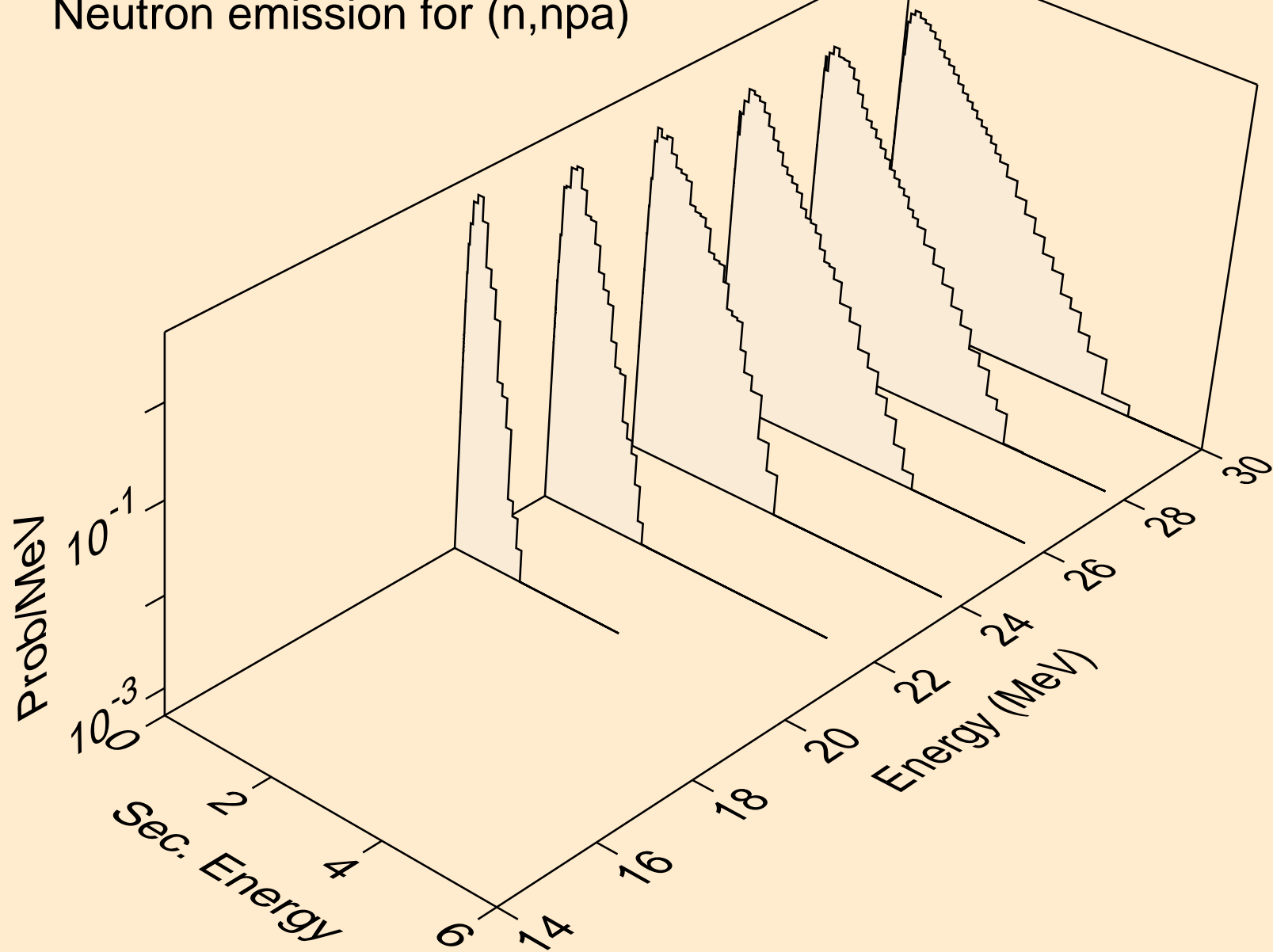

BR081 NEUTRON ACER TENDL-2021 LIBRARY; T=293.6K
Neutron emission for (n,n*c)

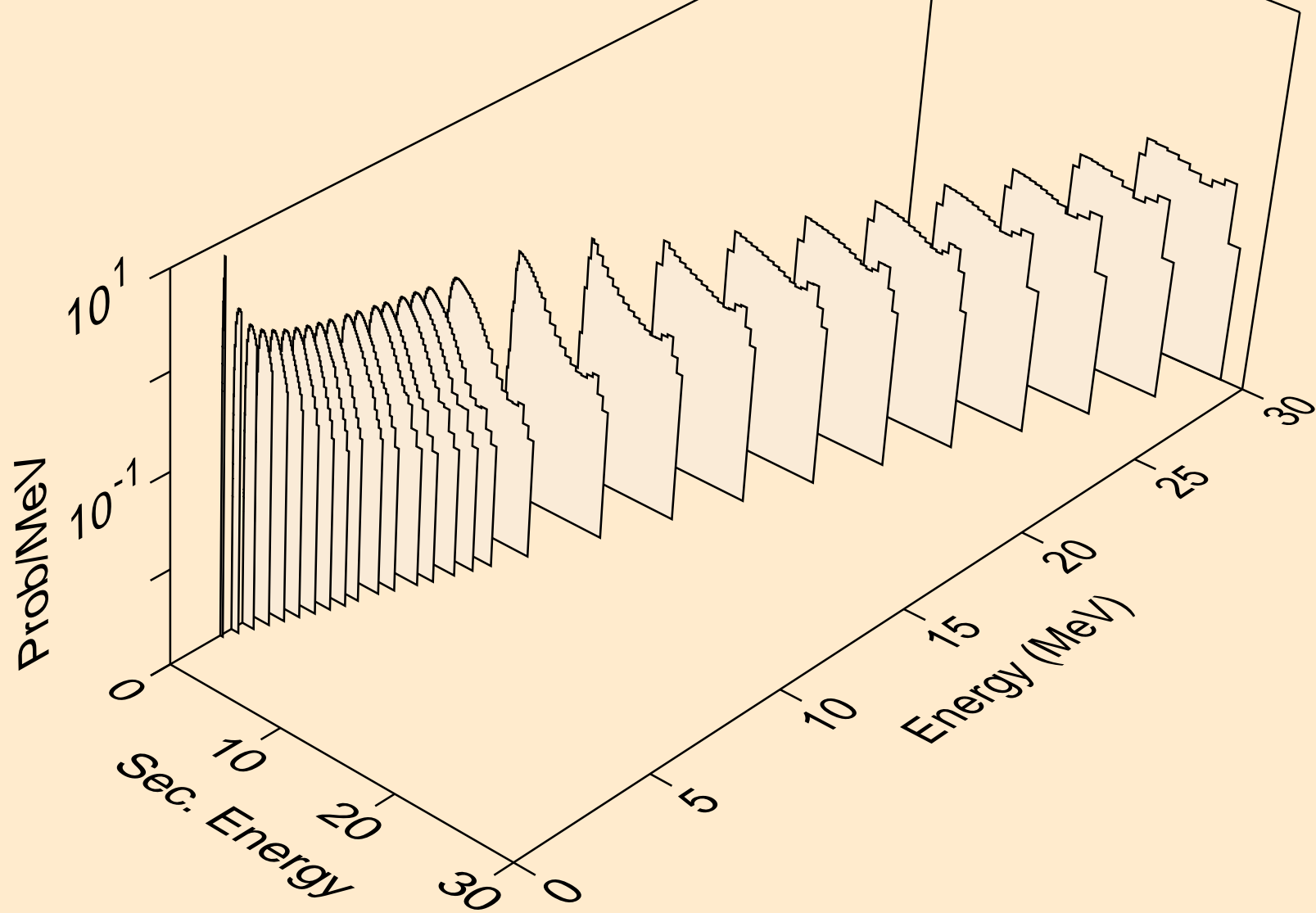

BR081 NEUTRON ACER TENDL-2021 LIBRARY; T=293.6K
Photon emission for (n,x)

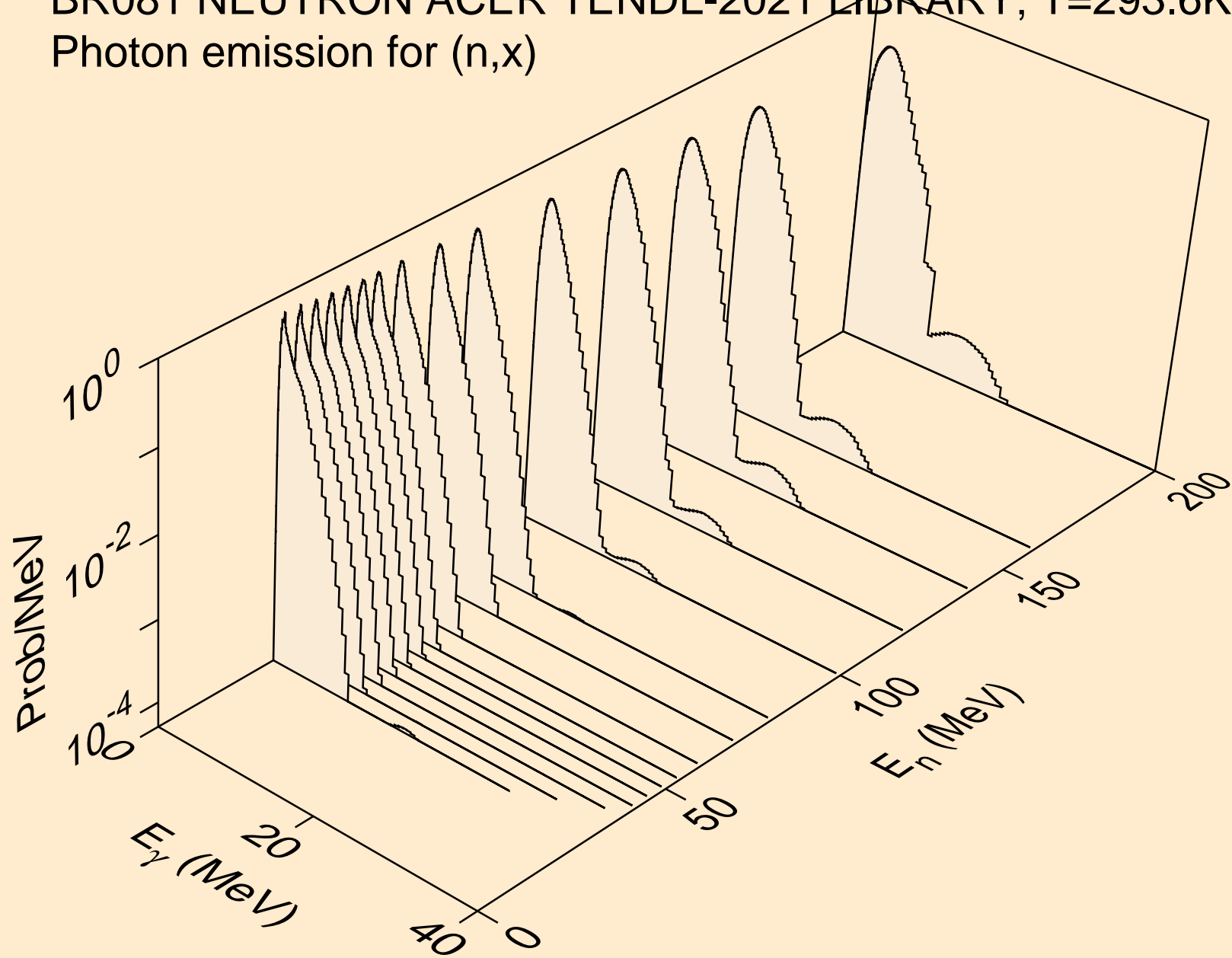

BR081 NEUTRON ACER TENDL-2021 LIBRARY; T=293.6K
Photon emission for (n,2nd)

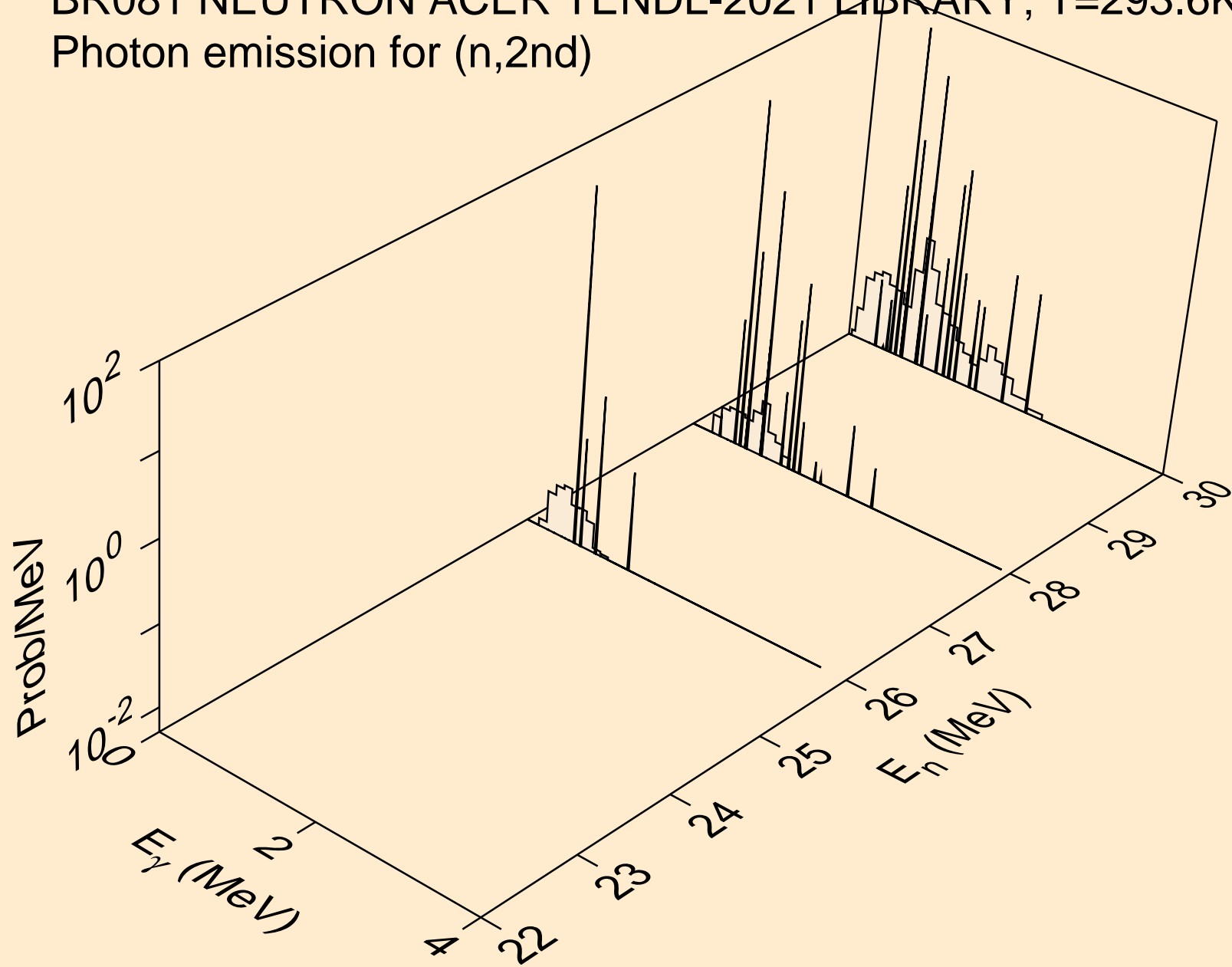

BR081 NEUTRON ACER TENDL-2021 LIBRARY; T=293.6K
Photon emission for (n,2n)

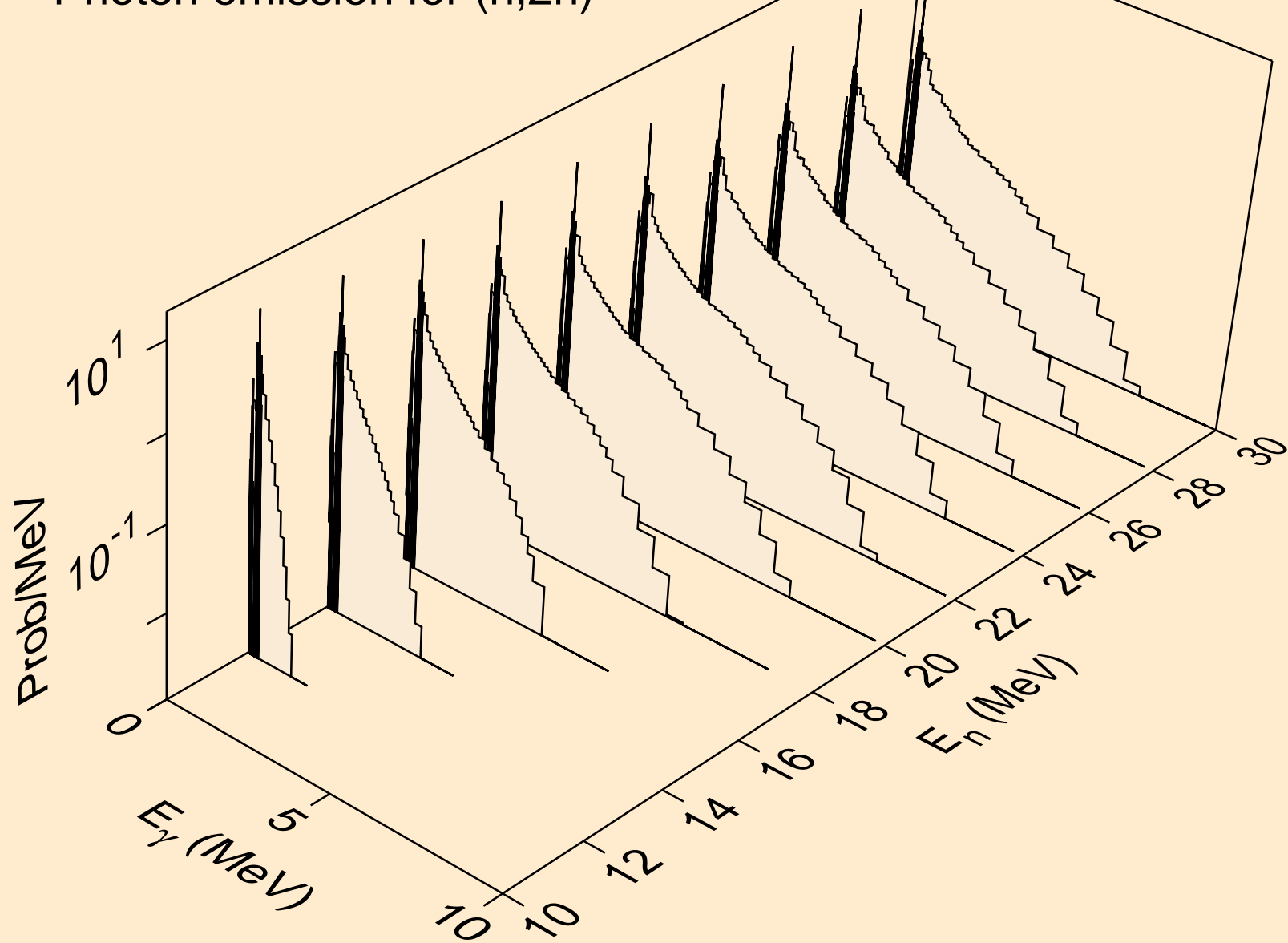

BR081 NEUTRON ACER TENDL-2021 LIBRARY; T=293.6K
Photon emission for (n,3n)

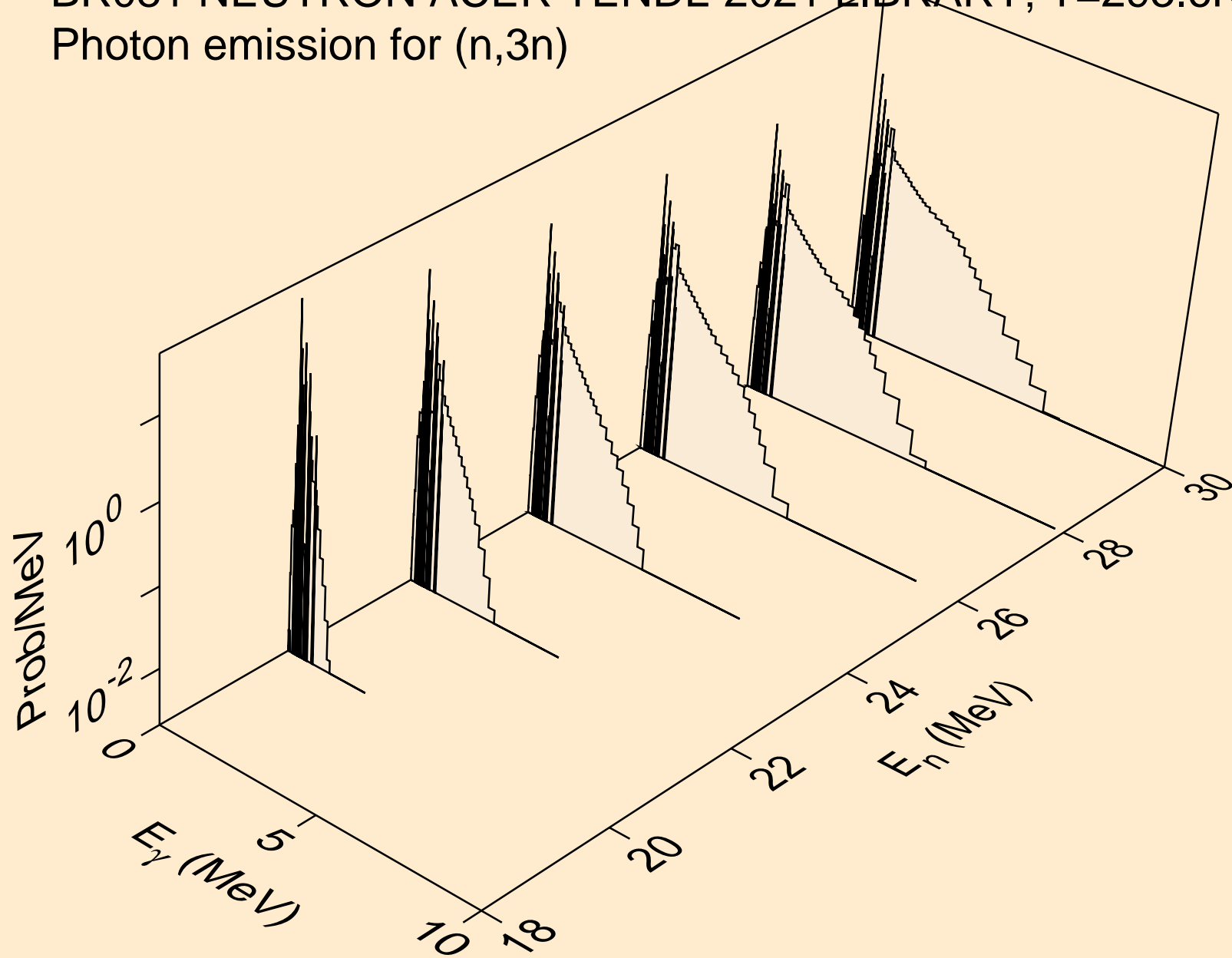

BR081 NEUTRON ACER TENDL-2021 LIBRARY; T=293.6K
Photon emission for (n,n*)a

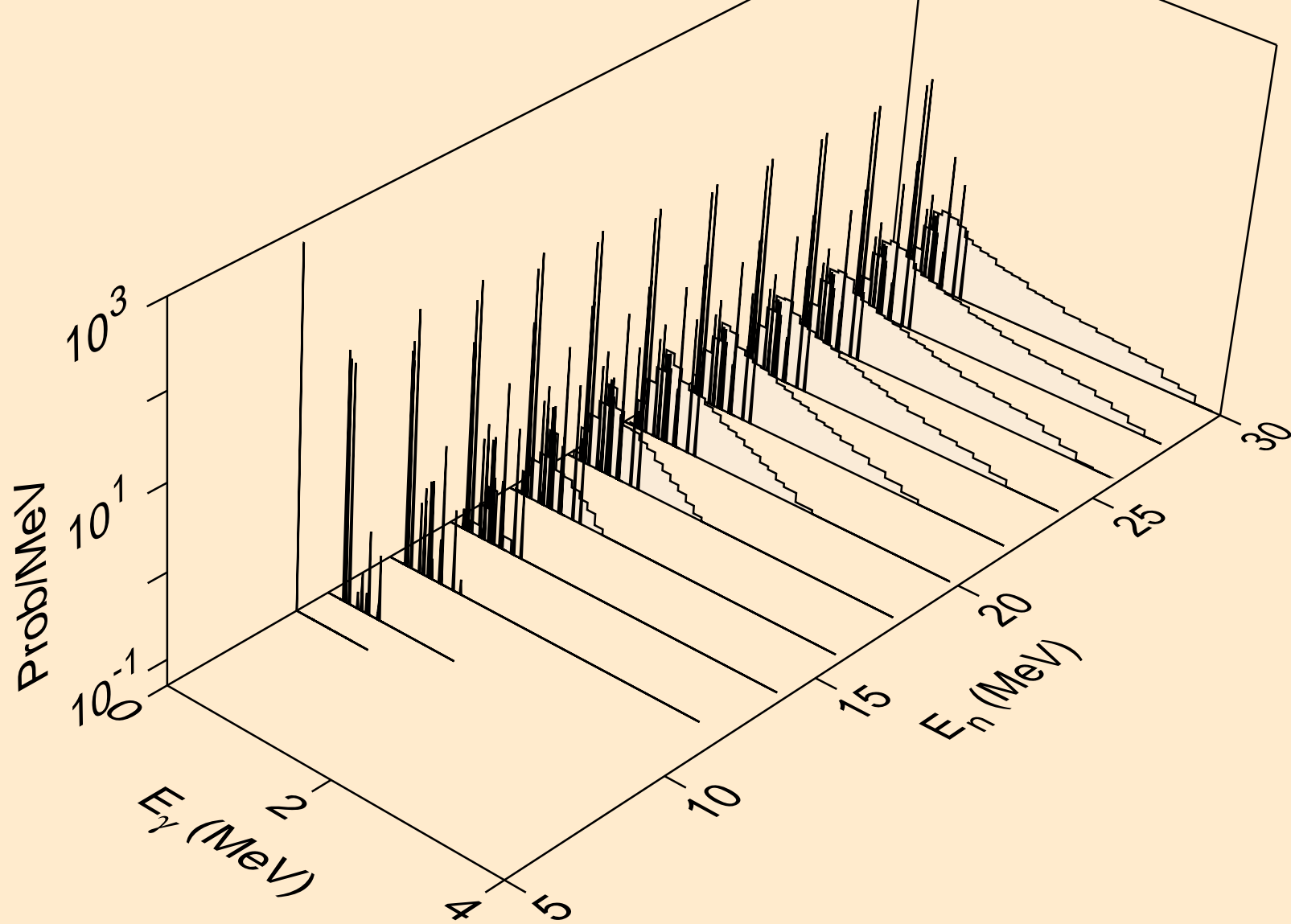

BR081 NEUTRON ACER TENDL-2021 LIBRARY; T=293.6K
Photon emission for (n,2n)a

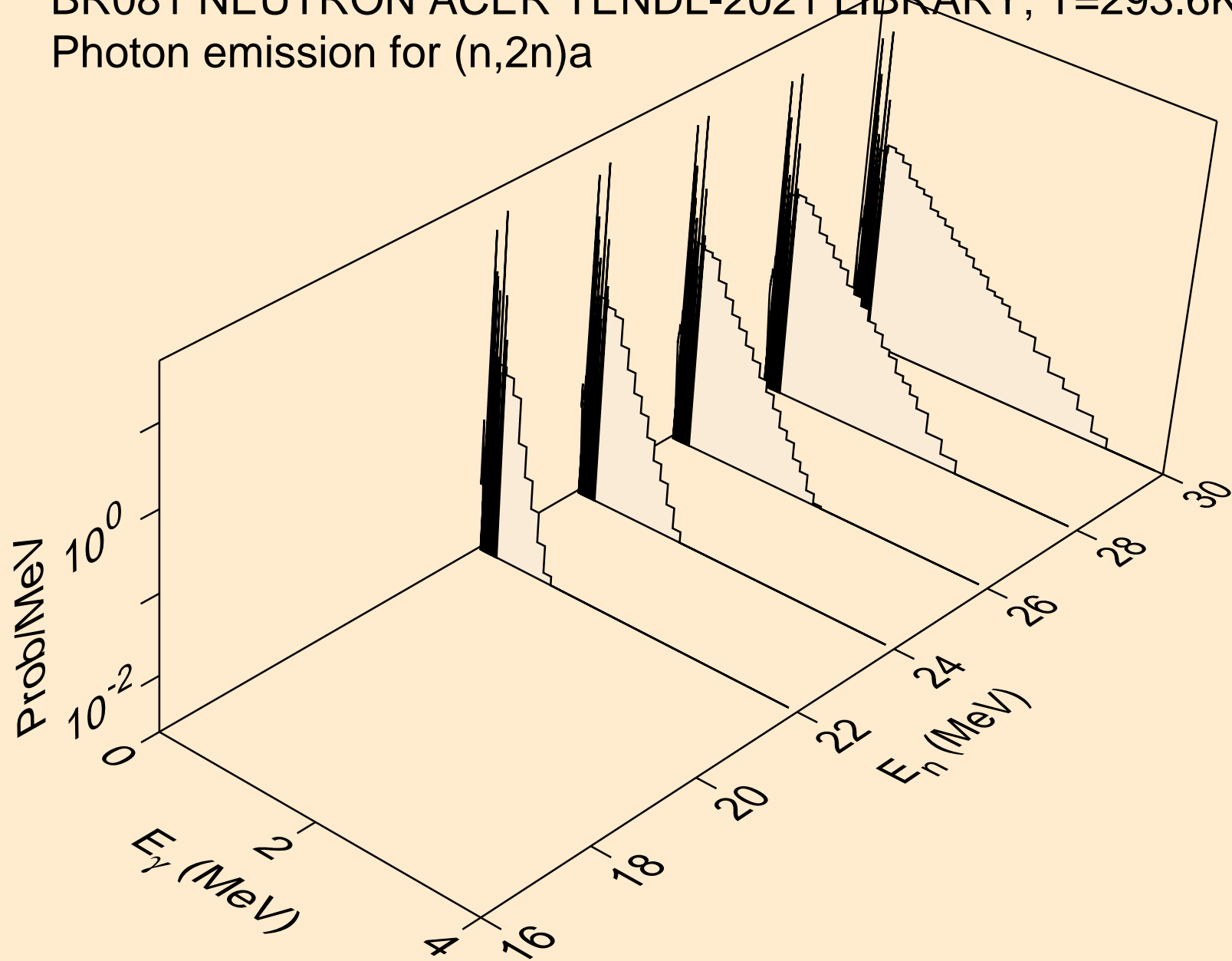

BR081 NEUTRON ACER TENDL-2021 LIBRARY; T=293.6K
Photon emission for (n,3n)a

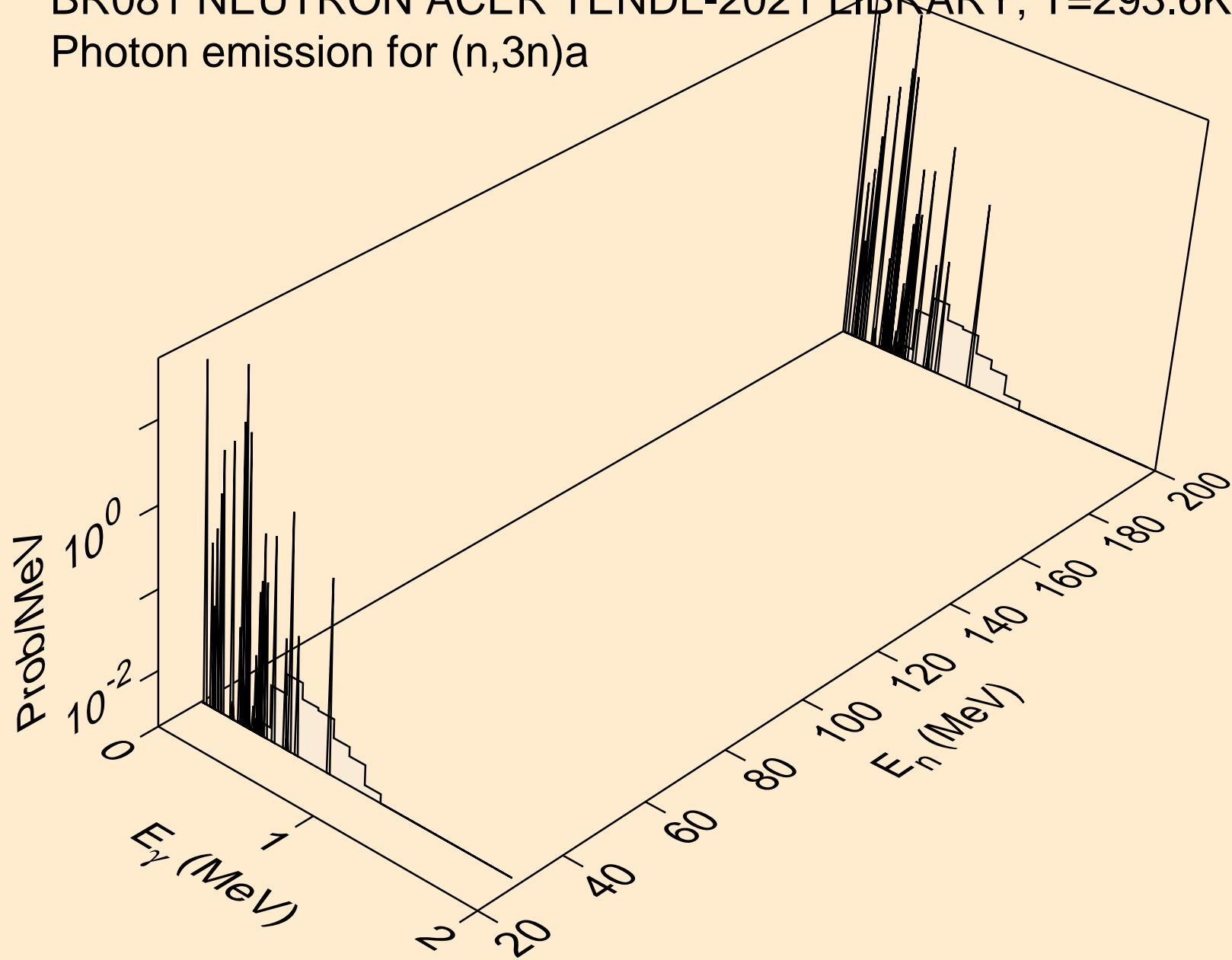

BR081 NEUTRON ACER TENDL-2021 LIBRARY; T=293.6K
Photon emission for (n,n*)p

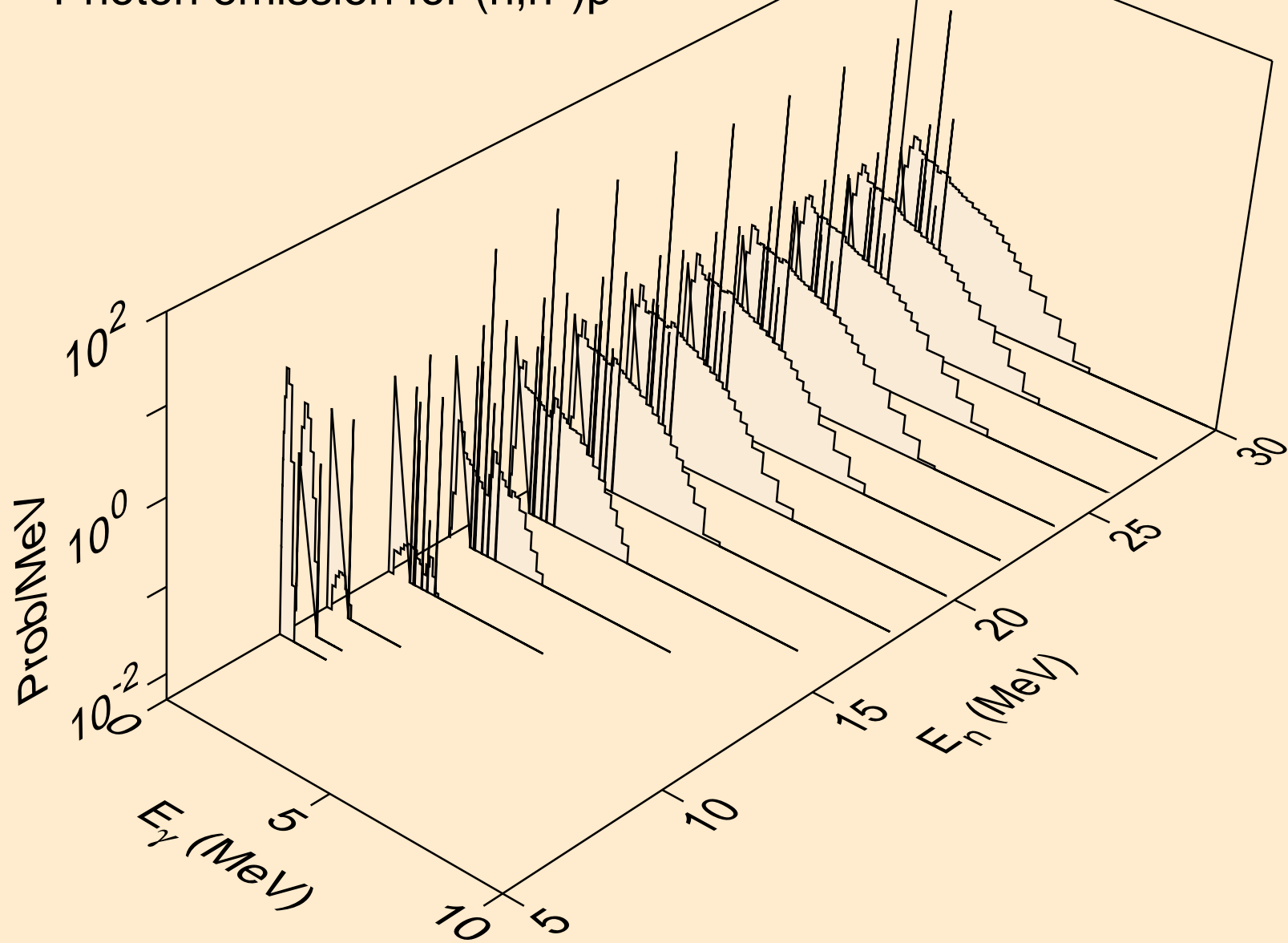

BR081 NEUTRON ACER TENDL-2021 LIBRARY; T=293.6K
Photon emission for (n,n*)2a

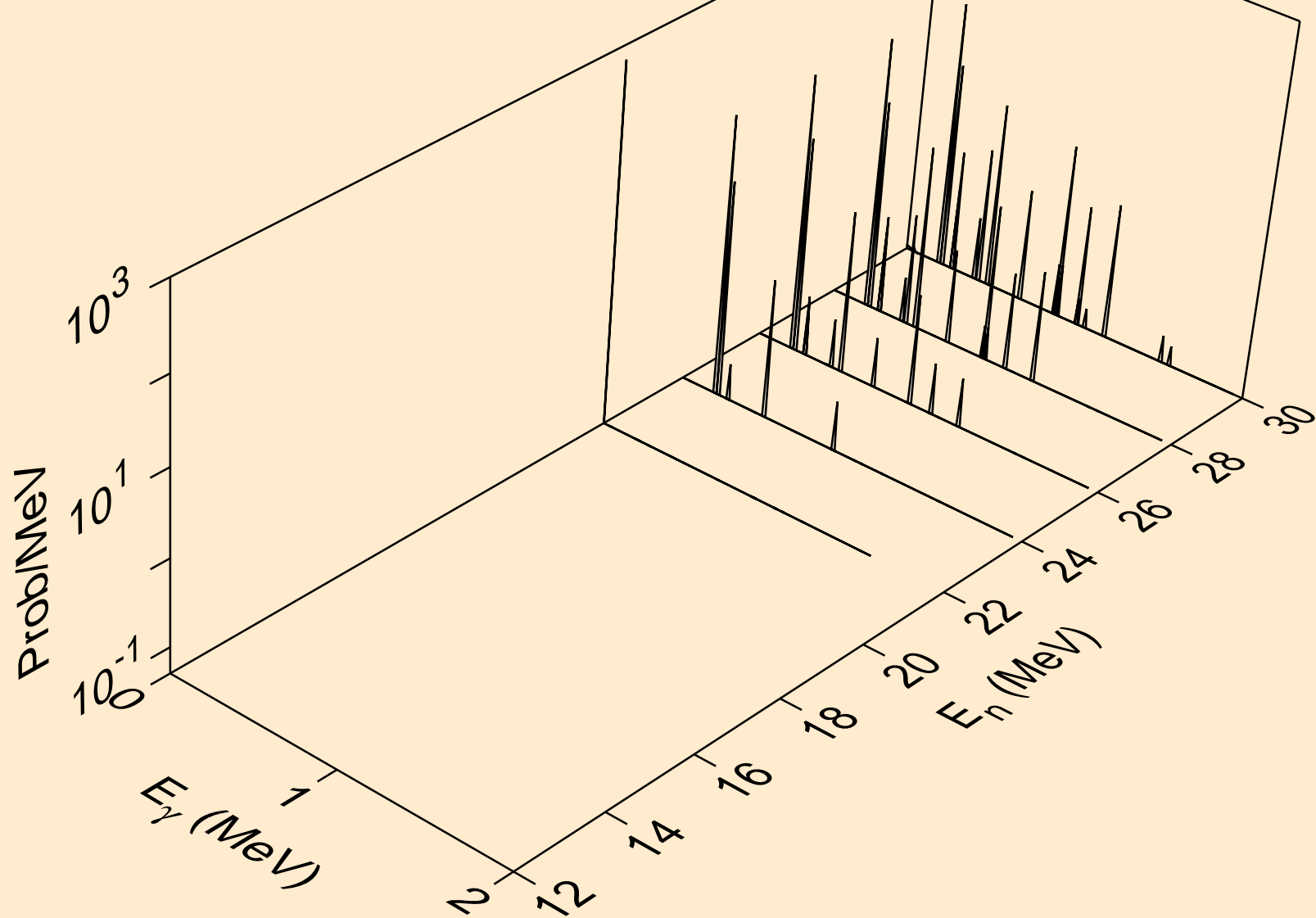

BR081 NEUTRON ACER TENDL-2021 LIBRARY; T=293.6K
Photon emission for (n,n*)d

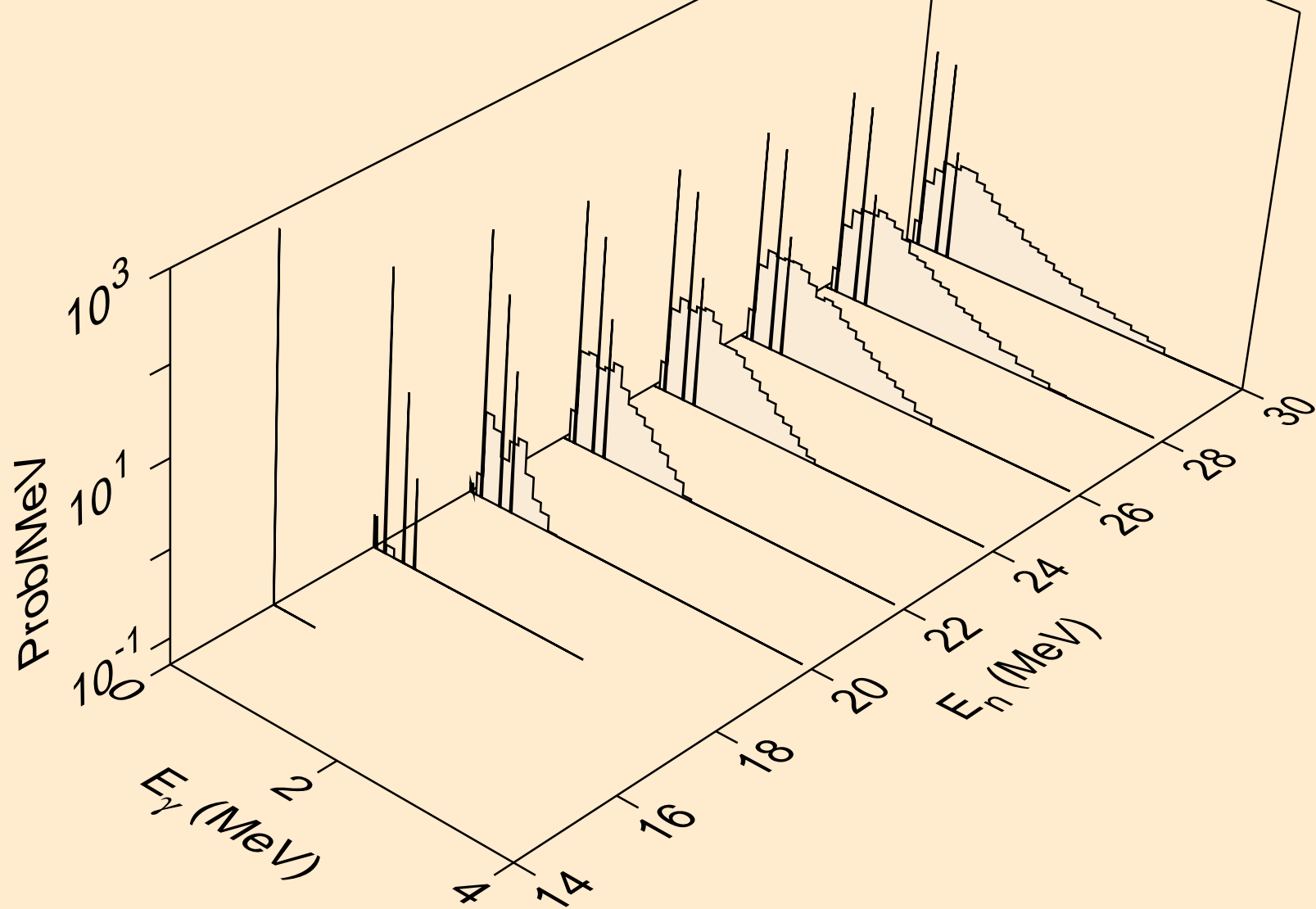

BR081 NEUTRON ACER TENDL-2021 LIBRARY; T=293.6K
Photon emission for (n,n*)t

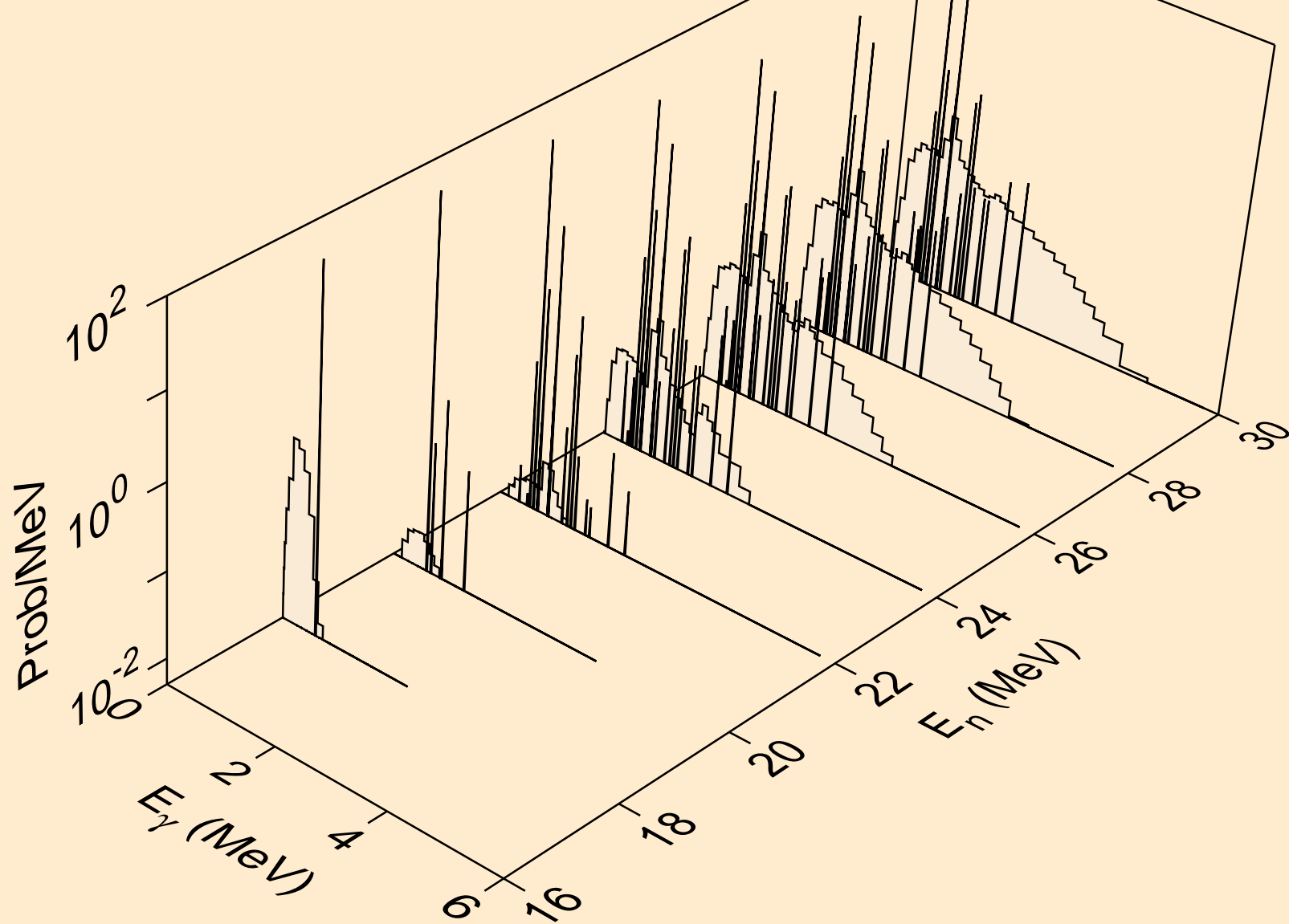

BR081 NEUTRON ACER TENDL-2021 LIBRARY; T=293.6K
Photon emission for (n,n*)he3

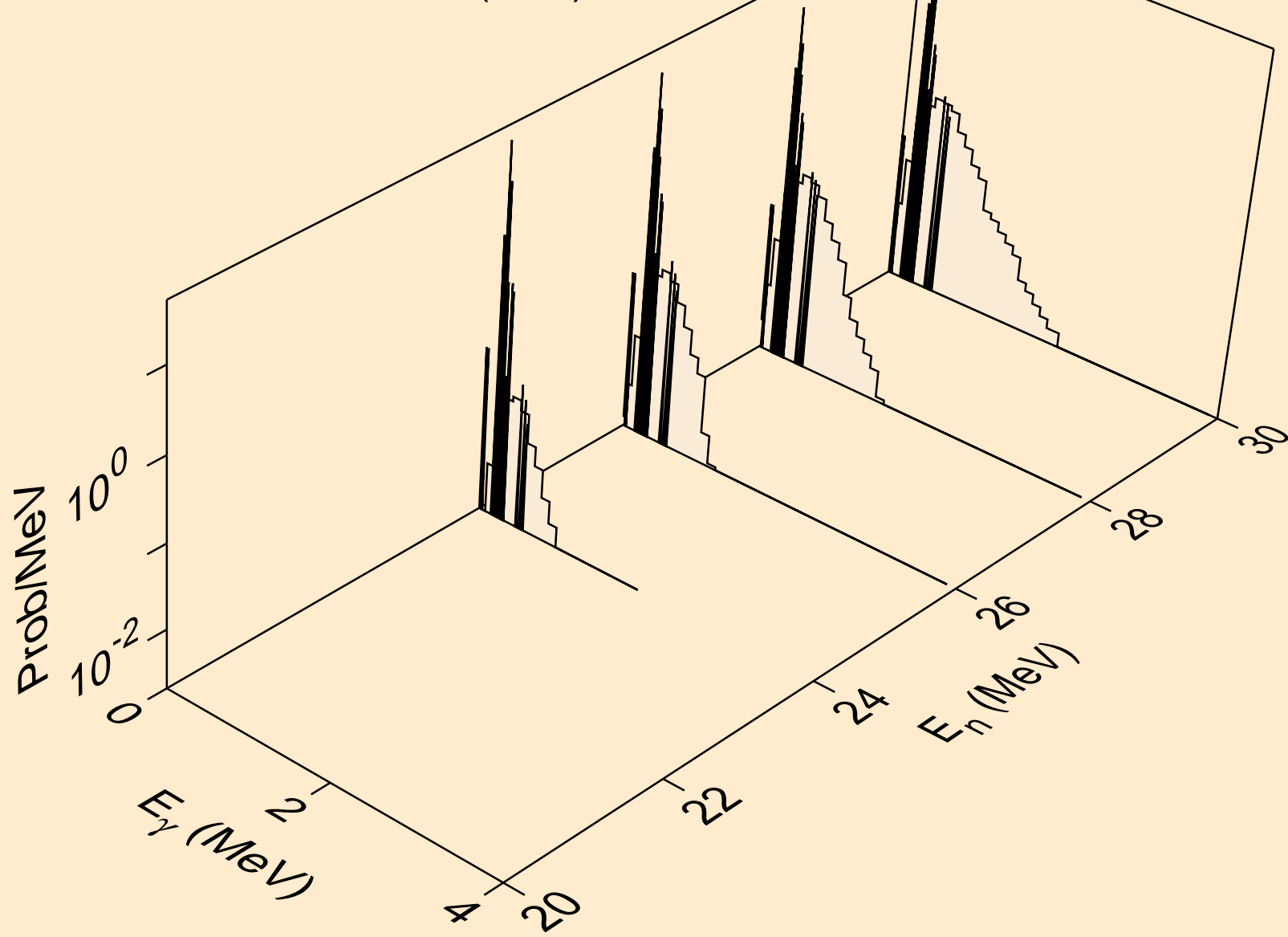

BR081 NEUTRON ACER TENDL-2021 LIBRARY; T=293.6K
Photon emission for (n,2np)

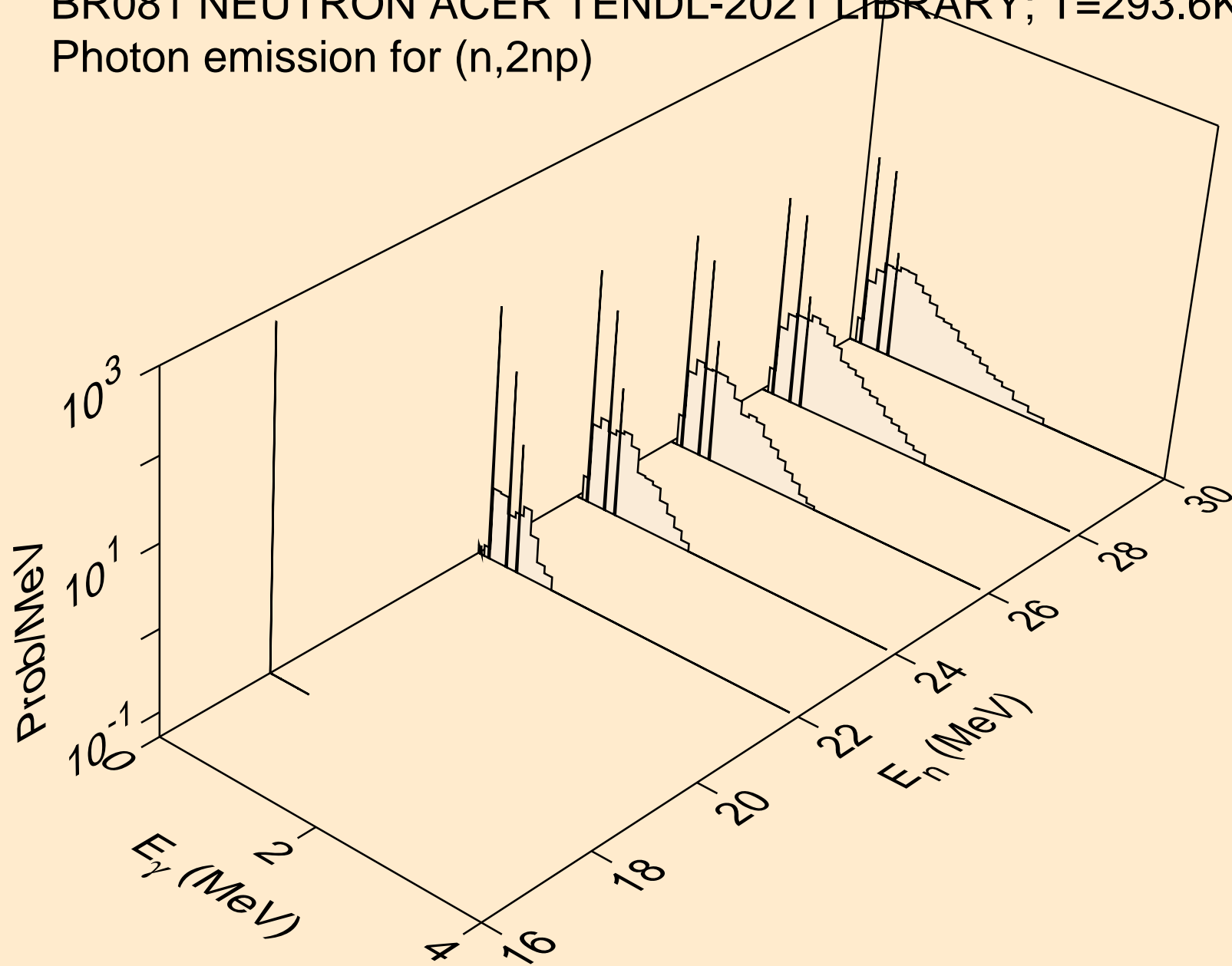

BR081 NEUTRON ACER TENDL-2021 LIBRARY; T=293.6K
Photon emission for (n,3np)

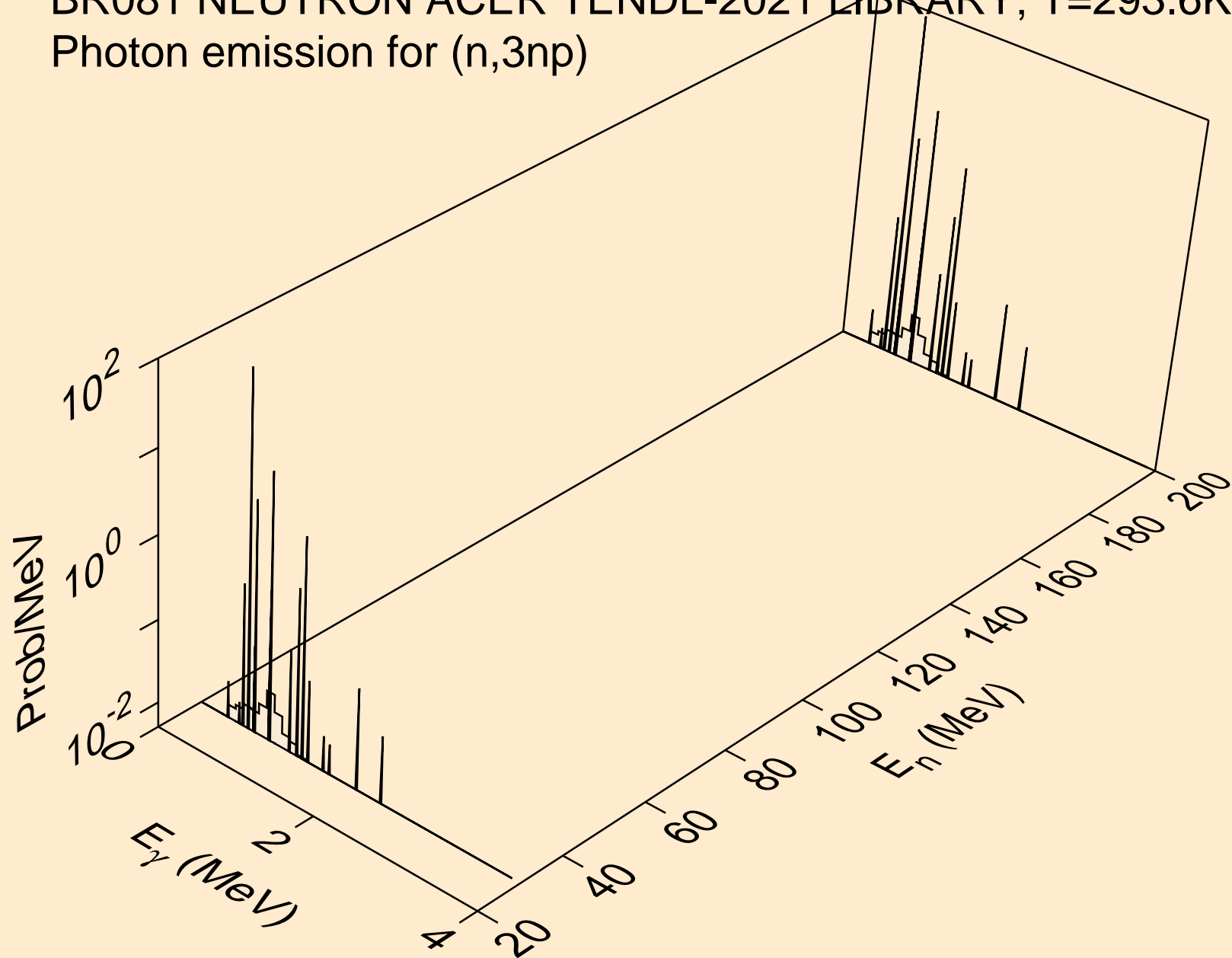

BR081 NEUTRON ACER TENDL-2021 LIBRARY; T=293.6K
Photon emission for (n,2np)

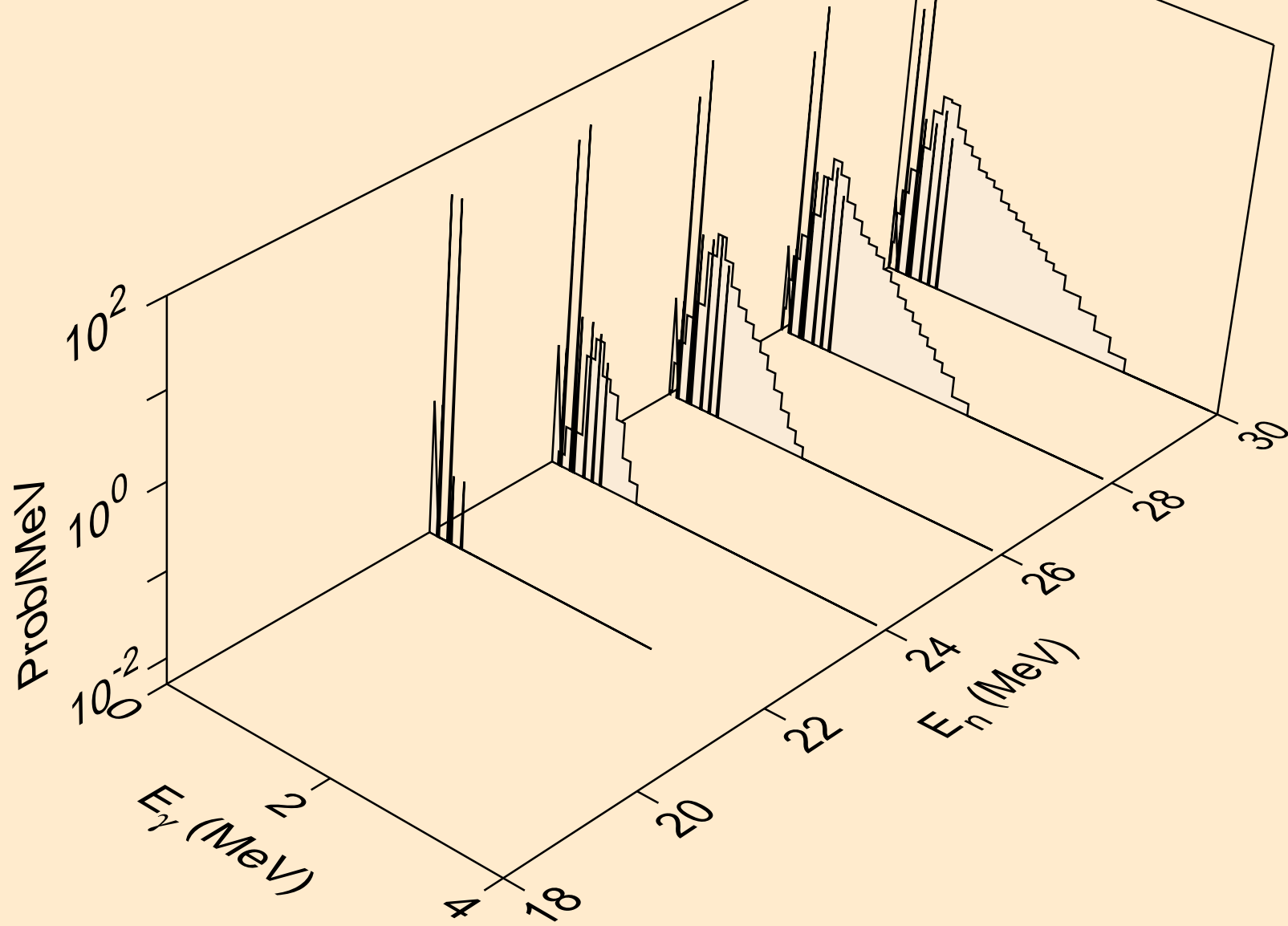

BR081 NEUTRON ACER TENDL-2021 LIBRARY; T=293.6K
Photon emission for (n,npa)

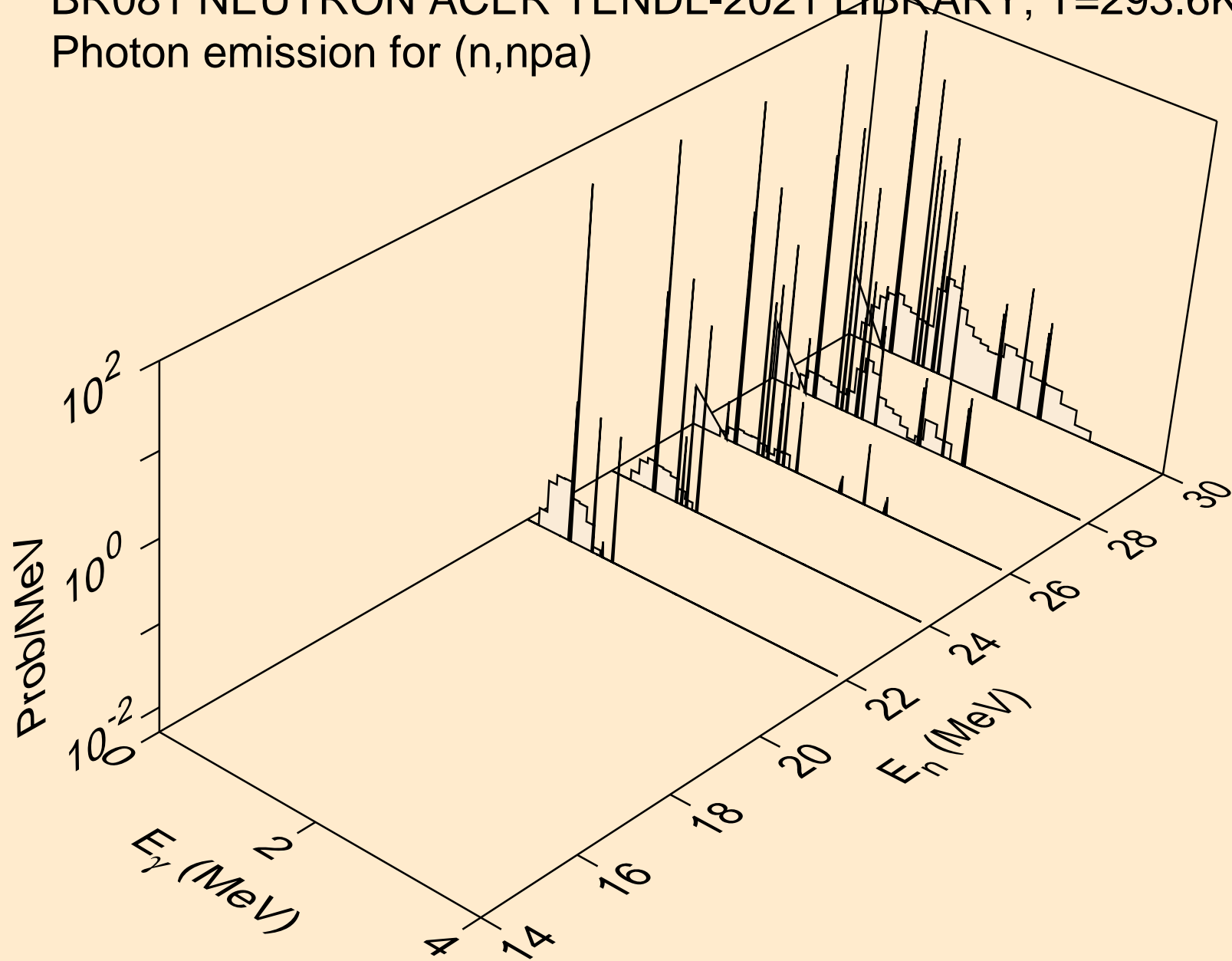

BR081 NEUTRON ACER TENDL-2021 LIBRARY; T=293.6K
Photon emission for (n,n*c)

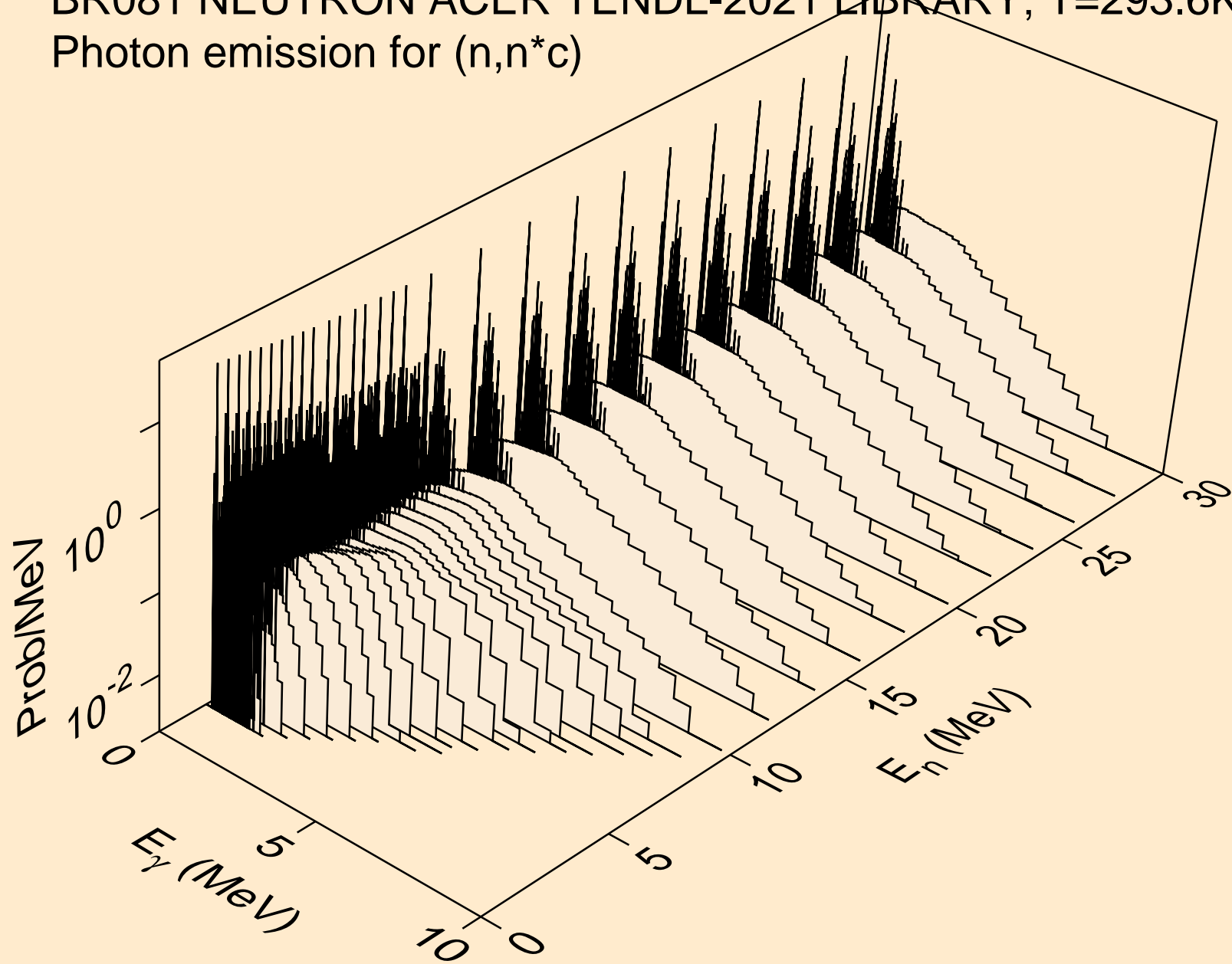

BR081 NEUTRON ACER TENDL-2021 LIBRARY; T=293.6K
Photon emission for (n,gma)

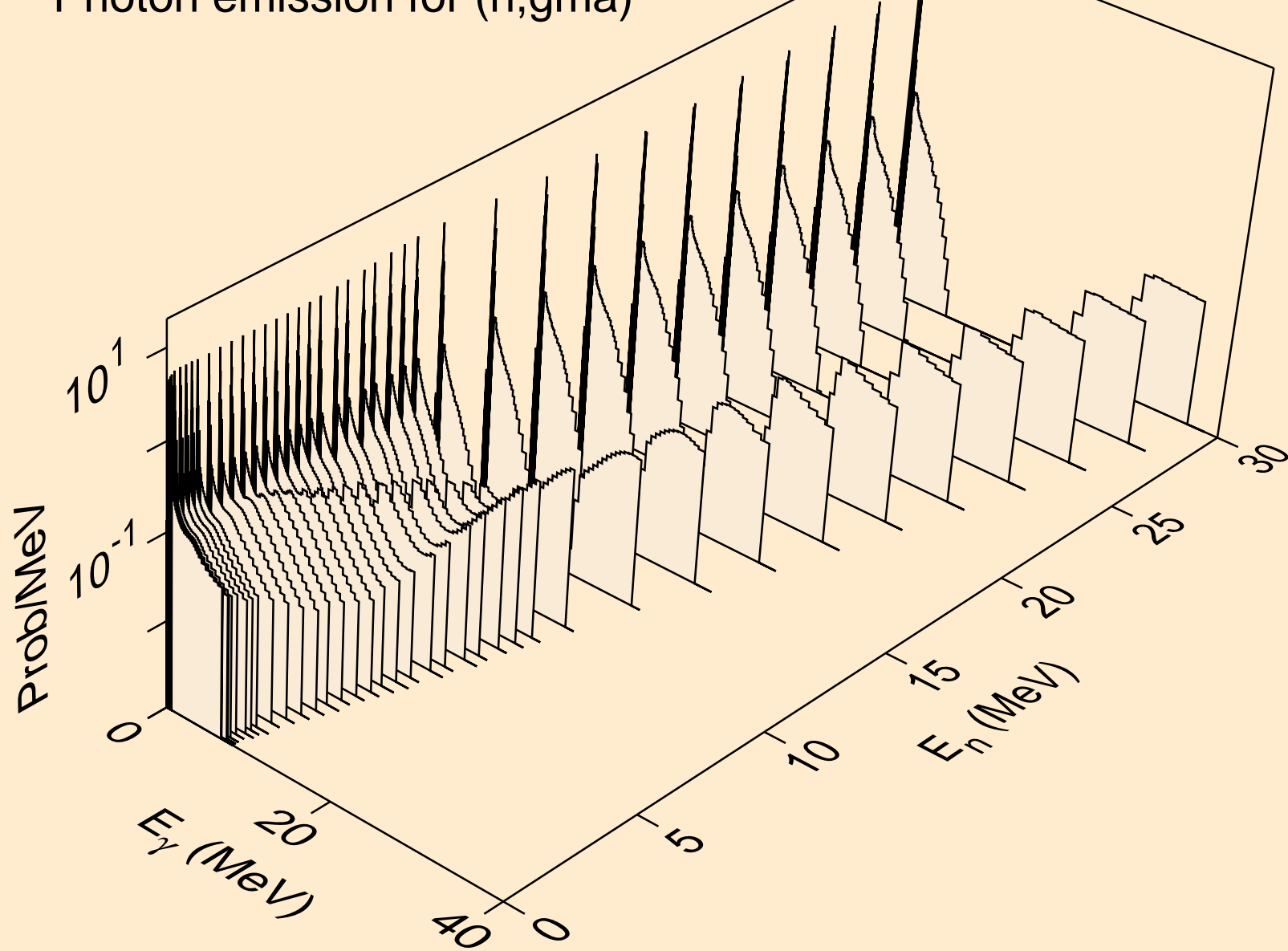

BR081 NEUTRON ACER TENDL-2021 LIBRARY; T=293.6K
Photon emission for (n,p)

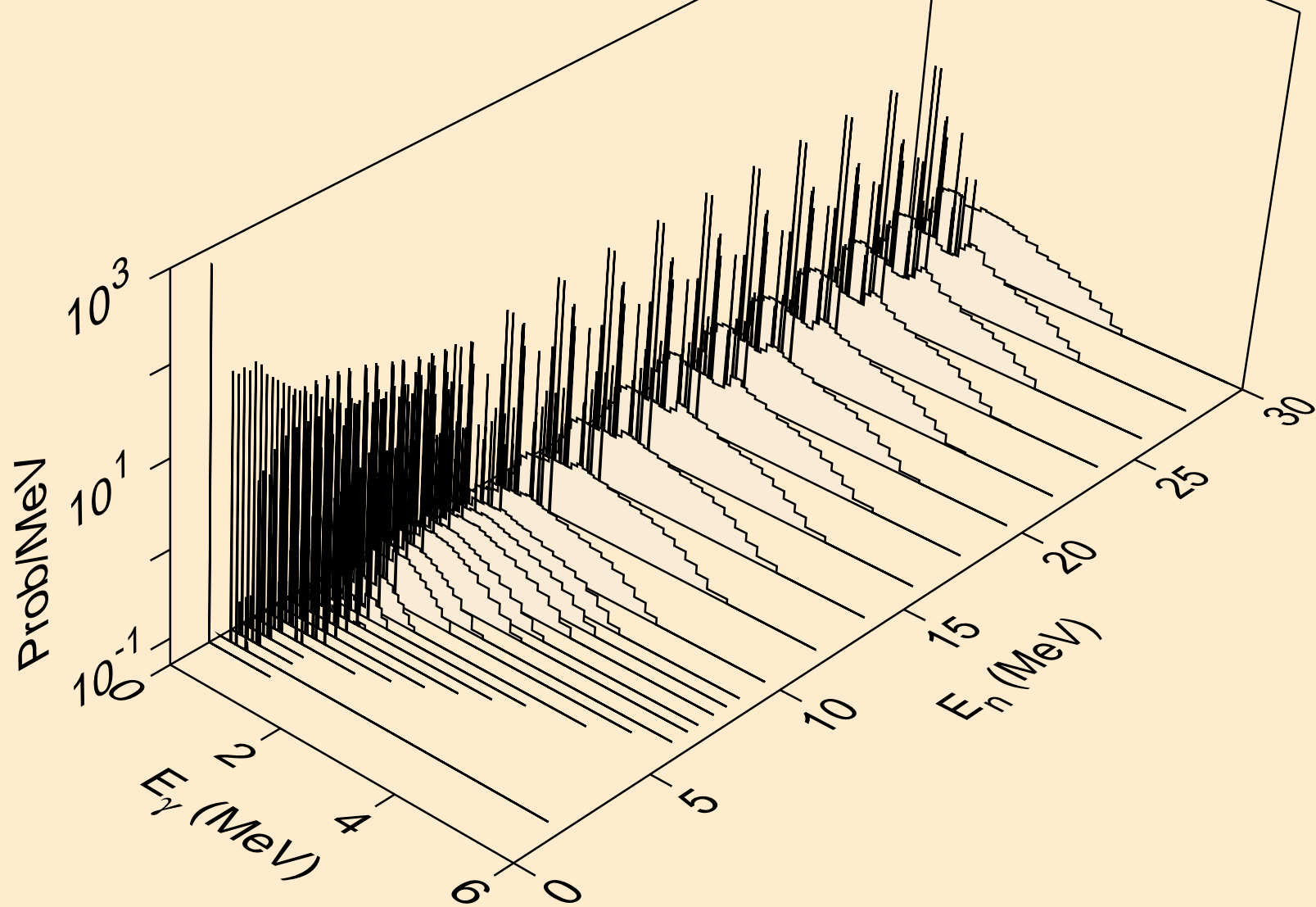

BR081 NEUTRON ACER TENDL-2021 LIBRARY; T=293.6K
Photon emission for (n,d)

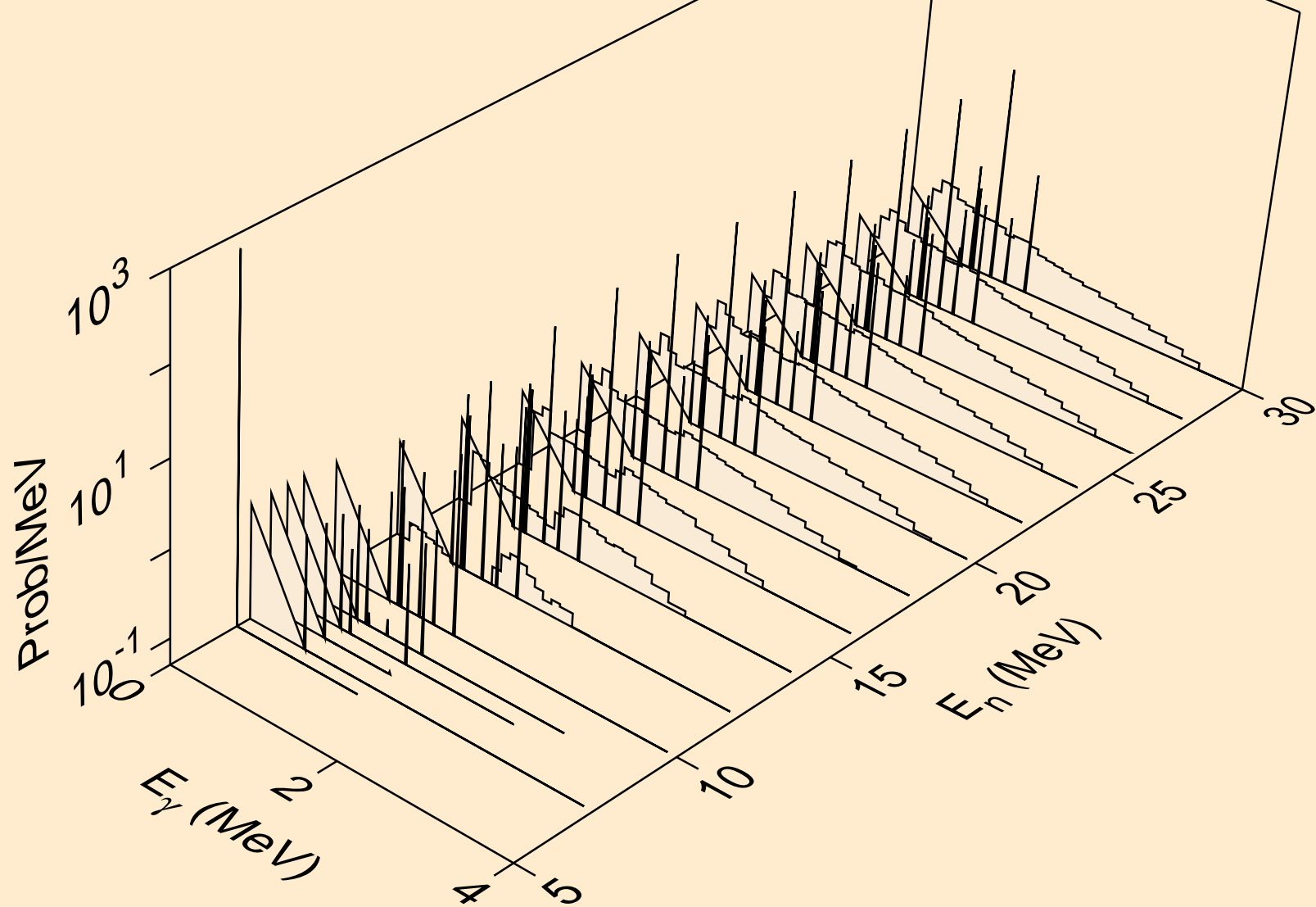

BR081 NEUTRON ACER TENDL-2021 LIBRARY; T=293.6K
Photon emission for (n,t)

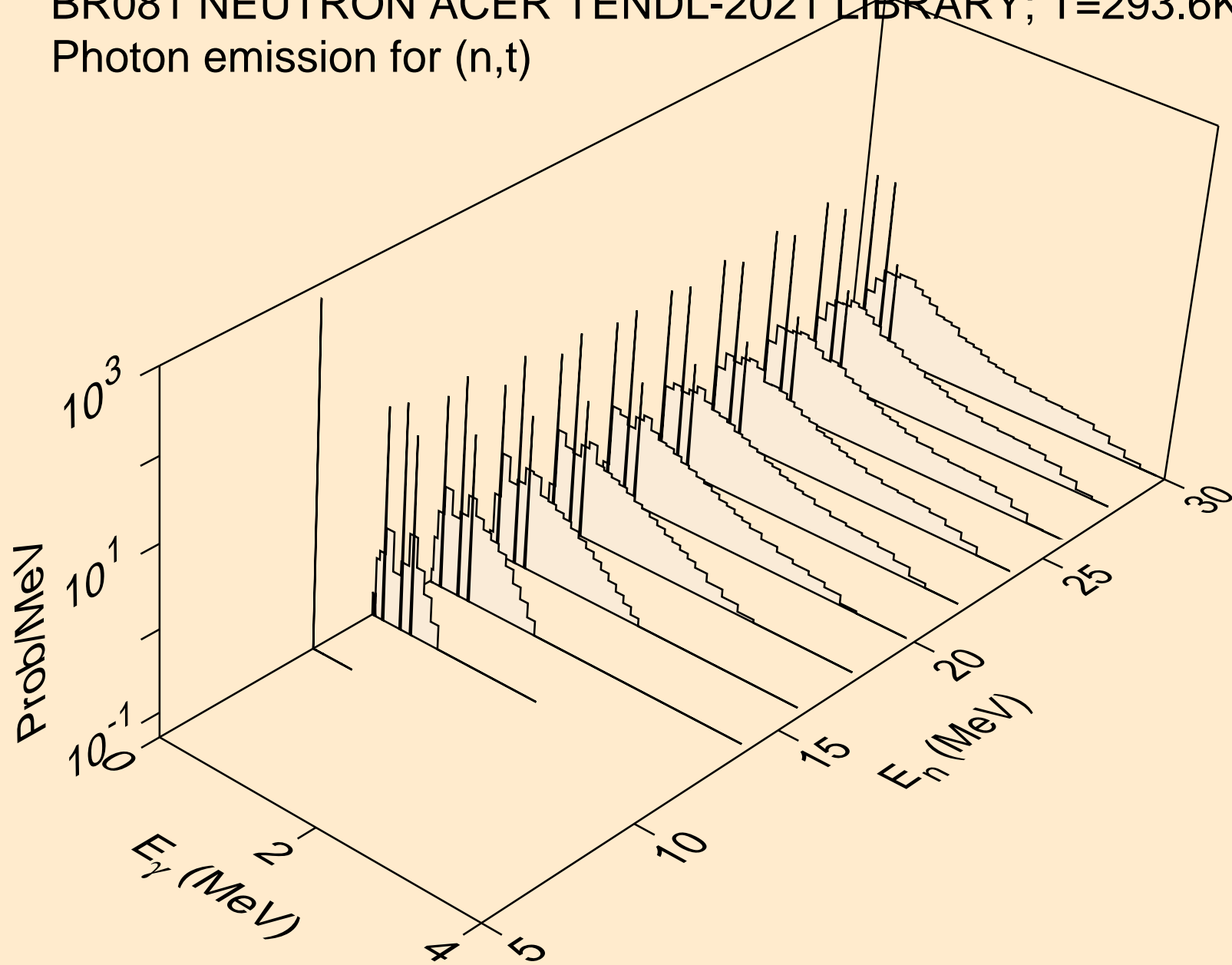

BR081 NEUTRON ACER TENDL-2021 LIBRARY; T=293.6K
Photon emission for (n,he3)

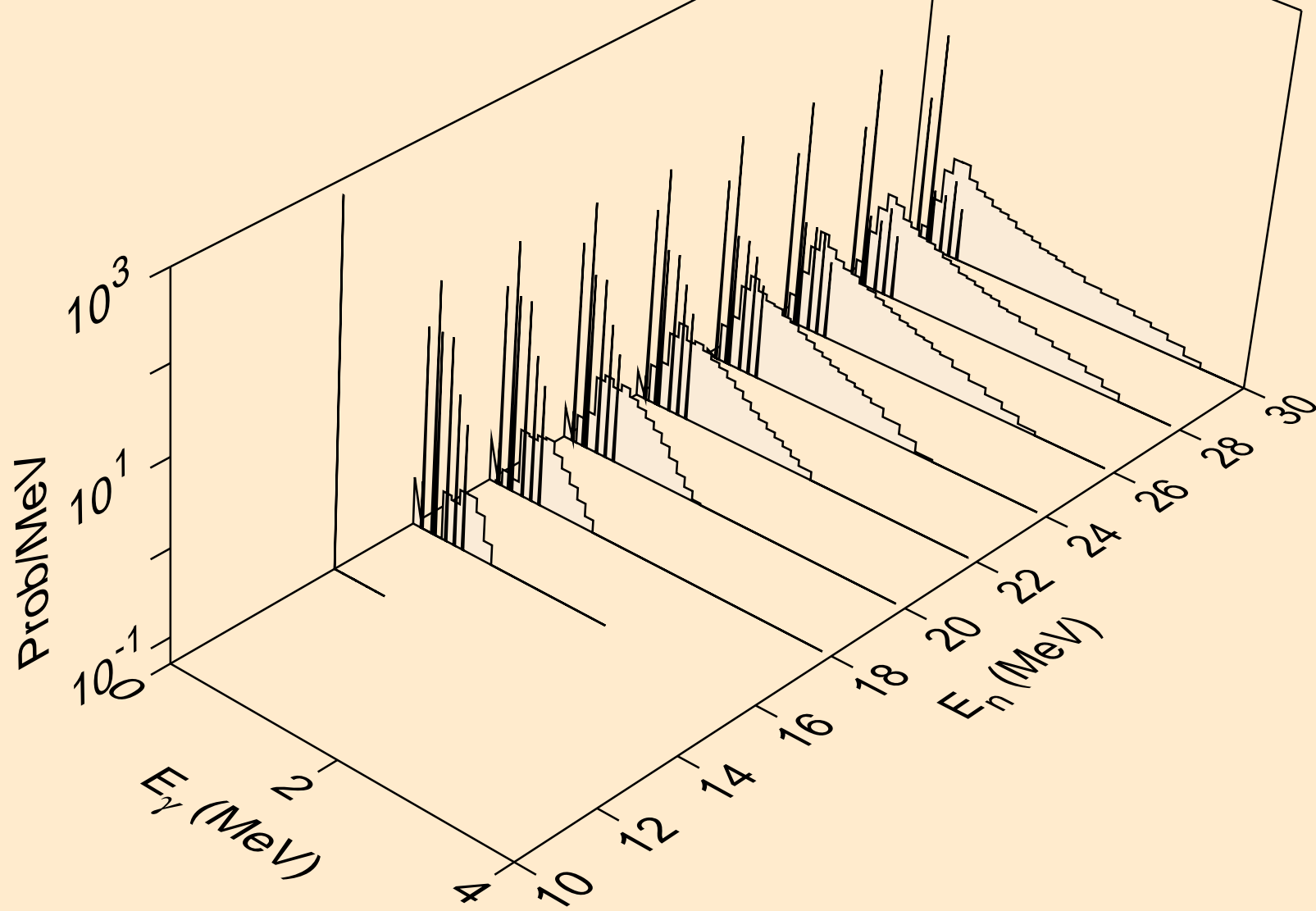

BR081 NEUTRON ACER TENDL-2021 LIBRARY; T=293.6K
Photon emission for (n,a)

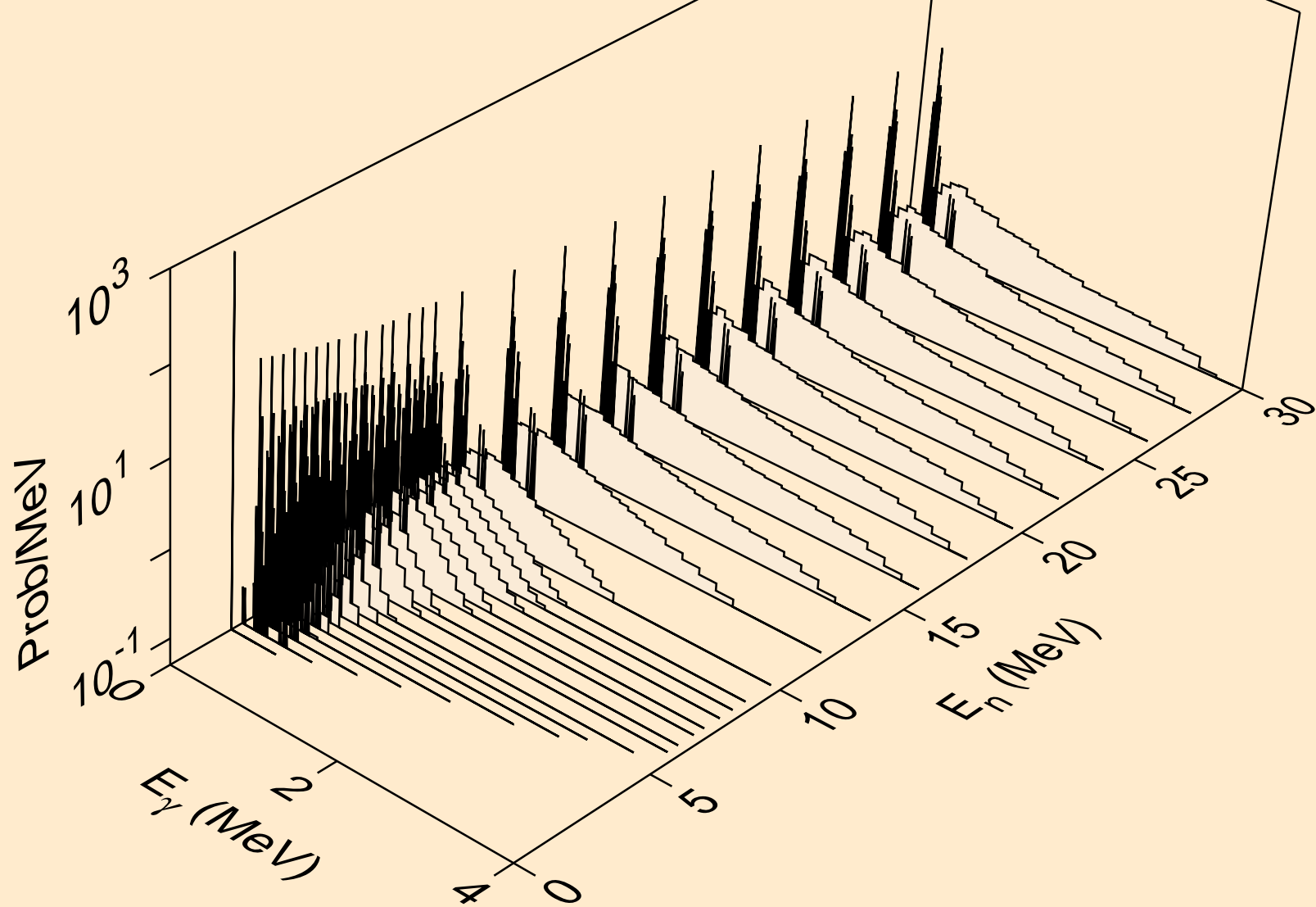

BR081 NEUTRON ACER TENDL-2021 LIBRARY; T=293.6K
Photon emission for (n,2a)

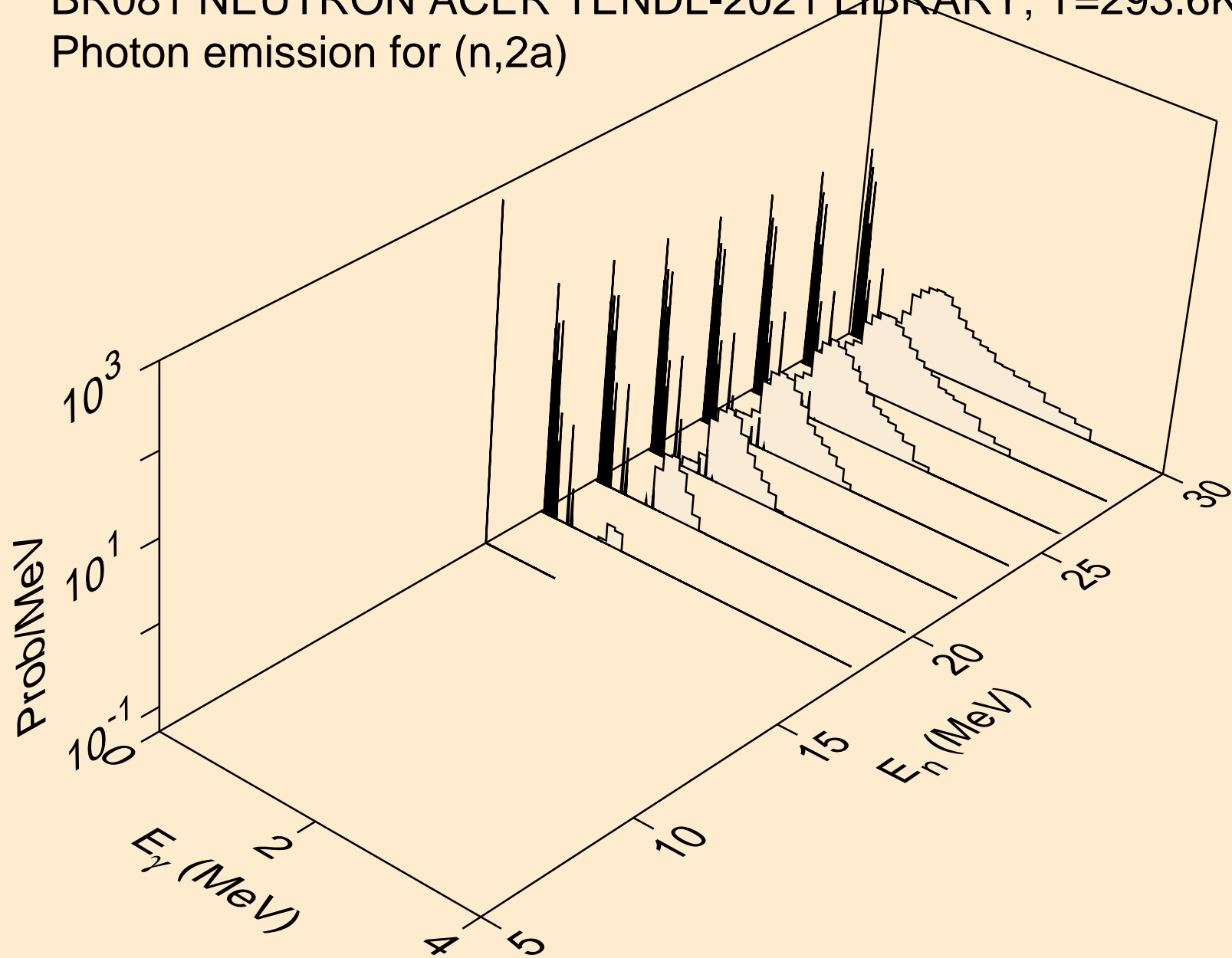

BR081 NEUTRON ACER TENDL-2021 LIBRARY; T=293.6K
Photon emission for (n,2p)

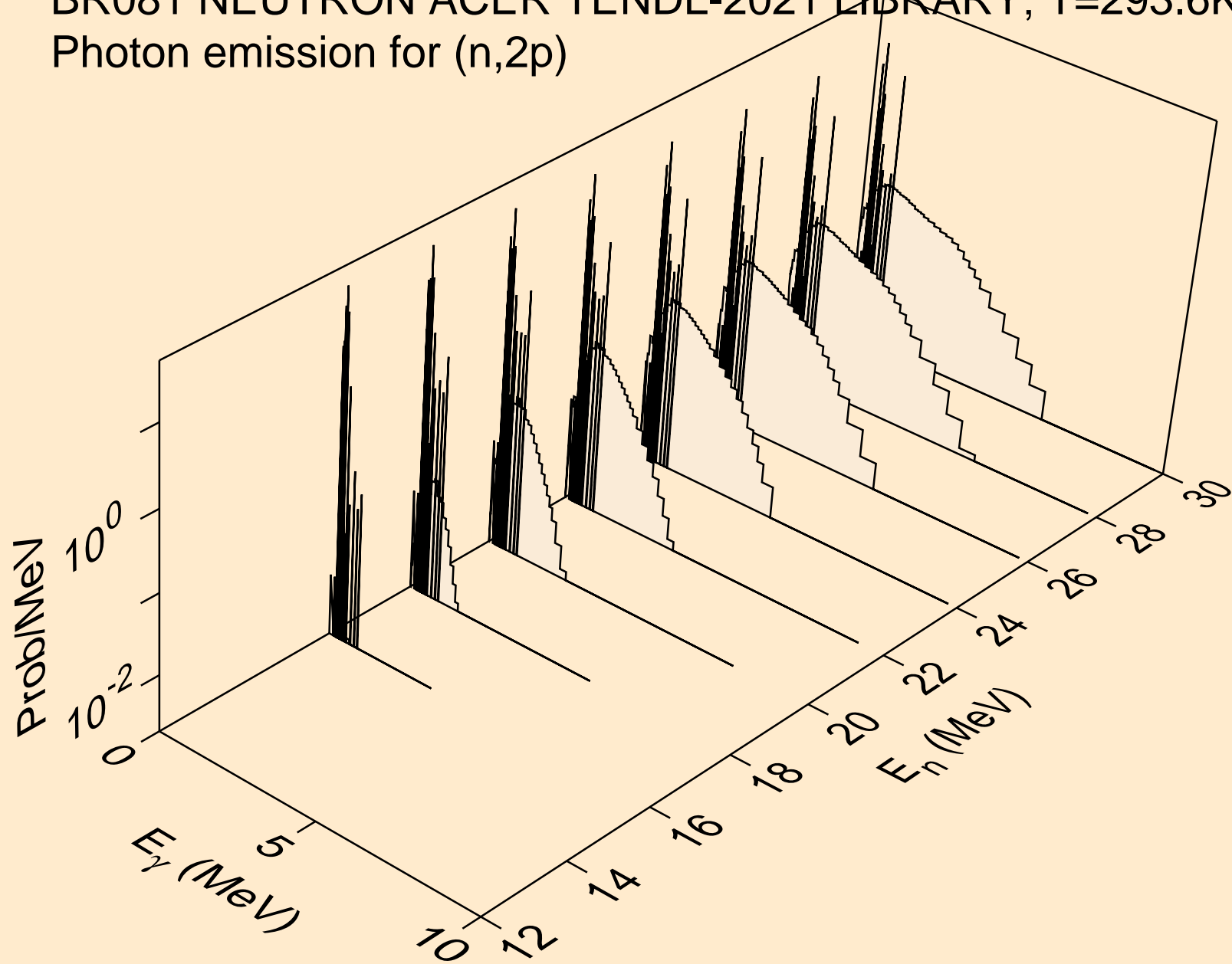

BR081 NEUTRON ACER TENDL-2021 LIBRARY; T=293.6K
Photon emission for (n,p)

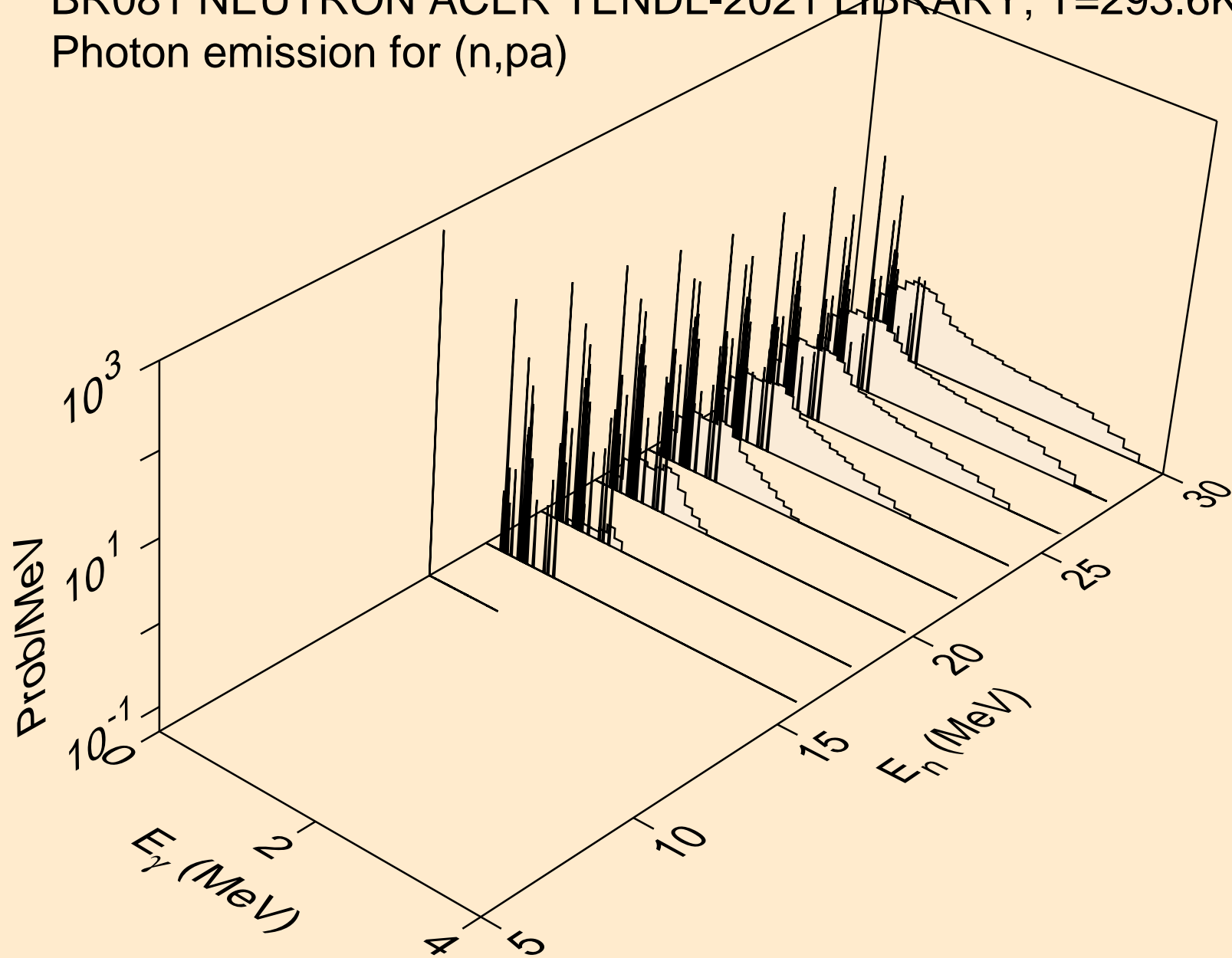

BR081 NEUTRON ACER TENDL-2021 LIBRARY; T=293.6K
Photon emission for (n,pd)

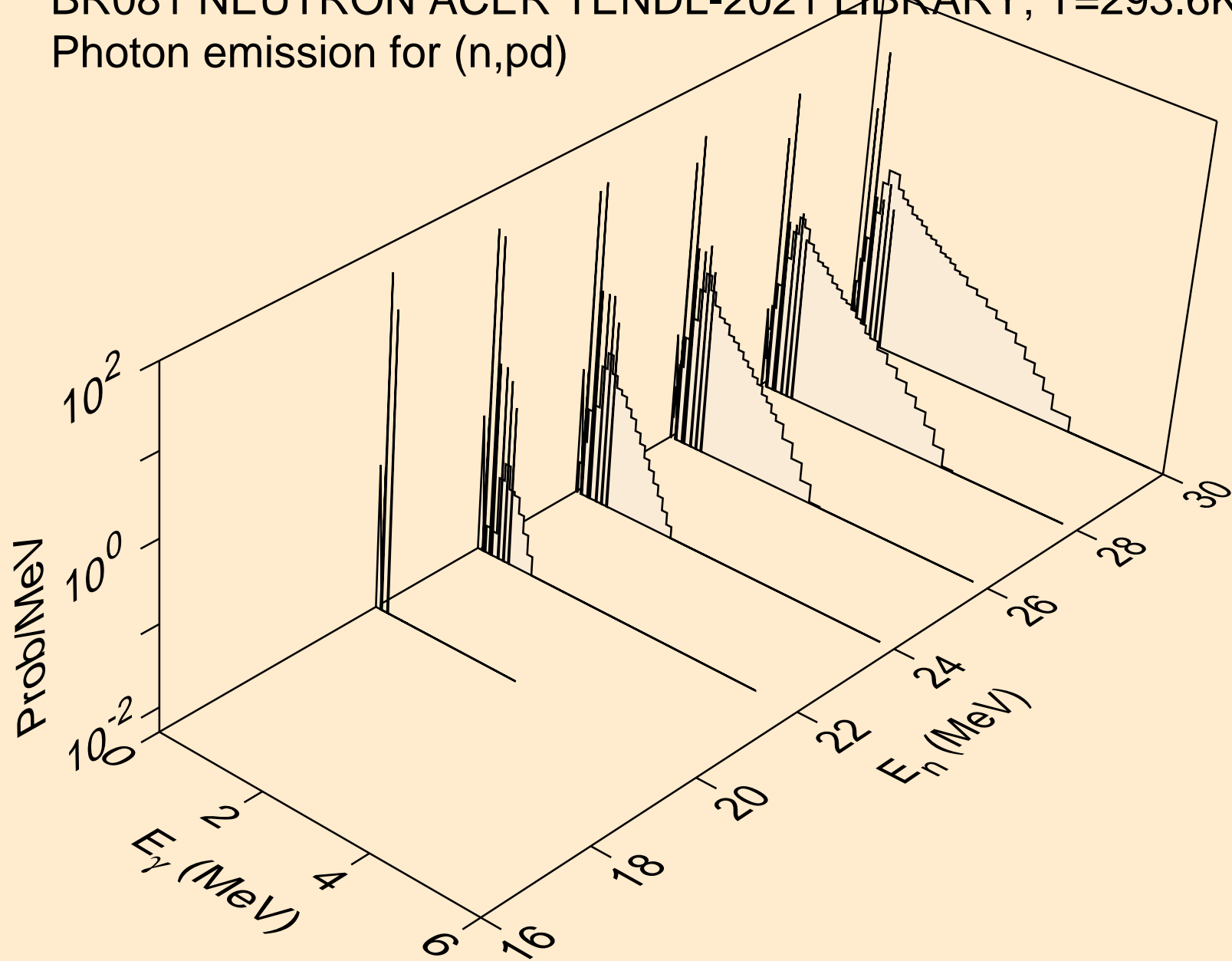

BR081 NEUTRON ACER TENDL-2021 LIBRARY; T=293.6K
Photon emission for (n,pt)

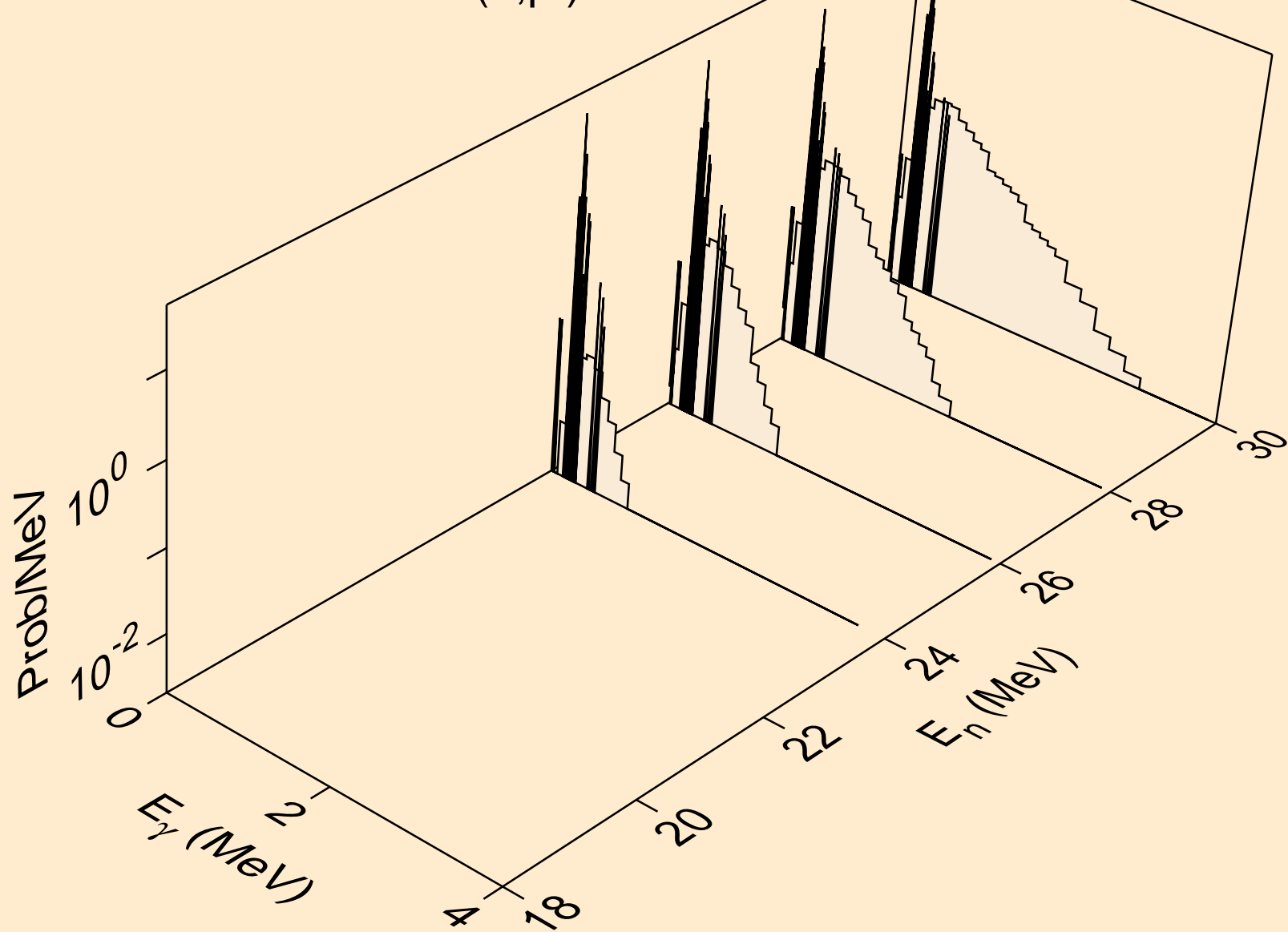

BR081 NEUTRON ACER TENDL-2021 LIBRARY; T=293.6K
Photon emission for (n,da)

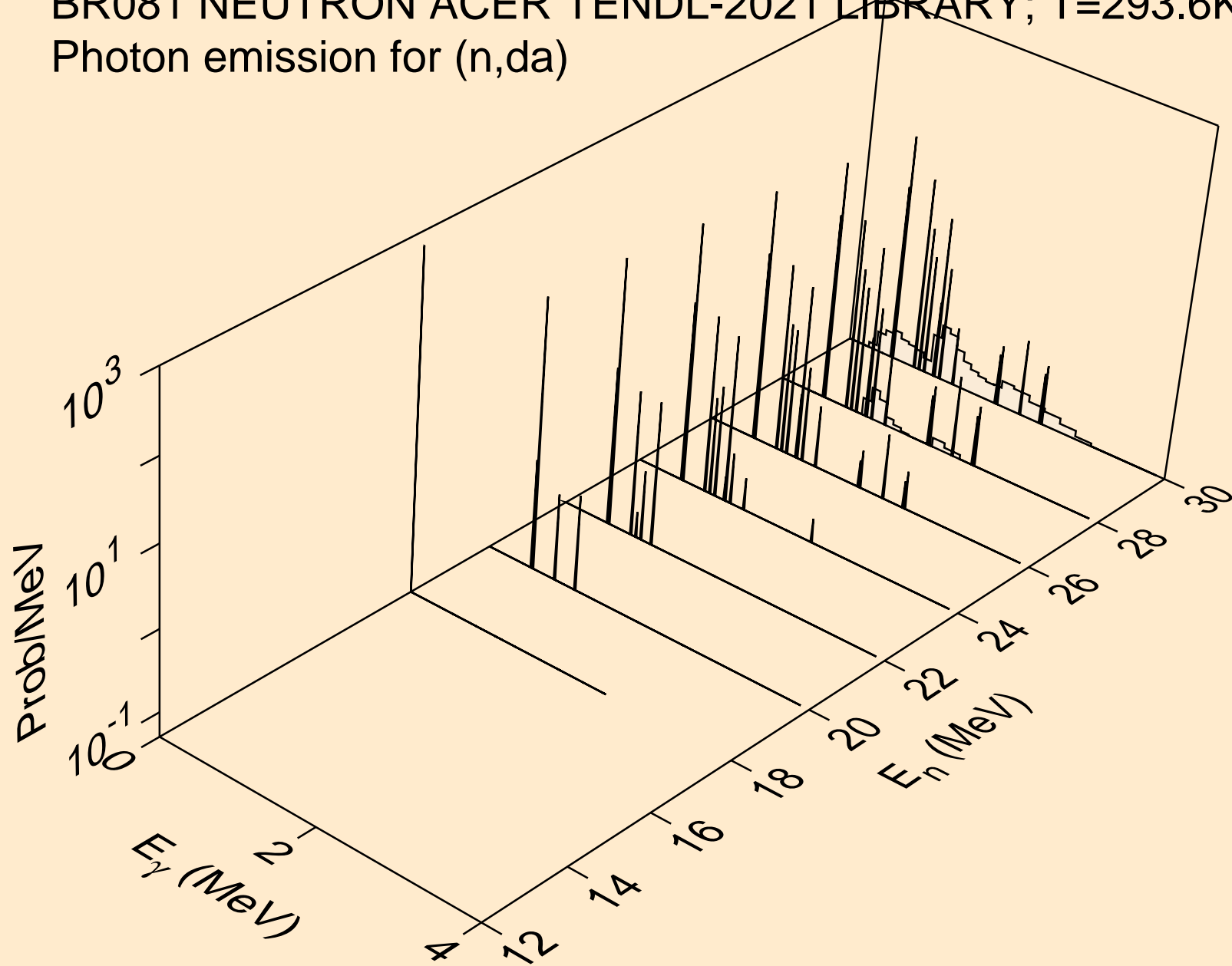

BR081 NEUTRON ACER TENDL-2021 LIBRARY; T=293.6K
thermal capture photon spectrum

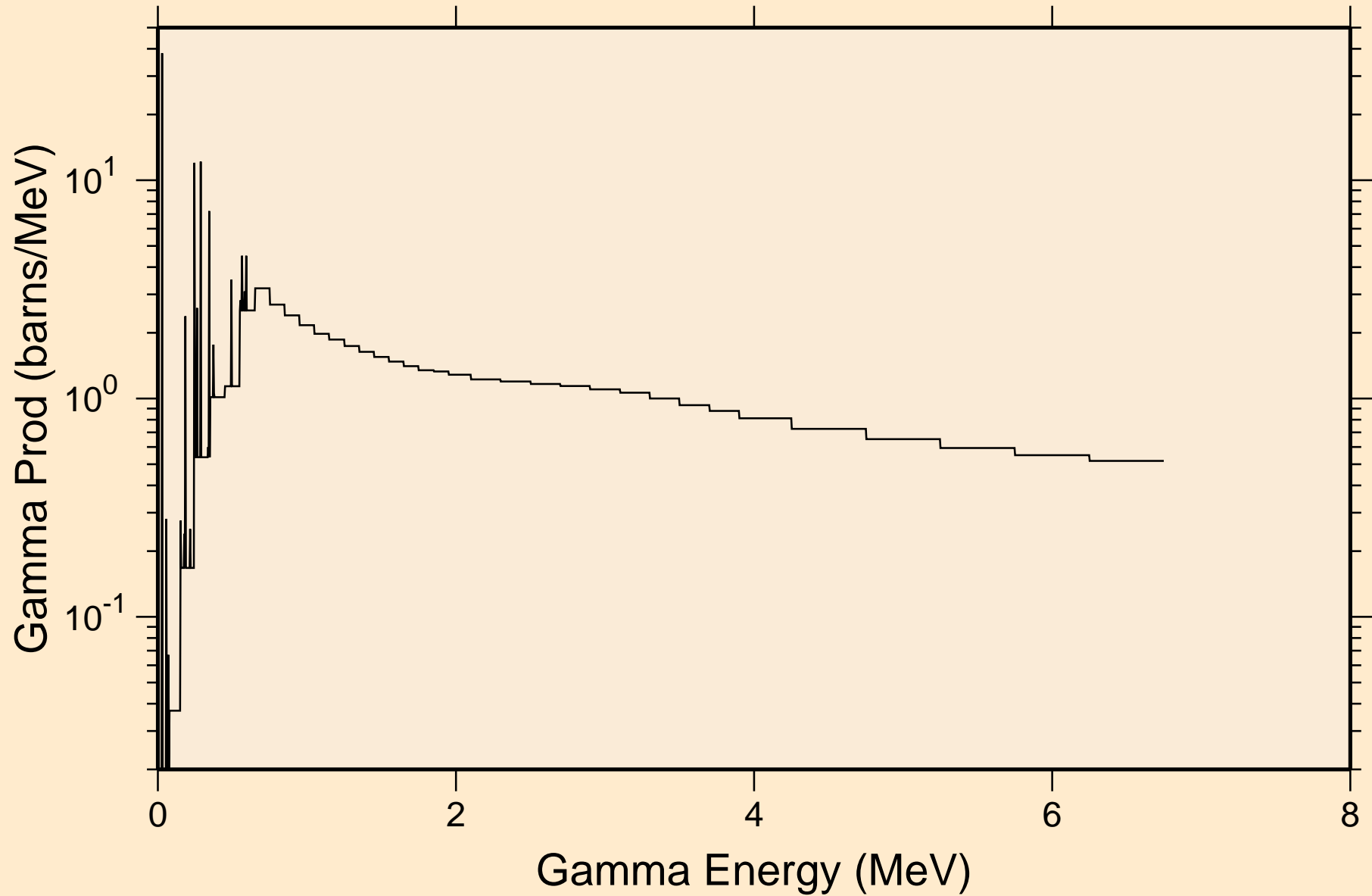

BR081 NEUTRON ACER TENDL-2021 LIBRARY; T=293.6K
14 MeV photon spectrum

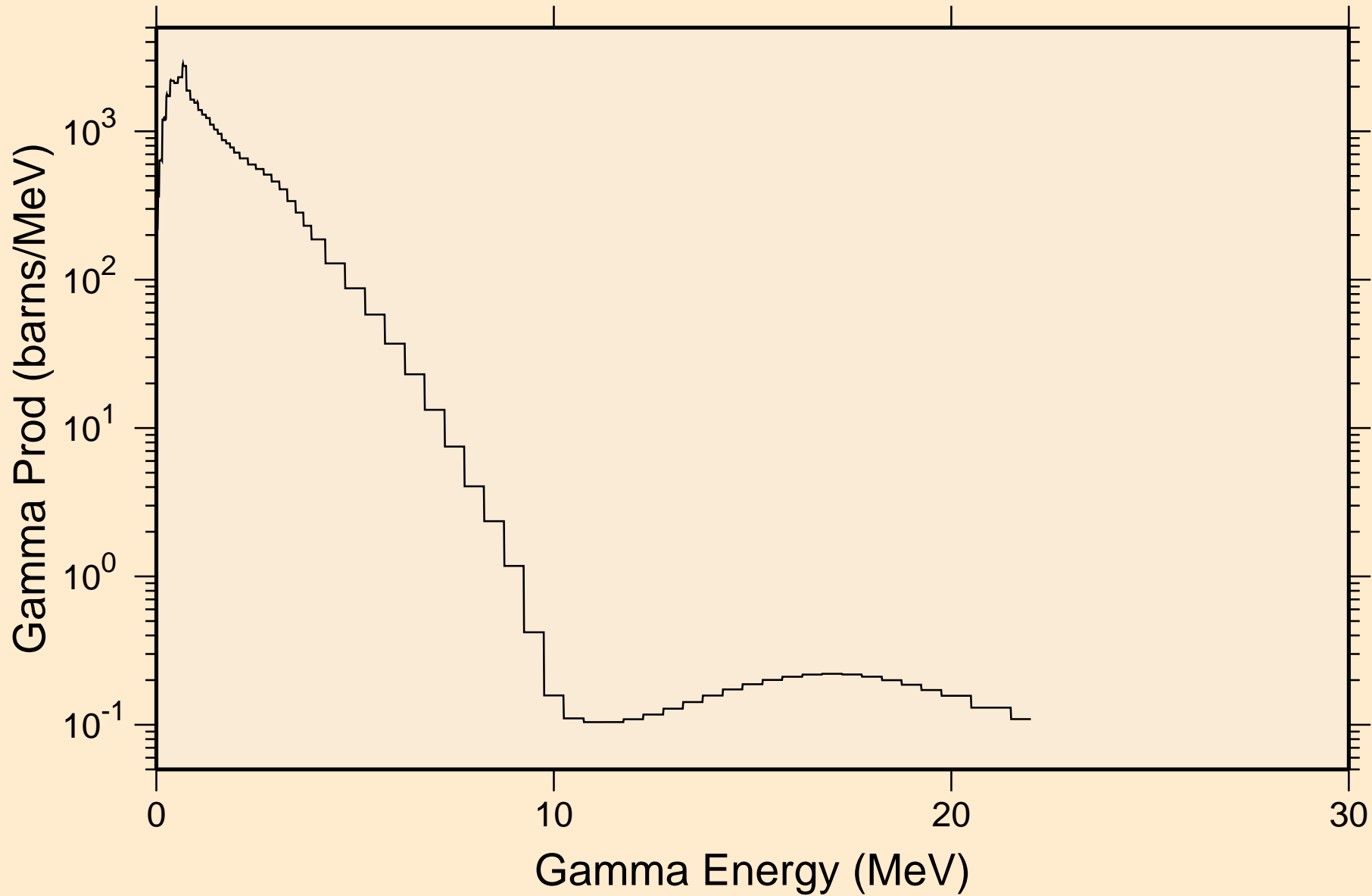

BR081 NEUTRON ACER TENDL-2021 LIBRARY; T=293.6K
Particle heating contributions

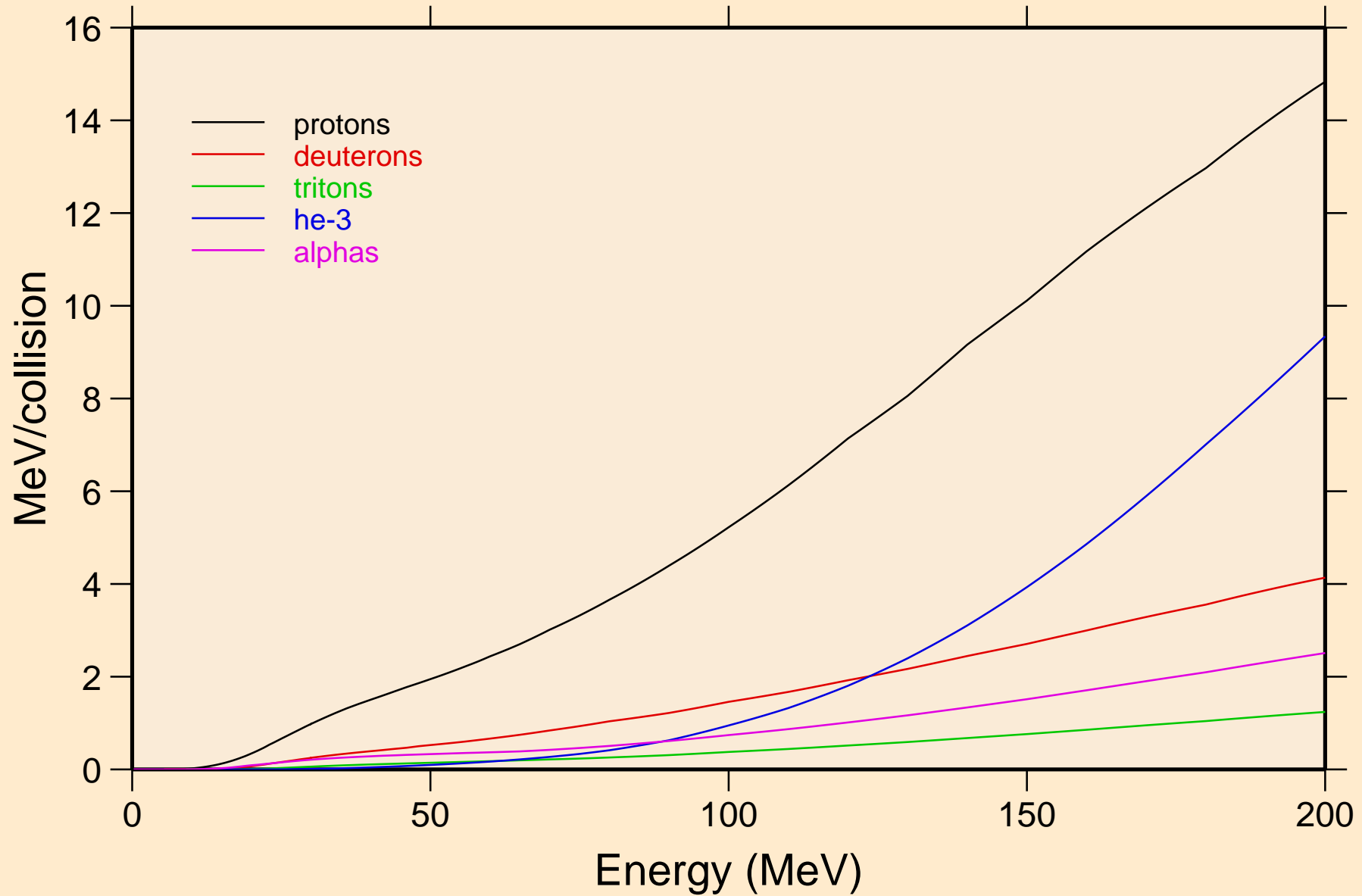

BR081 NEUTRON ACER TENDL-2021 LIBRARY; T=293.6K
Recoil Heating

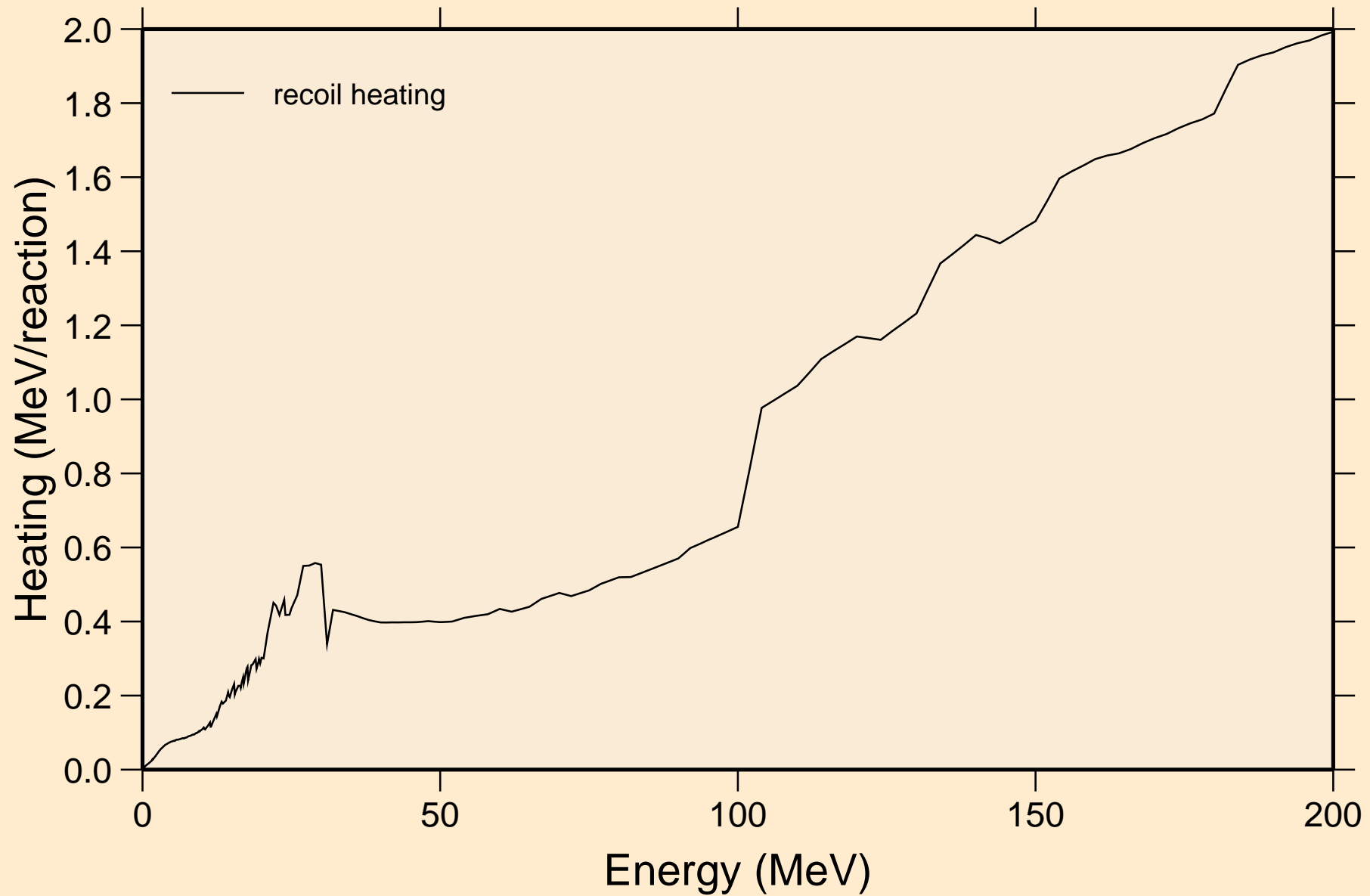

BR081 NEUTRON ACER TENDL-2021 LIBRARY; T=293.6K
Particle production cross sections

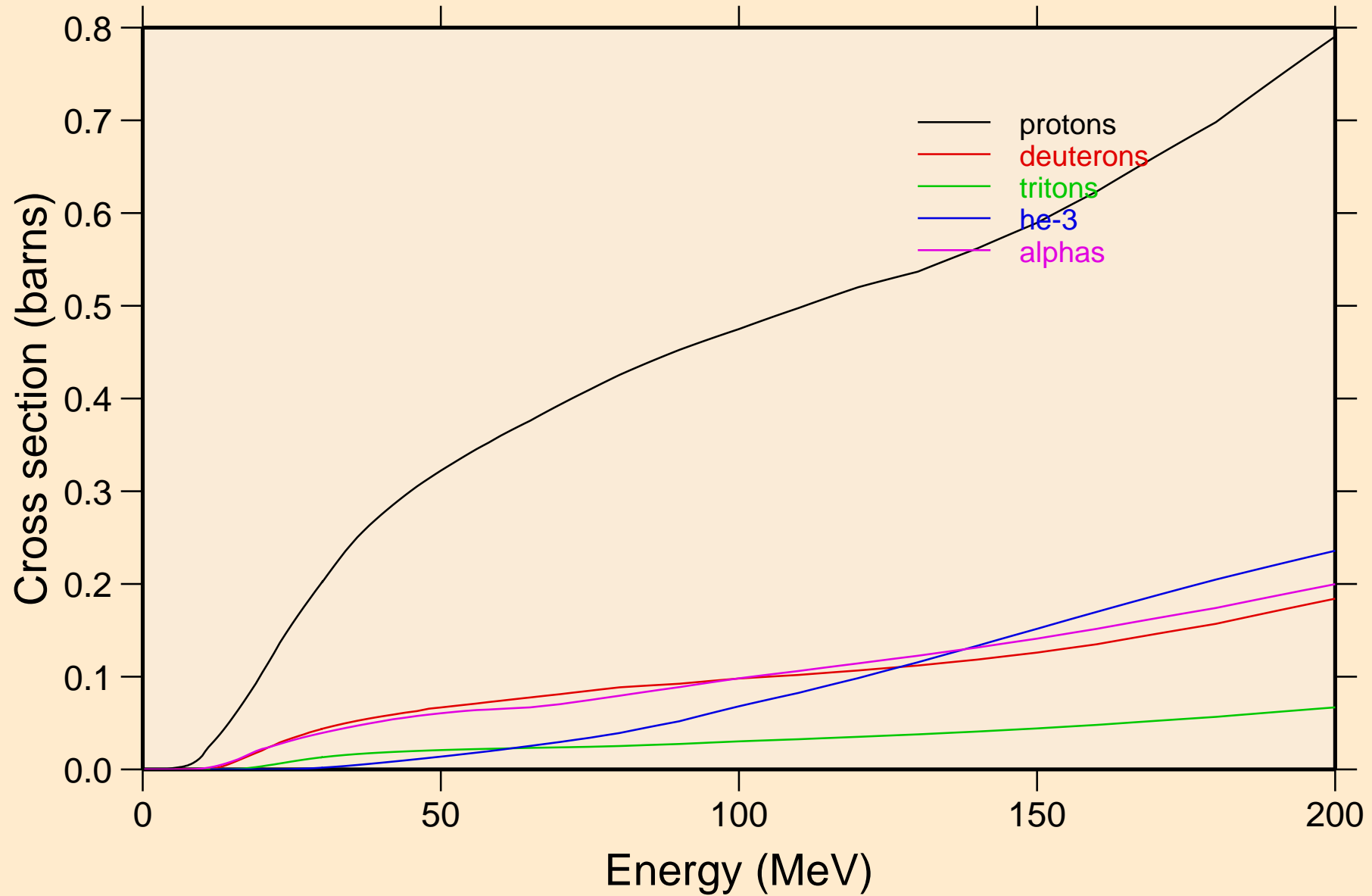

BR081 NEUTRON ACER TENDL-2021 LIBRARY; T=293.6K
protons from (n,x)

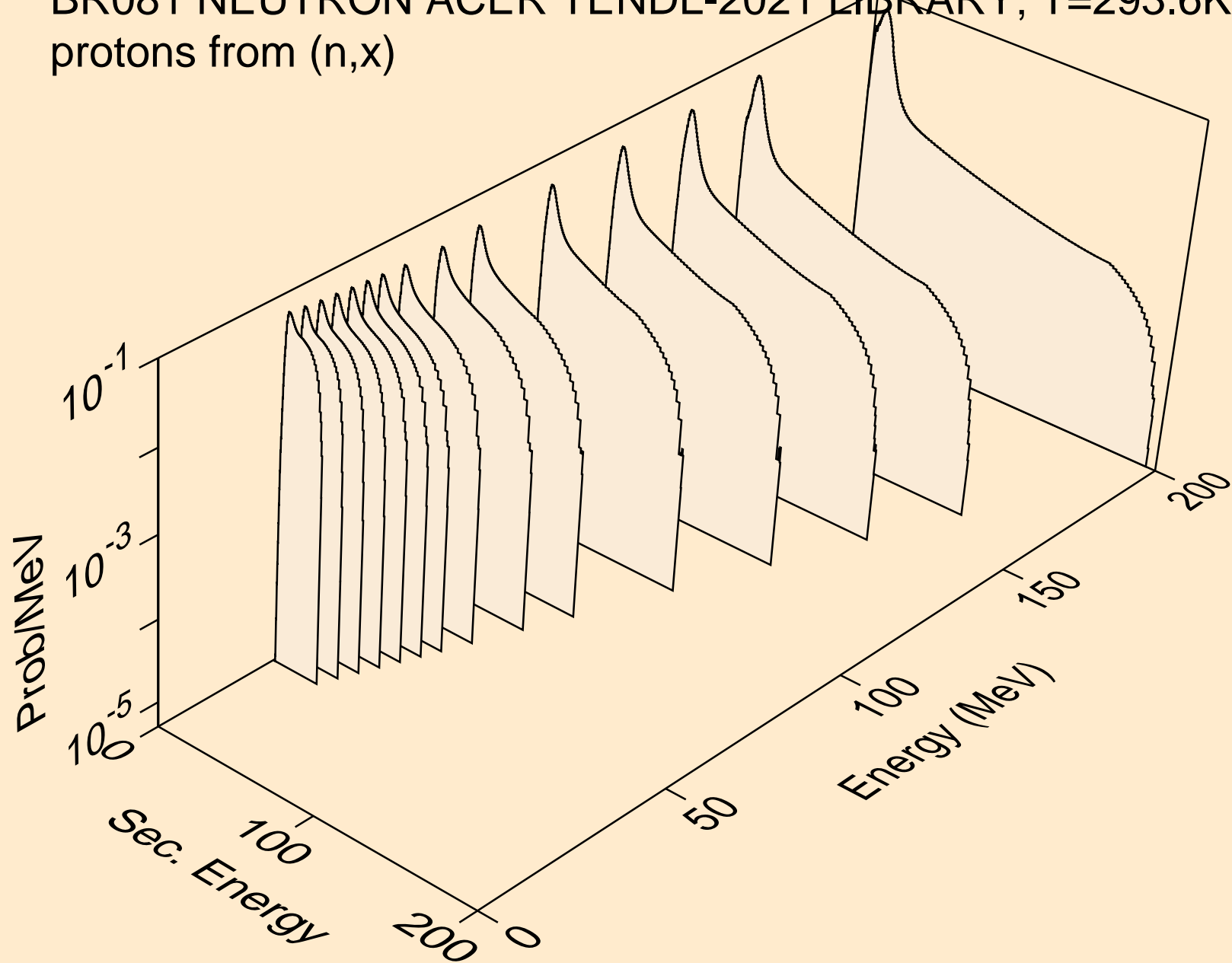

BR081 NEUTRON ACER TENDL-2021 LIBRARY; T=293.6K
protons from (n,n*)p

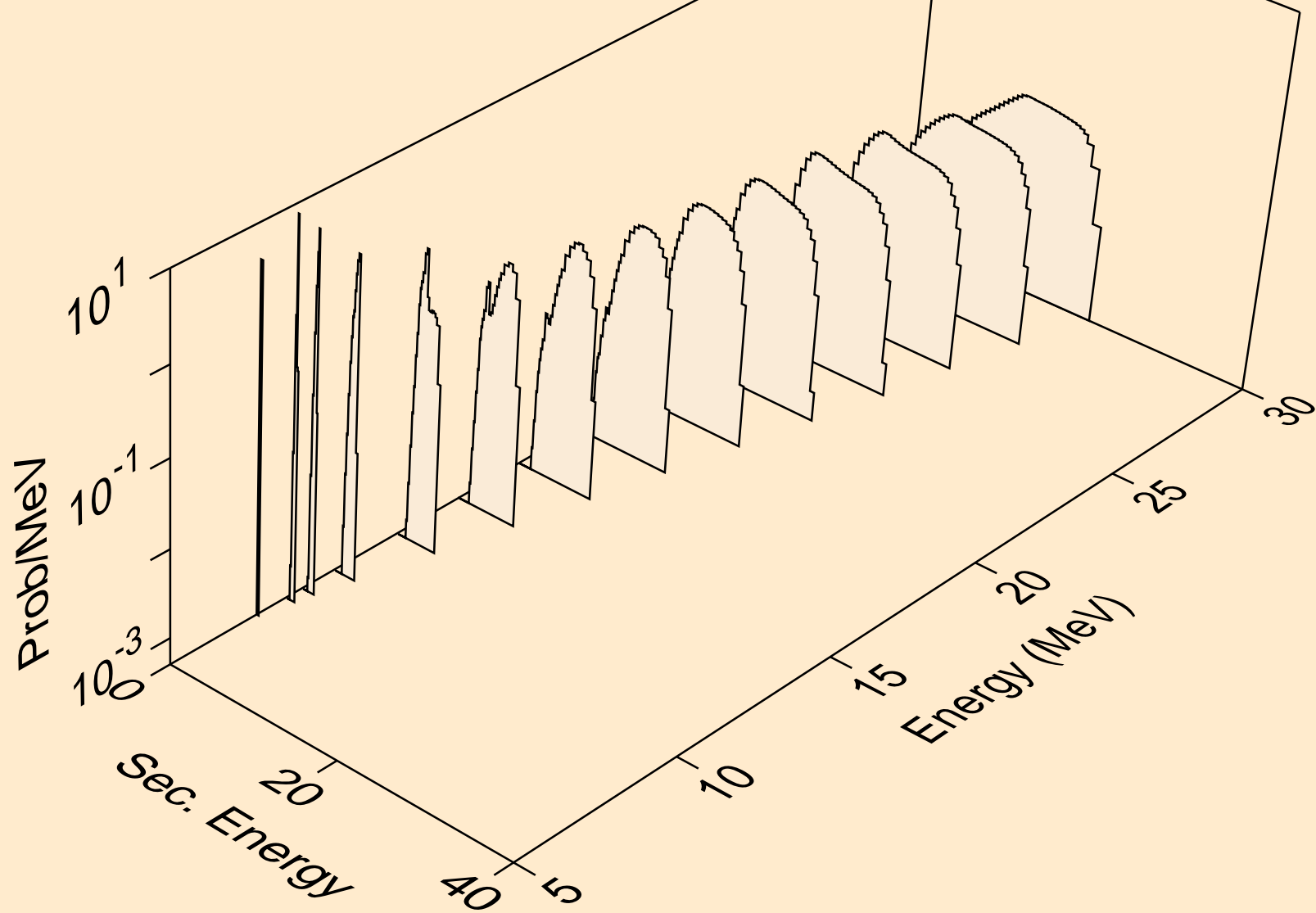

BR081 NEUTRON ACER TENDL-2021 LIBRARY; T=293.6K
protons from (n,2np)

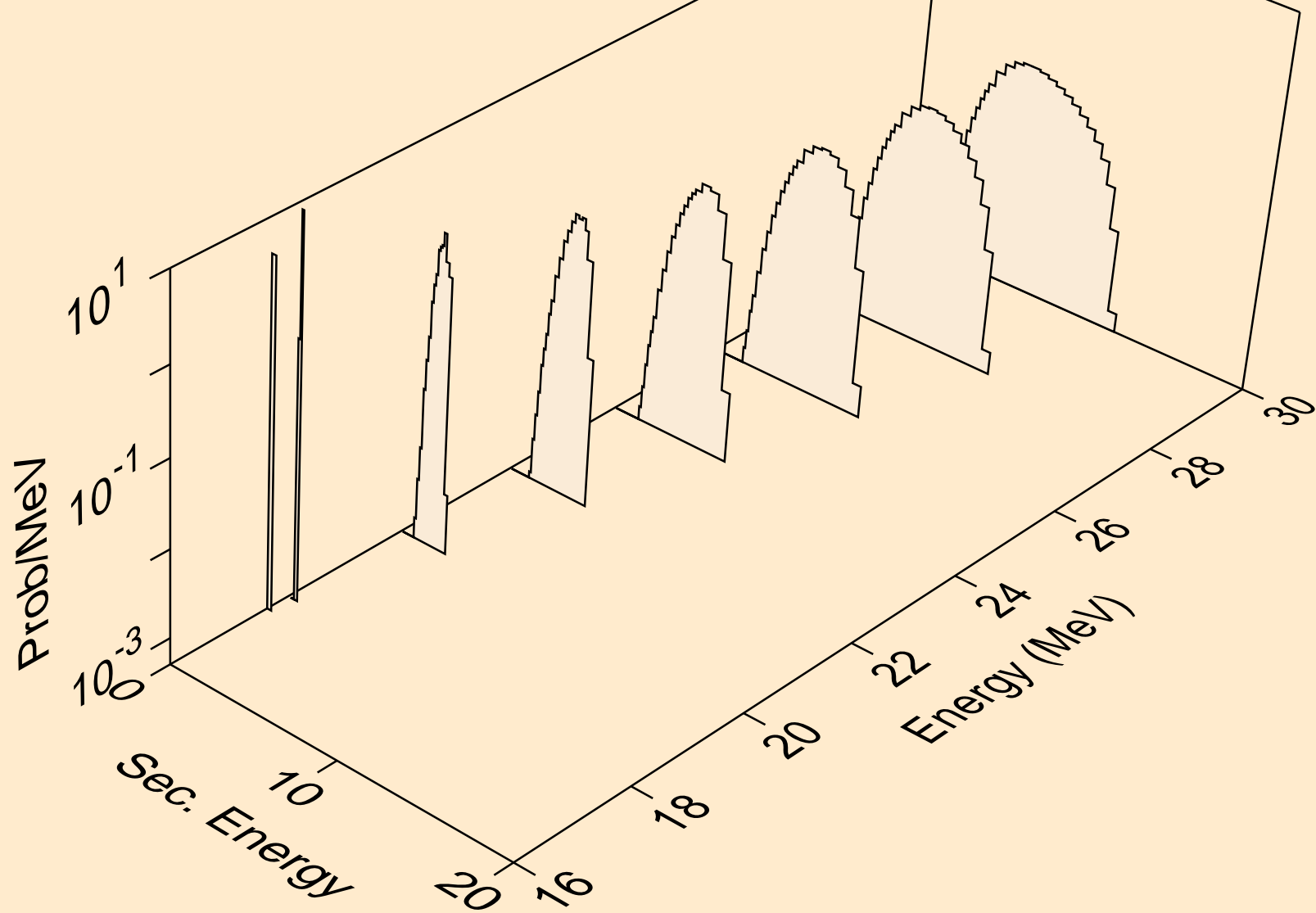

BR081 NEUTRON ACER TENDL-2021 LIBRARY; T=293.6K
protons from (n,3np)

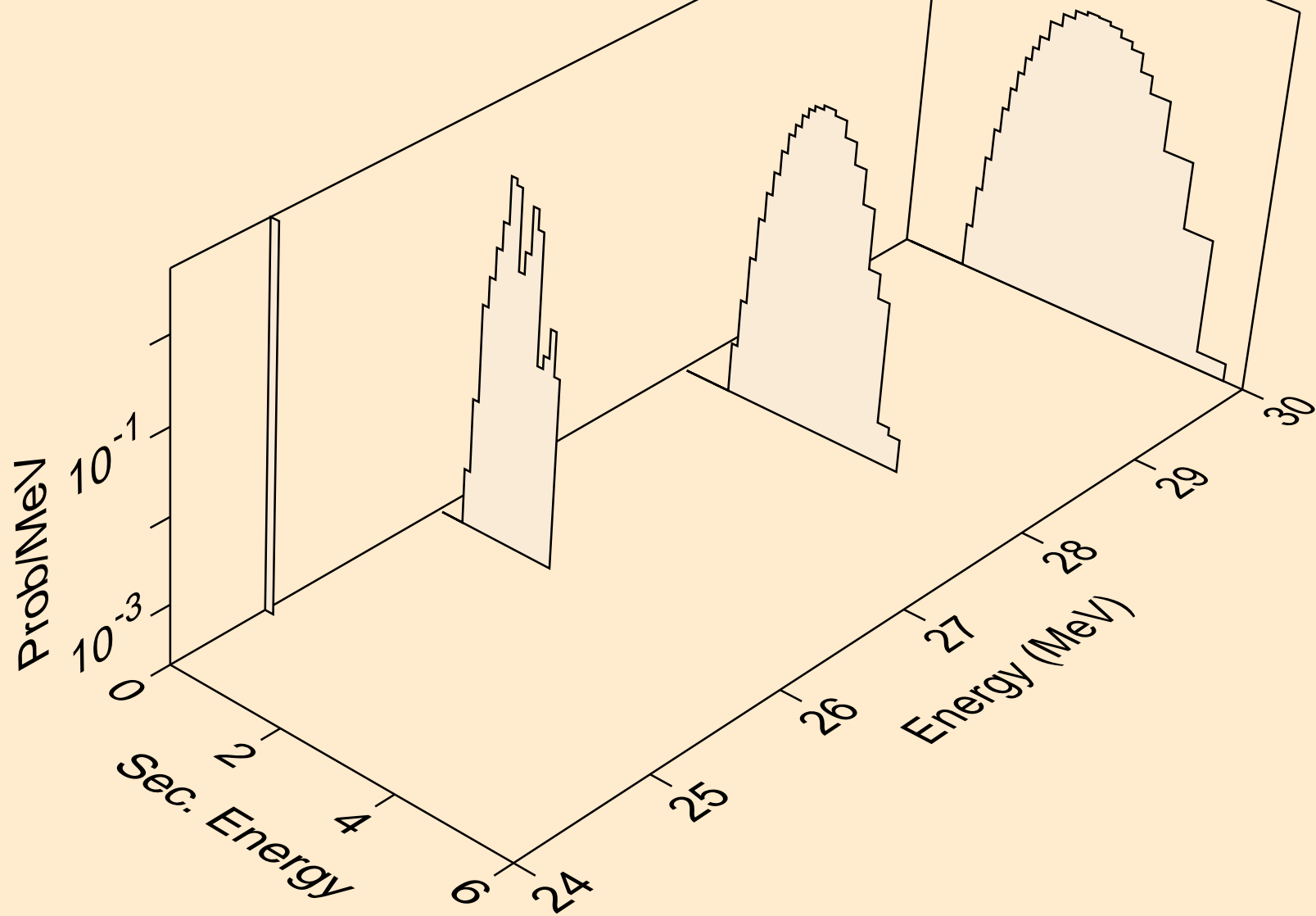

BR081 NEUTRON ACER TENDL-2021 LIBRARY; T=293.6K
protons from (n,2np)

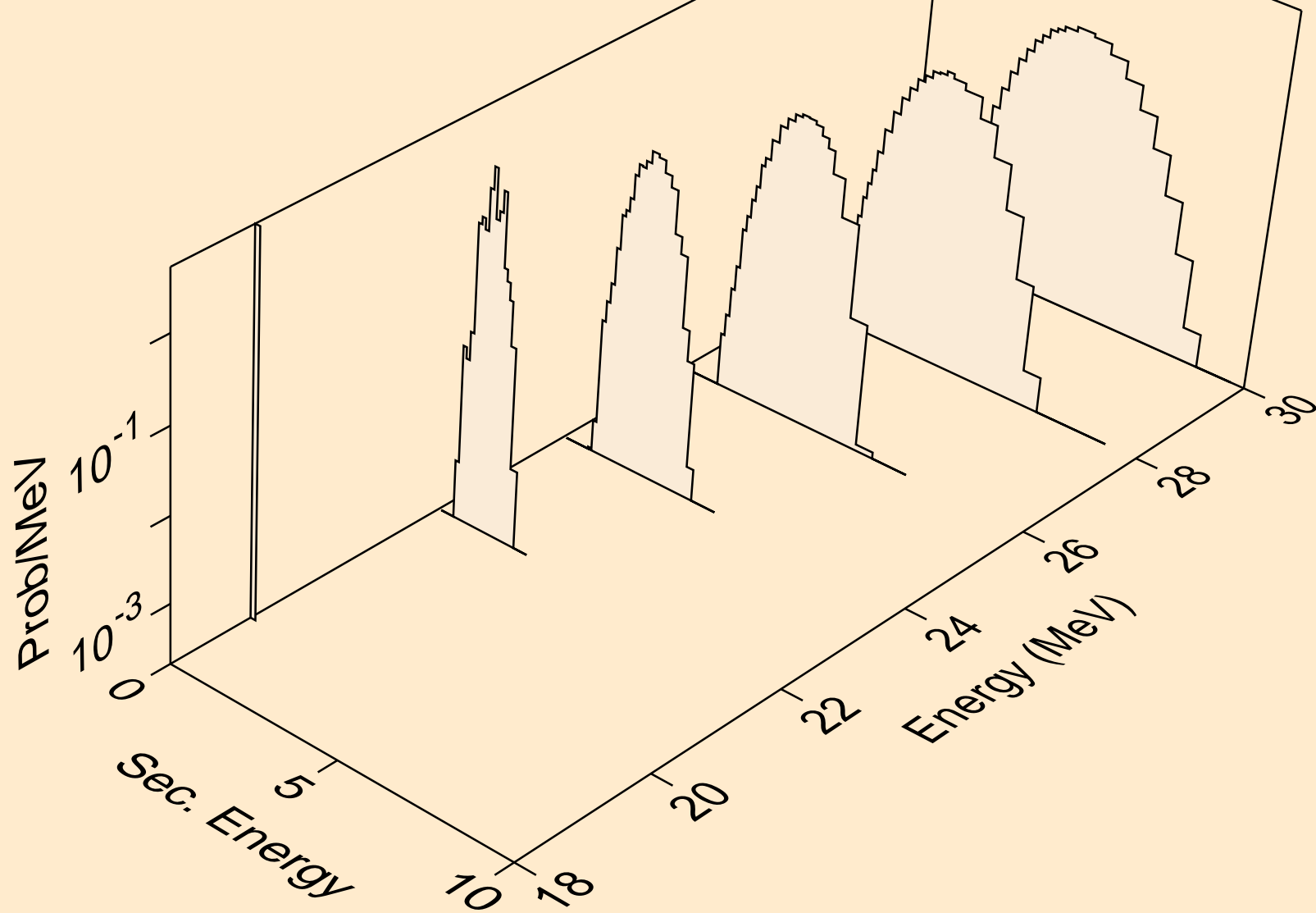

BR081 NEUTRON ACER TENDL-2021 LIBRARY; T=293.6K
protons from (n,npa)

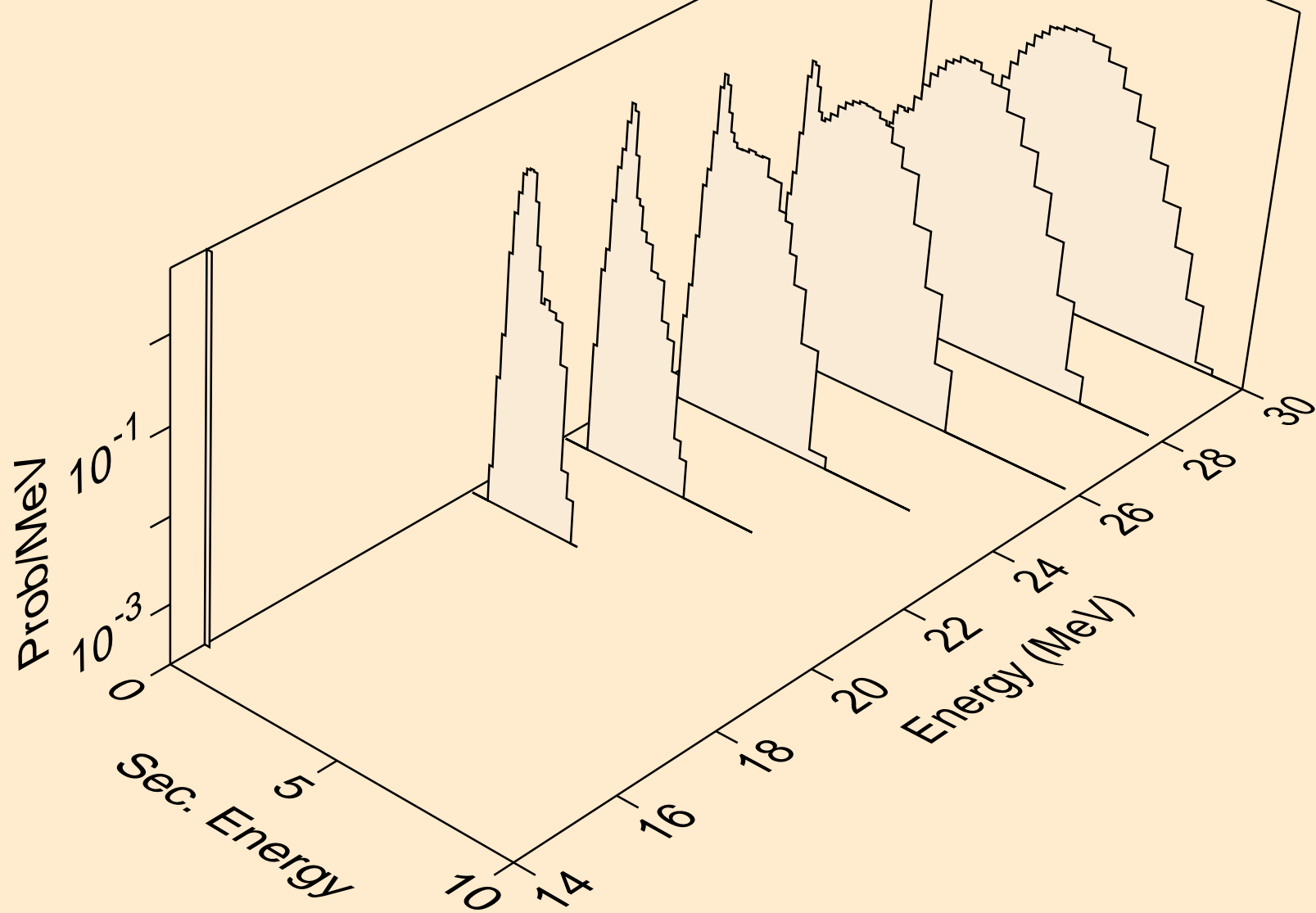

BR081 NEUTRON ACER TENDL-2021 LIBRARY; T=293.6K
protons from (n,p)

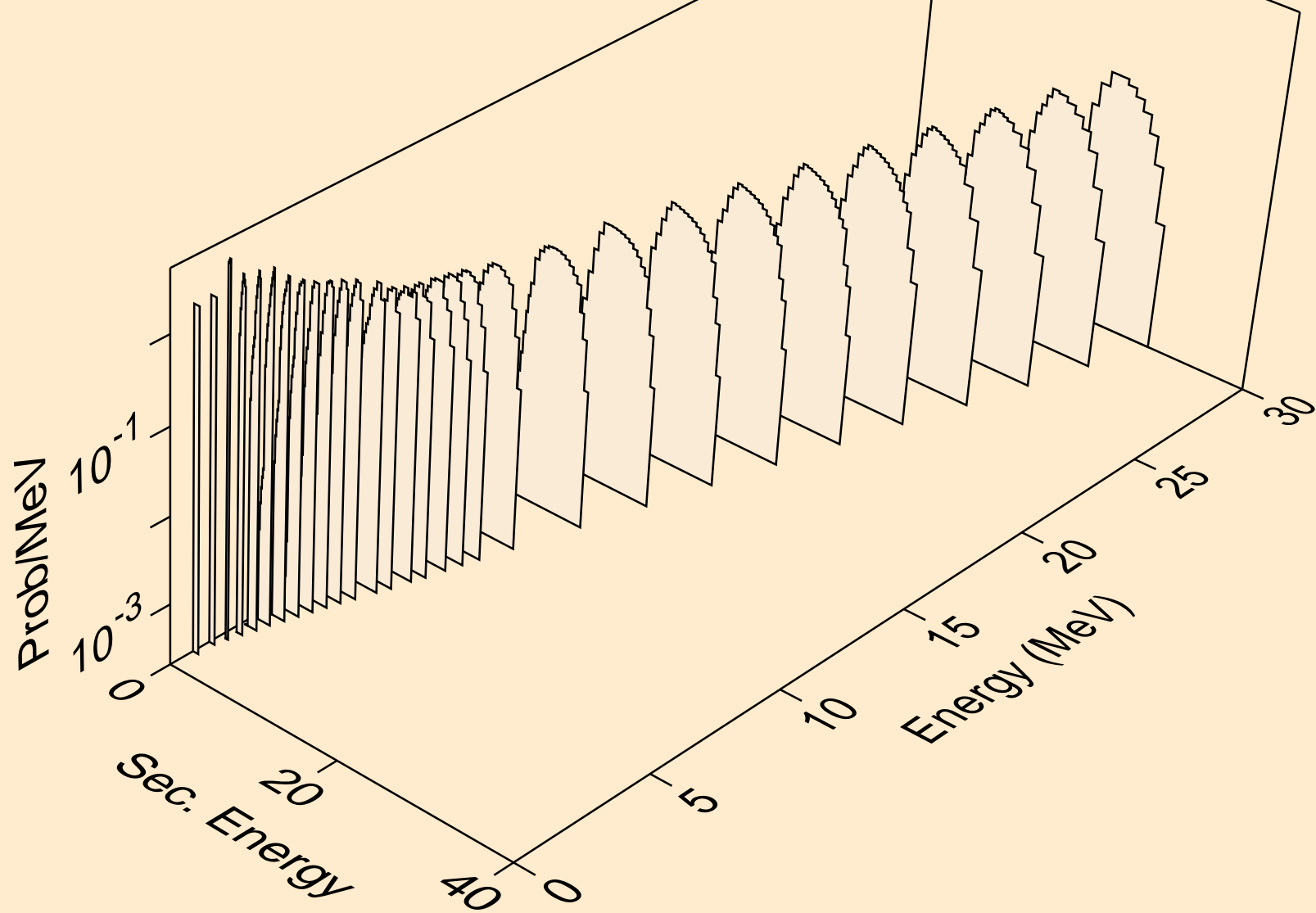

BR081 NEUTRON ACER TENDL-2021 LIBRARY; T=293.6K
protons from (n,2p)

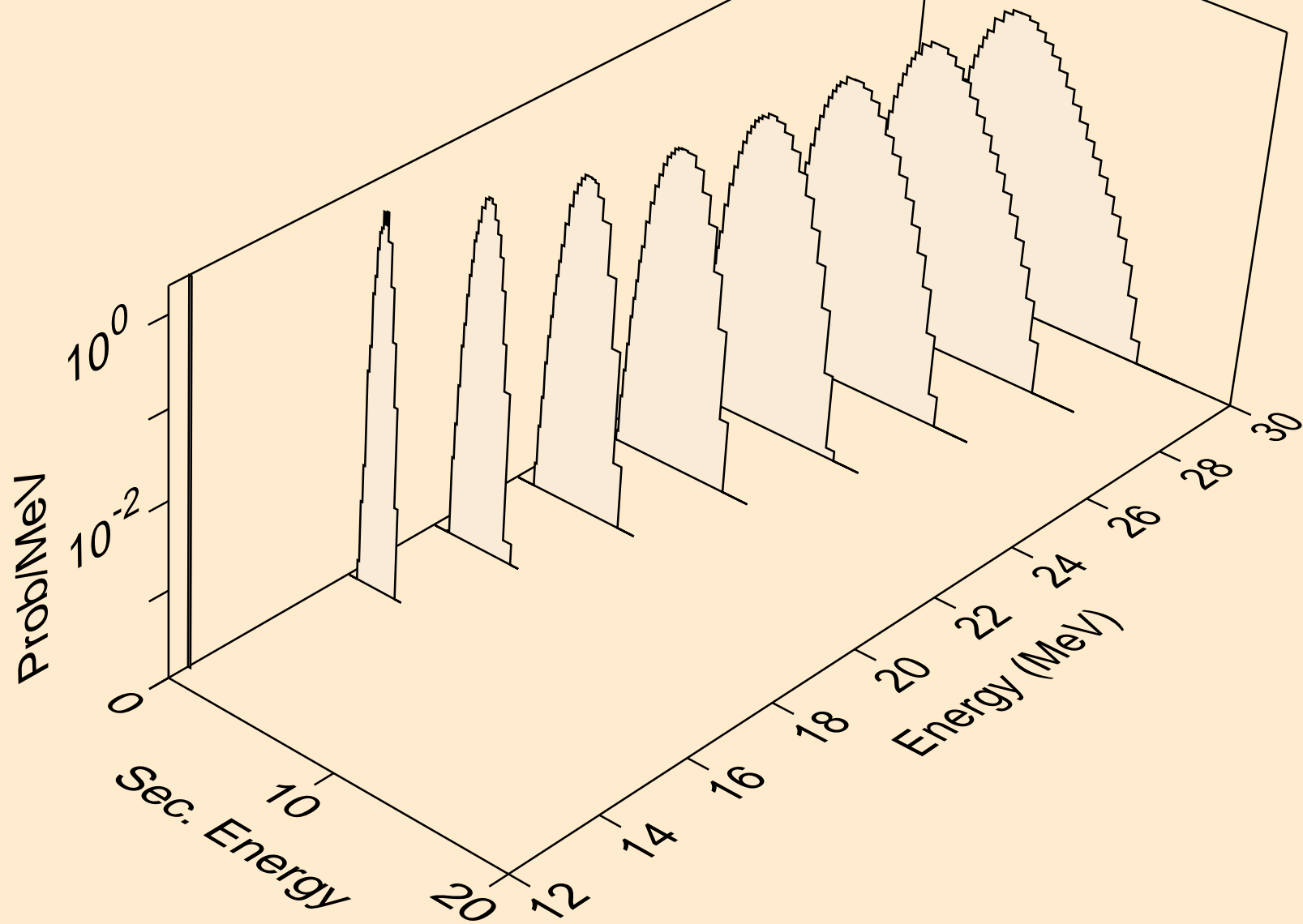

BR081 NEUTRON ACER TENDL-2021 LIBRARY; T=293.6K
protons from (n,p)

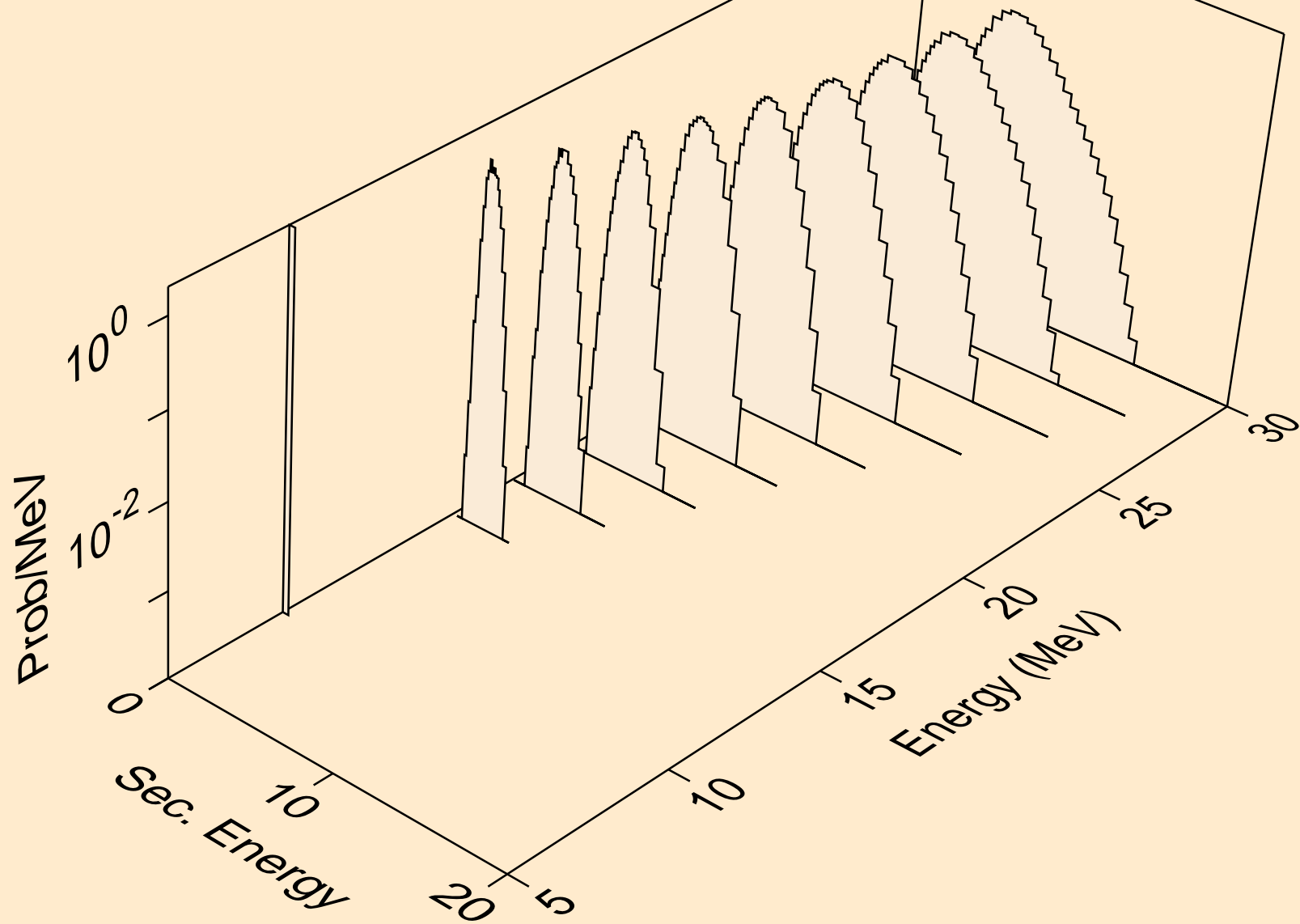

BR081 NEUTRON ACER TENDL-2021 LIBRARY; T=293.6K
protons from (n,pd)

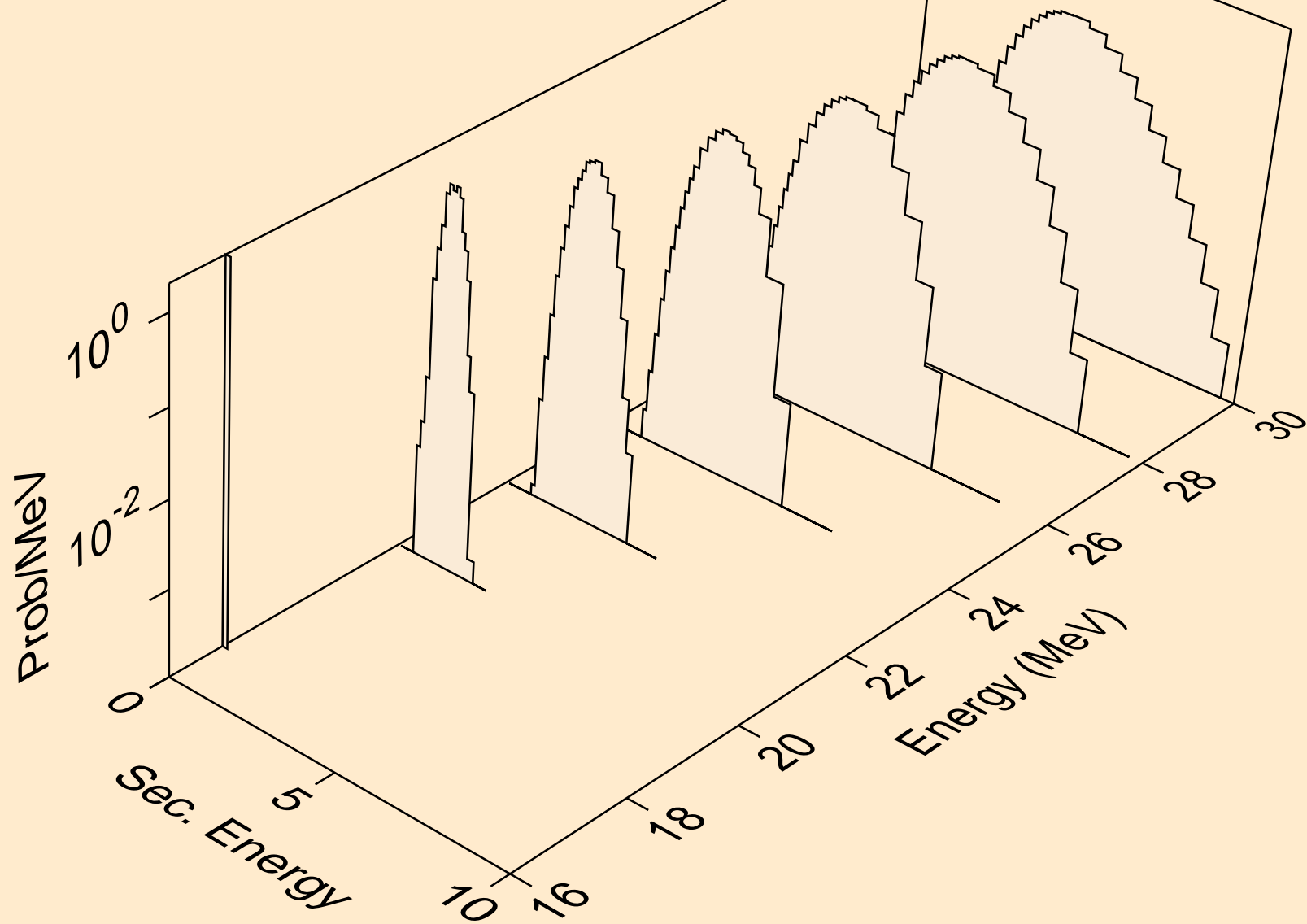

BR081 NEUTRON ACER TENDL-2021 LIBRARY; T=293.6K
protons from (n,pt)

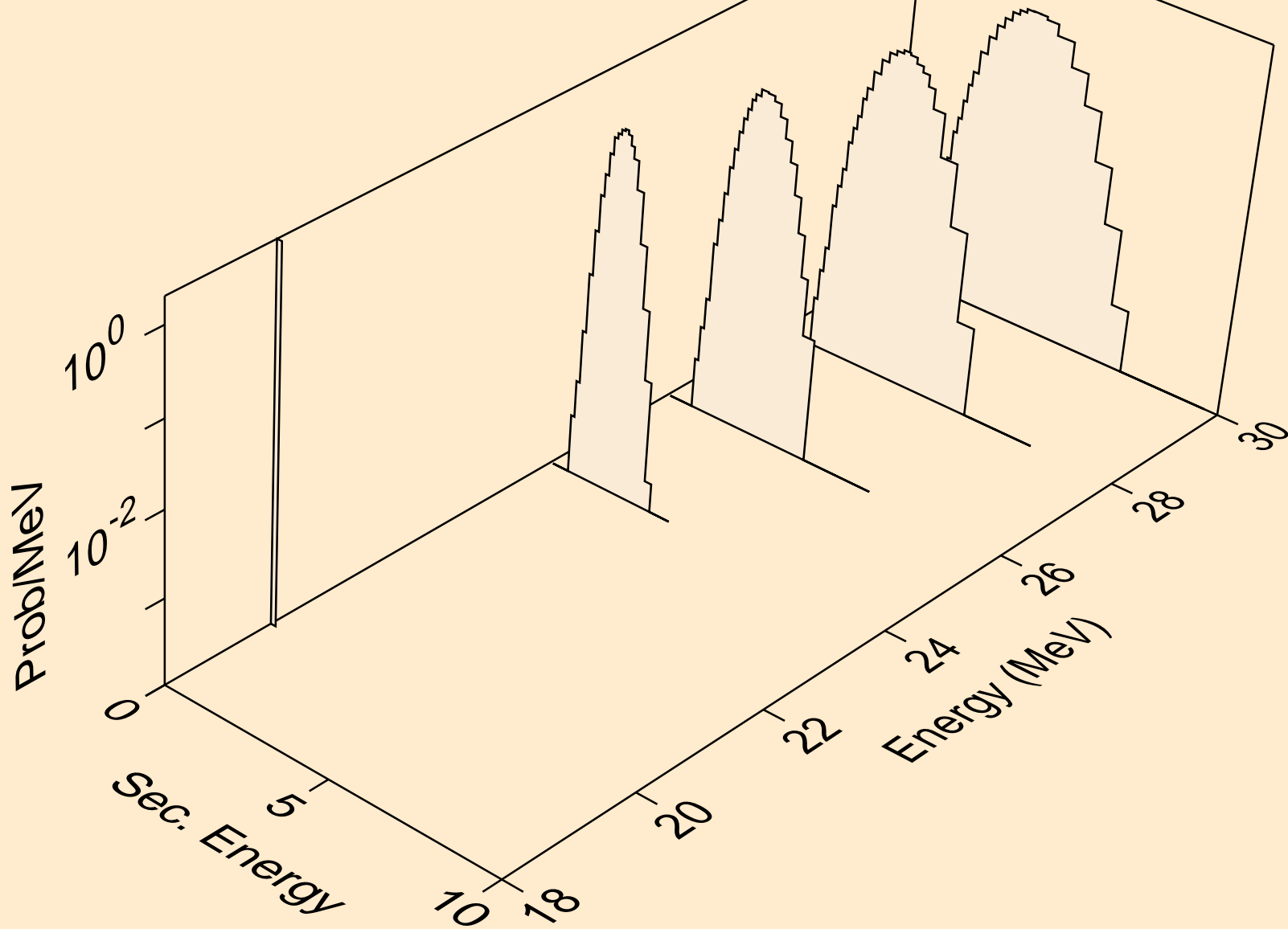

BR081 NEUTRON ACER TENDL-2021 LIBRARY; T=293.6K
deuterons from (n,x)

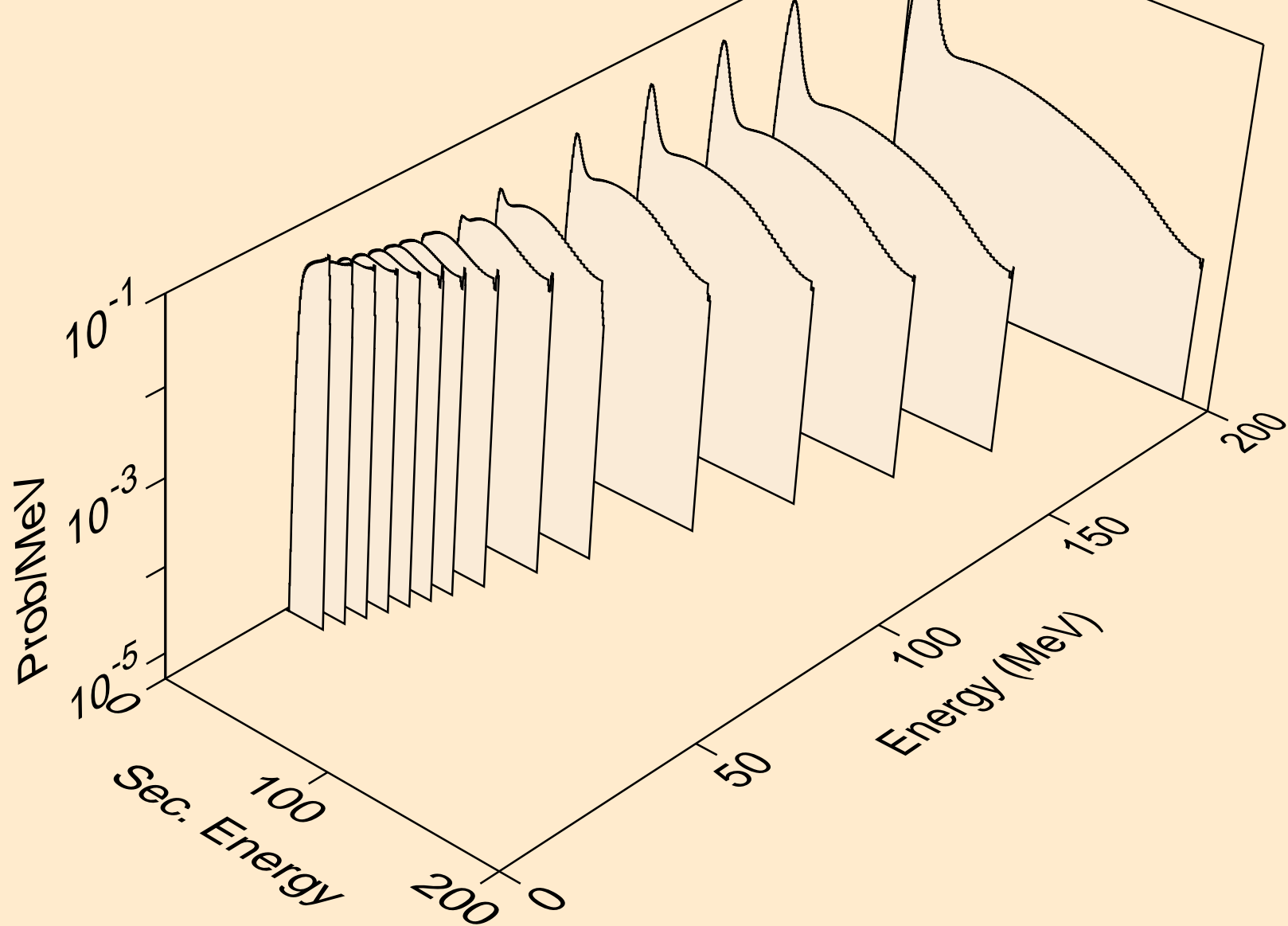

BR081 NEUTRON ACER TENDL-2021 LIBRARY; T=293.6K
deuterons from (n,2nd)

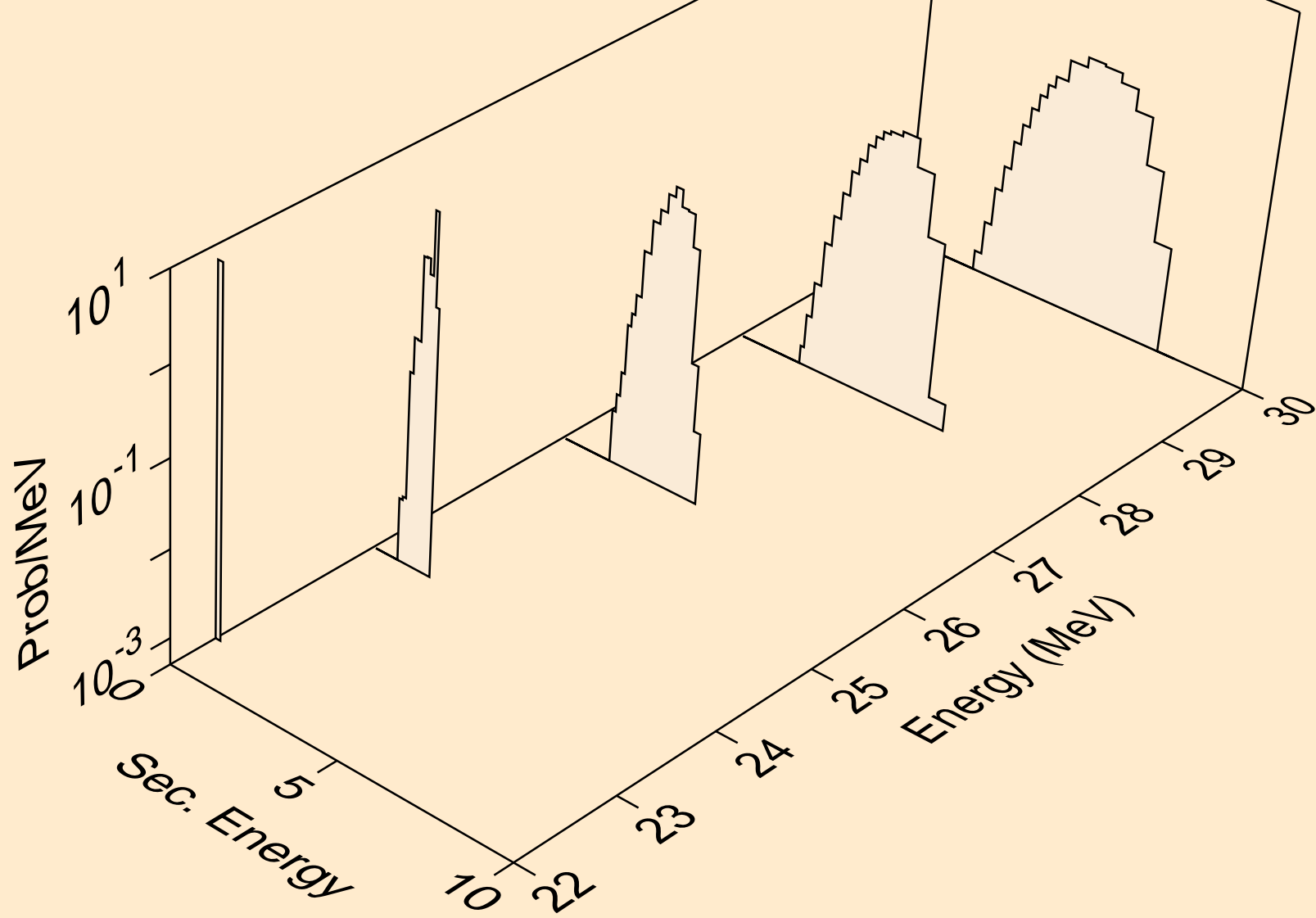

BR081 NEUTRON ACER TENDL-2021 LIBRARY; T=293.6K
deuterons from (n,n*)d

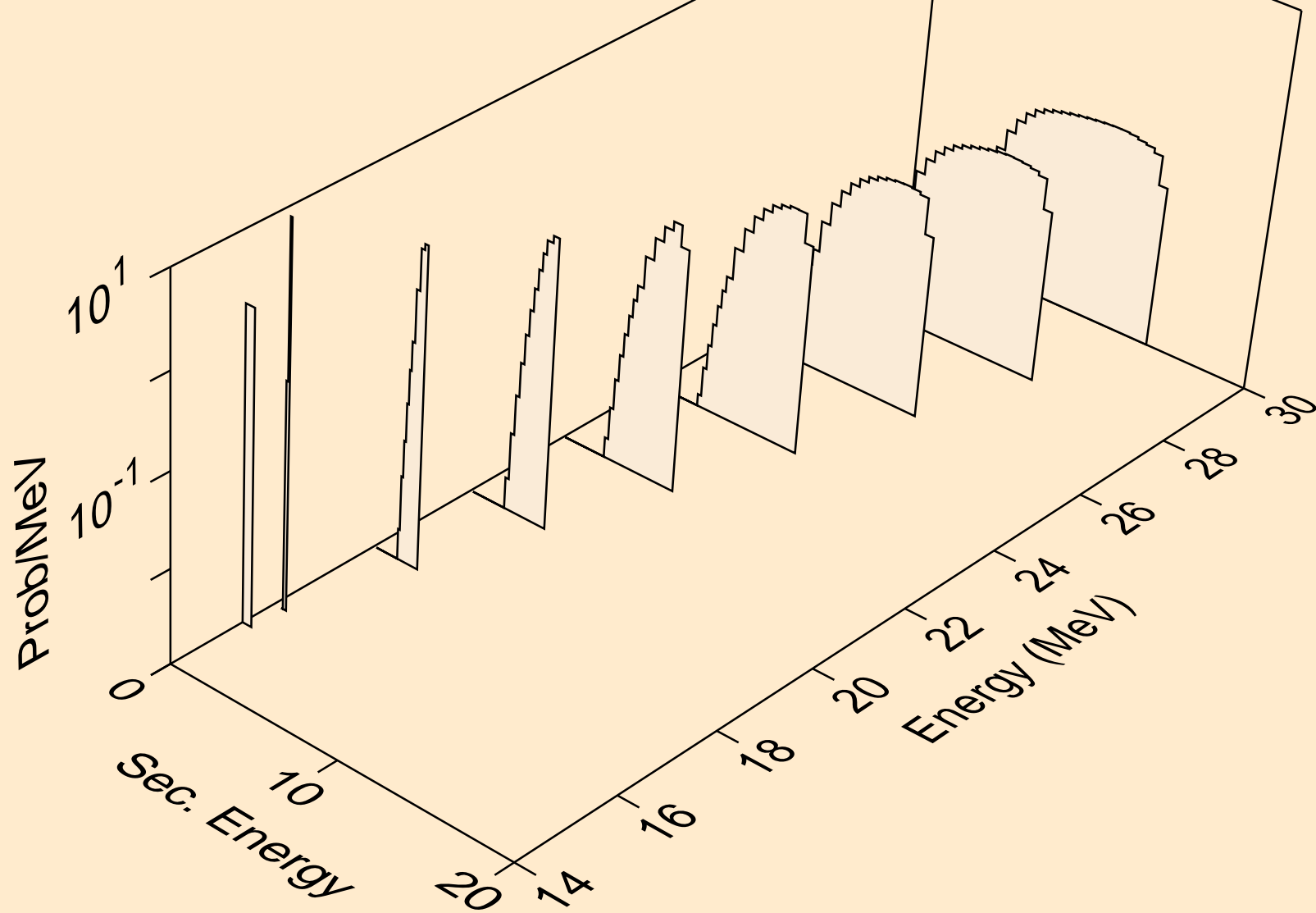

BR081 NEUTRON ACER TENDL-2021 LIBRARY; T=293.6K
deuterons from (n,d)

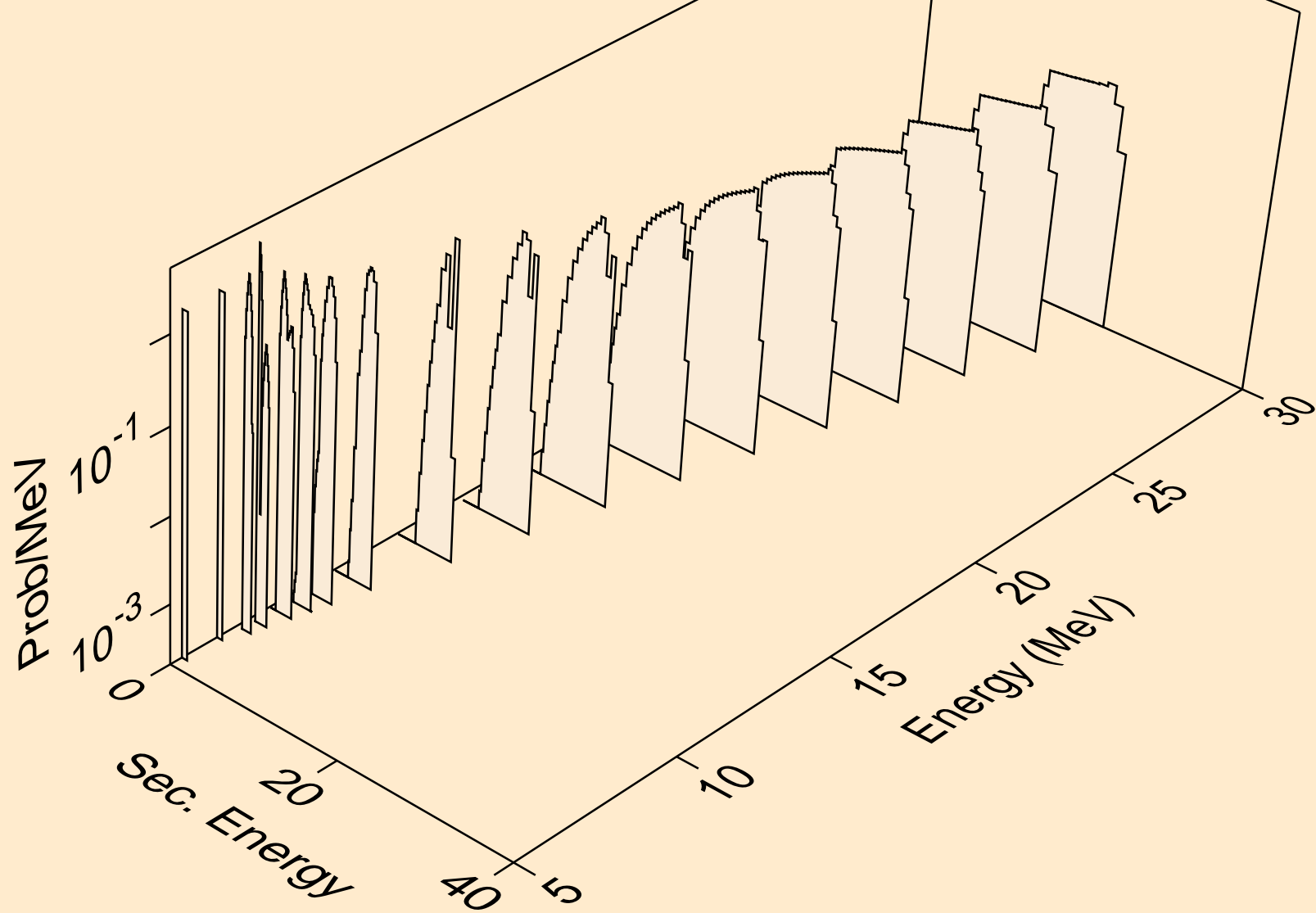

BR081 NEUTRON ACER TENDL-2021 LIBRARY; T=293.6K
deuterons from (n,pd)

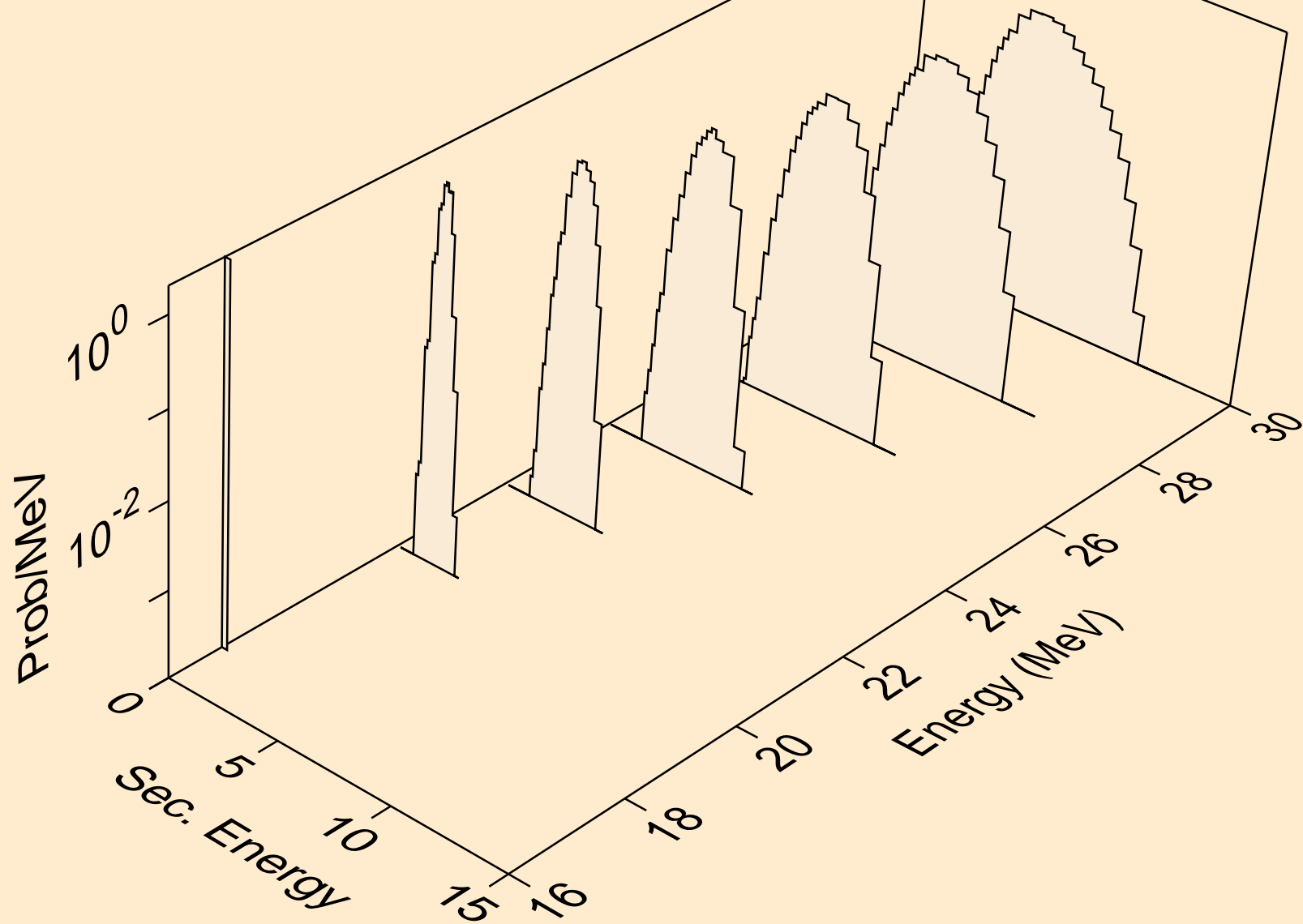

BR081 NEUTRON ACER TENDL-2021 LIBRARY; T=293.6K
deuterons from (n,da)

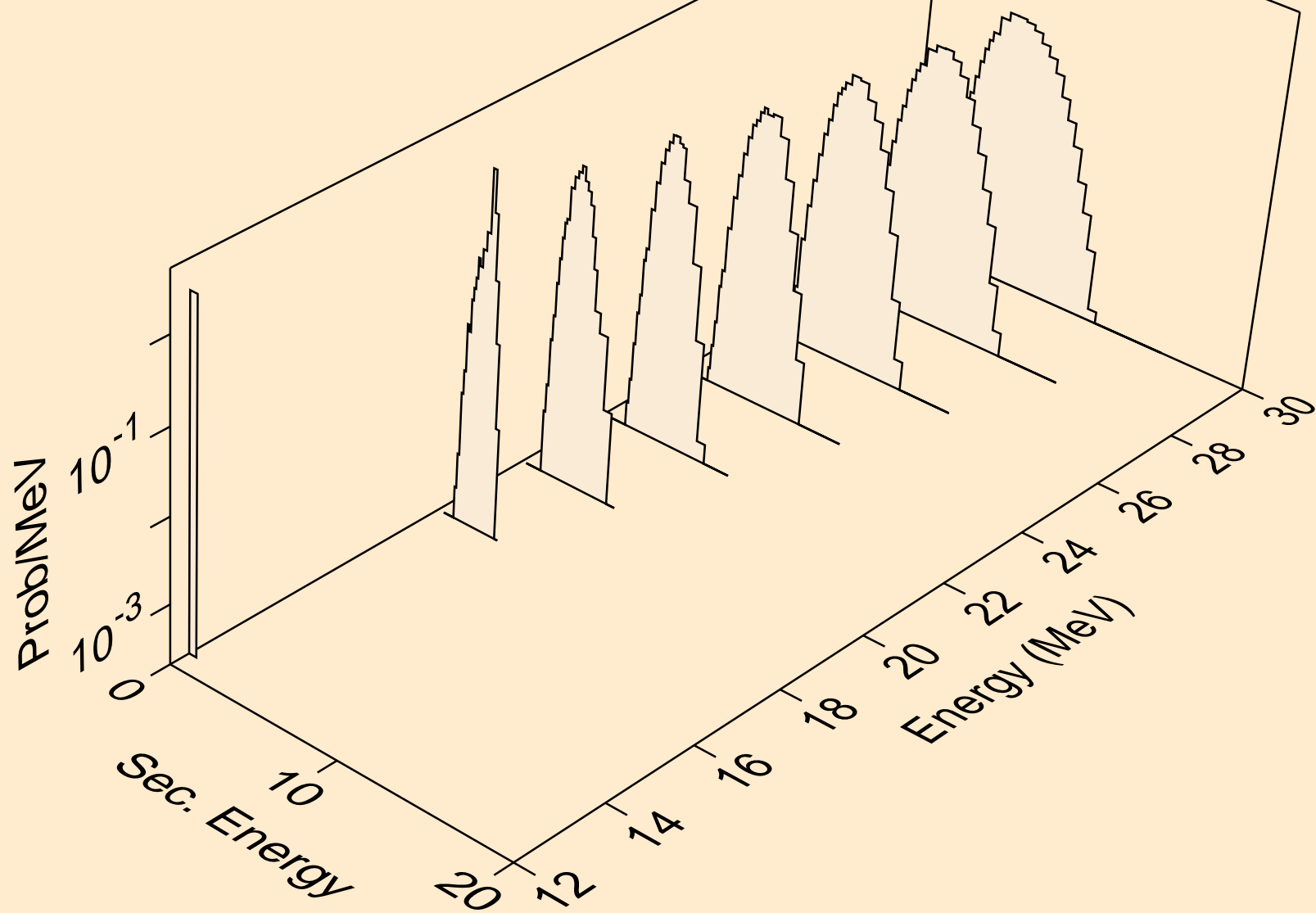

BR081 NEUTRON ACER TENDL-2021 LIBRARY; T=293.6K
tritons from (n,x)

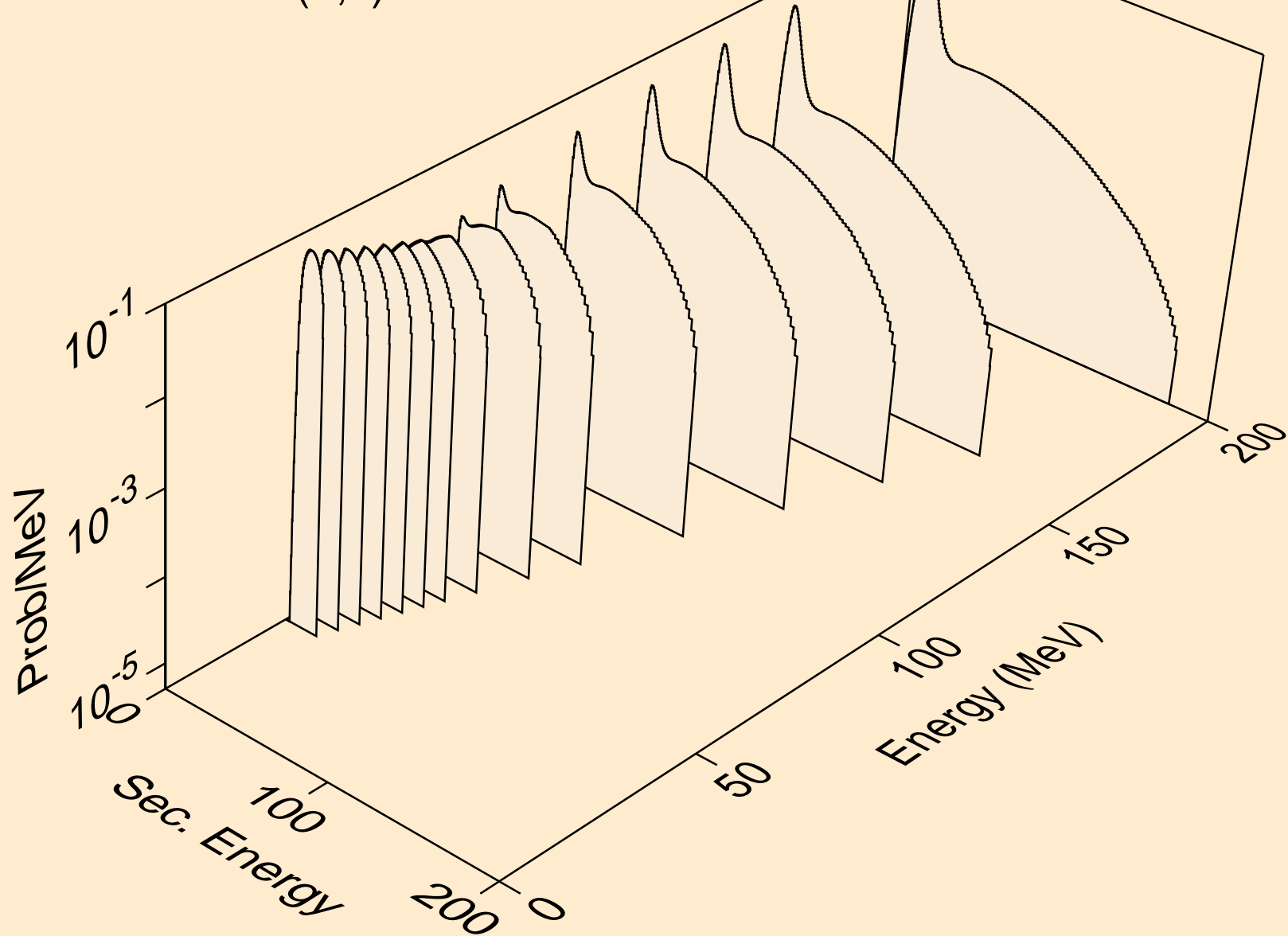

BR081 NEUTRON ACER TENDL-2021 LIBRARY; T=293.6K
tritons from (n,n*)t

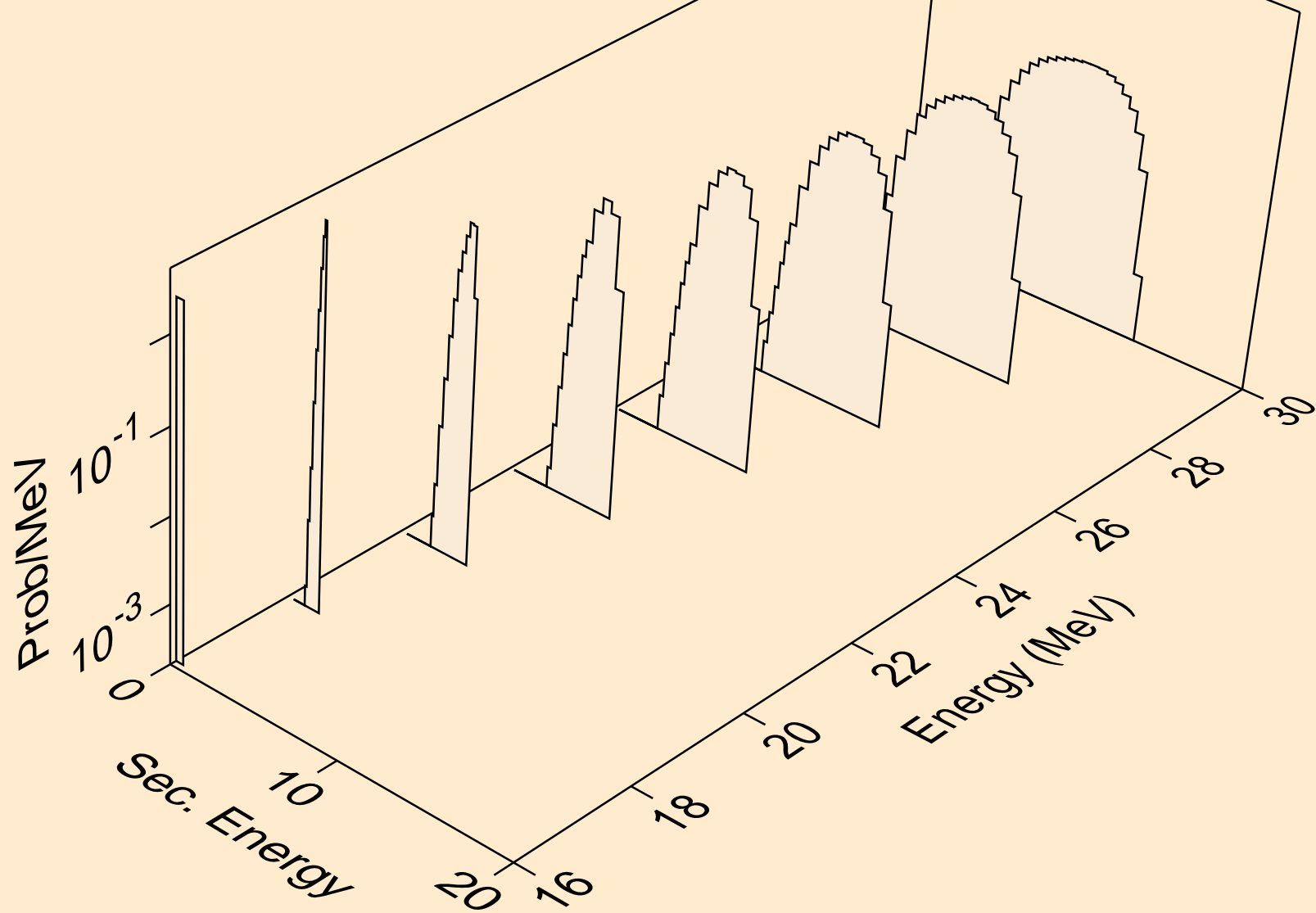

BR081 NEUTRON ACER TENDL-2021 LIBRARY; T=293.6K
tritons from (n,t)

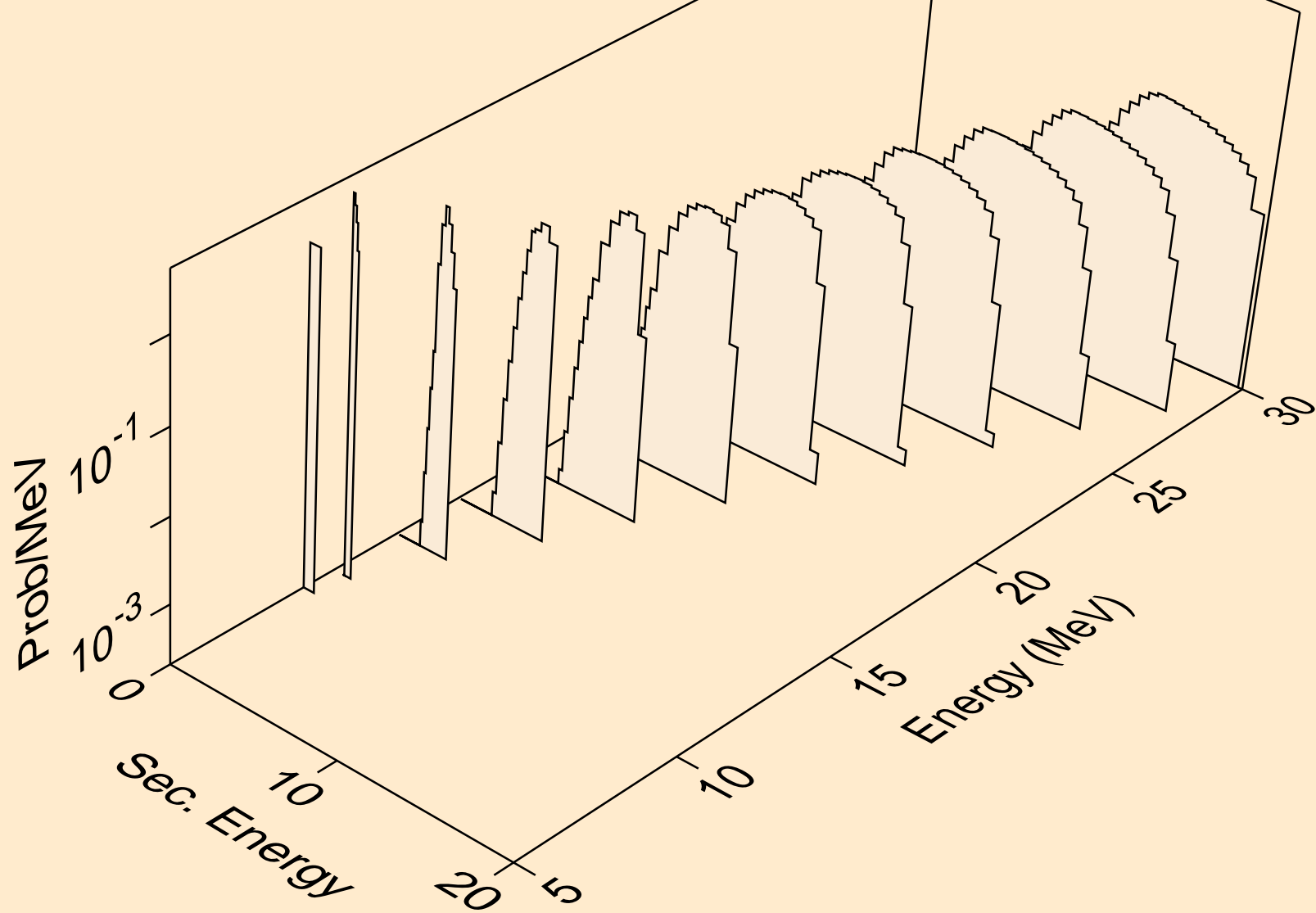

BR081 NEUTRON ACER TENDL-2021 LIBRARY; T=293.6K
tritons from (n,pt)

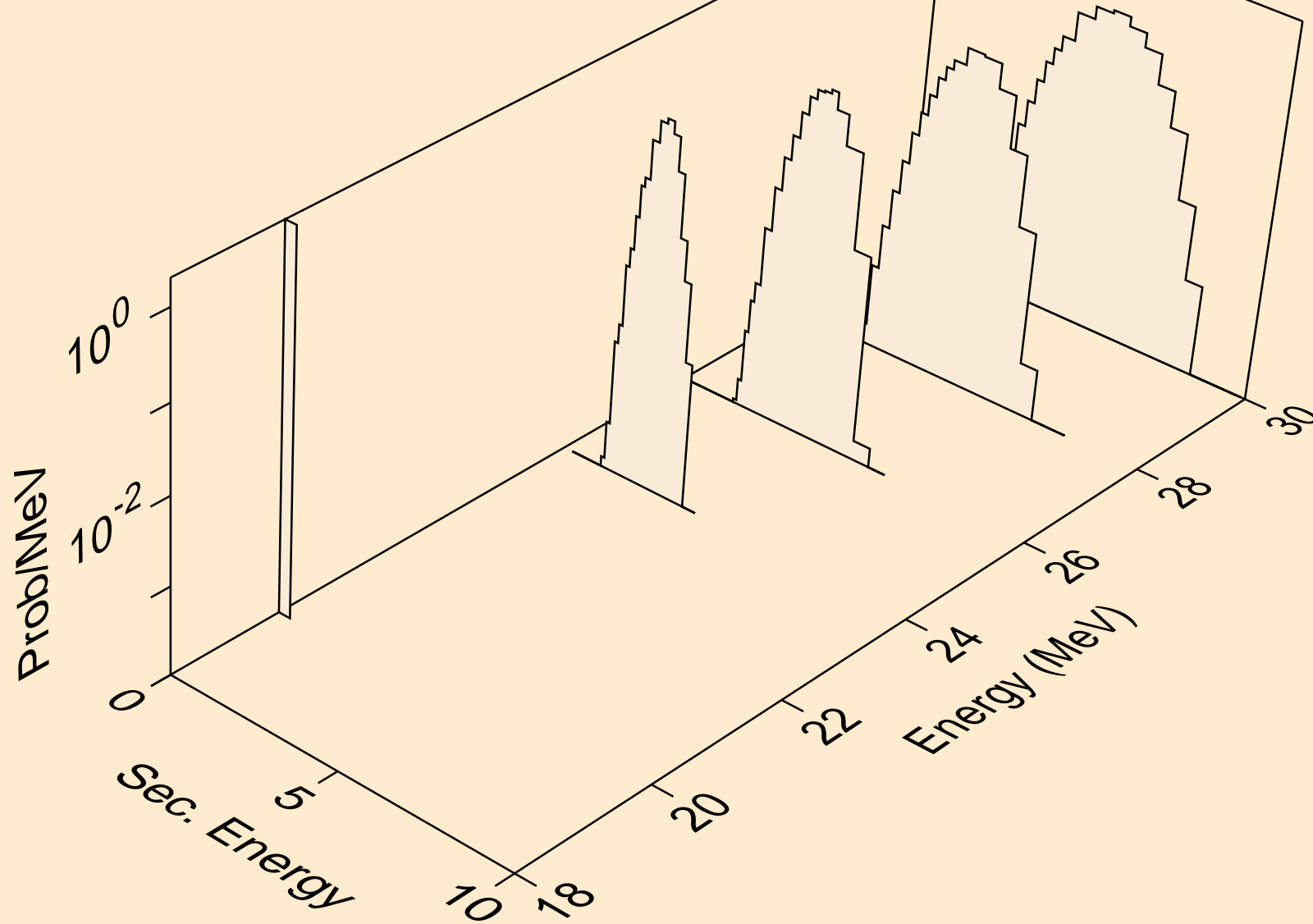

BR081 NEUTRON ACER TENDL-2021 LIBRARY; T=293.6K
he3s from (n,x)

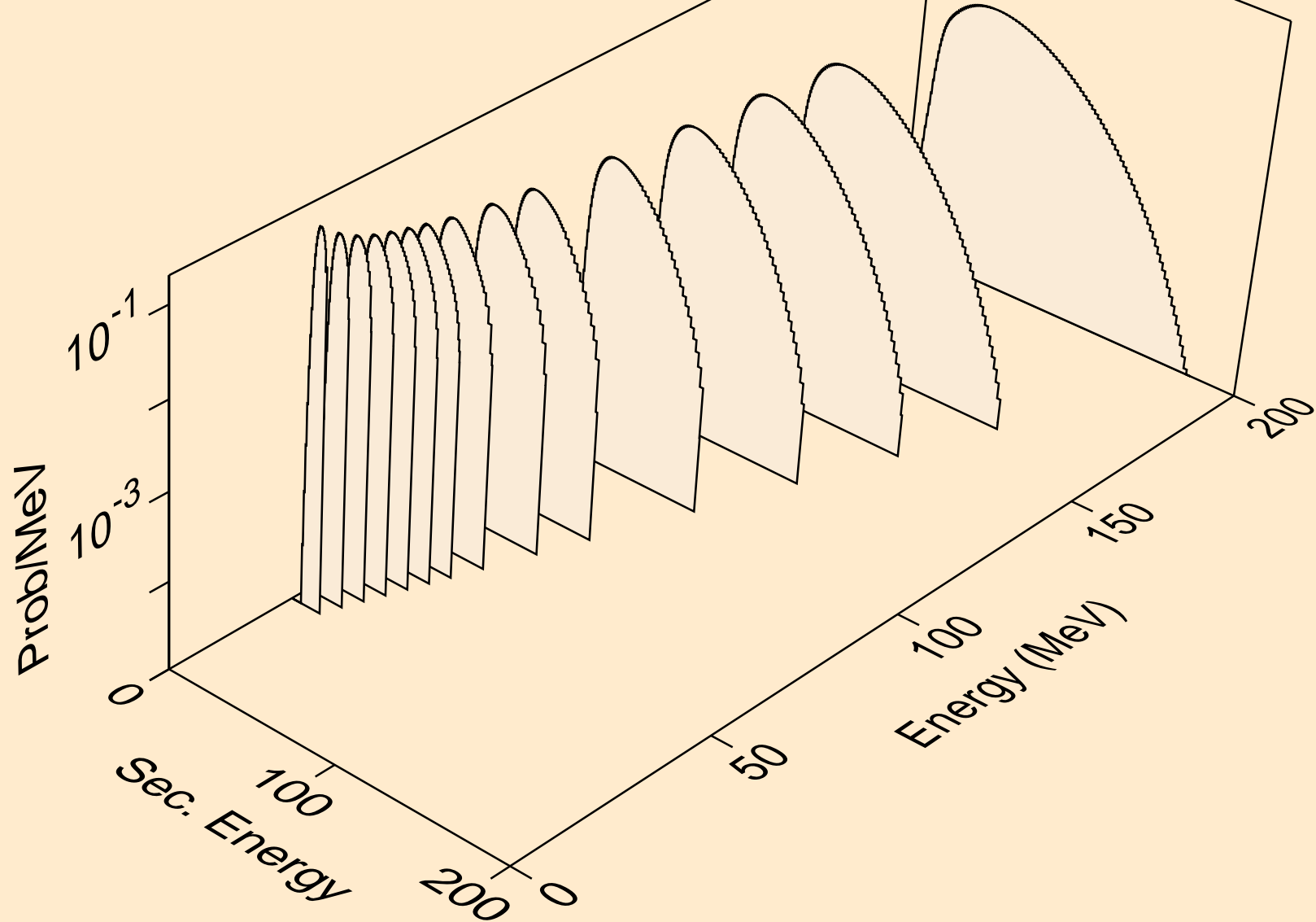

BR081 NEUTRON ACER TENDL-2021 LIBRARY; T=293.6K
he3s from (n,n*)he3

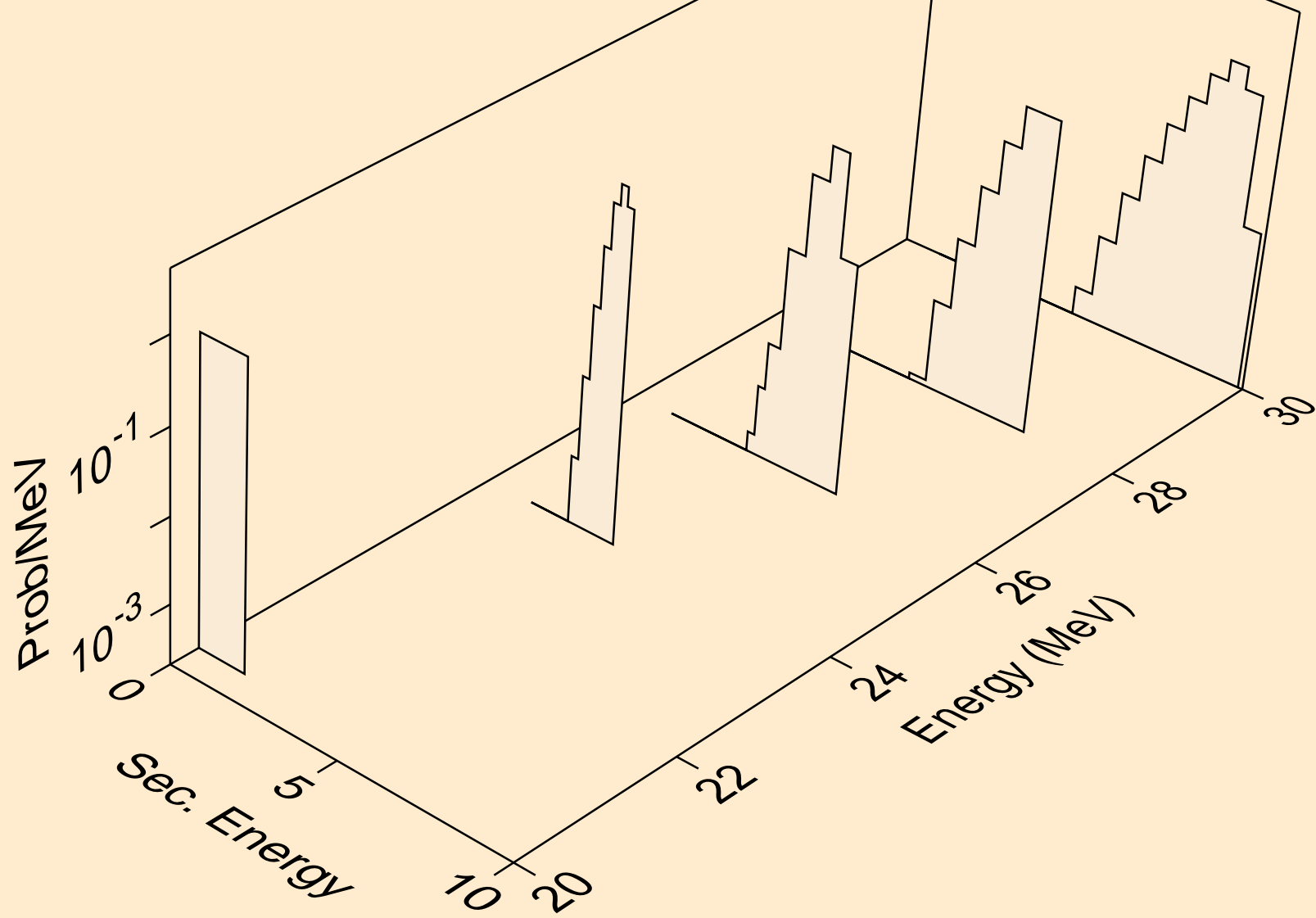

BR081 NEUTRON ACER TENDL-2021 LIBRARY; T=293.6K
he3s from (n,he3)

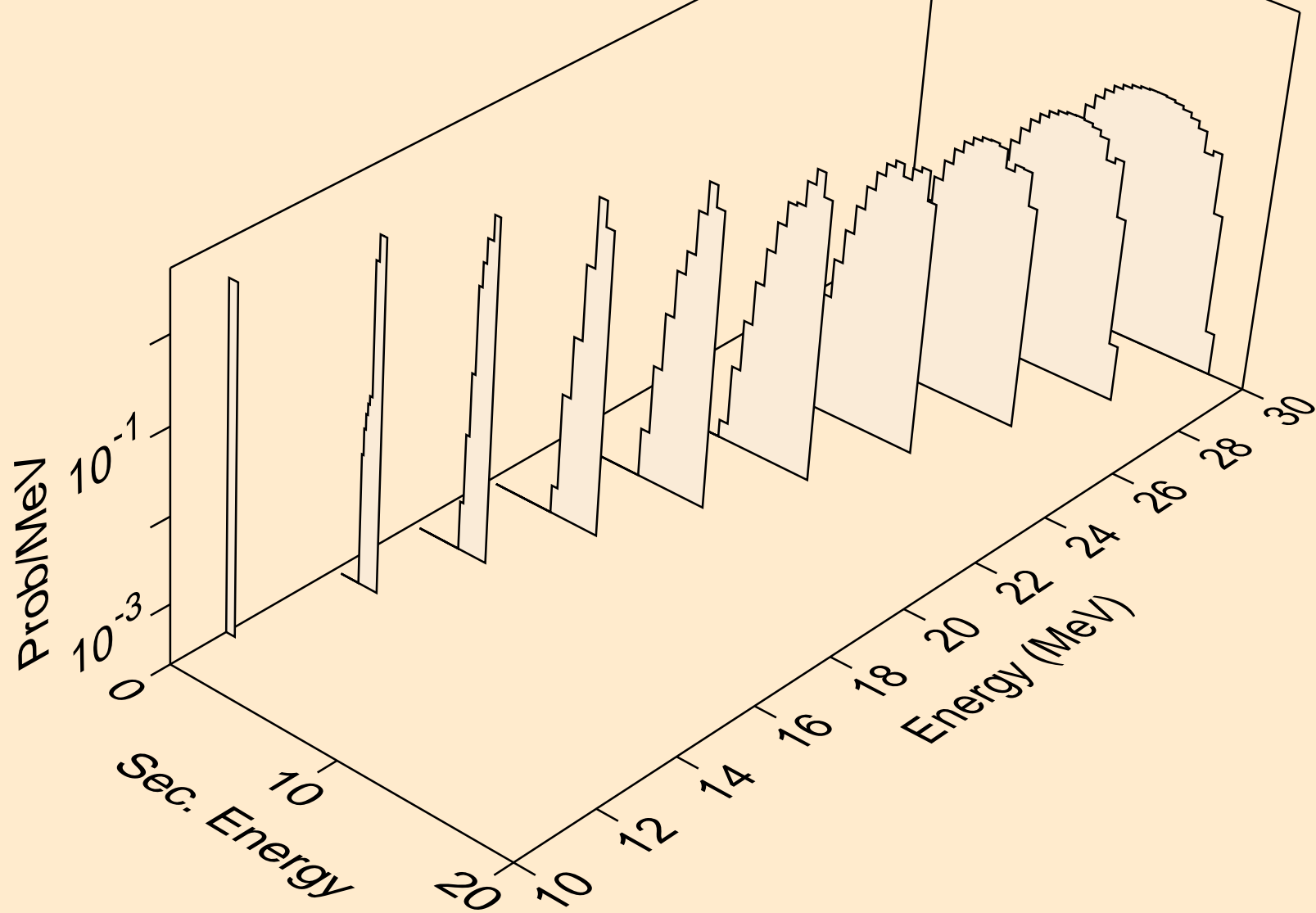

BR081 NEUTRON ACER TENDL-2021 LIBRARY; T=293.6K
alphas from (n,x)

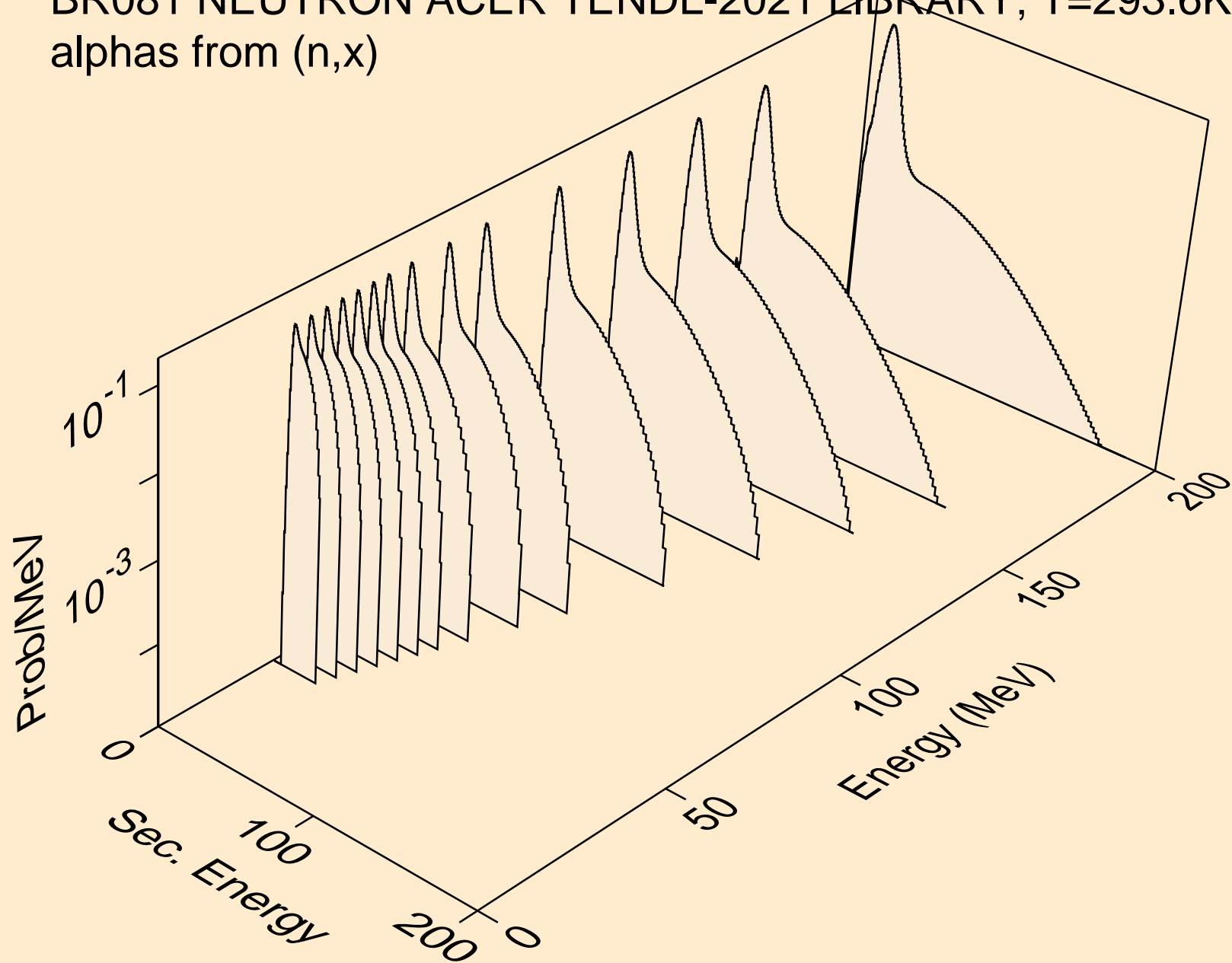

BR081 NEUTRON ACER TENDL-2021 LIBRARY; T=293.6K
alphas from (n,n*)a

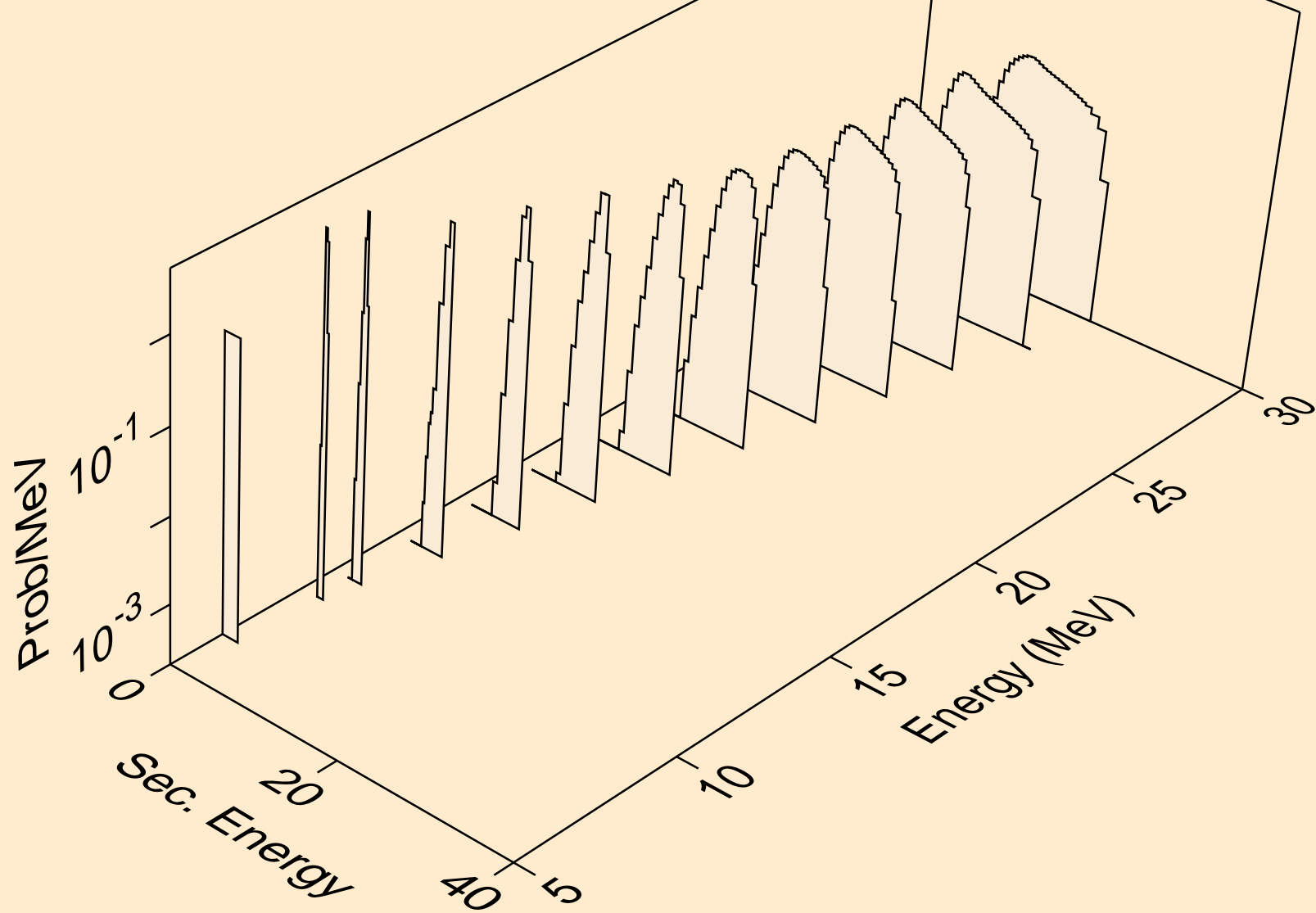

BR081 NEUTRON ACER TENDL-2021 LIBRARY; T=293.6K
alphas from (n,2n)a

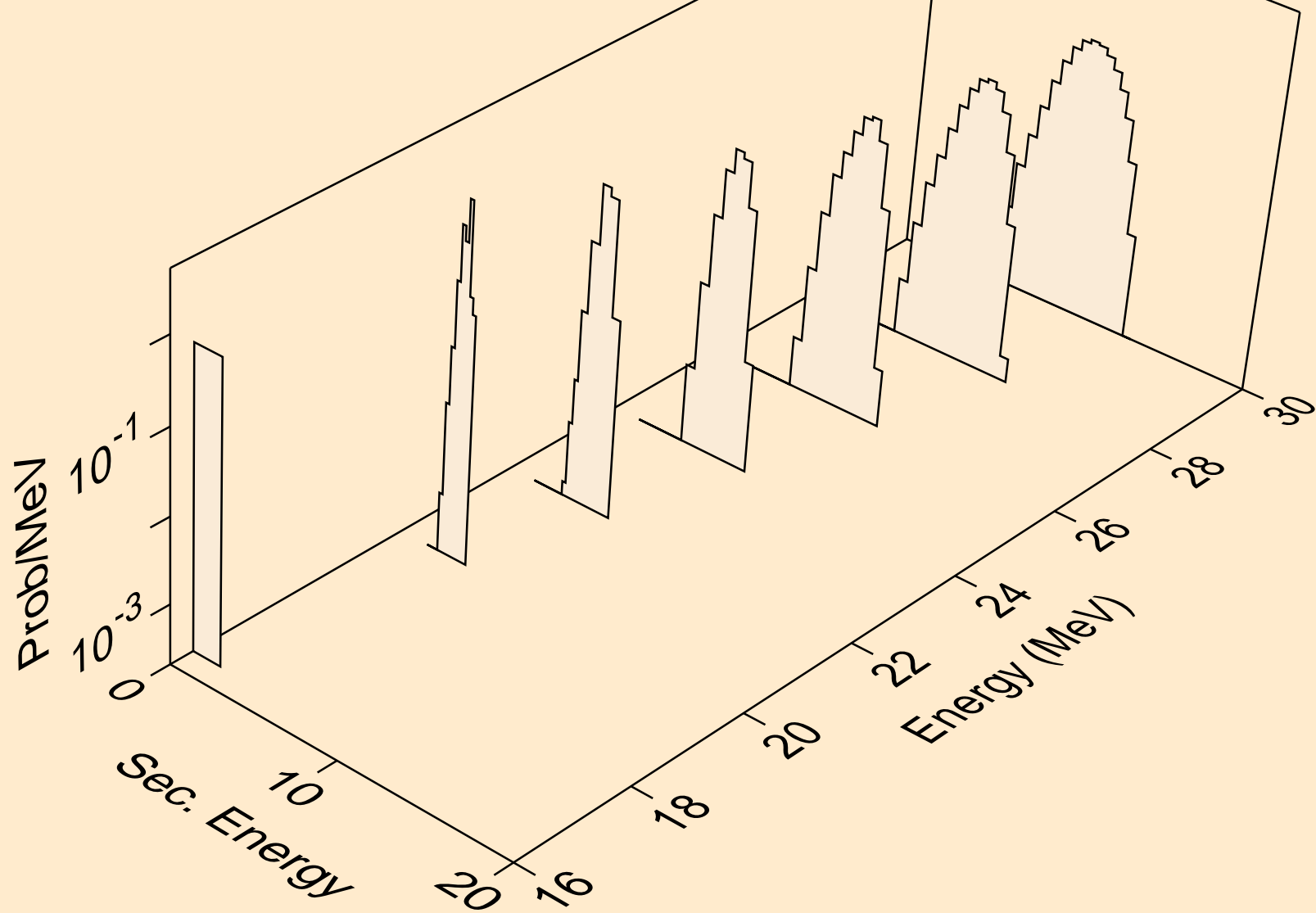

BR081 NEUTRON ACER TENDL-2021 LIBRARY; T=293.6K
alphas from (n,3n)a

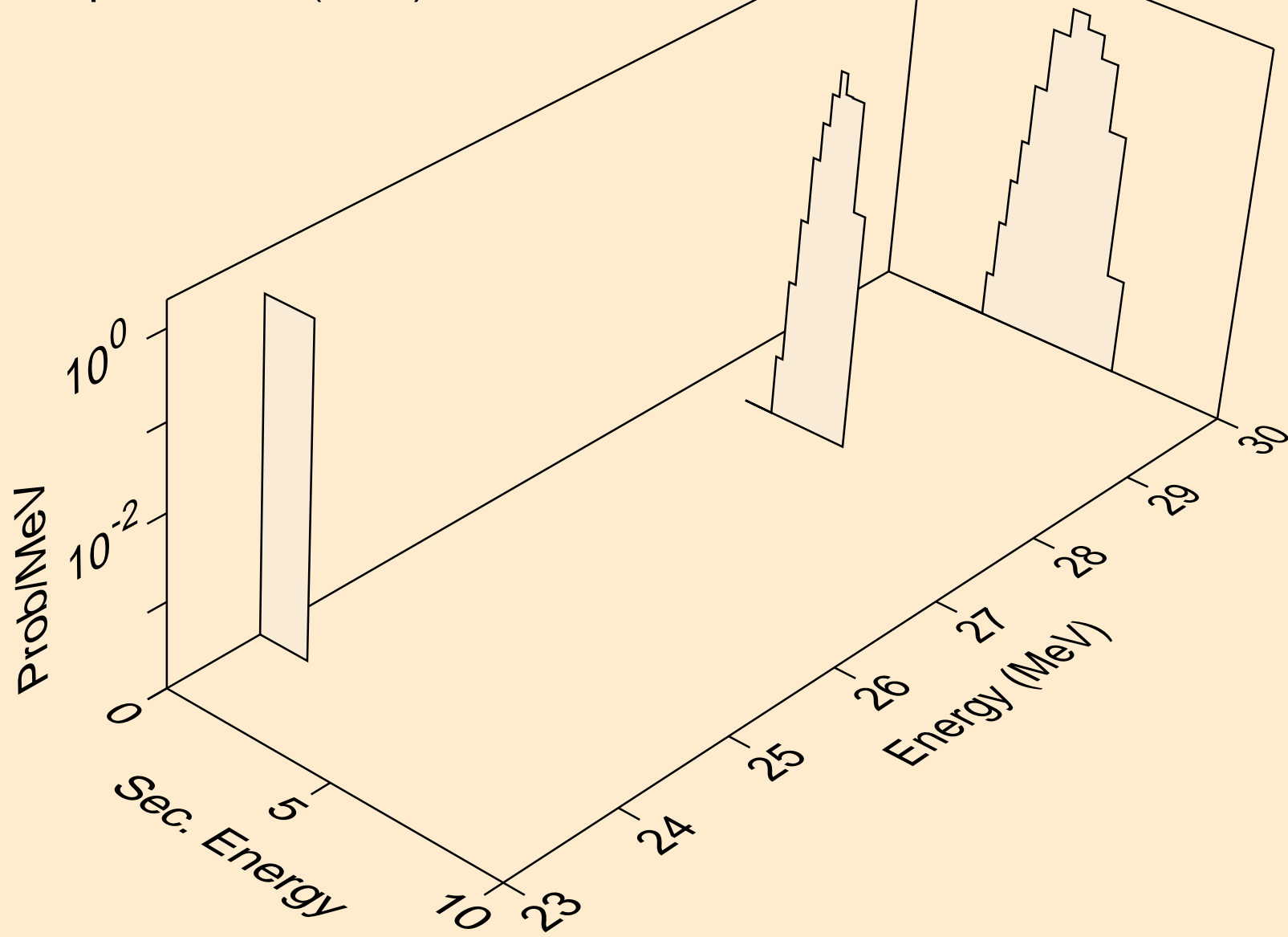

BR081 NEUTRON ACER TENDL-2021 LIBRARY; T=293.6K
alphas from (n,n*)2a

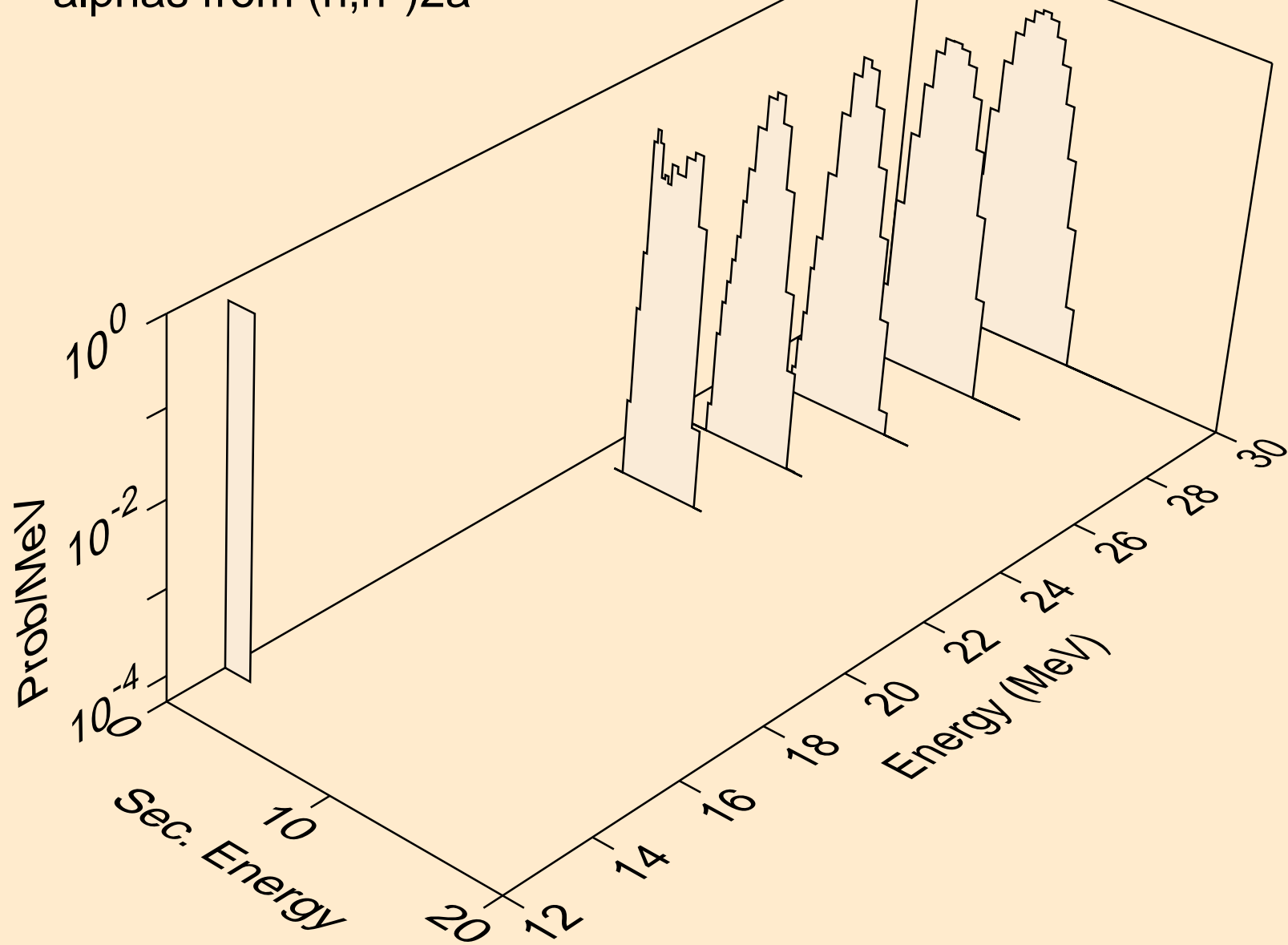

BR081 NEUTRON ACER TENDL-2021 LIBRARY; T=293.6K
alphas from (n,npa)

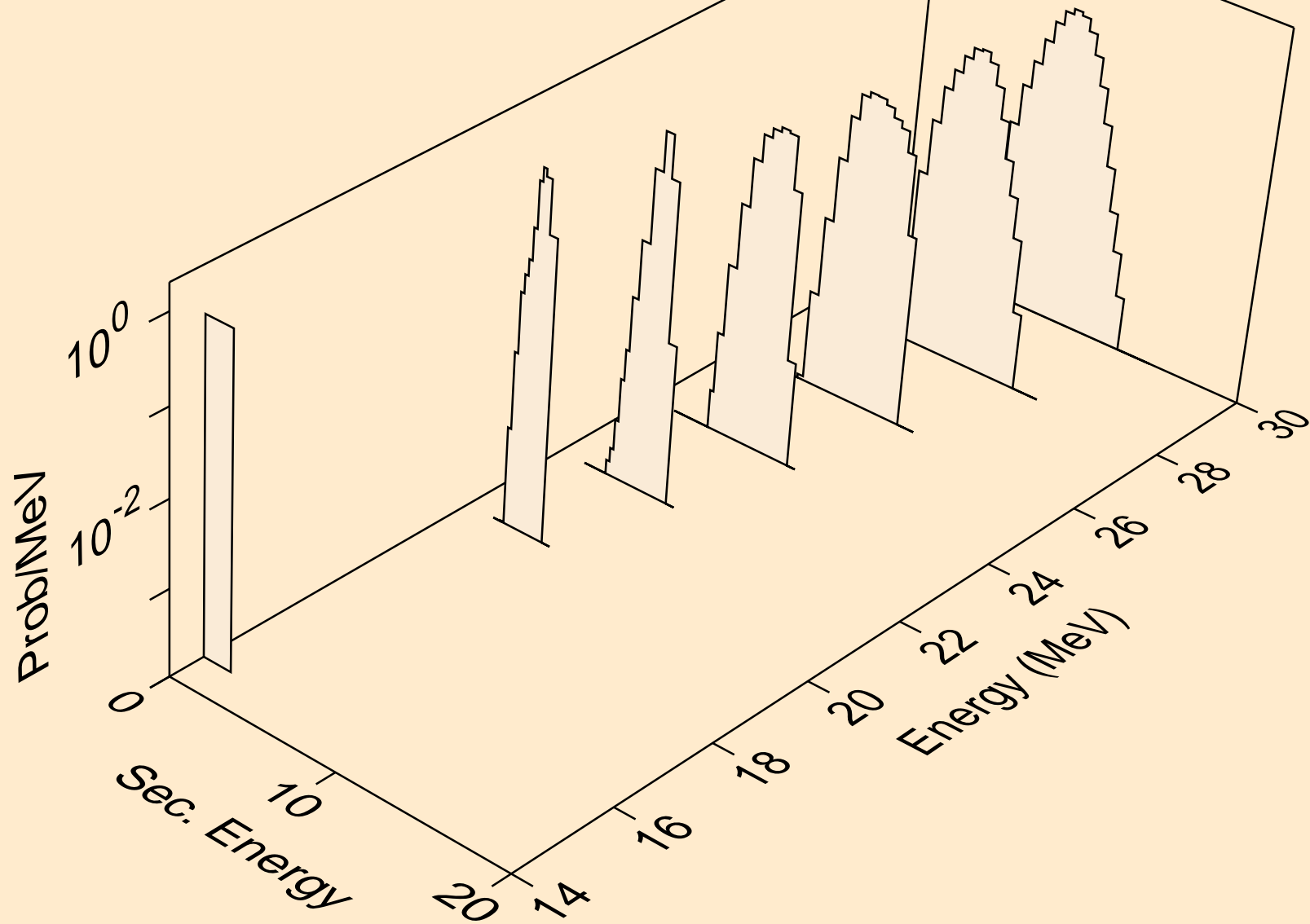

BR081 NEUTRON ACER TENDL-2021 LIBRARY; T=293.6K
alphas from (n,a)

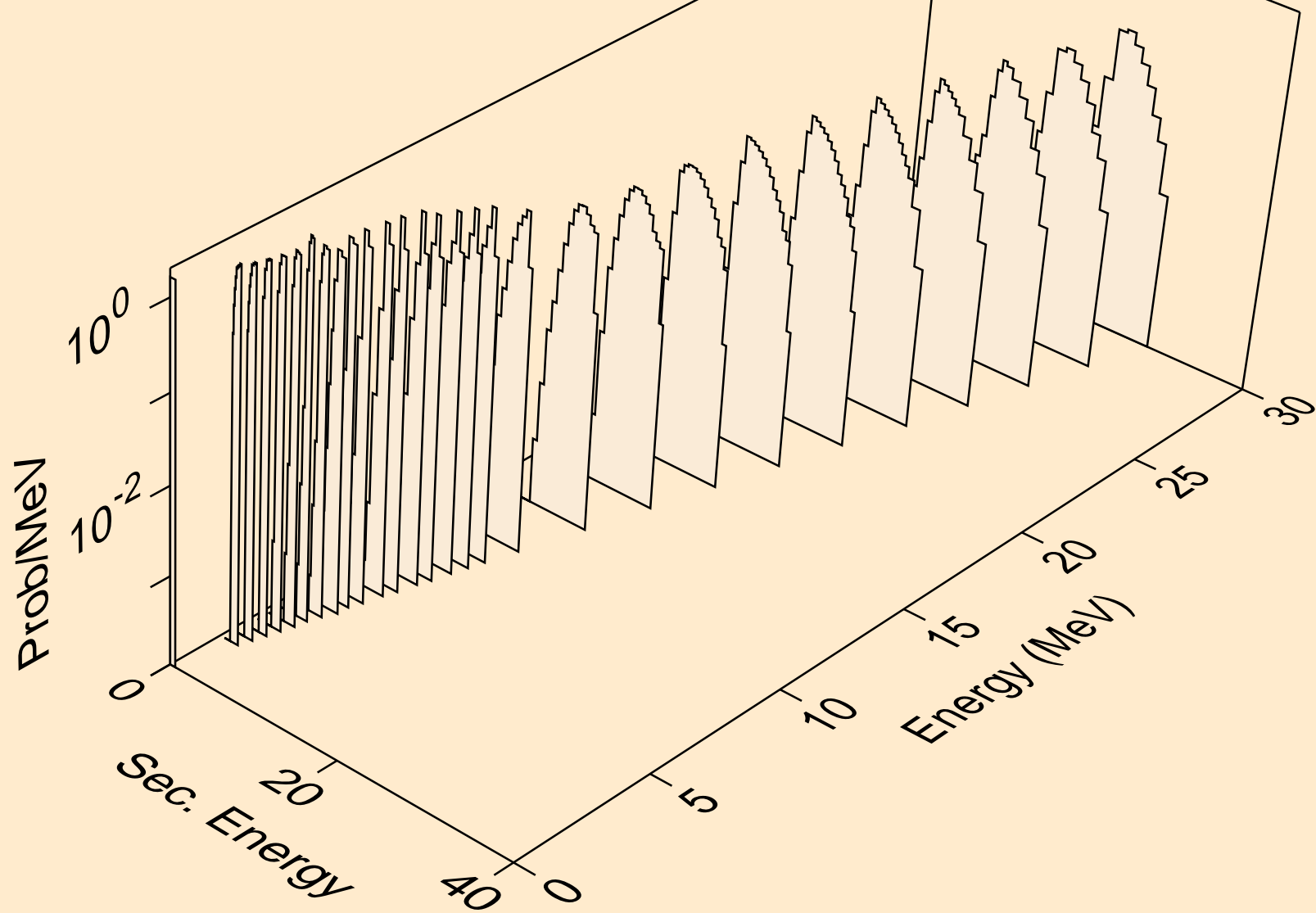

BR081 NEUTRON ACER TENDL-2021 LIBRARY; T=293.6K
alphas from (n,2a)

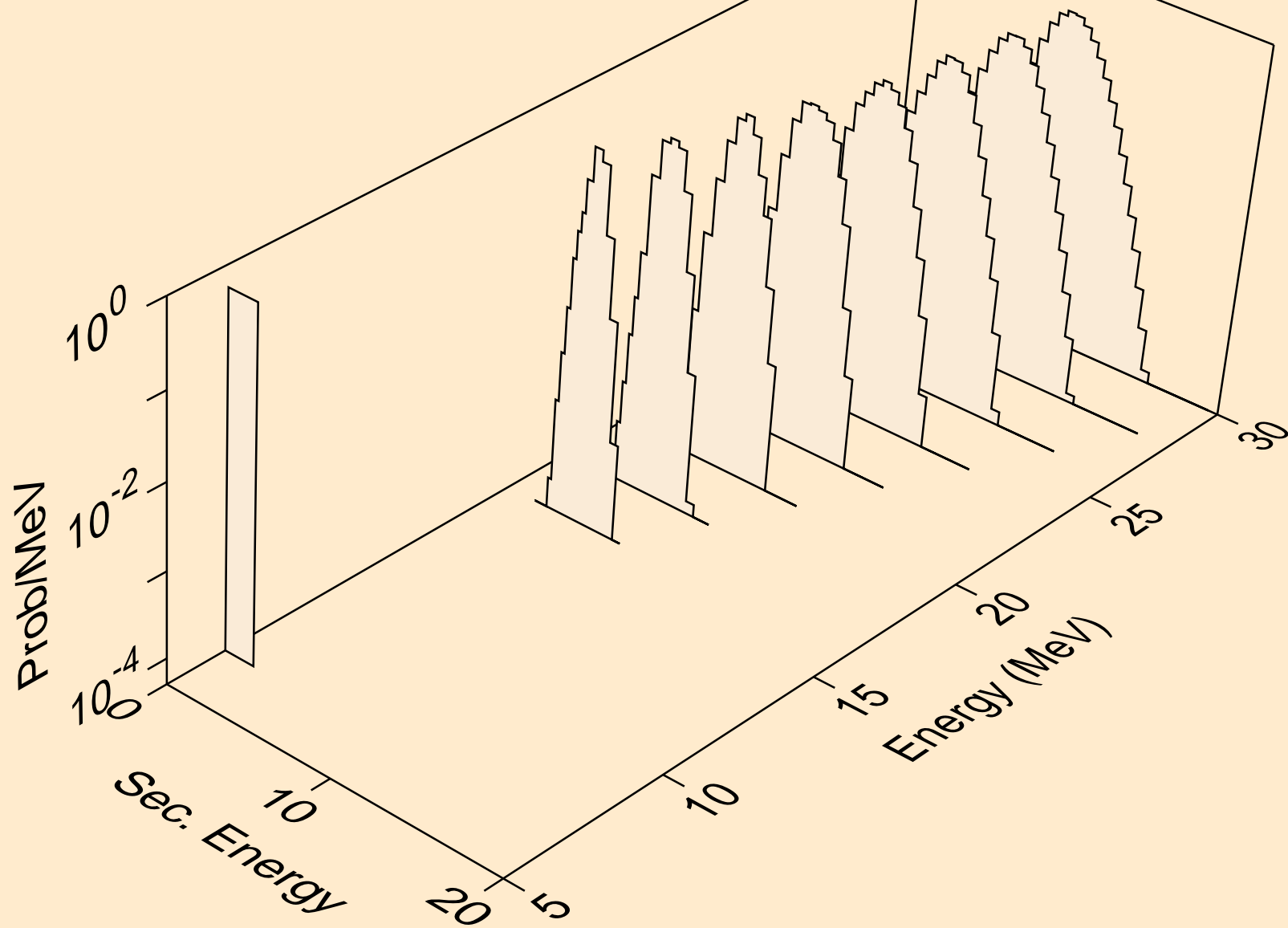

BR081 NEUTRON ACER TENDL-2021 LIBRARY; T=293.6K
alphas from (n,pa)

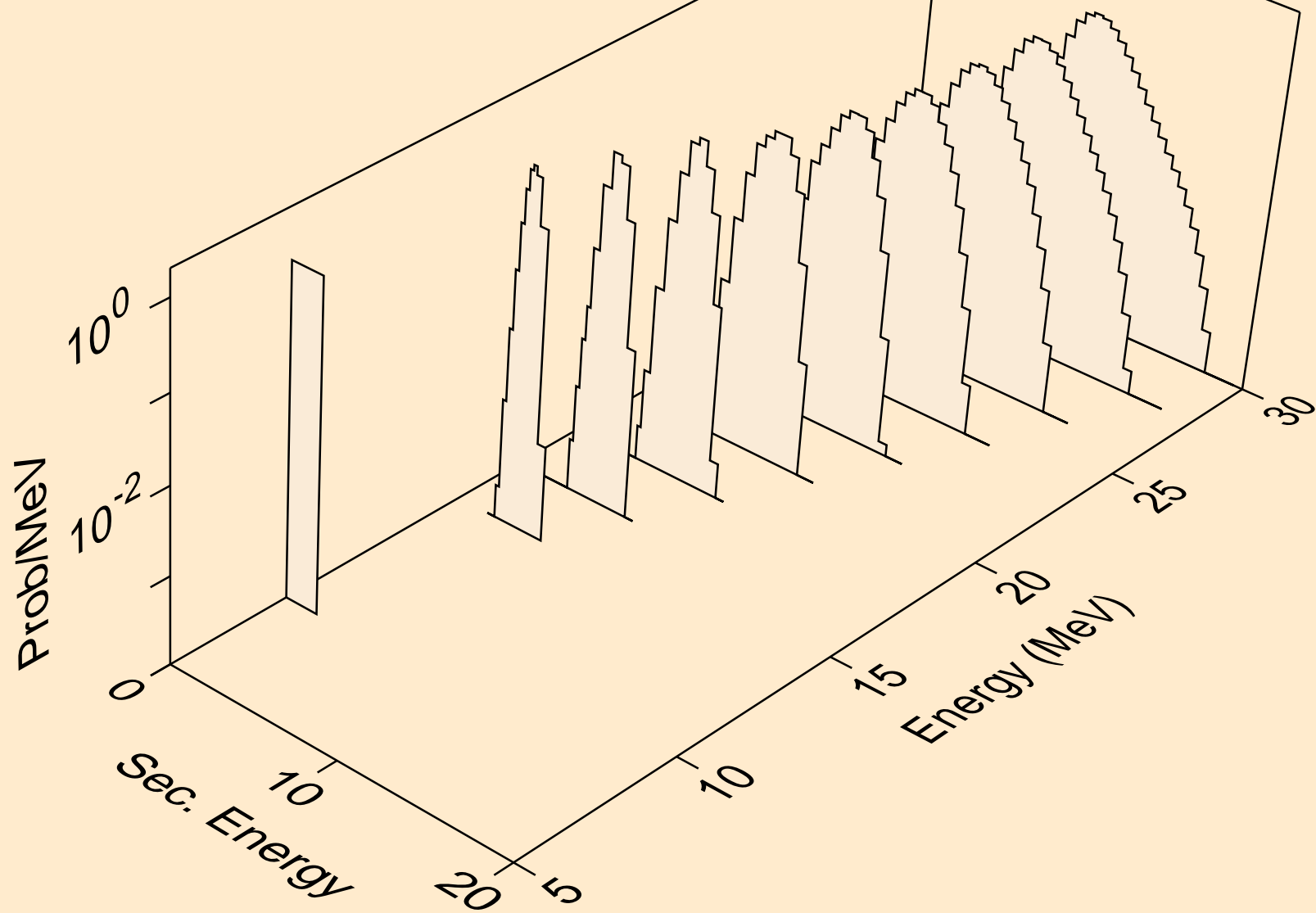

BR081 NEUTRON ACER TENDL-2021 LIBRARY; T=293.6K
alphas from (n,da)

