

BR084M NEUTRON ACER TENDL-2021 LIBRARY; T=293.6K
Principal cross sections

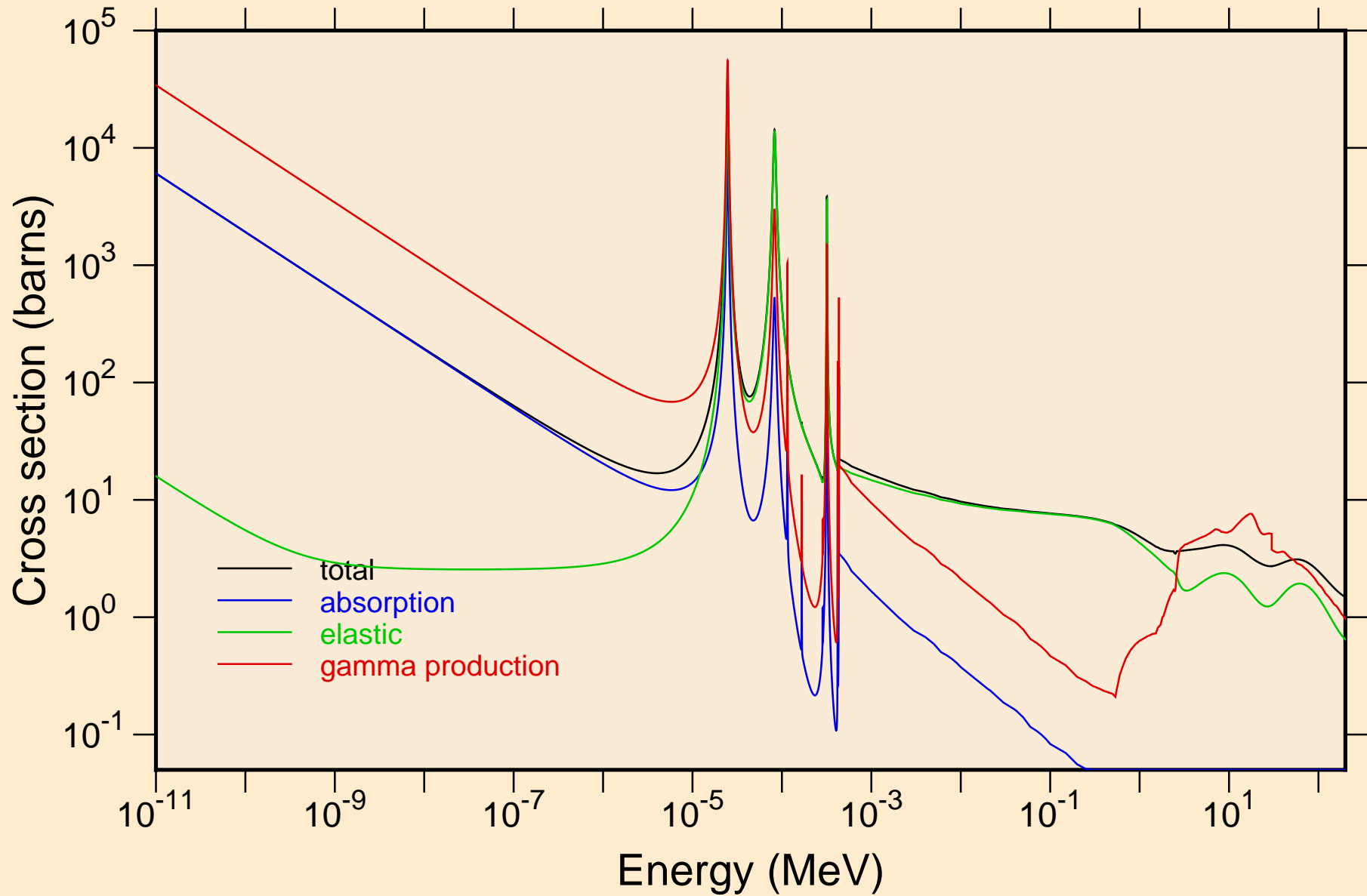

BR084M NEUTRON ACER TENDL-2021 LIBRARY; T=293.6K
resonance total cross section

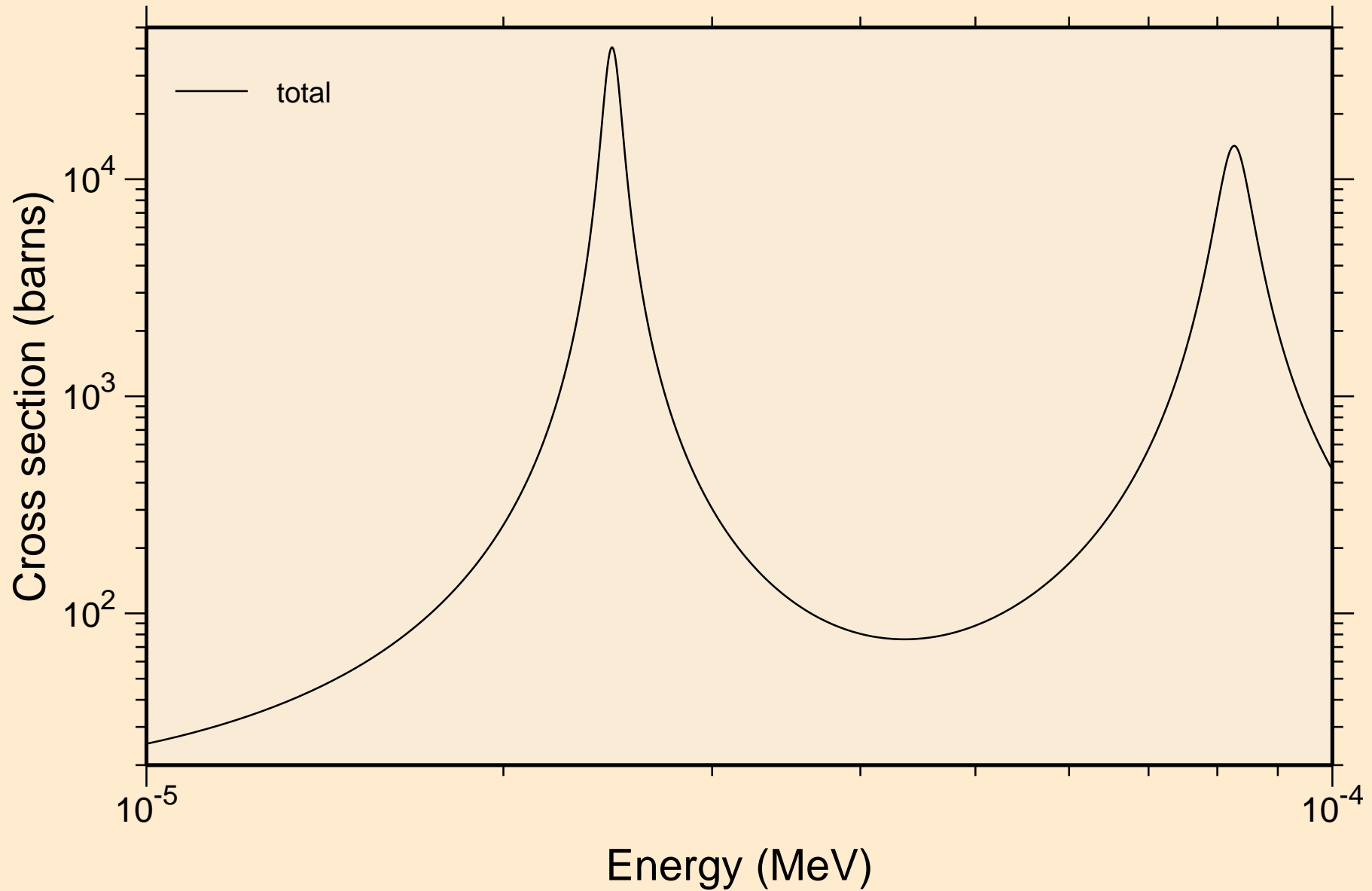

BR084M NEUTRON ACER TENDL-2021 LIBRARY; T=293.6K
resonance total cross section

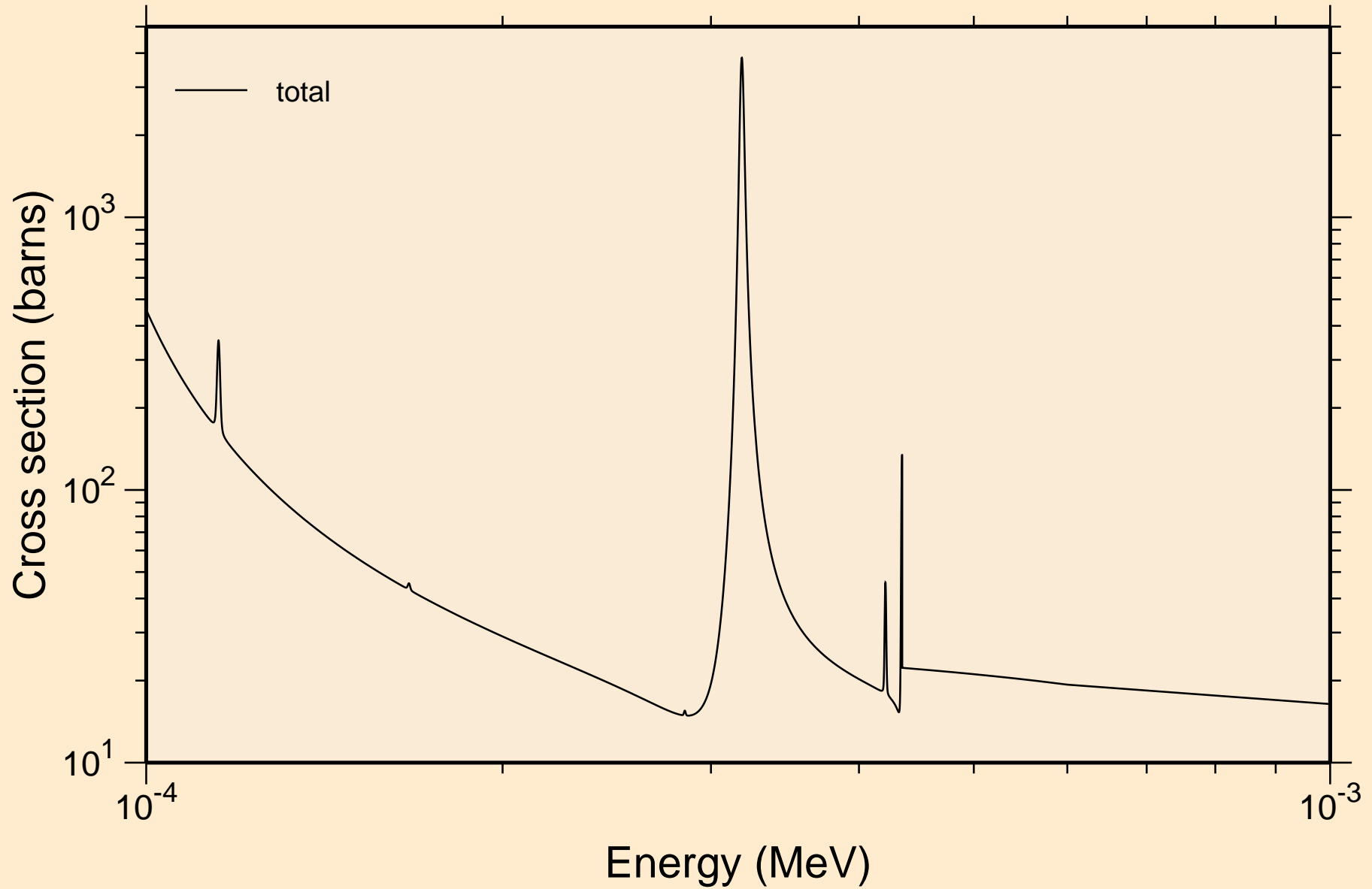

B̄R084M NEUTRON ACER TENDL-2021 LIBRARY; T=293.6K
resonance total cross section

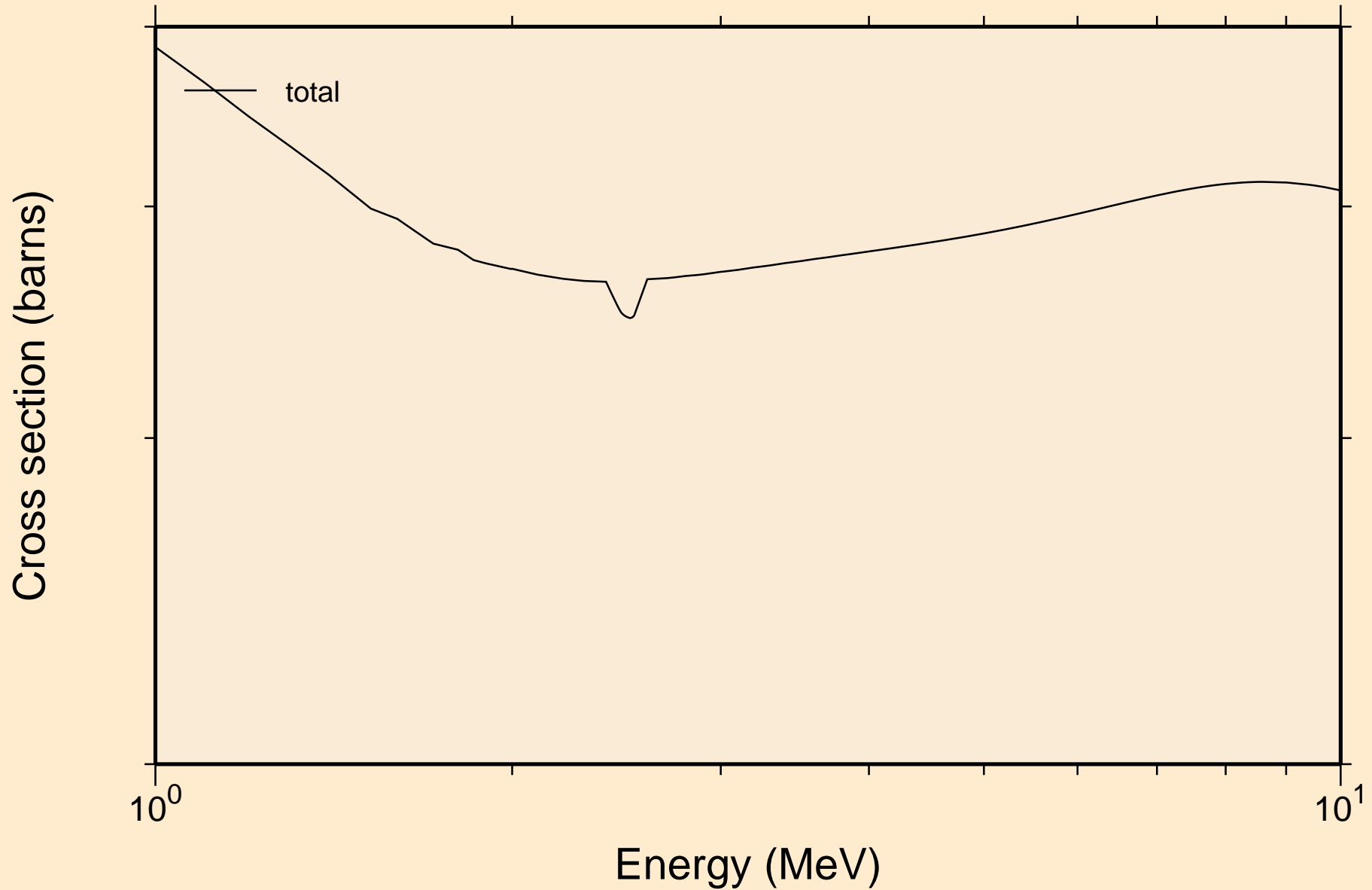

BR084M NEUTRON ACER TENDL-2021 LIBRARY; T=293.6K
resonance absorption cross sections

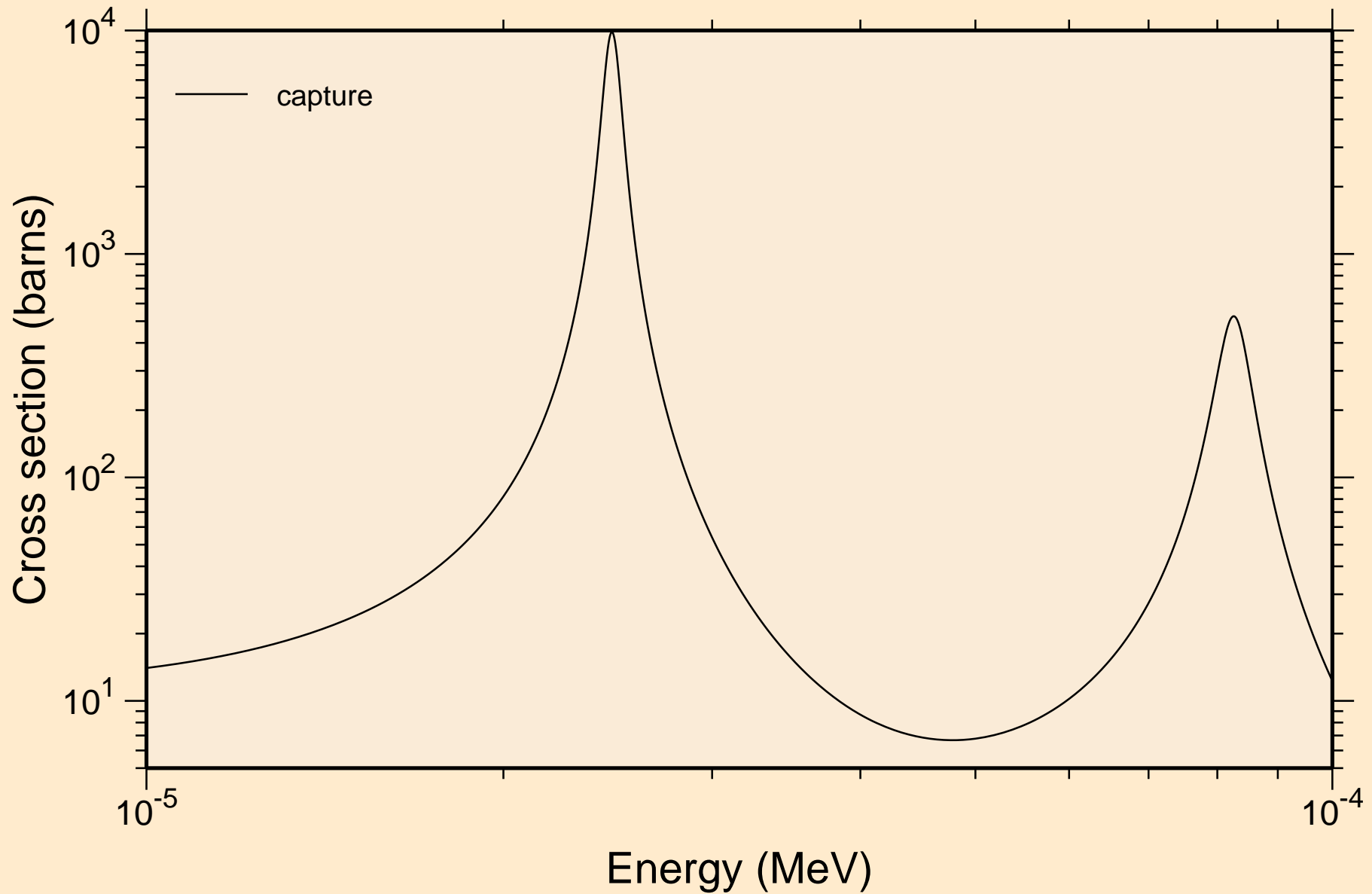

BR084M NEUTRON ACER TENDL-2021 LIBRARY; T=293.6K
resonance absorption cross sections

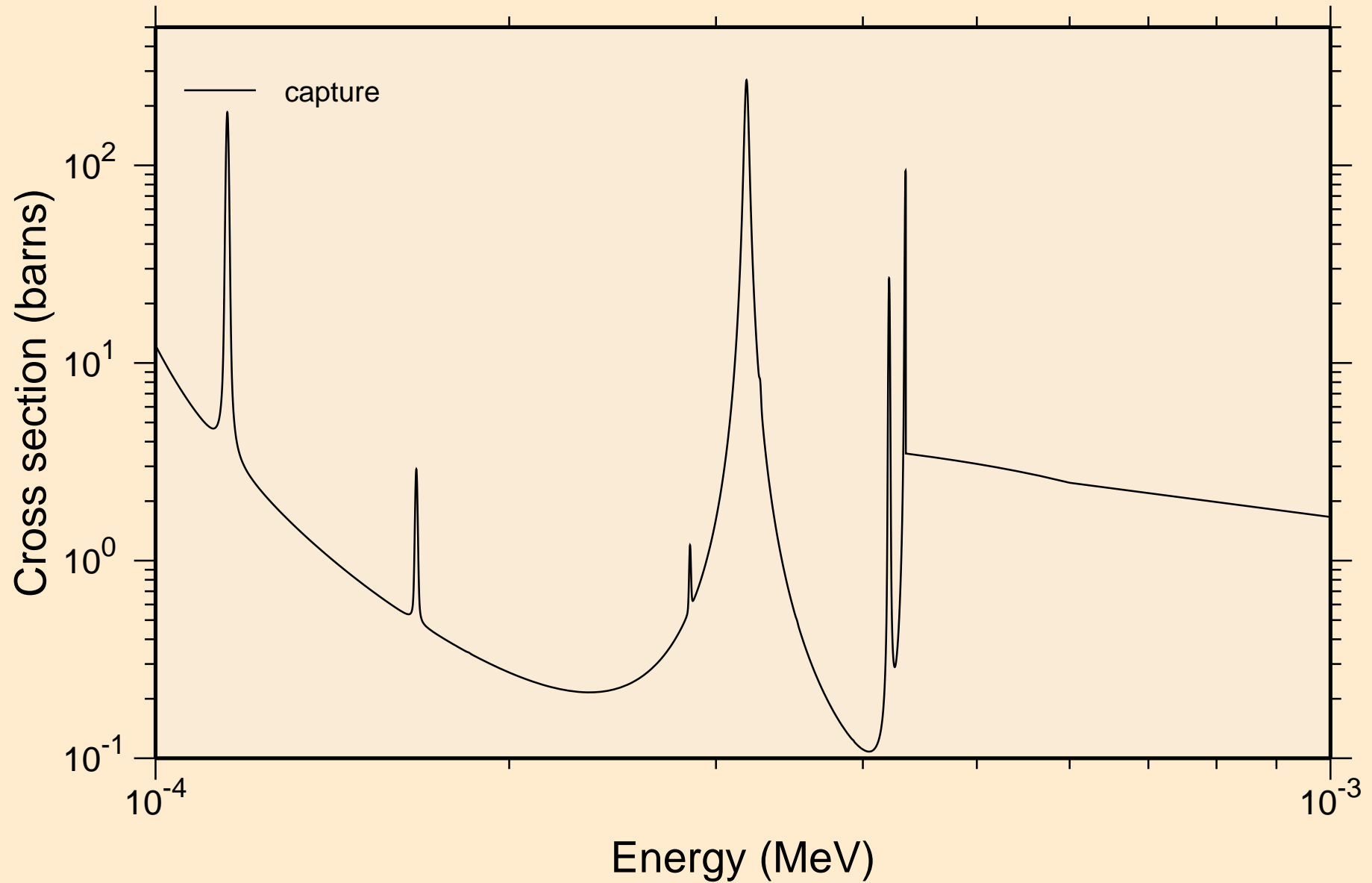

BR084M NEUTRON ACER TENDL-2021 LIBRARY; T=293.6K
resonance absorption cross sections

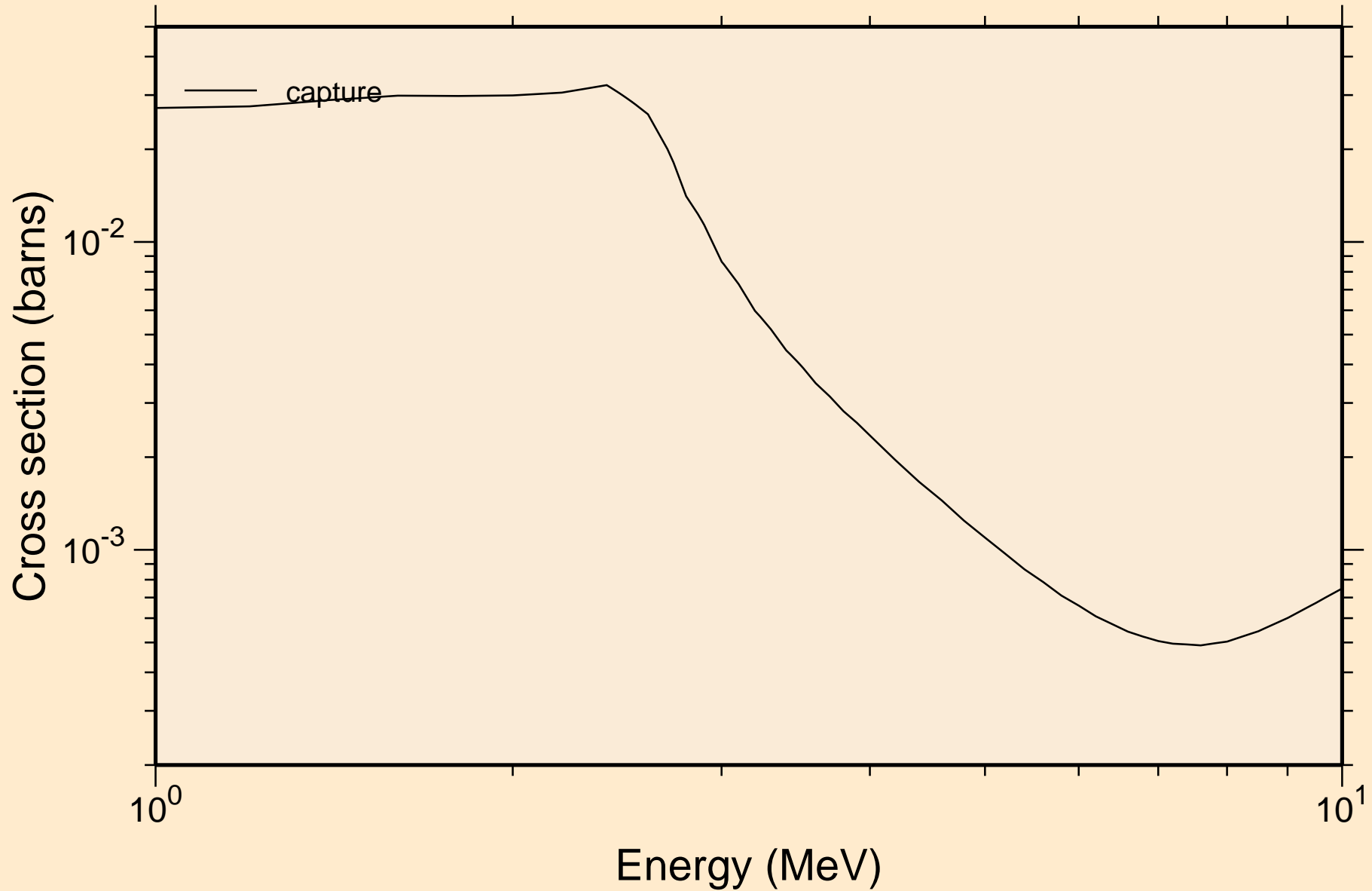

BR084M NEUTRON ACER TENDL-2021 LIBRARY; T=293.6K
Heating

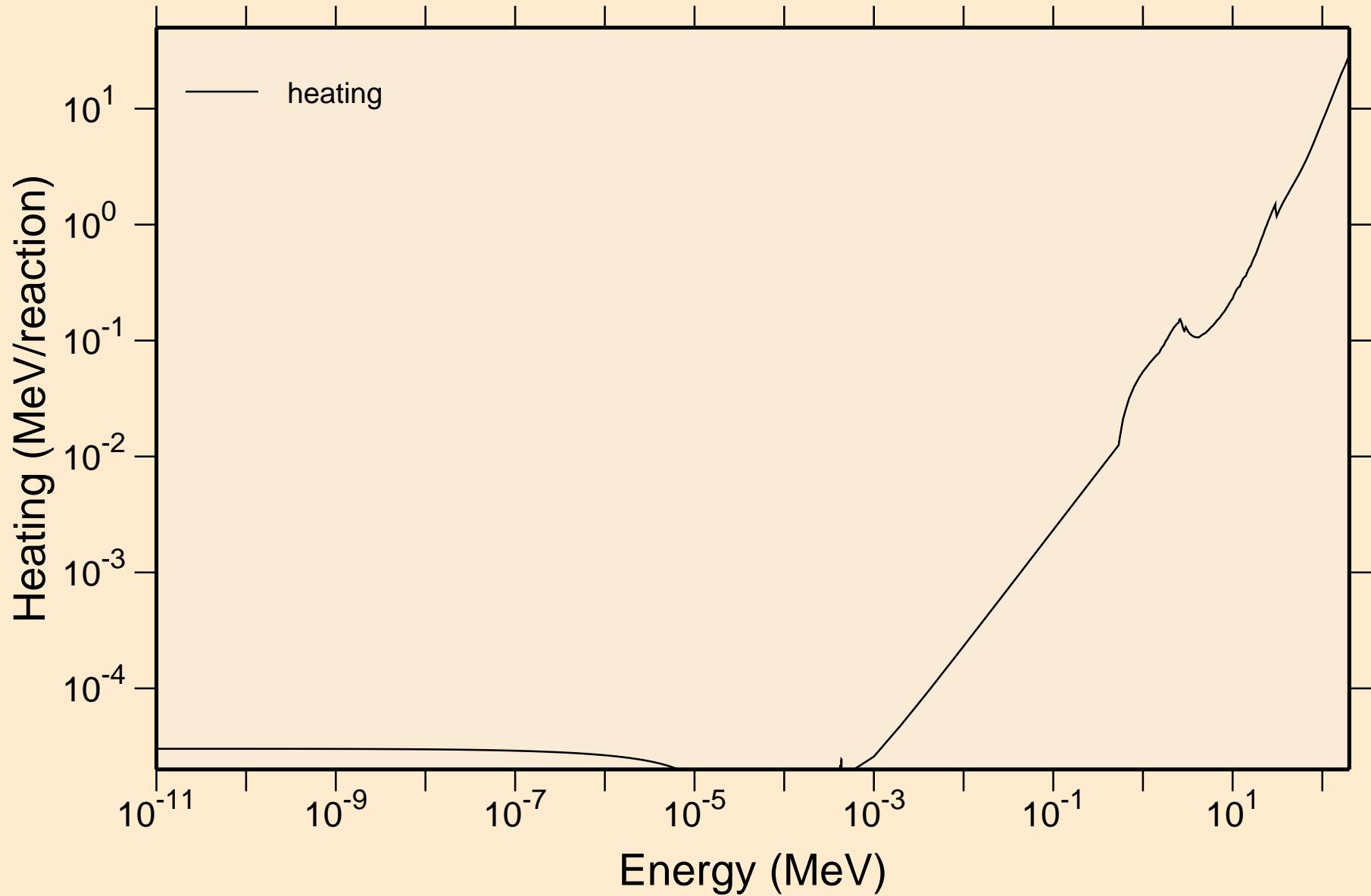

BR084M NEUTRON ACER TENDL-2021 LIBRARY; T=293.6K
Damage

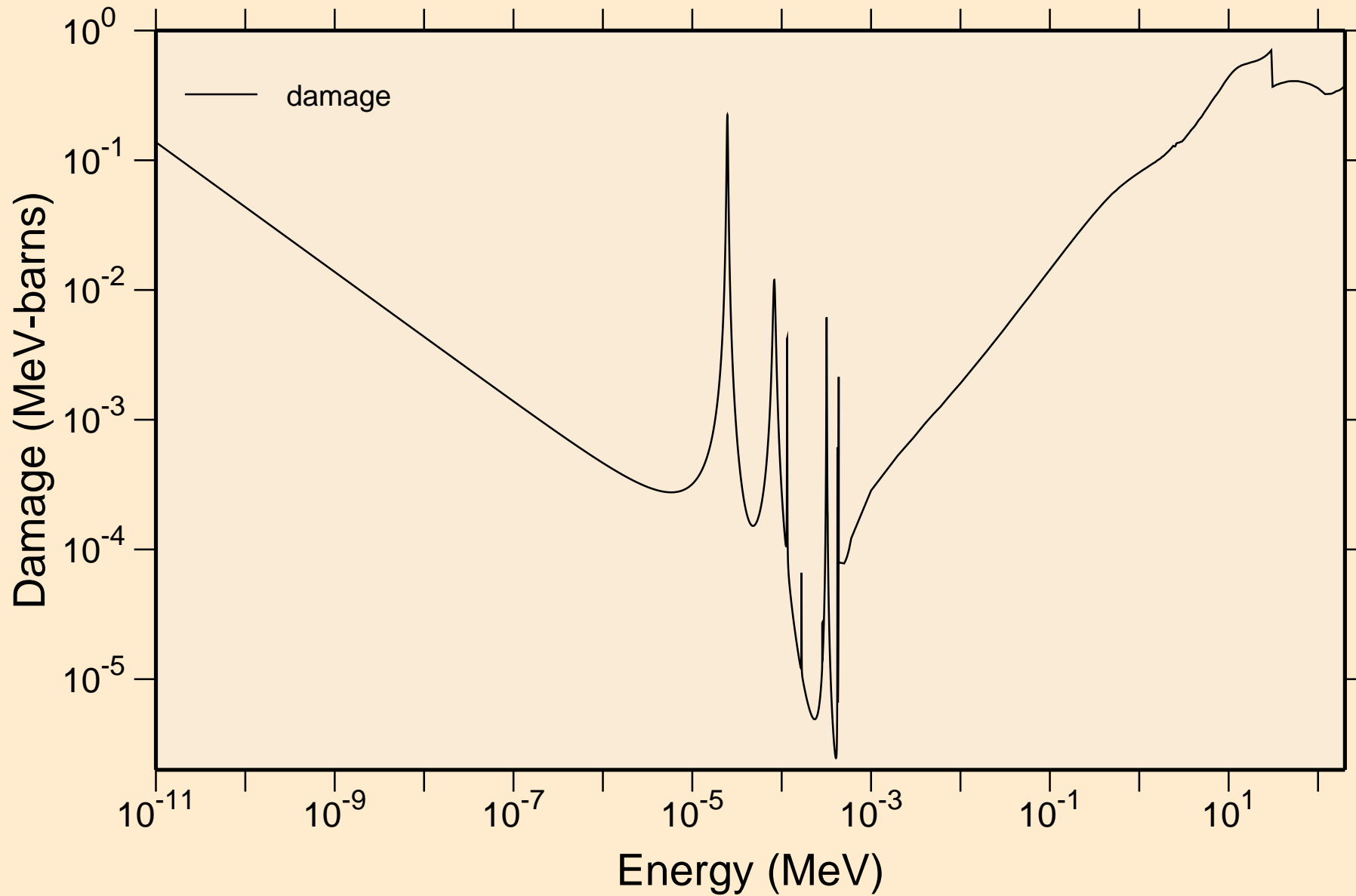

BR084M NEUTRON ACER TENDL-2021 LIBRARY; T=293.6K
Non-threshold reactions

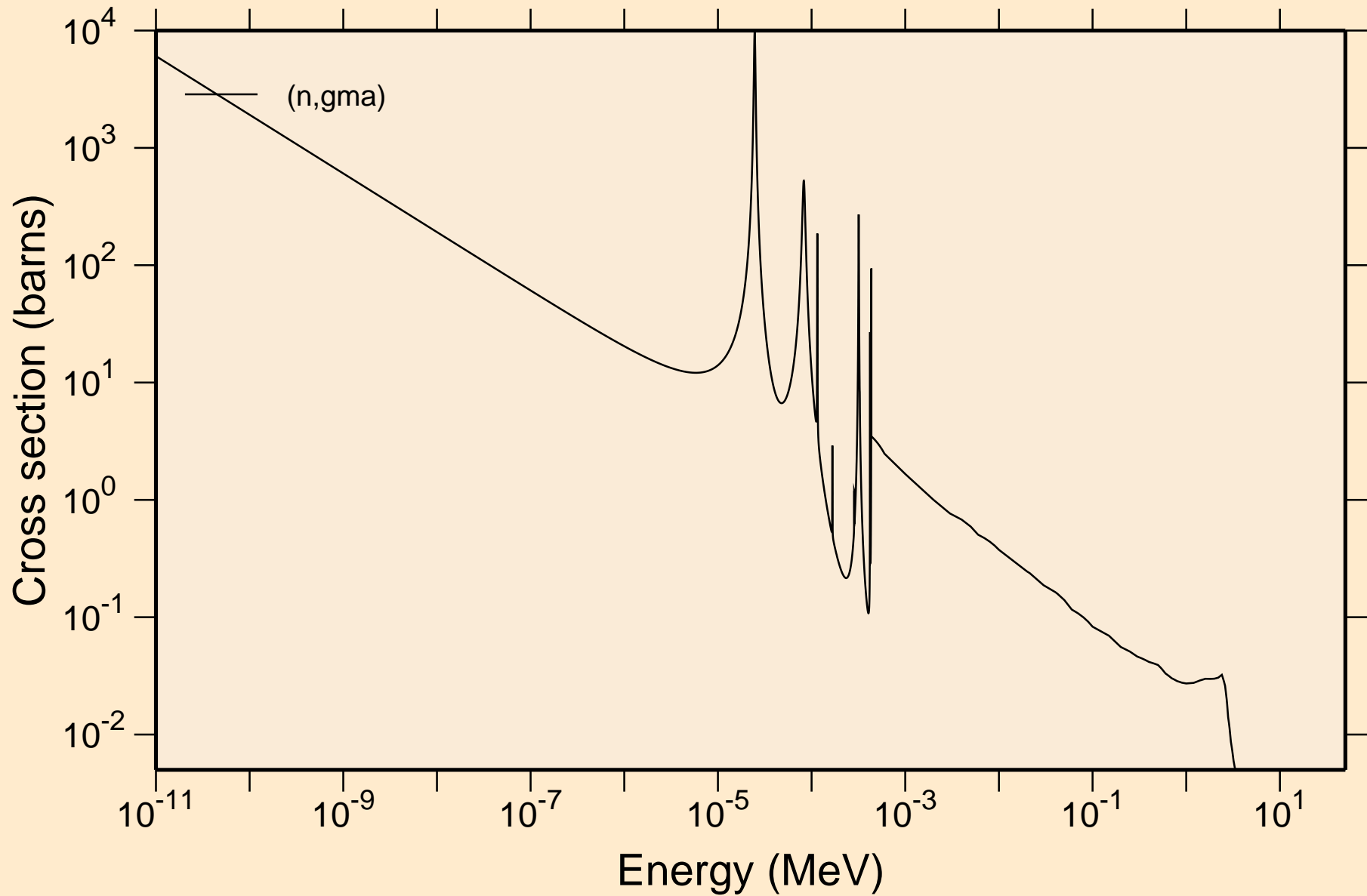

BR084M NEUTRON ACER TENDL-2021 LIBRARY; T=293.6K
Principal cross sections

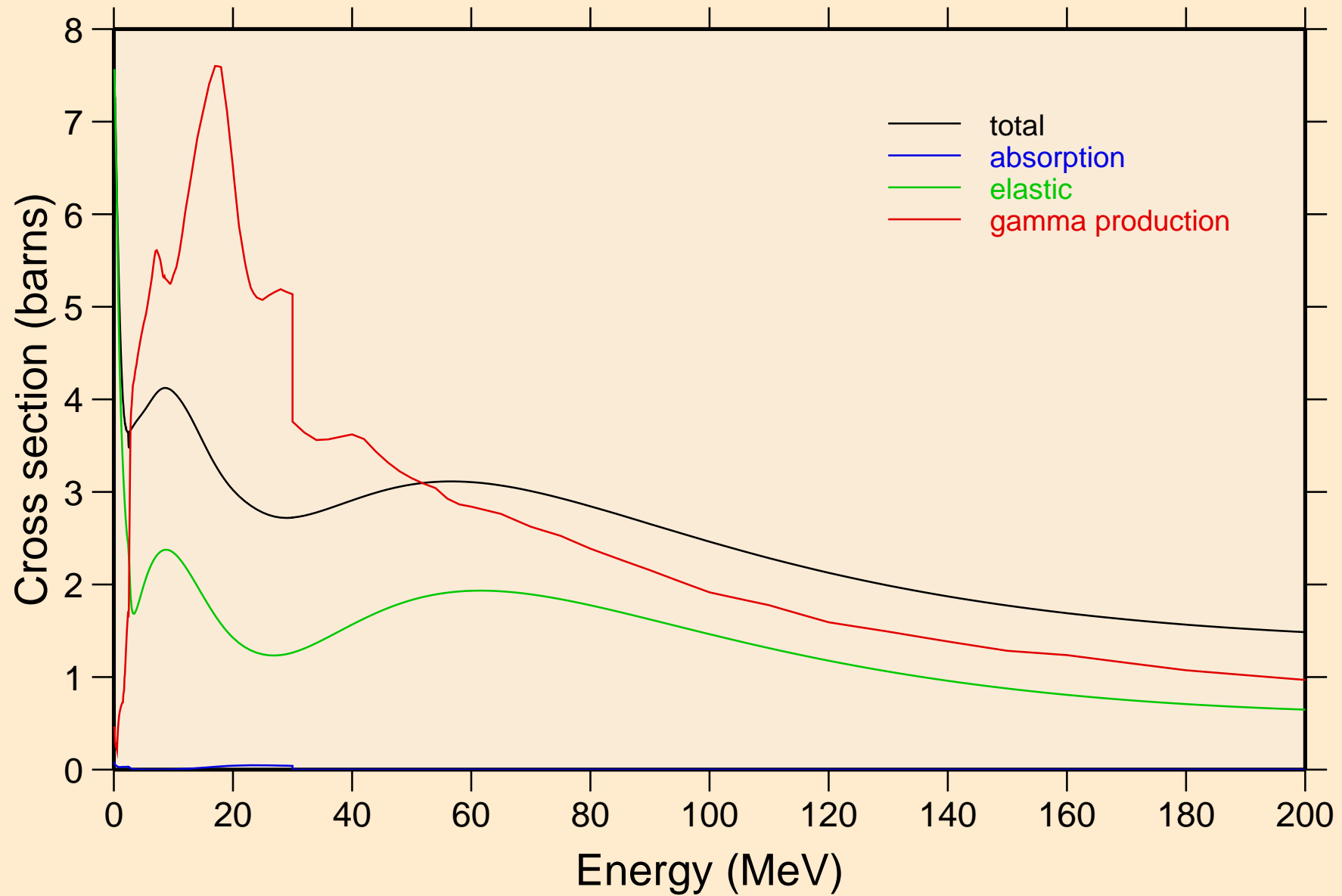

BR084M NEUTRON ACER TENDL-2021 LIBRARY; T=293.6K
Heating

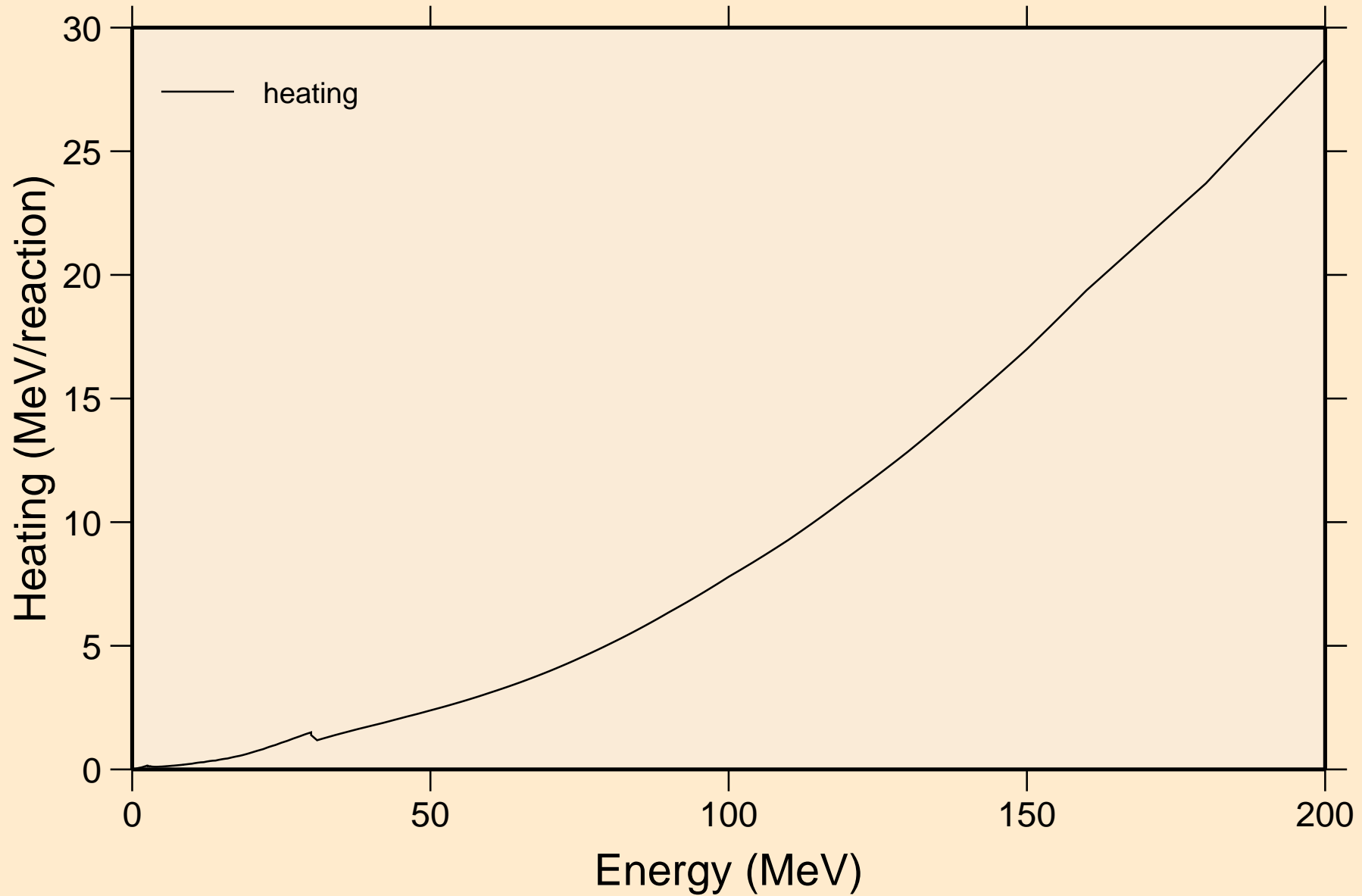

BR084M NEUTRON ACER TENDL-2021 LIBRARY; T=293.6K
Damage

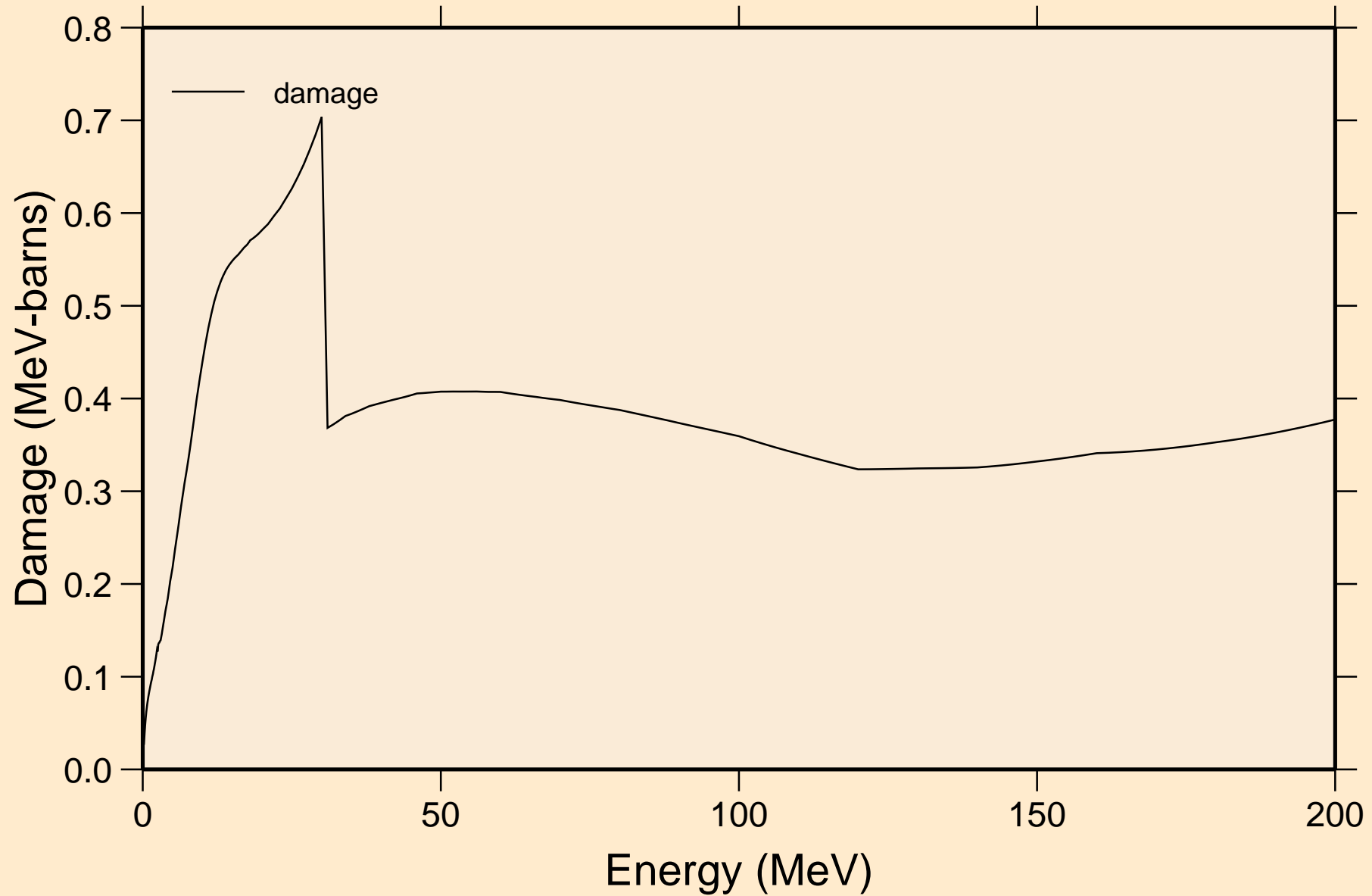

BR084M NEUTRON ACER TENDL-2021 LIBRARY; T=293.6K
Non-threshold reactions

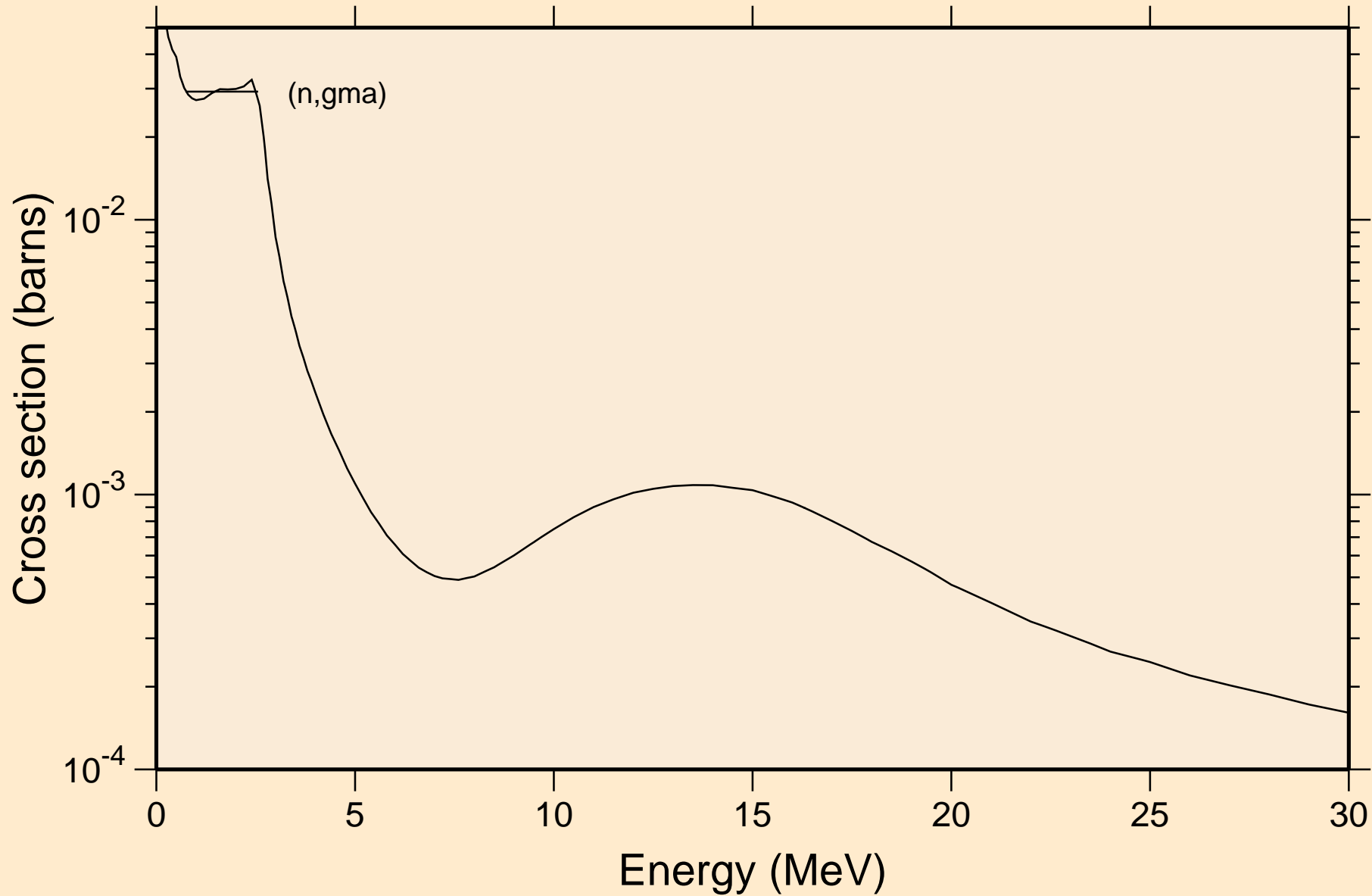

BR084M NEUTRON ACER TENDL-2021 LIBRARY; T=293.6K
Inelastic levels

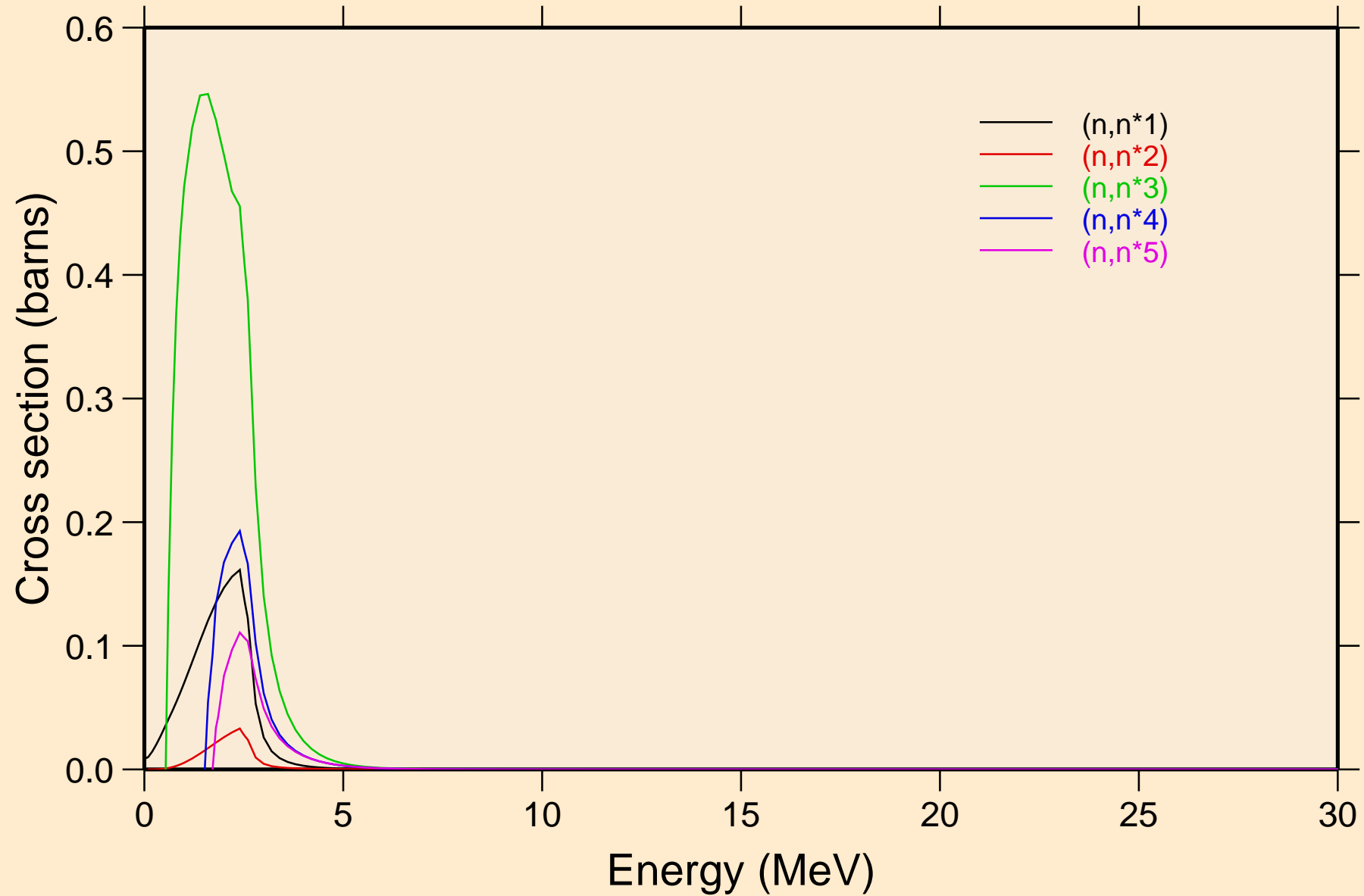

BR084M NEUTRON ACER TENDL-2021 LIBRARY; T=293.6K
Inelastic levels

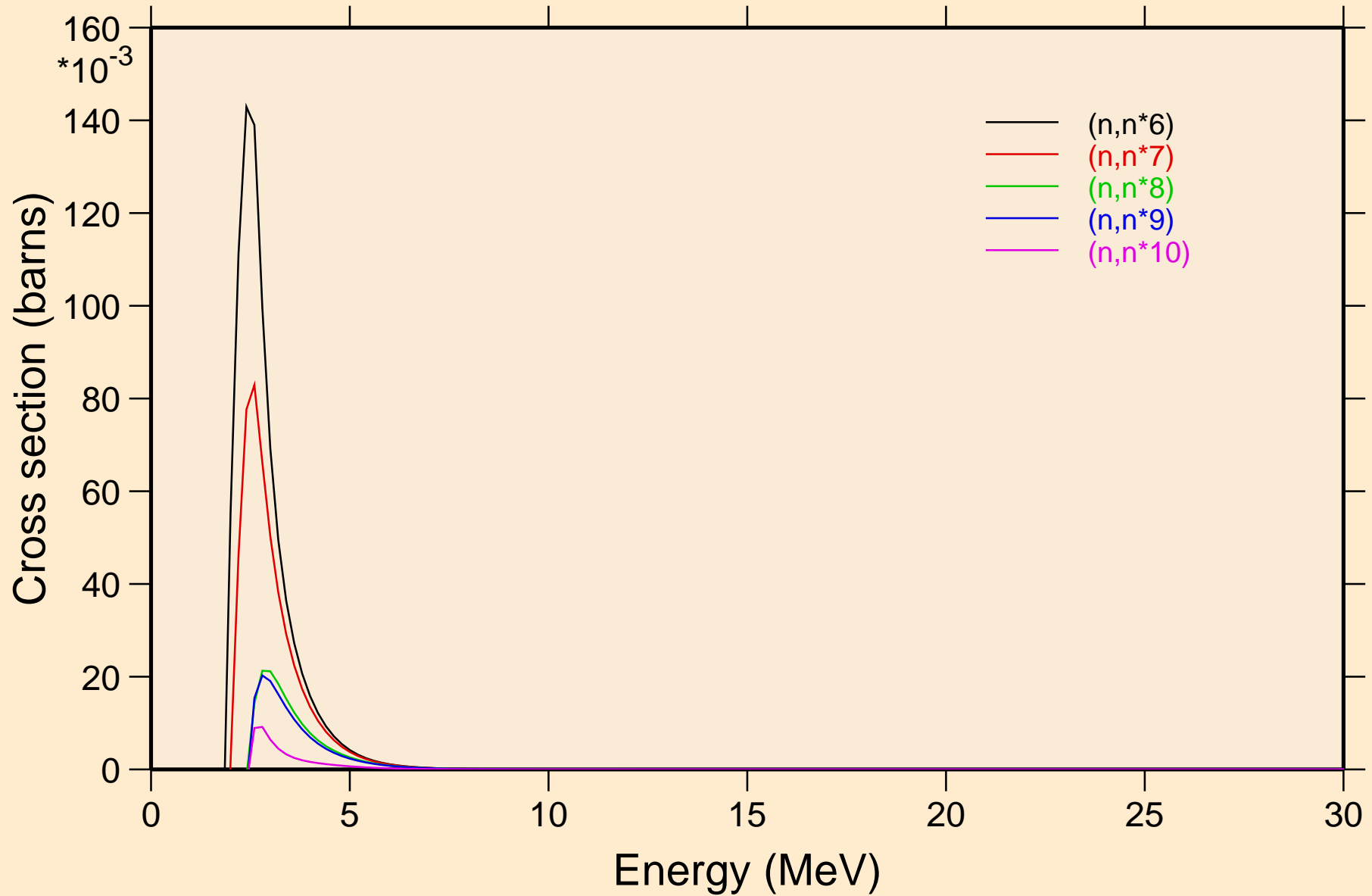

BR084M NEUTRON ACER TENDL-2021 LIBRARY; T=293.6K
Inelastic levels

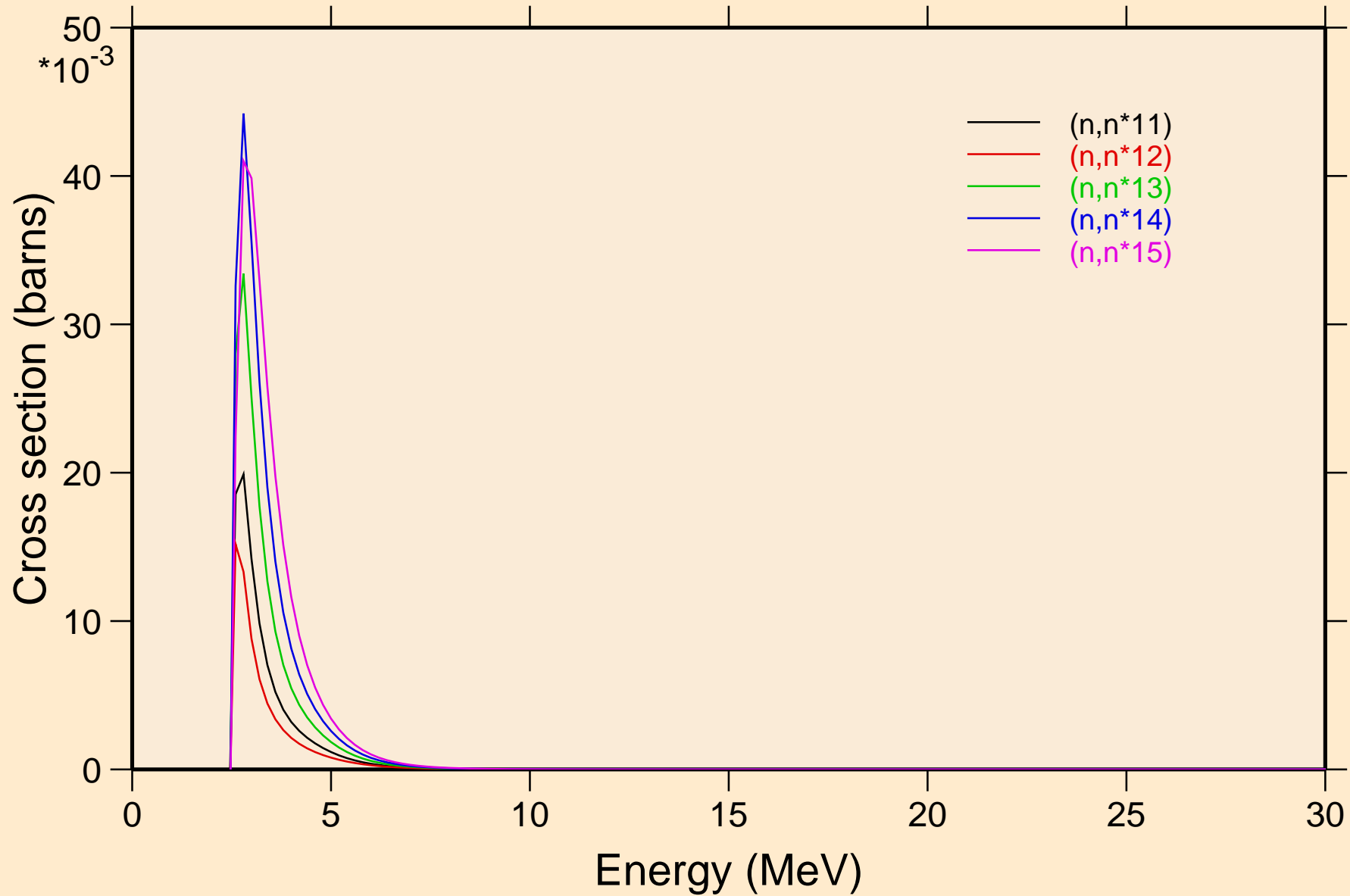

BR084M NEUTRON ACER TENDL-2021 LIBRARY; T=293.6K
Inelastic levels

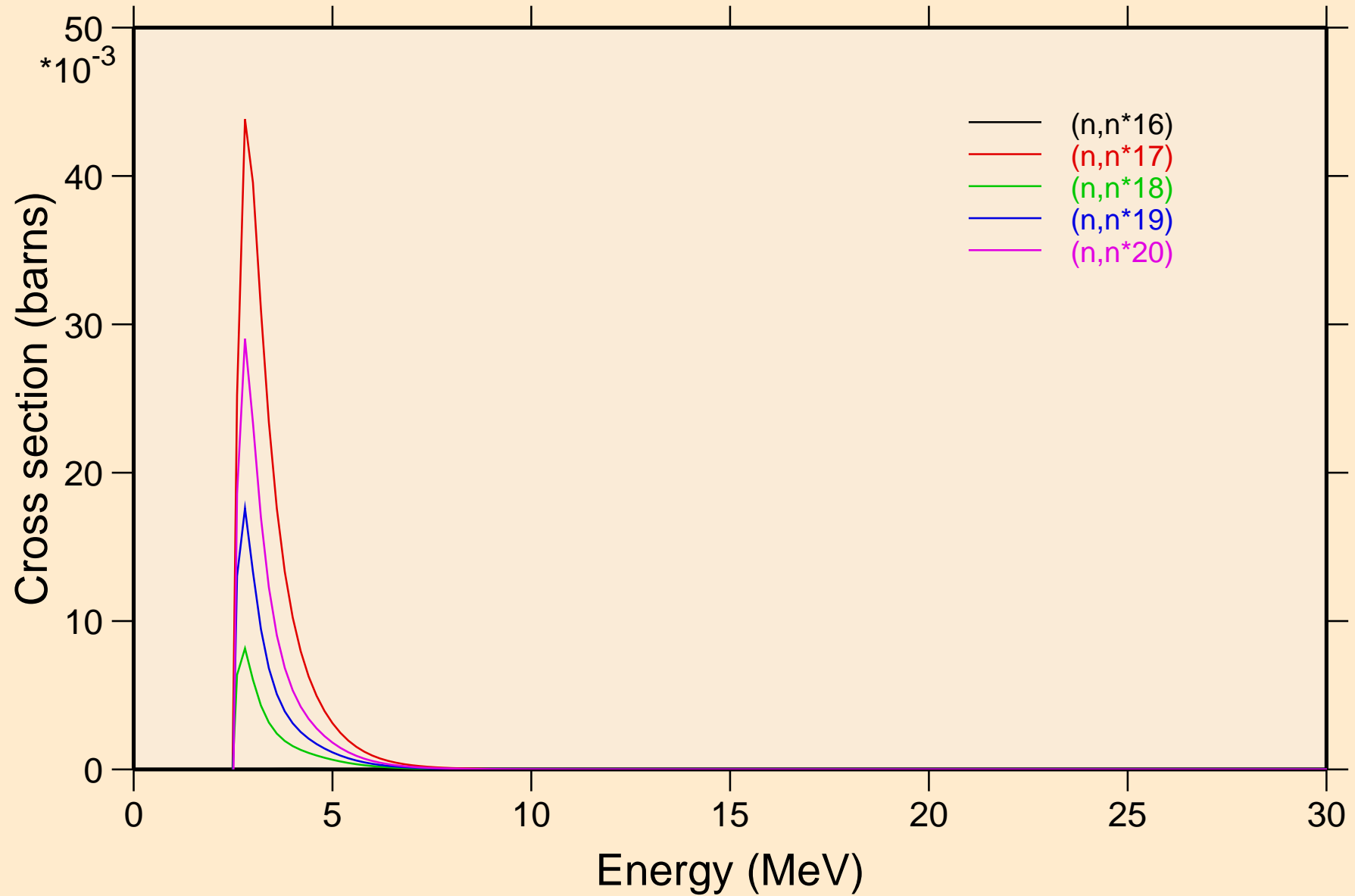

BR084M NEUTRON ACER TENDL-2021 LIBRARY; T=293.6K
Inelastic levels

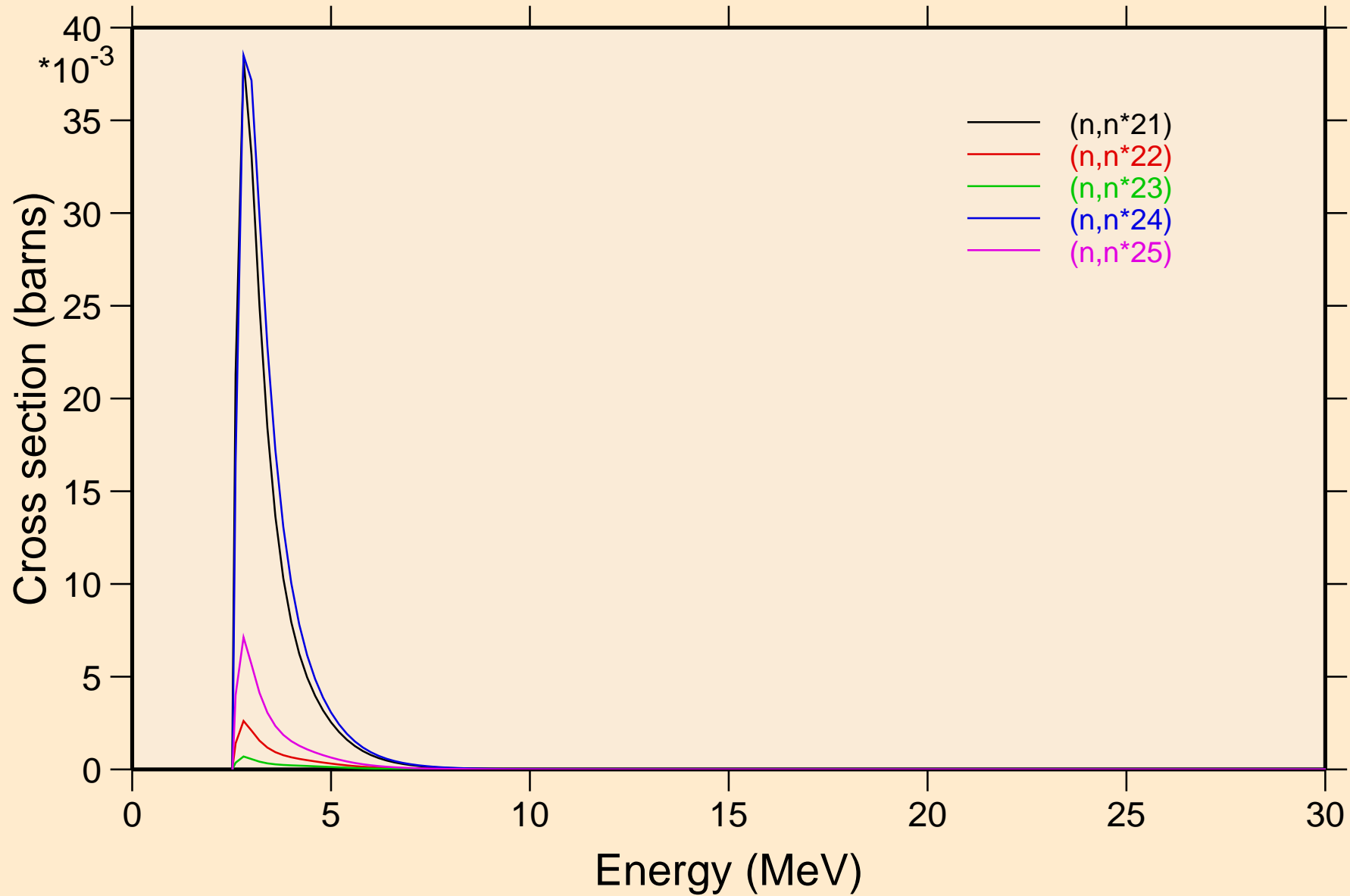

BR084M NEUTRON ACER TENDL-2021 LIBRARY; T=293.6K
Inelastic levels

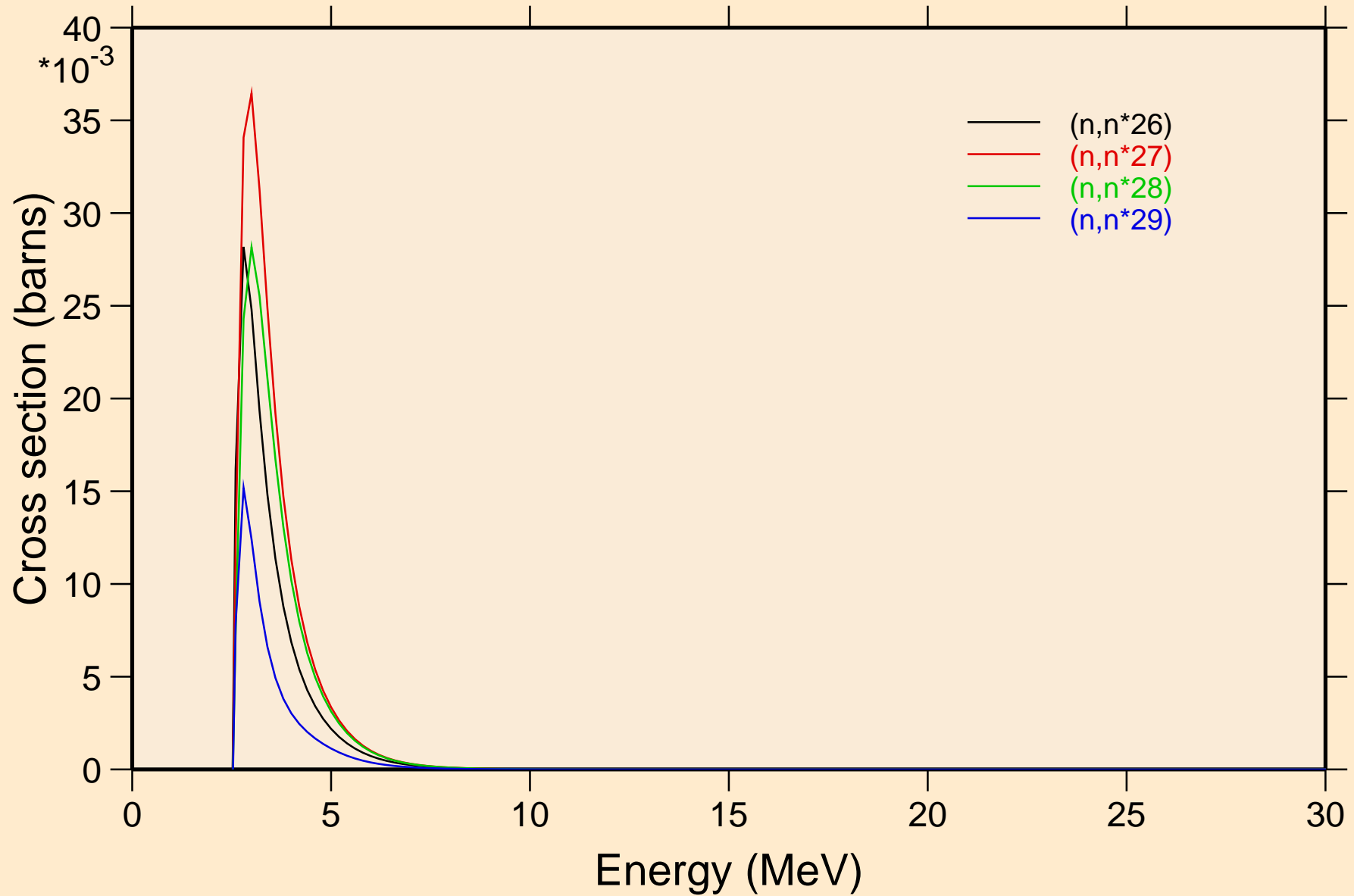

BR084M NEUTRON ACER TENDL-2021 LIBRARY; T=293.6K
Threshold reactions

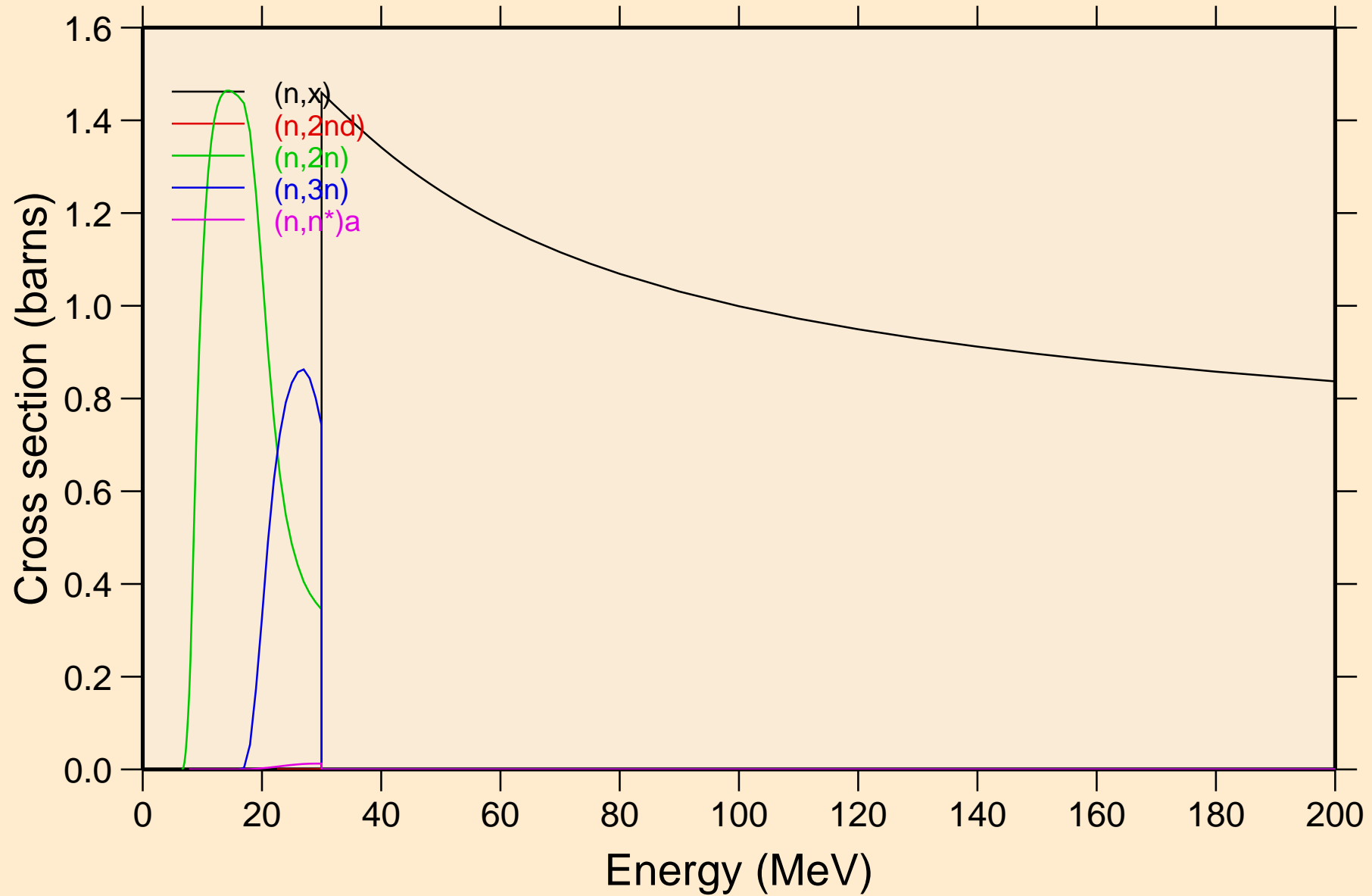

BR084M NEUTRON ACER TENDL-2021 LIBRARY; T=293.6K
Threshold reactions

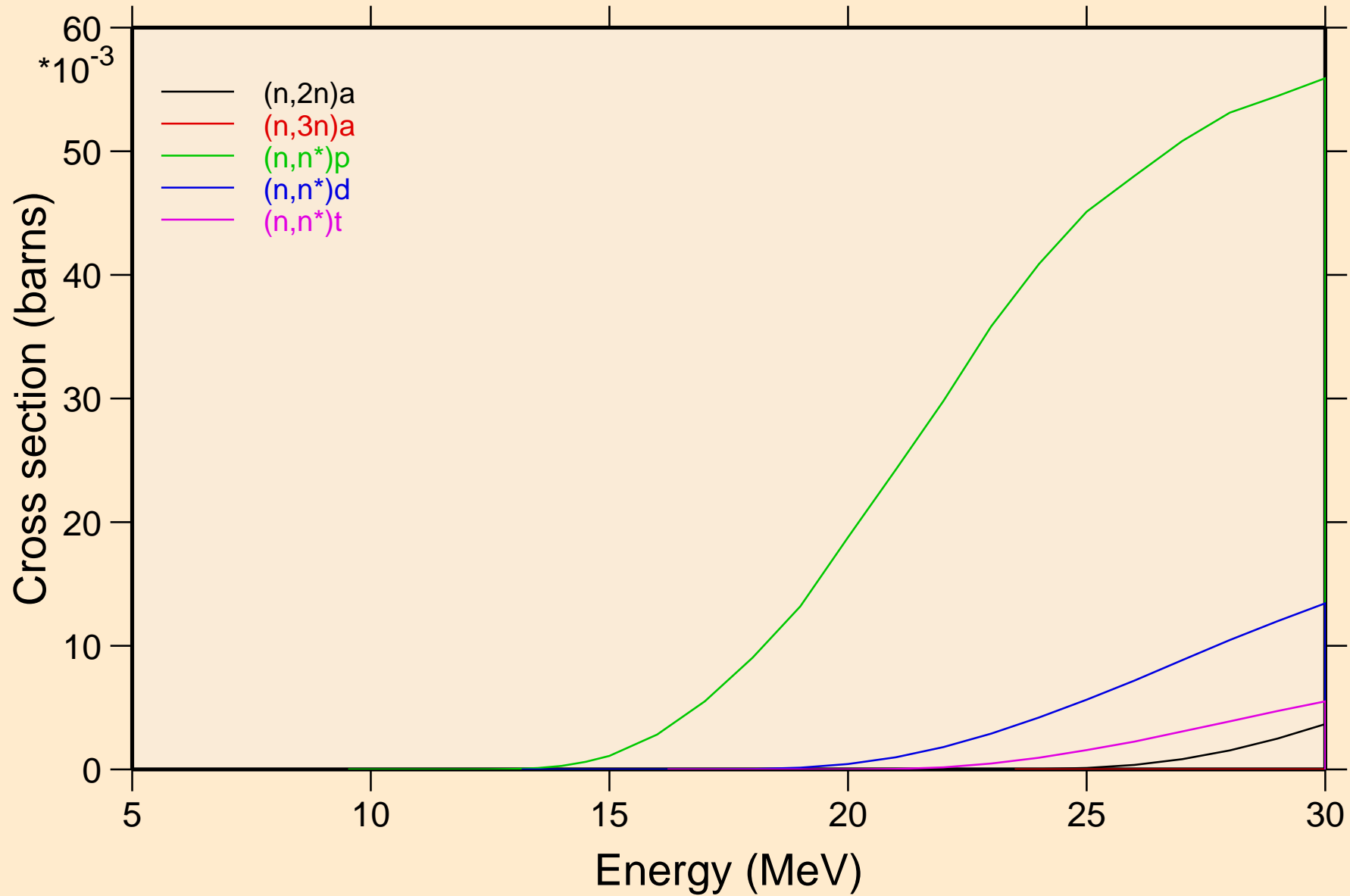

BR084M NEUTRON ACER TENDL-2021 LIBRARY; T=293.6K
Threshold reactions

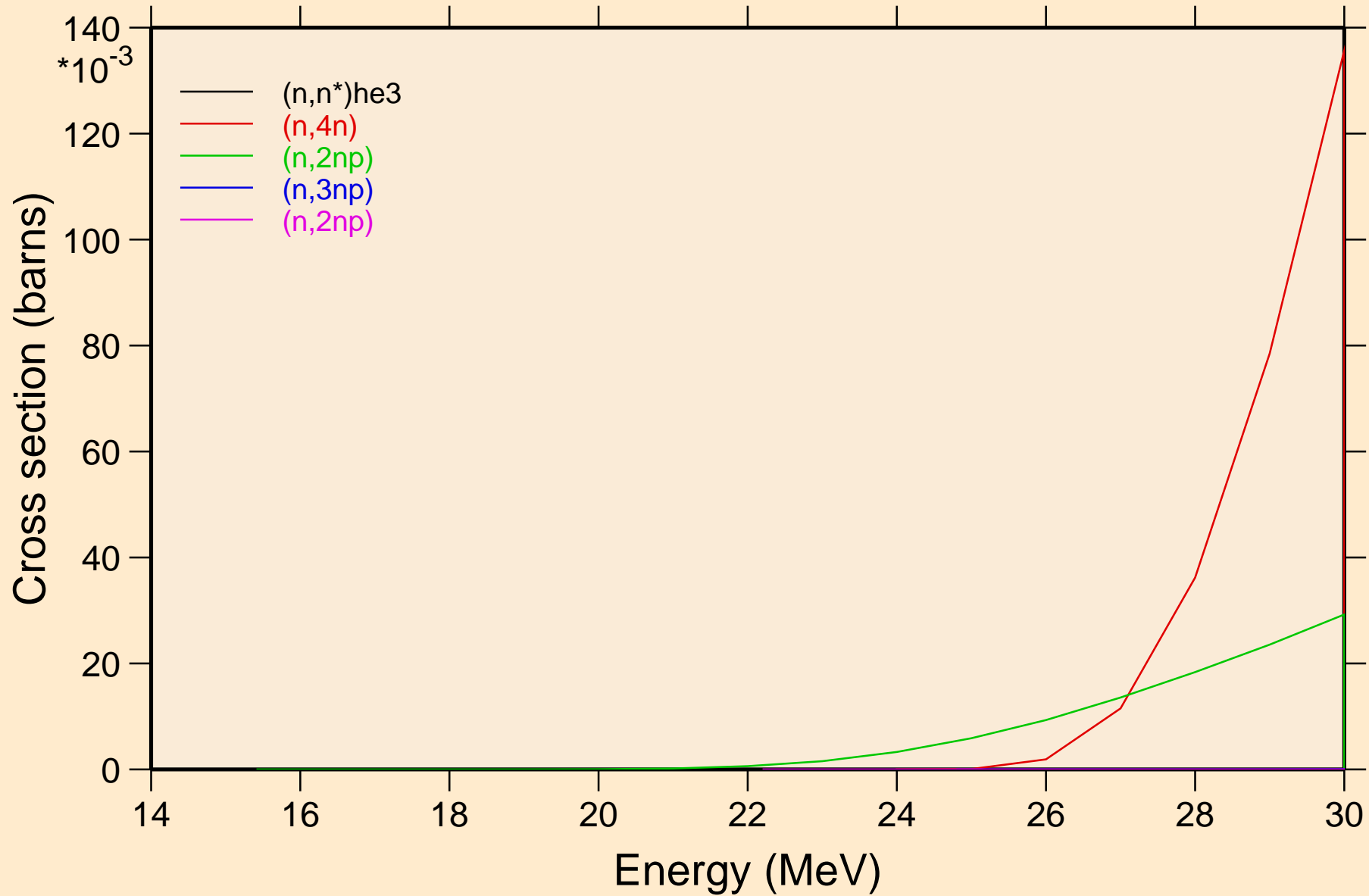

BR084M NEUTRON ACER TENDL-2021 LIBRARY; T=293.6K
Threshold reactions

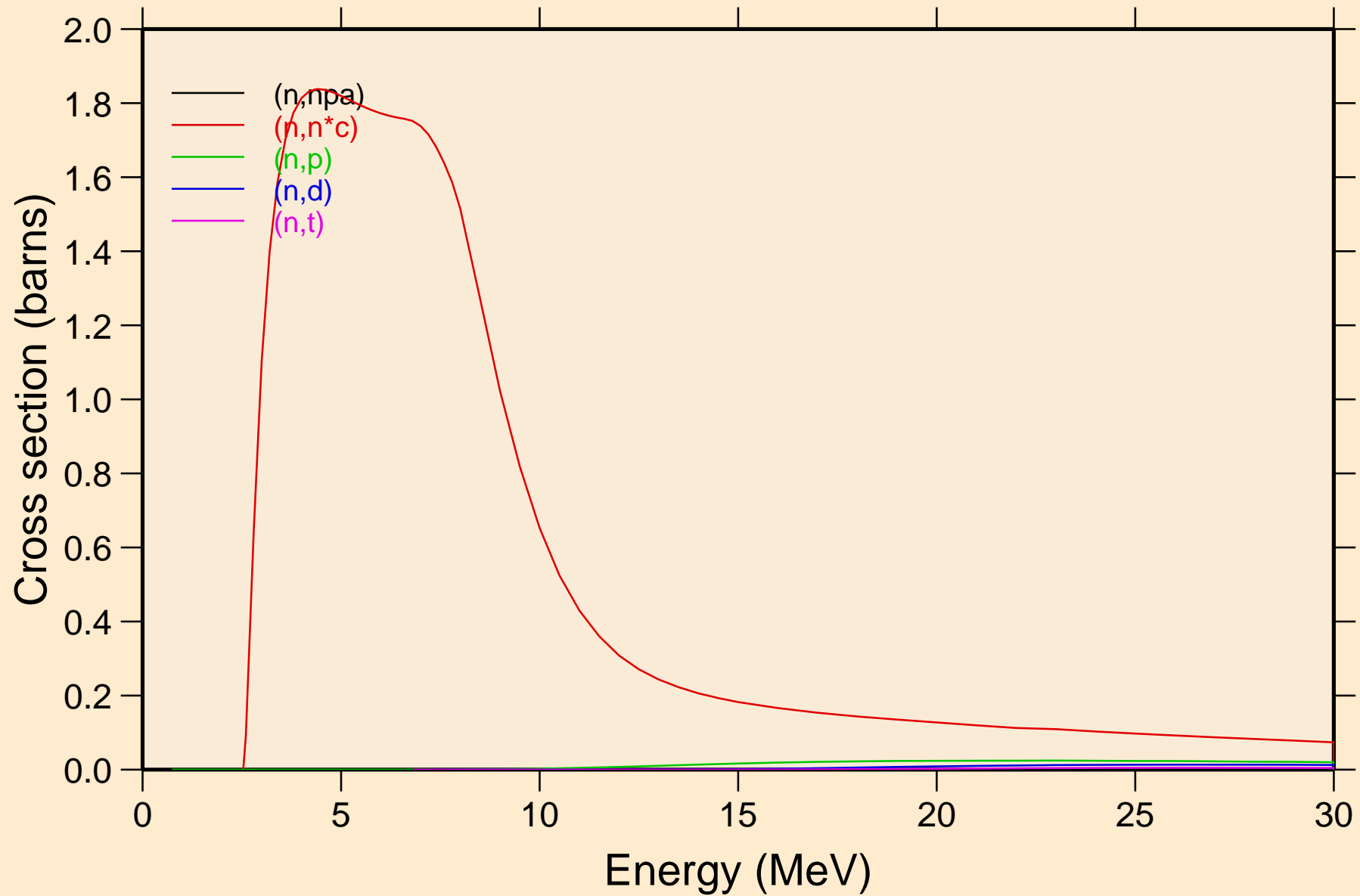

BR084M NEUTRON ACER TENDL-2021 LIBRARY; T=293.6K
Threshold reactions

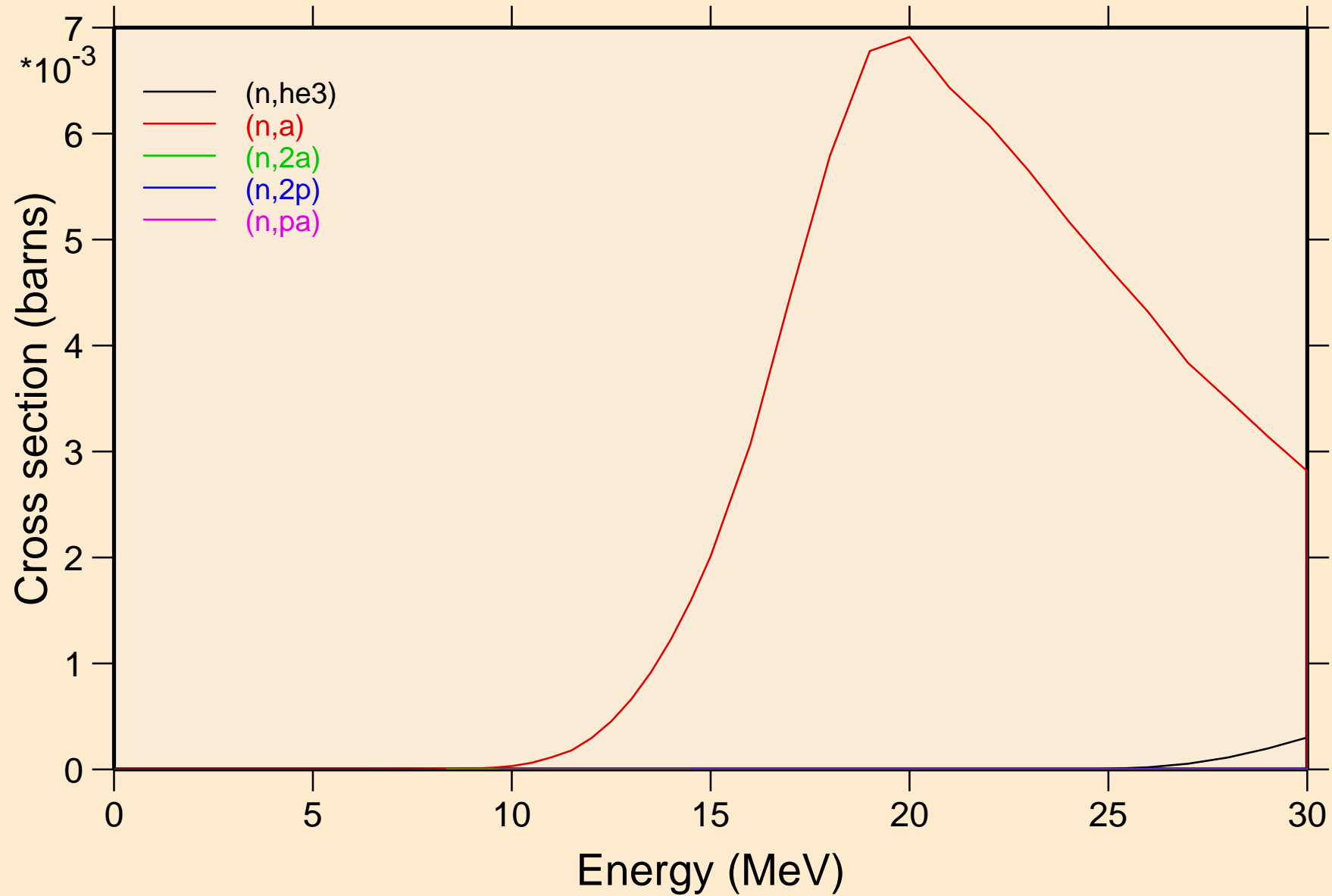

BR084M NEUTRON ACER TENDL-2021 LIBRARY; T=293.6K
Threshold reactions

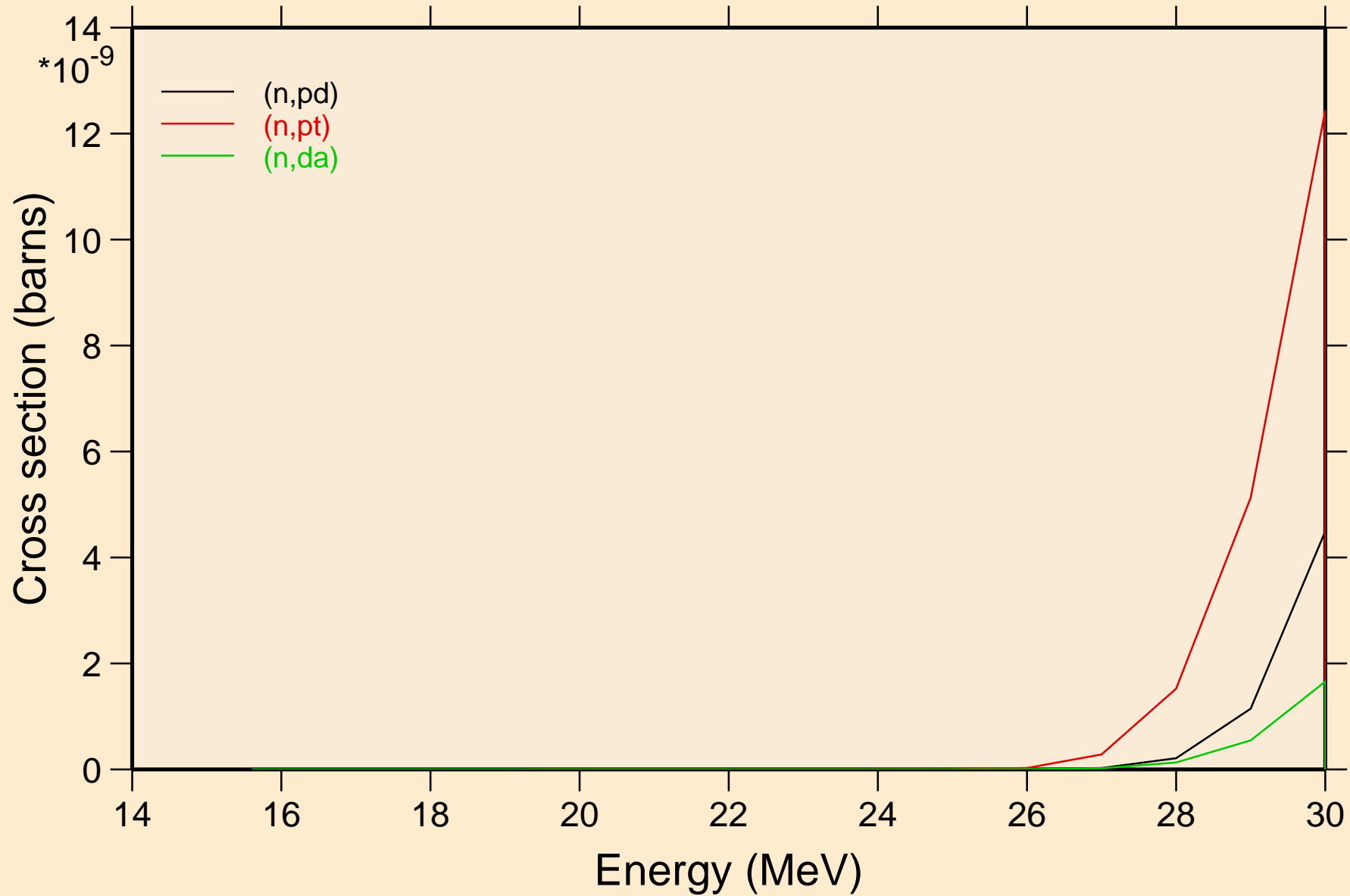

BR084M NEUTRON ACER TENDL-2021 LIBRARY; T=293.6K
Threshold reactions

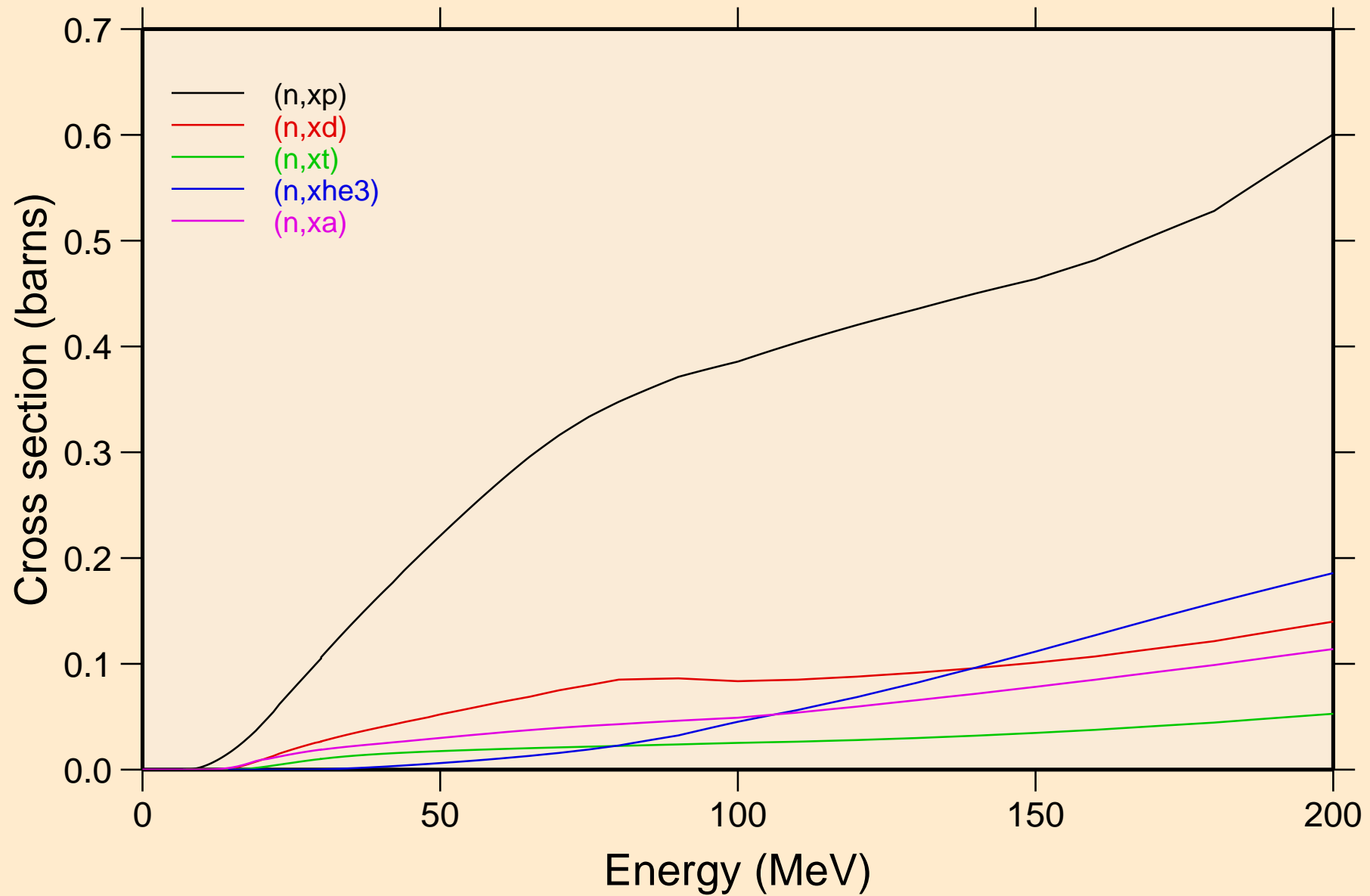

BR084M NEUTRON ACER TENDL-2021 LIBRARY; T=293.6K
angular distribution for elastic

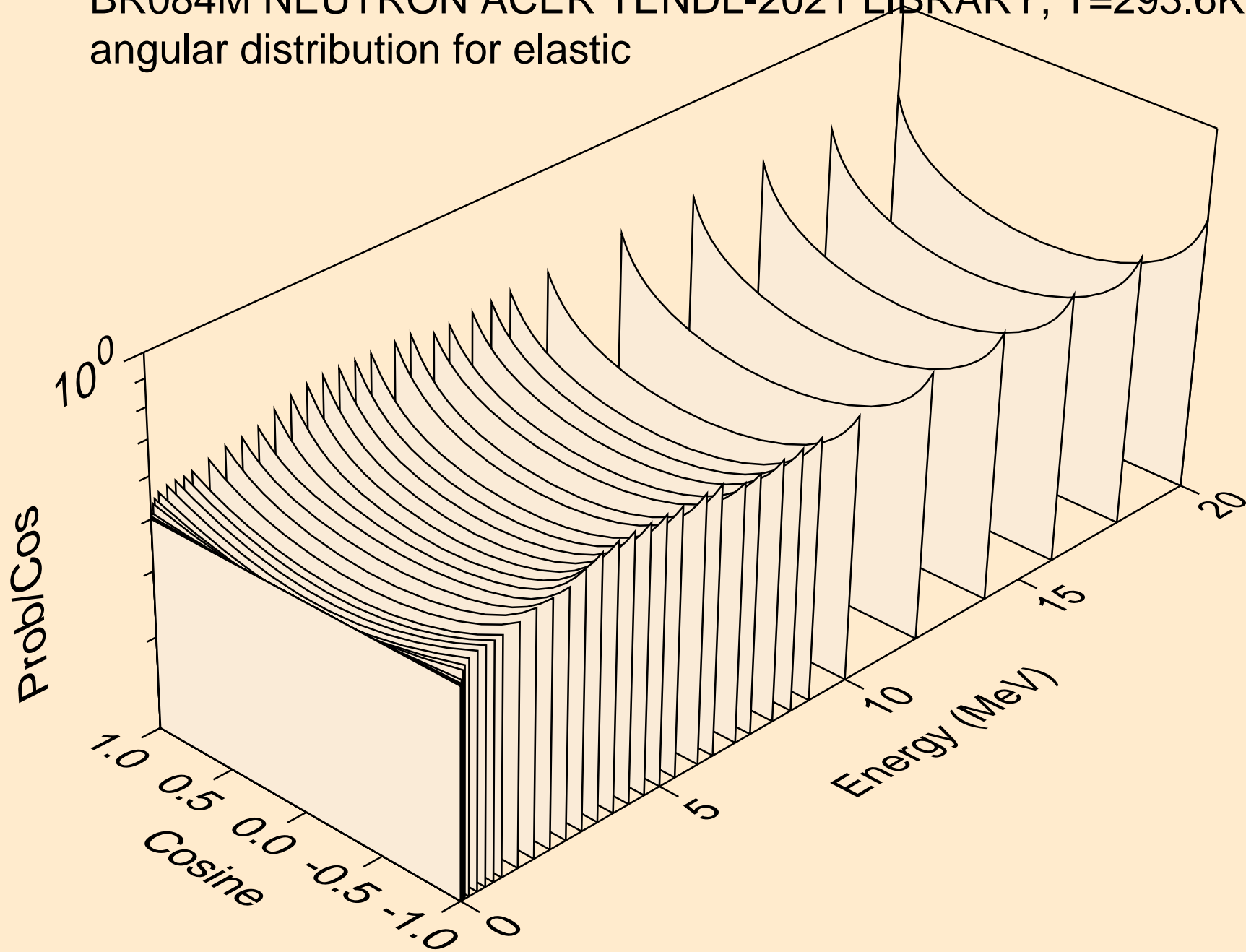

BR084M NEUTRON ACER TENDL-2021 LIBRARY; T=293.6K
angular distribution for elastic

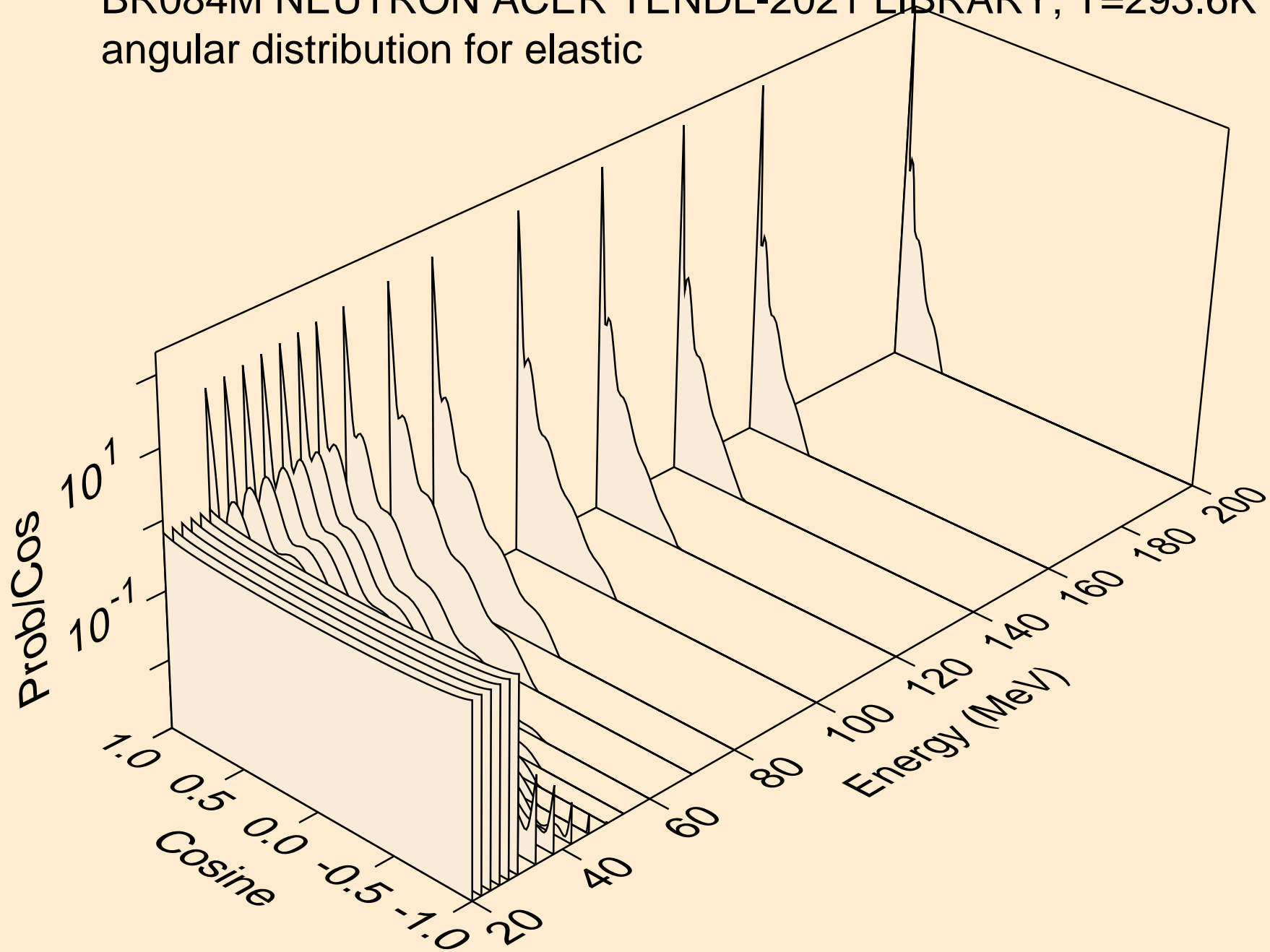

BR084M NEUTRON ACER TENDL-2021 LIBRARY; T=293.6K
angular distribution for (n,n*1)

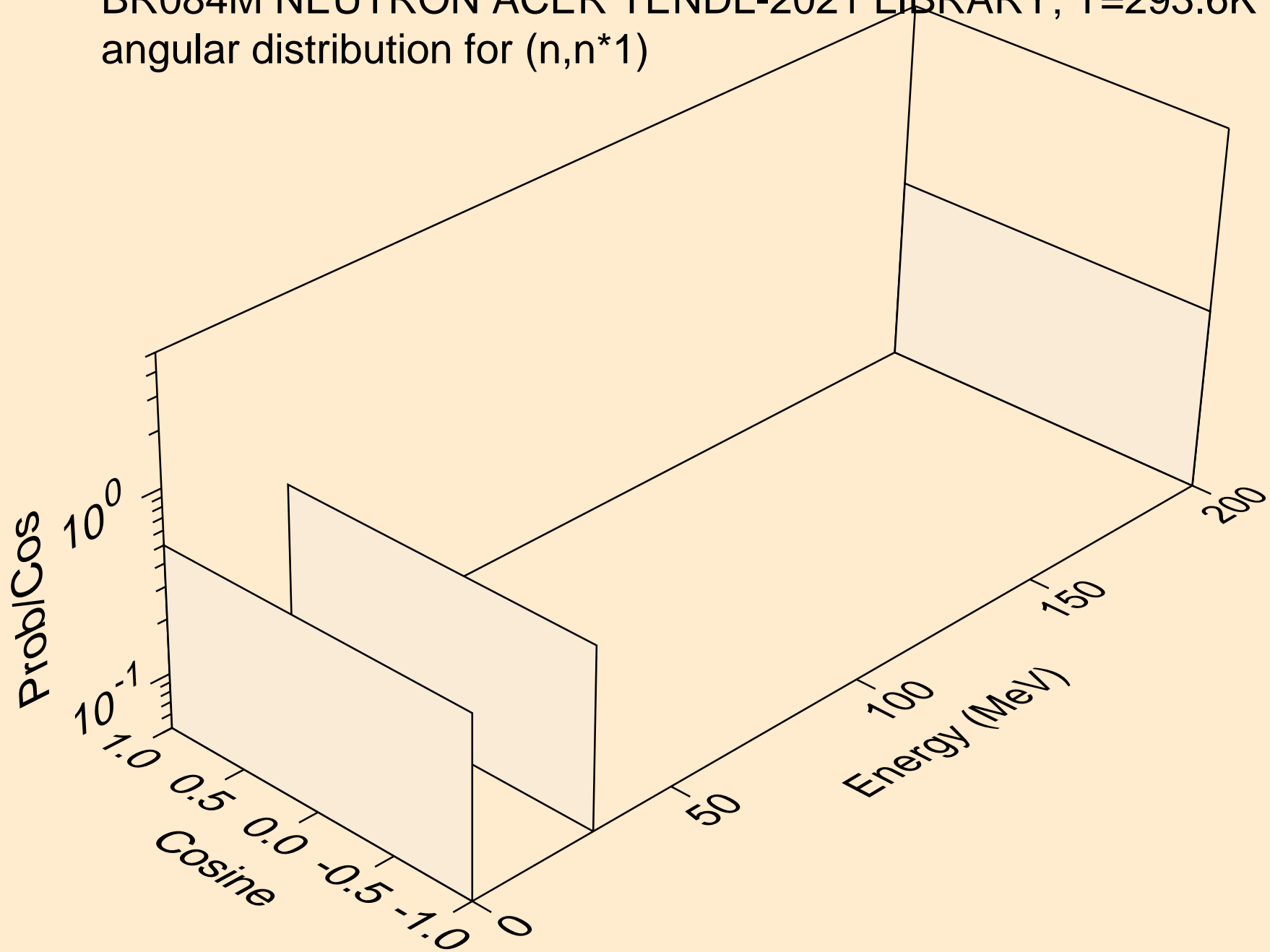

BR084M NEUTRON ACER TENDL-2021 LIBRARY; T=293.6K
angular distribution for (n,n*2)

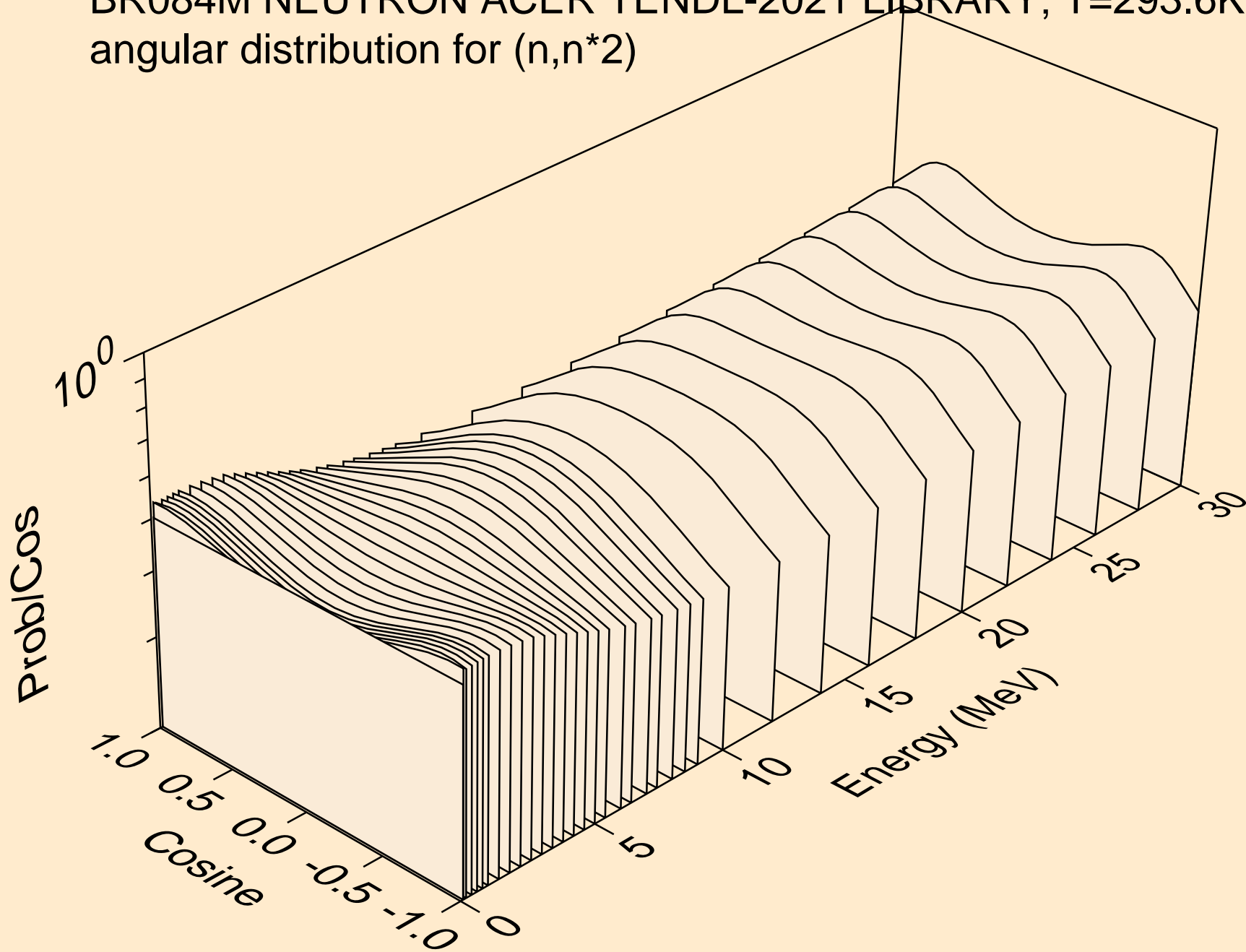

BR084M NEUTRON ACER TENDL-2021 LIBRARY; T=293.6K
angular distribution for (n,n*3)

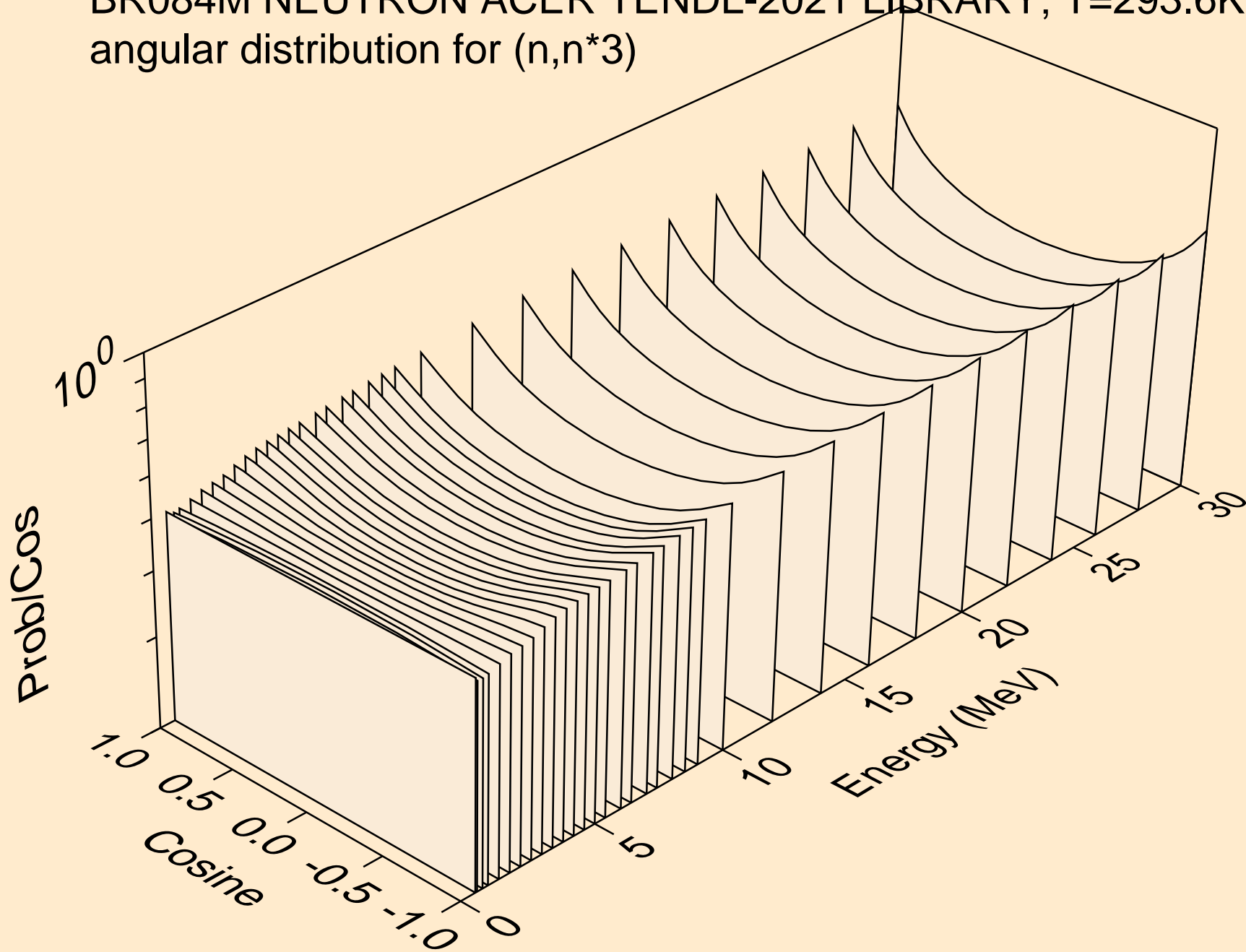

BR084M NEUTRON ACER TENDL-2021 LIBRARY; T=293.6K
angular distribution for (n,n*4)

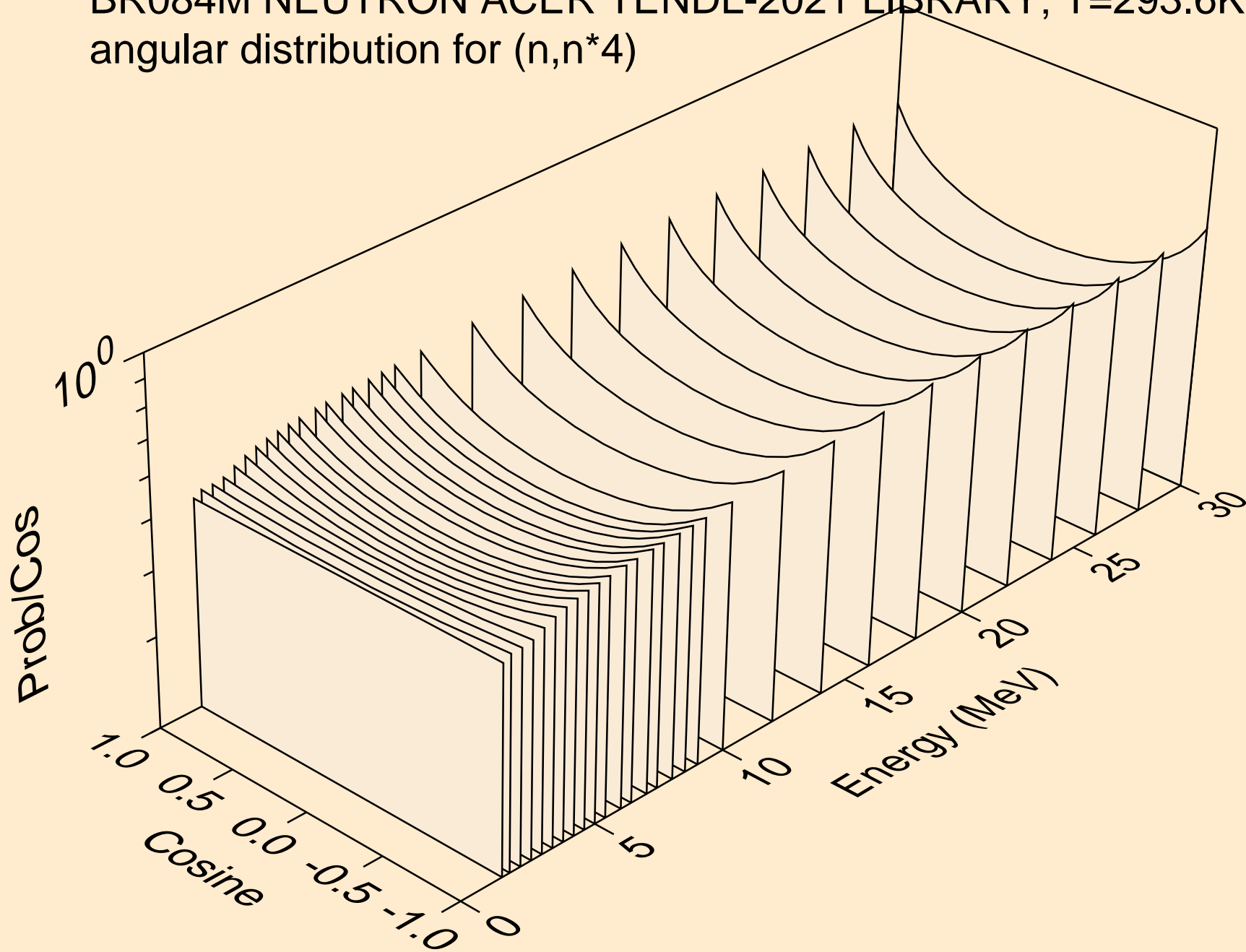

BR084M NEUTRON ACER TENDL-2021 LIBRARY; T=293.6K
angular distribution for (n,n*5)

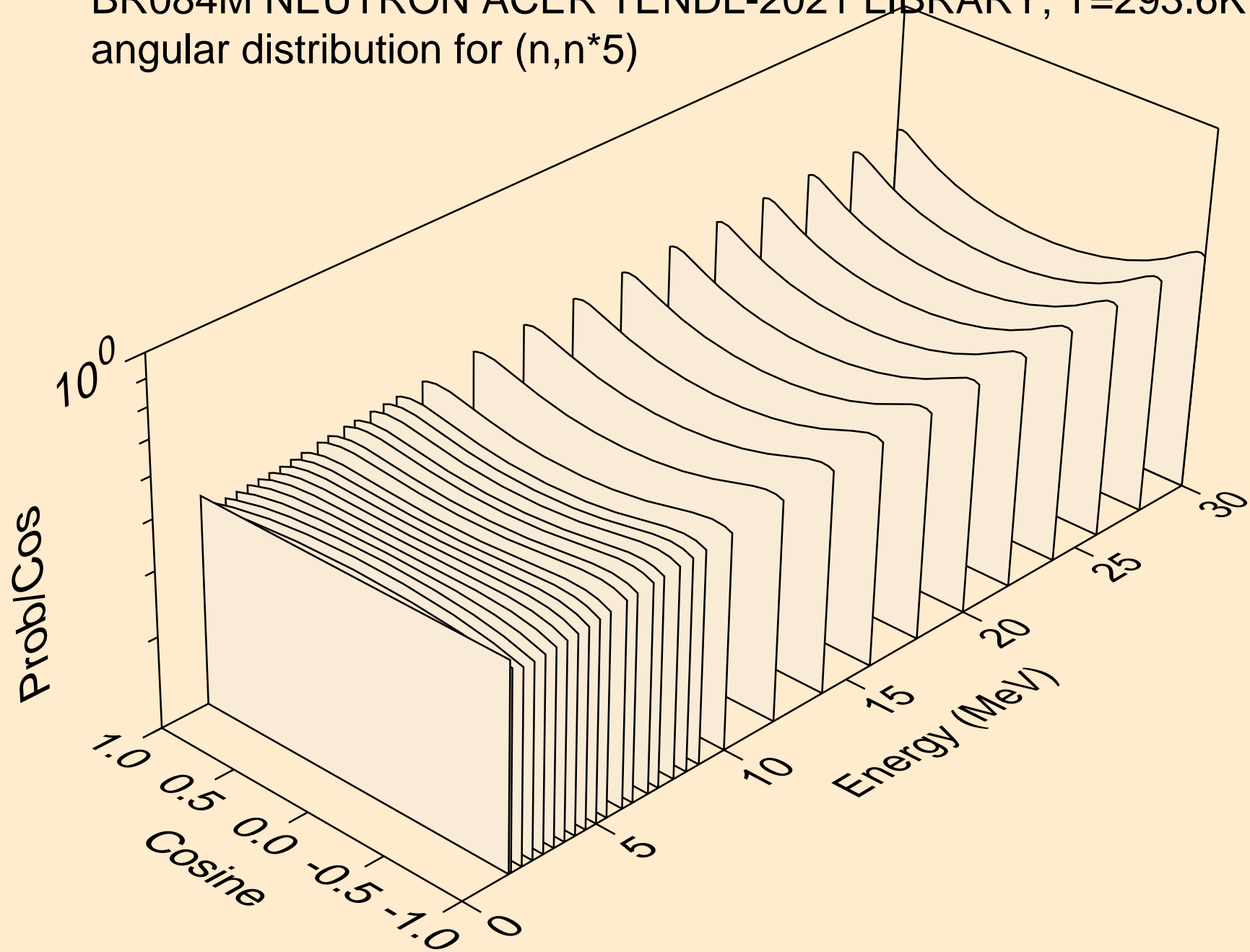

BR084M NEUTRON ACER TENDL-2021 LIBRARY; T=293.6K
angular distribution for (n,n*6)

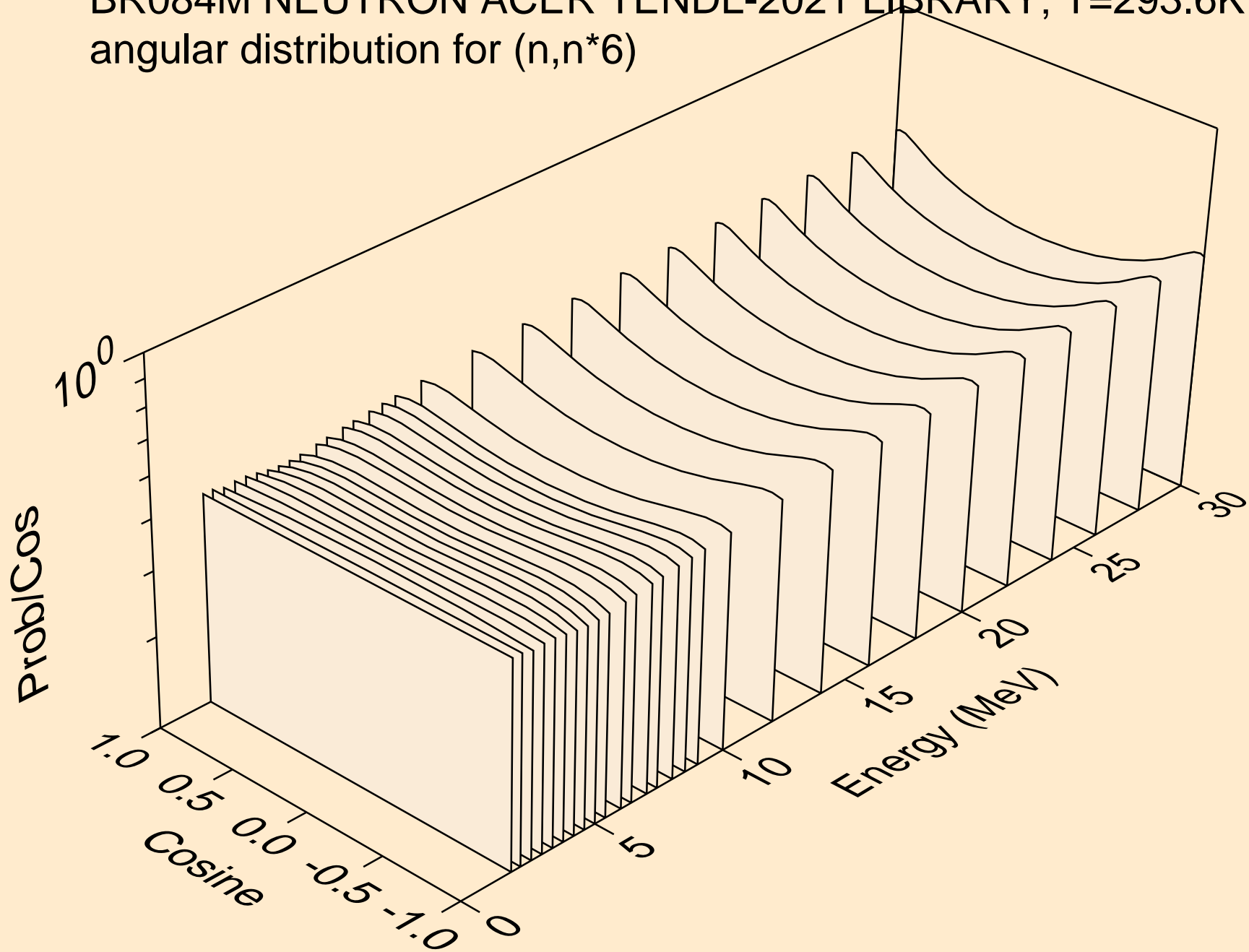

BR084M NEUTRON ACER TENDL-2021 LIBRARY; T=293.6K
angular distribution for (n,n*7)

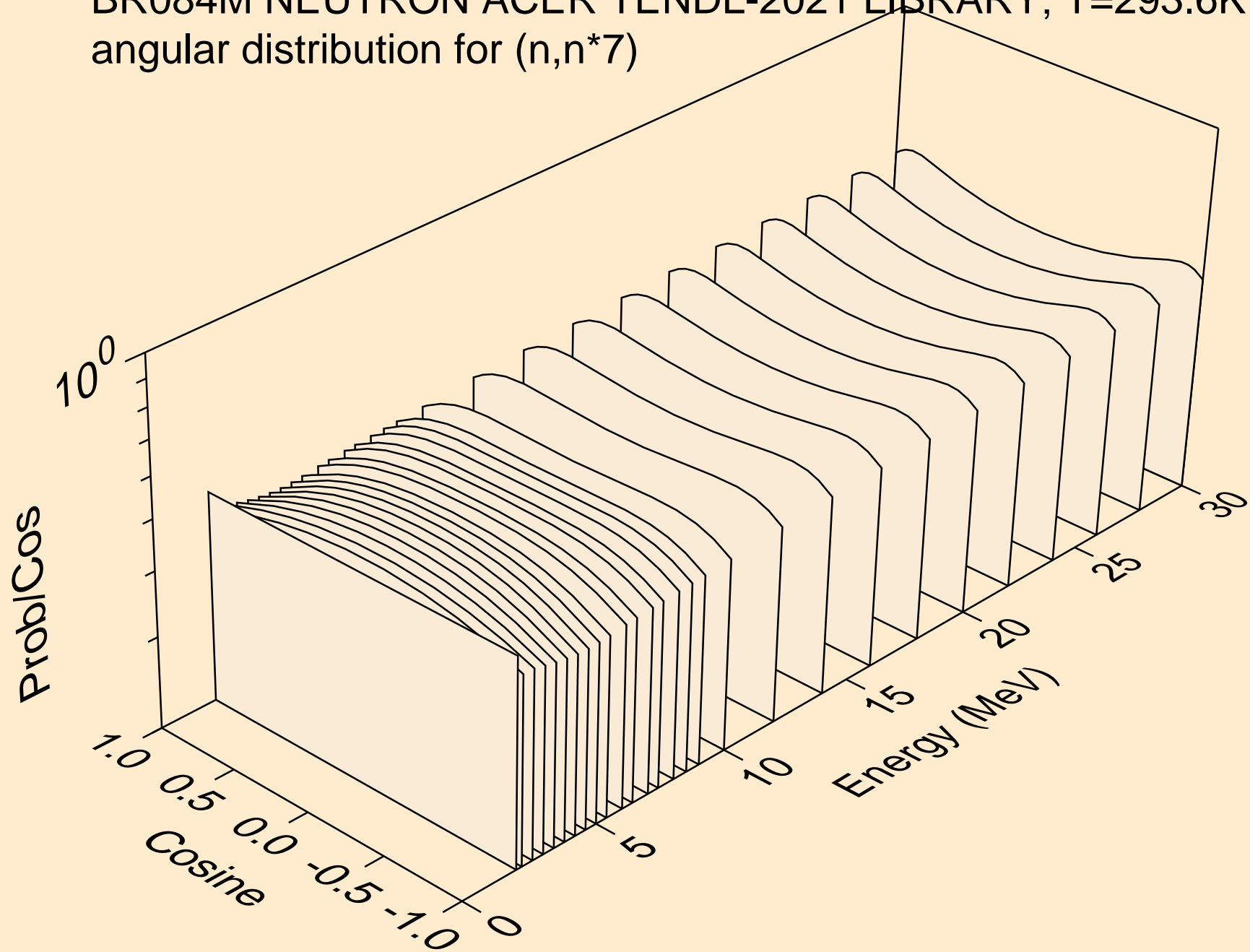

BR084M NEUTRON ACER TENDL-2021 LIBRARY; T=293.6K
angular distribution for (n,n*8)

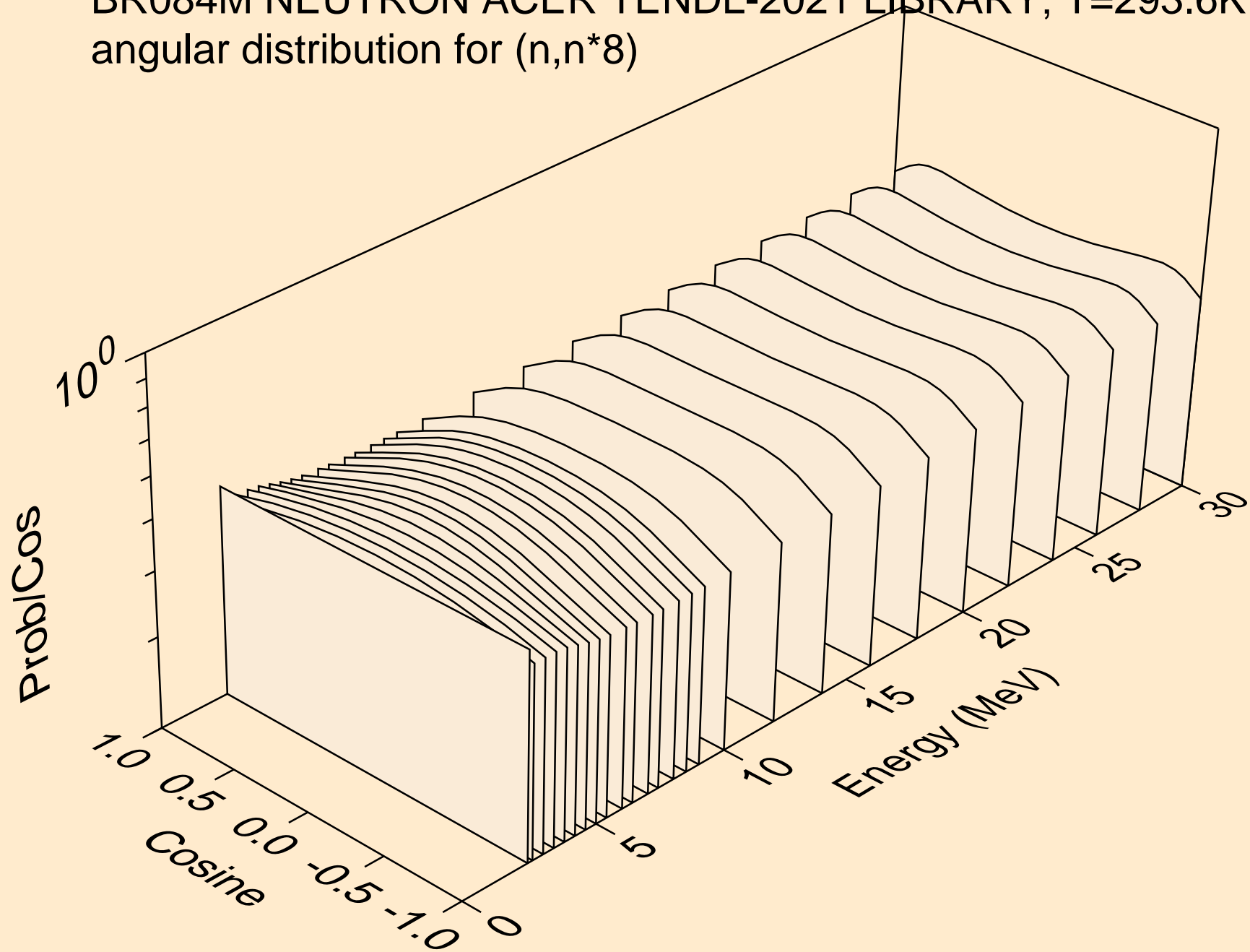

BR084M NEUTRON ACER TENDL-2021 LIBRARY; T=293.6K
angular distribution for (n,n*9)

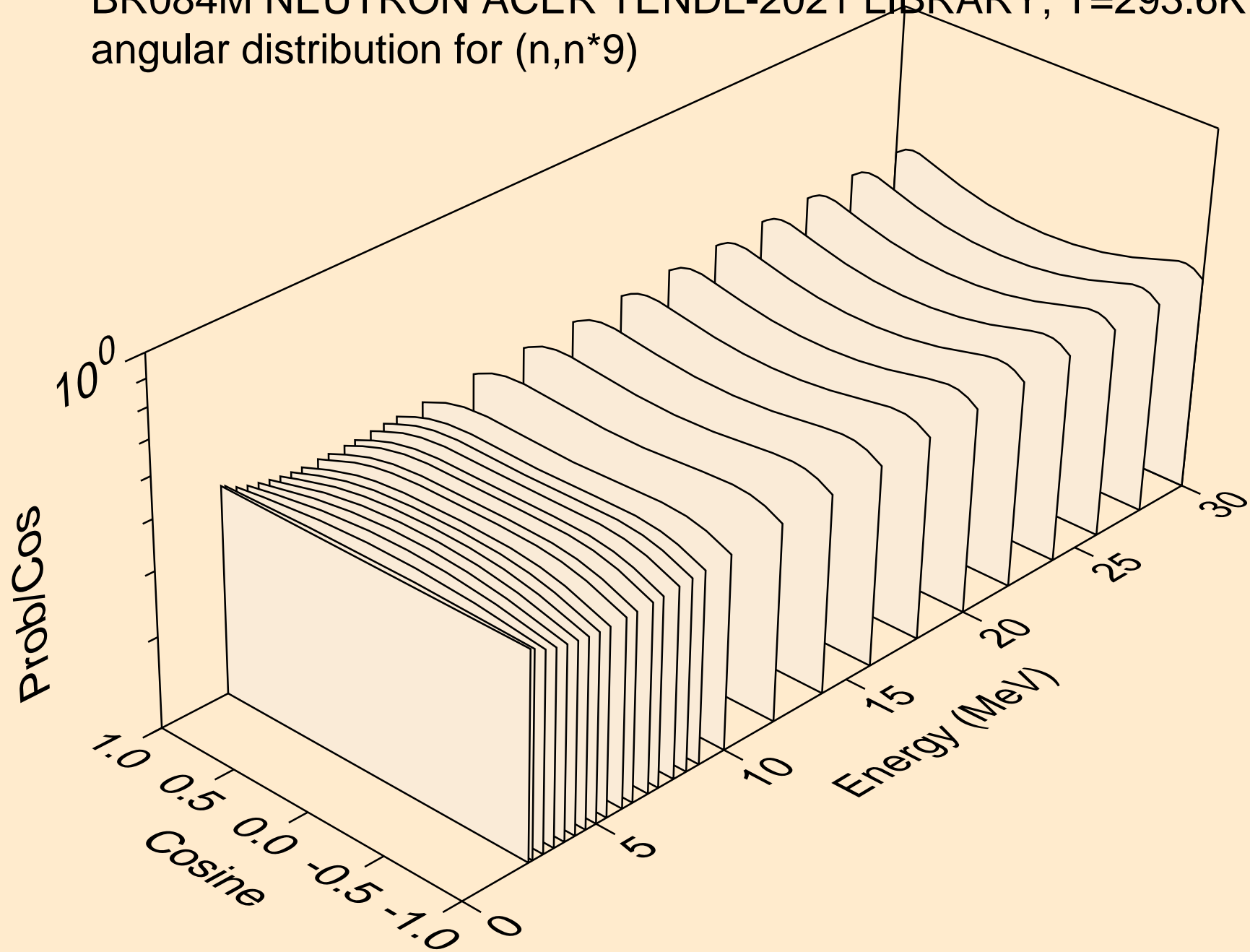

BR084M NEUTRON ACER TENDL-2021 LIBRARY; T=293.6K
angular distribution for (n,n*10)

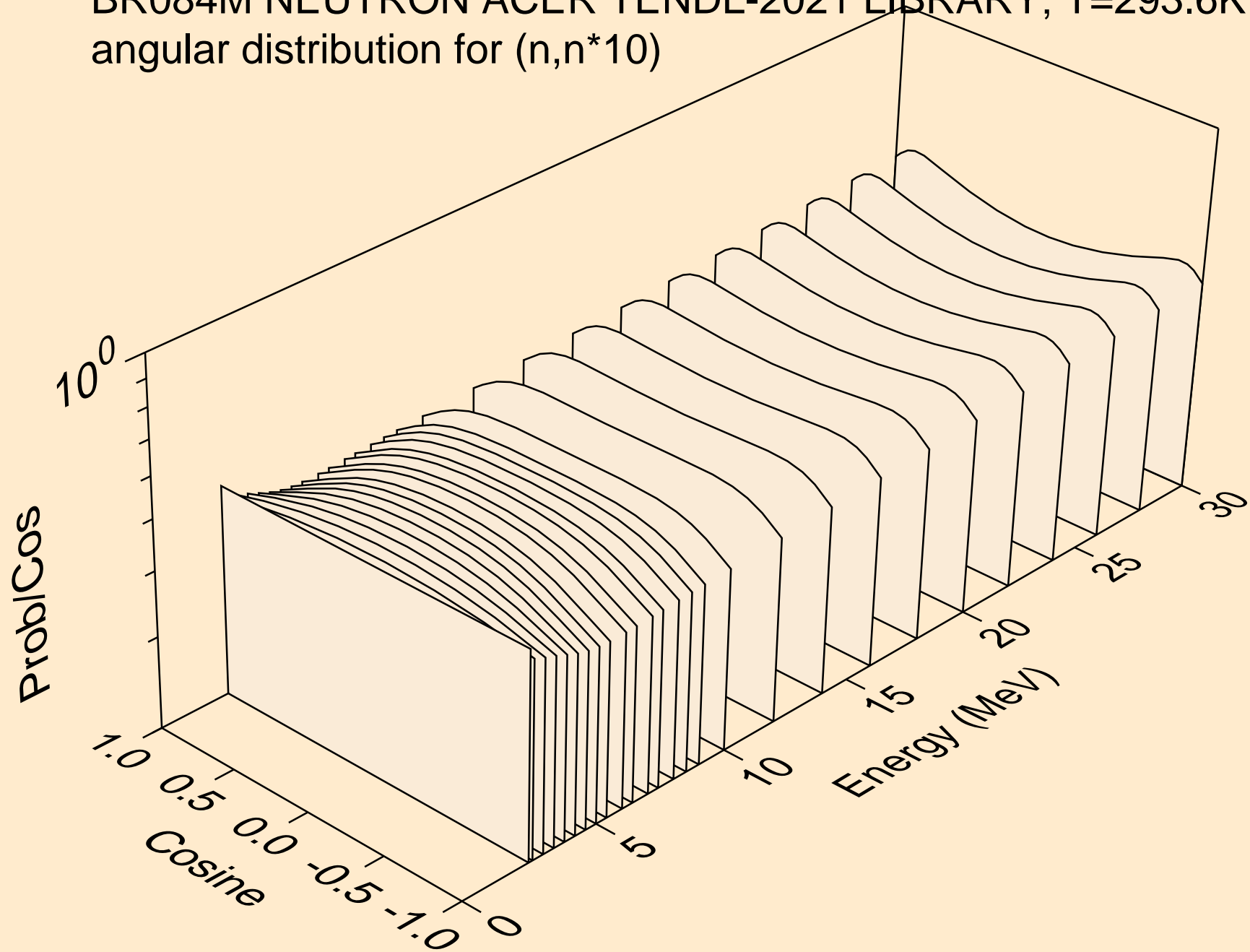

BR084M NEUTRON ACER TENDL-2021 LIBRARY; T=293.6K
angular distribution for (n,n*11)

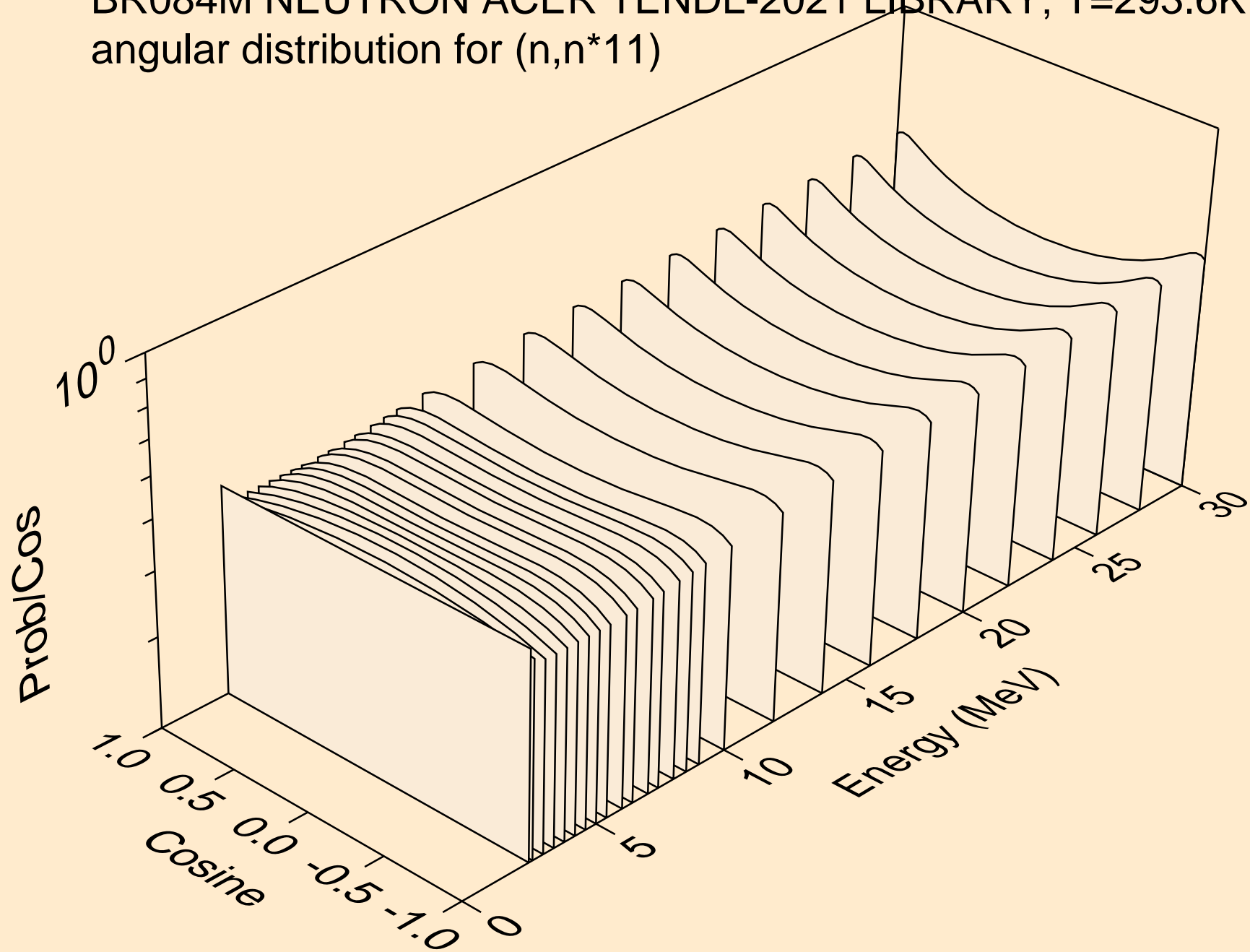

BR084M NEUTRON ACER TENDL-2021 LIBRARY; T=293.6K
angular distribution for (n,n*12)

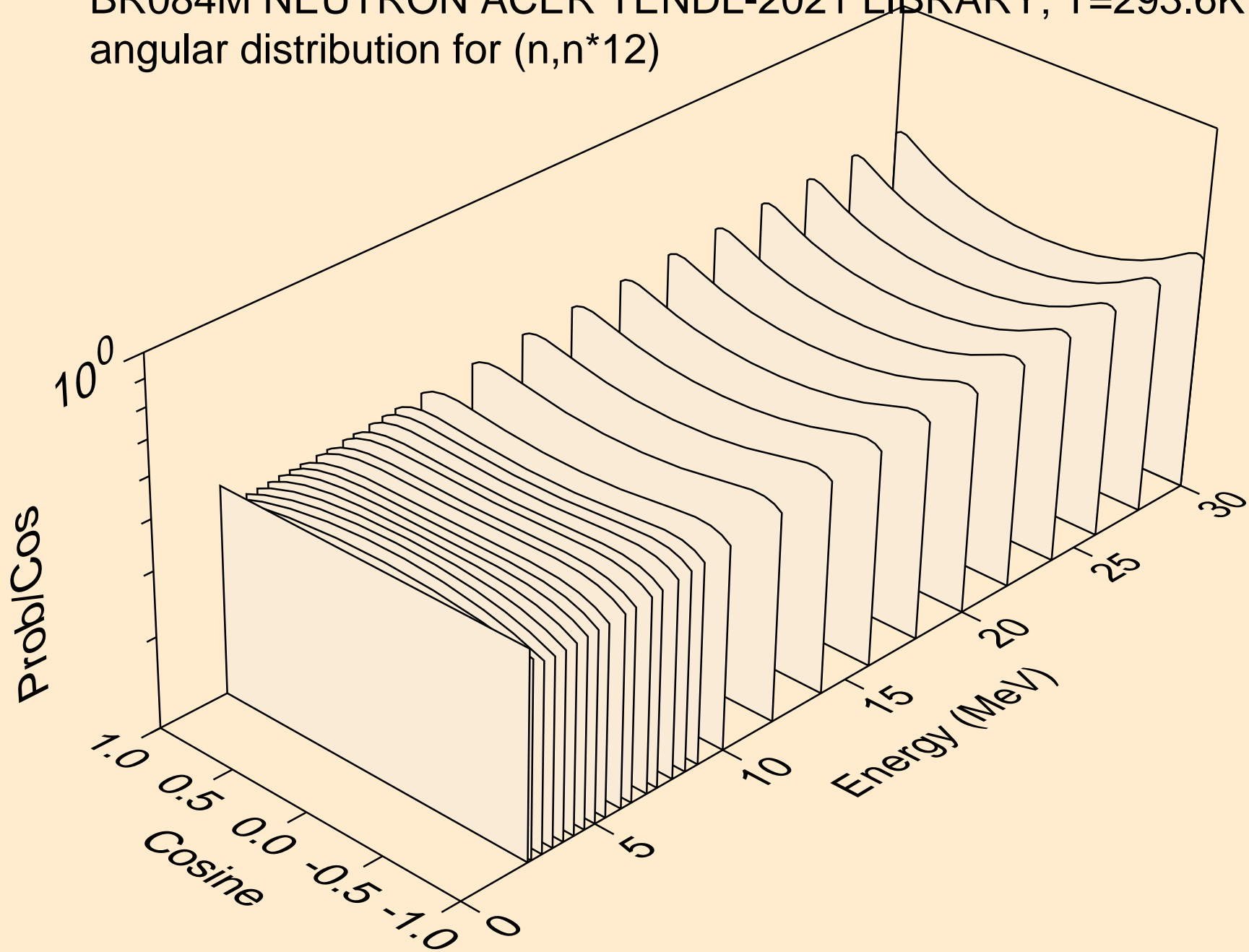

BR084M NEUTRON ACER TENDL-2021 LIBRARY; T=293.6K
angular distribution for (n,n*13)

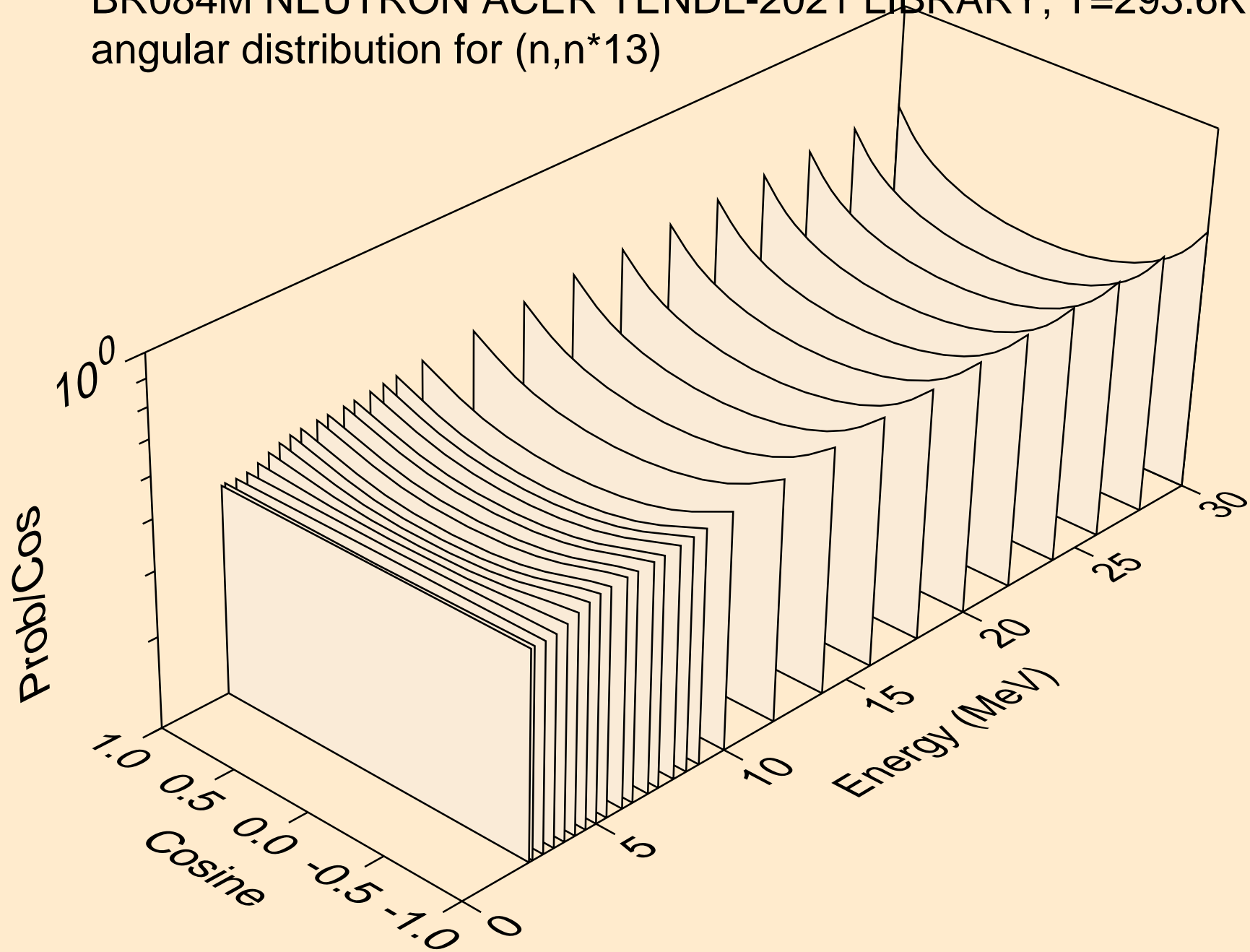

BR084M NEUTRON ACER TENDL-2021 LIBRARY; T=293.6K
angular distribution for (n,n*14)

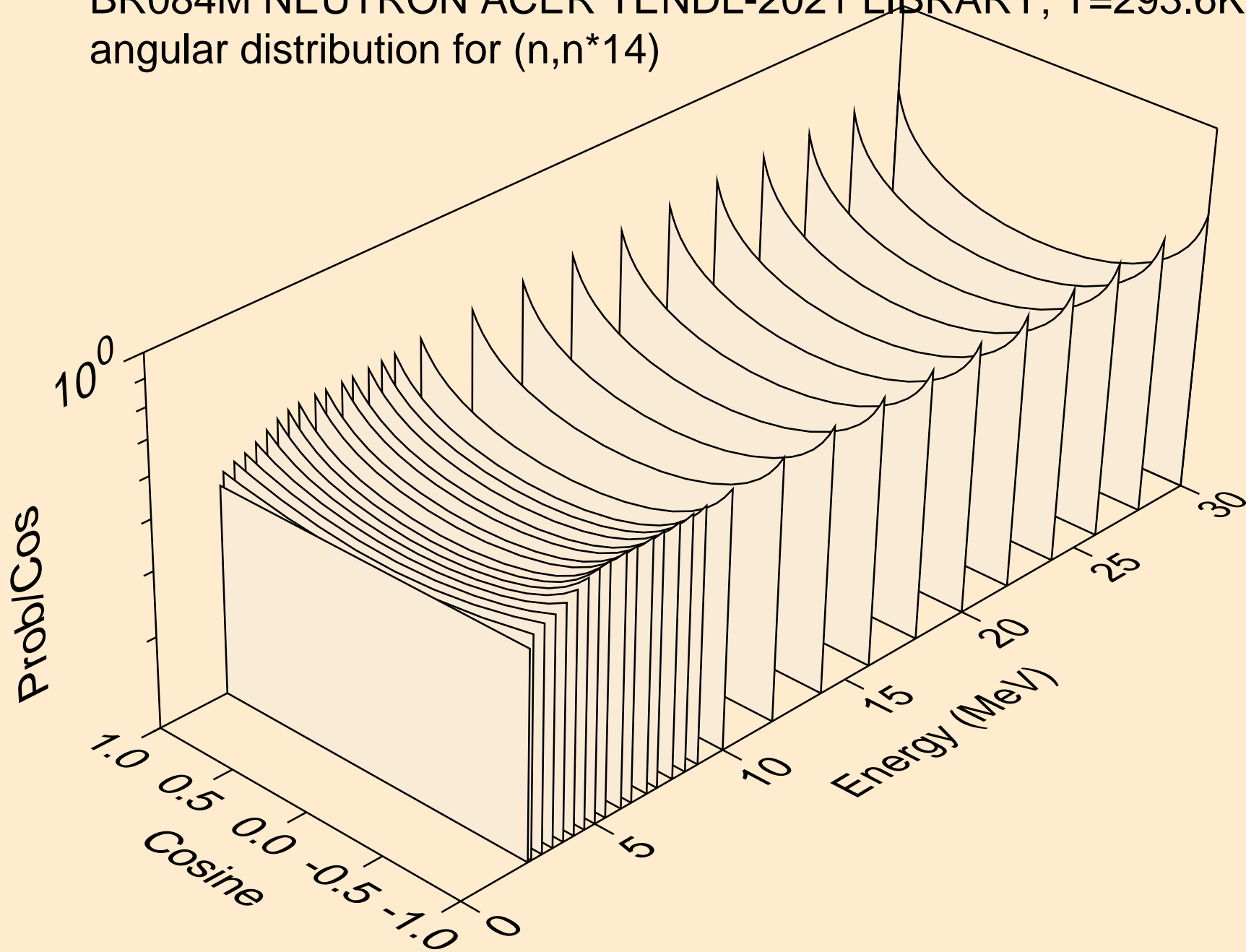

BR084M NEUTRON ACER TENDL-2021 LIBRARY; T=293.6K
angular distribution for (n,n*15)

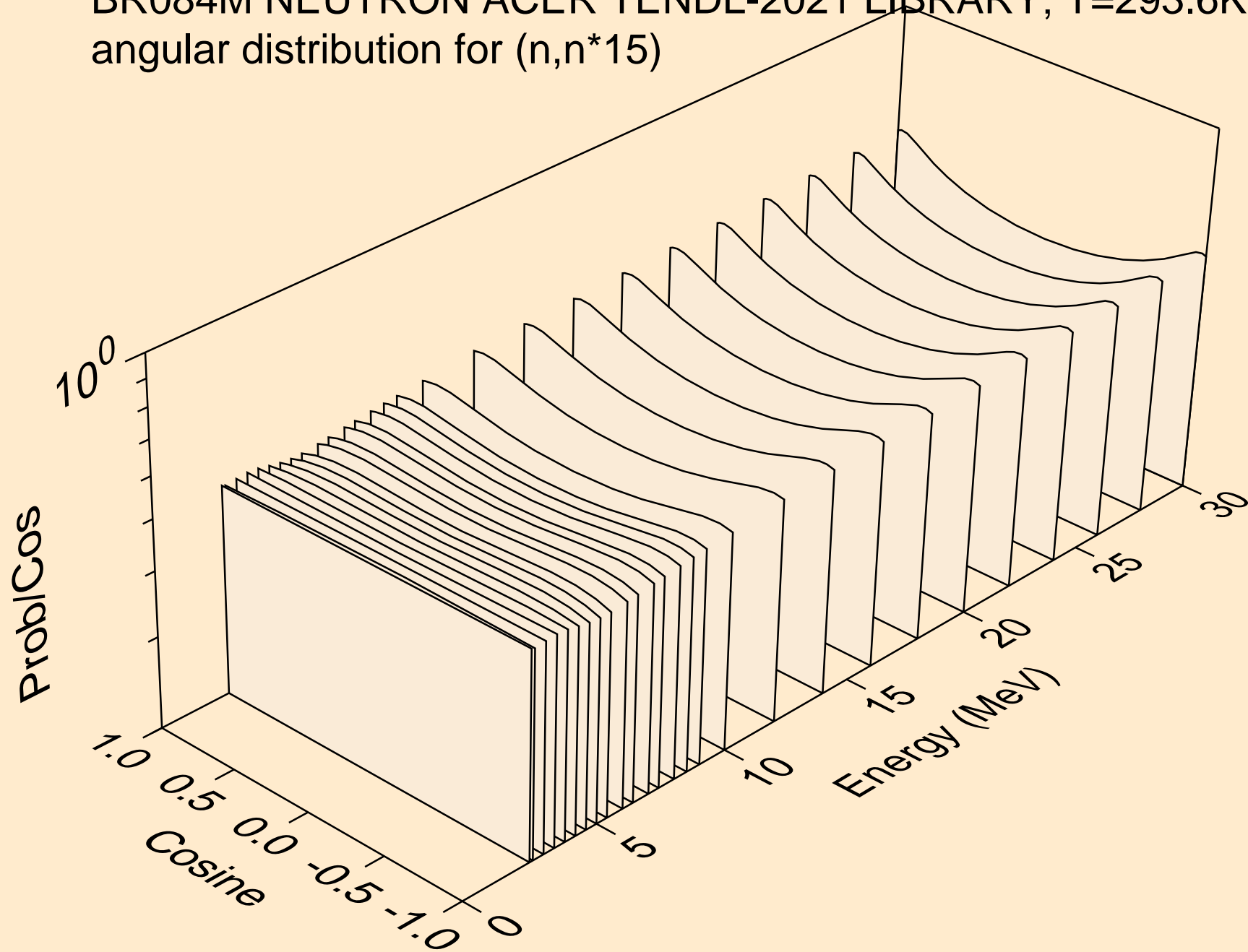

BR084M NEUTRON ACER TENDL-2021 LIBRARY; T=293.6K
angular distribution for (n,n*16)

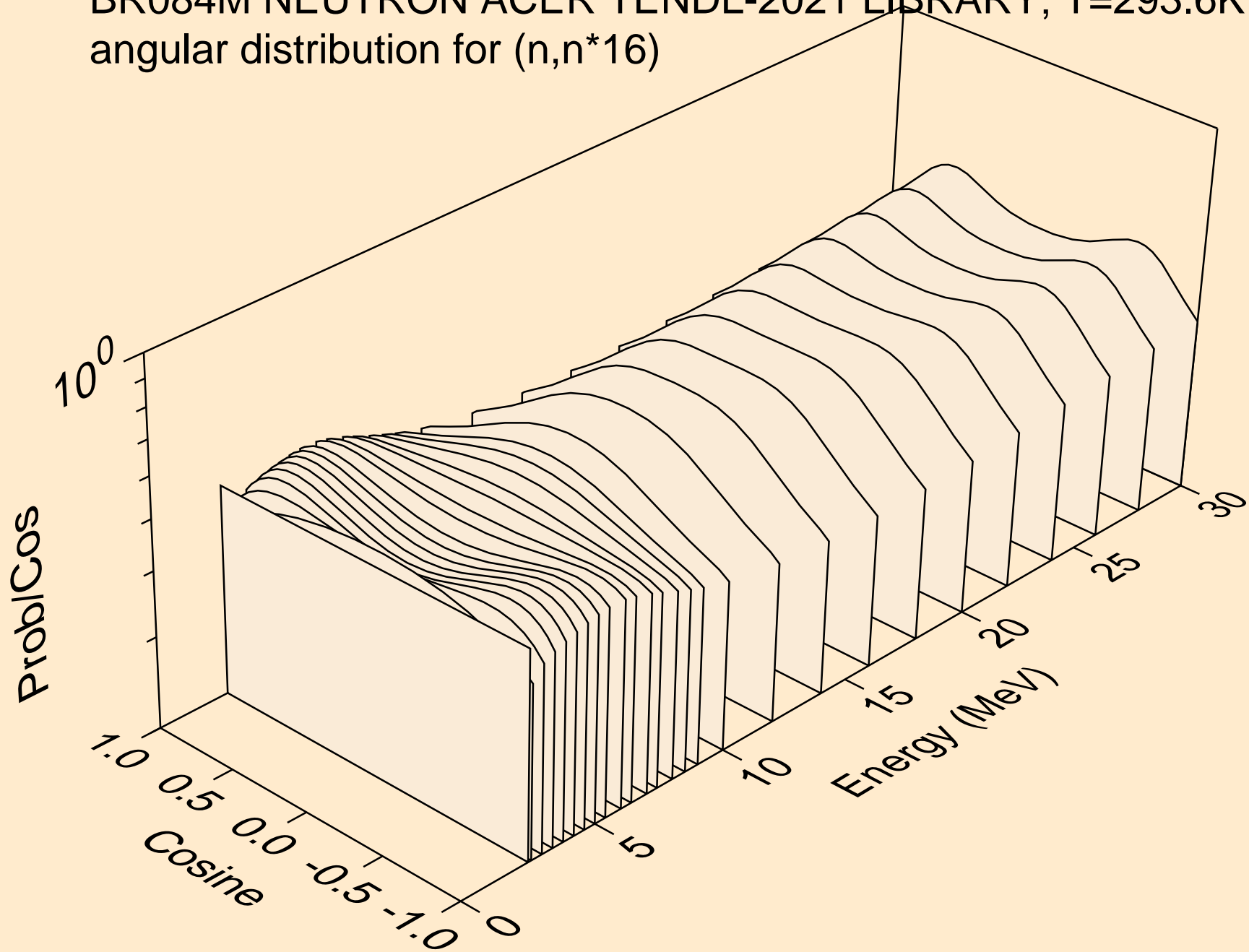

BR084M NEUTRON ACER TENDL-2021 LIBRARY; T=293.6K
angular distribution for (n,n*17)

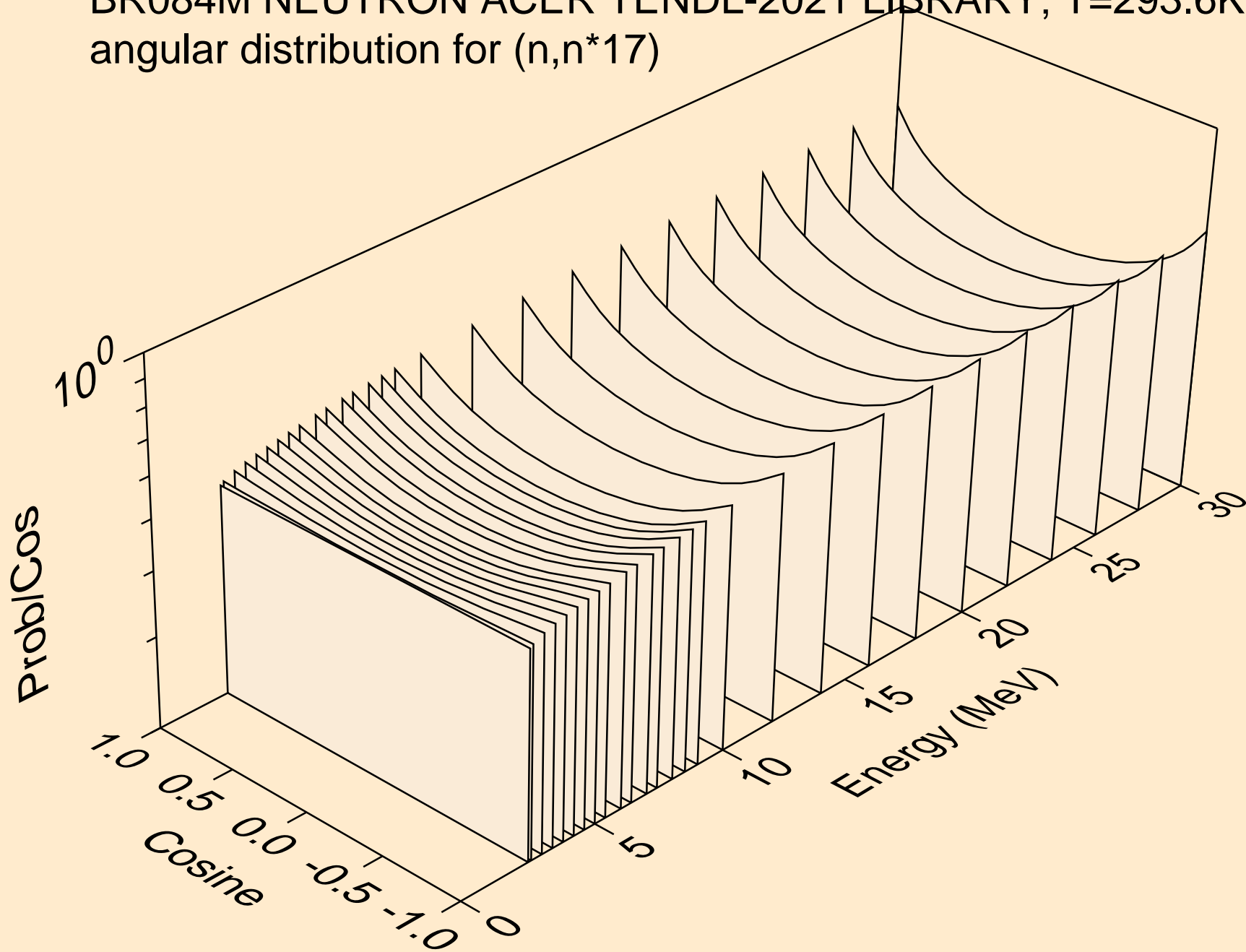

BR084M NEUTRON ACER TENDL-2021 LIBRARY; T=293.6K
angular distribution for (n,n*18)

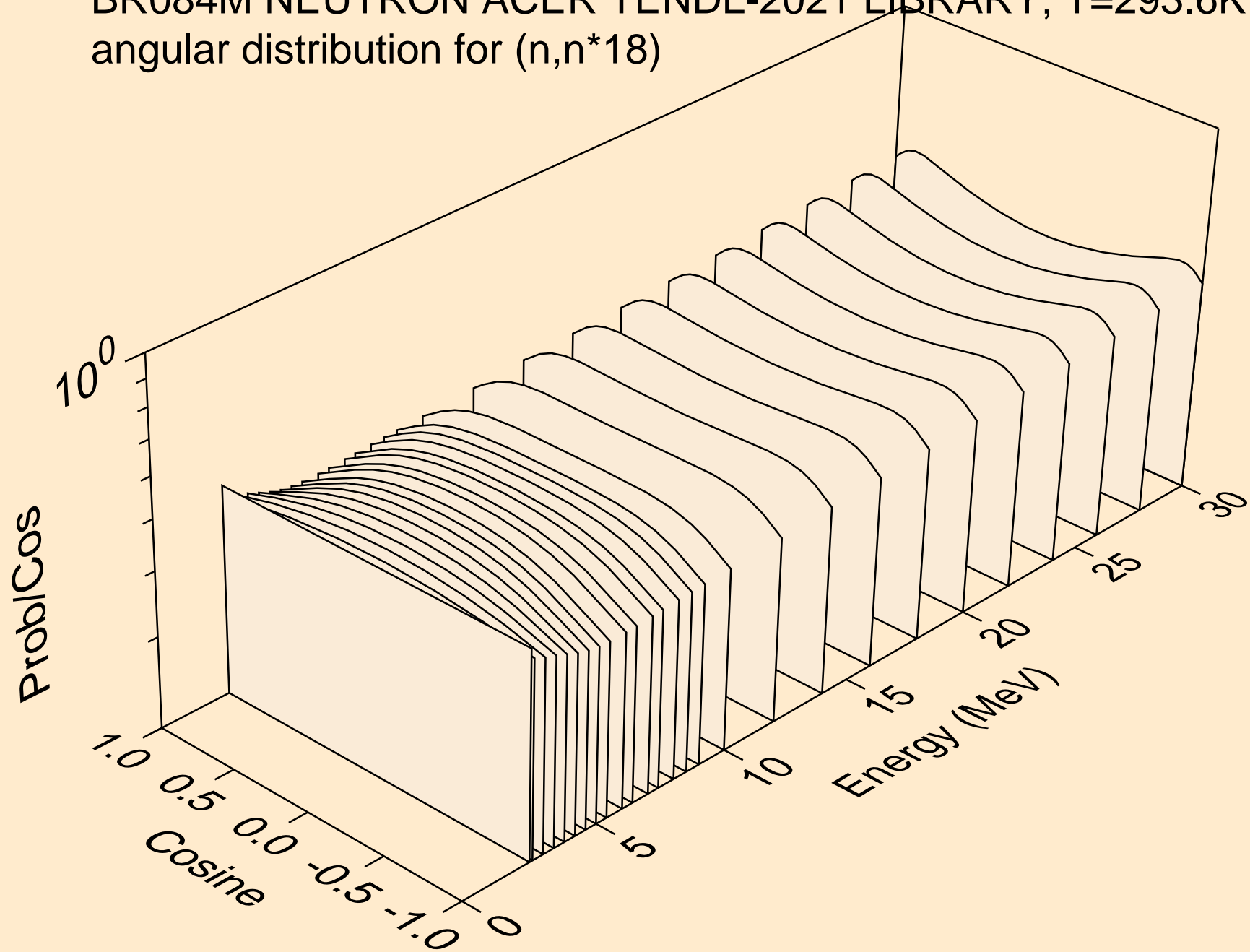

BR084M NEUTRON ACER TENDL-2021 LIBRARY; T=293.6K
angular distribution for (n,n*19)

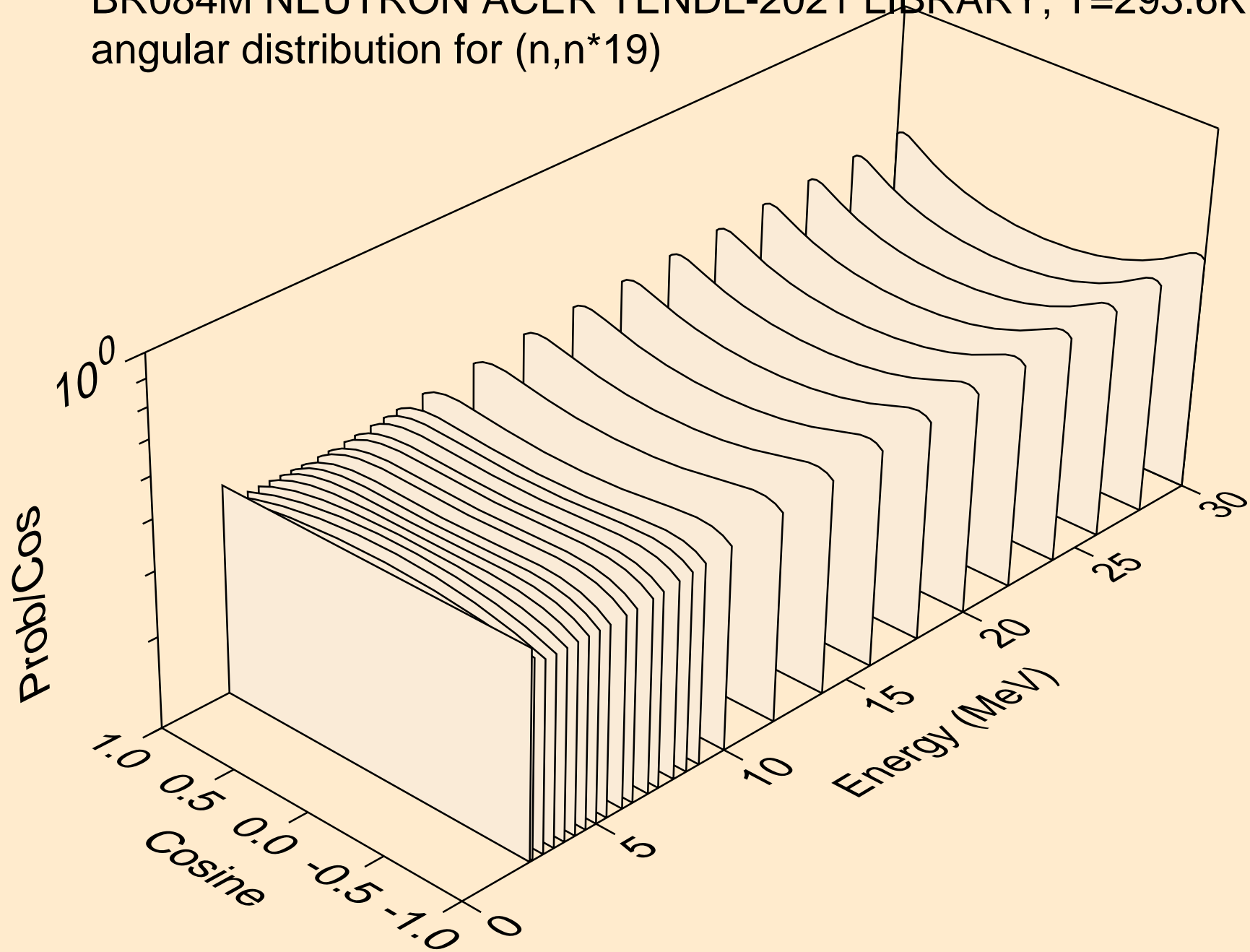

BR084M NEUTRON ACER TENDL-2021 LIBRARY; T=293.6K
angular distribution for (n,n*20)

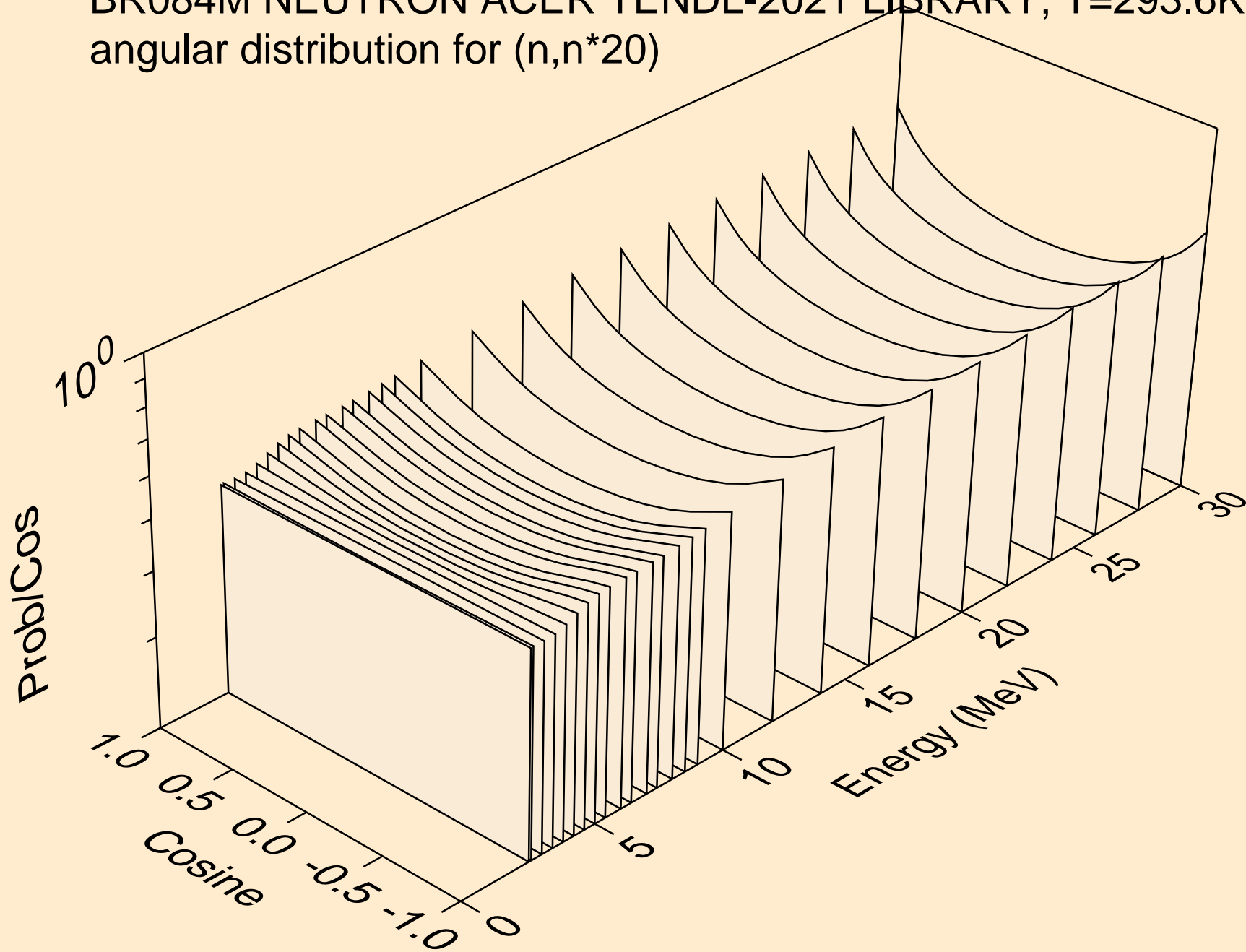

BR084M NEUTRON ACER TENDL-2021 LIBRARY; T=293.6K
angular distribution for (n,n*21)

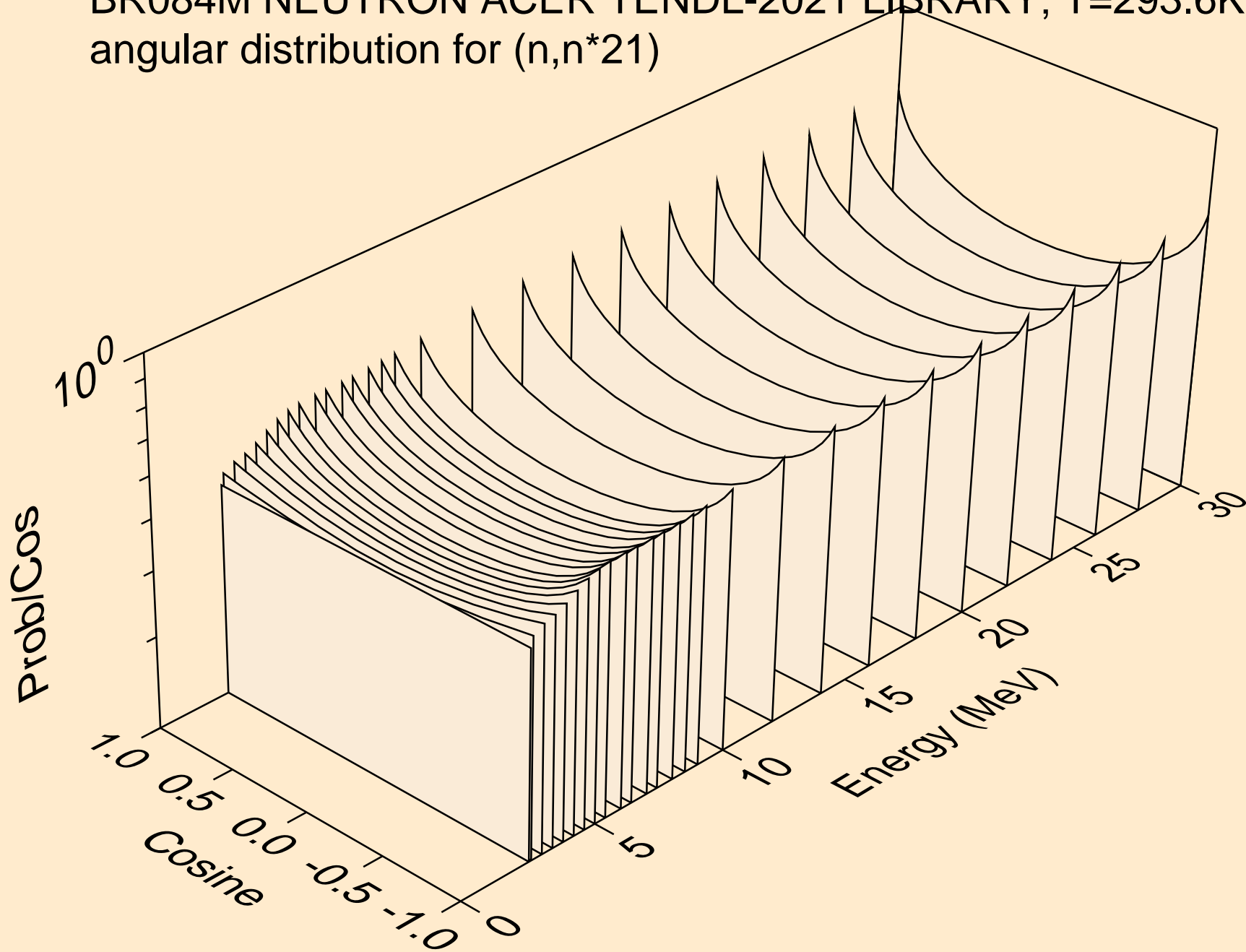

BR084M NEUTRON ACER TENDL-2021 LIBRARY; T=293.6K
angular distribution for (n,n*22)

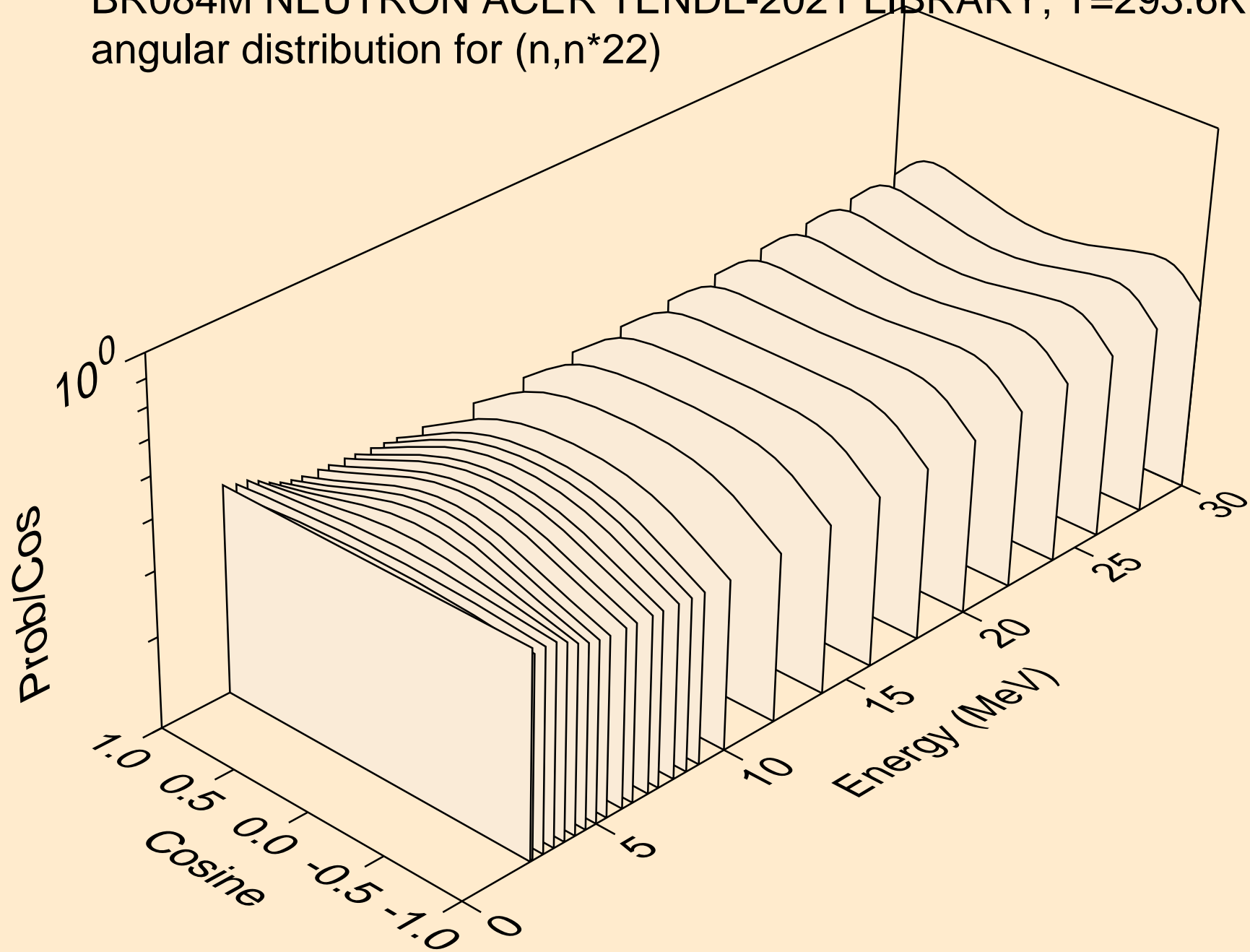

BR084M NEUTRON ACER TENDL-2021 LIBRARY; T=293.6K
angular distribution for (n,n*23)

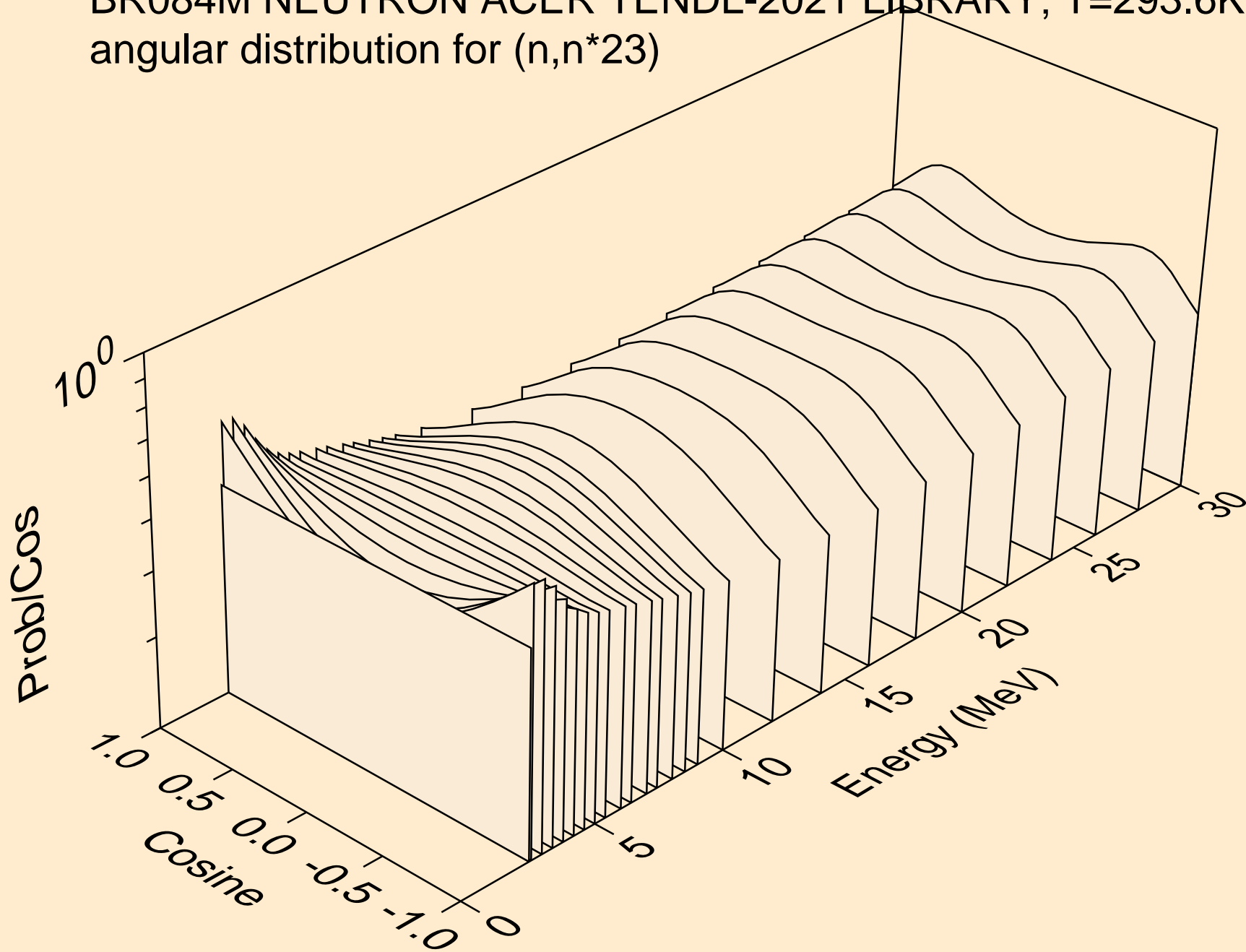

BR084M NEUTRON ACER TENDL-2021 LIBRARY; T=293.6K
angular distribution for (n,n*24)

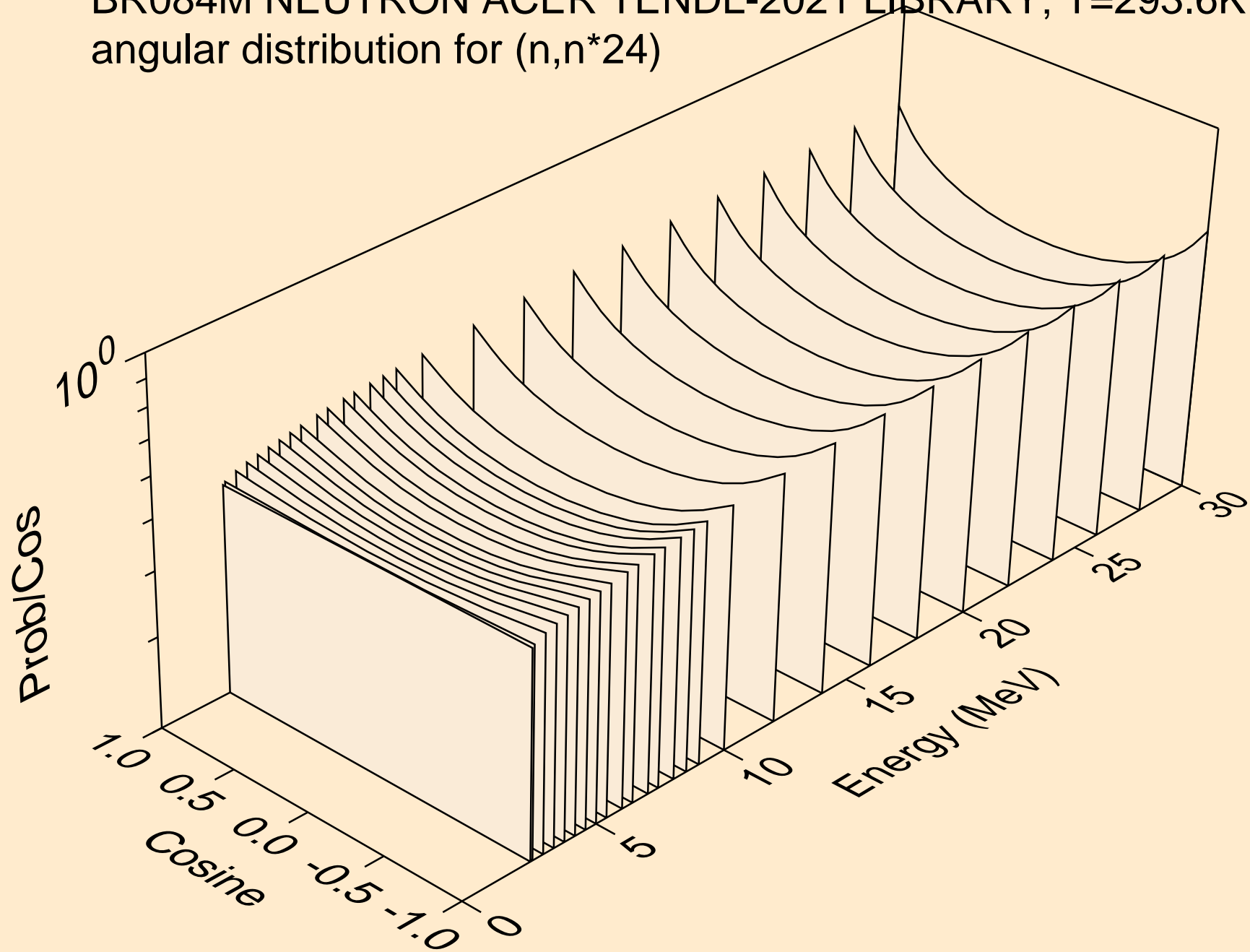

BR084M NEUTRON ACER TENDL-2021 LIBRARY; T=293.6K
angular distribution for (n,n*25)

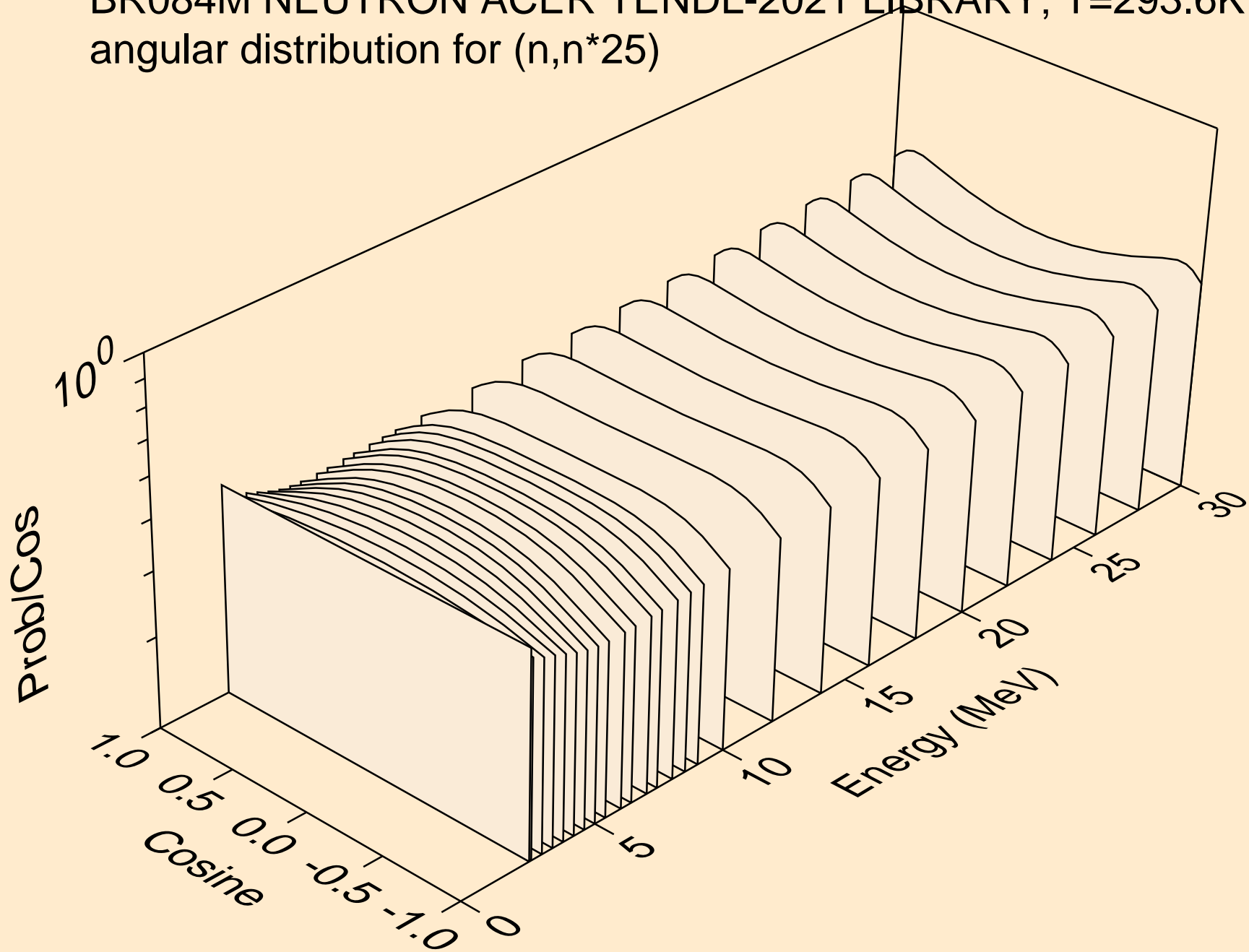

BR084M NEUTRON ACER TENDL-2021 LIBRARY; T=293.6K
angular distribution for (n,n*26)

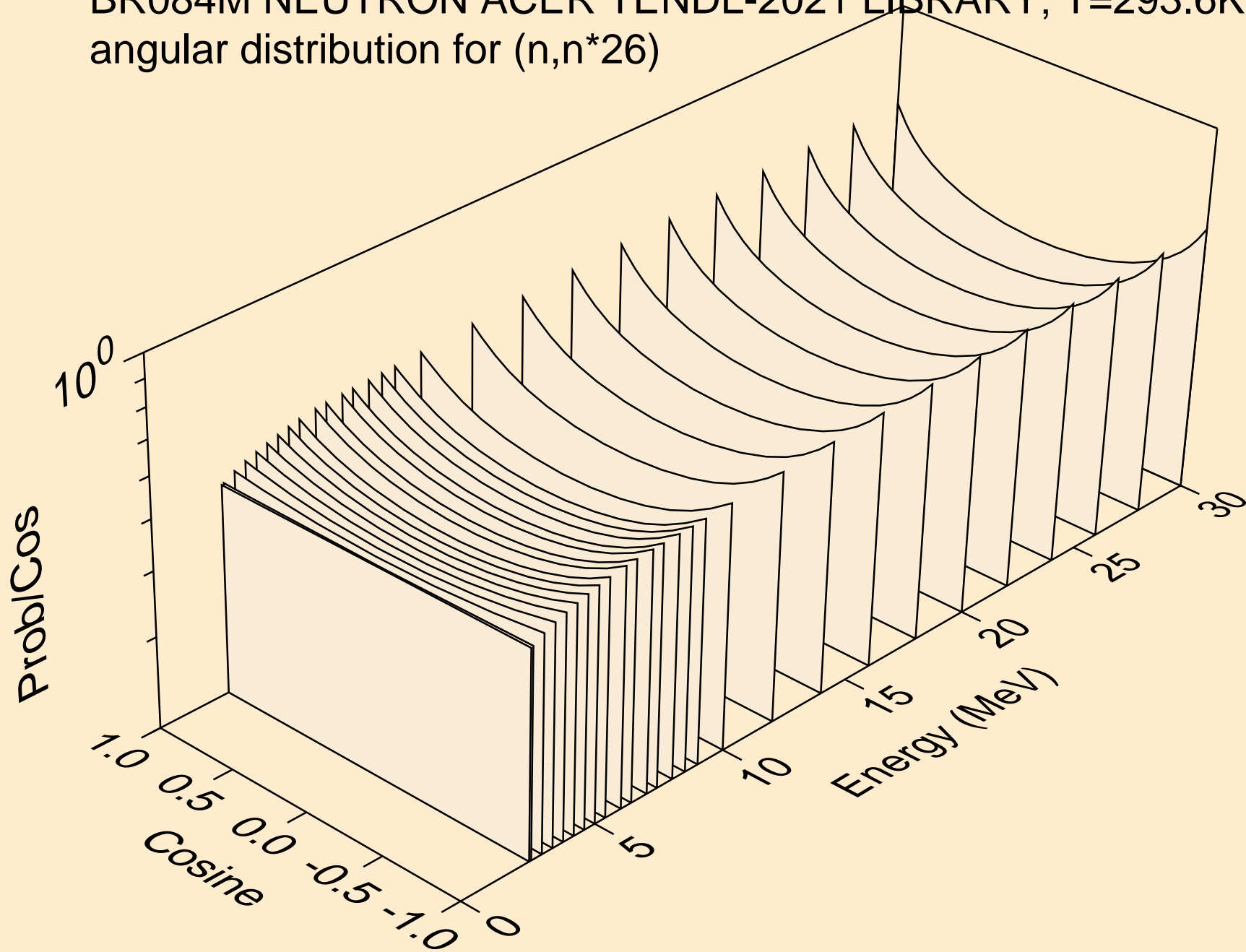

BR084M NEUTRON ACER TENDL-2021 LIBRARY; T=293.6K
angular distribution for (n,n*27)

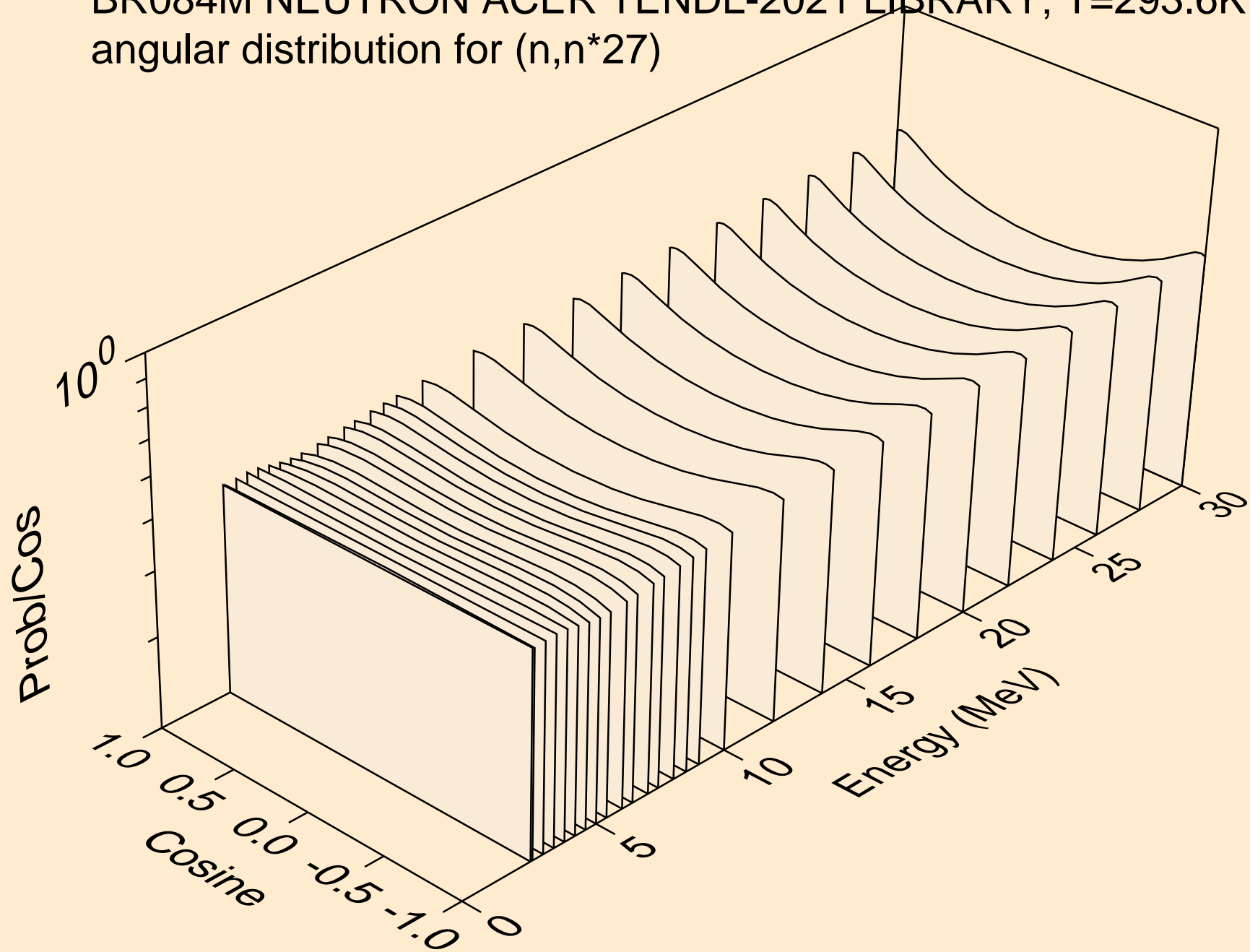

BR084M NEUTRON ACER TENDL-2021 LIBRARY; T=293.6K
angular distribution for (n,n*28)

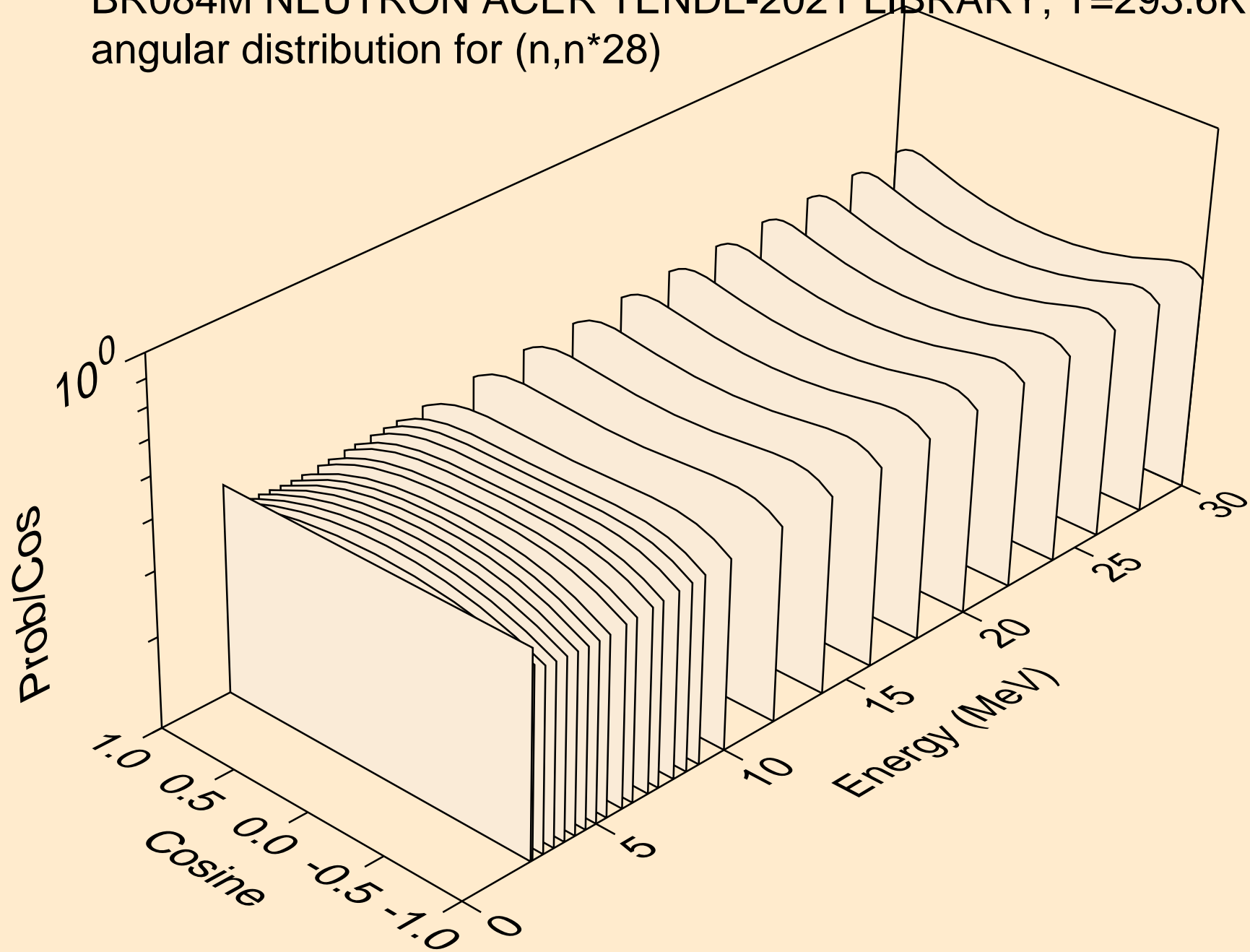

BR084M NEUTRON ACER TENDL-2021 LIBRARY; T=293.6K
angular distribution for (n,n*29)

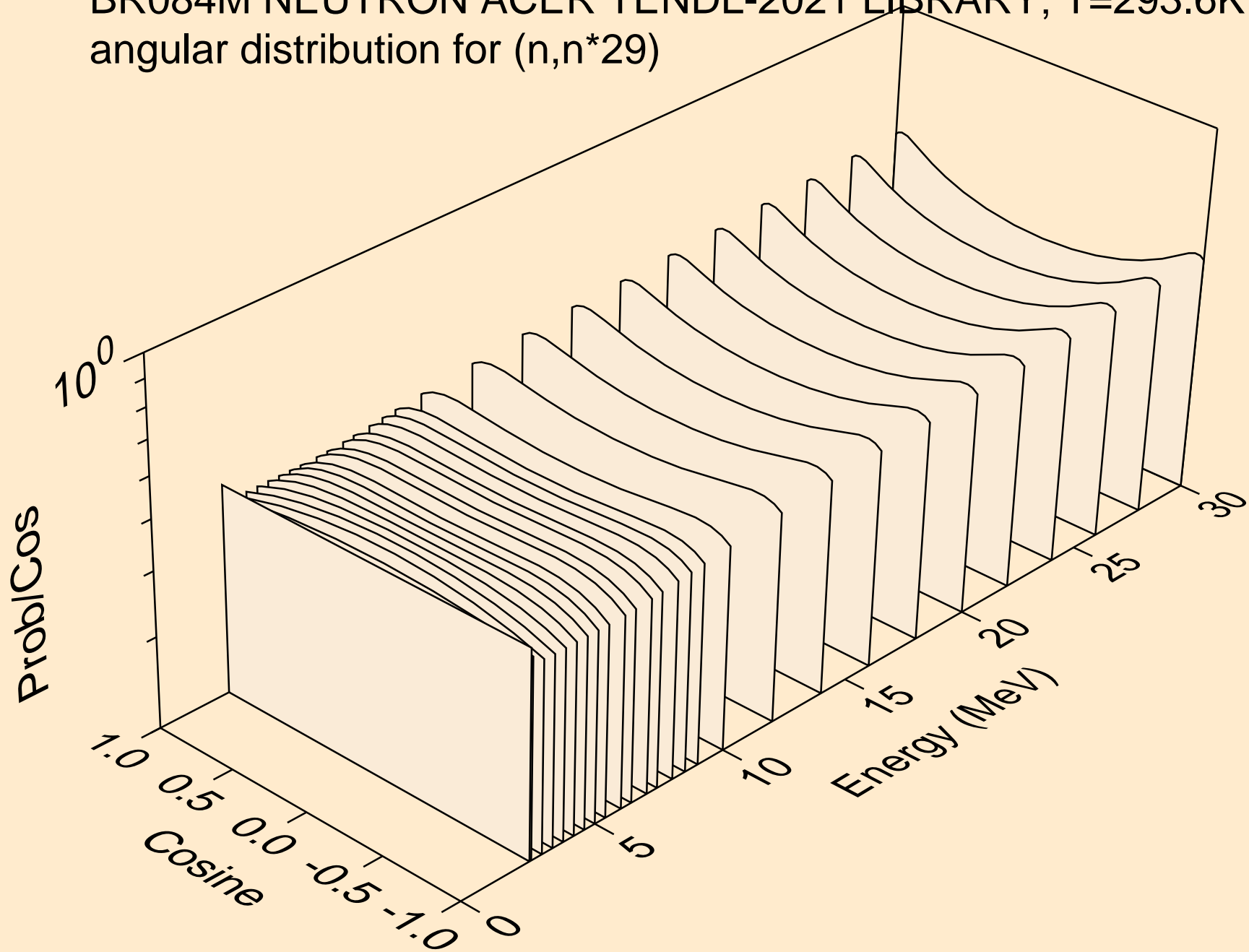

BR084M NEUTRON ACER TENDL-2021 LIBRARY; T=293.6K
Neutron emission for (n,x)

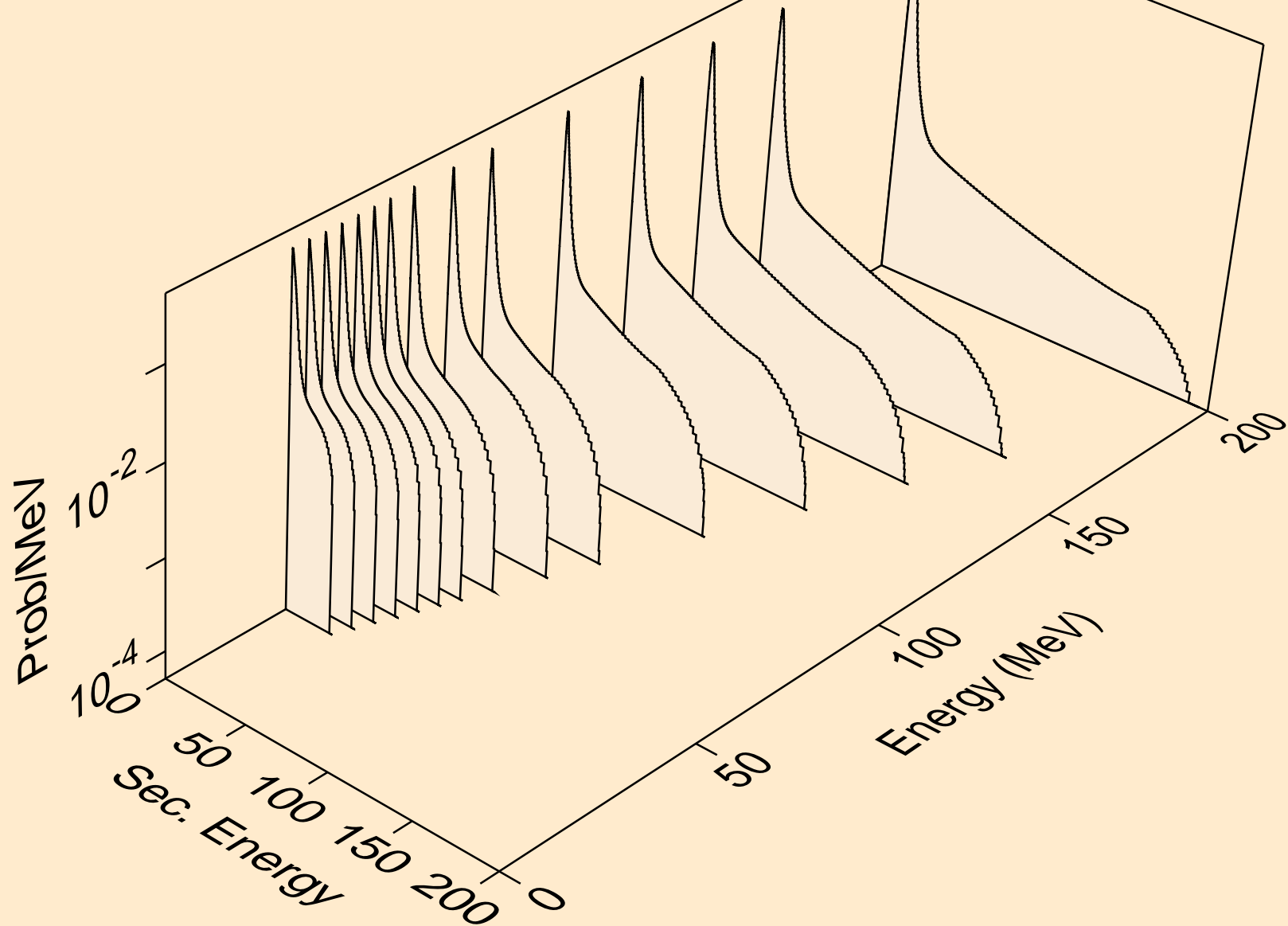

BR084M NEUTRON ACER TENDL-2021 LIBRARY; T=293.6K
Neutron emission for (n,2nd)

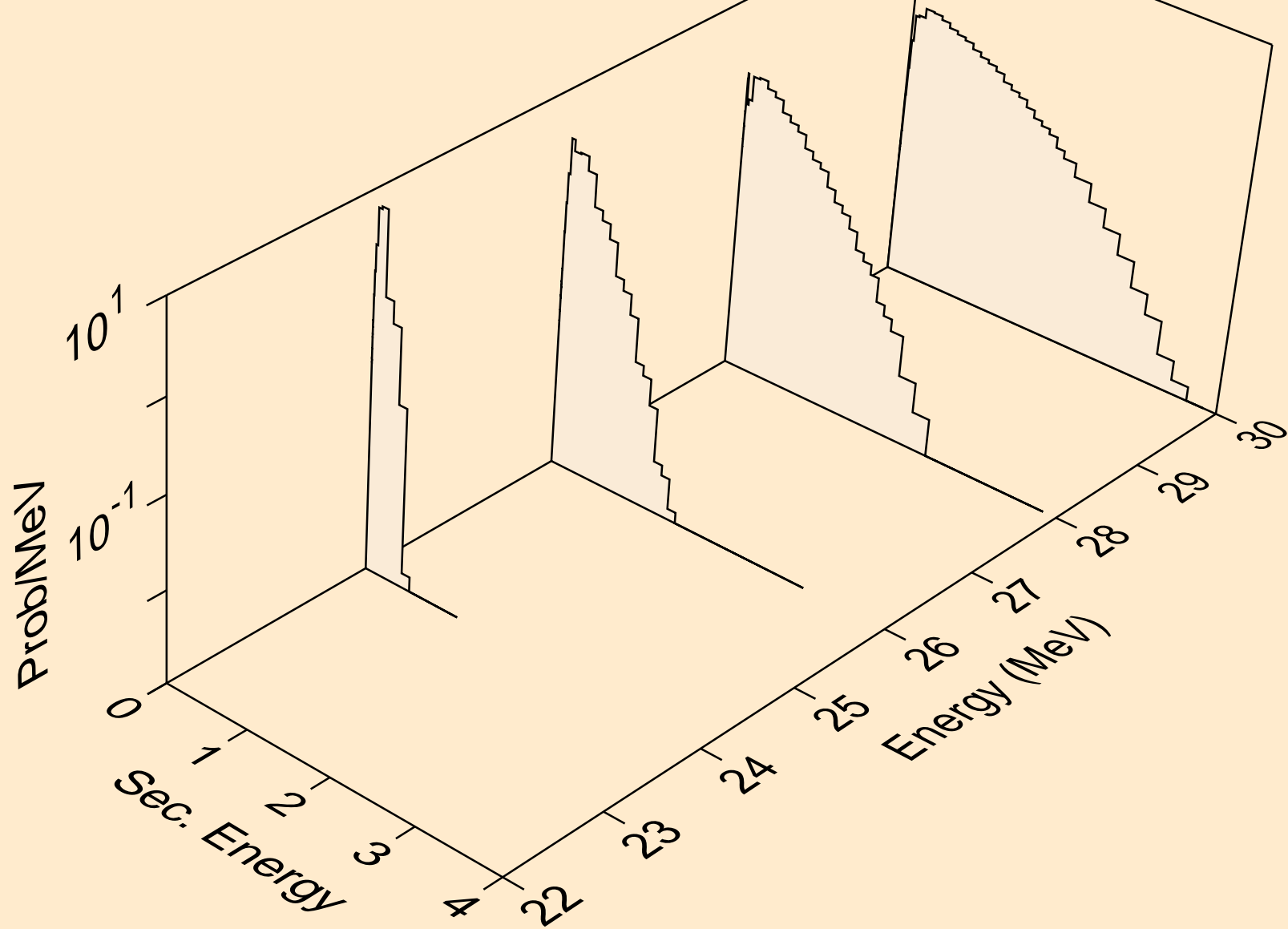

BR084M NEUTRON ACER TENDL-2021 LIBRARY; T=293.6K
Neutron emission for (n,2n)

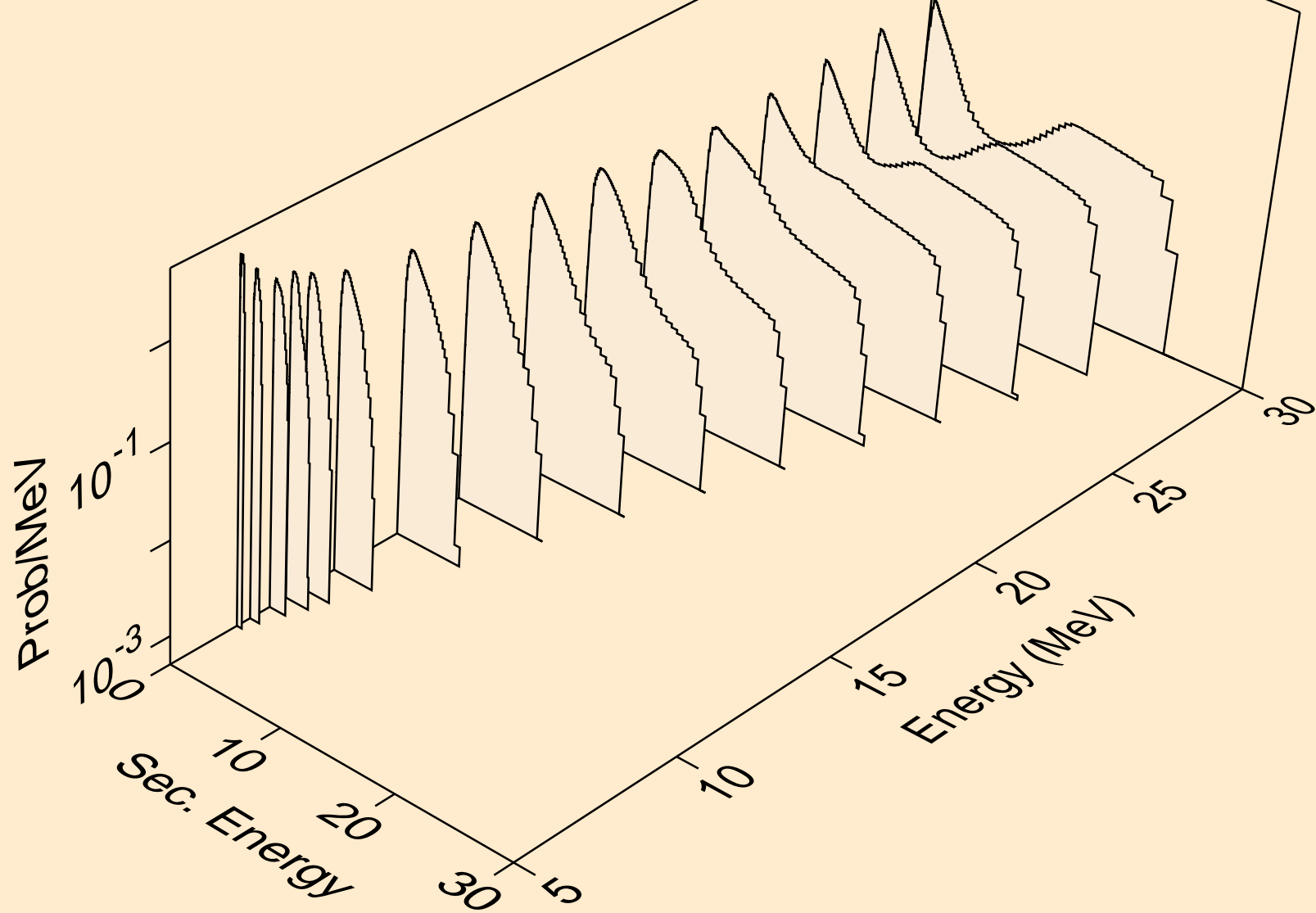

BR084M NEUTRON ACER TENDL-2021 LIBRARY; T=293.6K
Neutron emission for (n,3n)

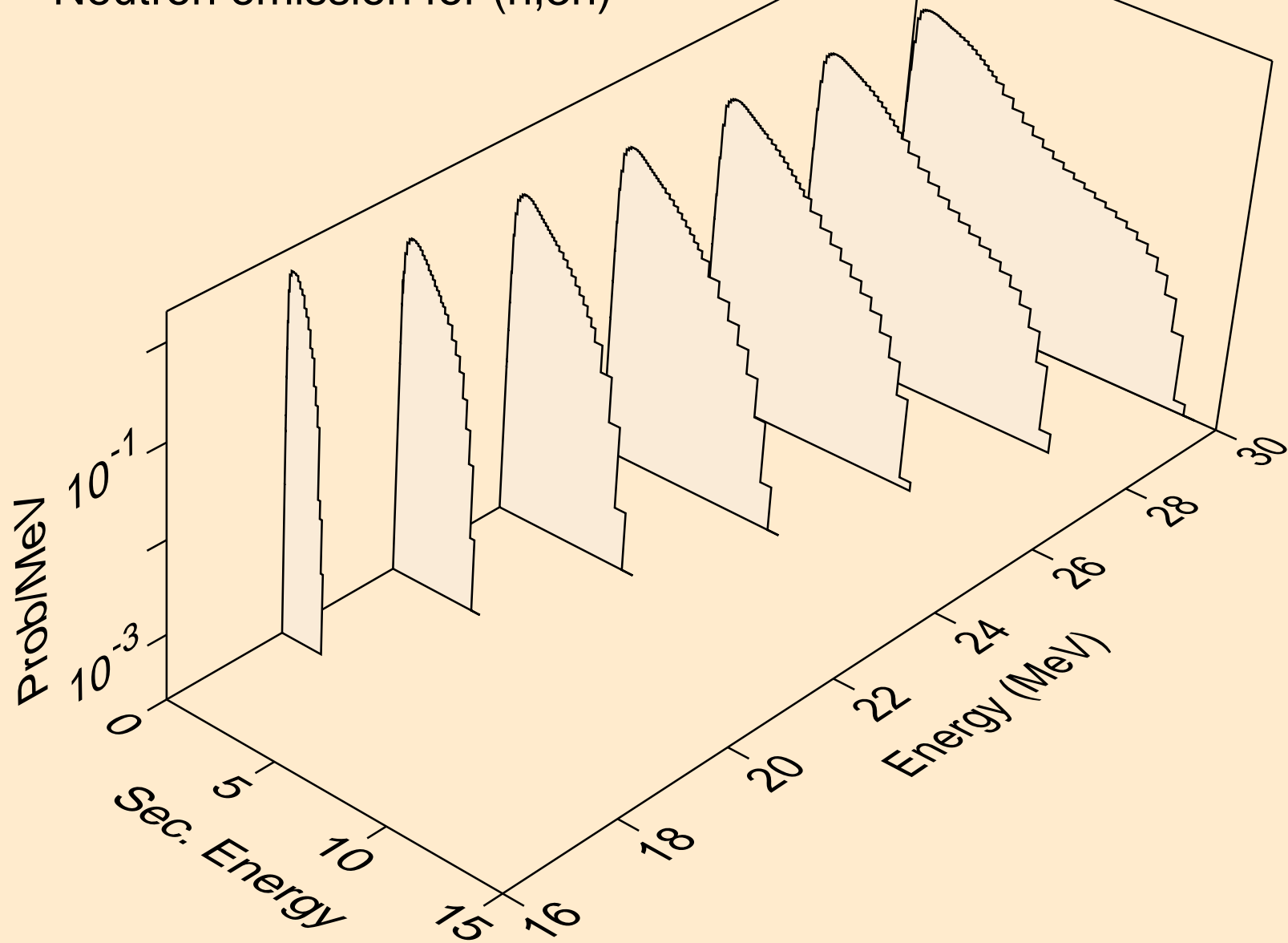

BR084M NEUTRON ACER TENDL-2021 LIBRARY; T=293.6K
Neutron emission for (n,n*)a

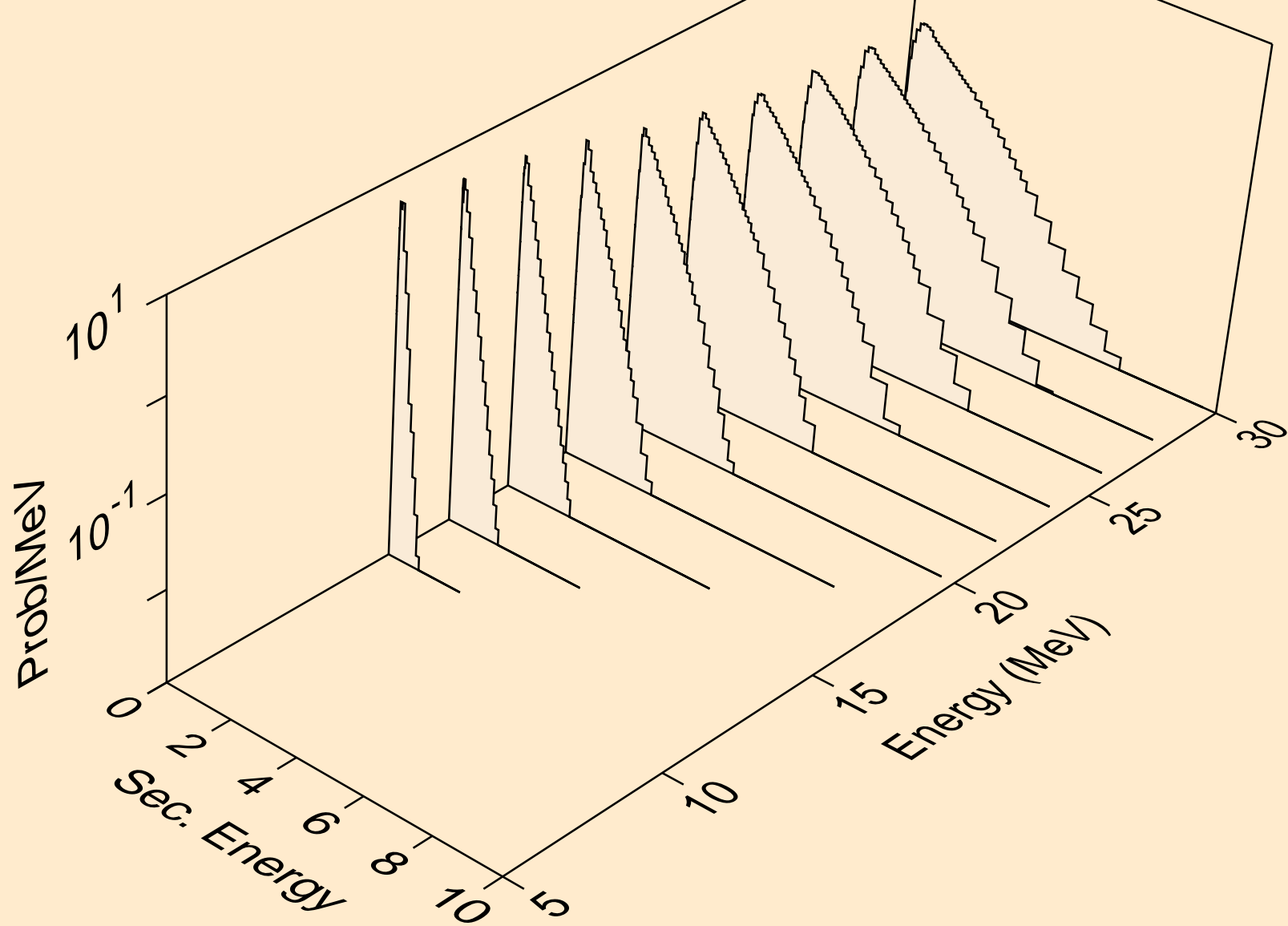

BR084M NEUTRON ACER TENDL-2021 LIBRARY; T=293.6K
Neutron emission for (n,2n)_a

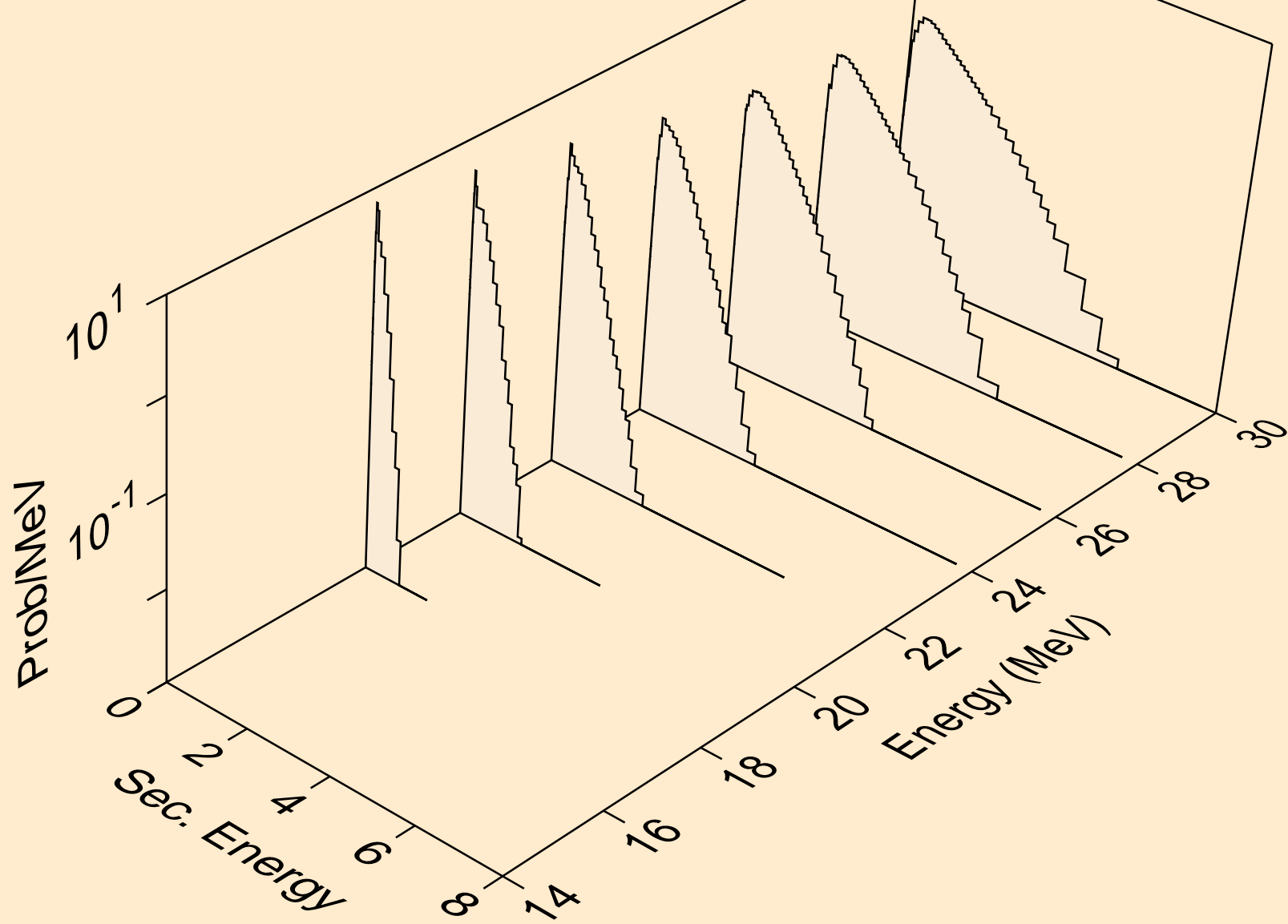

BR084M NEUTRON ACER TENDL-2021 LIBRARY; T=293.6K
Neutron emission for (n,3n)a

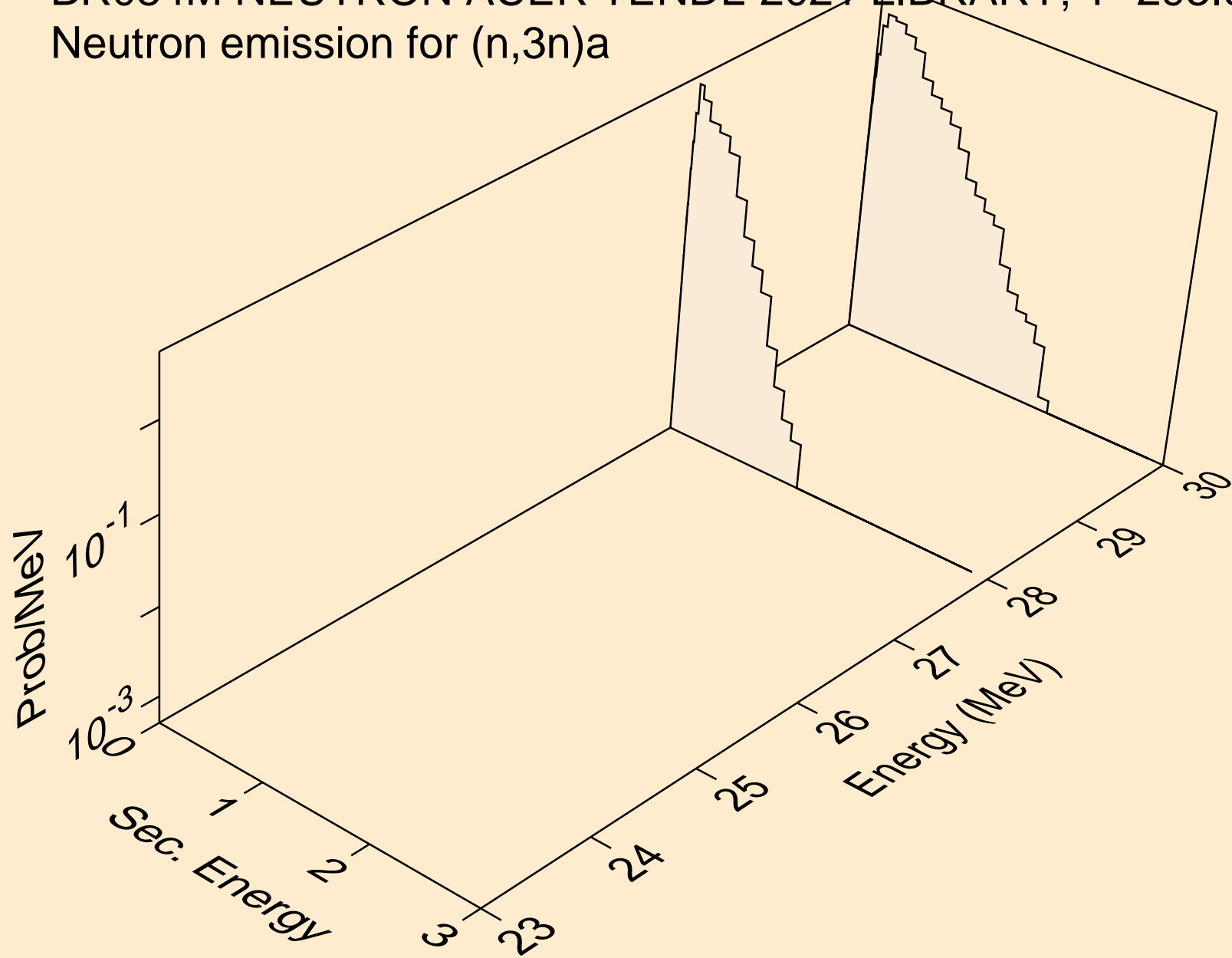

BR084M NEUTRON ACER TENDL-2021 LIBRARY; T=293.6K
Neutron emission for (n,n*)p

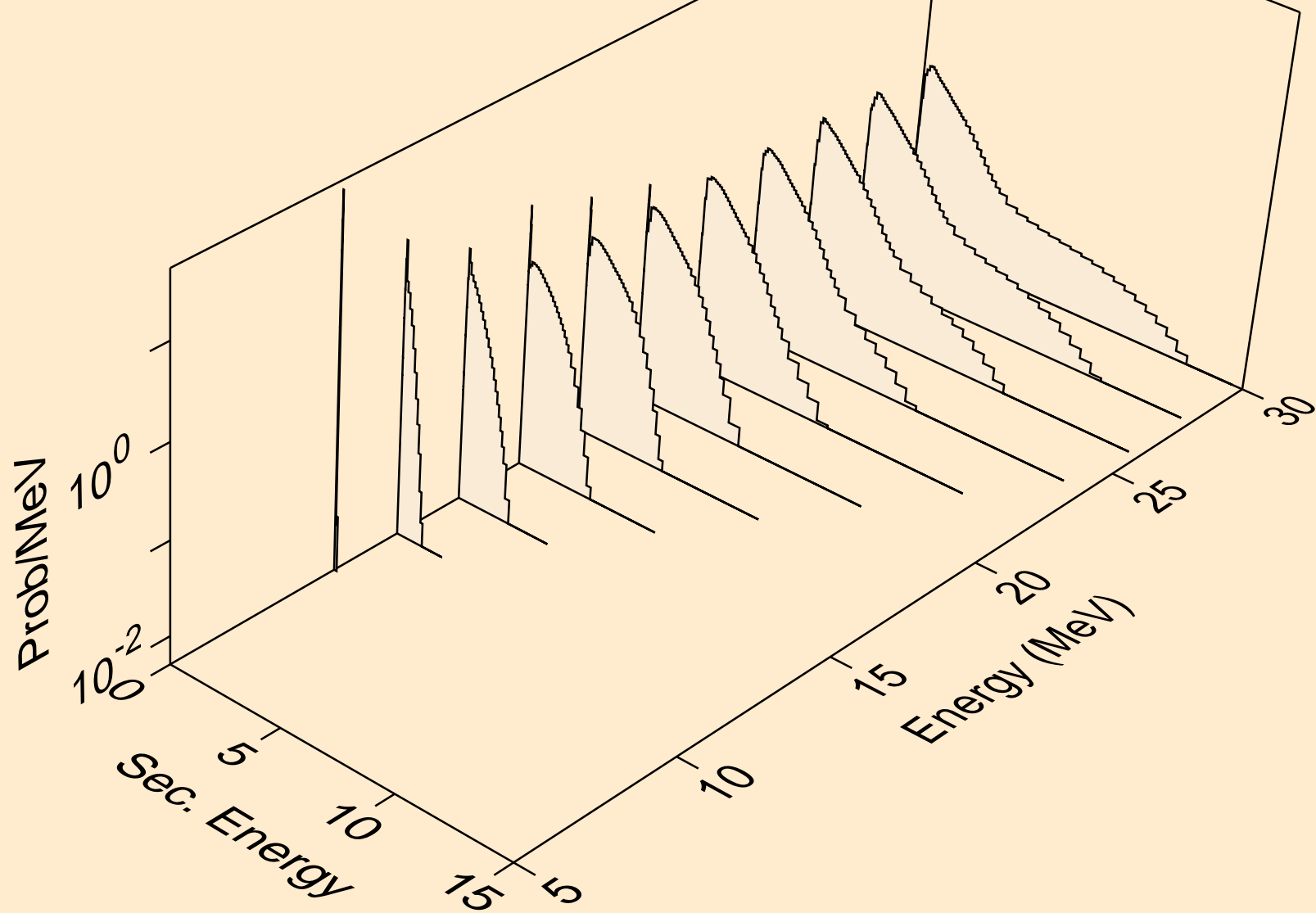

BR084M NEUTRON ACER TENDL-2021 LIBRARY; T=293.6K
Neutron emission for (n,n*)d

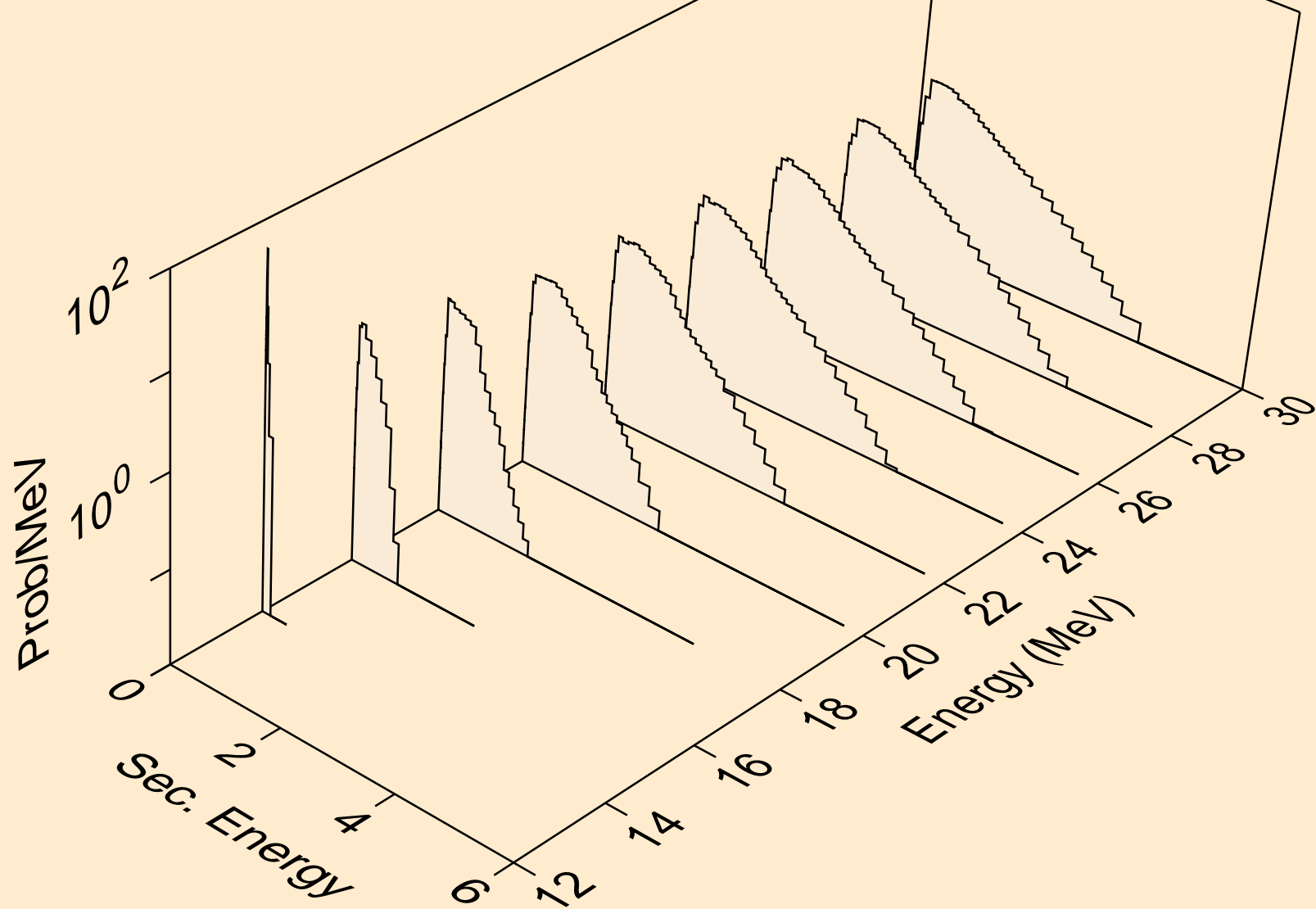

BR084M NEUTRON ACER TENDL-2021 LIBRARY; T=293.6K
Neutron emission for (n,n*)t

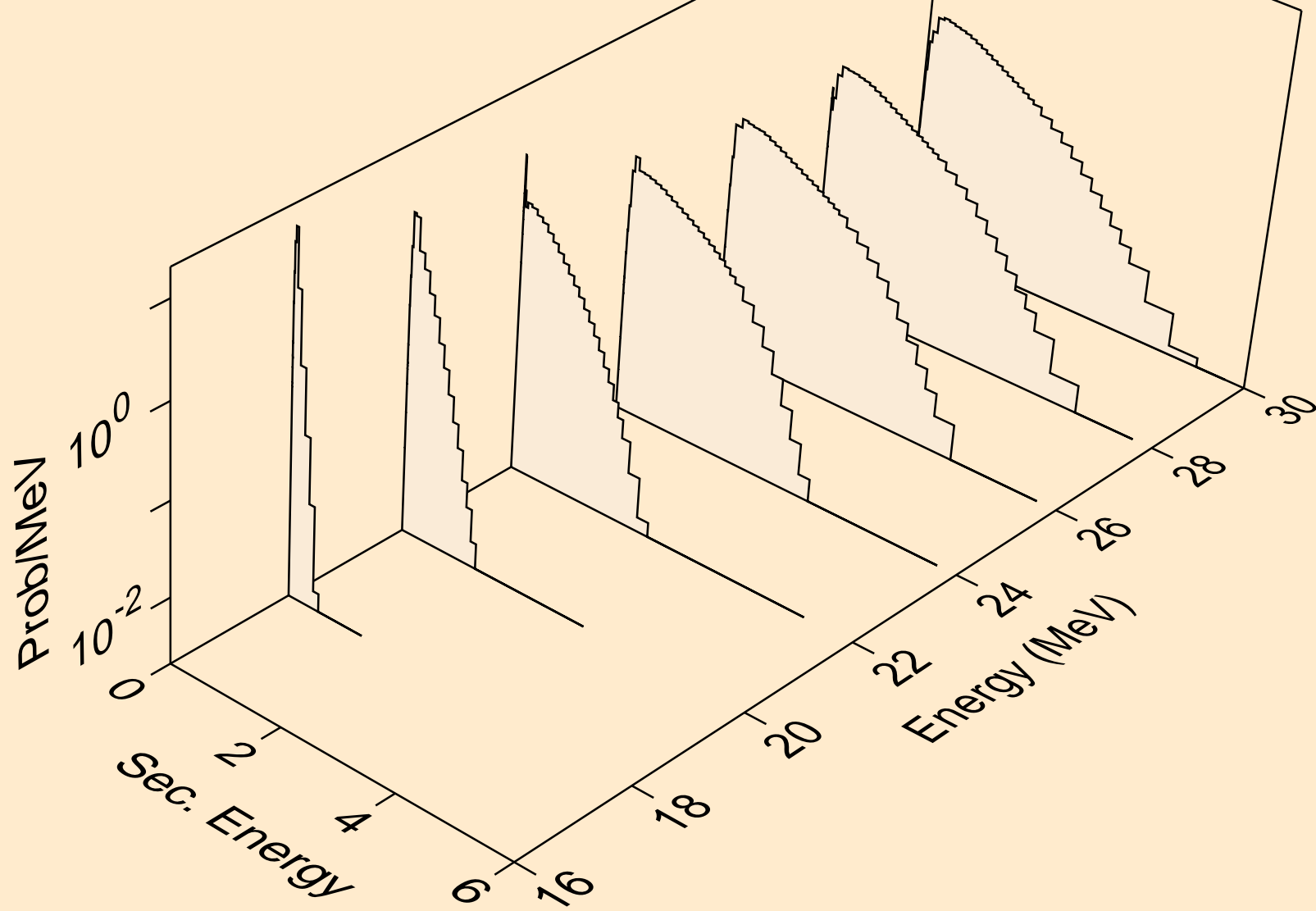

BR084M NEUTRON ACER TENDL-2021 LIBRARY; T=293.6K
Neutron emission for (n,n*)he3

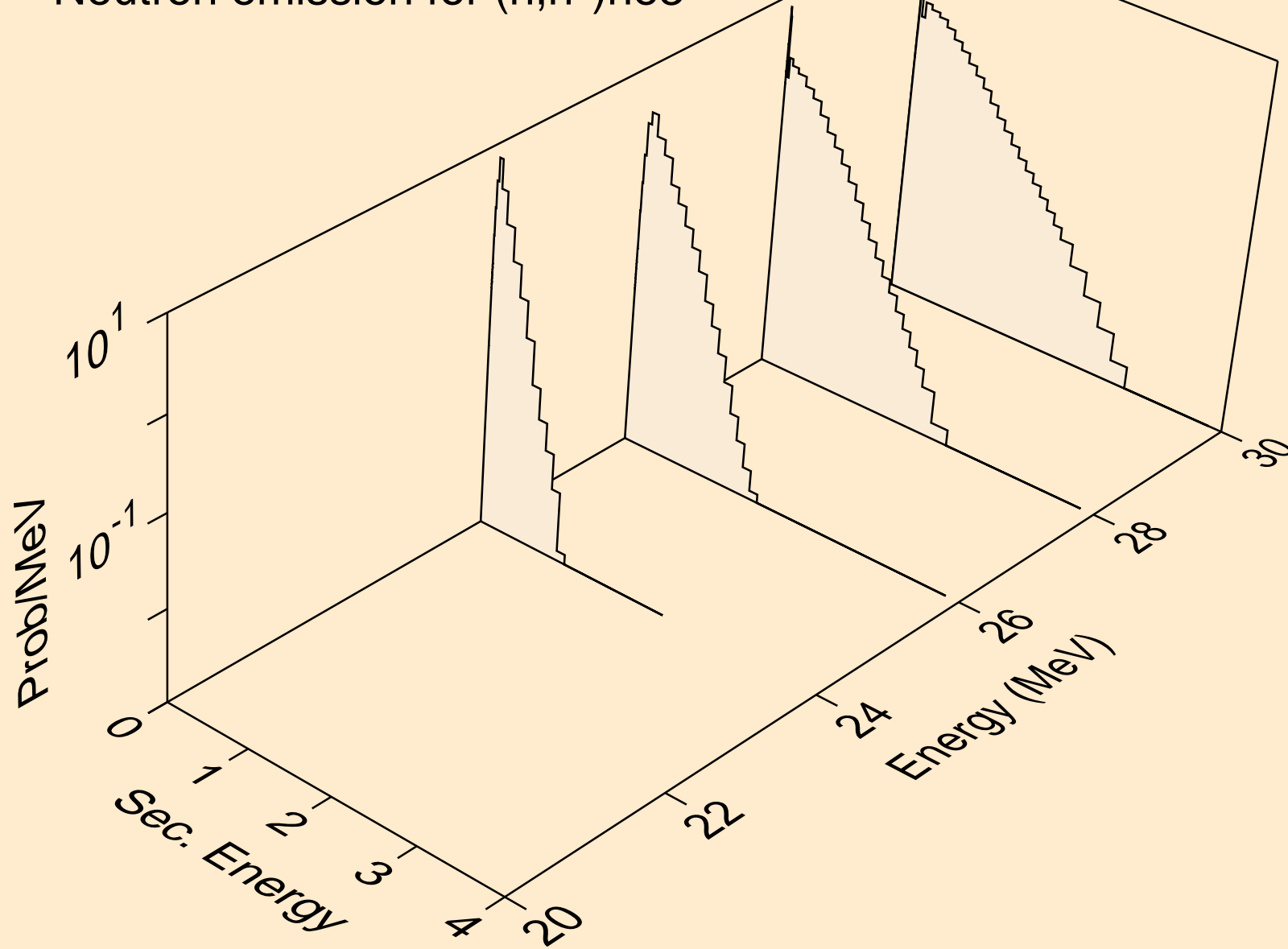

BR084M NEUTRON ACER TENDL-2021 LIBRARY; T=293.6K
Neutron emission for (n,4n)

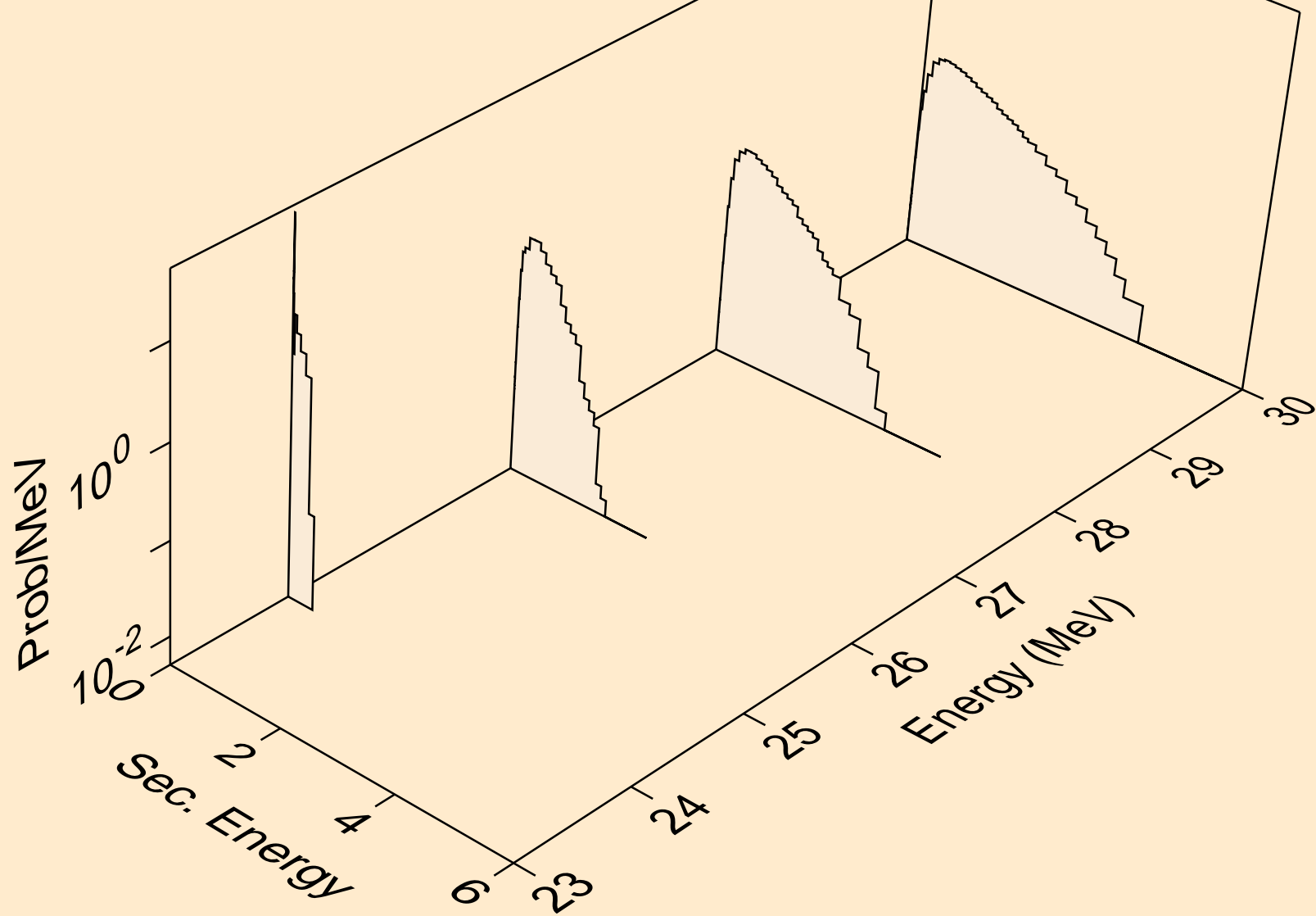

BR084M NEUTRON ACER TENDL-2021 LIBRARY; T=293.6K
Neutron emission for (n,2np)

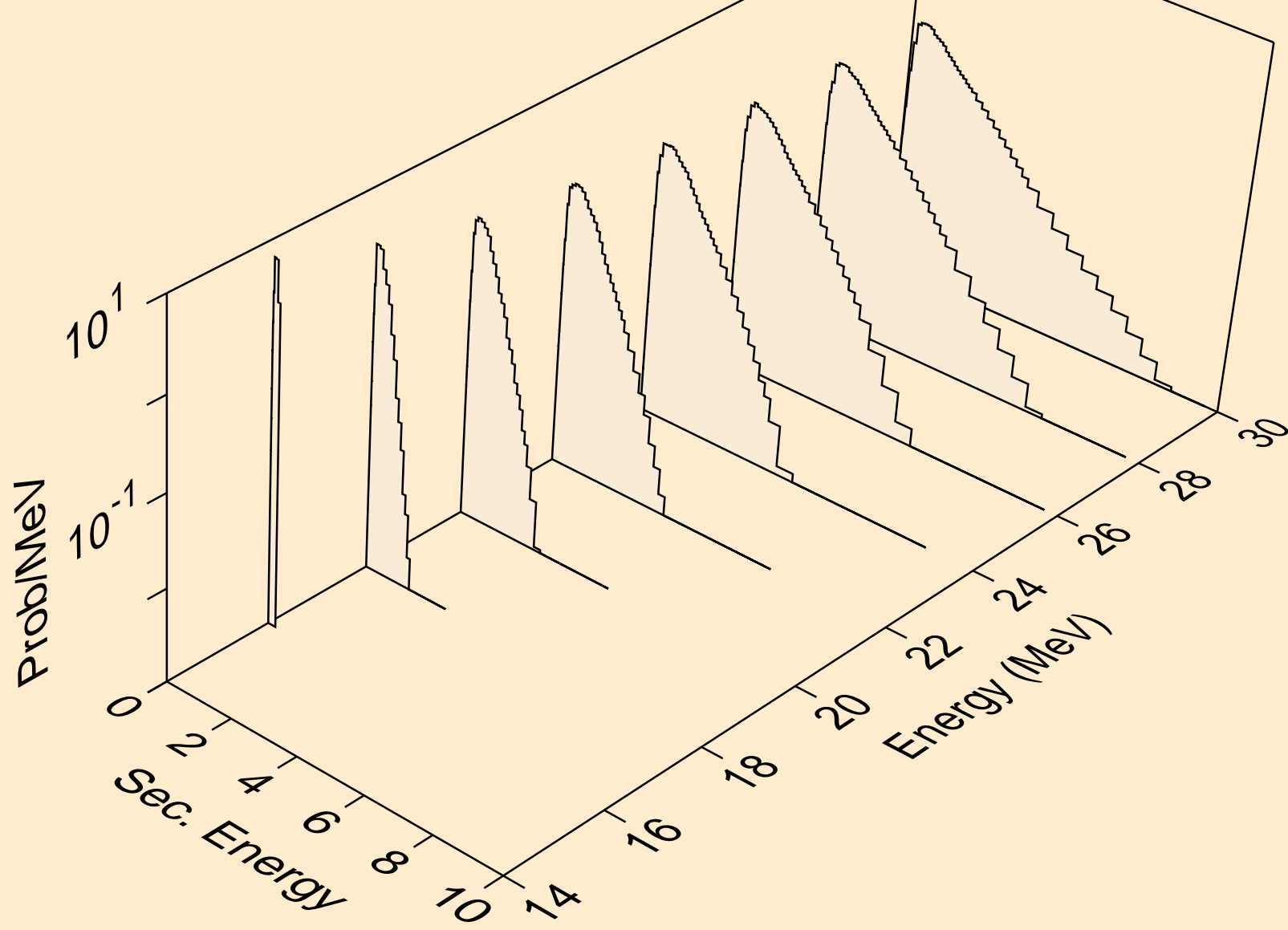

BR084M NEUTRON ACER TENDL-2021 LIBRARY; T=293.6K
Neutron emission for (n,3np)

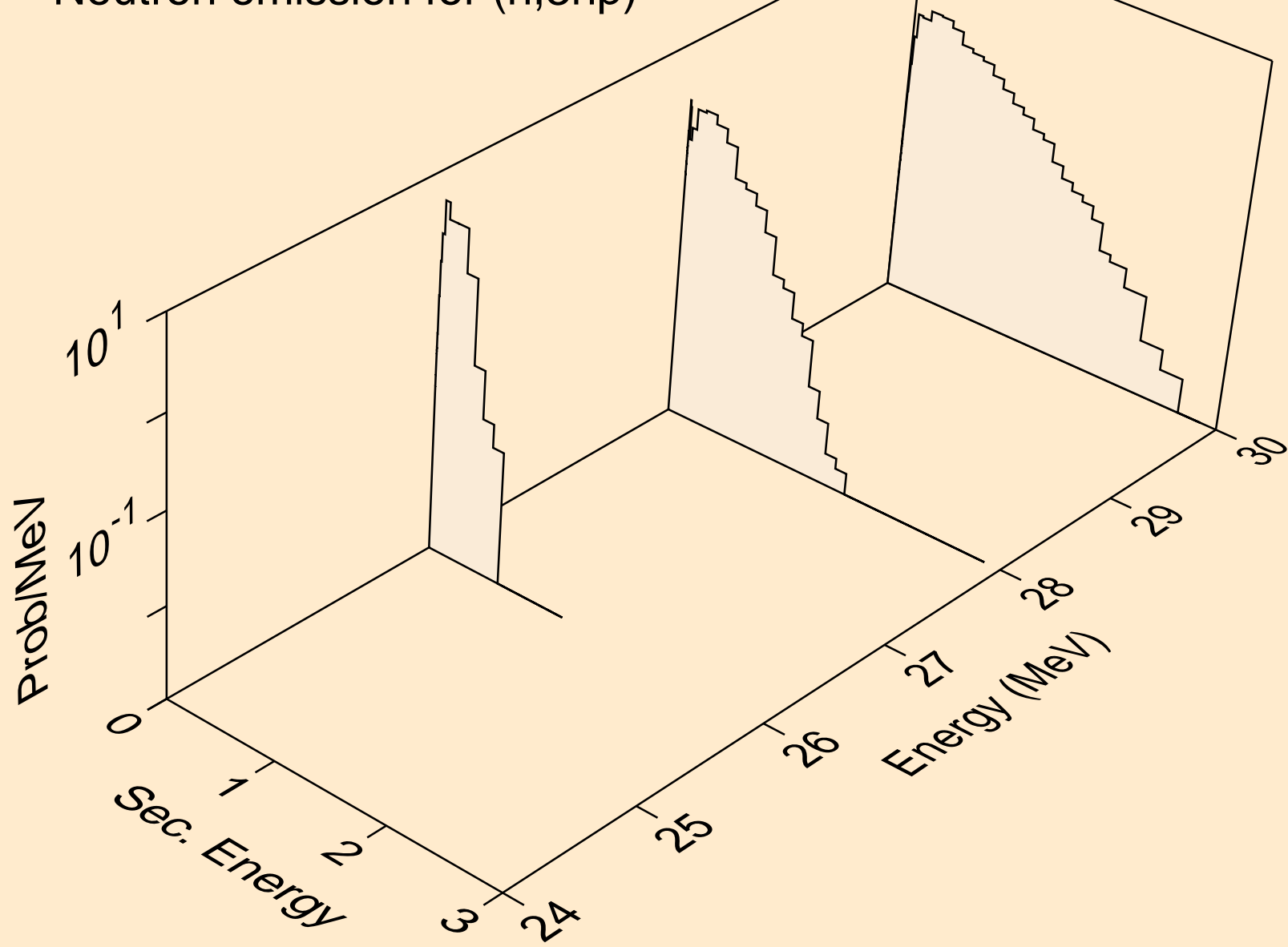

BR084M NEUTRON ACER TENDL-2021 LIBRARY; T=293.6K
Neutron emission for (n,2np)

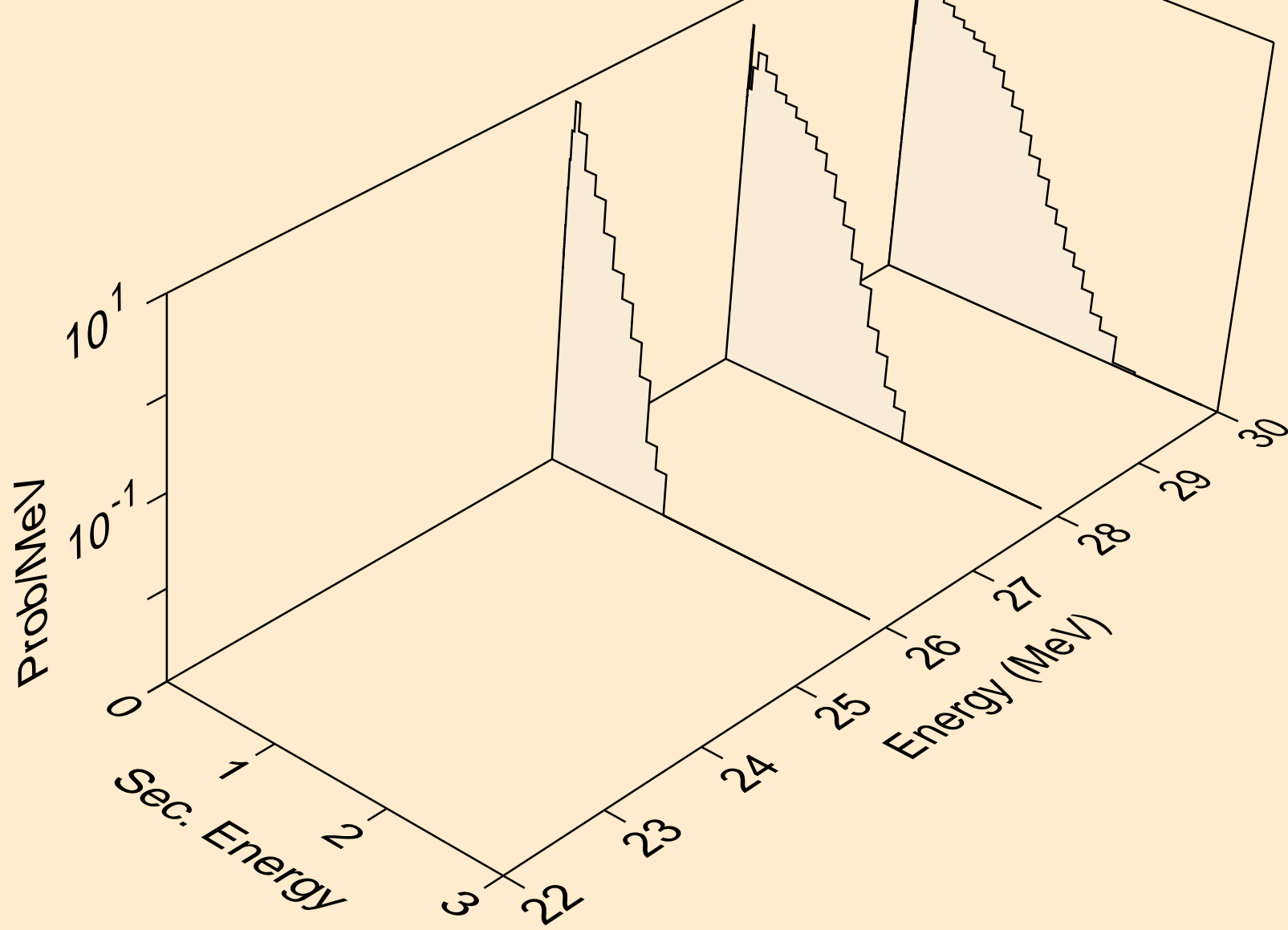

BR084M NEUTRON ACER TENDL-2021 LIBRARY; T=293.6K
Neutron emission for (n,npa)

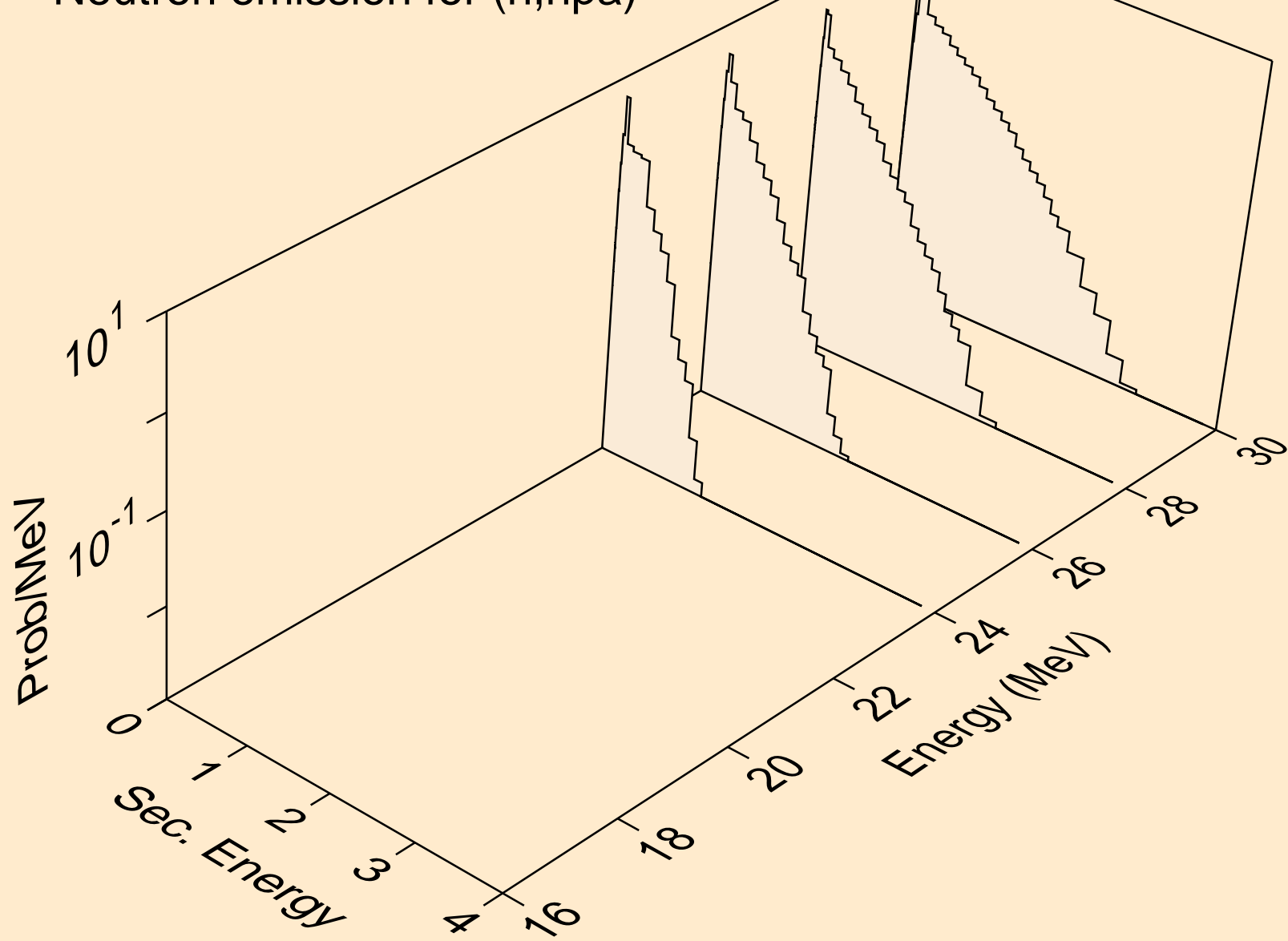

BR084M NEUTRON ACER TENDL-2021 LIBRARY; T=293.6K
Neutron emission for (n,n*c)

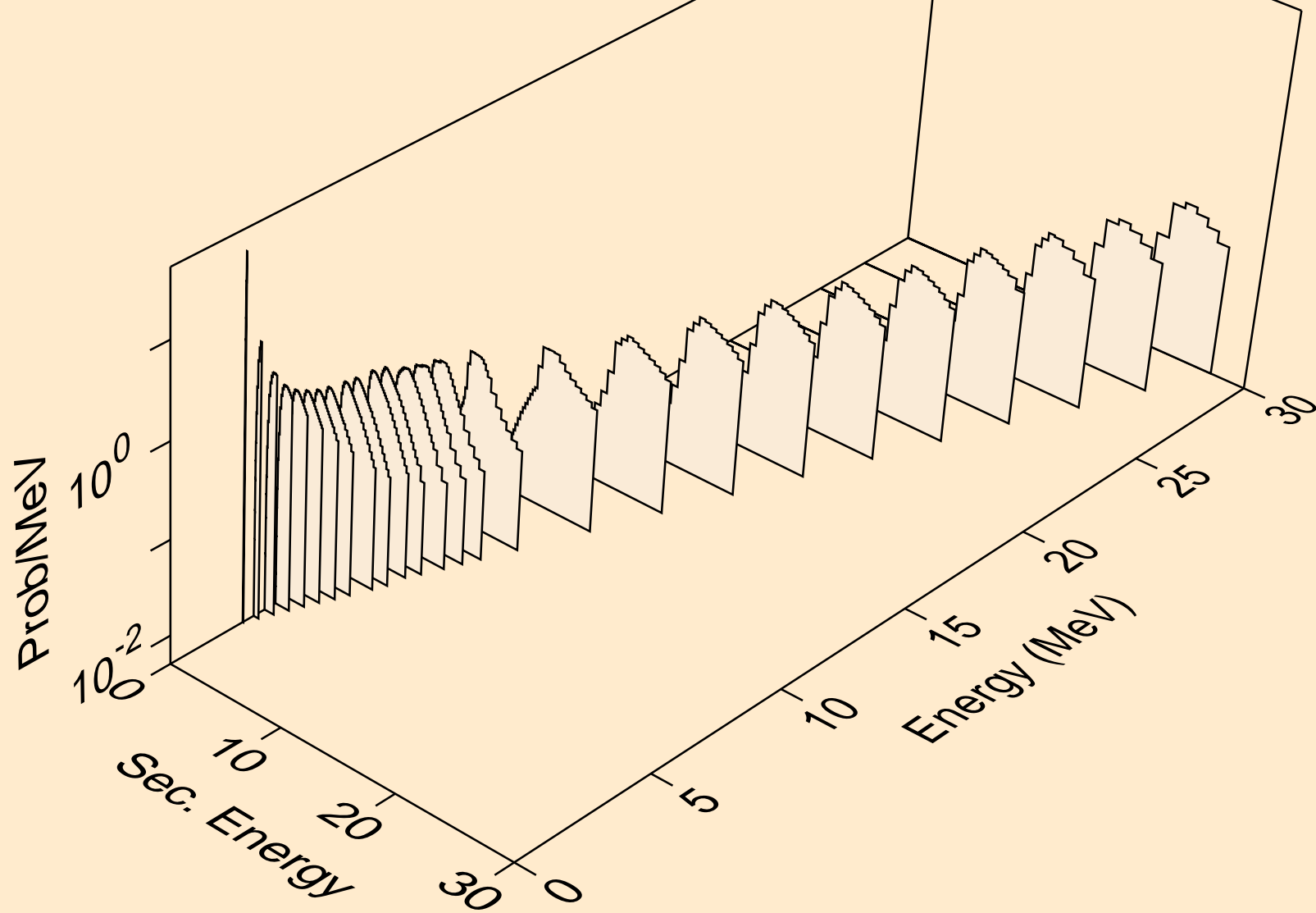

BR084M NEUTRON ACER TENDL-2021 LIBRARY; T=293.6K
Photon emission for (n,x)

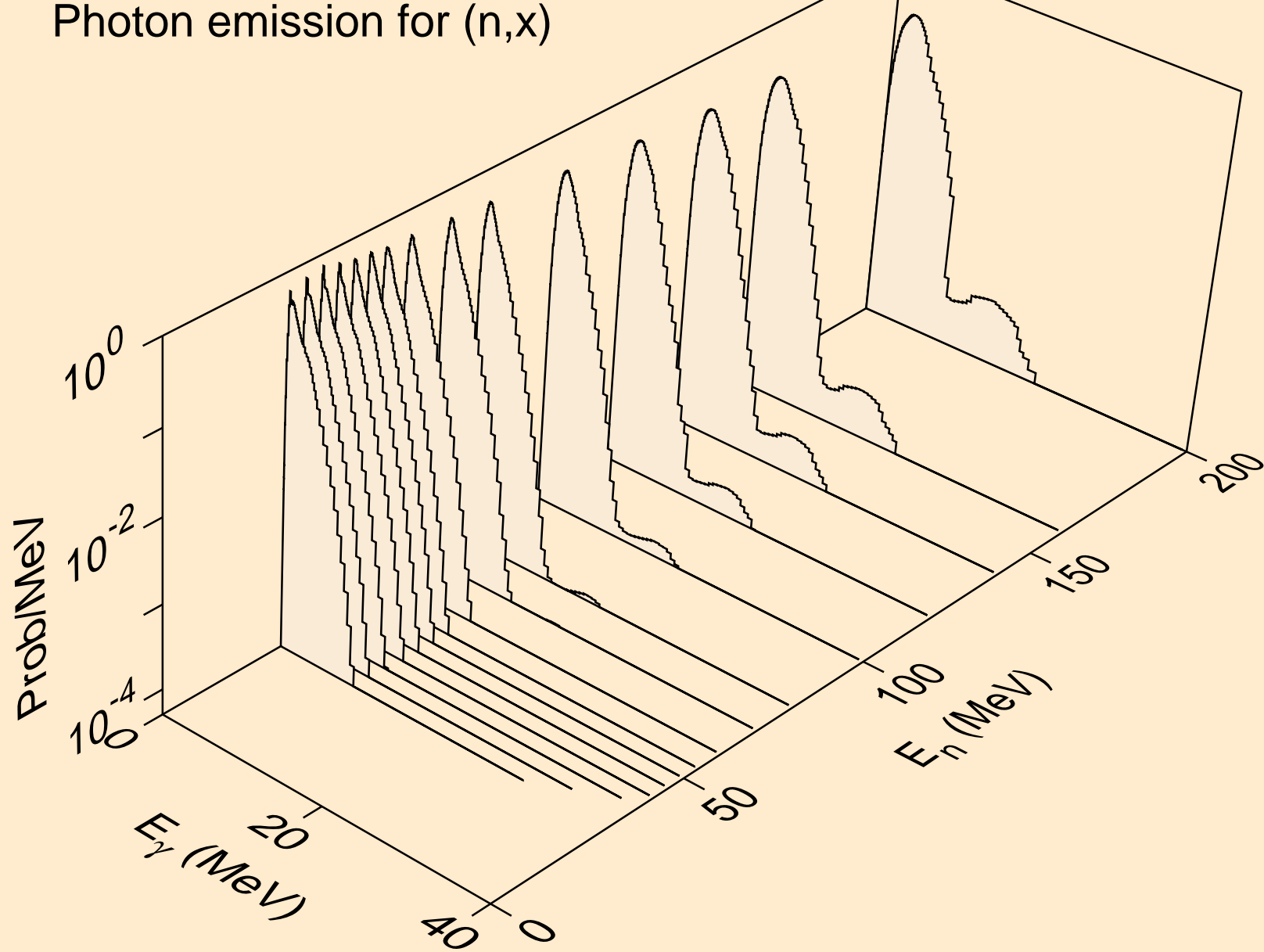

BR084M NEUTRON ACER TENDL-2021 LIBRARY; T=293.6K
Photon emission for (n,2nd)

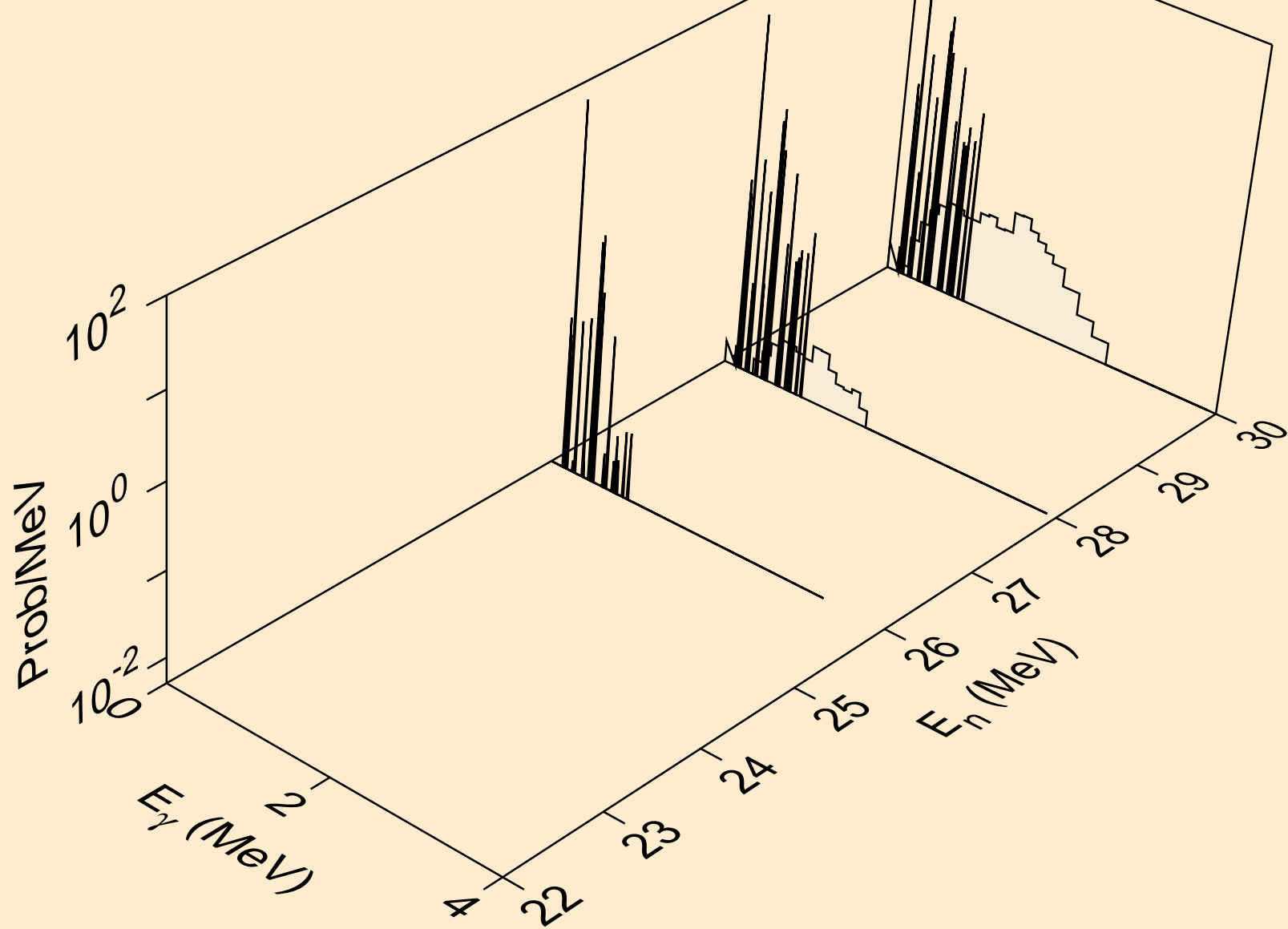

BR084M NEUTRON ACER TENDL-2021 LIBRARY; T=293.6K
Photon emission for (n,2n)

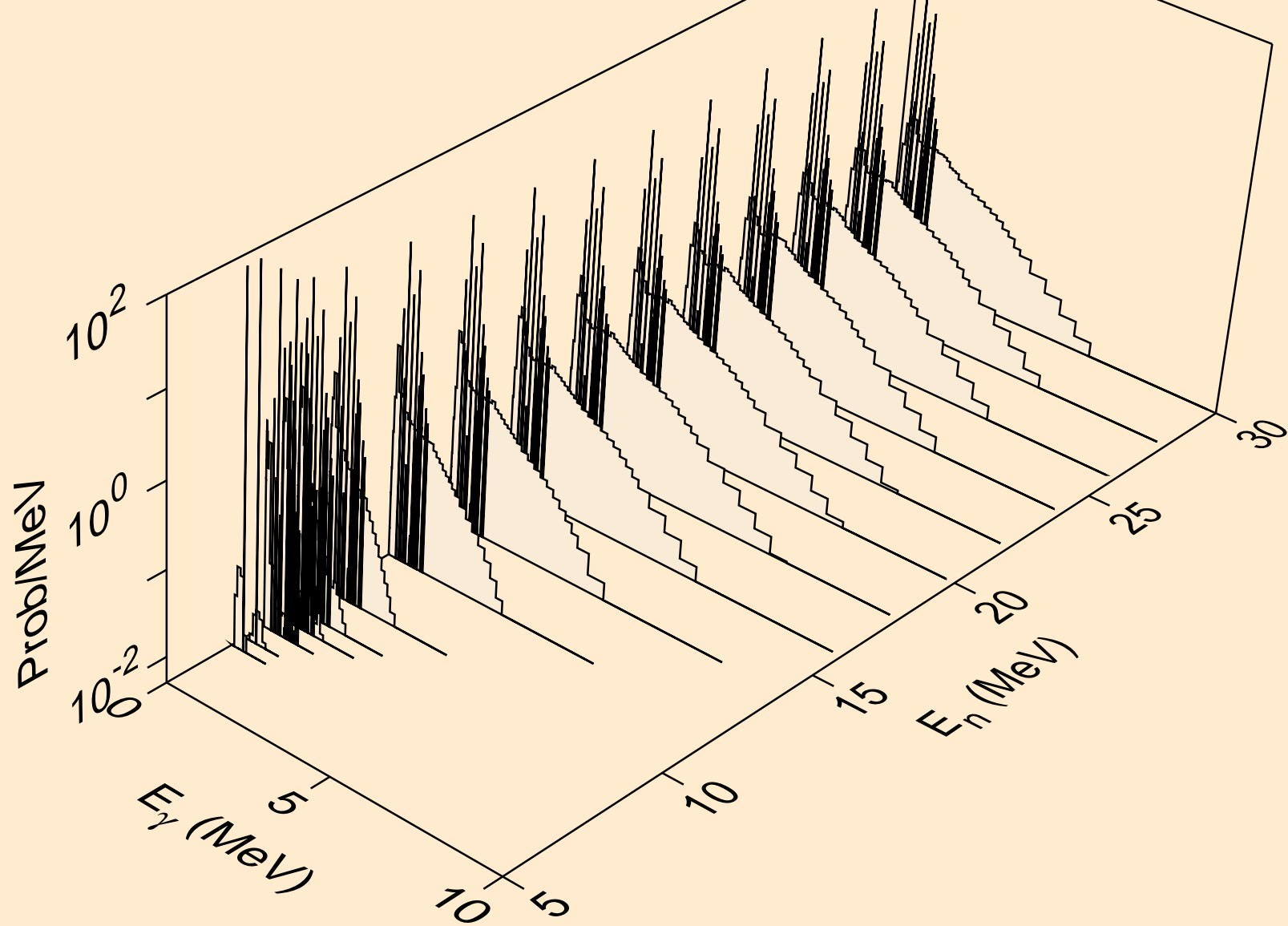

BR084M NEUTRON ACER TENDL-2021 LIBRARY; T=293.6K
Photon emission for (n,3n)

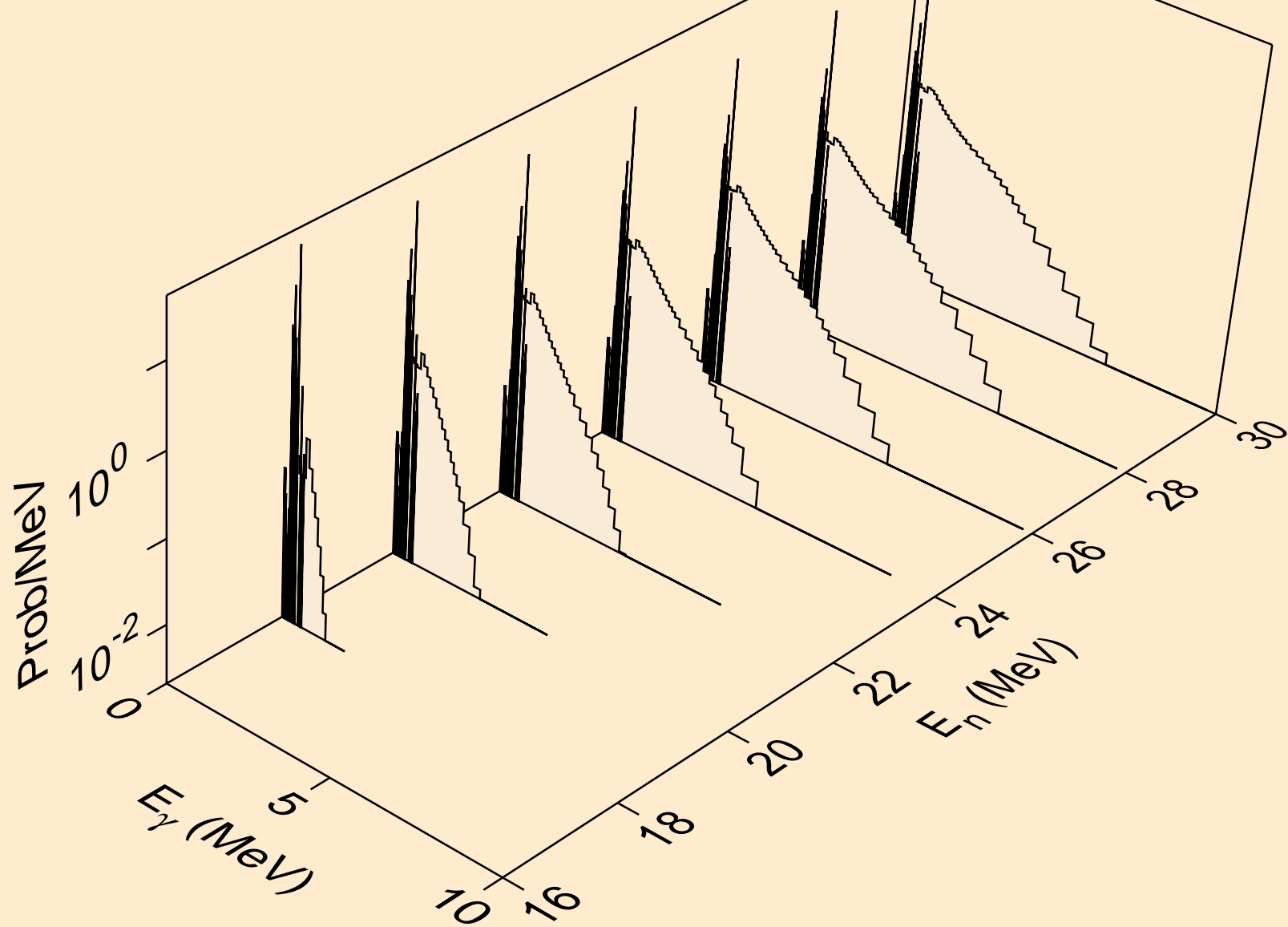

BR084M NEUTRON ACER TENDL-2021 LIBRARY; T=293.6K
Photon emission for (n,n*)a

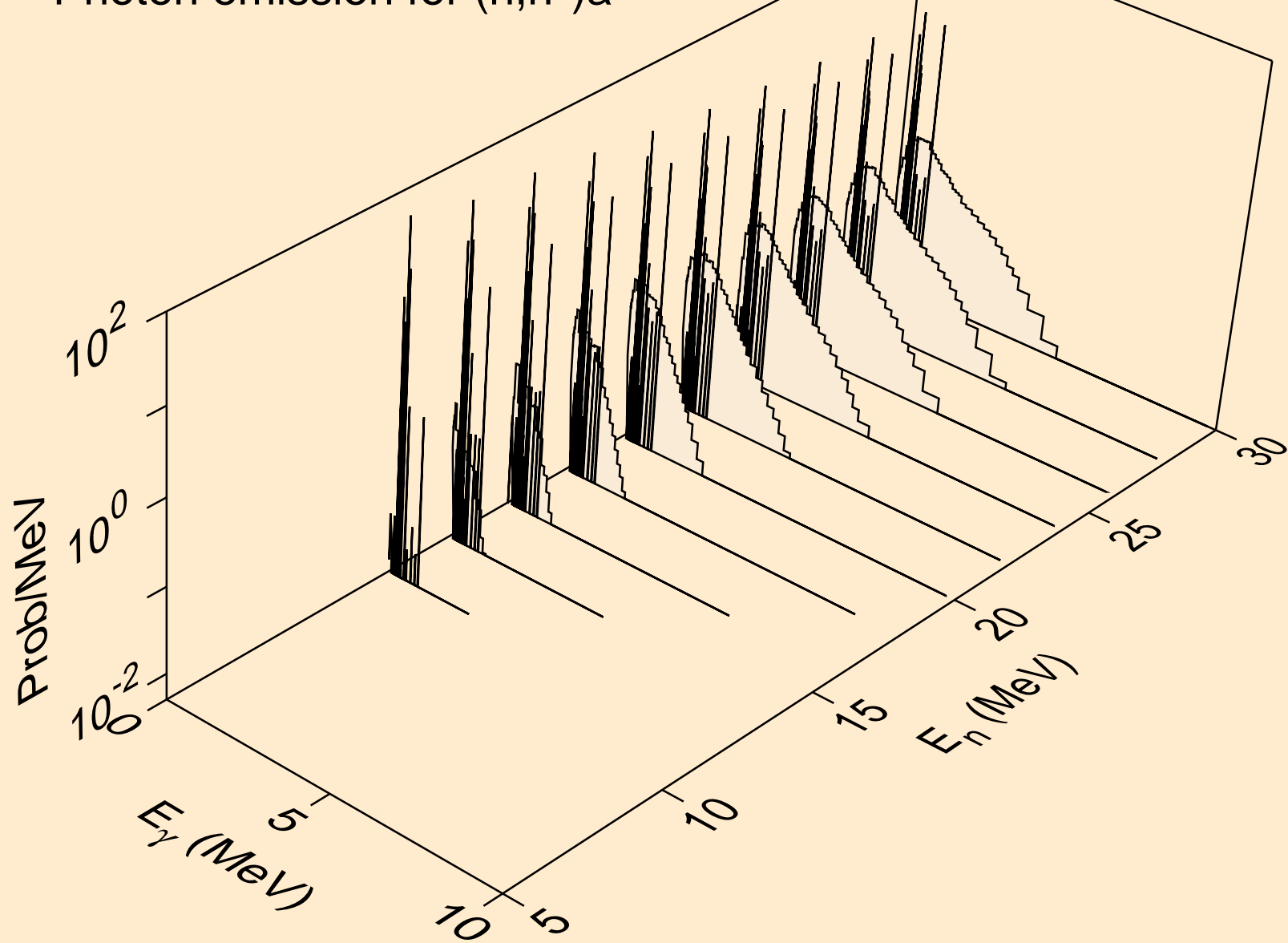

BR084M NEUTRON ACER TENDL-2021 LIBRARY; T=293.6K
Photon emission for (n,2n)a

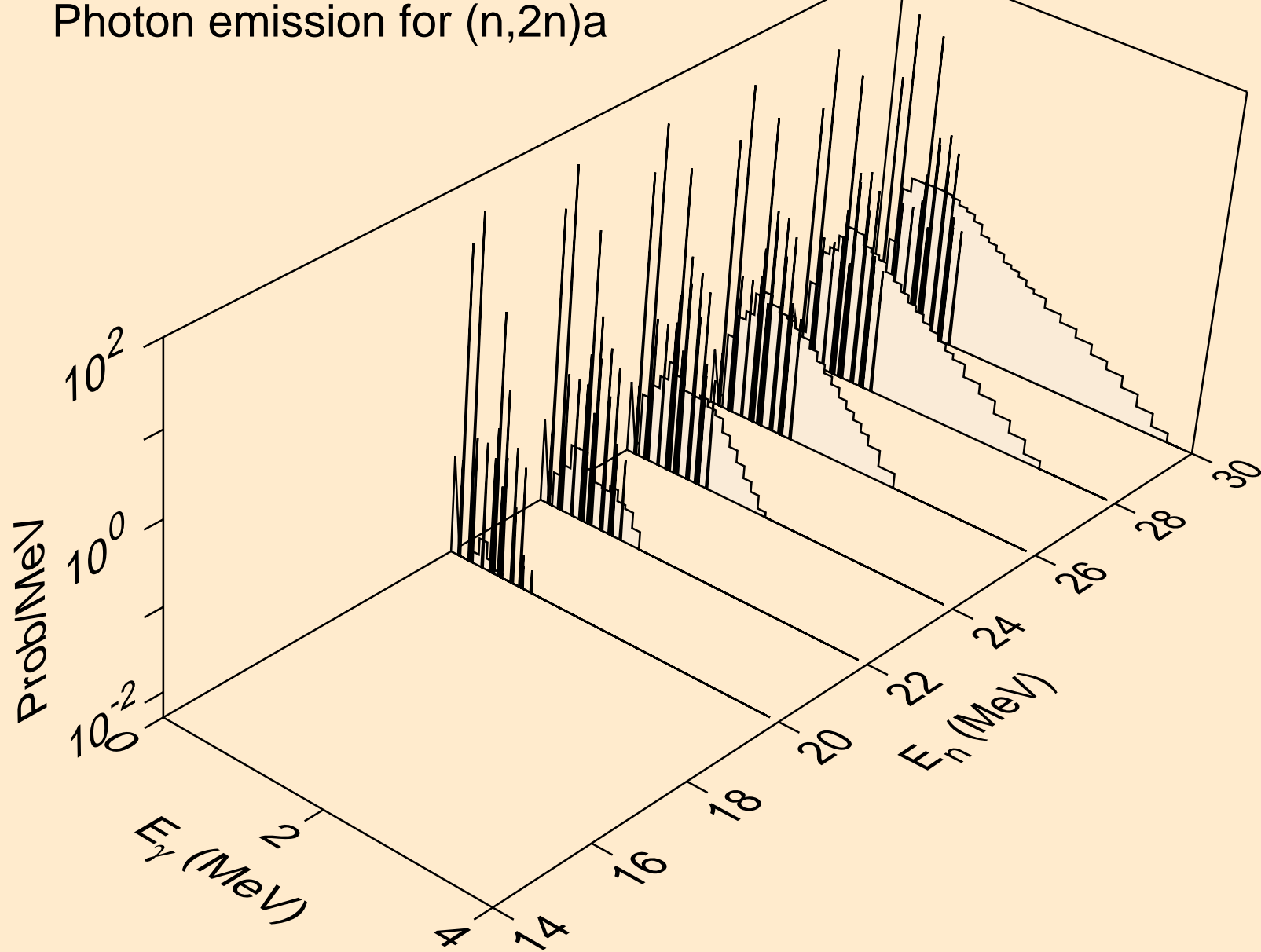

BR084M NEUTRON ACER TENDL-2021 LIBRARY; T=293.6K
Photon emission for (n,3n)a

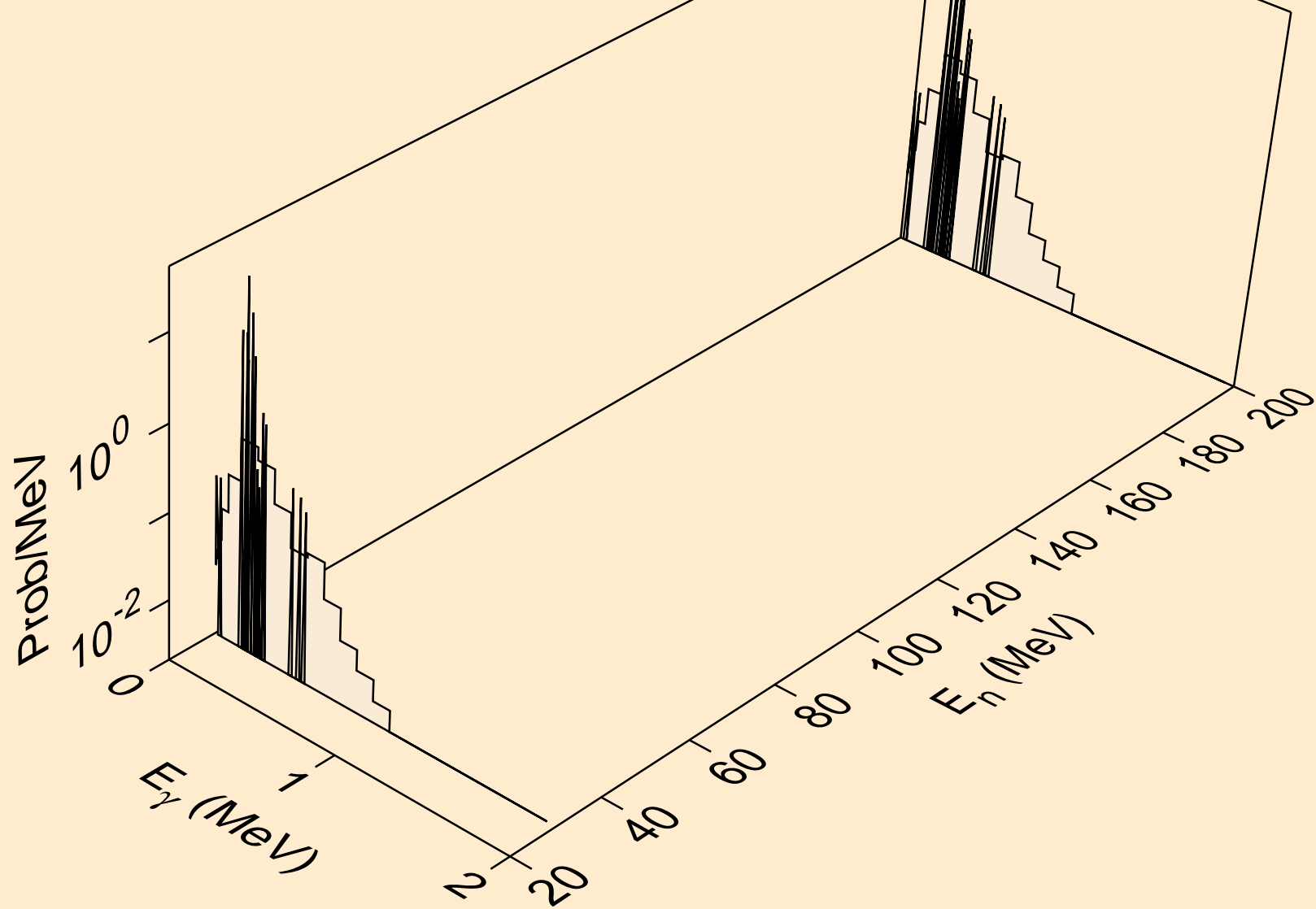

BR084M NEUTRON ACER TENDL-2021 LIBRARY; T=293.6K
Photon emission for (n,n*)p

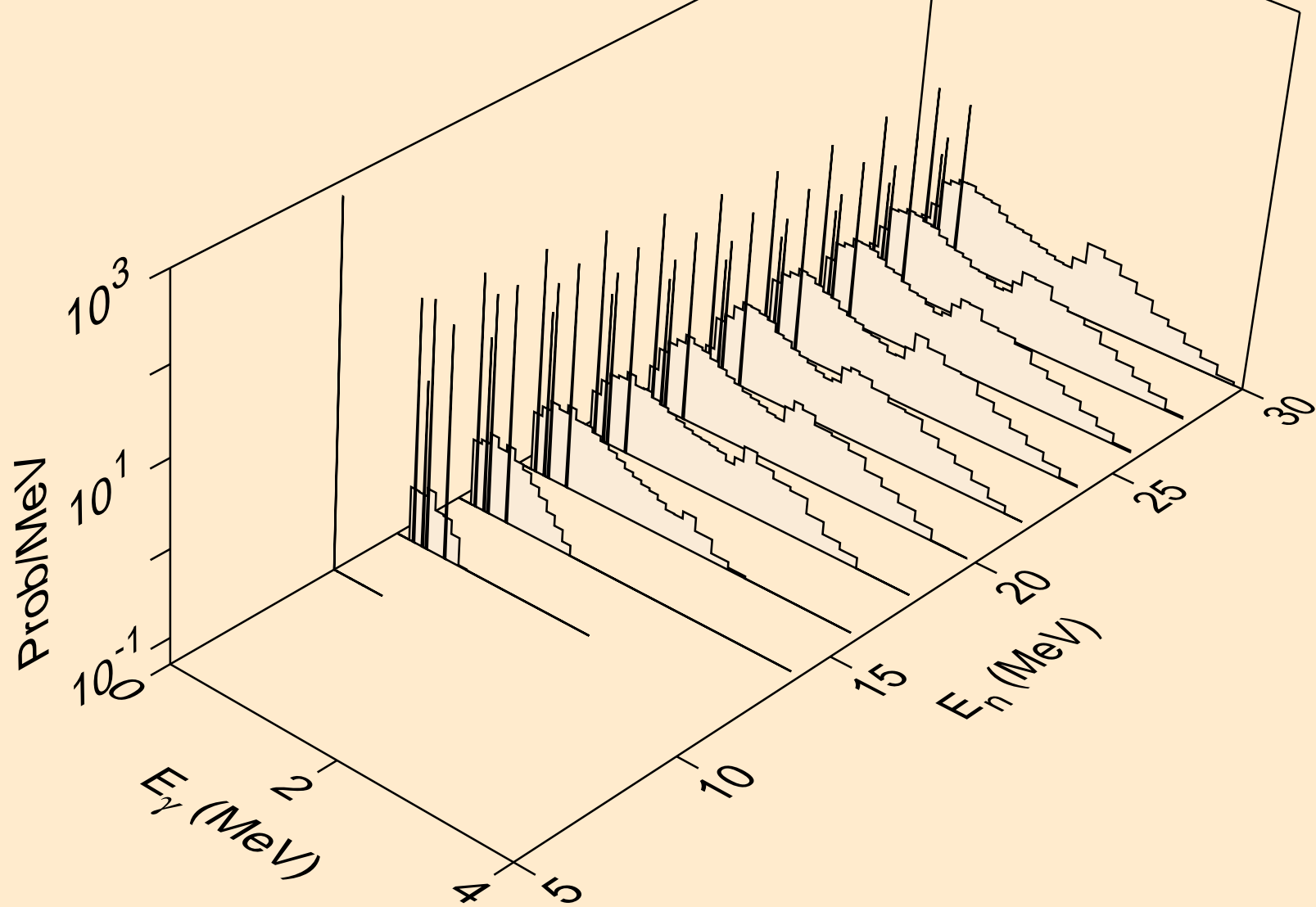

BR084M NEUTRON ACER TENDL-2021 LIBRARY; T=293.6K
Photon emission for (n,n*)d

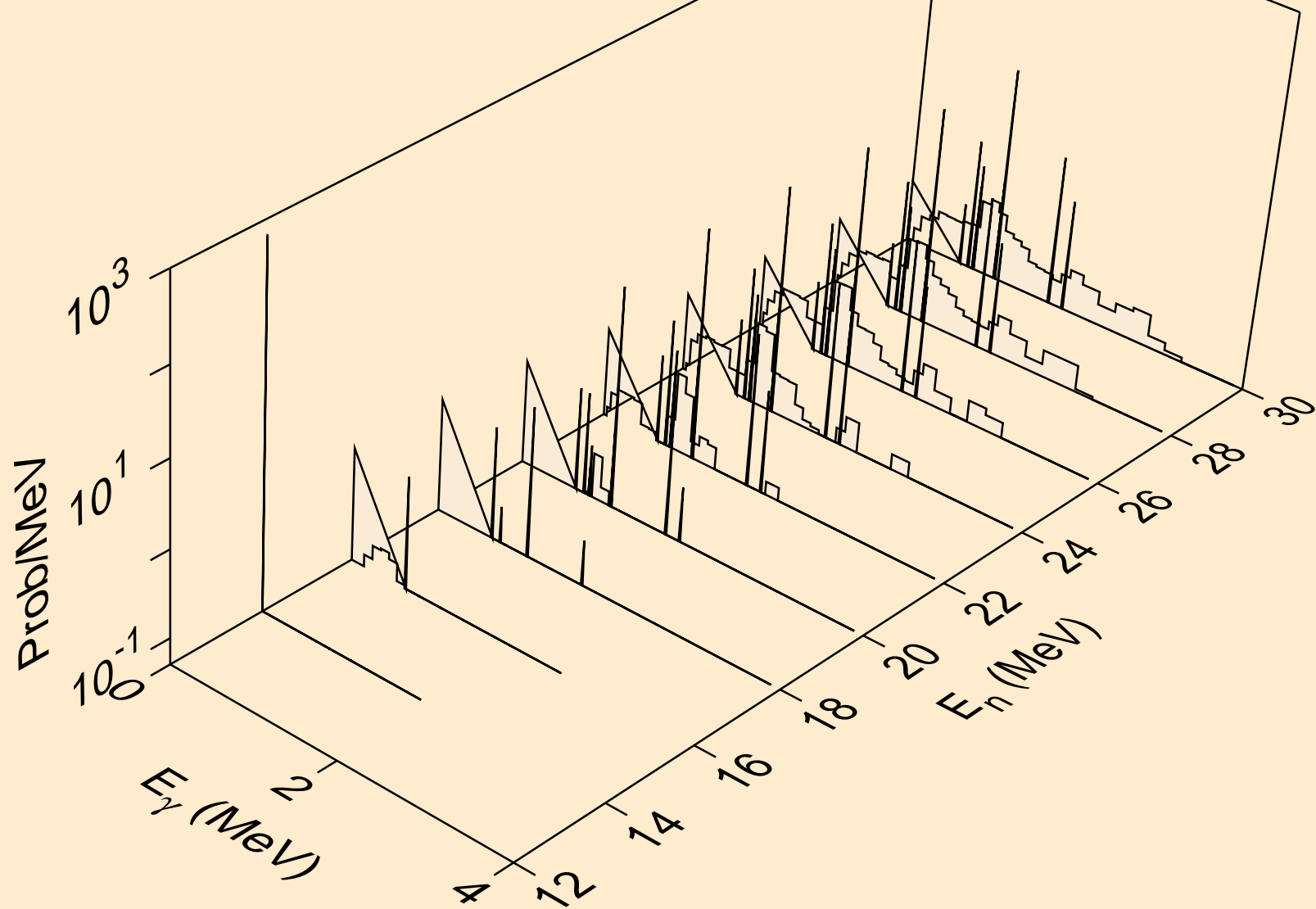

BR084M NEUTRON ACER TENDL-2021 LIBRARY; T=293.6K
Photon emission for (n,n*)t

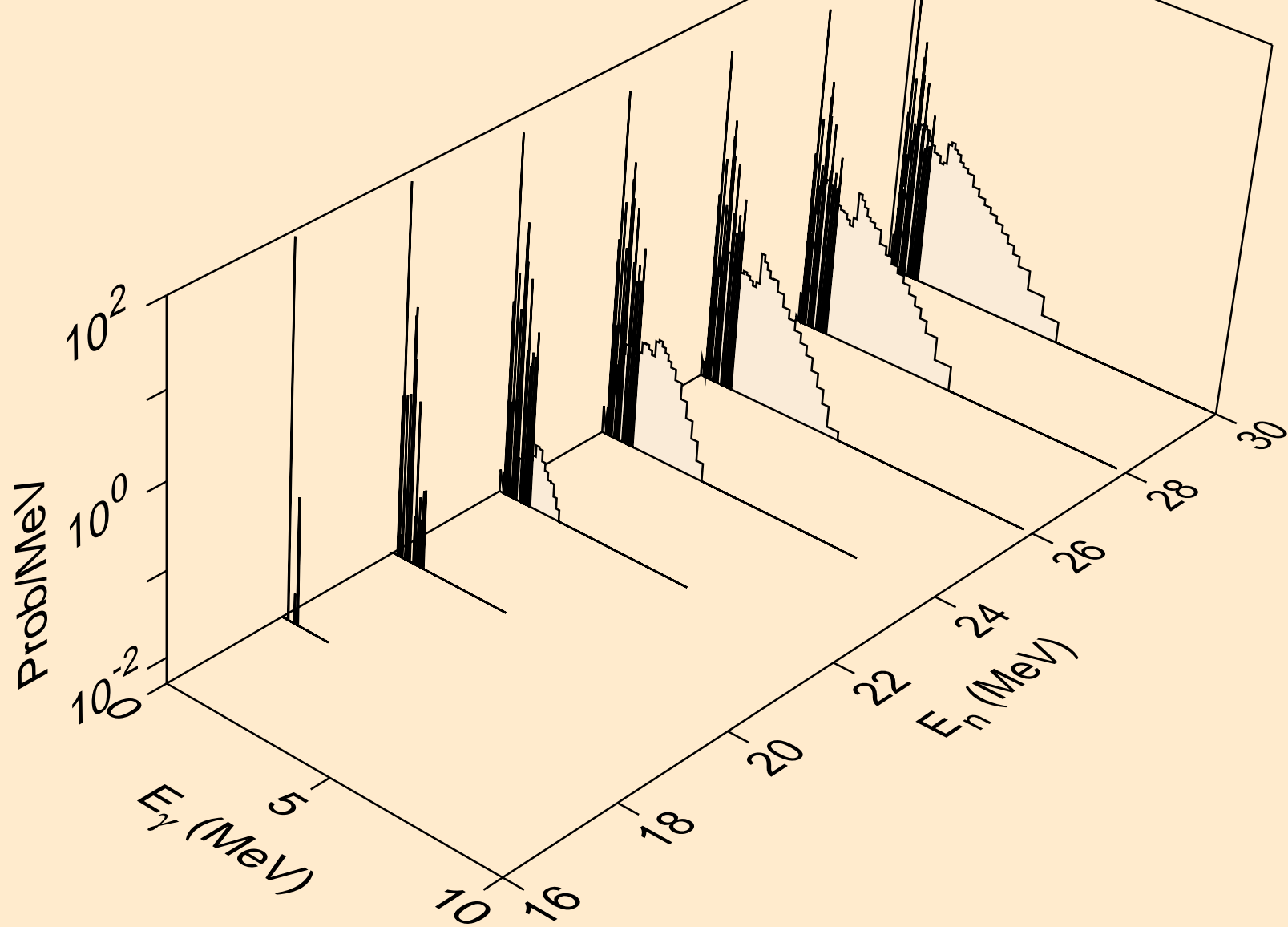

BR084M NEUTRON ACER TENDL-2021 LIBRARY; T=293.6K
Photon emission for (n,n*)he3

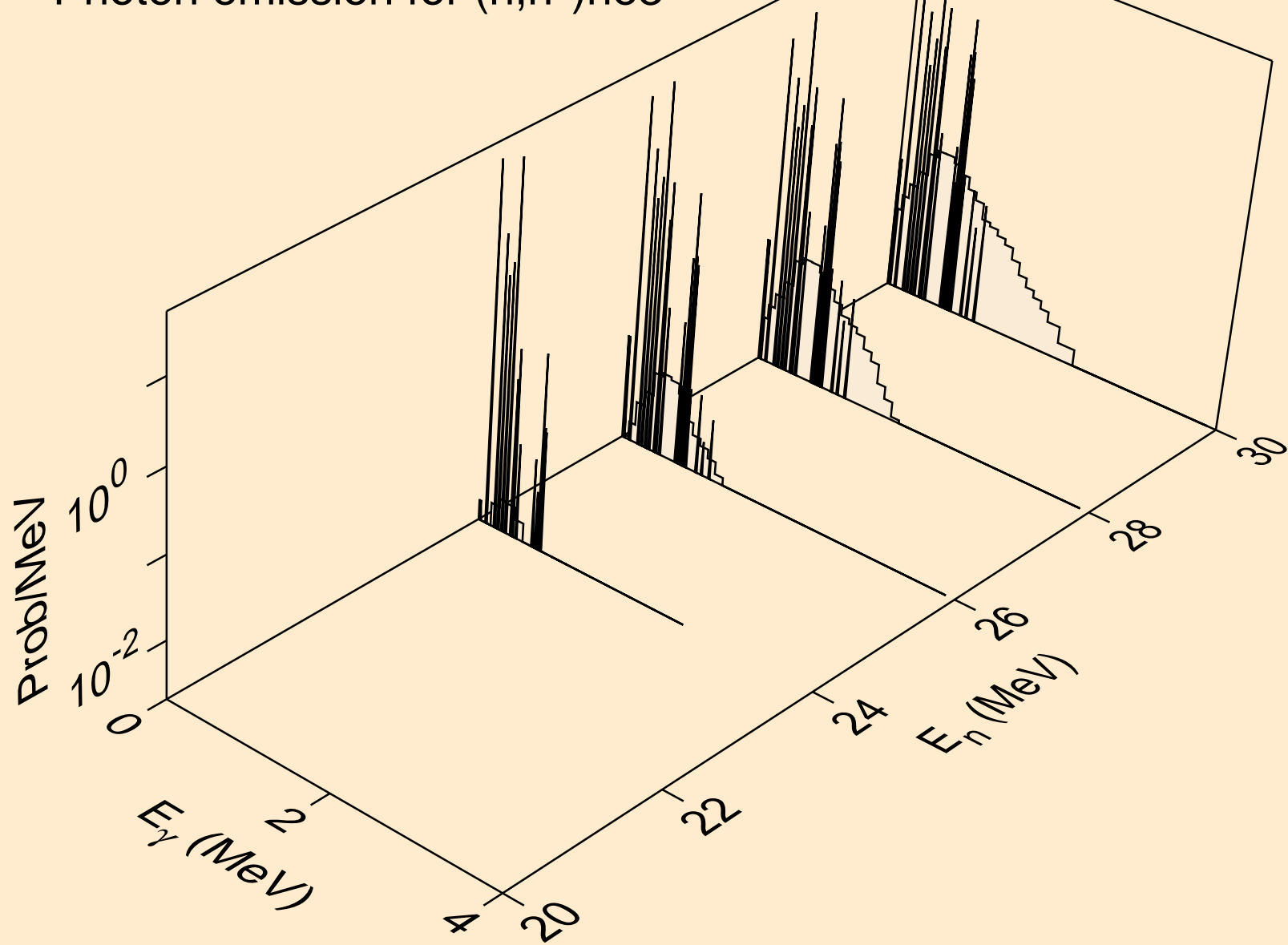

BR084M NEUTRON ACER TENDL-2021 LIBRARY; T=293.6K
Photon emission for (n,4n)

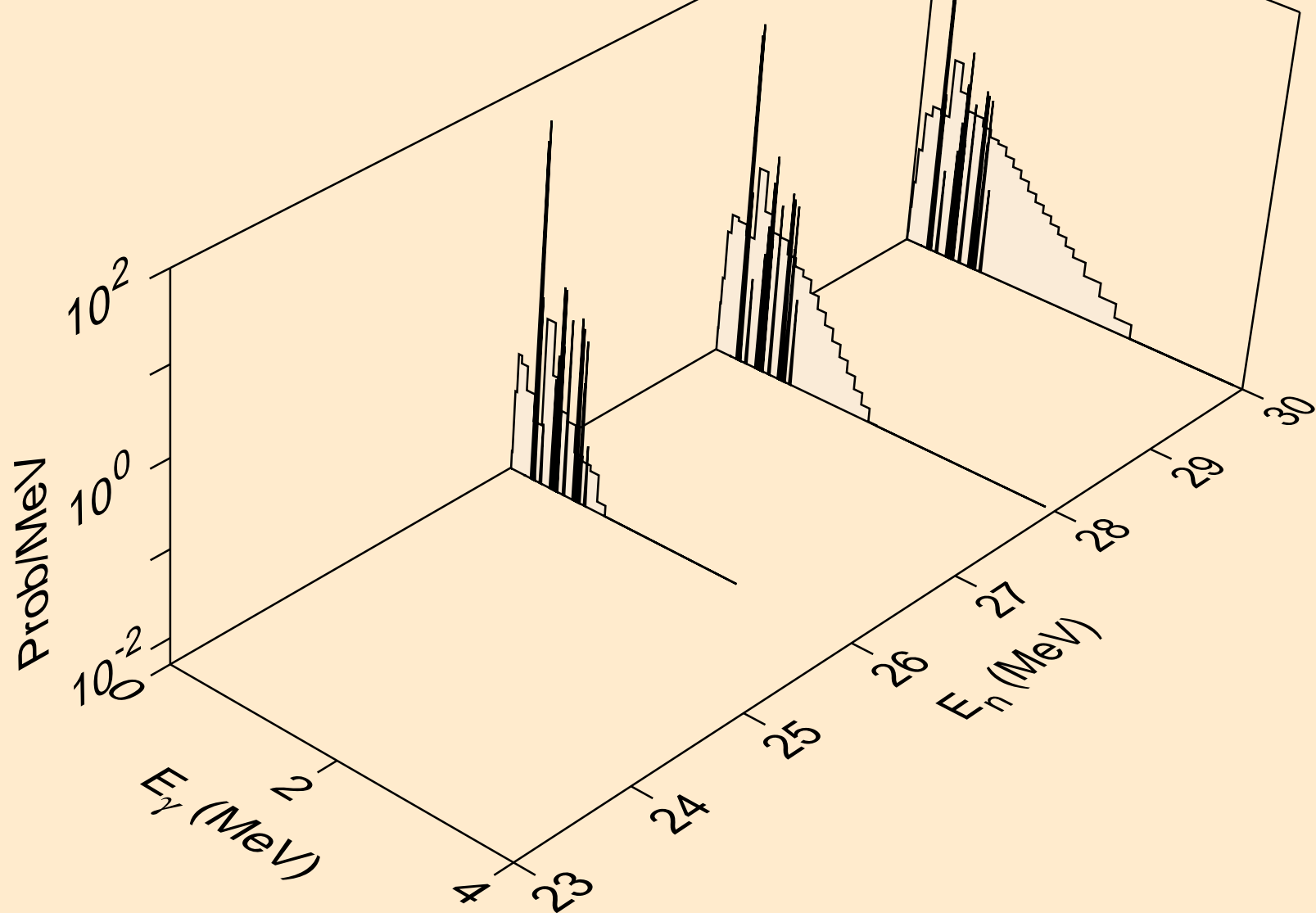

BR084M NEUTRON ACER TENDL-2021 LIBRARY; T=293.6K
Photon emission for (n,2np)

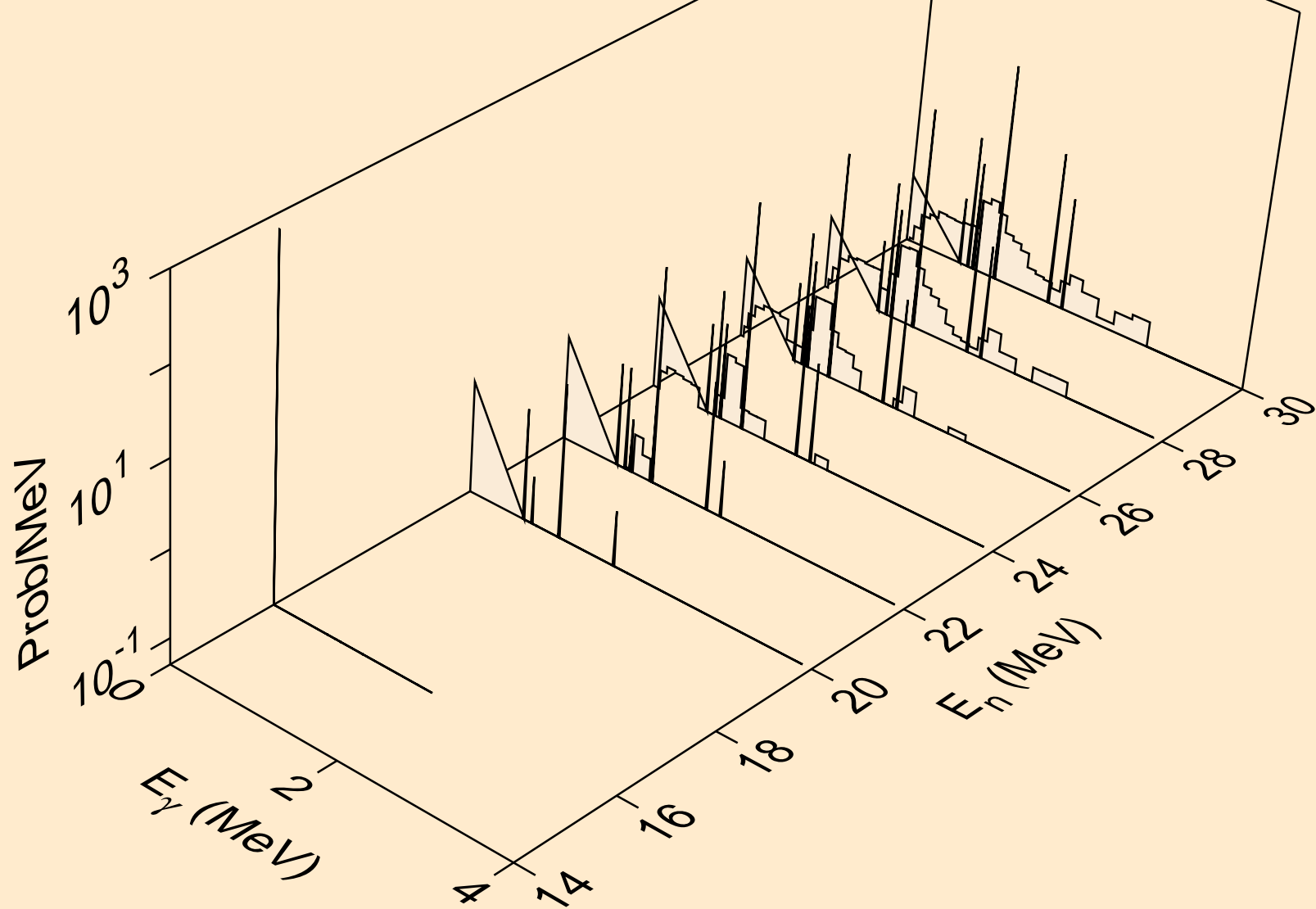

BR084M NEUTRON ACER TENDL-2021 LIBRARY; T=293.6K
Photon emission for (n,3np)

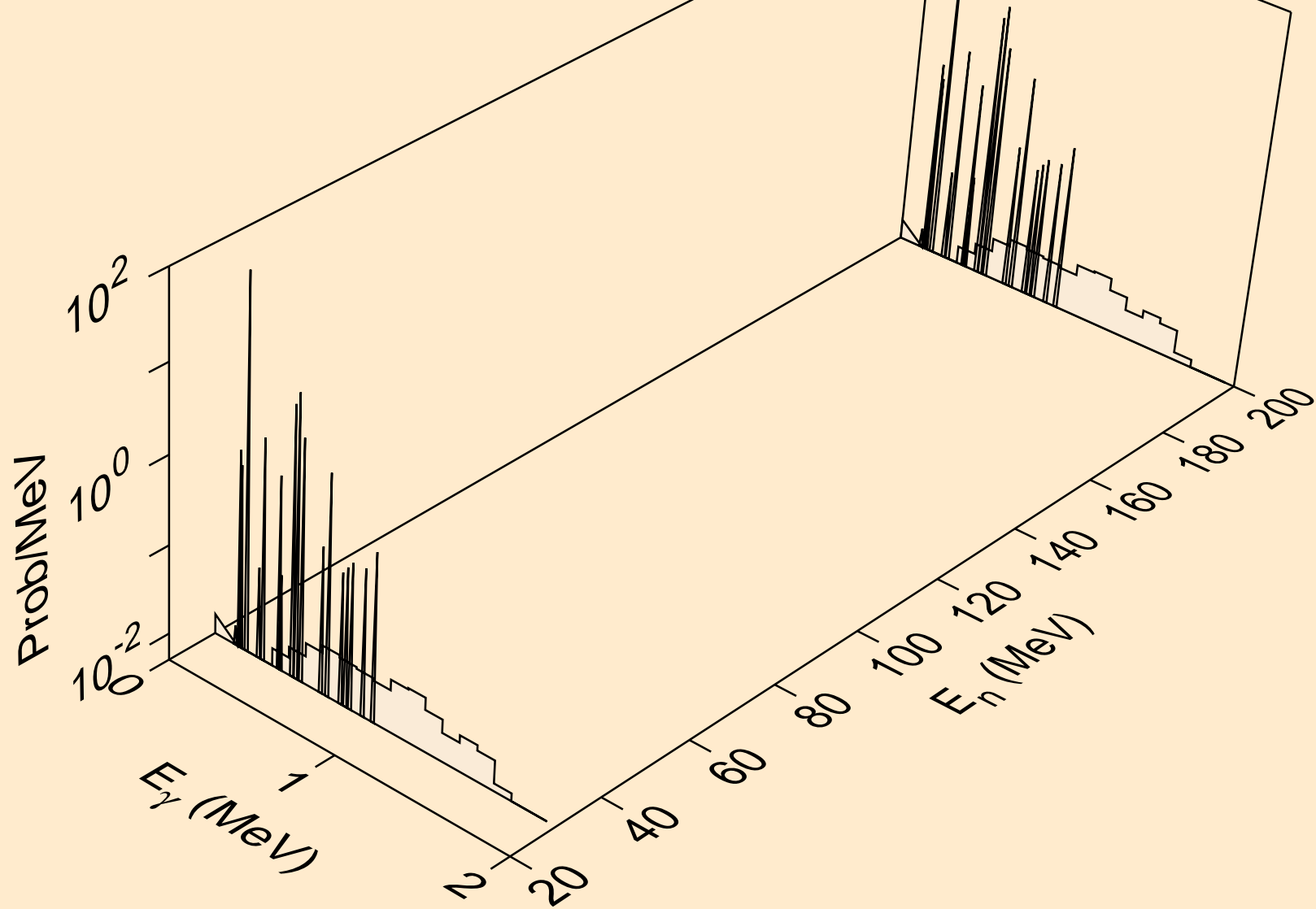

BR084M NEUTRON ACER TENDL-2021 LIBRARY; T=293.6K
Photon emission for (n,2np)

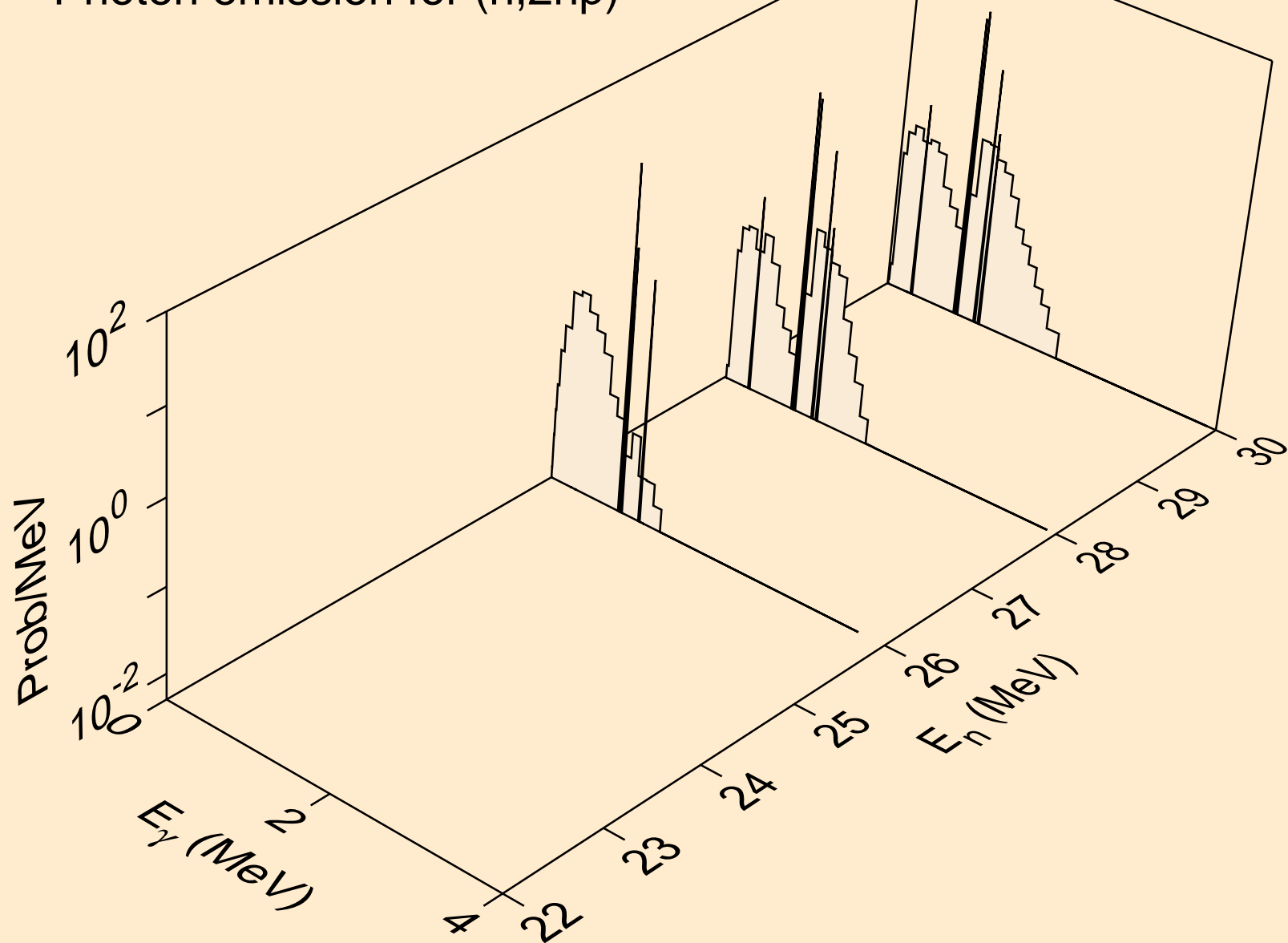

BR084M NEUTRON ACER TENDL-2021 LIBRARY; T=293.6K
Photon emission for (n,npa)

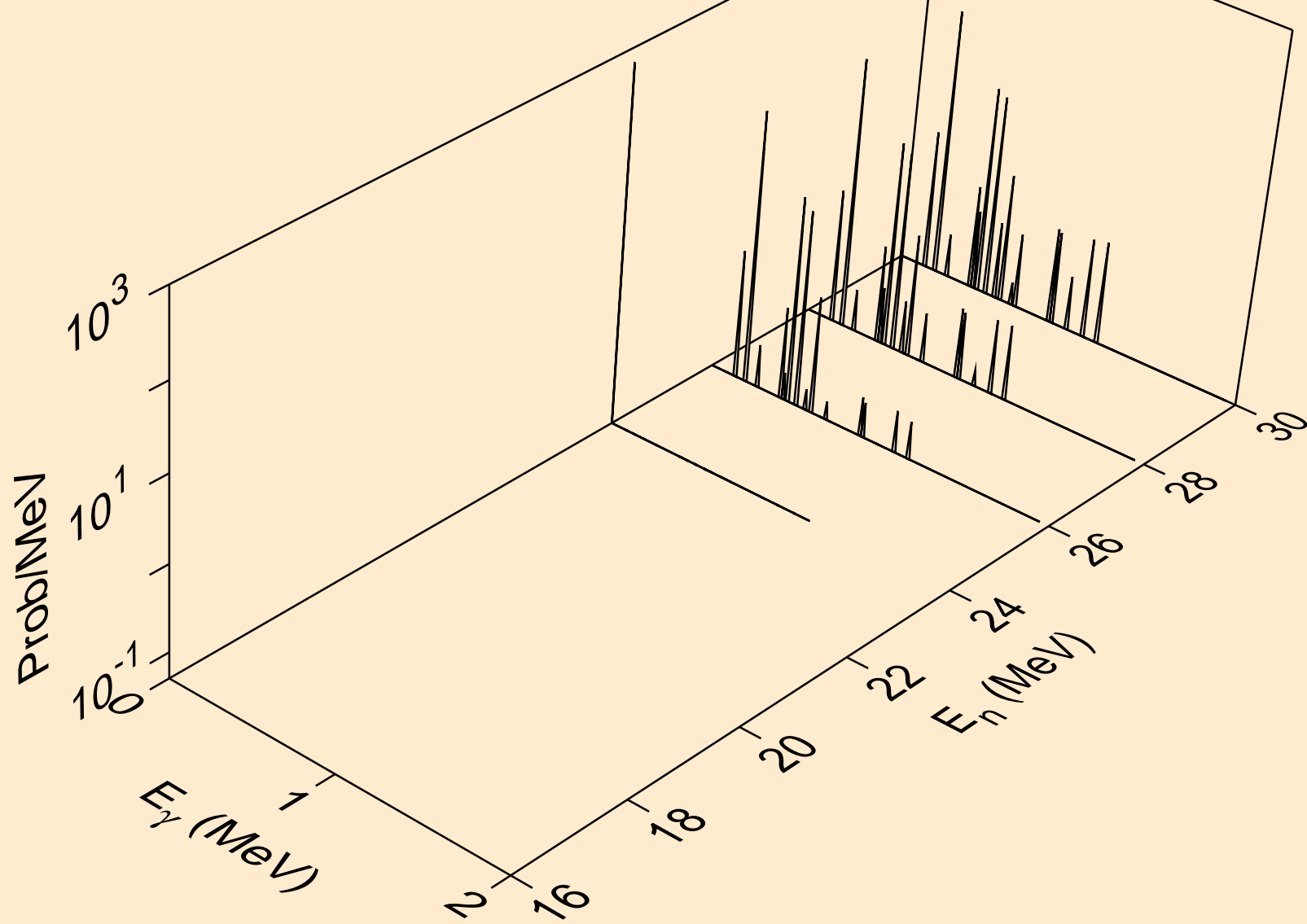

BR084M NEUTRON ACER TENDL-2021 LIBRARY; T=293.6K
Photon emission for (n,n*2)

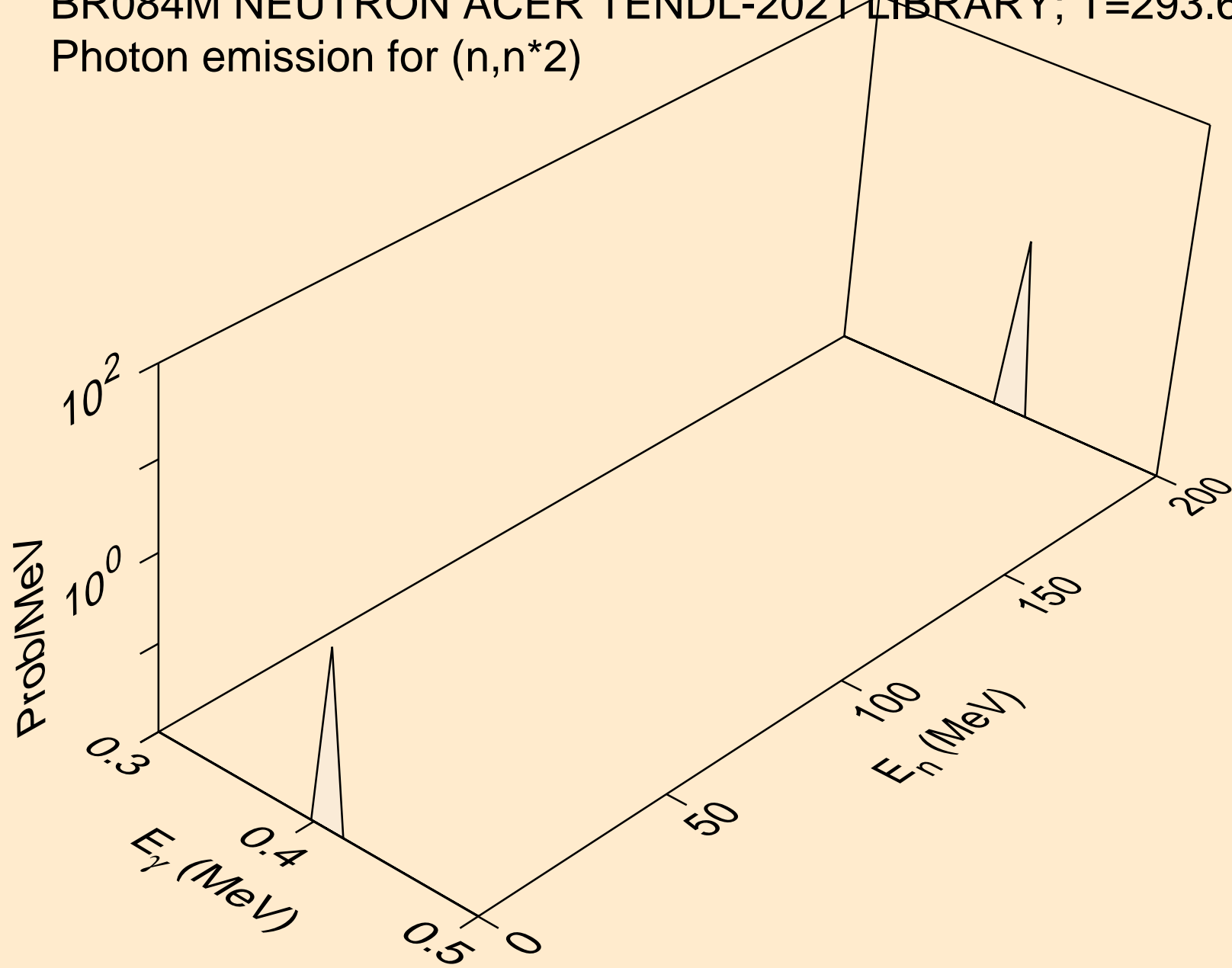

BR084M NEUTRON ACER TENDL-2021 LIBRARY; T=293.6K
Photon emission for (n,n*3)

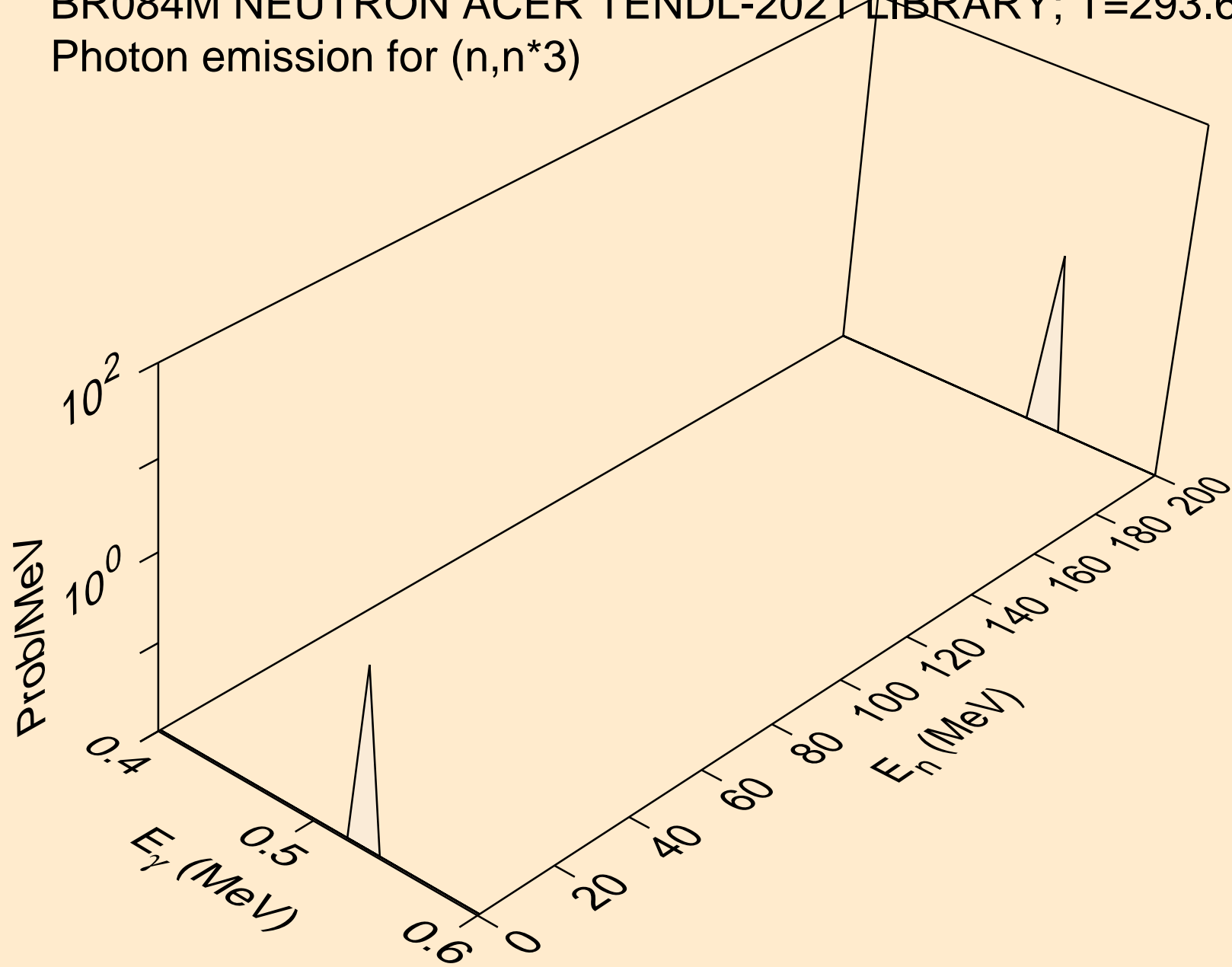

BR084M NEUTRON ACER TENDL-2021 LIBRARY; T=293.6K
Photon emission for (n,n*4)

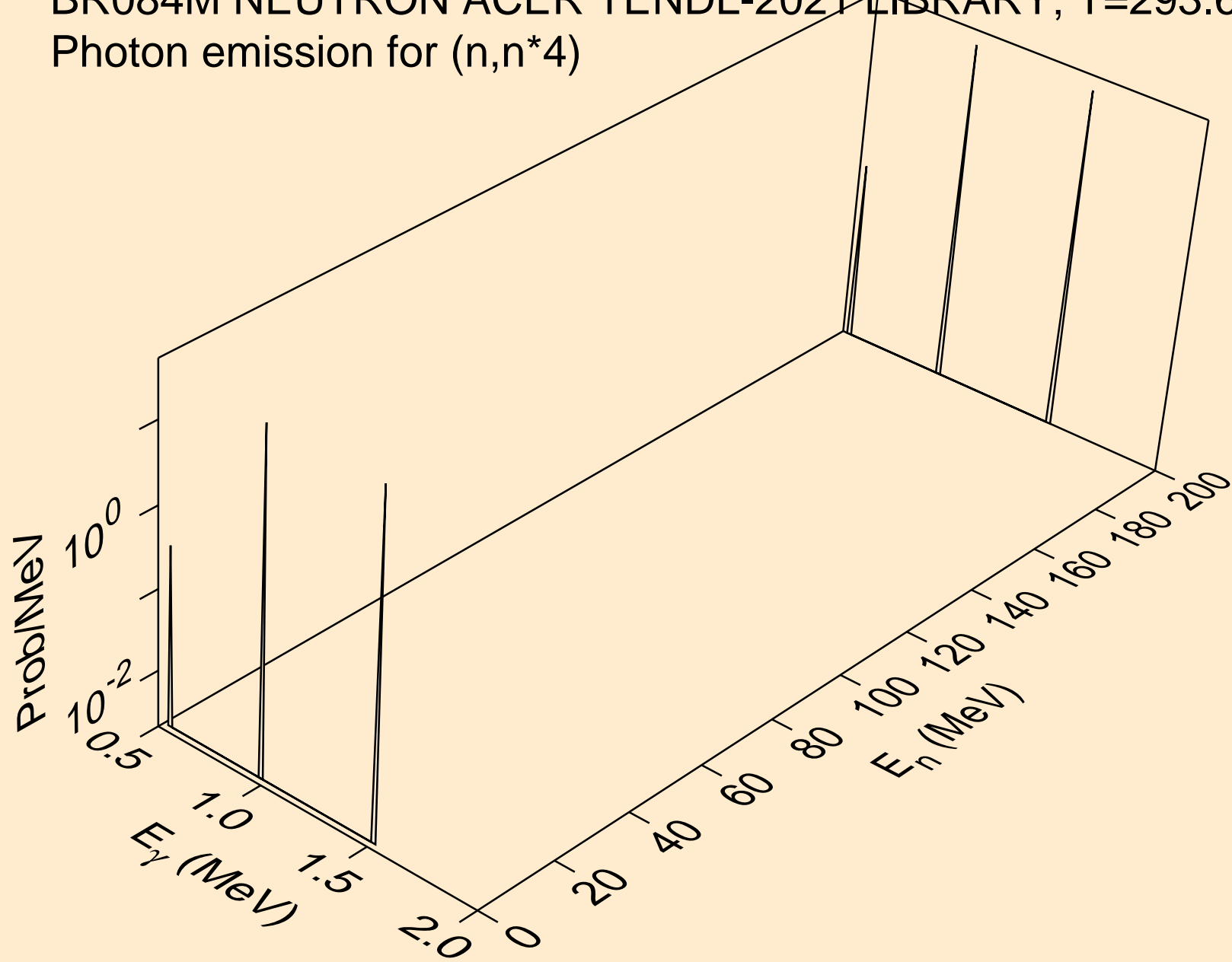

BR084M NEUTRON ACER TENDL-2021 LIBRARY; T=293.6K
Photon emission for (n,n*5)

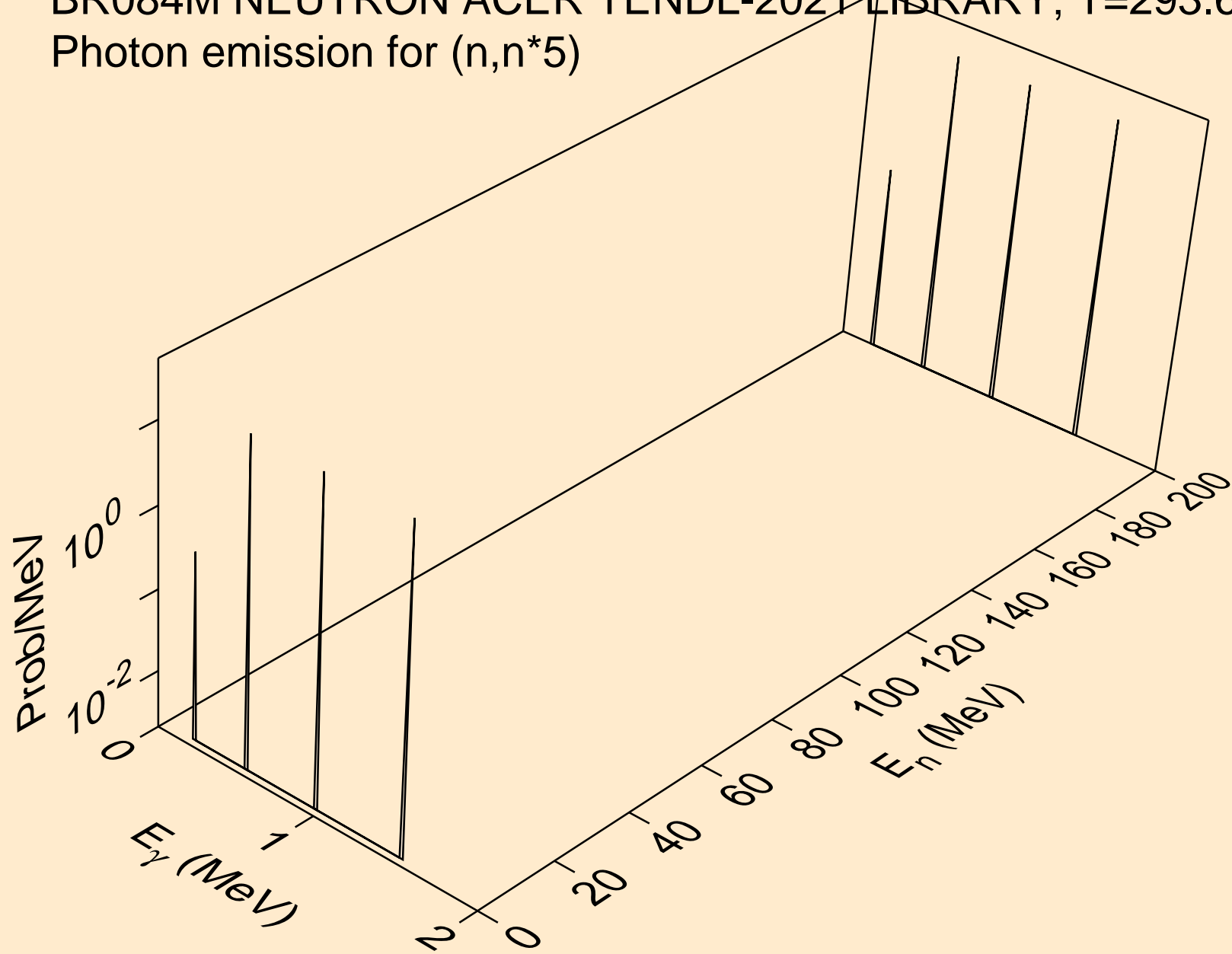

BR084M NEUTRON ACER TENDL-2021 LIBRARY; T=293.6K
Photon emission for (n,n*6)

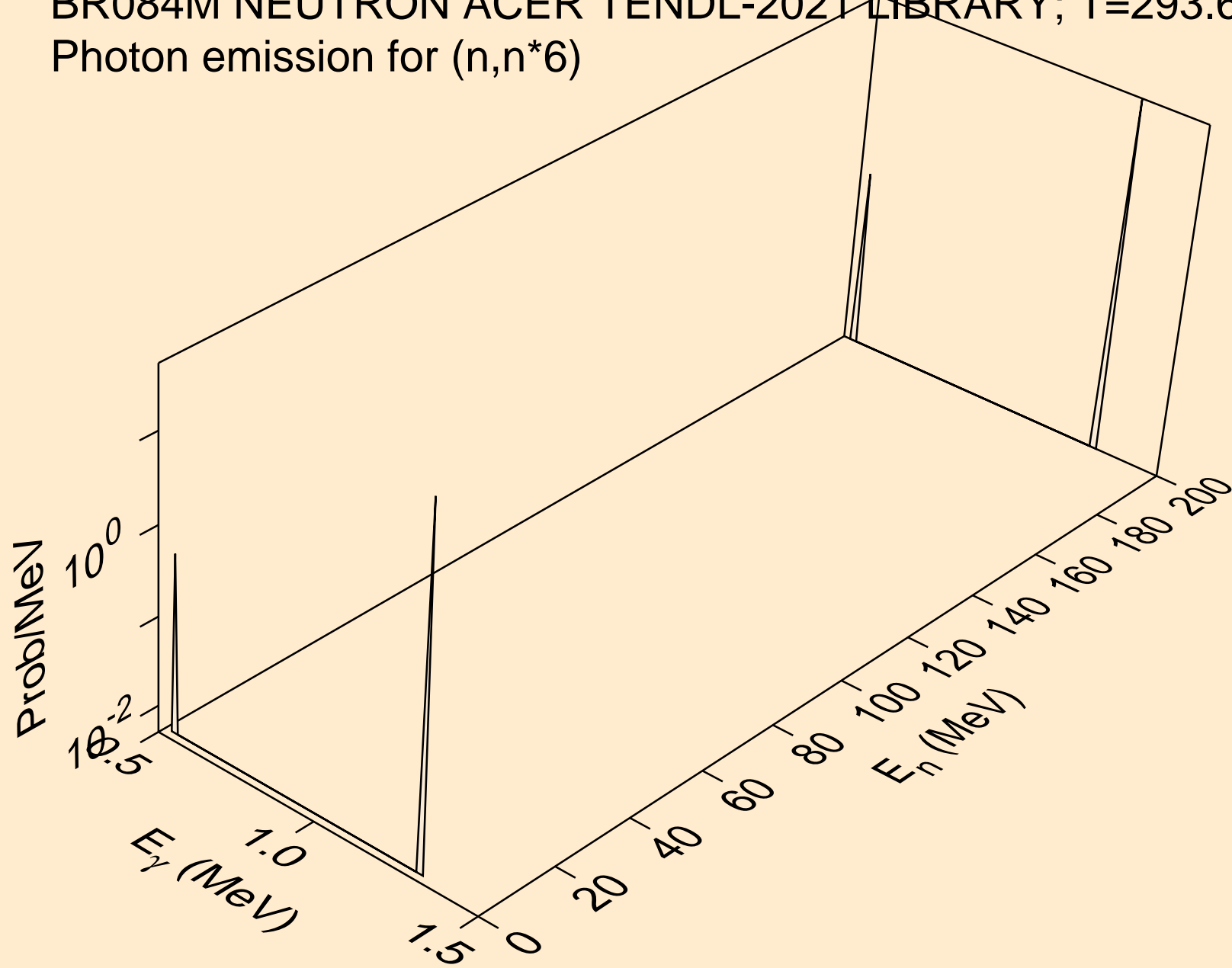

BR084M NEUTRON ACER TENDL-2021 LIBRARY; T=293.6K
Photon emission for (n,n*7)

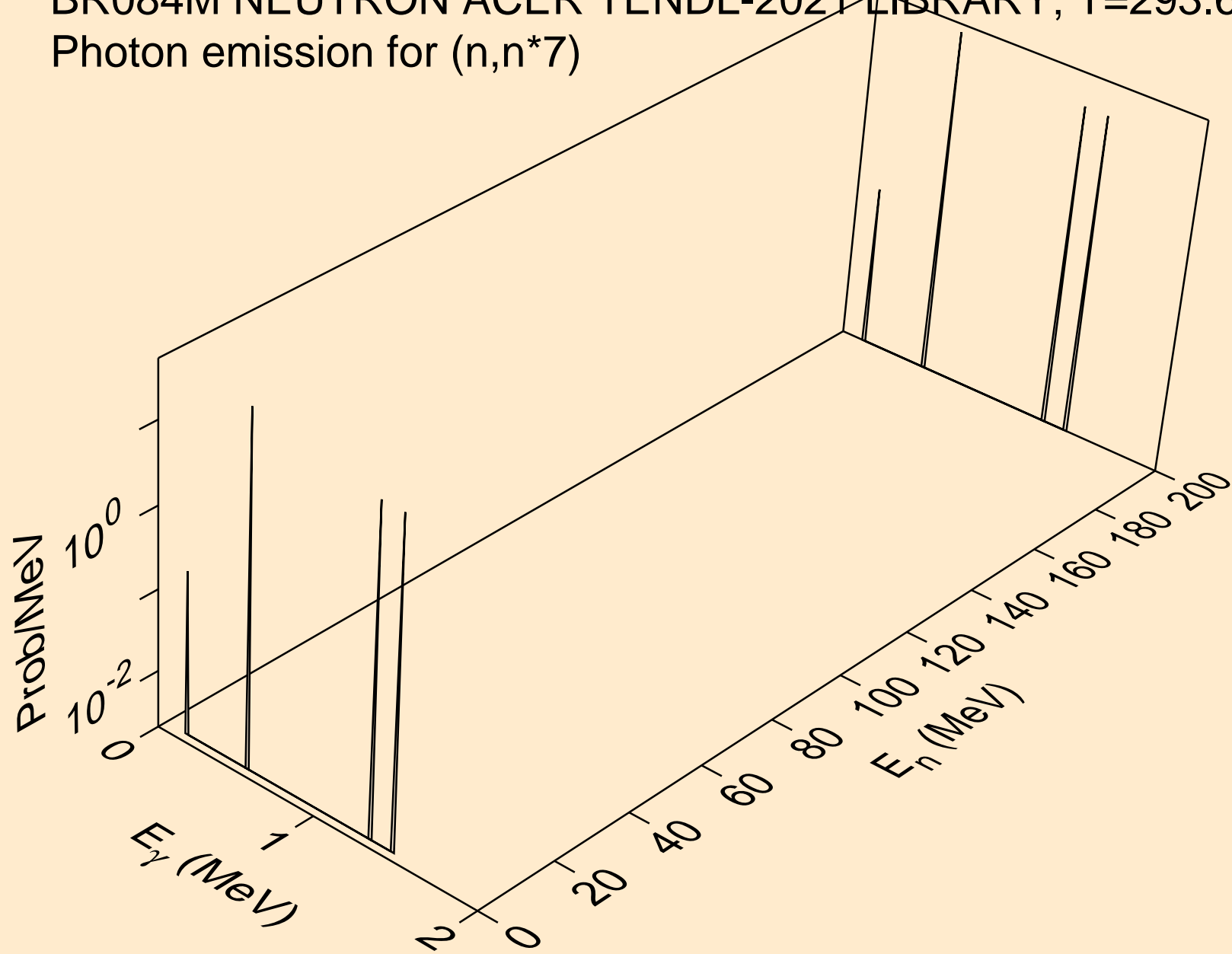

BR084M NEUTRON ACER TENDL-2021 LIBRARY; T=293.6K
Photon emission for (n,n*8)

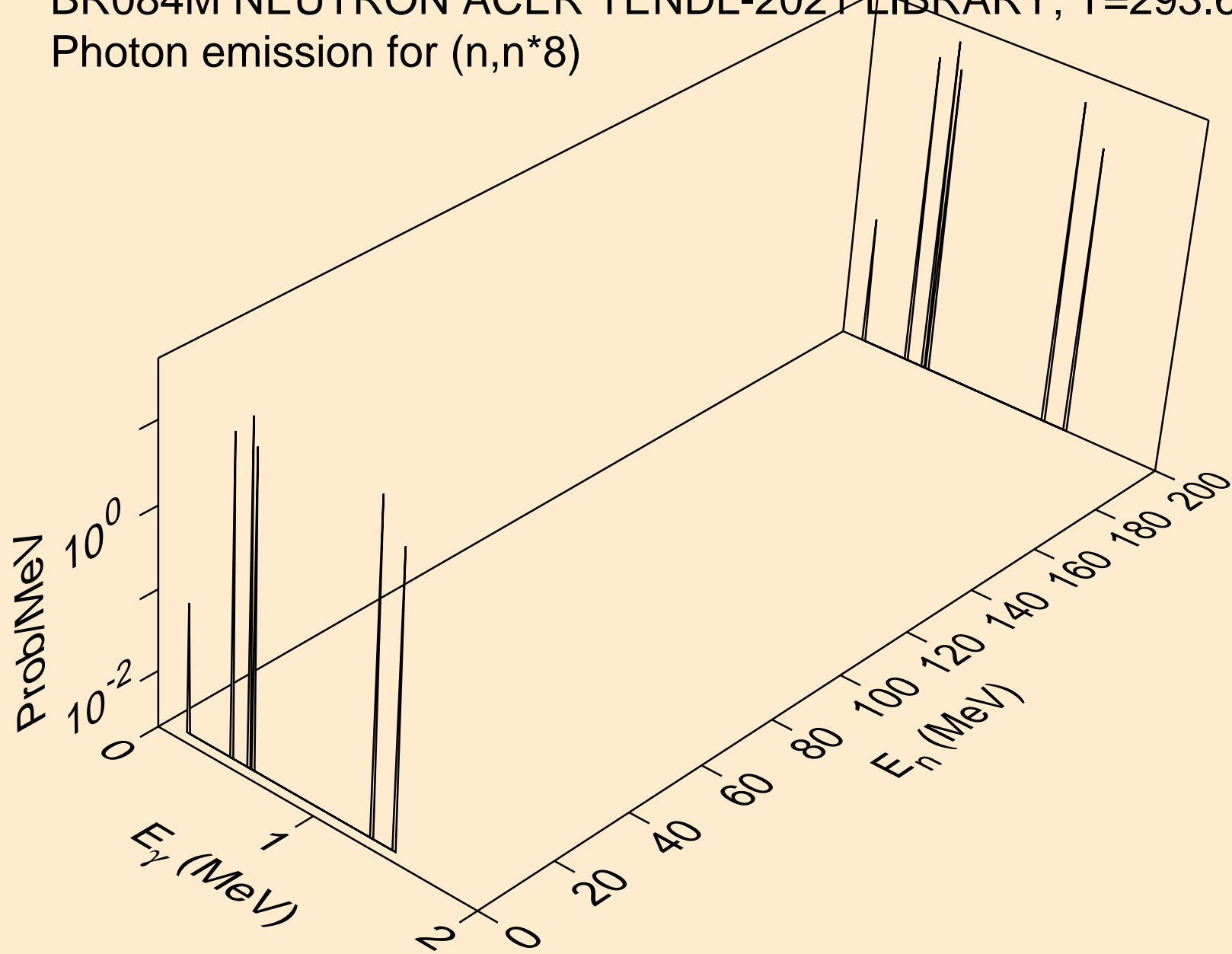

BR084M NEUTRON ACER TENDL-2021 LIBRARY; T=293.6K
Photon emission for (n,n*9)

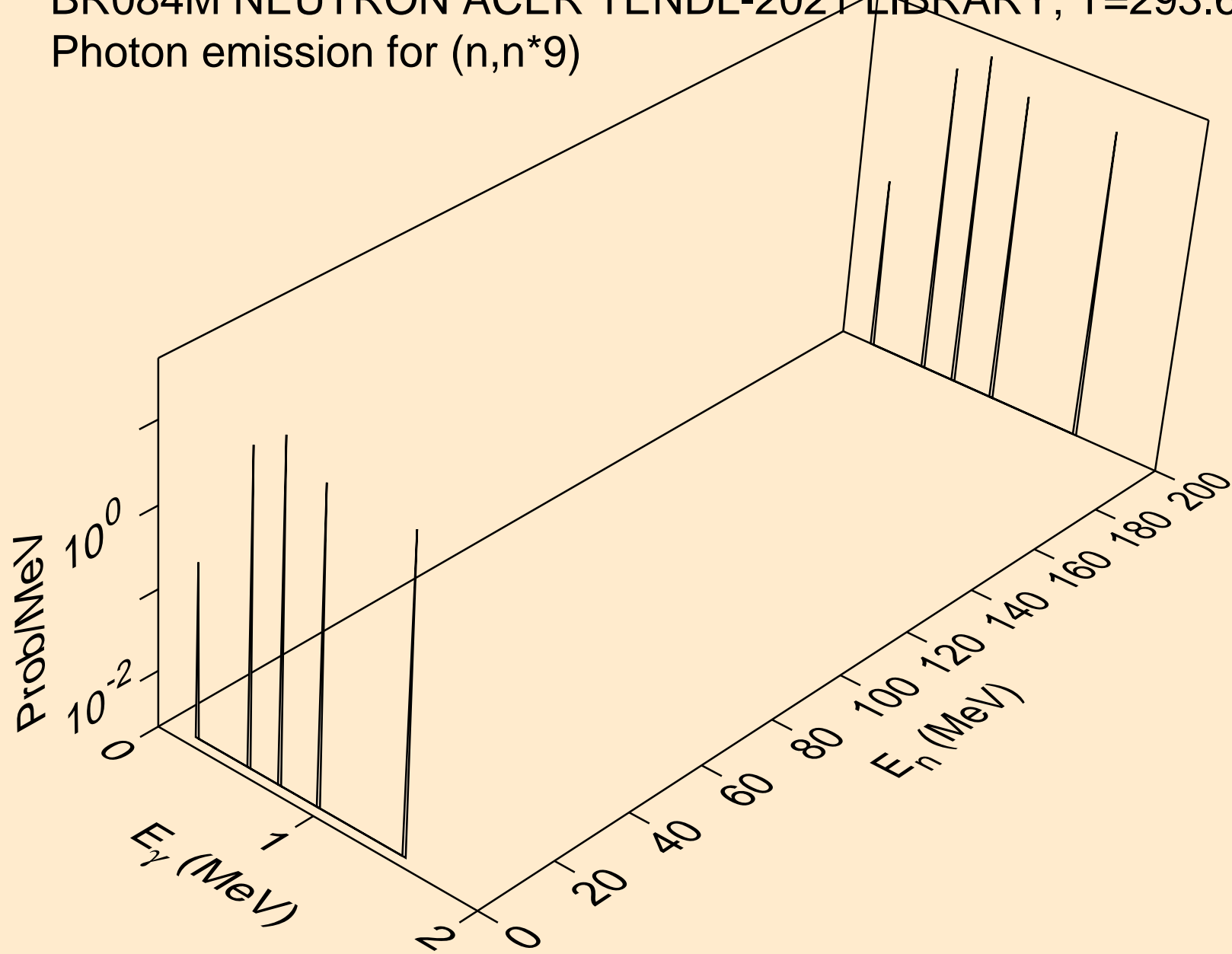

BR084M NEUTRON ACER TENDL-2021 LIBRARY; T=293.6K
Photon emission for (n,n*10)

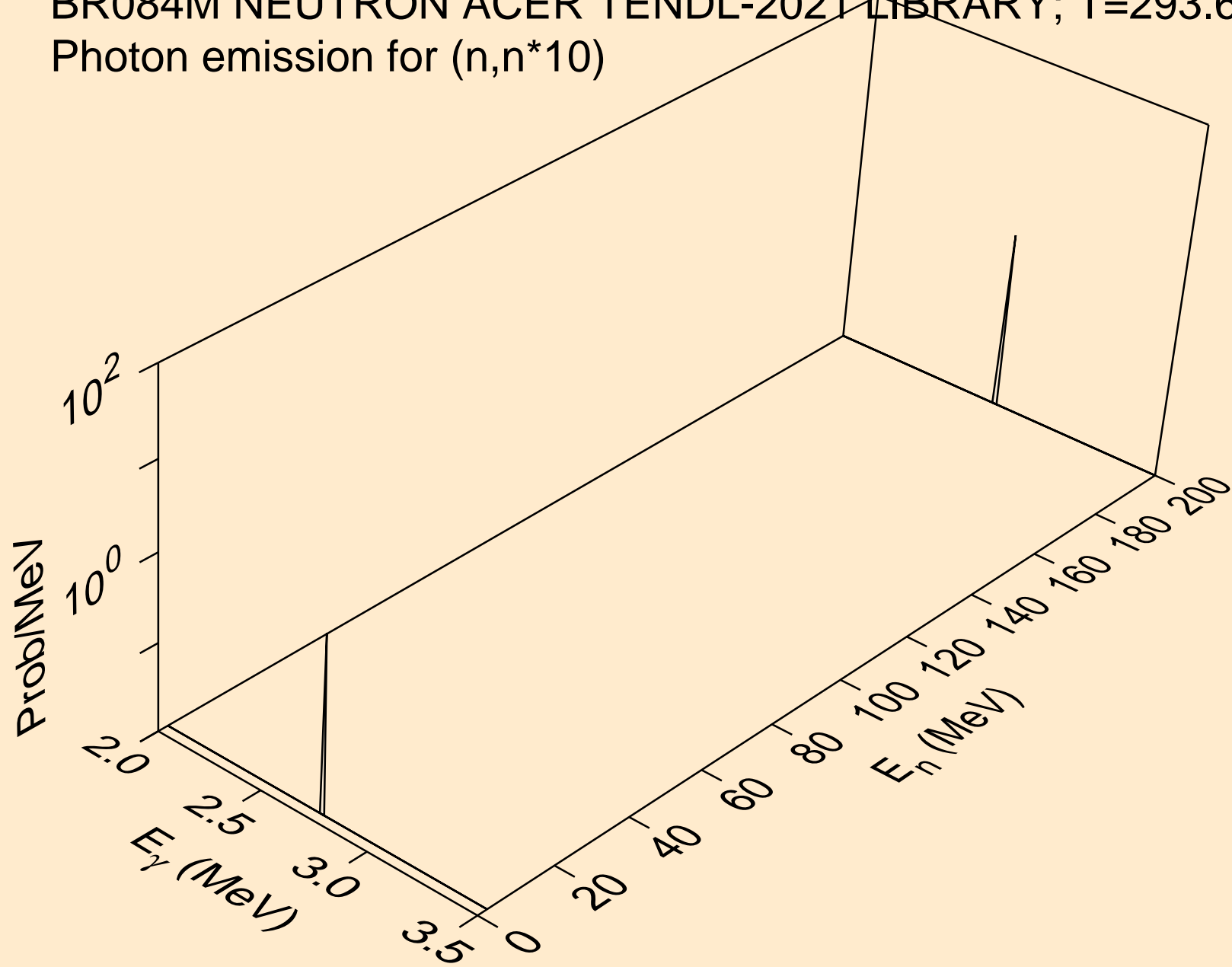

BR084M NEUTRON ACER TENDL-2021 LIBRARY; T=293.6K
Photon emission for (n,n*11)

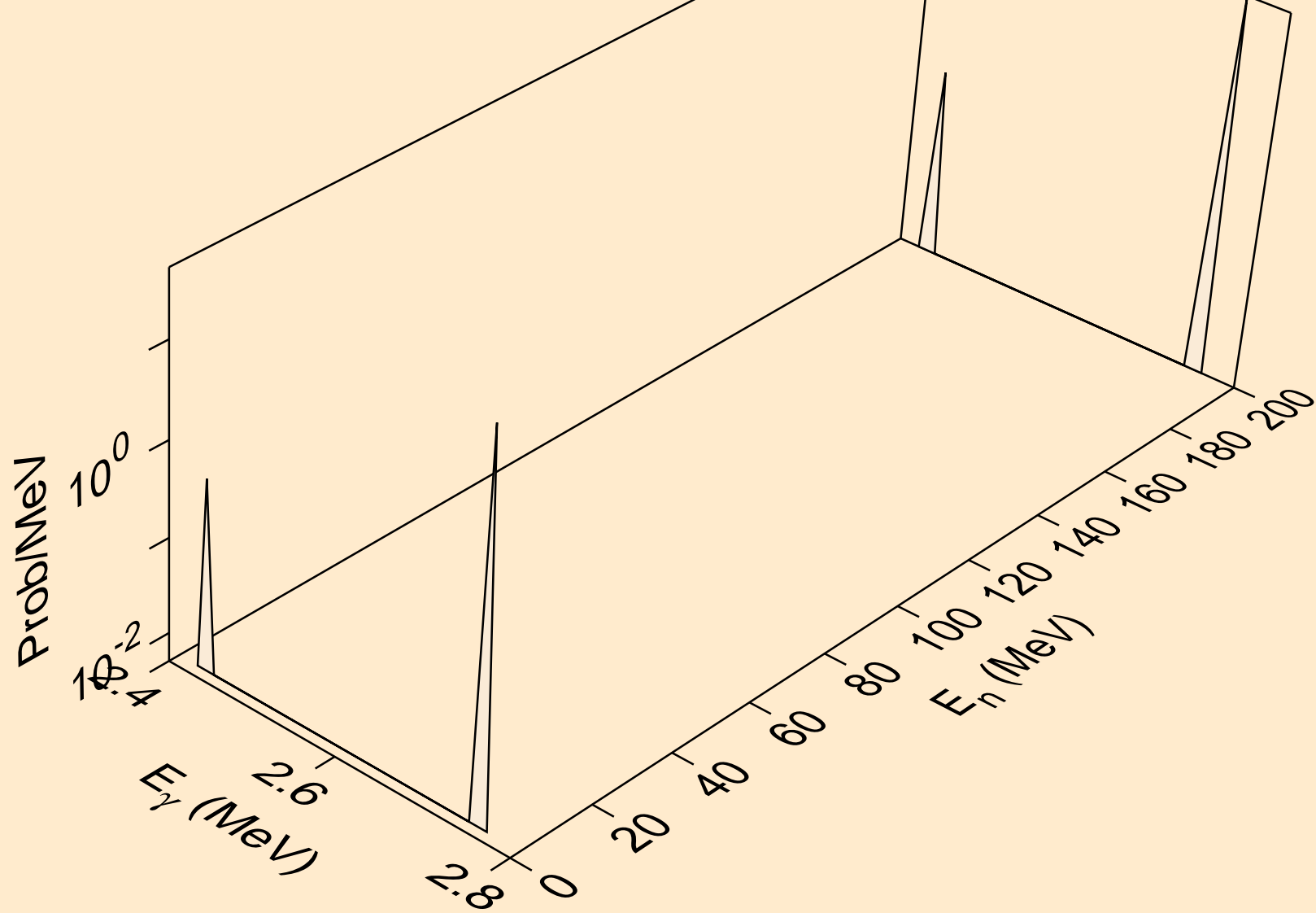

BR084M NEUTRON ACER TENDL-2021 LIBRARY; T=293.6K
Photon emission for (n,n*12)

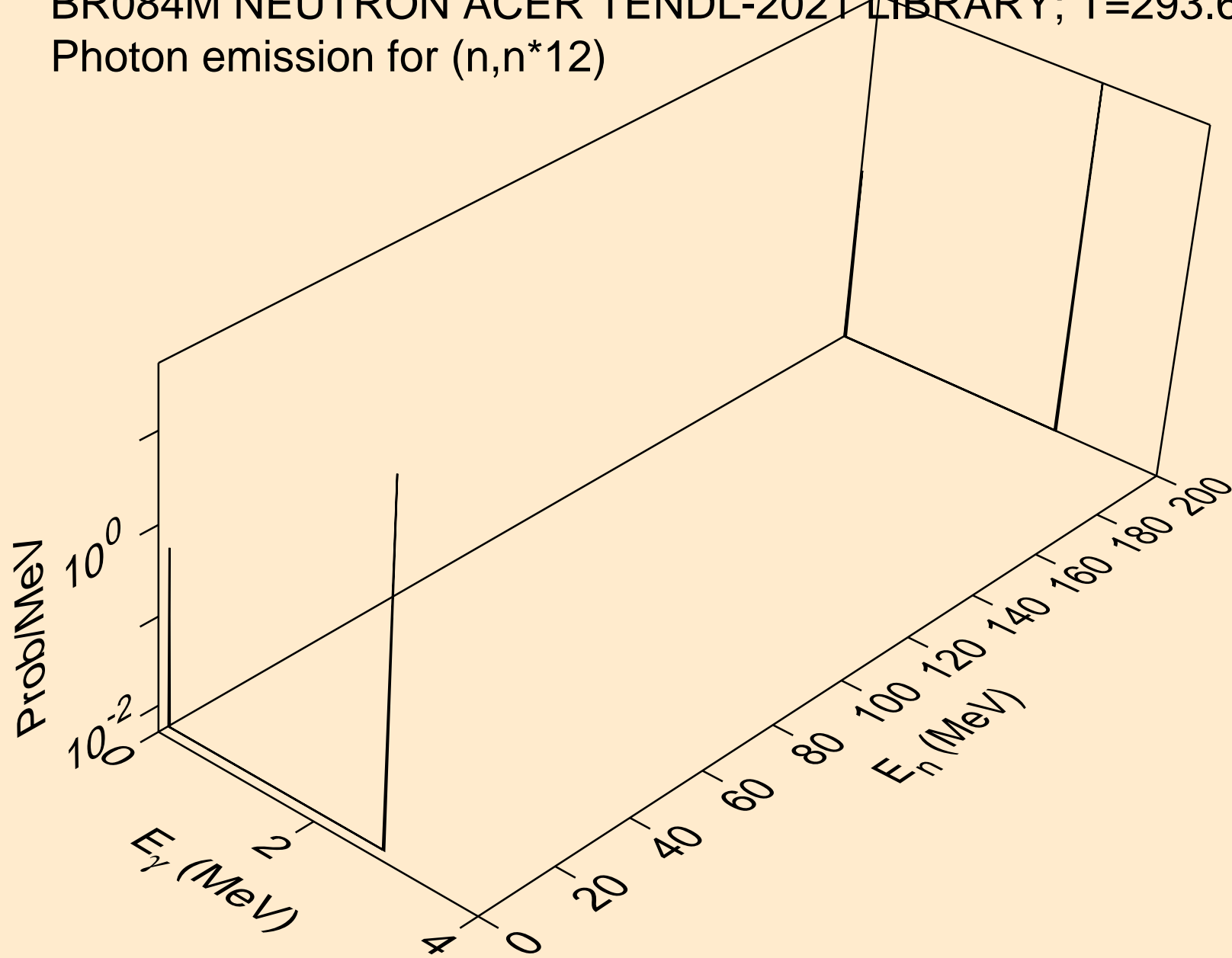

BR084M NEUTRON ACER TENDL-2021 LIBRARY; T=293.6K
Photon emission for (n,n*13)

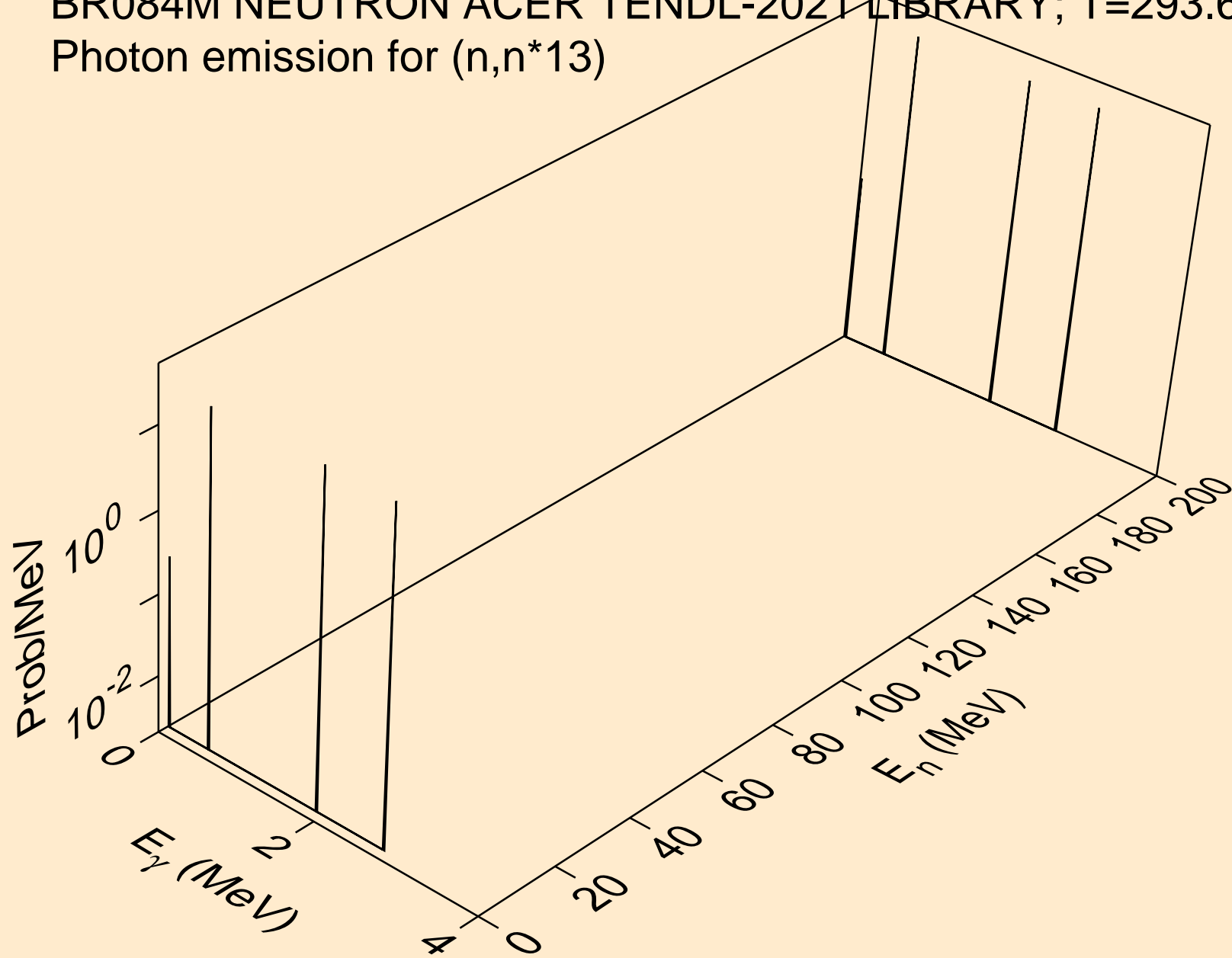

BR084M NEUTRON ACER TENDL-2021 LIBRARY; T=293.6K
Photon emission for (n,n*14)

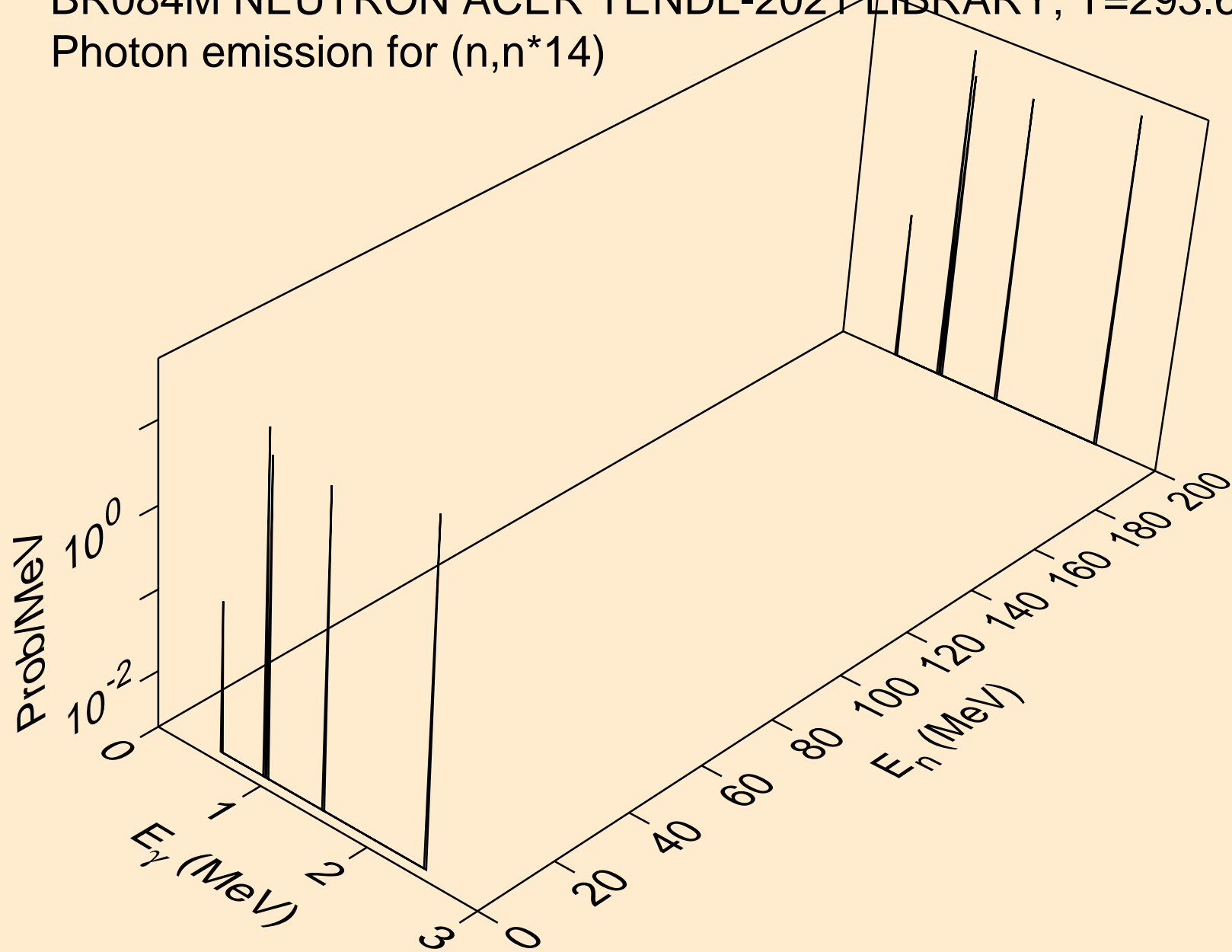

BR084M NEUTRON ACER TENDL-2021 LIBRARY; T=293.6K
Photon emission for (n,n*15)

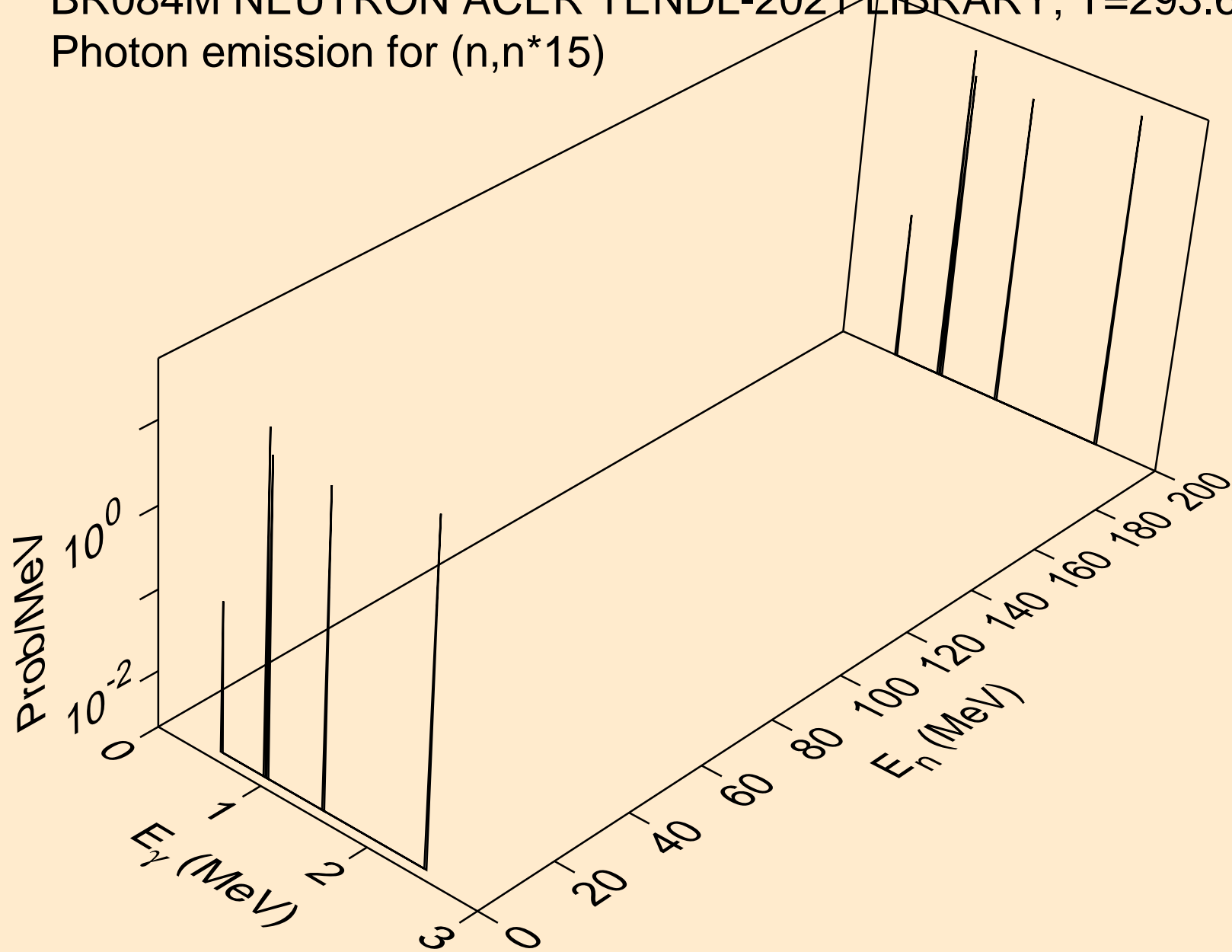

BR084M NEUTRON ACER TENDL-2021 LIBRARY; T=293.6K
Photon emission for (n,n*16)

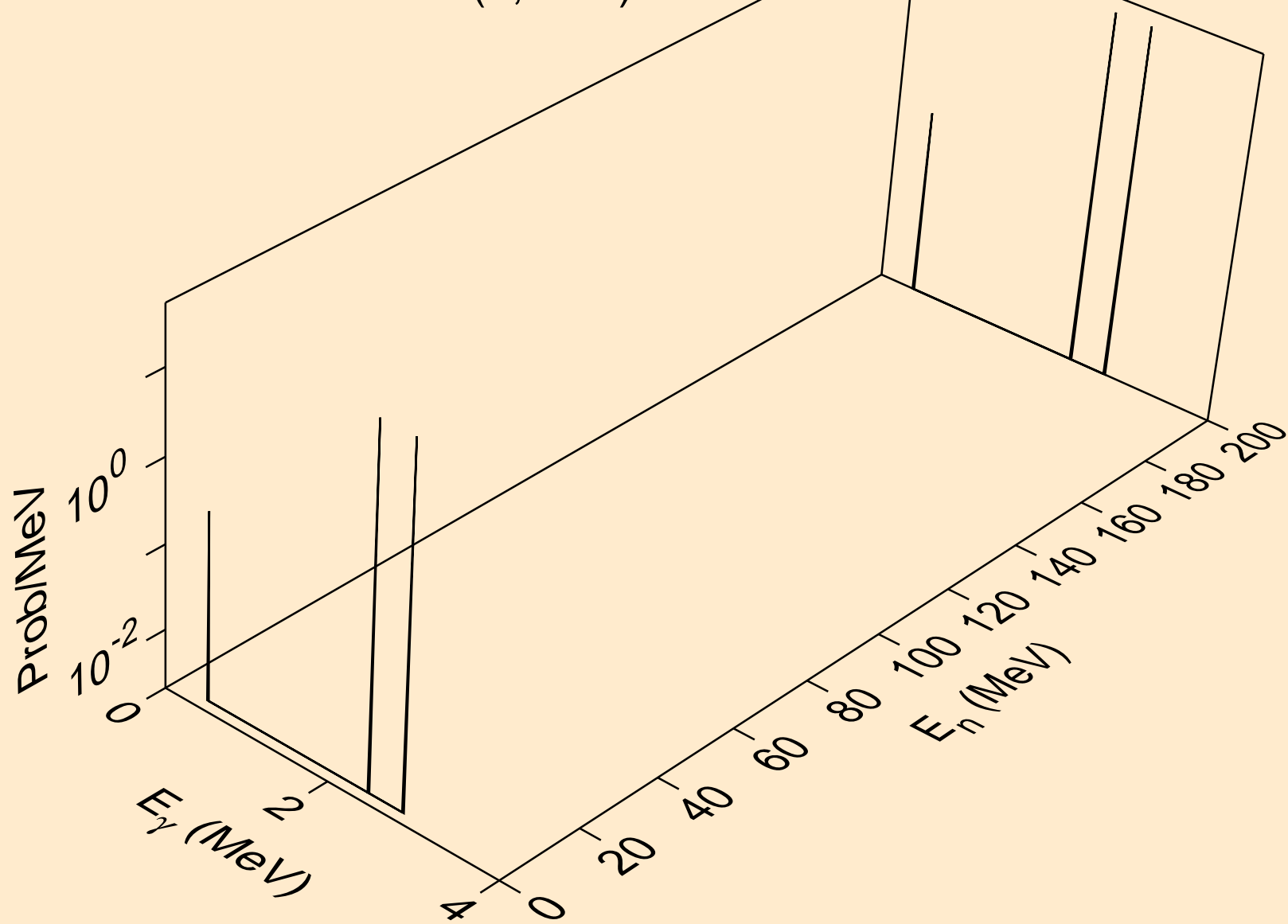

BR084M NEUTRON ACER TENDL-2021 LIBRARY; T=293.6K
Photon emission for (n,n*17)

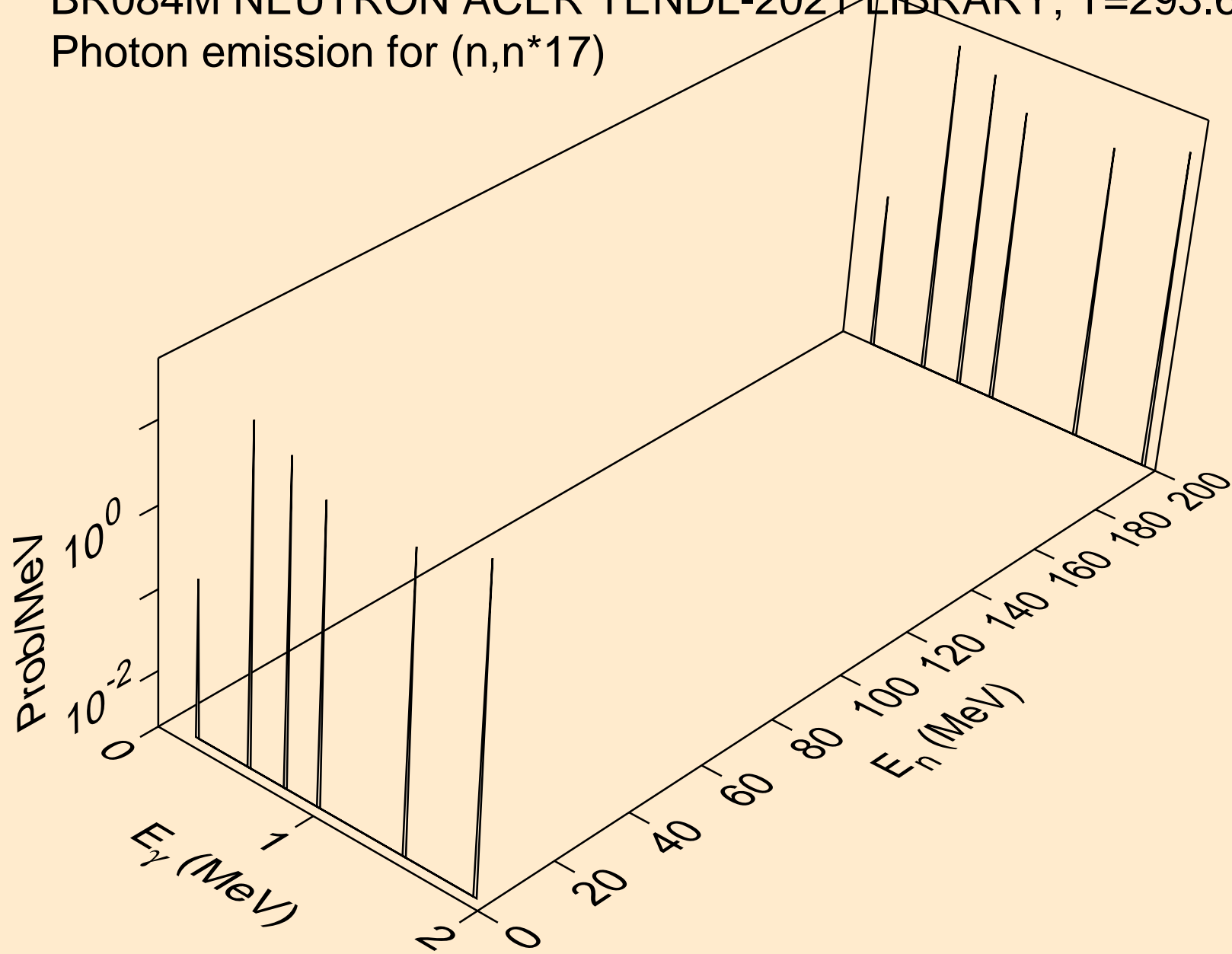

BR084M NEUTRON ACER TENDL-2021 LIBRARY; T=293.6K
Photon emission for (n,n*18)

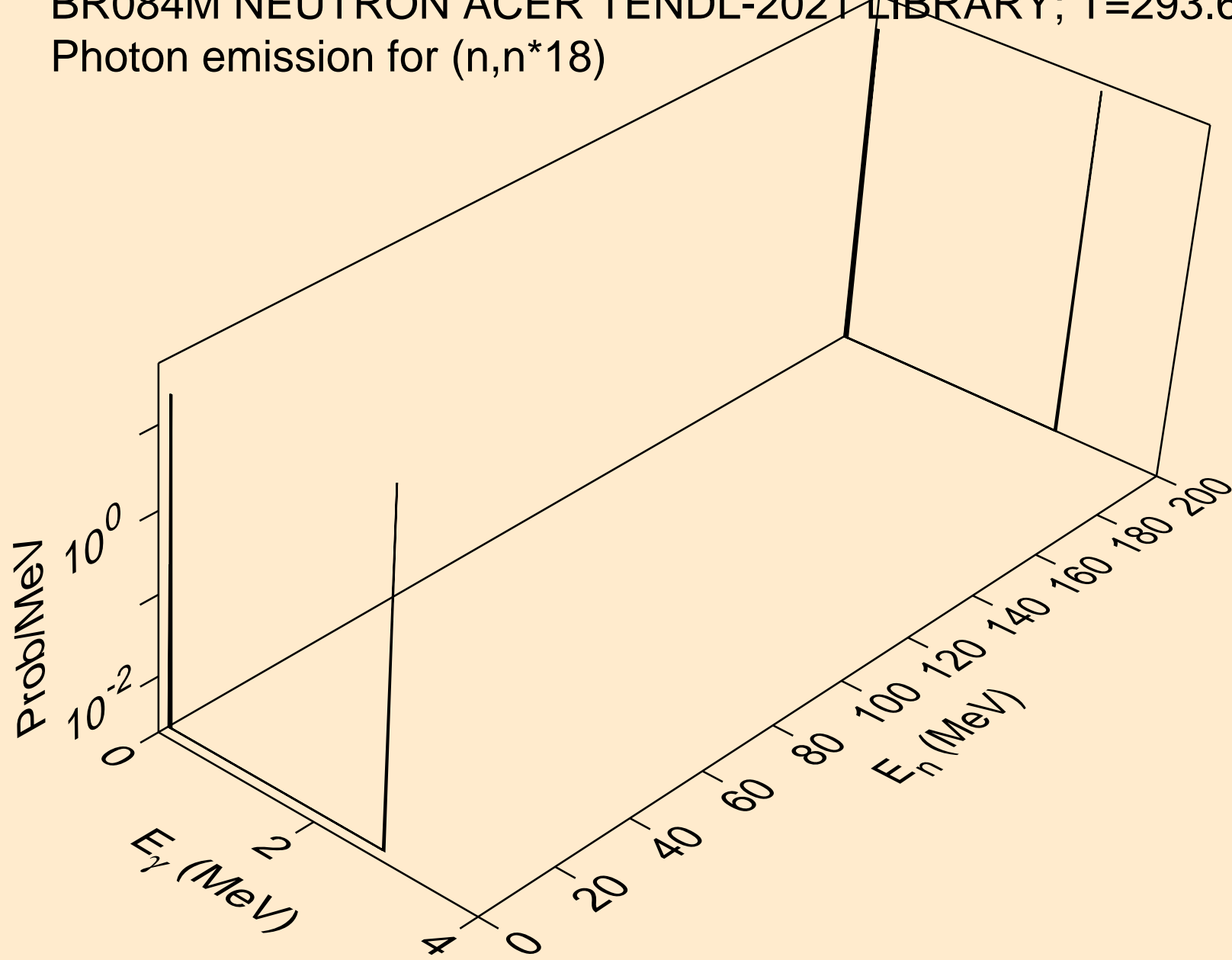

BR084M NEUTRON ACER TENDL-2021 LIBRARY; T=293.6K
Photon emission for (n,n*19)

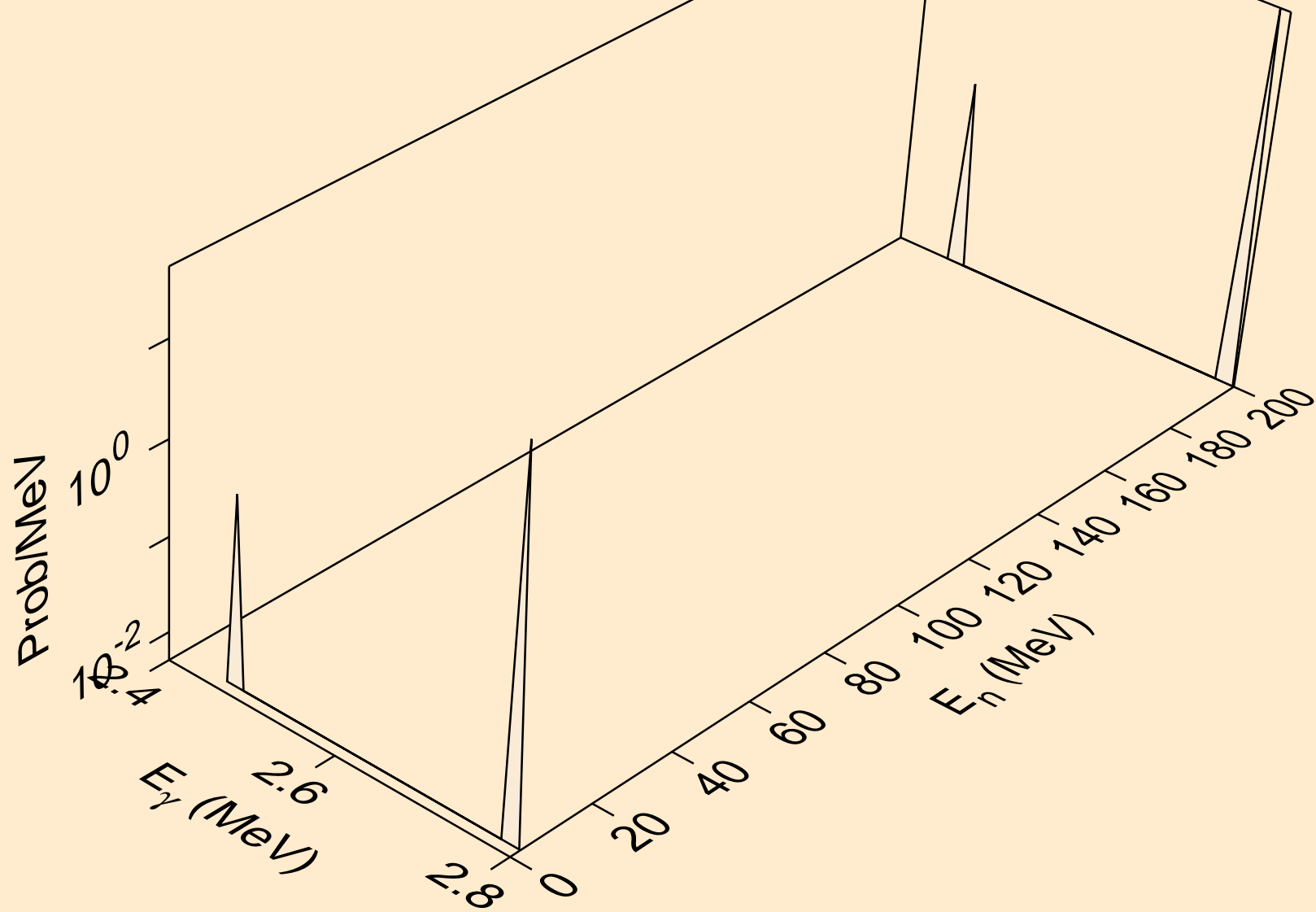

BR084M NEUTRON ACER TENDL-2021 LIBRARY; T=293.6K
Photon emission for (n,n*20)

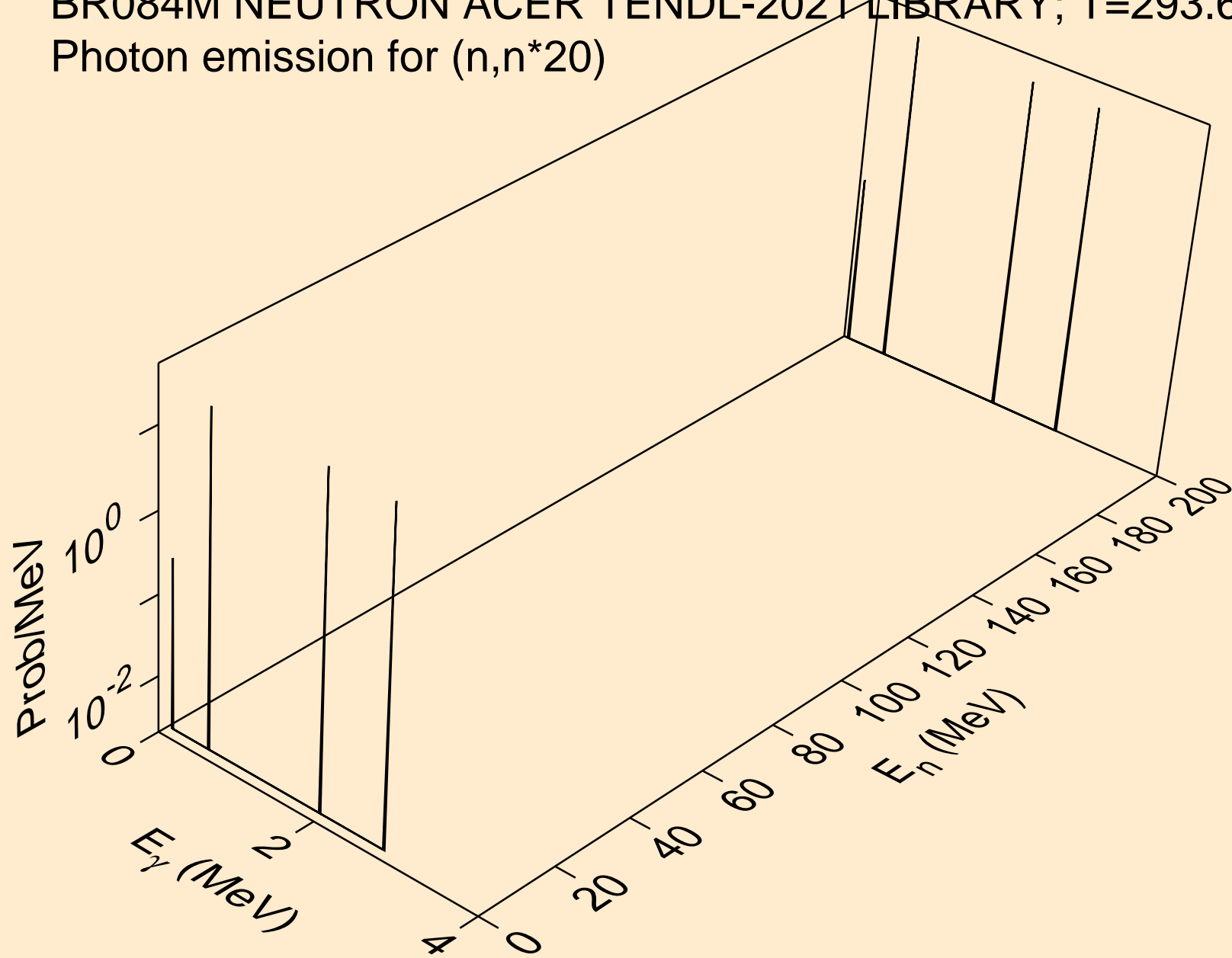

BR084M NEUTRON ACER TENDL-2021 LIBRARY; T=293.6K
Photon emission for (n,n*21)

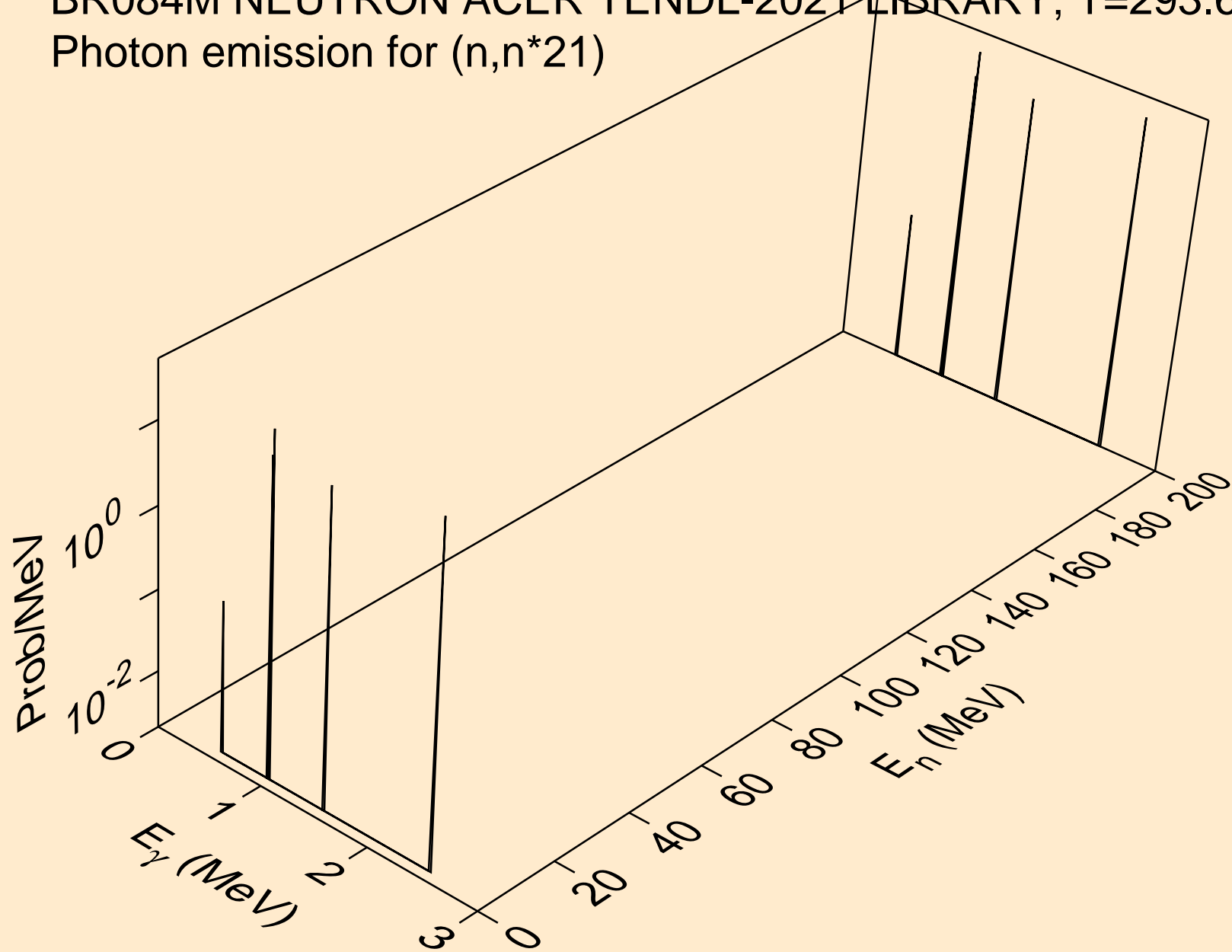

BR084M NEUTRON ACER TENDL-2021 LIBRARY; T=293.6K
Photon emission for (n,n*22)

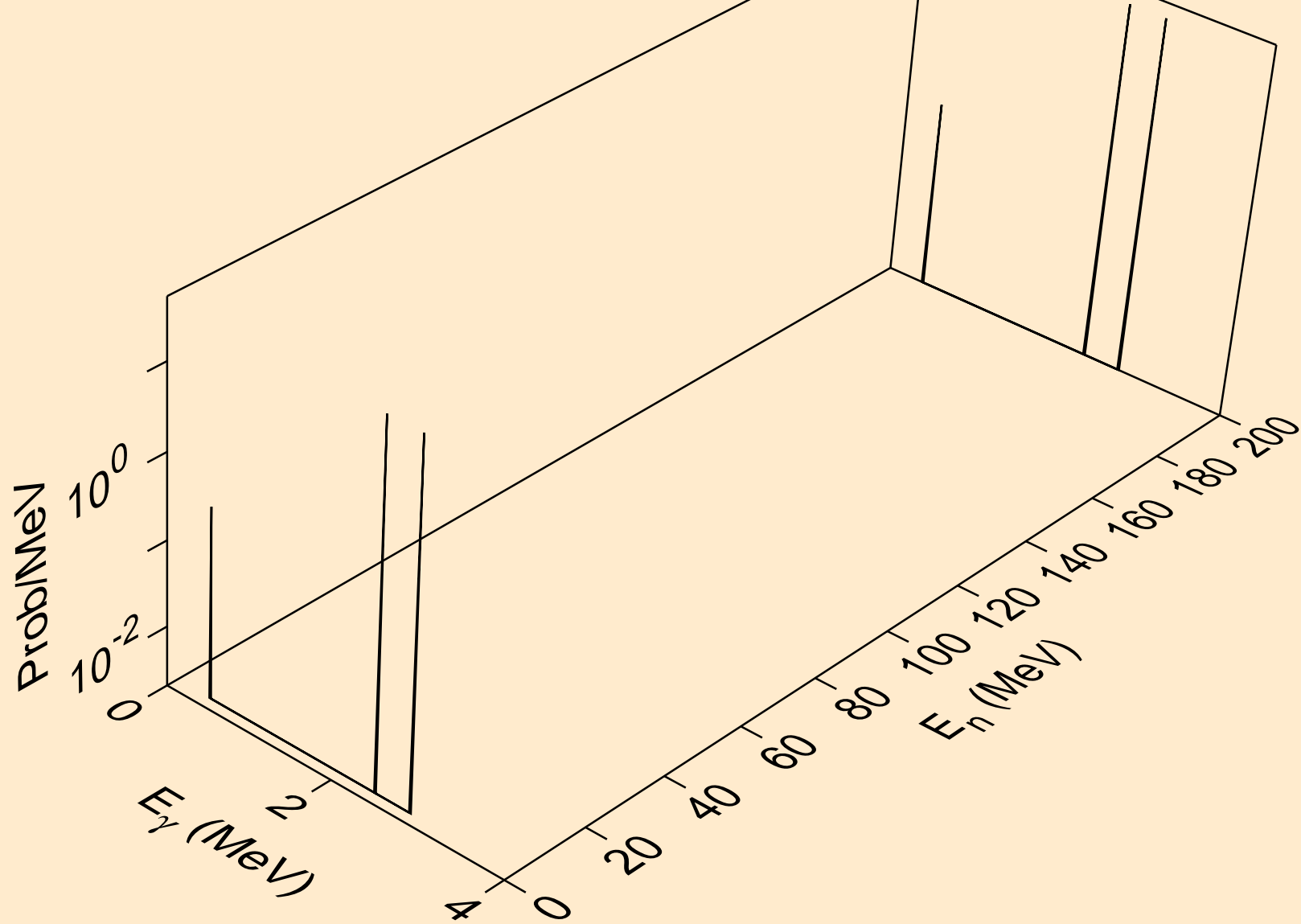

BR084M NEUTRON ACER TENDL-2021 LIBRARY; T=293.6K
Photon emission for (n,n*23)

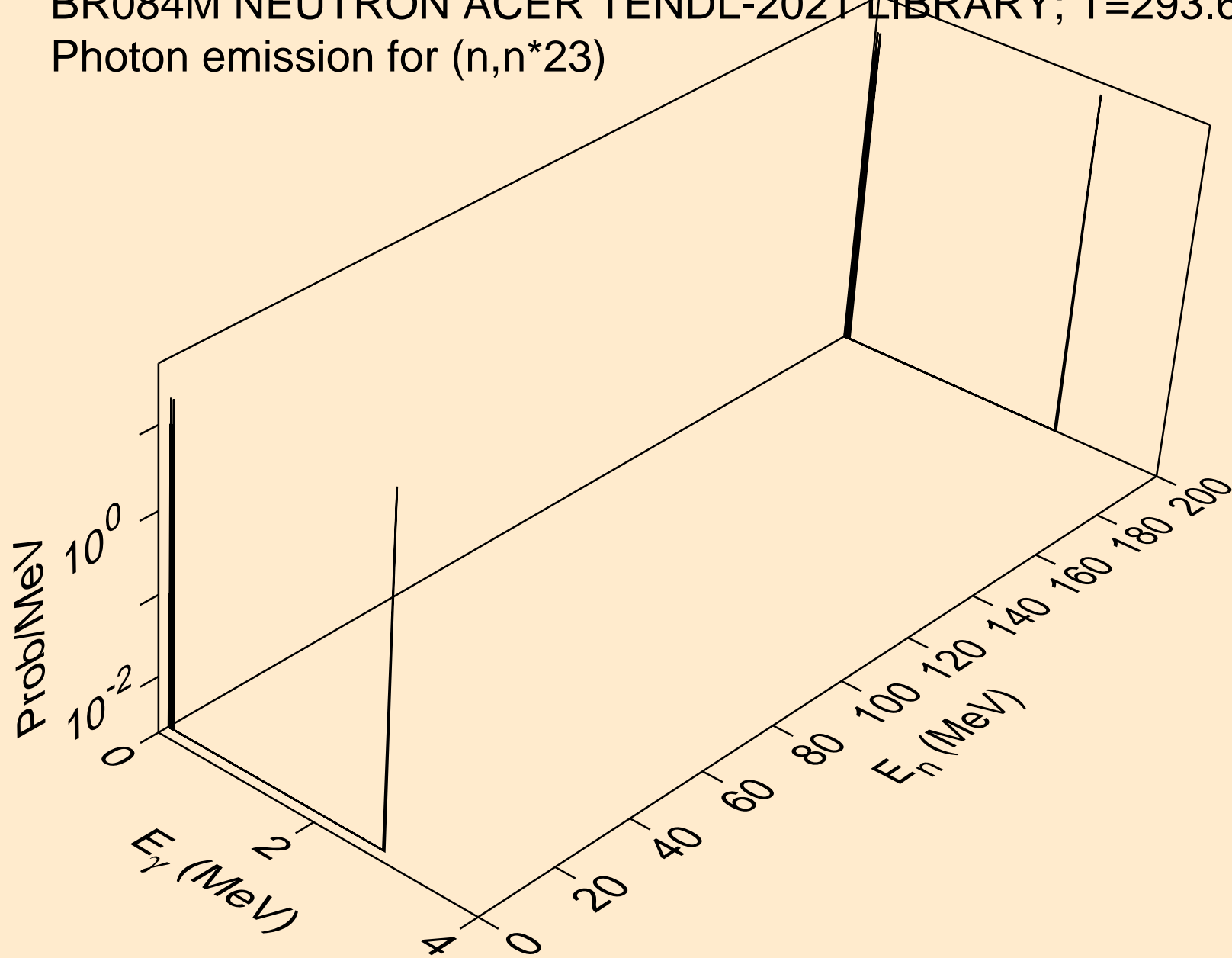

BR084M NEUTRON ACER TENDL-2021 LIBRARY; T=293.6K
Photon emission for (n,n*24)

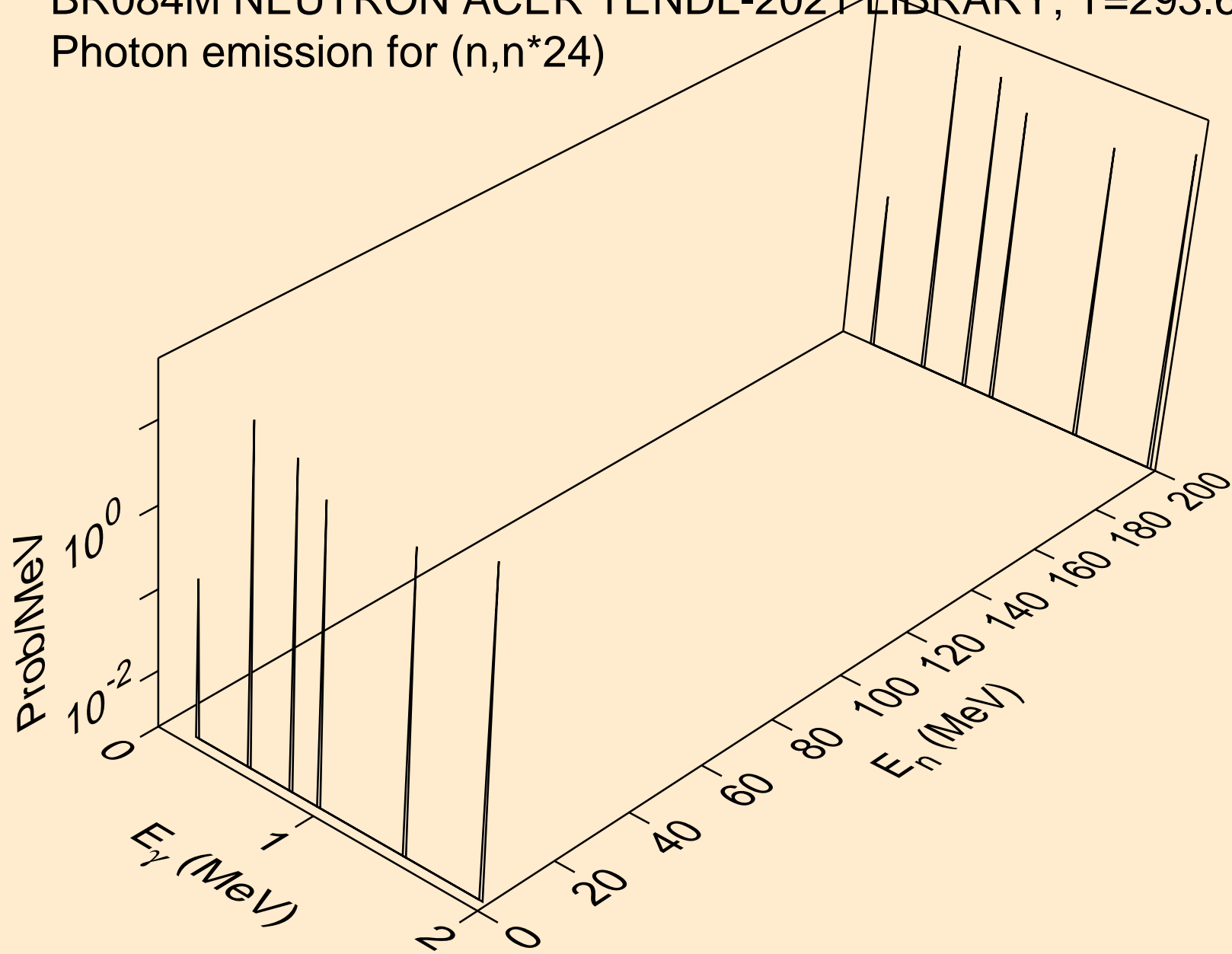

BR084M NEUTRON ACER TENDL-2021 LIBRARY; T=293.6K
Photon emission for (n,n*25)

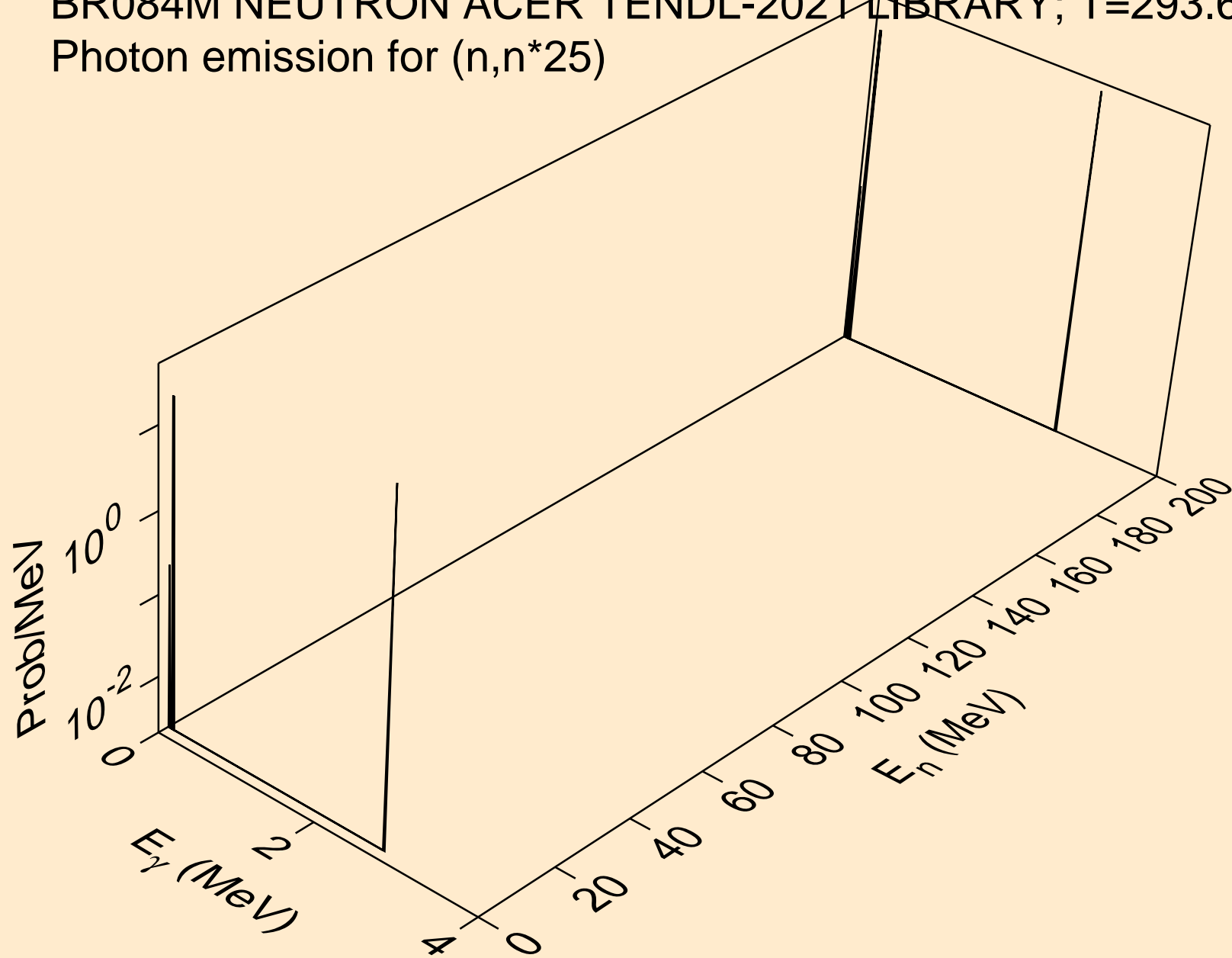

BR084M NEUTRON ACER TENDL-2021 LIBRARY; T=293.6K
Photon emission for (n,n*26)

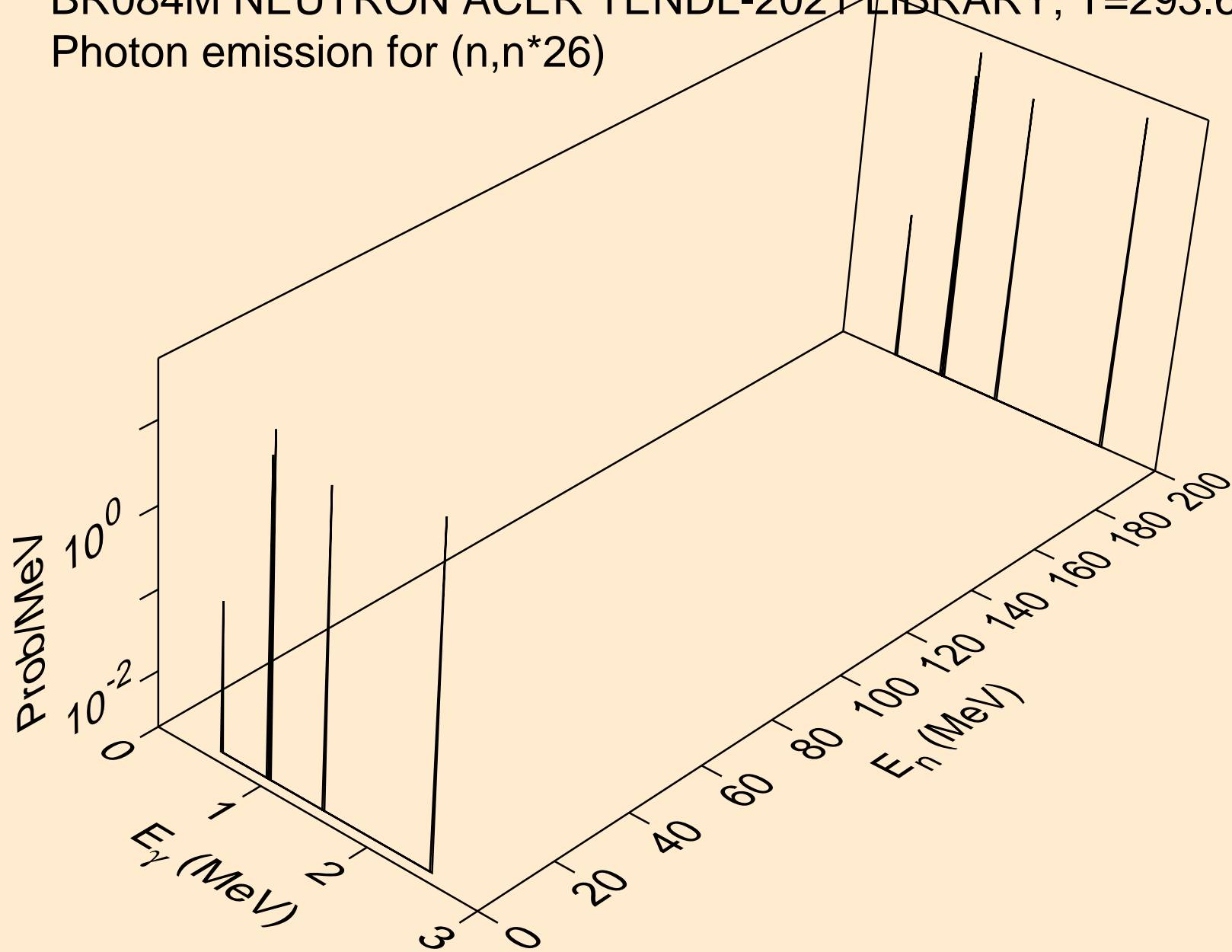

BR084M NEUTRON ACER TENDL-2021 LIBRARY; T=293.6K
Photon emission for (n,n*27)

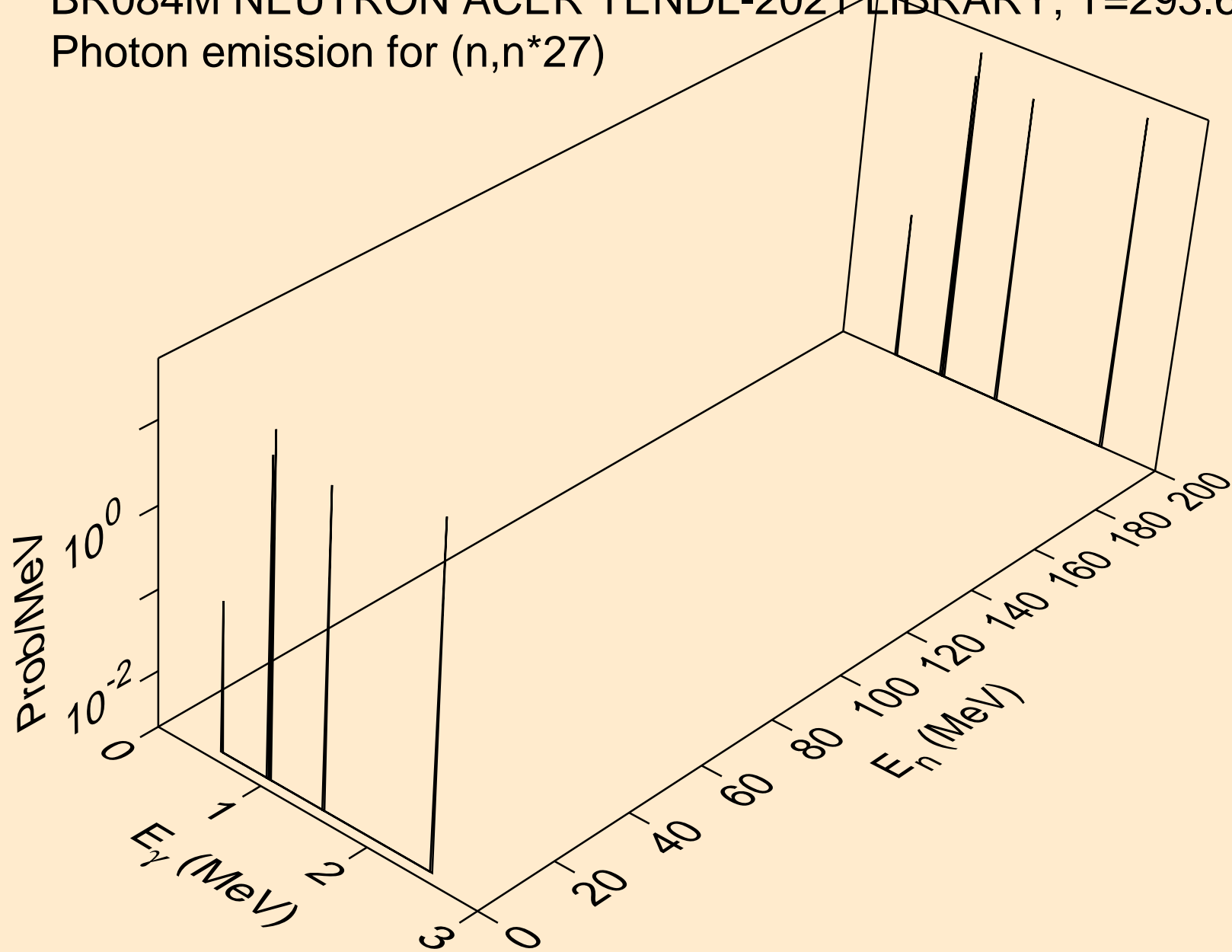

BR084M NEUTRON ACER TENDL-2021 LIBRARY; T=293.6K
Photon emission for (n,n*28)

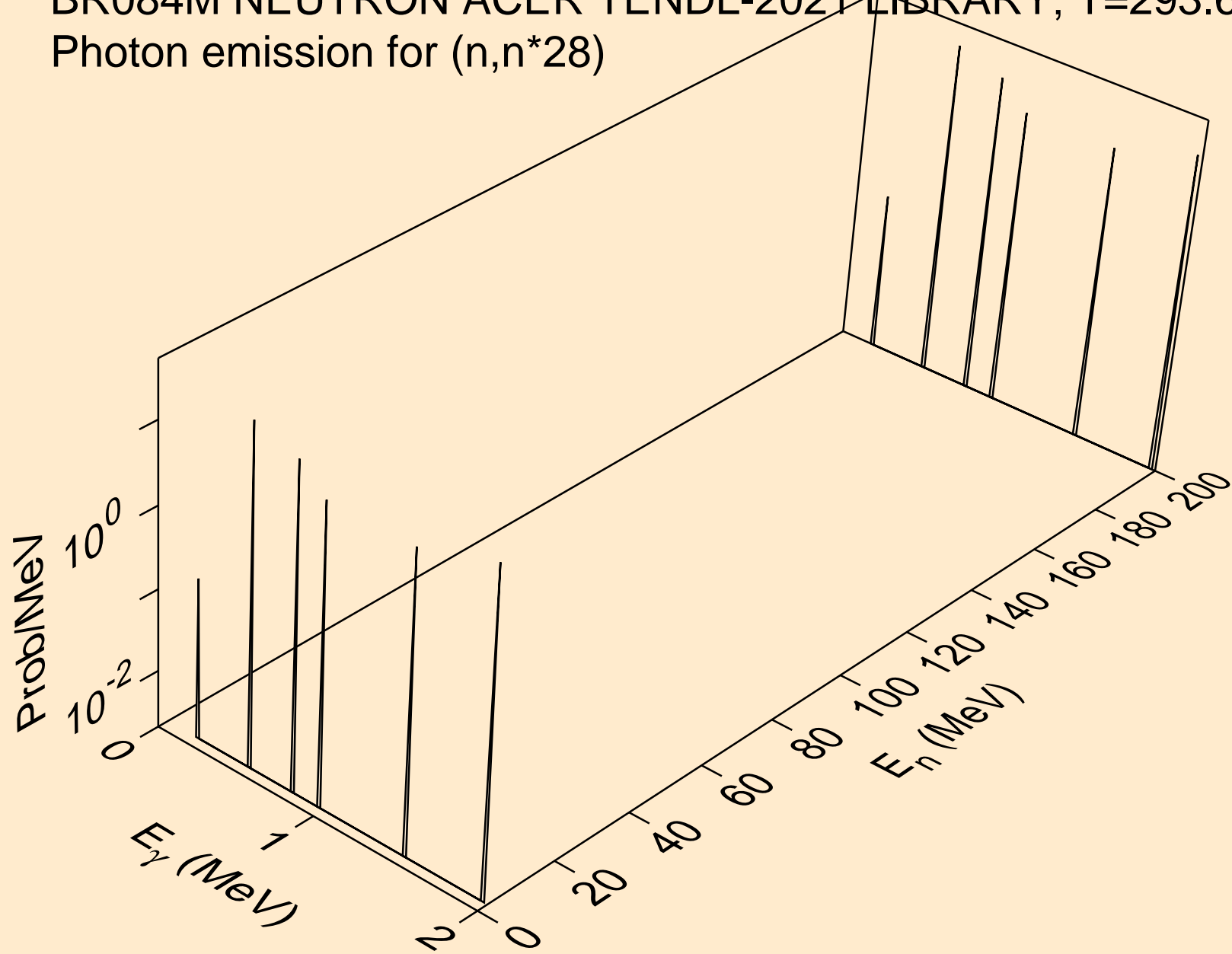

BR084M NEUTRON ACER TENDL-2021 LIBRARY; T=293.6K
Photon emission for (n,n*29)

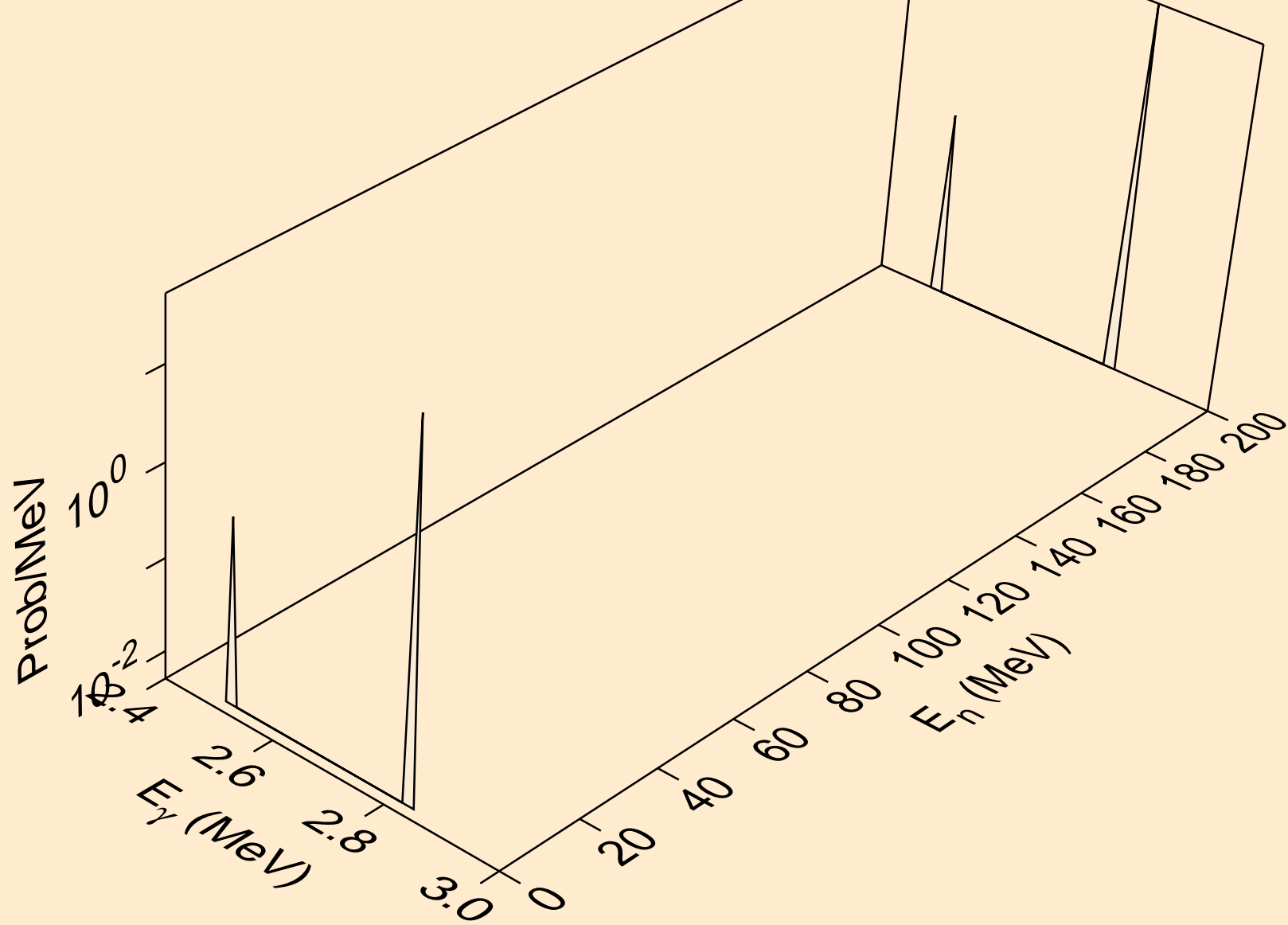

BR084M NEUTRON ACER TENDL-2021 LIBRARY; T=293.6K
Photon emission for (n,n*c)

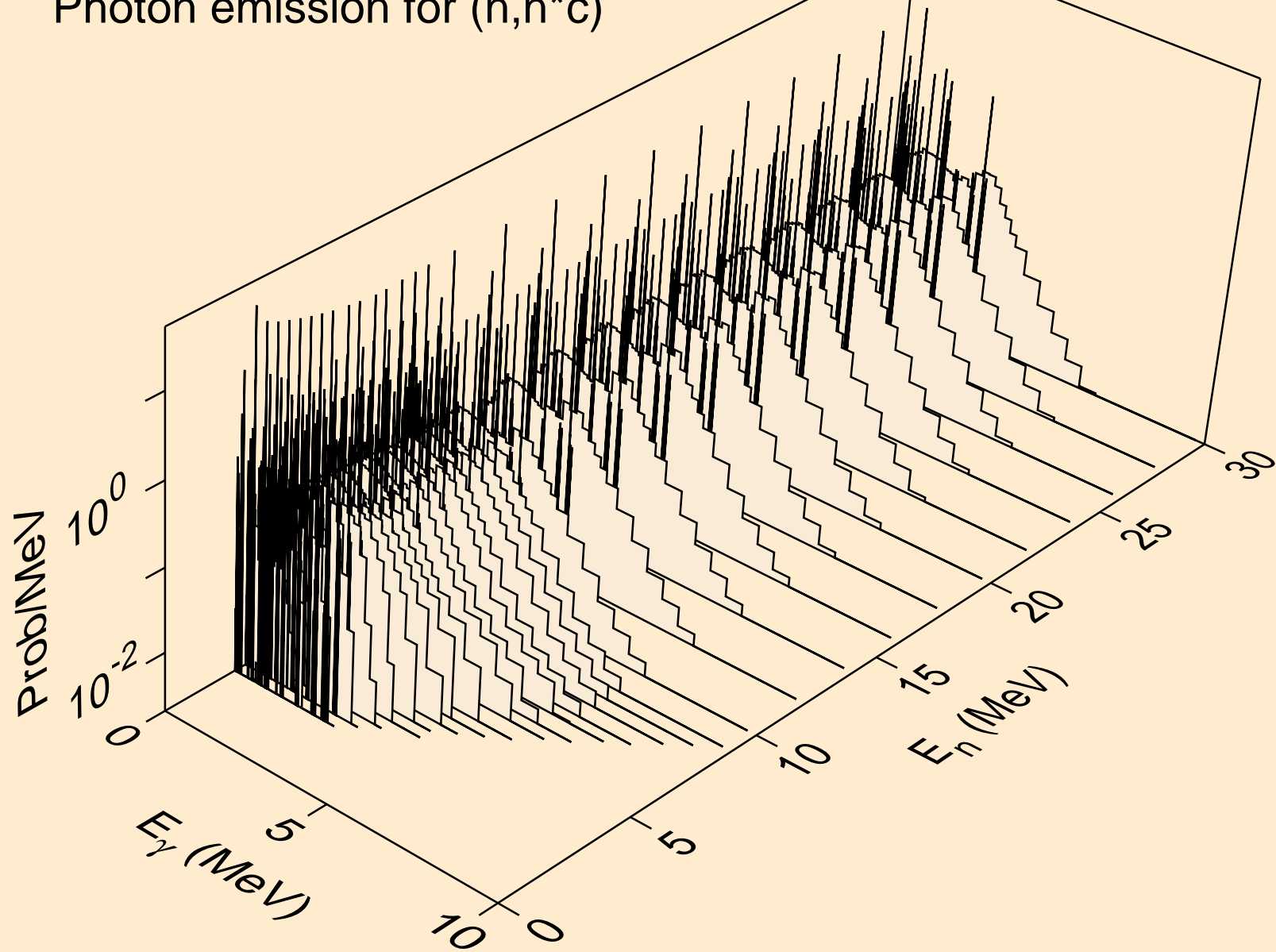

BR084M NEUTRON ACER TENDL-2021 LIBRARY; T=293.6K
Photon emission for (n,gma)

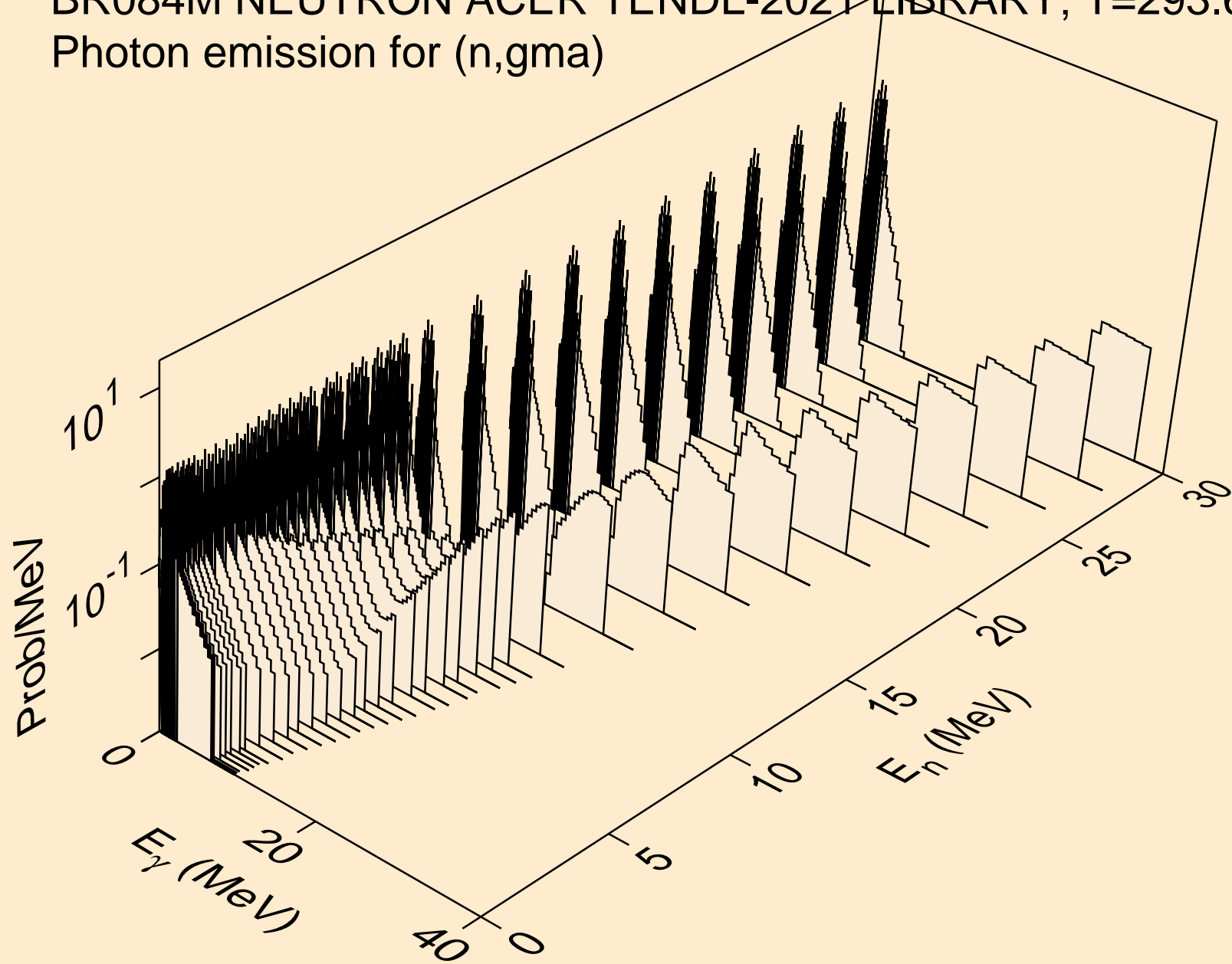

BR084M NEUTRON ACER TENDL-2021 LIBRARY; T=293.6K
Photon emission for (n,p)

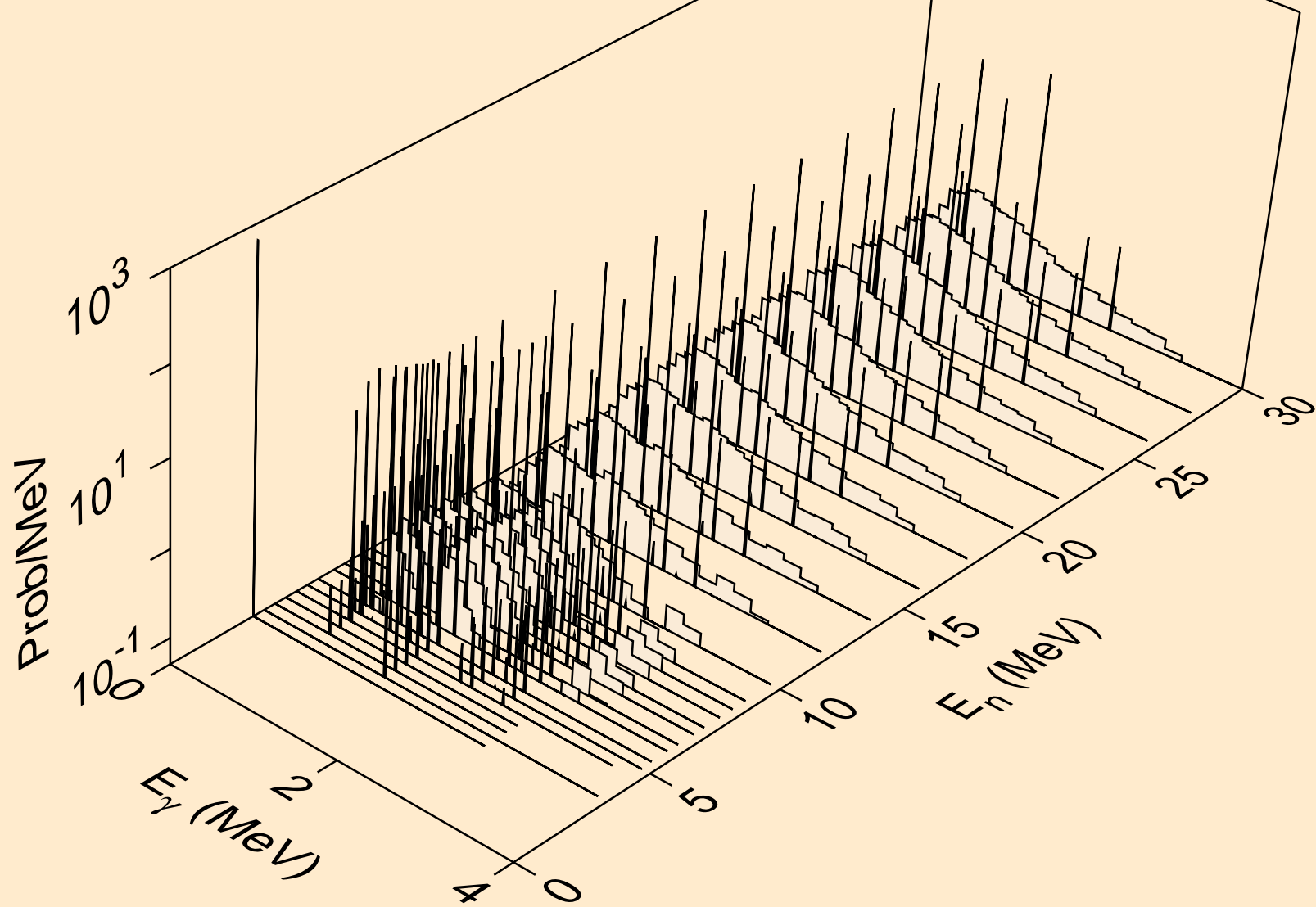

BR084M NEUTRON ACER TENDL-2021 LIBRARY; T=293.6K
Photon emission for (n,d)

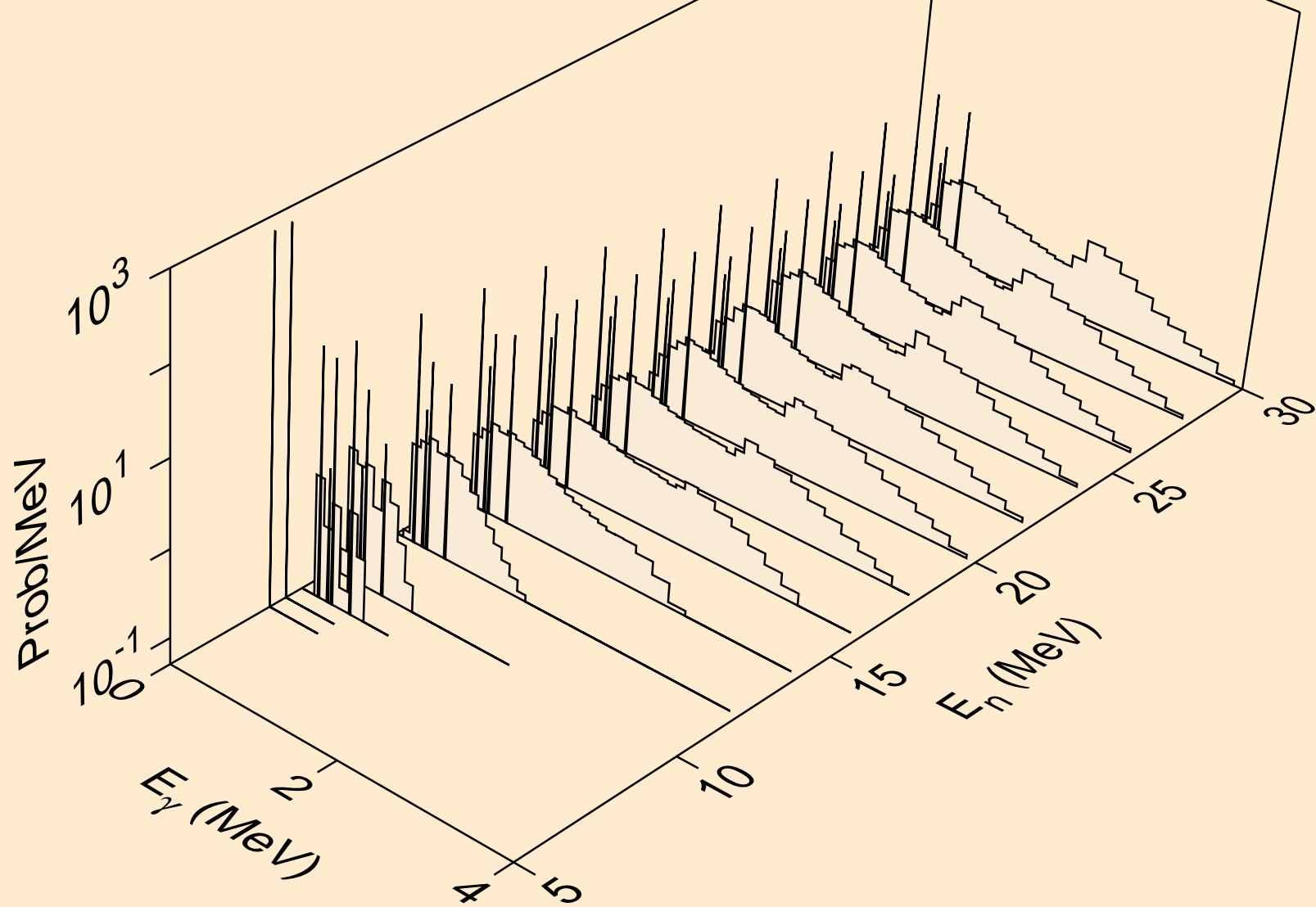

BR084M NEUTRON ACER TENDL-2021 LIBRARY; T=293.6K
Photon emission for (n,t)

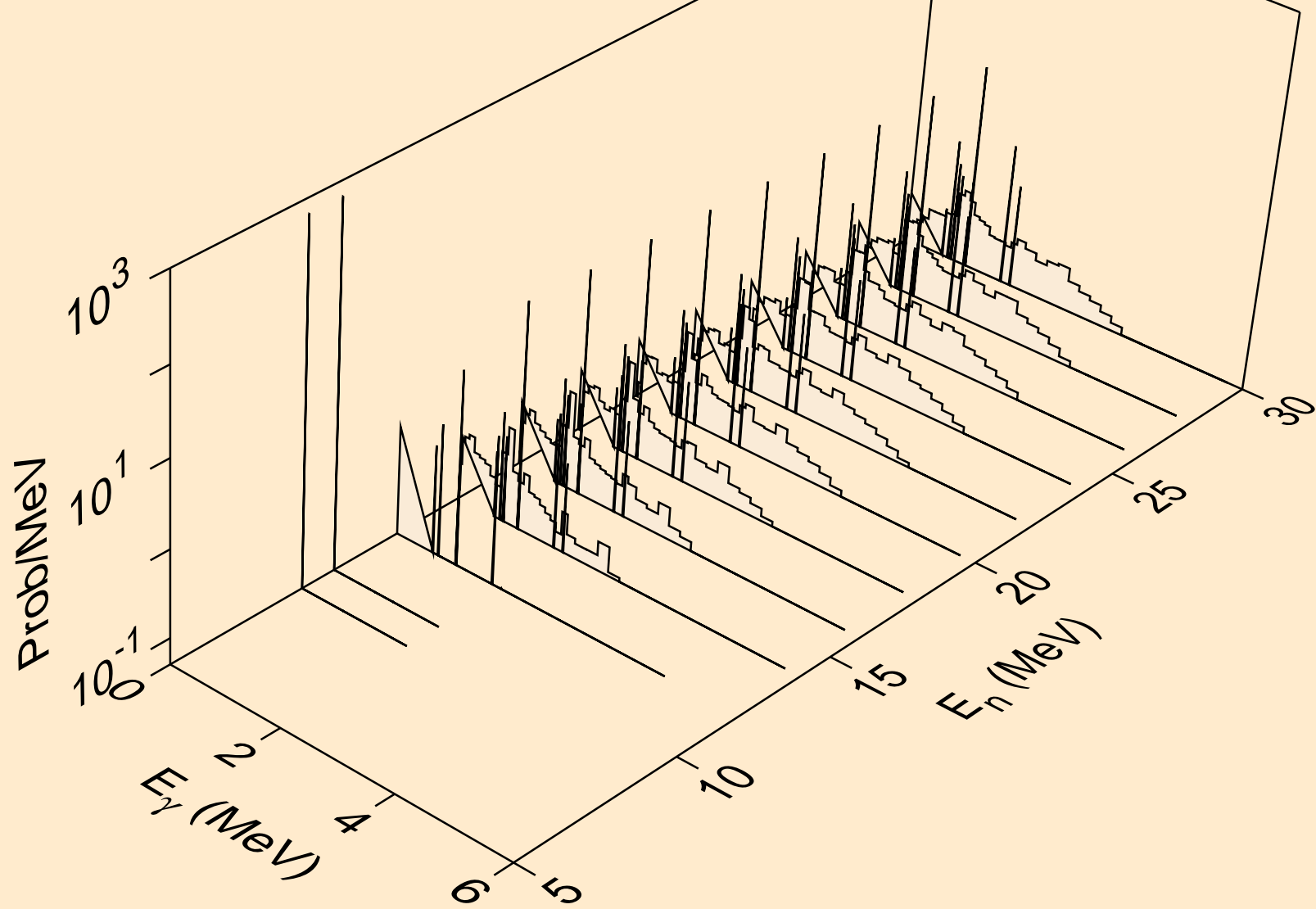

BR084M NEUTRON ACER TENDL-2021 LIBRARY; T=293.6K
Photon emission for (n,he3)

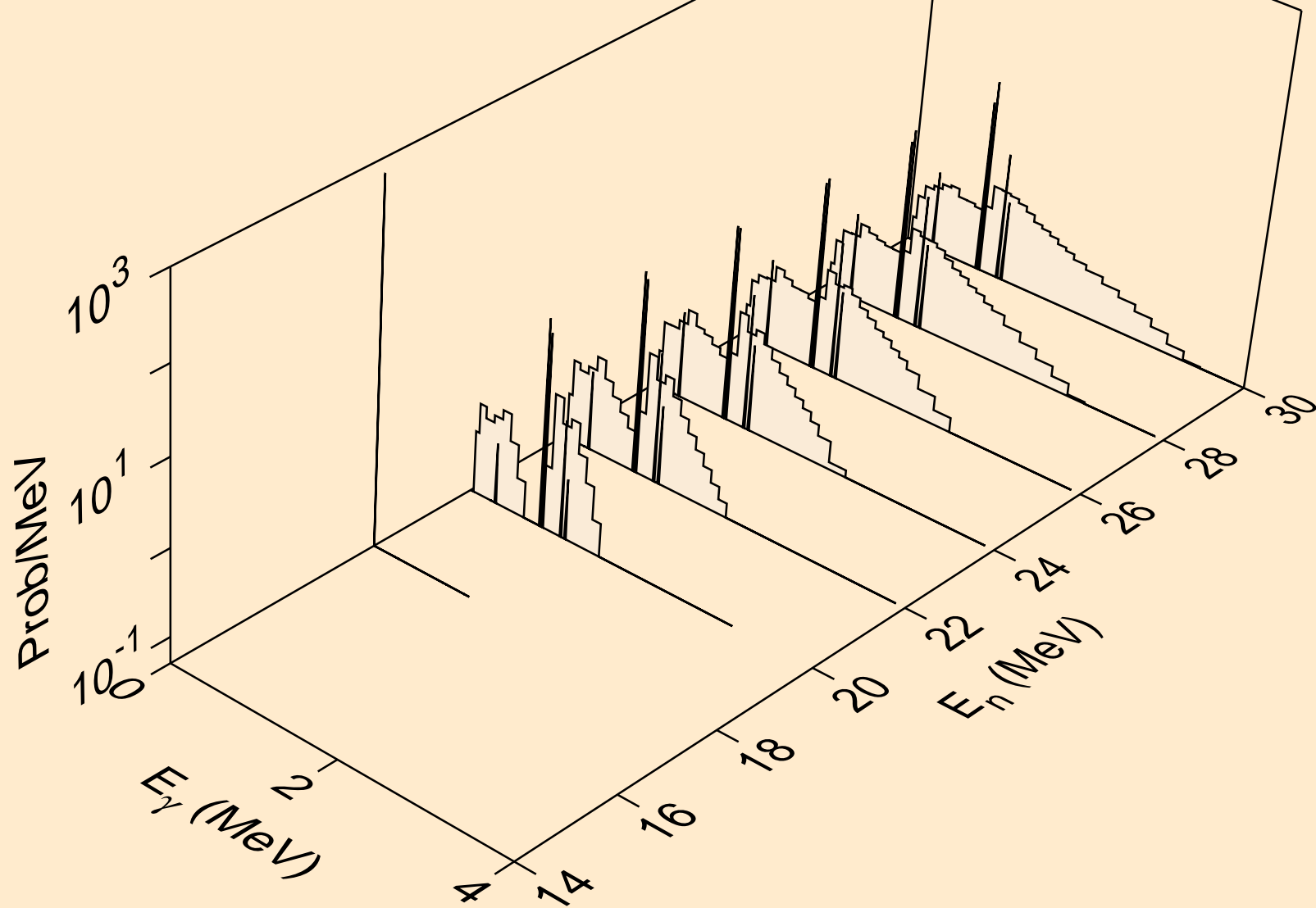

BR084M NEUTRON ACER TENDL-2021 LIBRARY; T=293.6K
Photon emission for (n,a)

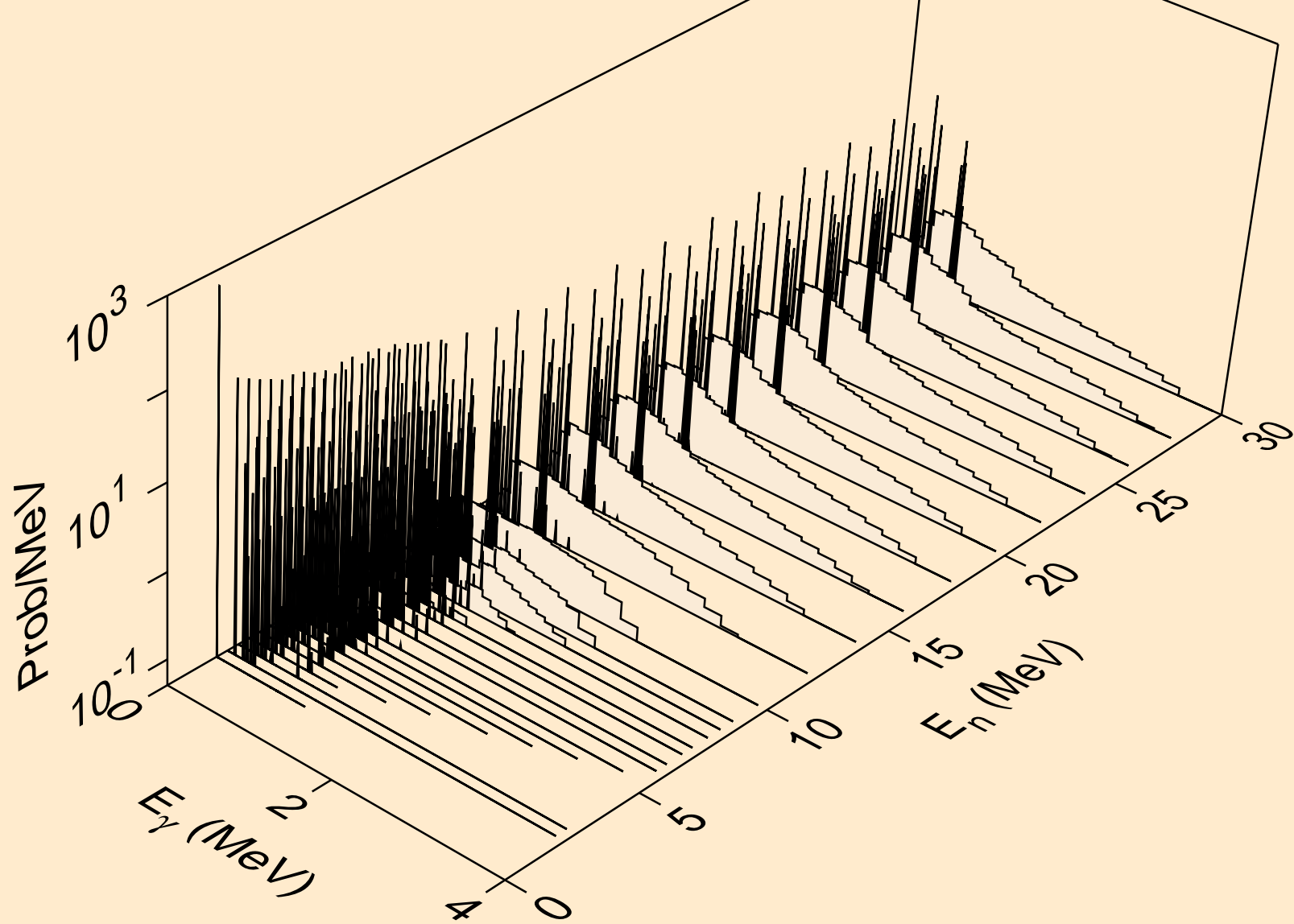

BR084M NEUTRON ACER TENDL-2021 LIBRARY; T=293.6K
Photon emission for (n,2a)

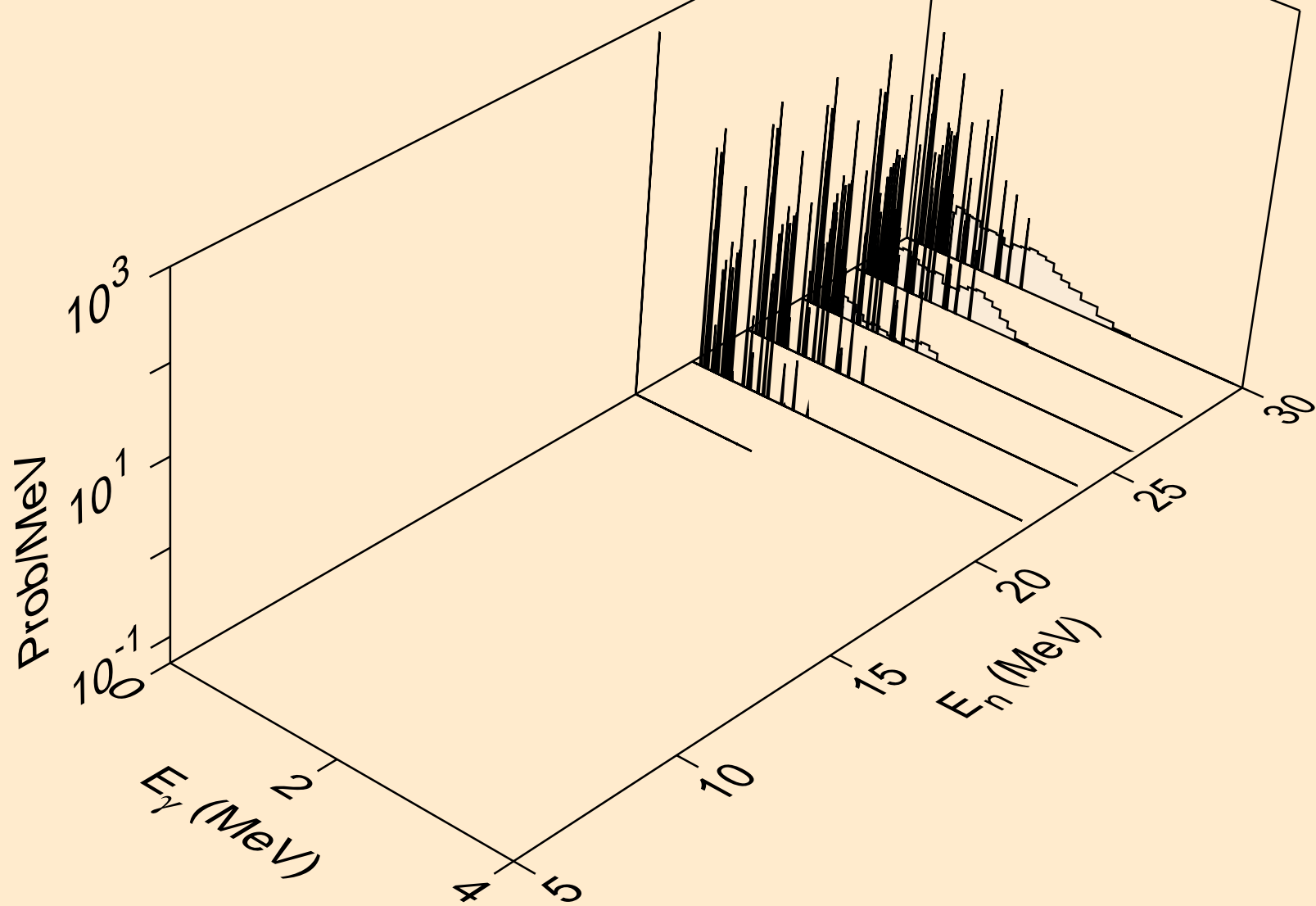

BR084M NEUTRON ACER TENDL-2021 LIBRARY; T=293.6K
Photon emission for (n,2p)

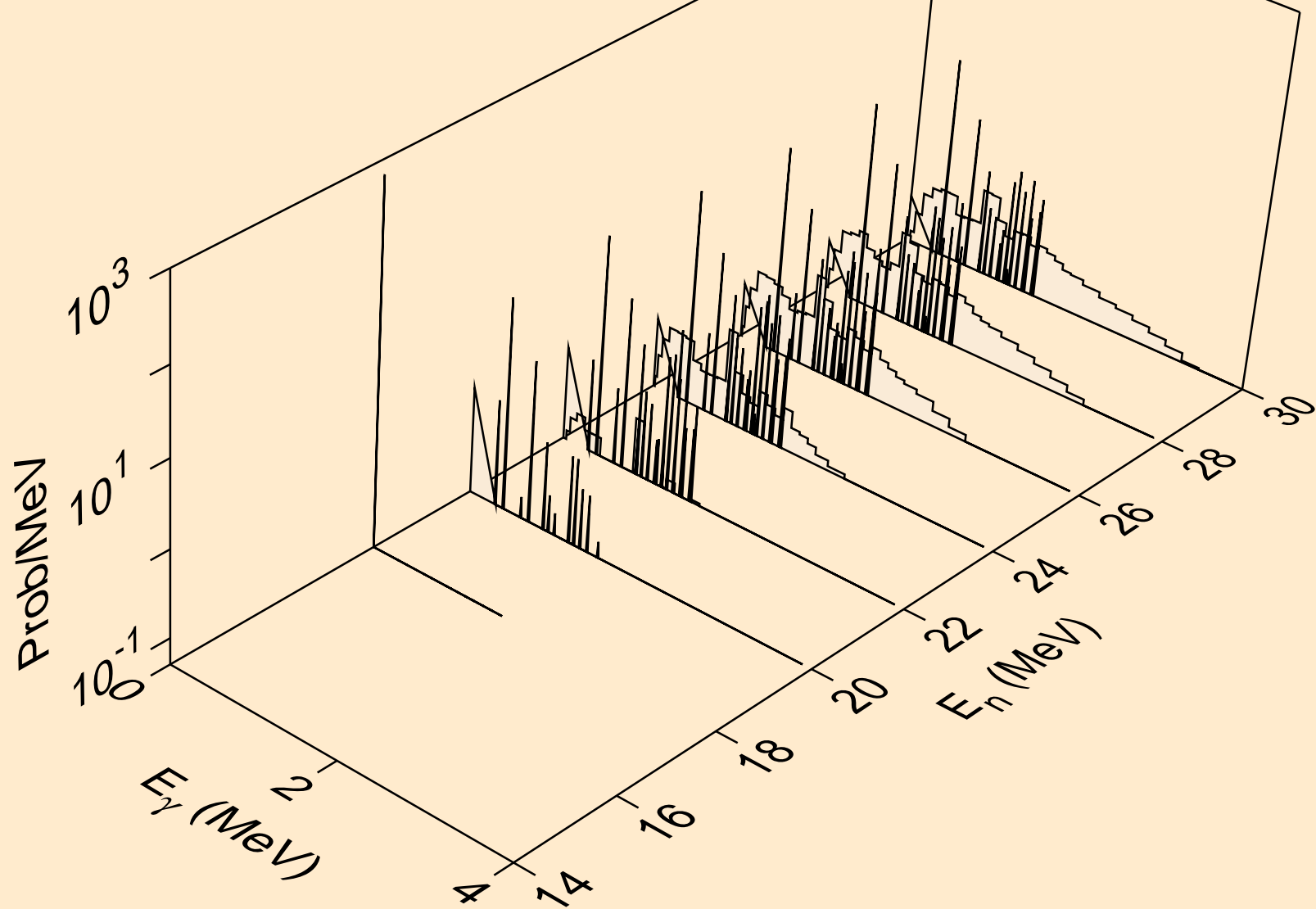

BR084M NEUTRON ACER TENDL-2021 LIBRARY; T=293.6K
Photon emission for (n,p)

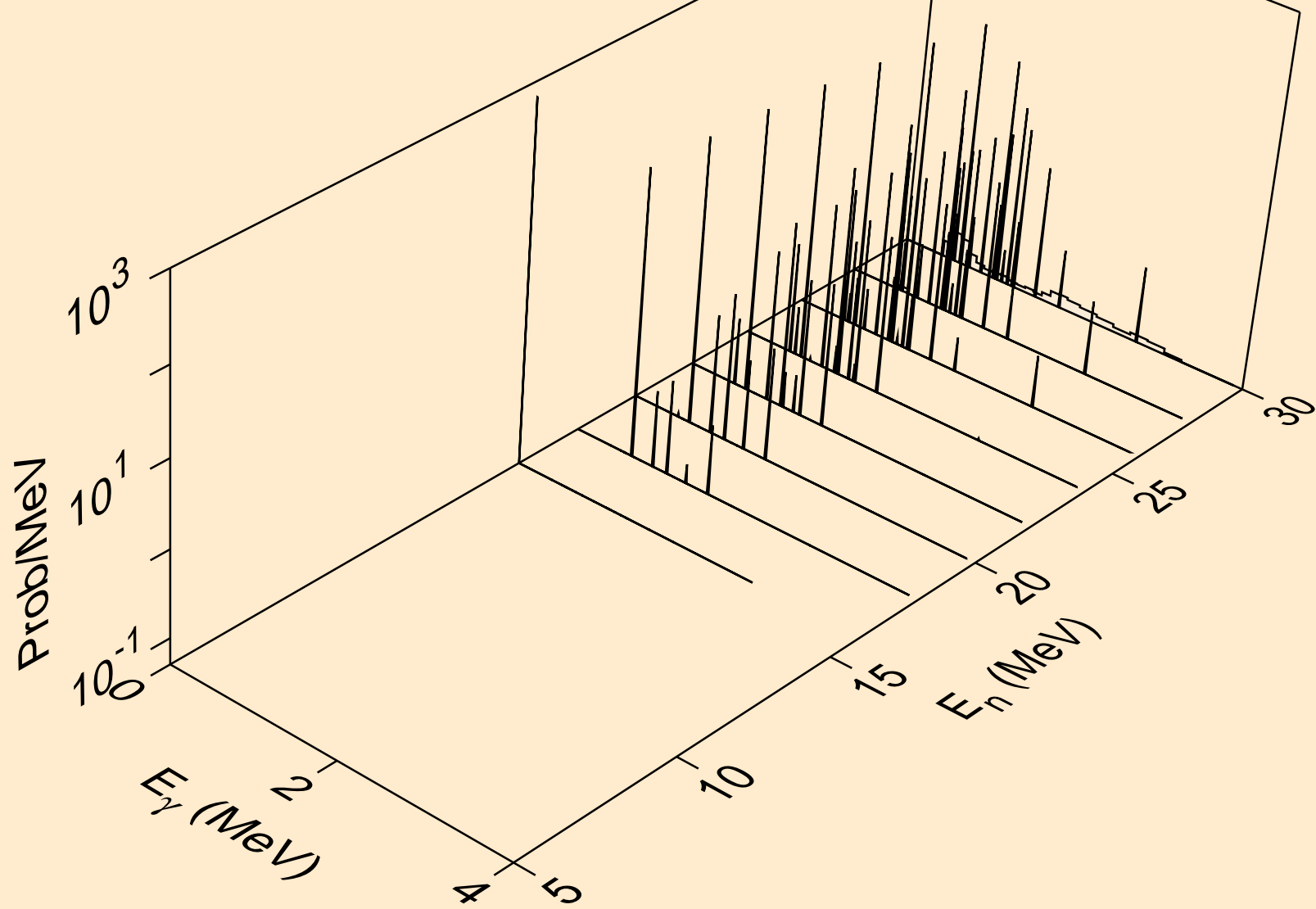

BR084M NEUTRON ACER TENDL-2021 LIBRARY; T=293.6K
Photon emission for (n,pd)

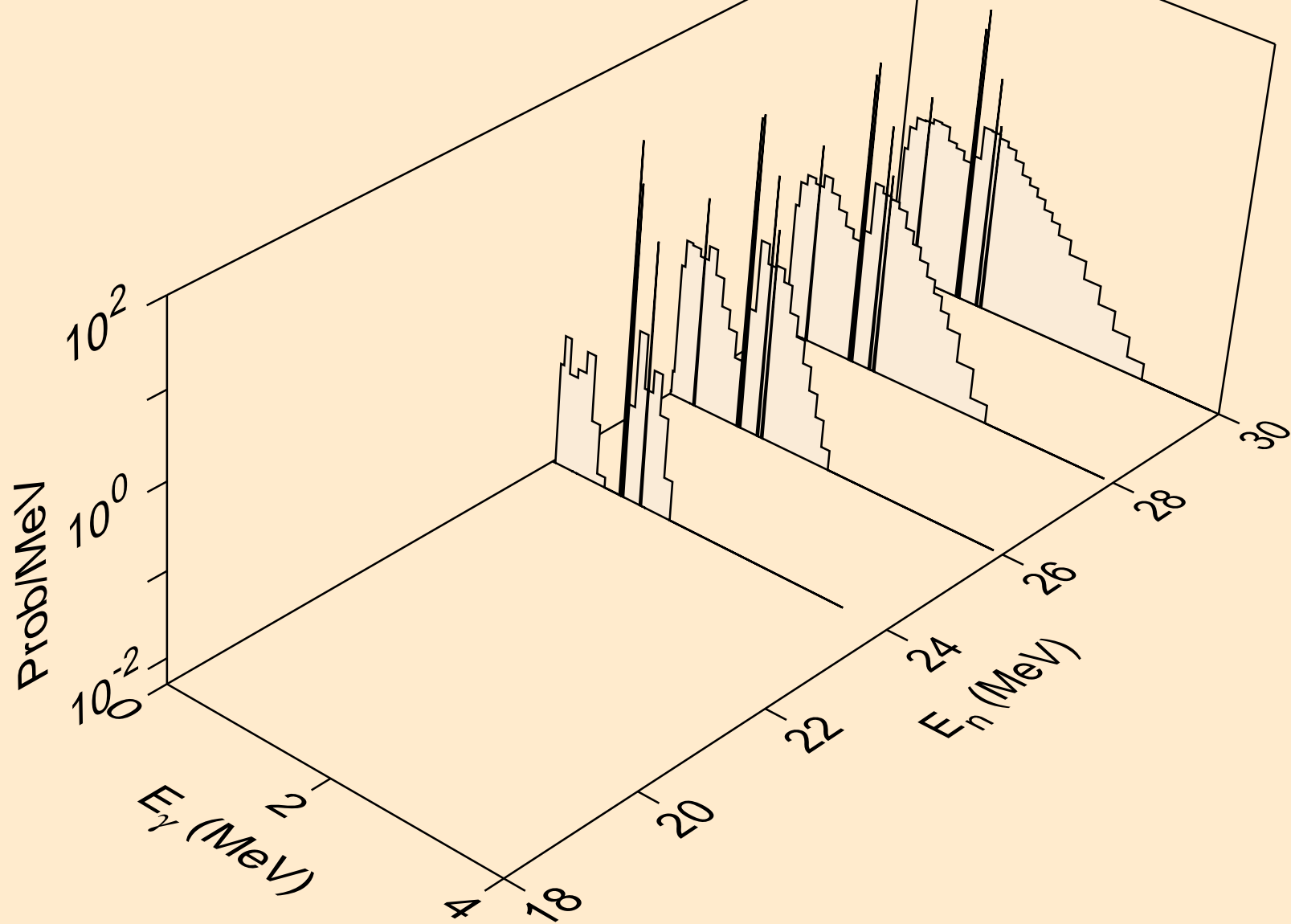

BR084M NEUTRON ACER TENDL-2021 LIBRARY; T=293.6K
Photon emission for (n,pt)

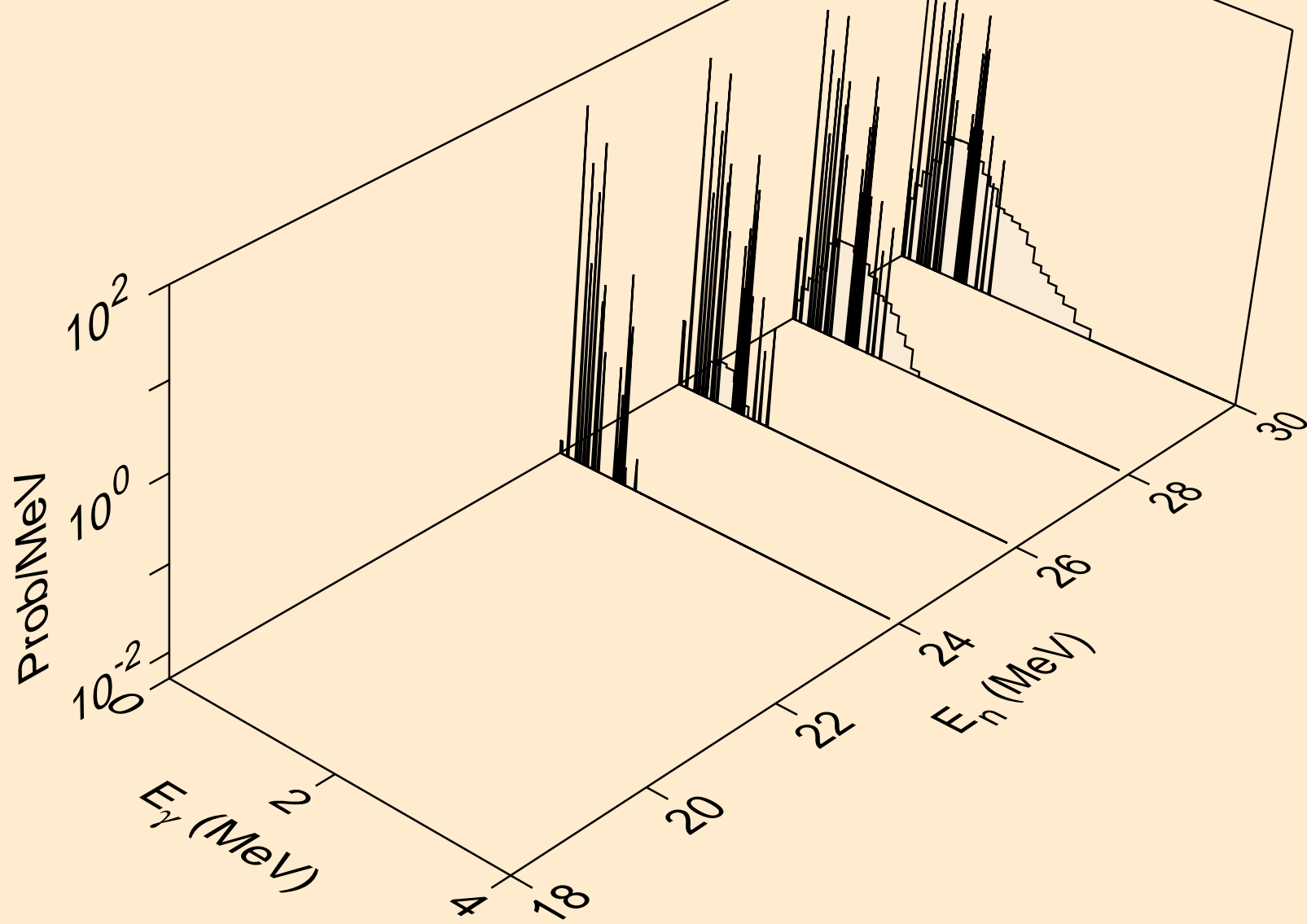

BR084M NEUTRON ACER TENDL-2021 LIBRARY; T=293.6K
Photon emission for (n,da)

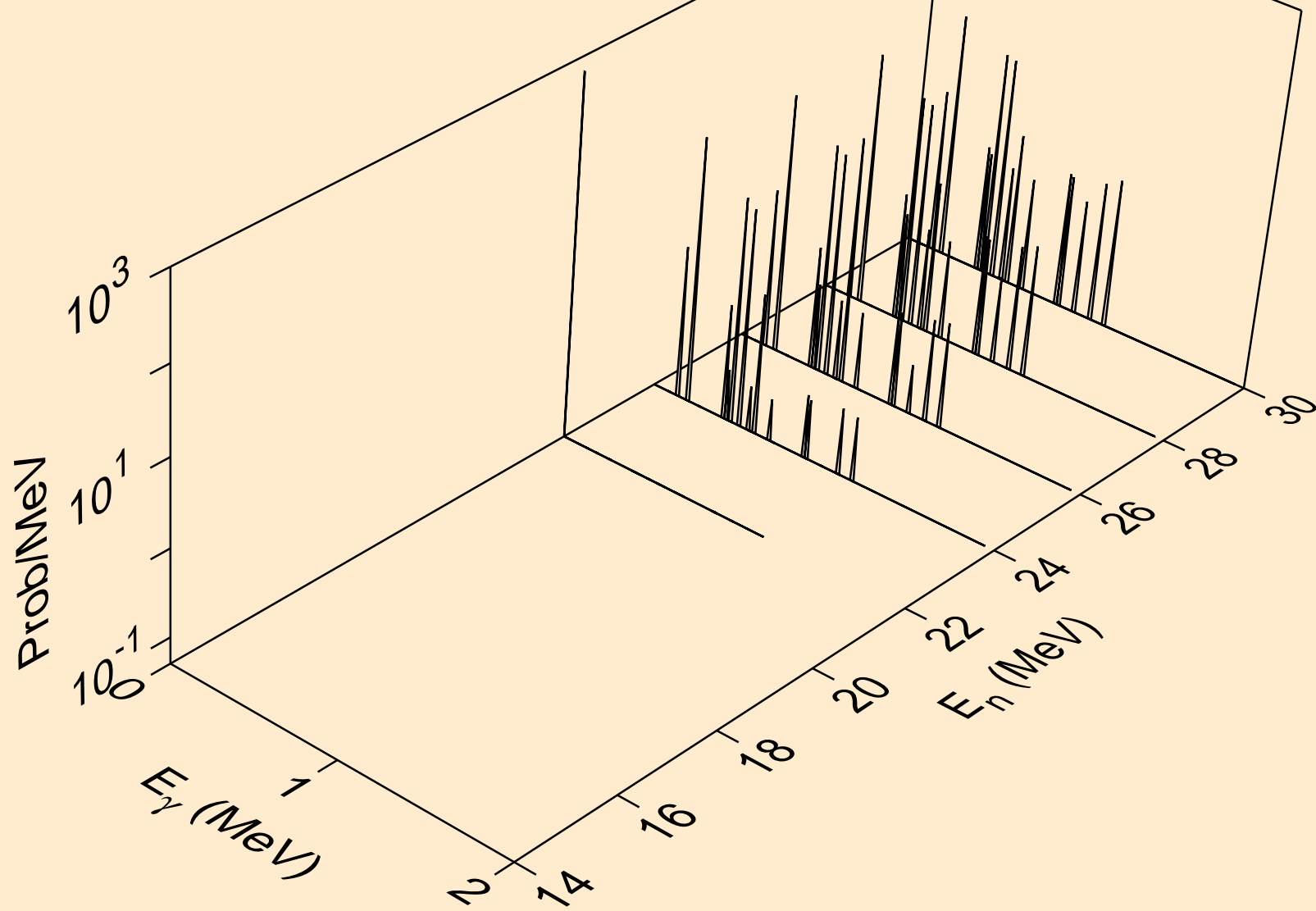

BR084M NEUTRON ACER TENDL-2021 LIBRARY; T=293.6K
thermal capture photon spectrum

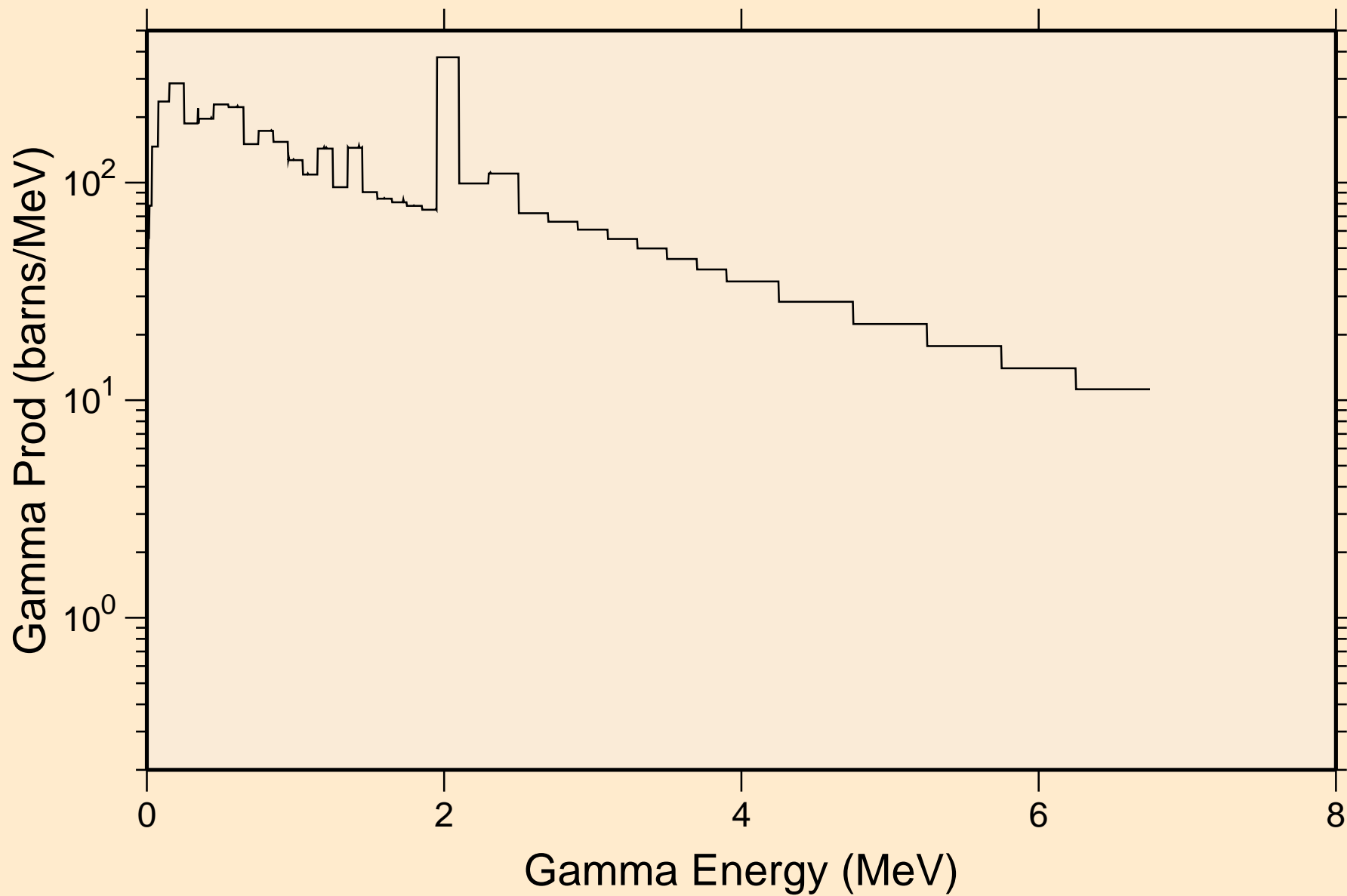

BR084M NEUTRON ACER TENDL-2021 LIBRARY; T=293.6K
14 MeV photon spectrum

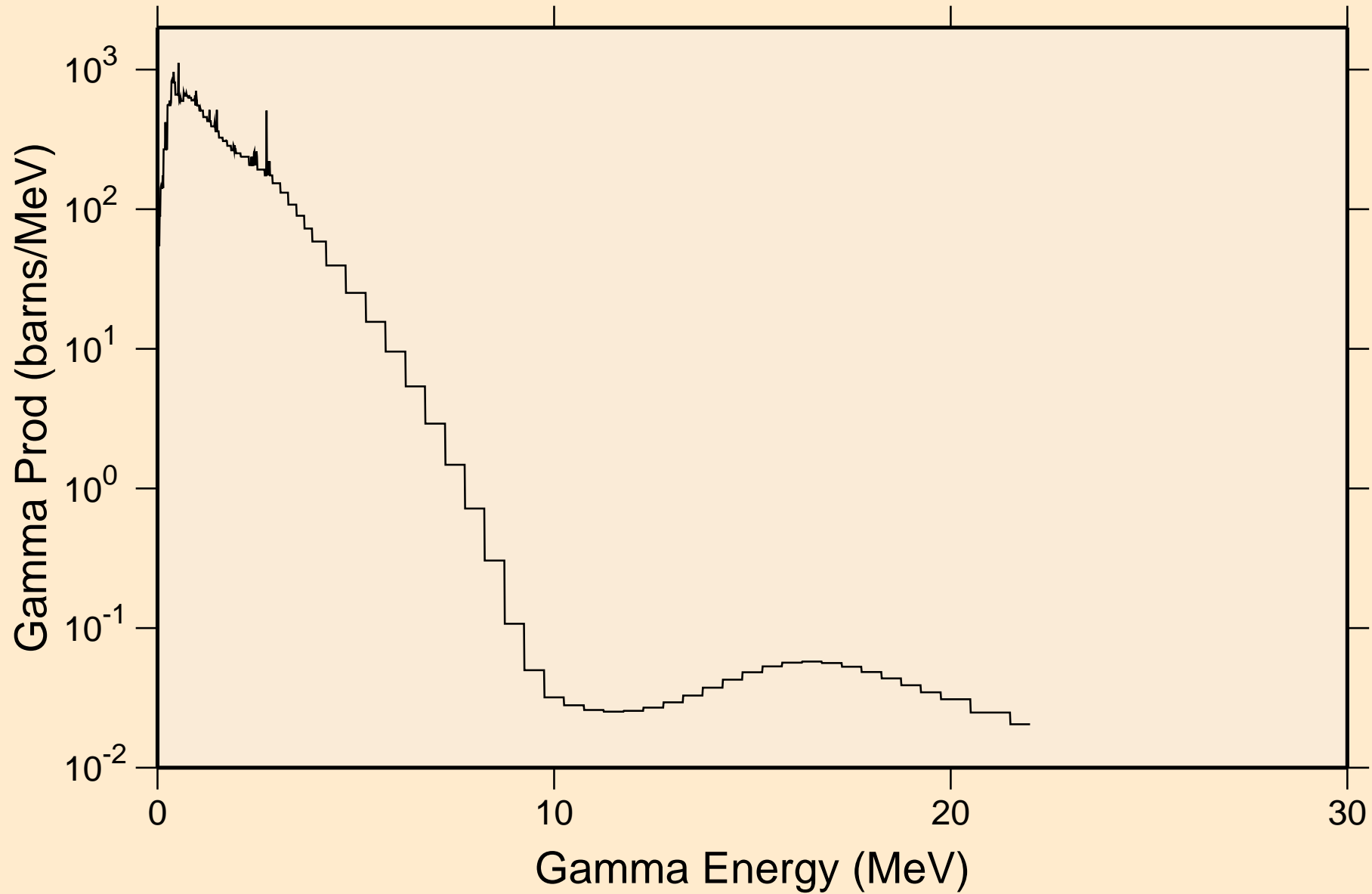

BR084M NEUTRON ACER TENDL-2021 LIBRARY; T=293.6K
Particle heating contributions

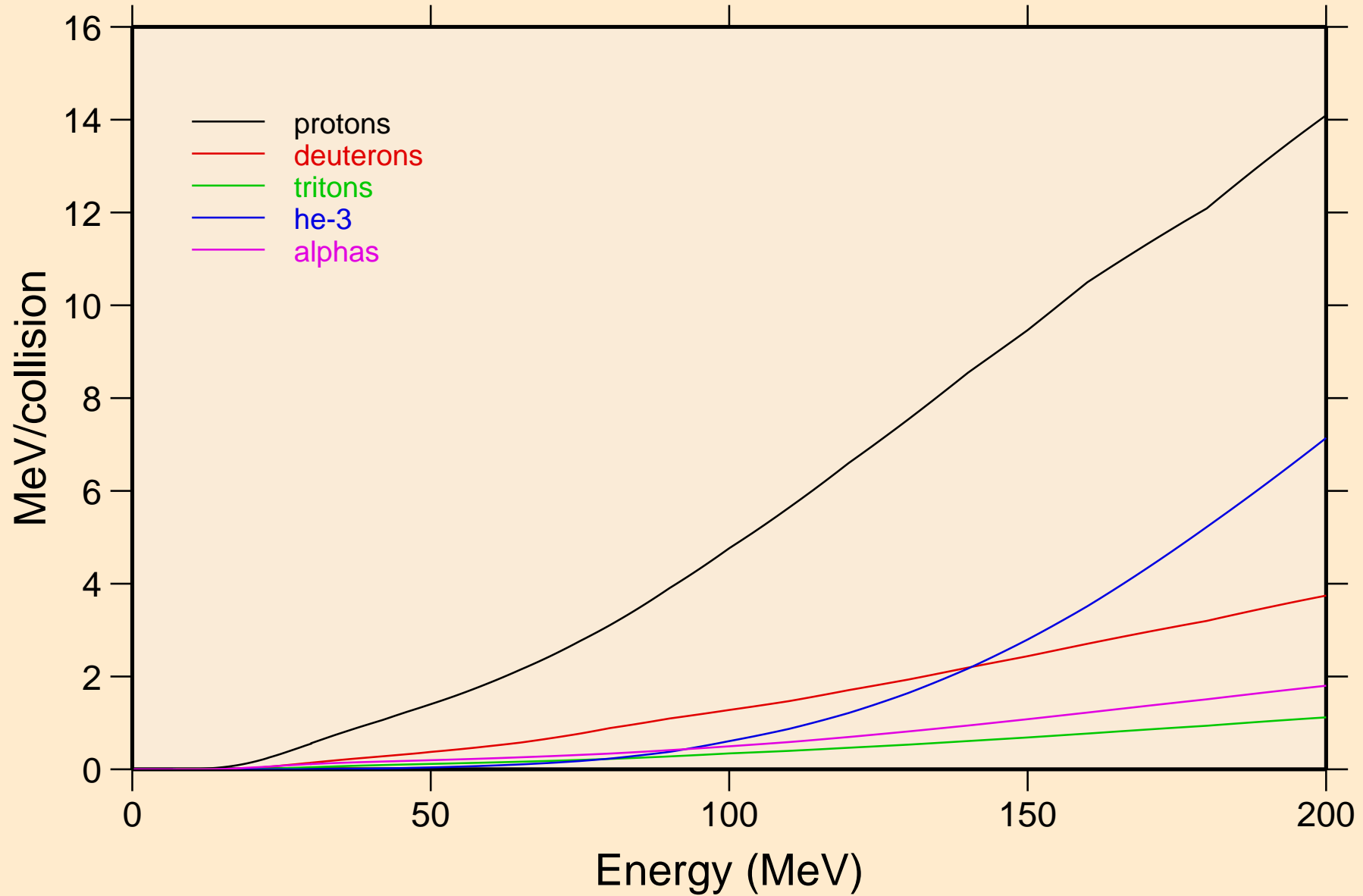

BR084M NEUTRON ACER TENDL-2021 LIBRARY; T=293.6K
Recoil Heating

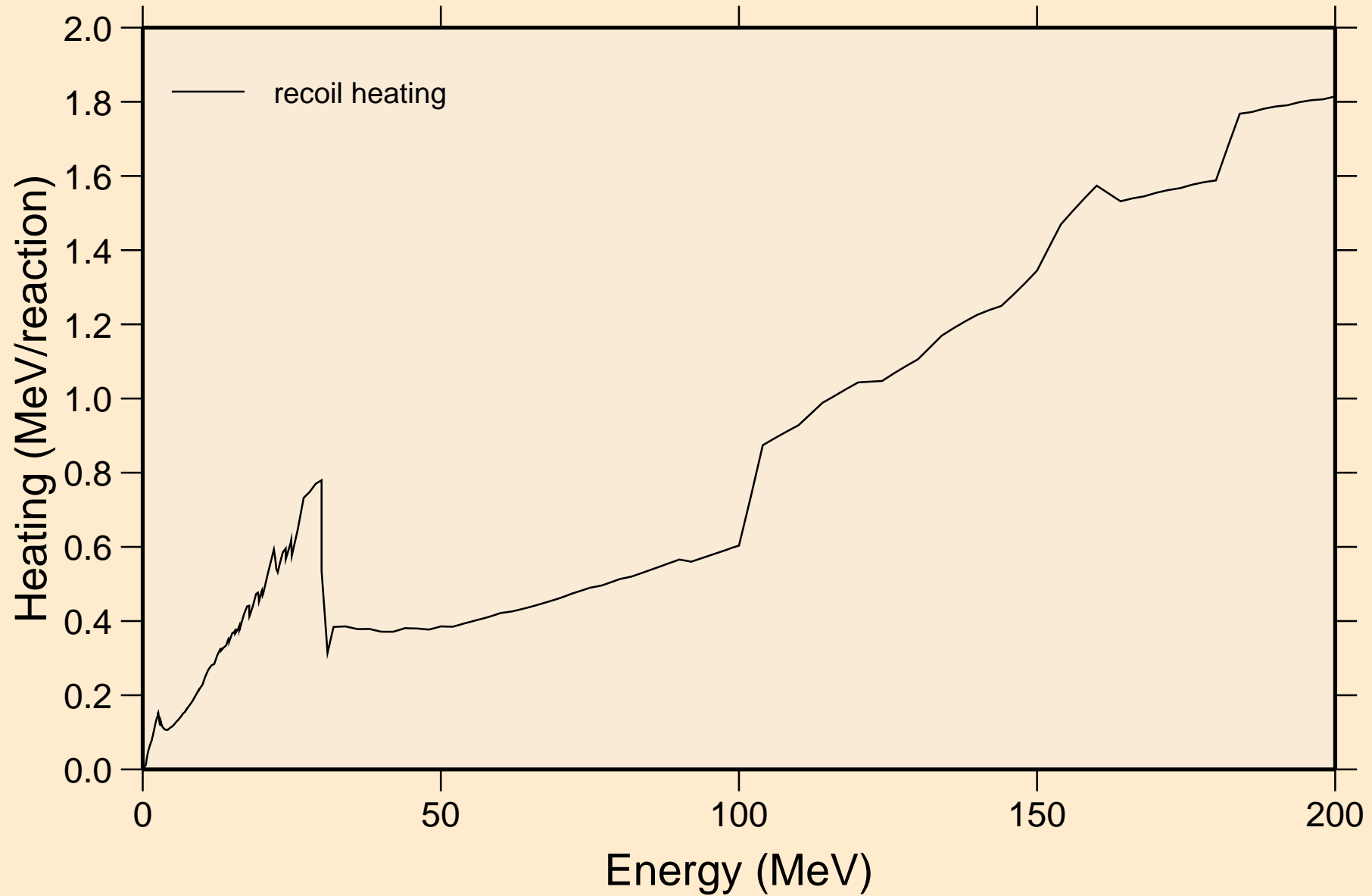

BR084M NEUTRON ACER TENDL-2021 LIBRARY; T=293.6K
Particle production cross sections

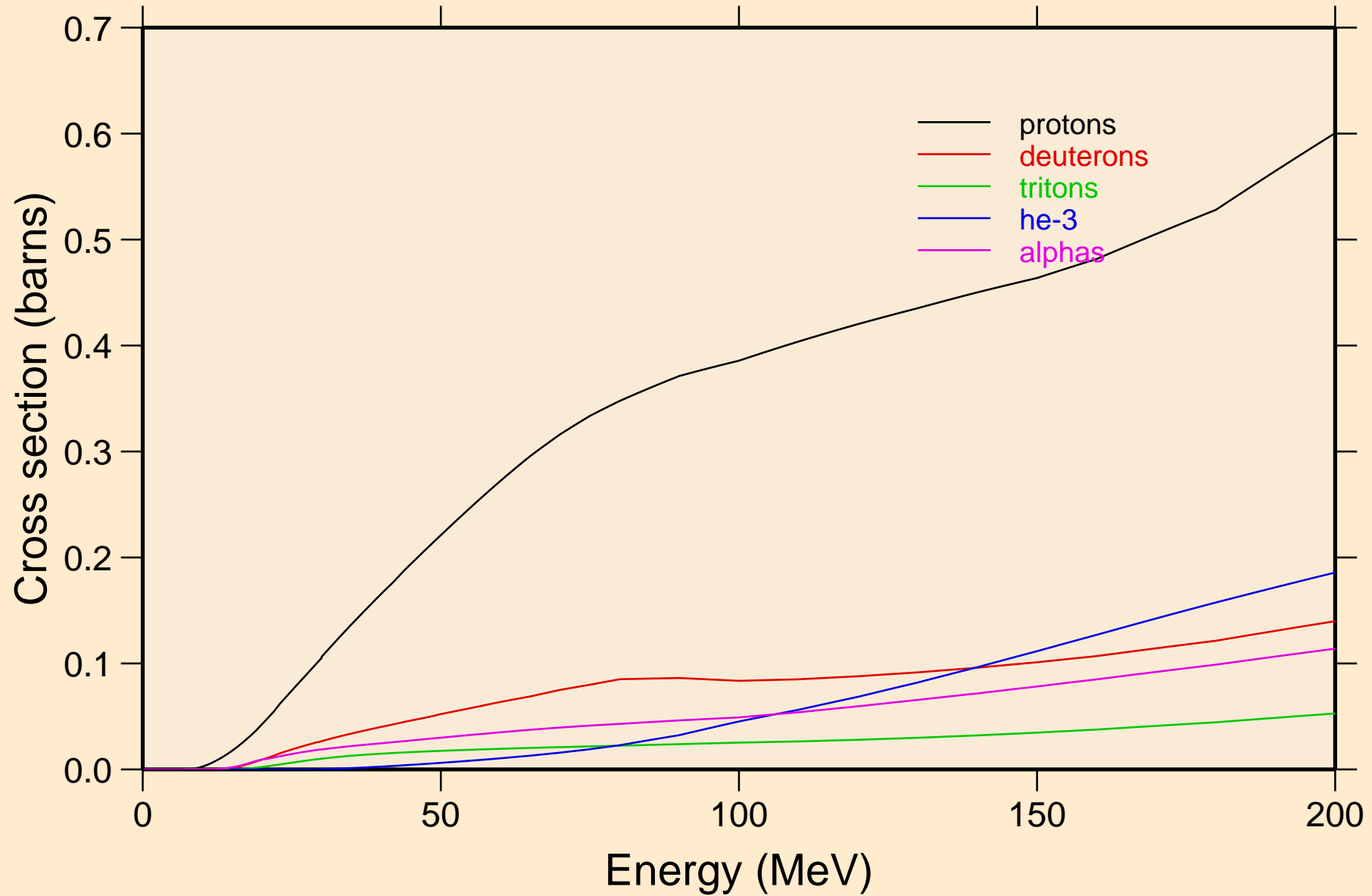

BR084M NEUTRON ACER TENDL-2021 LIBRARY; T=293.6K
protons from (n,x)

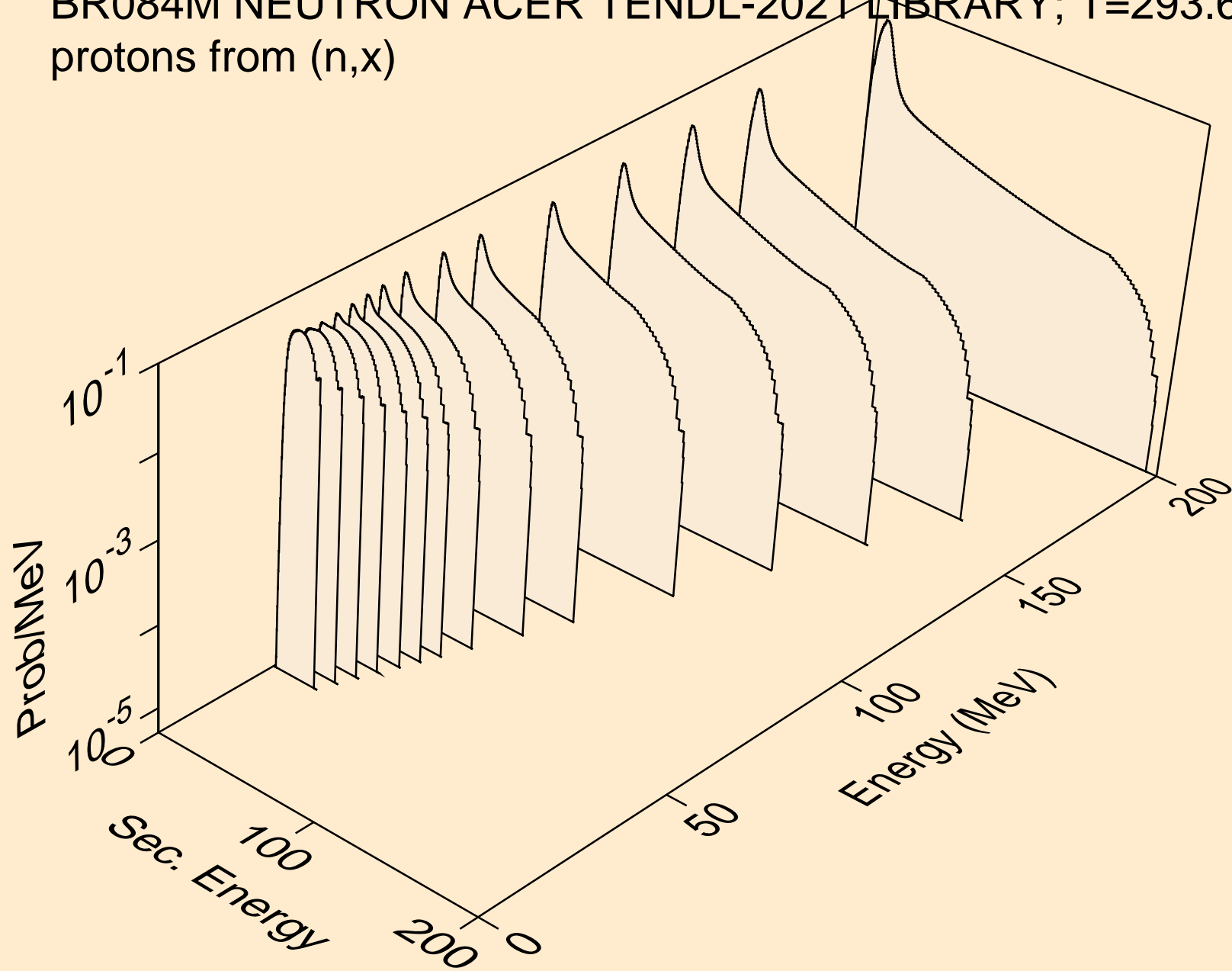

BR084M NEUTRON ACER TENDL-2021 LIBRARY; T=293.6K
protons from (n,n*)p

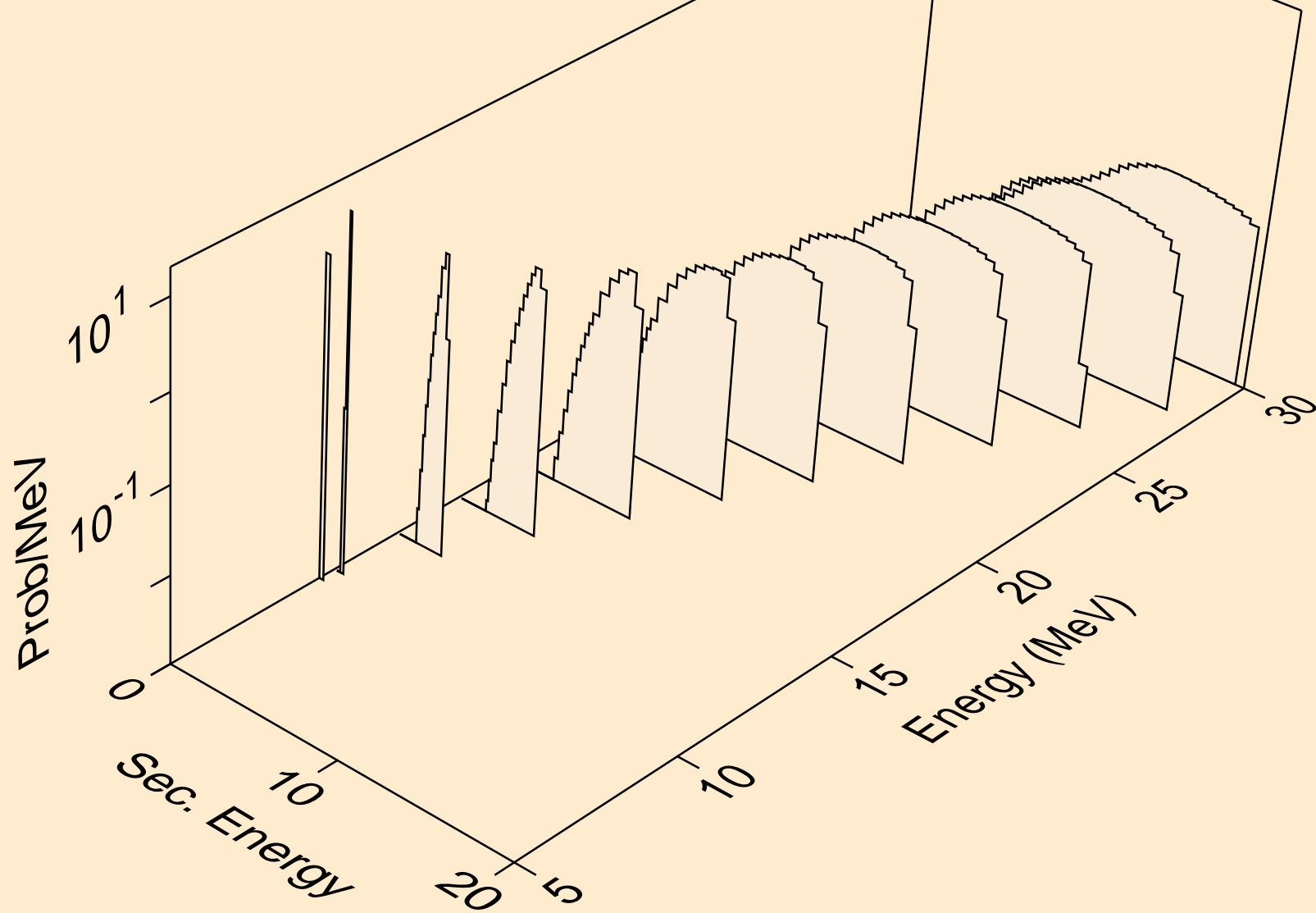

BR084M NEUTRON ACER TENDL-2021 LIBRARY; T=293.6K
protons from (n,2np)

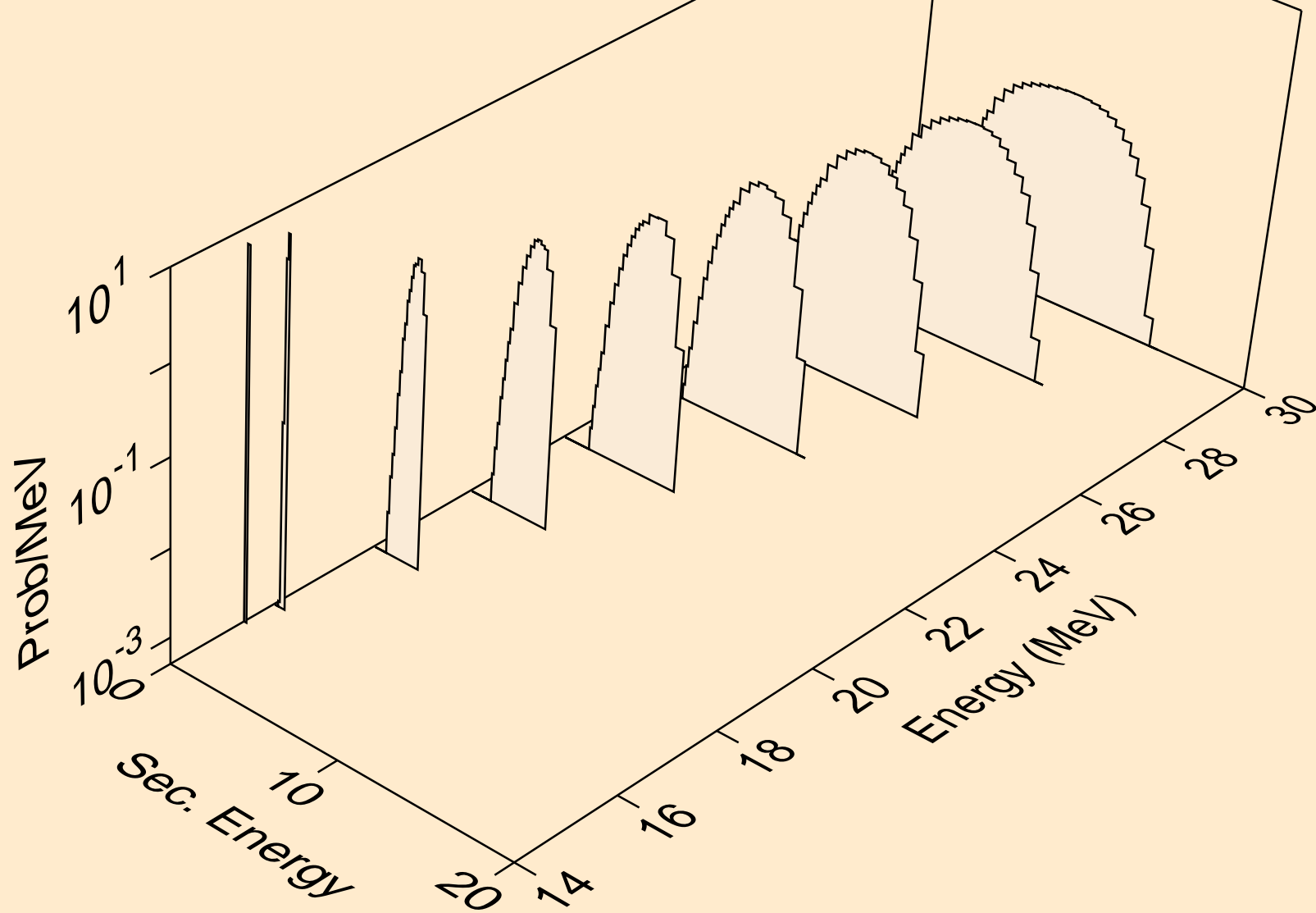

BR084M NEUTRON ACER TENDL-2021 LIBRARY; T=293.6K
protons from (n,3np)

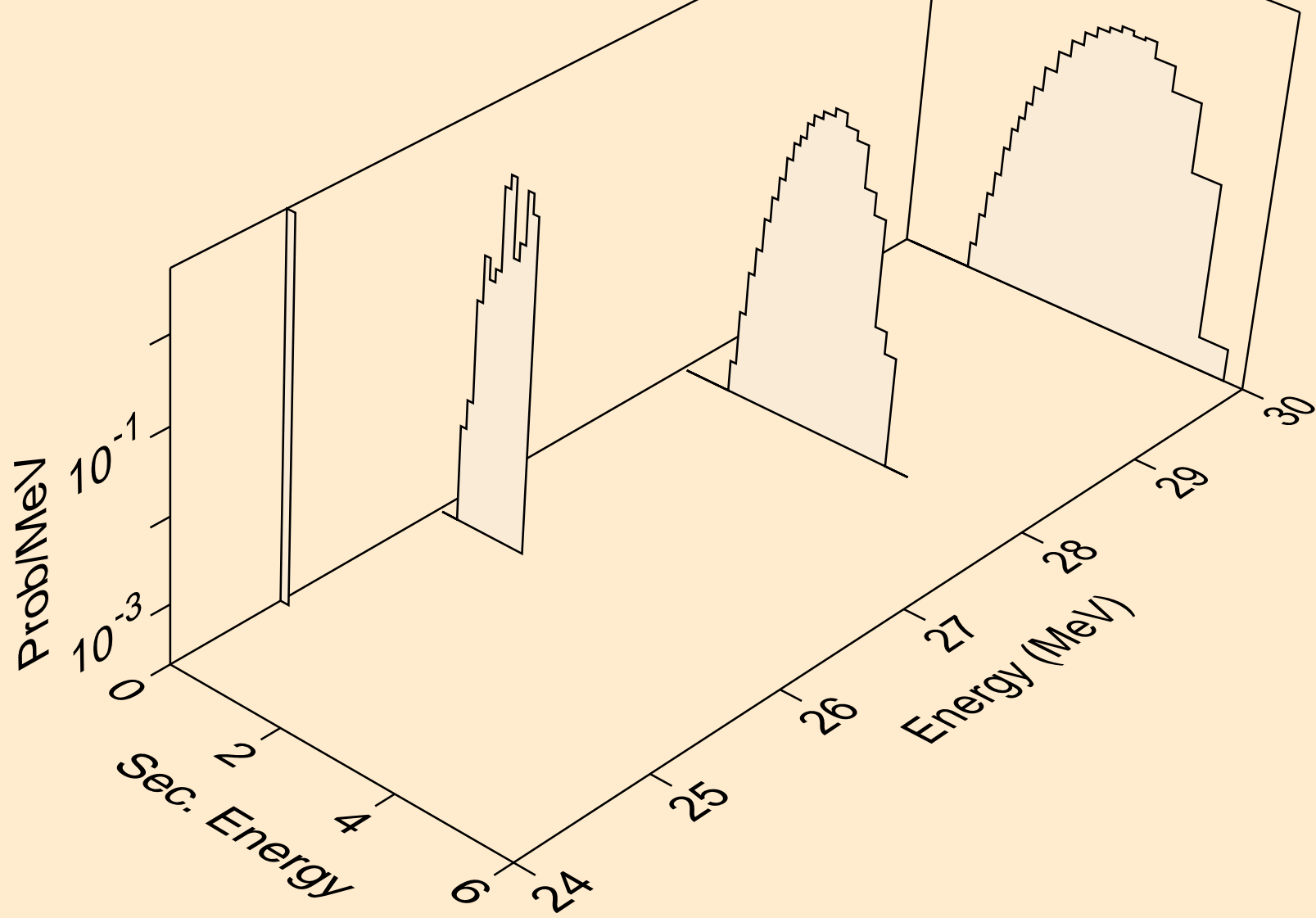

BR084M NEUTRON ACER TENDL-2021 LIBRARY; T=293.6K
protons from (n,2np)

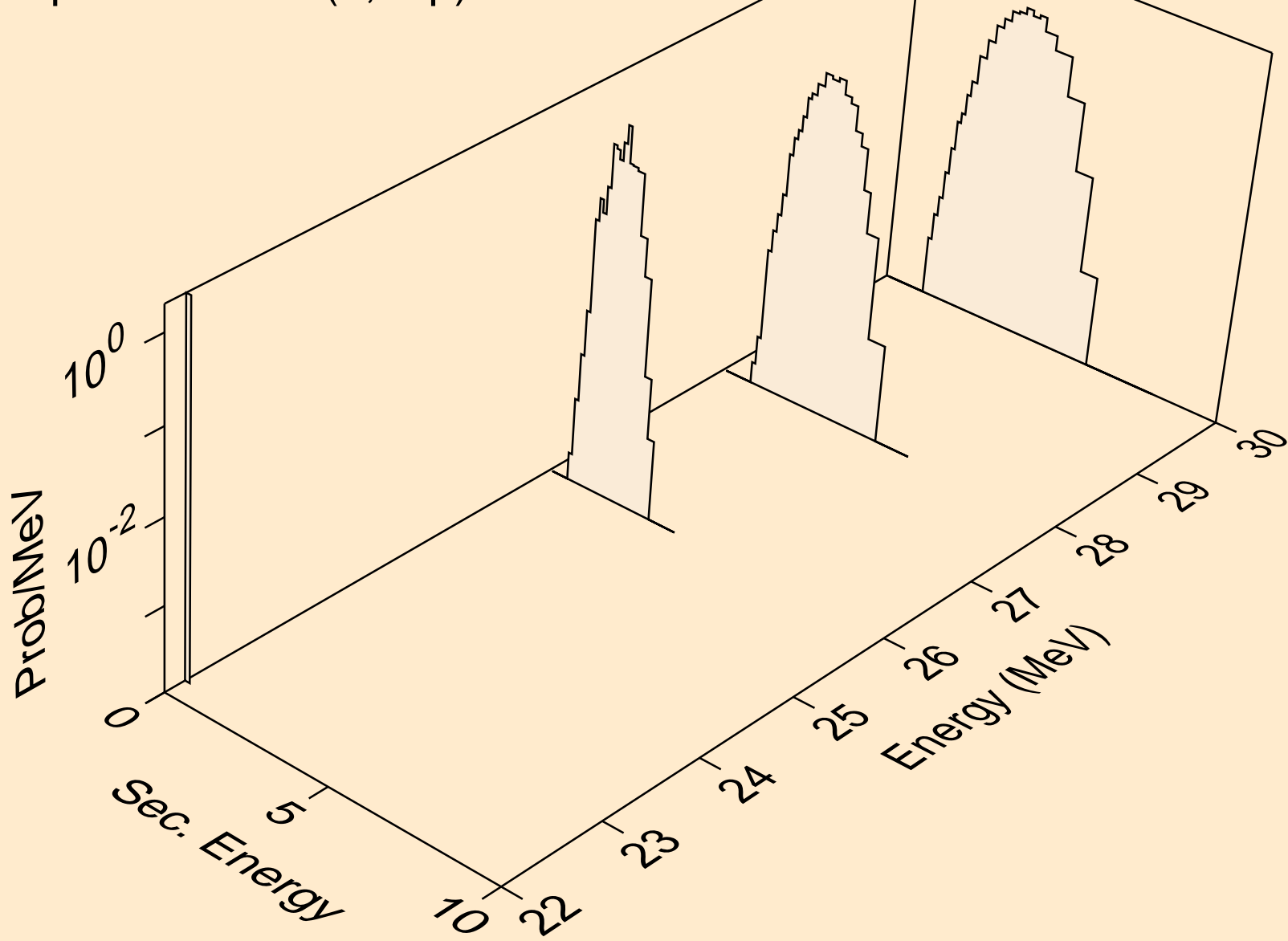

BR084M NEUTRON ACER TENDL-2021 LIBRARY; T=293.6K
protons from (n,npa)

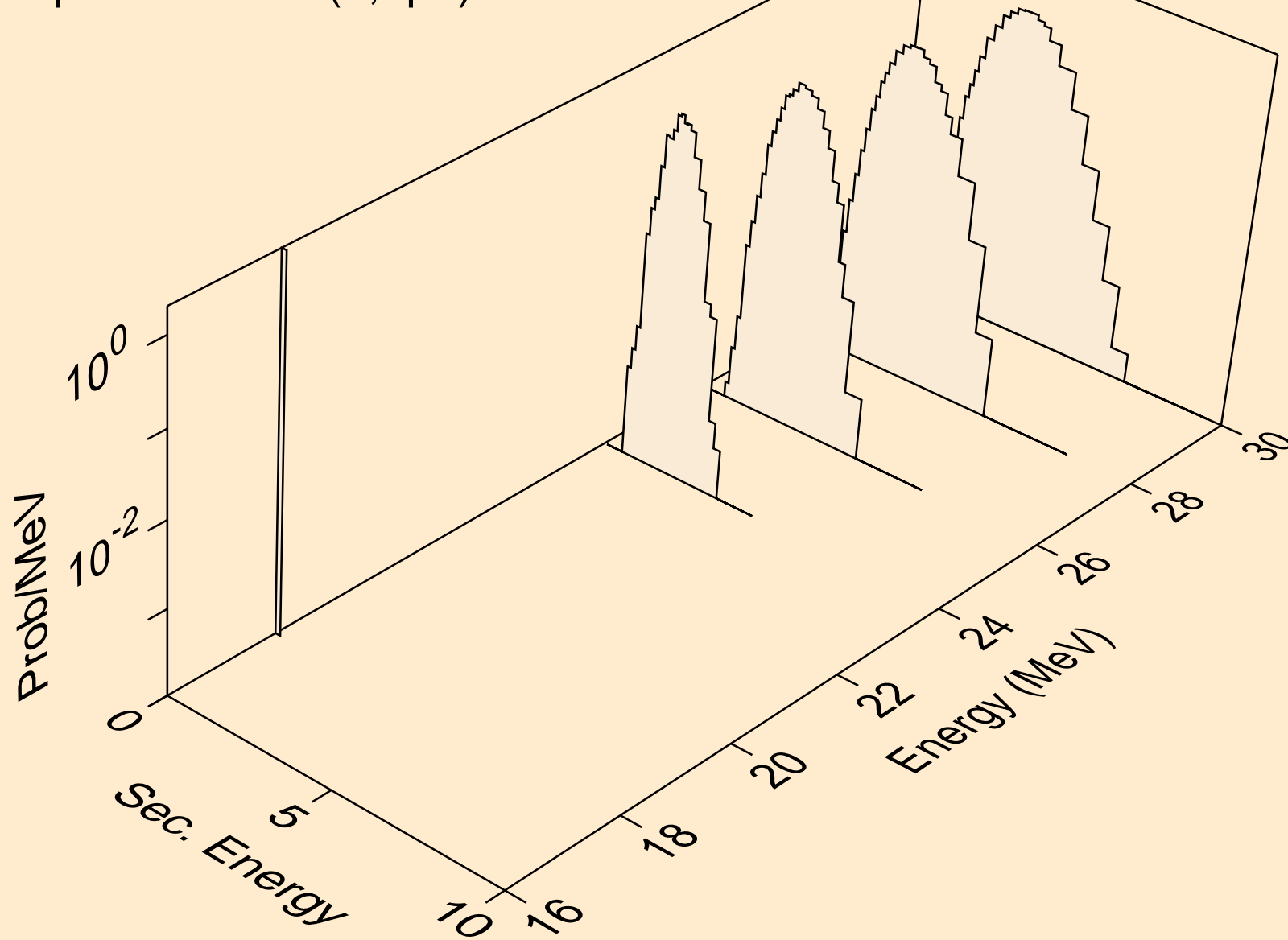

BR084M NEUTRON ACER TENDL-2021 LIBRARY; T=293.6K
protons from (n,p)

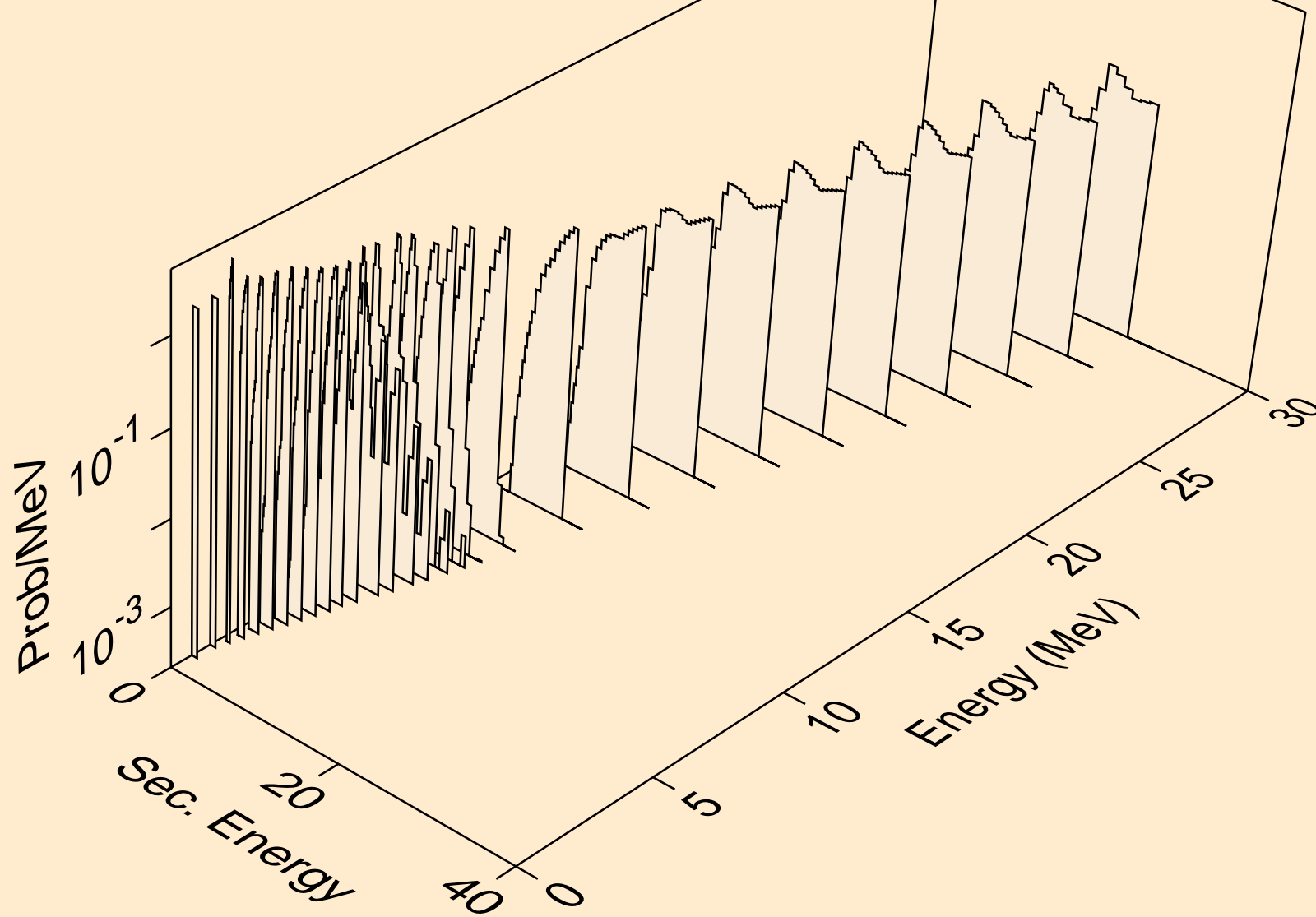

BR084M NEUTRON ACER TENDL-2021 LIBRARY; T=293.6K
protons from (n,2p)

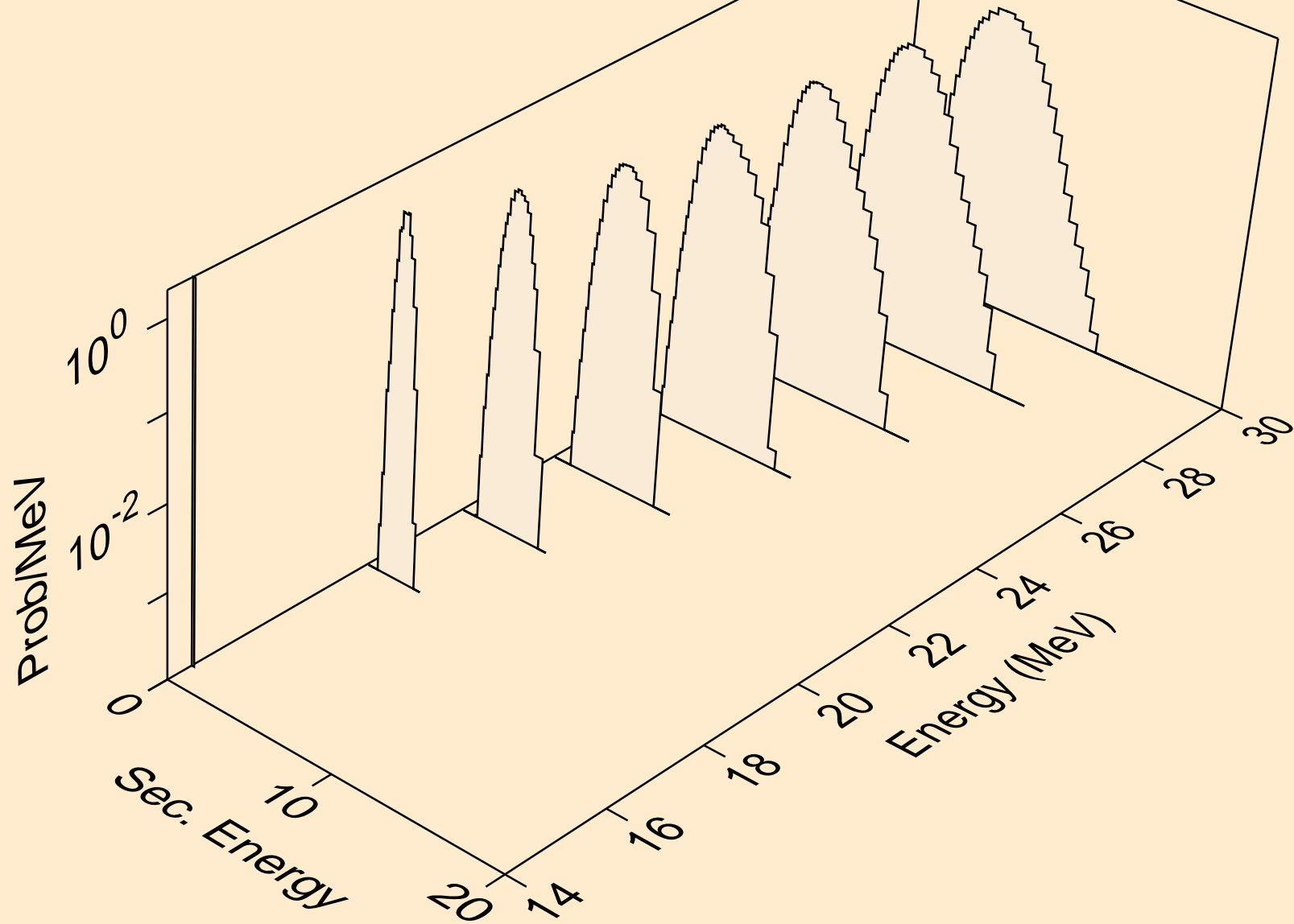

BR084M NEUTRON ACER TENDL-2021 LIBRARY; T=293.6K
protons from (n,p)

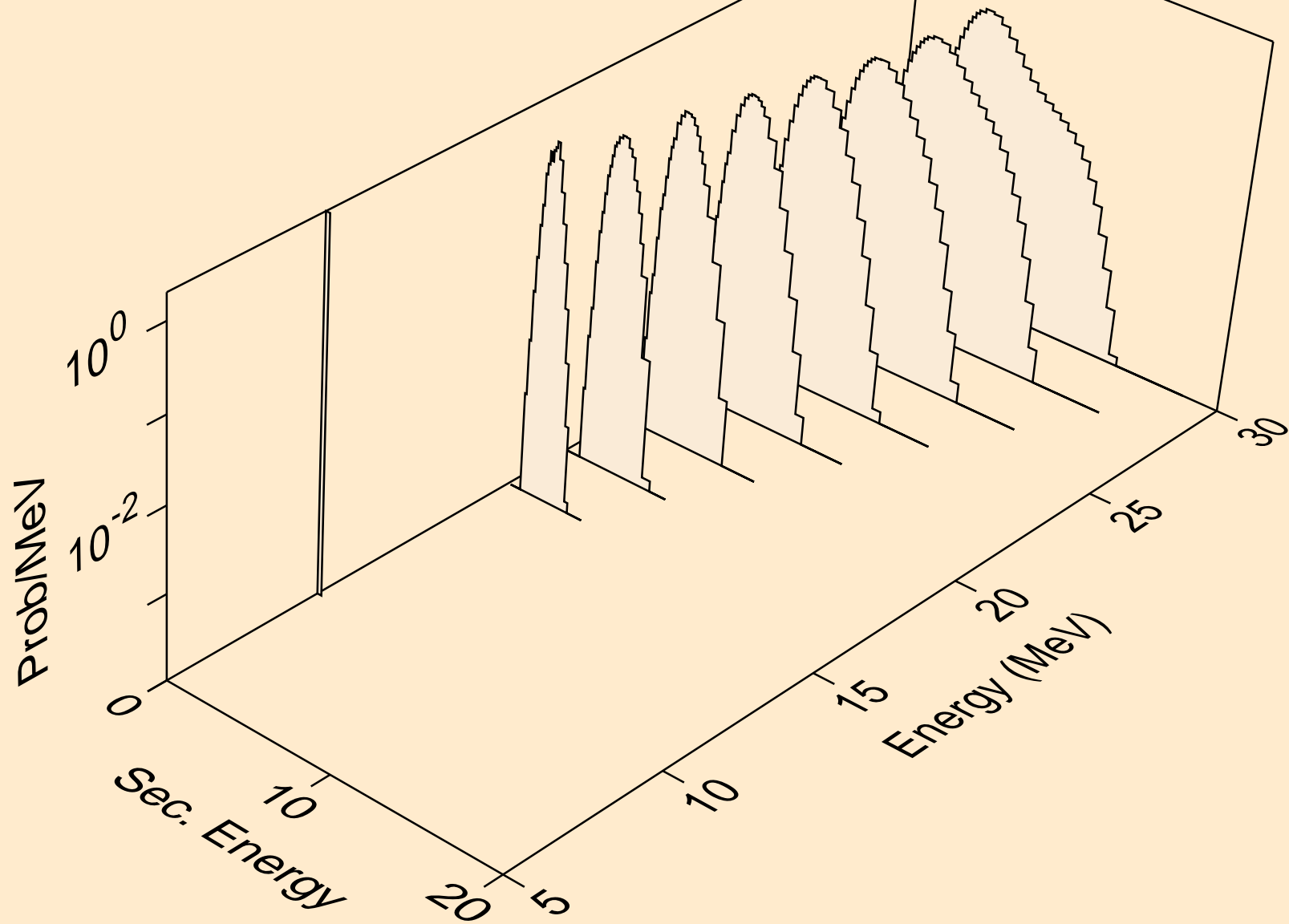

BR084M NEUTRON ACER TENDL-2021 LIBRARY; T=293.6K
protons from (n,pd)

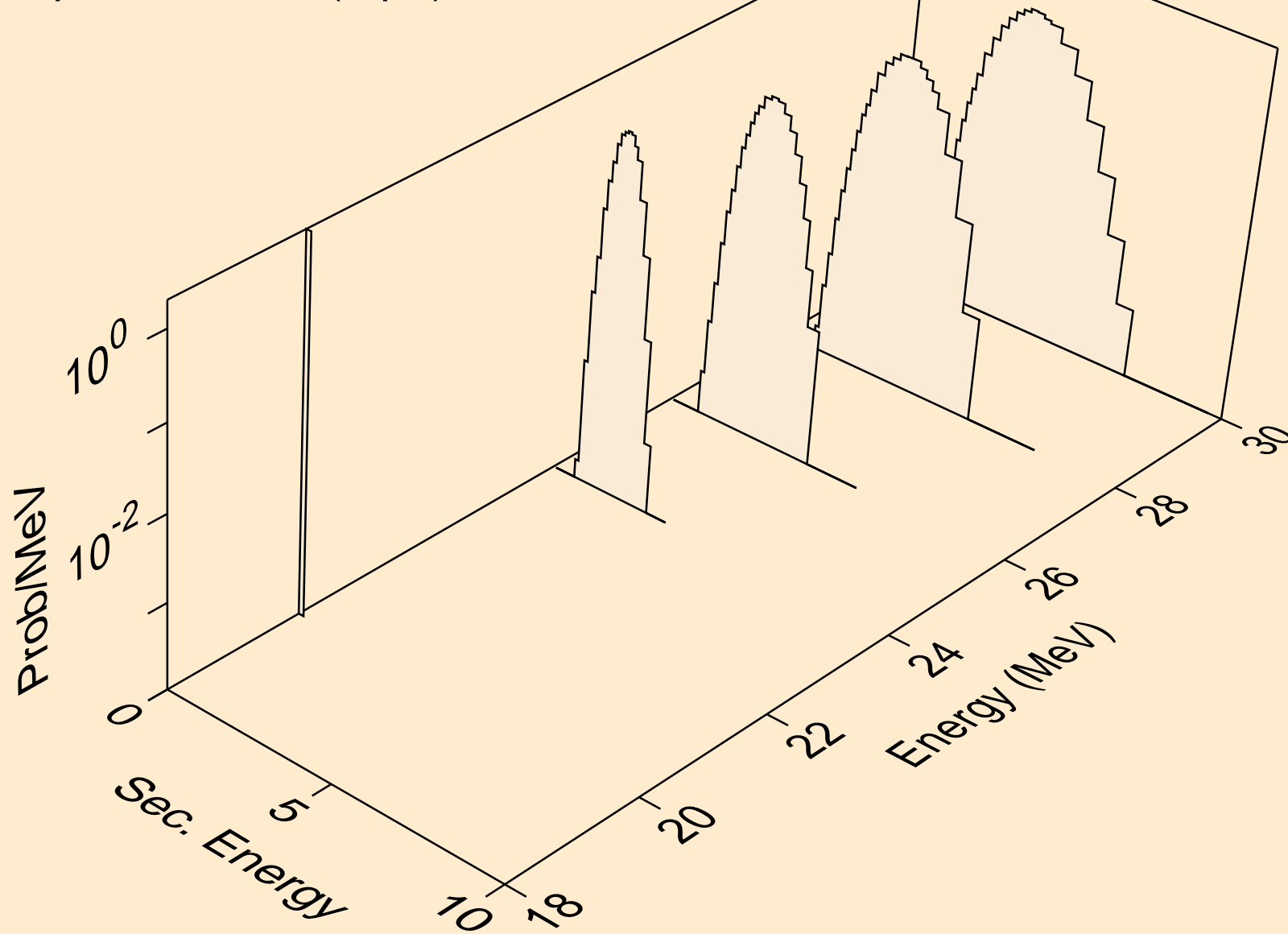

BR084M NEUTRON ACER TENDL-2021 LIBRARY; T=293.6K
protons from (n,pt)

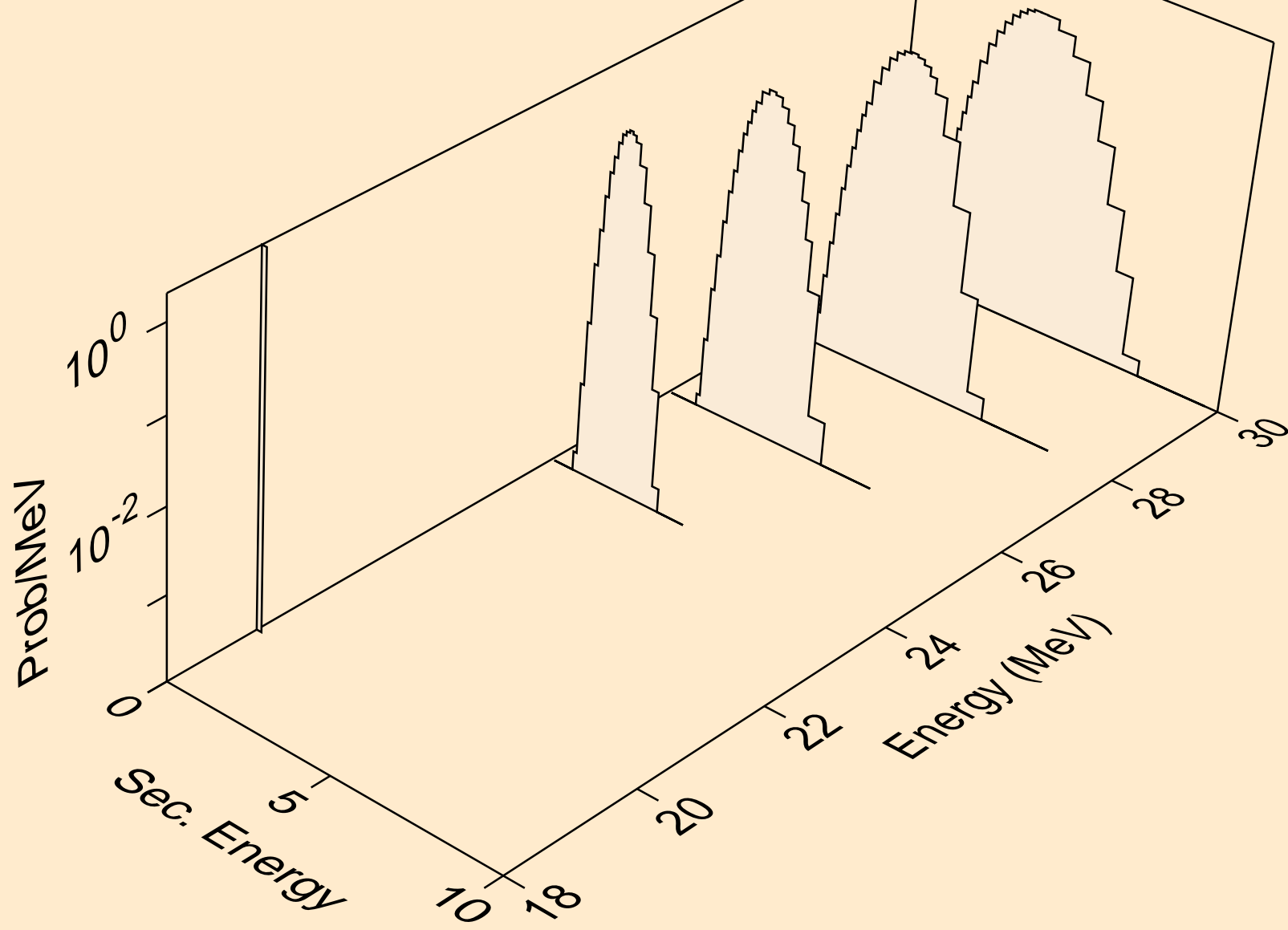

BR084M NEUTRON ACER TENDL-2021 LIBRARY; T=293.6K
deuterons from (n,x)

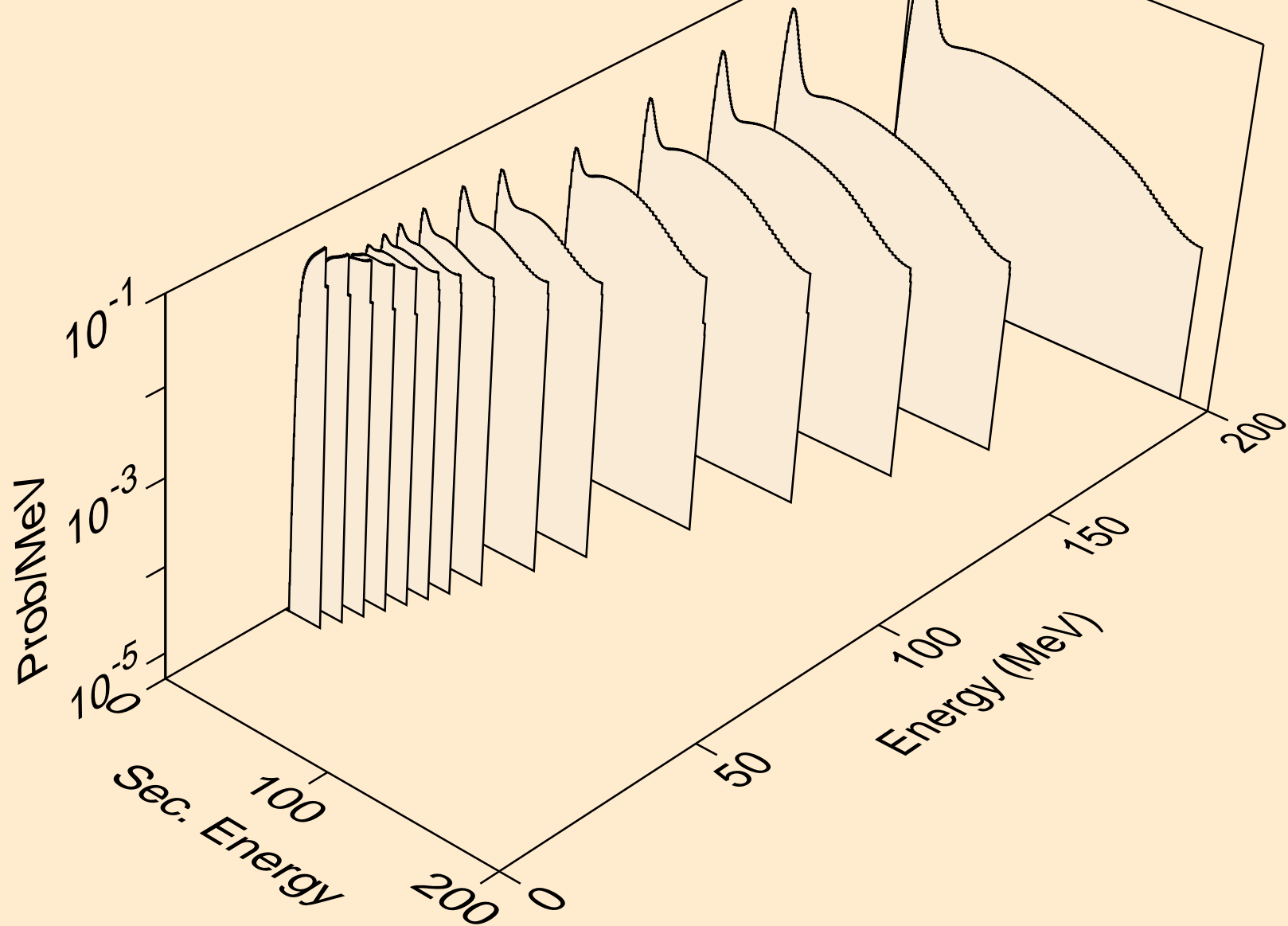

BR084M NEUTRON ACER TENDL-2021 LIBRARY; T=293.6K
deuterons from (n,2nd)

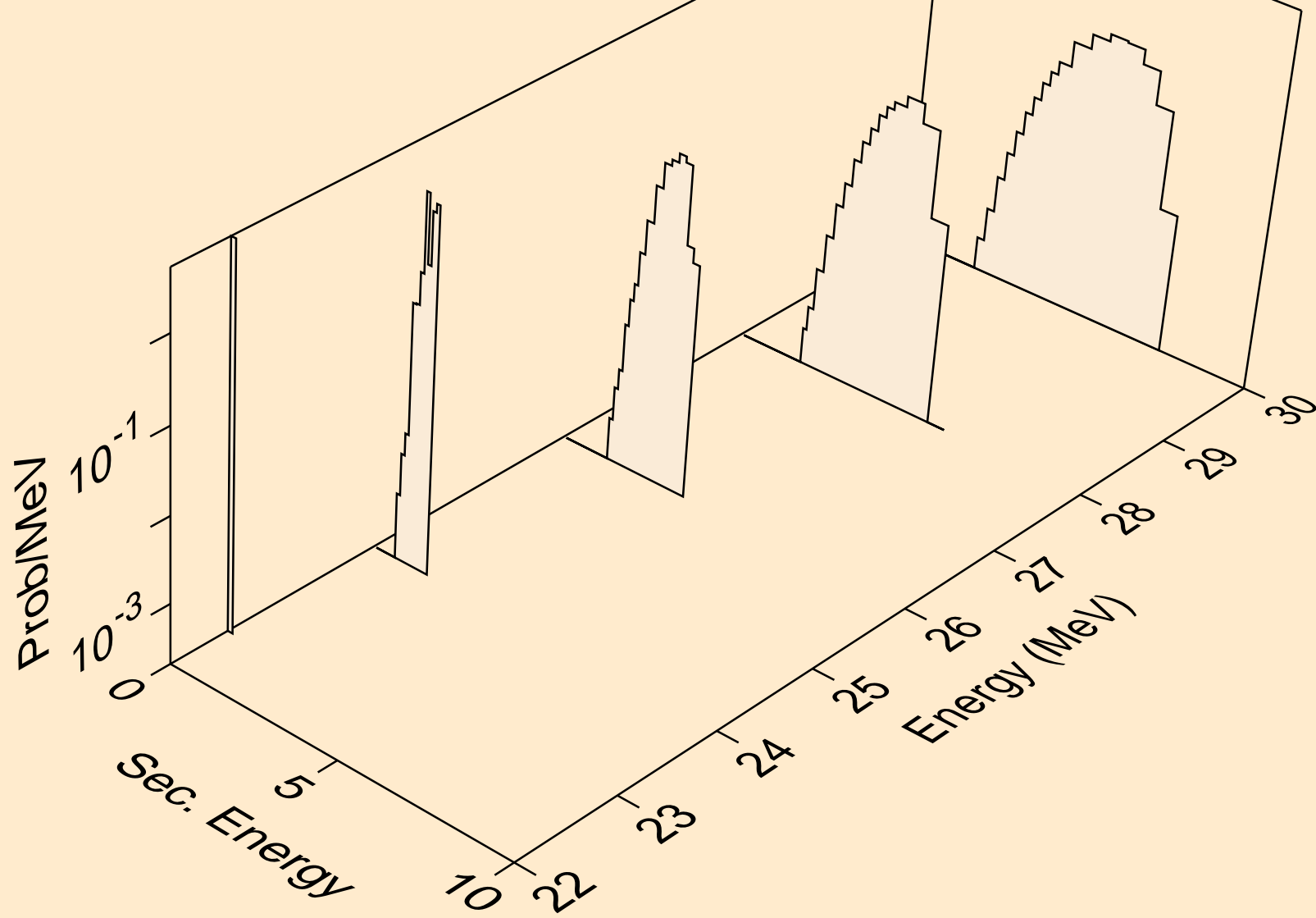

BR084M NEUTRON ACER TENDL-2021 LIBRARY; T=293.6K
deuterons from (n,n*)d

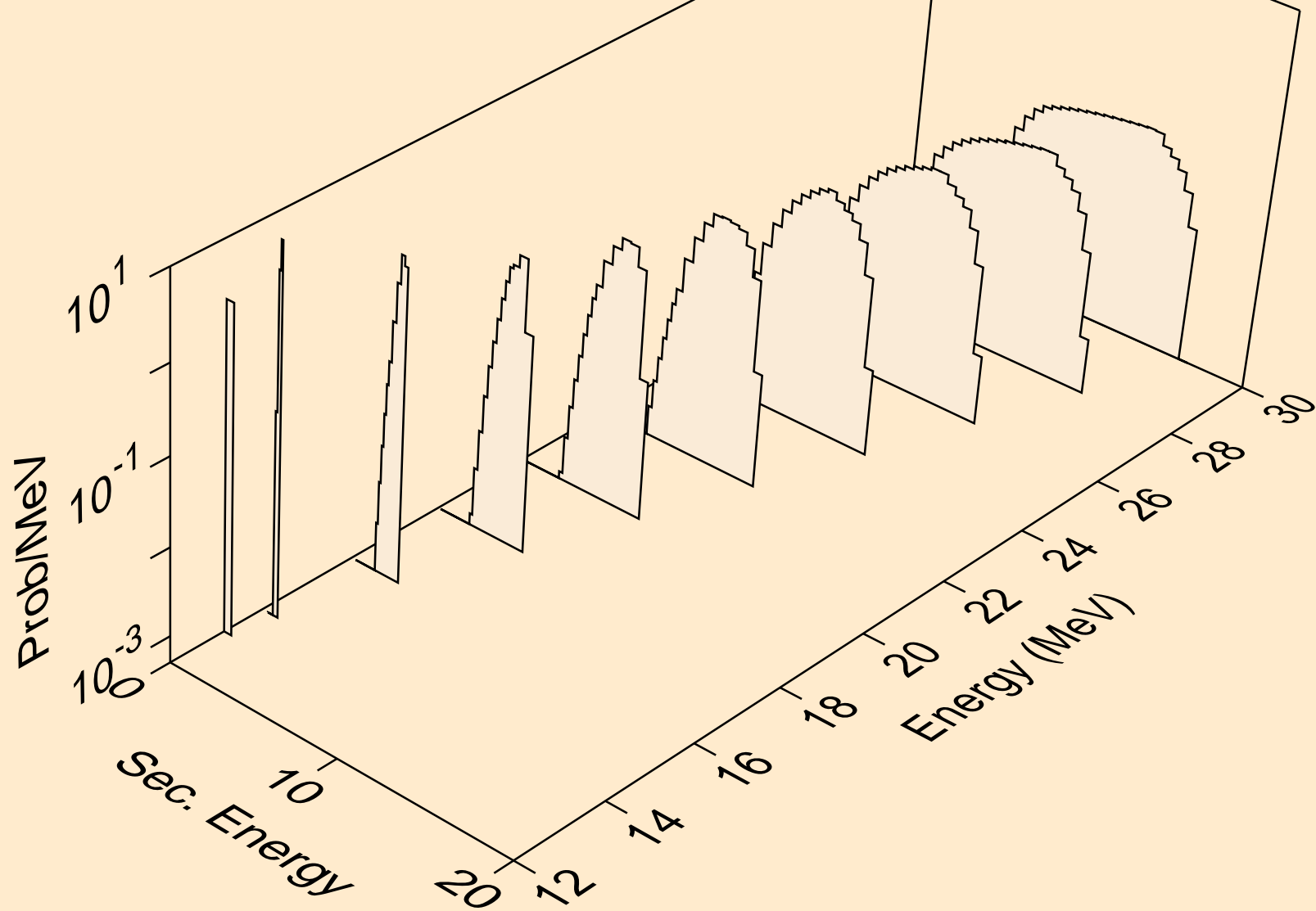

BR084M NEUTRON ACER TENDL-2021 LIBRARY; T=293.6K
deuterons from (n,d)

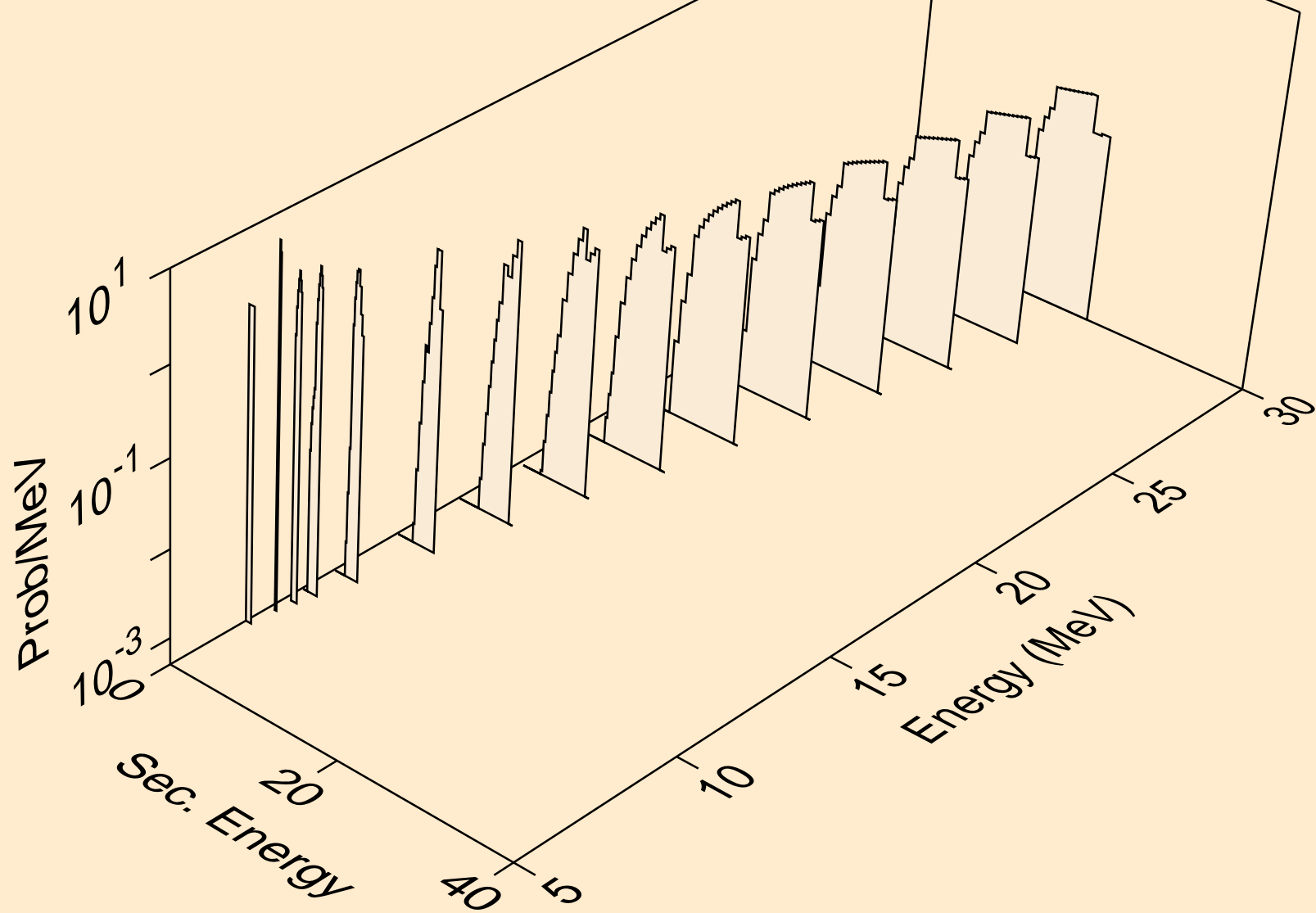

BR084M NEUTRON ACER TENDL-2021 LIBRARY; T=293.6K
deuterons from (n,pd)

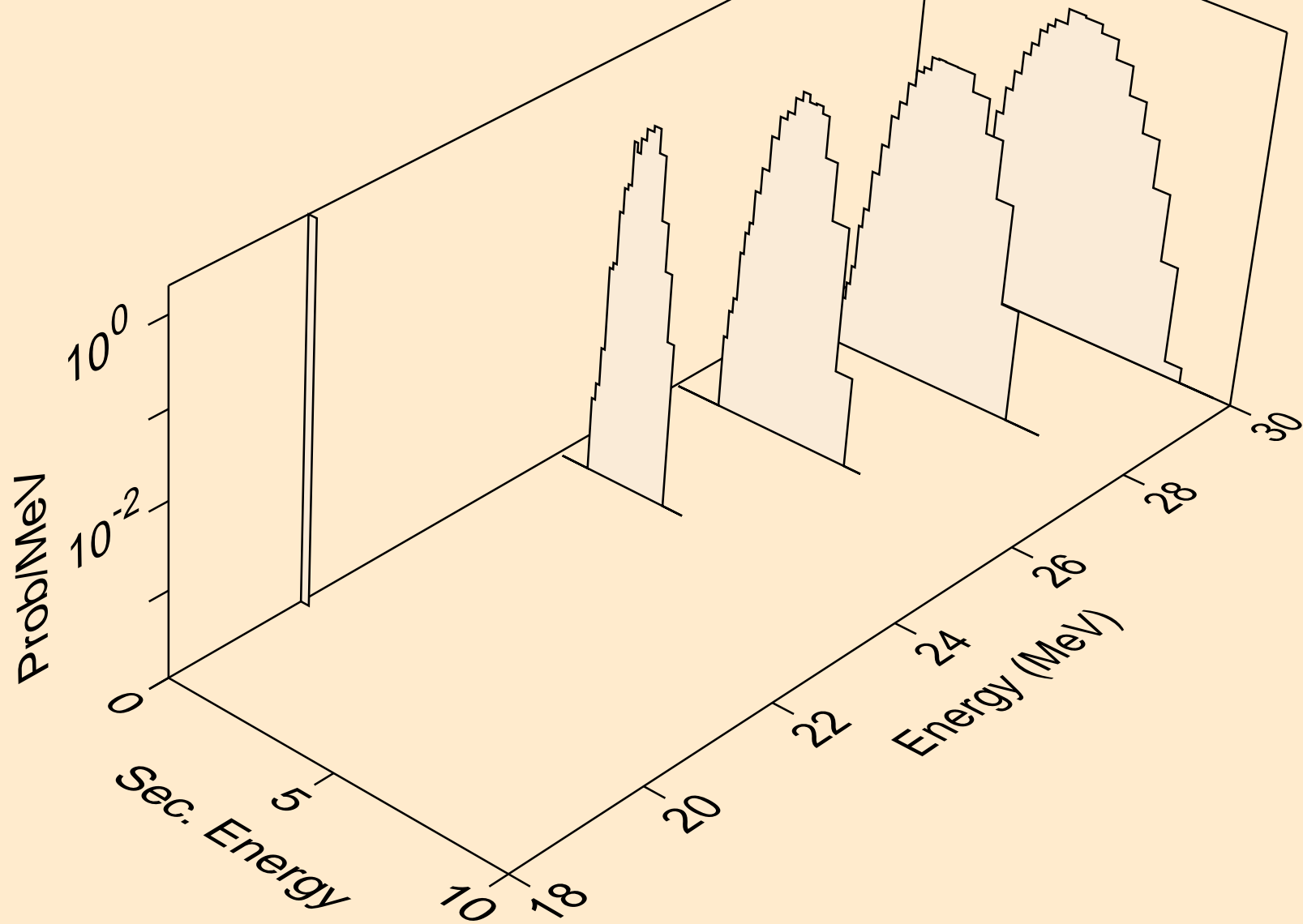

BR084M NEUTRON ACER TENDL-2021 LIBRARY; T=293.6K
deuterons from (n,da)

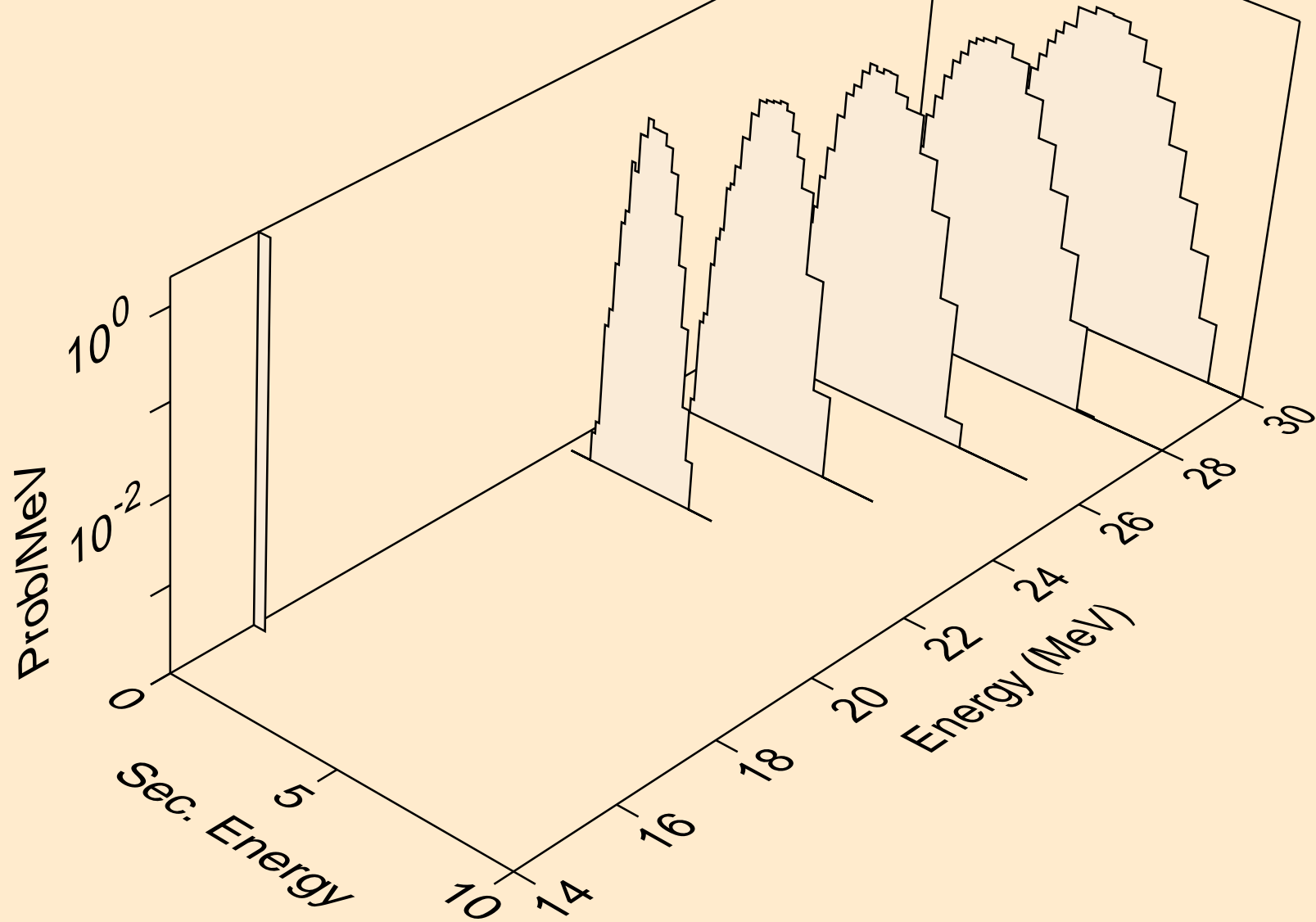

BR084M NEUTRON ACER TENDL-2021 LIBRARY; T=293.6K
tritons from (n,x)

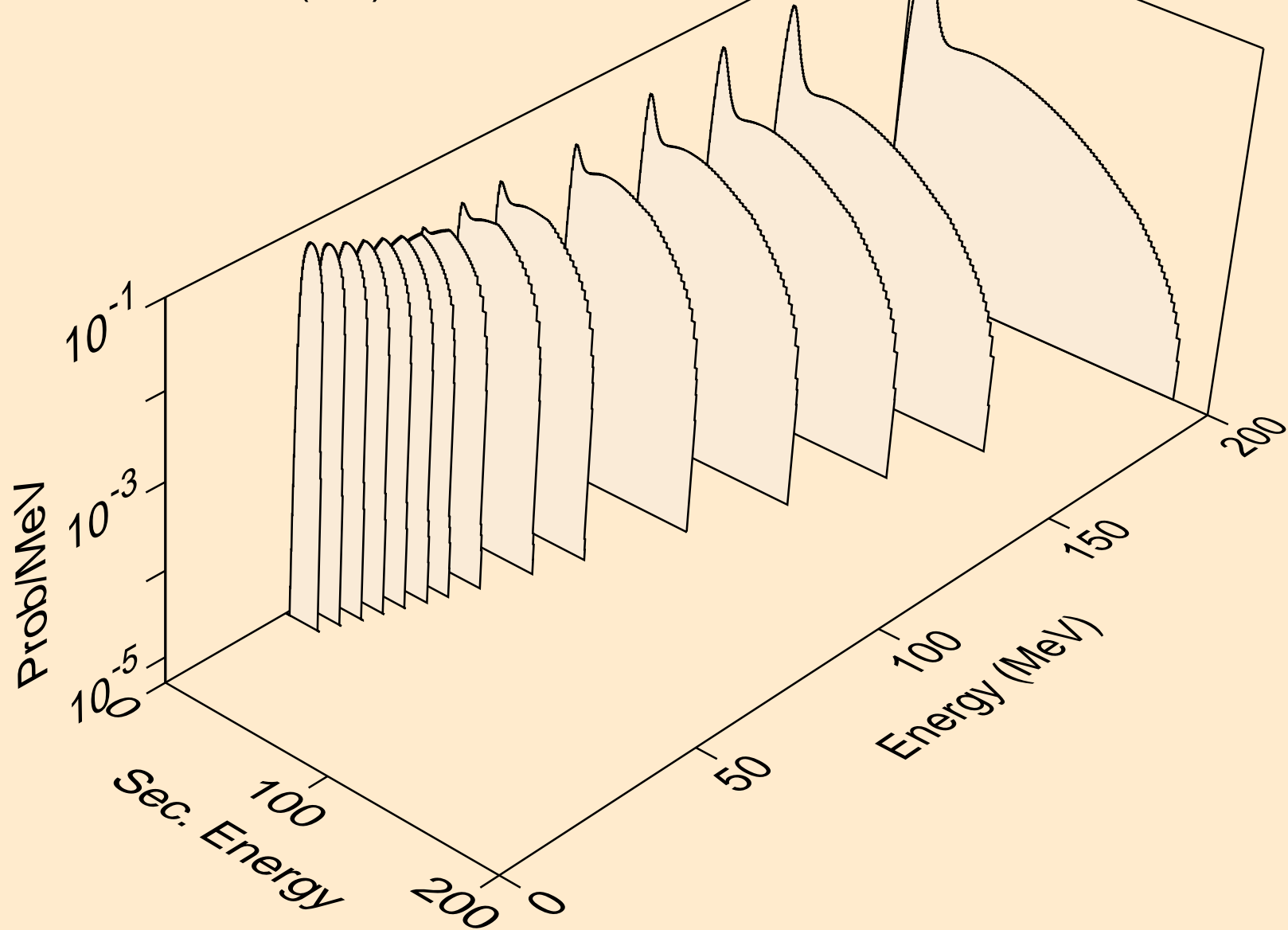

BR084M NEUTRON ACER TENDL-2021 LIBRARY; T=293.6K
tritons from (n,n*)t

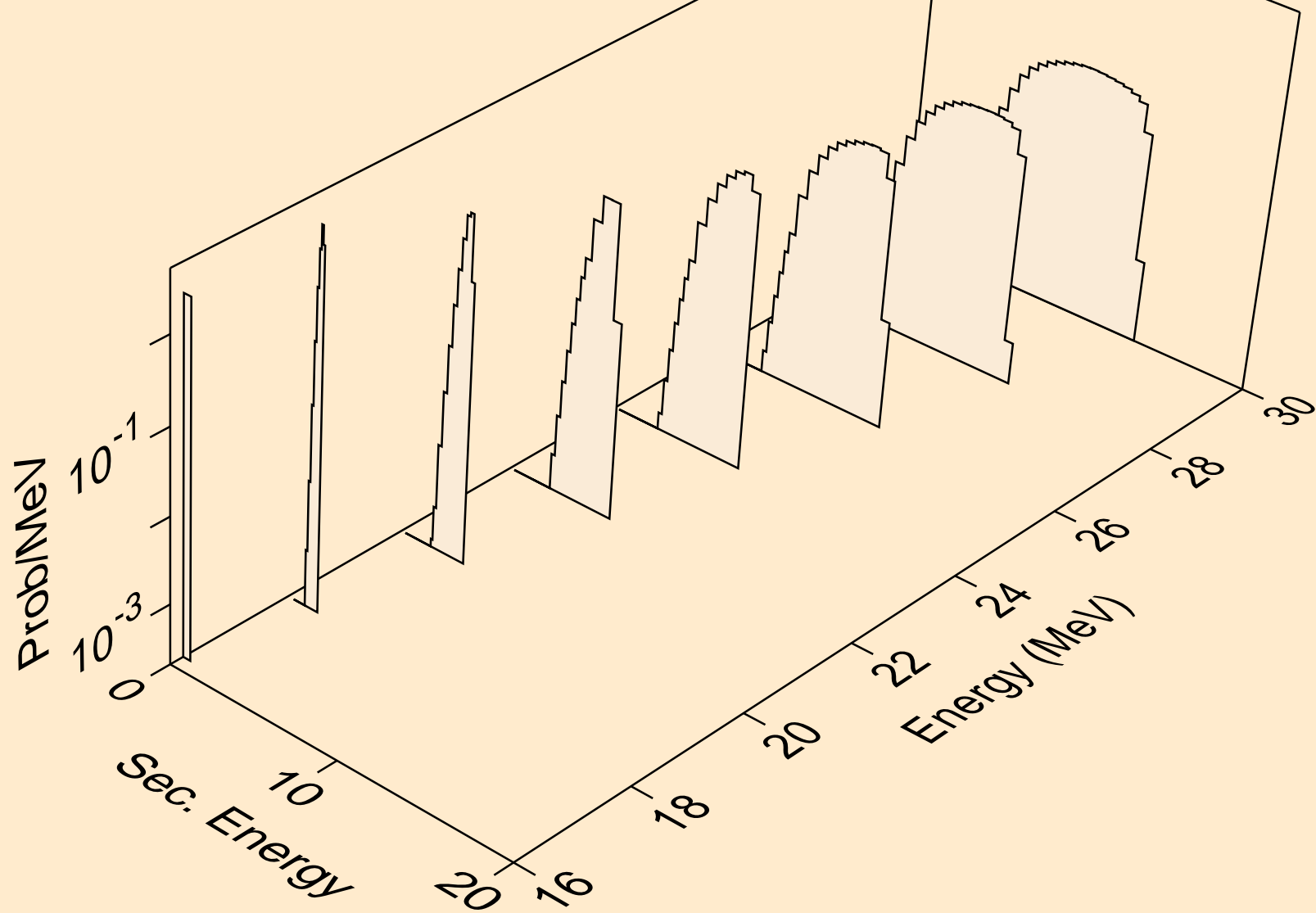

BR084M NEUTRON ACER TENDL-2021 LIBRARY; T=293.6K
tritons from (n,t)

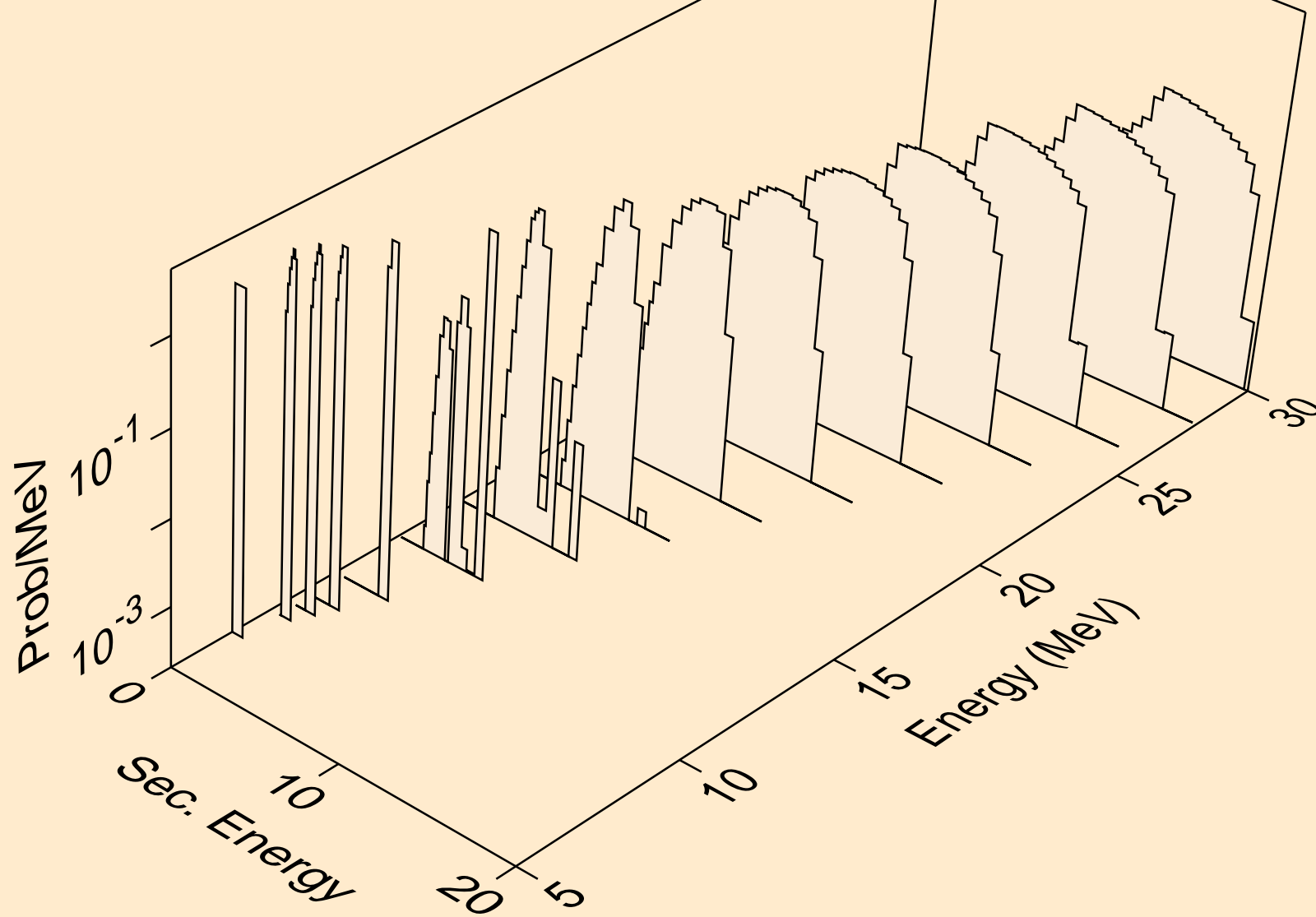

BR084M NEUTRON ACER TENDL-2021 LIBRARY; T=293.6K
tritons from (n,pt)

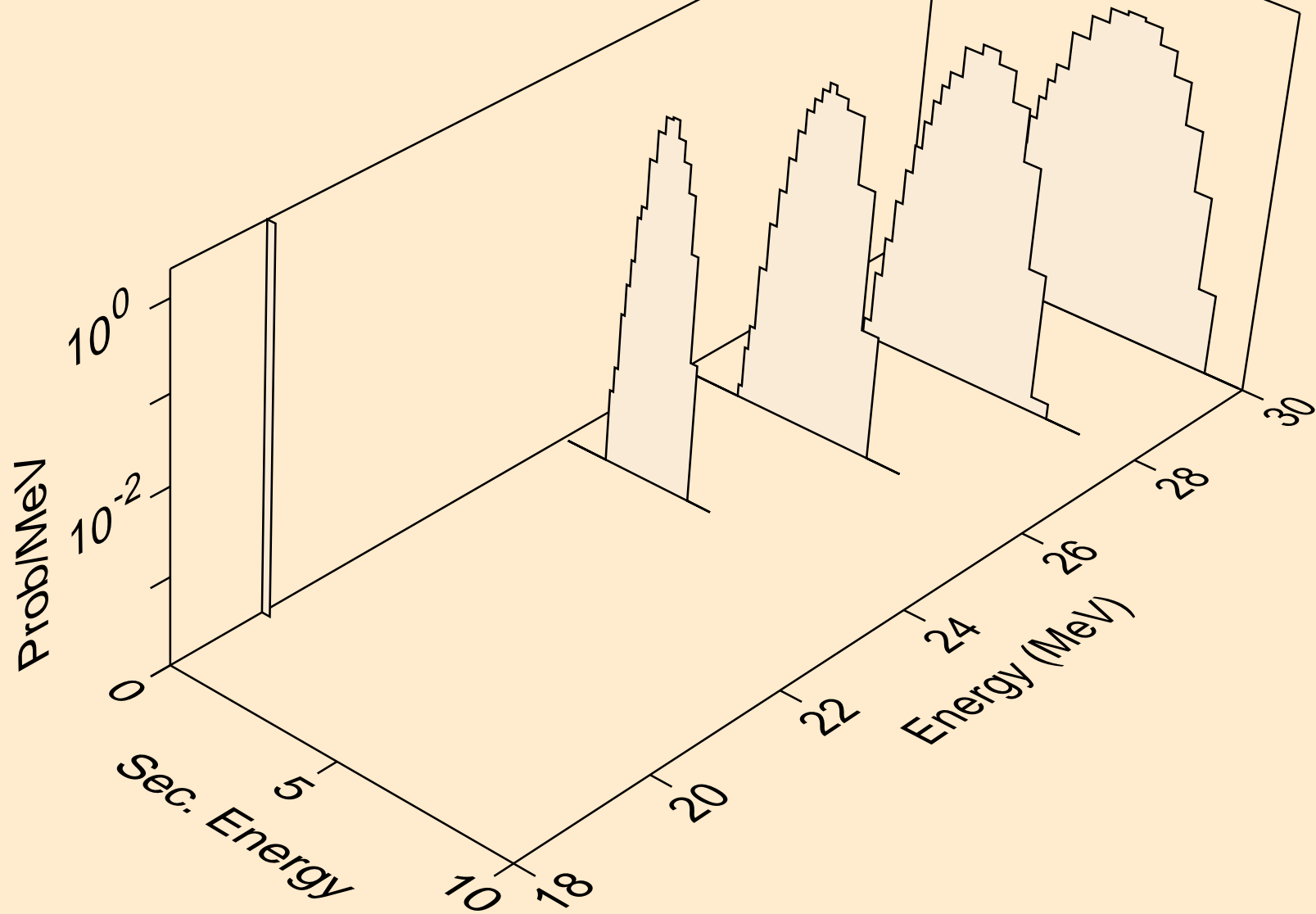

BR084M NEUTRON ACER TENDL-2021 LIBRARY; T=293.6K
he3s from (n,x)

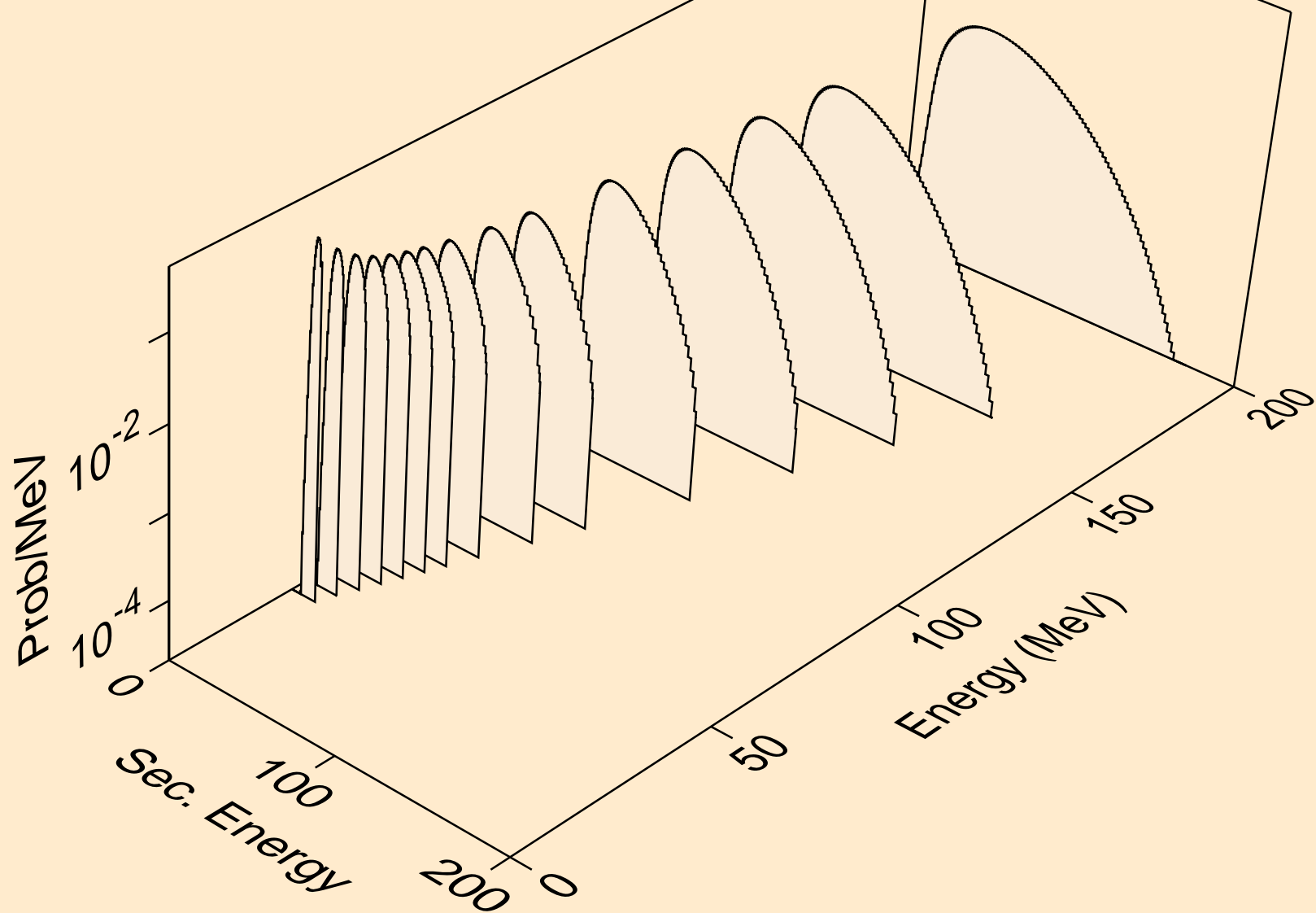

BR084M NEUTRON ACER TENDL-2021 LIBRARY; T=293.6K
he3s from (n,n*)he3

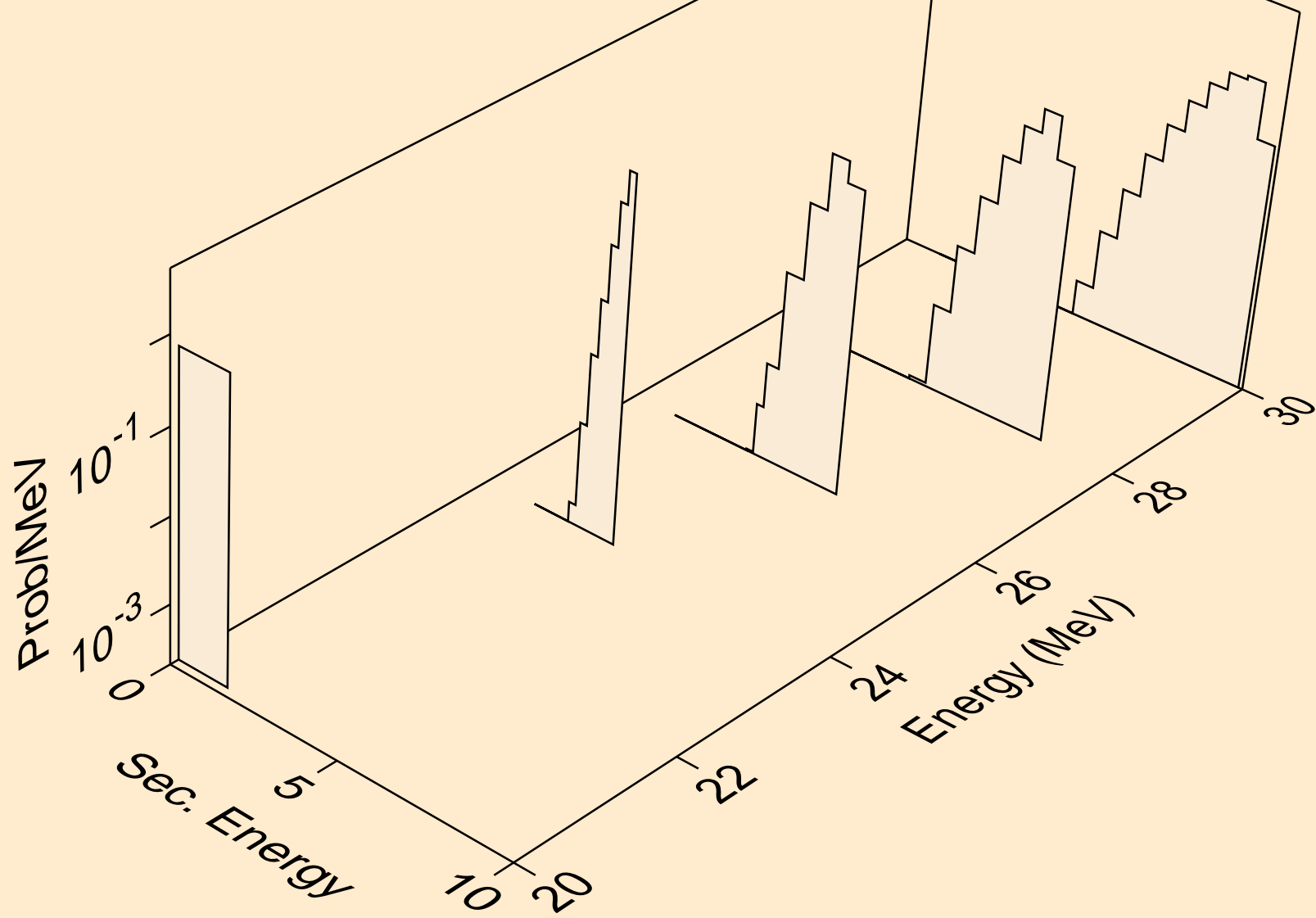

BR084M NEUTRON ACER TENDL-2021 LIBRARY; T=293.6K
he3s from (n,he3)

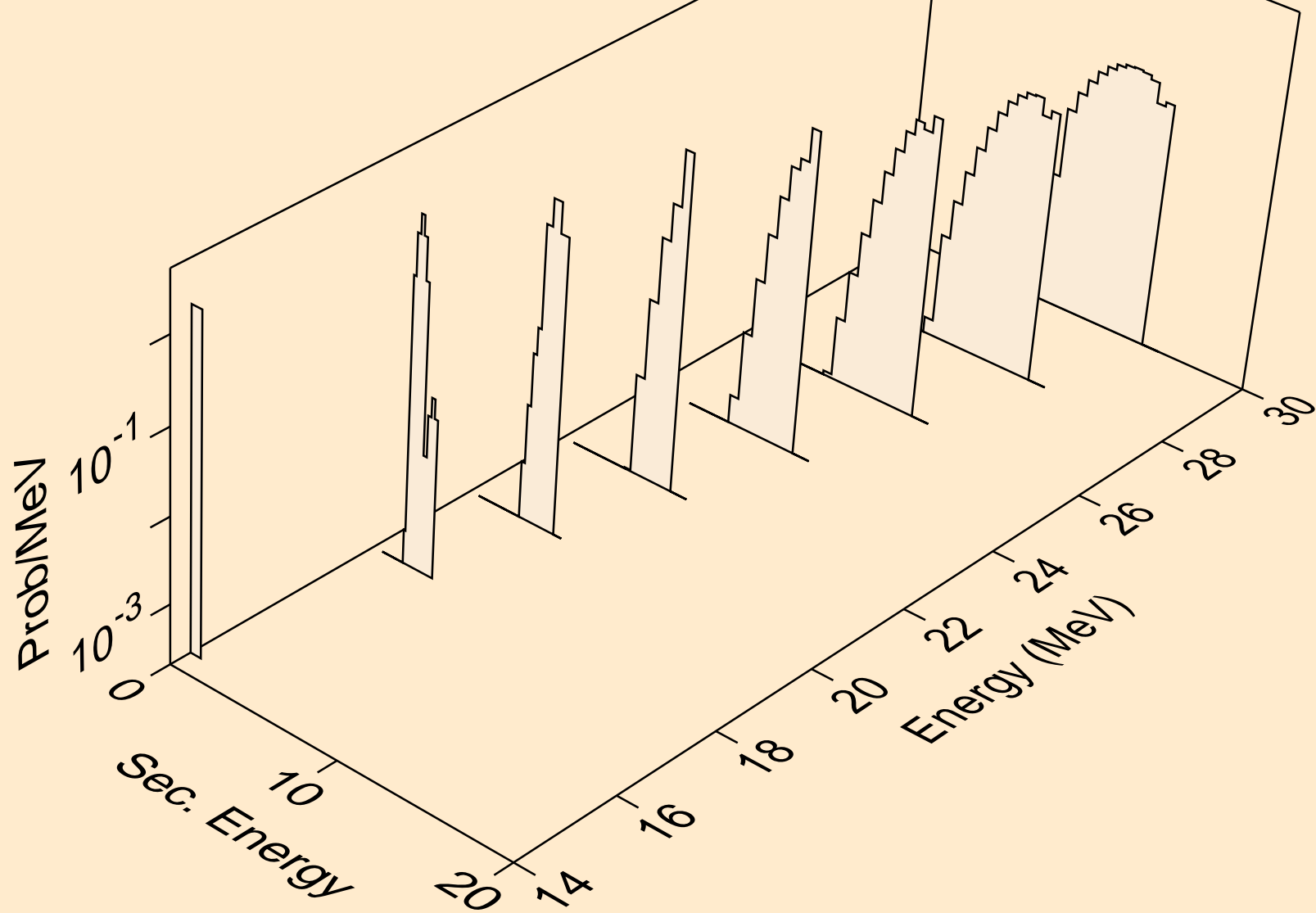

BR084M NEUTRON ACER TENDL-2021 LIBRARY; T=293.6K
alphas from (n,x)

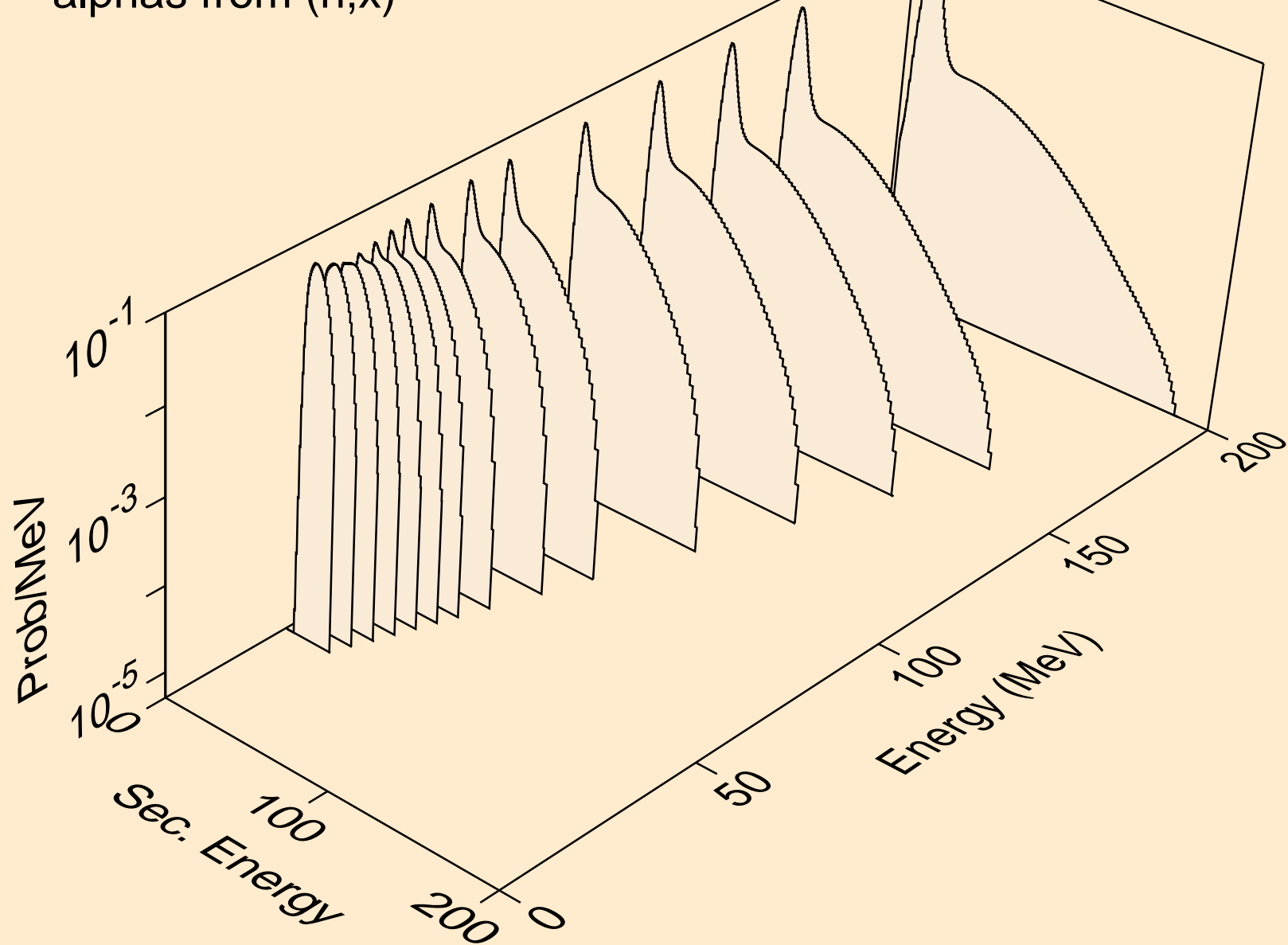

BR084M NEUTRON ACER TENDL-2021 LIBRARY; T=293.6K
alphas from (n,n*)a

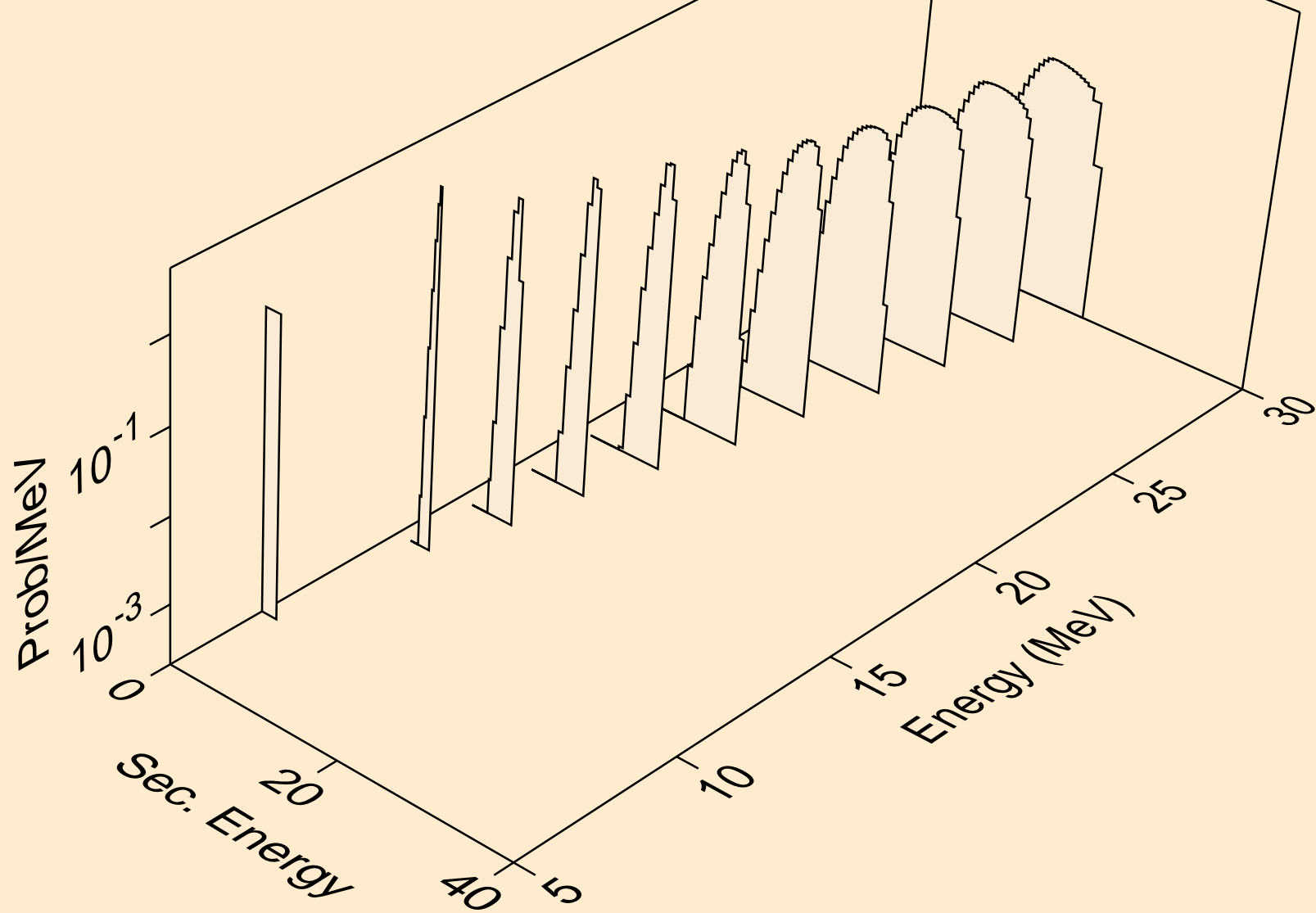

BR084M NEUTRON ACER TENDL-2021 LIBRARY; T=293.6K
alphas from (n,2n)a

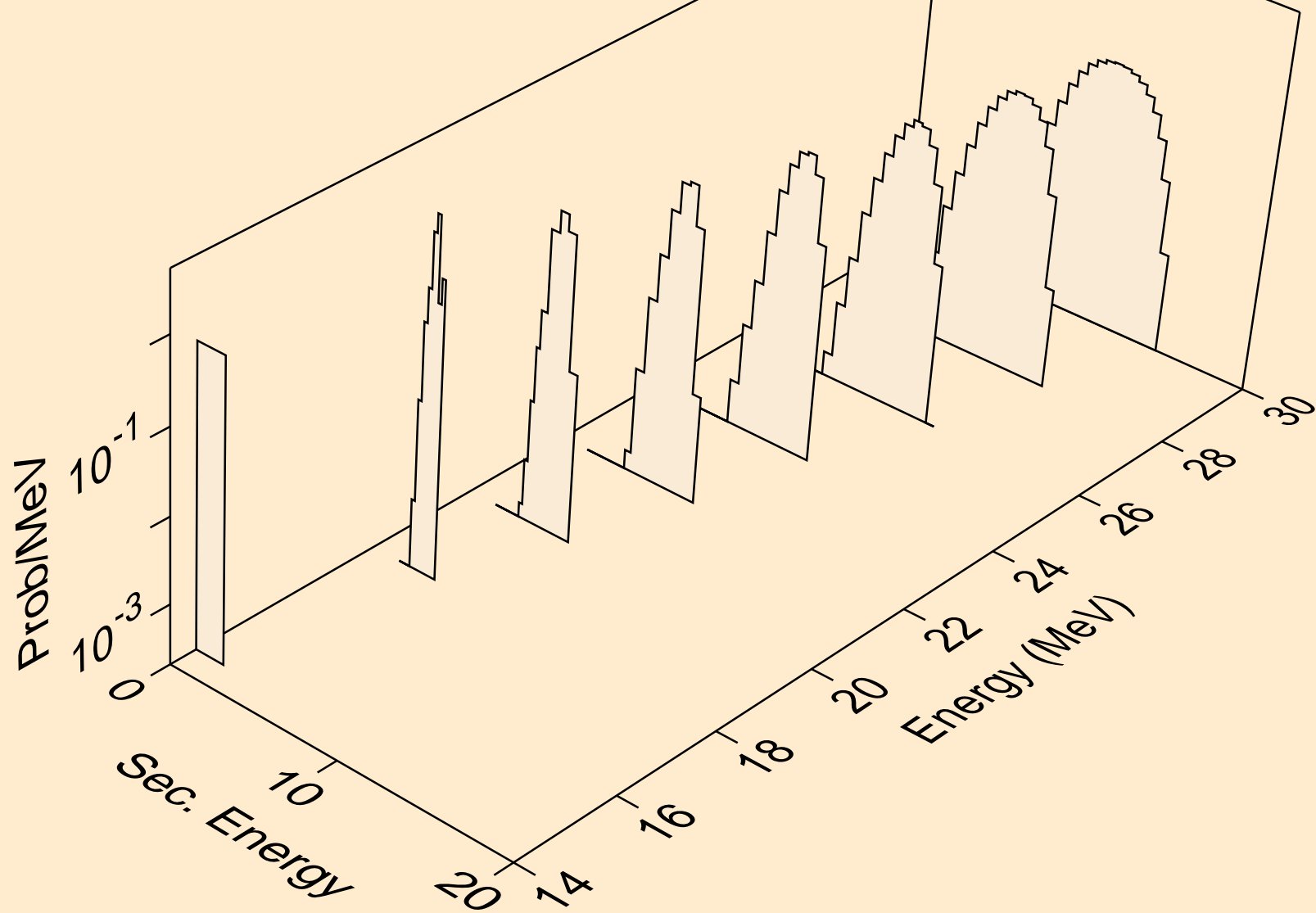

BR084M NEUTRON ACER TENDL-2021 LIBRARY; T=293.6K
alphas from (n,3n)a

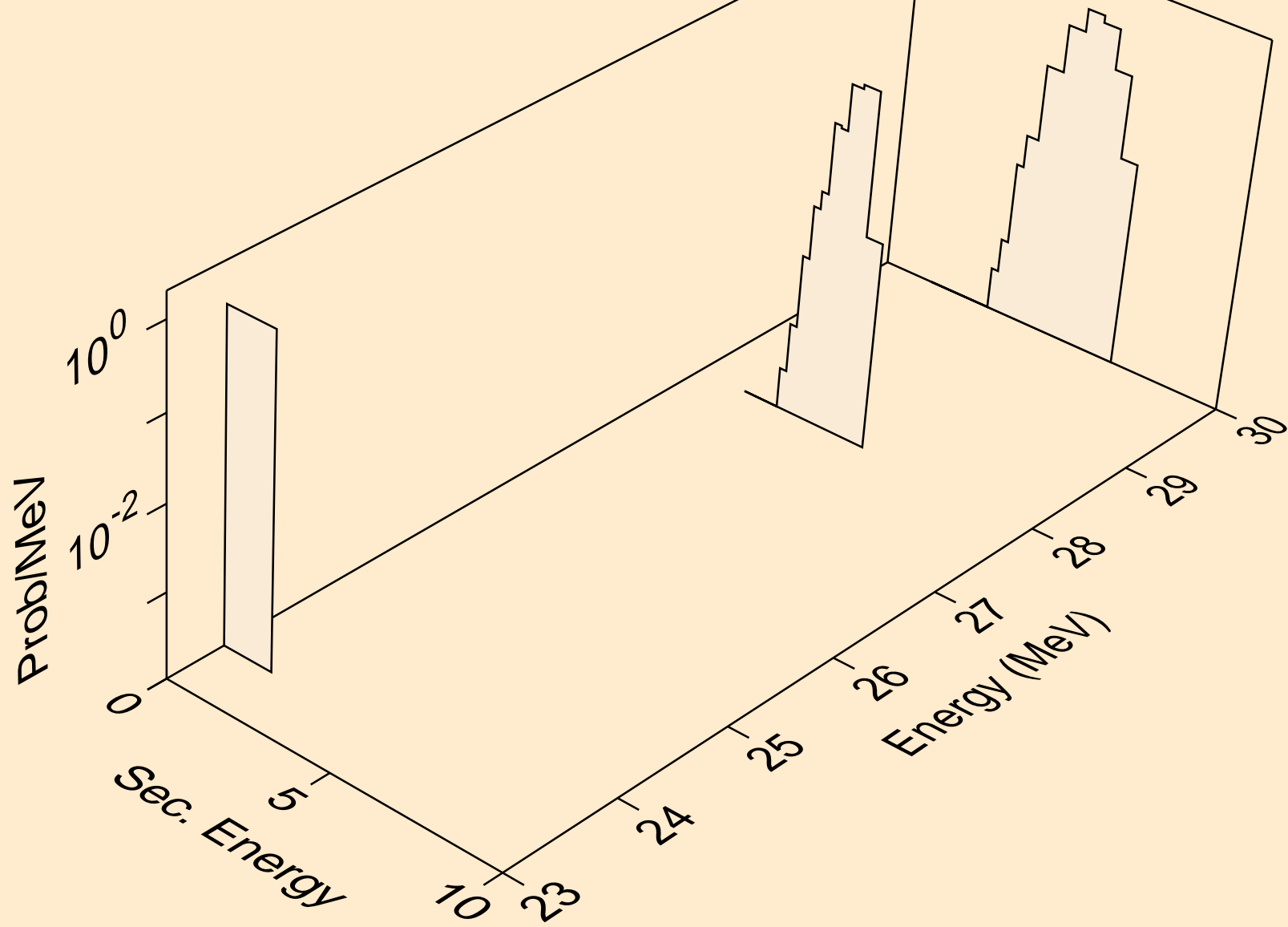

BR084M NEUTRON ACER TENDL-2021 LIBRARY; T=293.6K
alphas from (n,npa)

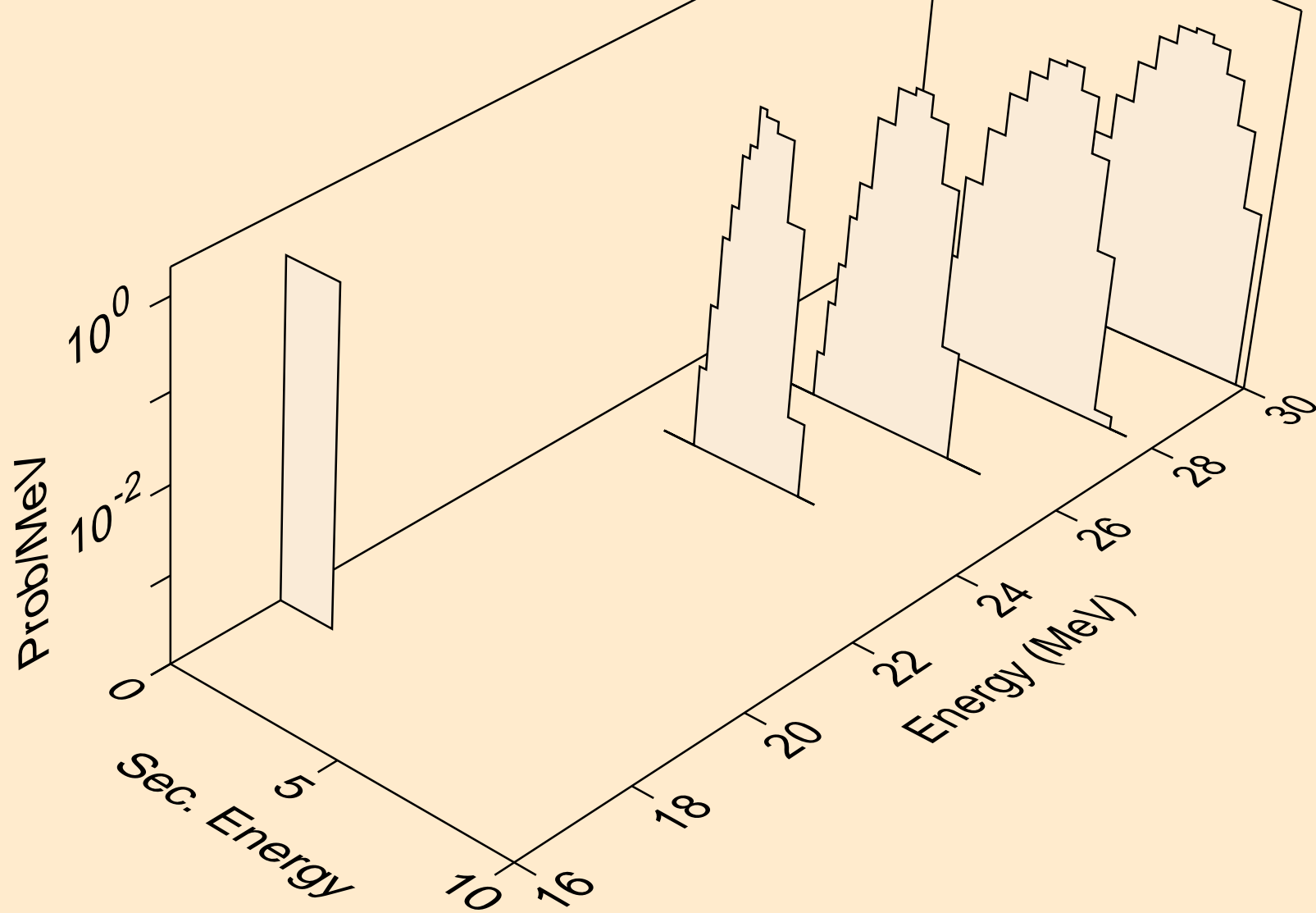

BR084M NEUTRON ACER TENDL-2021 LIBRARY; T=293.6K
alphas from (n,a)

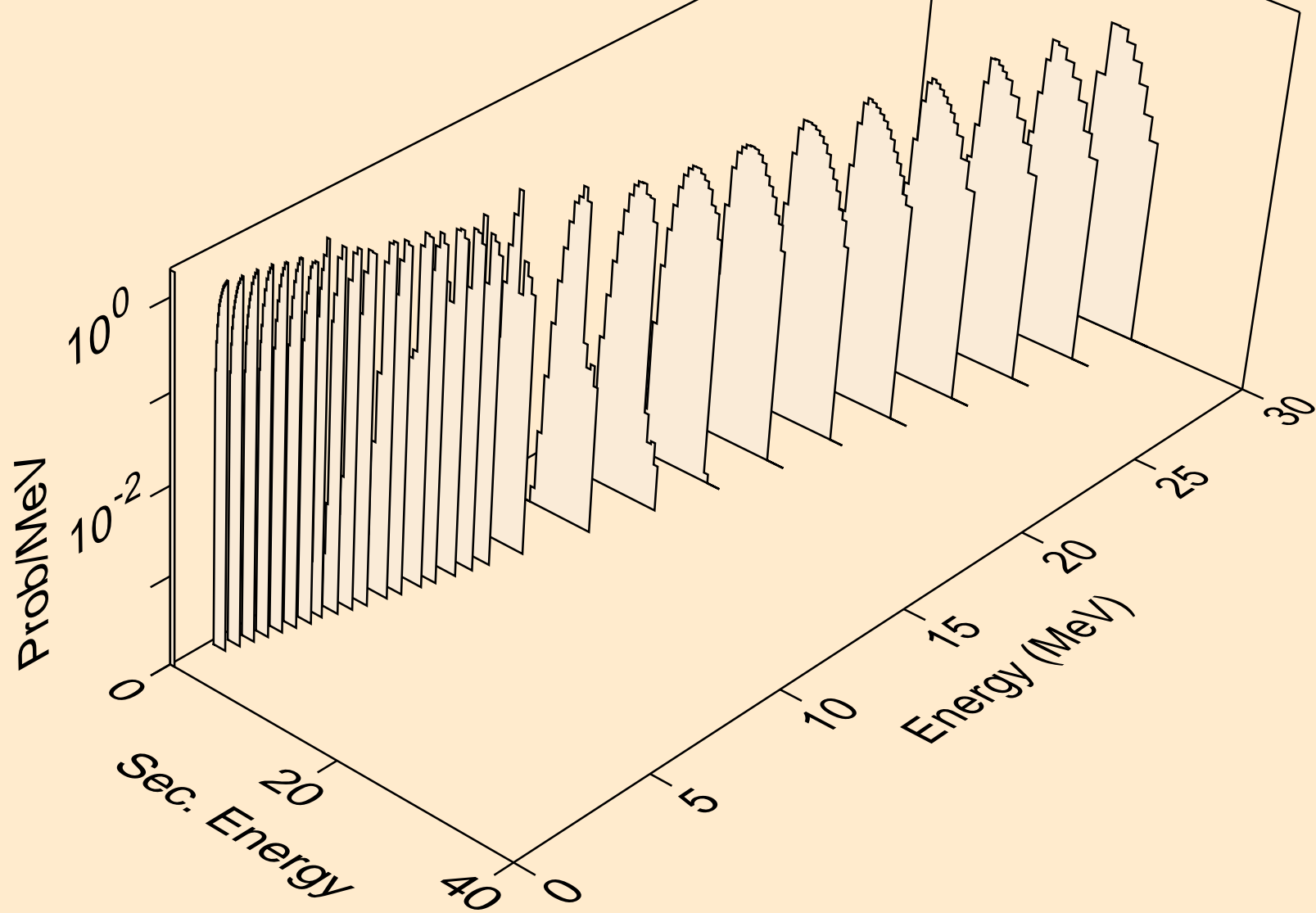

BR084M NEUTRON ACER TENDL-2021 LIBRARY; T=293.6K
alphas from (n,2a)

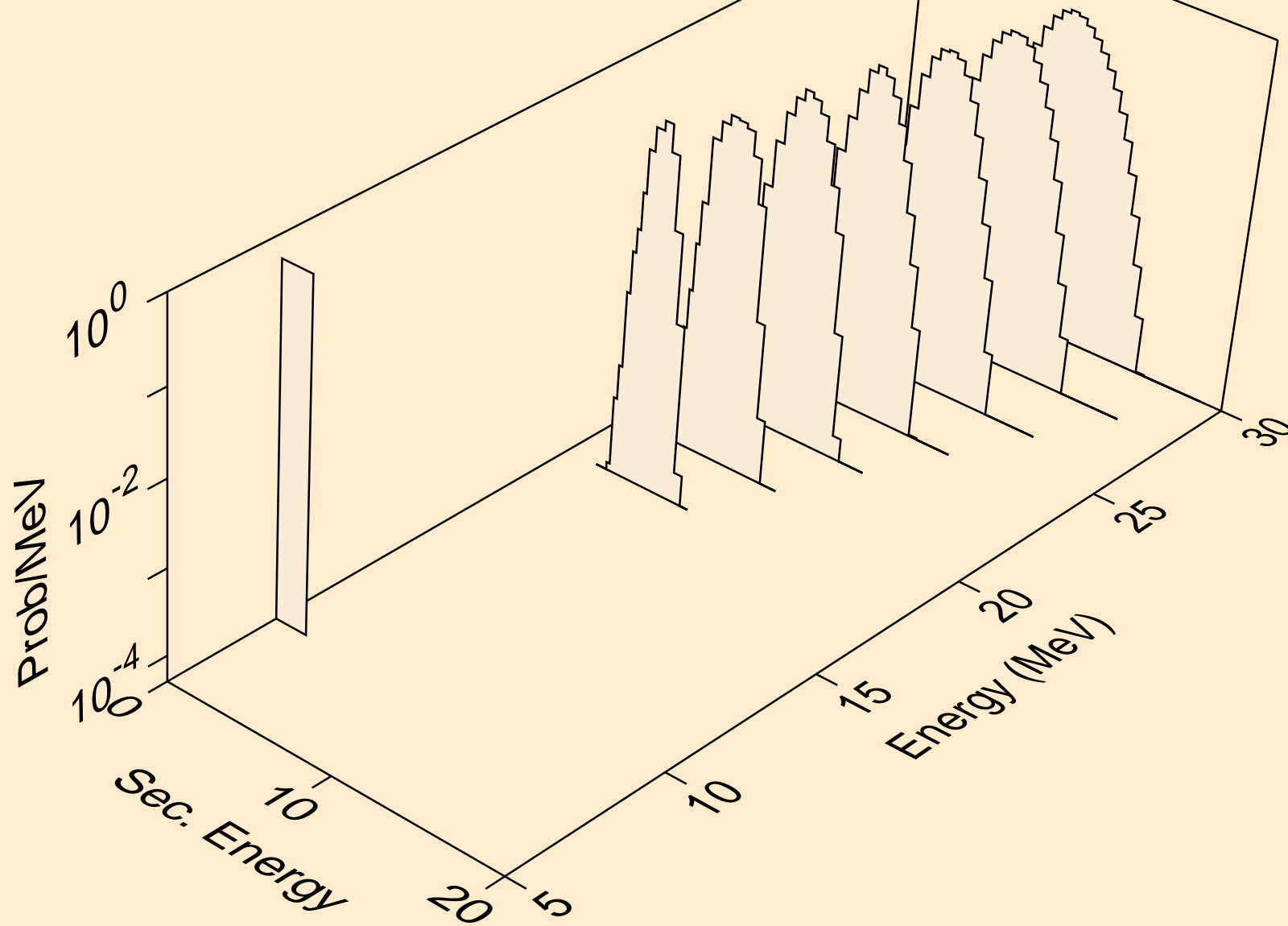

BR084M NEUTRON ACER TENDL-2021 LIBRARY; T=293.6K
alphas from (n,pa)

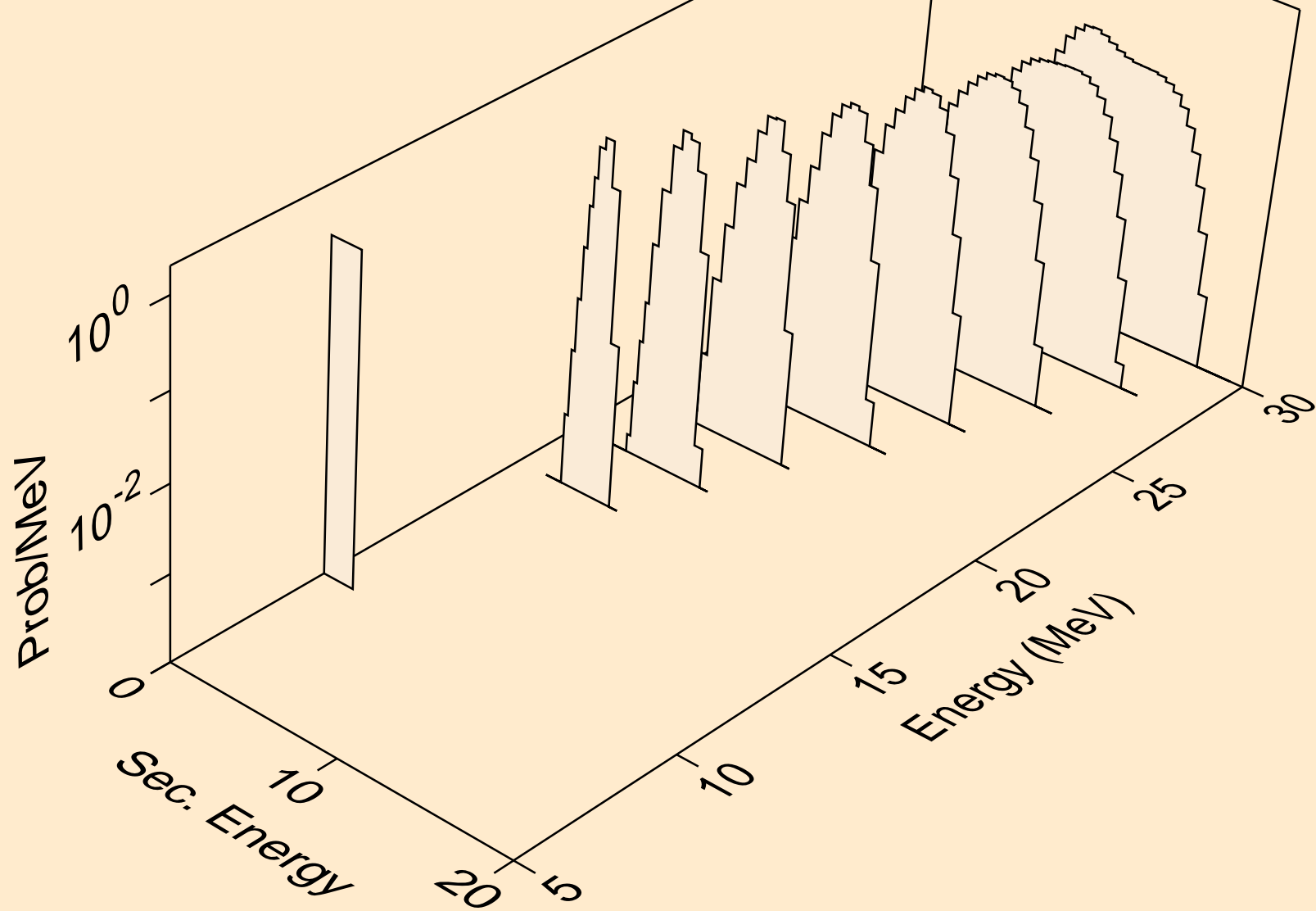

BR084M NEUTRON ACER TENDL-2021 LIBRARY; T=293.6K
alphas from (n,da)

