

CA040 NEUTRON ACER TENDL-2021 LIBRARY; T=293.6K
Principal cross sections

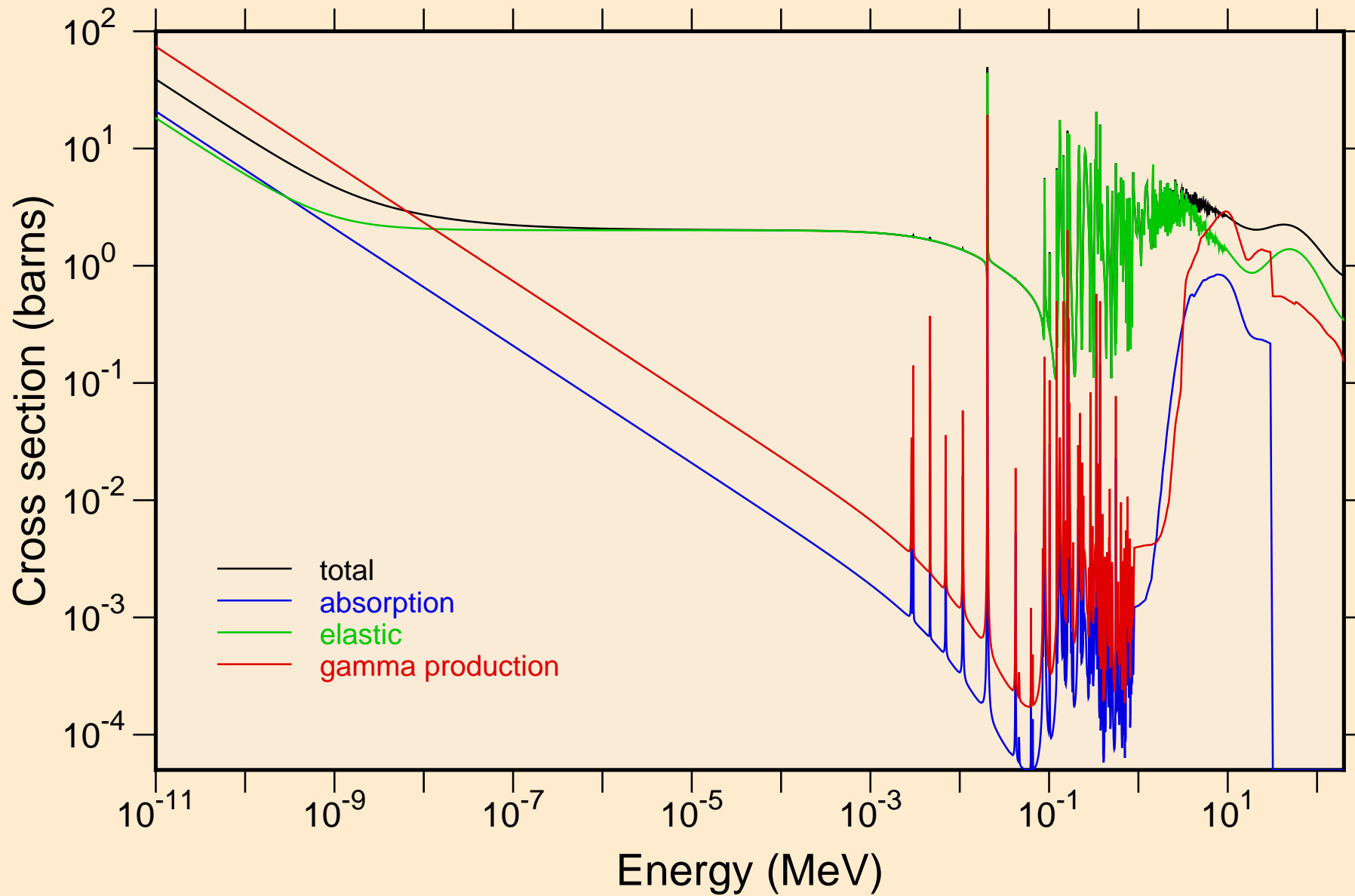

CA040 NEUTRON ACER TENDL-2021 LIBRARY; T=293.6K
resonance total cross section

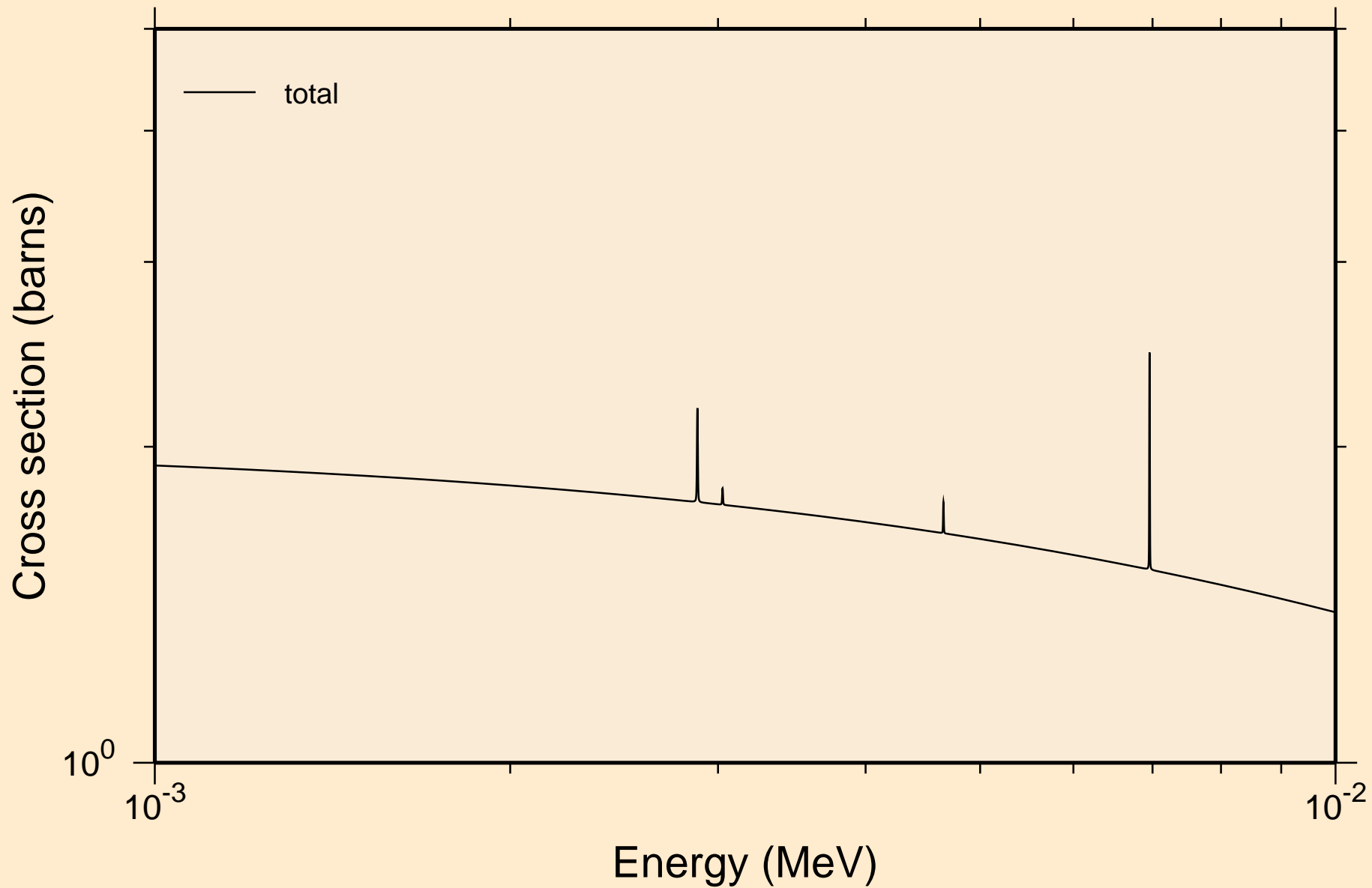

CA040 NEUTRON ACER TENDL-2021 LIBRARY; T=293.6K
resonance total cross section

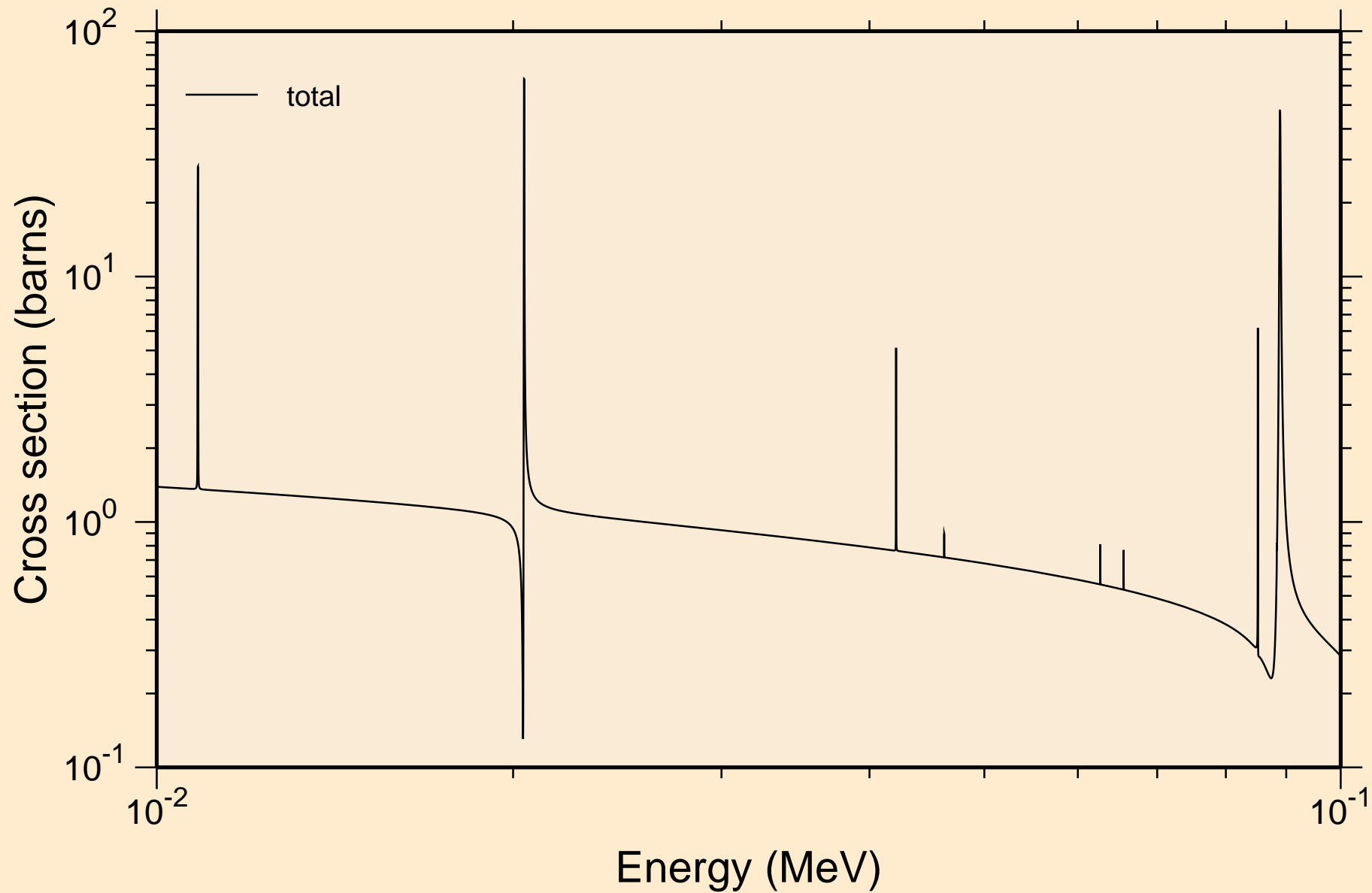

CA040 NEUTRON ACER TENDL-2021 LIBRARY; T=293.6K
resonance total cross section

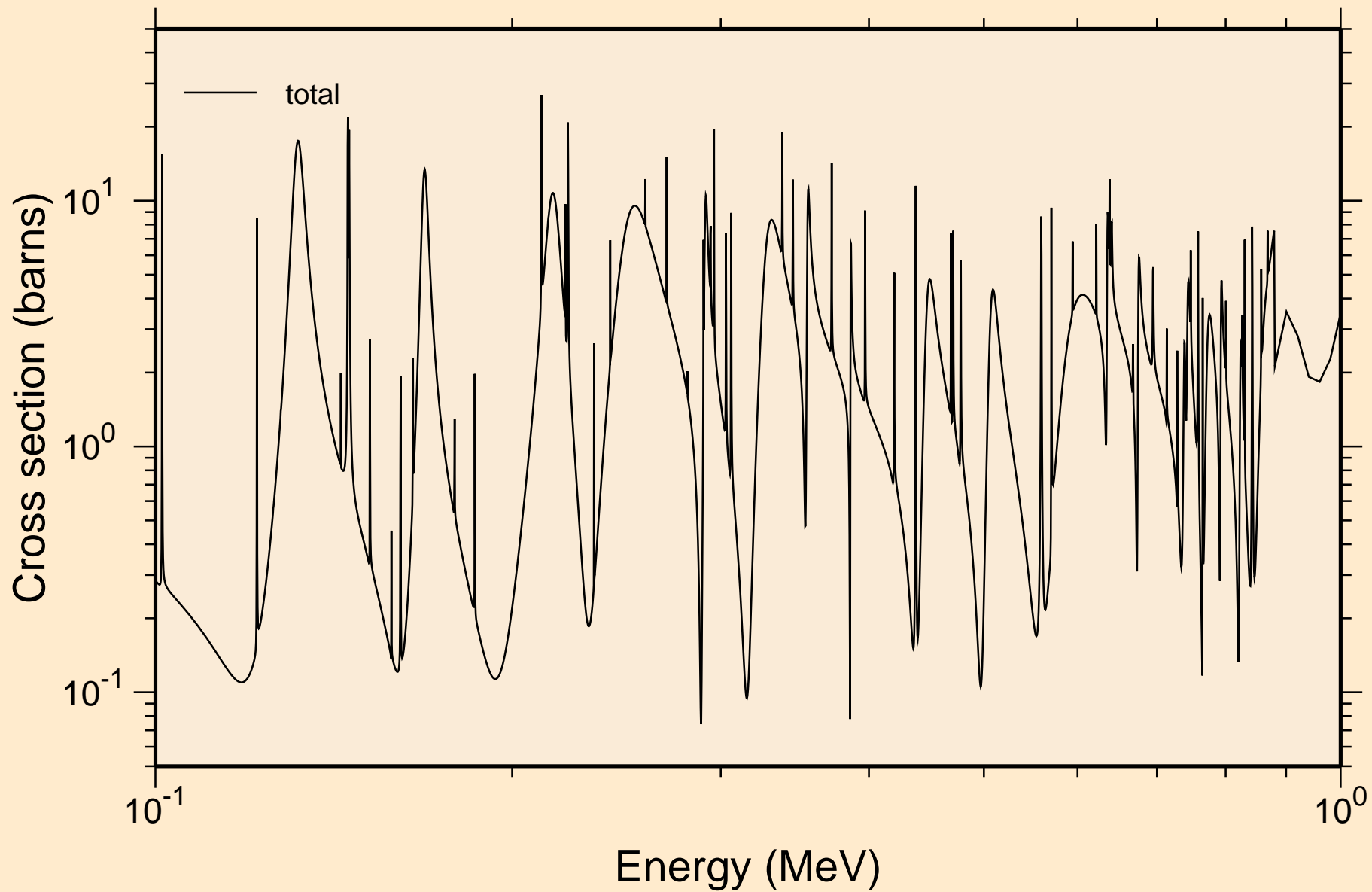

CA040 NEUTRON ACER TENDL-2021 LIBRARY; T=293.6K
resonance total cross section

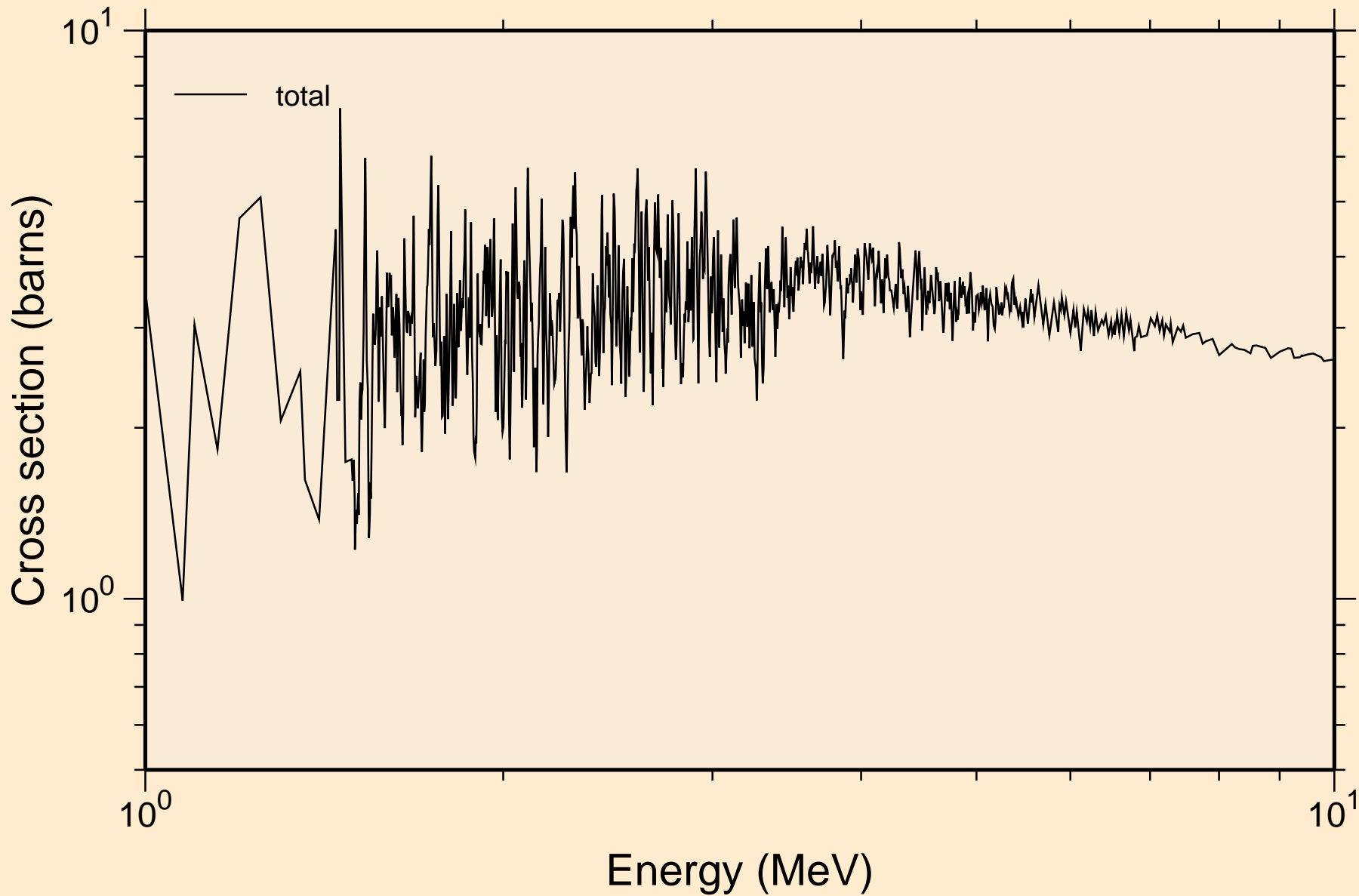

CA040 NEUTRON ACER TENDL-2021 LIBRARY; T=293.6K
resonance absorption cross sections

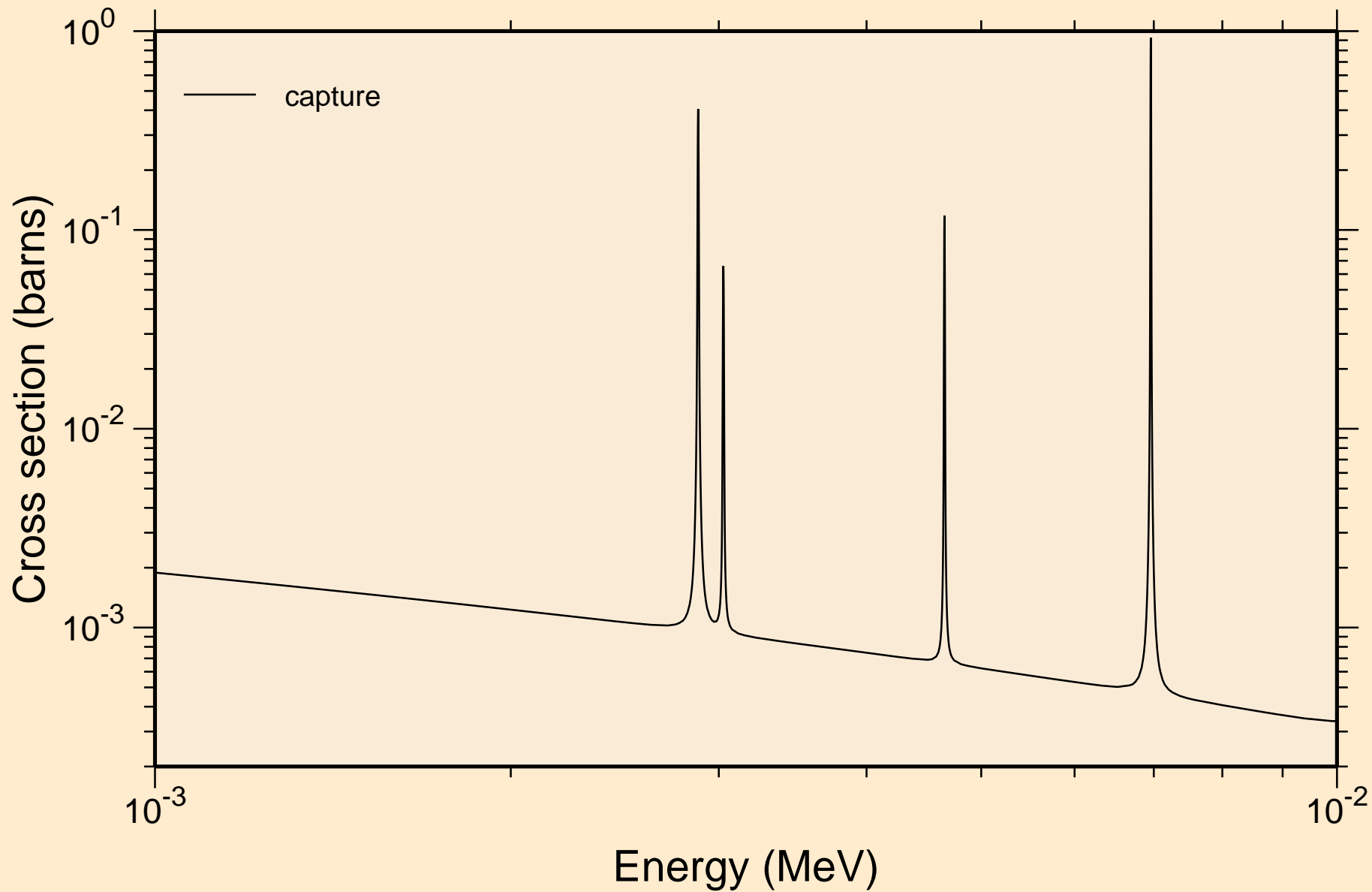

CA040 NEUTRON ACER TENDL-2021 LIBRARY; T=293.6K
resonance absorption cross sections

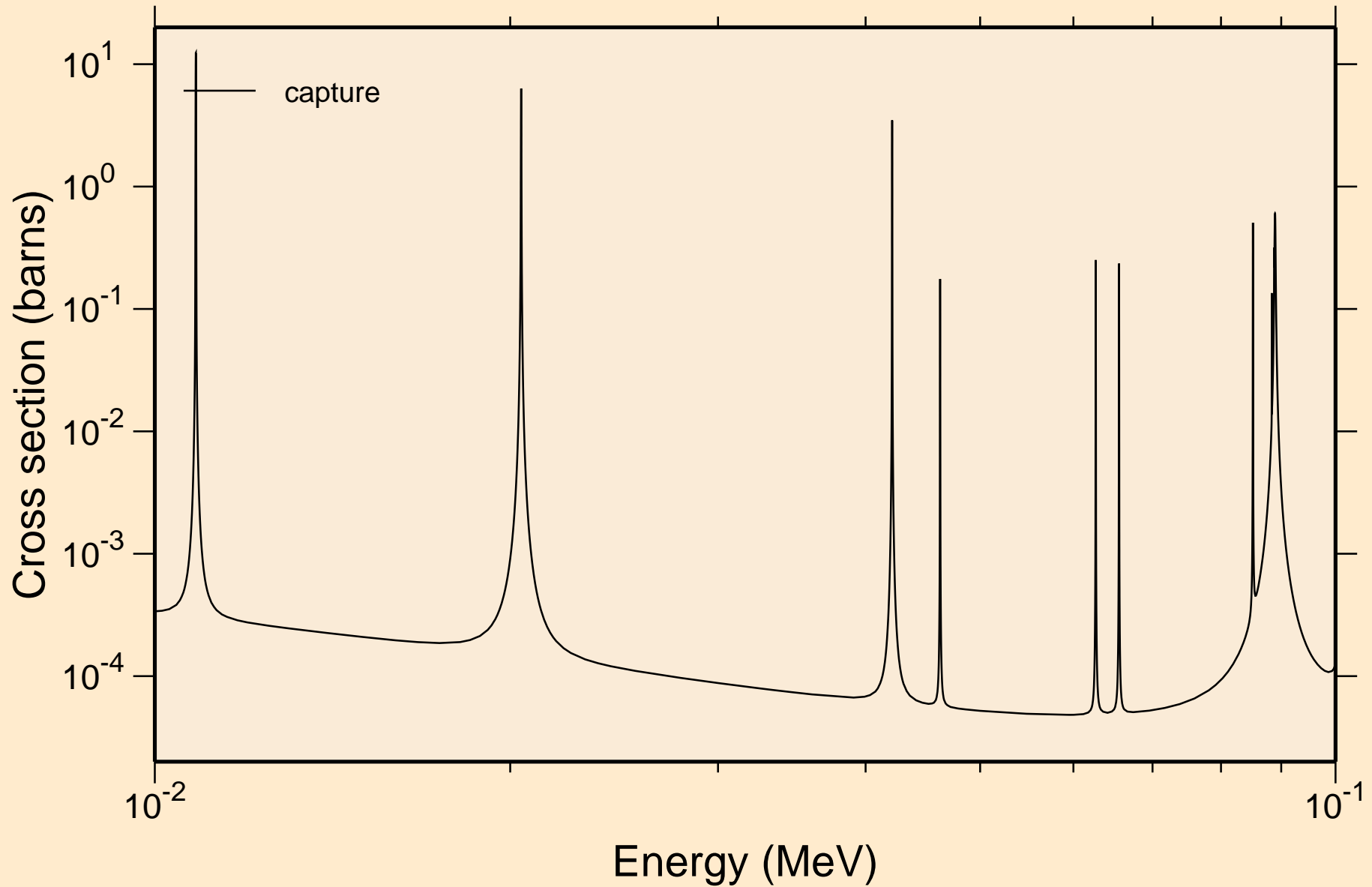

CA040 NEUTRON ACER TENDL-2021 LIBRARY; T=293.6K
resonance absorption cross sections

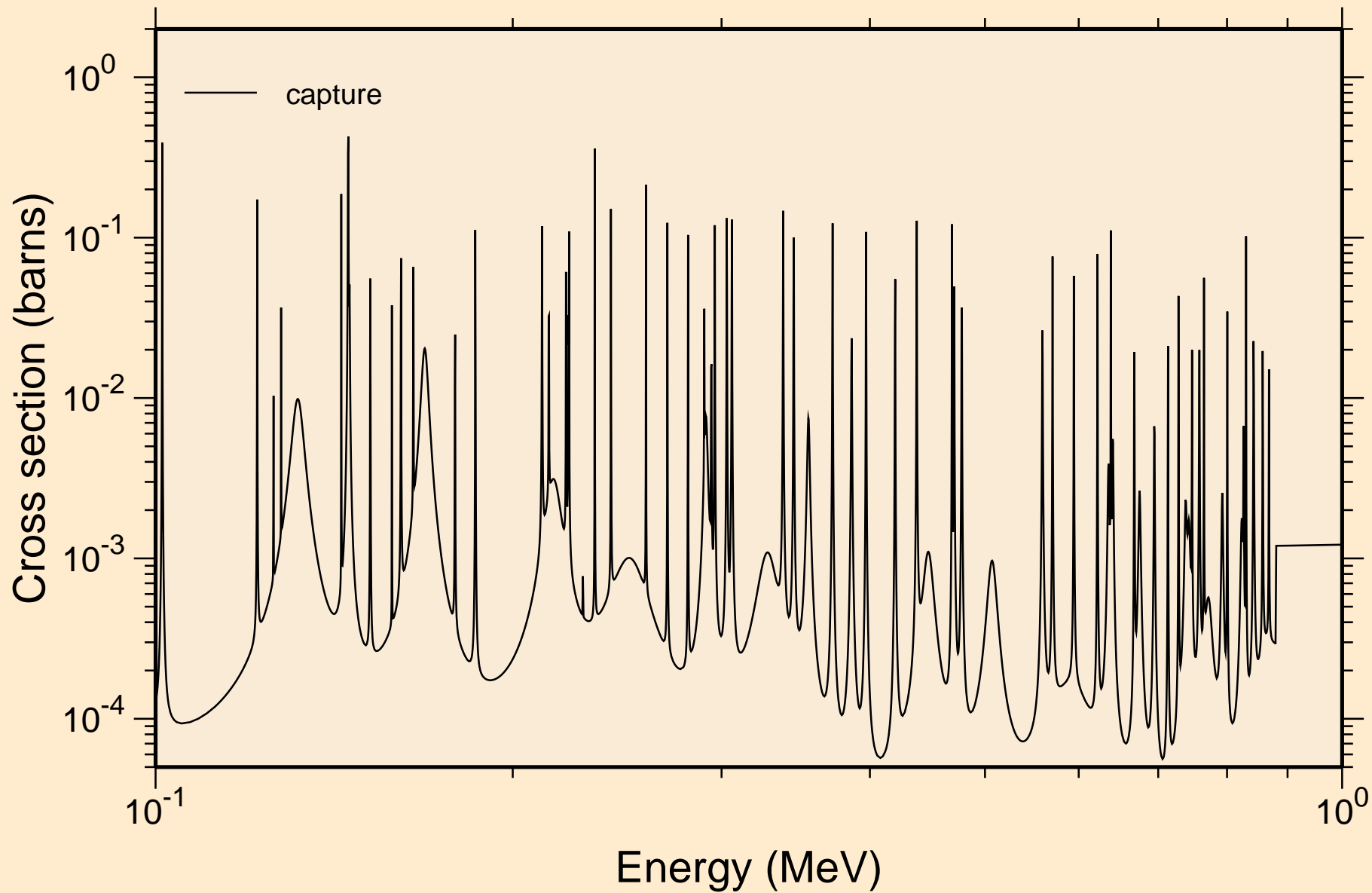

CA040 NEUTRON ACER TENDL-2021 LIBRARY; T=293.6K
resonance absorption cross sections

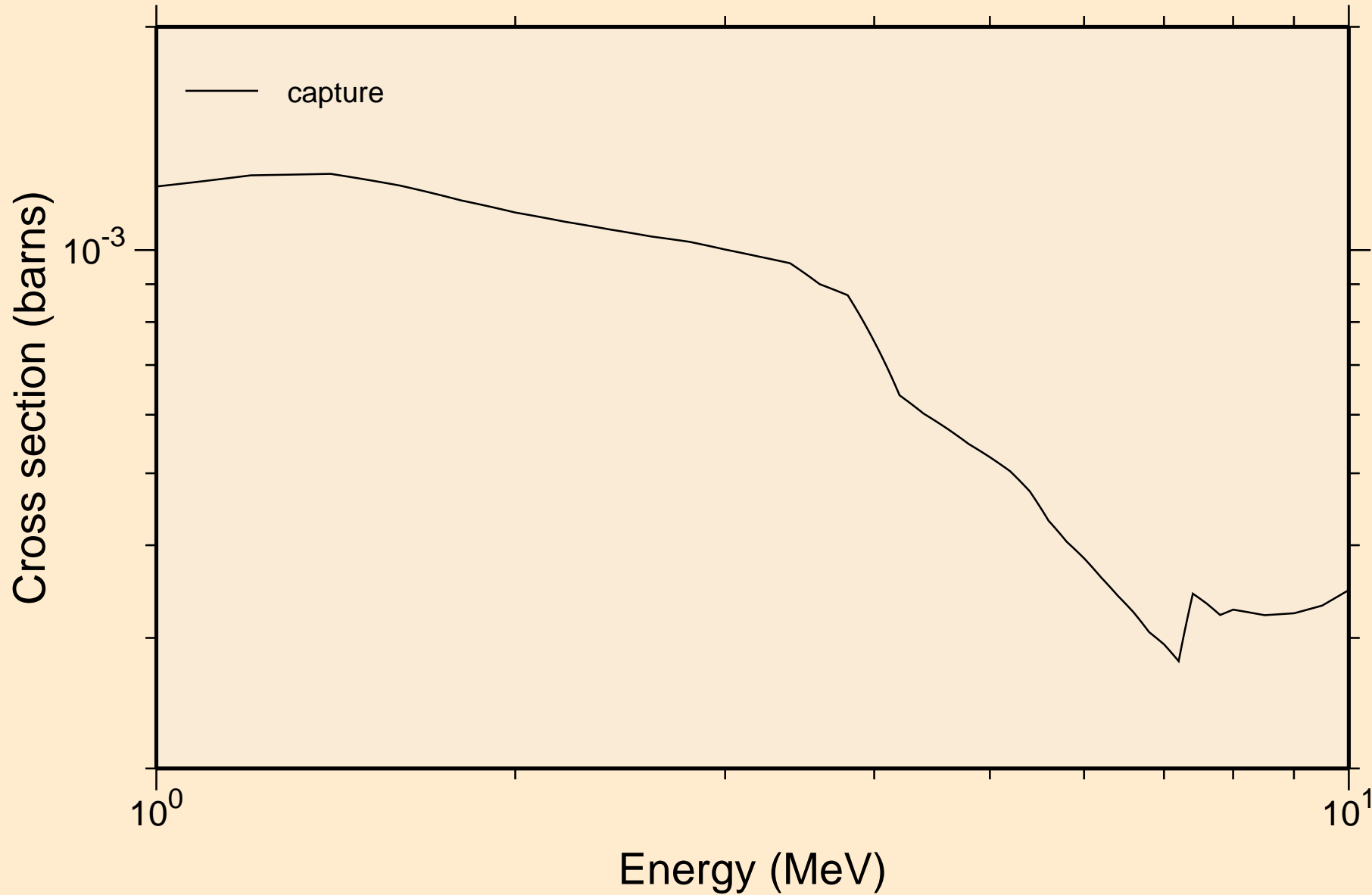

CA040 NEUTRON ACER TENDL-2021 LIBRARY; T=293.6K
Heating

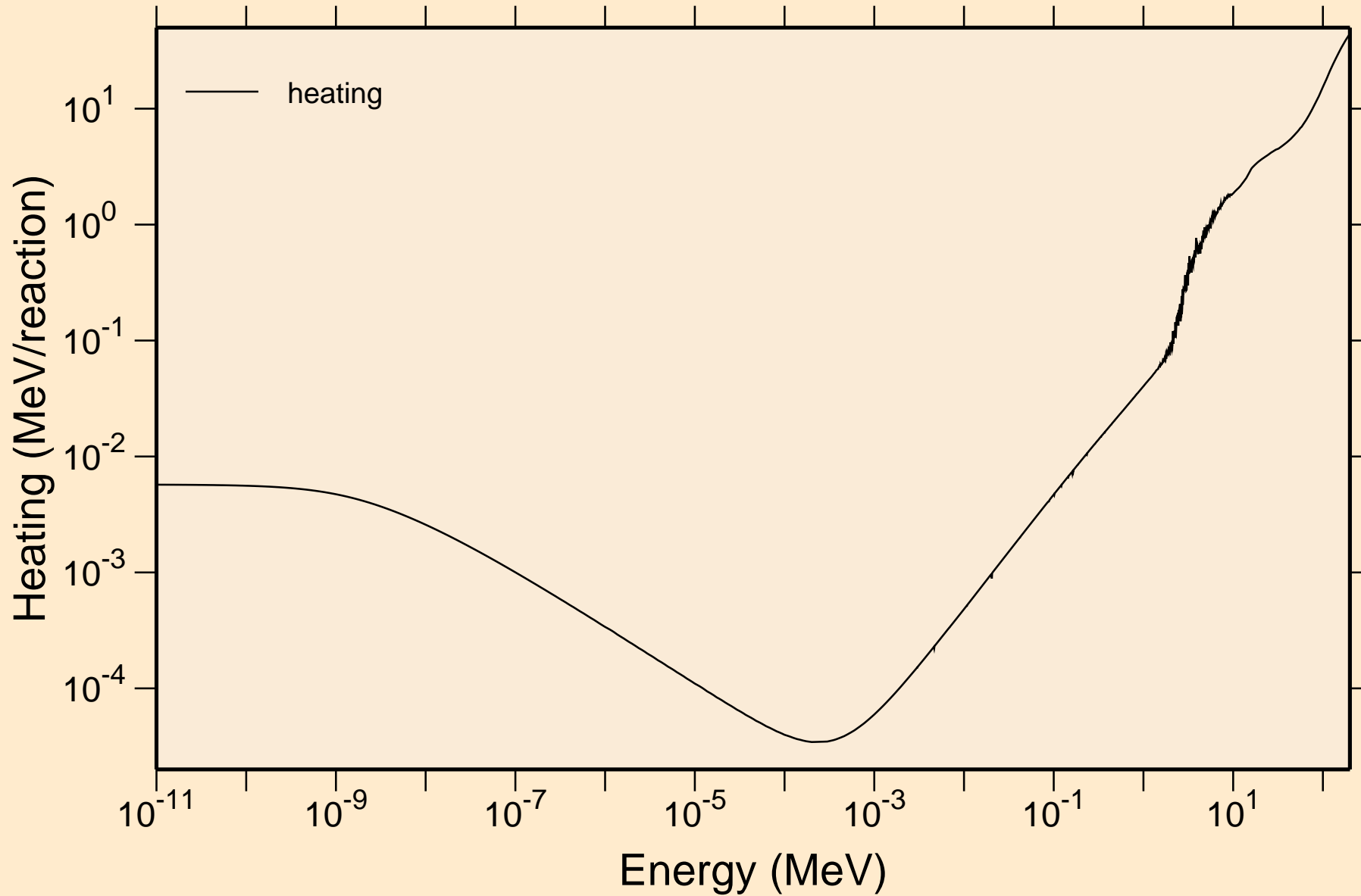

CA040 NEUTRON ACER TENDL-2021 LIBRARY; T=293.6K
Damage

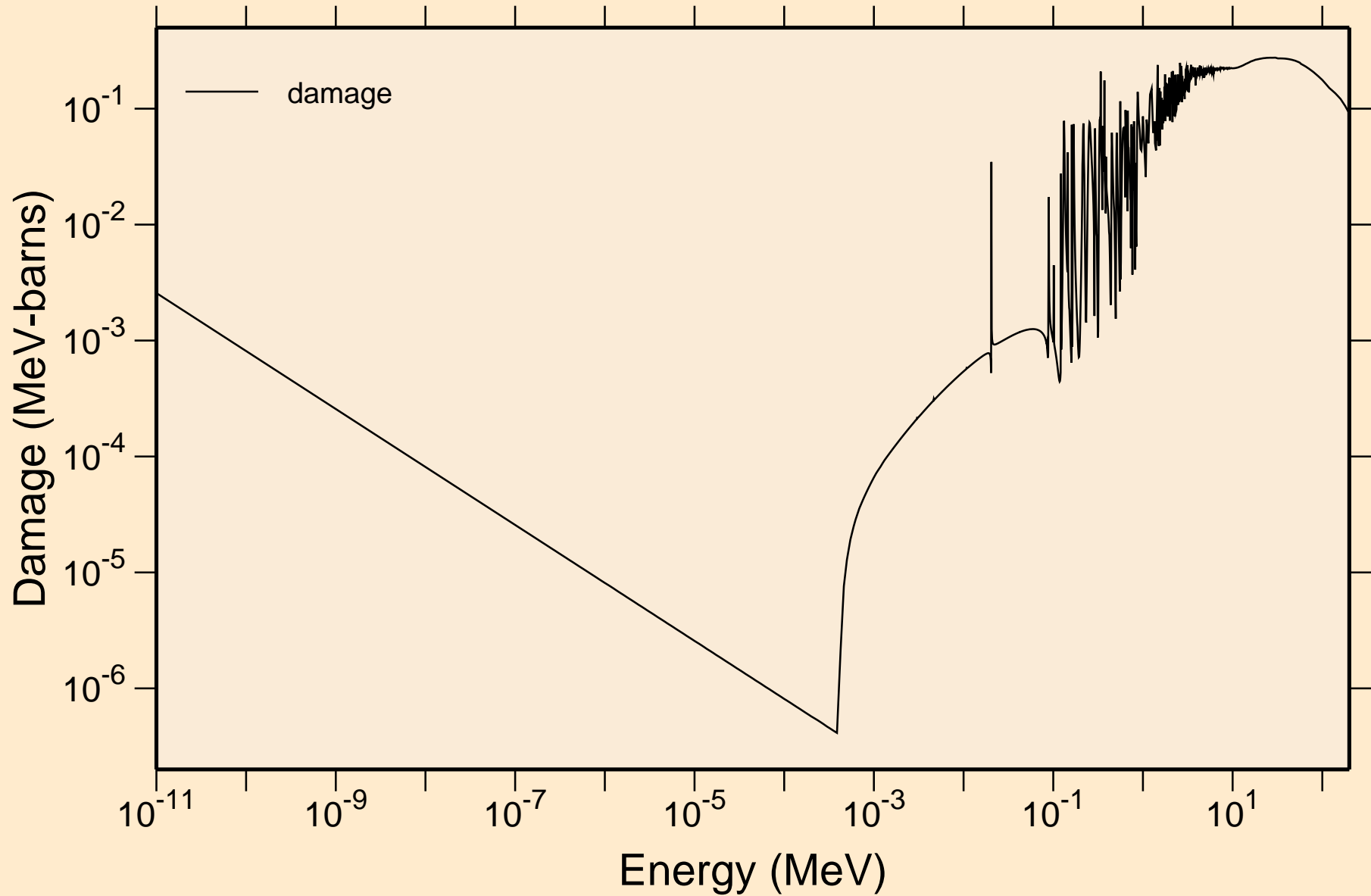

CA040 NEUTRON ACER TENDL-2021 LIBRARY; T=293.6K
Non-threshold reactions

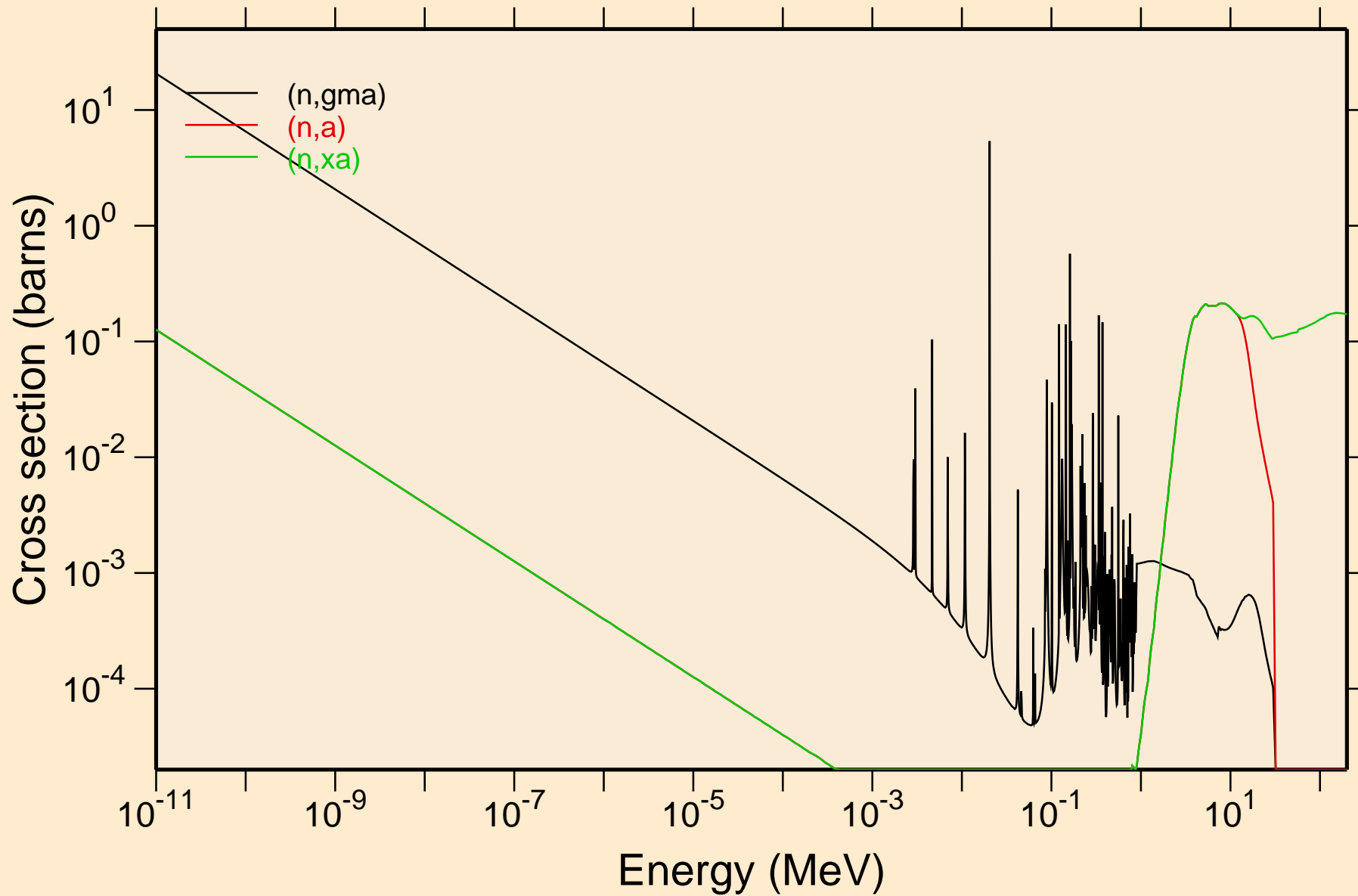

CA040 NEUTRON ACER TENDL-2021 LIBRARY; T=293.6K

Principal cross sections

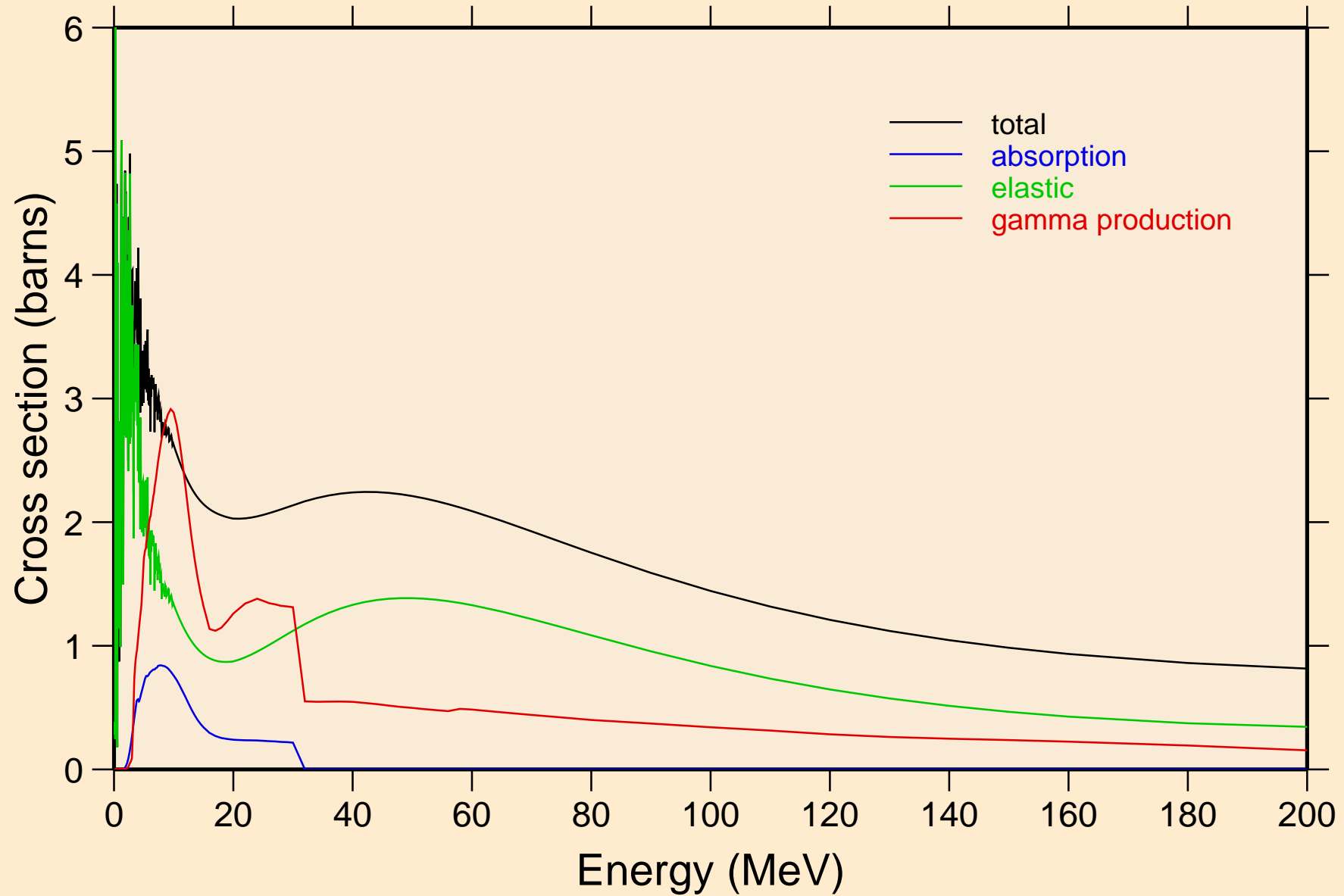

CA040 NEUTRON ACER TENDL-2021 LIBRARY; T=293.6K
Heating

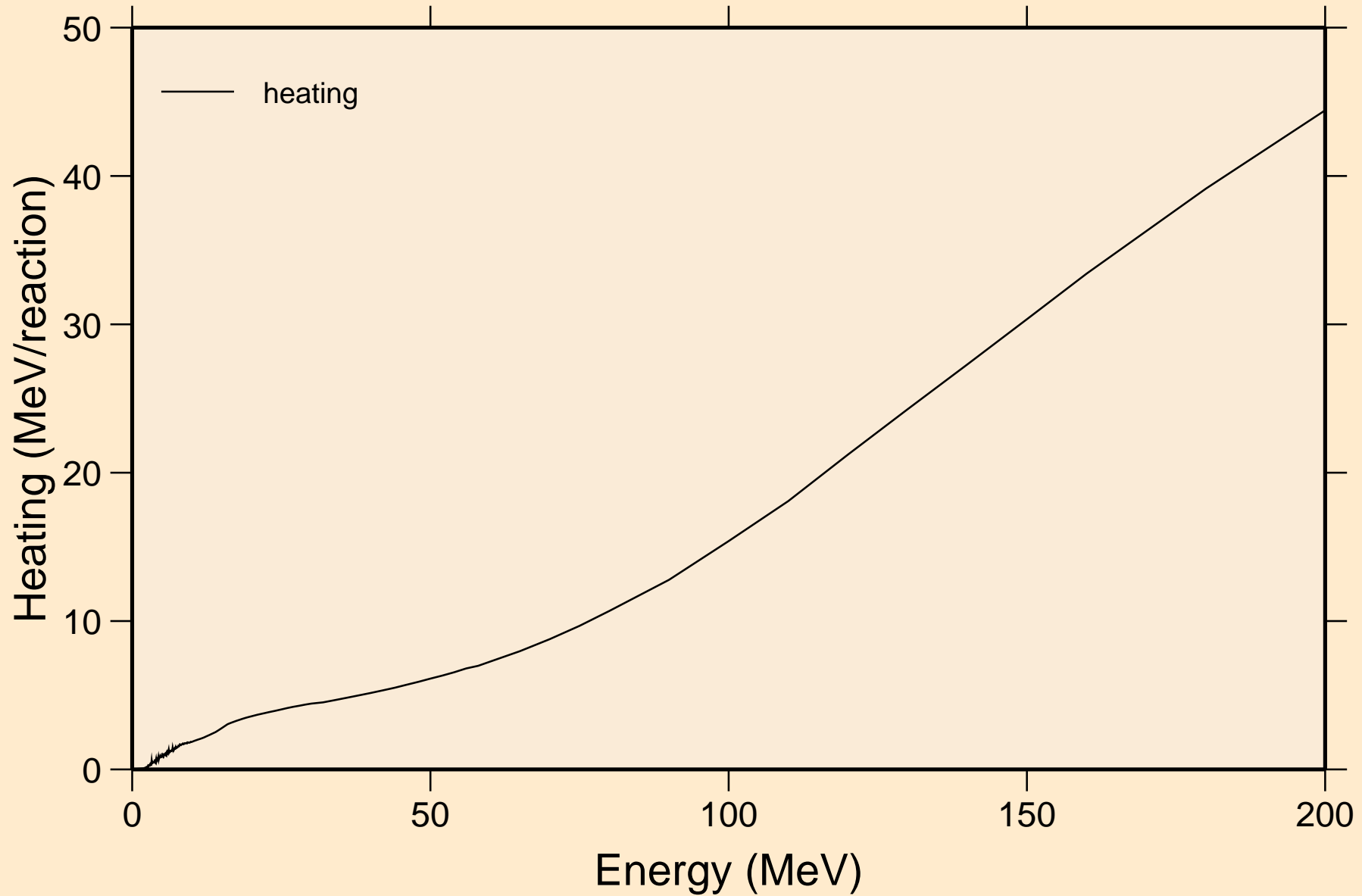

CA040 NEUTRON ACER TENDL-2021 LIBRARY; T=293.6K
Damage

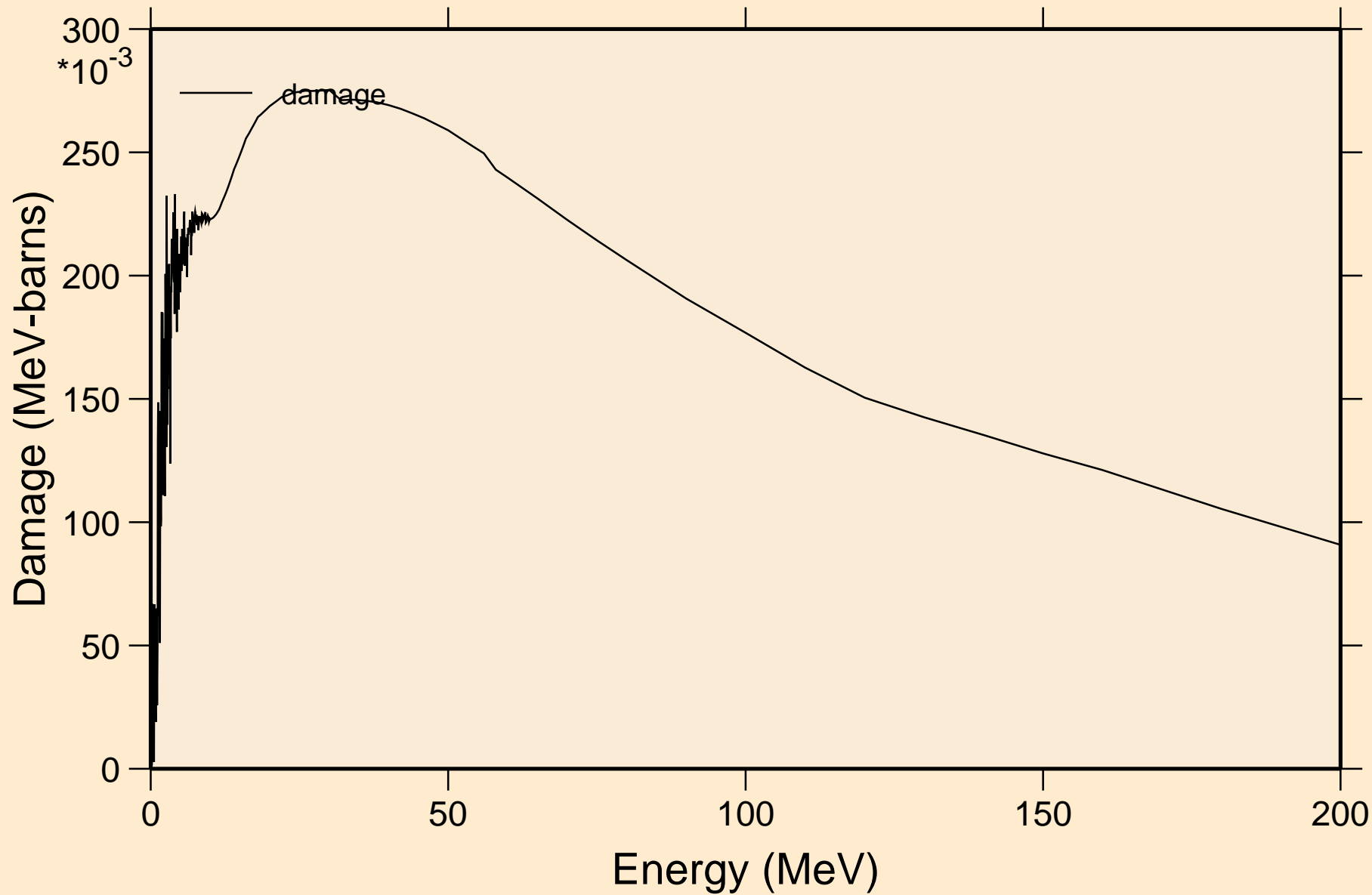

CA040 NEUTRON ACER TENDL-2021 LIBRARY; T=293.6K
Non-threshold reactions

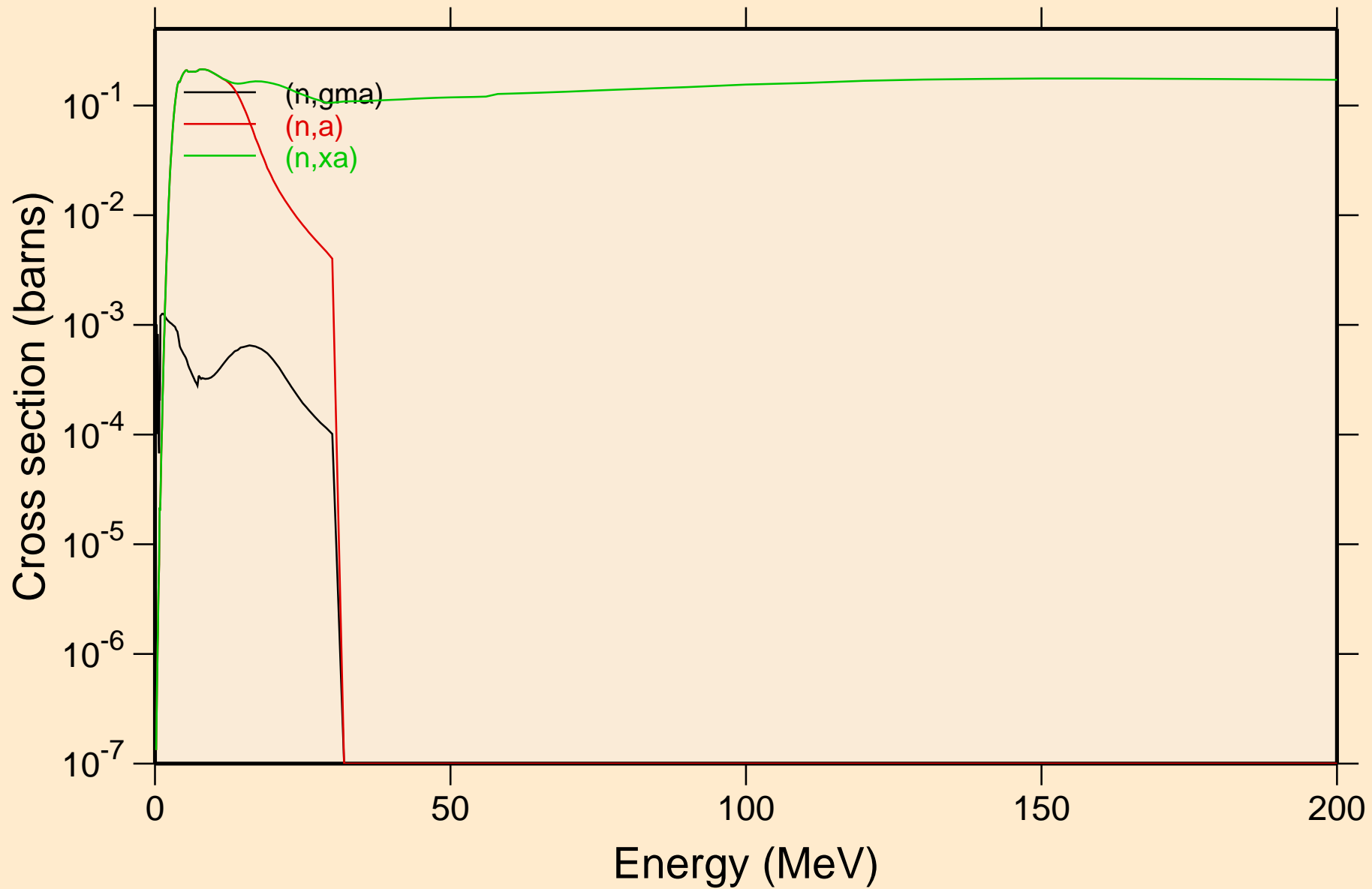

CA040 NEUTRON ACER TENDL-2021 LIBRARY; T=293.6K
Inelastic levels

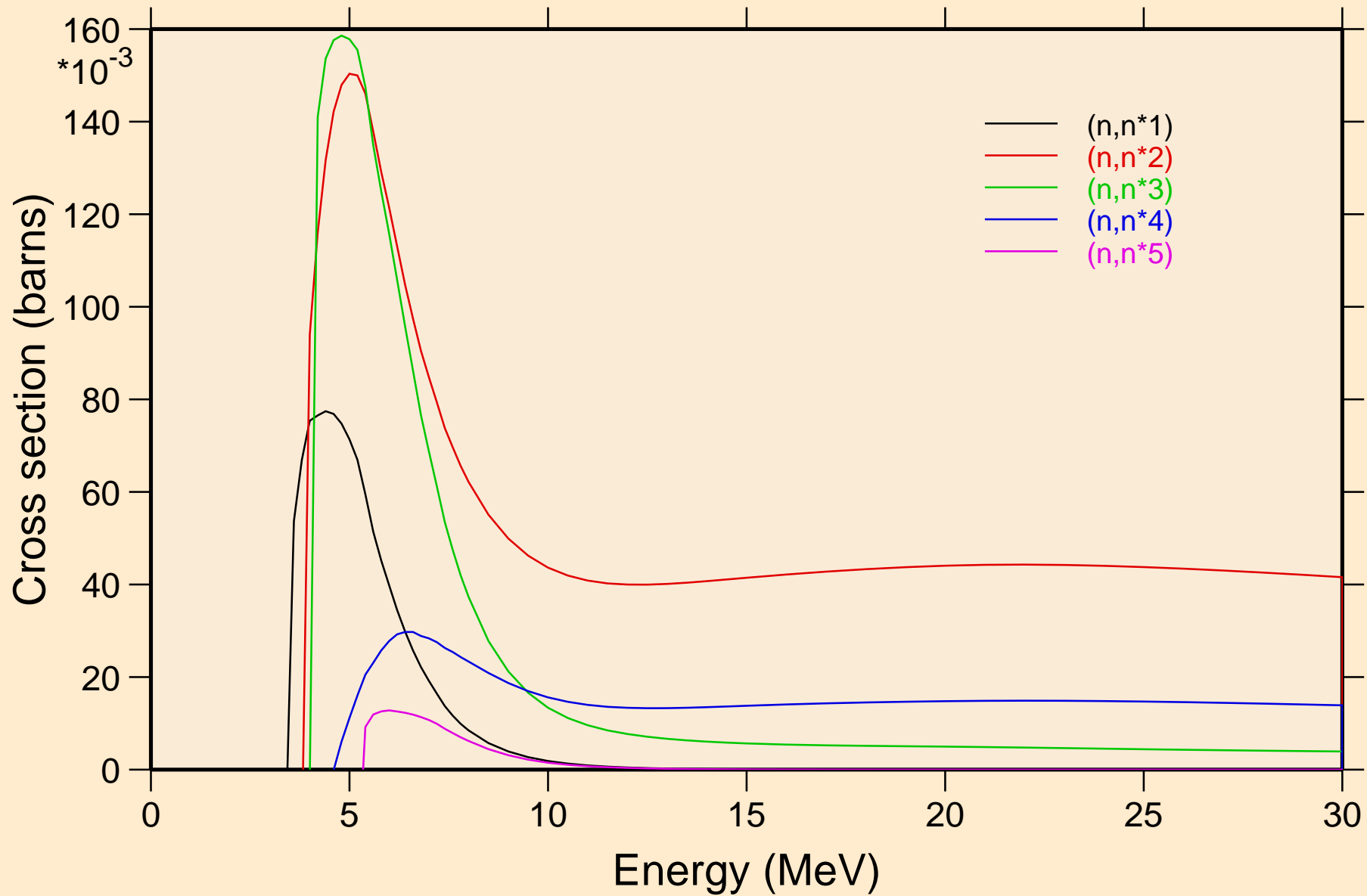

CA040 NEUTRON ACER TENDL-2021 LIBRARY; T=293.6K
Inelastic levels

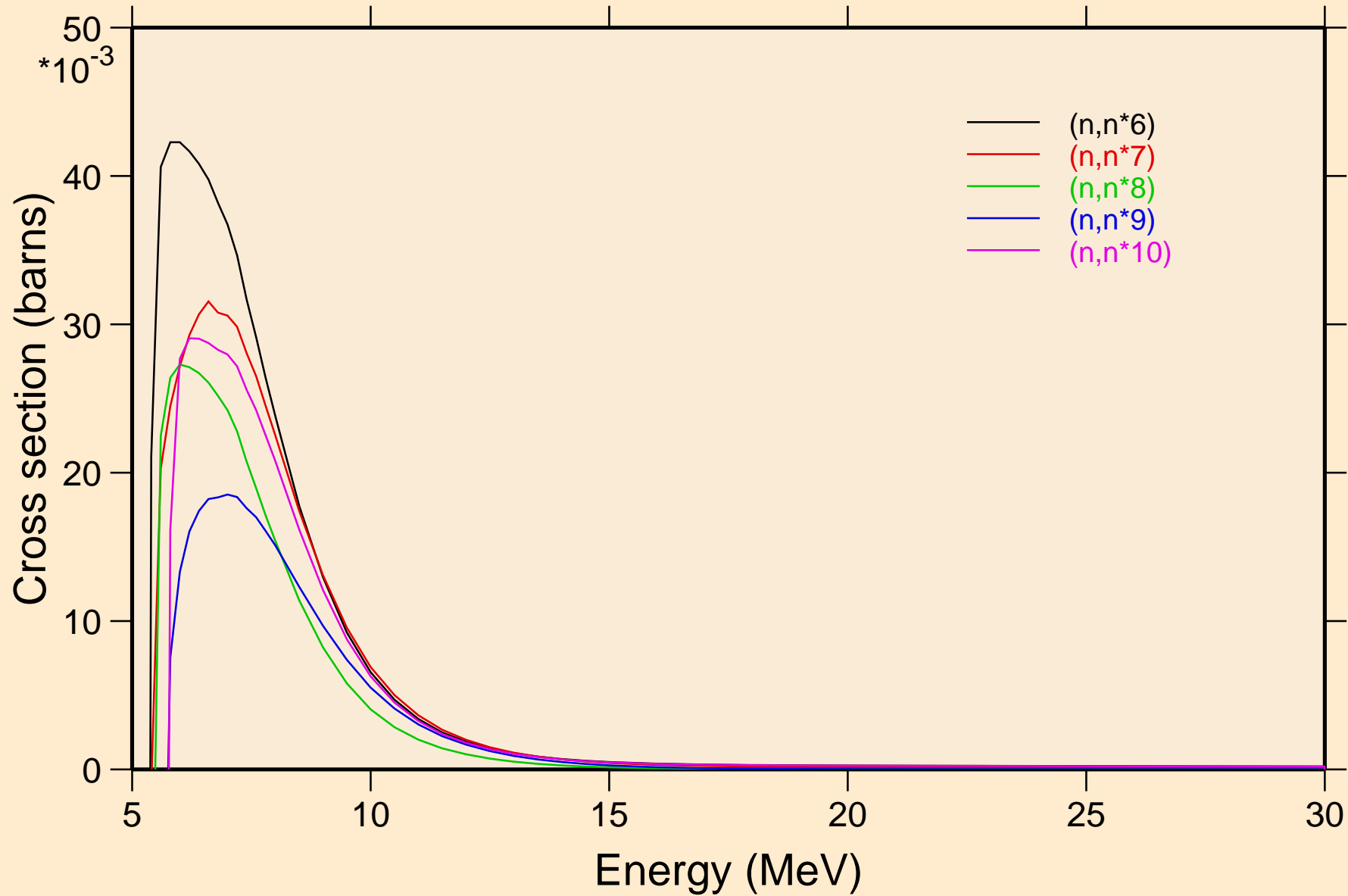

CA040 NEUTRON ACER TENDL-2021 LIBRARY; T=293.6K
Inelastic levels

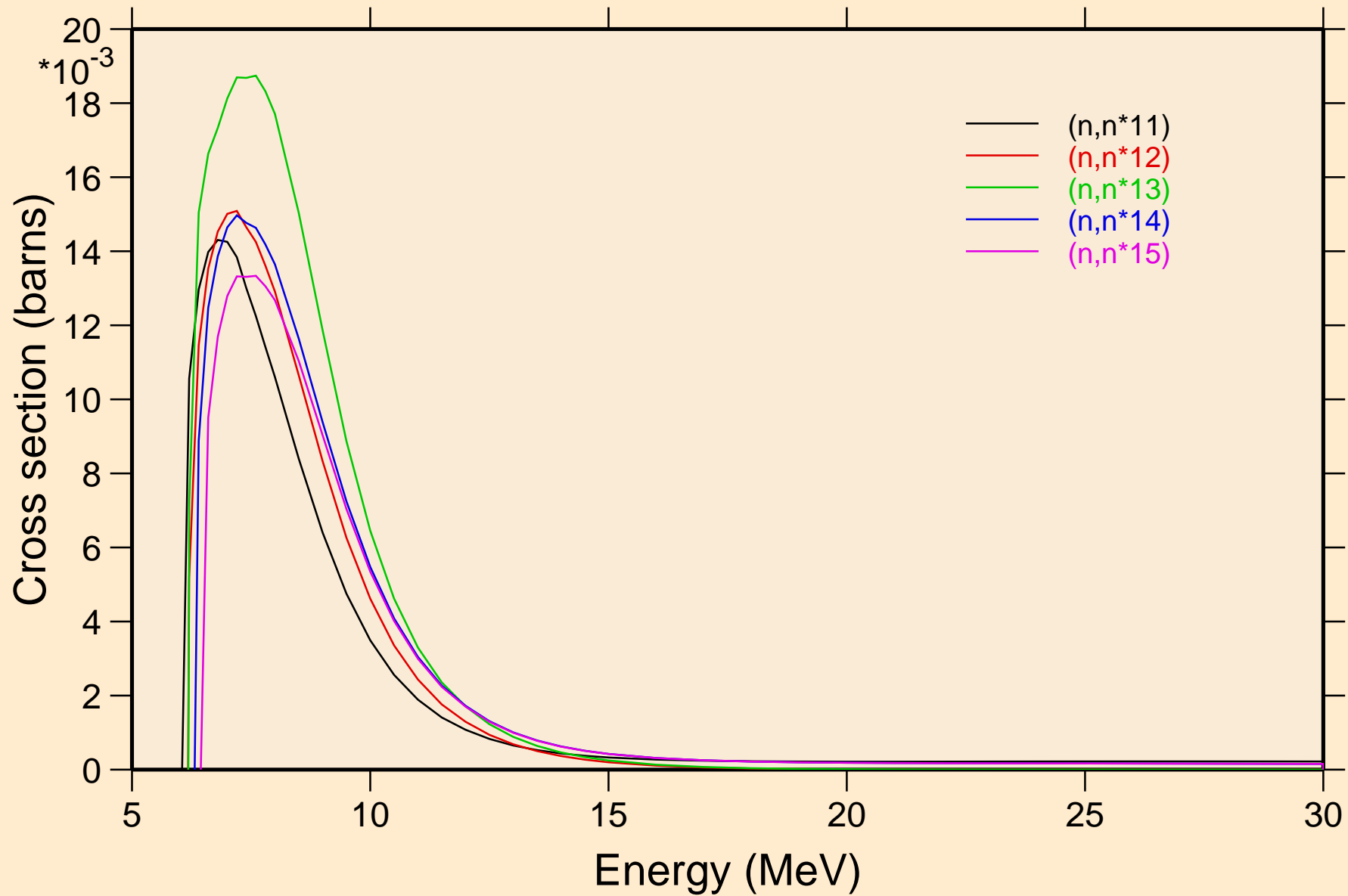

CA040 NEUTRON ACER TENDL-2021 LIBRARY; T=293.6K
Inelastic levels

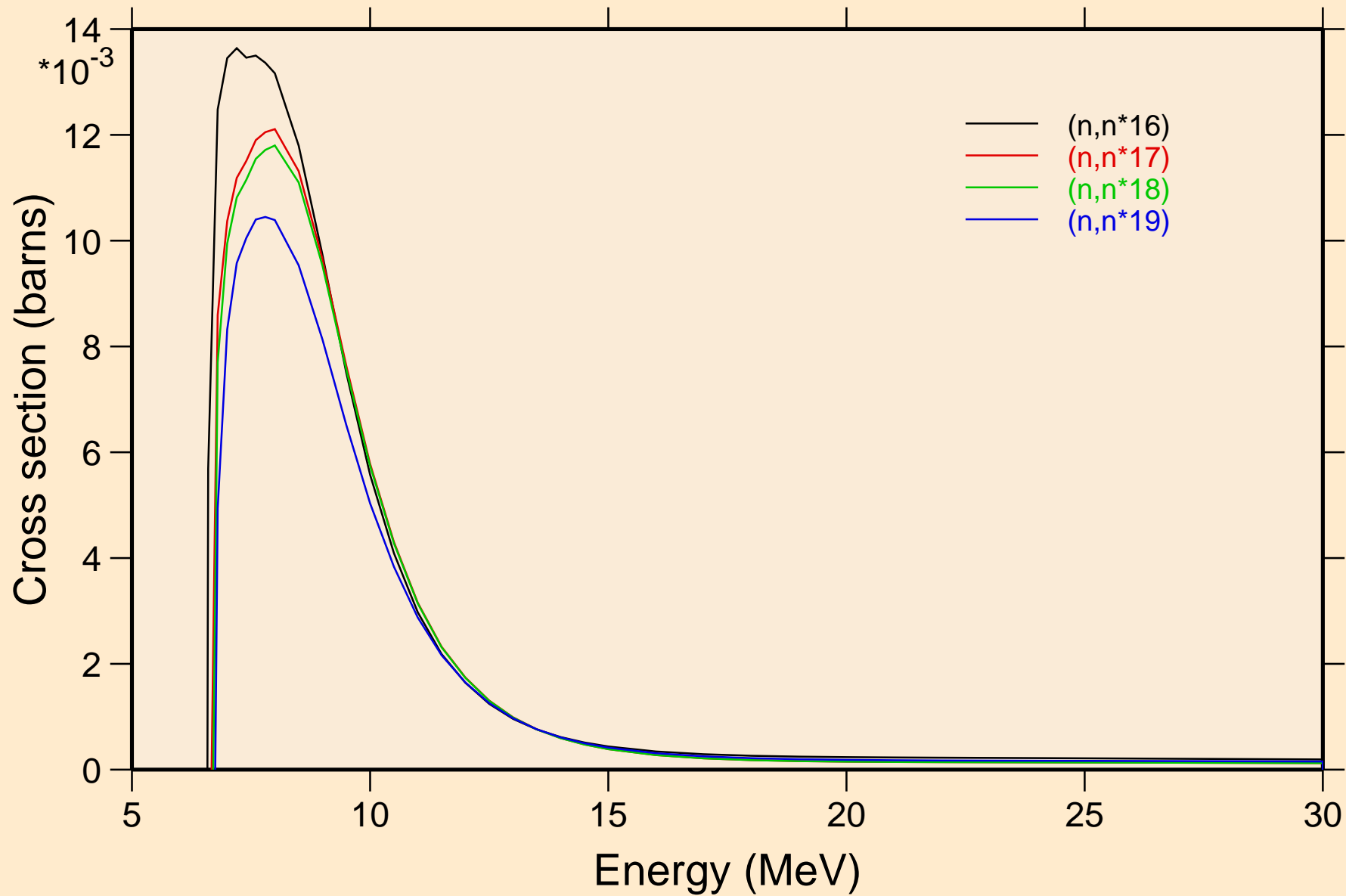

CA040 NEUTRON ACER TENDL-2021 LIBRARY; T=293.6K
Threshold reactions

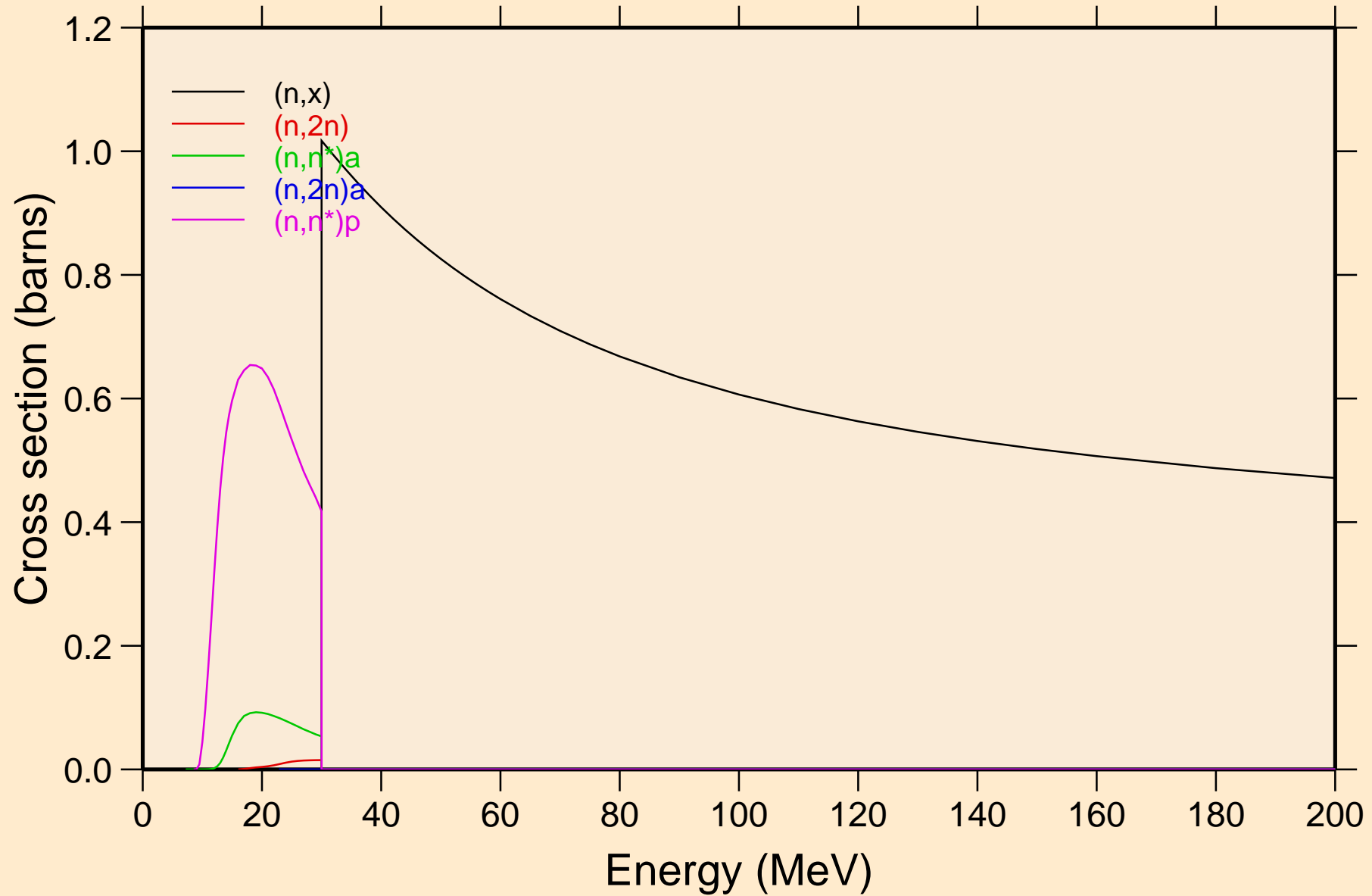

CA040 NEUTRON ACER TENDL-2021 LIBRARY; T=293.6K
Threshold reactions

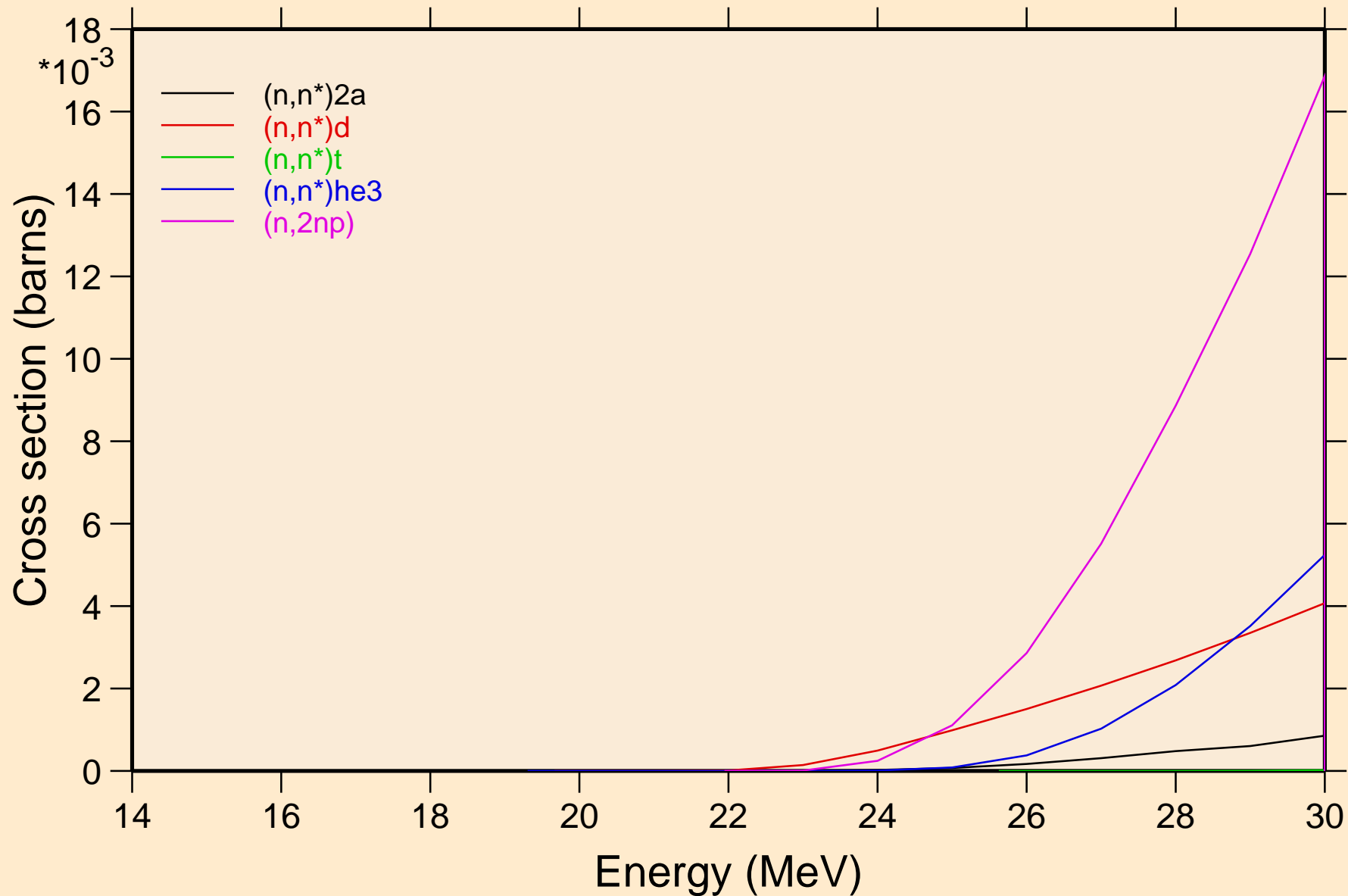

CA040 NEUTRON ACER TENDL-2021 LIBRARY; T=293.6K
Threshold reactions

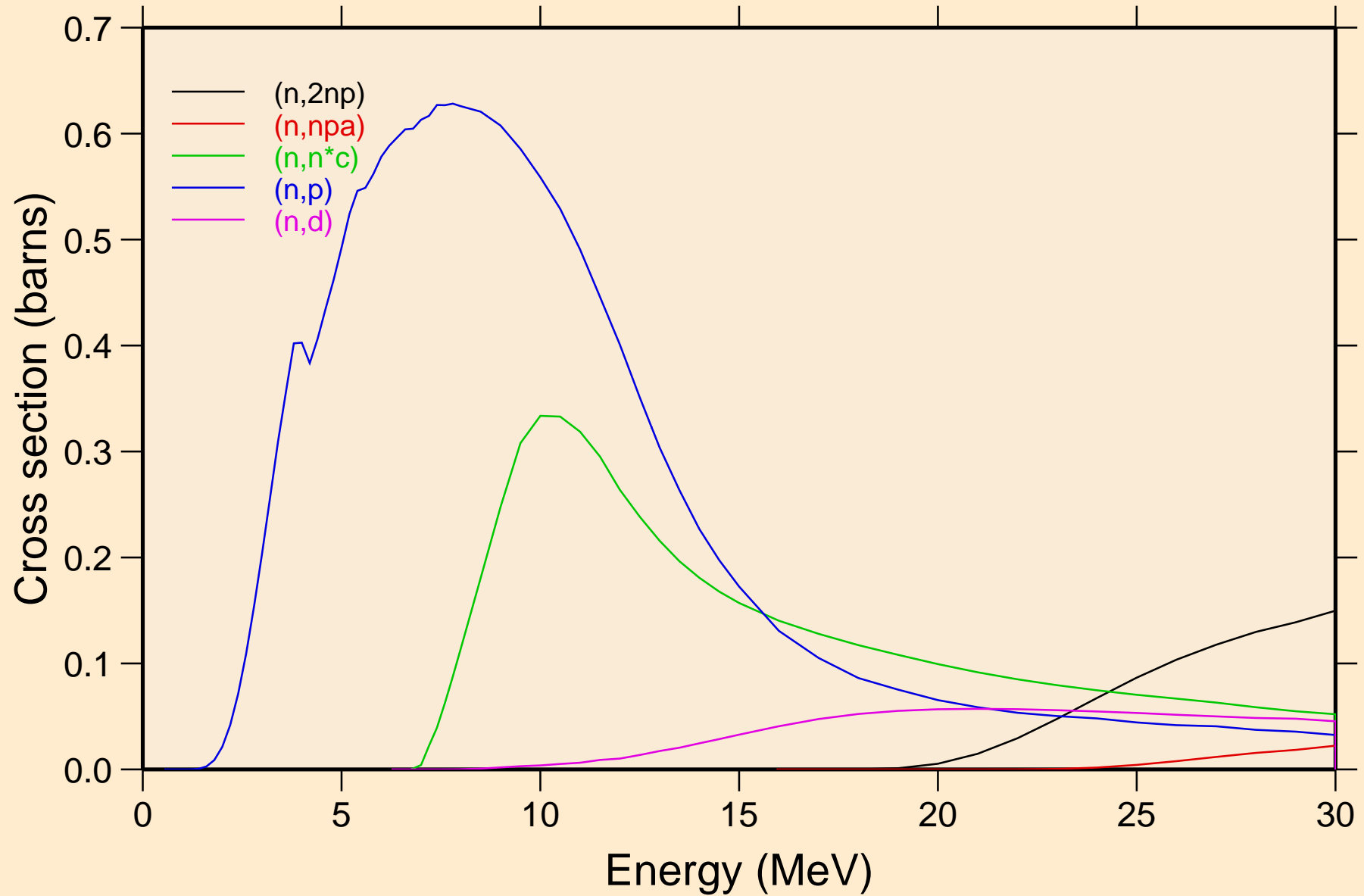

CA040 NEUTRON ACER TENDL-2021 LIBRARY; T=293.6K
Threshold reactions

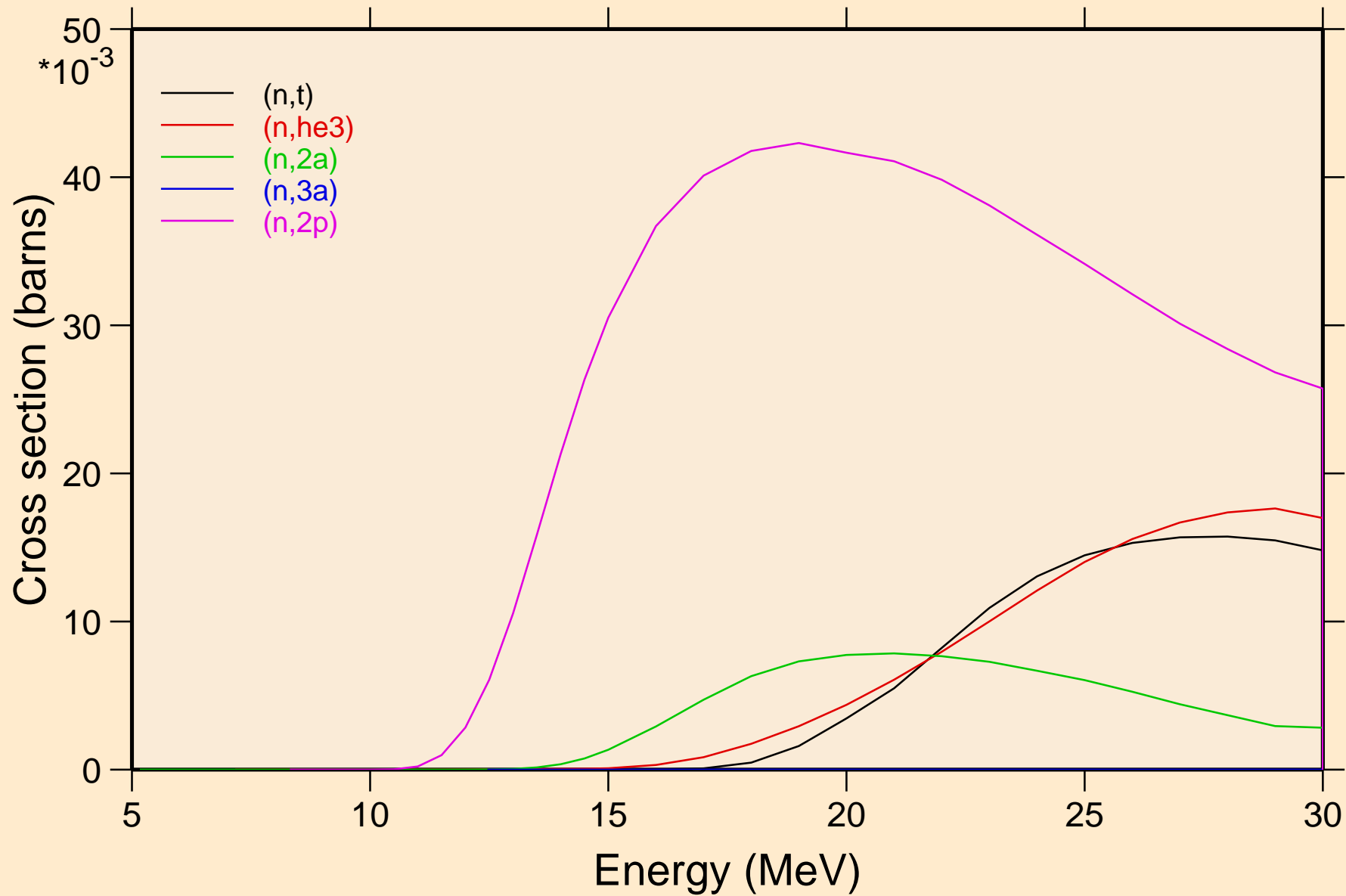

CA040 NEUTRON ACER TENDL-2021 LIBRARY; T=293.6K

Threshold reactions

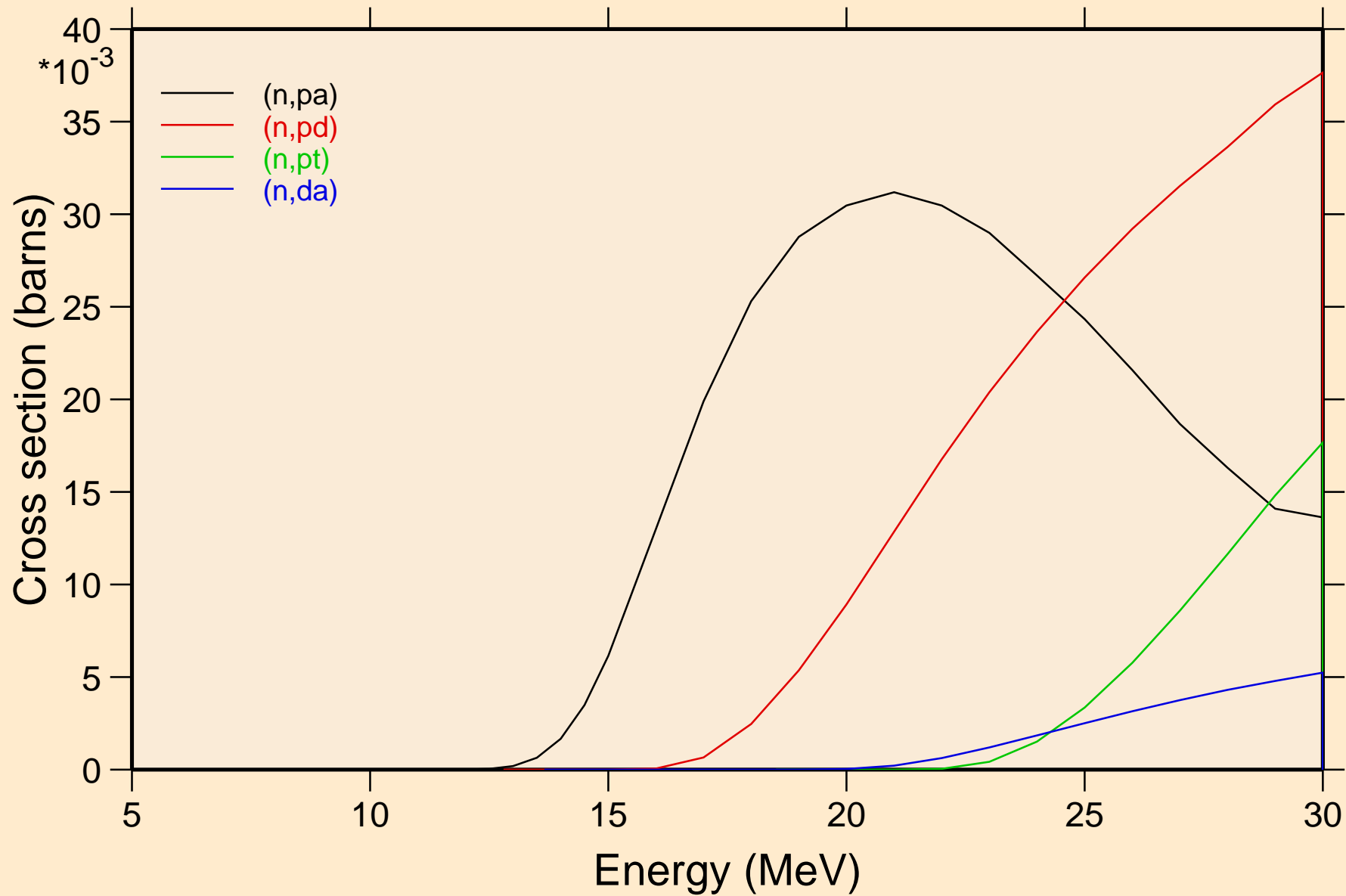

CA040 NEUTRON ACER TENDL-2021 LIBRARY; T=293.6K
Threshold reactions

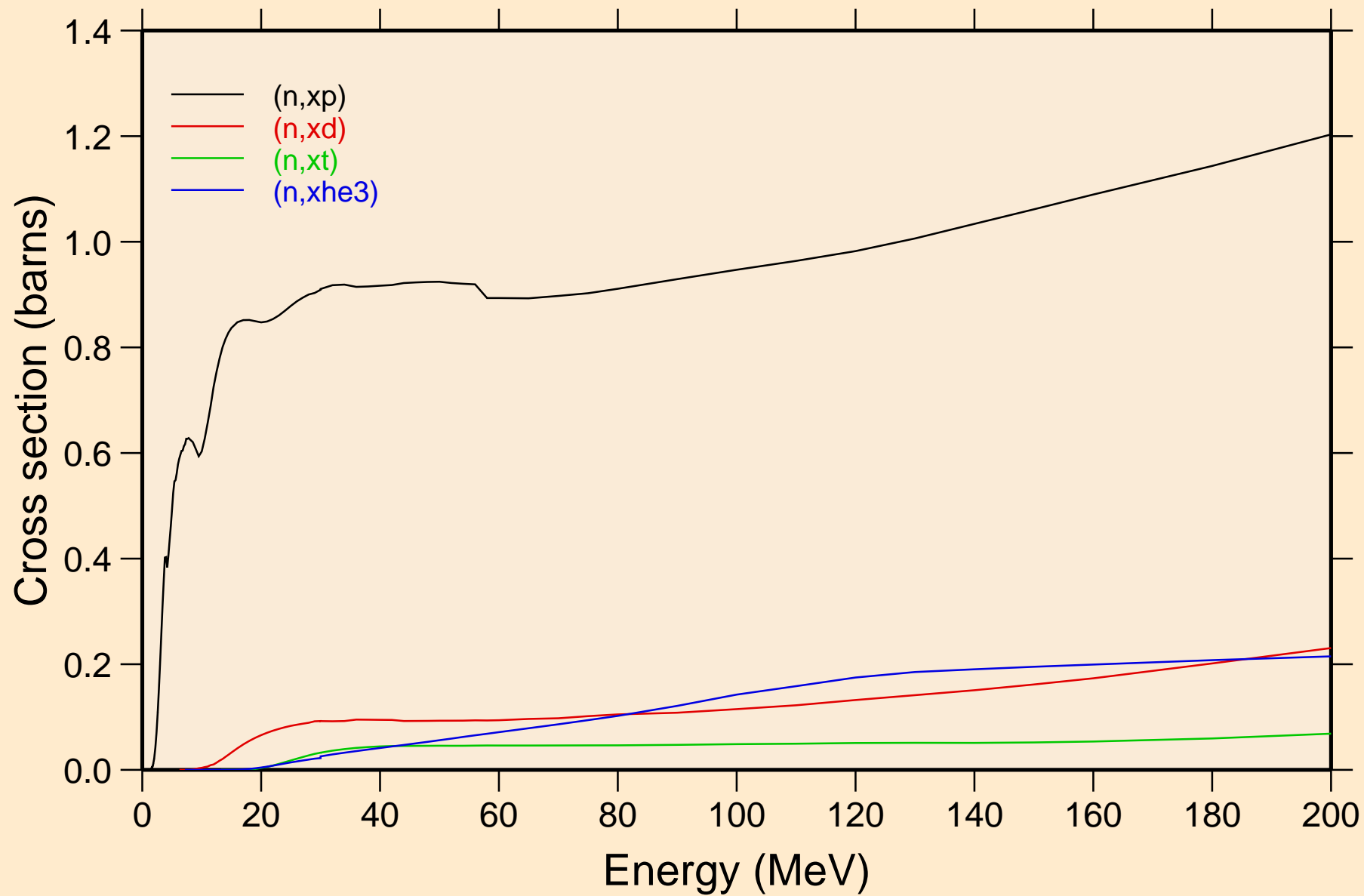

CA040 NEUTRON ACER TENDL-2021 LIBRARY; T=293.6K
angular distribution for elastic

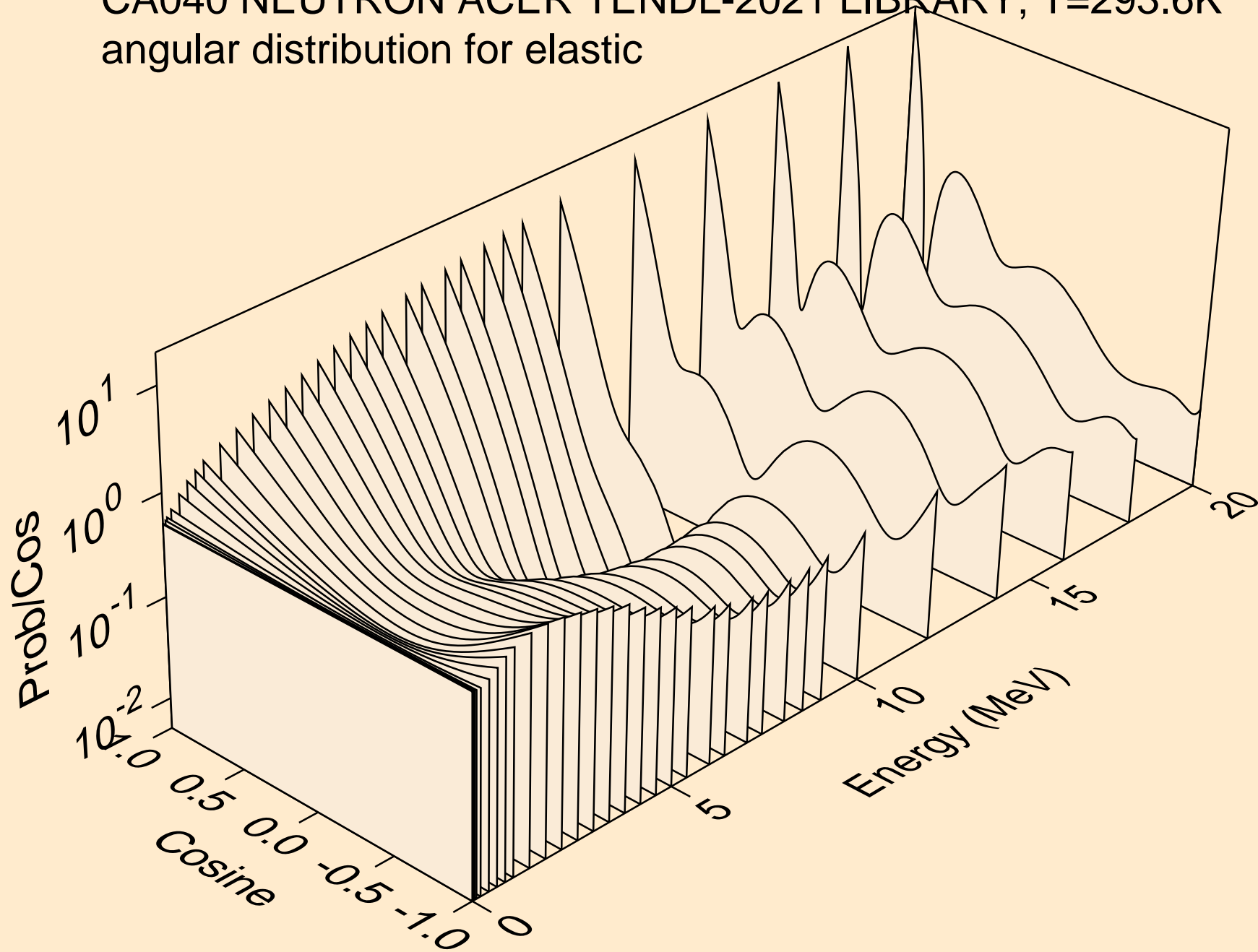

CA040 NEUTRON ACER TENDL-2021 LIBRARY; T=293.6K
angular distribution for elastic

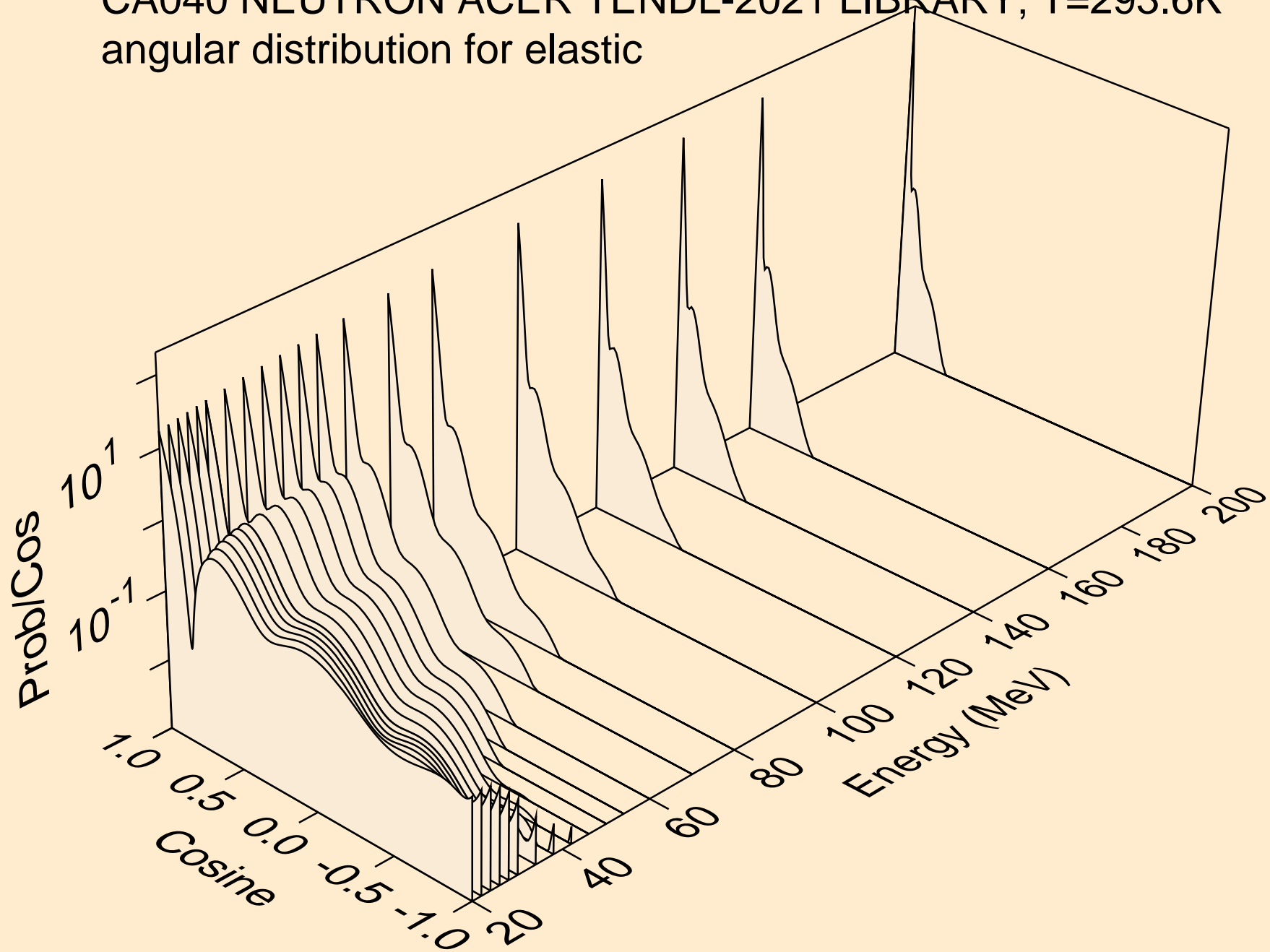

CA040 NEUTRON ACER TENDL-2021 LIBRARY; T=293.6K
angular distribution for (n,n*1)

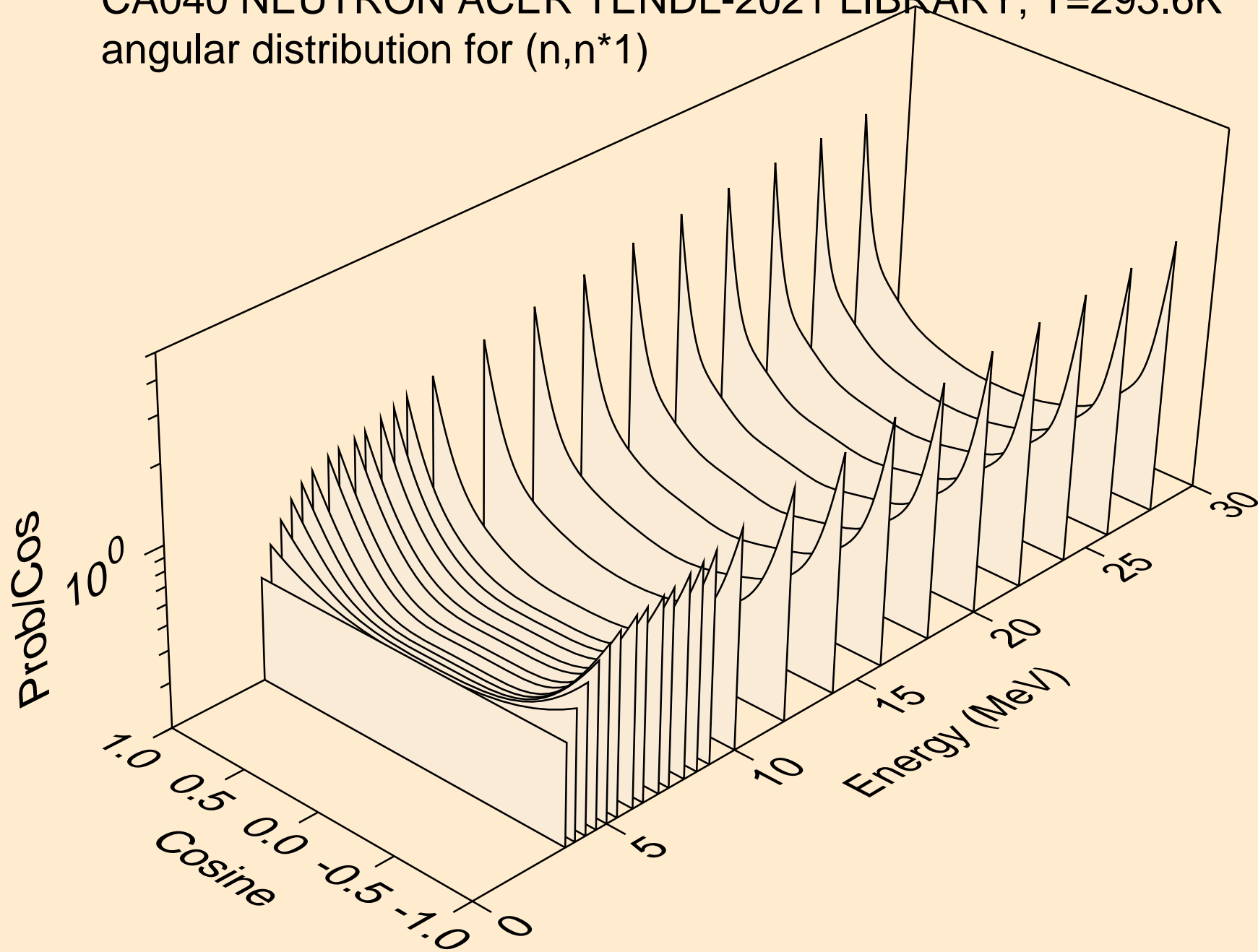

CA040 NEUTRON ACER TENDL-2021 LIBRARY; T=293.6K
angular distribution for (n,n*2)

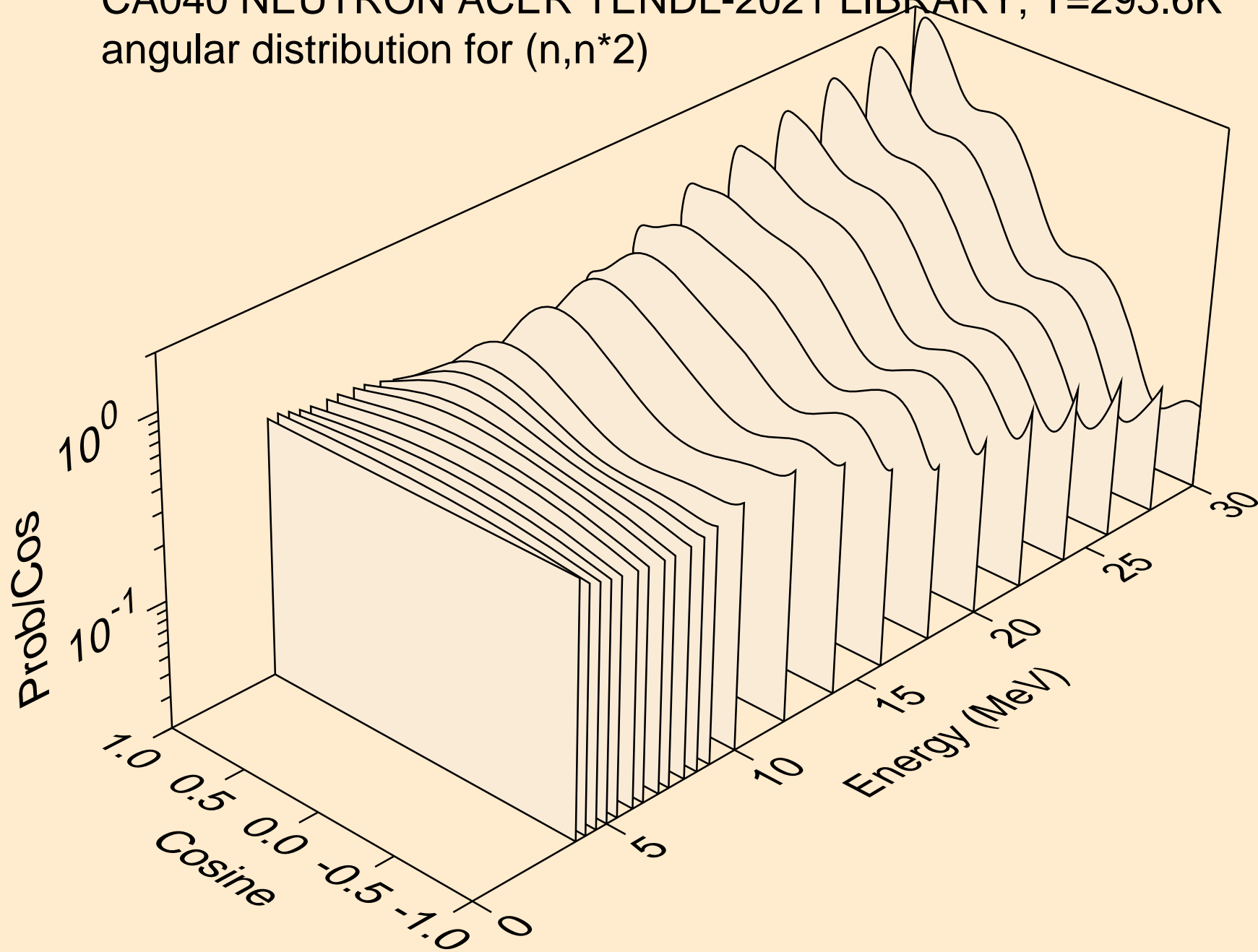

CA040 NEUTRON ACER TENDL-2021 LIBRARY; T=293.6K
angular distribution for (n,n*3)

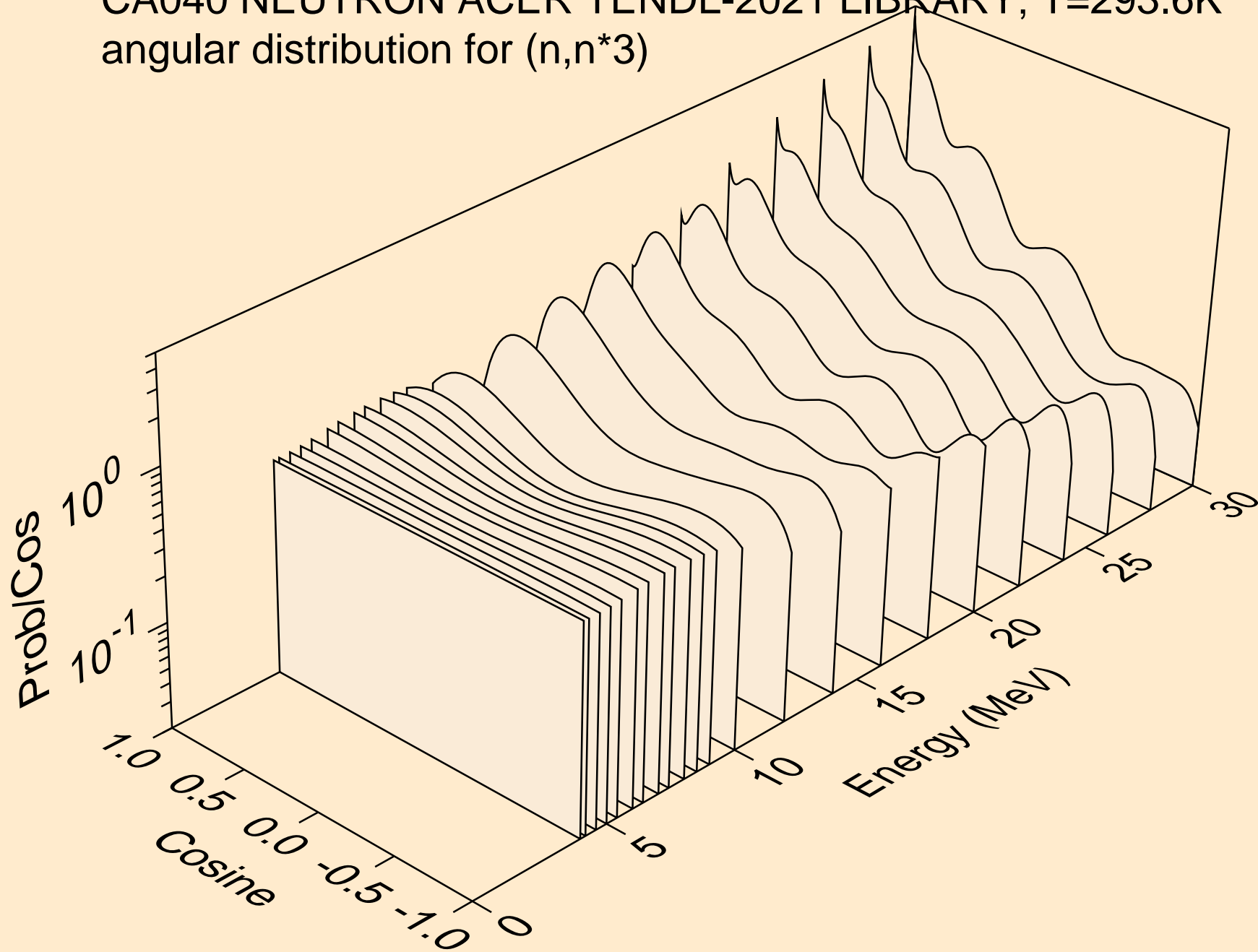

CA040 NEUTRON ACER TENDL-2021 LIBRARY; T=293.6K
angular distribution for (n,n*4)

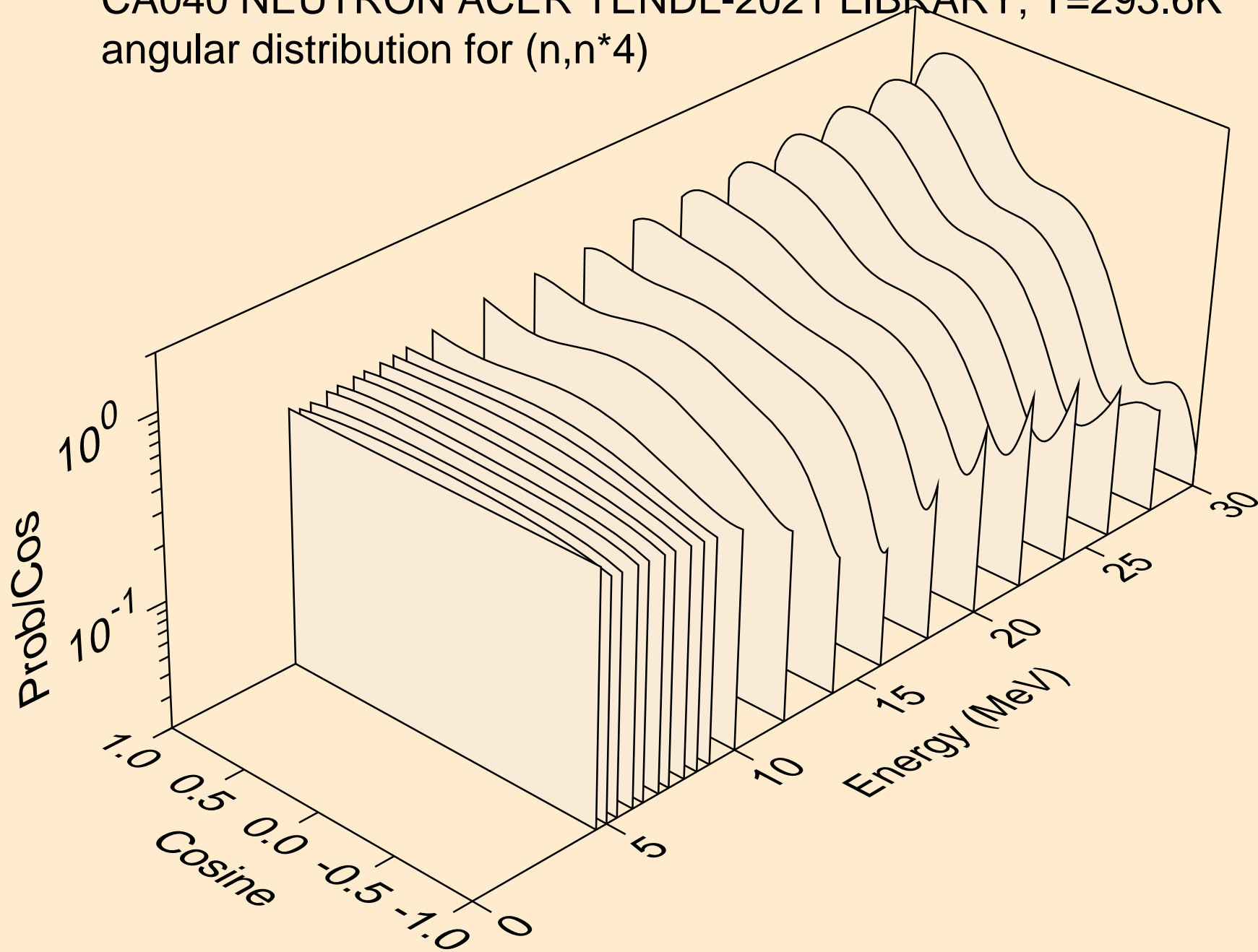

CA040 NEUTRON ACER TENDL-2021 LIBRARY; T=293.6K
angular distribution for (n,n*5)

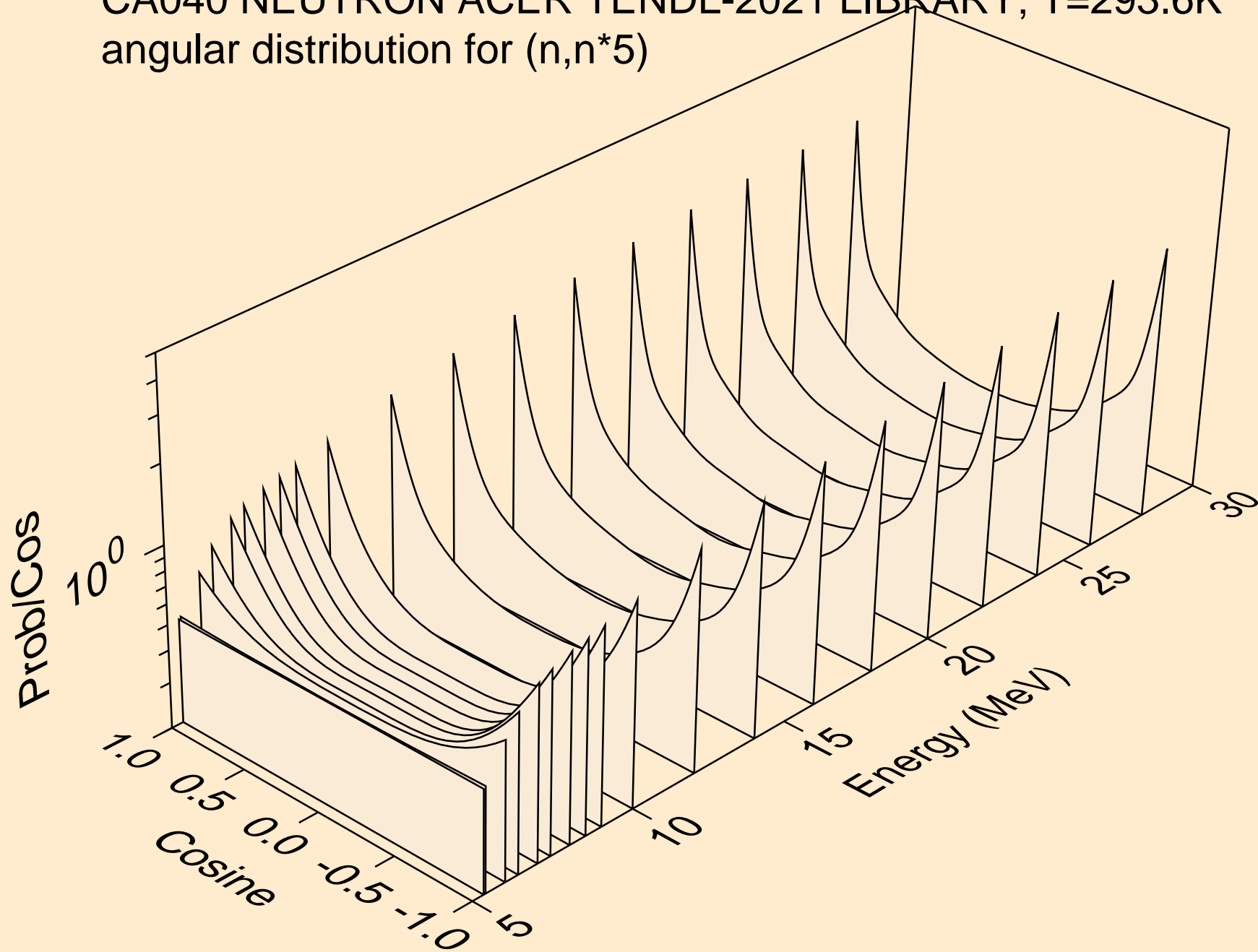

CA040 NEUTRON ACER TENDL-2021 LIBRARY; T=293.6K
angular distribution for (n,n*6)

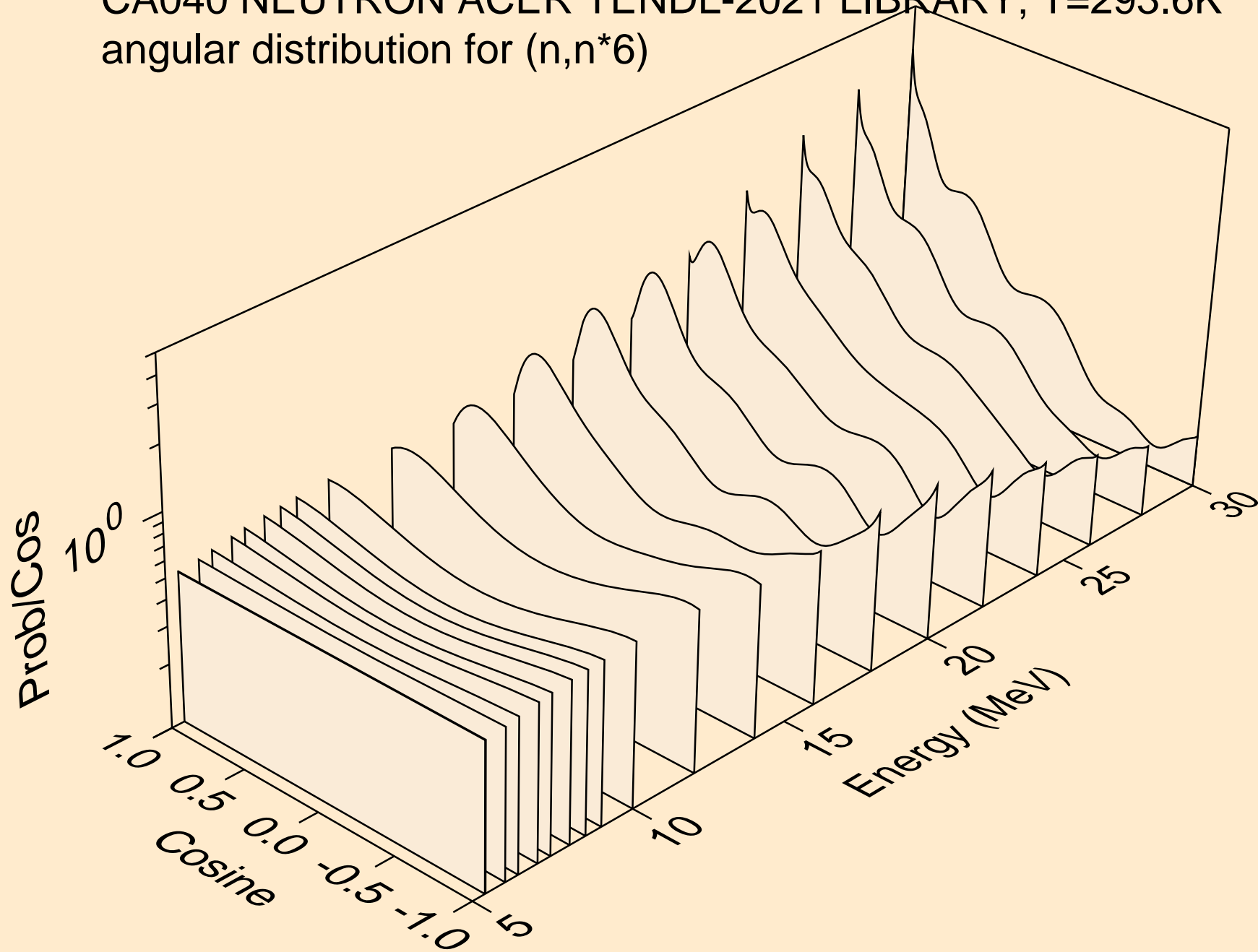

CA040 NEUTRON ACER TENDL-2021 LIBRARY; T=293.6K
angular distribution for (n,n*7)

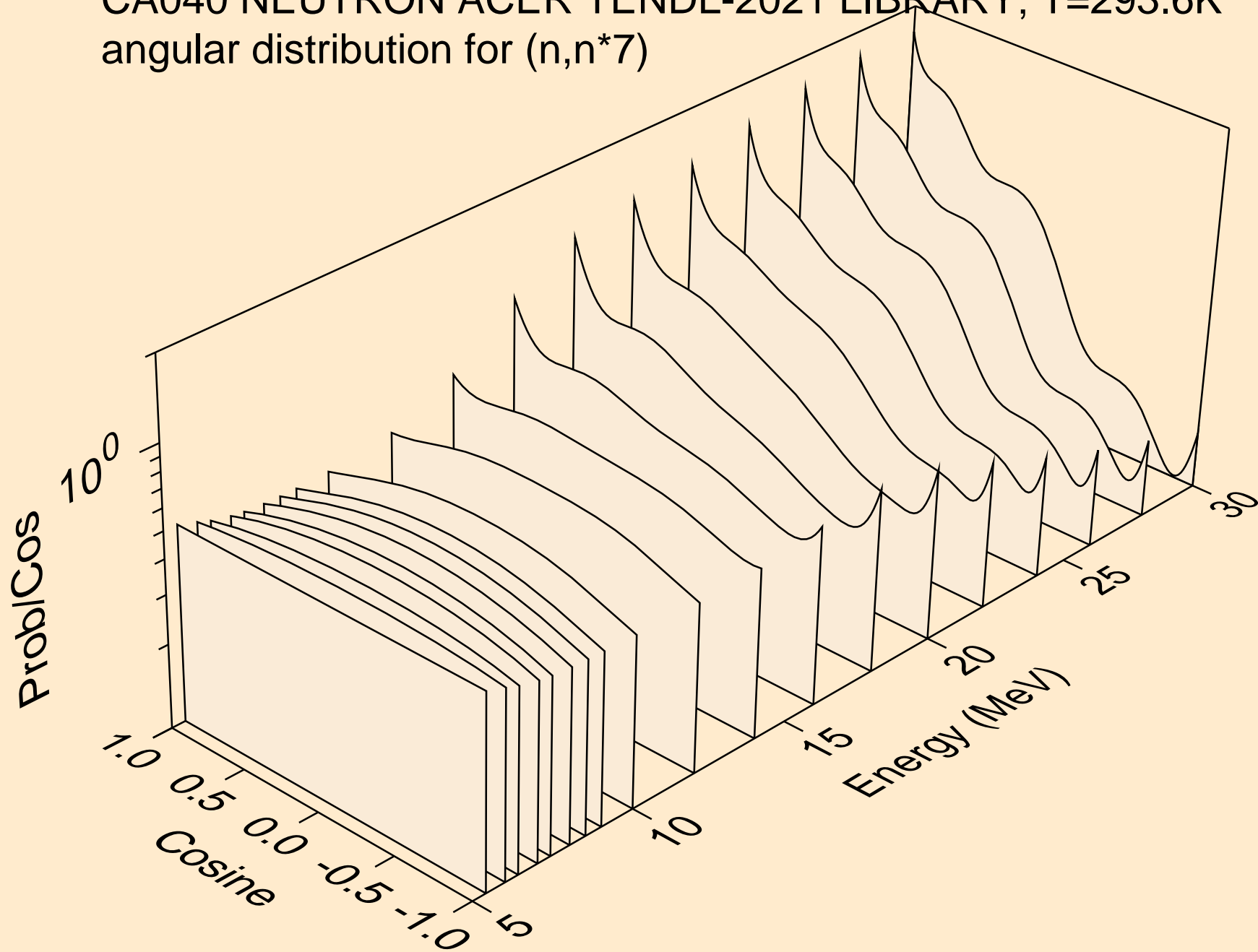

CA040 NEUTRON ACER TENDL-2021 LIBRARY; T=293.6K
angular distribution for (n,n*8)

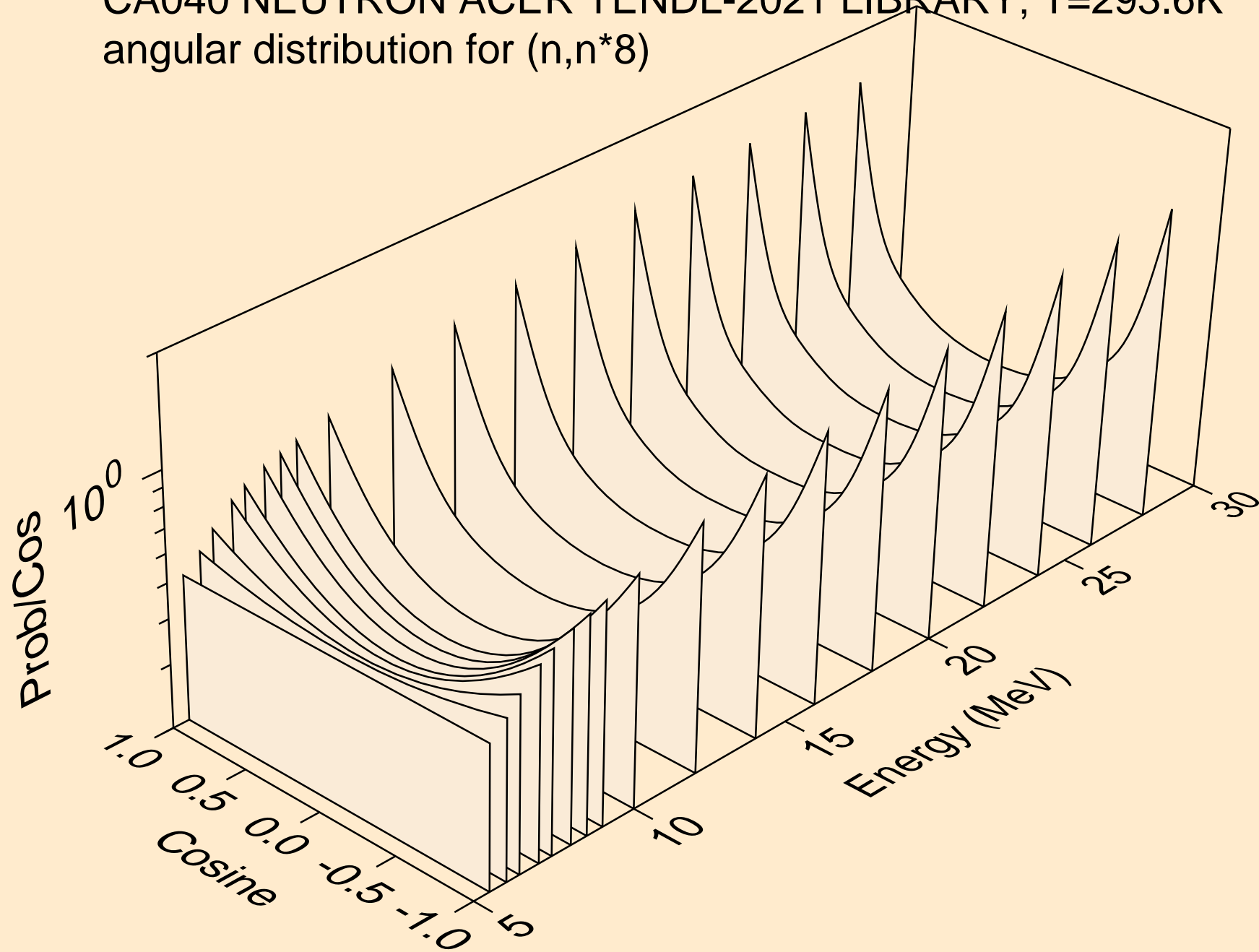

CA040 NEUTRON ACER TENDL-2021 LIBRARY; T=293.6K
angular distribution for (n,n*9)

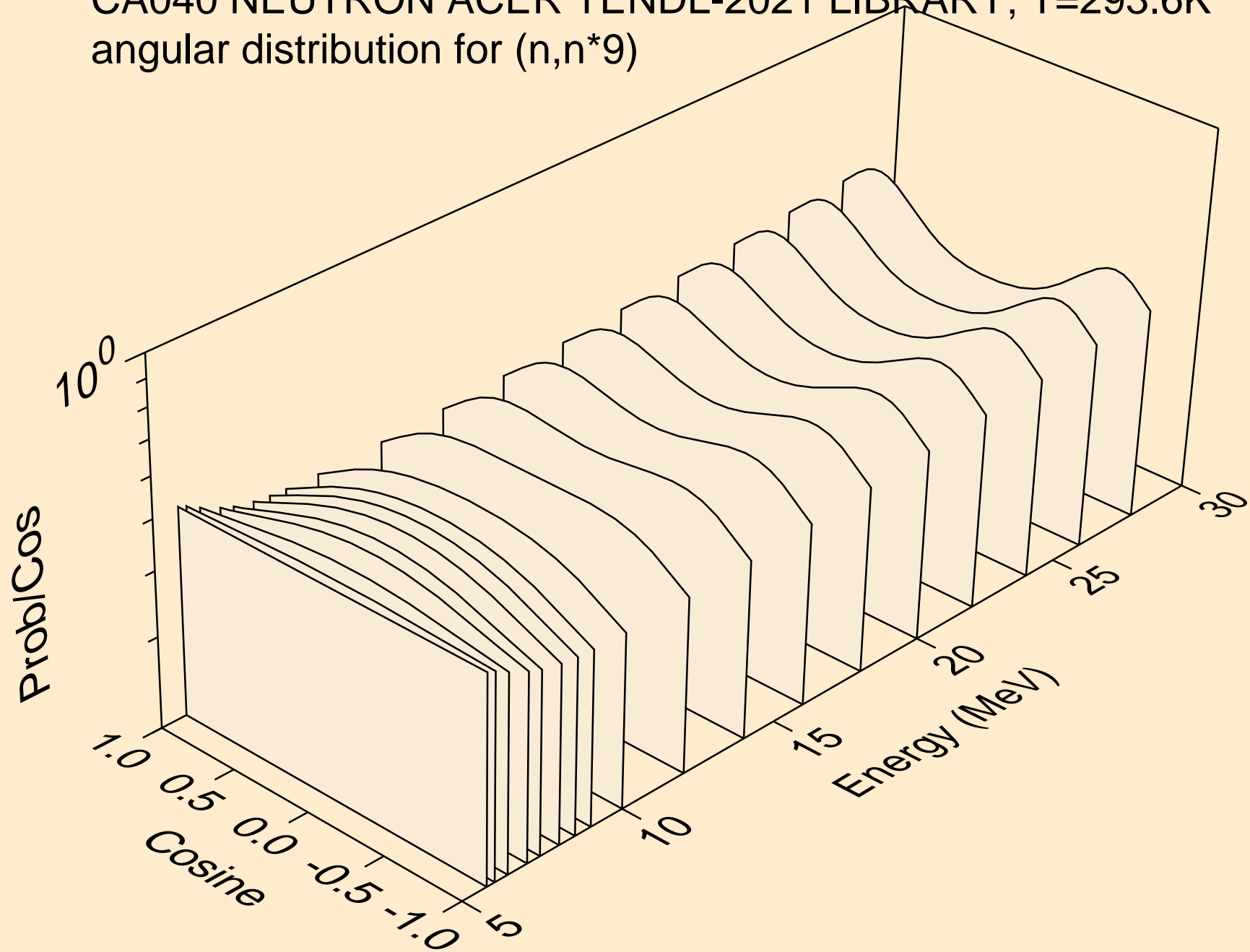

CA040 NEUTRON ACER TENDL-2021 LIBRARY; T=293.6K
angular distribution for (n,n*10)

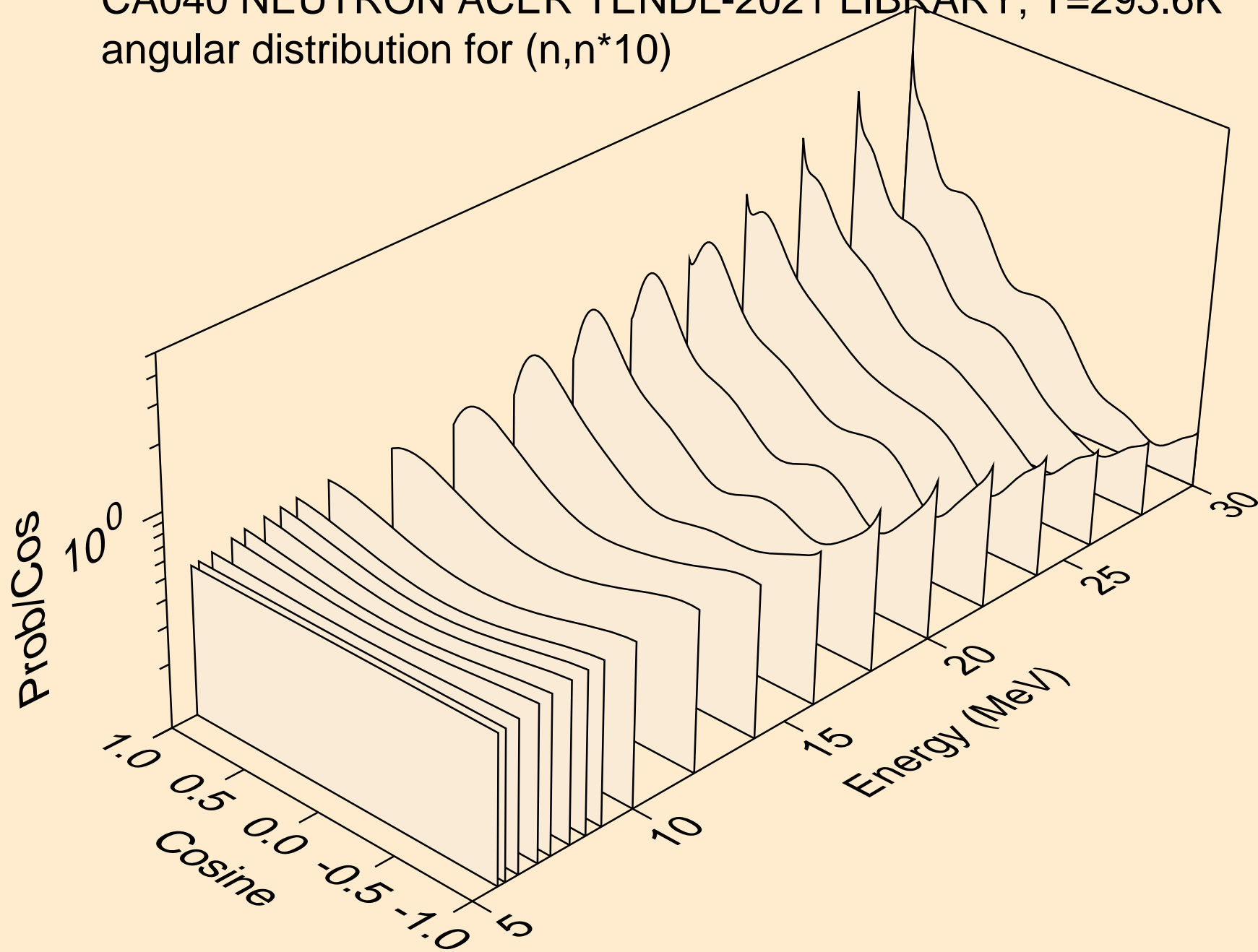

CA040 NEUTRON ACER TENDL-2021 LIBRARY; T=293.6K
angular distribution for (n,n*11)

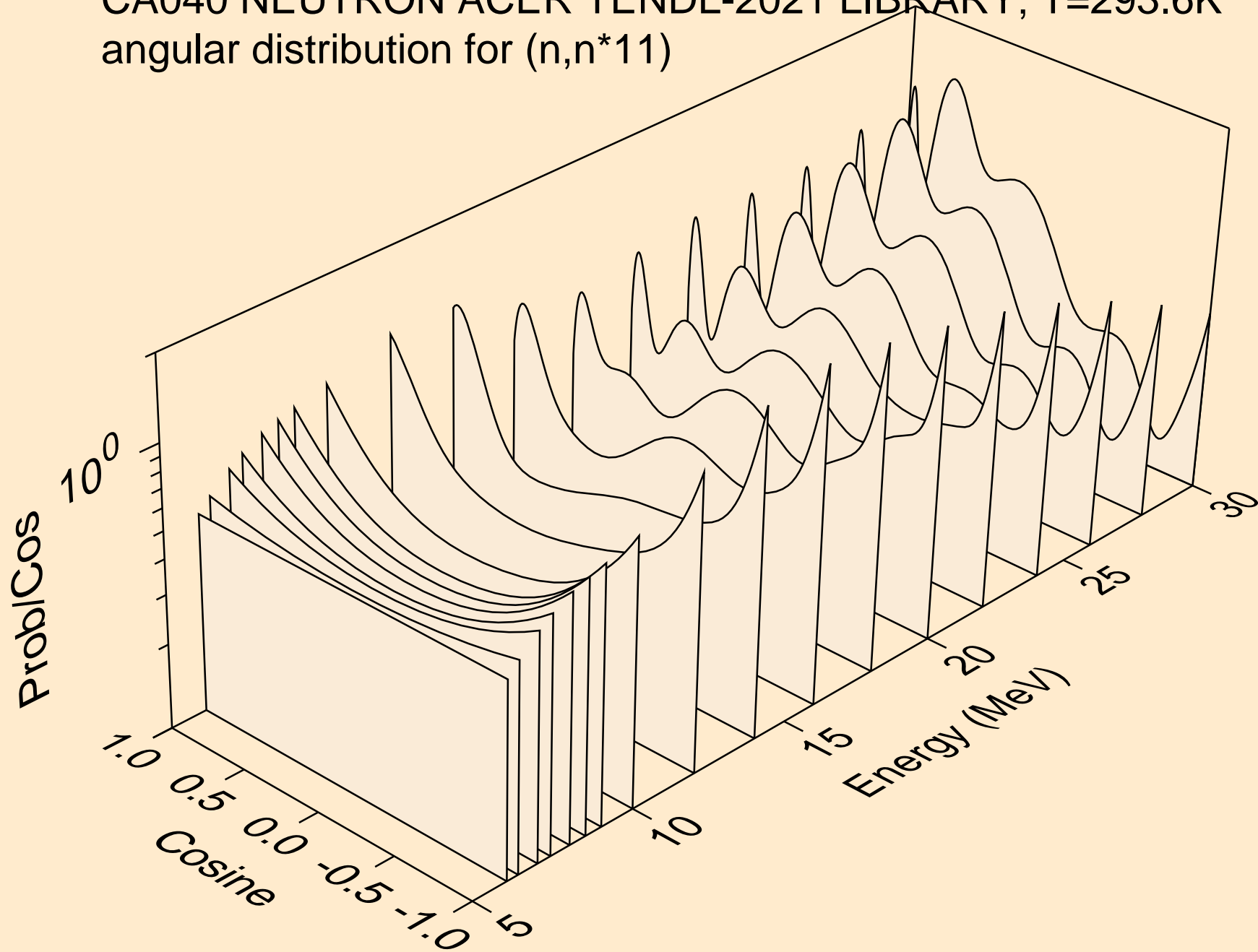

CA040 NEUTRON ACER TENDL-2021 LIBRARY; T=293.6K
angular distribution for (n,n*12)

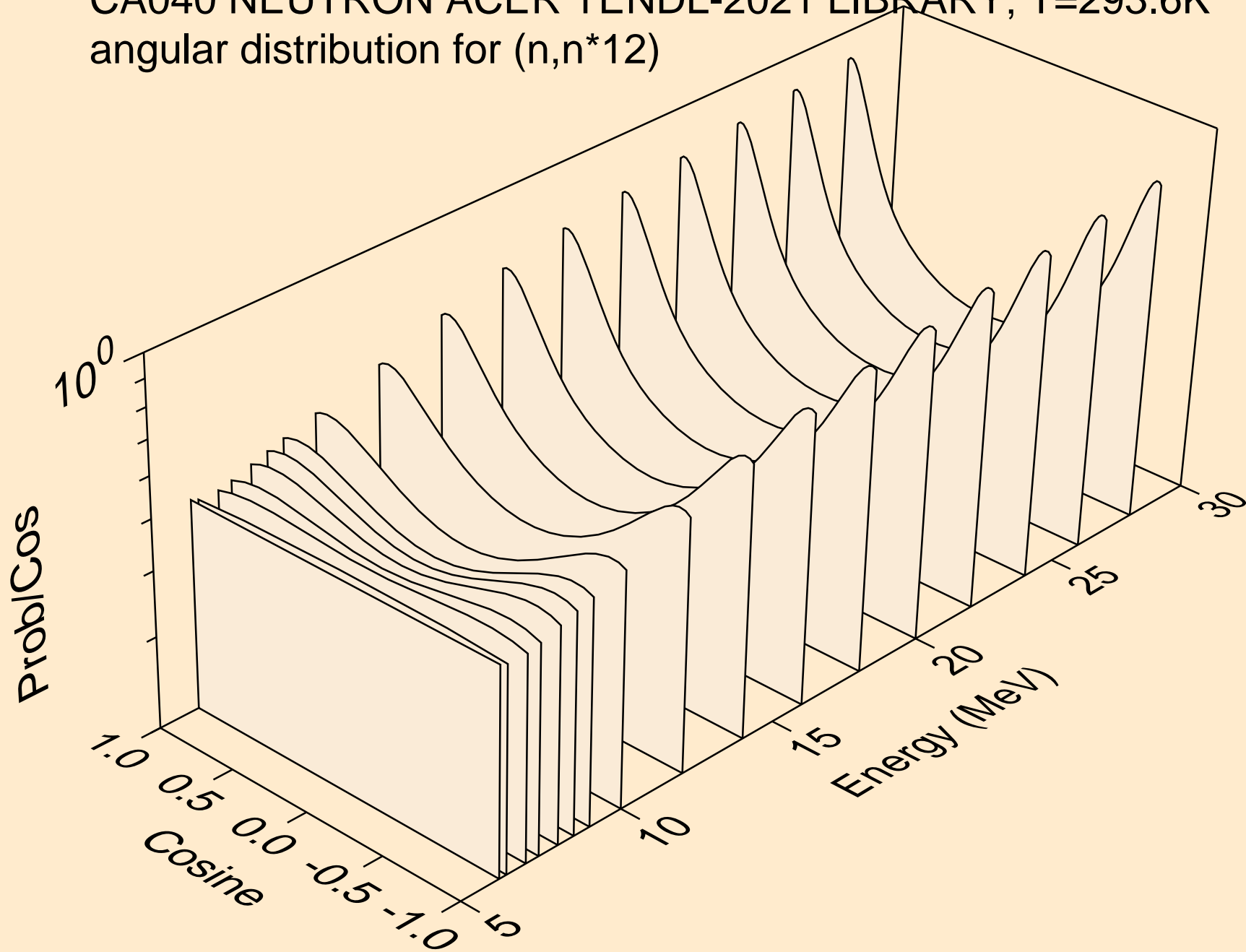

CA040 NEUTRON ACER TENDL-2021 LIBRARY; T=293.6K
angular distribution for (n,n*13)

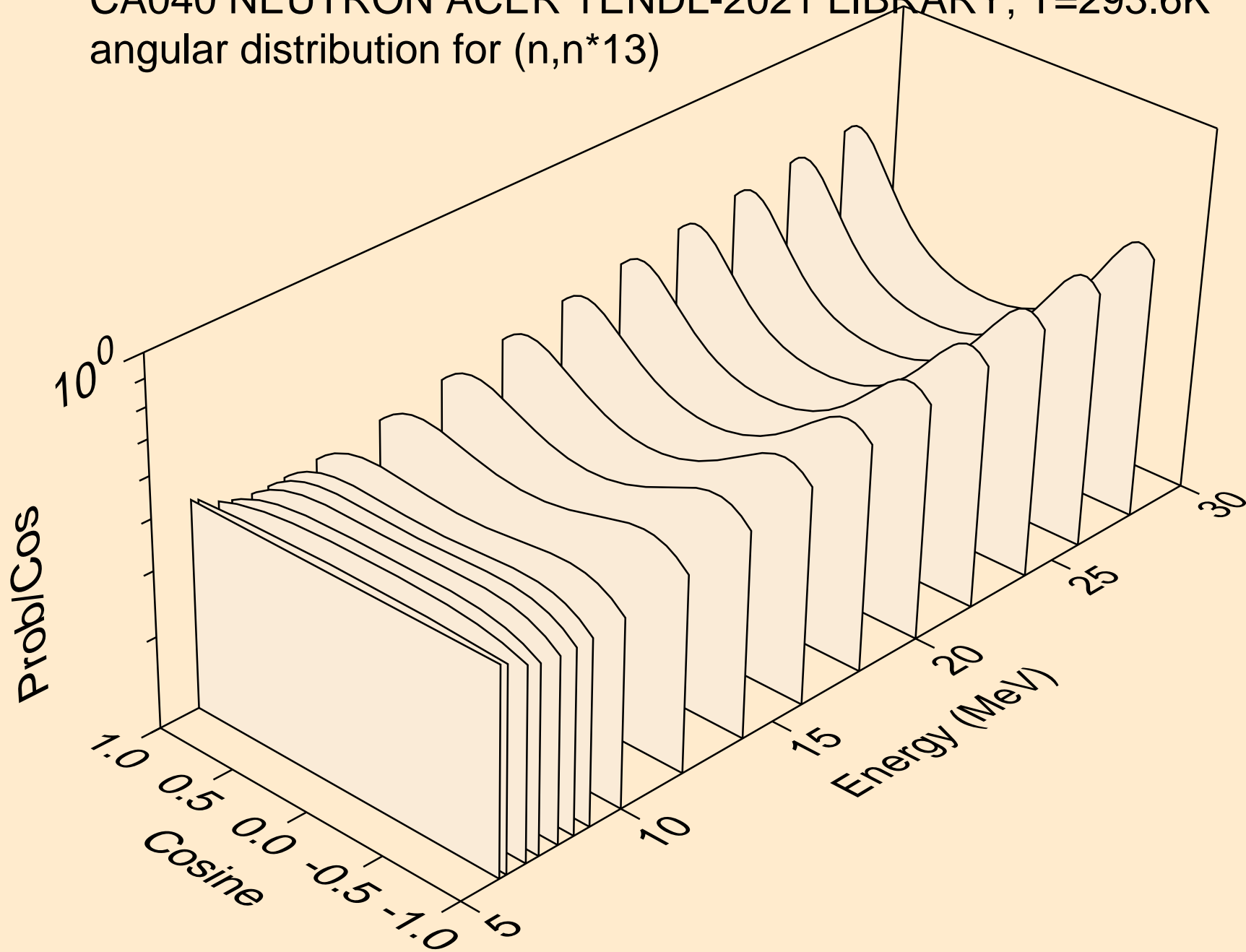

CA040 NEUTRON ACER TENDL-2021 LIBRARY; T=293.6K
angular distribution for (n,n*14)

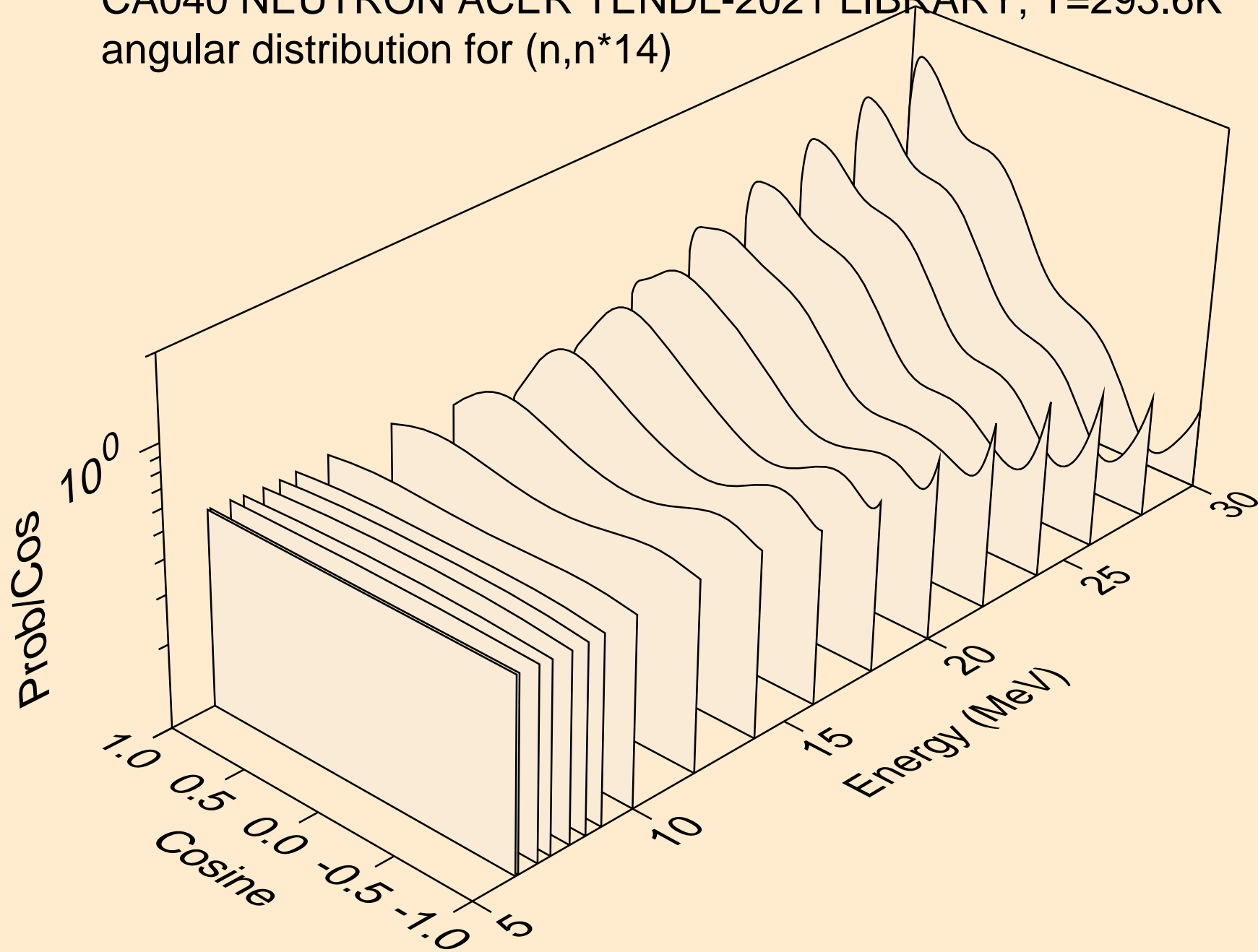

CA040 NEUTRON ACER TENDL-2021 LIBRARY; T=293.6K
angular distribution for (n,n*15)

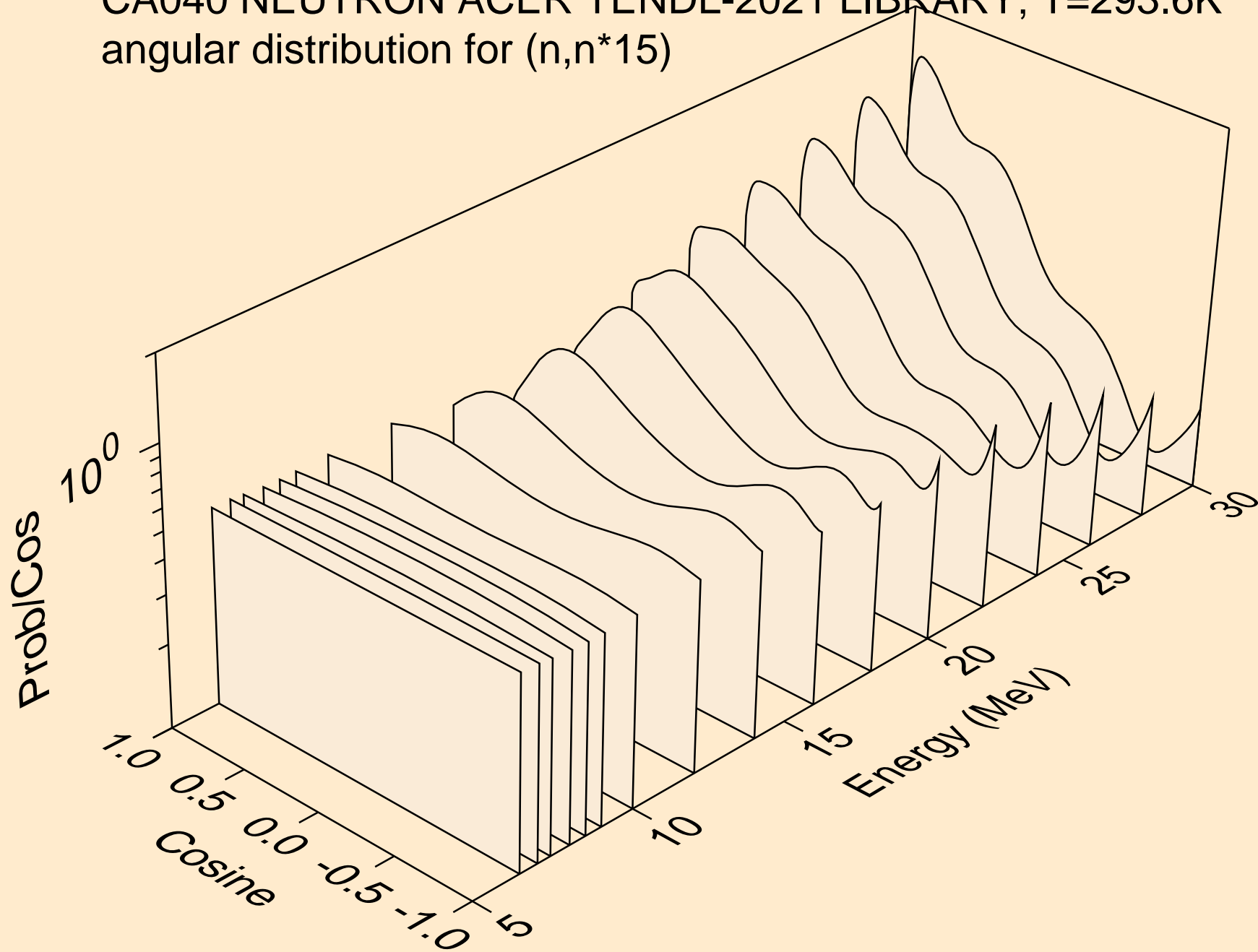

CA040 NEUTRON ACER TENDL-2021 LIBRARY; T=293.6K
angular distribution for (n,n*16)

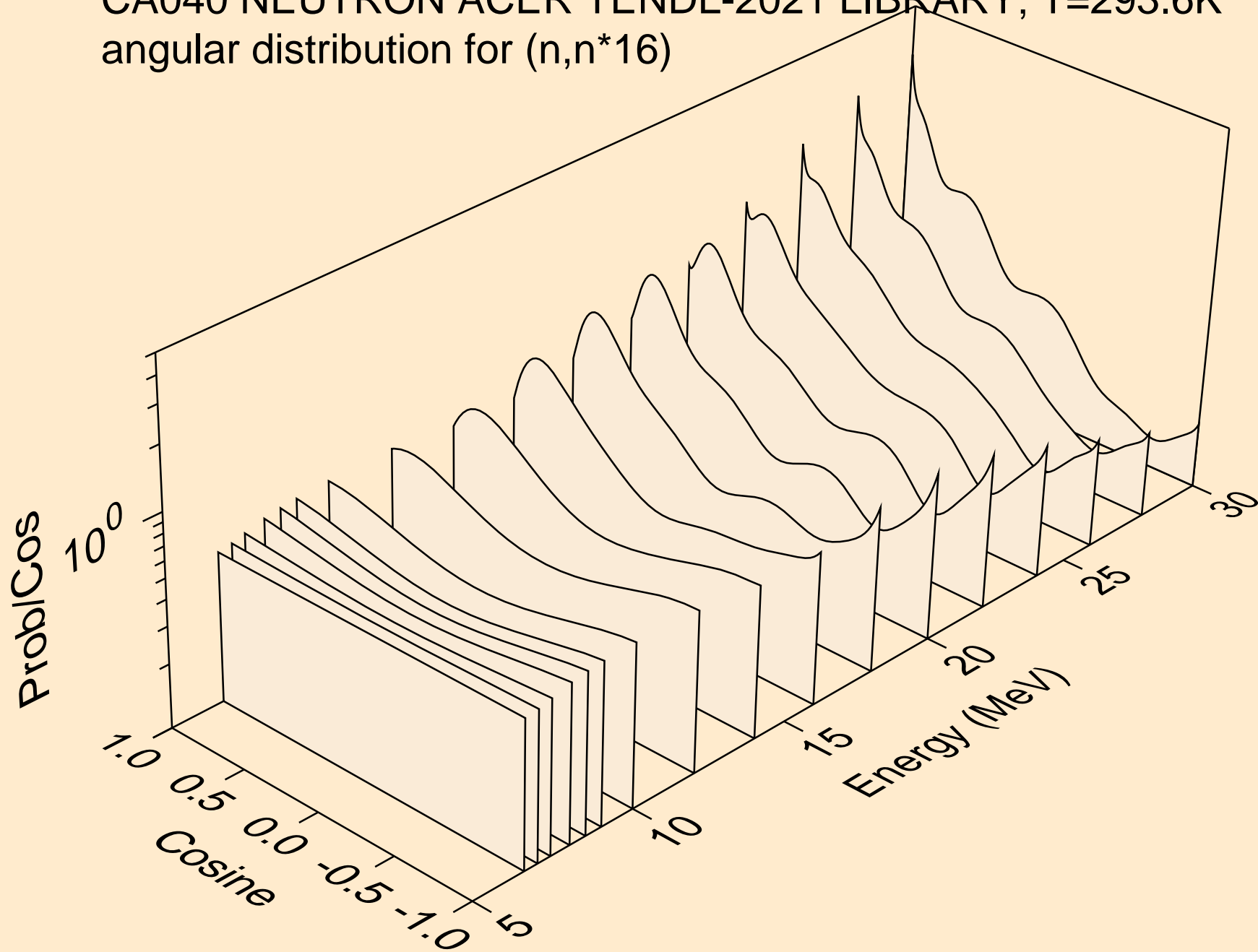

CA040 NEUTRON ACER TENDL-2021 LIBRARY; T=293.6K
angular distribution for (n,n*17)

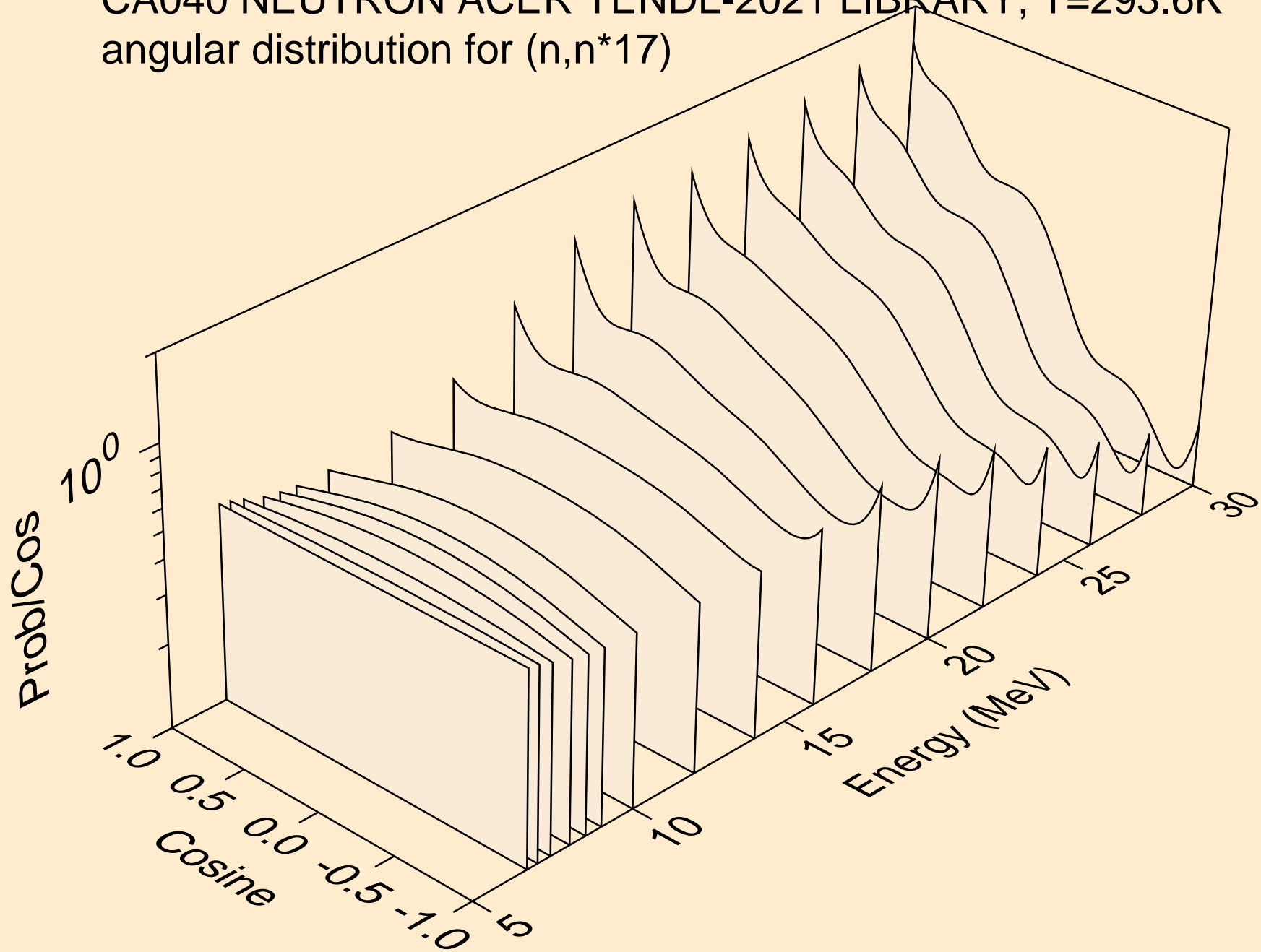

CA040 NEUTRON ACER TENDL-2021 LIBRARY; T=293.6K
angular distribution for (n,n*18)

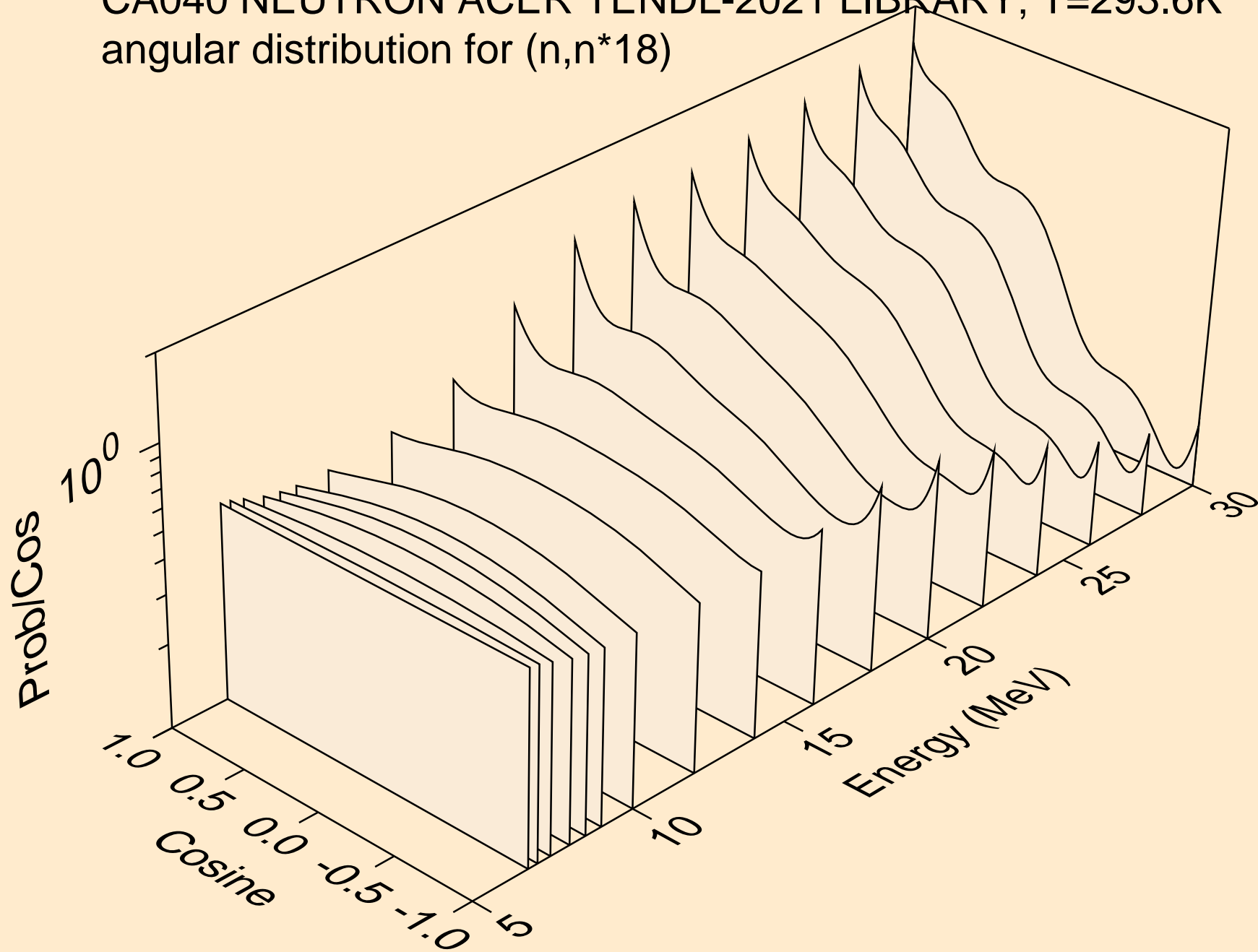

CA040 NEUTRON ACER TENDL-2021 LIBRARY; T=293.6K
angular distribution for (n,n*19)

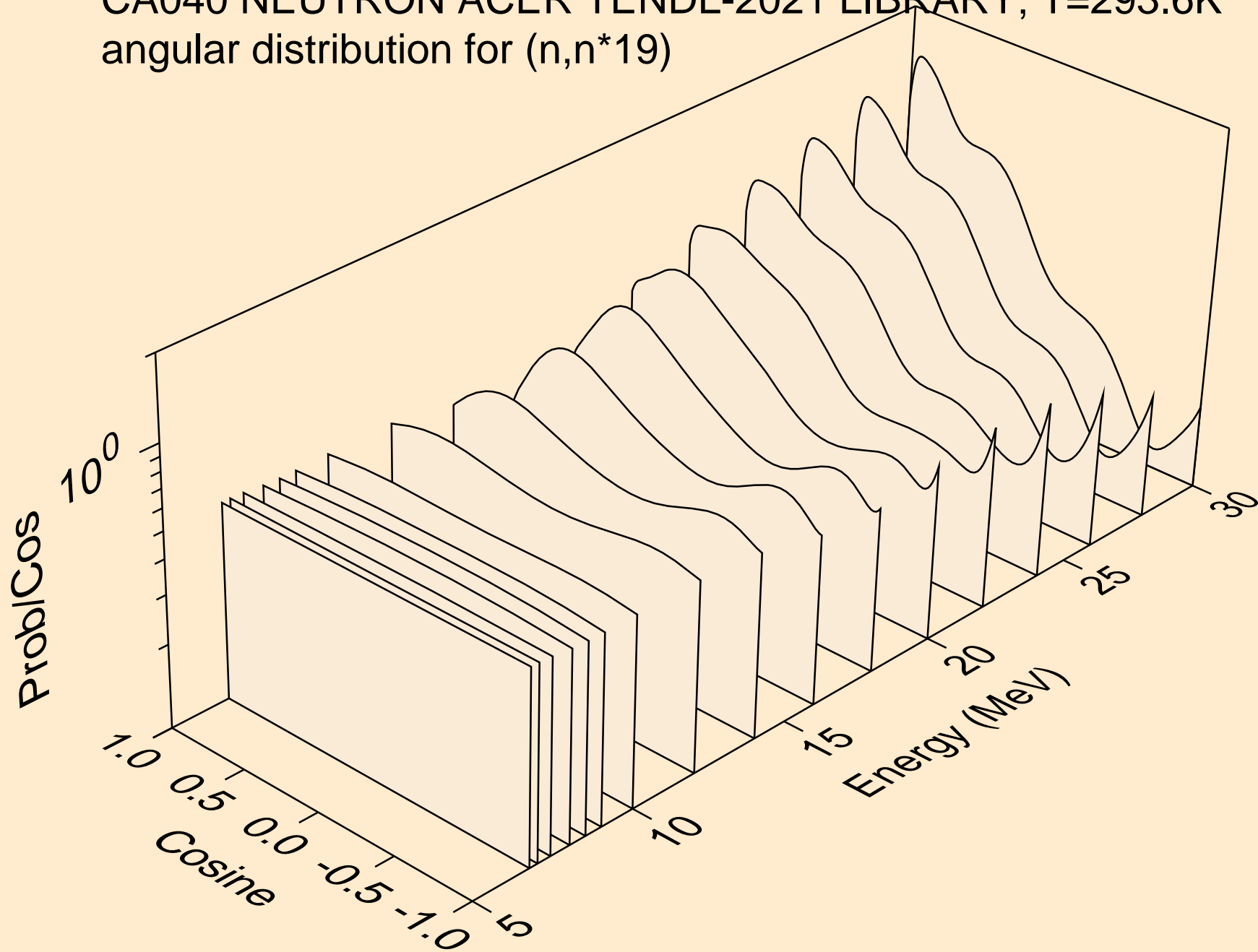

CA040 NEUTRON ACER TENDL-2021 LIBRARY; T=293.6K
Neutron emission for (n,x)

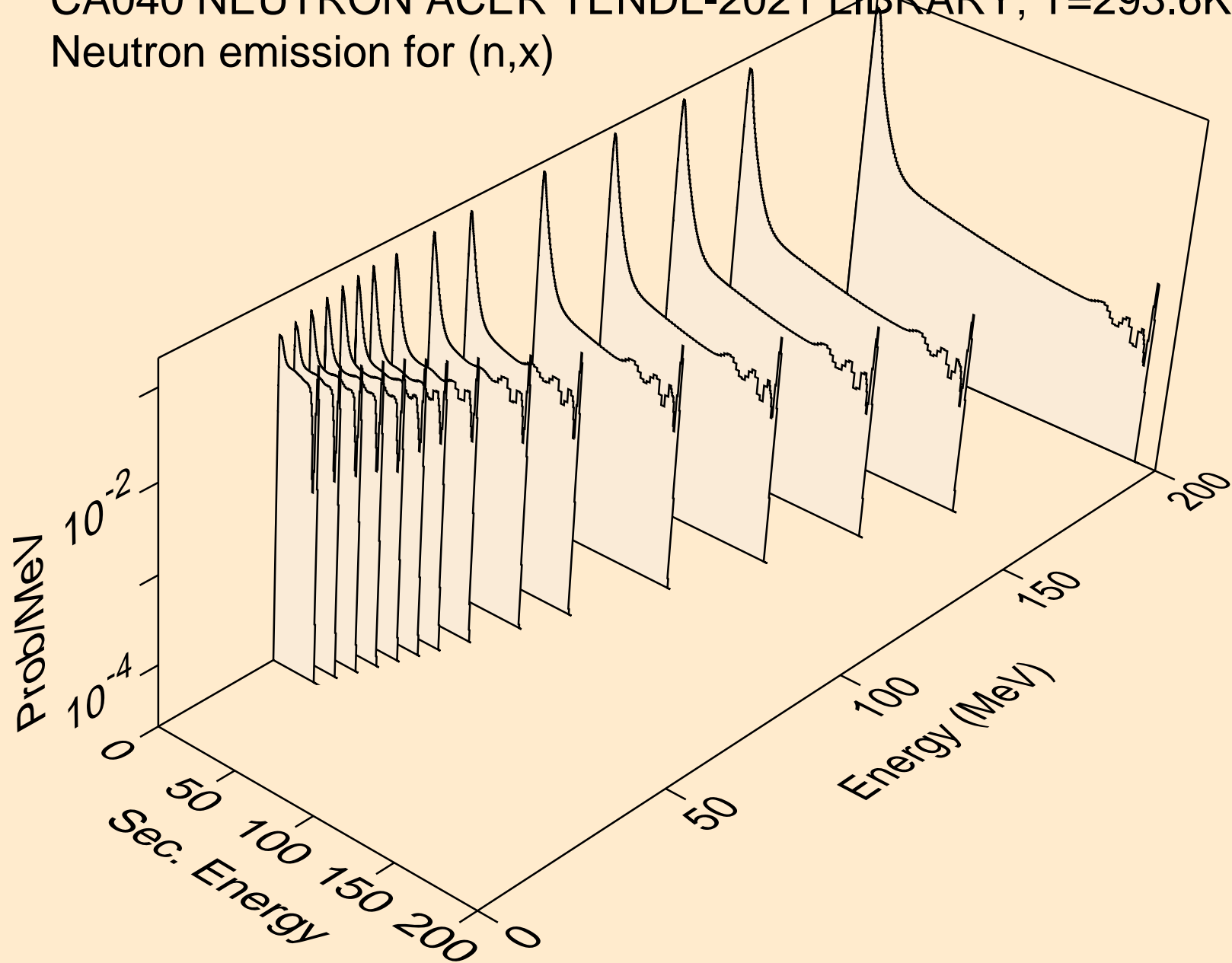

CA040 NEUTRON ACER TENDL-2021 LIBRARY; T=293.6K
Neutron emission for (n,2n)

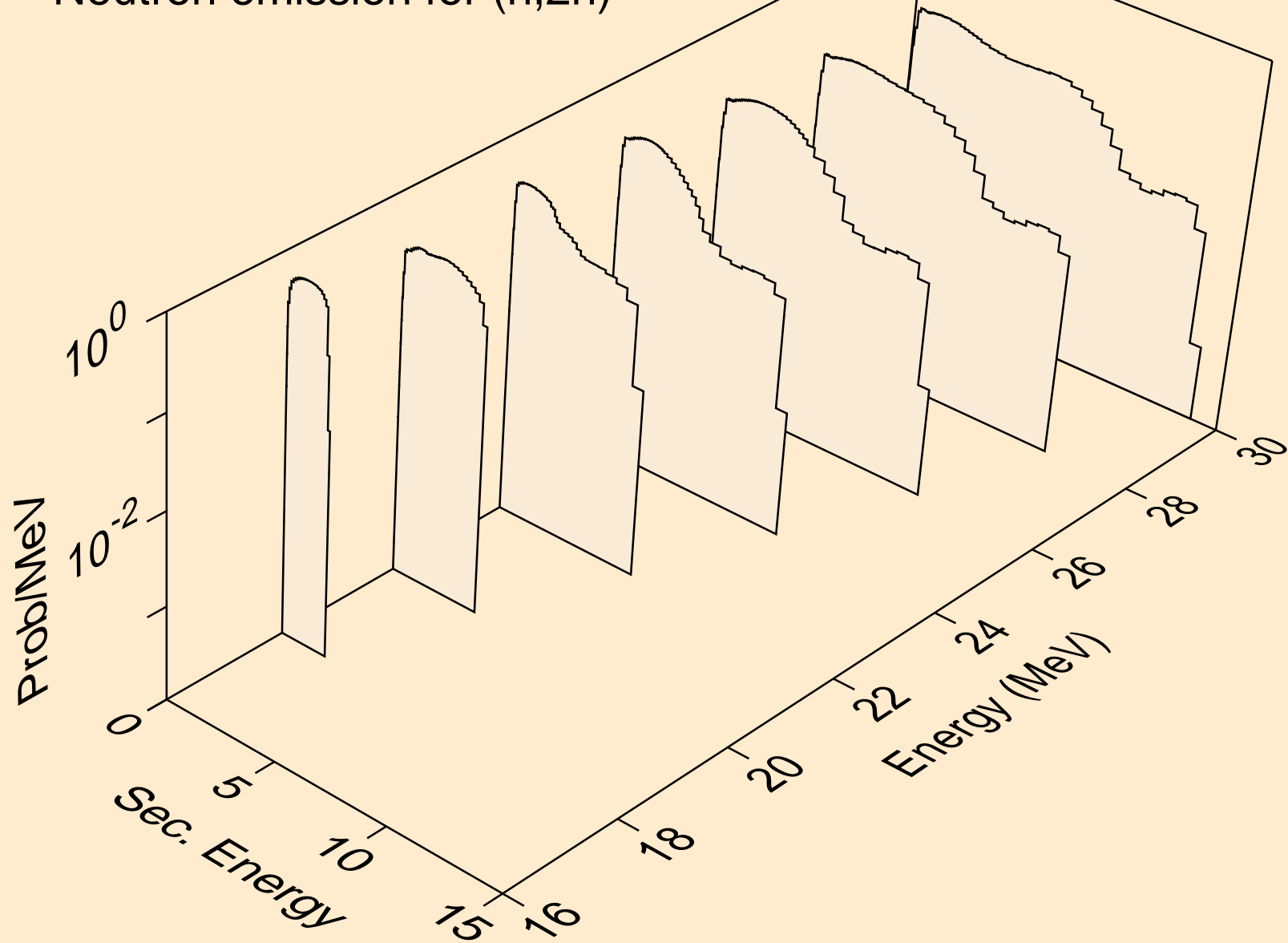

CA040 NEUTRON ACER TENDL-2021 LIBRARY; T=293.6K
Neutron emission for (n,n*)a

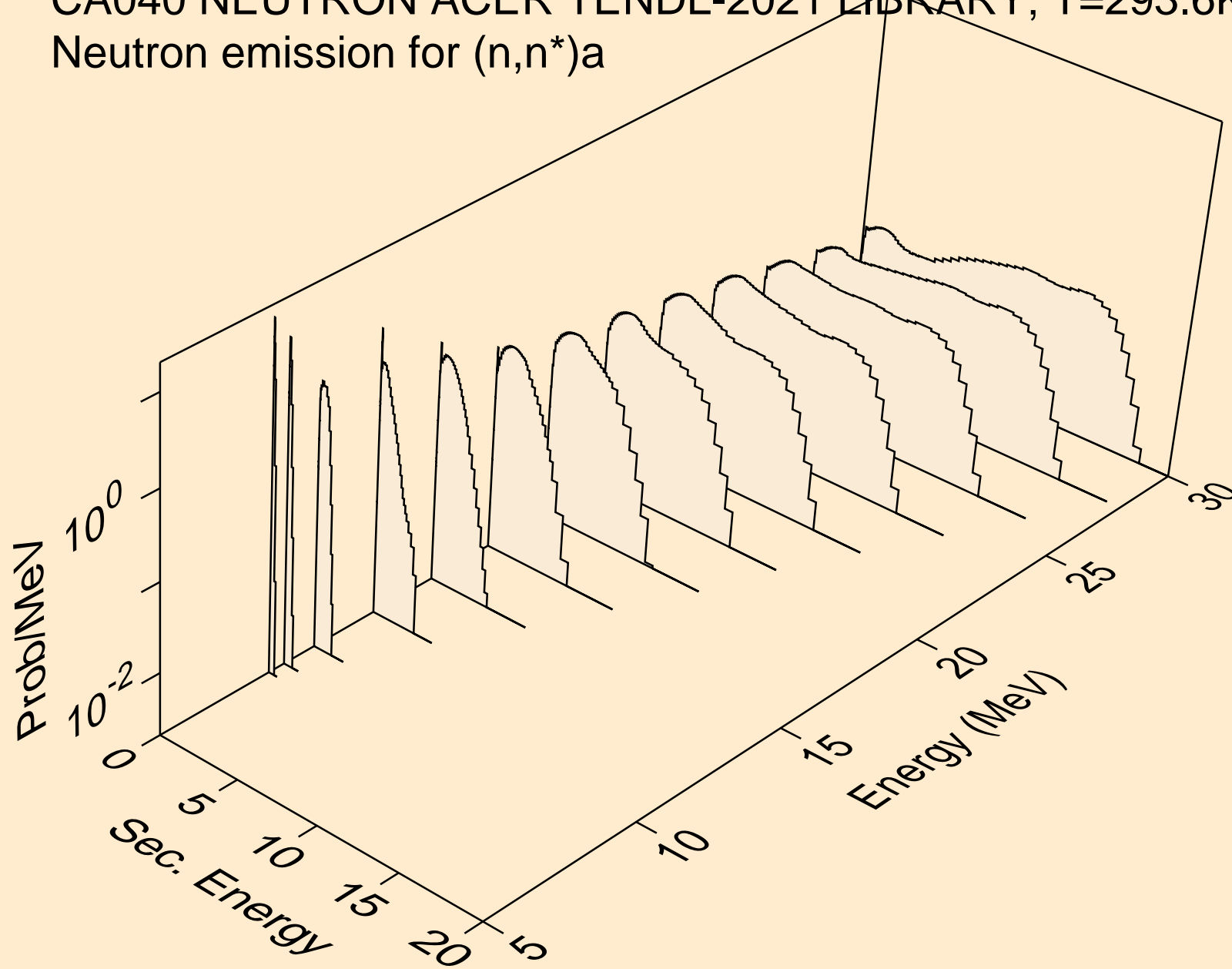

CA040 NEUTRON ACER TENDL-2021 LIBRARY; T=293.6K
Neutron emission for (n,2n)a

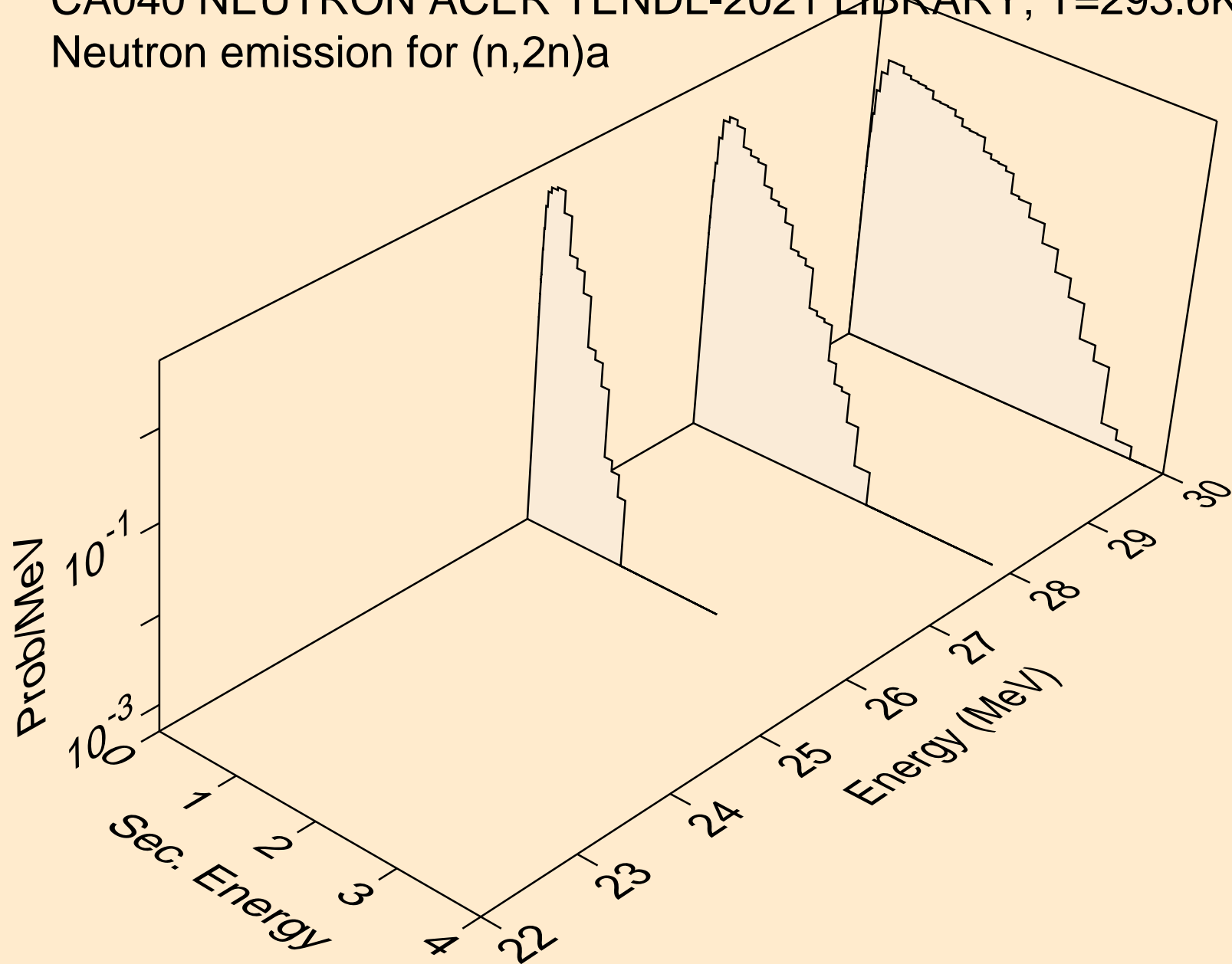

CA040 NEUTRON ACER TENDL-2021 LIBRARY; T=293.6K
Neutron emission for (n,n*)p

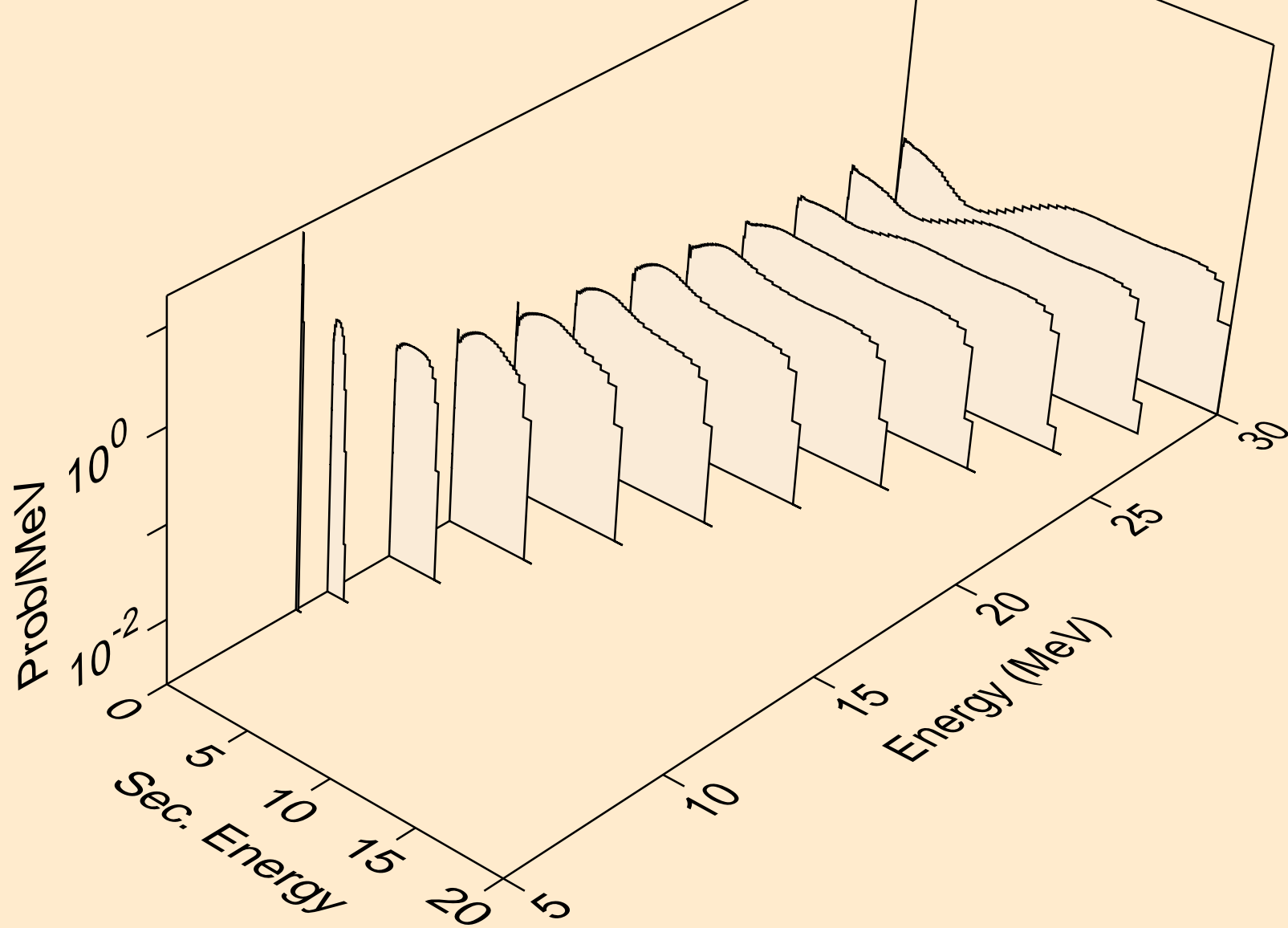

CA040 NEUTRON ACER TENDL-2021 LIBRARY; T=293.6K
Neutron emission for (n,n*)2a

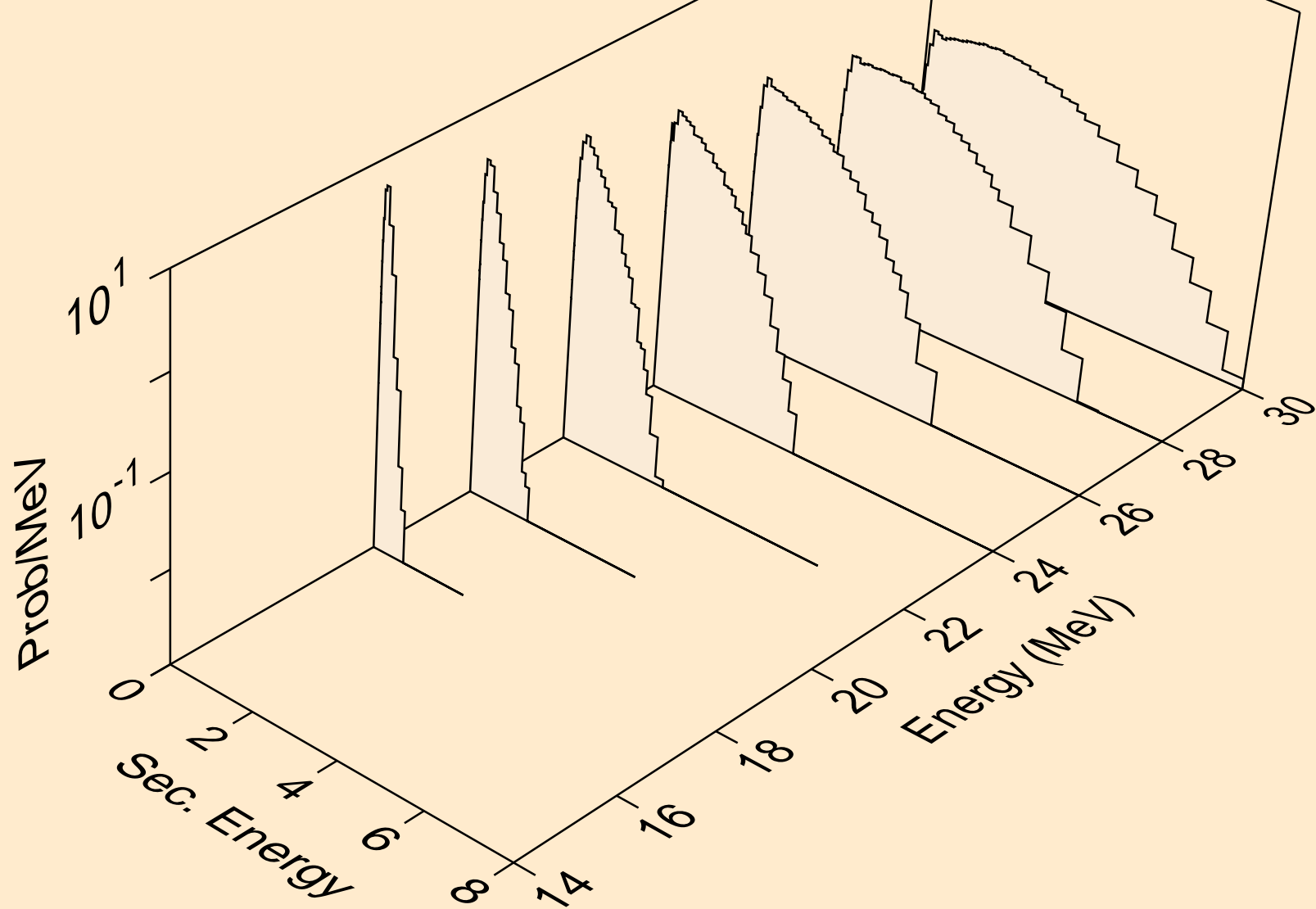

CA040 NEUTRON ACER TENDL-2021 LIBRARY; T=293.6K
Neutron emission for (n,n*)d

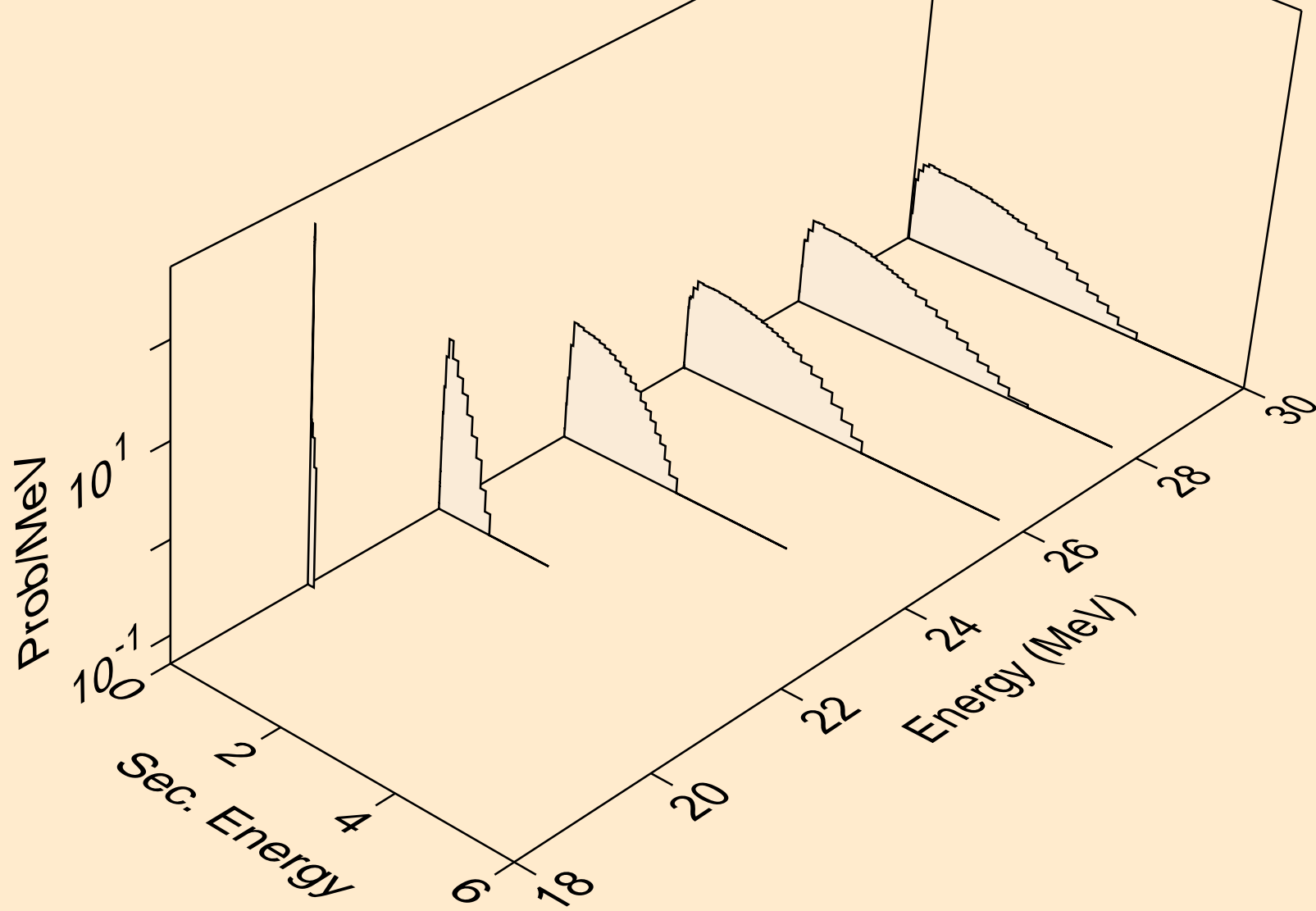

CA040 NEUTRON ACER TENDL-2021 LIBRARY; T=293.6K
Neutron emission for (n,n*)t

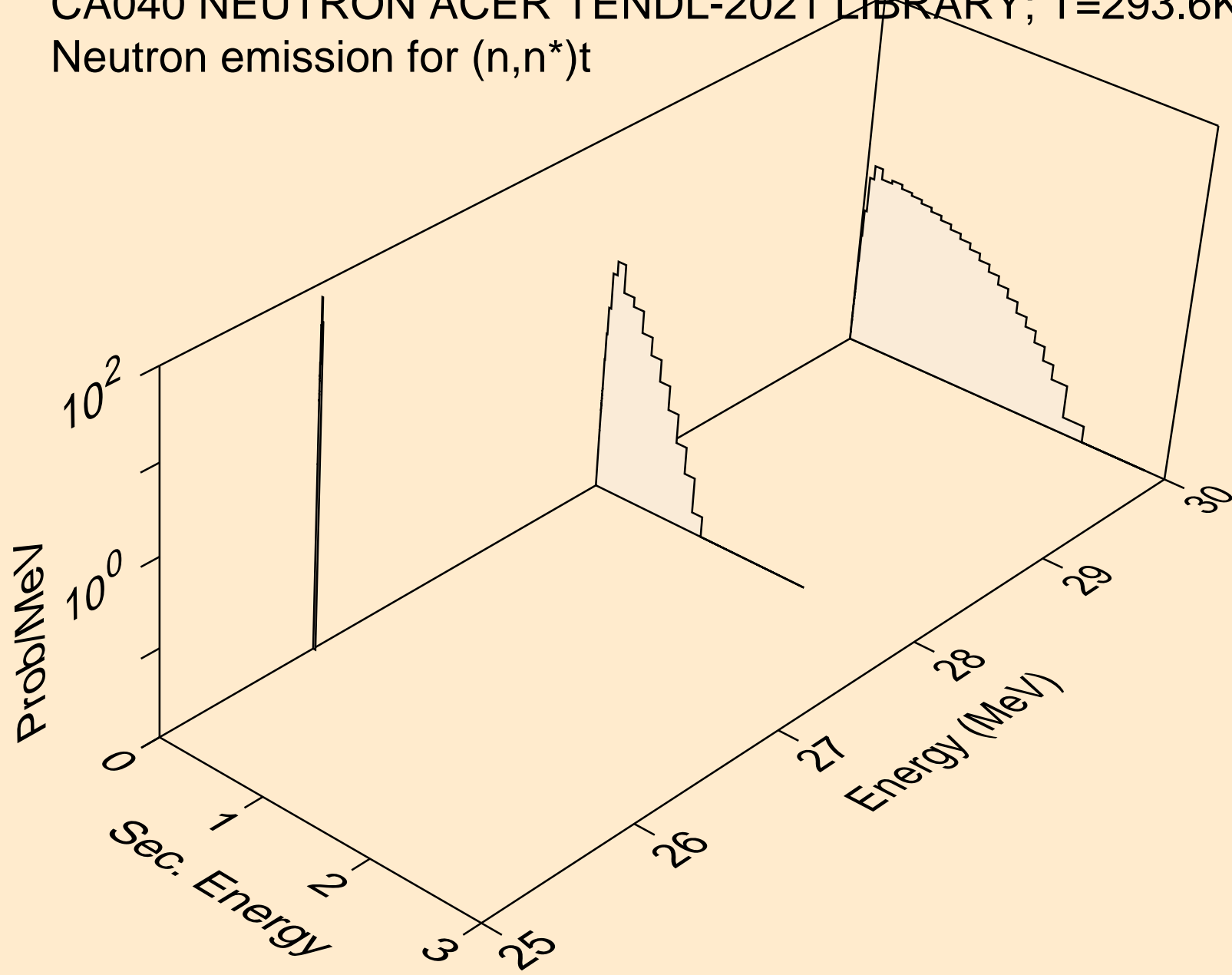

CA040 NEUTRON ACER TENDL-2021 LIBRARY; T=293.6K
Neutron emission for (n,n*)he3

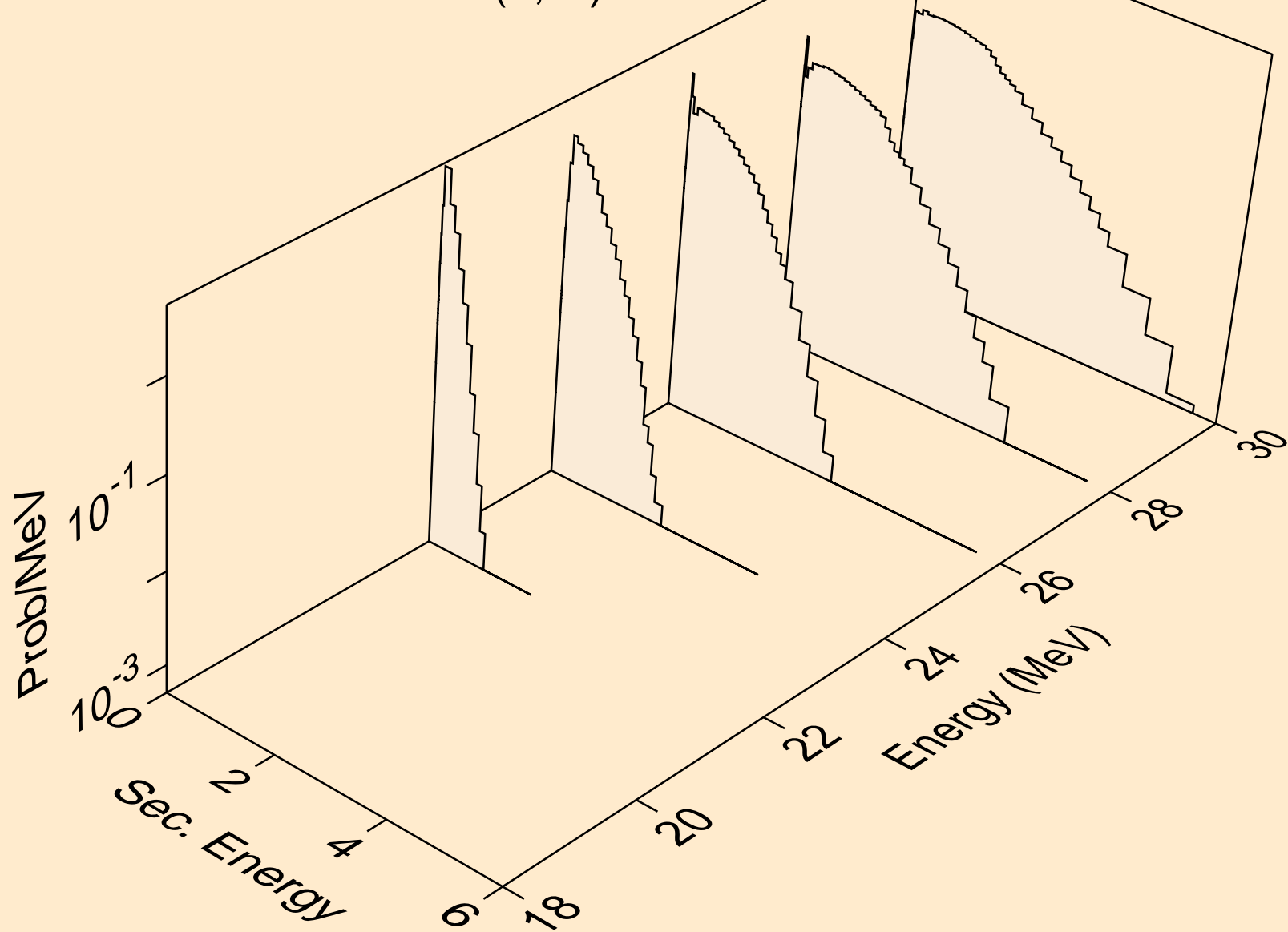

CA040 NEUTRON ACER TENDL-2021 LIBRARY; T=293.6K
Neutron emission for (n,2np)

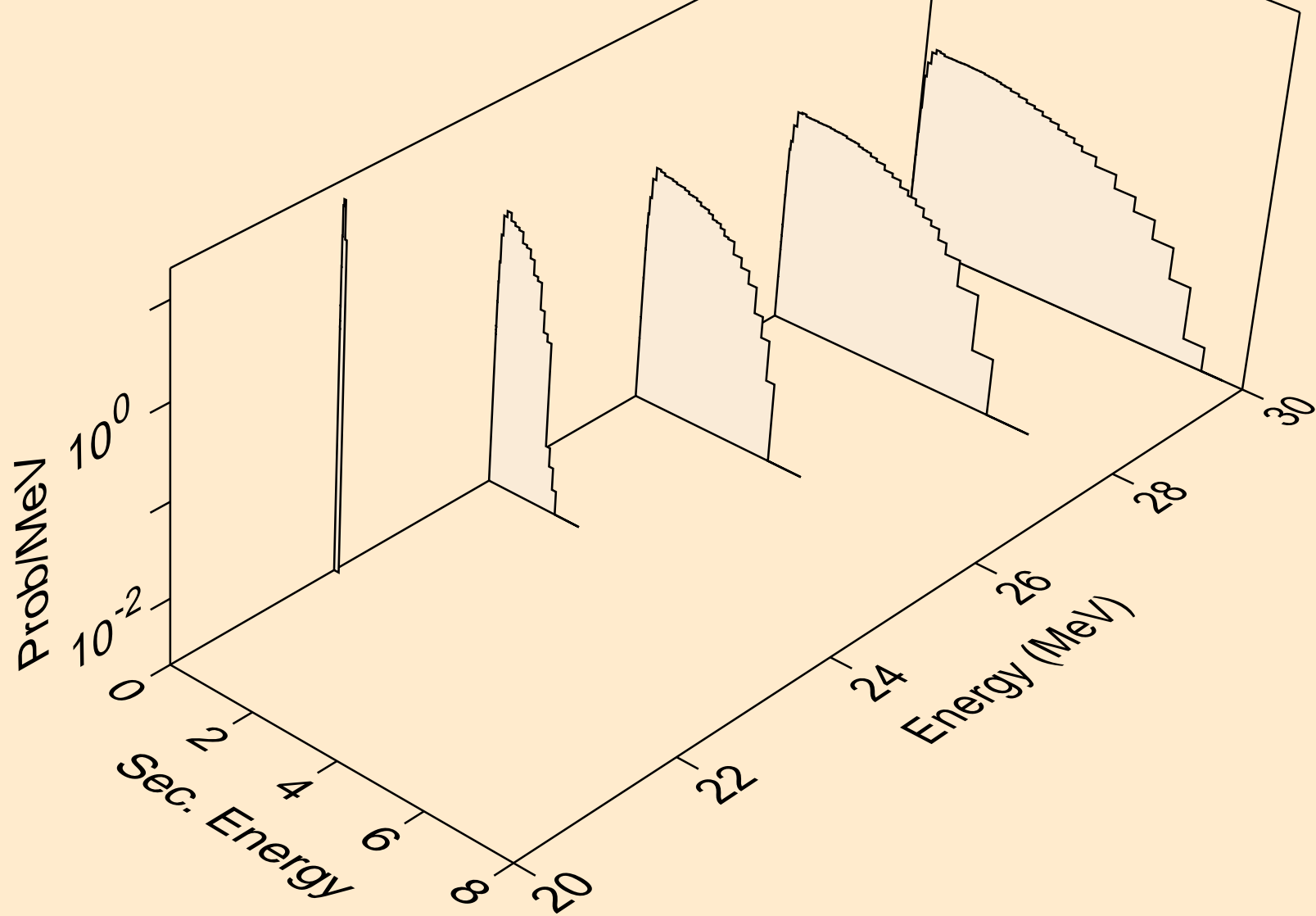

CA040 NEUTRON ACER TENDL-2021 LIBRARY; T=293.6K
Neutron emission for (n,2np)

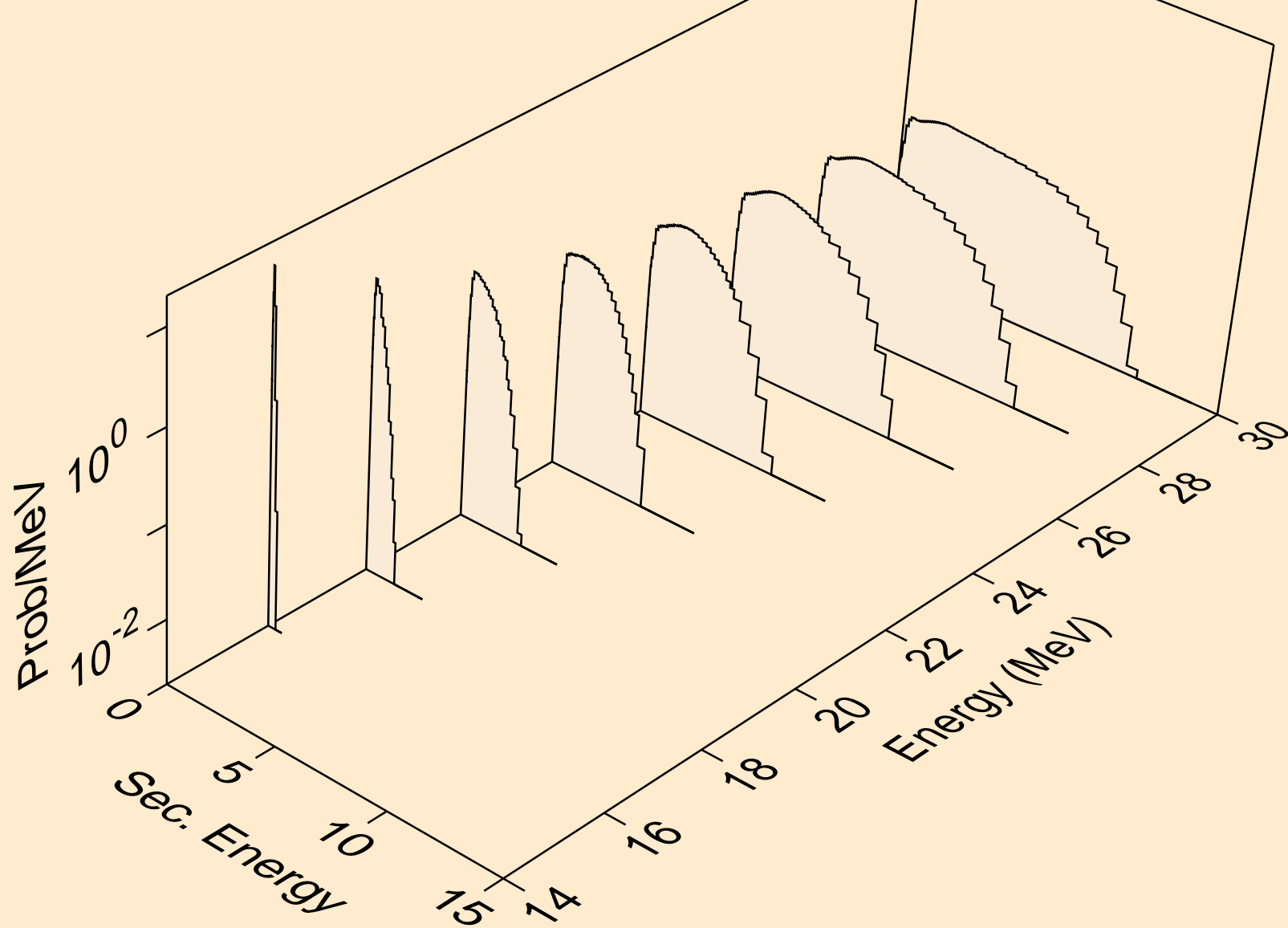

CA040 NEUTRON ACER TENDL-2021 LIBRARY; T=293.6K
Neutron emission for (n,npa)

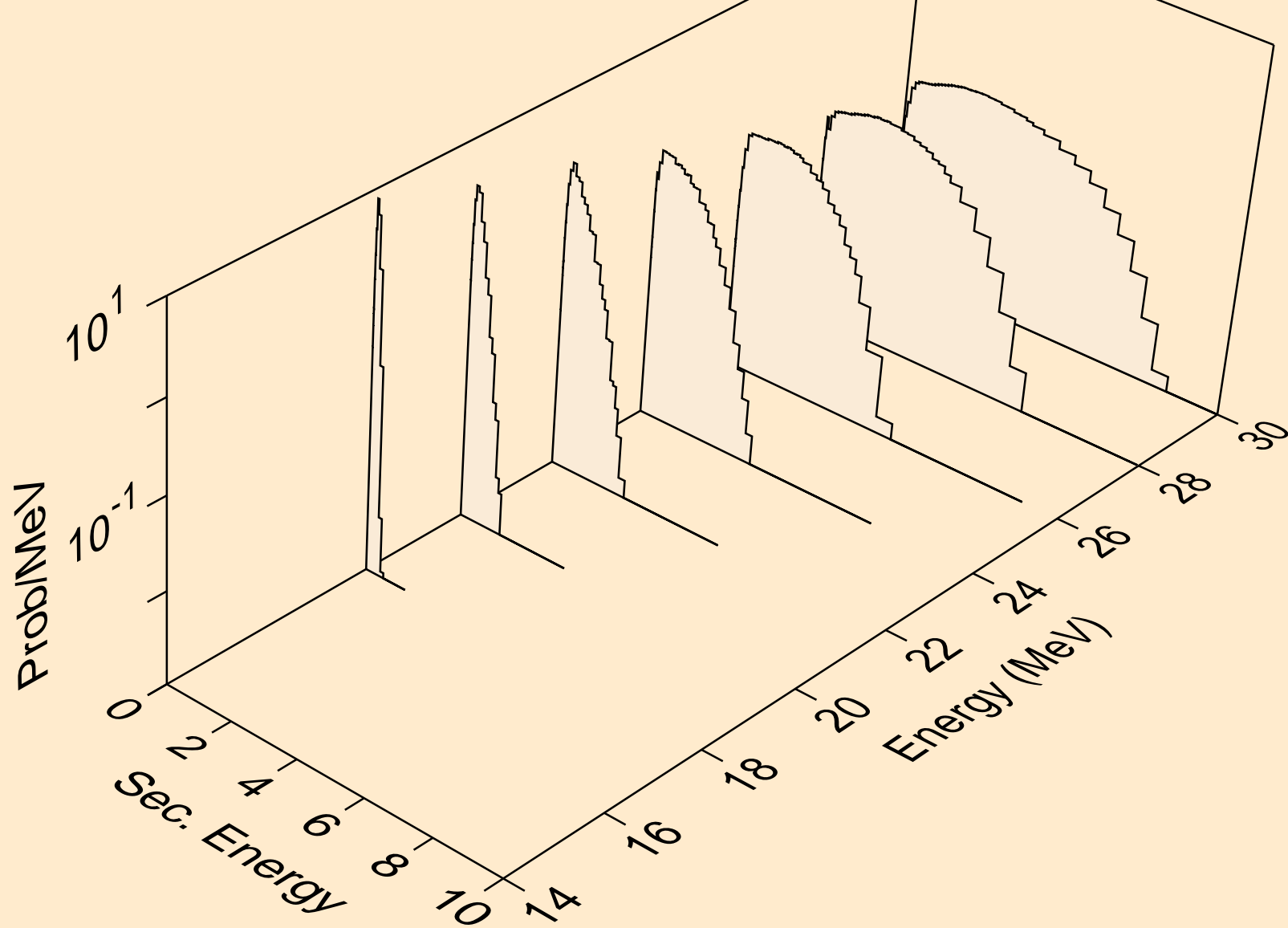

CA040 NEUTRON ACER TENDL-2021 LIBRARY; T=293.6K
Neutron emission for (n,n*c)

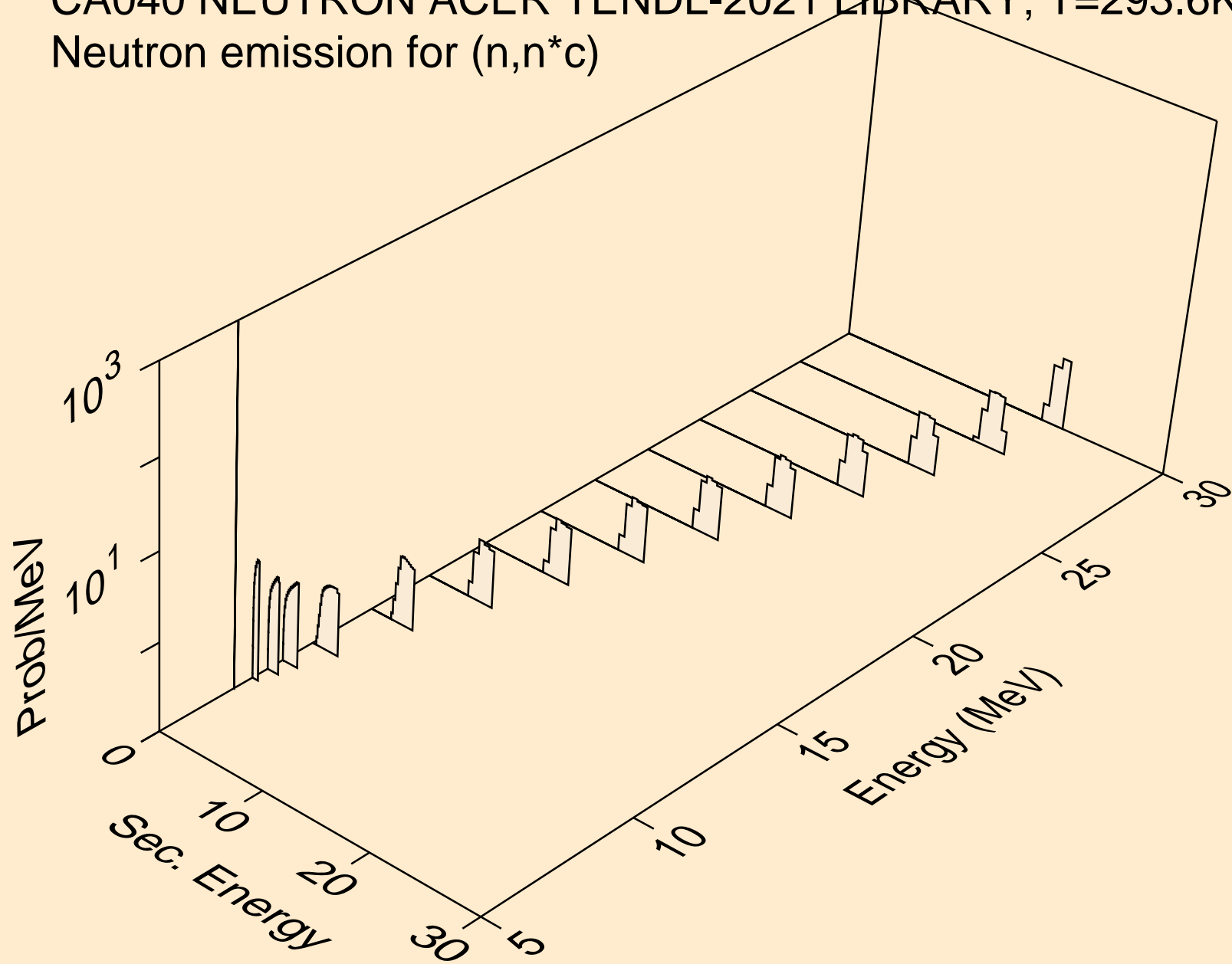

CA040 NEUTRON ACER TENDL-2021 LIBRARY; T=293.6K
Photon emission for (n,x)

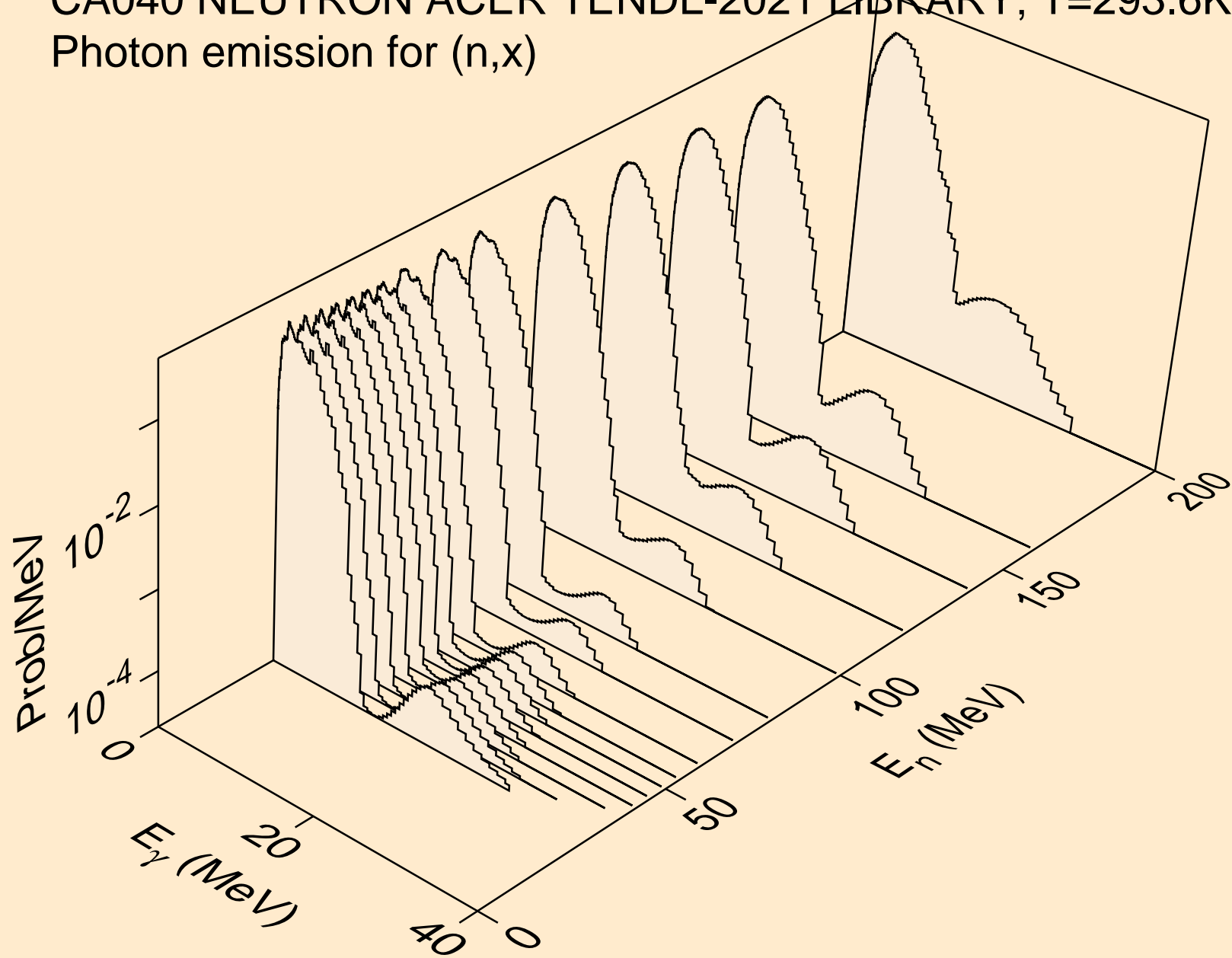

CA040 NEUTRON ACER TENDL-2021 LIBRARY; T=293.6K
Photon emission for (n,2n)

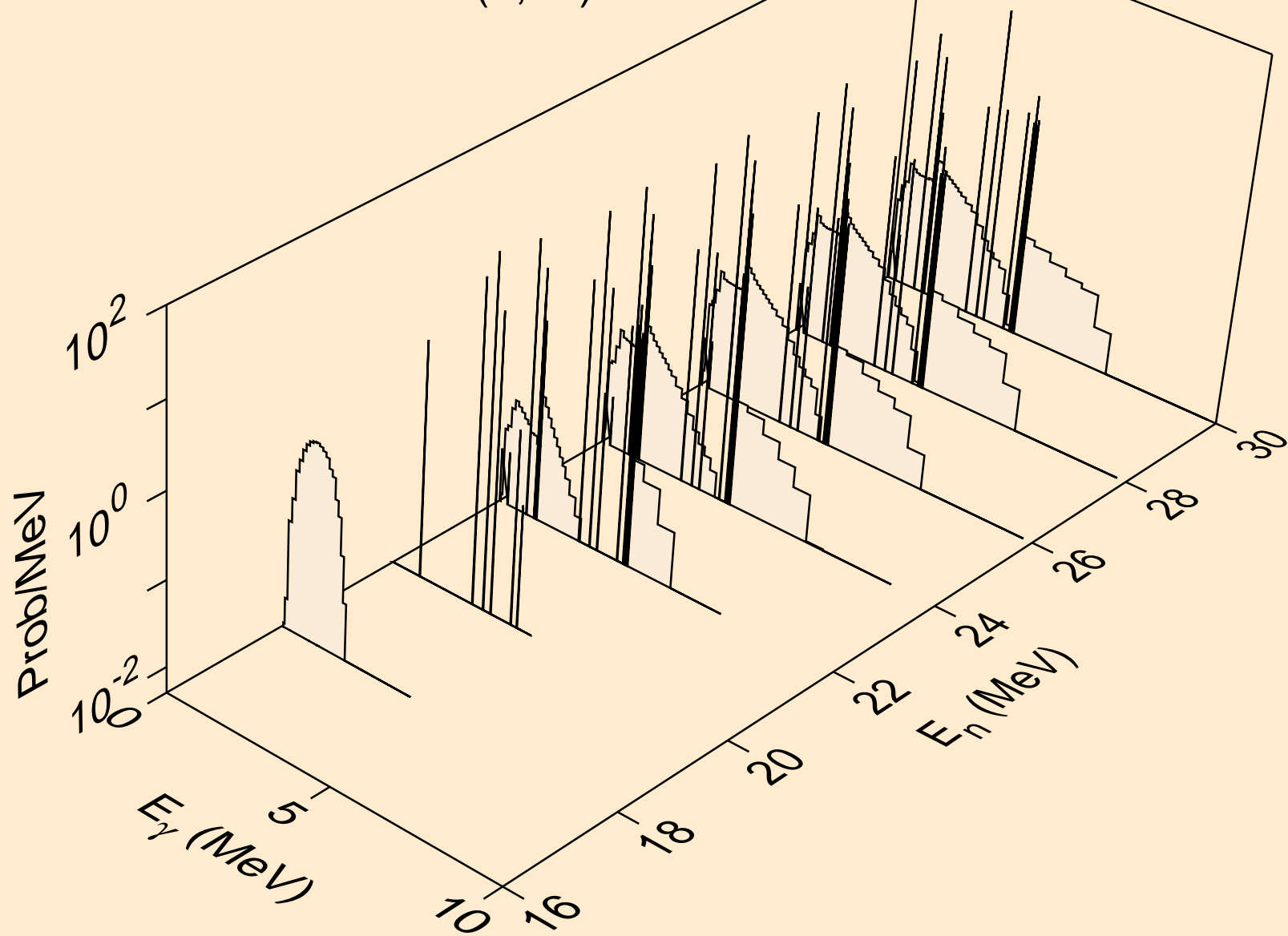

CA040 NEUTRON ACER TENDL-2021 LIBRARY; T=293.6K
Photon emission for (n,n*)a

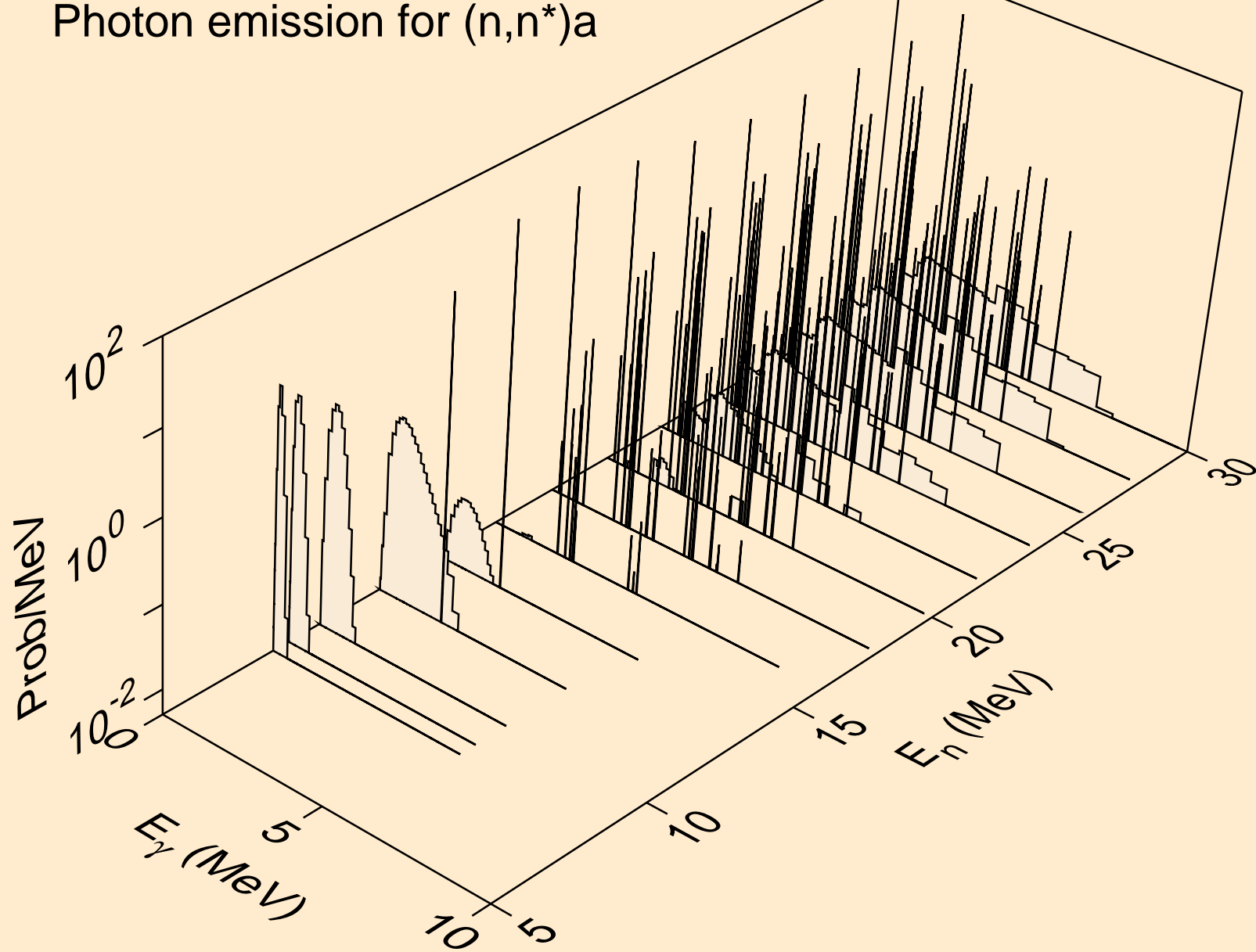

CA040 NEUTRON ACER TENDL-2021 LIBRARY; T=293.6K
Photon emission for (n,2n)a

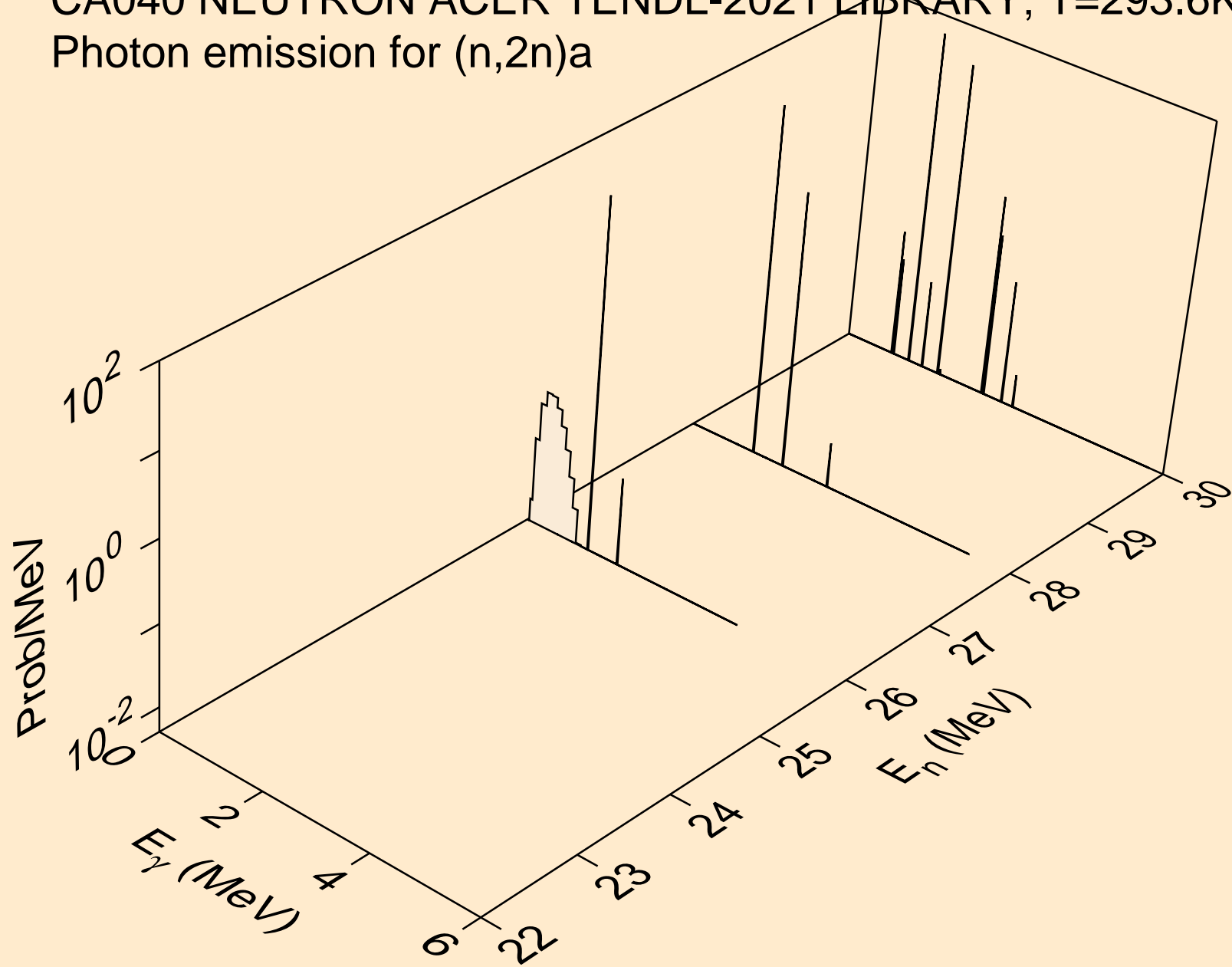

CA040 NEUTRON ACER TENDL-2021 LIBRARY; T=293.6K
Photon emission for (n,n*)p

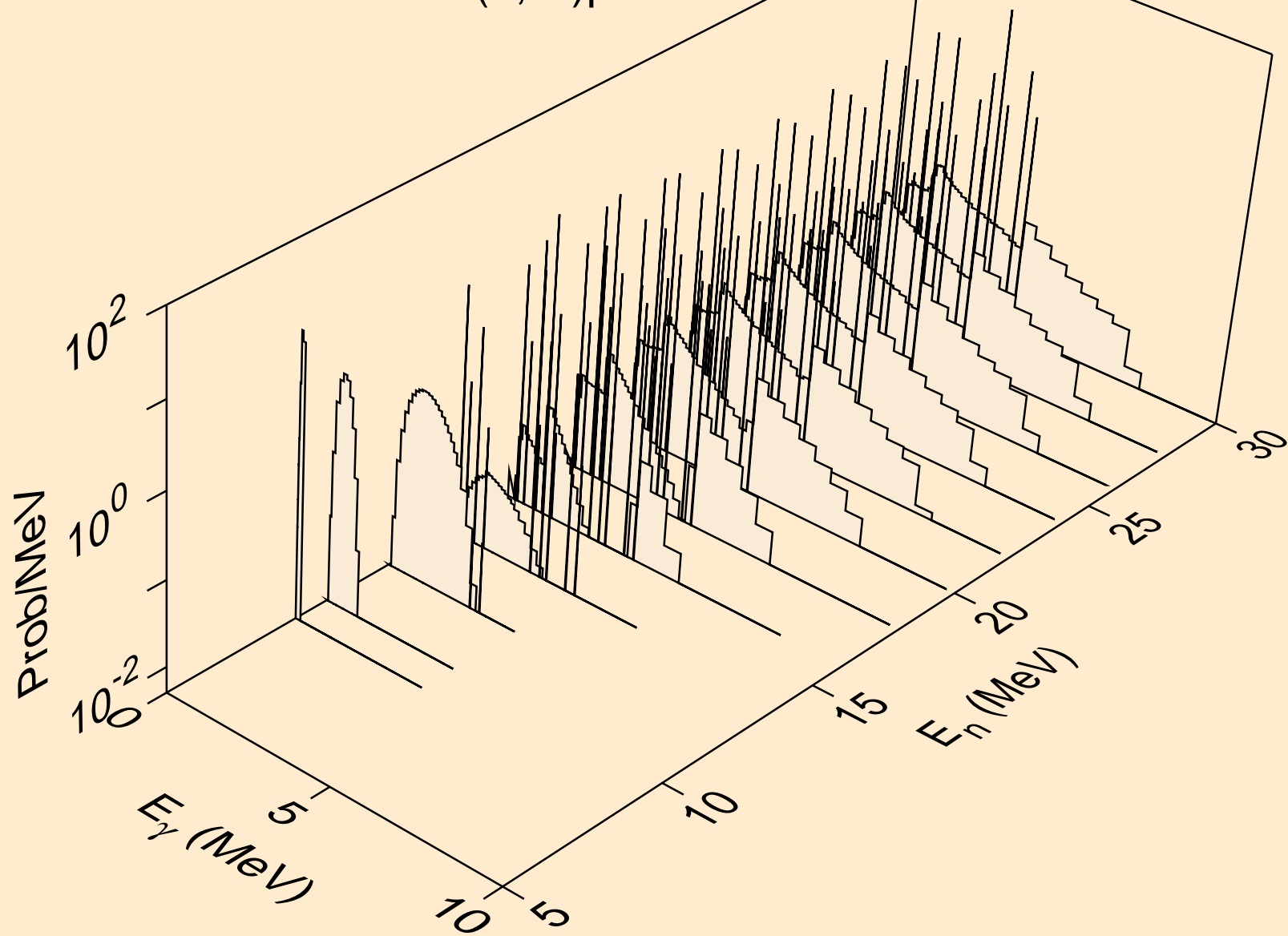

CA040 NEUTRON ACER TENDL-2021 LIBRARY; T=293.6K
Photon emission for (n,n*)2a

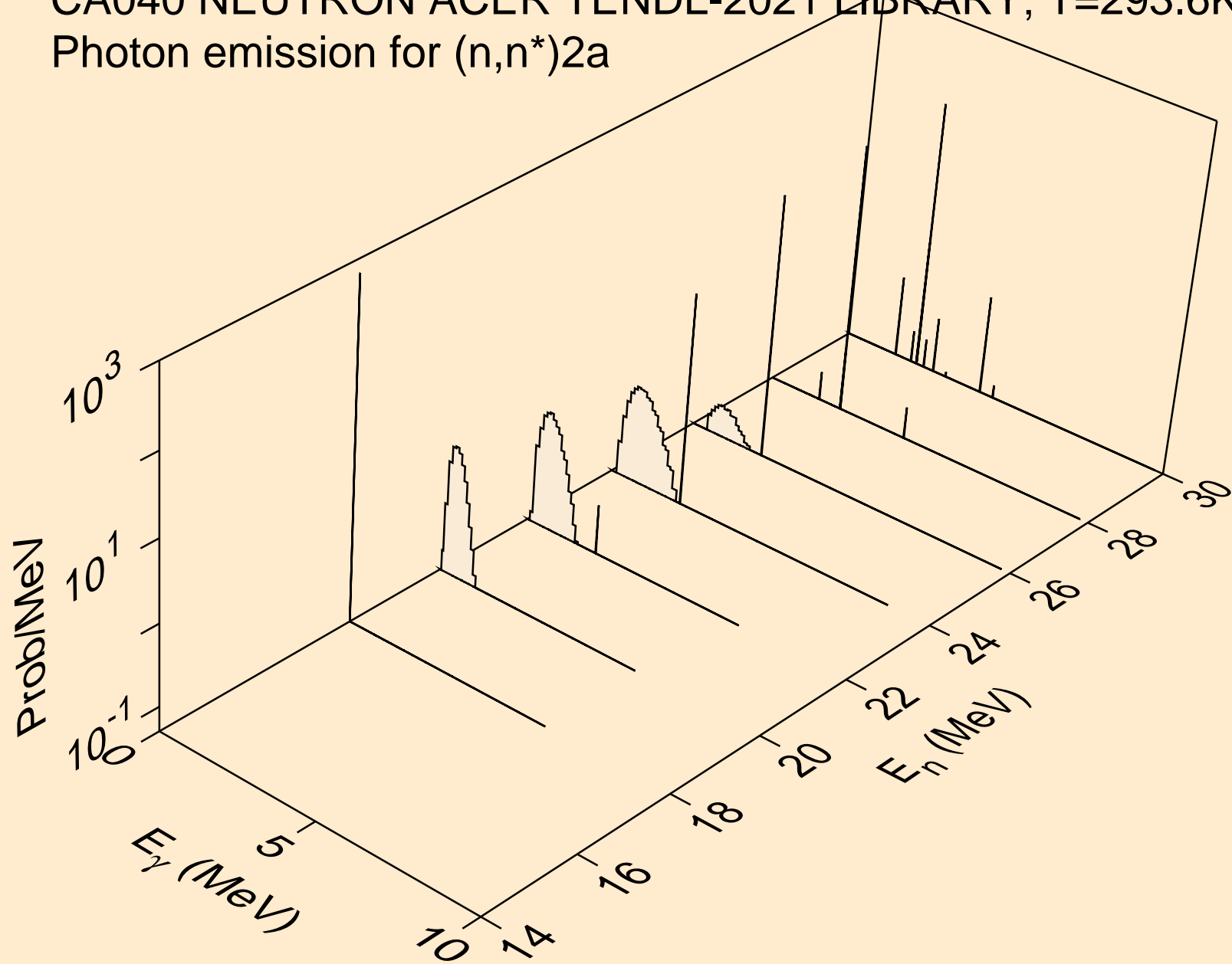

CA040 NEUTRON ACER TENDL-2021 LIBRARY; T=293.6K
Photon emission for (n,n*)d

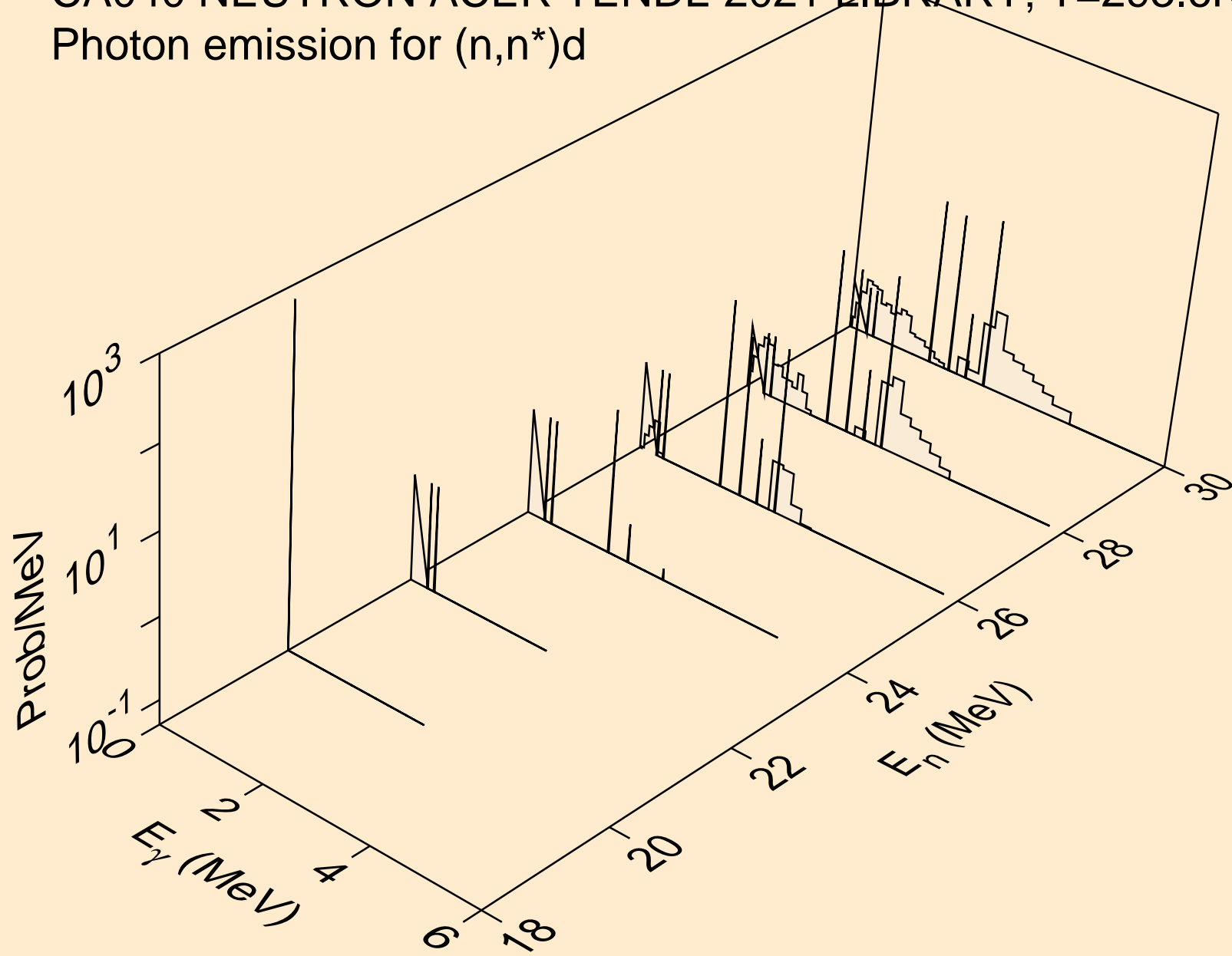

CA040 NEUTRON ACER TENDL-2021 LIBRARY; T=293.6K
Photon emission for (n,n*)t

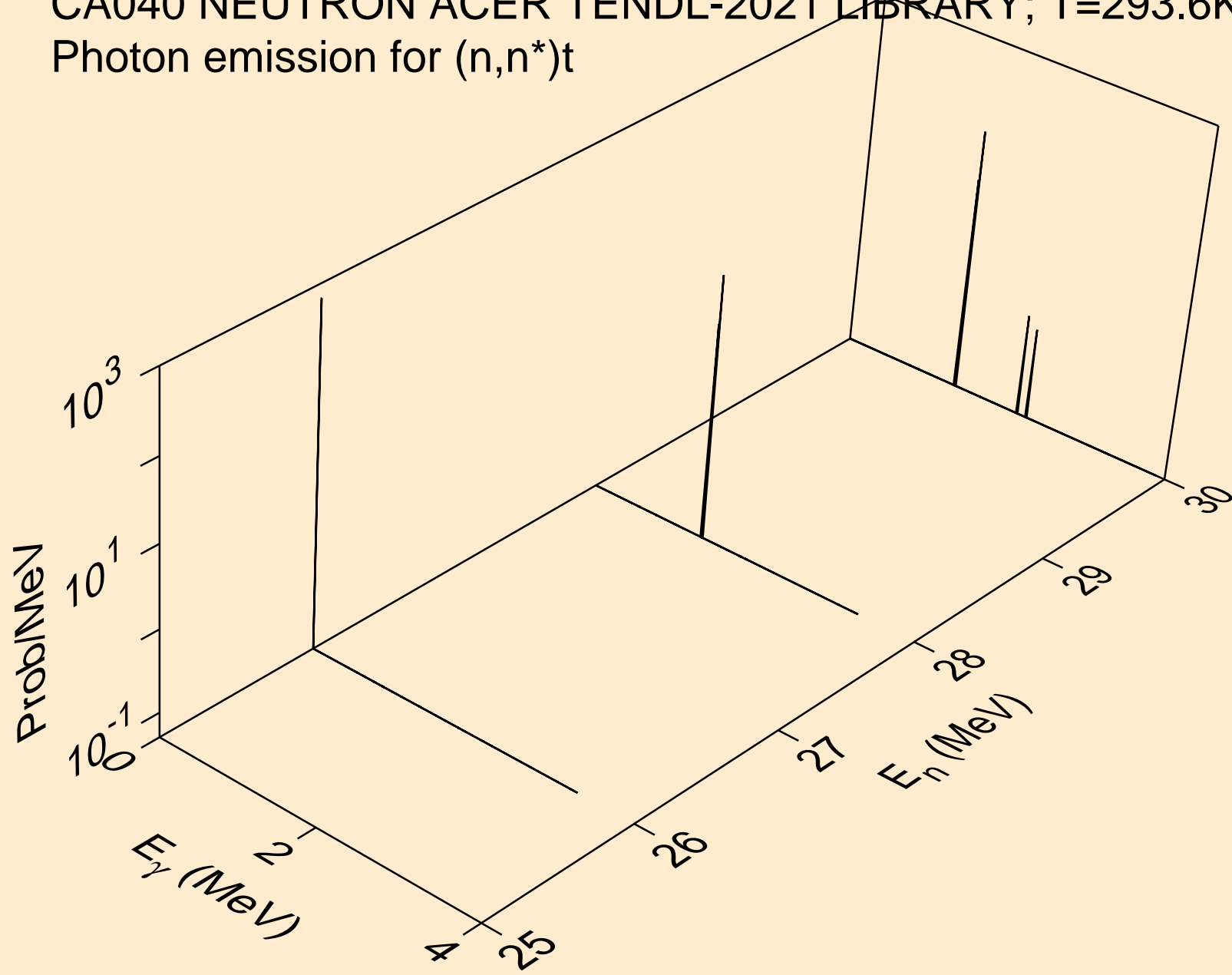

CA040 NEUTRON ACER TENDL-2021 LIBRARY; T=293.6K
Photon emission for (n,n*)he3

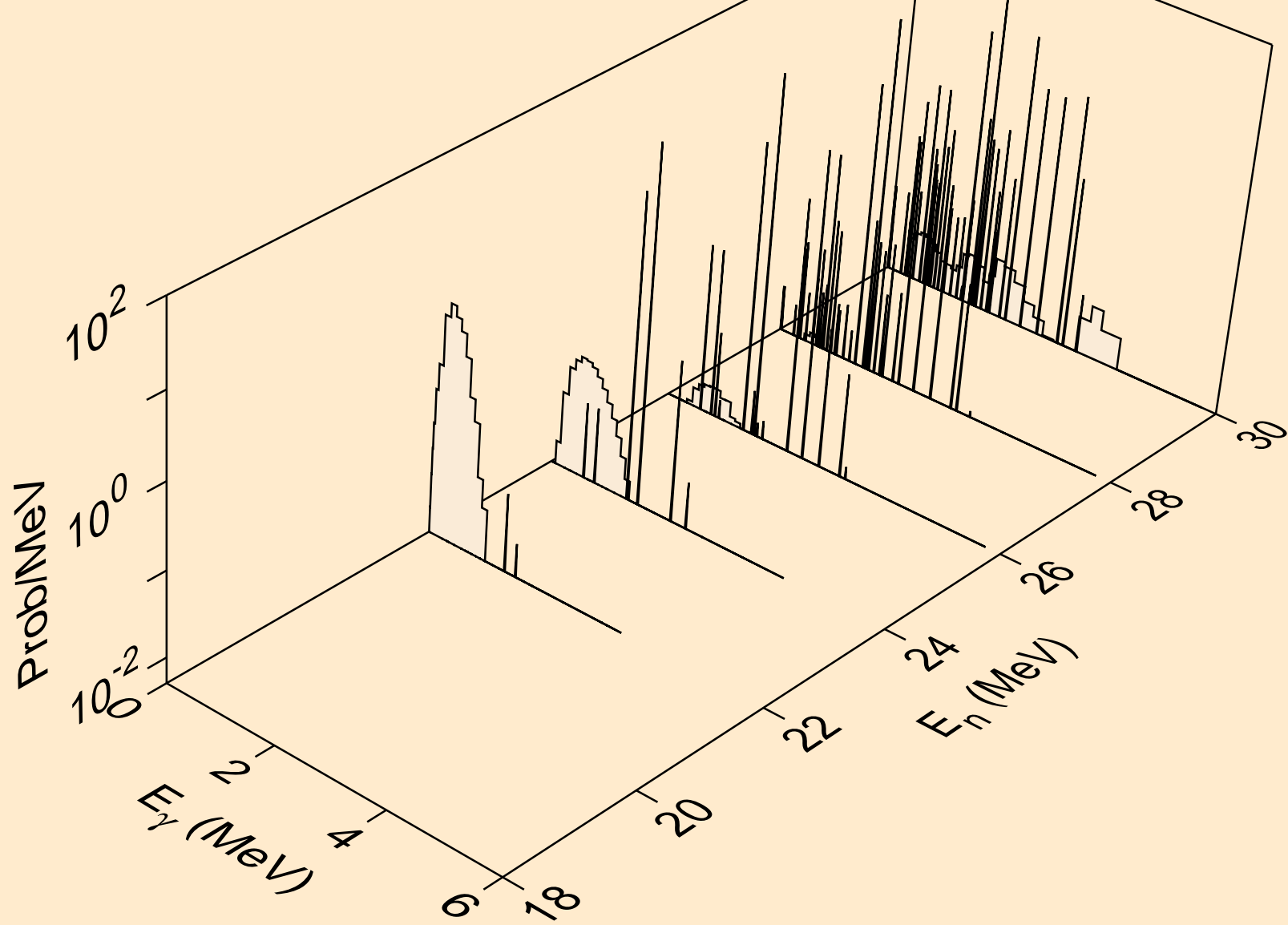

CA040 NEUTRON ACER TENDL-2021 LIBRARY; T=293.6K
Photon emission for (n,2np)

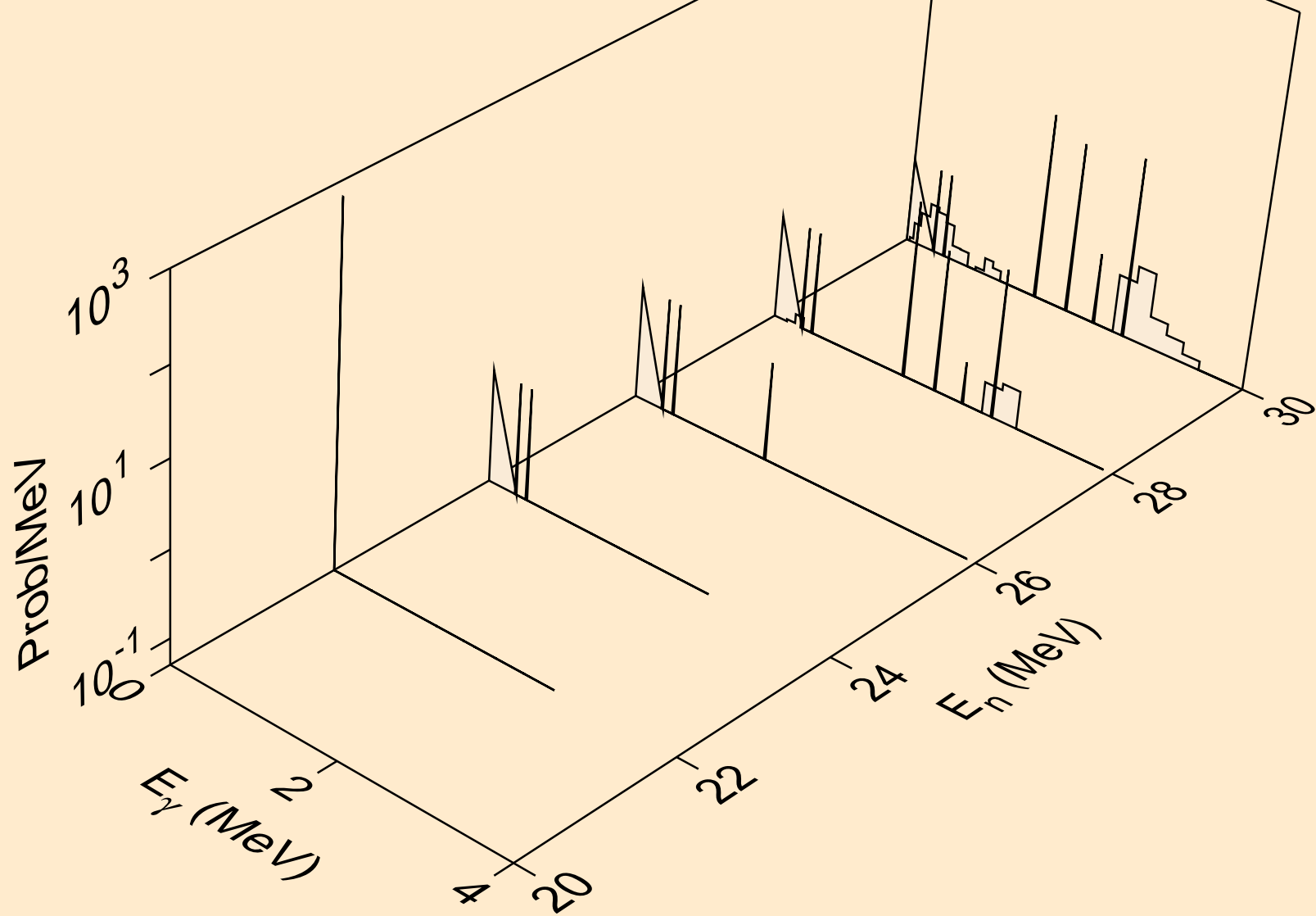

CA040 NEUTRON ACER TENDL-2021 LIBRARY; T=293.6K
Photon emission for (n,2np)

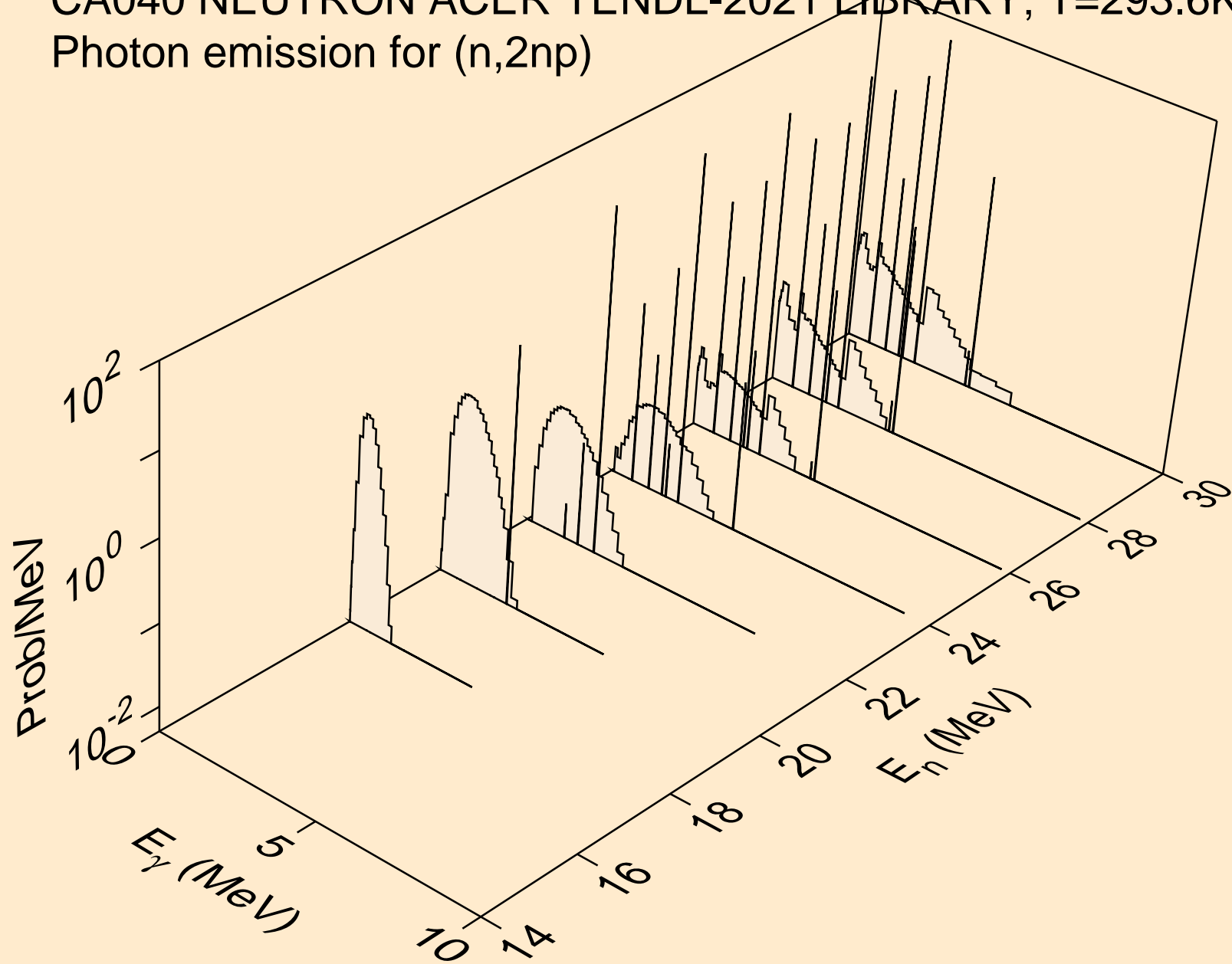

CA040 NEUTRON ACER TENDL-2021 LIBRARY; T=293.6K
Photon emission for (n,npa)

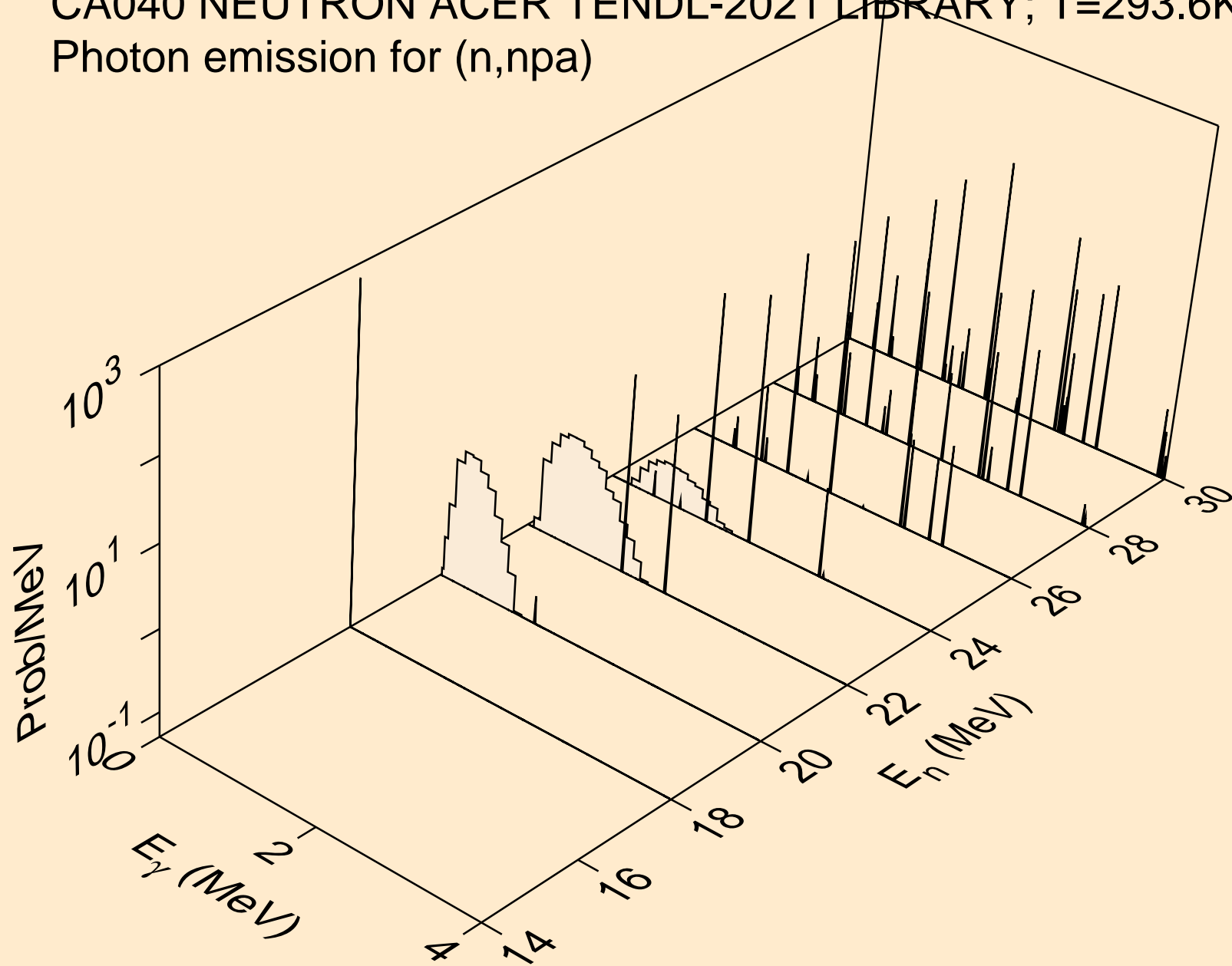

CA040 NEUTRON ACER TENDL-2021 LIBRARY; T=293.6K
Photon emission for (n,n*c)

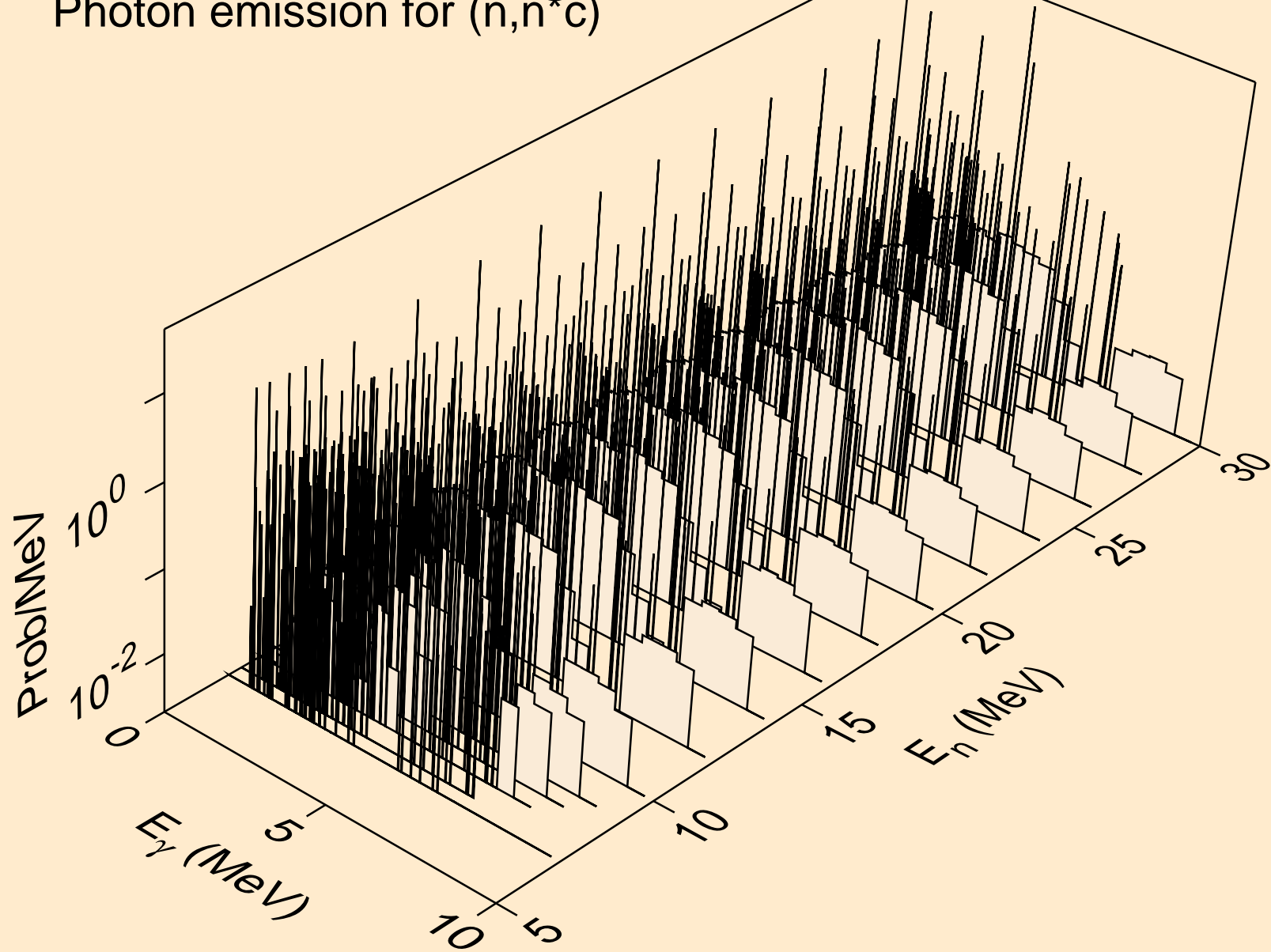

CA040 NEUTRON ACER TENDL-2021 LIBRARY; T=293.6K
Photon emission for (n,gma)

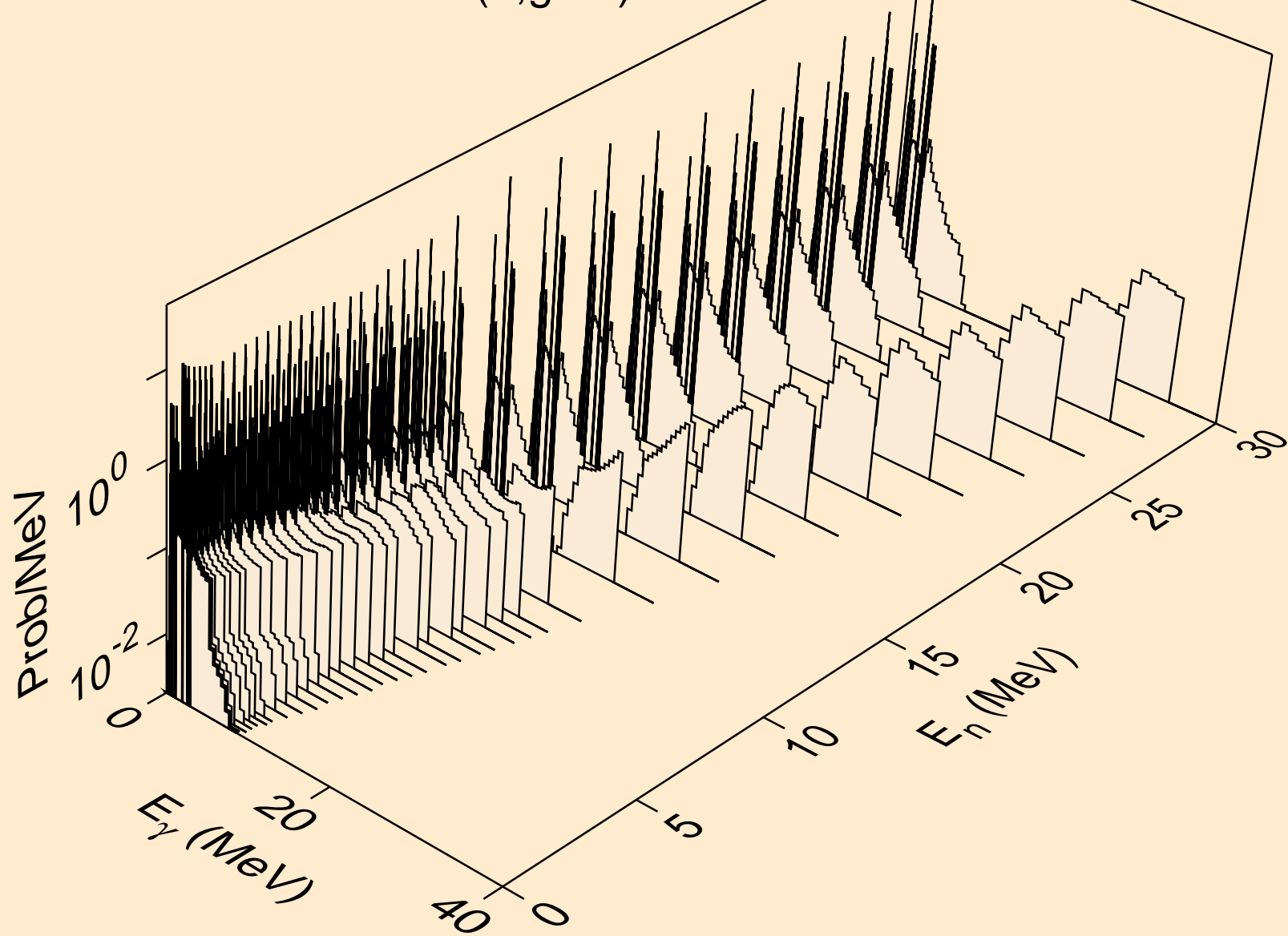

CA040 NEUTRON ACER TENDL-2021 LIBRARY; T=293.6K
Photon emission for (n,p)

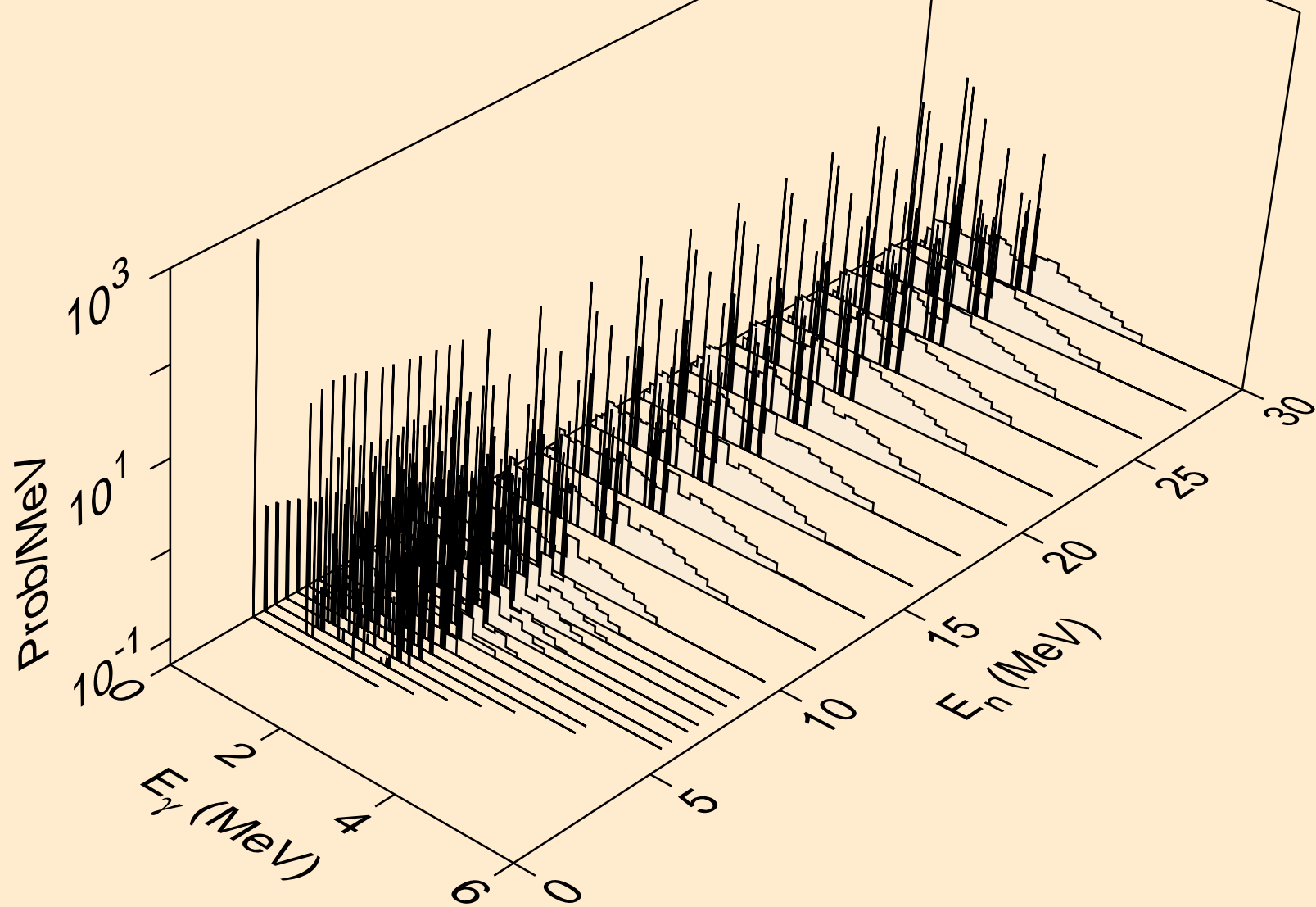

CA040 NEUTRON ACER TENDL-2021 LIBRARY; T=293.6K
Photon emission for (n,d)

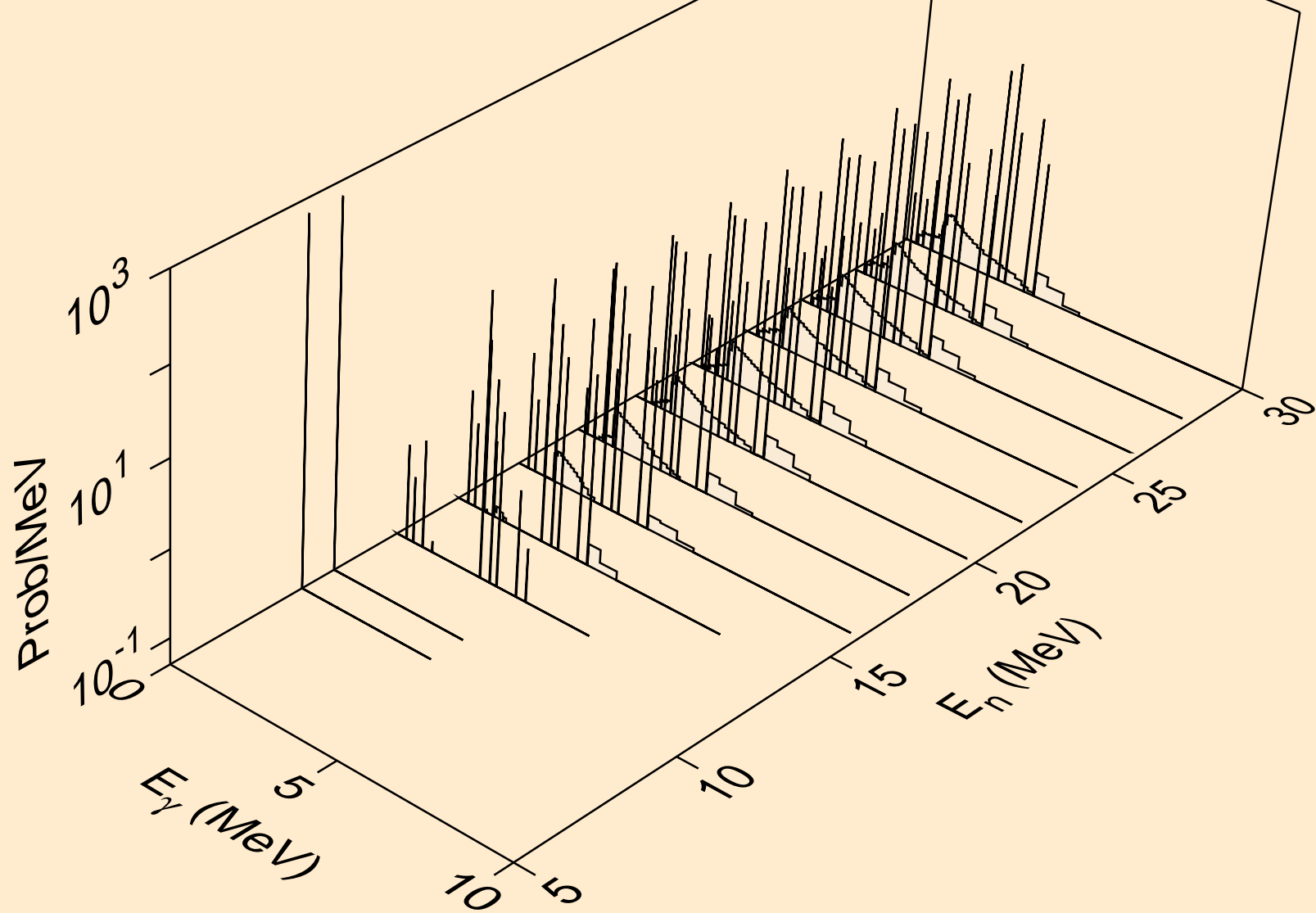

CA040 NEUTRON ACER TENDL-2021 LIBRARY; T=293.6K
Photon emission for (n,t)

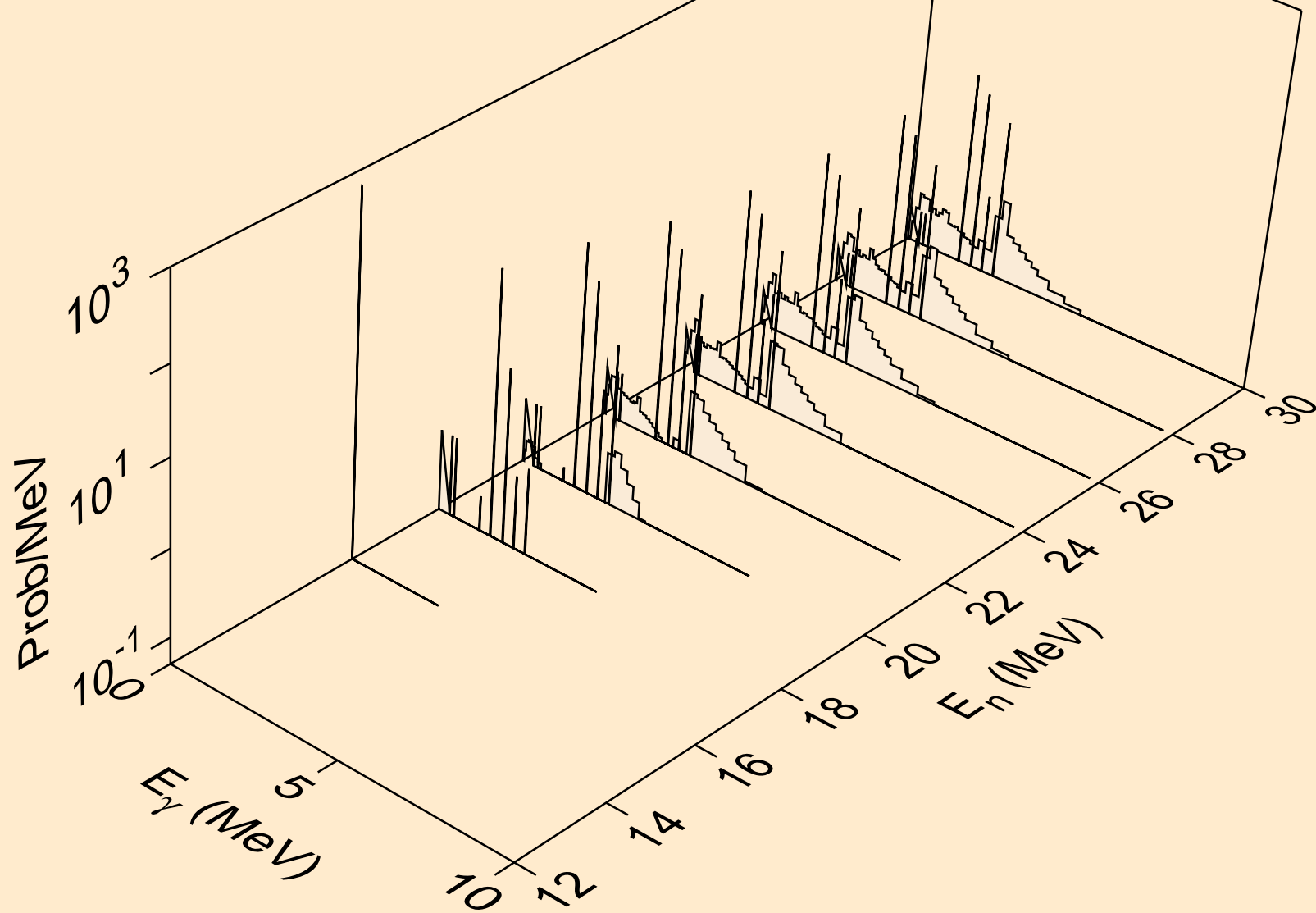

CA040 NEUTRON ACER TENDL-2021 LIBRARY; T=293.6K
Photon emission for (n,he3)

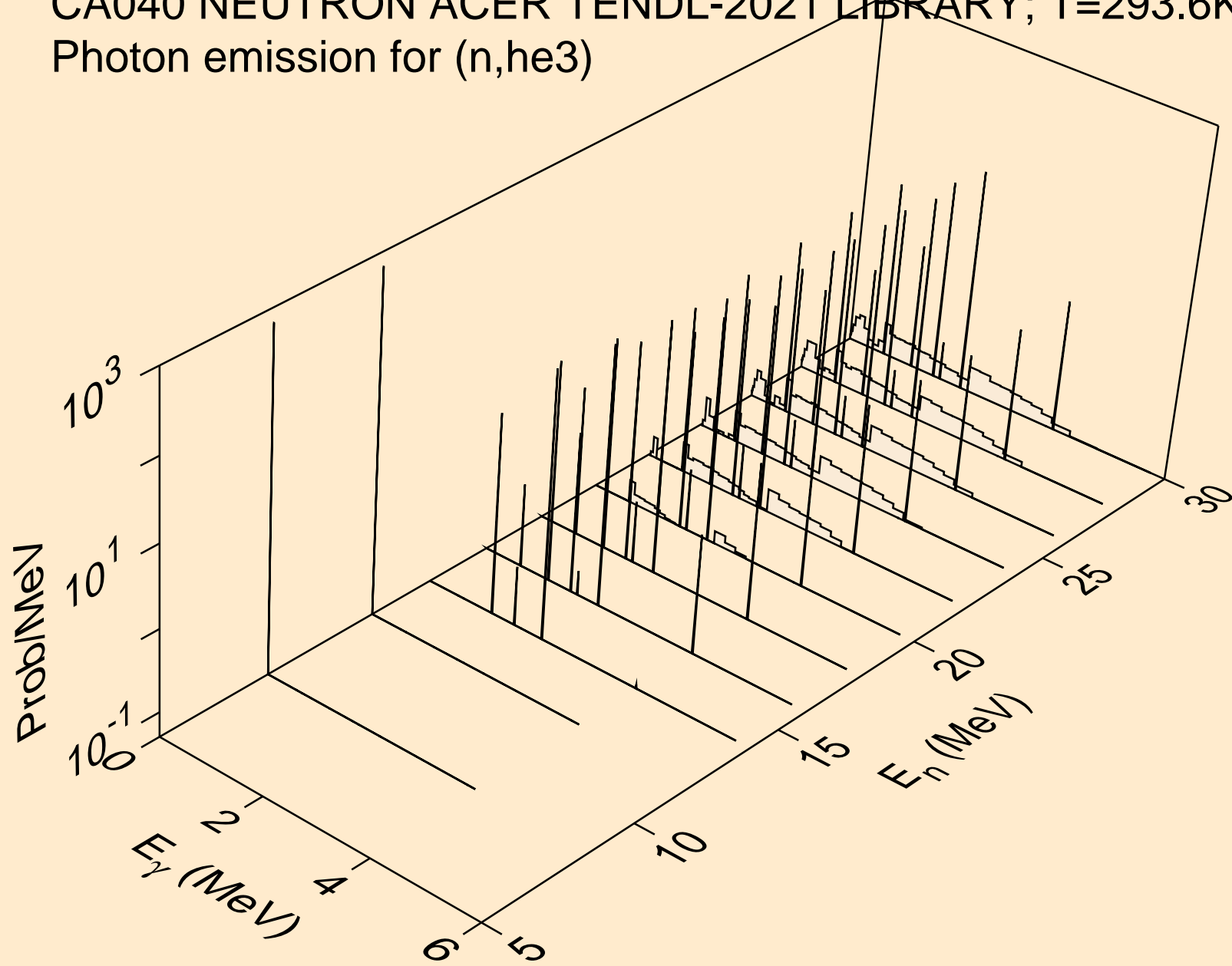

CA040 NEUTRON ACER TENDL-2021 LIBRARY; T=293.6K
Photon emission for (n,a)

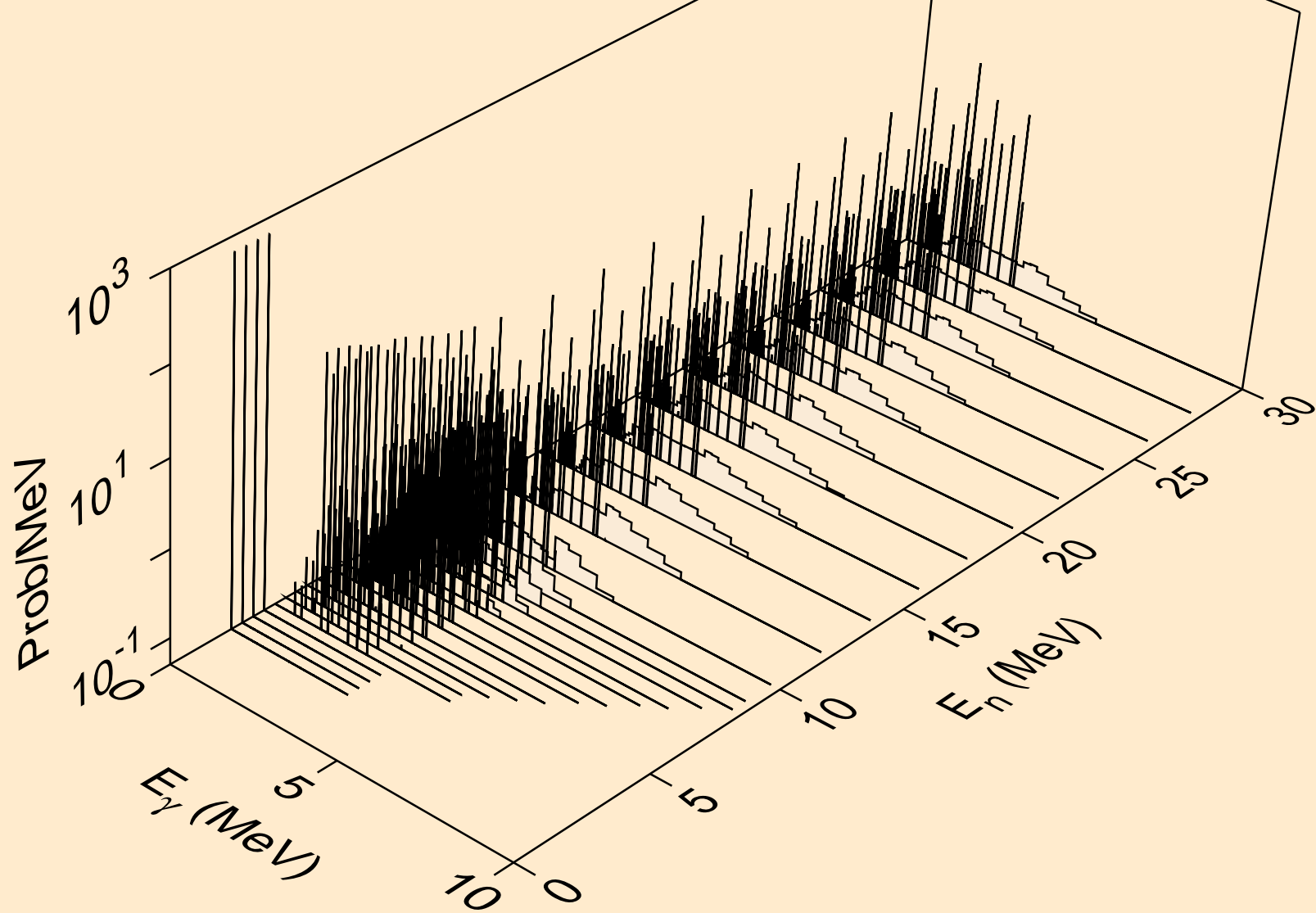

CA040 NEUTRON ACER TENDL-2021 LIBRARY; T=293.6K
Photon emission for (n,2a)

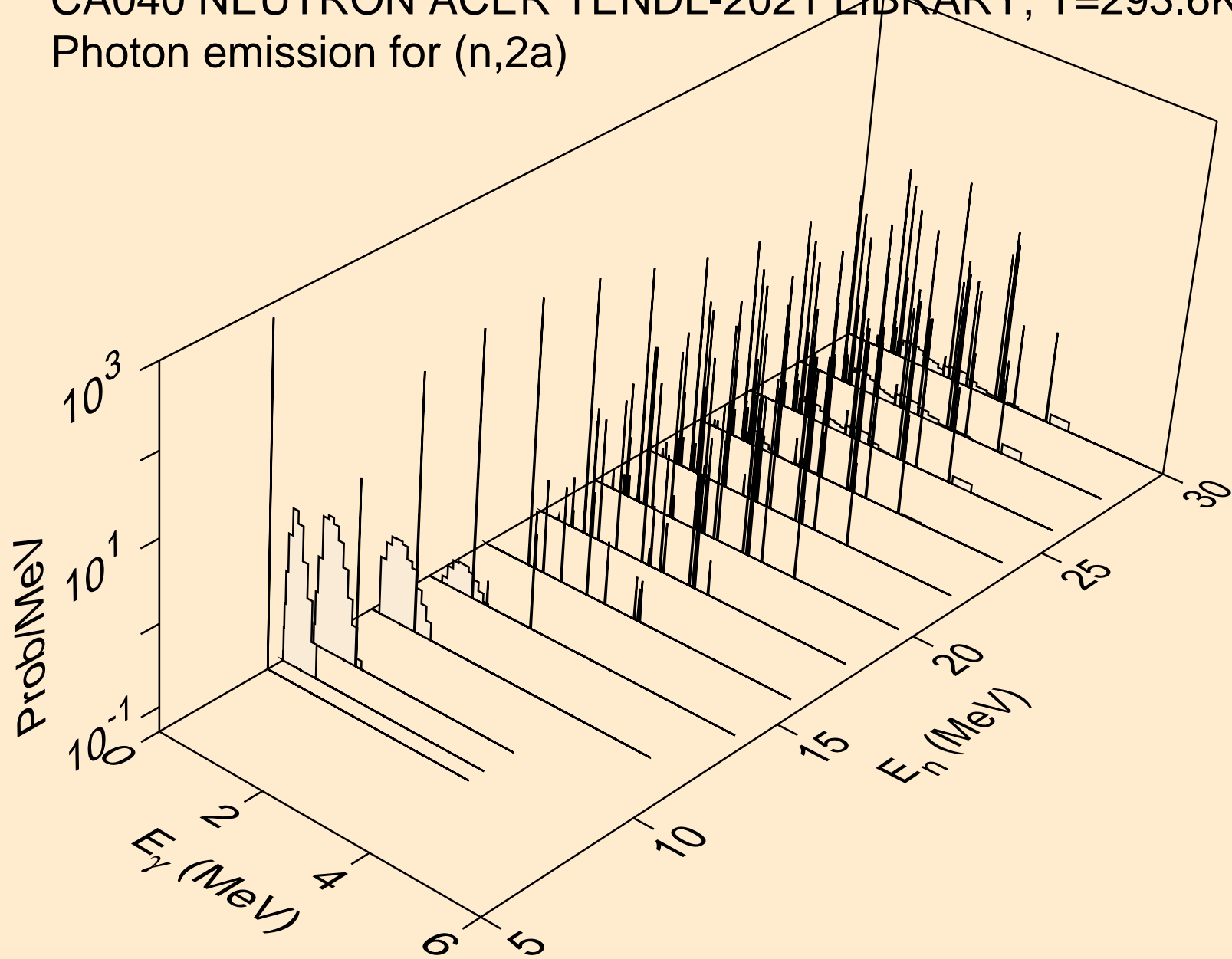

CA040 NEUTRON ACER TENDL-2021 LIBRARY; T=293.6K
Photon emission for (n,3a)

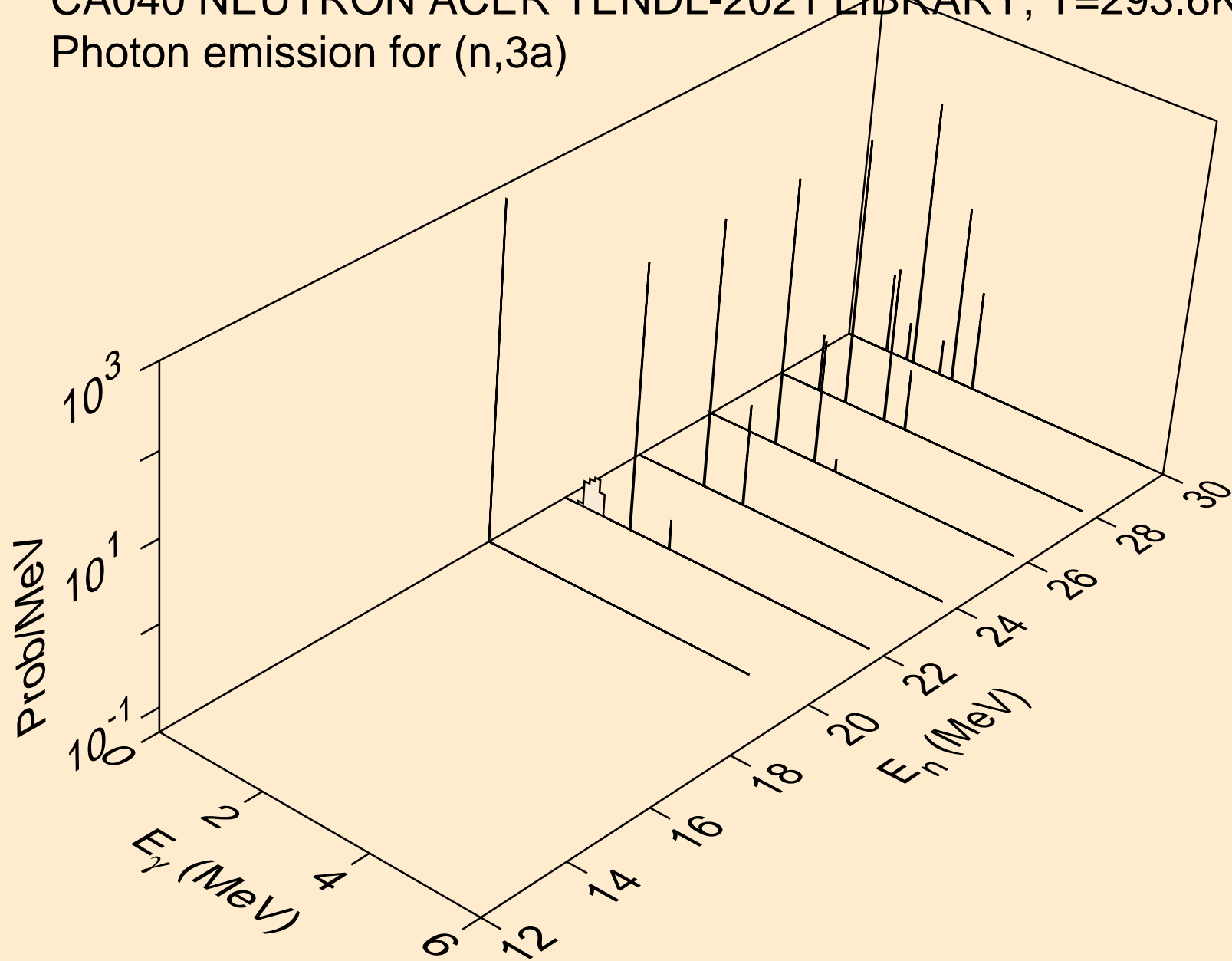

CA040 NEUTRON ACER TENDL-2021 LIBRARY; T=293.6K
Photon emission for (n,2p)

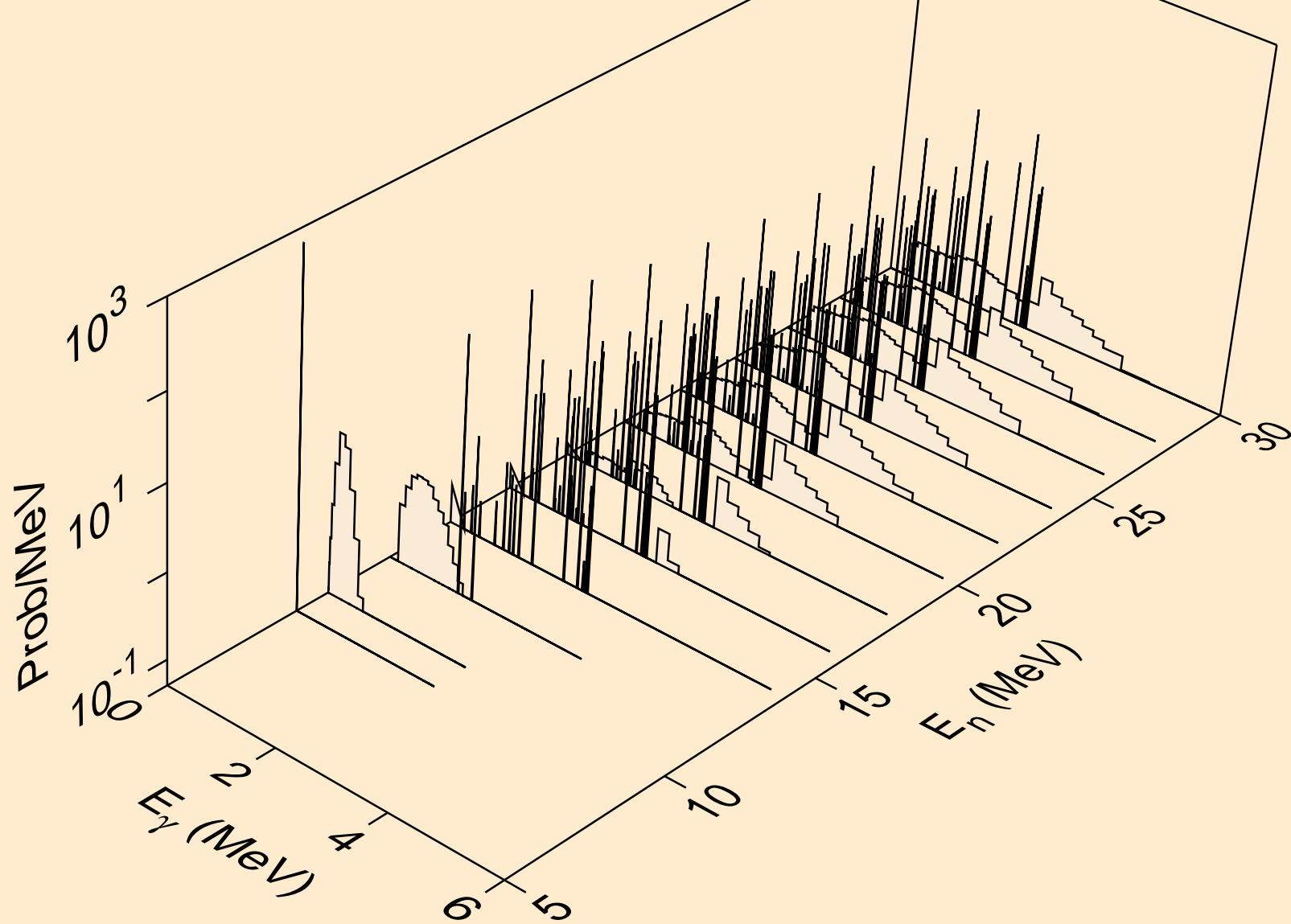

CA040 NEUTRON ACER TENDL-2021 LIBRARY; T=293.6K
Photon emission for (n,p)

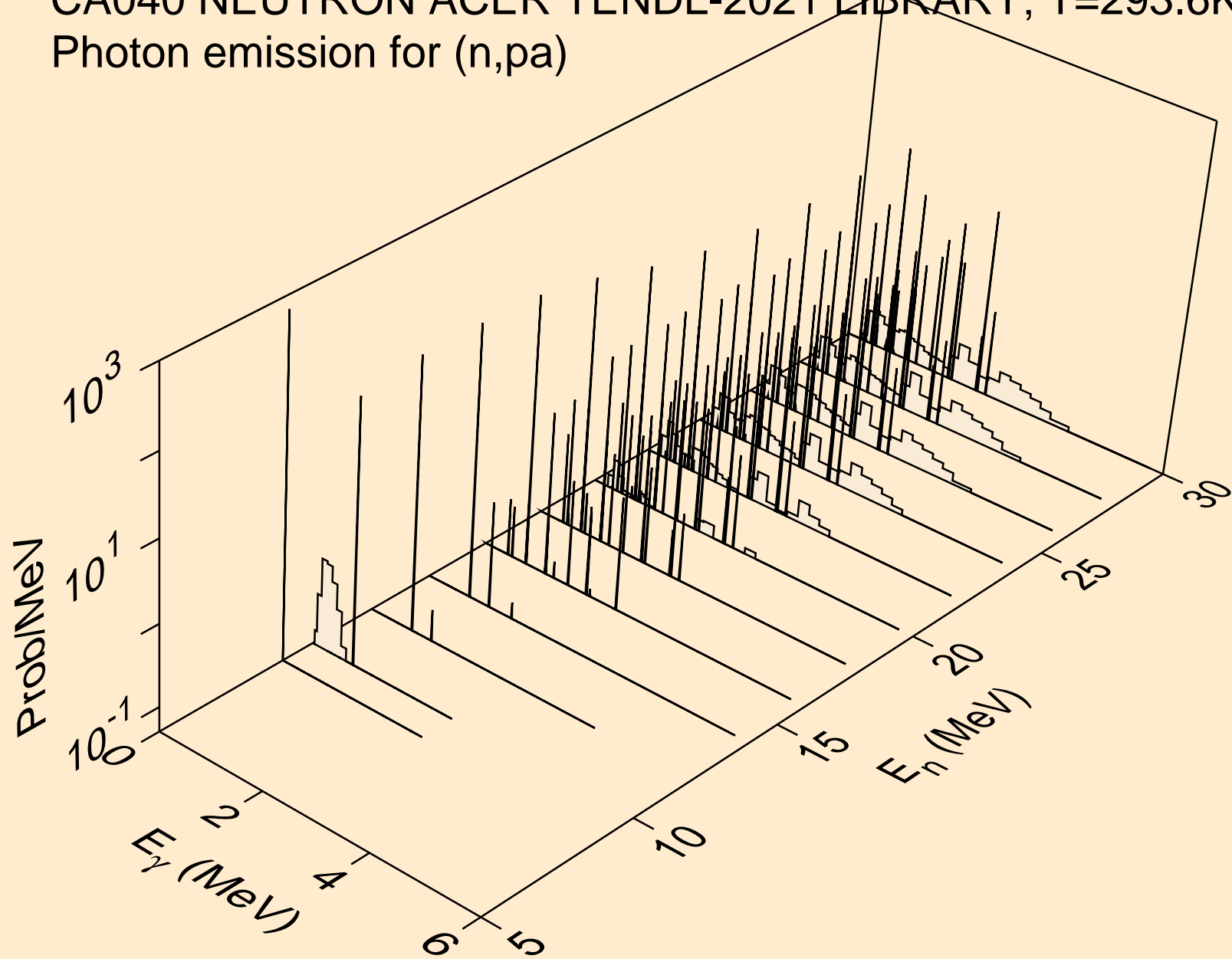

CA040 NEUTRON ACER TENDL-2021 LIBRARY; T=293.6K
Photon emission for (n,pd)

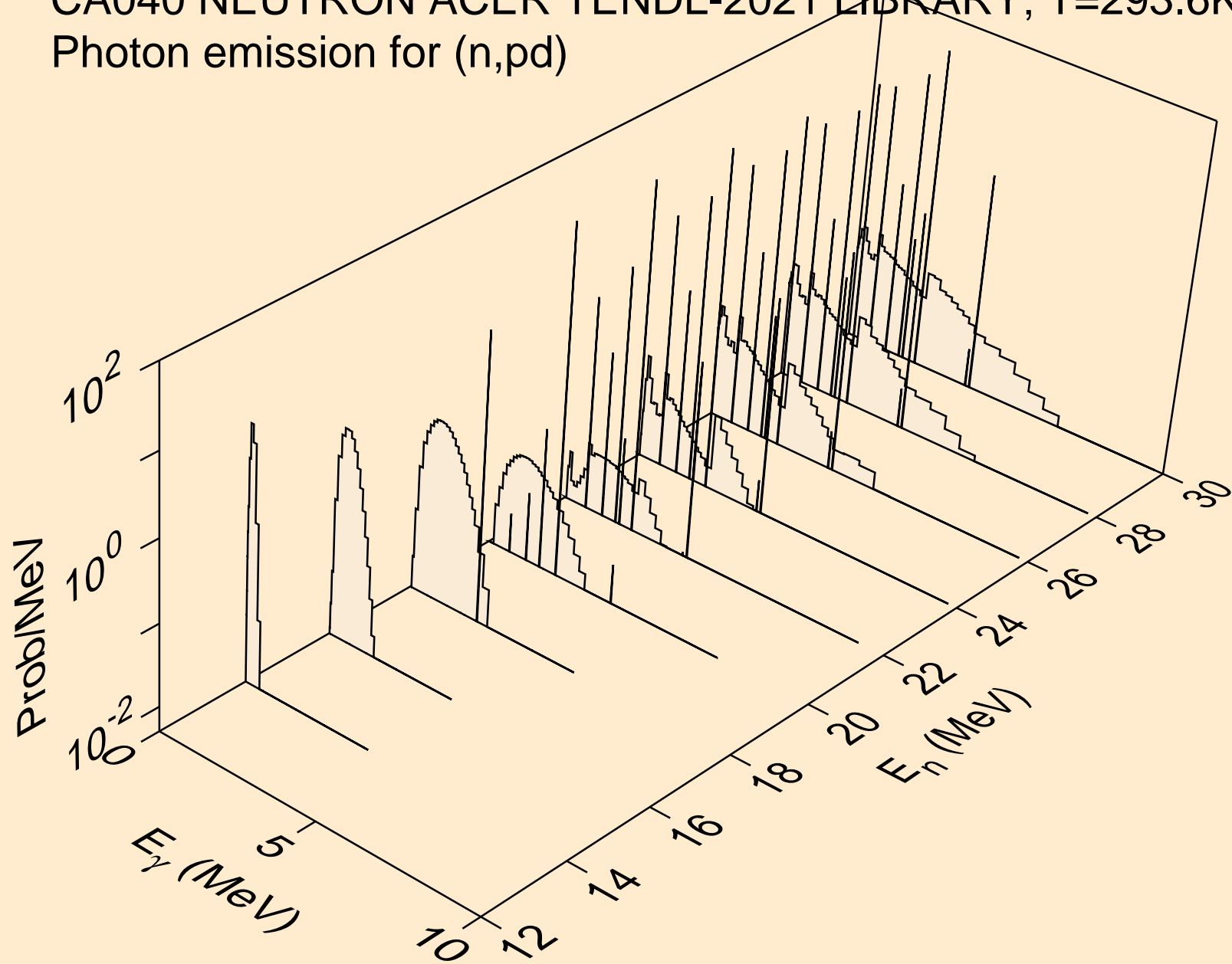

CA040 NEUTRON ACER TENDL-2021 LIBRARY; T=293.6K
Photon emission for (n,pt)

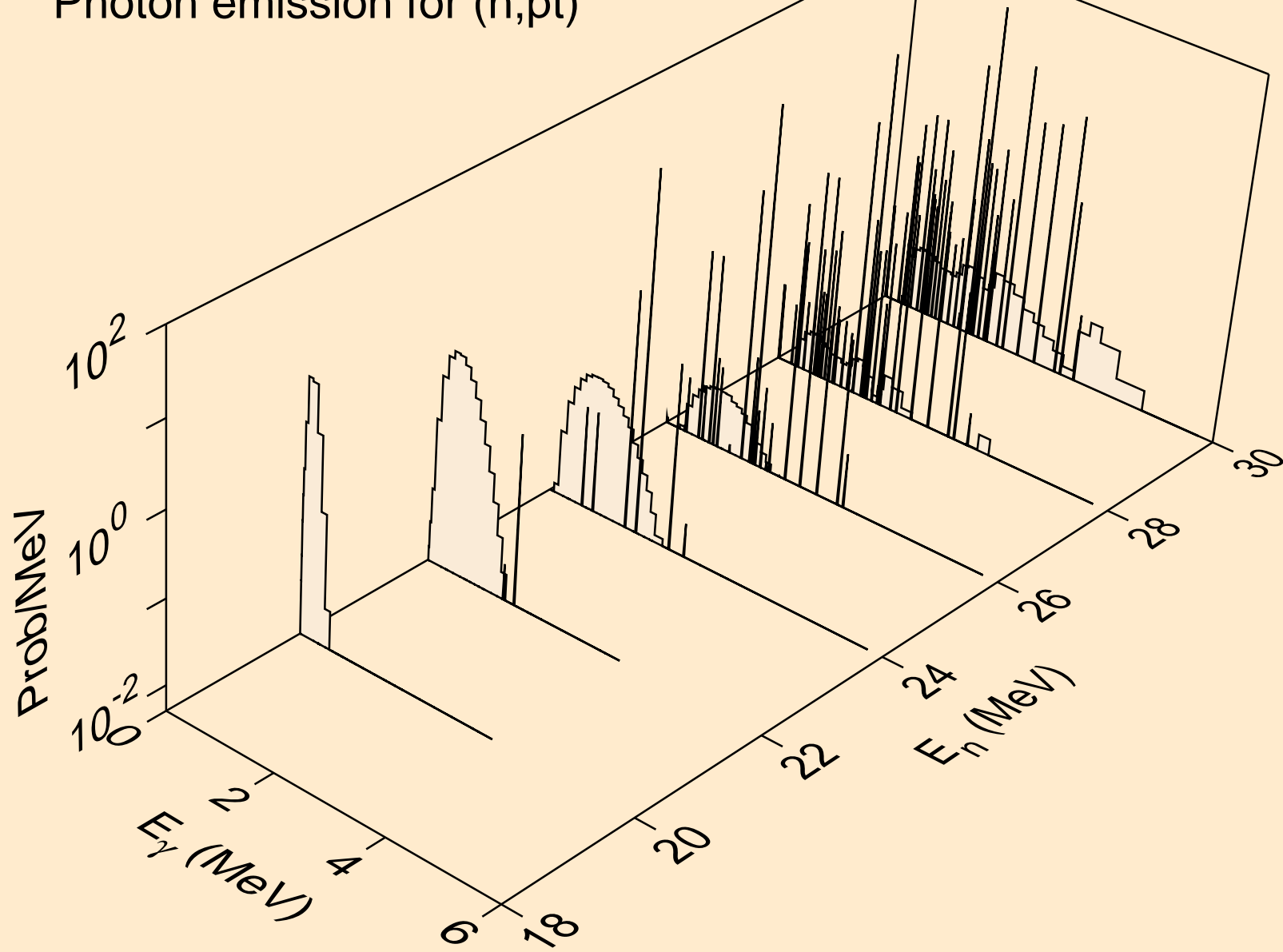

CA040 NEUTRON ACER TENDL-2021 LIBRARY; T=293.6K
Photon emission for (n,da)

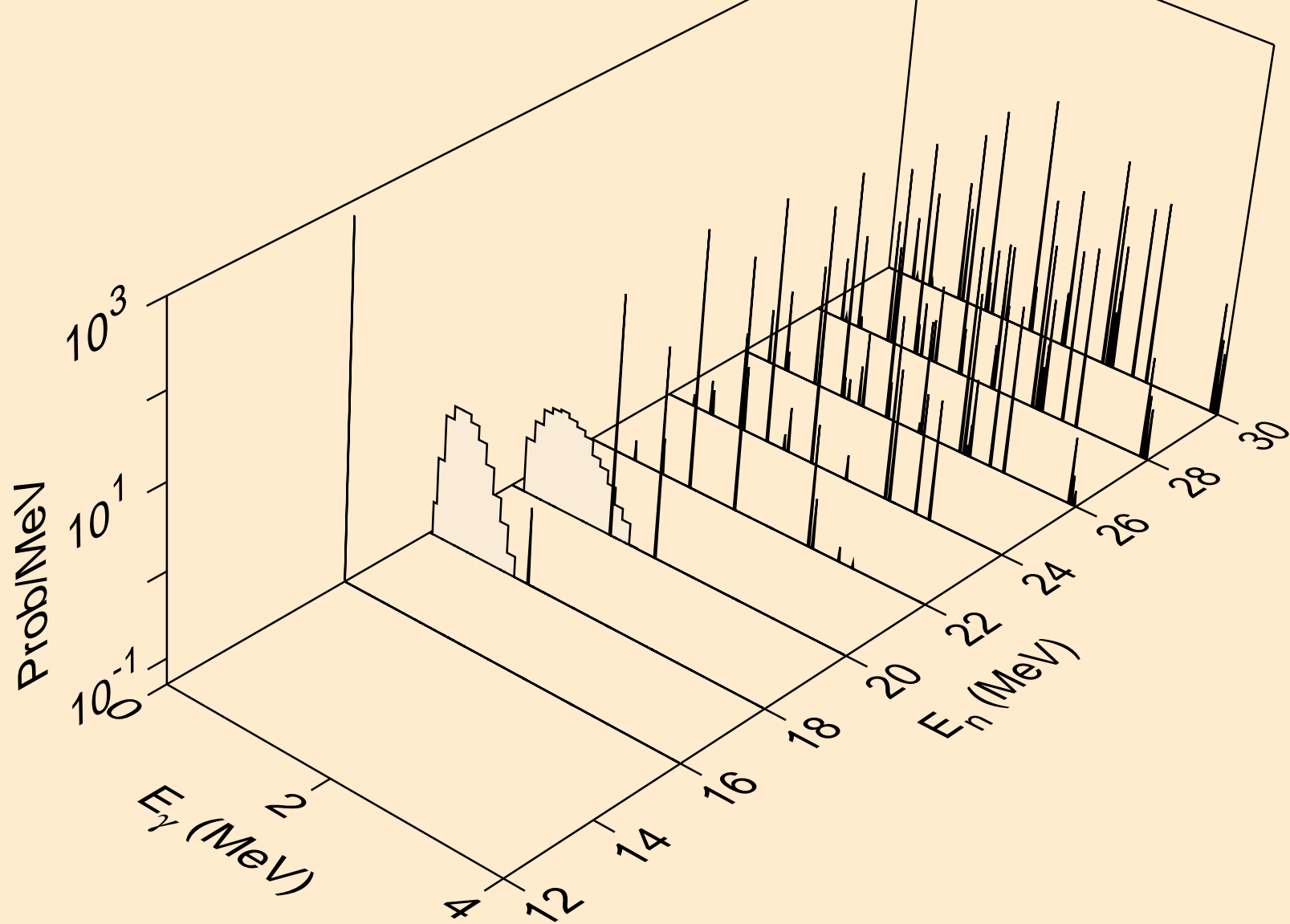

CA040 NEUTRON ACER TENDL-2021 LIBRARY; T=293.6K
thermal capture photon spectrum

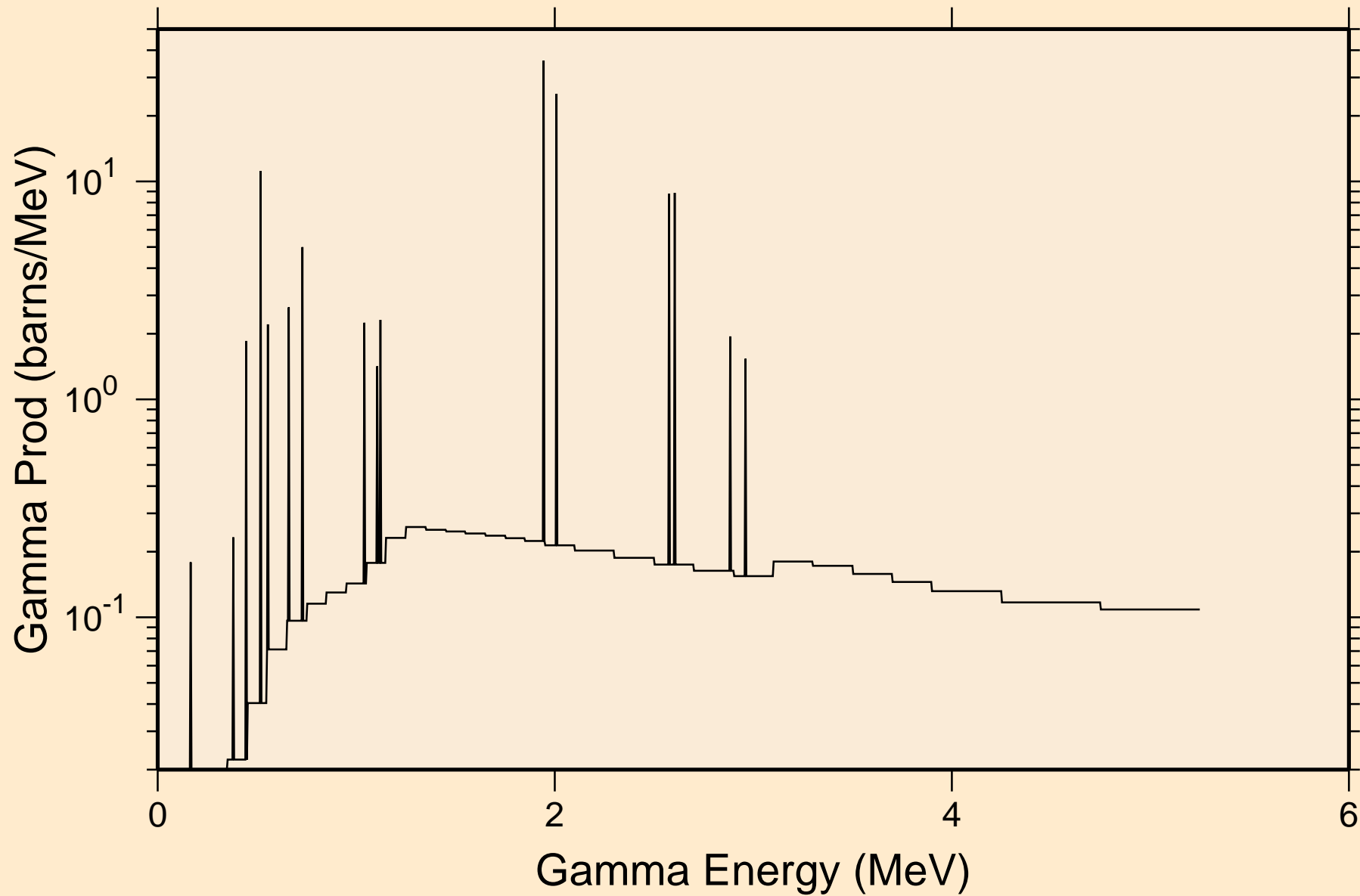

CA040 NEUTRON ACER TENDL-2021 LIBRARY; T=293.6K
14 MeV photon spectrum

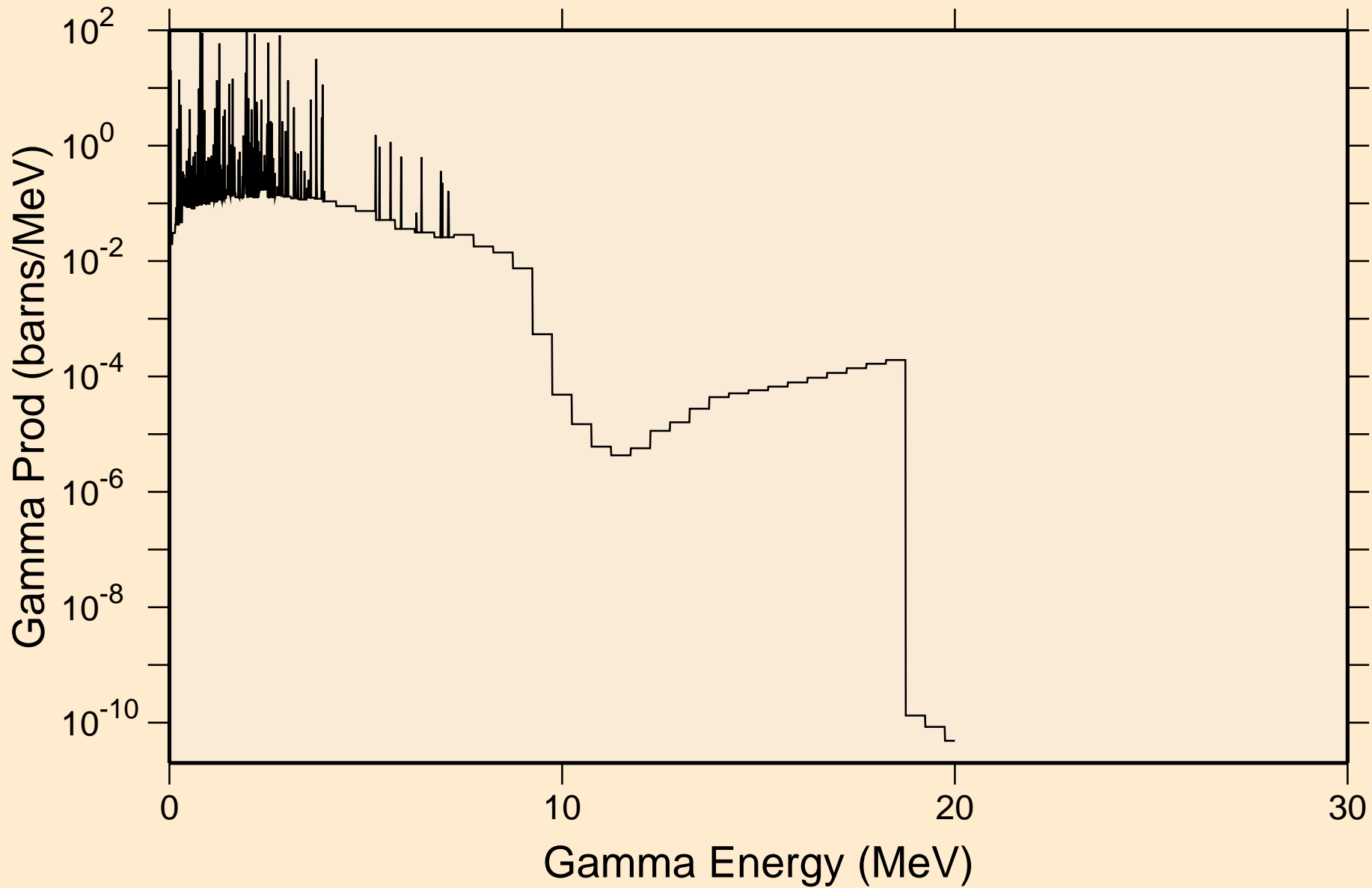

CA040 NEUTRON ACER TENDL-2021 LIBRARY; T=293.6K
Particle heating contributions

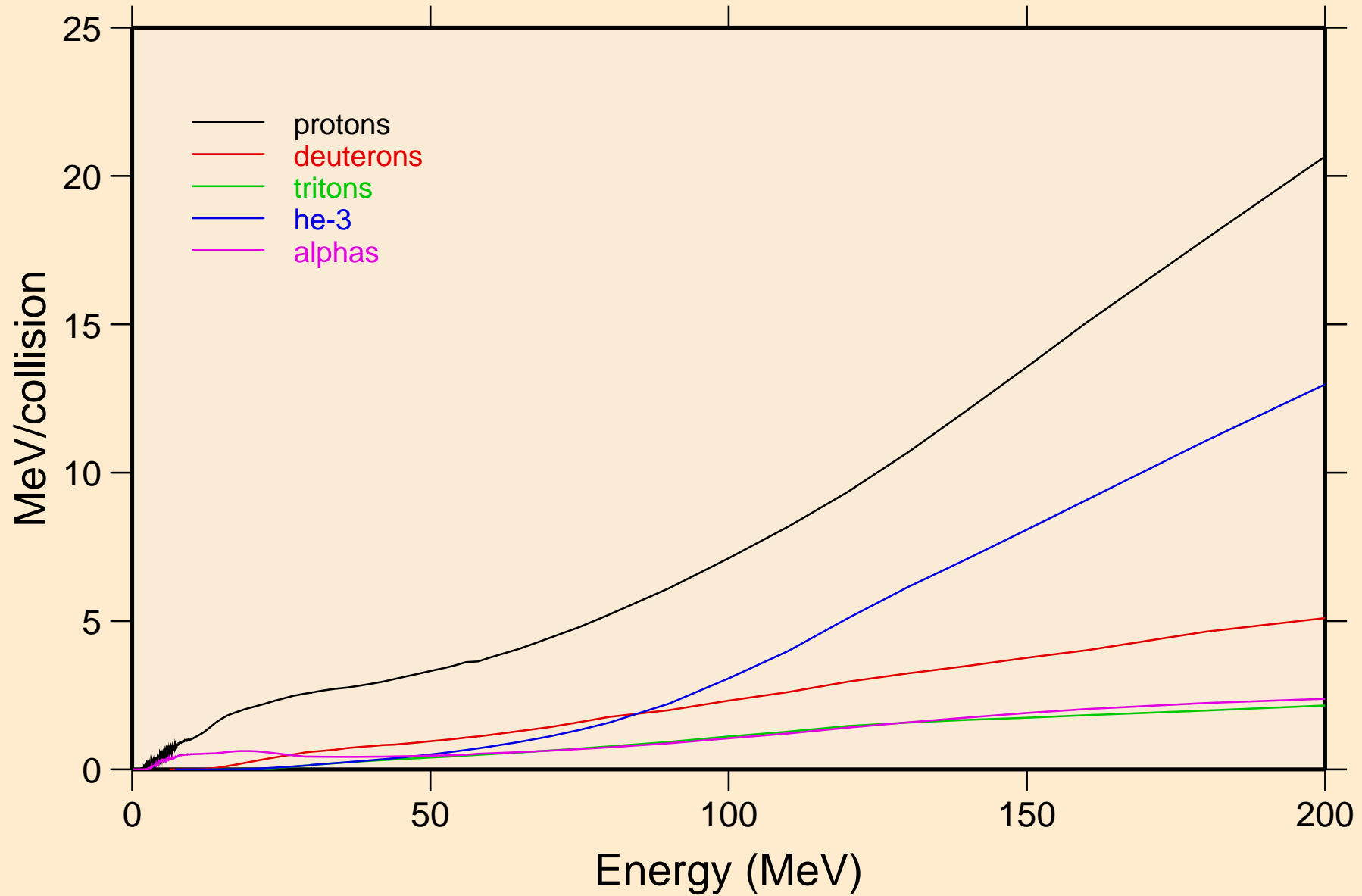

CA040 NEUTRON ACER TENDL-2021 LIBRARY; T=293.6K
Recoil Heating

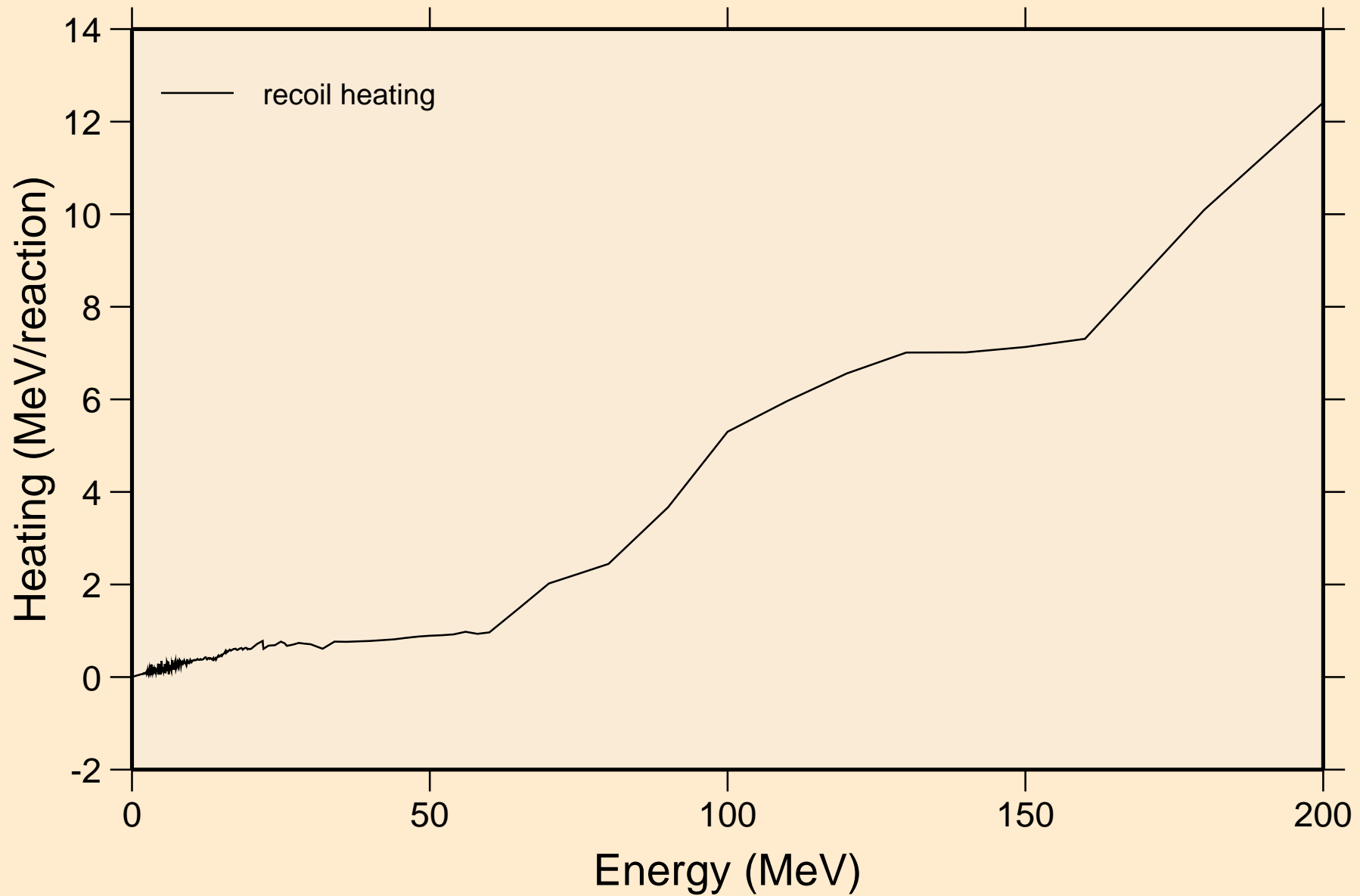

CA040 NEUTRON ACER TENDL-2021 LIBRARY; T=293.6K

Particle production cross sections

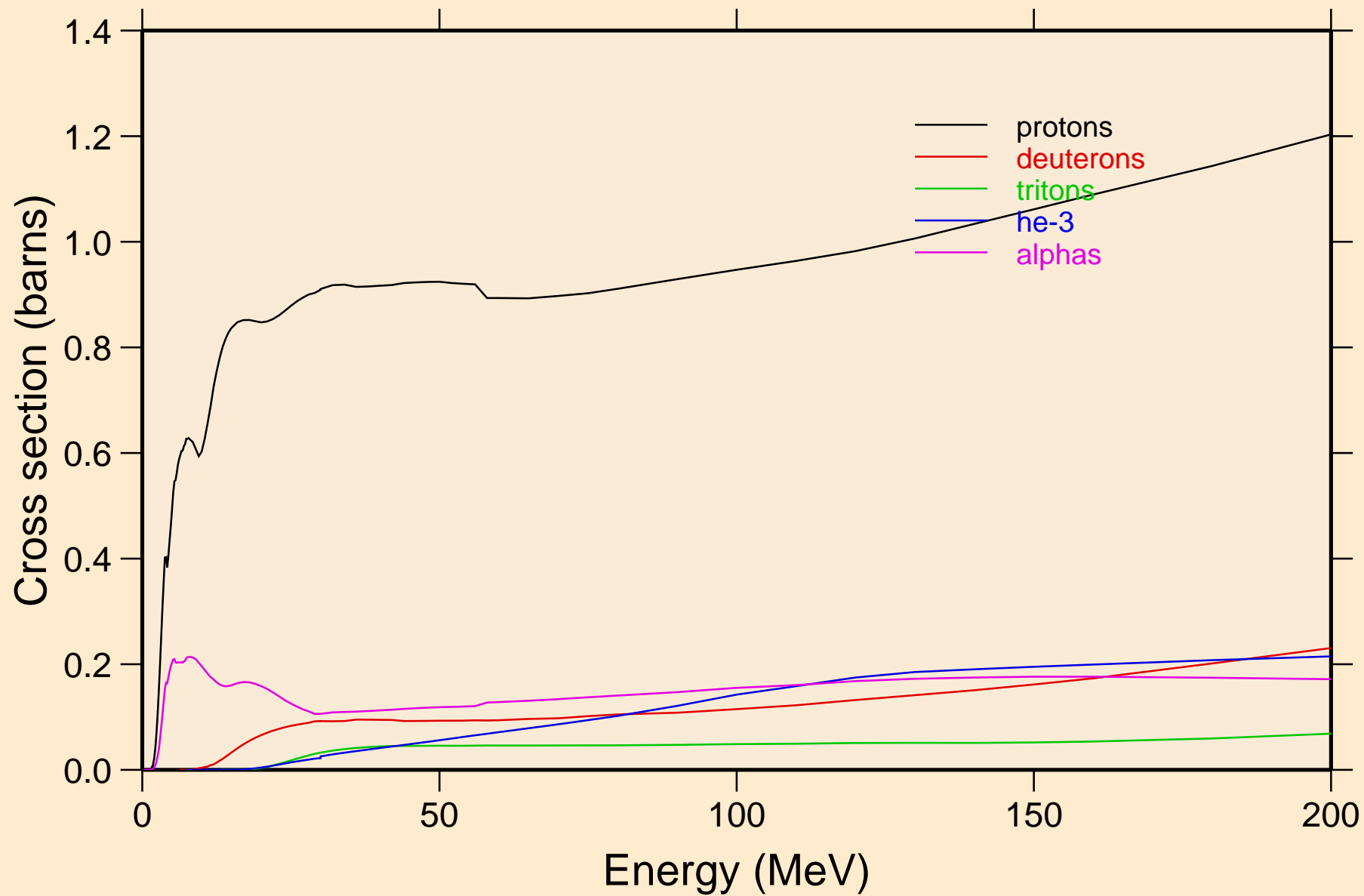

CA040 NEUTRON ACER TENDL-2021 LIBRARY; T=293.6K
protons from (n,x)

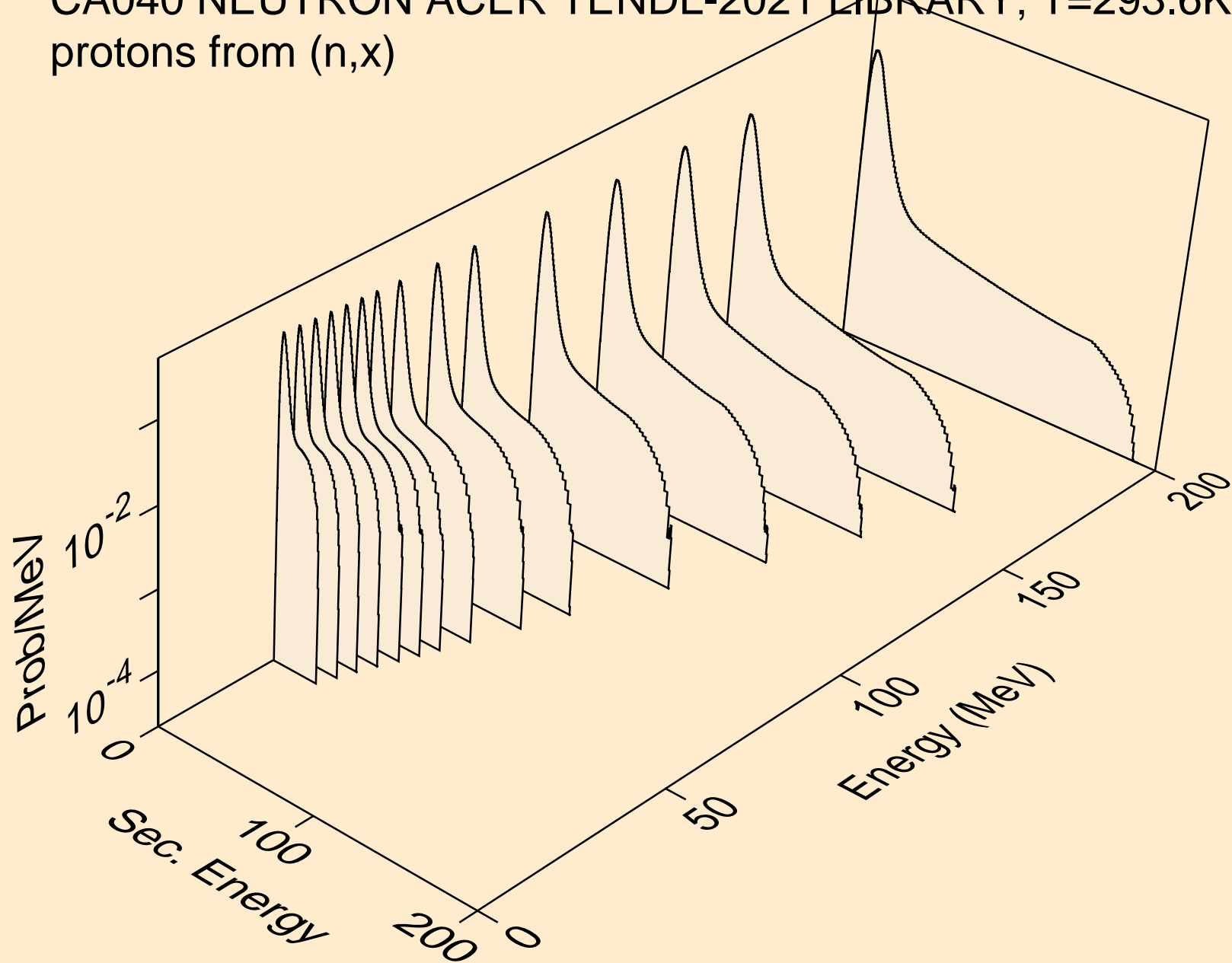

CA040 NEUTRON ACER TENDL-2021 LIBRARY; T=293.6K
protons from (n,n*)p

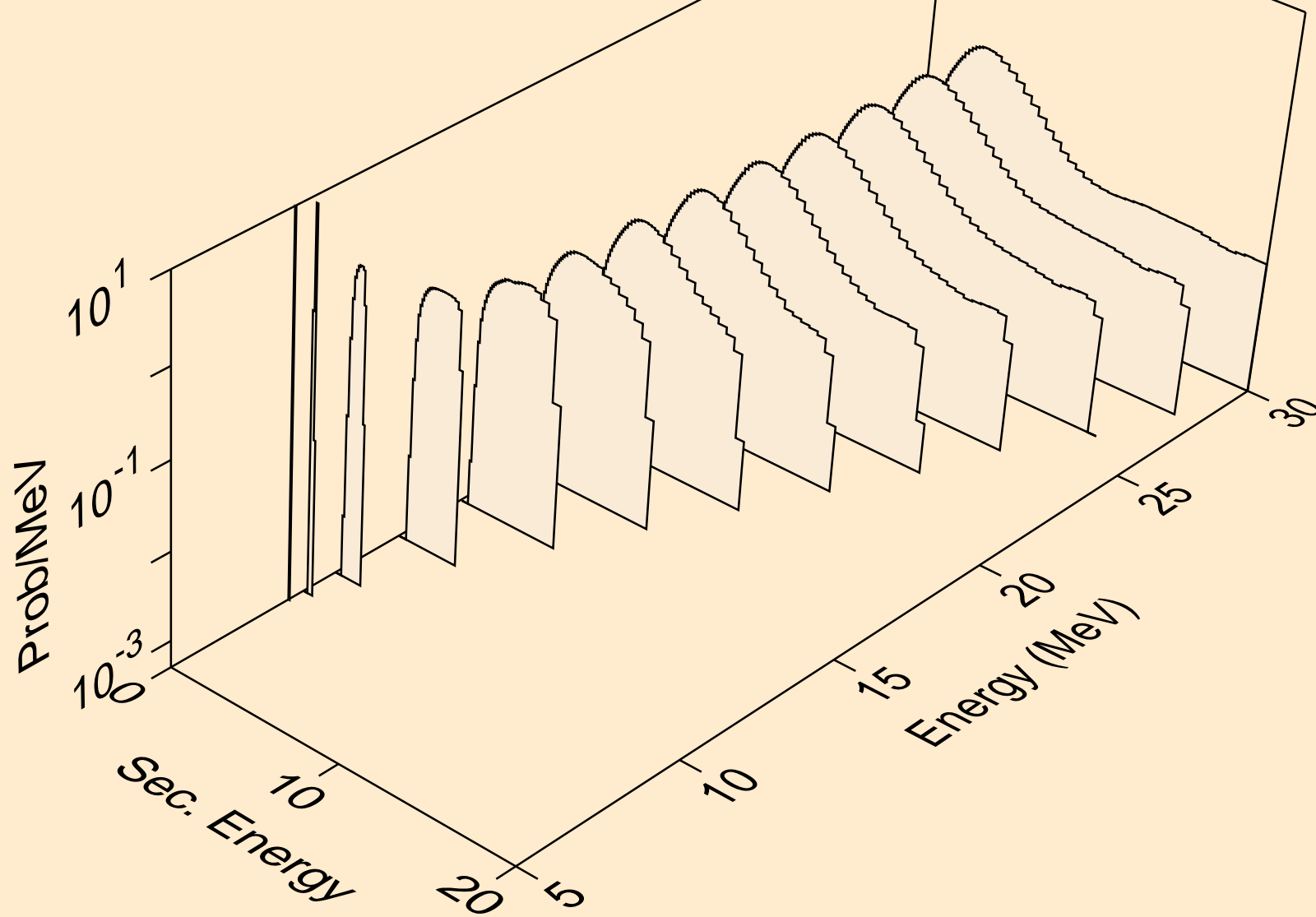

CA040 NEUTRON ACER TENDL-2021 LIBRARY; T=293.6K
protons from (n,2np)

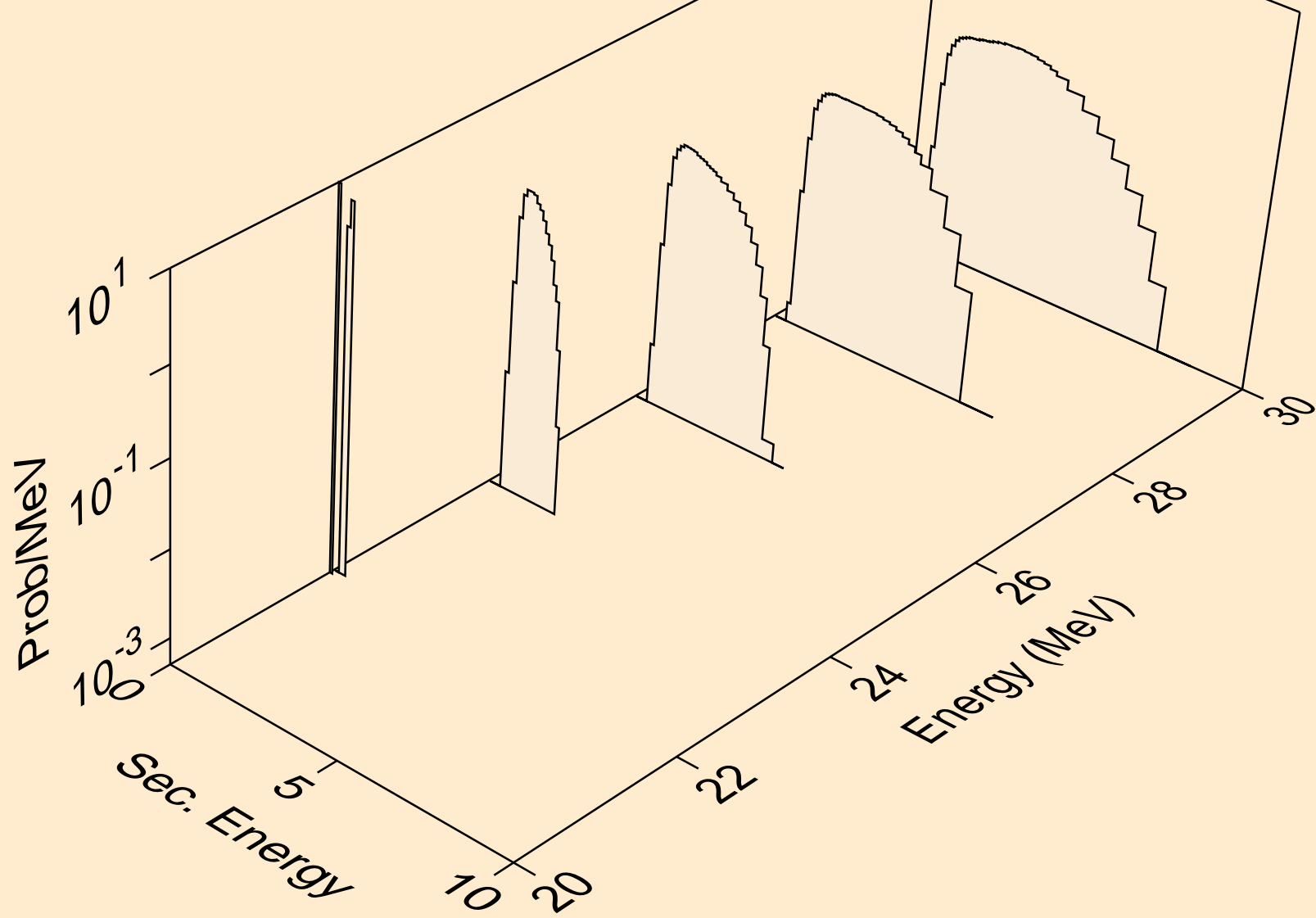

CA040 NEUTRON ACER TENDL-2021 LIBRARY; T=293.6K
protons from (n,2np)

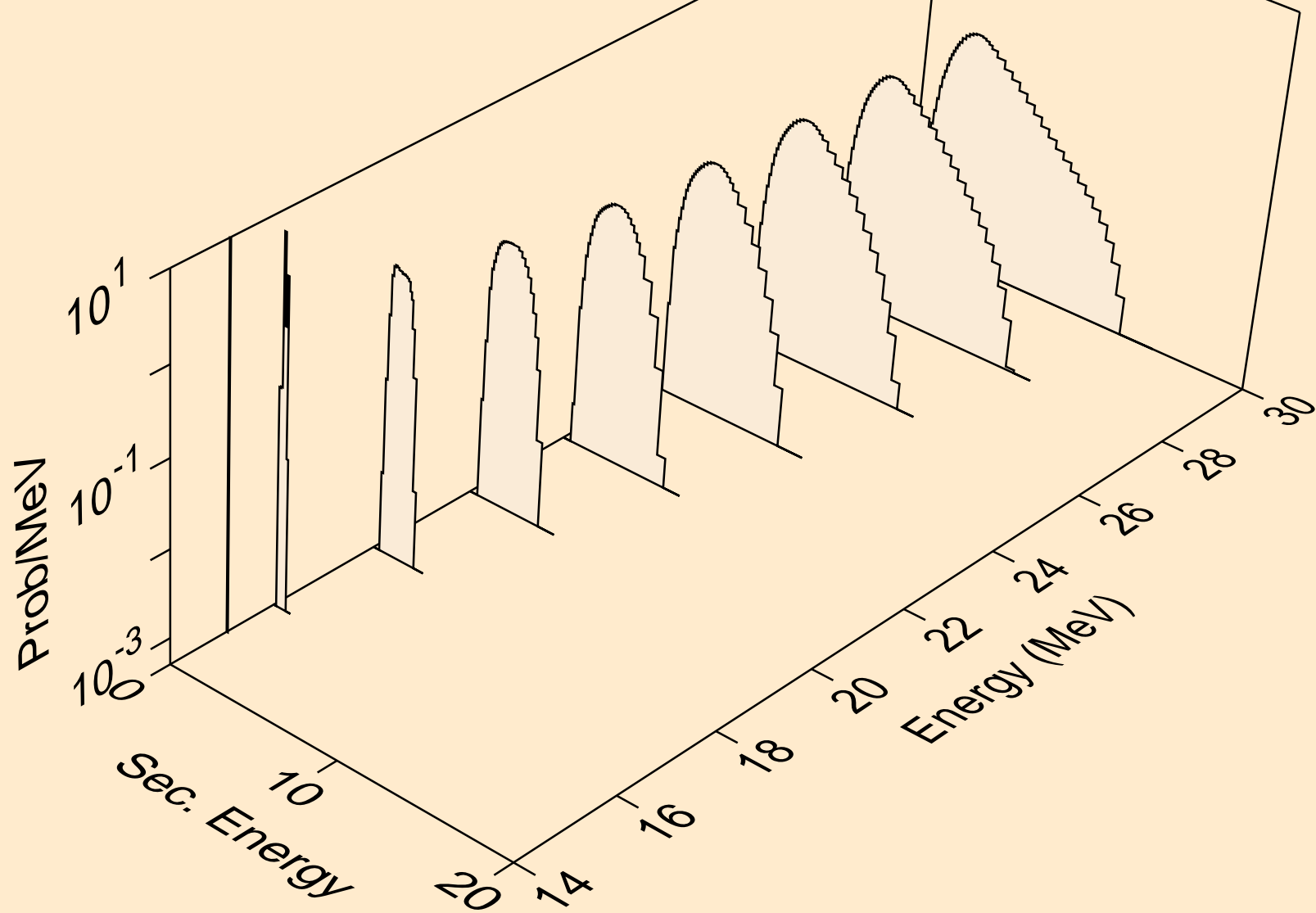

CA040 NEUTRON ACER TENDL-2021 LIBRARY; T=293.6K
protons from (n,npa)

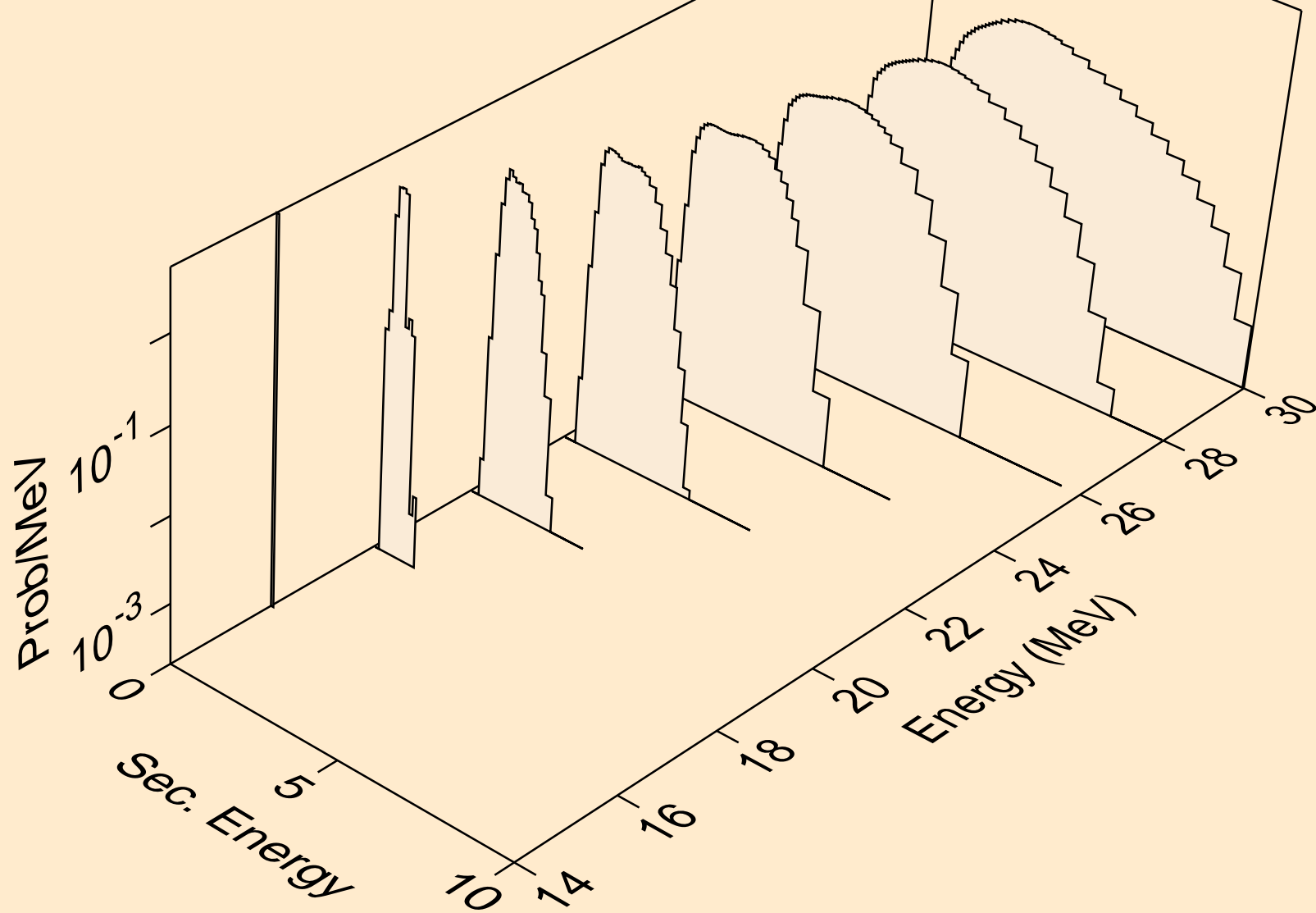

CA040 NEUTRON ACER TENDL-2021 LIBRARY; T=293.6K
protons from (n,p)

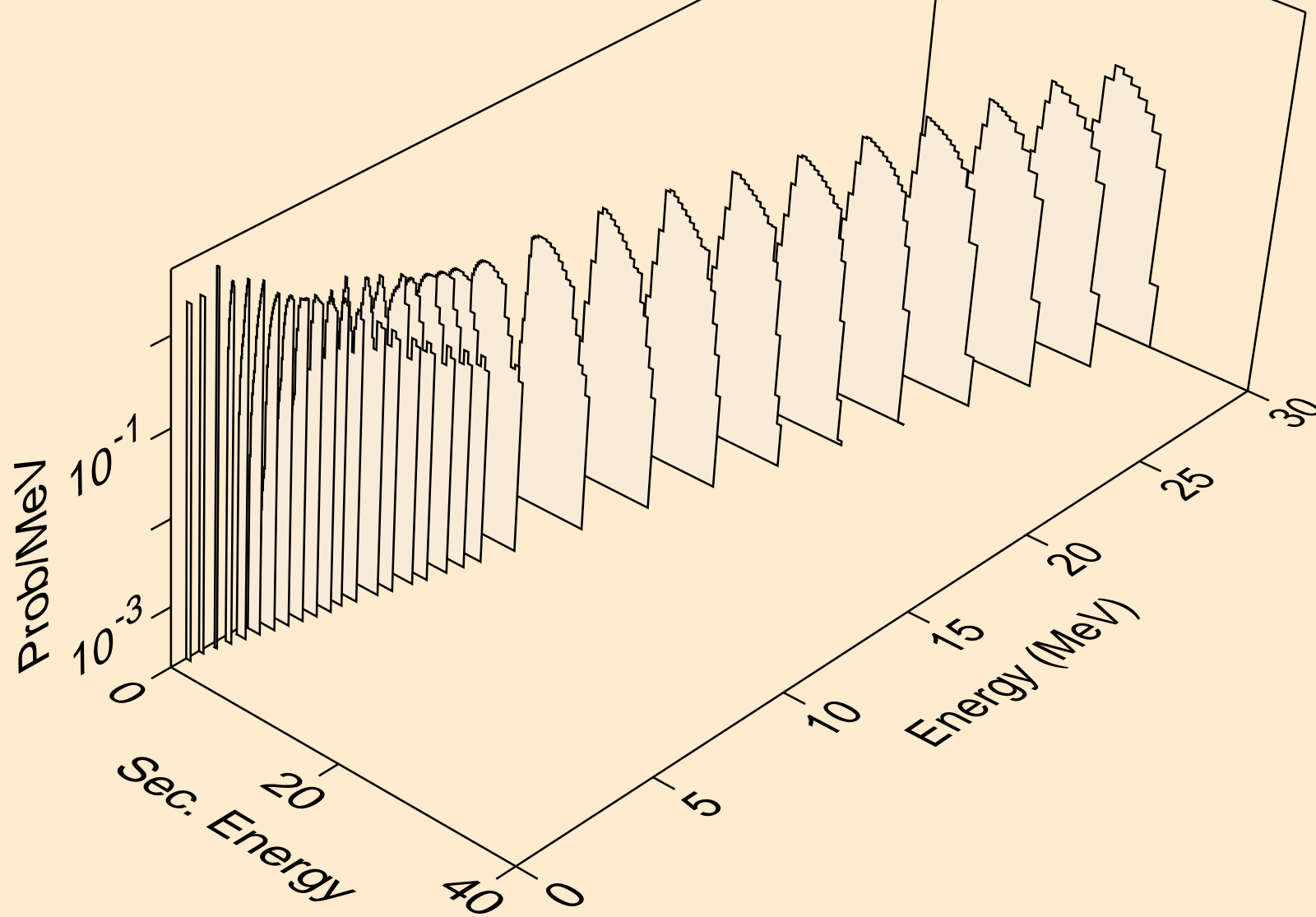

CA040 NEUTRON ACER TENDL-2021 LIBRARY; T=293.6K
protons from (n,2p)

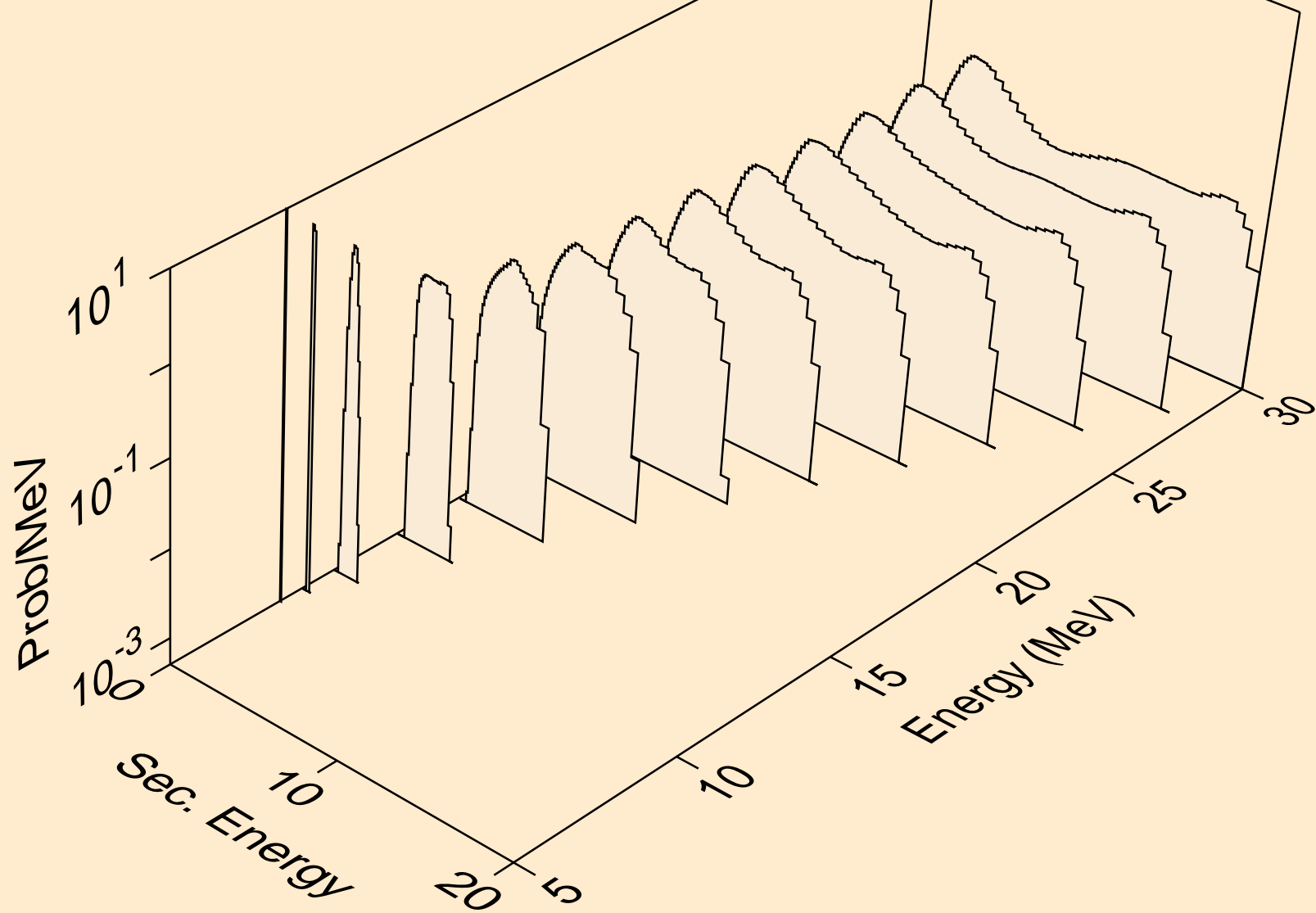

CA040 NEUTRON ACER TENDL-2021 LIBRARY; T=293.6K
protons from (n,p)

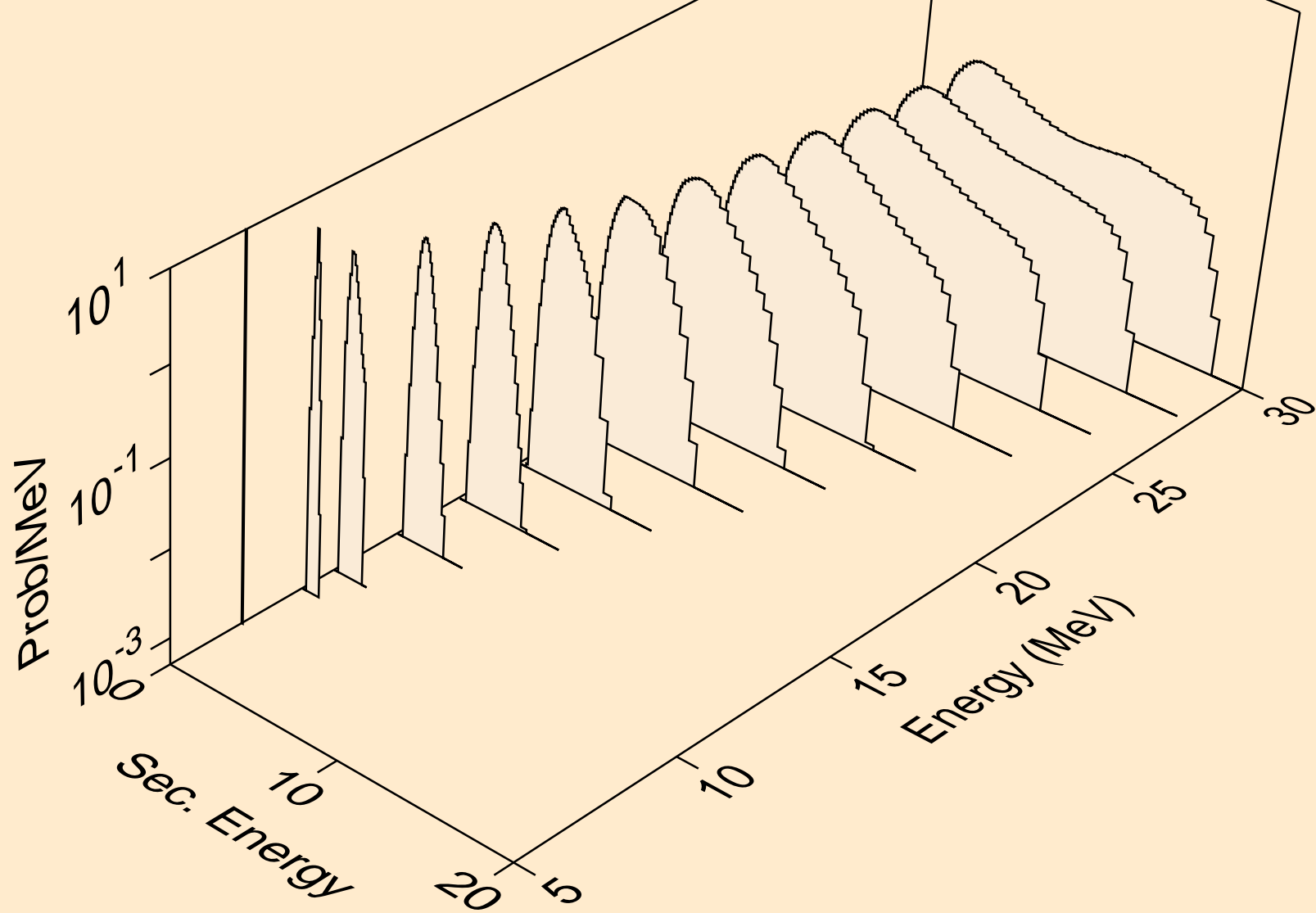

CA040 NEUTRON ACER TENDL-2021 LIBRARY; T=293.6K
protons from (n,pd)

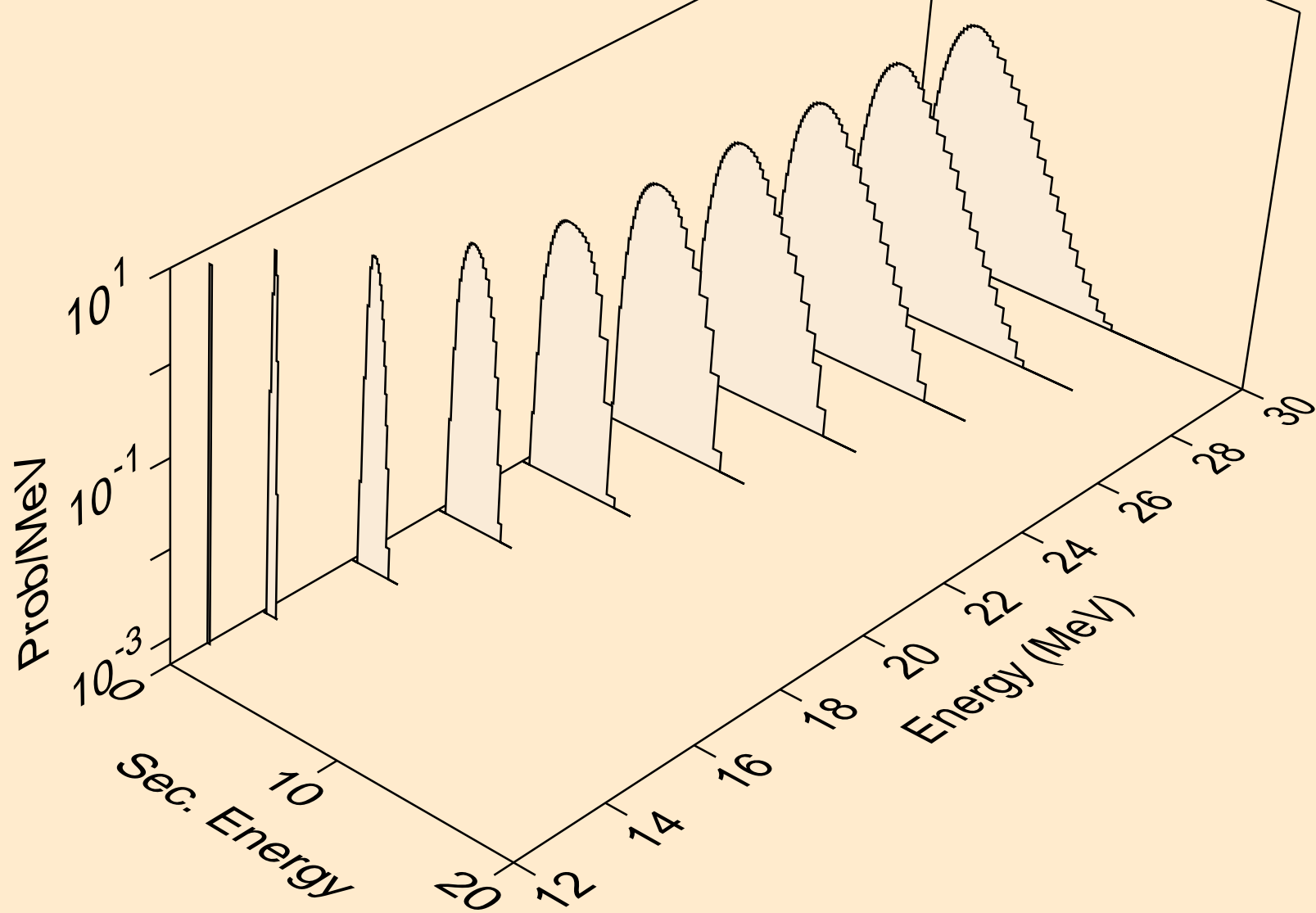

CA040 NEUTRON ACER TENDL-2021 LIBRARY; T=293.6K
protons from (n,pt)

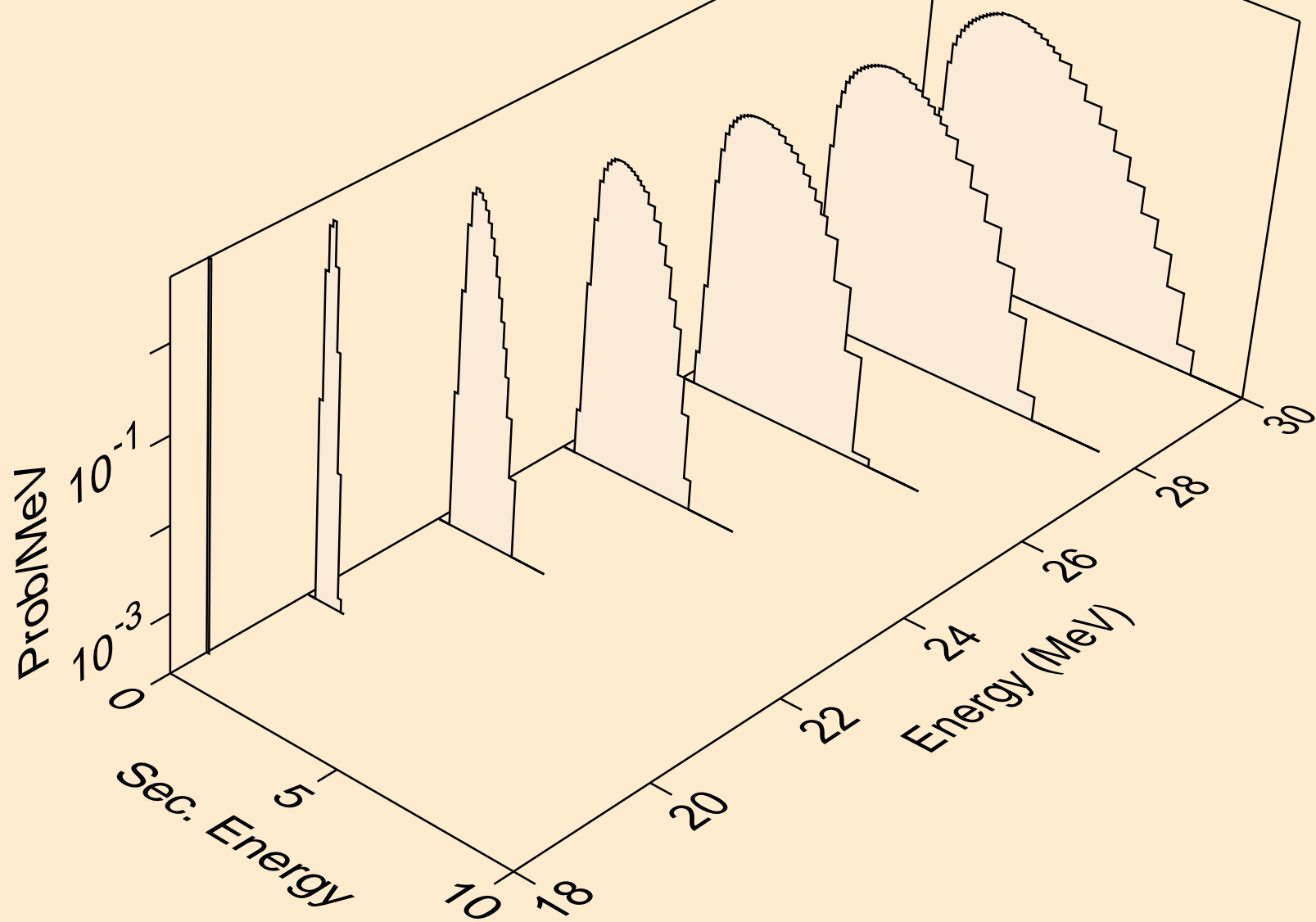

CA040 NEUTRON ACER TENDL-2021 LIBRARY; T=293.6K
deuterons from (n,x)

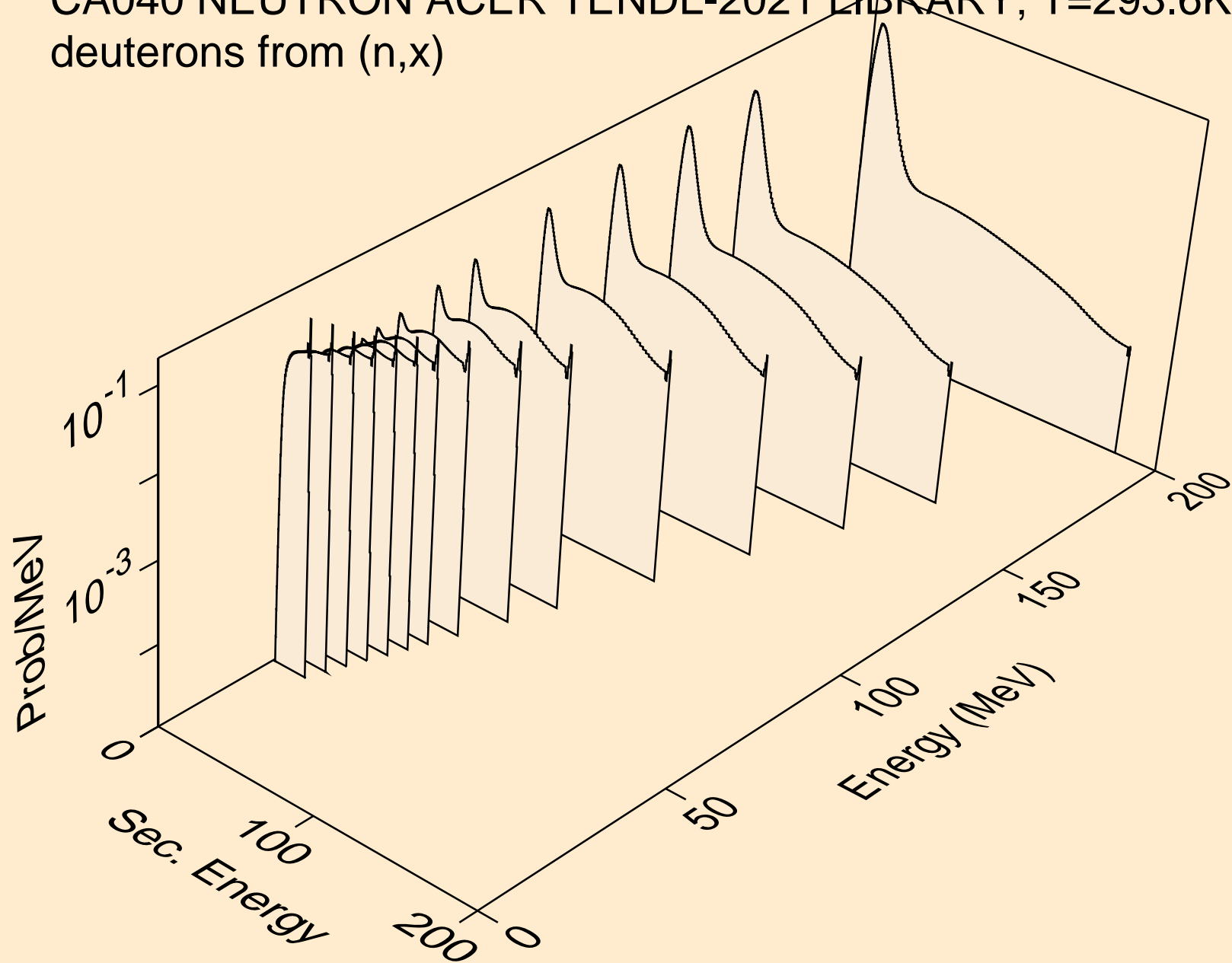

CA040 NEUTRON ACER TENDL-2021 LIBRARY; T=293.6K
deuterons from (n,n*)d

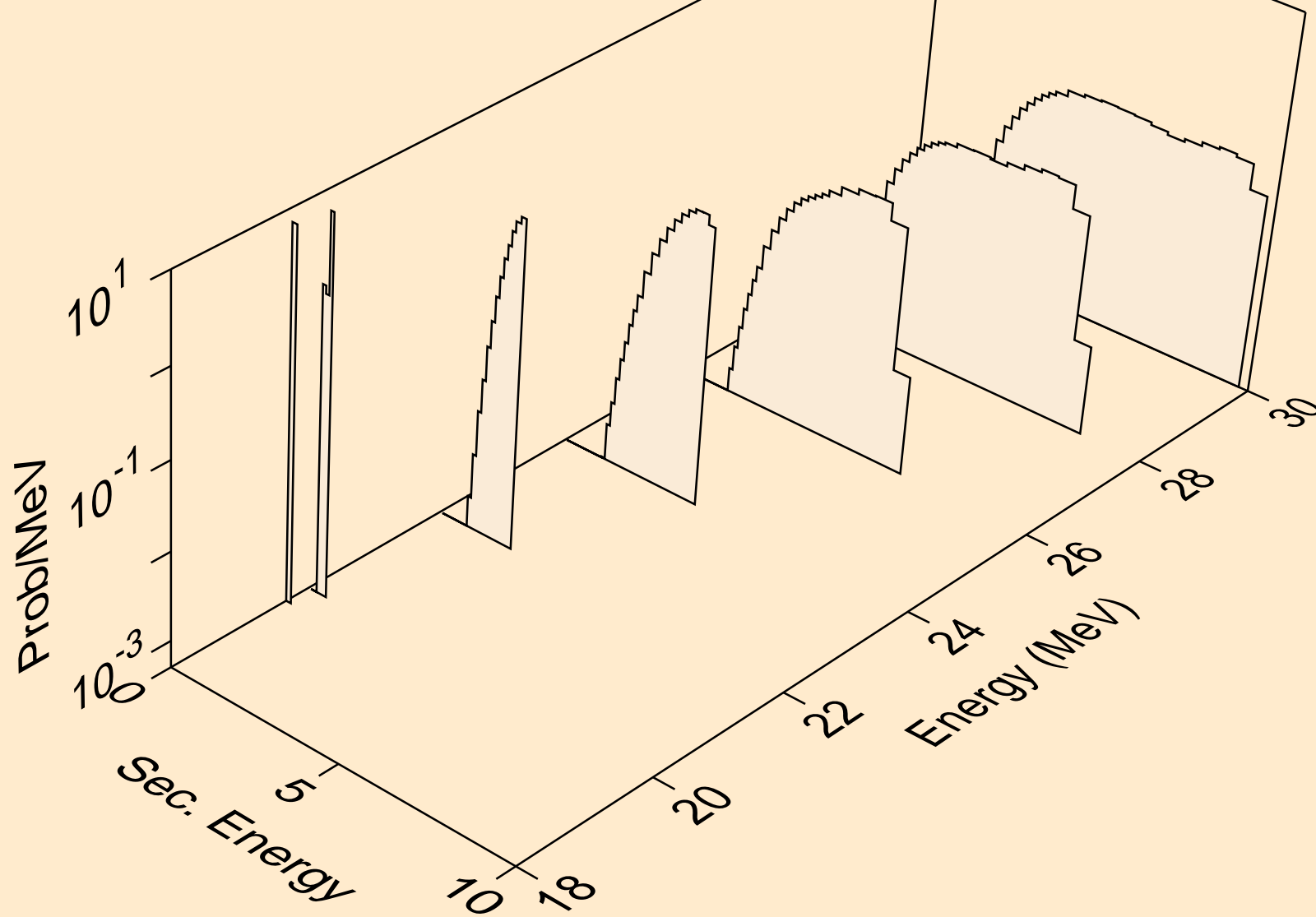

CA040 NEUTRON ACER TENDL-2021 LIBRARY; T=293.6K
deuterons from (n,d)

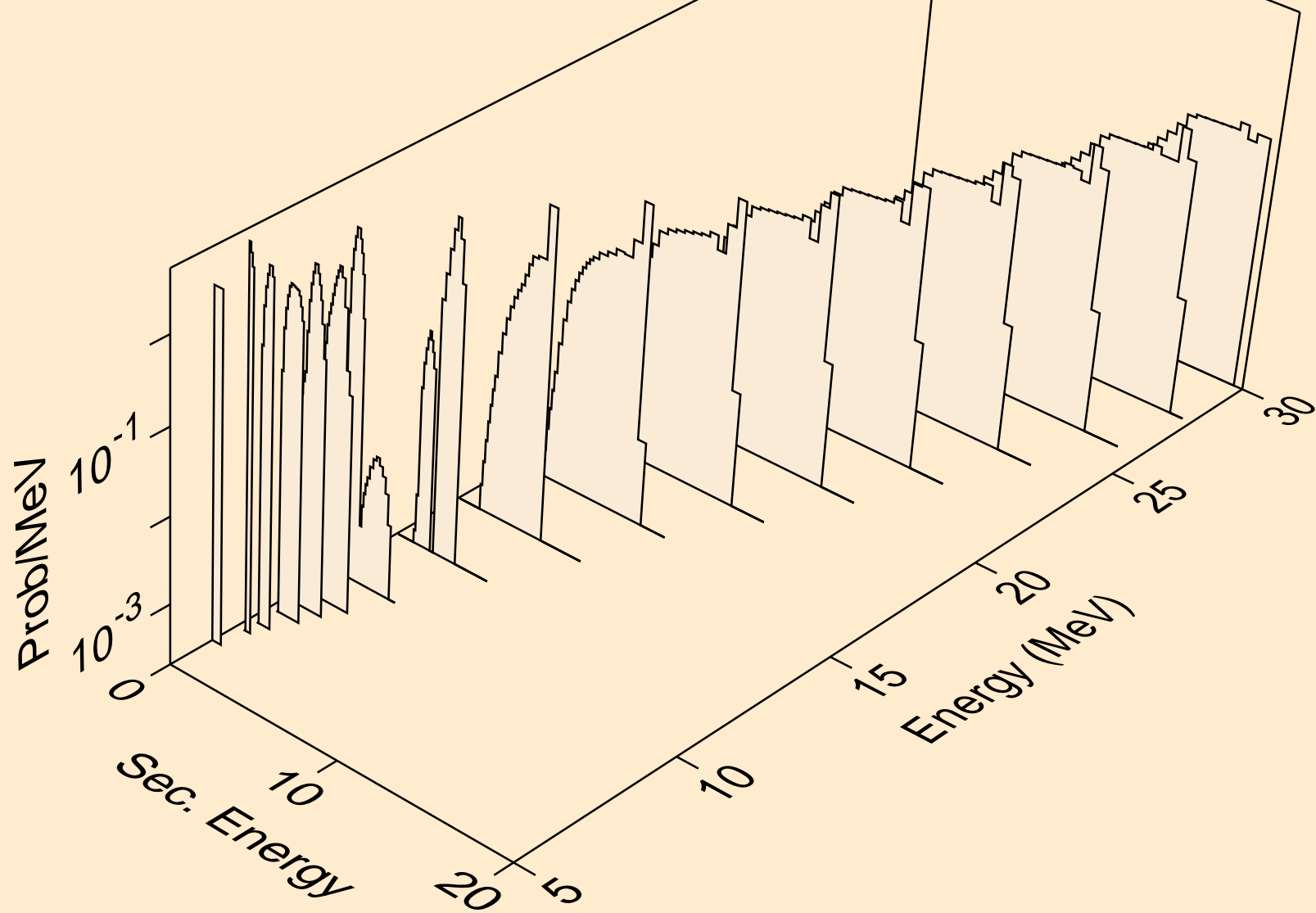

CA040 NEUTRON ACER TENDL-2021 LIBRARY; T=293.6K
deuterons from (n,pd)

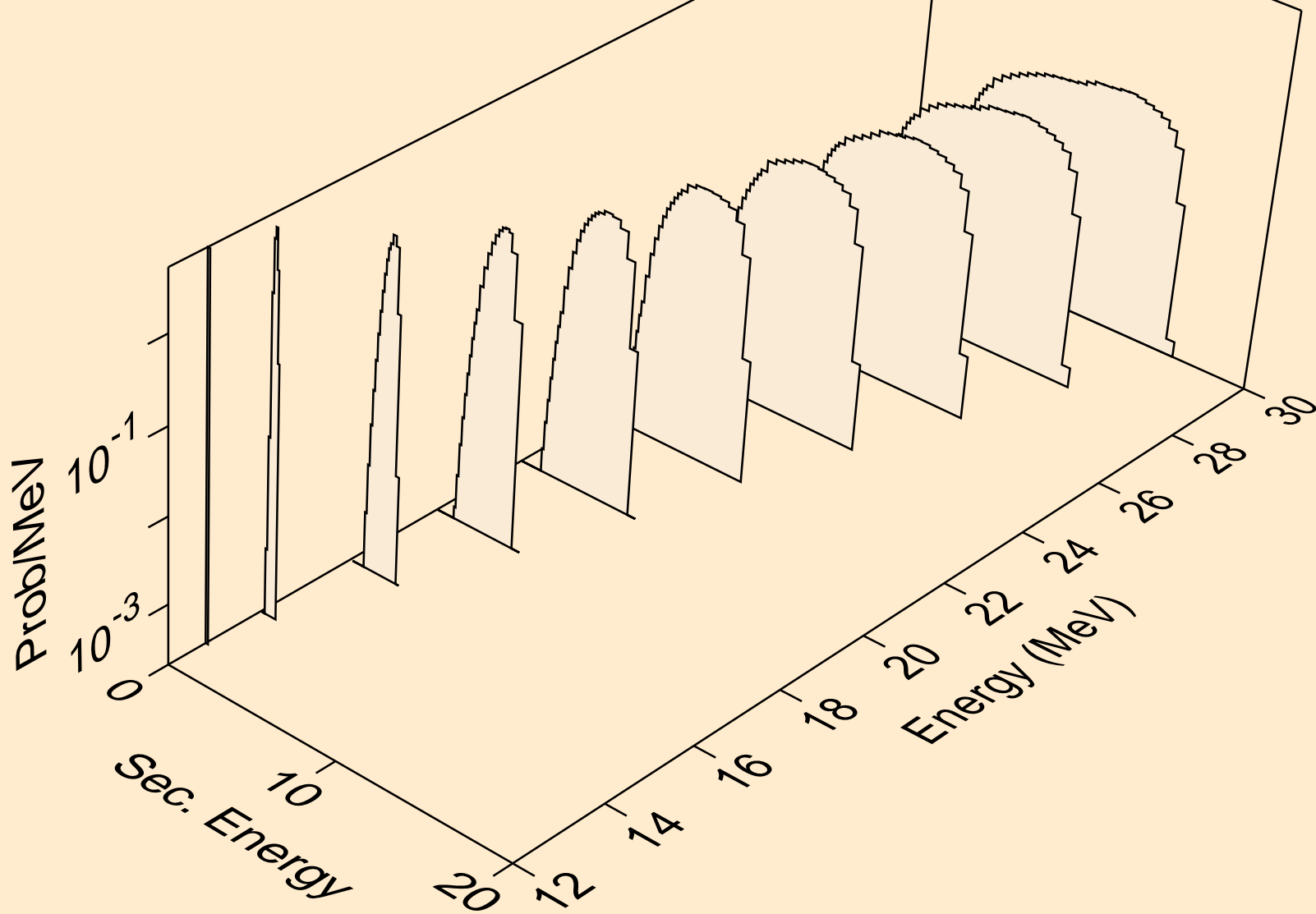

CA040 NEUTRON ACER TENDL-2021 LIBRARY; T=293.6K
deuterons from (n,da)

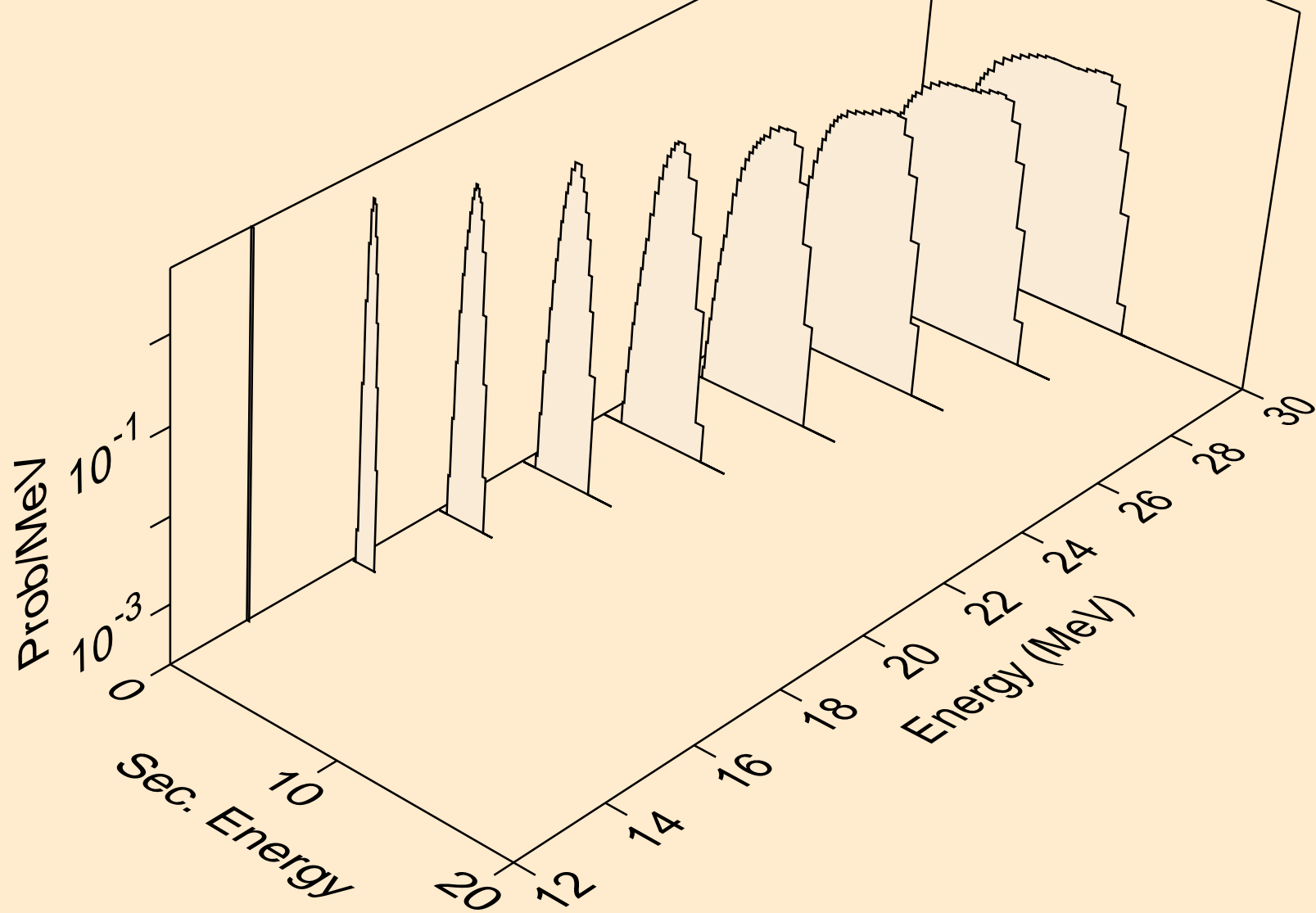

CA040 NEUTRON ACER TENDL-2021 LIBRARY; T=293.6K
tritons from (n,x)

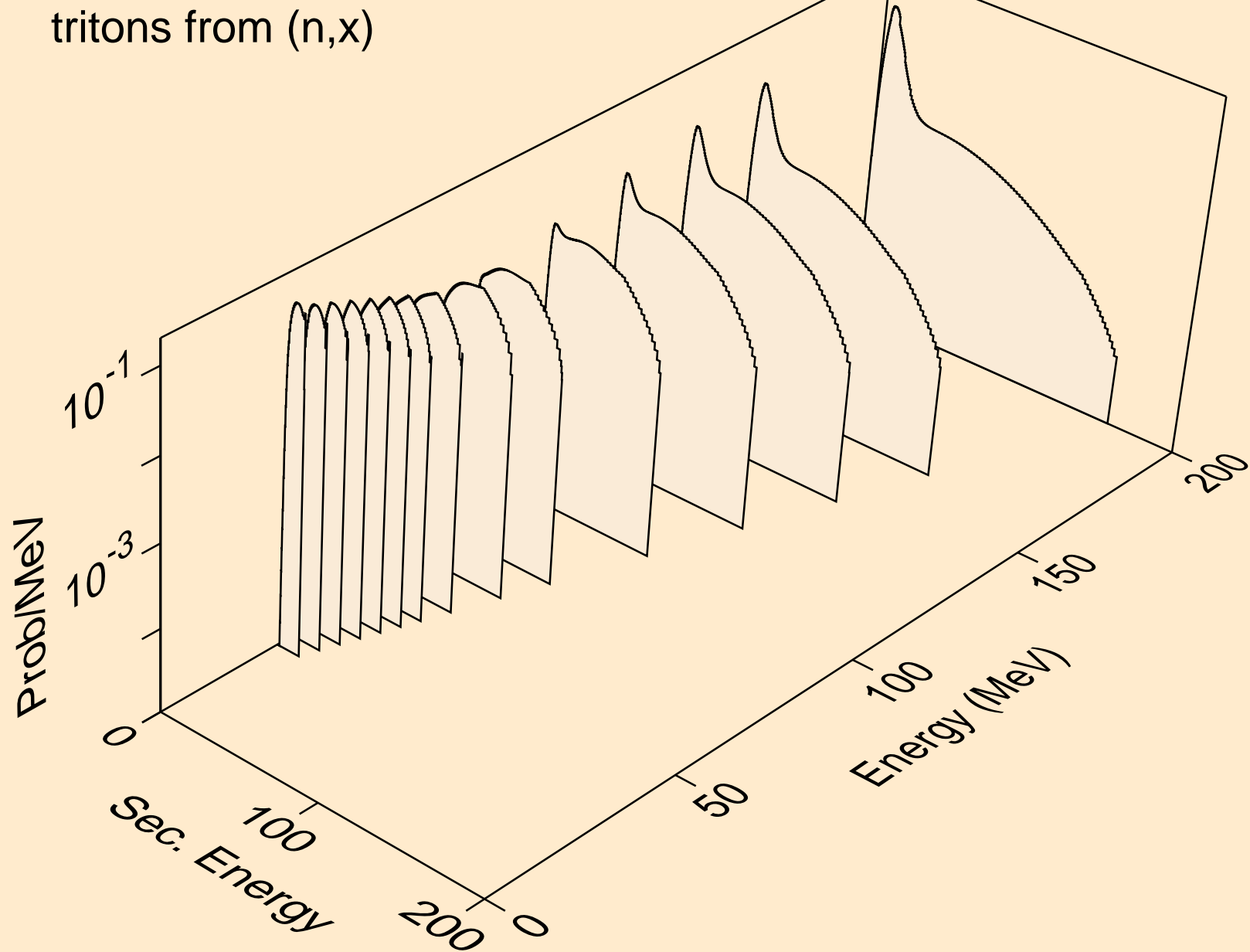

CA040 NEUTRON ACER TENDL-2021 LIBRARY; T=293.6K
tritons from (n,n*)t

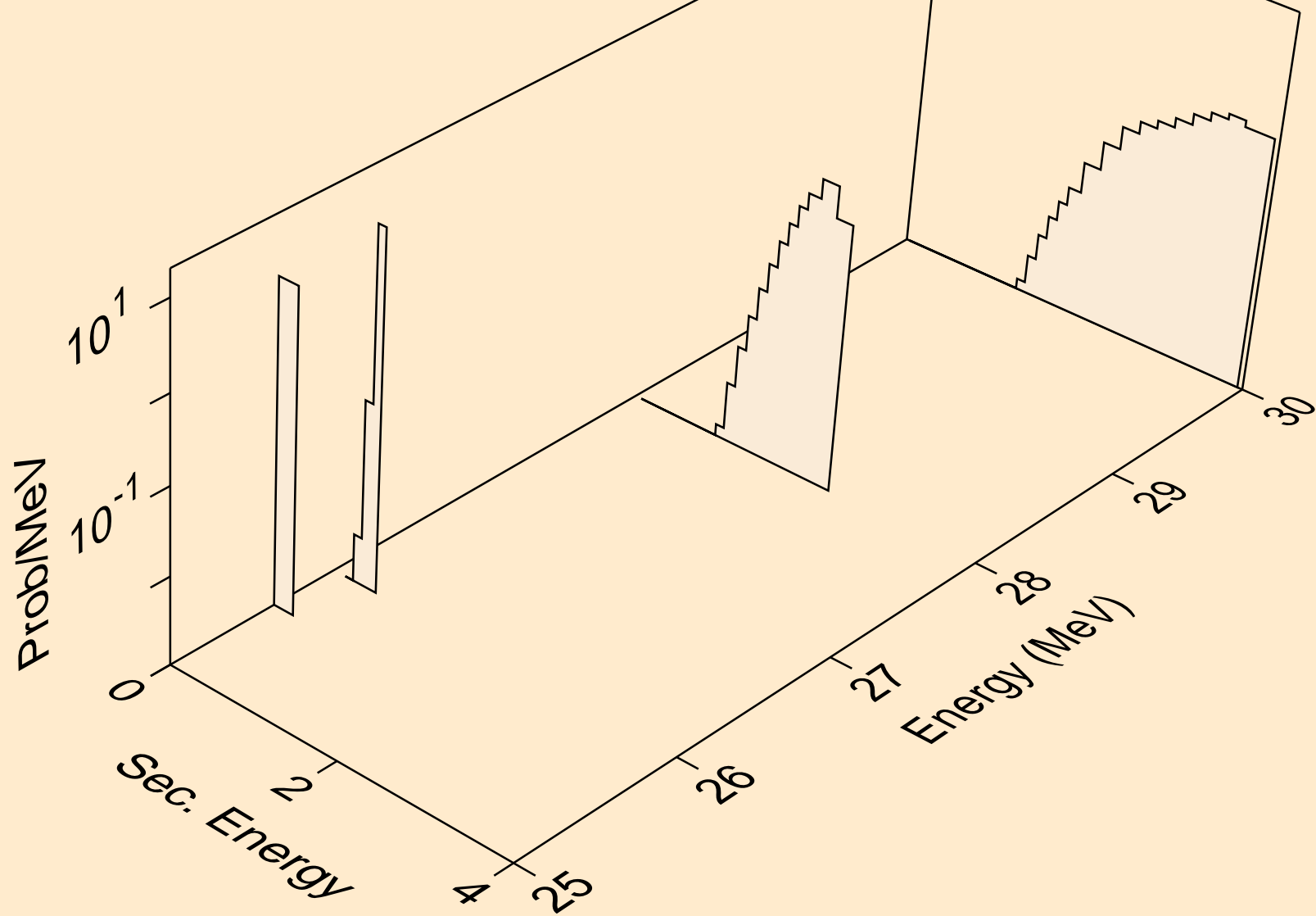

CA040 NEUTRON ACER TENDL-2021 LIBRARY; T=293.6K
tritons from (n,t)

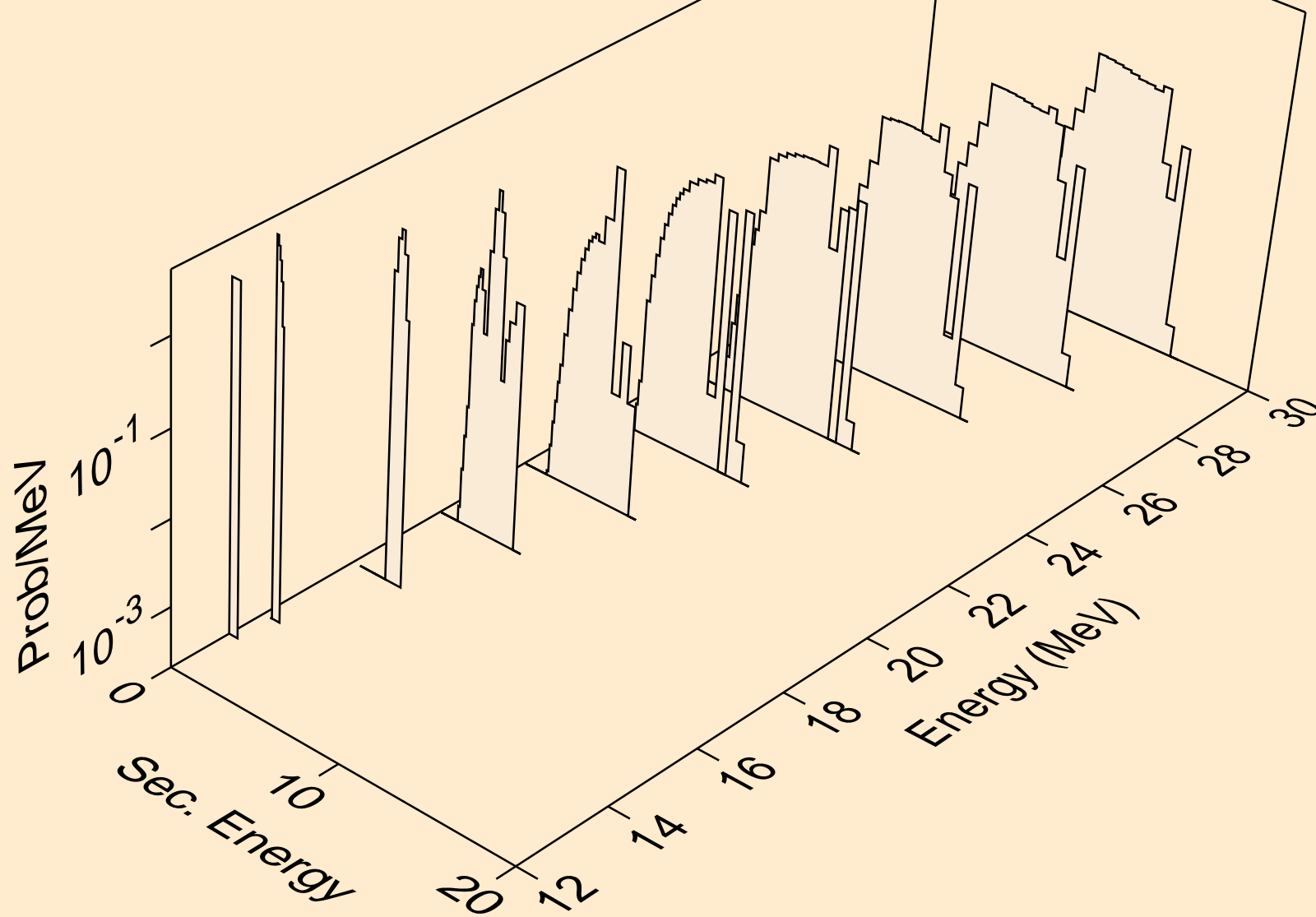

CA040 NEUTRON ACER TENDL-2021 LIBRARY; T=293.6K
tritons from (n,pt)

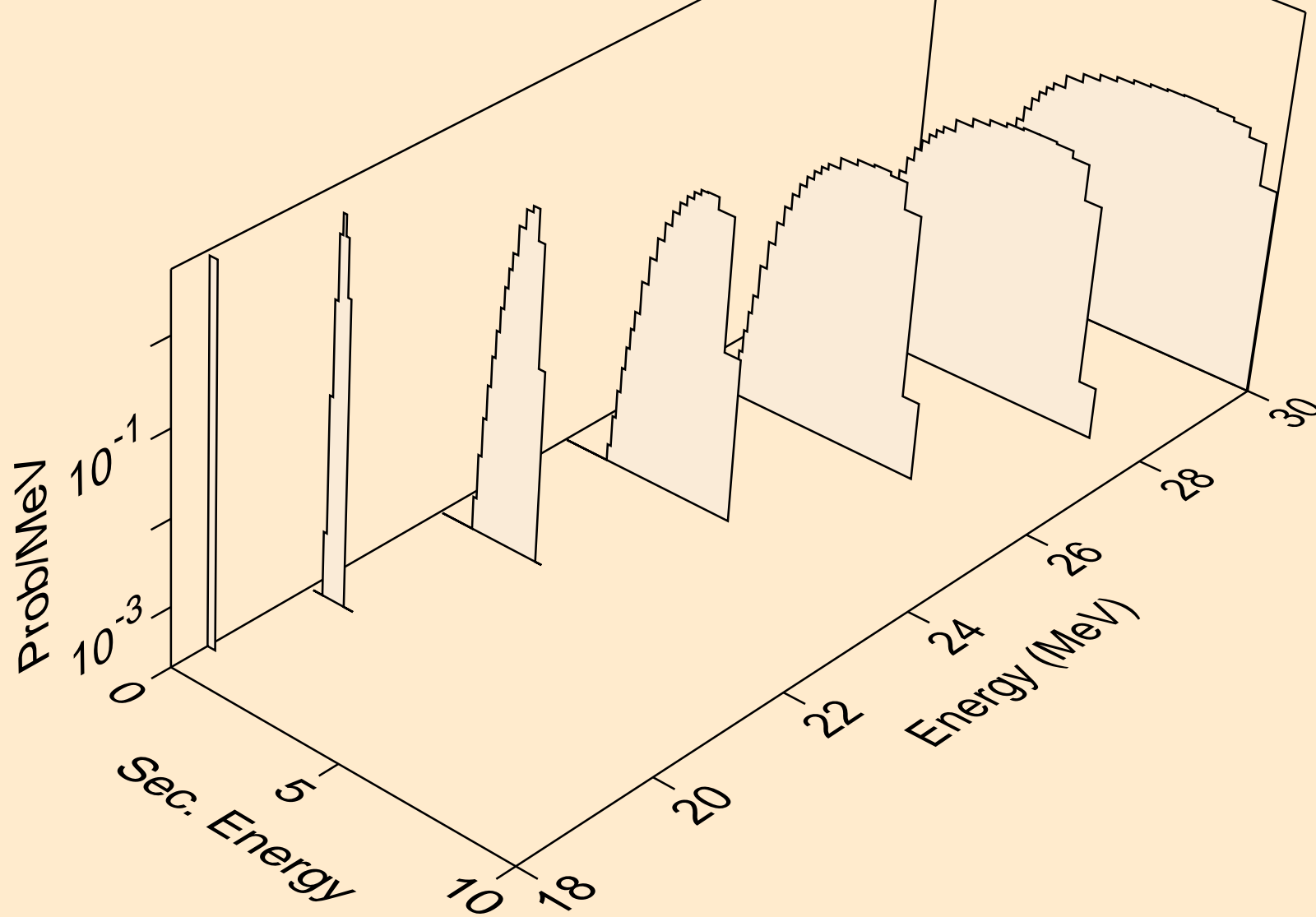

CA040 NEUTRON ACER TENDL-2021 LIBRARY; T=293.6K
he3s from (n,x)

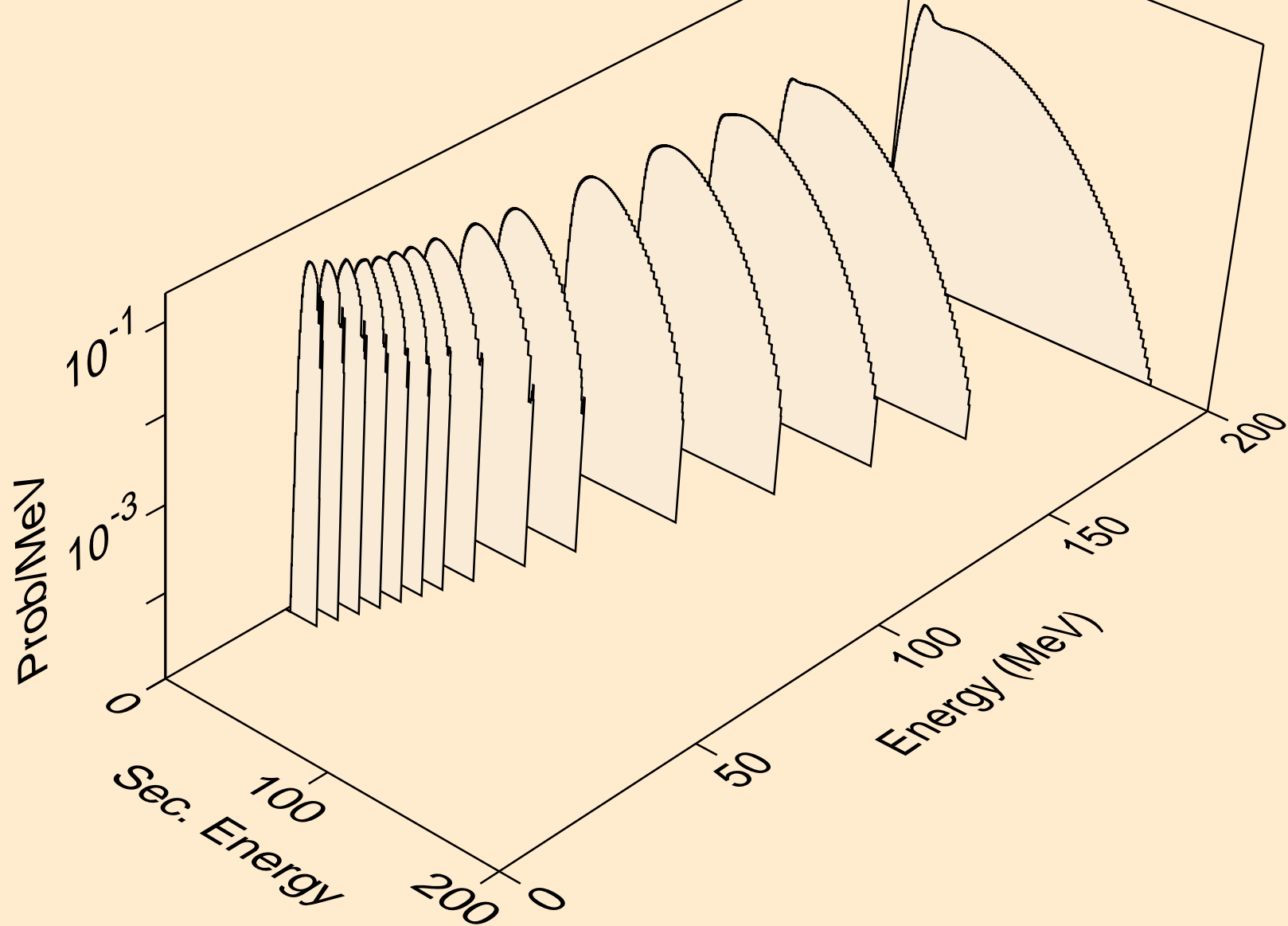

CA040 NEUTRON ACER TENDL-2021 LIBRARY; T=293.6K
he3s from (n,n*)he3

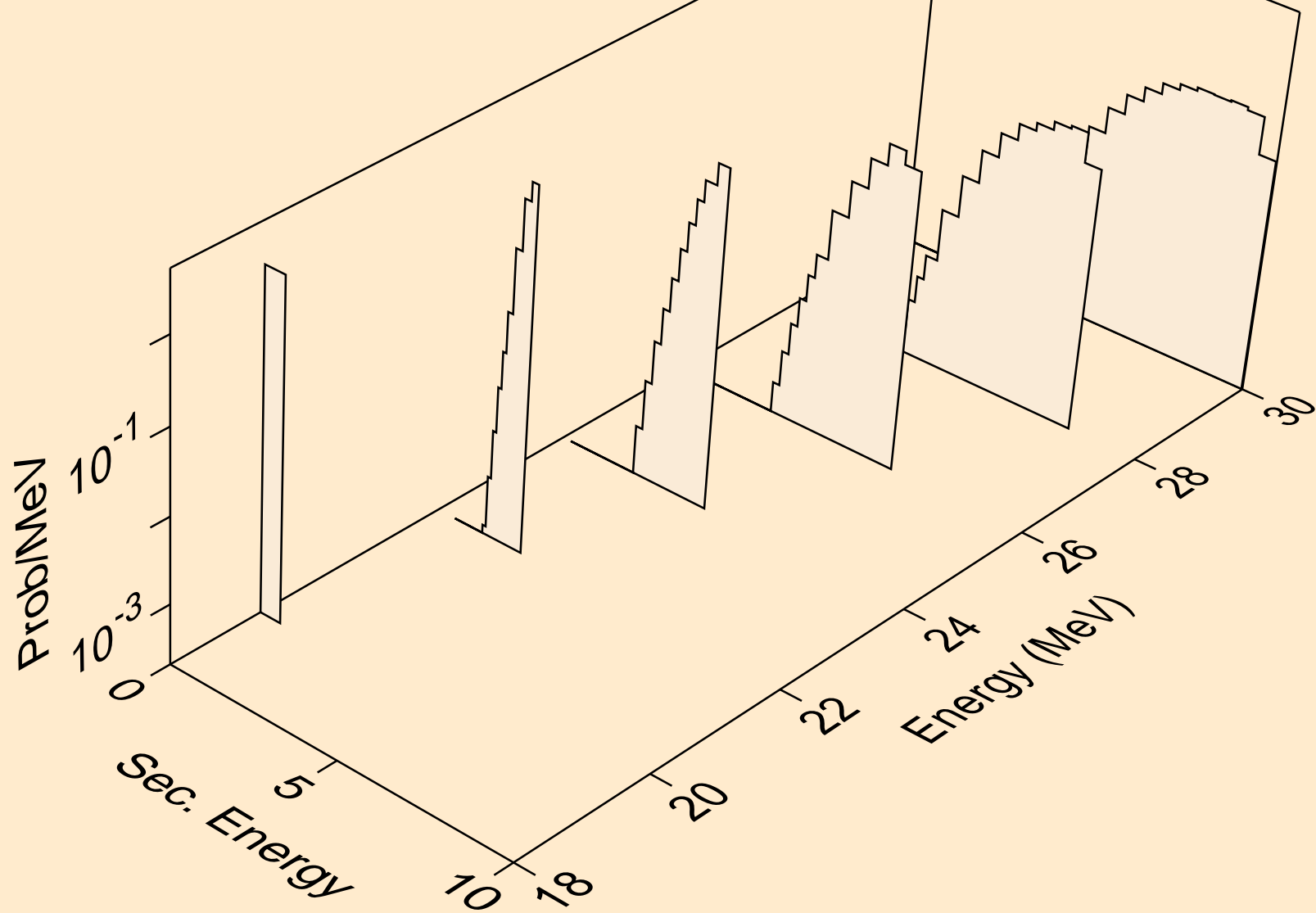

CA040 NEUTRON ACER TENDL-2021 LIBRARY; T=293.6K
he3s from (n,he3)

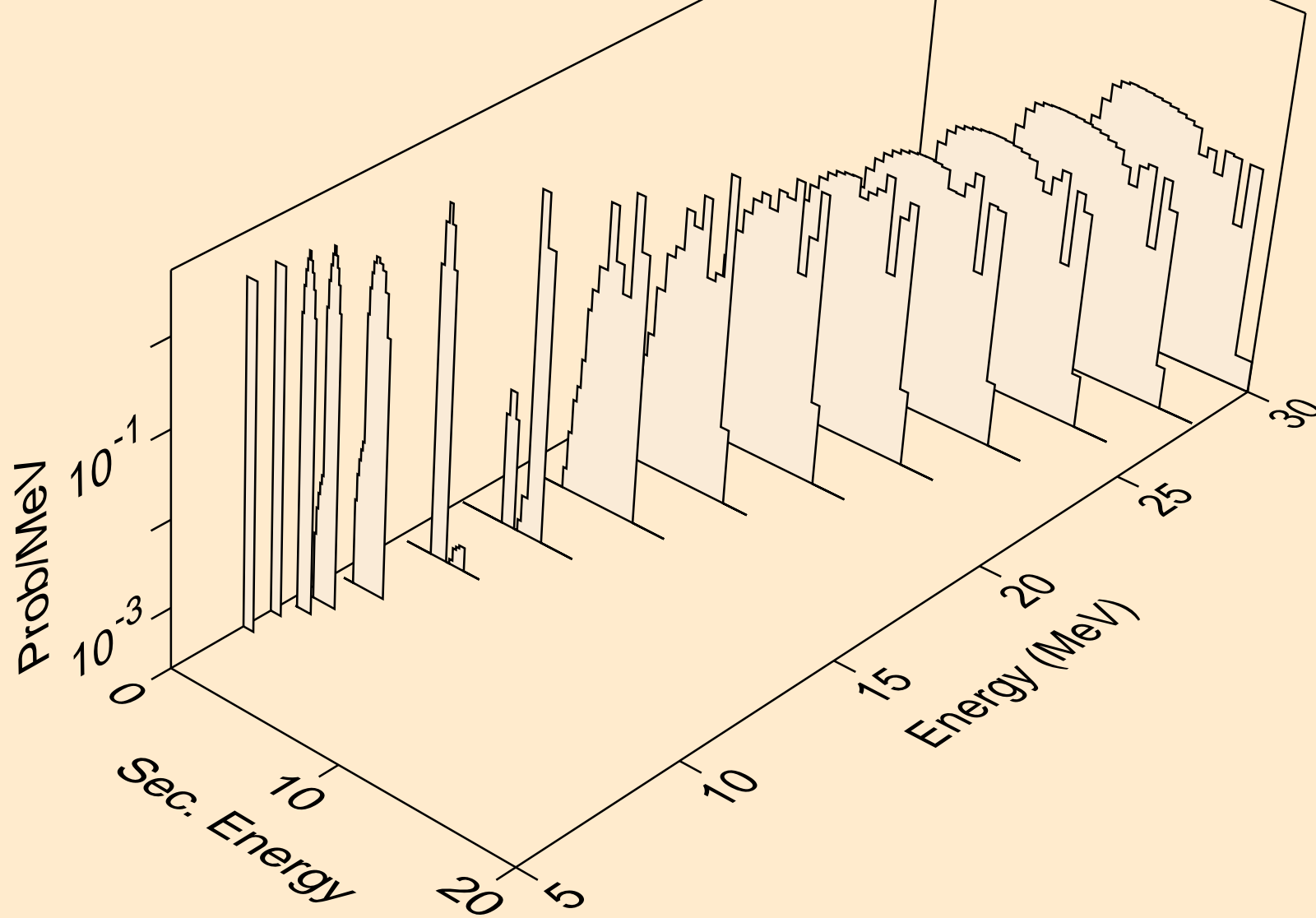

CA040 NEUTRON ACER TENDL-2021 LIBRARY; T=293.6K
alphas from (n,x)

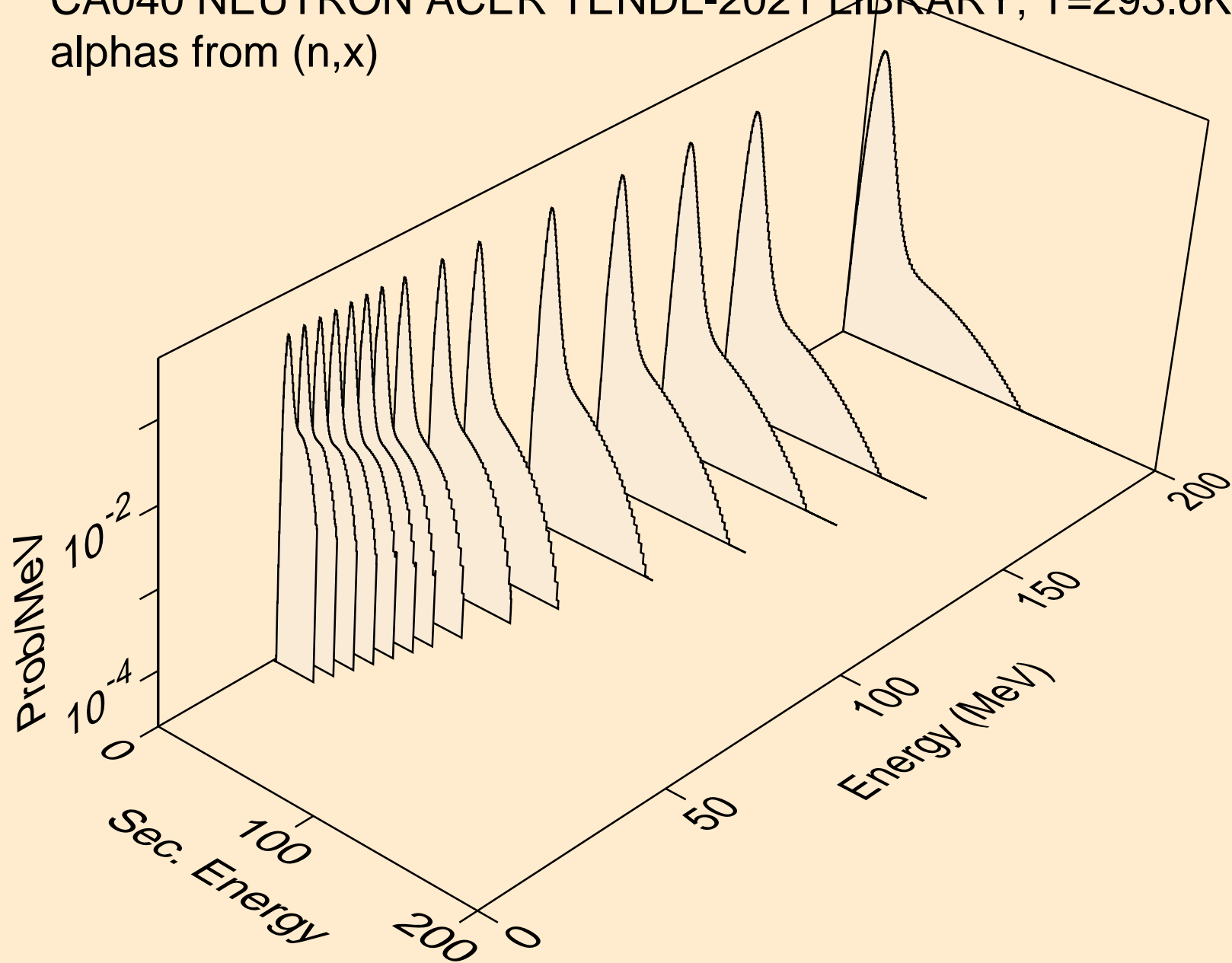

CA040 NEUTRON ACER TENDL-2021 LIBRARY; T=293.6K
alphas from (n,n*)a

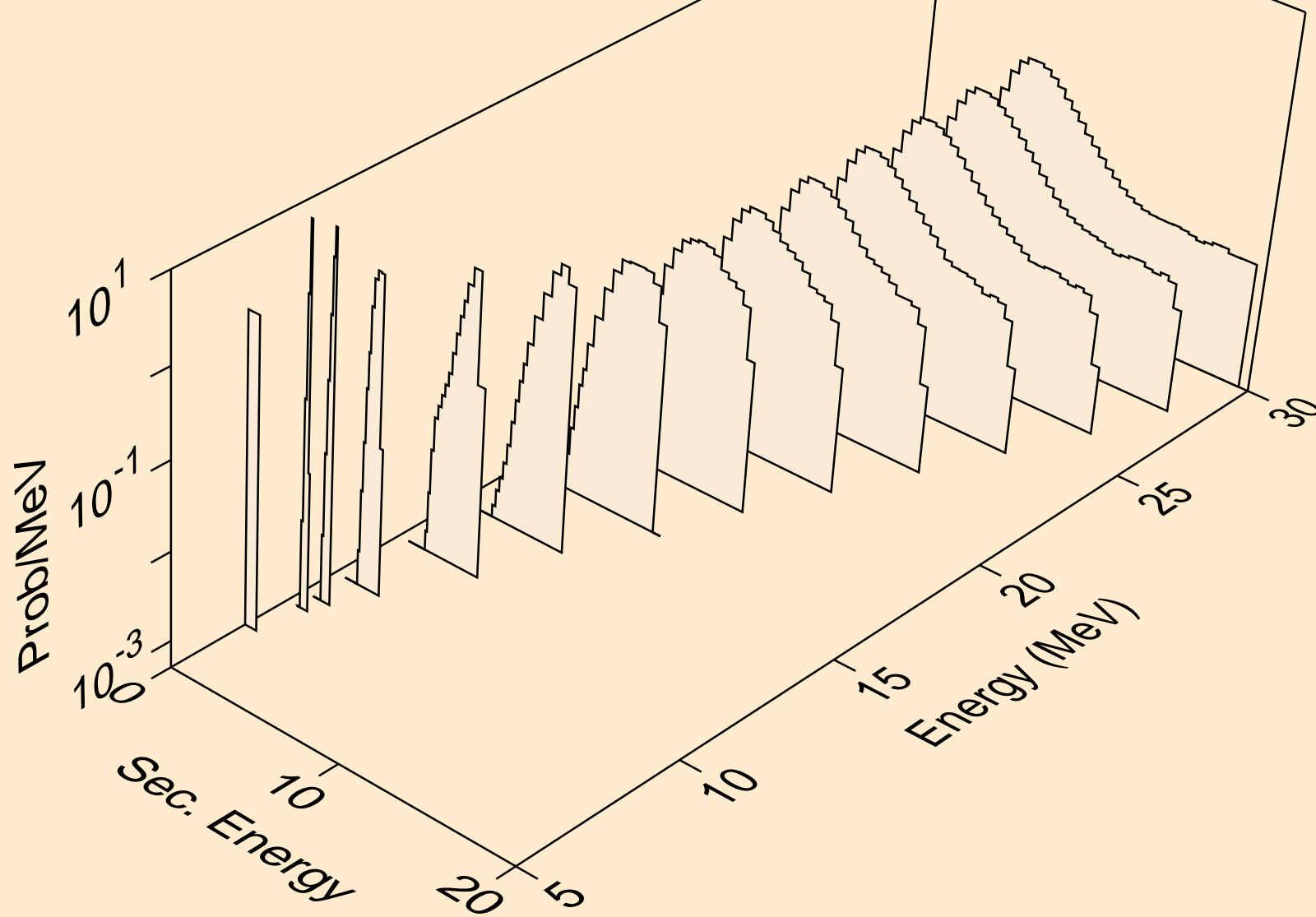

CA040 NEUTRON ACER TENDL-2021 LIBRARY; T=293.6K
alphas from (n,2n)a

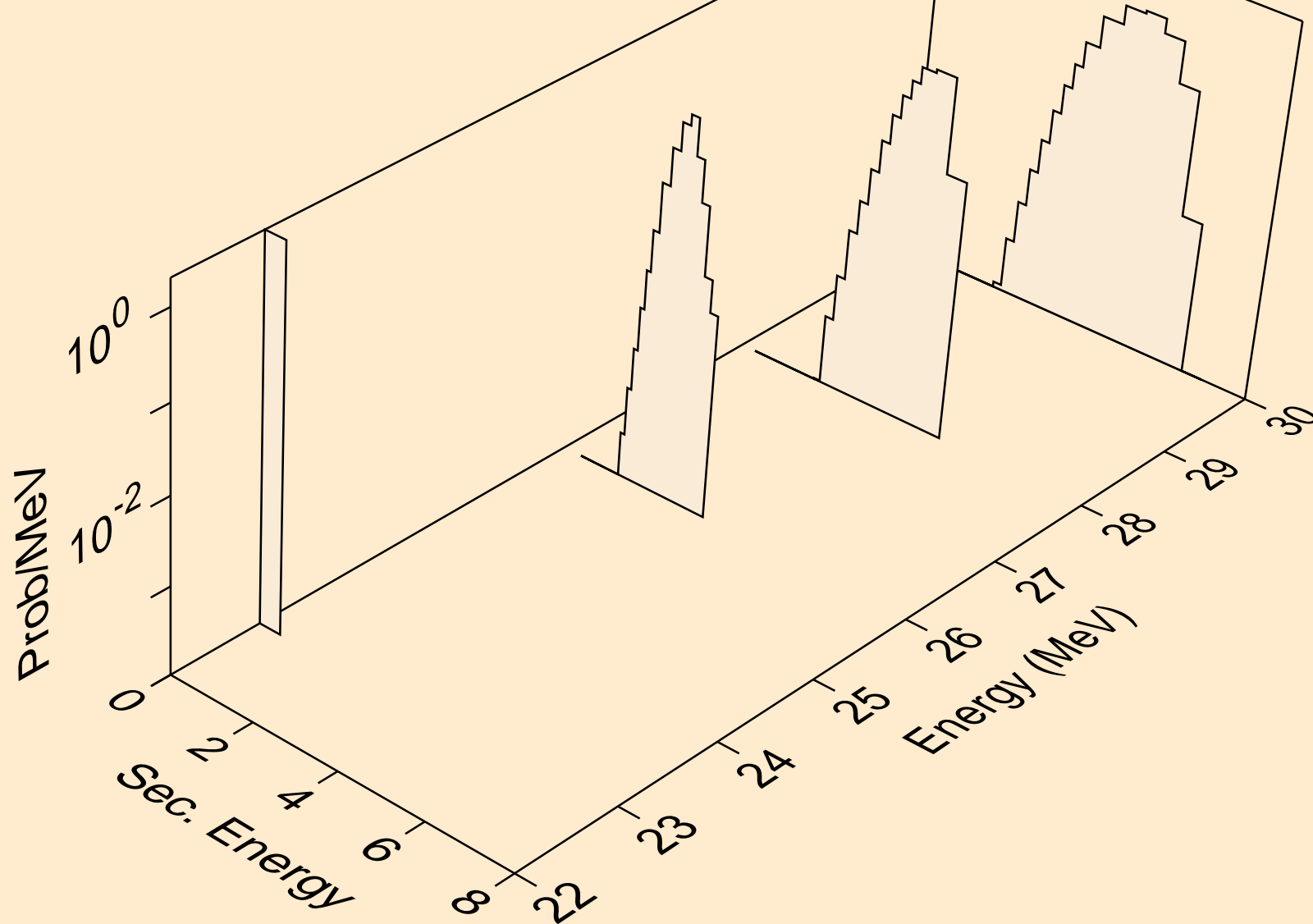

CA040 NEUTRON ACER TENDL-2021 LIBRARY; T=293.6K
alphas from (n,n*)2a

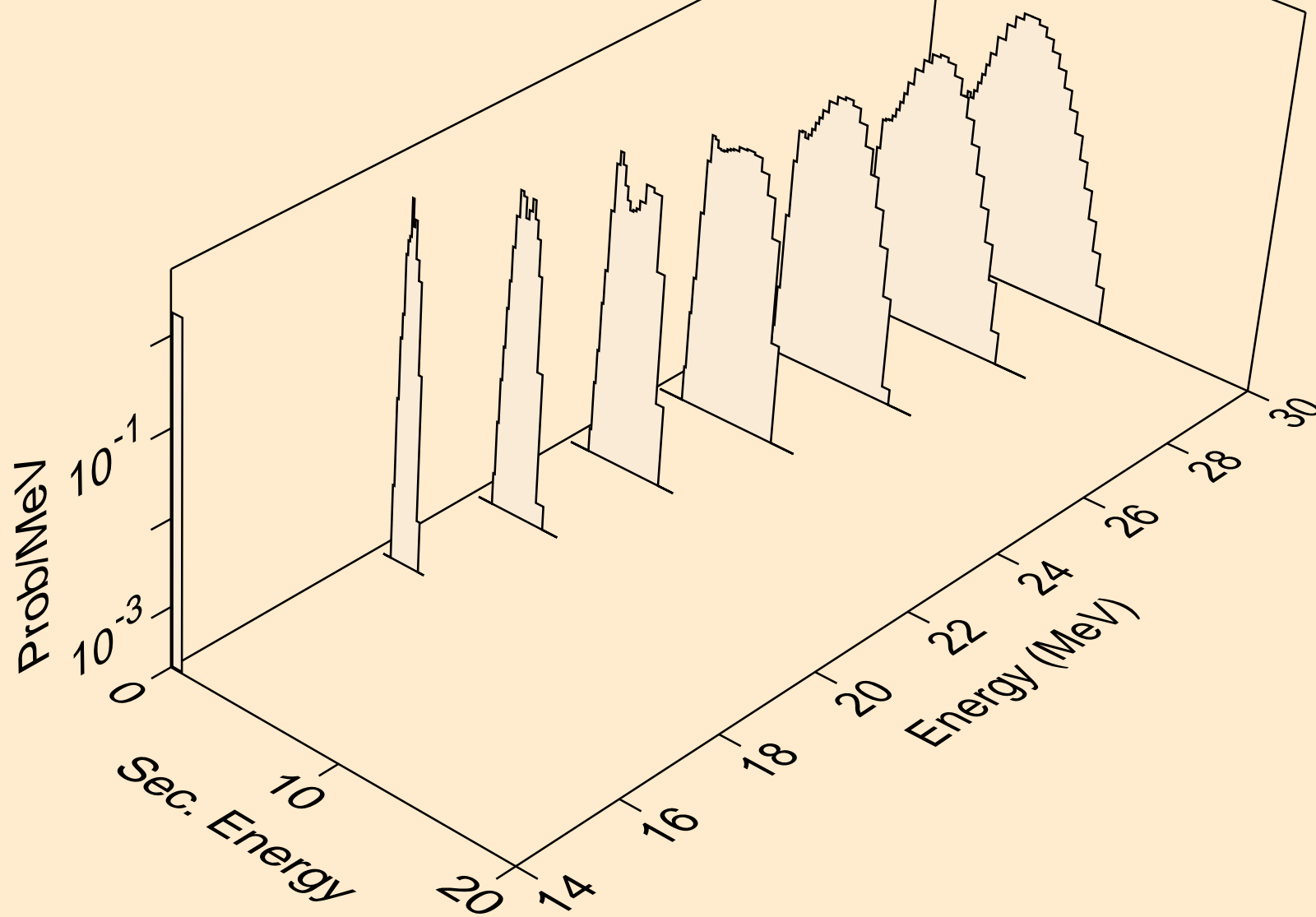

CA040 NEUTRON ACER TENDL-2021 LIBRARY; T=293.6K
alphas from (n,npa)

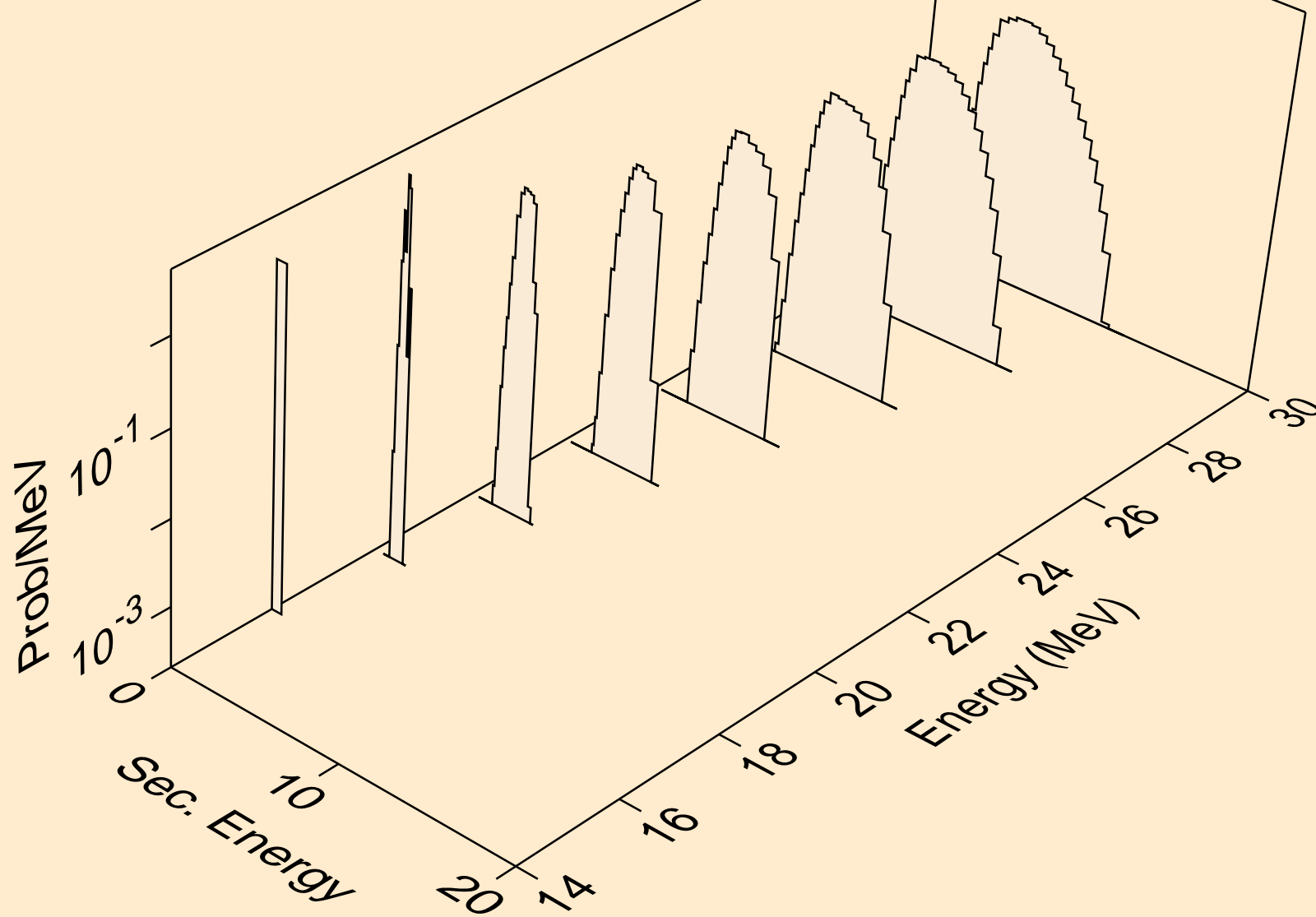

CA040 NEUTRON ACER TENDL-2021 LIBRARY; T=293.6K
alphas from (n,a)

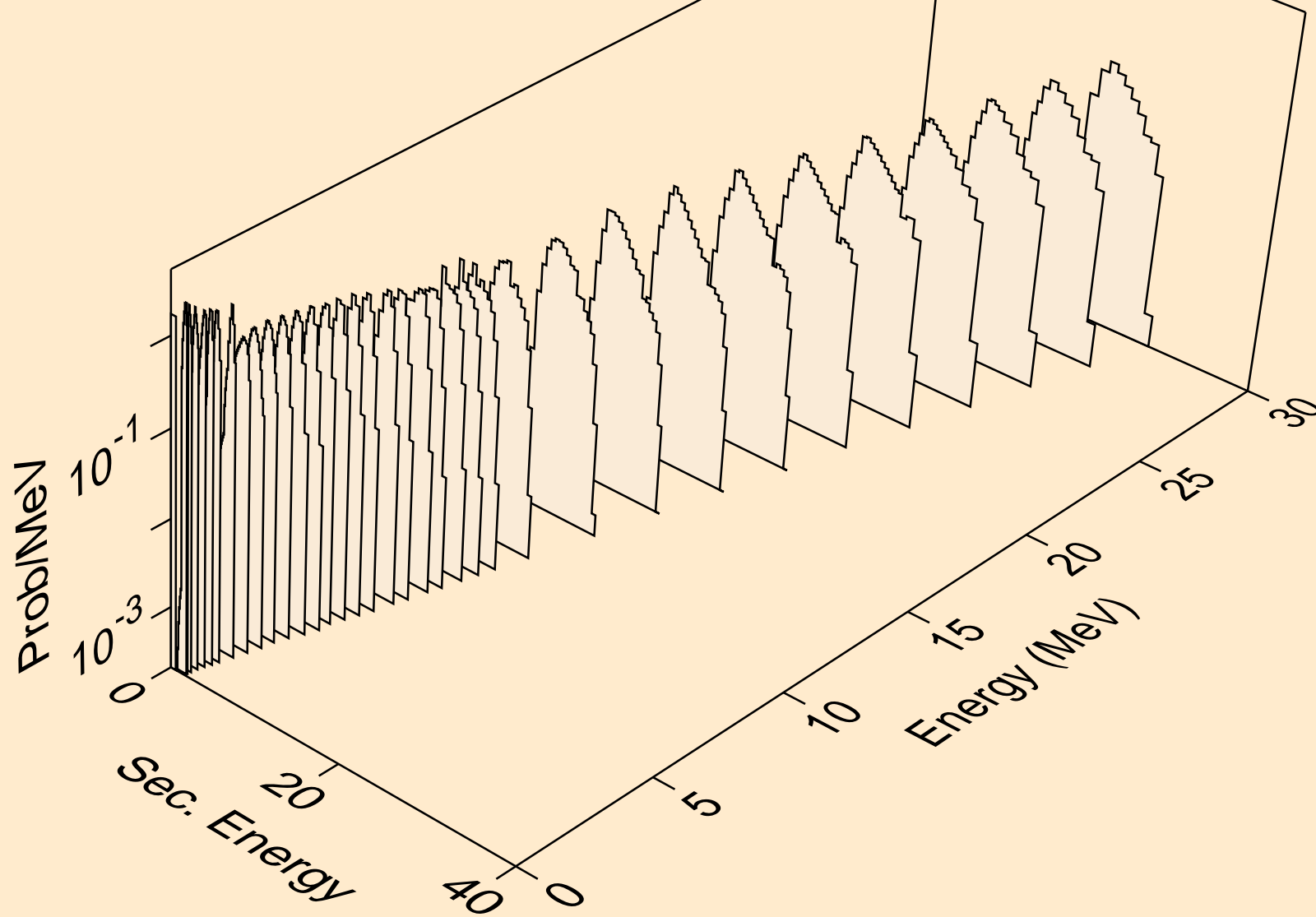

CA040 NEUTRON ACER TENDL-2021 LIBRARY; T=293.6K
alphas from (n,2a)

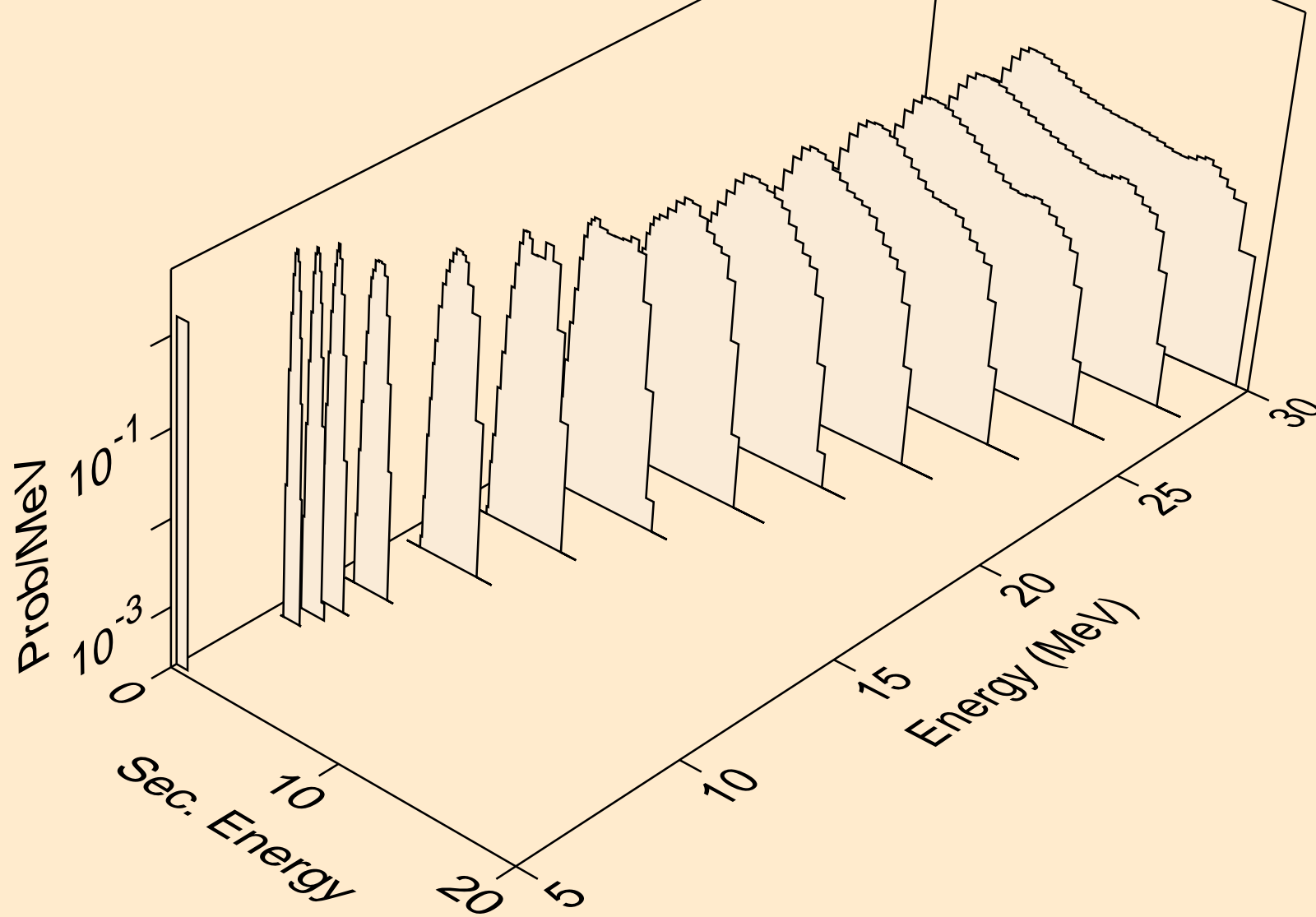

CA040 NEUTRON ACER TENDL-2021 LIBRARY; T=293.6K
alphas from (n,3a)

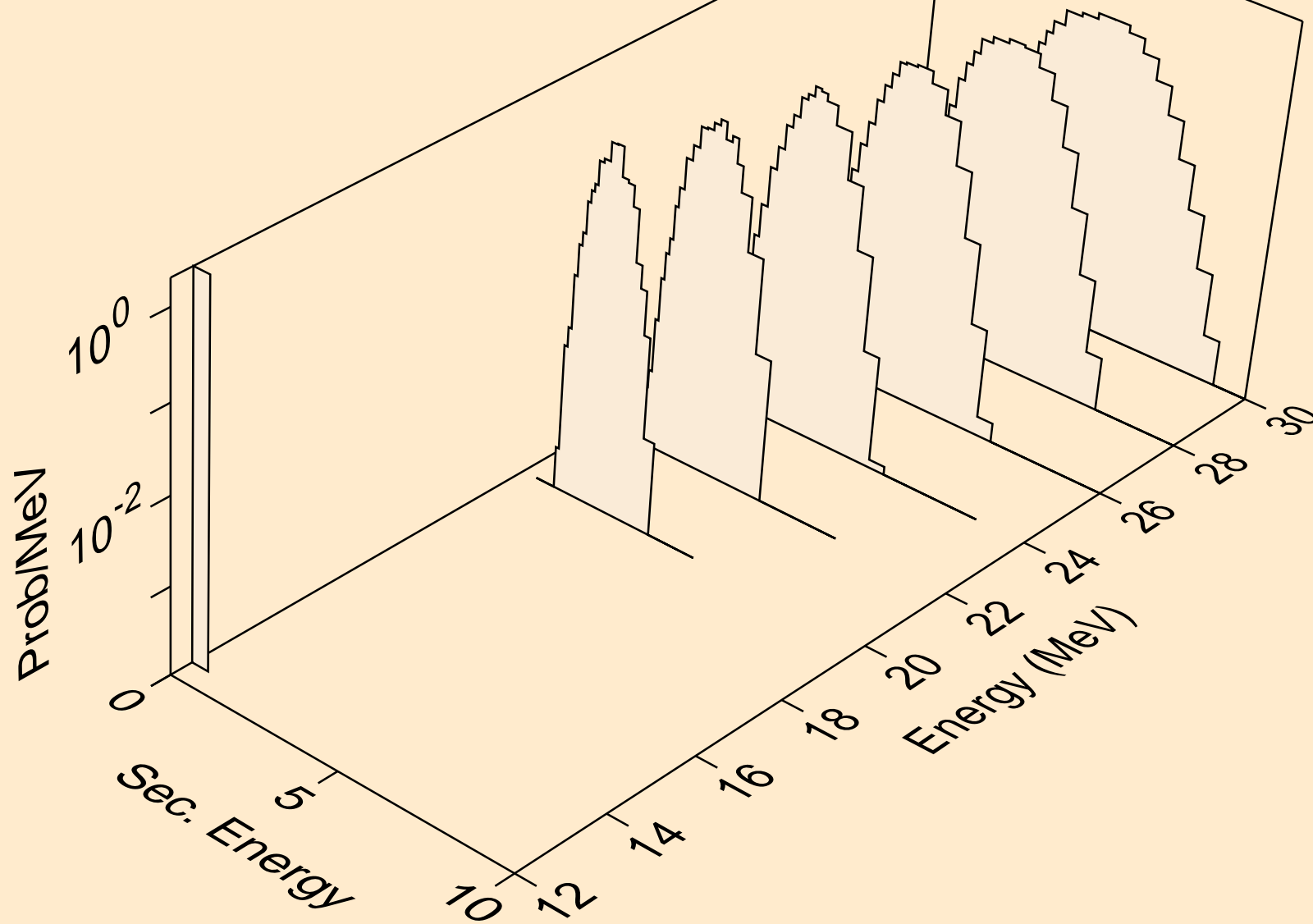

CA040 NEUTRON ACER TENDL-2021 LIBRARY; T=293.6K
alphas from (n,pa)

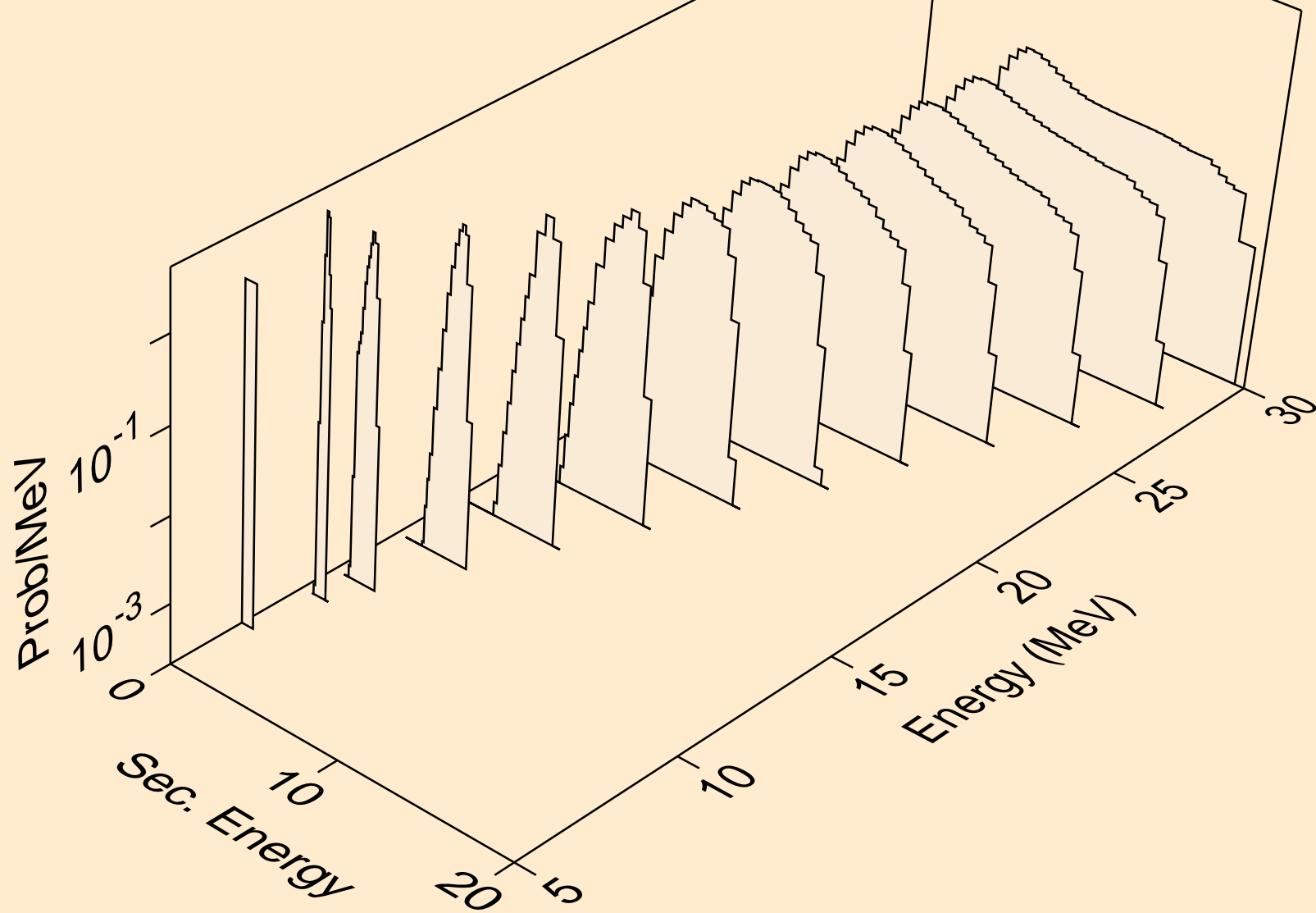

CA040 NEUTRON ACER TENDL-2021 LIBRARY; T=293.6K
alphas from (n,da)

