

CA046 NEUTRON ACER TENDL-2021 LIBRARY; T=293.6K

Principal cross sections

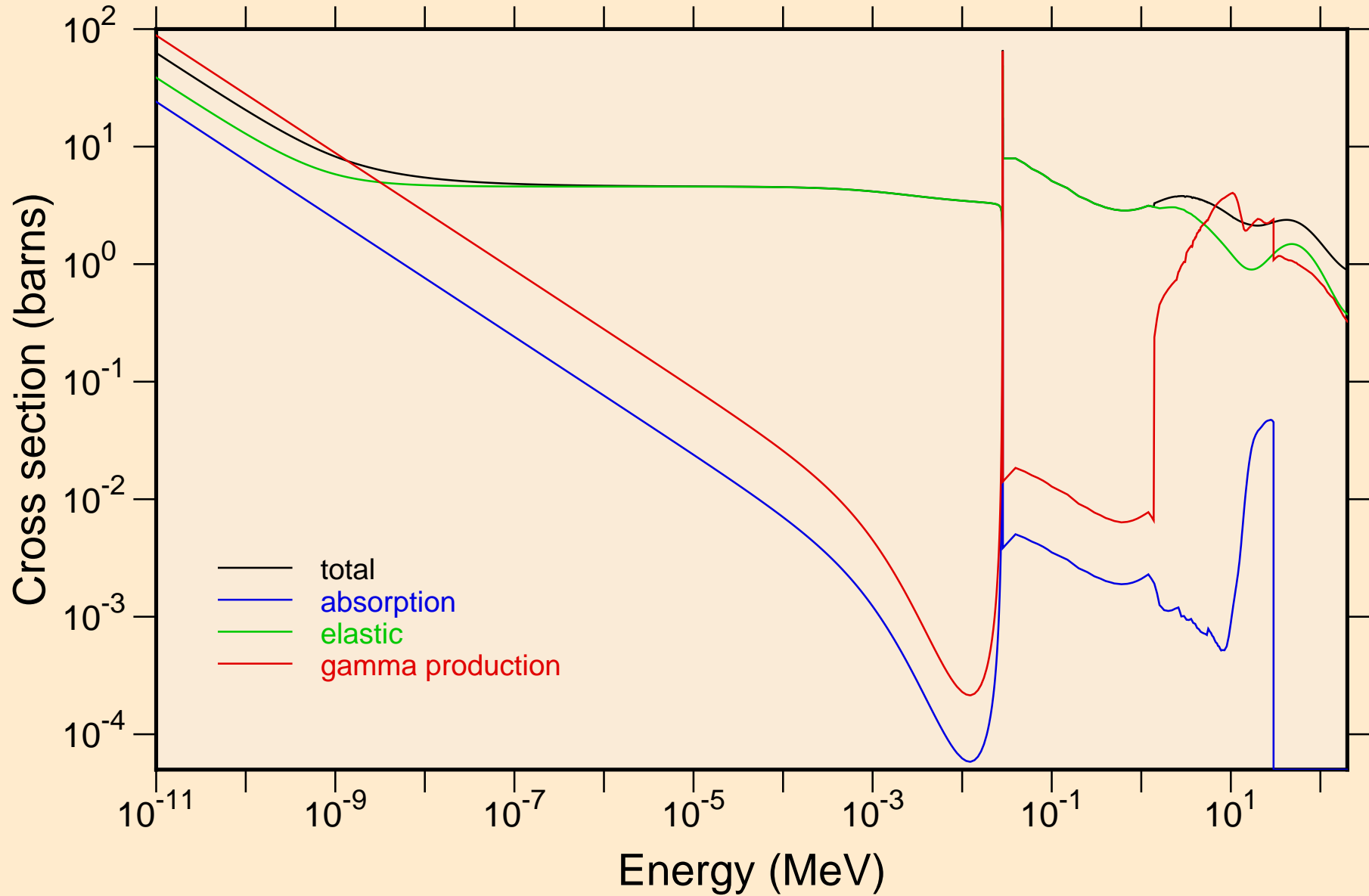

CA046 NEUTRON ACER TENDL-2021 LIBRARY; T=293.6K
Heating

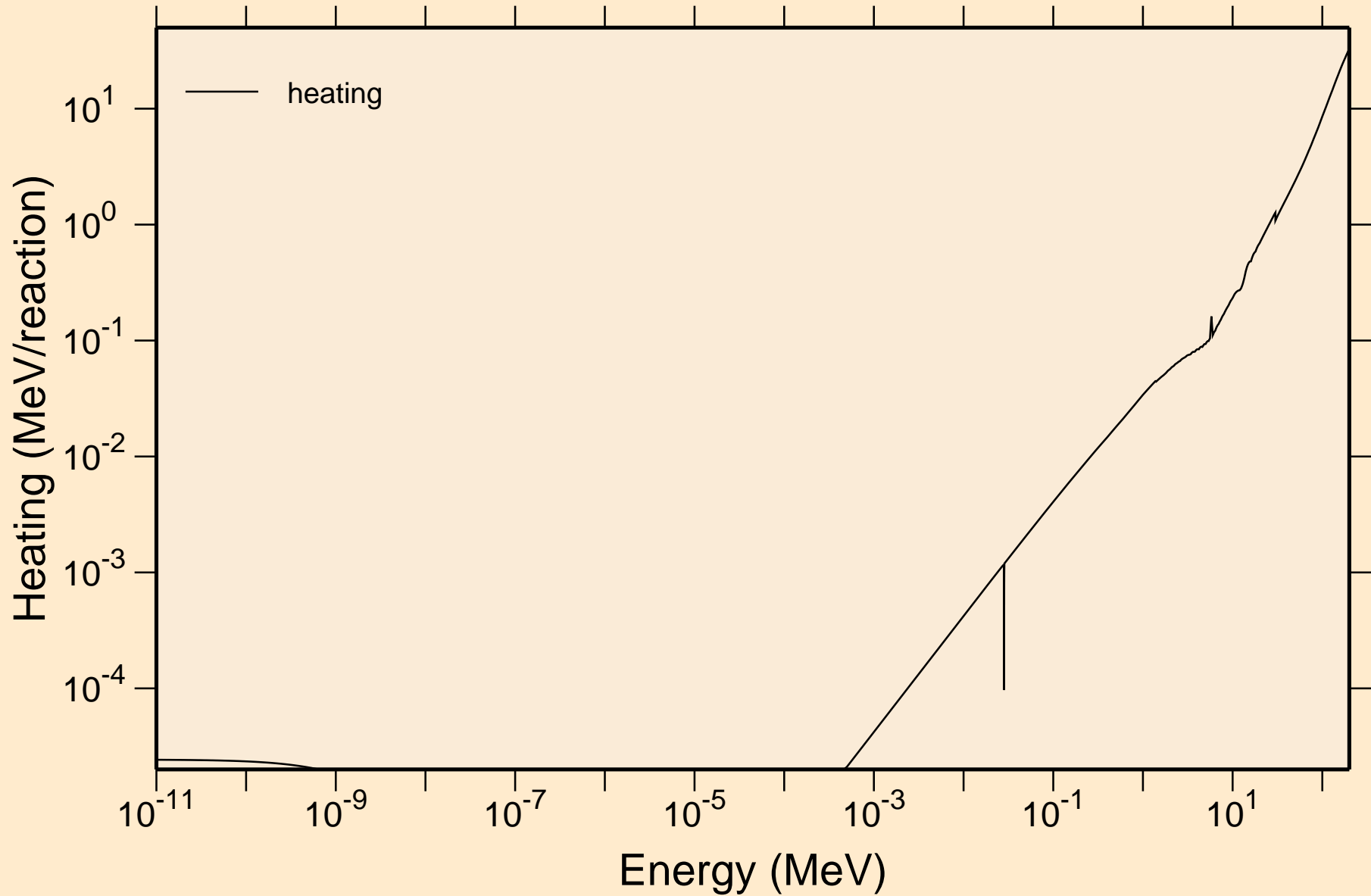

CA046 NEUTRON ACER TENDL-2021 LIBRARY; T=293.6K
Damage

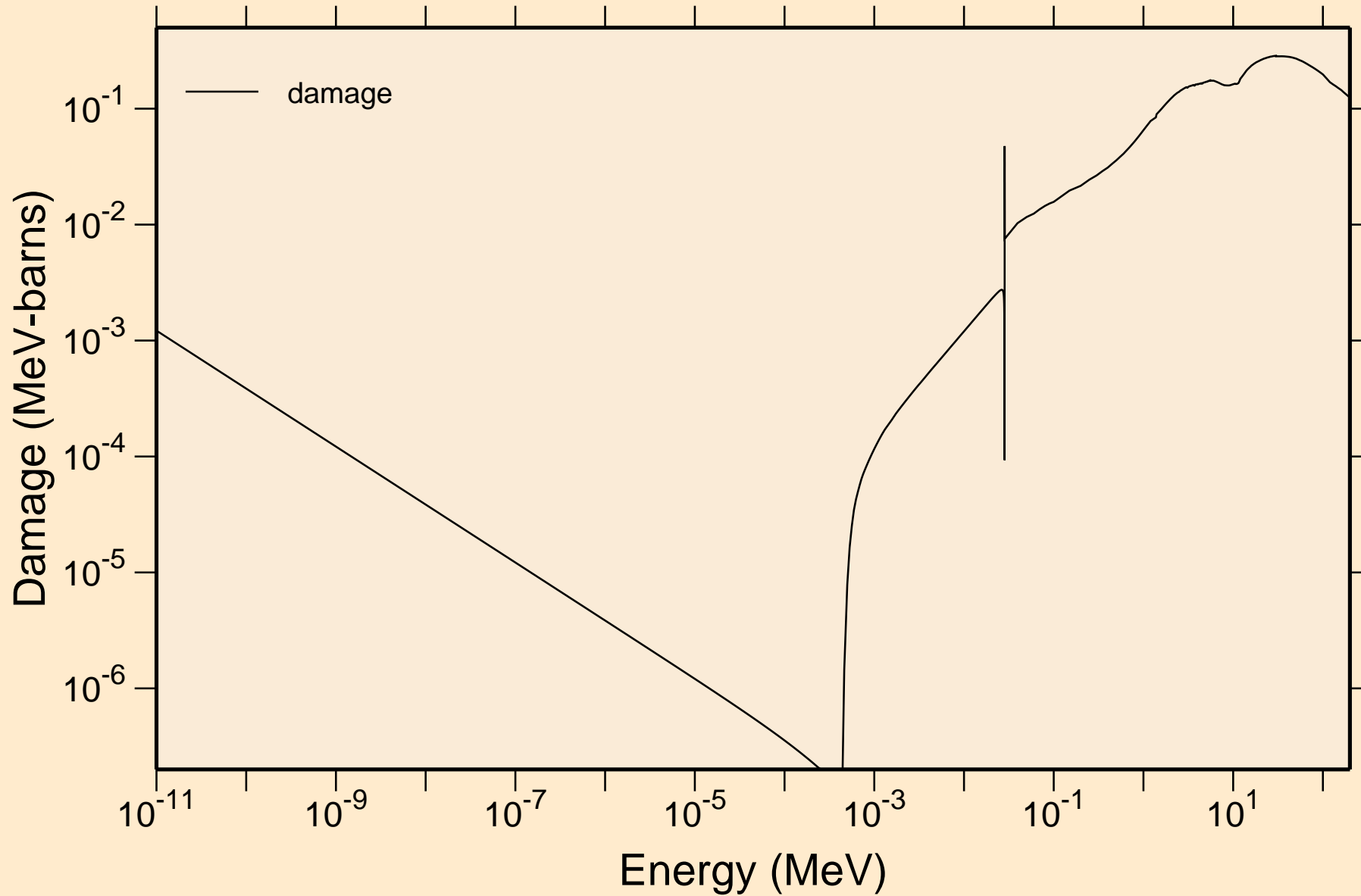

CA046 NEUTRON ACER TENDL-2021 LIBRARY; T=293.6K
Non-threshold reactions

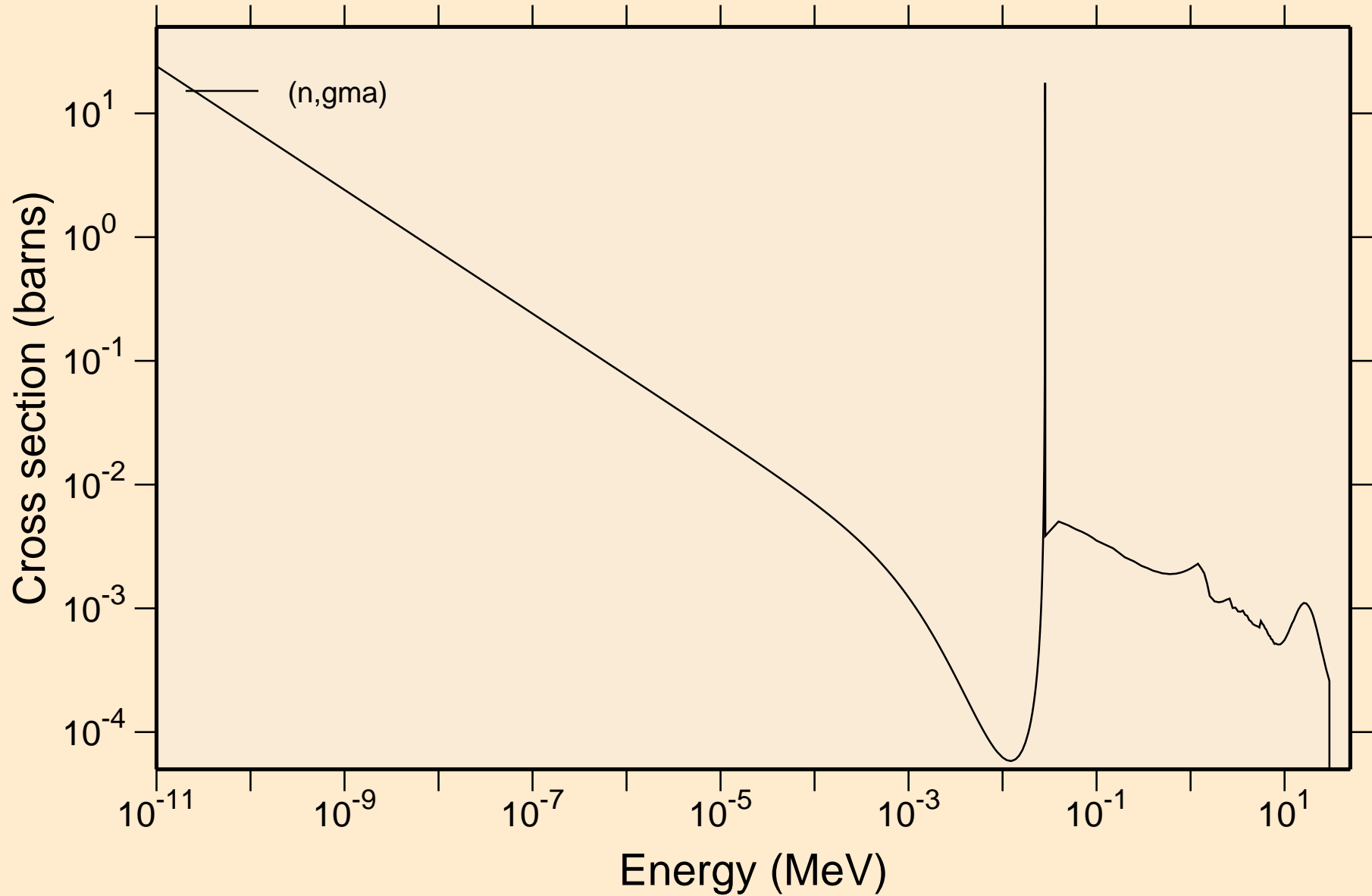

CA046 NEUTRON ACER TENDL-2021 LIBRARY; T=293.6K
Principal cross sections

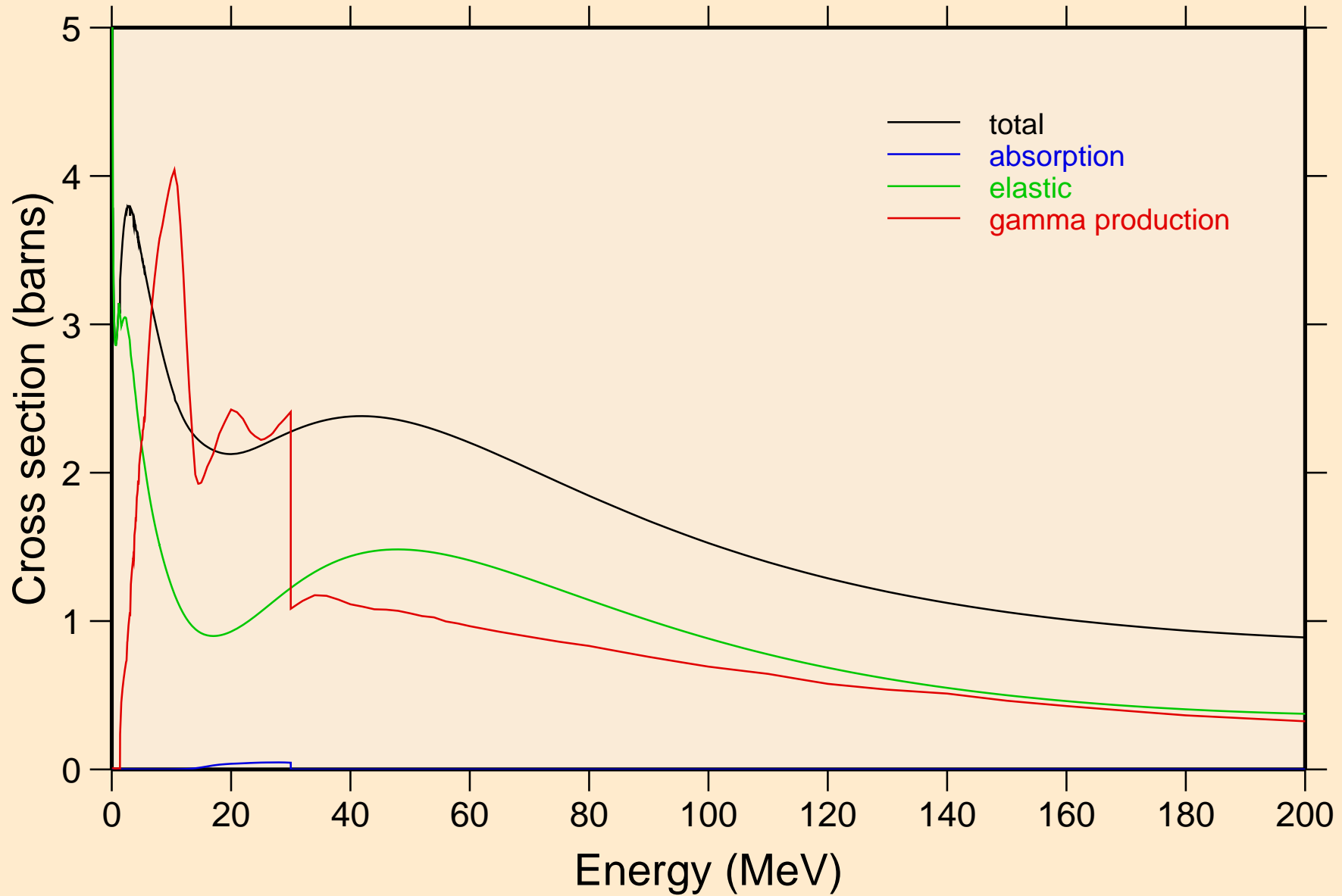

CA046 NEUTRON ACER TENDL-2021 LIBRARY; T=293.6K
Heating

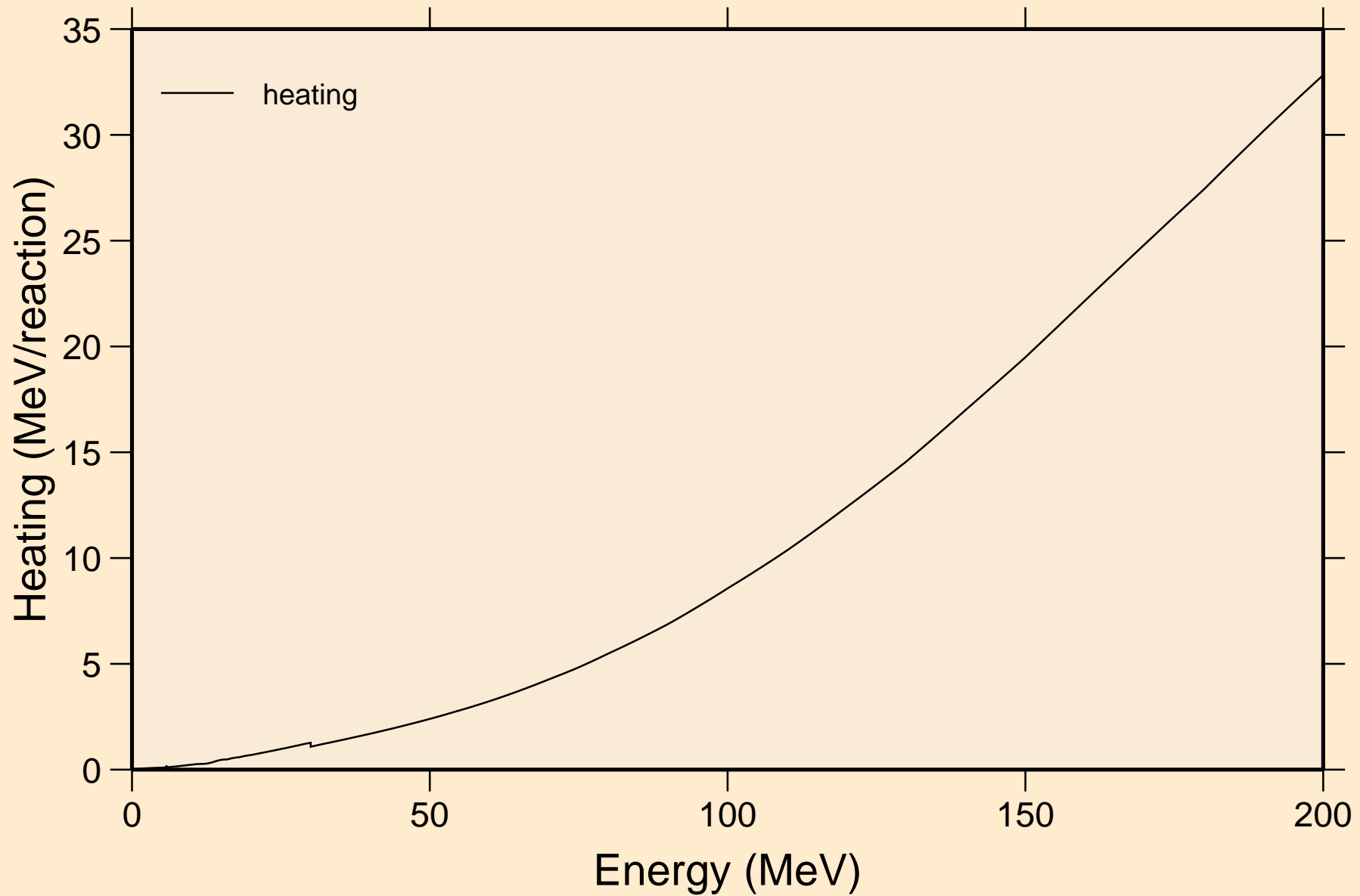

CA046 NEUTRON ACER TENDL-2021 LIBRARY; T=293.6K
Damage

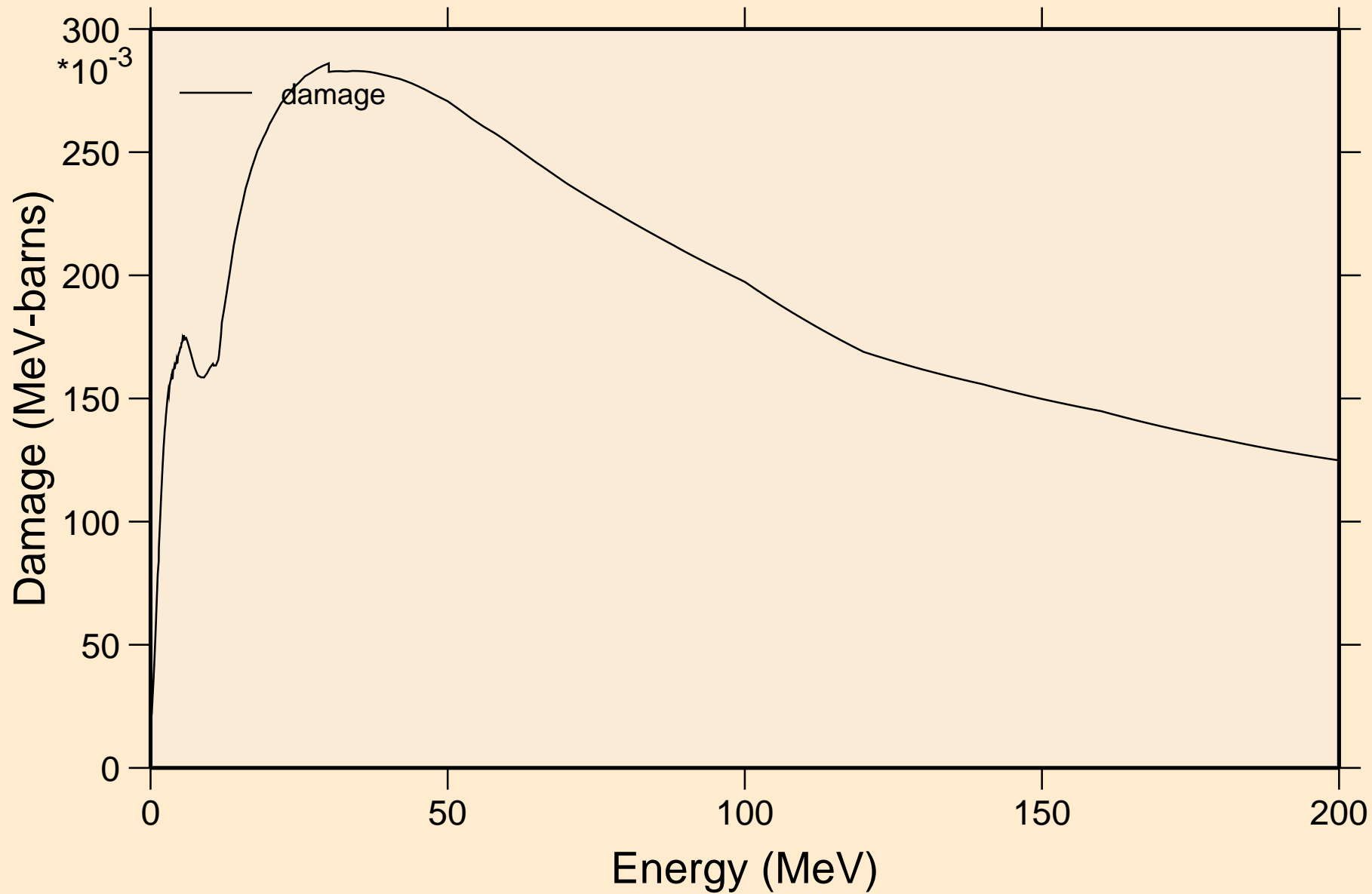

CA046 NEUTRON ACER TENDL-2021 LIBRARY; T=293.6K
Non-threshold reactions

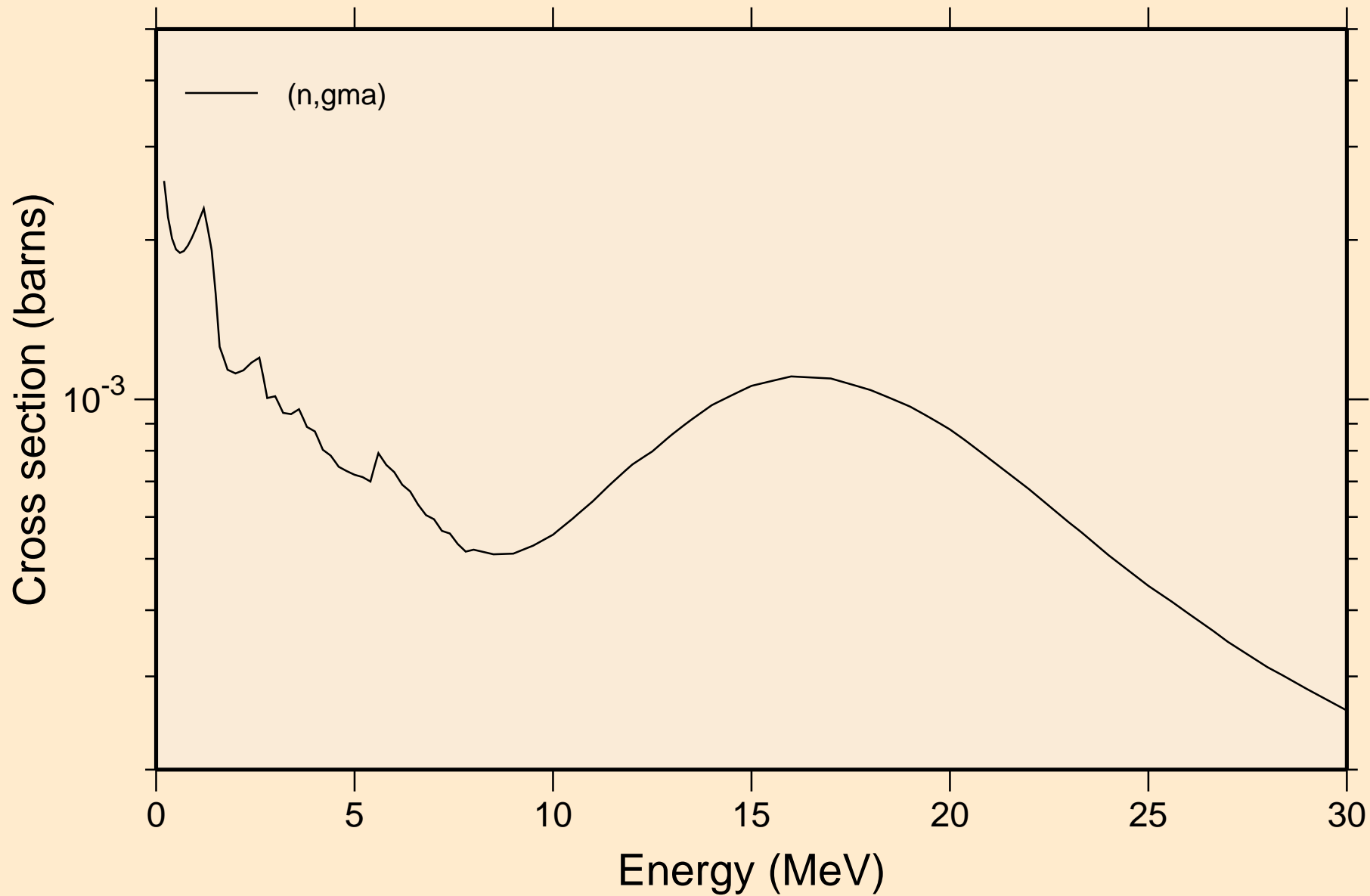

CA046 NEUTRON ACER TENDL-2021 LIBRARY; T=293.6K
Inelastic levels

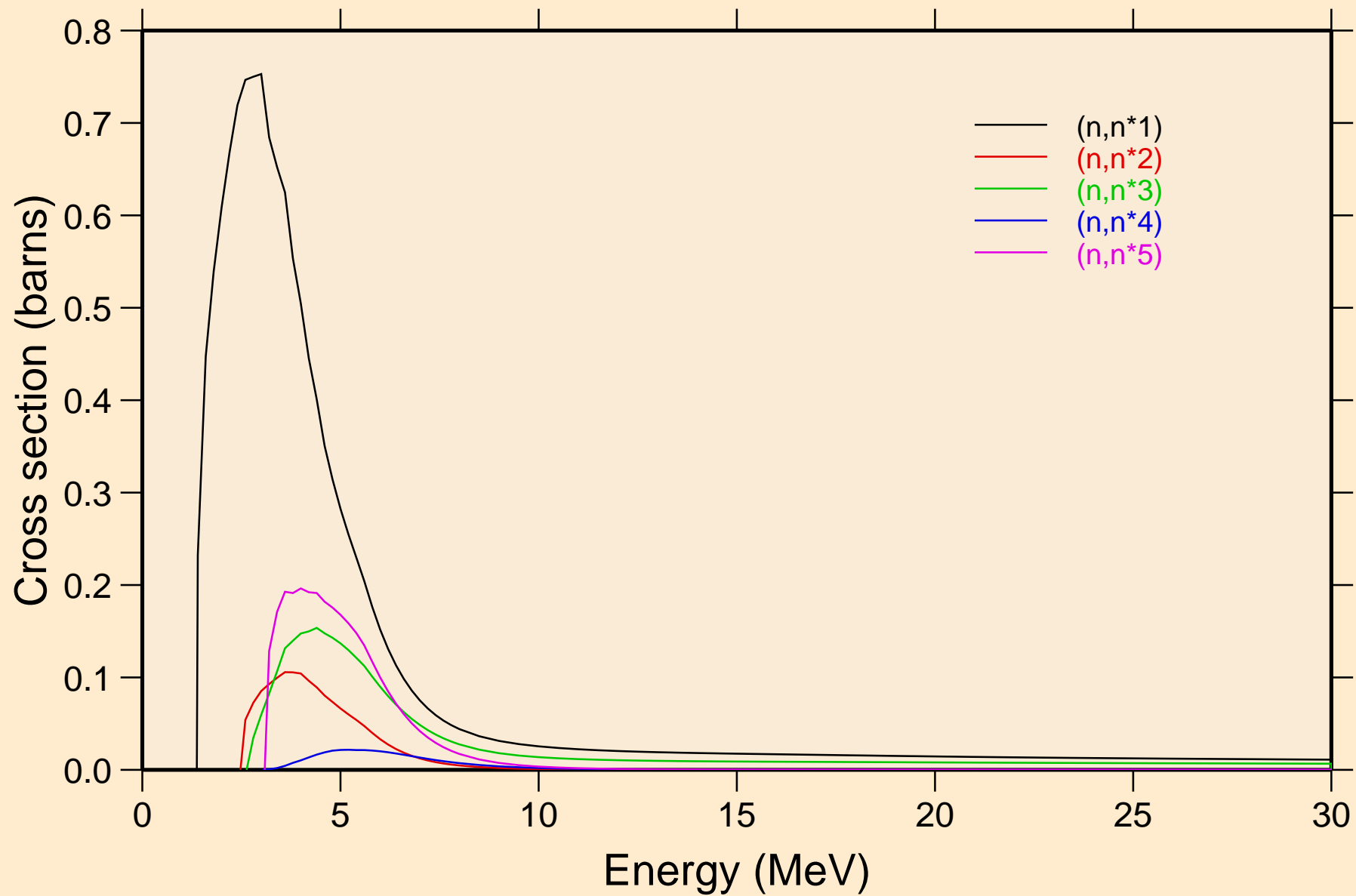

CA046 NEUTRON ACER TENDL-2021 LIBRARY; T=293.6K
Inelastic levels

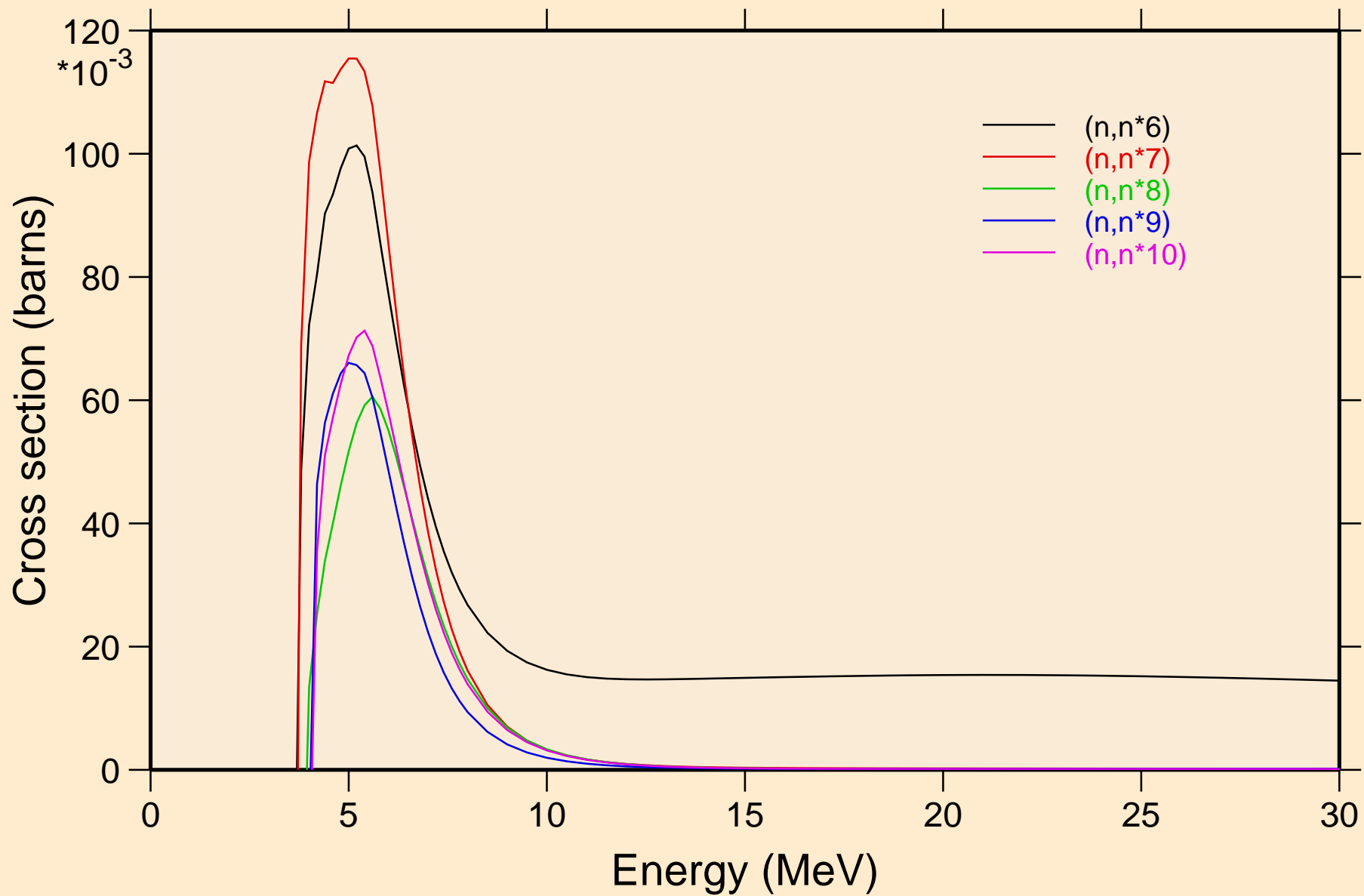

CA046 NEUTRON ACER TENDL-2021 LIBRARY; T=293.6K
Inelastic levels

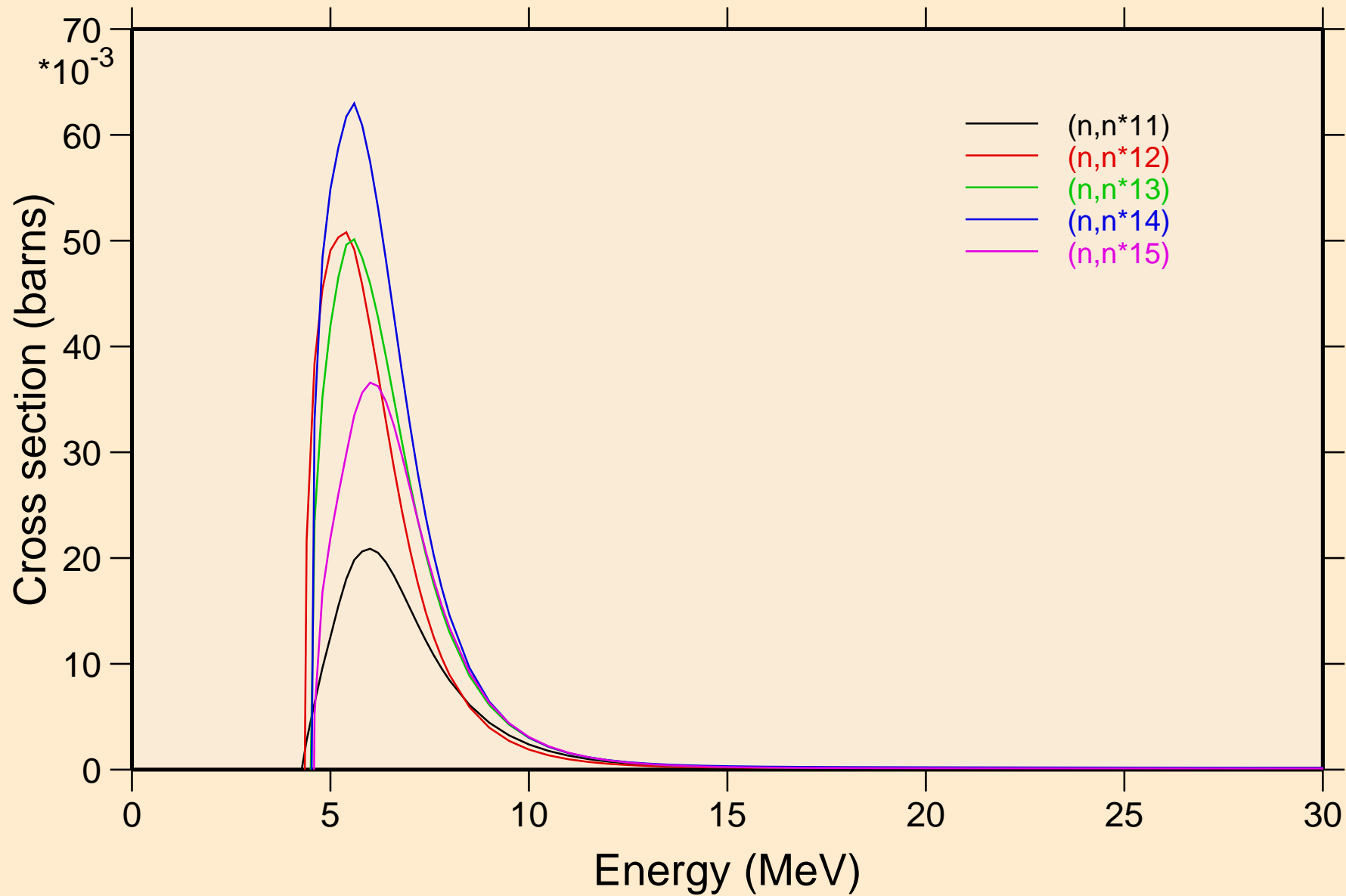

CA046 NEUTRON ACER TENDL-2021 LIBRARY; T=293.6K
Inelastic levels

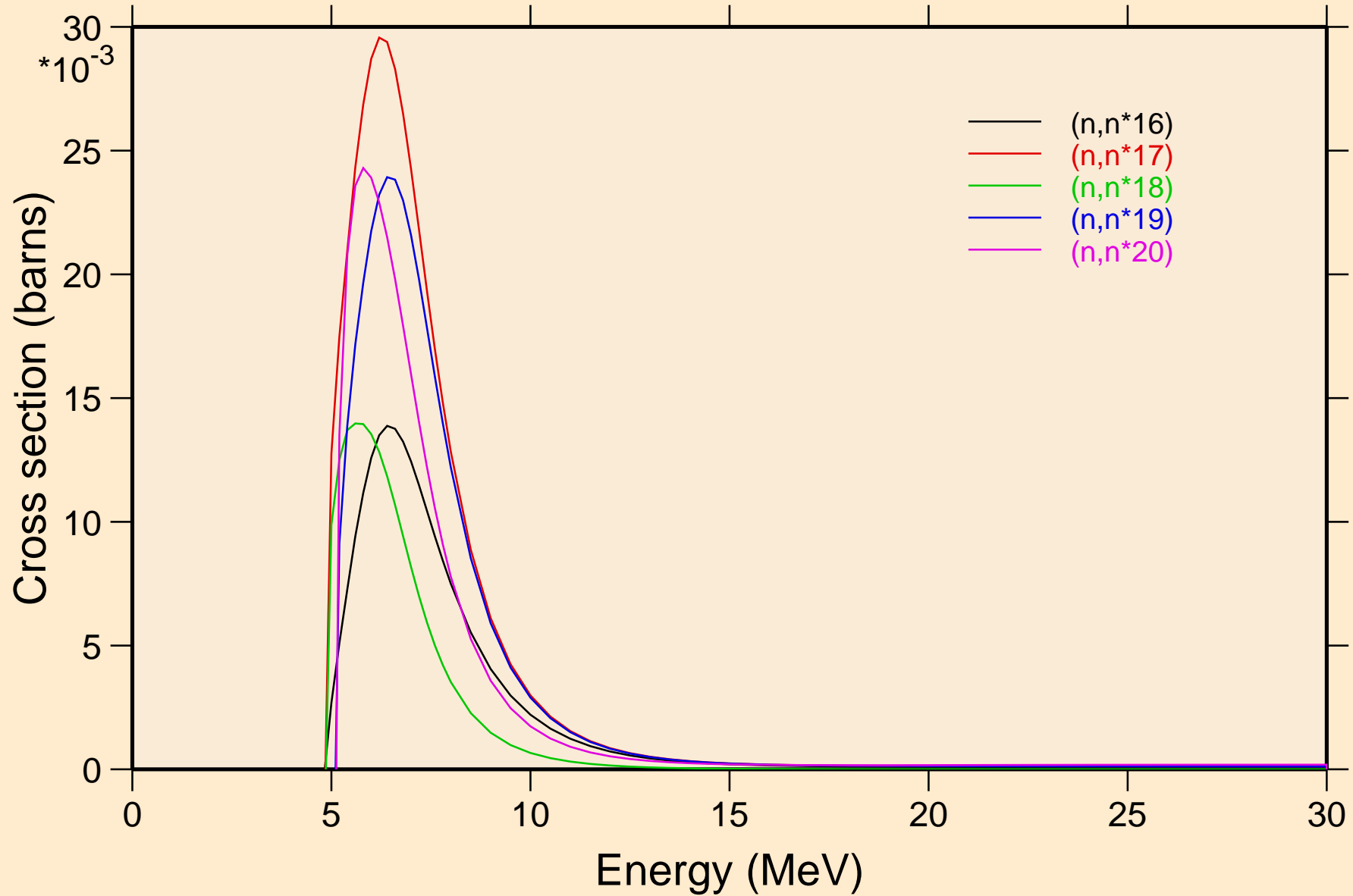

CA046 NEUTRON ACER TENDL-2021 LIBRARY; T=293.6K
Inelastic levels

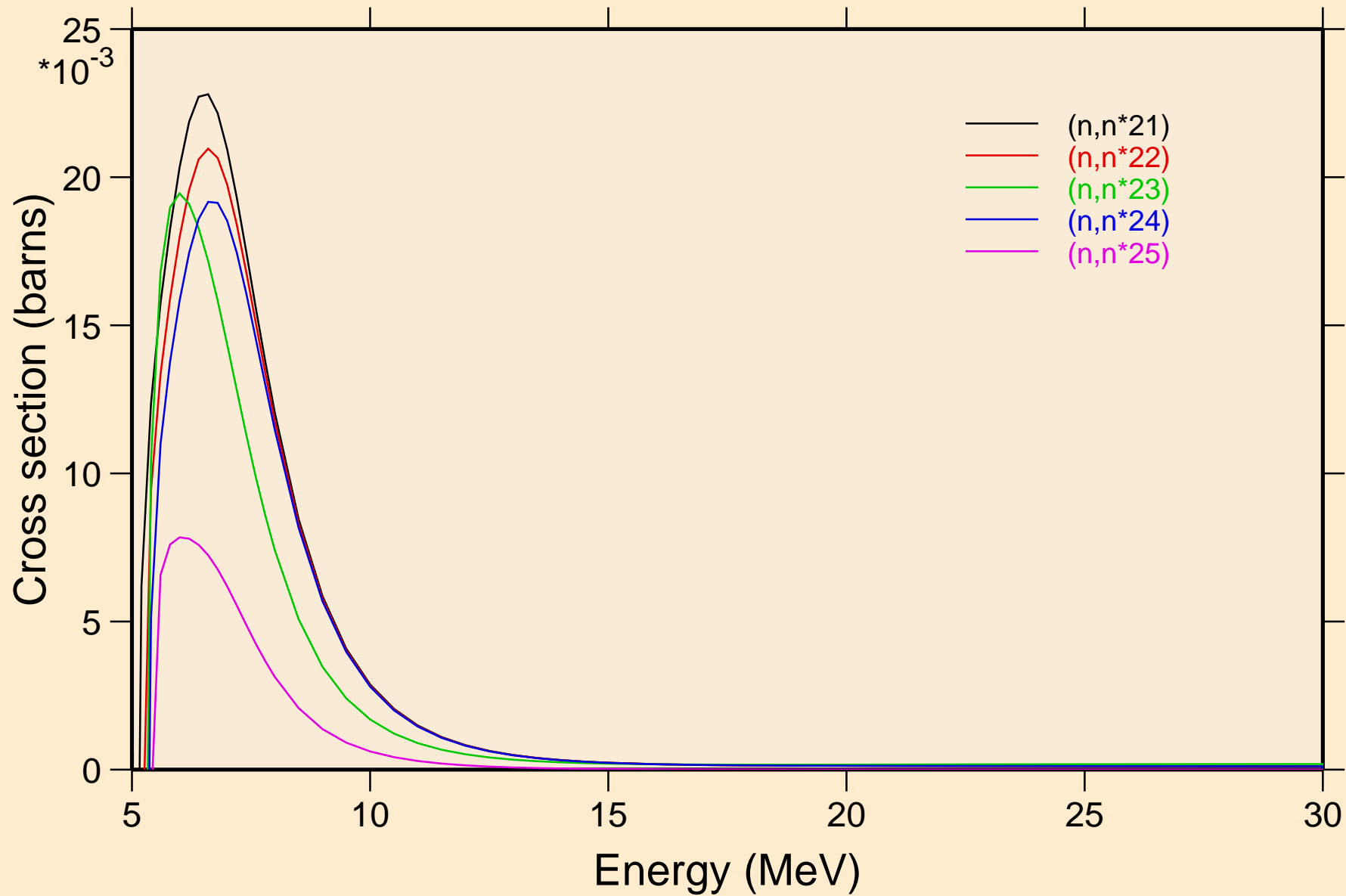

CA046 NEUTRON ACER TENDL-2021 LIBRARY; T=293.6K
Inelastic levels

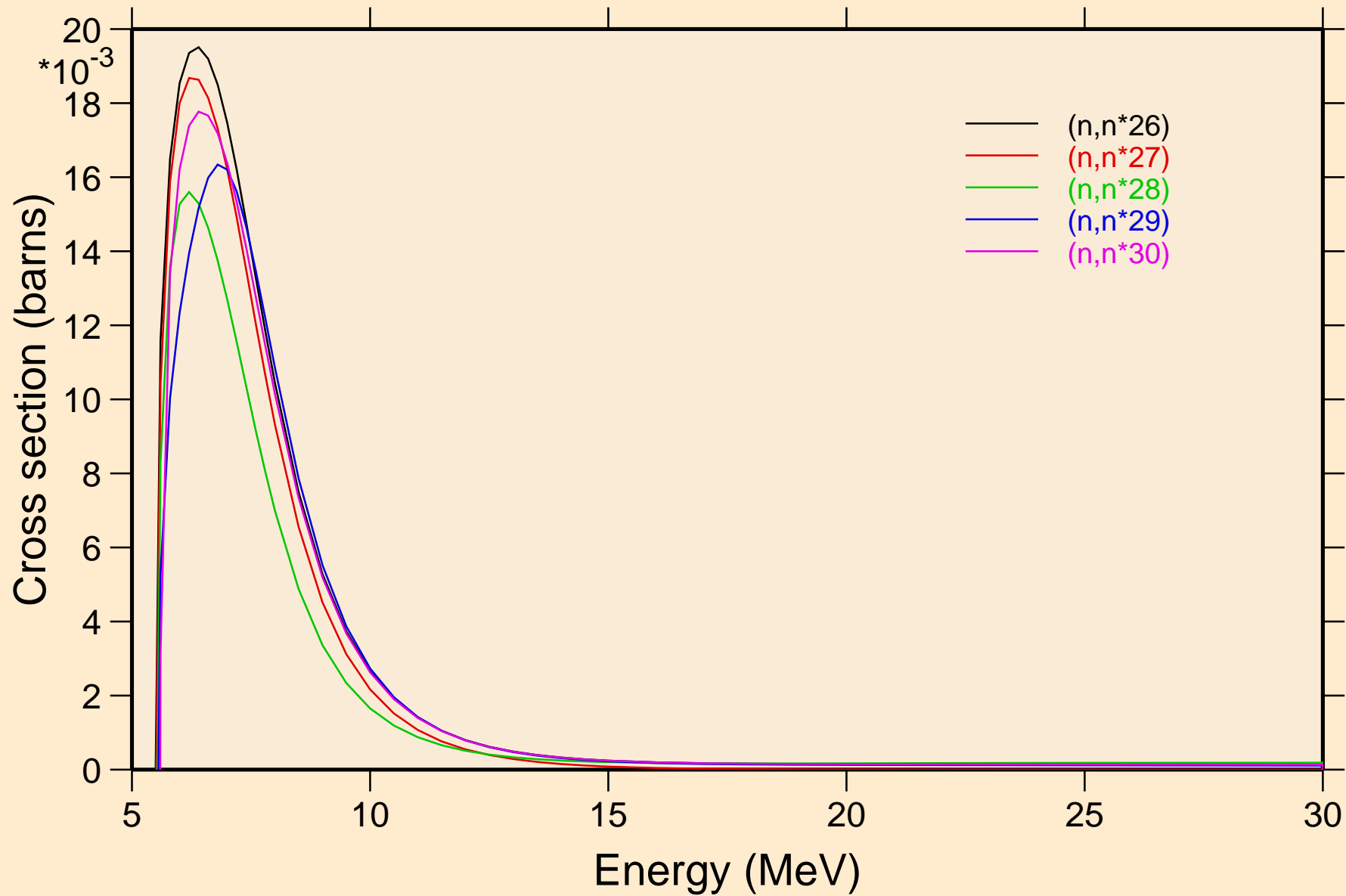

CA046 NEUTRON ACER TENDL-2021 LIBRARY; T=293.6K
Threshold reactions

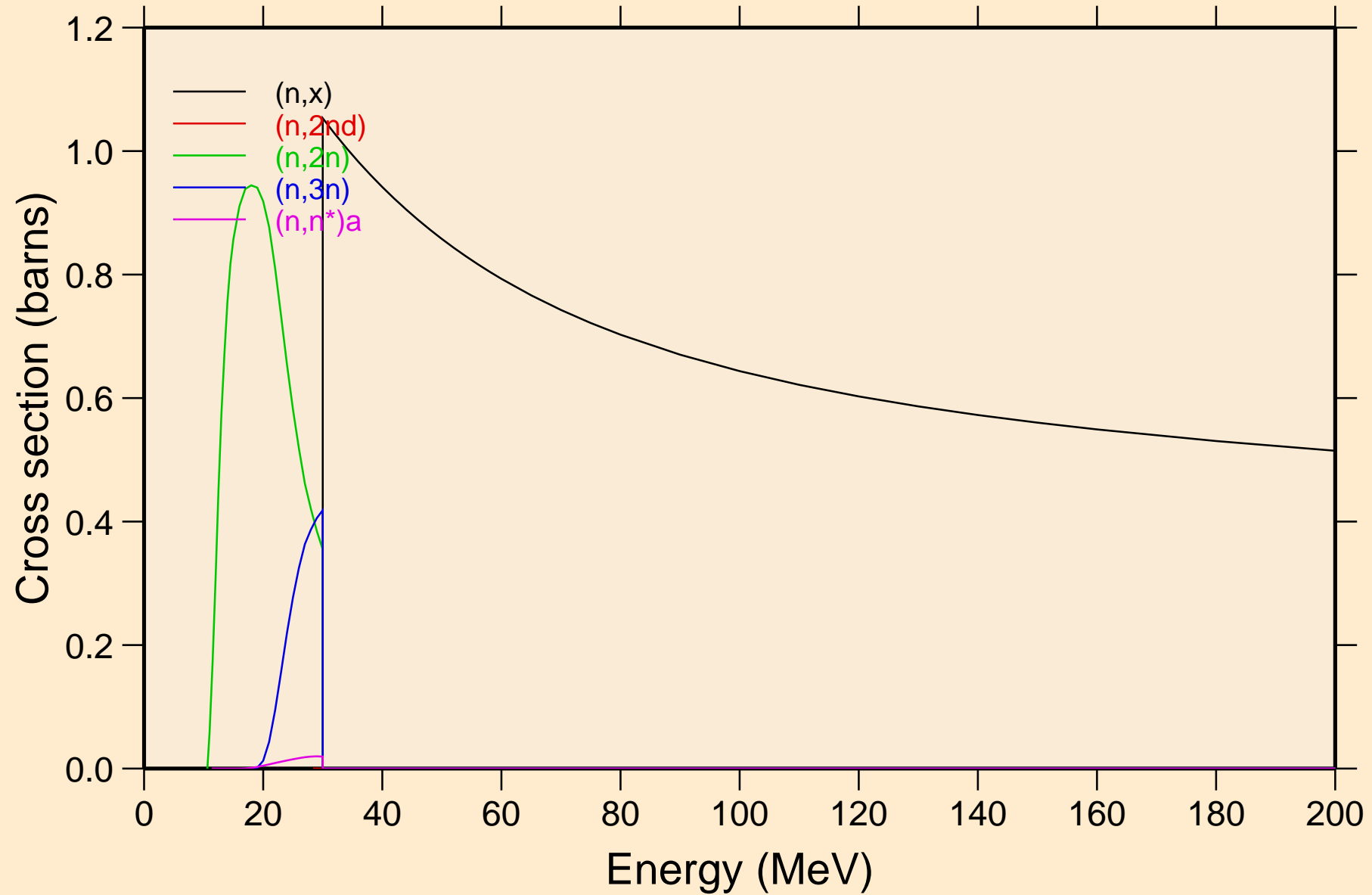

CA046 NEUTRON ACER TENDL-2021 LIBRARY; T=293.6K
Threshold reactions

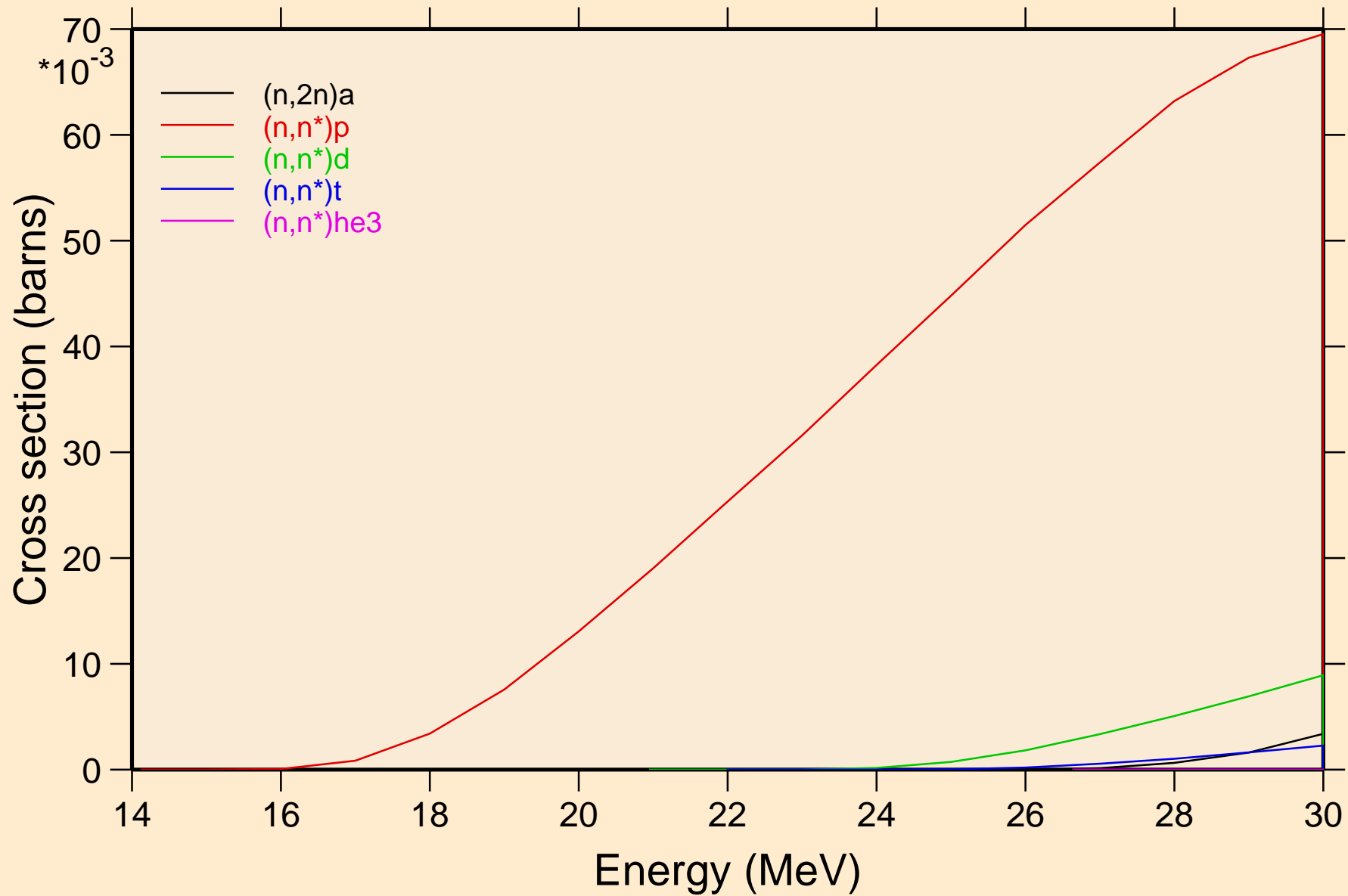

CA046 NEUTRON ACER TENDL-2021 LIBRARY; T=293.6K
Threshold reactions

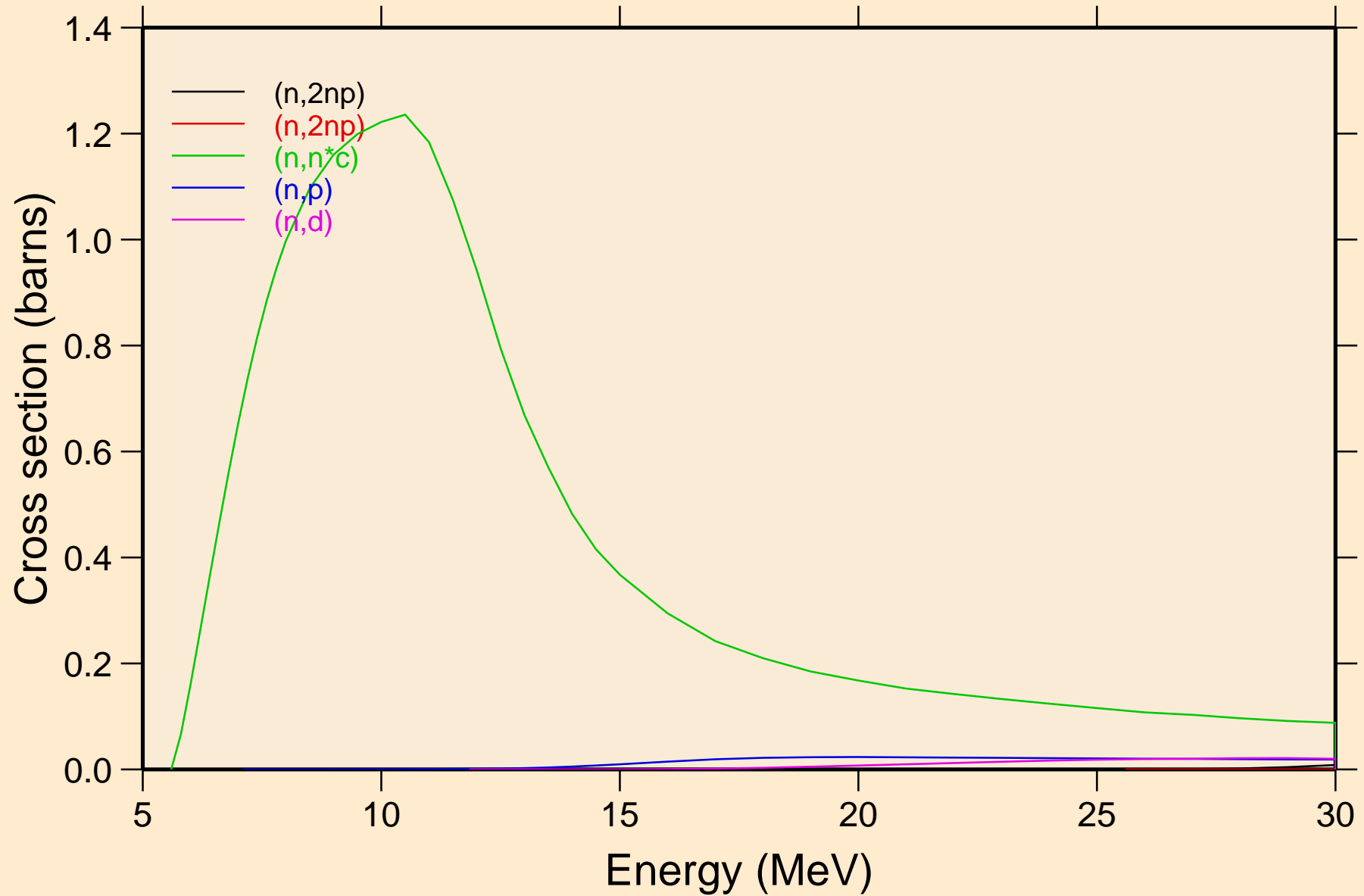

CA046 NEUTRON ACER TENDL-2021 LIBRARY; T=293.6K
Threshold reactions

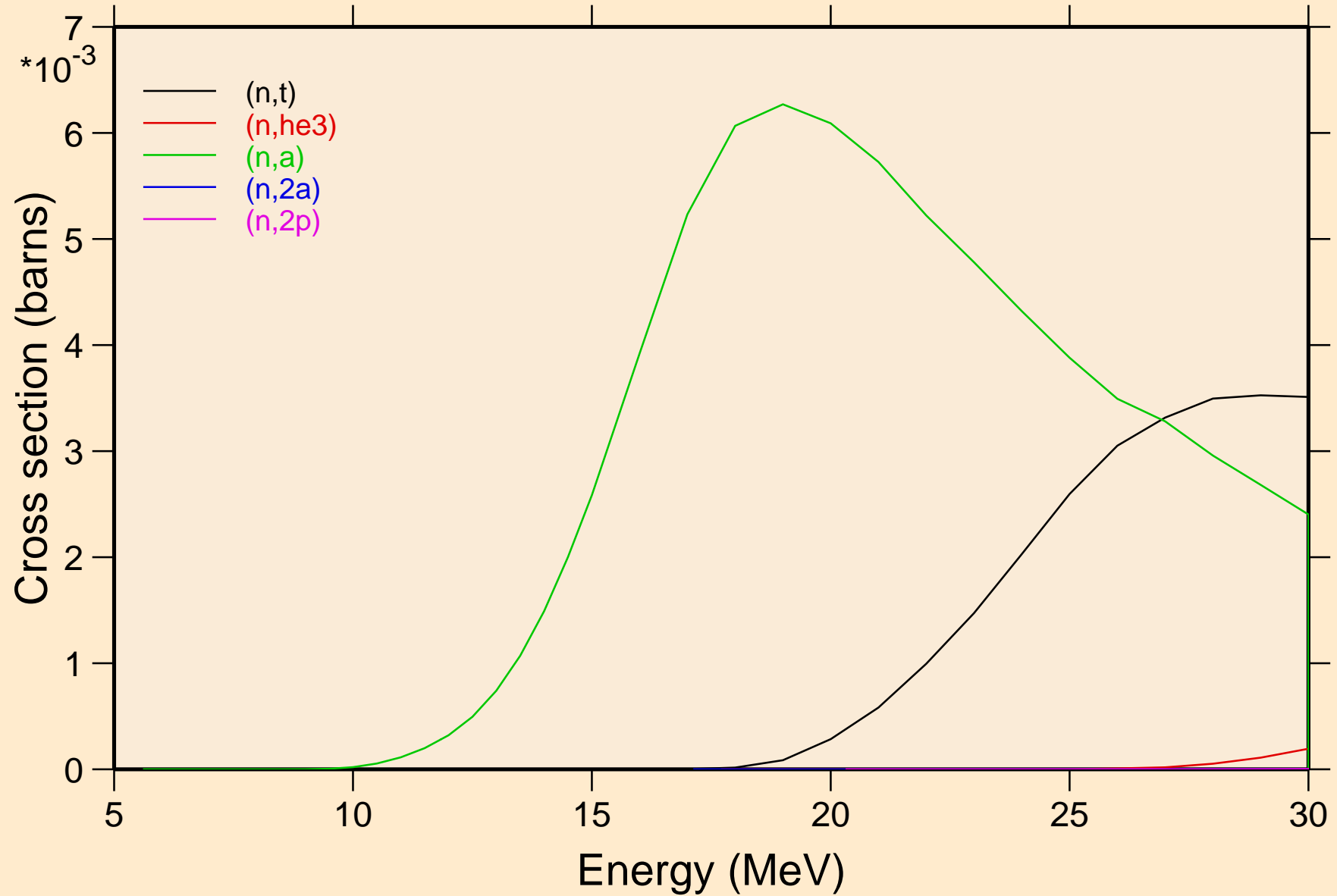

CA046 NEUTRON ACER TENDL-2021 LIBRARY; T=293.6K
Threshold reactions

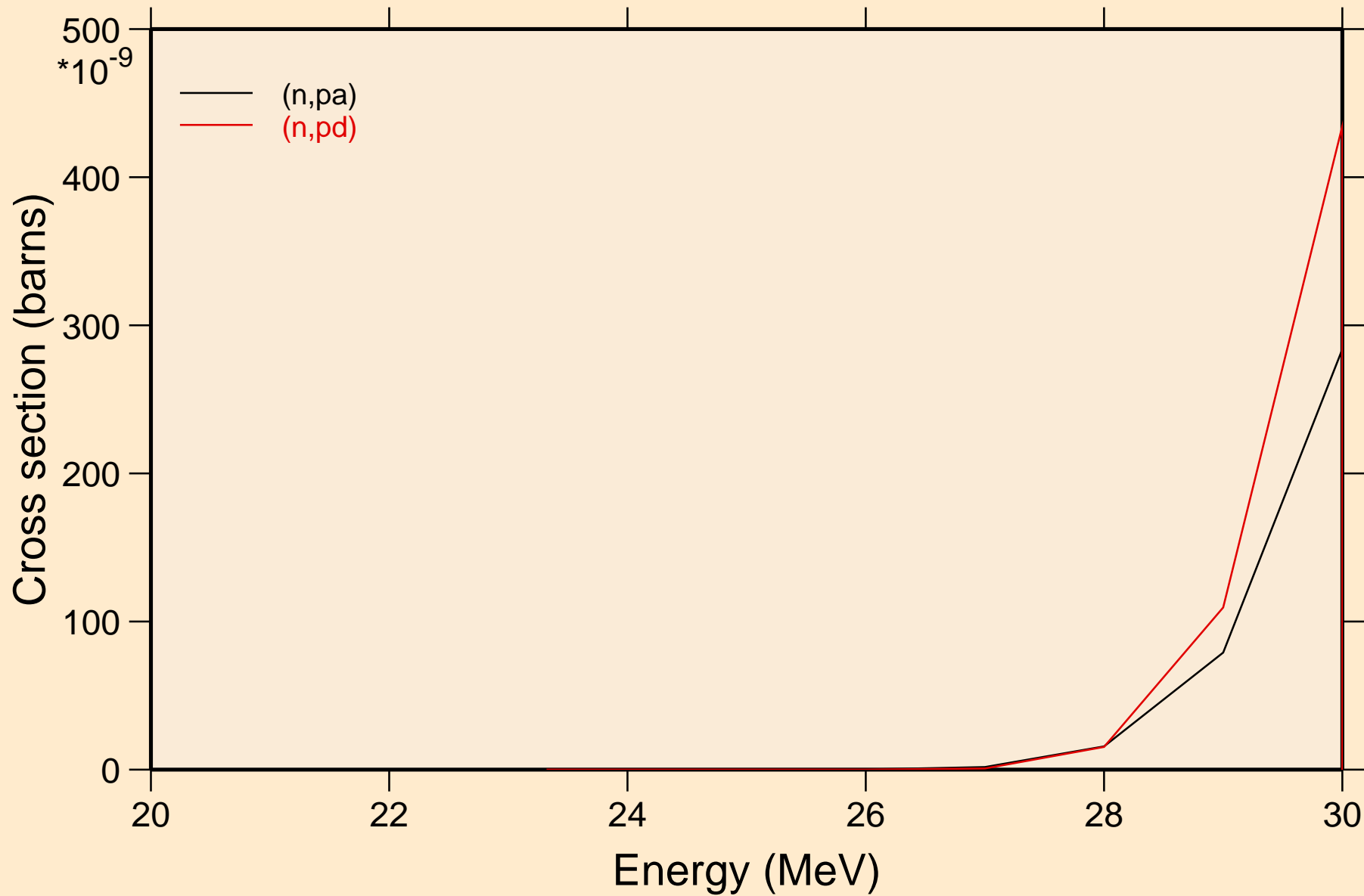

CA046 NEUTRON ACER TENDL-2021 LIBRARY; T=293.6K
Threshold reactions

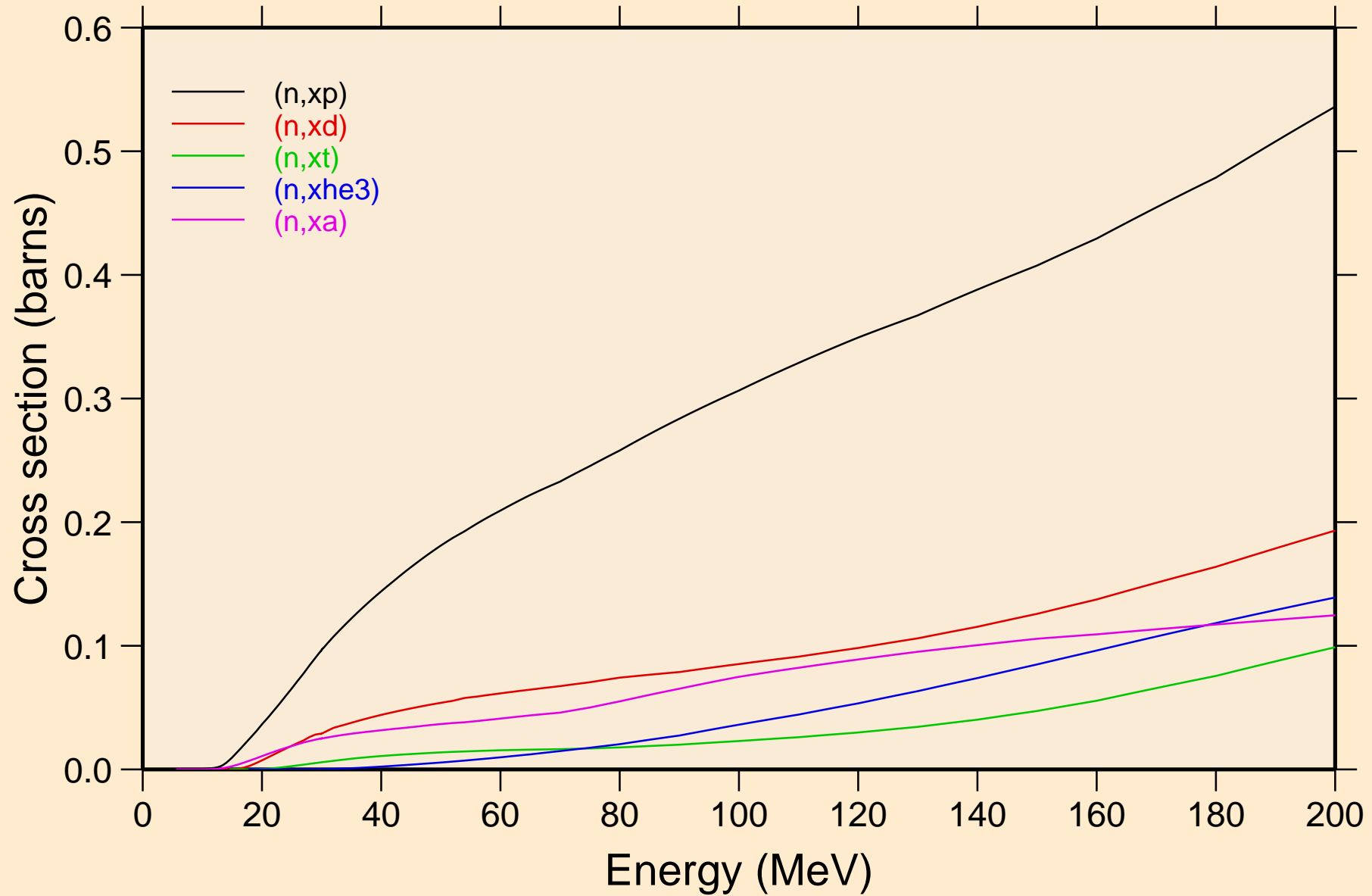

CA046 NEUTRON ACER TENDL-2021 LIBRARY; T=293.6K
angular distribution for elastic

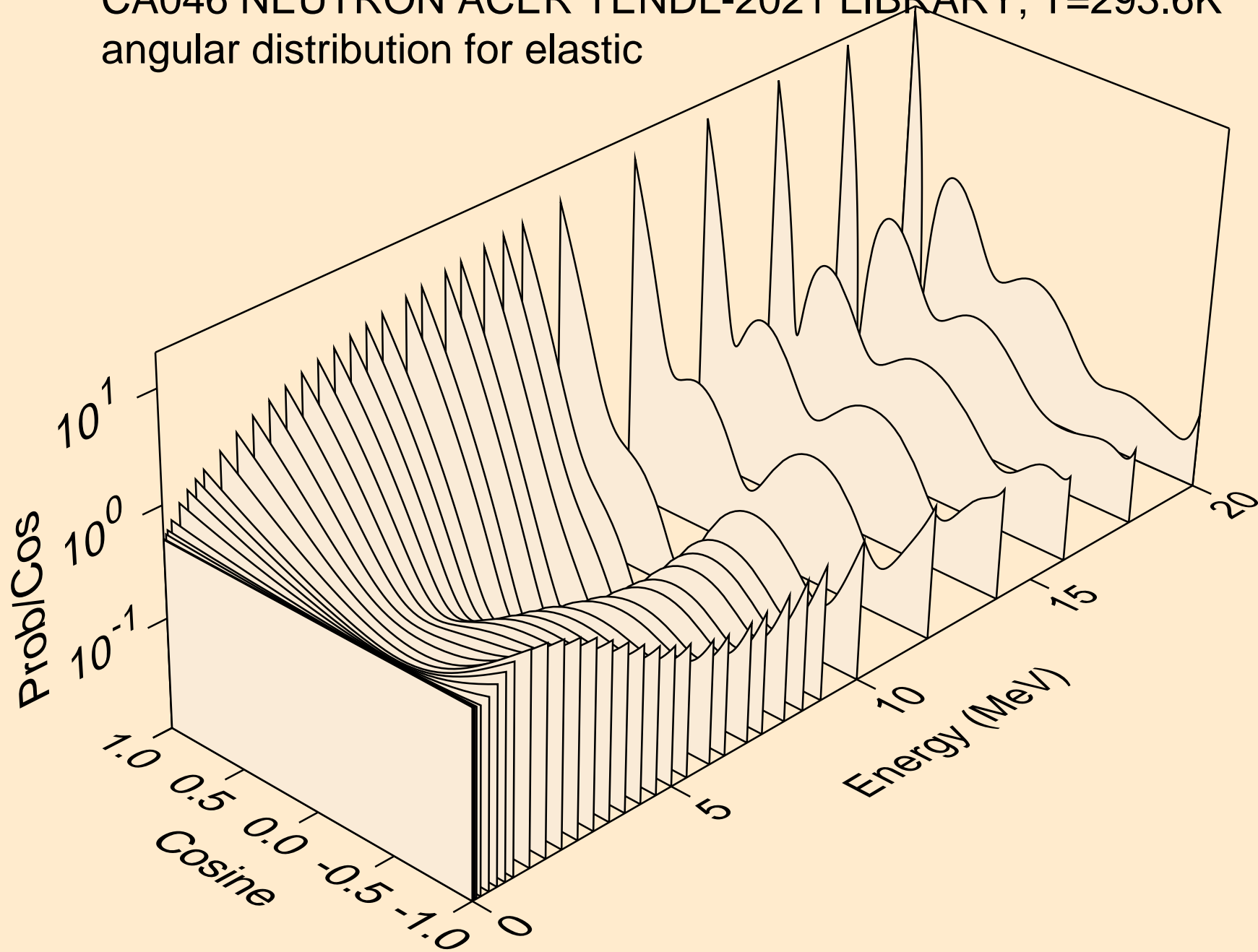

CA046 NEUTRON ACER TENDL-2021 LIBRARY; T=293.6K
angular distribution for elastic

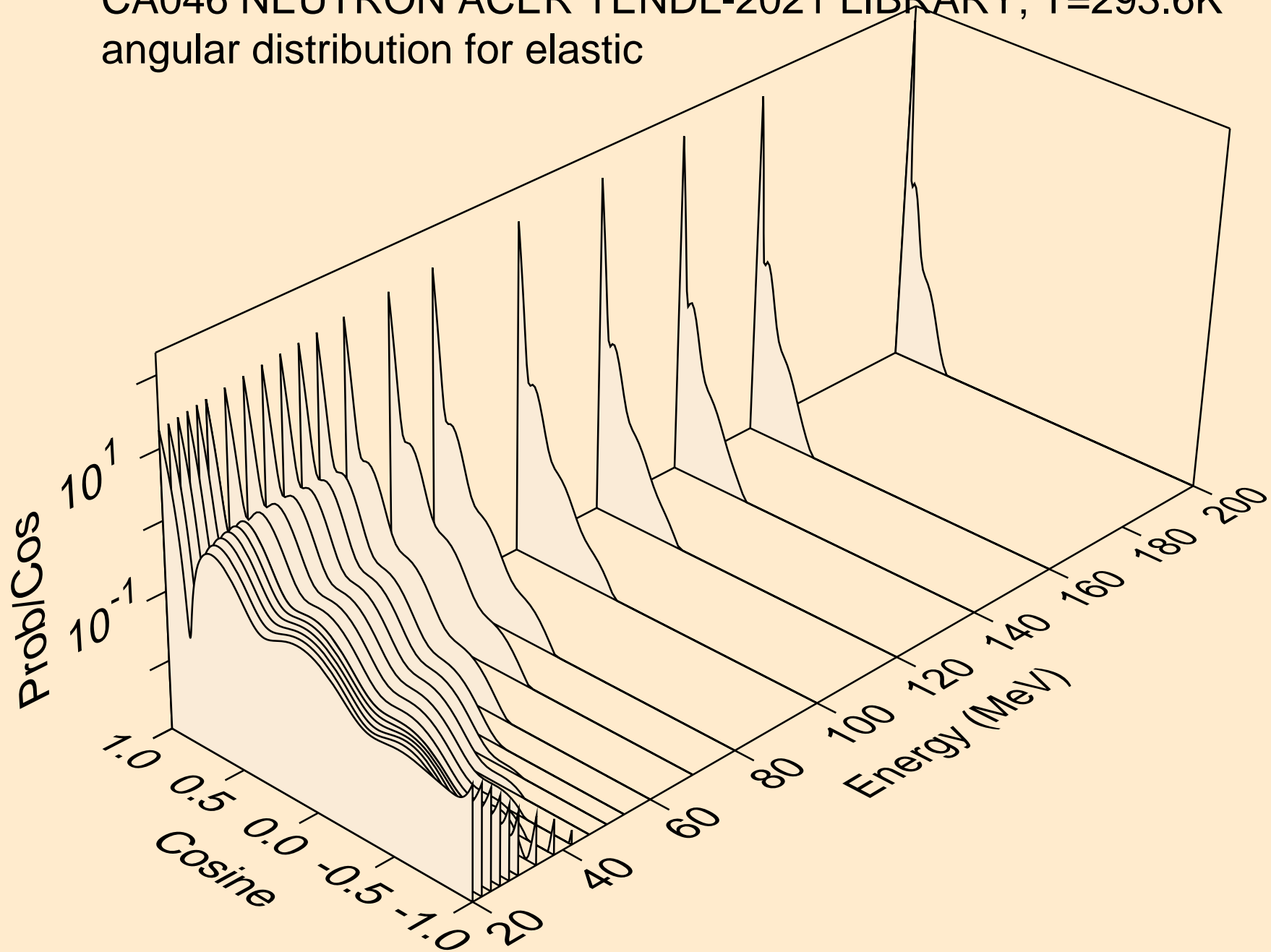

CA046 NEUTRON ACER TENDL-2021 LIBRARY; T=293.6K
angular distribution for (n,n*1)

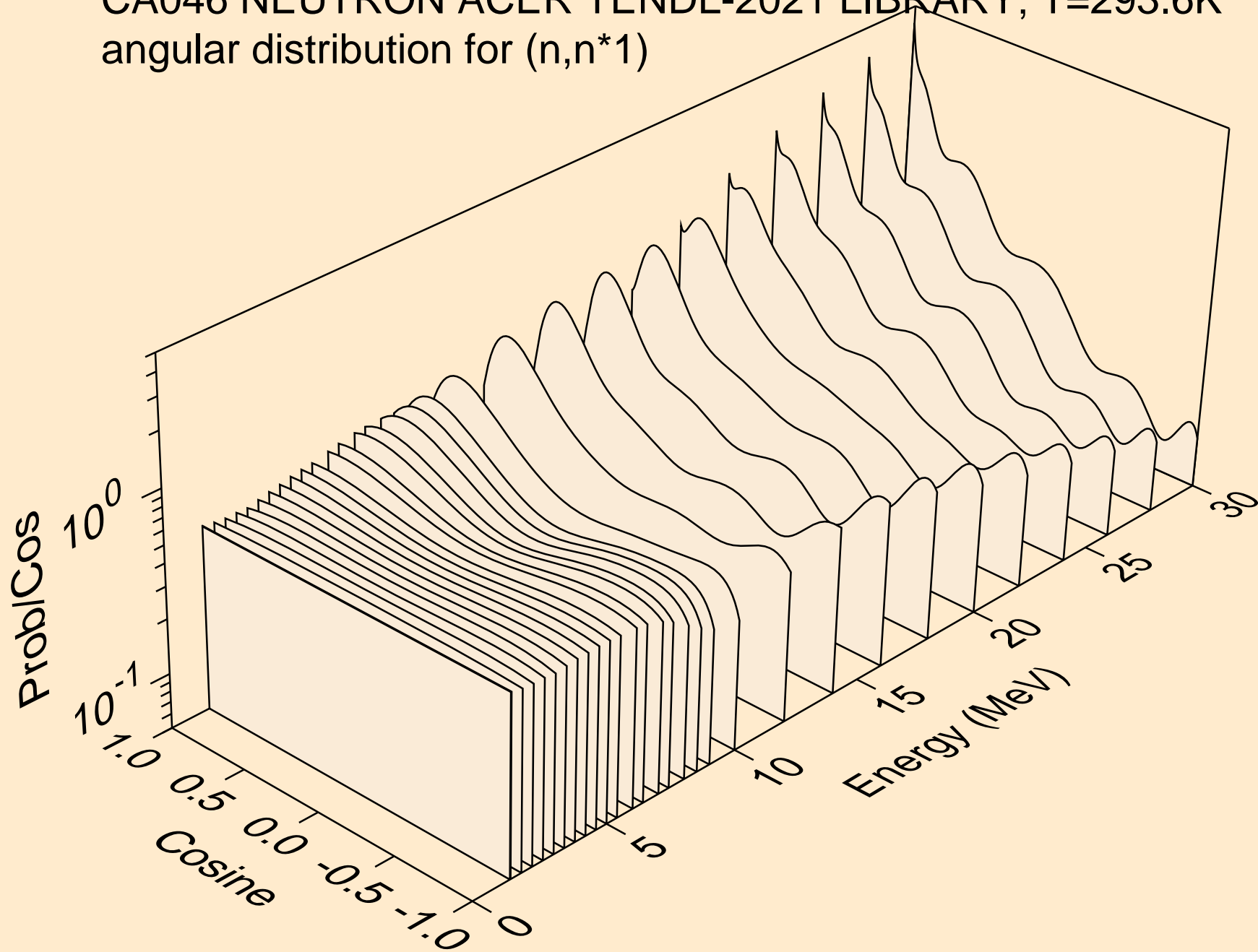

CA046 NEUTRON ACER TENDL-2021 LIBRARY; T=293.6K
angular distribution for (n,n*2)

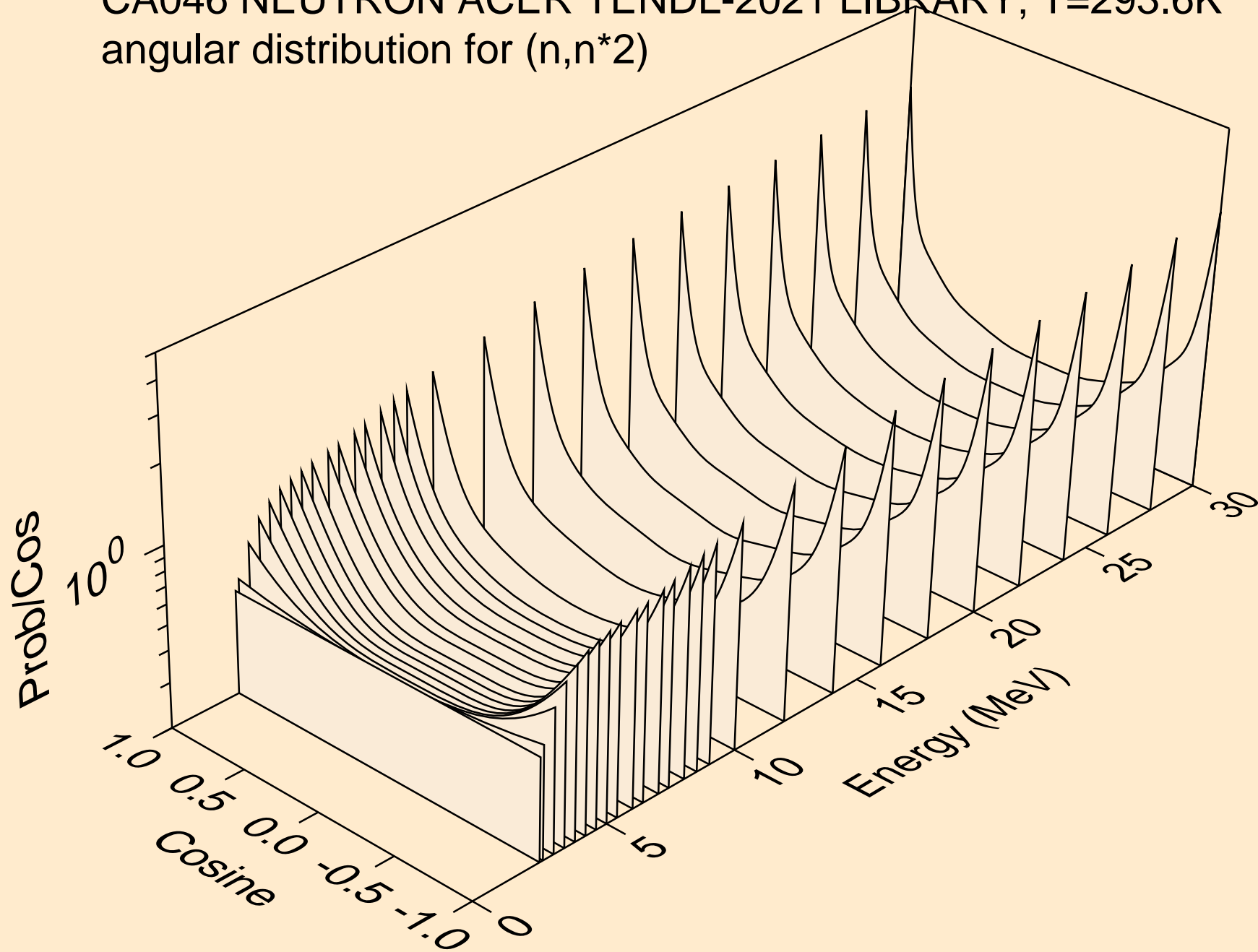

CA046 NEUTRON ACER TENDL-2021 LIBRARY; T=293.6K
angular distribution for (n,n*3)

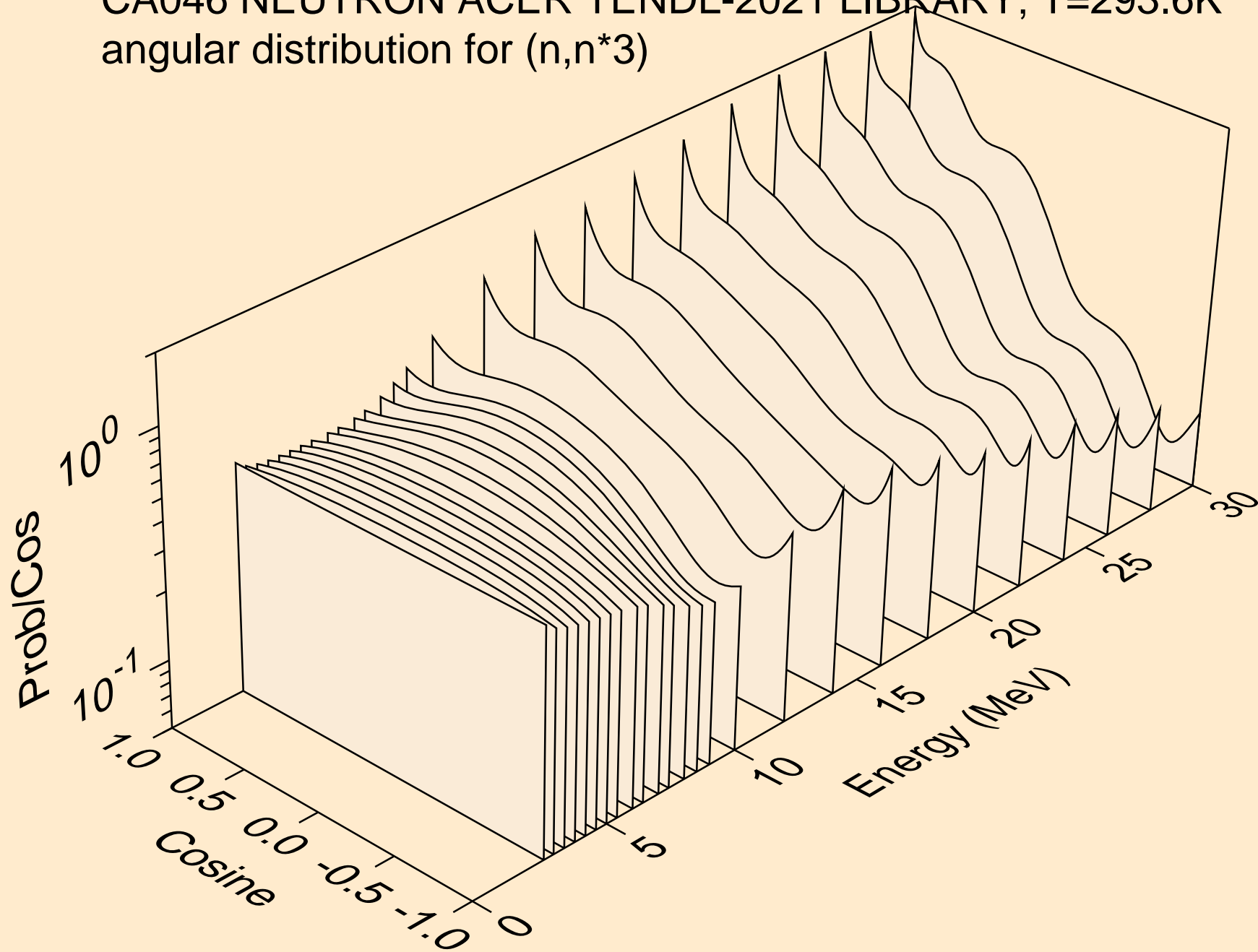

CA046 NEUTRON ACER TENDL-2021 LIBRARY; T=293.6K
angular distribution for (n,n*4)

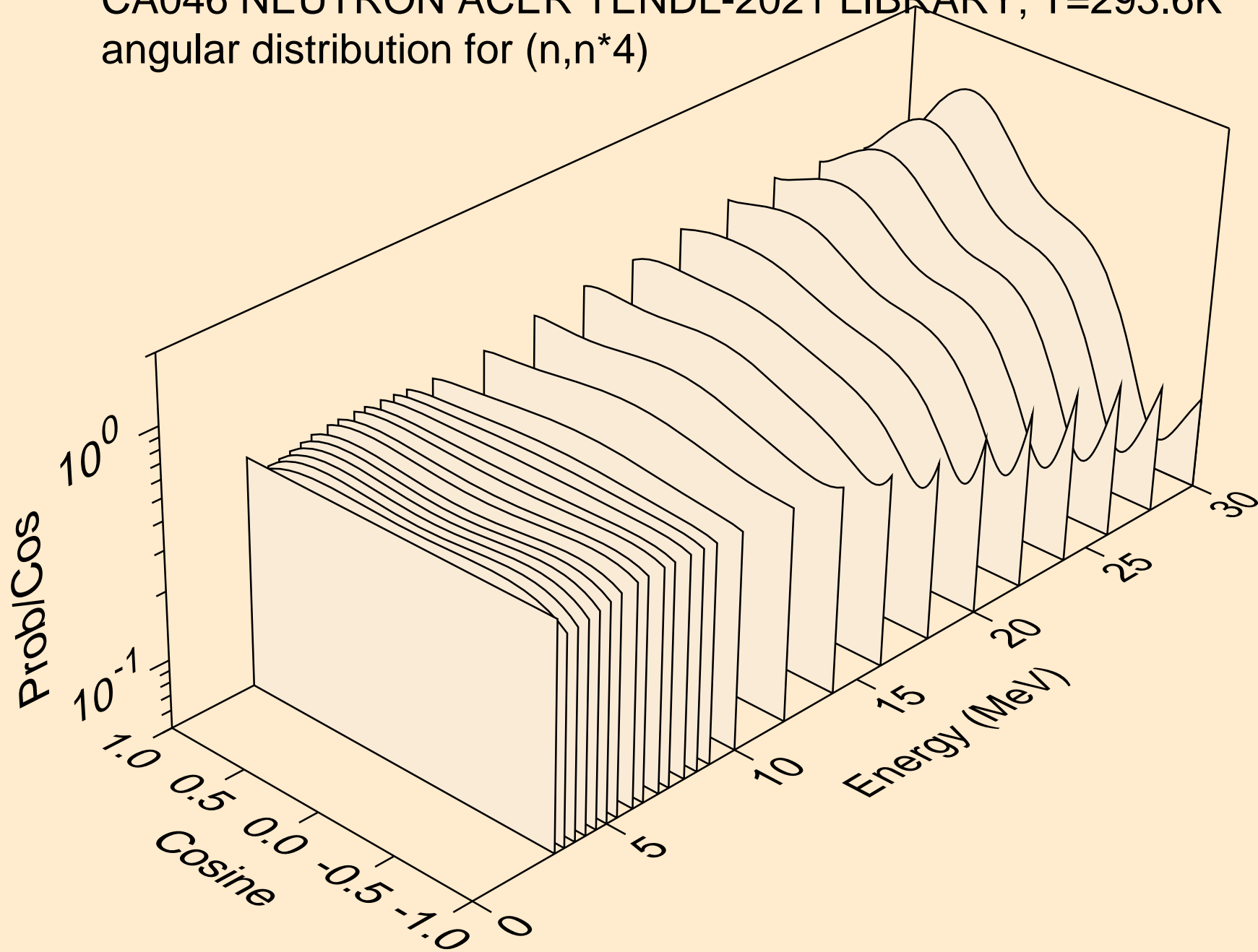

CA046 NEUTRON ACER TENDL-2021 LIBRARY; T=293.6K
angular distribution for (n,n*5)

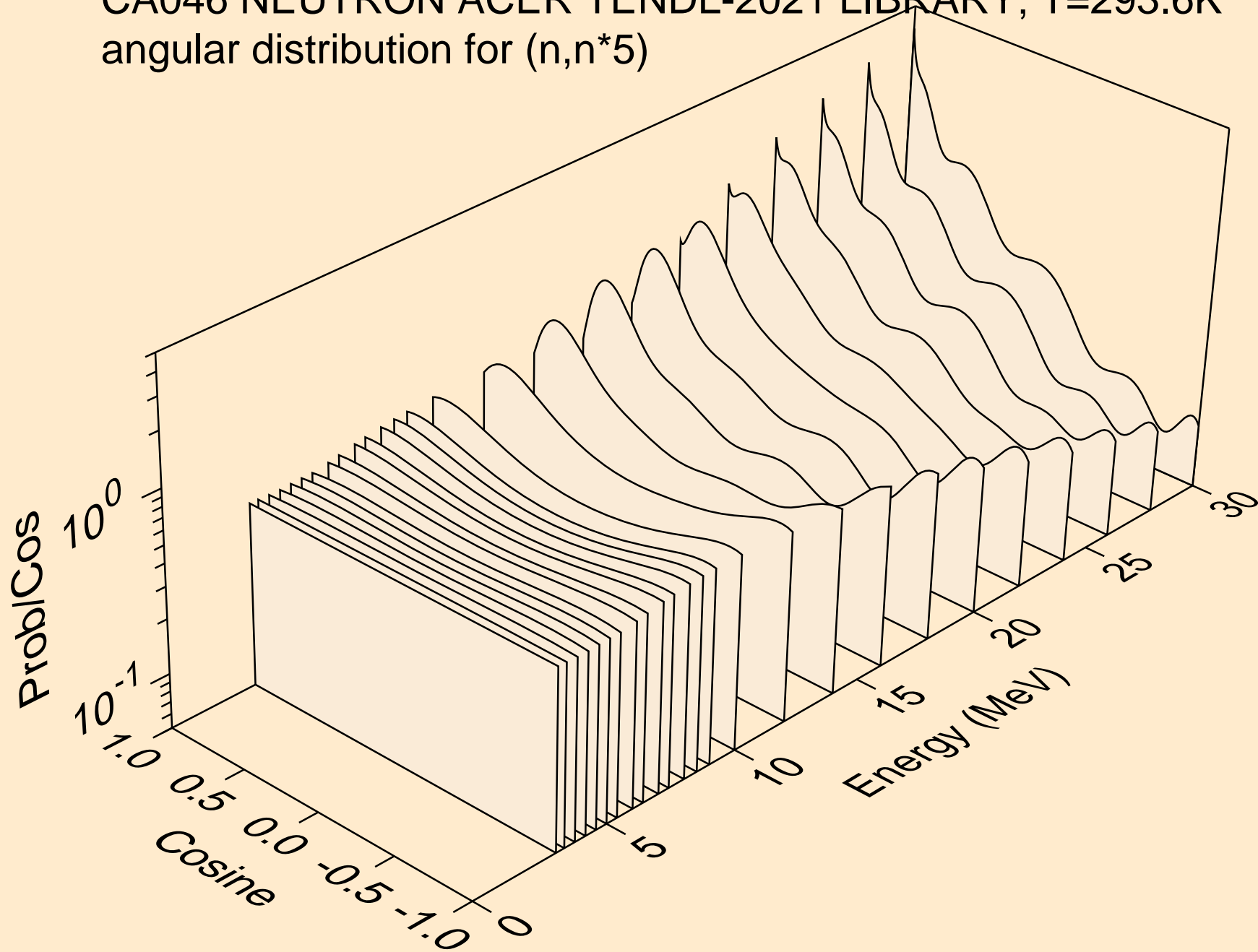

CA046 NEUTRON ACER TENDL-2021 LIBRARY; T=293.6K
angular distribution for (n,n*6)

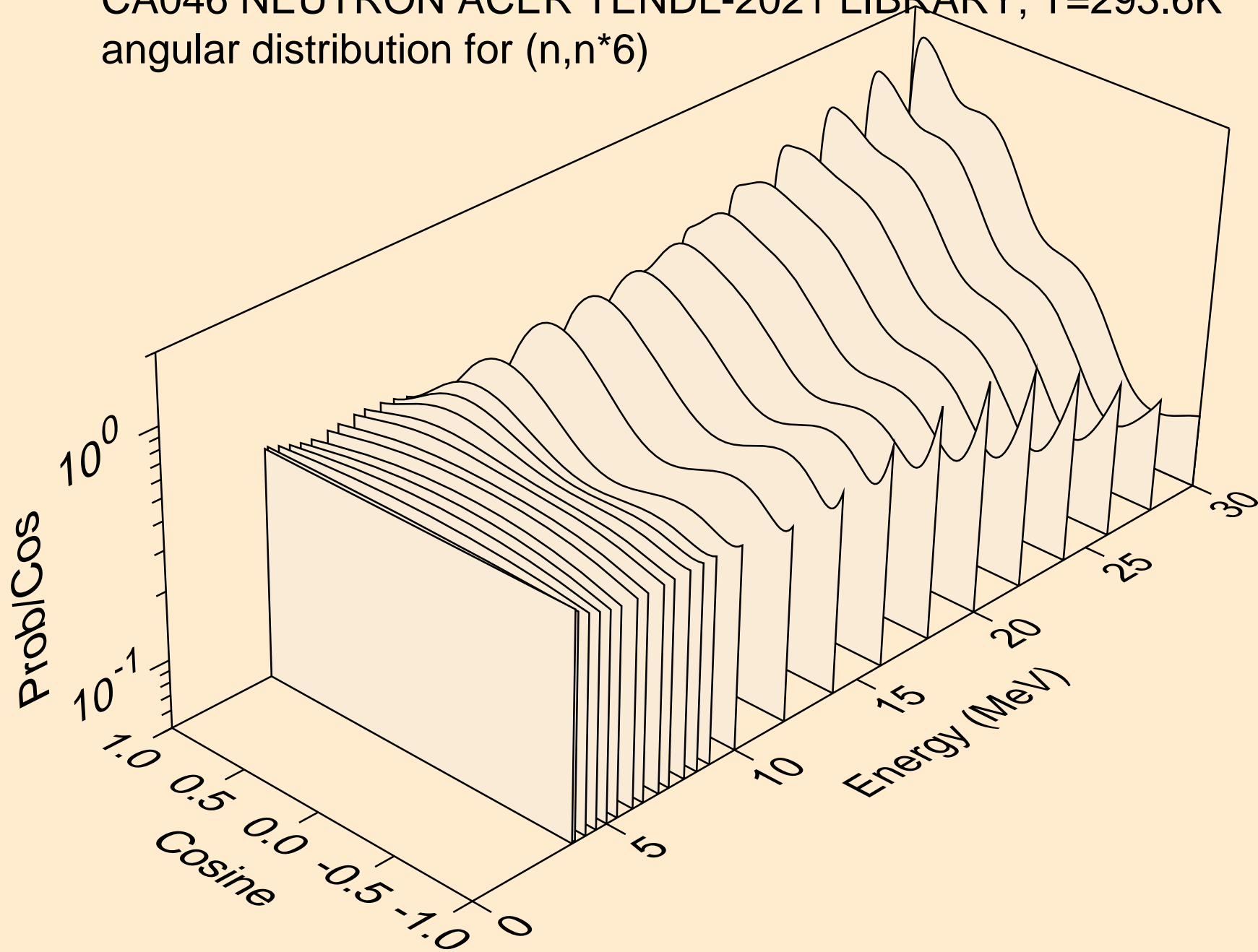

CA046 NEUTRON ACER TENDL-2021 LIBRARY; T=293.6K
angular distribution for (n,n*7)

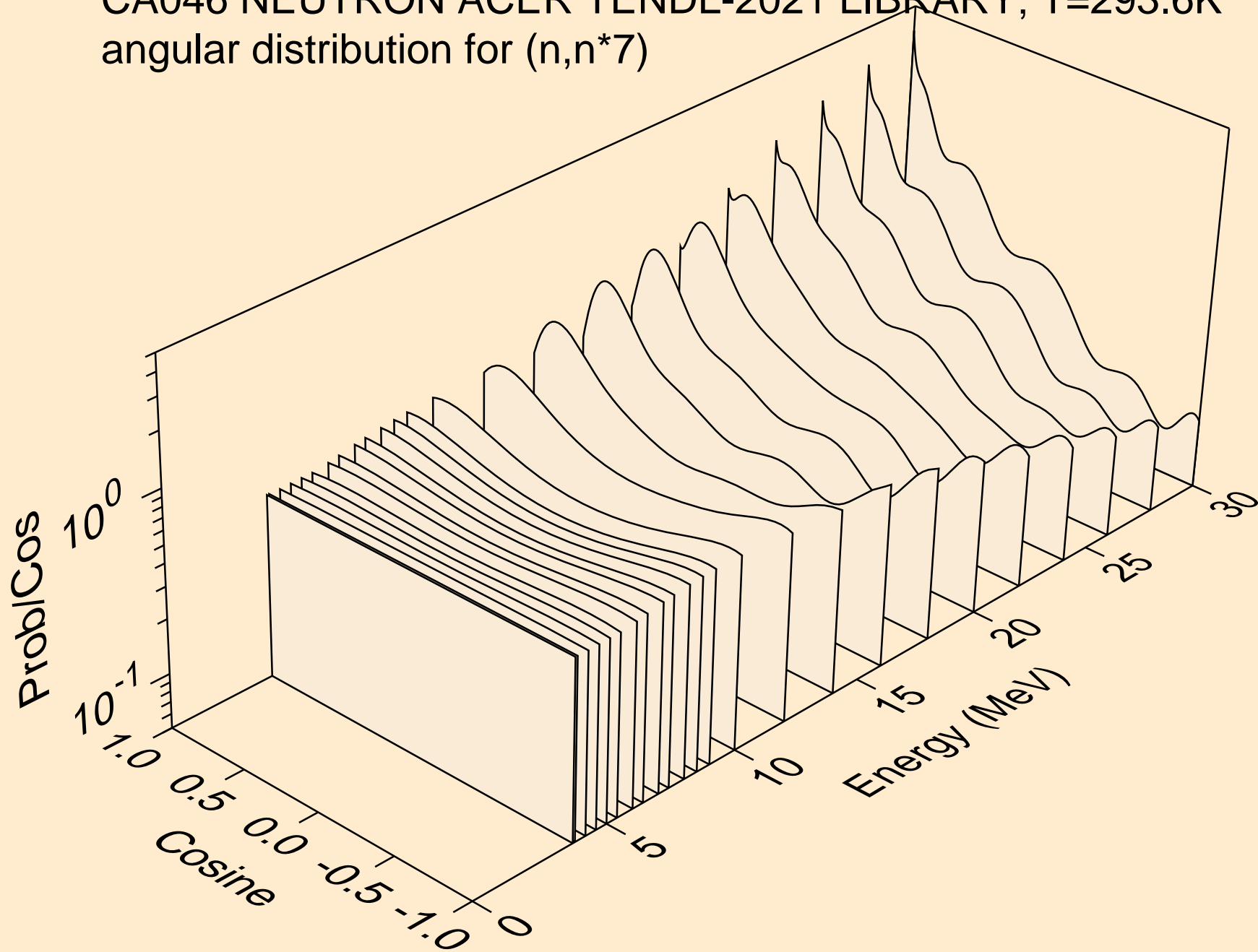

CA046 NEUTRON ACER TENDL-2021 LIBRARY; T=293.6K
angular distribution for (n,n*8)

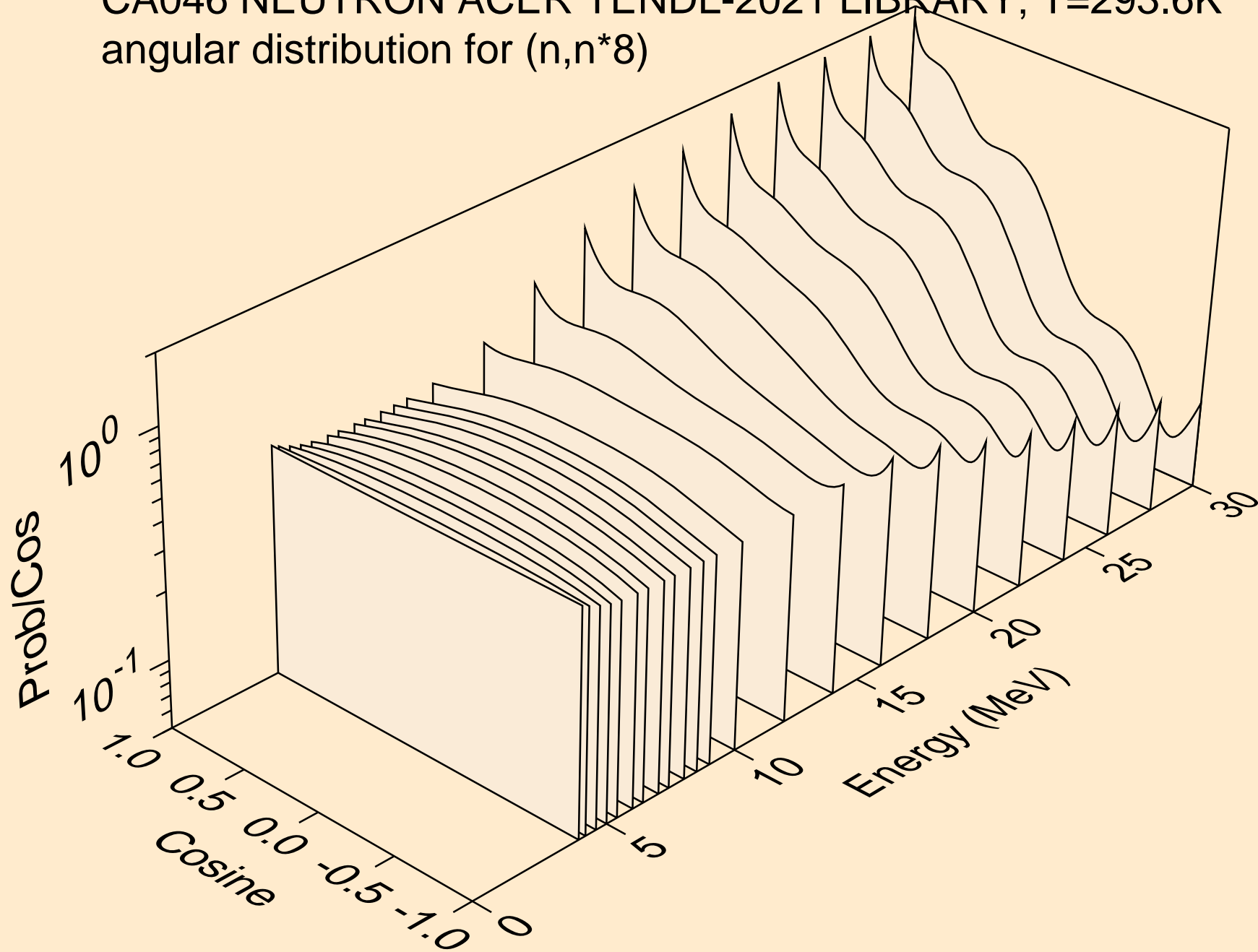

CA046 NEUTRON ACER TENDL-2021 LIBRARY; T=293.6K
angular distribution for (n,n*9)

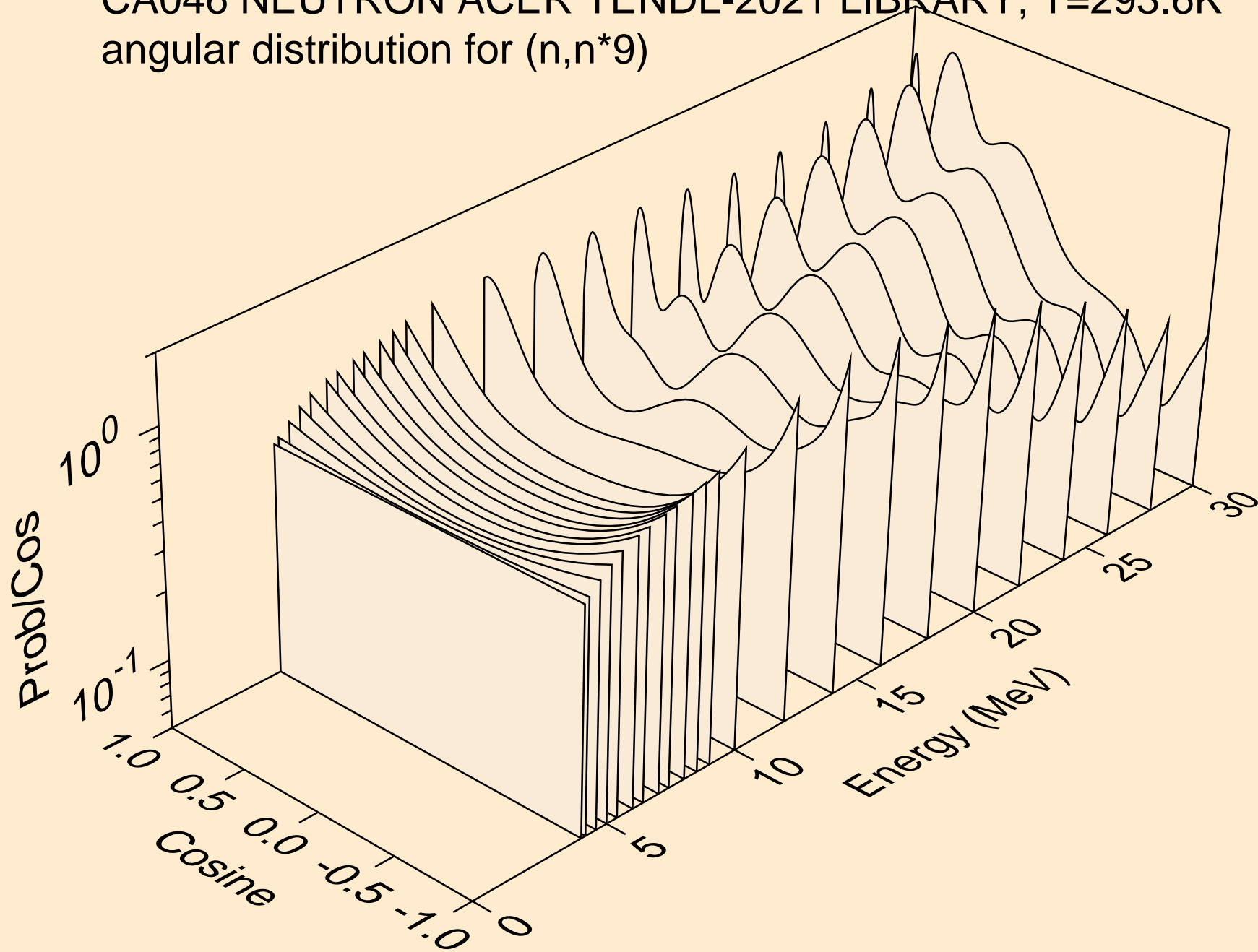

CA046 NEUTRON ACER TENDL-2021 LIBRARY; T=293.6K
angular distribution for (n,n*10)

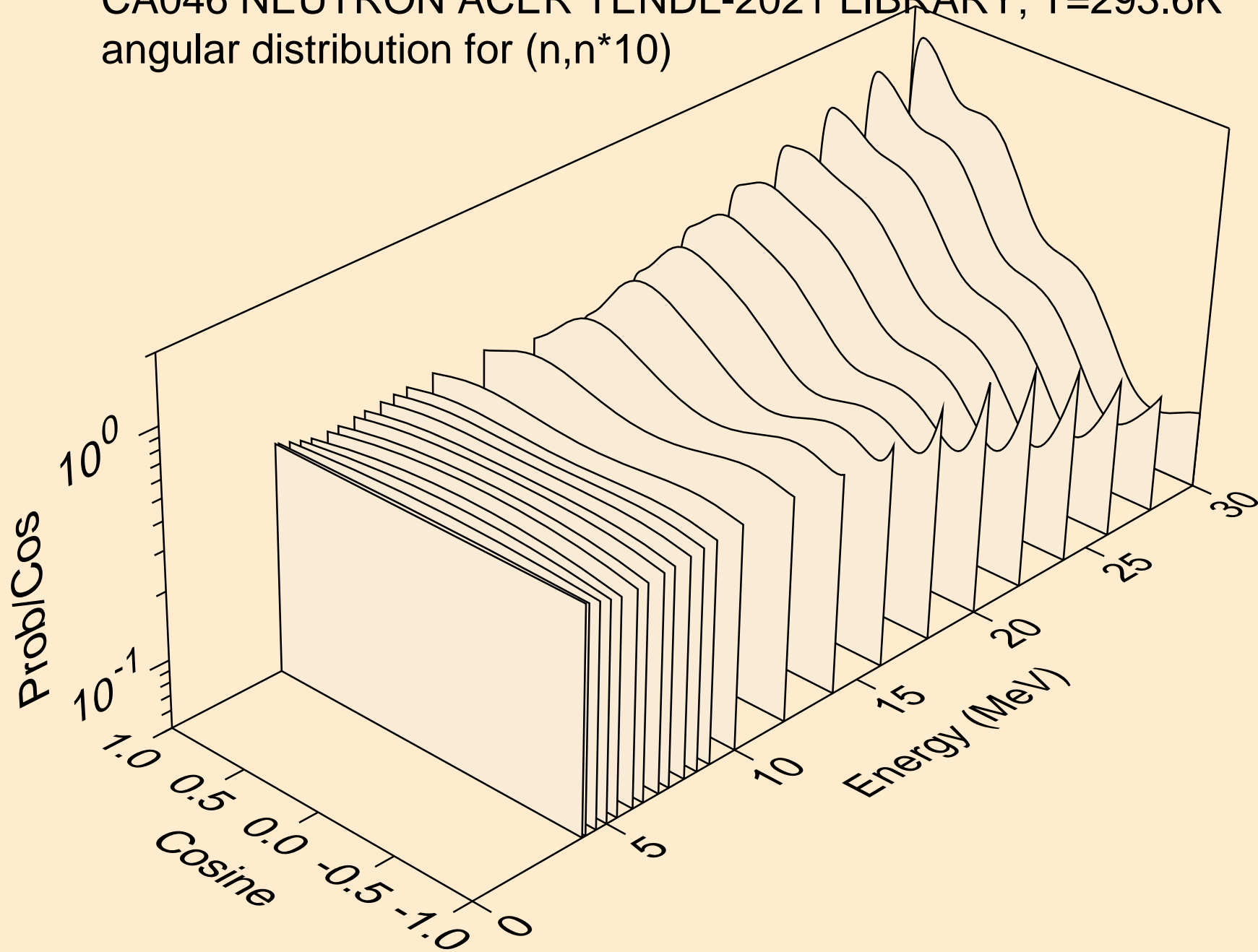

CA046 NEUTRON ACER TENDL-2021 LIBRARY; T=293.6K
angular distribution for (n,n*11)

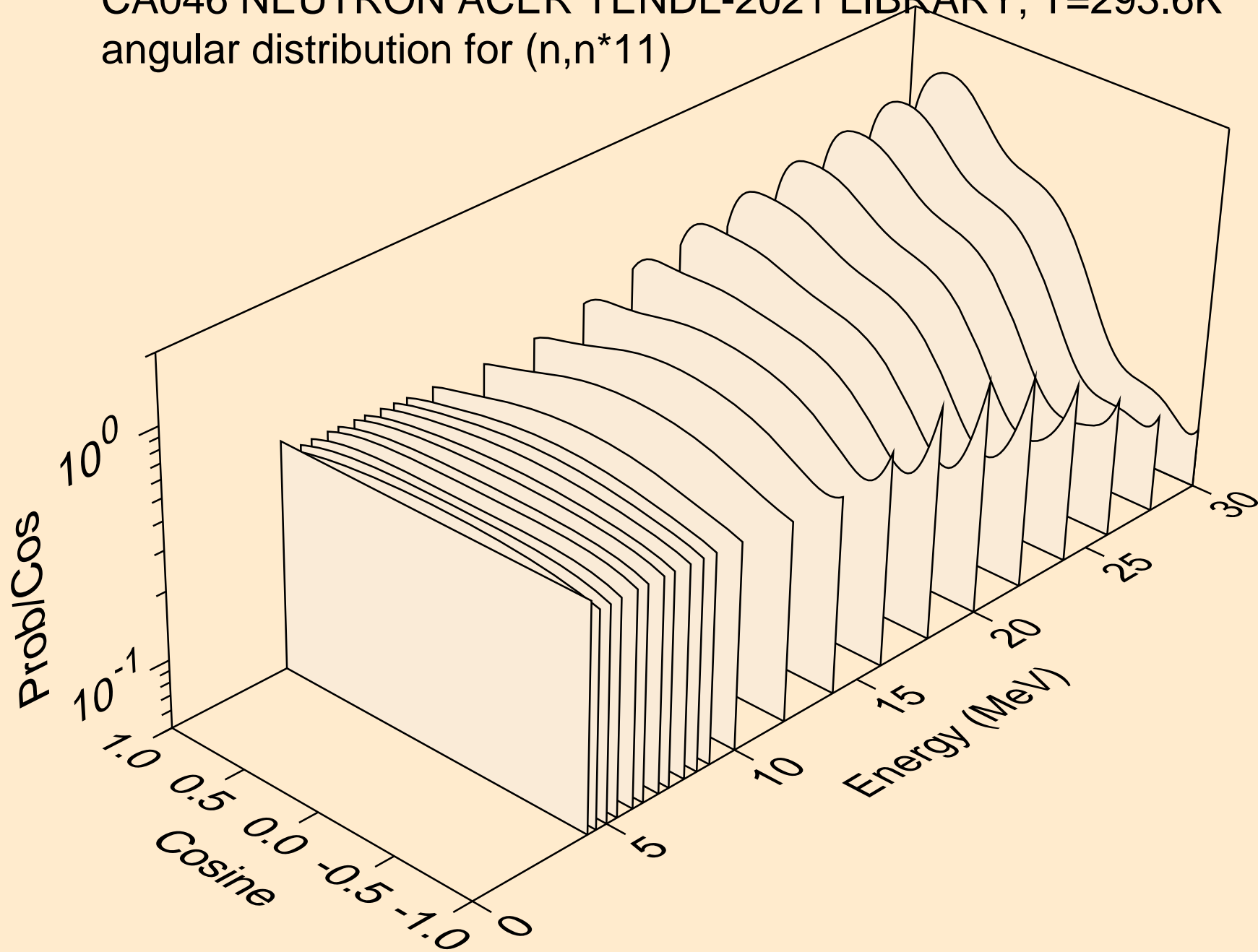

CA046 NEUTRON ACER TENDL-2021 LIBRARY; T=293.6K
angular distribution for (n,n*12)

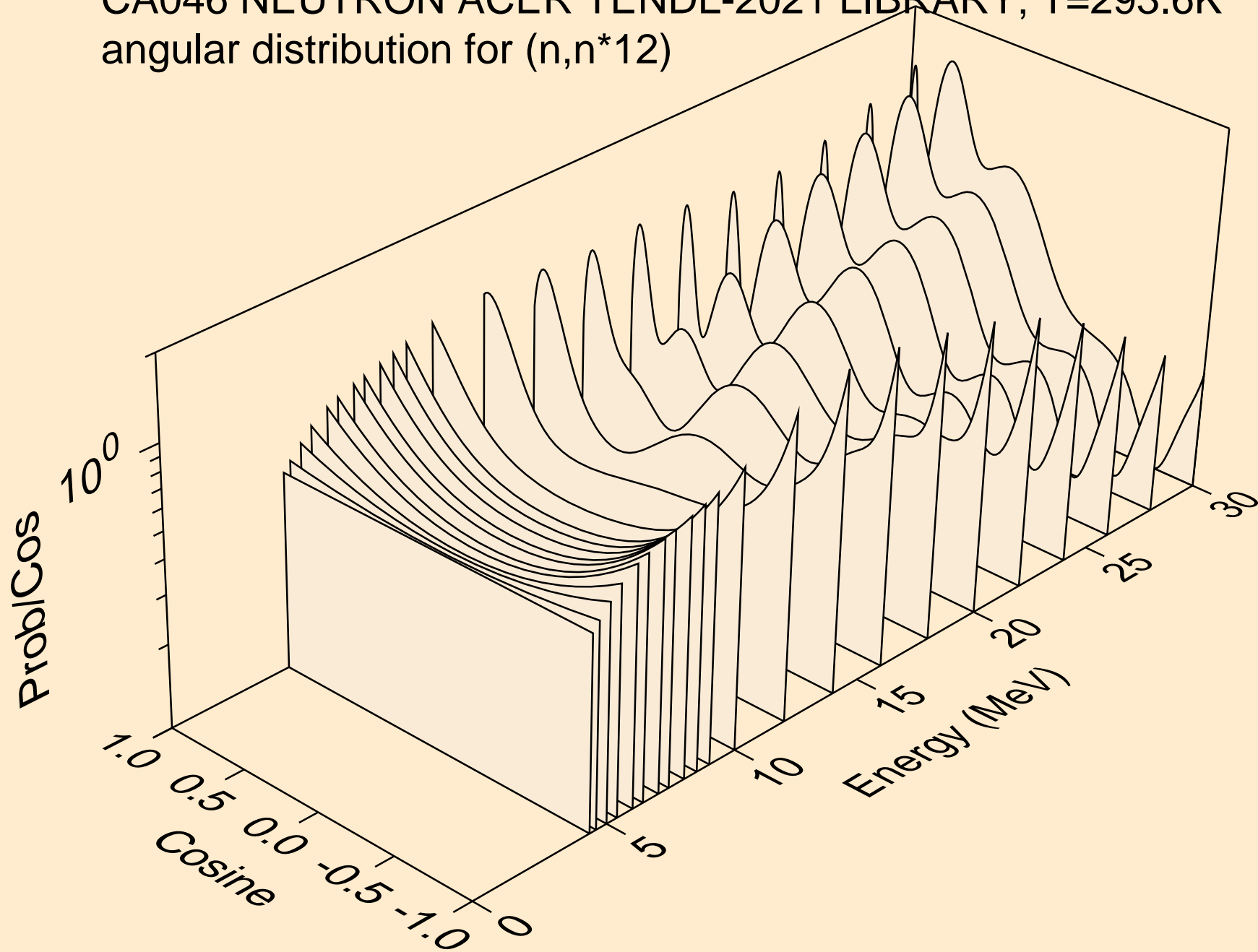

CA046 NEUTRON ACER TENDL-2021 LIBRARY; T=293.6K
angular distribution for (n,n*13)

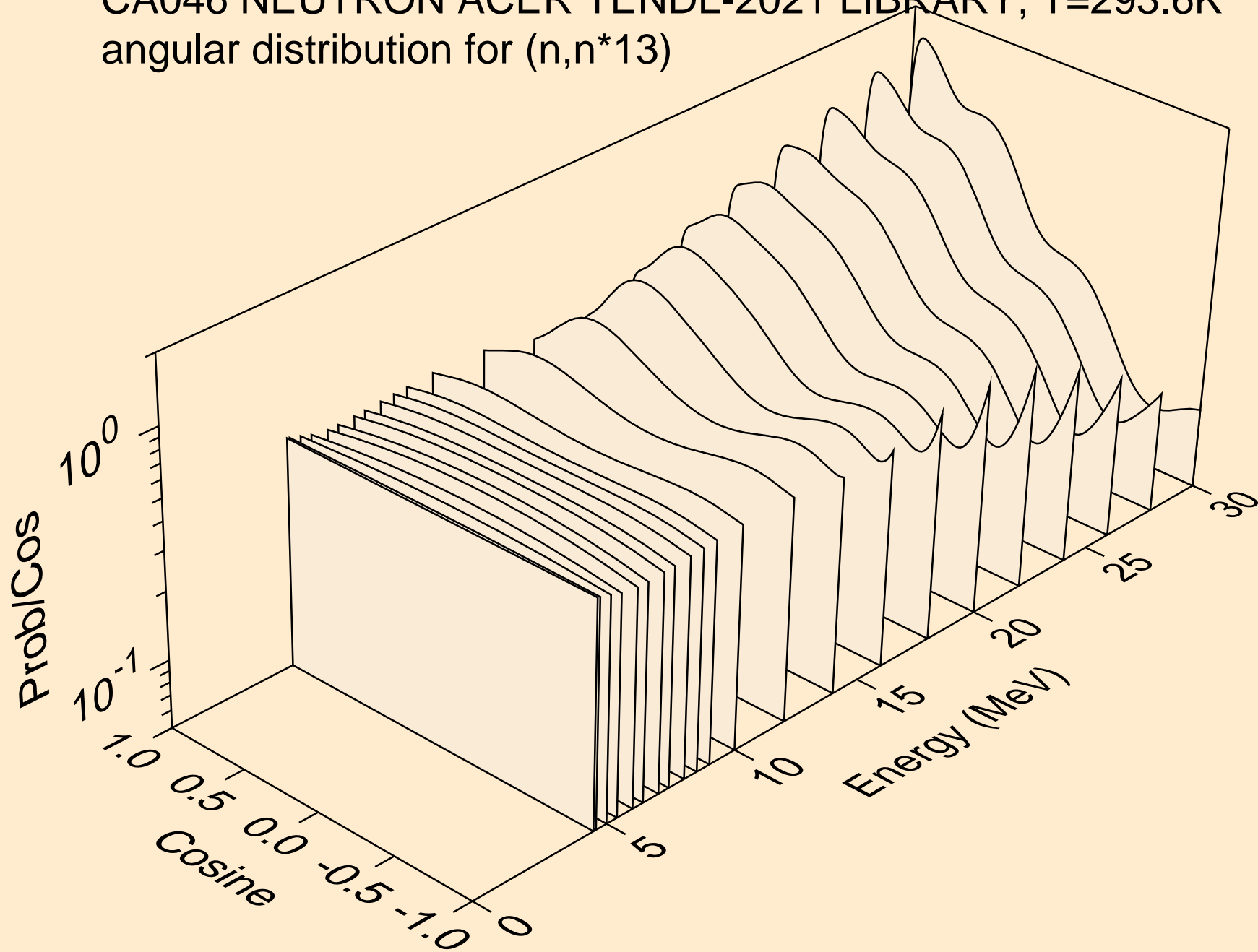

CA046 NEUTRON ACER TENDL-2021 LIBRARY; T=293.6K
angular distribution for (n,n*14)

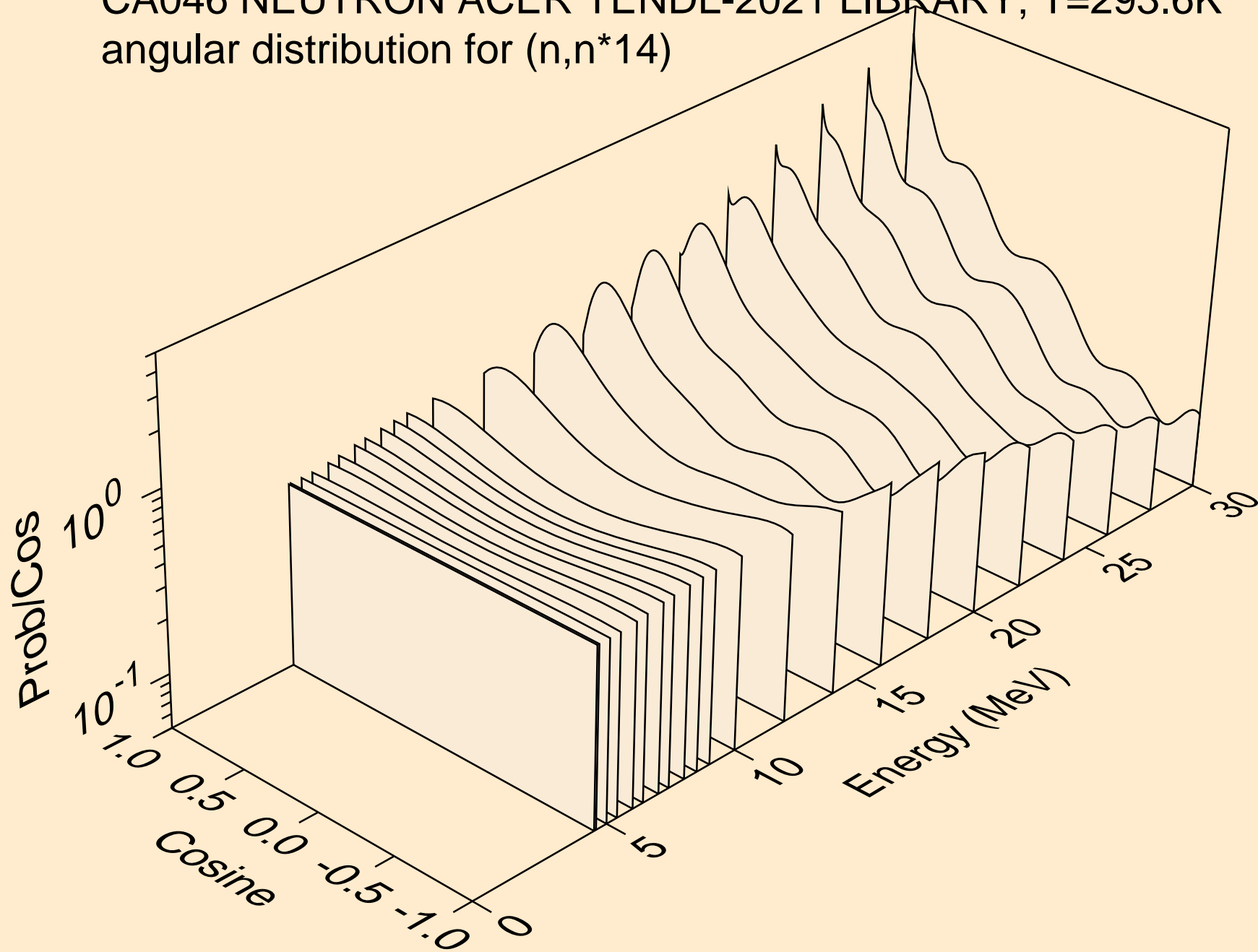

CA046 NEUTRON ACER TENDL-2021 LIBRARY; T=293.6K
angular distribution for (n,n*15)

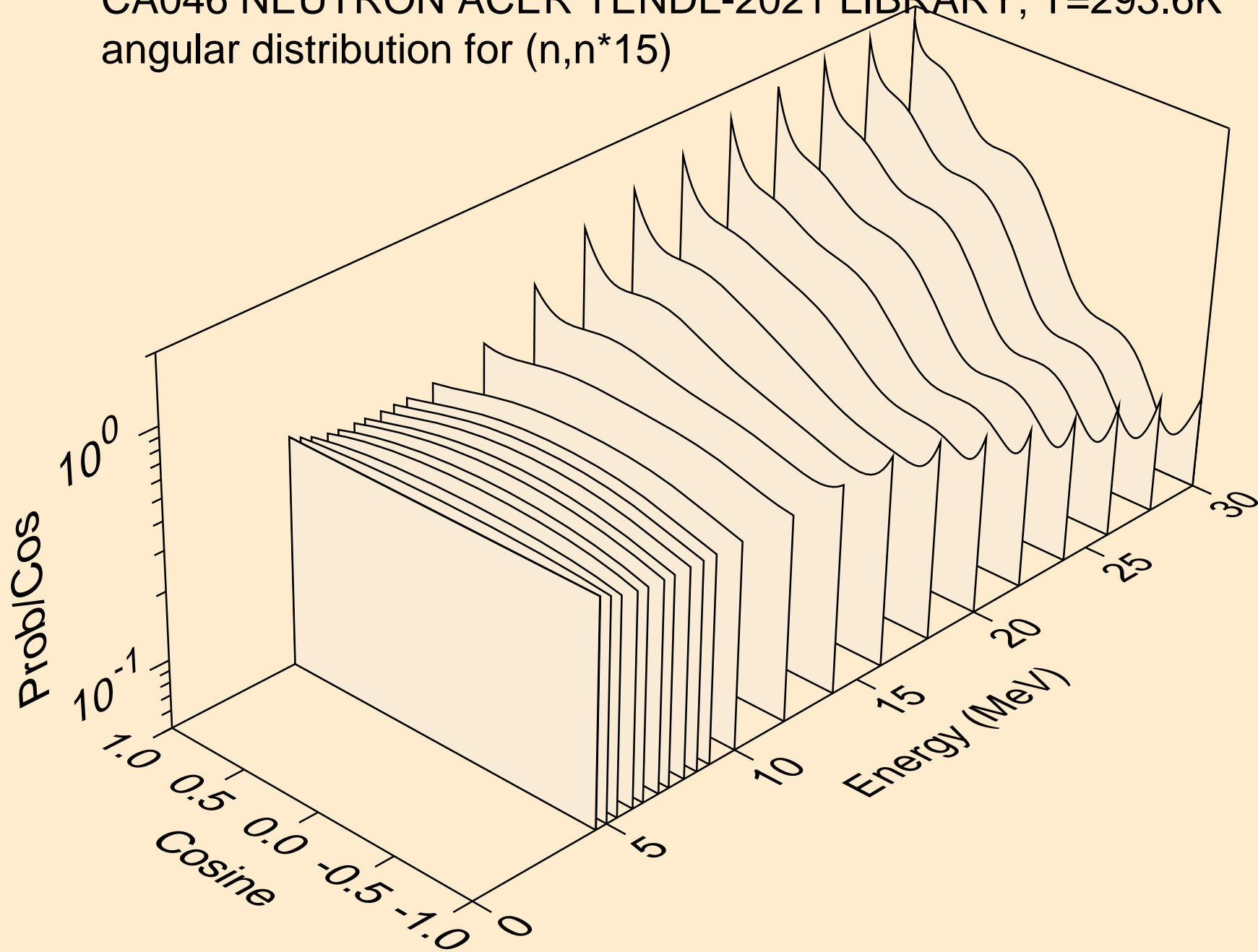

CA046 NEUTRON ACER TENDL-2021 LIBRARY; T=293.6K
angular distribution for (n,n*16)

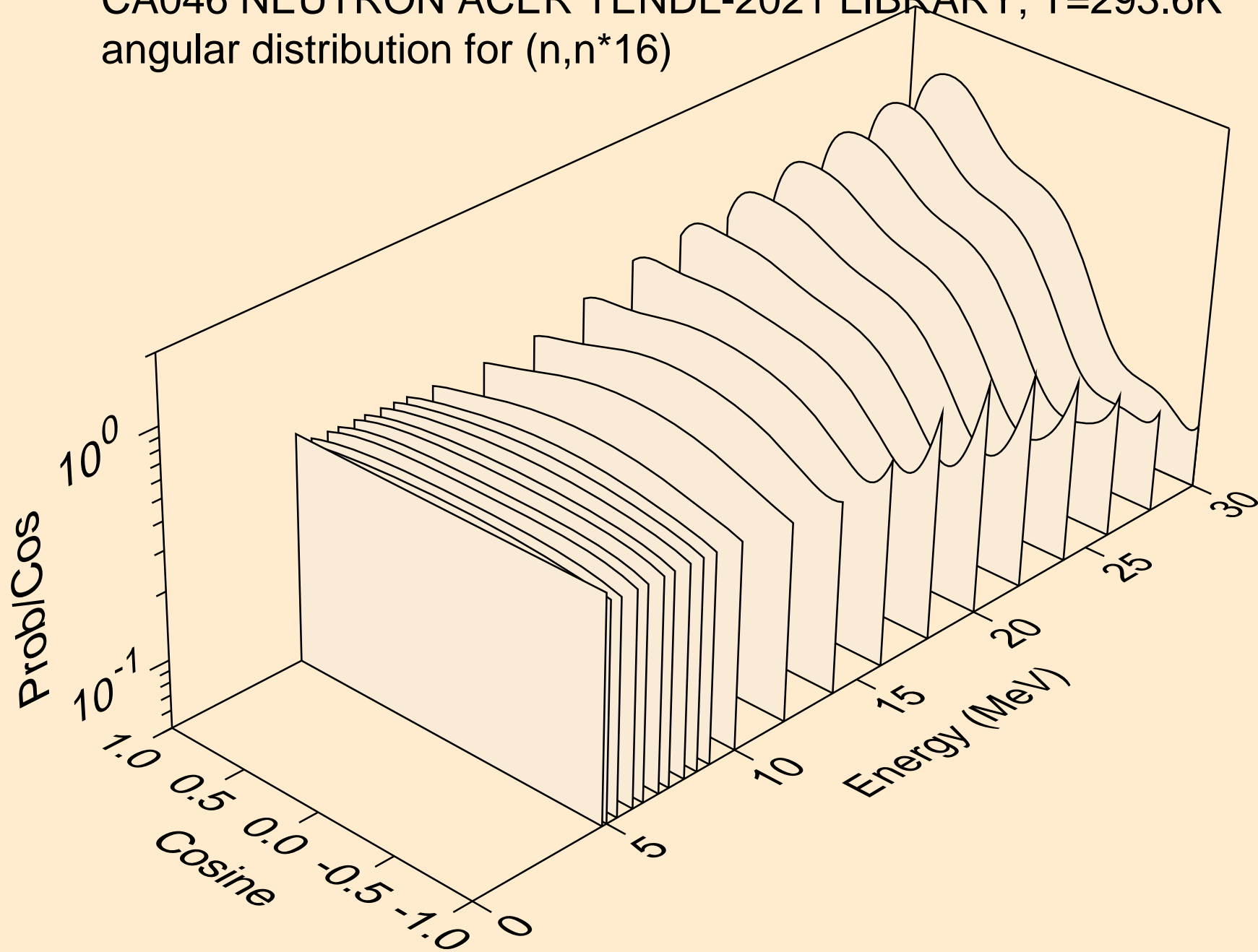

CA046 NEUTRON ACER TENDL-2021 LIBRARY; T=293.6K
angular distribution for (n,n*17)

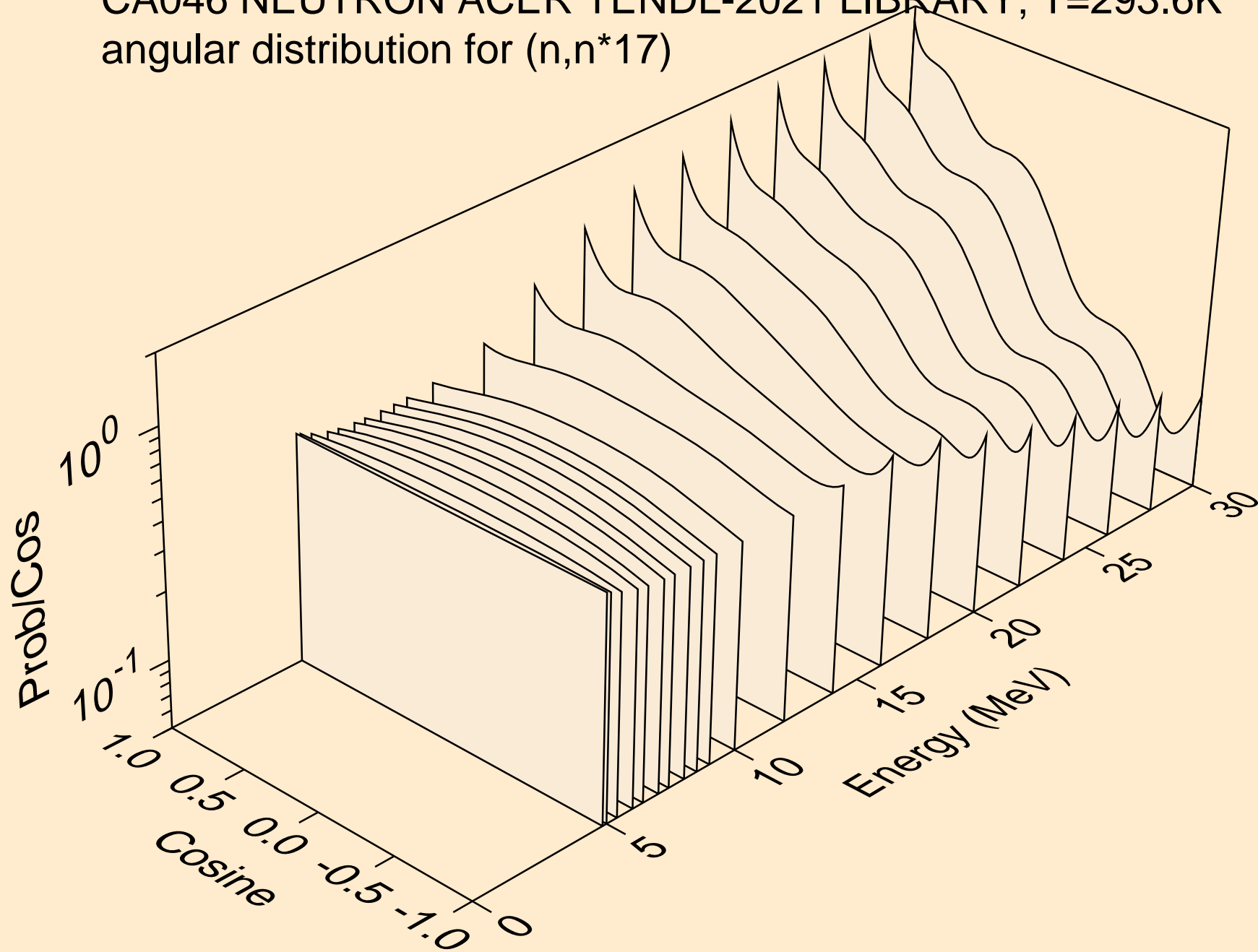

CA046 NEUTRON ACER TENDL-2021 LIBRARY; T=293.6K
angular distribution for (n,n*18)

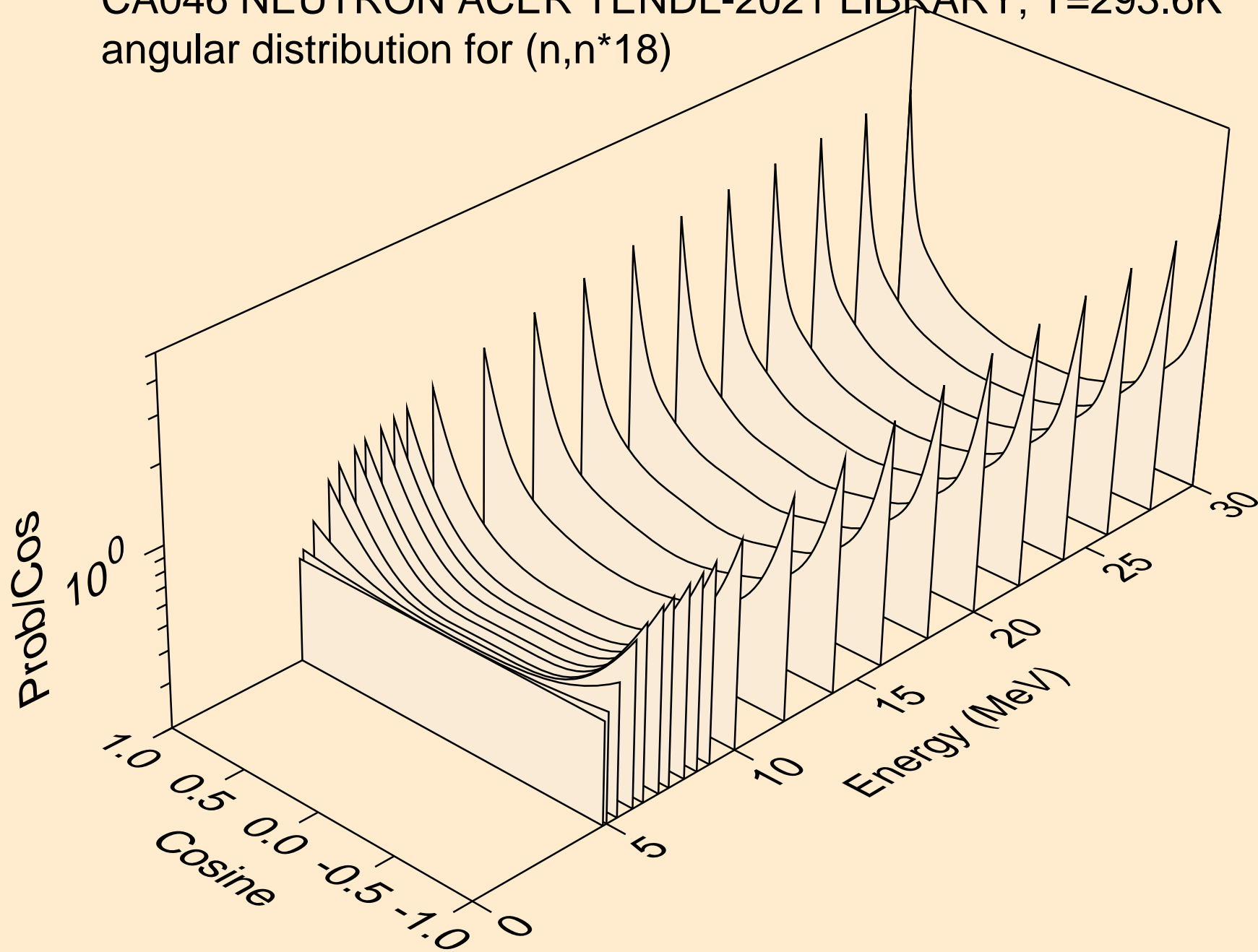

CA046 NEUTRON ACER TENDL-2021 LIBRARY; T=293.6K
angular distribution for (n,n*19)

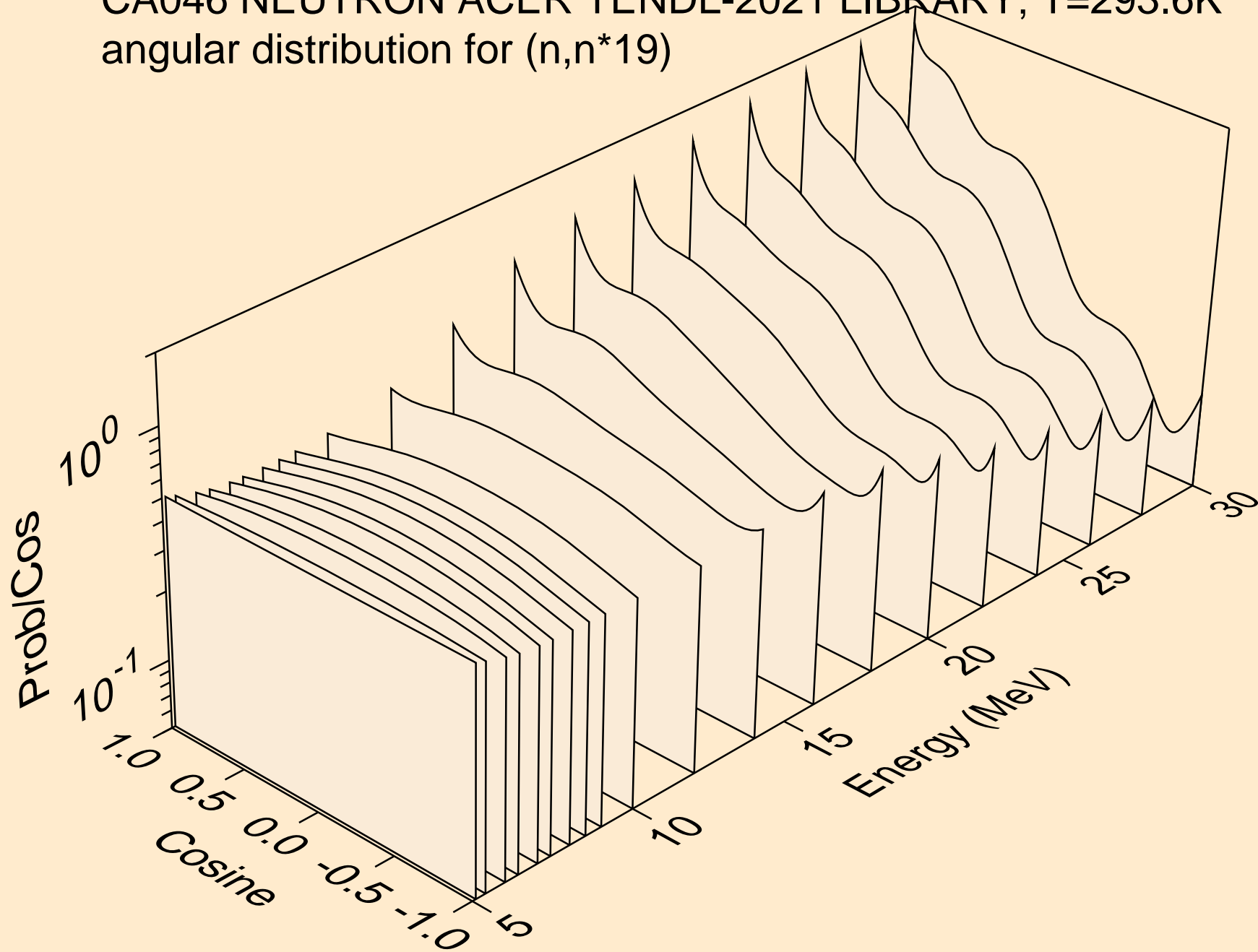

CA046 NEUTRON ACER TENDL-2021 LIBRARY; T=293.6K
angular distribution for (n,n*20)

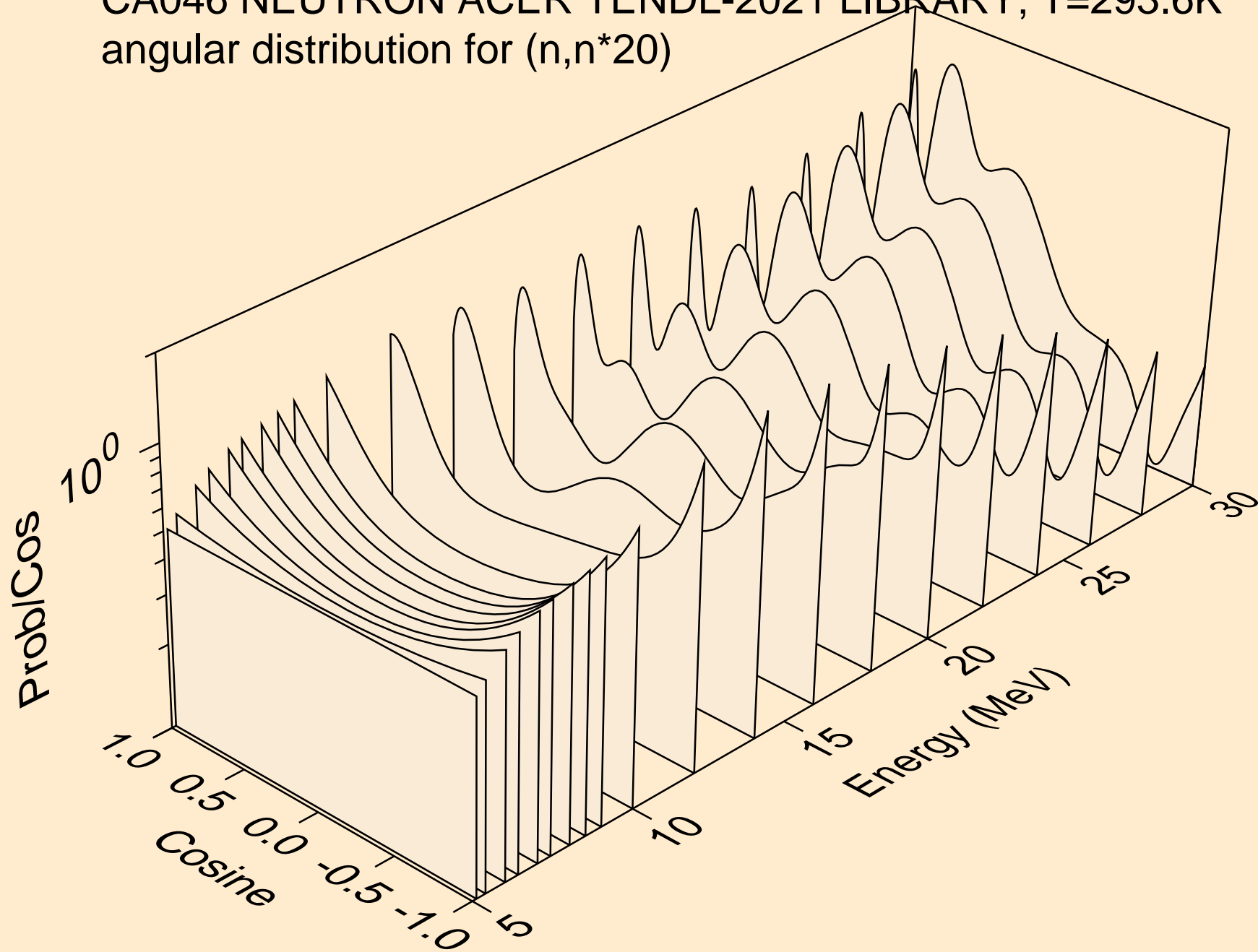

CA046 NEUTRON ACER TENDL-2021 LIBRARY; T=293.6K
angular distribution for (n,n*21)

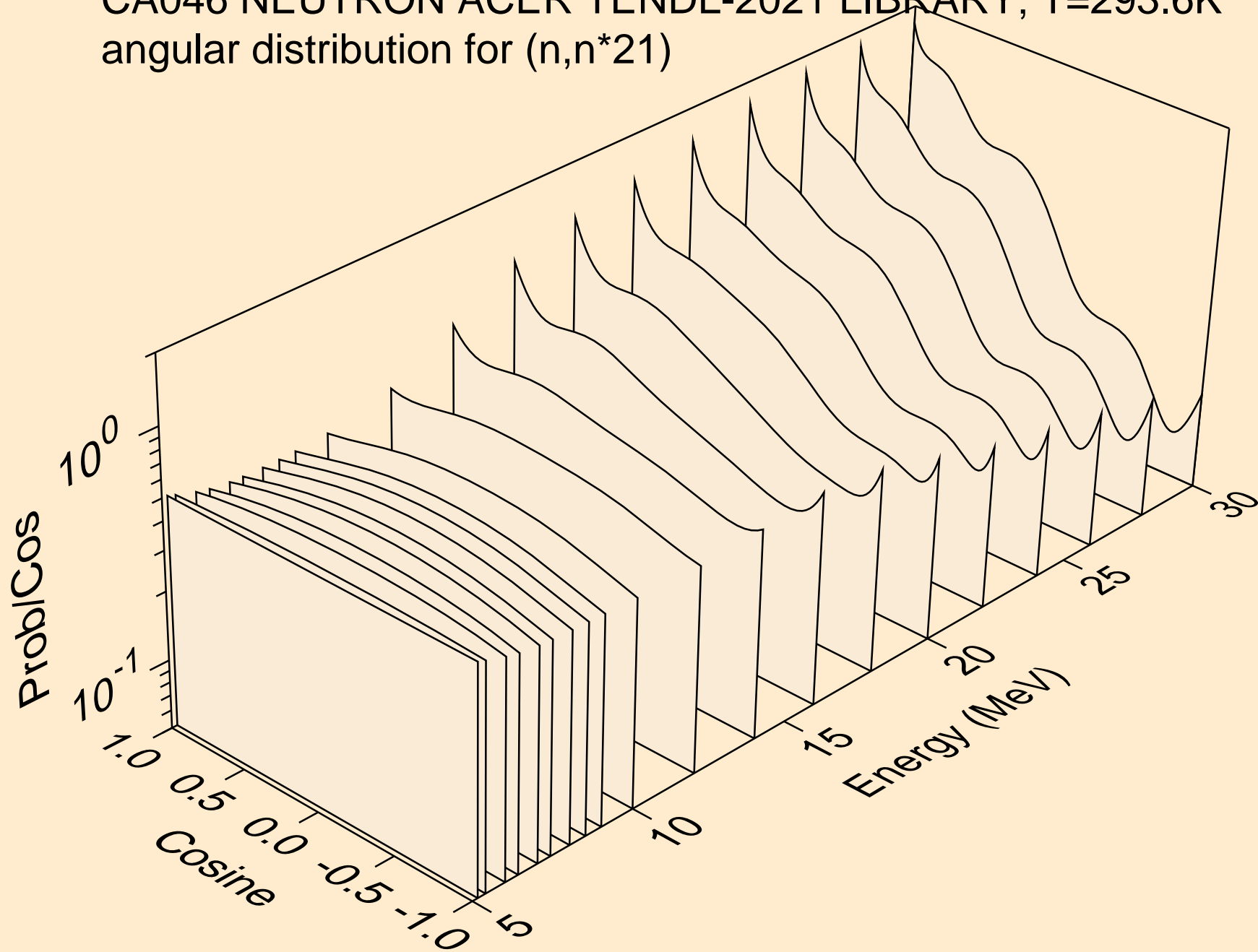

CA046 NEUTRON ACER TENDL-2021 LIBRARY; T=293.6K
angular distribution for (n,n*22)

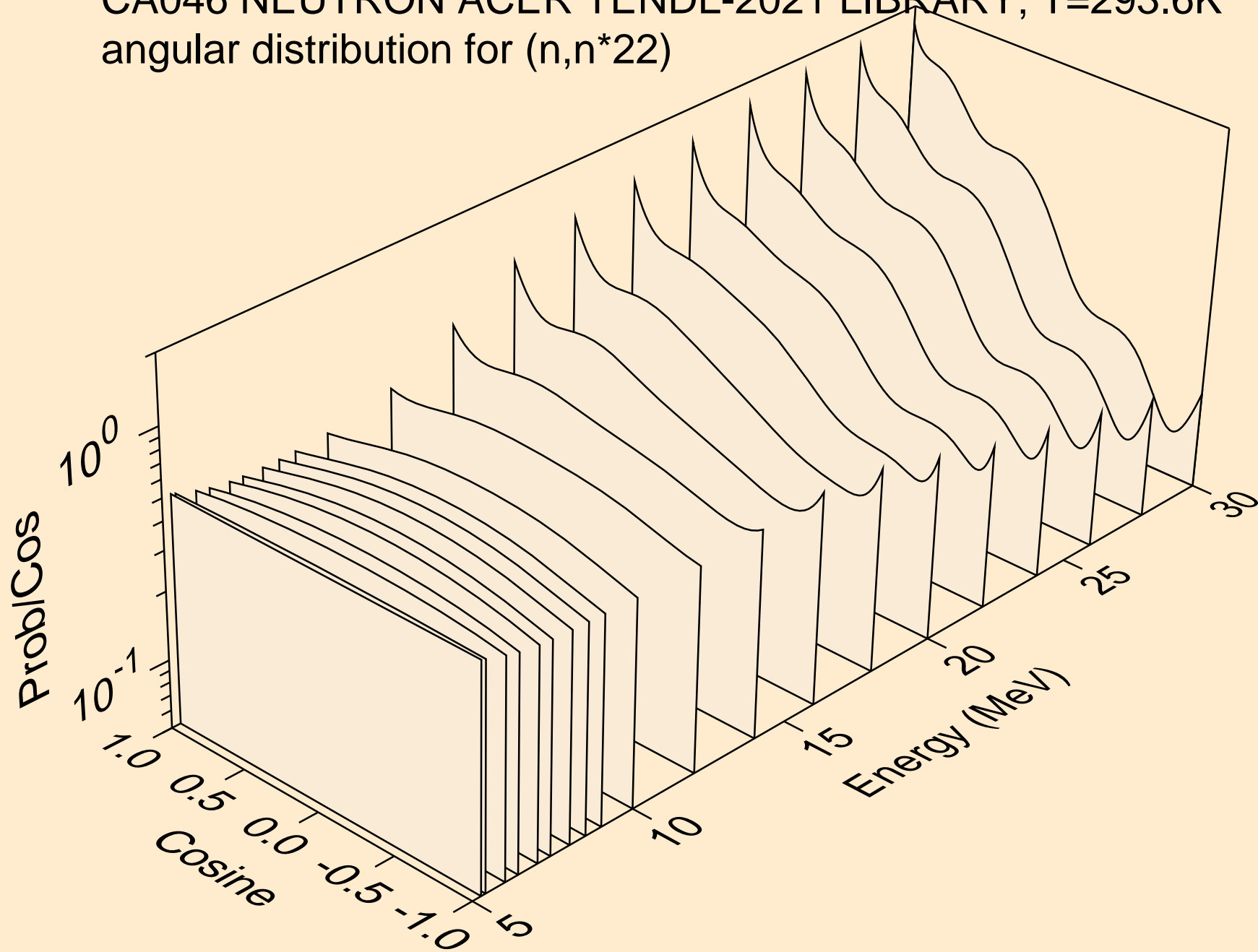

CA046 NEUTRON ACER TENDL-2021 LIBRARY; T=293.6K
angular distribution for (n,n*23)

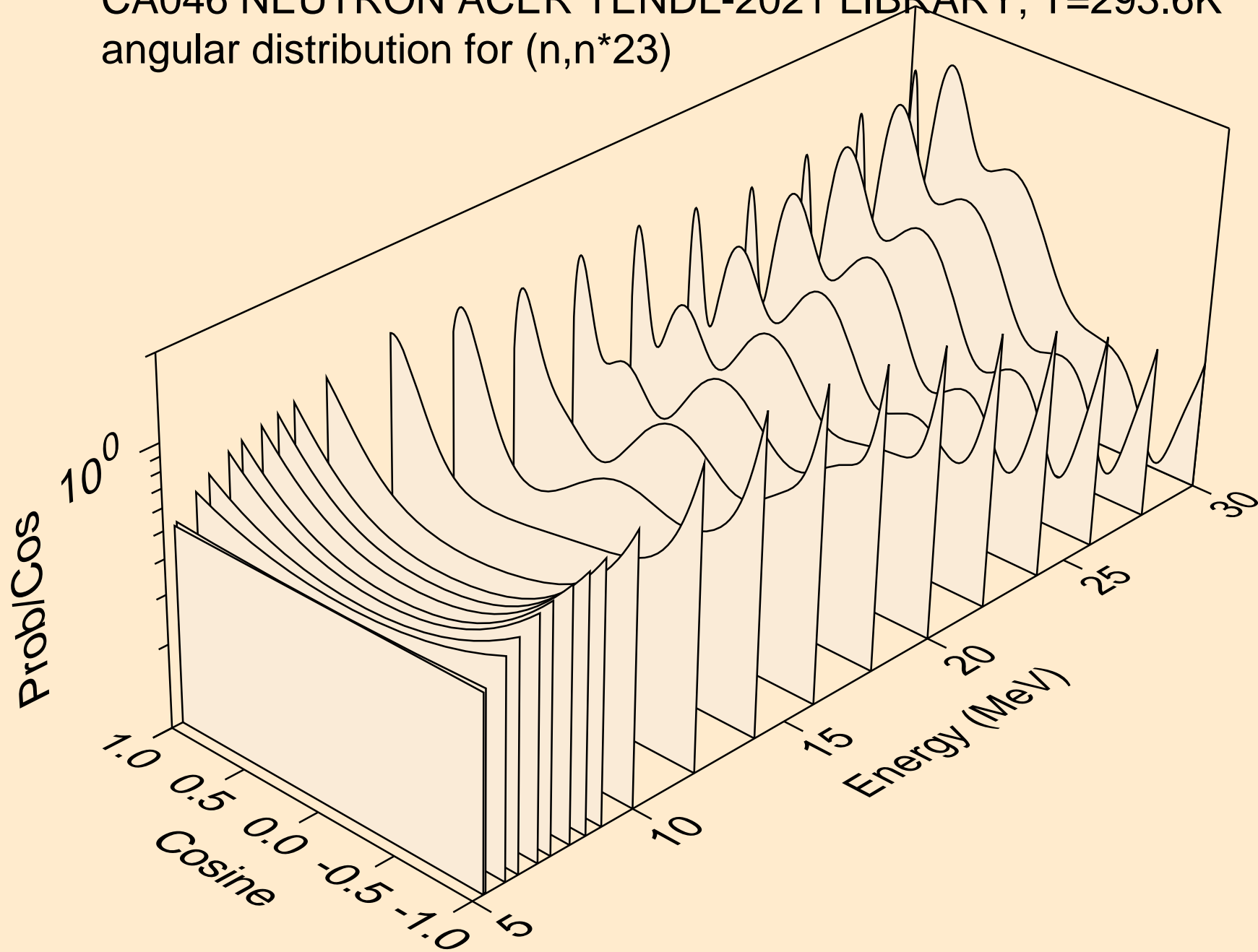

CA046 NEUTRON ACER TENDL-2021 LIBRARY; T=293.6K
angular distribution for (n,n*24)

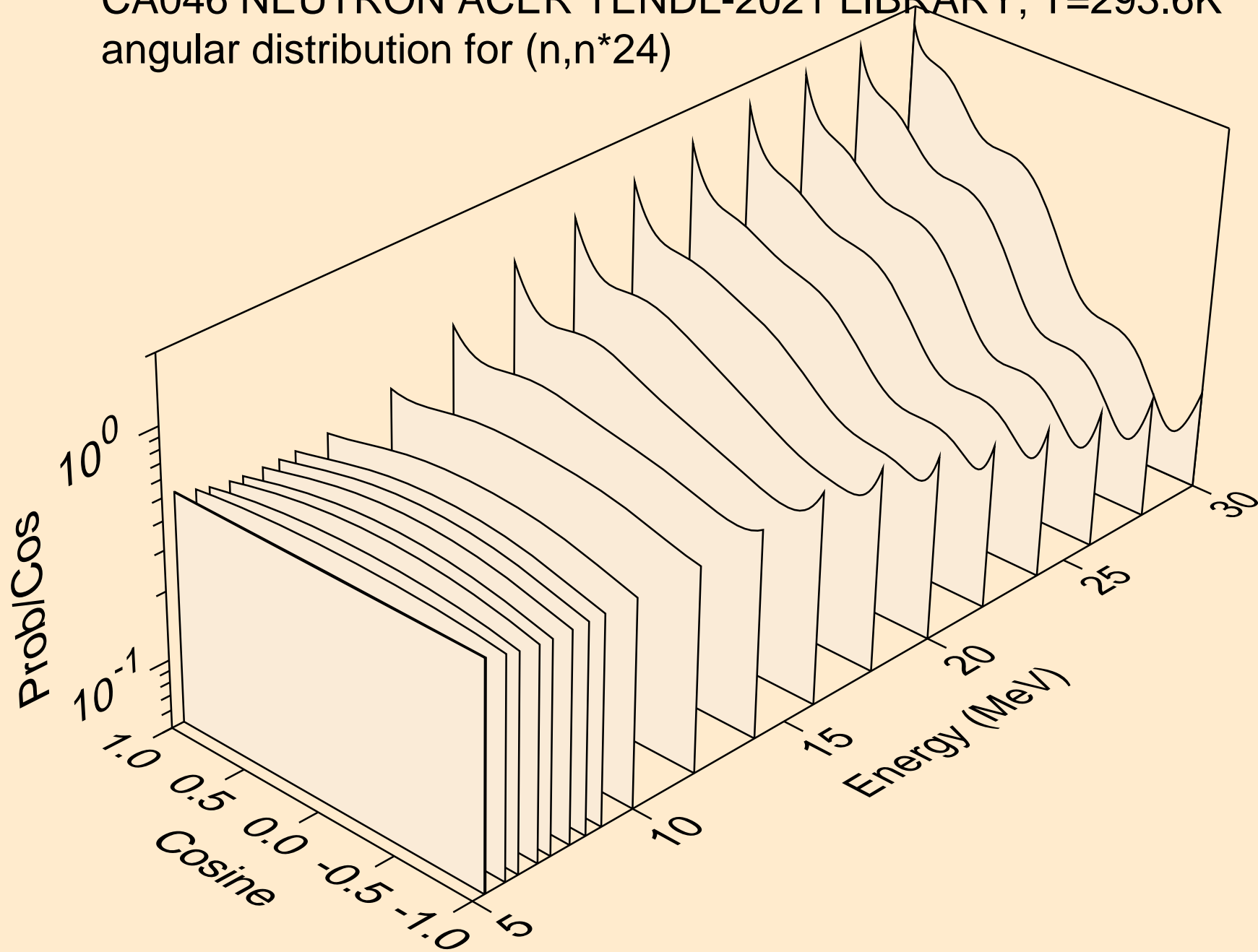

CA046 NEUTRON ACER TENDL-2021 LIBRARY; T=293.6K
angular distribution for (n,n*25)

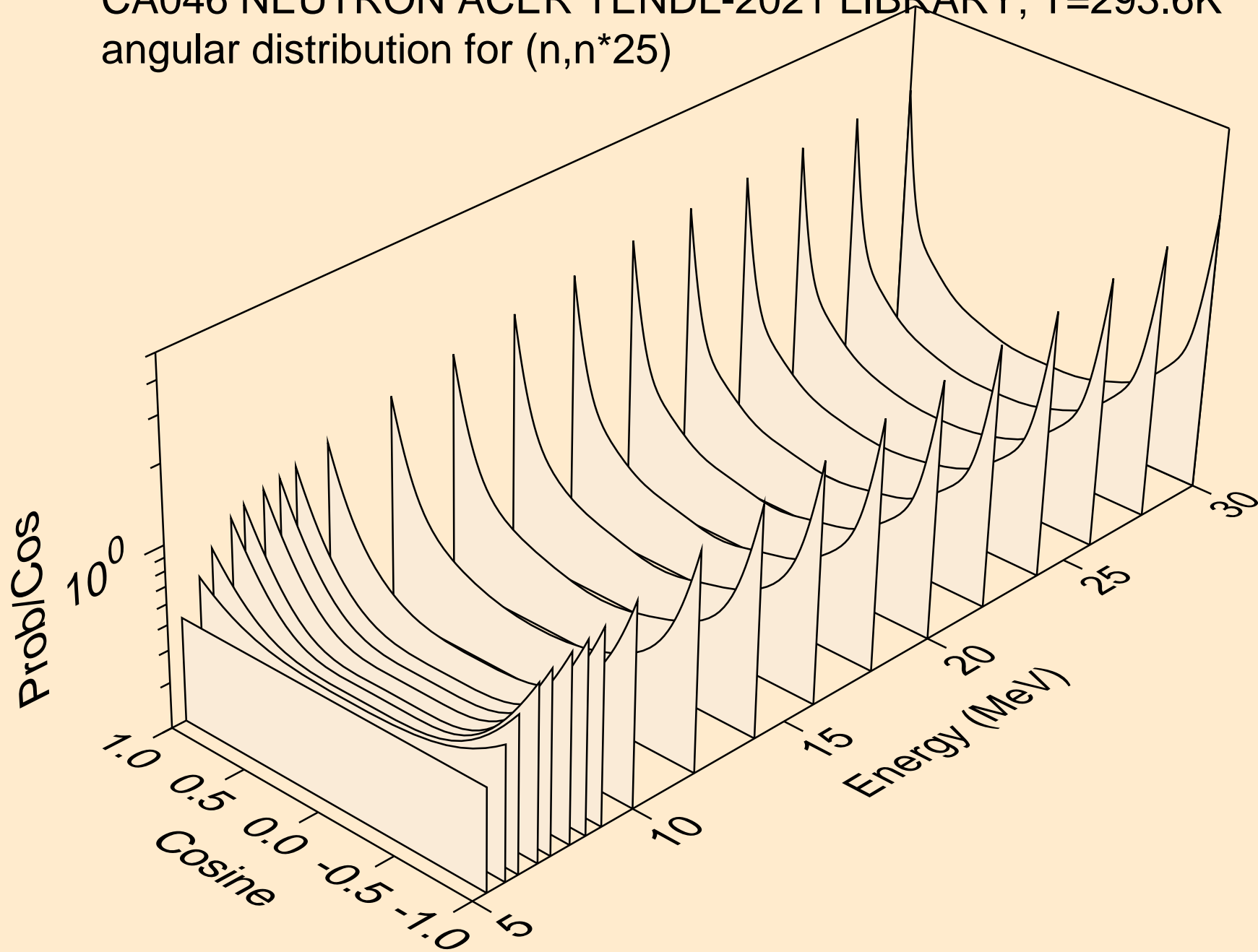

CA046 NEUTRON ACER TENDL-2021 LIBRARY; T=293.6K
angular distribution for (n,n*26)

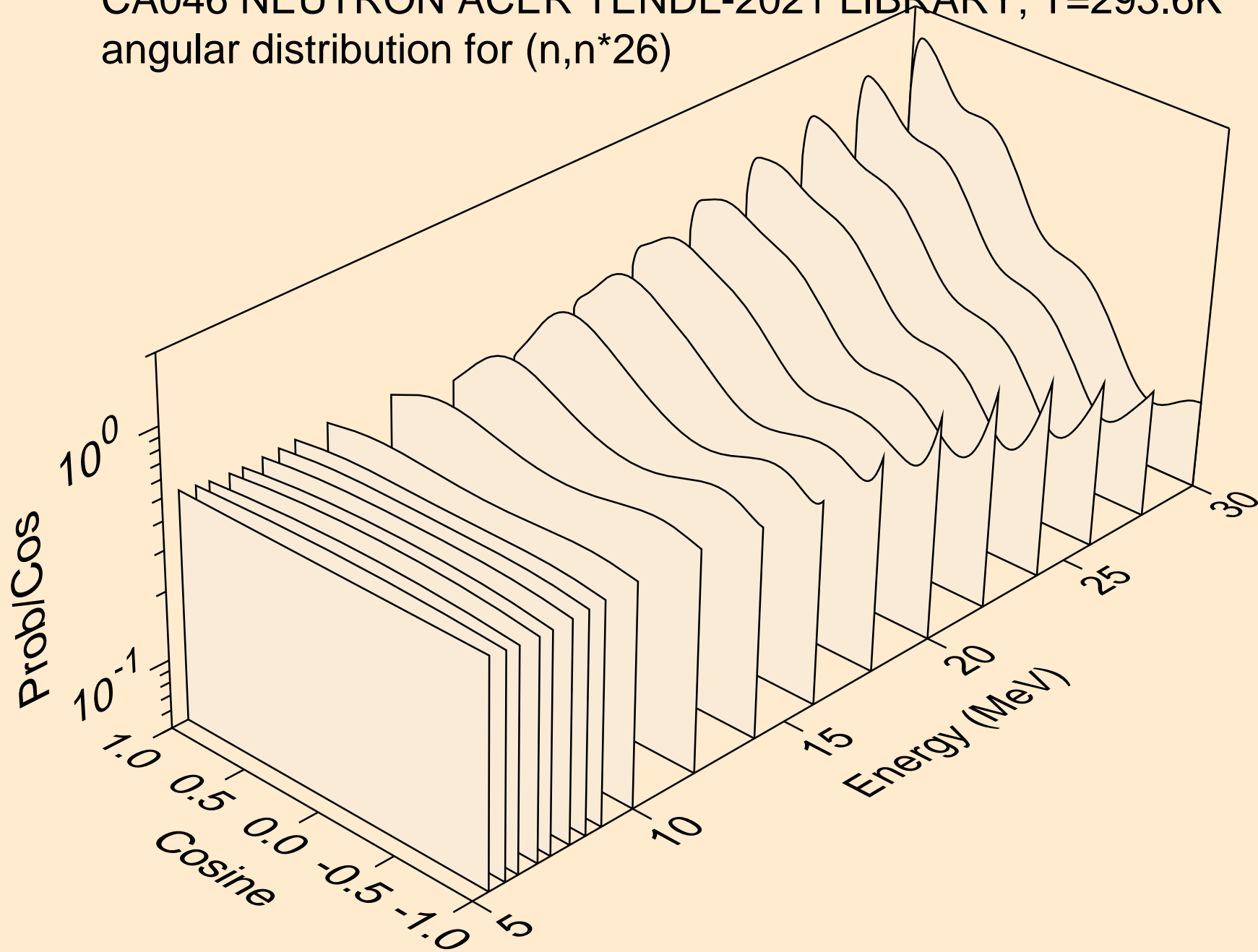

CA046 NEUTRON ACER TENDL-2021 LIBRARY; T=293.6K
angular distribution for (n,n*27)

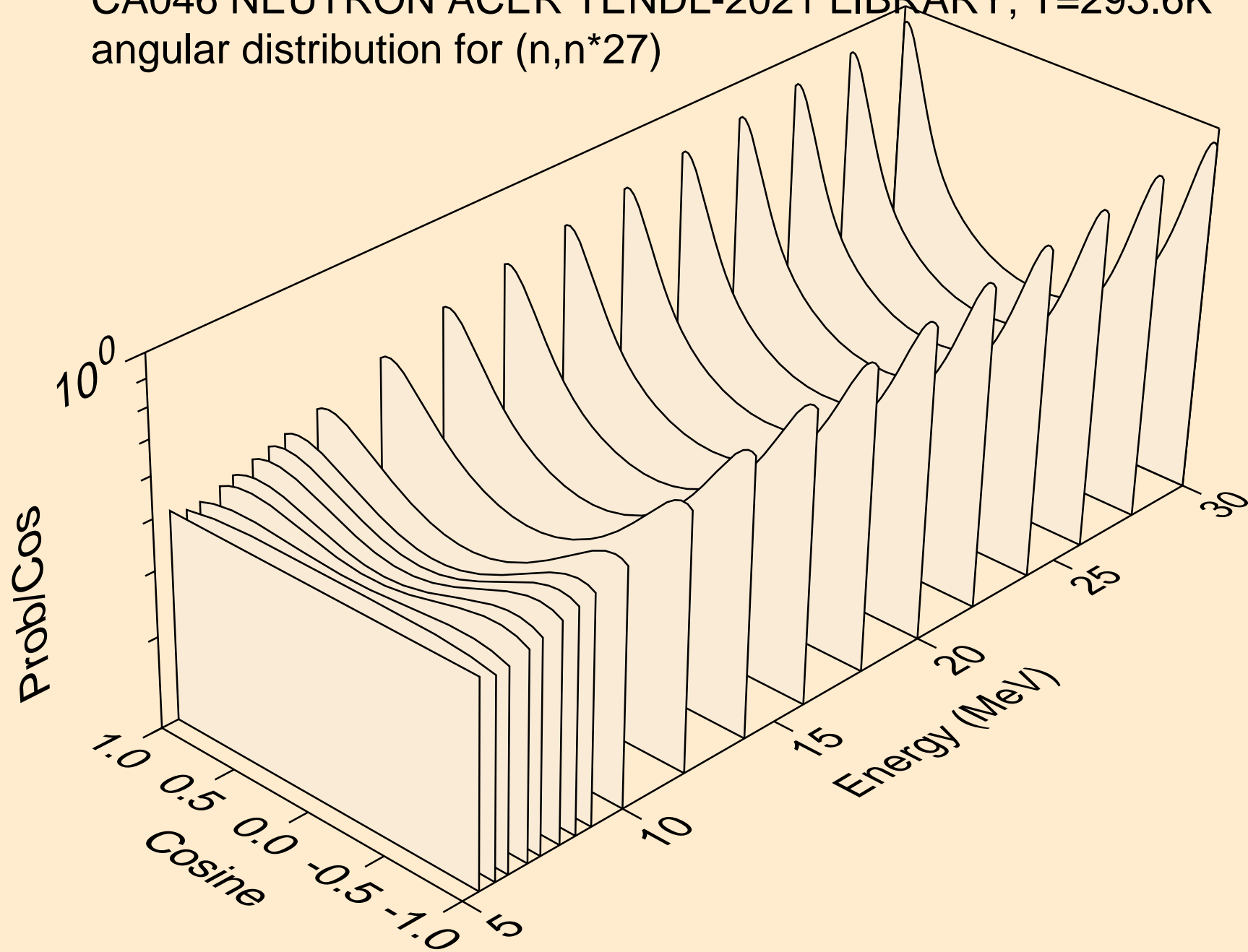

CA046 NEUTRON ACER TENDL-2021 LIBRARY; T=293.6K
angular distribution for (n,n*28)

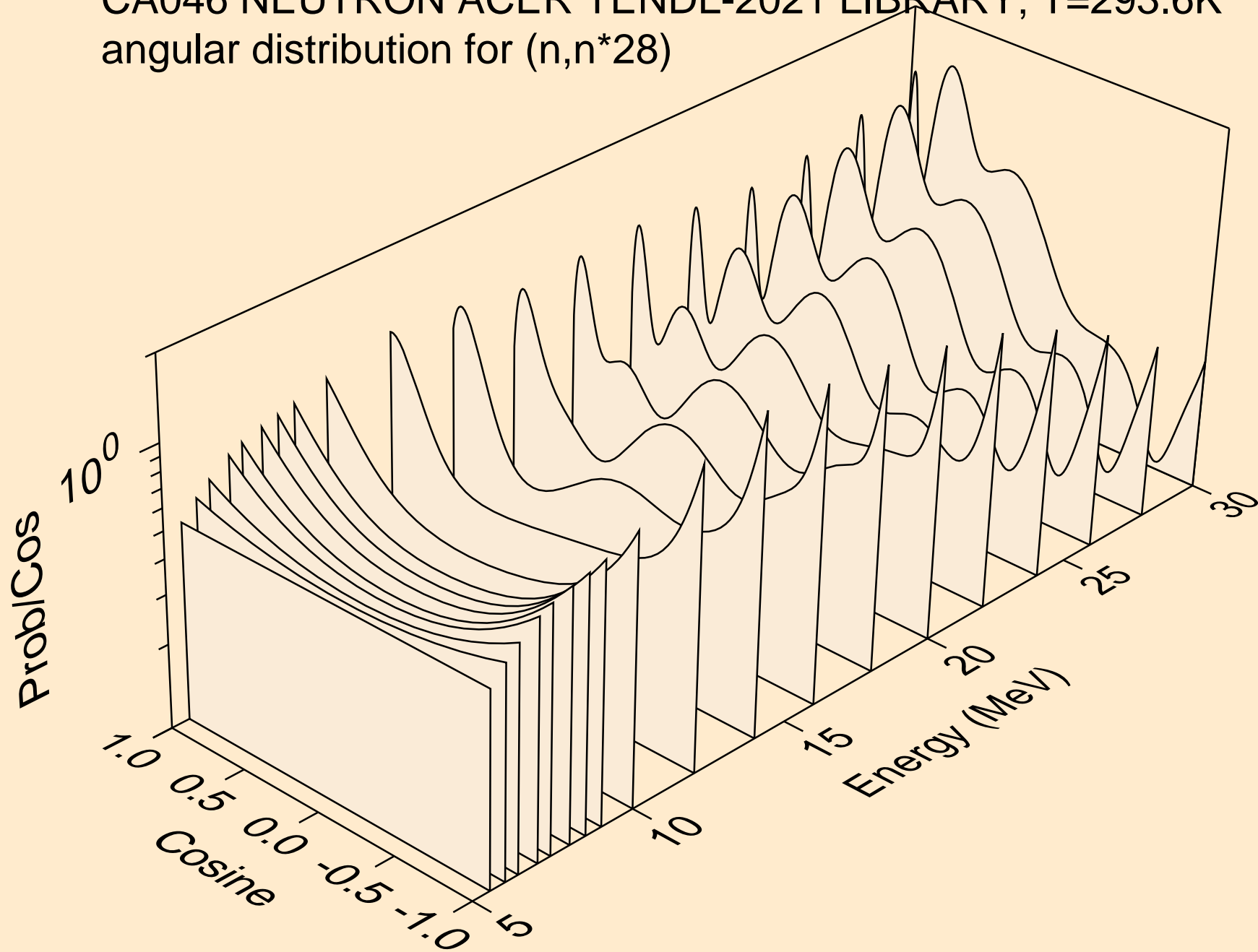

CA046 NEUTRON ACER TENDL-2021 LIBRARY; T=293.6K
angular distribution for (n,n*29)

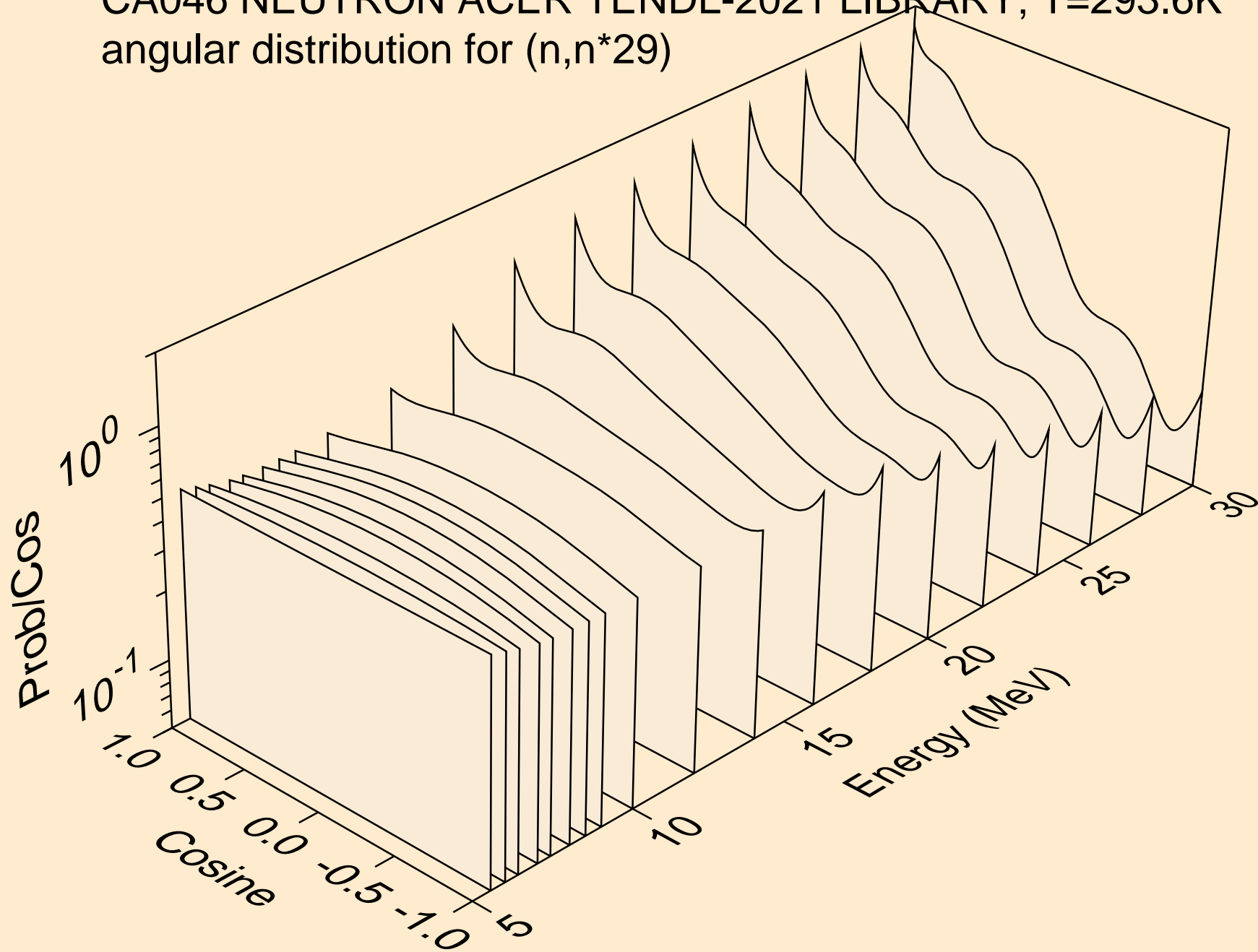

CA046 NEUTRON ACER TENDL-2021 LIBRARY; T=293.6K
angular distribution for (n,n*30)

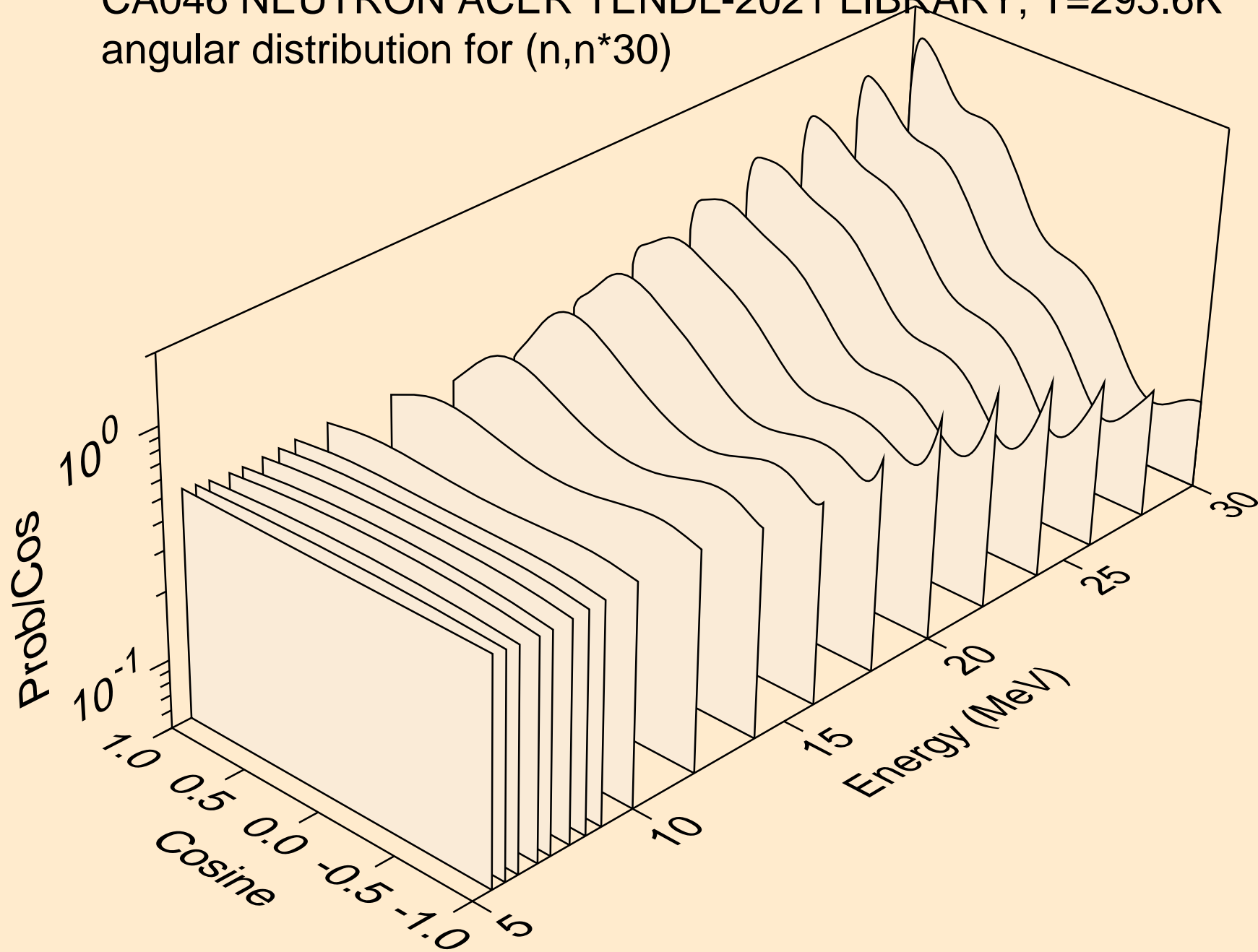

CA046 NEUTRON ACER TENDL-2021 LIBRARY; T=293.6K
Neutron emission for (n,x)

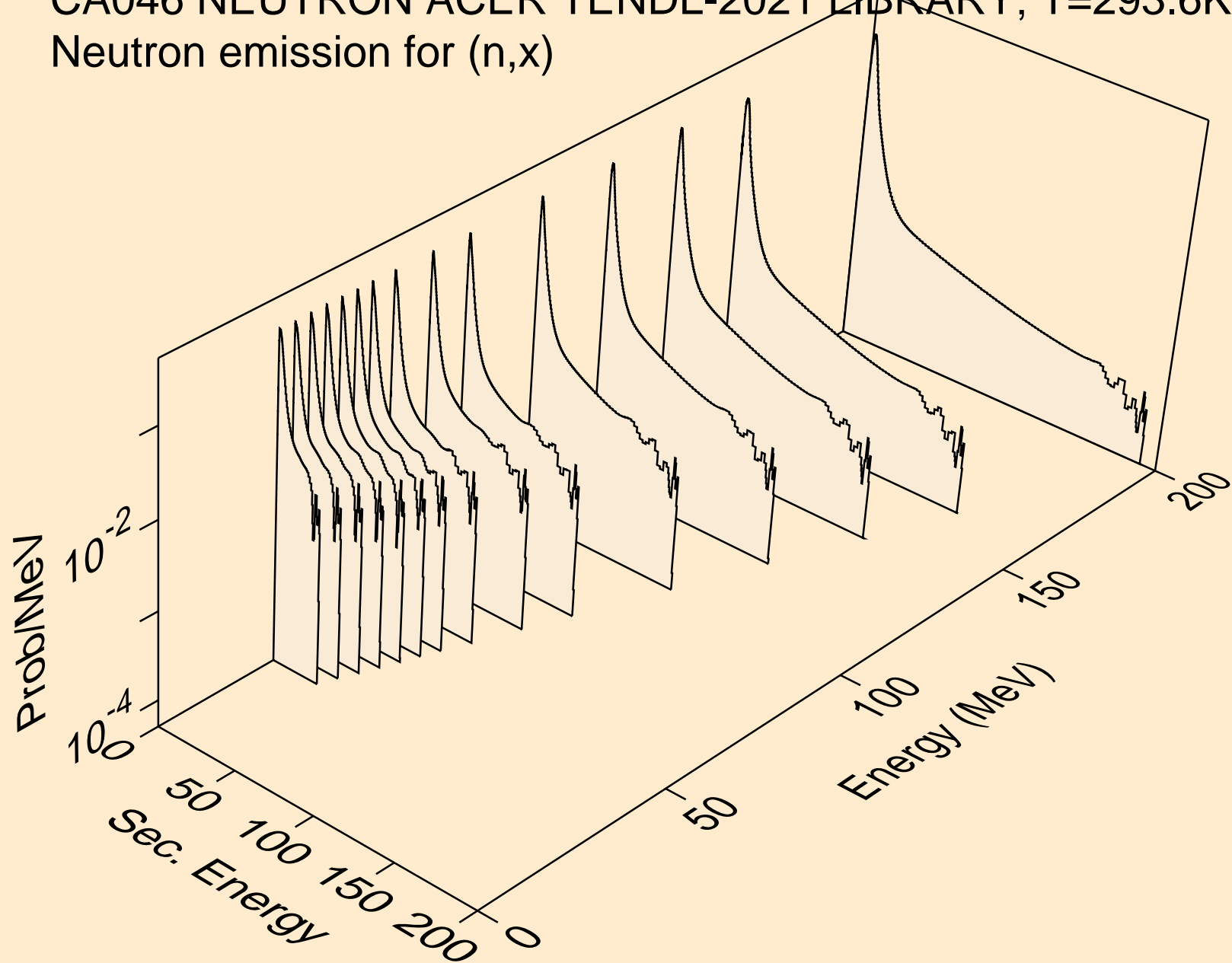

CA046 NEUTRON ACER TENDL-2021 LIBRARY; T=293.6K
Neutron emission for (n,2nd)

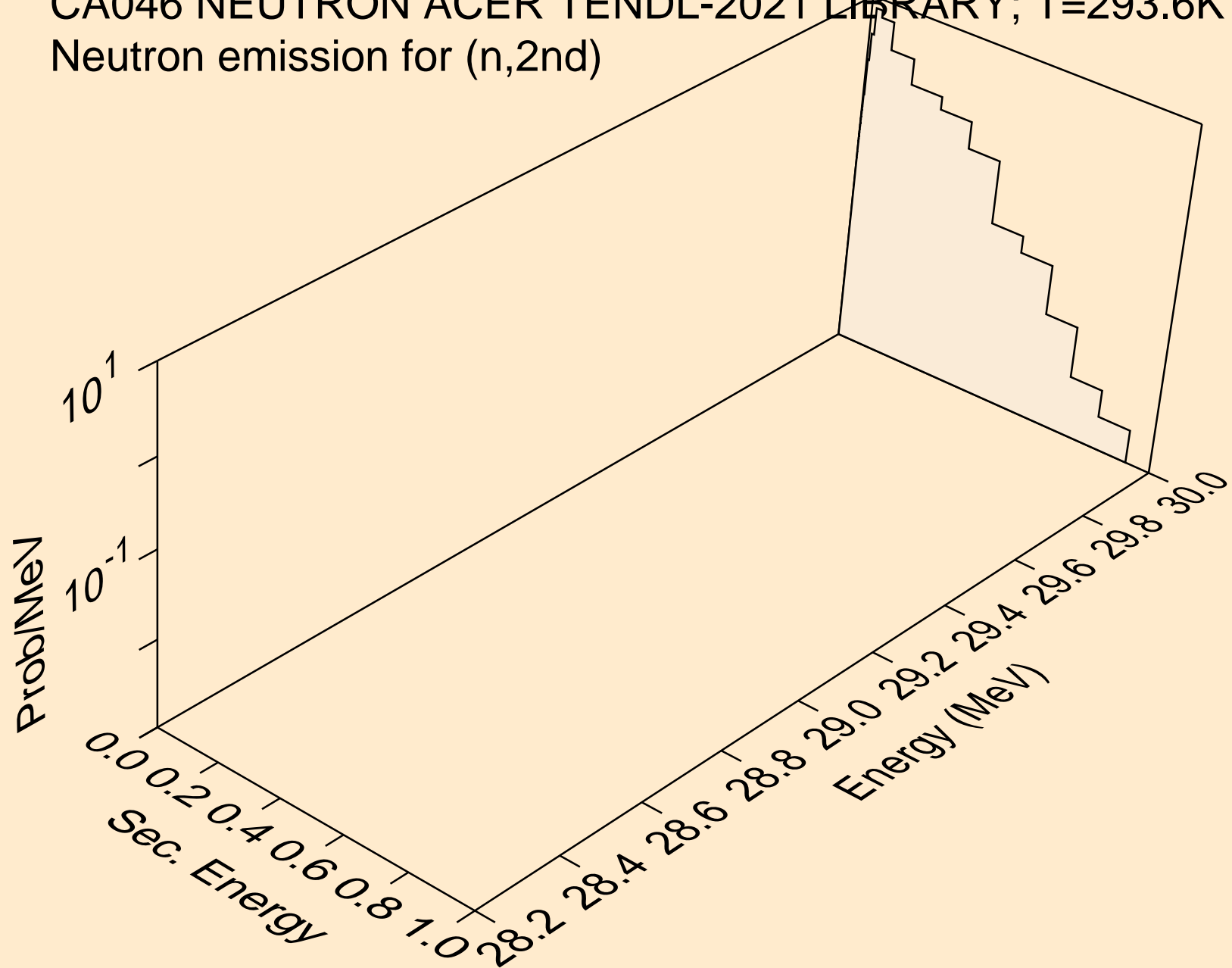

CA046 NEUTRON ACER TENDL-2021 LIBRARY; T=293.6K
Neutron emission for (n,2n)

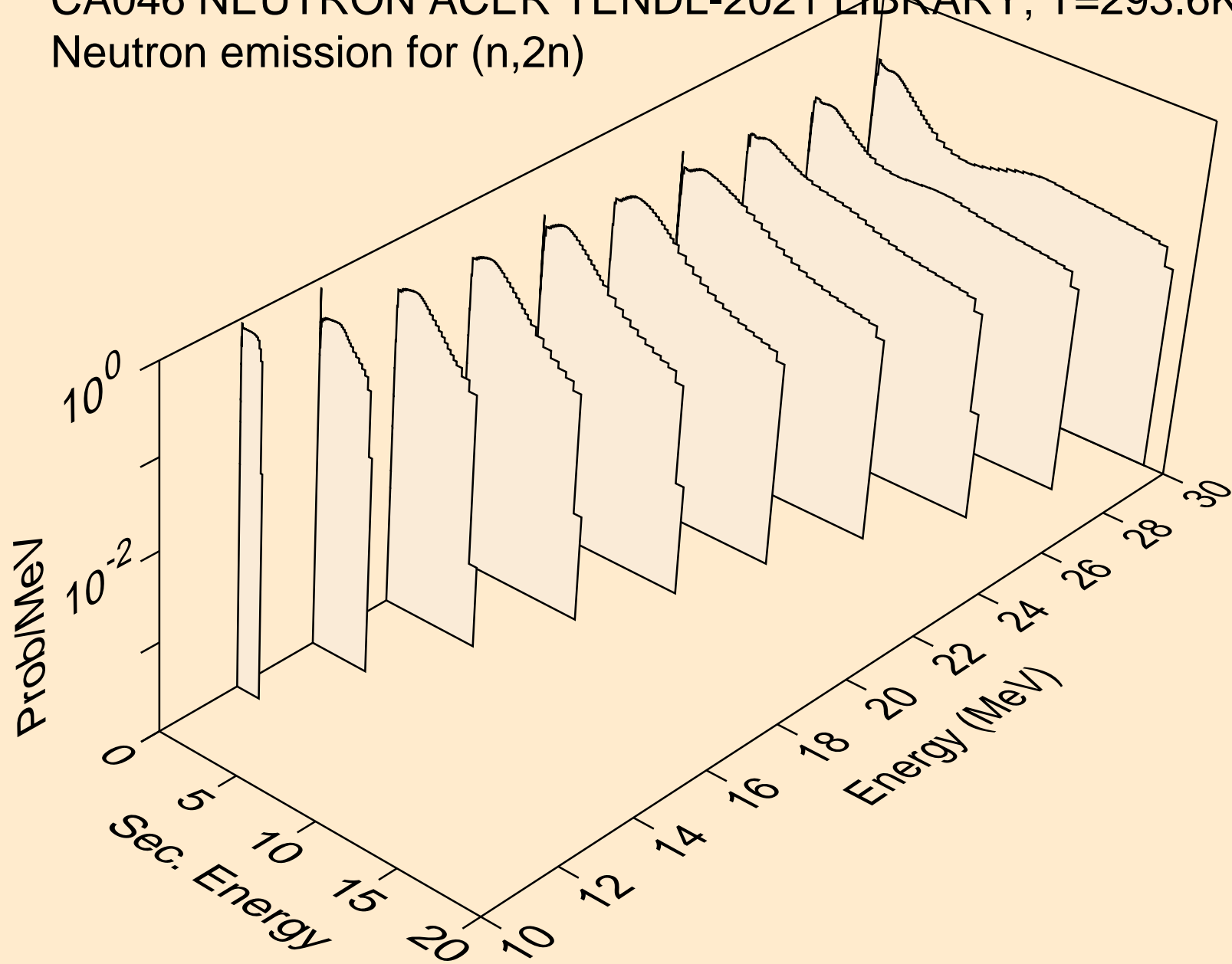

CA046 NEUTRON ACER TENDL-2021 LIBRARY; T=293.6K
Neutron emission for (n,3n)

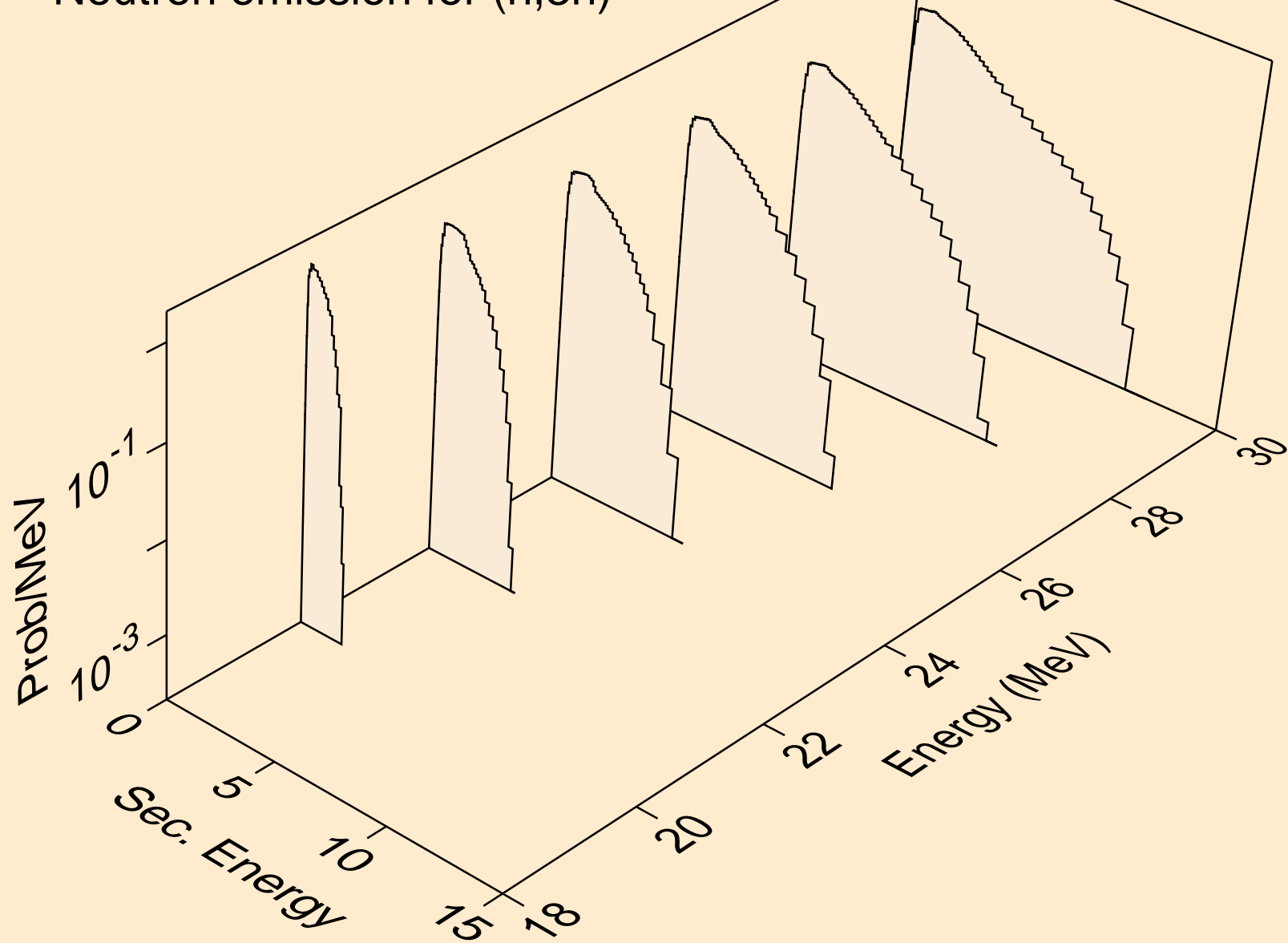

CA046 NEUTRON ACER TENDL-2021 LIBRARY; T=293.6K
Neutron emission for (n,n*)a

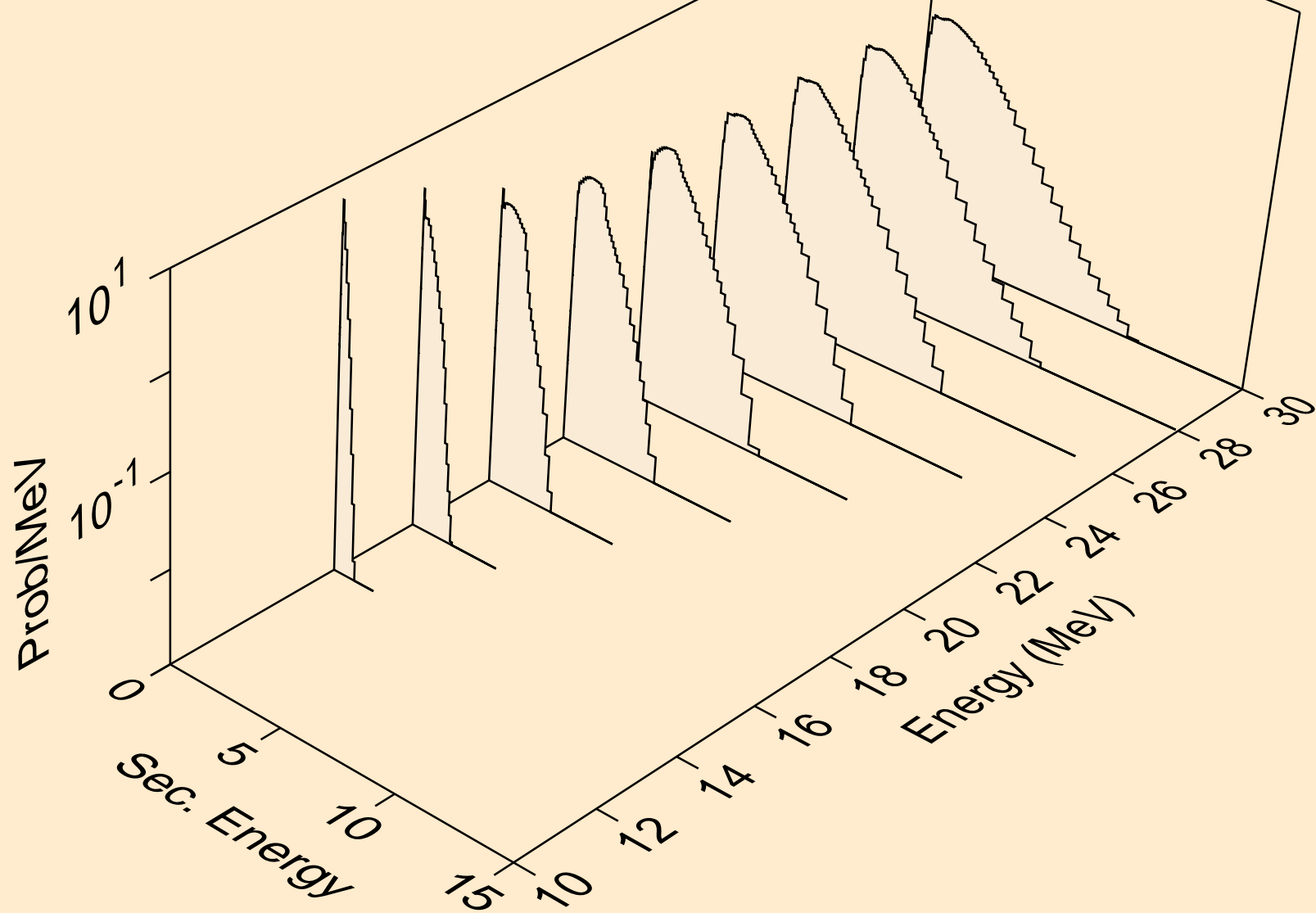

CA046 NEUTRON ACER TENDL-2021 LIBRARY; T=293.6K
Neutron emission for (n,2n)_a

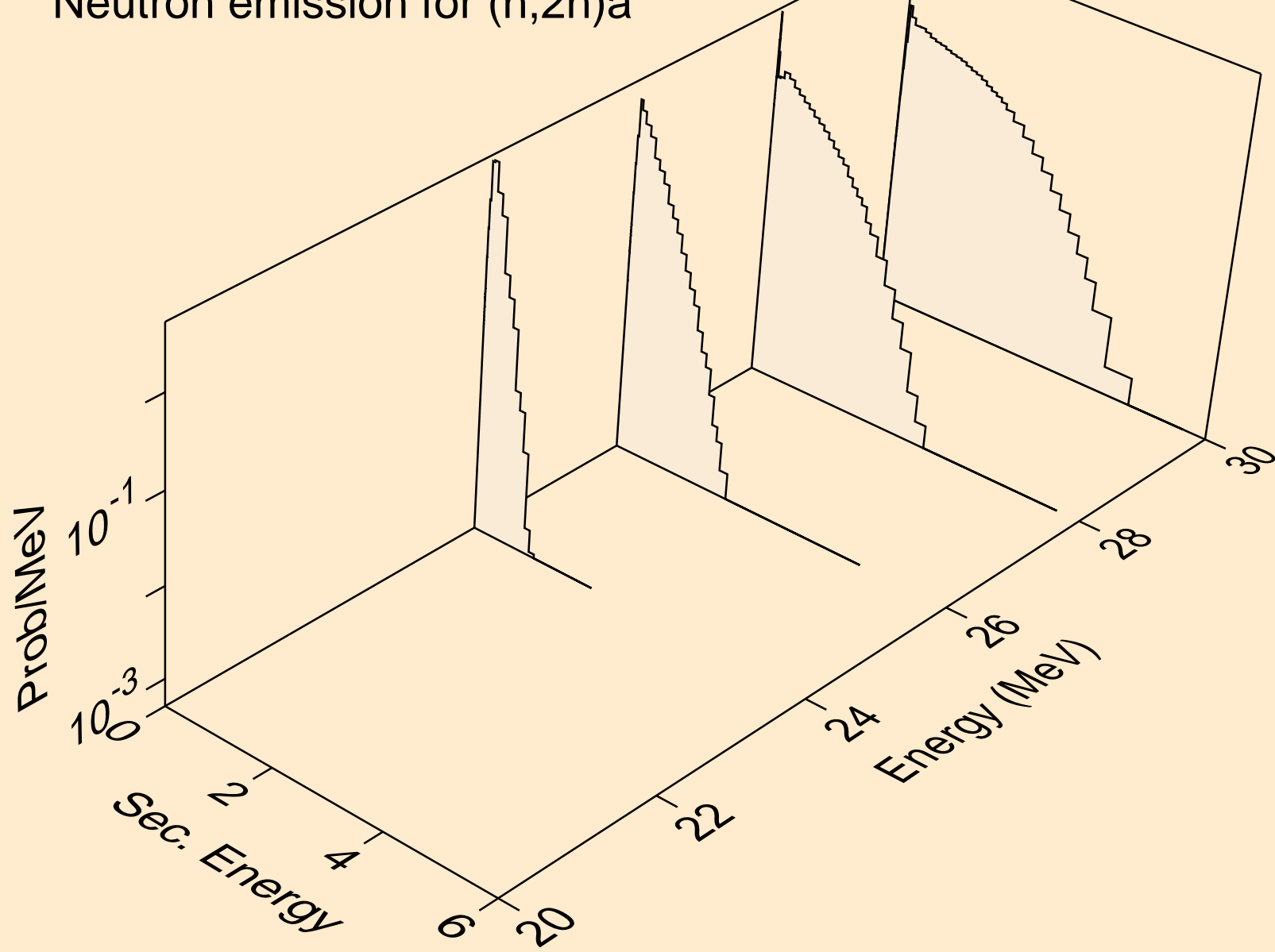

CA046 NEUTRON ACER TENDL-2021 LIBRARY; T=293.6K
Neutron emission for (n,n*)p

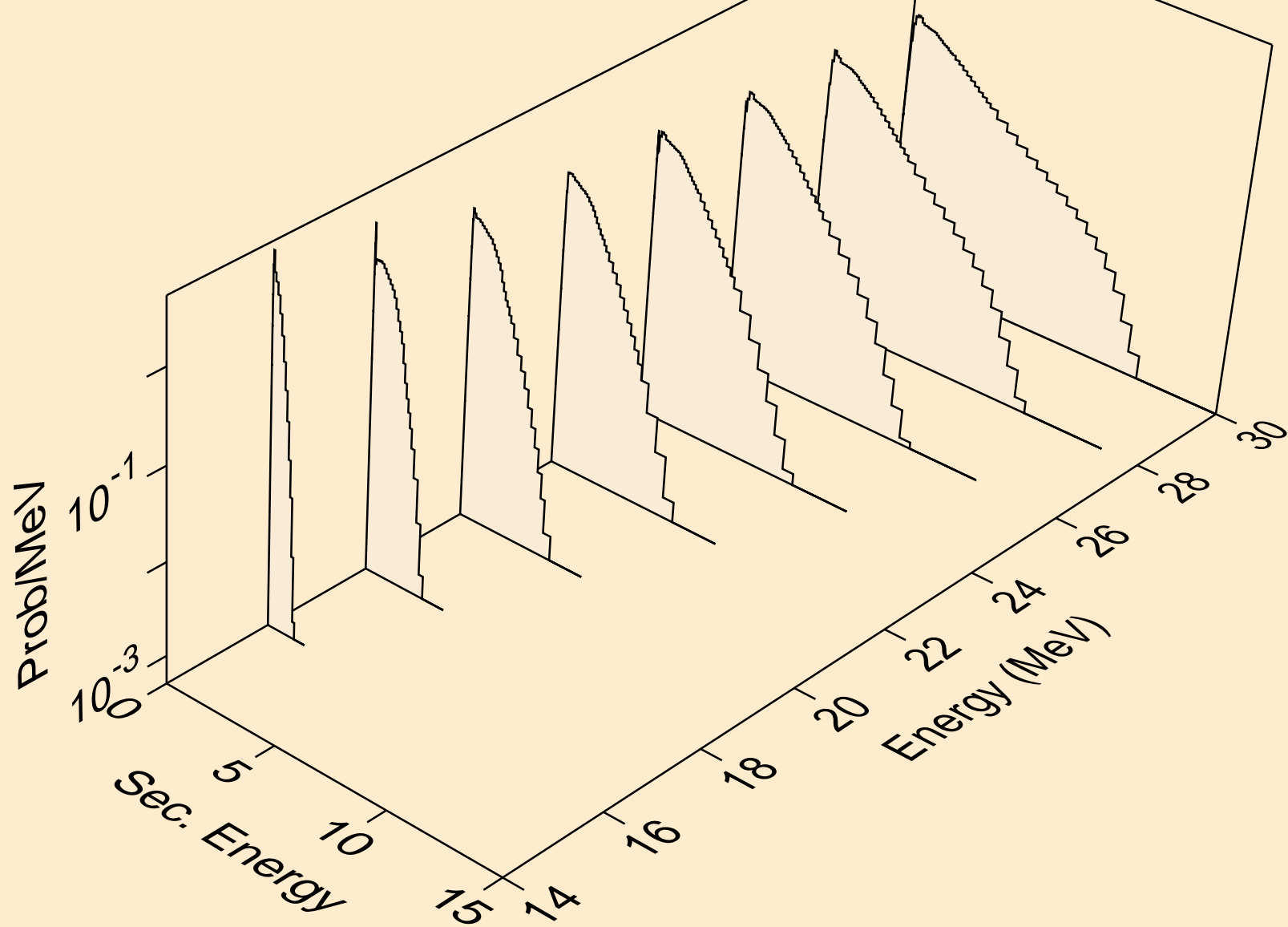

CA046 NEUTRON ACER TENDL-2021 LIBRARY; T=293.6K
Neutron emission for (n,n*)d

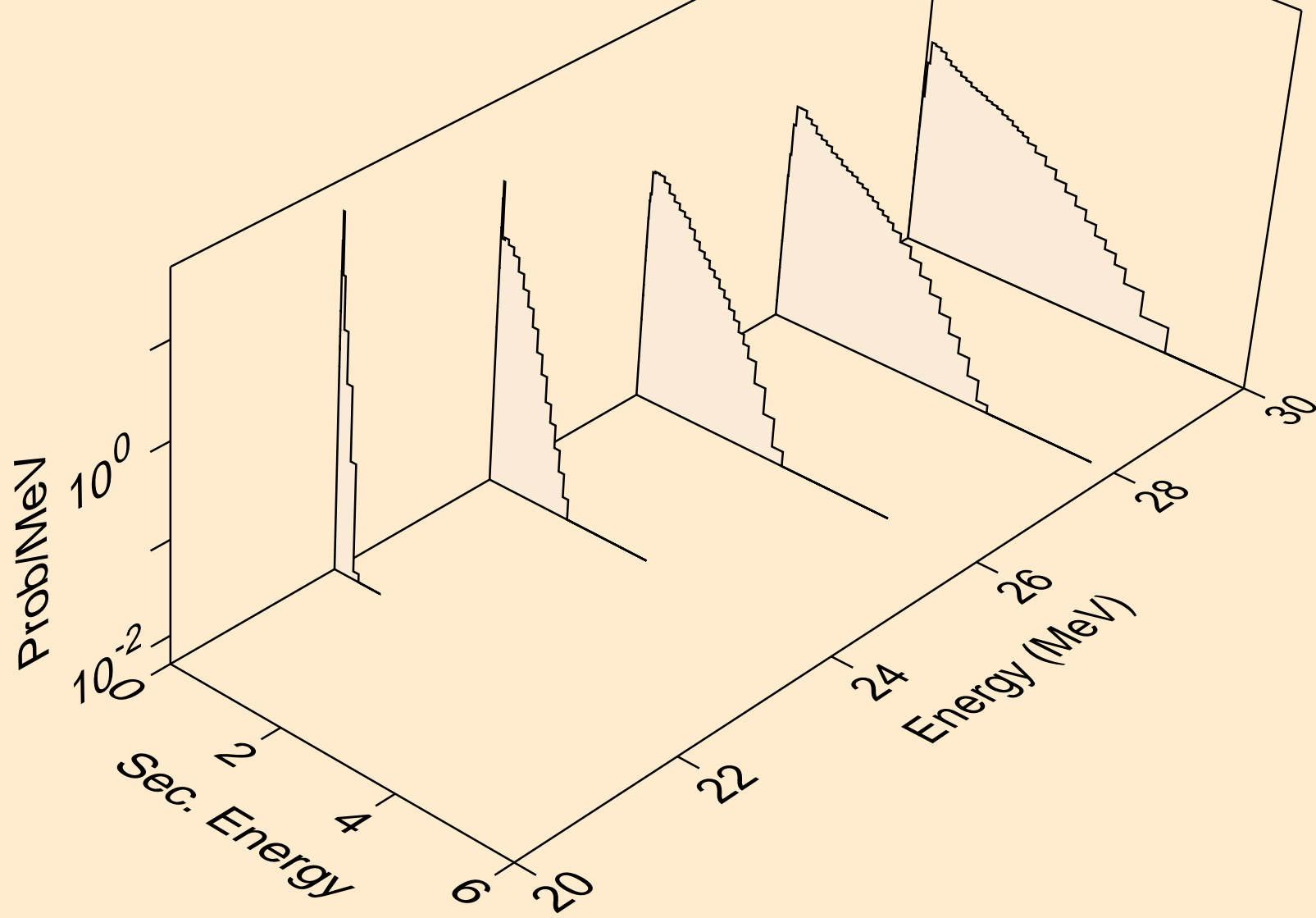

CA046 NEUTRON ACER TENDL-2021 LIBRARY; T=293.6K
Neutron emission for (n,n*)t

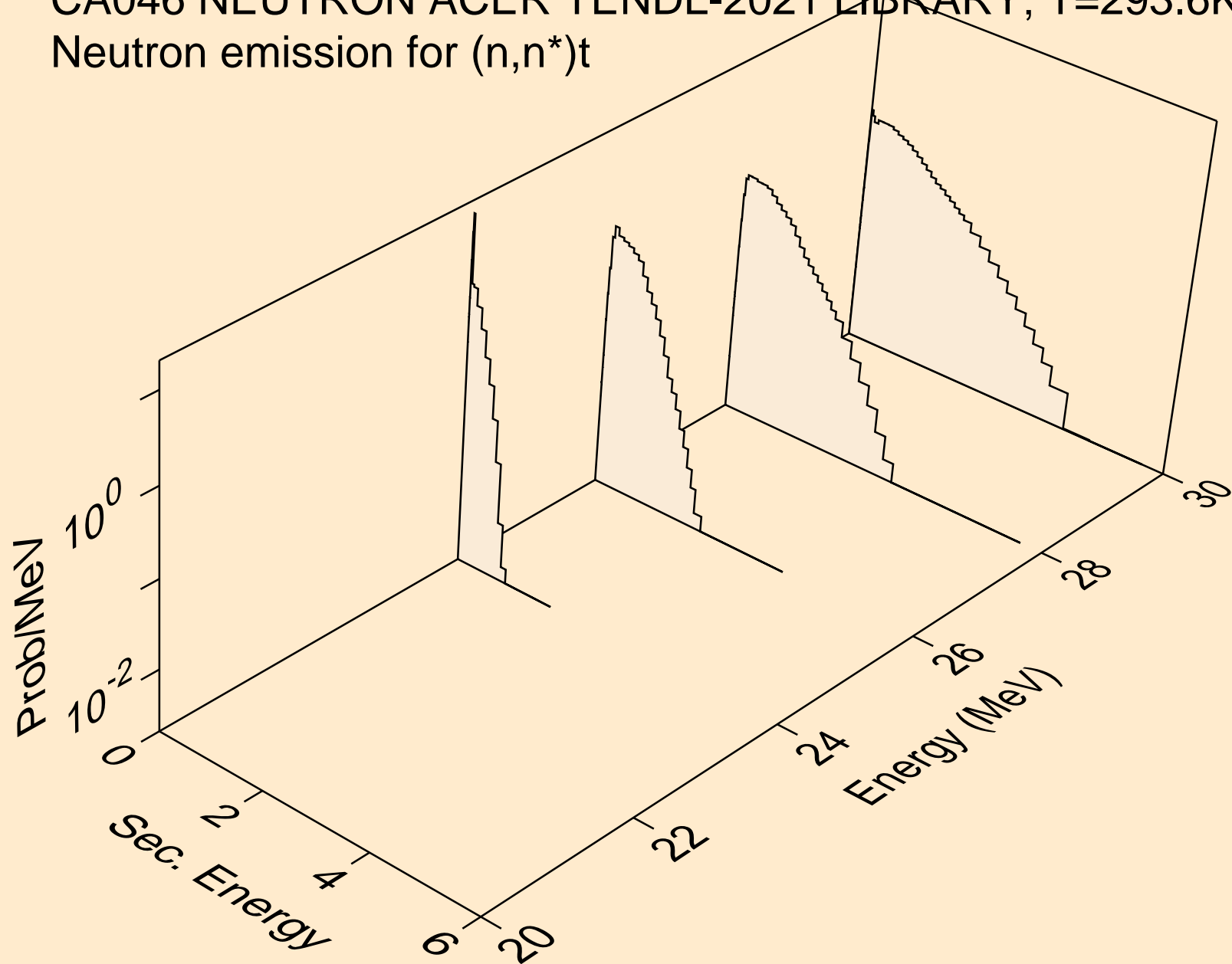

CA046 NEUTRON ACER TENDL-2021 LIBRARY; T=293.6K
Neutron emission for (n,n*)he3

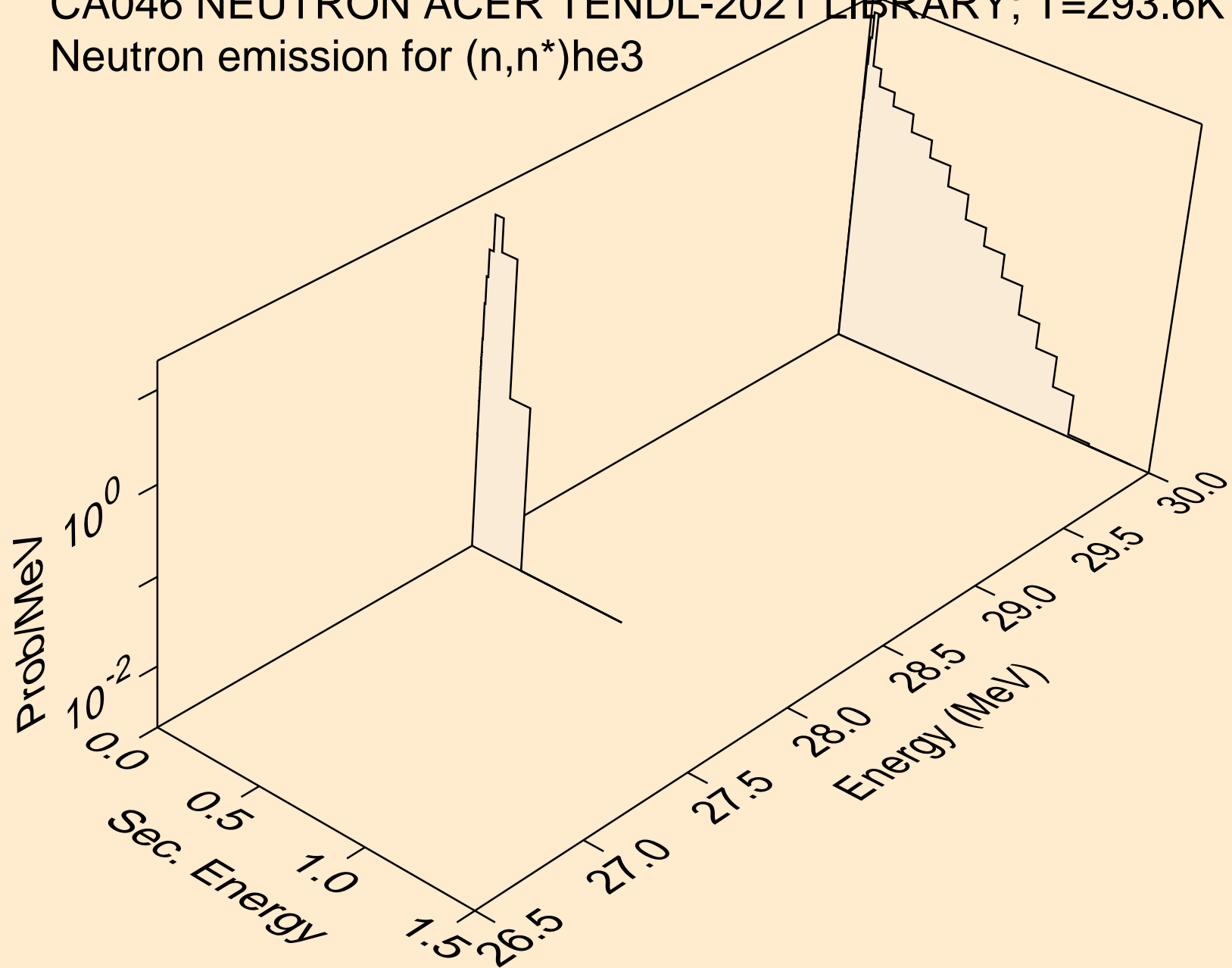

CA046 NEUTRON ACER TENDL-2021 LIBRARY; T=293.6K
Neutron emission for (n,2np)

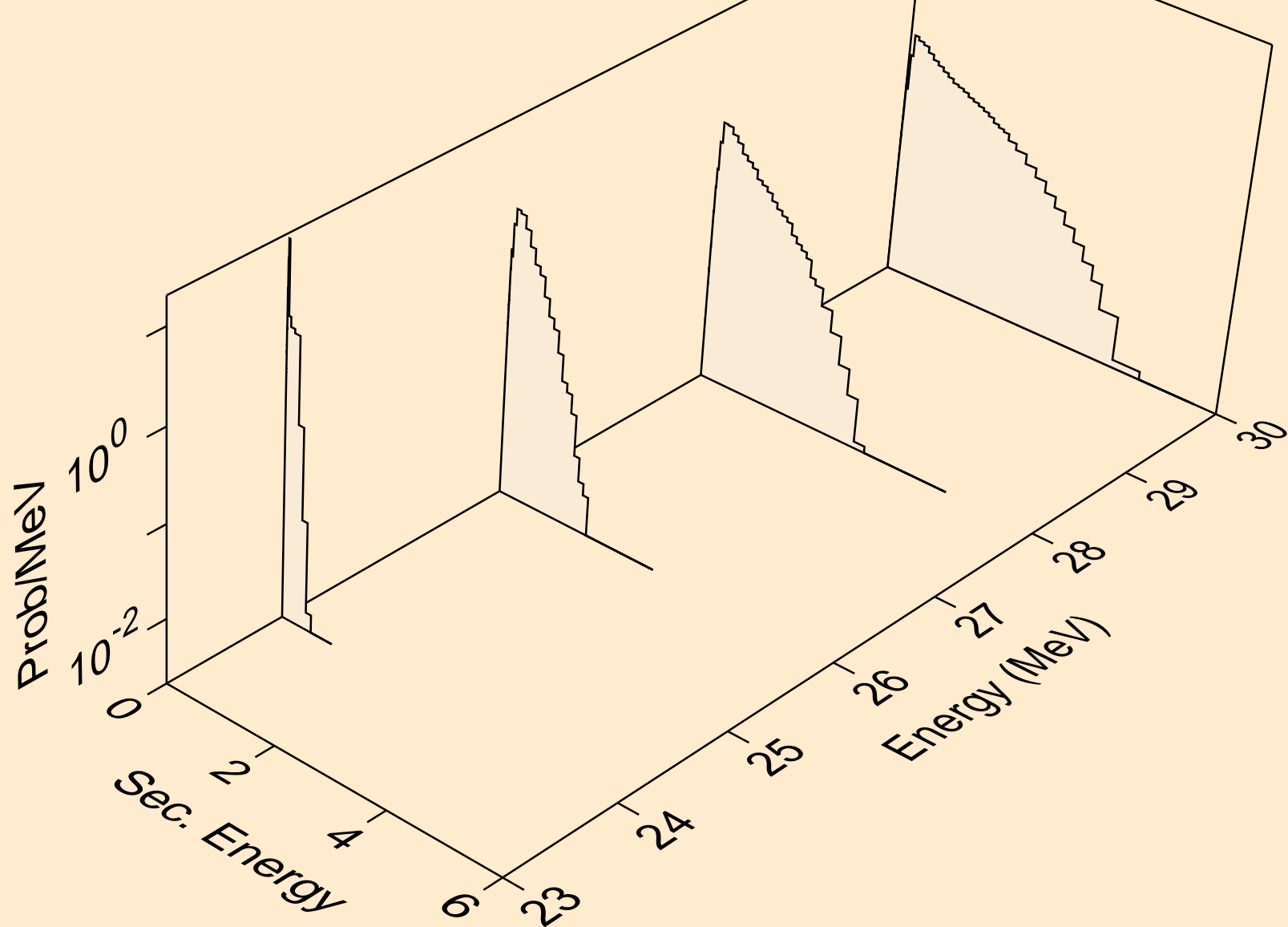

CA046 NEUTRON ACER TENDL-2021 LIBRARY; T=293.6K
Neutron emission for (n,2np)

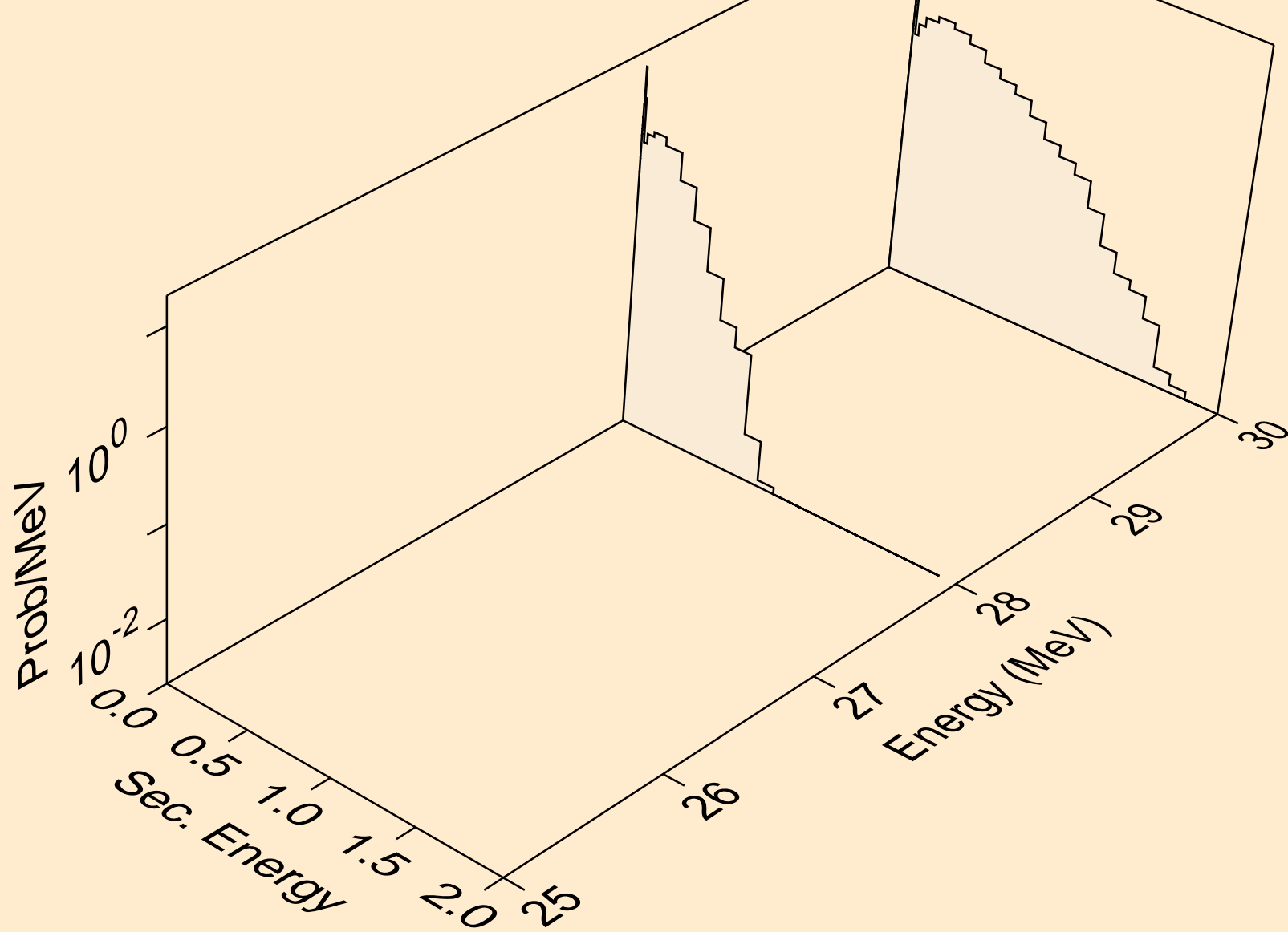

CA046 NEUTRON ACER TENDL-2021 LIBRARY; T=293.6K
Neutron emission for (n,n*c)

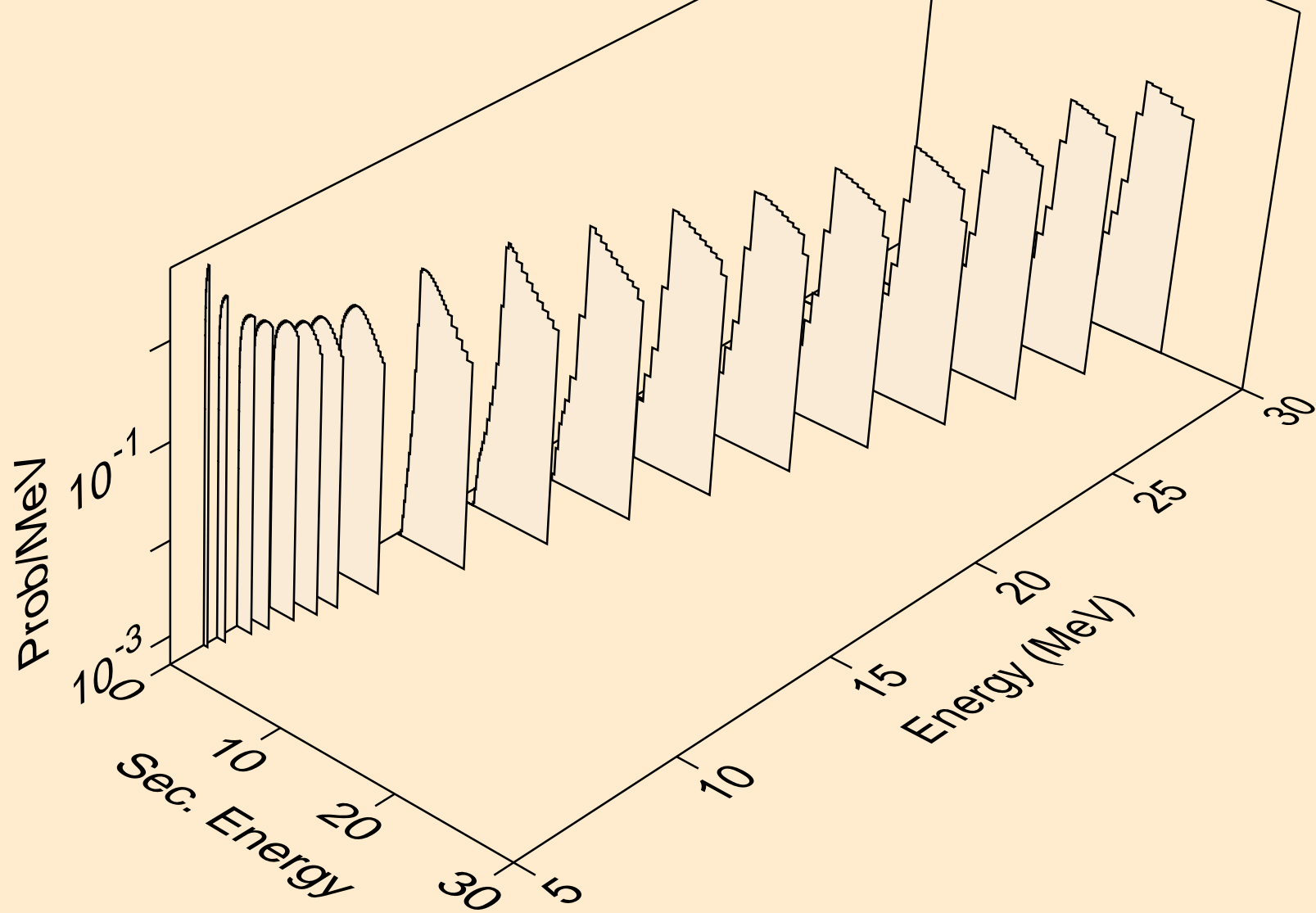

CA046 NEUTRON ACER TENDL-2021 LIBRARY; T=293.6K
Photon emission for (n,x)

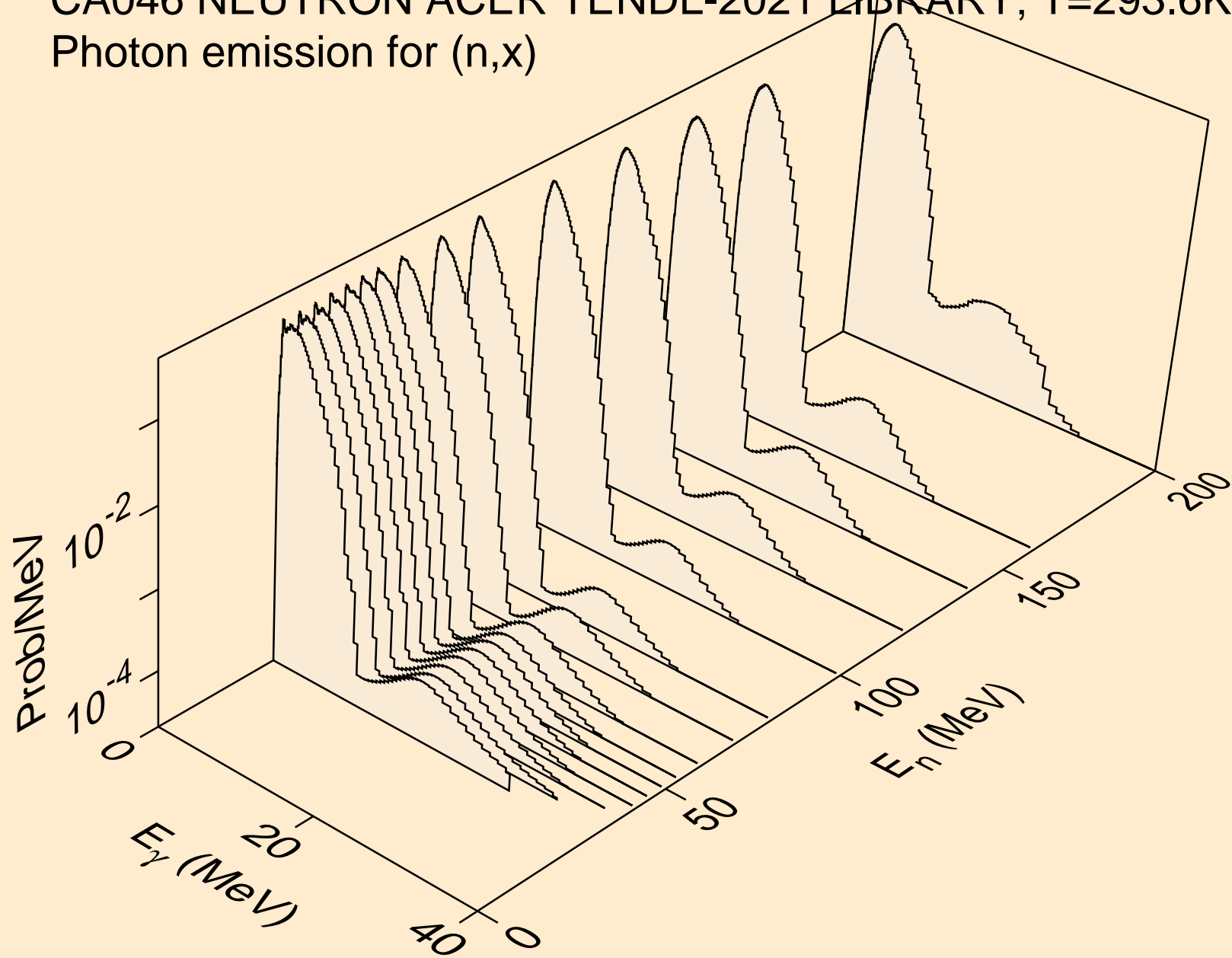

CA046 NEUTRON ACER TENDL-2021 LIBRARY; T=293.6K
Photon emission for (n,2nd)

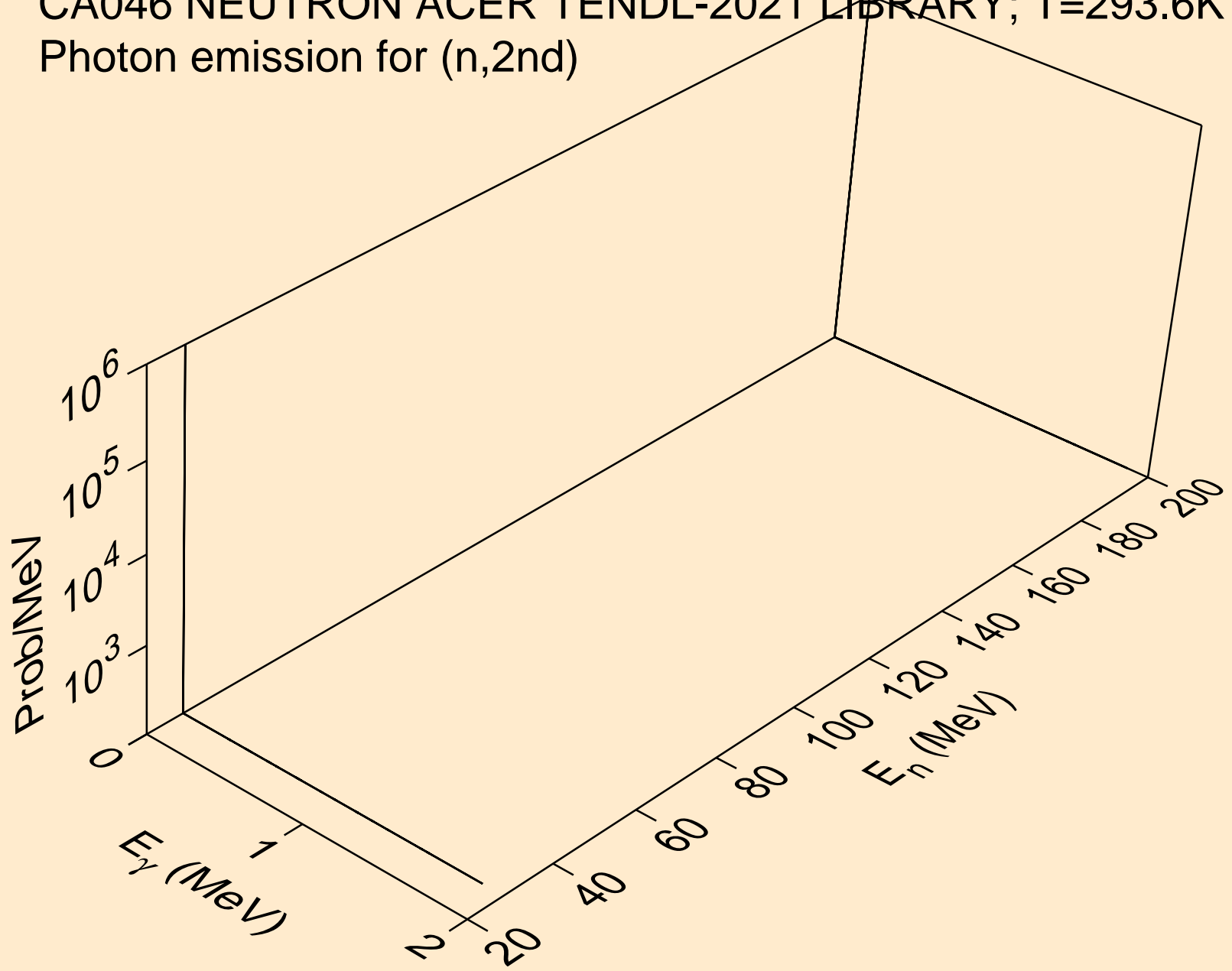

CA046 NEUTRON ACER TENDL-2021 LIBRARY; T=293.6K
Photon emission for (n,2n)

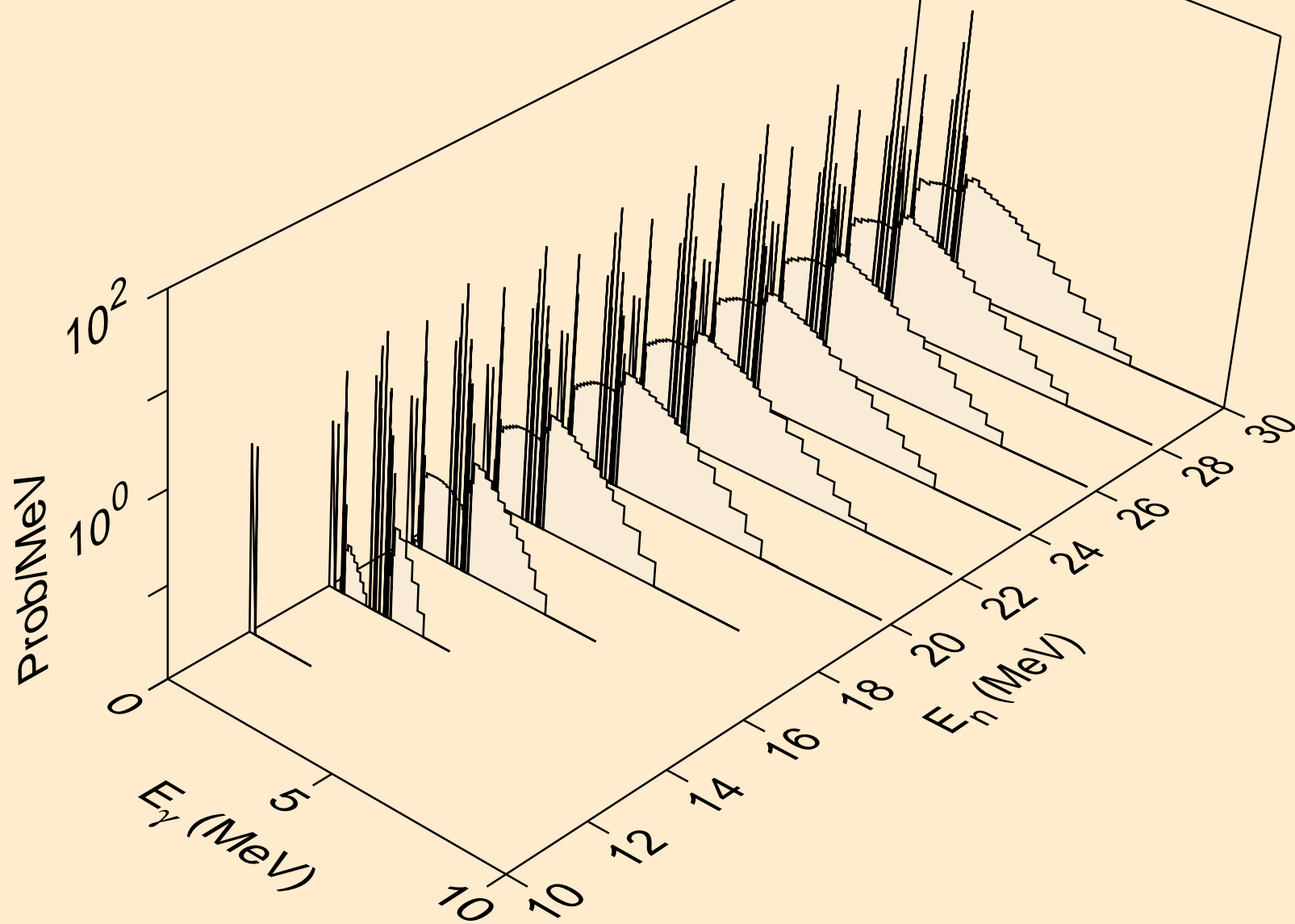

CA046 NEUTRON ACER TENDL-2021 LIBRARY; T=293.6K
Photon emission for (n,3n)

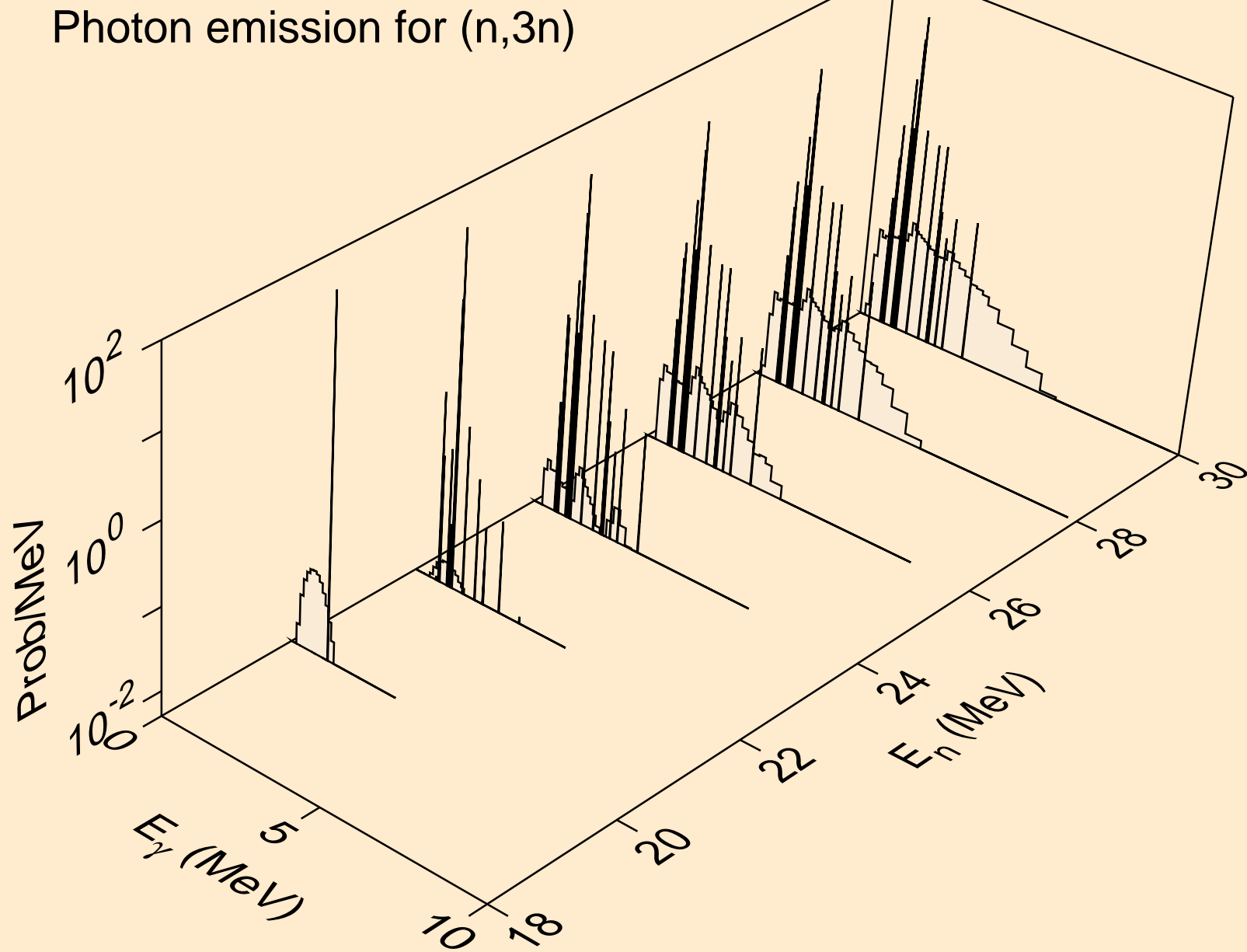

CA046 NEUTRON ACER TENDL-2021 LIBRARY; T=293.6K
Photon emission for (n,n*)a

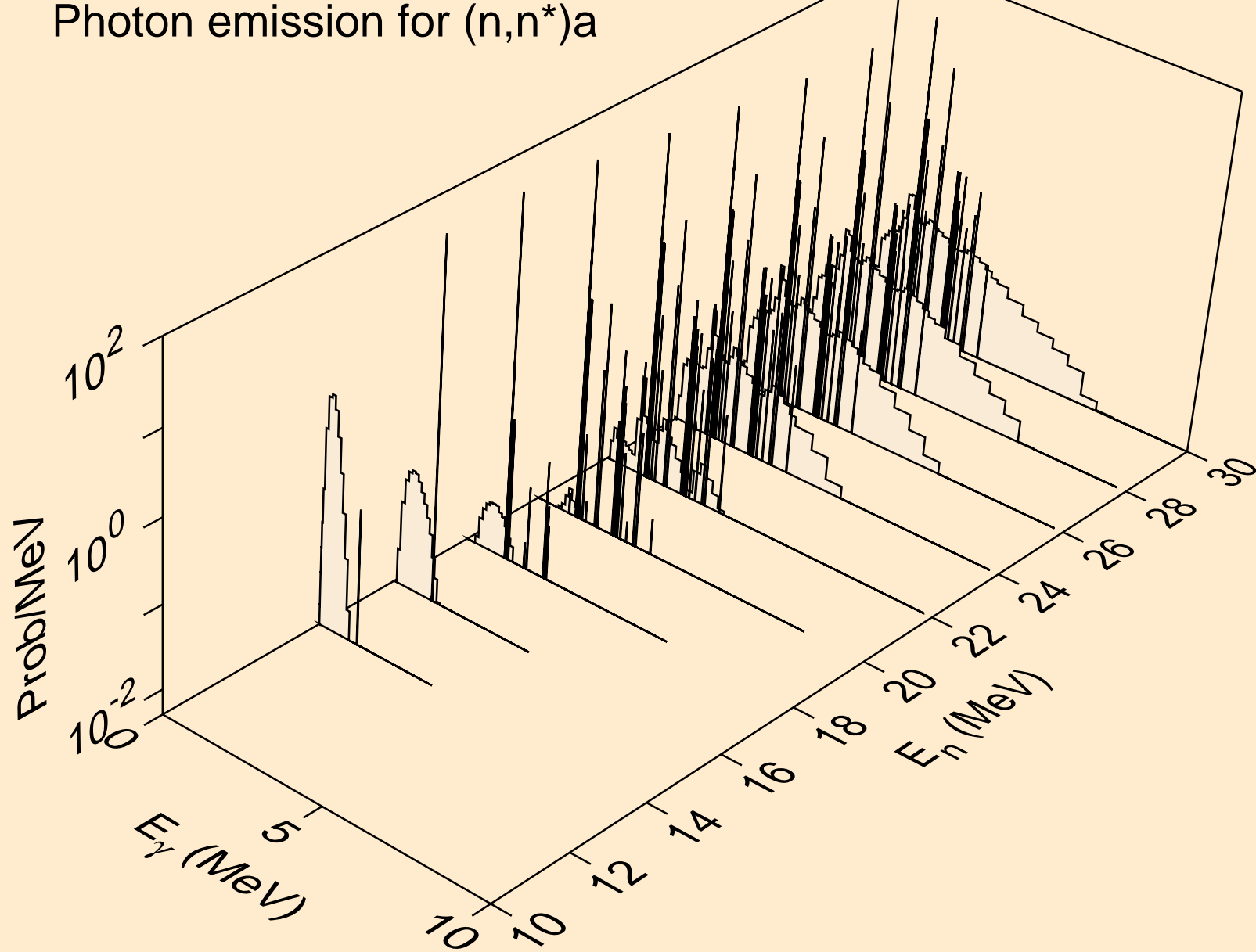

CA046 NEUTRON ACER TENDL-2021 LIBRARY; T=293.6K
Photon emission for (n,2n)a

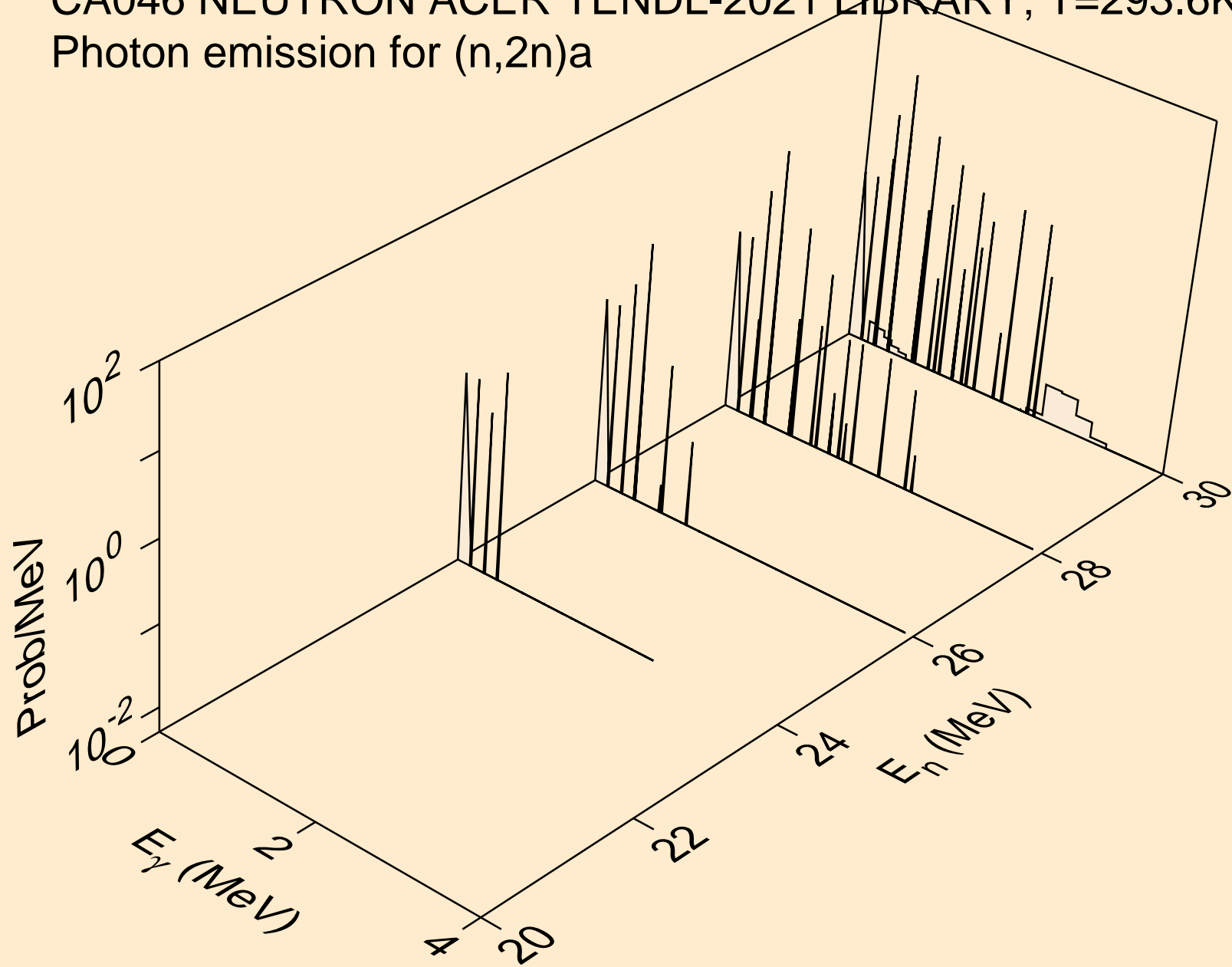

CA046 NEUTRON ACER TENDL-2021 LIBRARY; T=293.6K
Photon emission for (n,n*)p

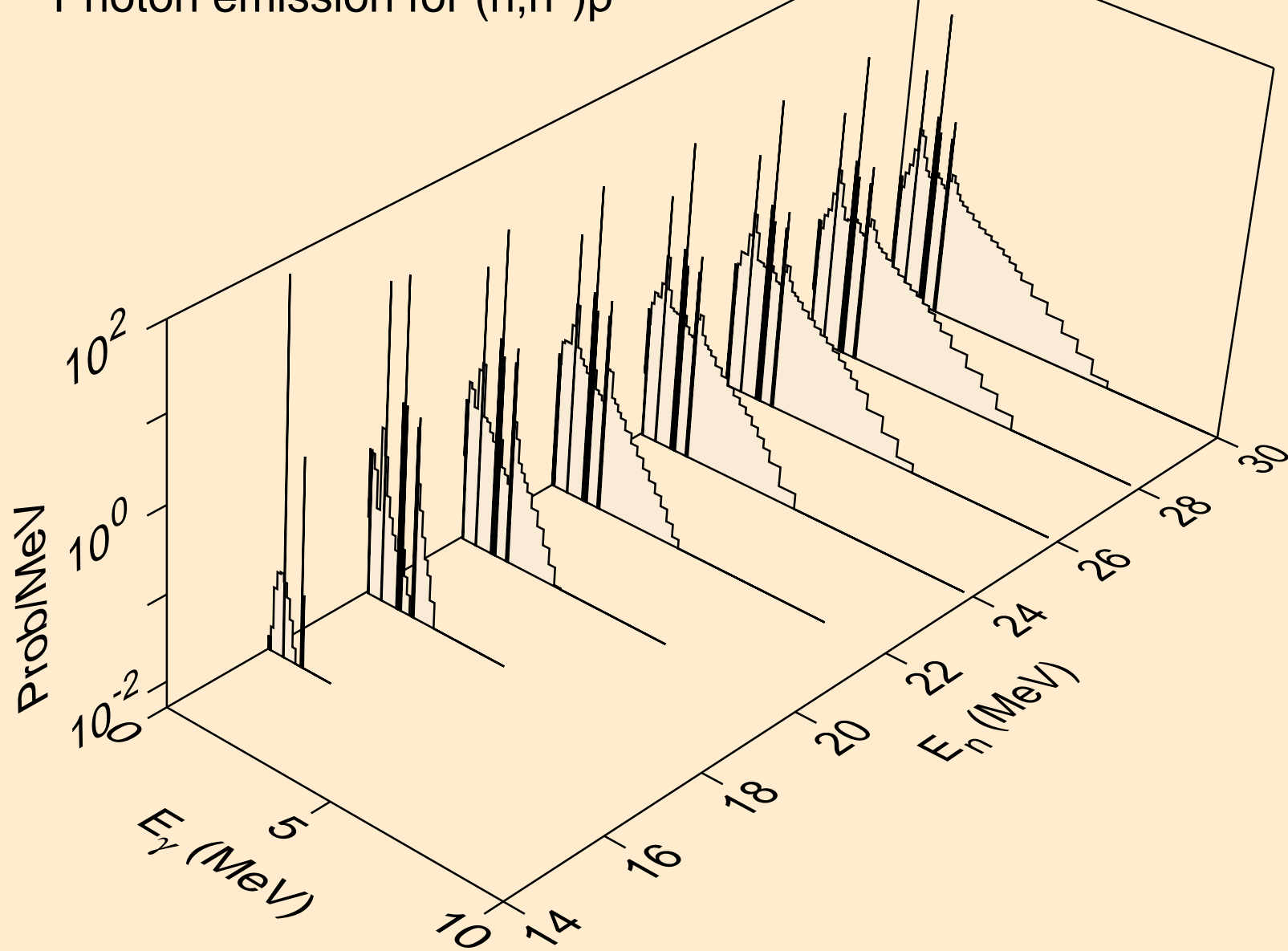

CA046 NEUTRON ACER TENDL-2021 LIBRARY; T=293.6K
Photon emission for (n,n*)d

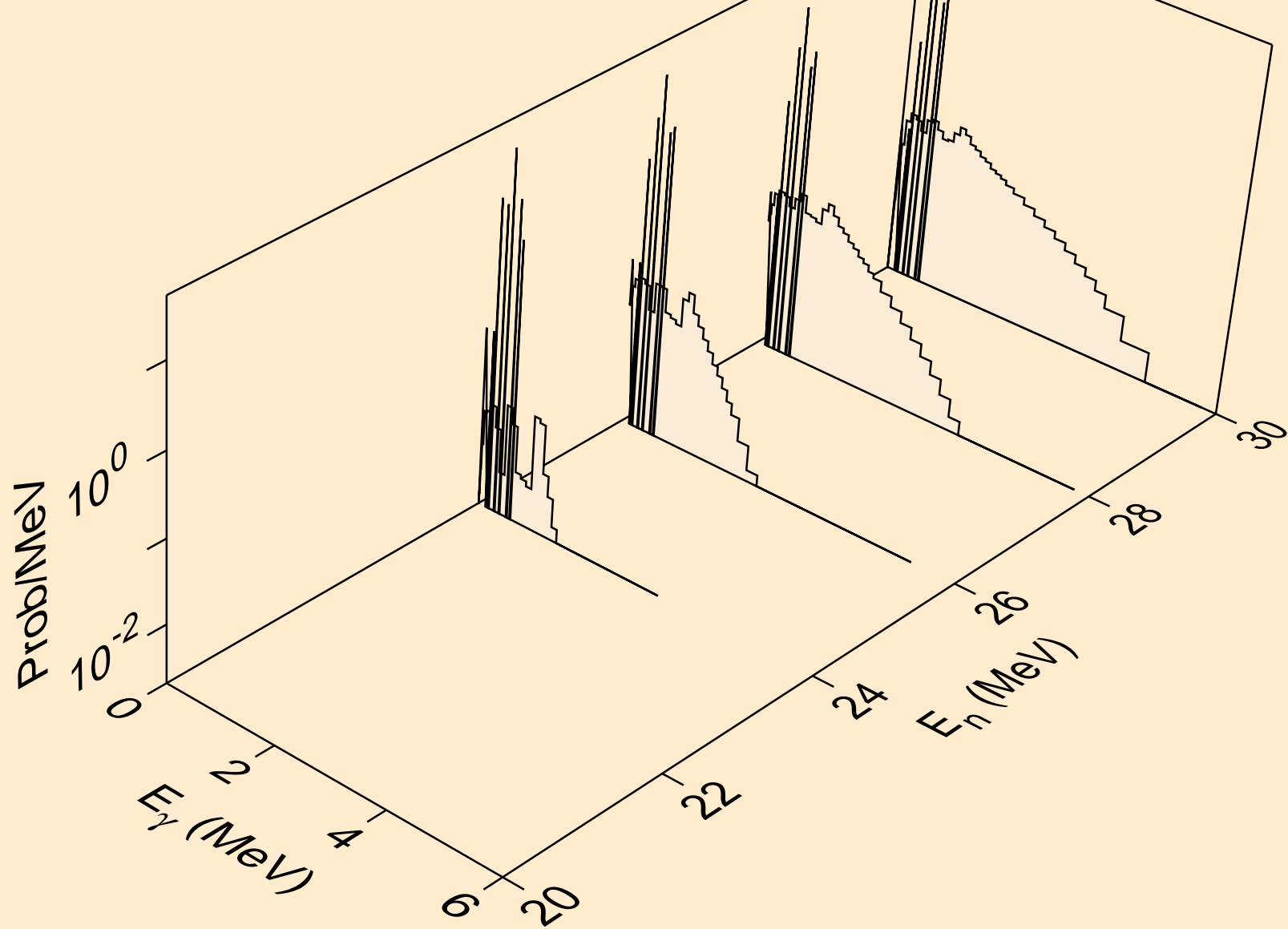

CA046 NEUTRON ACER TENDL-2021 LIBRARY; T=293.6K
Photon emission for (n,n*)t

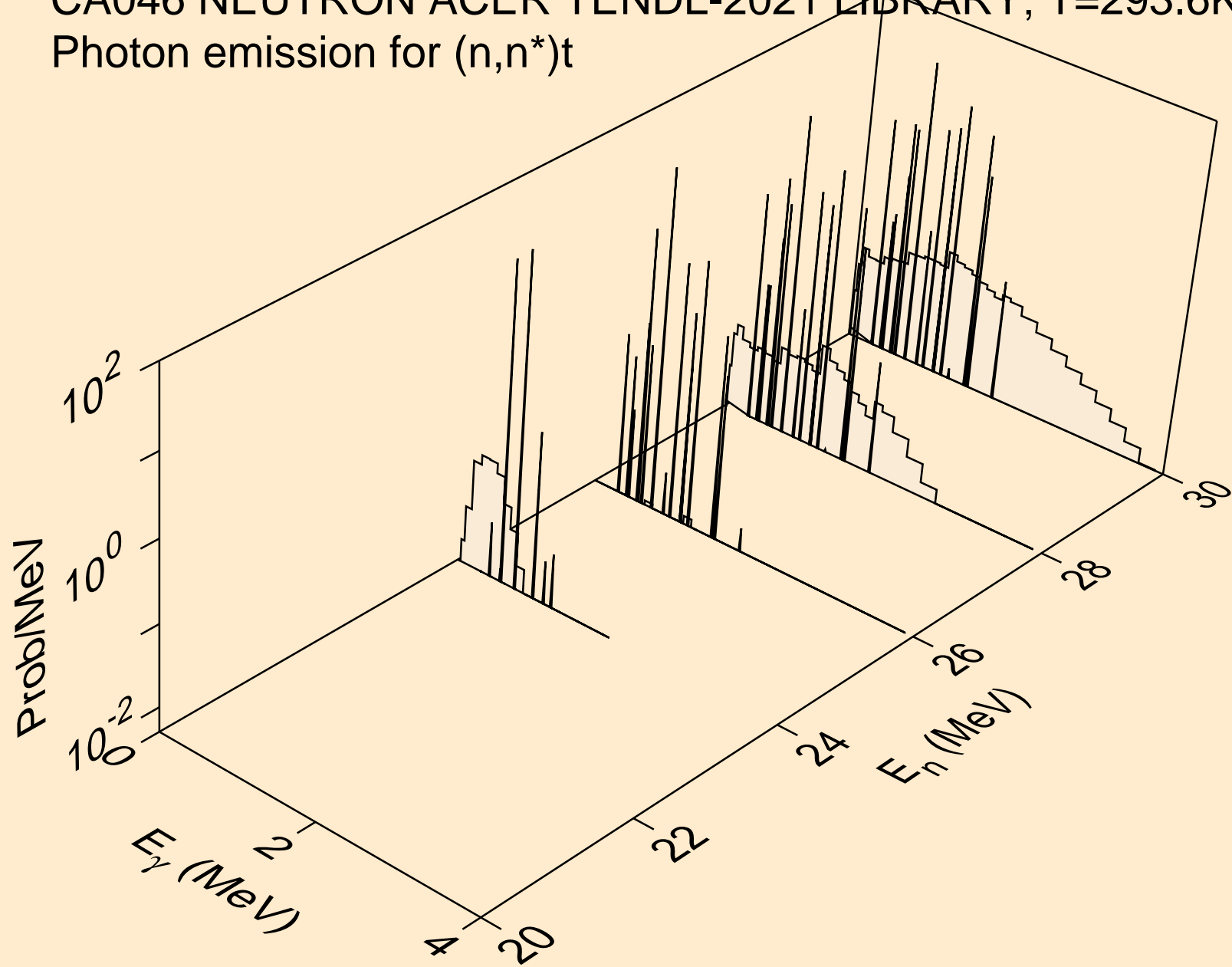

CA046 NEUTRON ACER TENDL-2021 LIBRARY; T=293.6K
Photon emission for (n,n*)he3

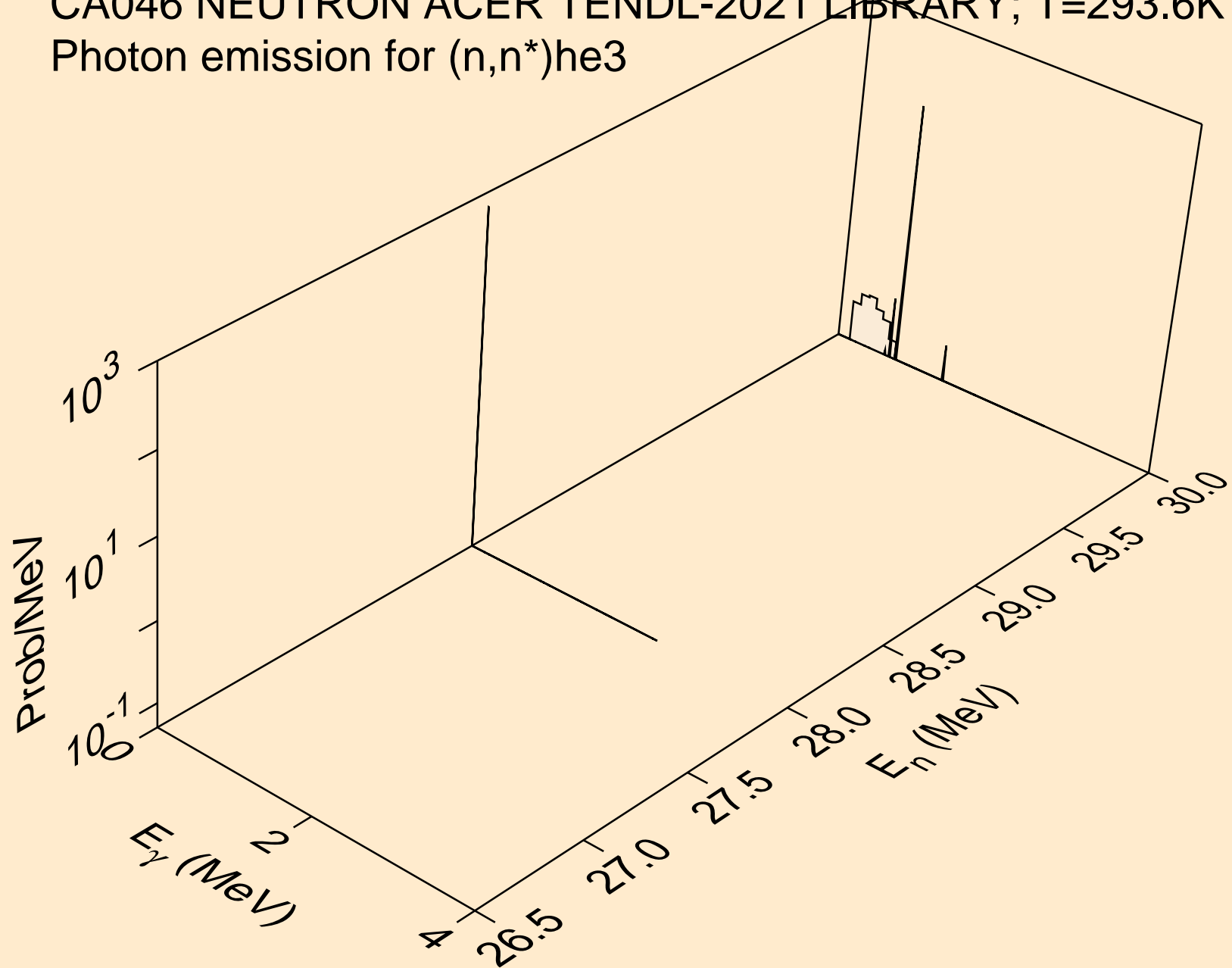

CA046 NEUTRON ACER TENDL-2021 LIBRARY; T=293.6K
Photon emission for (n,2np)

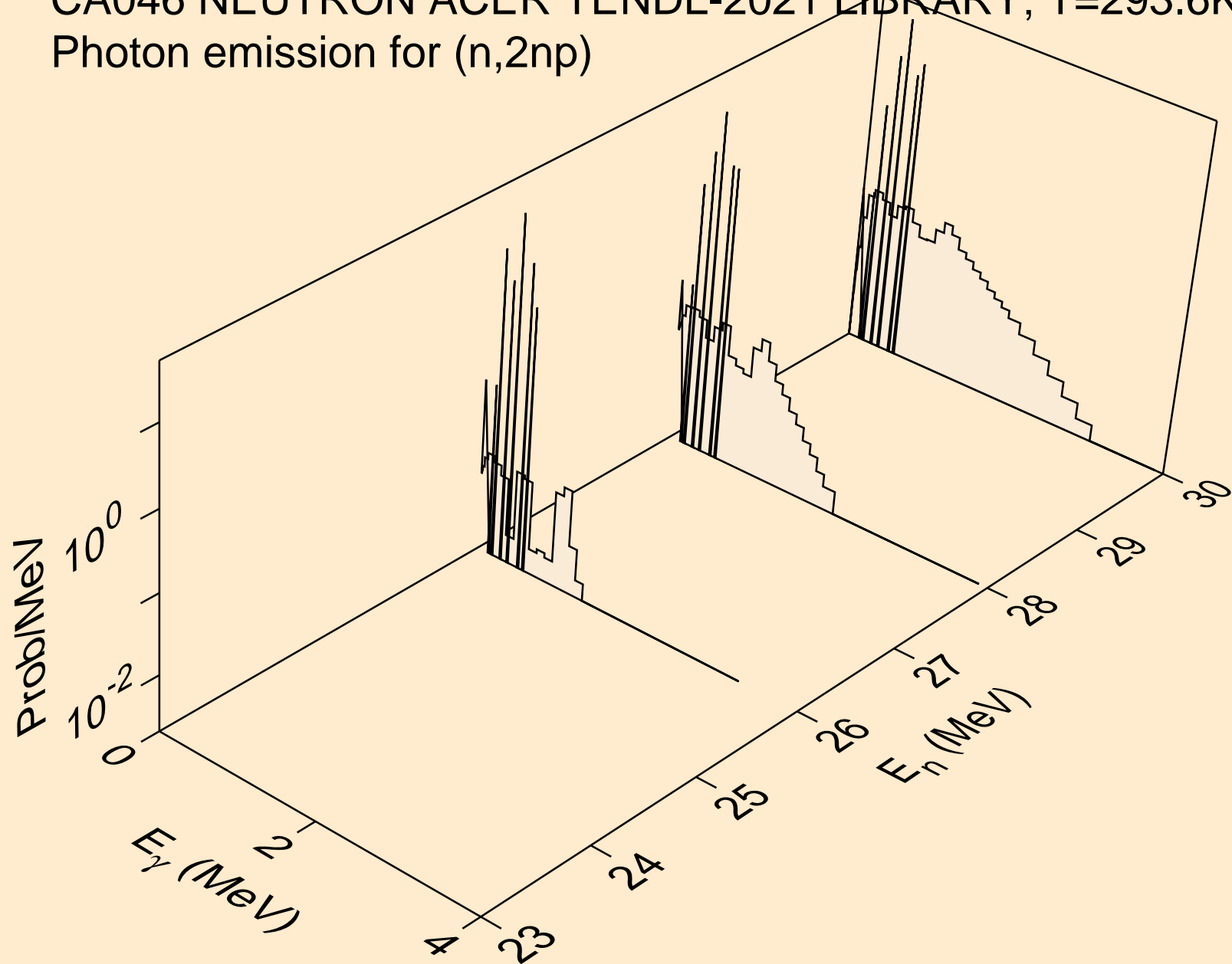

CA046 NEUTRON ACER TENDL-2021 LIBRARY; T=293.6K
Photon emission for (n,2np)

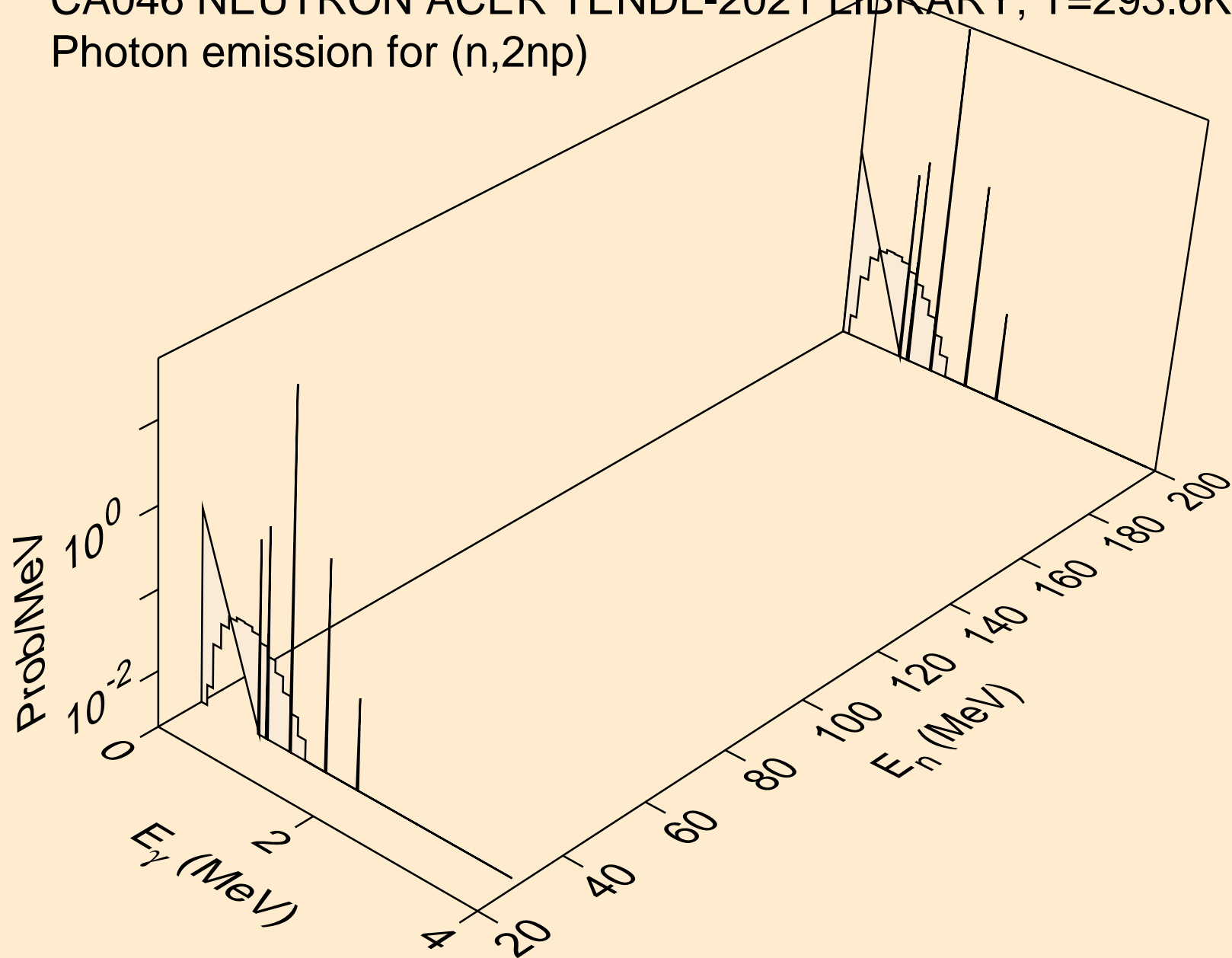

CA046 NEUTRON ACER TENDL-2021 LIBRARY; T=293.6K
Photon emission for (n,n*c)

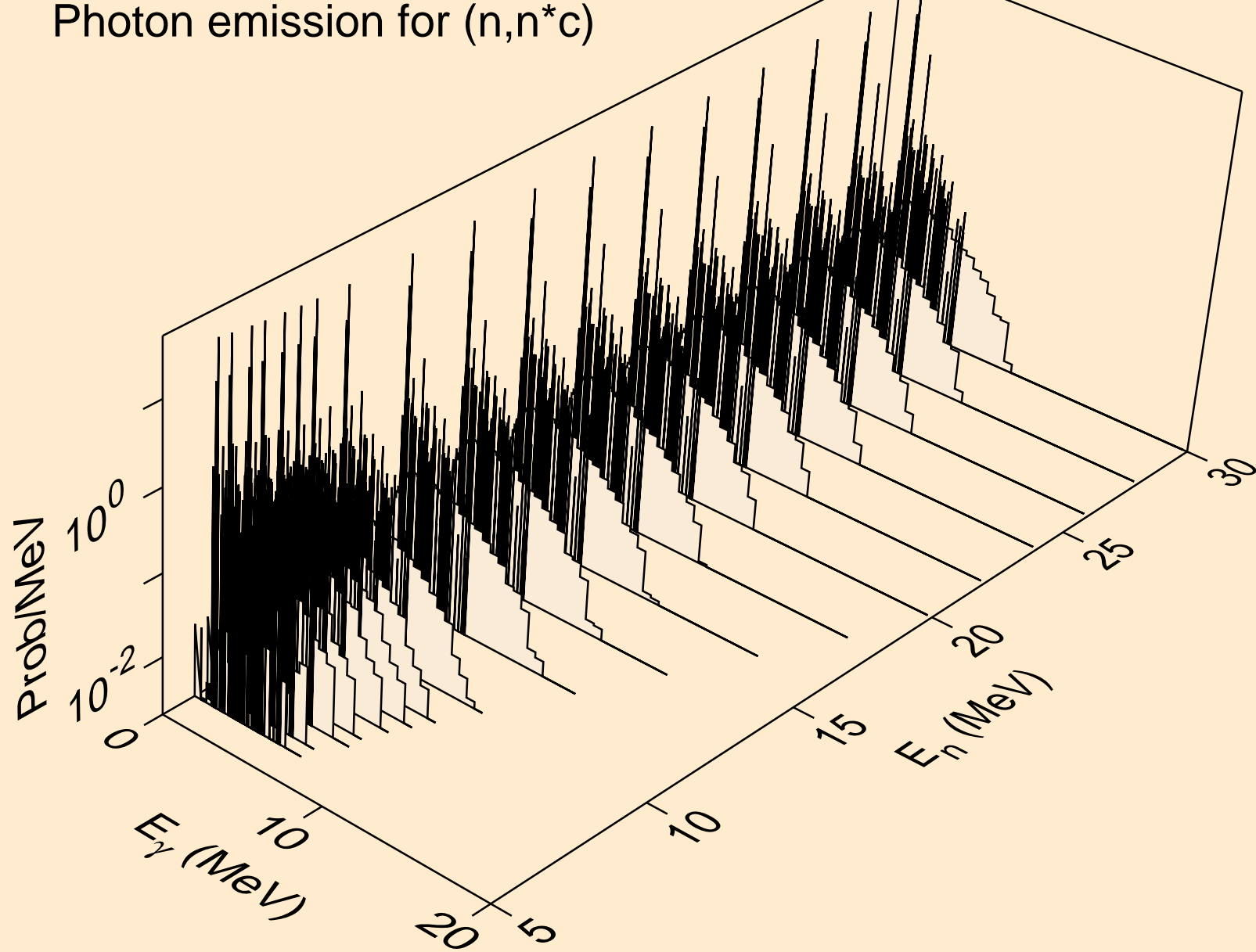

CA046 NEUTRON ACER TENDL-2021 LIBRARY; T=293.6K
Photon emission for (n,gma)

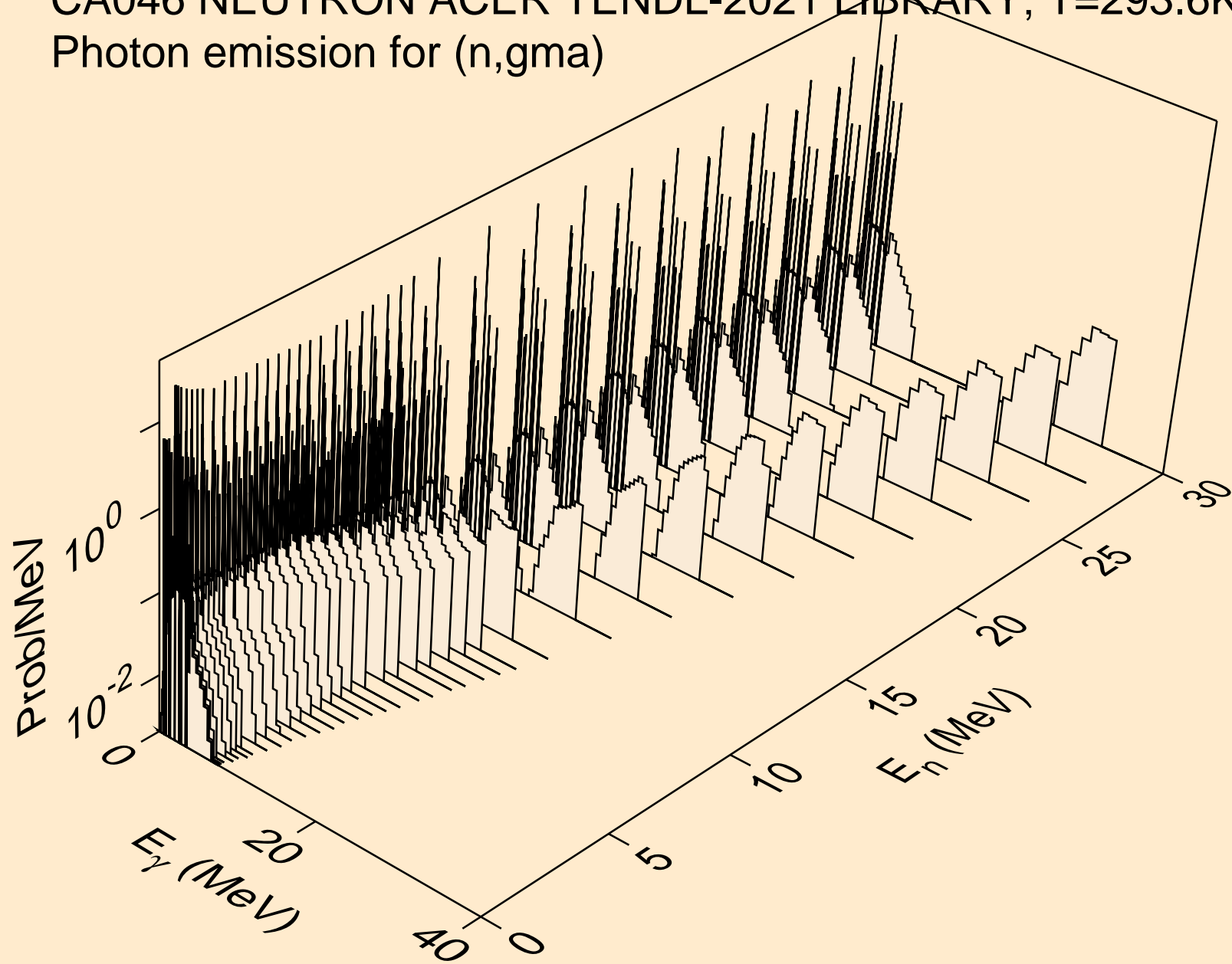

CA046 NEUTRON ACER TENDL-2021 LIBRARY; T=293.6K
Photon emission for (n,p)

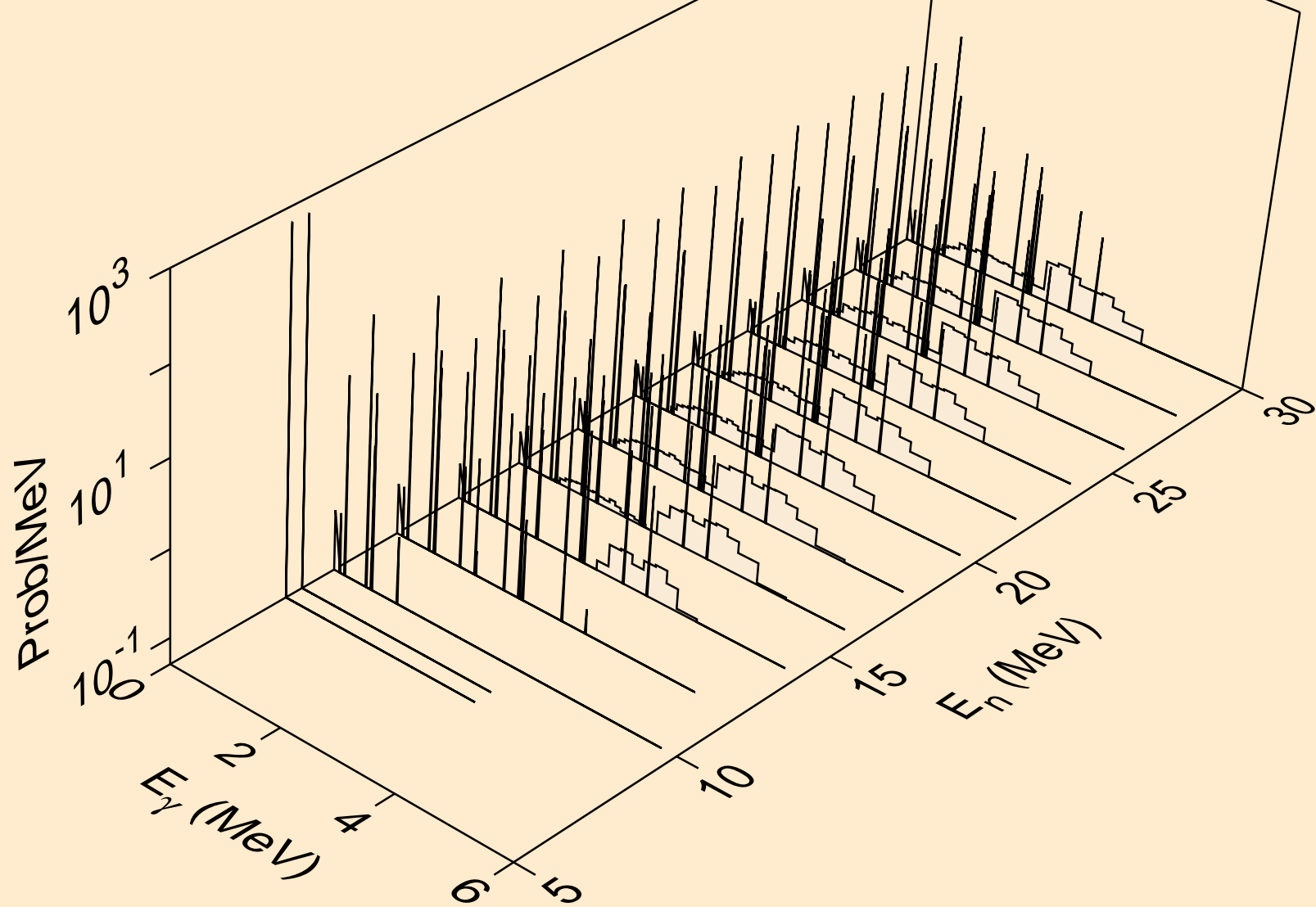

CA046 NEUTRON ACER TENDL-2021 LIBRARY; T=293.6K
Photon emission for (n,d)

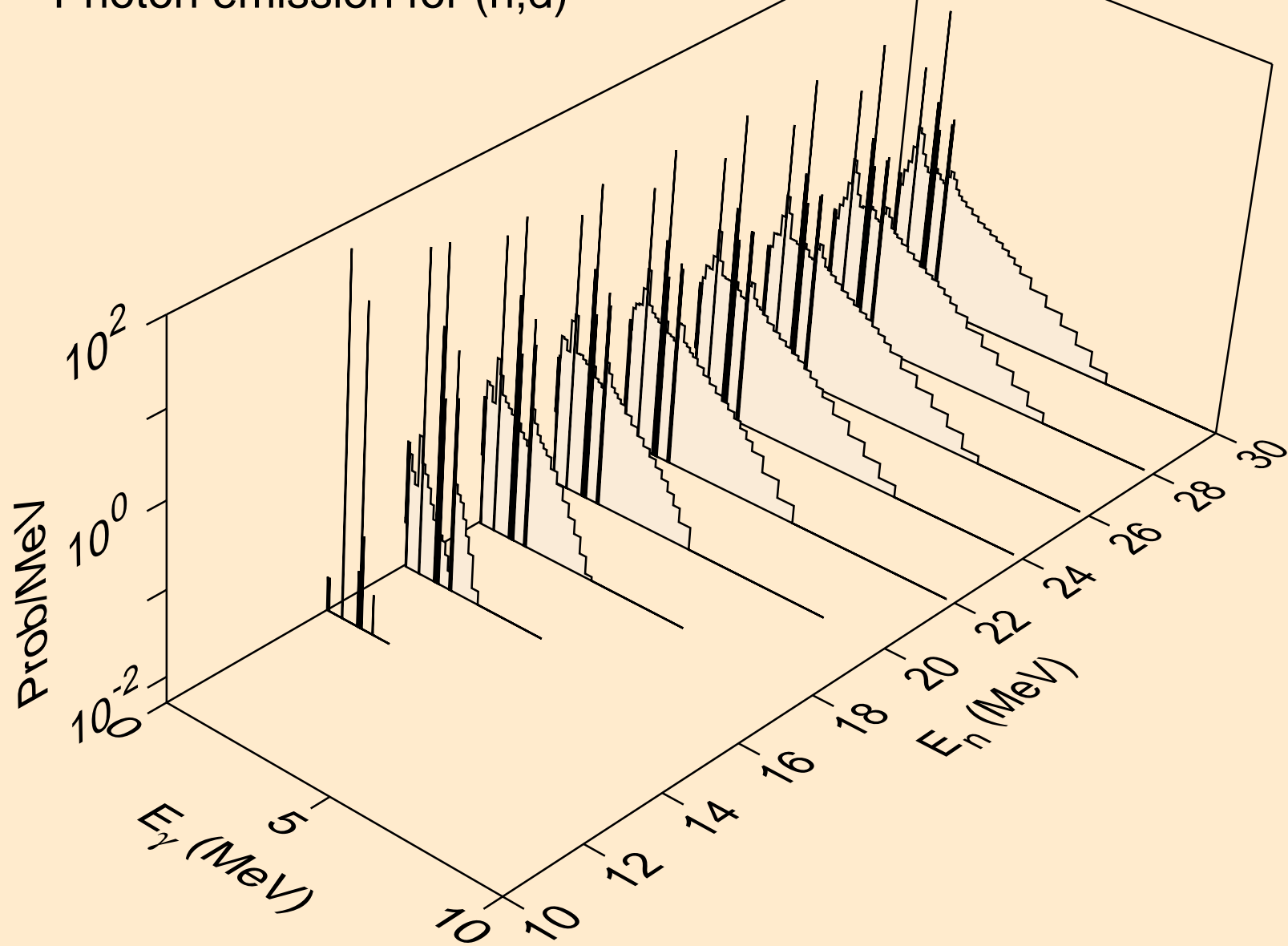

CA046 NEUTRON ACER TENDL-2021 LIBRARY; T=293.6K
Photon emission for (n,t)

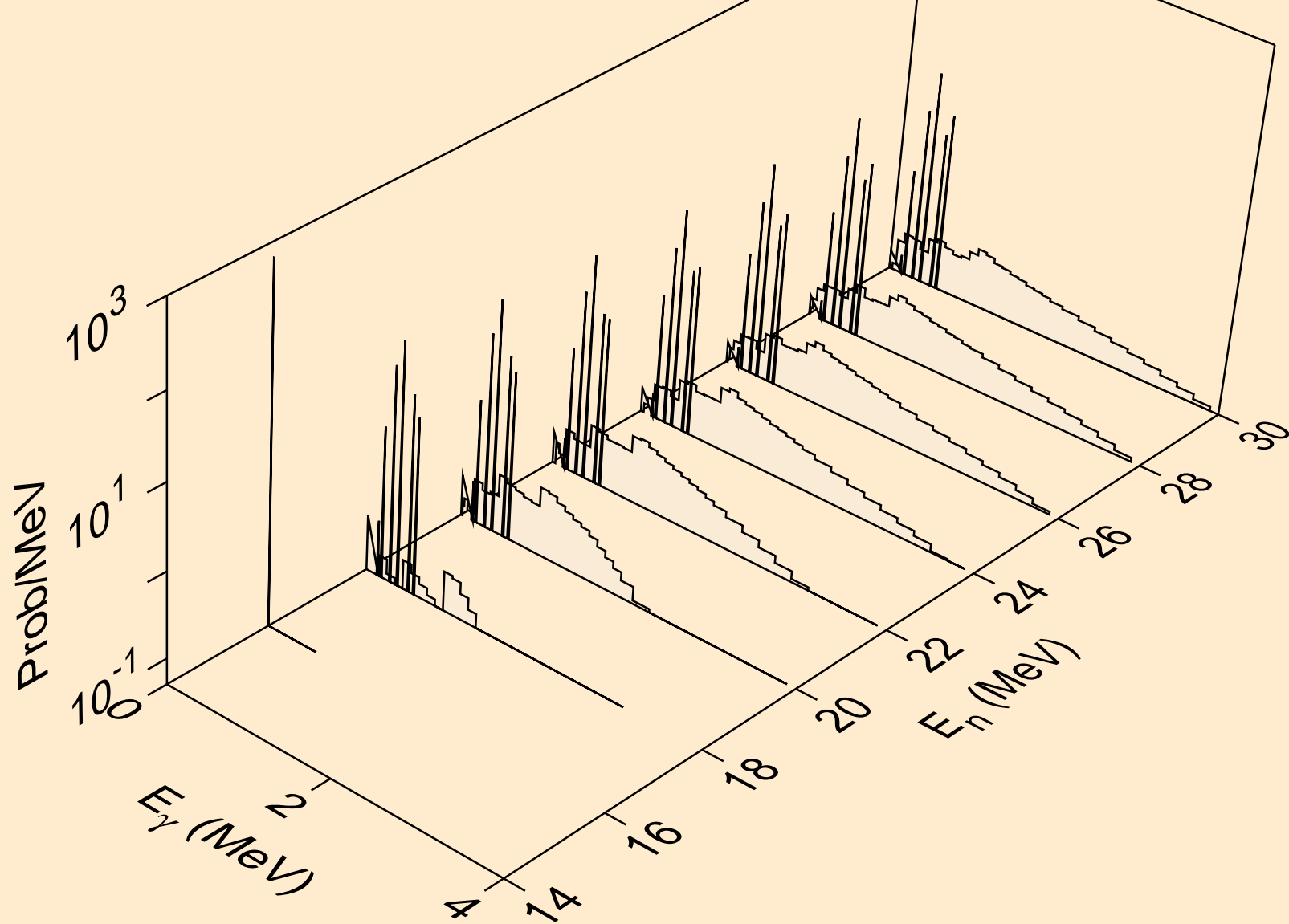

CA046 NEUTRON ACER TENDL-2021 LIBRARY; T=293.6K
Photon emission for (n,he3)

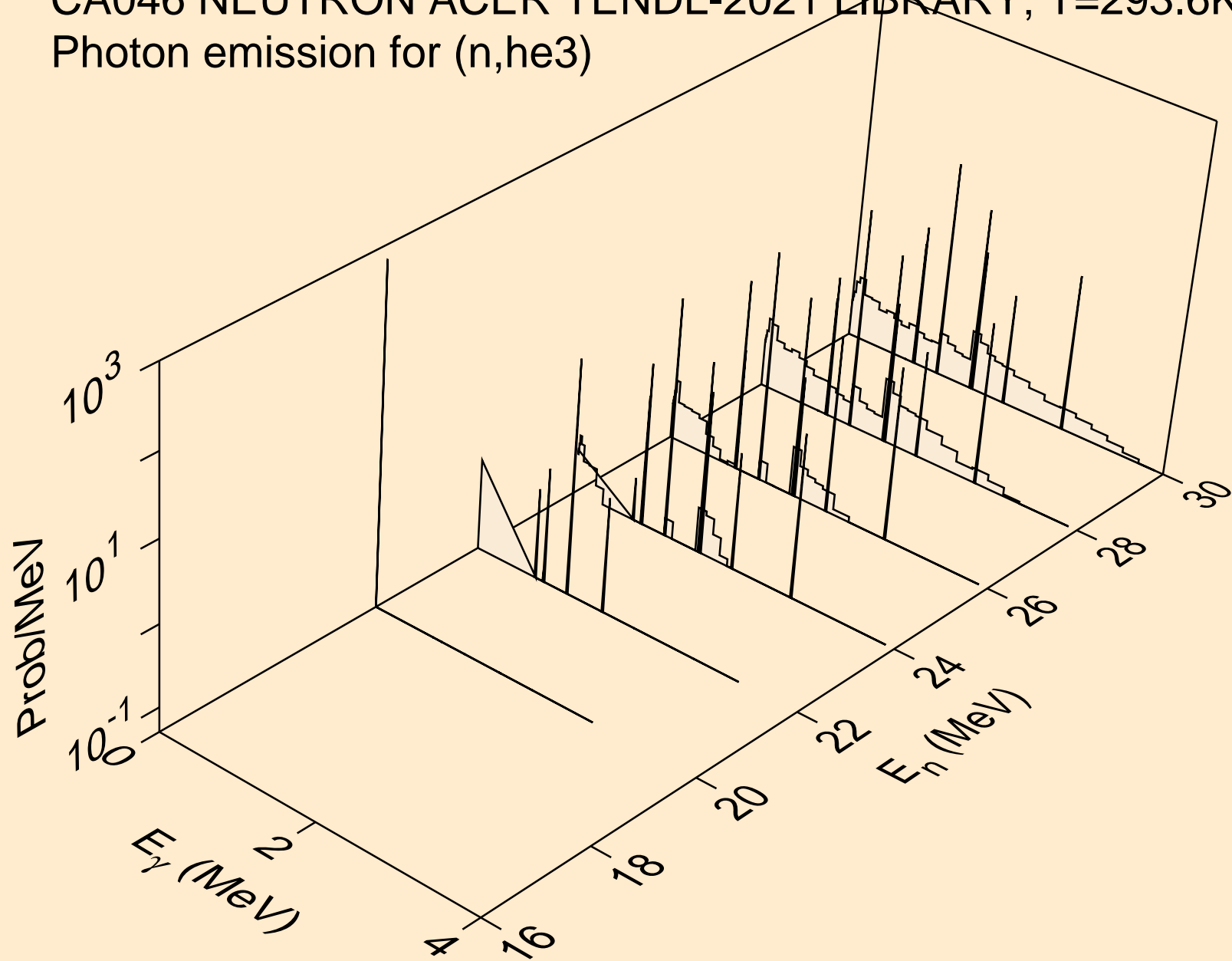

CA046 NEUTRON ACER TENDL-2021 LIBRARY; T=293.6K
Photon emission for (n,a)

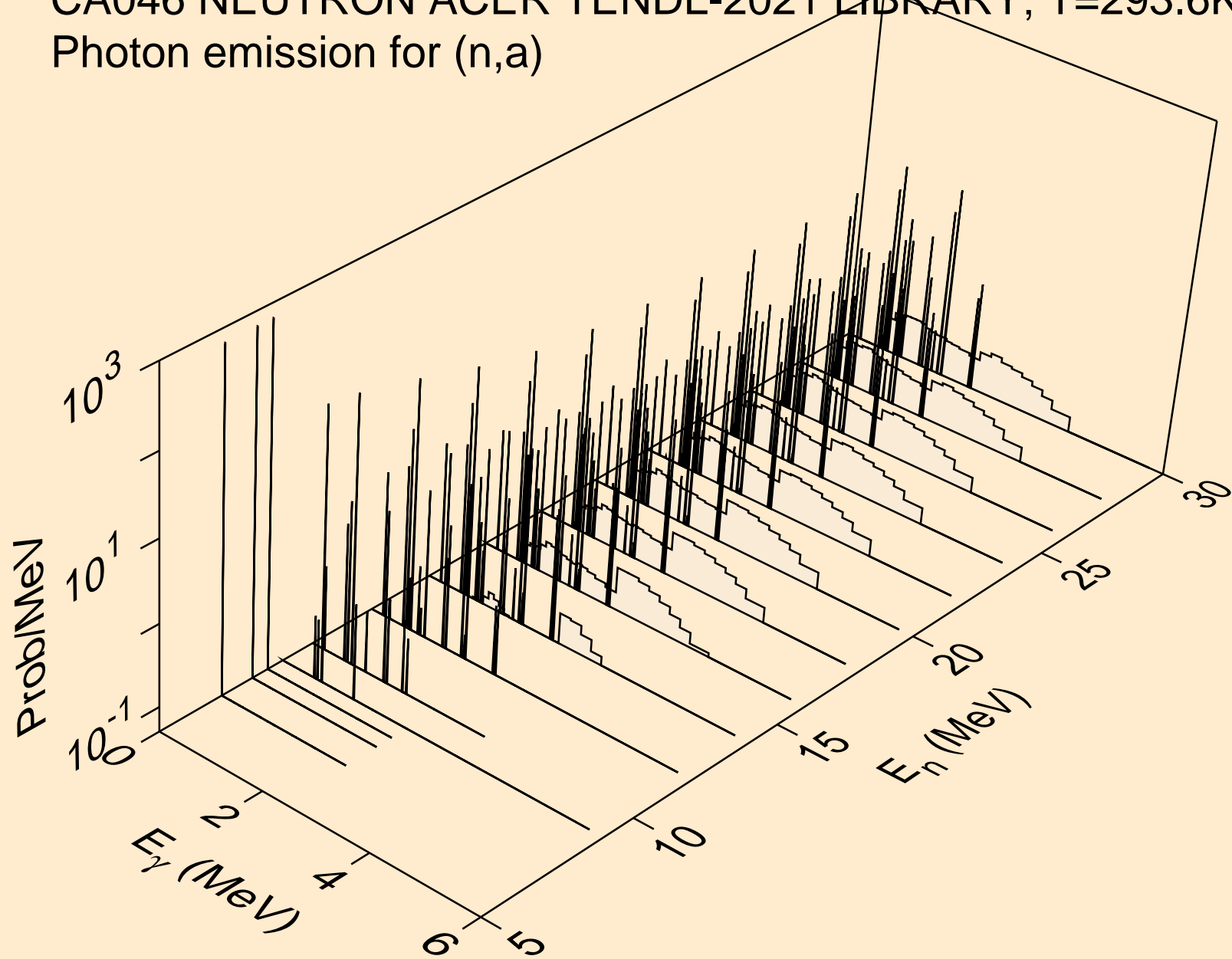

CA046 NEUTRON ACER TENDL-2021 LIBRARY; T=293.6K
Photon emission for (n,2a)

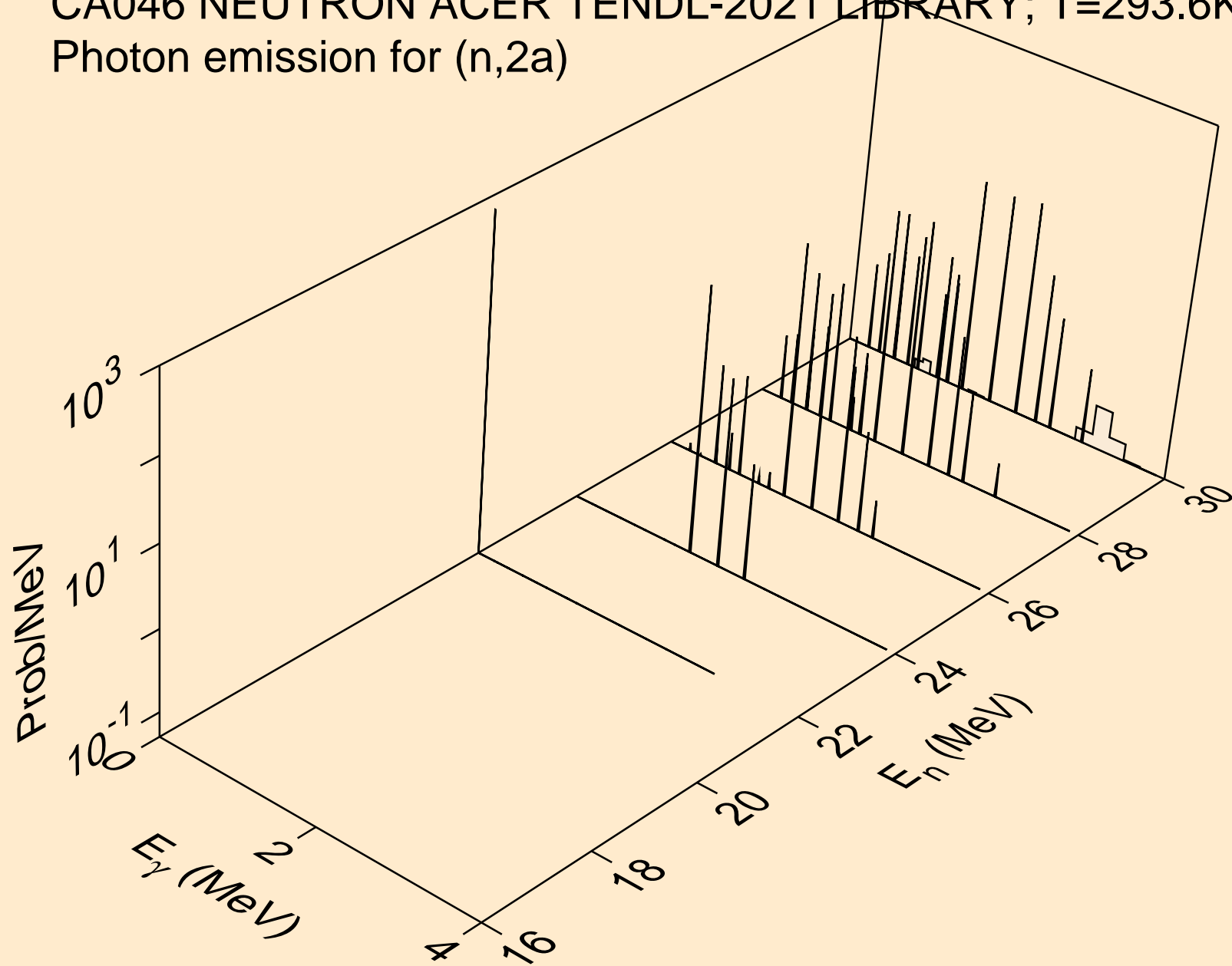

CA046 NEUTRON ACER TENDL-2021 LIBRARY; T=293.6K
Photon emission for (n,2p)

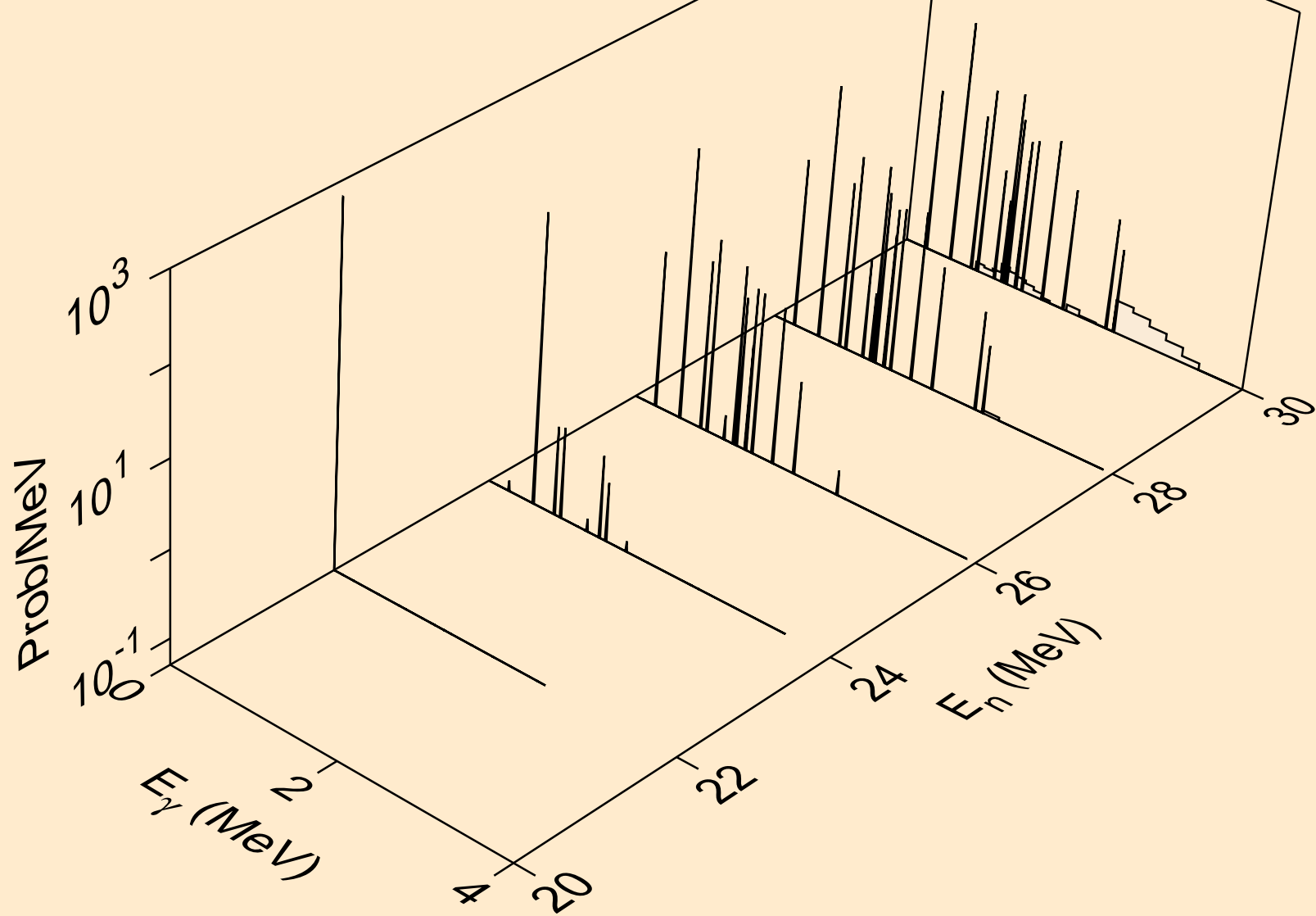

CA046 NEUTRON ACER TENDL-2021 LIBRARY; T=293.6K
Photon emission for (n,p α)

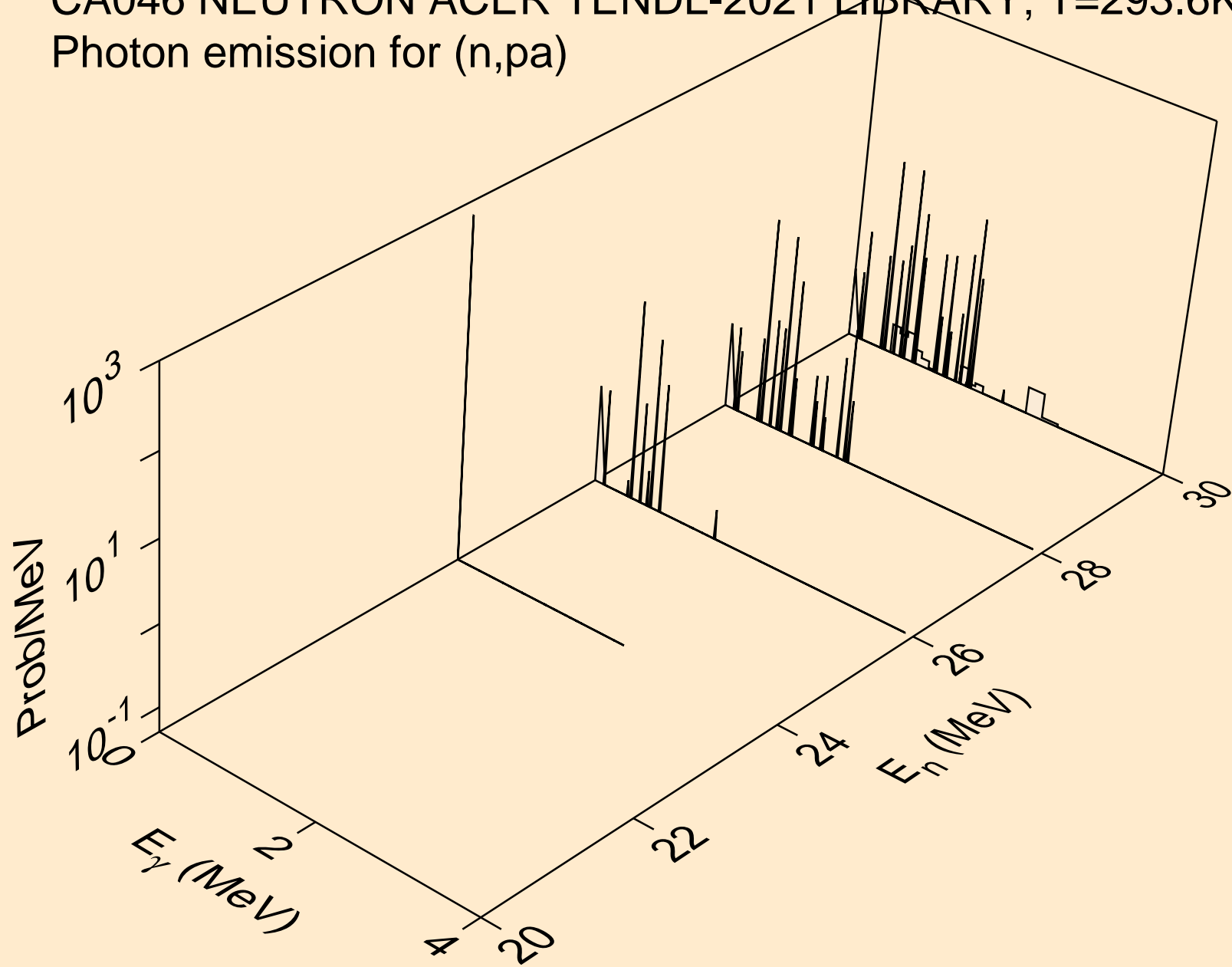

CA046 NEUTRON ACER TENDL-2021 LIBRARY; T=293.6K
Photon emission for (n,pd)

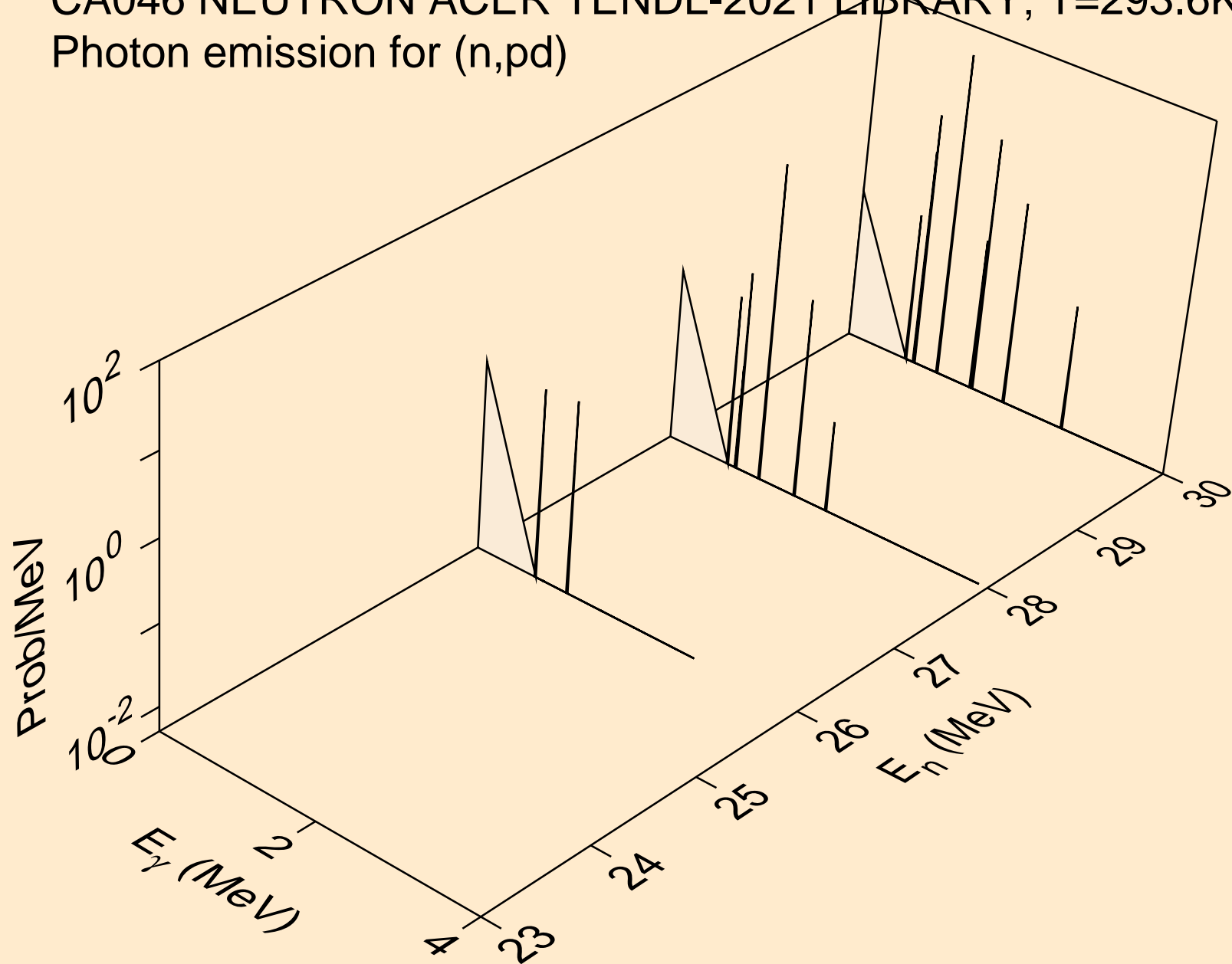

CA046 NEUTRON ACER TENDL-2021 LIBRARY; T=293.6K
thermal capture photon spectrum

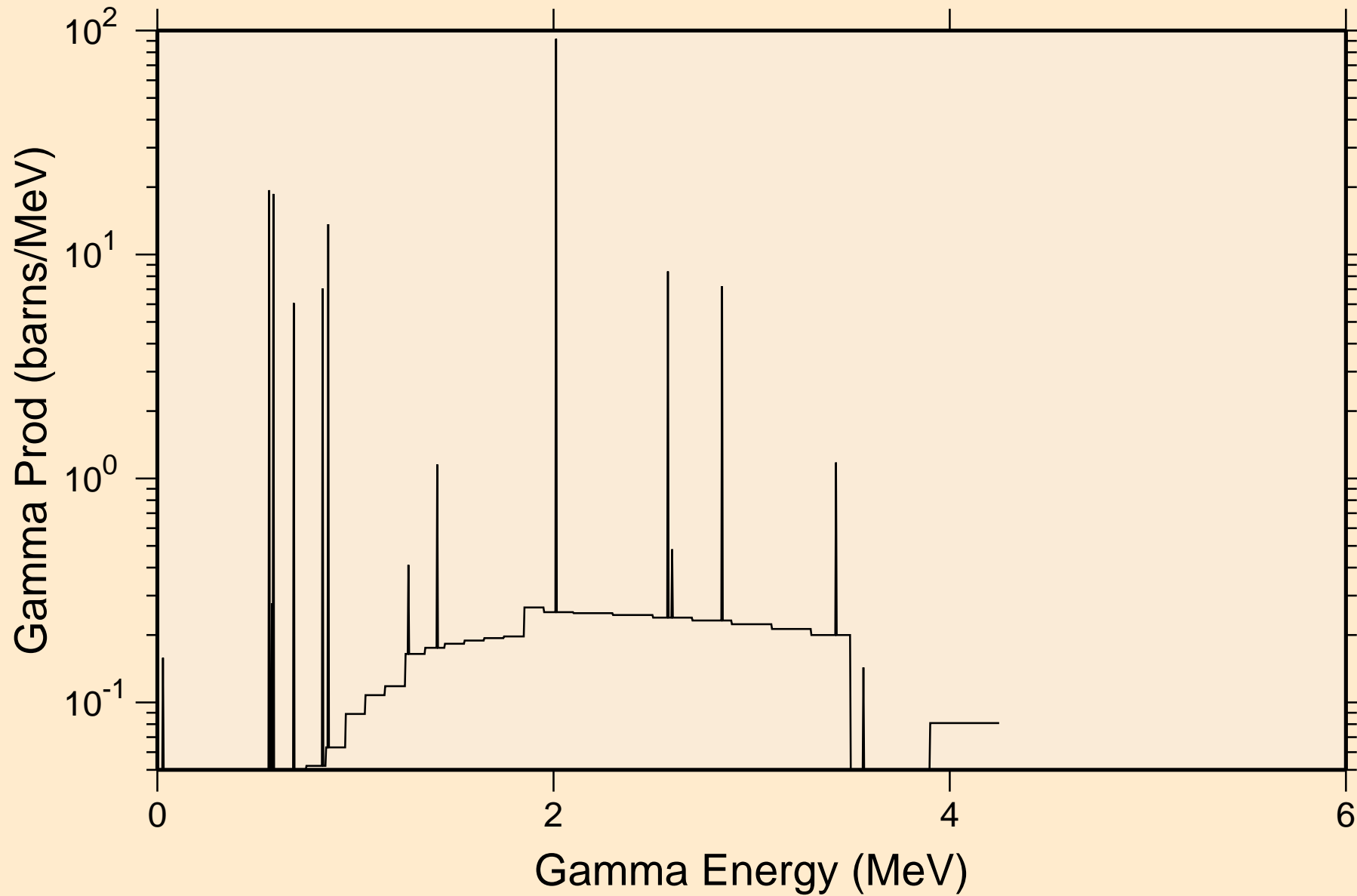

CA046 NEUTRON ACER TENDL-2021 LIBRARY; T=293.6K
14 MeV photon spectrum

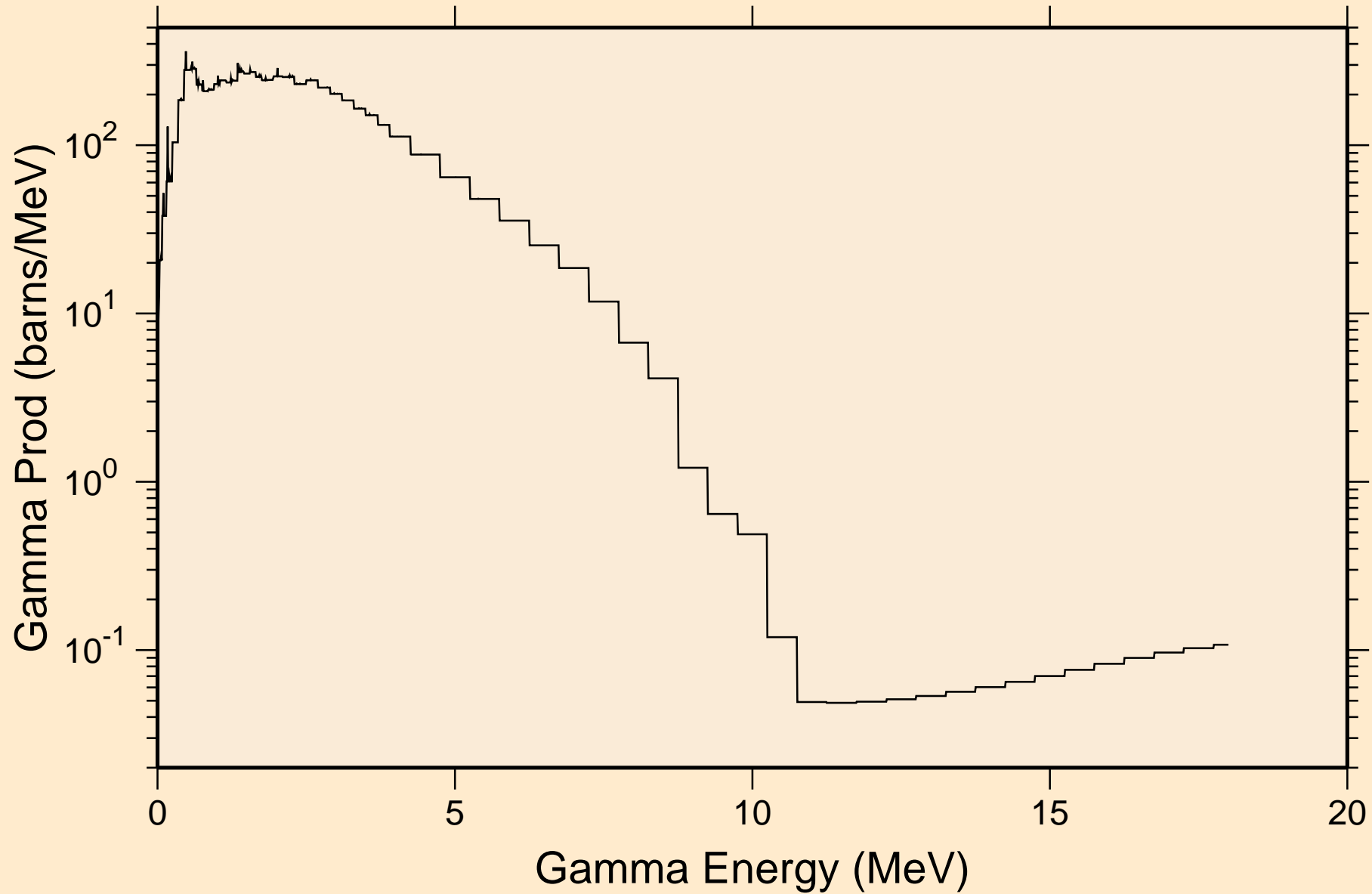

CA046 NEUTRON ACER TENDL-2021 LIBRARY; T=293.6K
Particle heating contributions

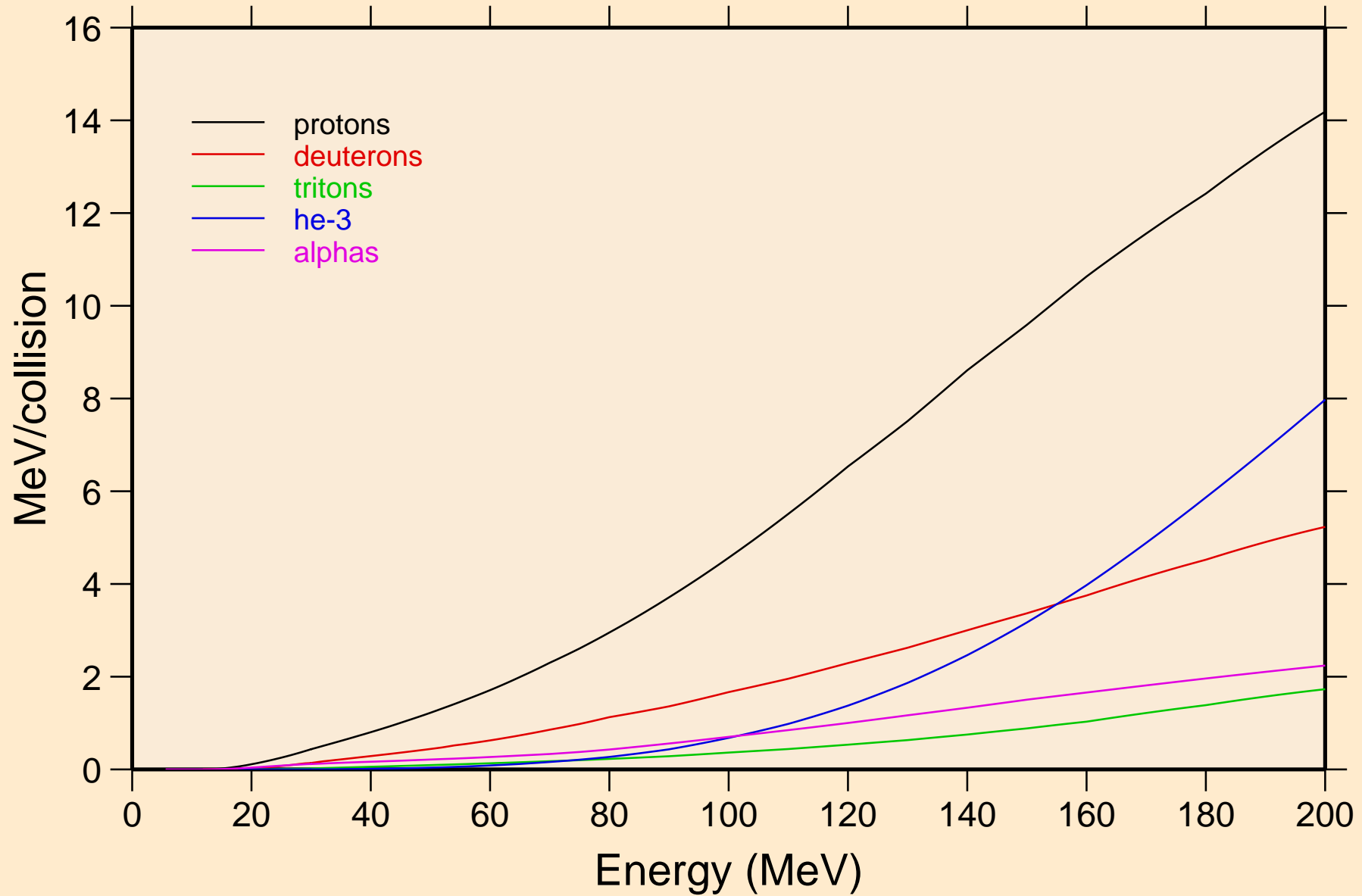

CA046 NEUTRON ACER TENDL-2021 LIBRARY; T=293.6K
Recoil Heating

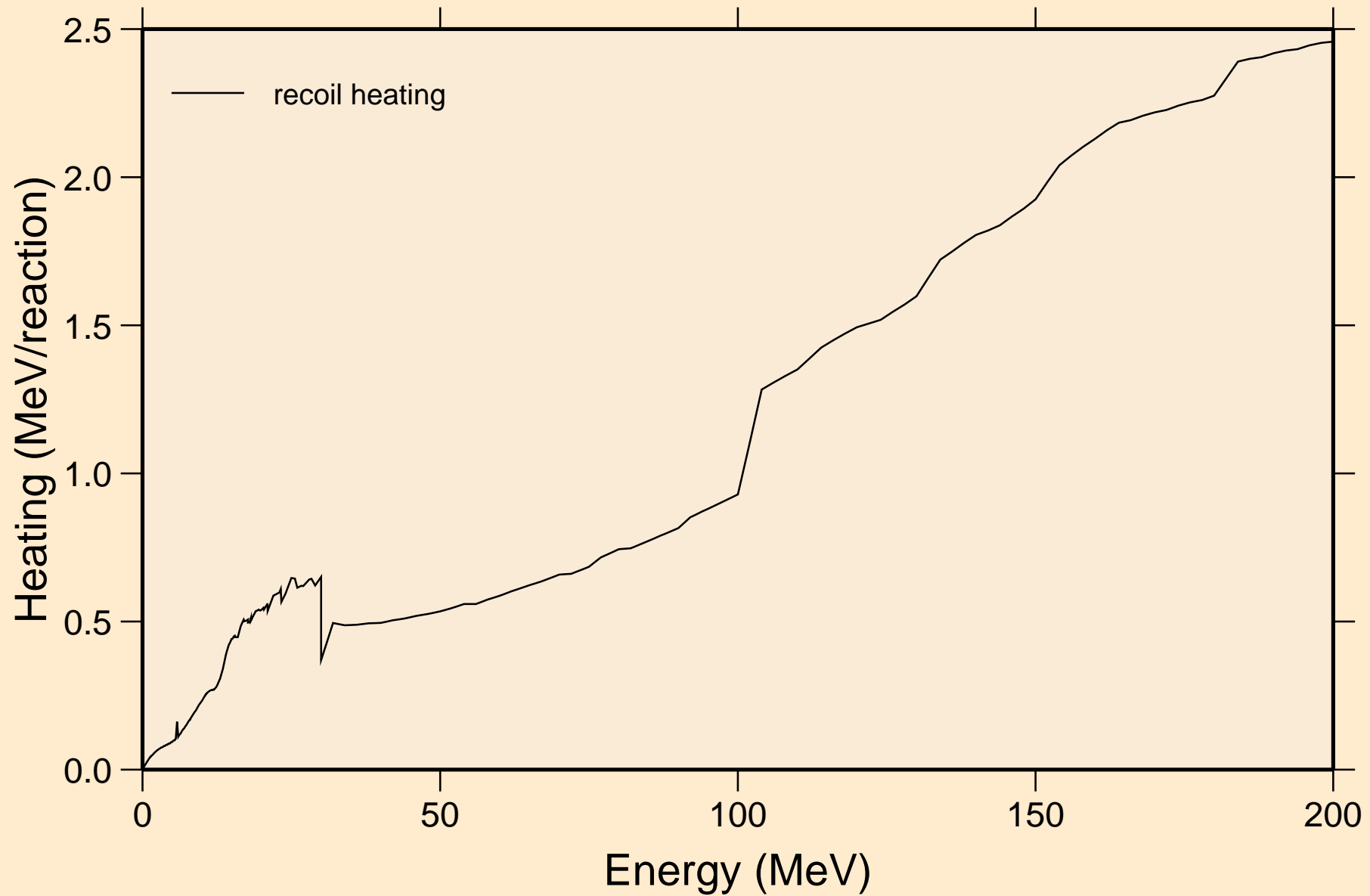

CA046 NEUTRON ACER TENDL-2021 LIBRARY; T=293.6K
Particle production cross sections

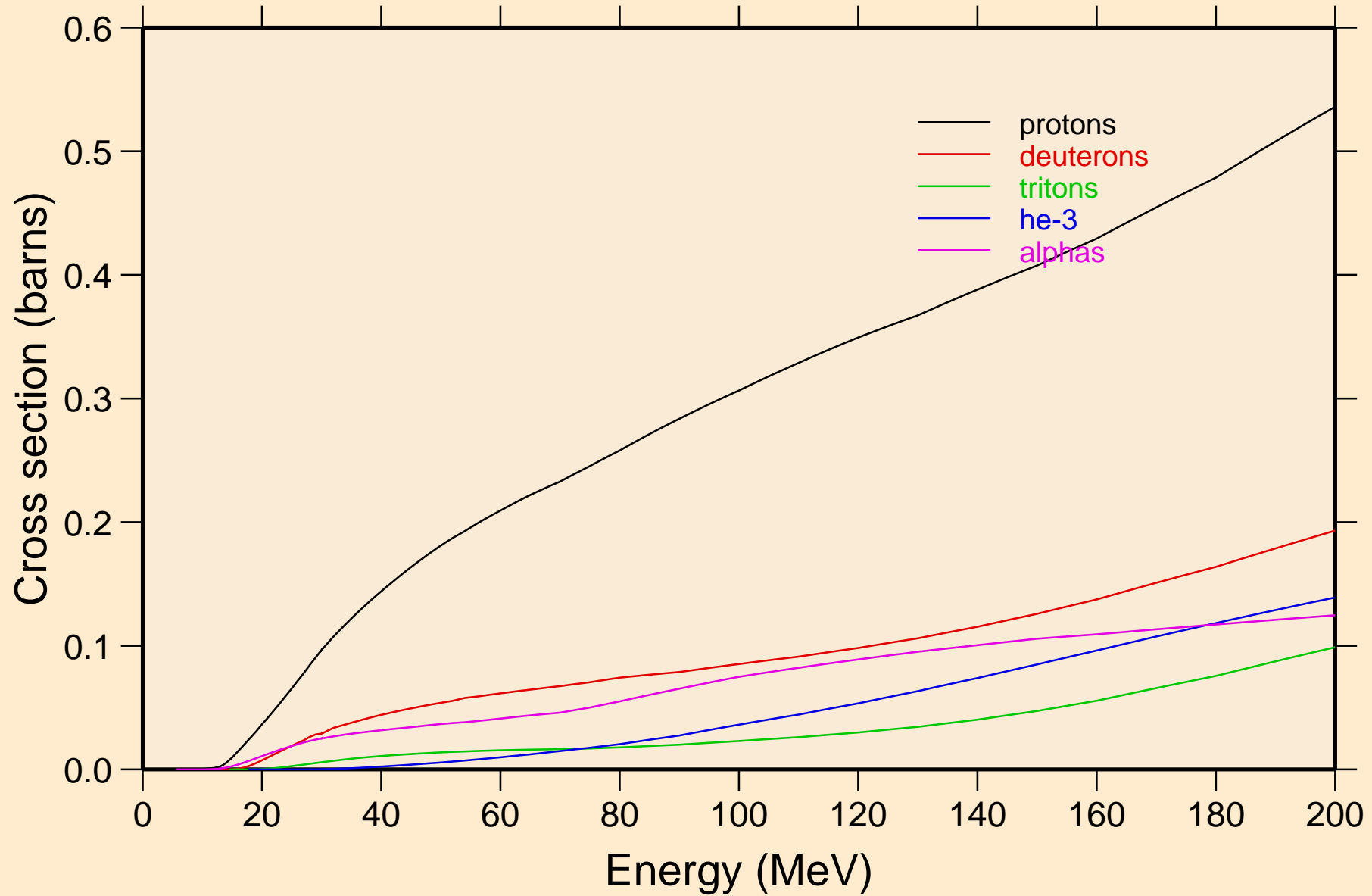

CA046 NEUTRON ACER TENDL-2021 LIBRARY; T=293.6K
protons from (n,x)

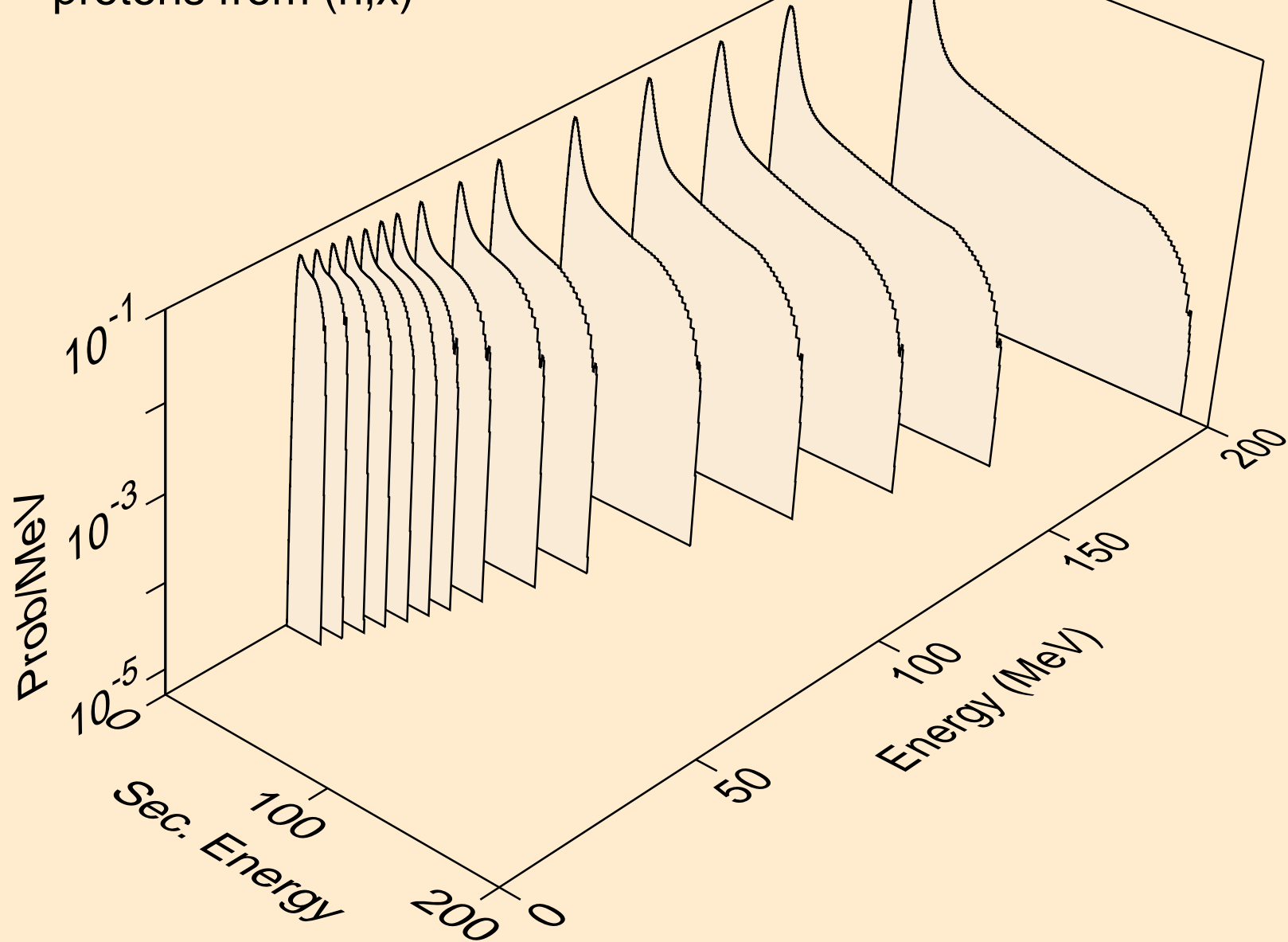

CA046 NEUTRON ACER TENDL-2021 LIBRARY; T=293.6K
protons from (n,n*)p

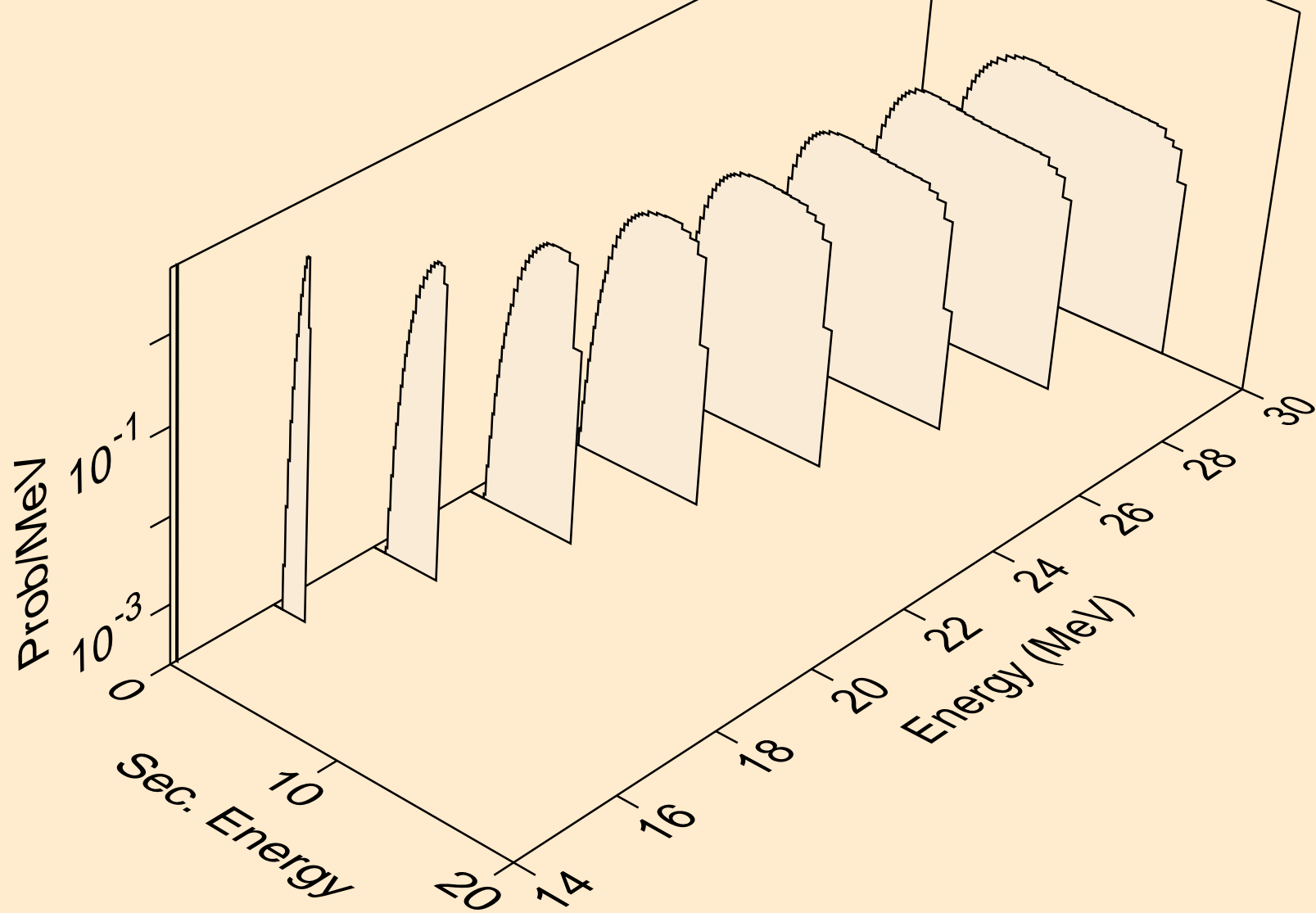

CA046 NEUTRON ACER TENDL-2021 LIBRARY; T=293.6K
protons from (n,2np)

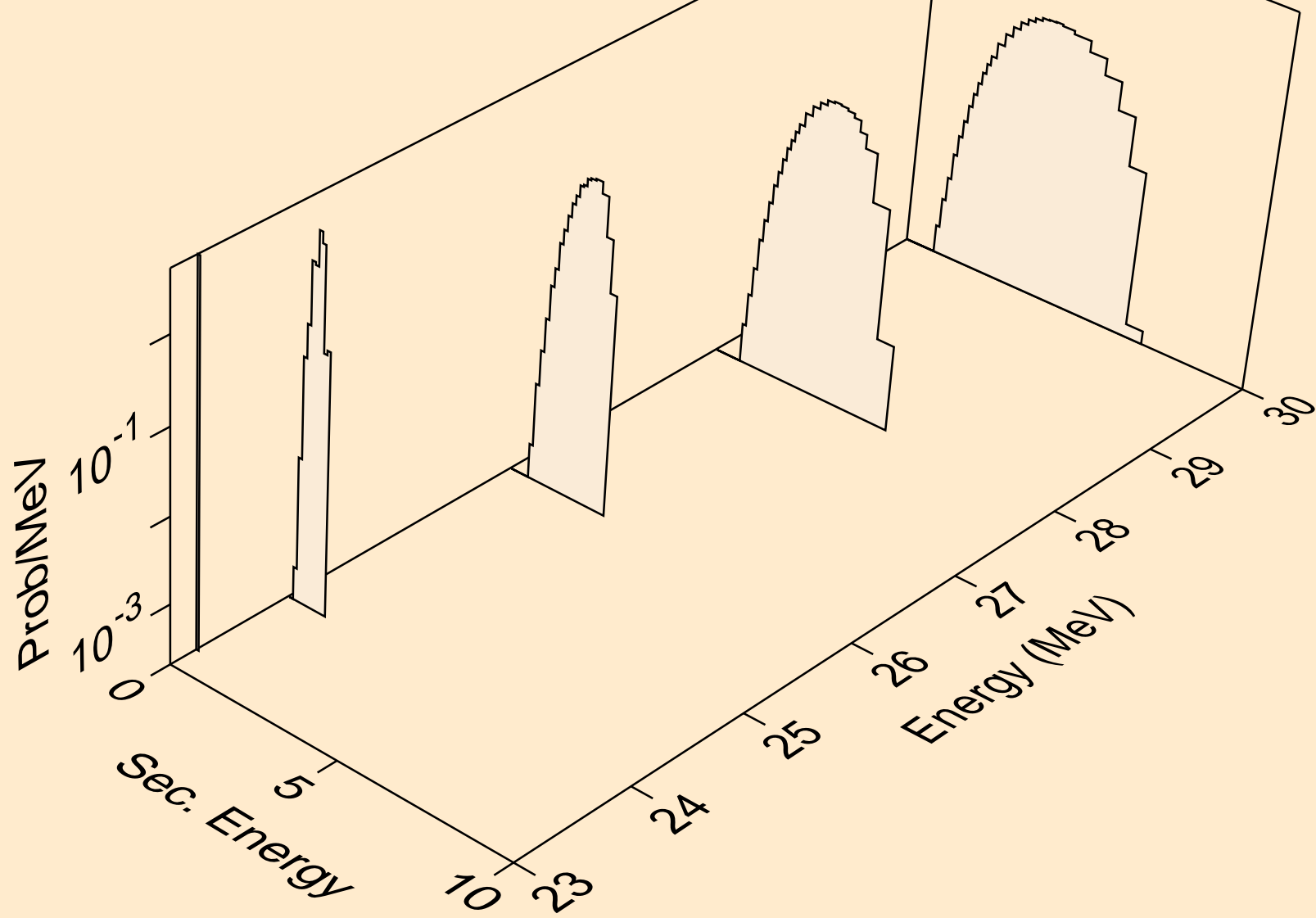

CA046 NEUTRON ACER TENDL-2021 LIBRARY; T=293.6K
protons from (n,2np)

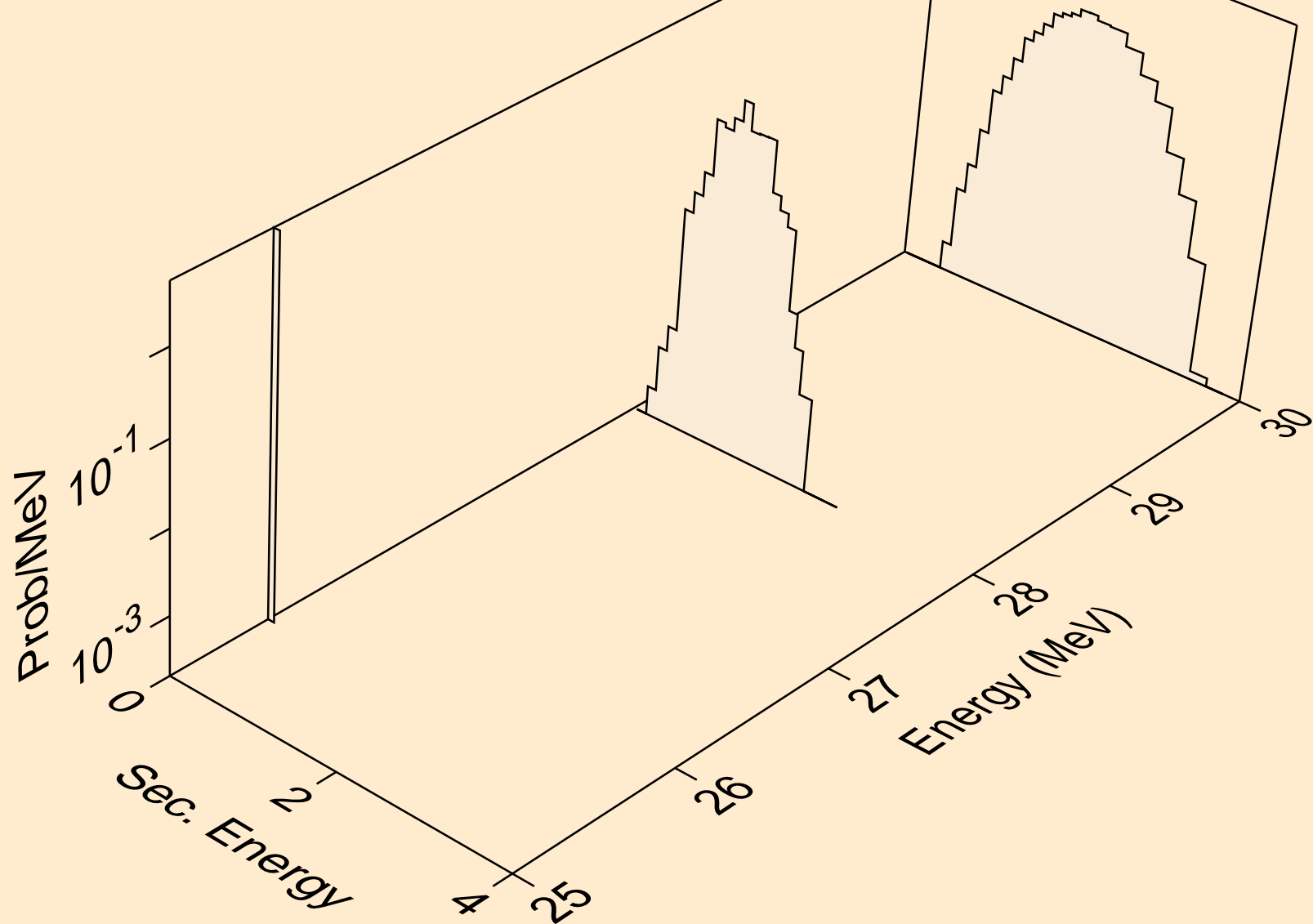

CA046 NEUTRON ACER TENDL-2021 LIBRARY; T=293.6K
protons from (n,p)

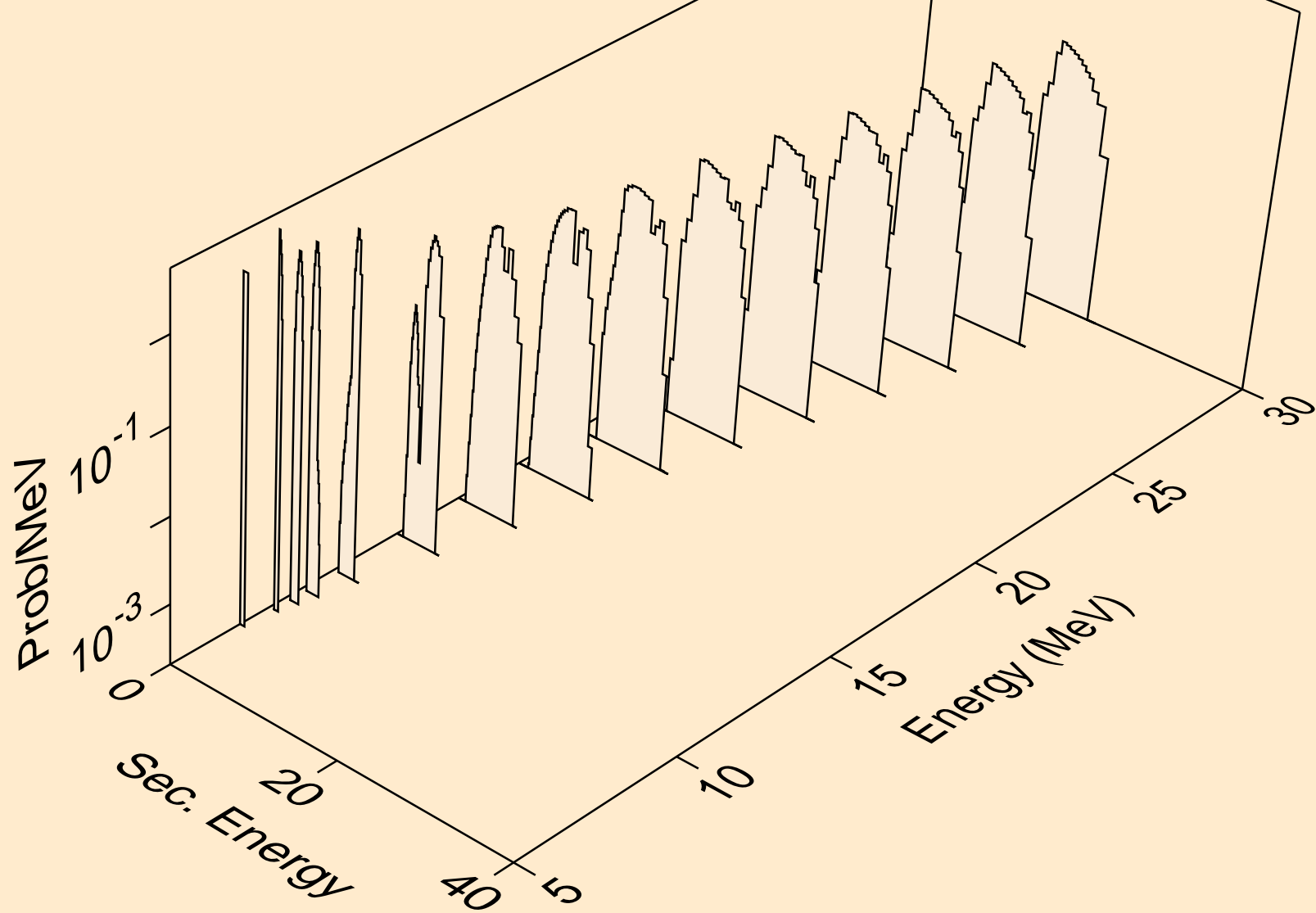

CA046 NEUTRON ACER TENDL-2021 LIBRARY; T=293.6K
protons from (n,2p)

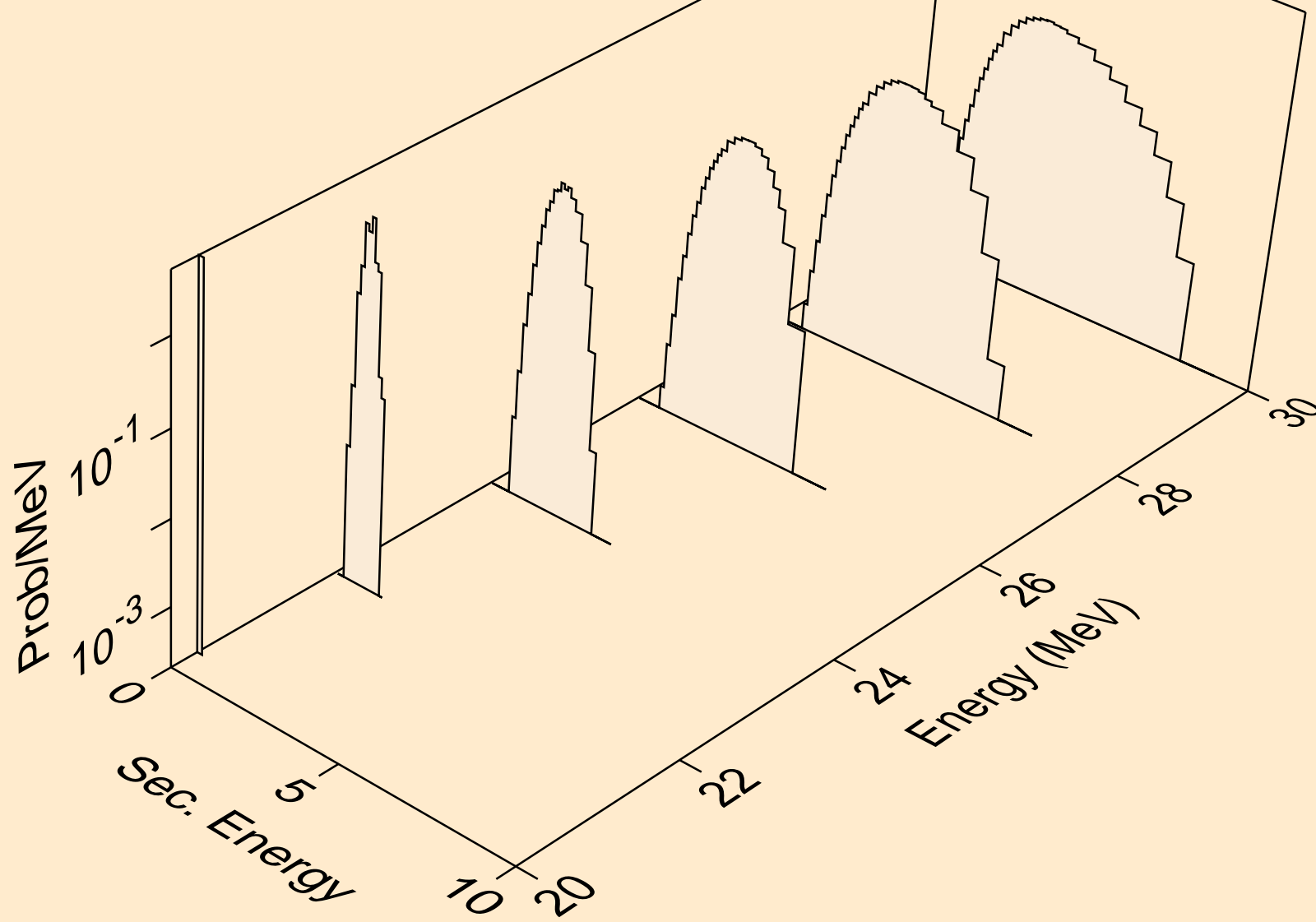

CA046 NEUTRON ACER TENDL-2021 LIBRARY; T=293.6K
protons from (n,pa)

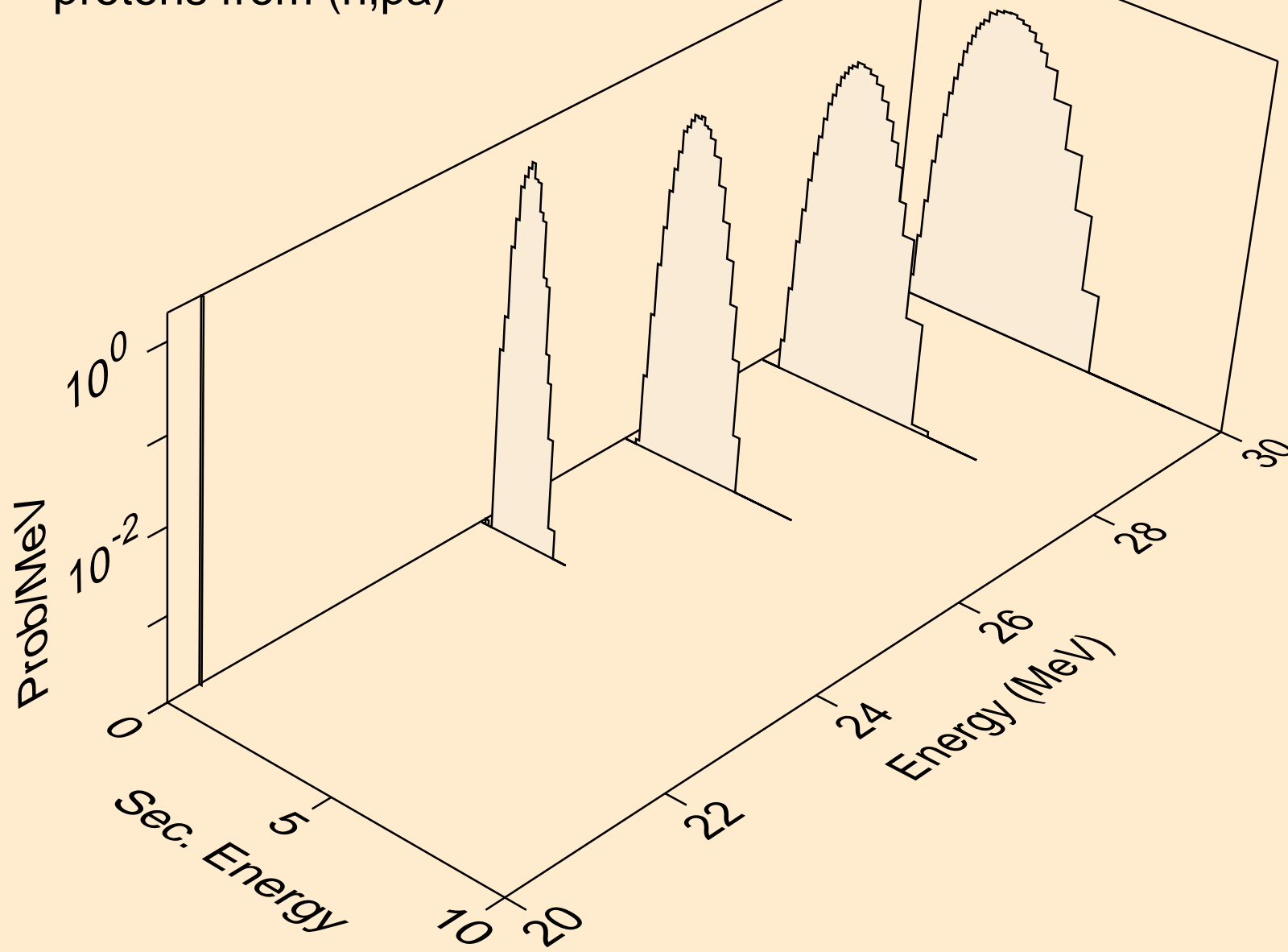

CA046 NEUTRON ACER TENDL-2021 LIBRARY; T=293.6K
protons from (n,pd)

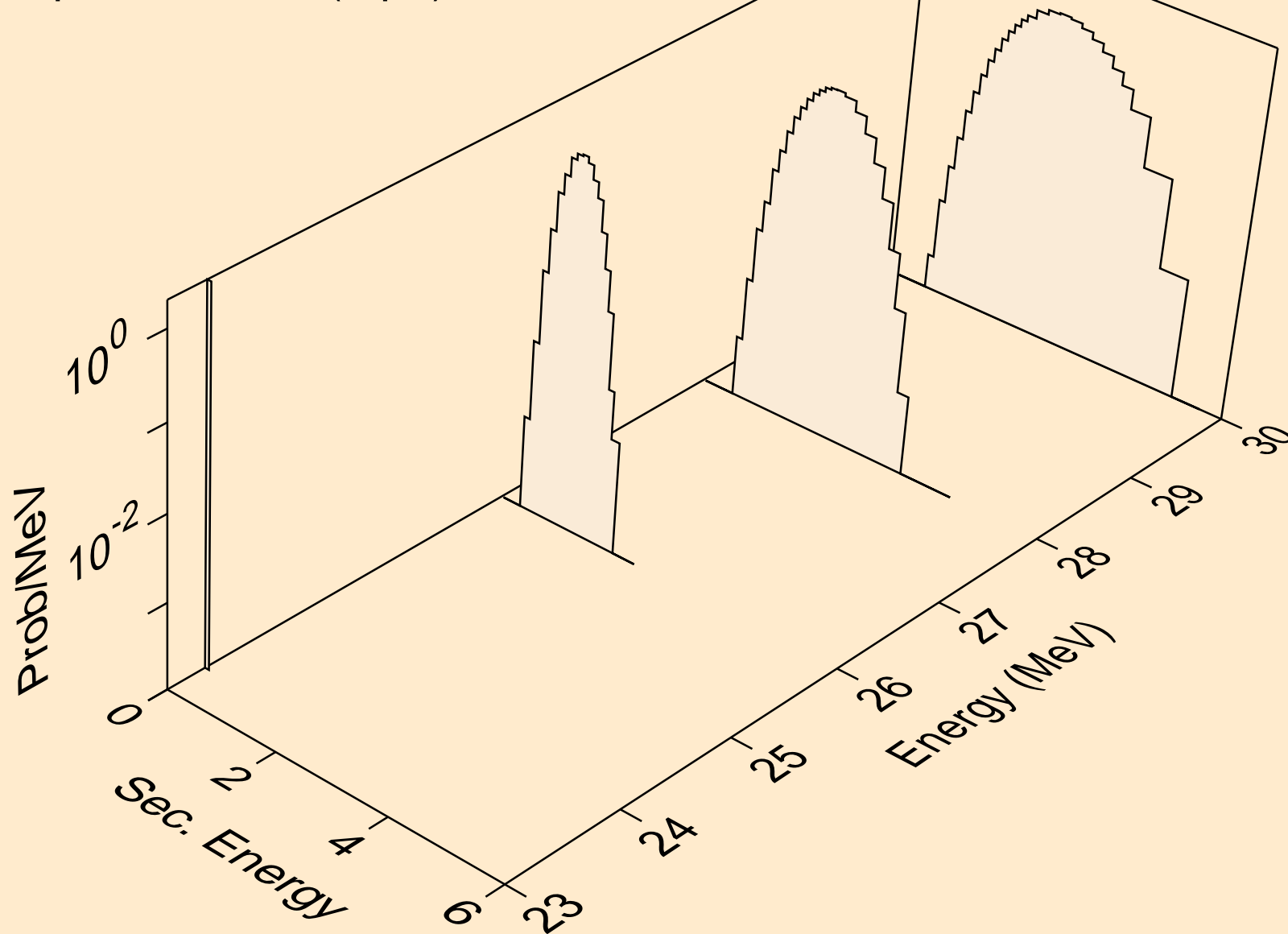

CA046 NEUTRON ACER TENDL-2021 LIBRARY; T=293.6K
deuterons from (n,x)

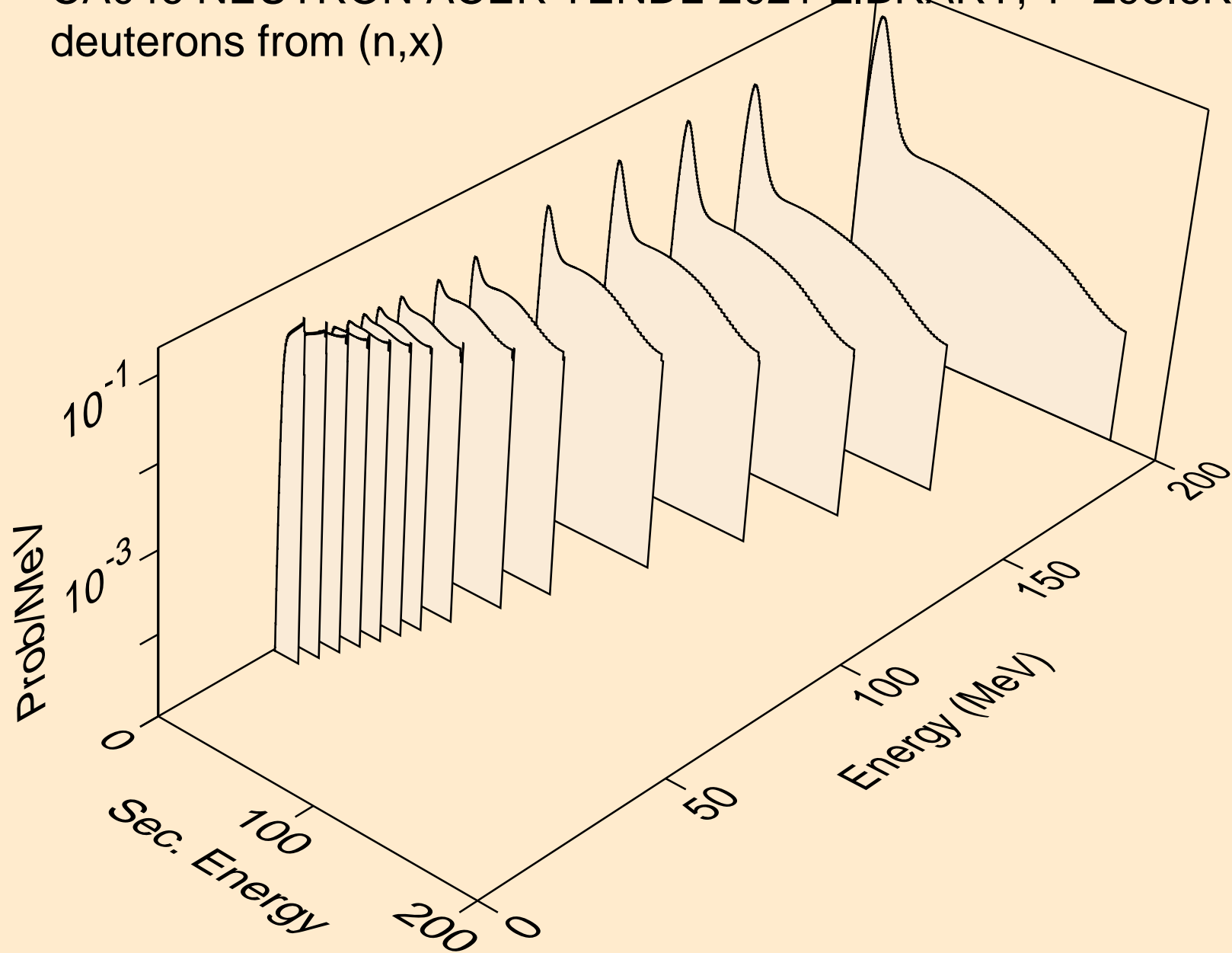

CA046 NEUTRON ACER TENDL-2021 LIBRARY; T=293.6K
deuterons from (n,2nd)

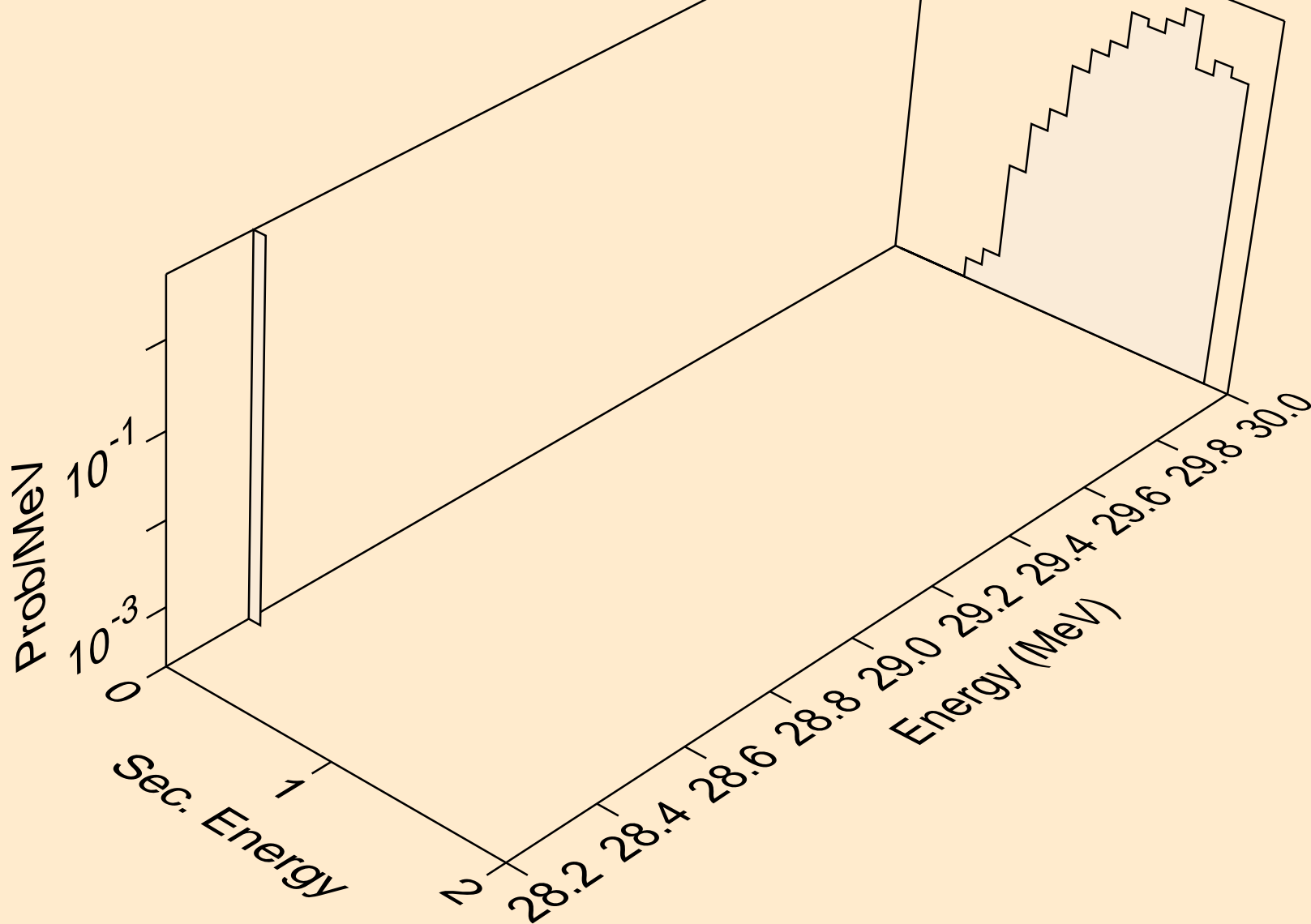

CA046 NEUTRON ACER TENDL-2021 LIBRARY; T=293.6K
deuterons from (n,n*)d

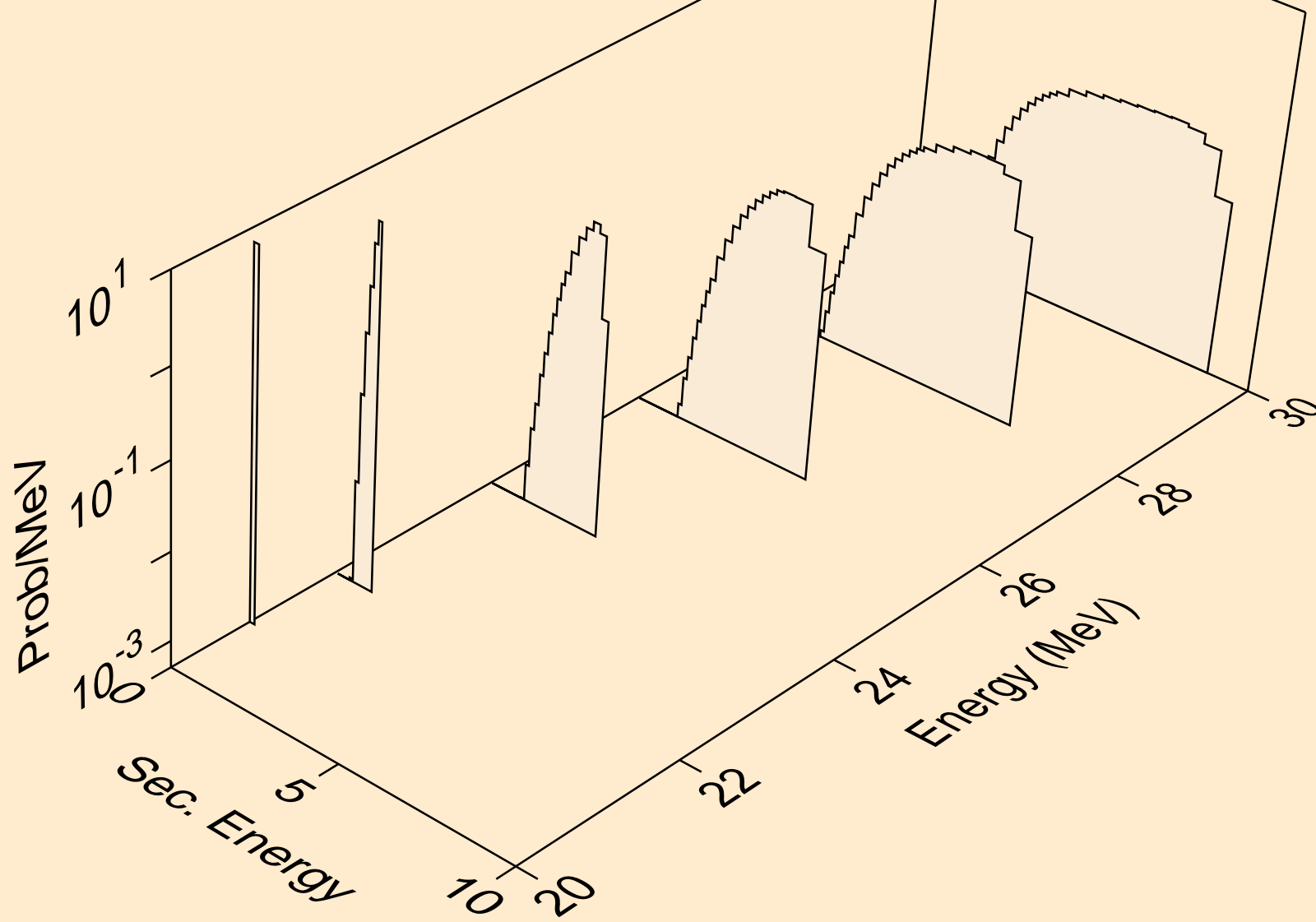

CA046 NEUTRON ACER TENDL-2021 LIBRARY; T=293.6K
deuterons from (n,d)

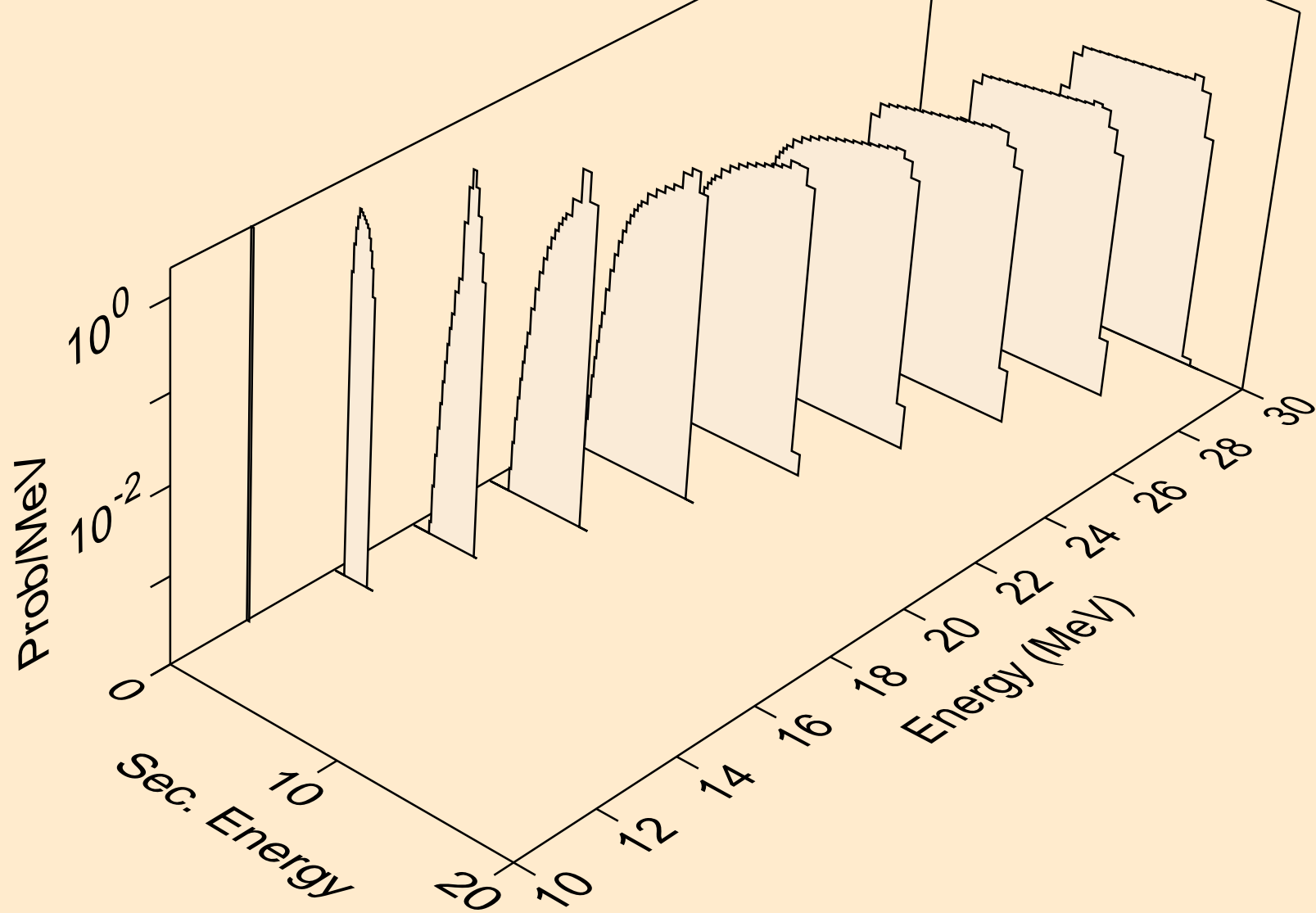

CA046 NEUTRON ACER TENDL-2021 LIBRARY; T=293.6K
deuterons from (n,pd)

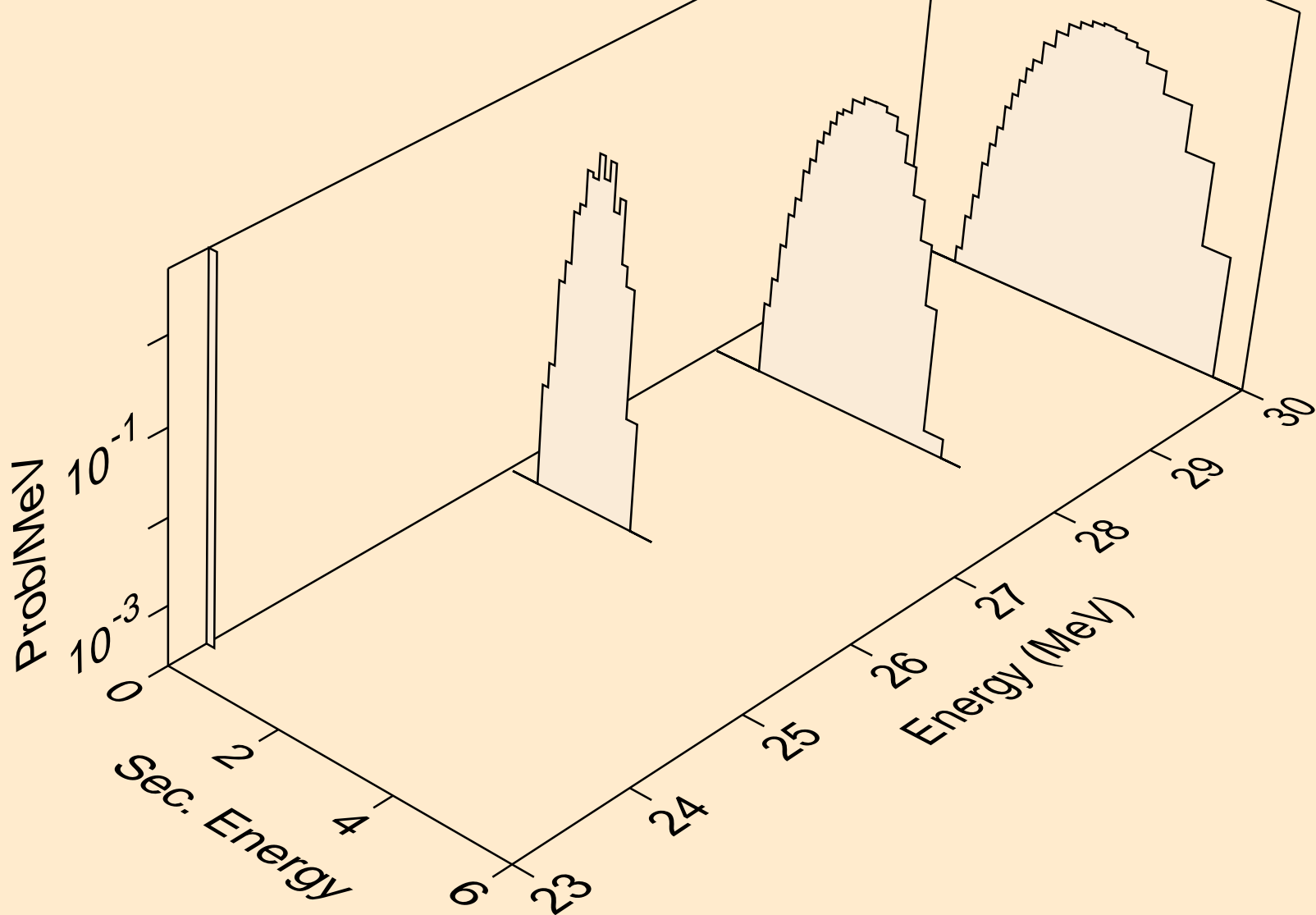

CA046 NEUTRON ACER TENDL-2021 LIBRARY; T=293.6K
tritons from (n,x)

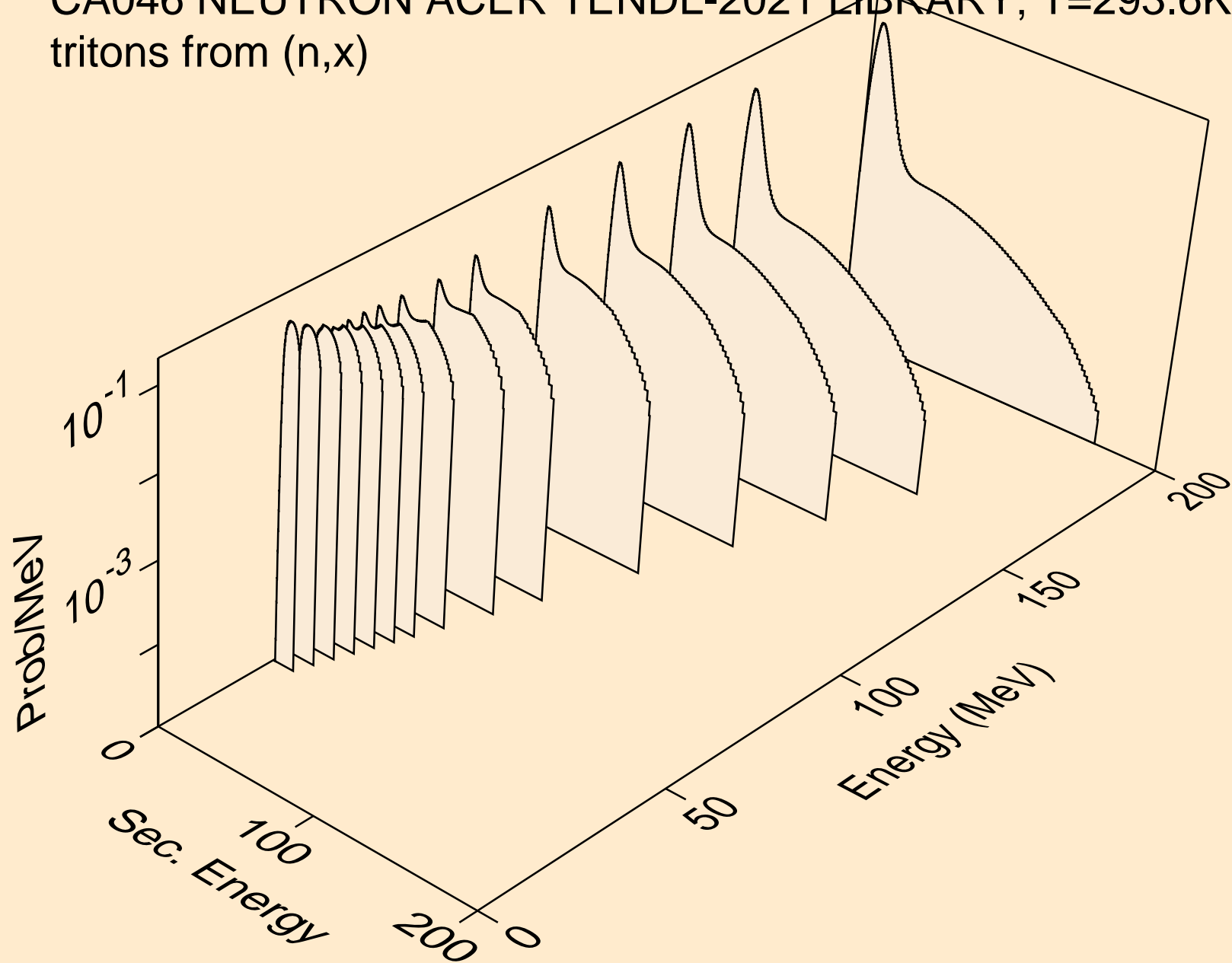

CA046 NEUTRON ACER TENDL-2021 LIBRARY; T=293.6K
tritons from (n,n*)t

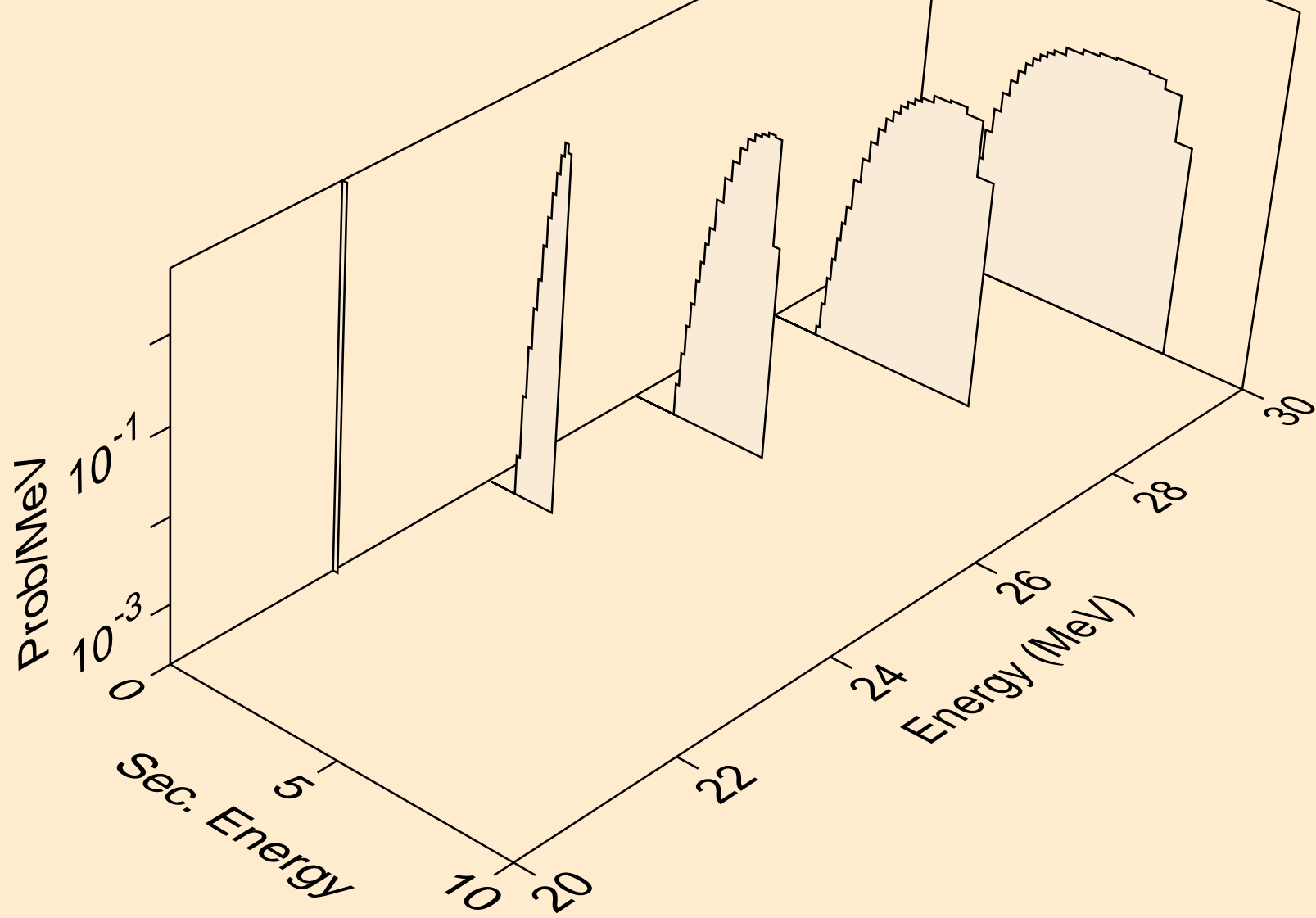

CA046 NEUTRON ACER TENDL-2021 LIBRARY; T=293.6K
tritons from (n,t)

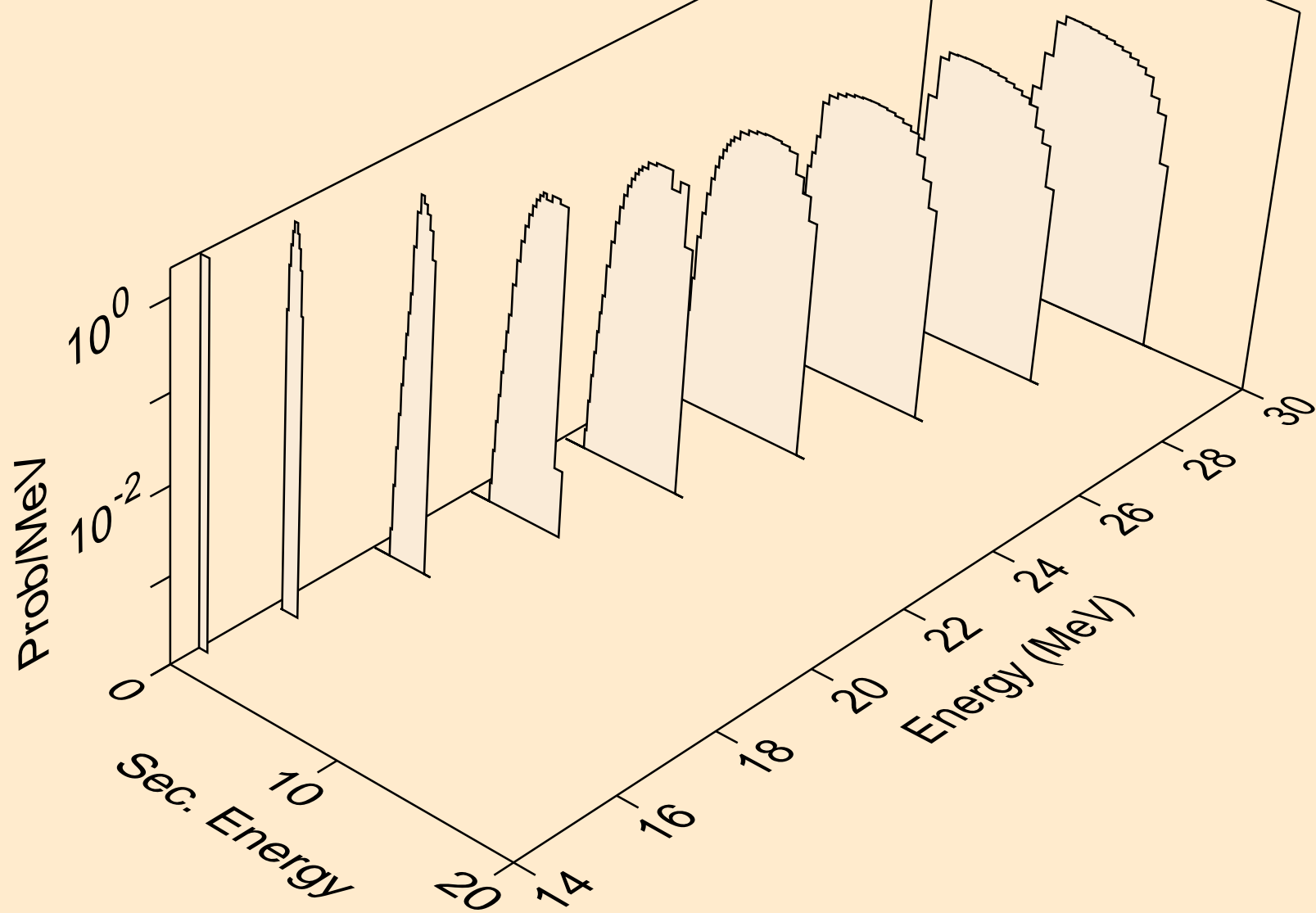

CA046 NEUTRON ACER TENDL-2021 LIBRARY; T=293.6K
he3s from (n,x)

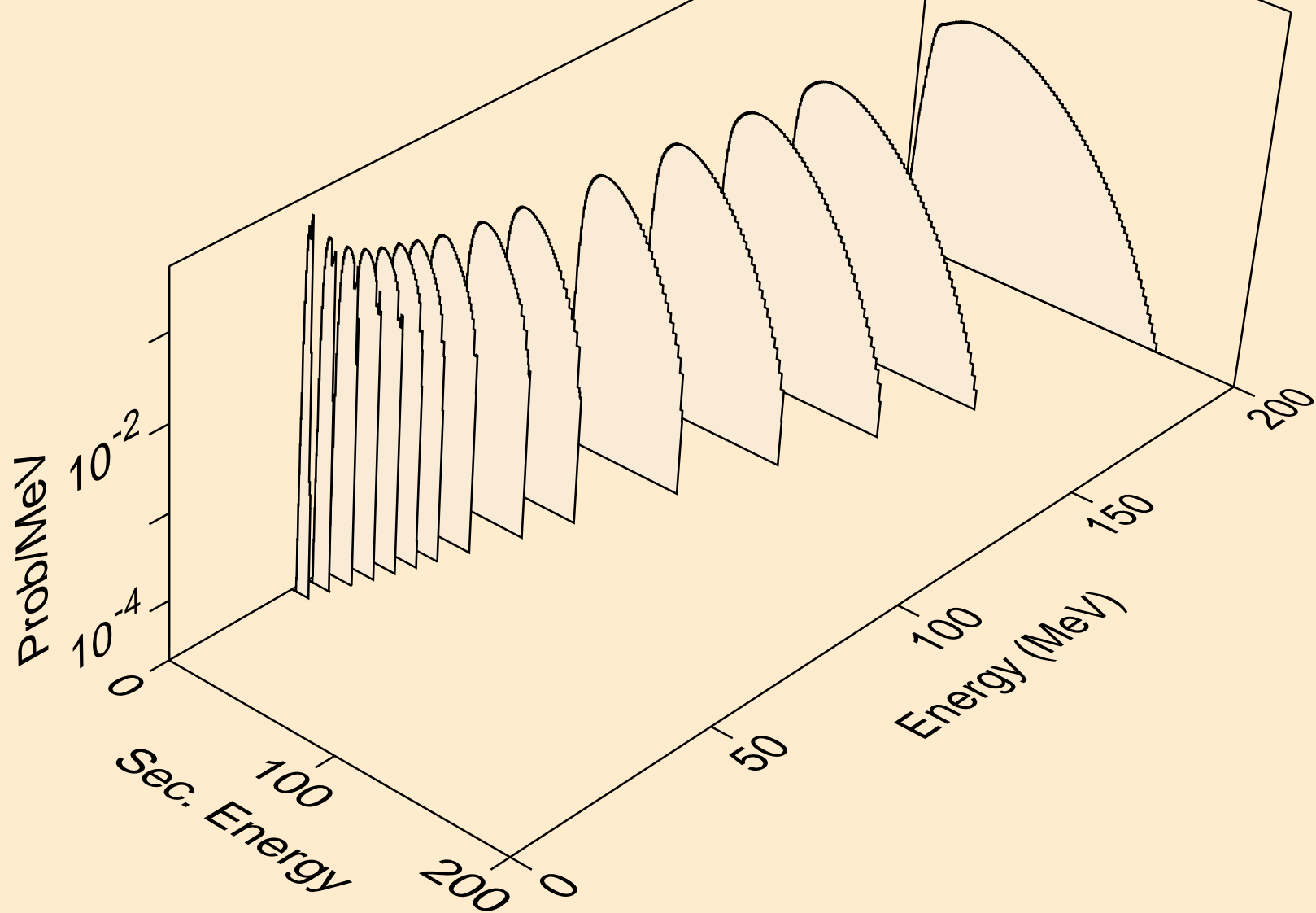

CA046 NEUTRON ACER TENDL-2021 LIBRARY; T=293.6K
he3s from (n,n*)he3

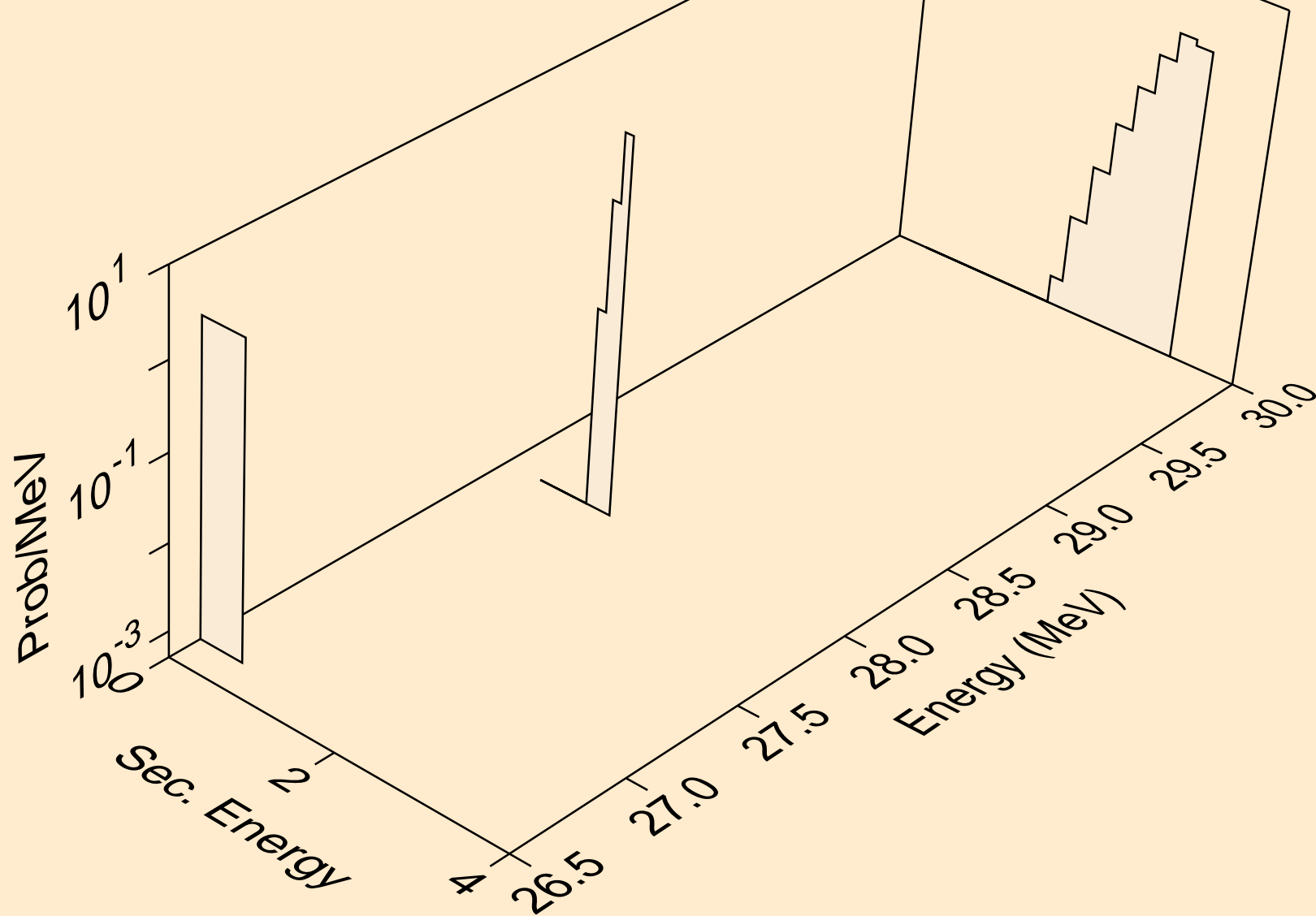

CA046 NEUTRON ACER TENDL-2021 LIBRARY; T=293.6K
he3s from (n,he3)

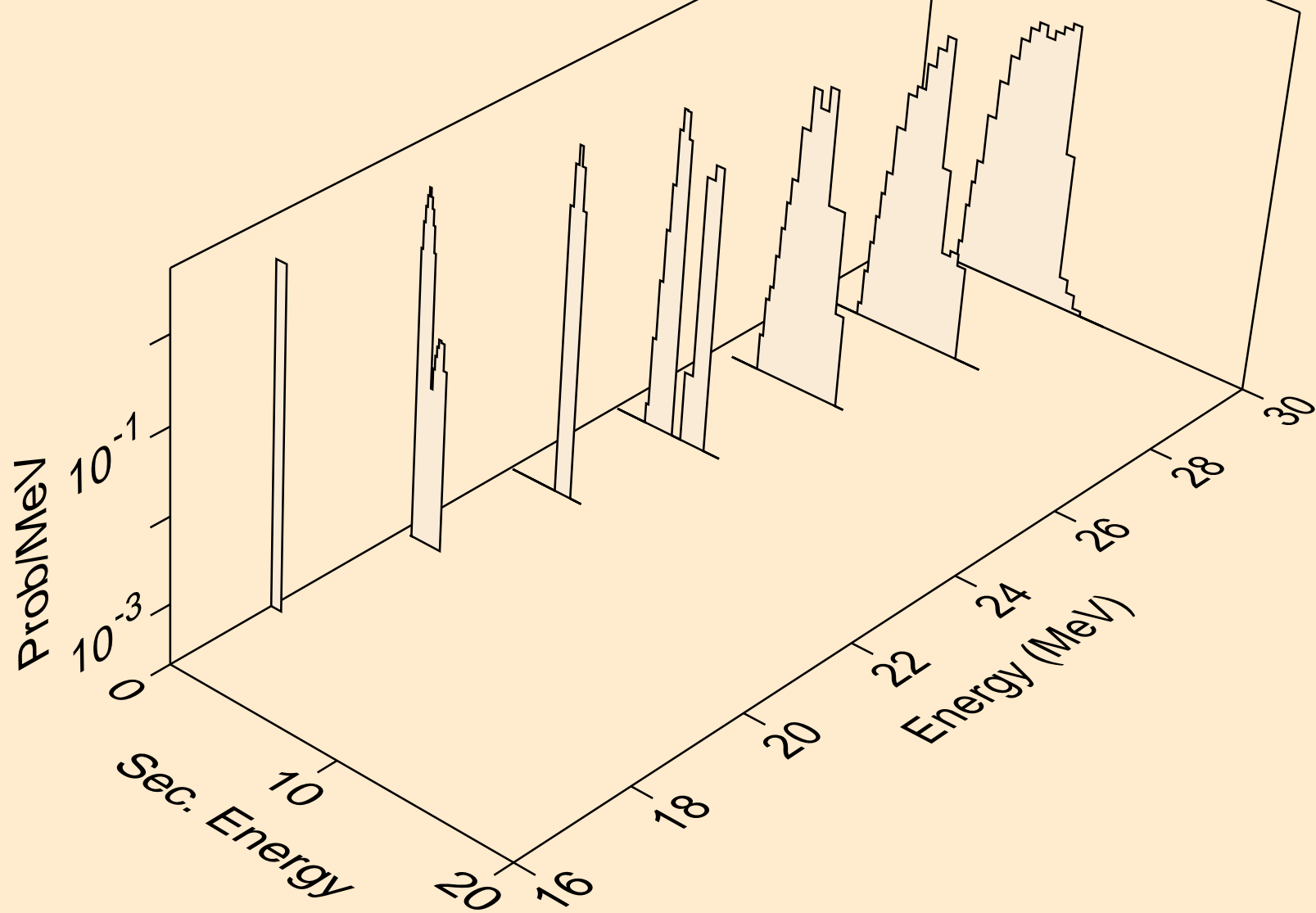

CA046 NEUTRON ACER TENDL-2021 LIBRARY; T=293.6K
alphas from (n,x)

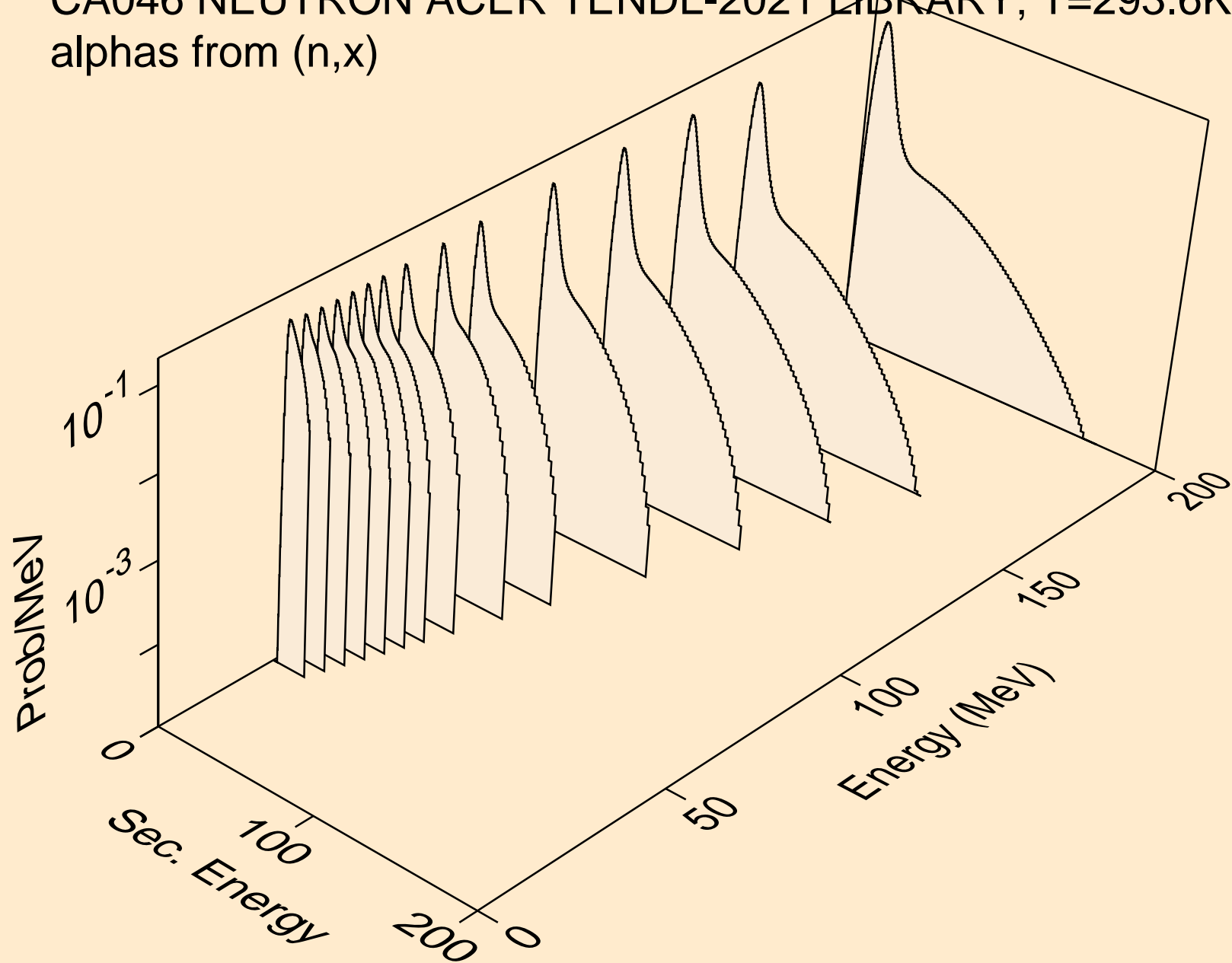

CA046 NEUTRON ACER TENDL-2021 LIBRARY; T=293.6K
alphas from (n,n*)a

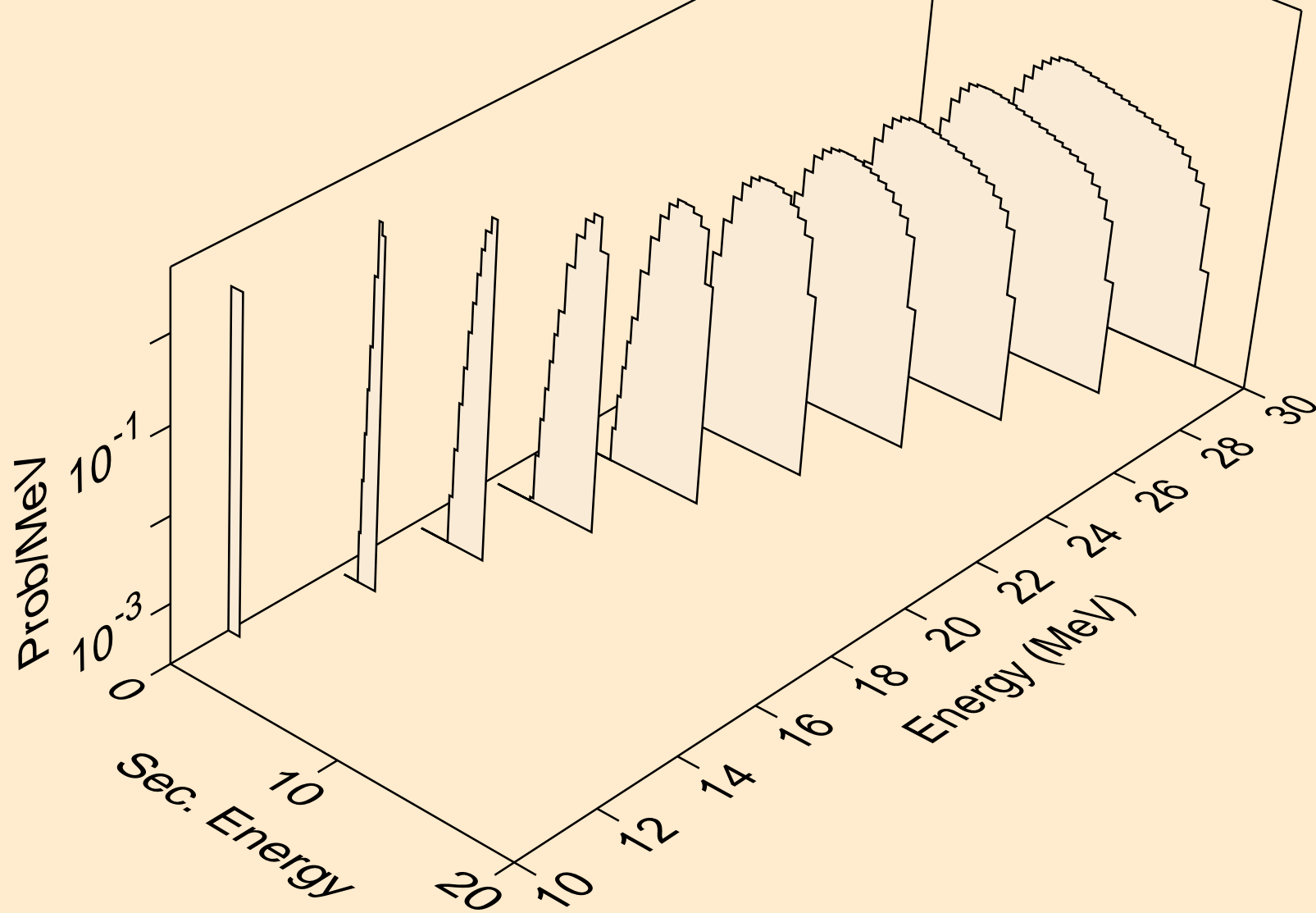

CA046 NEUTRON ACER TENDL-2021 LIBRARY; T=293.6K
alphas from (n,2n)a

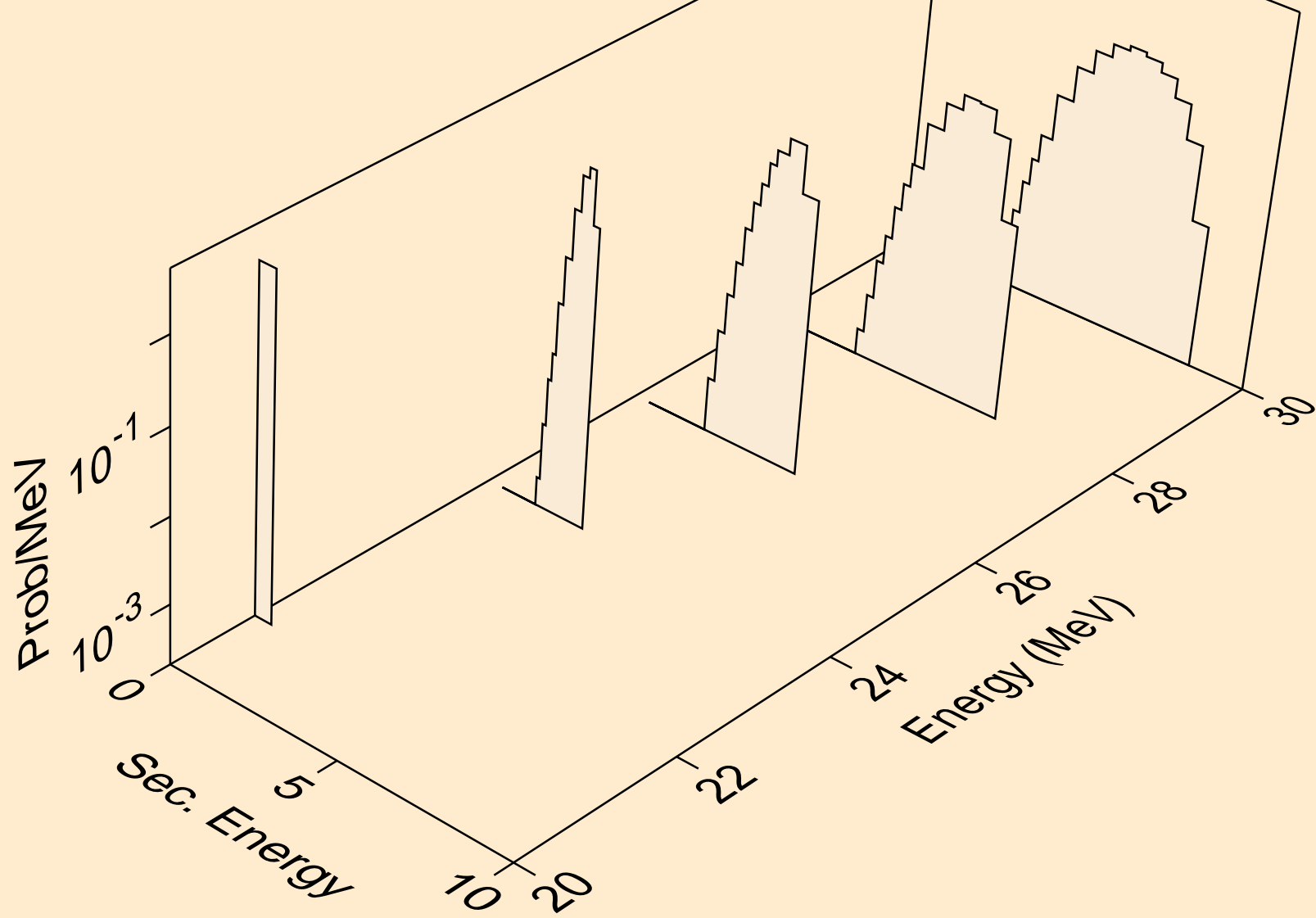

CA046 NEUTRON ACER TENDL-2021 LIBRARY; T=293.6K
alphas from (n,a)

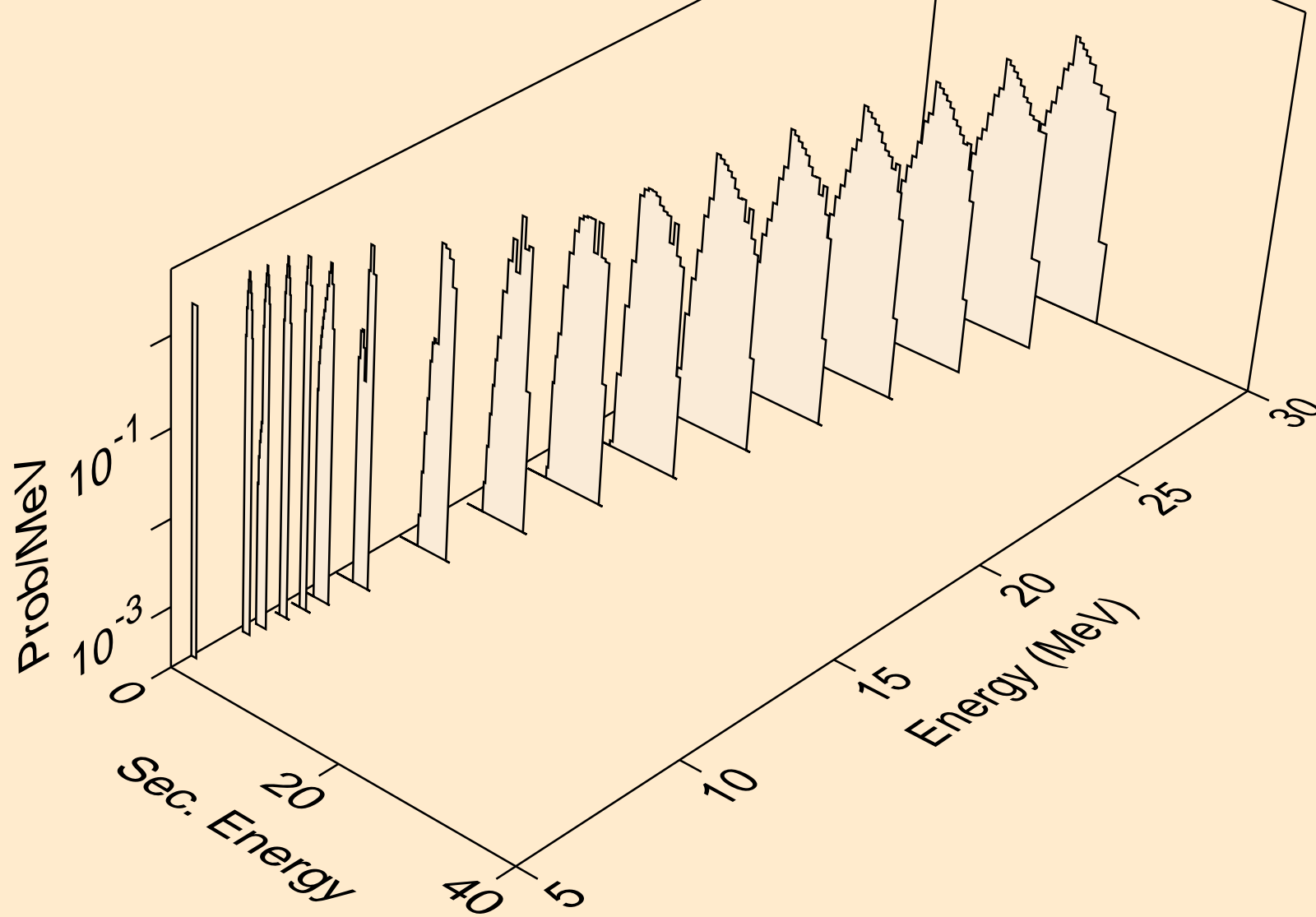

CA046 NEUTRON ACER TENDL-2021 LIBRARY; T=293.6K
alphas from (n,2a)

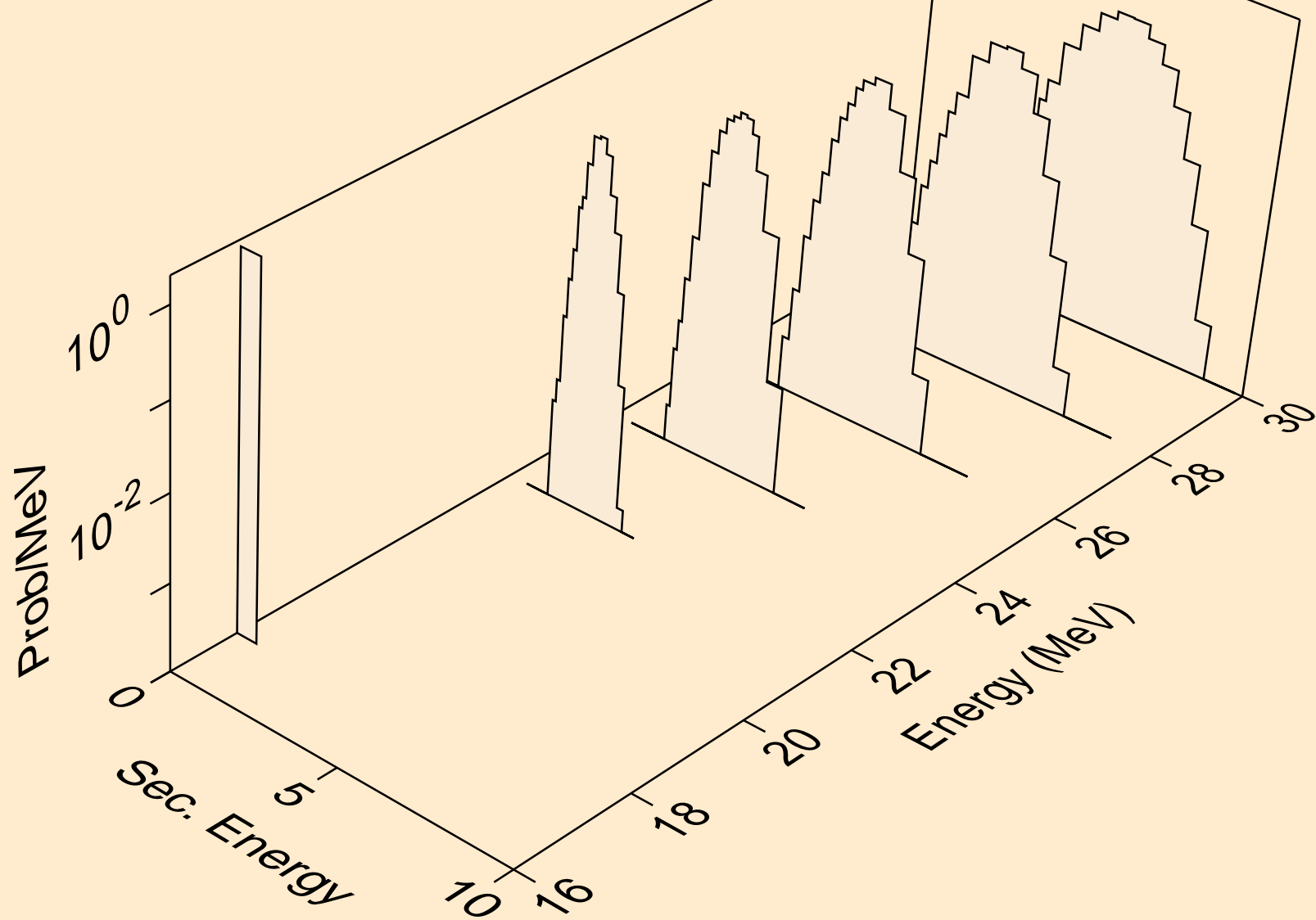

CA046 NEUTRON ACER TENDL-2021 LIBRARY; T=293.6K
alphas from (n,pa)

