

# CA050 NEUTRON ACER TENDL-2021 LIBRARY; T=293.6K

## Principal cross sections

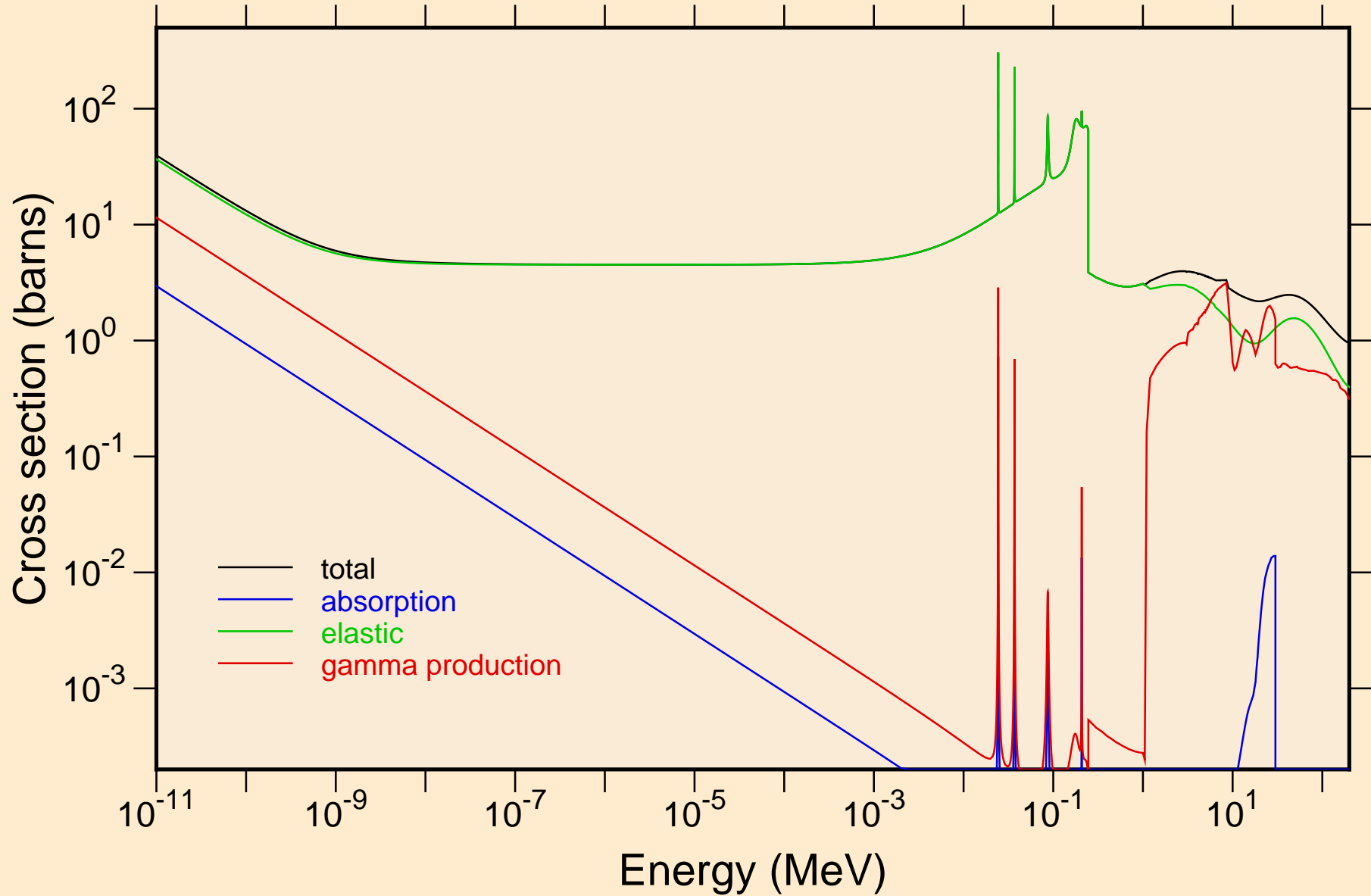

CA050 NEUTRON ACER TENDL-2021 LIBRARY; T=293.6K  
Heating

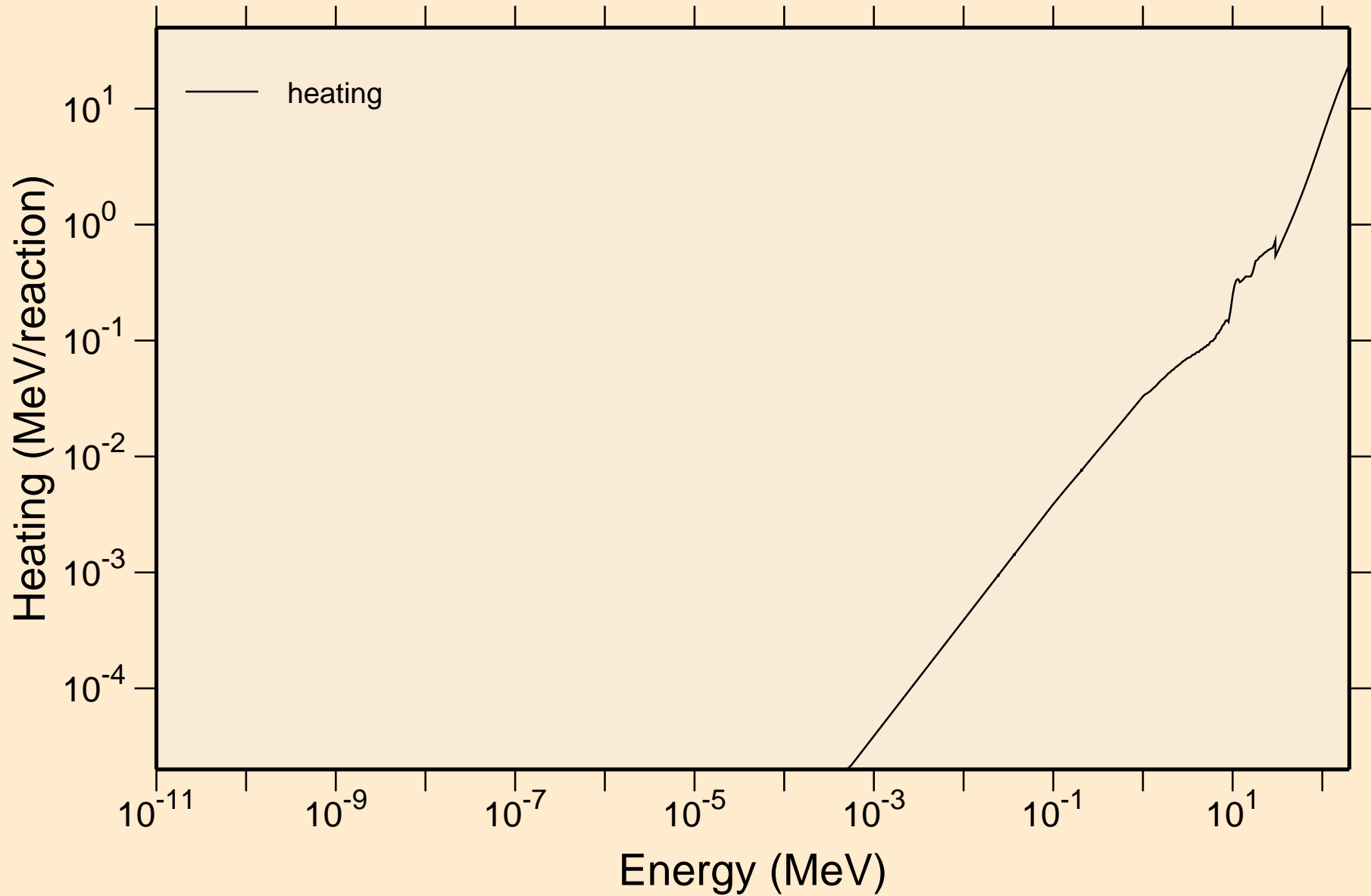

CA050 NEUTRON ACER TENDL-2021 LIBRARY; T=293.6K  
Damage

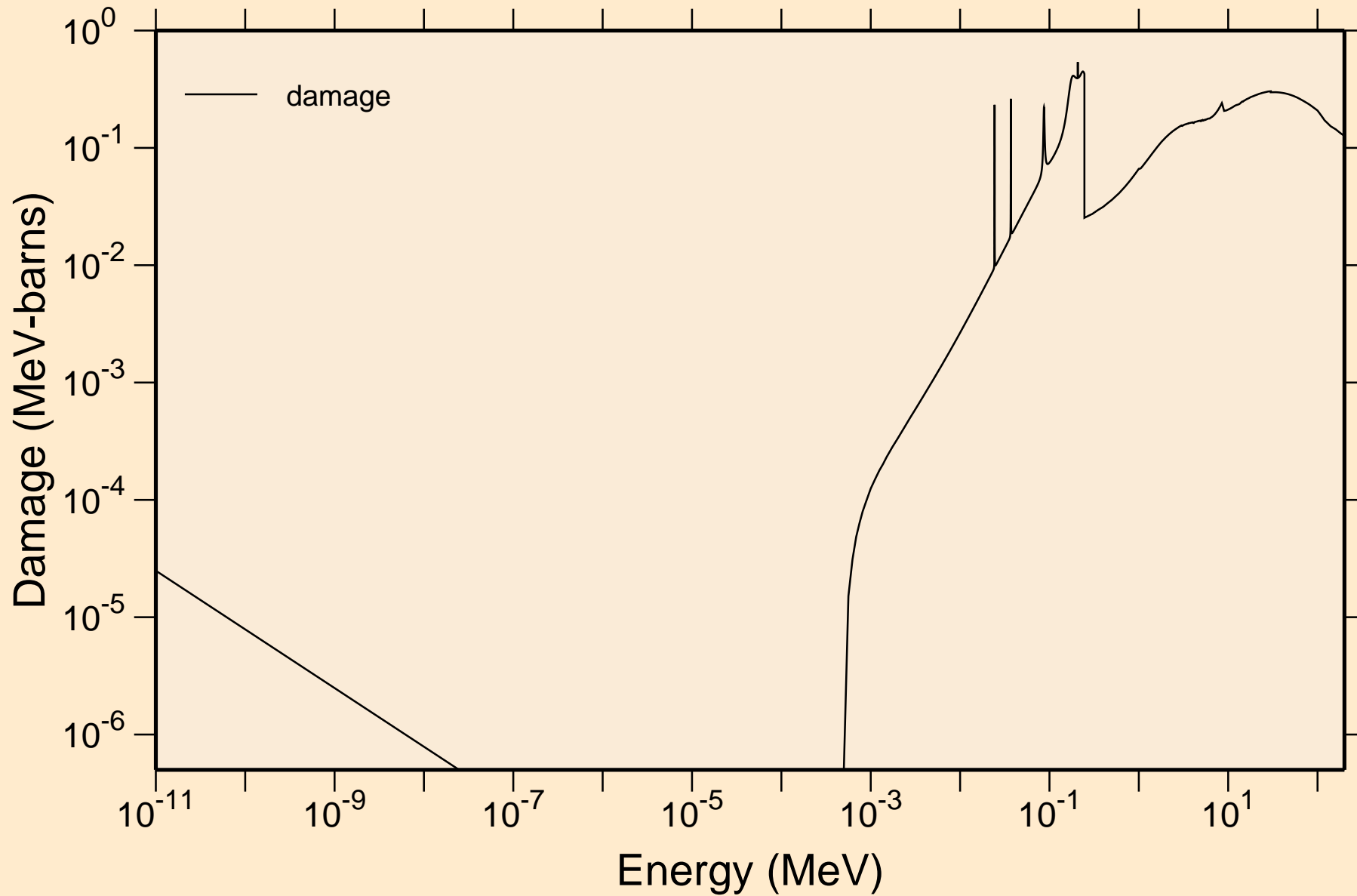

CA050 NEUTRON ACER TENDL-2021 LIBRARY; T=293.6K  
Non-threshold reactions

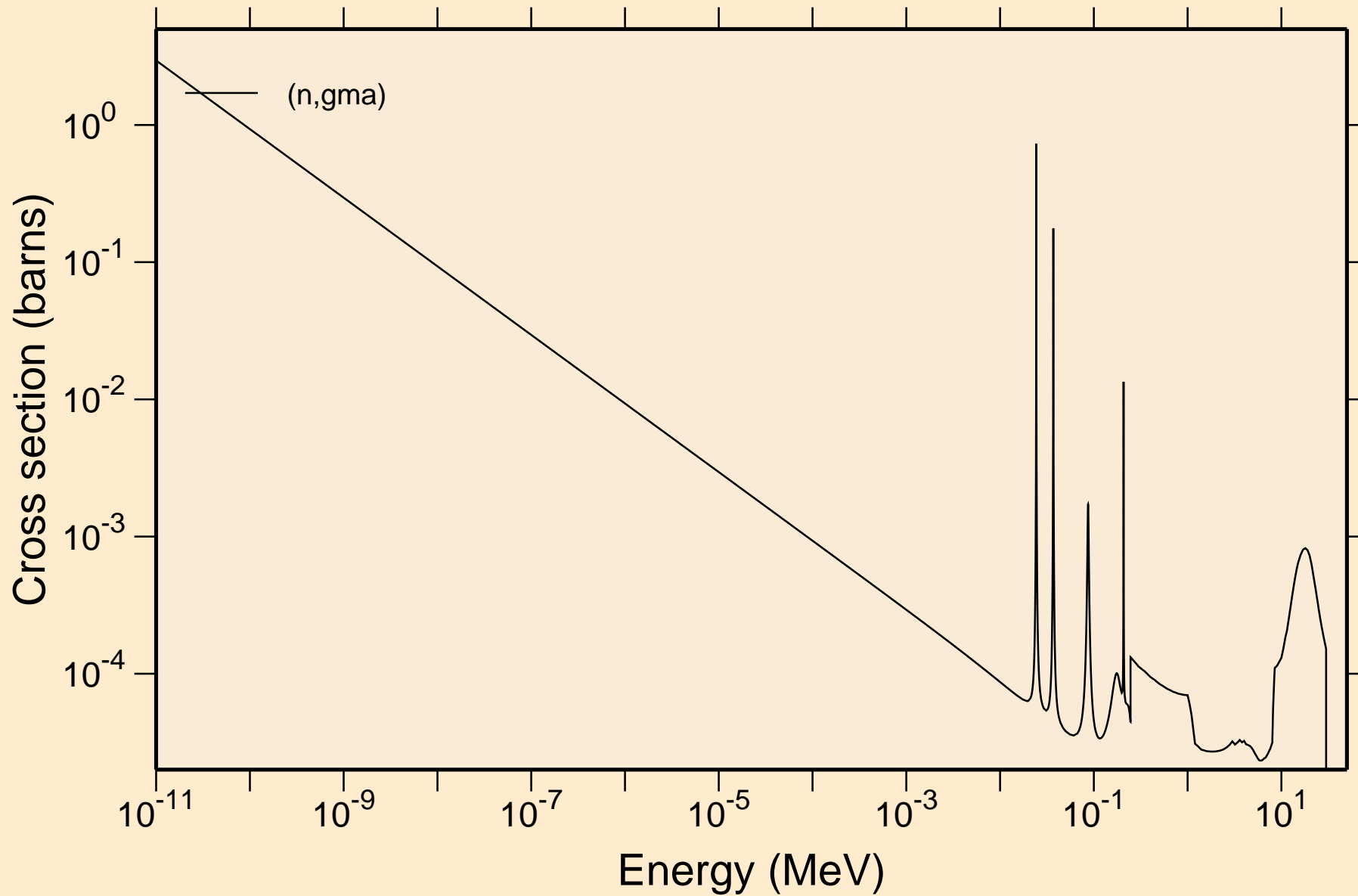

# CA050 NEUTRON ACER TENDL-2021 LIBRARY; T=293.6K

## Principal cross sections

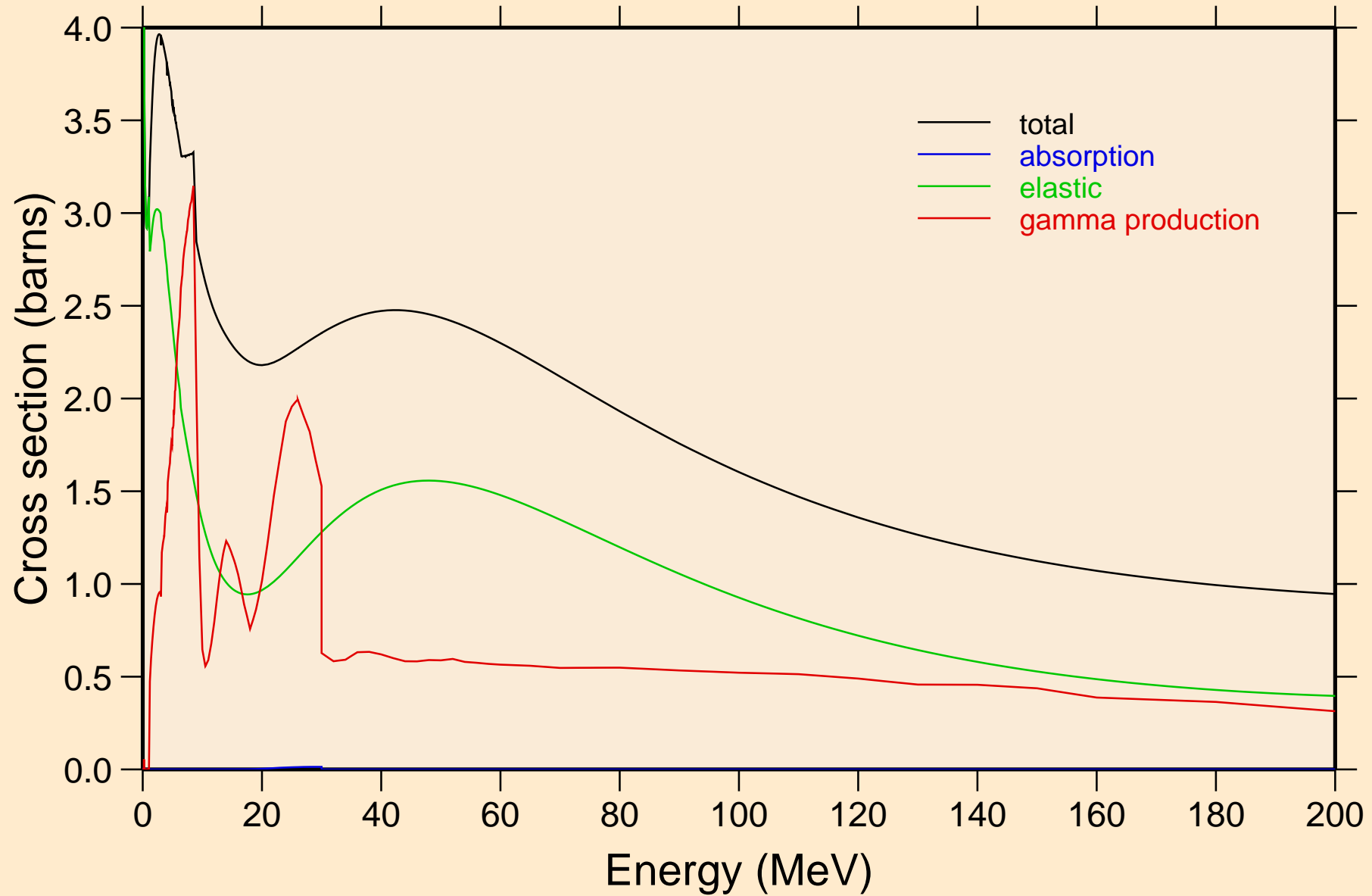

CA050 NEUTRON ACER TENDL-2021 LIBRARY; T=293.6K  
Heating

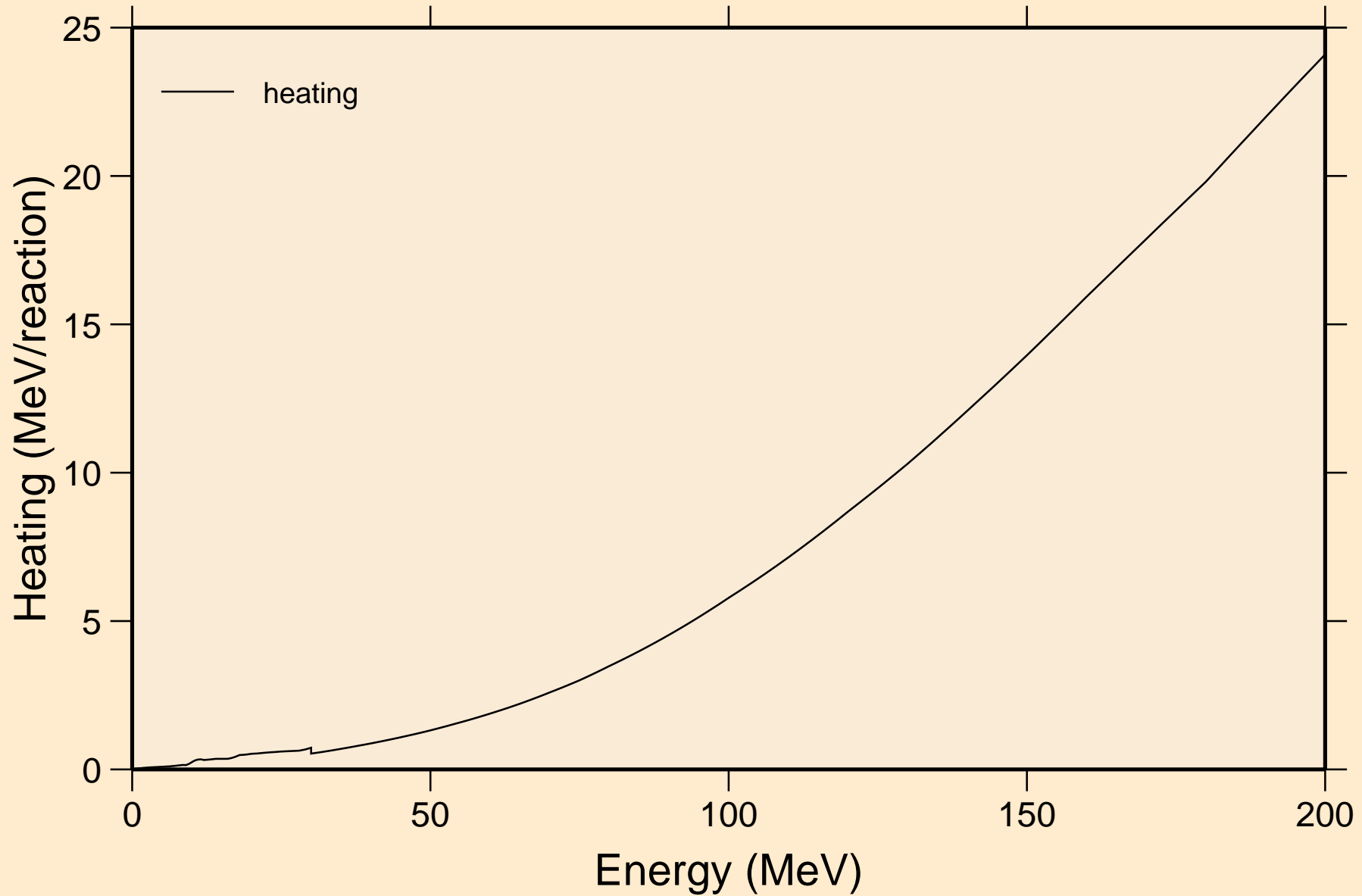

CA050 NEUTRON ACER TENDL-2021 LIBRARY; T=293.6K  
Damage

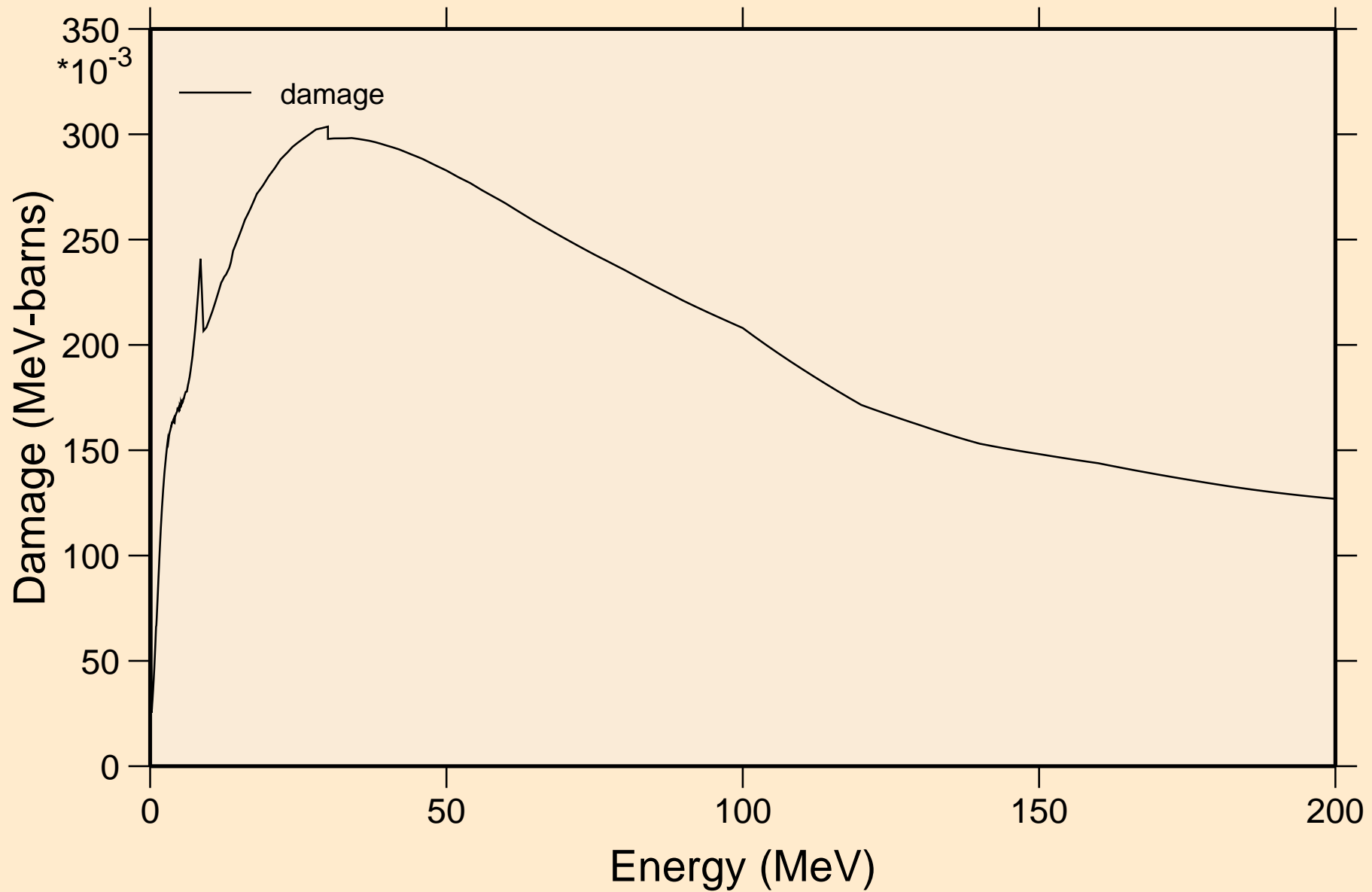

CA050 NEUTRON ACER TENDL-2021 LIBRARY; T=293.6K  
Non-threshold reactions

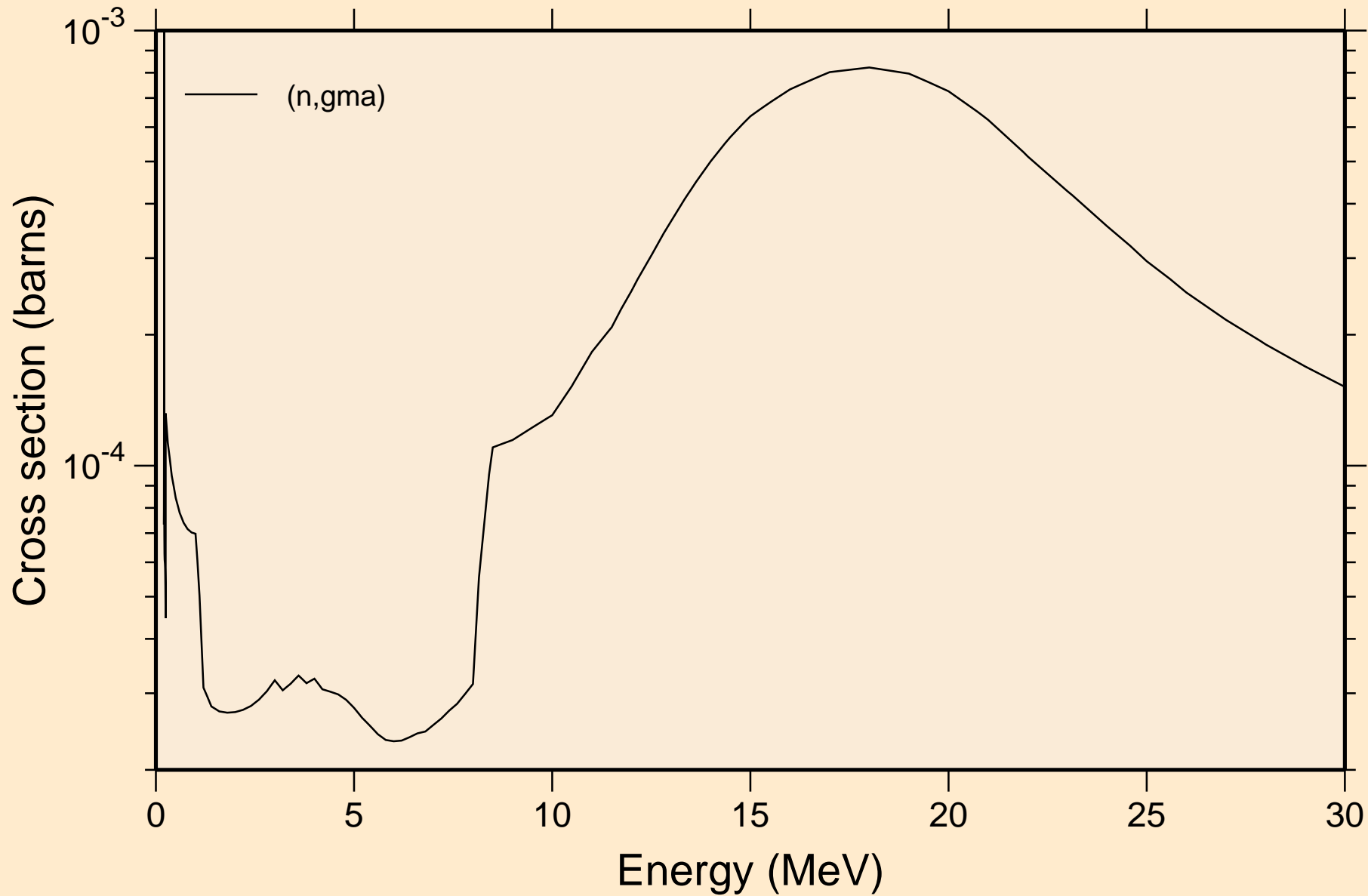



CA050 NEUTRON ACER TENDL-2021 LIBRARY; T=293.6K  
Inelastic levels

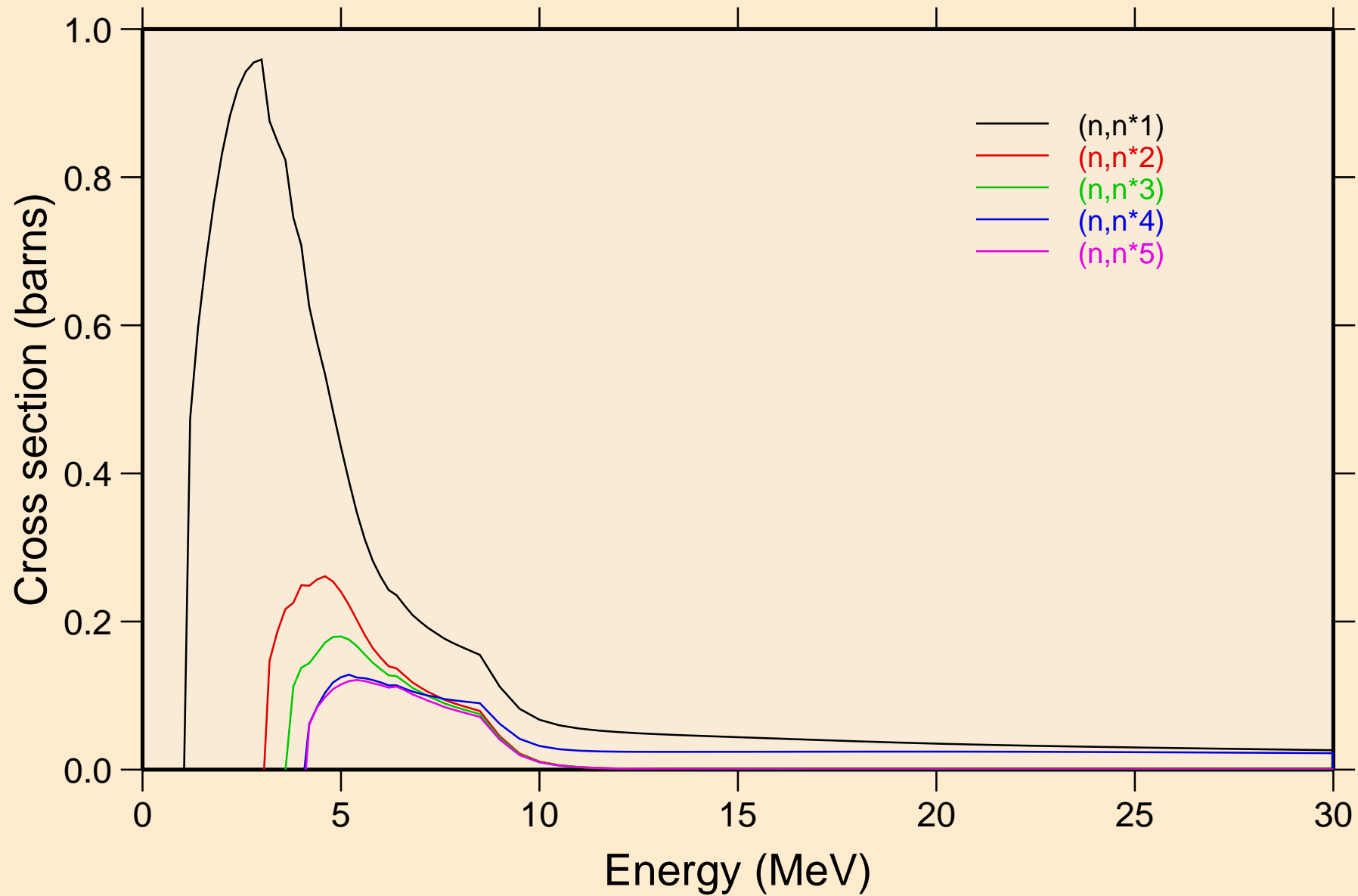

CA050 NEUTRON ACER TENDL-2021 LIBRARY; T=293.6K  
Inelastic levels

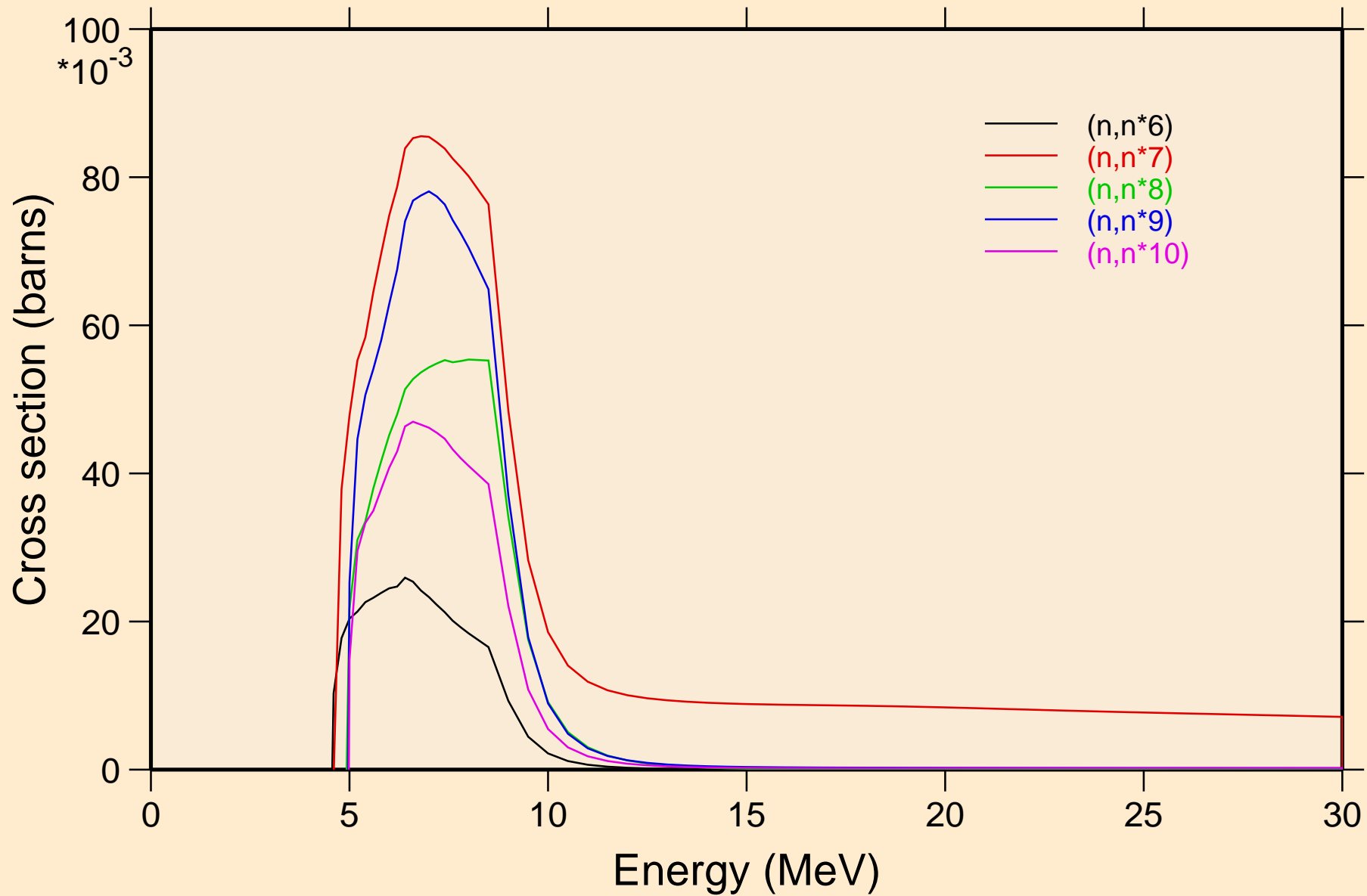

CA050 NEUTRON ACER TENDL-2021 LIBRARY; T=293.6K  
Inelastic levels

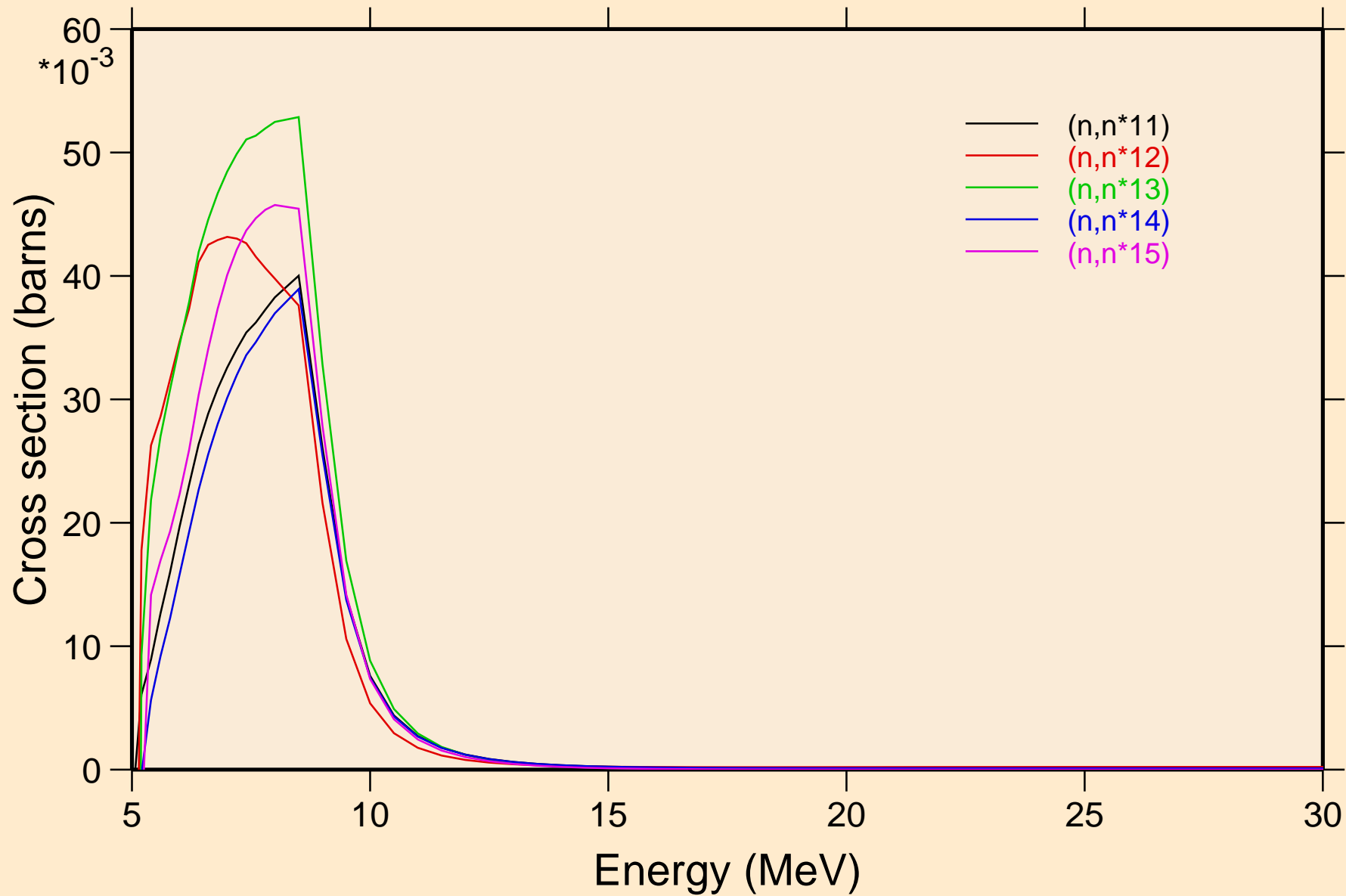

CA050 NEUTRON ACER TENDL-2021 LIBRARY; T=293.6K  
Inelastic levels

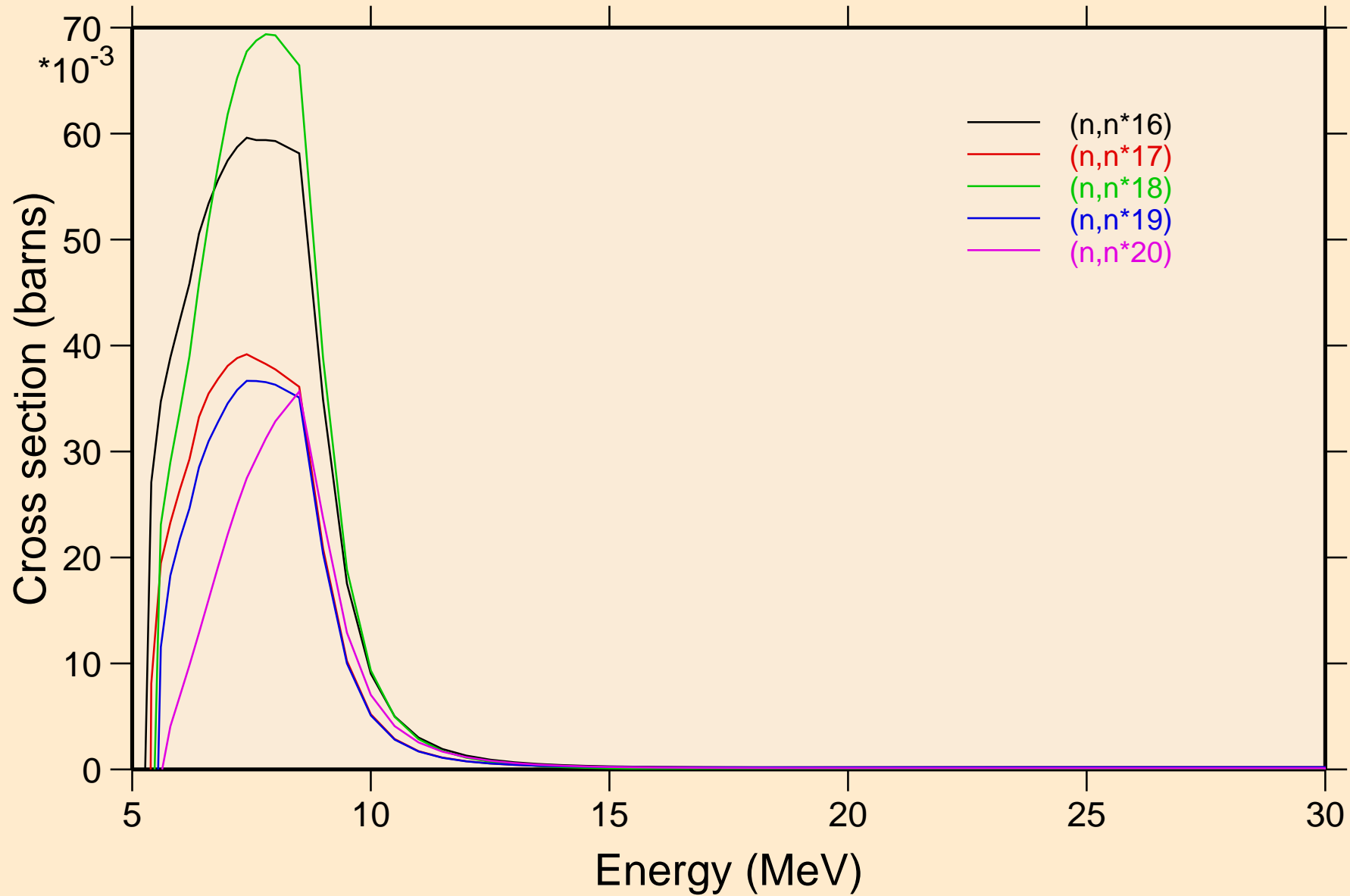

CA050 NEUTRON ACER TENDL-2021 LIBRARY; T=293.6K  
Inelastic levels

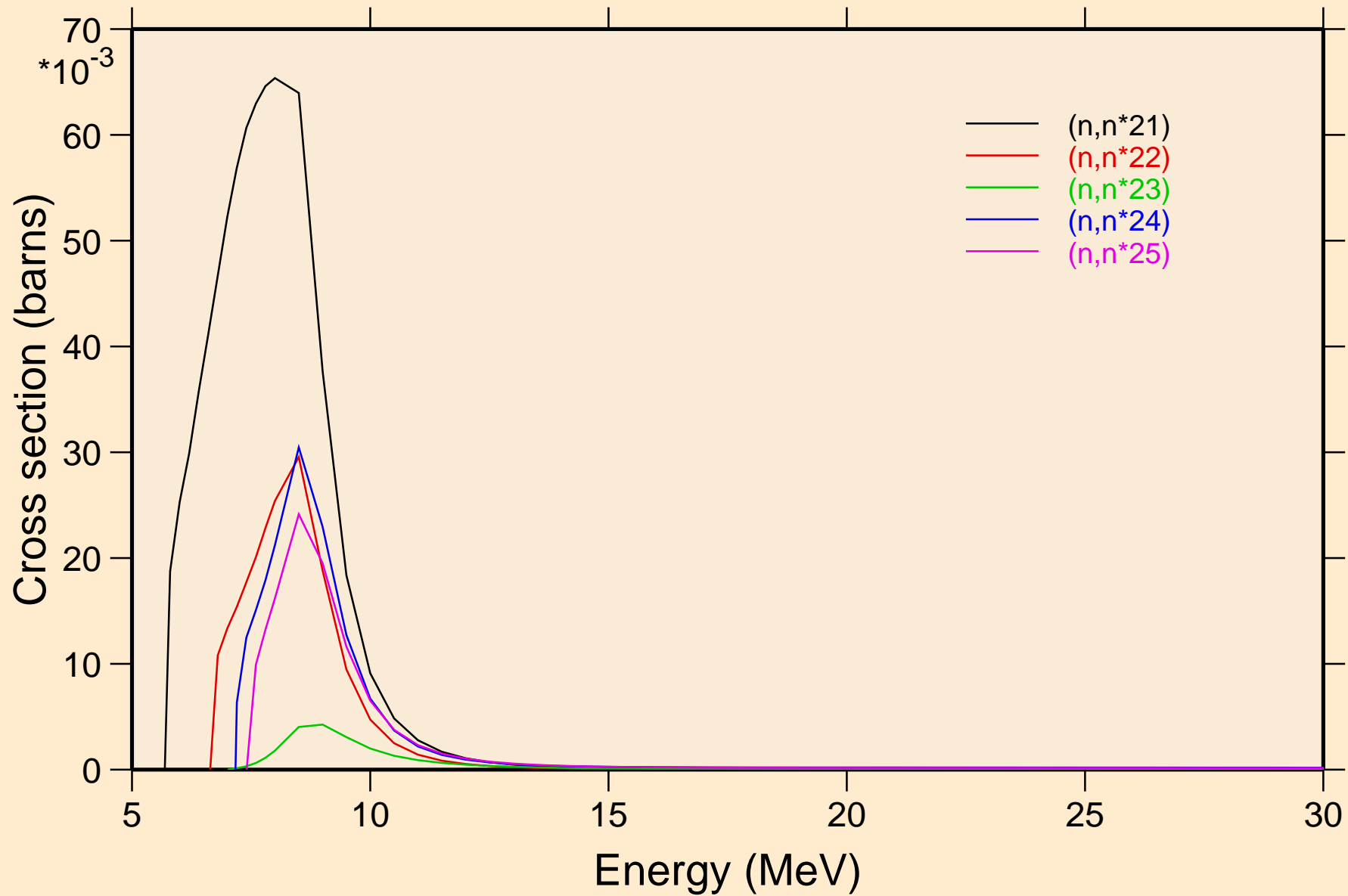

CA050 NEUTRON ACER TENDL-2021 LIBRARY; T=293.6K  
Inelastic levels

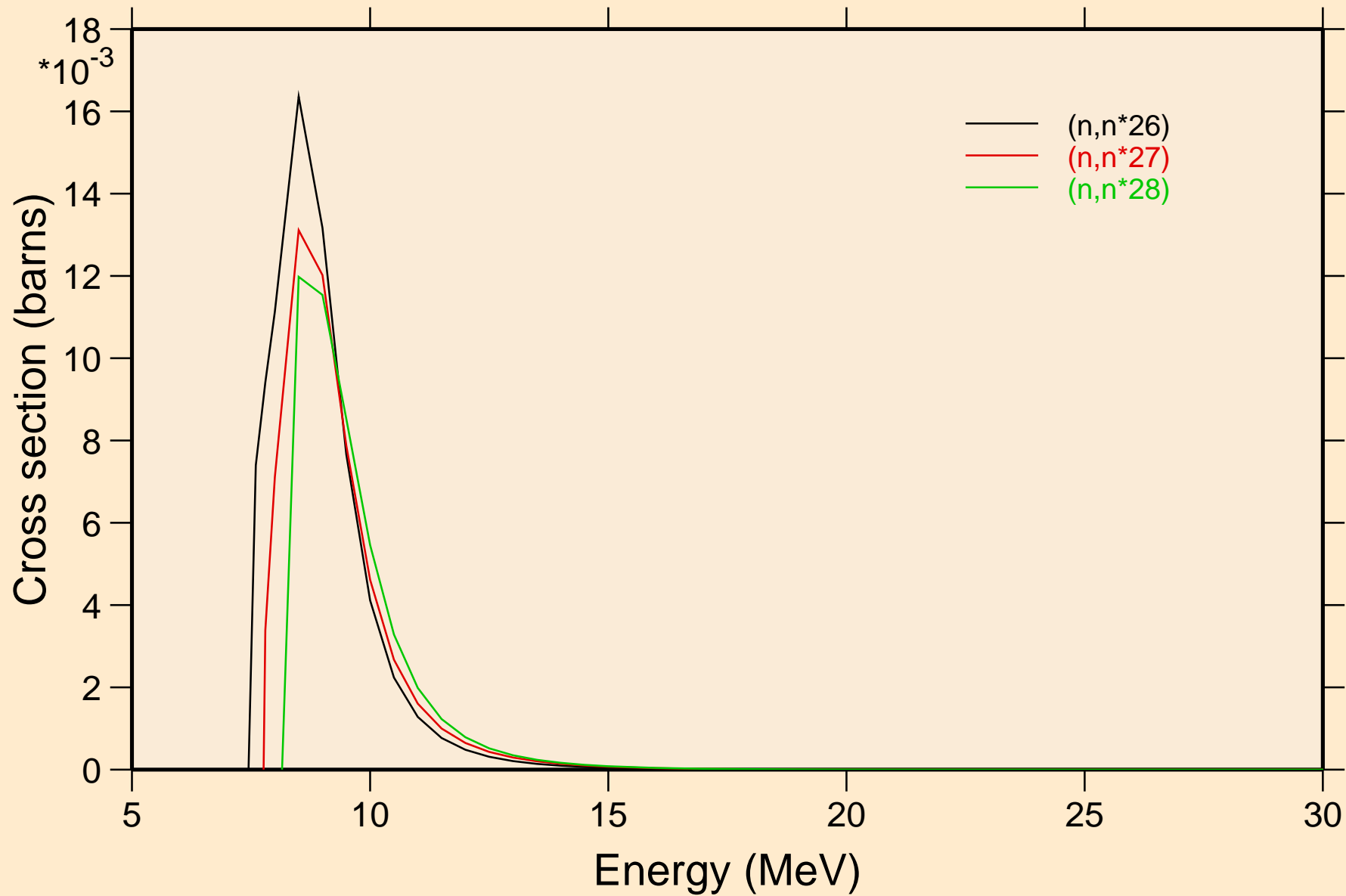

CA050 NEUTRON ACER TENDL-2021 LIBRARY; T=293.6K  
Threshold reactions

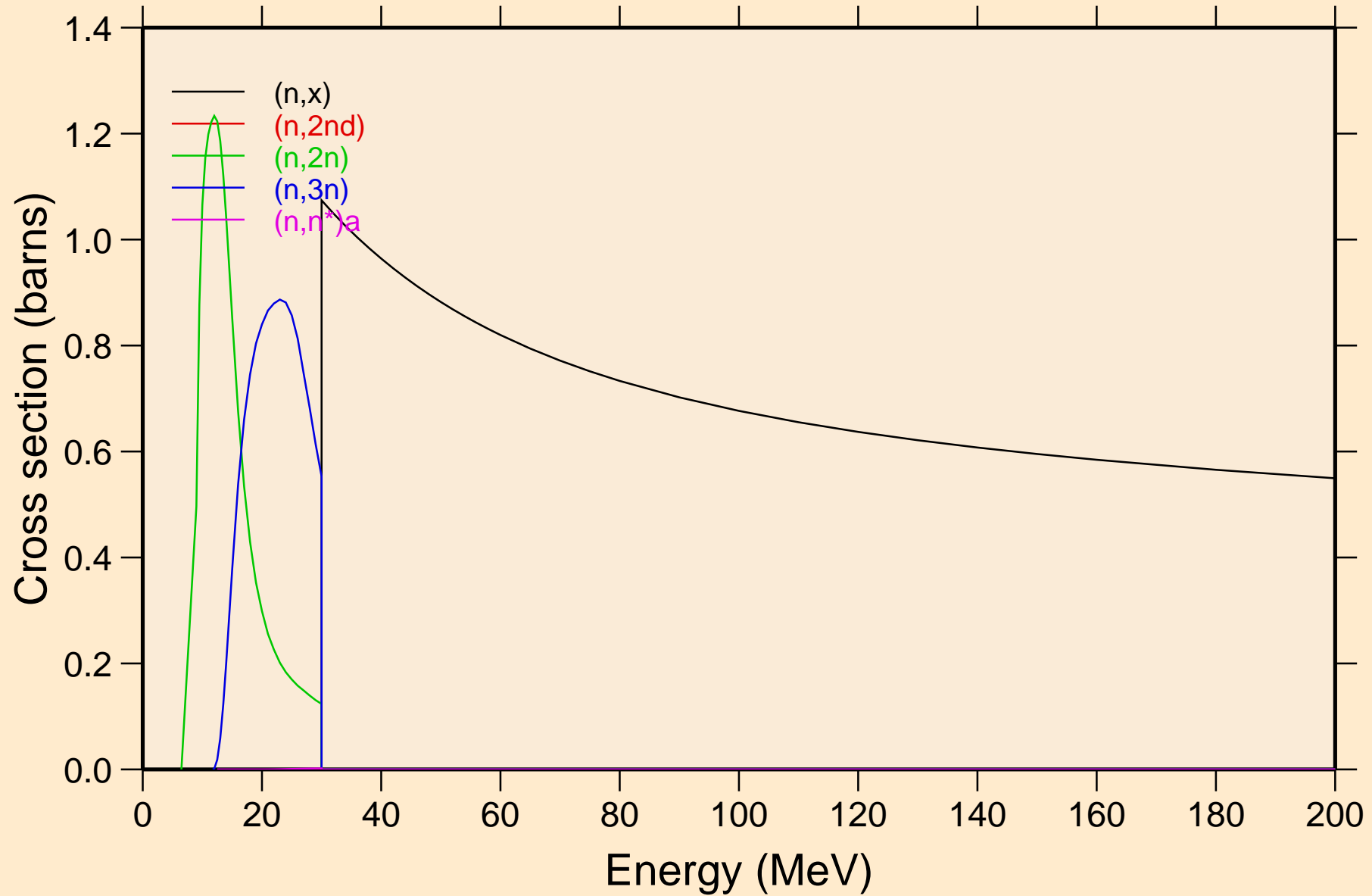

CA050 NEUTRON ACER TENDL-2021 LIBRARY; T=293.6K  
Threshold reactions

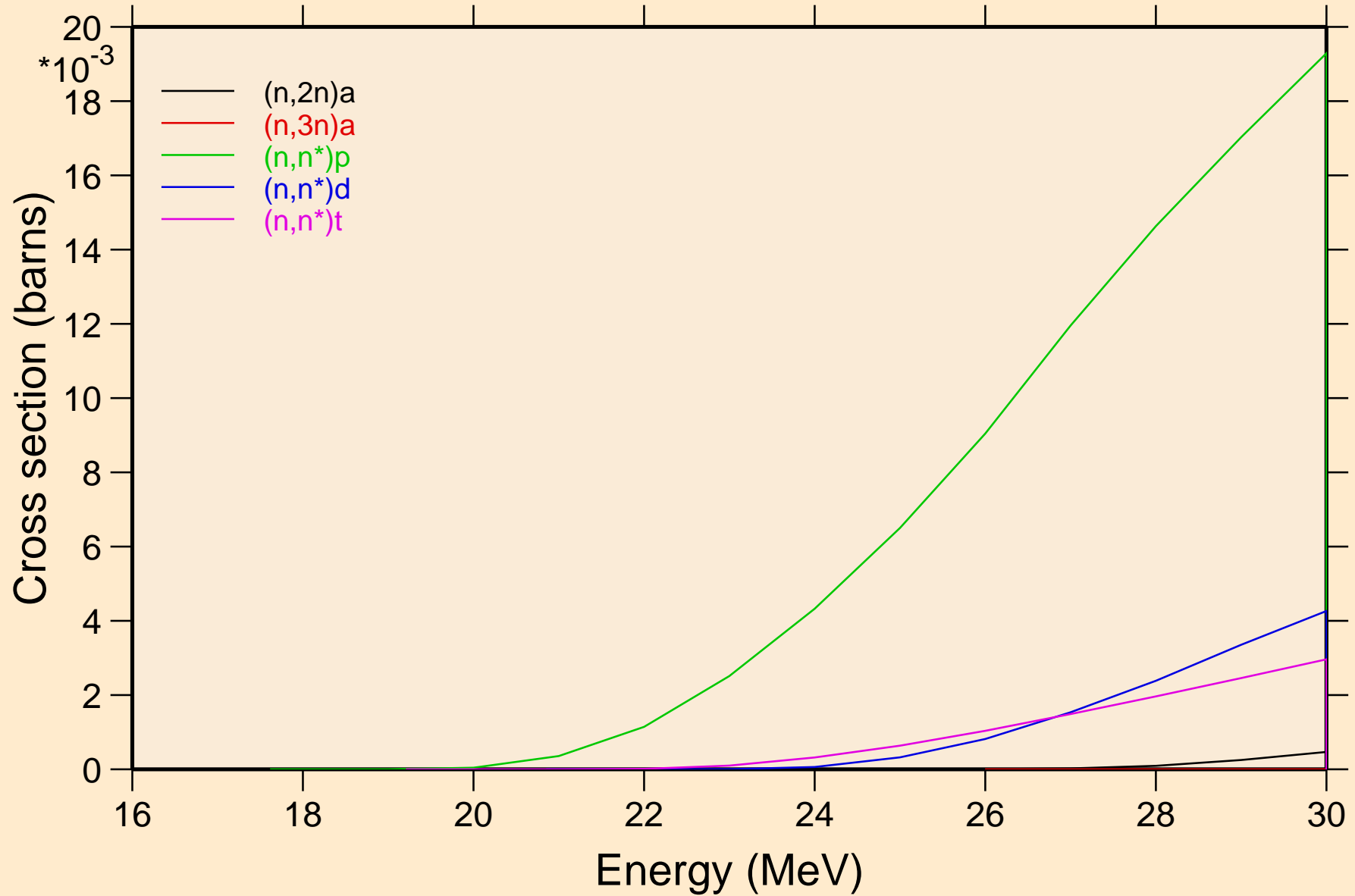



CA050 NEUTRON ACER TENDL-2021 LIBRARY; T=293.6K  
Threshold reactions

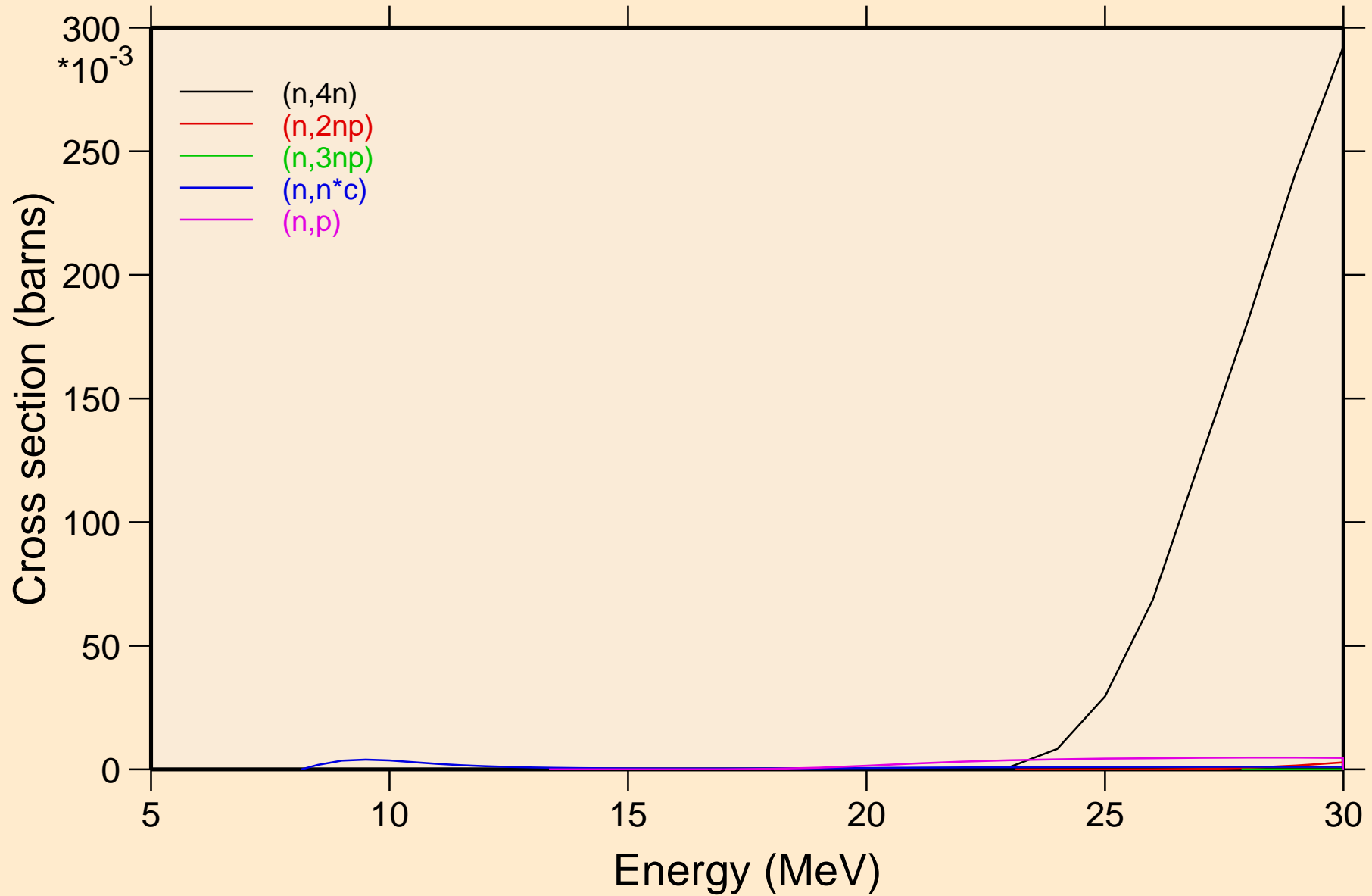

CA050 NEUTRON ACER TENDL-2021 LIBRARY; T=293.6K  
Threshold reactions

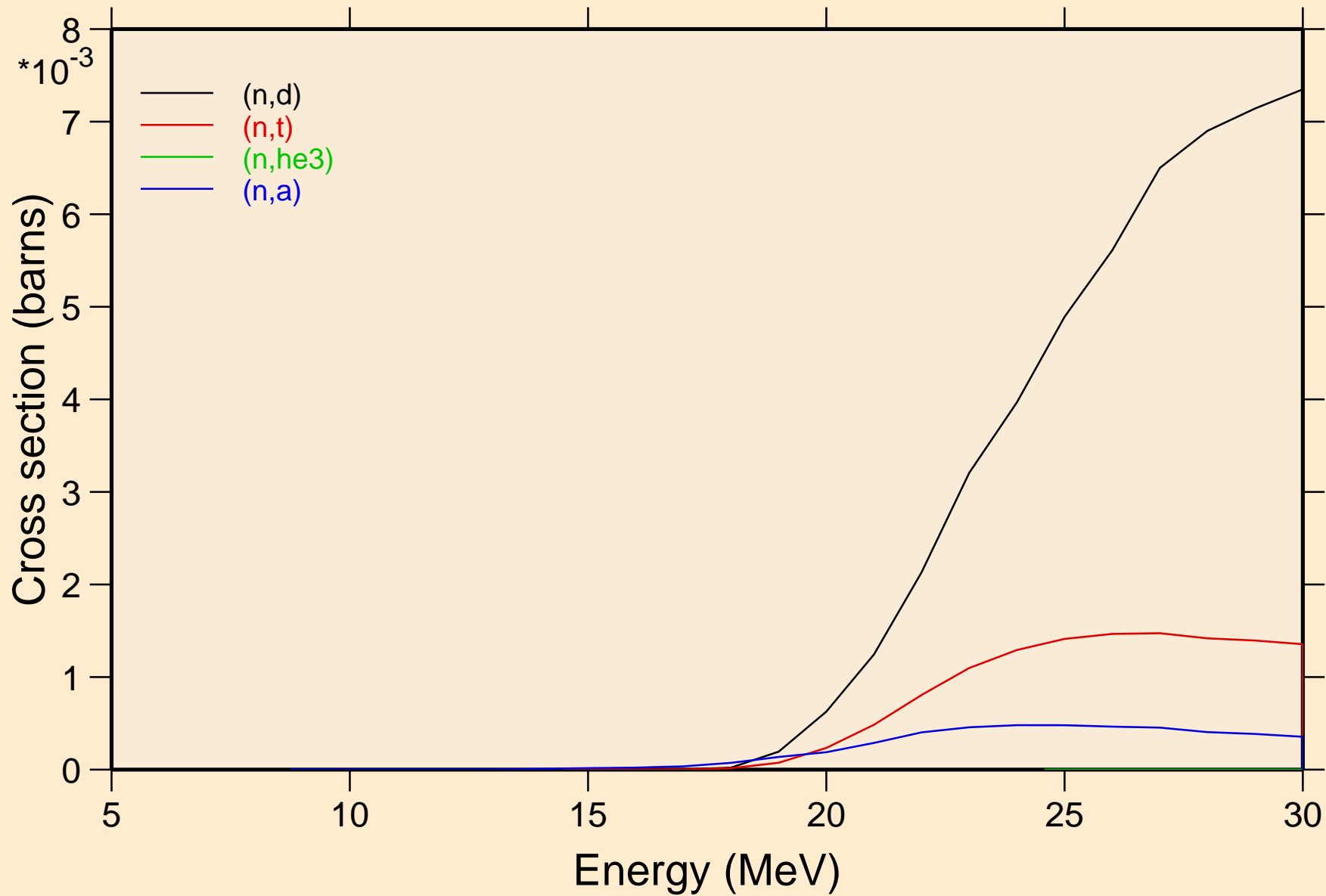

# CA050 NEUTRON ACER TENDL-2021 LIBRARY; T=293.6K

## Threshold reactions

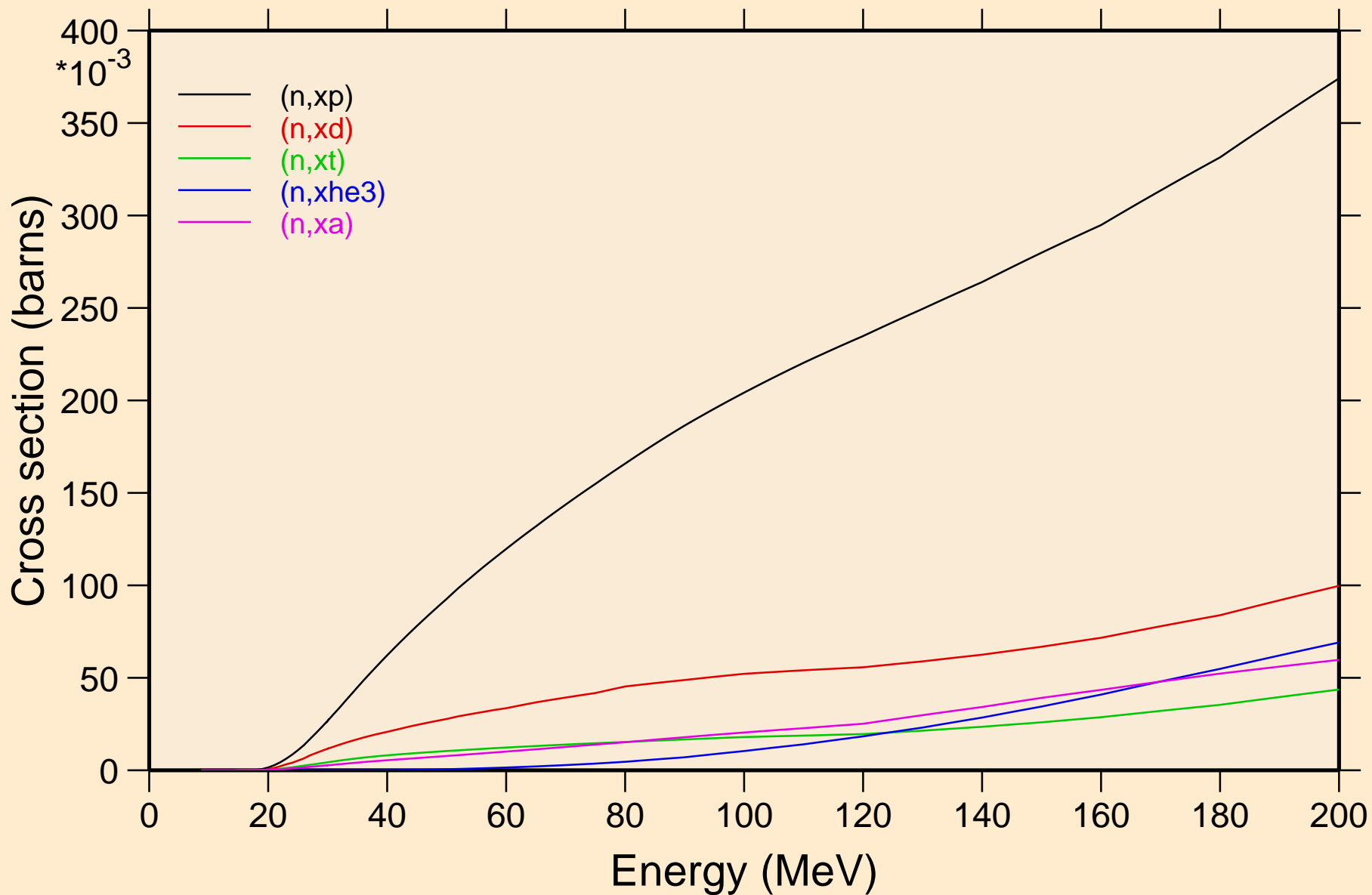

CA050 NEUTRON ACER TENDL-2021 LIBRARY; T=293.6K  
angular distribution for elastic

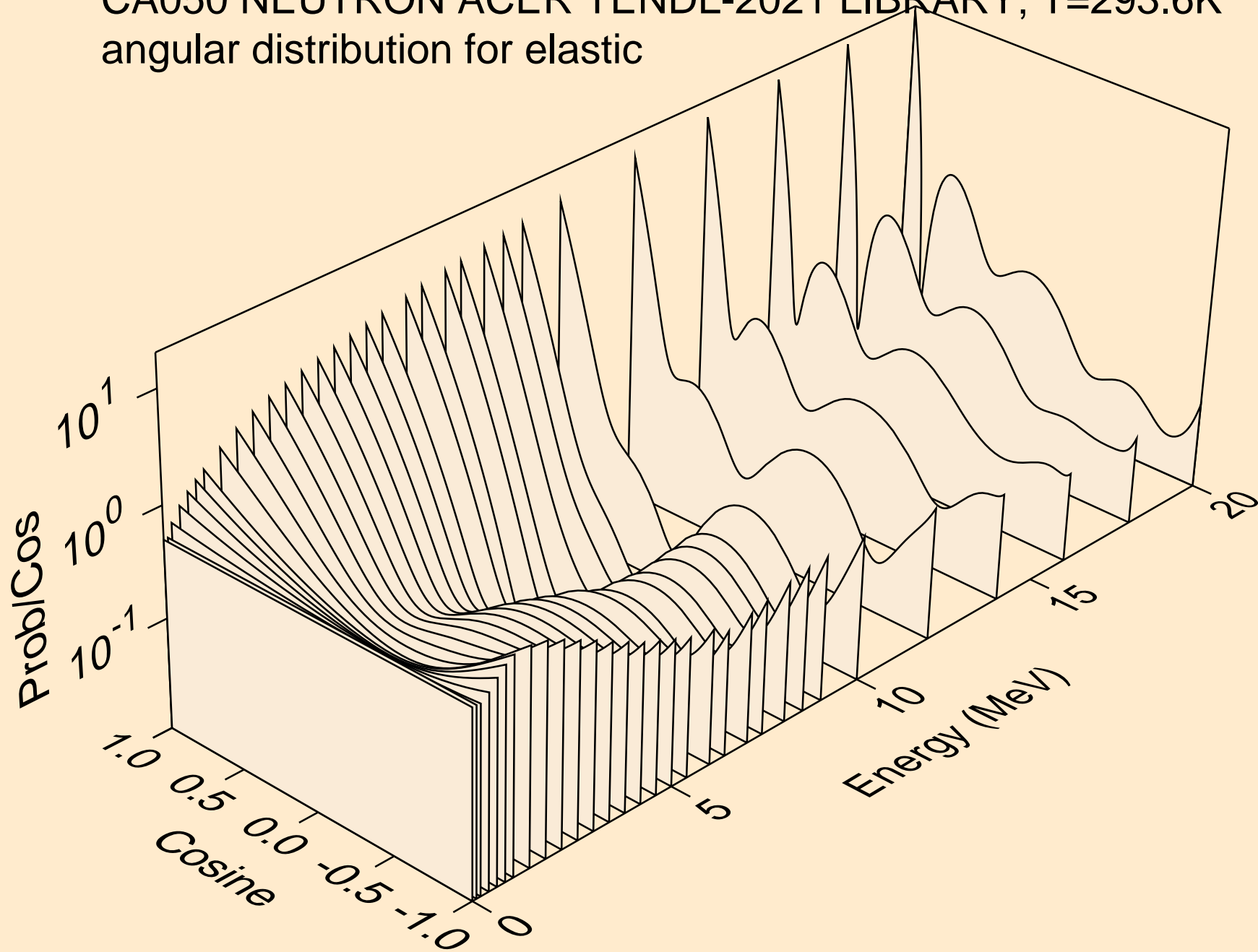

CA050 NEUTRON ACER TENDL-2021 LIBRARY; T=293.6K  
angular distribution for elastic

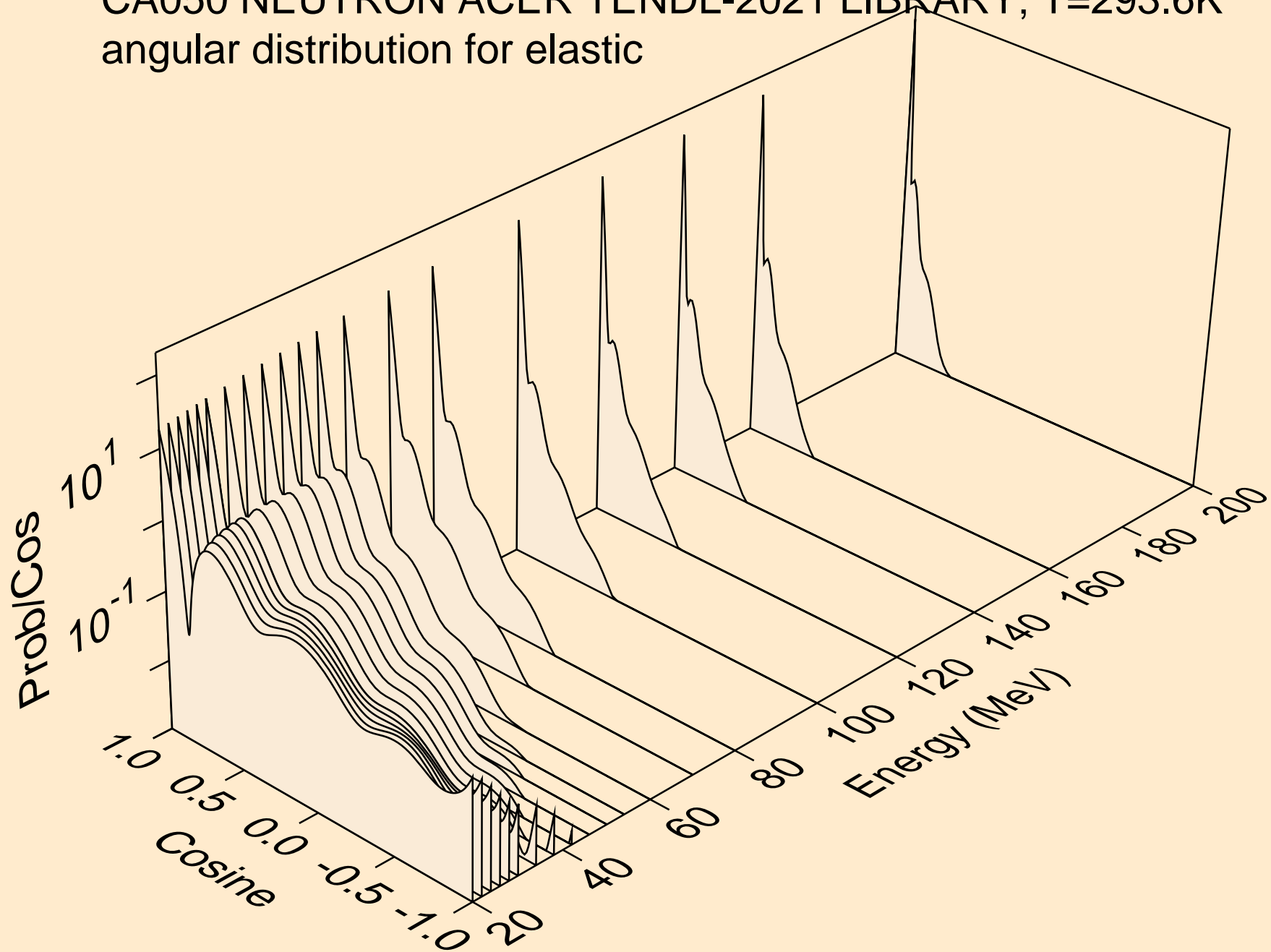

CA050 NEUTRON ACER TENDL-2021 LIBRARY; T=293.6K  
angular distribution for (n,n\*1)

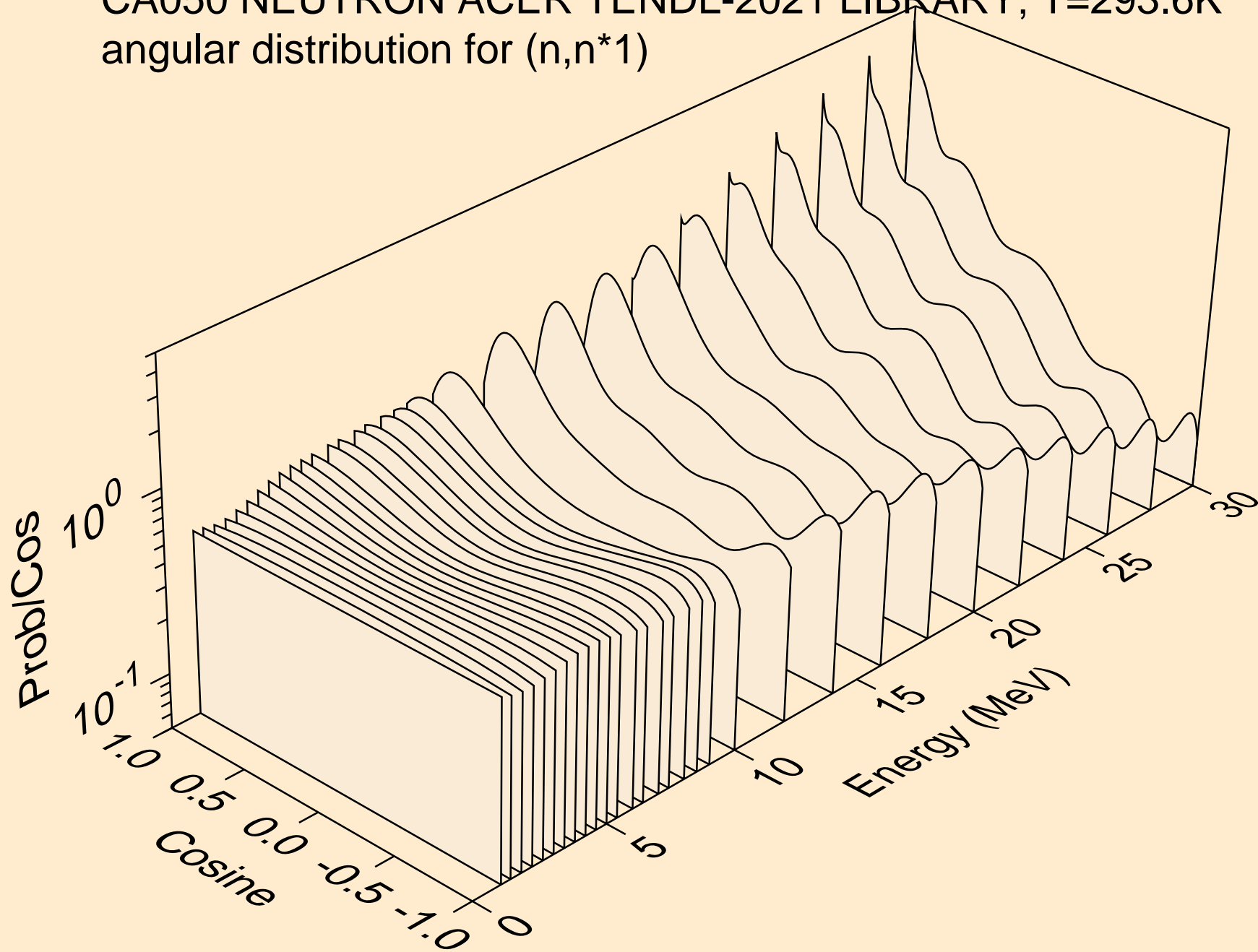

CA050 NEUTRON ACER TENDL-2021 LIBRARY; T=293.6K  
angular distribution for (n,n\*2)

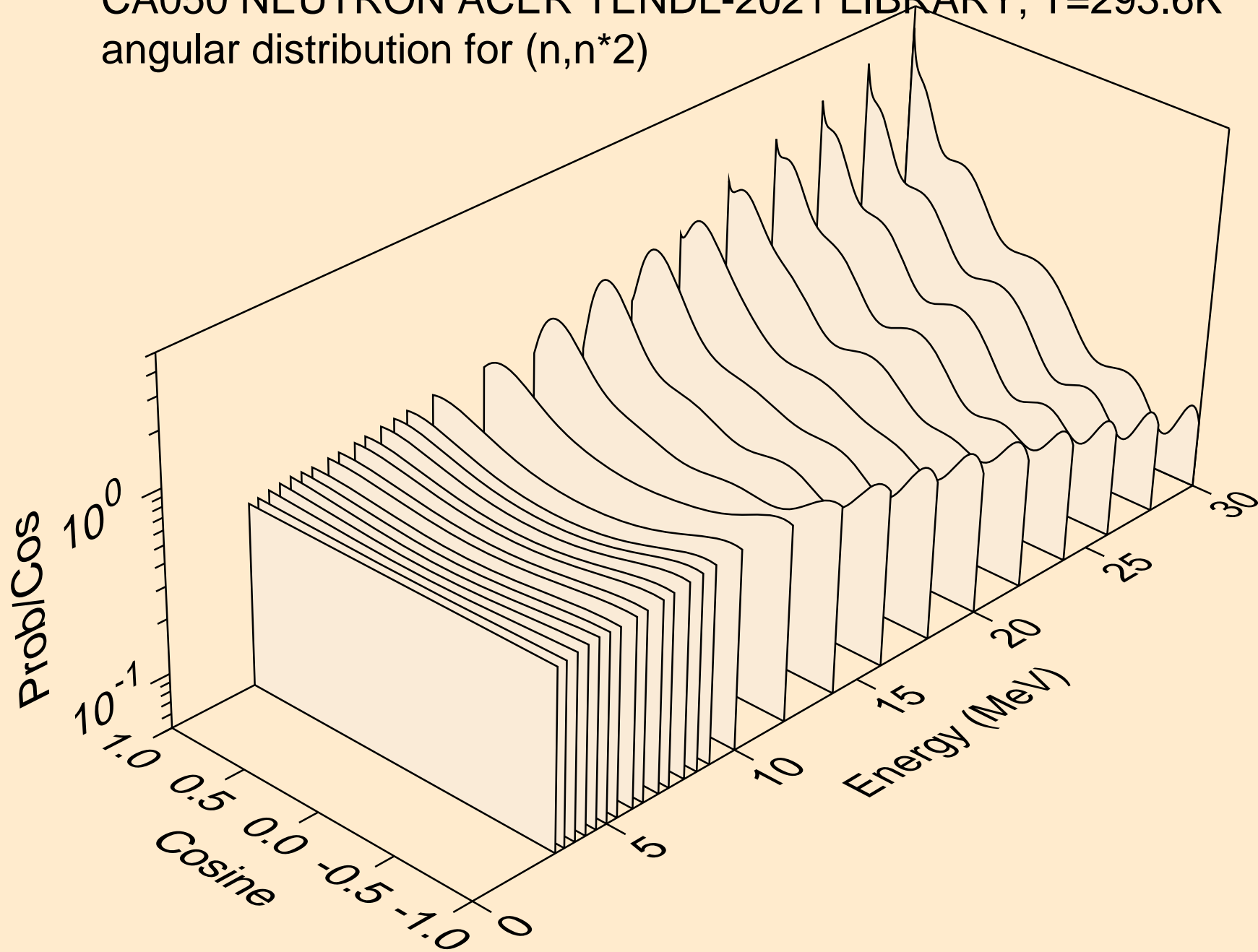

CA050 NEUTRON ACER TENDL-2021 LIBRARY; T=293.6K  
angular distribution for (n,n\*3)

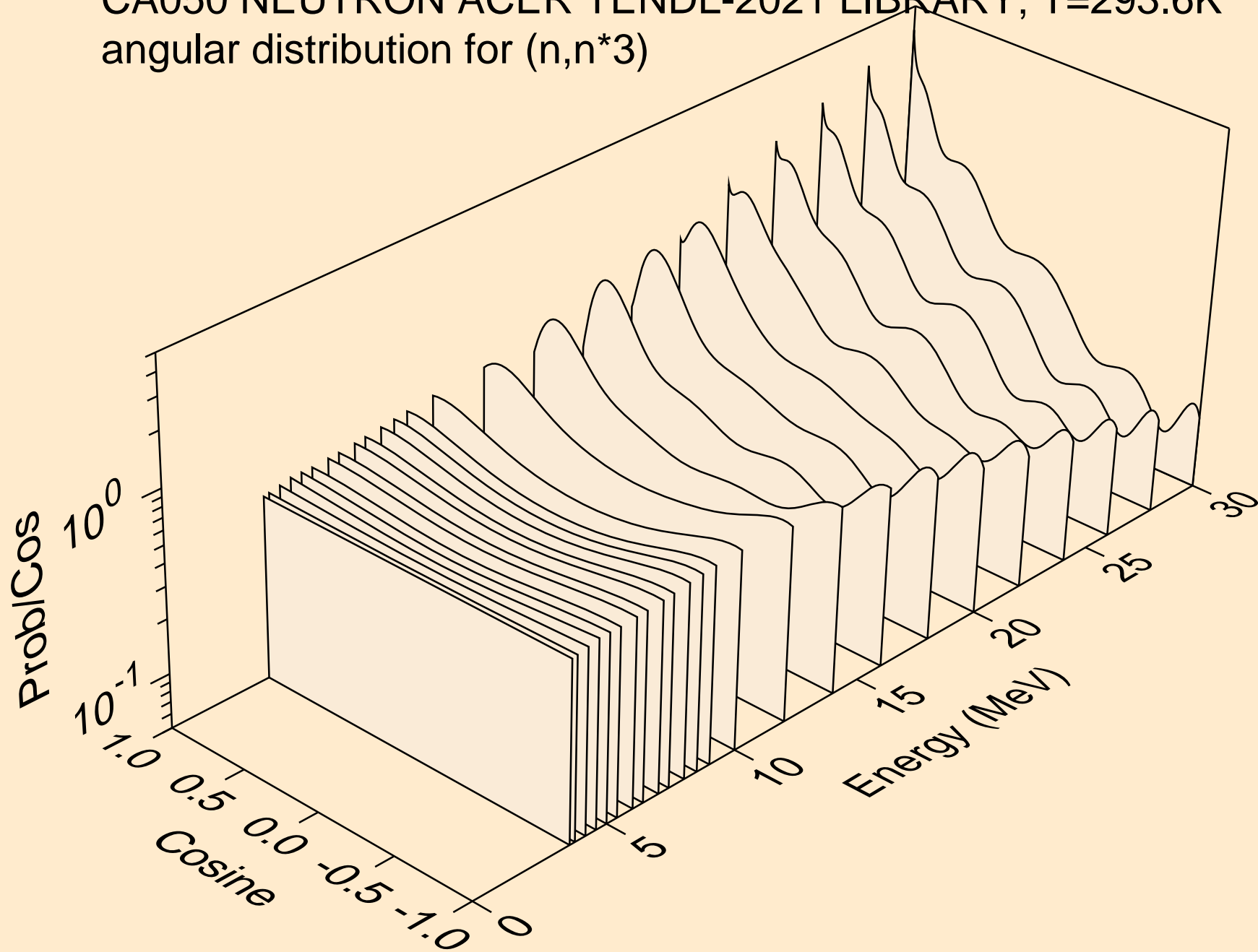



CA050 NEUTRON ACER TENDL-2021 LIBRARY; T=293.6K  
angular distribution for (n,n\*4)

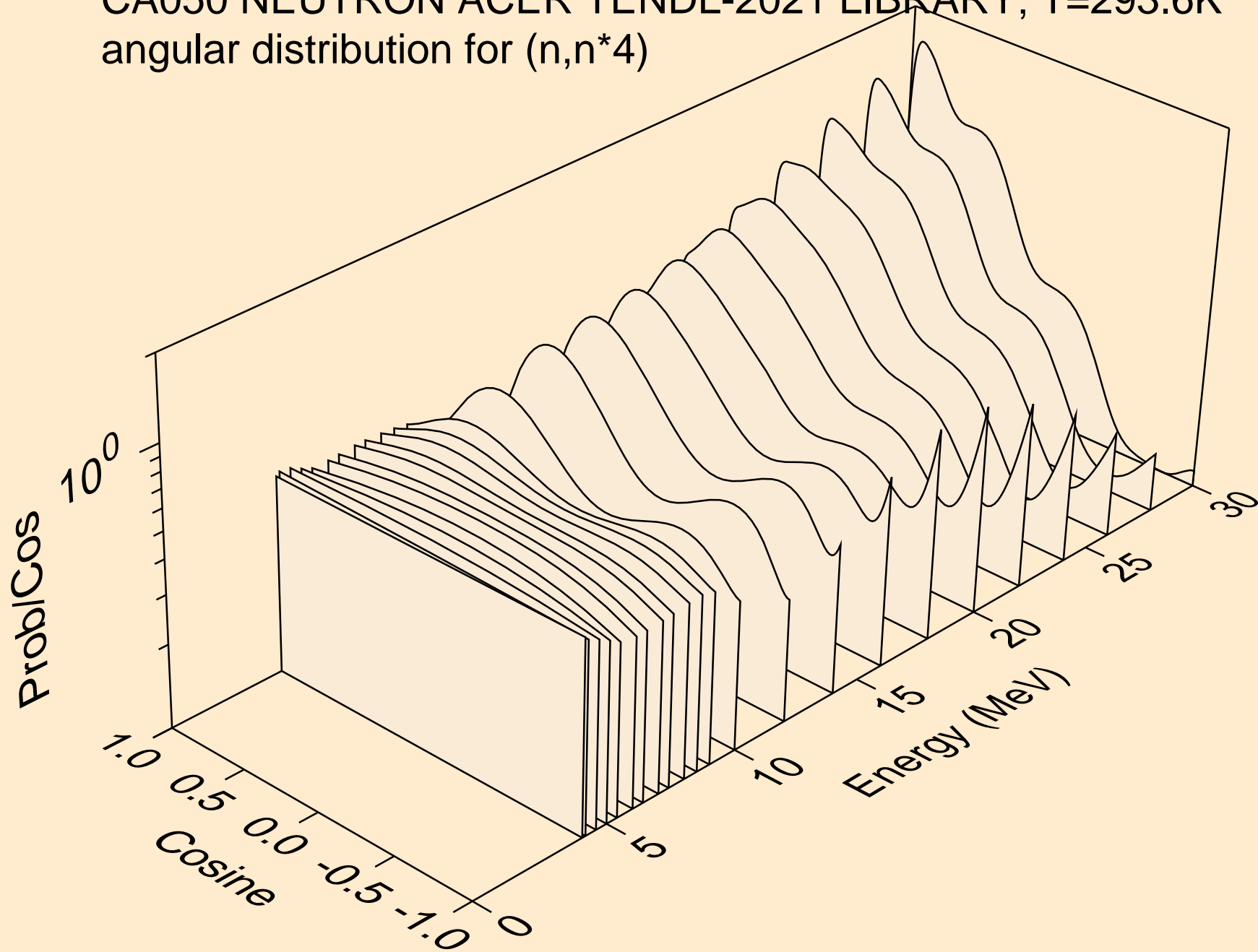

CA050 NEUTRON ACER TENDL-2021 LIBRARY; T=293.6K  
angular distribution for (n,n\*5)

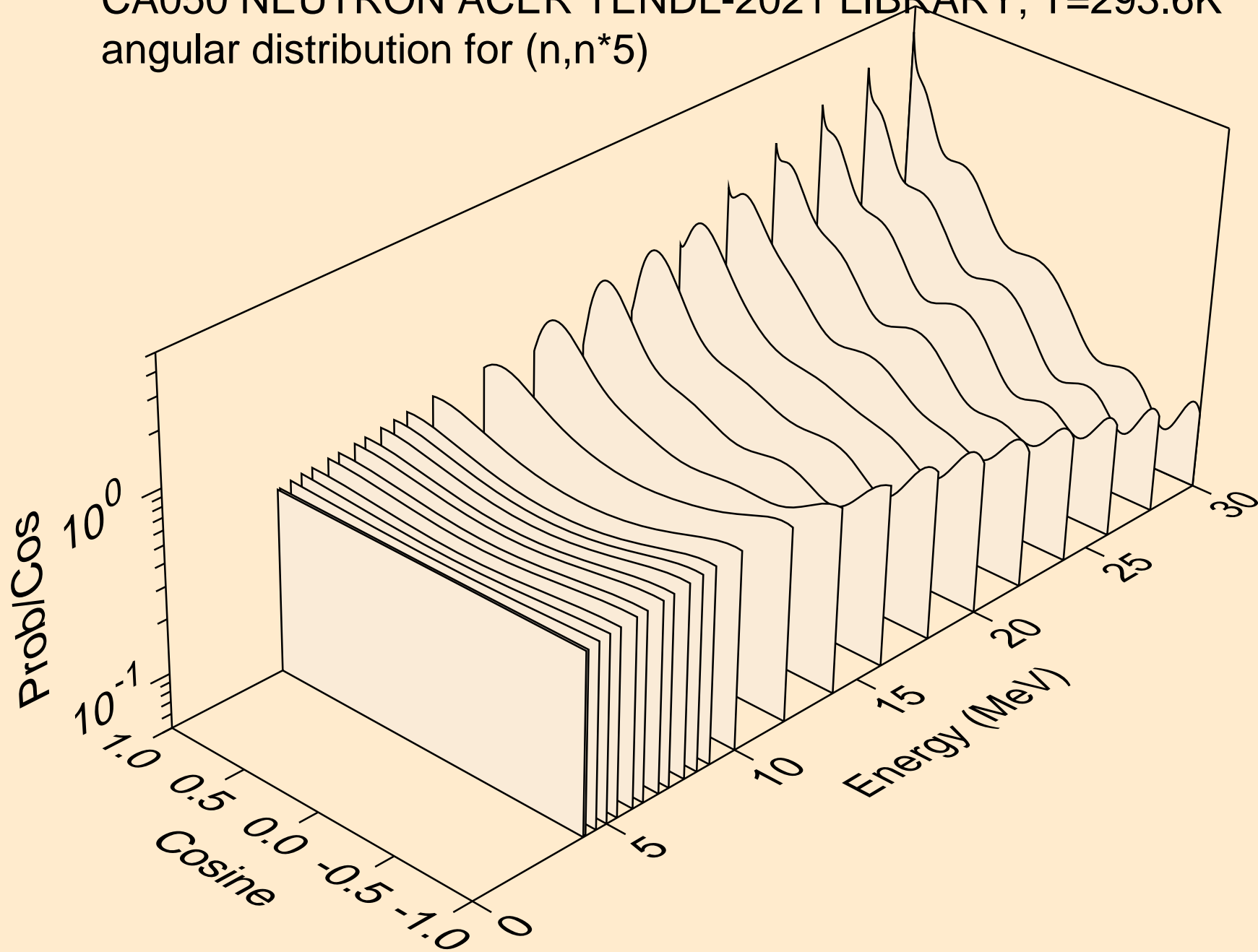

CA050 NEUTRON ACER TENDL-2021 LIBRARY; T=293.6K  
angular distribution for (n,n\*6)

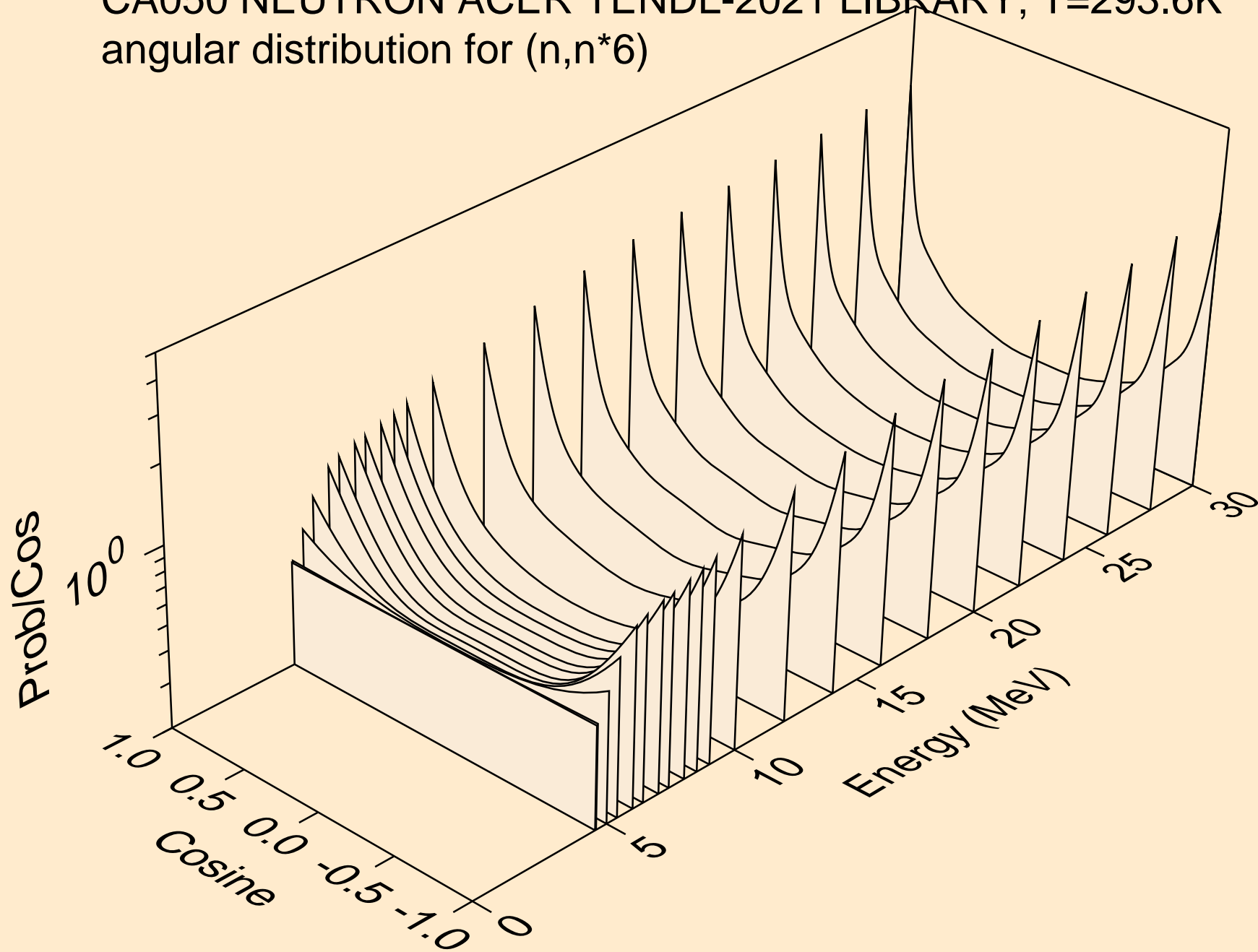

CA050 NEUTRON ACER TENDL-2021 LIBRARY; T=293.6K  
angular distribution for (n,n\*7)

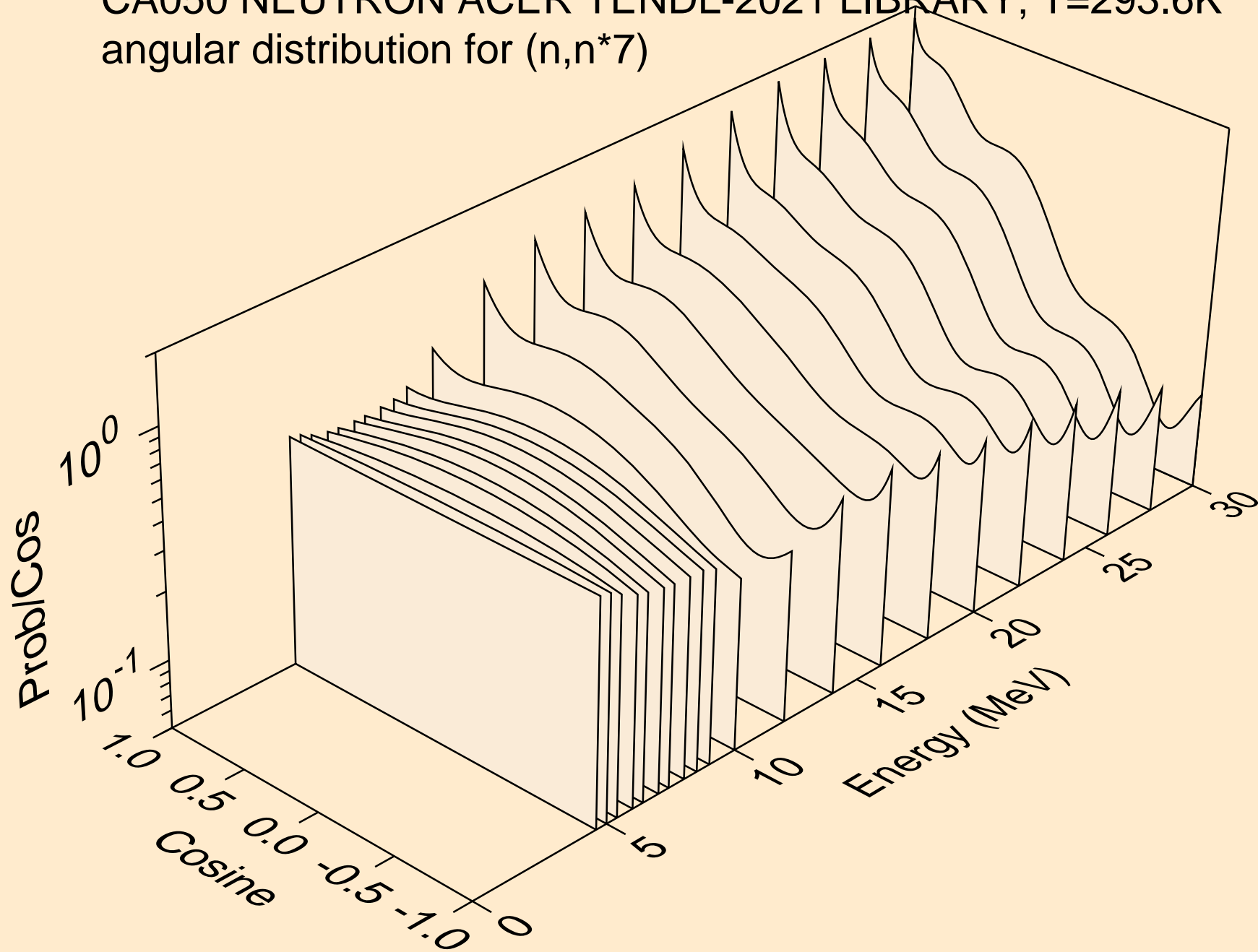

CA050 NEUTRON ACER TENDL-2021 LIBRARY; T=293.6K  
angular distribution for (n,n\*8)

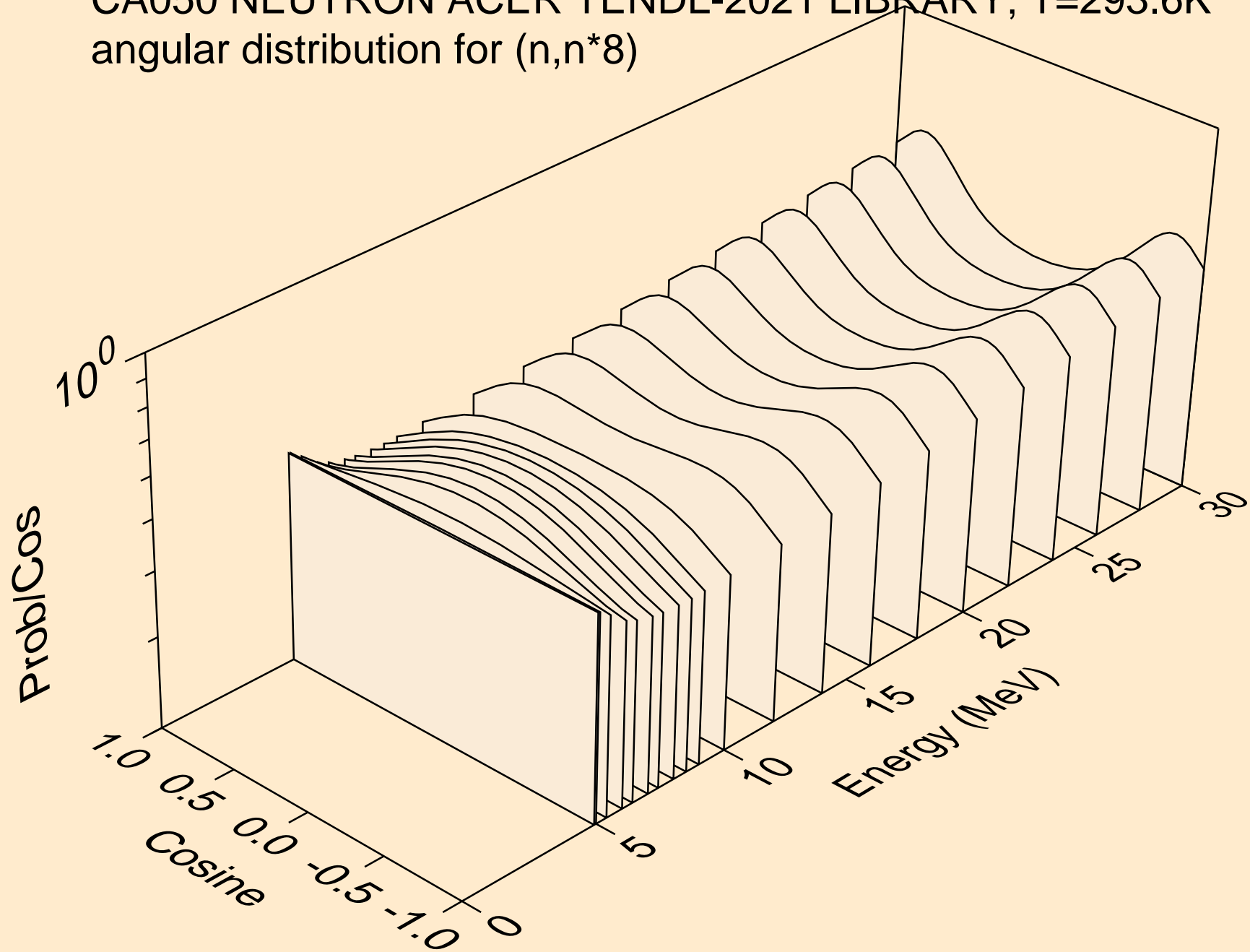

CA050 NEUTRON ACER TENDL-2021 LIBRARY; T=293.6K  
angular distribution for (n,n\*9)

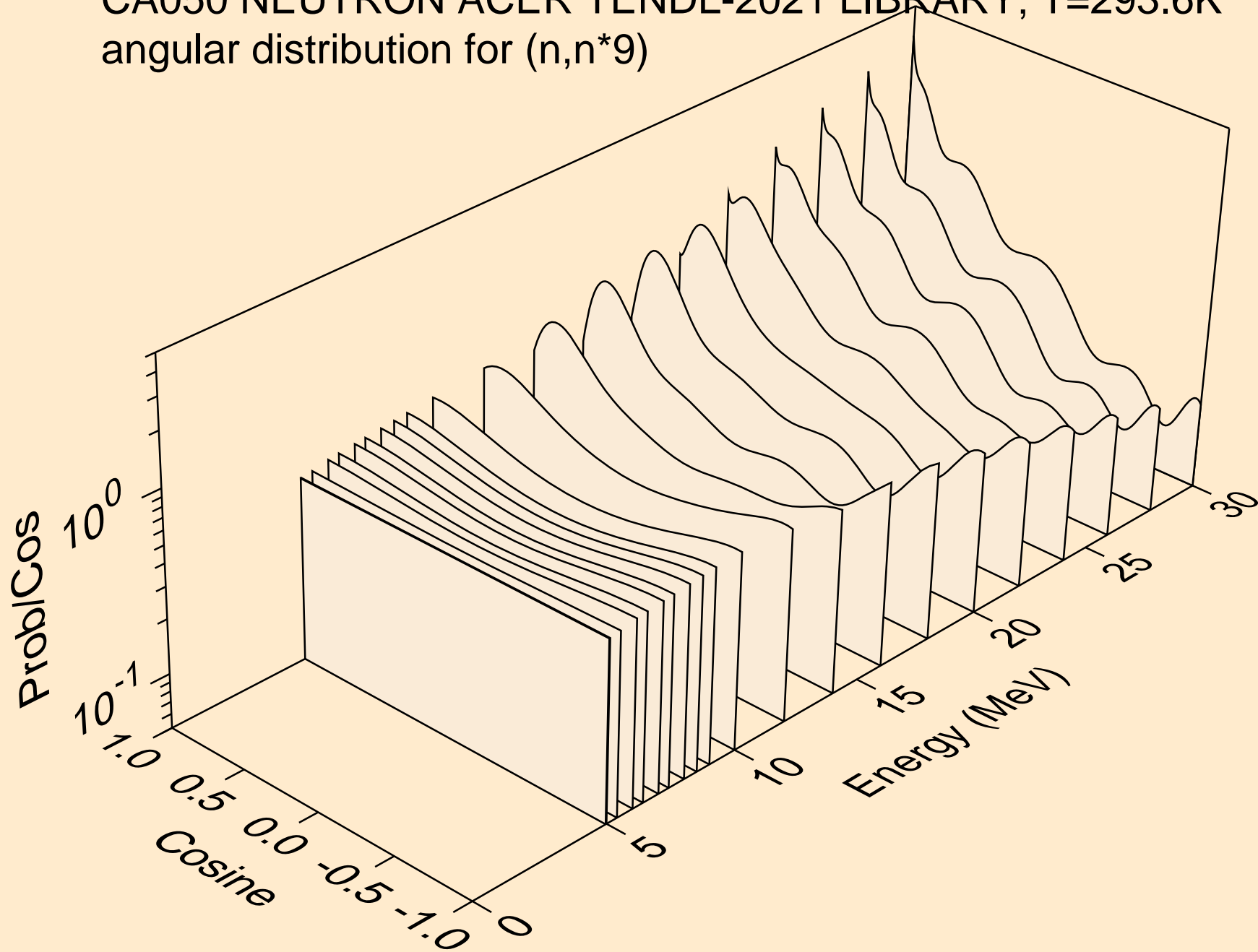

CA050 NEUTRON ACER TENDL-2021 LIBRARY; T=293.6K  
angular distribution for (n,n\*10)

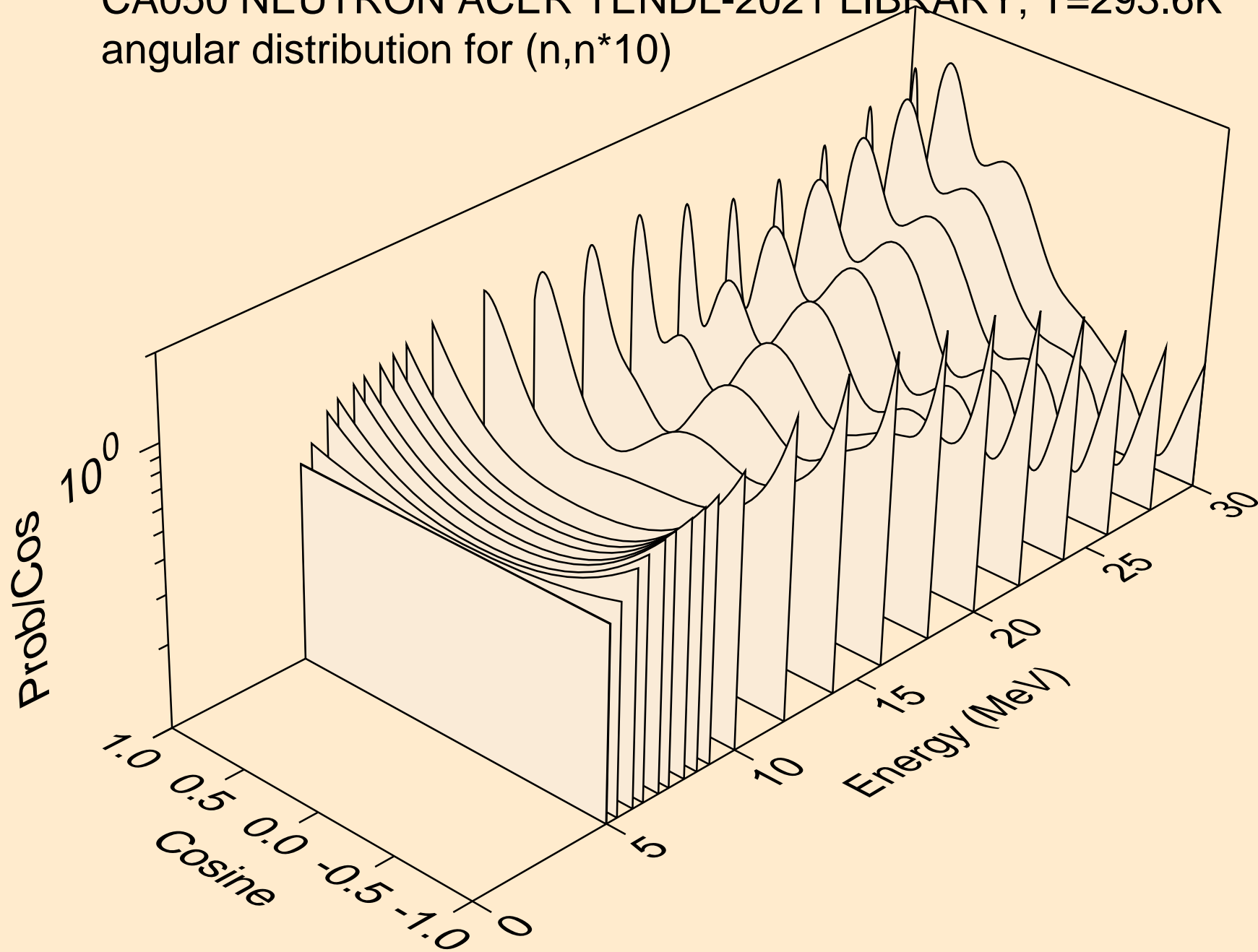

CA050 NEUTRON ACER TENDL-2021 LIBRARY; T=293.6K  
angular distribution for (n,n\*11)

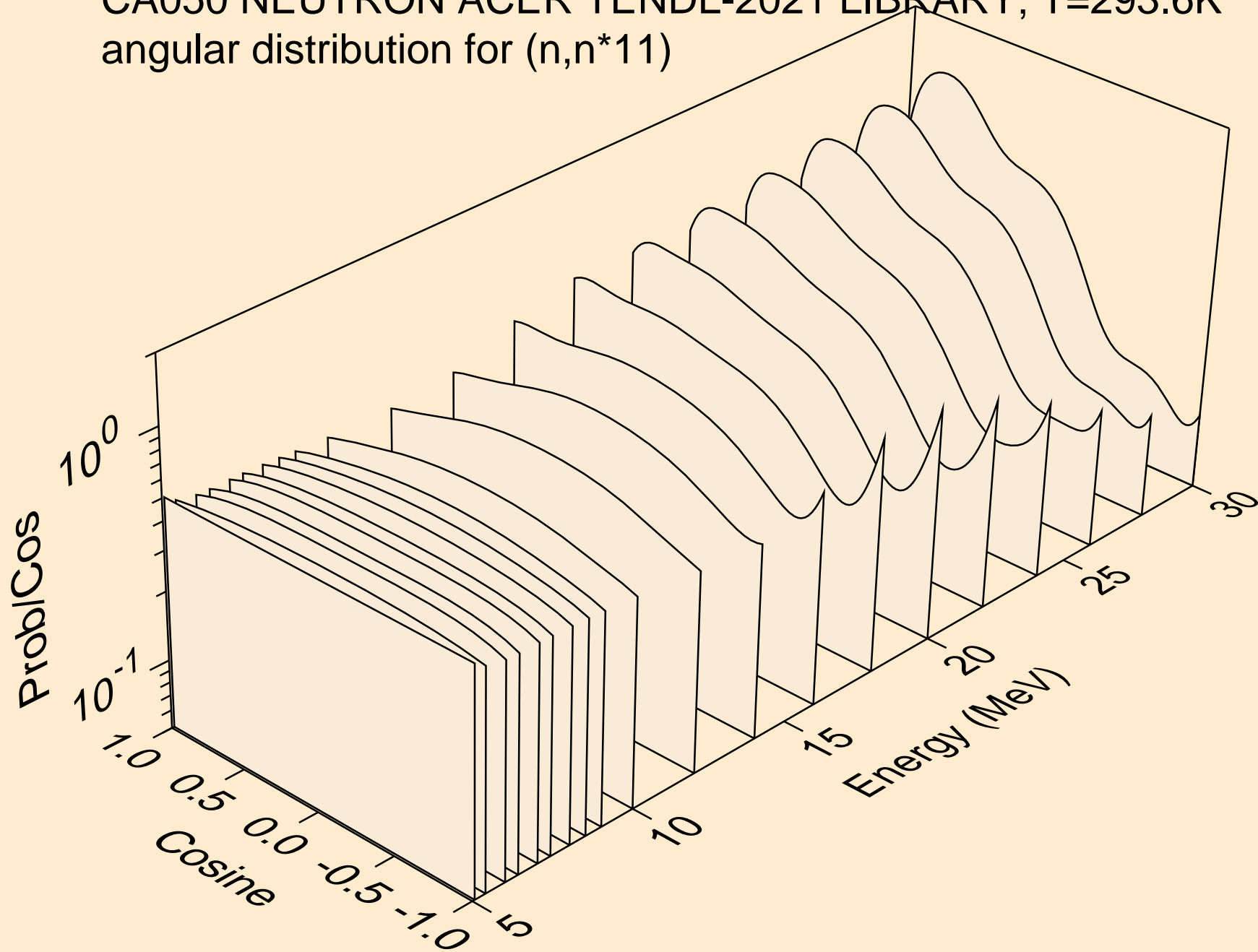



CA050 NEUTRON ACER TENDL-2021 LIBRARY; T=293.6K  
angular distribution for (n,n\*12)

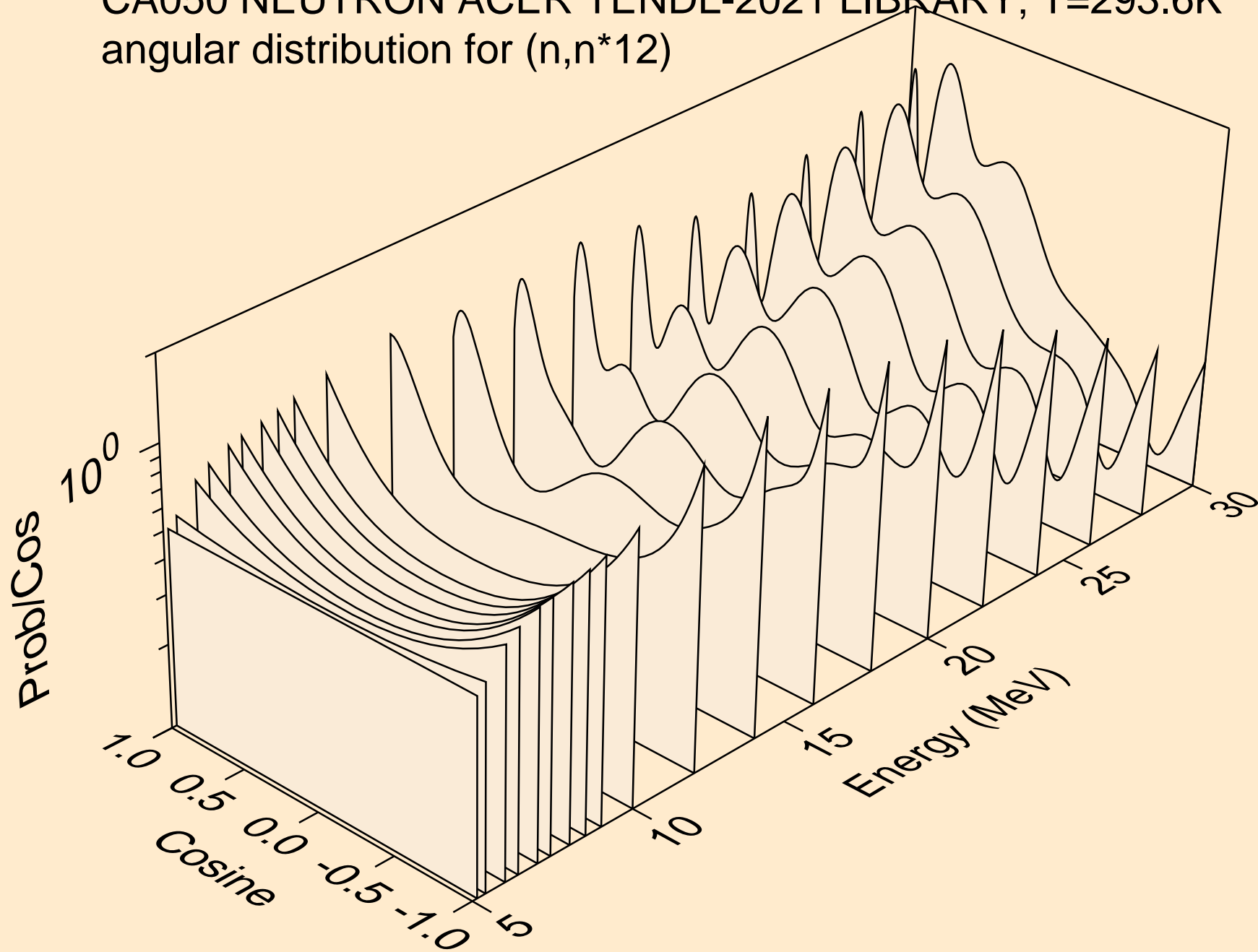

CA050 NEUTRON ACER TENDL-2021 LIBRARY; T=293.6K  
angular distribution for (n,n\*13)

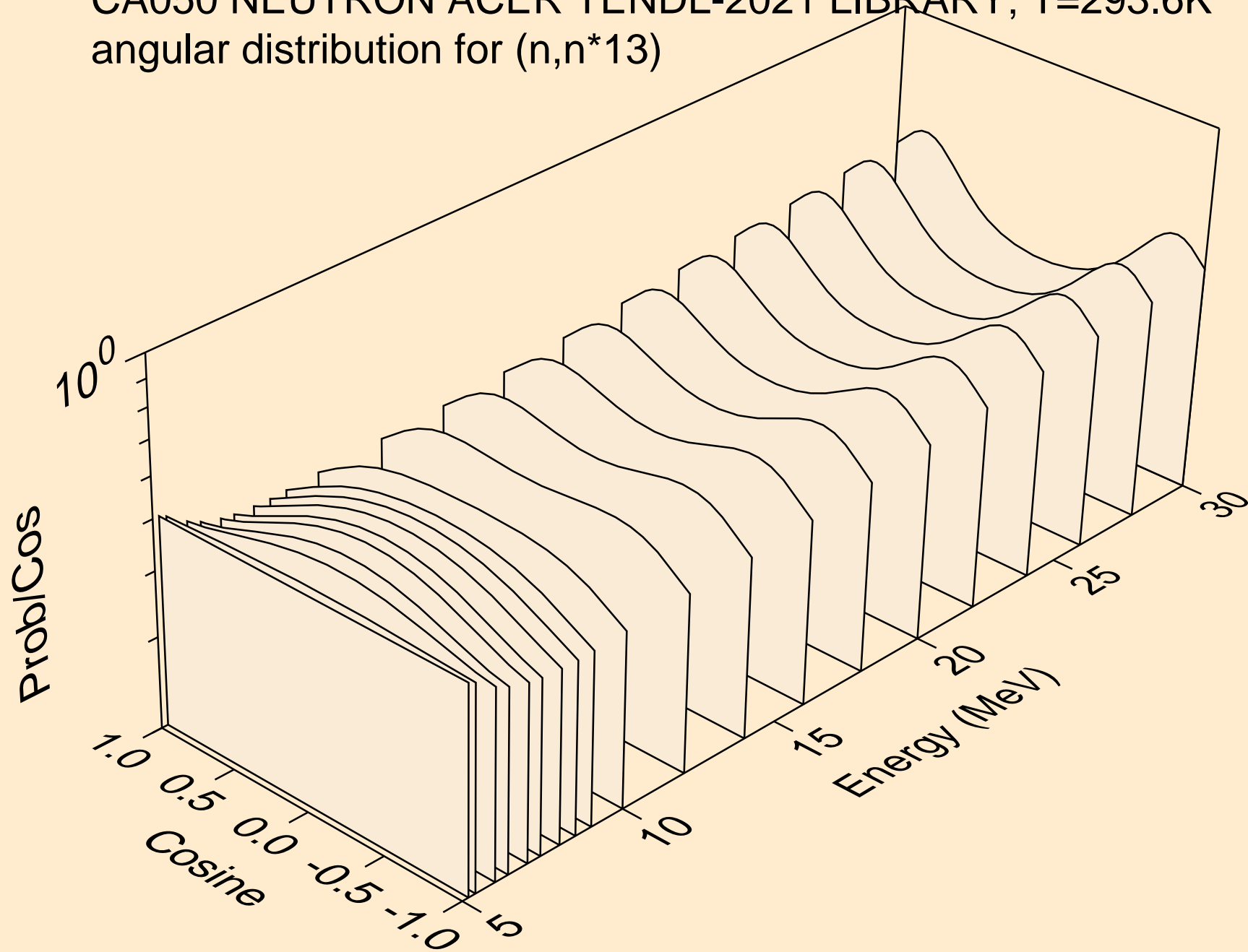

CA050 NEUTRON ACER TENDL-2021 LIBRARY; T=293.6K  
angular distribution for (n,n\*14)

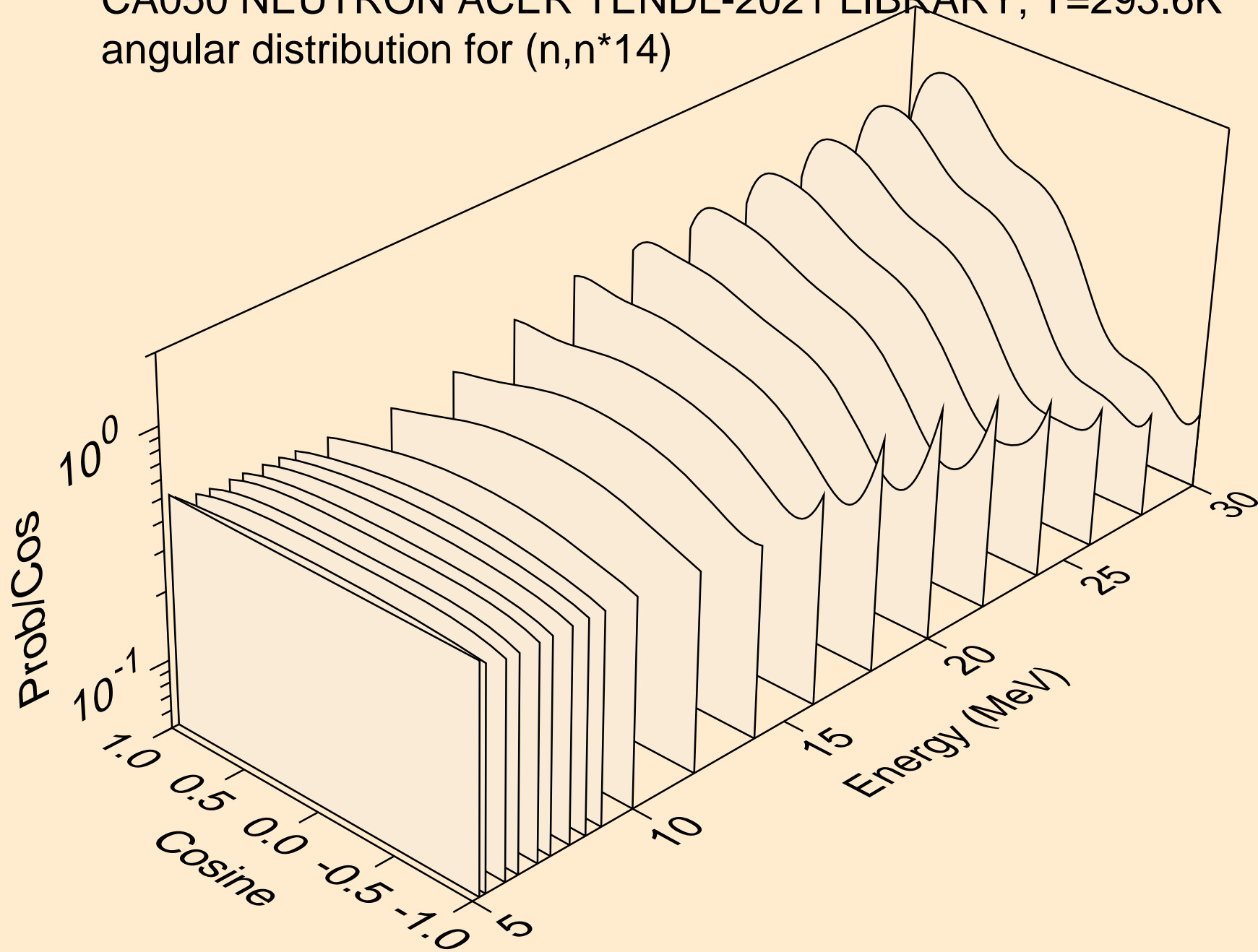

CA050 NEUTRON ACER TENDL-2021 LIBRARY; T=293.6K  
angular distribution for (n,n\*15)

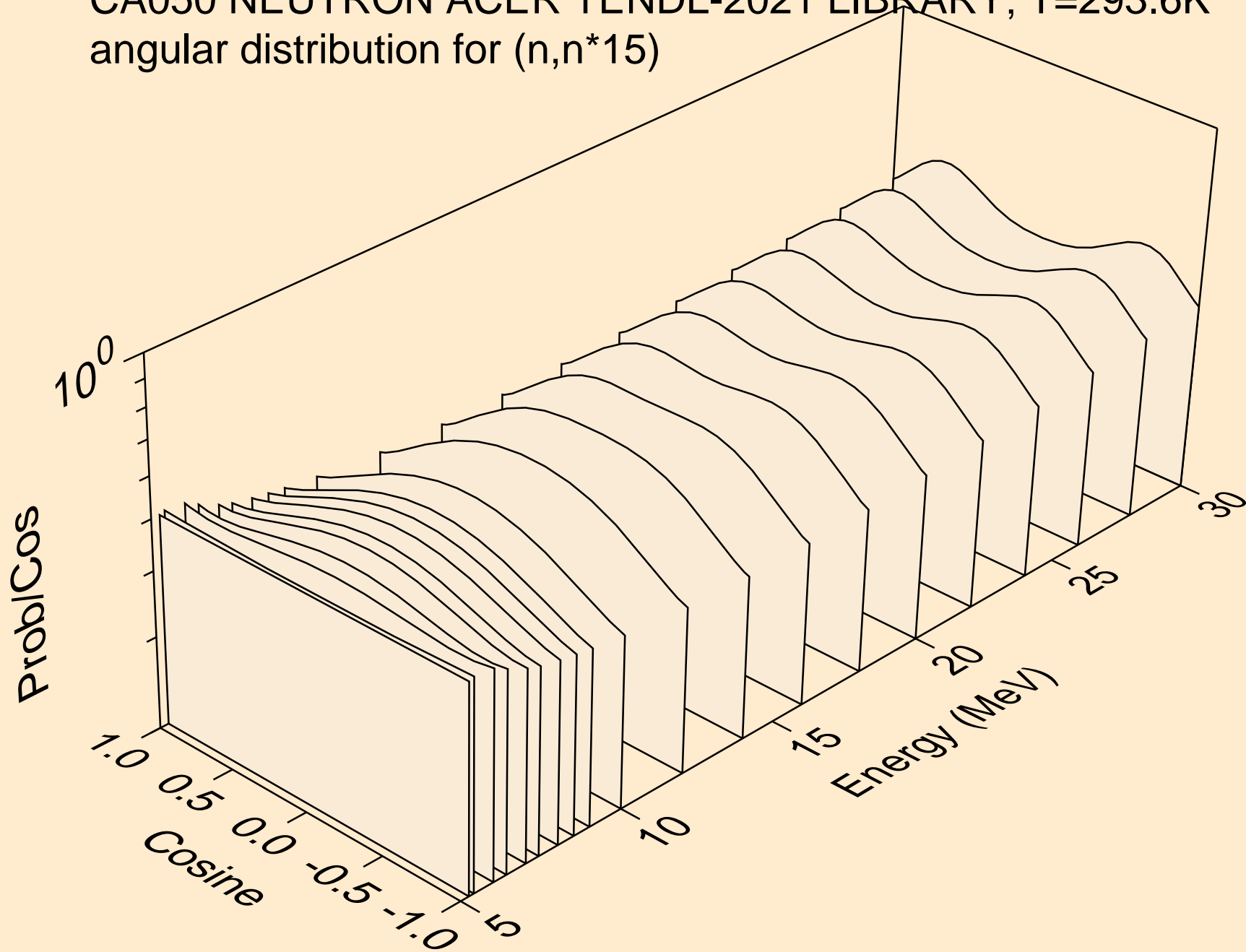

CA050 NEUTRON ACER TENDL-2021 LIBRARY; T=293.6K  
angular distribution for (n,n\*16)

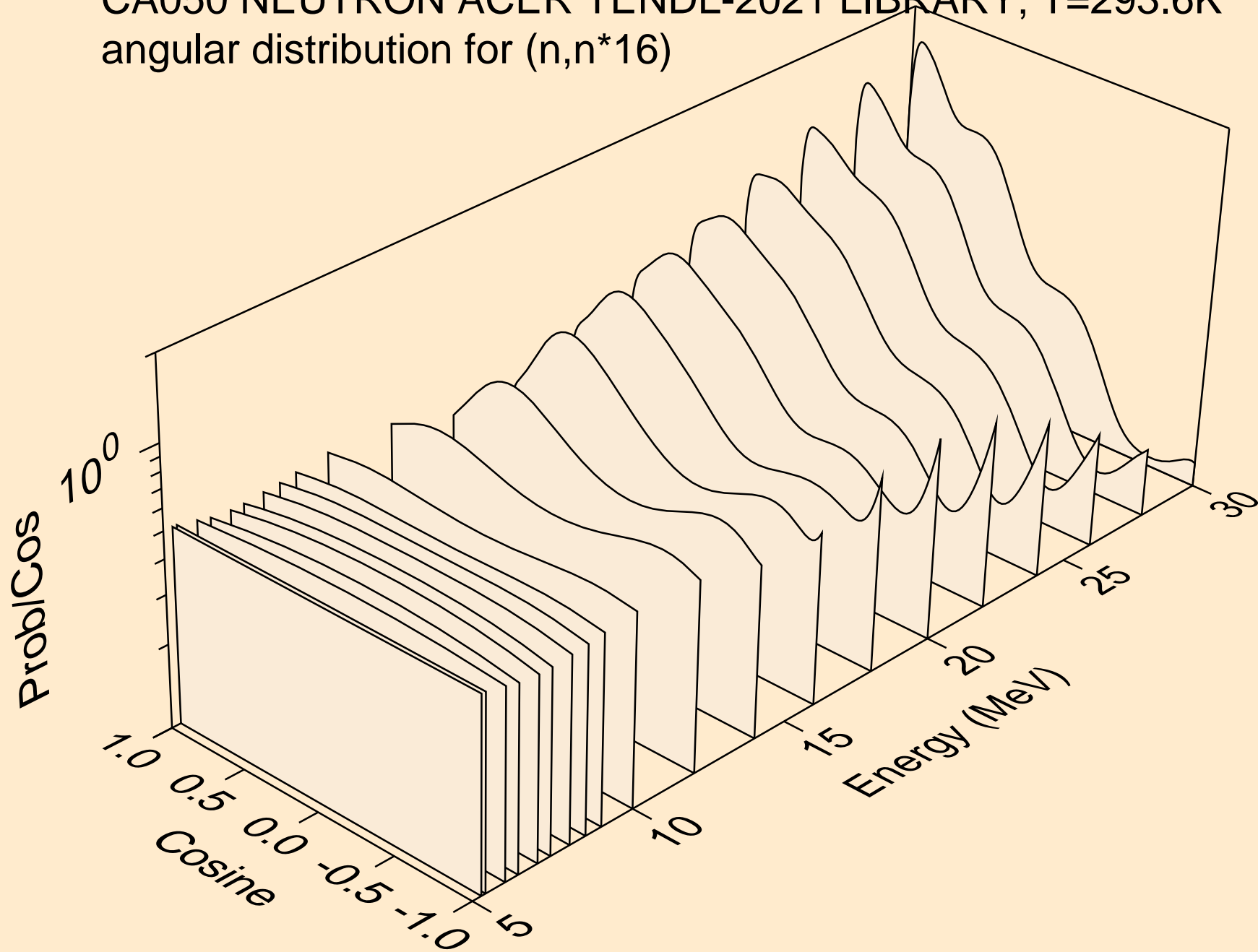

CA050 NEUTRON ACER TENDL-2021 LIBRARY; T=293.6K  
angular distribution for (n,n\*17)

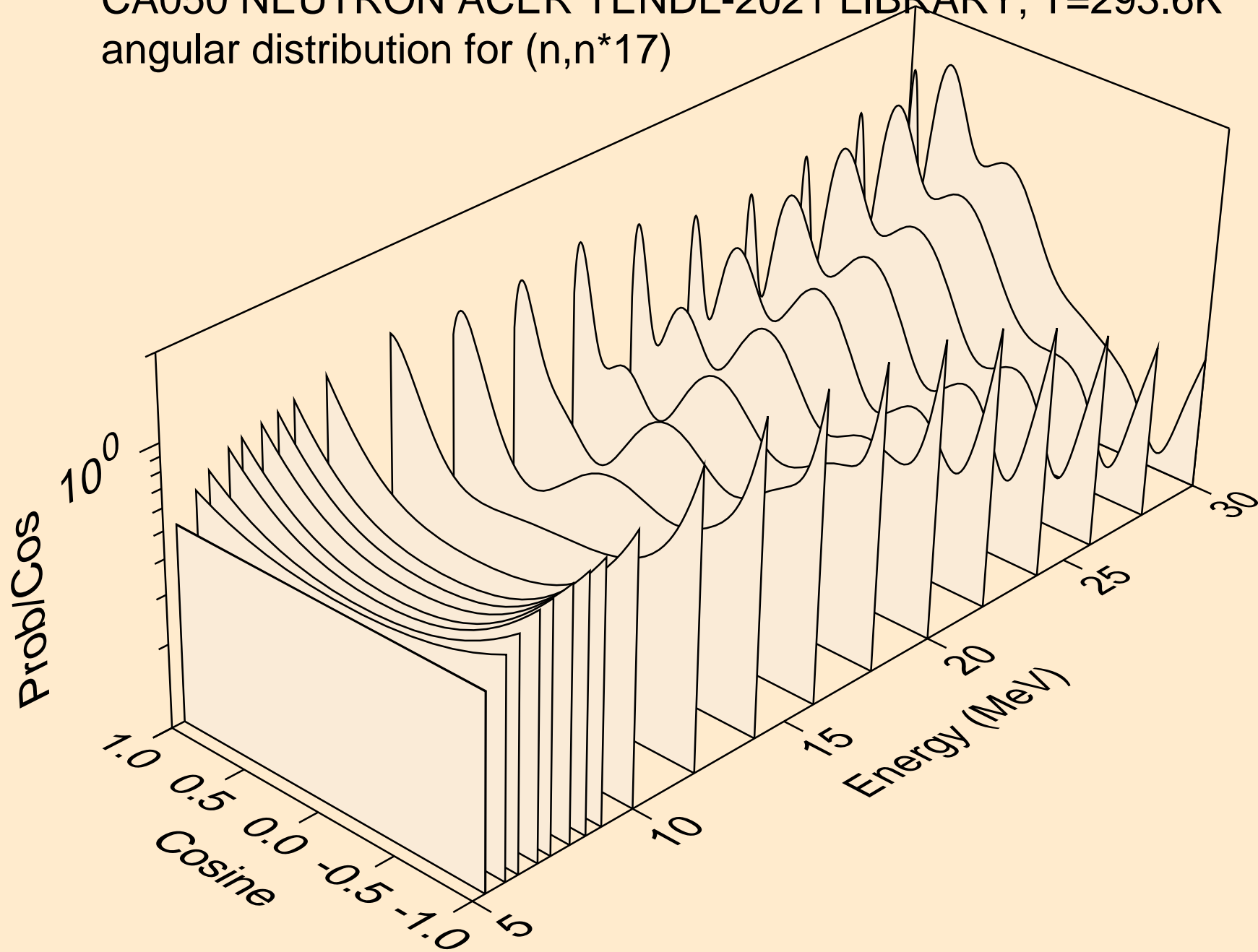

CA050 NEUTRON ACER TENDL-2021 LIBRARY; T=293.6K  
angular distribution for (n,n\*18)

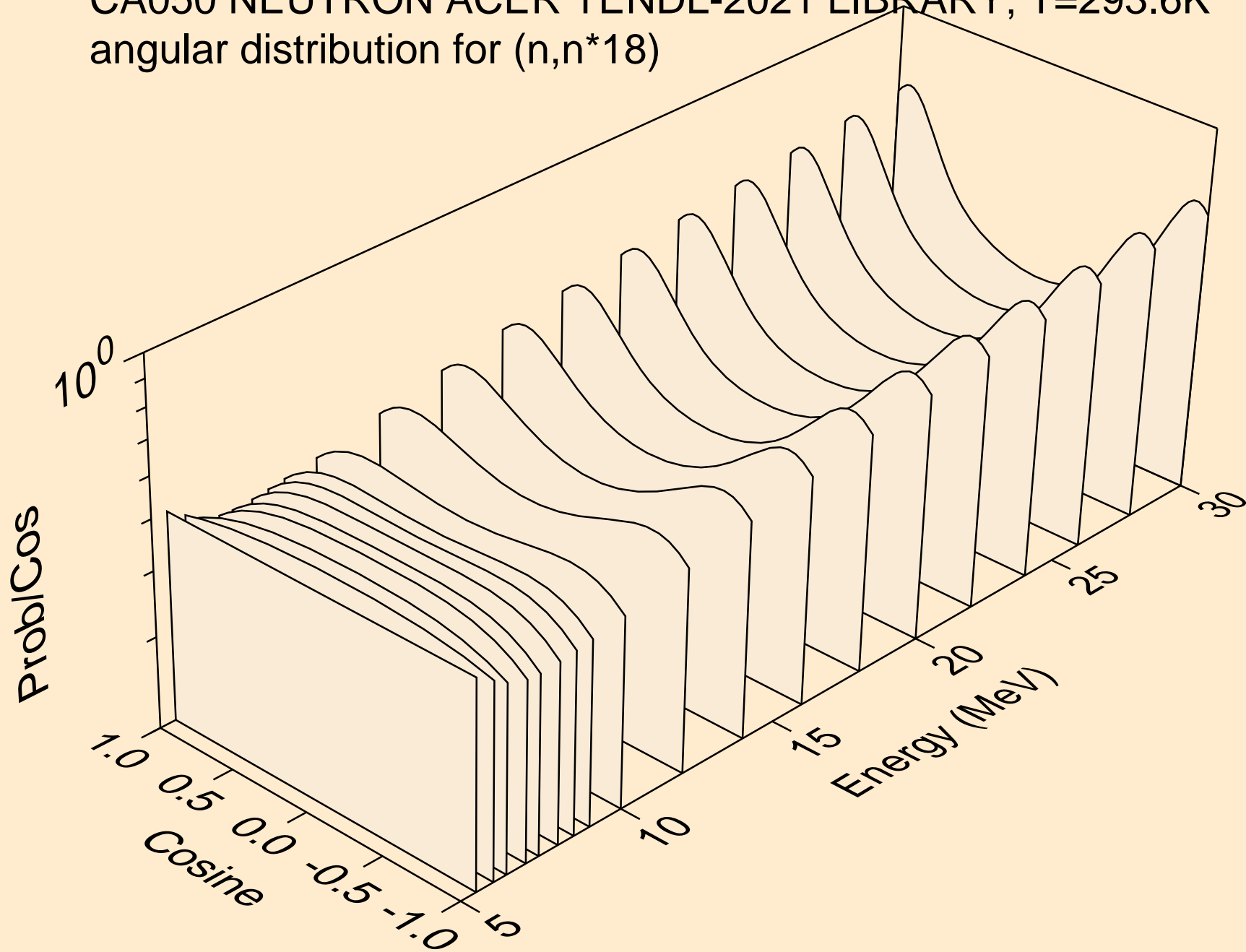

CA050 NEUTRON ACER TENDL-2021 LIBRARY; T=293.6K  
angular distribution for (n,n\*19)

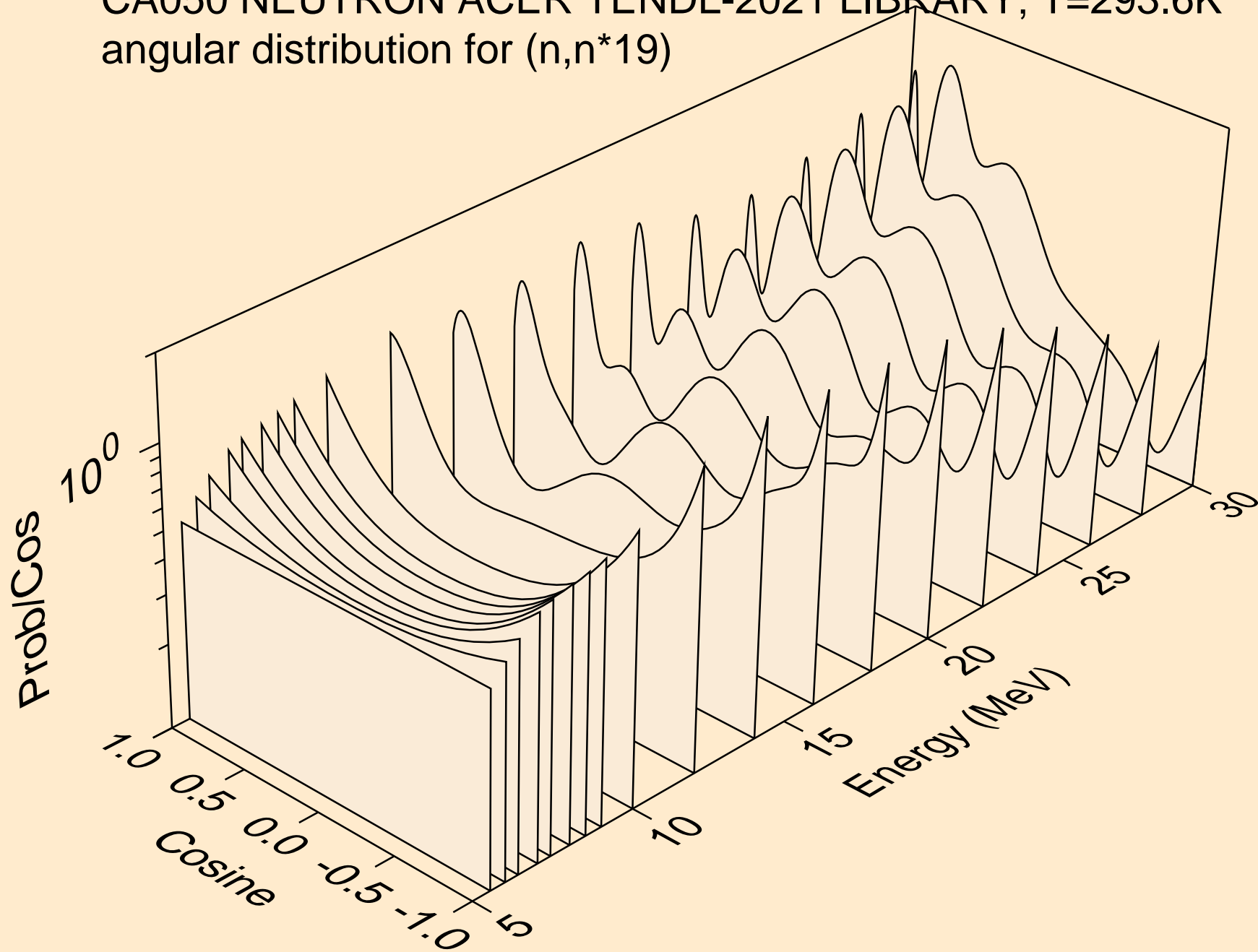



CA050 NEUTRON ACER TENDL-2021 LIBRARY; T=293.6K  
angular distribution for (n,n\*20)

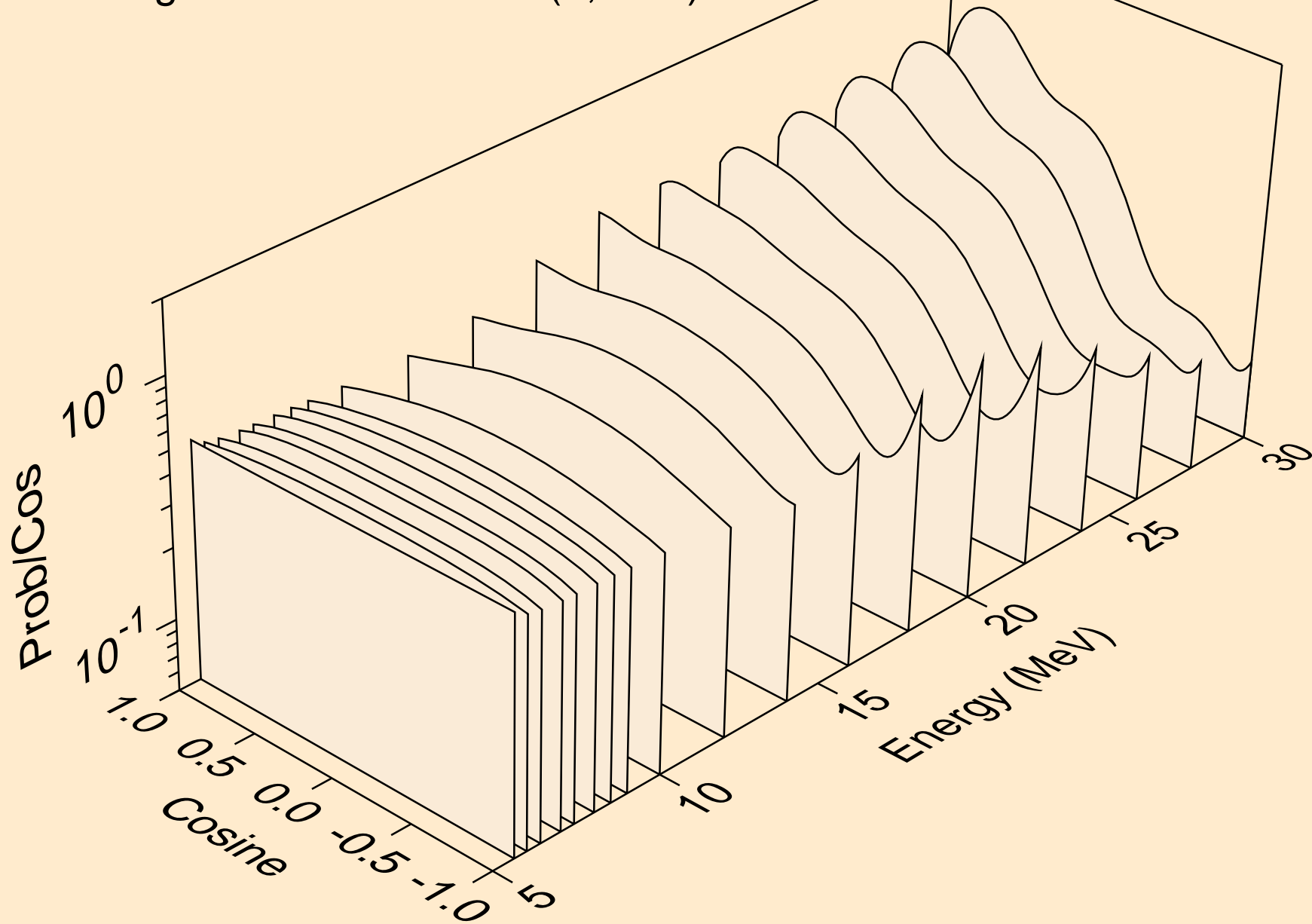

CA050 NEUTRON ACER TENDL-2021 LIBRARY; T=293.6K  
angular distribution for (n,n\*21)

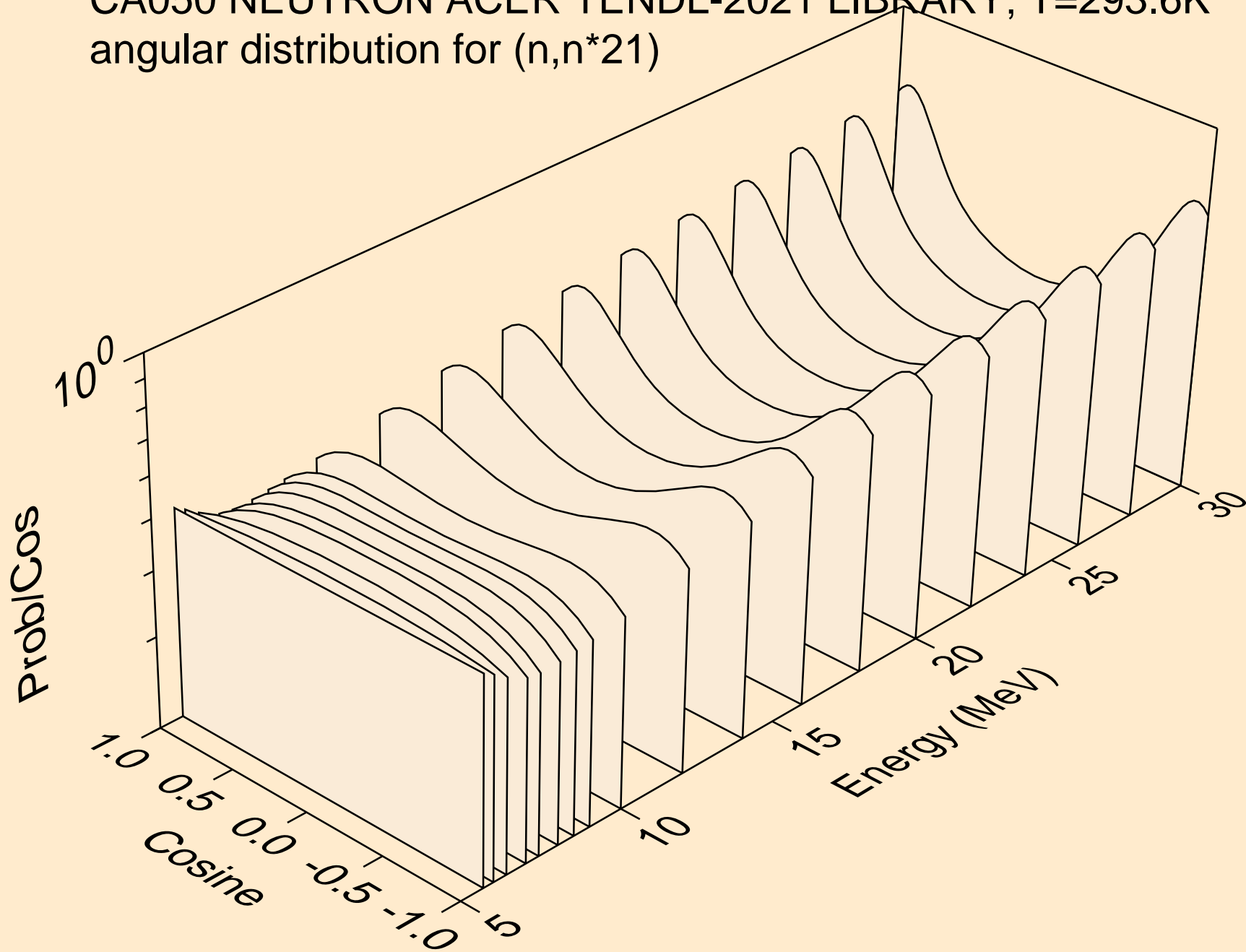

CA050 NEUTRON ACER TENDL-2021 LIBRARY; T=293.6K  
angular distribution for (n,n\*22)

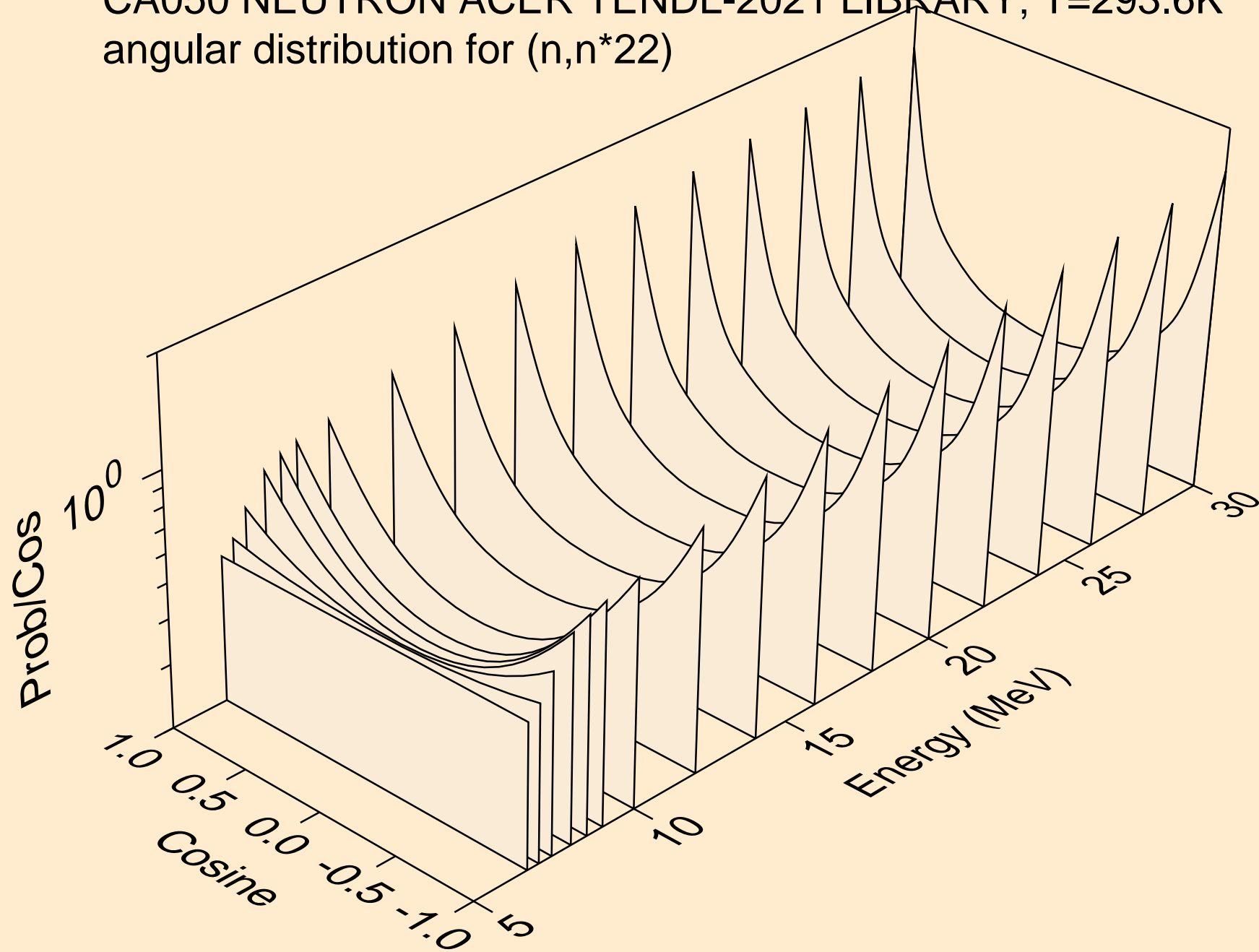

CA050 NEUTRON ACER TENDL-2021 LIBRARY; T=293.6K  
angular distribution for (n,n\*23)

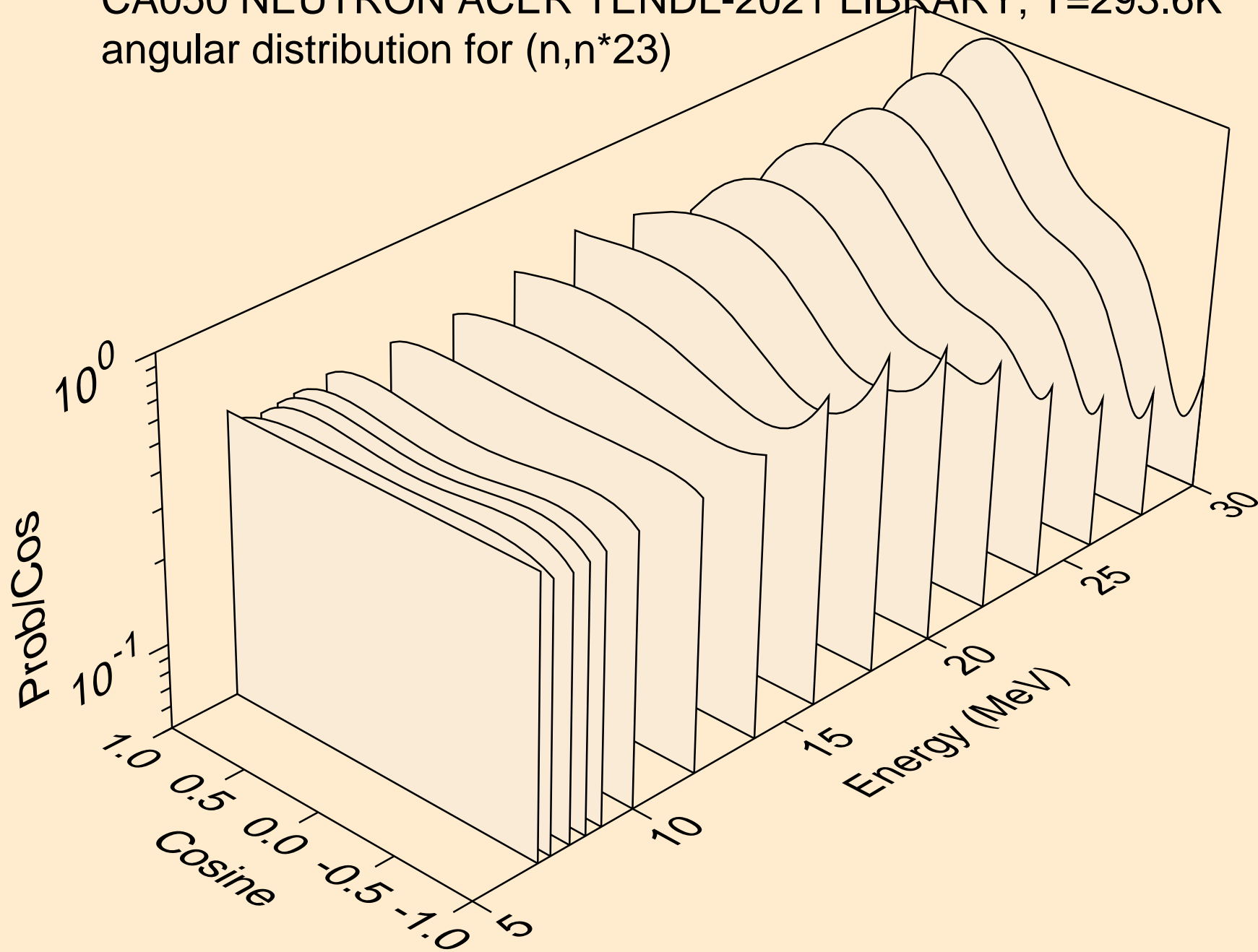

CA050 NEUTRON ACER TENDL-2021 LIBRARY; T=293.6K  
angular distribution for (n,n\*24)

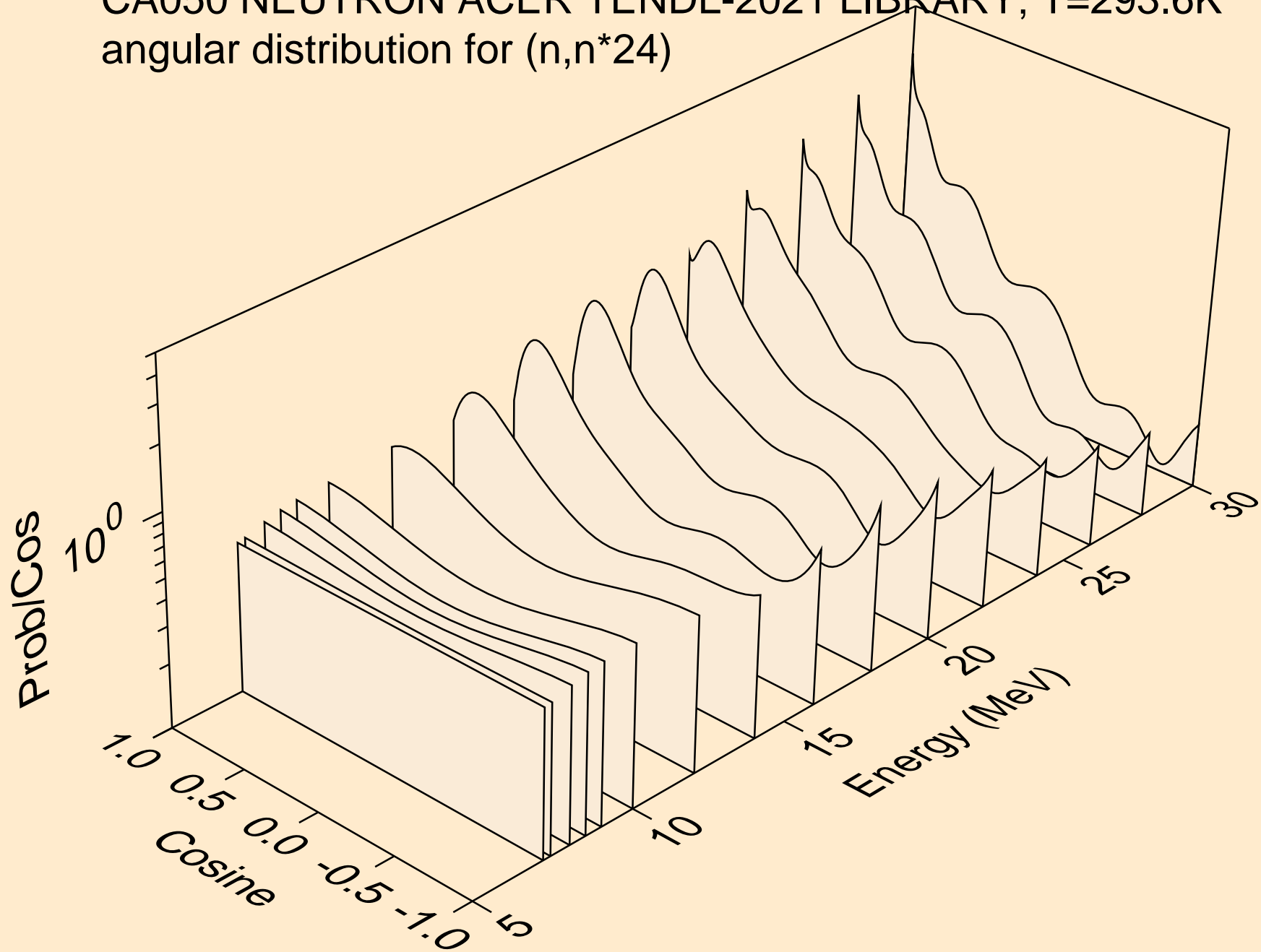

CA050 NEUTRON ACER TENDL-2021 LIBRARY; T=293.6K  
angular distribution for (n,n\*25)

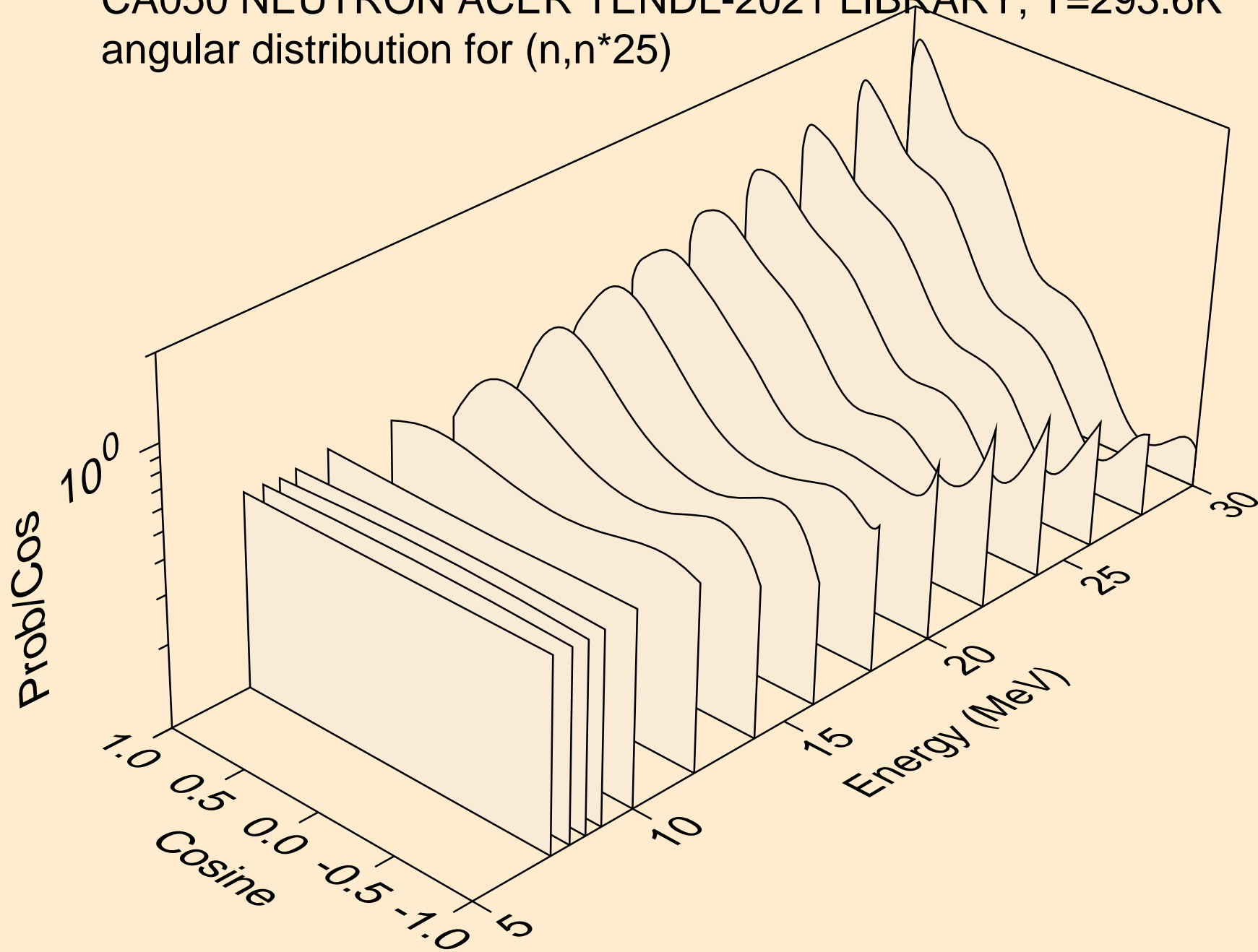

CA050 NEUTRON ACER TENDL-2021 LIBRARY; T=293.6K  
angular distribution for (n,n\*26)

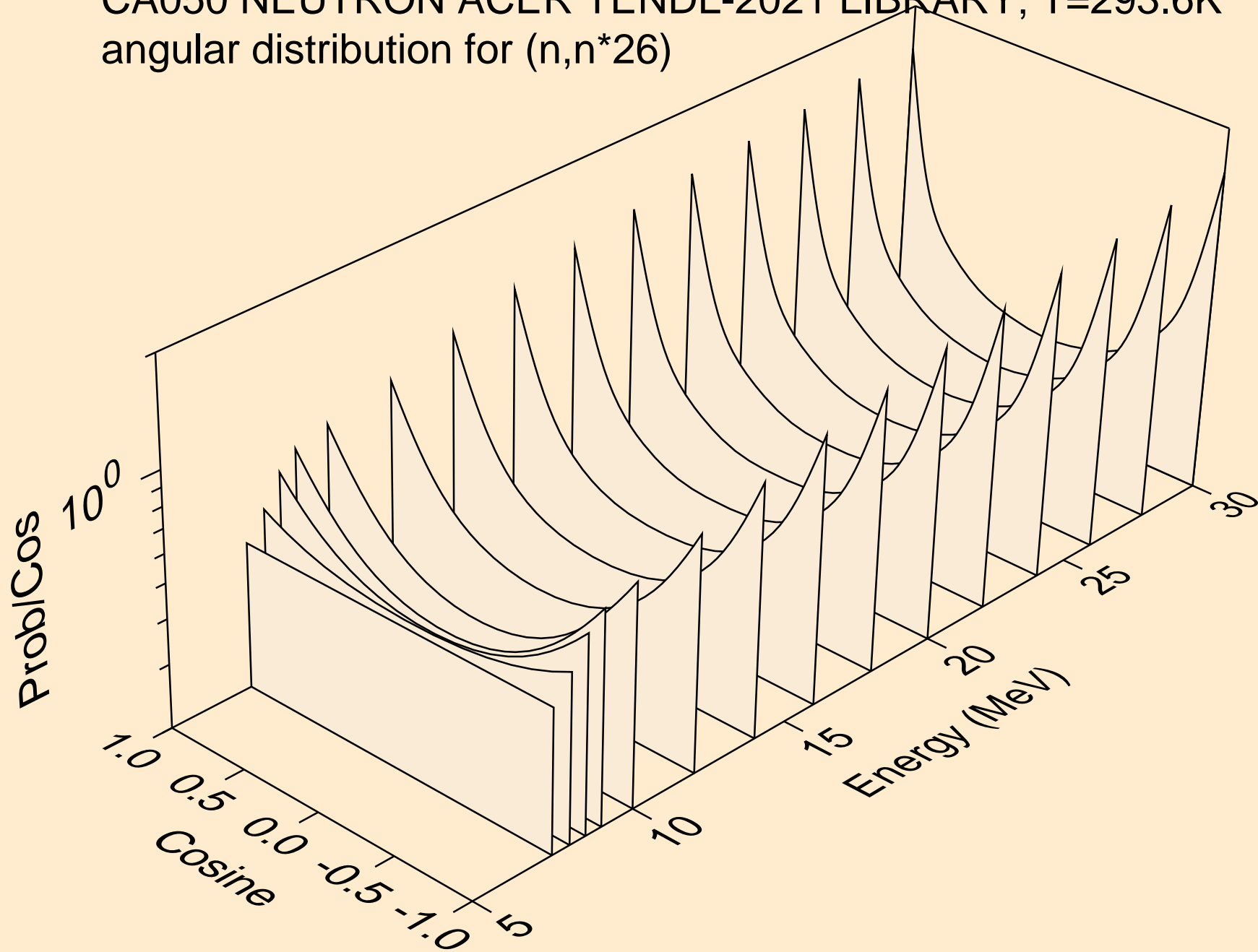

CA050 NEUTRON ACER TENDL-2021 LIBRARY; T=293.6K  
angular distribution for (n,n\*27)

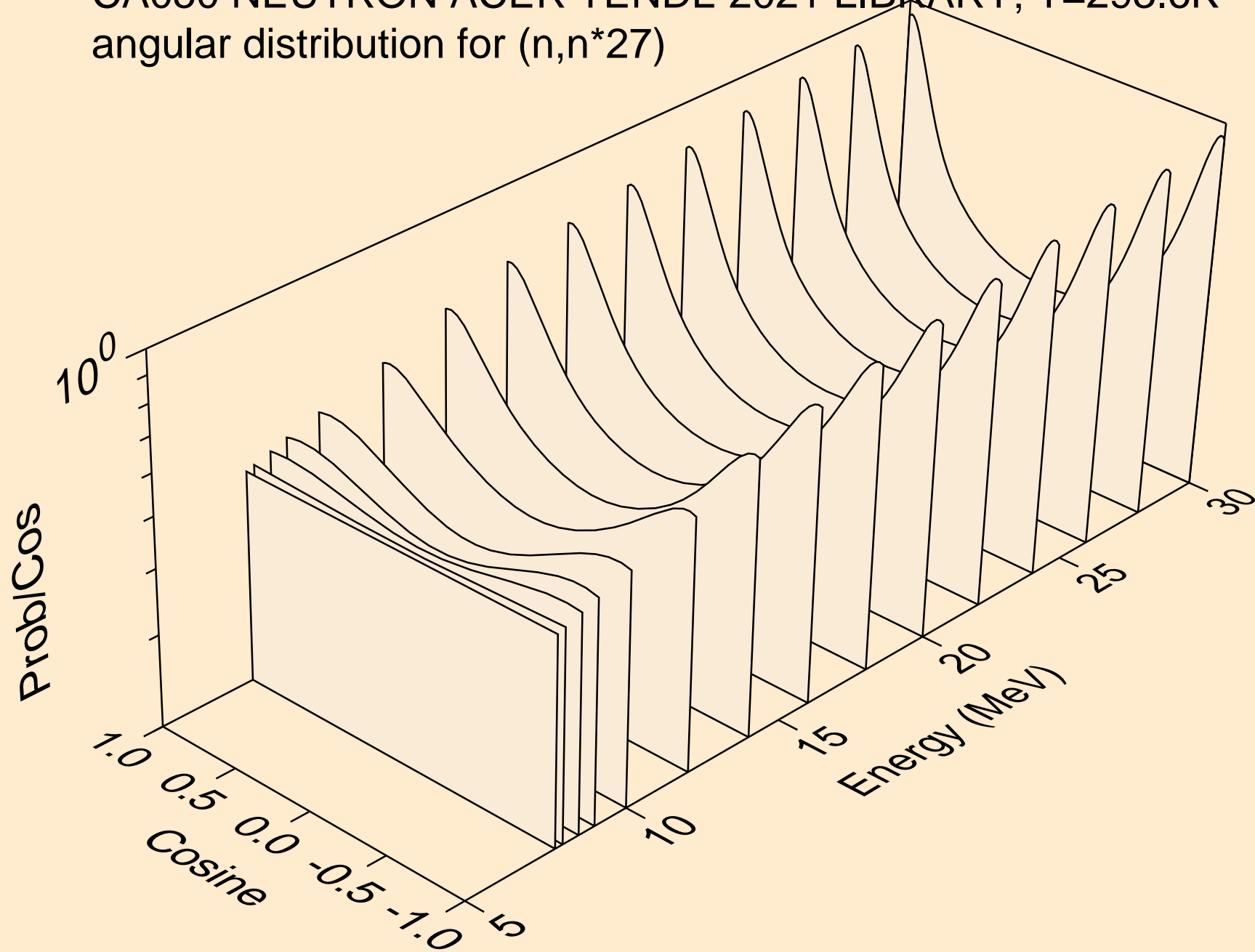



CA050 NEUTRON ACER TENDL-2021 LIBRARY; T=293.6K  
angular distribution for (n,n\*28)

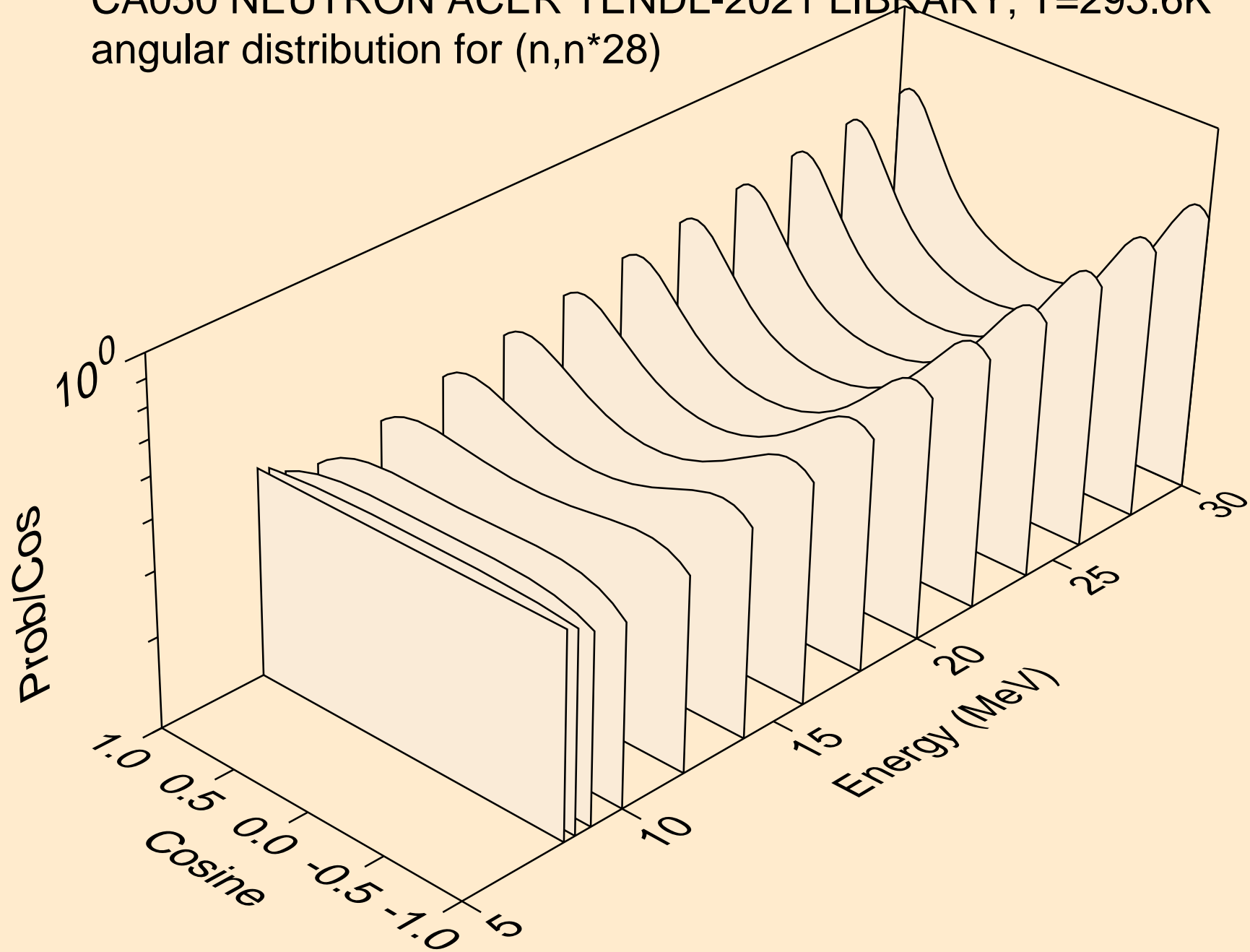

CA050 NEUTRON ACER TENDL-2021 LIBRARY; T=293.6K  
Neutron emission for (n,x)

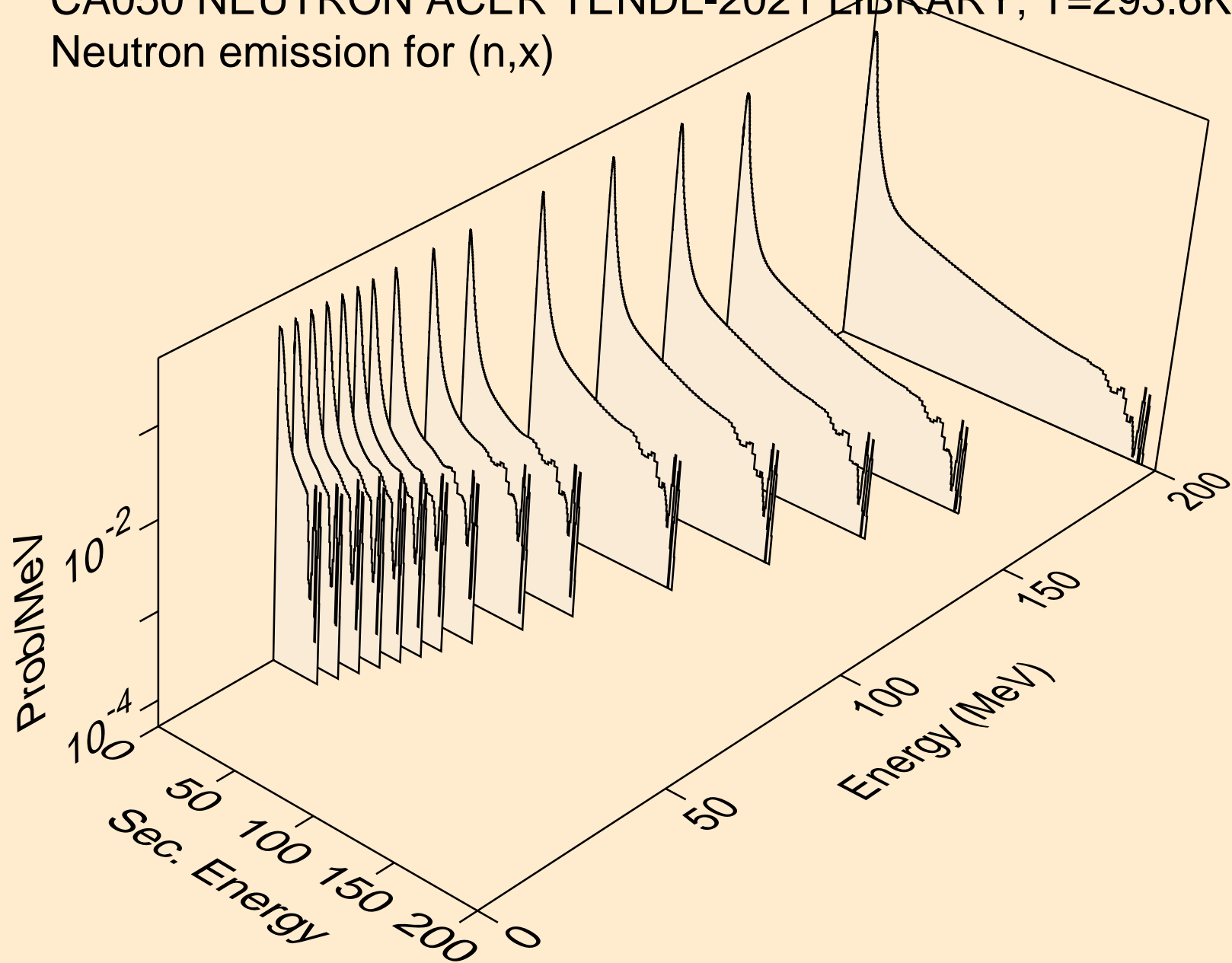

CA050 NEUTRON ACER TENDL-2021 LIBRARY; T=293.6K  
Neutron emission for (n,2nd)

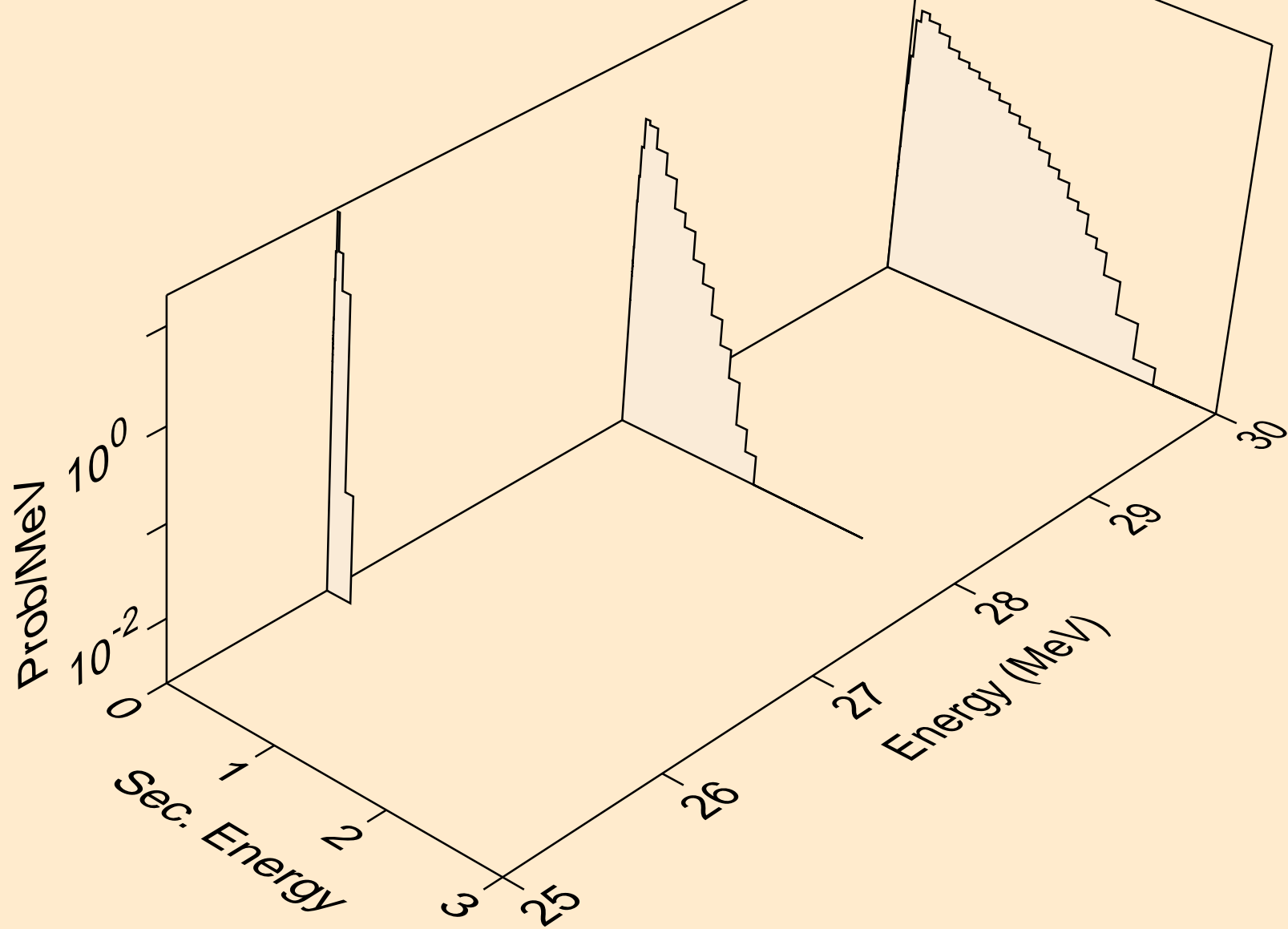

CA050 NEUTRON ACER TENDL-2021 LIBRARY; T=293.6K  
Neutron emission for (n,2n)

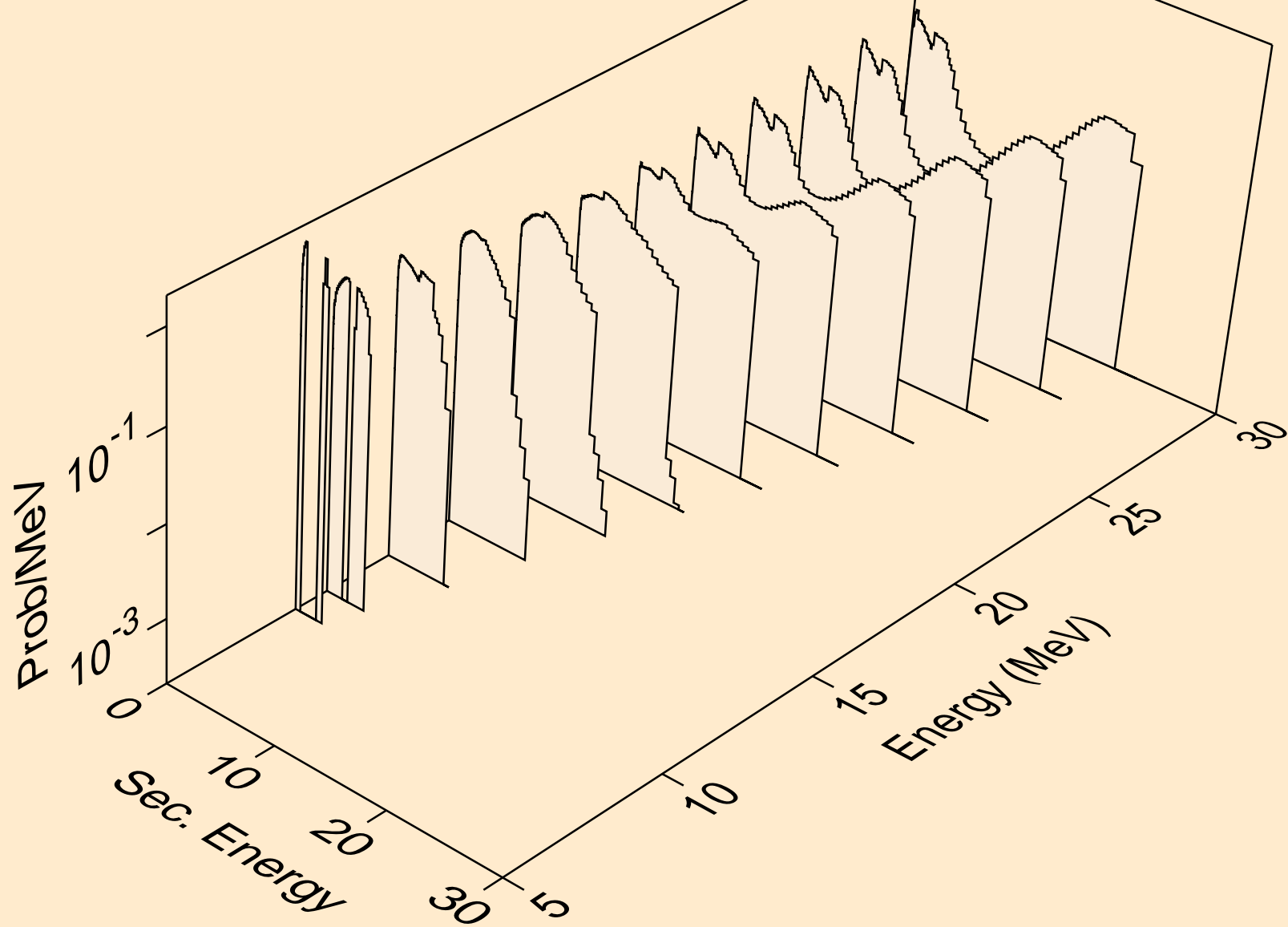

CA050 NEUTRON ACER TENDL-2021 LIBRARY; T=293.6K  
Neutron emission for (n,3n)

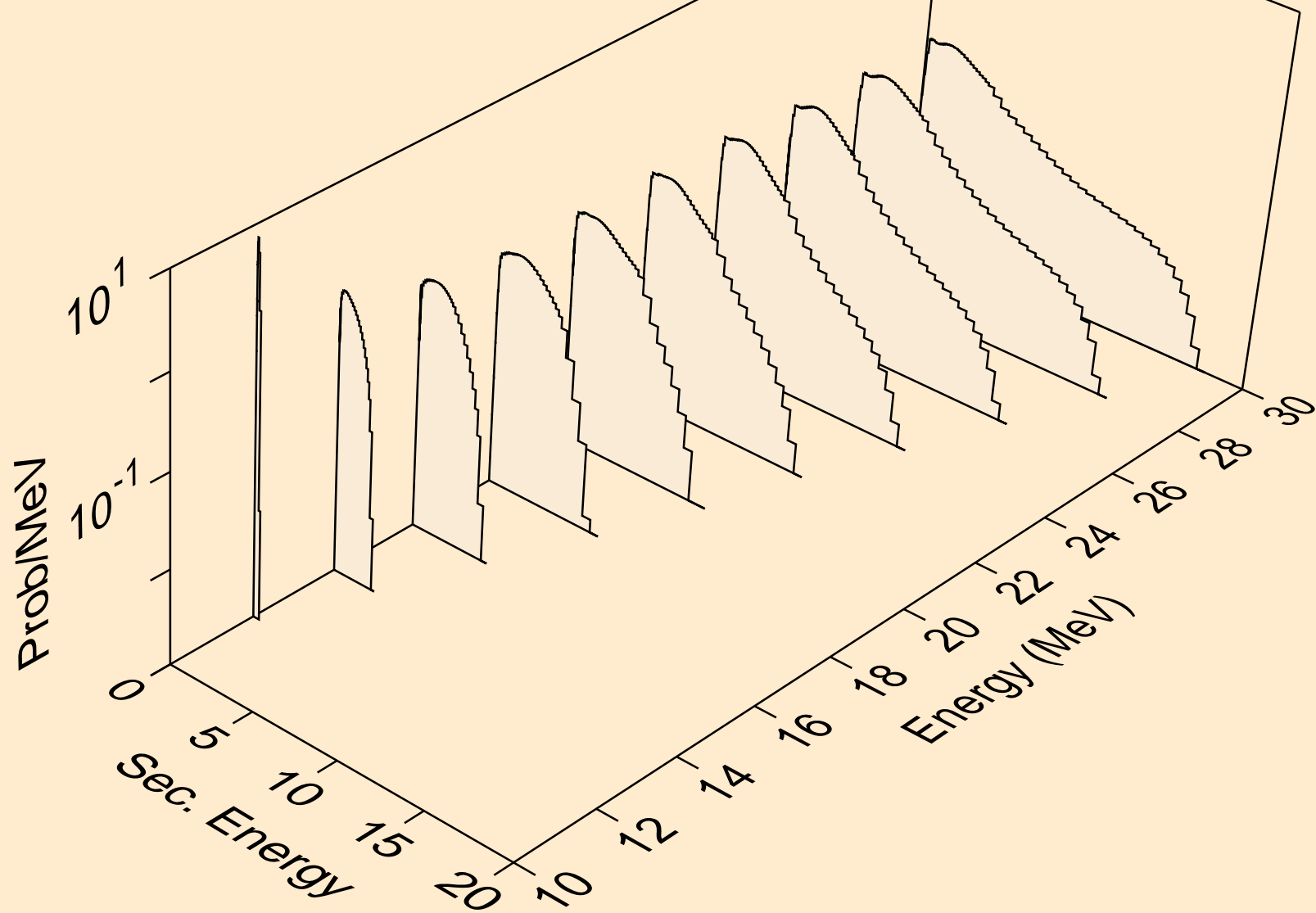

CA050 NEUTRON ACER TENDL-2021 LIBRARY; T=293.6K  
Neutron emission for (n,n\*)a

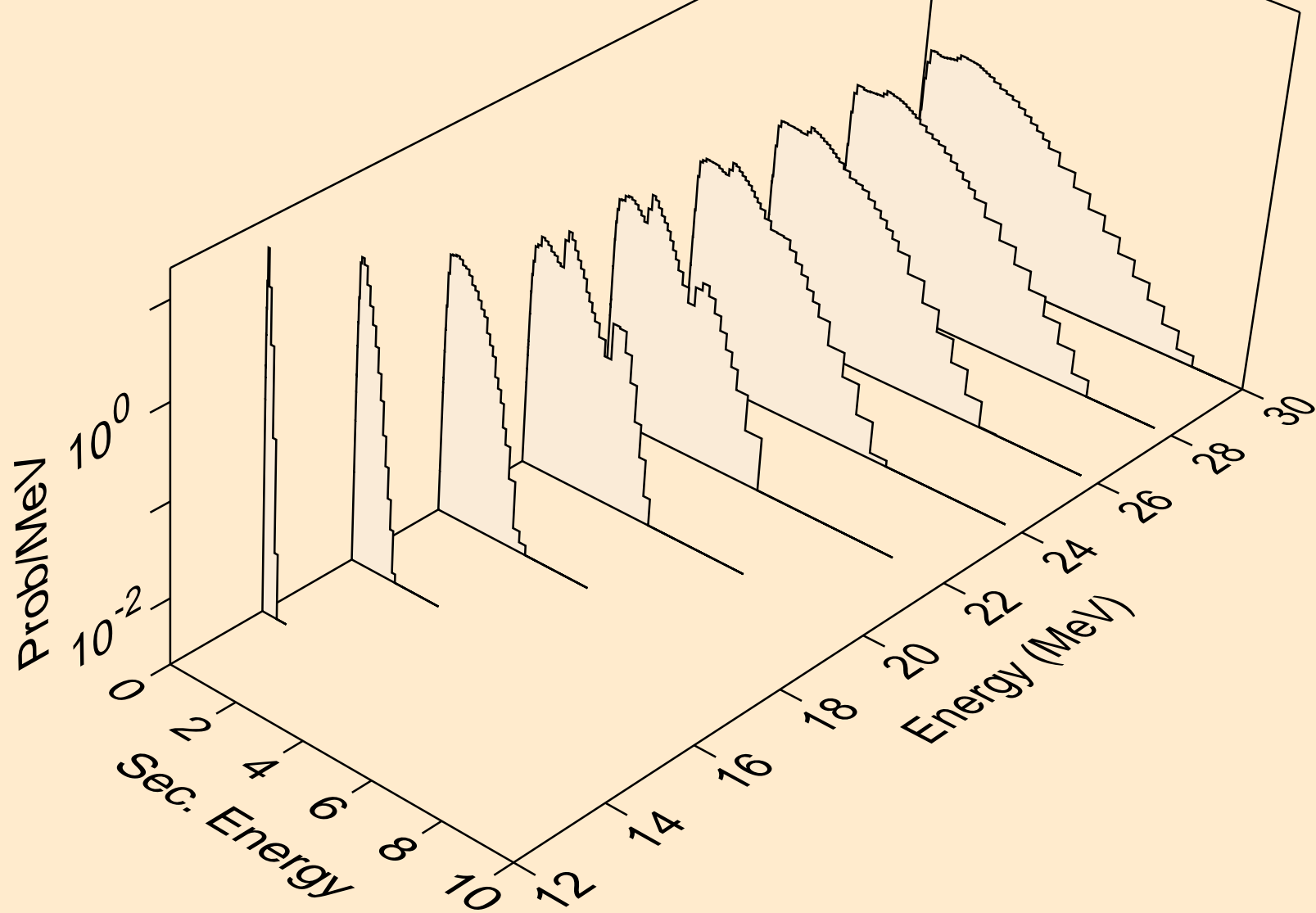

CA050 NEUTRON ACER TENDL-2021 LIBRARY; T=293.6K  
Neutron emission for (n,2n)a

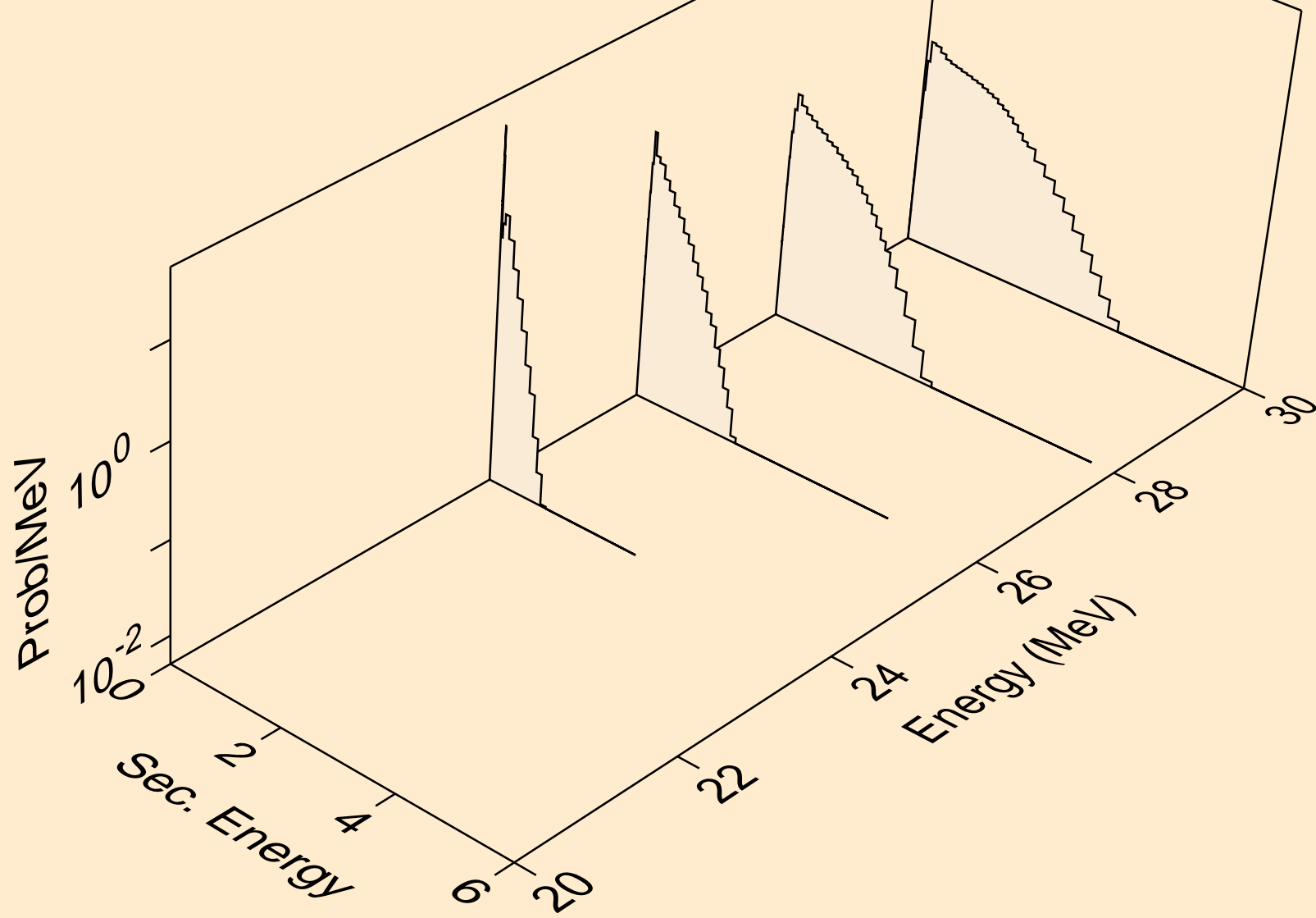

CA050 NEUTRON ACER TENDL-2021 LIBRARY; T=293.6K  
Neutron emission for (n,3n)a

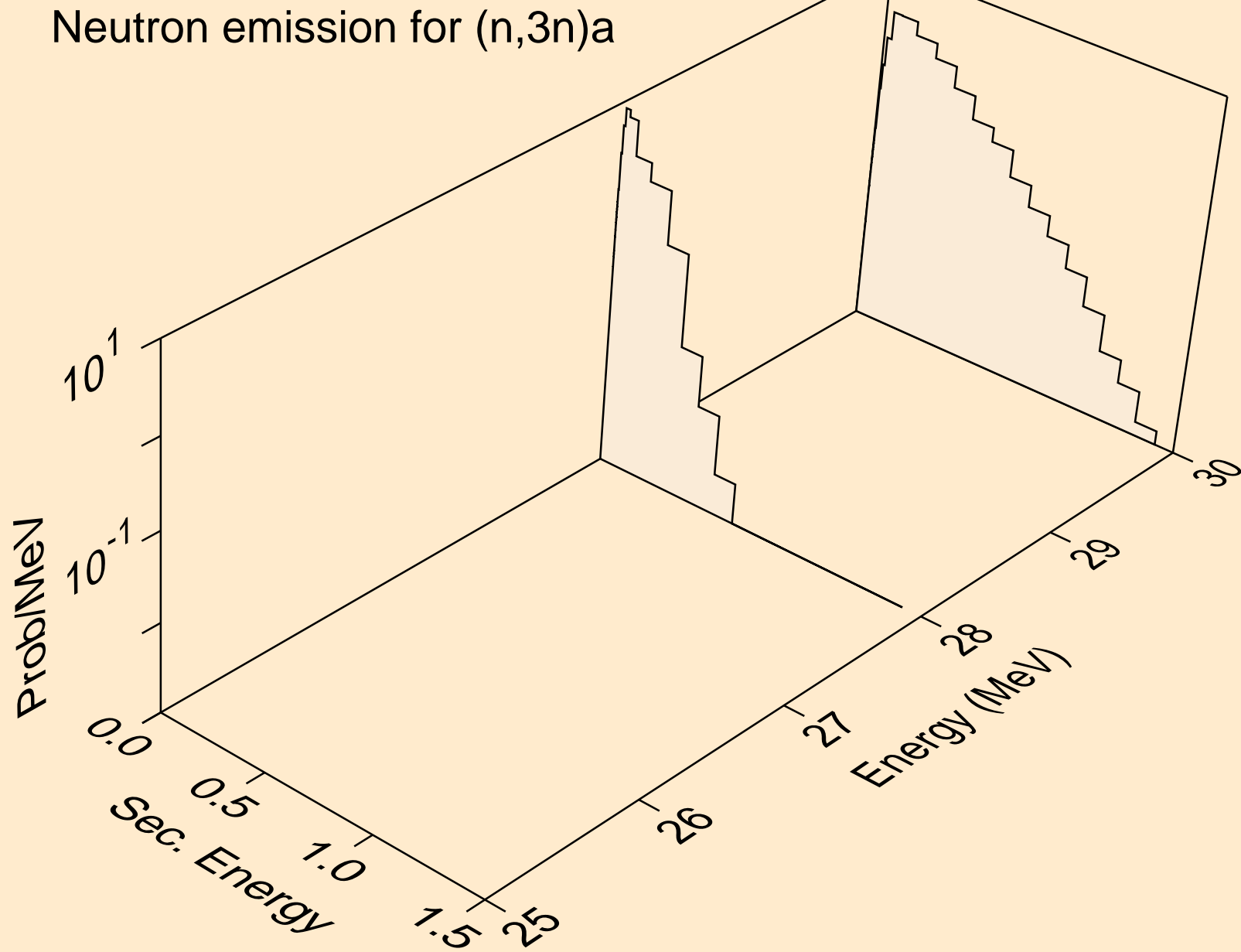



CA050 NEUTRON ACER TENDL-2021 LIBRARY; T=293.6K  
Neutron emission for (n,n\*)p

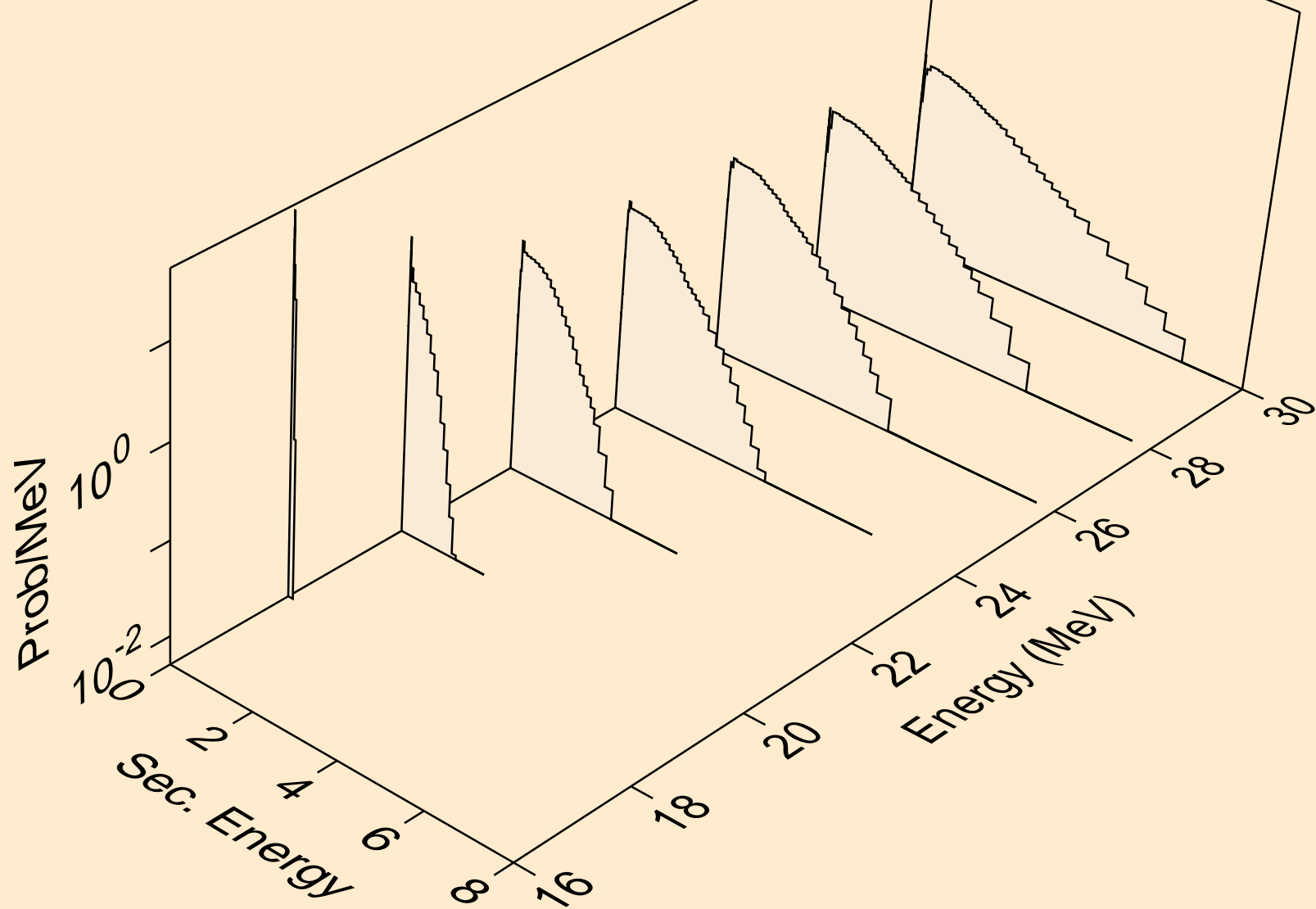

CA050 NEUTRON ACER TENDL-2021 LIBRARY; T=293.6K  
Neutron emission for (n,n\*)d

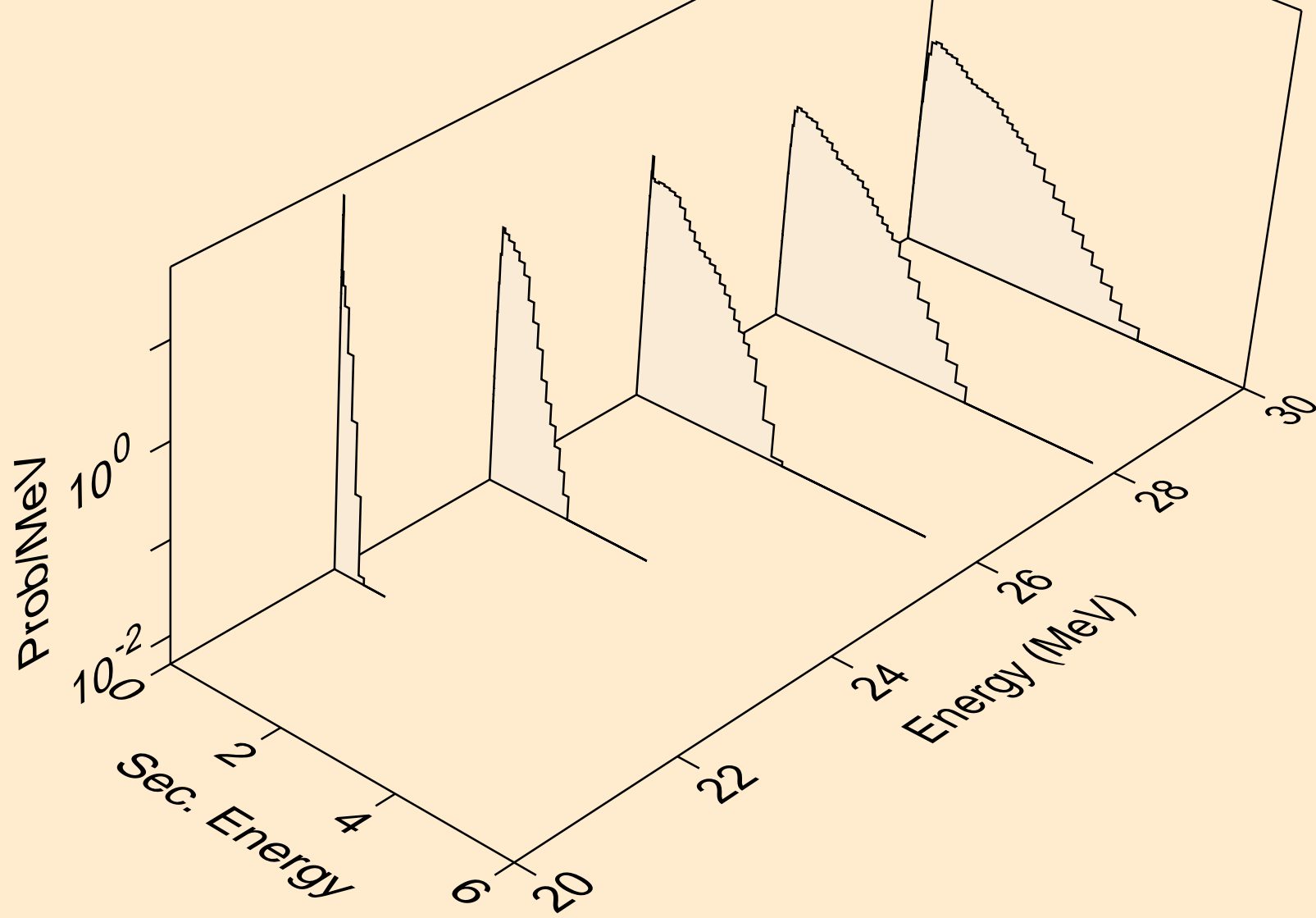

CA050 NEUTRON ACER TENDL-2021 LIBRARY; T=293.6K  
Neutron emission for (n,n\*)t

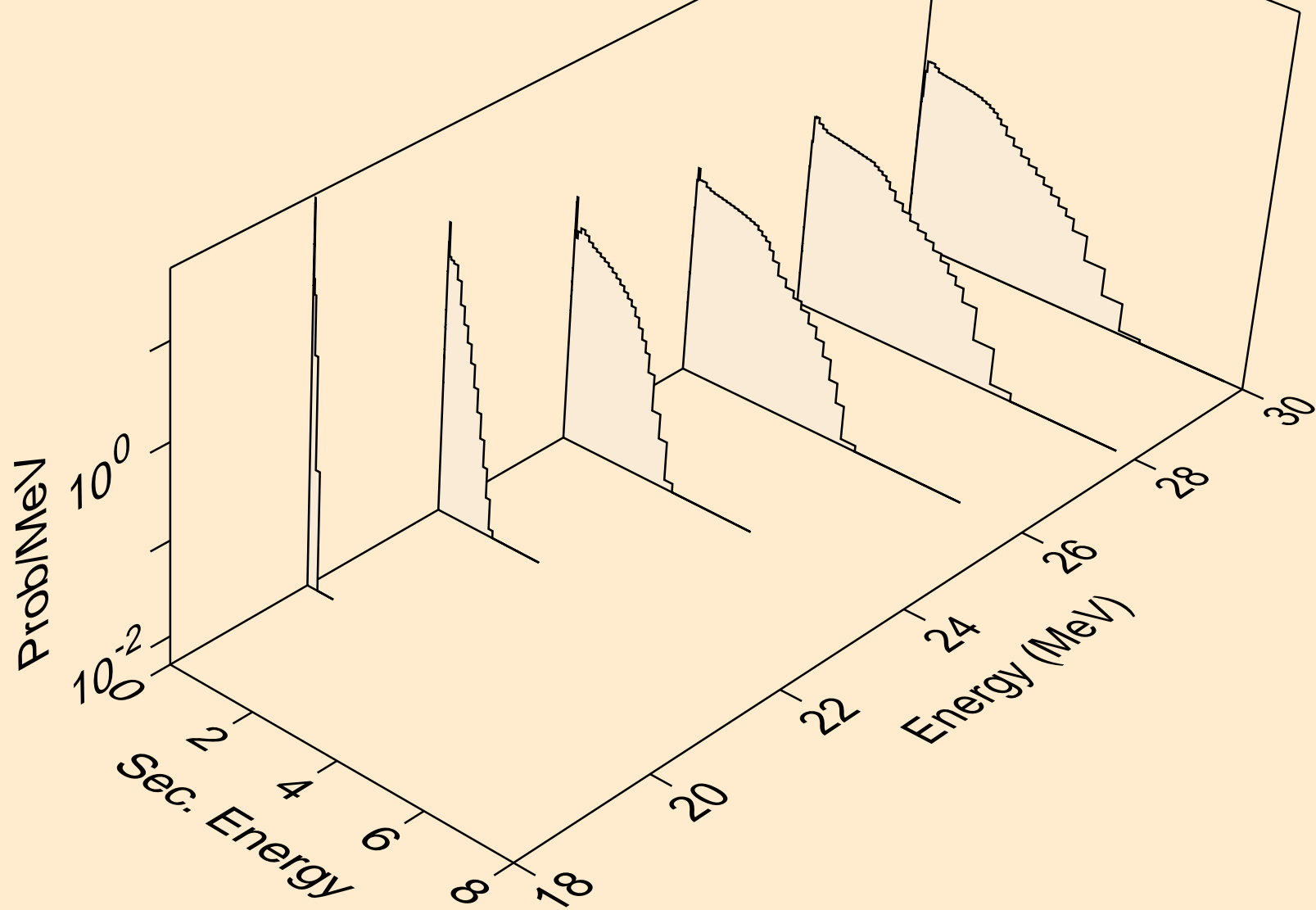

CA050 NEUTRON ACER TENDL-2021 LIBRARY; T=293.6K  
Neutron emission for (n,4n)

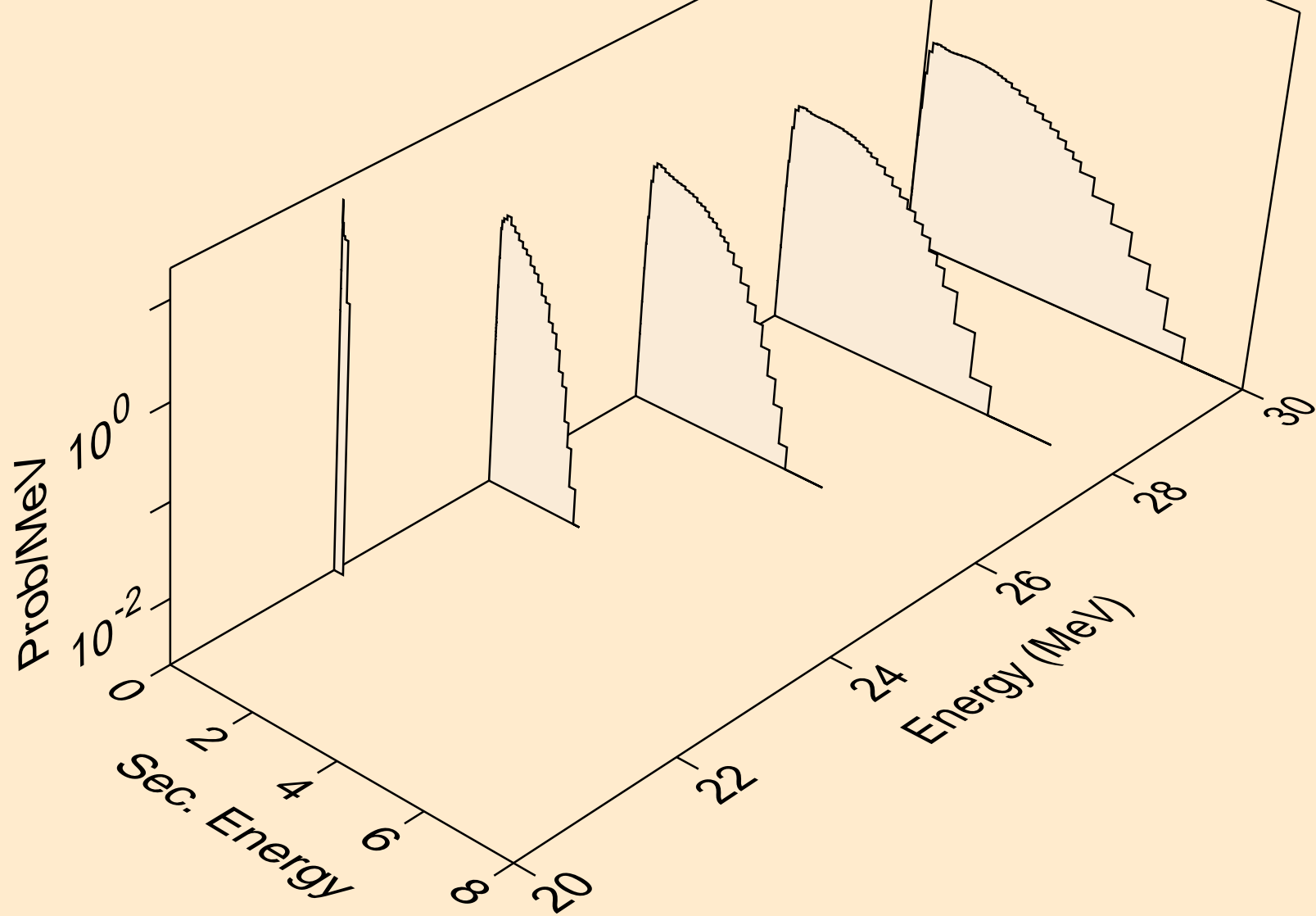

CA050 NEUTRON ACER TENDL-2021 LIBRARY; T=293.6K  
Neutron emission for (n,2np)

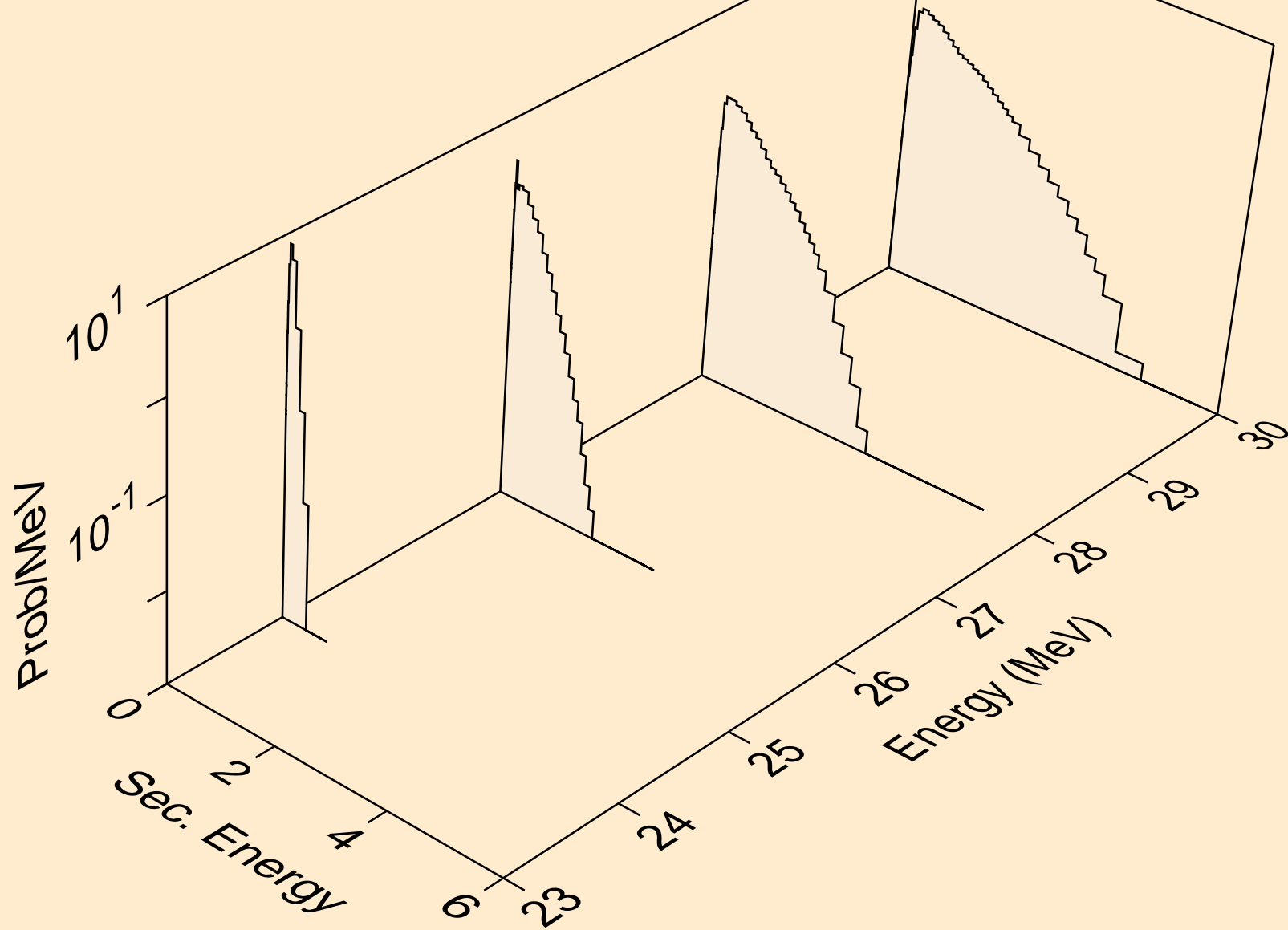

CA050 NEUTRON ACER TENDL-2021 LIBRARY; T=293.6K  
Neutron emission for (n,3np)

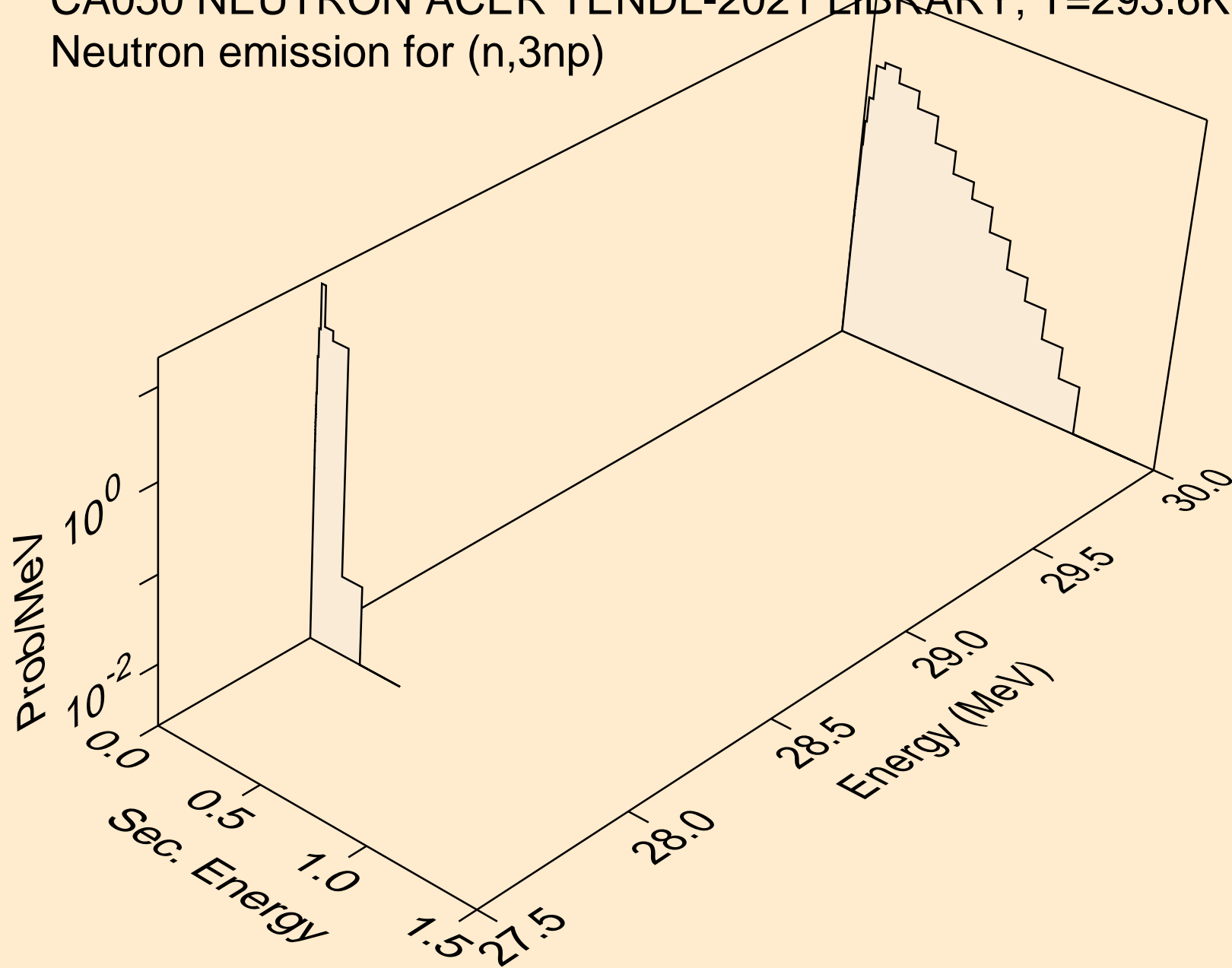

CA050 NEUTRON ACER TENDL-2021 LIBRARY; T=293.6K  
Neutron emission for (n,n\*c)

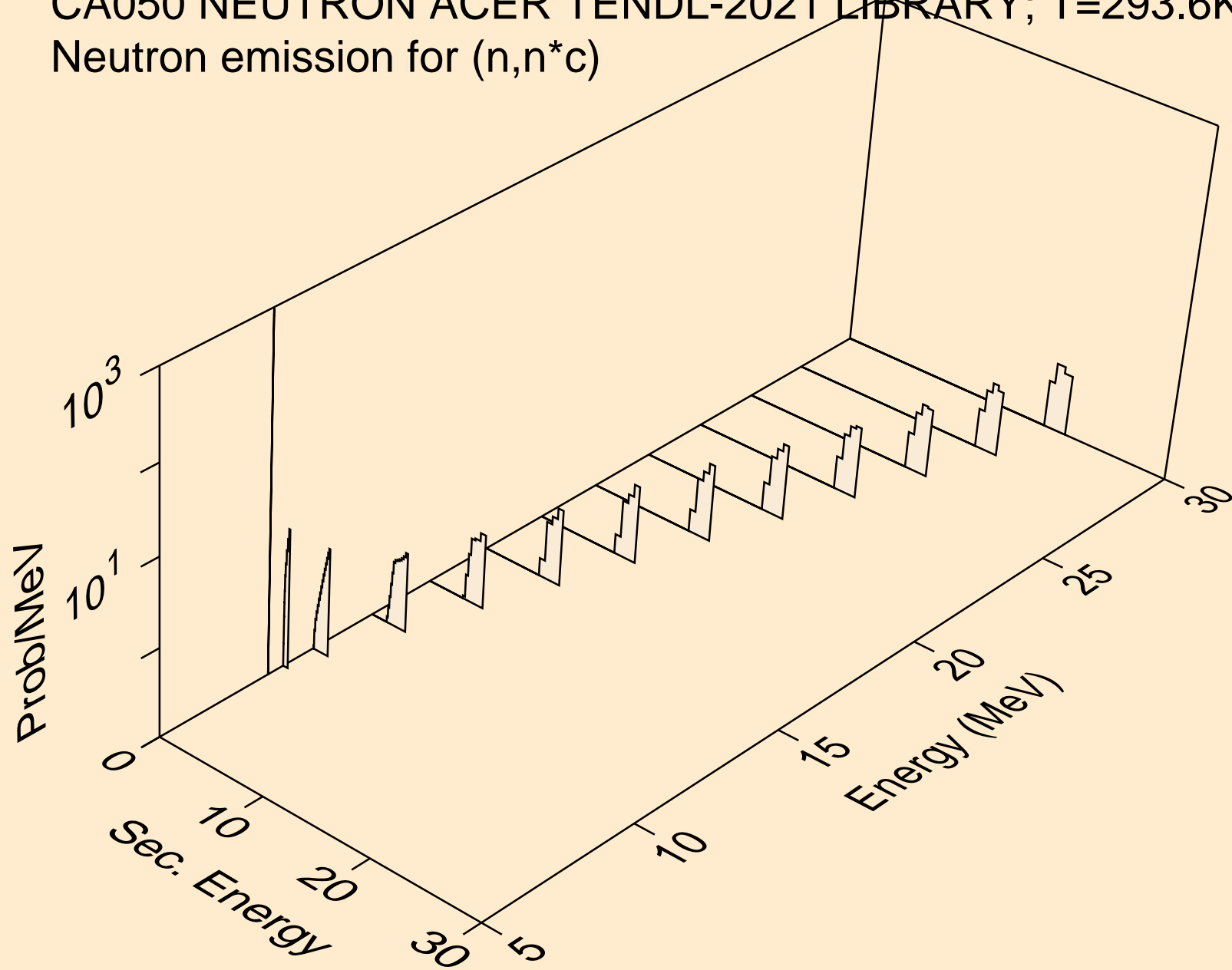

CA050 NEUTRON ACER TENDL-2021 LIBRARY; T=293.6K  
Photon emission for (n,x)

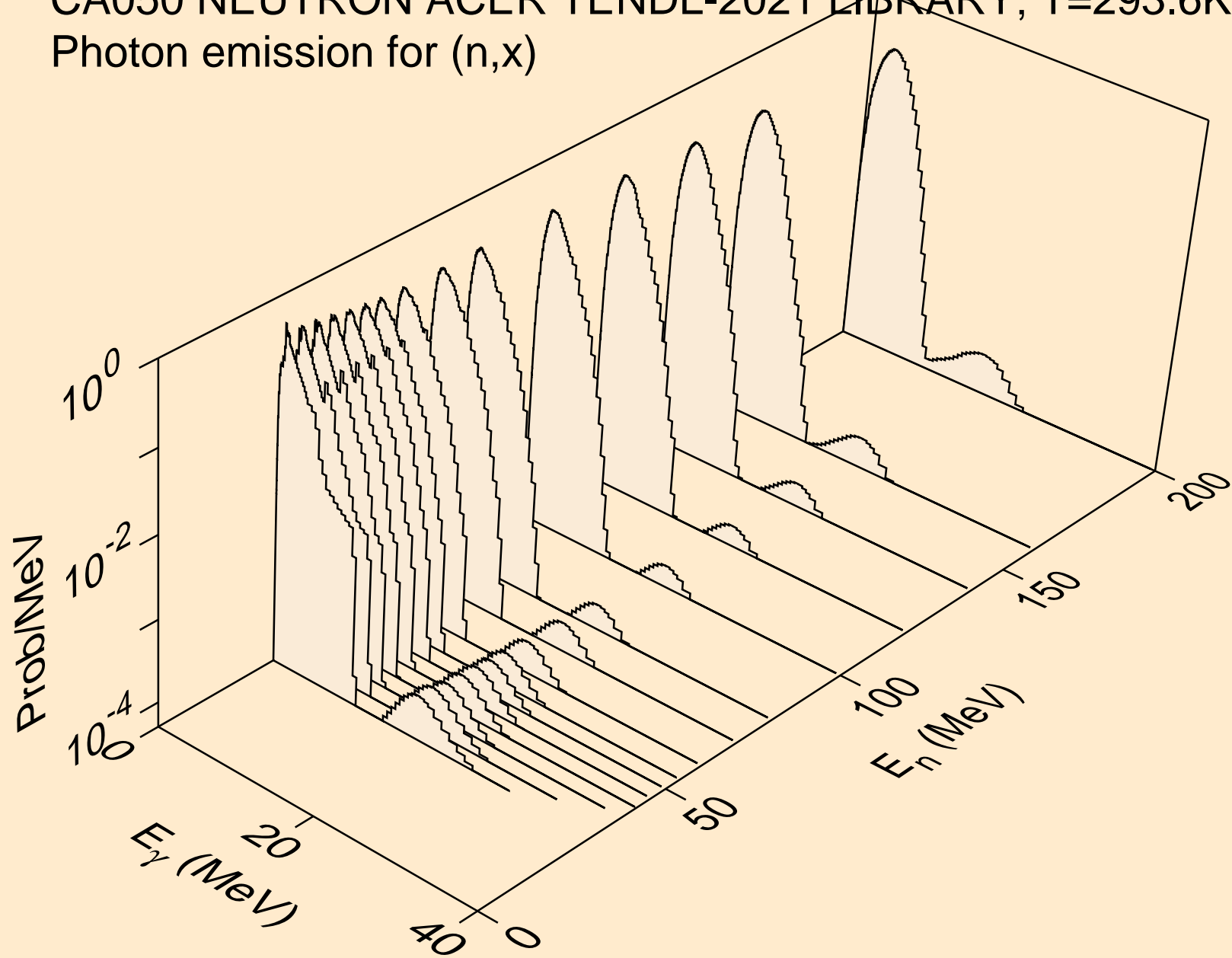



CA050 NEUTRON ACER TENDL-2021 LIBRARY; T=293.6K  
Photon emission for (n,2nd)

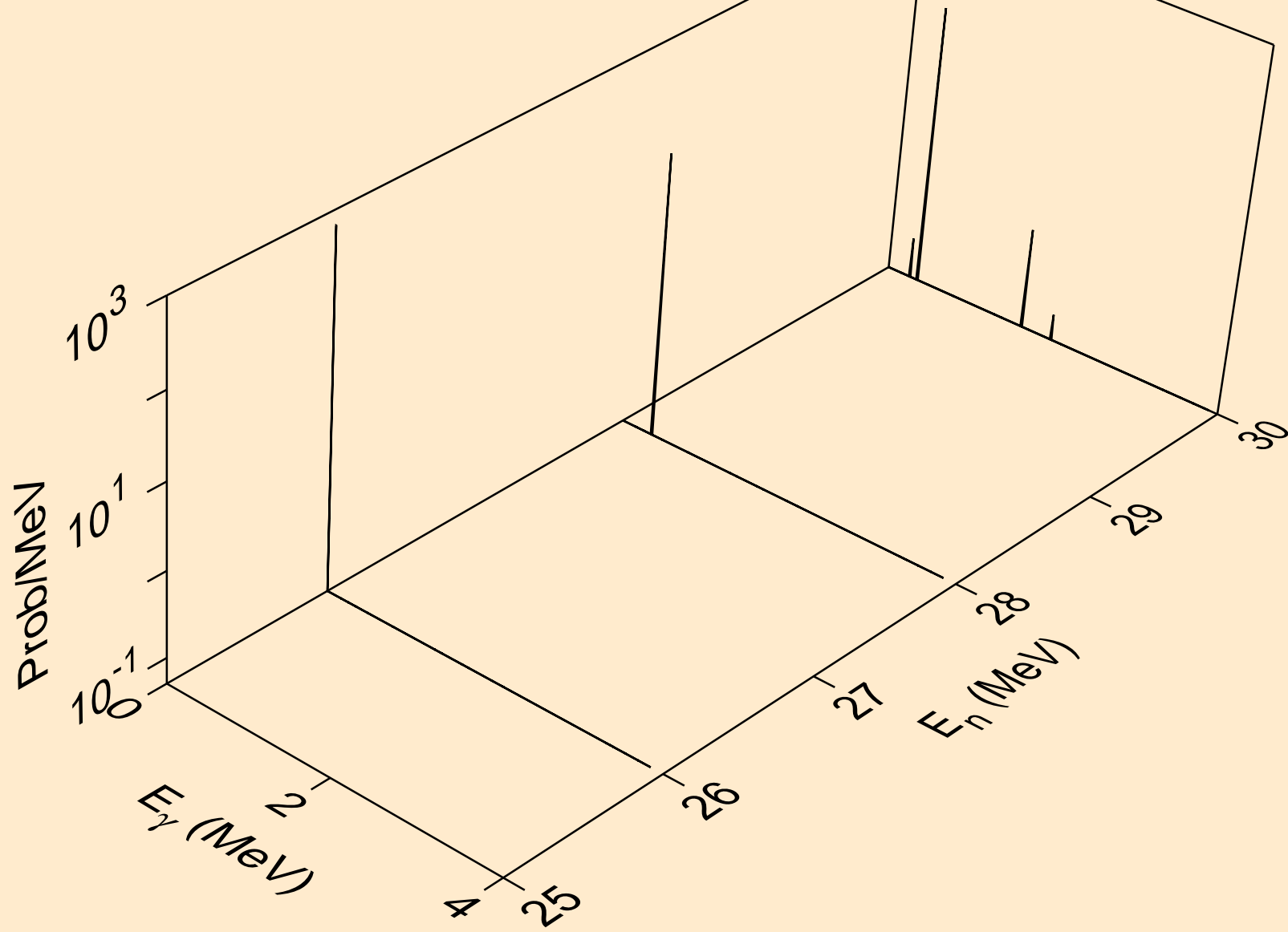

CA050 NEUTRON ACER TENDL-2021 LIBRARY; T=293.6K  
Photon emission for (n,2n)

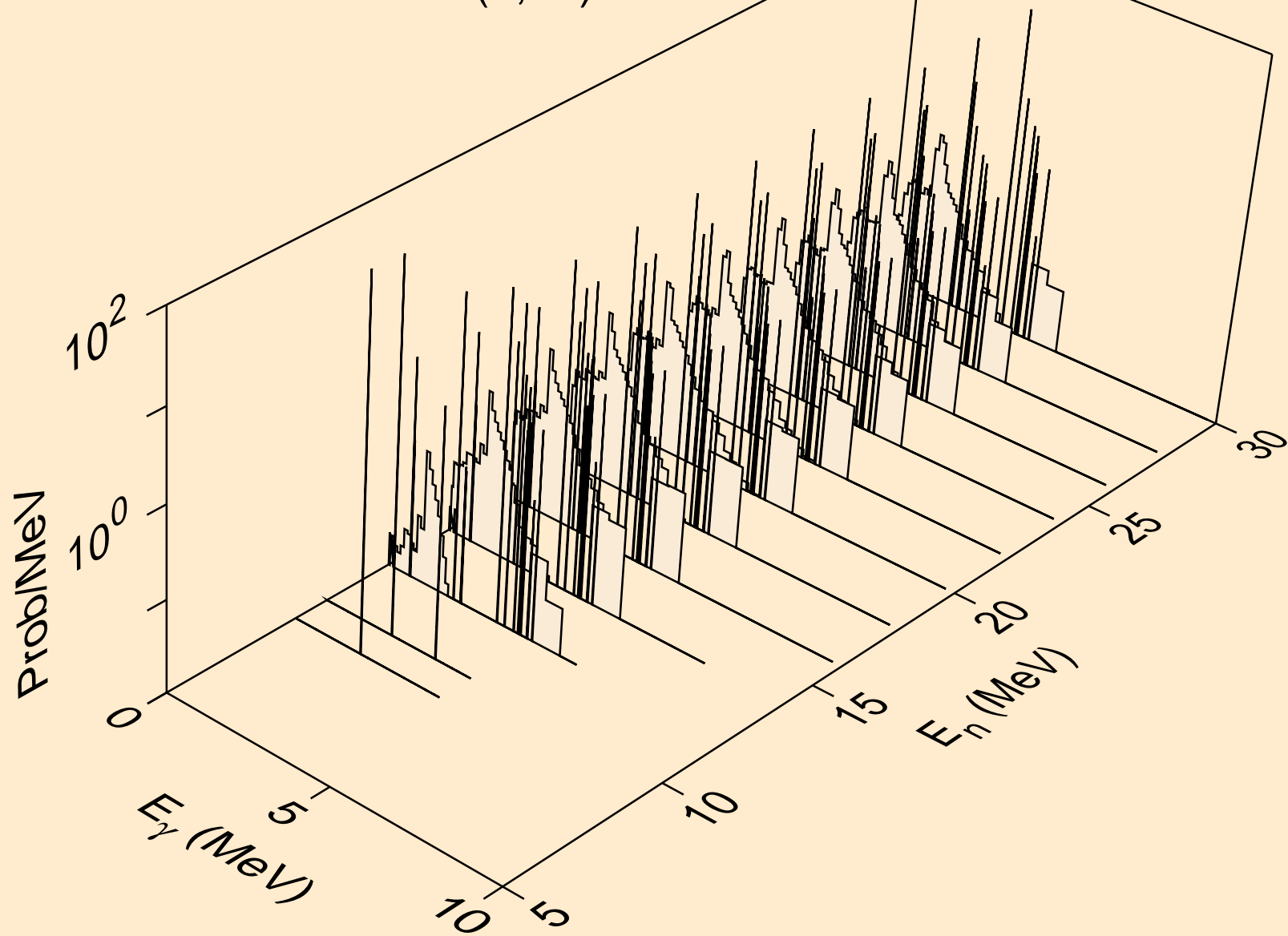

CA050 NEUTRON ACER TENDL-2021 LIBRARY; T=293.6K  
Photon emission for (n,3n)

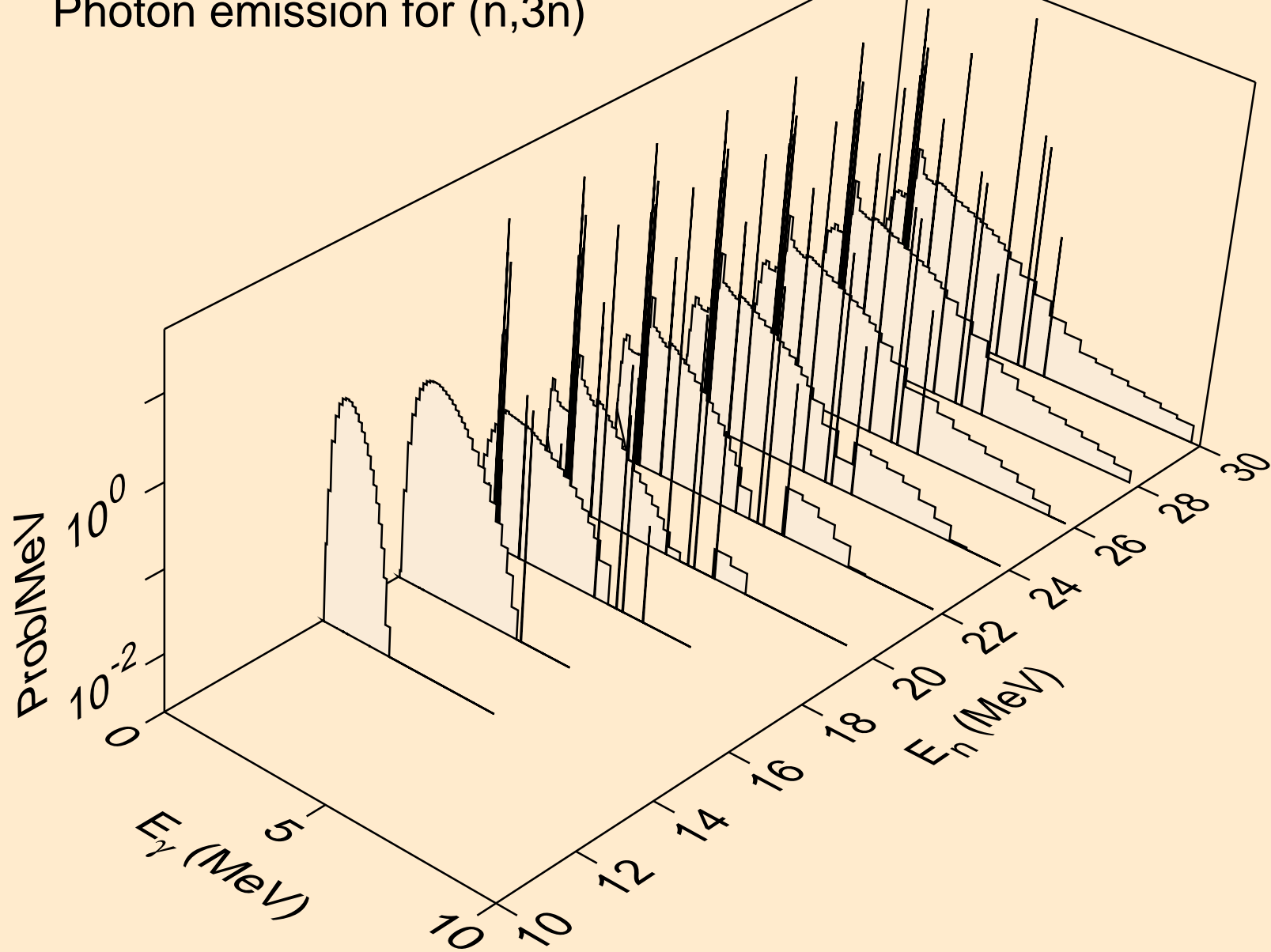

CA050 NEUTRON ACER TENDL-2021 LIBRARY; T=293.6K  
Photon emission for (n,n\*)a

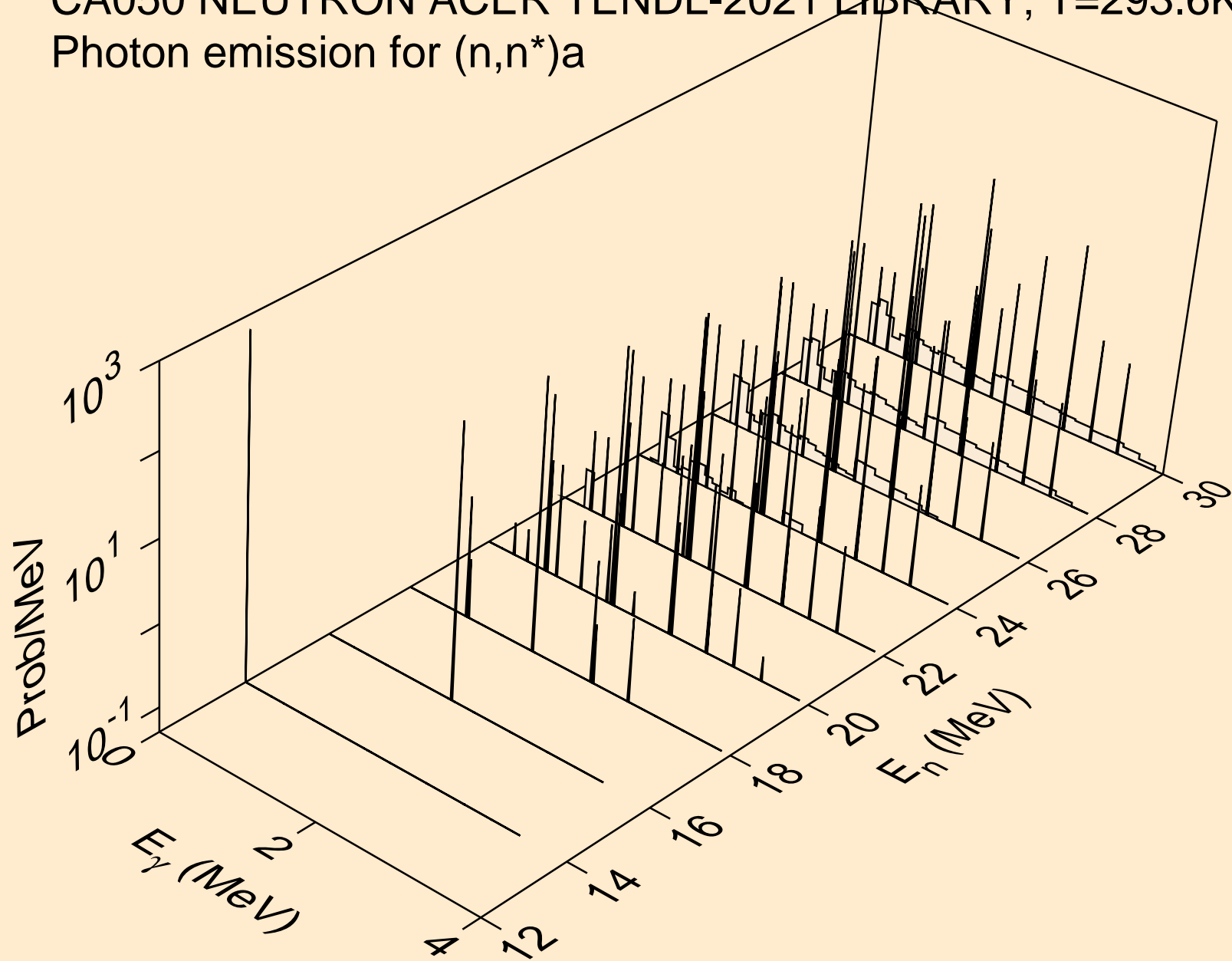

CA050 NEUTRON ACER TENDL-2021 LIBRARY; T=293.6K  
Photon emission for (n,2n)a

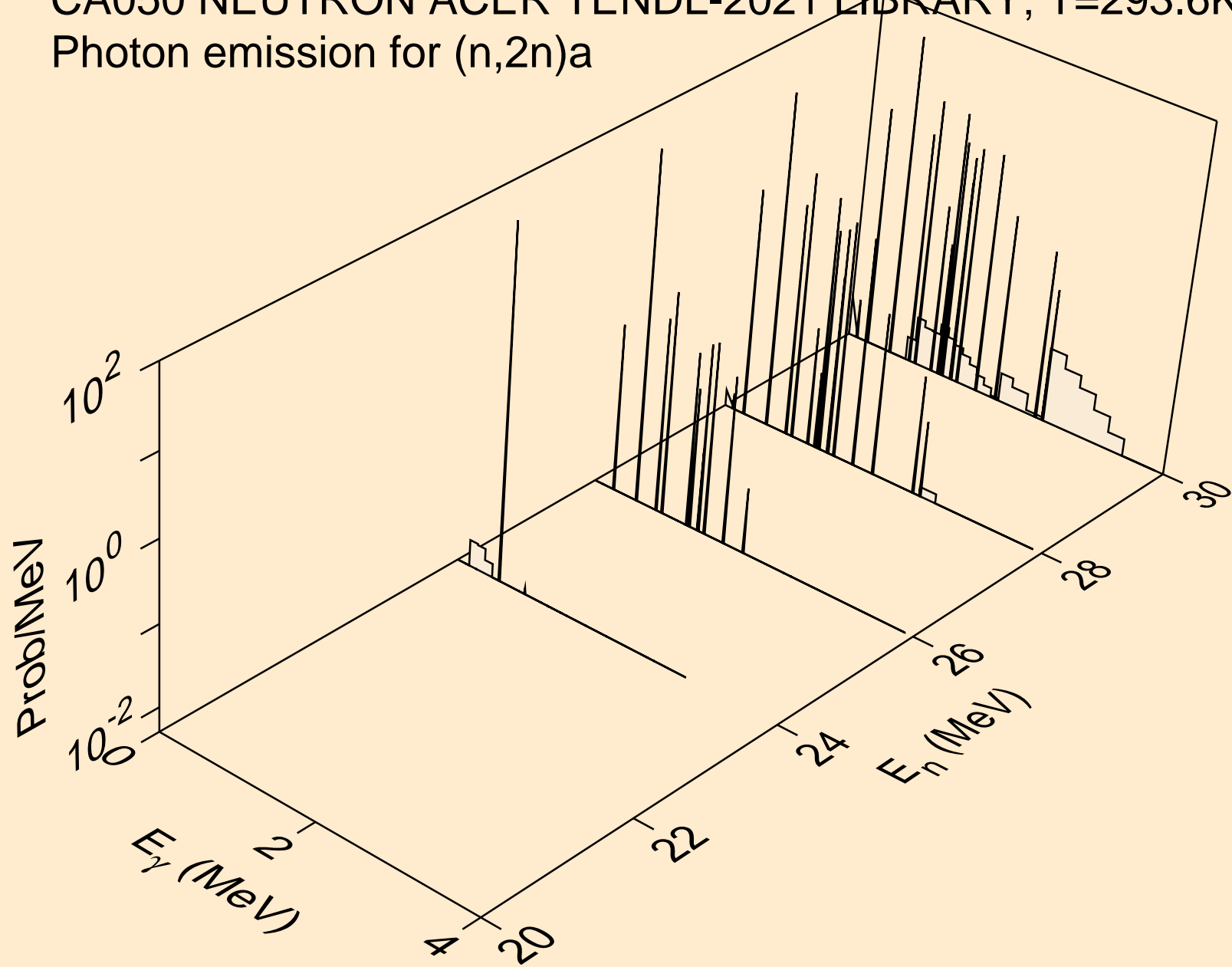

CA050 NEUTRON ACER TENDL-2021 LIBRARY; T=293.6K  
Photon emission for (n,3n)a

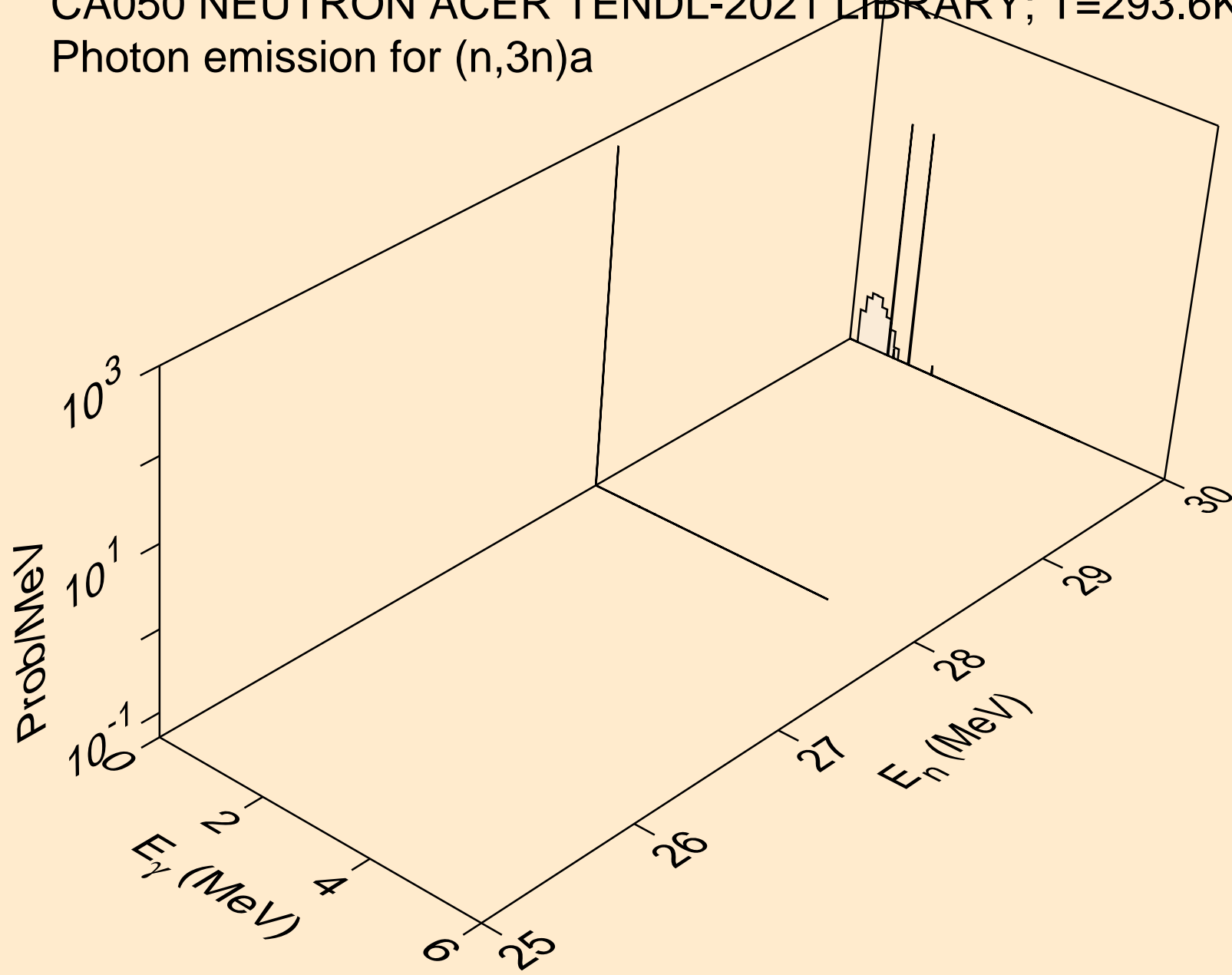

CA050 NEUTRON ACER TENDL-2021 LIBRARY; T=293.6K  
Photon emission for (n,n\*)p

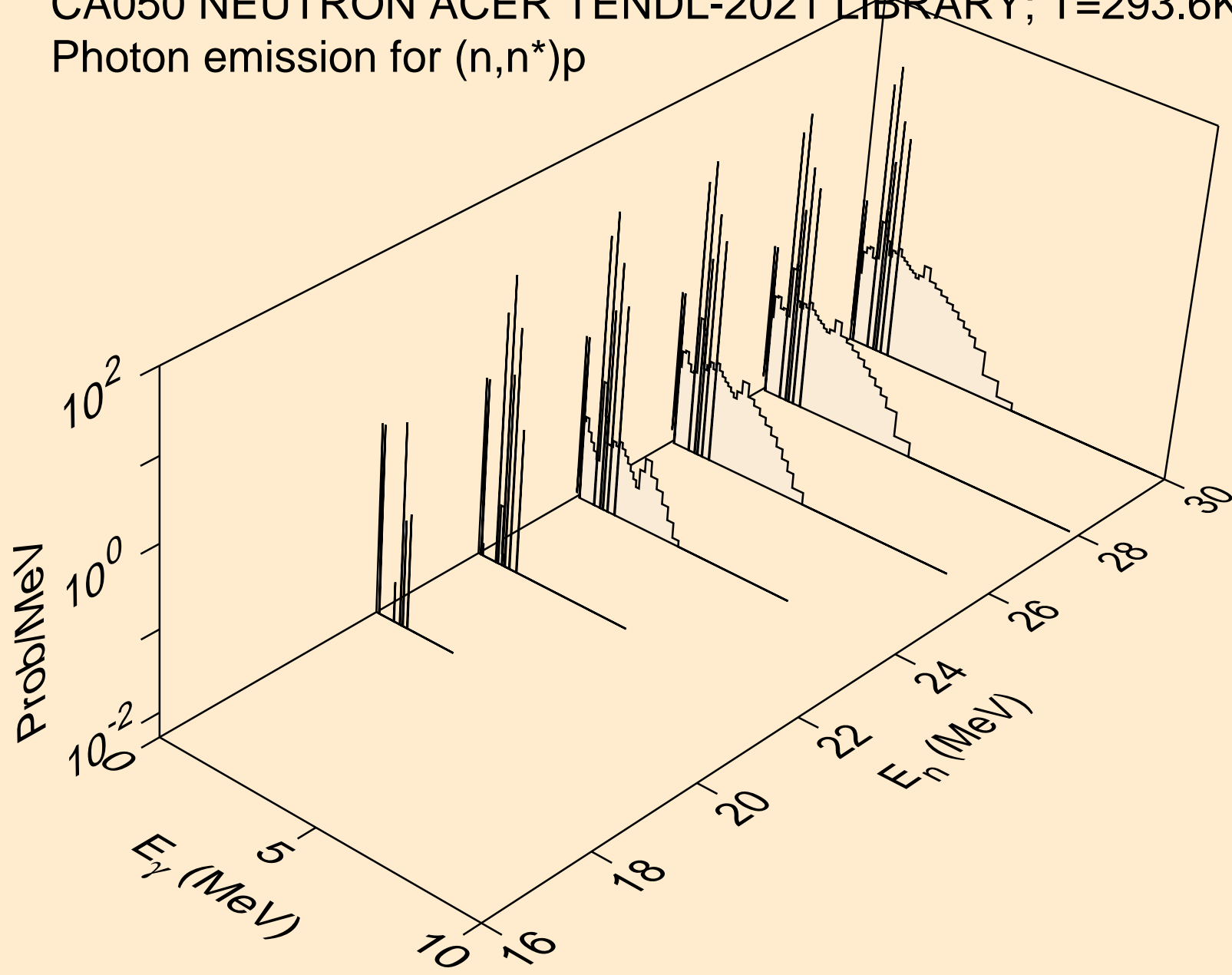

CA050 NEUTRON ACER TENDL-2021 LIBRARY; T=293.6K  
Photon emission for (n,n\*)d

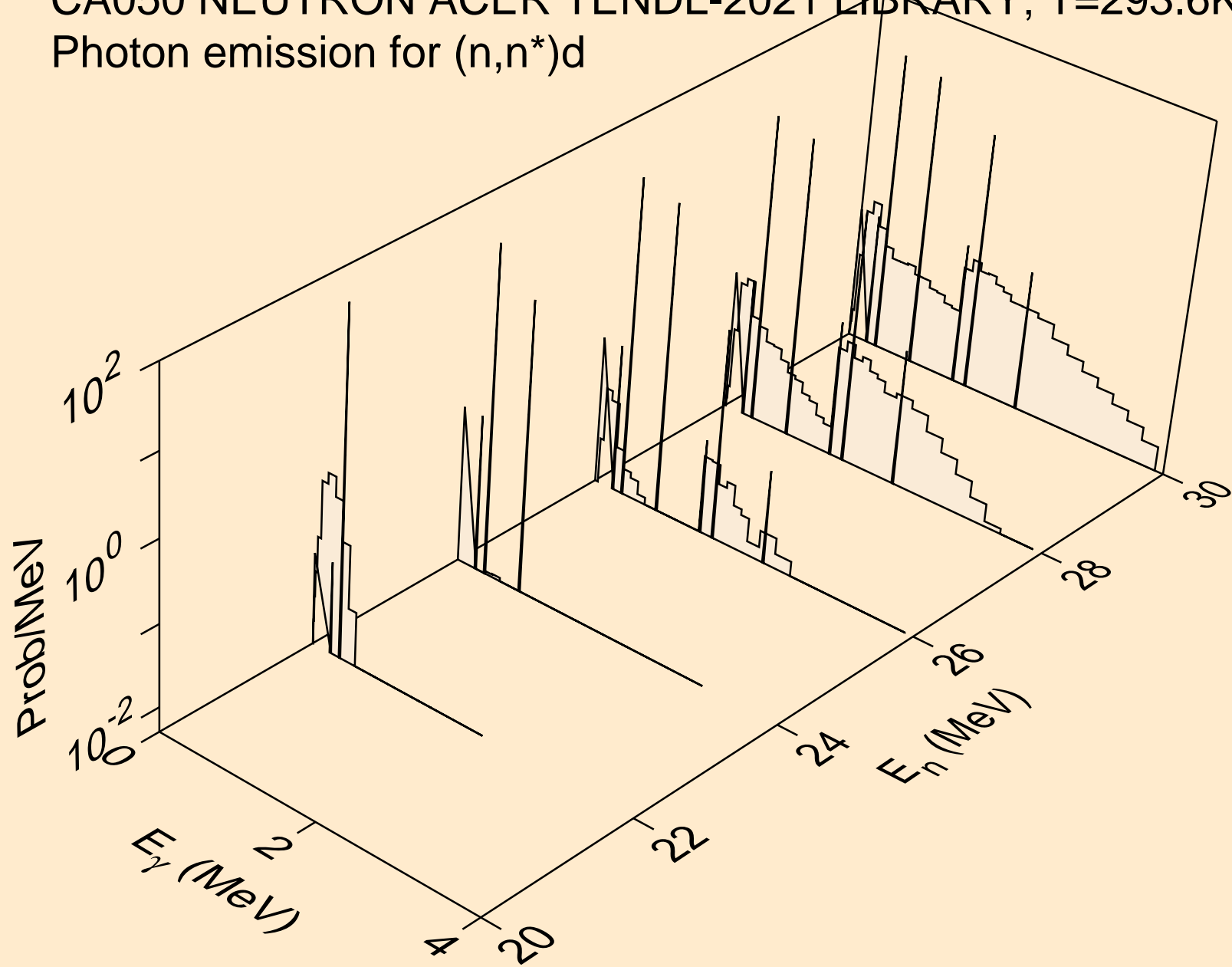



CA050 NEUTRON ACER TENDL-2021 LIBRARY; T=293.6K  
Photon emission for (n,n\*)t

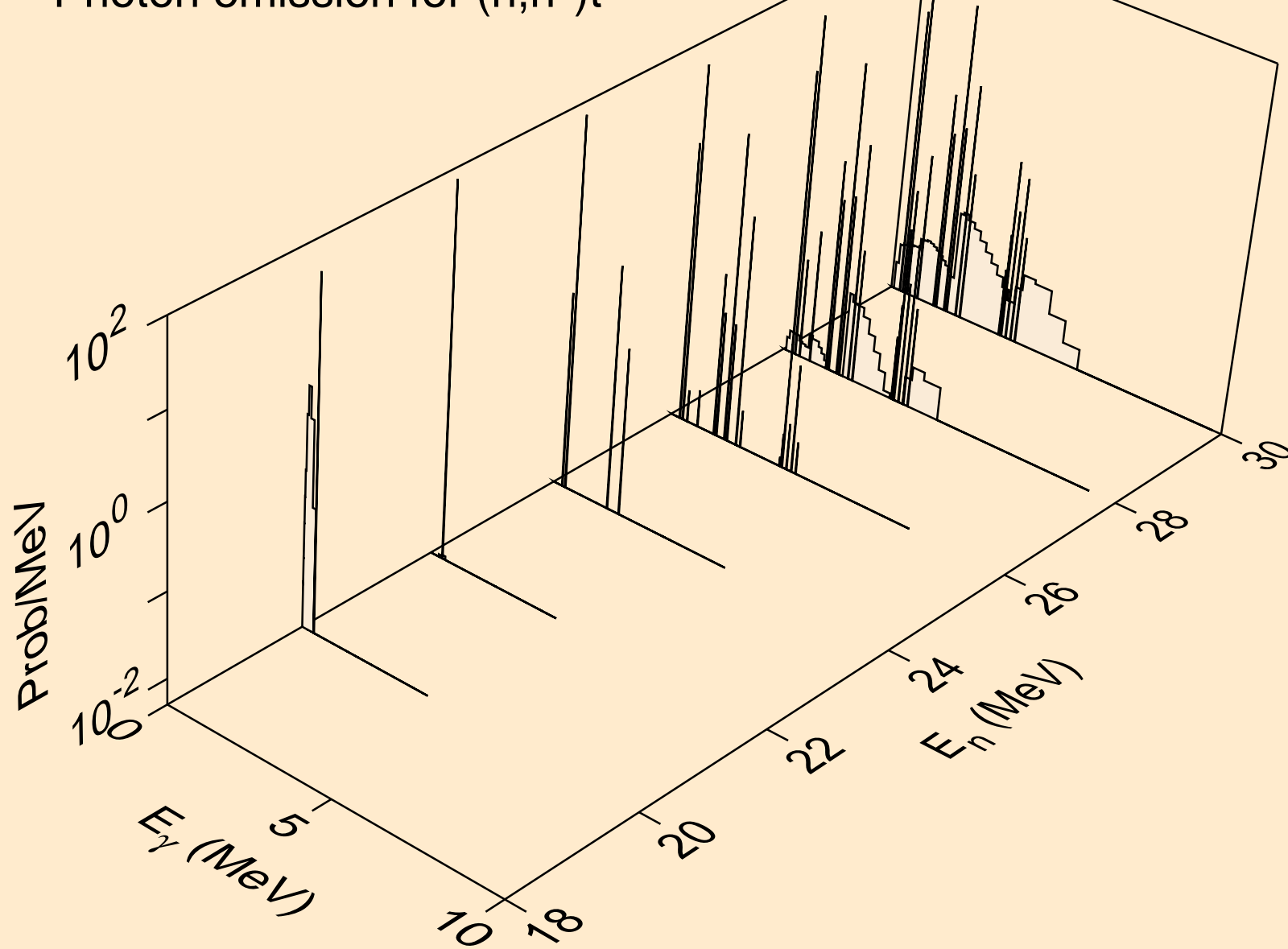

CA050 NEUTRON ACER TENDL-2021 LIBRARY; T=293.6K  
Photon emission for (n,4n)

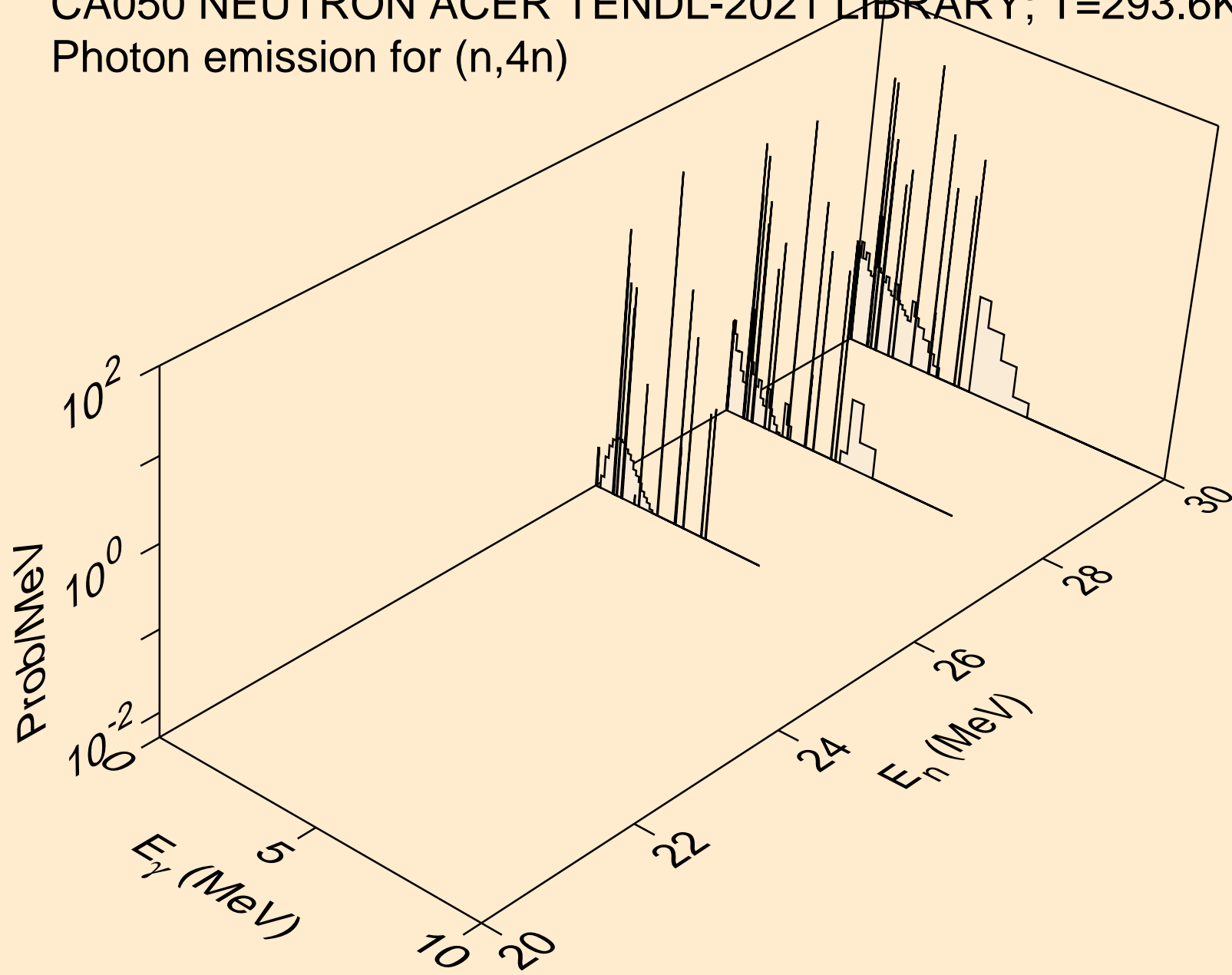

CA050 NEUTRON ACER TENDL-2021 LIBRARY; T=293.6K  
Photon emission for (n,2np)

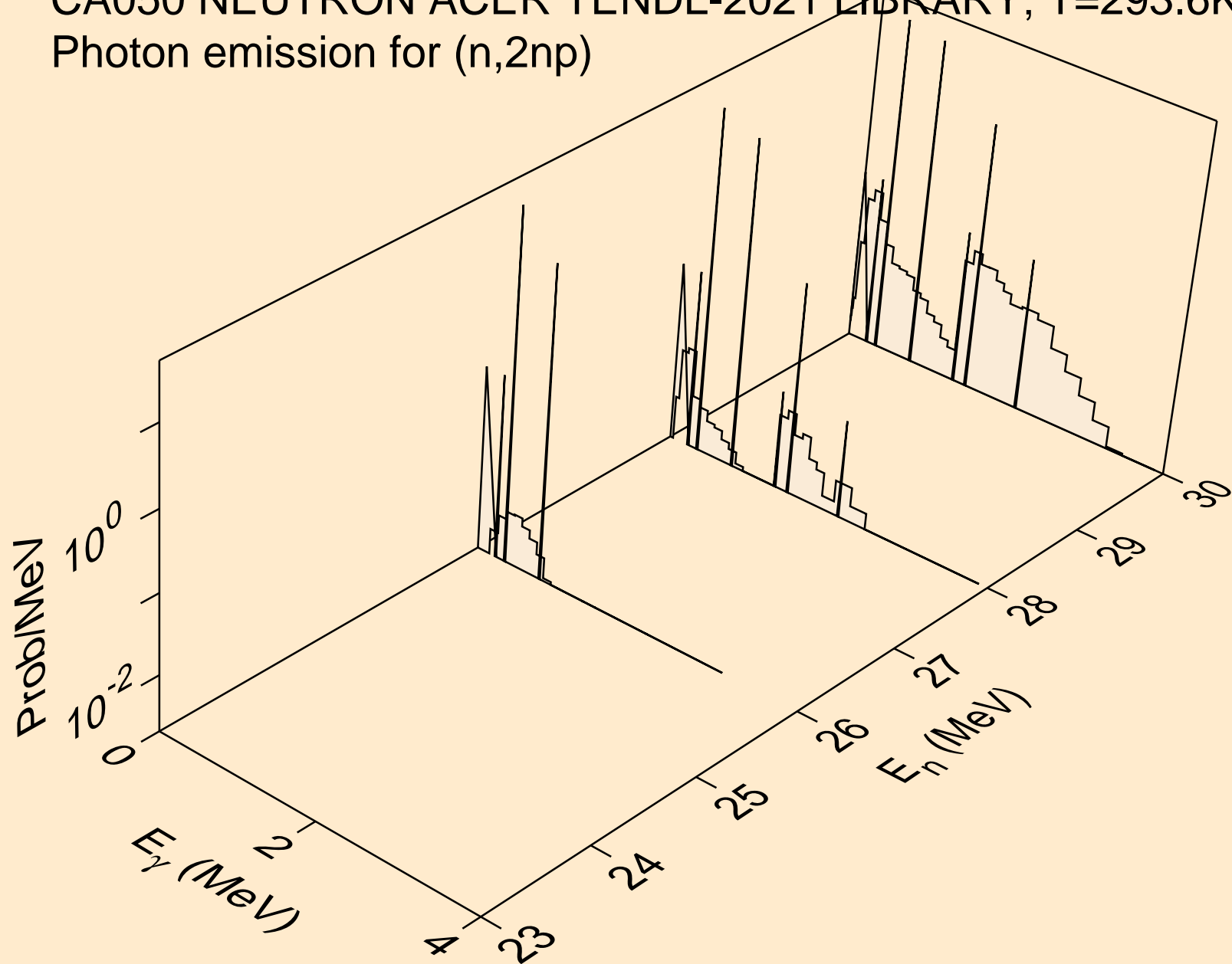

CA050 NEUTRON ACER TENDL-2021 LIBRARY; T=293.6K  
Photon emission for (n,3np)

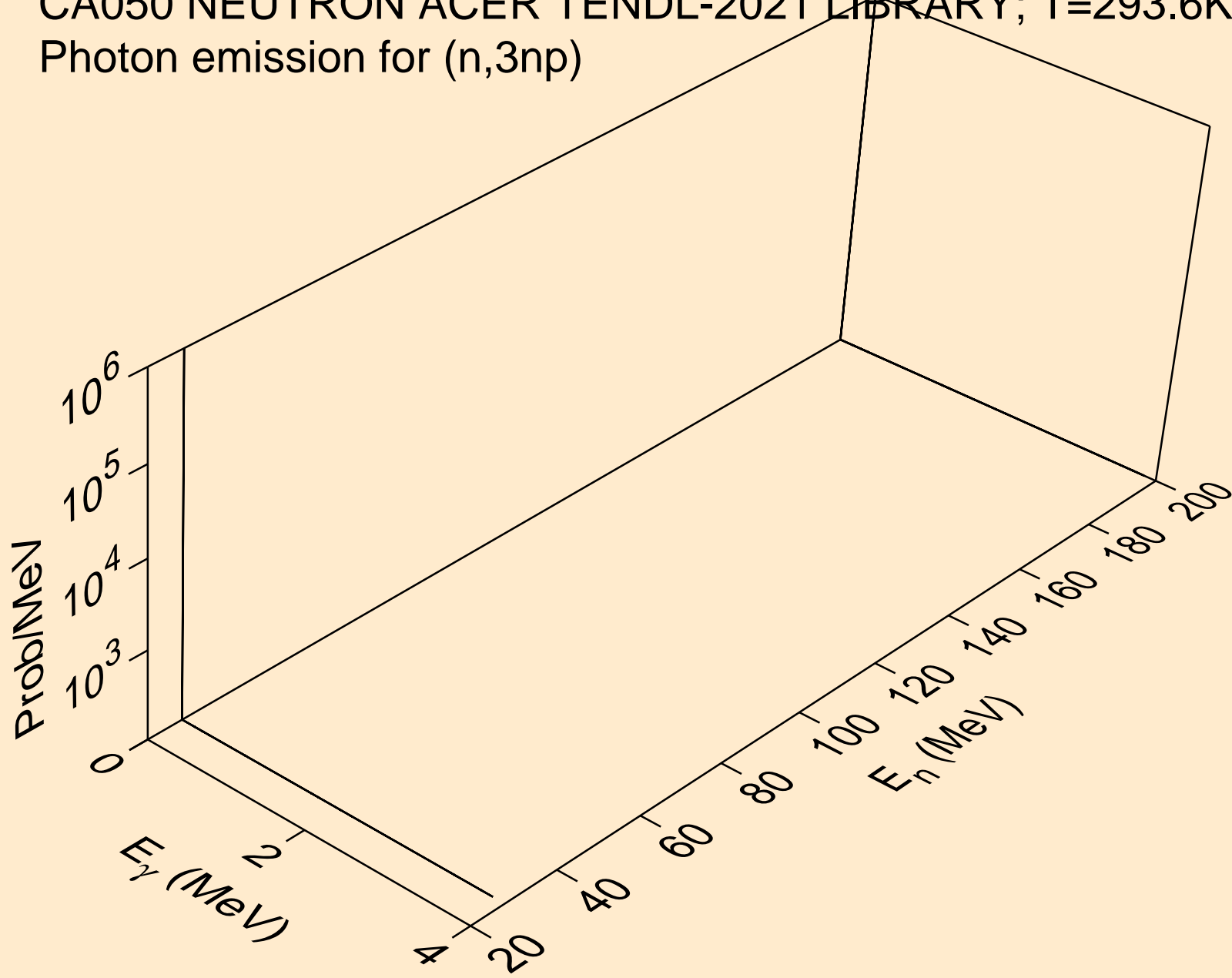

CA050 NEUTRON ACER TENDL-2021 LIBRARY; T=293.6K  
Photon emission for (n,n\*c)

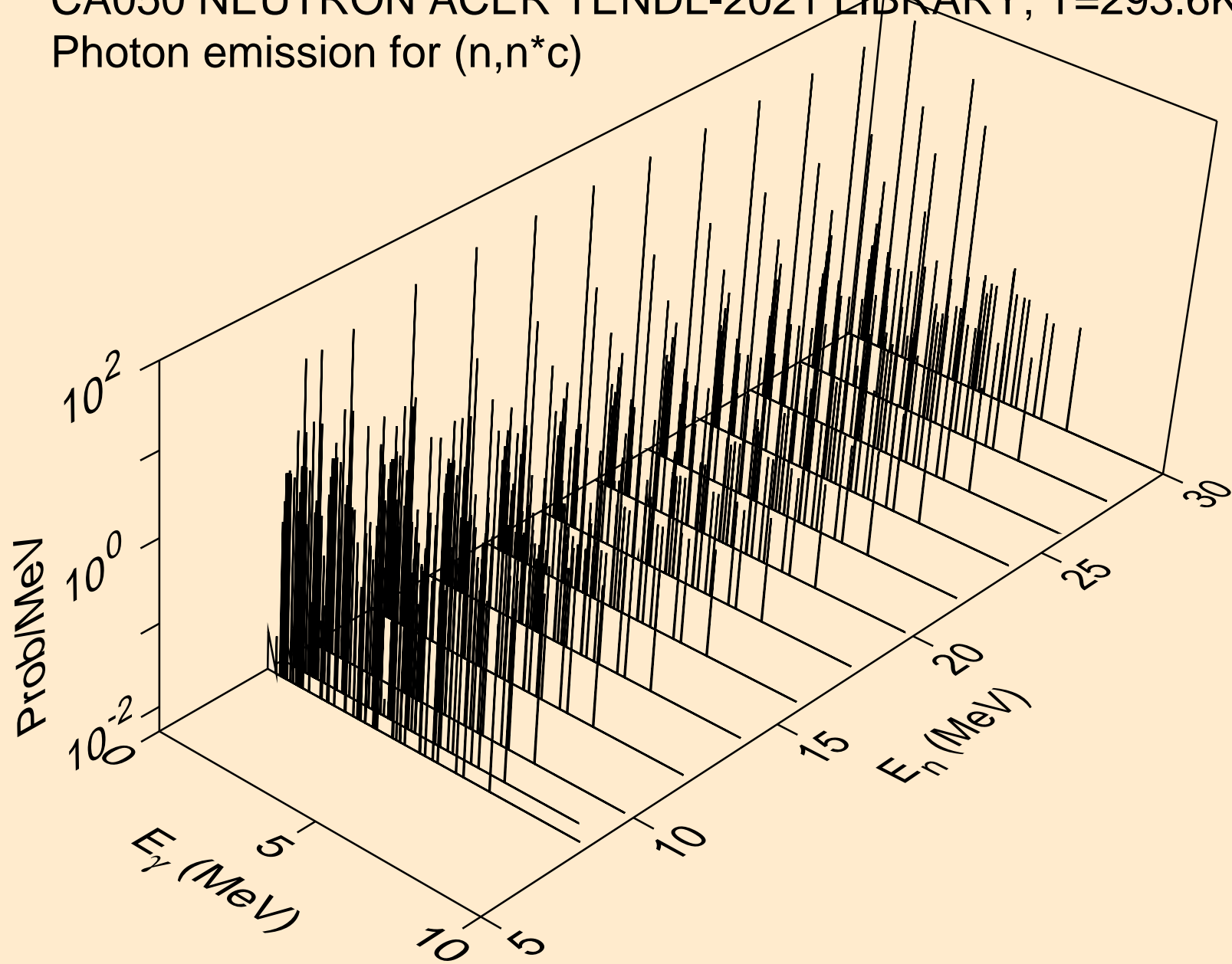

CA050 NEUTRON ACER TENDL-2021 LIBRARY; T=293.6K  
Photon emission for (n,gma)

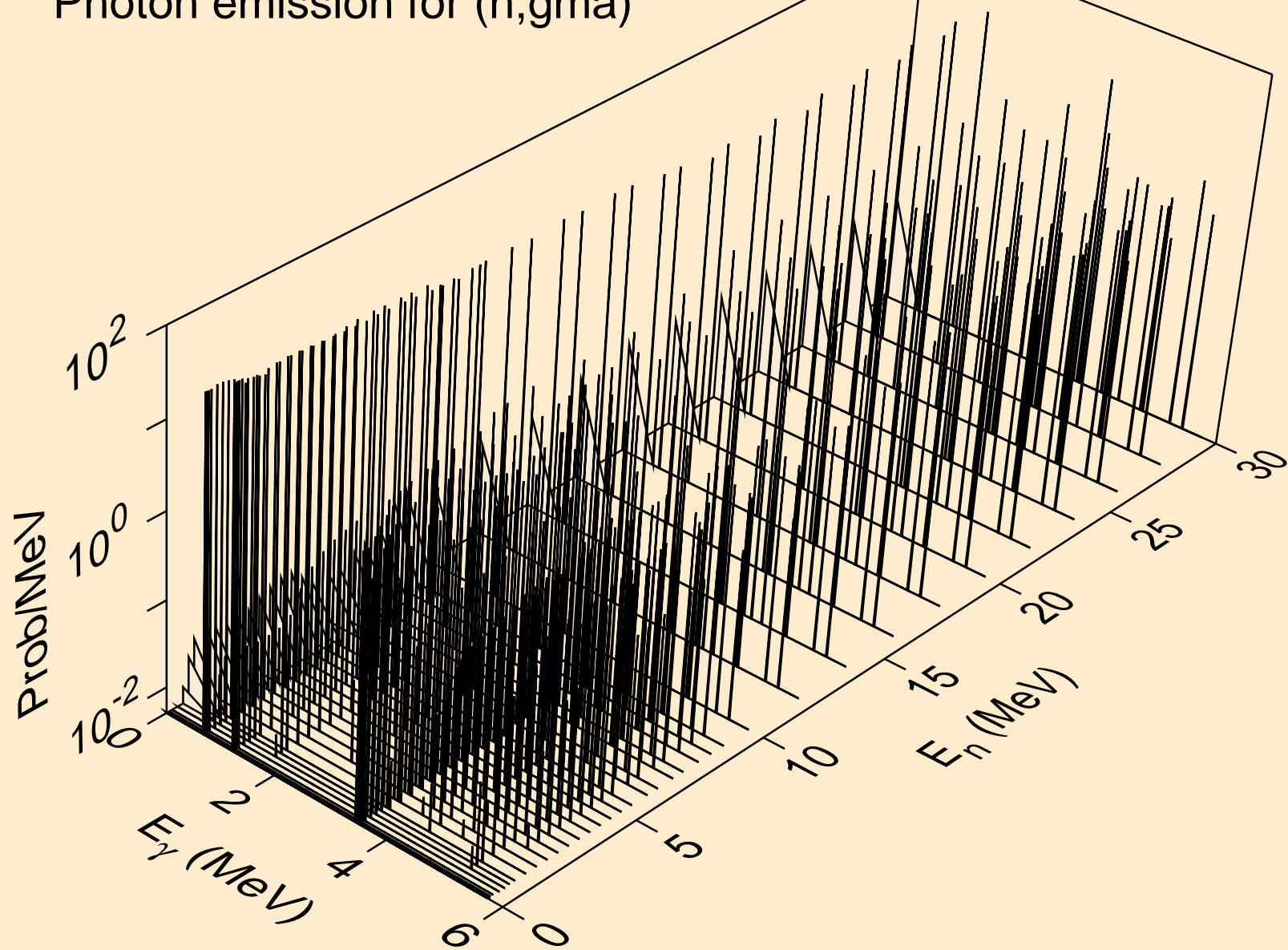

CA050 NEUTRON ACER TENDL-2021 LIBRARY; T=293.6K  
Photon emission for (n,p)

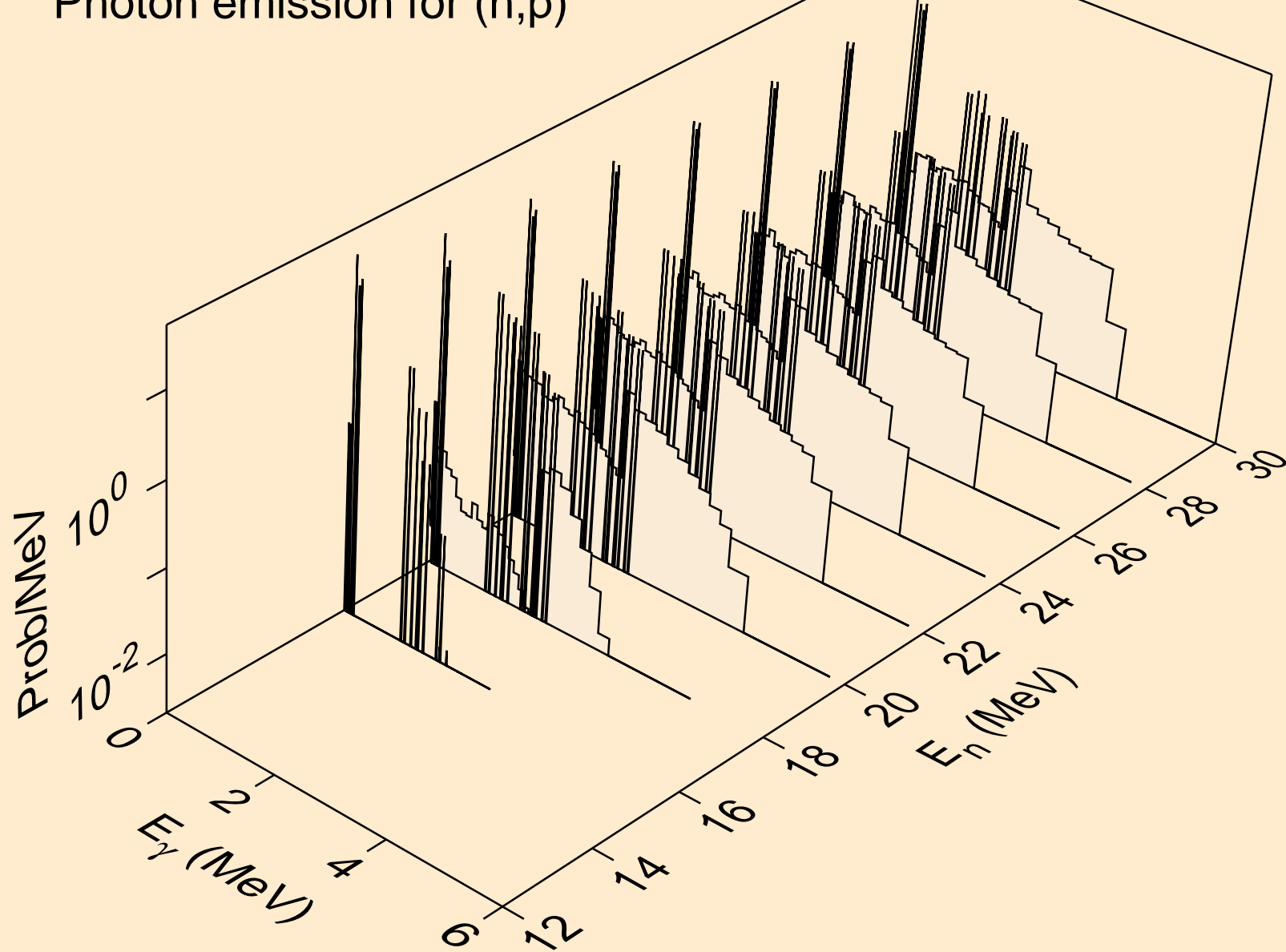

CA050 NEUTRON ACER TENDL-2021 LIBRARY; T=293.6K  
Photon emission for (n,d)

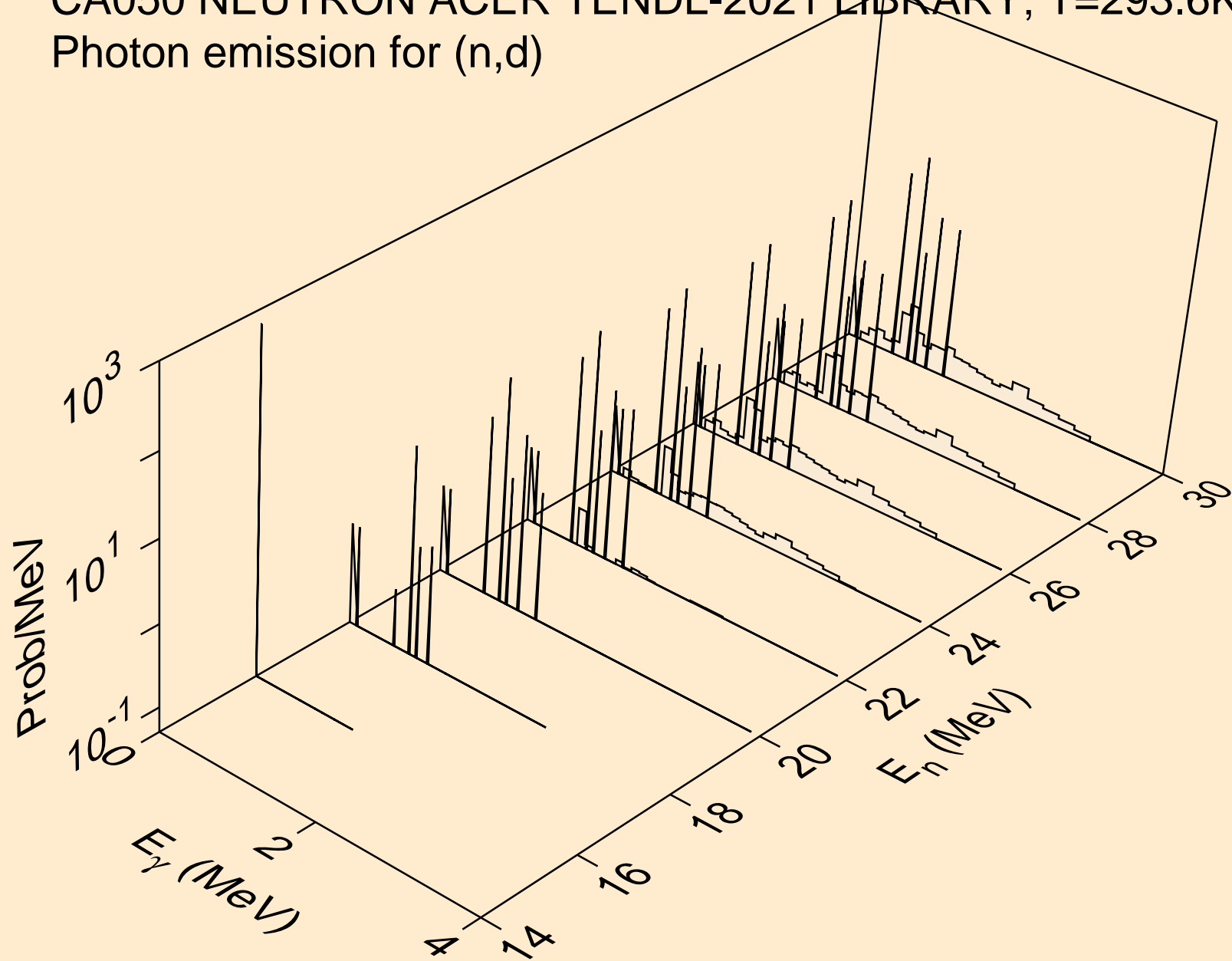



CA050 NEUTRON ACER TENDL-2021 LIBRARY; T=293.6K  
Photon emission for (n,t)

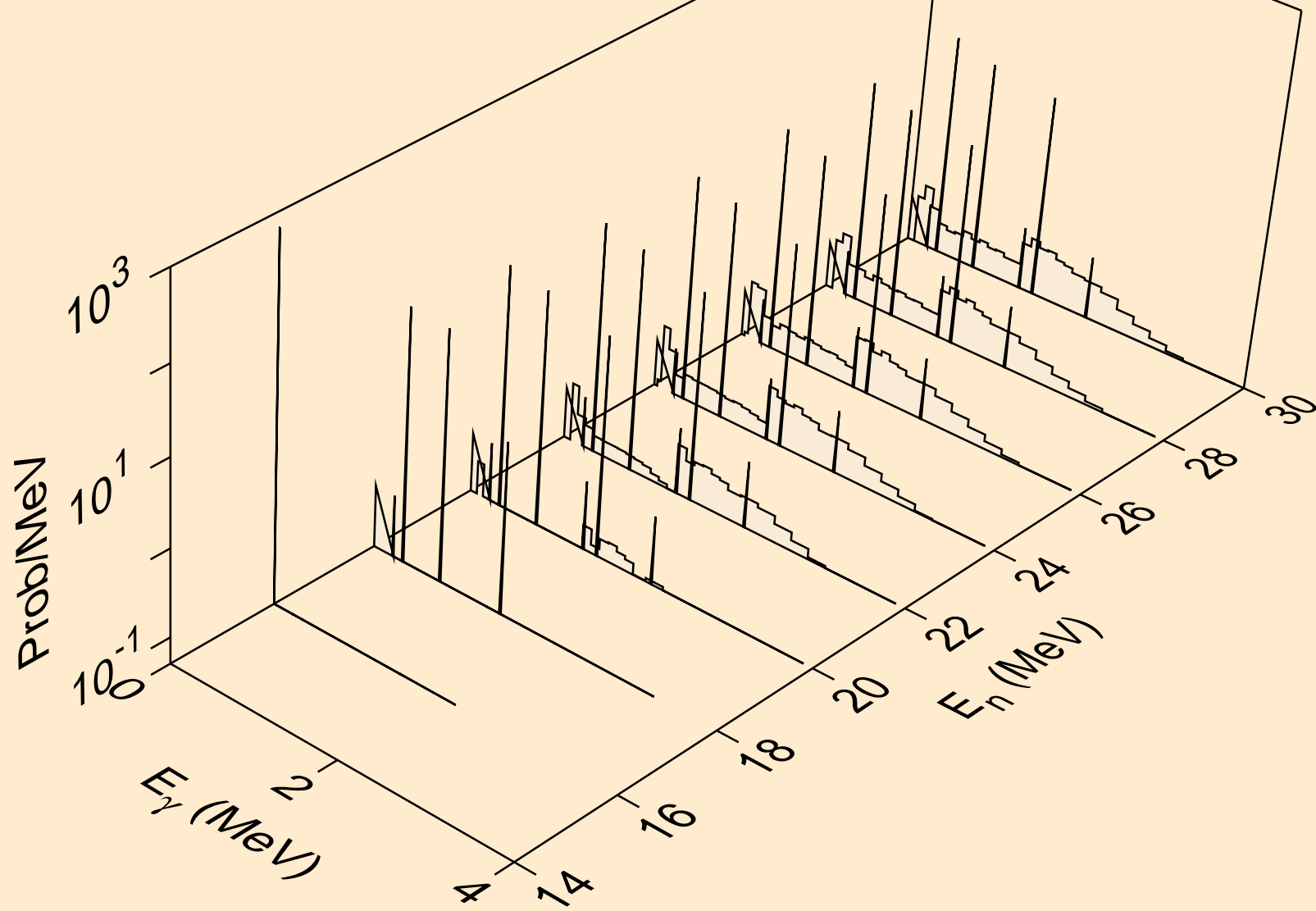

CA050 NEUTRON ACER TENDL-2021 LIBRARY; T=293.6K  
Photon emission for (n,he3)

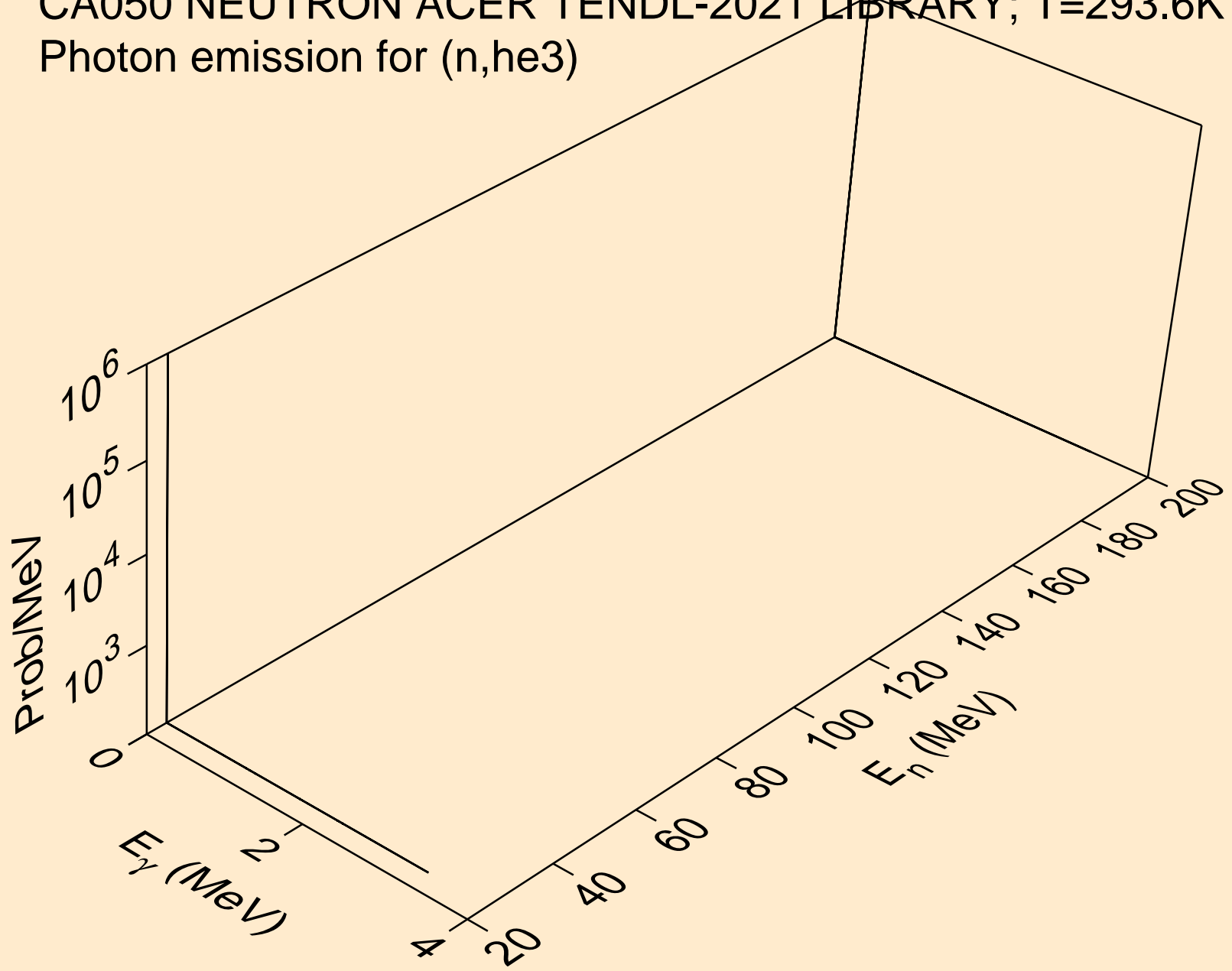

CA050 NEUTRON ACER TENDL-2021 LIBRARY; T=293.6K  
Photon emission for (n,a)

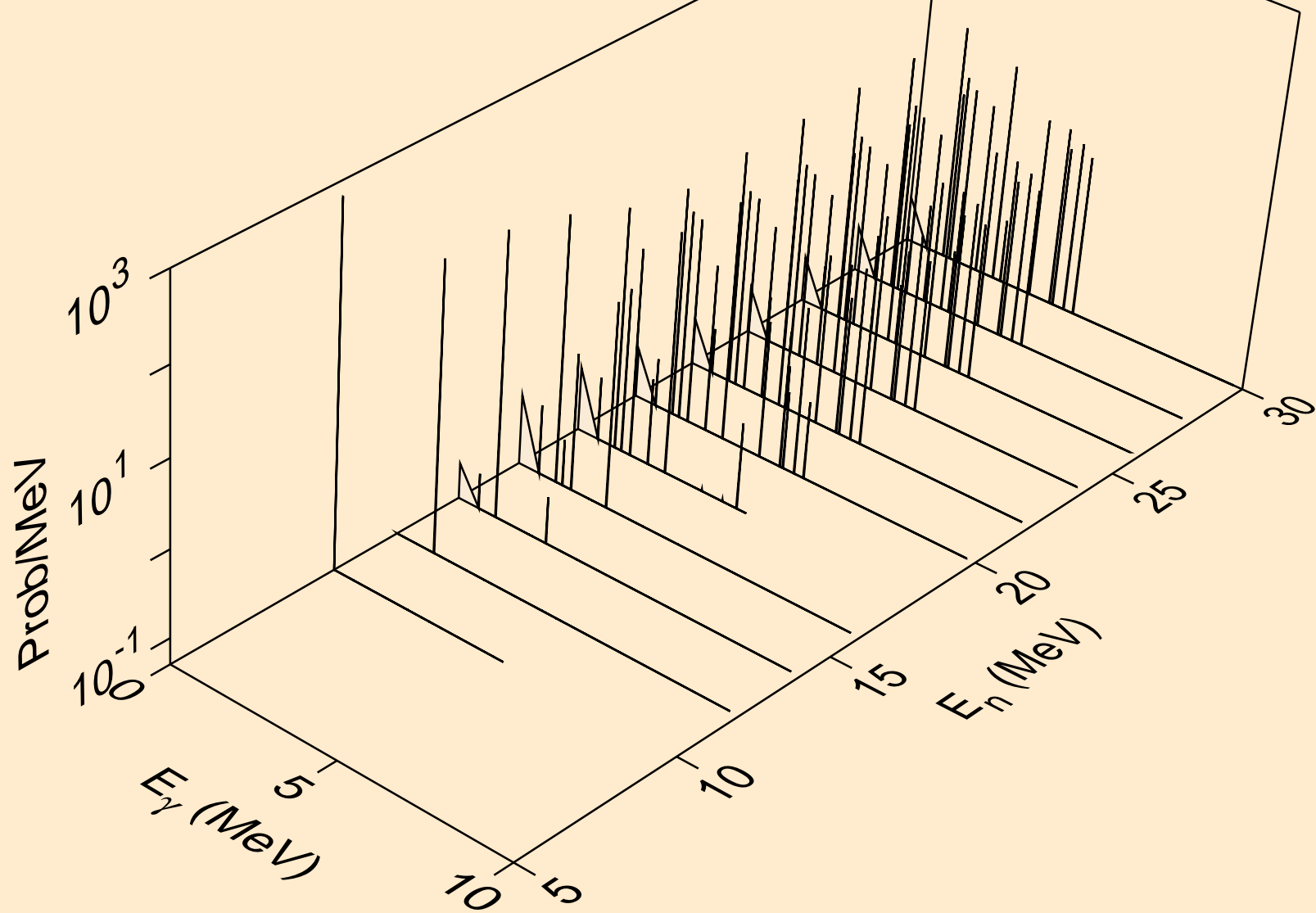

CA050 NEUTRON ACER TENDL-2021 LIBRARY; T=293.6K  
thermal capture photon spectrum

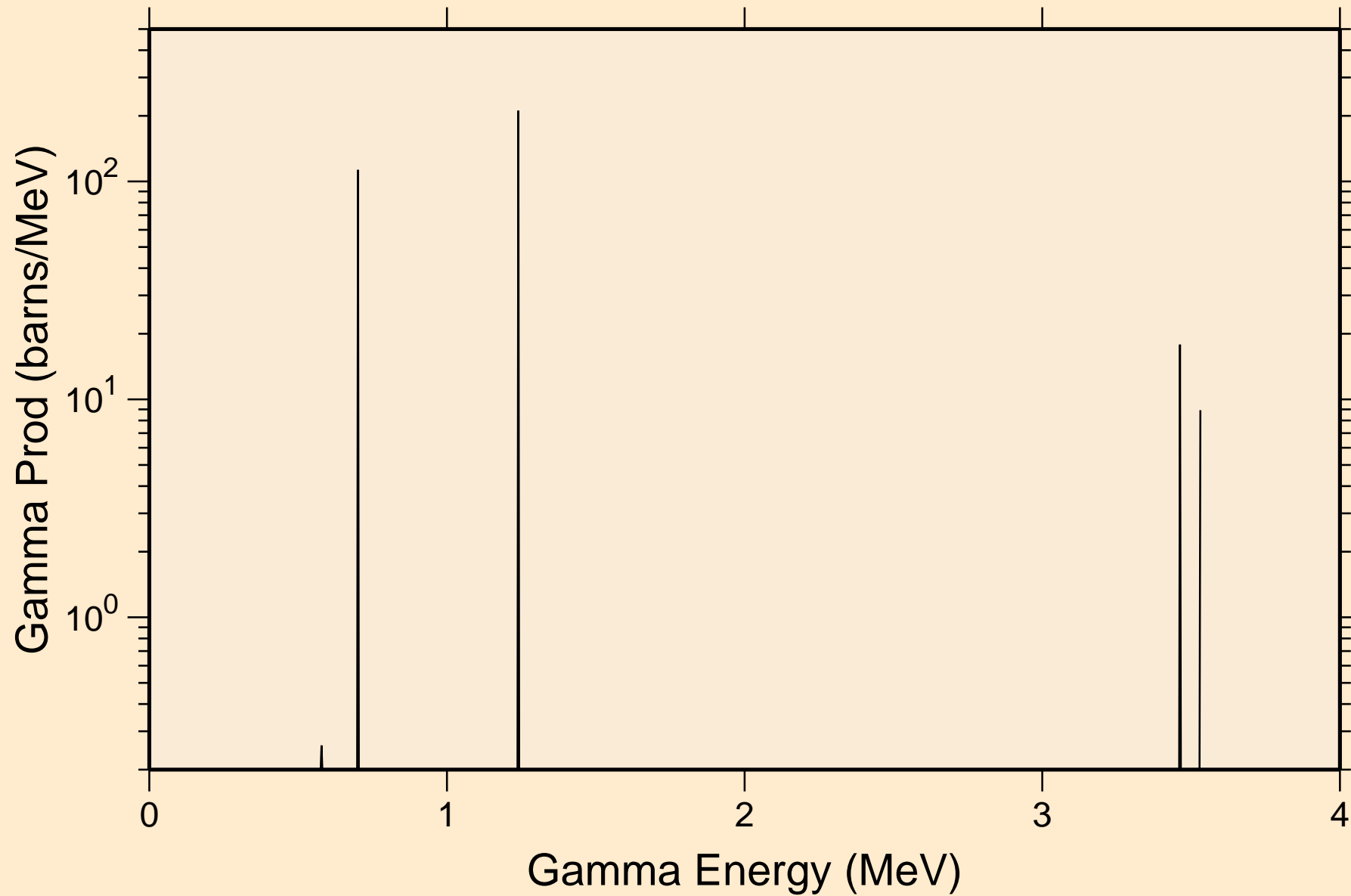

CA050 NEUTRON ACER TENDL-2021 LIBRARY; T=293.6K  
14 MeV photon spectrum

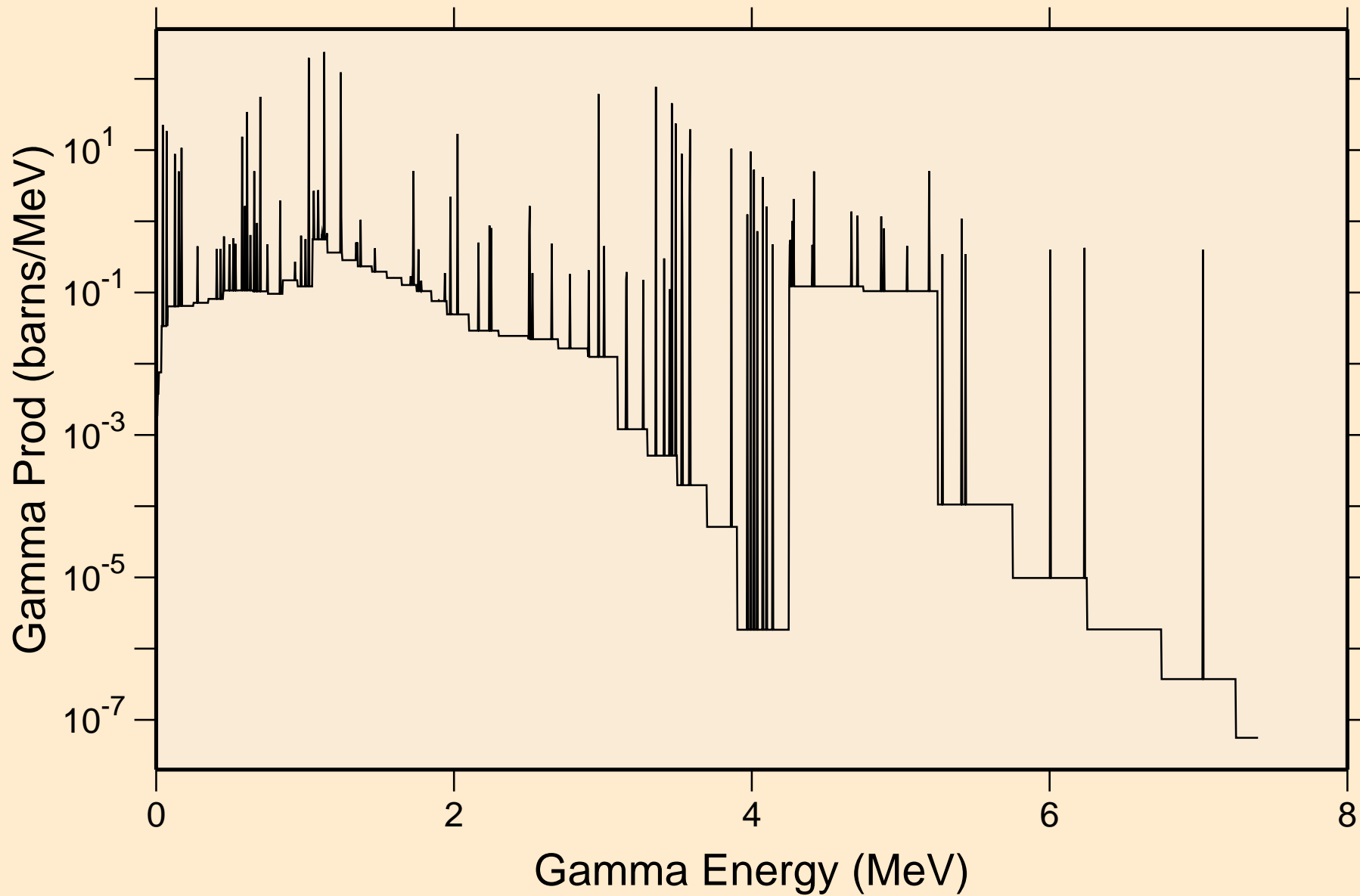

CA050 NEUTRON ACER TENDL-2021 LIBRARY; T=293.6K  
Particle heating contributions

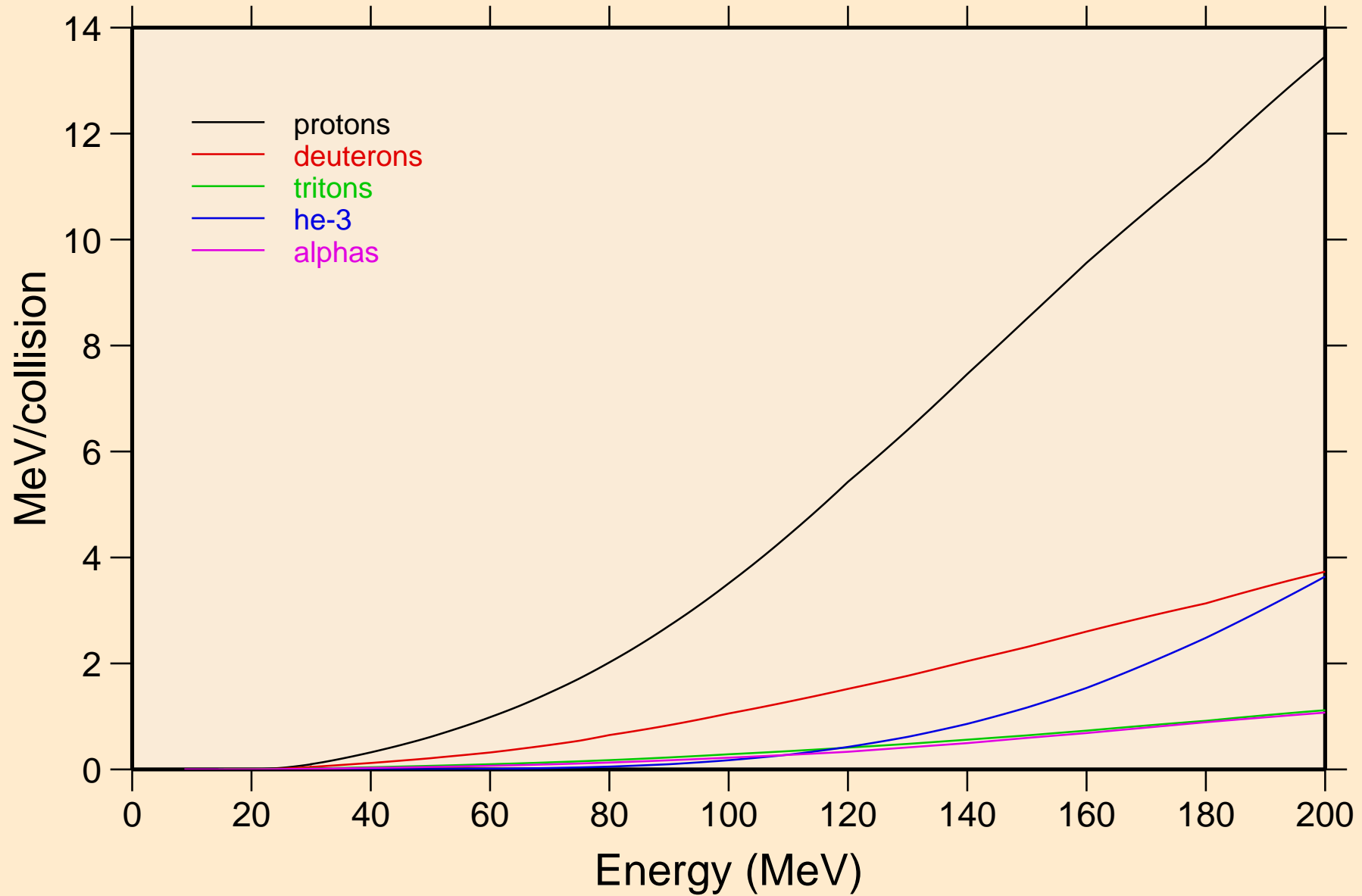

CA050 NEUTRON ACER TENDL-2021 LIBRARY; T=293.6K  
Recoil Heating

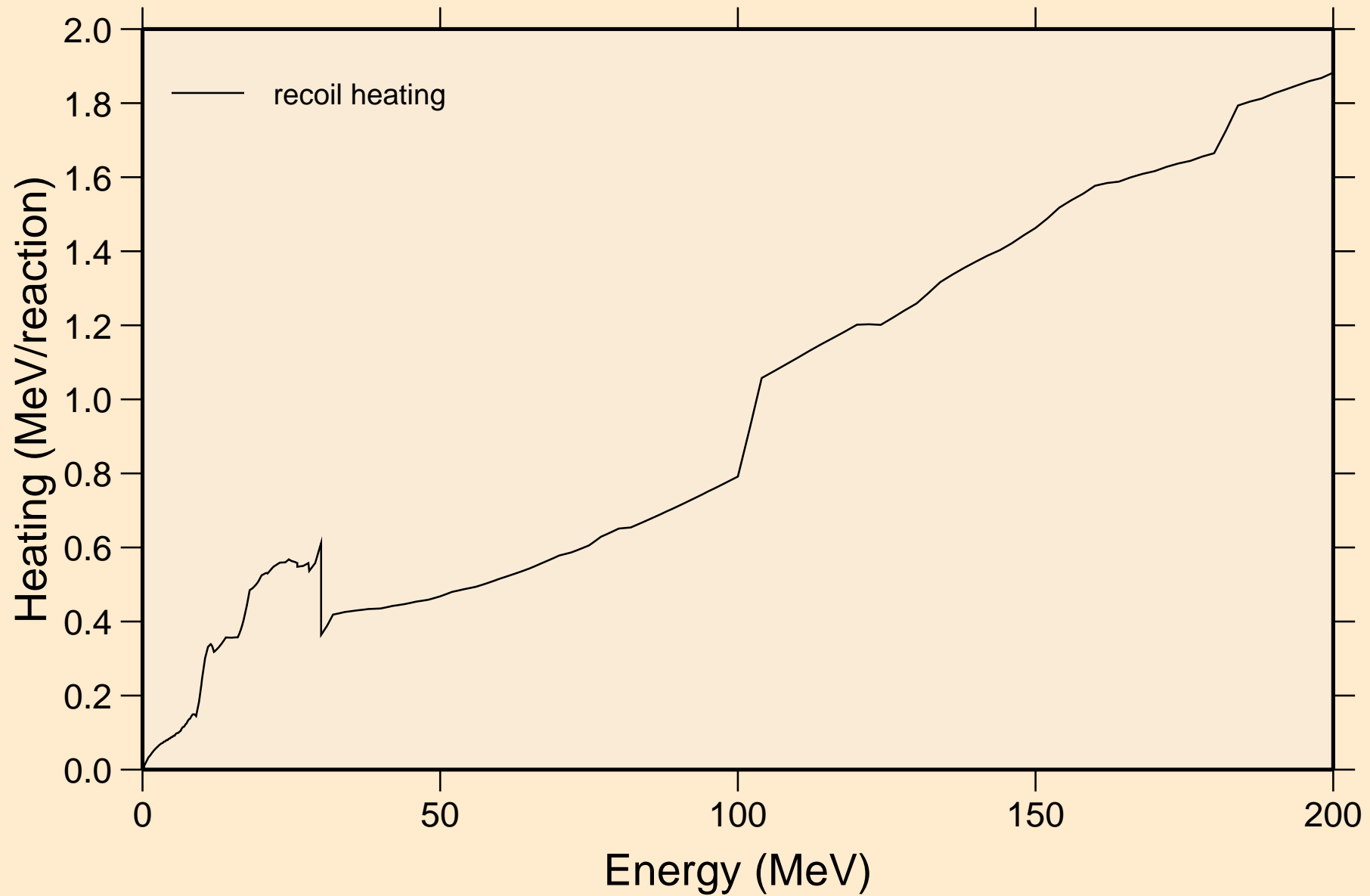

# CA050 NEUTRON ACER TENDL-2021 LIBRARY; T=293.6K

## Particle production cross sections

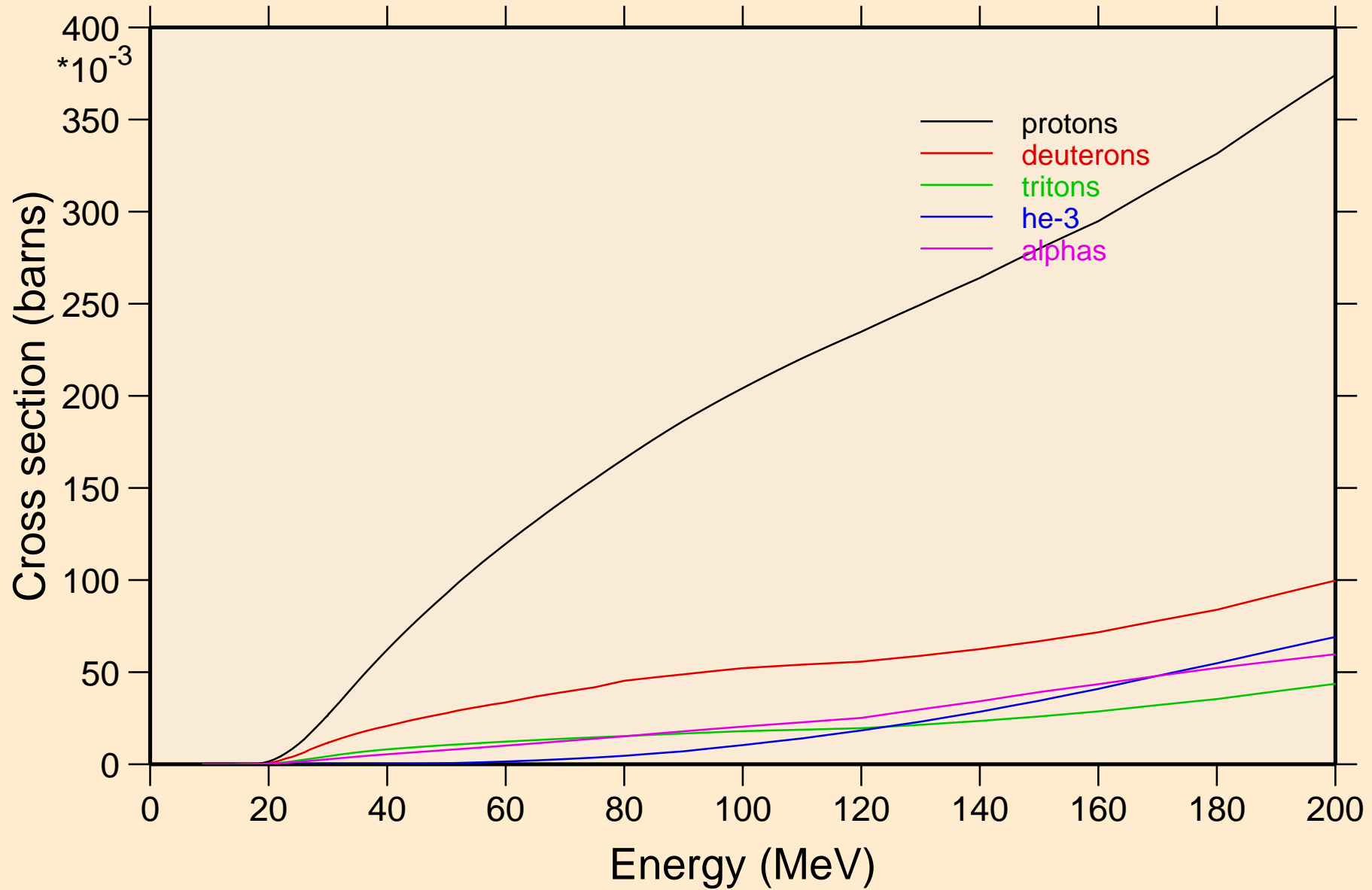



CA050 NEUTRON ACER TENDL-2021 LIBRARY; T=293.6K  
protons from (n,x)

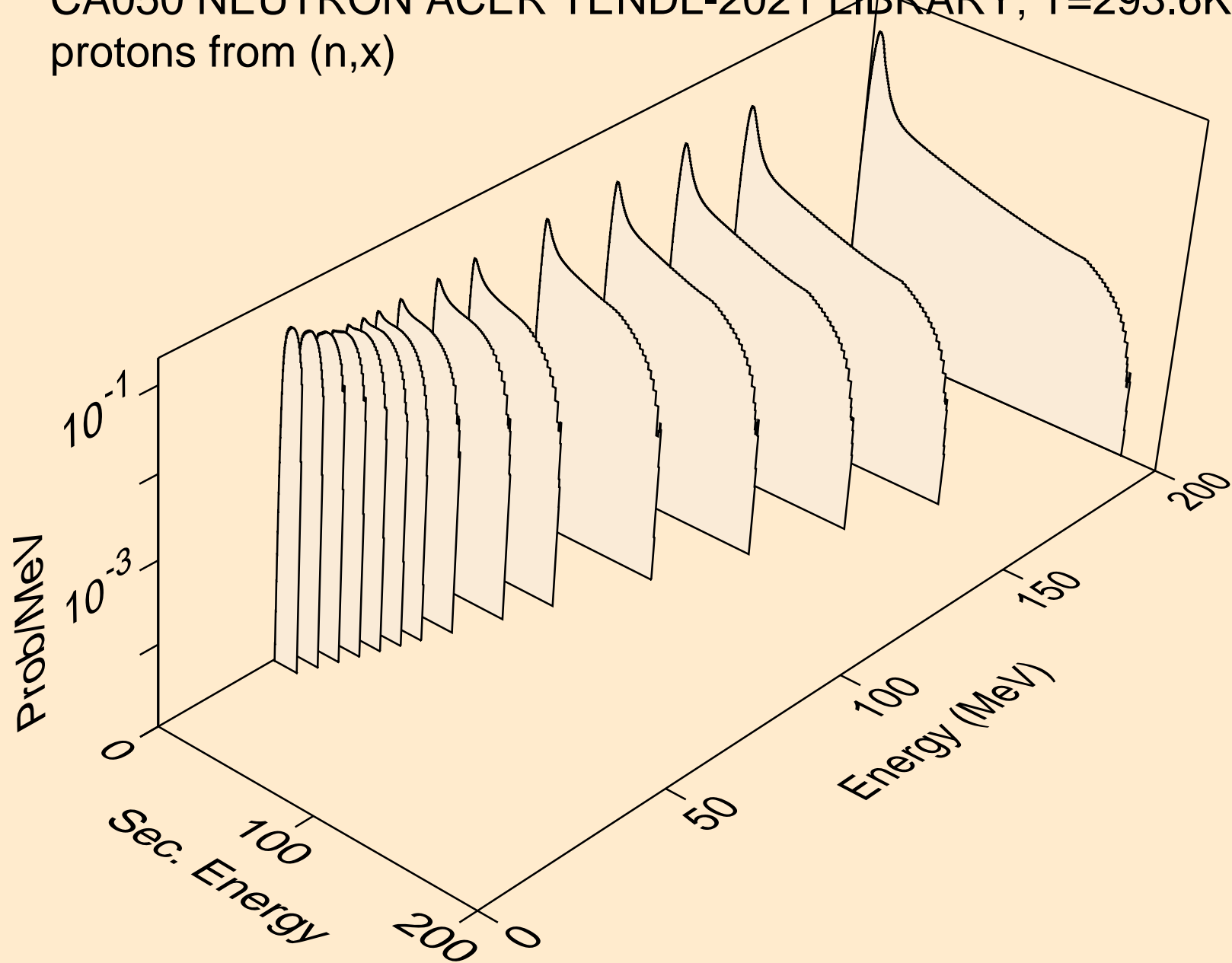

CA050 NEUTRON ACER TENDL-2021 LIBRARY; T=293.6K  
protons from (n,n\*)p

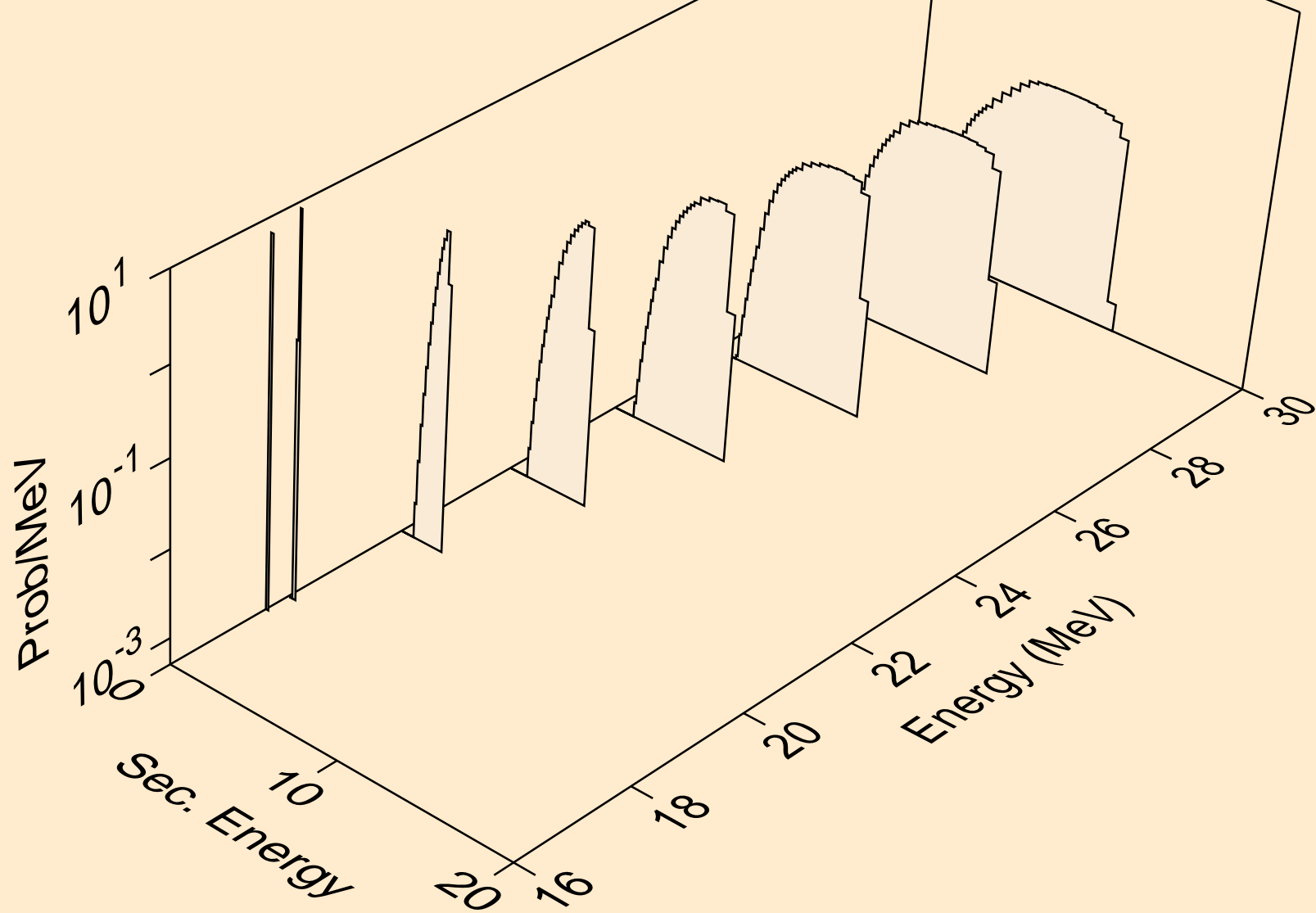

CA050 NEUTRON ACER TENDL-2021 LIBRARY; T=293.6K  
protons from (n,2np)

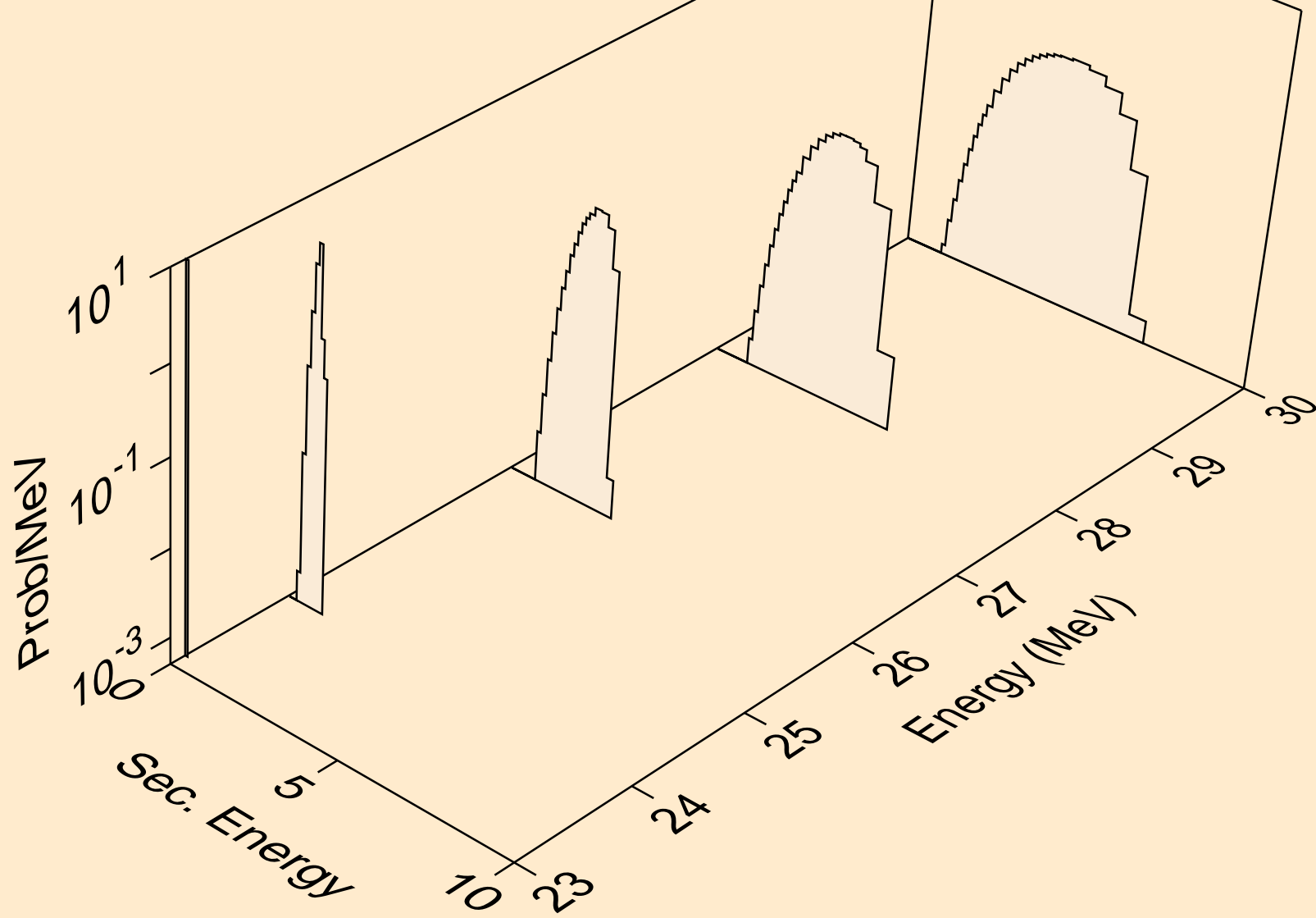

CA050 NEUTRON ACER TENDL-2021 LIBRARY; T=293.6K  
protons from (n,3np)

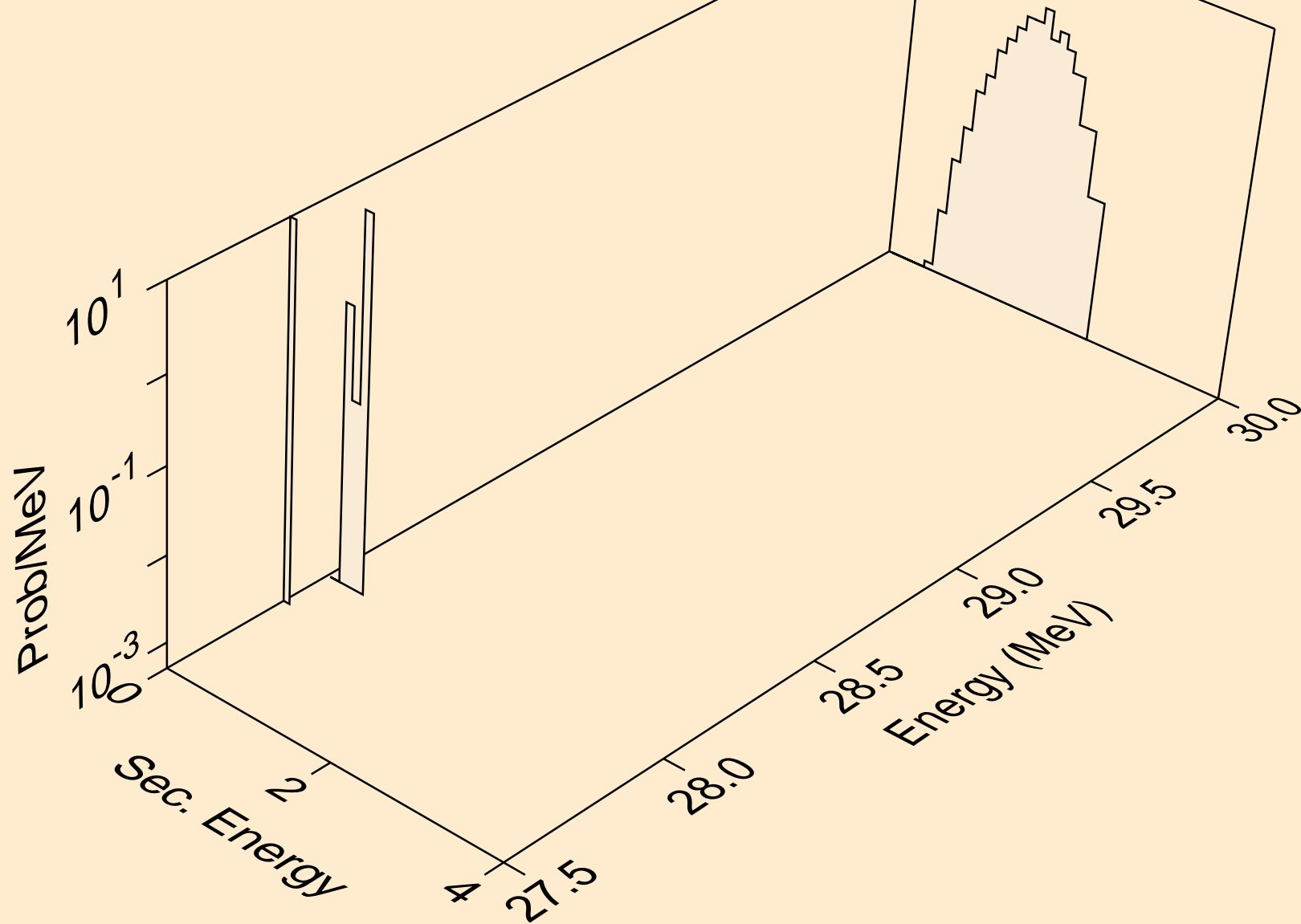

CA050 NEUTRON ACER TENDL-2021 LIBRARY; T=293.6K  
protons from (n,p)

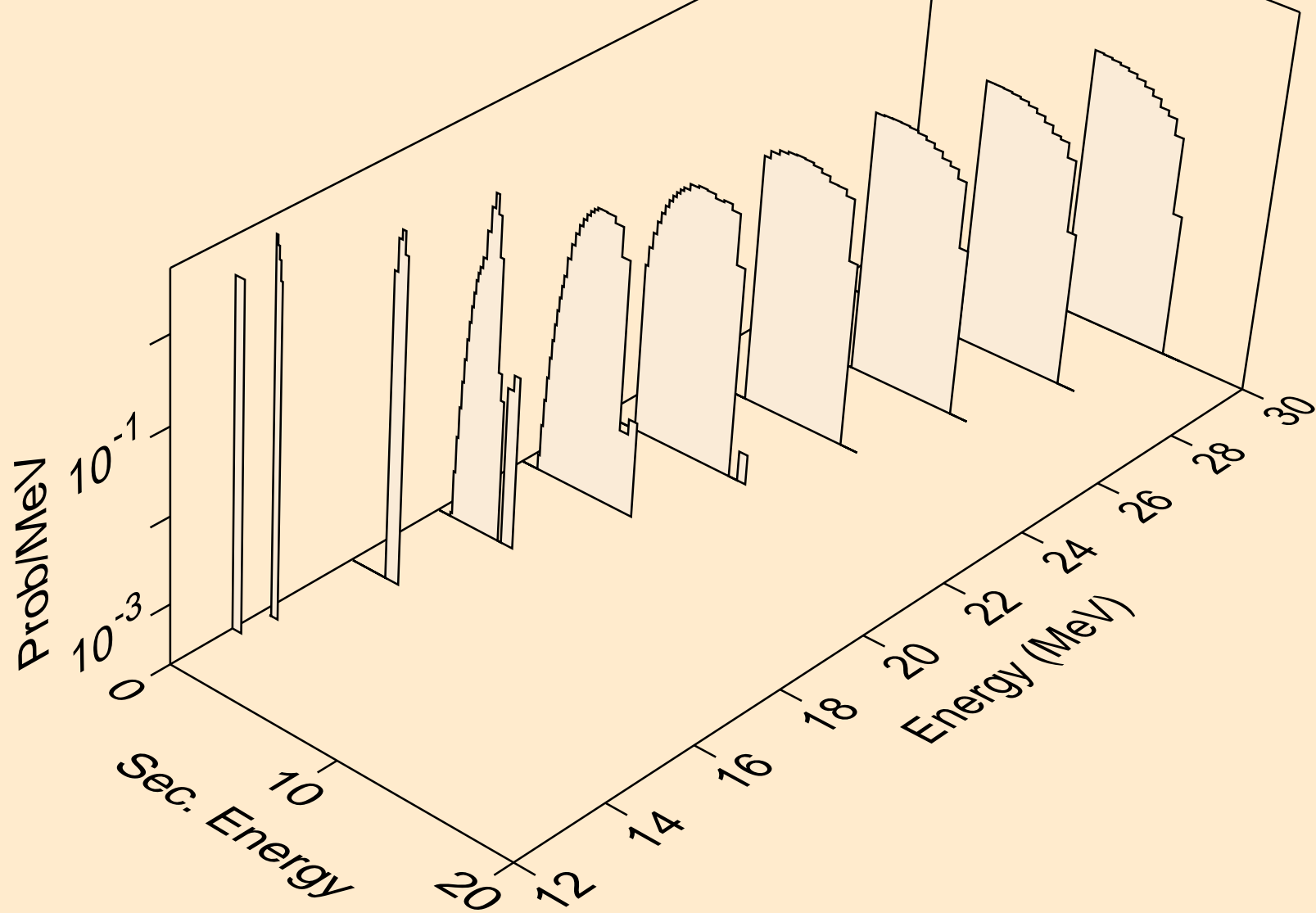

CA050 NEUTRON ACER TENDL-2021 LIBRARY; T=293.6K  
deuterons from (n,x)

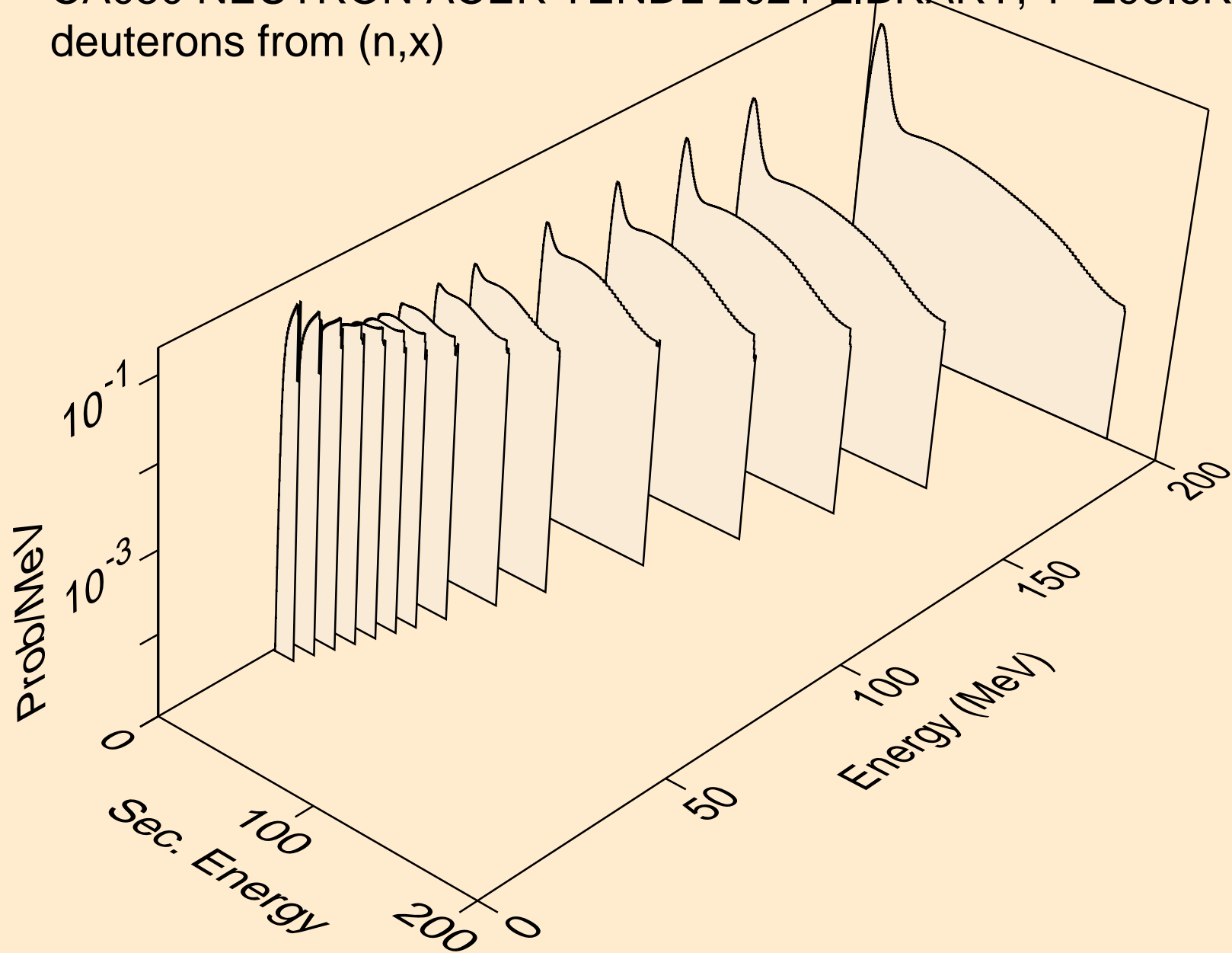

CA050 NEUTRON ACER TENDL-2021 LIBRARY; T=293.6K  
deuterons from (n,2nd)

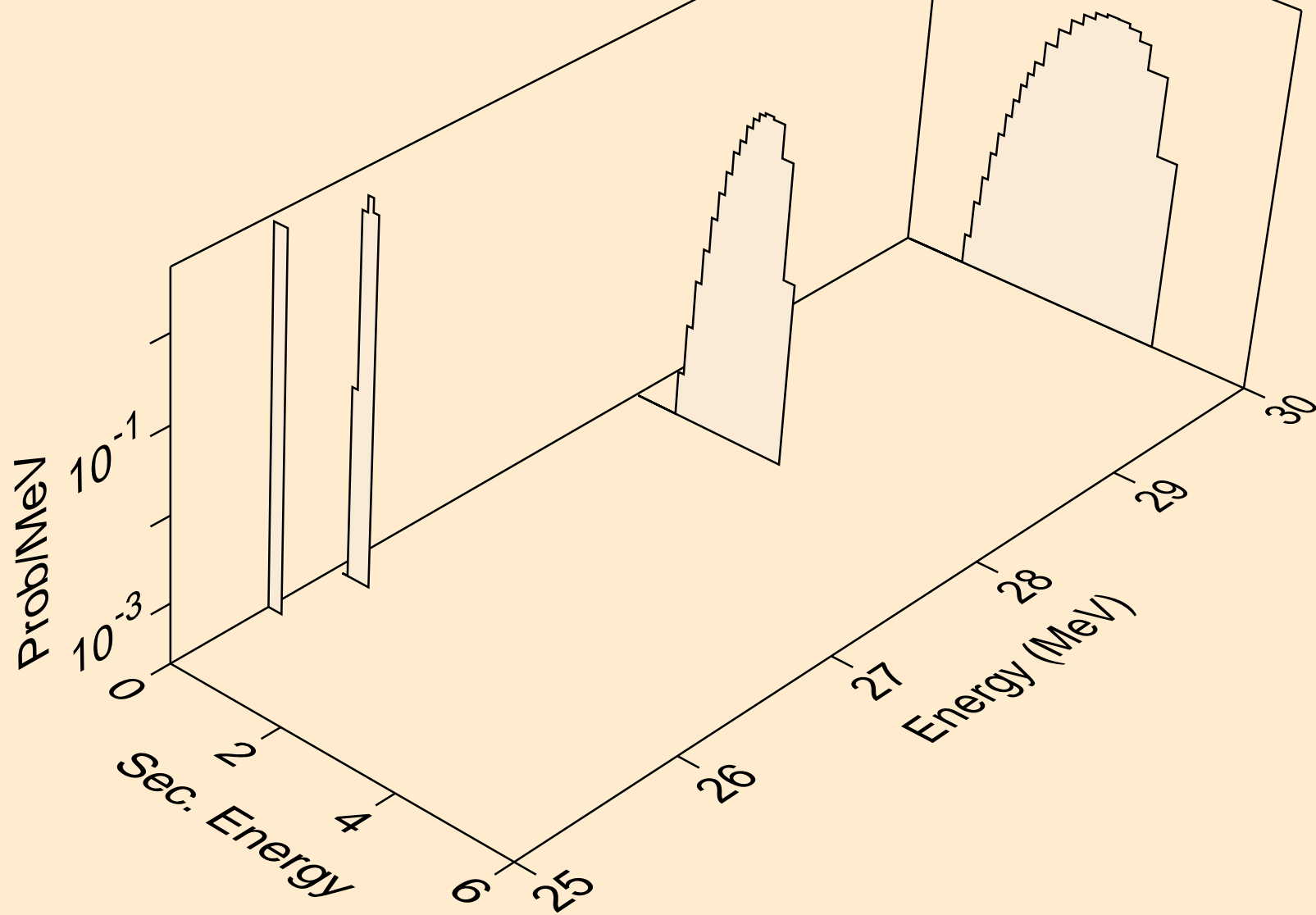

CA050 NEUTRON ACER TENDL-2021 LIBRARY; T=293.6K  
deuterons from (n,n\*)d

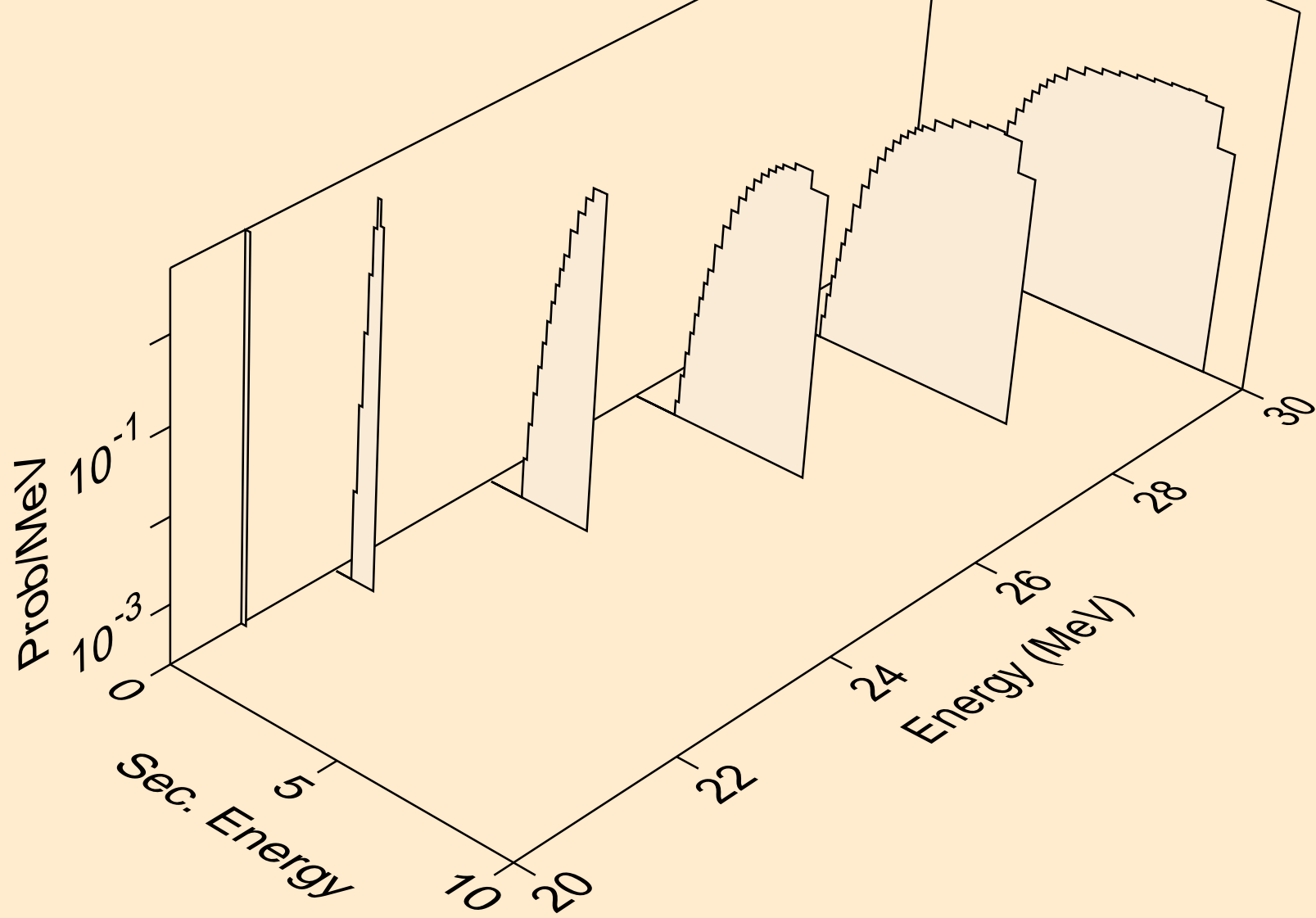



CA050 NEUTRON ACER TENDL-2021 LIBRARY; T=293.6K  
deuterons from (n,d)

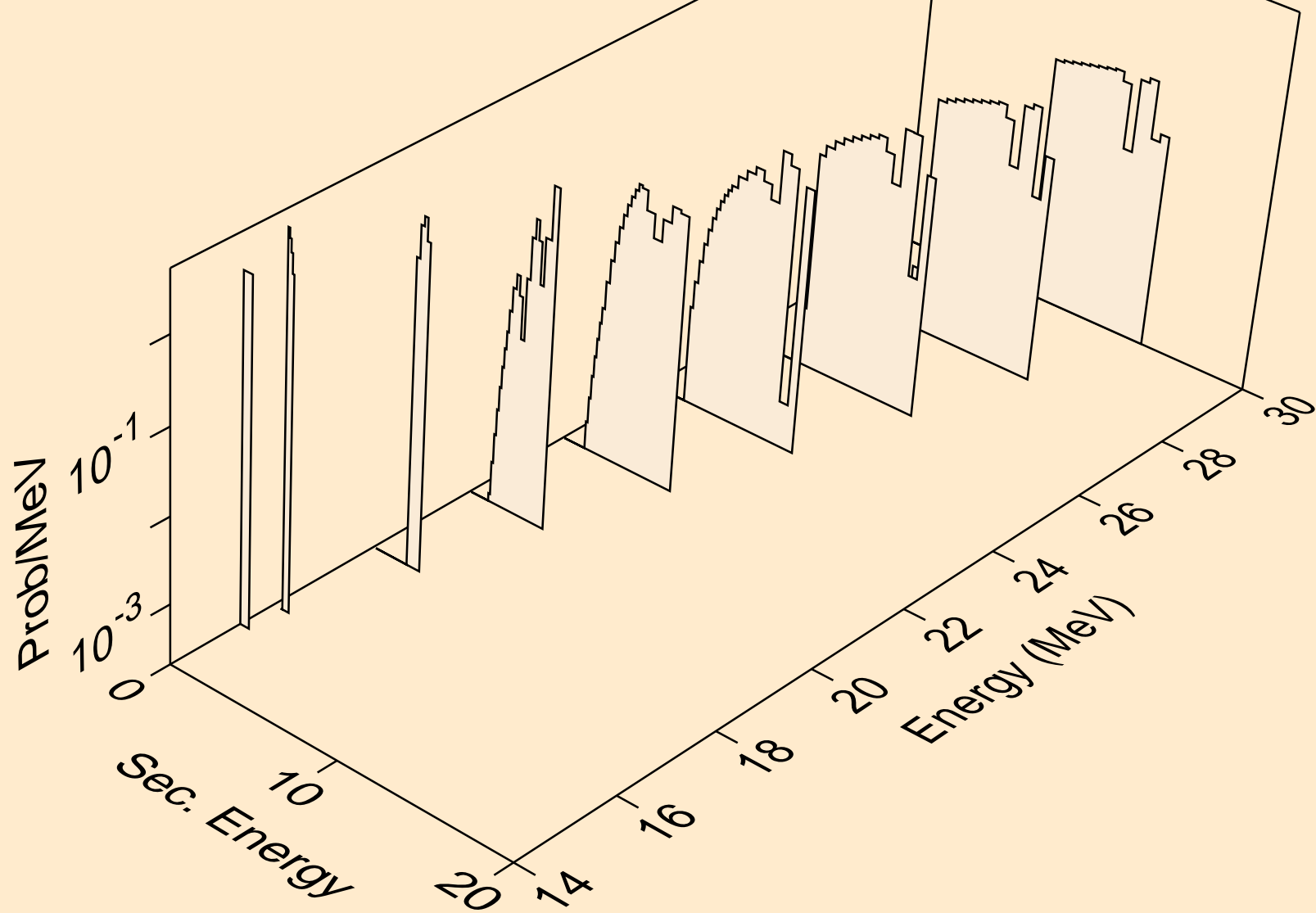

CA050 NEUTRON ACER TENDL-2021 LIBRARY; T=293.6K  
tritons from (n,x)

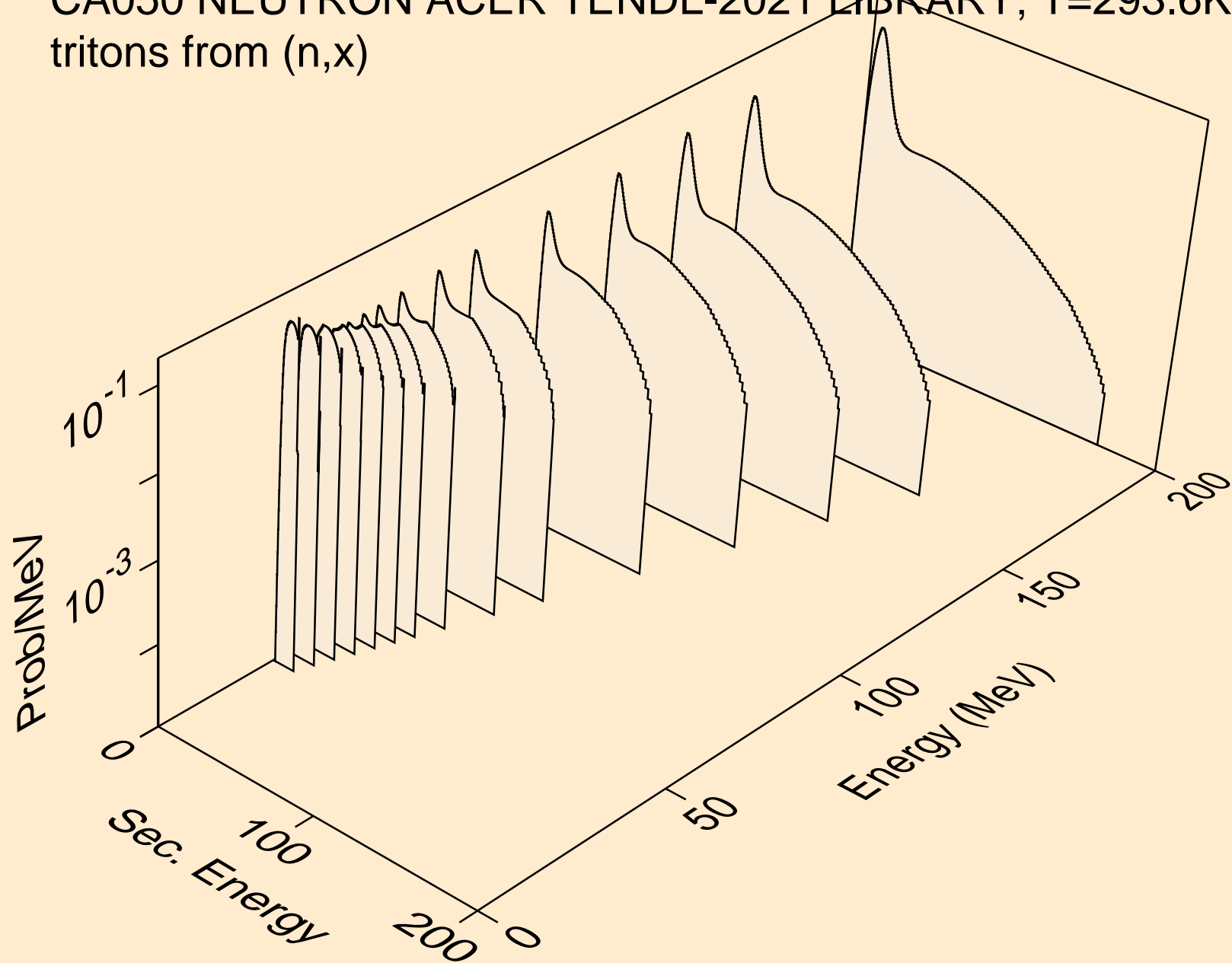

CA050 NEUTRON ACER TENDL-2021 LIBRARY; T=293.6K  
tritons from (n,n\*)t

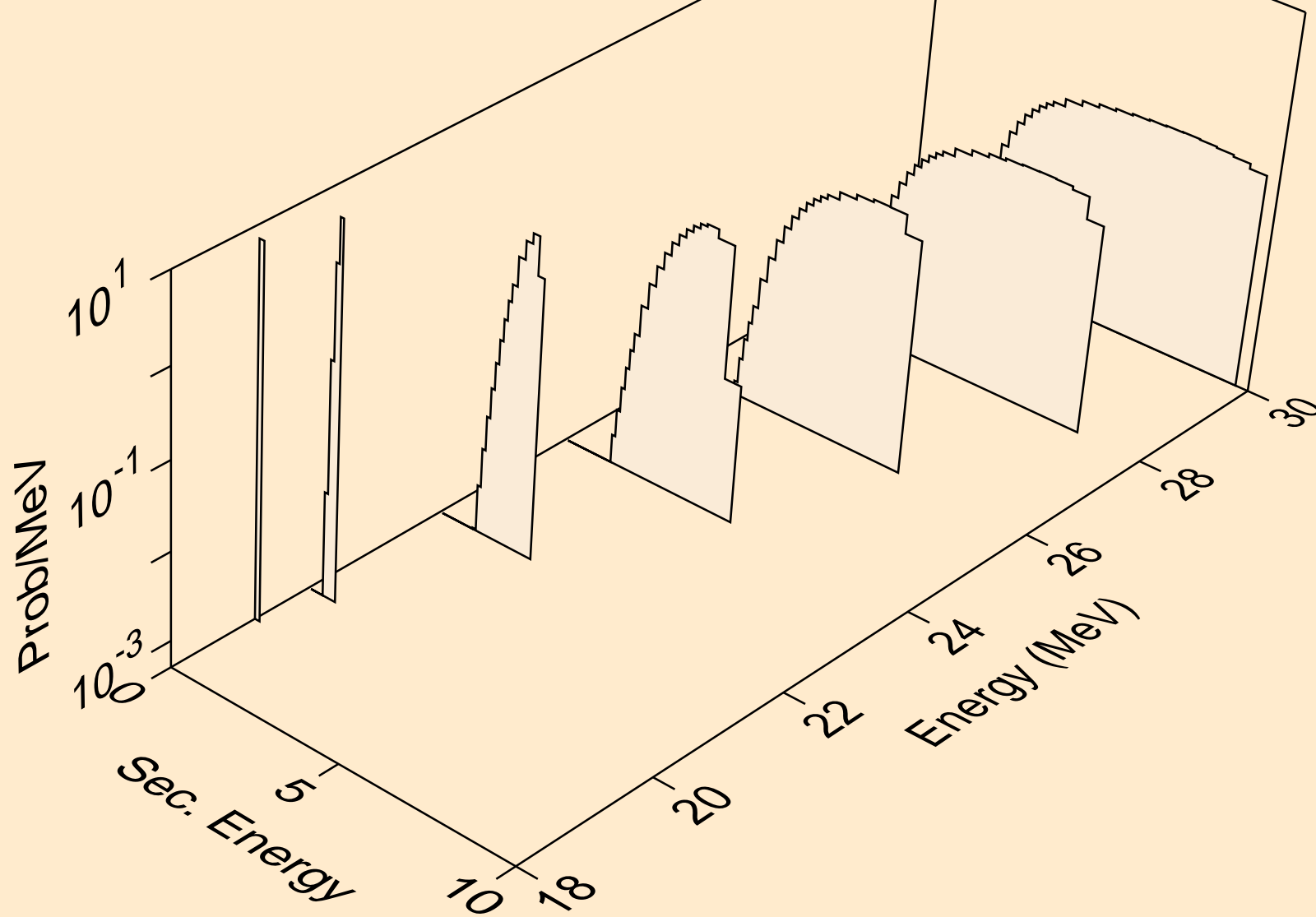

CA050 NEUTRON ACER TENDL-2021 LIBRARY; T=293.6K  
tritons from (n,t)

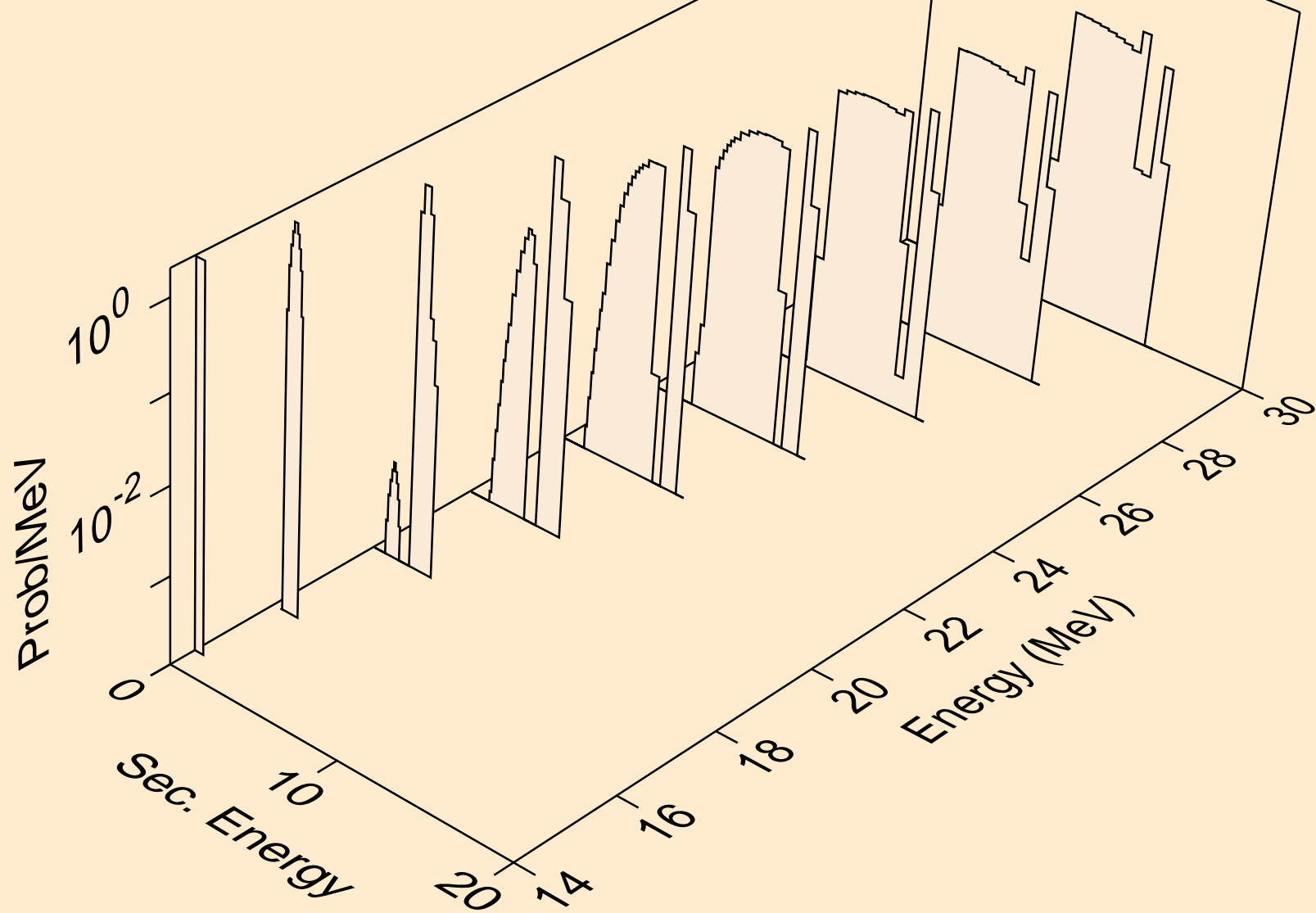

CA050 NEUTRON ACER TENDL-2021 LIBRARY; T=293.6K  
he3s from (n,x)

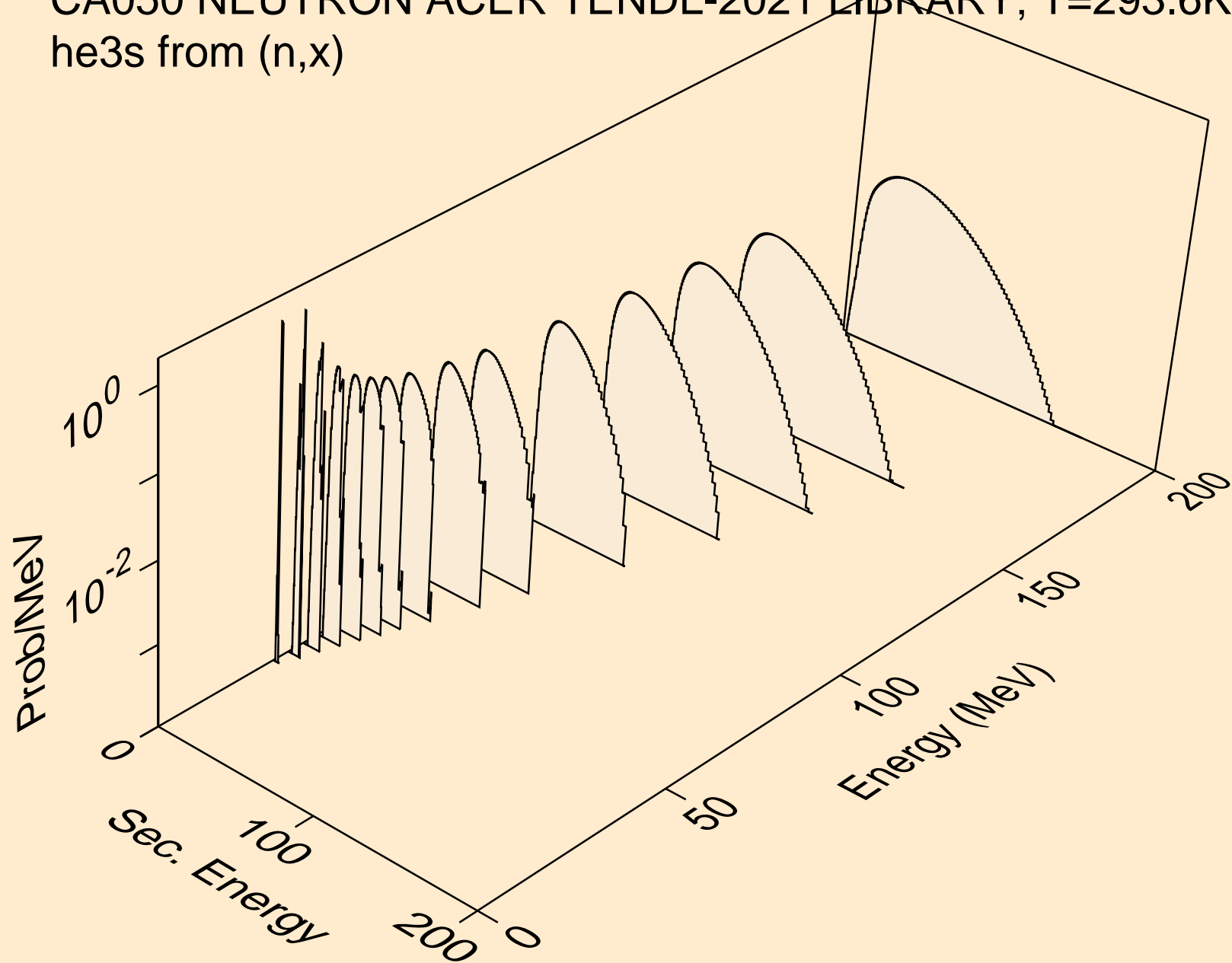

CA050 NEUTRON ACER TENDL-2021 LIBRARY; T=293.6K  
he3s from (n,he3)

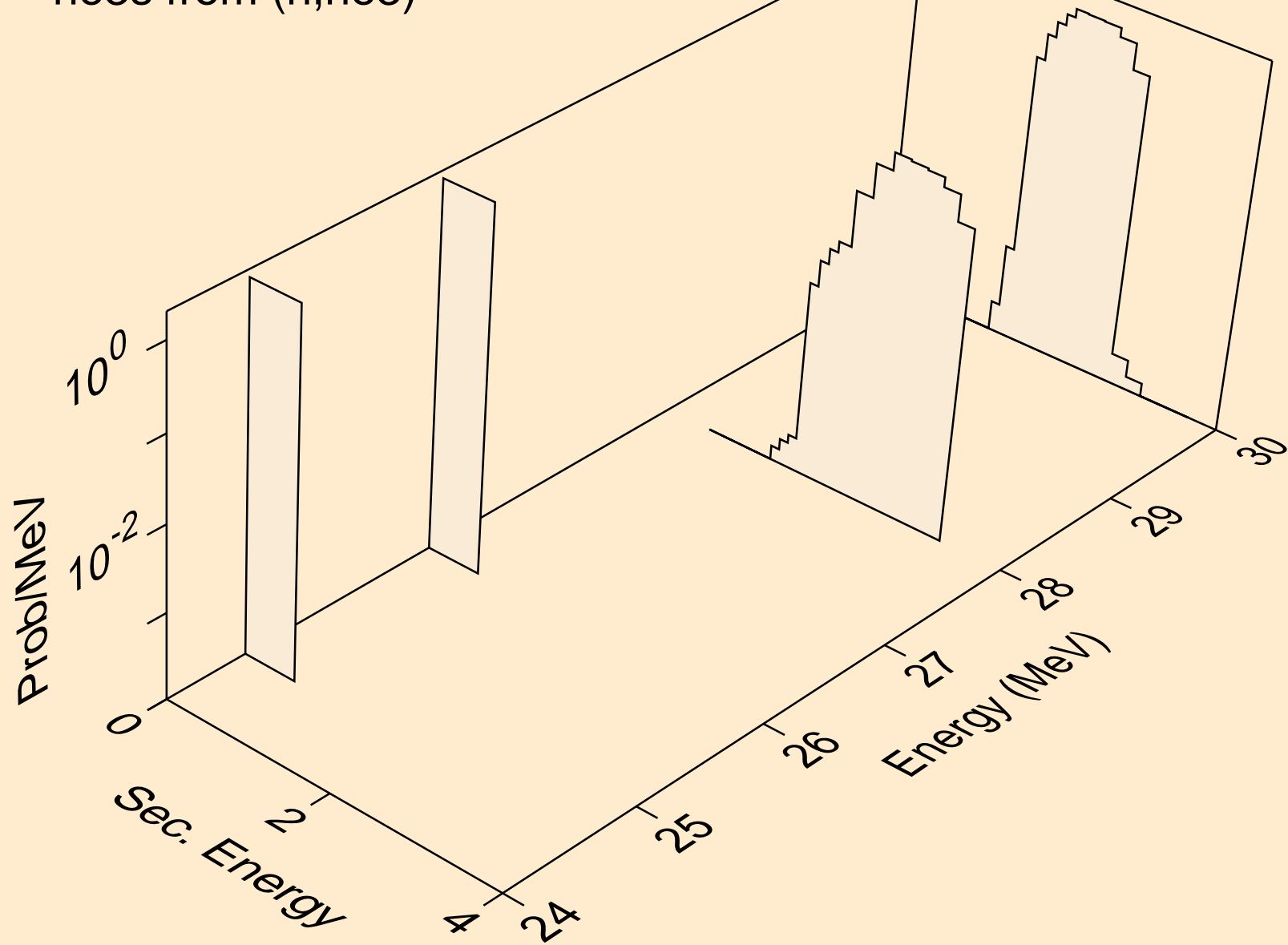

CA050 NEUTRON ACER TENDL-2021 LIBRARY; T=293.6K  
alphas from (n,x)

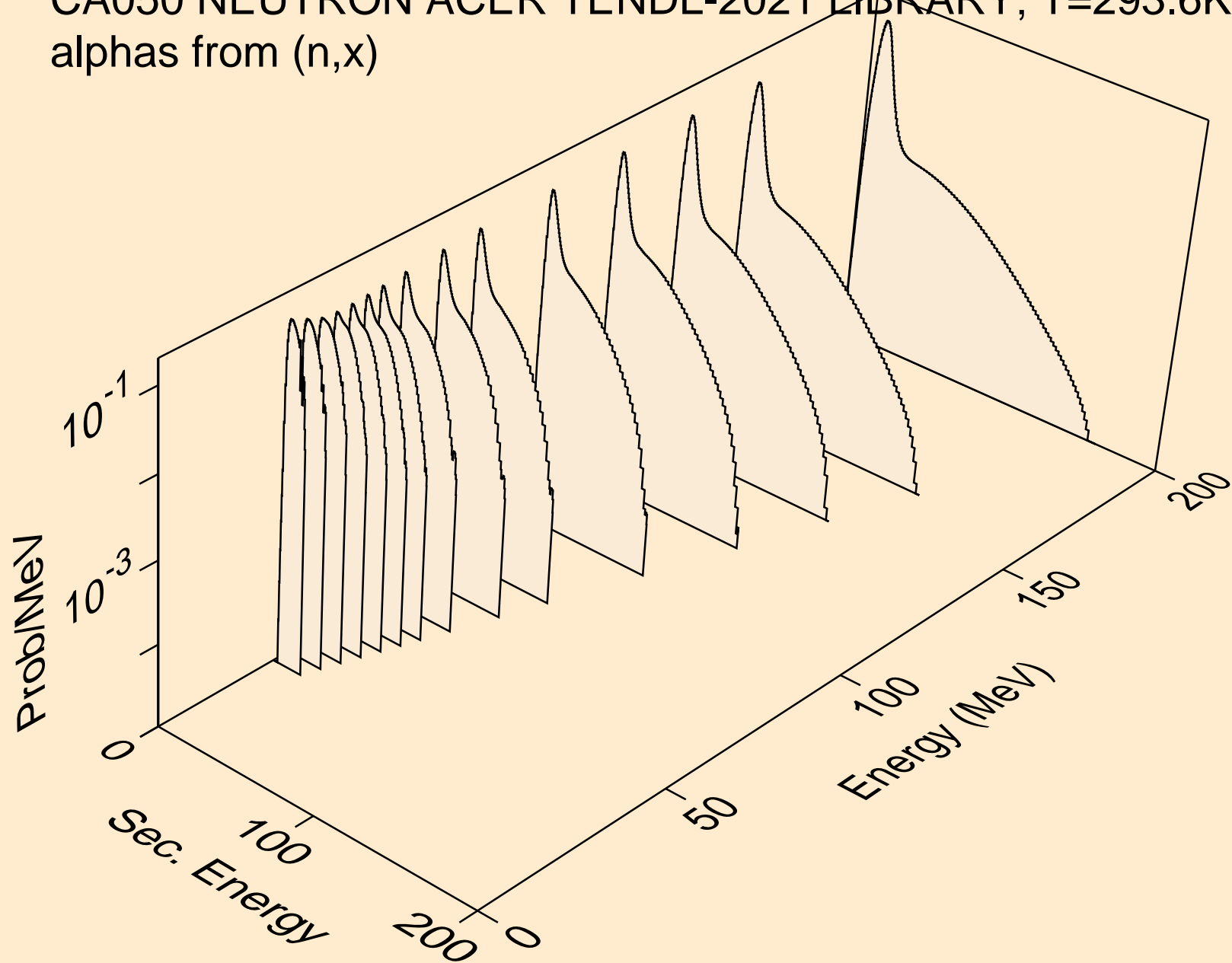

CA050 NEUTRON ACER TENDL-2021 LIBRARY; T=293.6K  
alphas from (n,n\*)a

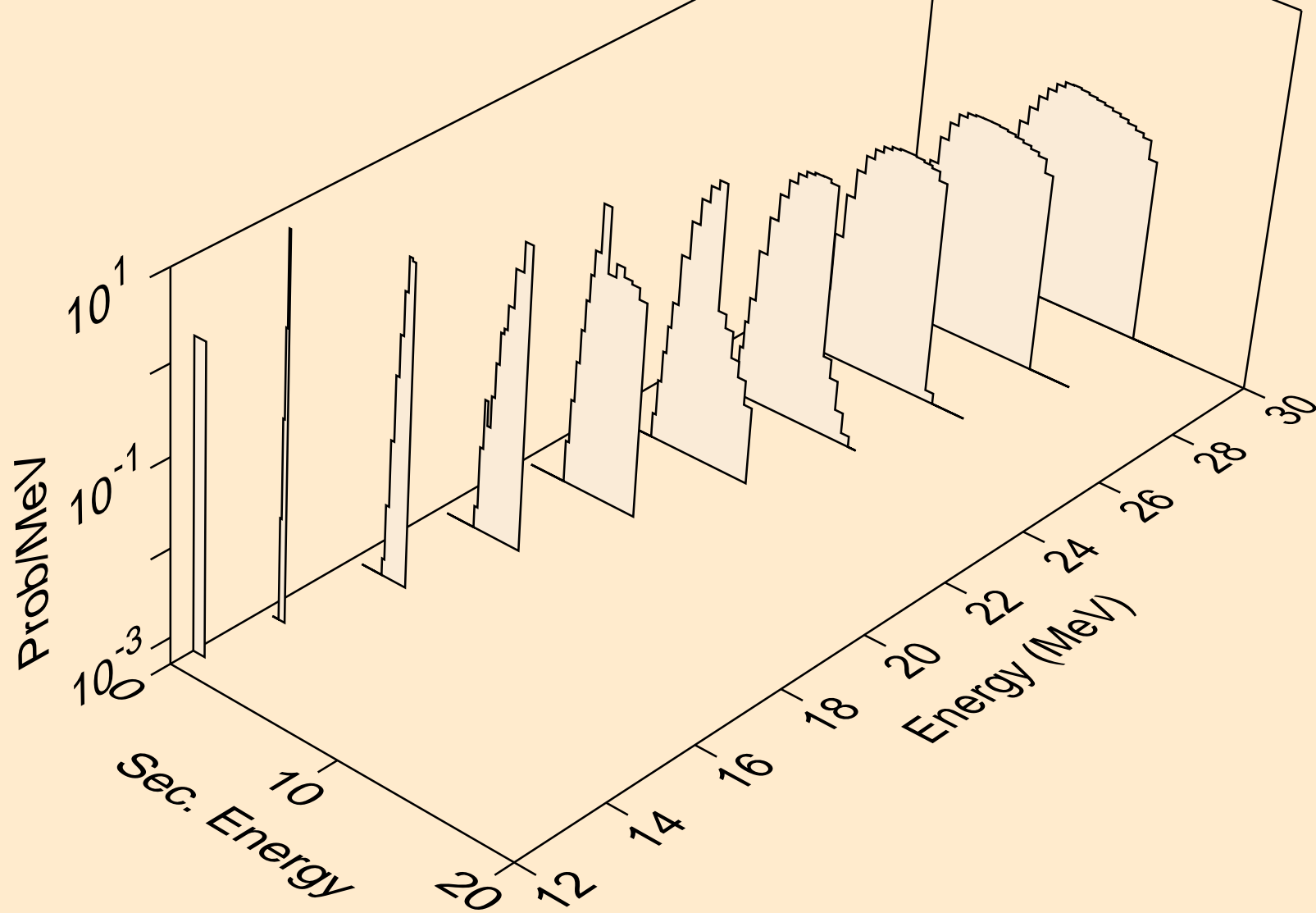



CA050 NEUTRON ACER TENDL-2021 LIBRARY; T=293.6K  
alphas from (n,2n)a

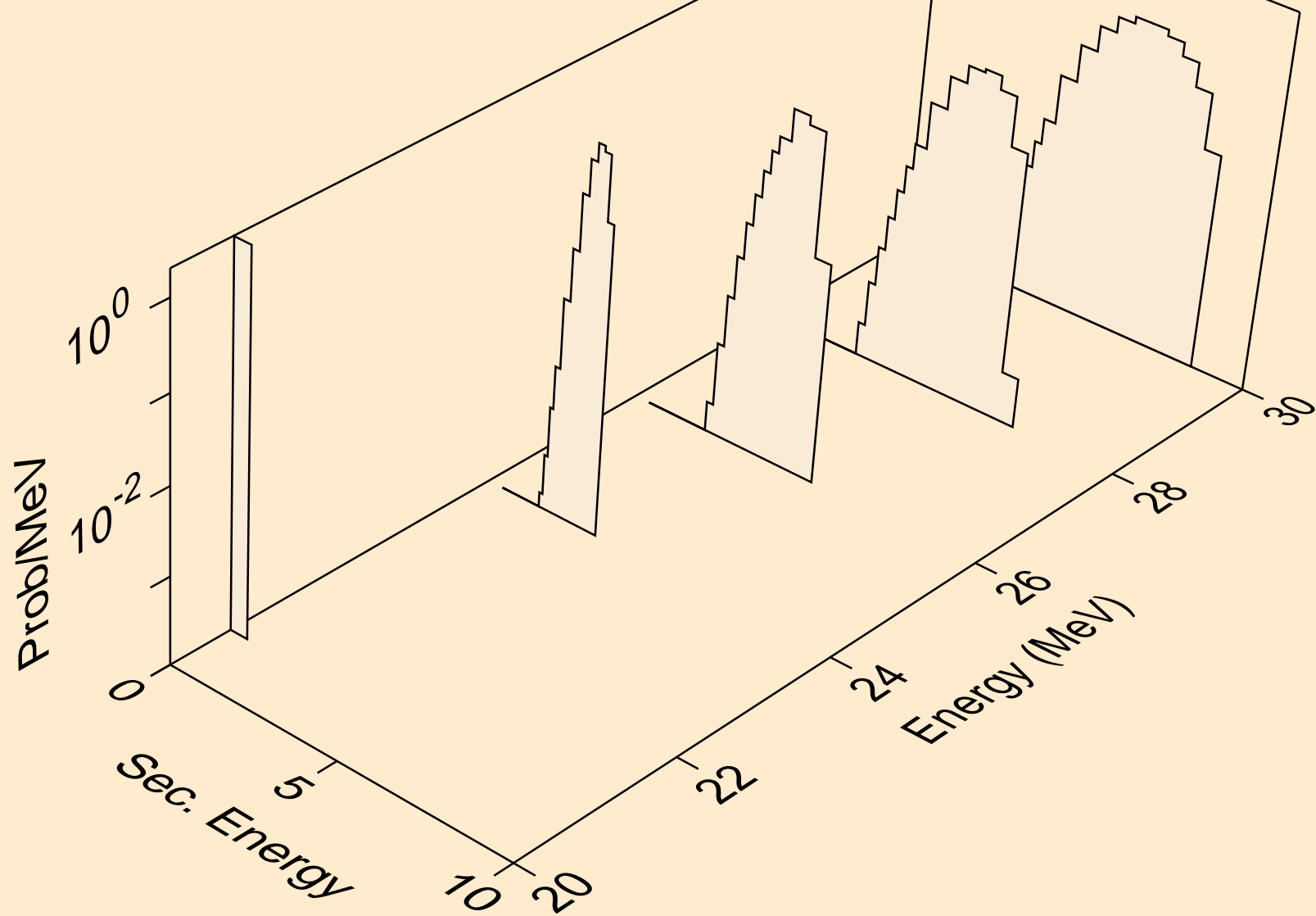

CA050 NEUTRON ACER TENDL-2021 LIBRARY; T=293.6K  
alphas from (n,3n)a

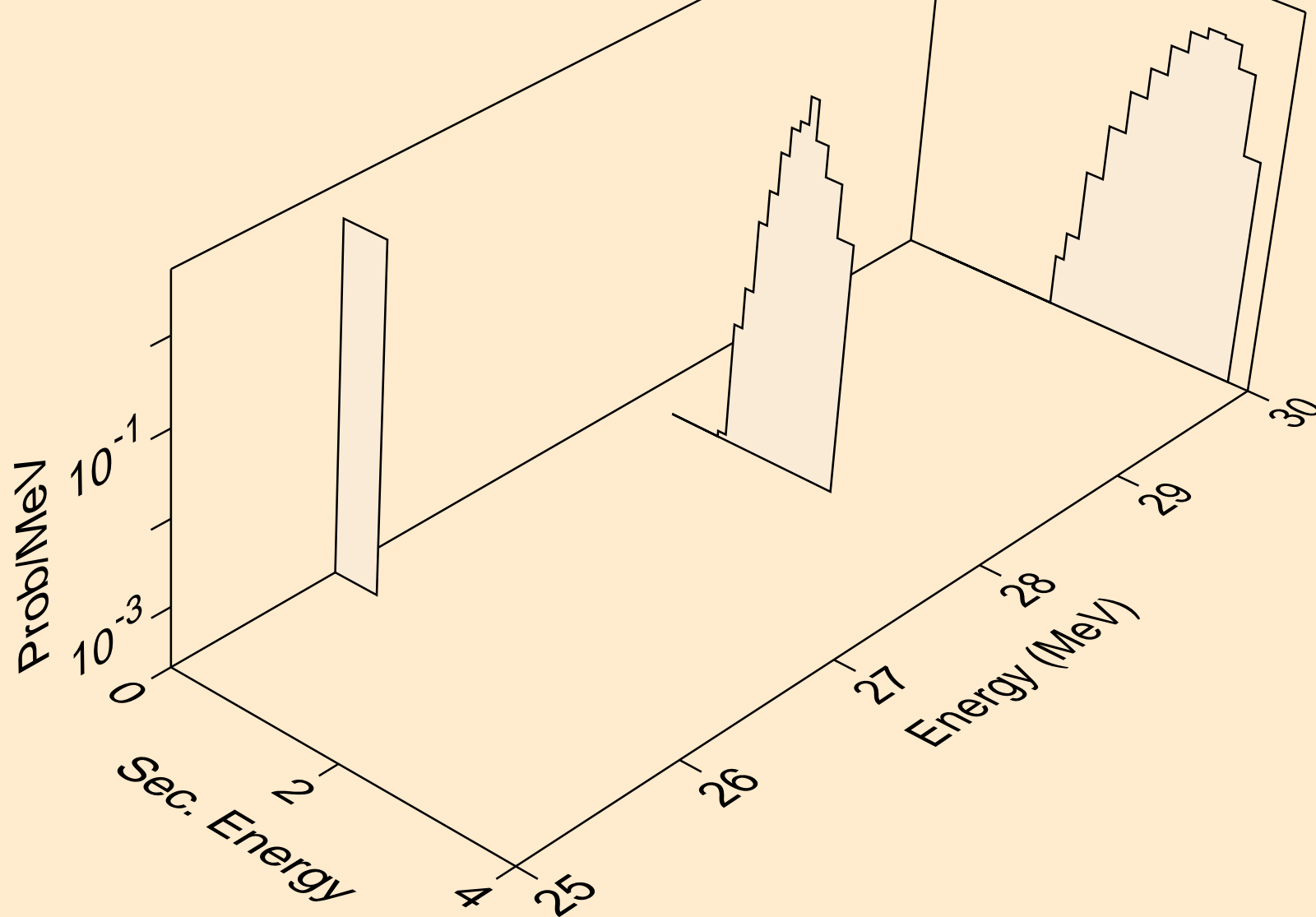

CA050 NEUTRON ACER TENDL-2021 LIBRARY; T=293.6K  
alphas from (n,a)

