

CD100 NEUTRON ACER TENDL-2021 LIBRARY; T=293.6K

Principal cross sections

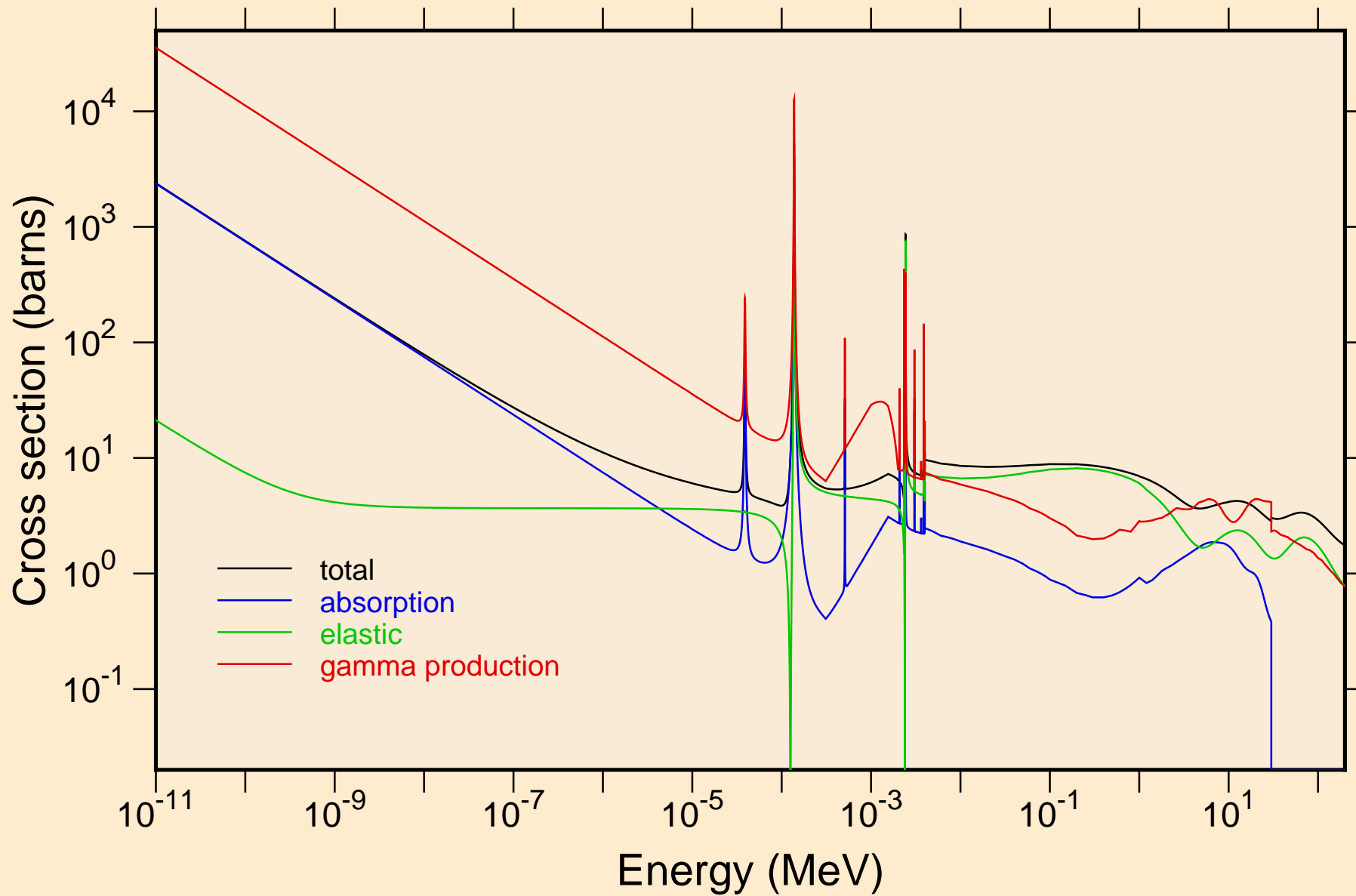

CD100 NEUTRON ACER TENDL-2021 LIBRARY; T=293.6K
resonance total cross section

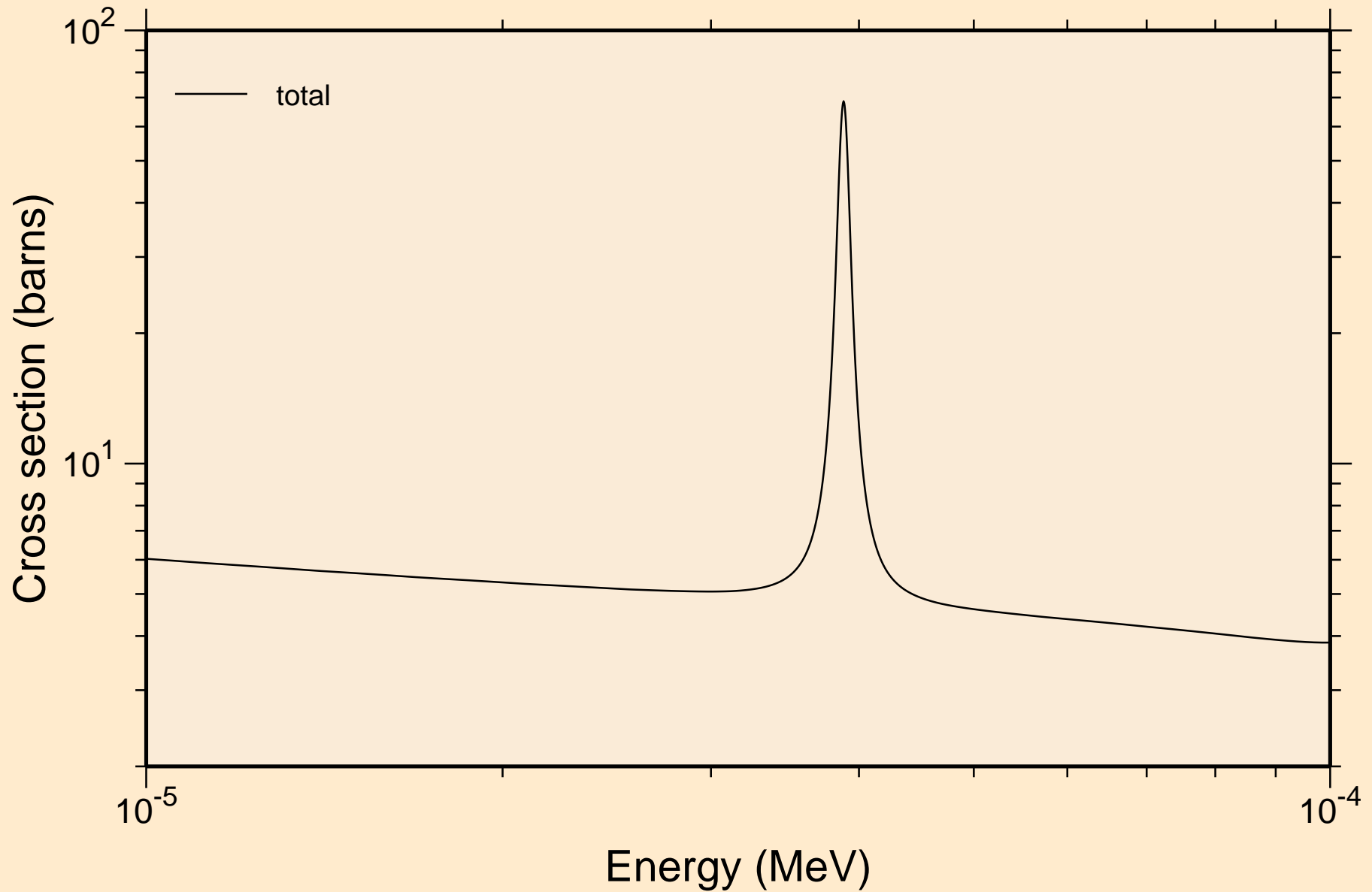

CD100 NEUTRON ACER TENDL-2021 LIBRARY; T=293.6K
resonance total cross section

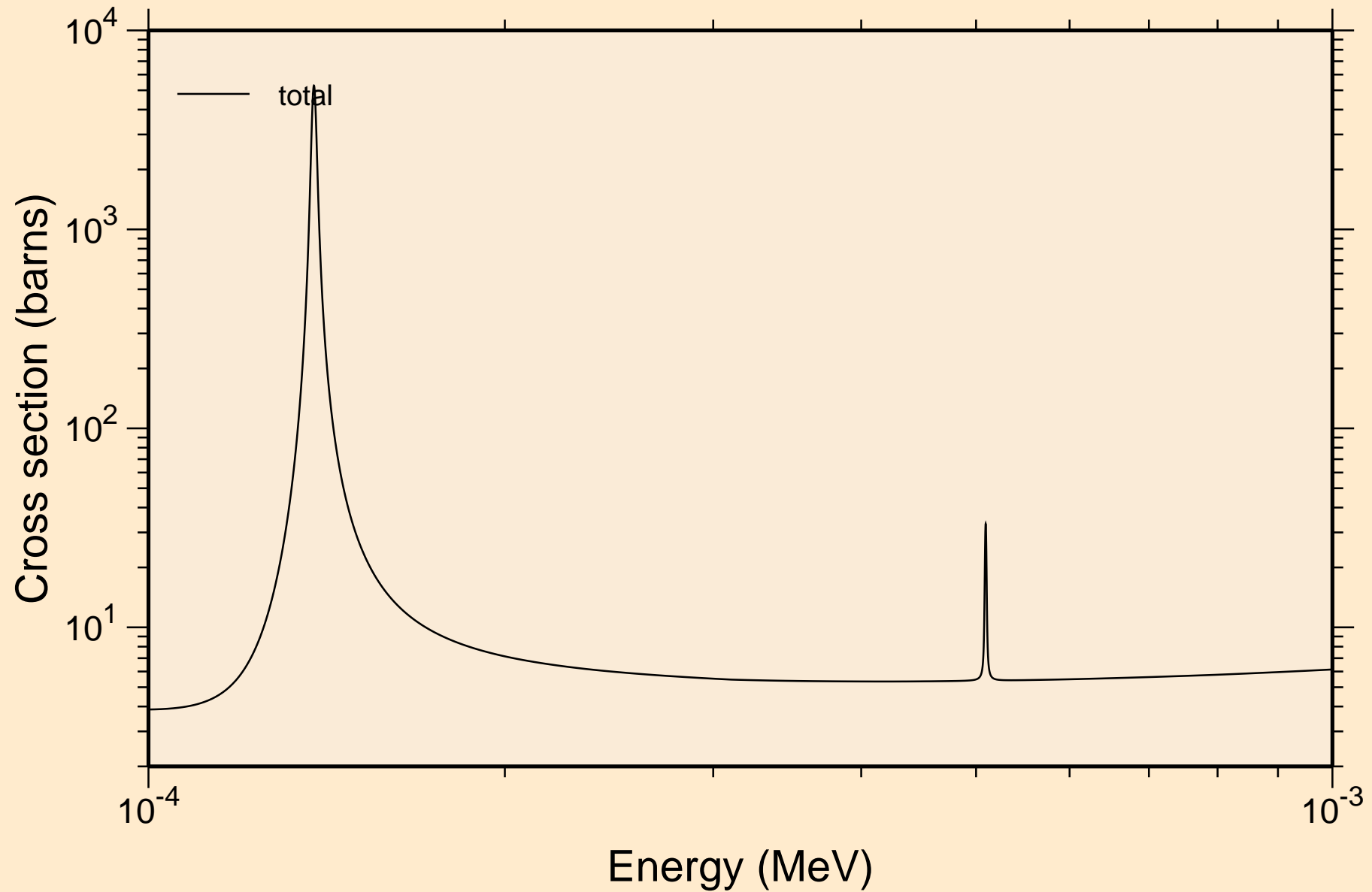

CD100 NEUTRON ACER TENDL-2021 LIBRARY; T=293.6K
resonance total cross section

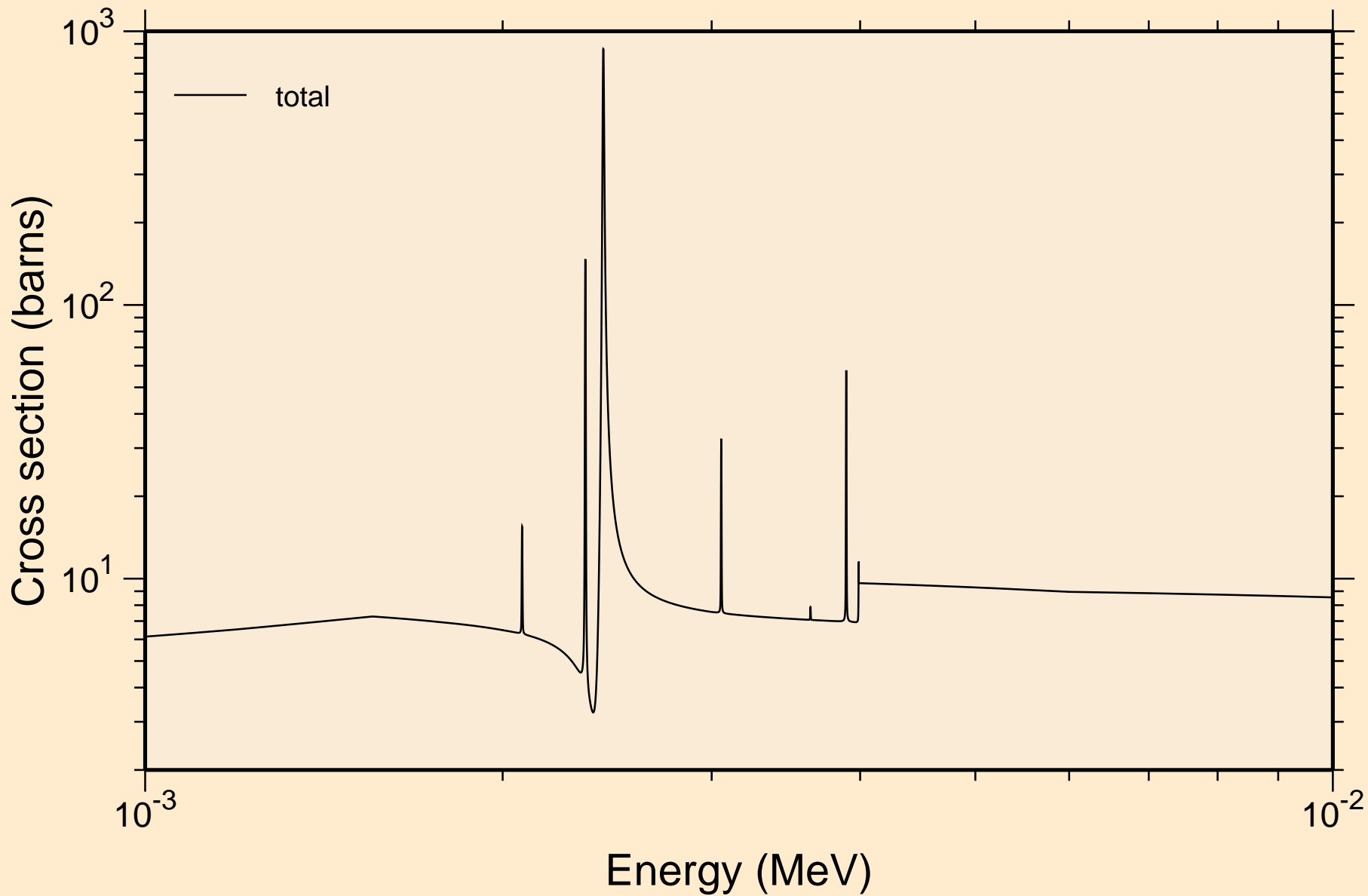

CD100 NEUTRON ACER TENDL-2021 LIBRARY; T=293.6K
resonance total cross section

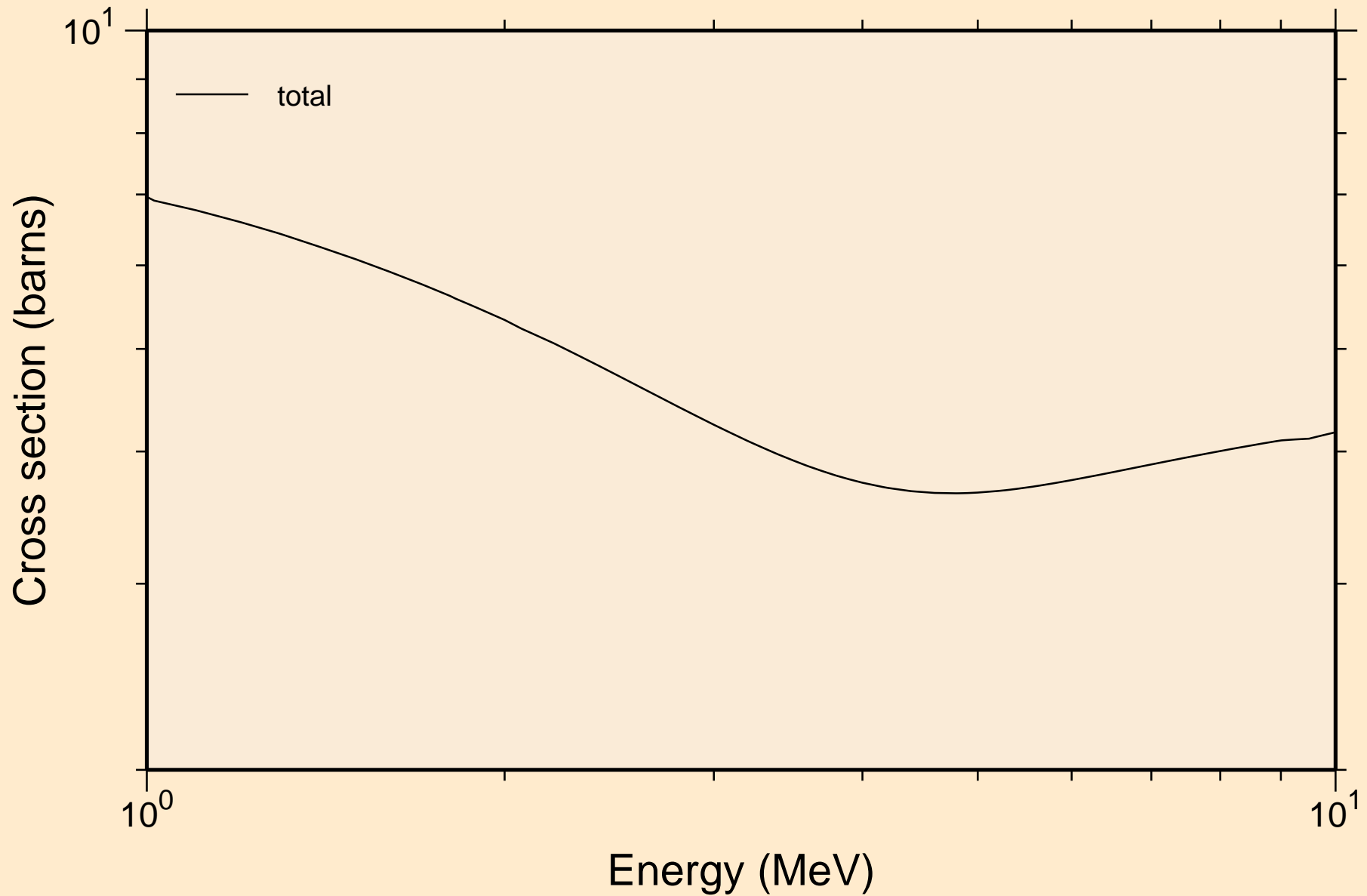

CD100 NEUTRON ACER TENDL-2021 LIBRARY; T=293.6K
resonance absorption cross sections

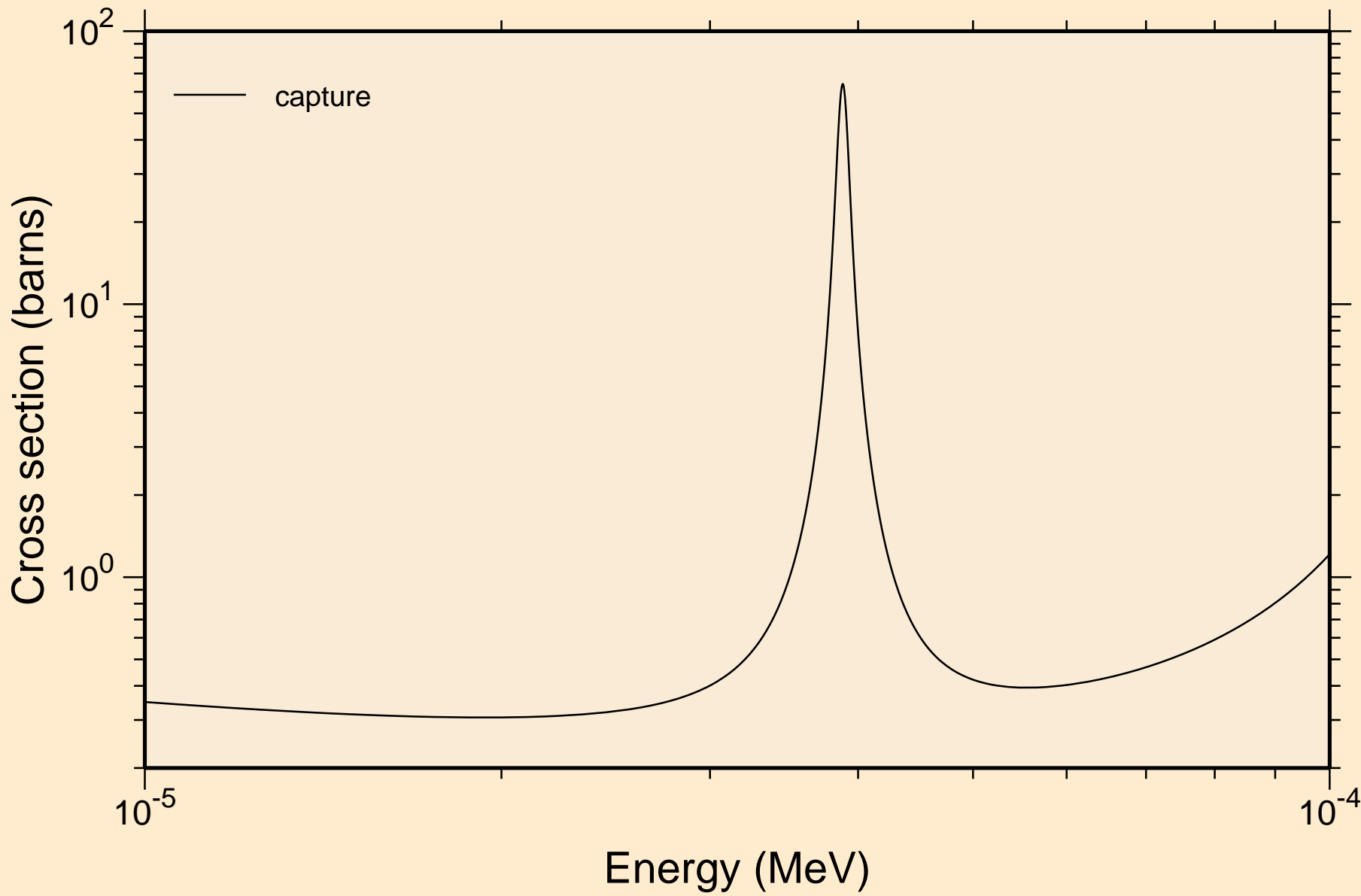

CD100 NEUTRON ACER TENDL-2021 LIBRARY; T=293.6K
resonance absorption cross sections

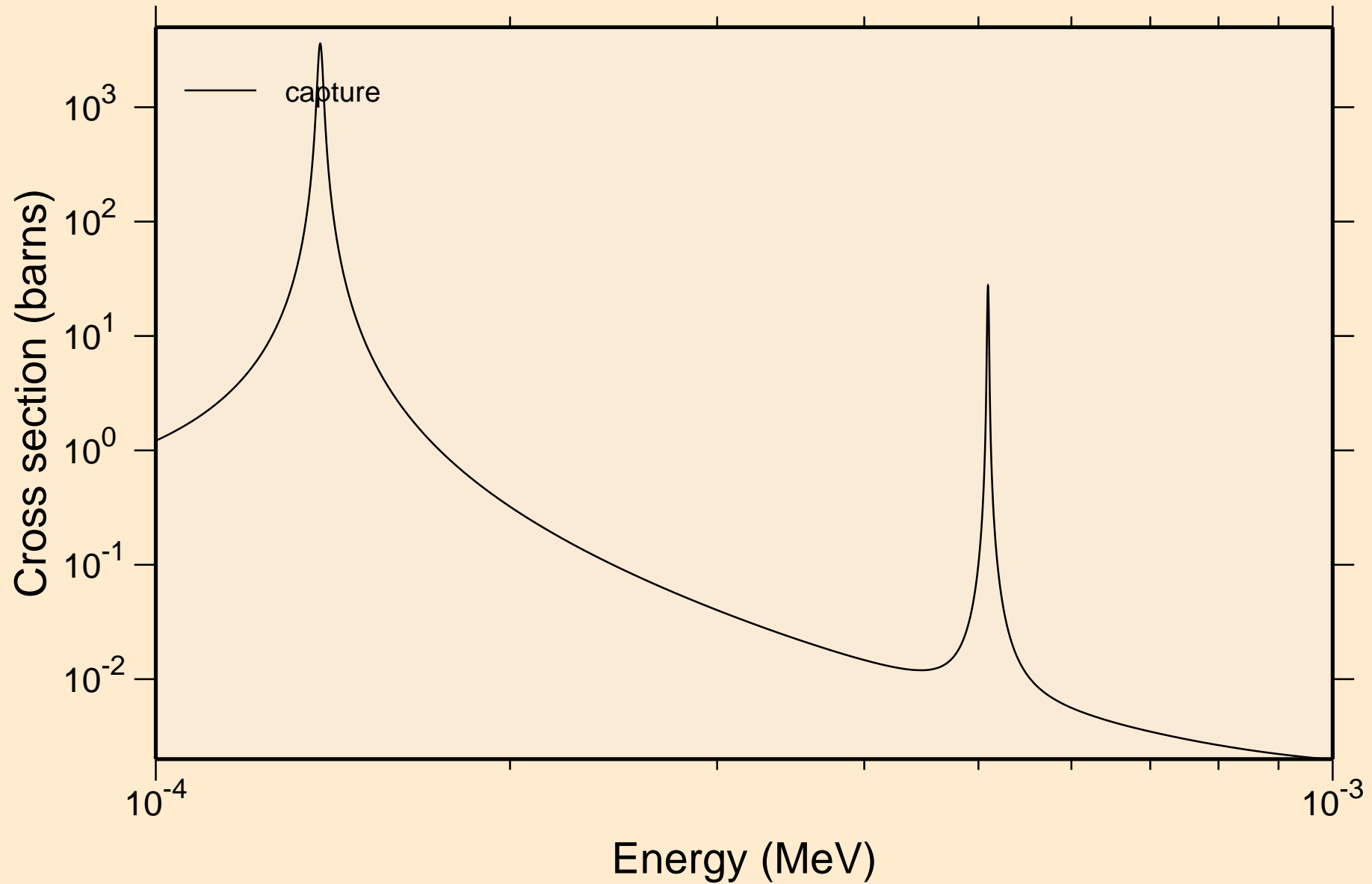

CD100 NEUTRON ACER TENDL-2021 LIBRARY; T=293.6K
resonance absorption cross sections

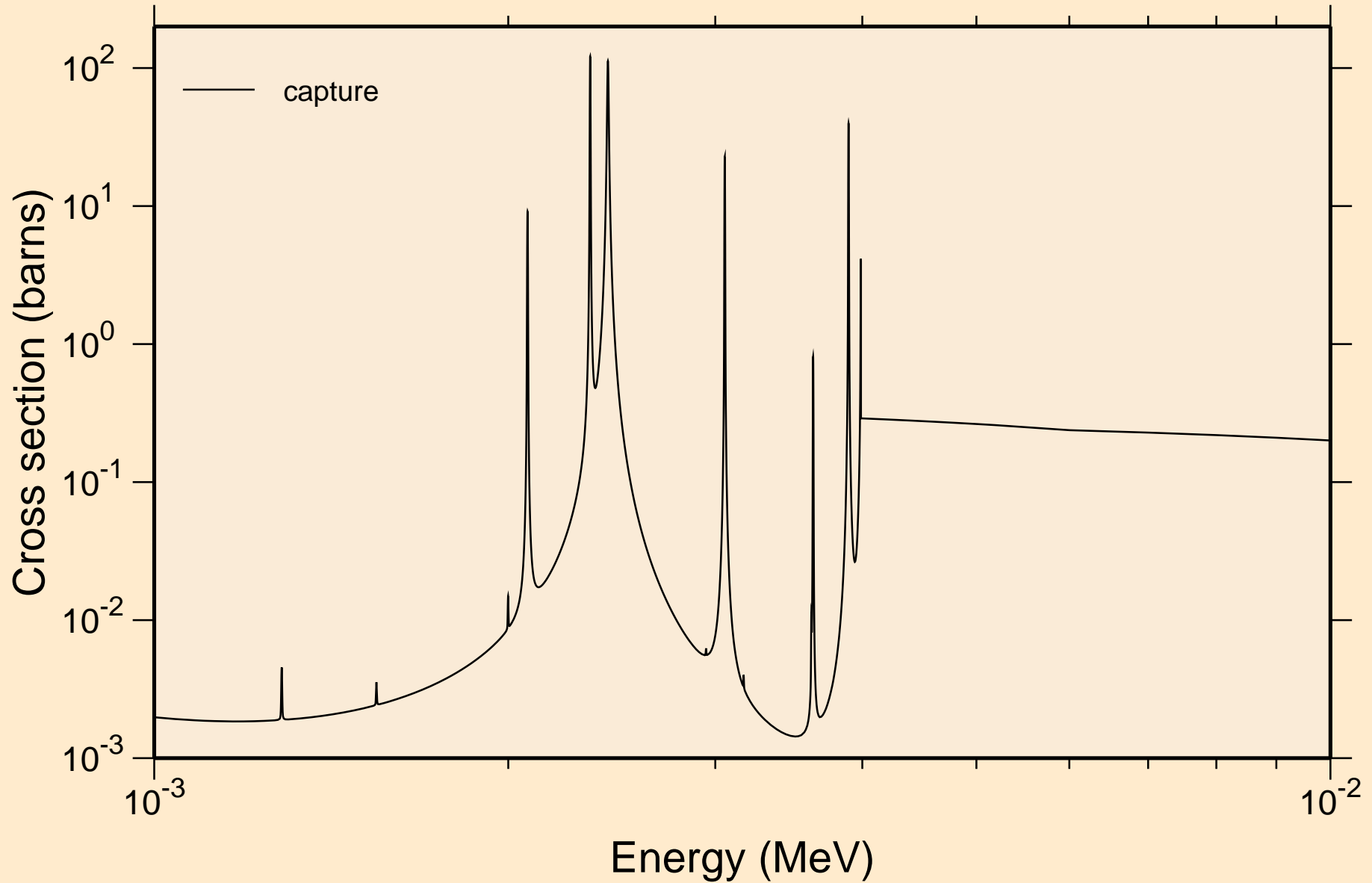

CD100 NEUTRON ACER TENDL-2021 LIBRARY; T=293.6K
resonance absorption cross sections

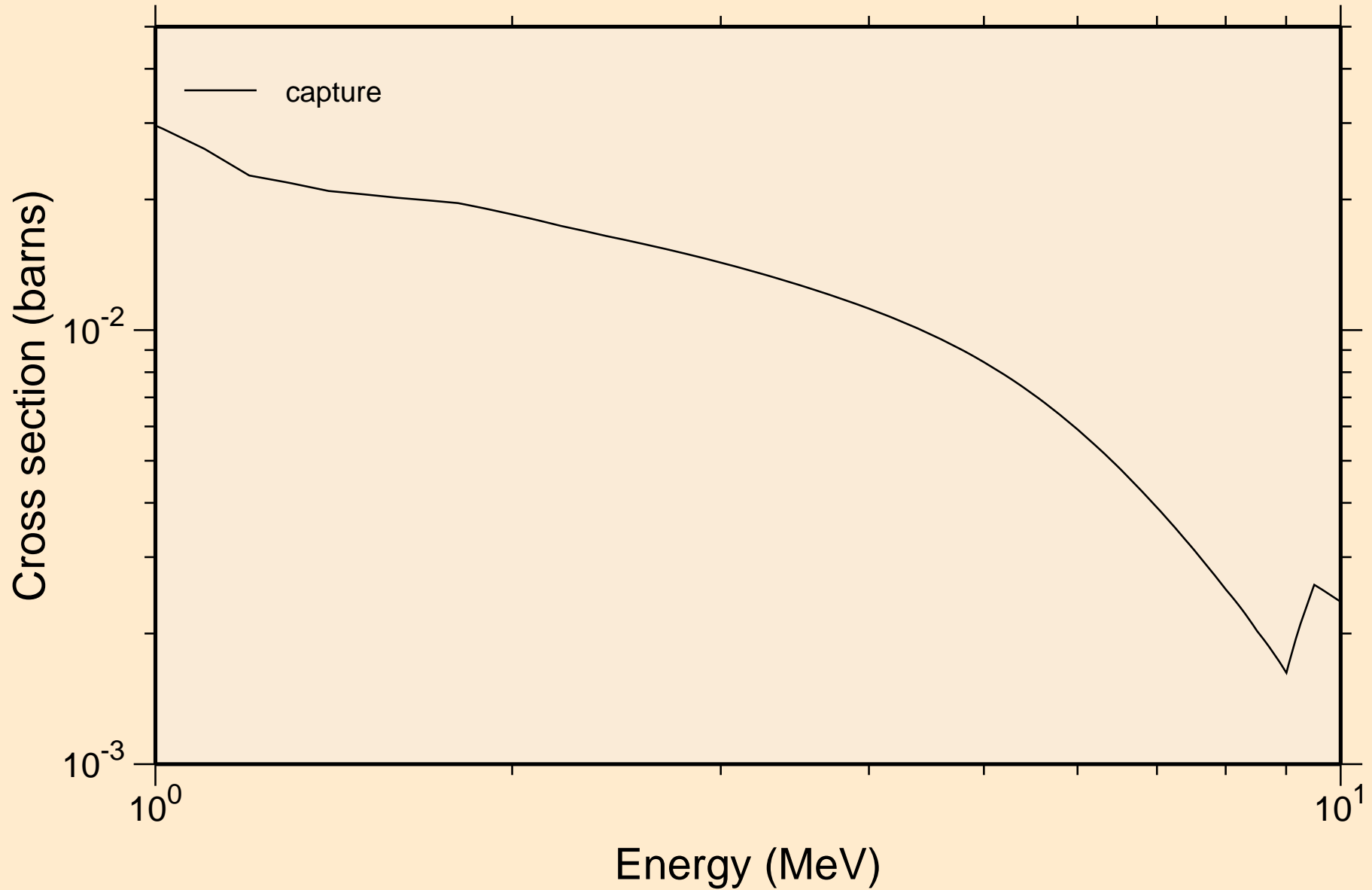

CD100 NEUTRON ACER TENDL-2021 LIBRARY; T=293.6K
Heating

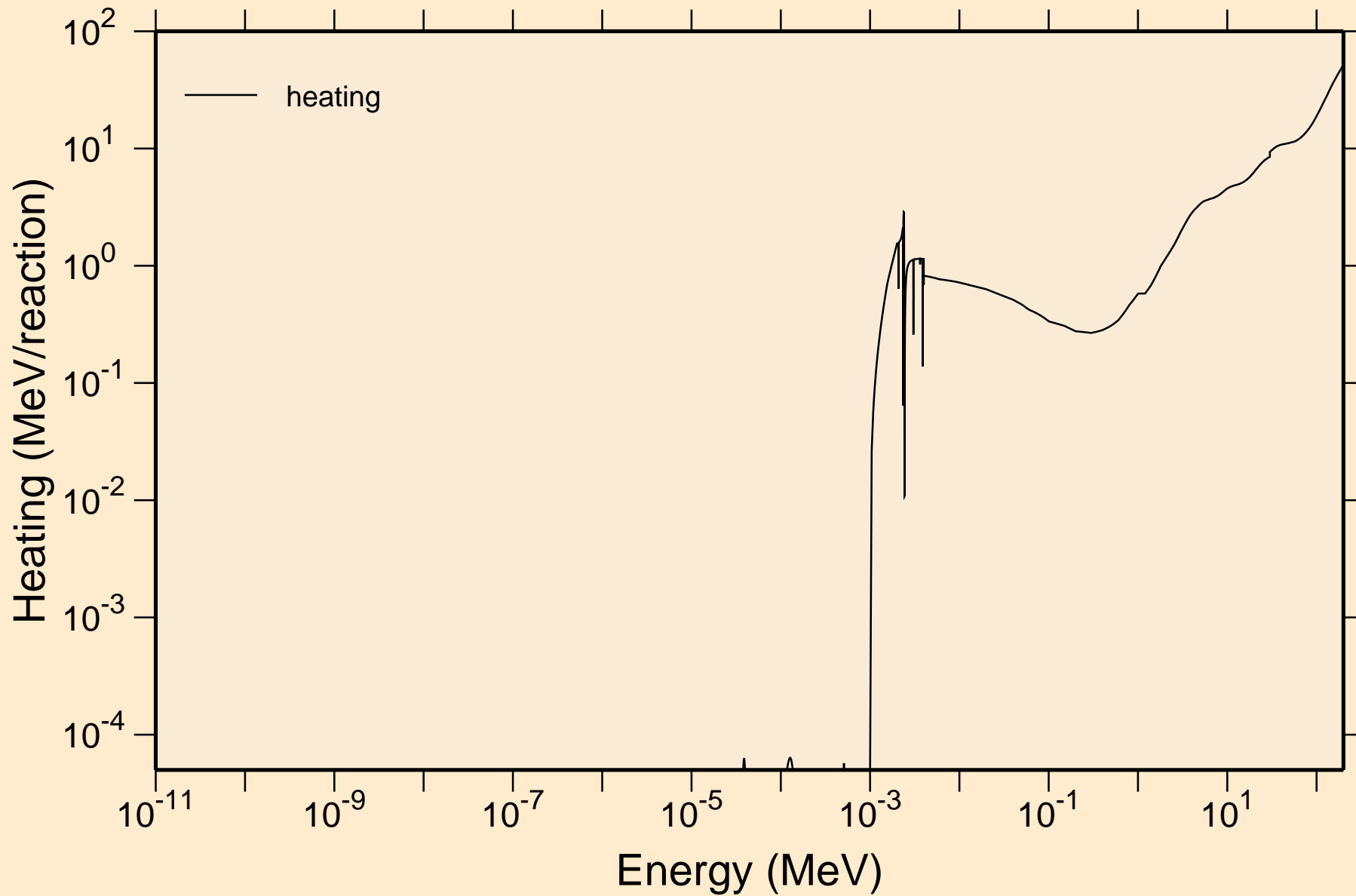

CD100 NEUTRON ACER TENDL-2021 LIBRARY; T=293.6K
Damage

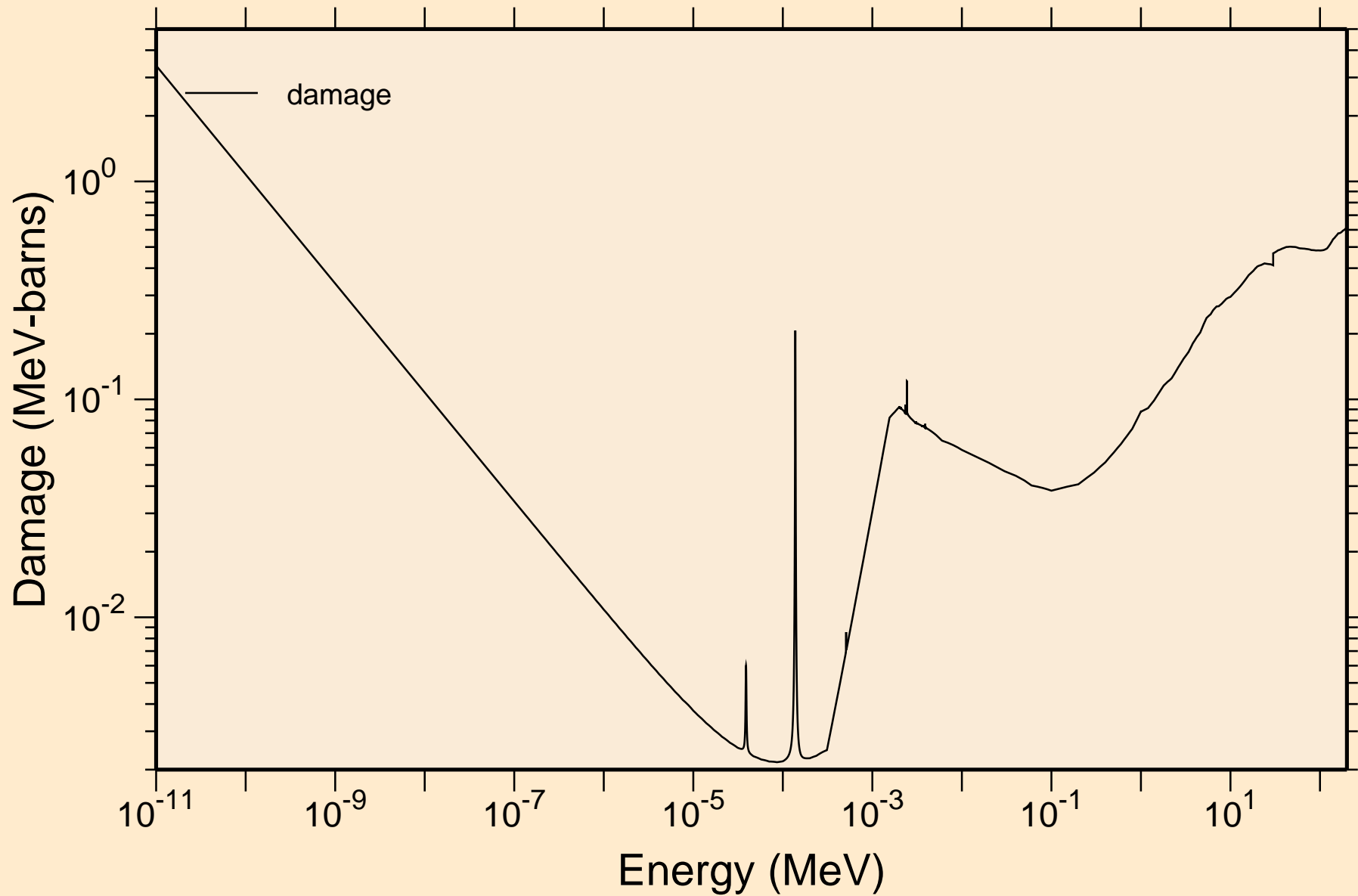

CD100 NEUTRON ACER TENDL-2021 LIBRARY; T=293.6K

Non-threshold reactions

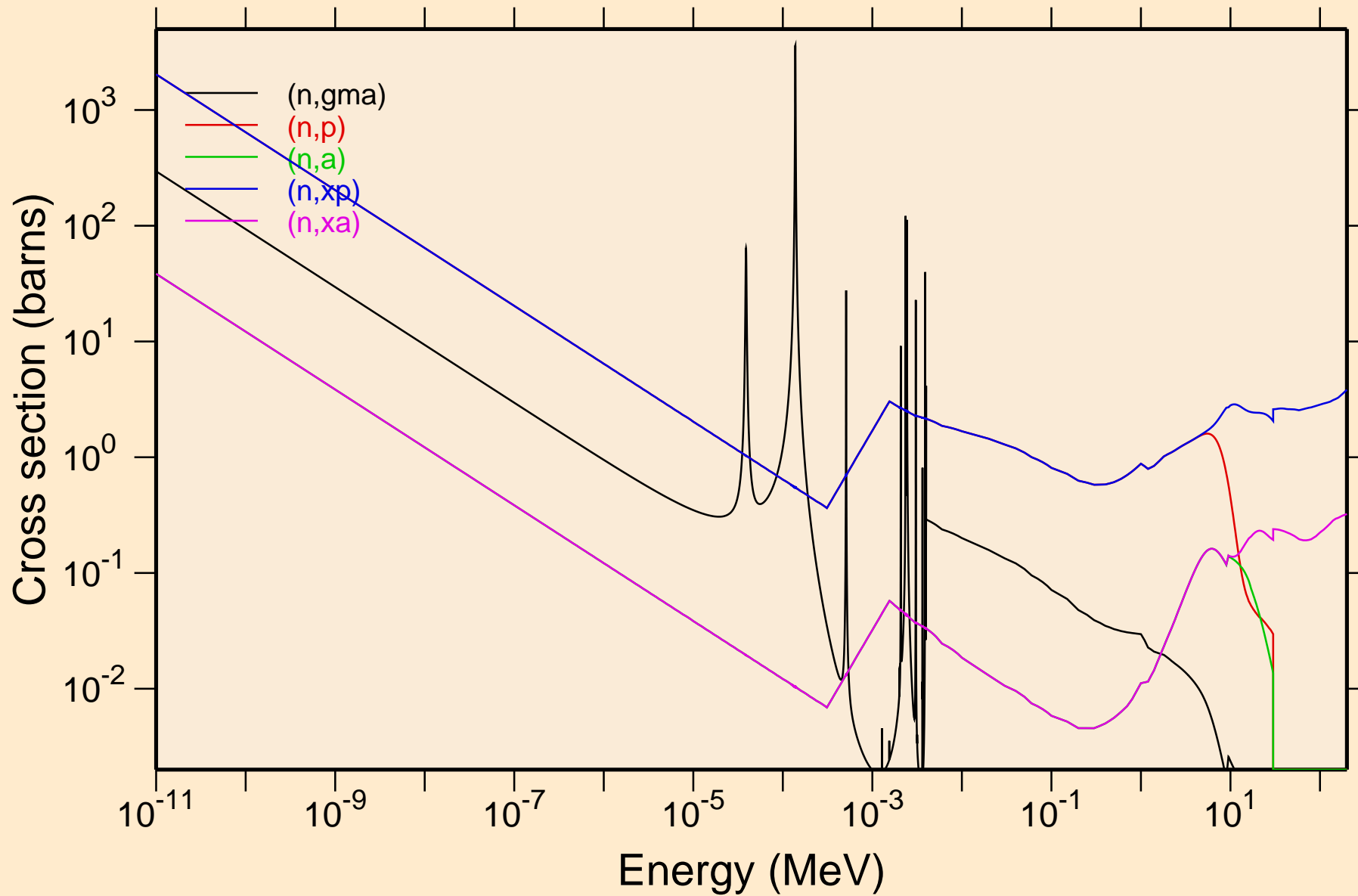

CD100 NEUTRON ACER TENDL-2021 LIBRARY; T=293.6K

Principal cross sections

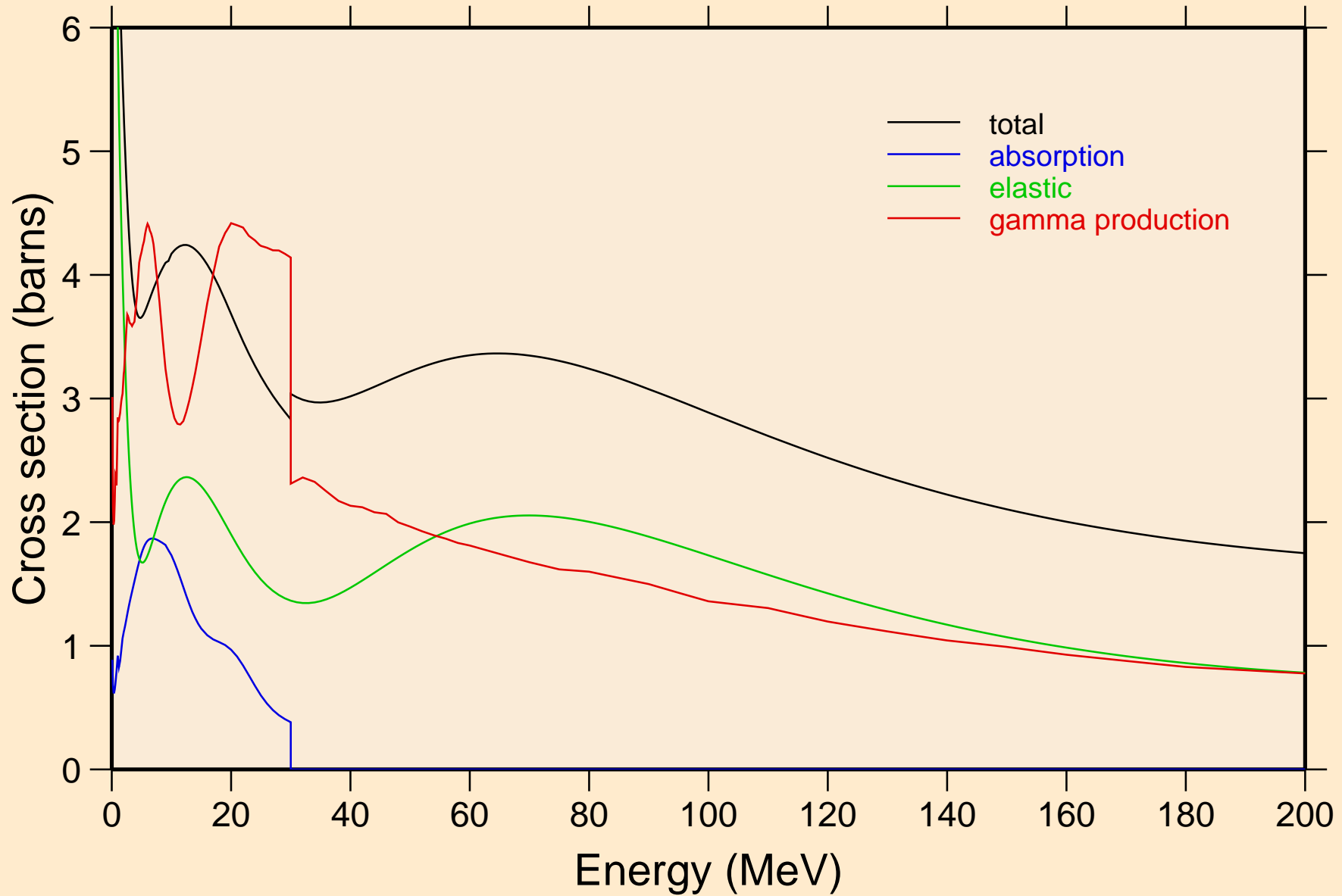

CD100 NEUTRON ACER TENDL-2021 LIBRARY; T=293.6K
Heating

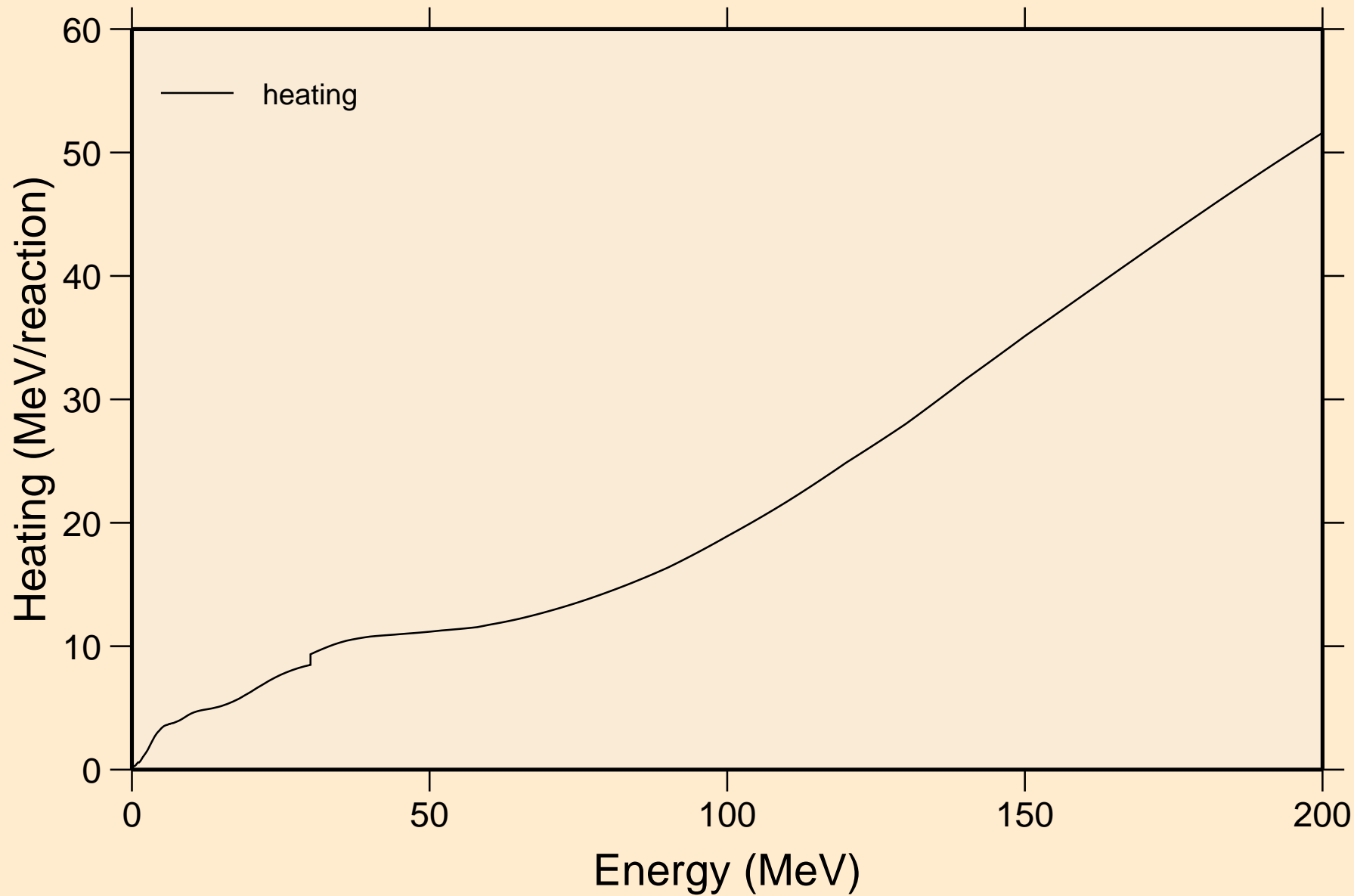

CD100 NEUTRON ACER TENDL-2021 LIBRARY; T=293.6K

Damage

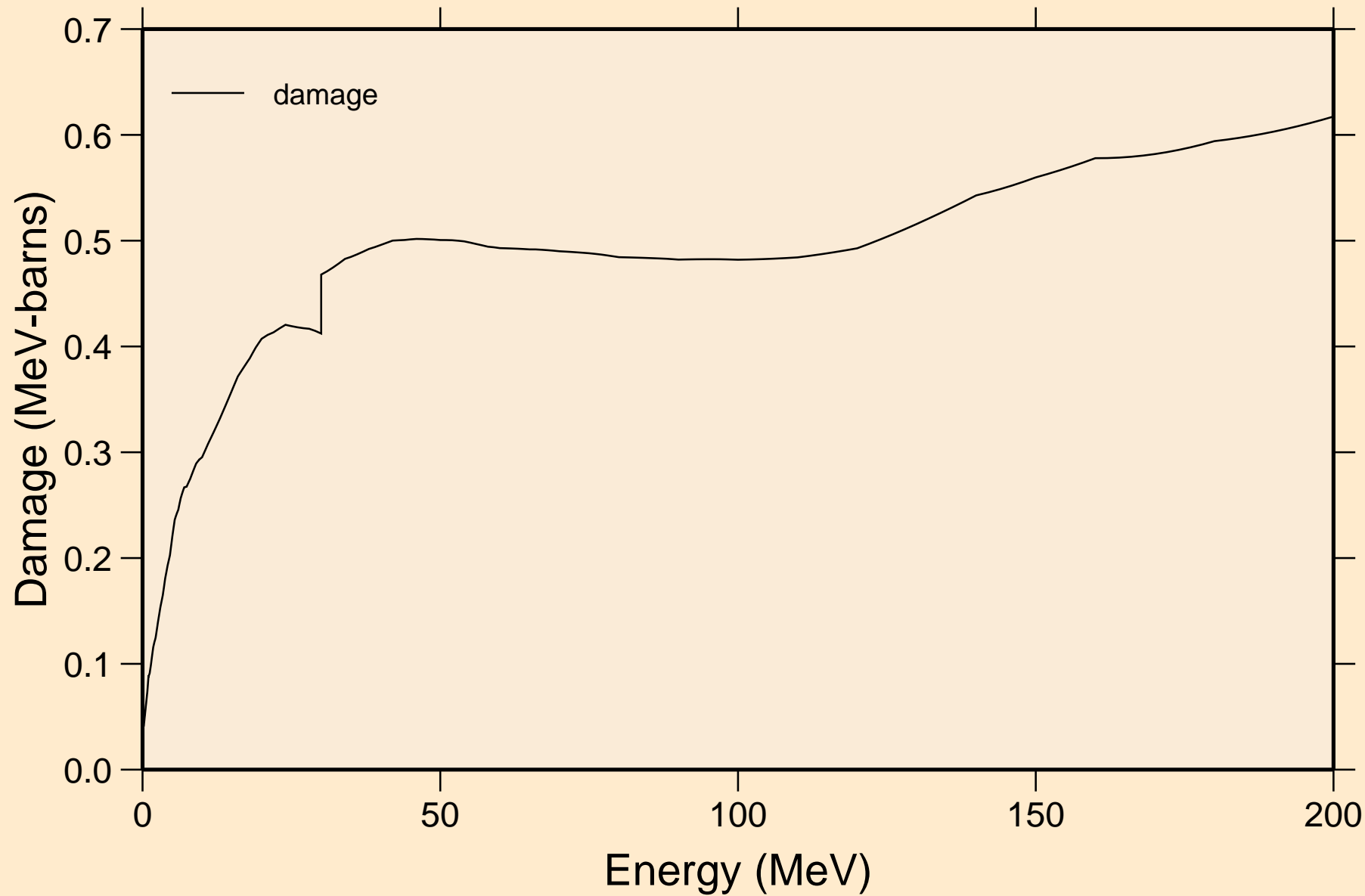

CD100 NEUTRON ACER TENDL-2021 LIBRARY; T=293.6K

Non-threshold reactions

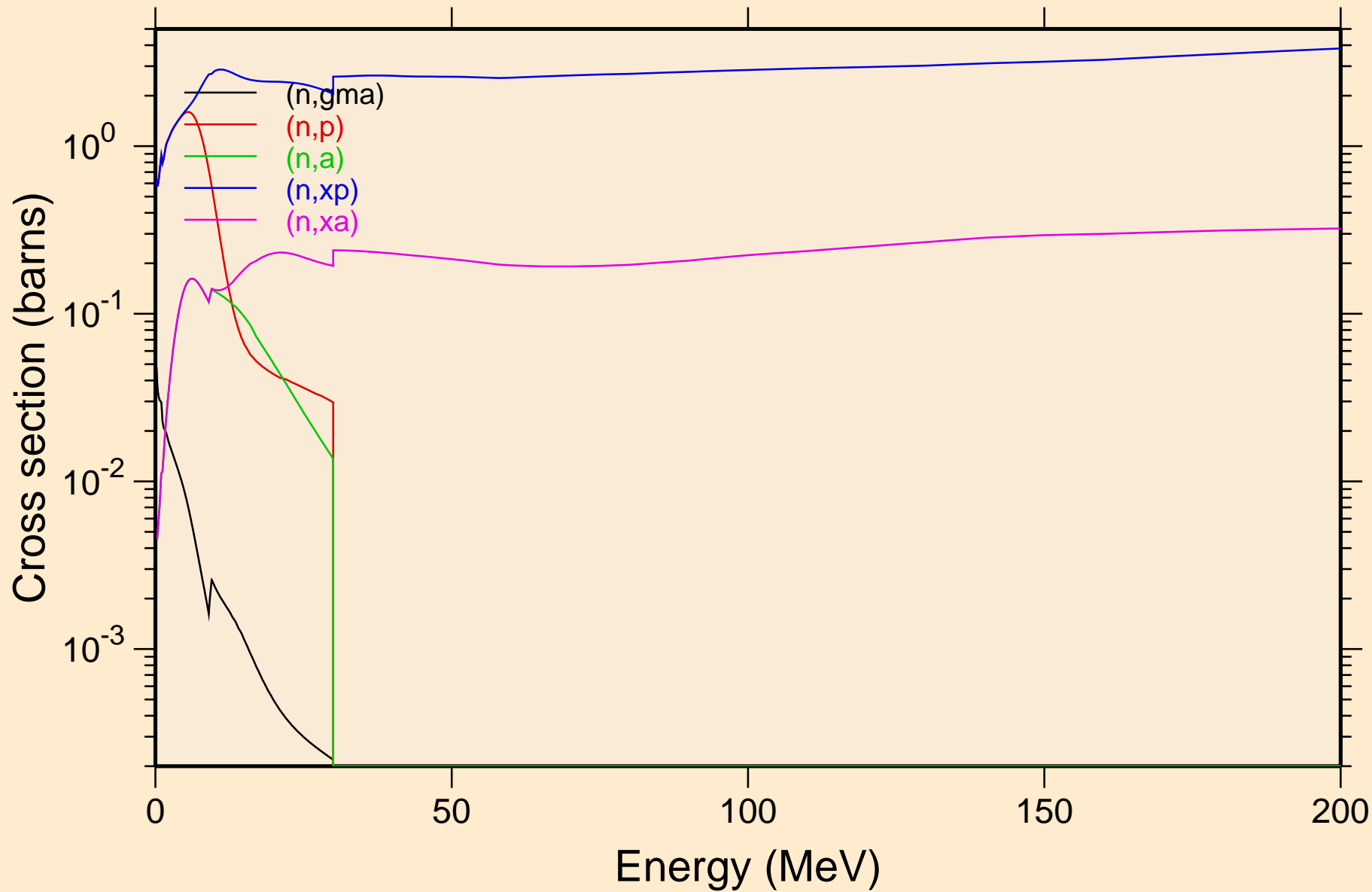

CD100 NEUTRON ACER TENDL-2021 LIBRARY; T=293.6K
Inelastic levels

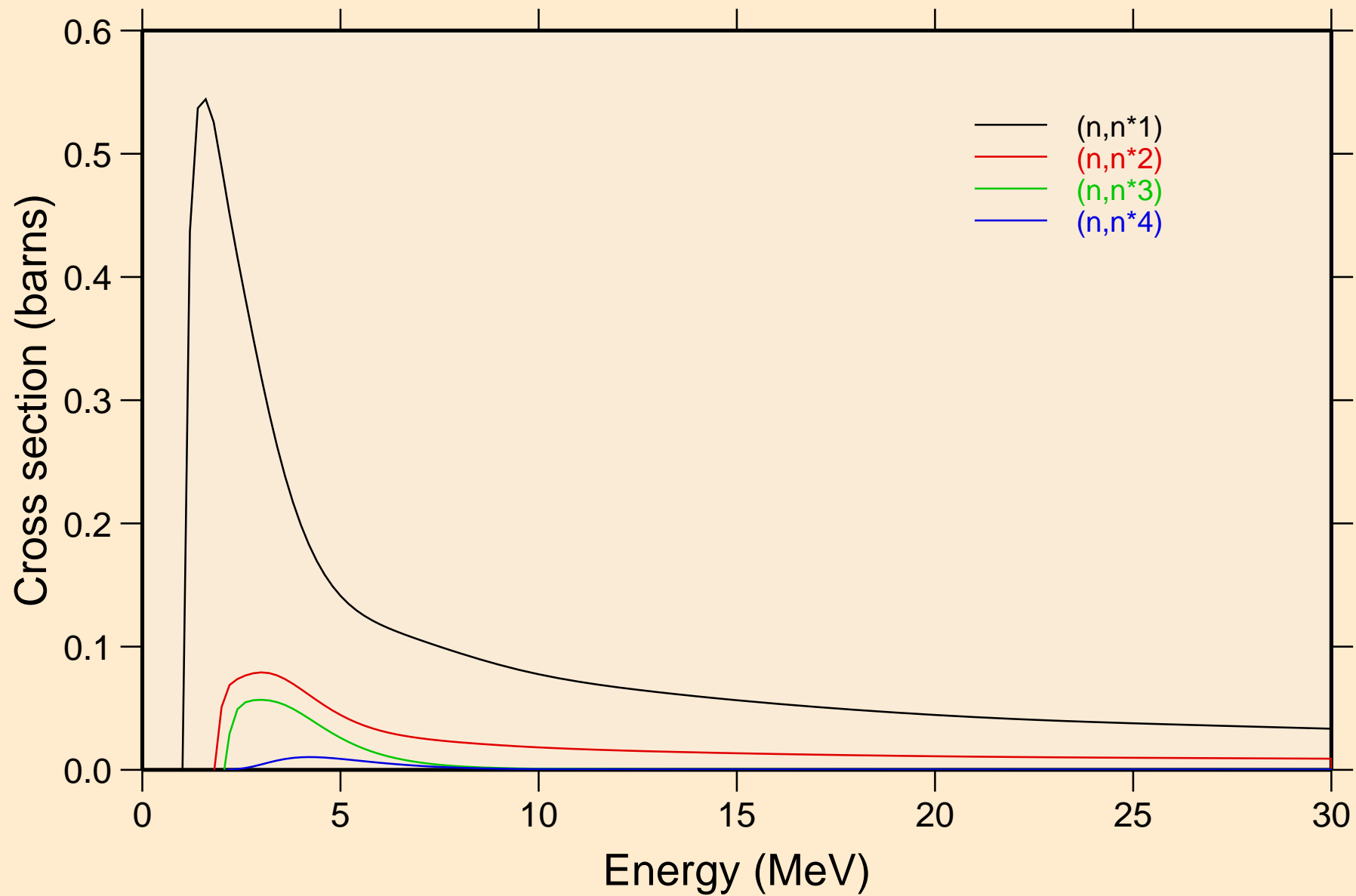

CD100 NEUTRON ACER TENDL-2021 LIBRARY; T=293.6K
Threshold reactions

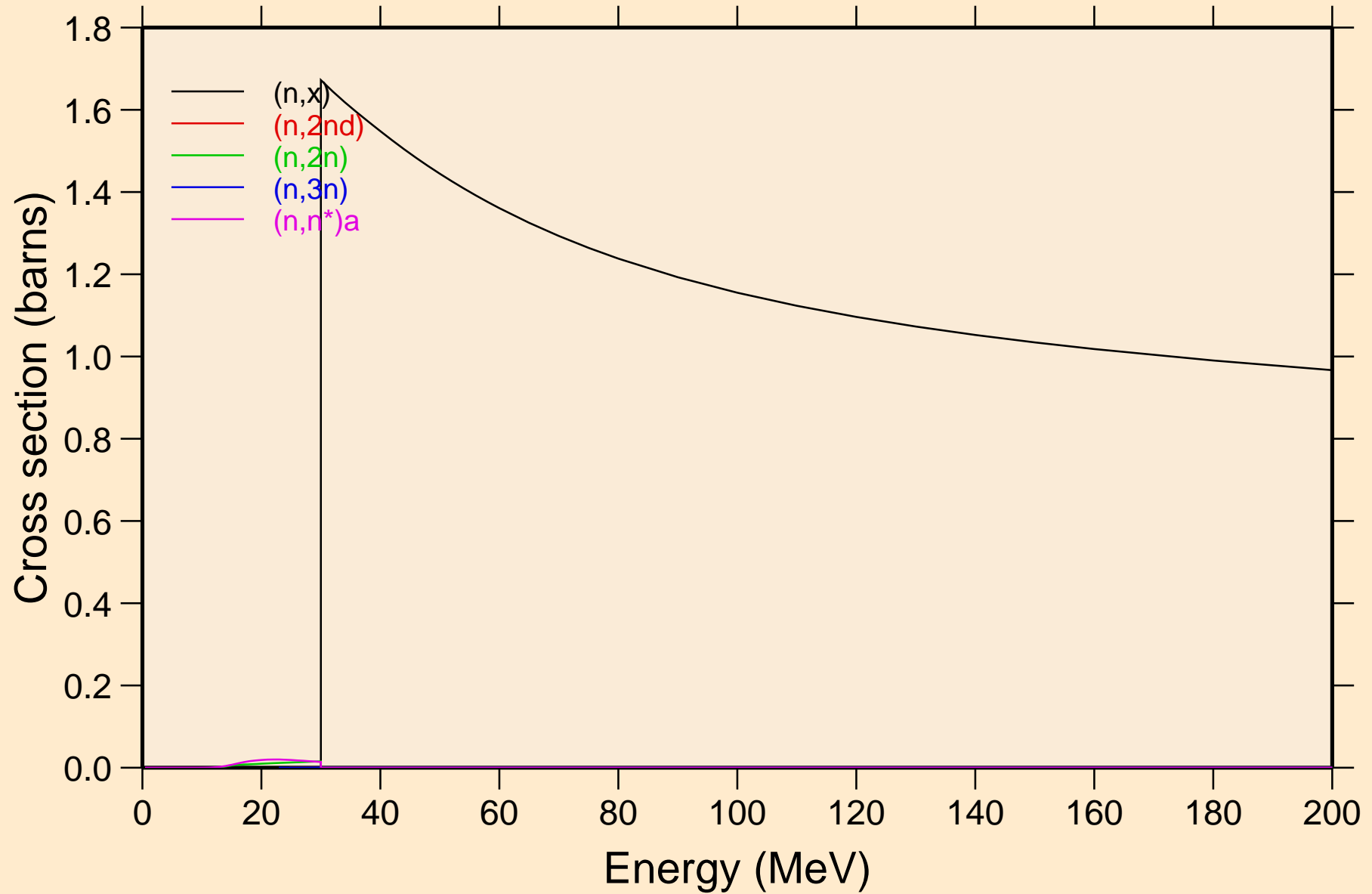

CD100 NEUTRON ACER TENDL-2021 LIBRARY; T=293.6K
Threshold reactions

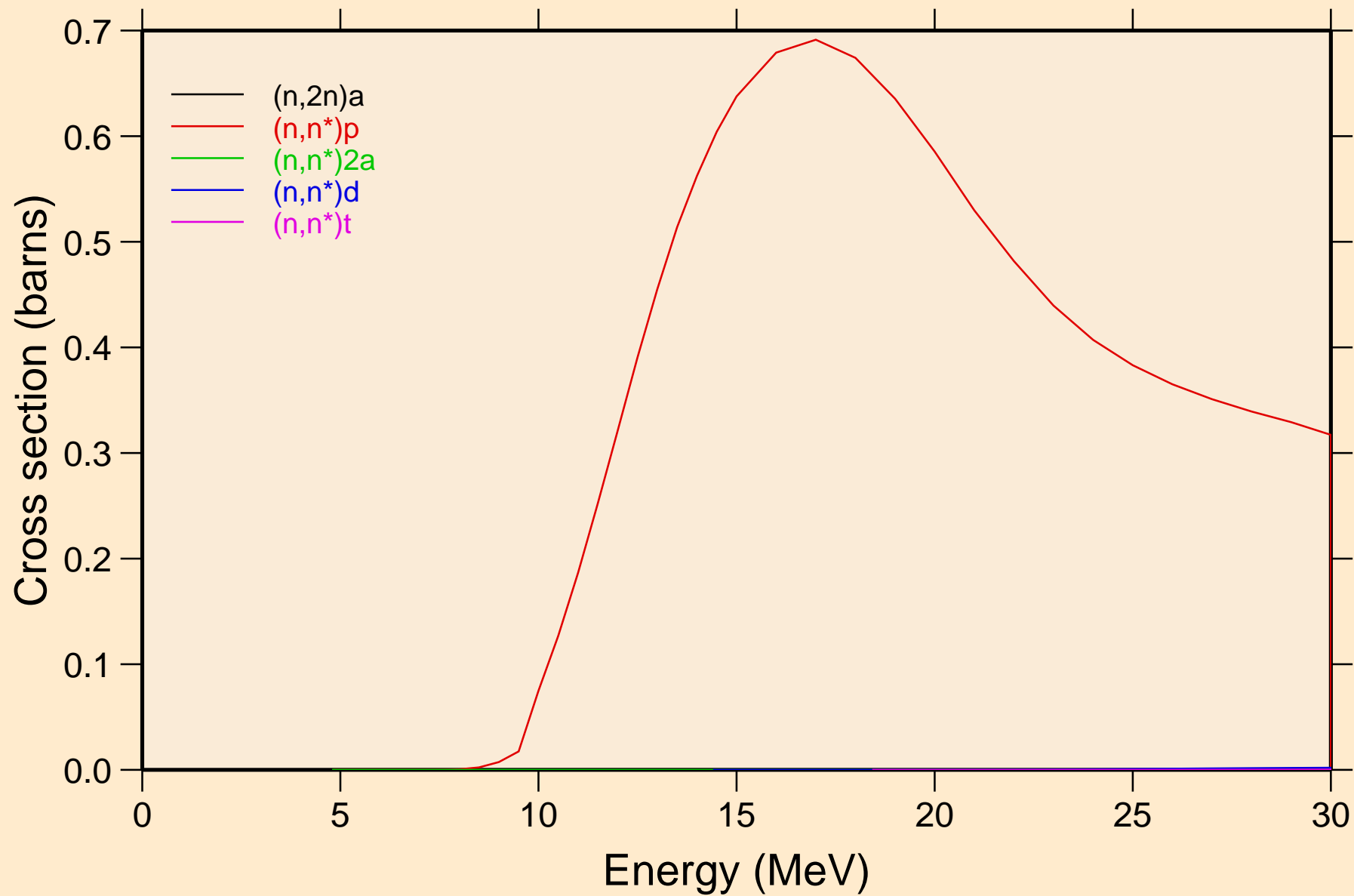

CD100 NEUTRON ACER TENDL-2021 LIBRARY; T=293.6K
Threshold reactions

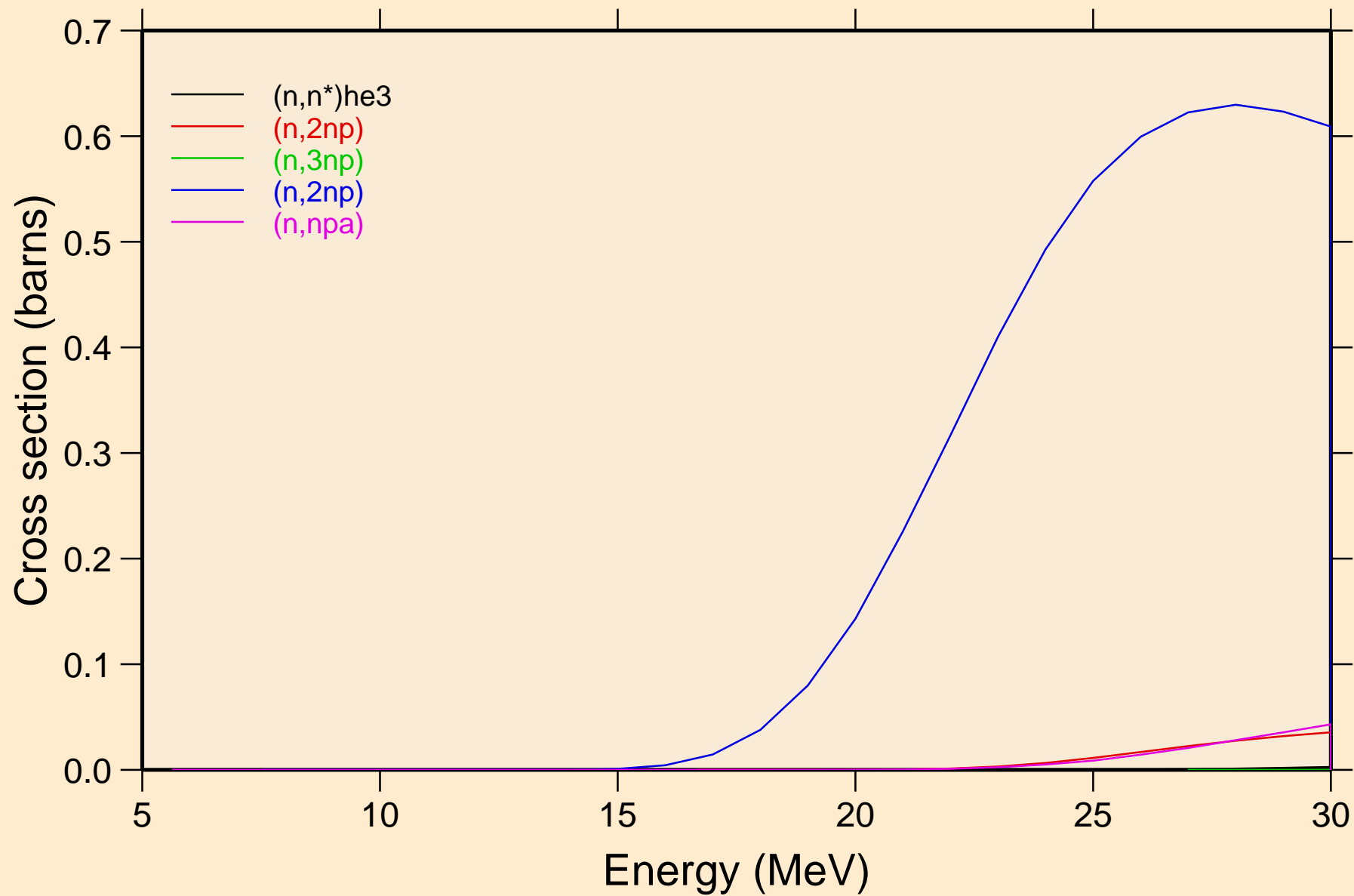

CD100 NEUTRON ACER TENDL-2021 LIBRARY; T=293.6K

Threshold reactions

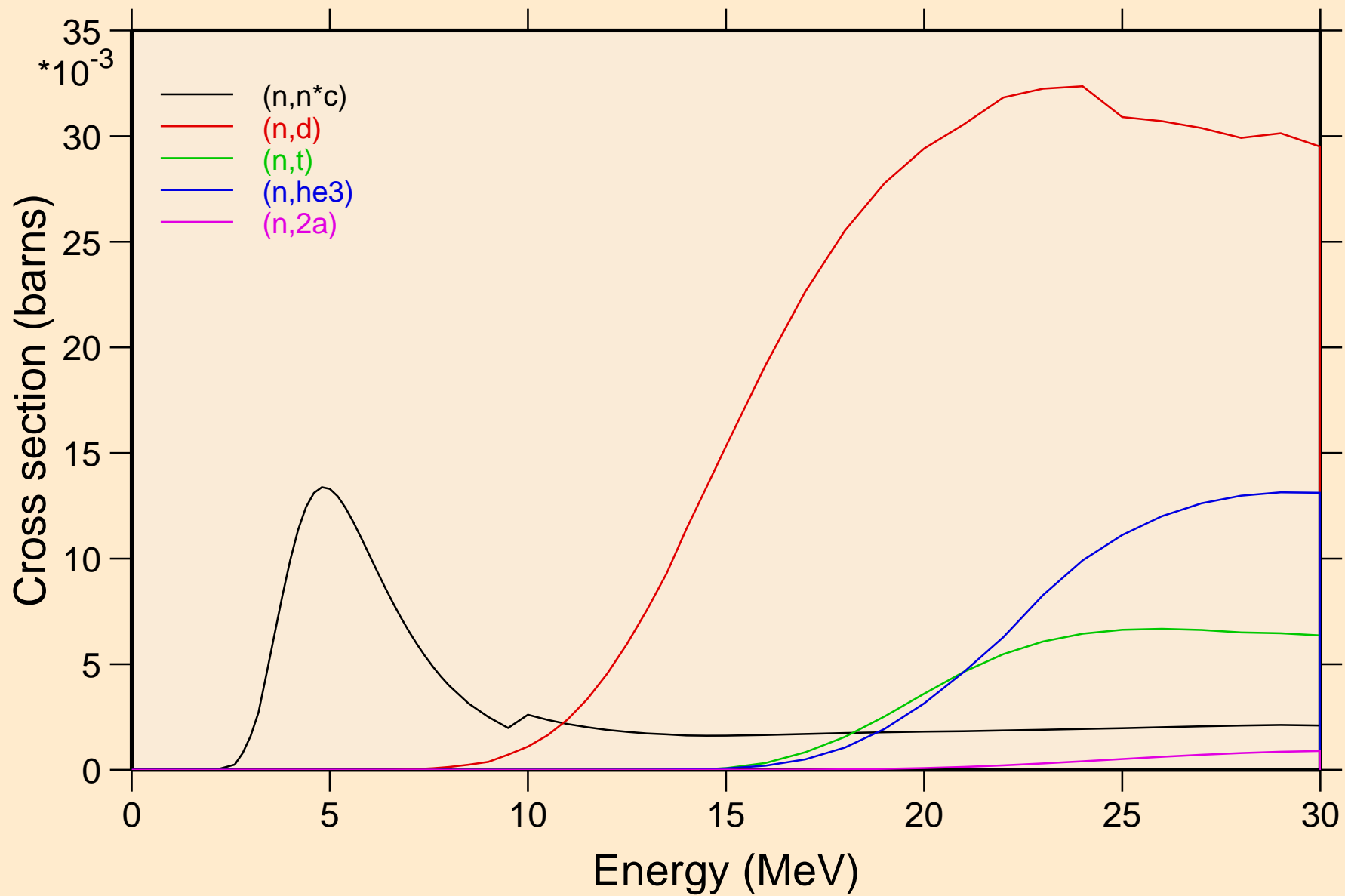

CD100 NEUTRON ACER TENDL-2021 LIBRARY; T=293.6K
Threshold reactions

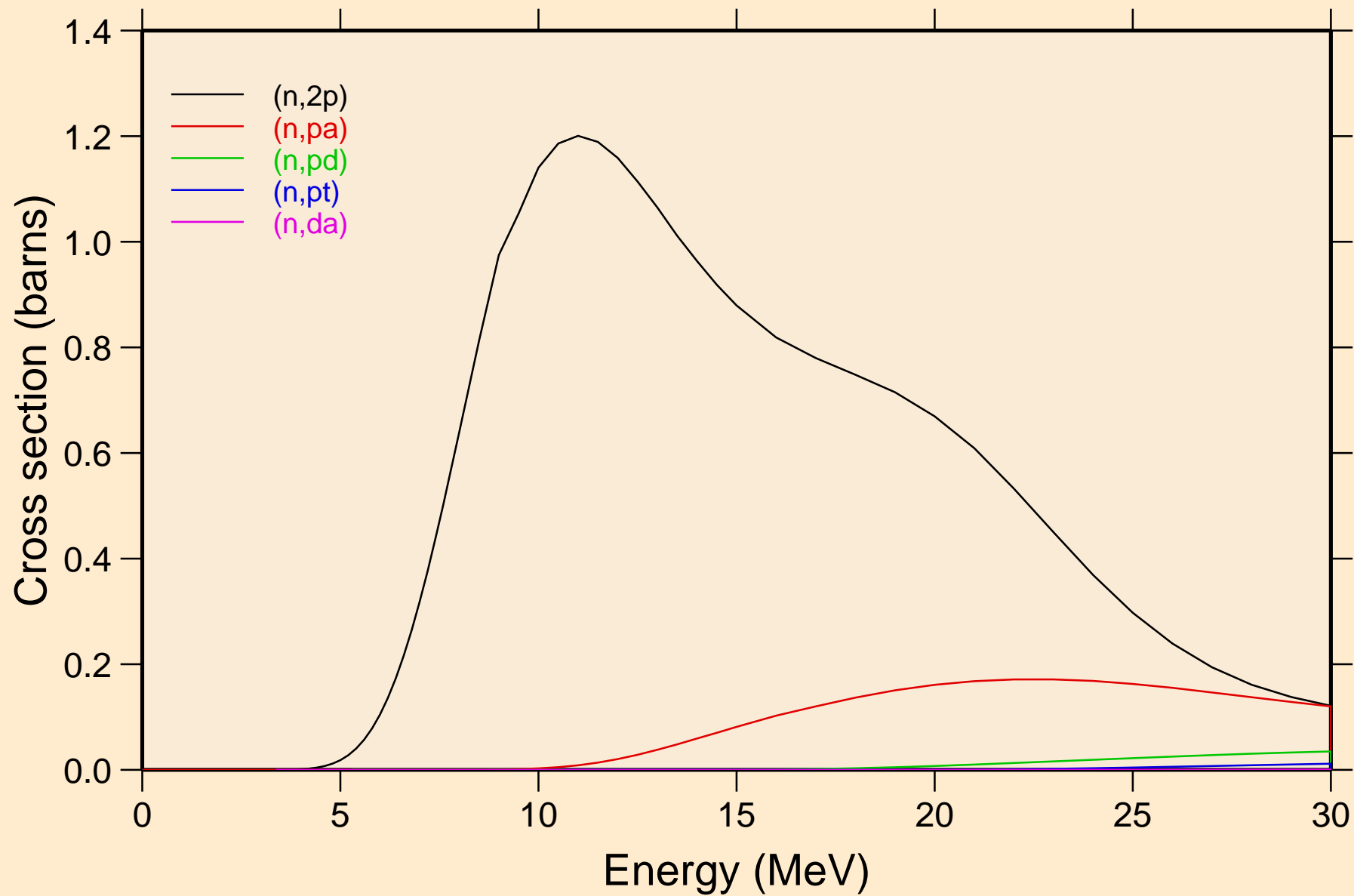

CD100 NEUTRON ACER TENDL-2021 LIBRARY; T=293.6K

Threshold reactions

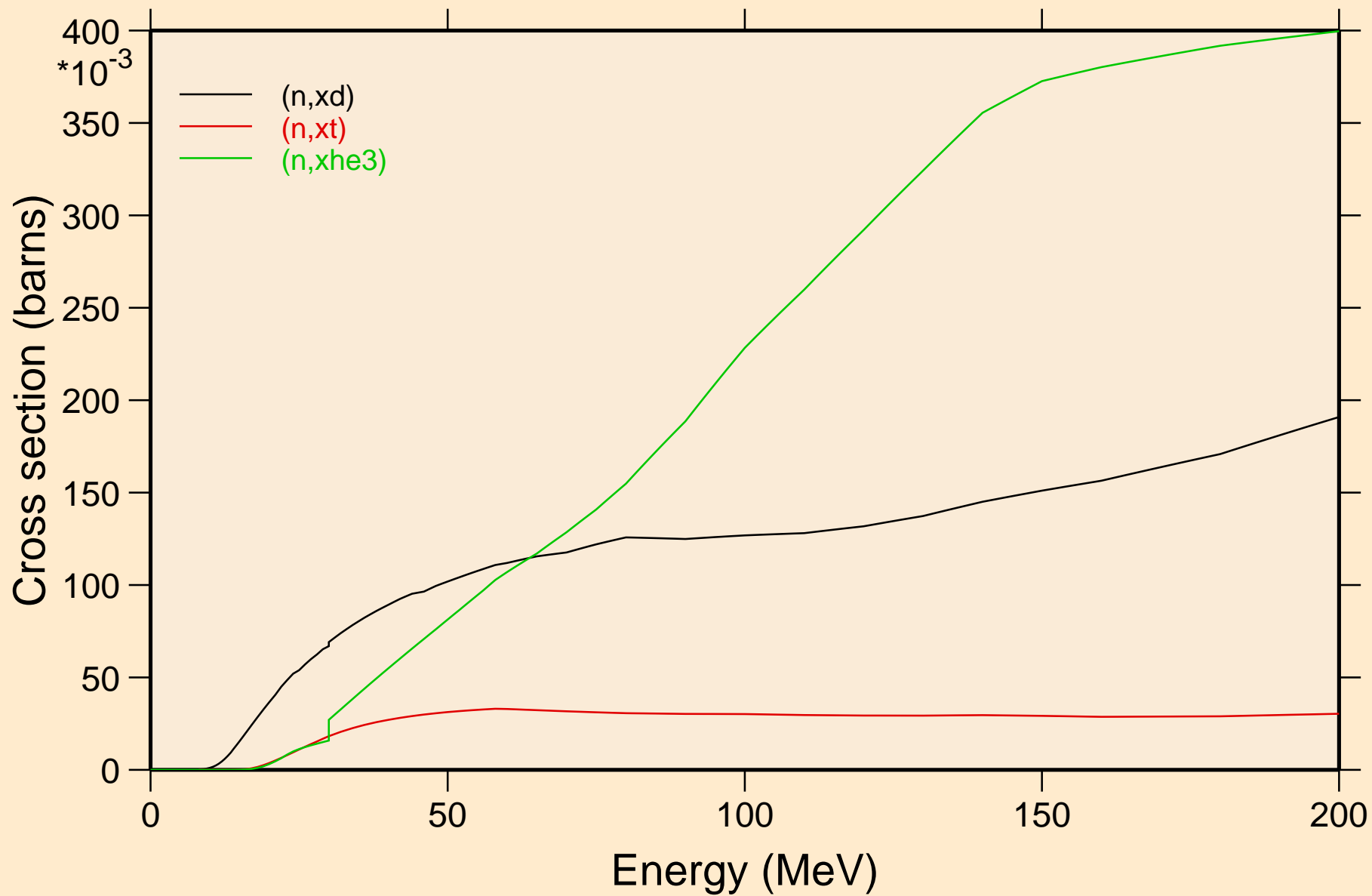

CD100 NEUTRON ACER TENDL-2021 LIBRARY; T=293.6K
angular distribution for elastic

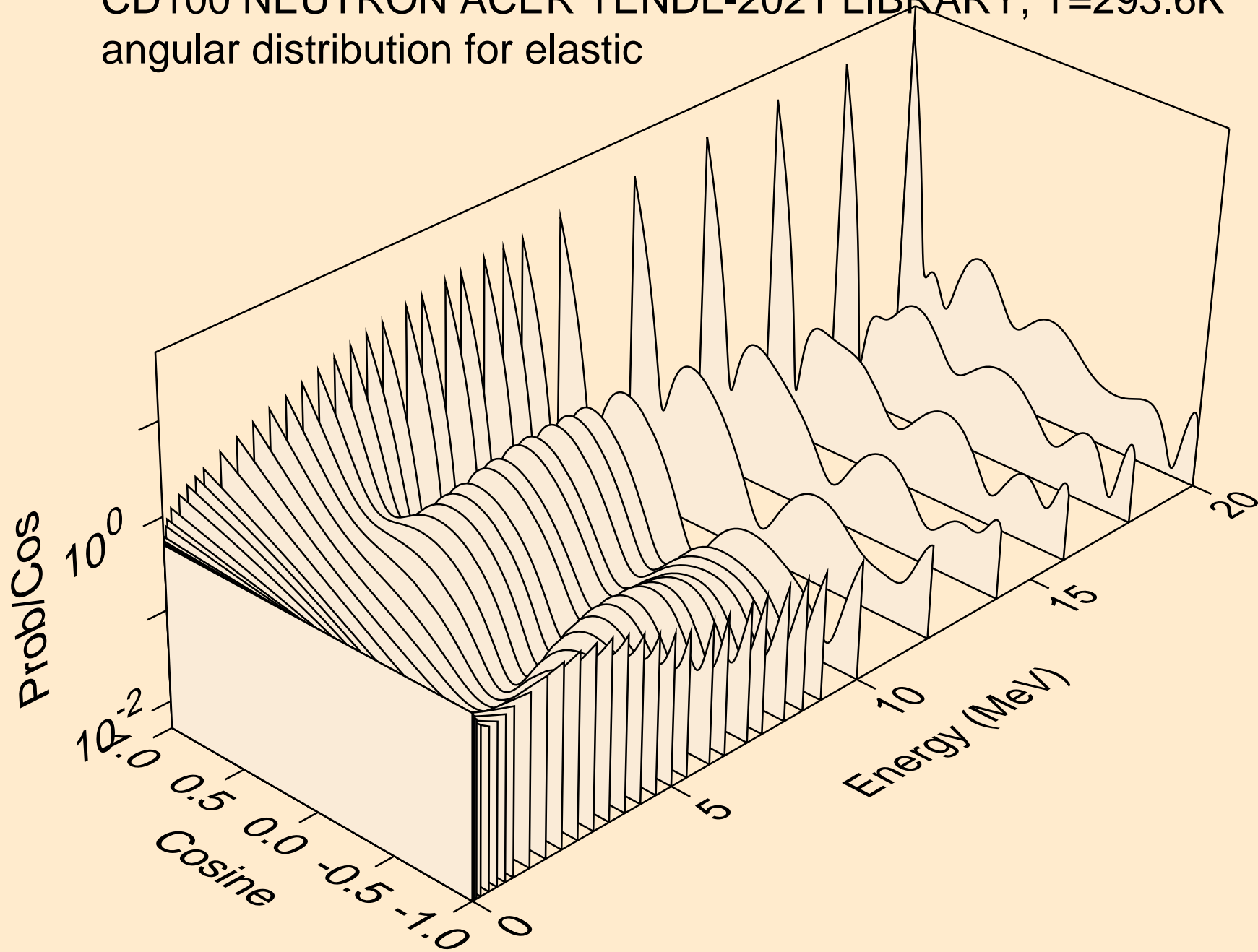

CD100 NEUTRON ACER TENDL-2021 LIBRARY; T=293.6K
angular distribution for elastic

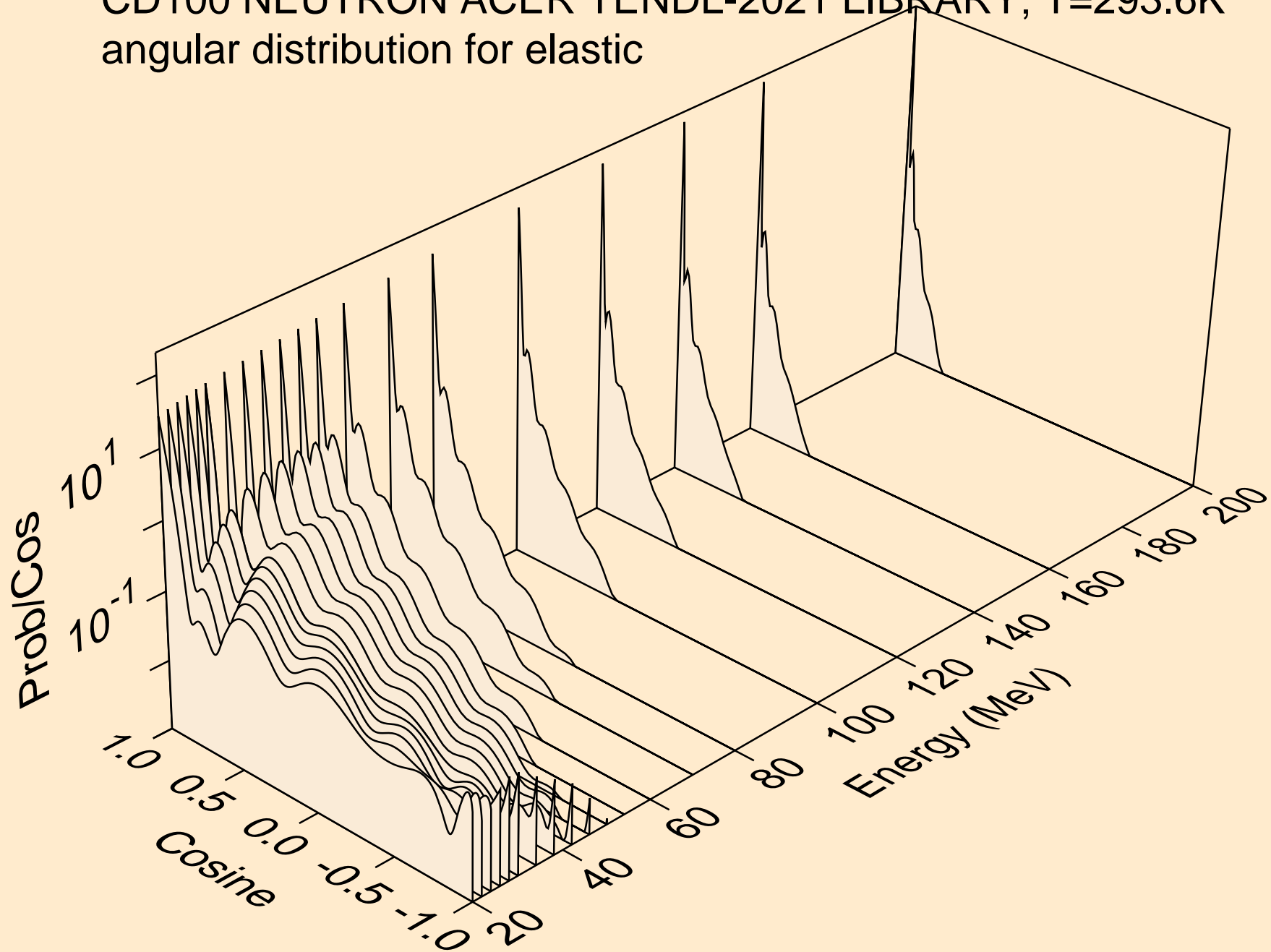

CD100 NEUTRON ACER TENDL-2021 LIBRARY; T=293.6K
angular distribution for (n,n*1)

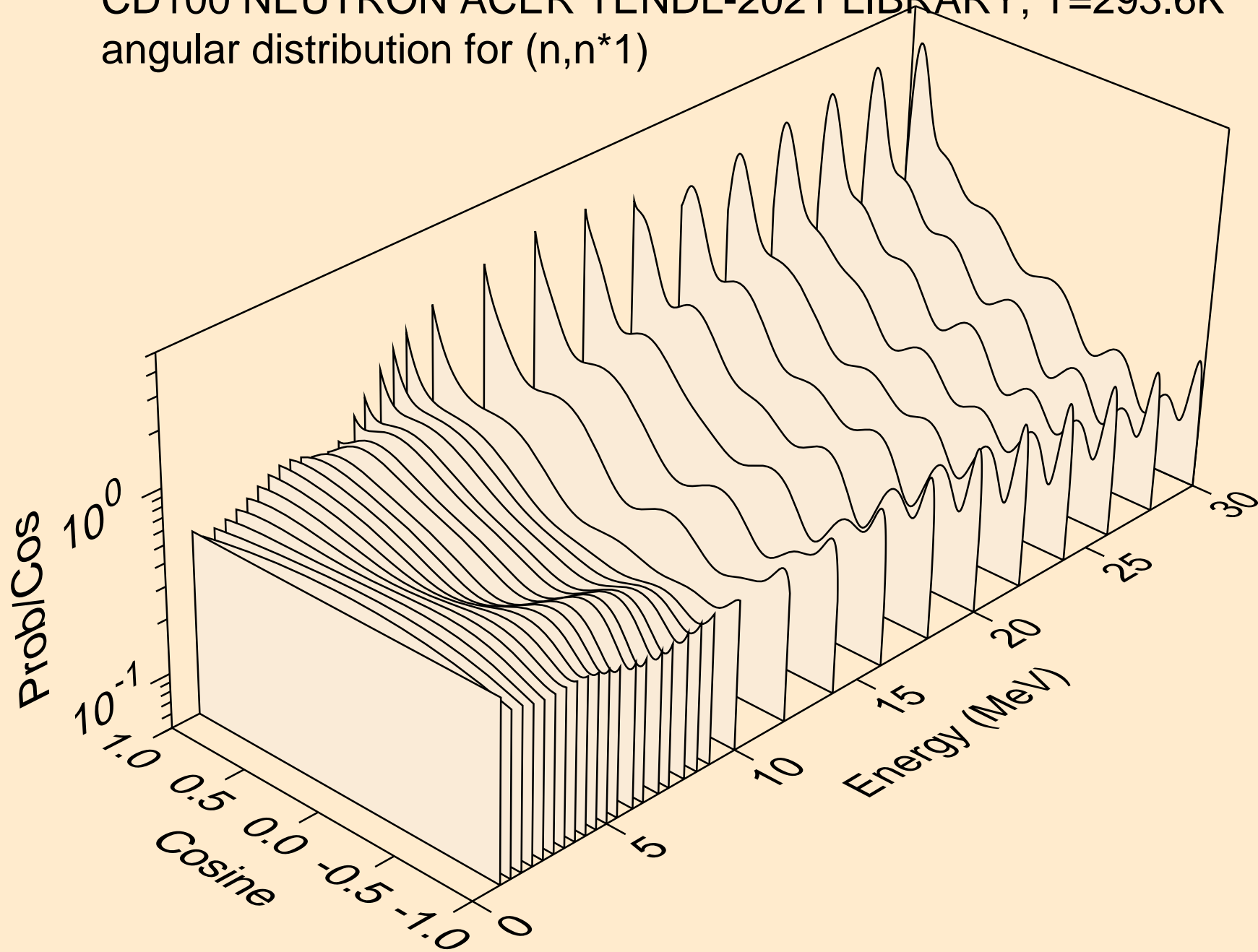

CD100 NEUTRON ACER TENDL-2021 LIBRARY; T=293.6K
angular distribution for (n,n*2)

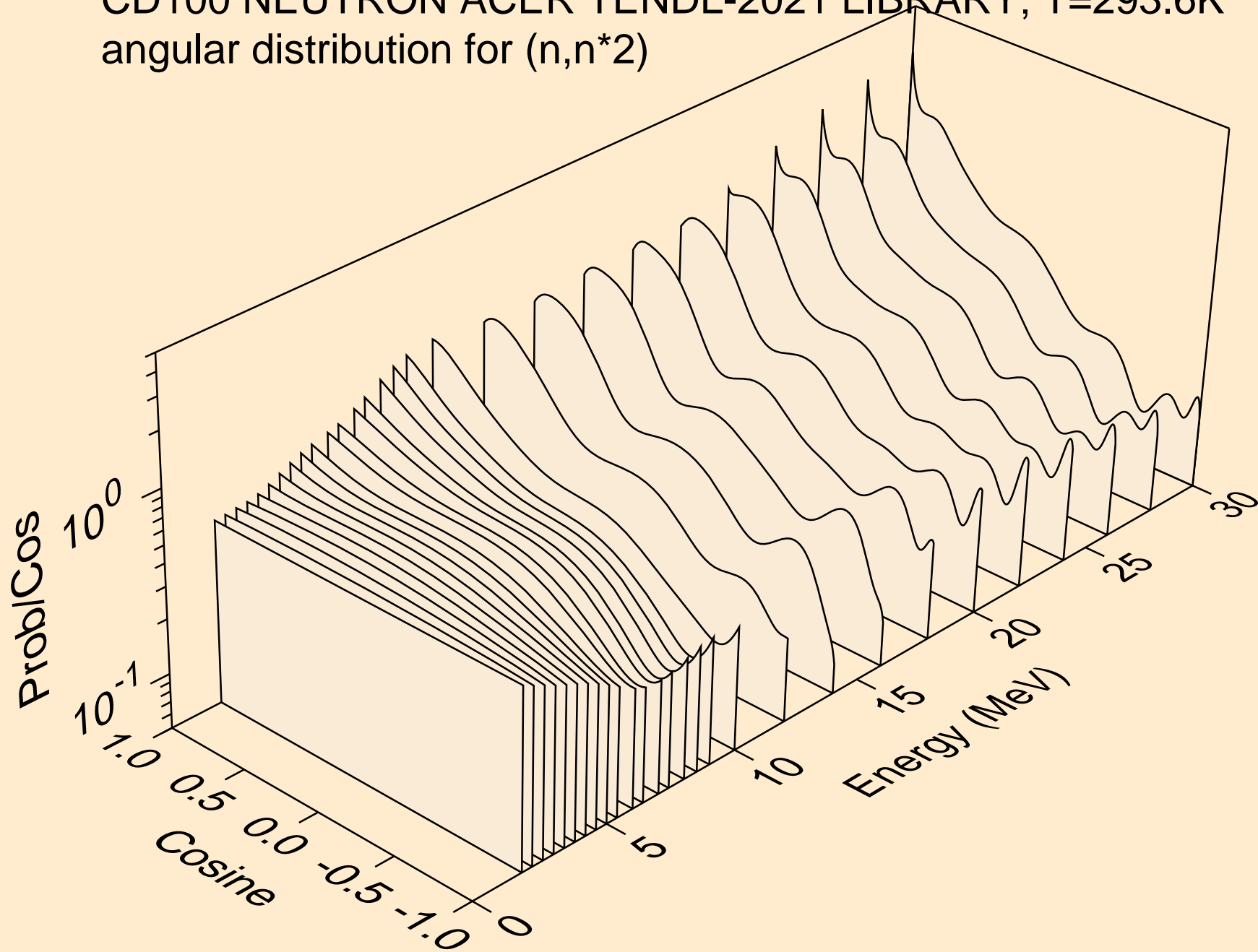

CD100 NEUTRON ACER TENDL-2021 LIBRARY; T=293.6K
angular distribution for (n,n*3)

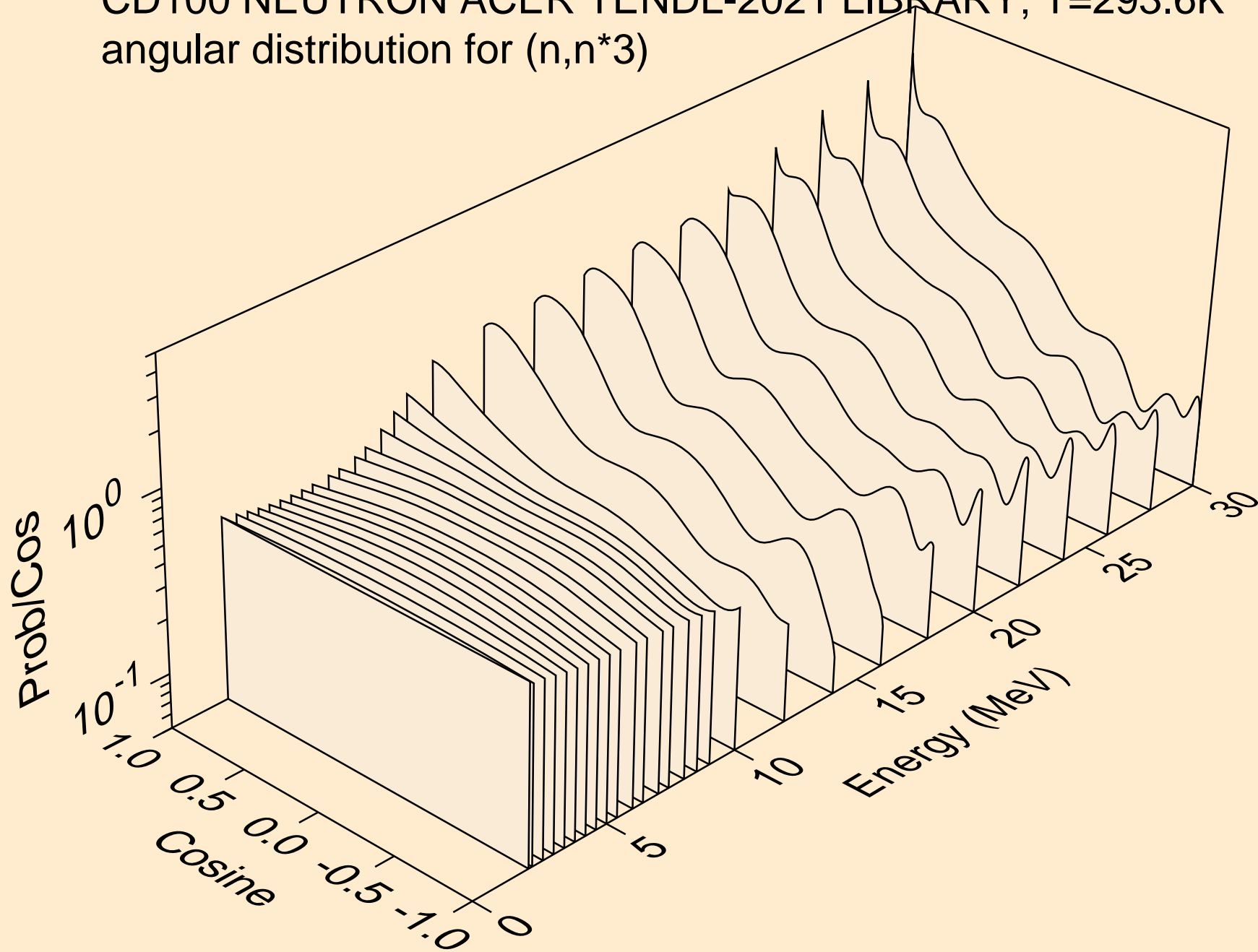

CD100 NEUTRON ACER TENDL-2021 LIBRARY; T=293.6K
angular distribution for (n,n*4)

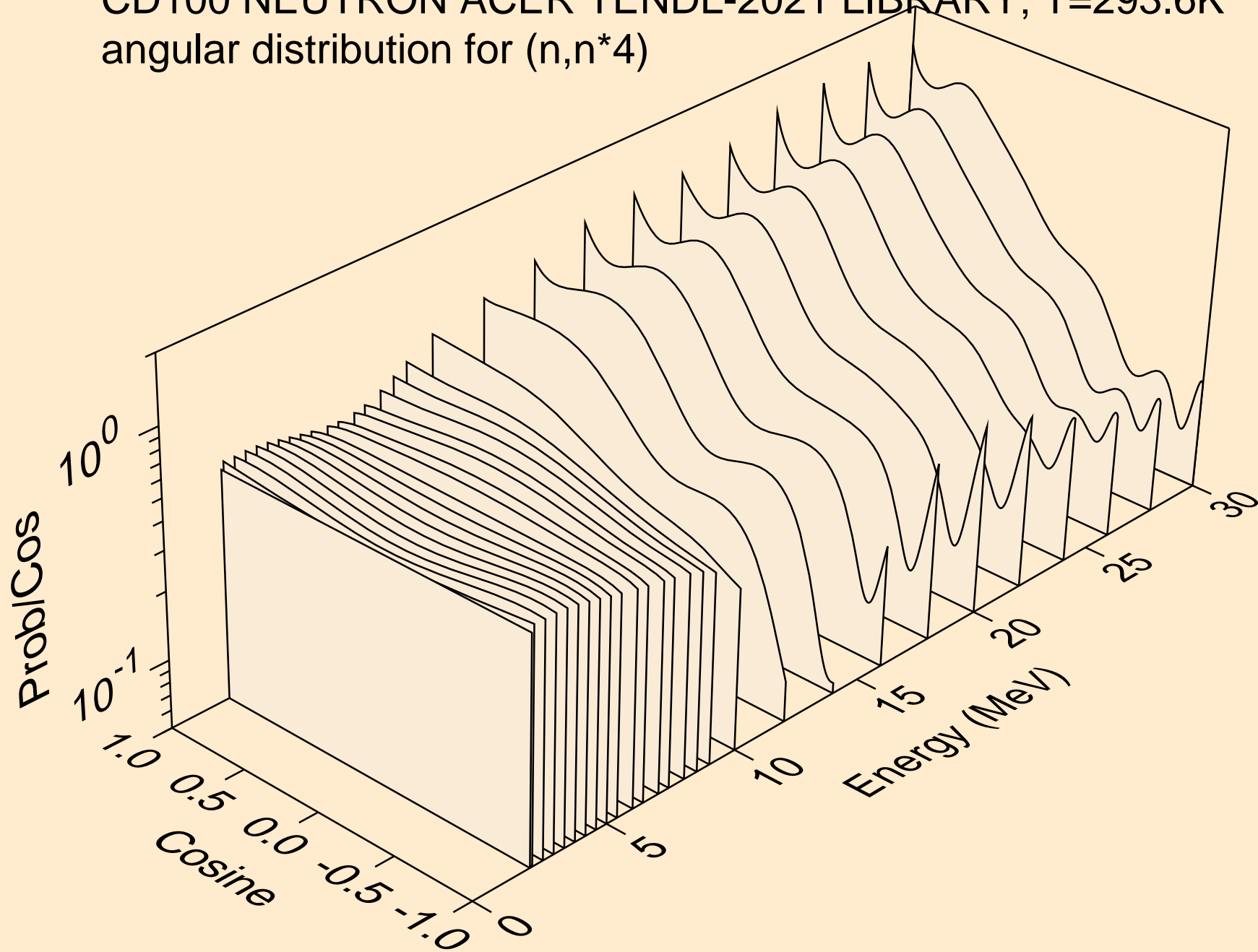

CD100 NEUTRON ACER TENDL-2021 LIBRARY; T=293.6K
Neutron emission for (n,x)

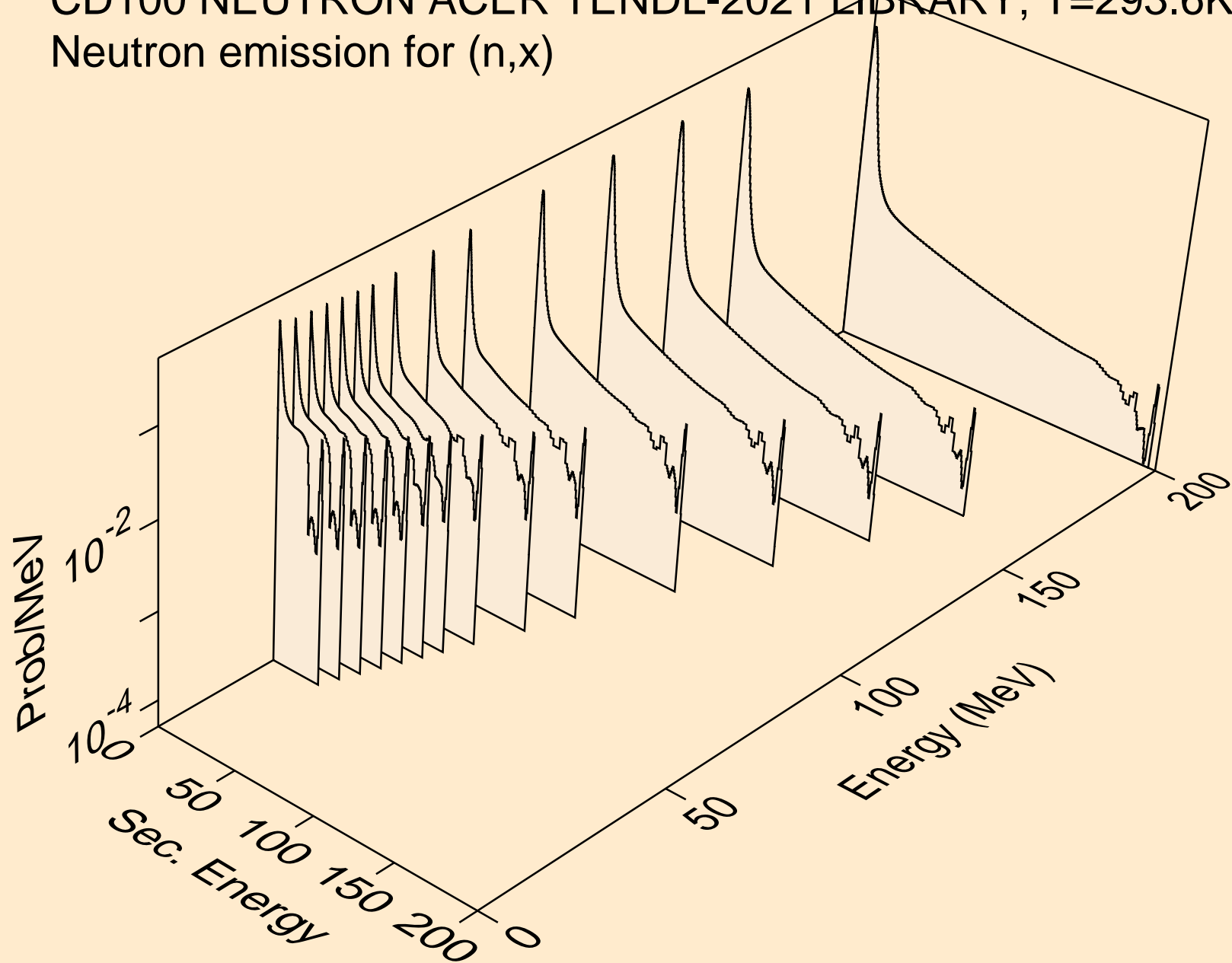

CD100 NEUTRON ACER TENDL-2021 LIBRARY; T=293.6K
Neutron emission for (n,2nd)

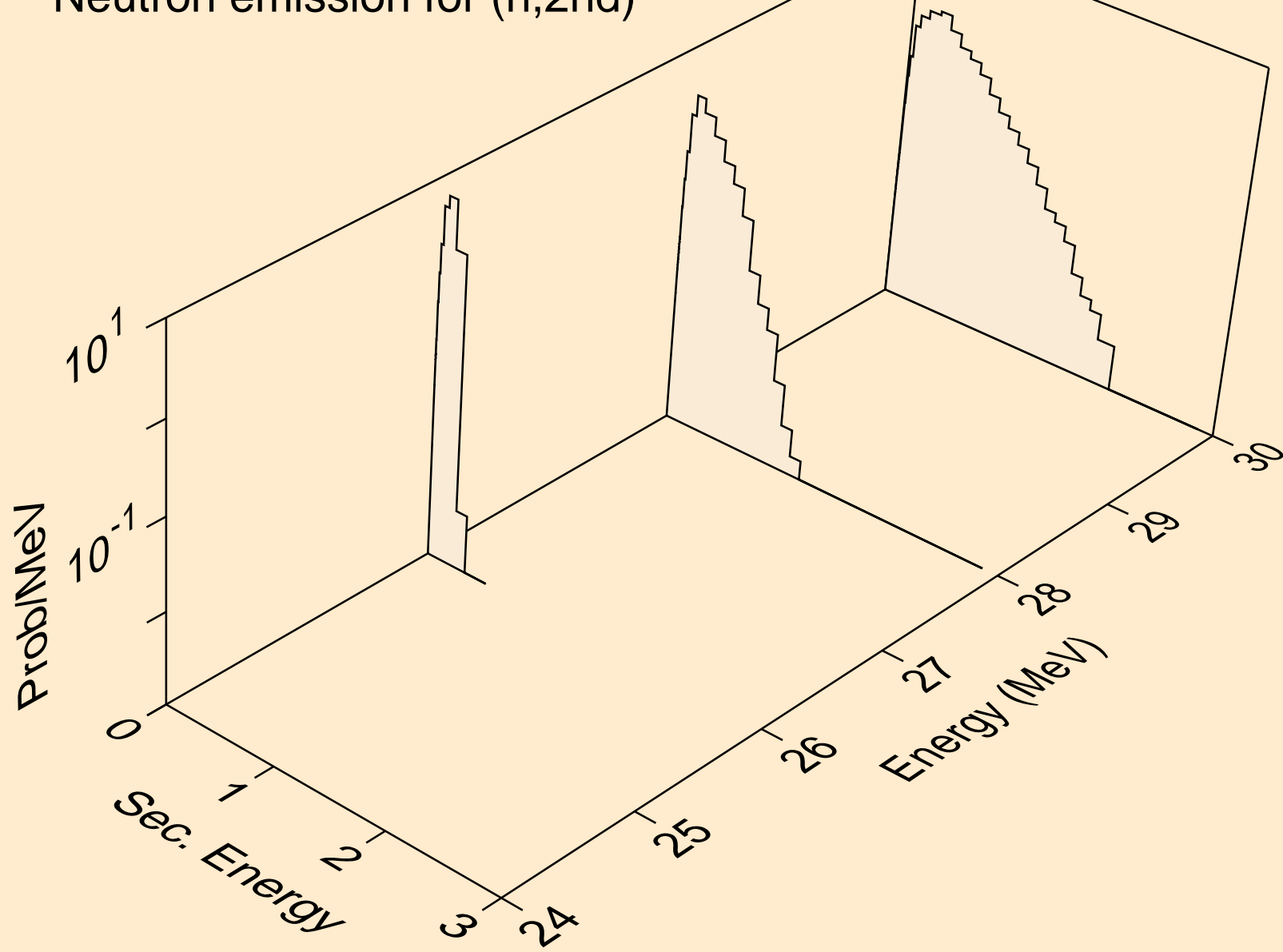

CD100 NEUTRON ACER TENDL-2021 LIBRARY; T=293.6K
Neutron emission for (n,2n)

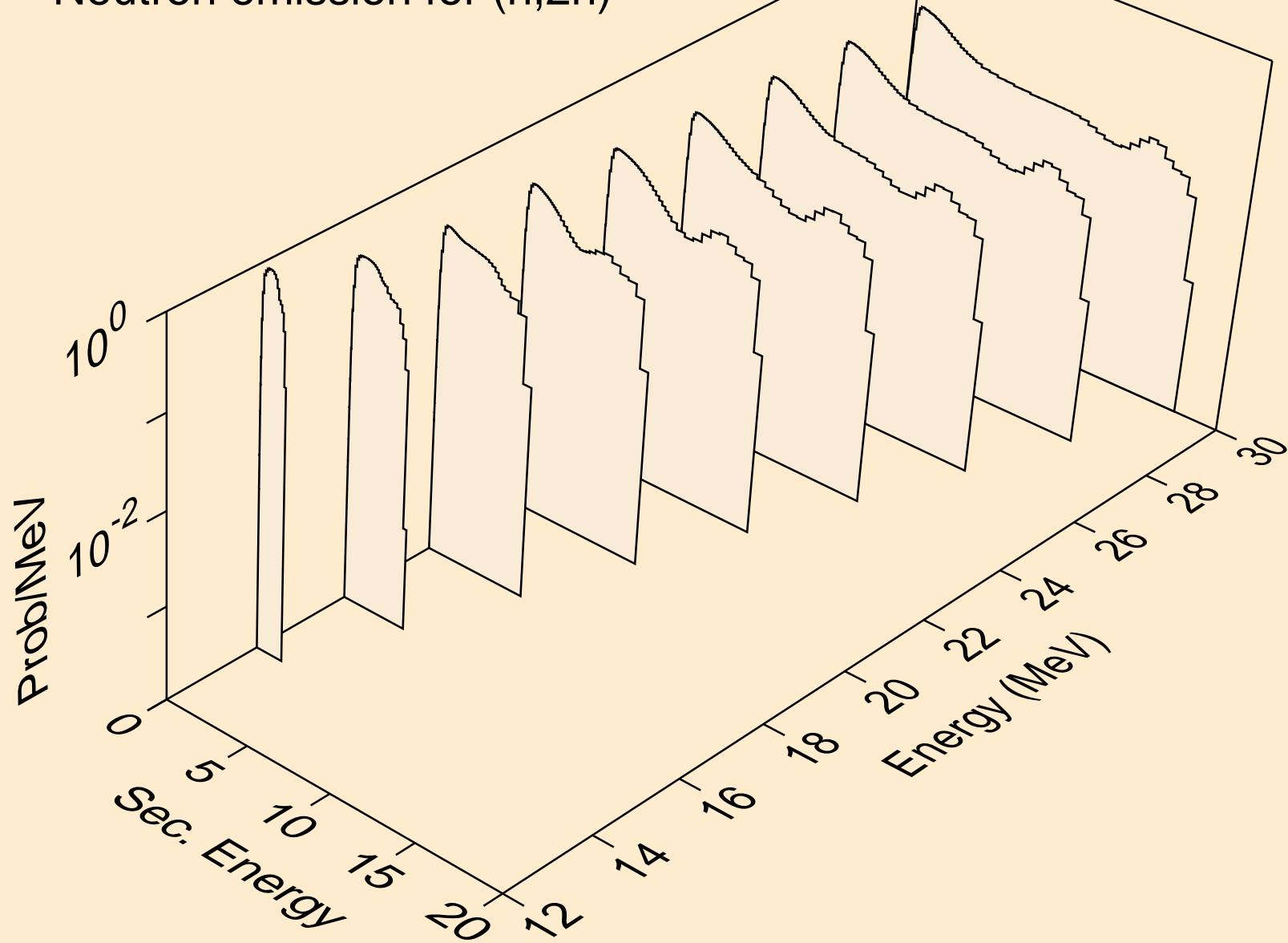

CD100 NEUTRON ACER TENDL-2021 LIBRARY; T=293.6K
Neutron emission for (n,3n)

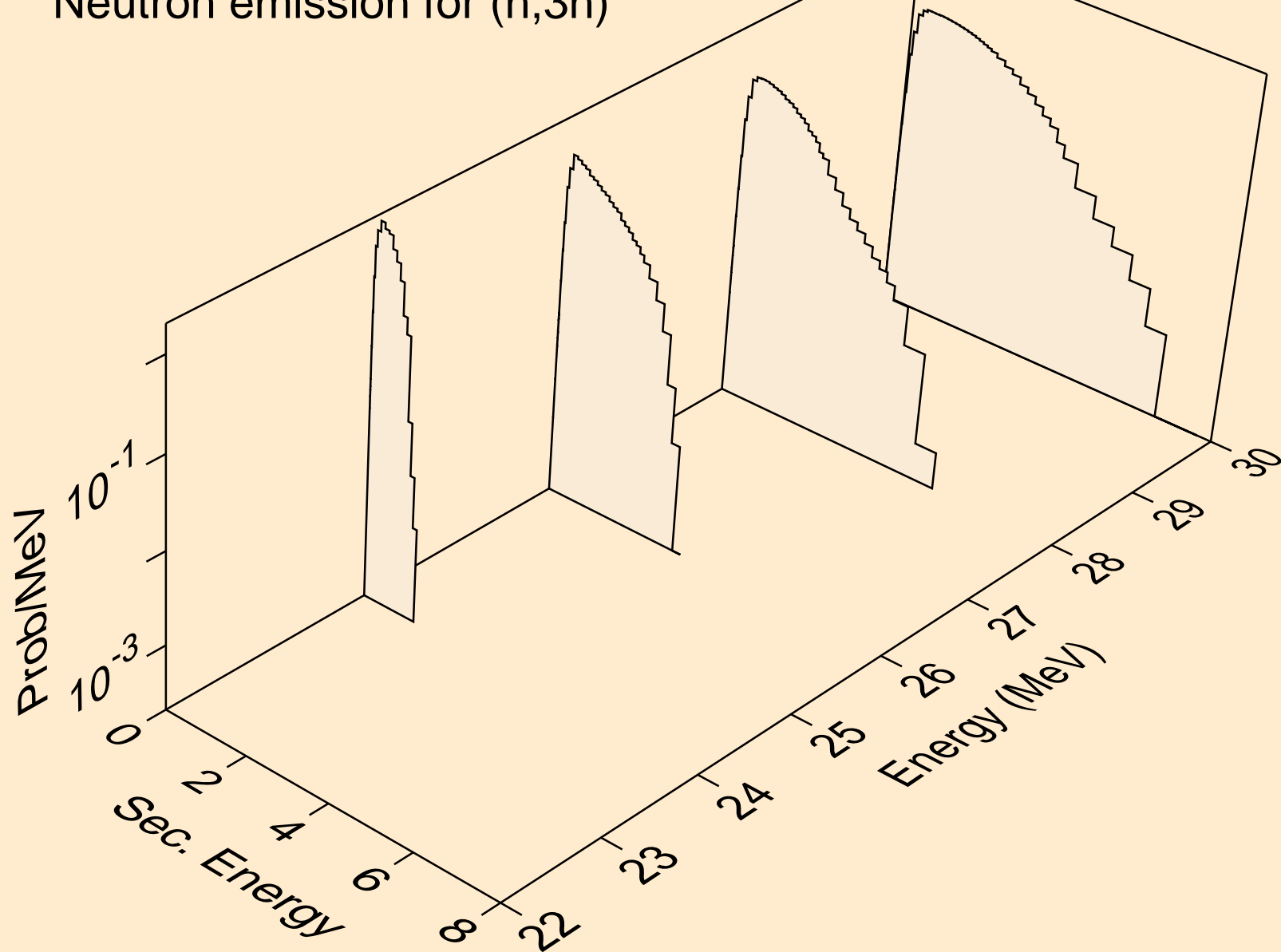

CD100 NEUTRON ACER TENDL-2021 LIBRARY; T=293.6K
Neutron emission for (n,n*)a

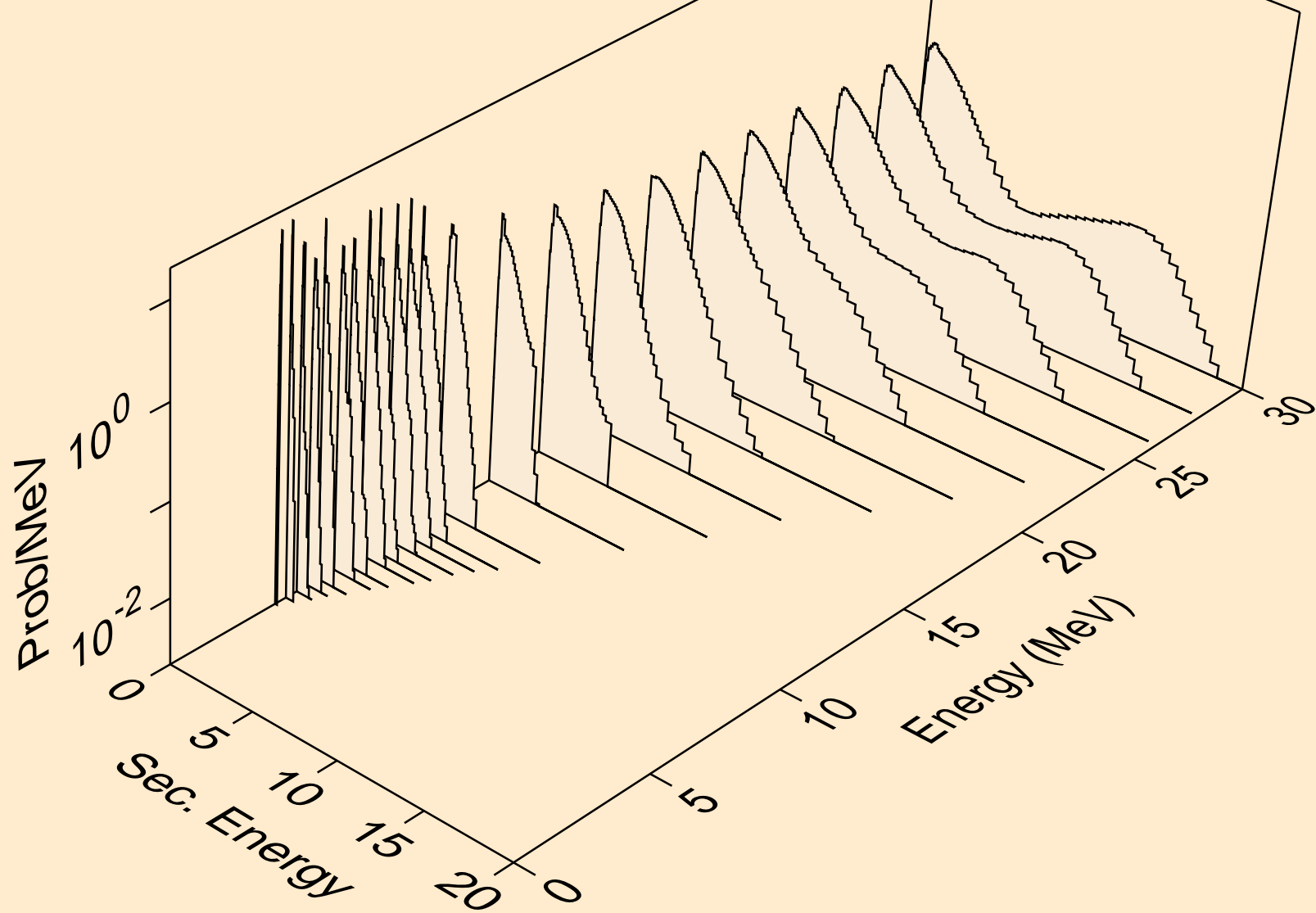

CD100 NEUTRON ACER TENDL-2021 LIBRARY; T=293.6K
Neutron emission for (n,2n)_a

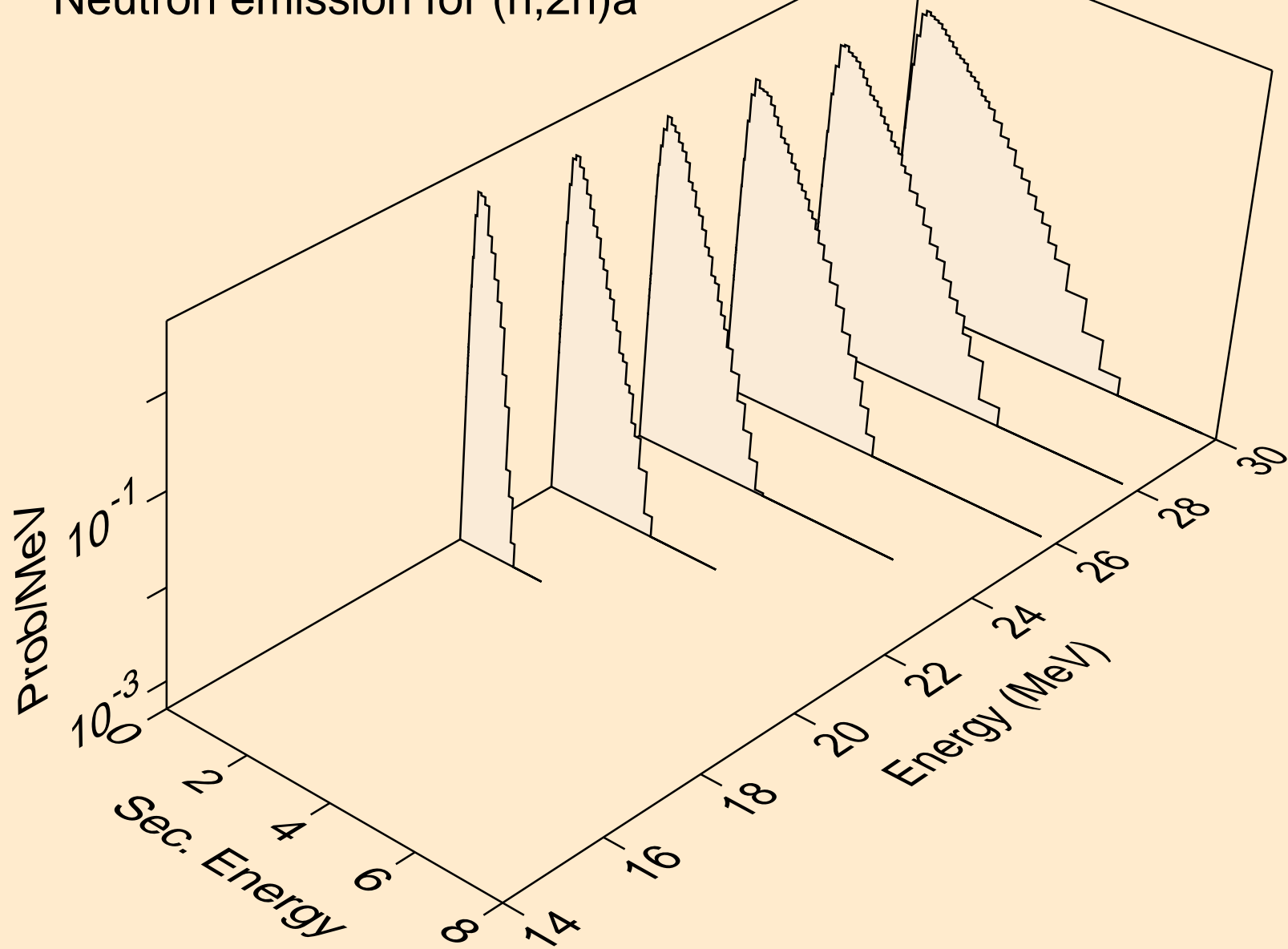

CD100 NEUTRON ACER TENDL-2021 LIBRARY; T=293.6K
Neutron emission for (n,n*)p

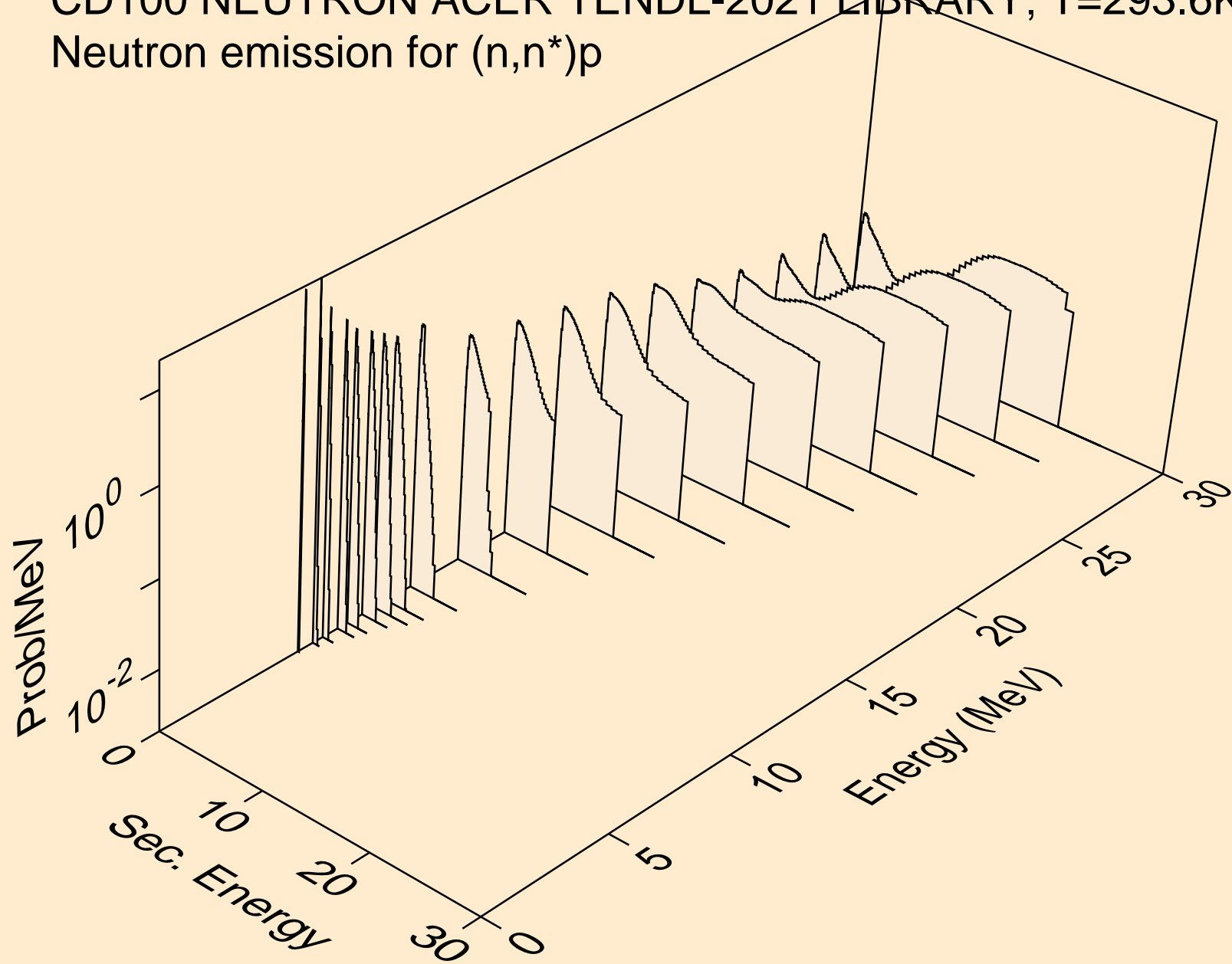

CD100 NEUTRON ACER TENDL-2021 LIBRARY; T=293.6K
Neutron emission for (n,n*)2a

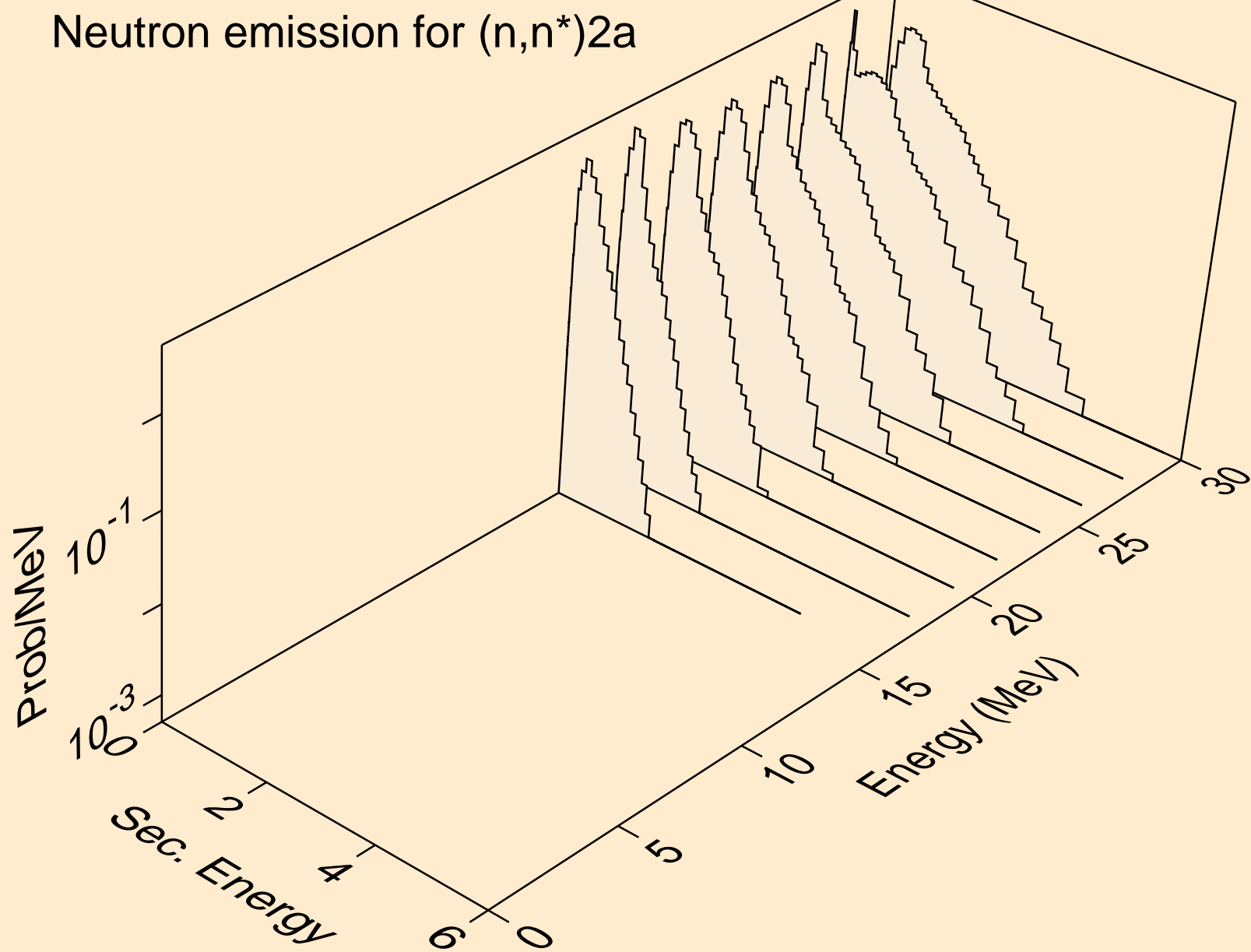

CD100 NEUTRON ACER TENDL-2021 LIBRARY; T=293.6K
Neutron emission for (n,n*)d

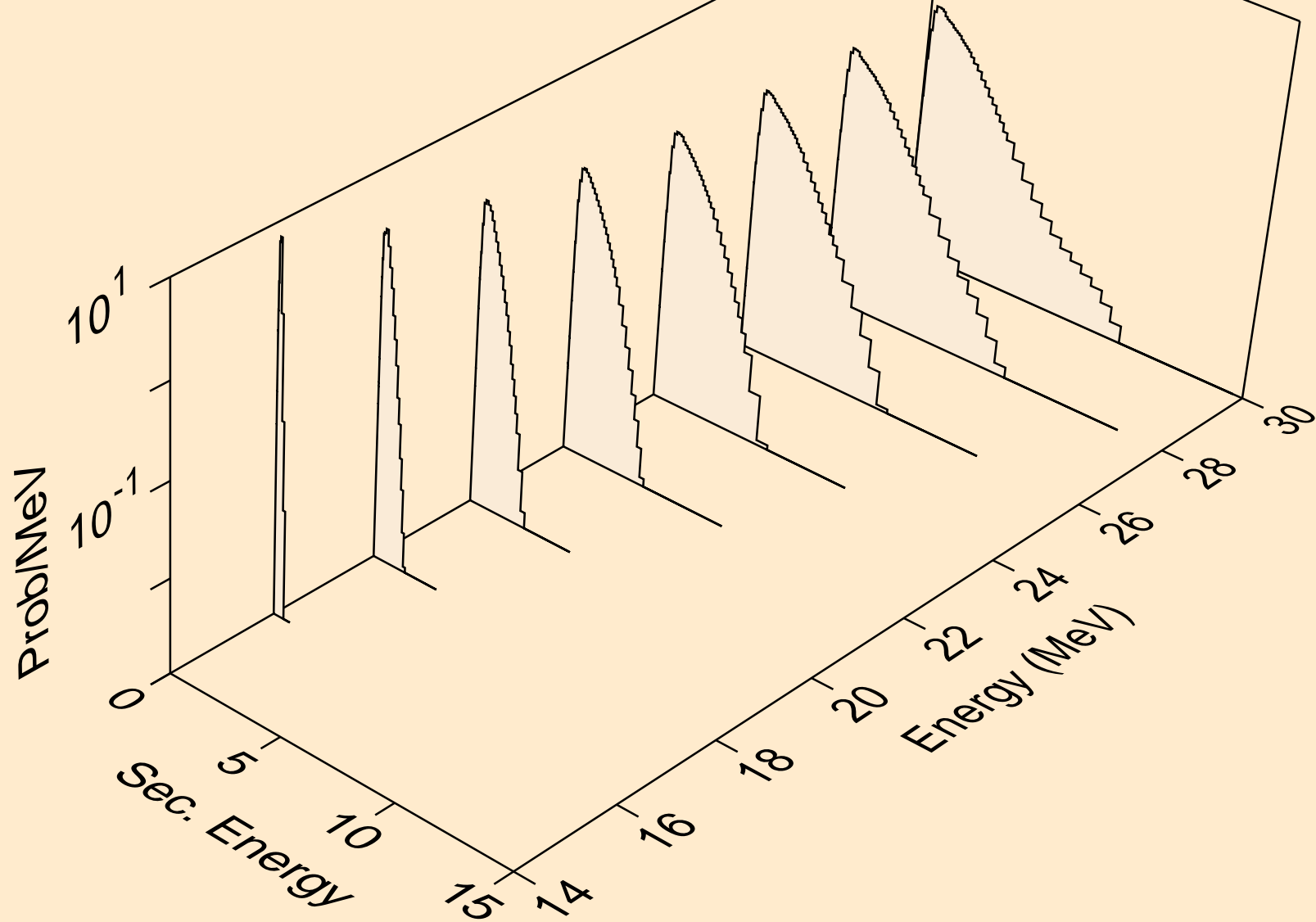

CD100 NEUTRON ACER TENDL-2021 LIBRARY; T=293.6K
Neutron emission for (n,n*)t

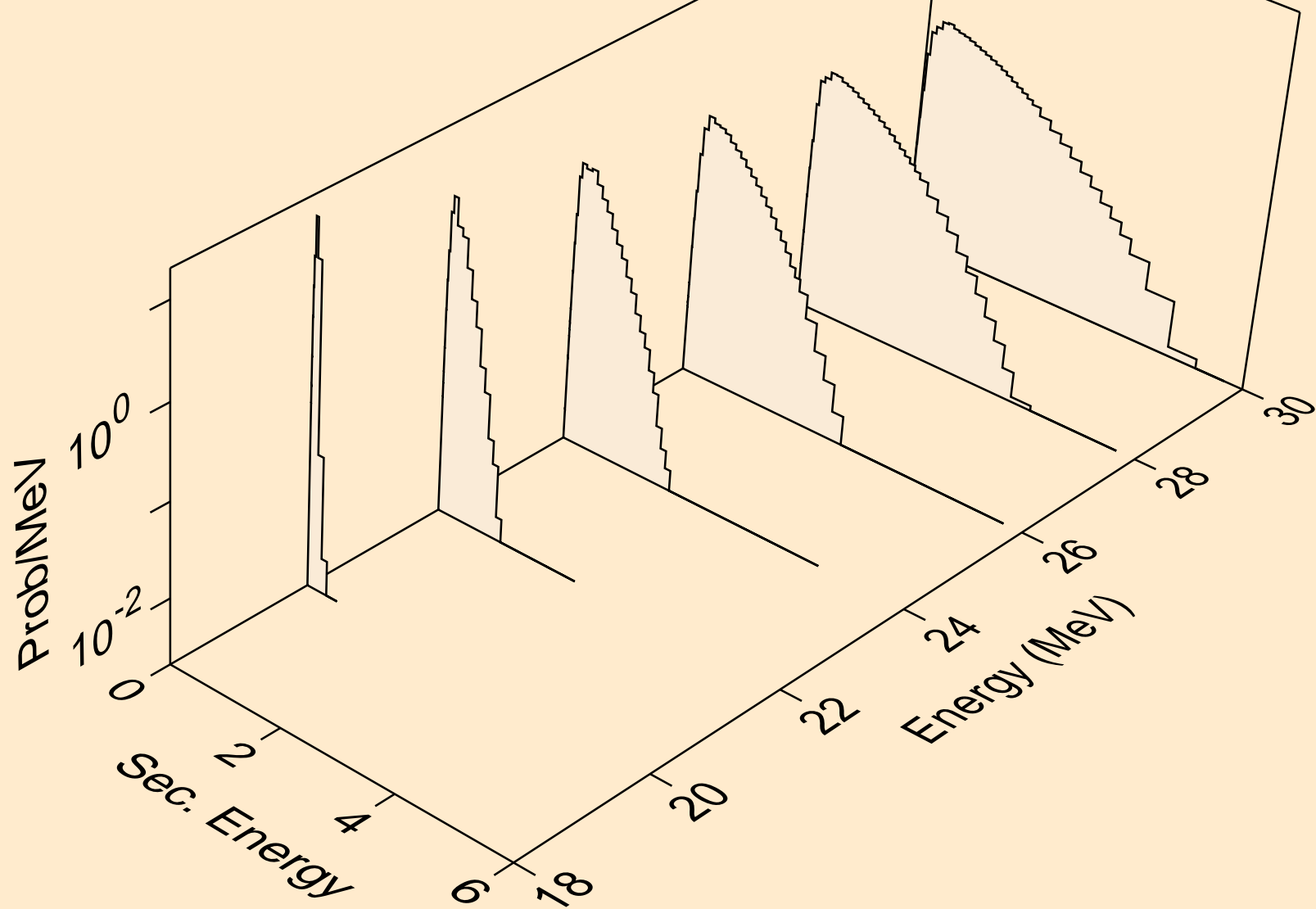

CD100 NEUTRON ACER TENDL-2021 LIBRARY; T=293.6K
Neutron emission for (n,n*)he3

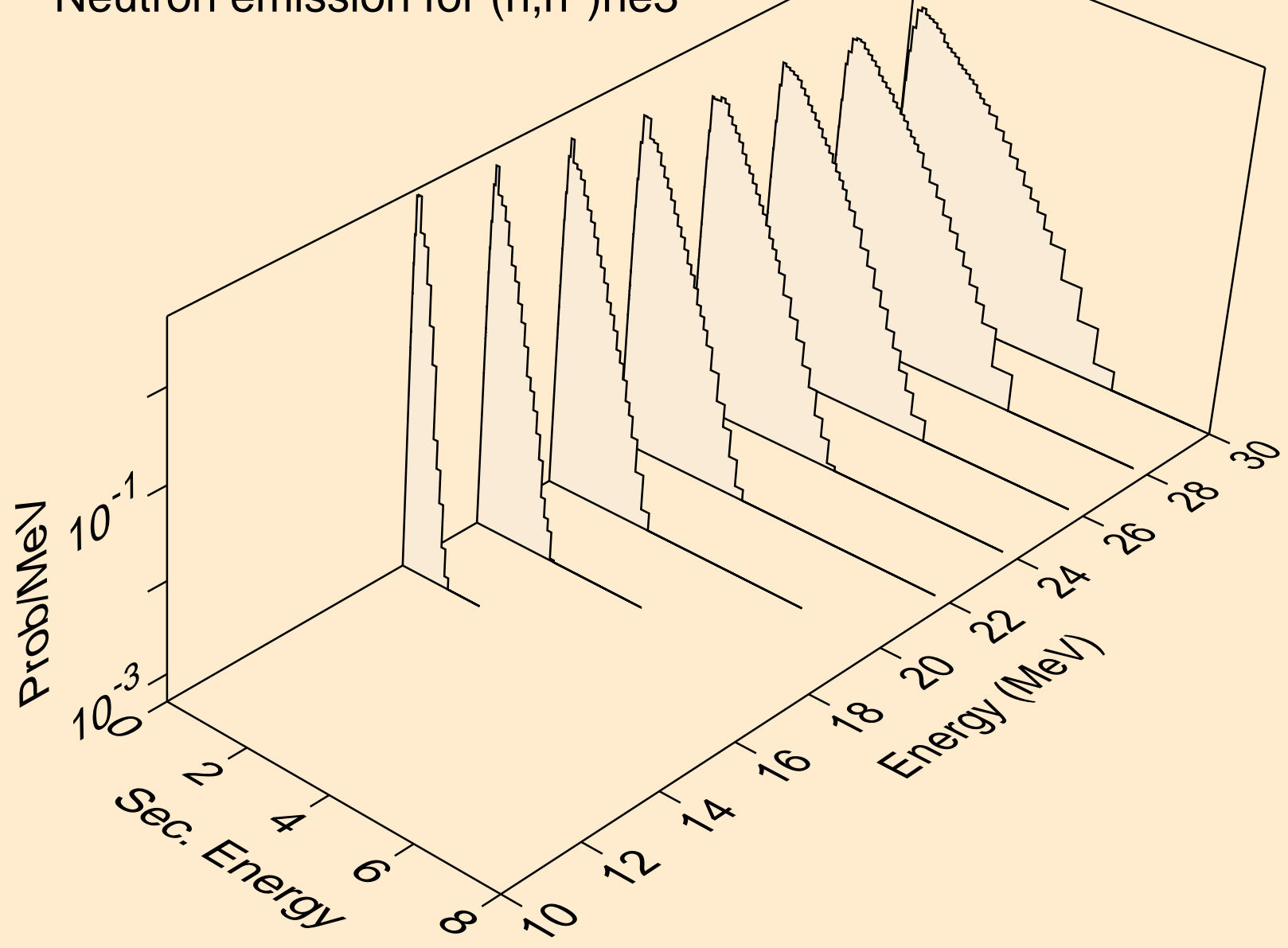

CD100 NEUTRON ACER TENDL-2021 LIBRARY; T=293.6K
Neutron emission for (n,2np)

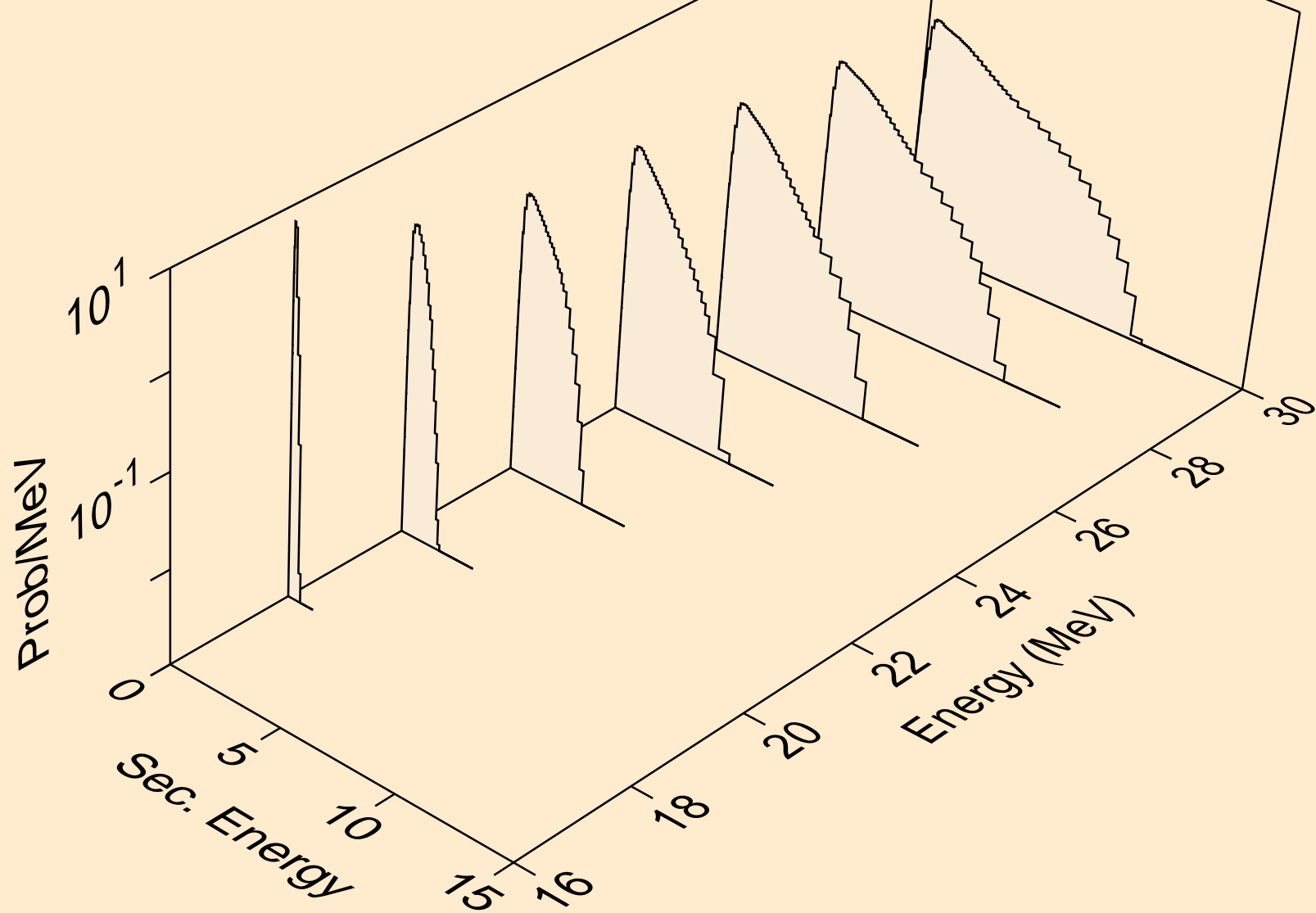

CD100 NEUTRON ACER TENDL-2021 LIBRARY; T=293.6K
Neutron emission for (n,3np)

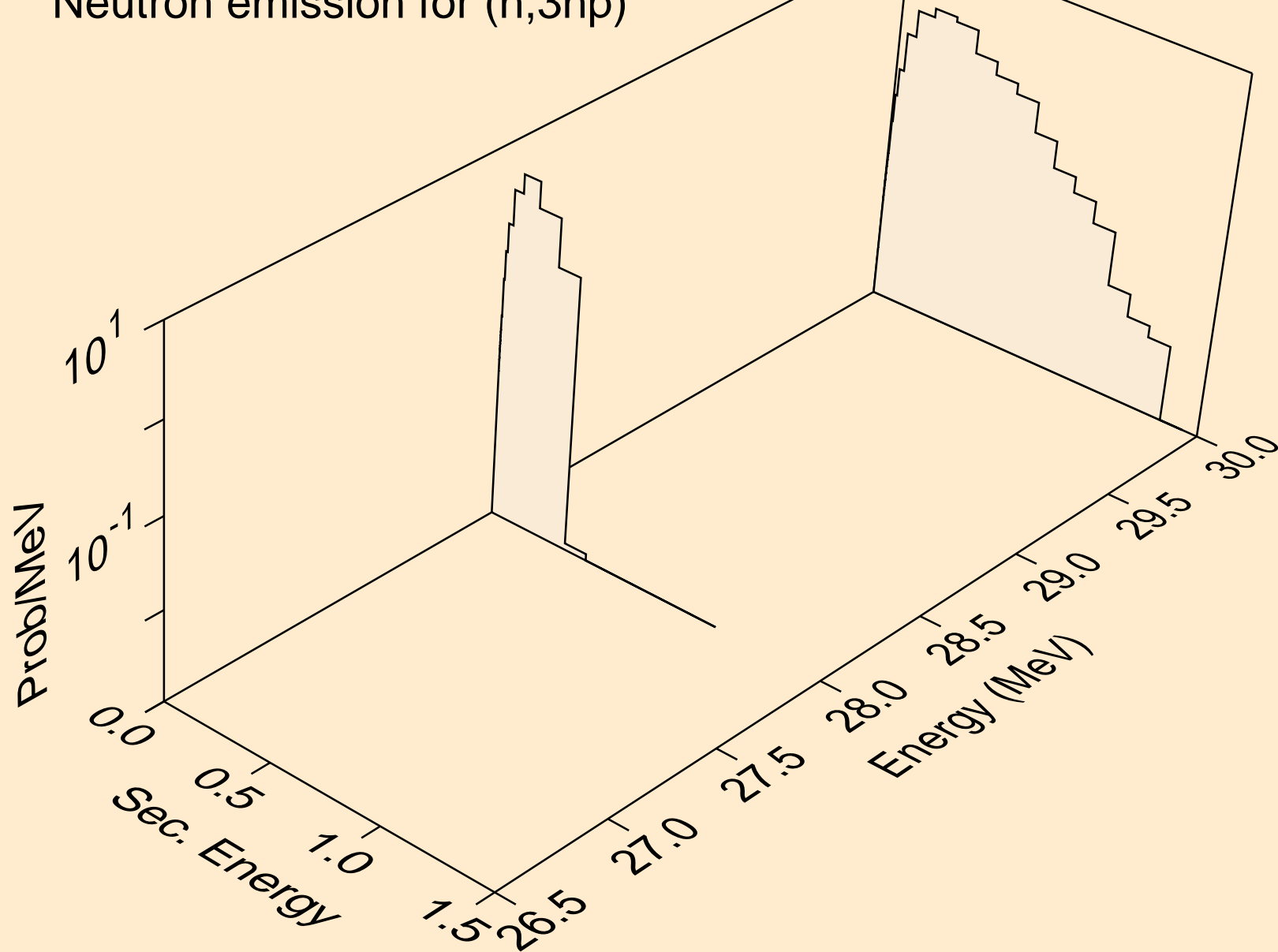

CD100 NEUTRON ACER TENDL-2021 LIBRARY; T=293.6K
Neutron emission for (n,2np)

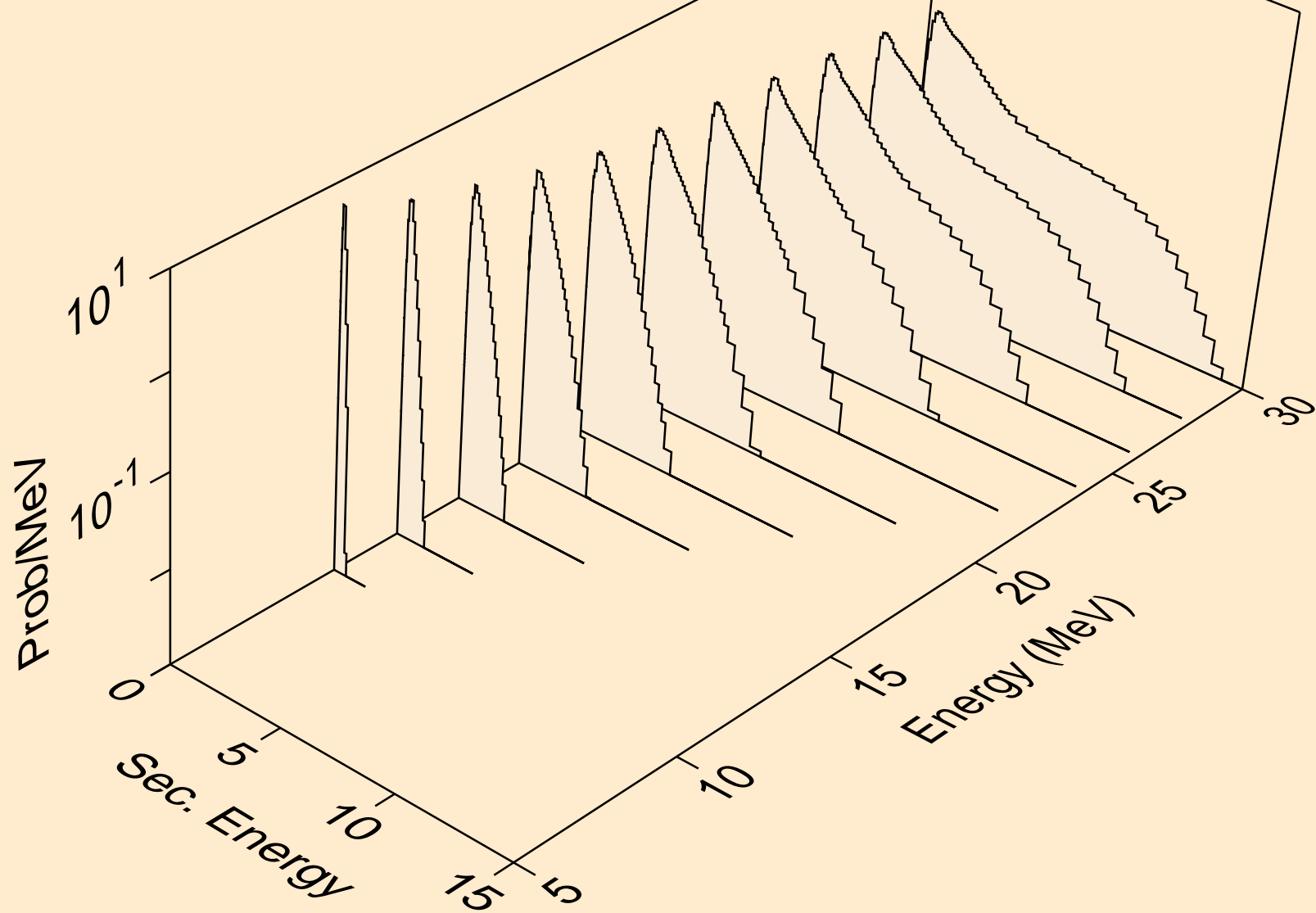

CD100 NEUTRON ACER TENDL-2021 LIBRARY; T=293.6K
Neutron emission for (n,npa)

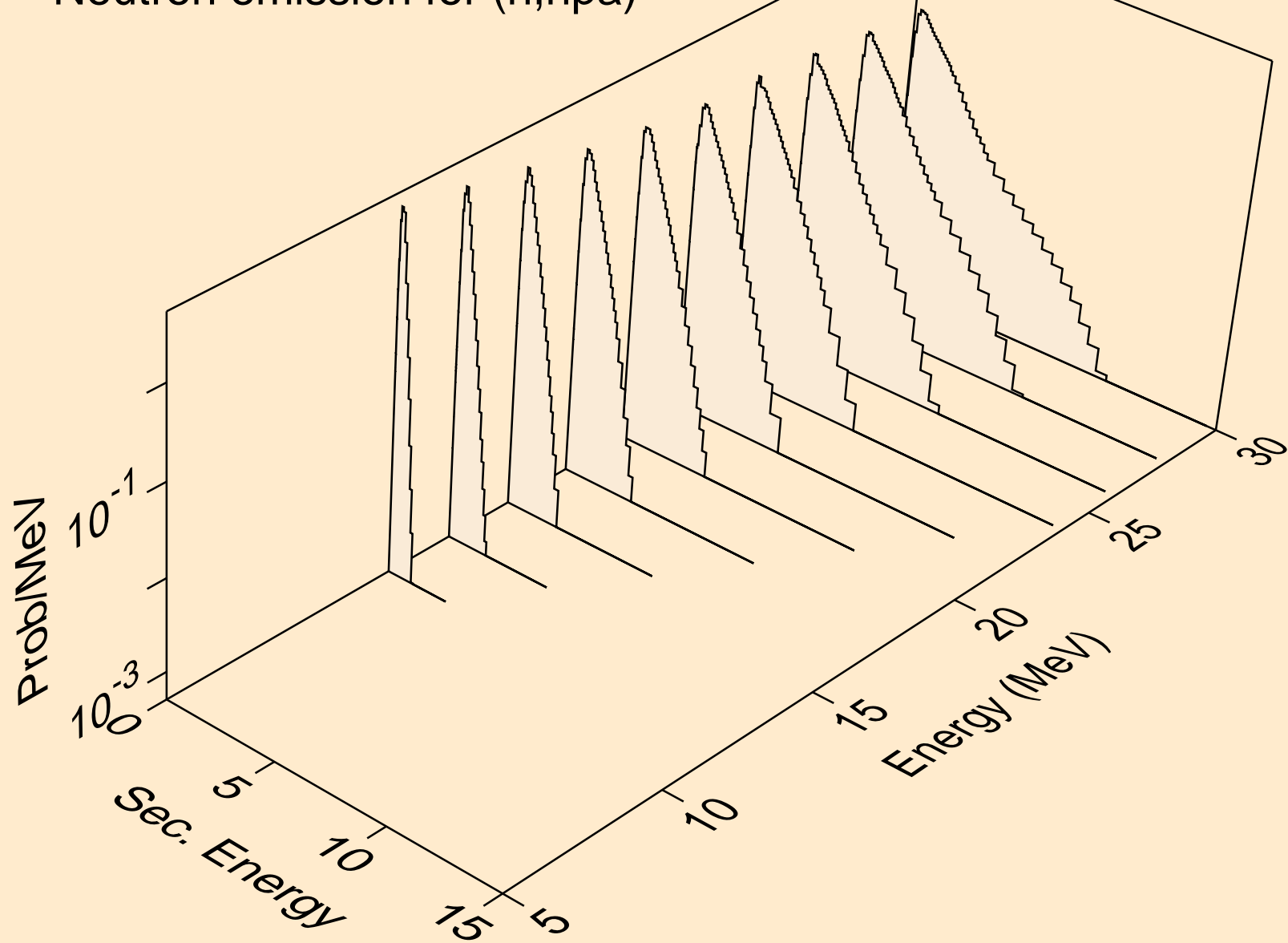

CD100 NEUTRON ACER TENDL-2021 LIBRARY; T=293.6K
Neutron emission for (n,n*c)

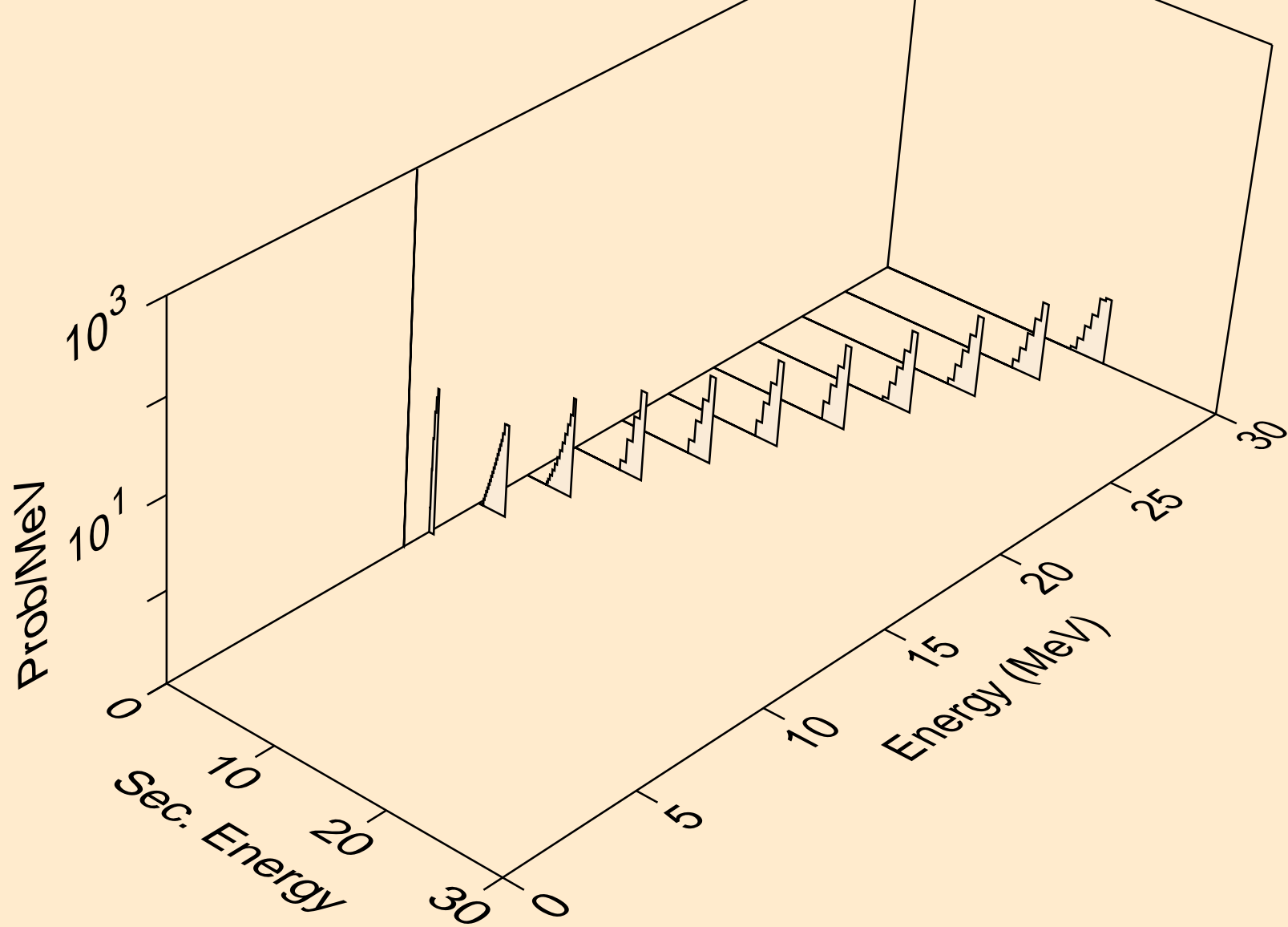

CD100 NEUTRON ACER TENDL-2021 LIBRARY; T=293.6K
Photon emission for (n,x)

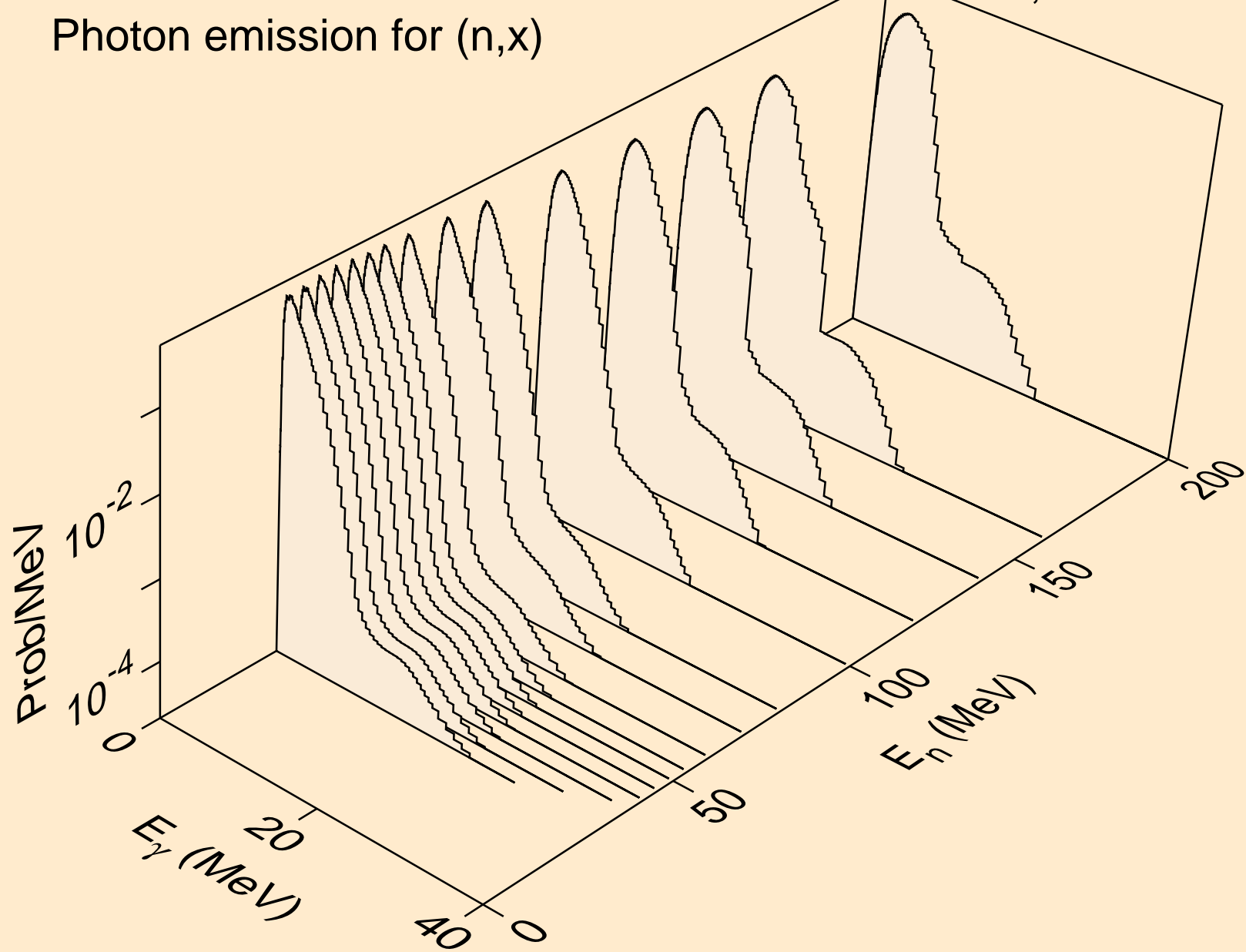

CD100 NEUTRON ACER TENDL-2021 LIBRARY; T=293.6K
Photon emission for (n,2nd)

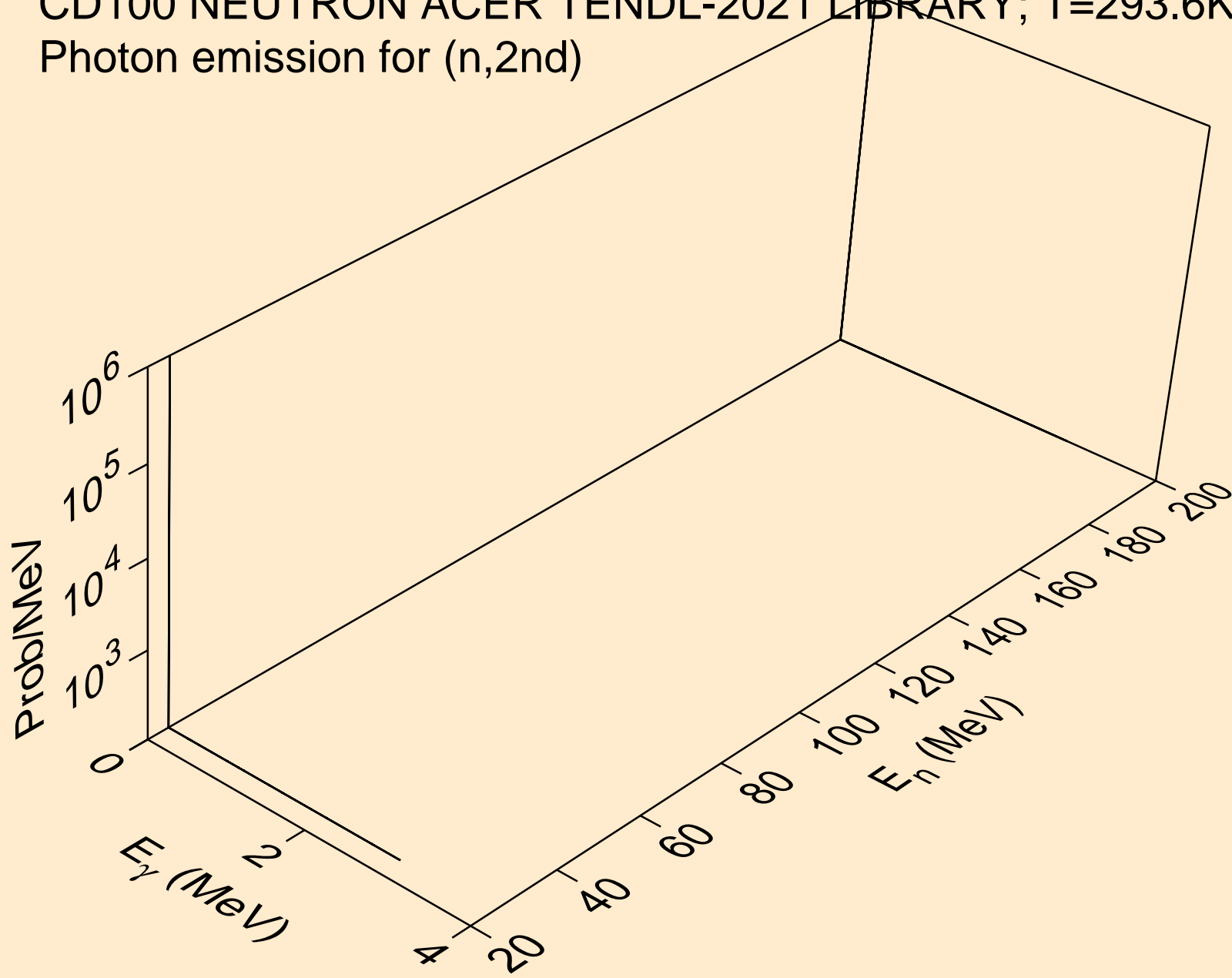

CD100 NEUTRON ACER TENDL-2021 LIBRARY; T=293.6K
Photon emission for (n,2n)

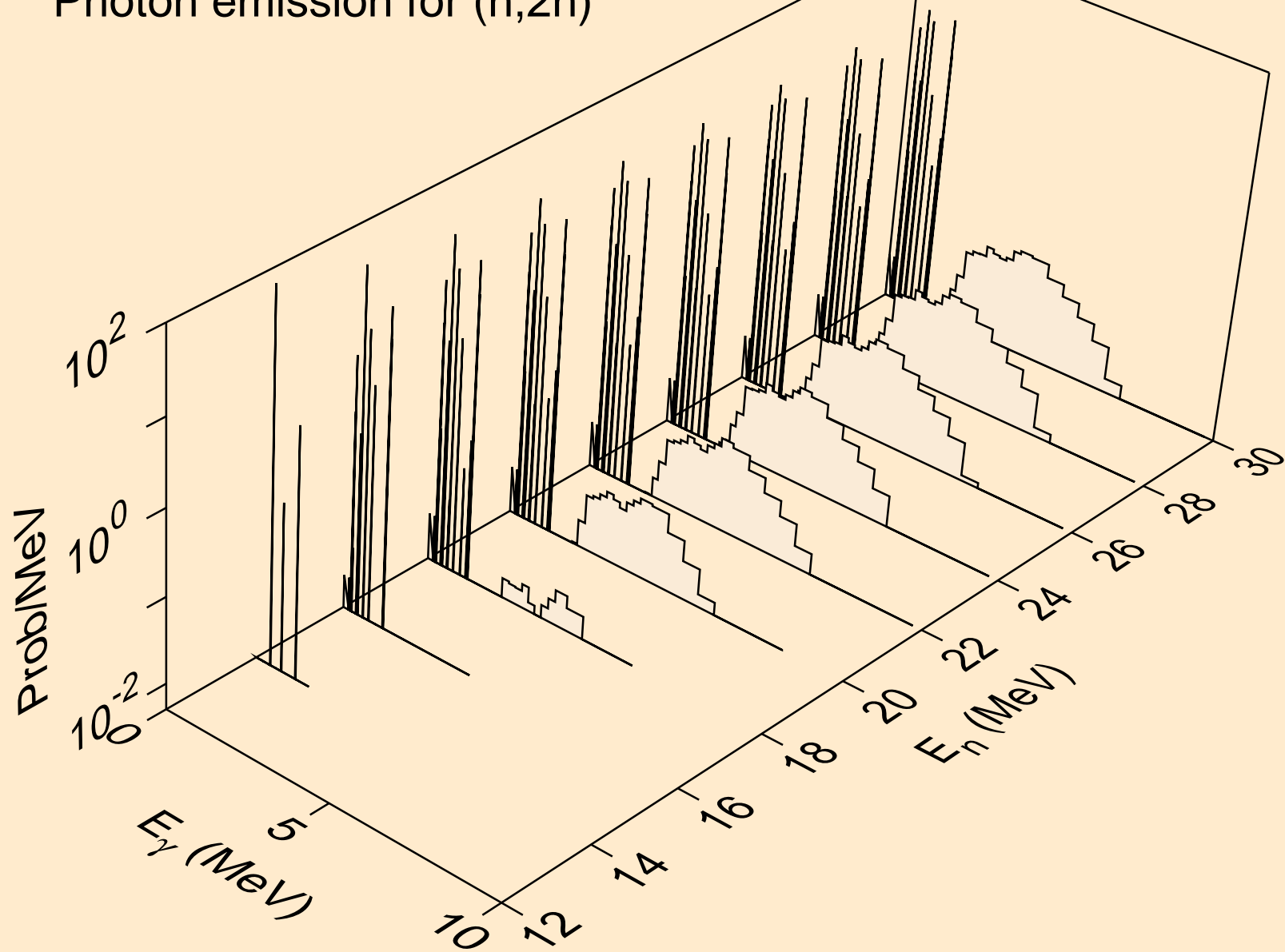

CD100 NEUTRON ACER TENDL-2021 LIBRARY; T=293.6K
Photon emission for (n,3n)

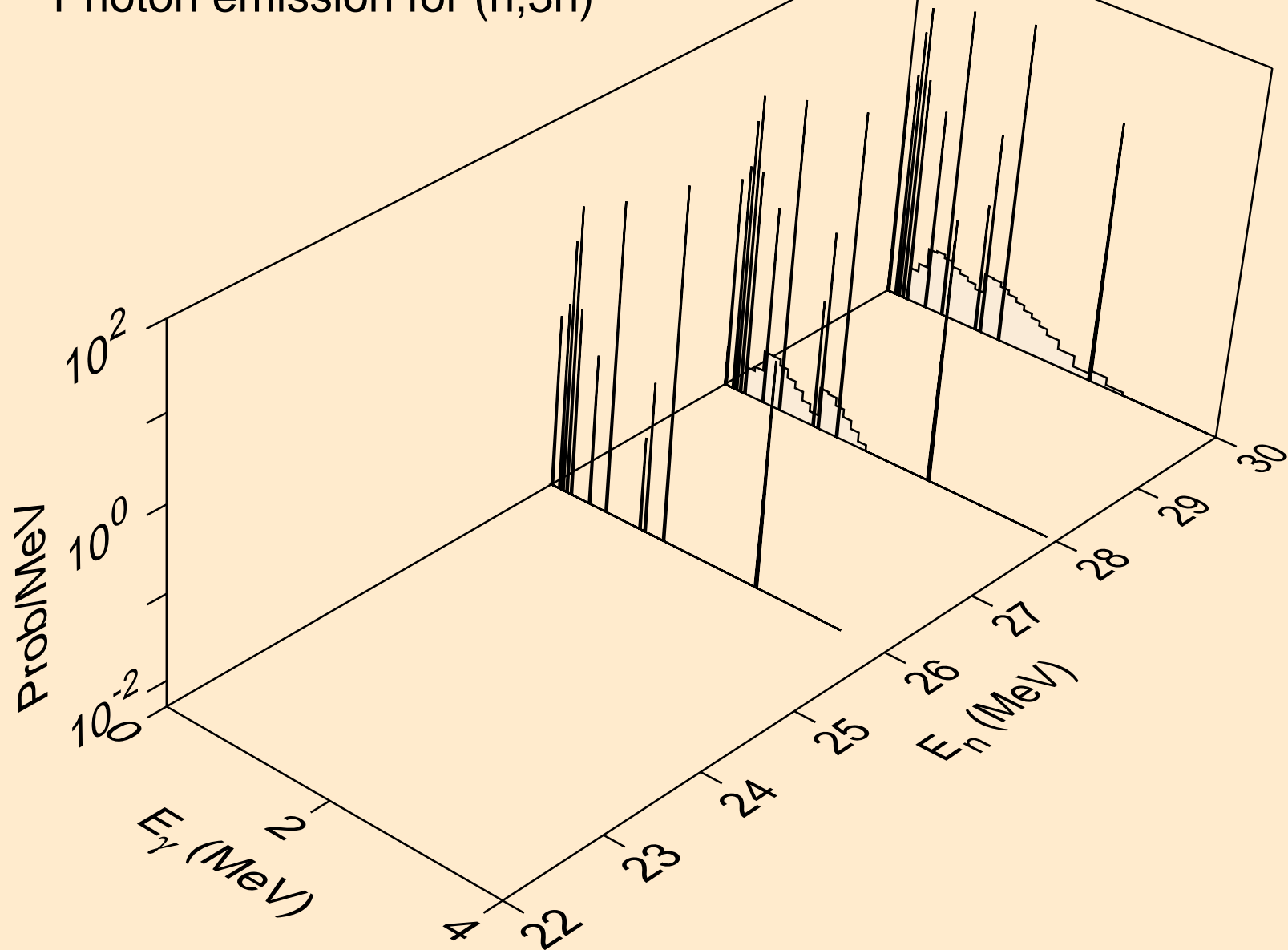

CD100 NEUTRON ACER TENDL-2021 LIBRARY; T=293.6K
Photon emission for (n,n*)a

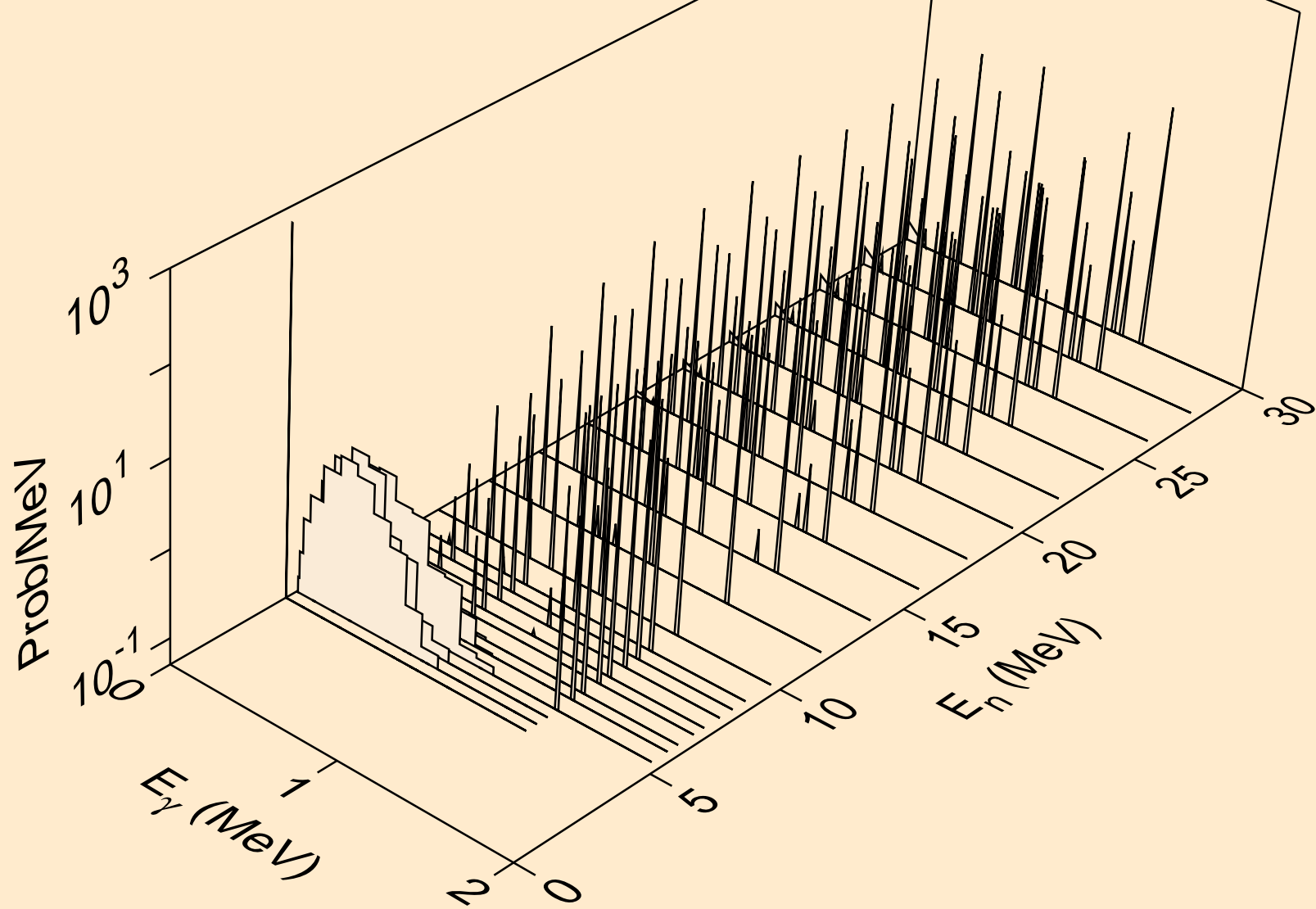

CD100 NEUTRON ACER TENDL-2021 LIBRARY; T=293.6K
Photon emission for (n,2n)a

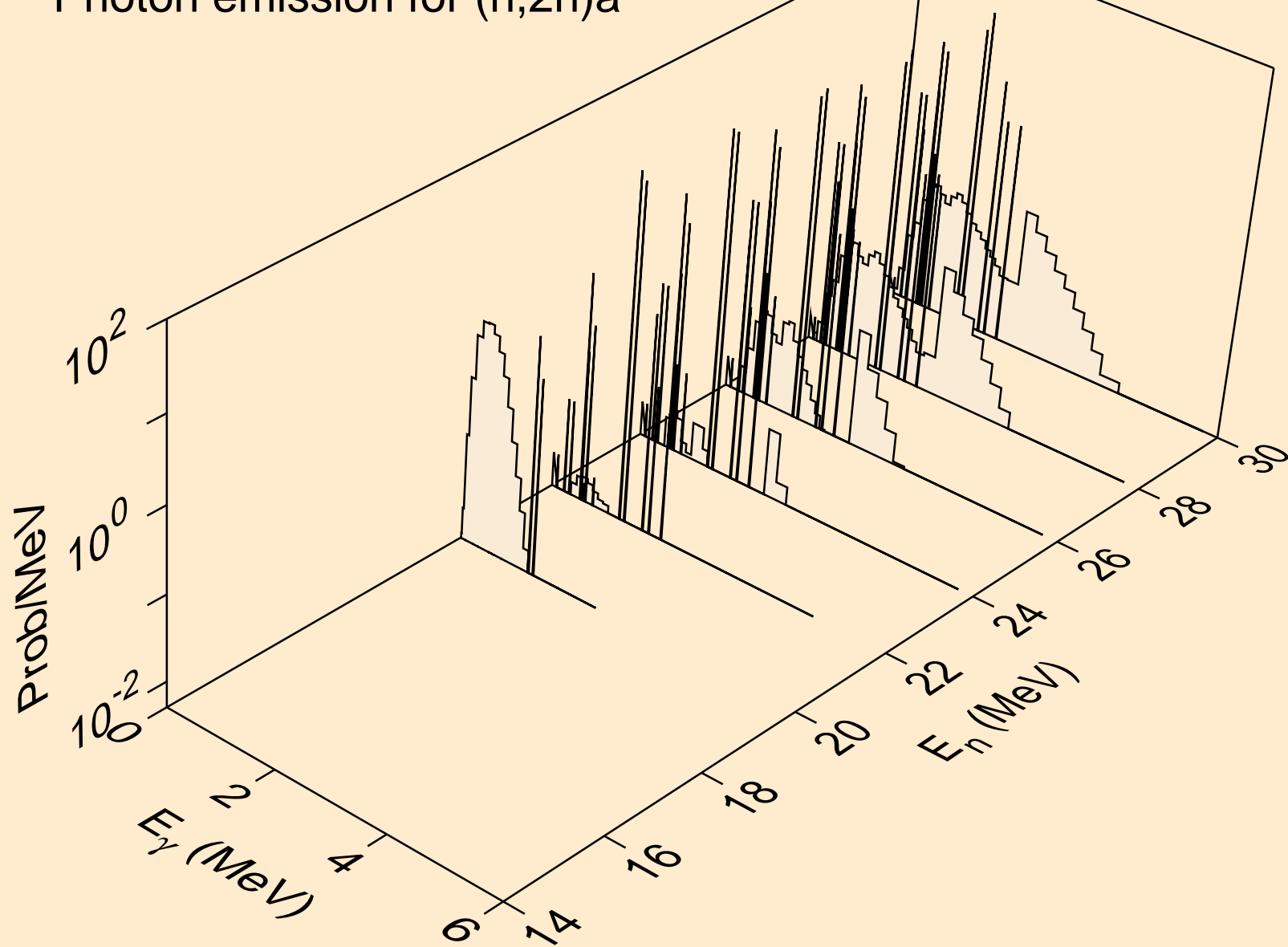

CD100 NEUTRON ACER TENDL-2021 LIBRARY; T=293.6K
Photon emission for (n,n*)p

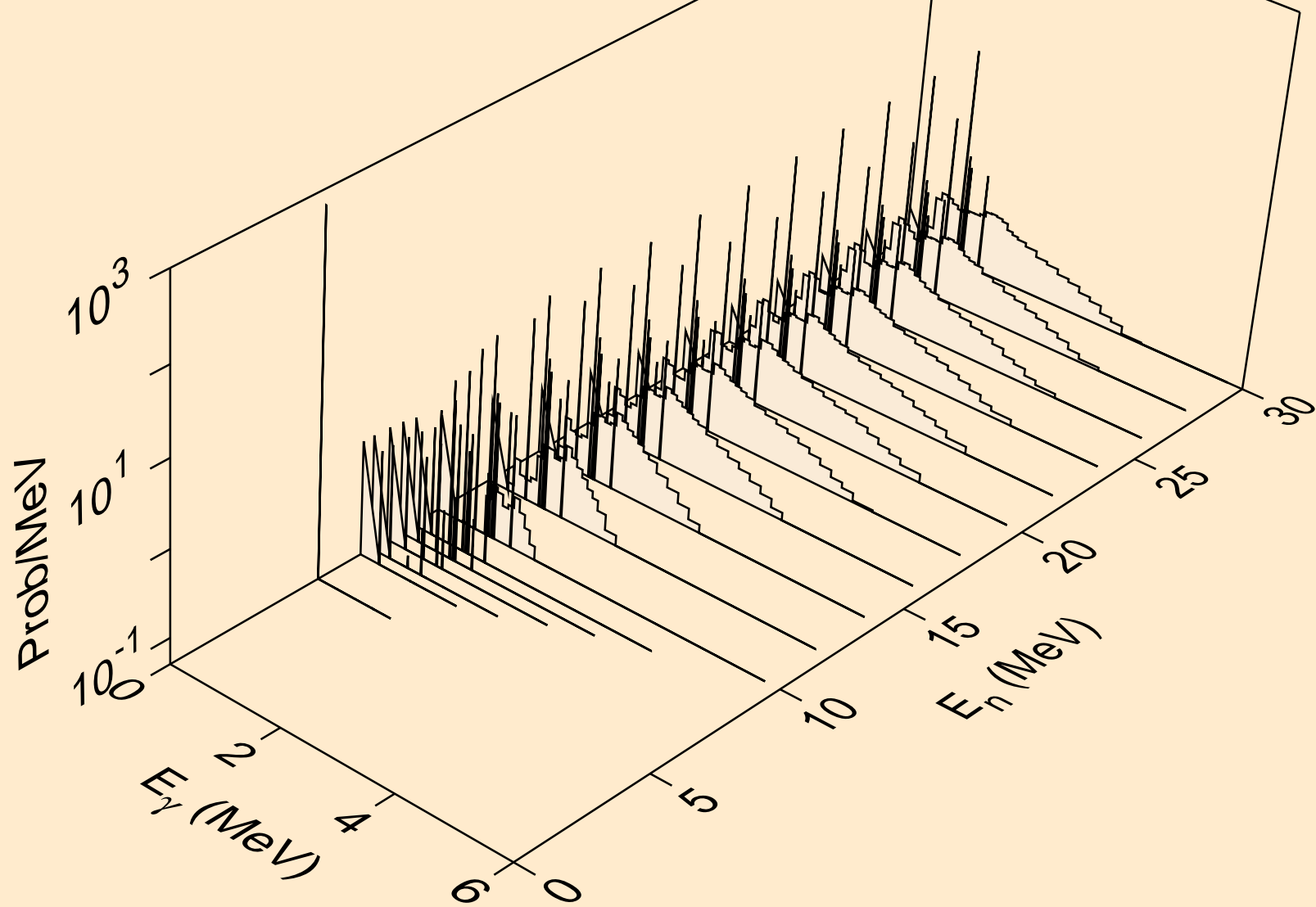

CD100 NEUTRON ACER TENDL-2021 LIBRARY; T=293.6K
Photon emission for (n,n*)2a

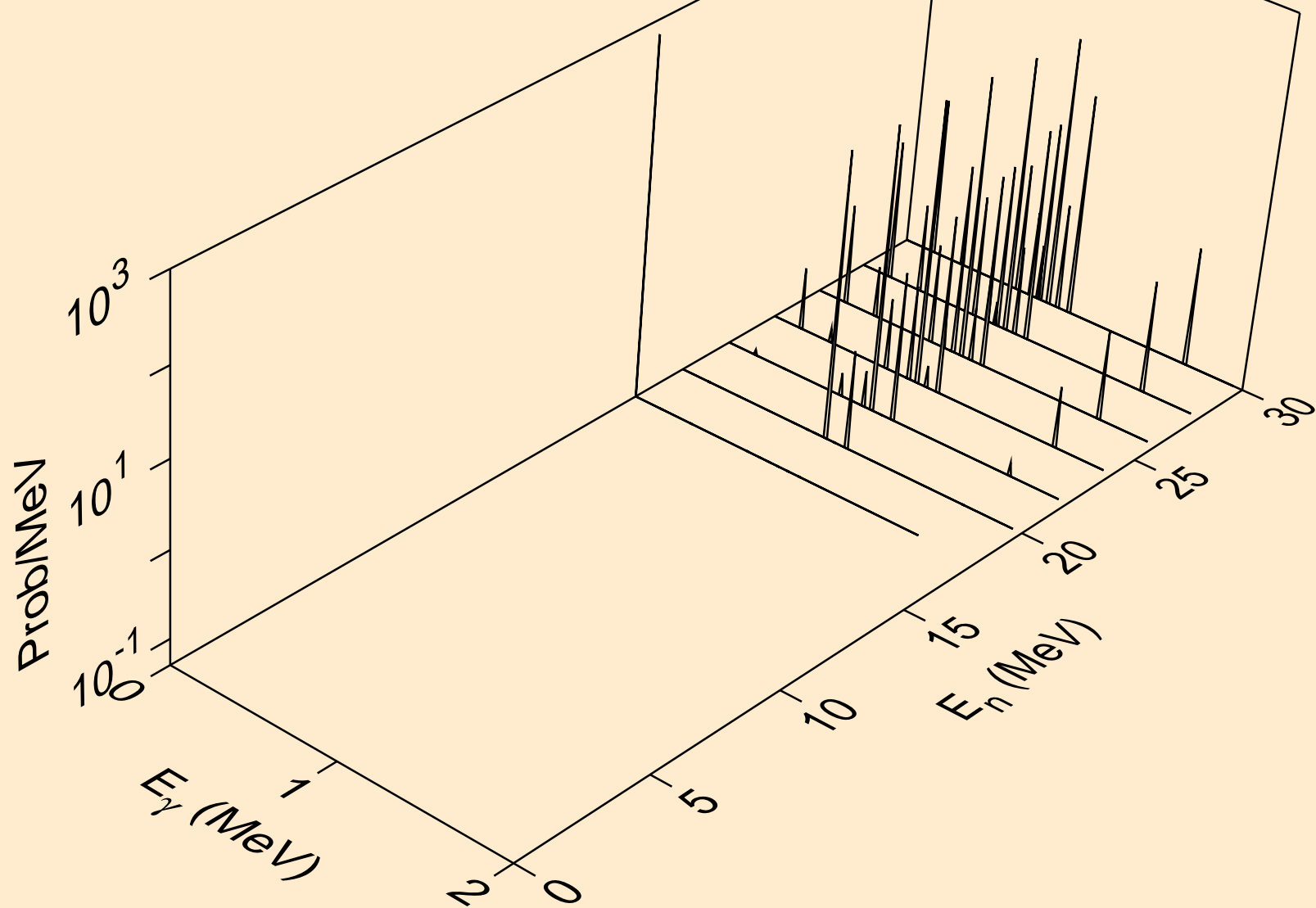

CD100 NEUTRON ACER TENDL-2021 LIBRARY; T=293.6K
Photon emission for (n,n*)d

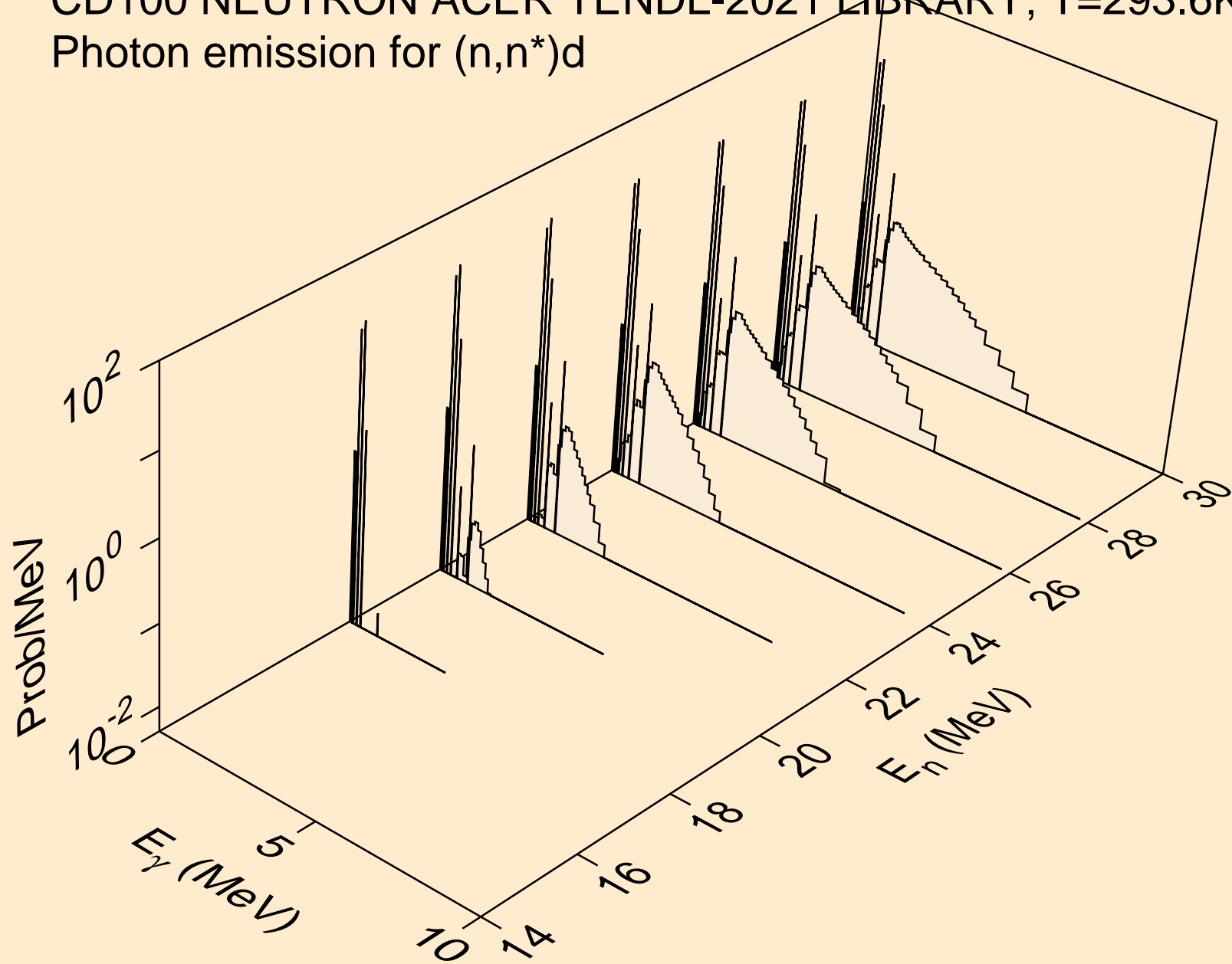

CD100 NEUTRON ACER TENDL-2021 LIBRARY; T=293.6K
Photon emission for (n,n*)t

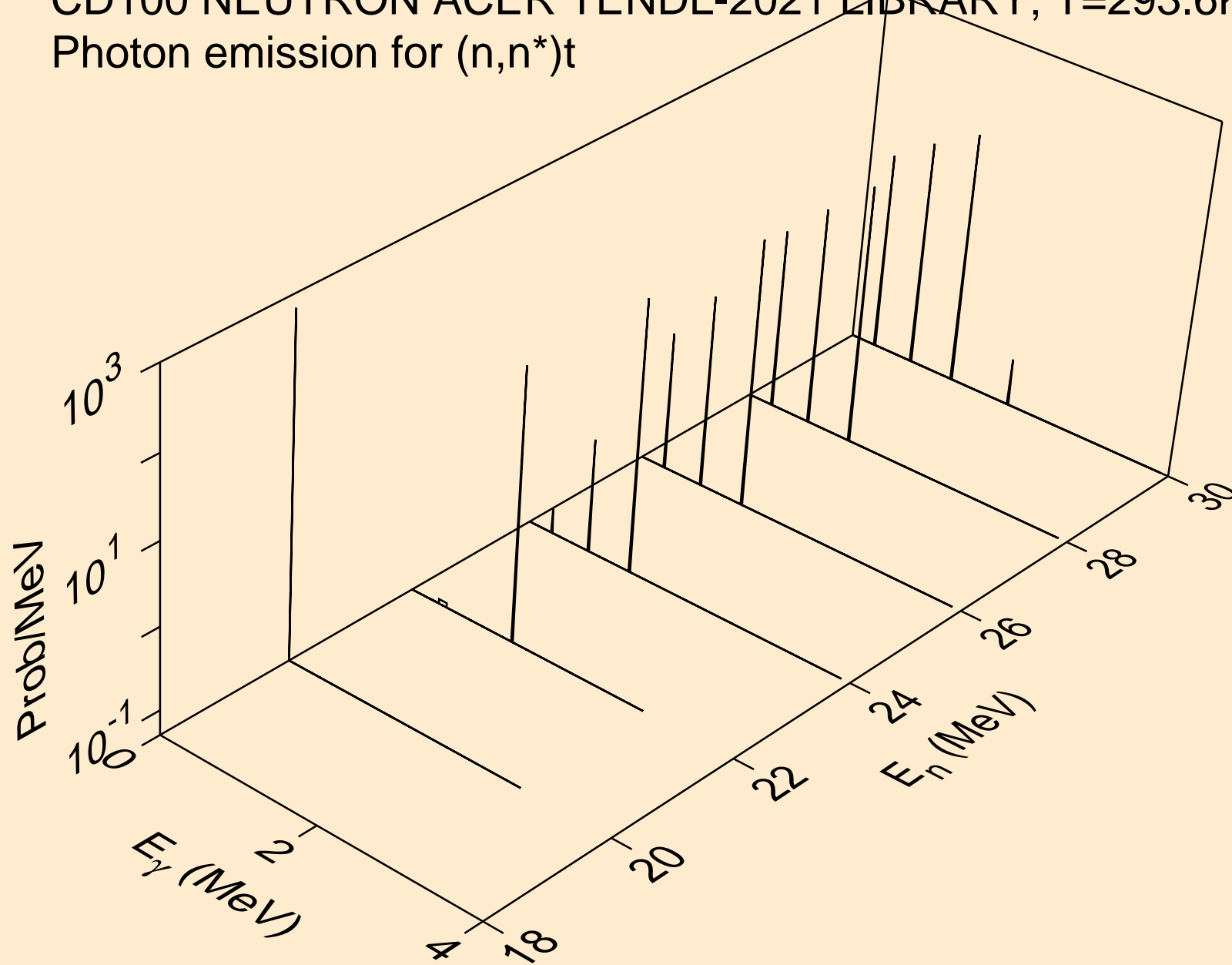

CD100 NEUTRON ACER TENDL-2021 LIBRARY; T=293.6K
Photon emission for (n,n*)he3

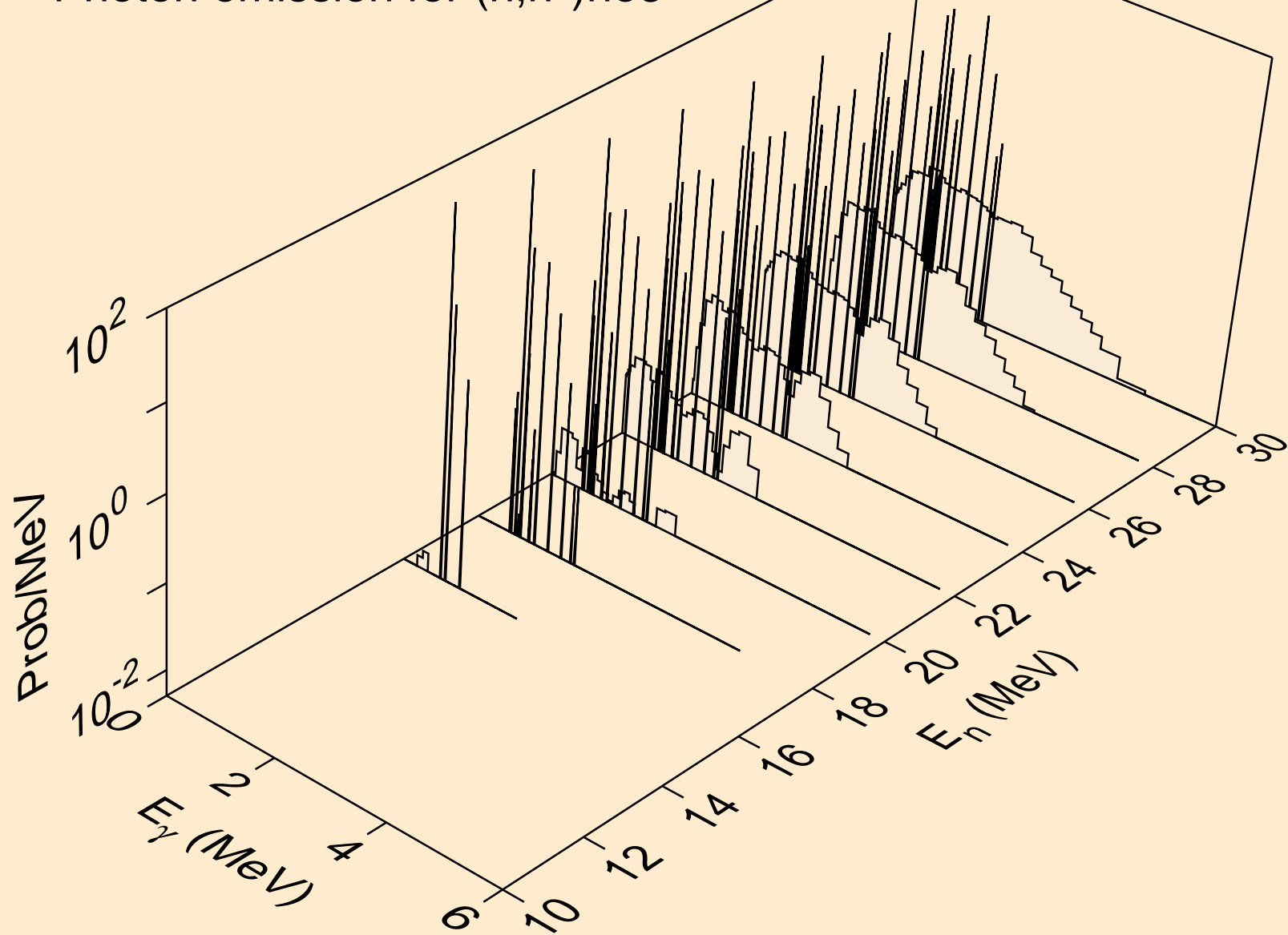

CD100 NEUTRON ACER TENDL-2021 LIBRARY; T=293.6K
Photon emission for (n,2np)

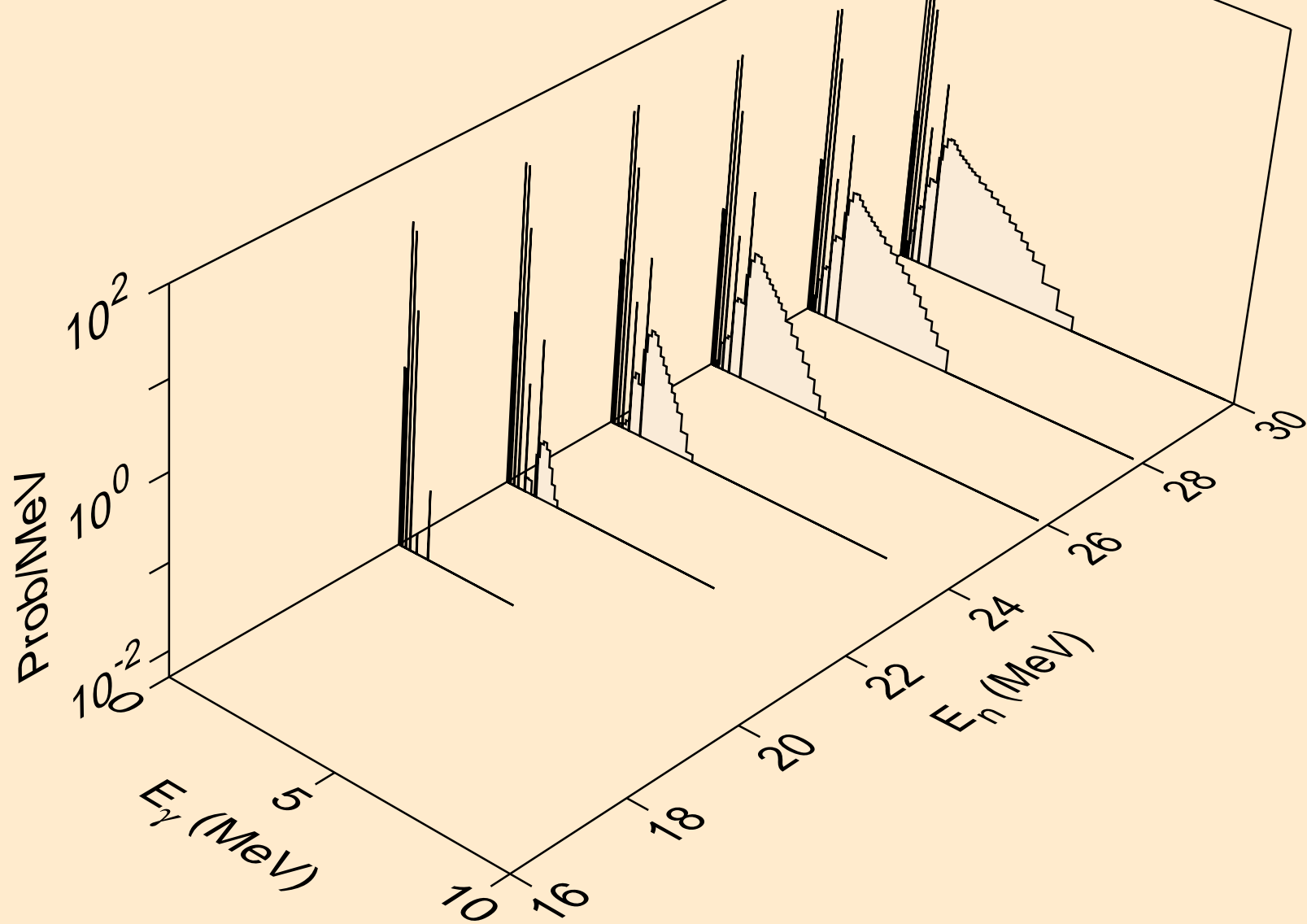

CD100 NEUTRON ACER TENDL-2021 LIBRARY; T=293.6K
Photon emission for (n,3np)

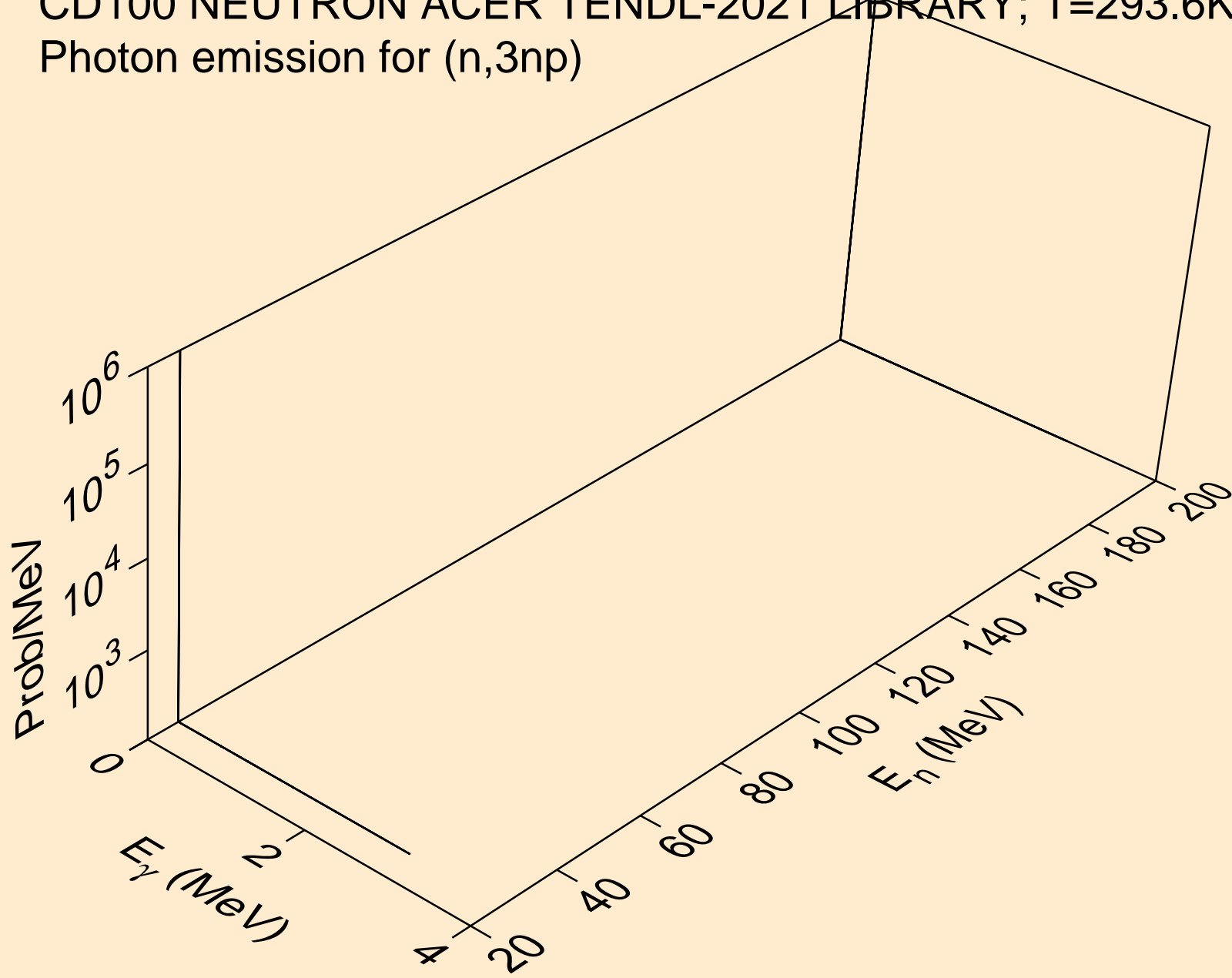

CD100 NEUTRON ACER TENDL-2021 LIBRARY; T=293.6K
Photon emission for (n,2np)

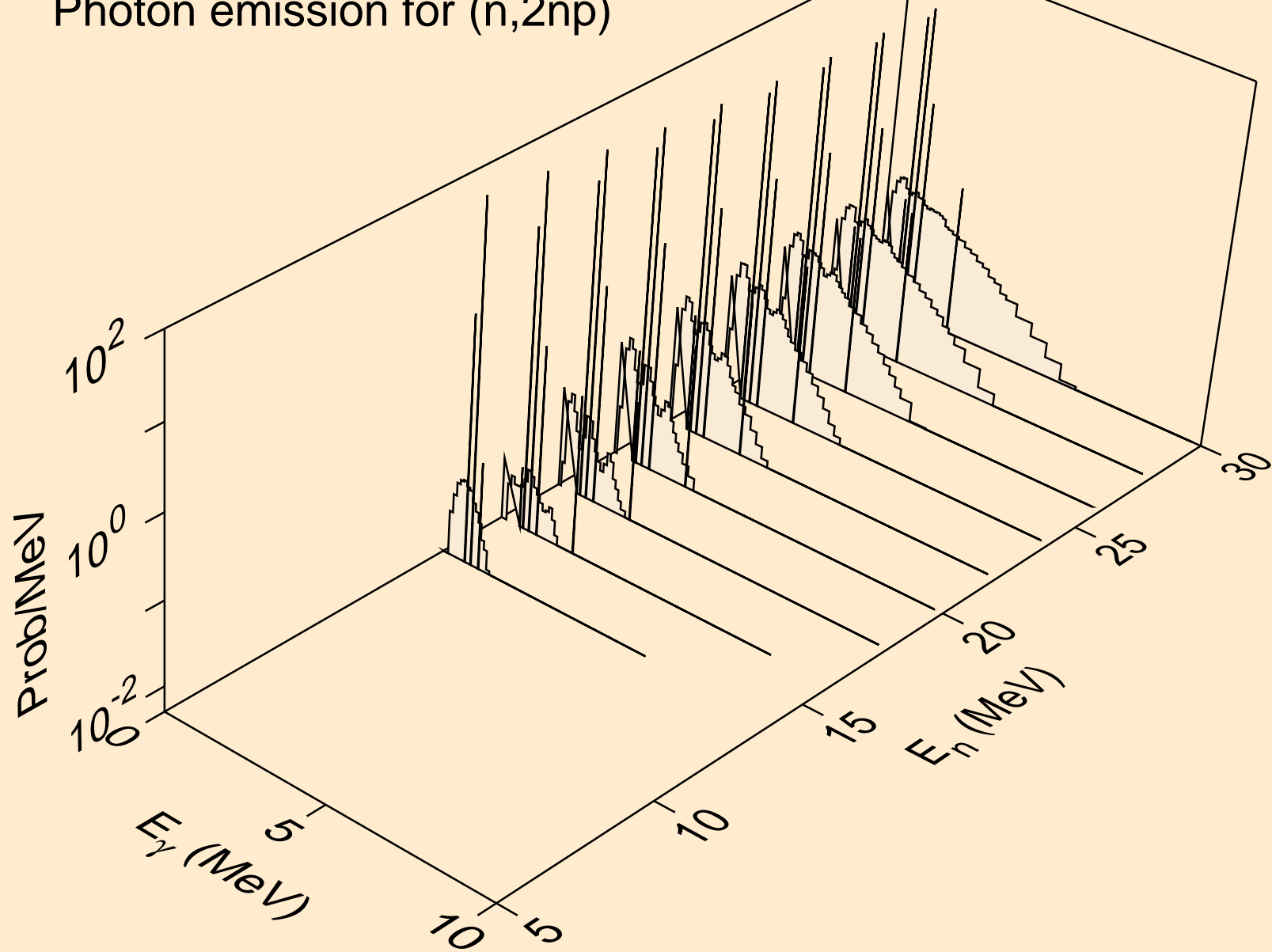

CD100 NEUTRON ACER TENDL-2021 LIBRARY; T=293.6K
Photon emission for (n,npa)

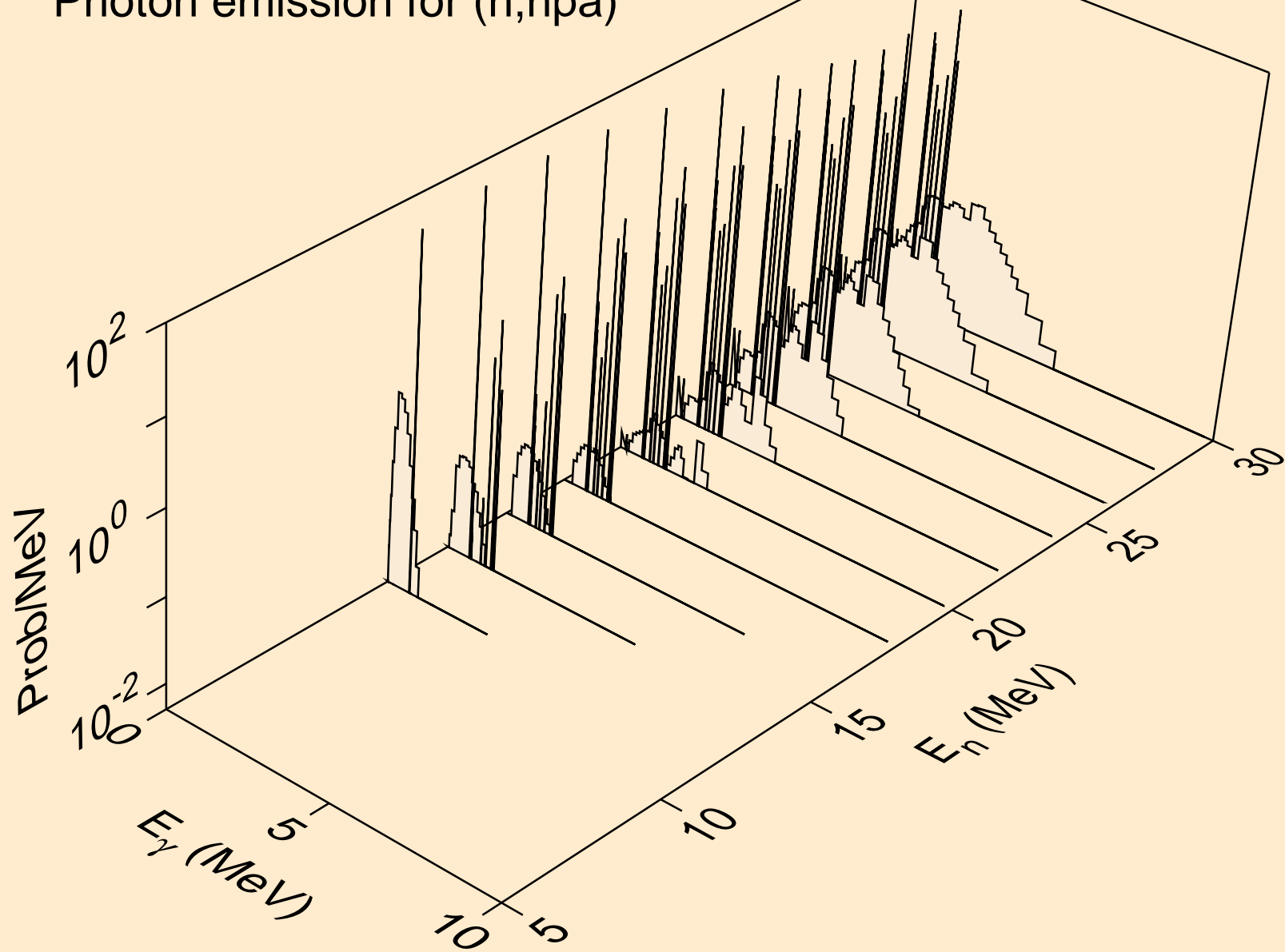

CD100 NEUTRON ACER TENDL-2021 LIBRARY; T=293.6K
Photon emission for (n,n*c)

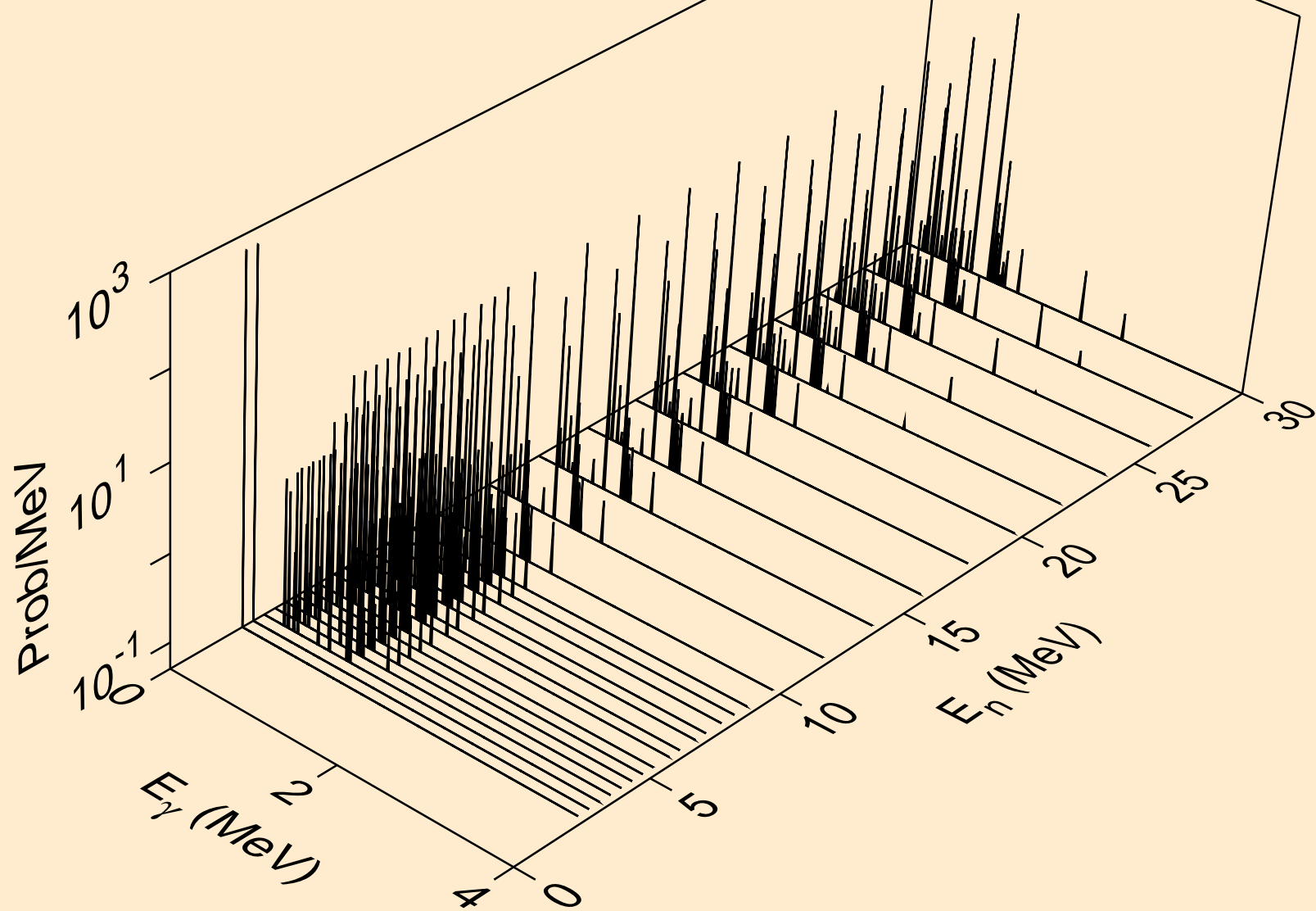

CD100 NEUTRON ACER TENDL-2021 LIBRARY; T=293.6K
Photon emission for (n,gma)

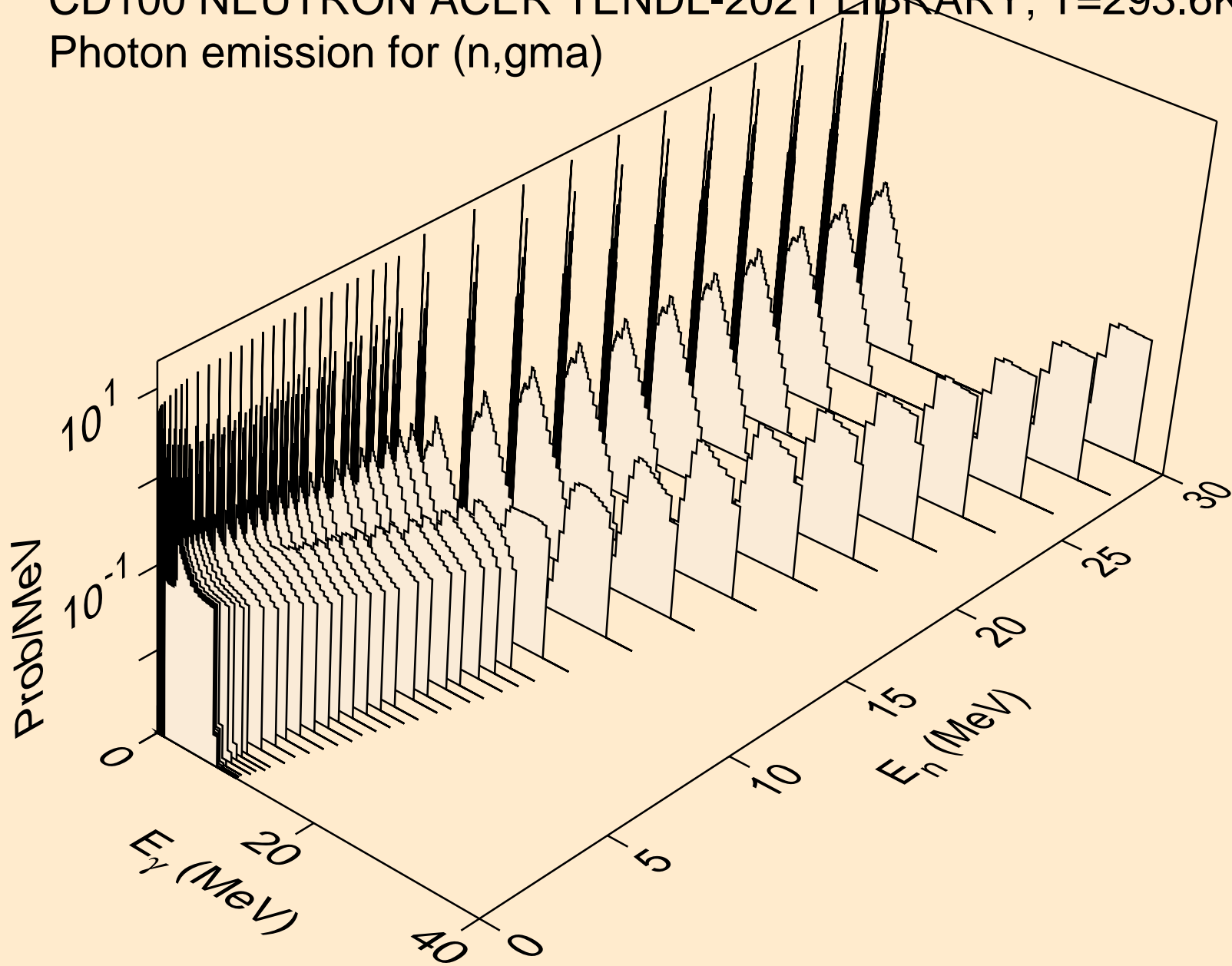

CD100 NEUTRON ACER TENDL-2021 LIBRARY; T=293.6K
Photon emission for (n,p)

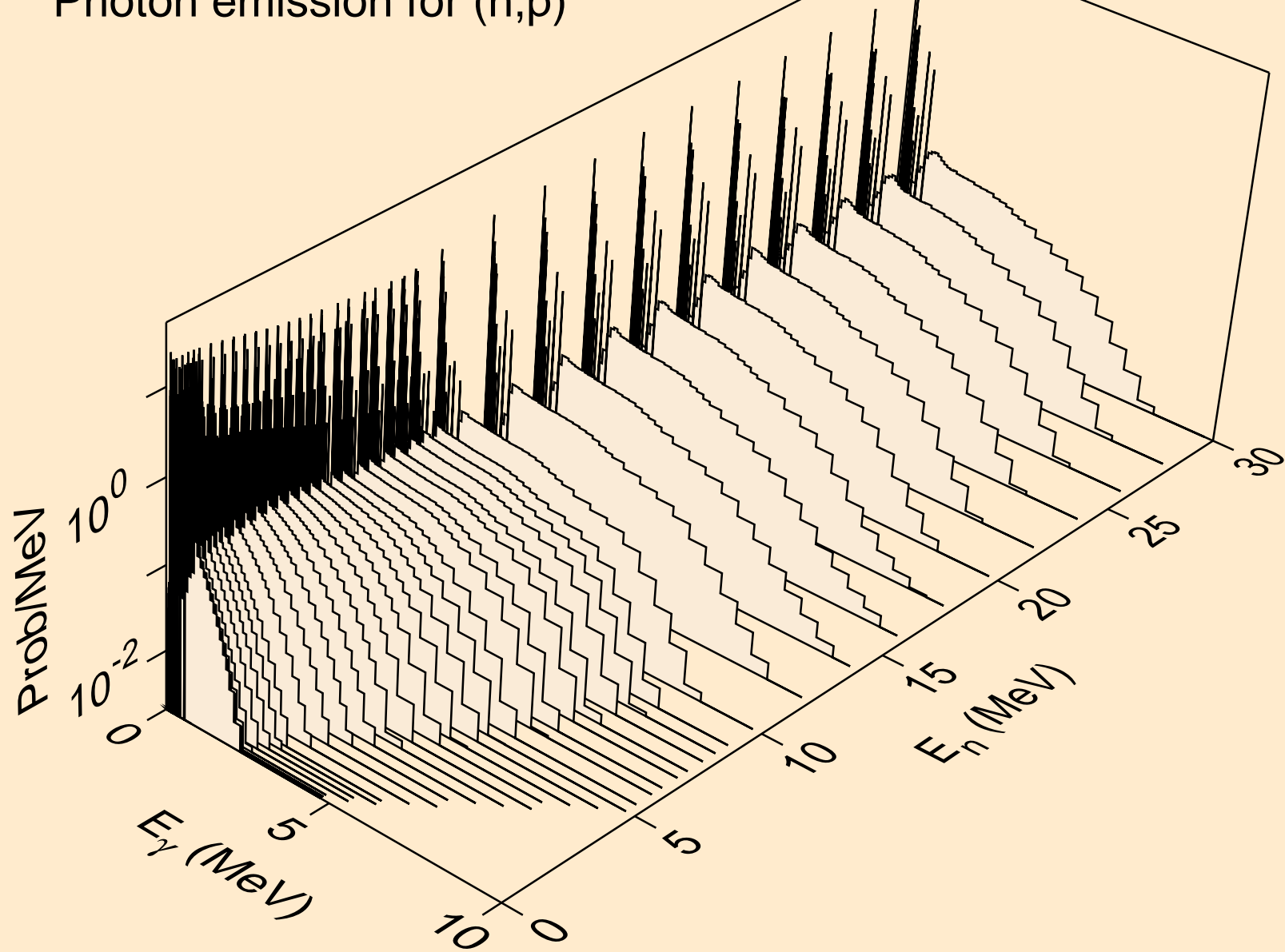

CD100 NEUTRON ACER TENDL-2021 LIBRARY; T=293.6K
Photon emission for (n,d)

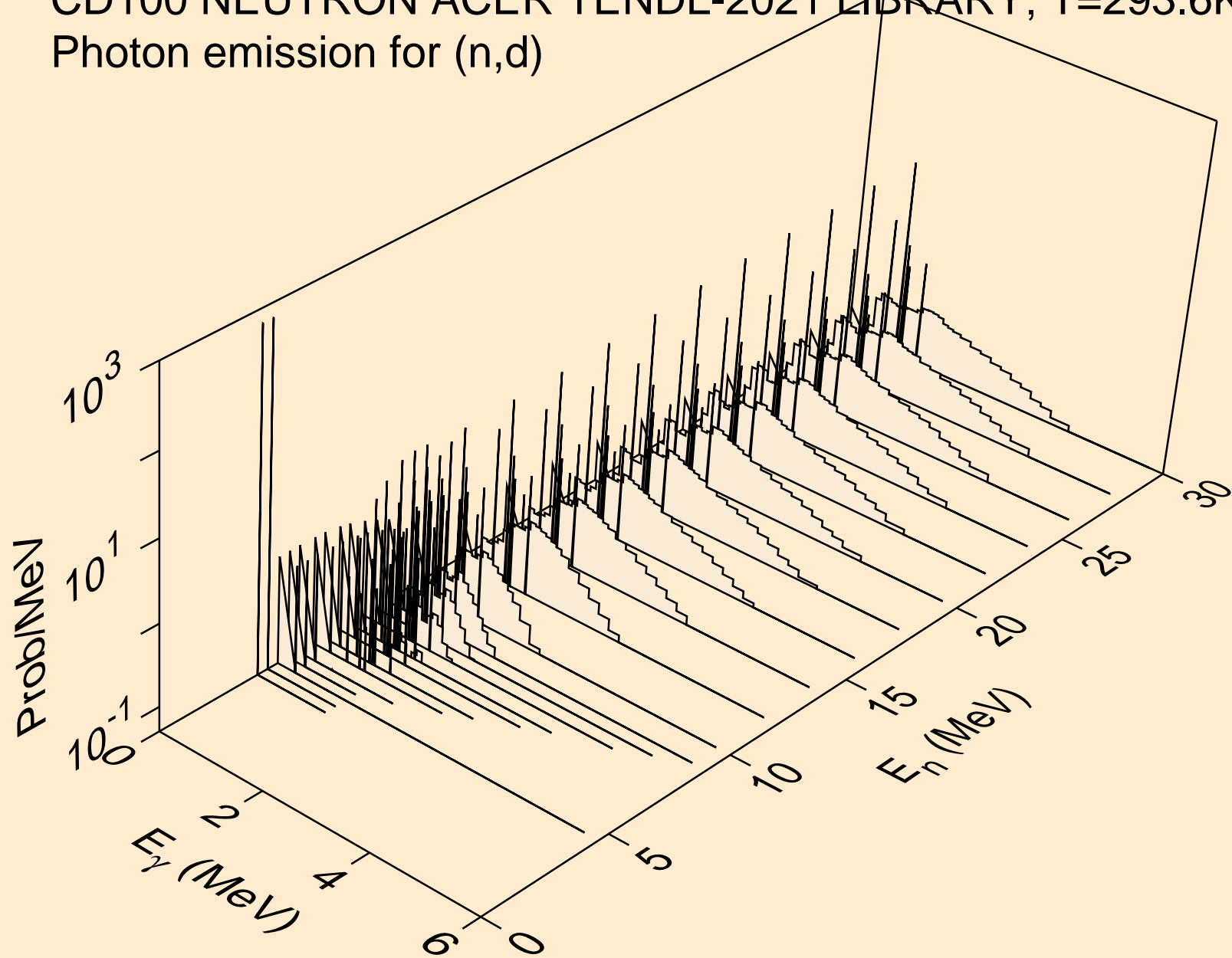

CD100 NEUTRON ACER TENDL-2021 LIBRARY; T=293.6K
Photon emission for (n,t)

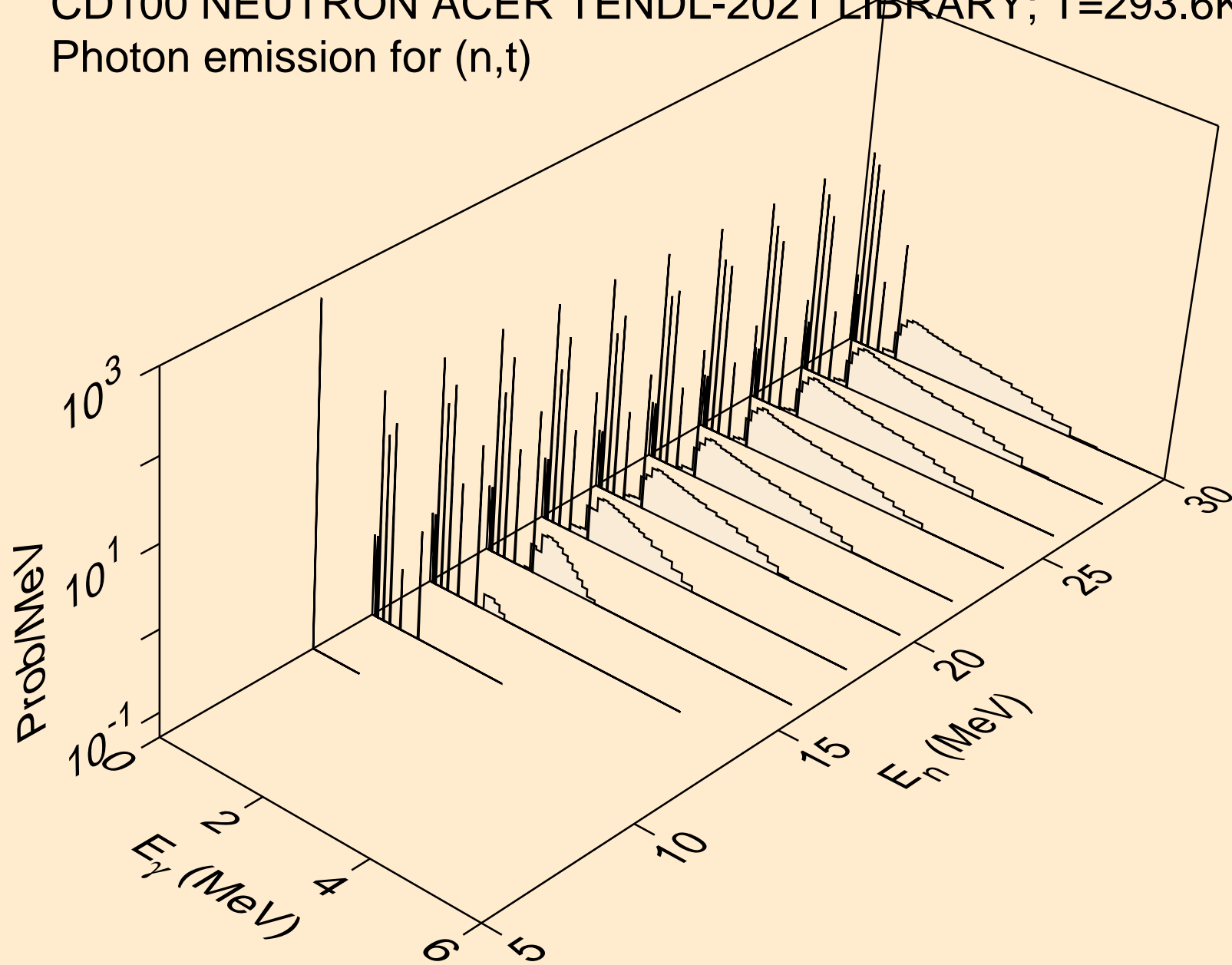

CD100 NEUTRON ACER TENDL-2021 LIBRARY; T=293.6K
Photon emission for (n,he3)

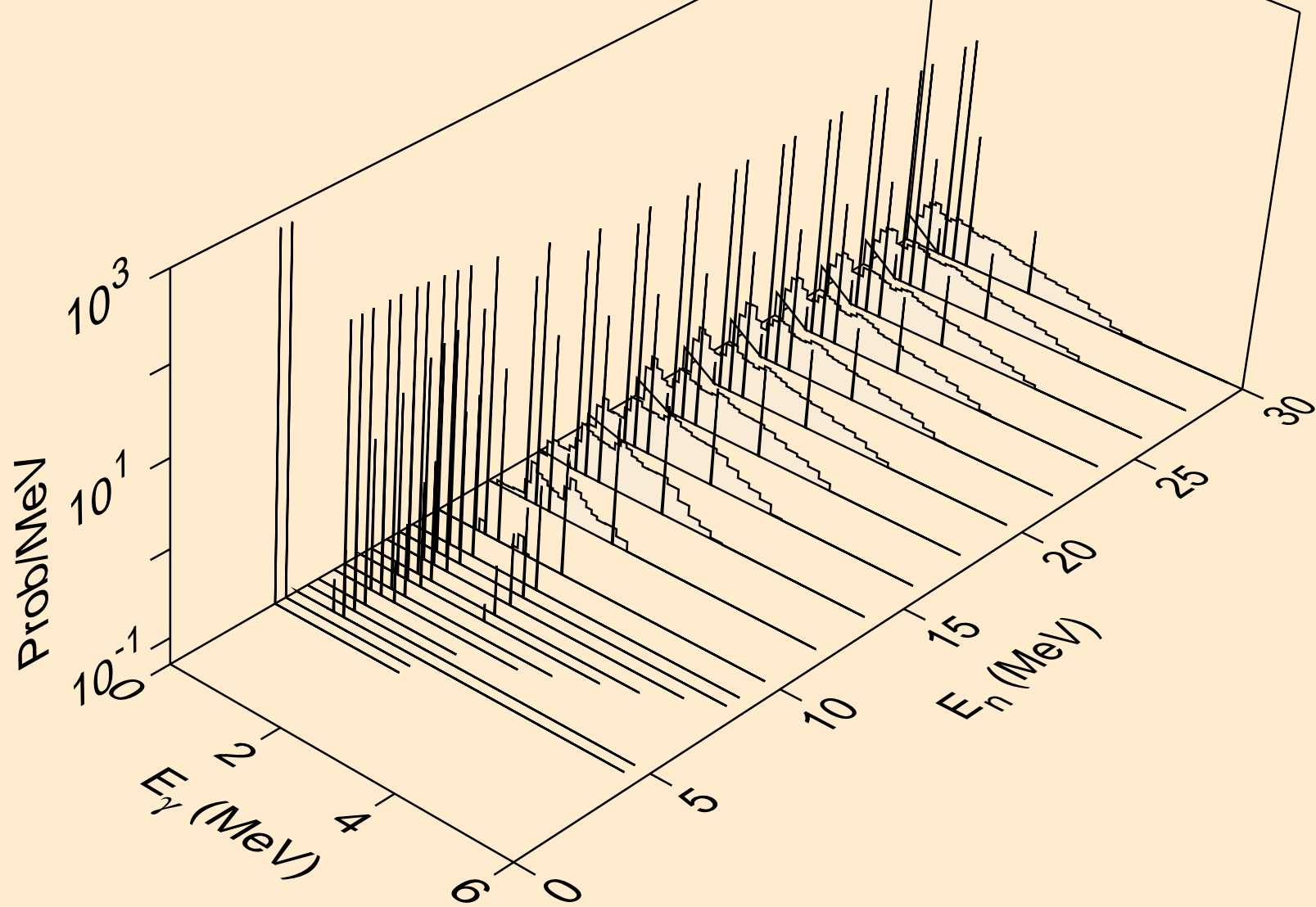

CD100 NEUTRON ACER TENDL-2021 LIBRARY; T=293.6K
Photon emission for (n,a)

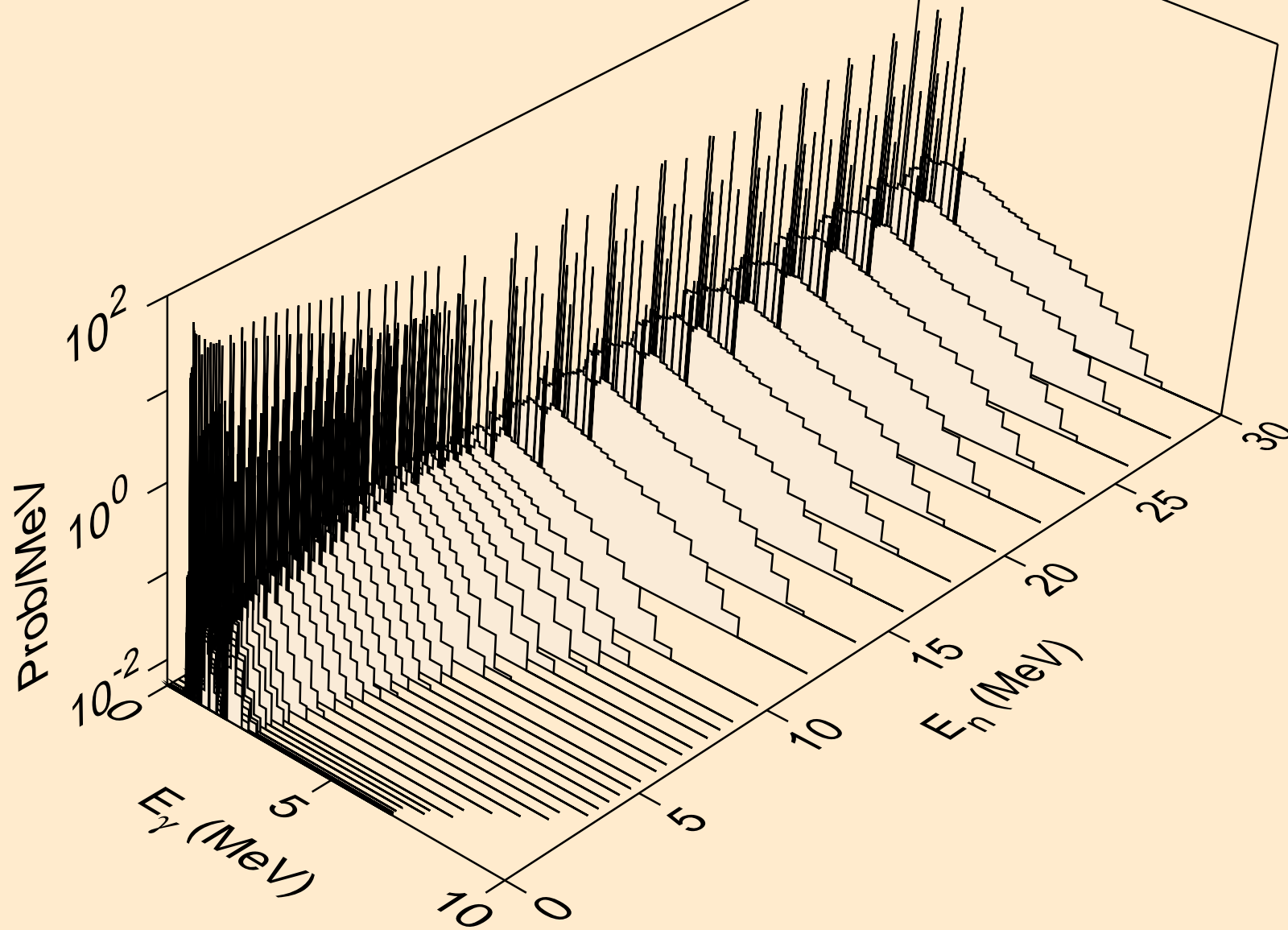

CD100 NEUTRON ACER TENDL-2021 LIBRARY; T=293.6K
Photon emission for (n,2a)

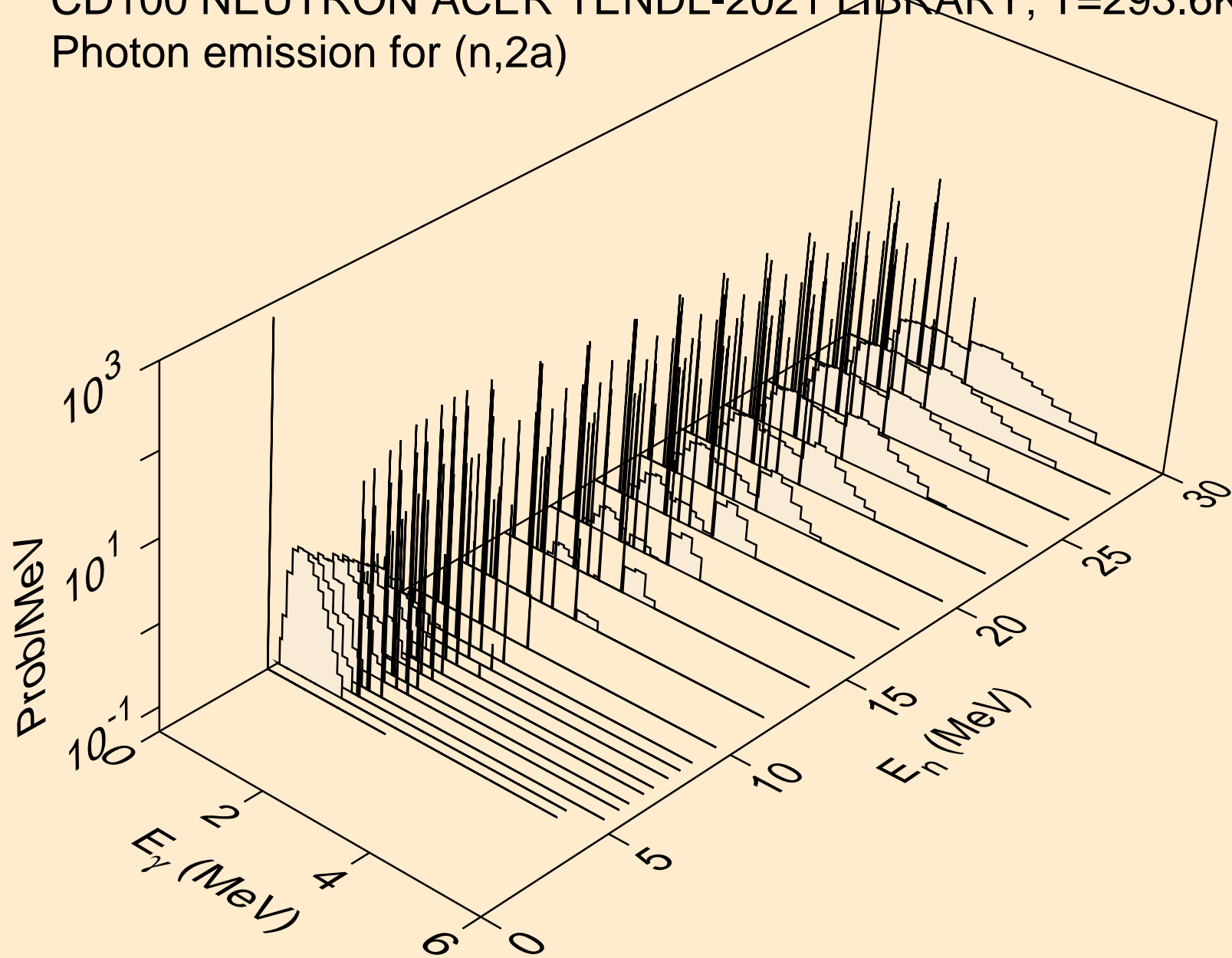

CD100 NEUTRON ACER TENDL-2021 LIBRARY; T=293.6K
Photon emission for (n,2p)

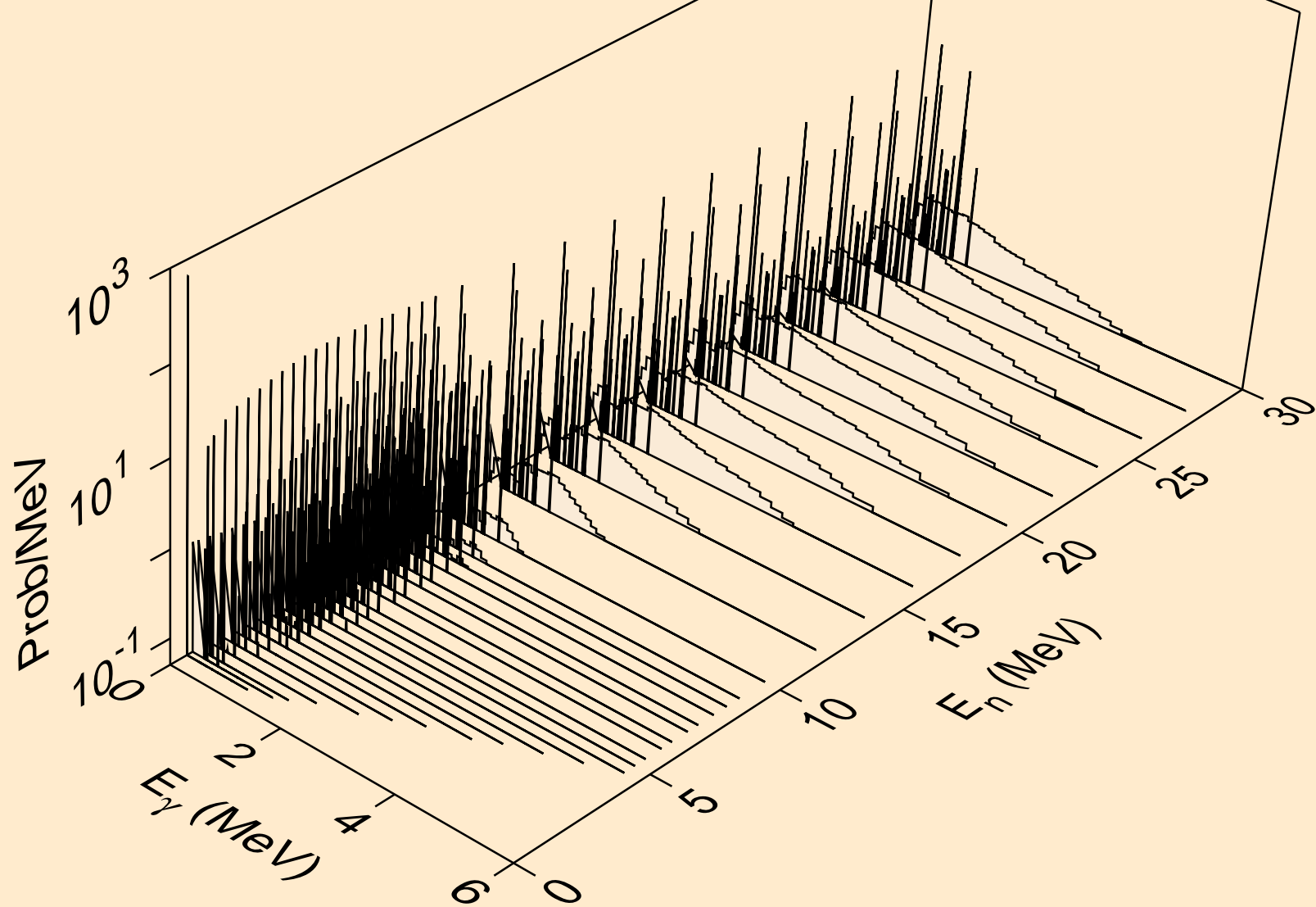

CD100 NEUTRON ACER TENDL-2021 LIBRARY; T=293.6K
Photon emission for (n,p)

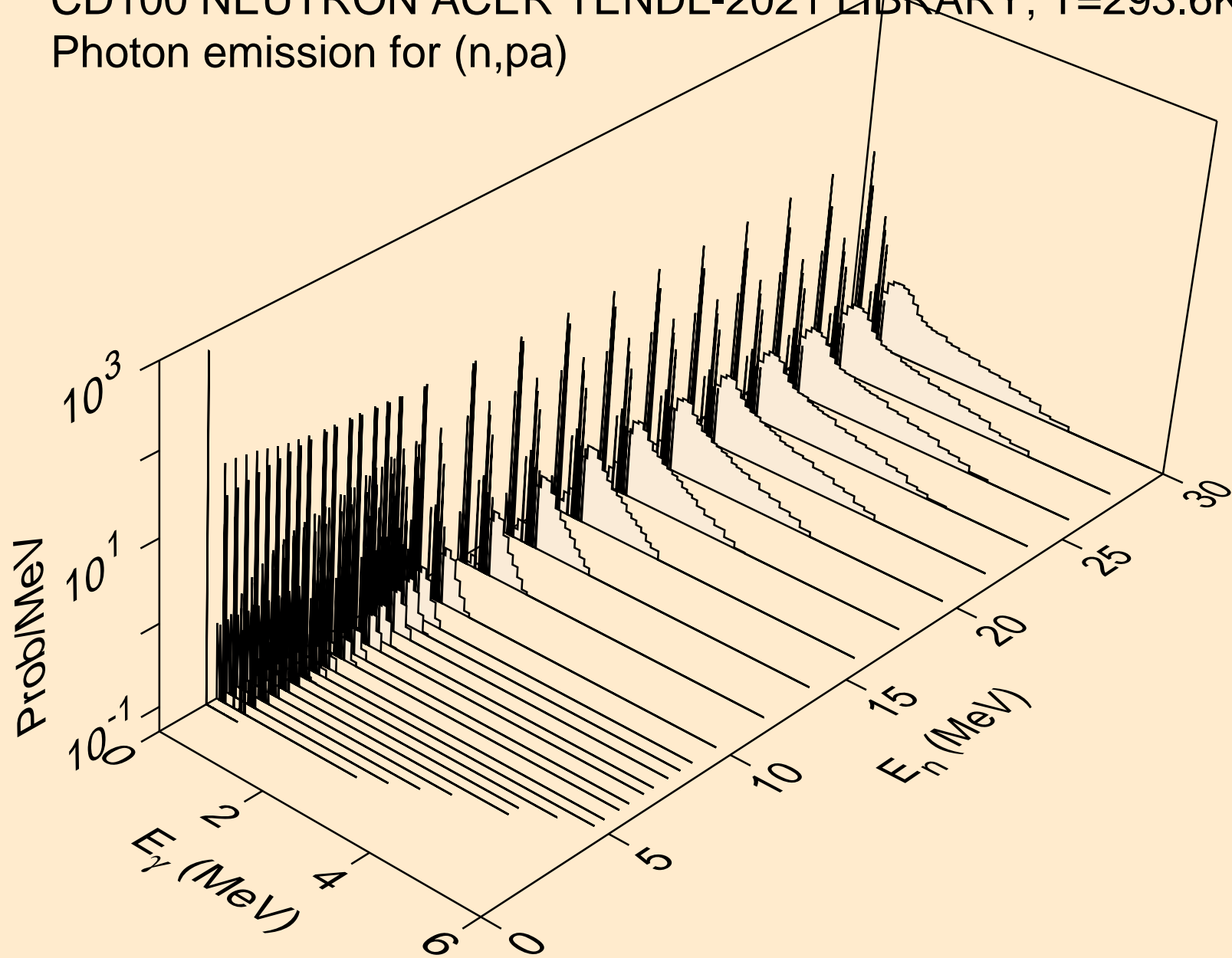

CD100 NEUTRON ACER TENDL-2021 LIBRARY; T=293.6K
Photon emission for (n,pd)

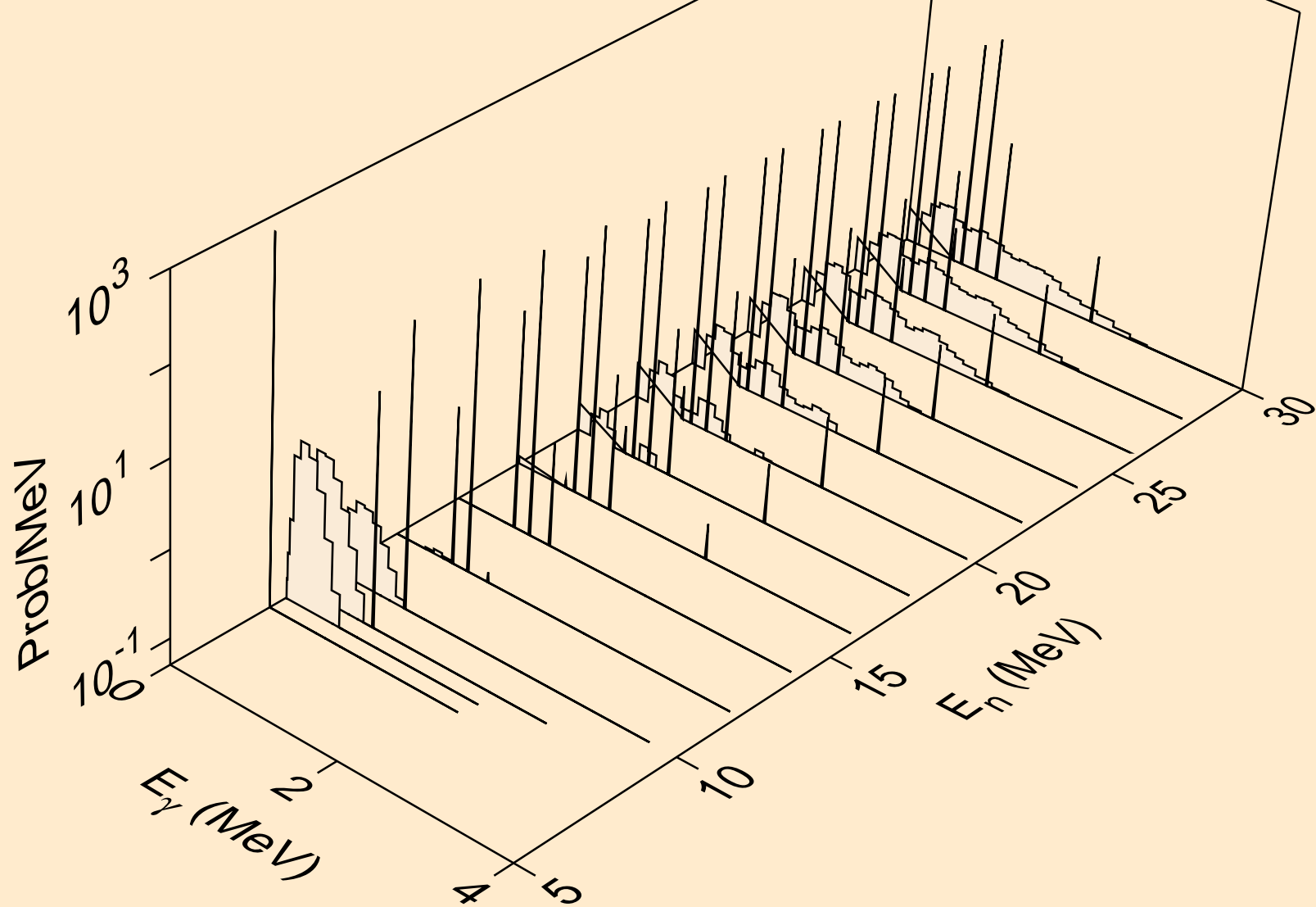

CD100 NEUTRON ACER TENDL-2021 LIBRARY; T=293.6K
Photon emission for (n,pt)

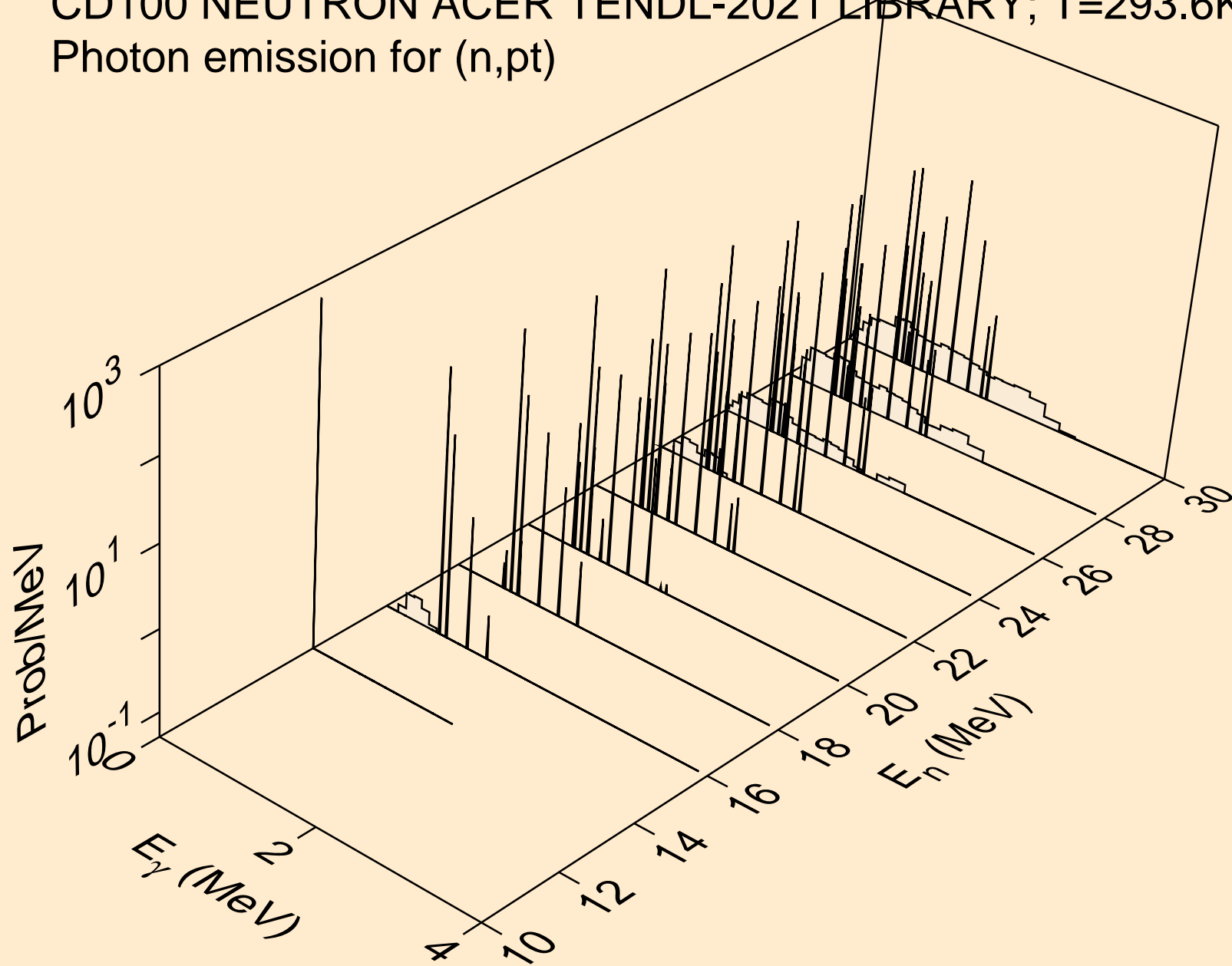

CD100 NEUTRON ACER TENDL-2021 LIBRARY; T=293.6K
Photon emission for (n,da)

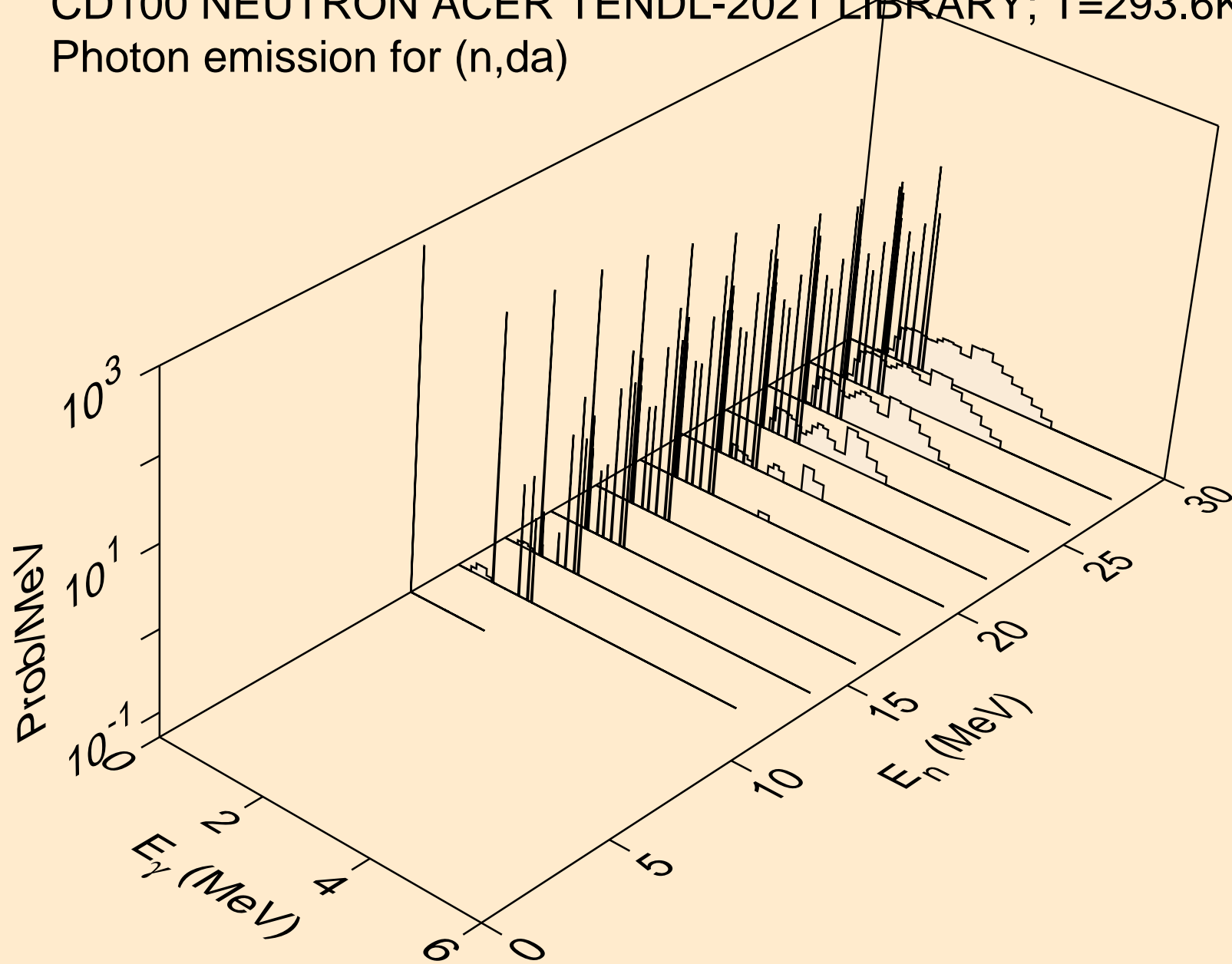

CD100 NEUTRON ACER TENDL-2021 LIBRARY; T=293.6K
thermal capture photon spectrum

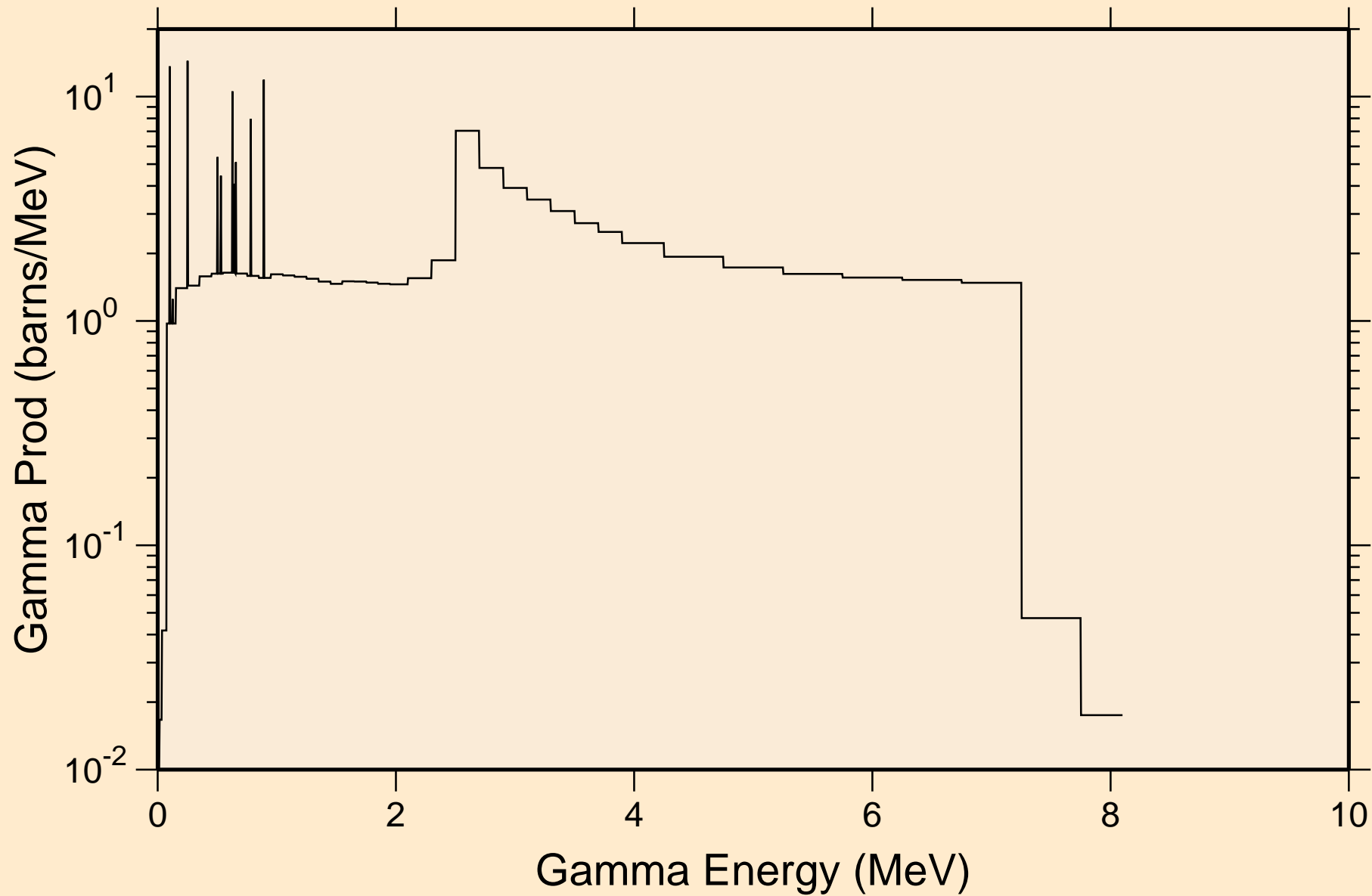

CD100 NEUTRON ACER TENDL-2021 LIBRARY; T=293.6K
14 MeV photon spectrum

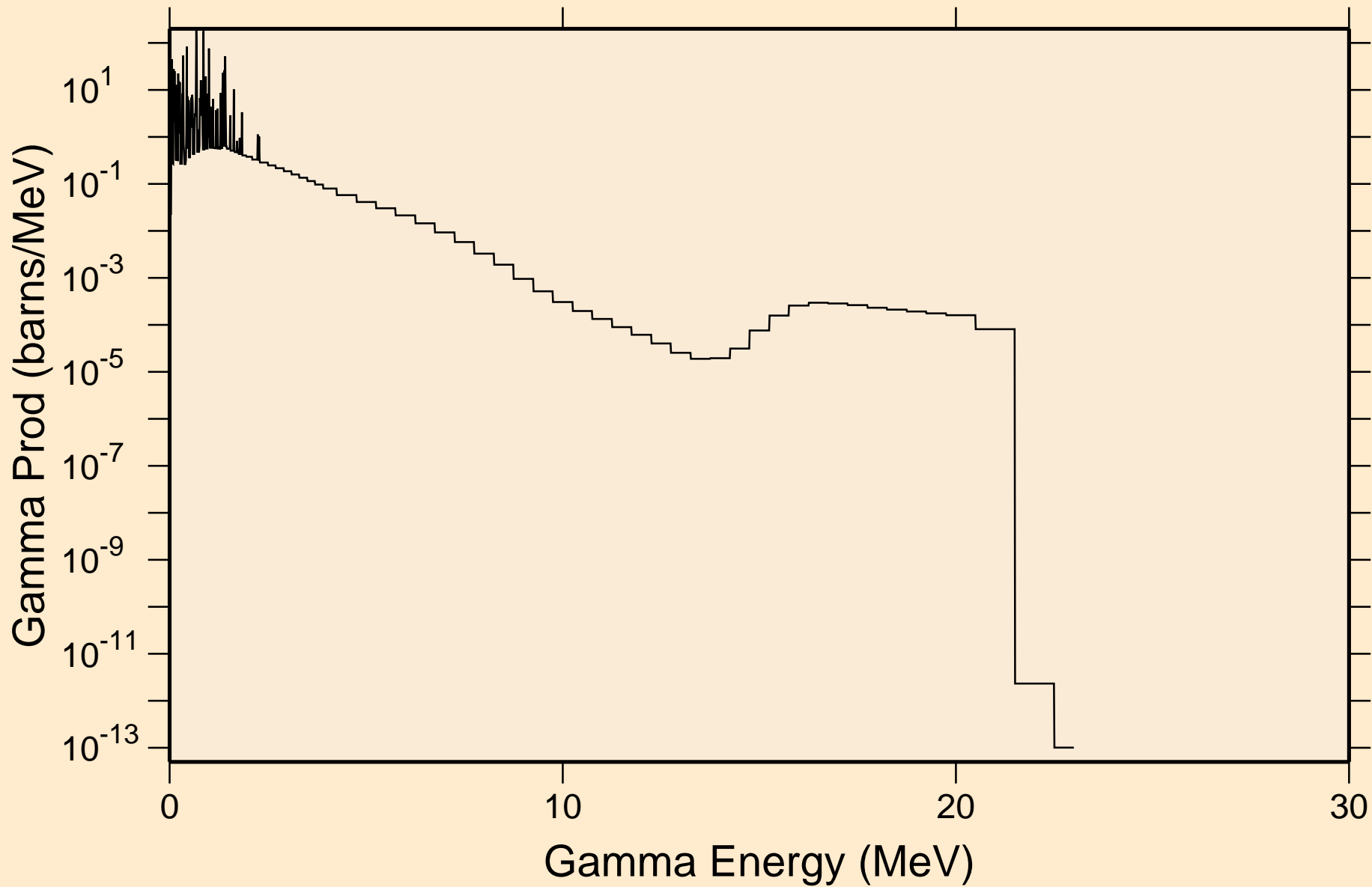

CD100 NEUTRON ACER TENDL-2021 LIBRARY; T=293.6K

Particle heating contributions

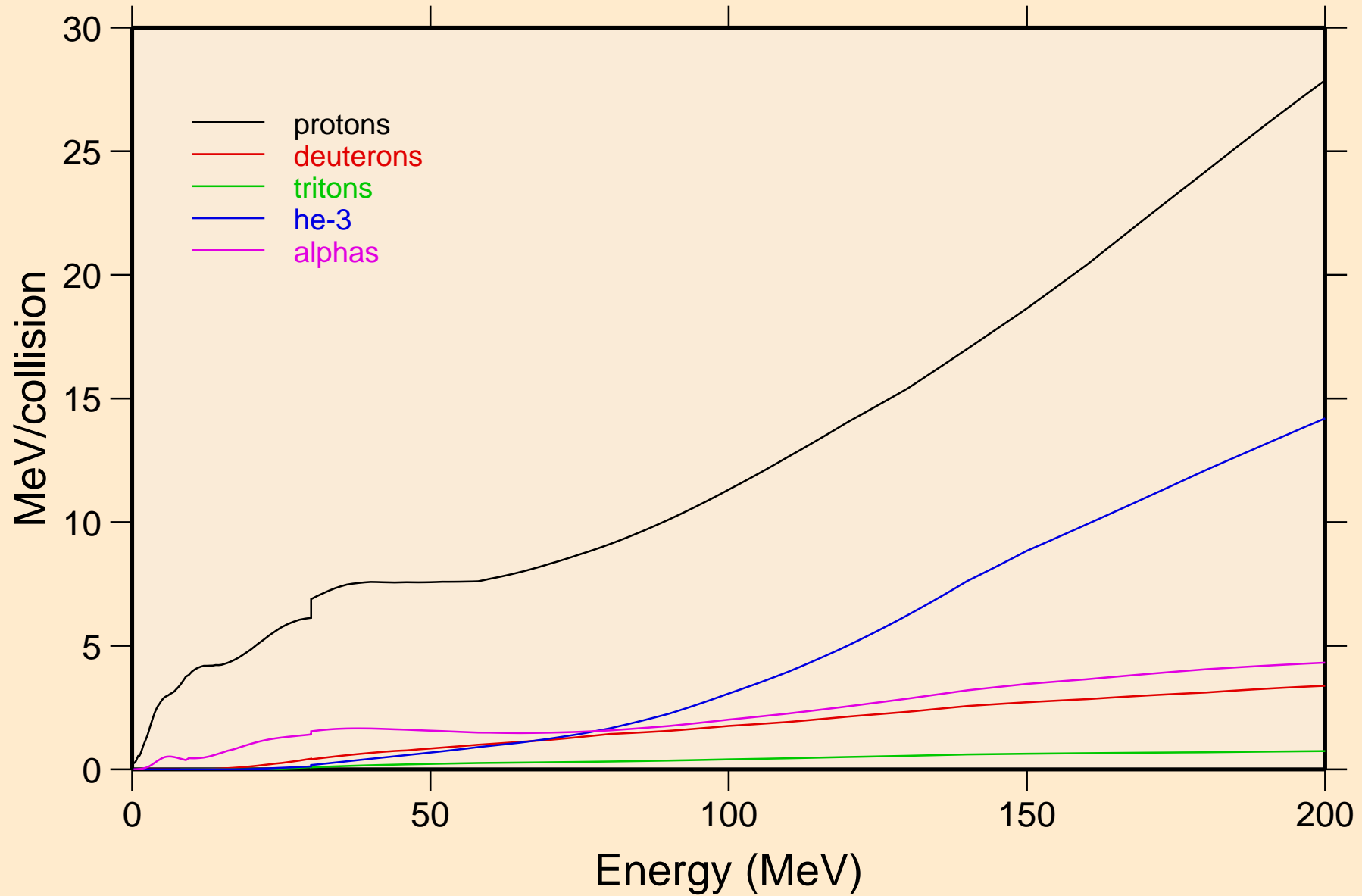

CD100 NEUTRON ACER TENDL-2021 LIBRARY; T=293.6K

Recoil Heating

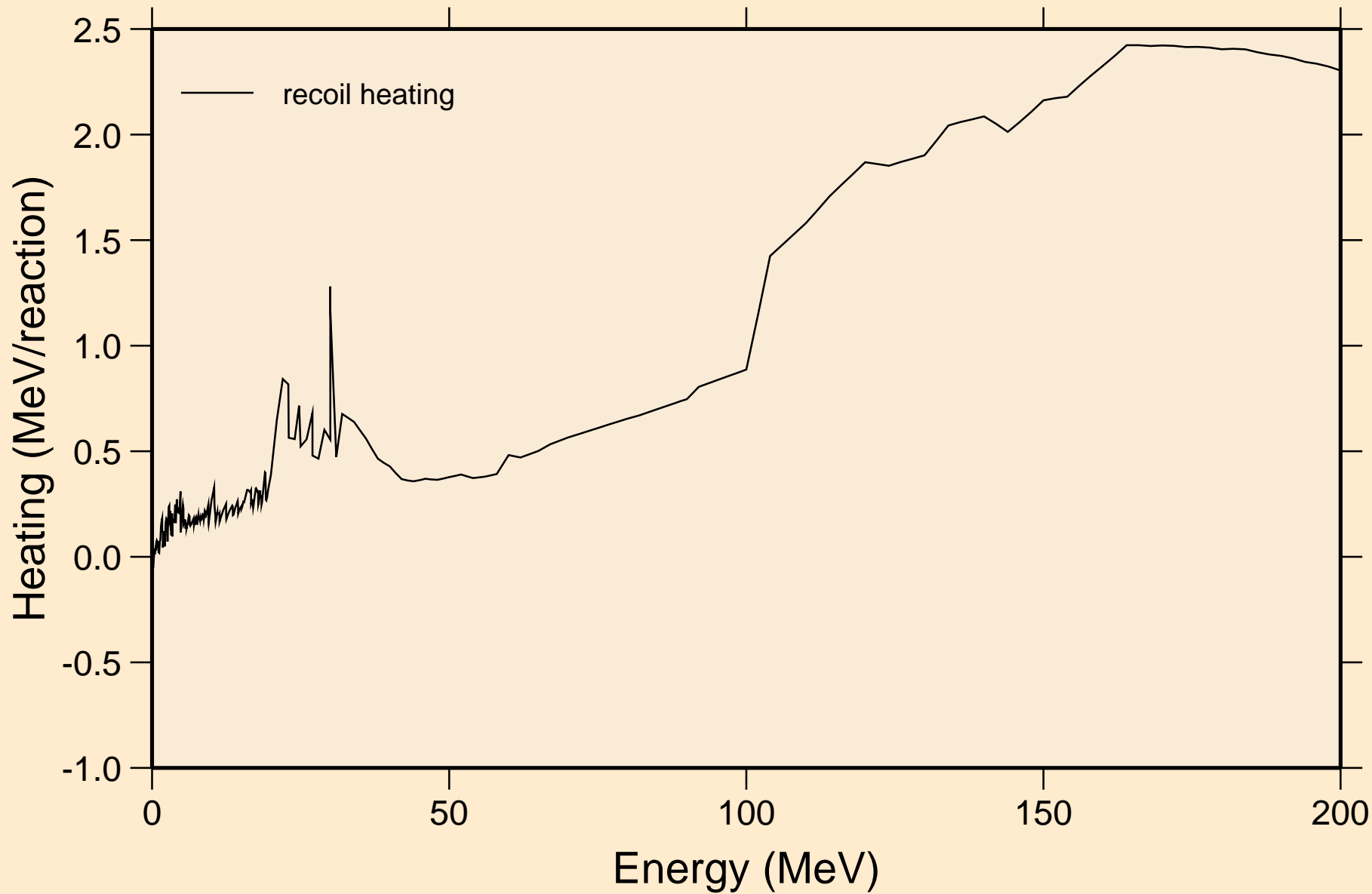

CD100 NEUTRON ACER TENDL-2021 LIBRARY; T=293.6K

Particle production cross sections

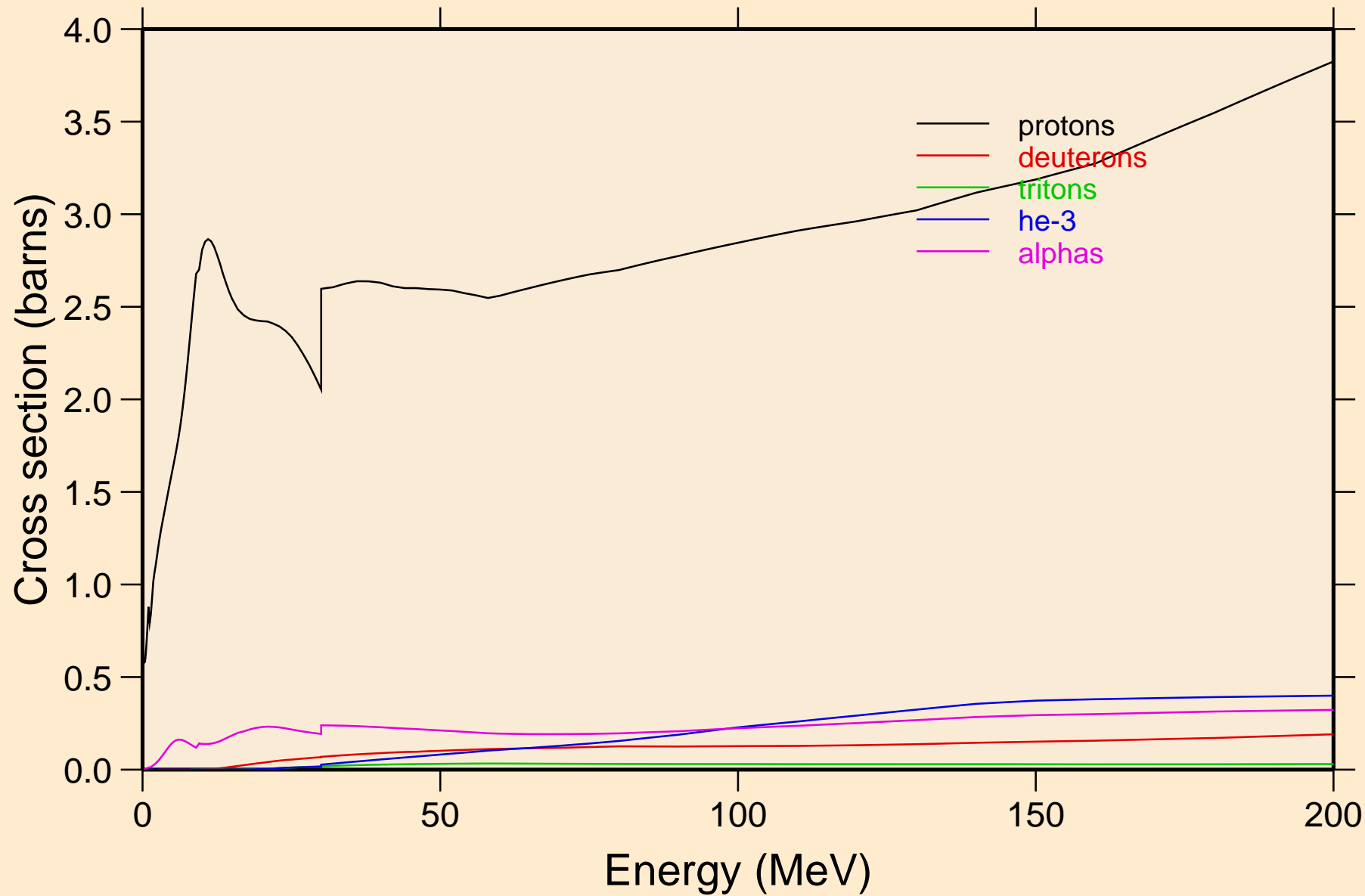

CD100 NEUTRON ACER TENDL-2021 LIBRARY; T=293.6K
protons from (n,x)

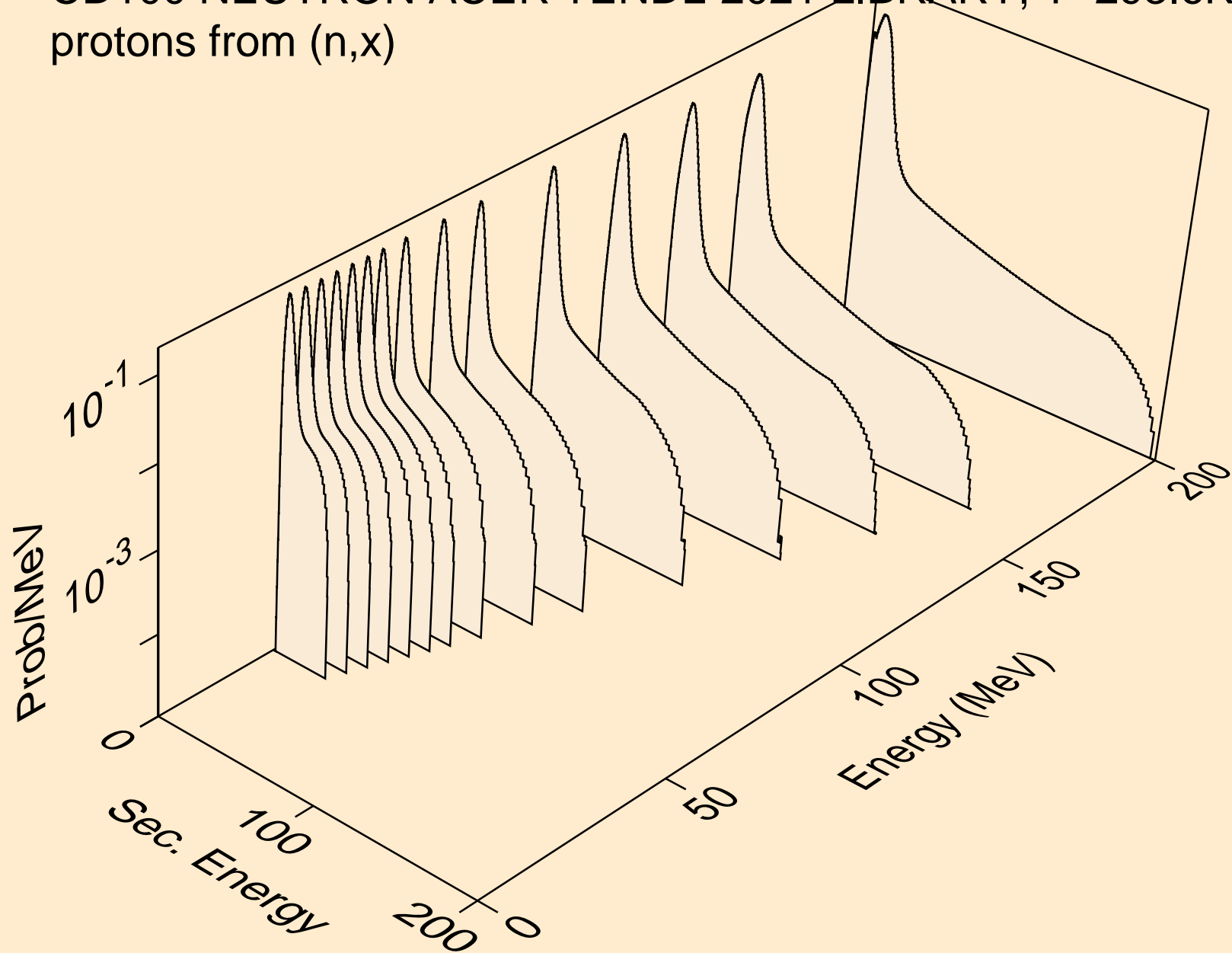

CD100 NEUTRON ACER TENDL-2021 LIBRARY; T=293.6K
protons from (n,n*)p

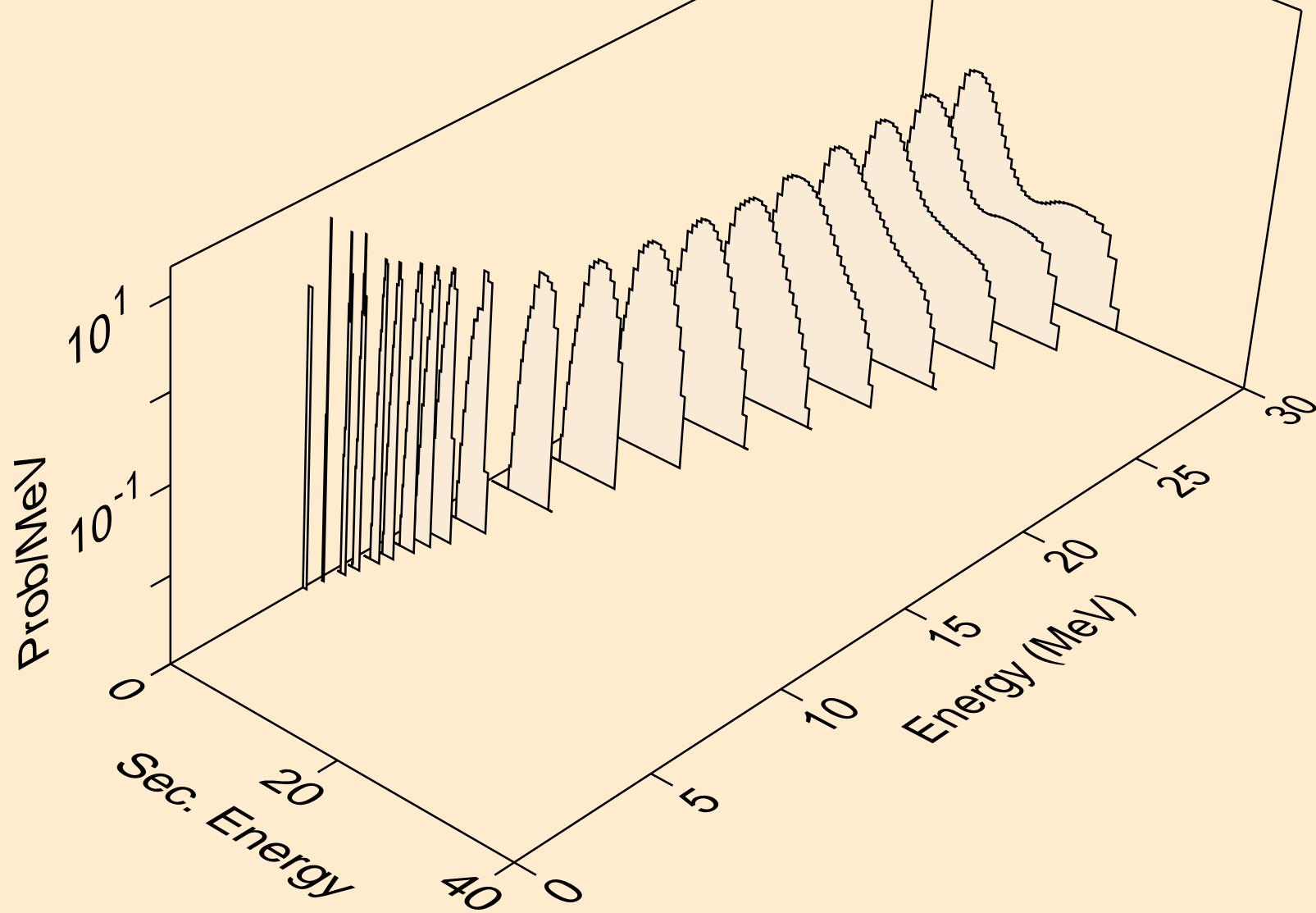

CD100 NEUTRON ACER TENDL-2021 LIBRARY; T=293.6K
protons from (n,2np)

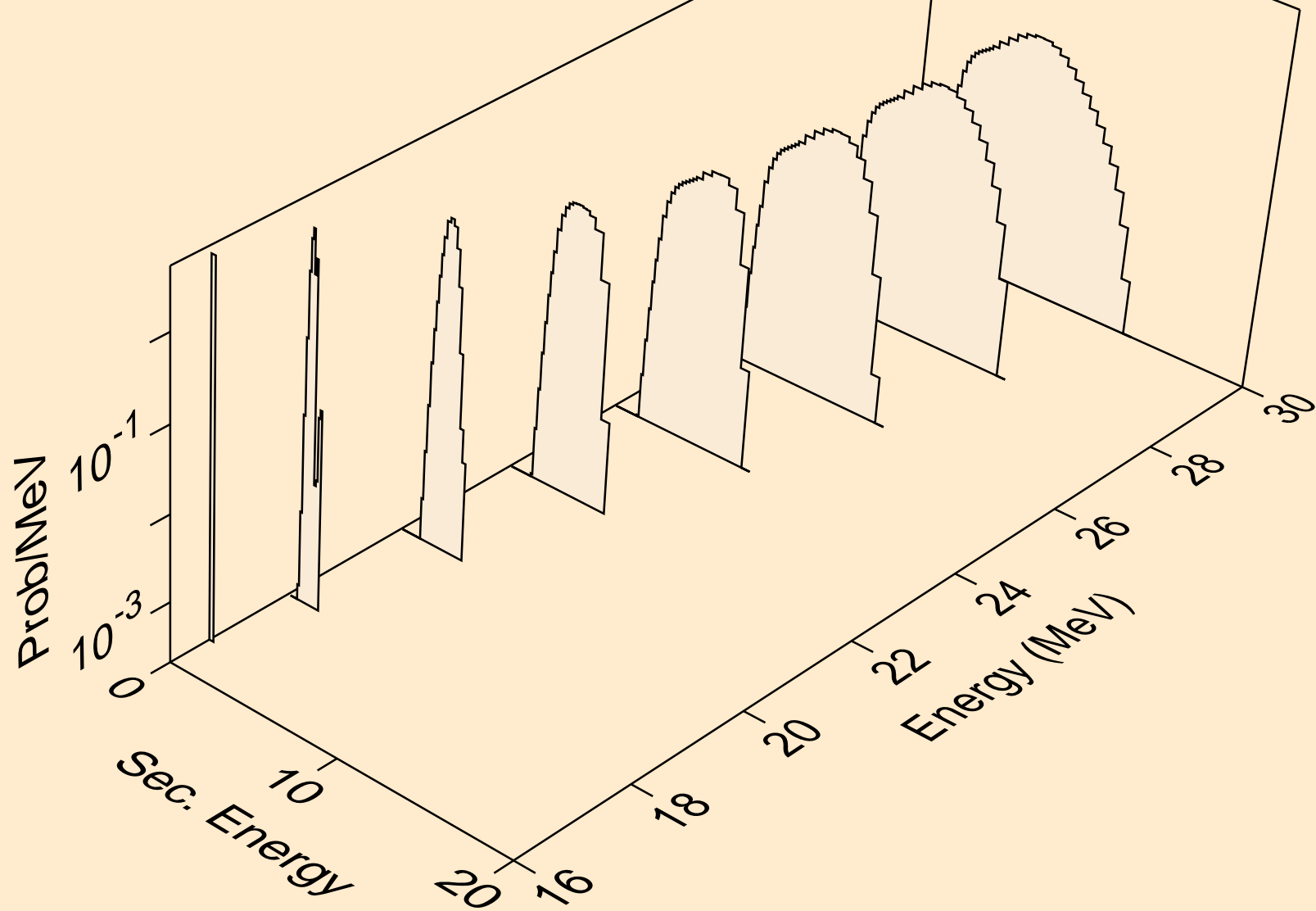

CD100 NEUTRON ACER TENDL-2021 LIBRARY; T=293.6K
protons from (n,3np)

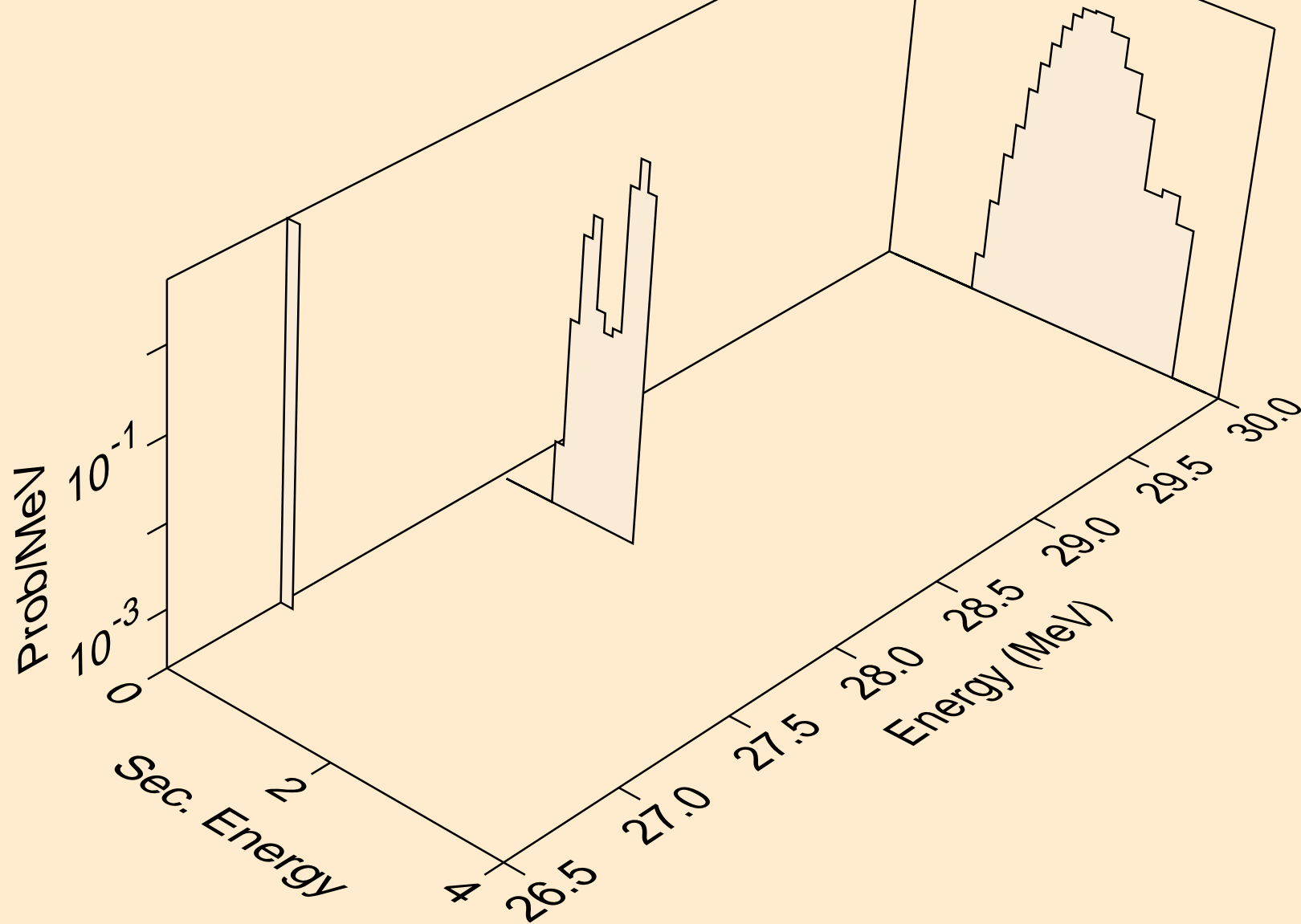

CD100 NEUTRON ACER TENDL-2021 LIBRARY; T=293.6K
protons from (n,2np)

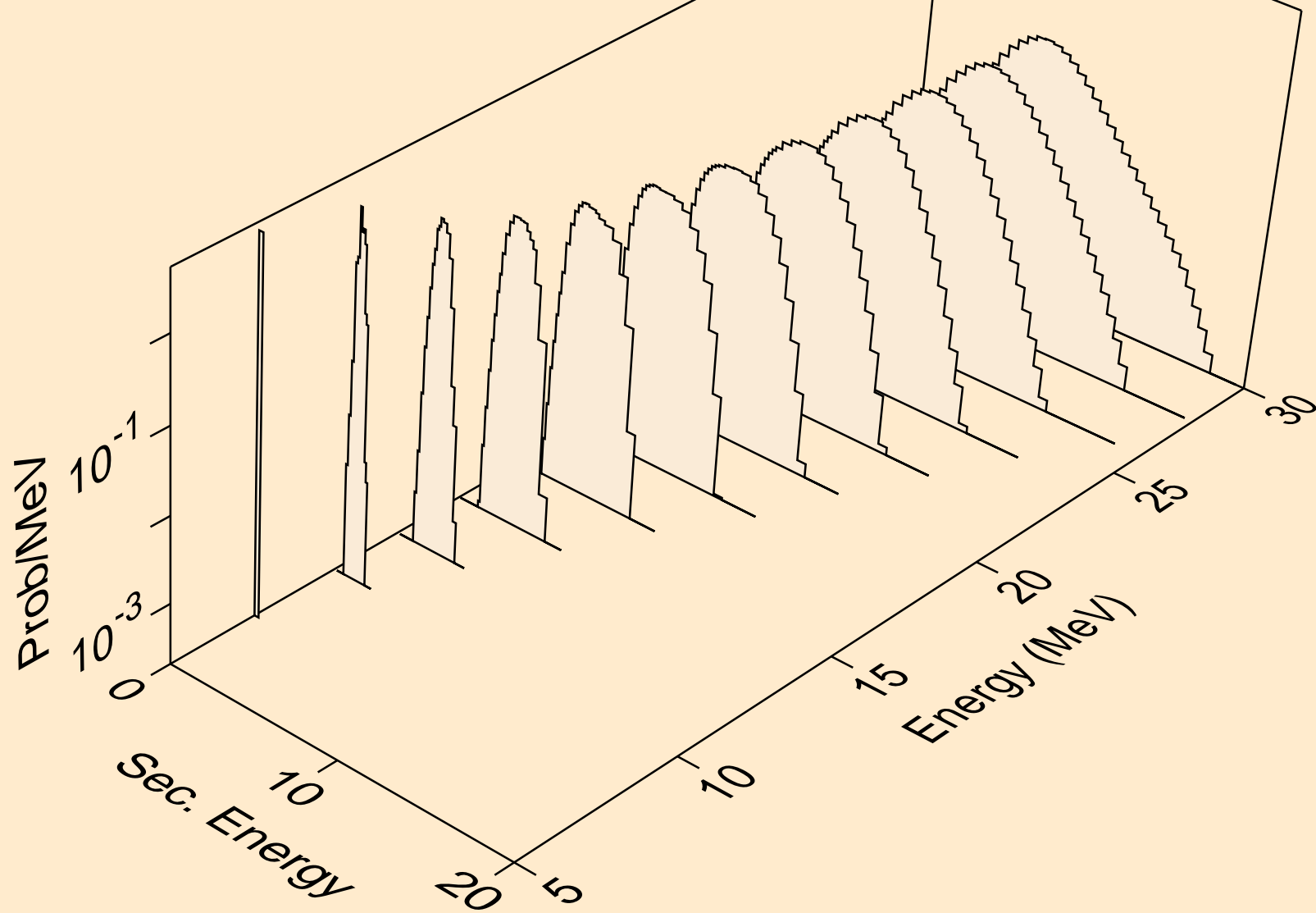

CD100 NEUTRON ACER TENDL-2021 LIBRARY; T=293.6K
protons from (n,npa)

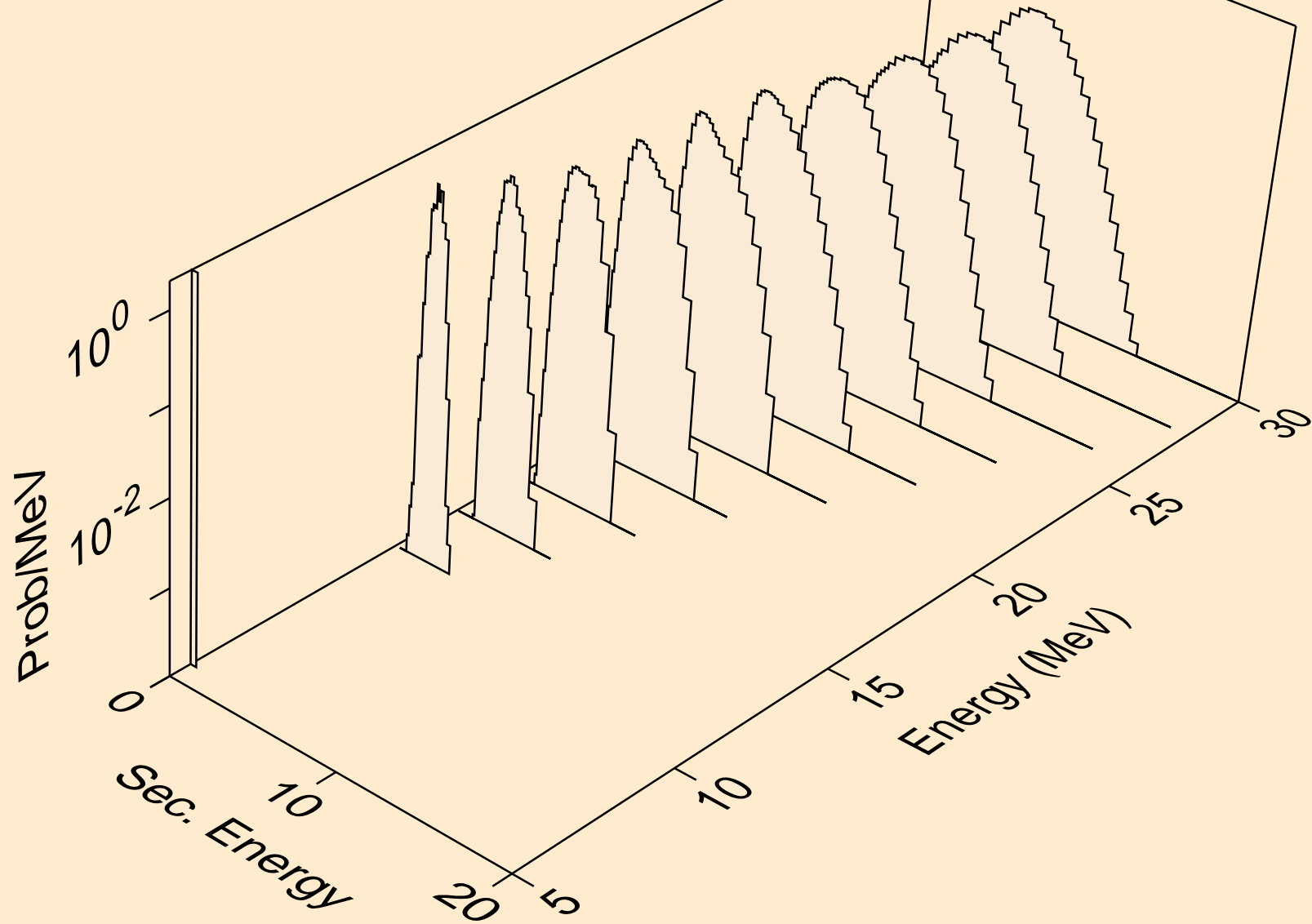

CD100 NEUTRON ACER TENDL-2021 LIBRARY; T=293.6K
protons from (n,p)

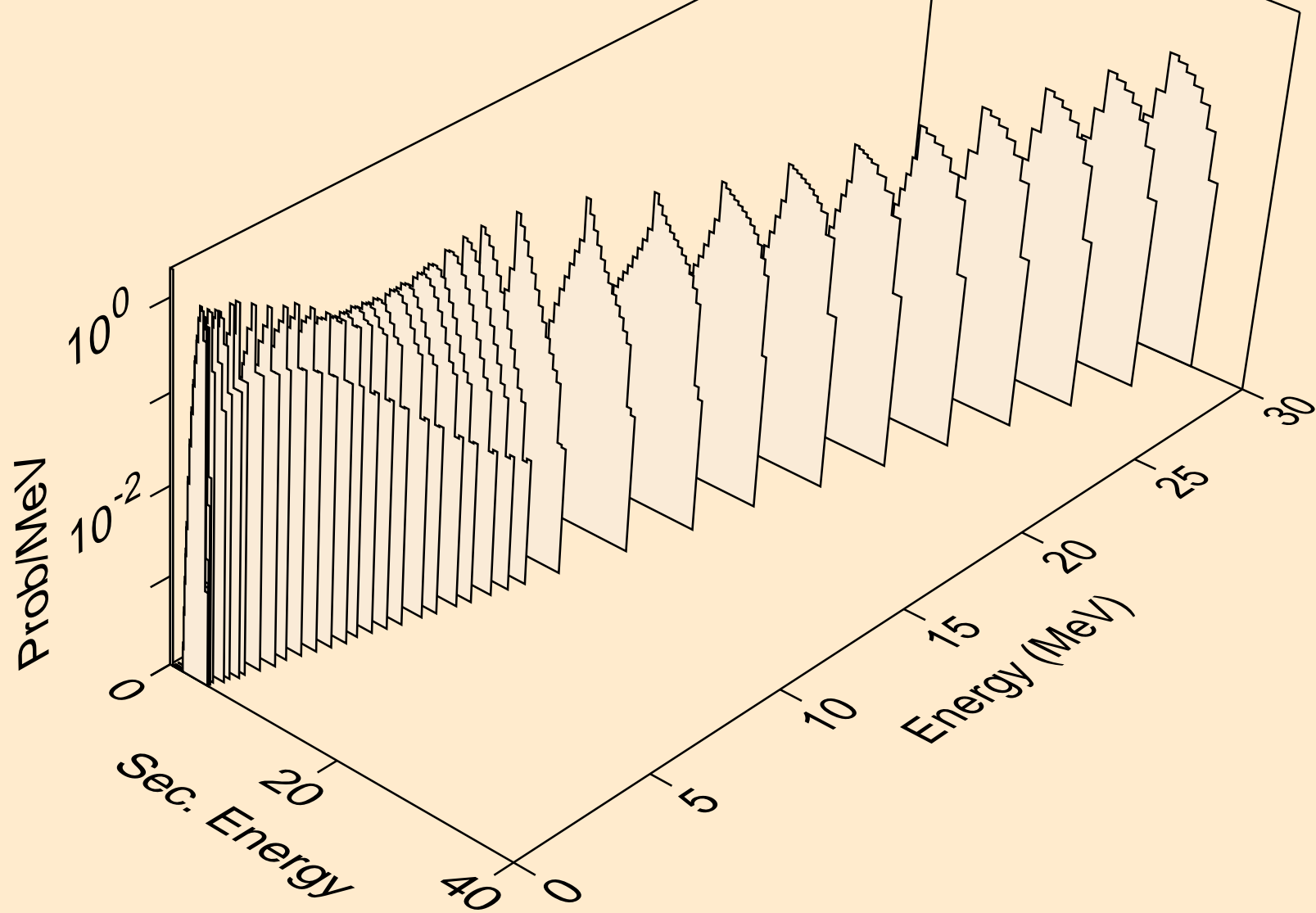

CD100 NEUTRON ACER TENDL-2021 LIBRARY; T=293.6K
protons from (n,2p)

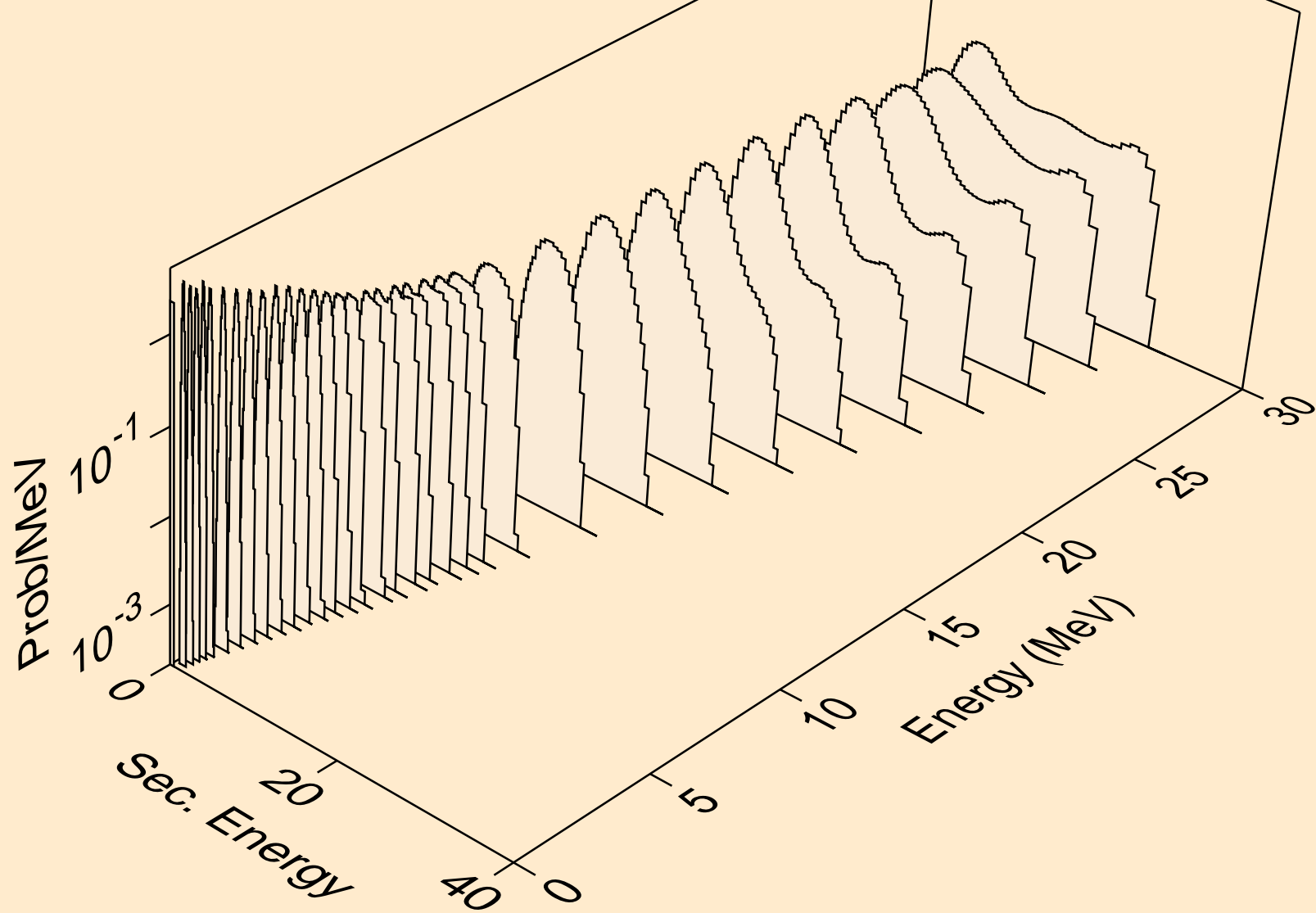

CD100 NEUTRON ACER TENDL-2021 LIBRARY; T=293.6K
protons from (n,p)

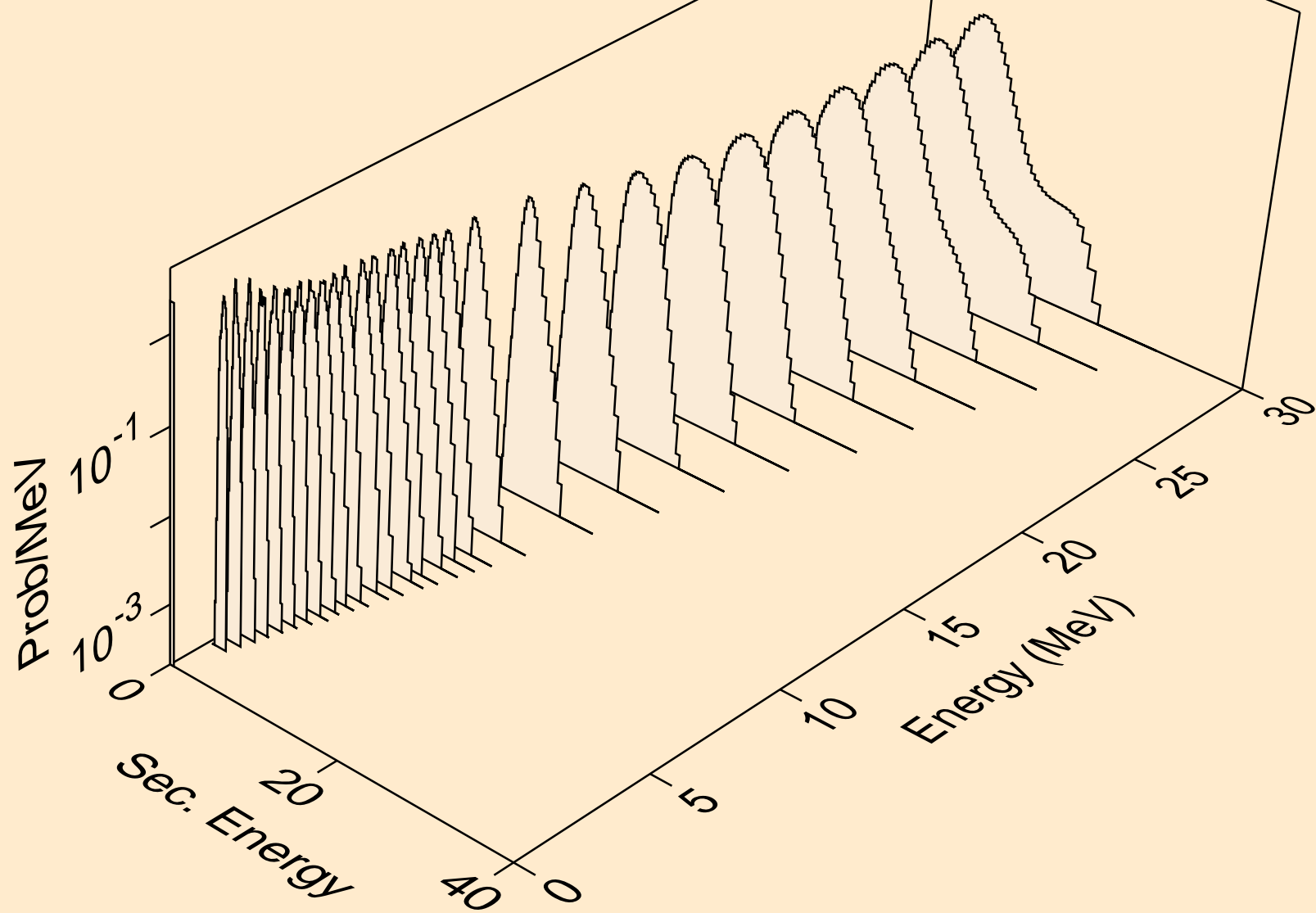

CD100 NEUTRON ACER TENDL-2021 LIBRARY; T=293.6K
protons from (n,pd)

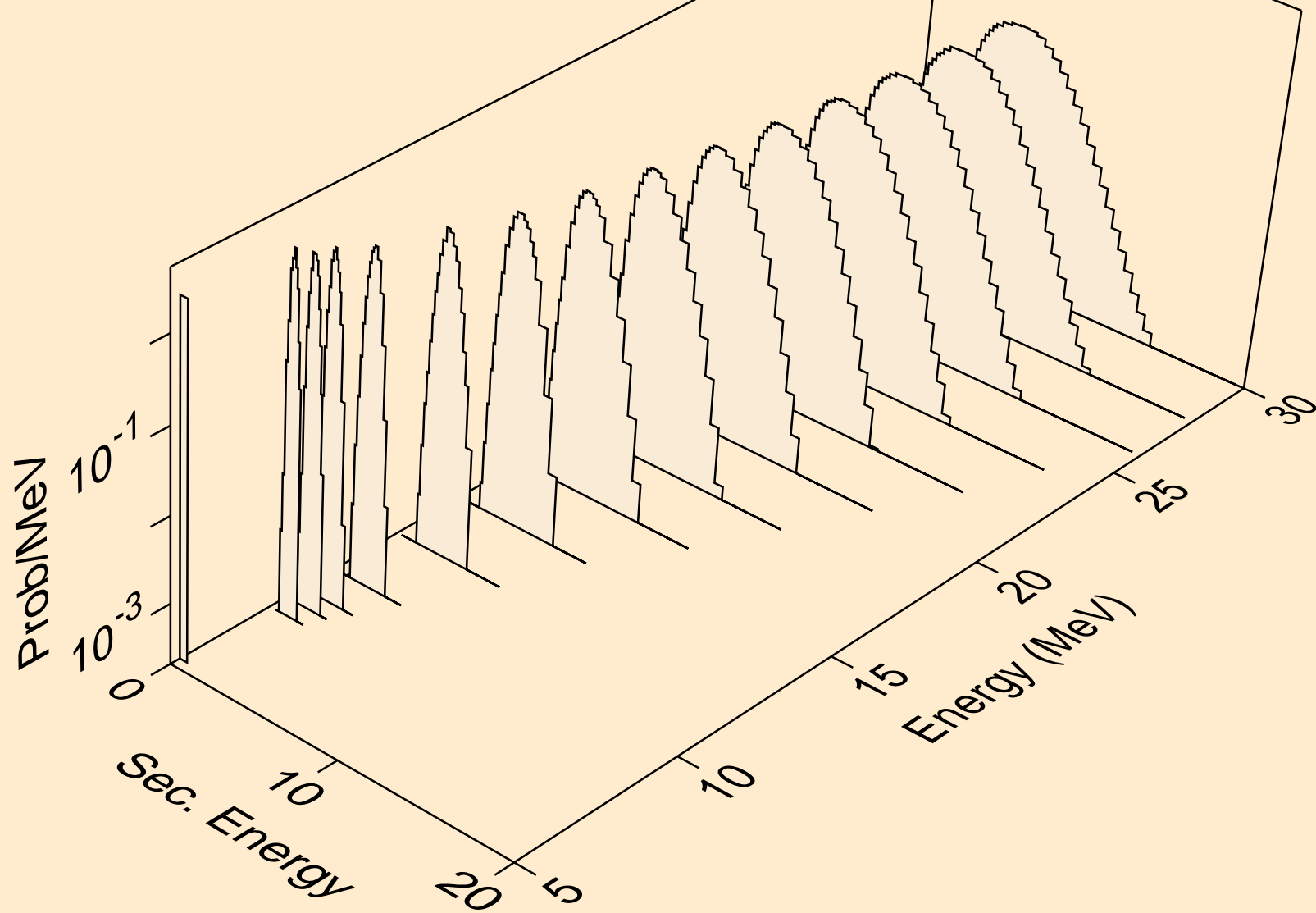

CD100 NEUTRON ACER TENDL-2021 LIBRARY; T=293.6K
protons from (n,pt)

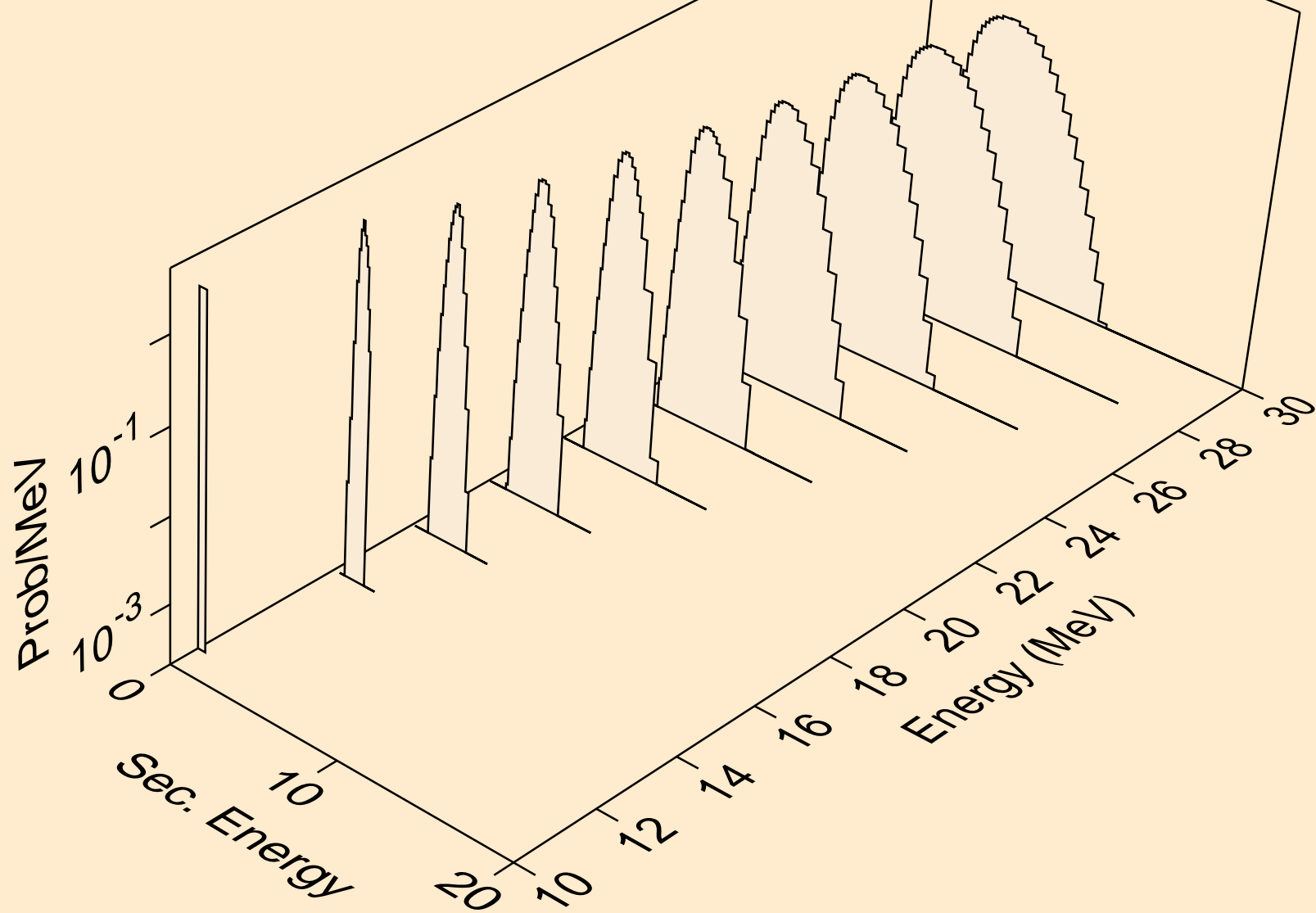

CD100 NEUTRON ACER TENDL-2021 LIBRARY; T=293.6K
deuterons from (n,x)

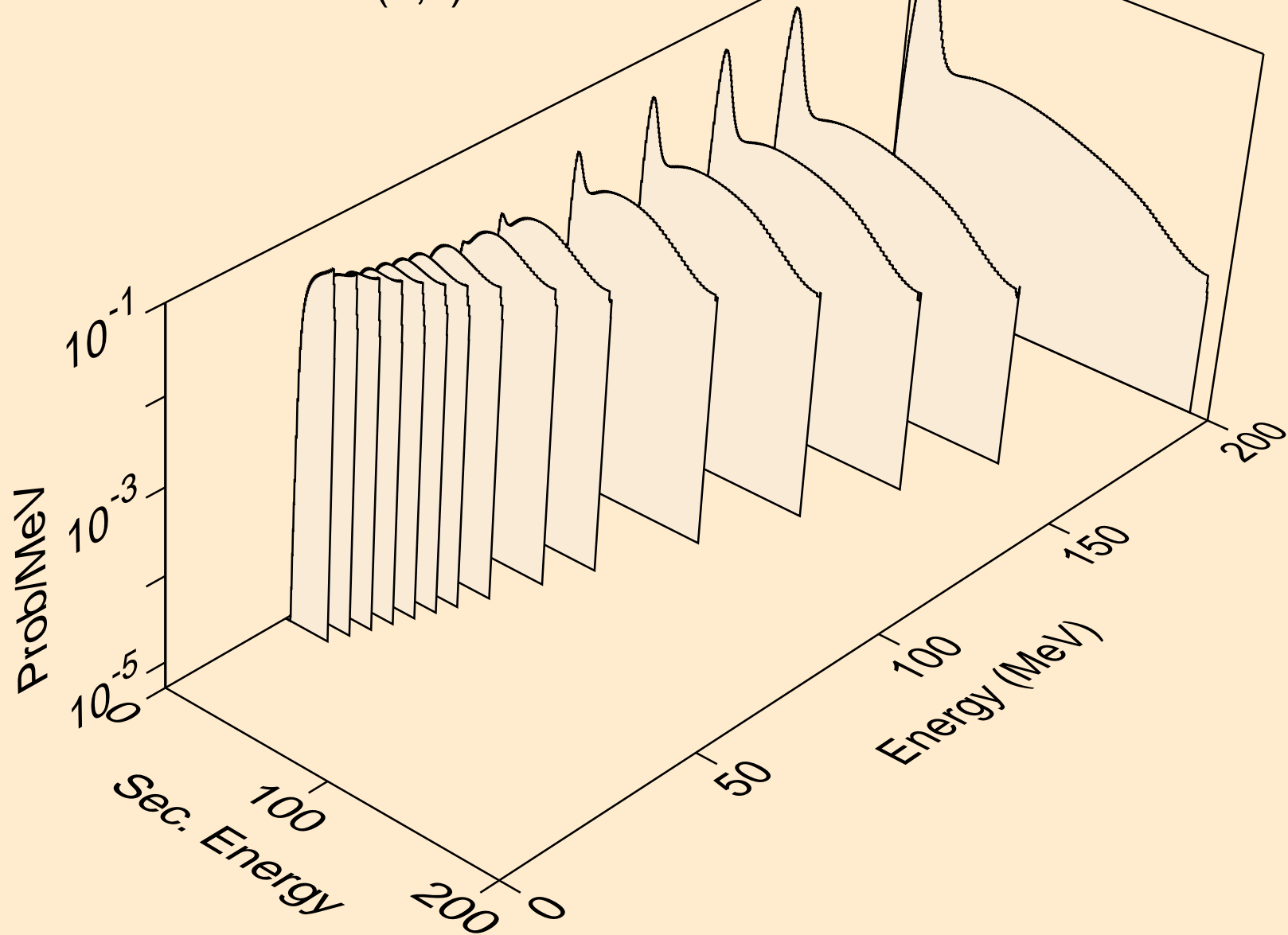

CD100 NEUTRON ACER TENDL-2021 LIBRARY; T=293.6K
deuterons from (n,2nd)

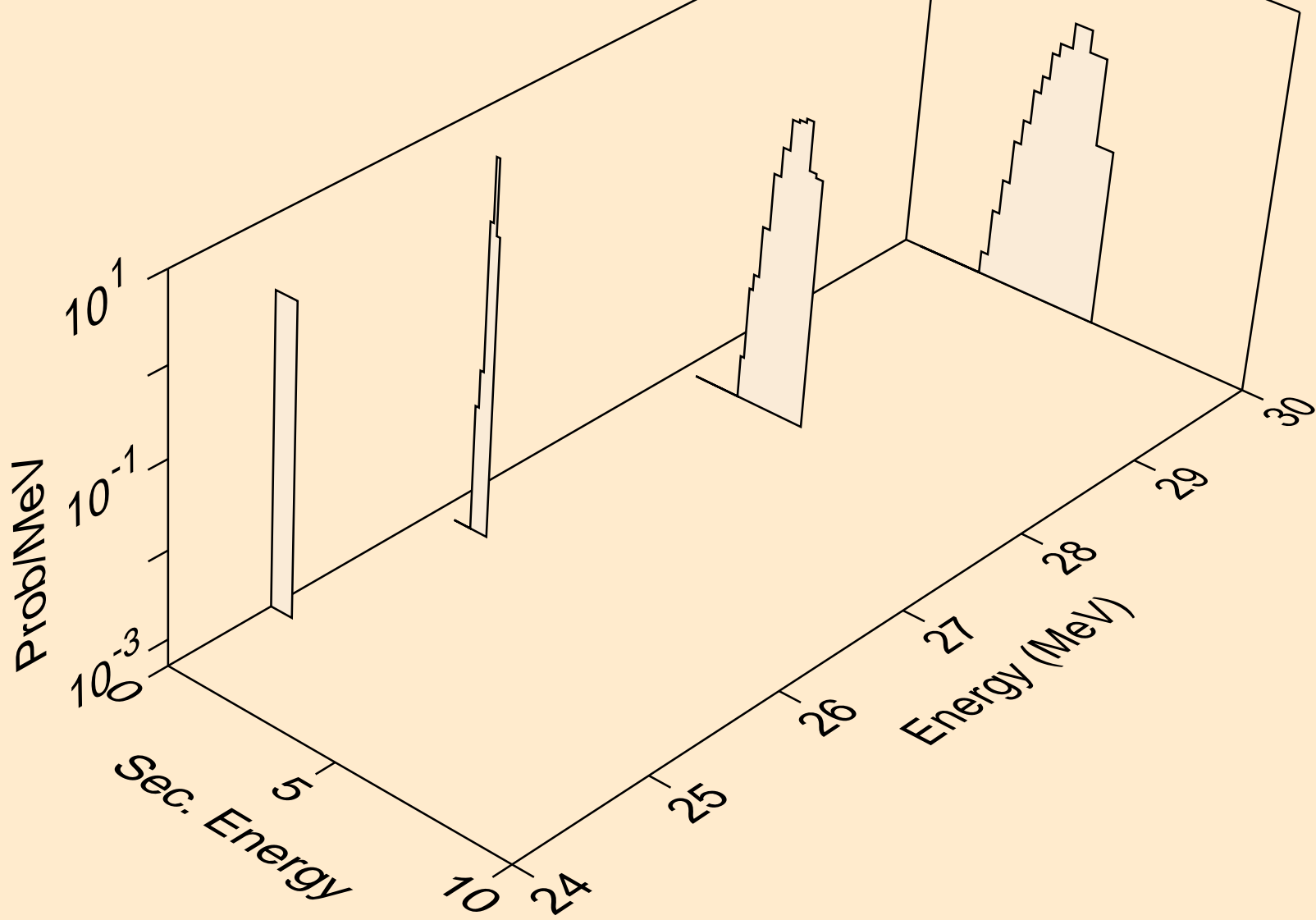

CD100 NEUTRON ACER TENDL-2021 LIBRARY; T=293.6K
deuterons from (n,n*)d

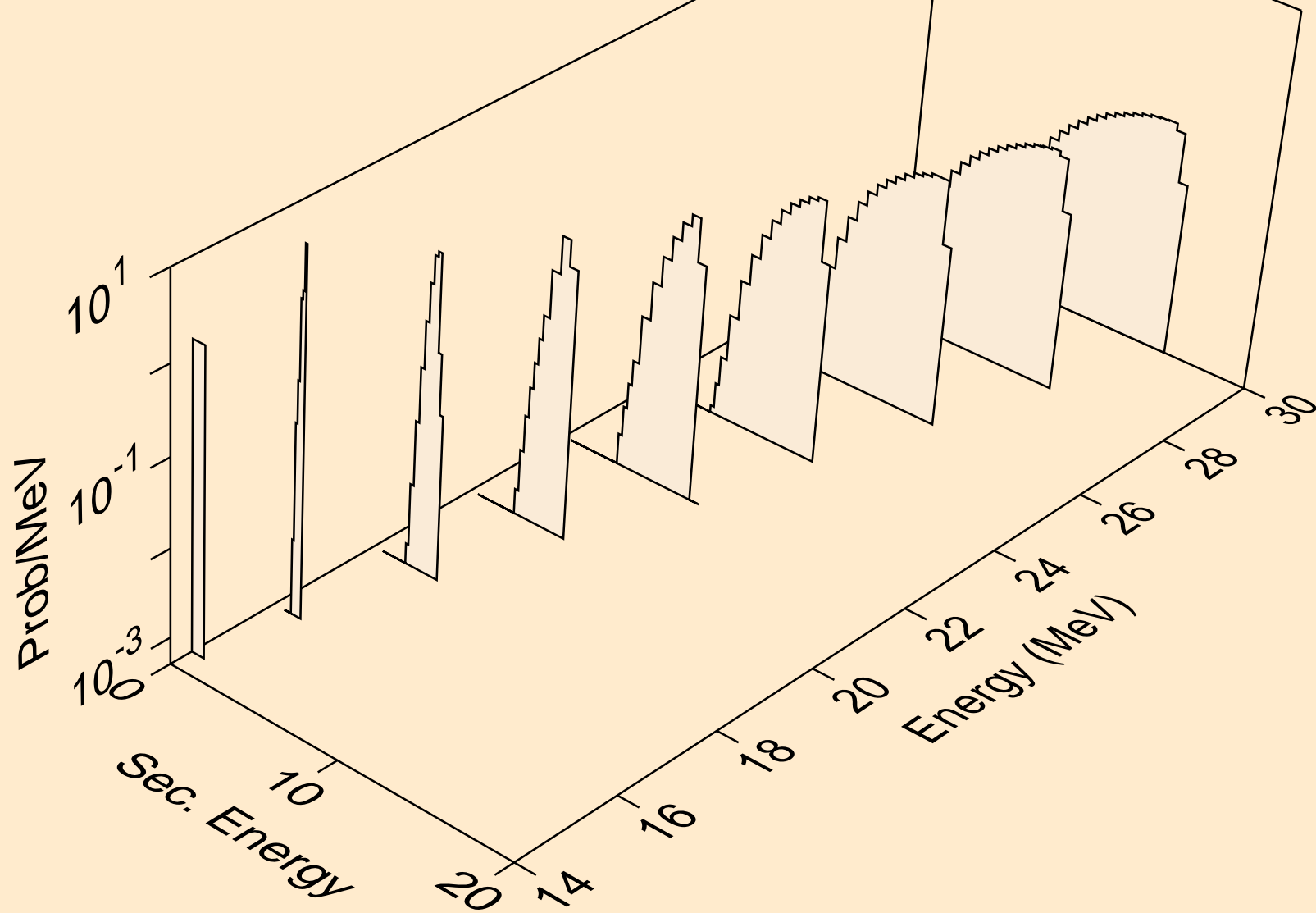

CD100 NEUTRON ACER TENDL-2021 LIBRARY; T=293.6K
deuterons from (n,d)

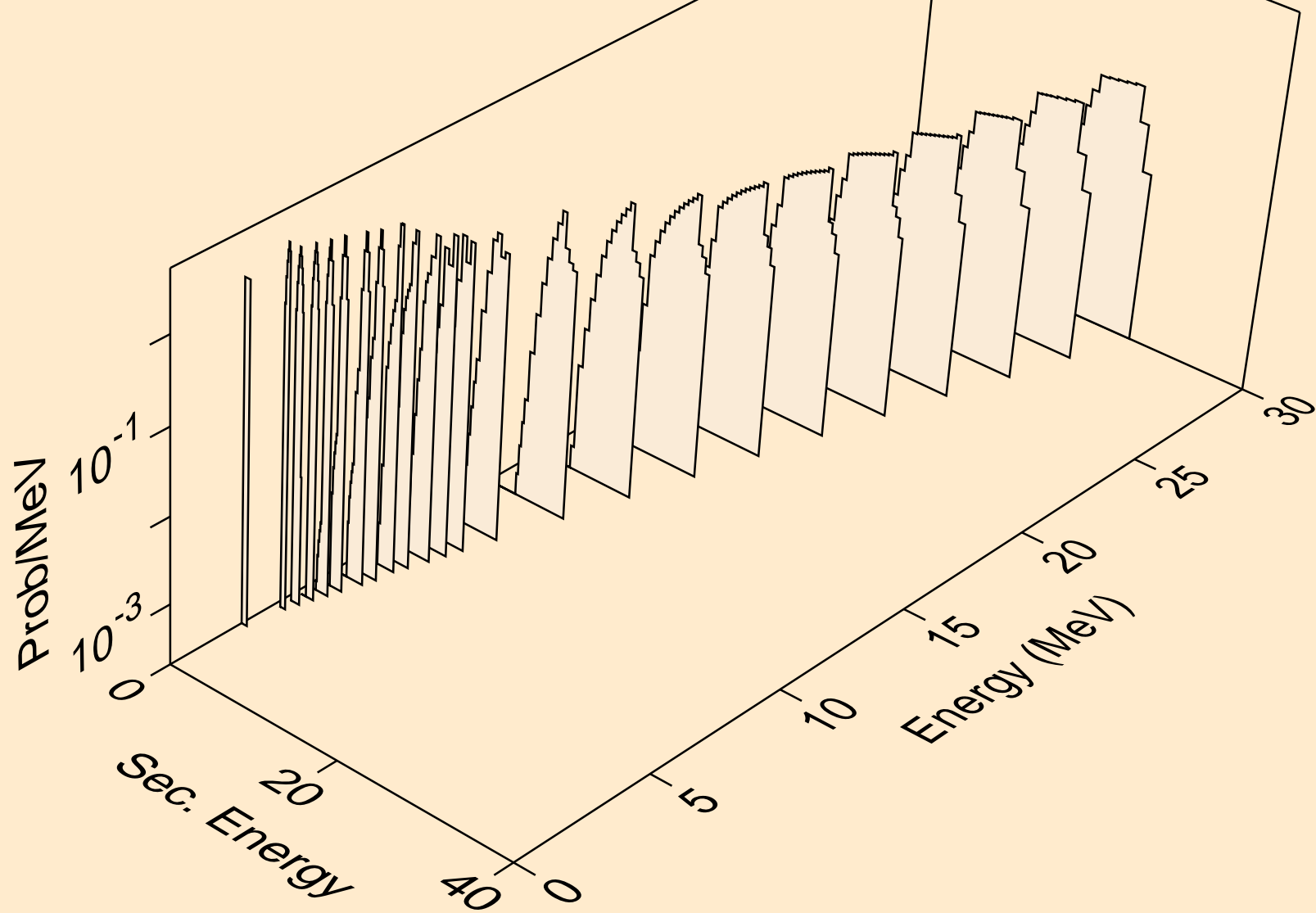

CD100 NEUTRON ACER TENDL-2021 LIBRARY; T=293.6K
deuterons from (n,pd)

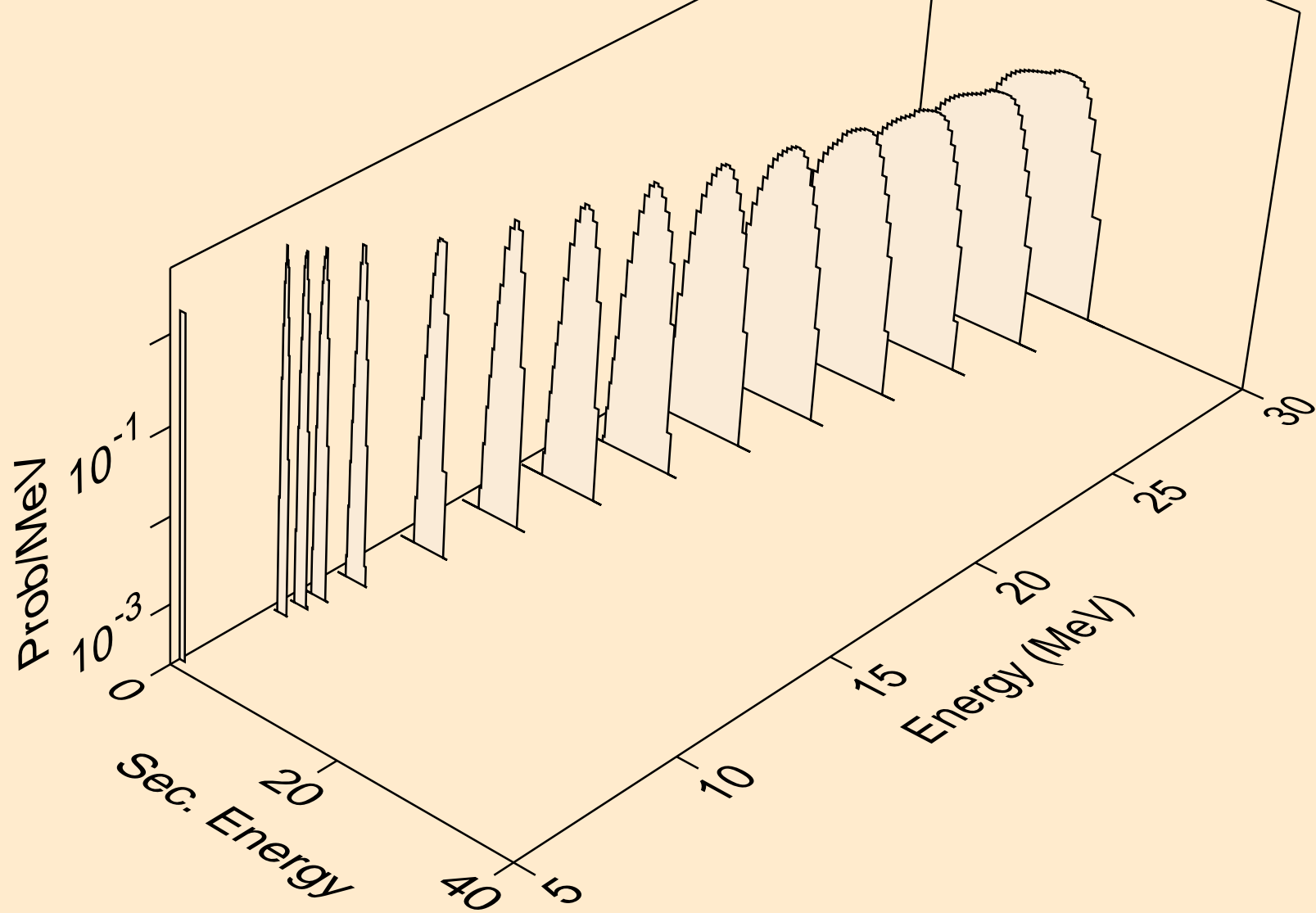

CD100 NEUTRON ACER TENDL-2021 LIBRARY; T=293.6K
deuterons from (n,da)

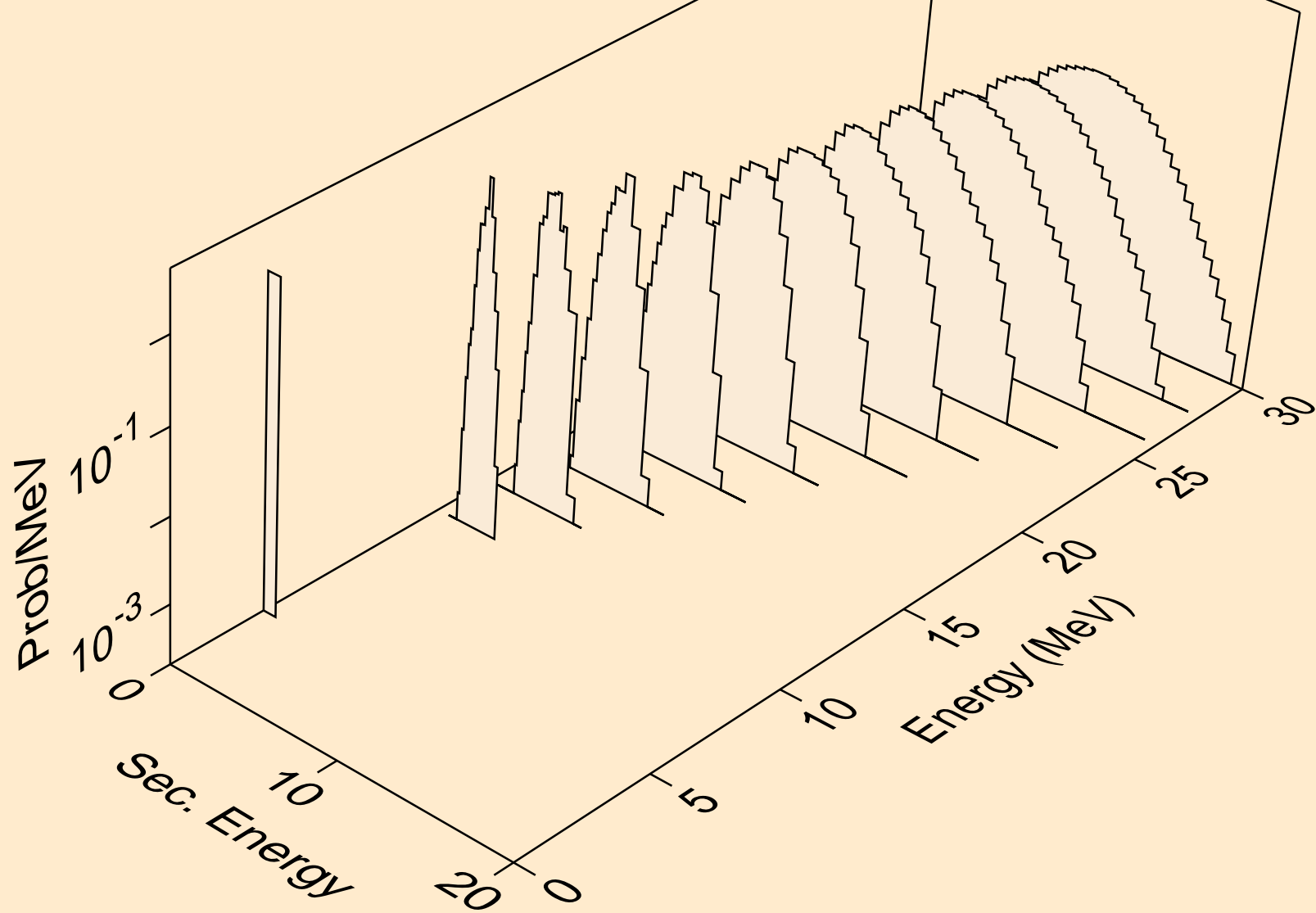

CD100 NEUTRON ACER TENDL-2021 LIBRARY; T=293.6K
tritons from (n,x)

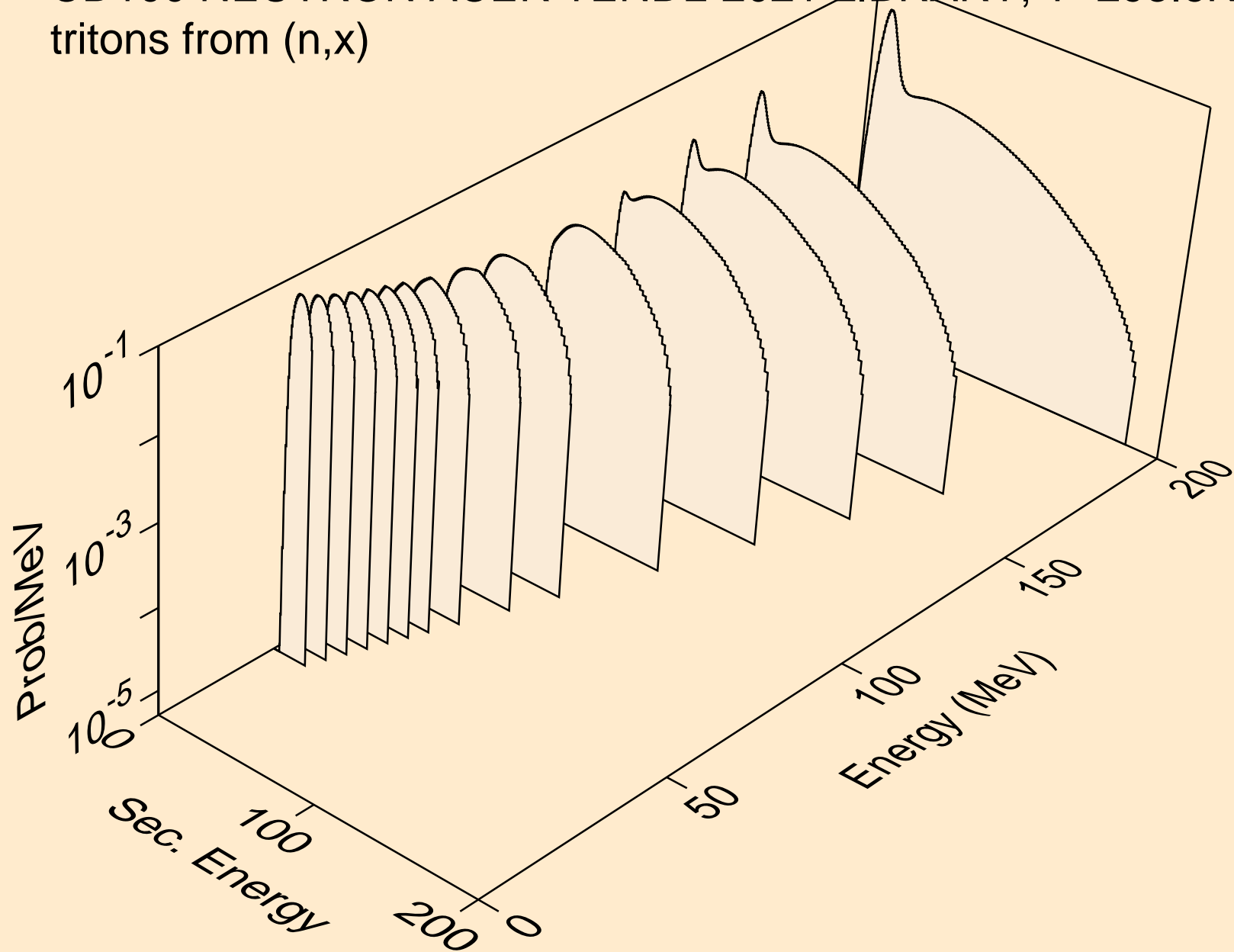

CD100 NEUTRON ACER TENDL-2021 LIBRARY; T=293.6K
tritons from (n,n*)t

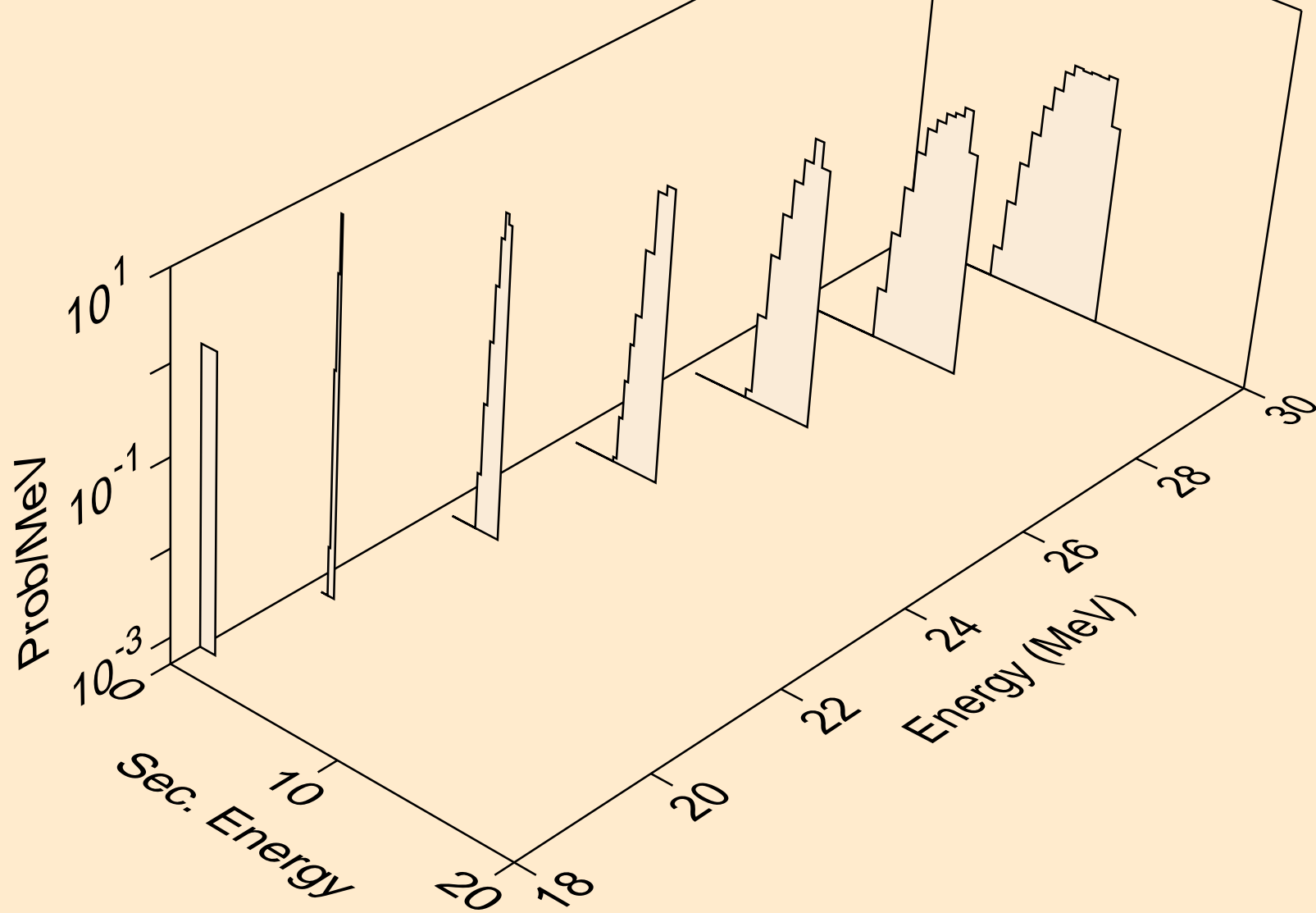

CD100 NEUTRON ACER TENDL-2021 LIBRARY; T=293.6K
tritons from (n,t)

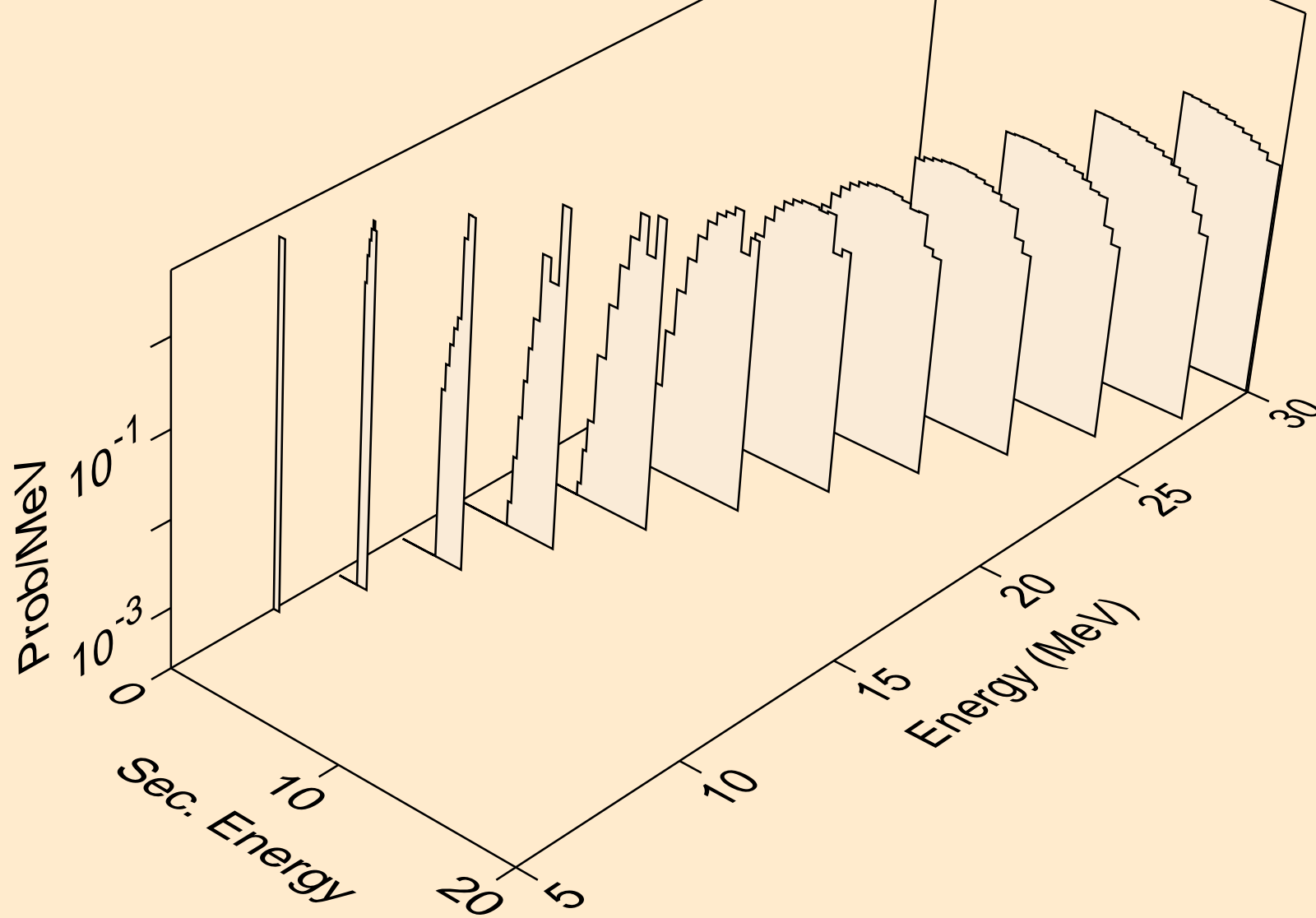

CD100 NEUTRON ACER TENDL-2021 LIBRARY; T=293.6K
tritons from (n,pt)

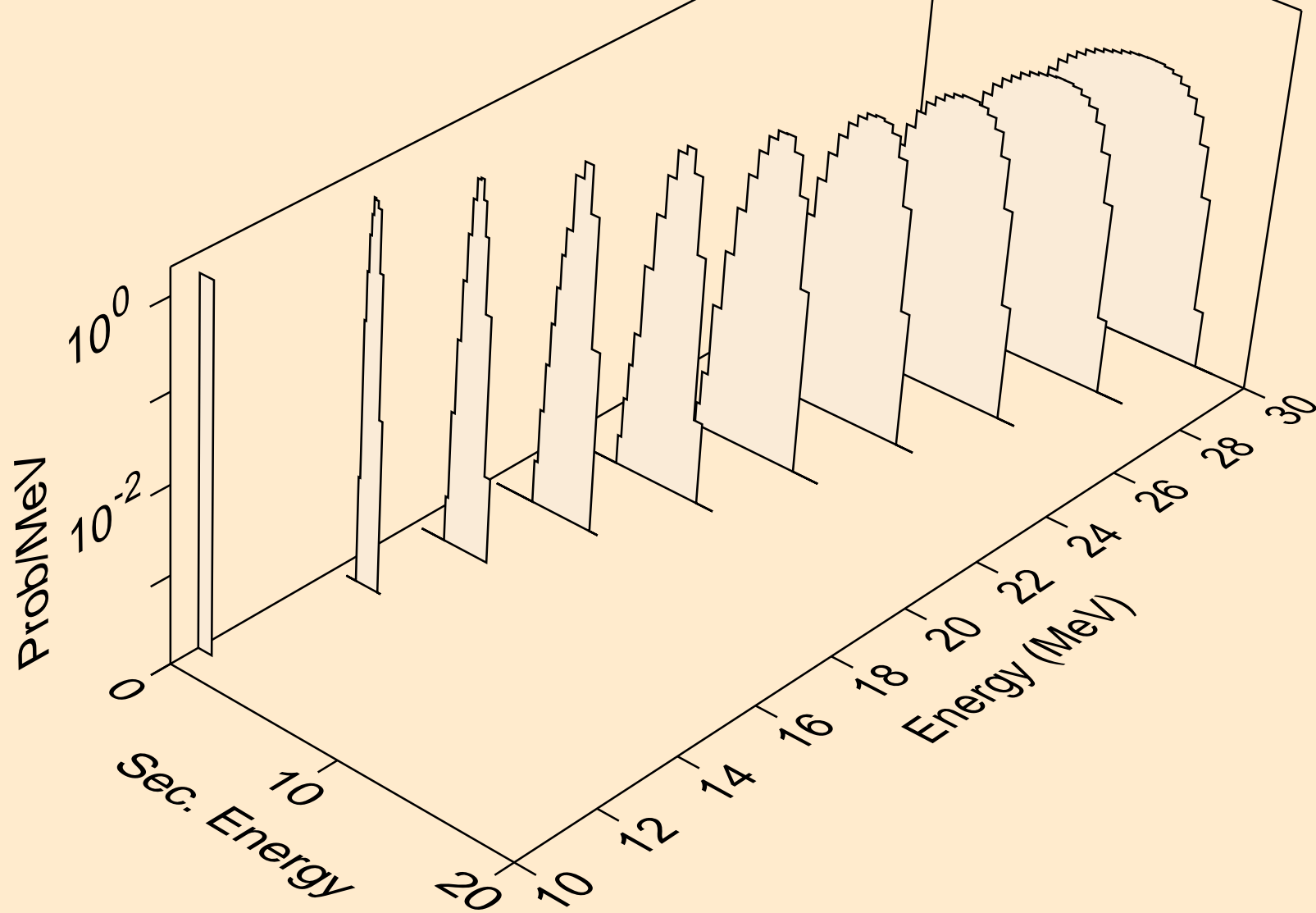

CD100 NEUTRON ACER TENDL-2021 LIBRARY; T=293.6K
he3s from (n,x)

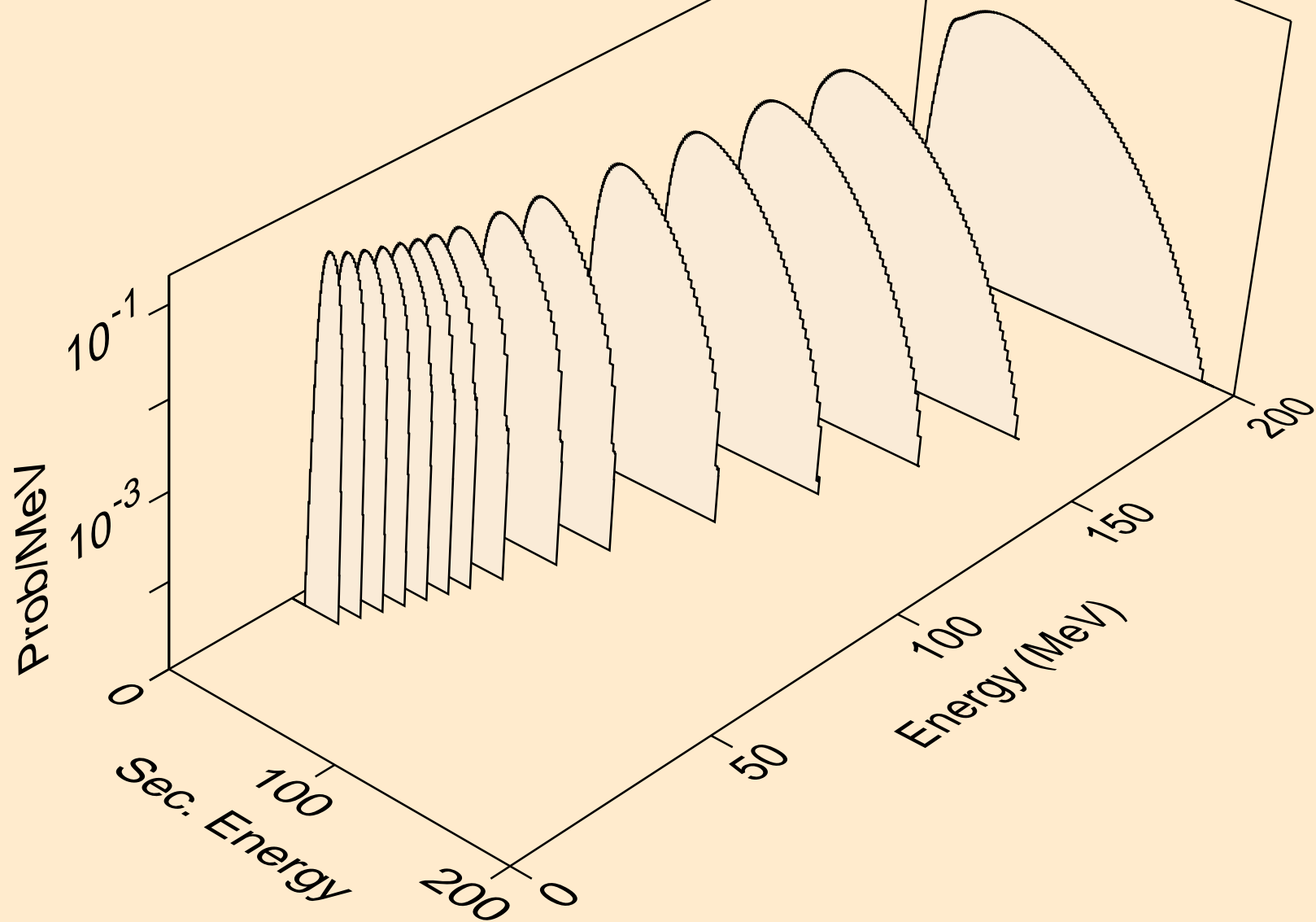

CD100 NEUTRON ACER TENDL-2021 LIBRARY; T=293.6K
he3s from (n,n*)he3

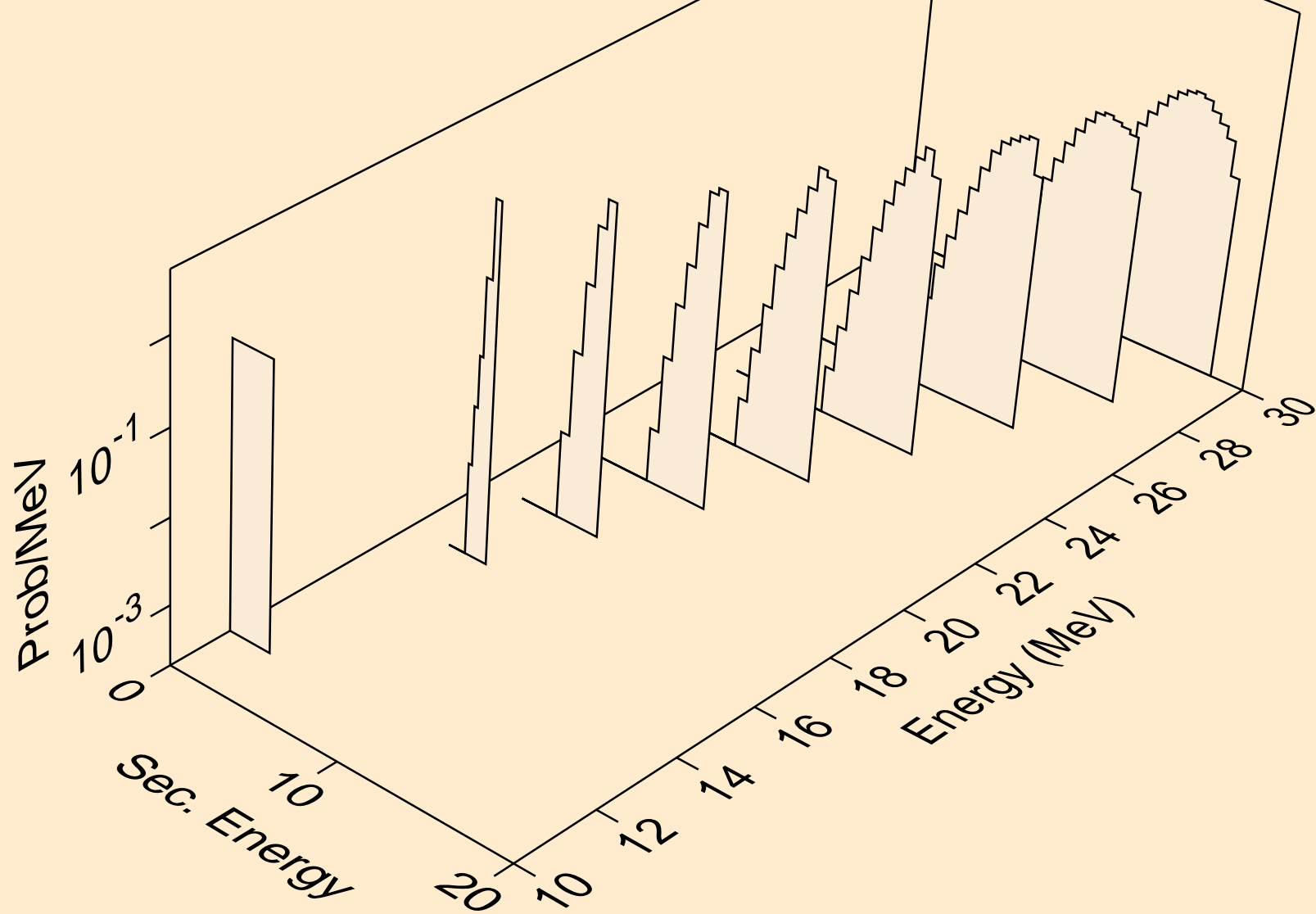

CD100 NEUTRON ACER TENDL-2021 LIBRARY; T=293.6K
he3s from (n,he3)

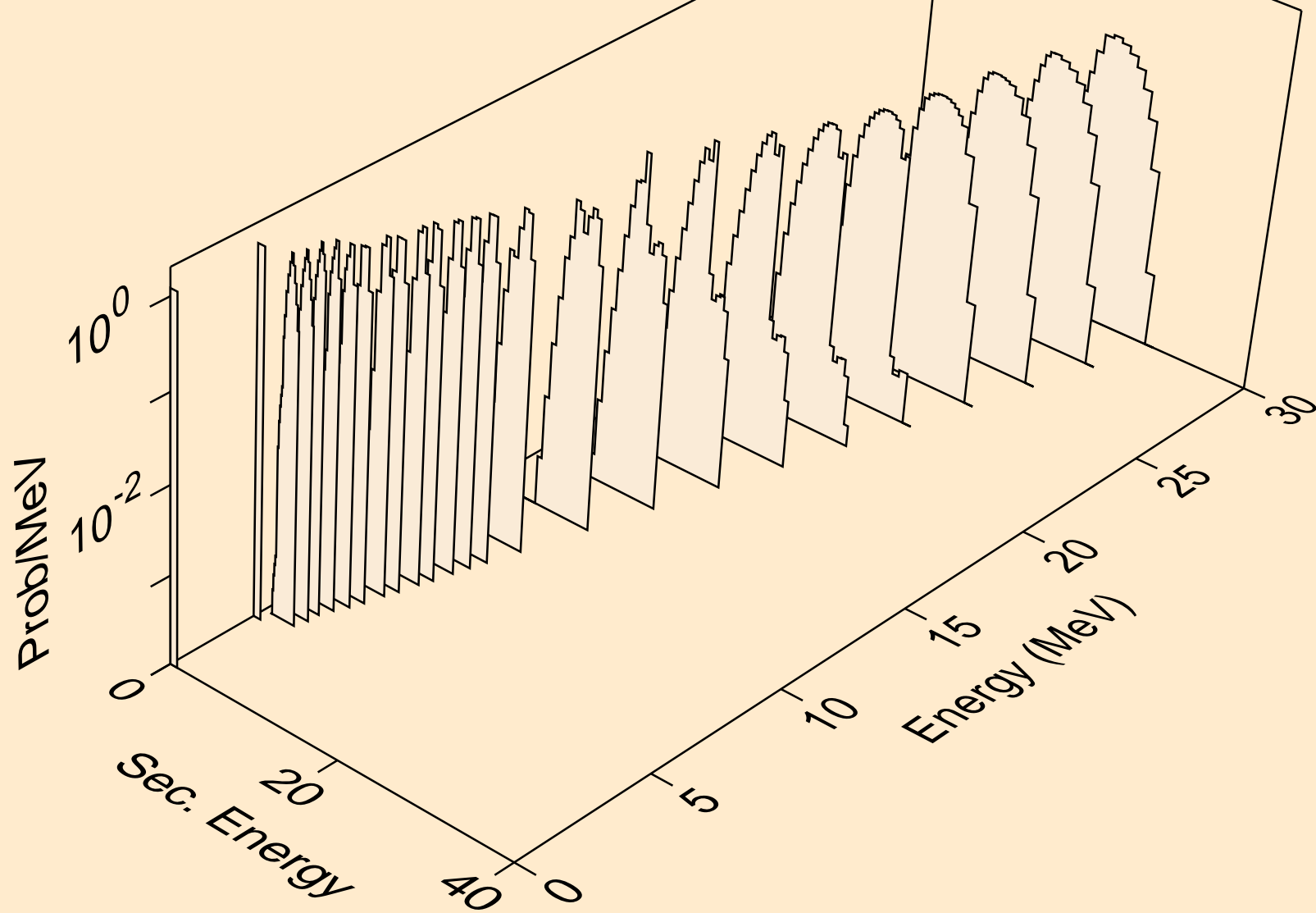

CD100 NEUTRON ACER TENDL-2021 LIBRARY; T=293.6K
alphas from (n,x)

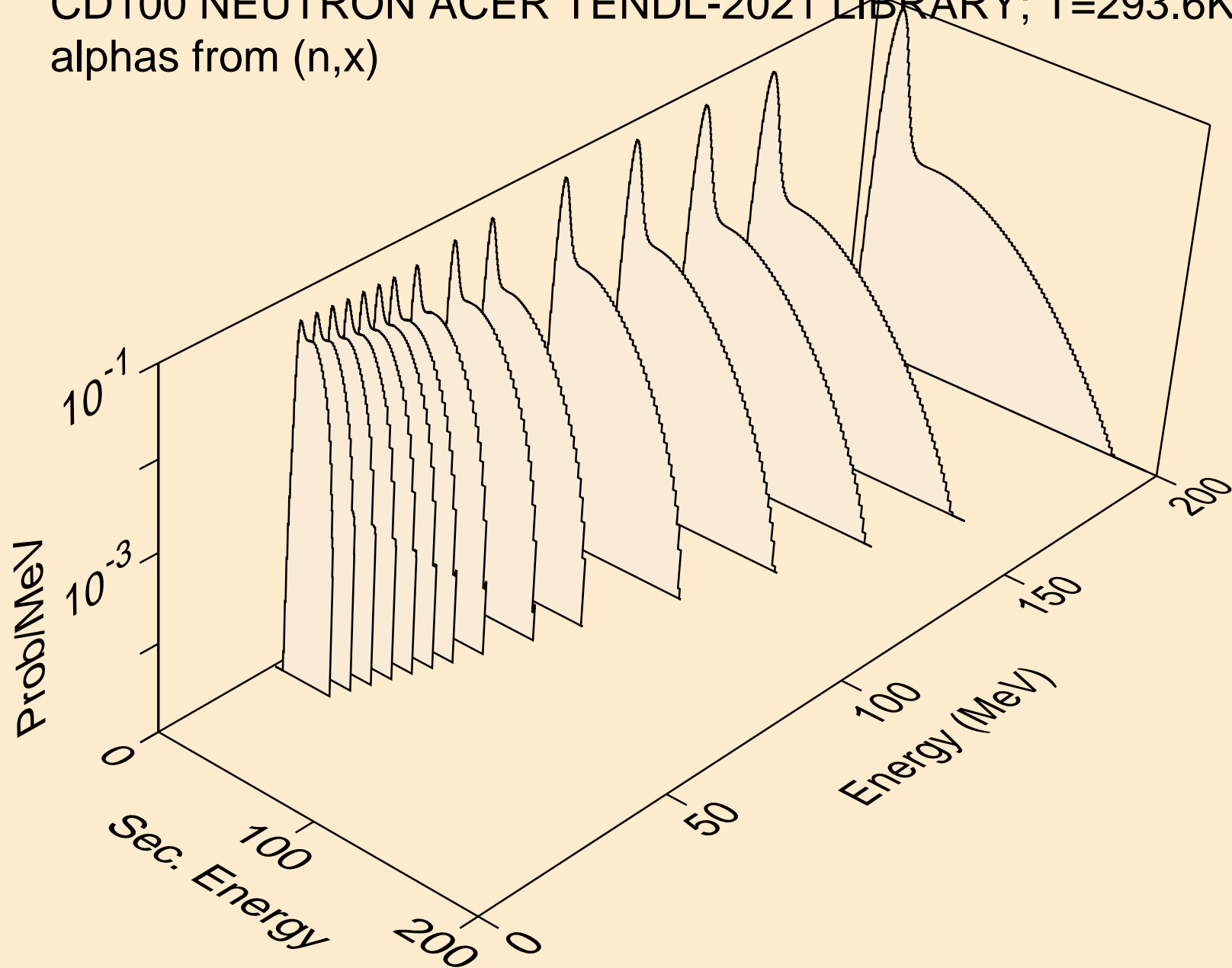

CD100 NEUTRON ACER TENDL-2021 LIBRARY; T=293.6K
alphas from (n,n*)a

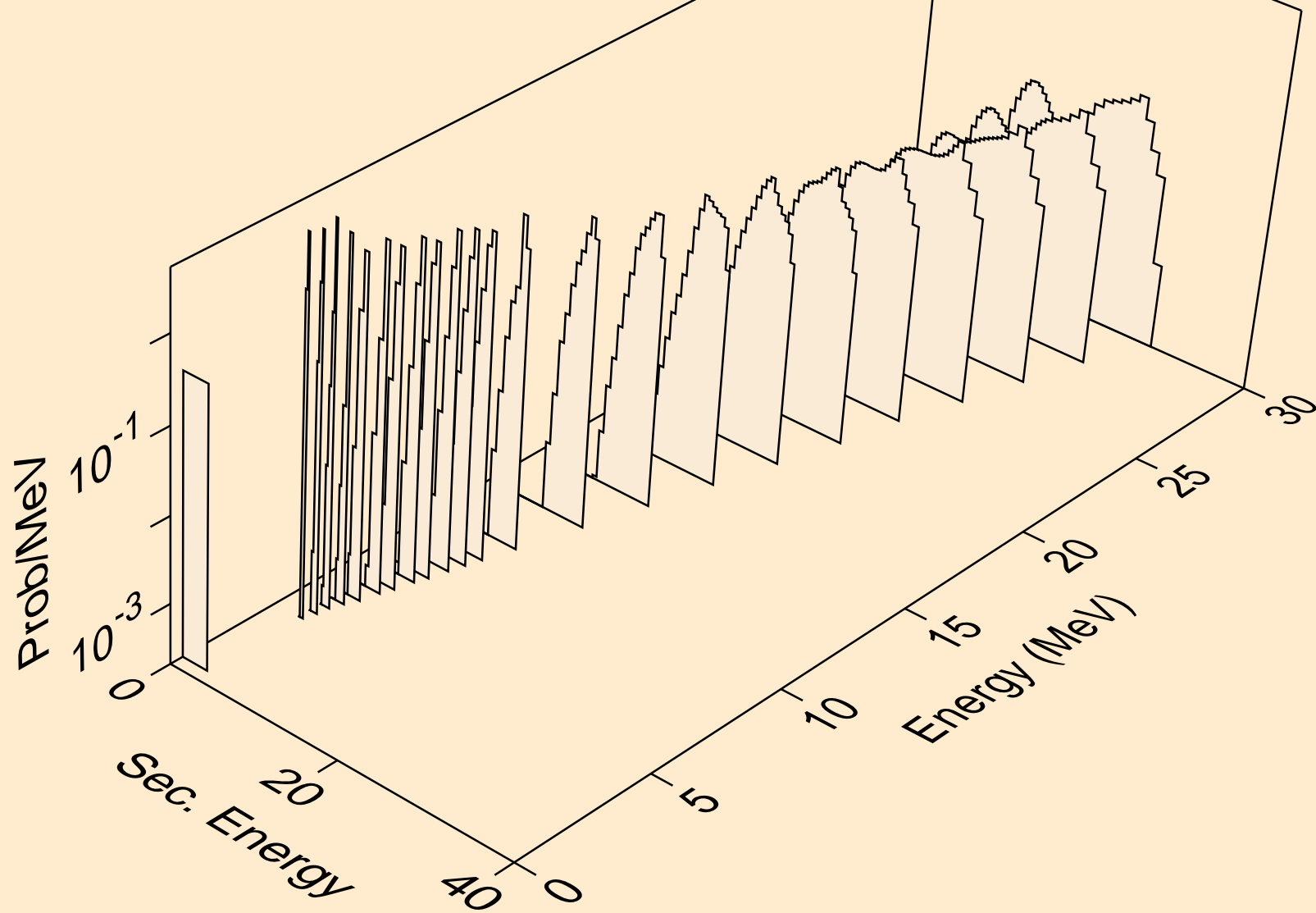

CD100 NEUTRON ACER TENDL-2021 LIBRARY; T=293.6K
alphas from (n,2n)a

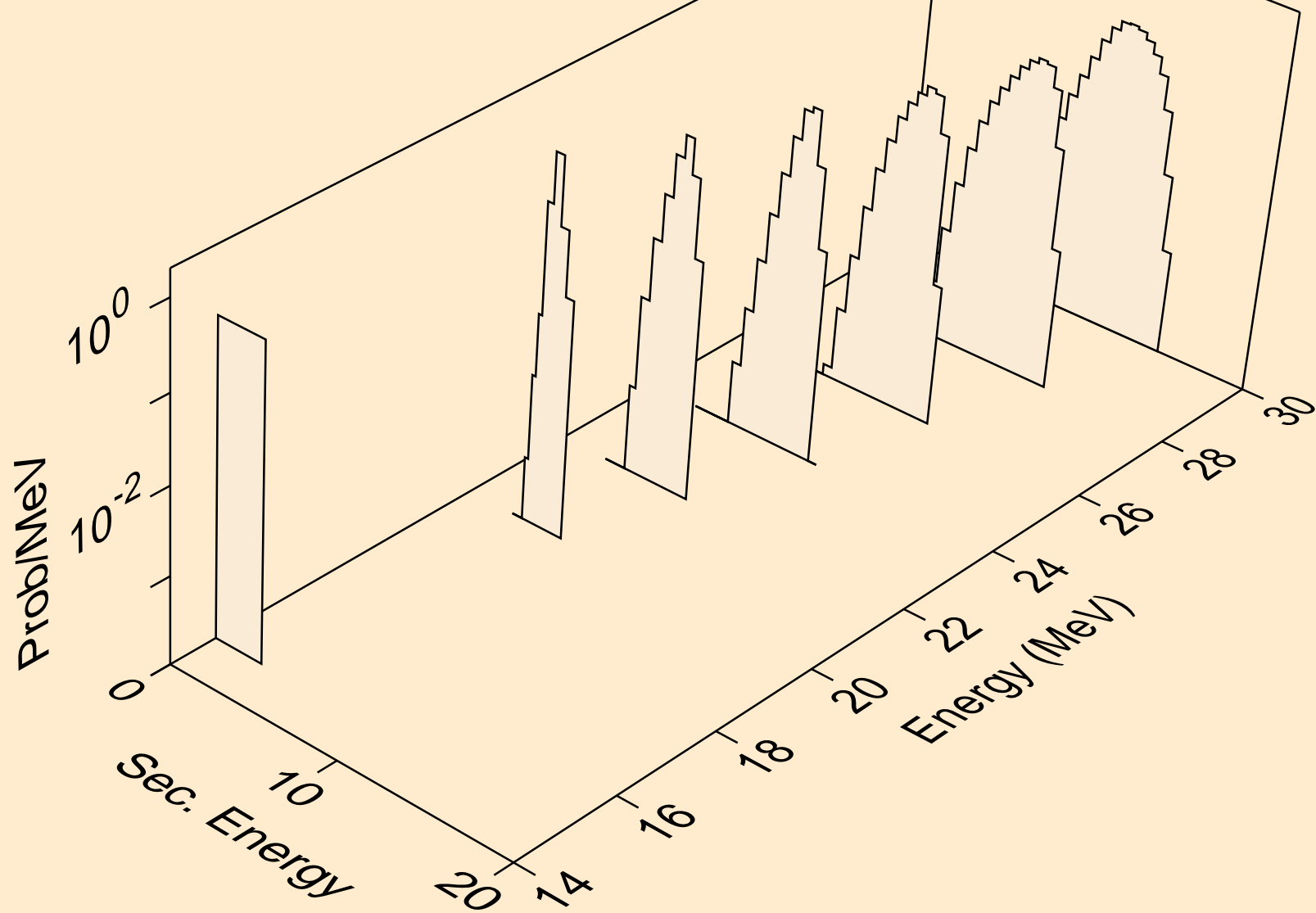

CD100 NEUTRON ACER TENDL-2021 LIBRARY; T=293.6K
alphas from (n,n*)2a

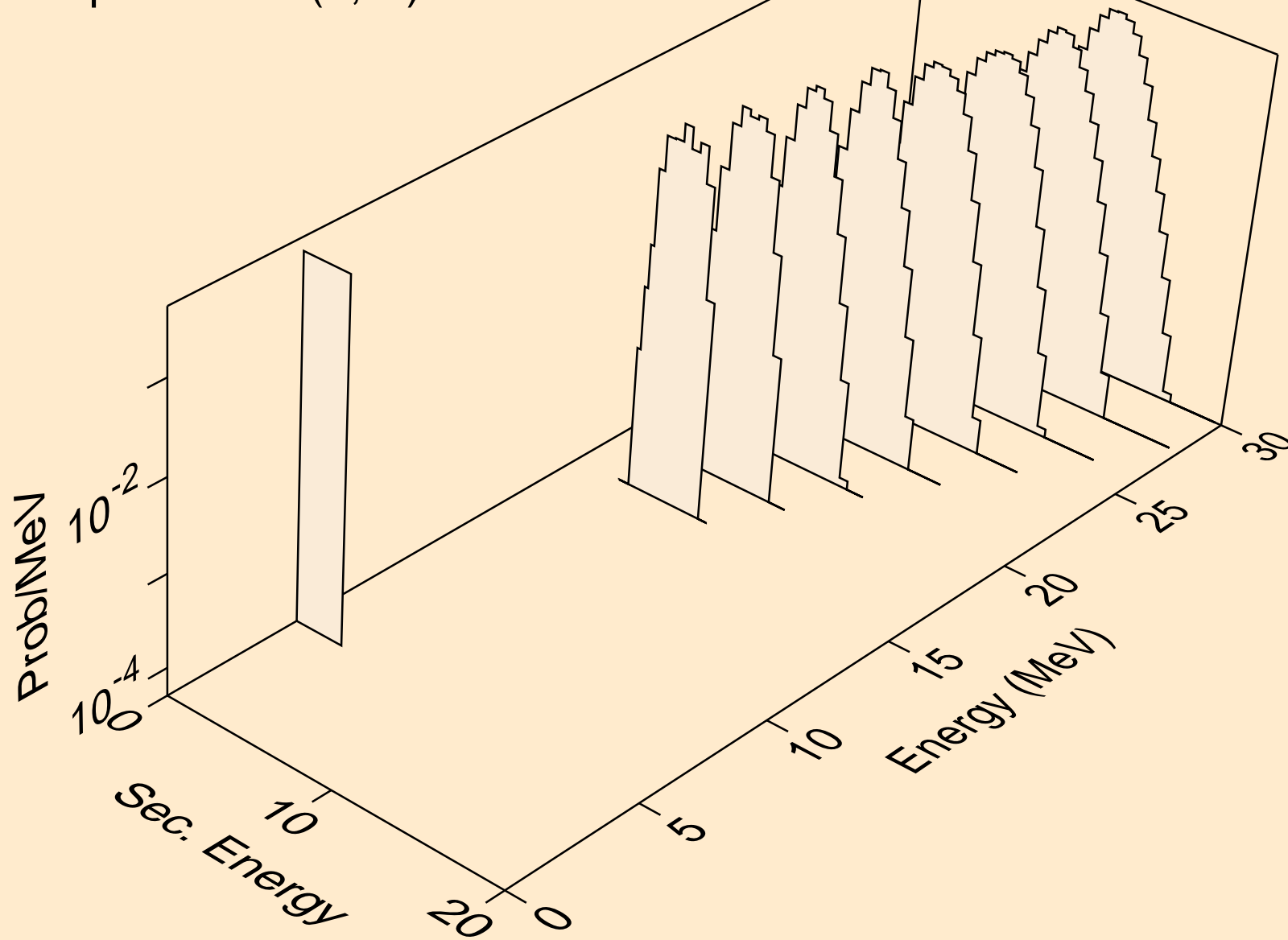

CD100 NEUTRON ACER TENDL-2021 LIBRARY; T=293.6K
alphas from (n,npa)

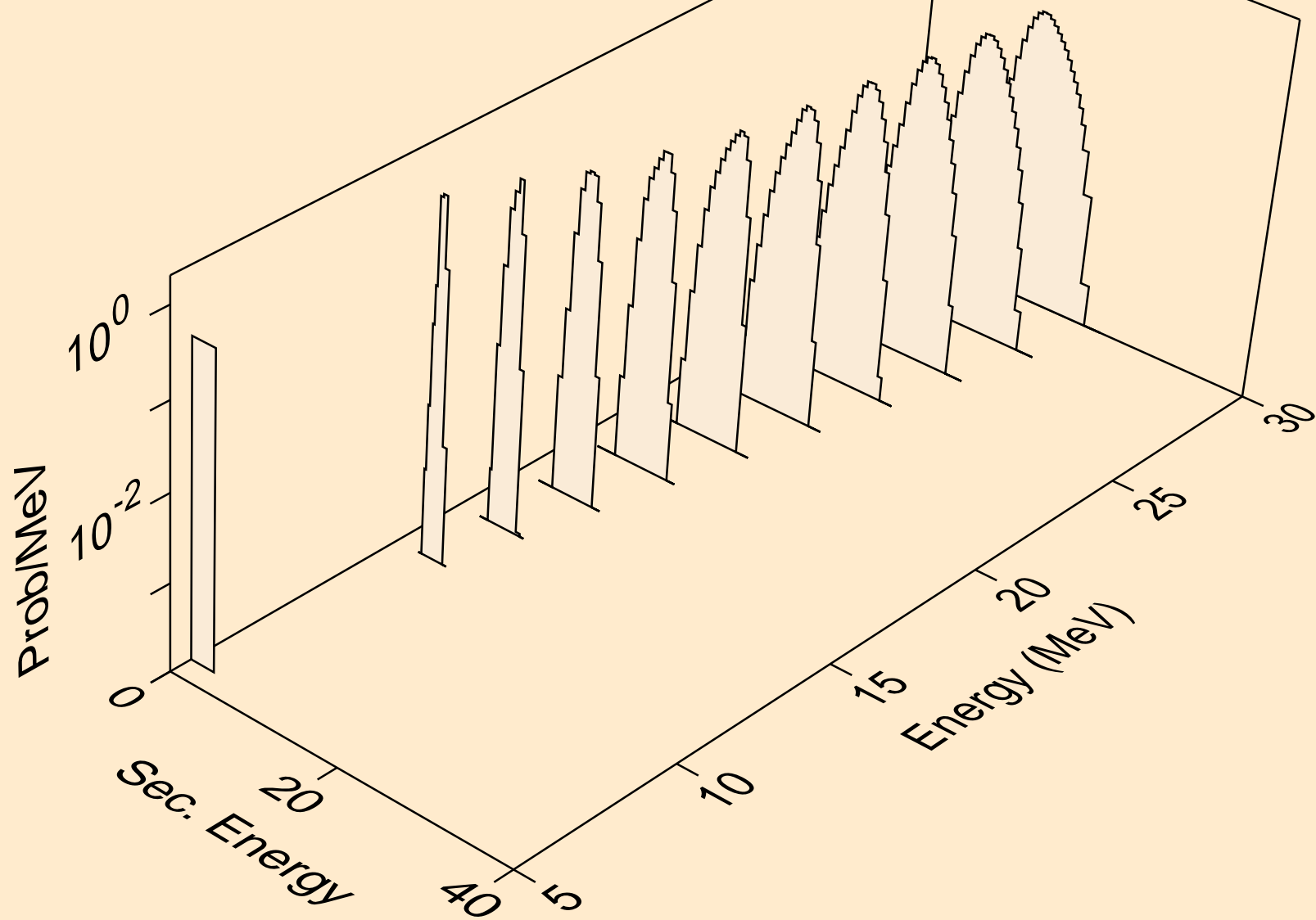

CD100 NEUTRON ACER TENDL-2021 LIBRARY; T=293.6K
alphas from (n,a)

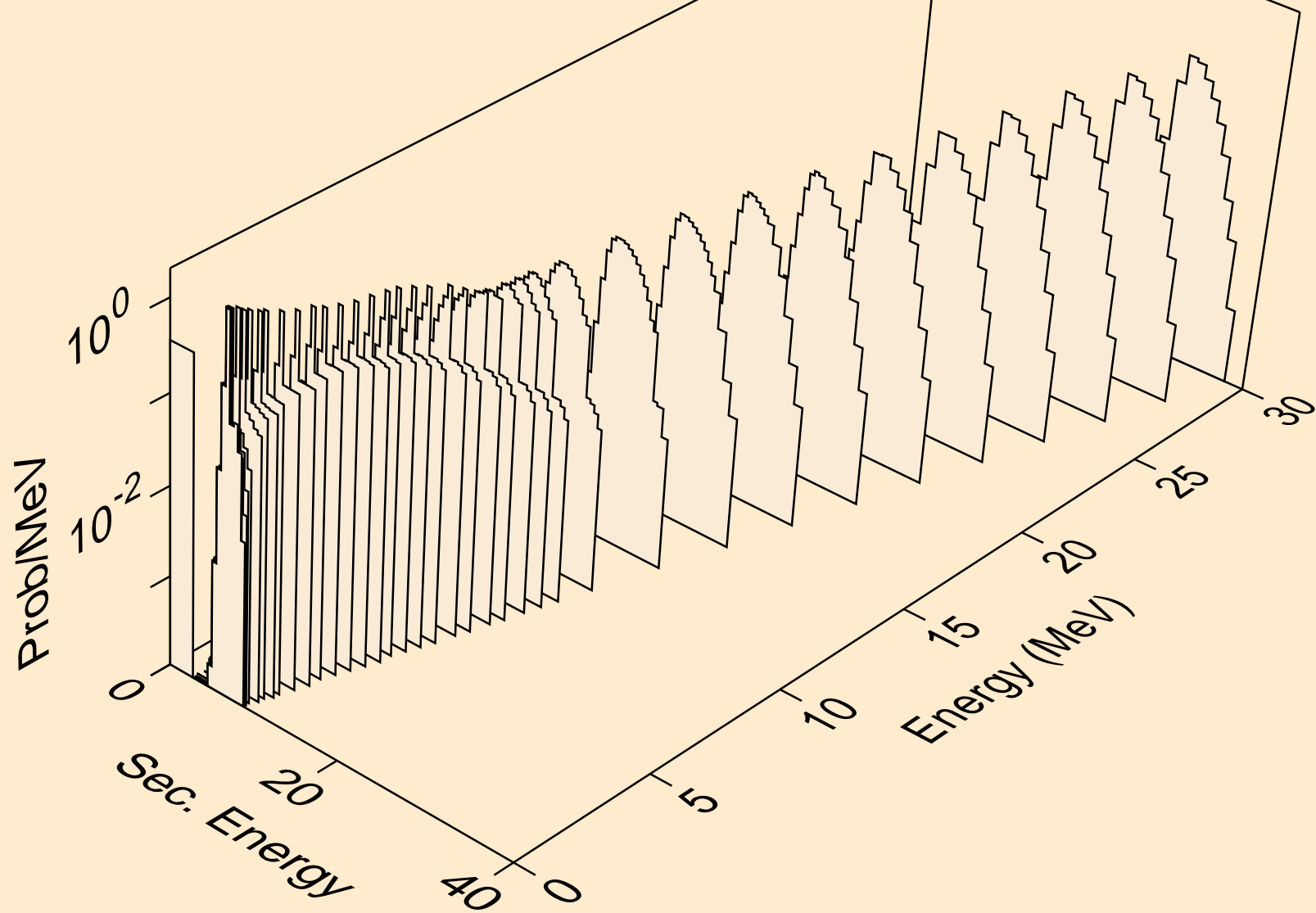

CD100 NEUTRON ACER TENDL-2021 LIBRARY; T=293.6K
alphas from (n,2a)

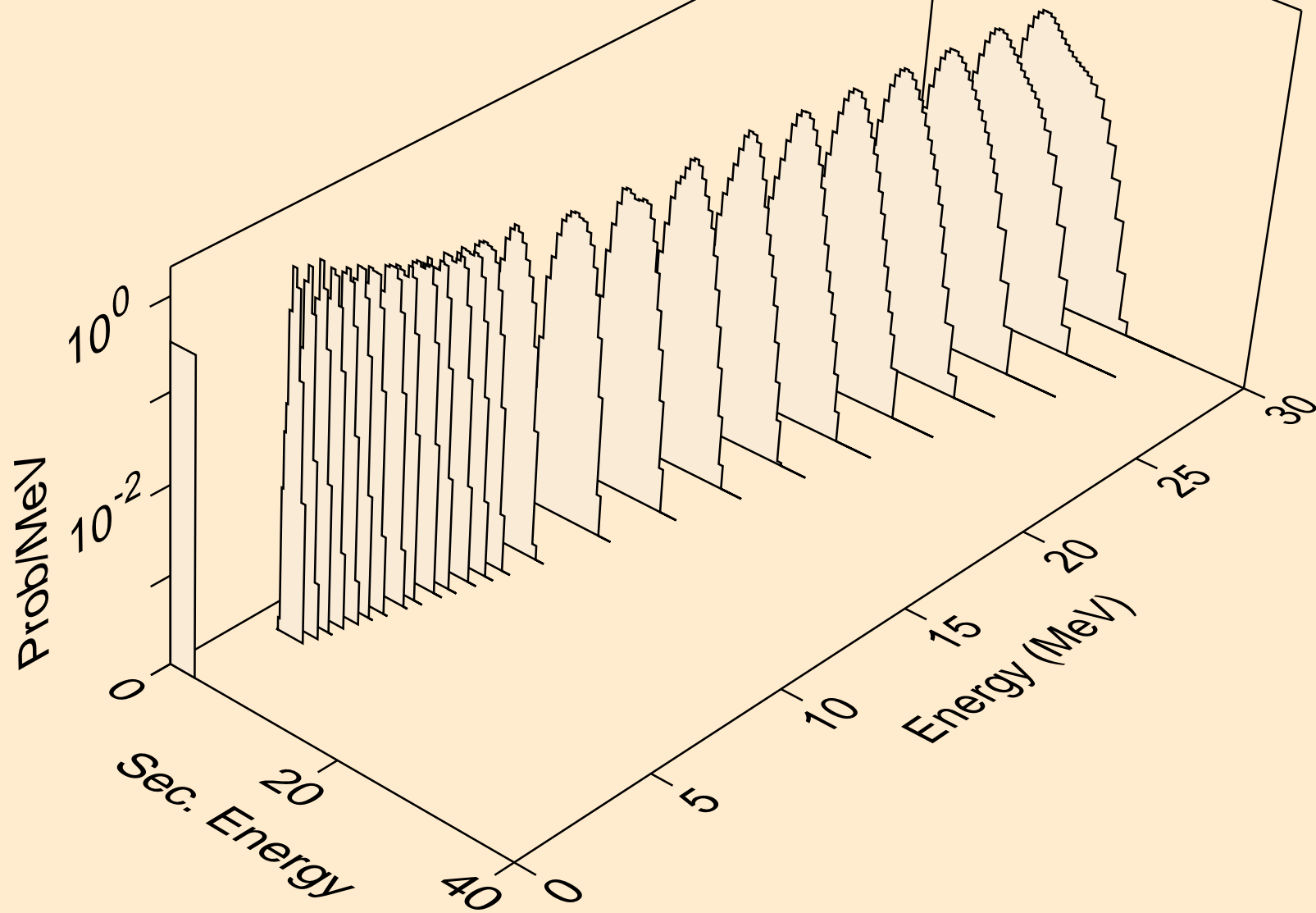

CD100 NEUTRON ACER TENDL-2021 LIBRARY; T=293.6K
alphas from (n,pa)

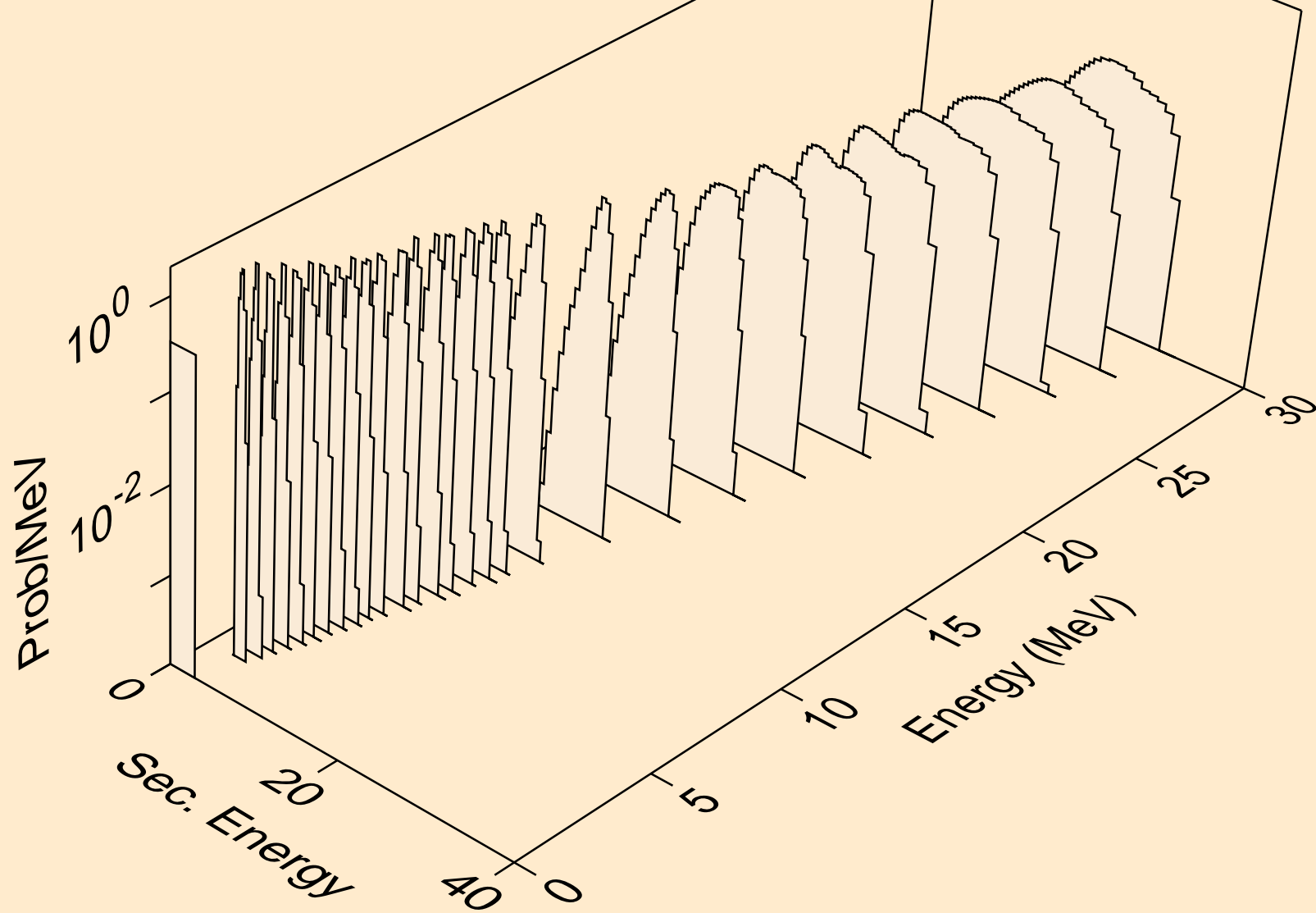

CD100 NEUTRON ACER TENDL-2021 LIBRARY; T=293.6K
alphas from (n,da)

