

CD108 NEUTRON ACER TENDL-2021 LIBRARY; T=293.6K

Principal cross sections

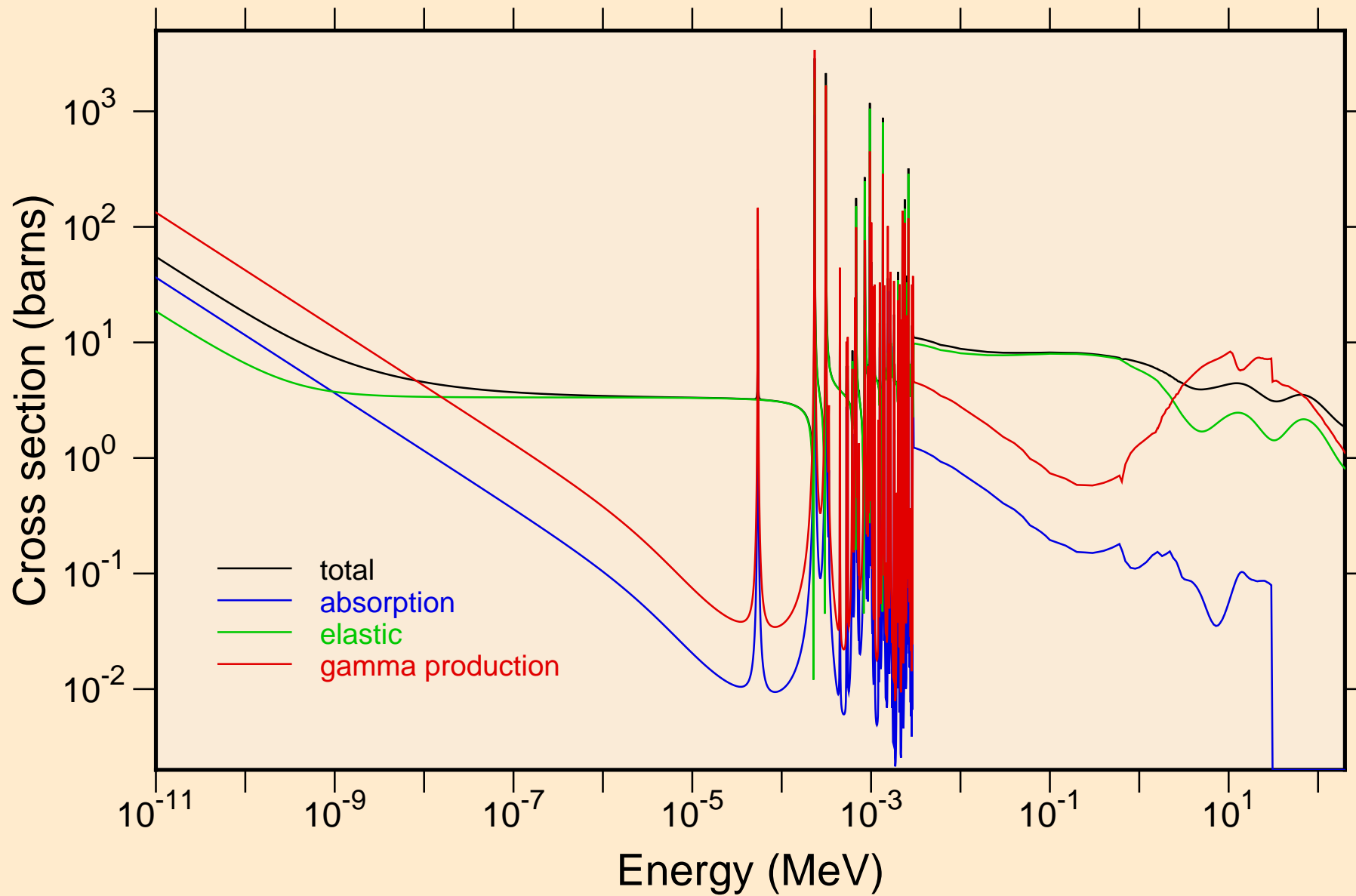

CD108 NEUTRON ACER TENDL-2021 LIBRARY; T=293.6K
resonance total cross section

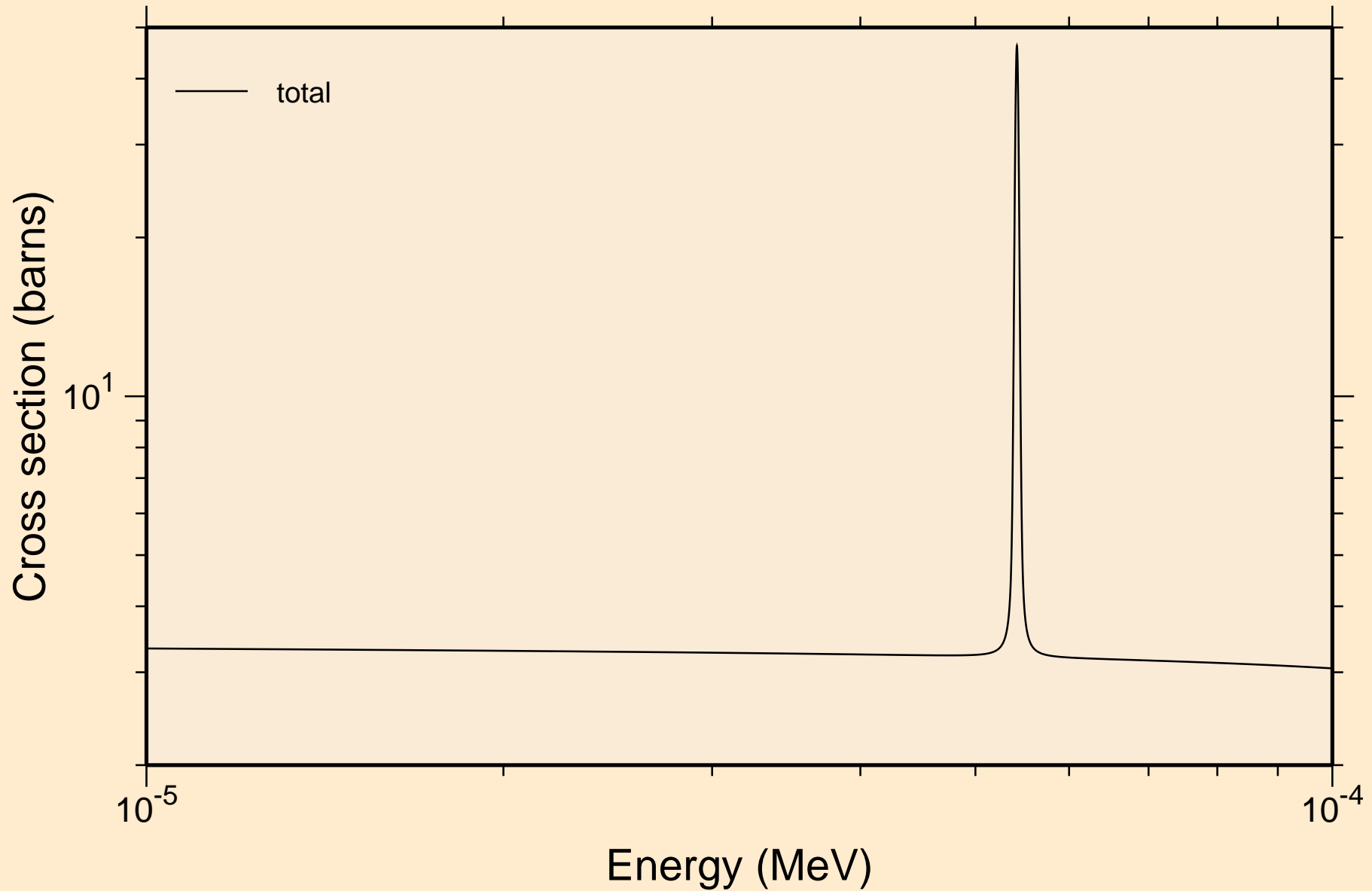

CD108 NEUTRON ACER TENDL-2021 LIBRARY; T=293.6K
resonance total cross section

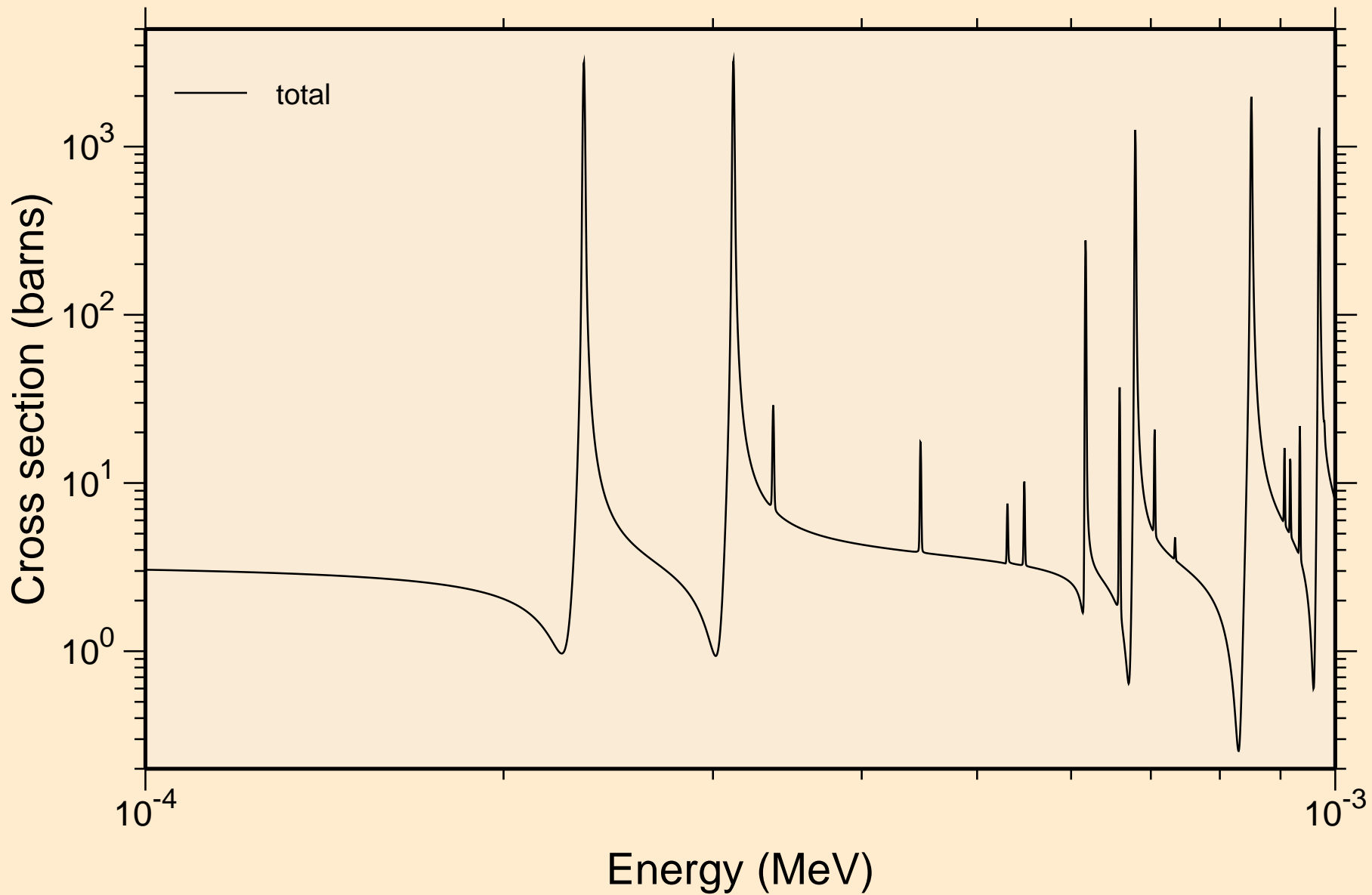

CD108 NEUTRON ACER TENDL-2021 LIBRARY; T=293.6K
resonance total cross section

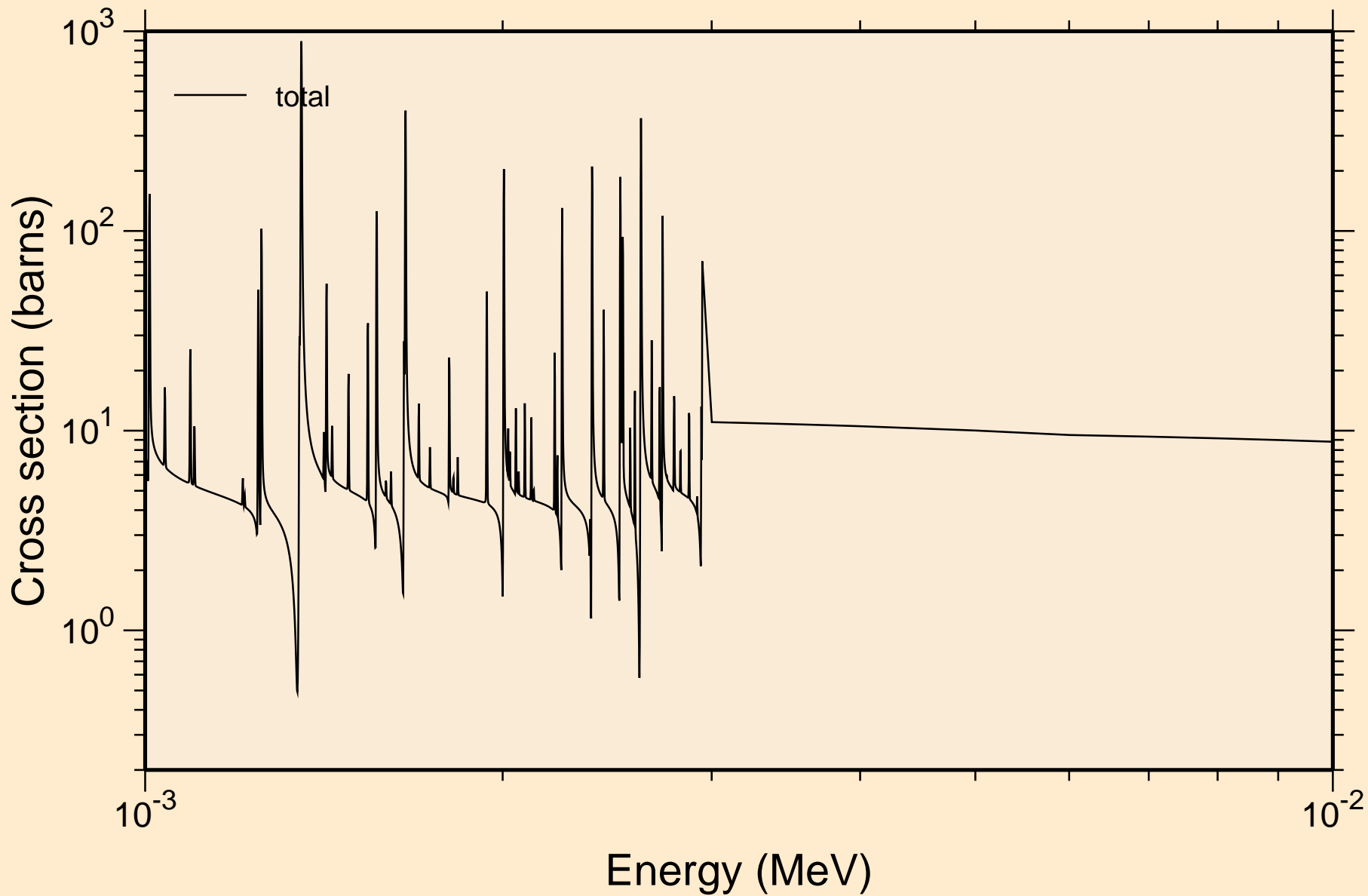

CD108 NEUTRON ACER TENDL-2021 LIBRARY; T=293.6K
resonance total cross section

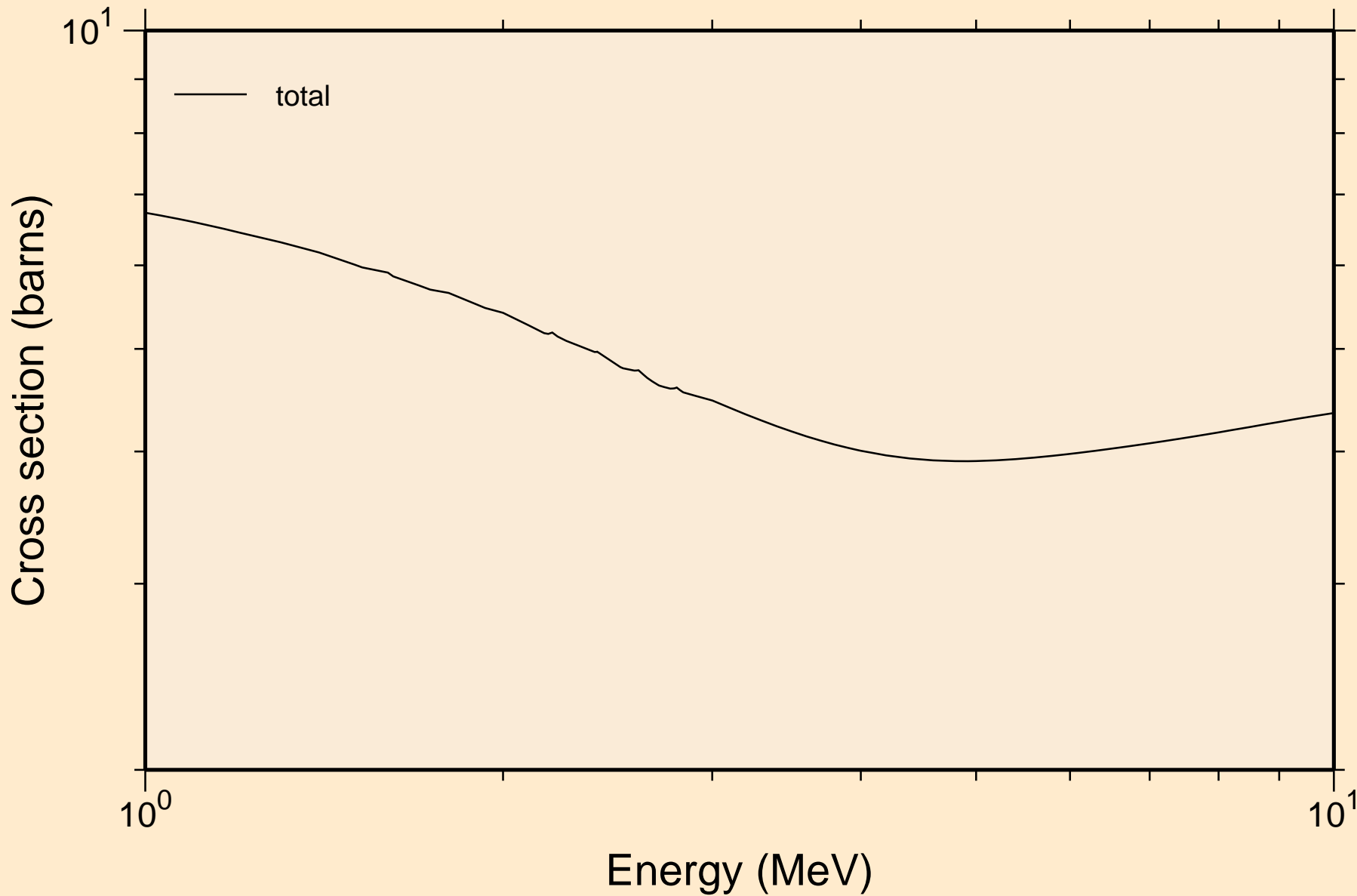

CD108 NEUTRON ACER TENDL-2021 LIBRARY; T=293.6K
resonance absorption cross sections

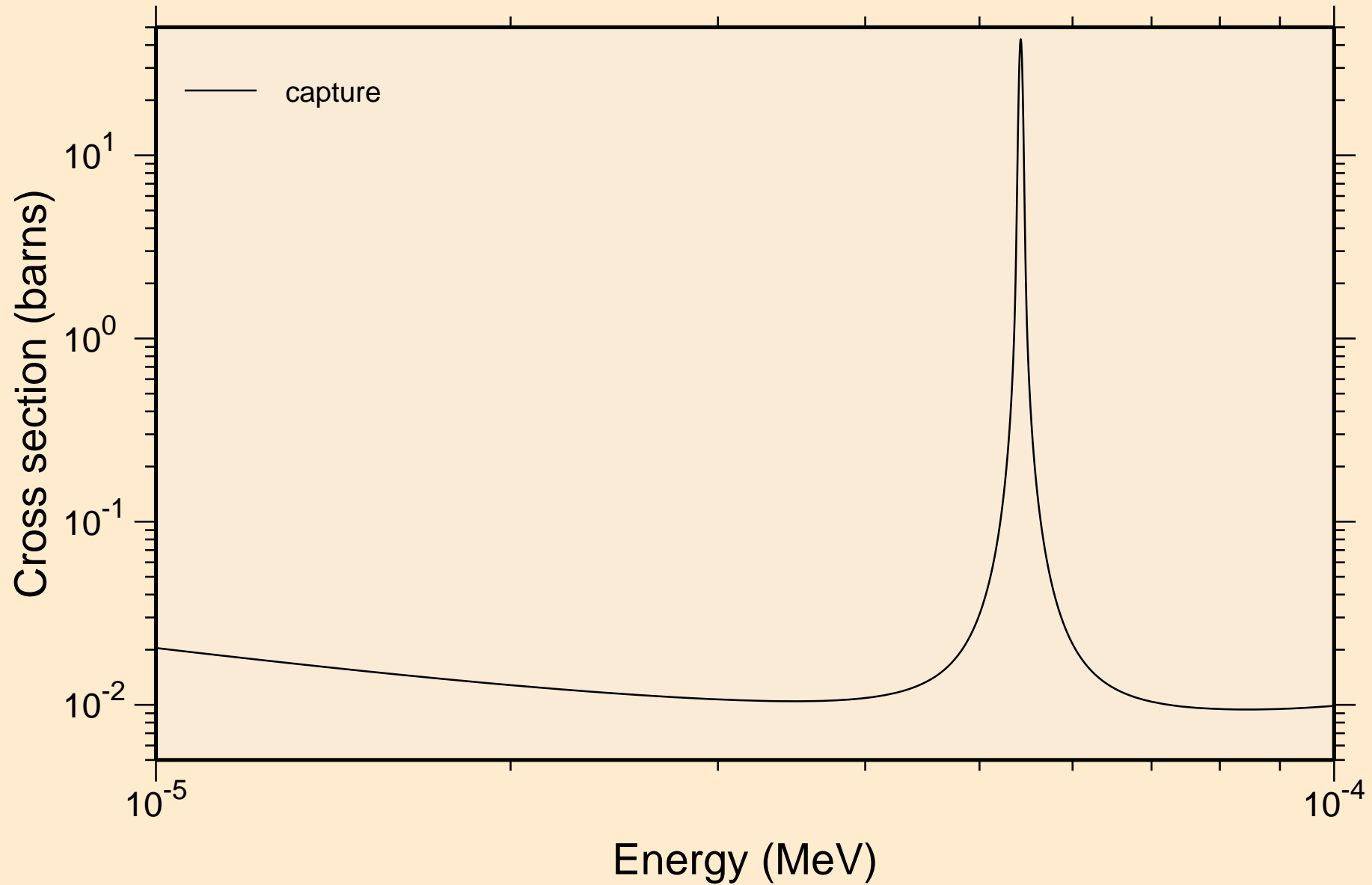

CD108 NEUTRON ACER TENDL-2021 LIBRARY; T=293.6K
resonance absorption cross sections

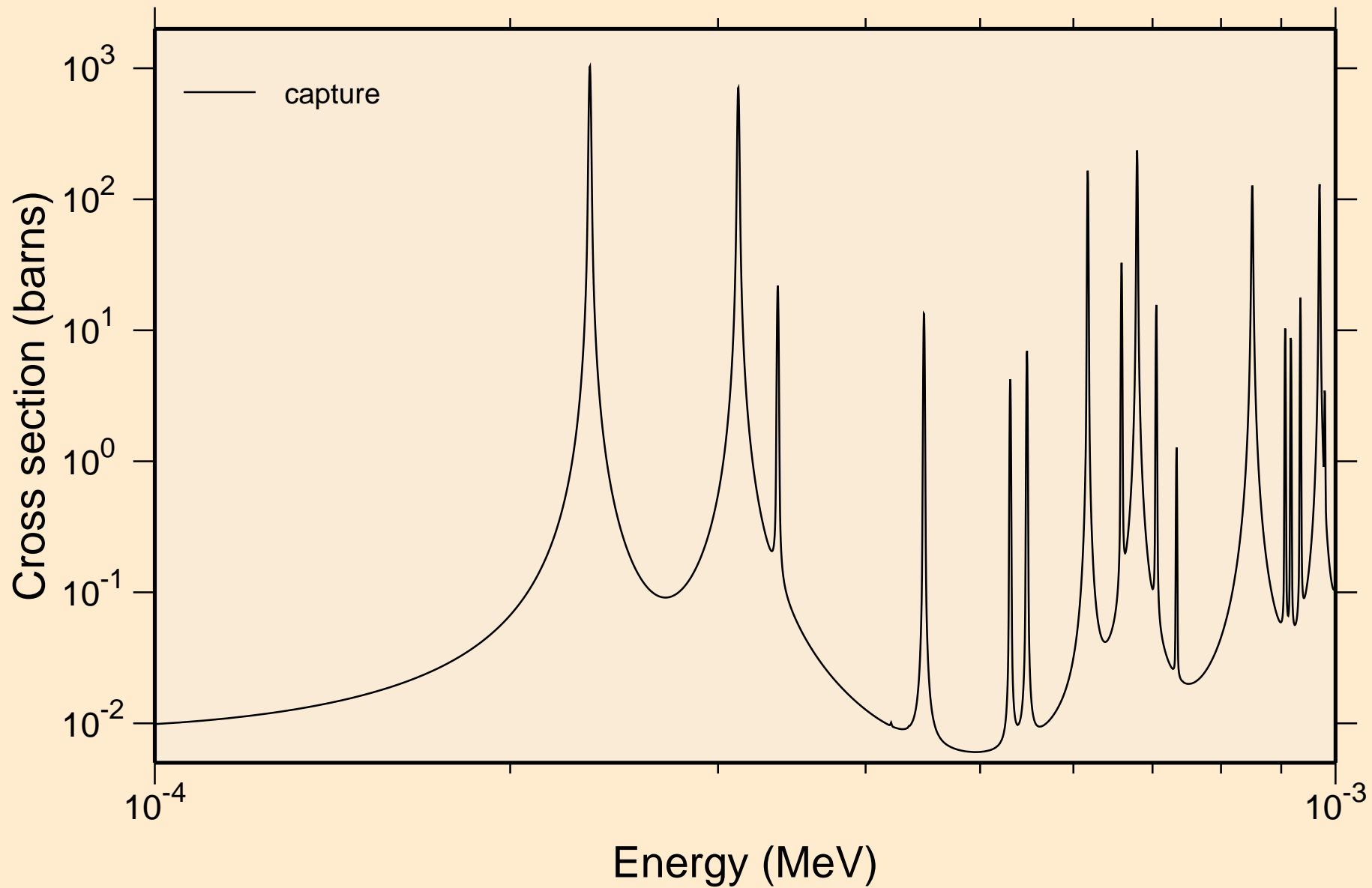

CD108 NEUTRON ACER TENDL-2021 LIBRARY; T=293.6K
resonance absorption cross sections

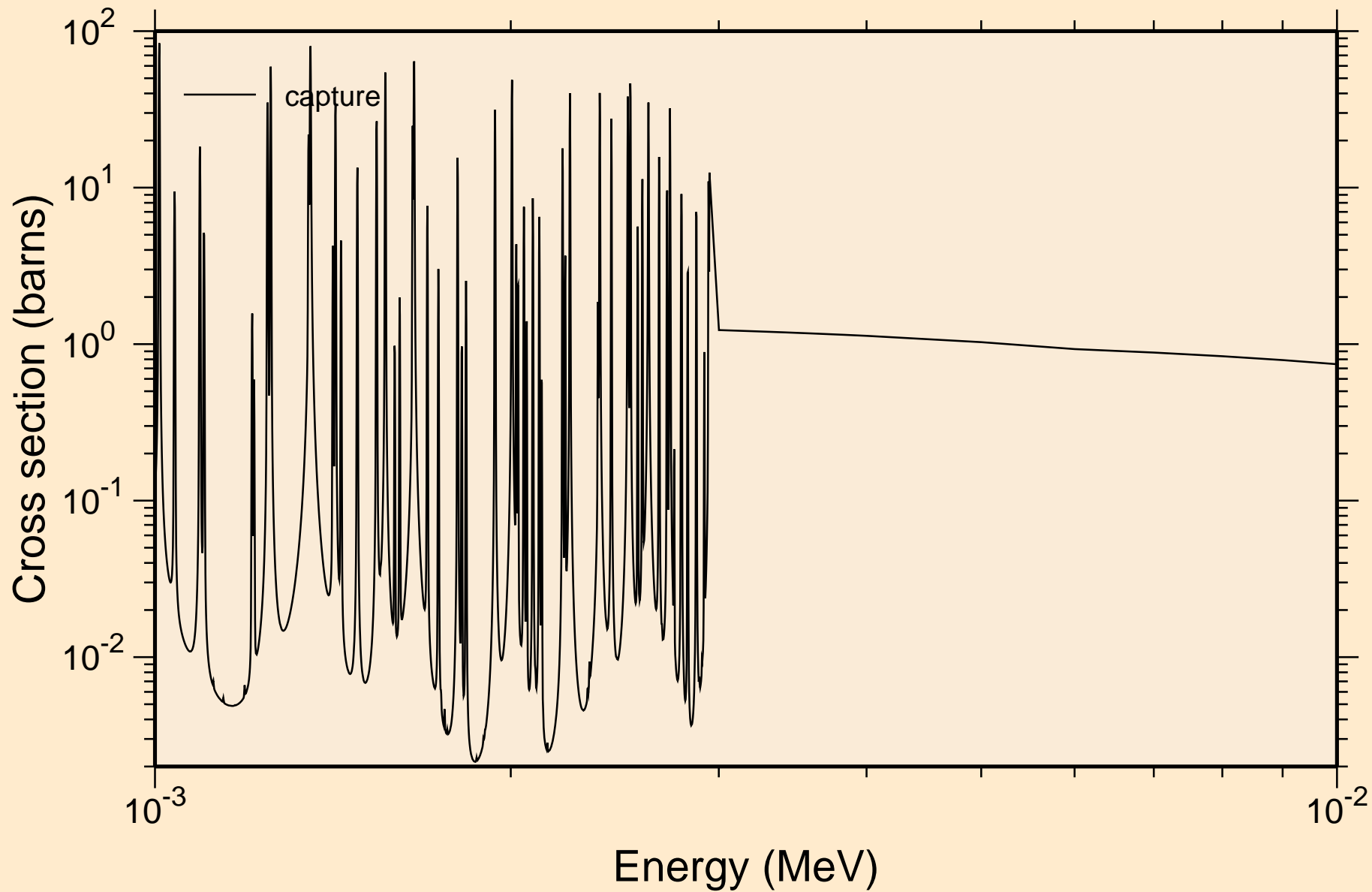

CD108 NEUTRON ACER TENDL-2021 LIBRARY; T=293.6K
resonance absorption cross sections

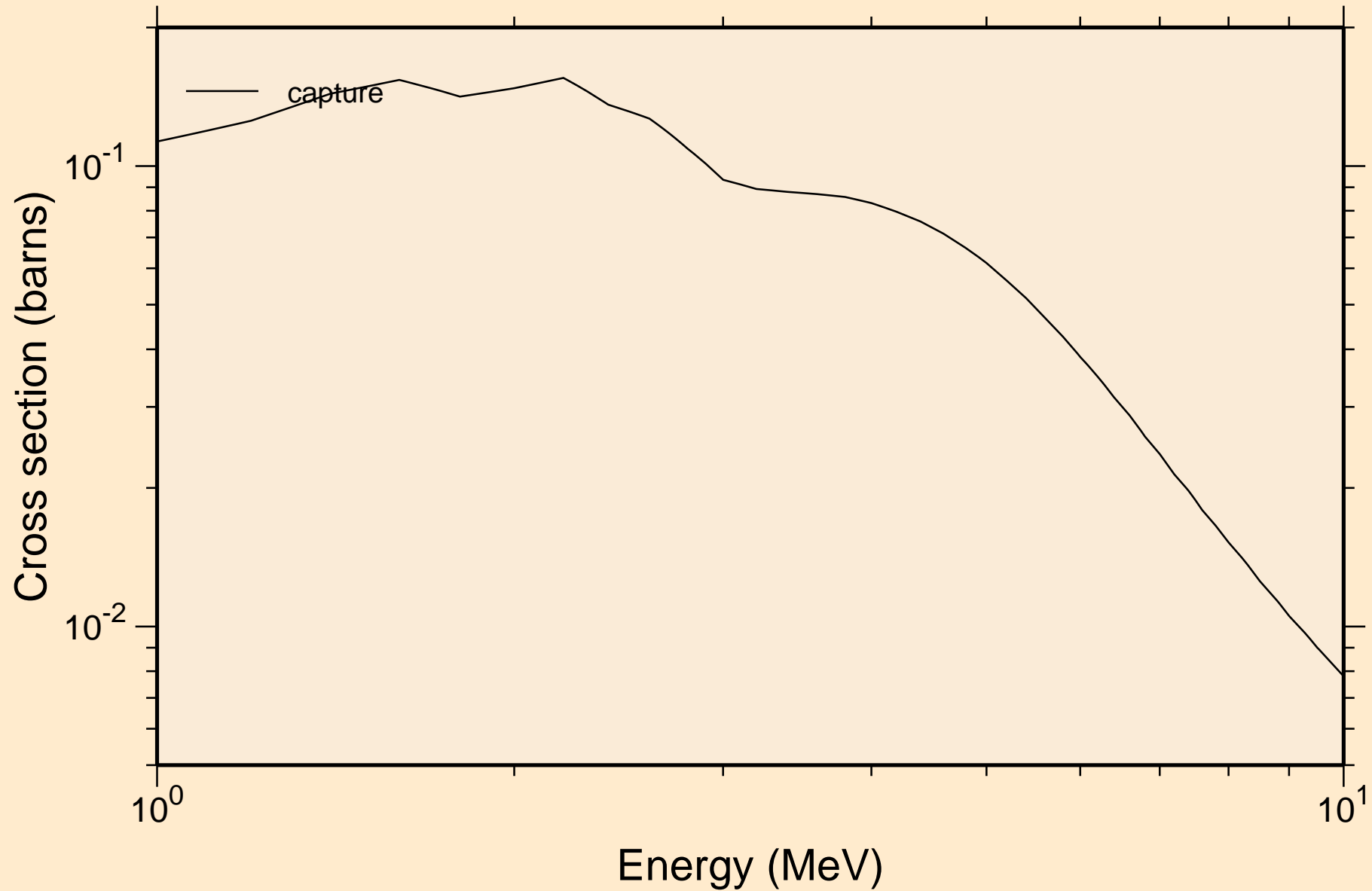

CD108 NEUTRON ACER TENDL-2021 LIBRARY; T=293.6K
Heating

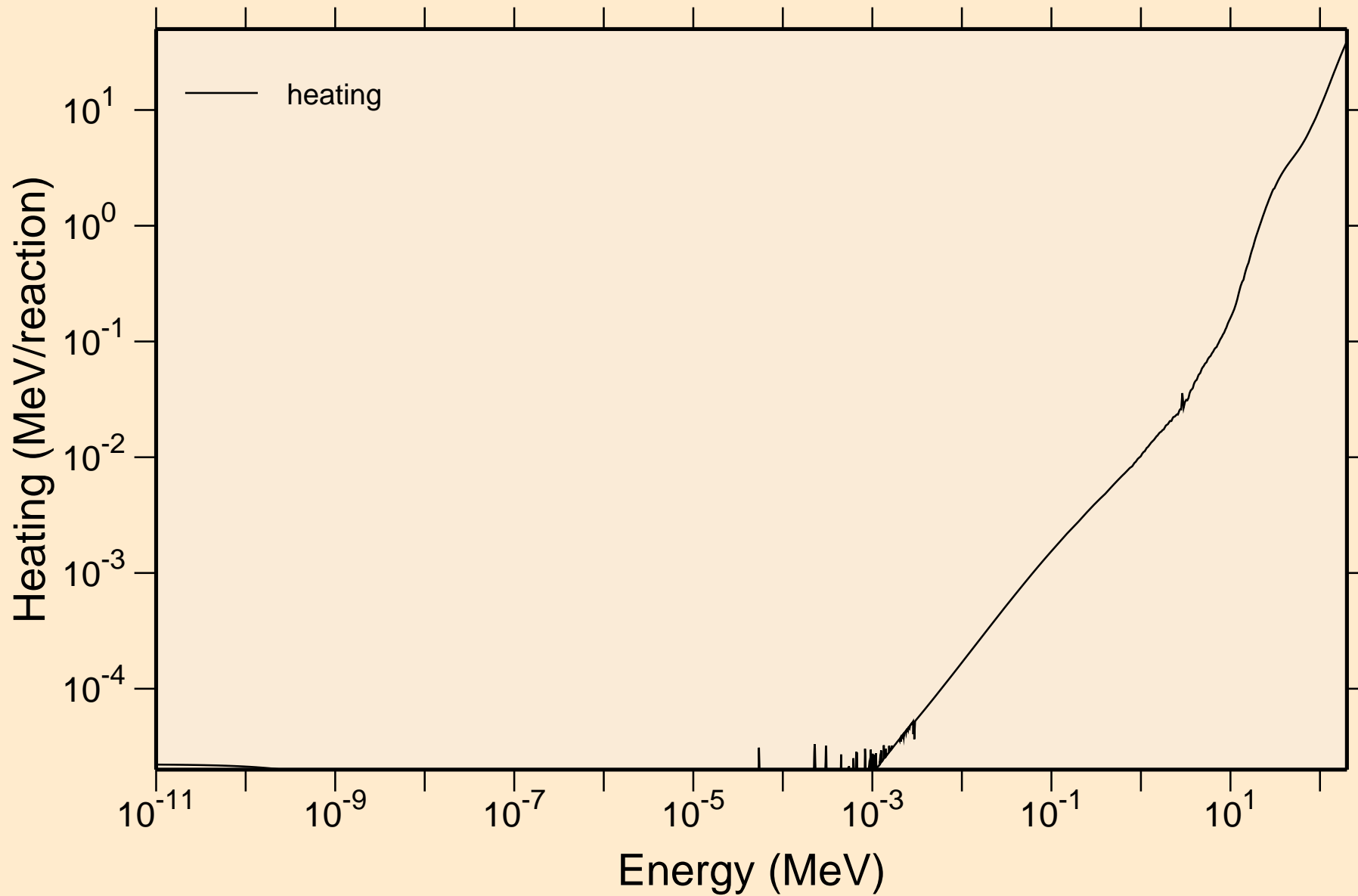

CD108 NEUTRON ACER TENDL-2021 LIBRARY; T=293.6K

Damage

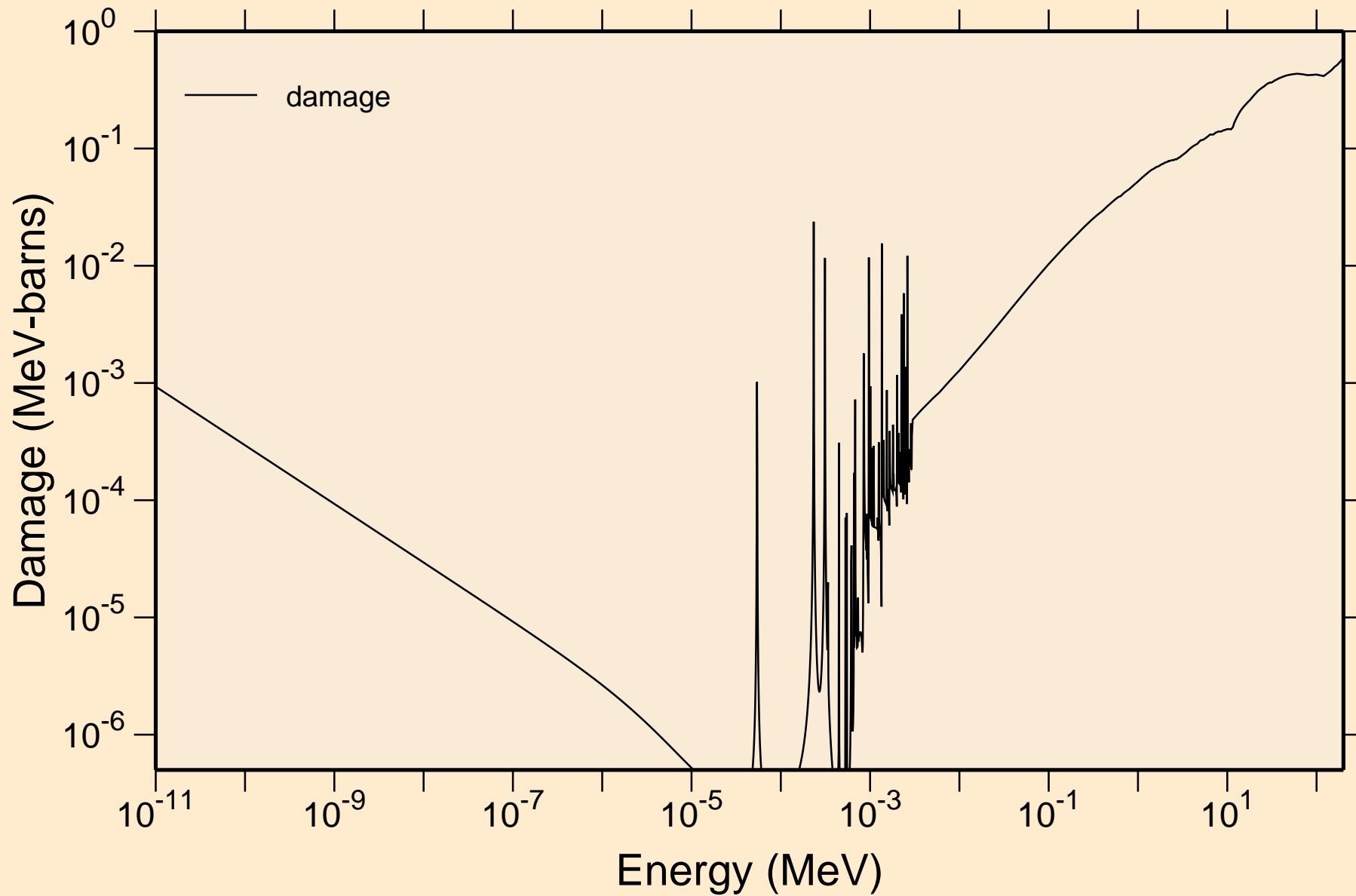

CD108 NEUTRON ACER TENDL-2021 LIBRARY; T=293.6K
Non-threshold reactions

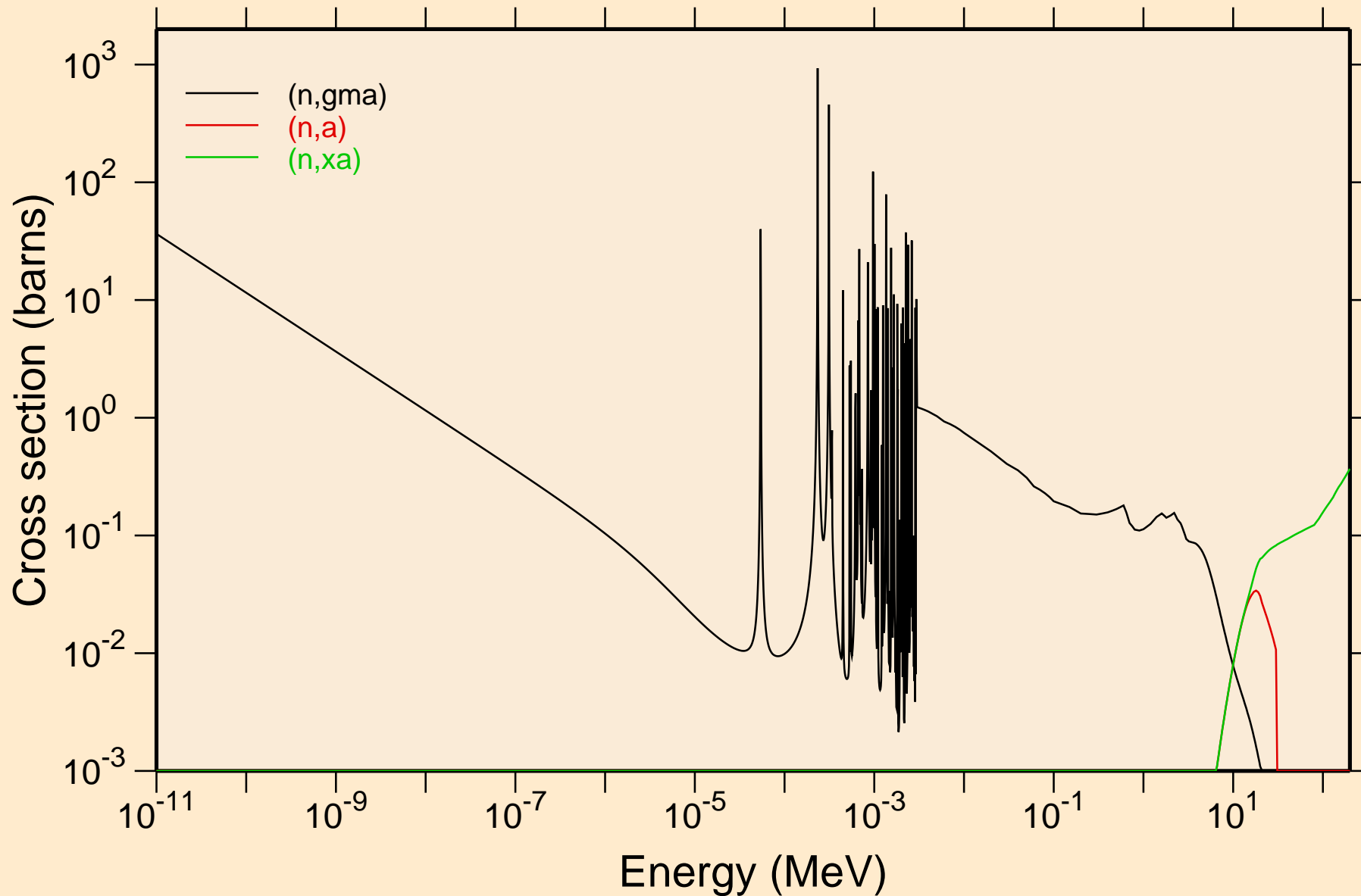

CD108 NEUTRON ACER TENDL-2021 LIBRARY; T=293.6K

Principal cross sections

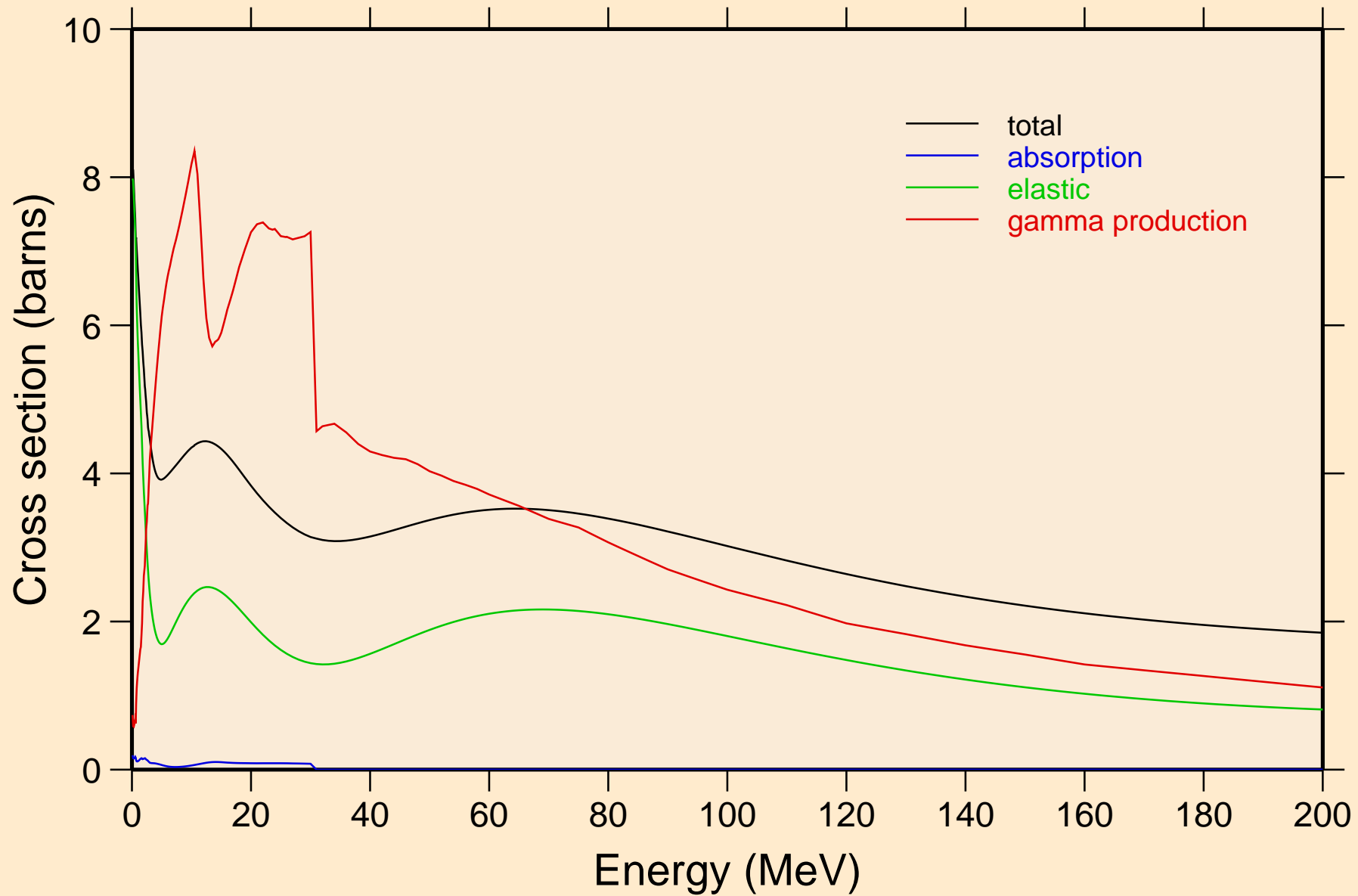

CD108 NEUTRON ACER TENDL-2021 LIBRARY; T=293.6K
Heating

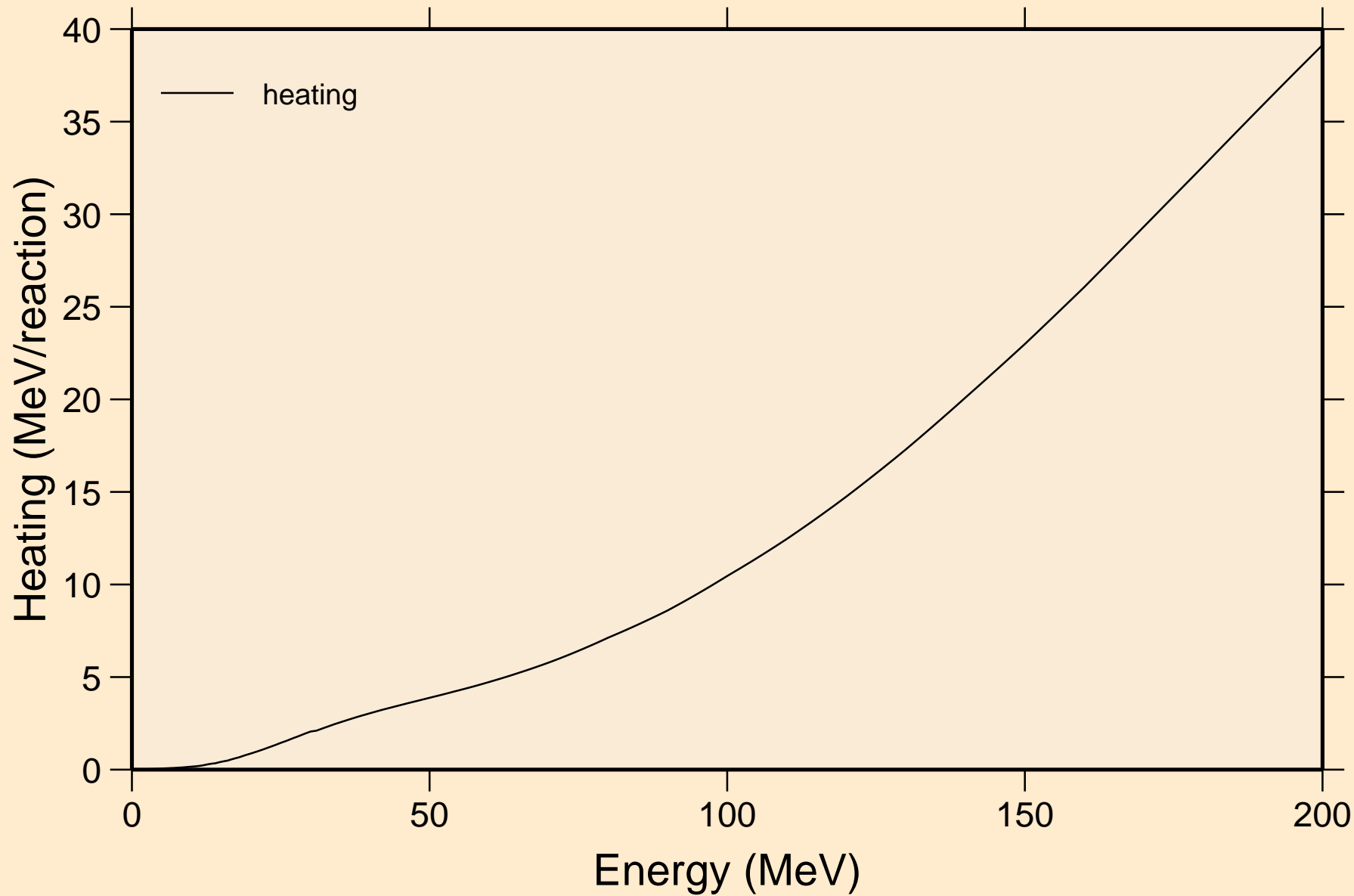

CD108 NEUTRON ACER TENDL-2021 LIBRARY; T=293.6K
Damage

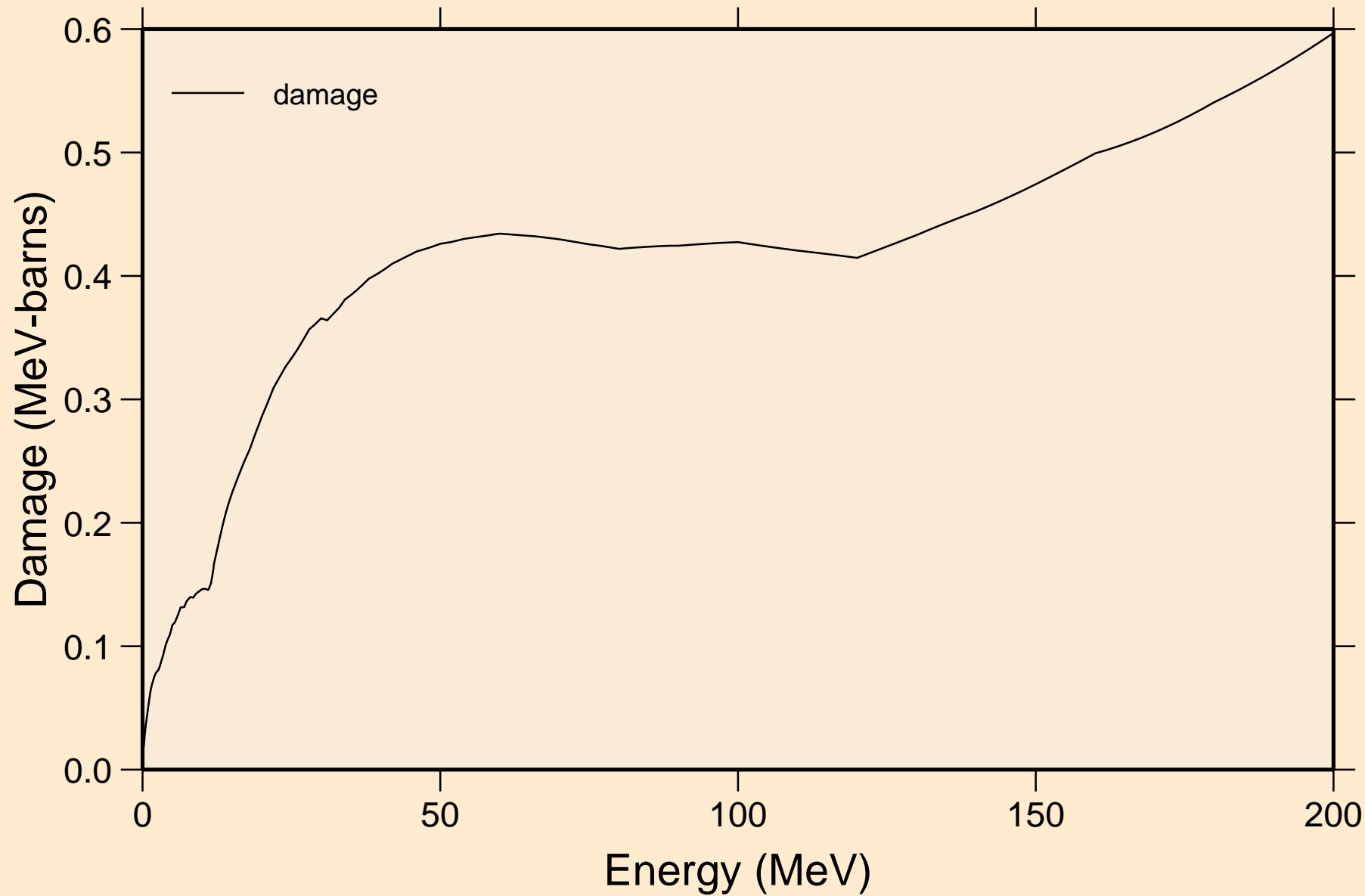

CD108 NEUTRON ACER TENDL-2021 LIBRARY; T=293.6K

Non-threshold reactions

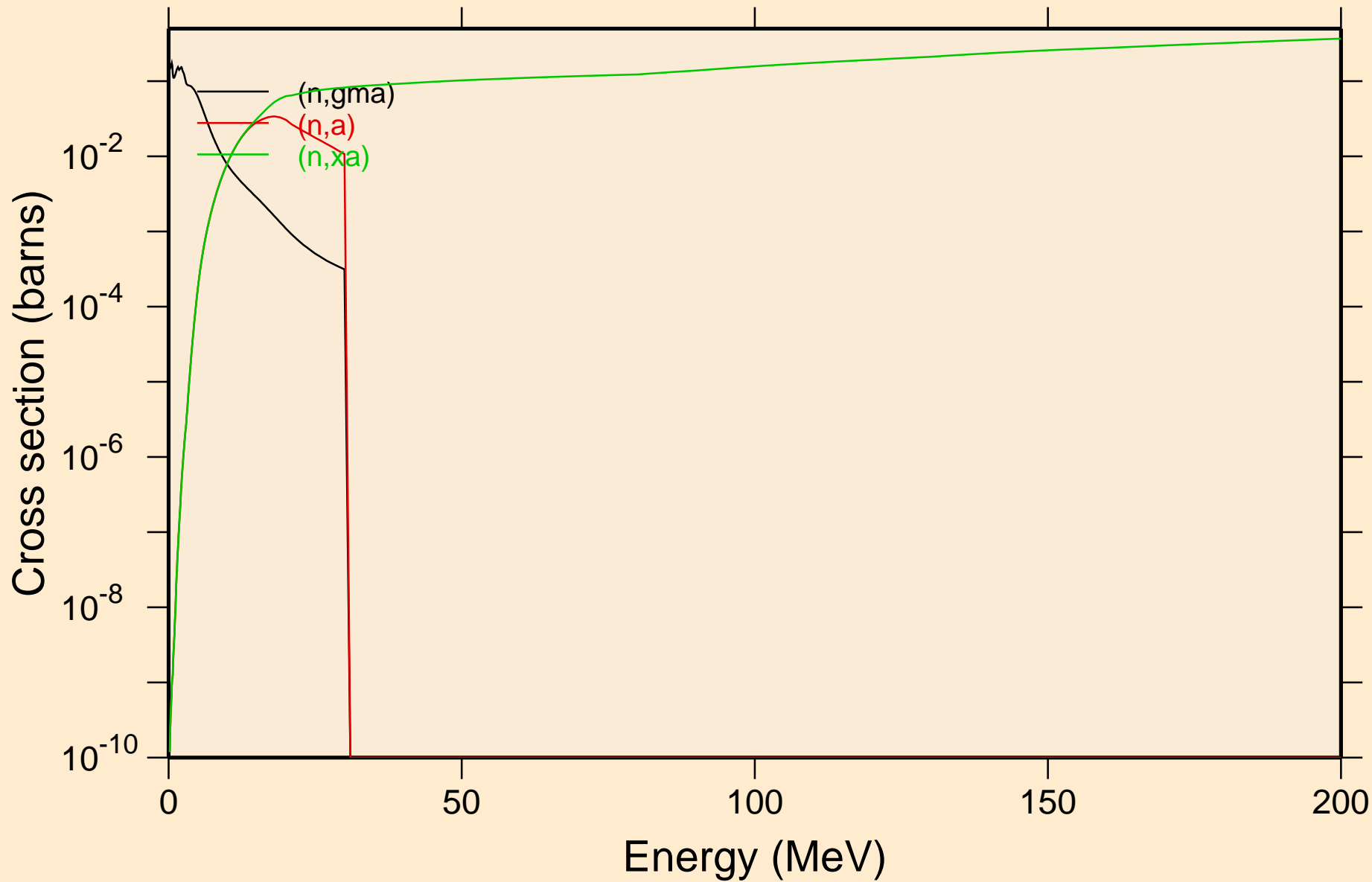

CD108 NEUTRON ACER TENDL-2021 LIBRARY; T=293.6K
Inelastic levels

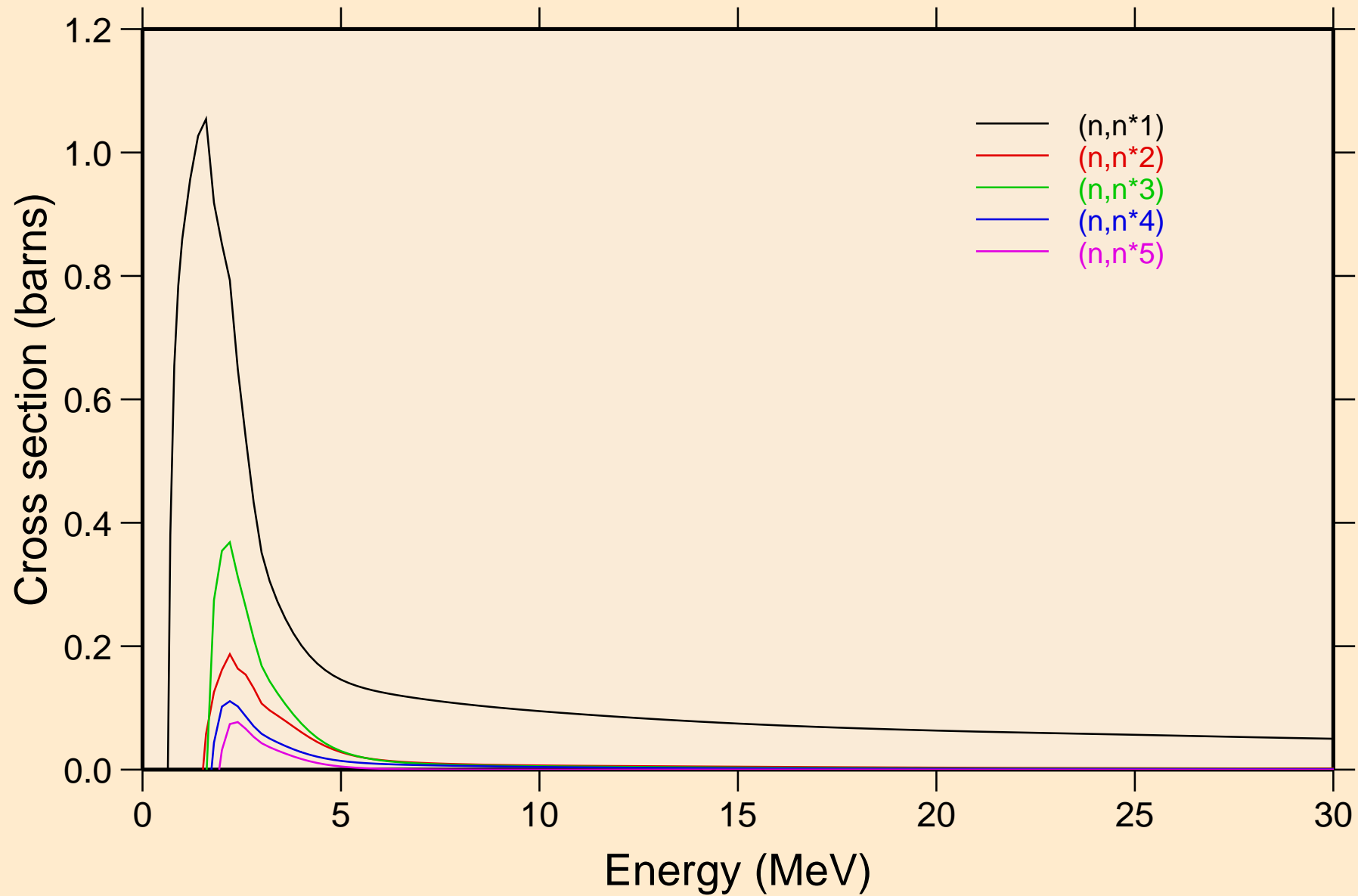

CD108 NEUTRON ACER TENDL-2021 LIBRARY; T=293.6K

Inelastic levels

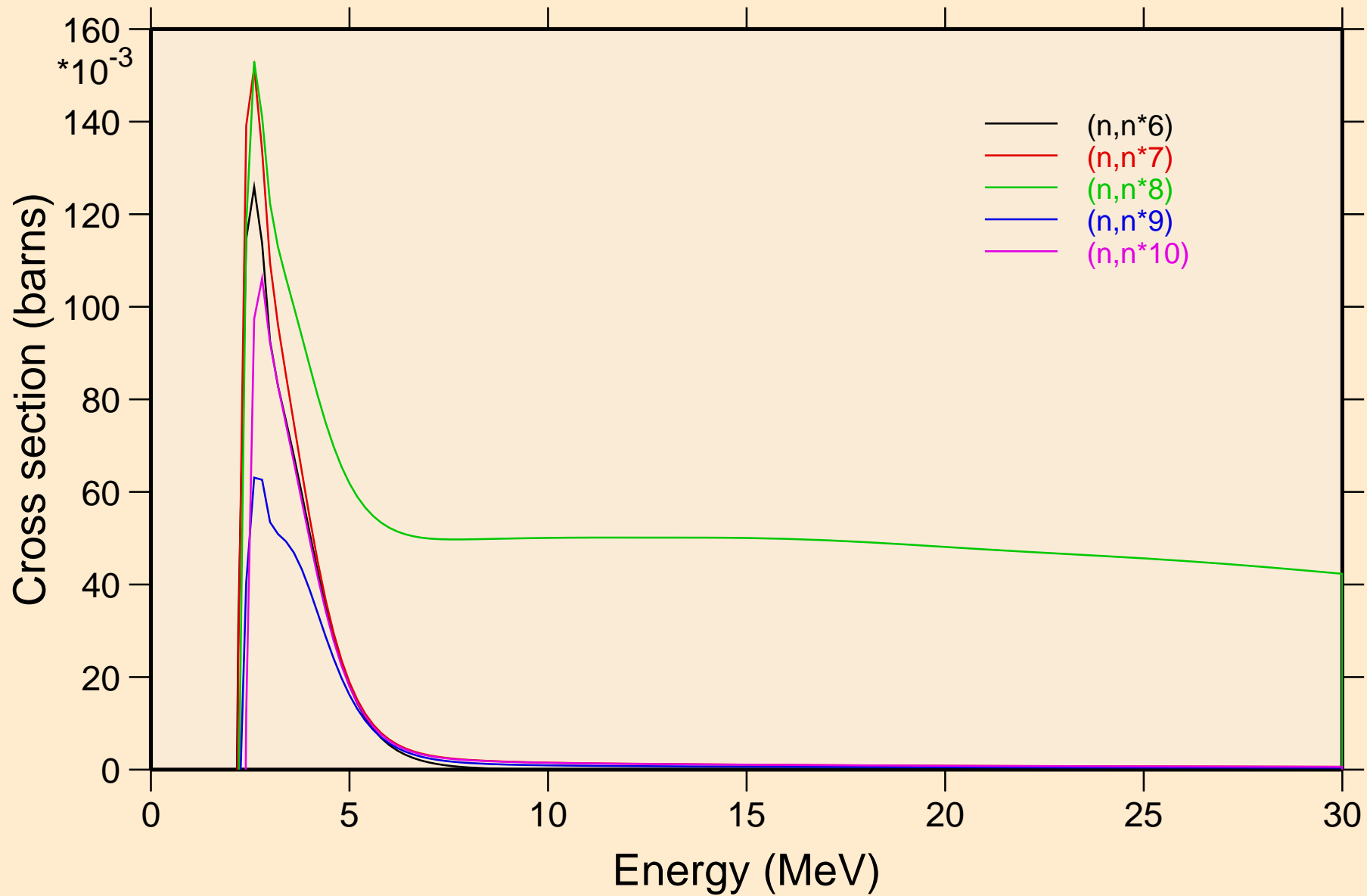

CD108 NEUTRON ACER TENDL-2021 LIBRARY; T=293.6K

Inelastic levels

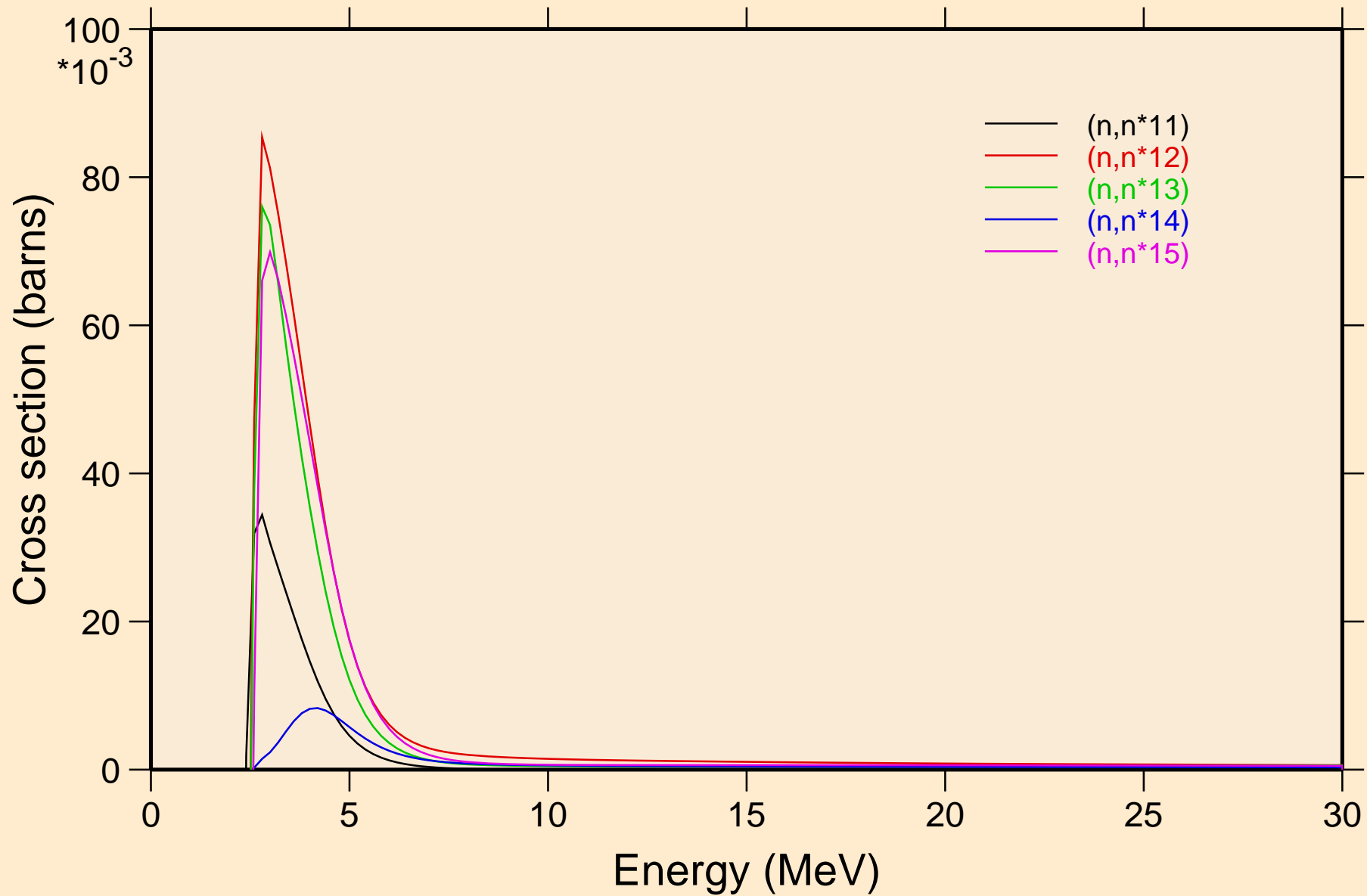

CD108 NEUTRON ACER TENDL-2021 LIBRARY; T=293.6K
Inelastic levels

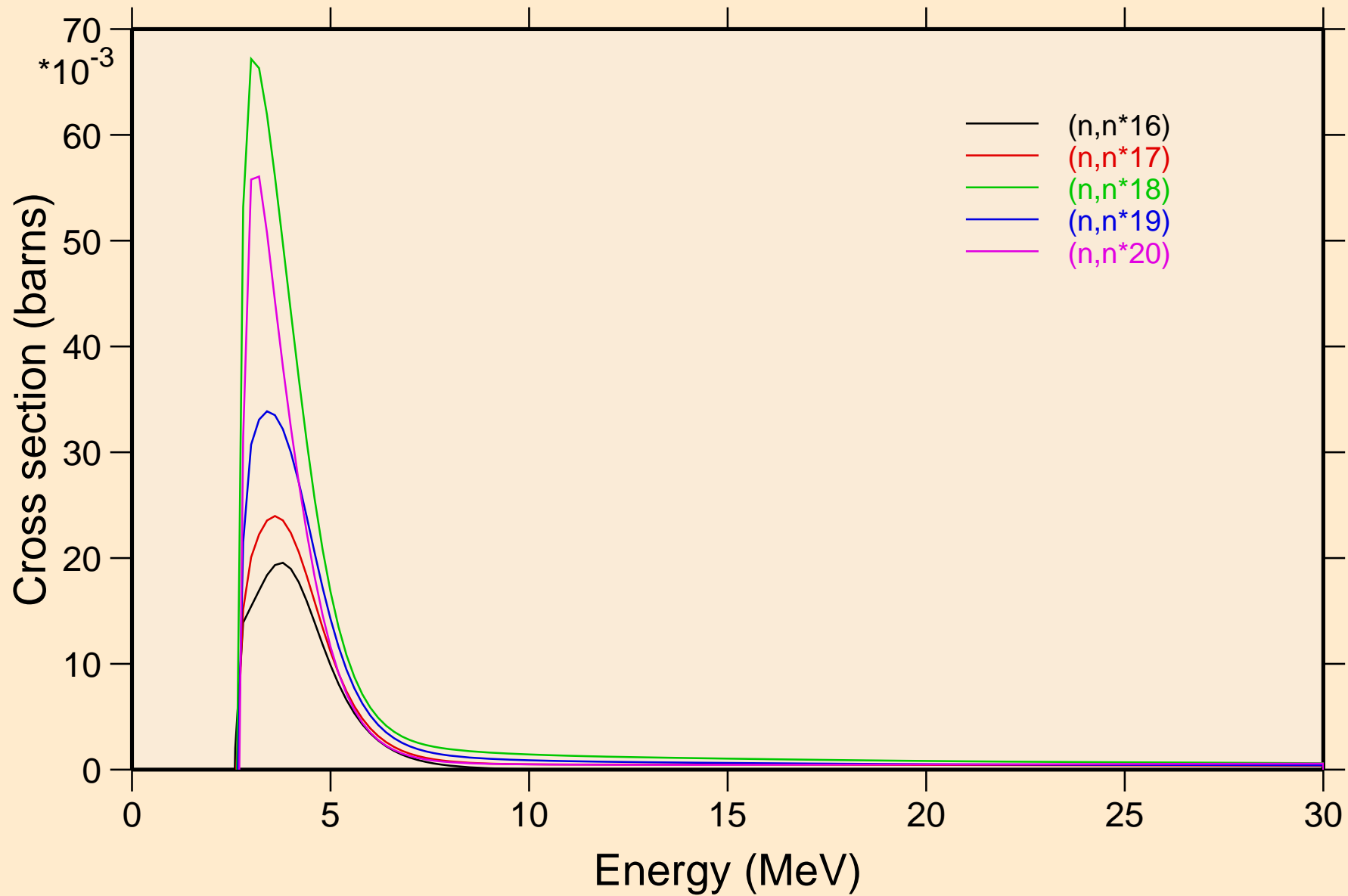

CD108 NEUTRON ACER TENDL-2021 LIBRARY; T=293.6K
Inelastic levels

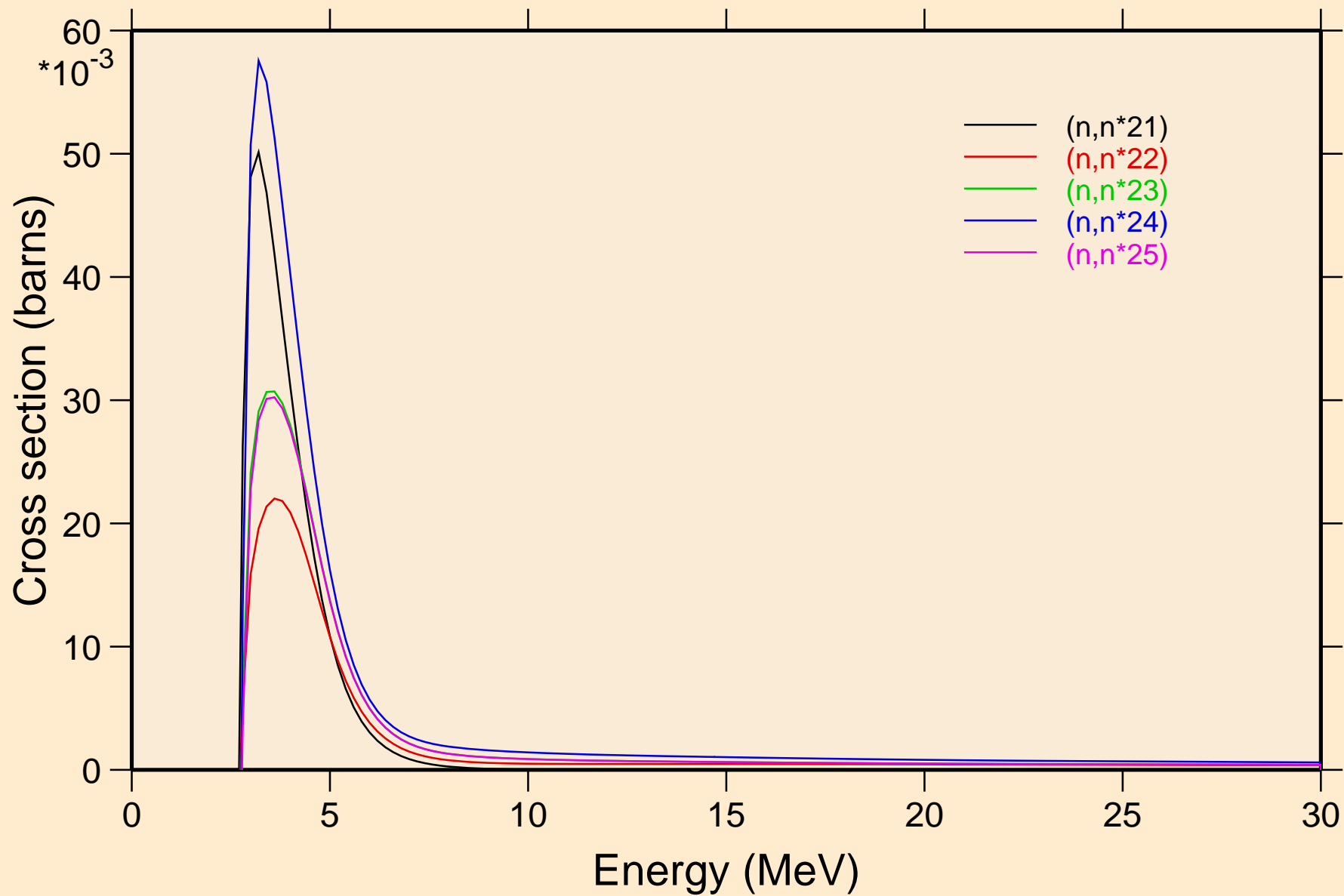

CD108 NEUTRON ACER TENDL-2021 LIBRARY; T=293.6K
Inelastic levels

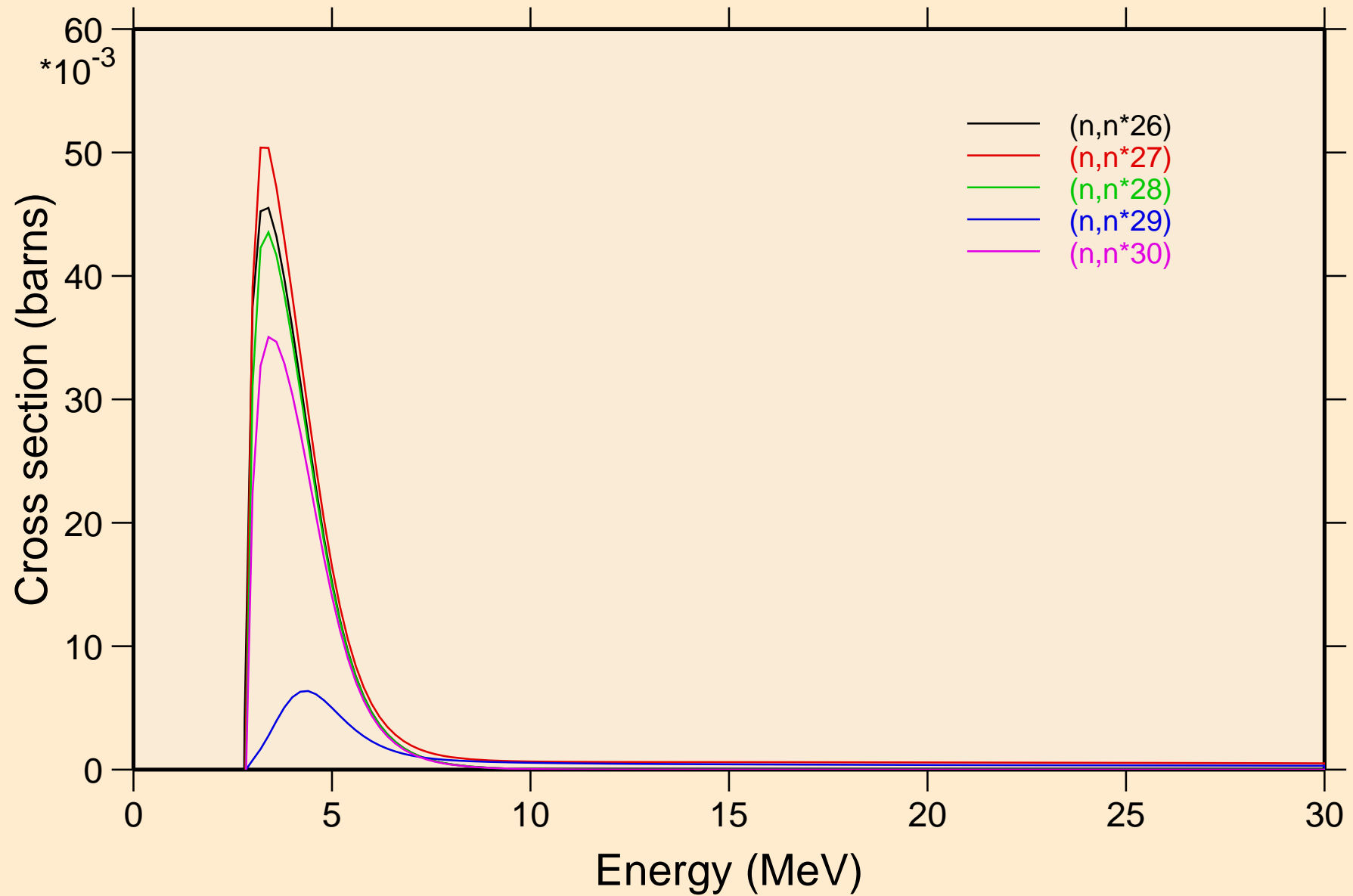

CD108 NEUTRON ACER TENDL-2021 LIBRARY; T=293.6K
Threshold reactions

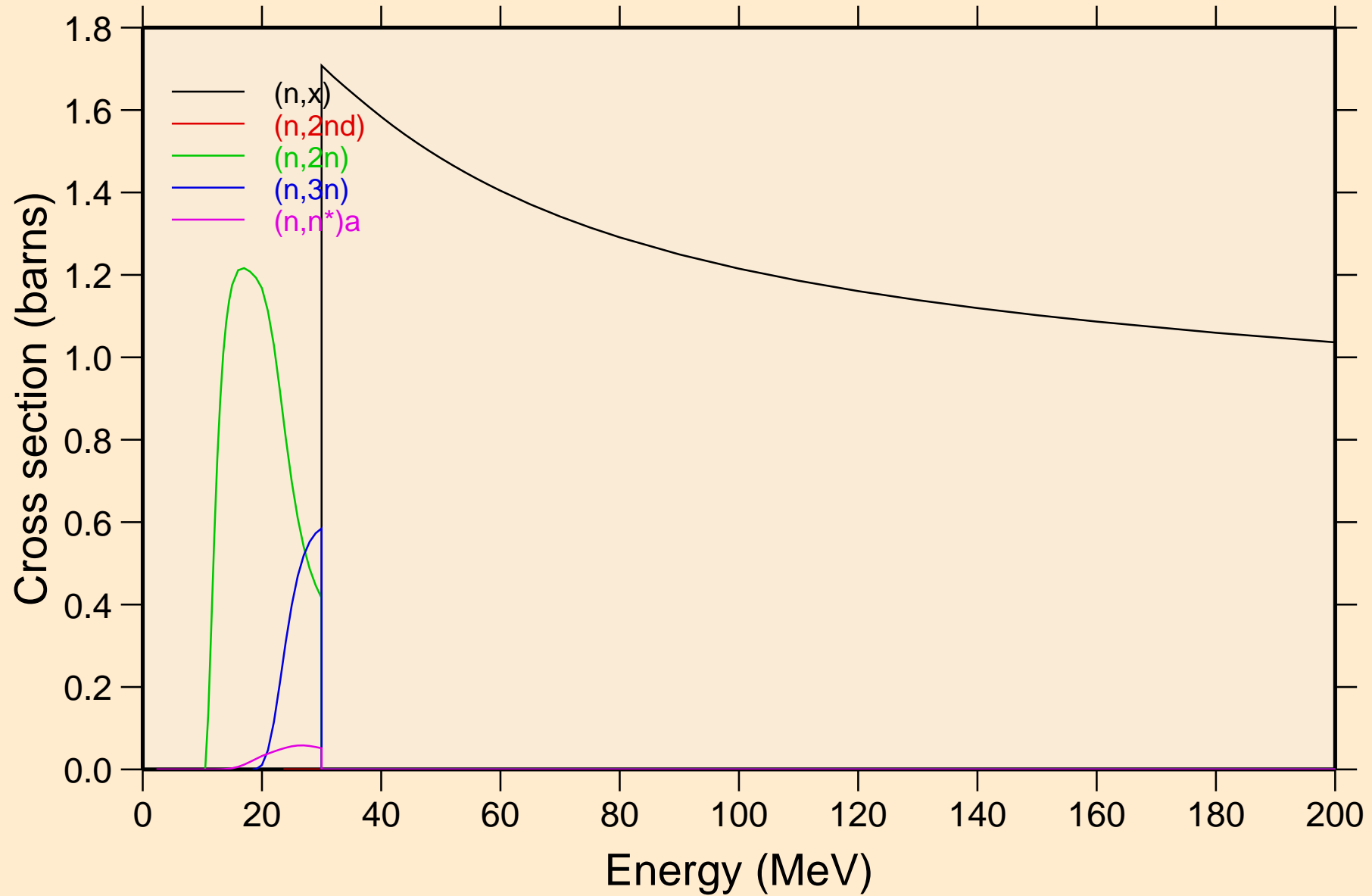

CD108 NEUTRON ACER TENDL-2021 LIBRARY; T=293.6K

Threshold reactions

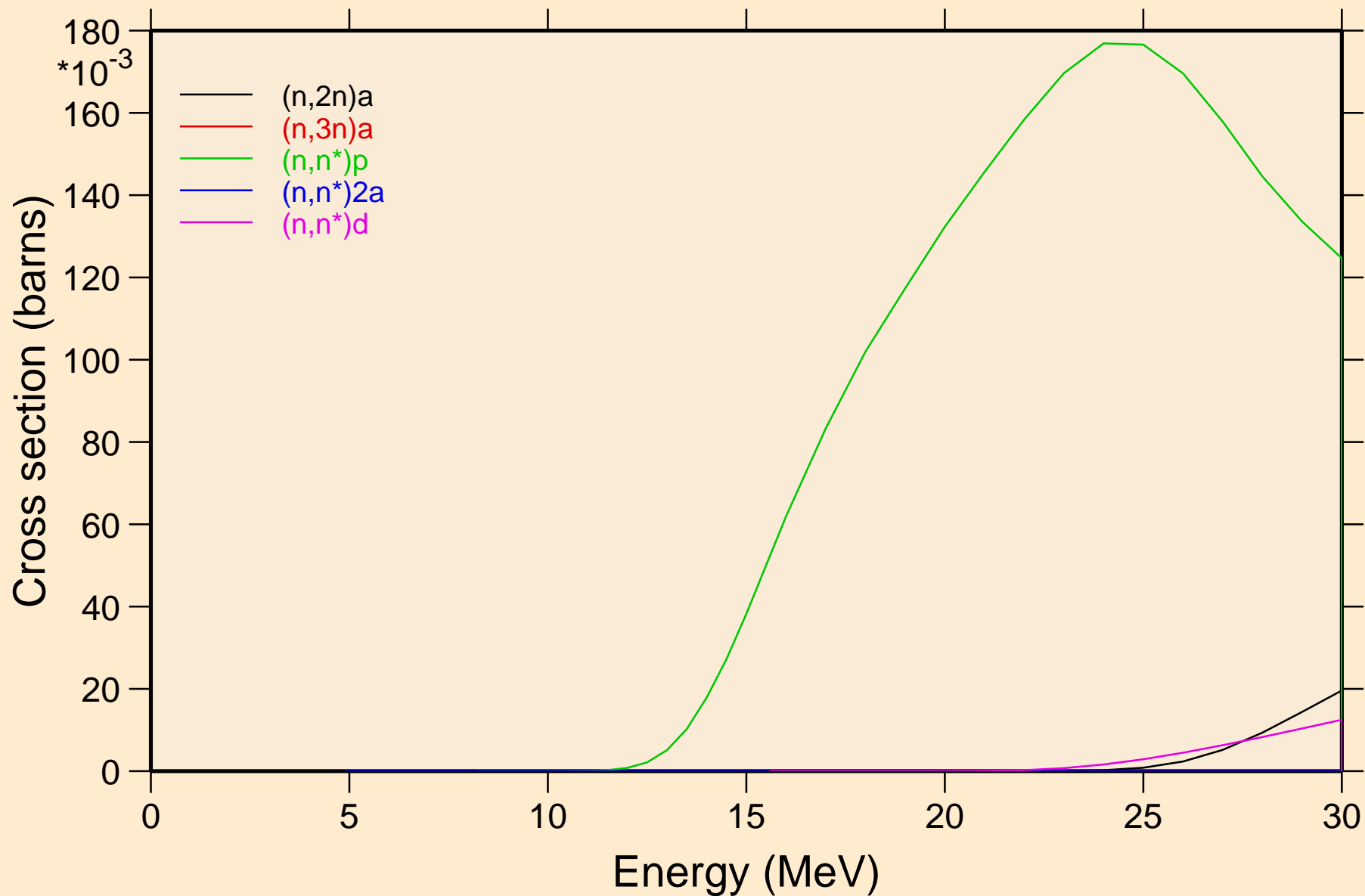

CD108 NEUTRON ACER TENDL-2021 LIBRARY; T=293.6K

Threshold reactions

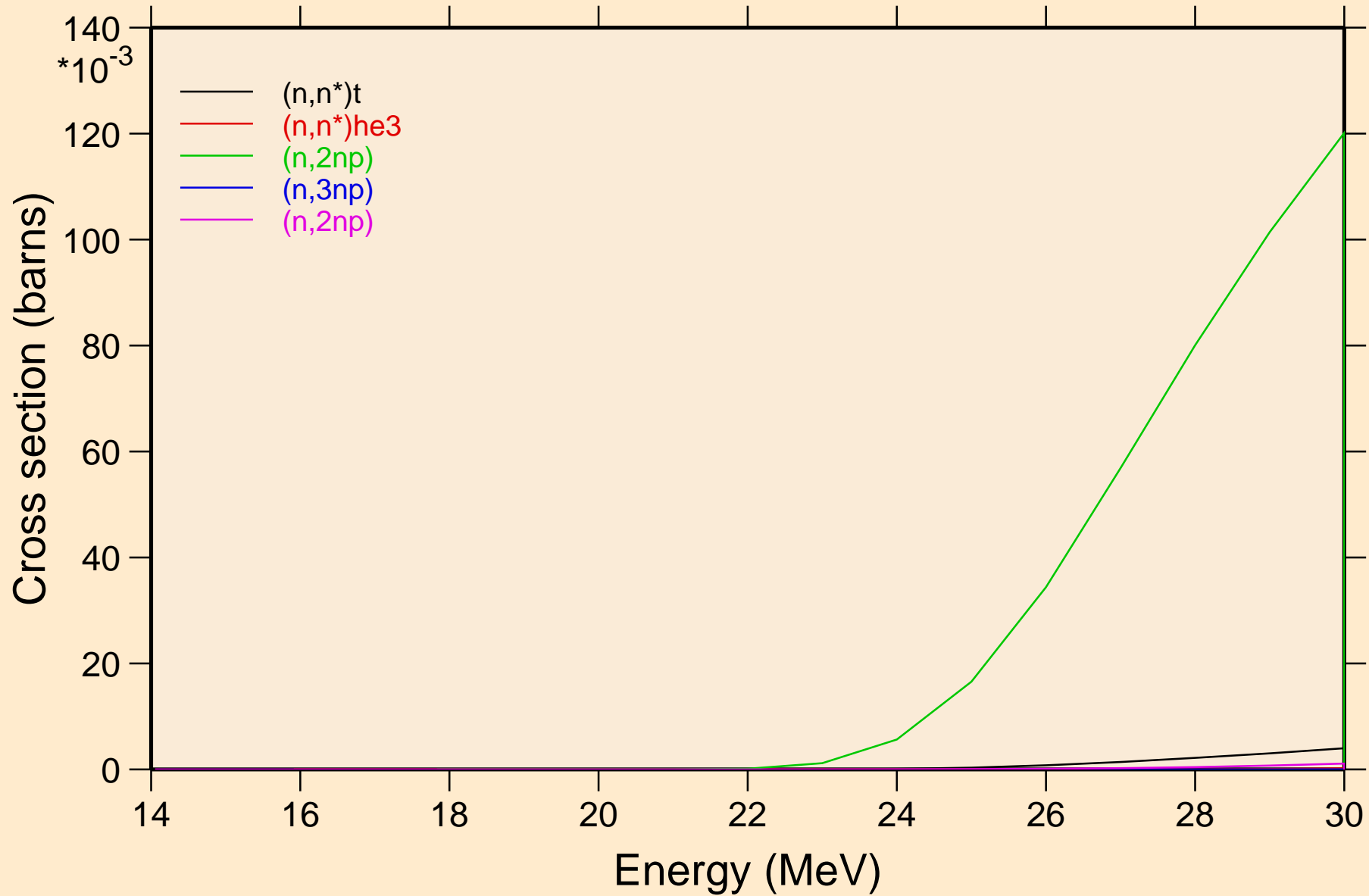

CD108 NEUTRON ACER TENDL-2021 LIBRARY; T=293.6K

Threshold reactions

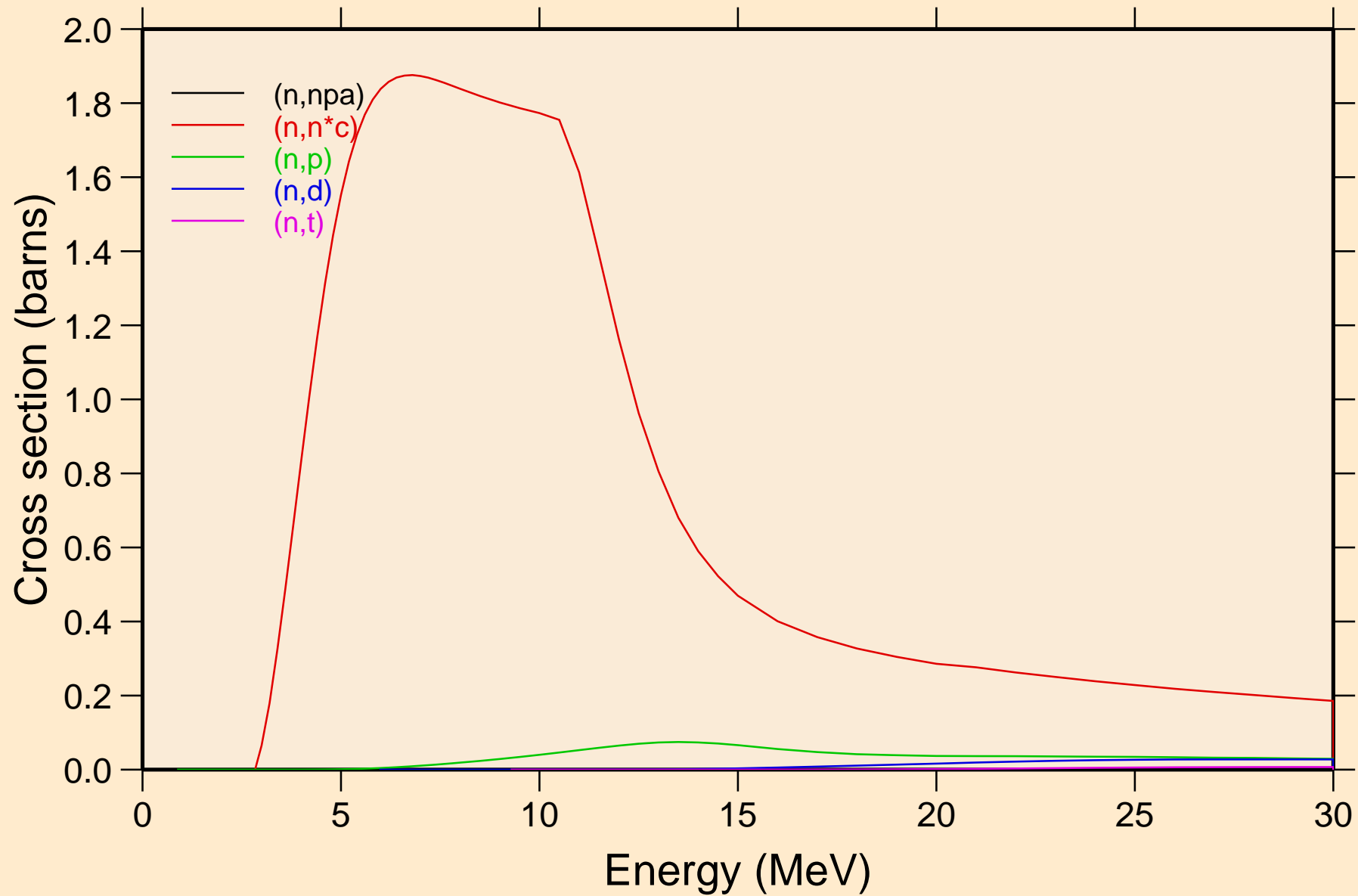

CD108 NEUTRON ACER TENDL-2021 LIBRARY; T=293.6K

Threshold reactions

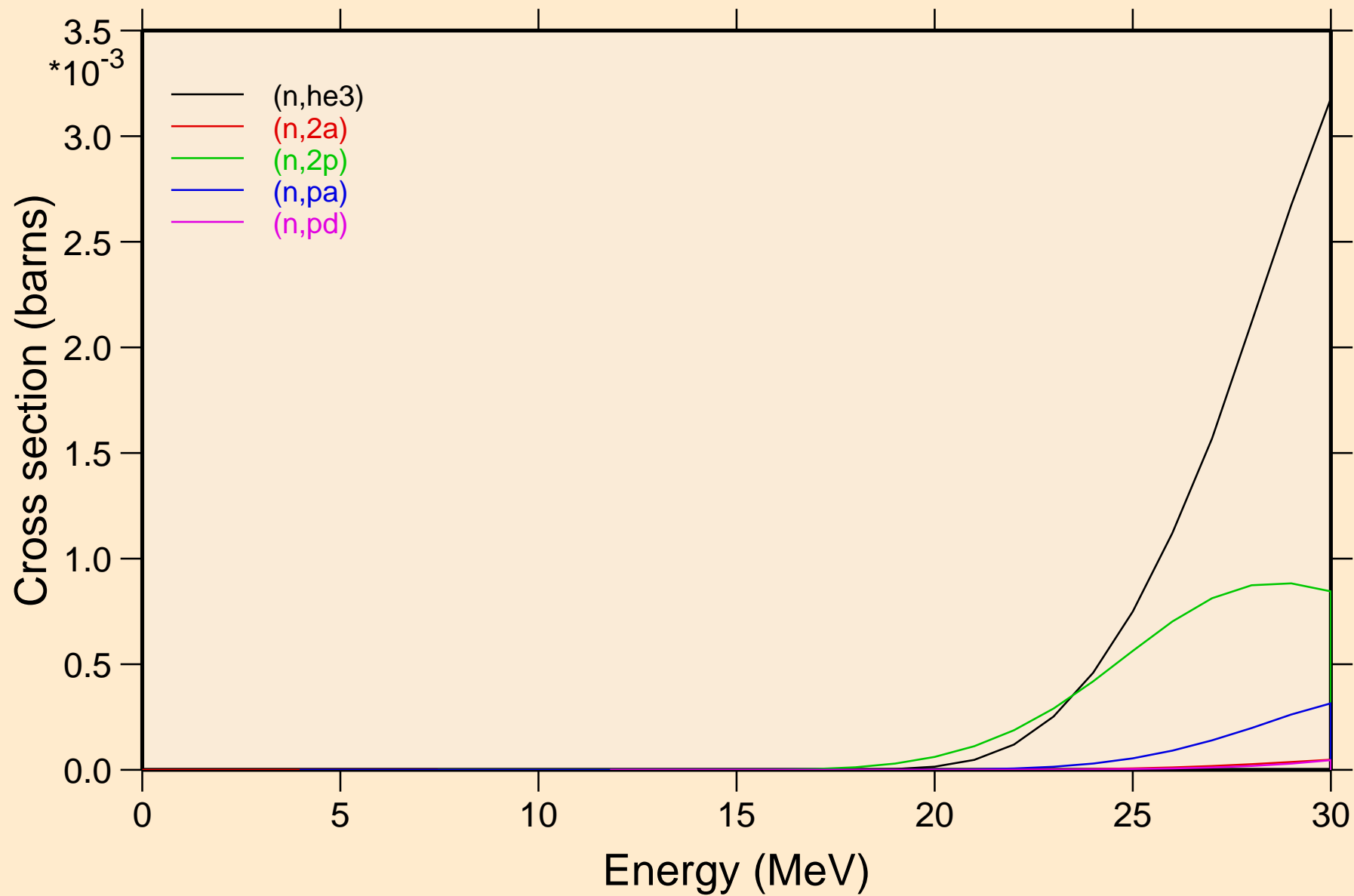

CD108 NEUTRON ACER TENDL-2021 LIBRARY; T=293.6K

Threshold reactions

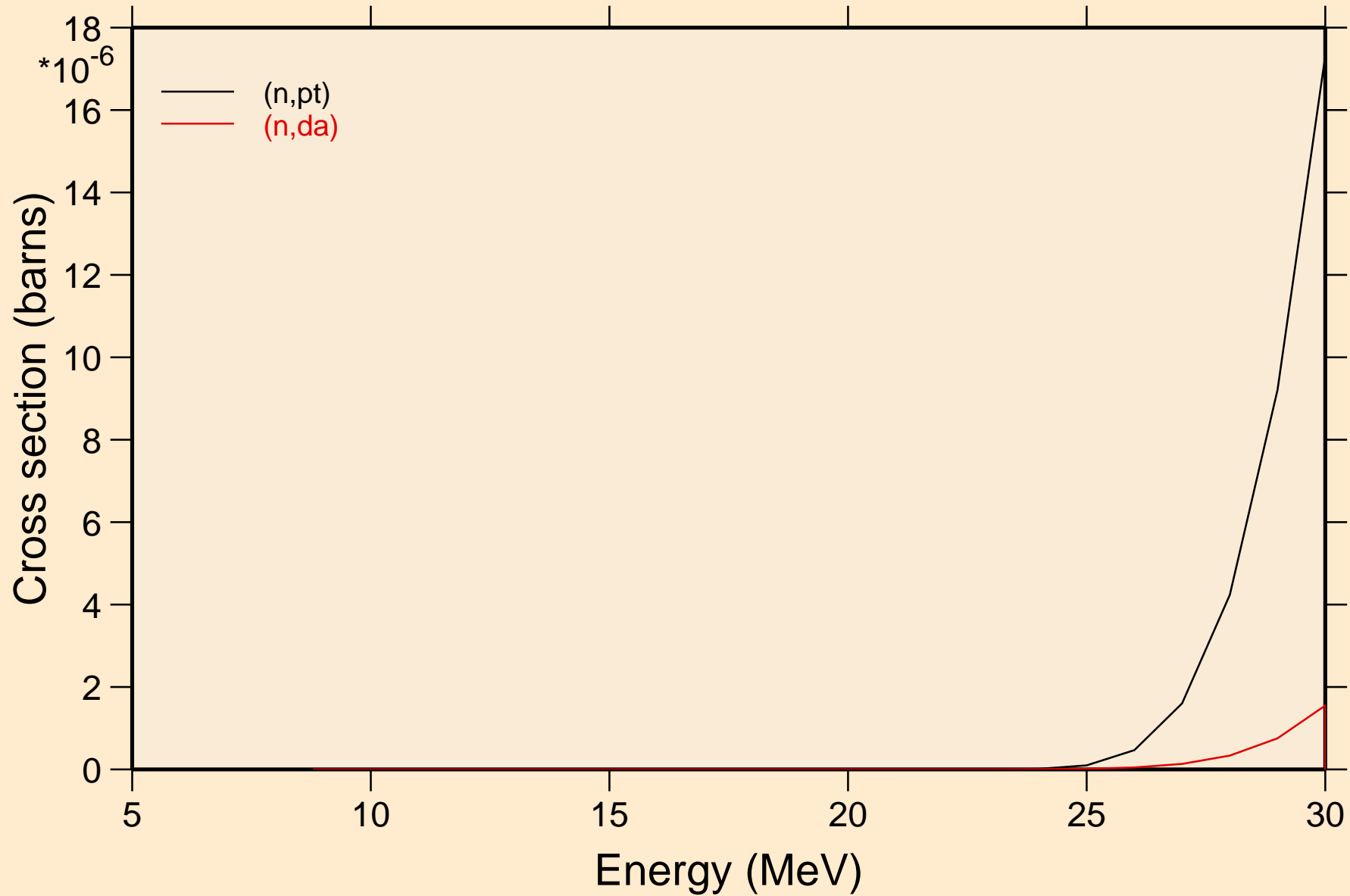

CD108 NEUTRON ACER TENDL-2021 LIBRARY; T=293.6K

Threshold reactions

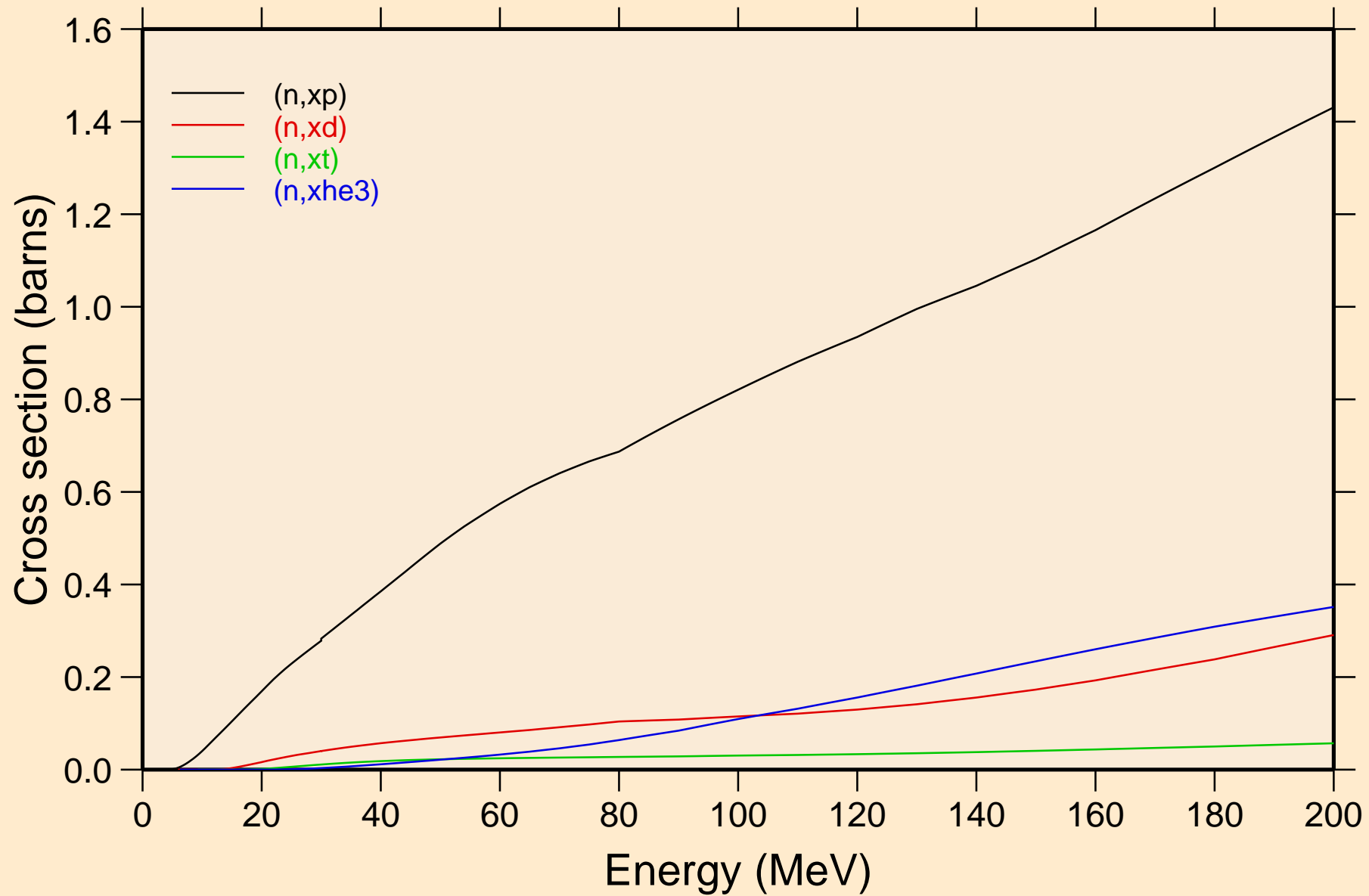

CD108 NEUTRON ACER TENDL-2021 LIBRARY; T=293.6K
angular distribution for elastic

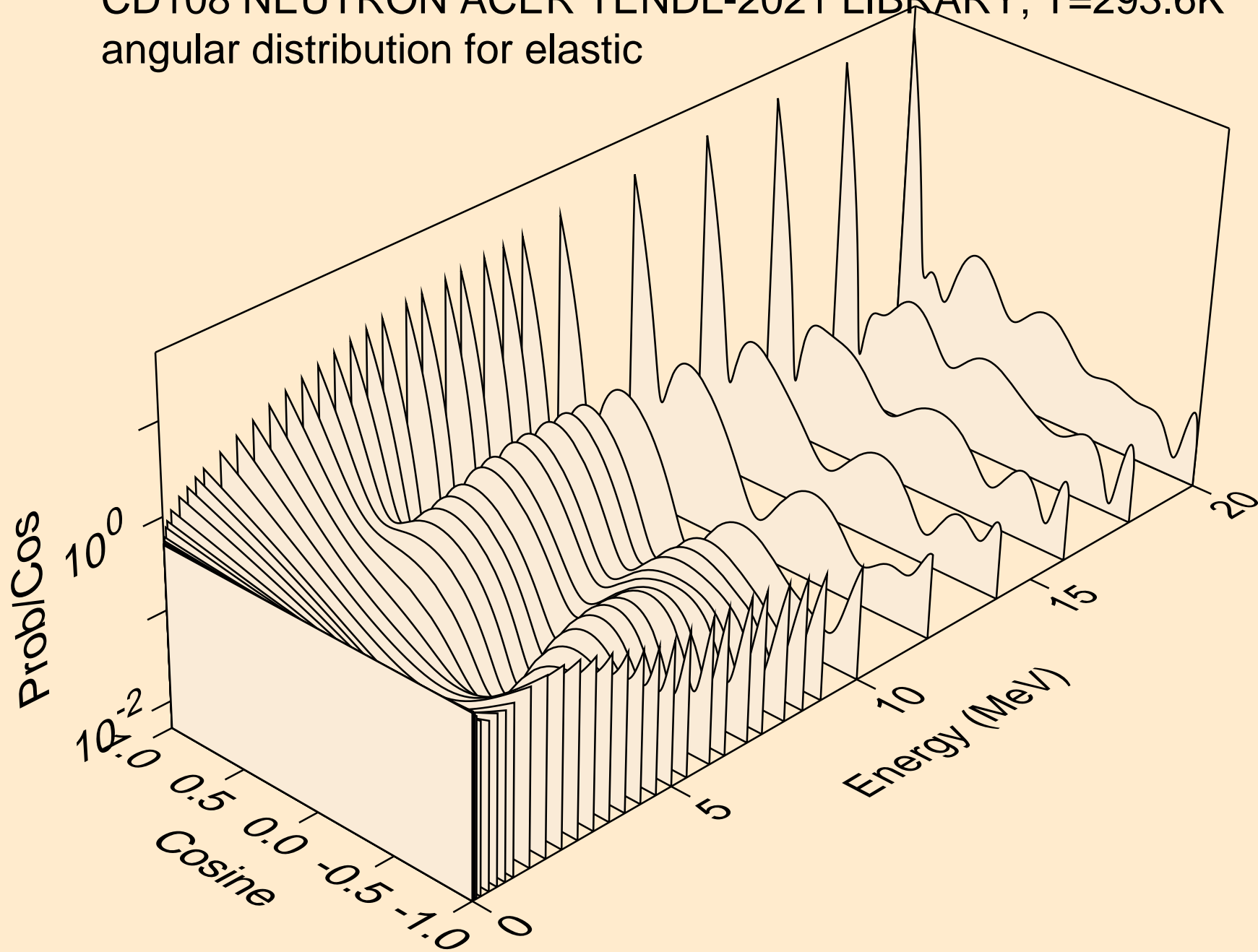

CD108 NEUTRON ACER TENDL-2021 LIBRARY; T=293.6K
angular distribution for elastic

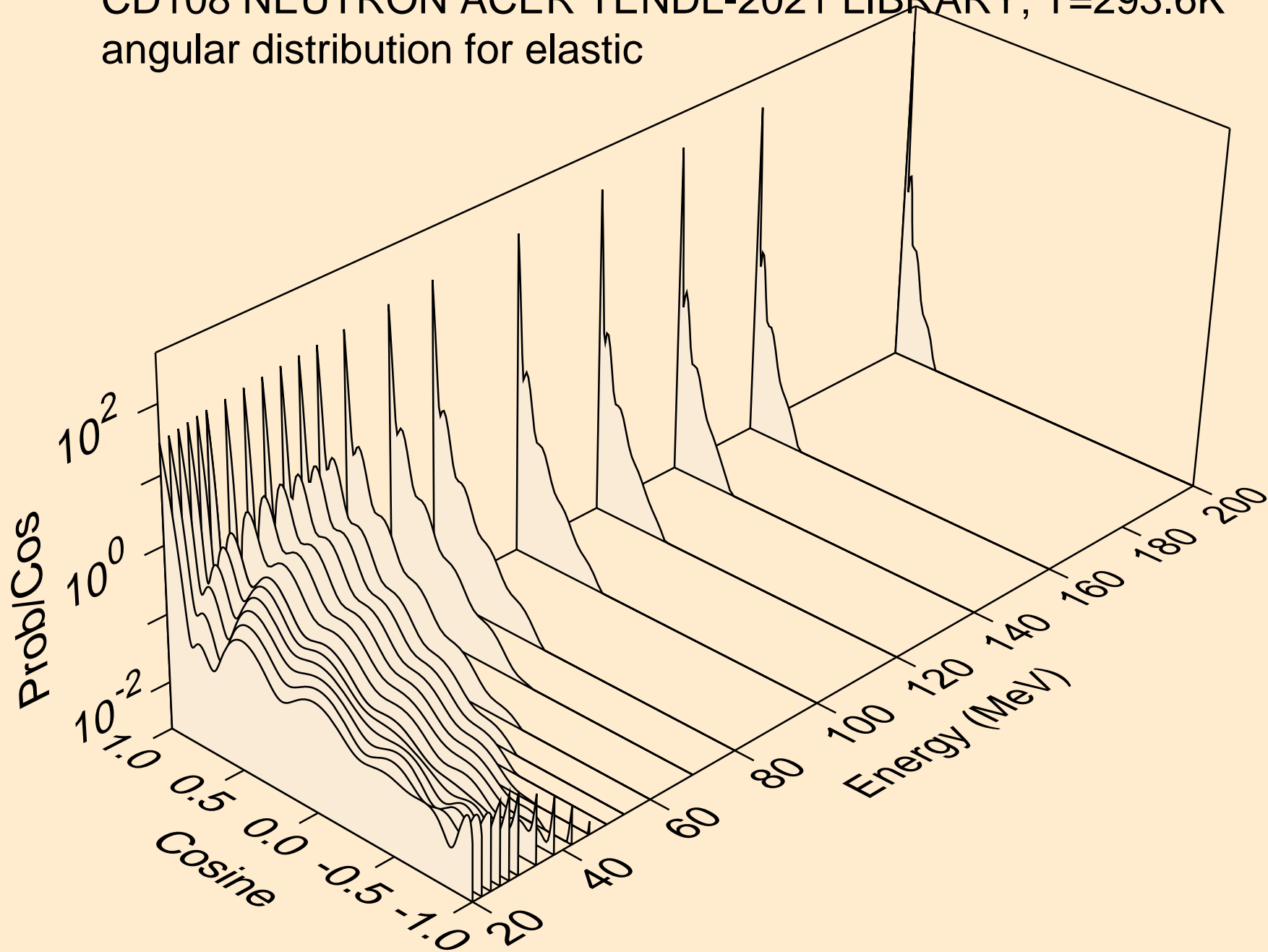

CD108 NEUTRON ACER TENDL-2021 LIBRARY; T=293.6K
angular distribution for (n,n*1)

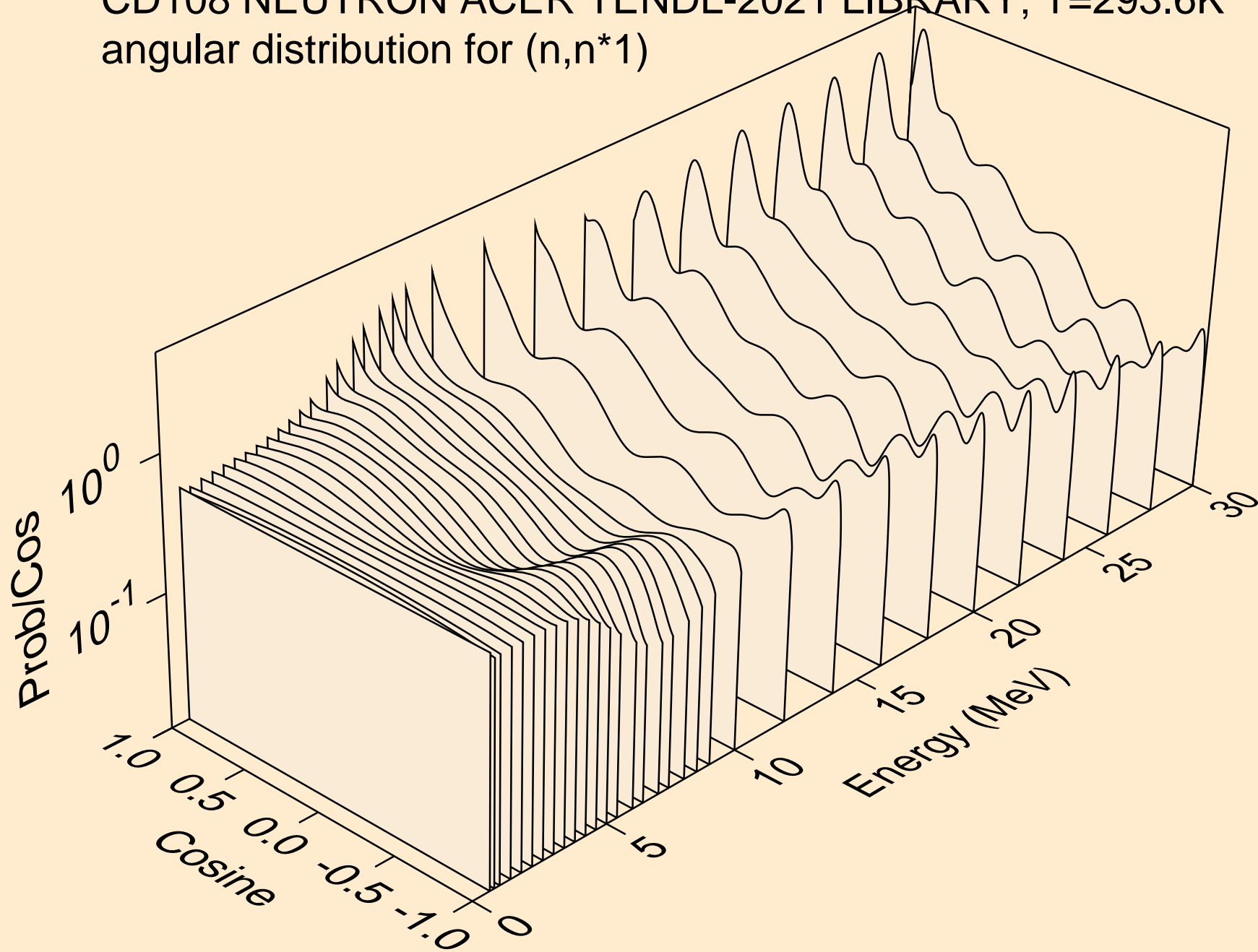

CD108 NEUTRON ACER TENDL-2021 LIBRARY; T=293.6K
angular distribution for (n,n*2)

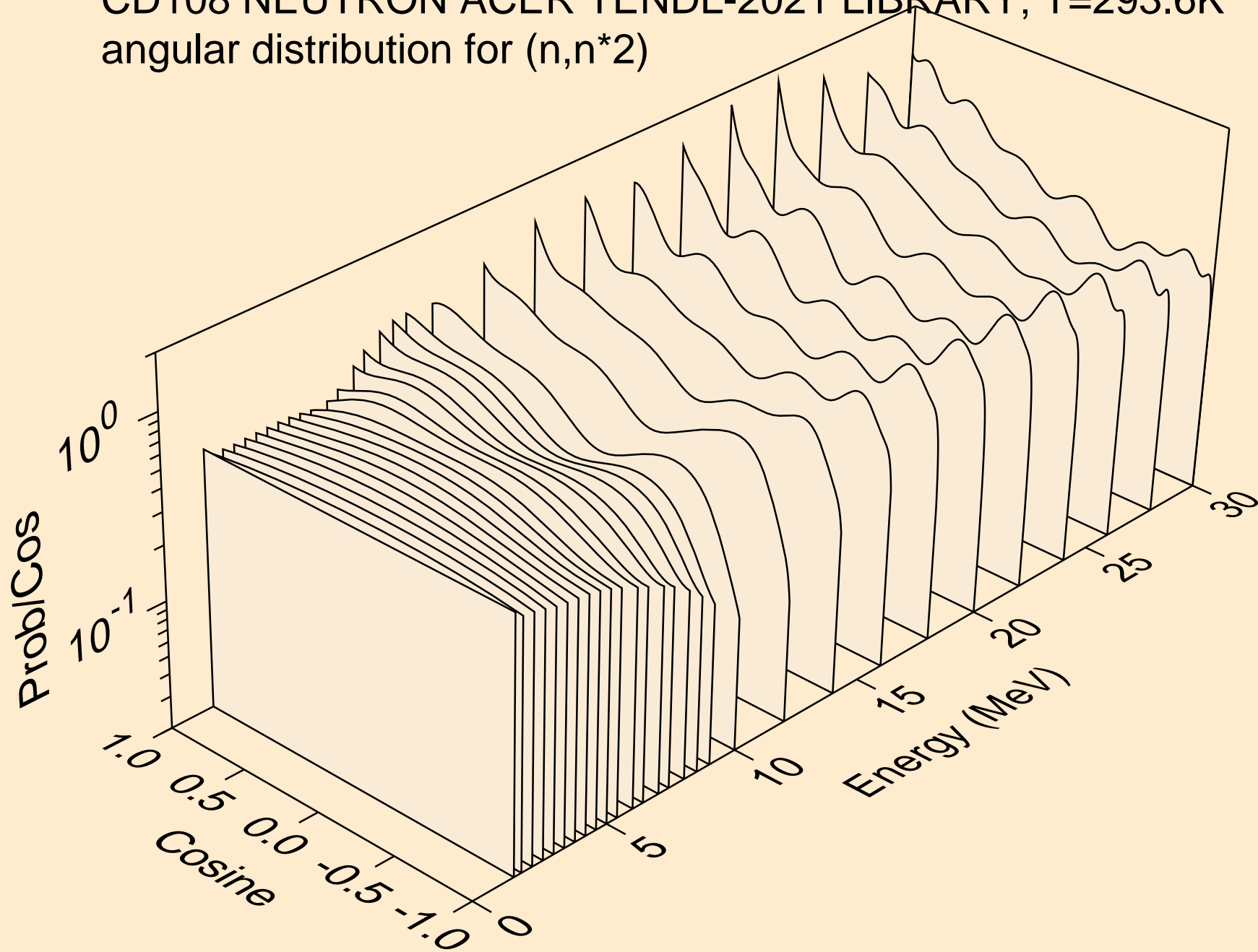

CD108 NEUTRON ACER TENDL-2021 LIBRARY; T=293.6K
angular distribution for (n,n*3)

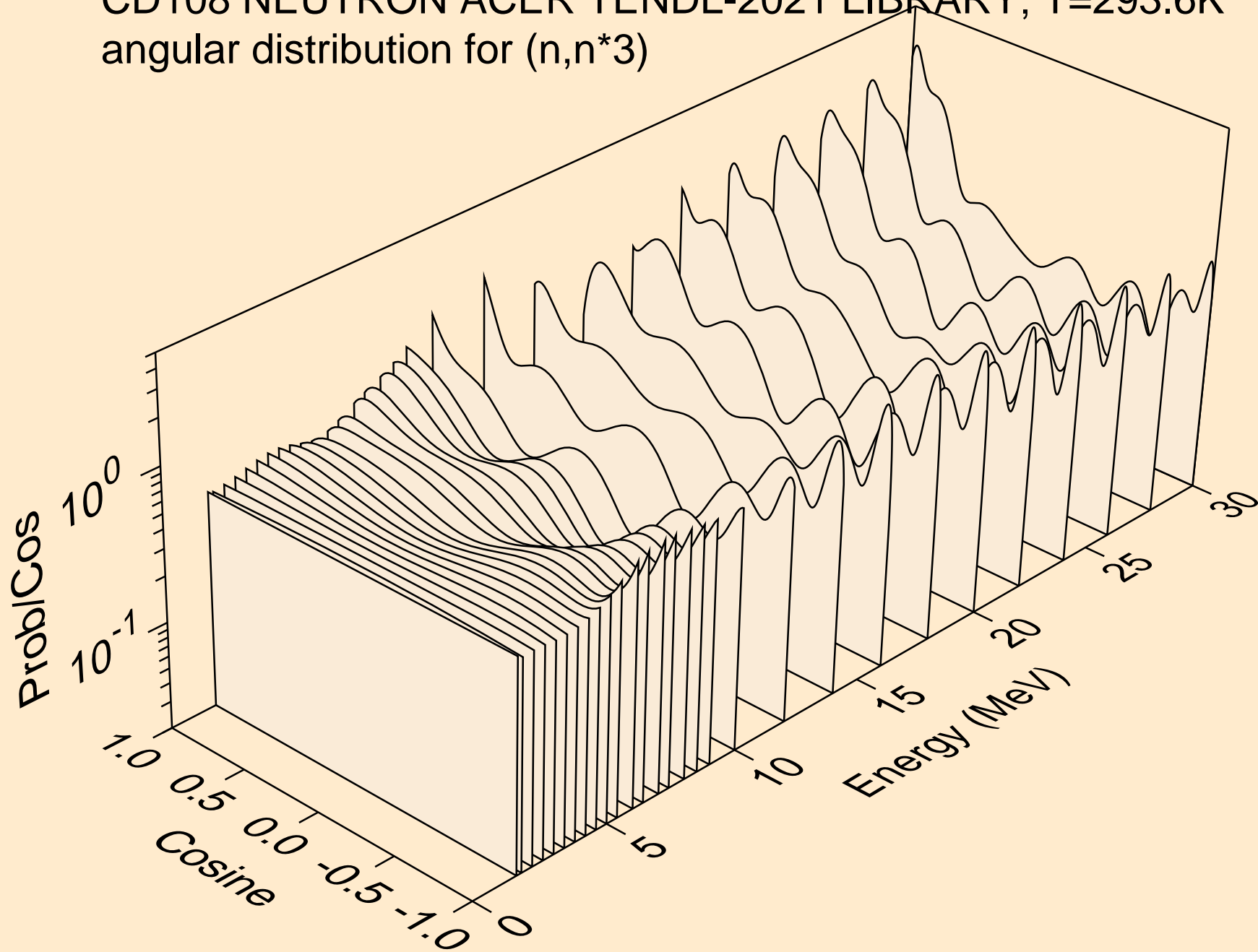

CD108 NEUTRON ACER TENDL-2021 LIBRARY; T=293.6K
angular distribution for (n,n*4)

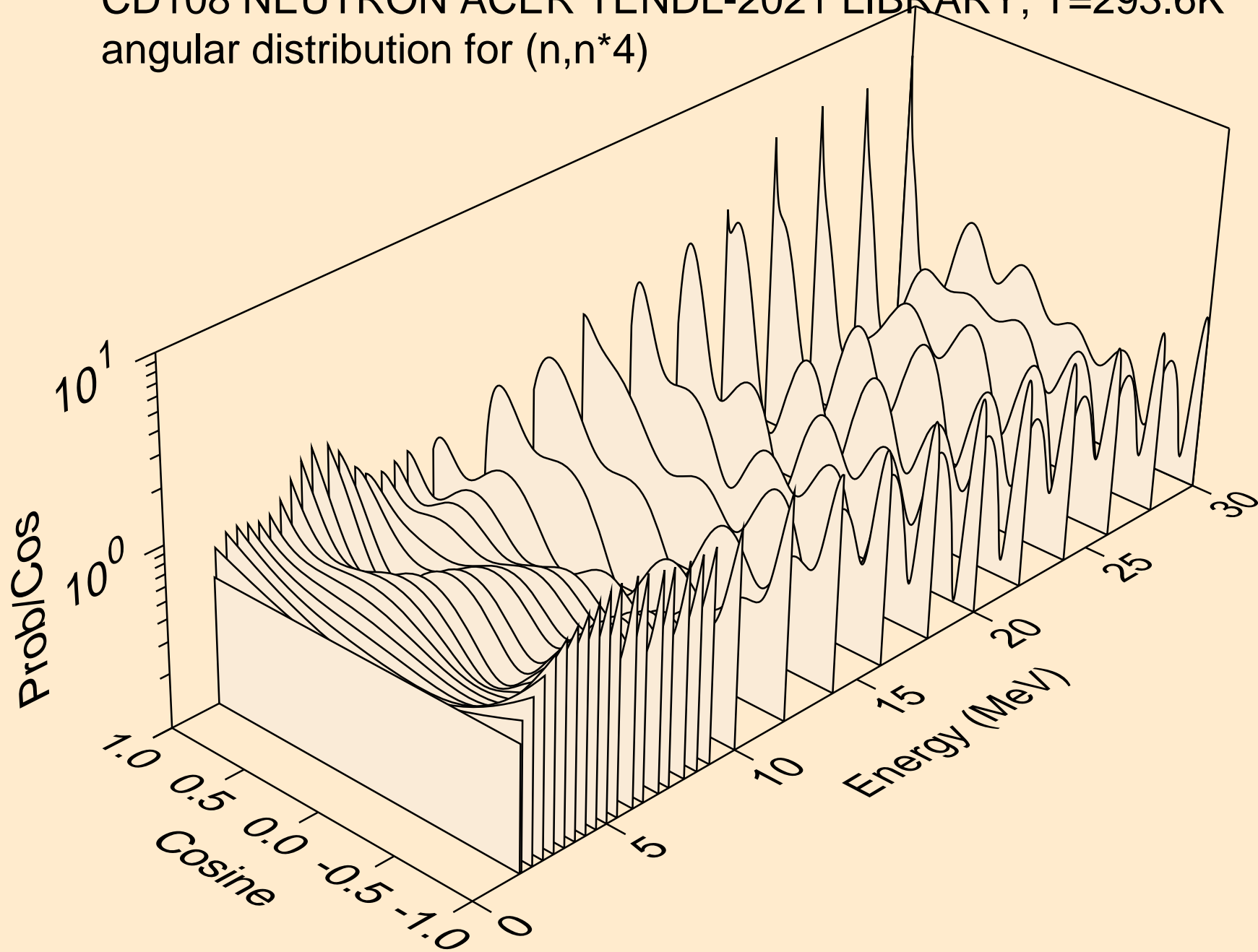

CD108 NEUTRON ACER TENDL-2021 LIBRARY; T=293.6K
angular distribution for (n,n*5)

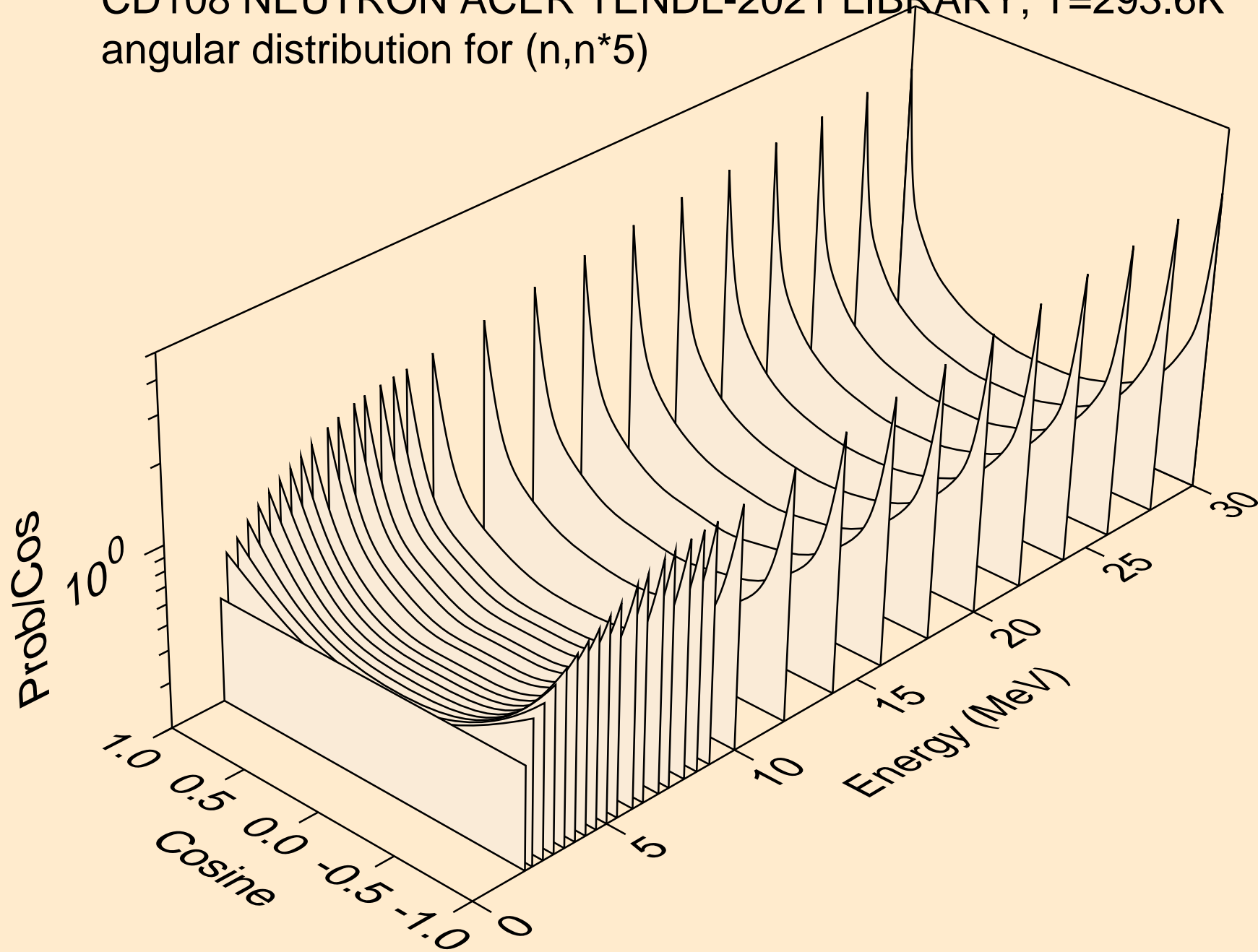

CD108 NEUTRON ACER TENDL-2021 LIBRARY; T=293.6K
angular distribution for (n,n*6)

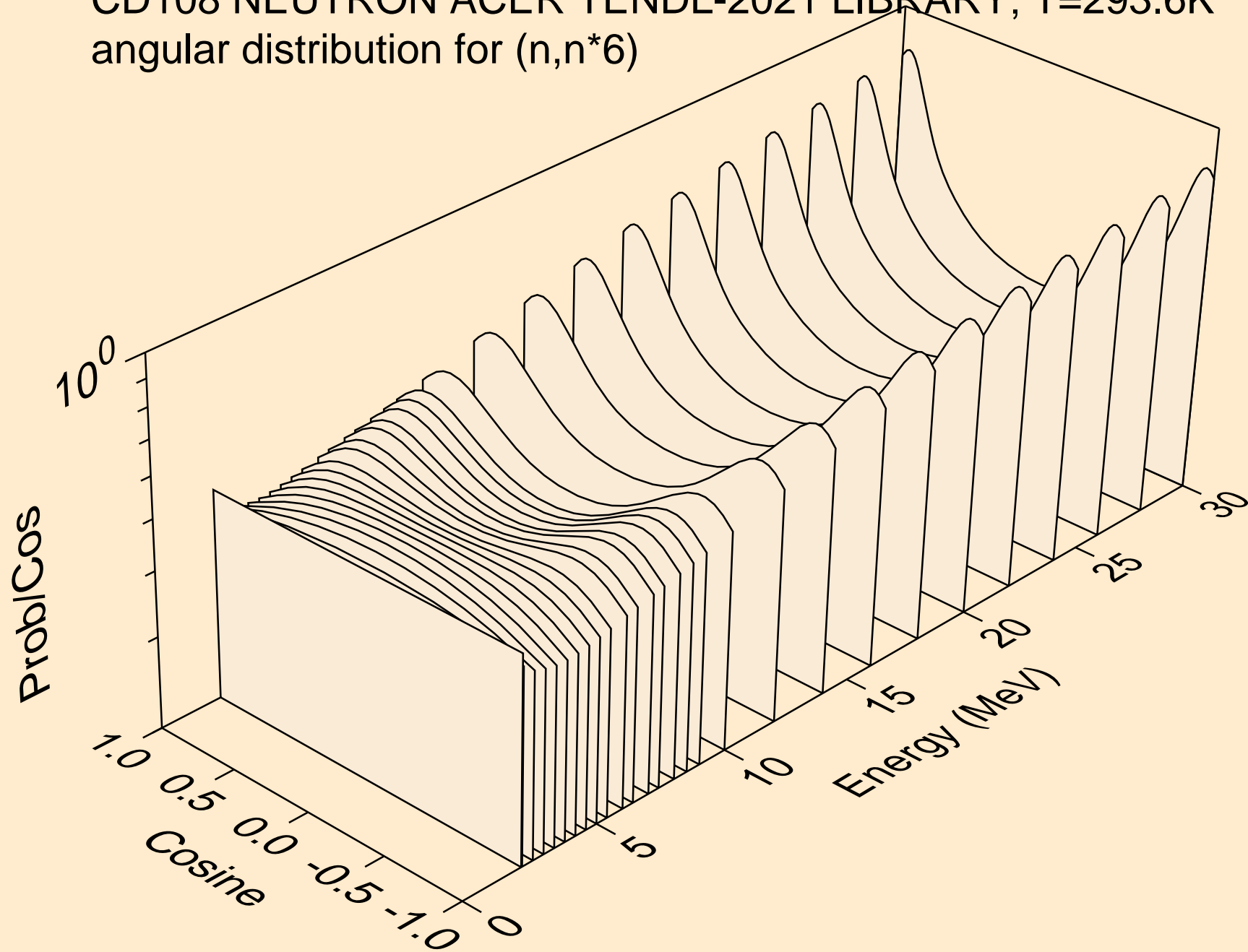

CD108 NEUTRON ACER TENDL-2021 LIBRARY; T=293.6K
angular distribution for (n,n*7)

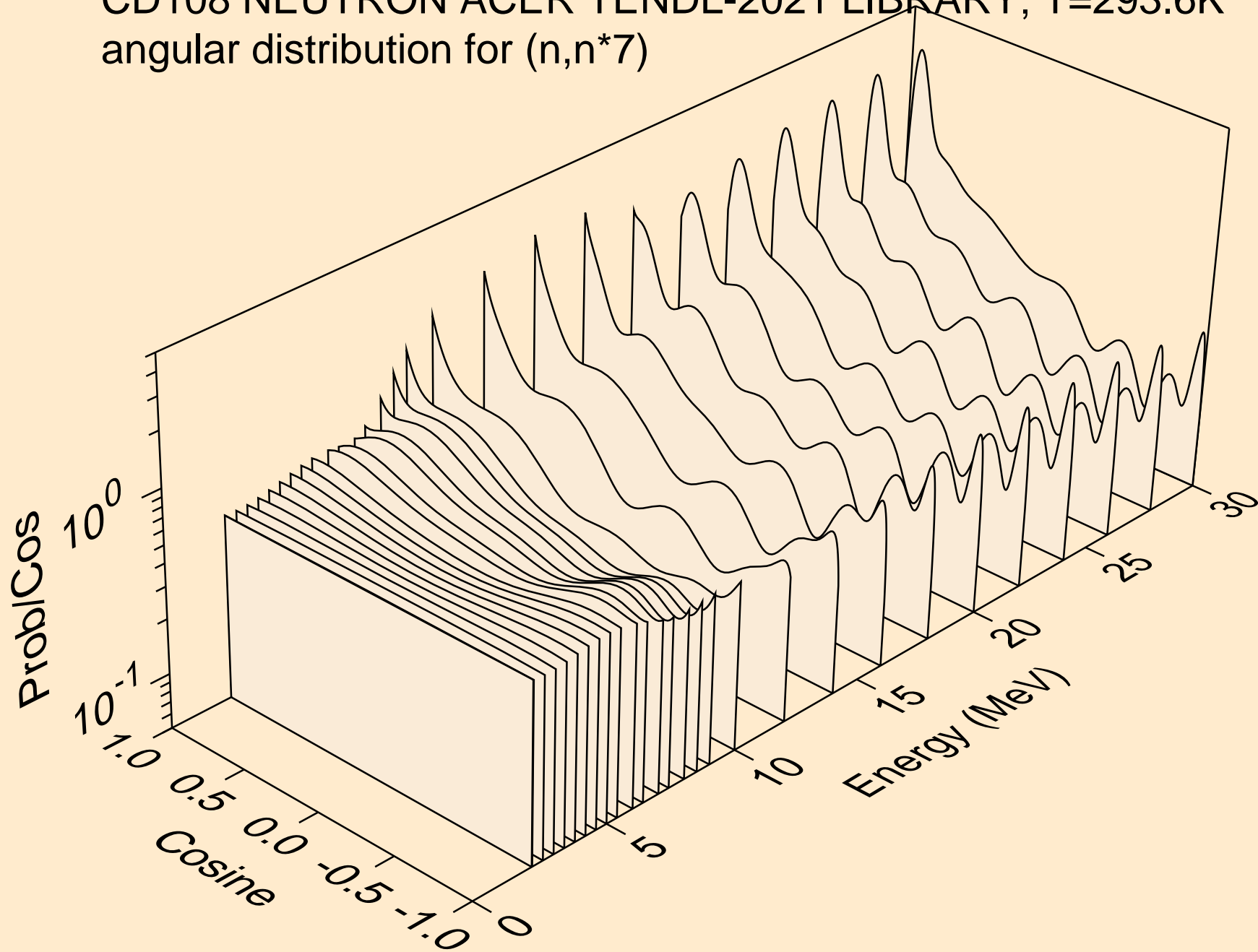

CD108 NEUTRON ACER TENDL-2021 LIBRARY; T=293.6K
angular distribution for (n,n*8)

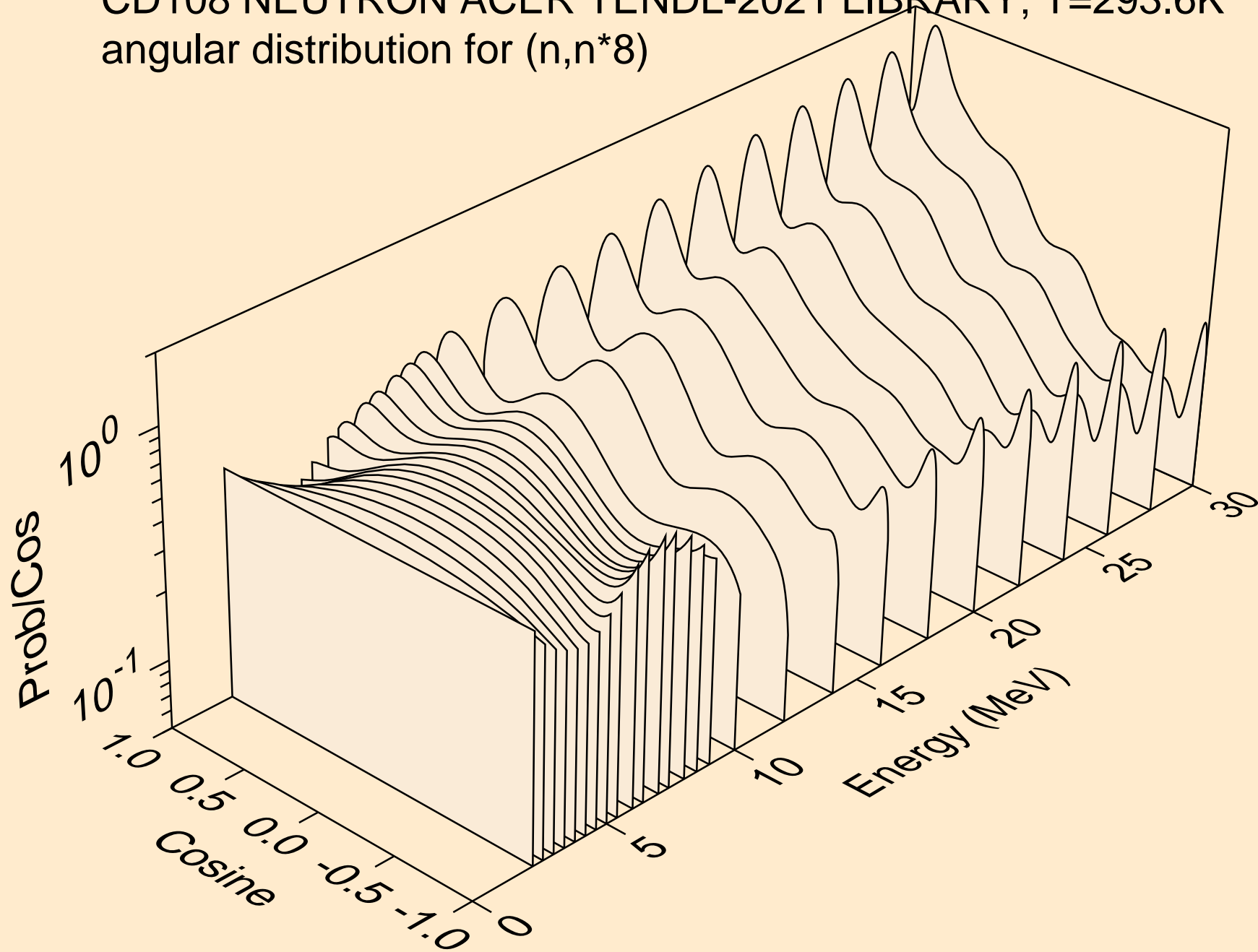

CD108 NEUTRON ACER TENDL-2021 LIBRARY; T=293.6K
angular distribution for (n,n*9)

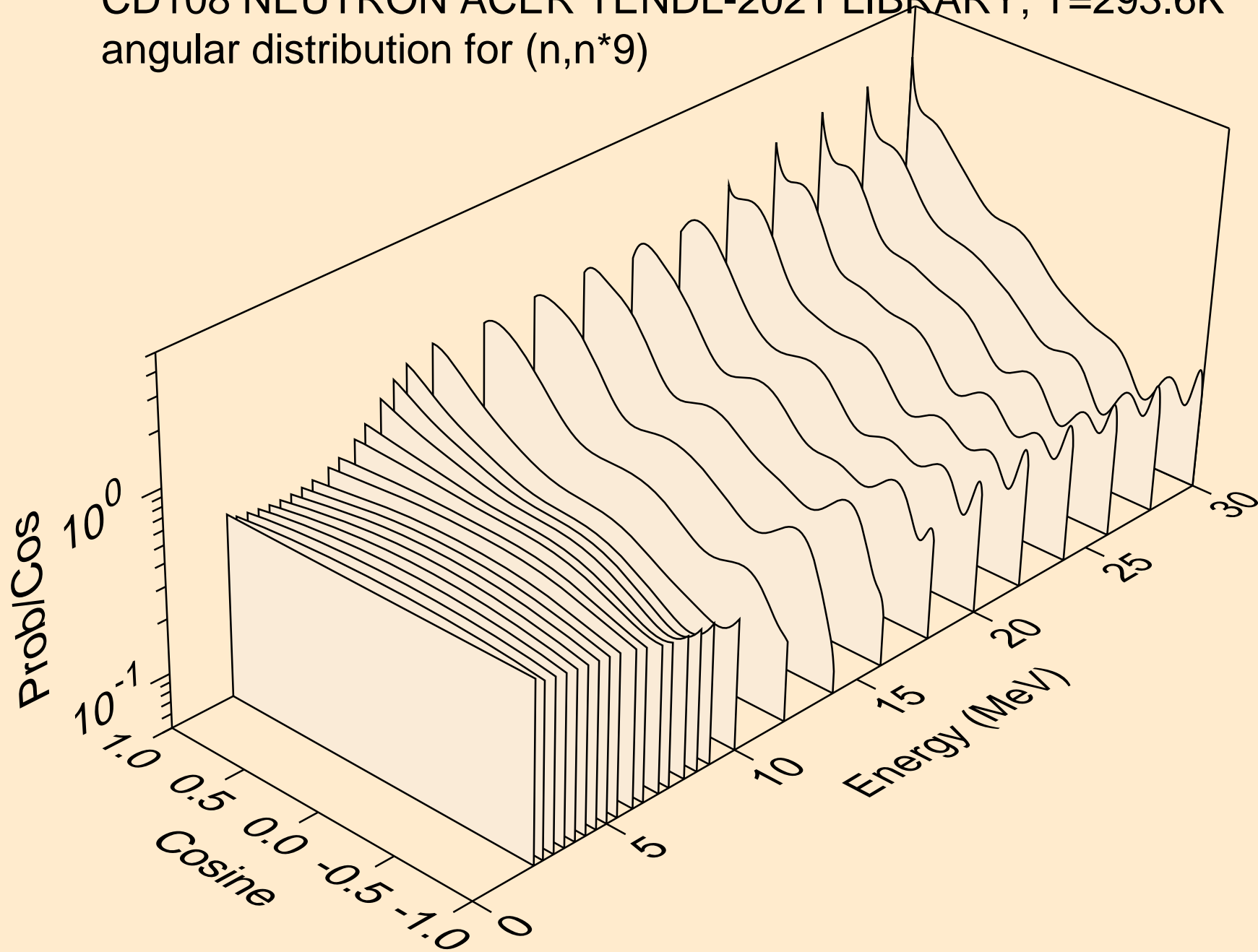

CD108 NEUTRON ACER TENDL-2021 LIBRARY; T=293.6K
angular distribution for (n,n*10)

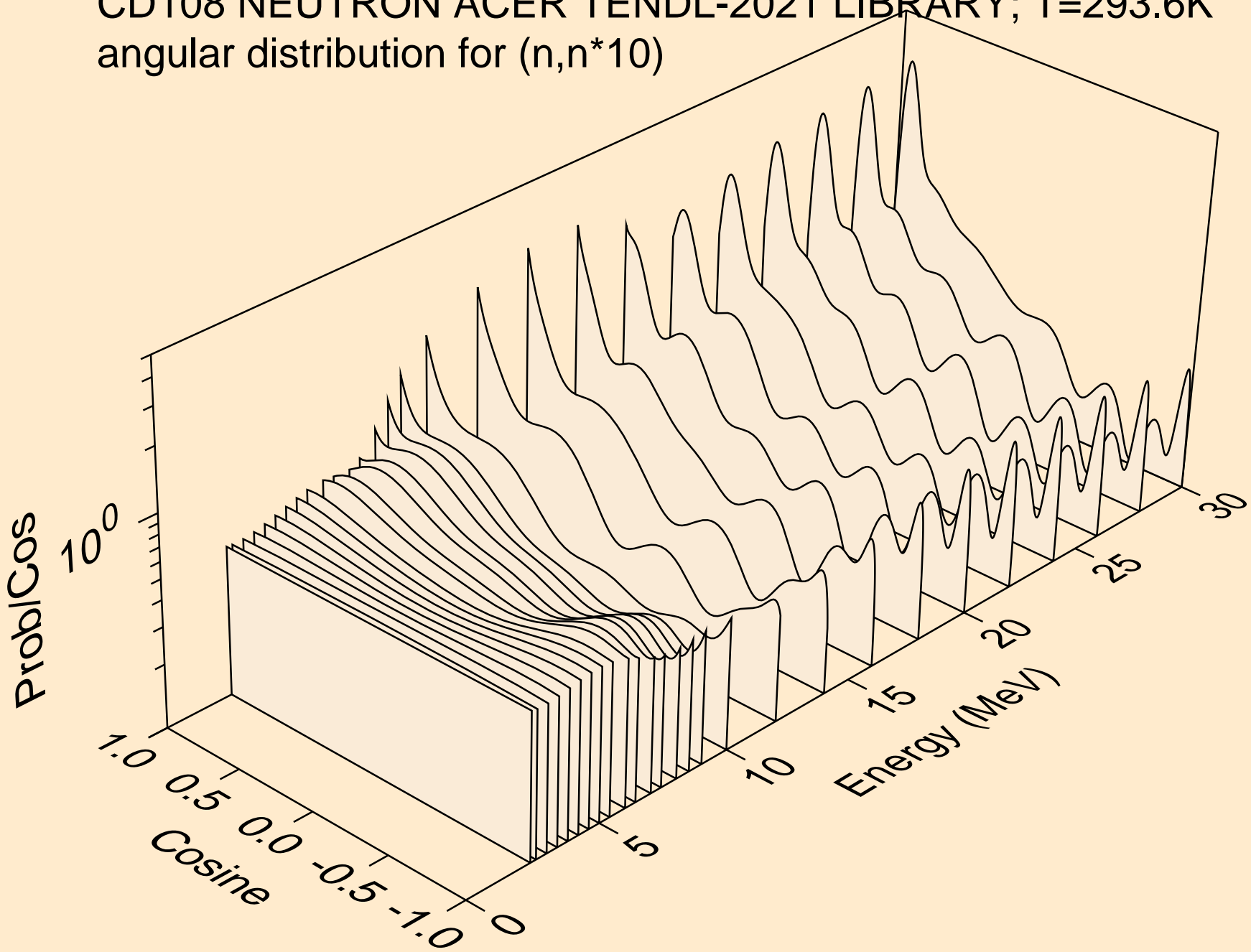

CD108 NEUTRON ACER TENDL-2021 LIBRARY; T=293.6K
angular distribution for (n,n*11)

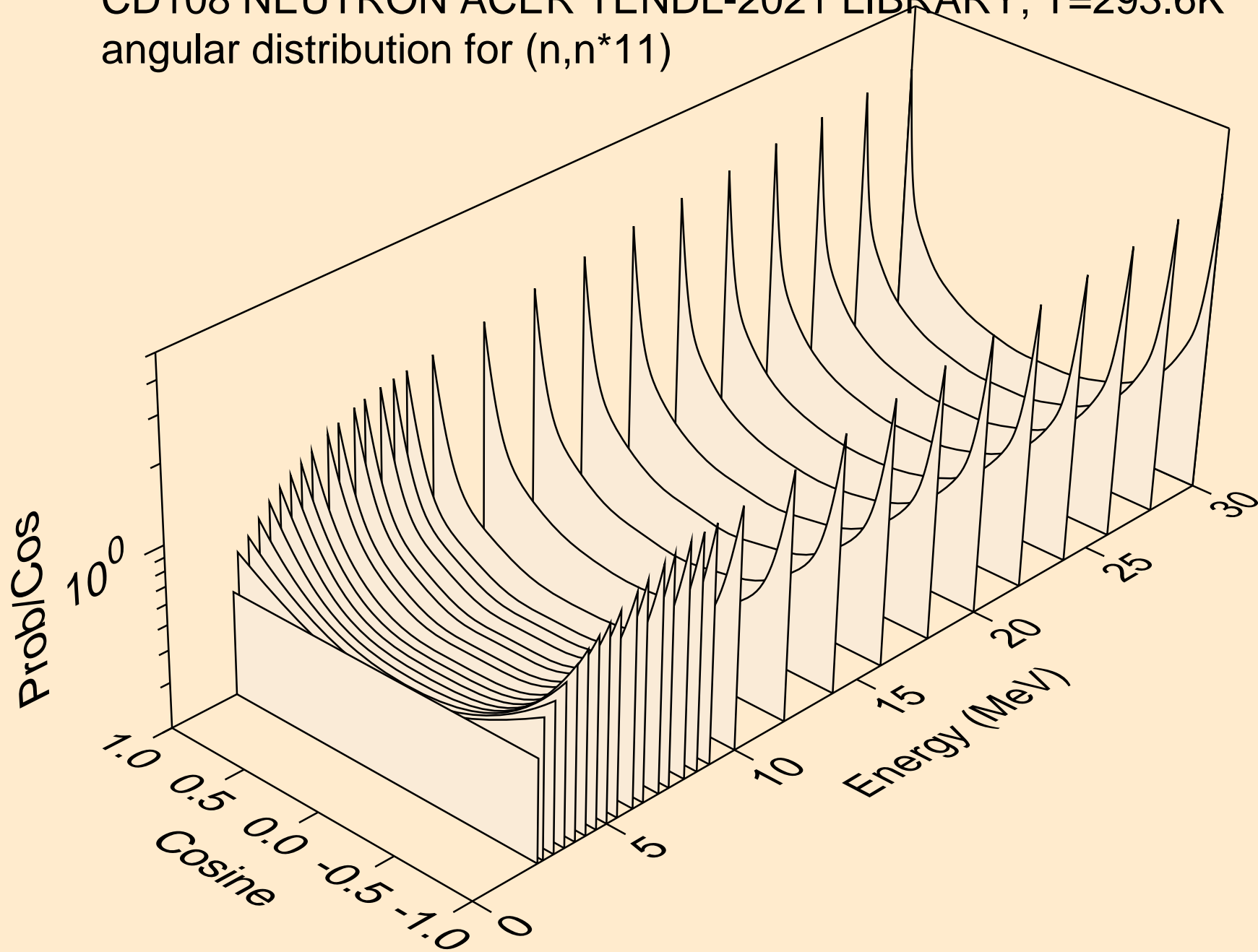

CD108 NEUTRON ACER TENDL-2021 LIBRARY; T=293.6K
angular distribution for (n,n*12)

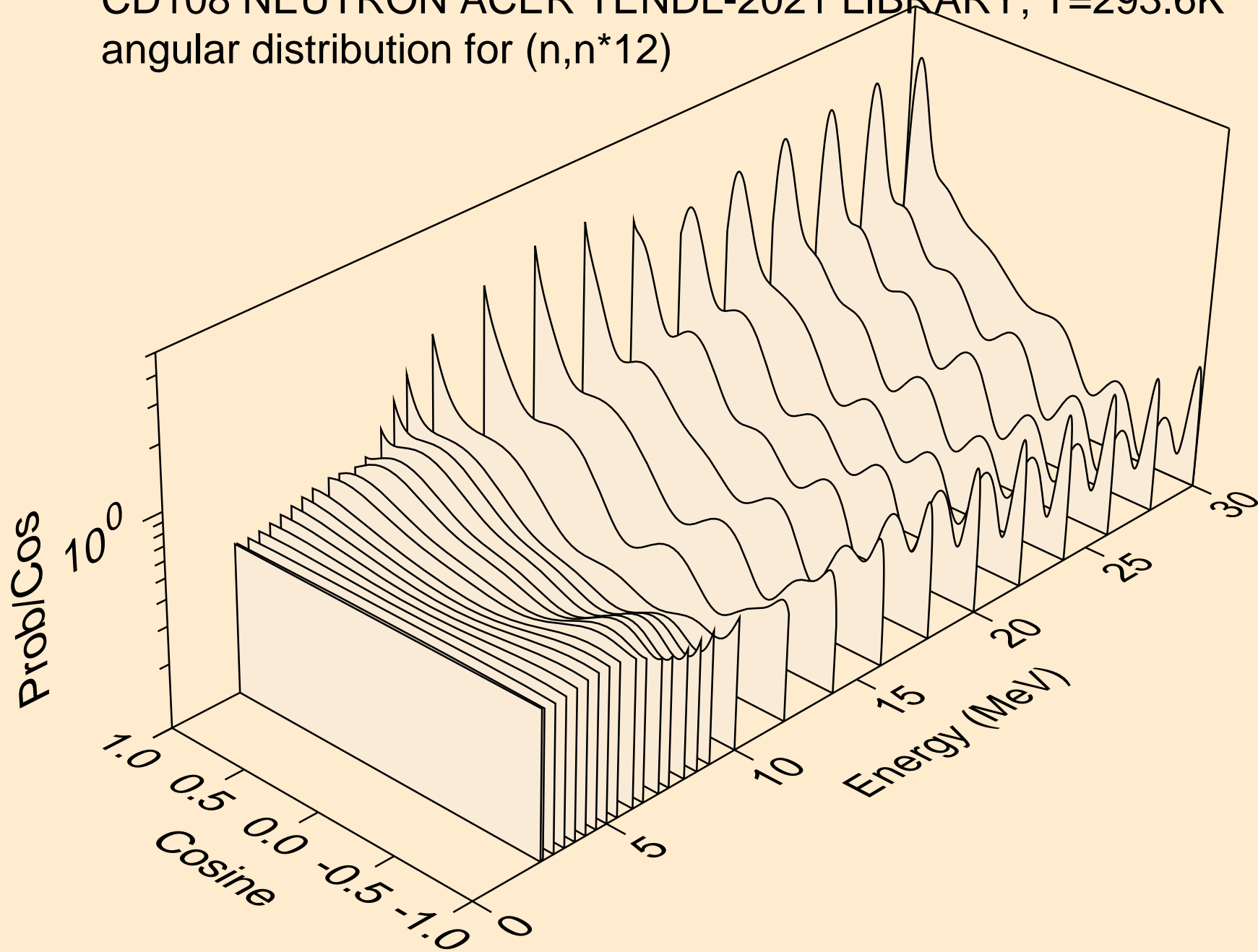

CD108 NEUTRON ACER TENDL-2021 LIBRARY; T=293.6K
angular distribution for (n,n*13)

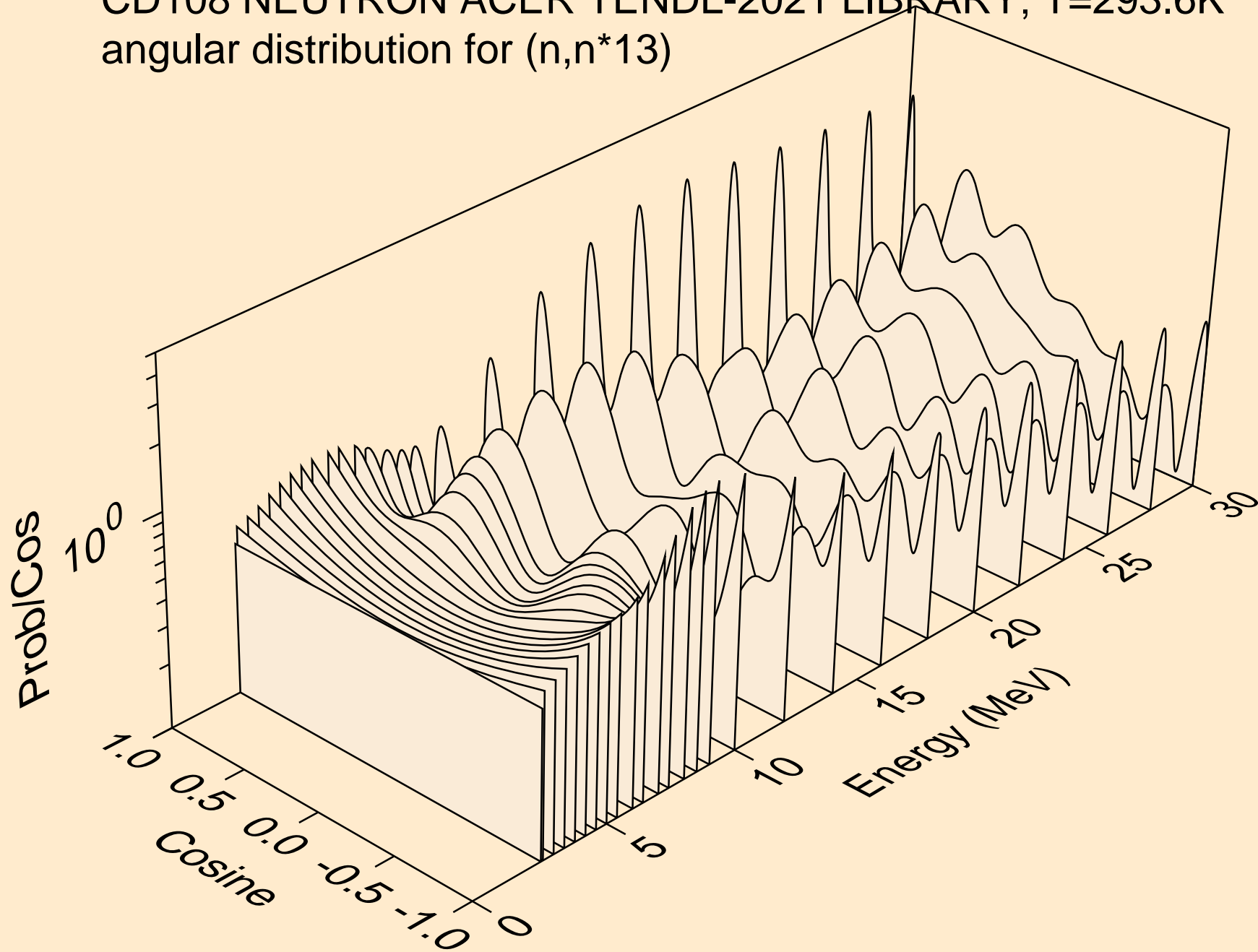

CD108 NEUTRON ACER TENDL-2021 LIBRARY; T=293.6K
angular distribution for (n,n*14)

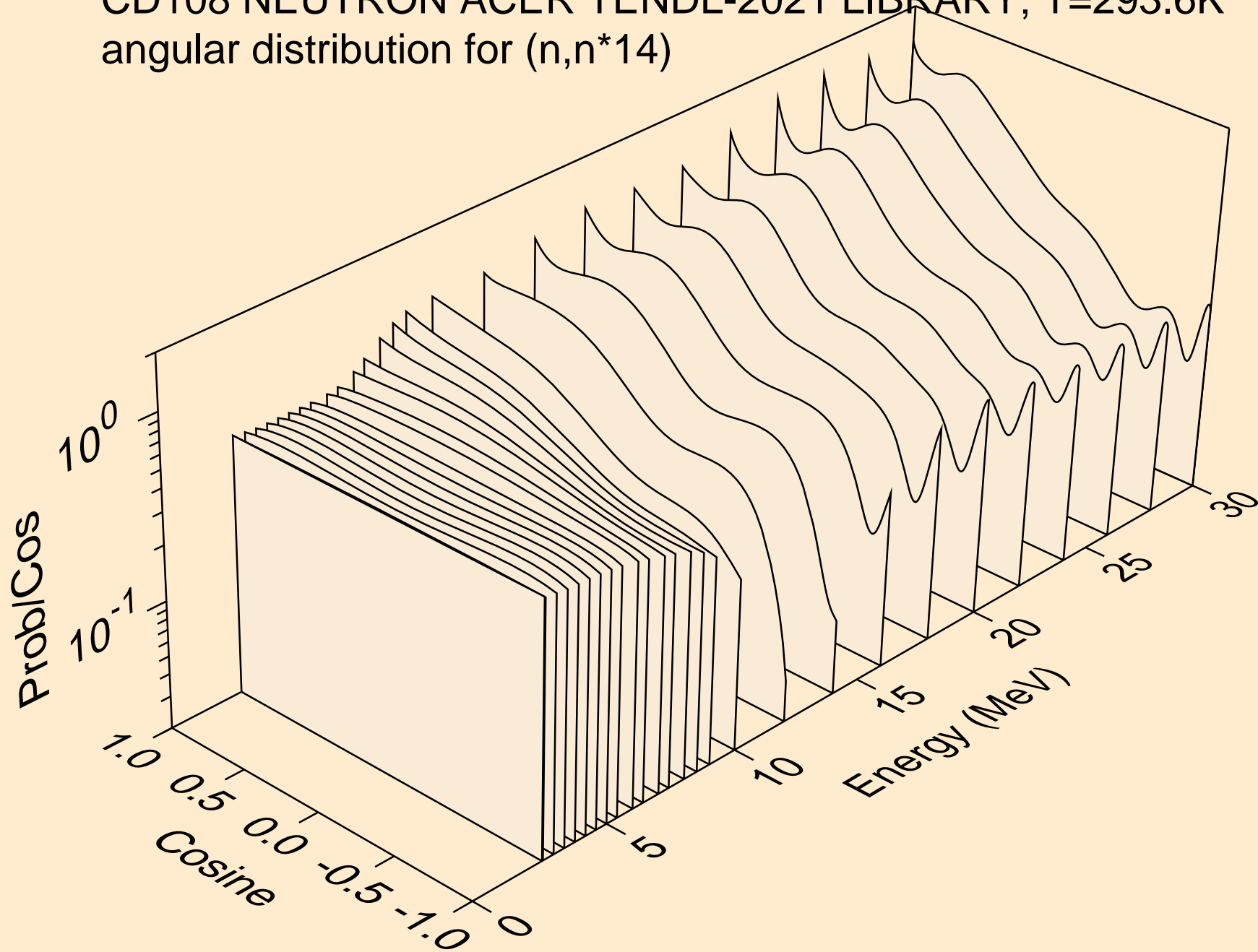

CD108 NEUTRON ACER TENDL-2021 LIBRARY; T=293.6K
angular distribution for (n,n*15)

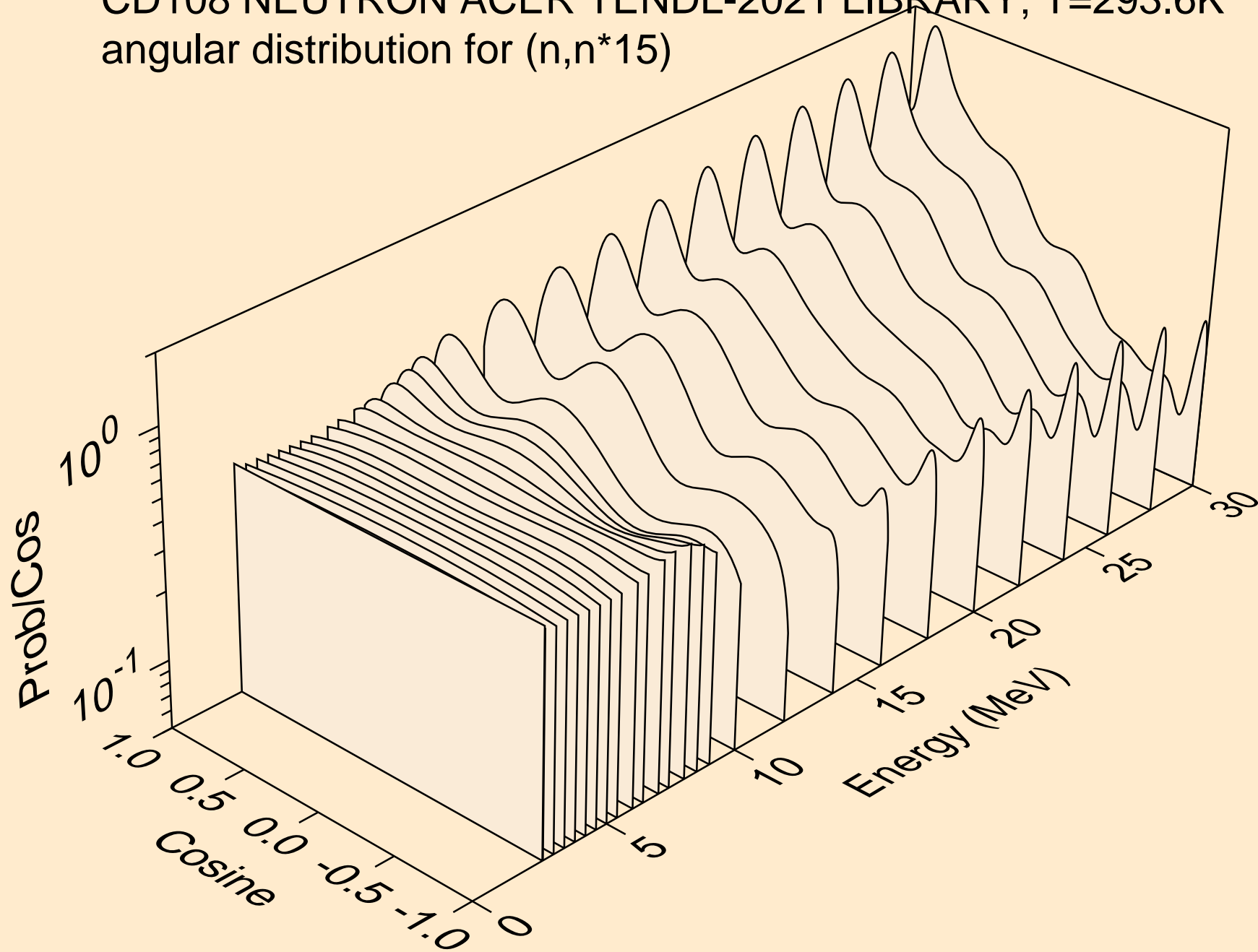

CD108 NEUTRON ACER TENDL-2021 LIBRARY; T=293.6K
angular distribution for (n,n*16)

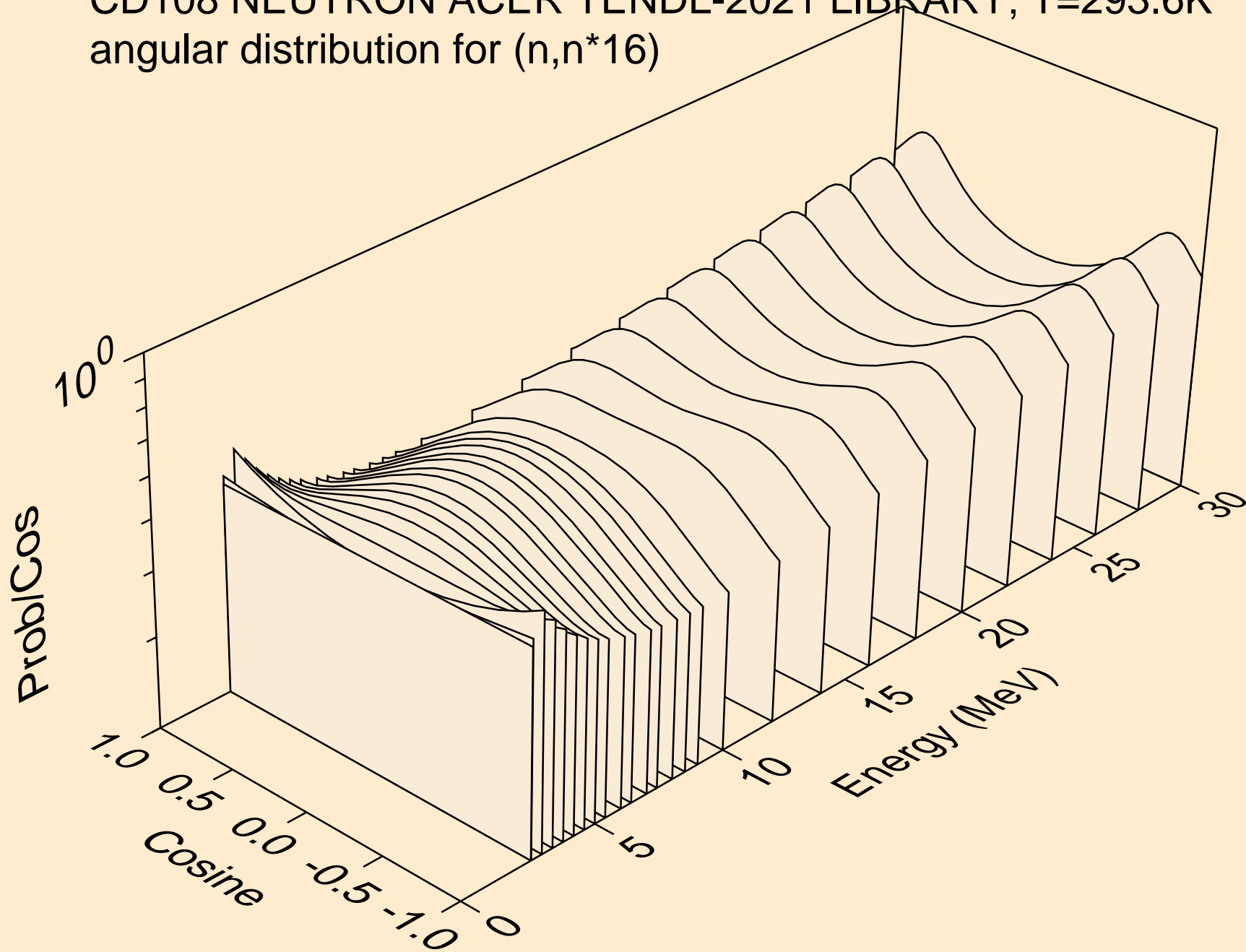

CD108 NEUTRON ACER TENDL-2021 LIBRARY; T=293.6K
angular distribution for (n,n*17)

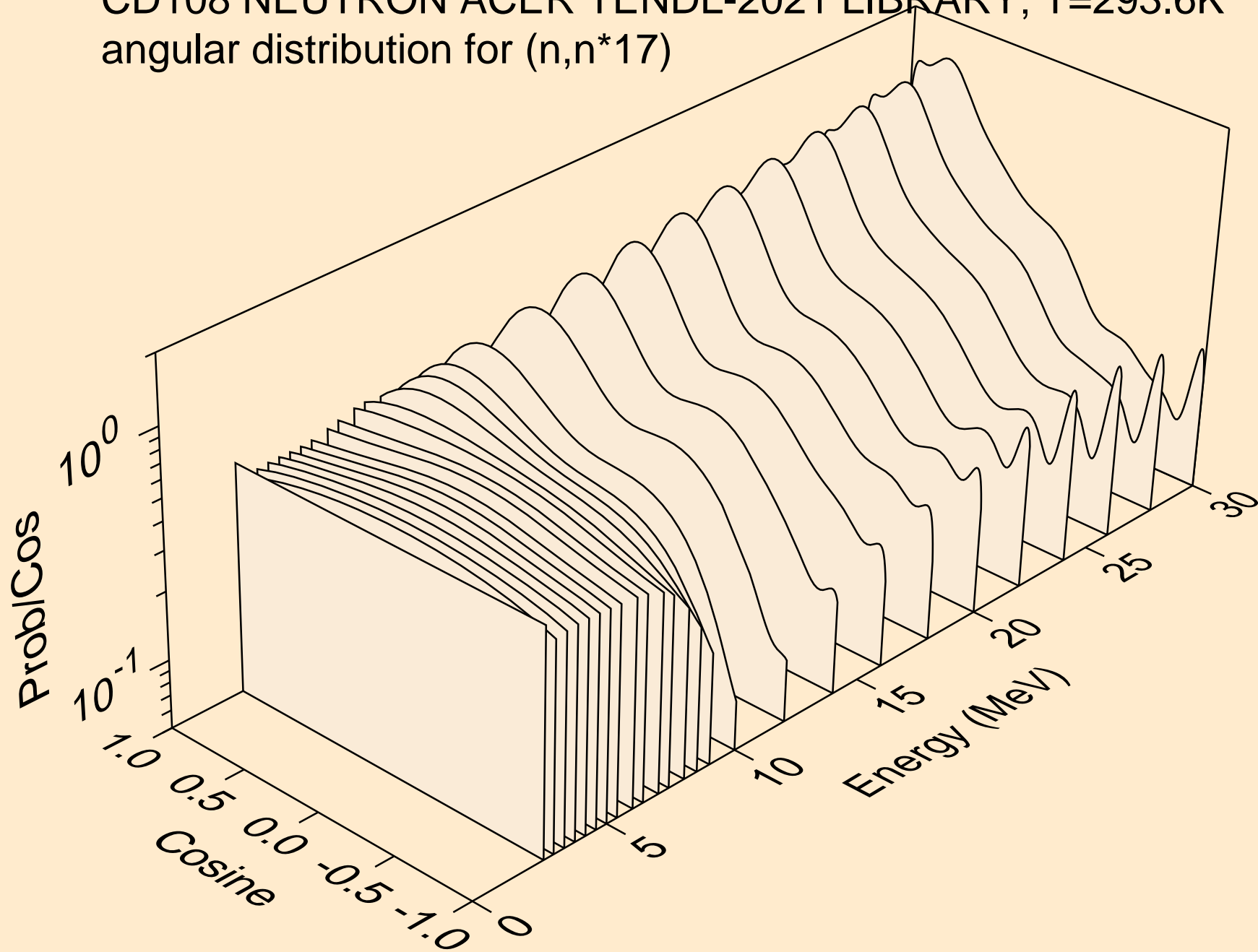

CD108 NEUTRON ACER TENDL-2021 LIBRARY; T=293.6K
angular distribution for (n,n*18)

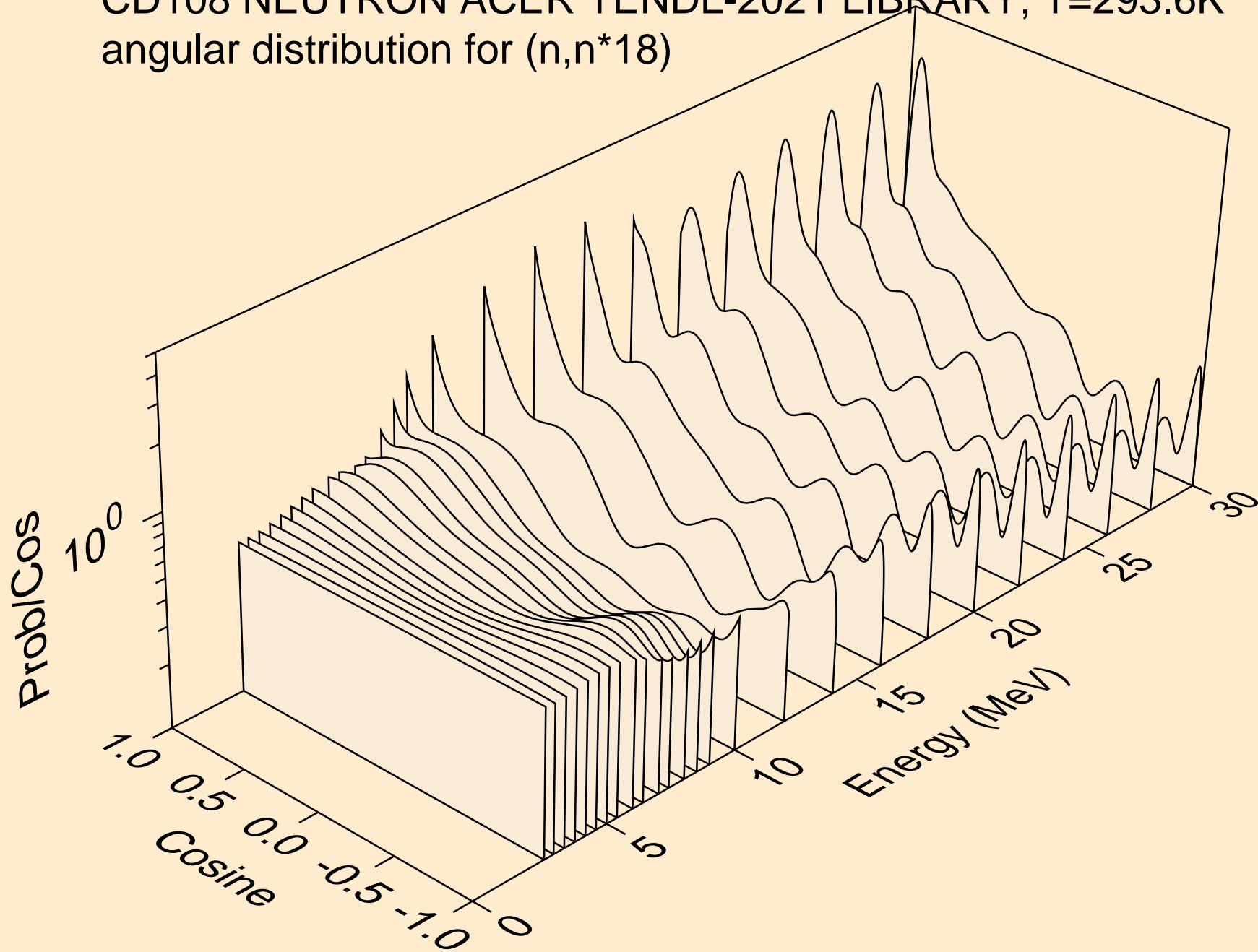

CD108 NEUTRON ACER TENDL-2021 LIBRARY; T=293.6K
angular distribution for (n,n*19)

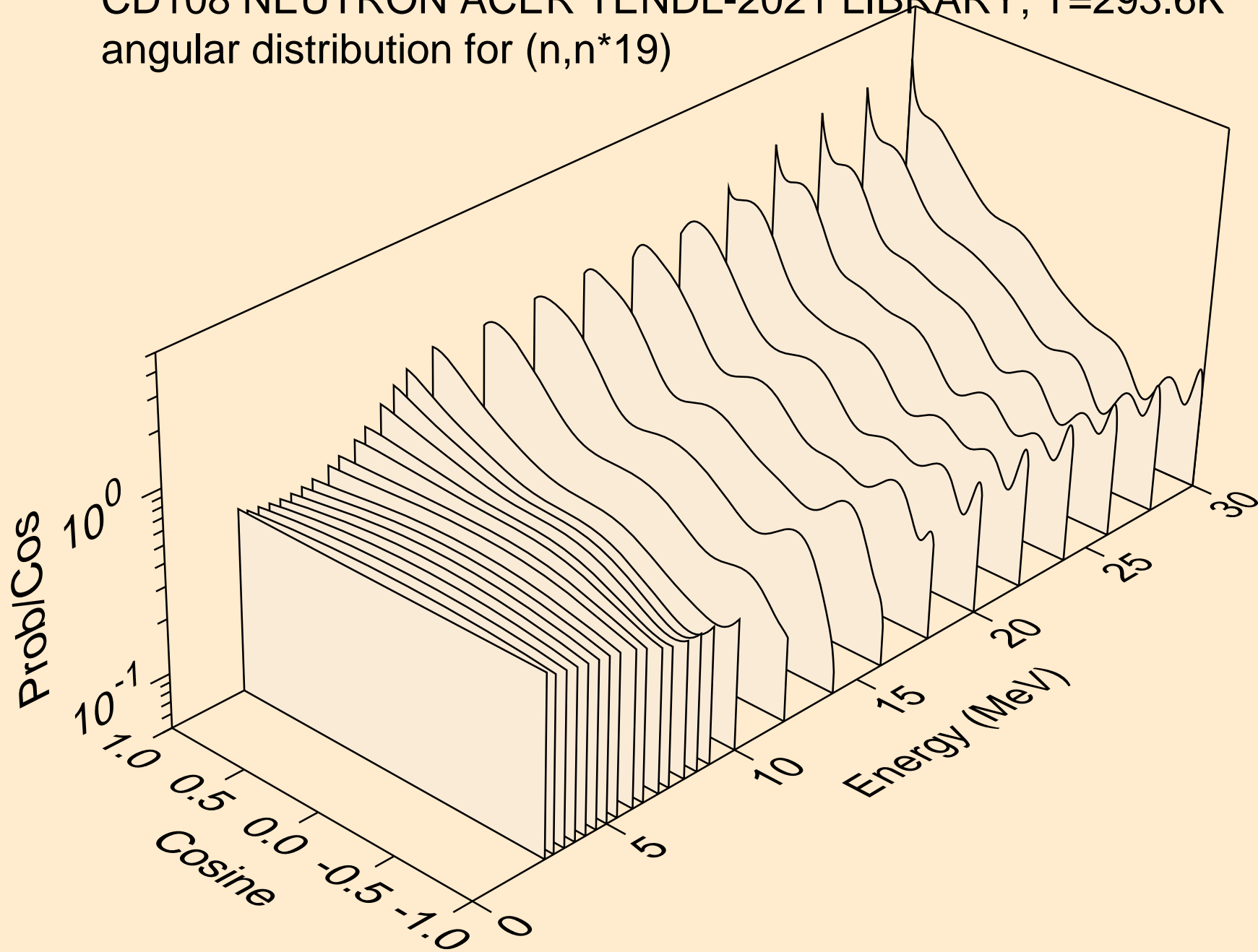

CD108 NEUTRON ACER TENDL-2021 LIBRARY; T=293.6K
angular distribution for (n,n*20)

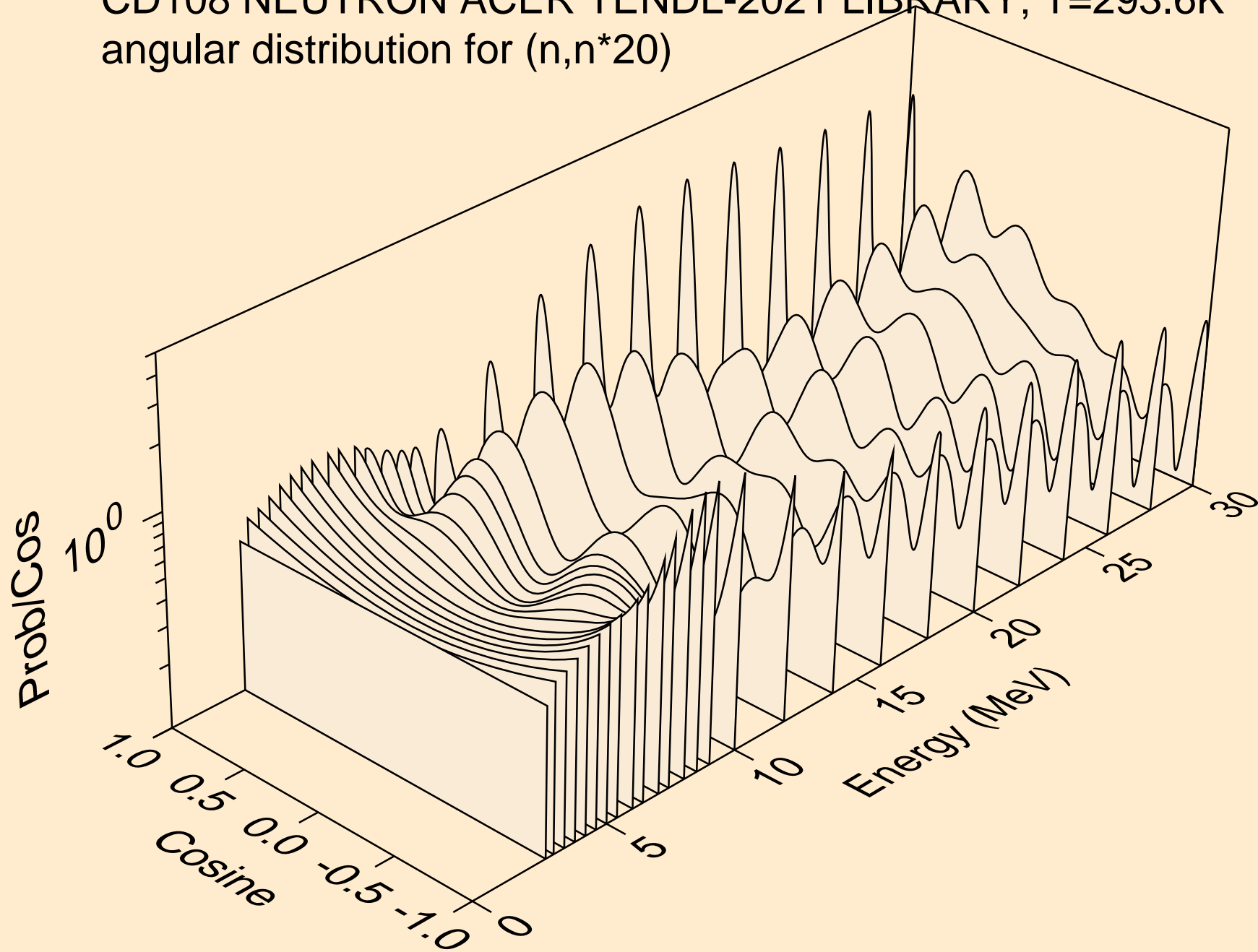

CD108 NEUTRON ACER TENDL-2021 LIBRARY; T=293.6K
angular distribution for (n,n*21)

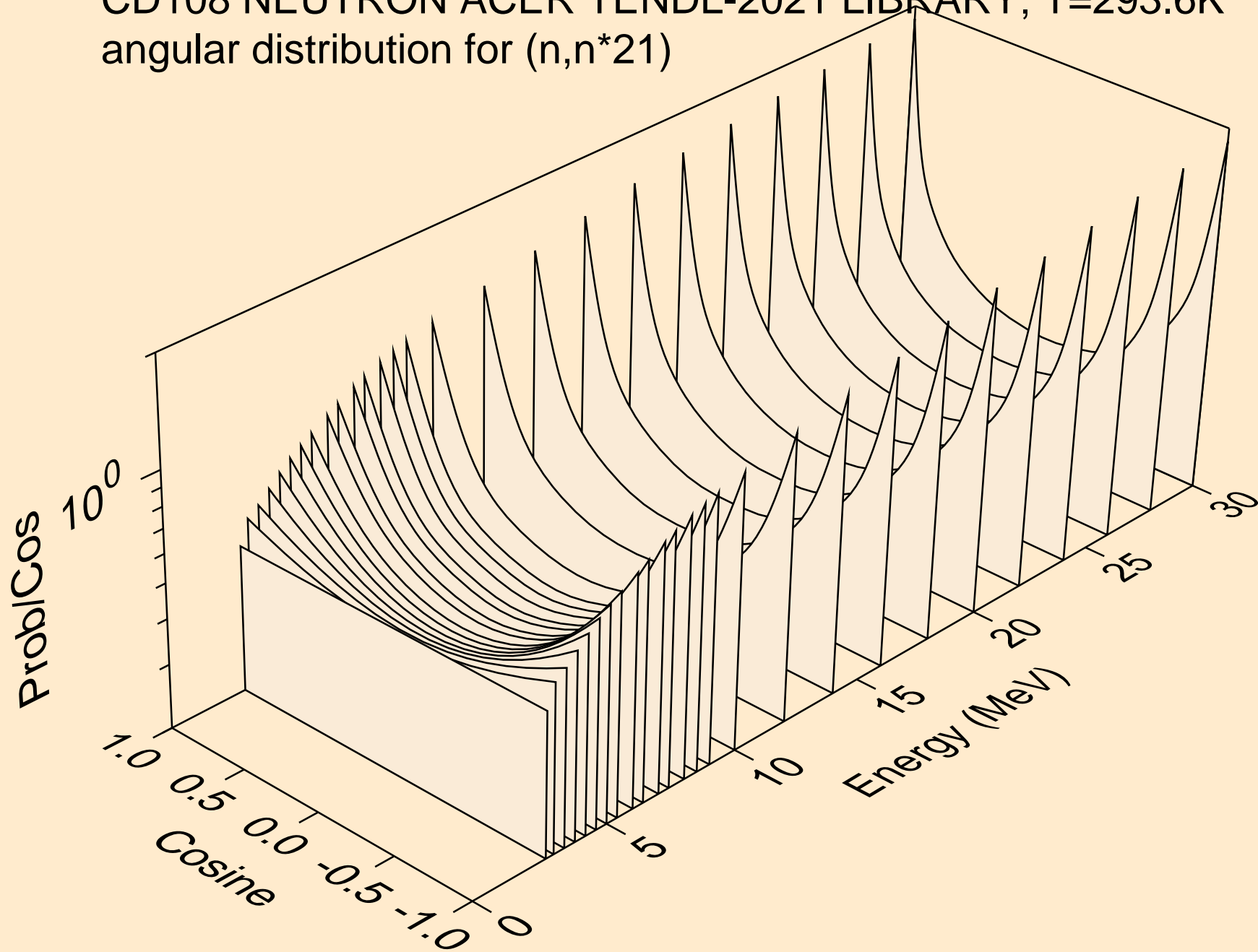

CD108 NEUTRON ACER TENDL-2021 LIBRARY; T=293.6K
angular distribution for (n,n*22)

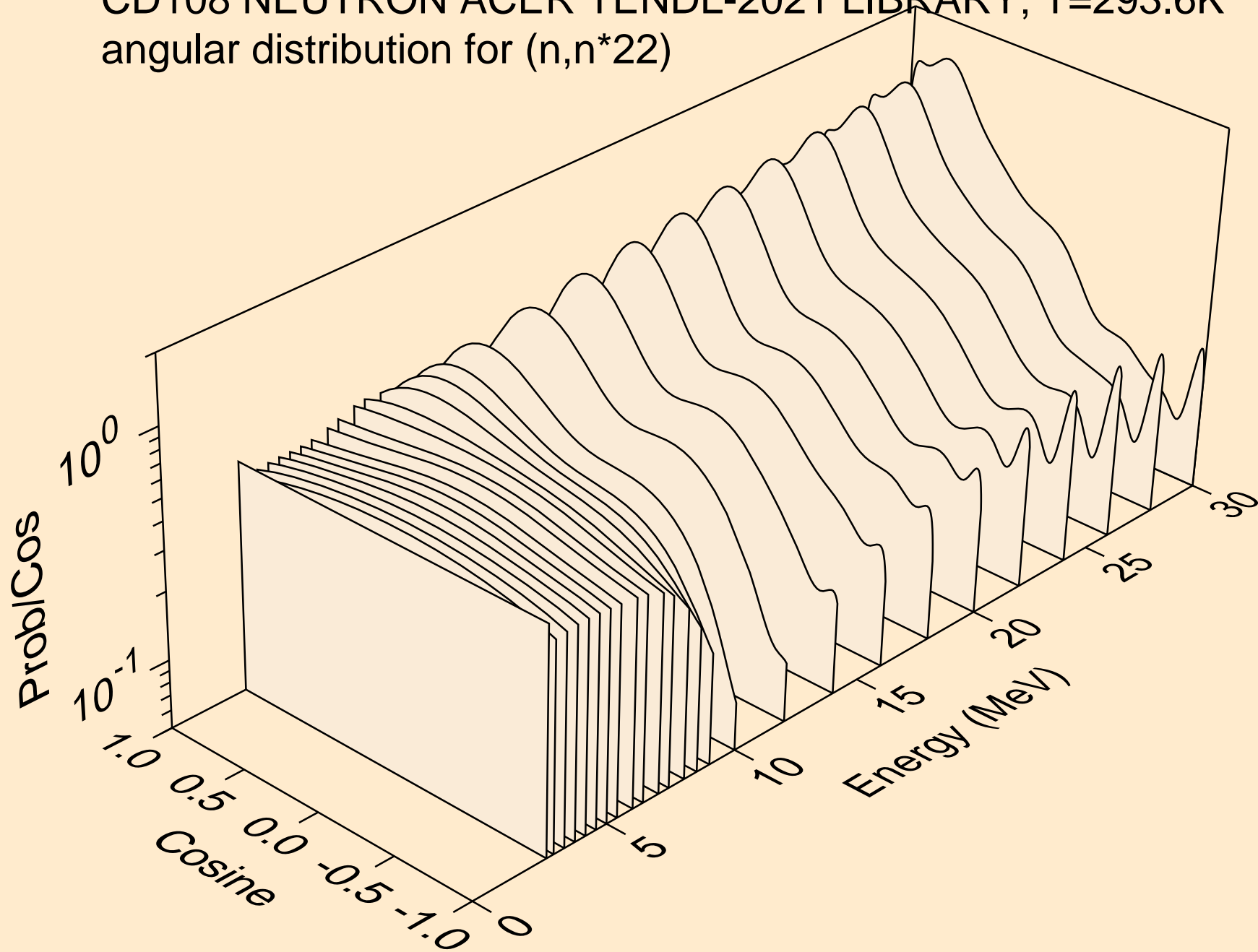

CD108 NEUTRON ACER TENDL-2021 LIBRARY; T=293.6K
angular distribution for (n,n*23)

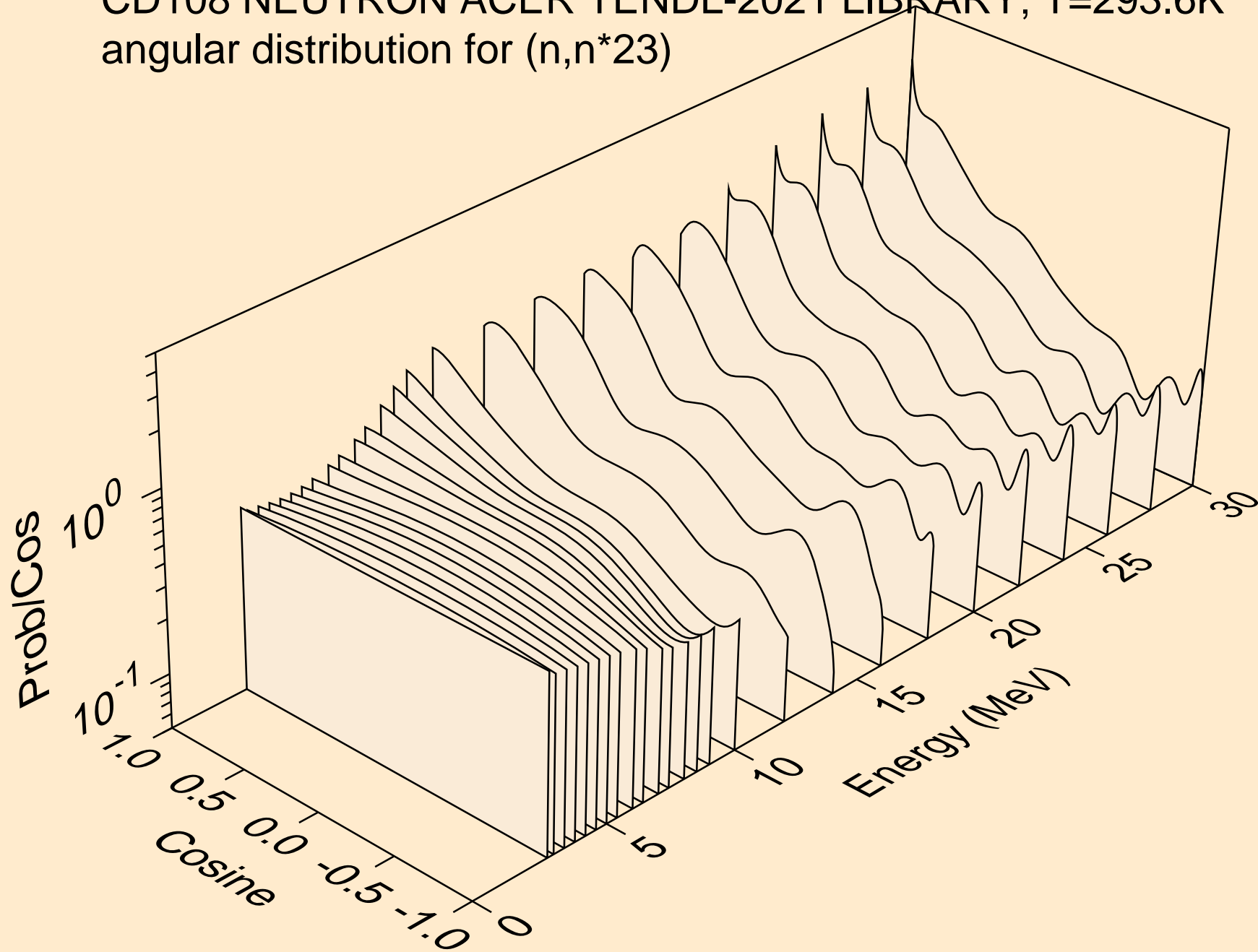

CD108 NEUTRON ACER TENDL-2021 LIBRARY; T=293.6K
angular distribution for (n,n*24)

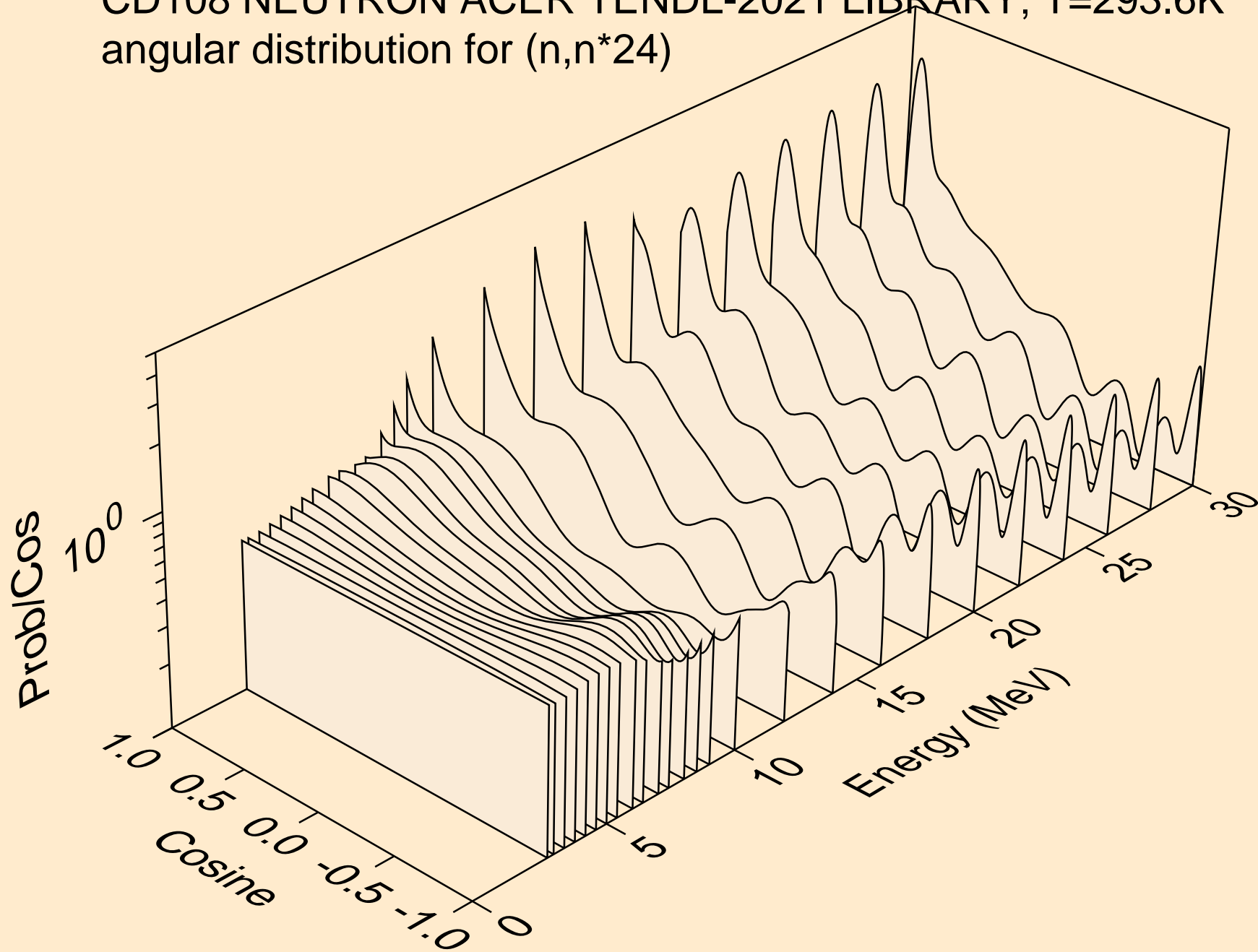

CD108 NEUTRON ACER TENDL-2021 LIBRARY; T=293.6K
angular distribution for (n,n*25)

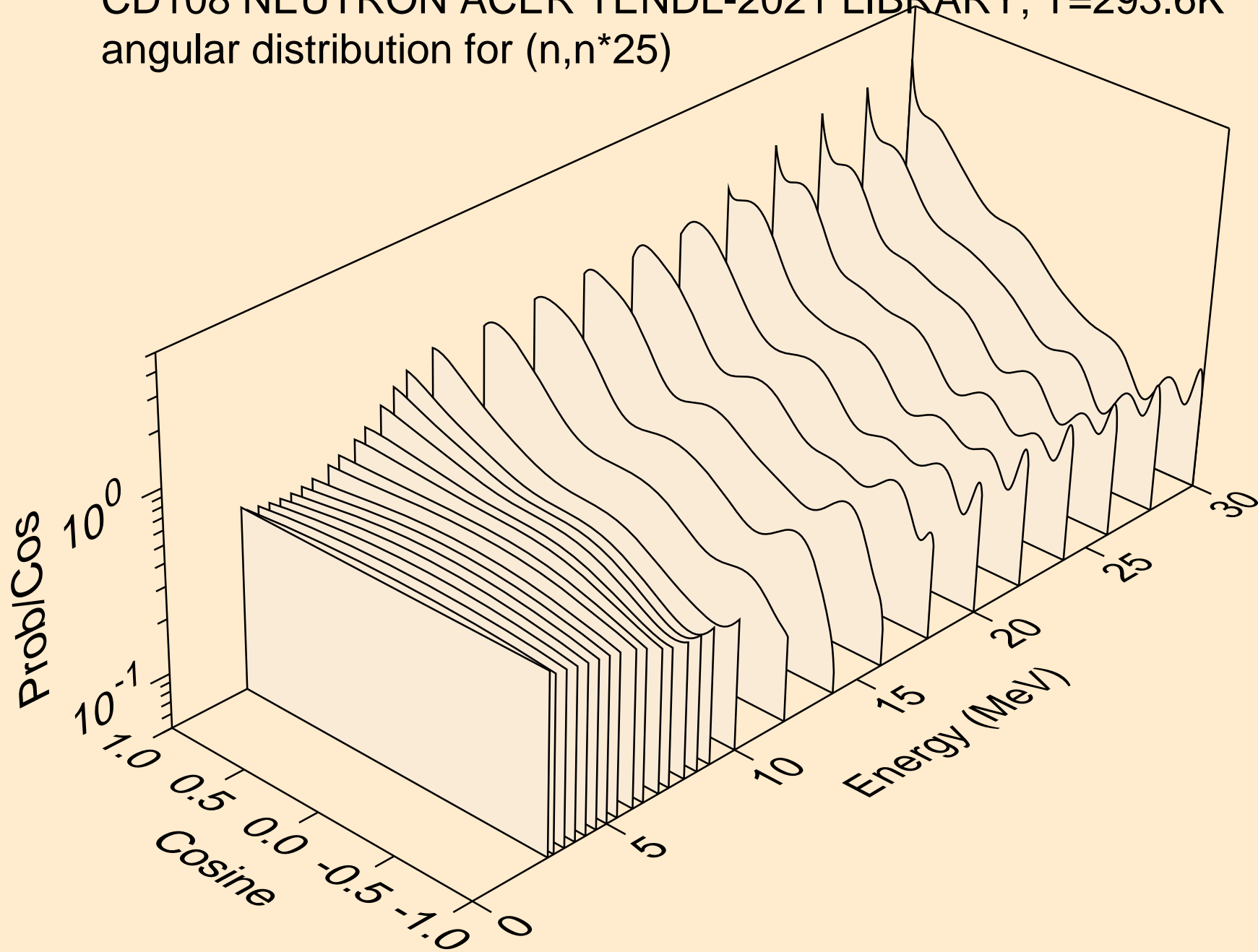

CD108 NEUTRON ACER TENDL-2021 LIBRARY; T=293.6K
angular distribution for (n,n*26)

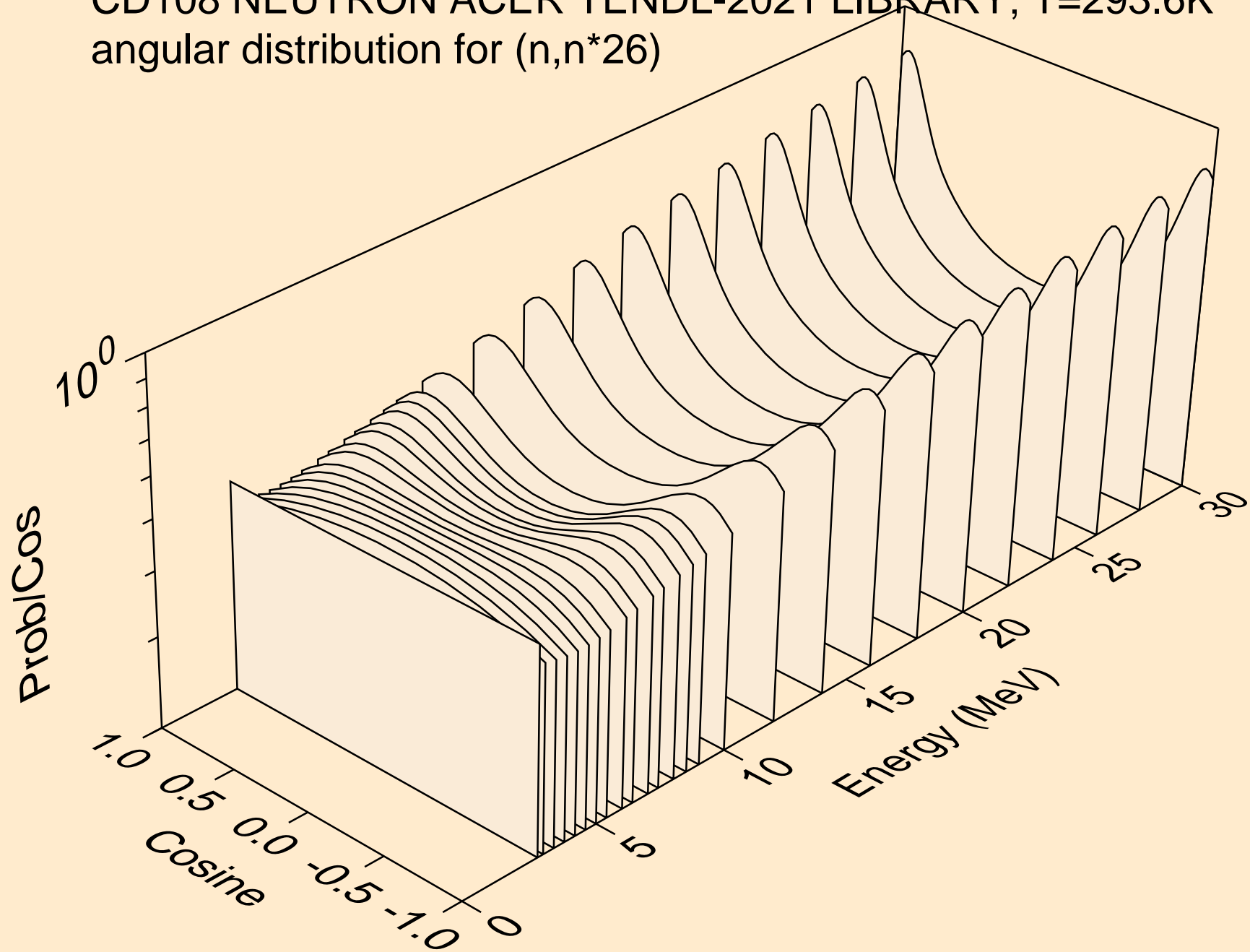

CD108 NEUTRON ACER TENDL-2021 LIBRARY; T=293.6K
angular distribution for (n,n*27)

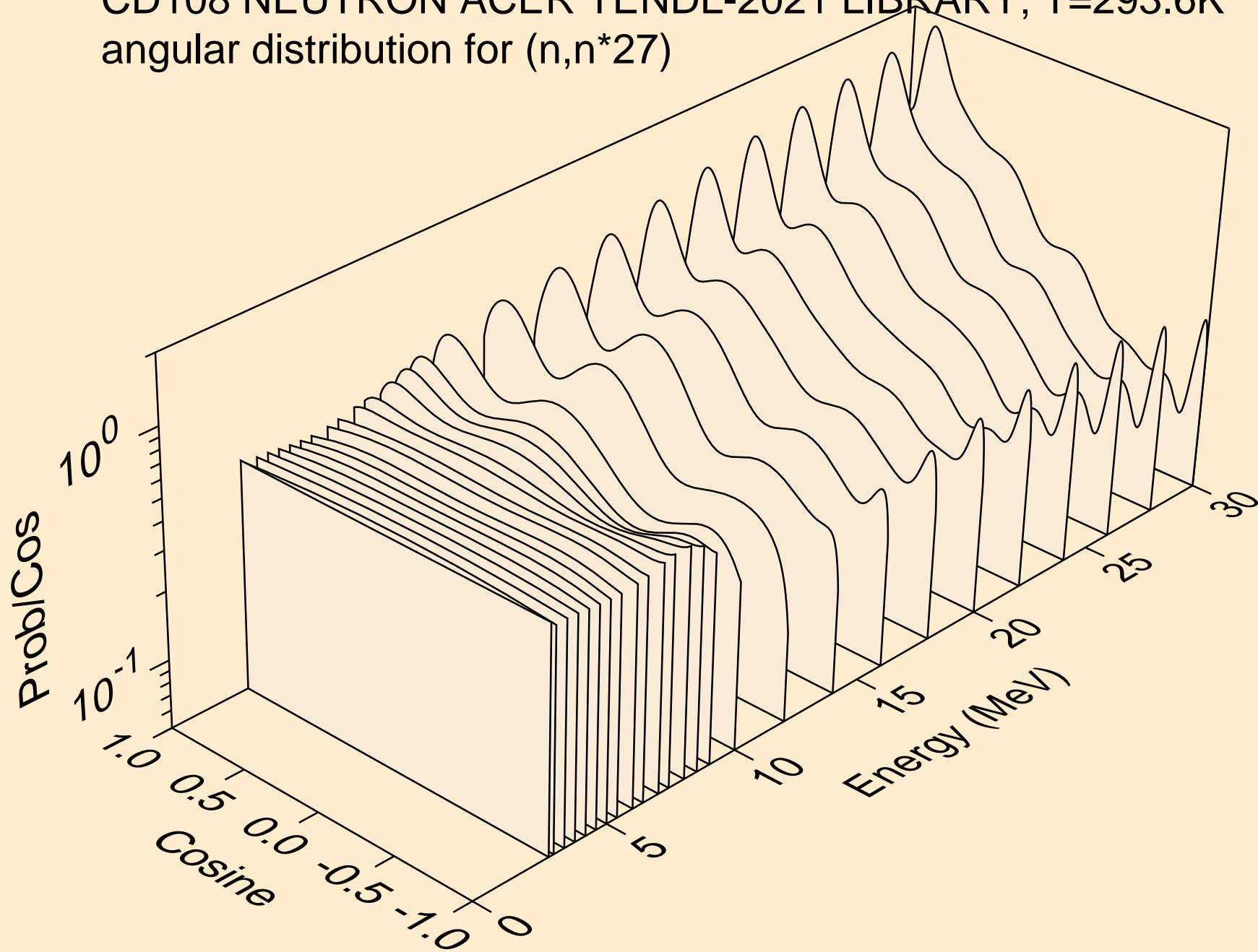

CD108 NEUTRON ACER TENDL-2021 LIBRARY; T=293.6K
angular distribution for (n,n*28)

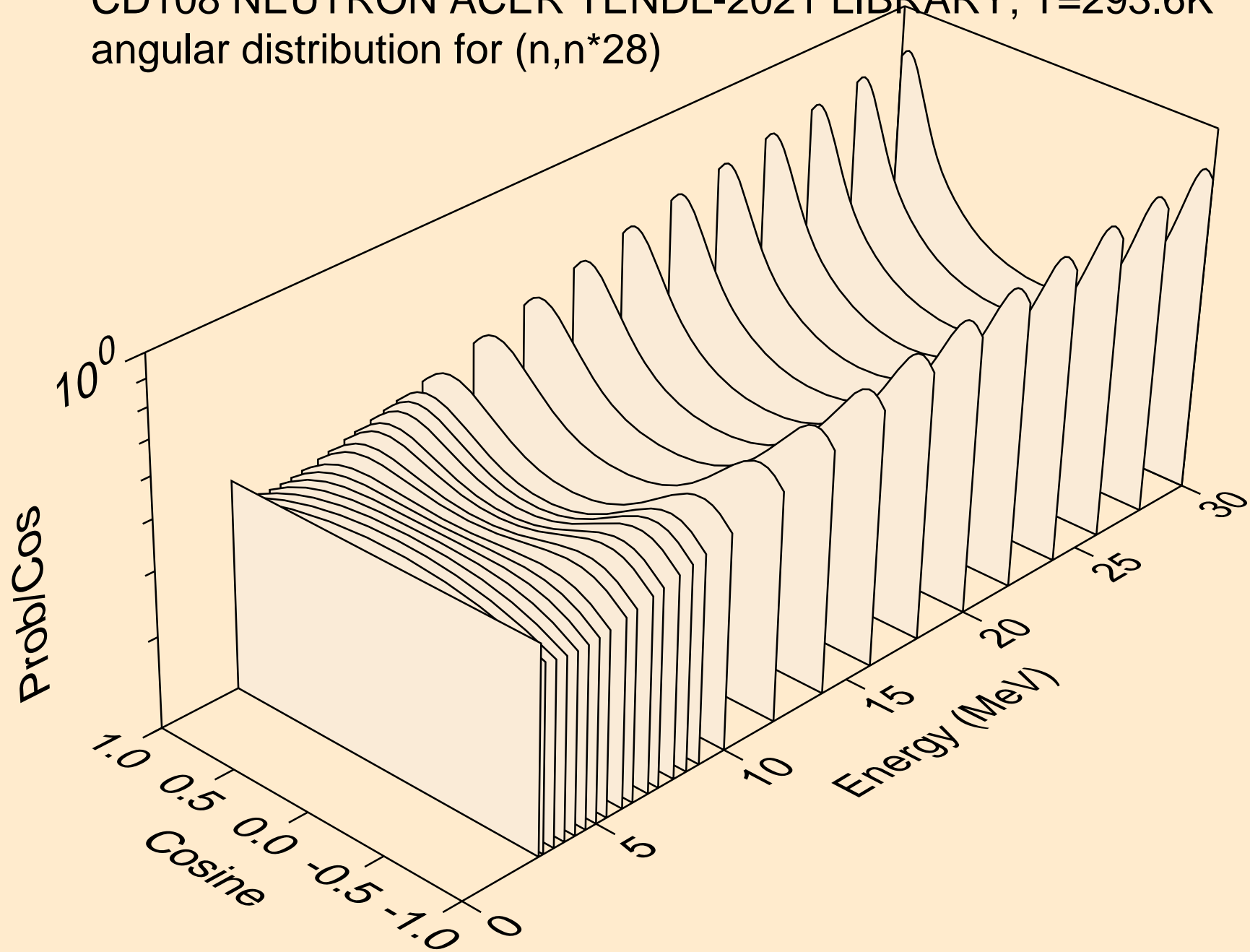

CD108 NEUTRON ACER TENDL-2021 LIBRARY; T=293.6K
angular distribution for (n,n*29)

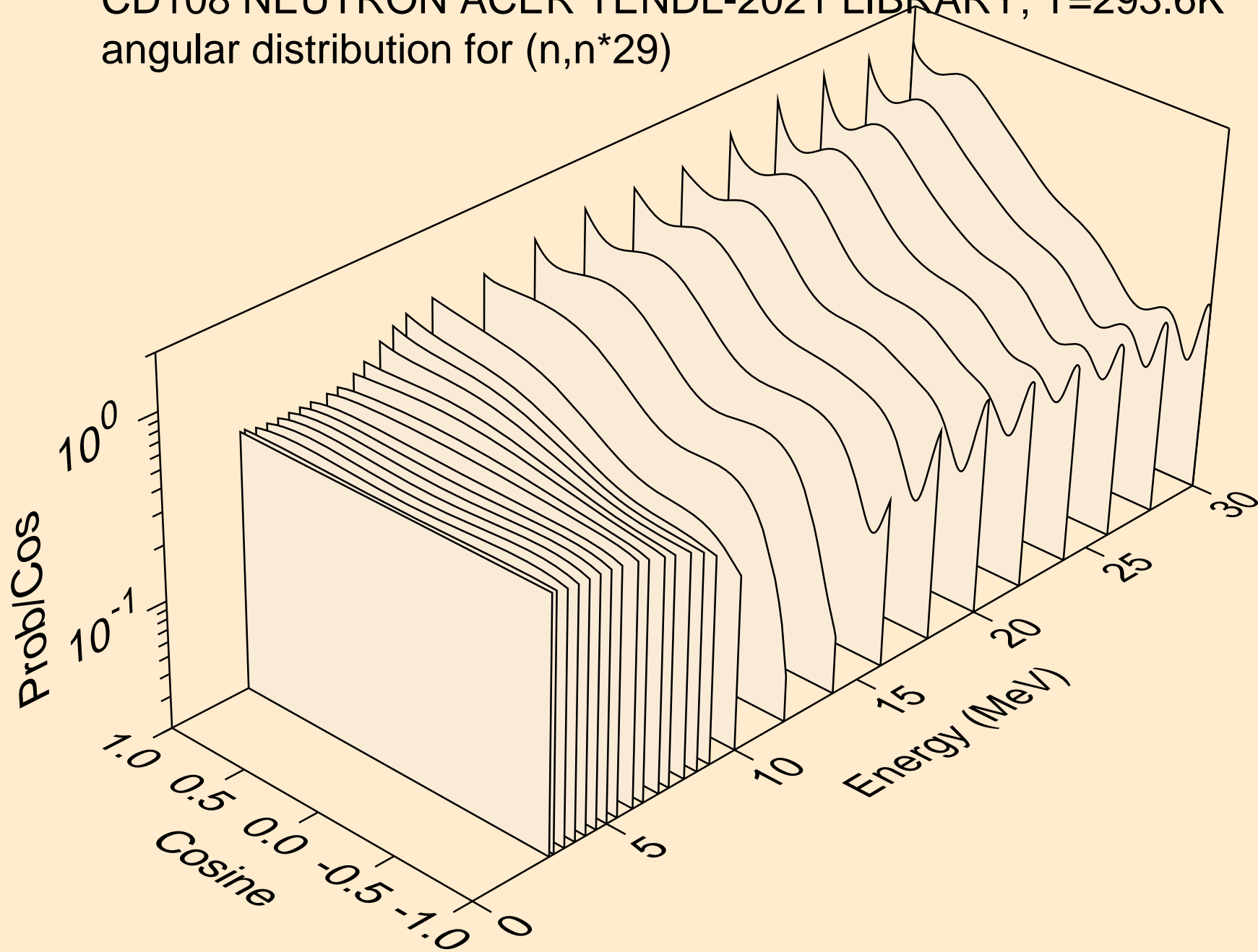

CD108 NEUTRON ACER TENDL-2021 LIBRARY; T=293.6K
angular distribution for (n,n*30)

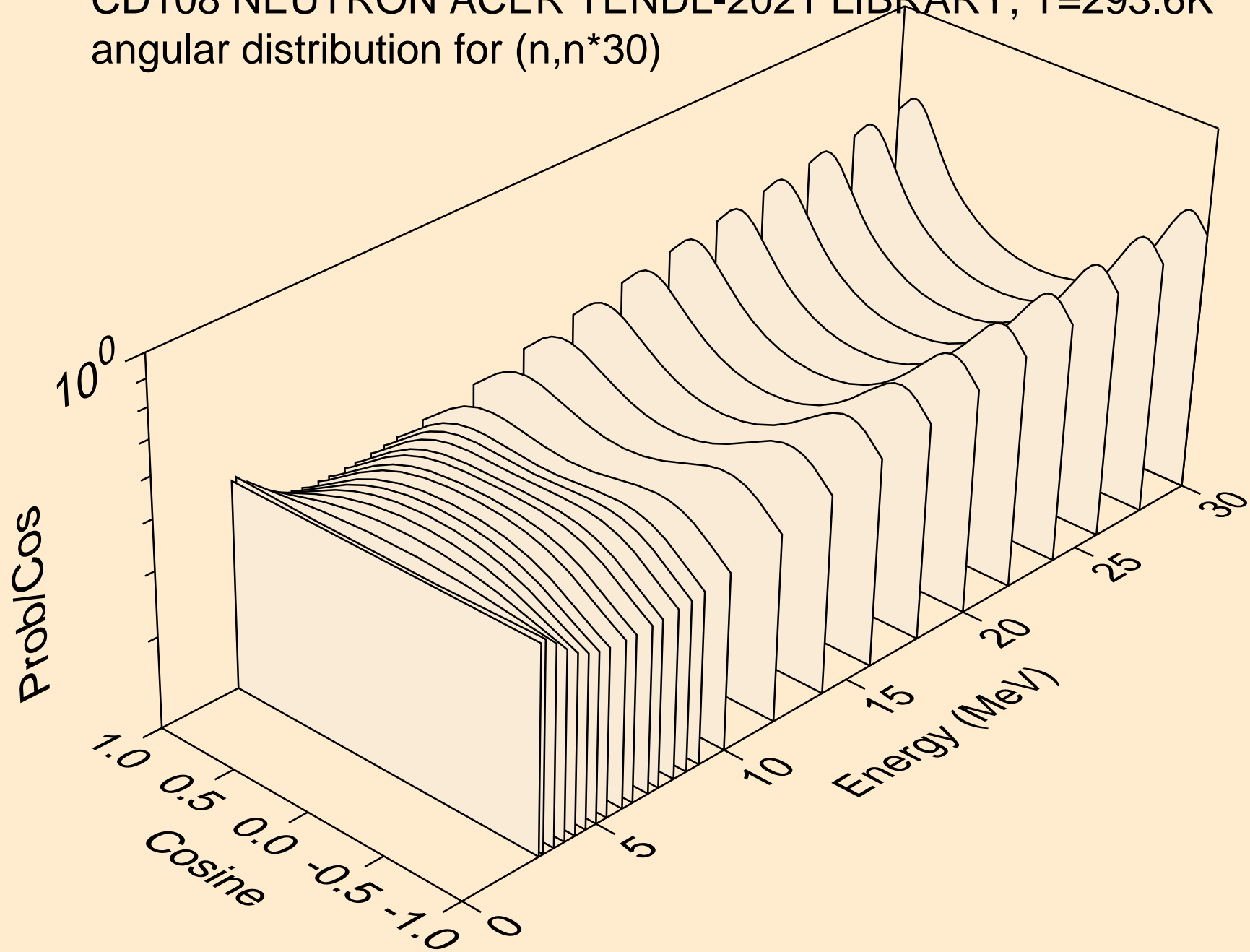

CD108 NEUTRON ACER TENDL-2021 LIBRARY; T=293.6K
Neutron emission for (n,x)

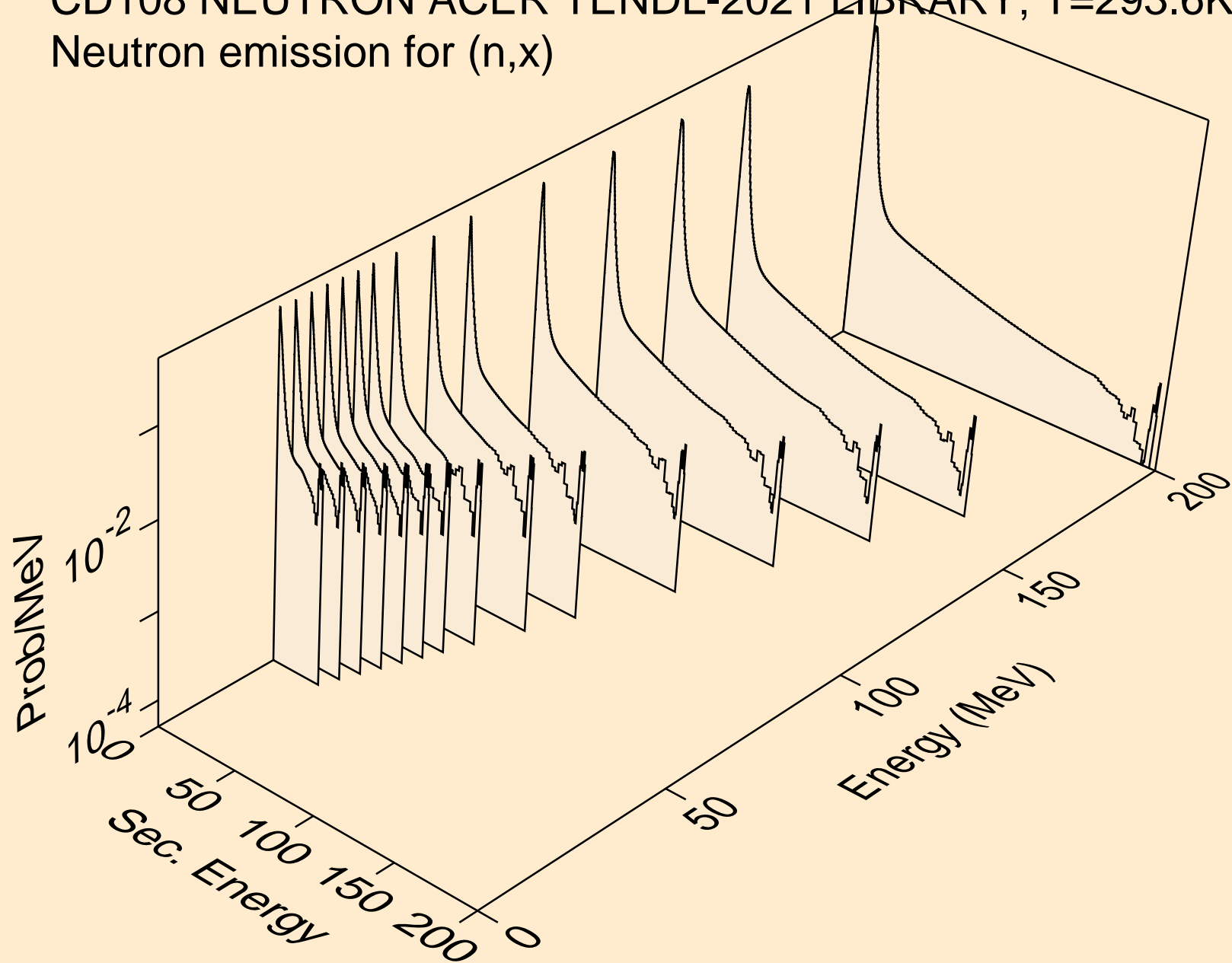

CD108 NEUTRON ACER TENDL-2021 LIBRARY; T=293.6K
Neutron emission for (n,2nd)

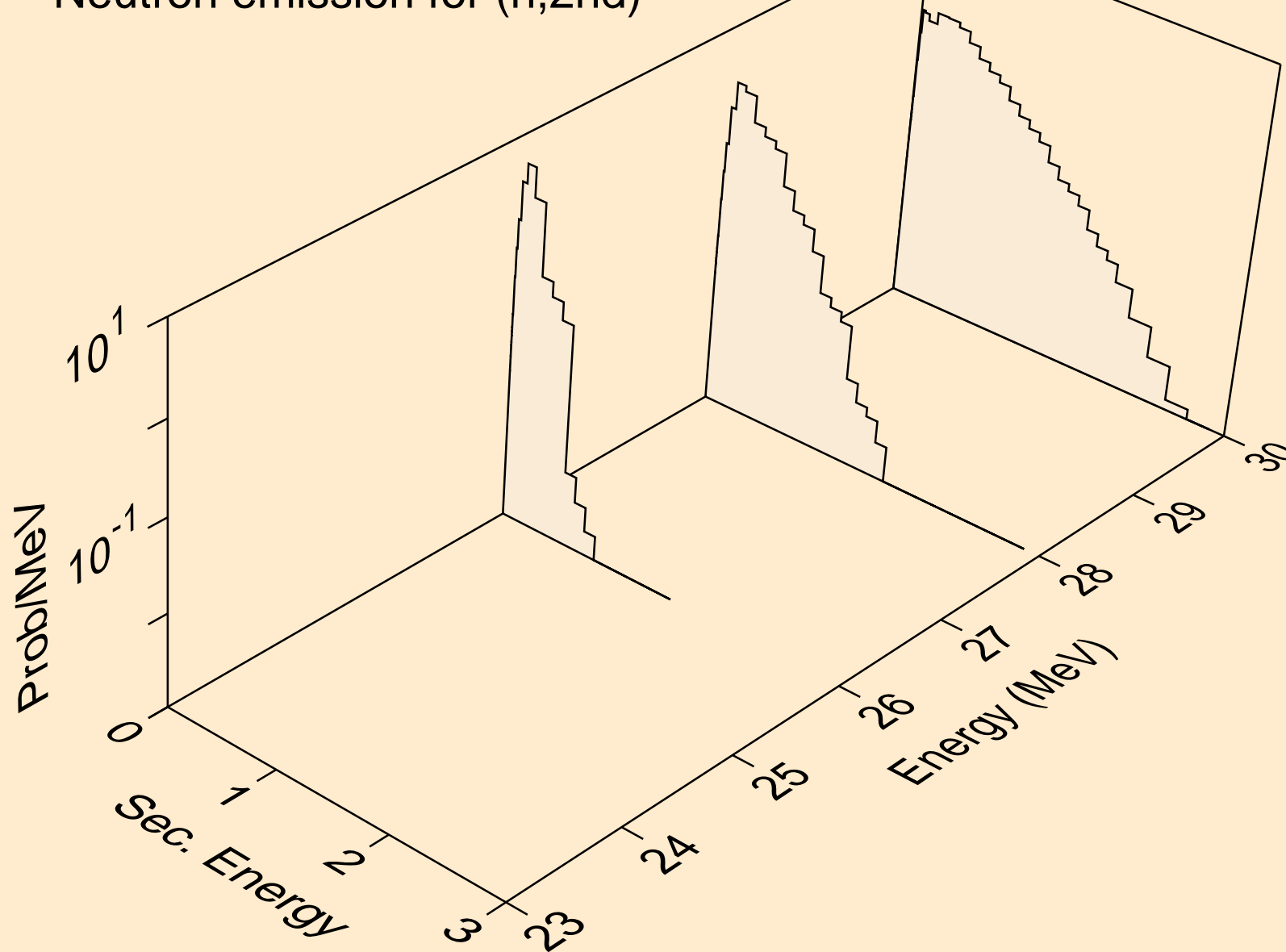

CD108 NEUTRON ACER TENDL-2021 LIBRARY; T=293.6K
Neutron emission for (n,2n)

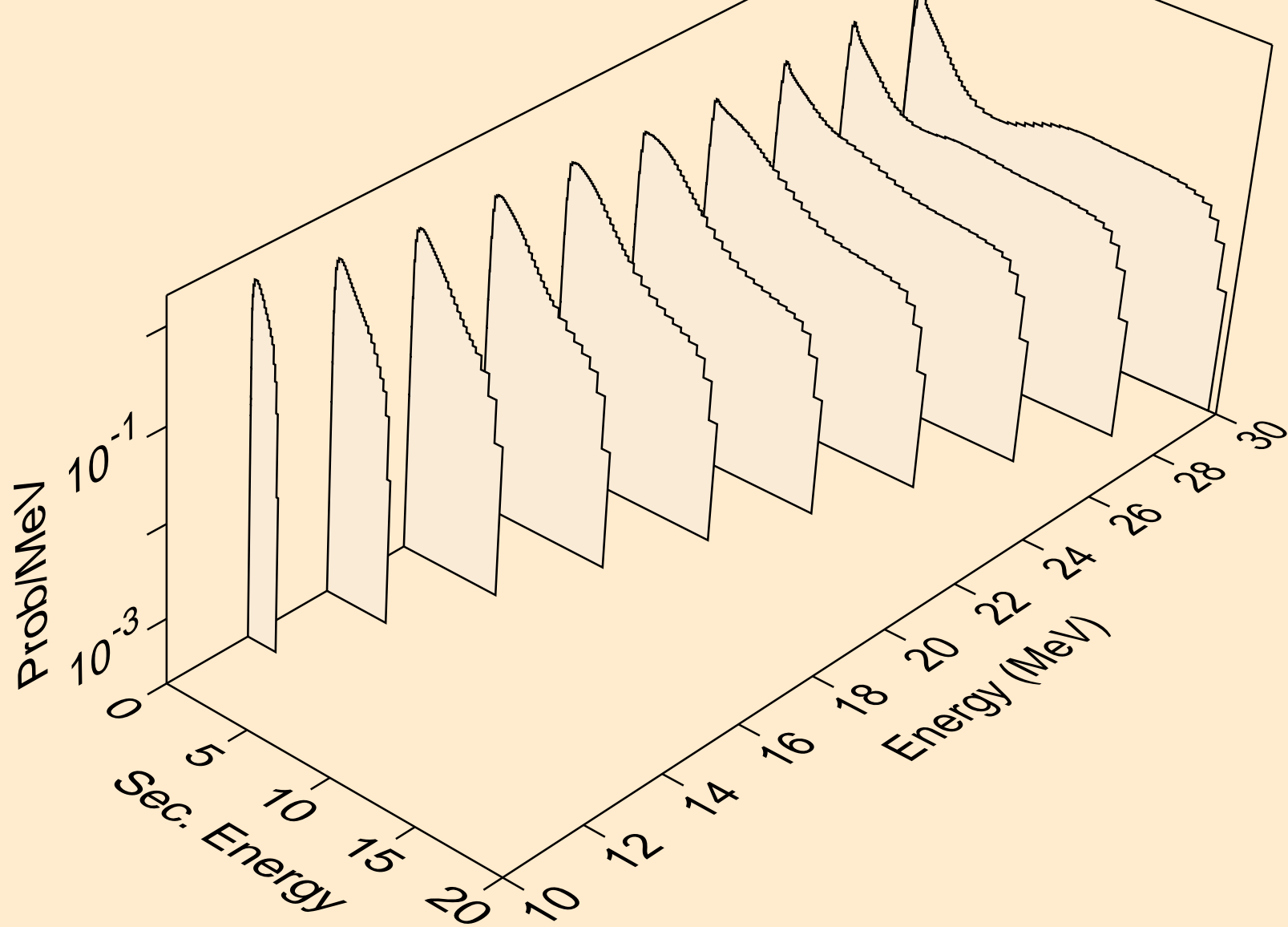

CD108 NEUTRON ACER TENDL-2021 LIBRARY; T=293.6K
Neutron emission for (n,3n)

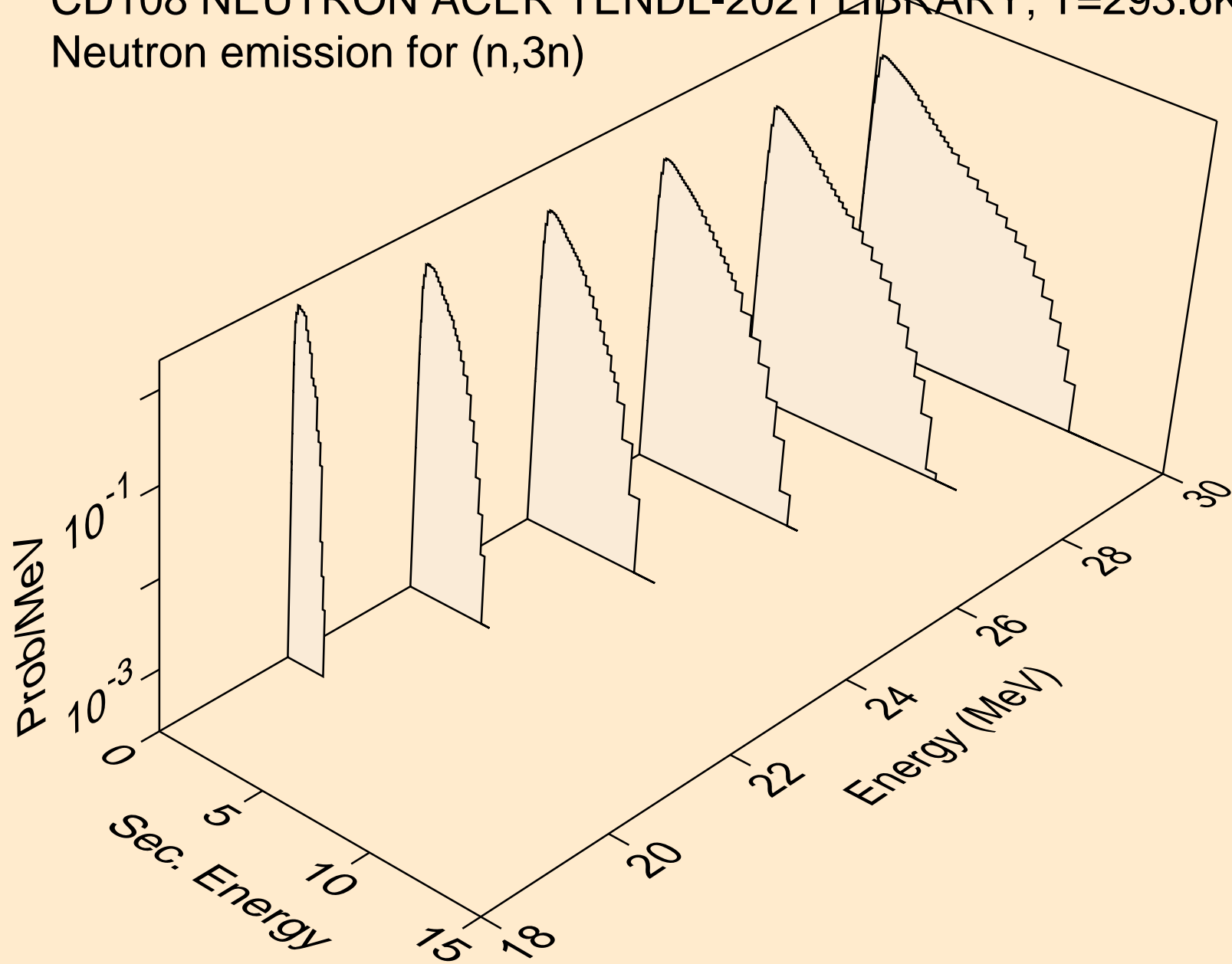

CD108 NEUTRON ACER TENDL-2021 LIBRARY; T=293.6K
Neutron emission for (n,n*)a

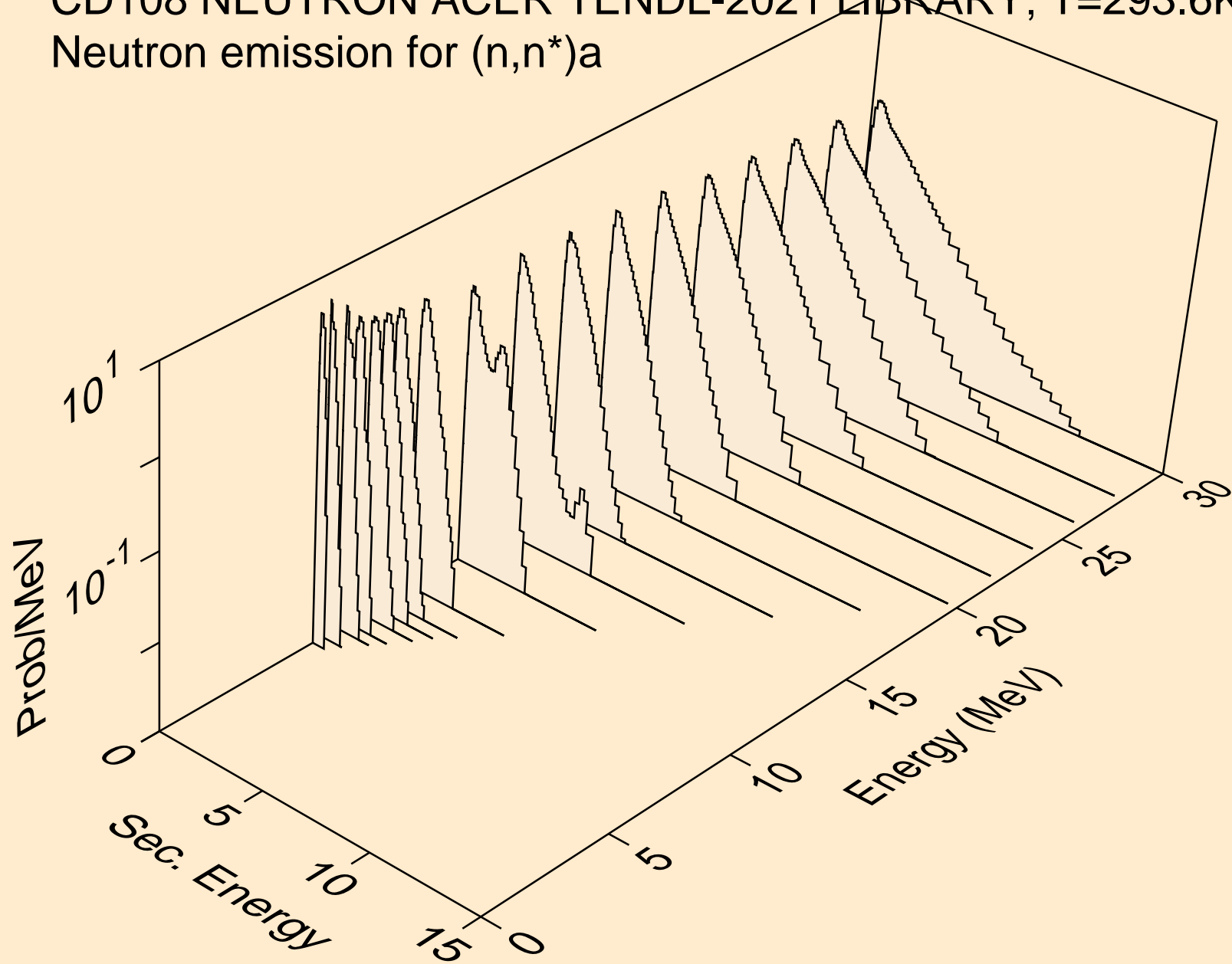

CD108 NEUTRON ACER TENDL-2021 LIBRARY; T=293.6K
Neutron emission for (n,2n)a

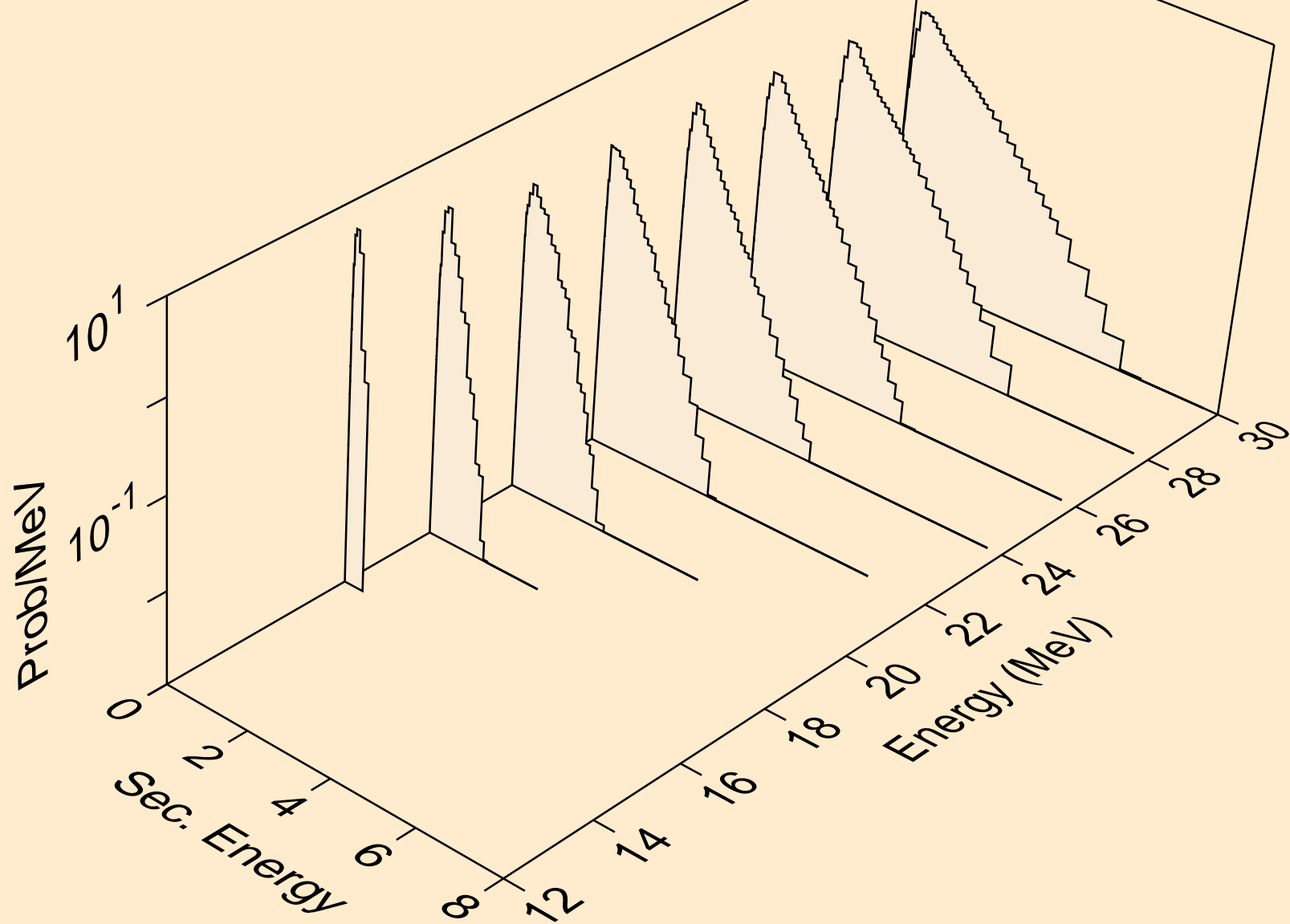

CD108 NEUTRON ACER TENDL-2021 LIBRARY; T=293.6K
Neutron emission for (n,3n)a

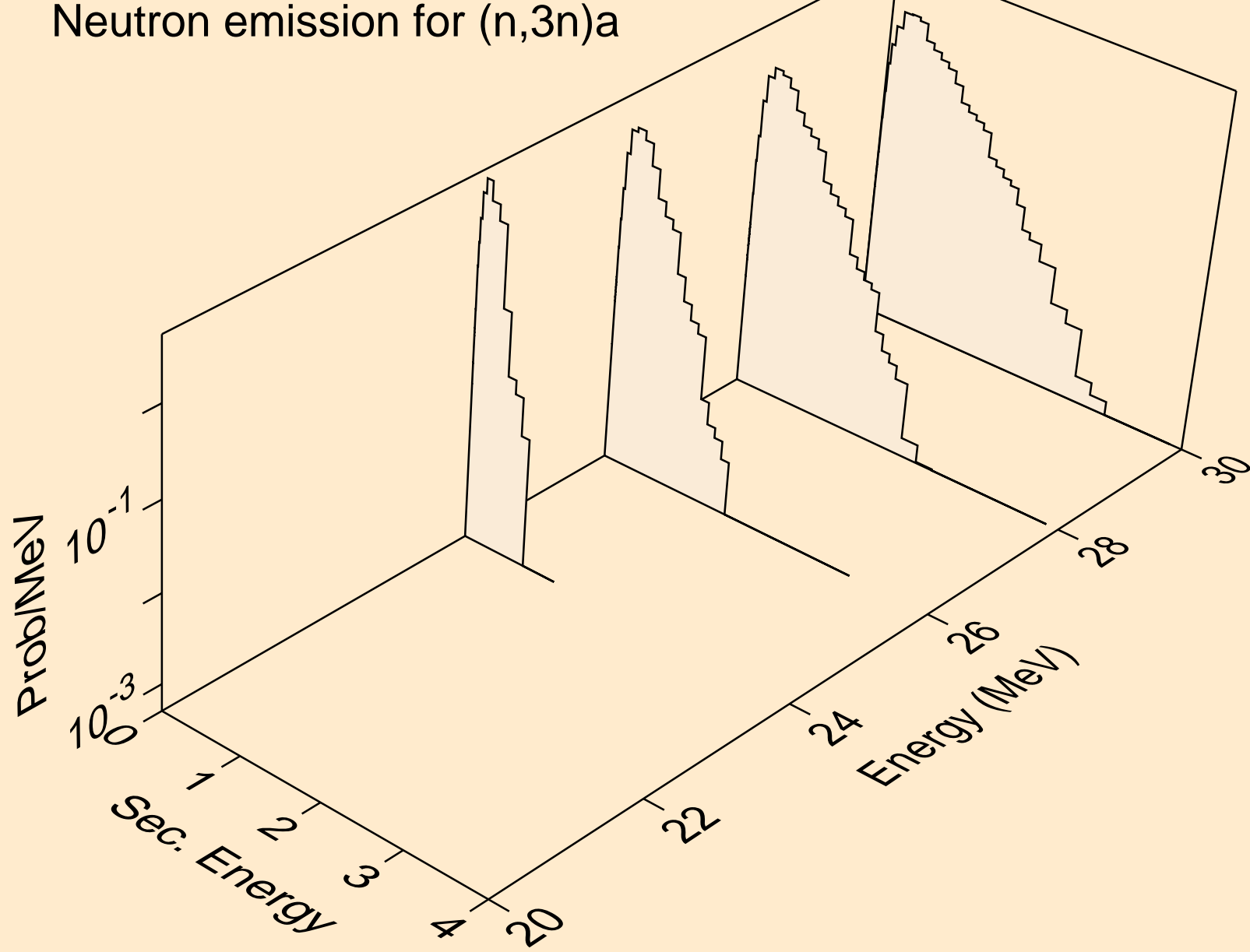

CD108 NEUTRON ACER TENDL-2021 LIBRARY; T=293.6K
Neutron emission for (n,n*)p

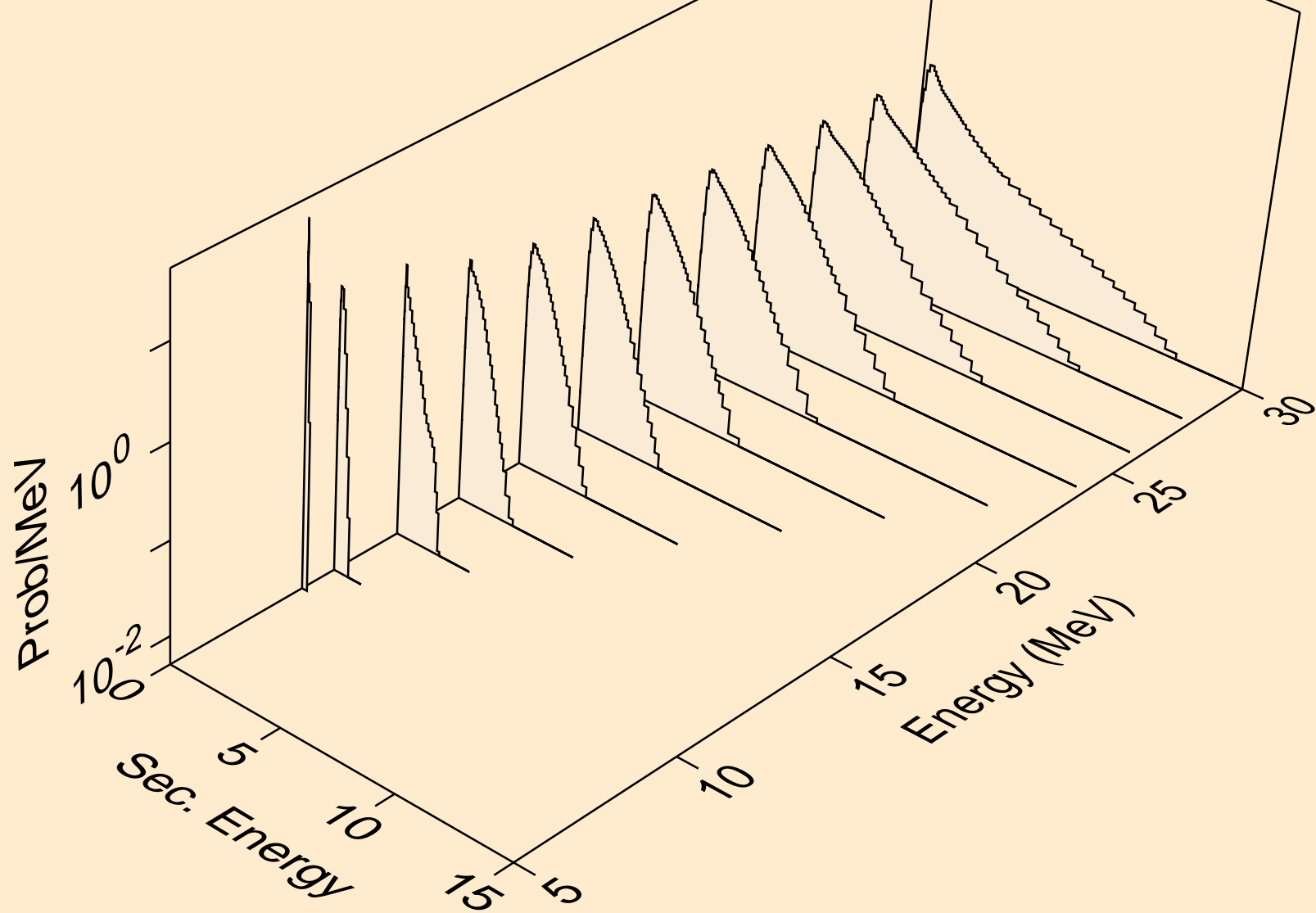

CD108 NEUTRON ACER TENDL-2021 LIBRARY; T=293.6K
Neutron emission for (n,n*)2a

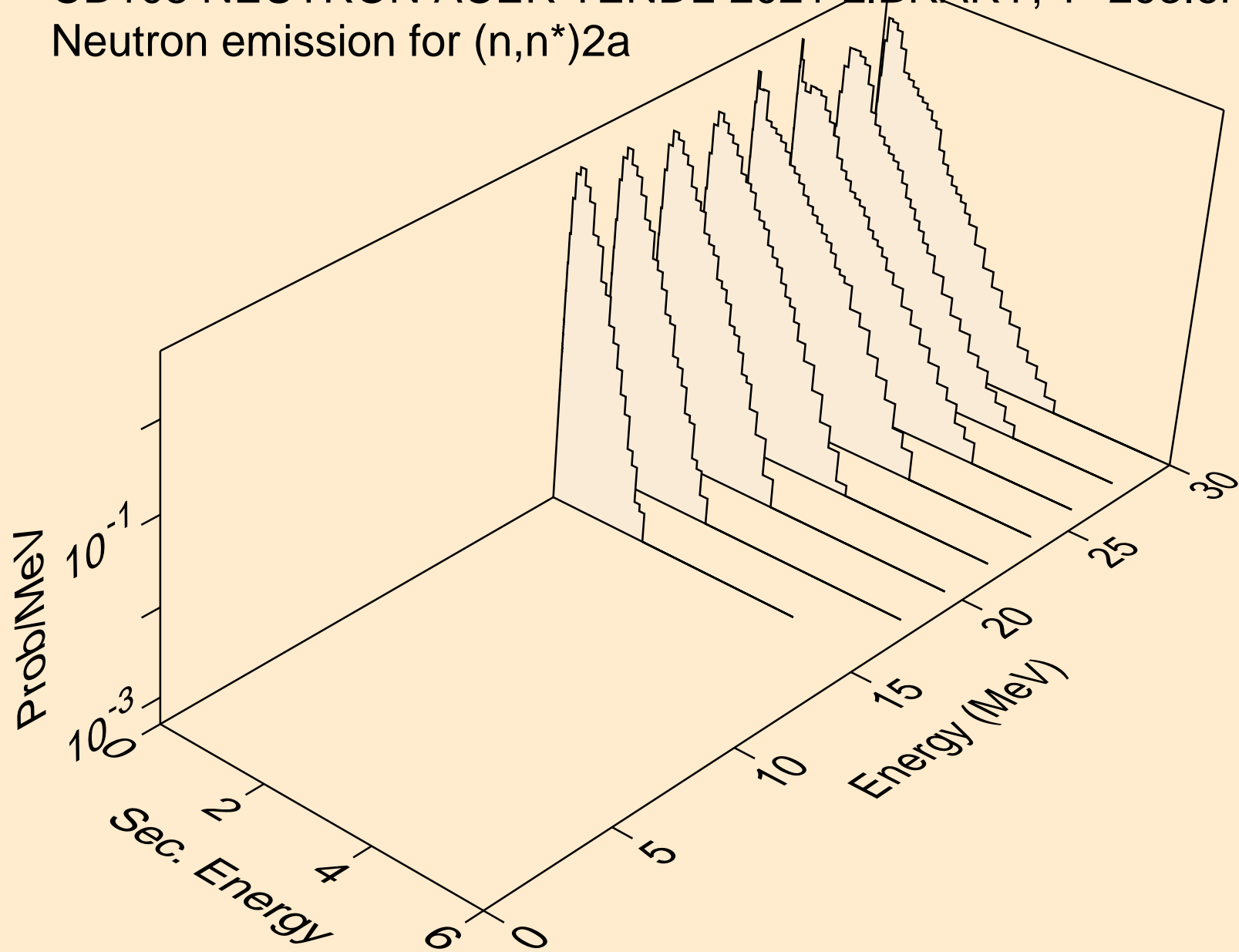

CD108 NEUTRON ACER TENDL-2021 LIBRARY; T=293.6K
Neutron emission for (n,n*)d

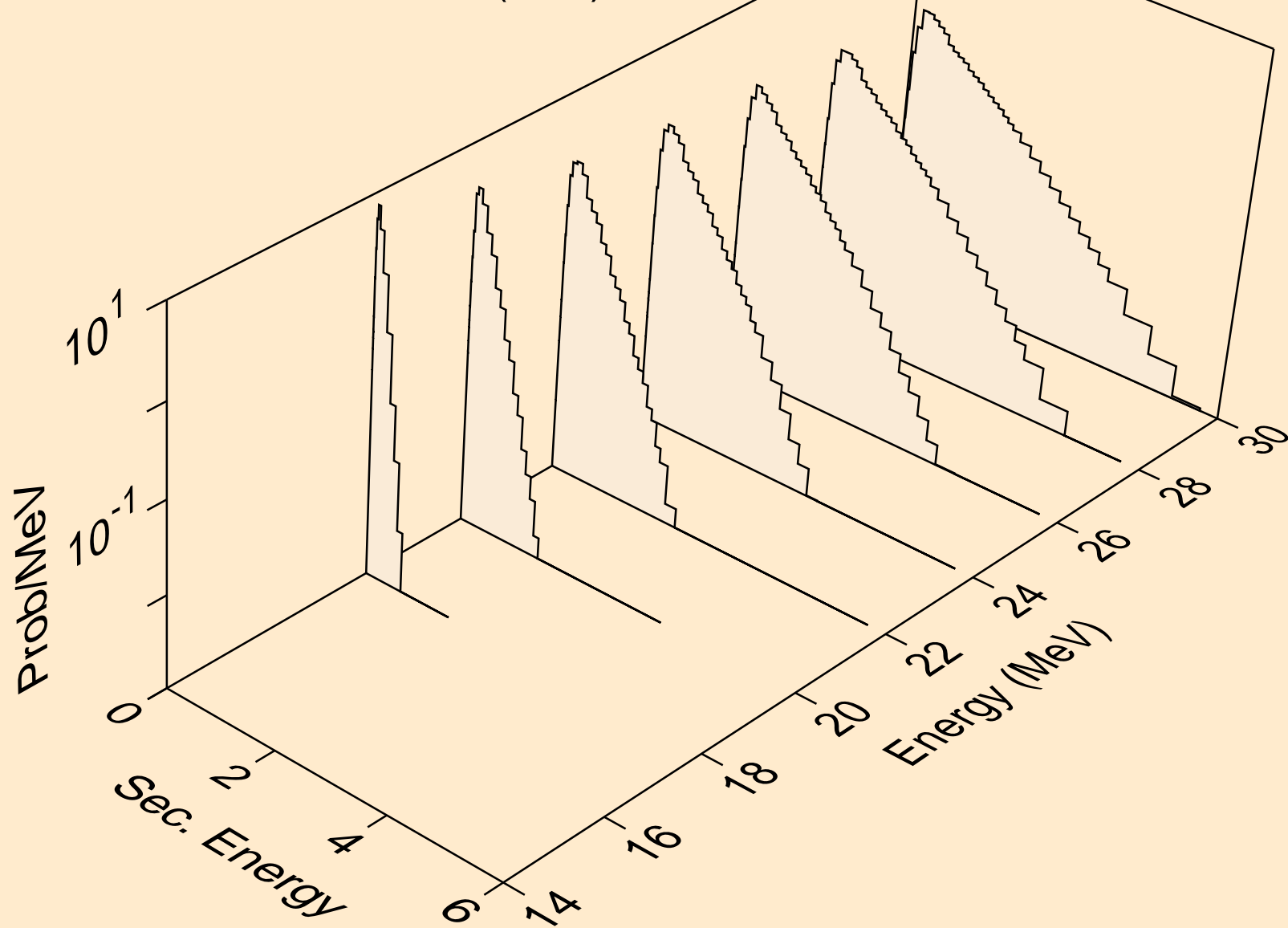

CD108 NEUTRON ACER TENDL-2021 LIBRARY; T=293.6K
Neutron emission for (n,n*)t

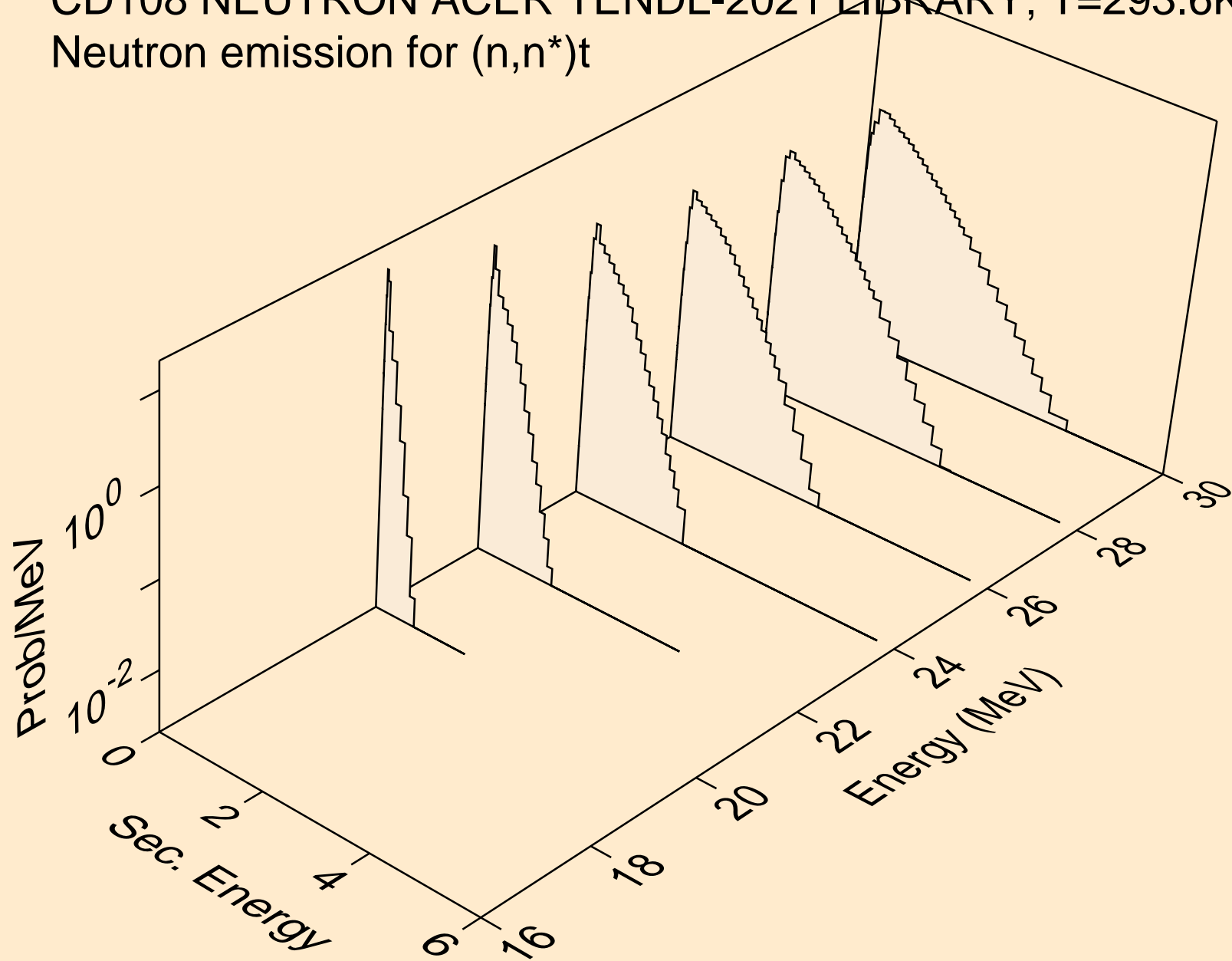

CD108 NEUTRON ACER TENDL-2021 LIBRARY; T=293.6K
Neutron emission for (n,n*)he3

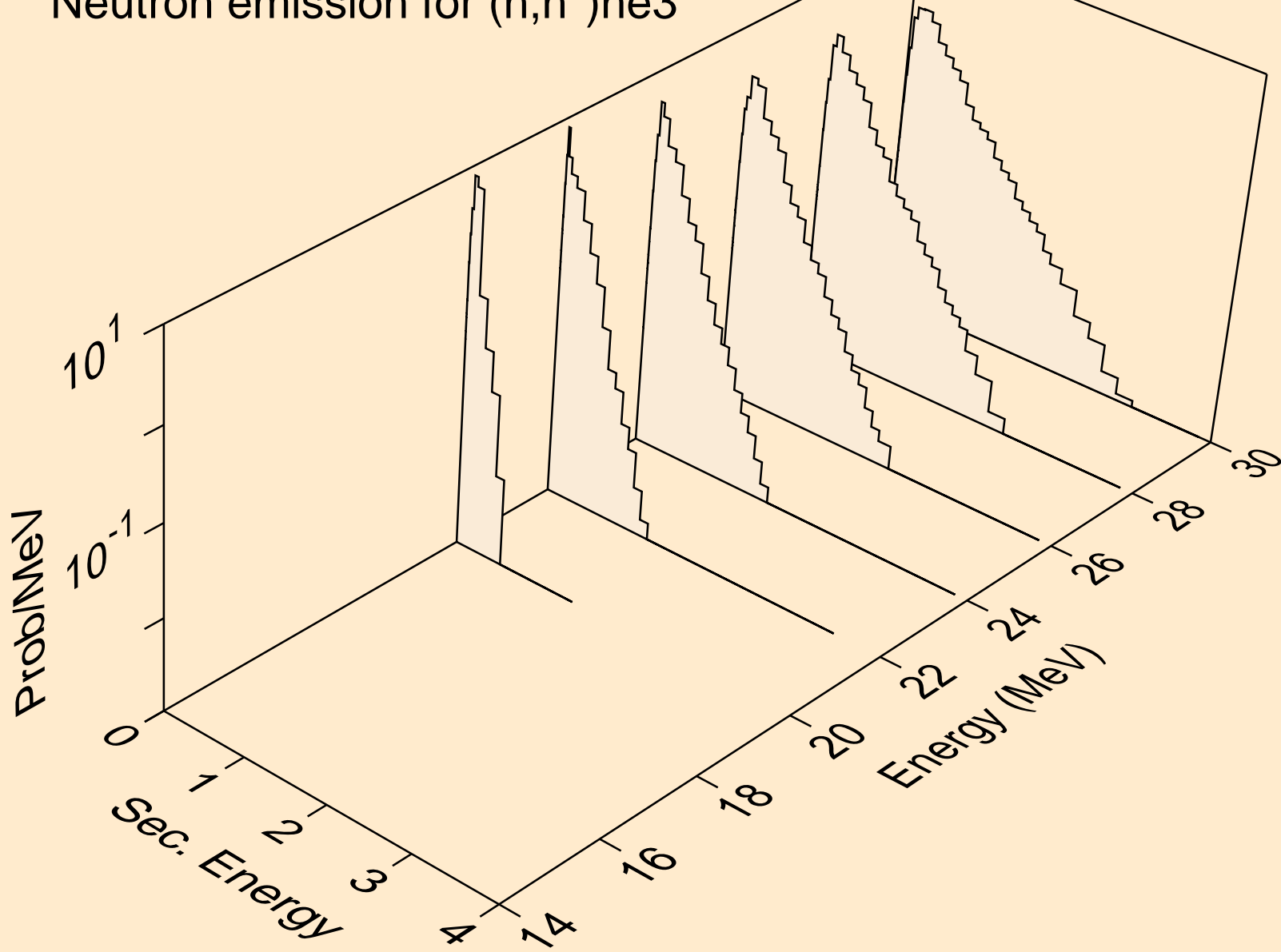

CD108 NEUTRON ACER TENDL-2021 LIBRARY; T=293.6K
Neutron emission for (n,2np)

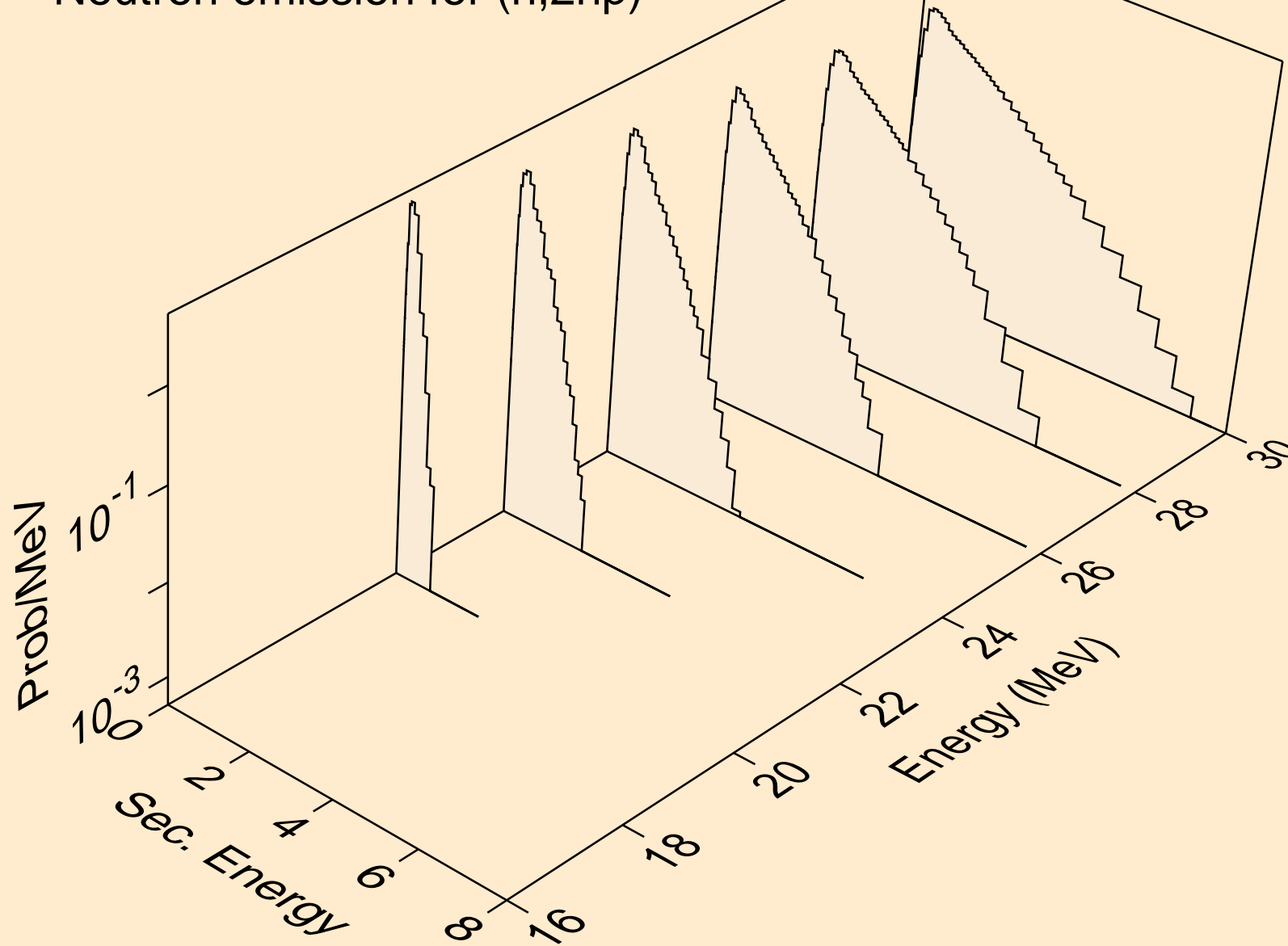

CD108 NEUTRON ACER TENDL-2021 LIBRARY; T=293.6K
Neutron emission for (n,3np)

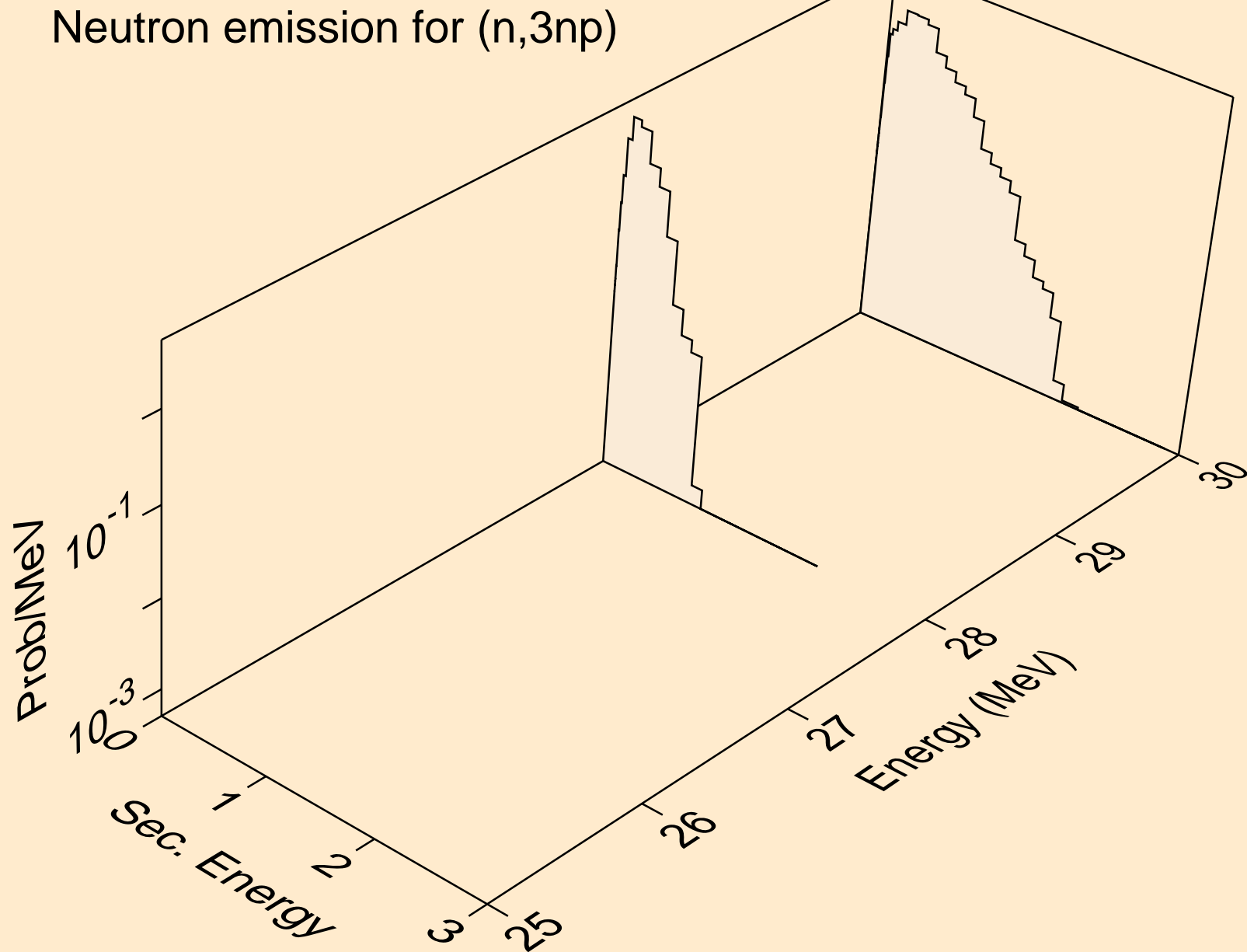

CD108 NEUTRON ACER TENDL-2021 LIBRARY; T=293.6K
Neutron emission for (n,2np)

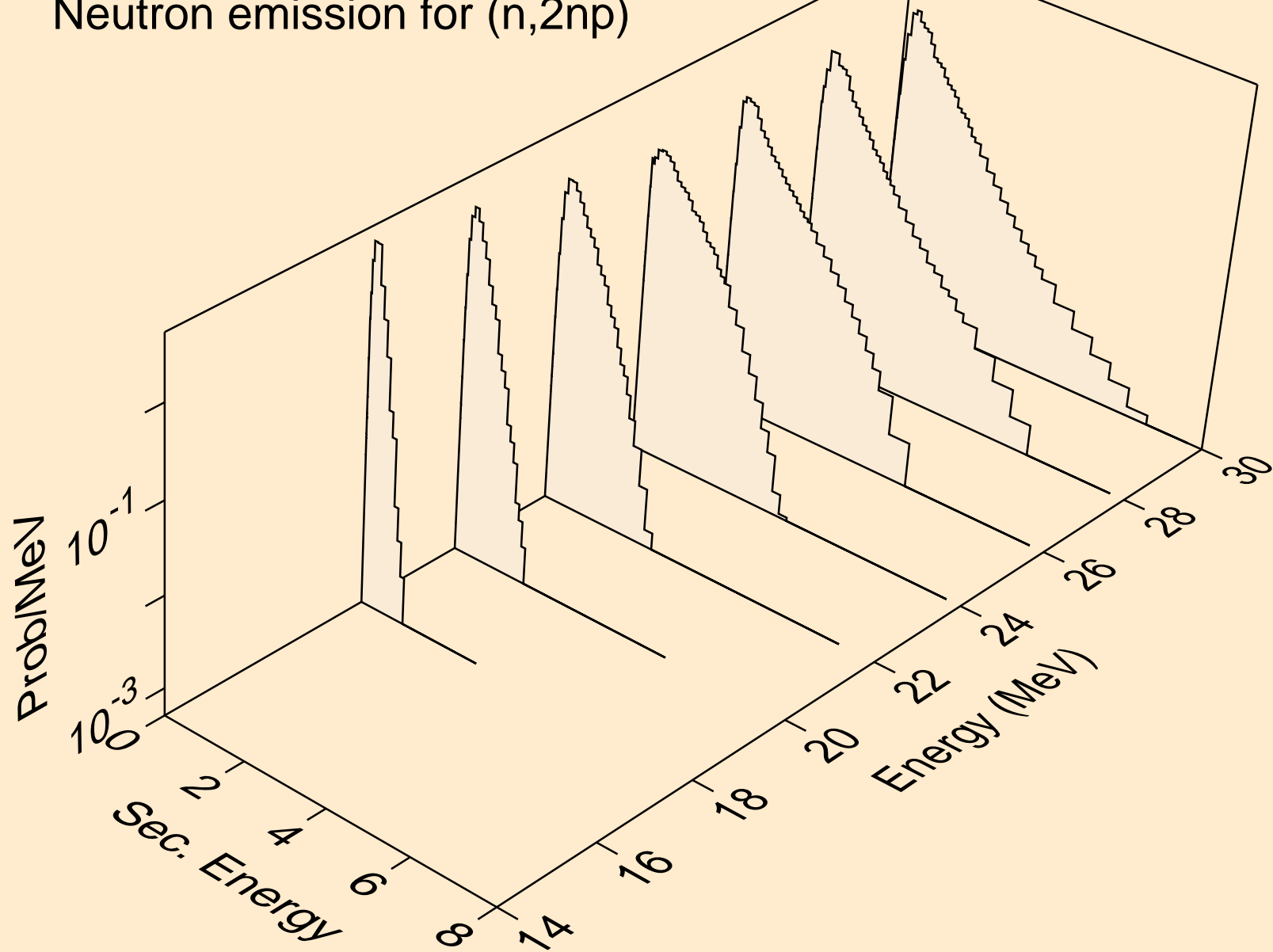

CD108 NEUTRON ACER TENDL-2021 LIBRARY; T=293.6K
Neutron emission for (n,npa)

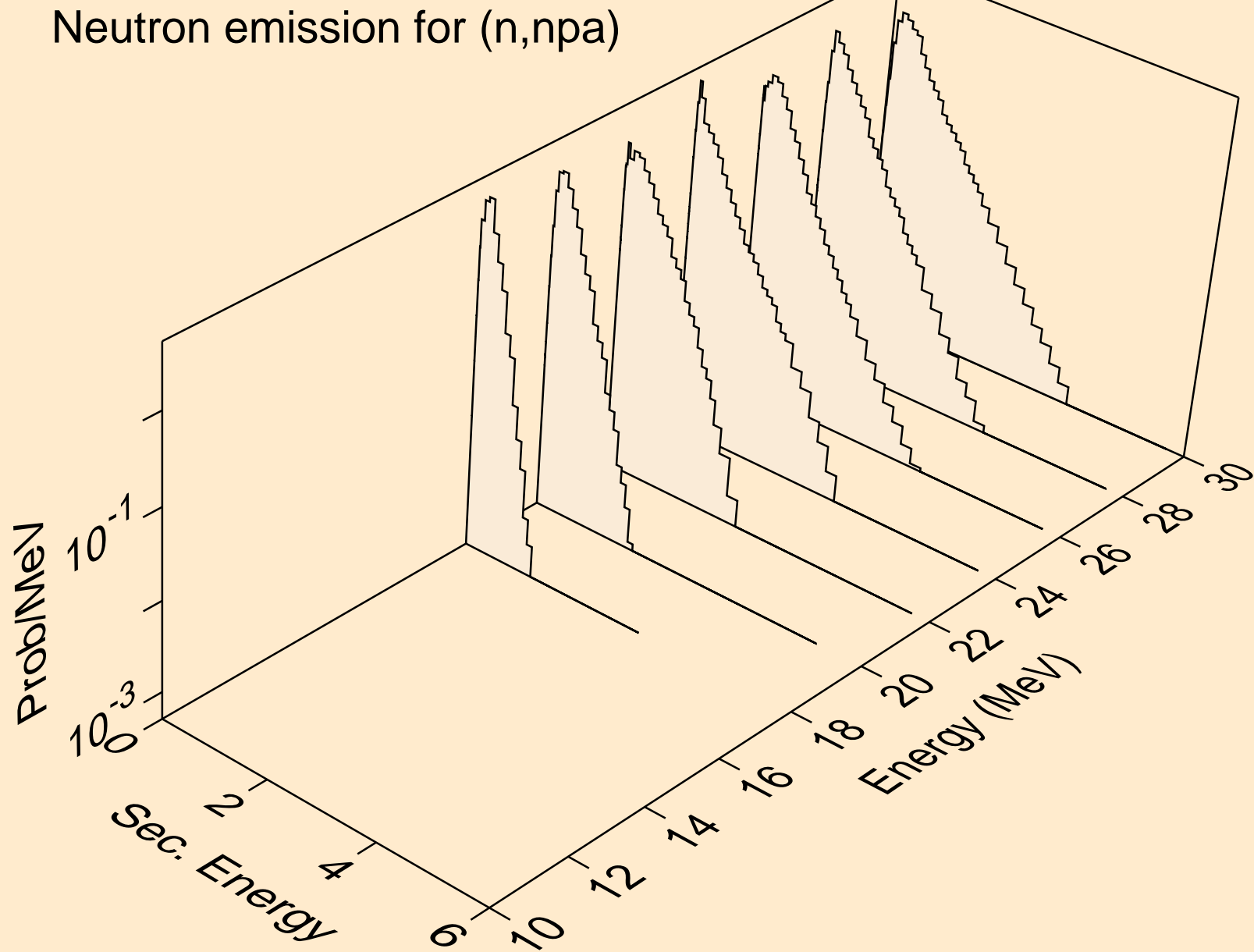

CD108 NEUTRON ACER TENDL-2021 LIBRARY; T=293.6K
Neutron emission for (n,n*c)

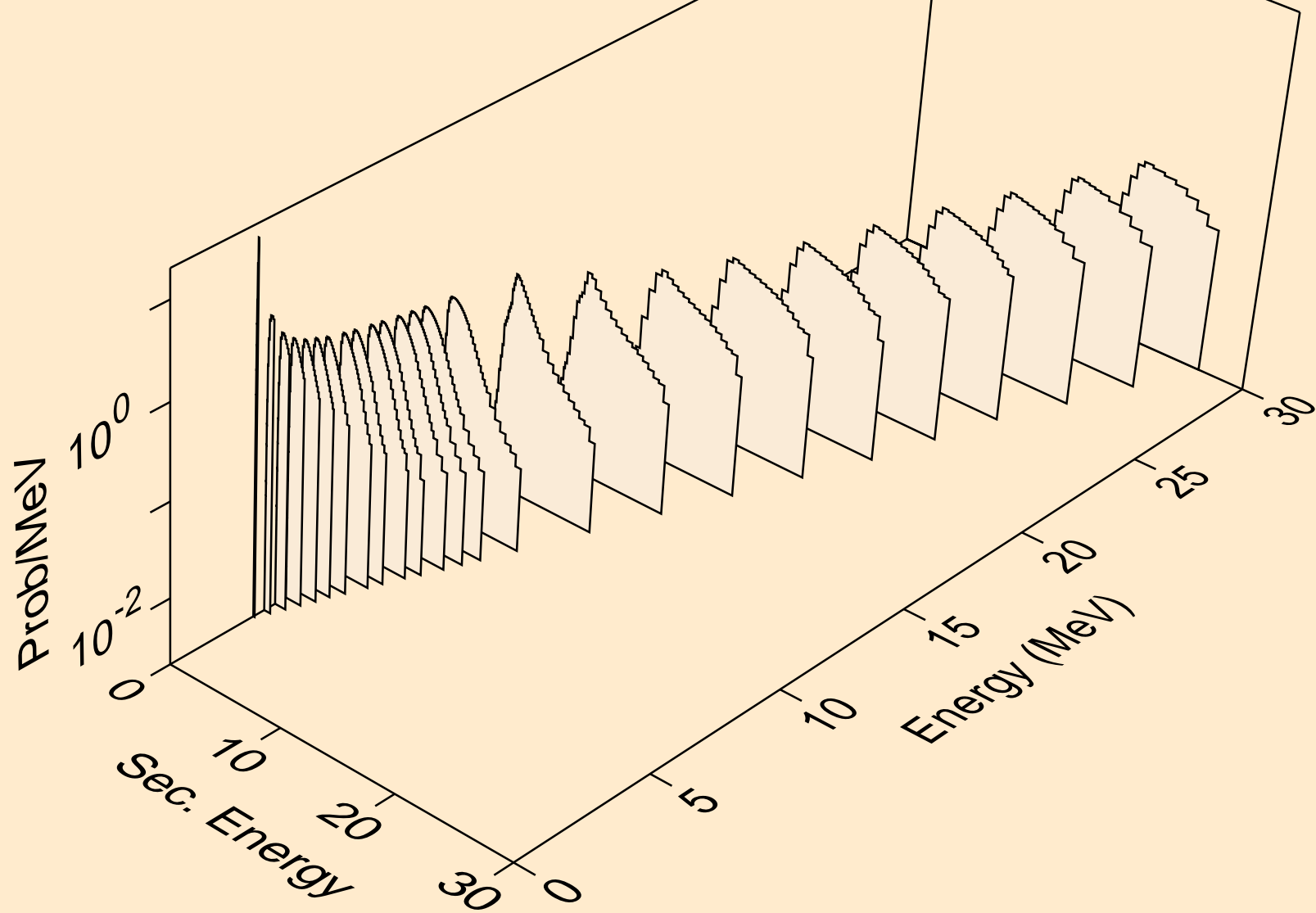

CD108 NEUTRON ACER TENDL-2021 LIBRARY; T=293.6K
Photon emission for (n,x)

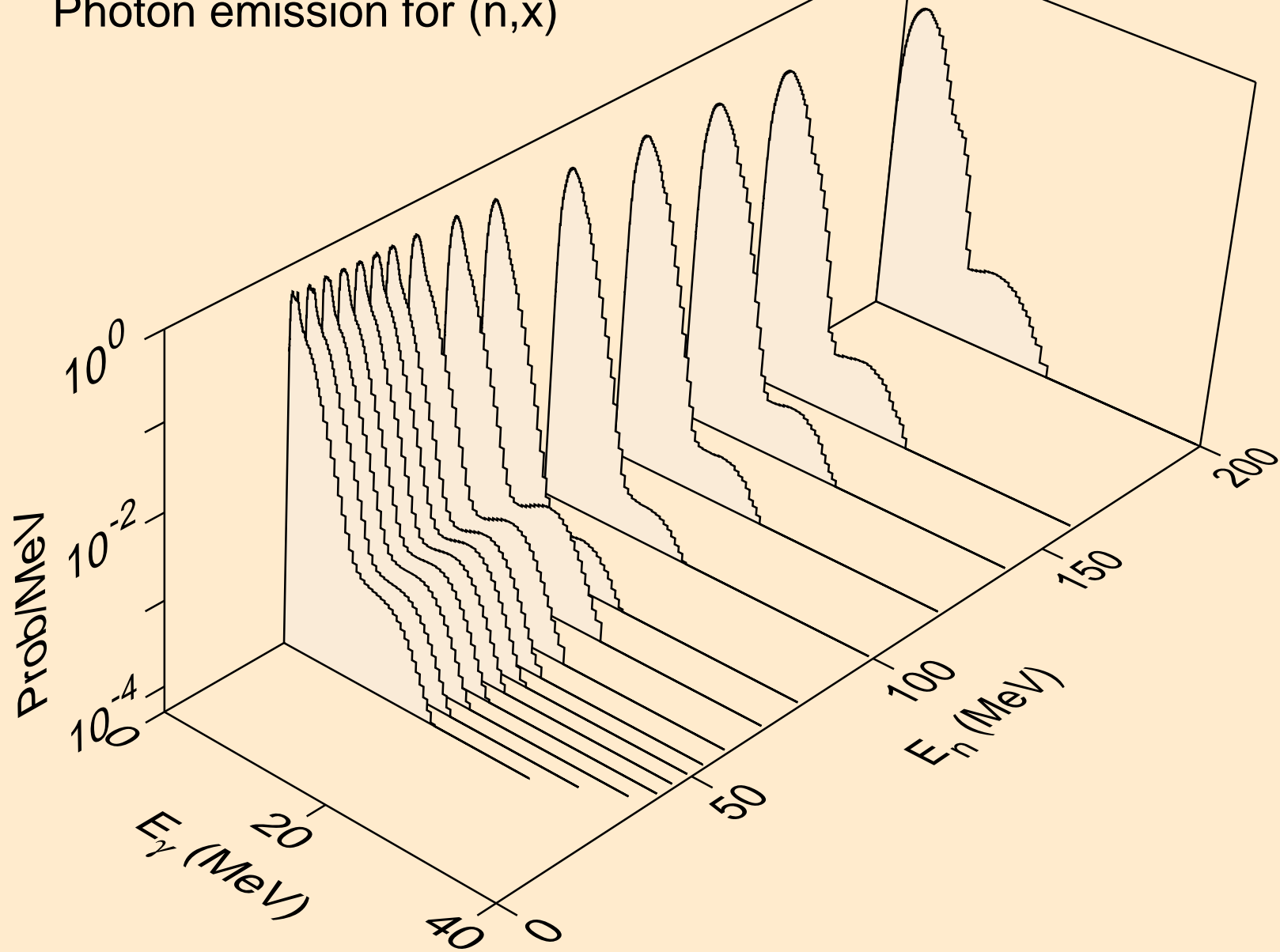

CD108 NEUTRON ACER TENDL-2021 LIBRARY; T=293.6K
Photon emission for (n,2nd)

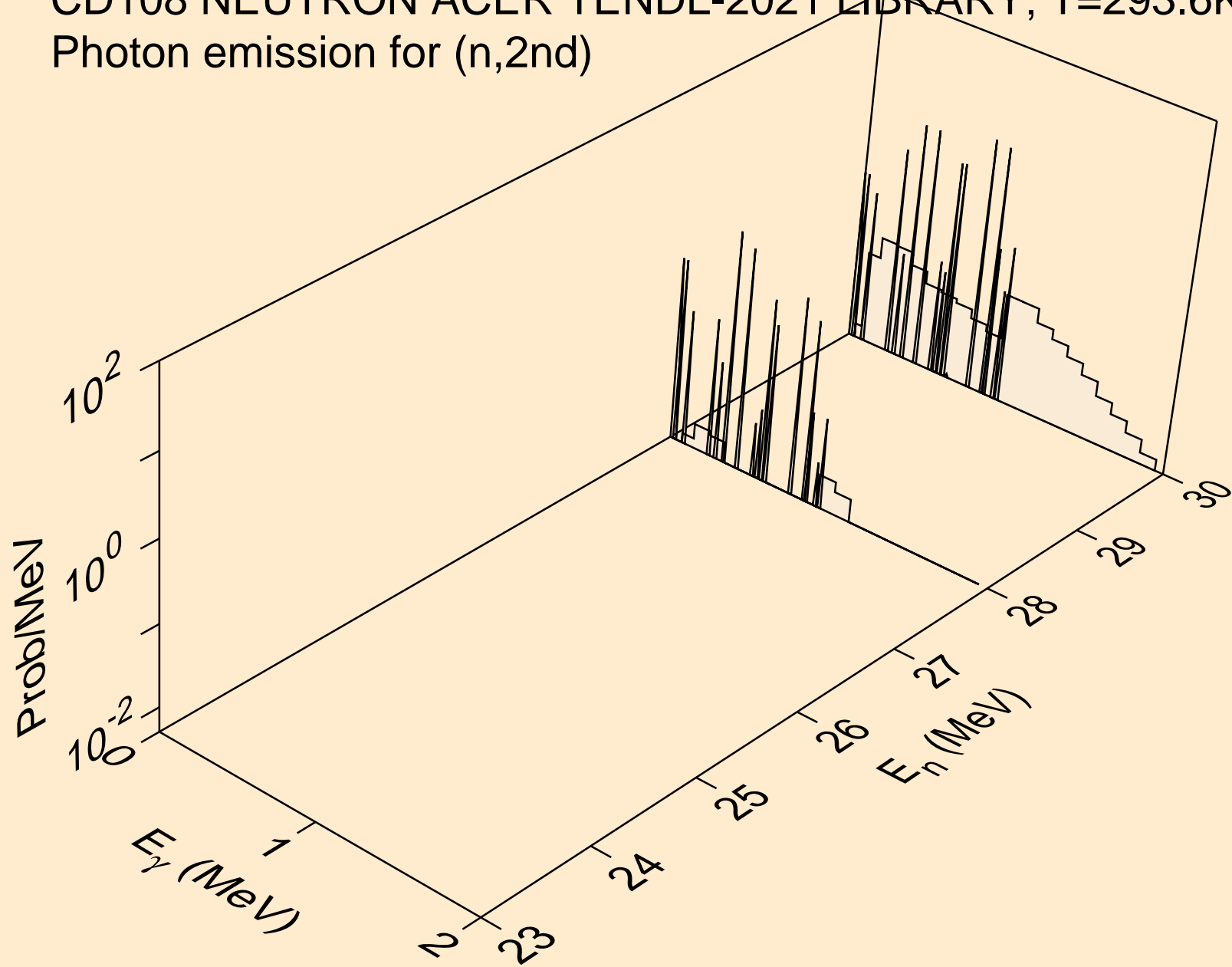

CD108 NEUTRON ACER TENDL-2021 LIBRARY; T=293.6K
Photon emission for (n,2n)

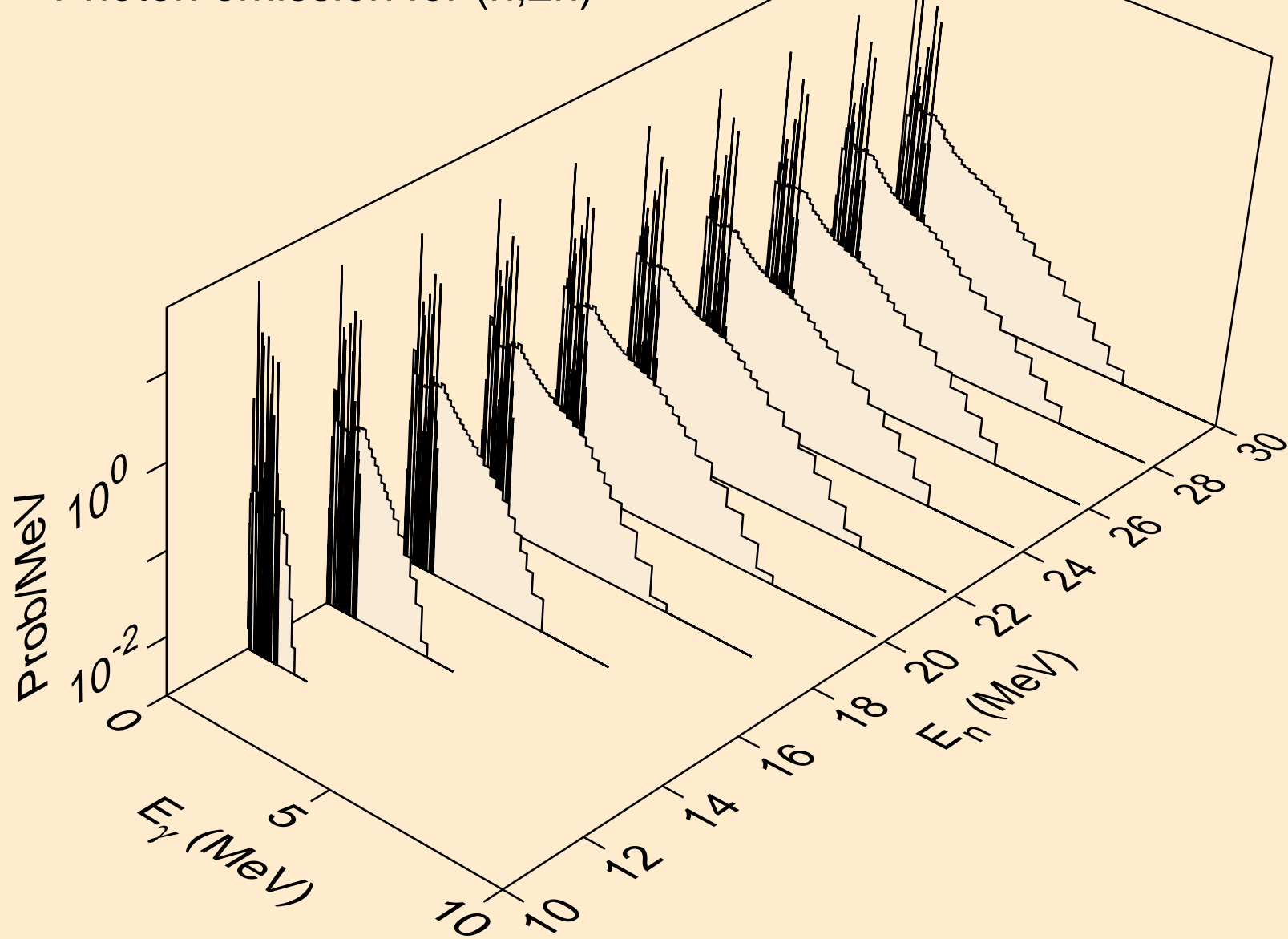

CD108 NEUTRON ACER TENDL-2021 LIBRARY; T=293.6K
Photon emission for (n,3n)

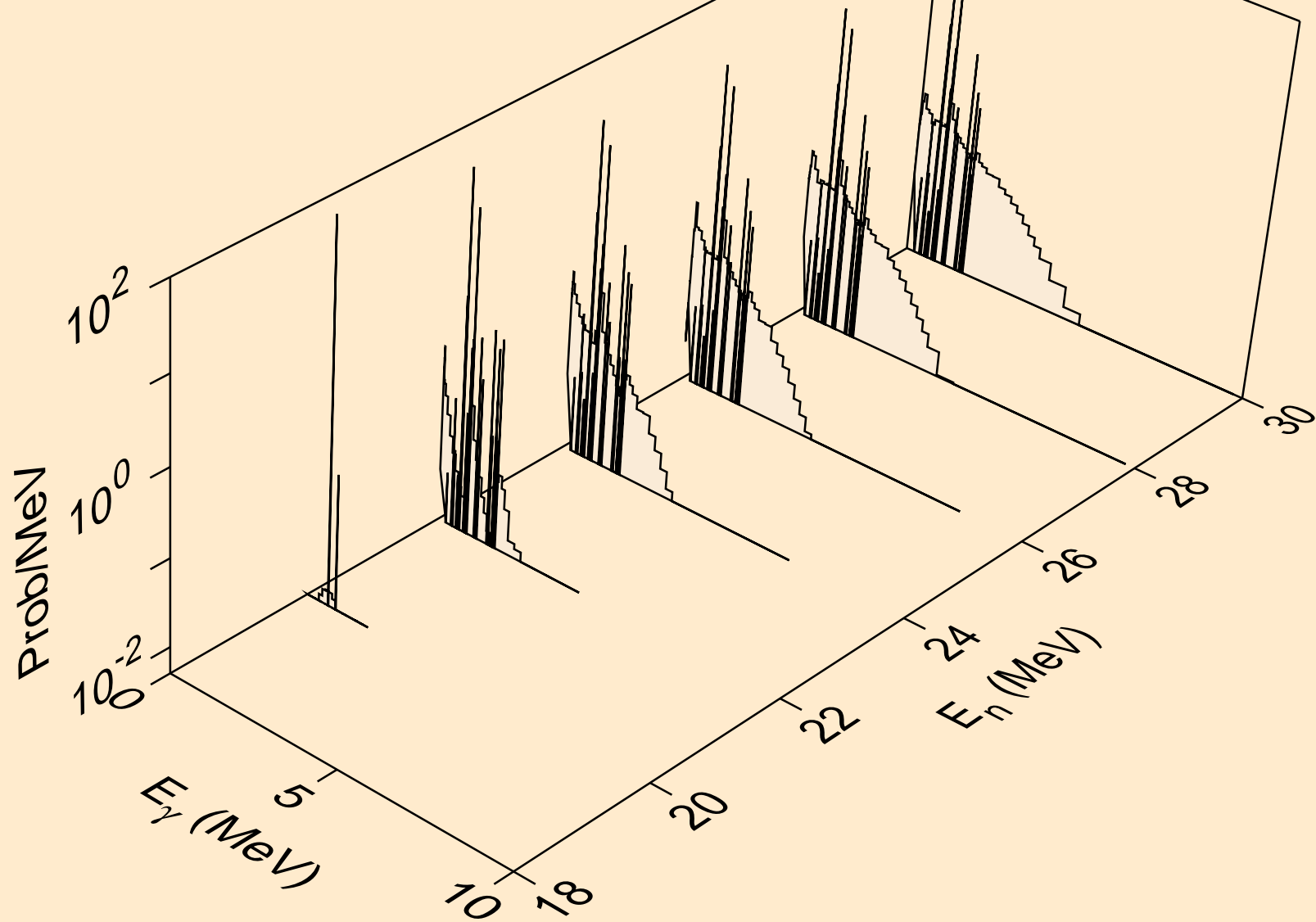

CD108 NEUTRON ACER TENDL-2021 LIBRARY; T=293.6K
Photon emission for (n,n*)a

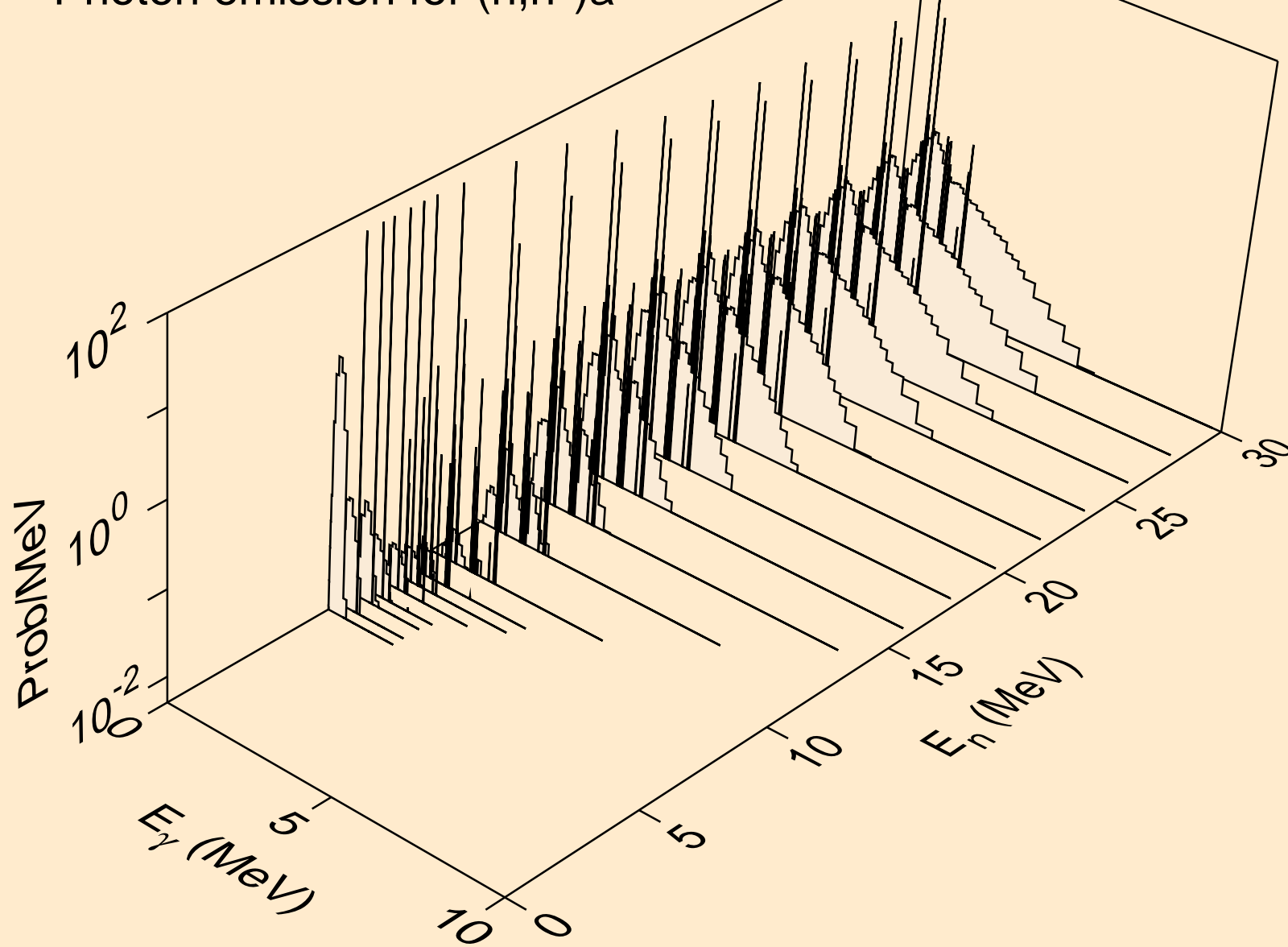

CD108 NEUTRON ACER TENDL-2021 LIBRARY; T=293.6K
Photon emission for (n,2n)a

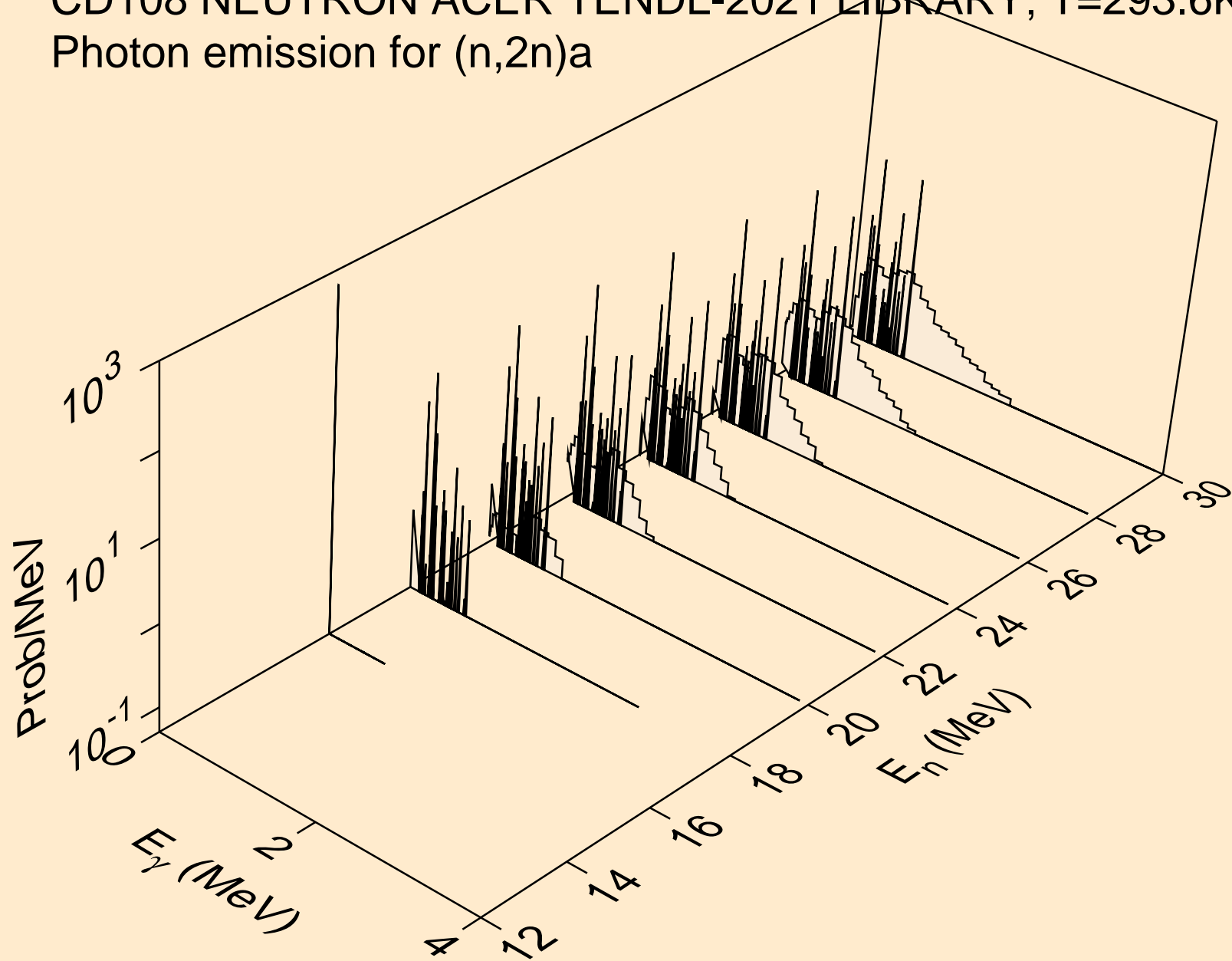

CD108 NEUTRON ACER TENDL-2021 LIBRARY; T=293.6K
Photon emission for (n,3n)a

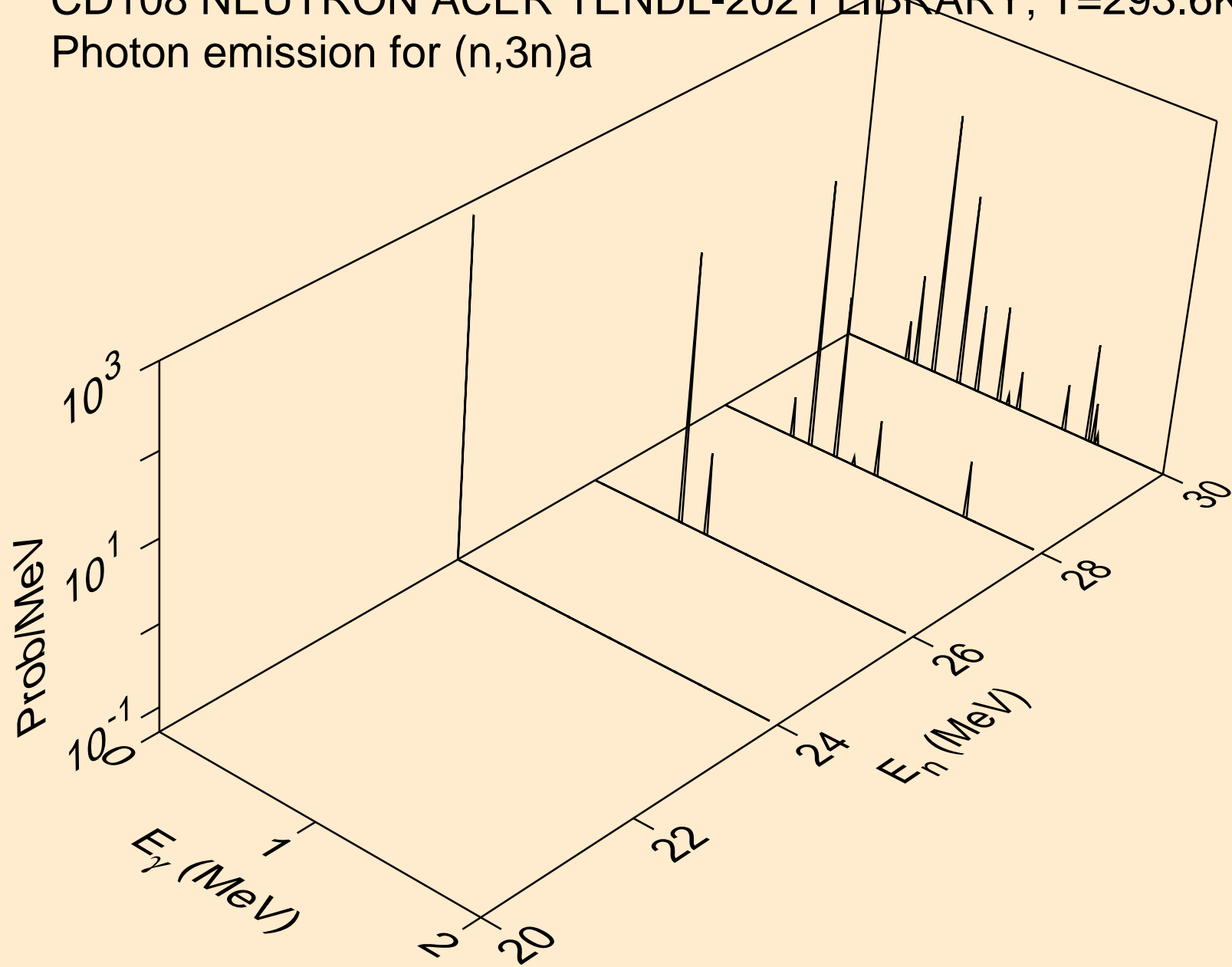

CD108 NEUTRON ACER TENDL-2021 LIBRARY; T=293.6K
Photon emission for (n,n*)p

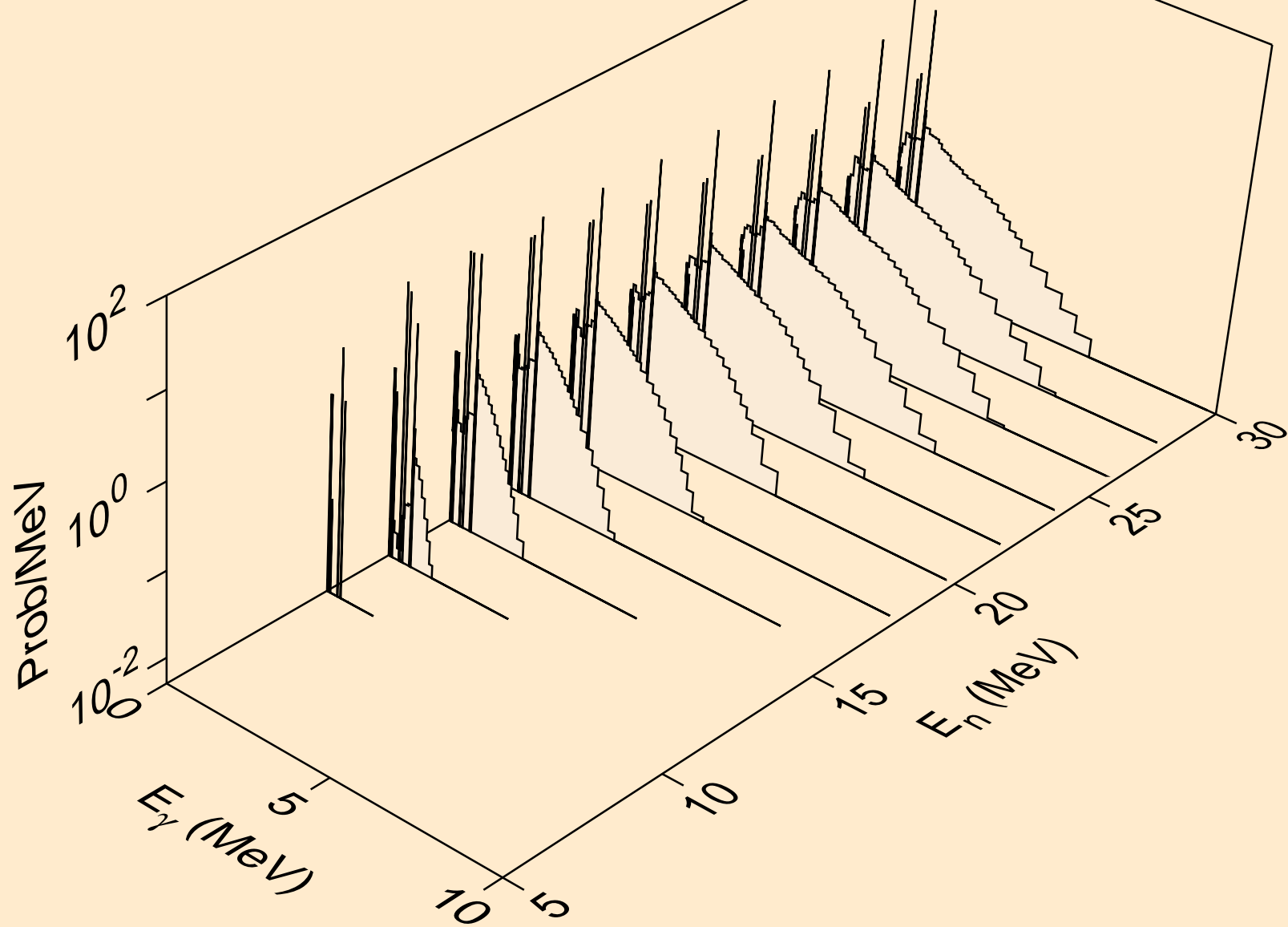

CD108 NEUTRON ACER TENDL-2021 LIBRARY; T=293.6K
Photon emission for (n,n*)2a

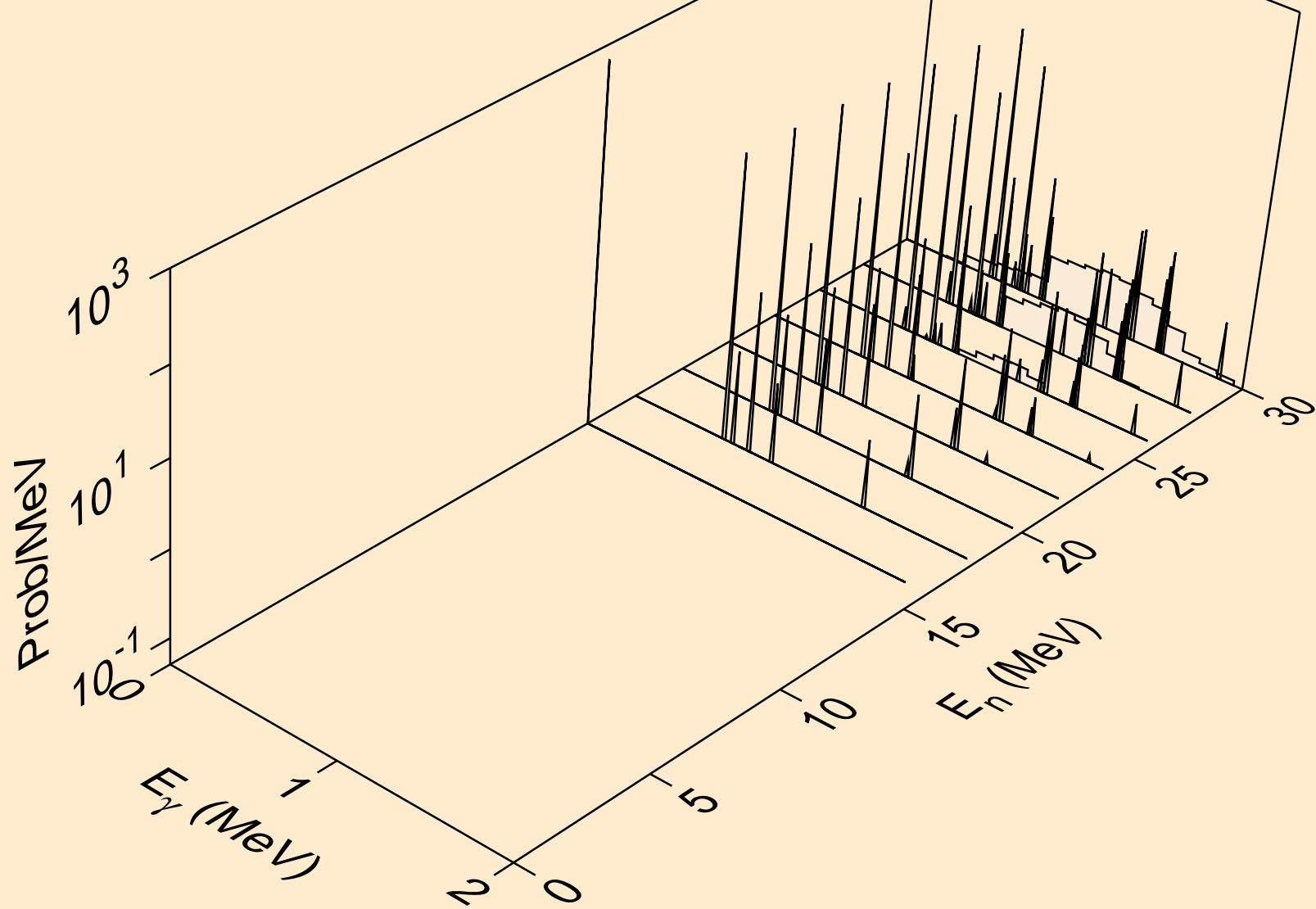

CD108 NEUTRON ACER TENDL-2021 LIBRARY; T=293.6K
Photon emission for (n,n*)d

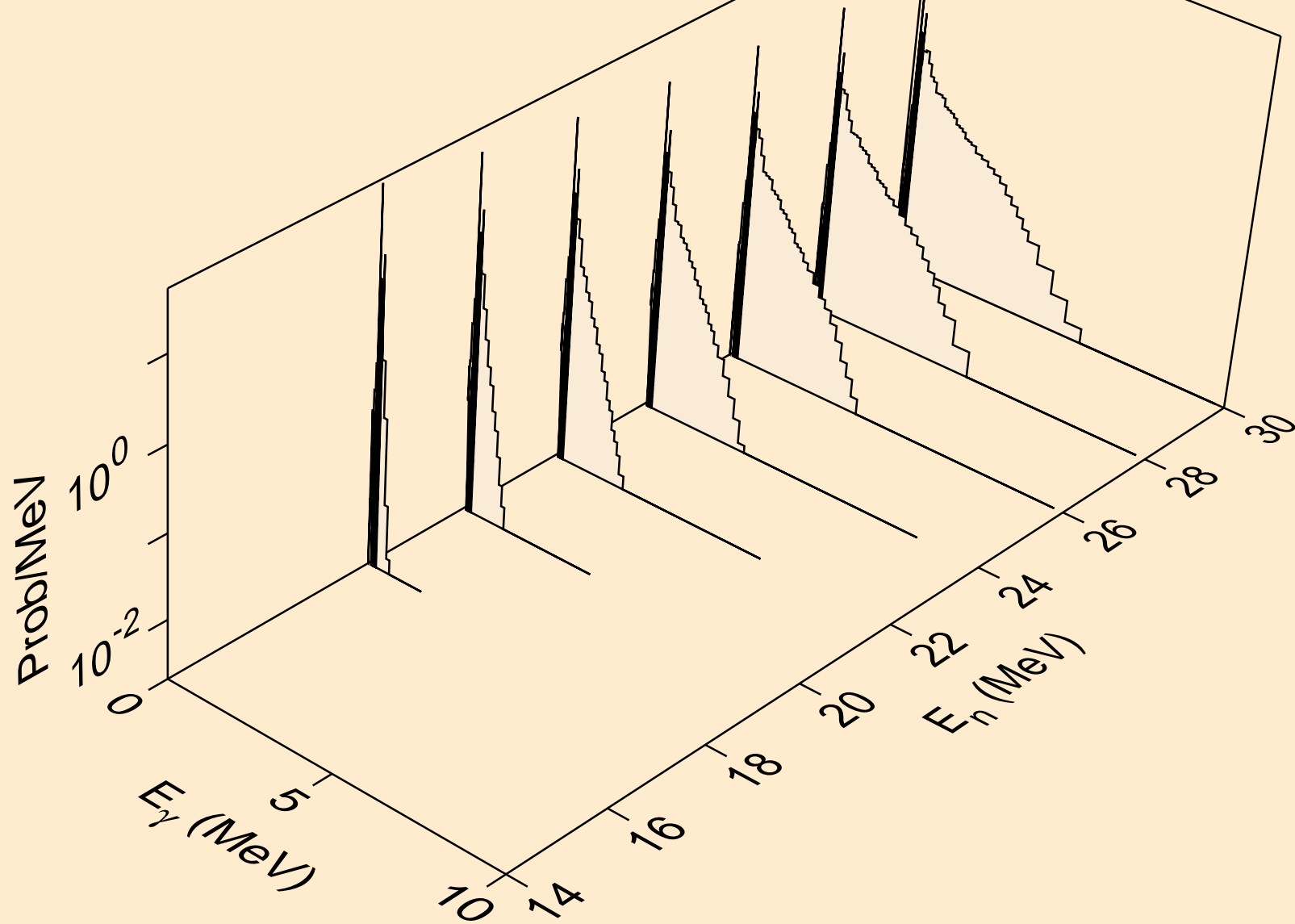

CD108 NEUTRON ACER TENDL-2021 LIBRARY; T=293.6K
Photon emission for (n,n*)t

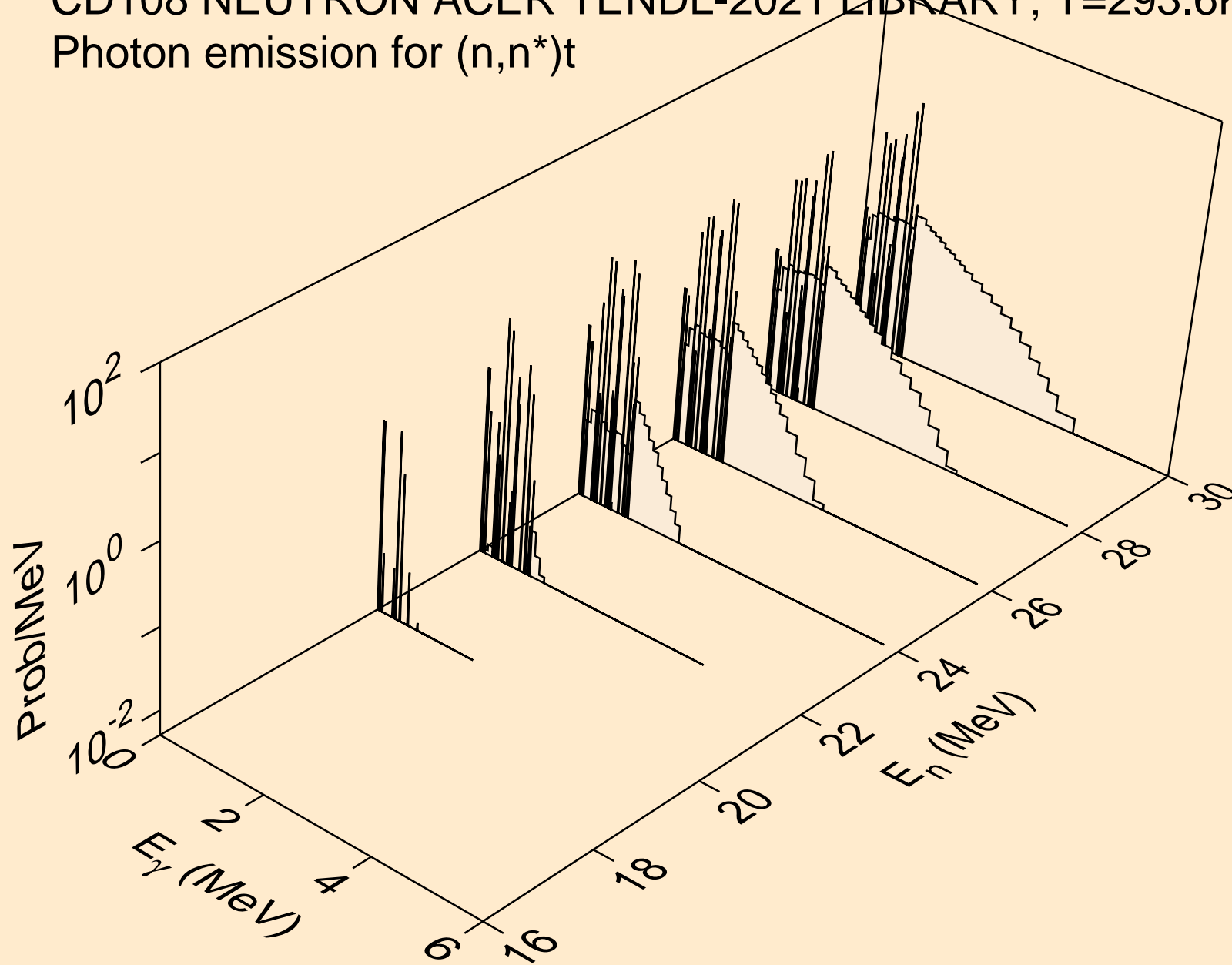

CD108 NEUTRON ACER TENDL-2021 LIBRARY; T=293.6K
Photon emission for (n,n*)he3

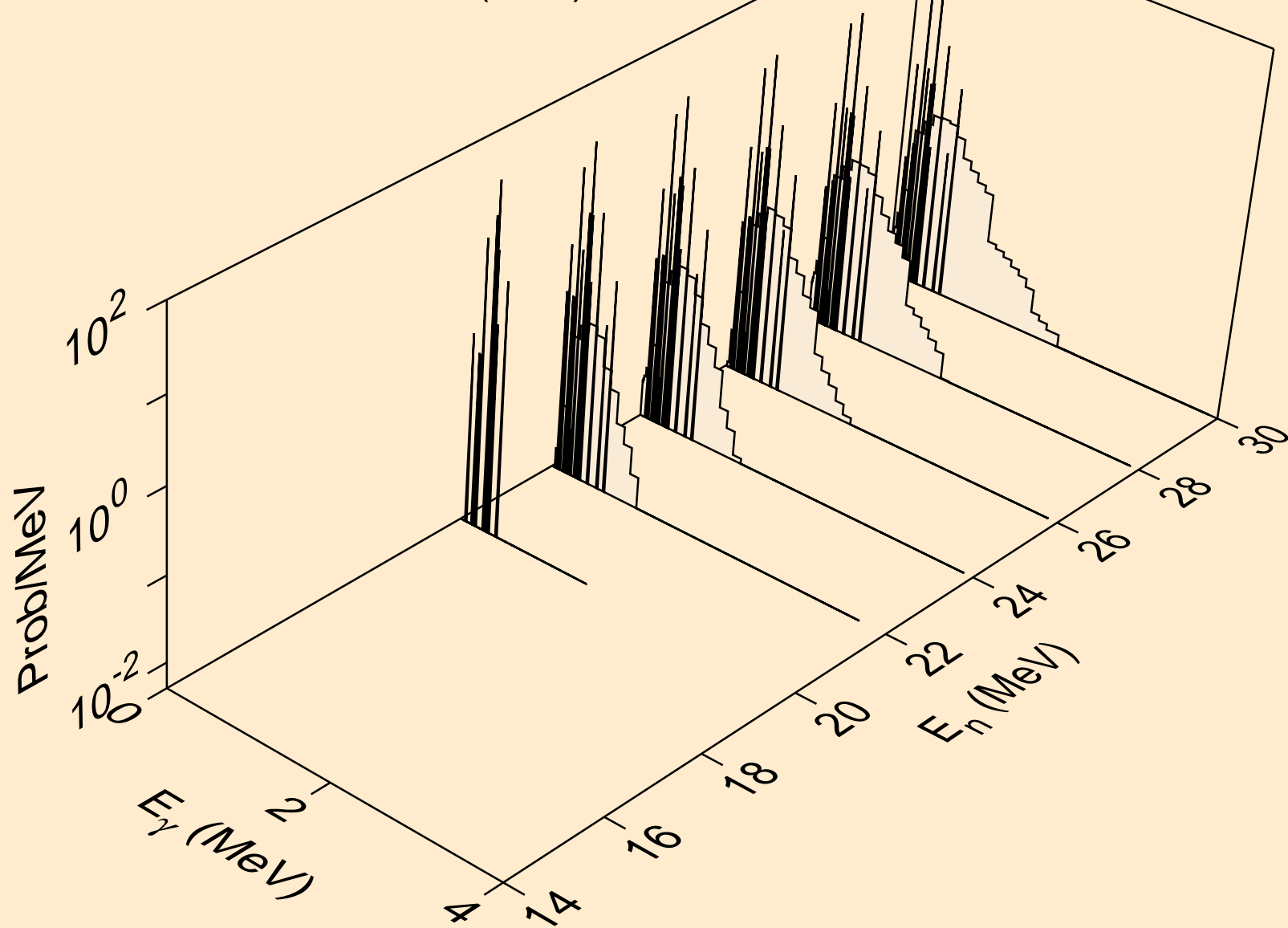

CD108 NEUTRON ACER TENDL-2021 LIBRARY; T=293.6K
Photon emission for (n,2np)

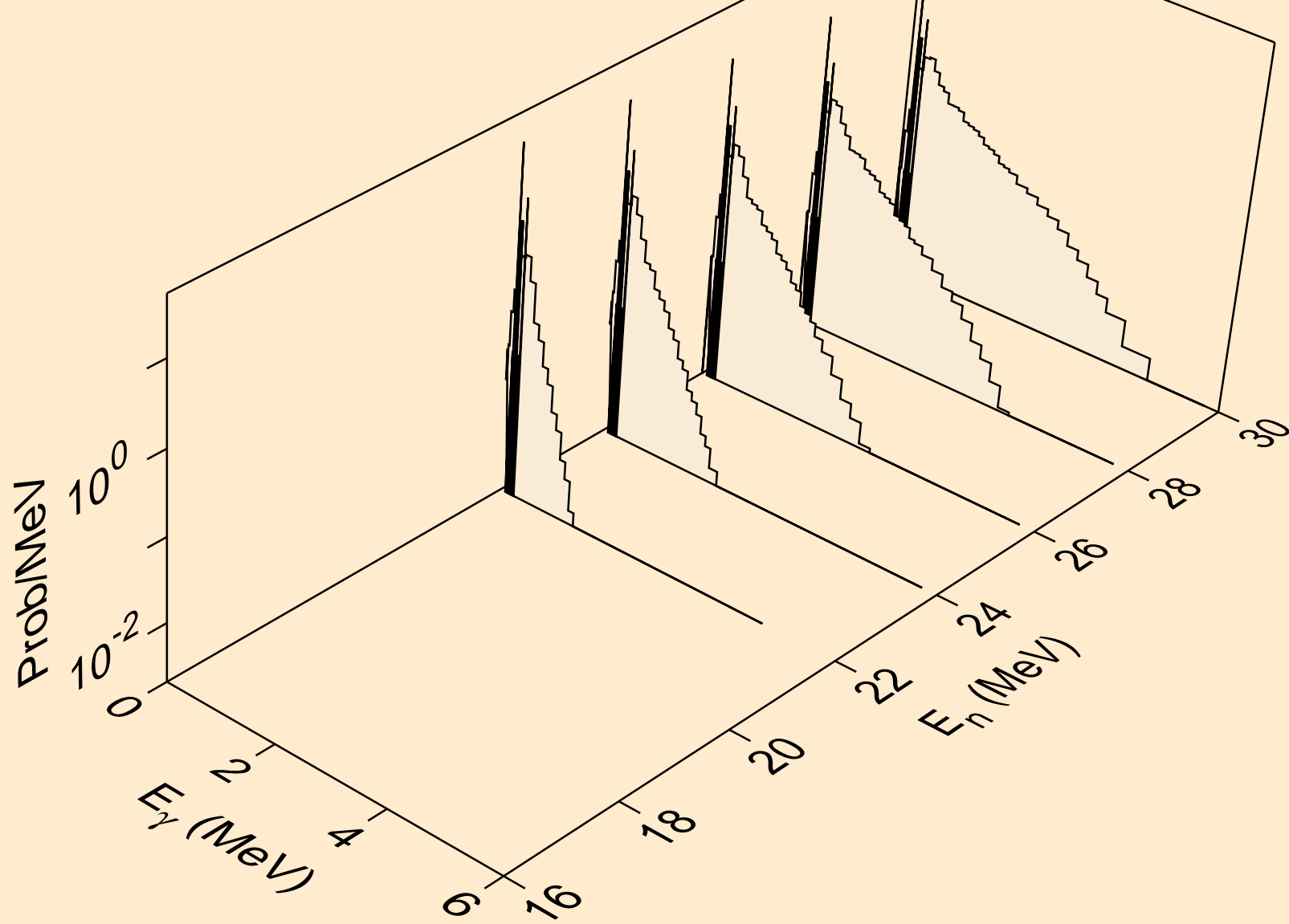

CD108 NEUTRON ACER TENDL-2021 LIBRARY; T=293.6K
Photon emission for (n,3np)

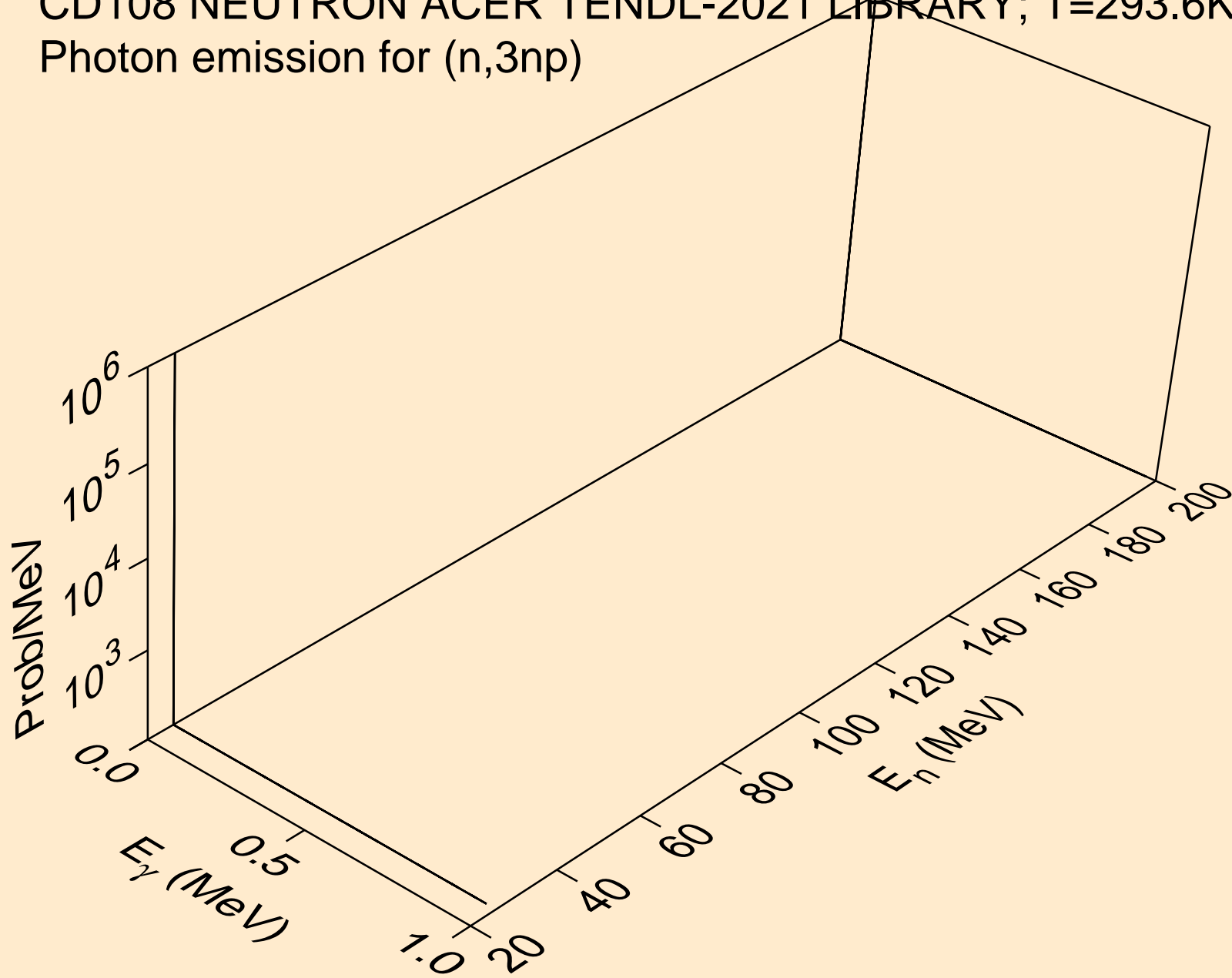

CD108 NEUTRON ACER TENDL-2021 LIBRARY; T=293.6K
Photon emission for (n,2np)

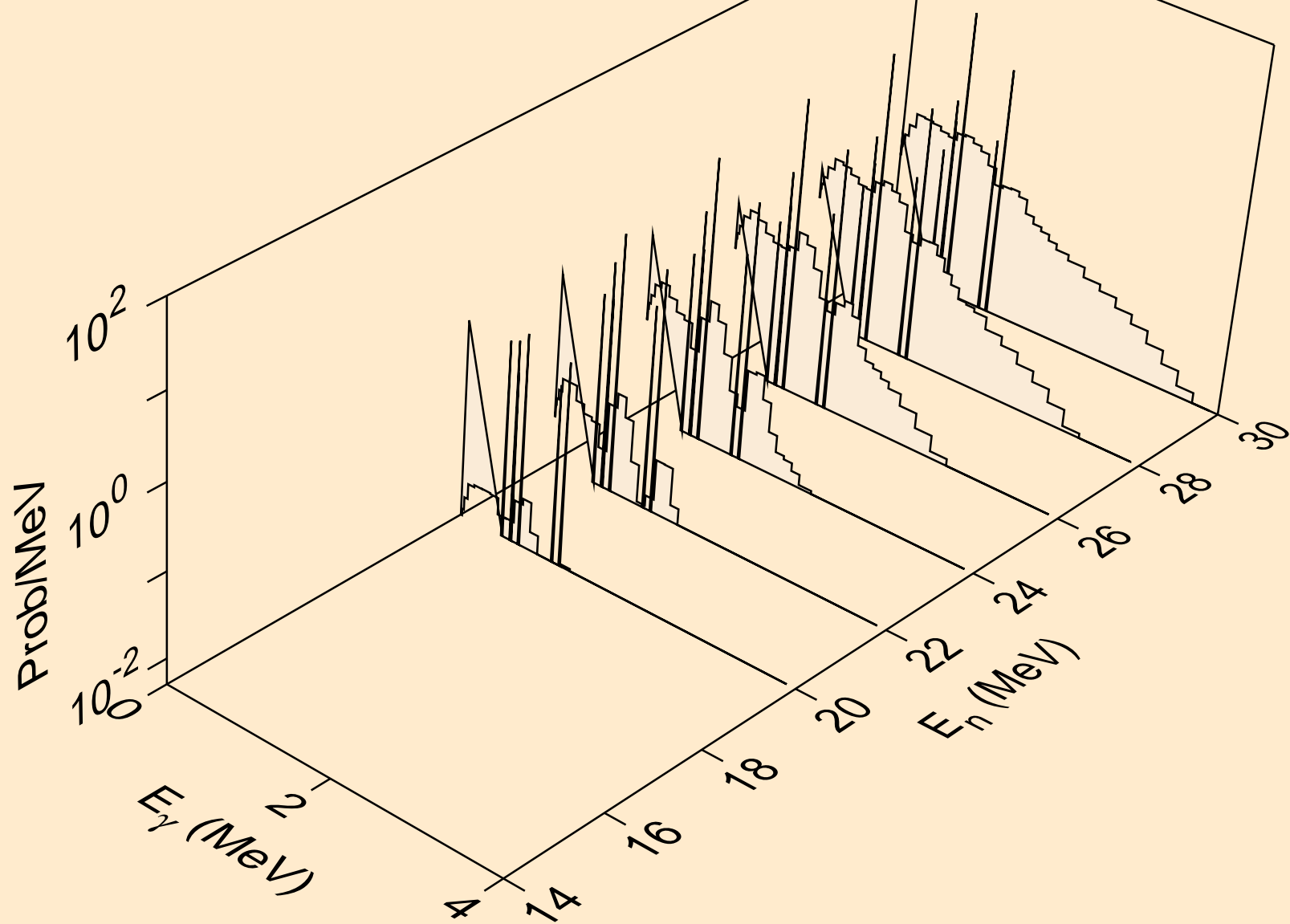

CD108 NEUTRON ACER TENDL-2021 LIBRARY; T=293.6K
Photon emission for (n,npa)

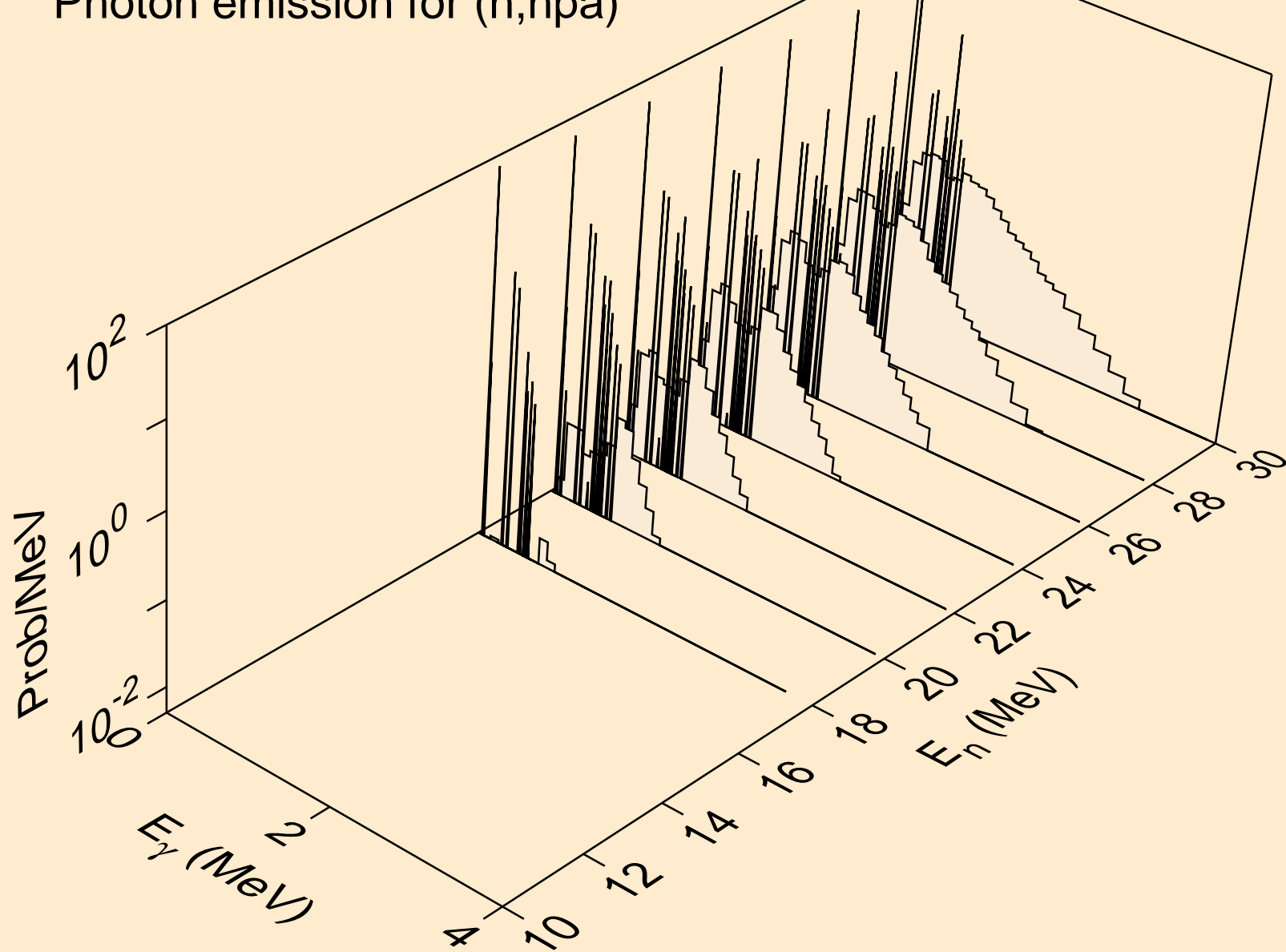

CD108 NEUTRON ACER TENDL-2021 LIBRARY; T=293.6K
Photon emission for (n,n*c)

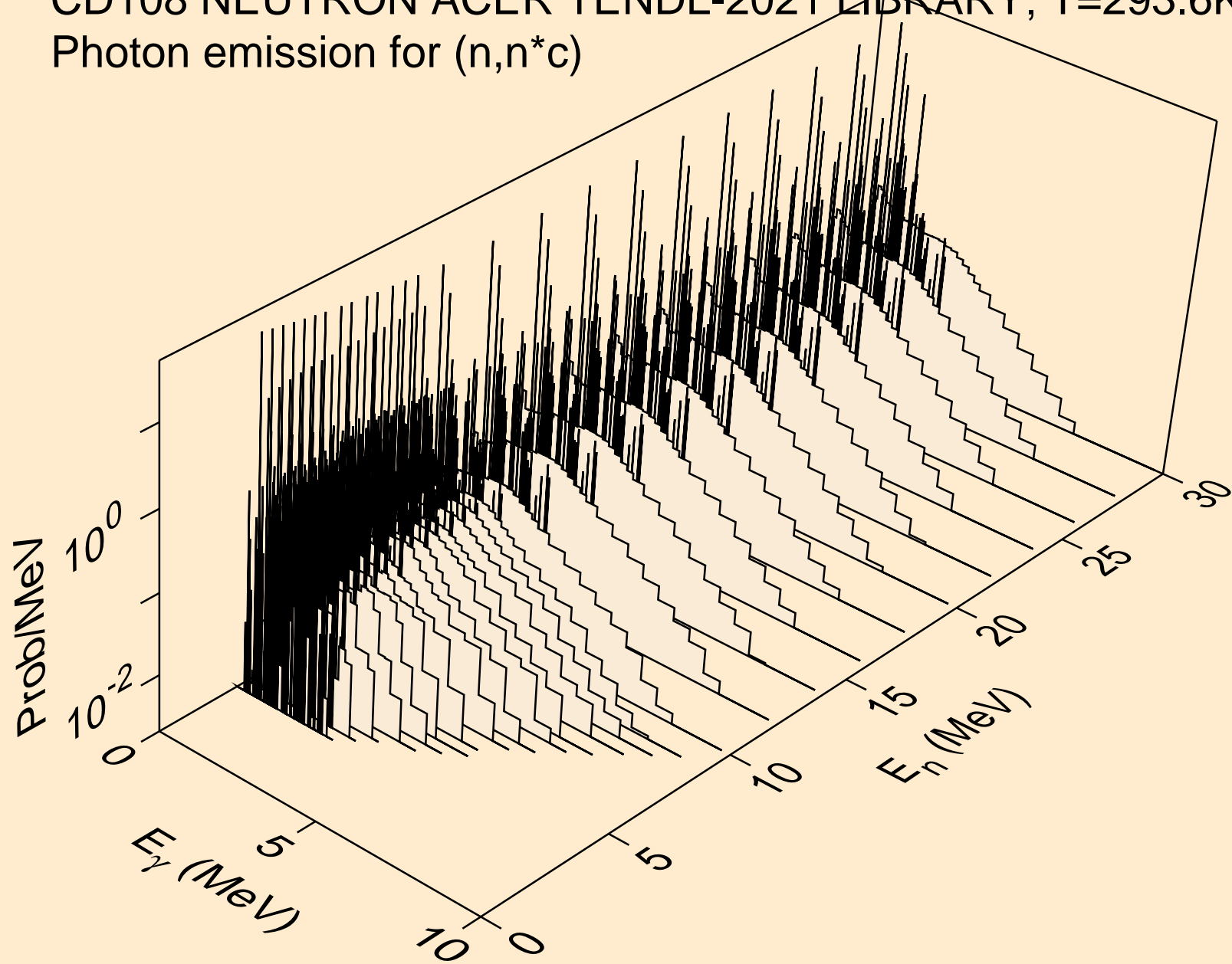

CD108 NEUTRON ACER TENDL-2021 LIBRARY; T=293.6K
Photon emission for (n,gma)

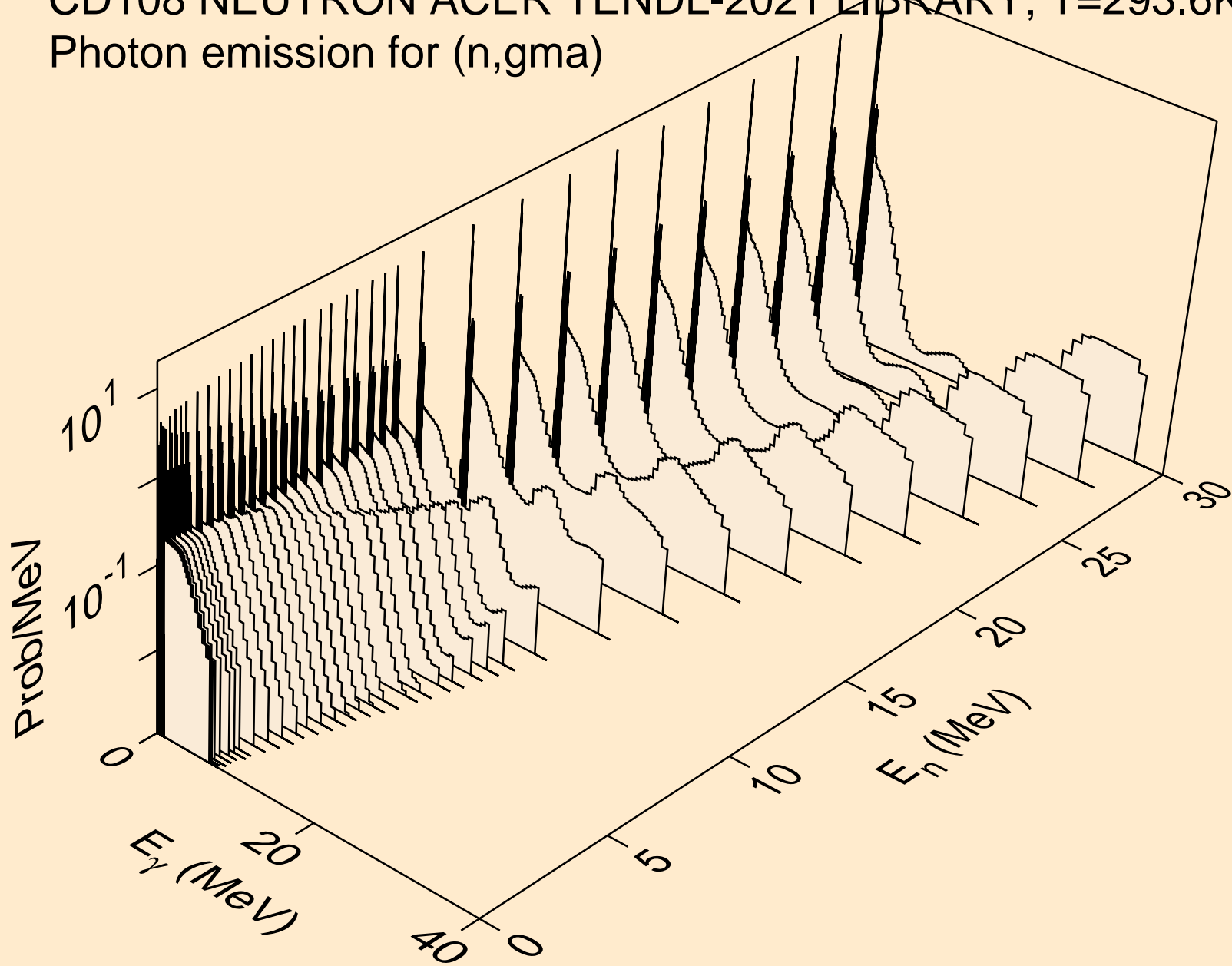

CD108 NEUTRON ACER TENDL-2021 LIBRARY; T=293.6K
Photon emission for (n,p)

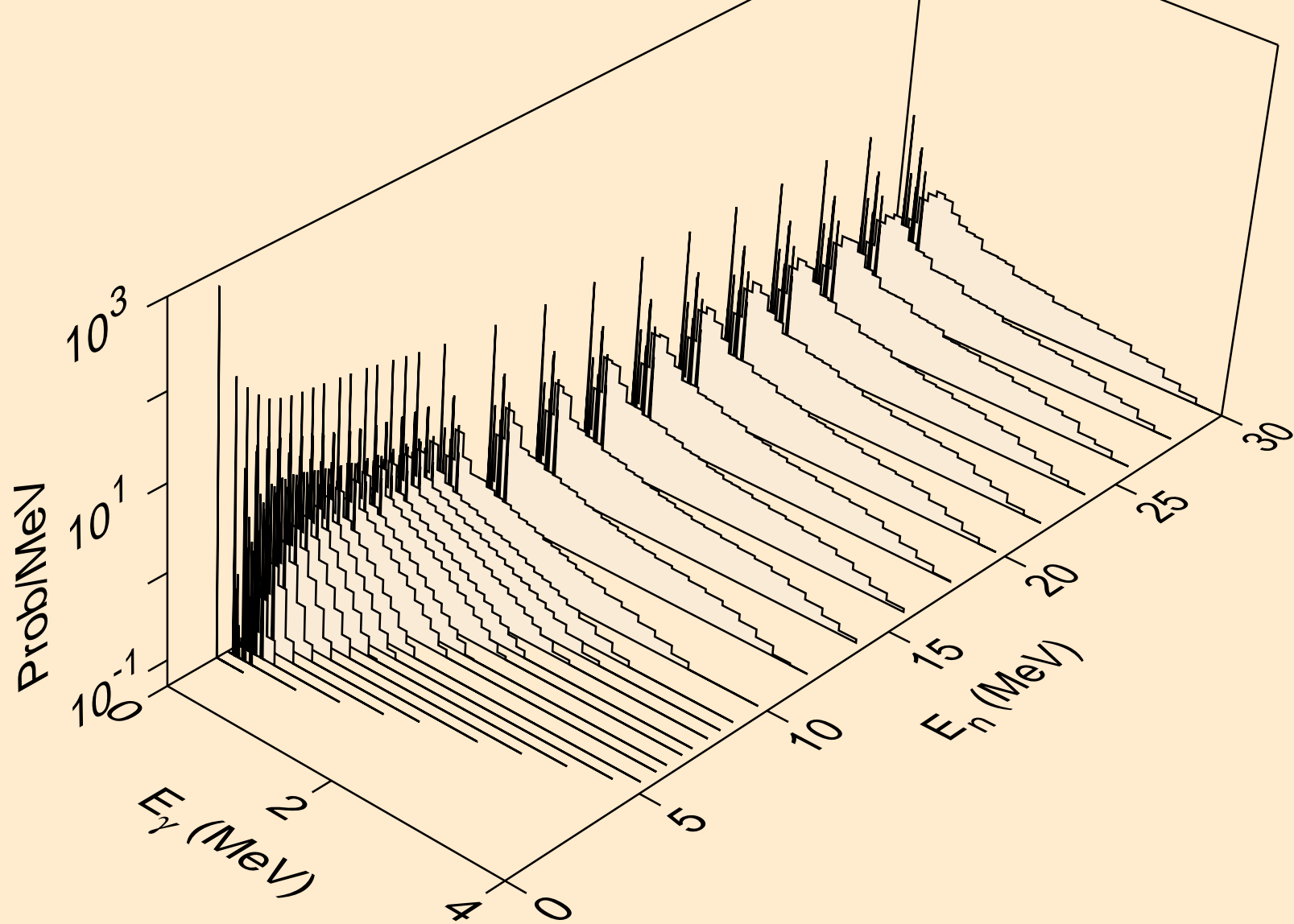

CD108 NEUTRON ACER TENDL-2021 LIBRARY; T=293.6K
Photon emission for (n,d)

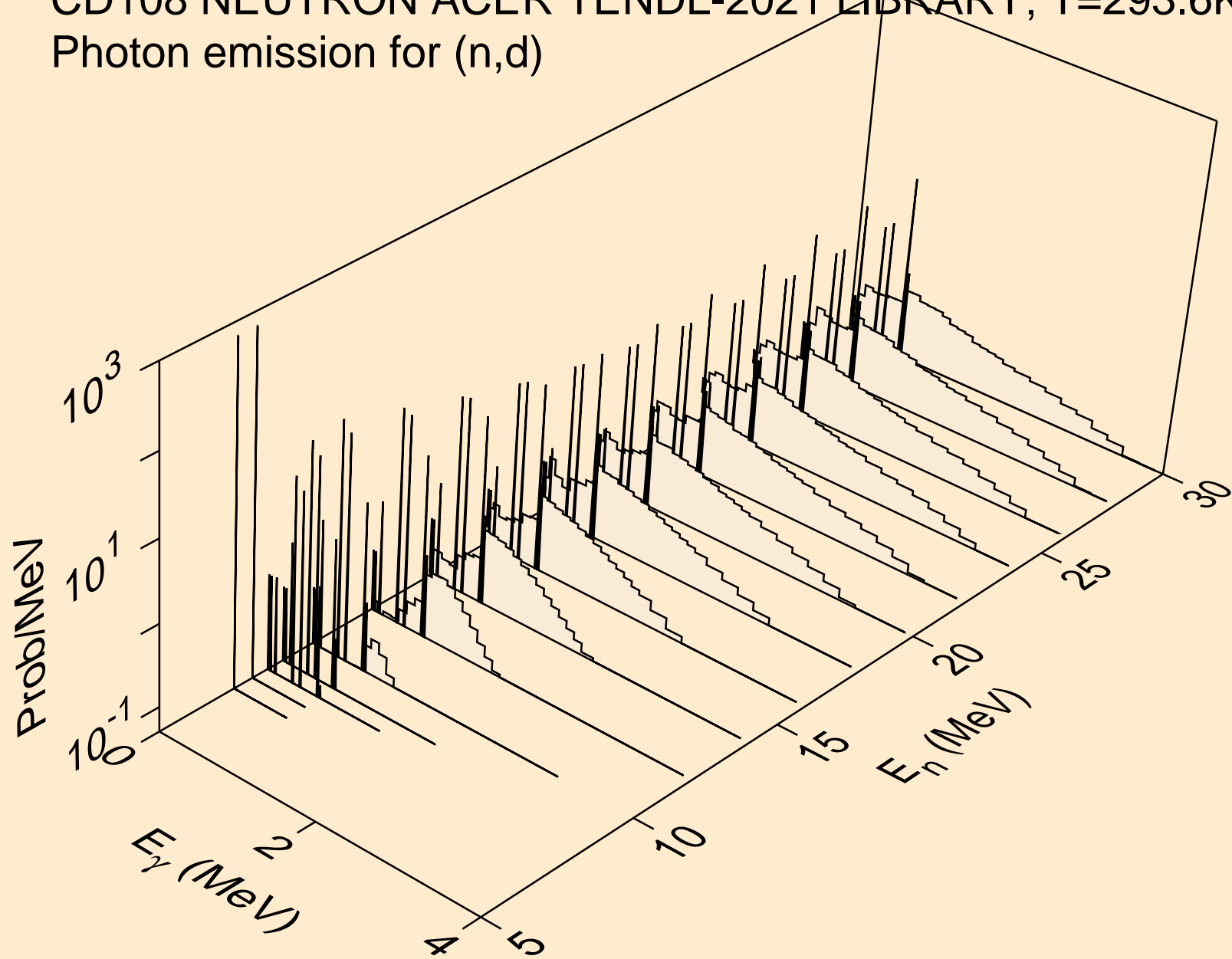

CD108 NEUTRON ACER TENDL-2021 LIBRARY; T=293.6K
Photon emission for (n,t)

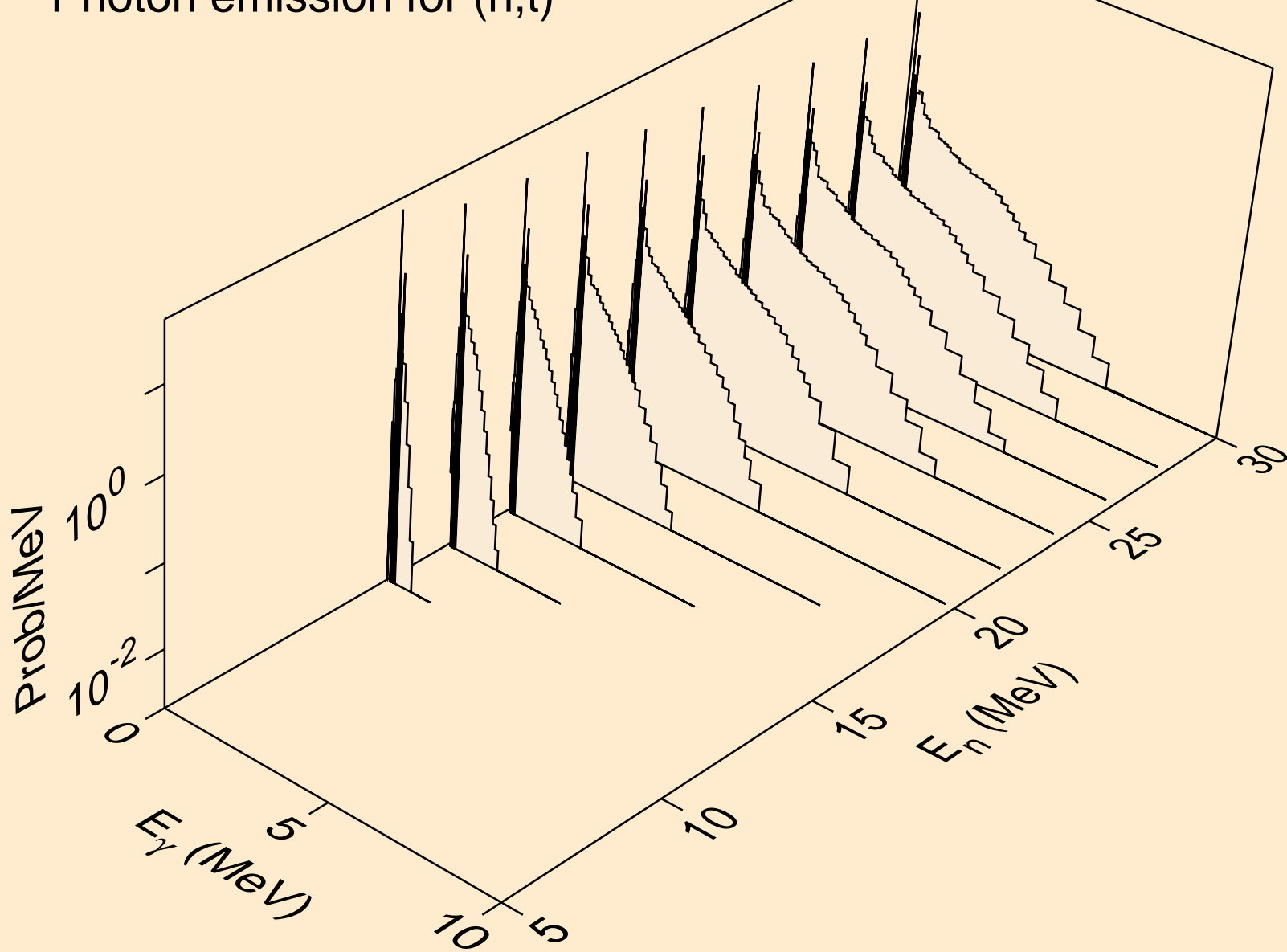

CD108 NEUTRON ACER TENDL-2021 LIBRARY; T=293.6K
Photon emission for (n,he3)

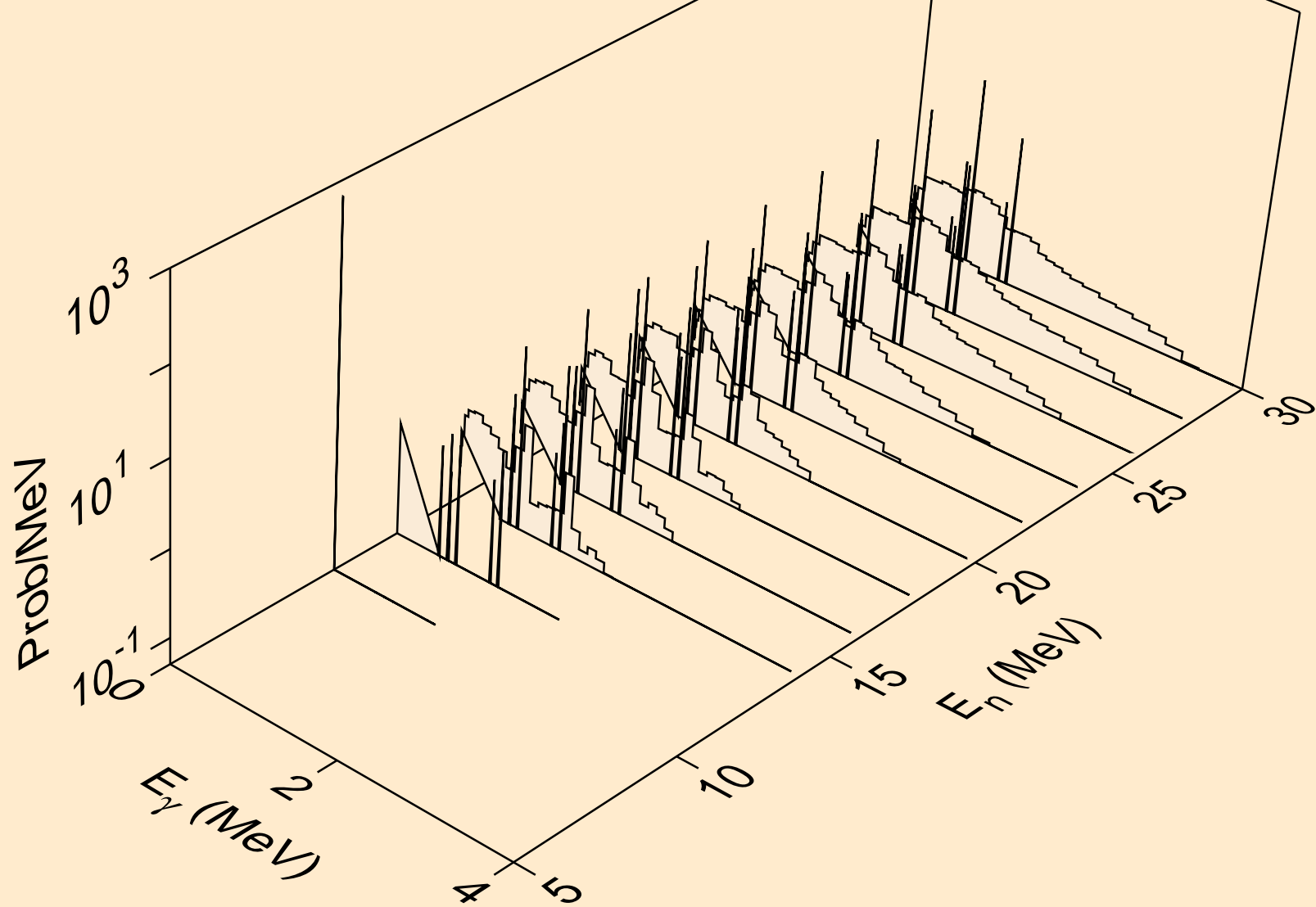

CD108 NEUTRON ACER TENDL-2021 LIBRARY; T=293.6K
Photon emission for (n,a)

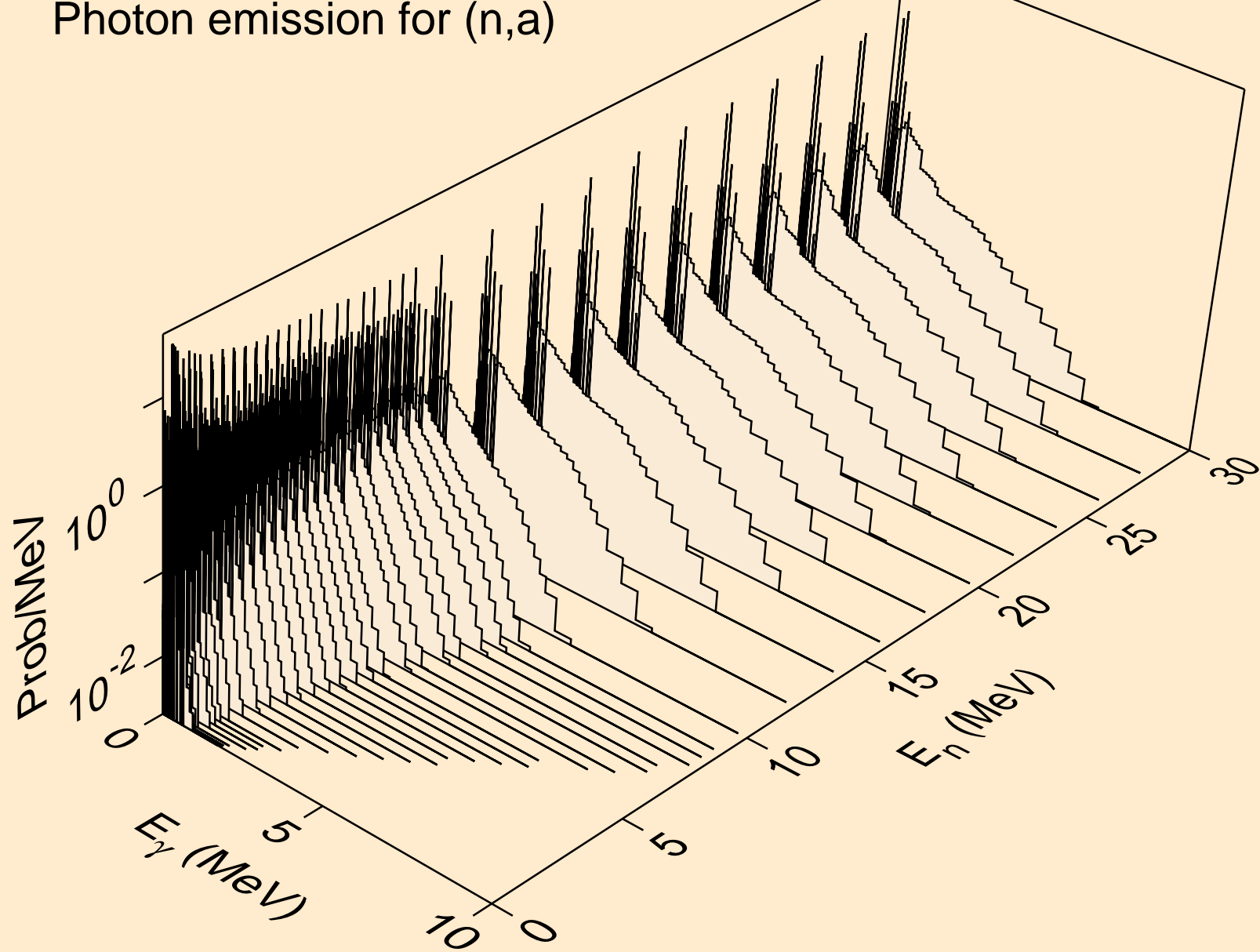

CD108 NEUTRON ACER TENDL-2021 LIBRARY; T=293.6K
Photon emission for (n,2a)

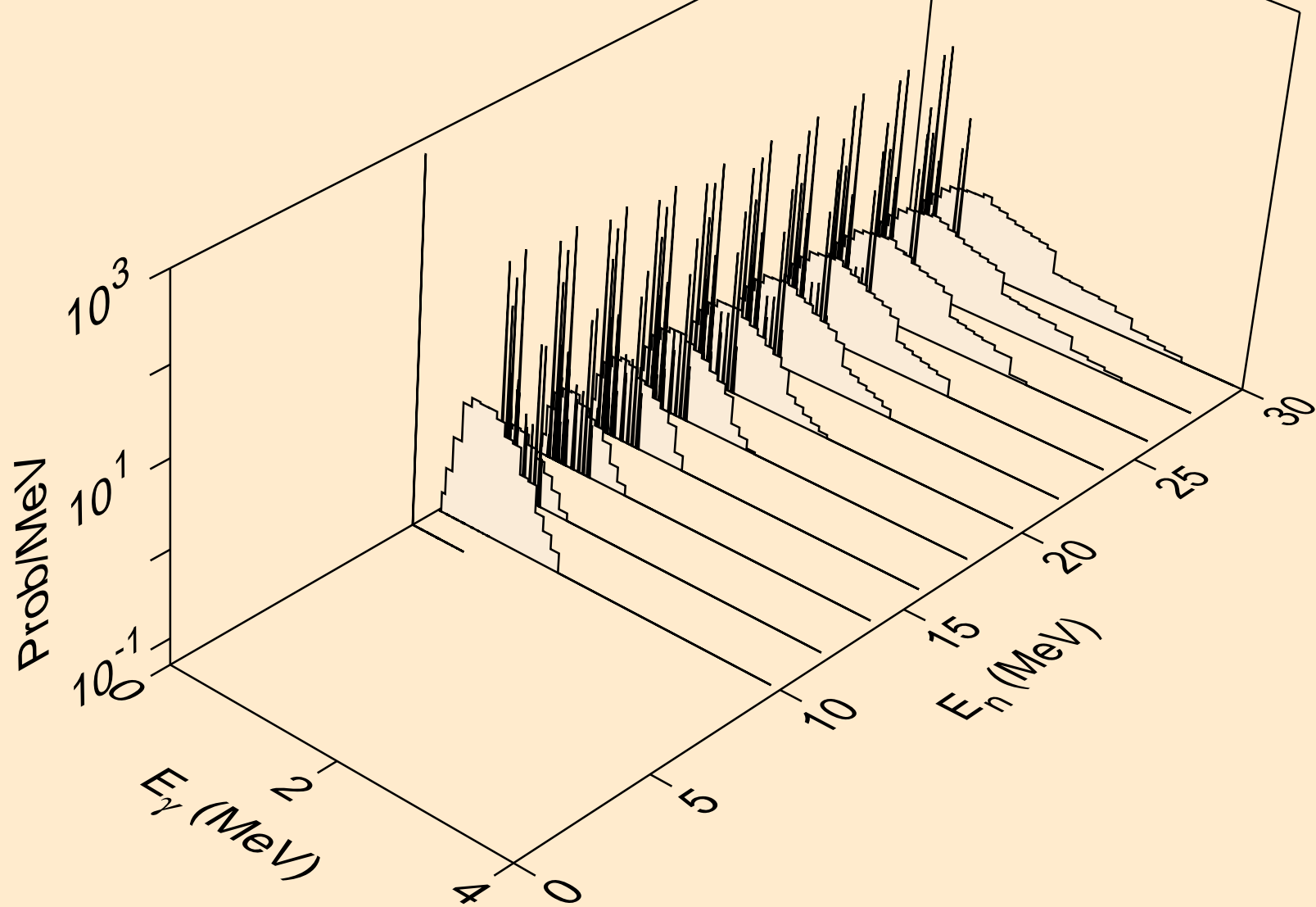

CD108 NEUTRON ACER TENDL-2021 LIBRARY; T=293.6K
Photon emission for (n,2p)

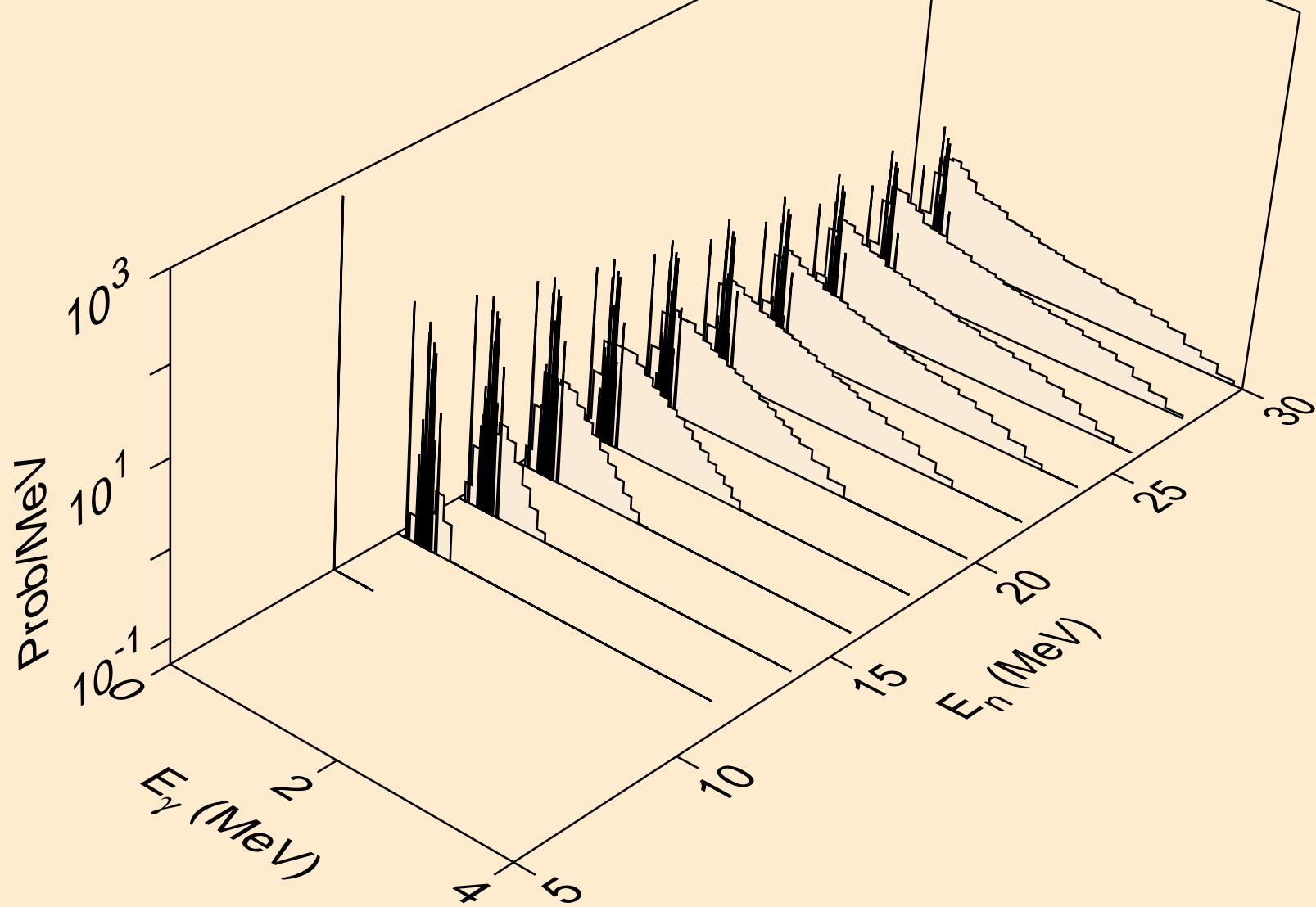

CD108 NEUTRON ACER TENDL-2021 LIBRARY; T=293.6K
Photon emission for (n,p)

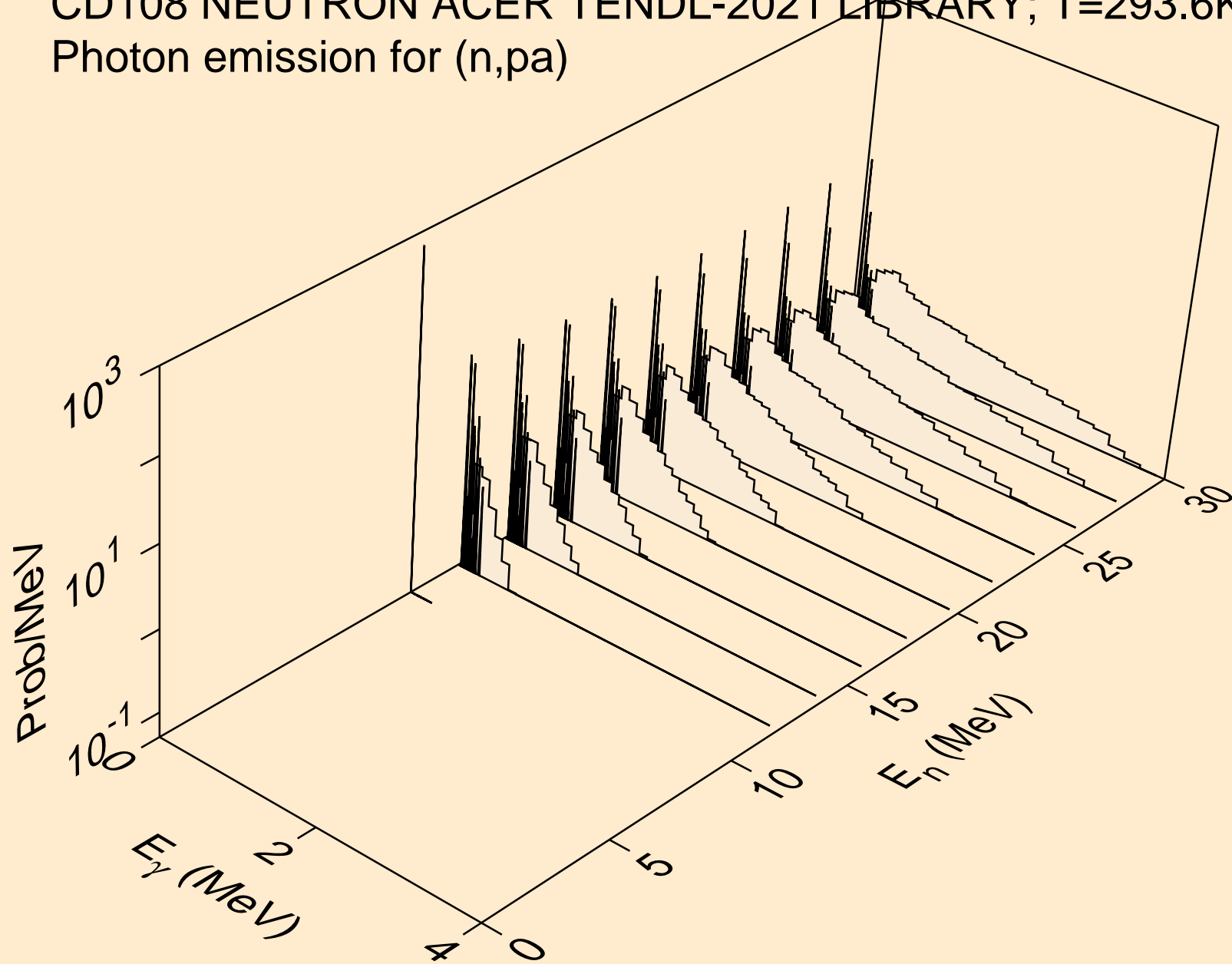

CD108 NEUTRON ACER TENDL-2021 LIBRARY; T=293.6K
Photon emission for (n,pd)

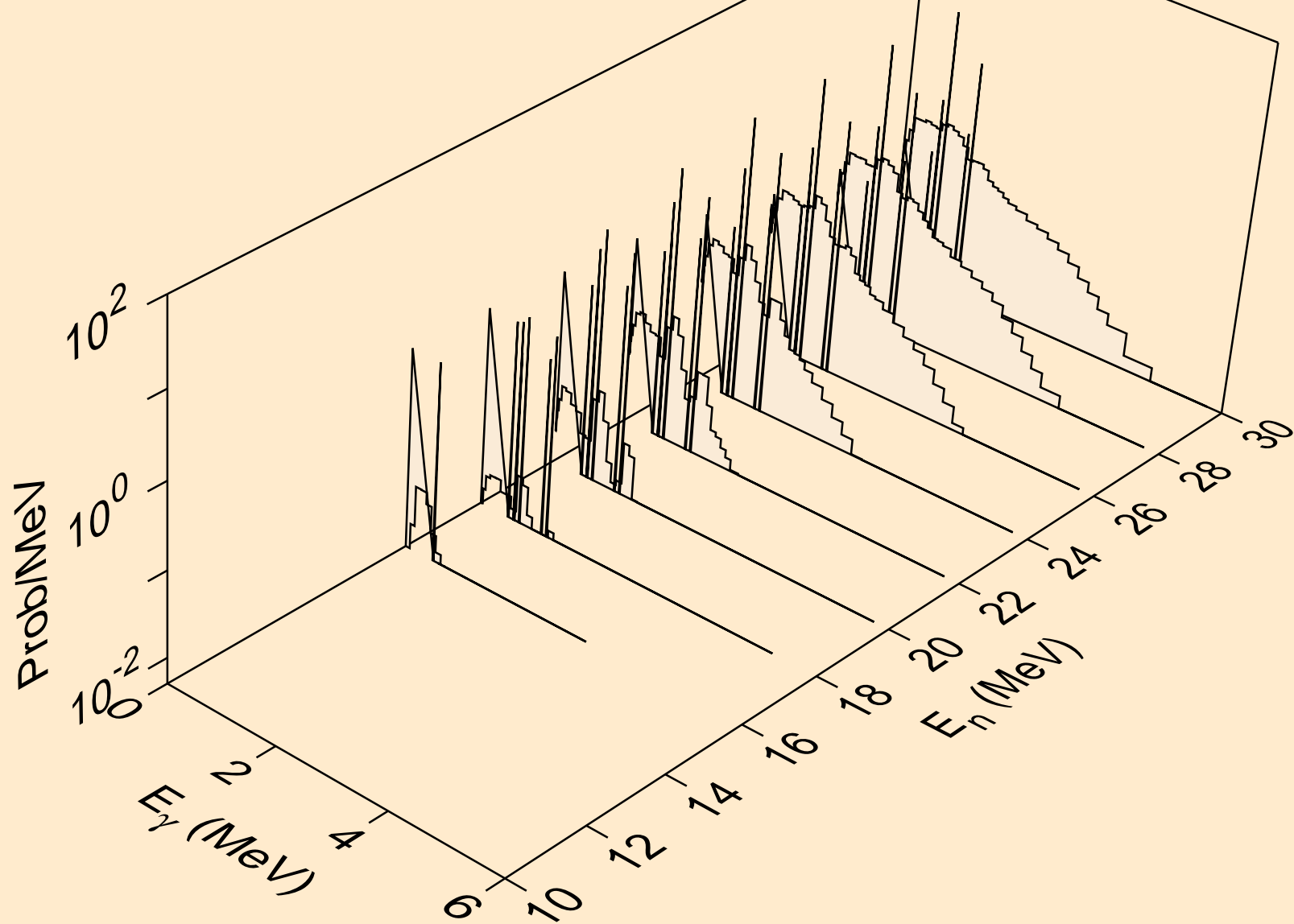

CD108 NEUTRON ACER TENDL-2021 LIBRARY; T=293.6K
Photon emission for (n,pt)

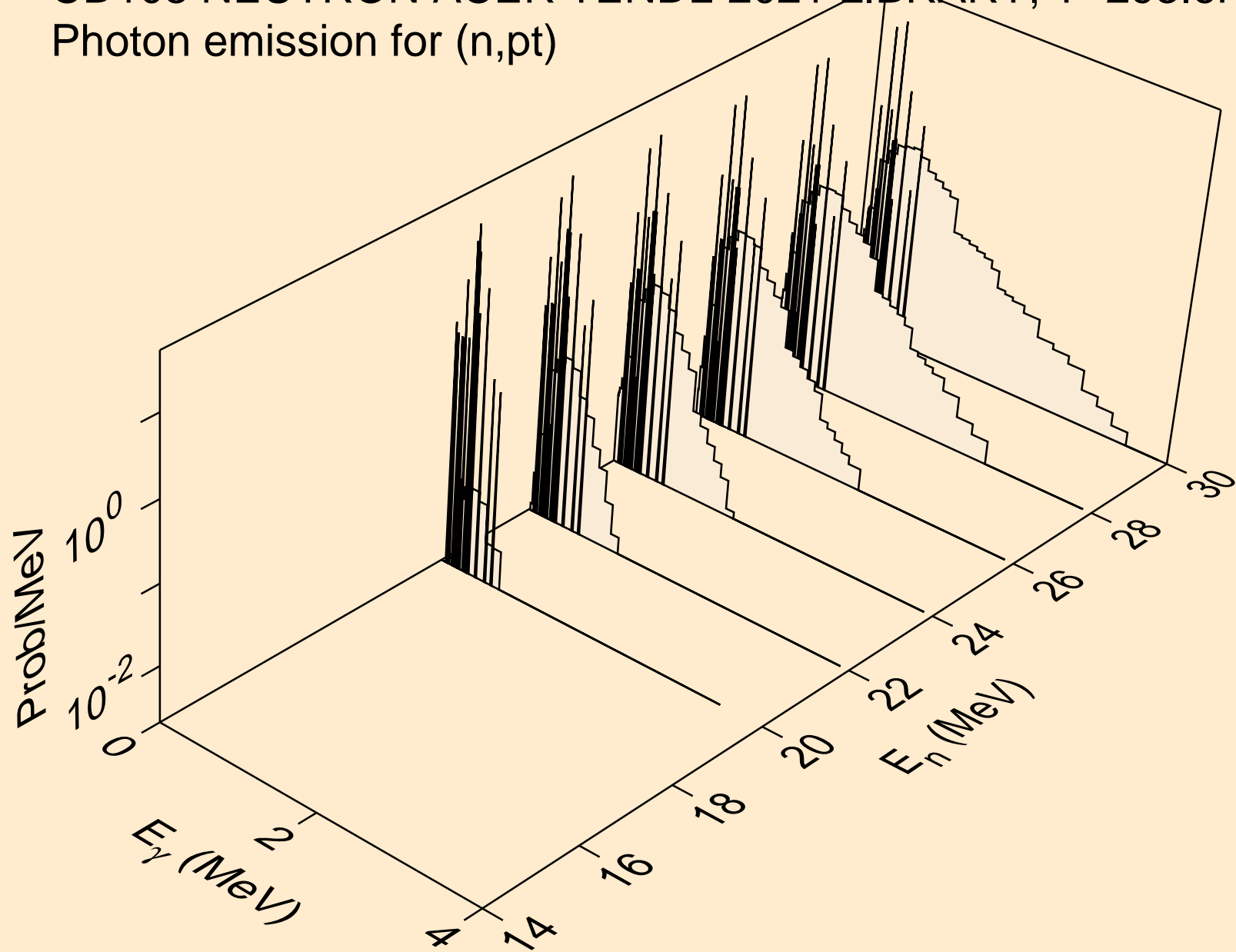

CD108 NEUTRON ACER TENDL-2021 LIBRARY; T=293.6K
Photon emission for (n,da)

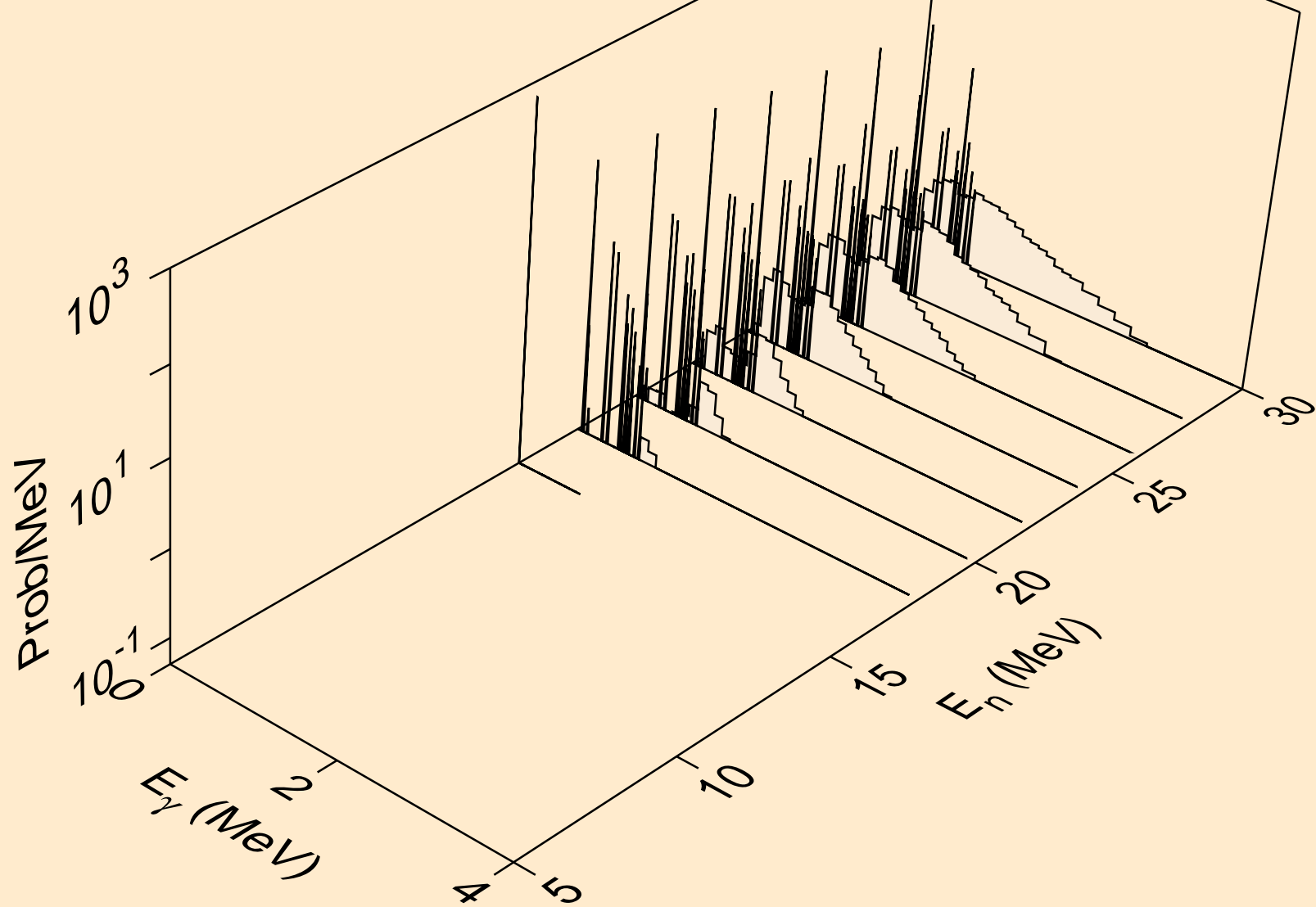

CD108 NEUTRON ACER TENDL-2021 LIBRARY; T=293.6K
thermal capture photon spectrum

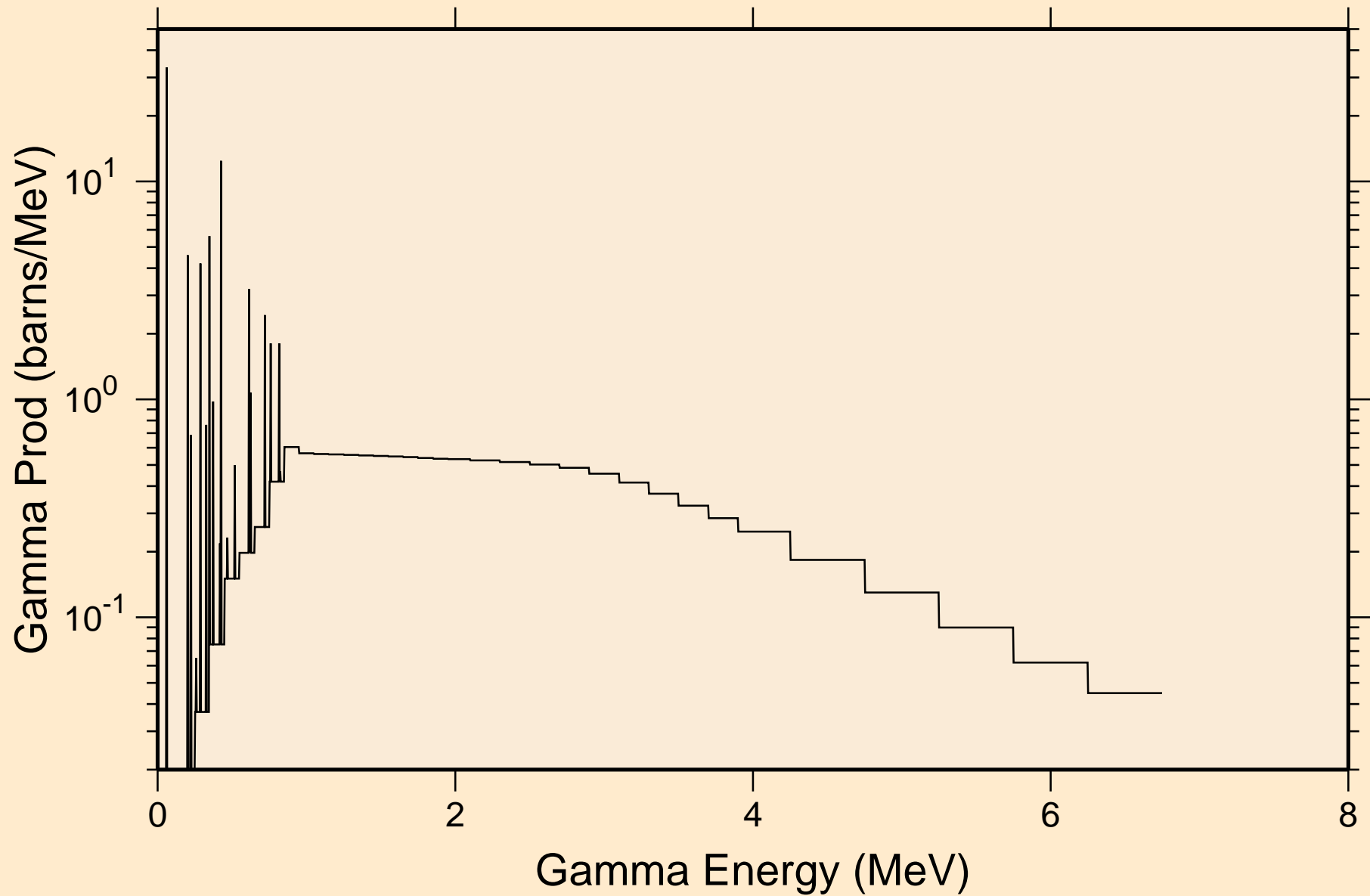

CD108 NEUTRON ACER TENDL-2021 LIBRARY; T=293.6K
14 MeV photon spectrum

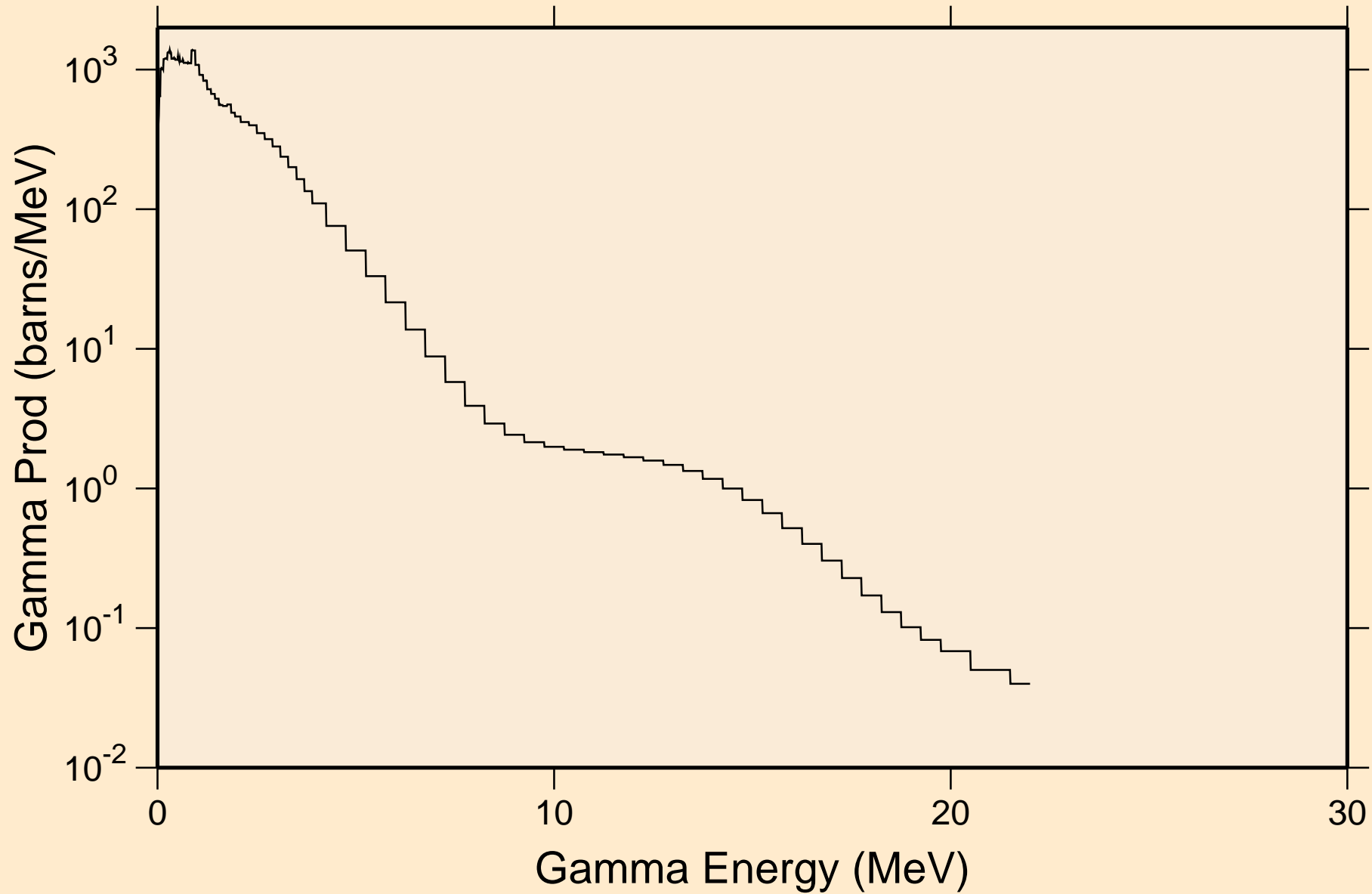

CD108 NEUTRON ACER TENDL-2021 LIBRARY; T=293.6K

Particle heating contributions

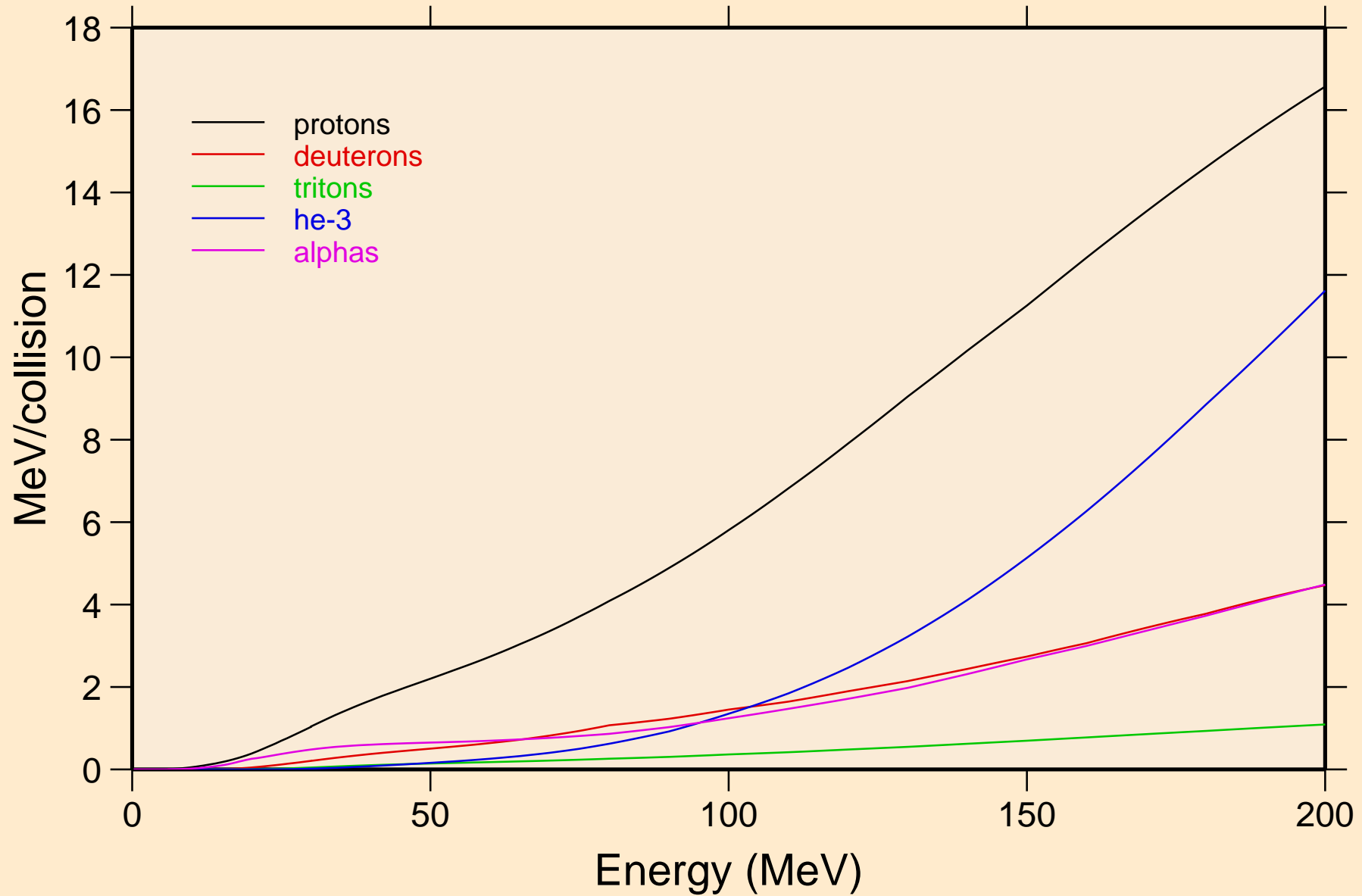

CD108 NEUTRON ACER TENDL-2021 LIBRARY; T=293.6K
Recoil Heating

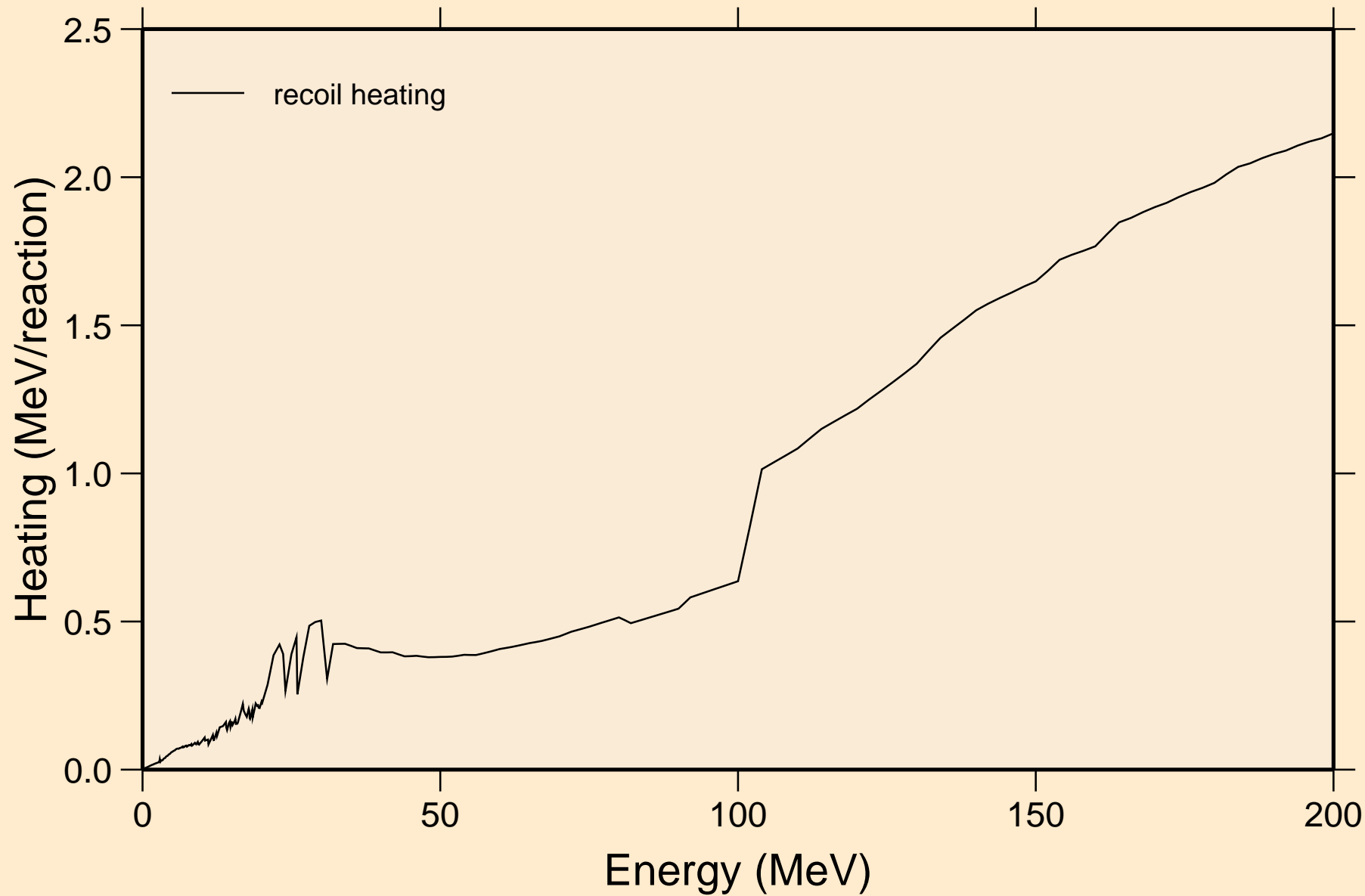

CD108 NEUTRON ACER TENDL-2021 LIBRARY; T=293.6K

Particle production cross sections

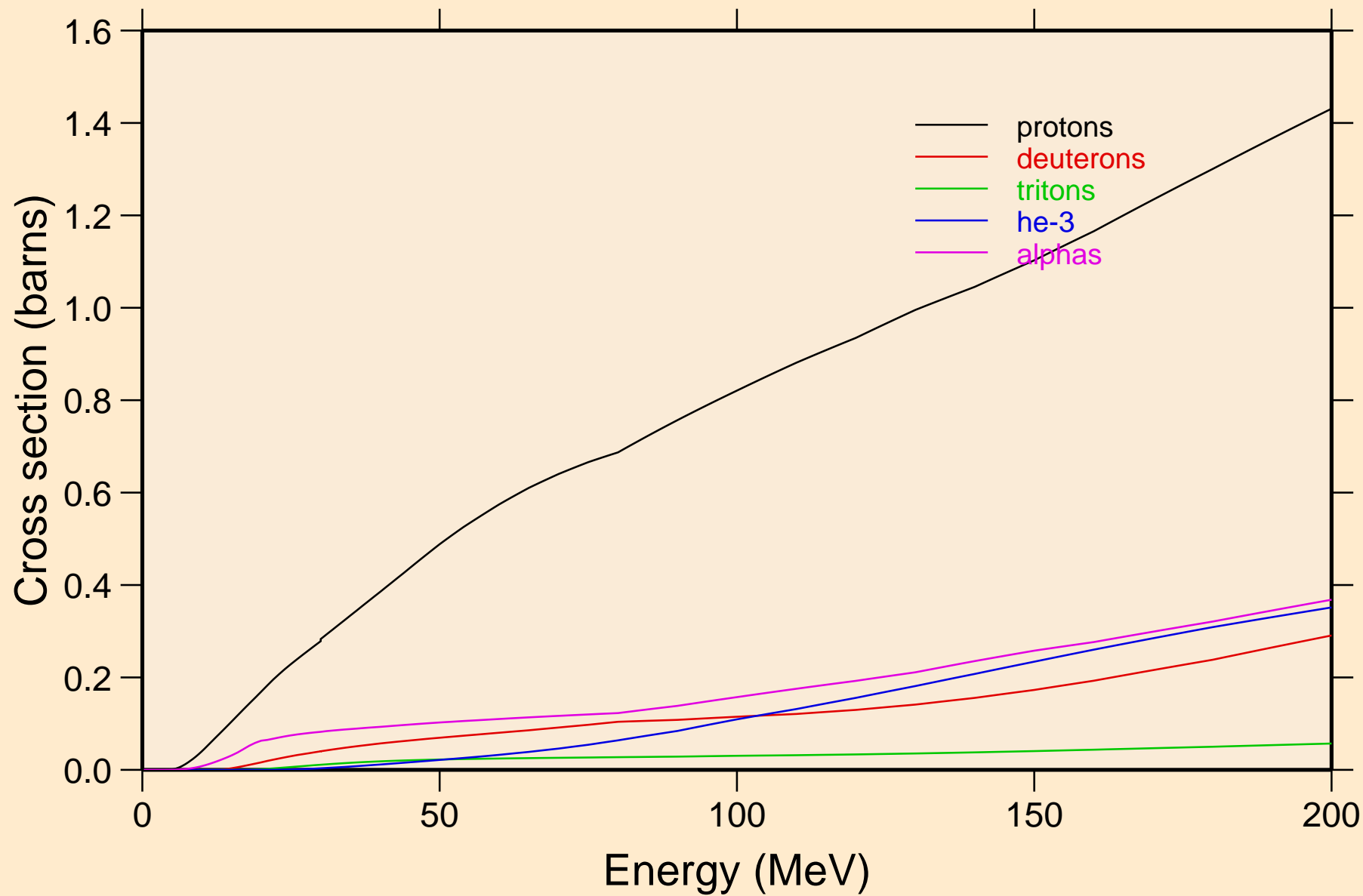

CD108 NEUTRON ACER TENDL-2021 LIBRARY; T=293.6K
protons from (n,x)

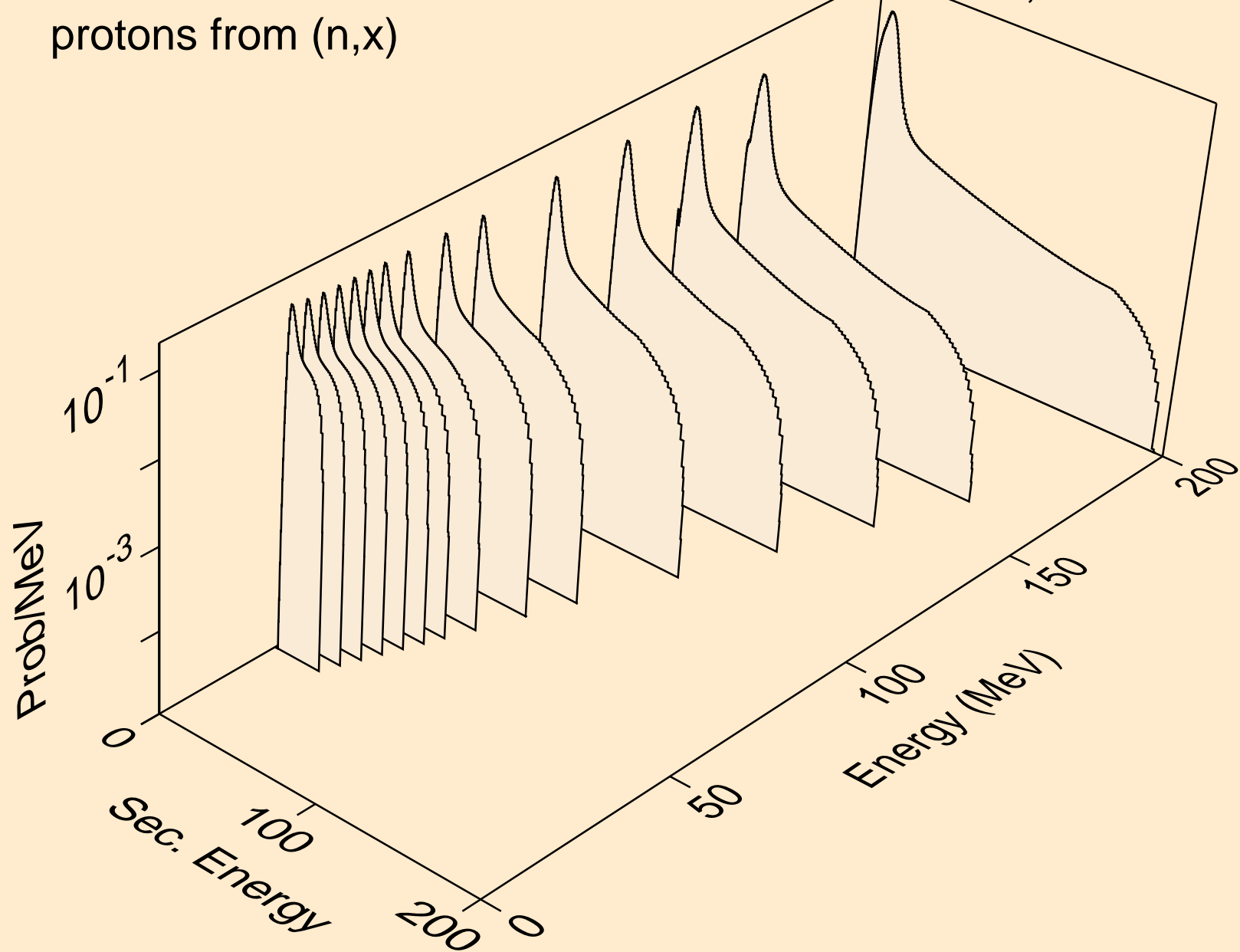

CD108 NEUTRON ACER TENDL-2021 LIBRARY; T=293.6K
protons from (n,n*)p

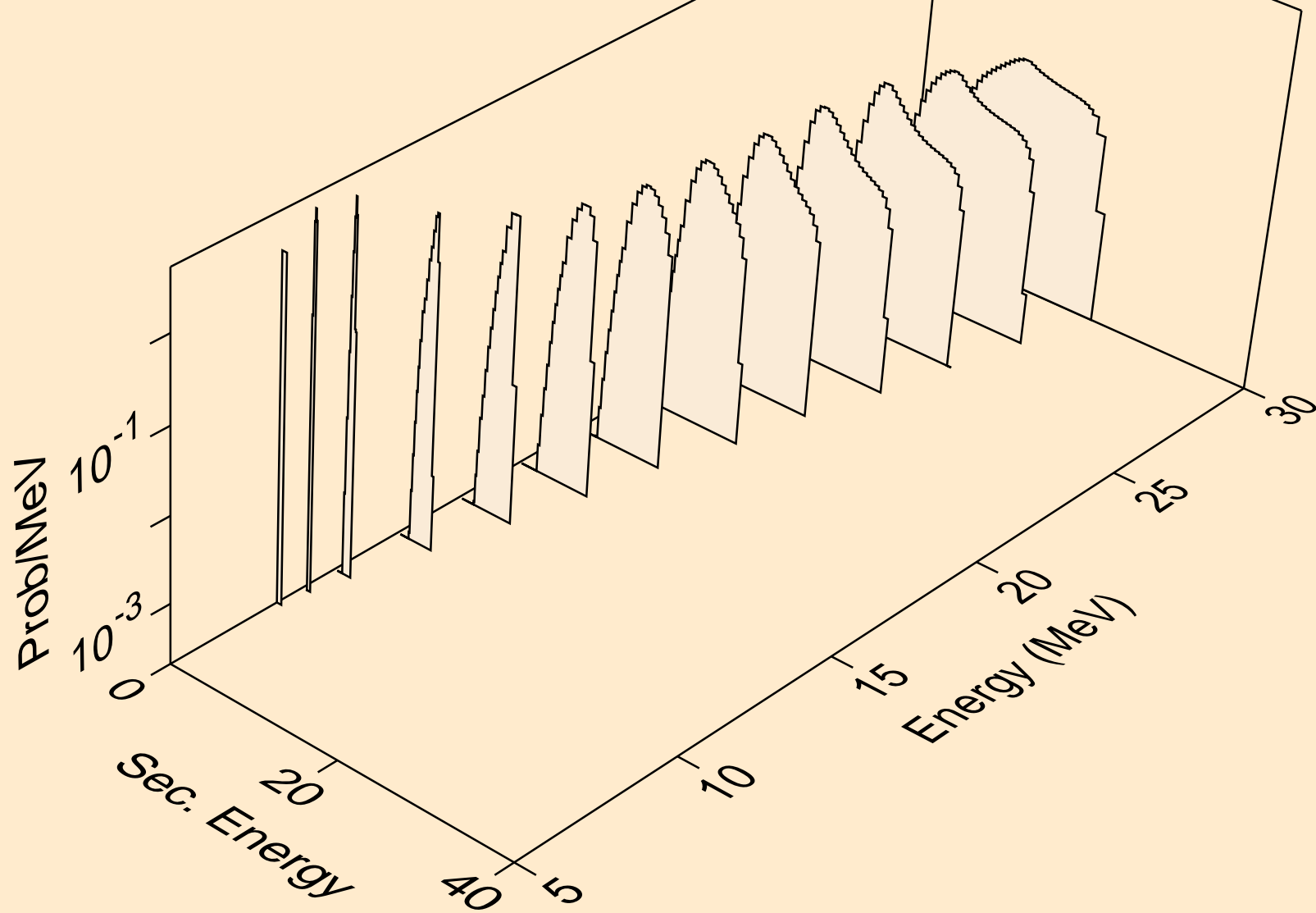

CD108 NEUTRON ACER TENDL-2021 LIBRARY; T=293.6K
protons from (n,2np)

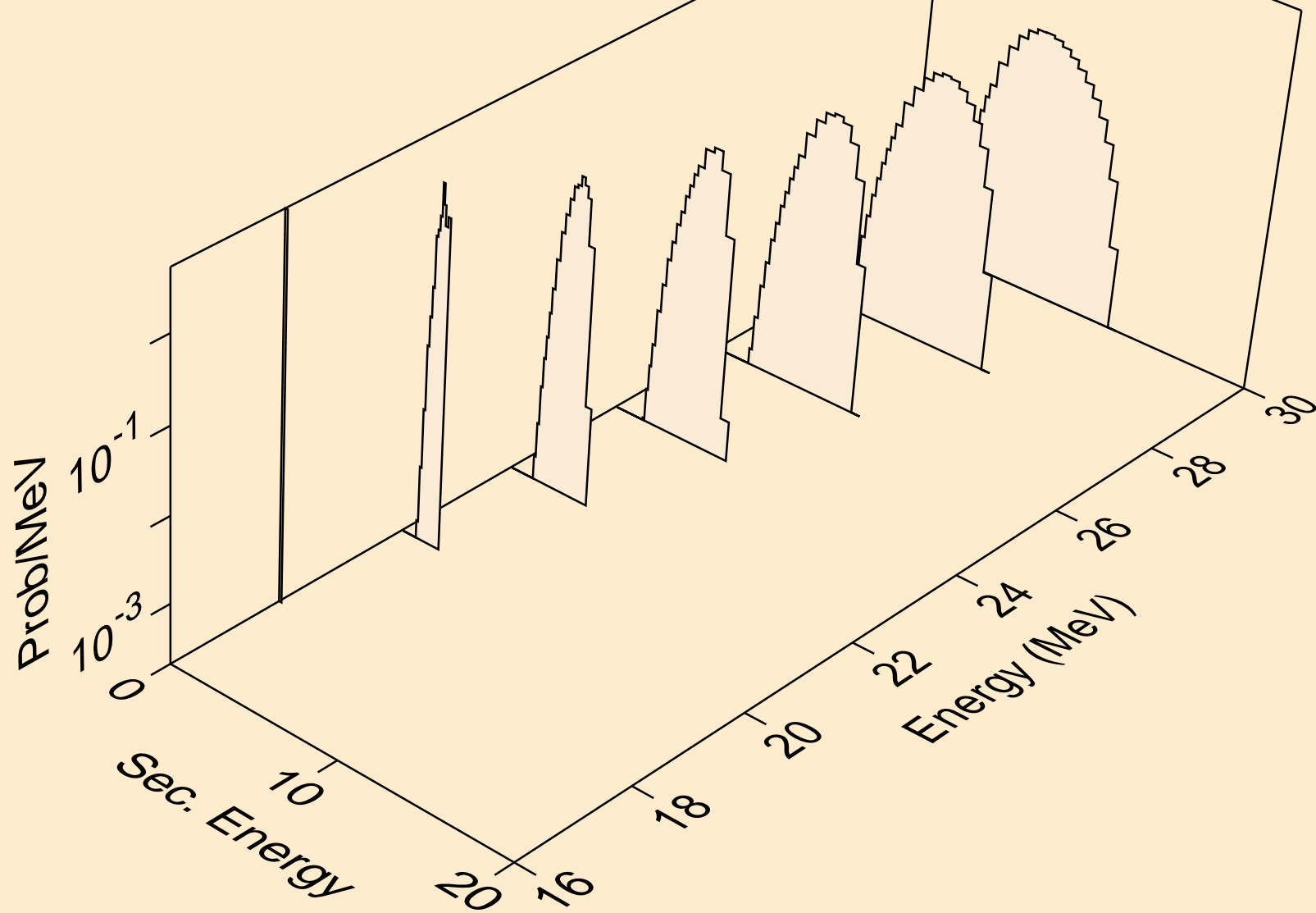

CD108 NEUTRON ACER TENDL-2021 LIBRARY; T=293.6K
protons from (n,3np)

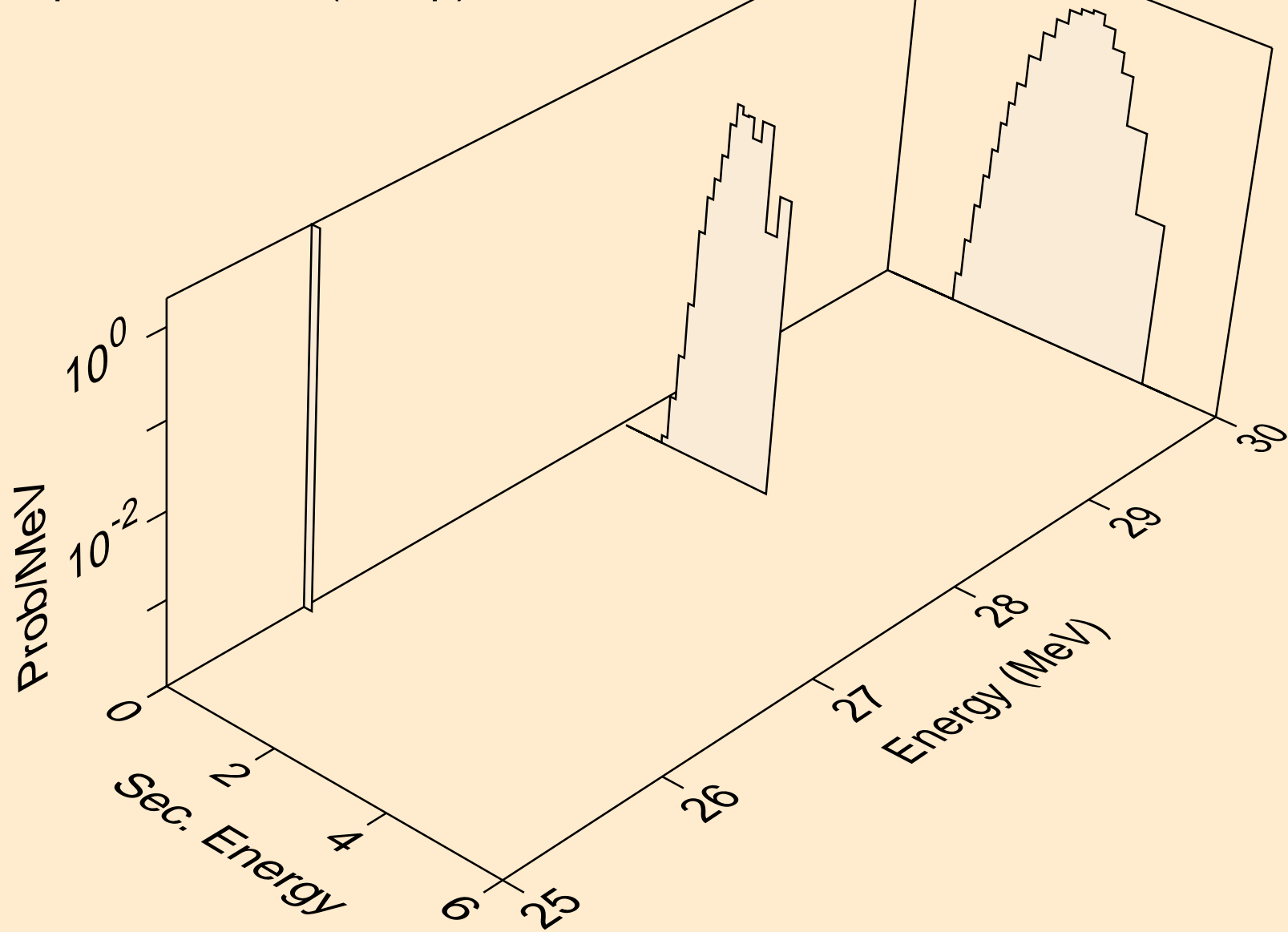

CD108 NEUTRON ACER TENDL-2021 LIBRARY; T=293.6K
protons from (n,2np)

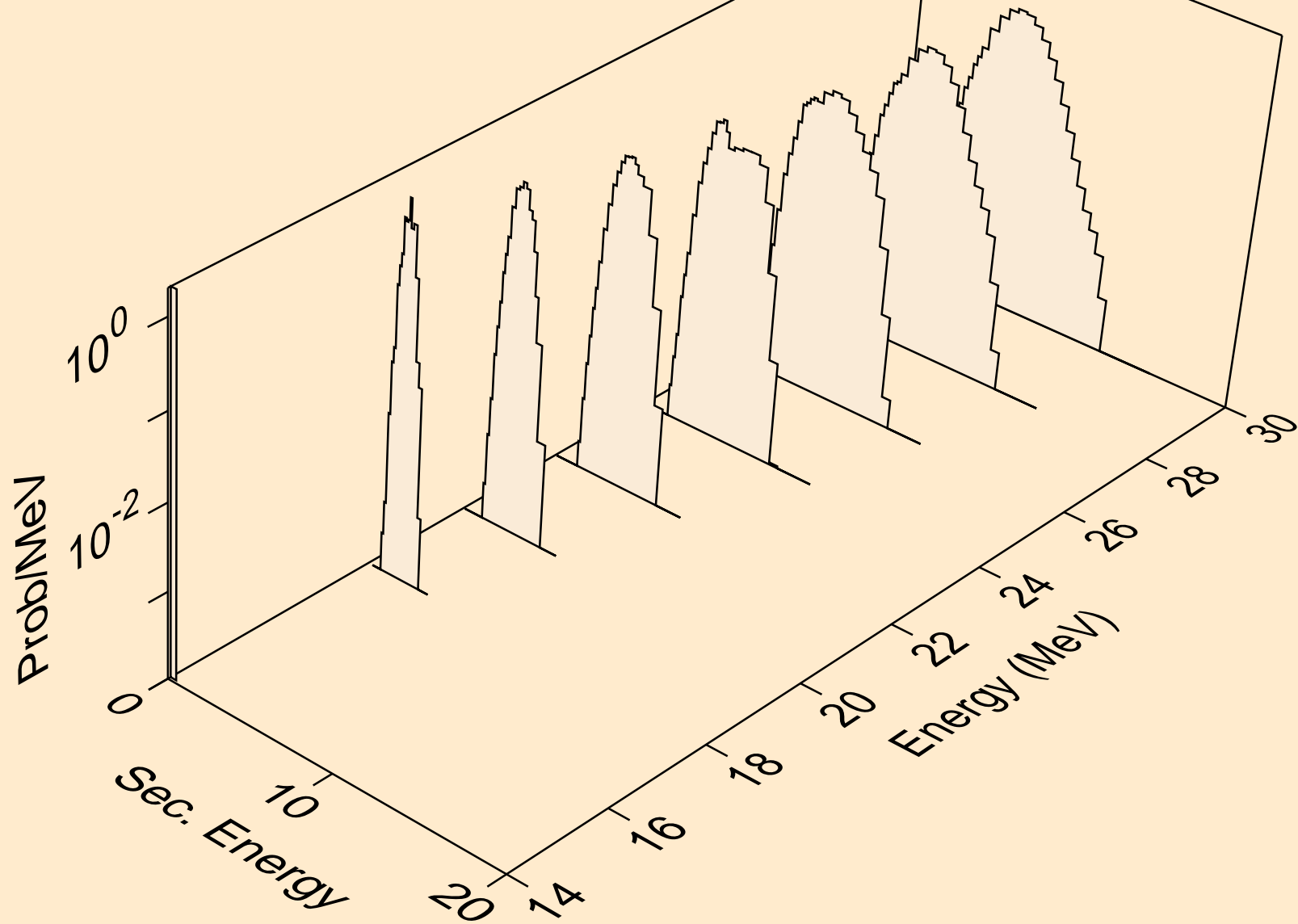

CD108 NEUTRON ACER TENDL-2021 LIBRARY; T=293.6K
protons from (n,npa)

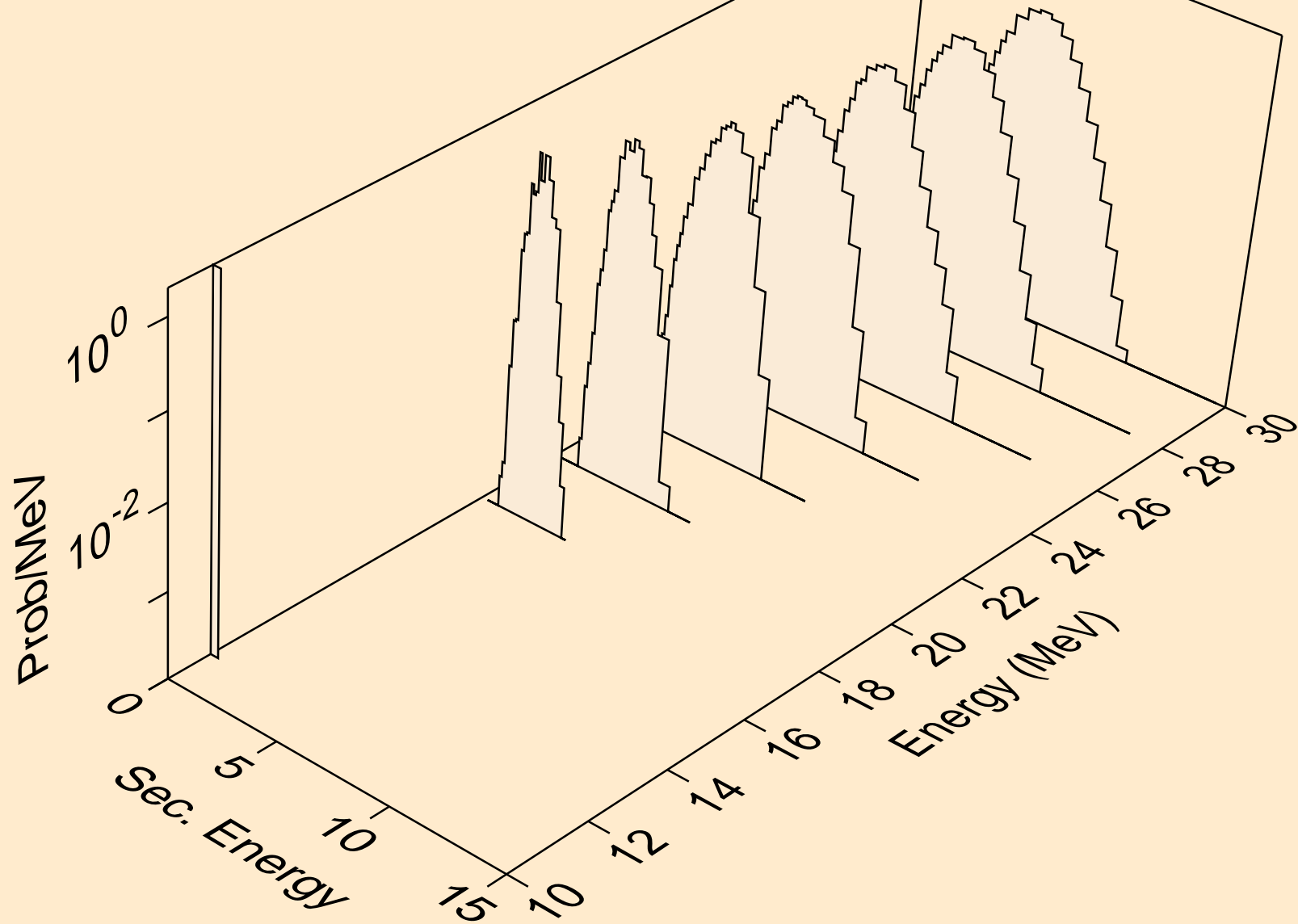

CD108 NEUTRON ACER TENDL-2021 LIBRARY; T=293.6K
protons from (n,p)

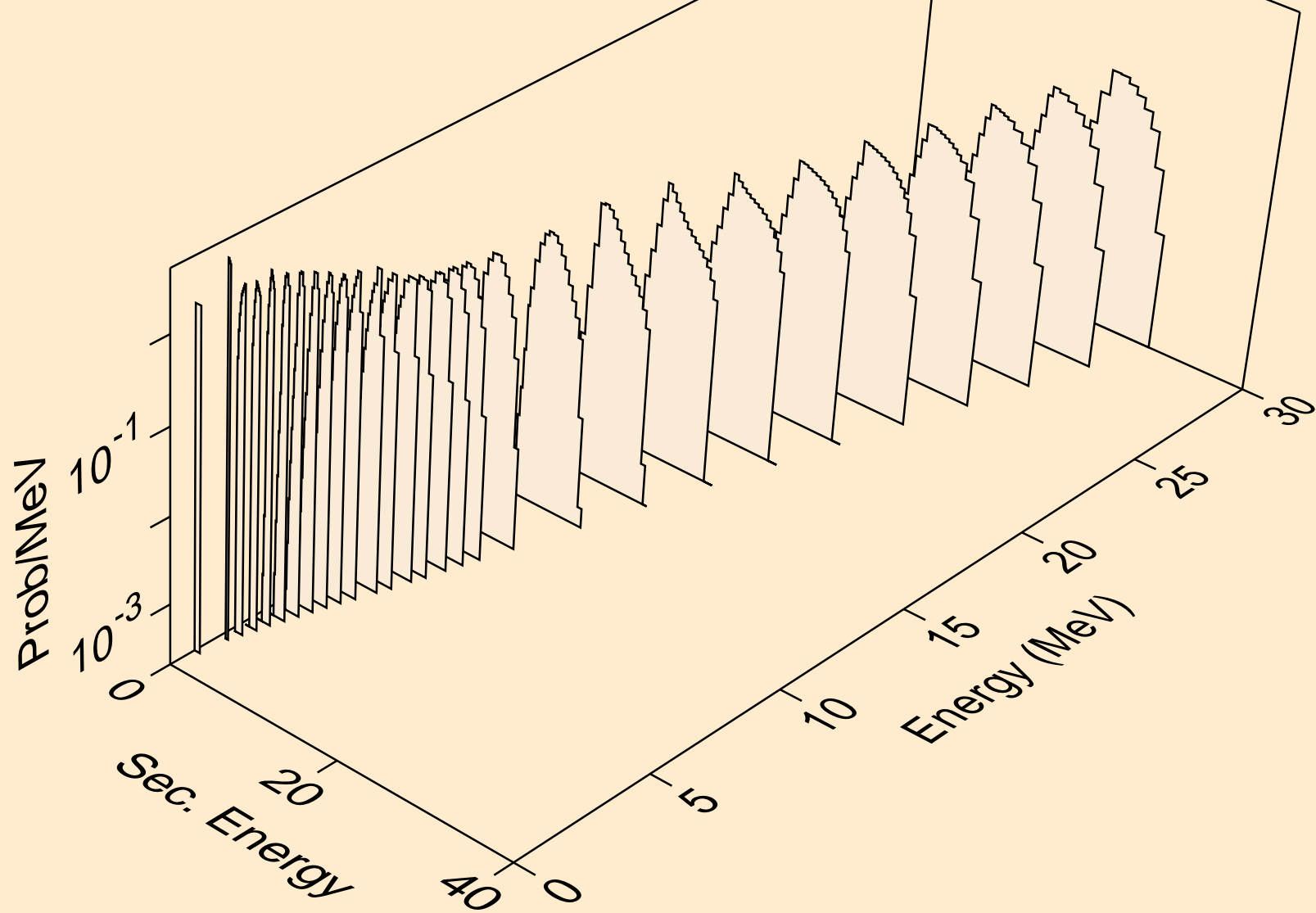

CD108 NEUTRON ACER TENDL-2021 LIBRARY; T=293.6K
protons from (n,2p)

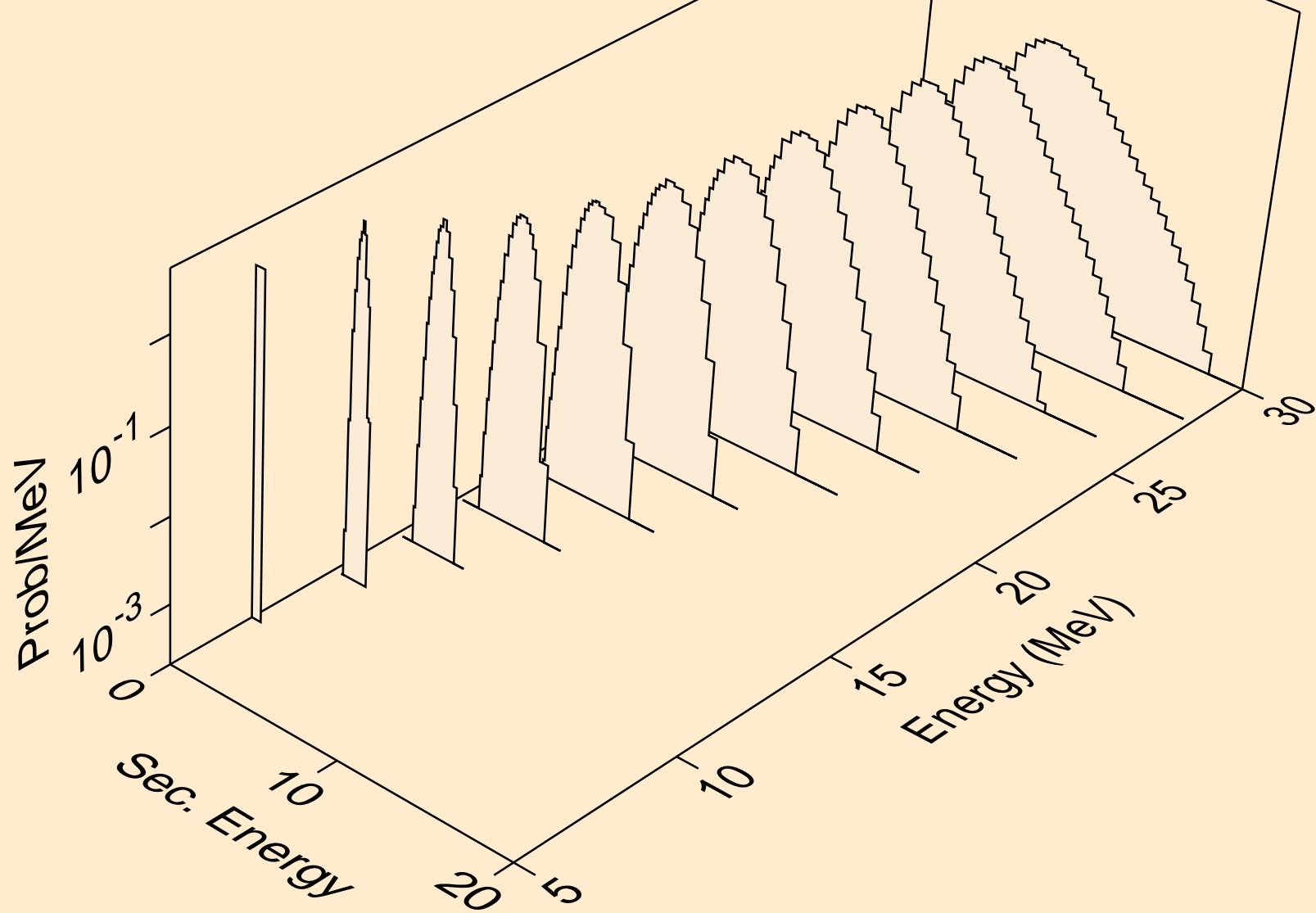

CD108 NEUTRON ACER TENDL-2021 LIBRARY; T=293.6K
protons from (n,p)

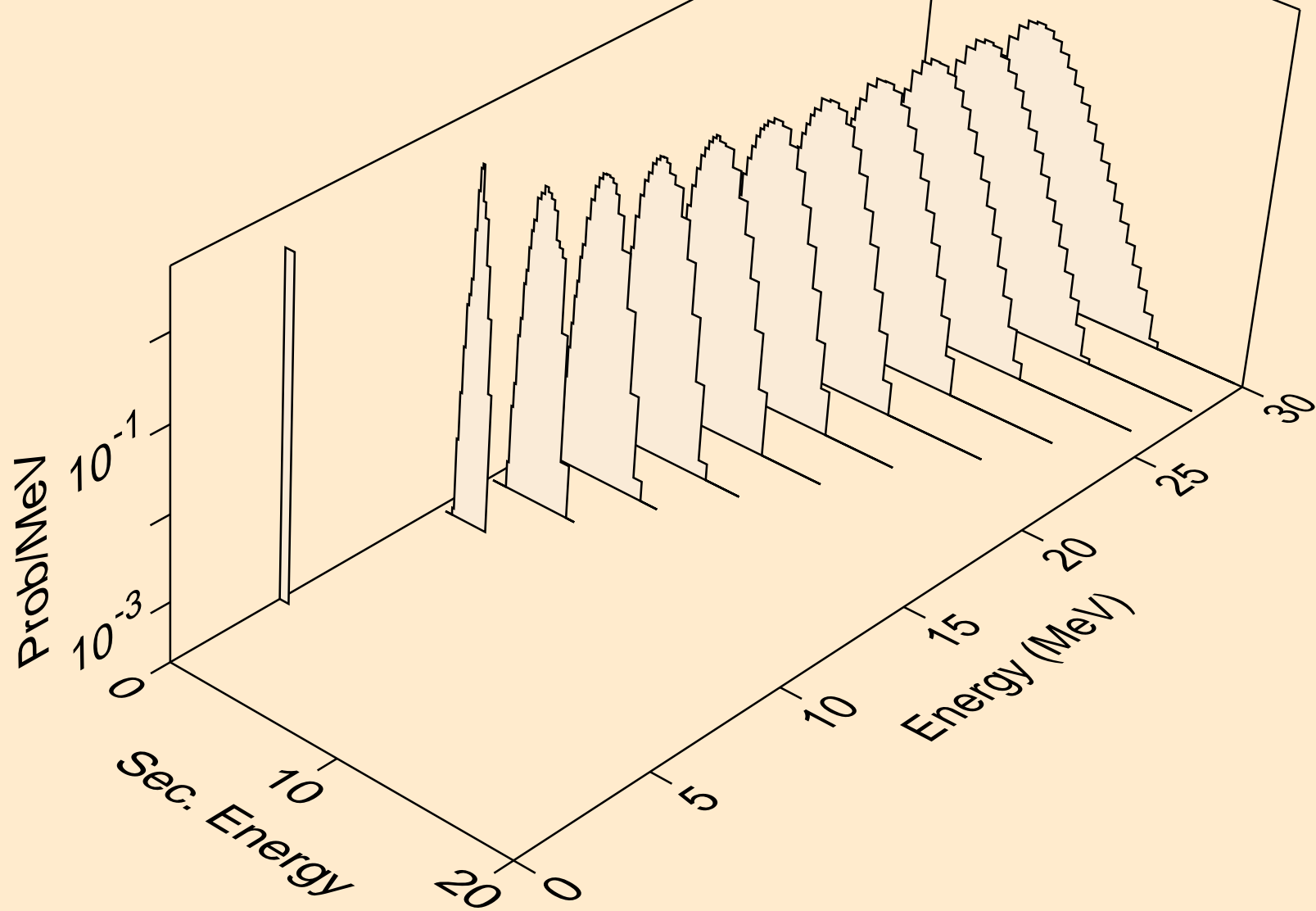

CD108 NEUTRON ACER TENDL-2021 LIBRARY; T=293.6K
protons from (n,pd)

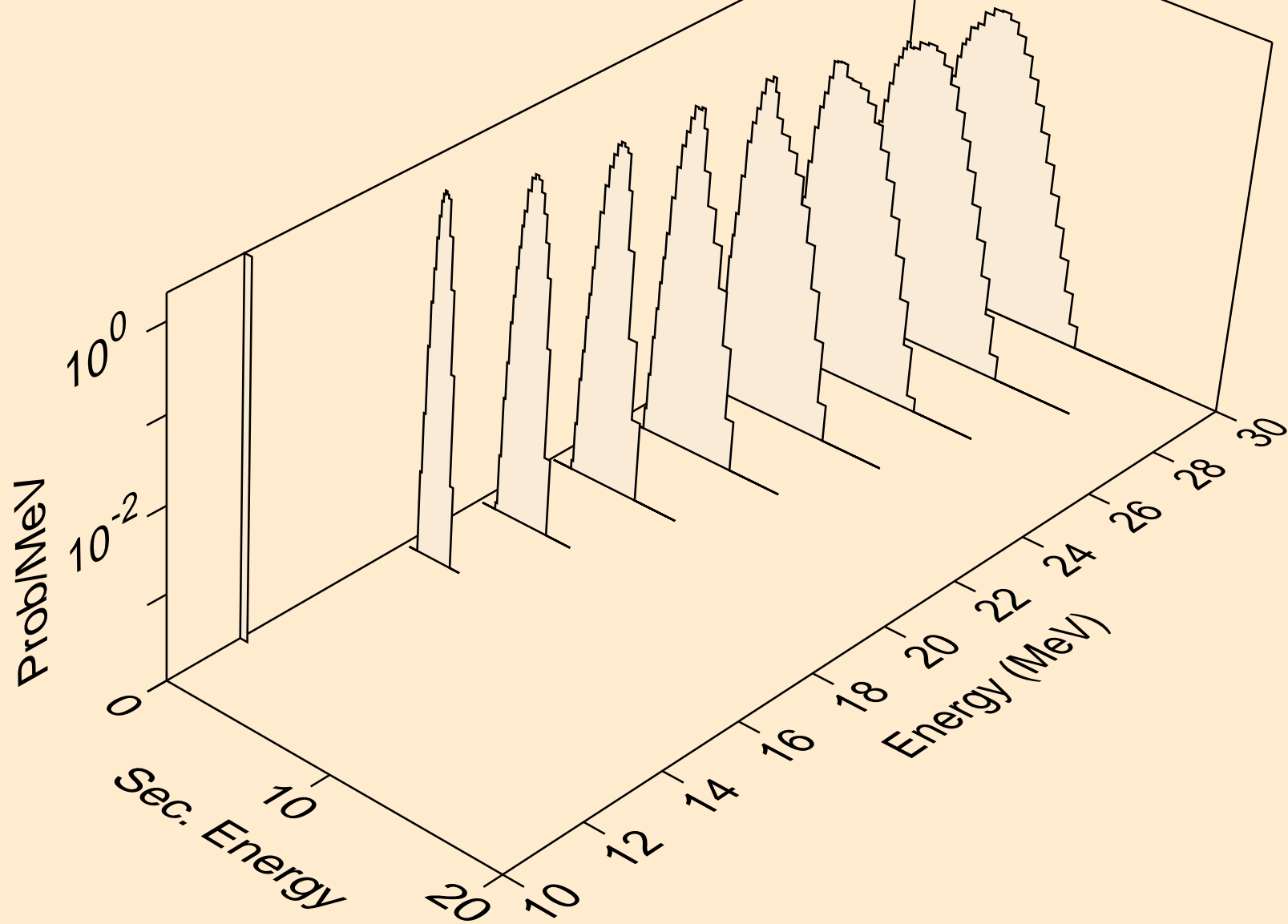

CD108 NEUTRON ACER TENDL-2021 LIBRARY; T=293.6K
protons from (n,pt)

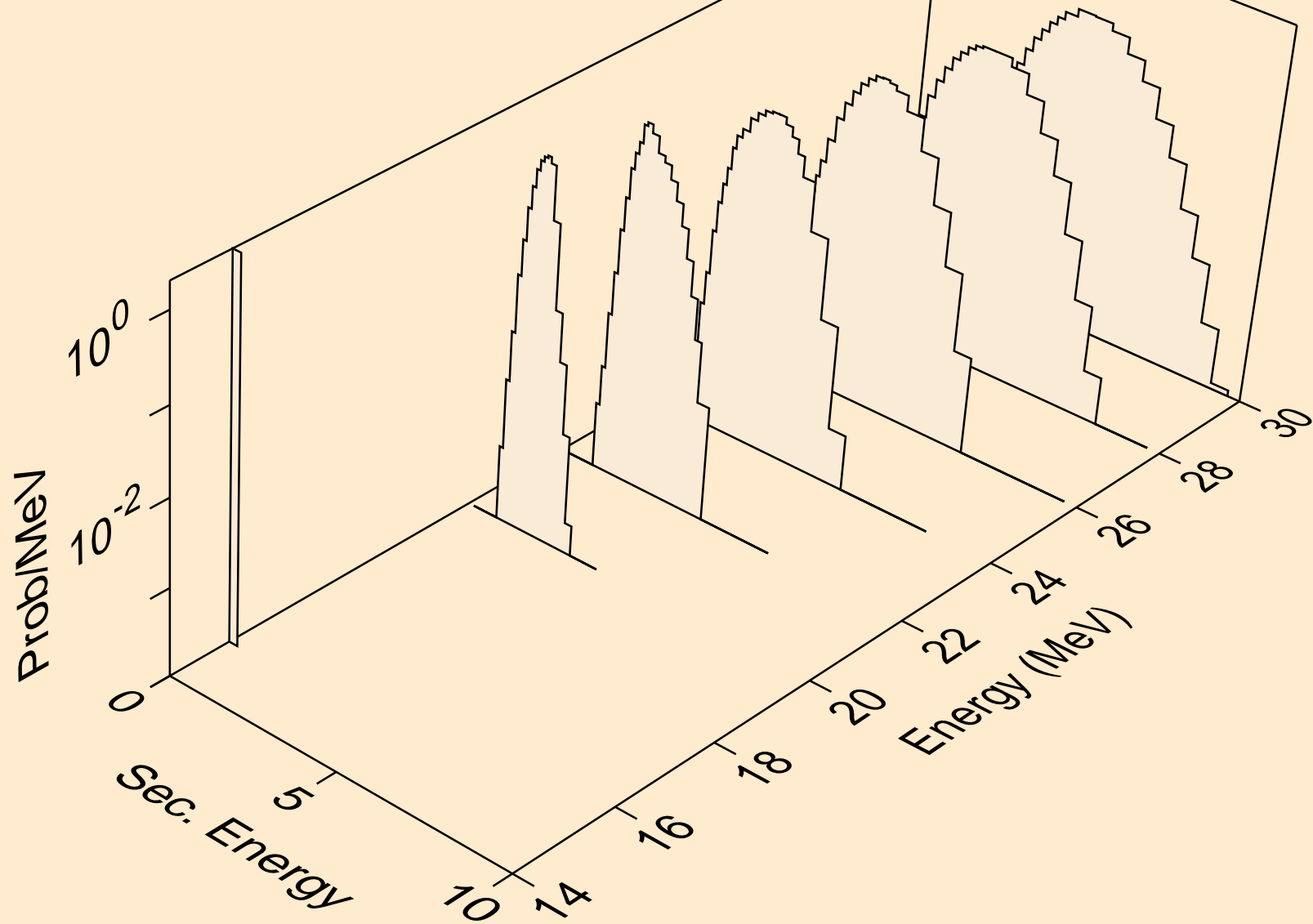

CD108 NEUTRON ACER TENDL-2021 LIBRARY; T=293.6K
deuterons from (n,x)

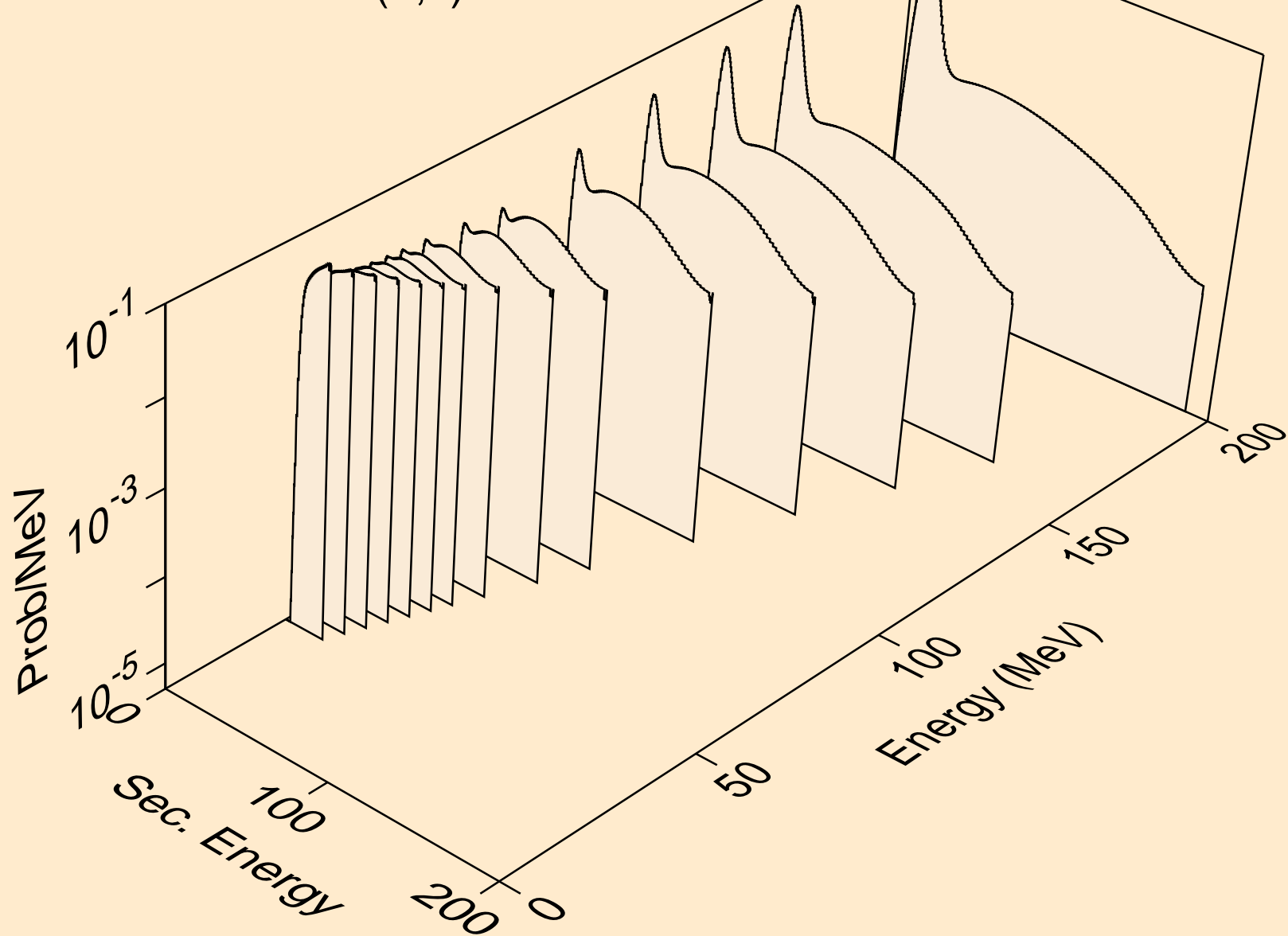

CD108 NEUTRON ACER TENDL-2021 LIBRARY; T=293.6K
deuterons from (n,2nd)

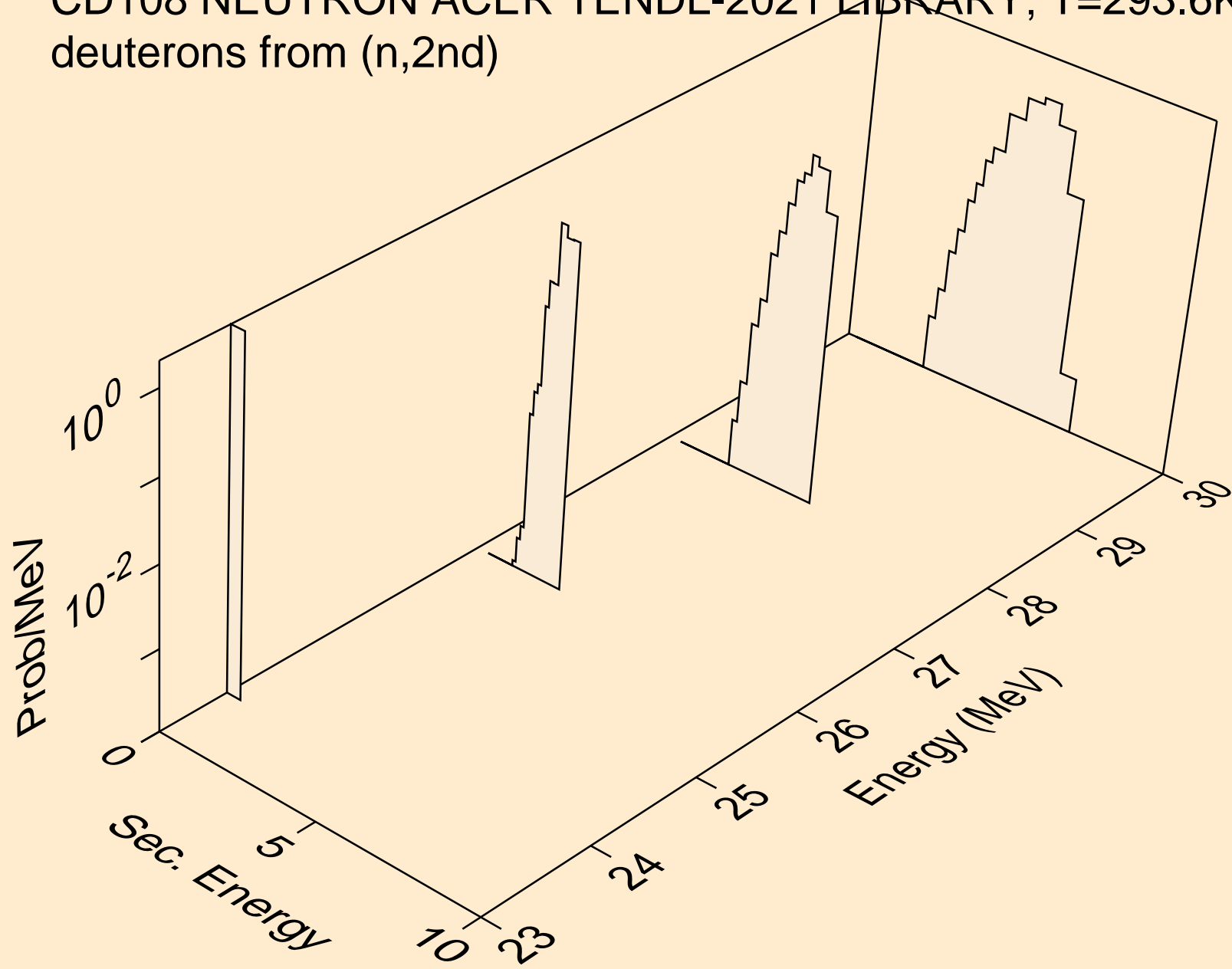

CD108 NEUTRON ACER TENDL-2021 LIBRARY; T=293.6K
deuterons from (n,n*)d

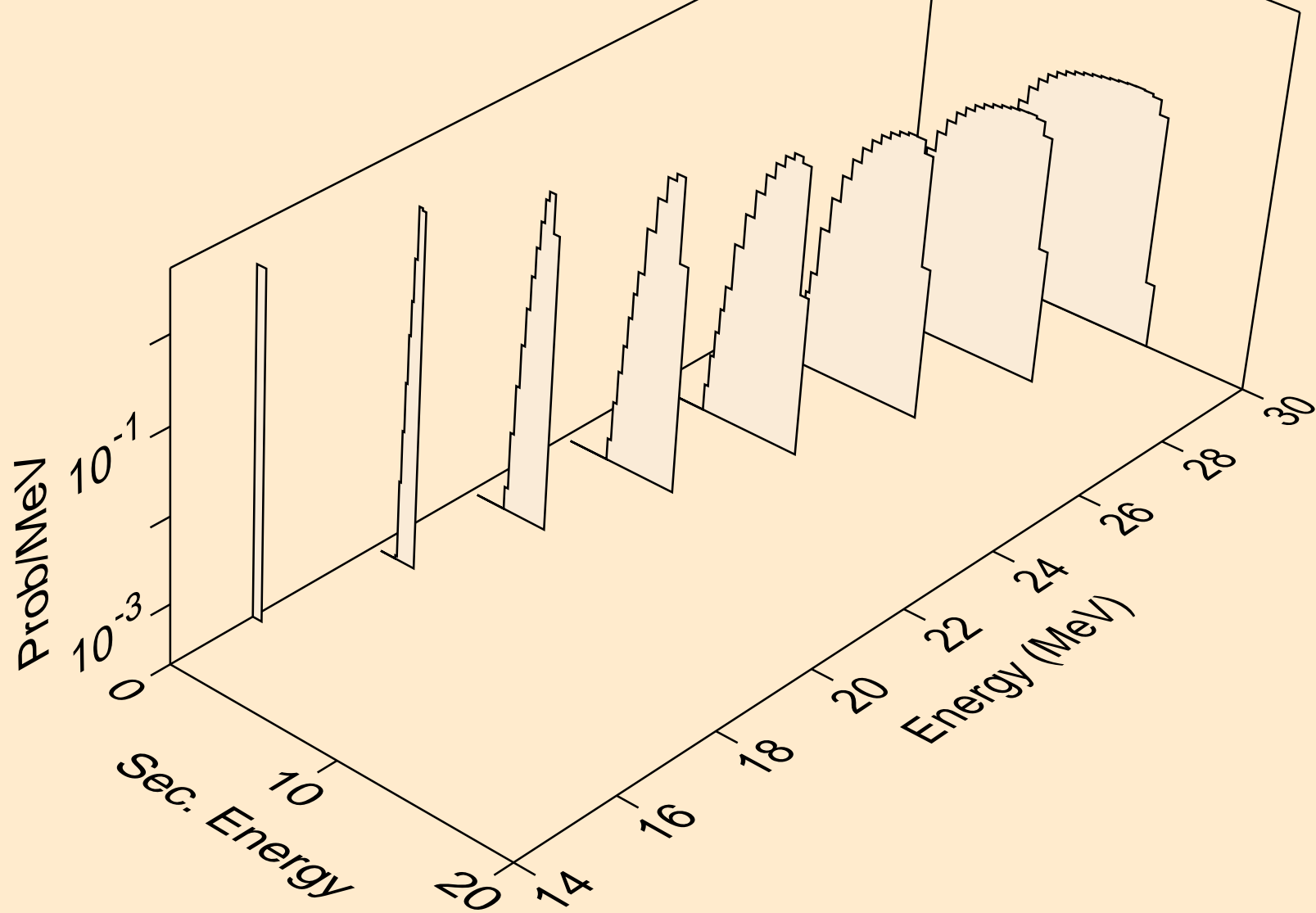

CD108 NEUTRON ACER TENDL-2021 LIBRARY; T=293.6K
deuterons from (n,d)

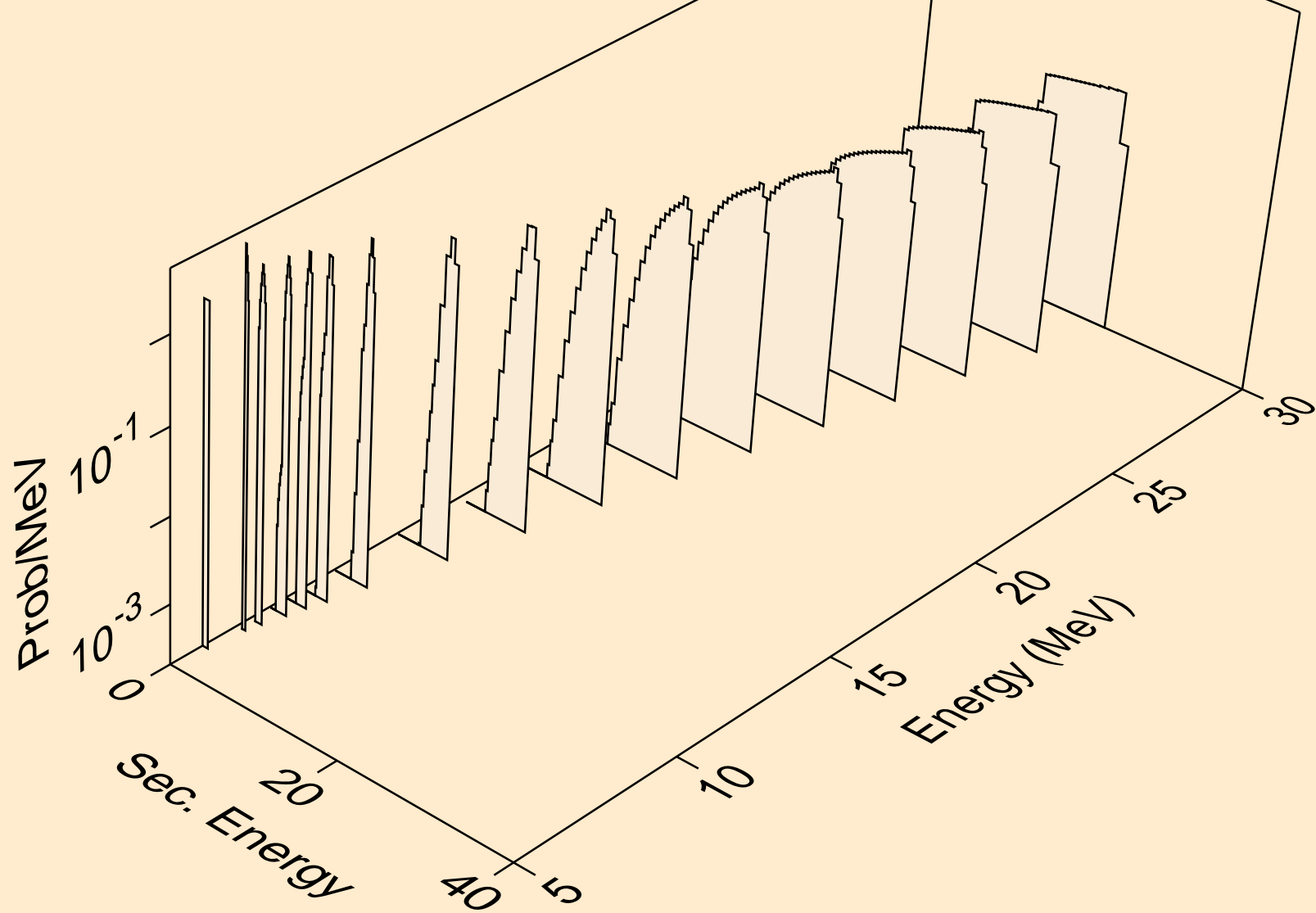

CD108 NEUTRON ACER TENDL-2021 LIBRARY; T=293.6K
deuterons from (n,pd)

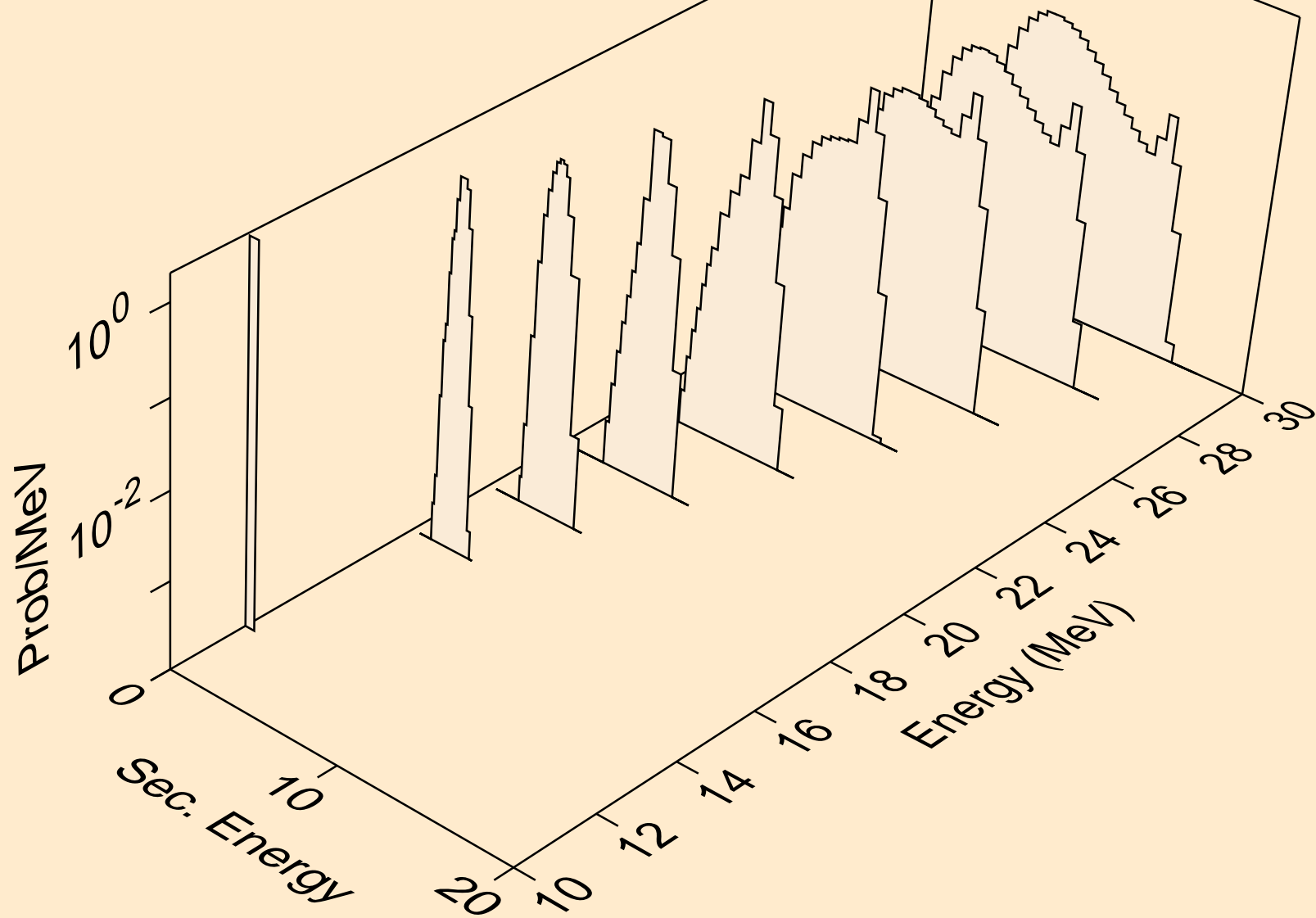

CD108 NEUTRON ACER TENDL-2021 LIBRARY; T=293.6K
deuterons from (n,da)

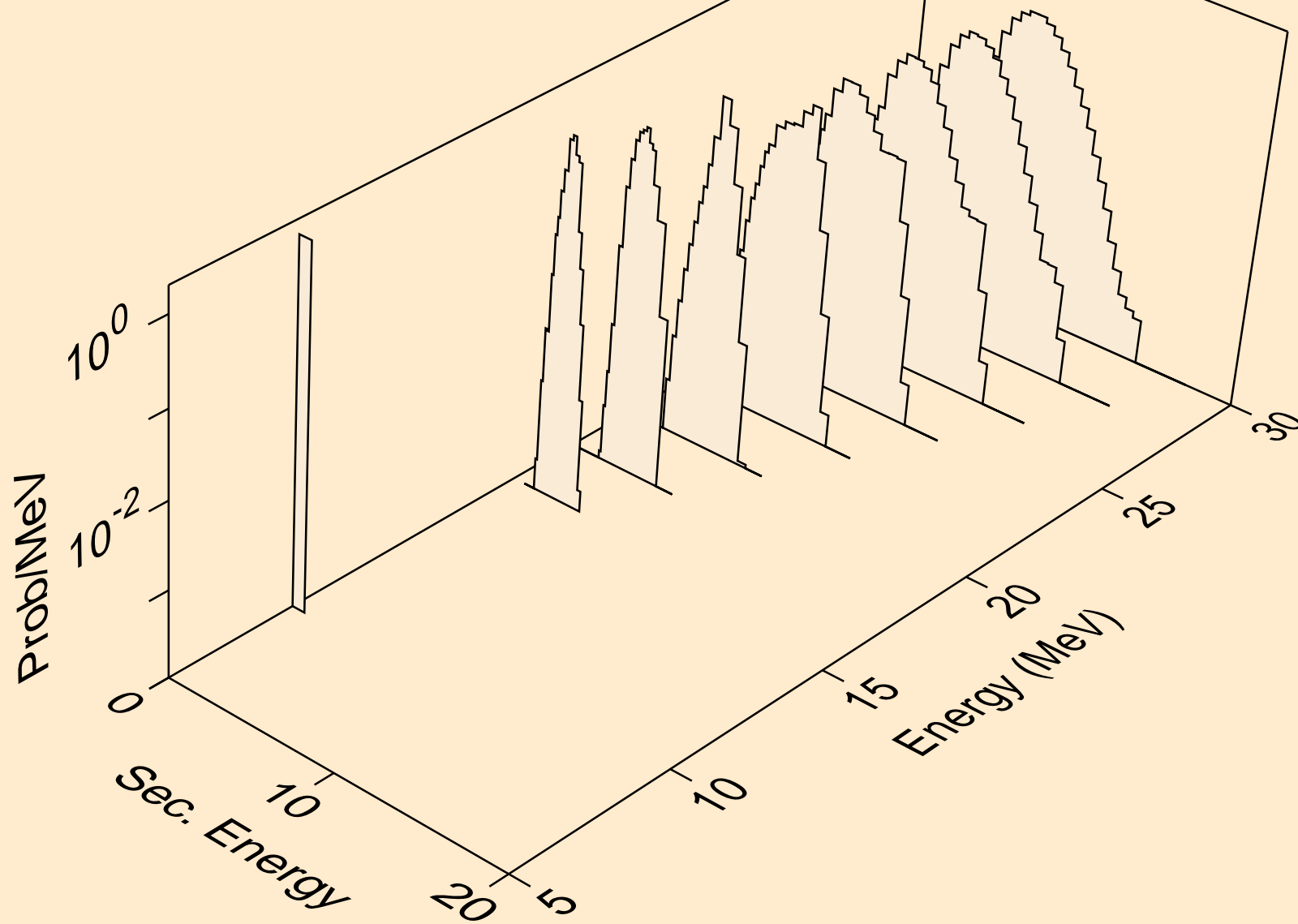

CD108 NEUTRON ACER TENDL-2021 LIBRARY; T=293.6K
tritons from (n,x)

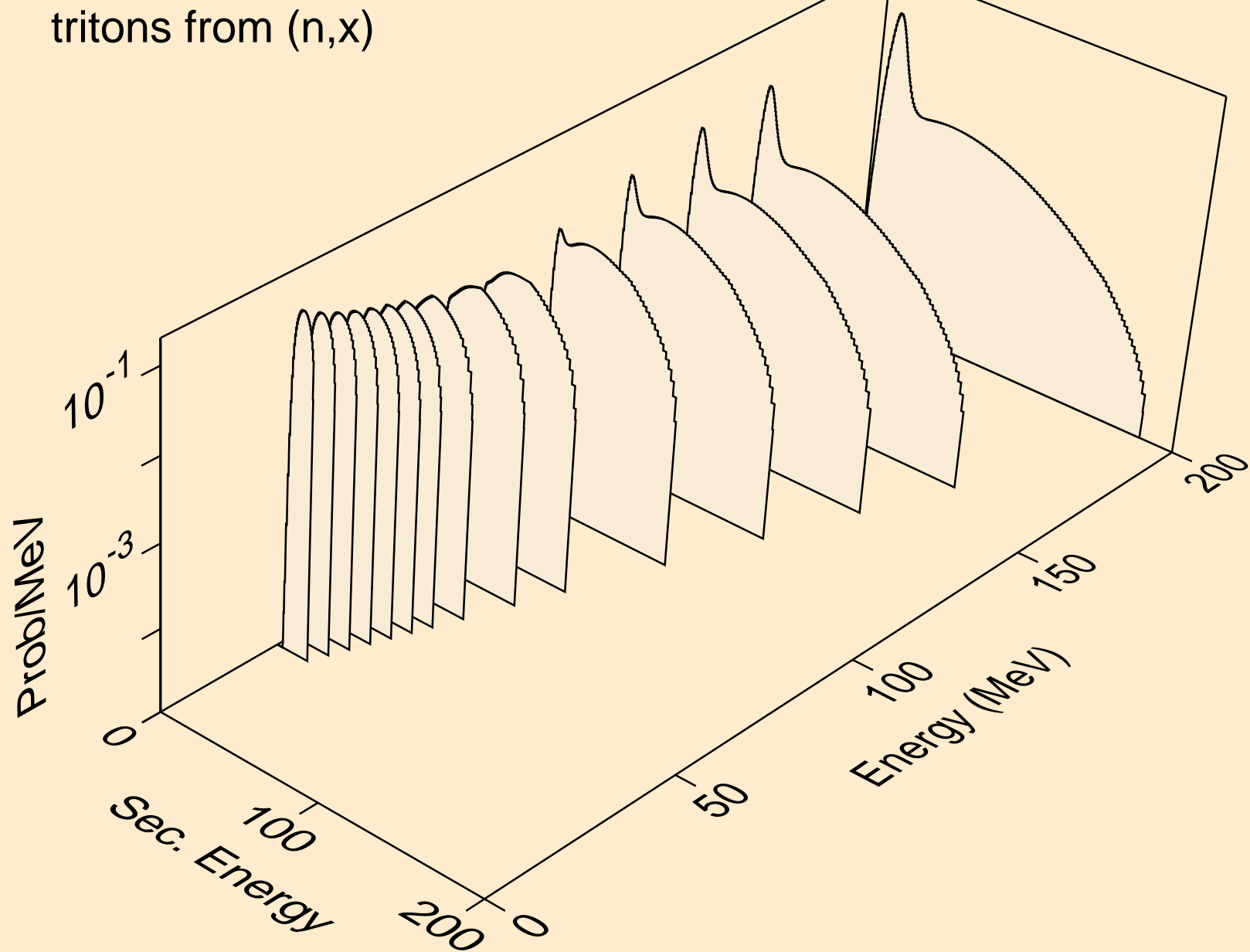

CD108 NEUTRON ACER TENDL-2021 LIBRARY; T=293.6K
tritons from (n,n*)t

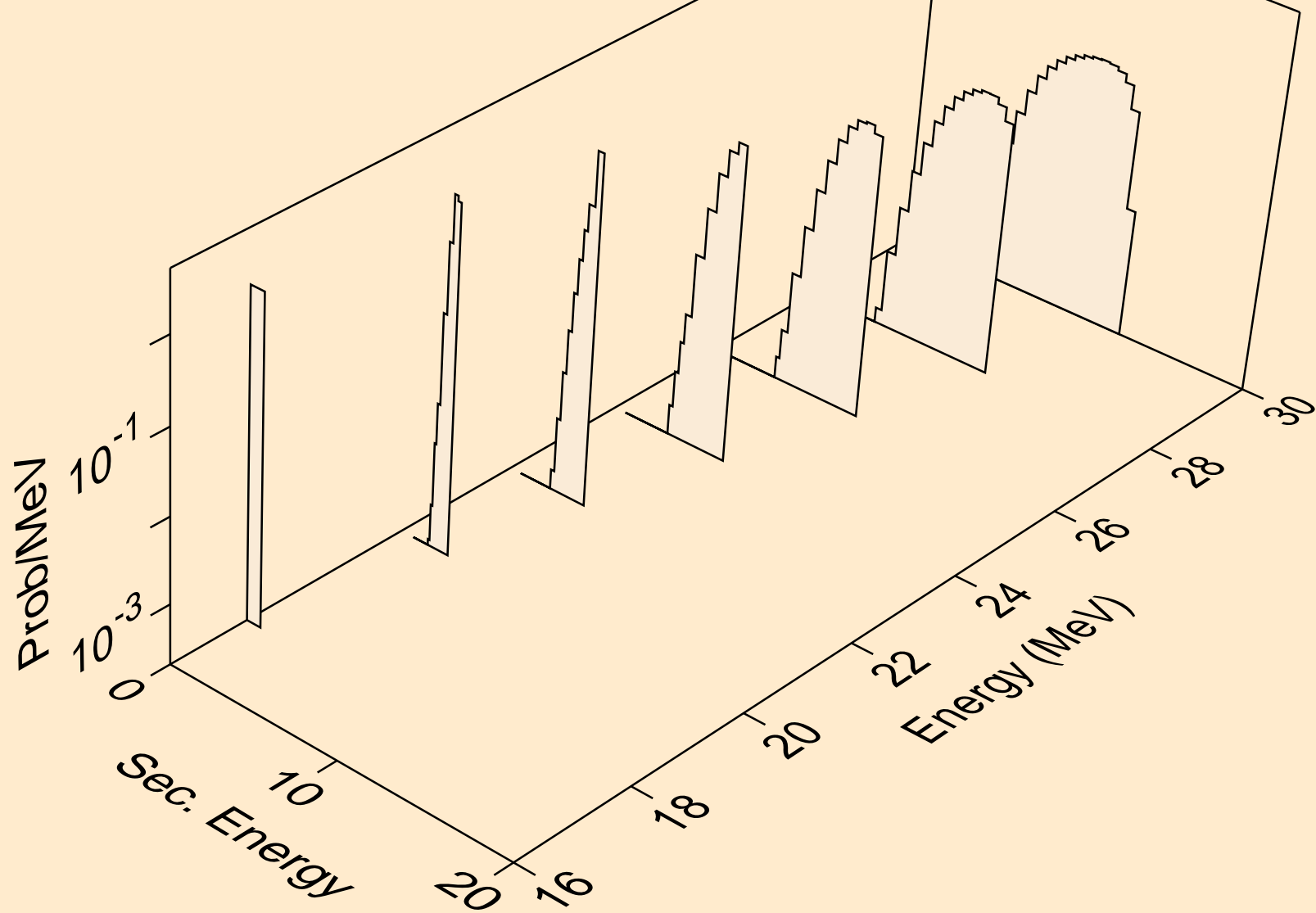

CD108 NEUTRON ACER TENDL-2021 LIBRARY; T=293.6K
tritons from (n,t)

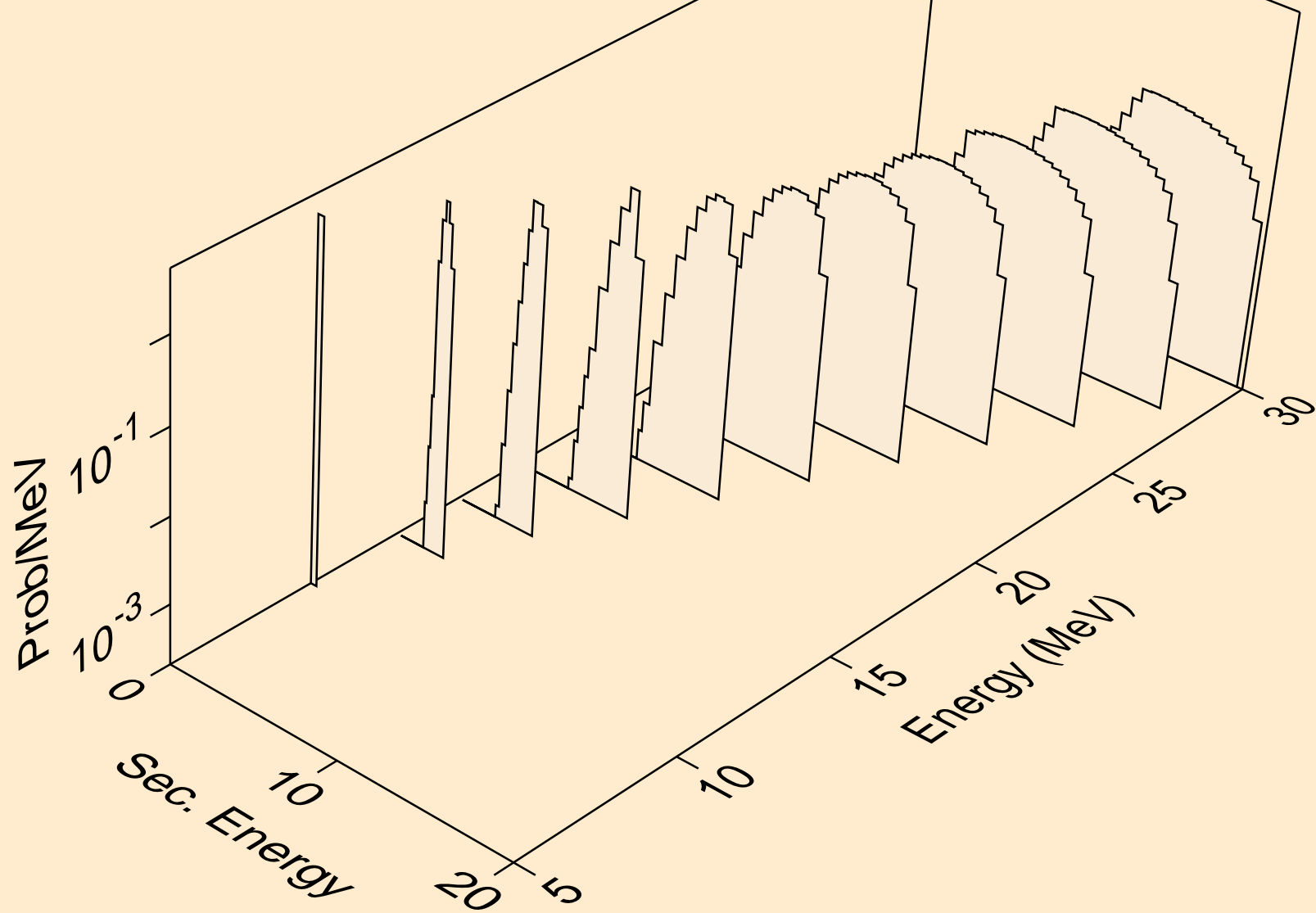

CD108 NEUTRON ACER TENDL-2021 LIBRARY; T=293.6K
tritons from (n,pt)

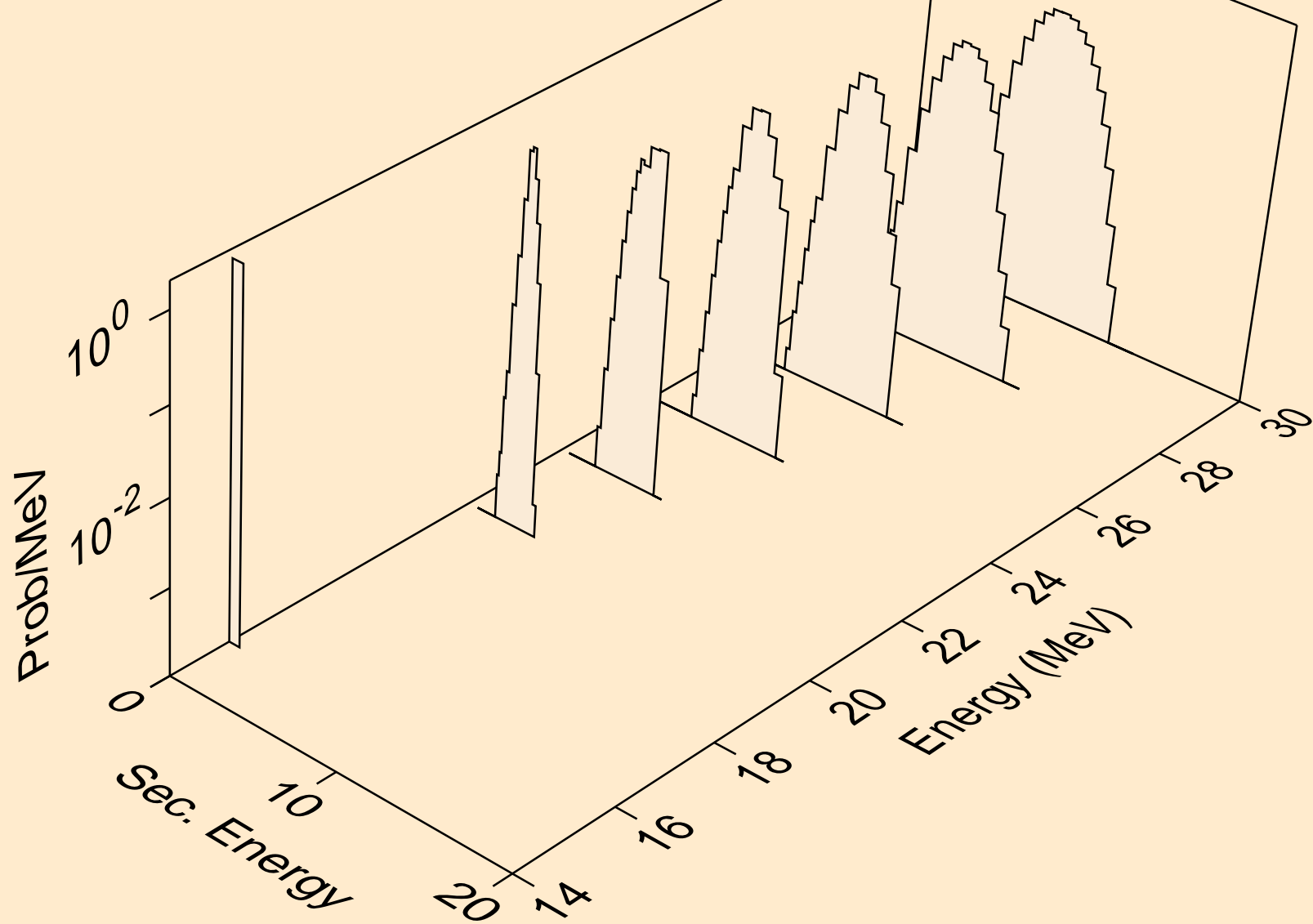

CD108 NEUTRON ACER TENDL-2021 LIBRARY; T=293.6K
he3s from (n,x)

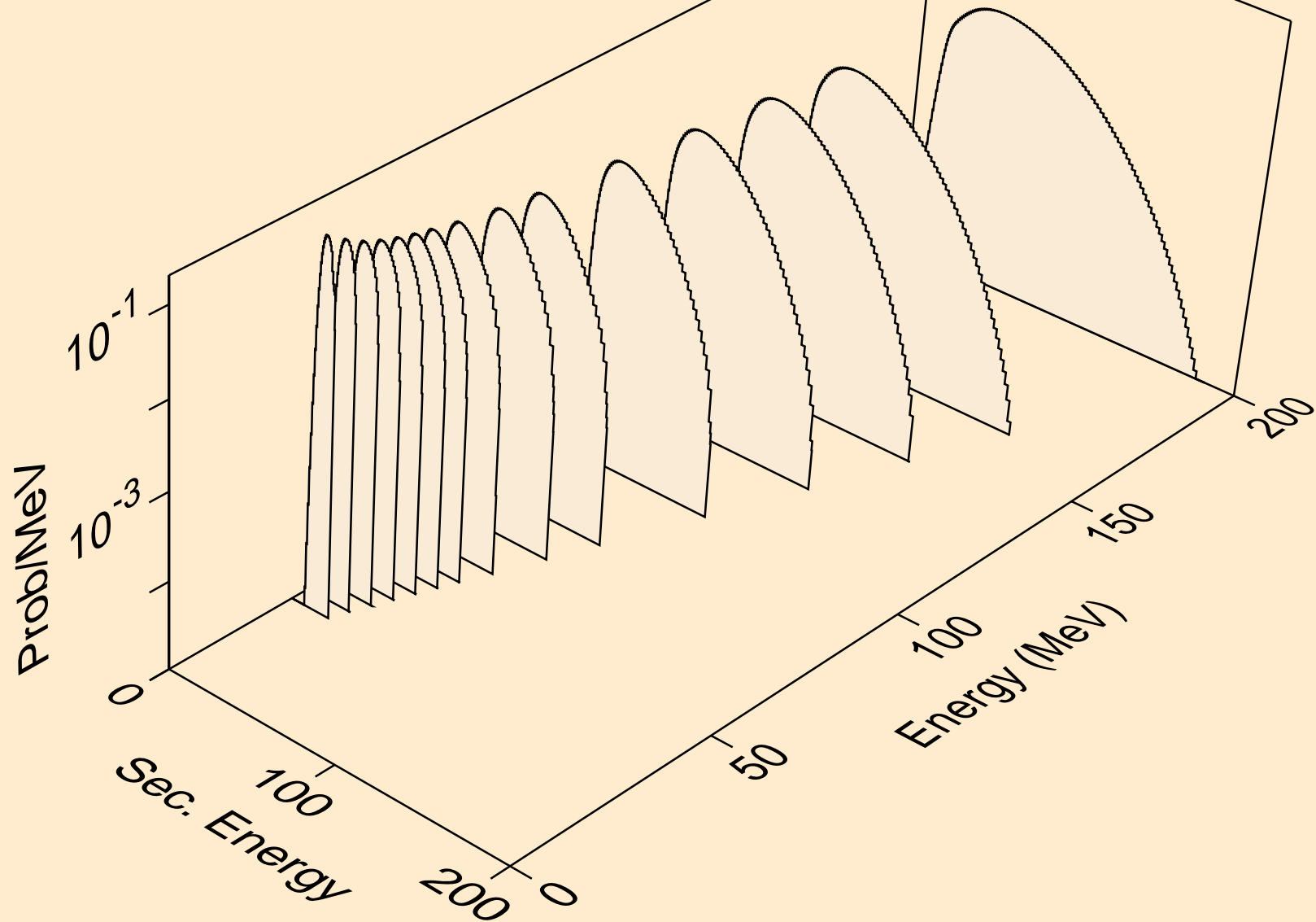

CD108 NEUTRON ACER TENDL-2021 LIBRARY; T=293.6K
he3s from (n,n*)he3

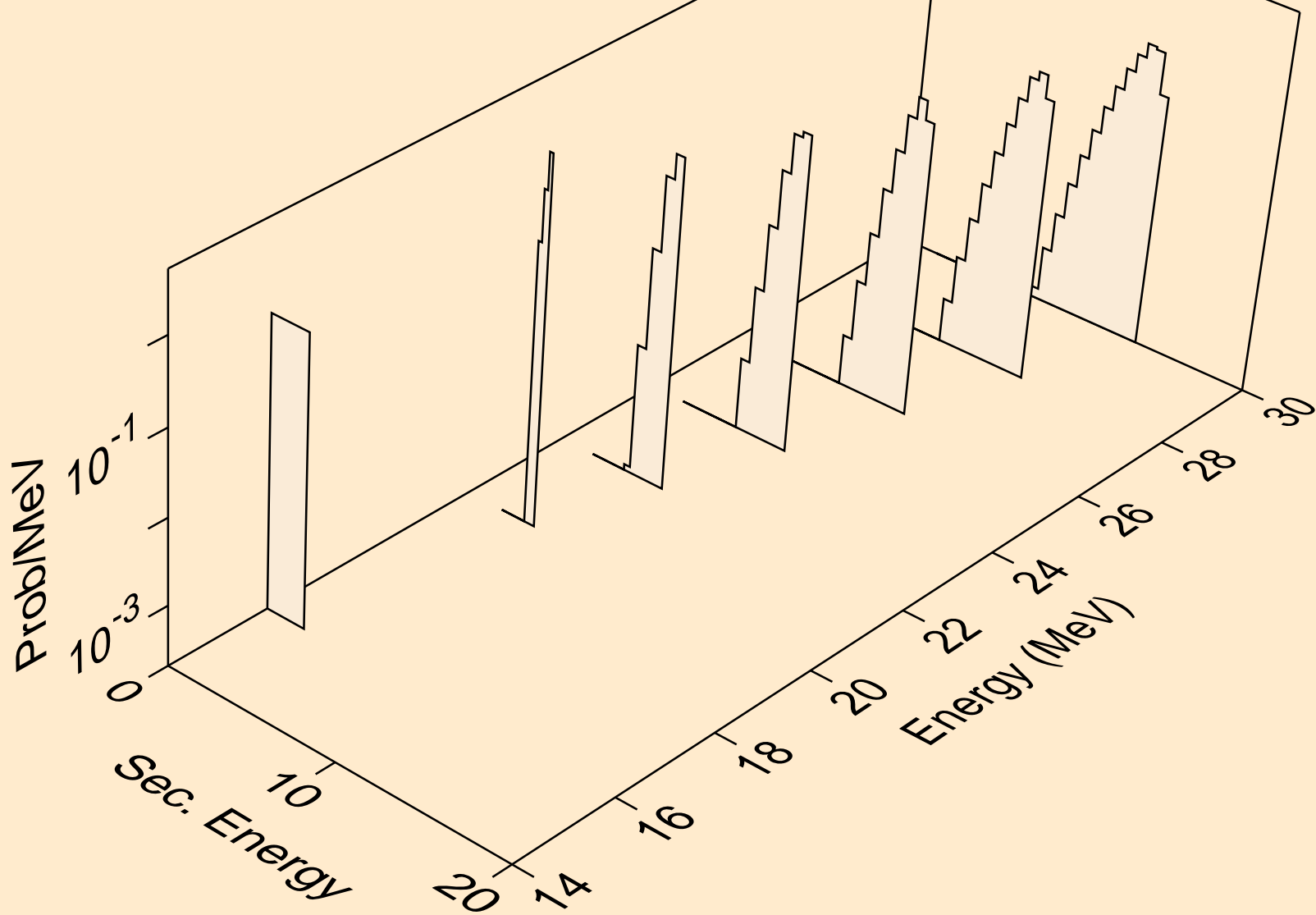

CD108 NEUTRON ACER TENDL-2021 LIBRARY; T=293.6K
he3s from (n,he3)

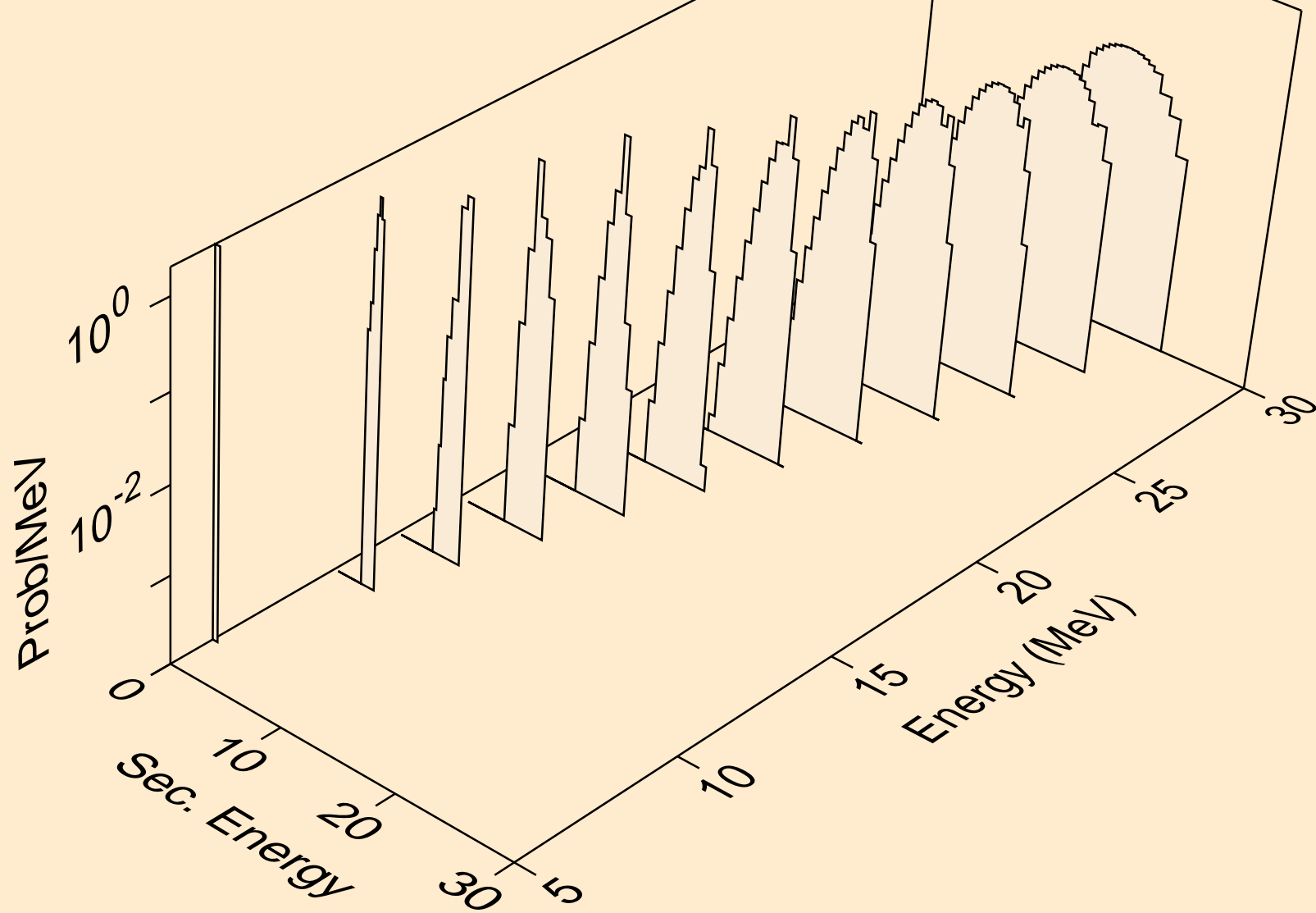

CD108 NEUTRON ACER TENDL-2021 LIBRARY; T=293.6K
alphas from (n,x)

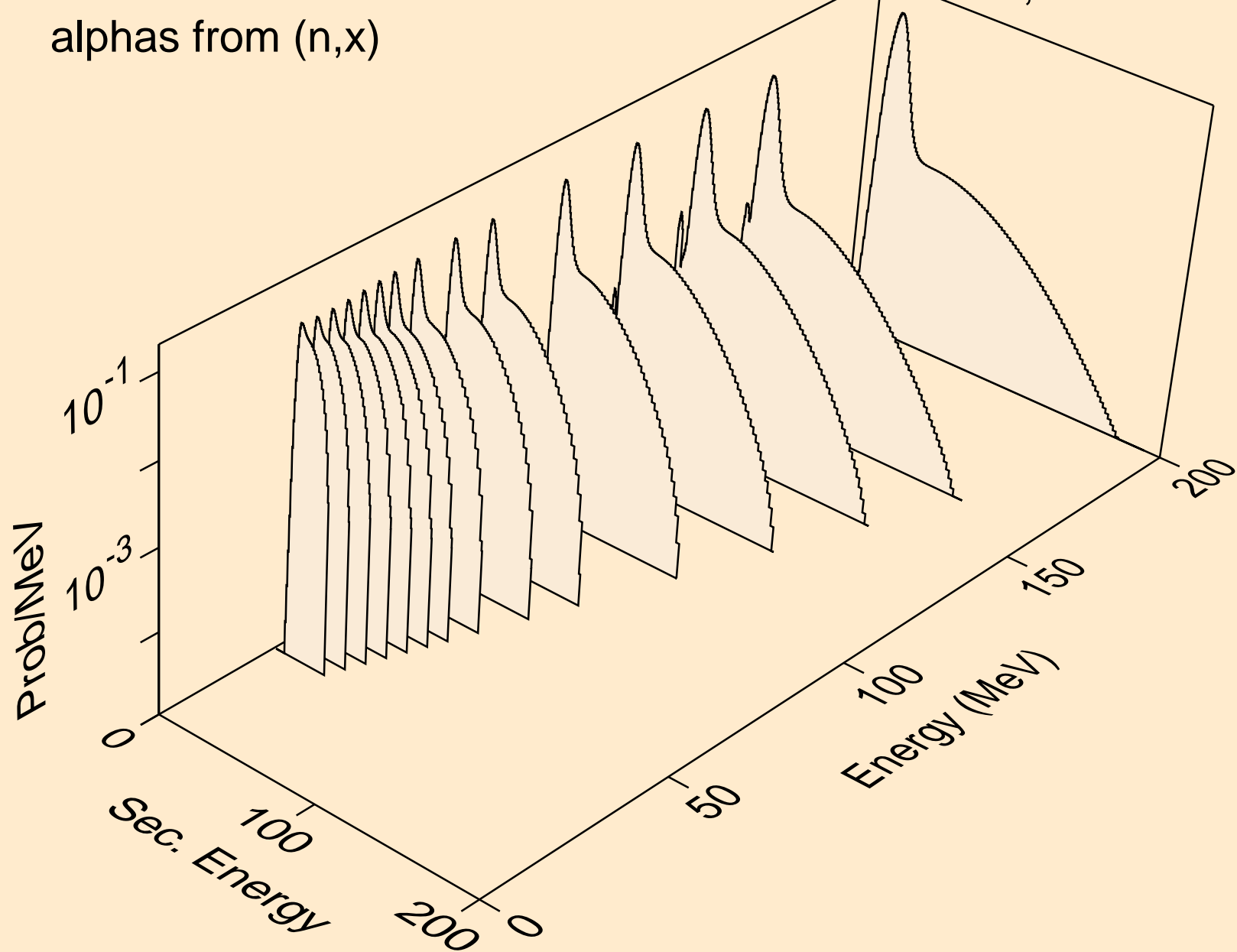

CD108 NEUTRON ACER TENDL-2021 LIBRARY; T=293.6K
alphas from (n,n*)a

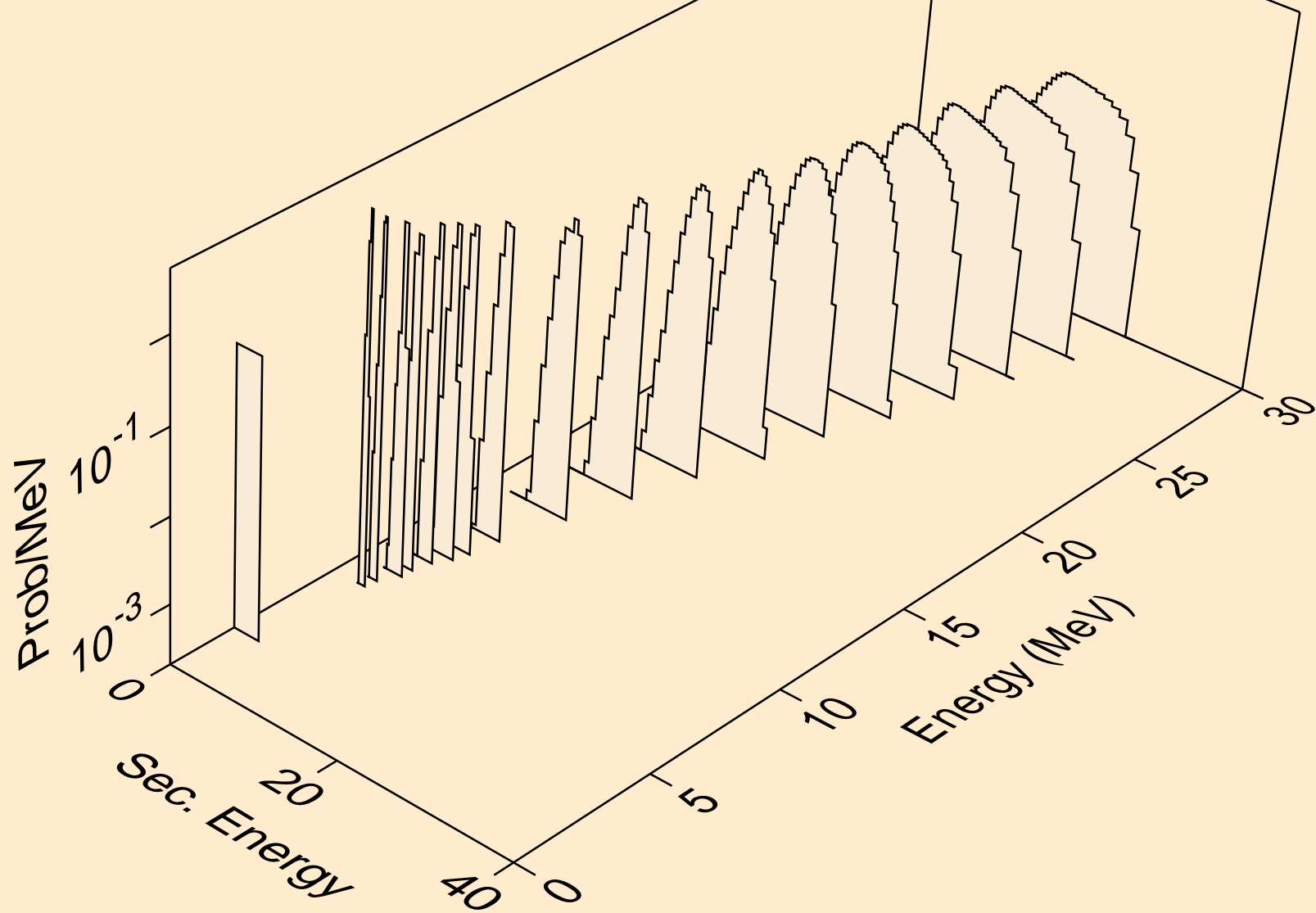

CD108 NEUTRON ACER TENDL-2021 LIBRARY; T=293.6K
alphas from (n,2n)a

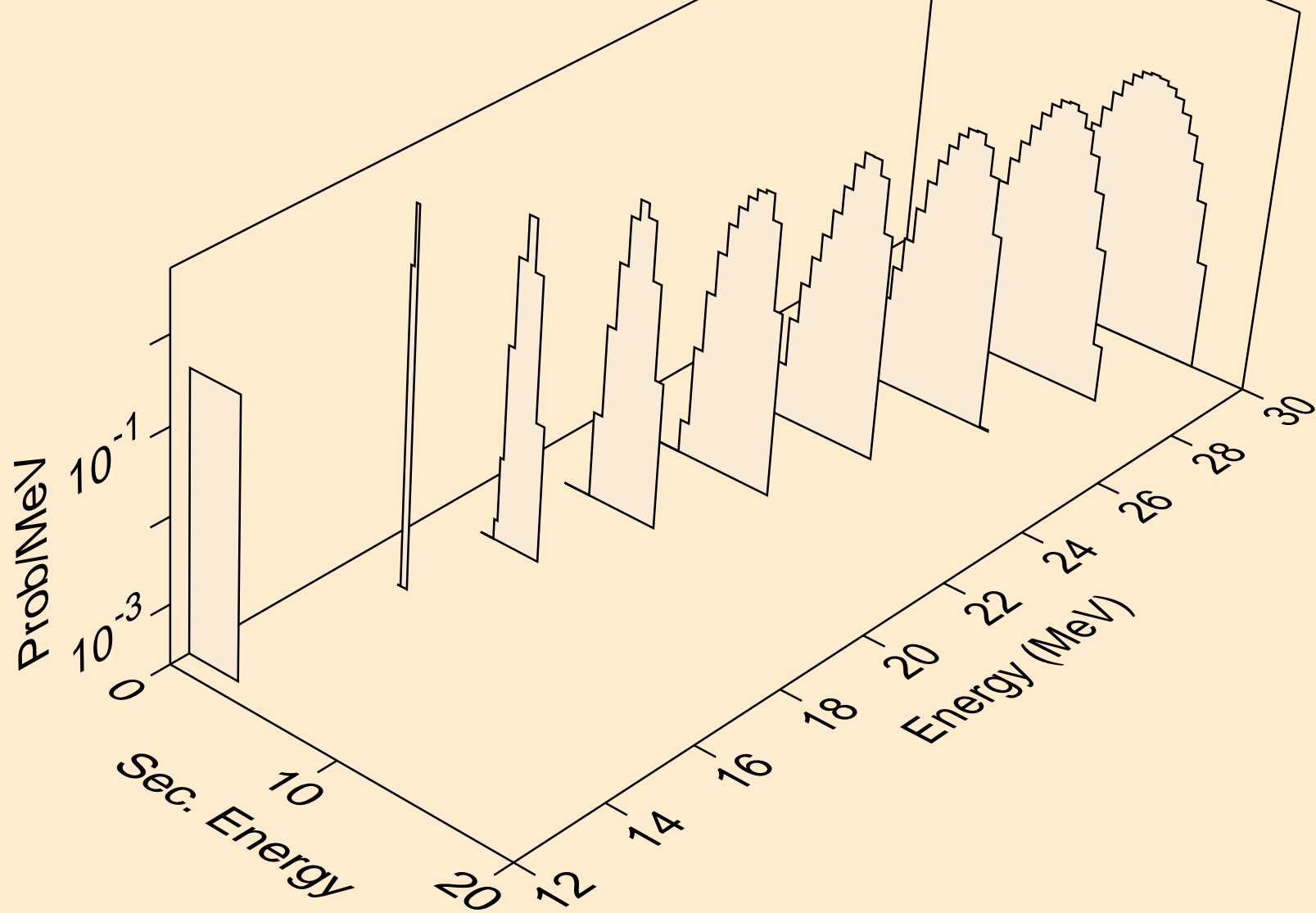

CD108 NEUTRON ACER TENDL-2021 LIBRARY; T=293.6K
alphas from (n,3n)a

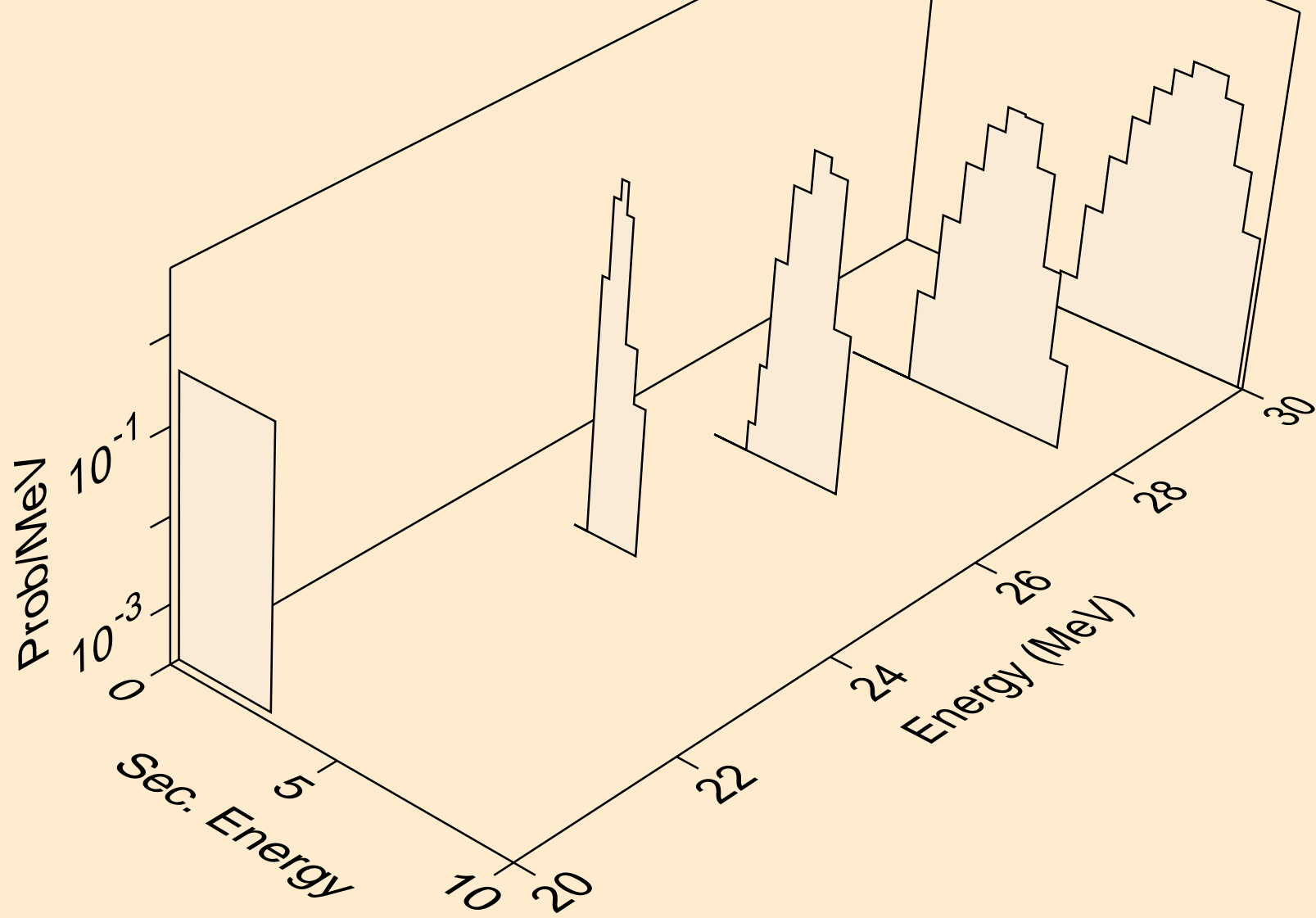

CD108 NEUTRON ACER TENDL-2021 LIBRARY; T=293.6K
alphas from (n,n*)2a

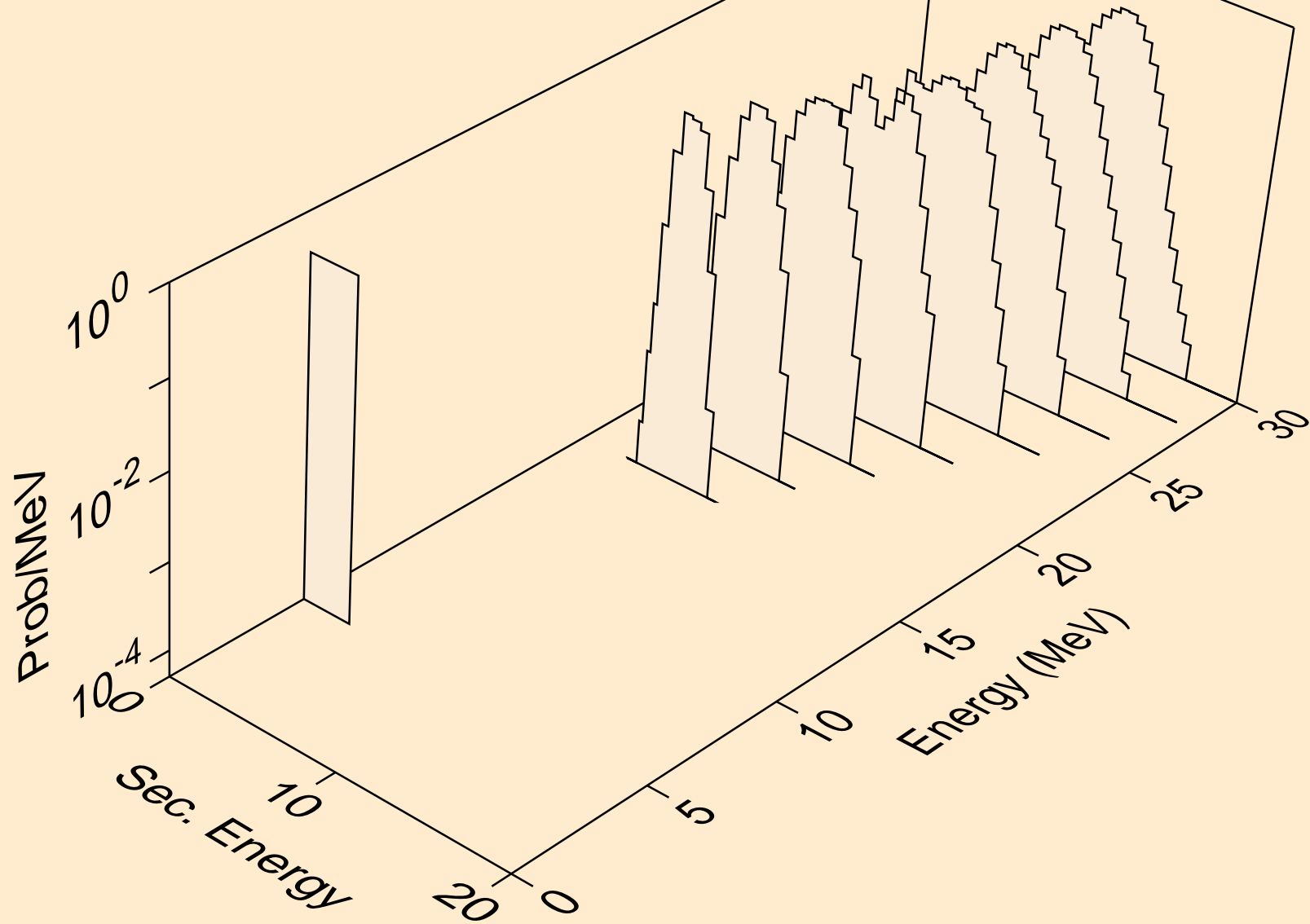

CD108 NEUTRON ACER TENDL-2021 LIBRARY; T=293.6K
alphas from (n,npa)

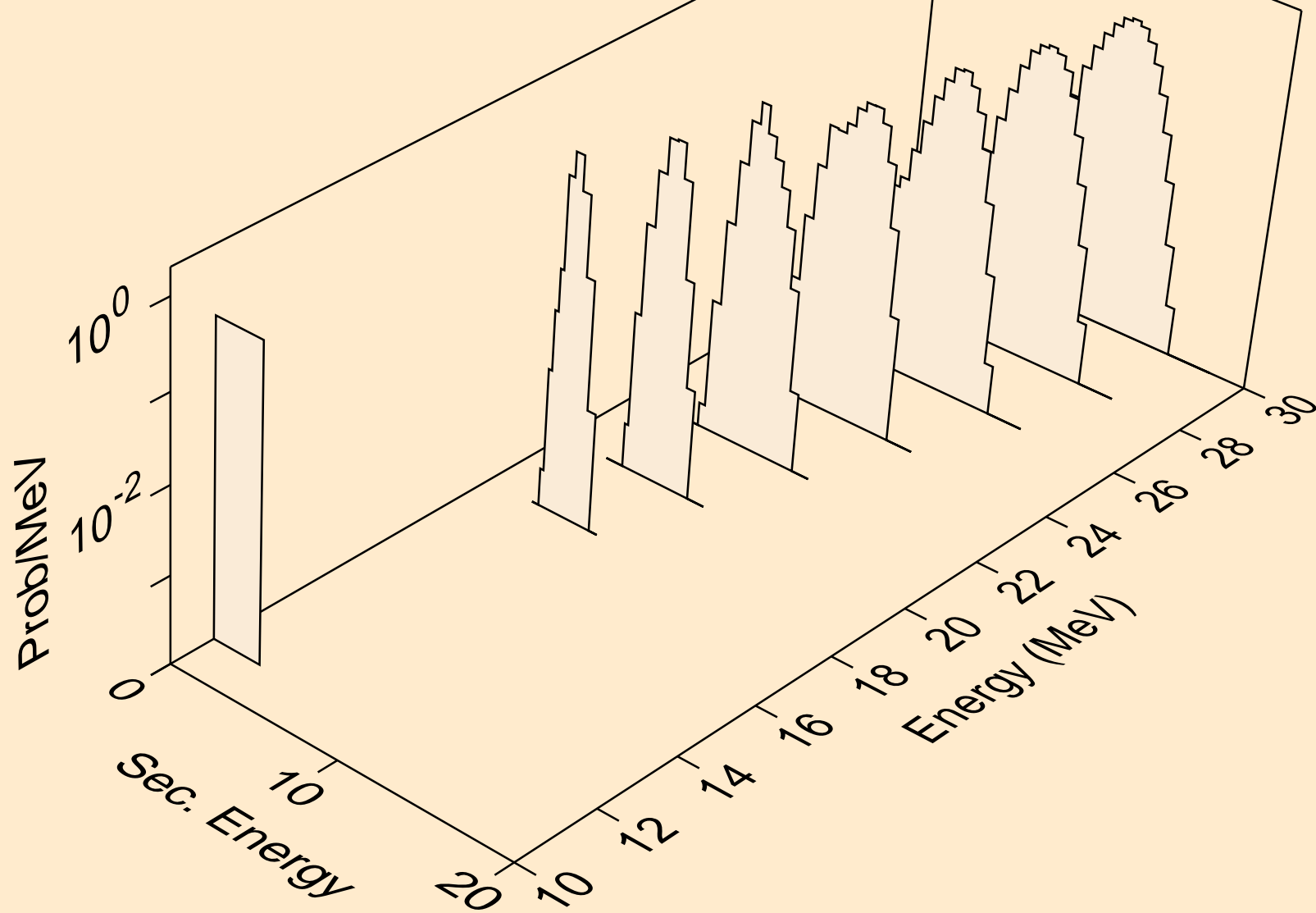

CD108 NEUTRON ACER TENDL-2021 LIBRARY; T=293.6K
alphas from (n,a)

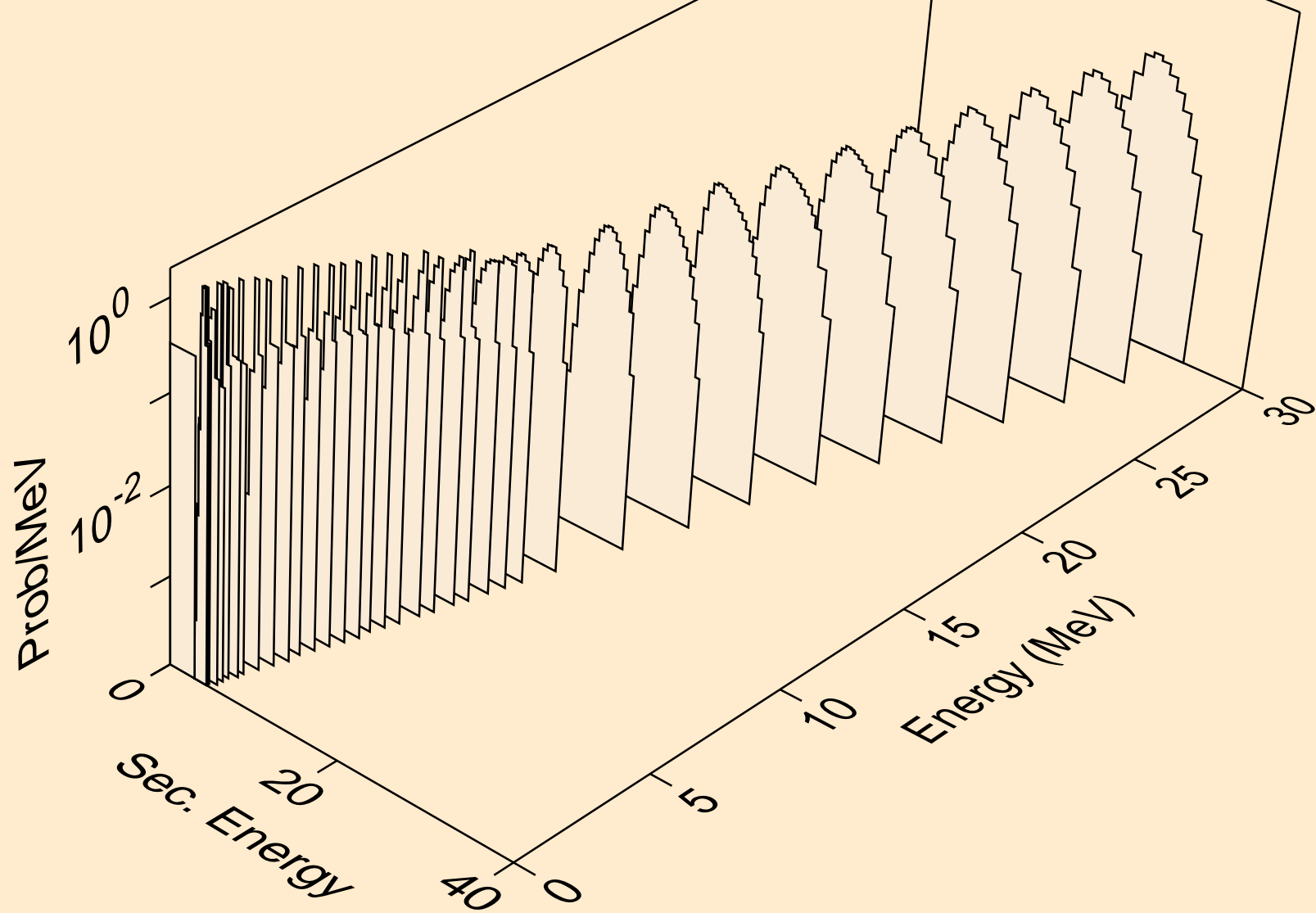

CD108 NEUTRON ACER TENDL-2021 LIBRARY; T=293.6K
alphas from (n,2a)

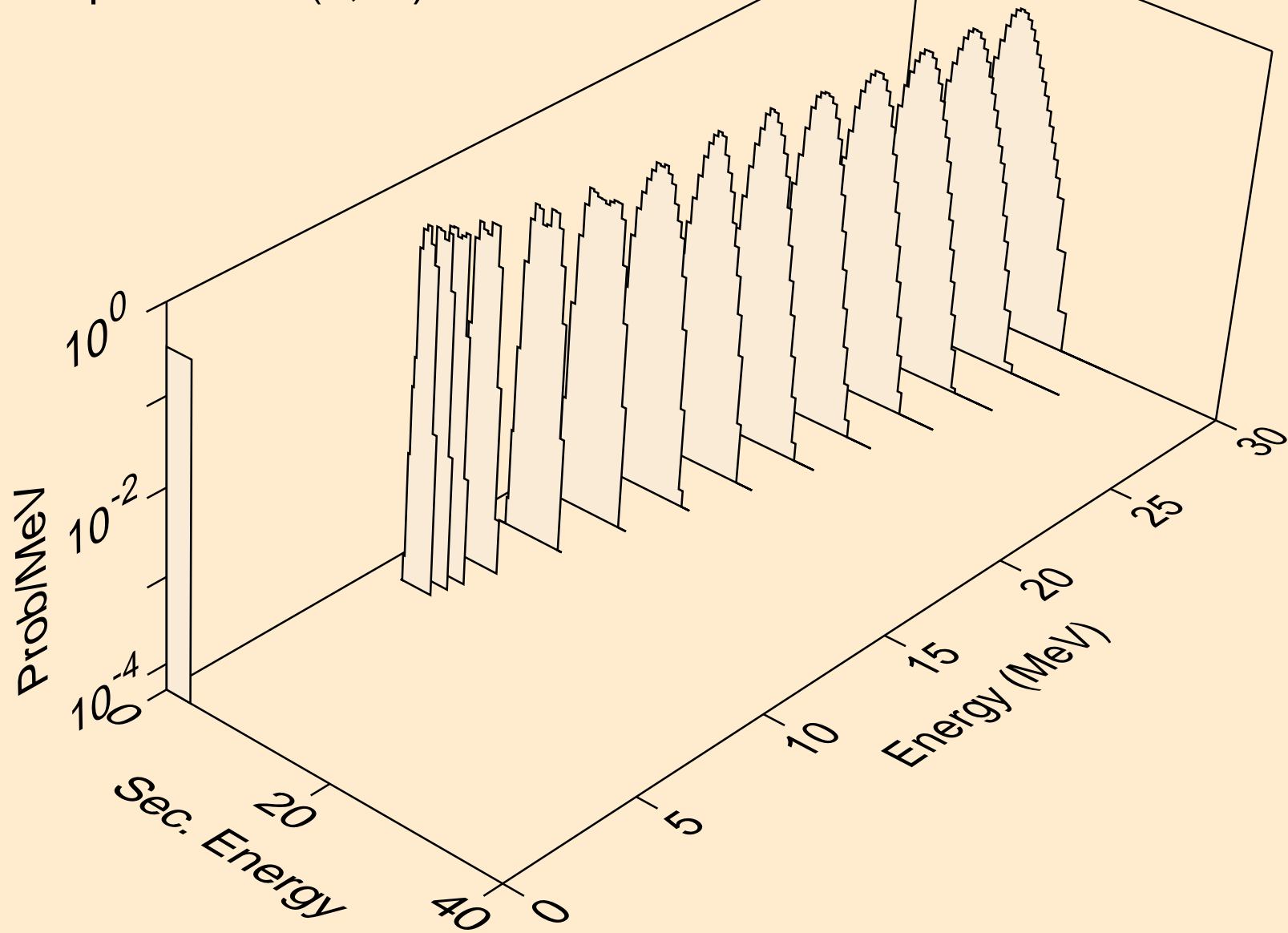

CD108 NEUTRON ACER TENDL-2021 LIBRARY; T=293.6K
alphas from (n,pa)

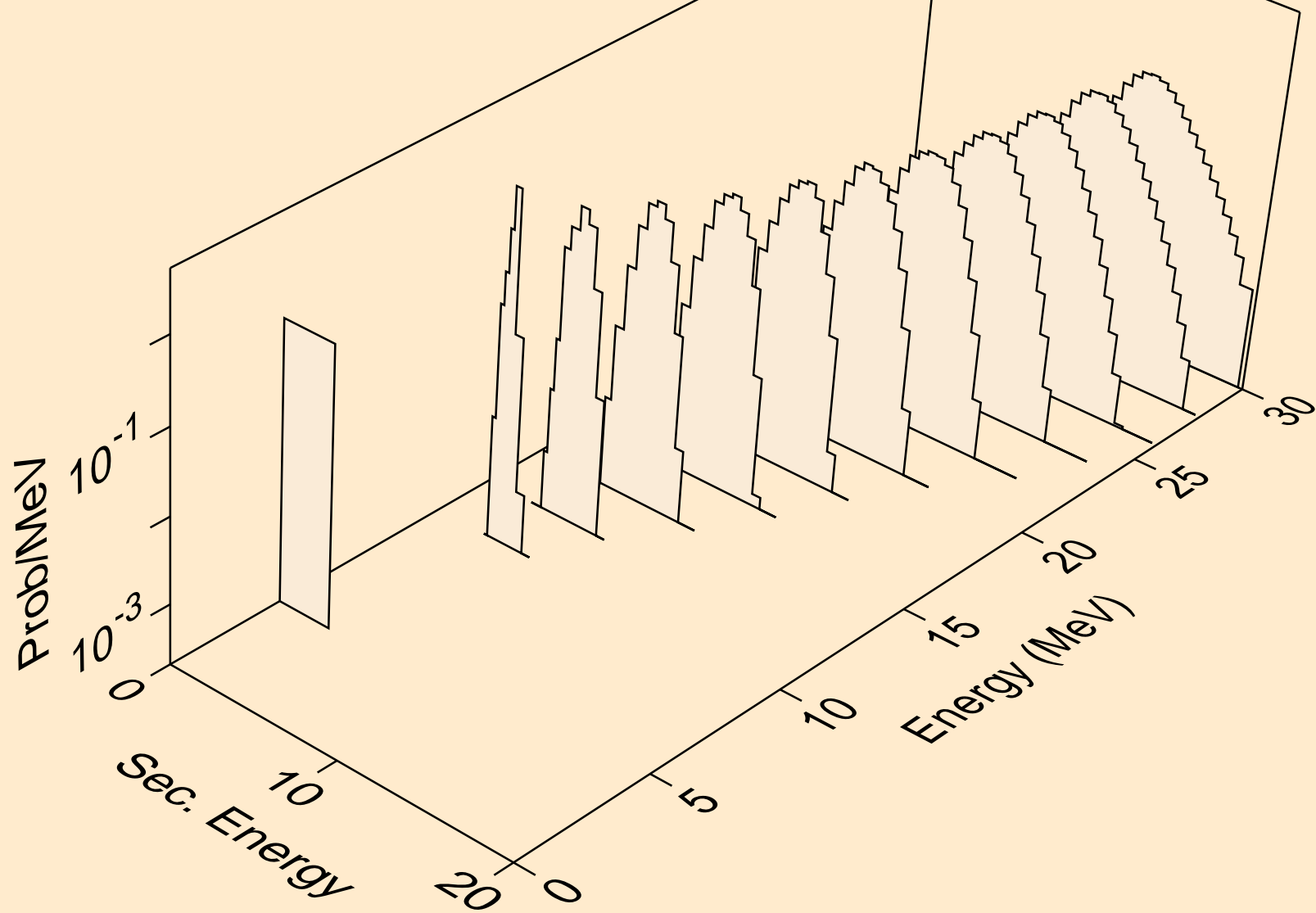

CD108 NEUTRON ACER TENDL-2021 LIBRARY; T=293.6K
alphas from (n,da)

