

CE123 NEUTRON ACER TENDL-2021 LIBRARY; T=293.6K
Principal cross sections

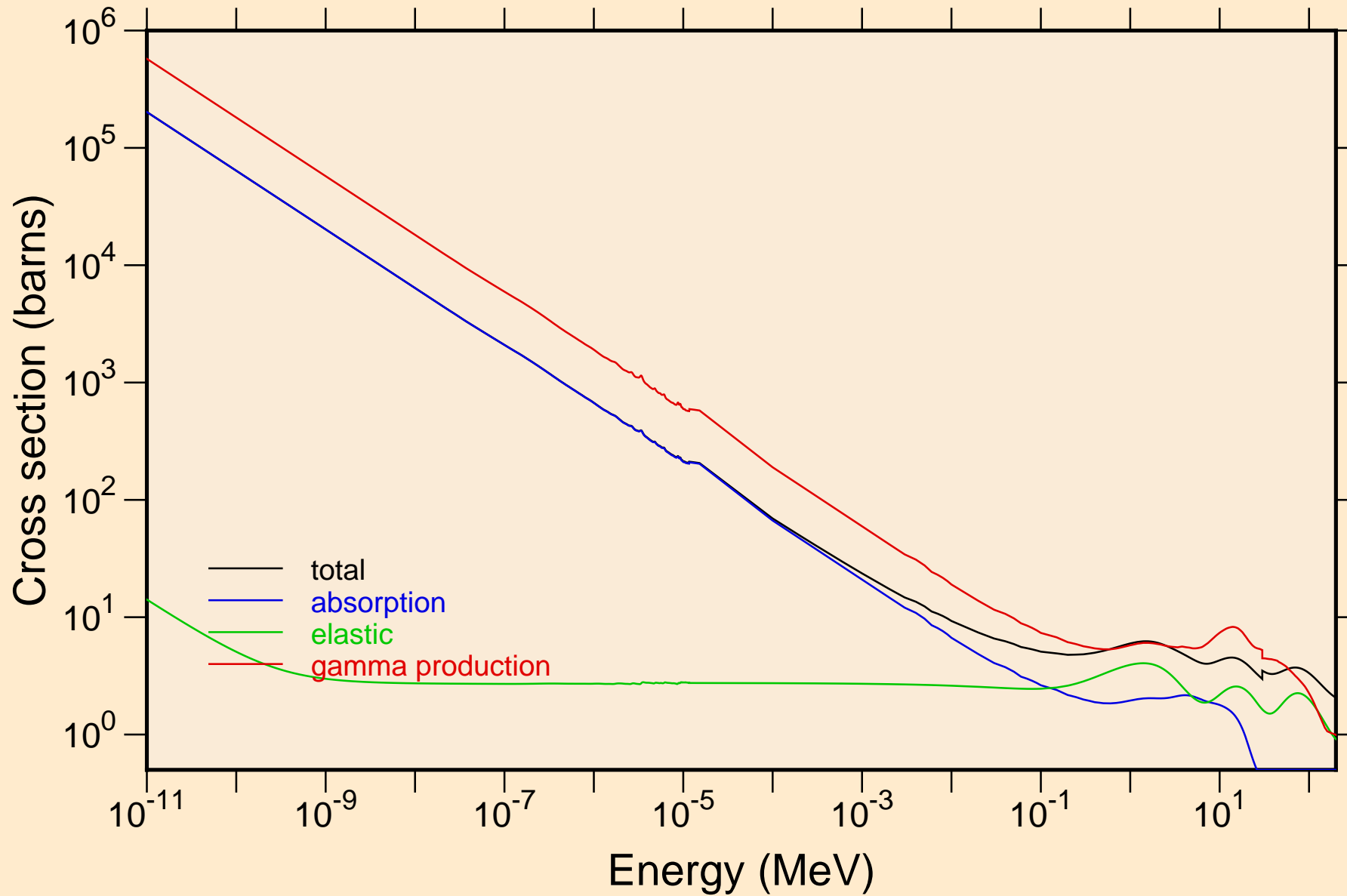

CE123 NEUTRON ACER TENDL-2021 LIBRARY; T=293.6K
Heating

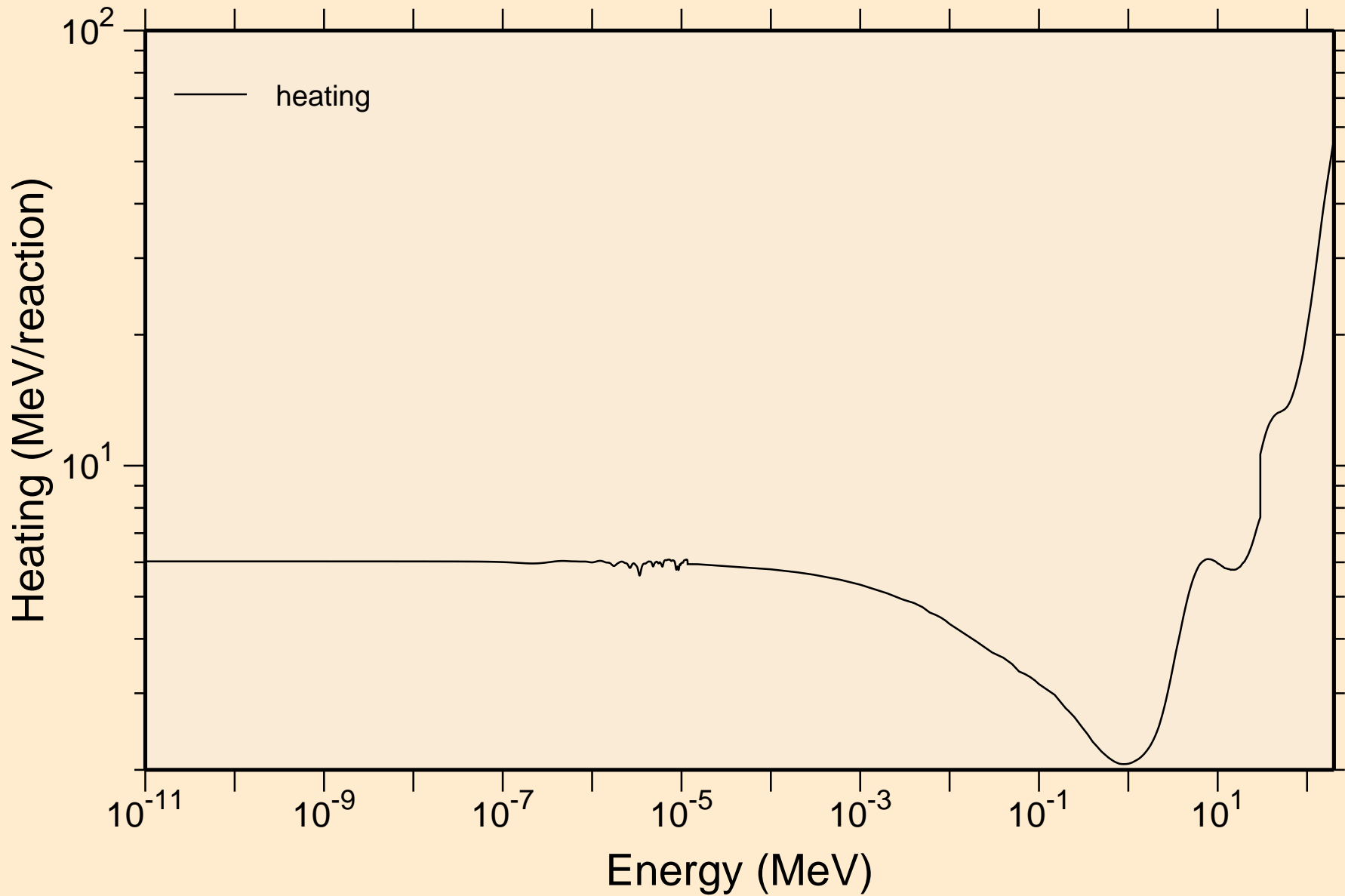

CE123 NEUTRON ACER TENDL-2021 LIBRARY; T=293.6K
Damage

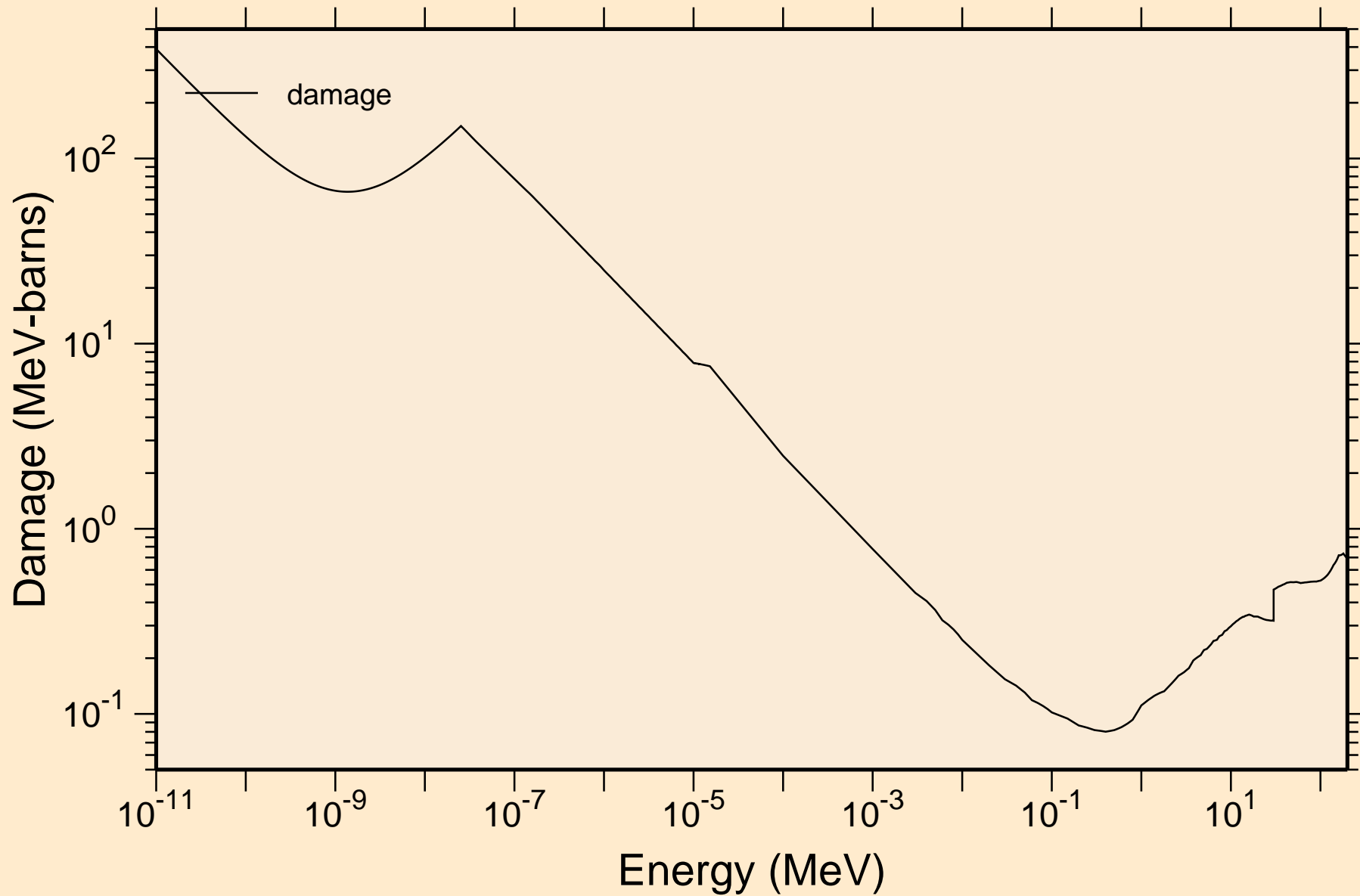

CE123 NEUTRON ACER TENDL-2021 LIBRARY; T=293.6K
Non-threshold reactions

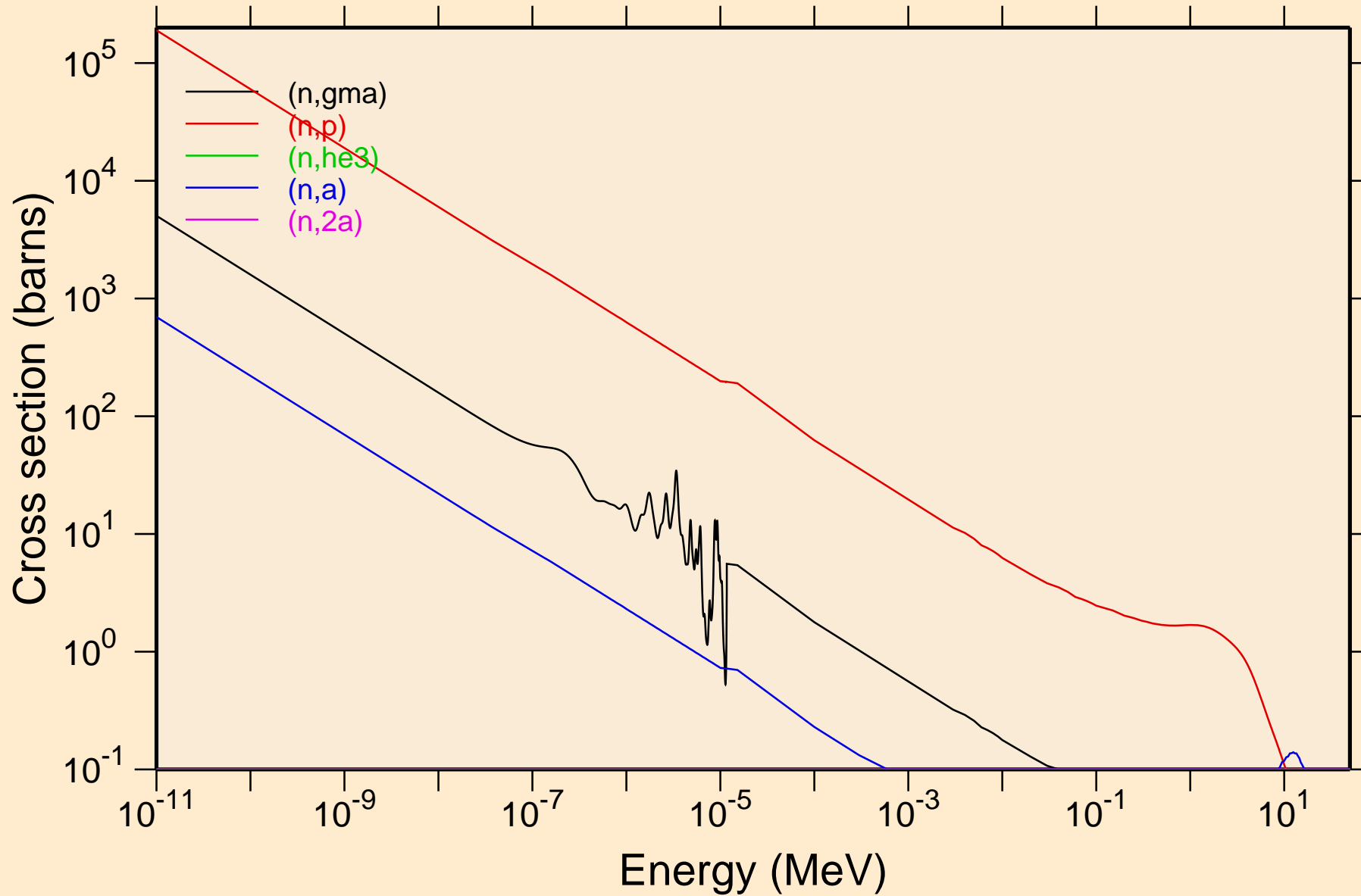

CE123 NEUTRON ACER TENDL-2021 LIBRARY; T=293.6K
Non-threshold reactions

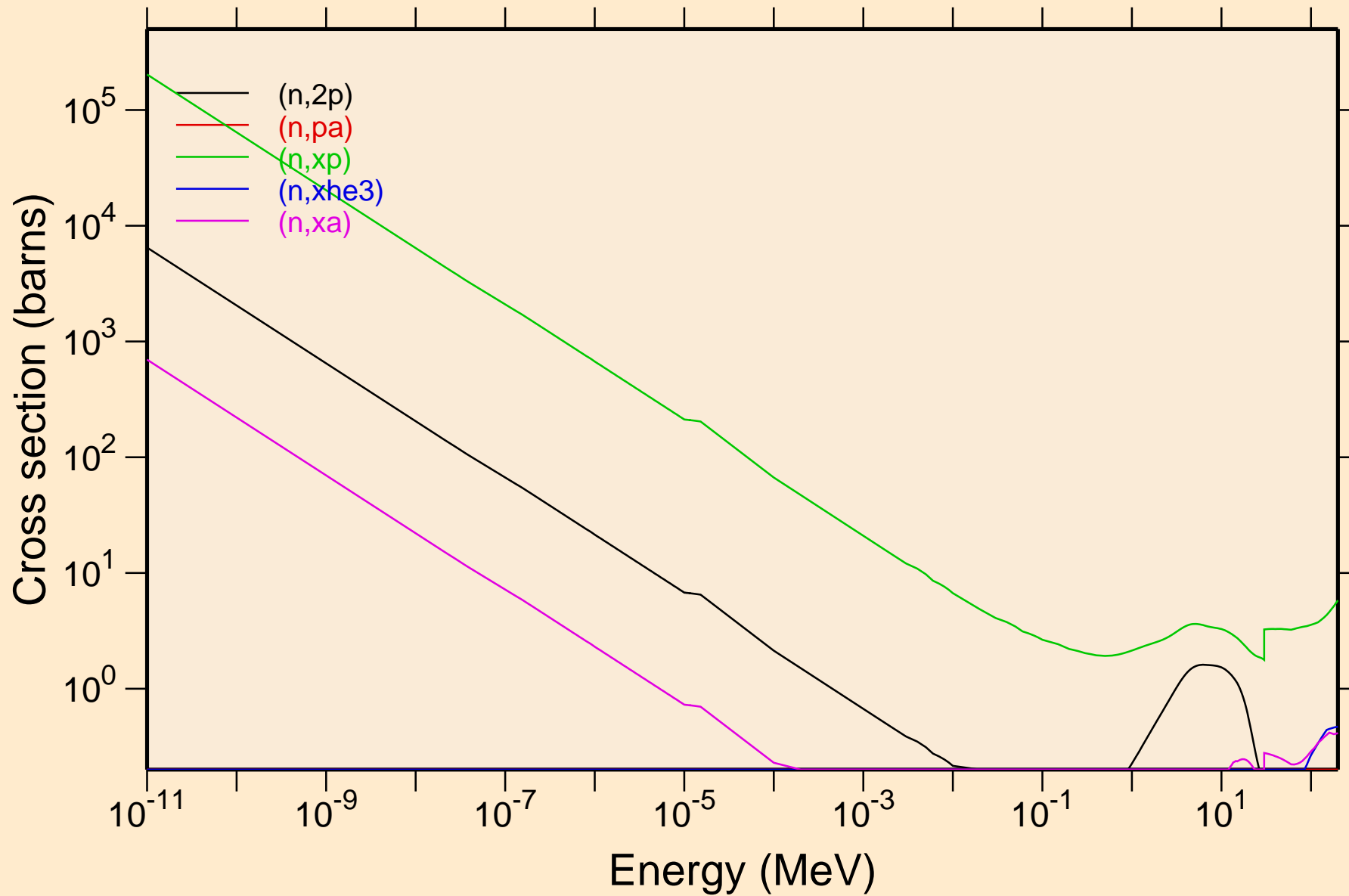

CE123 NEUTRON ACER TENDL-2021 LIBRARY; T=293.6K

Principal cross sections

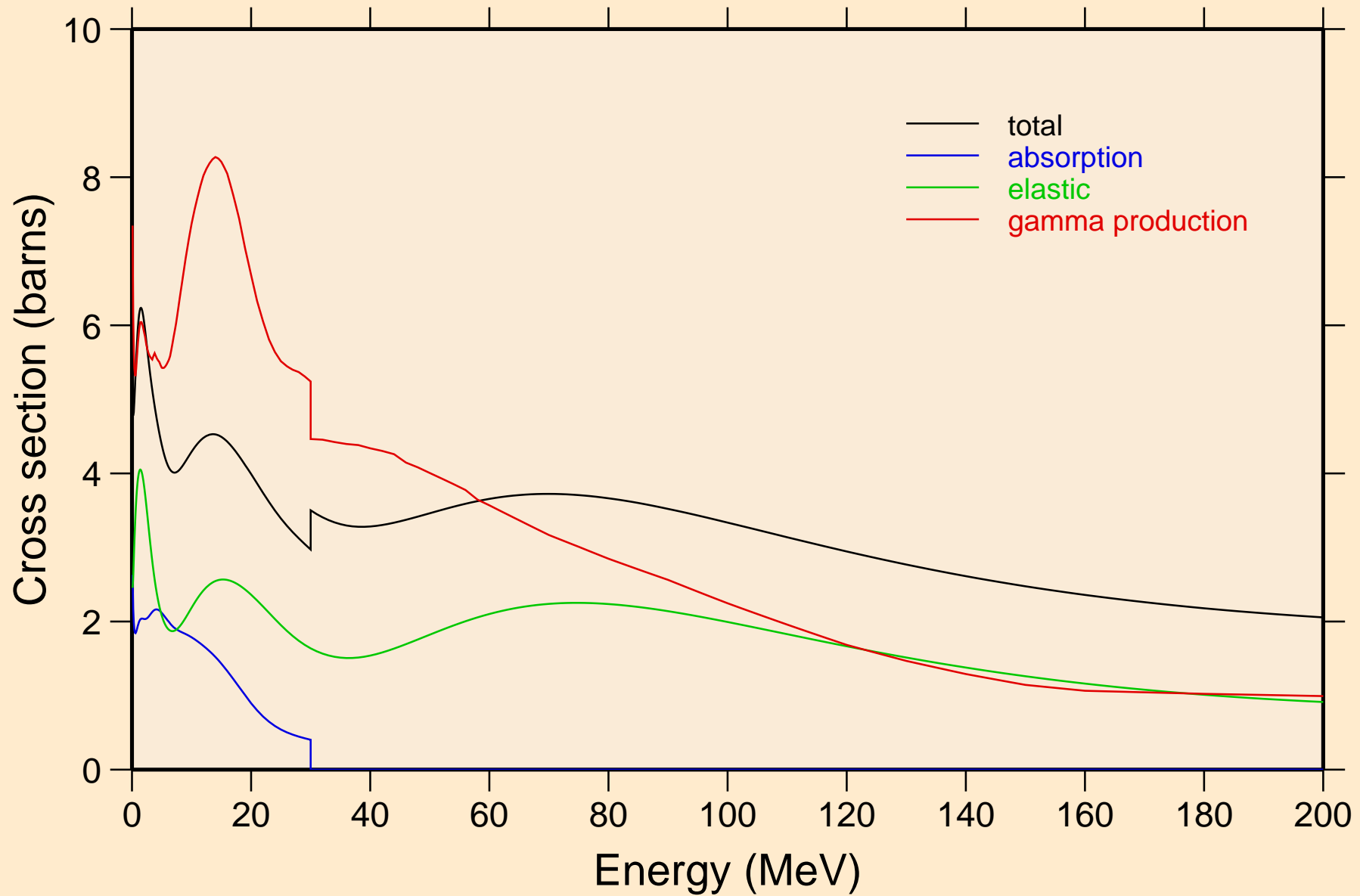

CE123 NEUTRON ACER TENDL-2021 LIBRARY; T=293.6K
Heating

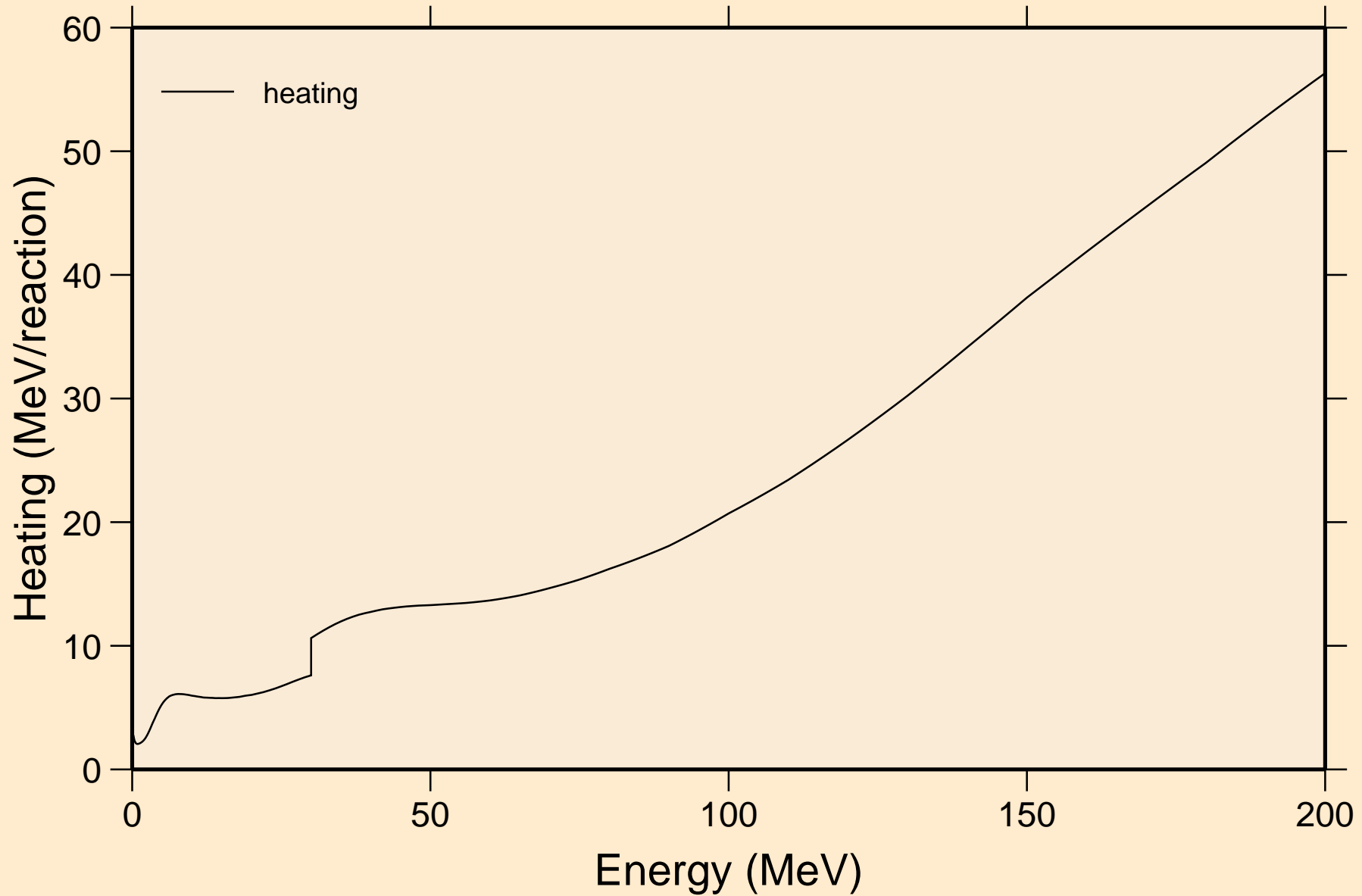

CE123 NEUTRON ACER TENDL-2021 LIBRARY; T=293.6K

Damage

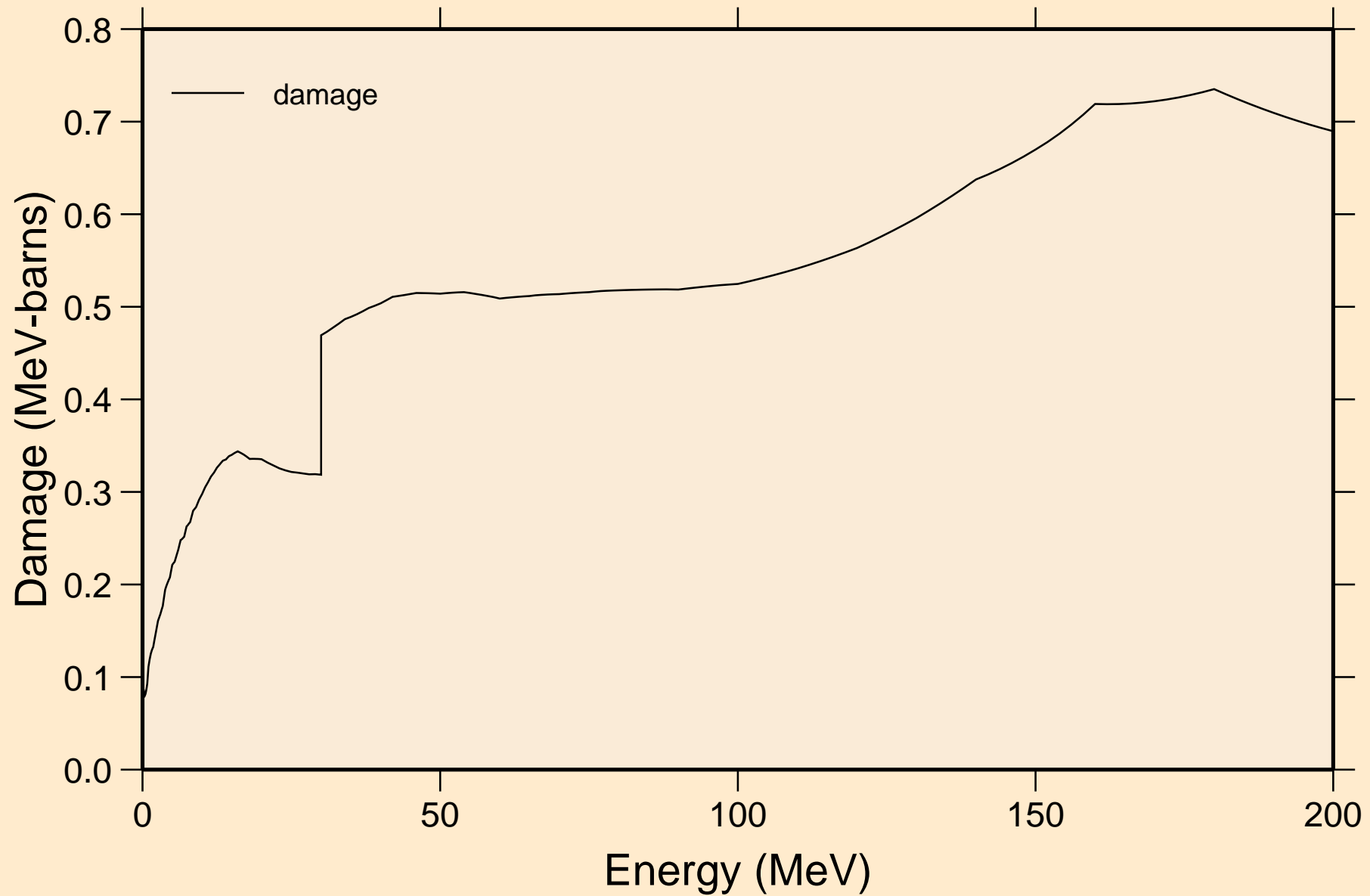

CE123 NEUTRON ACER TENDL-2021 LIBRARY; T=293.6K
Non-threshold reactions

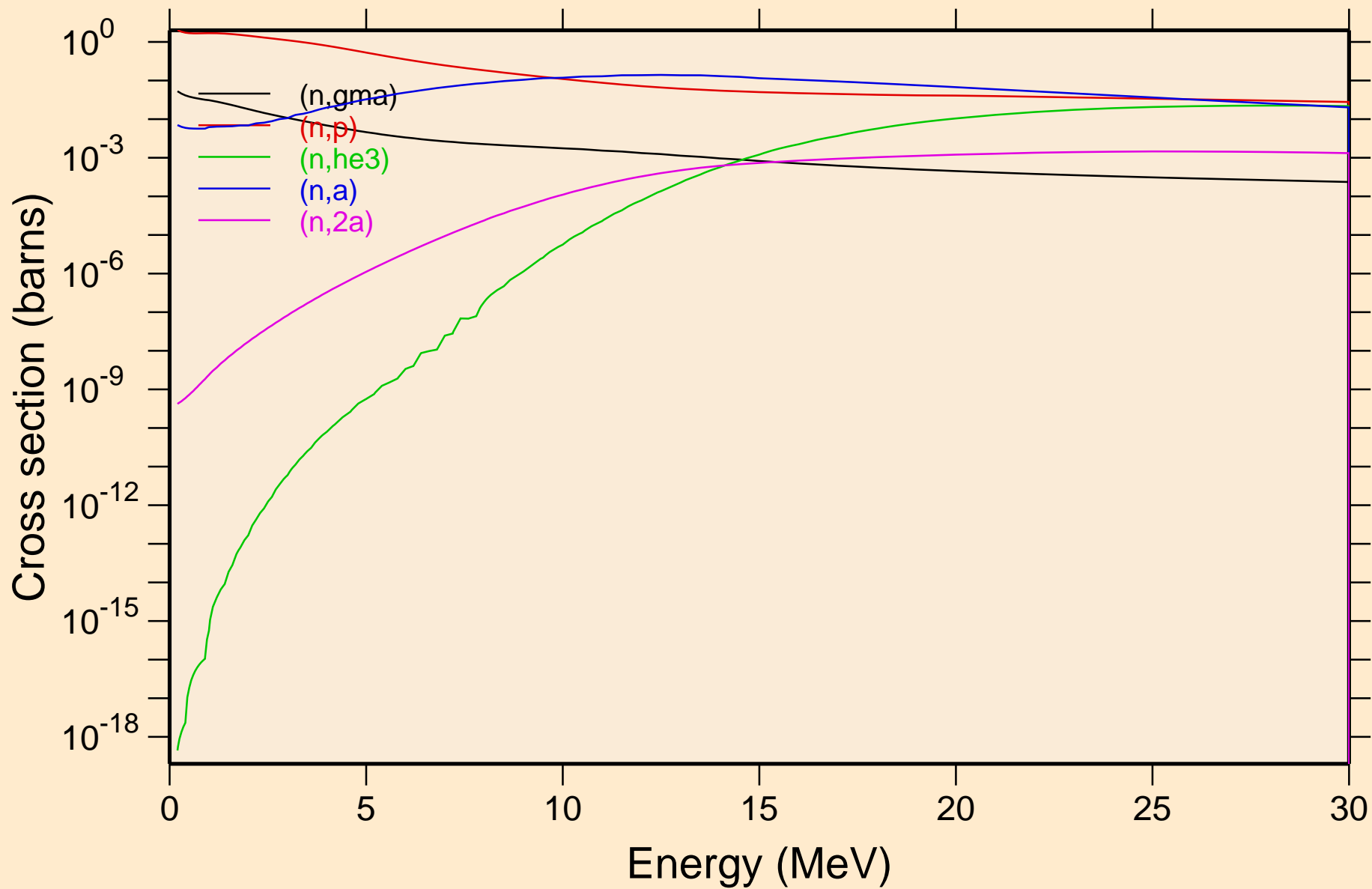

CE123 NEUTRON ACER TENDL-2021 LIBRARY; T=293.6K
Non-threshold reactions

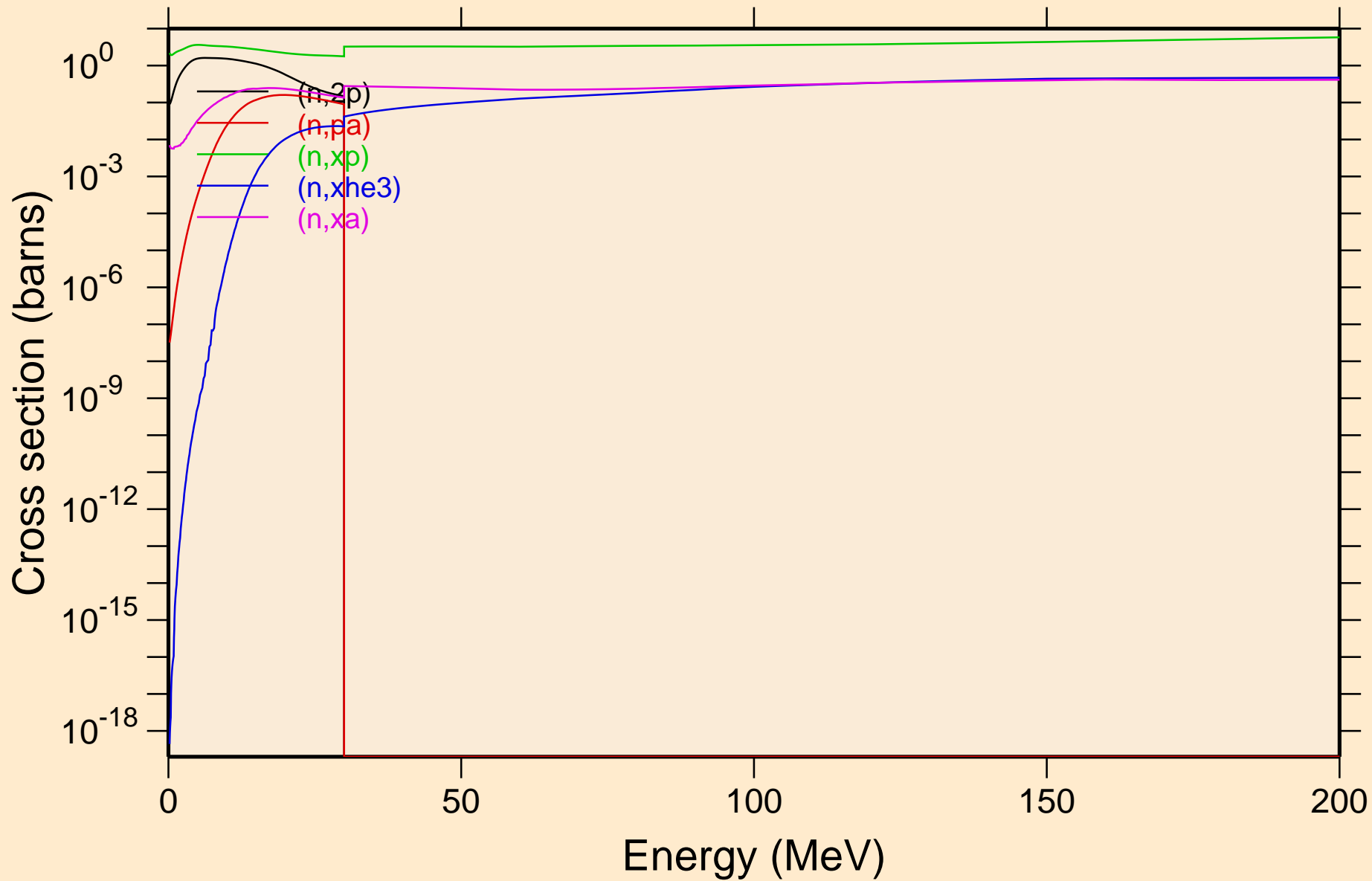

CE123 NEUTRON ACER TENDL-2021 LIBRARY; T=293.6K
Inelastic levels

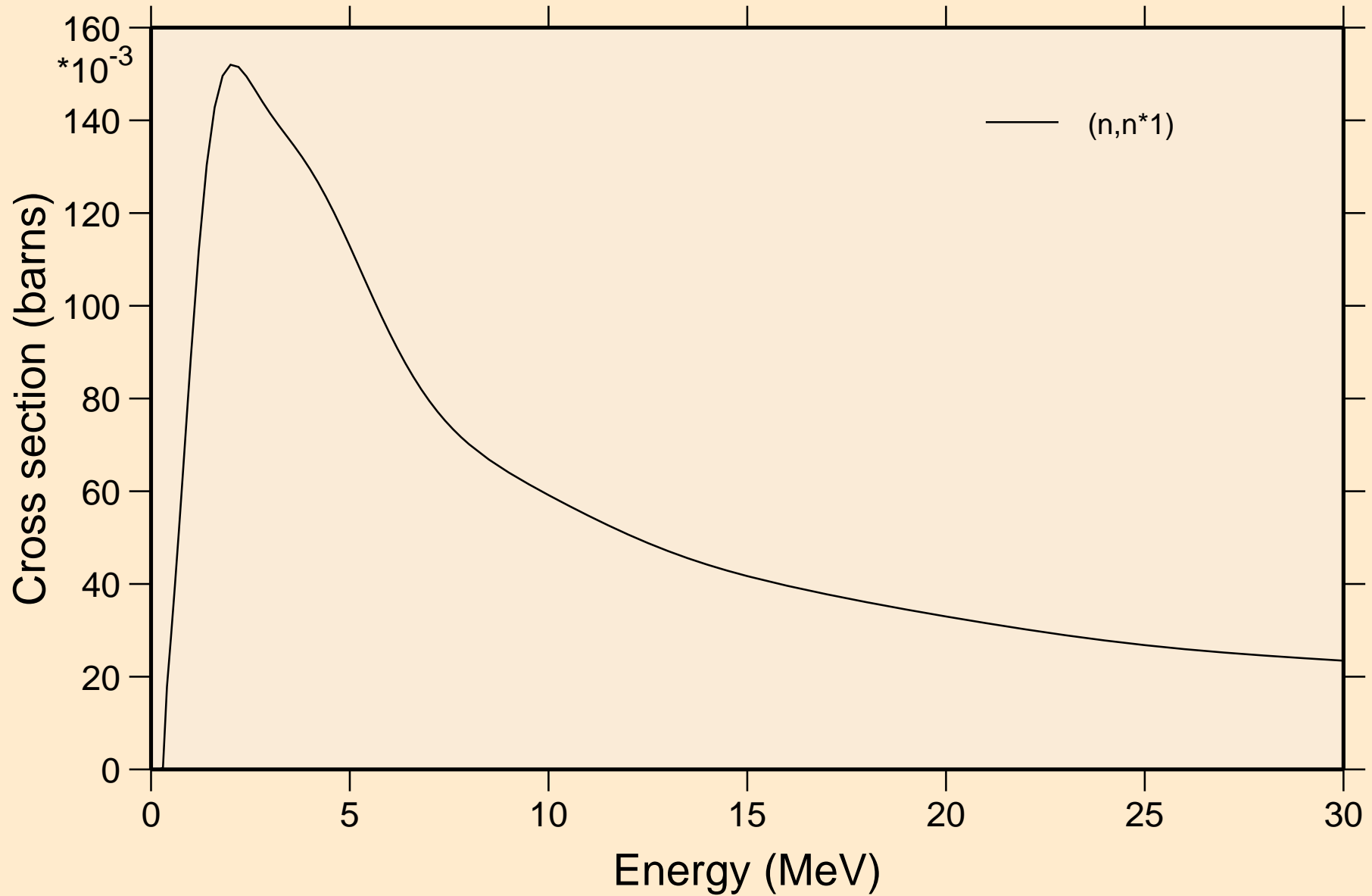

CE123 NEUTRON ACER TENDL-2021 LIBRARY; T=293.6K
Threshold reactions

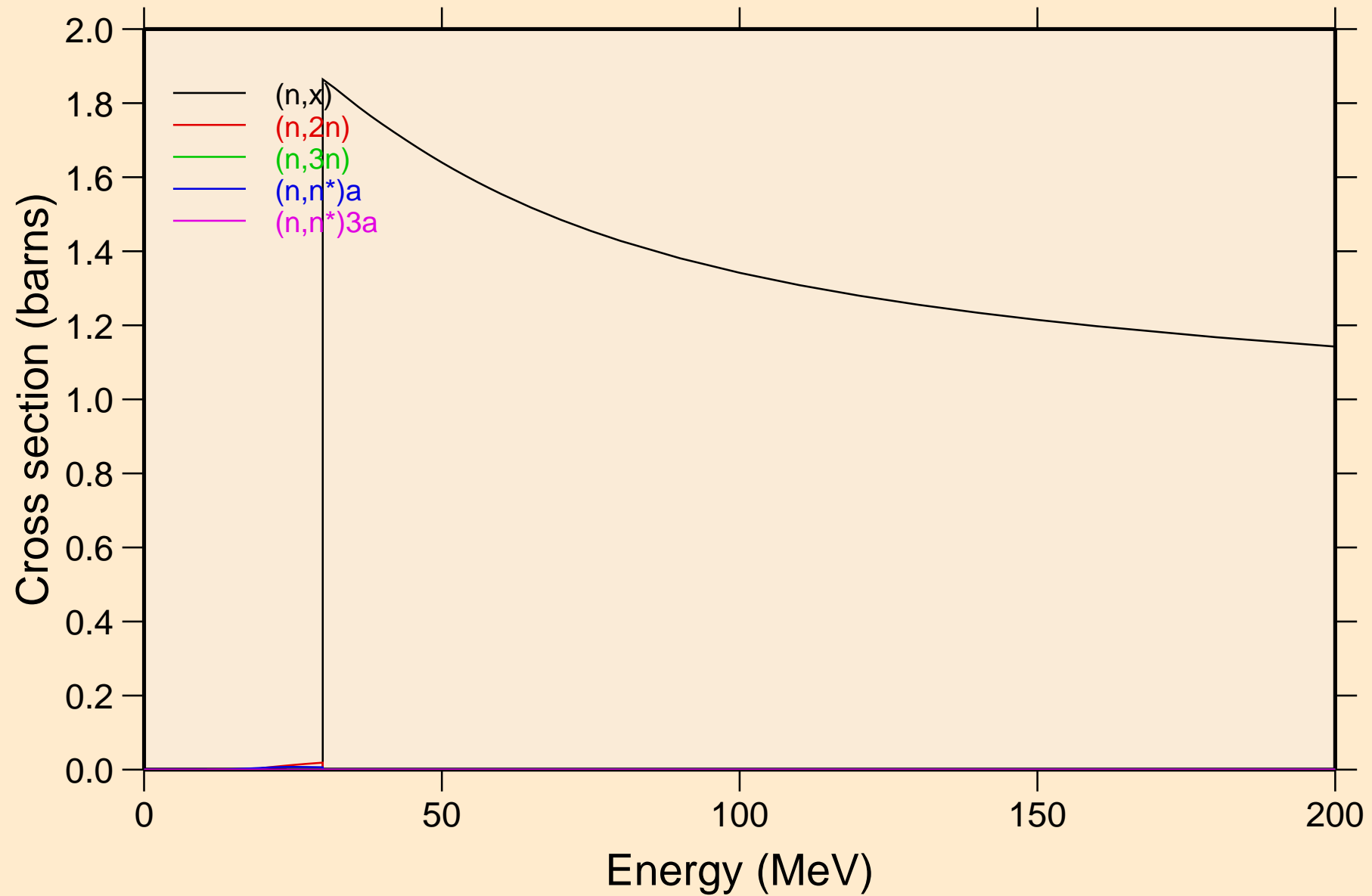

CE123 NEUTRON ACER TENDL-2021 LIBRARY; T=293.6K
Threshold reactions

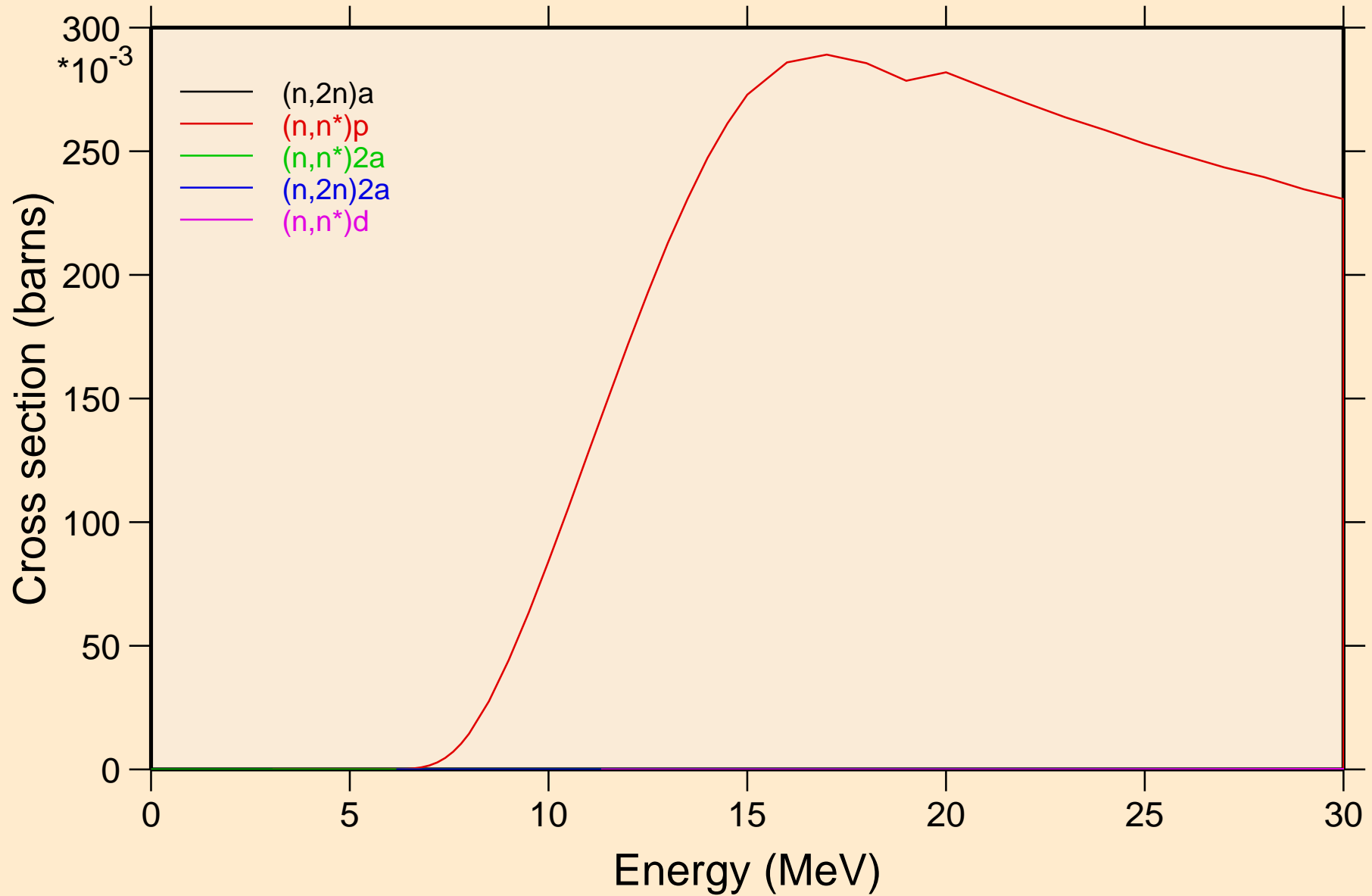

CE123 NEUTRON ACER TENDL-2021 LIBRARY; T=293.6K
Threshold reactions

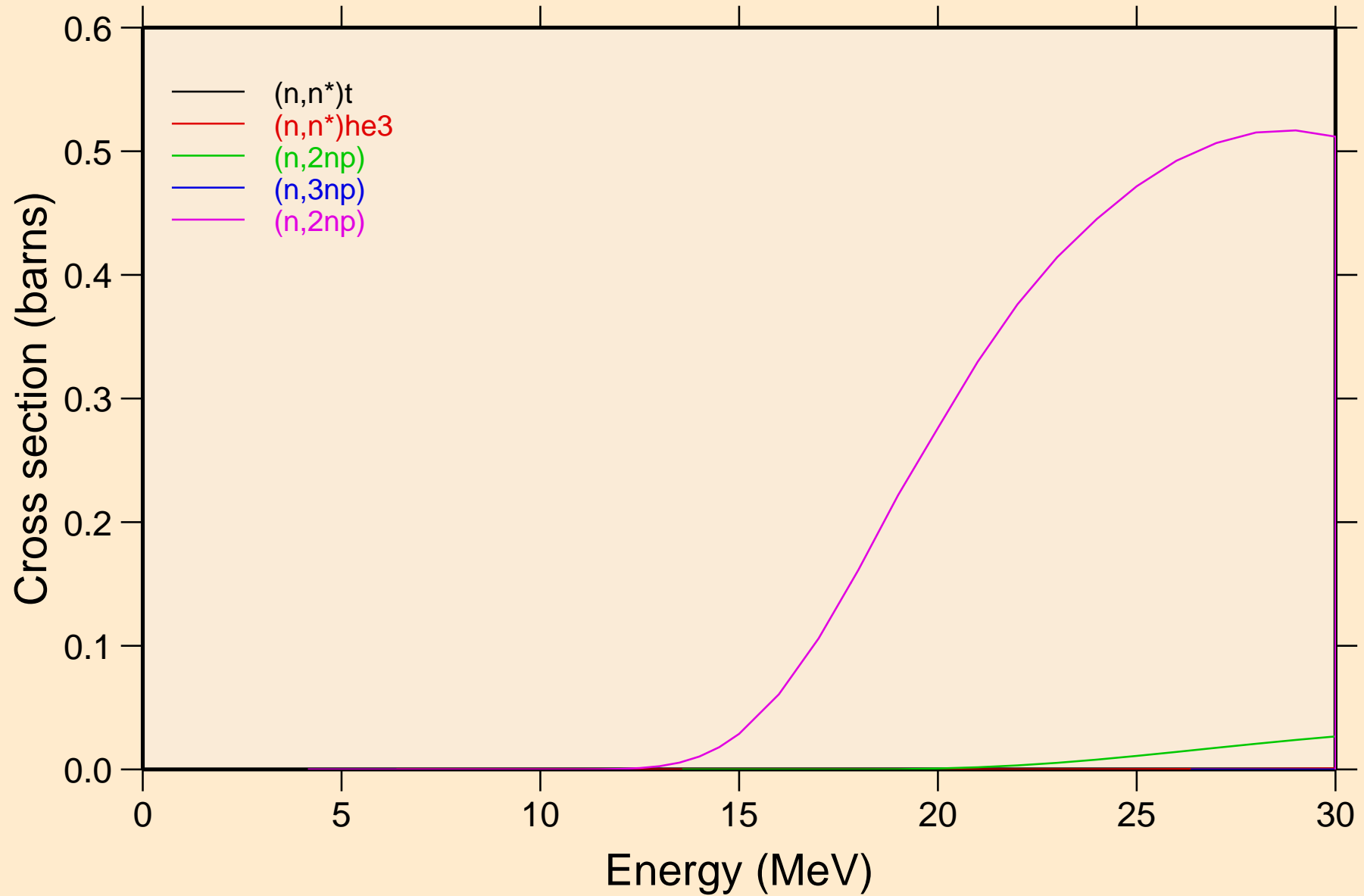

CE123 NEUTRON ACER TENDL-2021 LIBRARY; T=293.6K
Threshold reactions

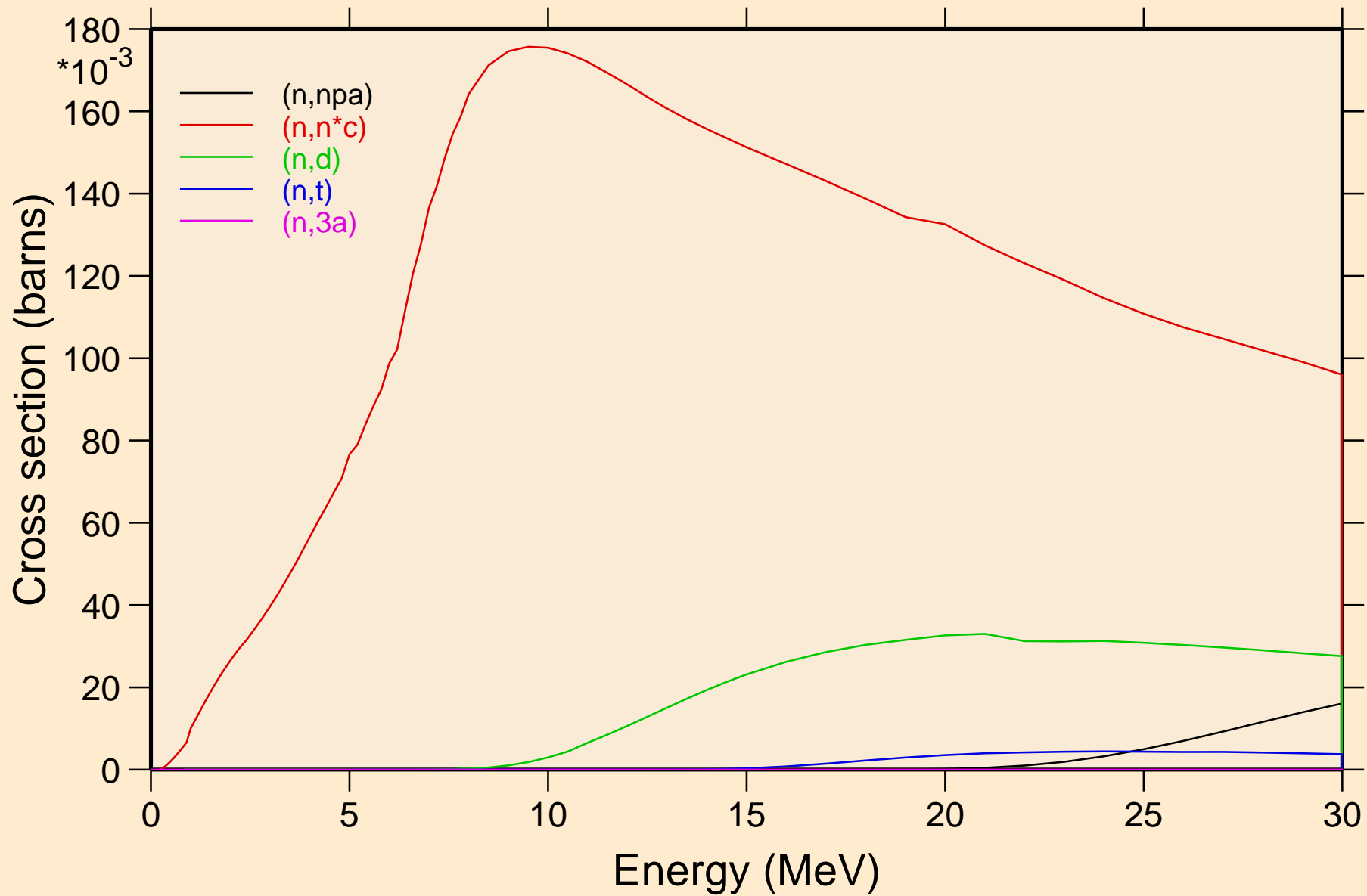

CE123 NEUTRON ACER TENDL-2021 LIBRARY; T=293.6K
Threshold reactions

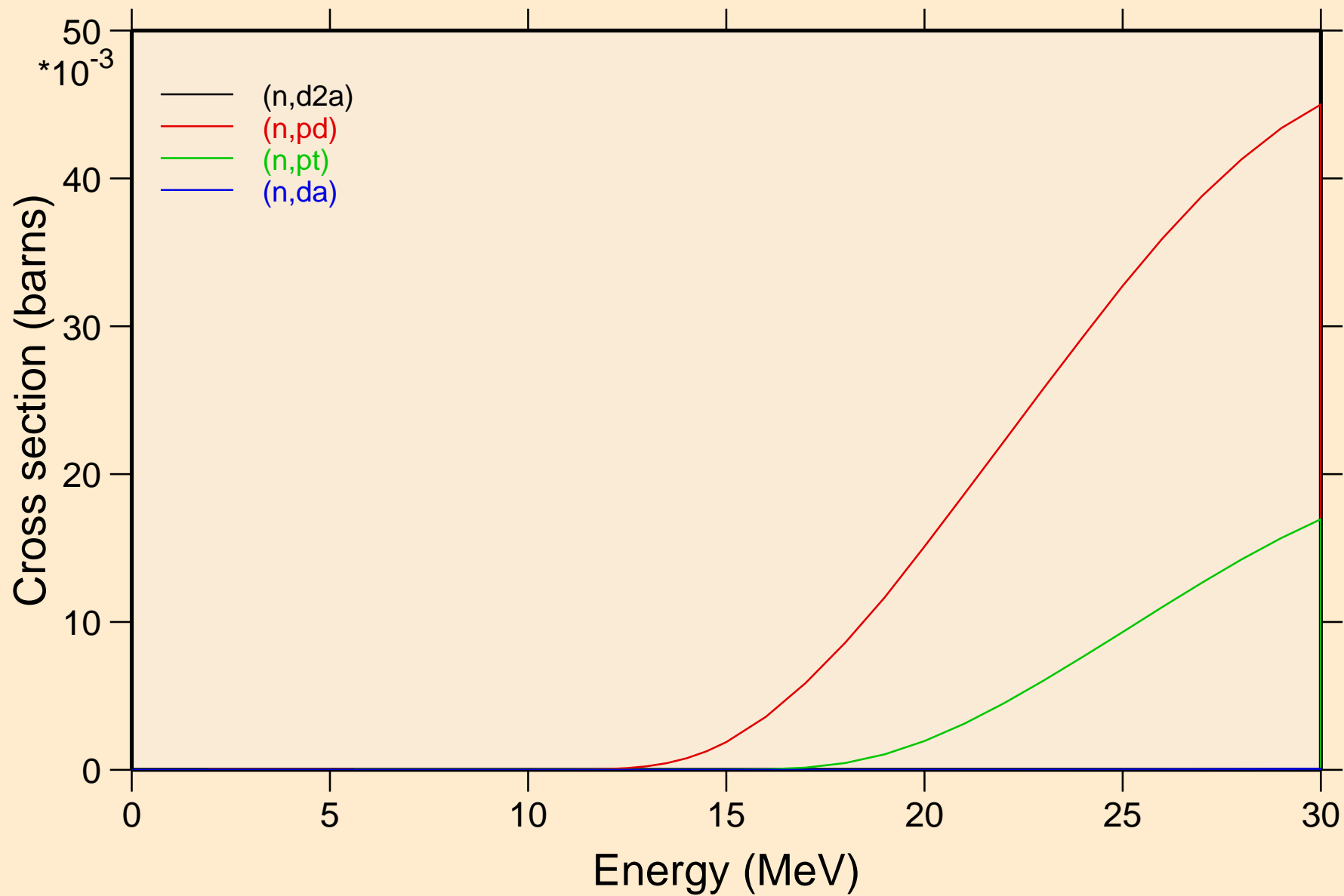

CE123 NEUTRON ACER TENDL-2021 LIBRARY; T=293.6K
Threshold reactions

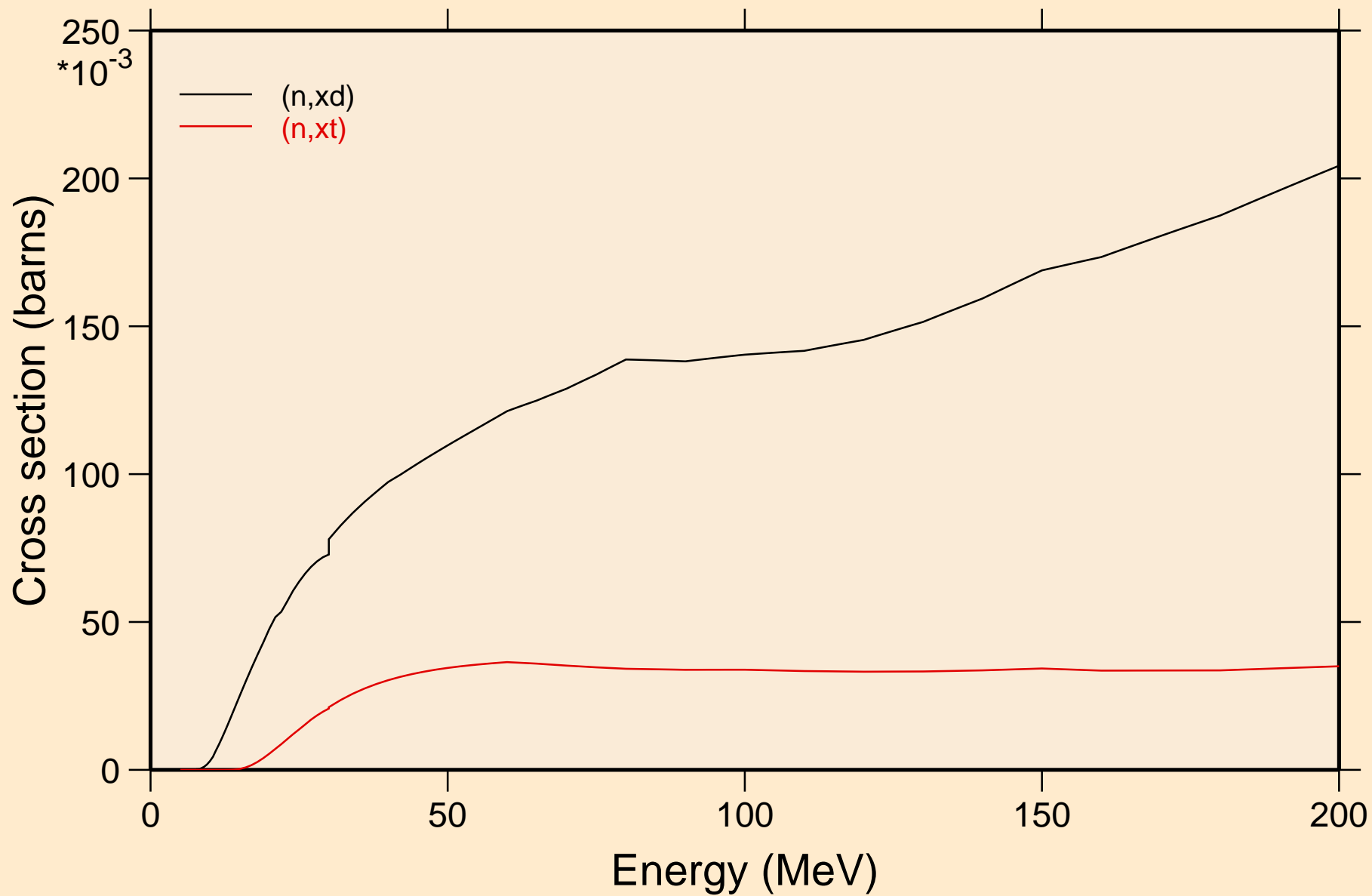

CE123 NEUTRON ACER TENDL-2021 LIBRARY; T=293.6K
angular distribution for elastic

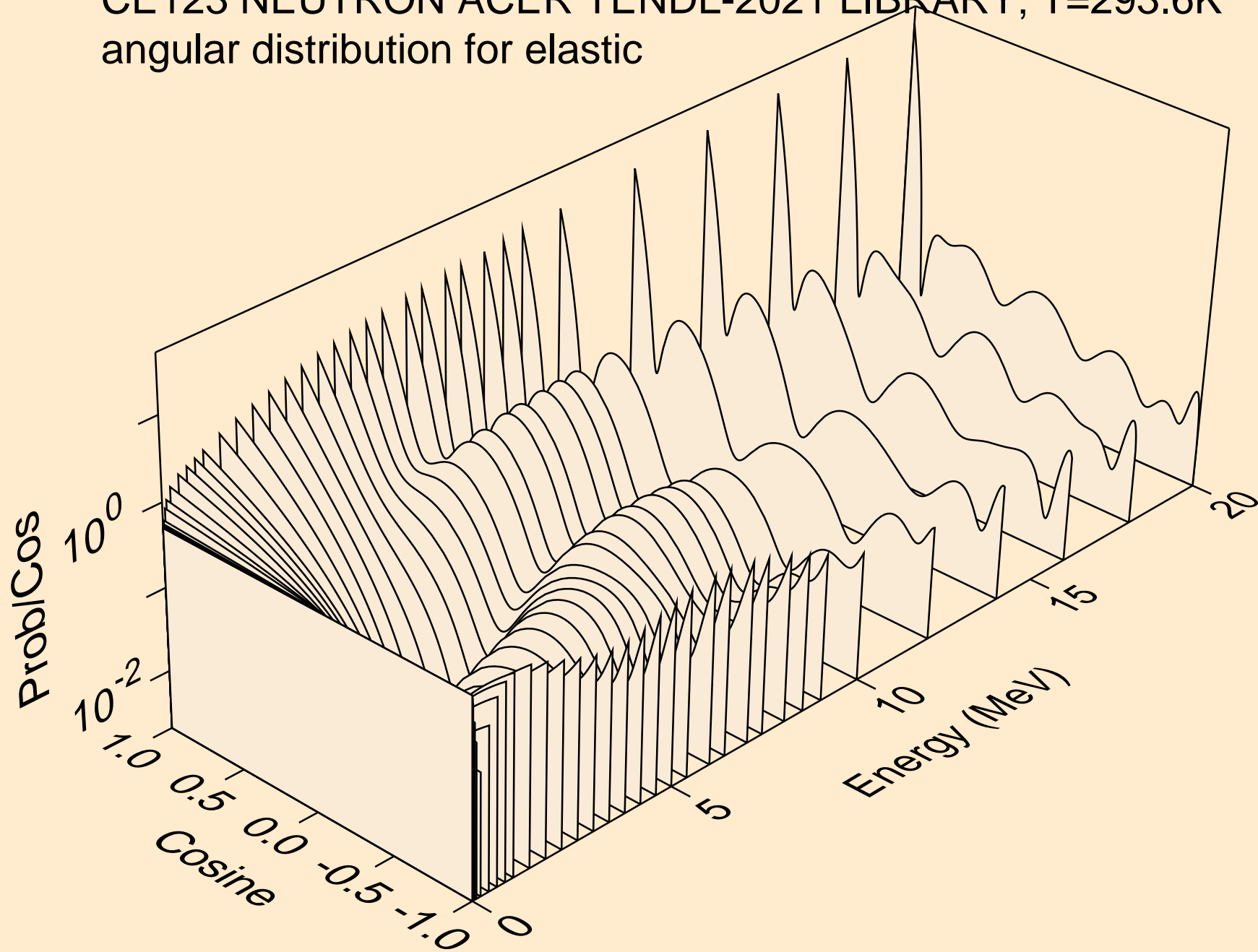

CE123 NEUTRON ACER TENDL-2021 LIBRARY; T=293.6K
angular distribution for elastic

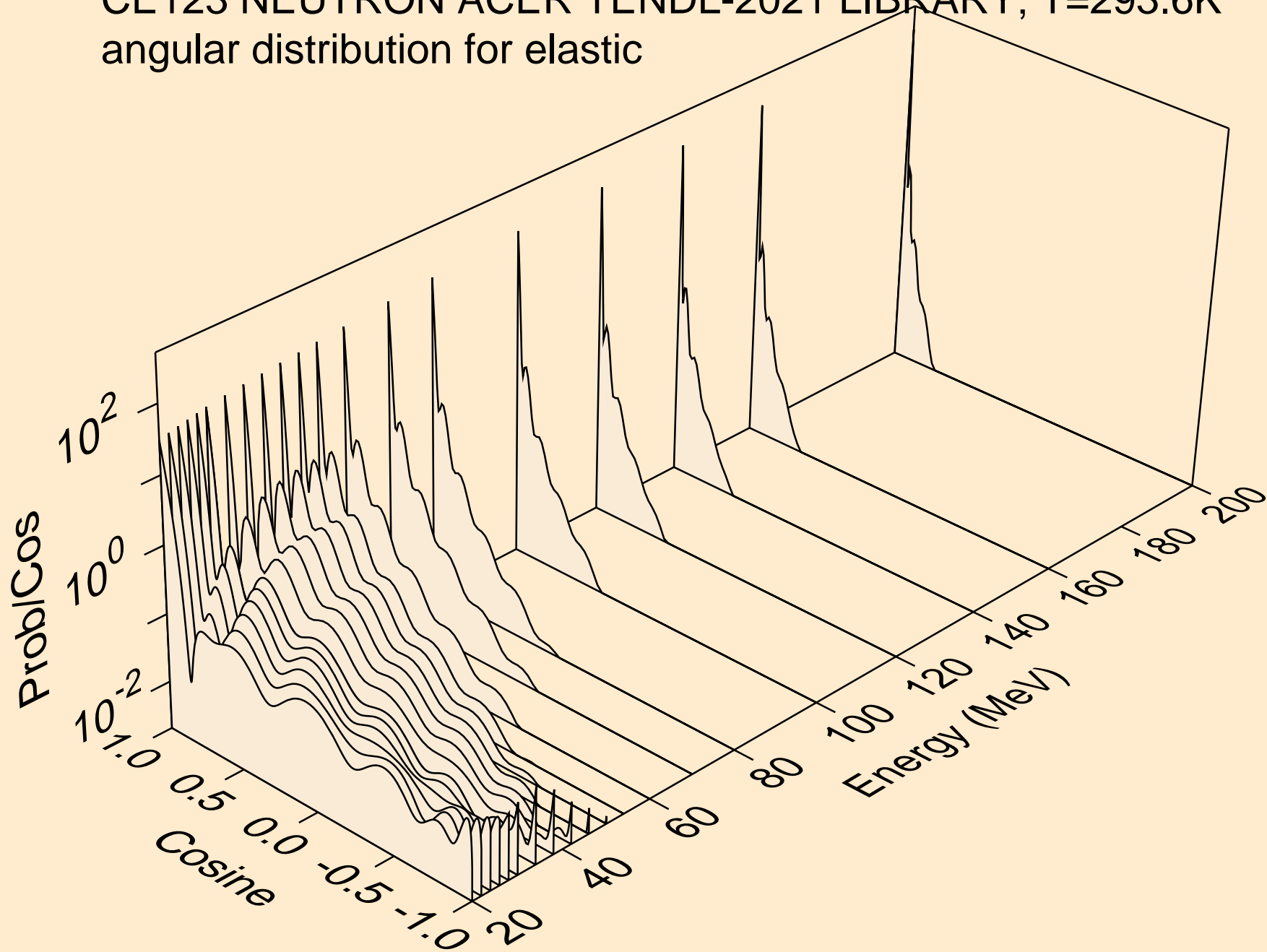

CE123 NEUTRON ACER TENDL-2021 LIBRARY; T=293.6K
angular distribution for (n,n*1)

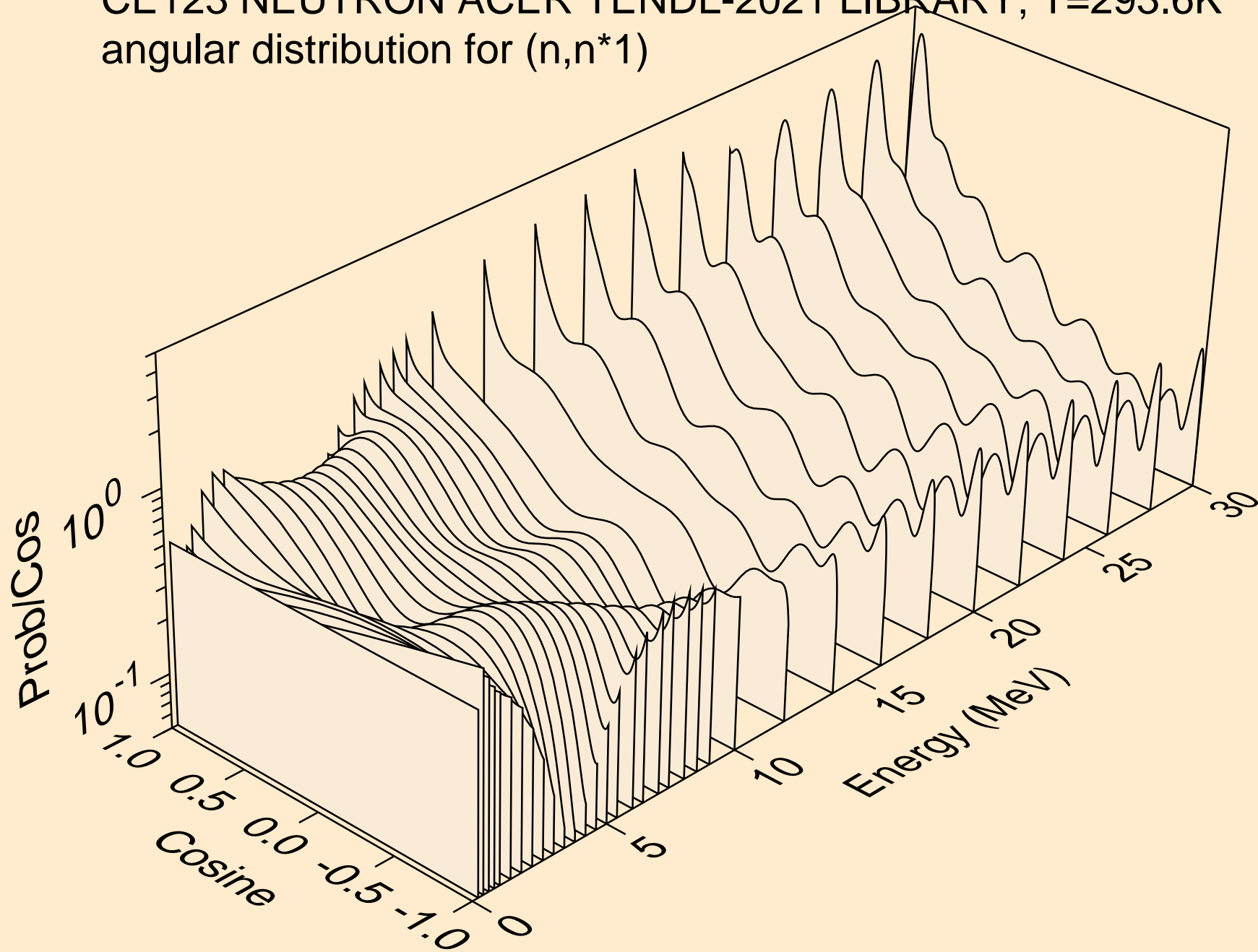

CE123 NEUTRON ACER TENDL-2021 LIBRARY; T=293.6K
Neutron emission for (n,x)

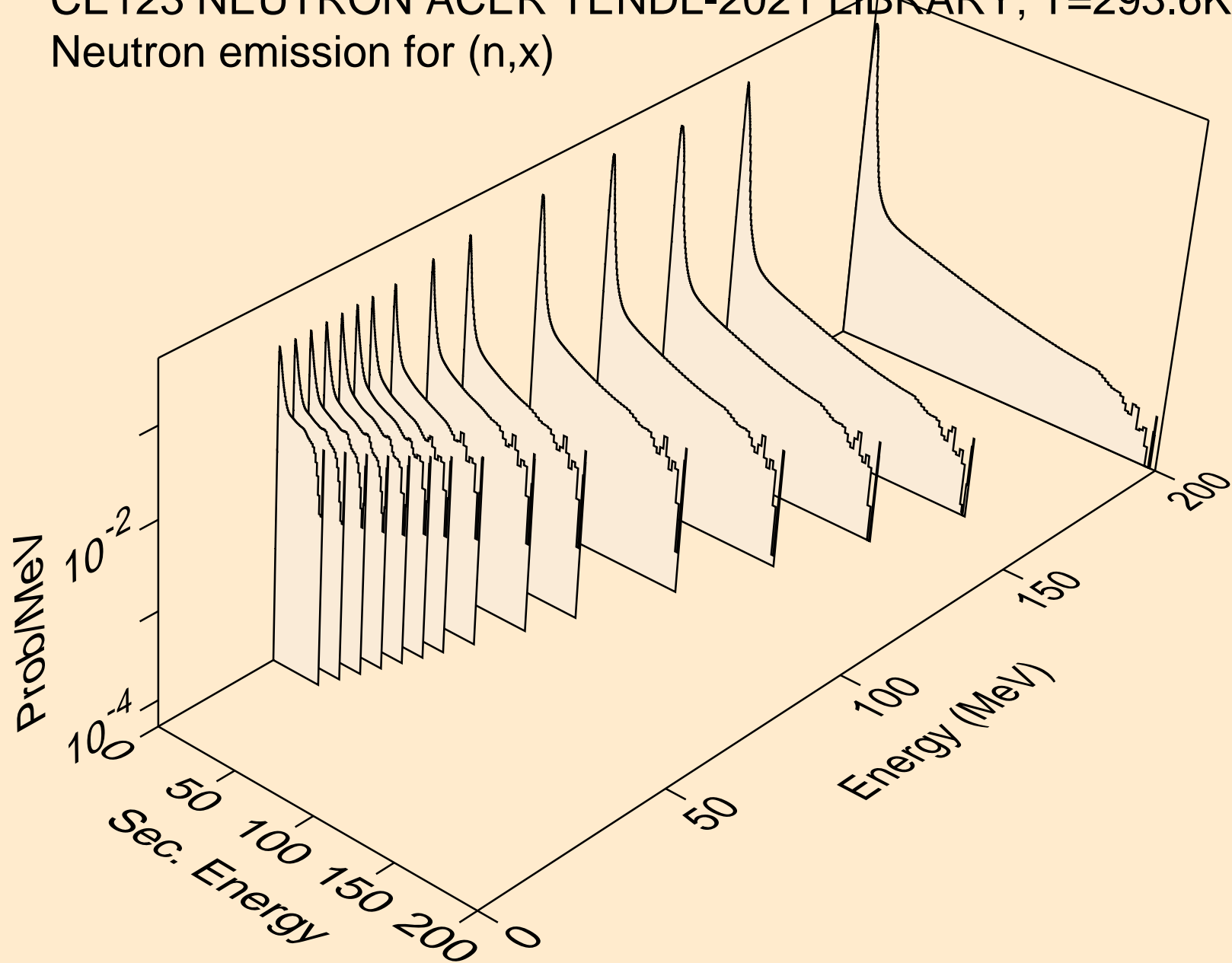

CE123 NEUTRON ACER TENDL-2021 LIBRARY; T=293.6K
Neutron emission for (n,2n)

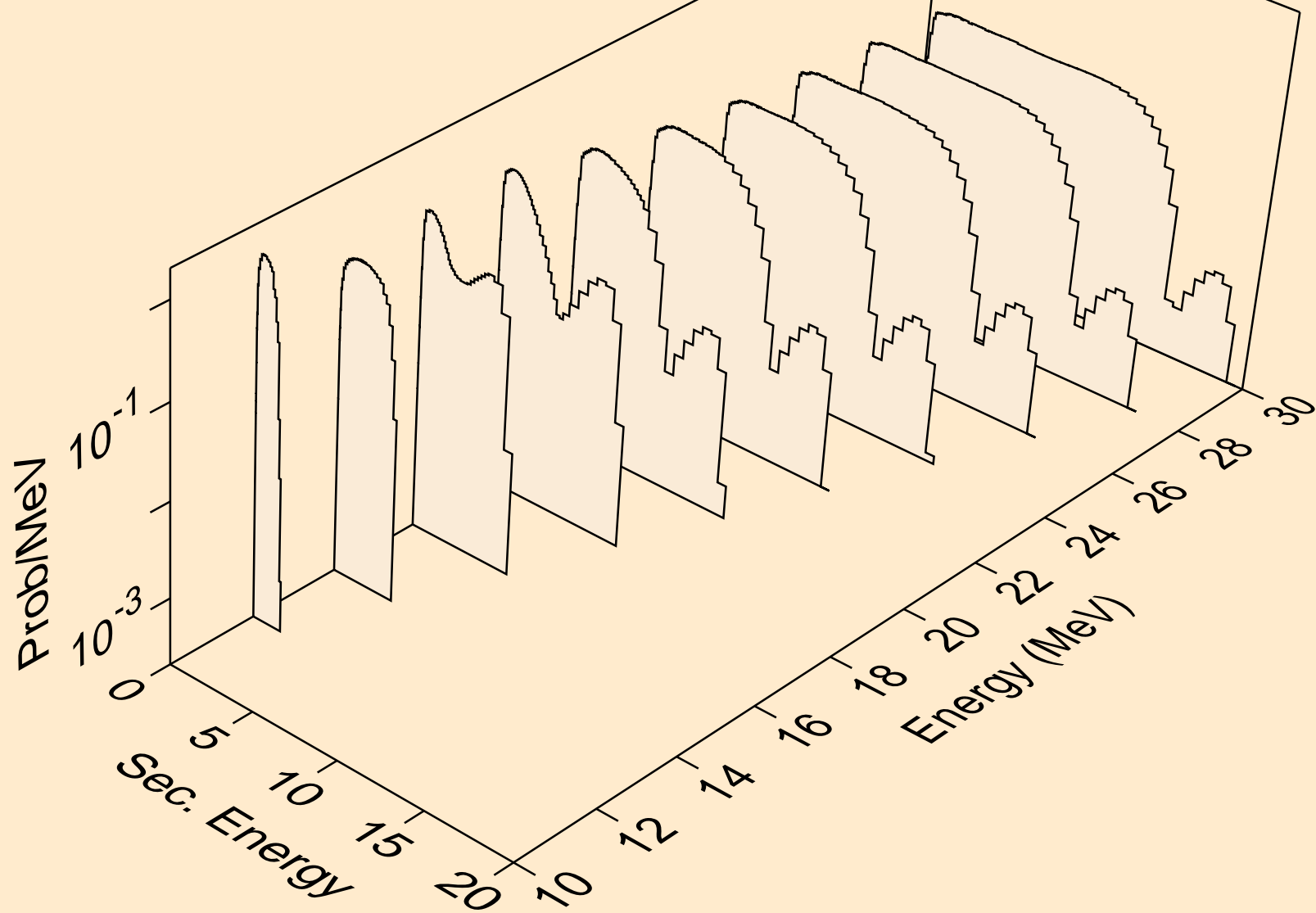

CE123 NEUTRON ACER TENDL-2021 LIBRARY; T=293.6K
Neutron emission for (n,3n)

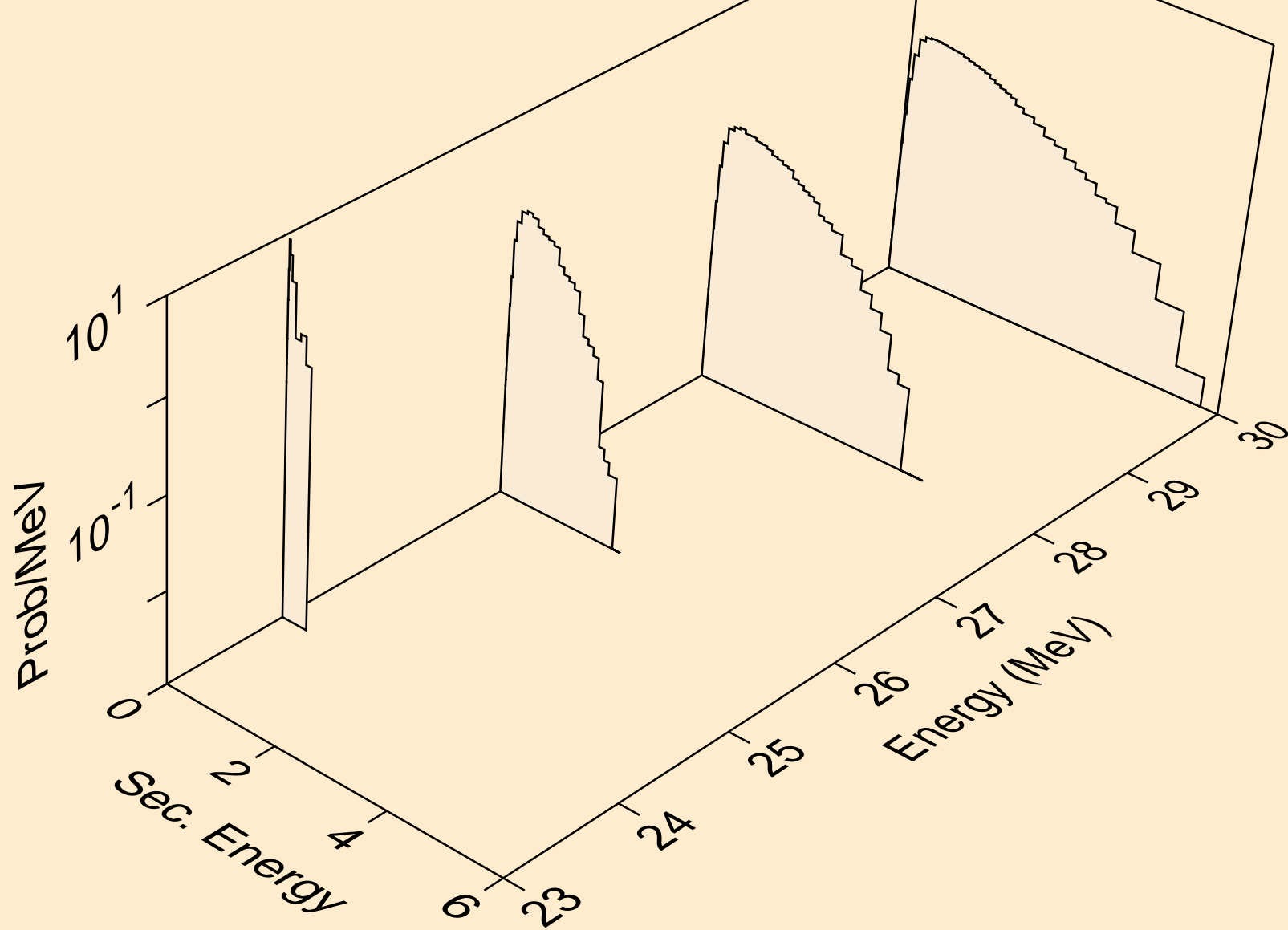

CE123 NEUTRON ACER TENDL-2021 LIBRARY; T=293.6K
Neutron emission for (n,n*)a

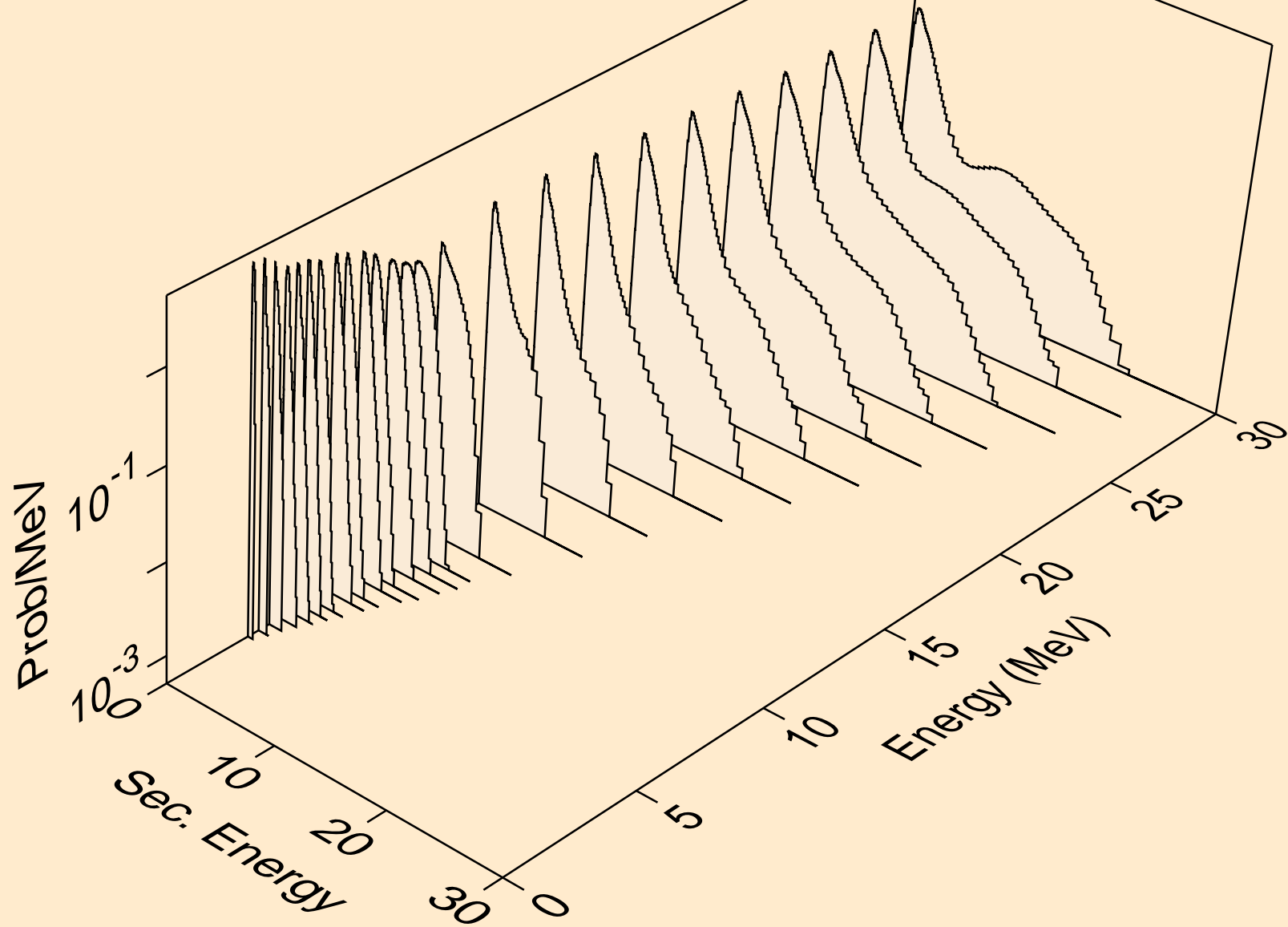

CE123 NEUTRON ACER TENDL-2021 LIBRARY; T=293.6K
Neutron emission for (n,n*)3a

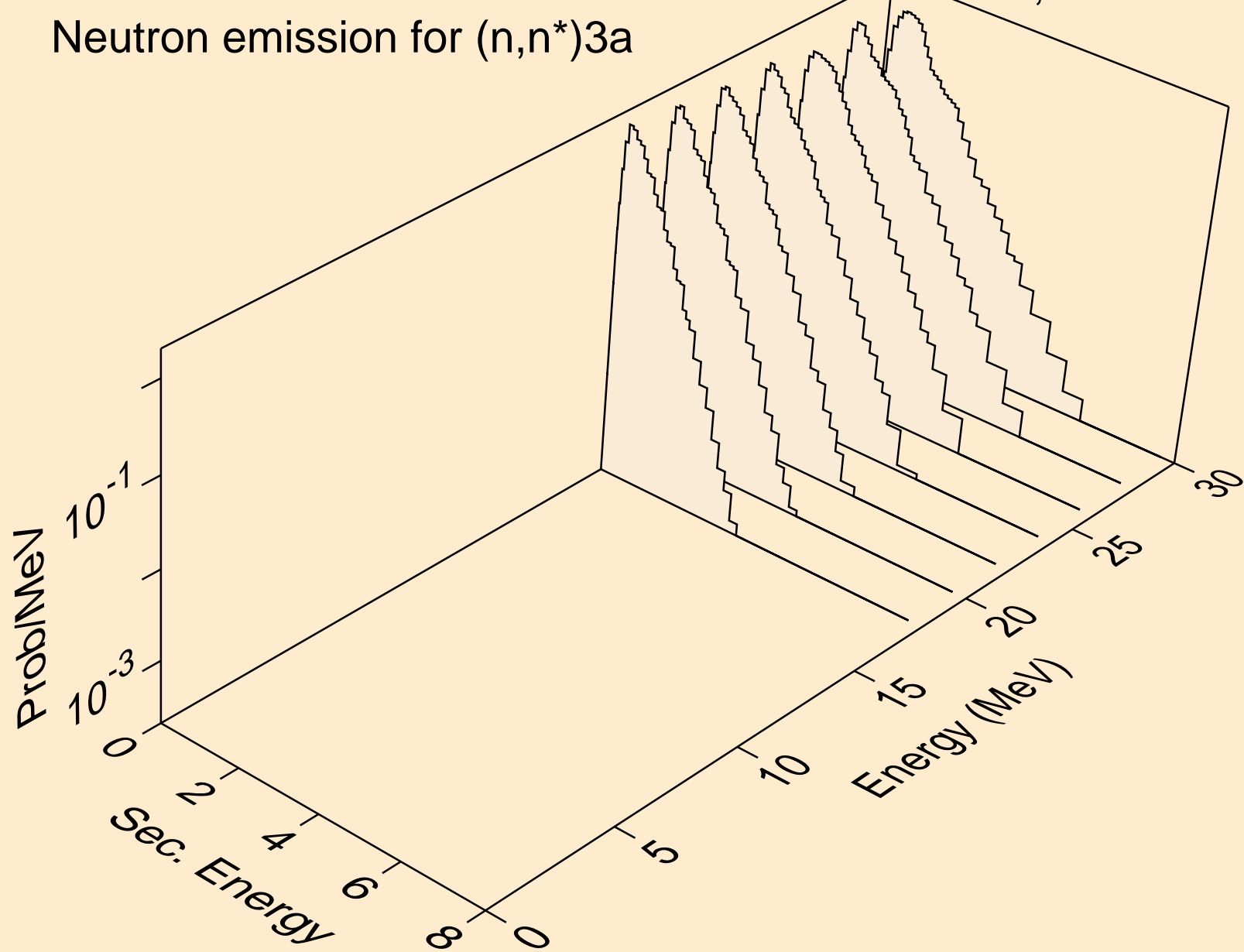

CE123 NEUTRON ACER TENDL-2021 LIBRARY; T=293.6K
Neutron emission for (n,2n)_a

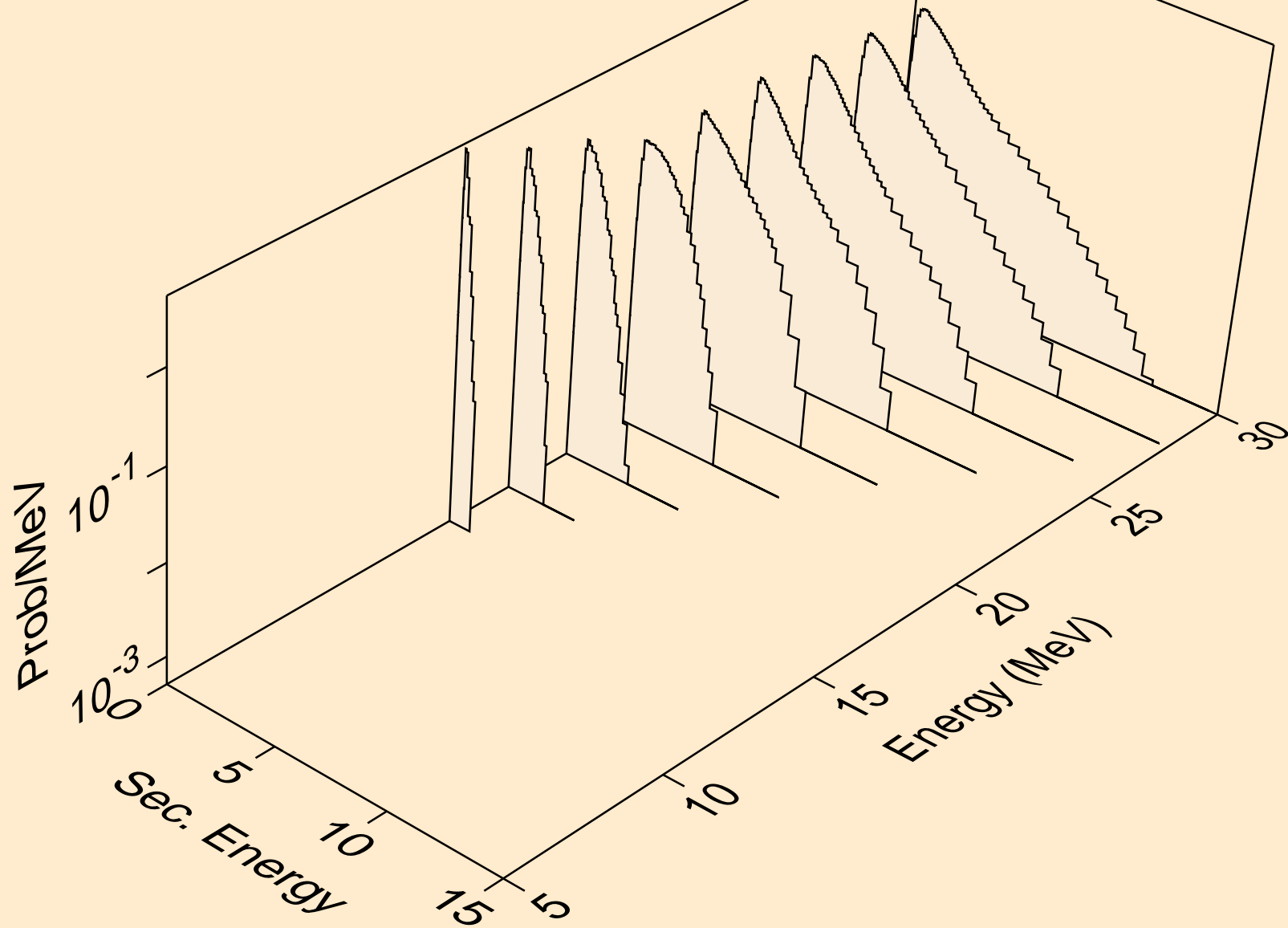

CE123 NEUTRON ACER TENDL-2021 LIBRARY; T=293.6K
Neutron emission for (n,n*)p

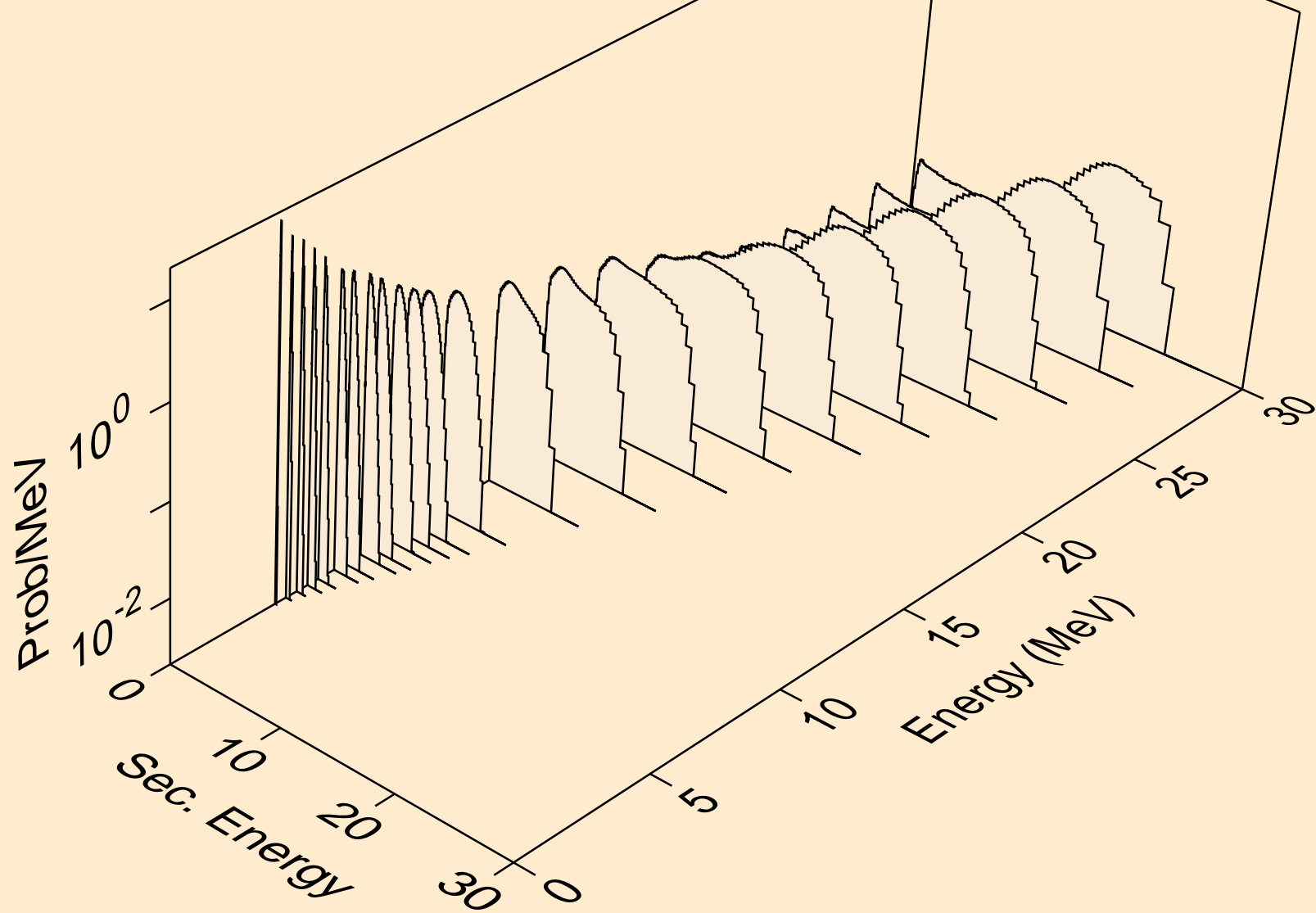

CE123 NEUTRON ACER TENDL-2021 LIBRARY; T=293.6K
Neutron emission for (n,n*)2a

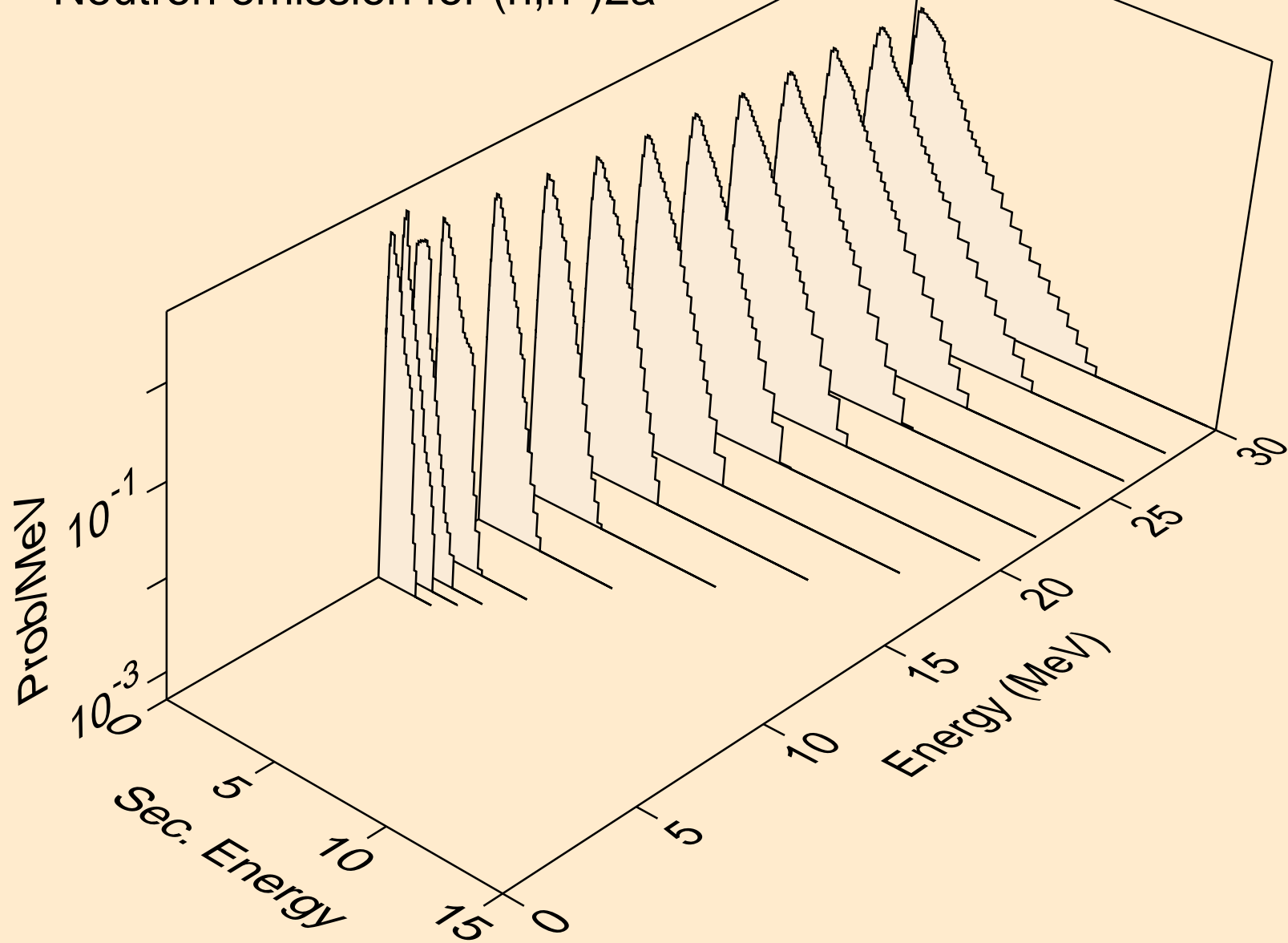

CE123 NEUTRON ACER TENDL-2021 LIBRARY; T=293.6K
Neutron emission for (n,2n)2a

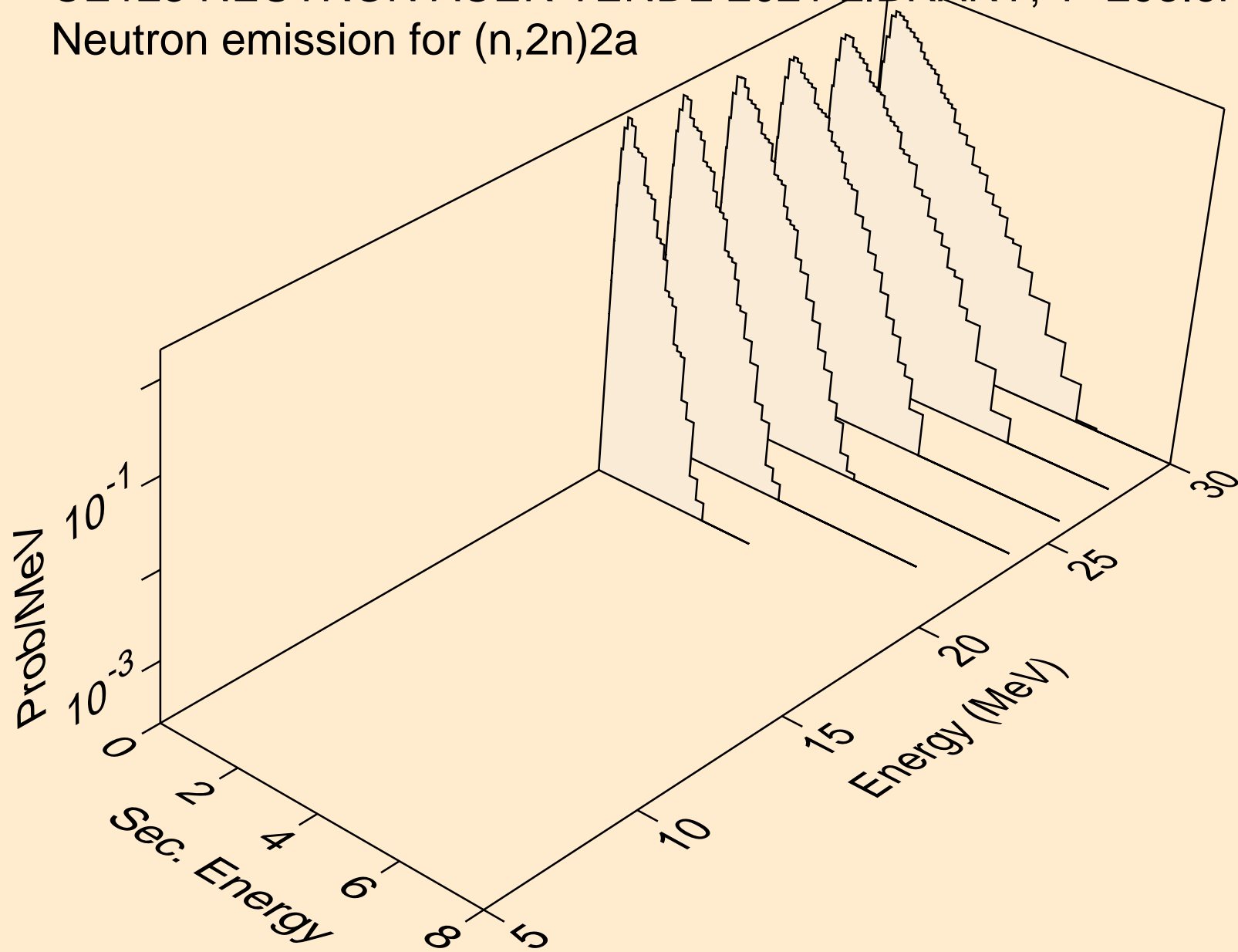

CE123 NEUTRON ACER TENDL-2021 LIBRARY; T=293.6K
Neutron emission for (n,n*)d

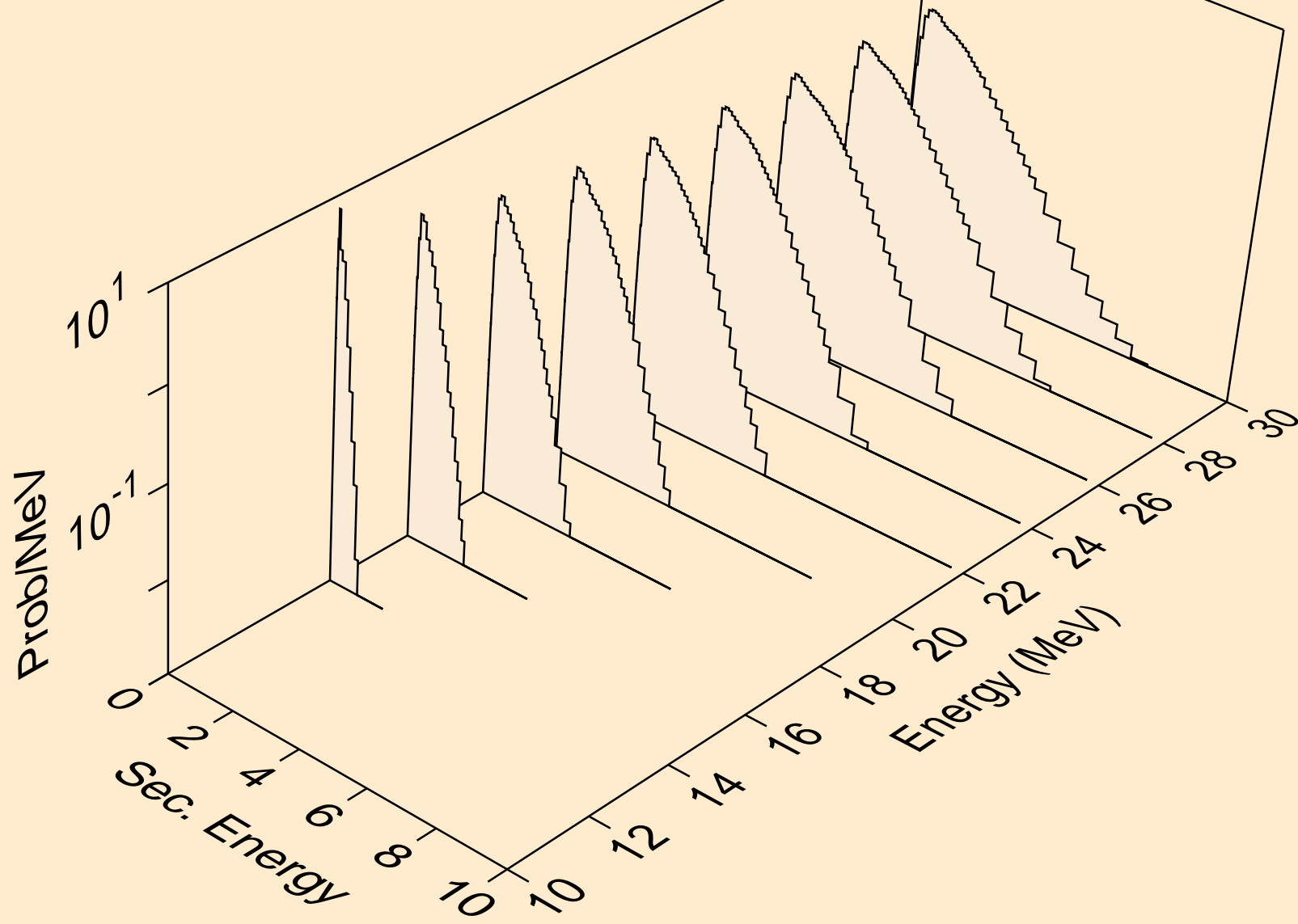

CE123 NEUTRON ACER TENDL-2021 LIBRARY; T=293.6K
Neutron emission for (n,n*)t

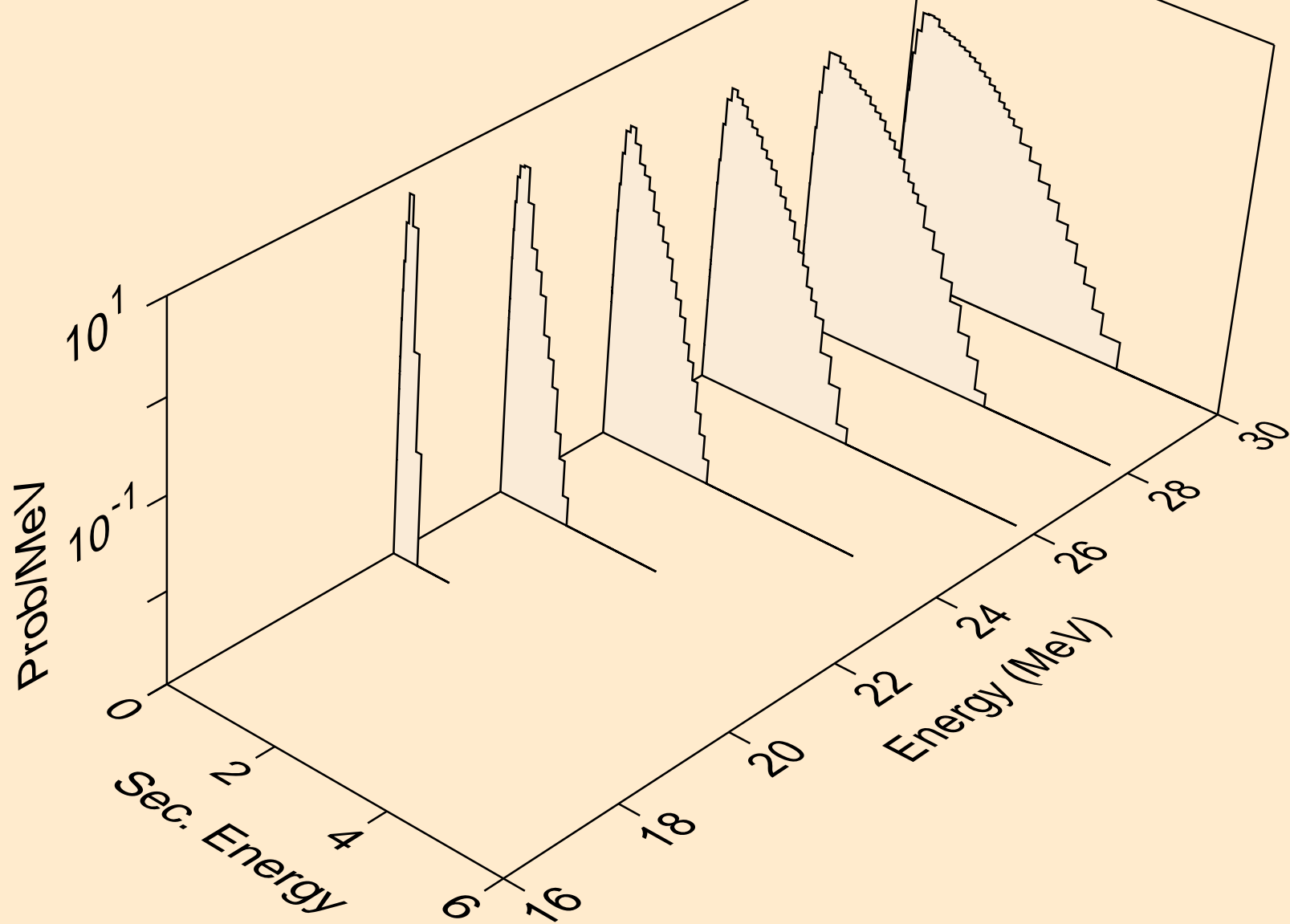

CE123 NEUTRON ACER TENDL-2021 LIBRARY; T=293.6K
Neutron emission for (n,n*)he3

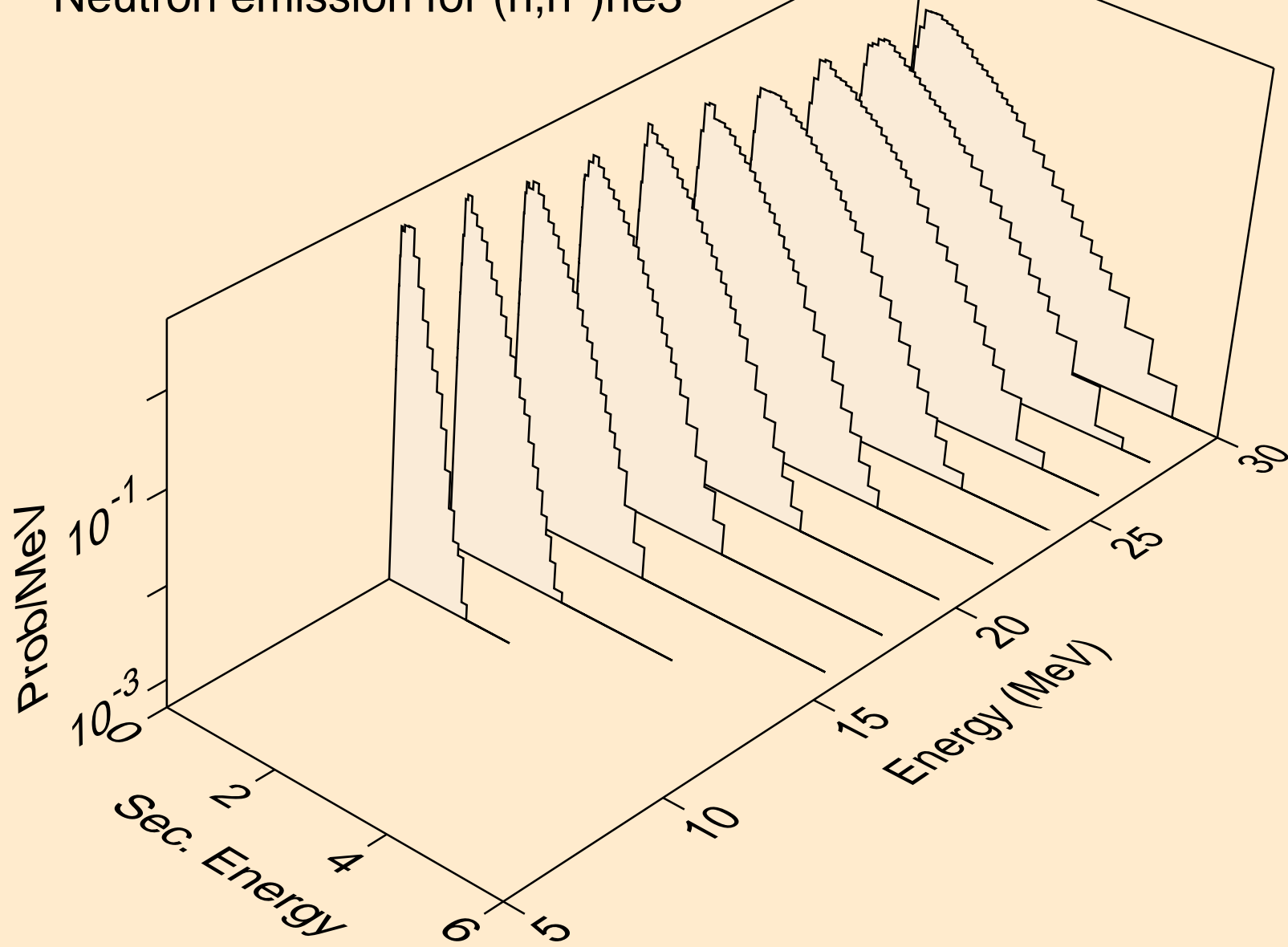

CE123 NEUTRON ACER TENDL-2021 LIBRARY; T=293.6K
Neutron emission for (n,2np)

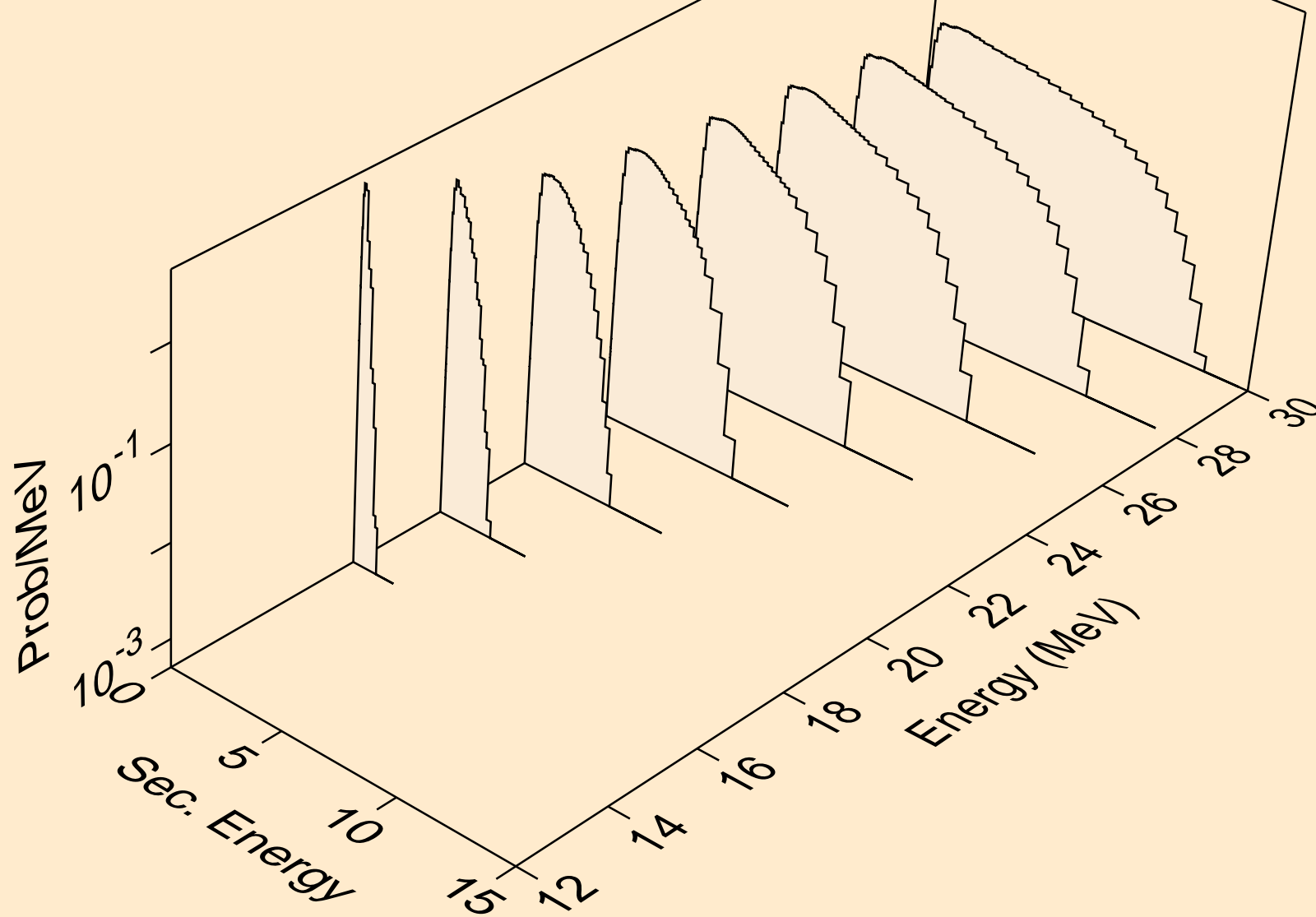

CE123 NEUTRON ACER TENDL-2021 LIBRARY; T=293.6K
Neutron emission for (n,3np)

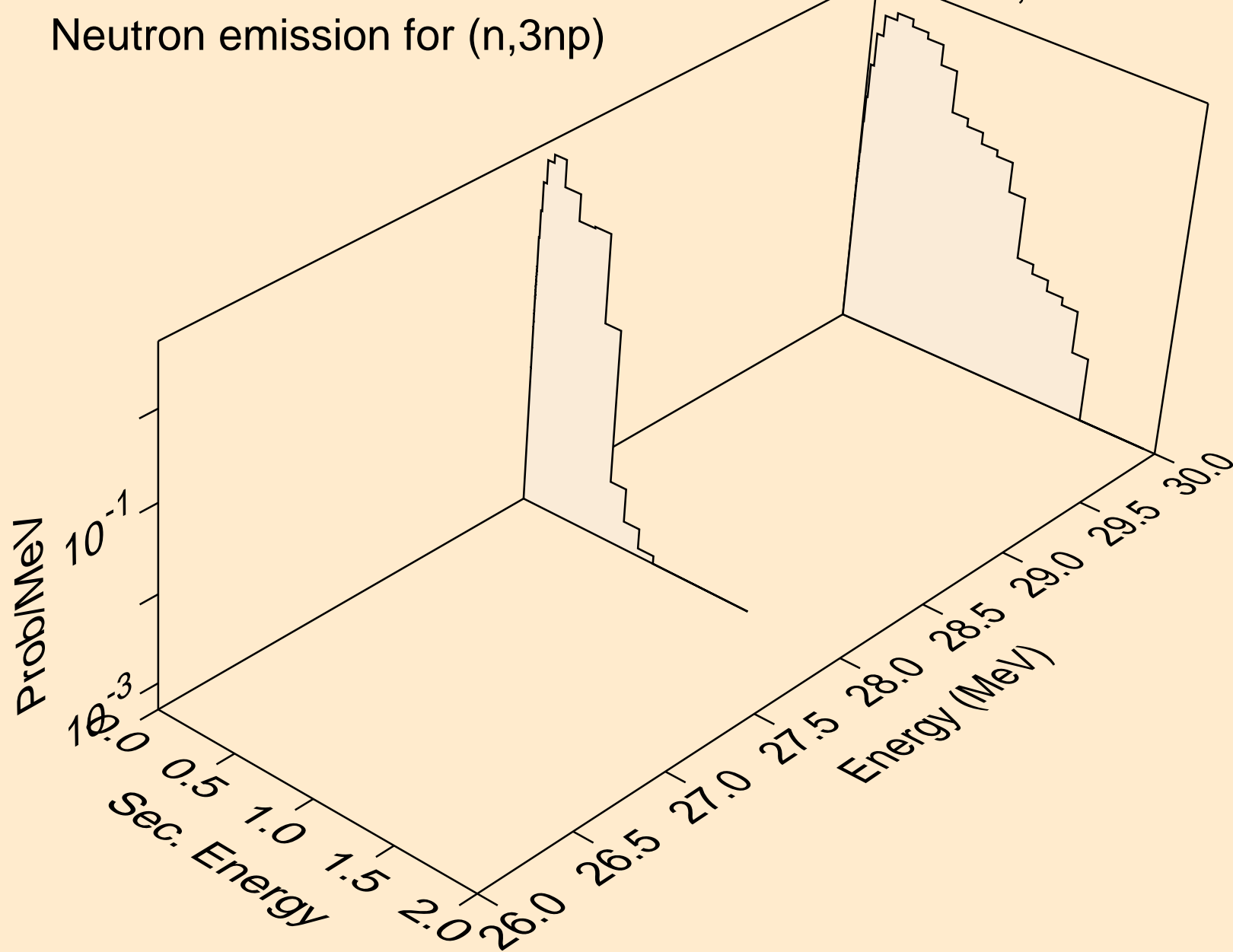

CE123 NEUTRON ACER TENDL-2021 LIBRARY; T=293.6K
Neutron emission for (n,2np)

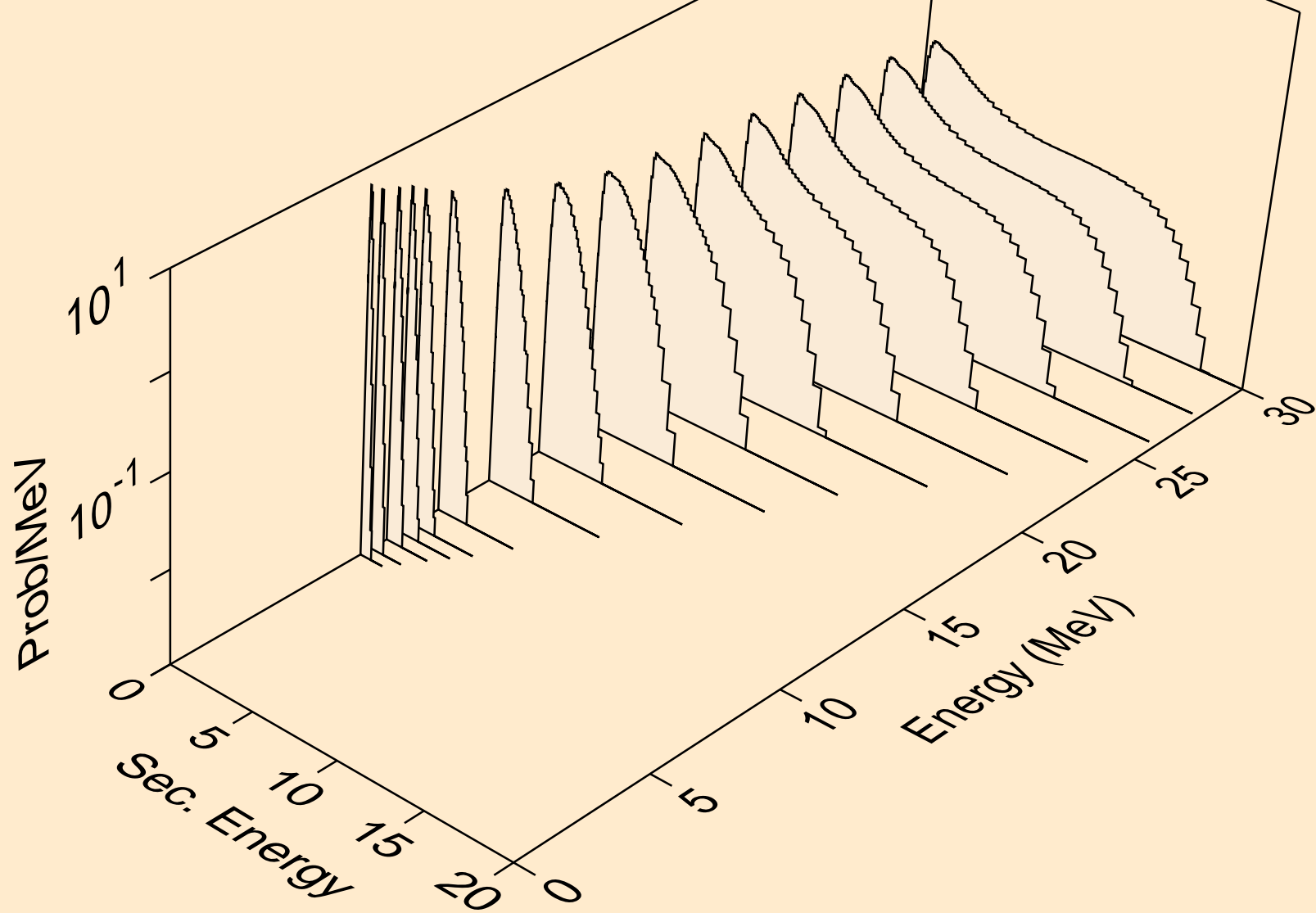

CE123 NEUTRON ACER TENDL-2021 LIBRARY; T=293.6K
Neutron emission for (n,npa)

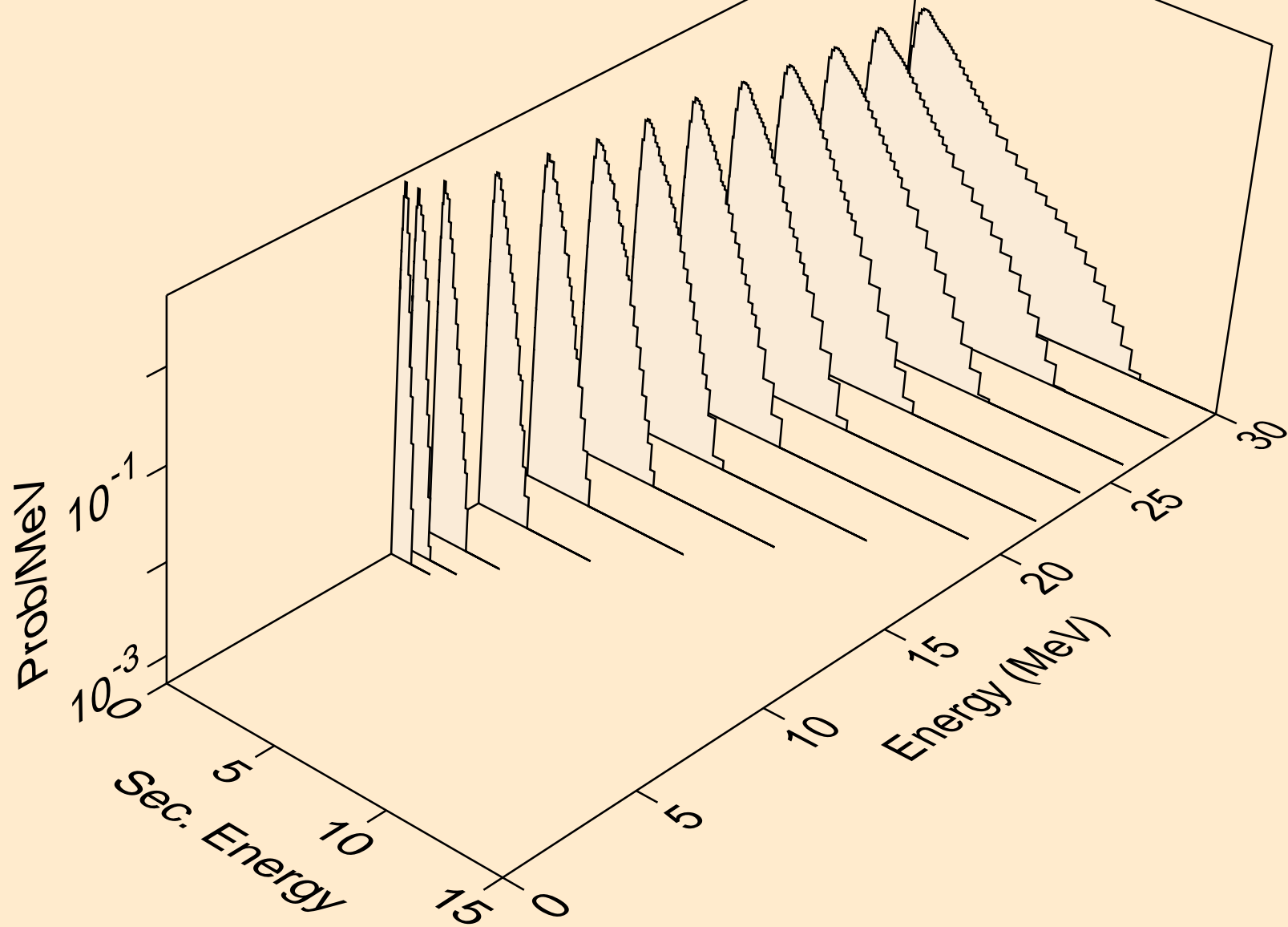

CE123 NEUTRON ACER TENDL-2021 LIBRARY; T=293.6K
Neutron emission for (n,n*c)

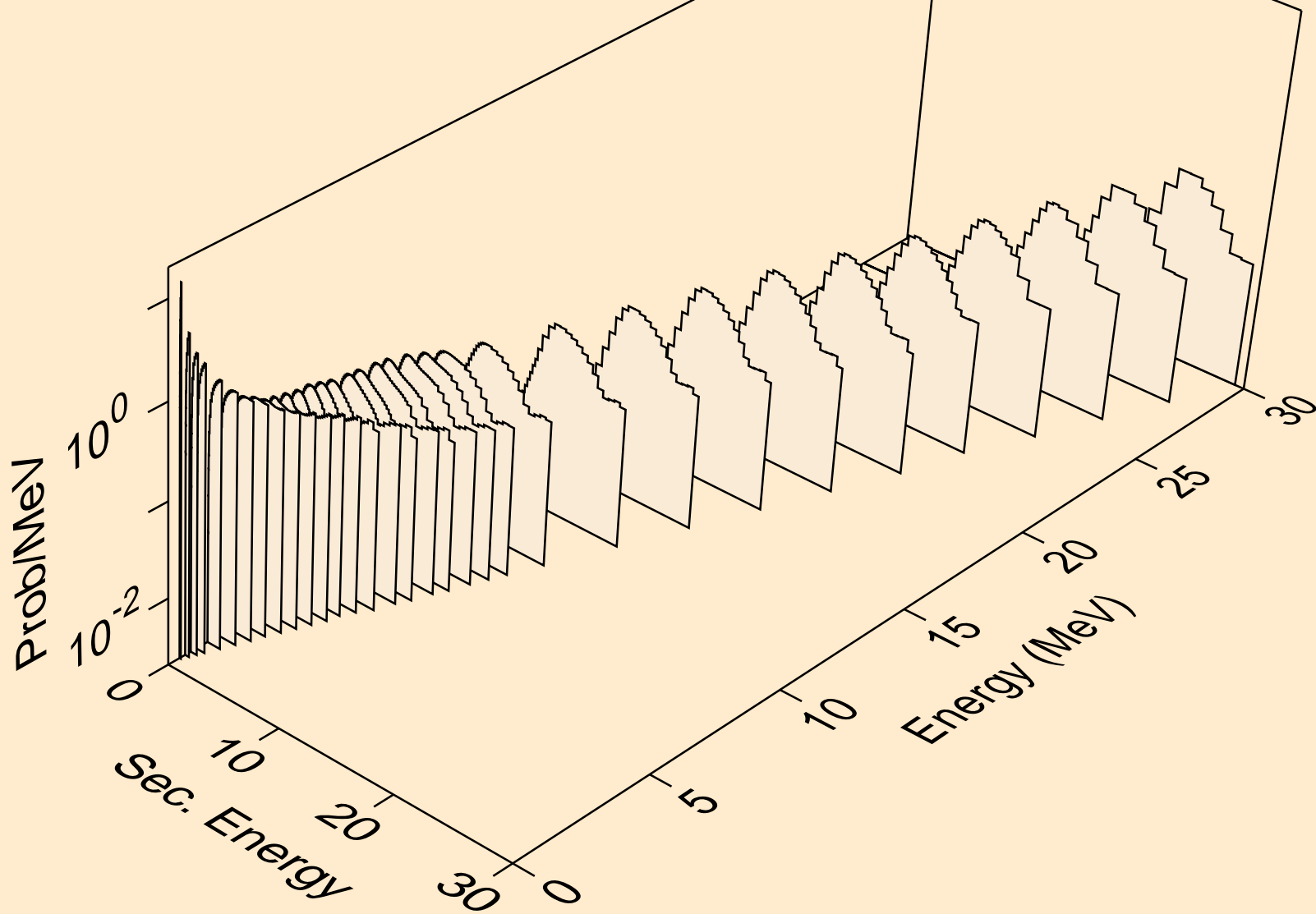

CE123 NEUTRON ACER TENDL-2021 LIBRARY; T=293.6K
Photon emission for (n,x)

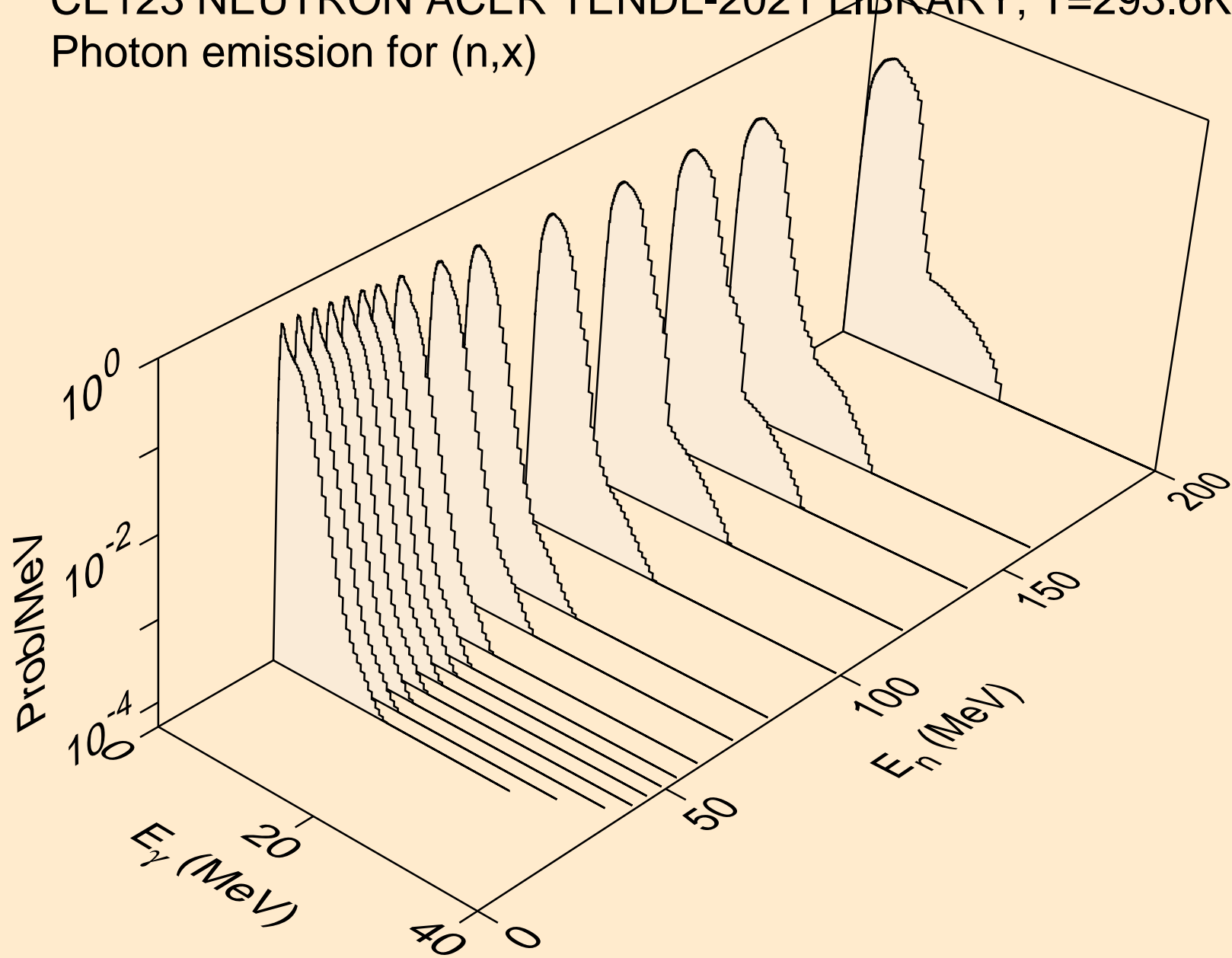

CE123 NEUTRON ACER TENDL-2021 LIBRARY; T=293.6K
Photon emission for (n,2n)

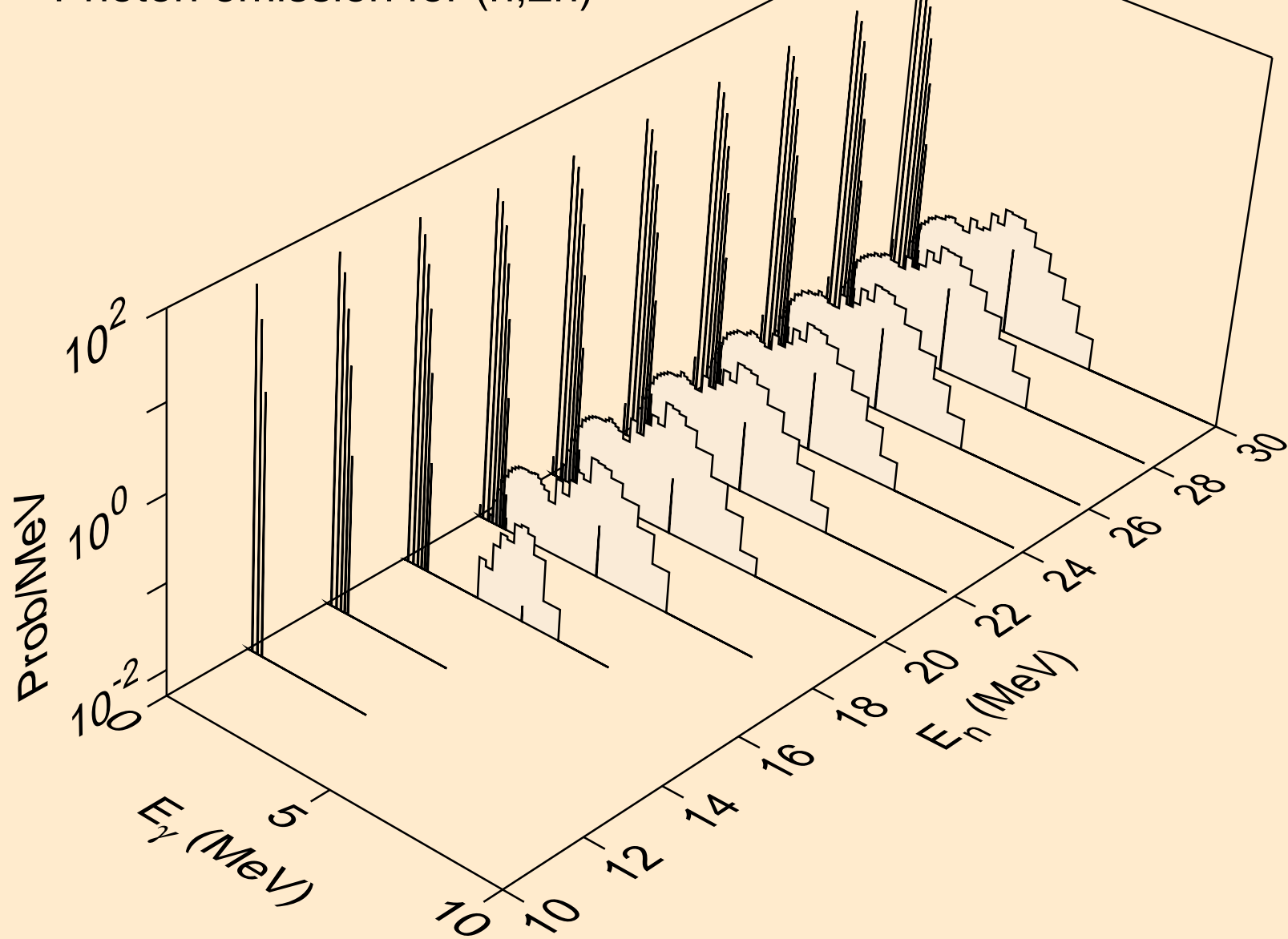

CE123 NEUTRON ACER TENDL-2021 LIBRARY; T=293.6K
Photon emission for (n,3n)

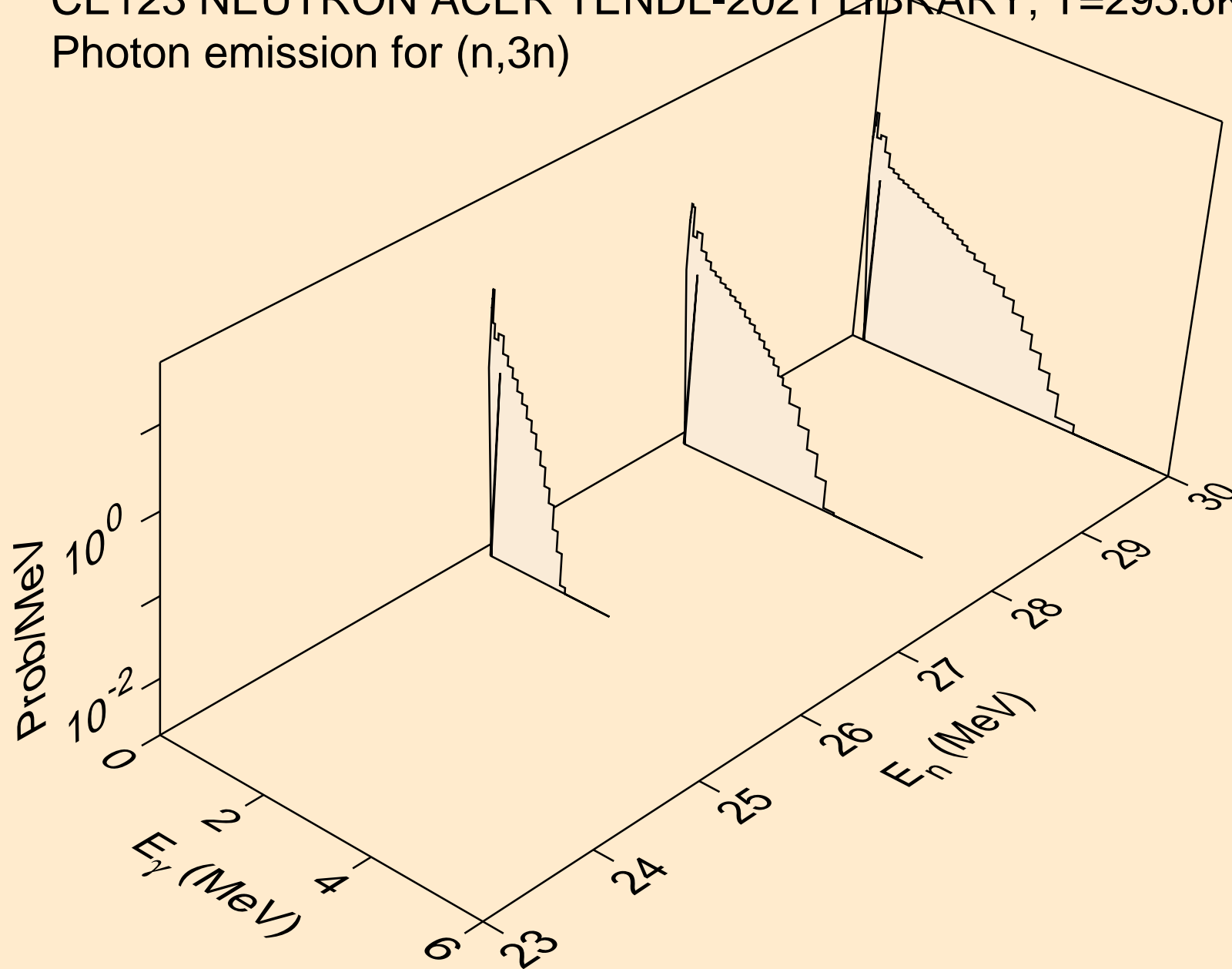

CE123 NEUTRON ACER TENDL-2021 LIBRARY; T=293.6K
Photon emission for (n,n*)a

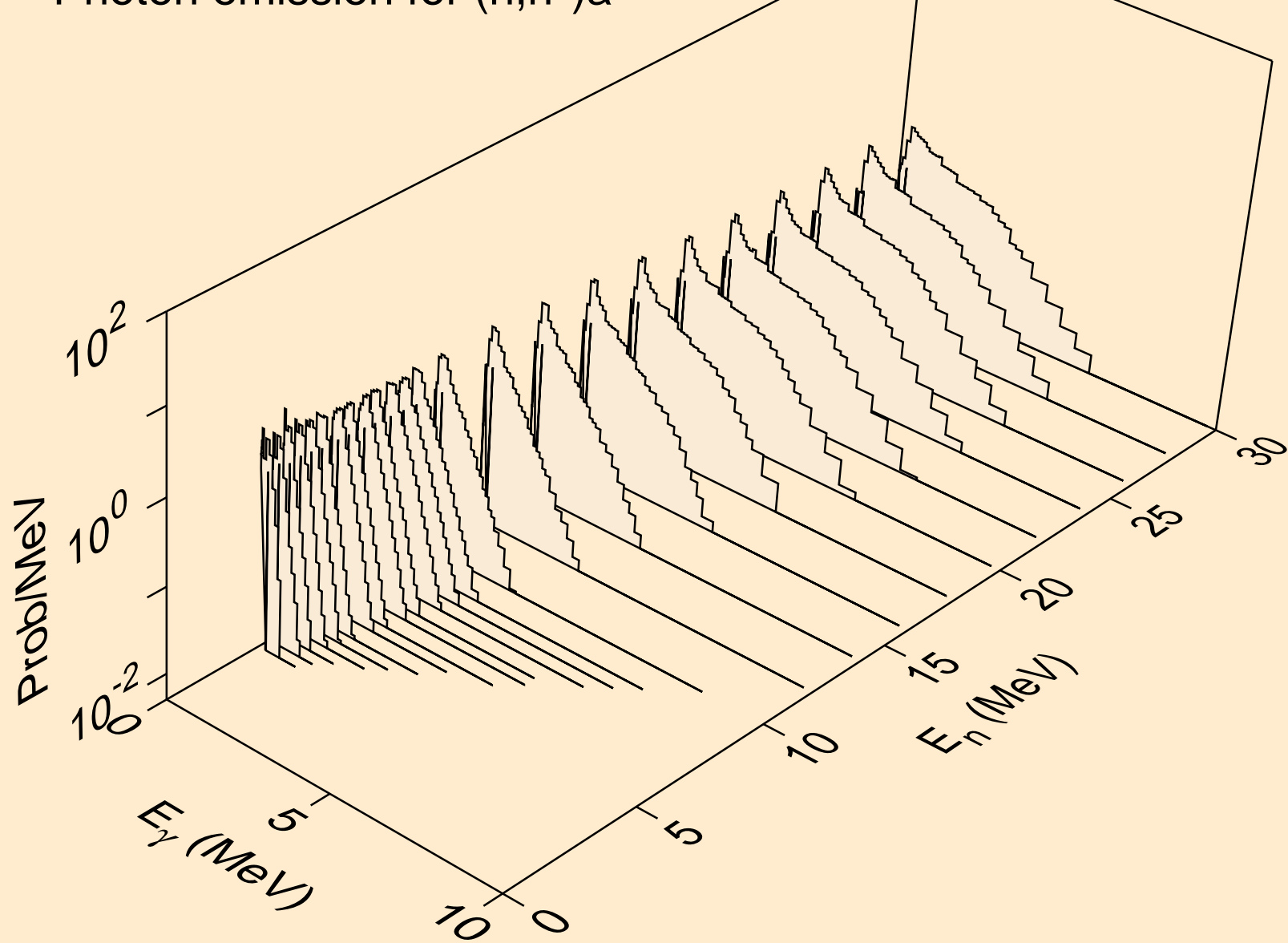

CE123 NEUTRON ACER TENDL-2021 LIBRARY; T=293.6K
Photon emission for (n,n*)3a

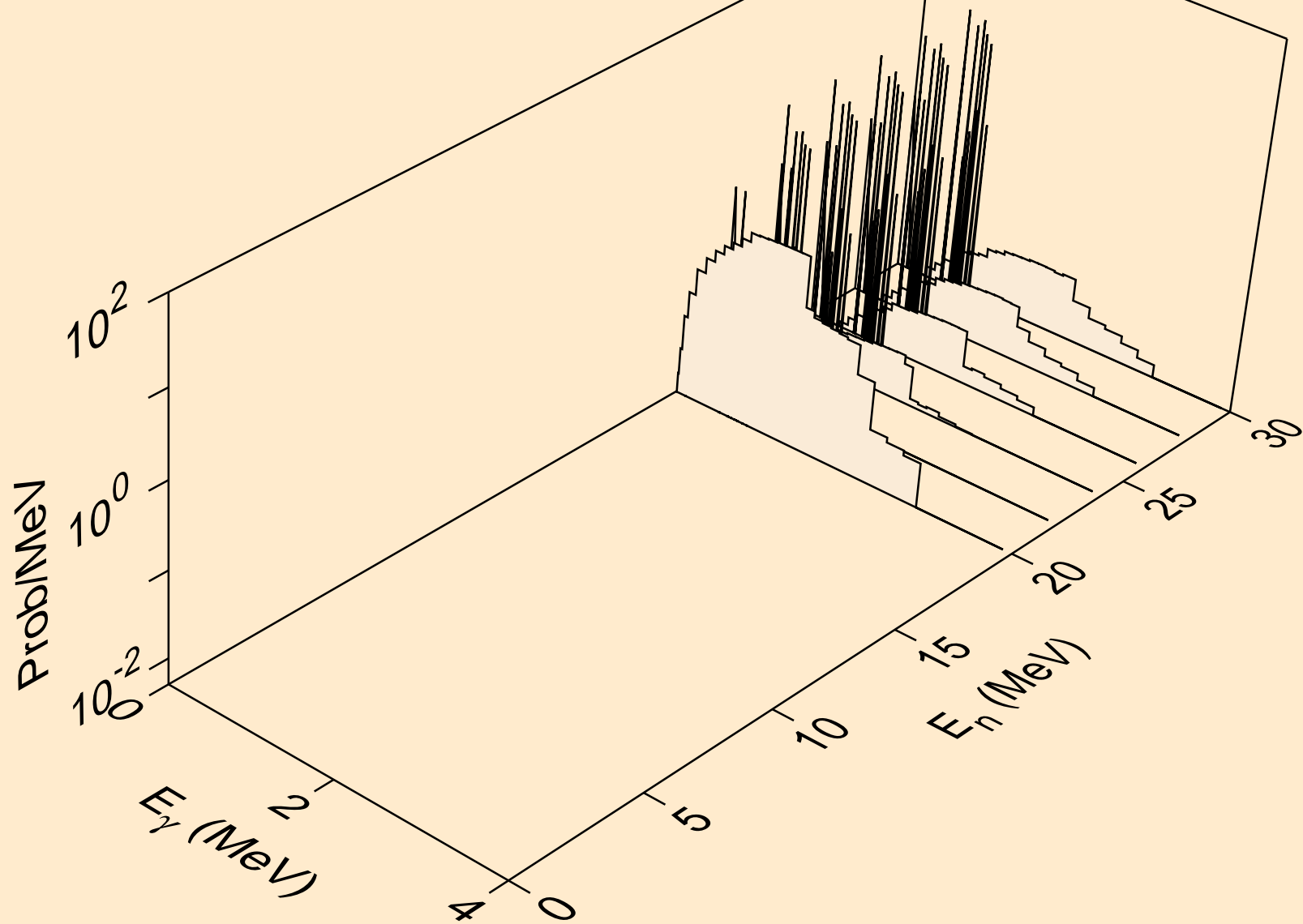

CE123 NEUTRON ACER TENDL-2021 LIBRARY; T=293.6K
Photon emission for (n,2n)a

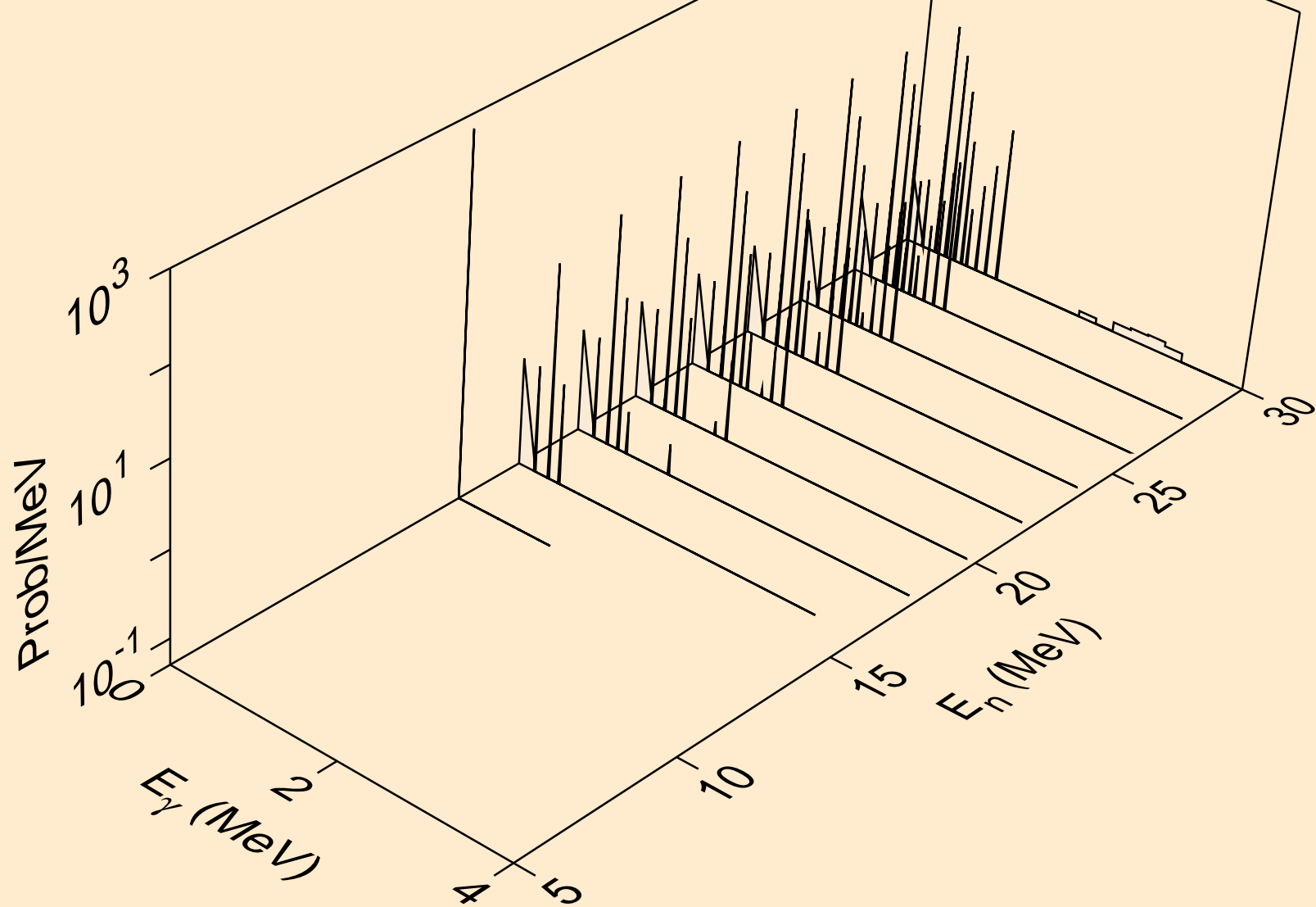

CE123 NEUTRON ACER TENDL-2021 LIBRARY; T=293.6K
Photon emission for (n,n*)p

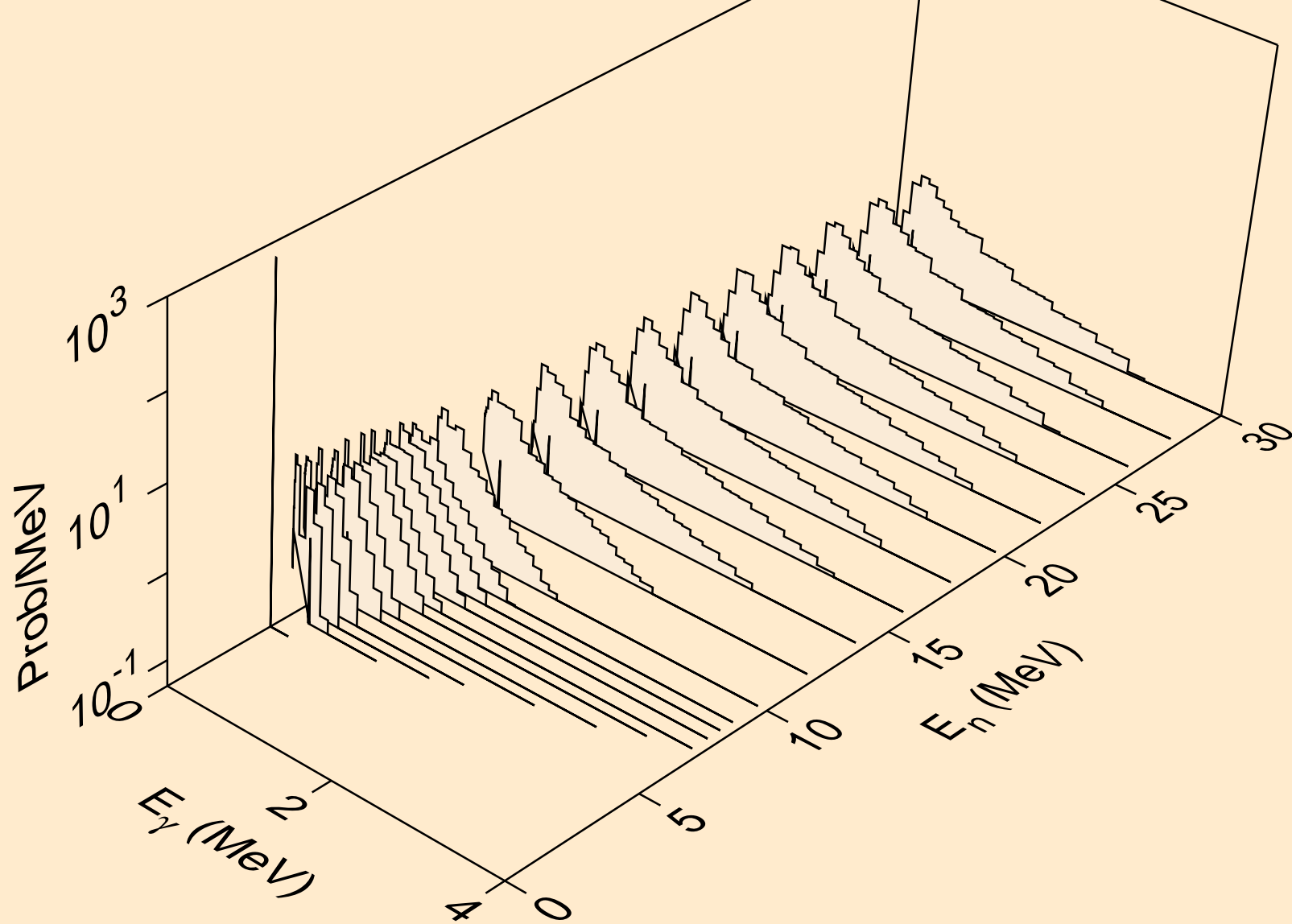

CE123 NEUTRON ACER TENDL-2021 LIBRARY; T=293.6K
Photon emission for (n,n*)2a

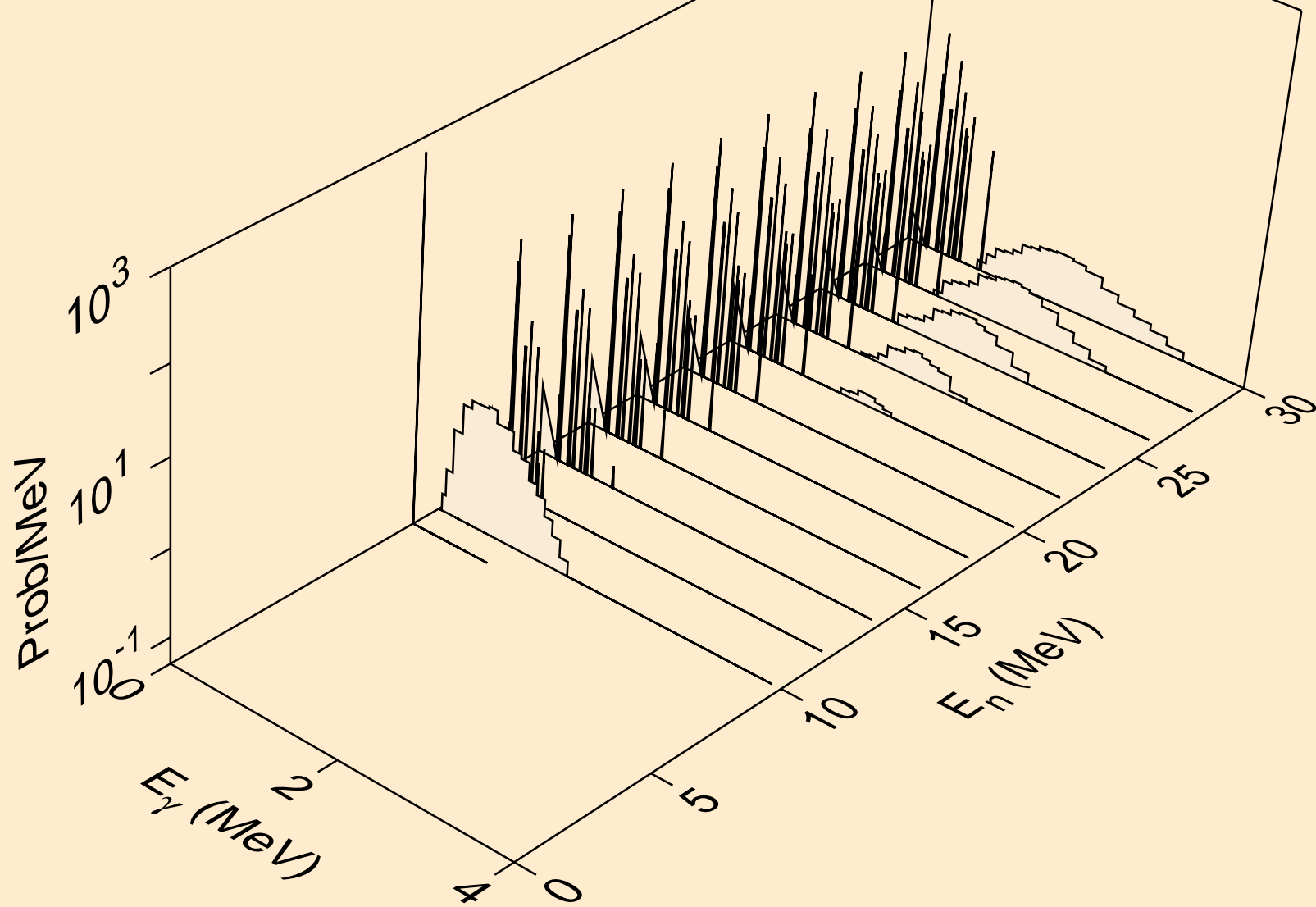

CE123 NEUTRON ACER TENDL-2021 LIBRARY; T=293.6K
Photon emission for (n,2n)2a

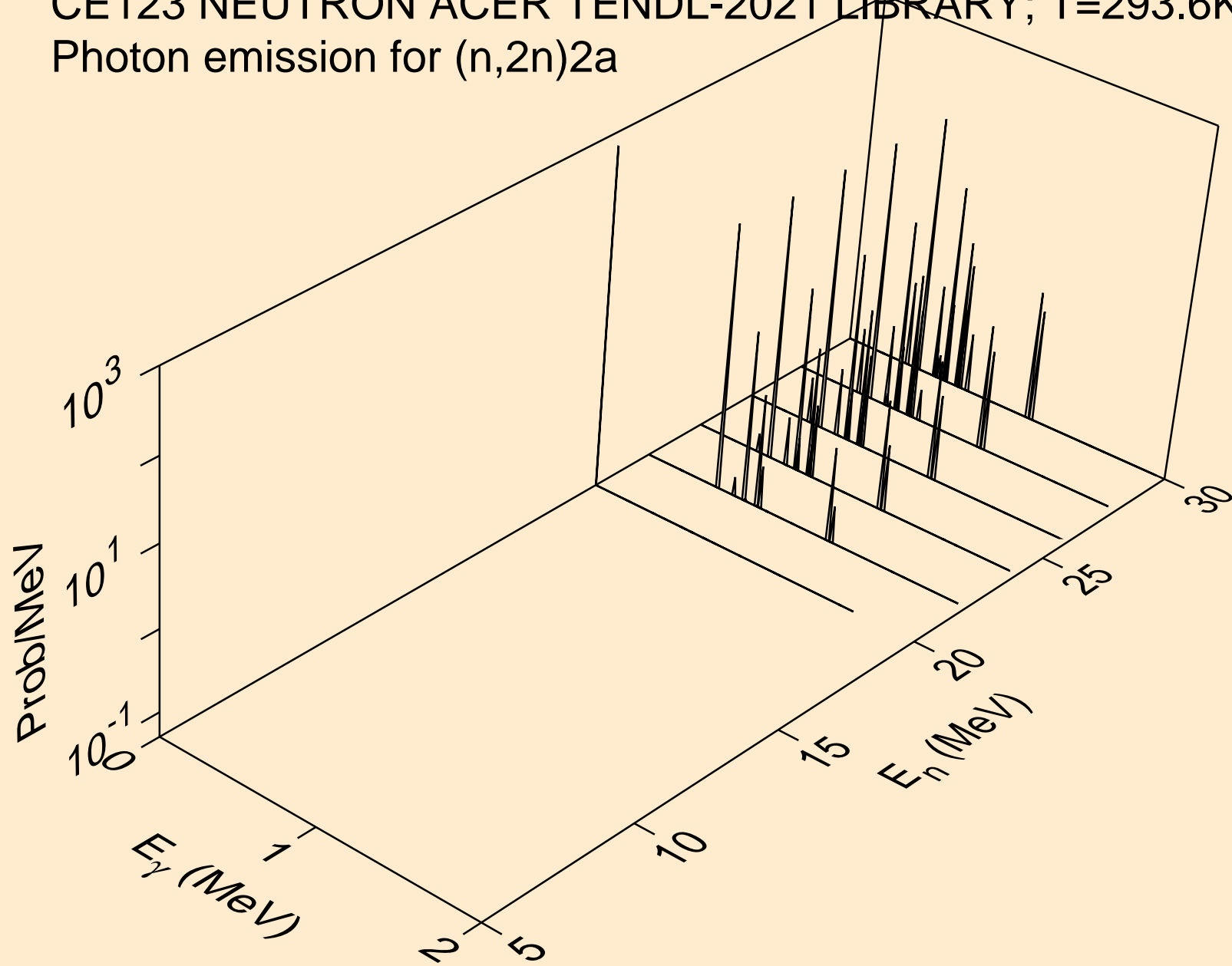

CE123 NEUTRON ACER TENDL-2021 LIBRARY; T=293.6K
Photon emission for (n,n*)d

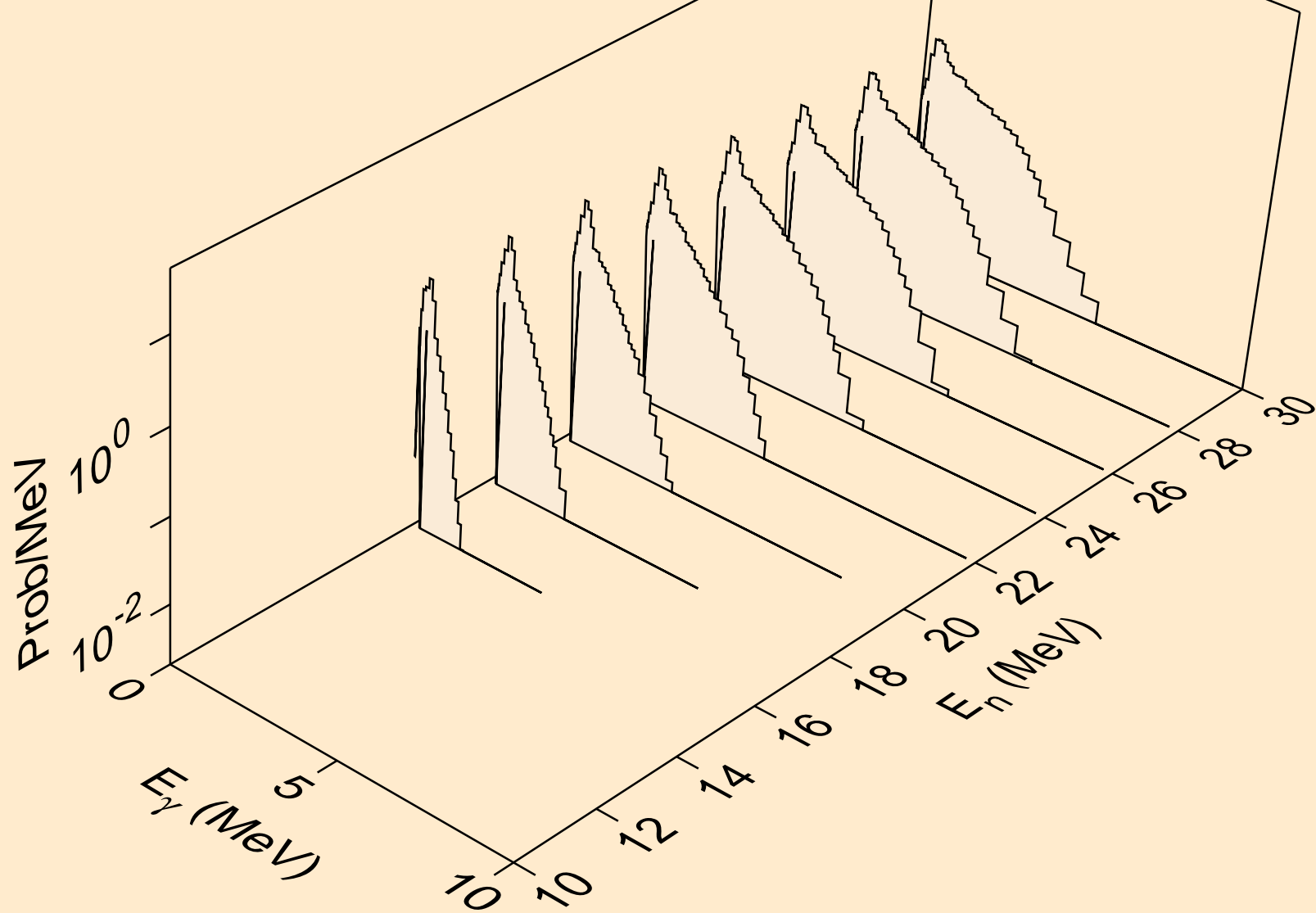

CE123 NEUTRON ACER TENDL-2021 LIBRARY; T=293.6K
Photon emission for (n,n*)t

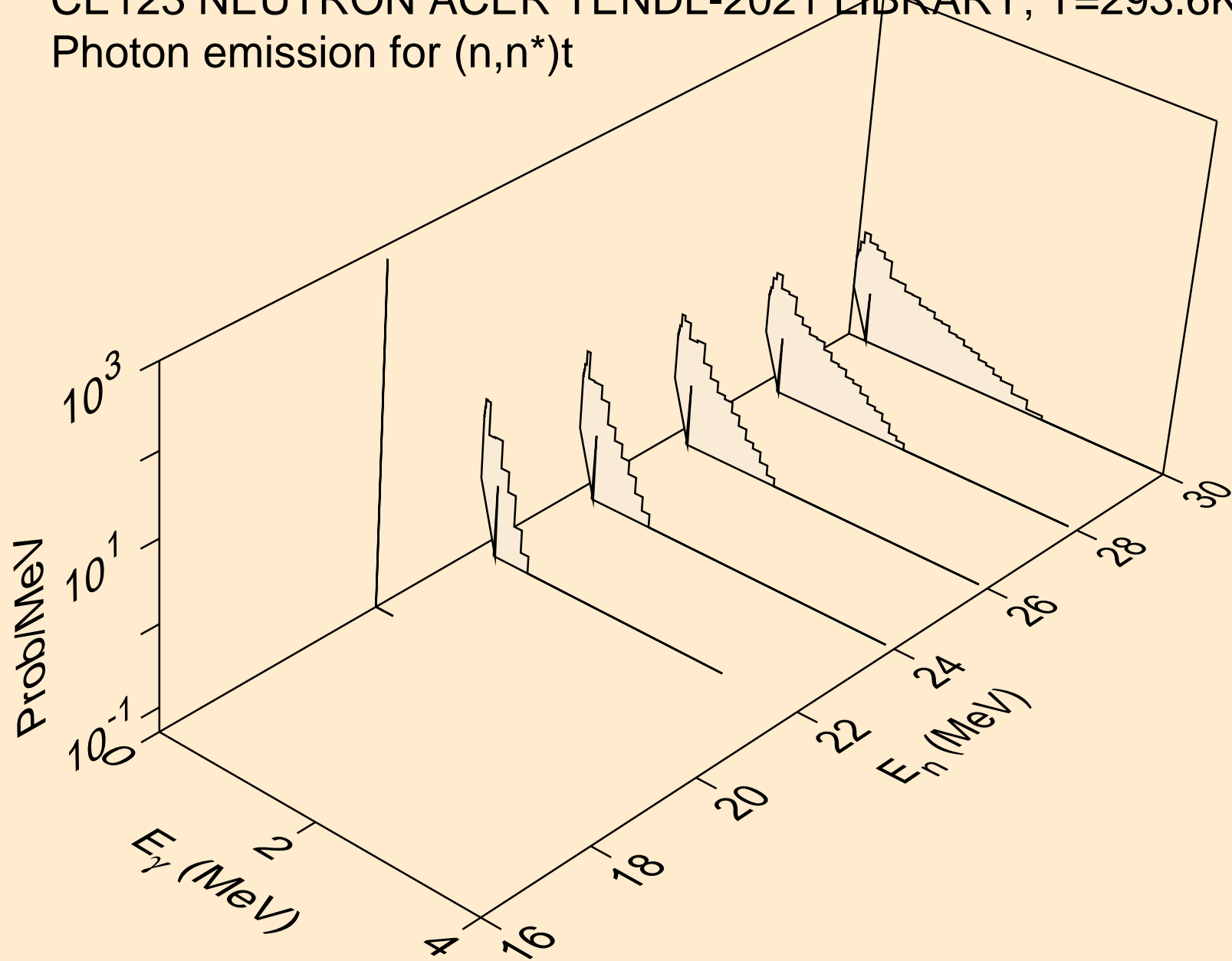

CE123 NEUTRON ACER TENDL-2021 LIBRARY; T=293.6K
Photon emission for (n,n*)he3

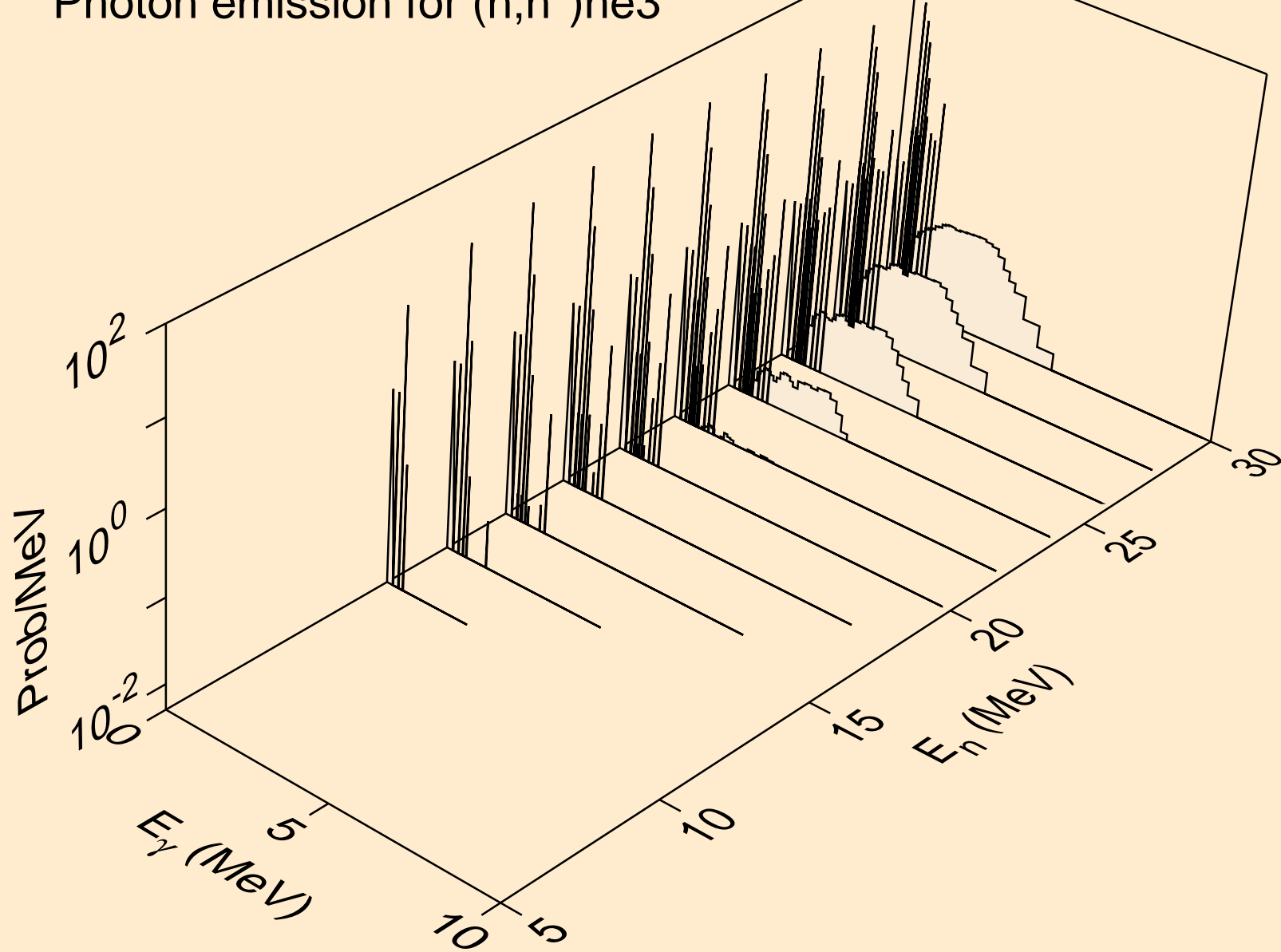

CE123 NEUTRON ACER TENDL-2021 LIBRARY; T=293.6K
Photon emission for (n,2np)

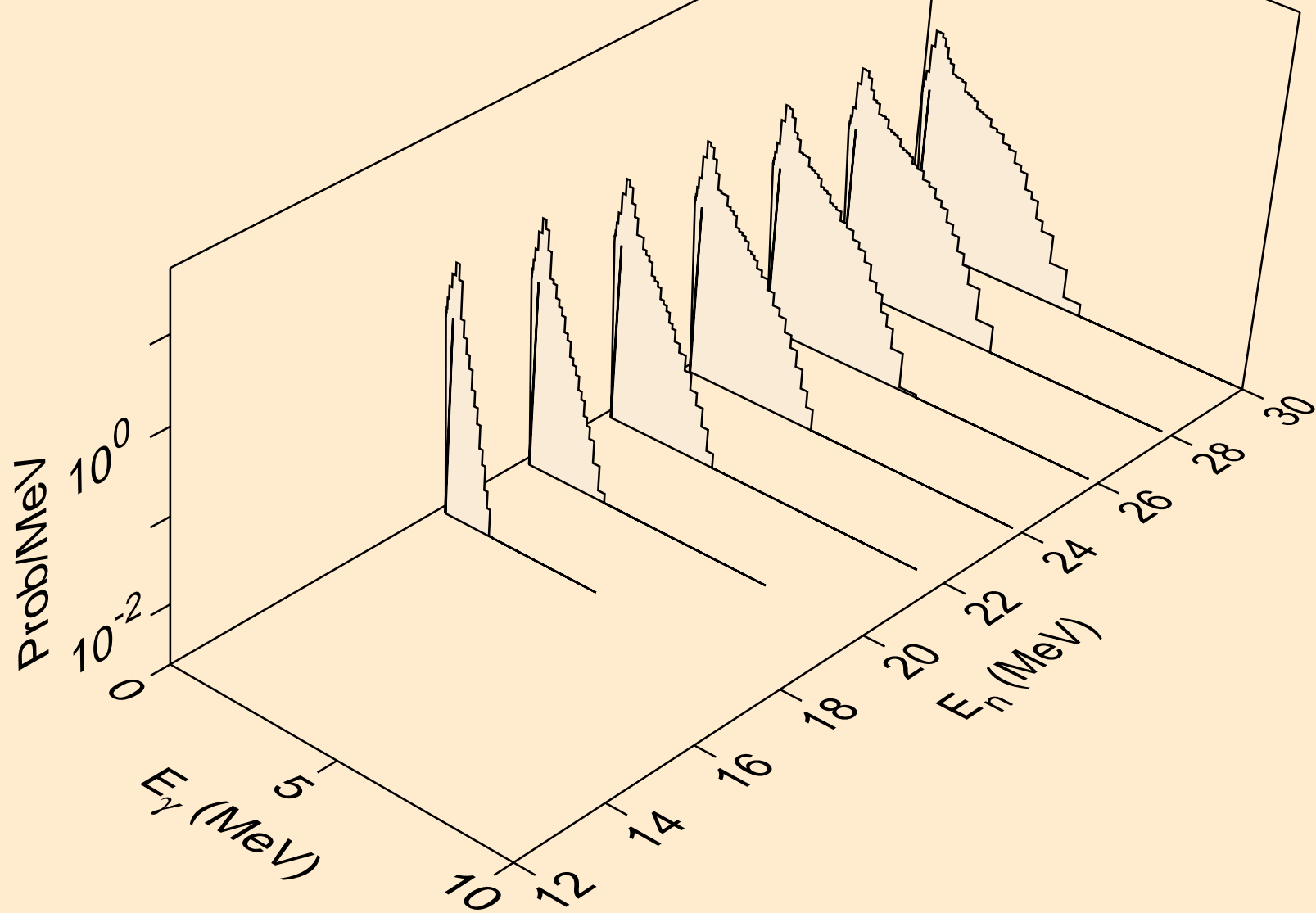

CE123 NEUTRON ACER TENDL-2021 LIBRARY; T=293.6K
Photon emission for (n,3np)

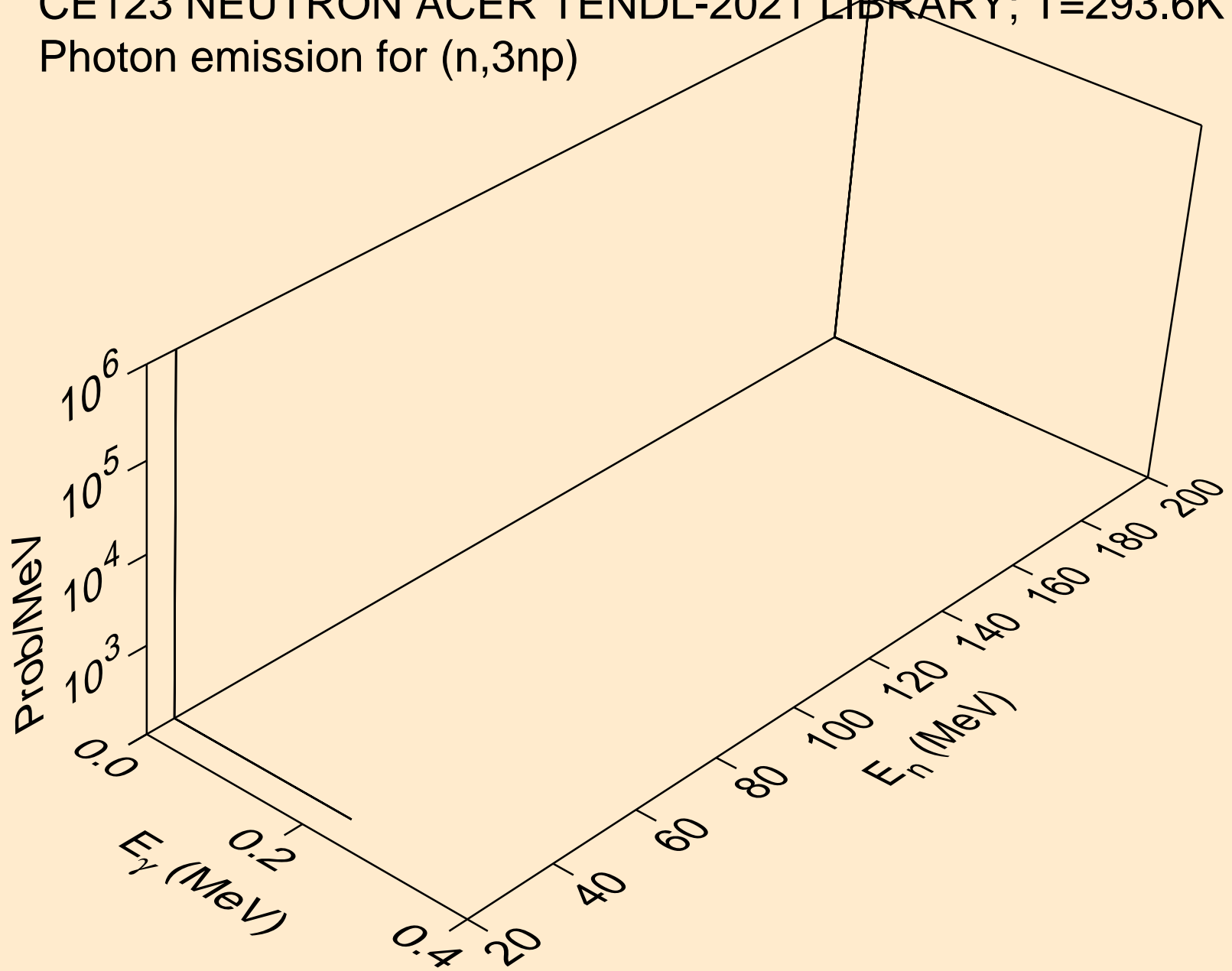

CE123 NEUTRON ACER TENDL-2021 LIBRARY; T=293.6K
Photon emission for (n,2np)

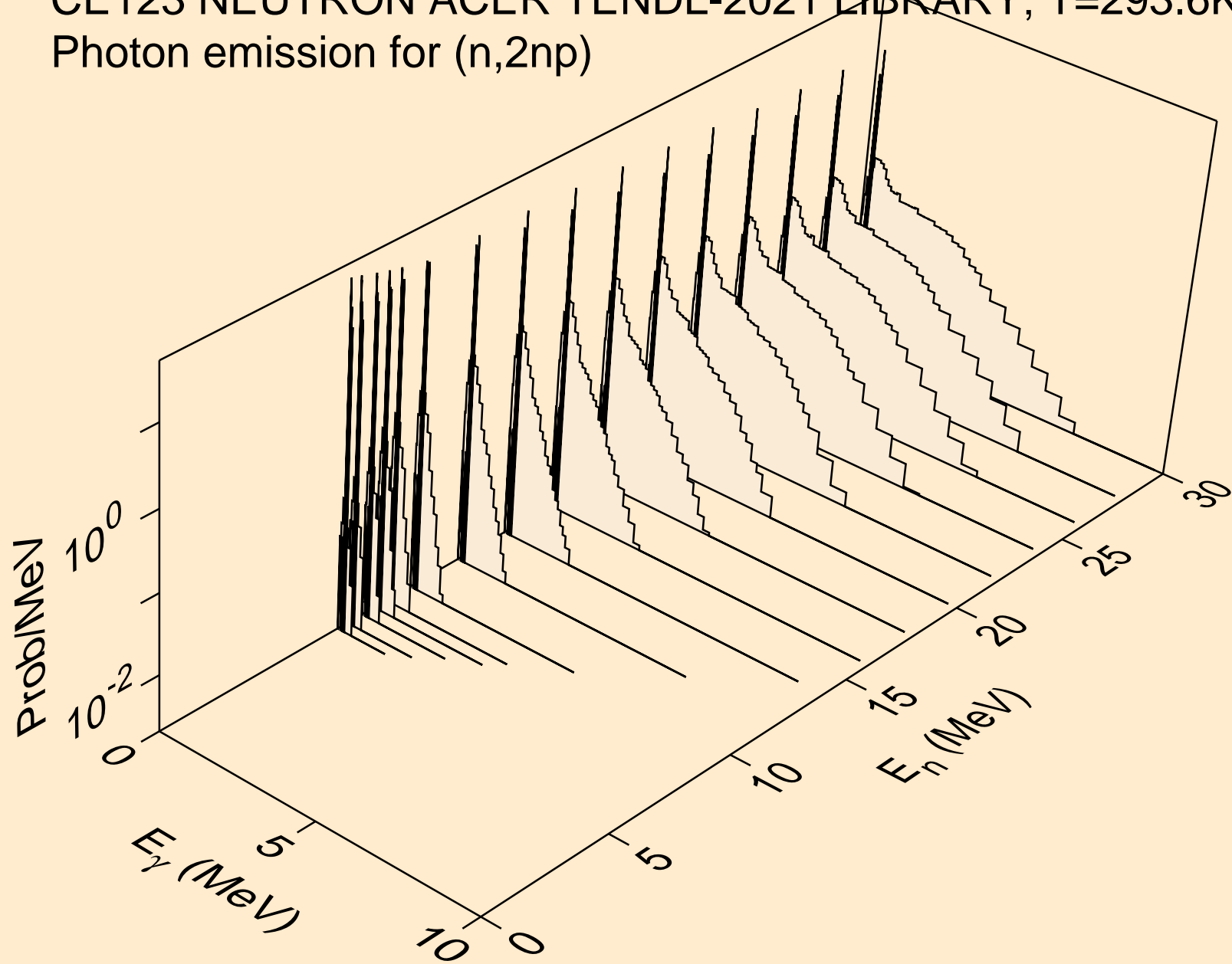

CE123 NEUTRON ACER TENDL-2021 LIBRARY; T=293.6K
Photon emission for (n,npa)

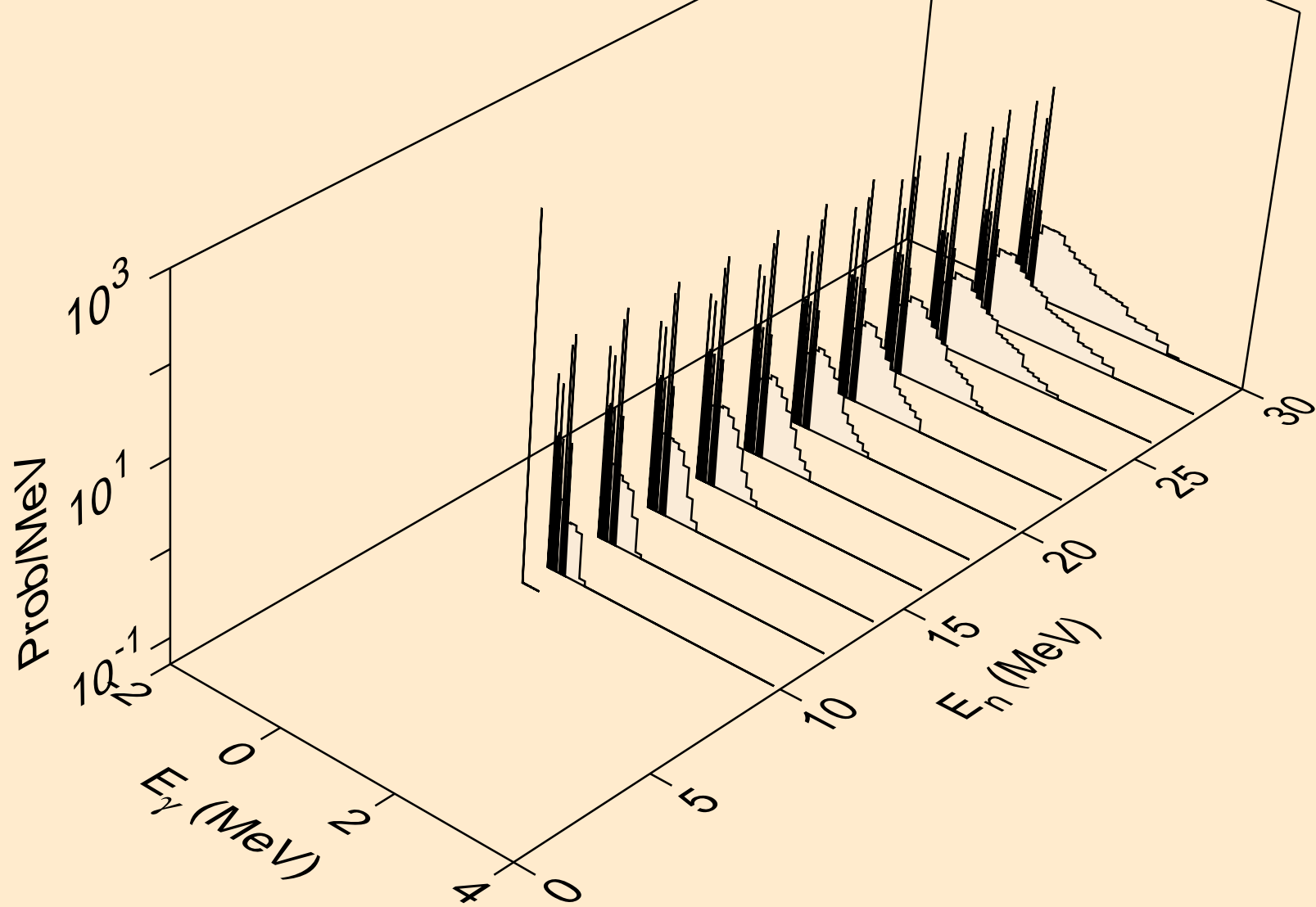

CE123 NEUTRON ACER TENDL-2021 LIBRARY; T=293.6K
Photon emission for (n,n*c)

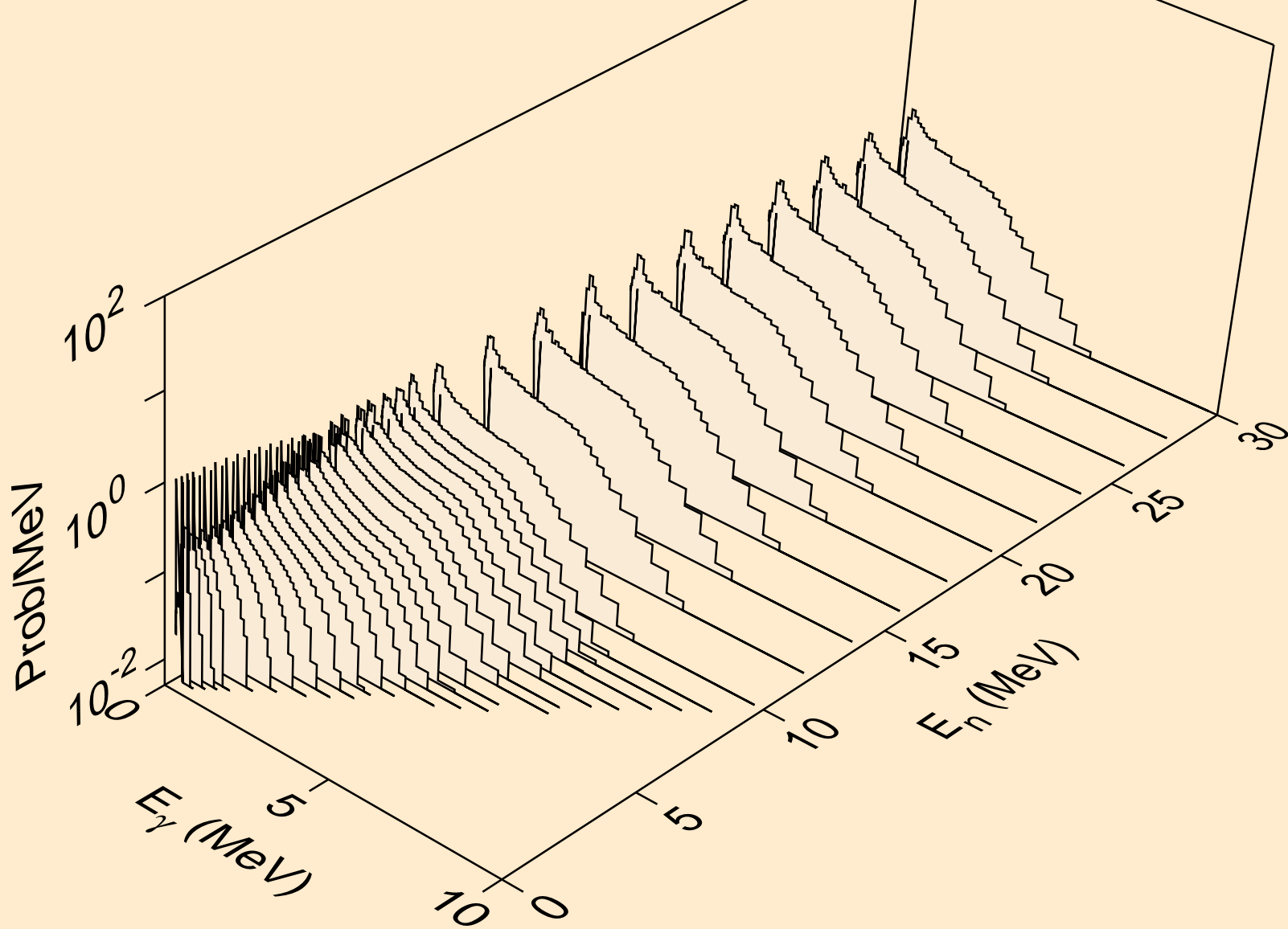

CE123 NEUTRON ACER TENDL-2021 LIBRARY; T=293.6K
Photon emission for (n,gma)

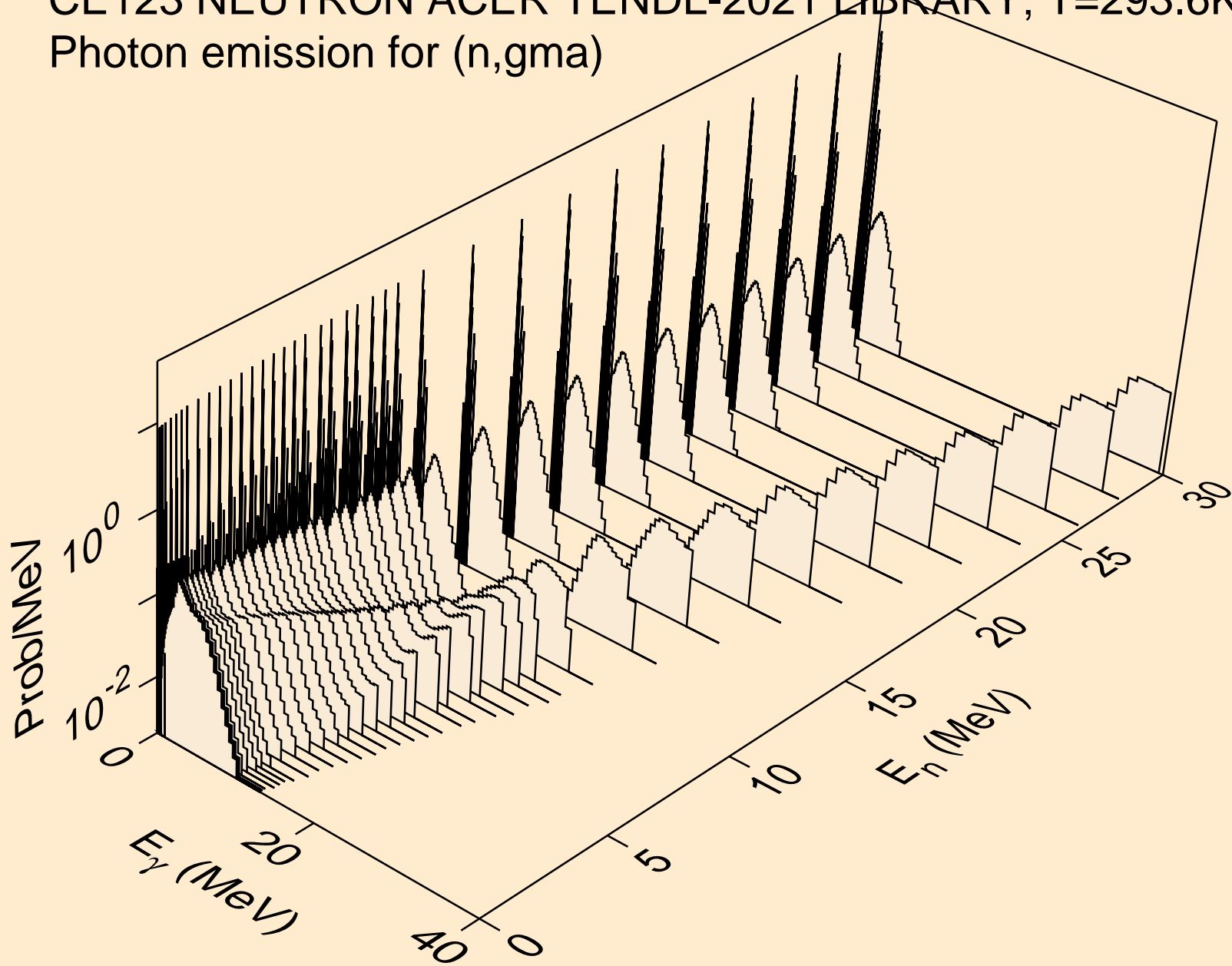

CE123 NEUTRON ACER TENDL-2021 LIBRARY; T=293.6K
Photon emission for (n,p)

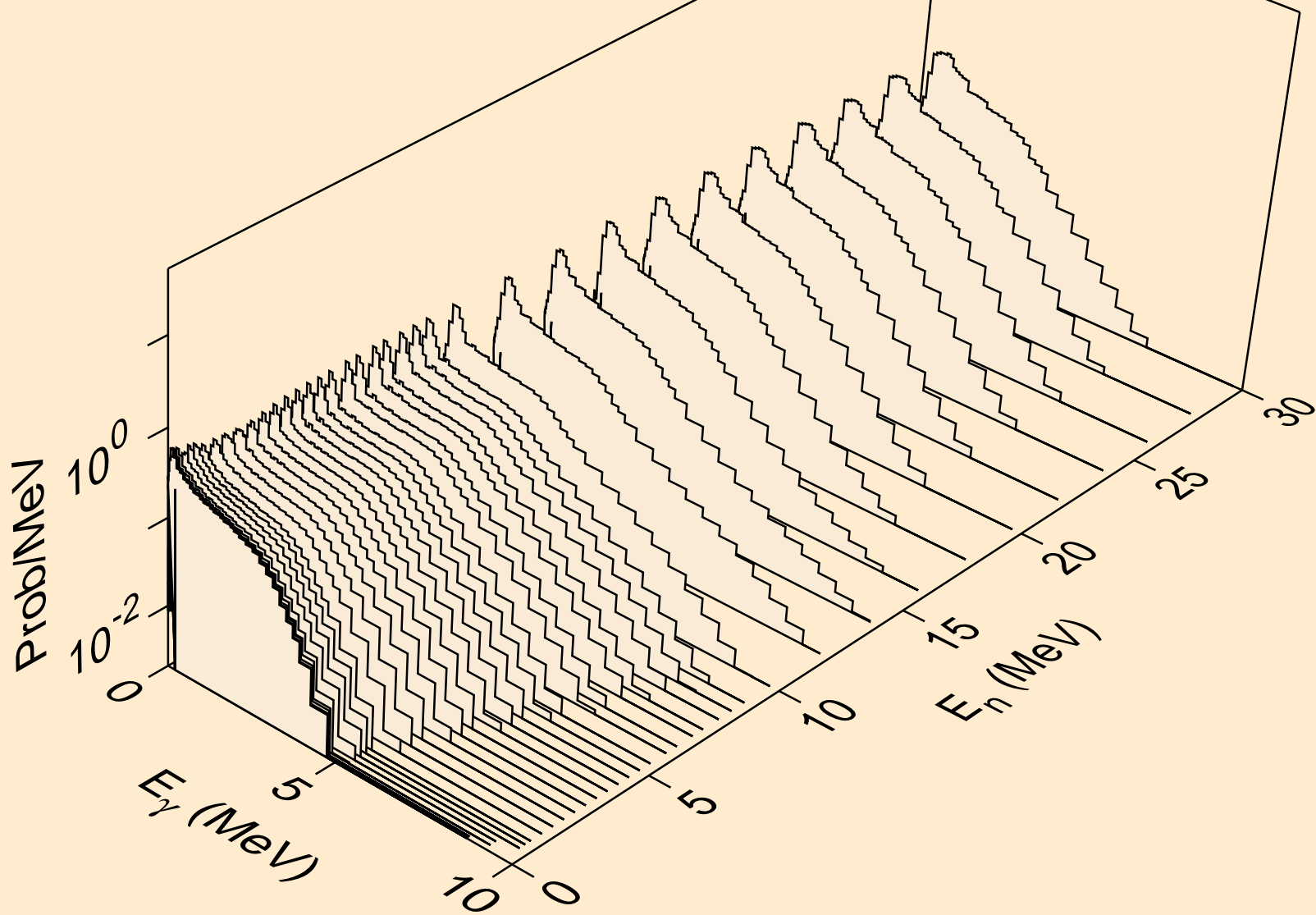

CE123 NEUTRON ACER TENDL-2021 LIBRARY; T=293.6K
Photon emission for (n,d)

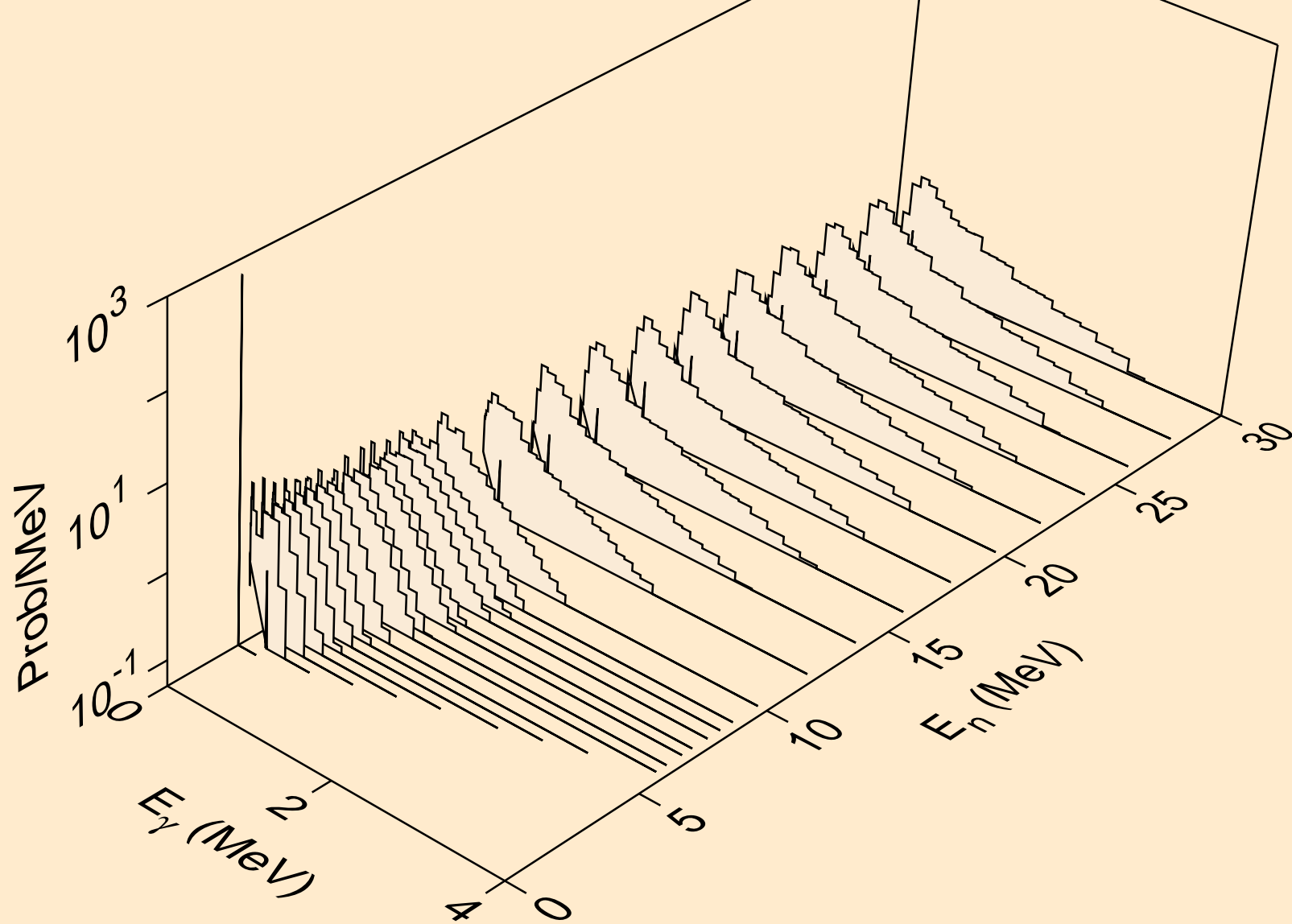

CE123 NEUTRON ACER TENDL-2021 LIBRARY; T=293.6K
Photon emission for (n,t)

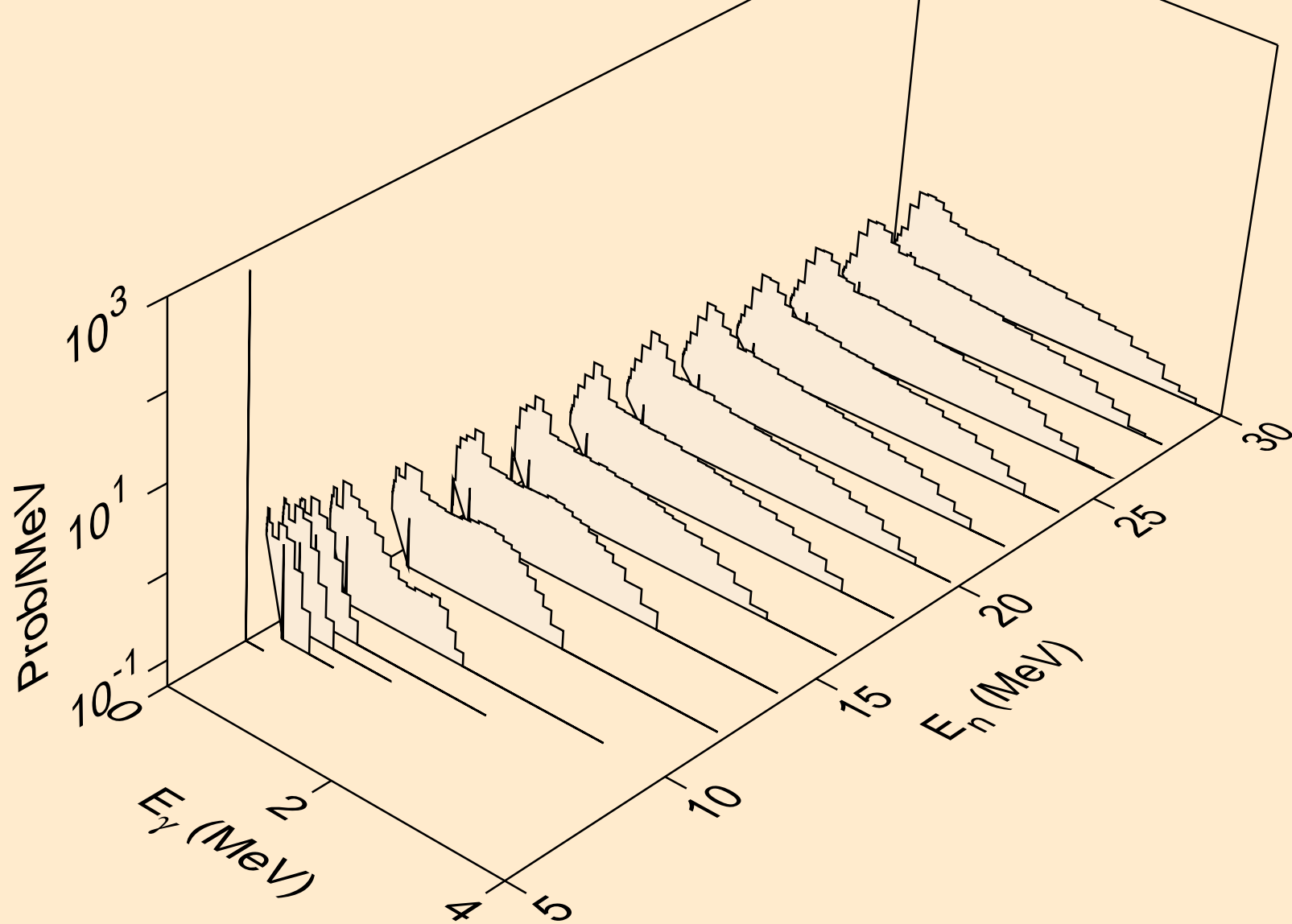

CE123 NEUTRON ACER TENDL-2021 LIBRARY; T=293.6K
Photon emission for (n,he3)

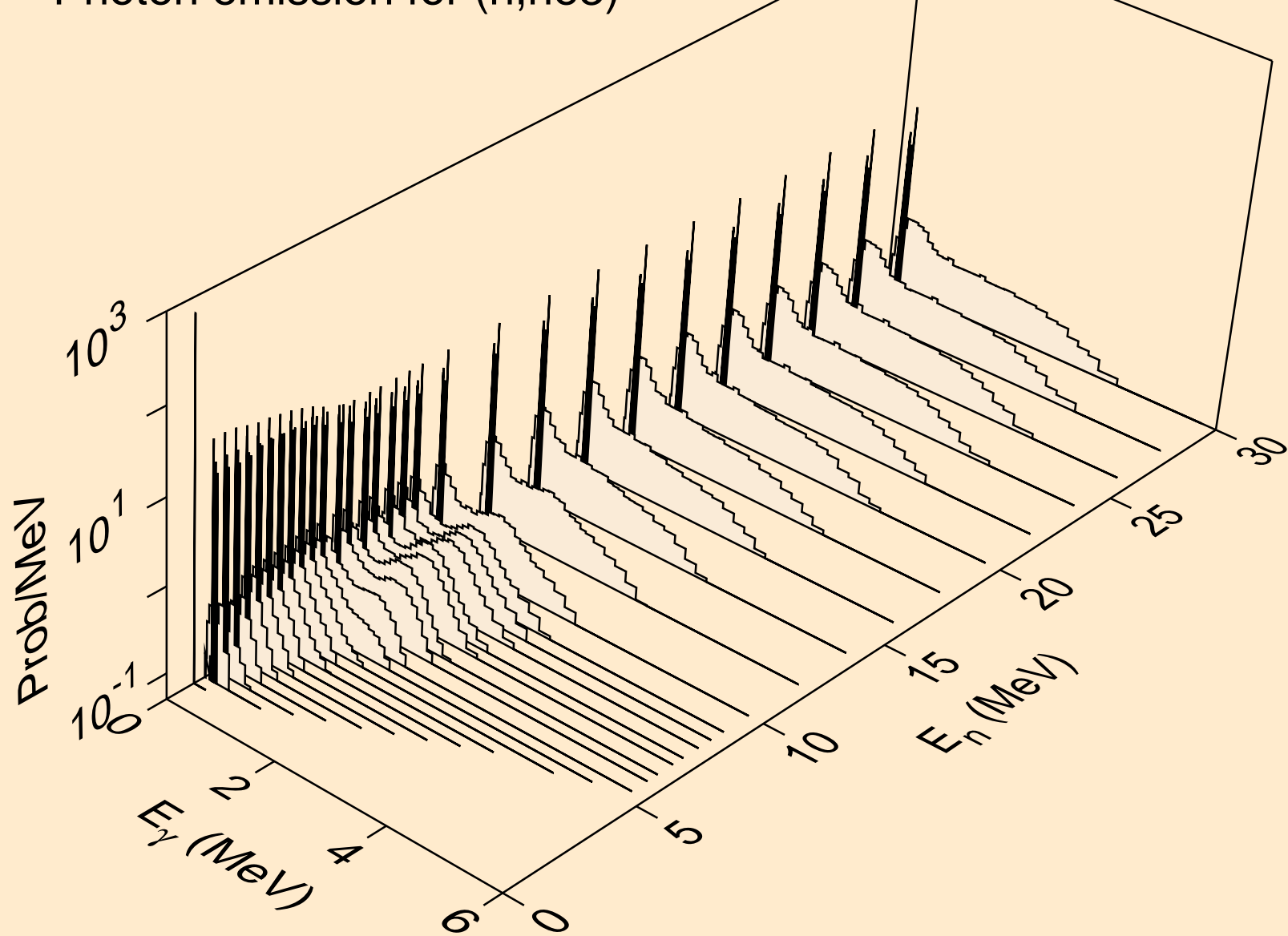

CE123 NEUTRON ACER TENDL-2021 LIBRARY; T=293.6K
Photon emission for (n,a)

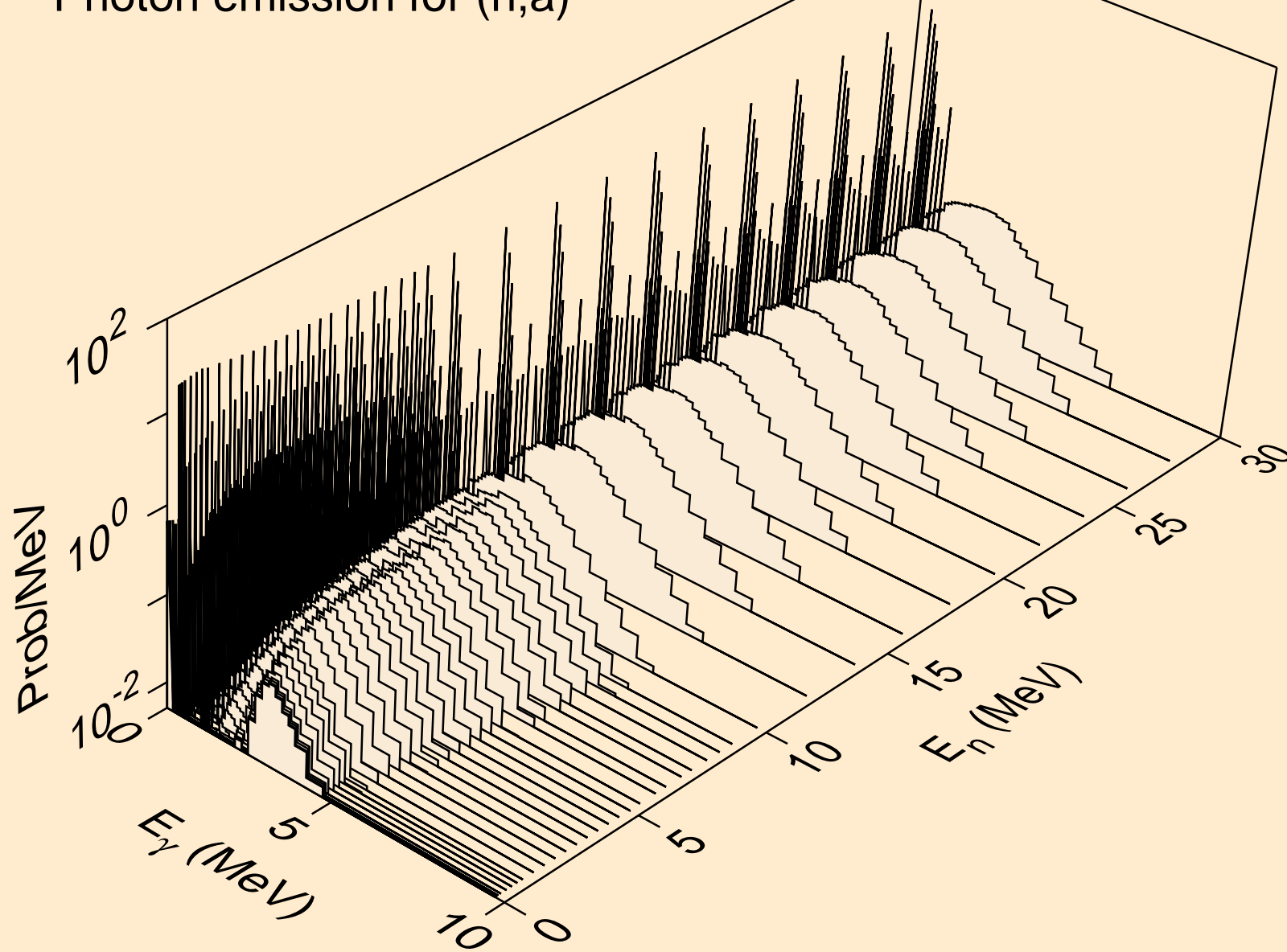

CE123 NEUTRON ACER TENDL-2021 LIBRARY; T=293.6K
Photon emission for (n,2a)

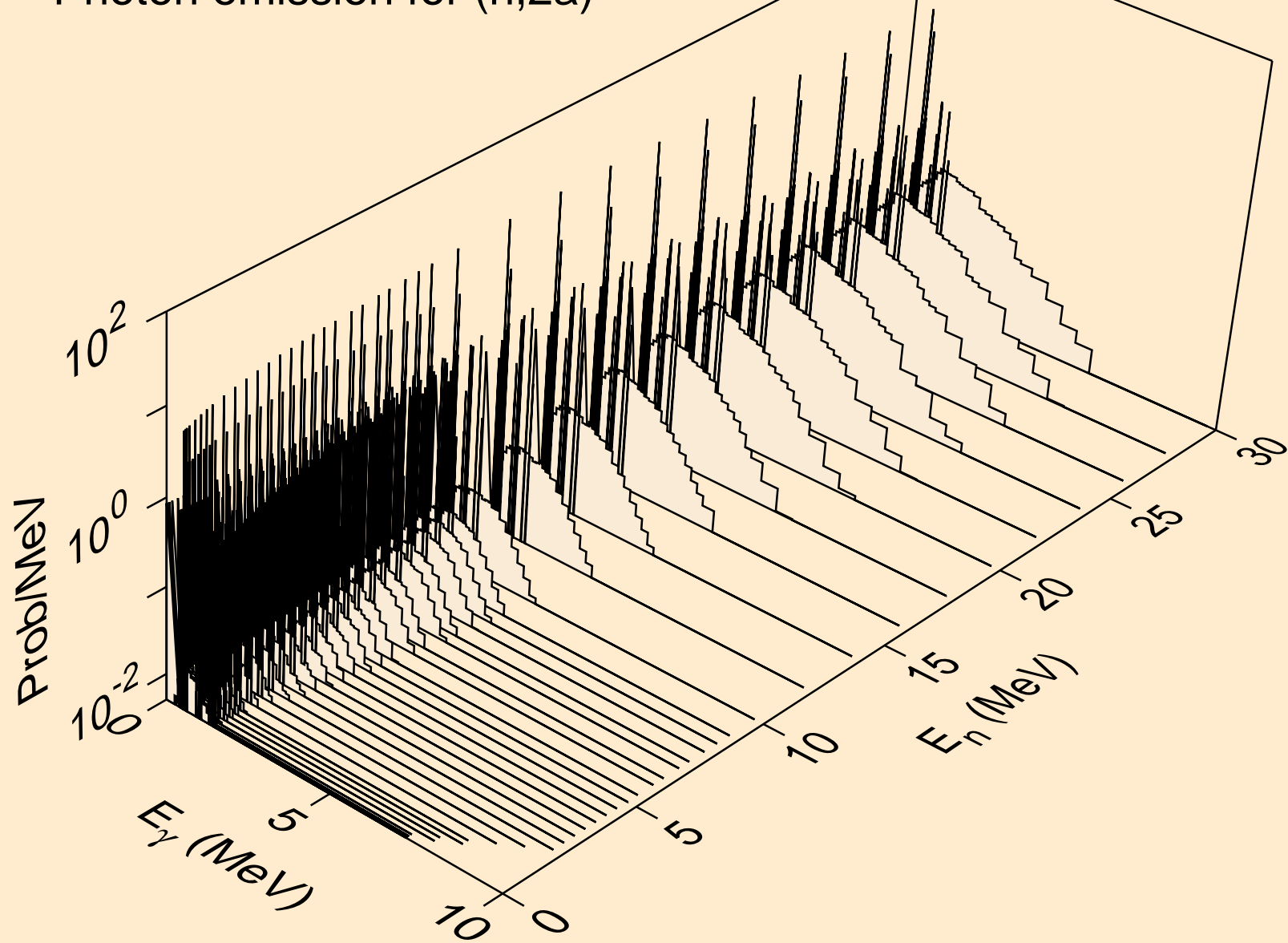

CE123 NEUTRON ACER TENDL-2021 LIBRARY; T=293.6K
Photon emission for (n,3a)

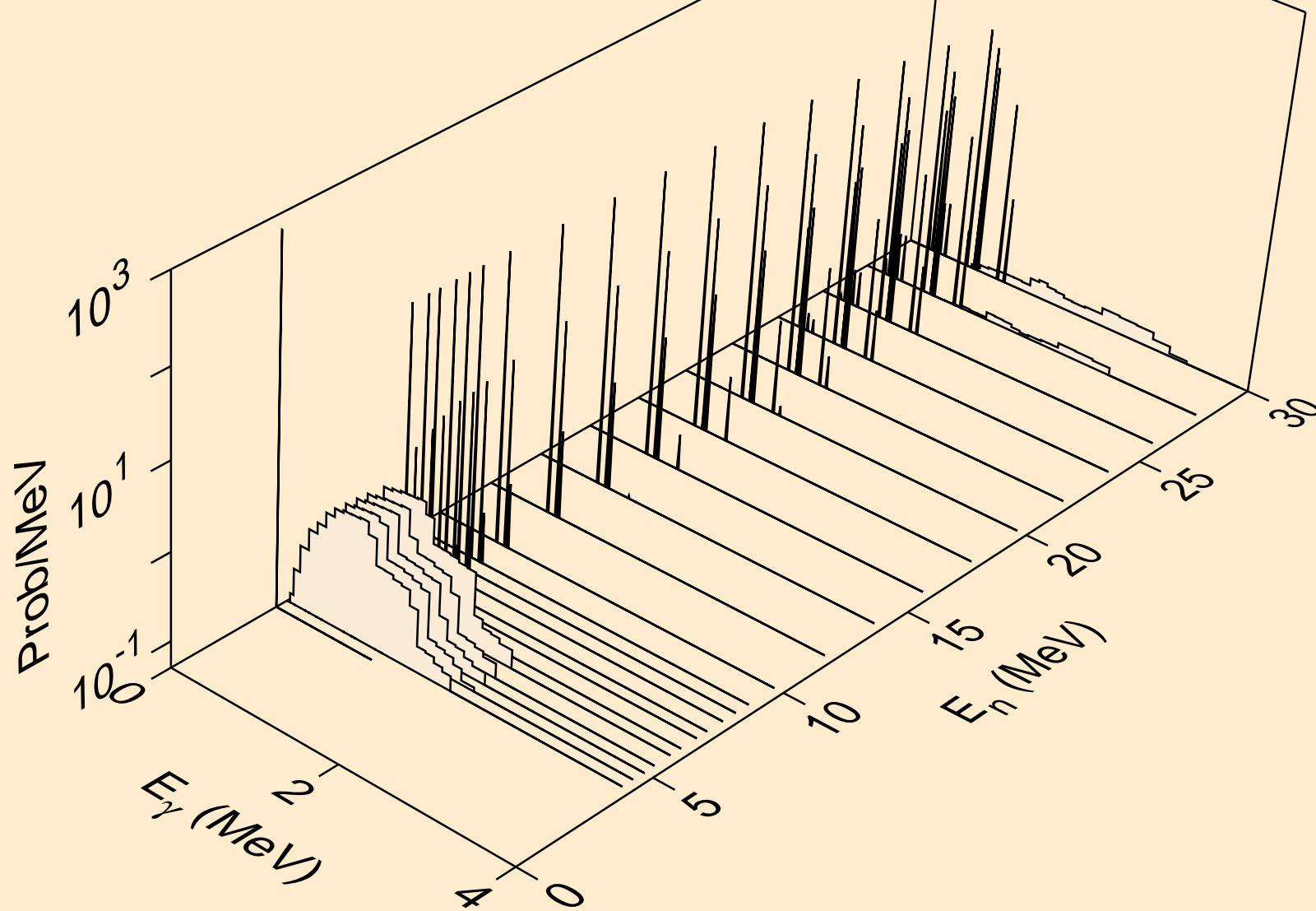

CE123 NEUTRON ACER TENDL-2021 LIBRARY; T=293.6K
Photon emission for (n,2p)

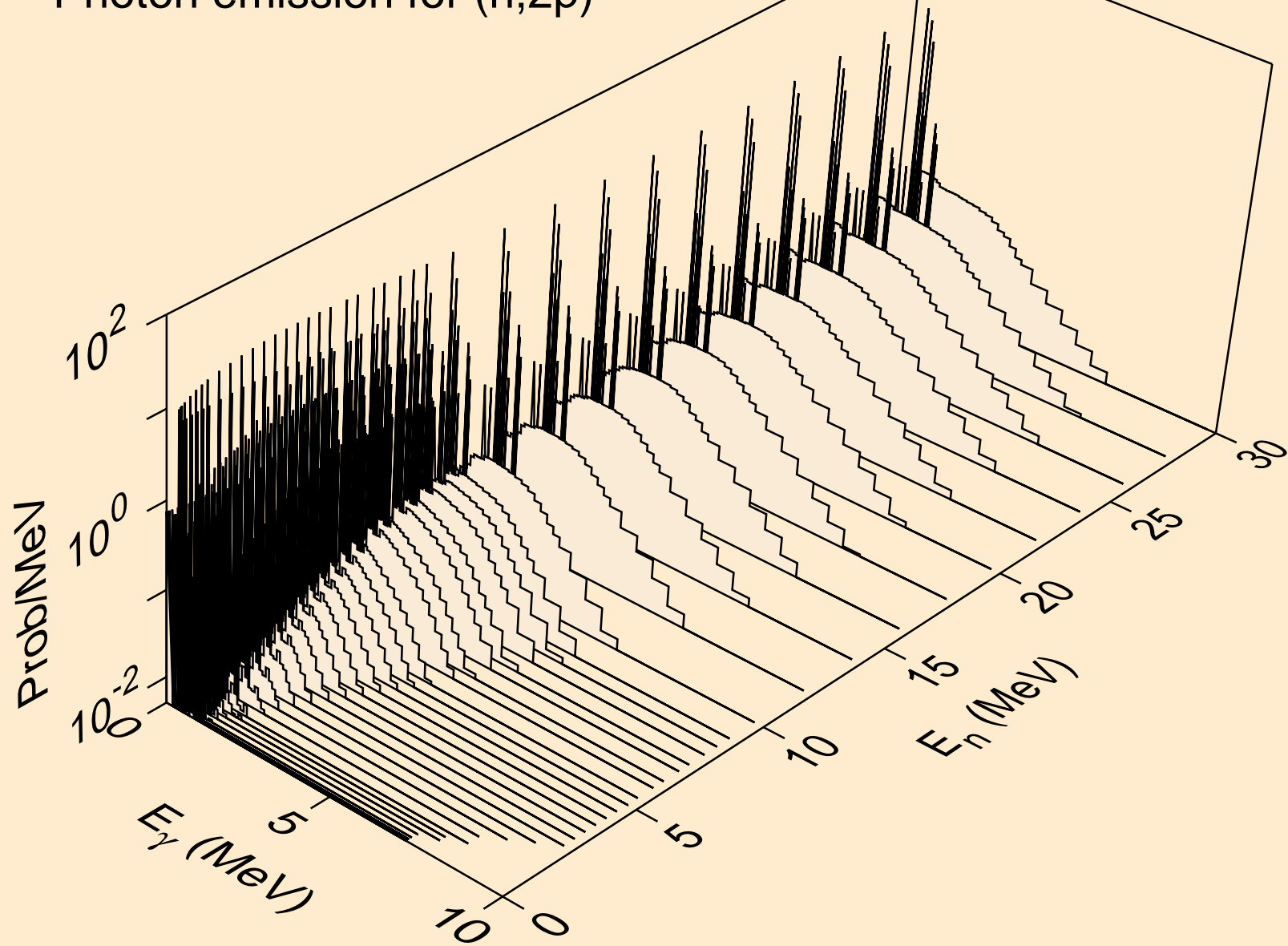

CE123 NEUTRON ACER TENDL-2021 LIBRARY; T=293.6K
Photon emission for (n,p α)

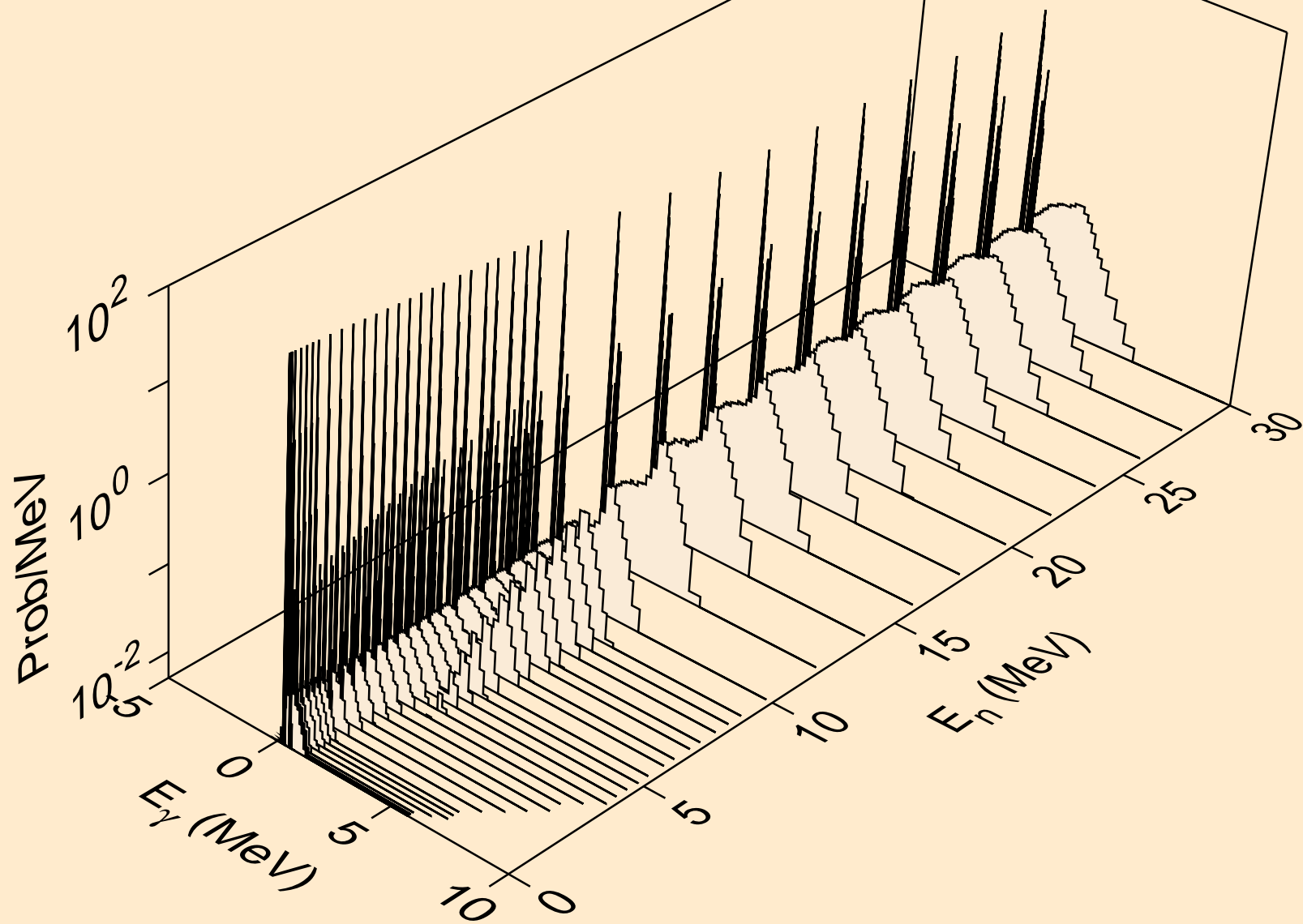

CE123 NEUTRON ACER TENDL-2021 LIBRARY; T=293.6K
Photon emission for (n,d2a)

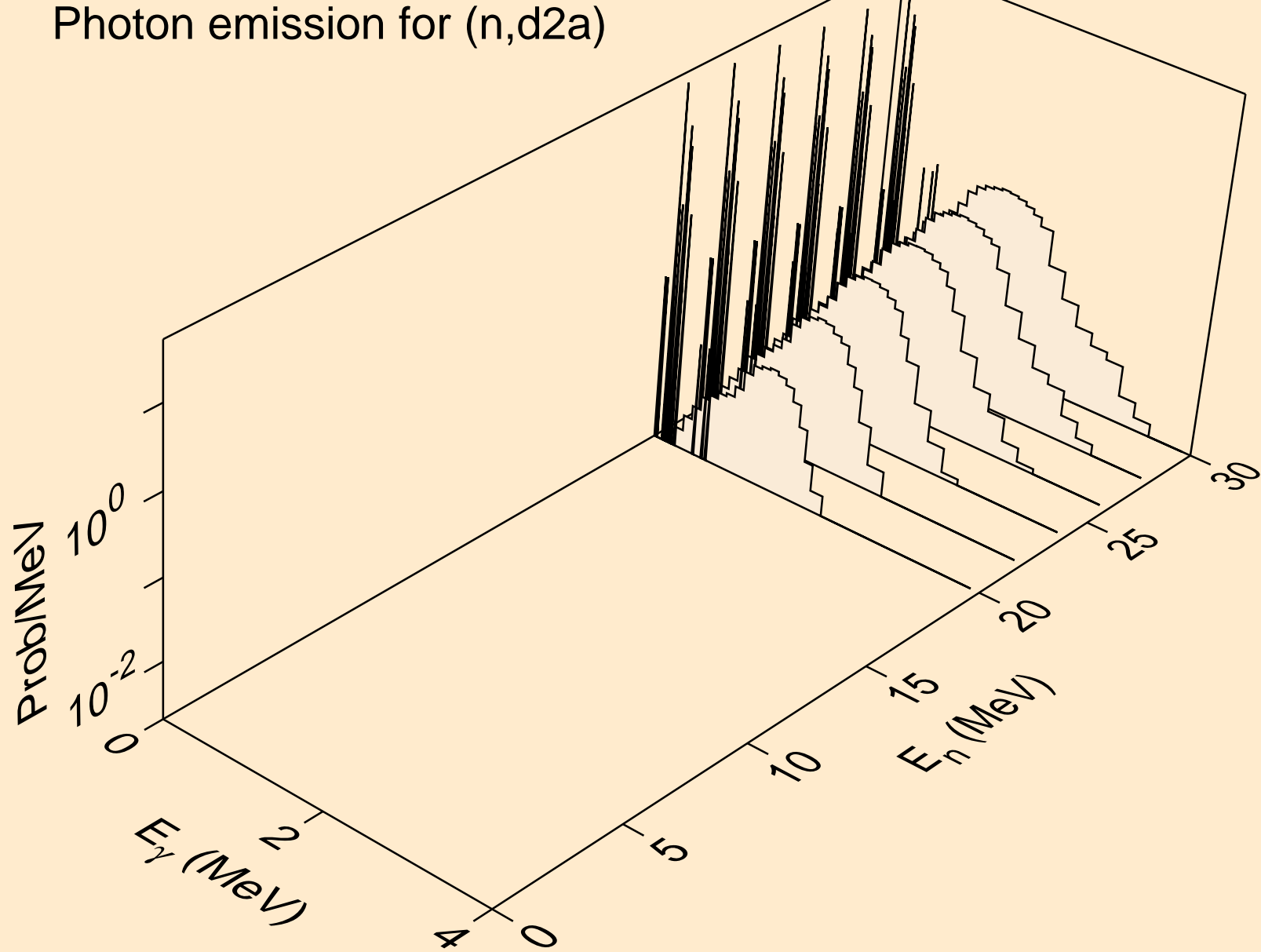

CE123 NEUTRON ACER TENDL-2021 LIBRARY; T=293.6K
Photon emission for (n,pd)

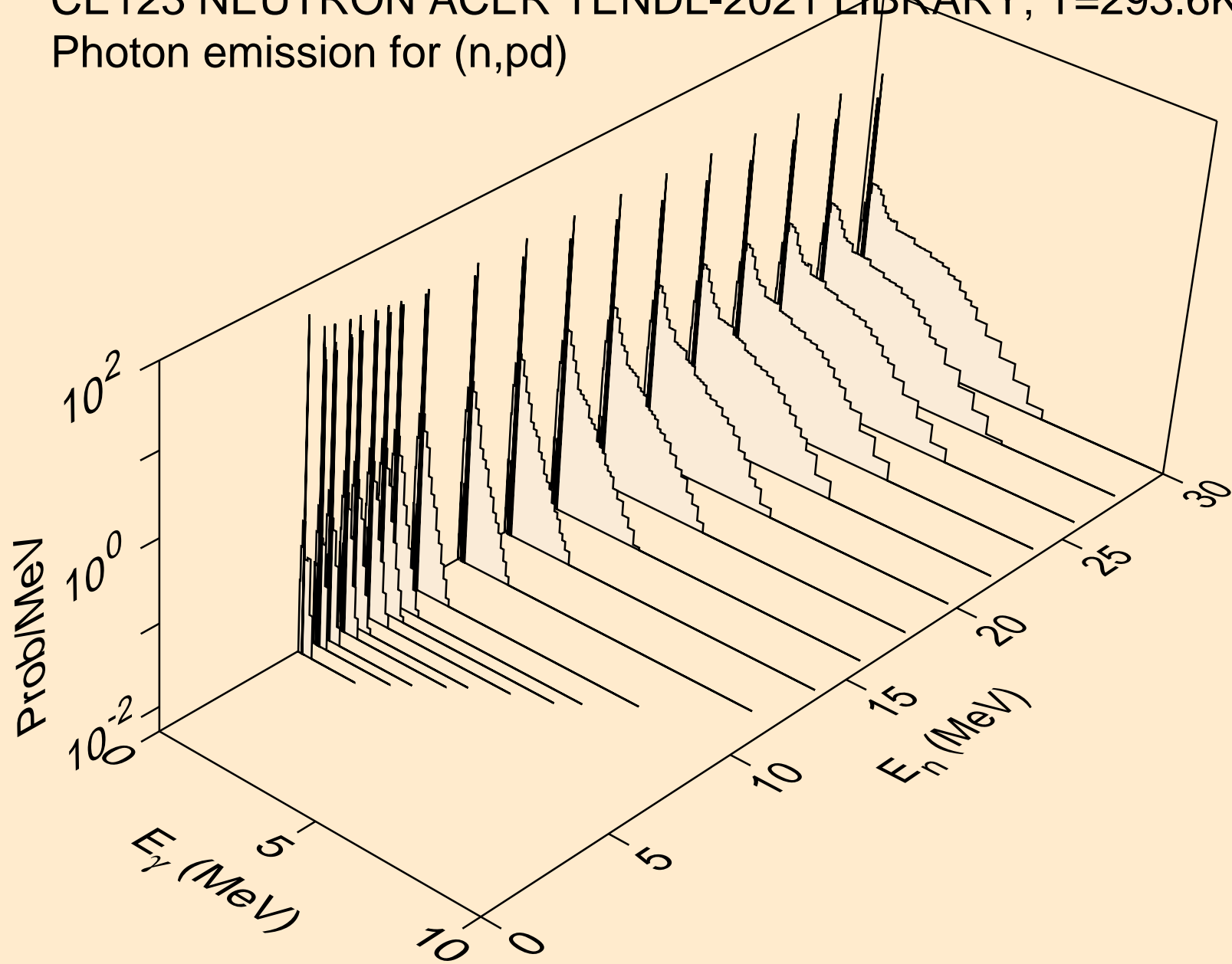

CE123 NEUTRON ACER TENDL-2021 LIBRARY; T=293.6K
Photon emission for (n,pt)

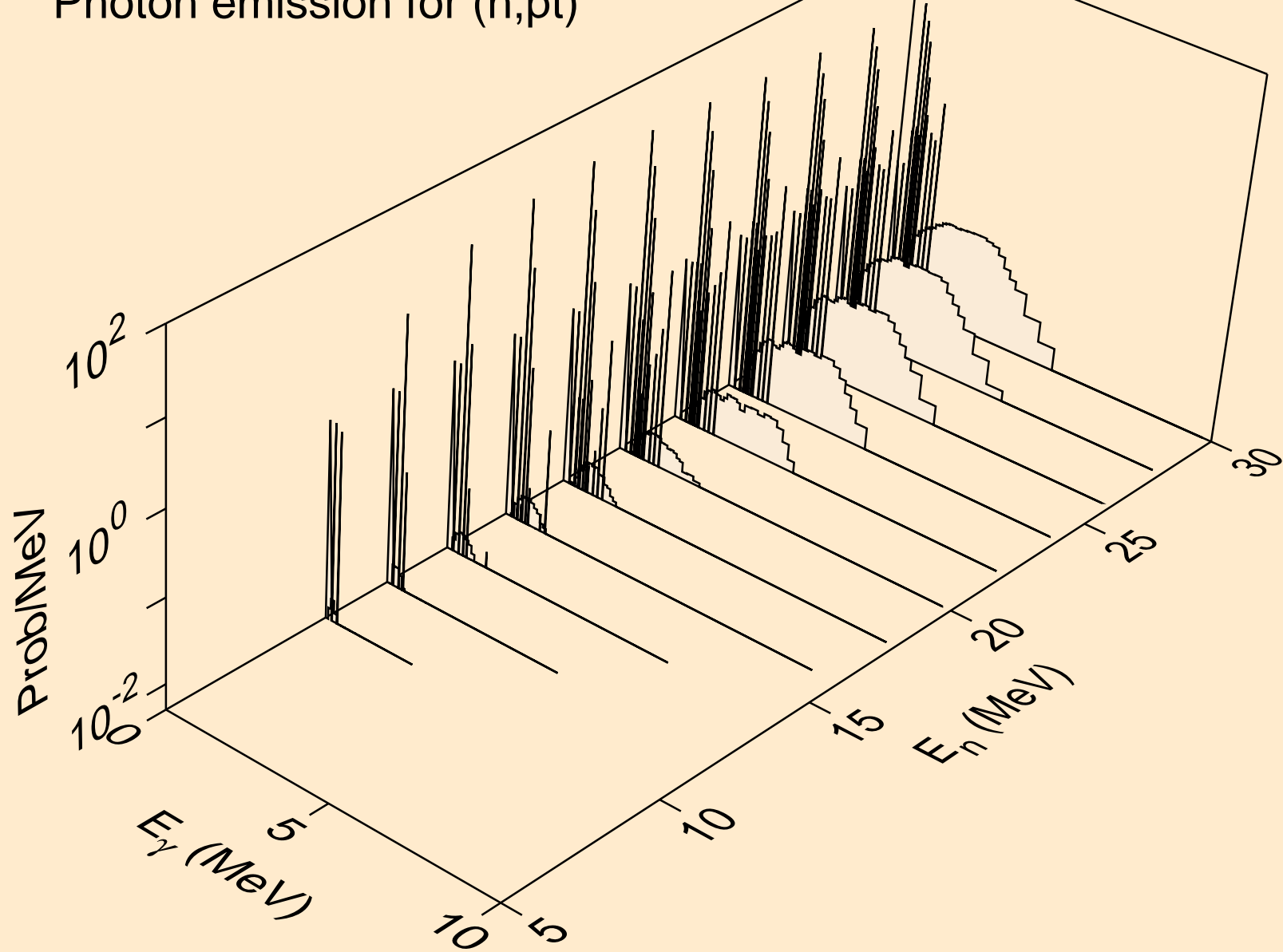

CE123 NEUTRON ACER TENDL-2021 LIBRARY; T=293.6K
Photon emission for (n,da)

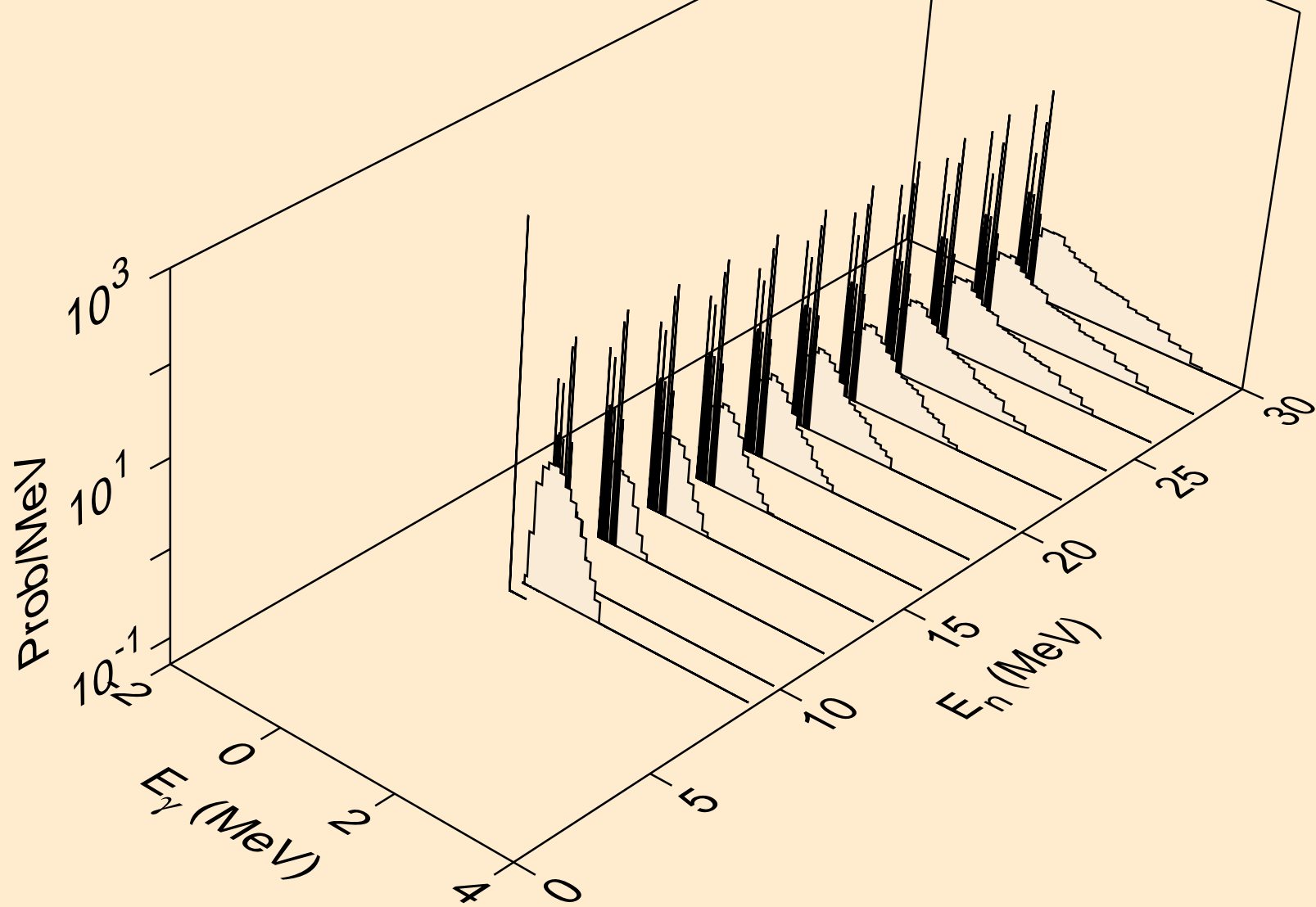

CE123 NEUTRON ACER TENDL-2021 LIBRARY; T=293.6K
thermal capture photon spectrum

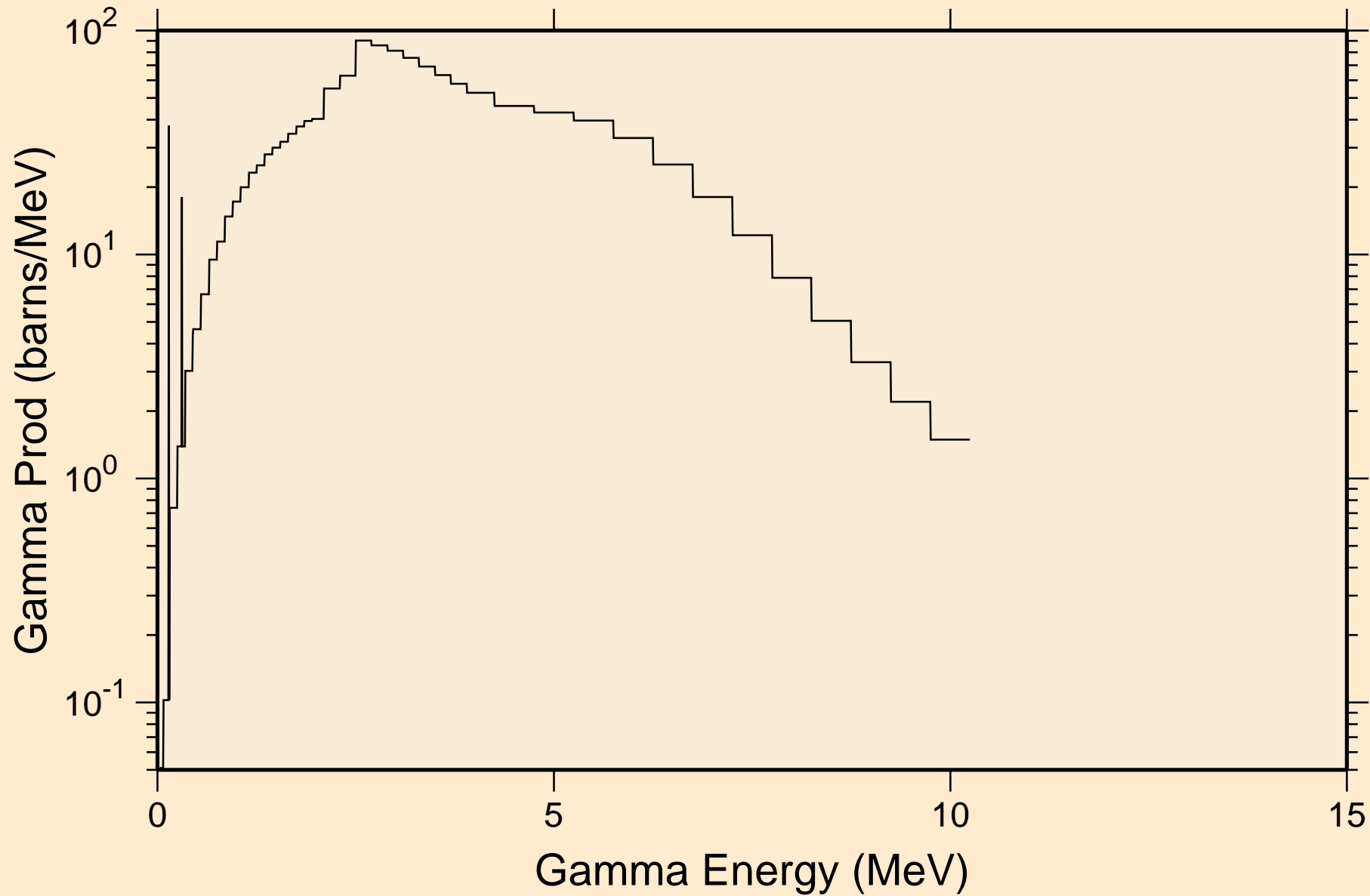

CE123 NEUTRON ACER TENDL-2021 LIBRARY; T=293.6K
14 MeV photon spectrum

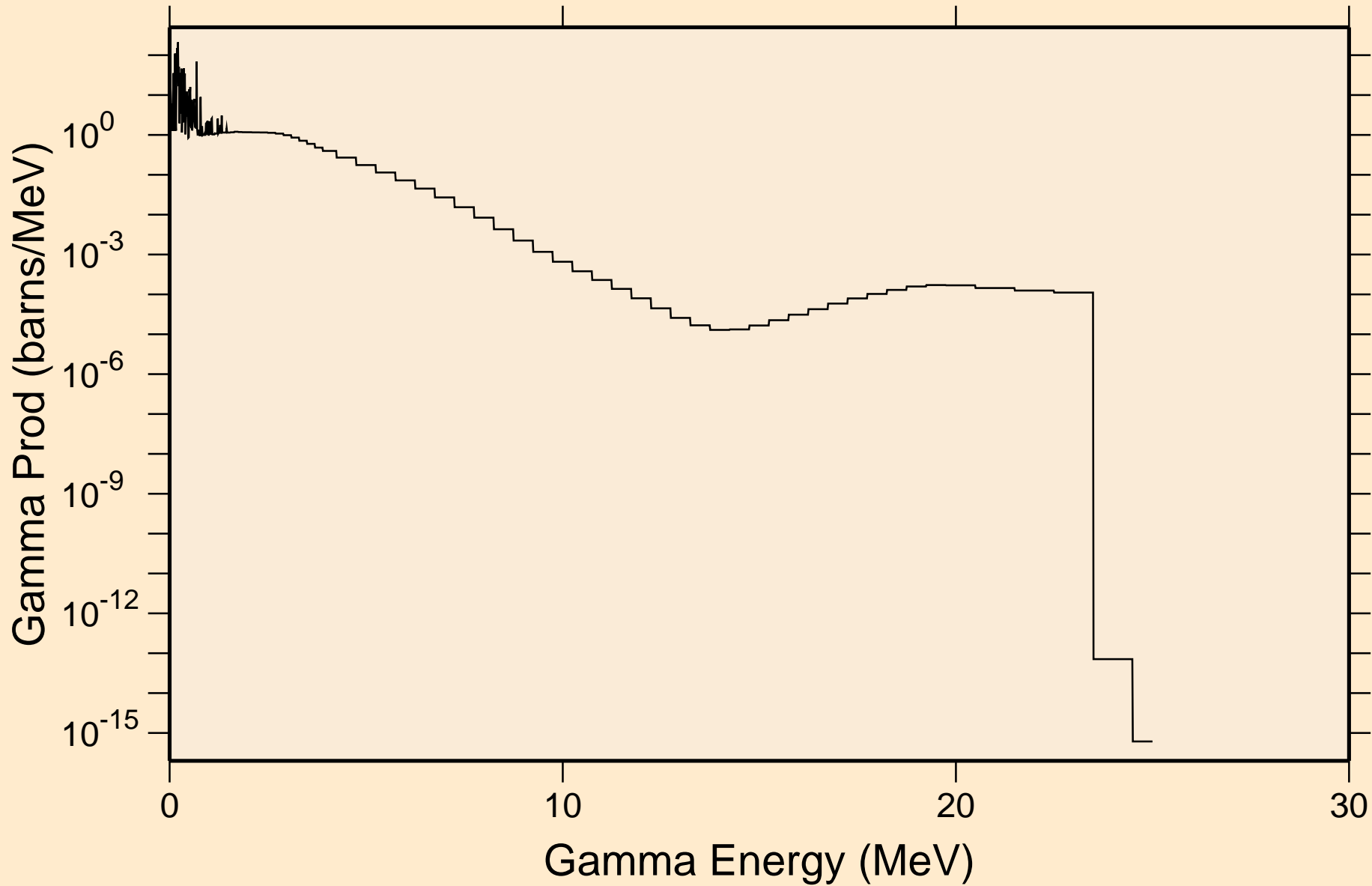

CE123 NEUTRON ACER TENDL-2021 LIBRARY; T=293.6K

Particle heating contributions

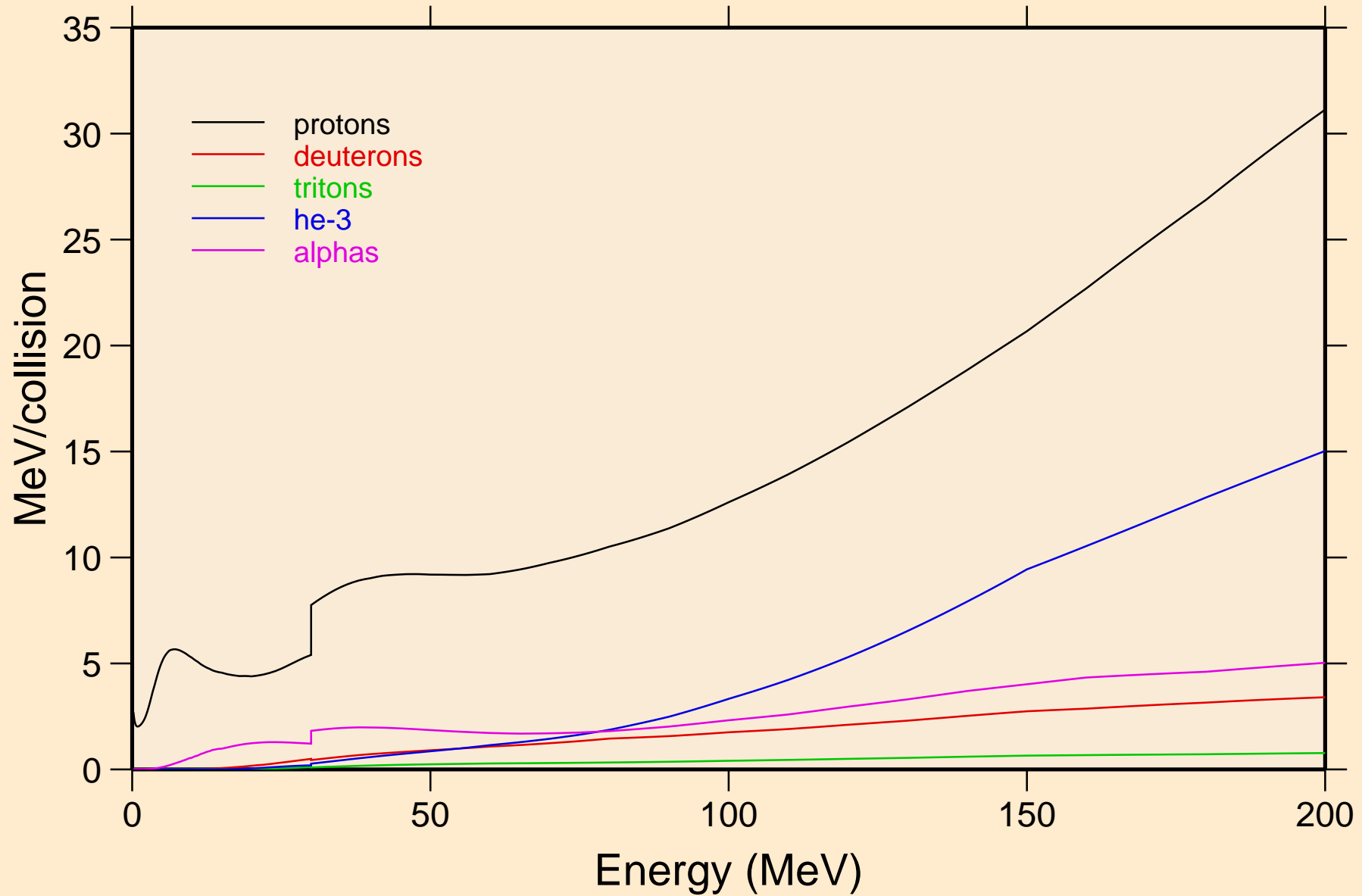

CE123 NEUTRON ACER TENDL-2021 LIBRARY; T=293.6K
Recoil Heating

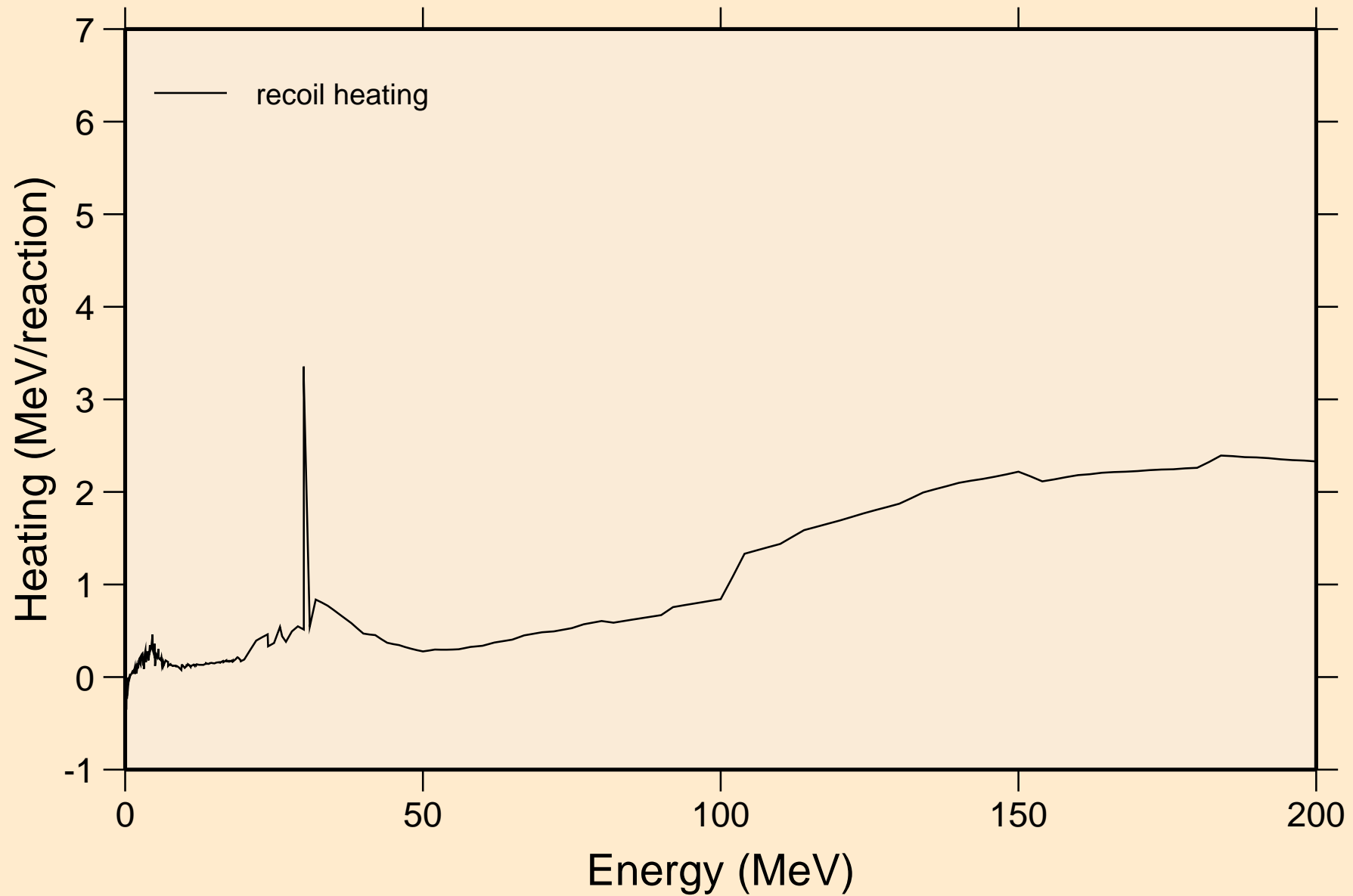

CE123 NEUTRON ACER TENDL-2021 LIBRARY; T=293.6K
Particle production cross sections

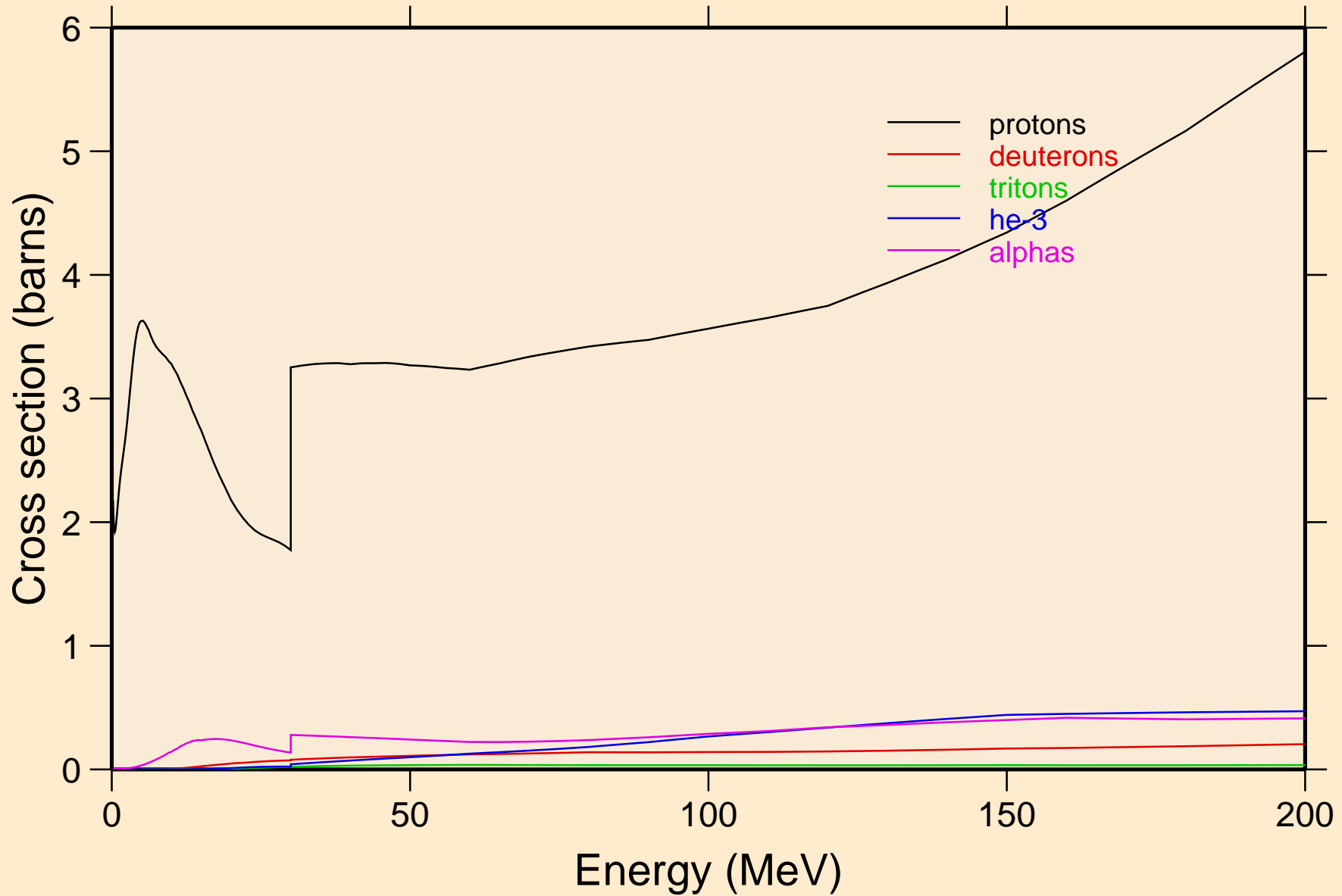

CE123 NEUTRON ACER TENDL-2021 LIBRARY; T=293.6K
protons from (n,x)

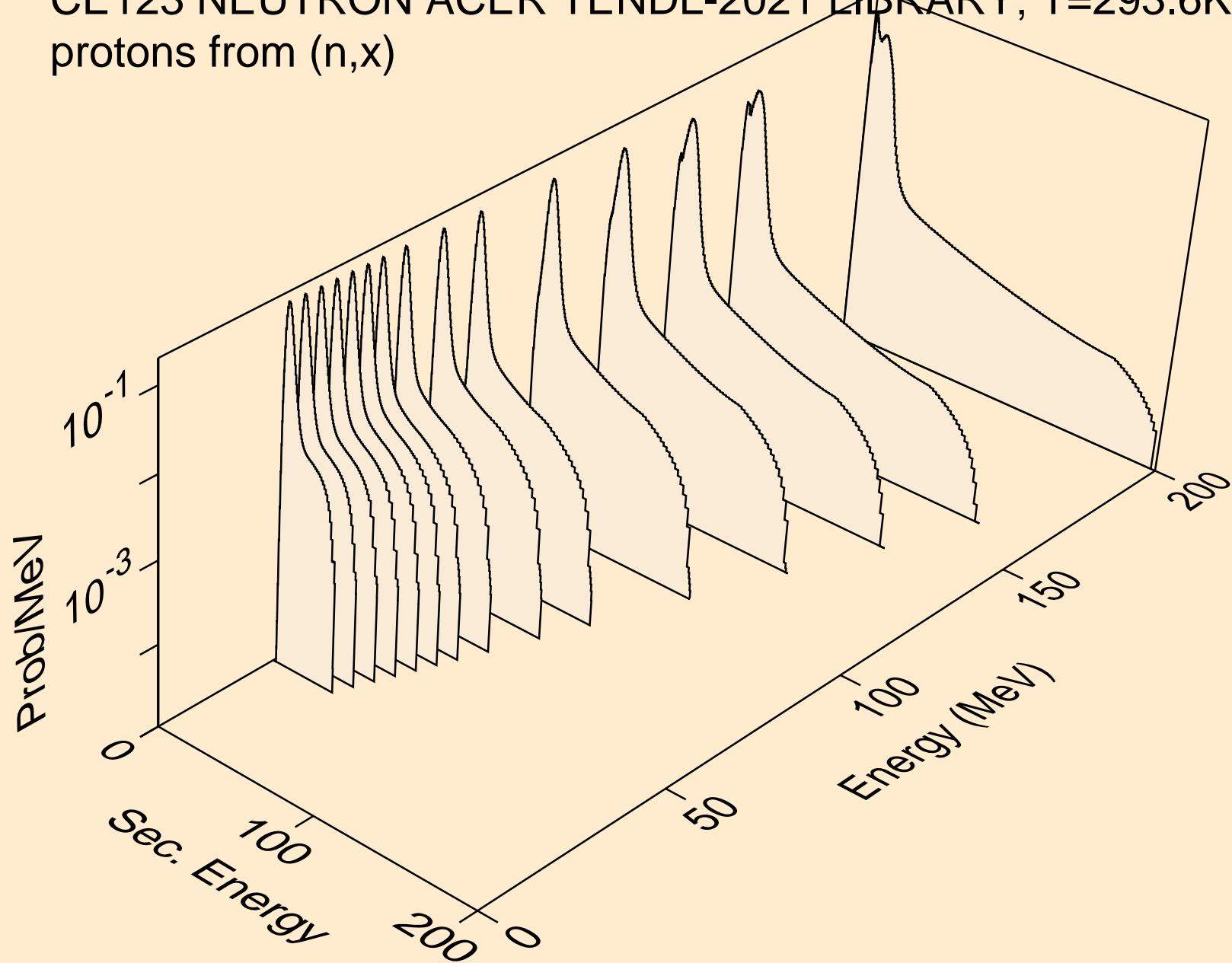

CE123 NEUTRON ACER TENDL-2021 LIBRARY; T=293.6K
protons from (n,n*)p

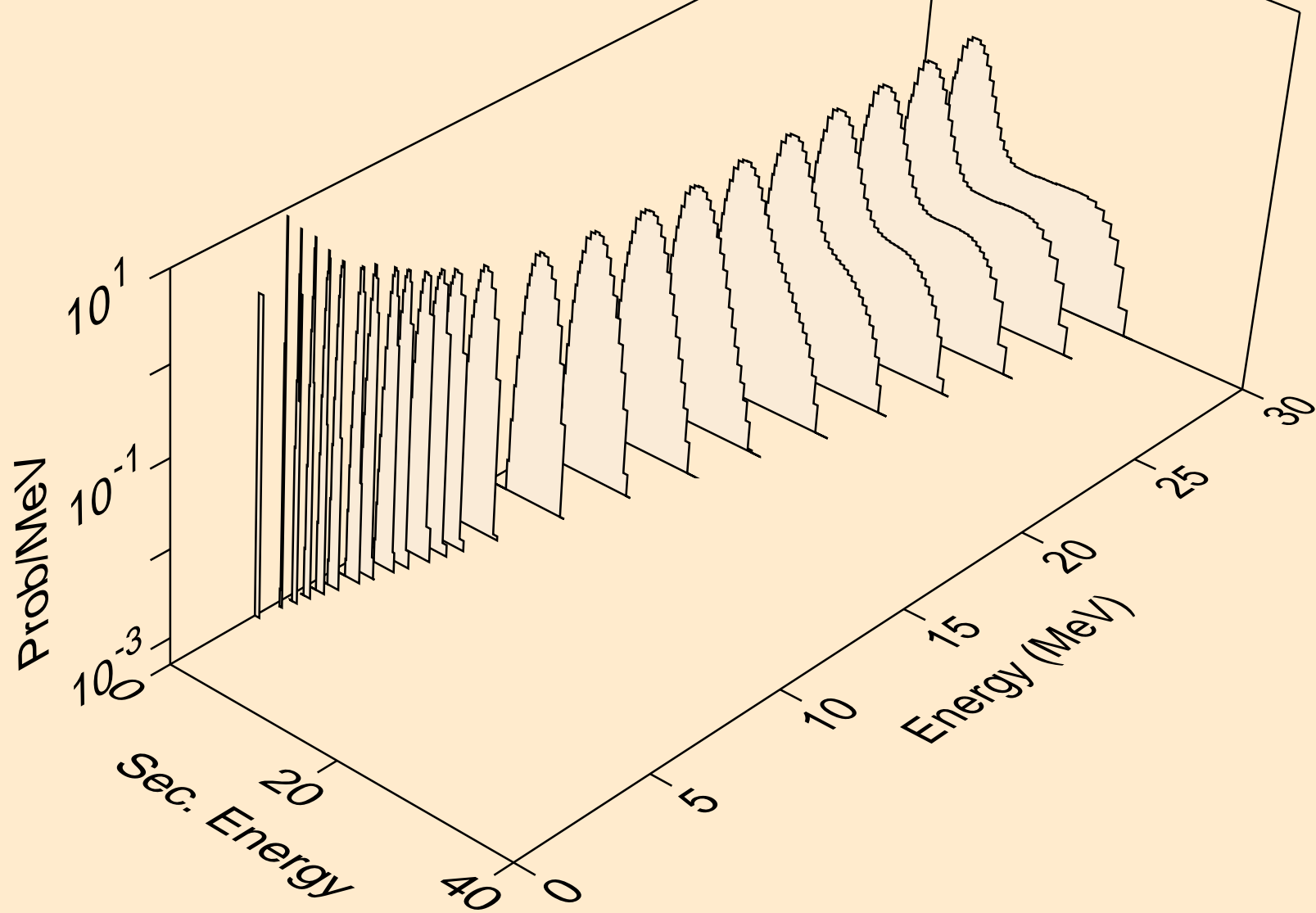

CE123 NEUTRON ACER TENDL-2021 LIBRARY; T=293.6K
protons from (n,2np)

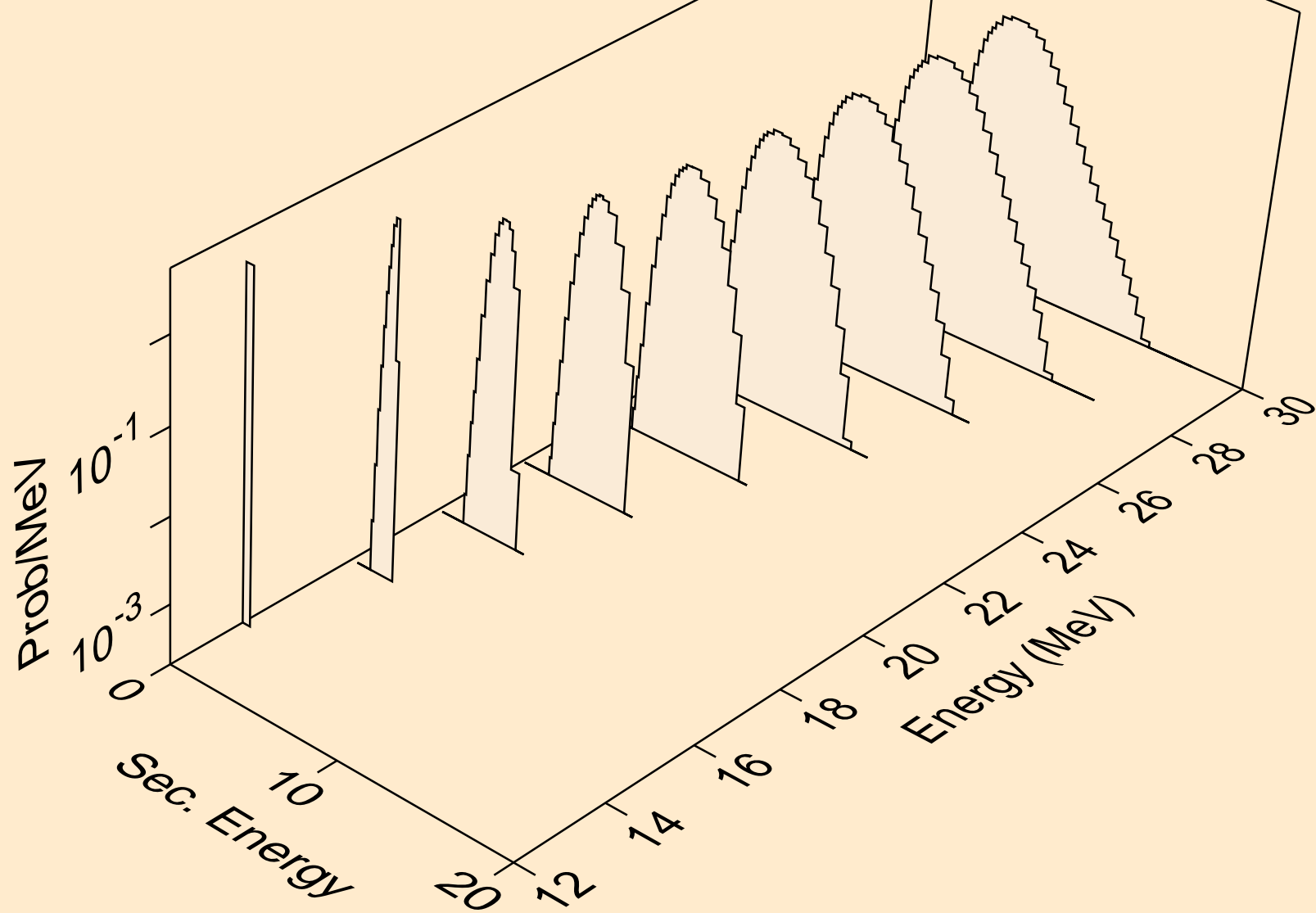

CE123 NEUTRON ACER TENDL-2021 LIBRARY; T=293.6K
protons from (n,3np)

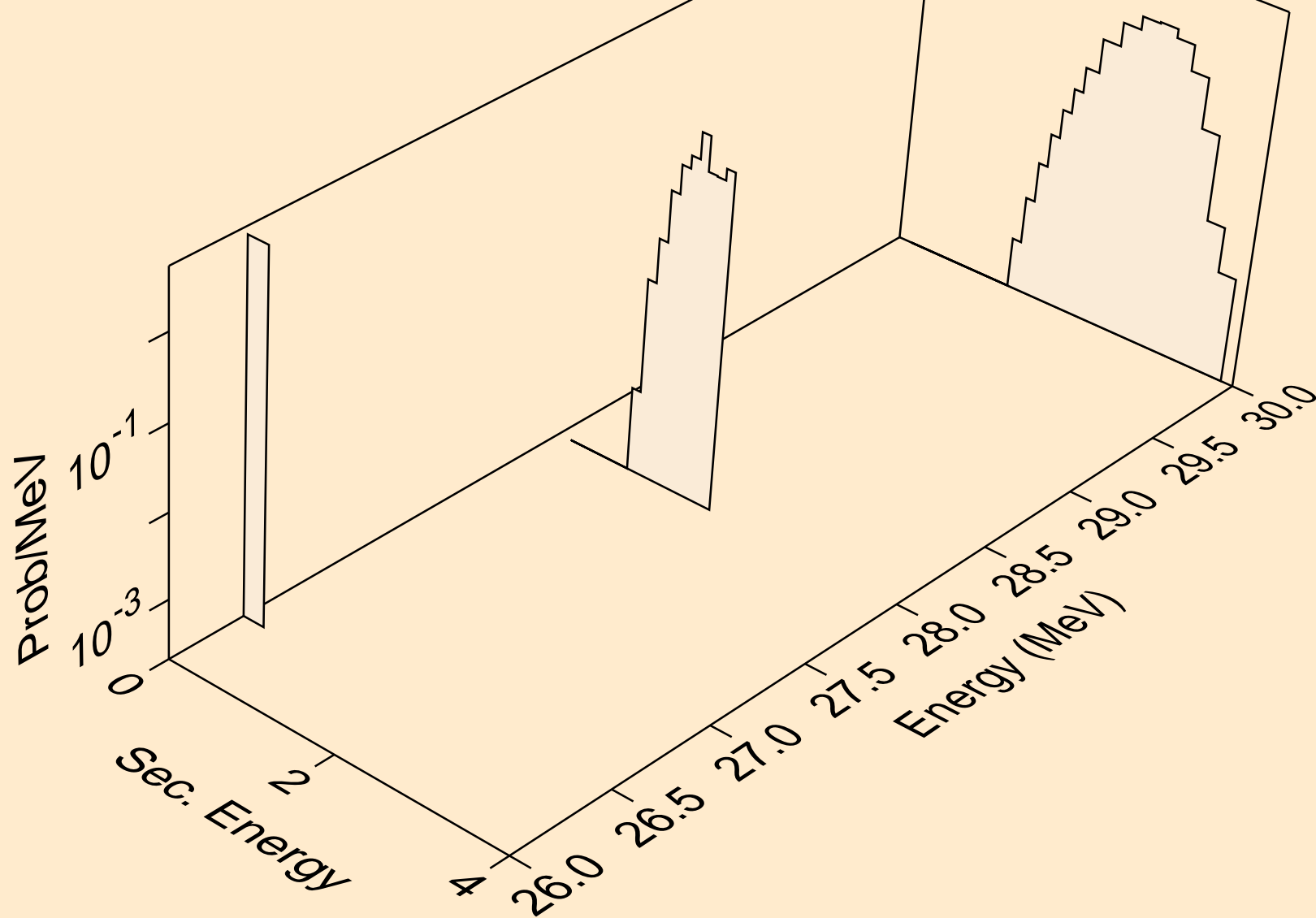

CE123 NEUTRON ACER TENDL-2021 LIBRARY; T=293.6K
protons from (n,2np)

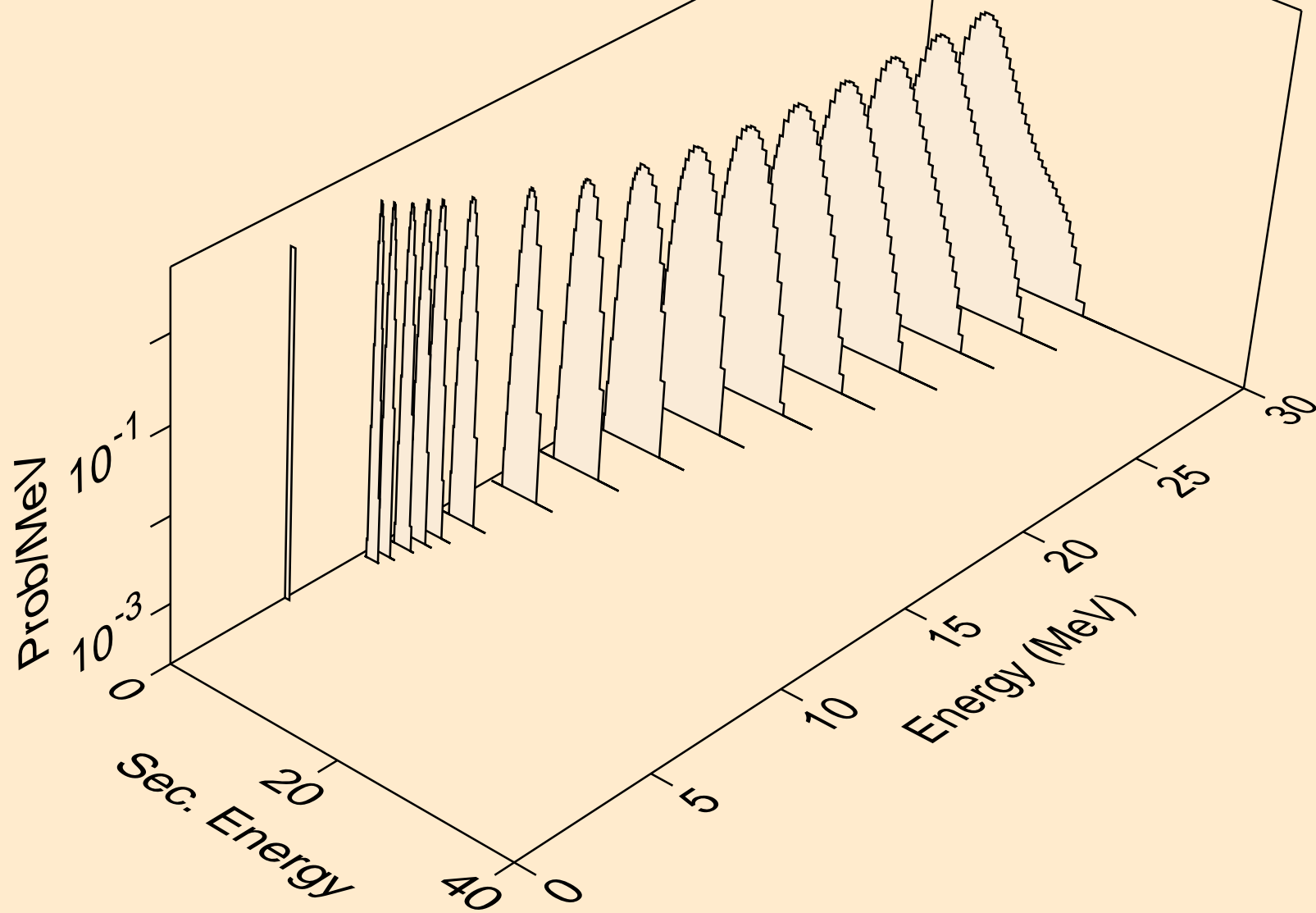

CE123 NEUTRON ACER TENDL-2021 LIBRARY; T=293.6K
protons from (n,npa)

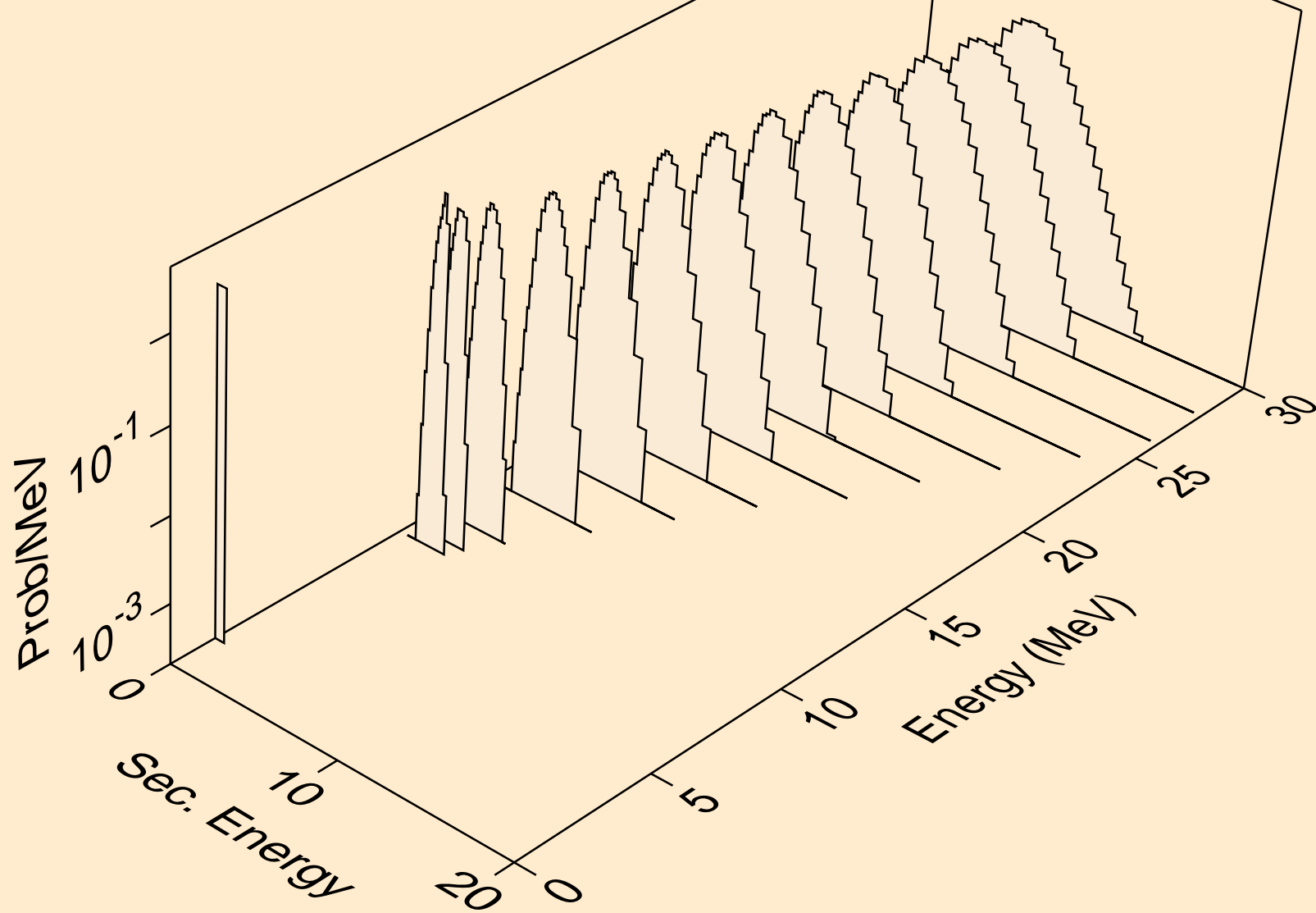

CE123 NEUTRON ACER TENDL-2021 LIBRARY; T=293.6K
protons from (n,p)

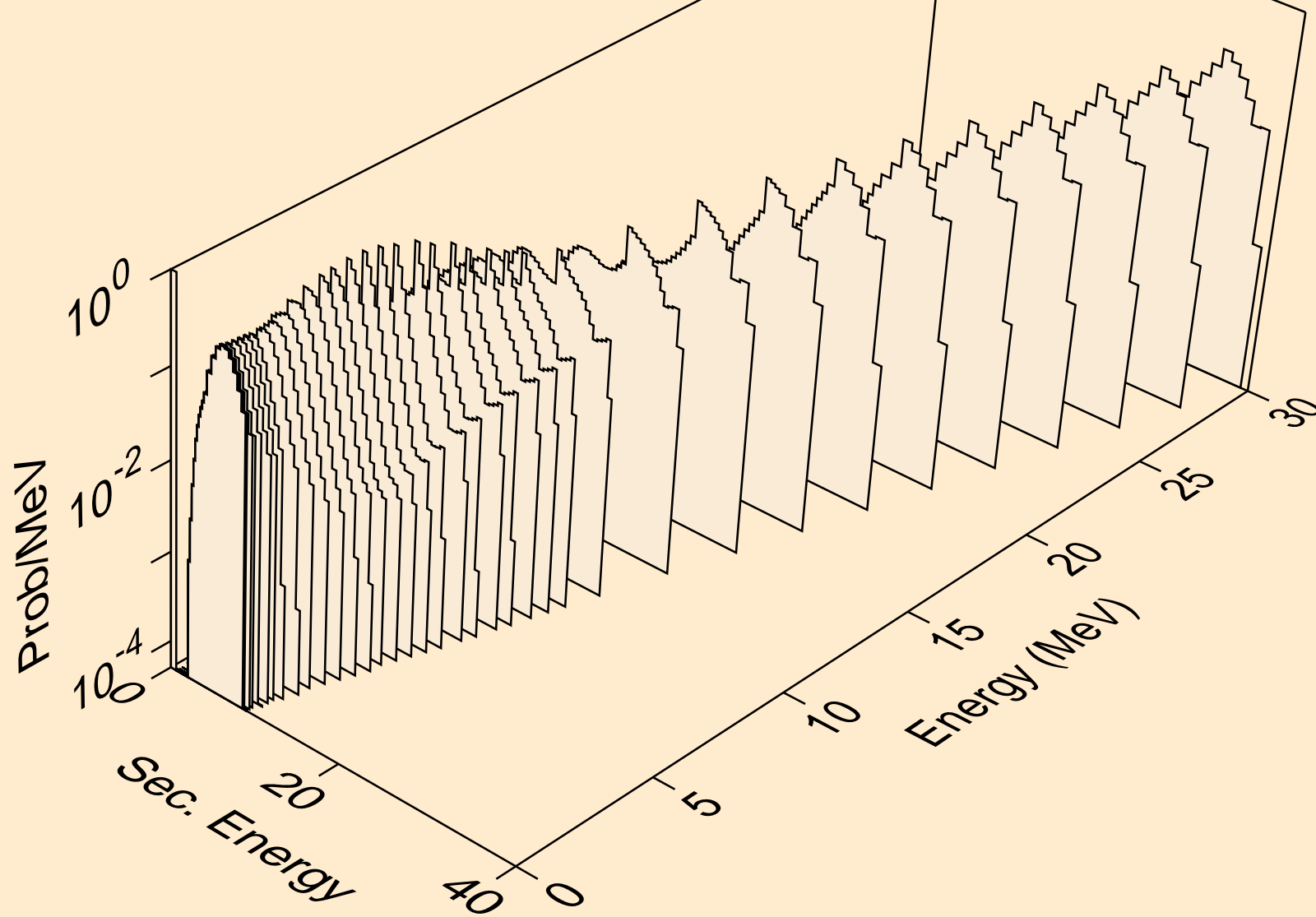

CE123 NEUTRON ACER TENDL-2021 LIBRARY; T=293.6K
protons from (n,2p)

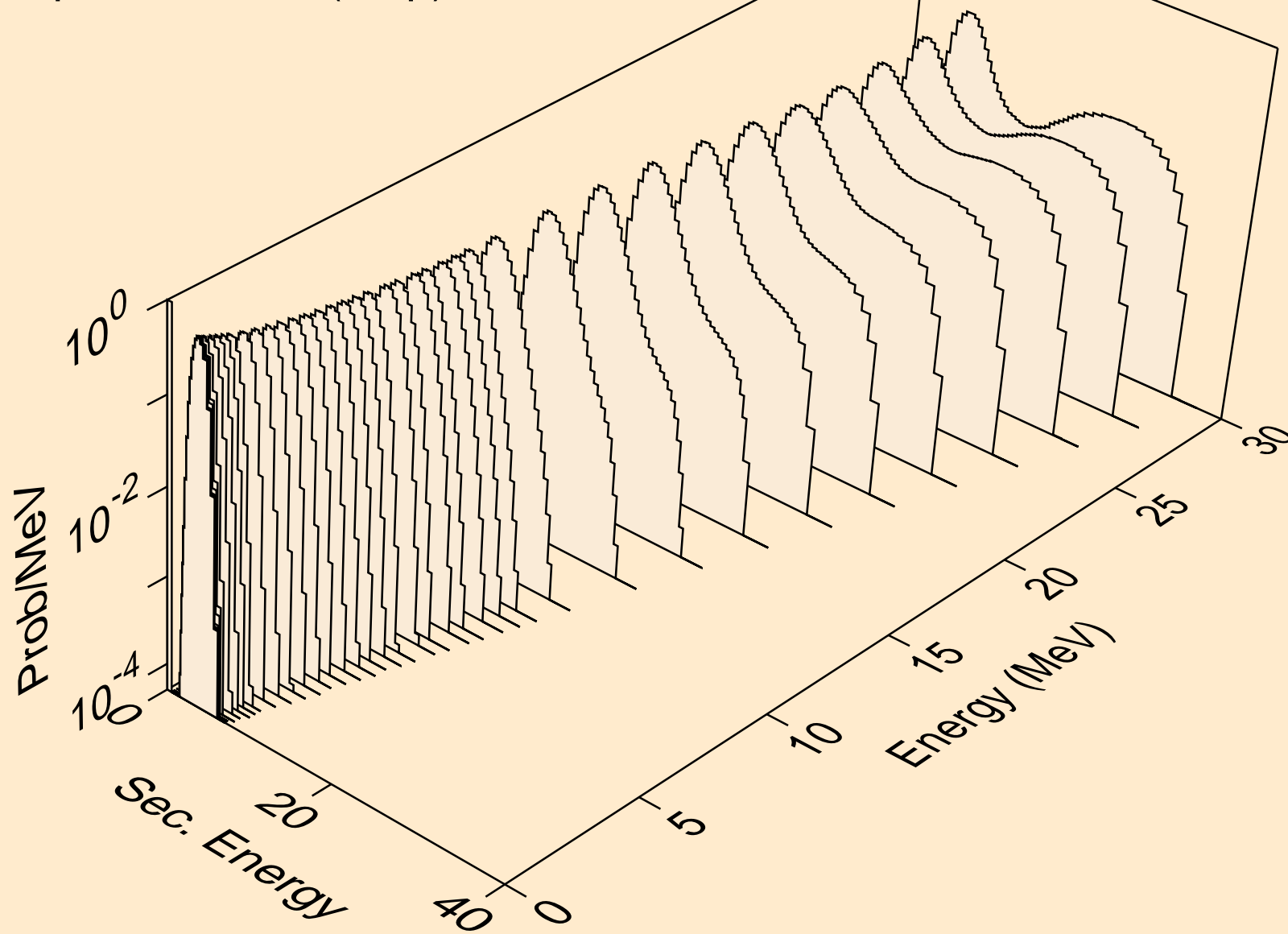

CE123 NEUTRON ACER TENDL-2021 LIBRARY; T=293.6K
protons from (n,p)

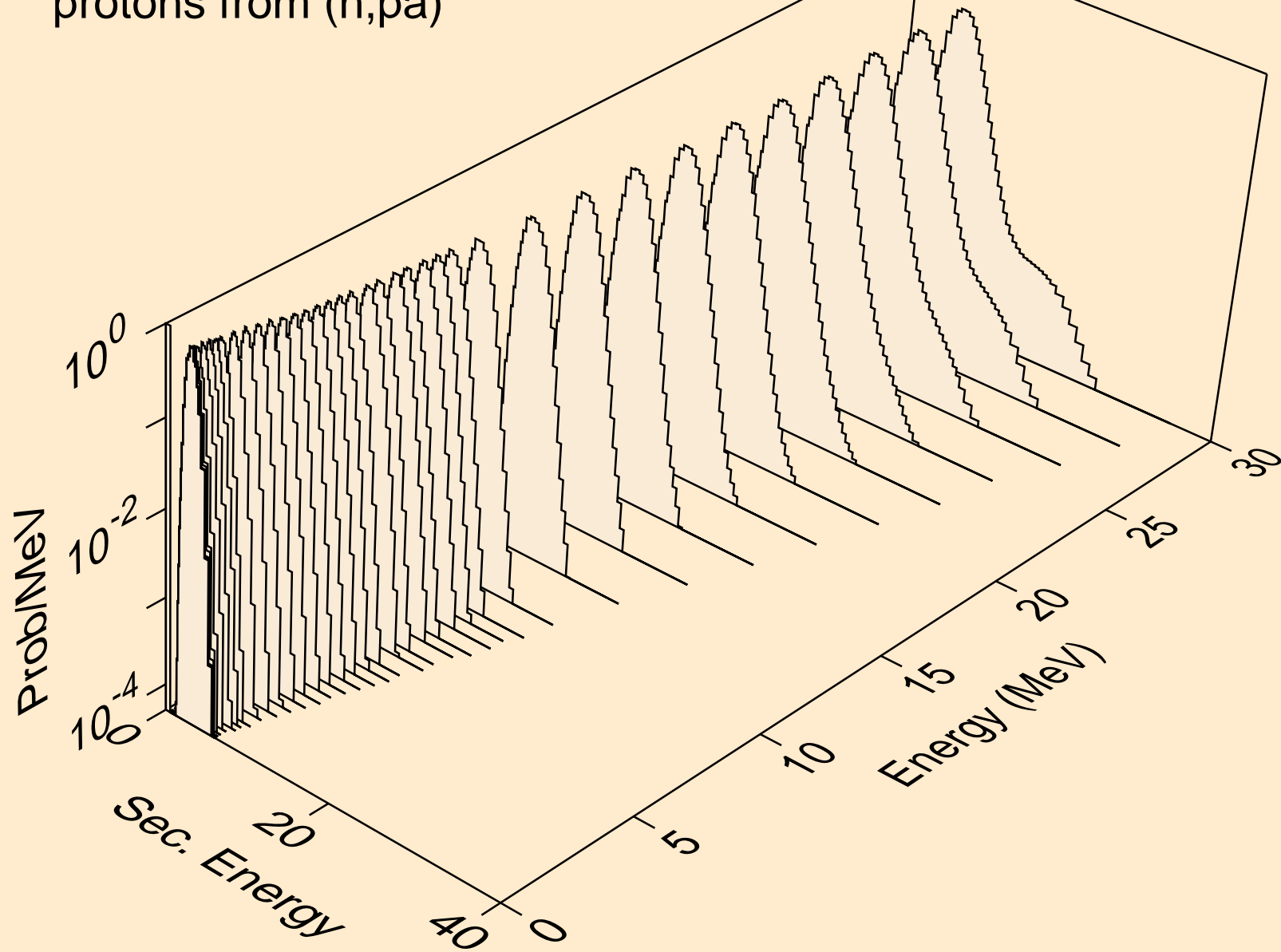

CE123 NEUTRON ACER TENDL-2021 LIBRARY; T=293.6K
protons from (n,pd)

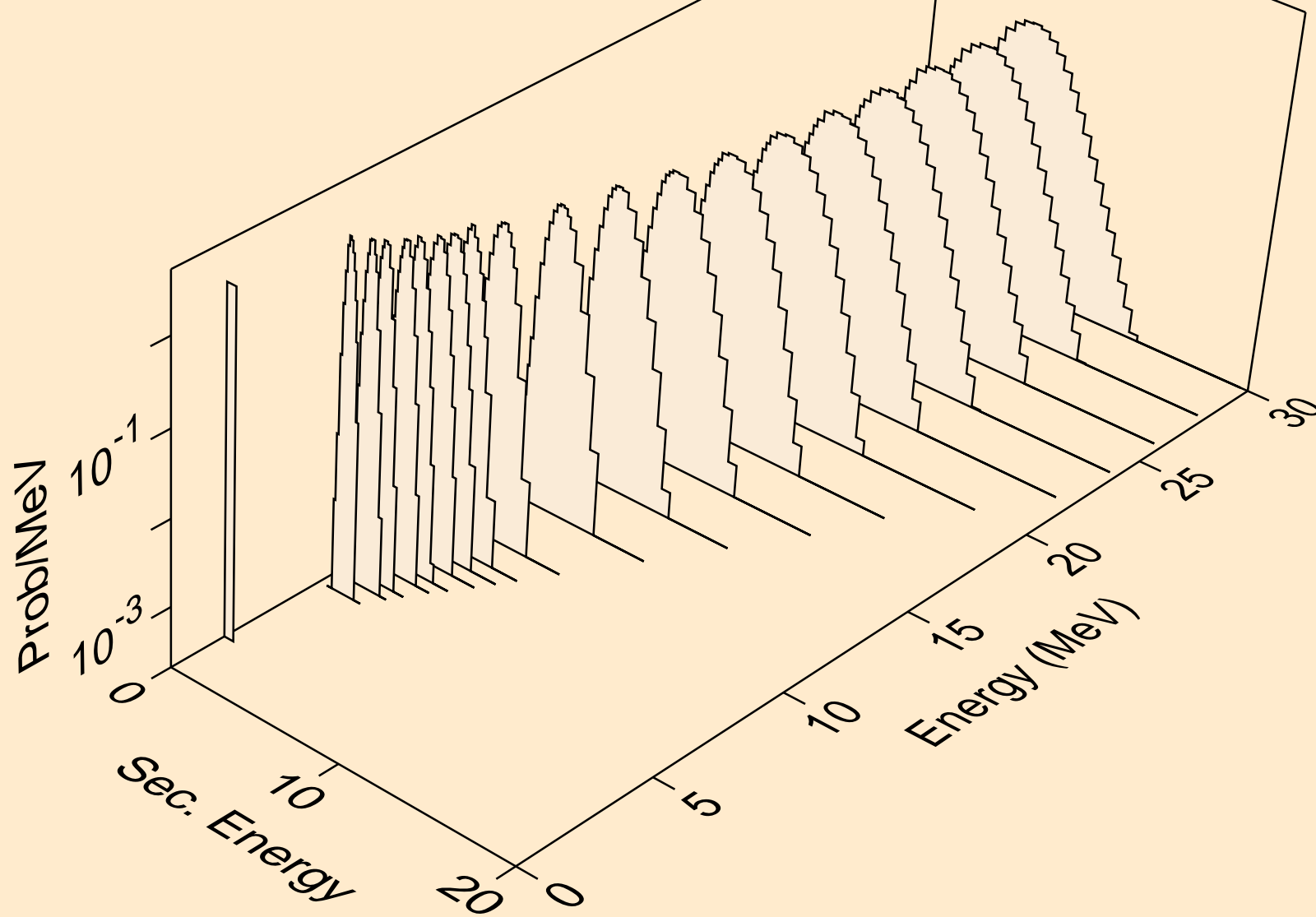

CE123 NEUTRON ACER TENDL-2021 LIBRARY; T=293.6K
protons from (n,pt)

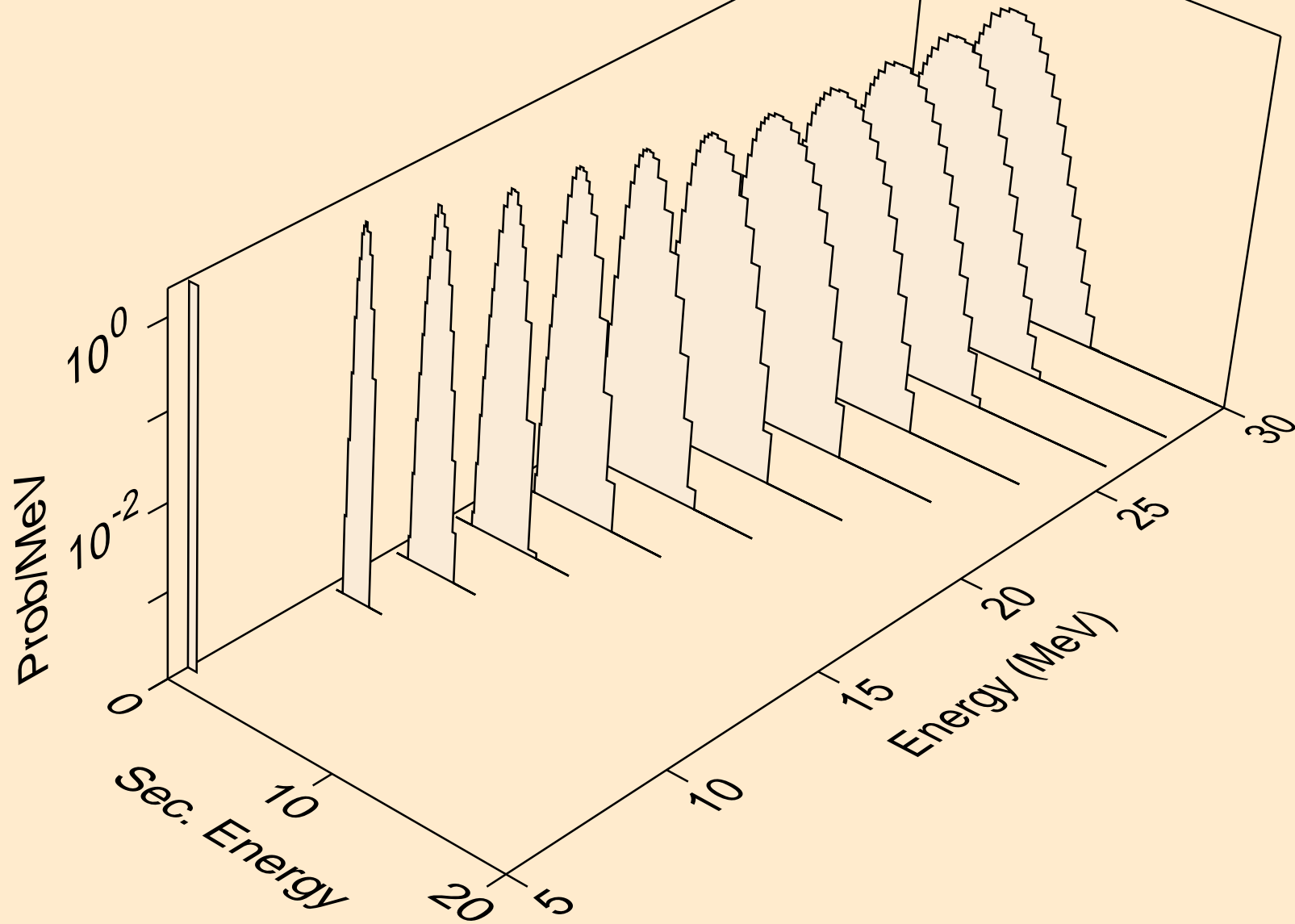

CE123 NEUTRON ACER TENDL-2021 LIBRARY; T=293.6K
deuterons from (n,x)

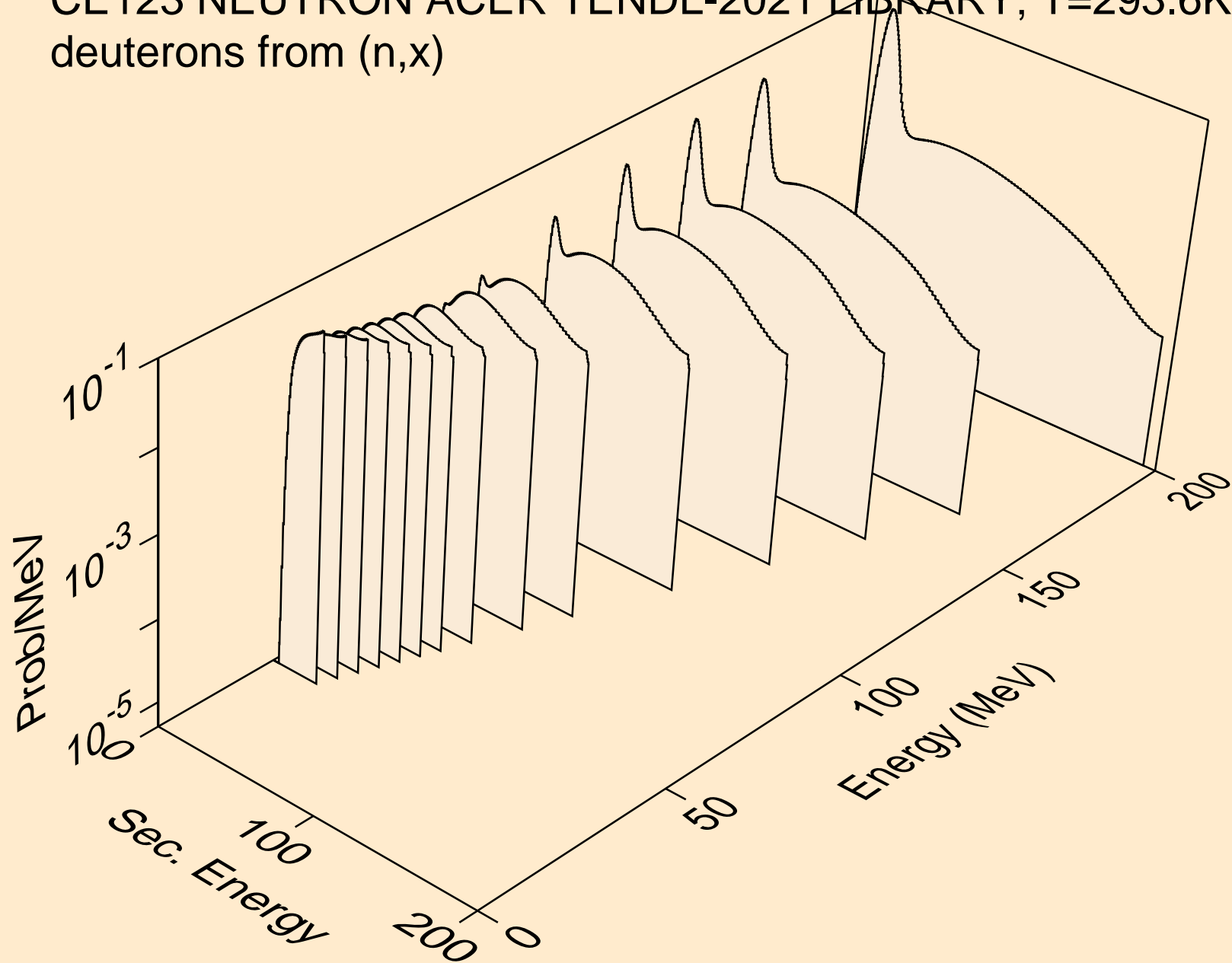

CE123 NEUTRON ACER TENDL-2021 LIBRARY; T=293.6K
deuterons from (n,n*)d

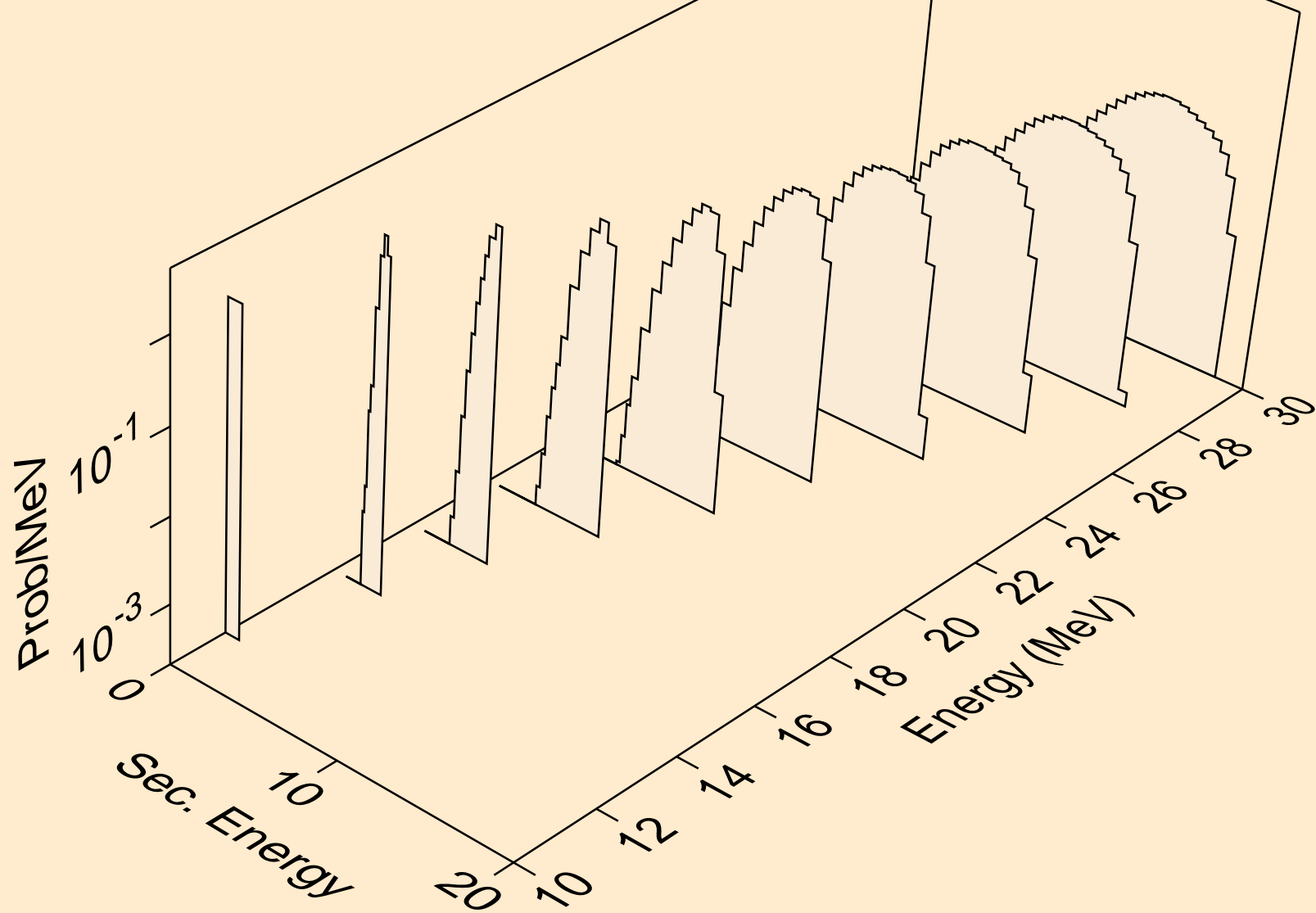

CE123 NEUTRON ACER TENDL-2021 LIBRARY; T=293.6K
deuterons from (n,d)

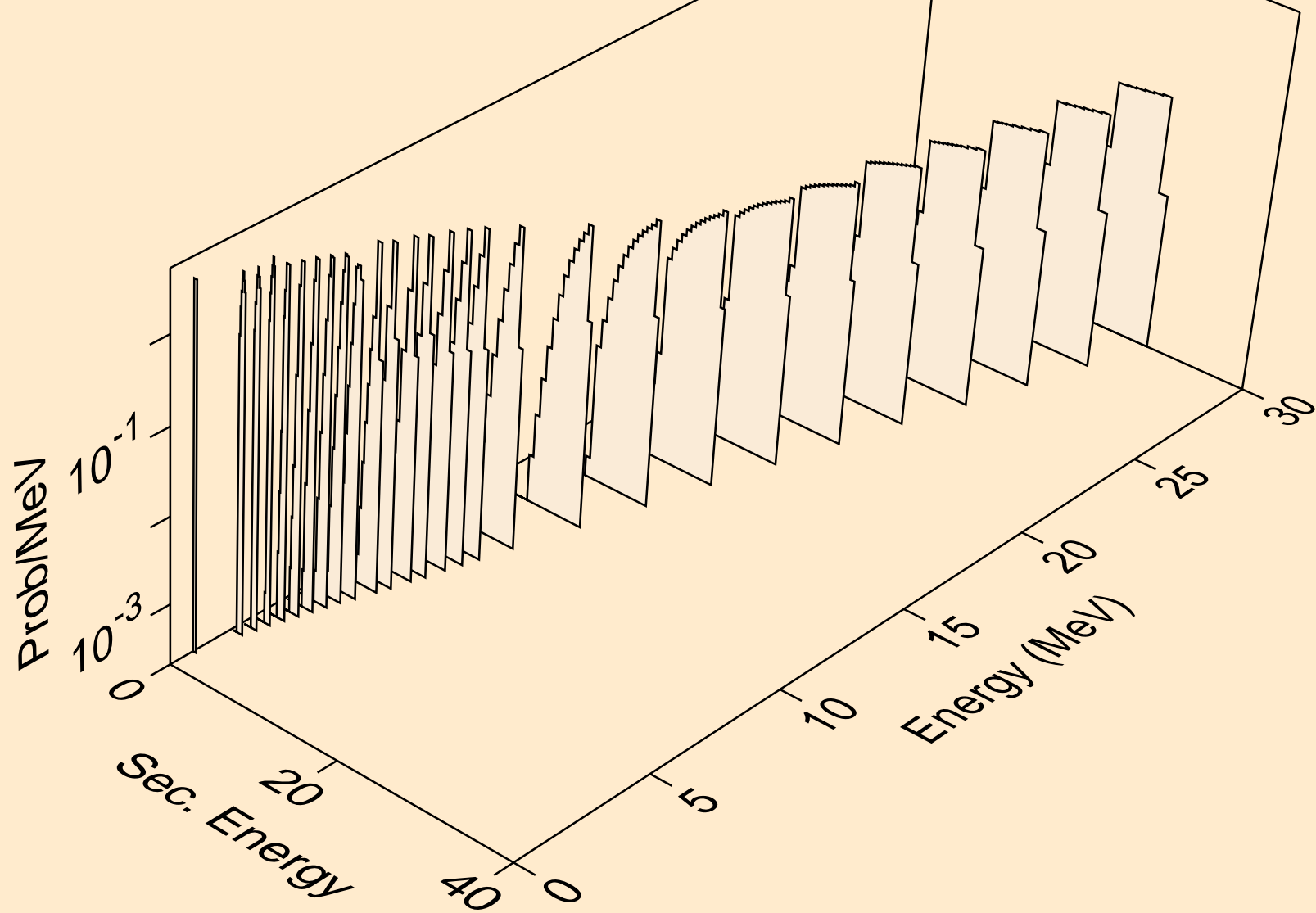

CE123 NEUTRON ACER TENDL-2021 LIBRARY; T=293.6K
deuterons from (n,d2a)

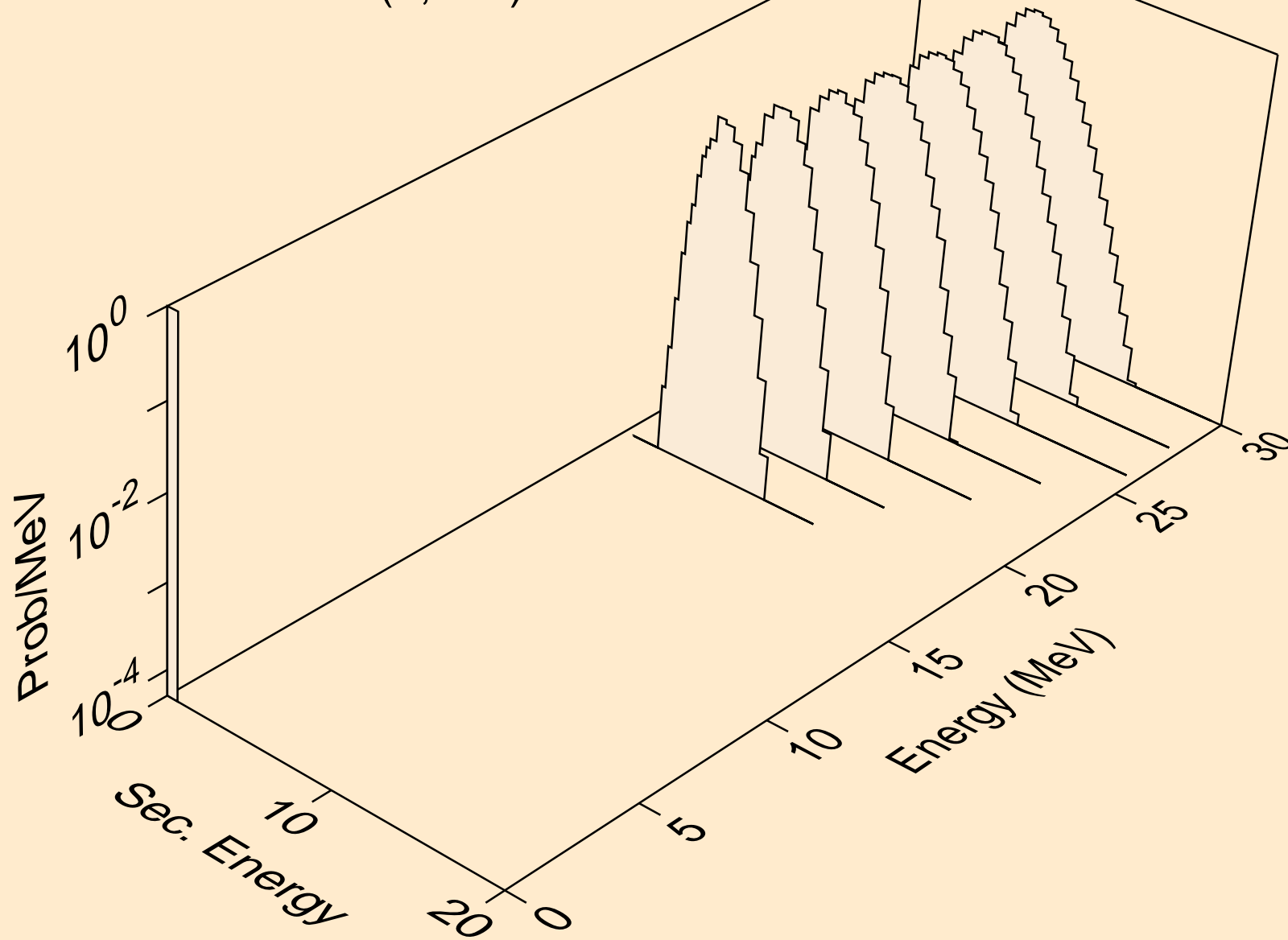

CE123 NEUTRON ACER TENDL-2021 LIBRARY; T=293.6K
deuterons from (n,pd)

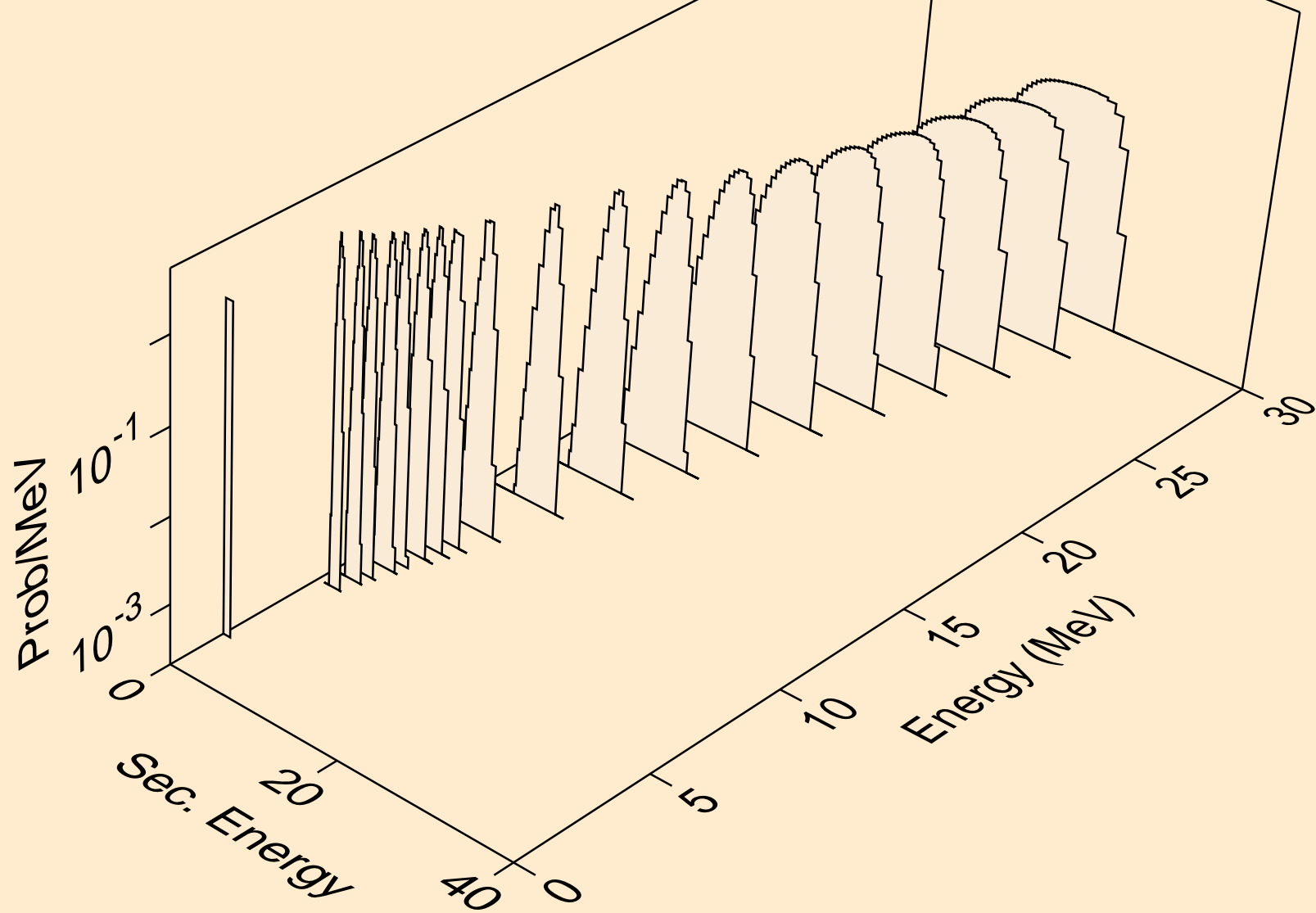

CE123 NEUTRON ACER TENDL-2021 LIBRARY; T=293.6K
deuterons from (n,da)

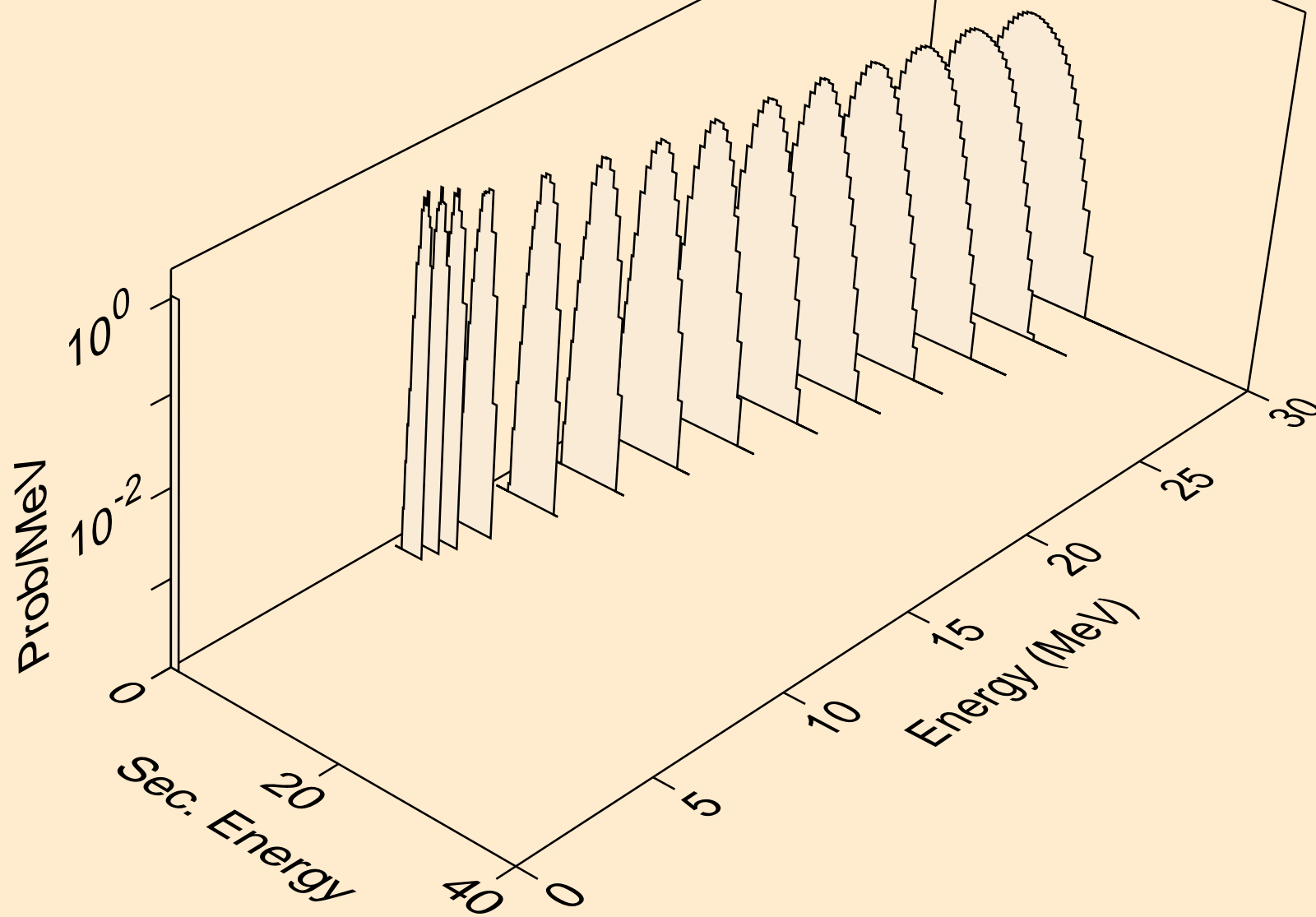

CE123 NEUTRON ACER TENDL-2021 LIBRARY; T=293.6K
tritons from (n,x)

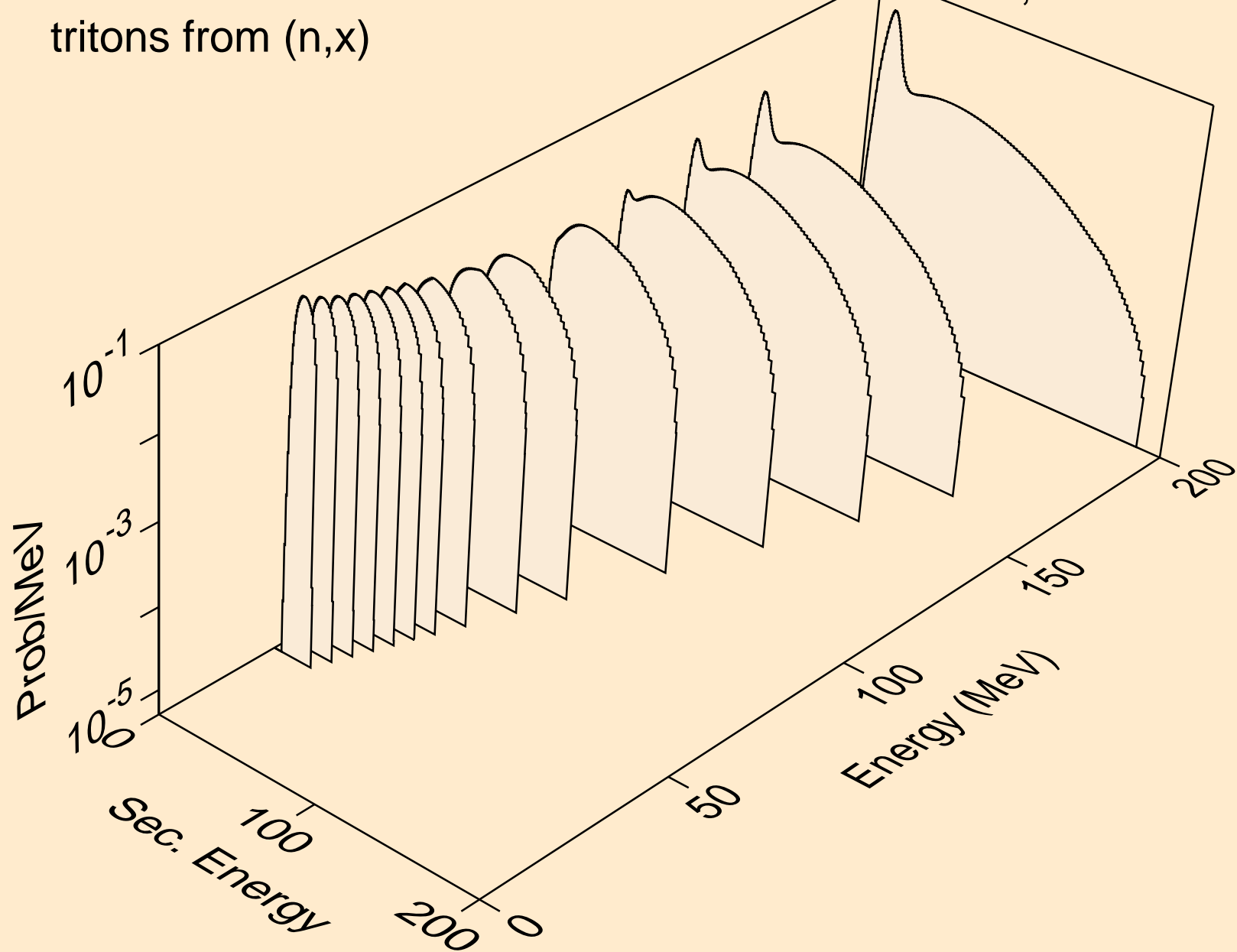

CE123 NEUTRON ACER TENDL-2021 LIBRARY; T=293.6K
tritons from (n,n*)t

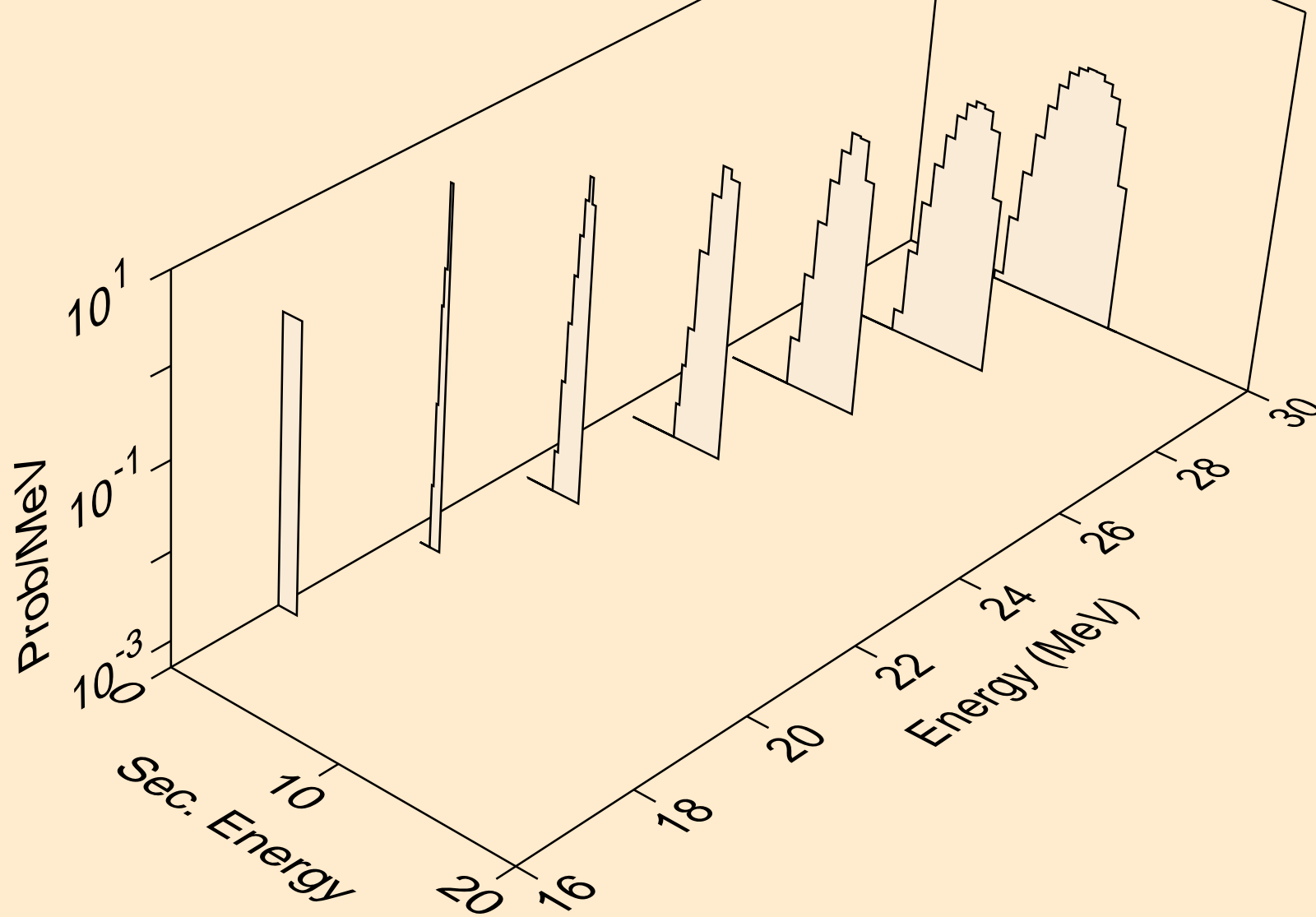

CE123 NEUTRON ACER TENDL-2021 LIBRARY; T=293.6K
tritons from (n,t)

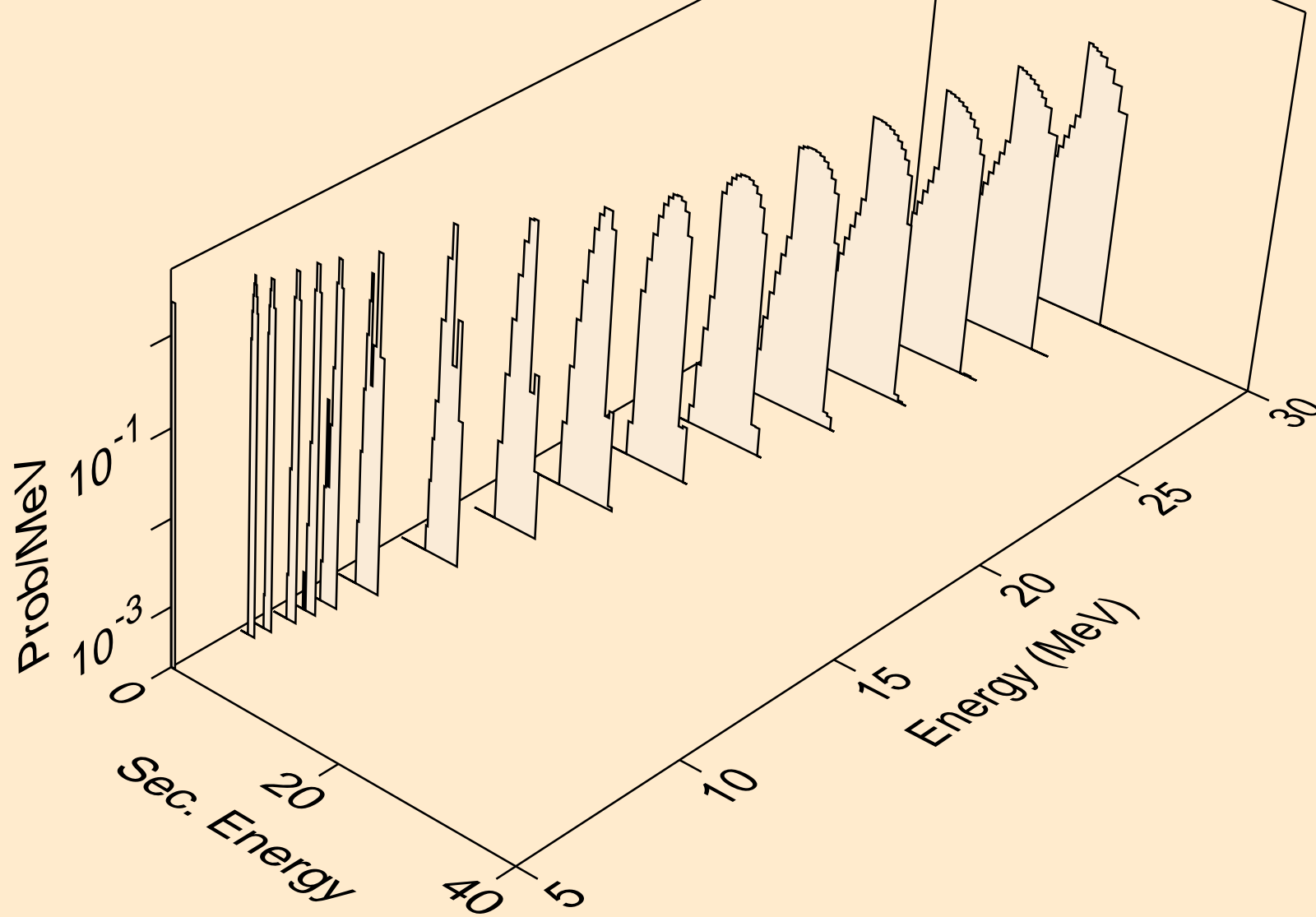

CE123 NEUTRON ACER TENDL-2021 LIBRARY; T=293.6K
tritons from (n,pt)

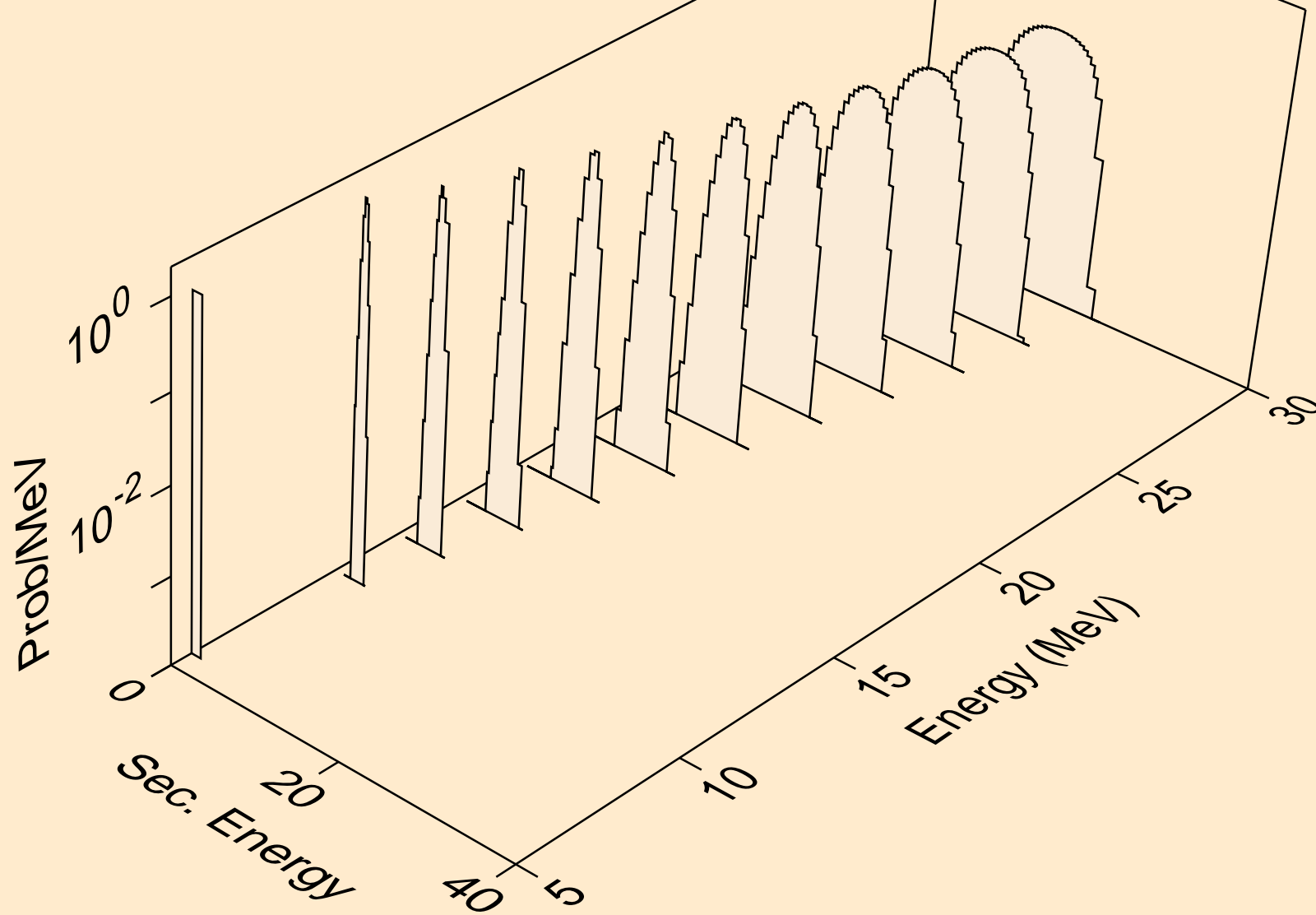

CE123 NEUTRON ACER TENDL-2021 LIBRARY; T=293.6K
he3s from (n,x)

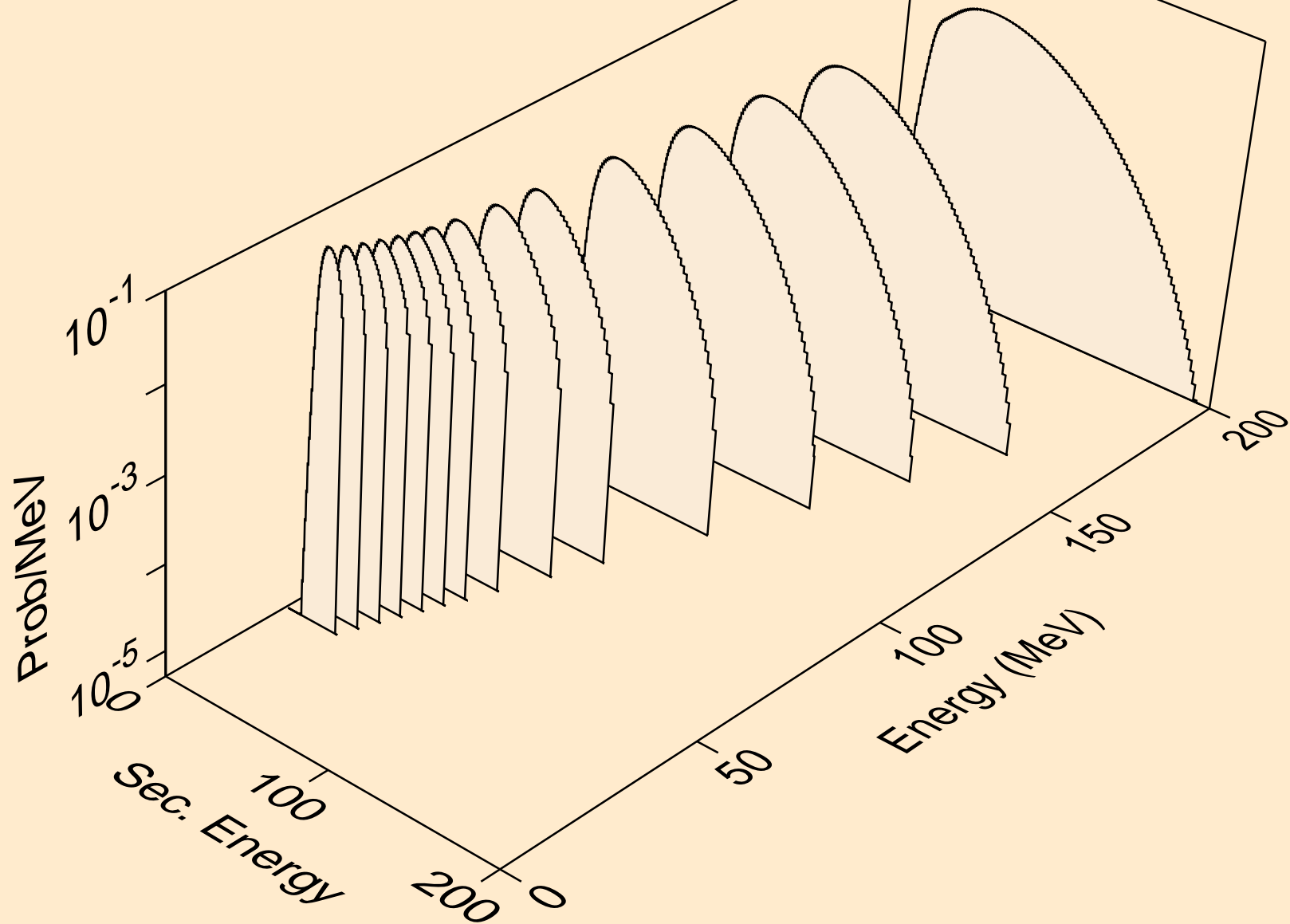

CE123 NEUTRON ACER TENDL-2021 LIBRARY; T=293.6K
he3s from (n,n*)he3

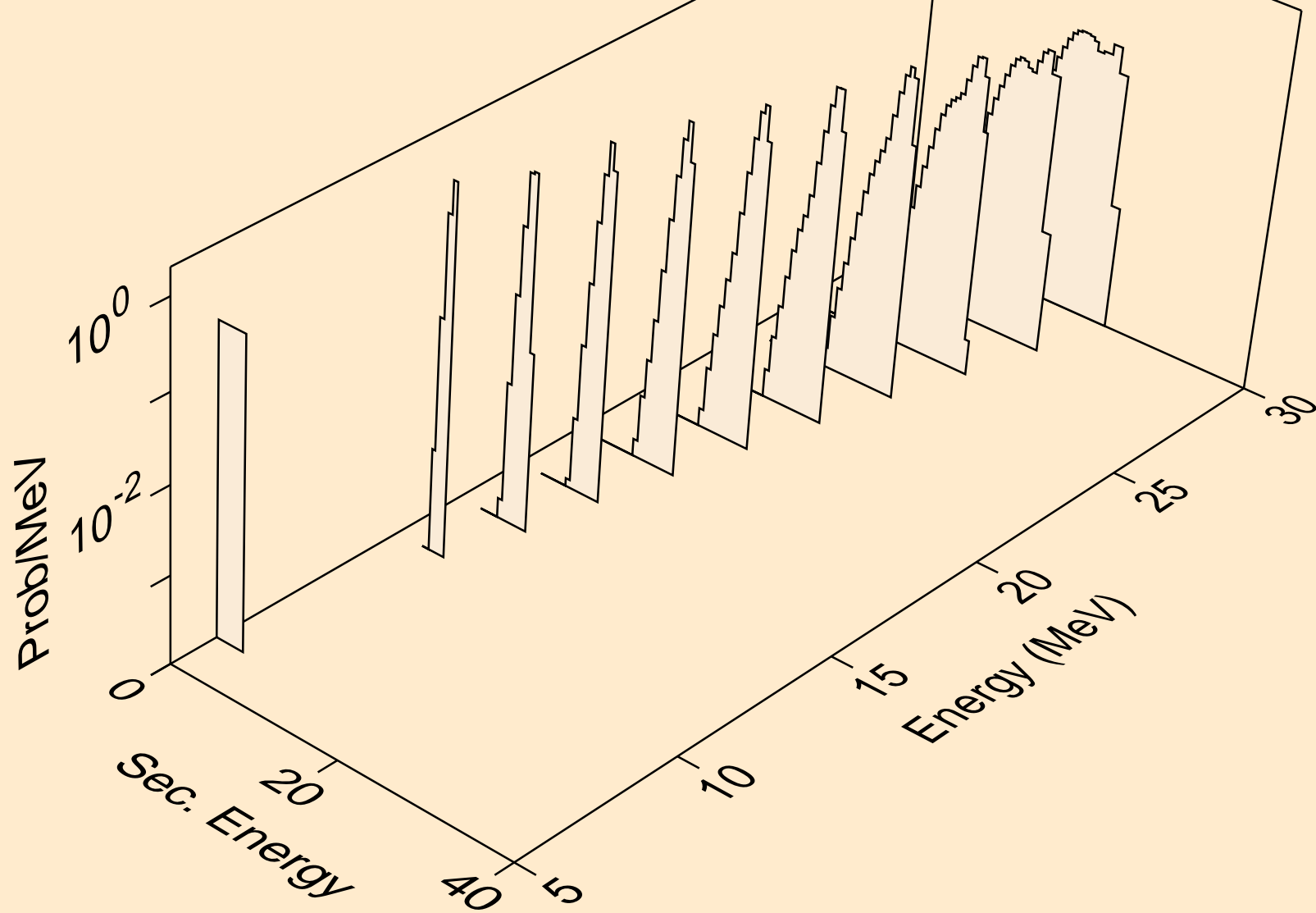

CE123 NEUTRON ACER TENDL-2021 LIBRARY; T=293.6K
he3s from (n,he3)

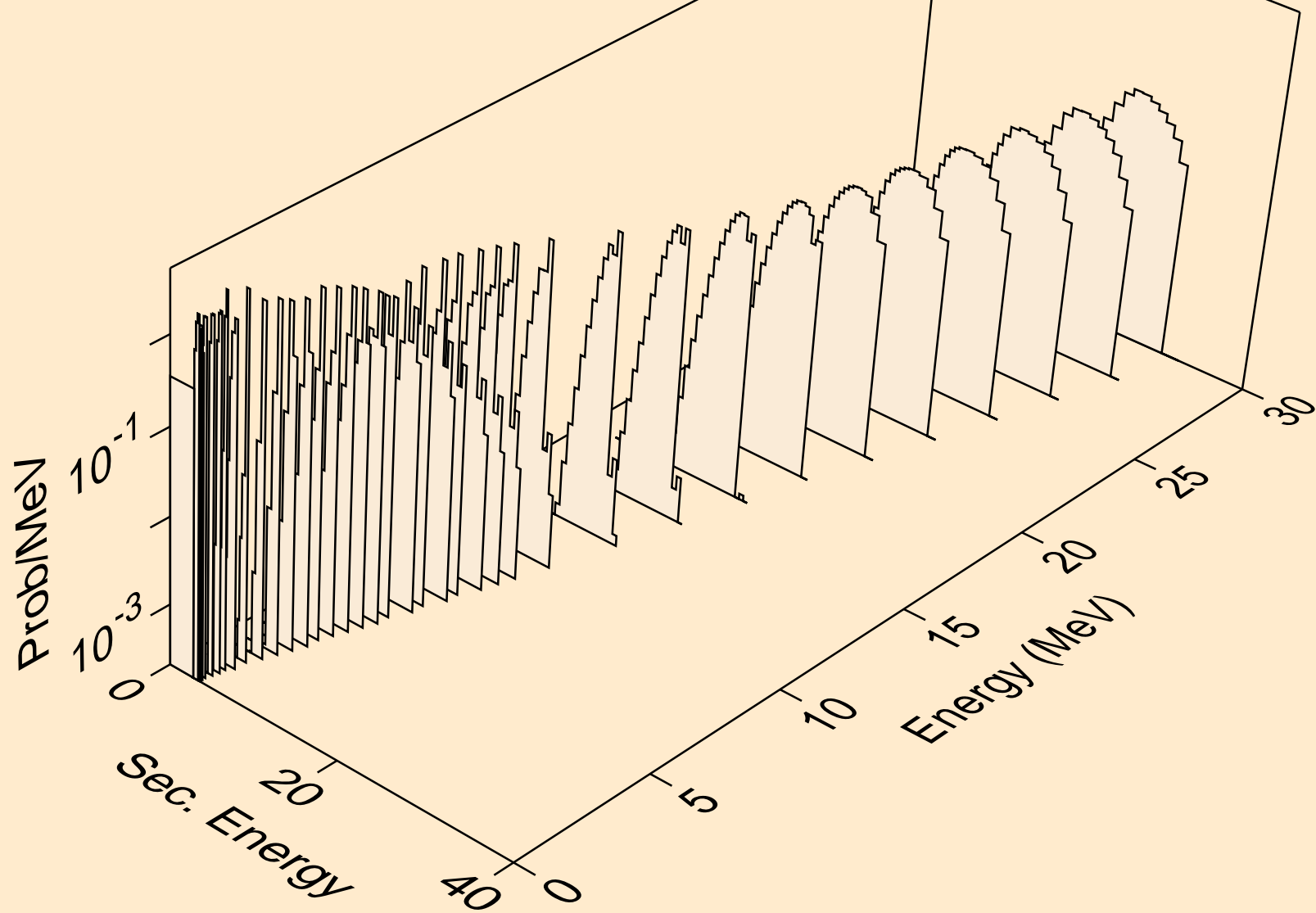

CE123 NEUTRON ACER TENDL-2021 LIBRARY; T=293.6K
alphas from (n,x)

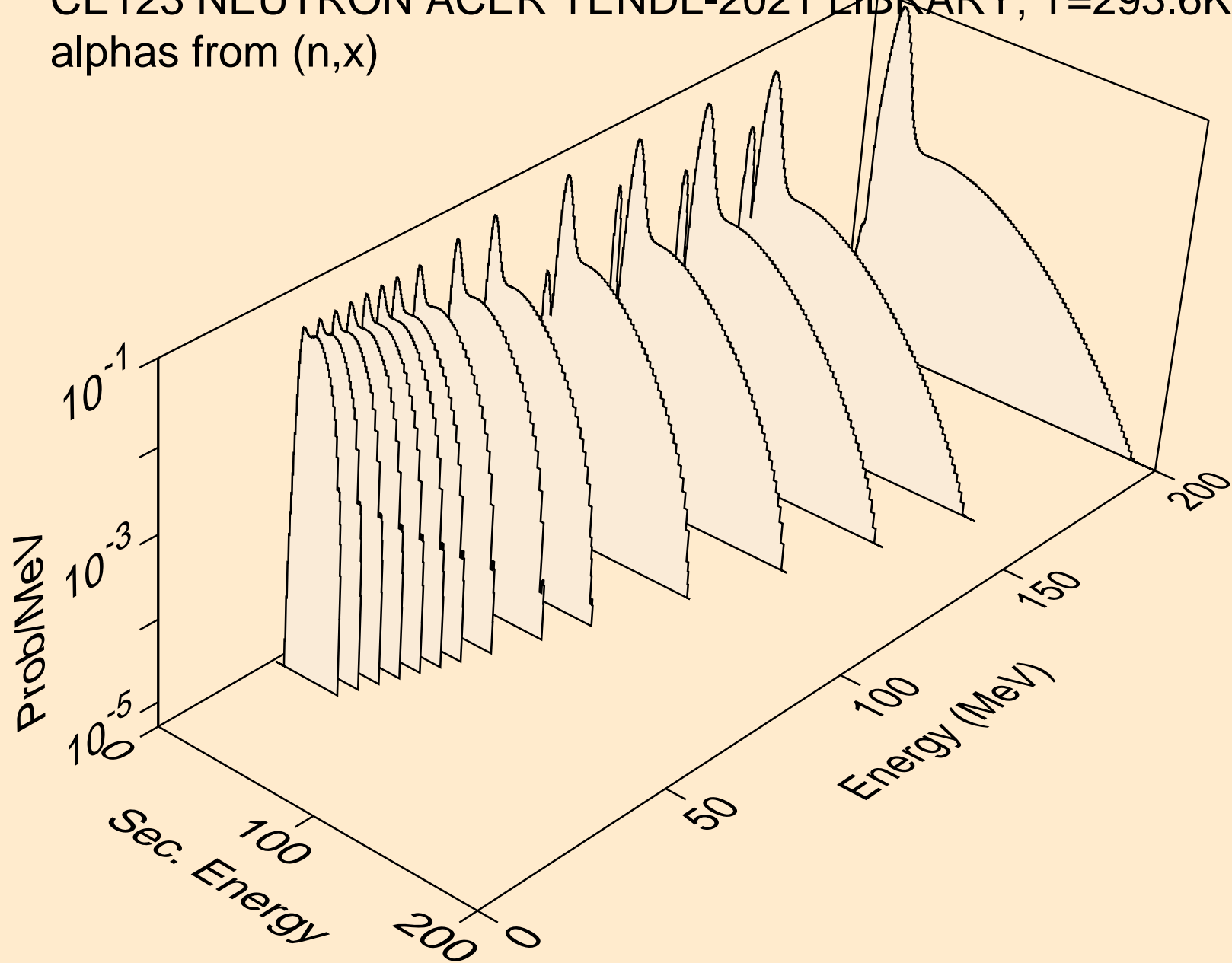

CE123 NEUTRON ACER TENDL-2021 LIBRARY; T=293.6K
alphas from (n,n*)a

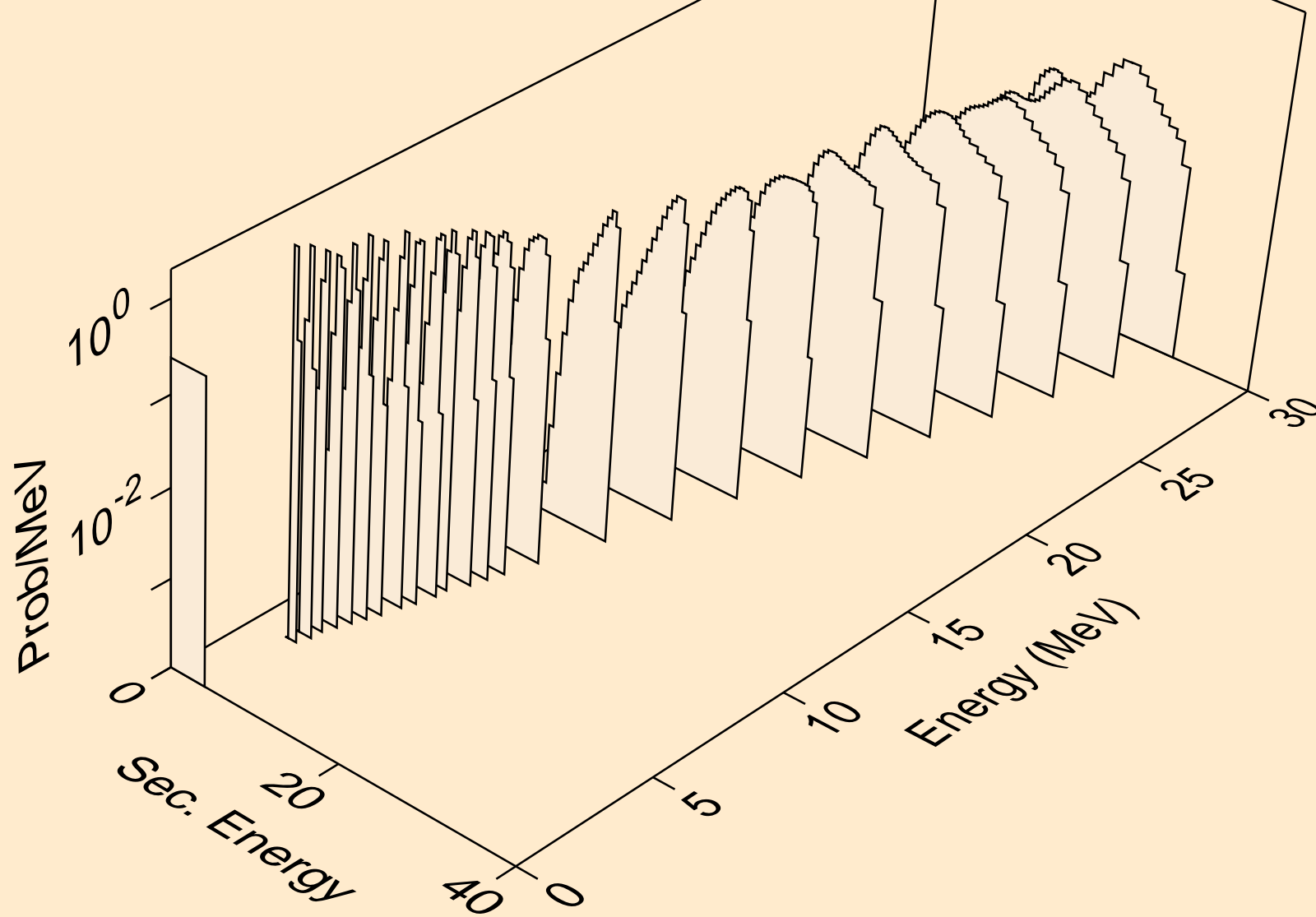

CE123 NEUTRON ACER TENDL-2021 LIBRARY; T=293.6K
alphas from (n,n*)3a

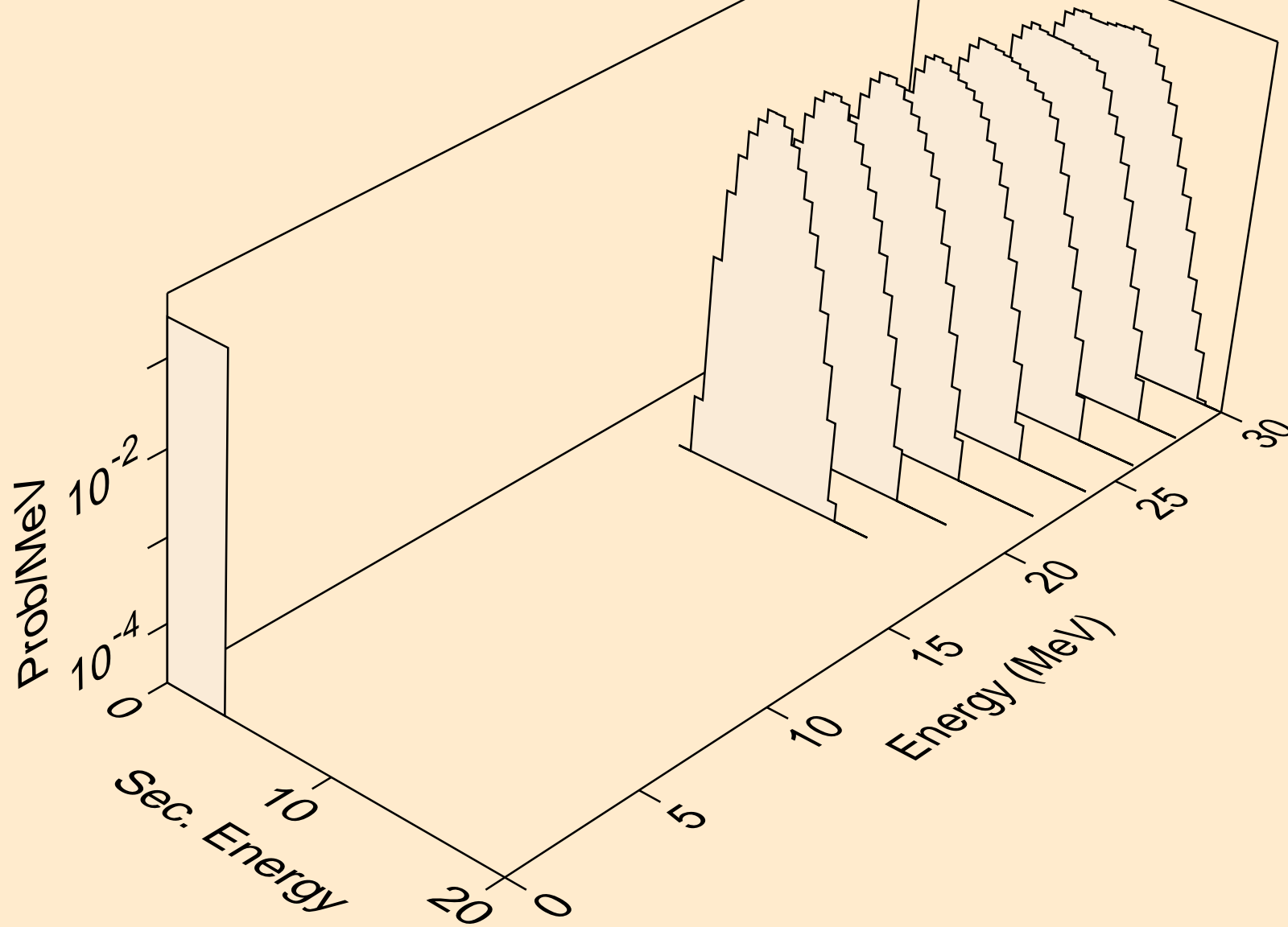

CE123 NEUTRON ACER TENDL-2021 LIBRARY; T=293.6K
alphas from (n,2n)a

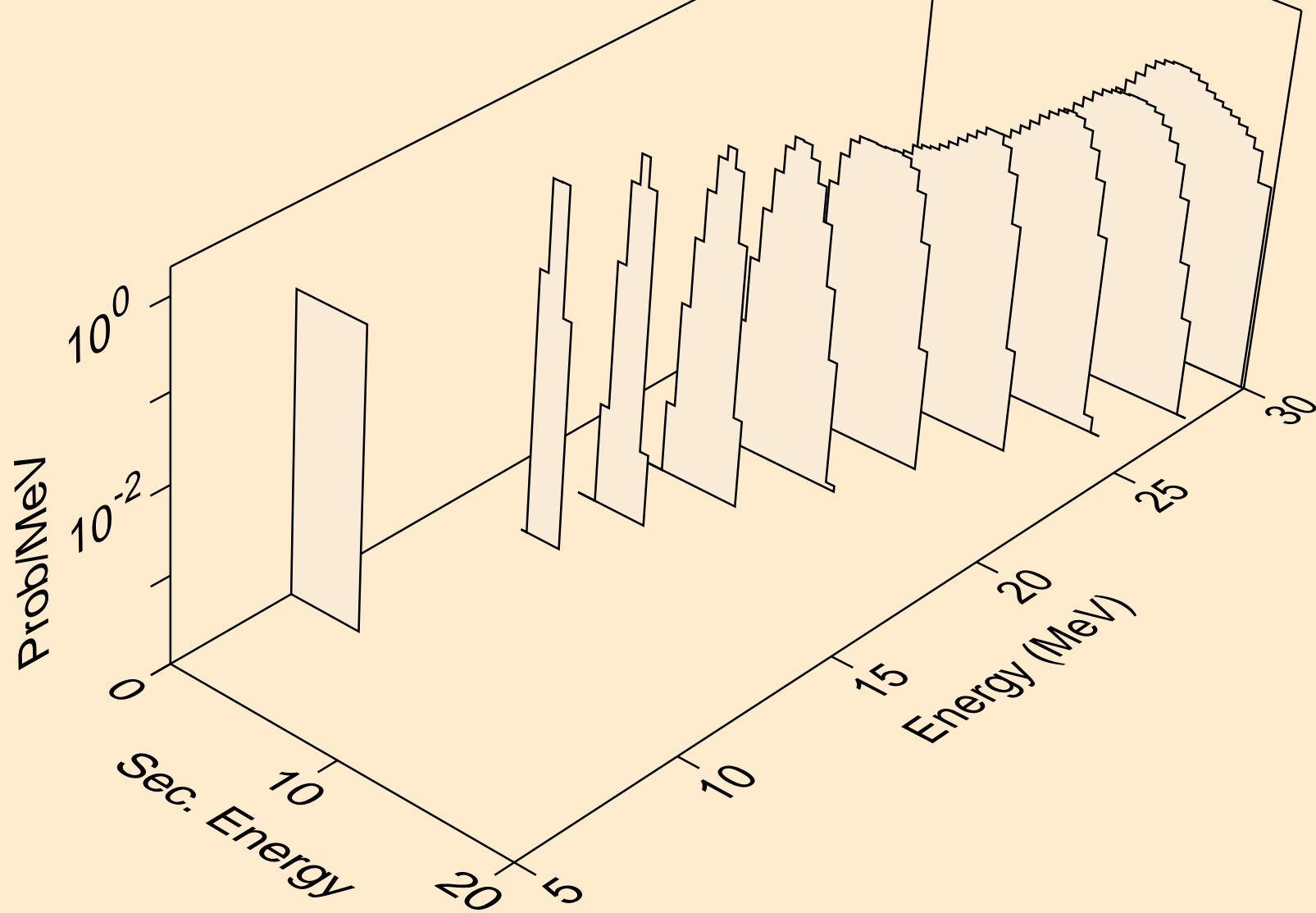

CE123 NEUTRON ACER TENDL-2021 LIBRARY; T=293.6K
alphas from (n,n*)2a

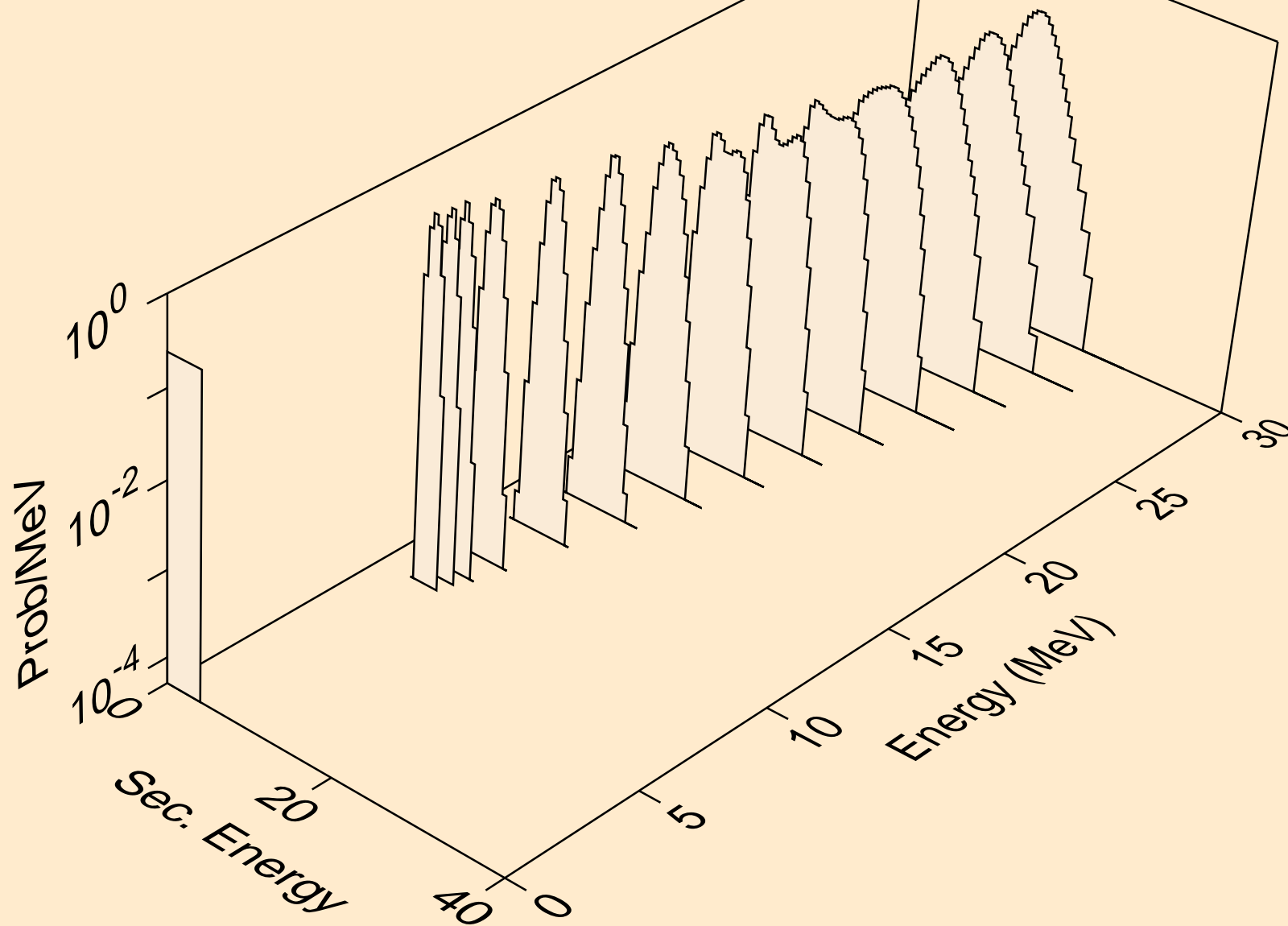

CE123 NEUTRON ACER TENDL-2021 LIBRARY; T=293.6K
alphas from (n,2n)2a

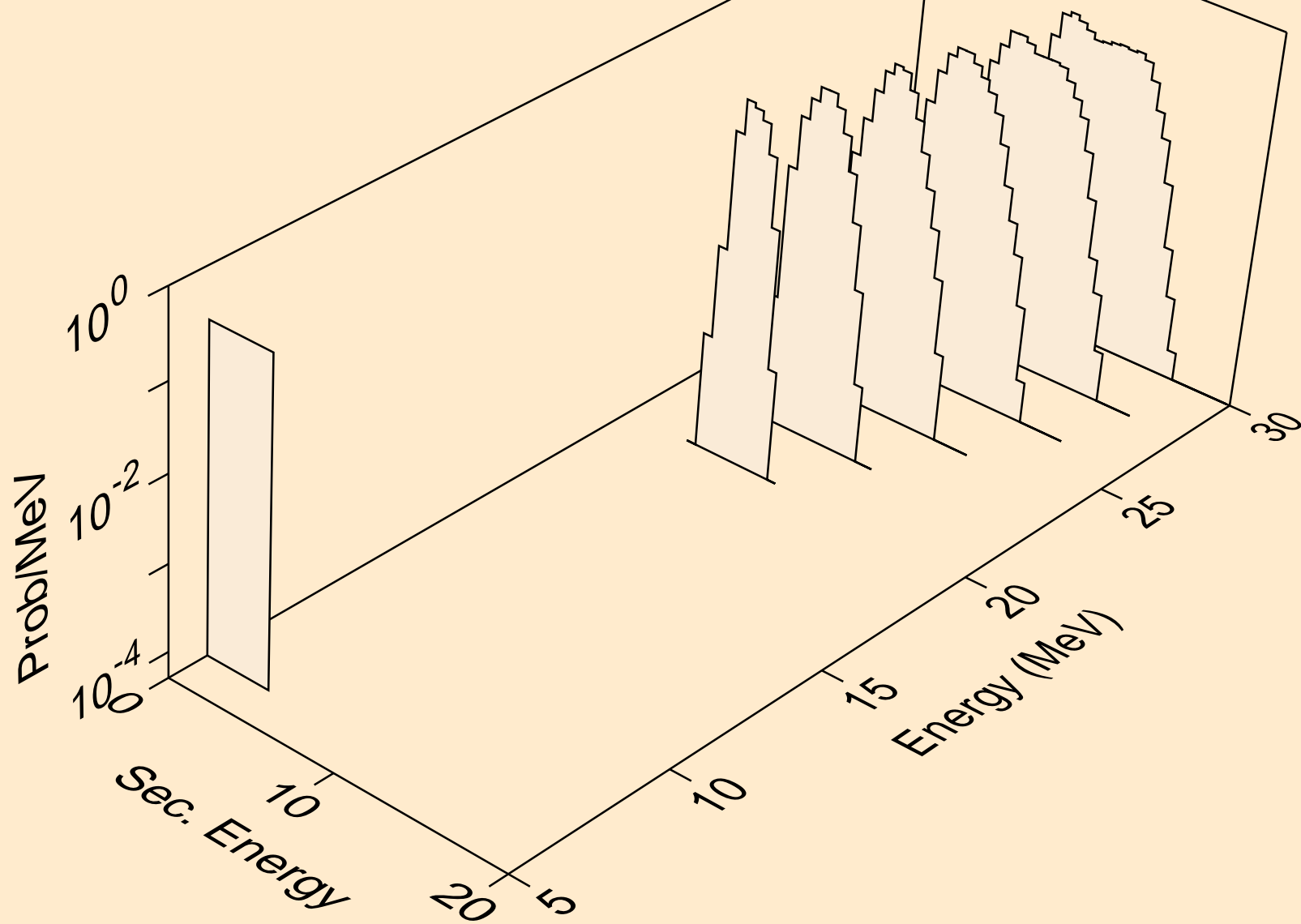

CE123 NEUTRON ACER TENDL-2021 LIBRARY; T=293.6K
alphas from (n,npa)

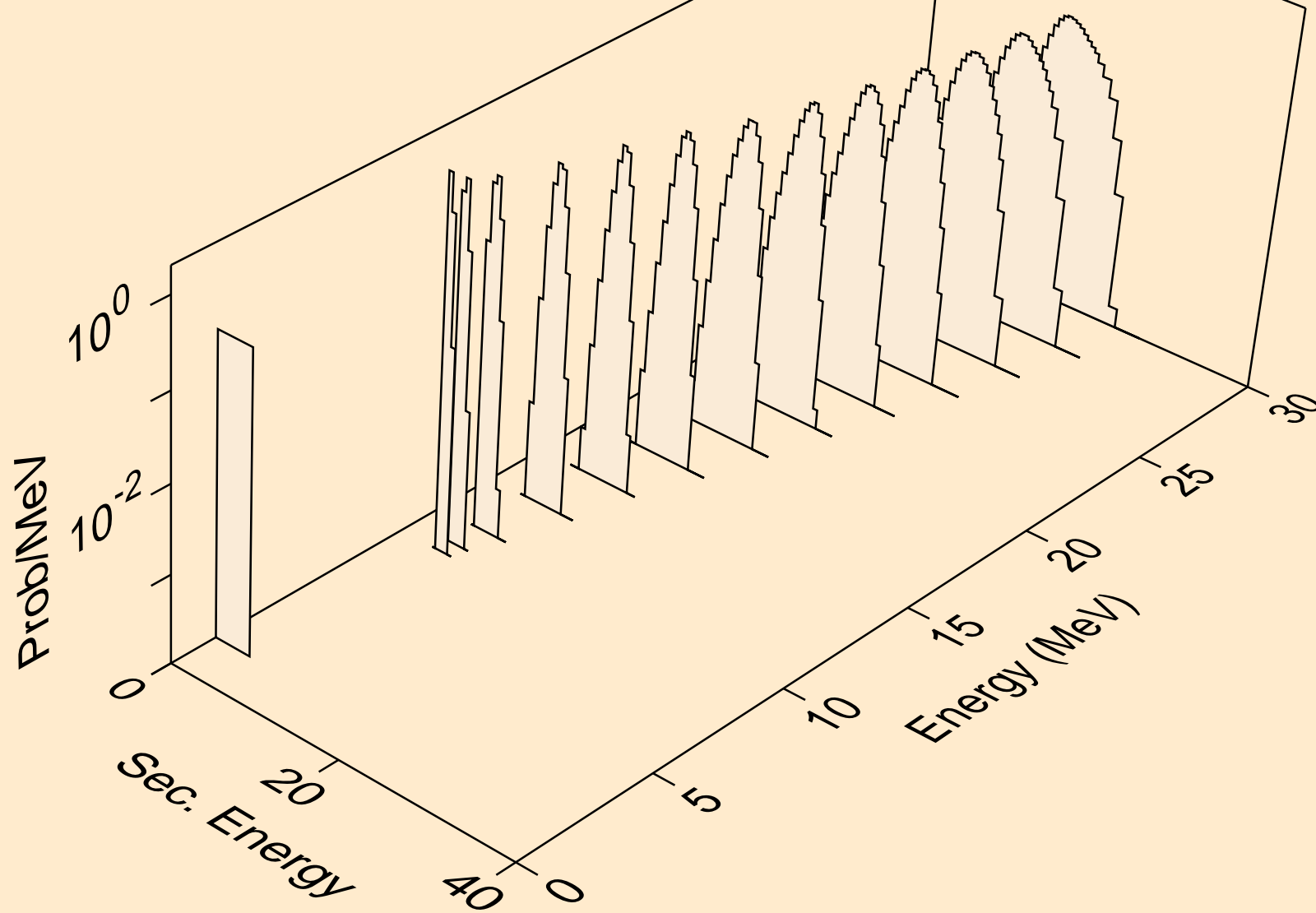

CE123 NEUTRON ACER TENDL-2021 LIBRARY; T=293.6K
alphas from (n,a)

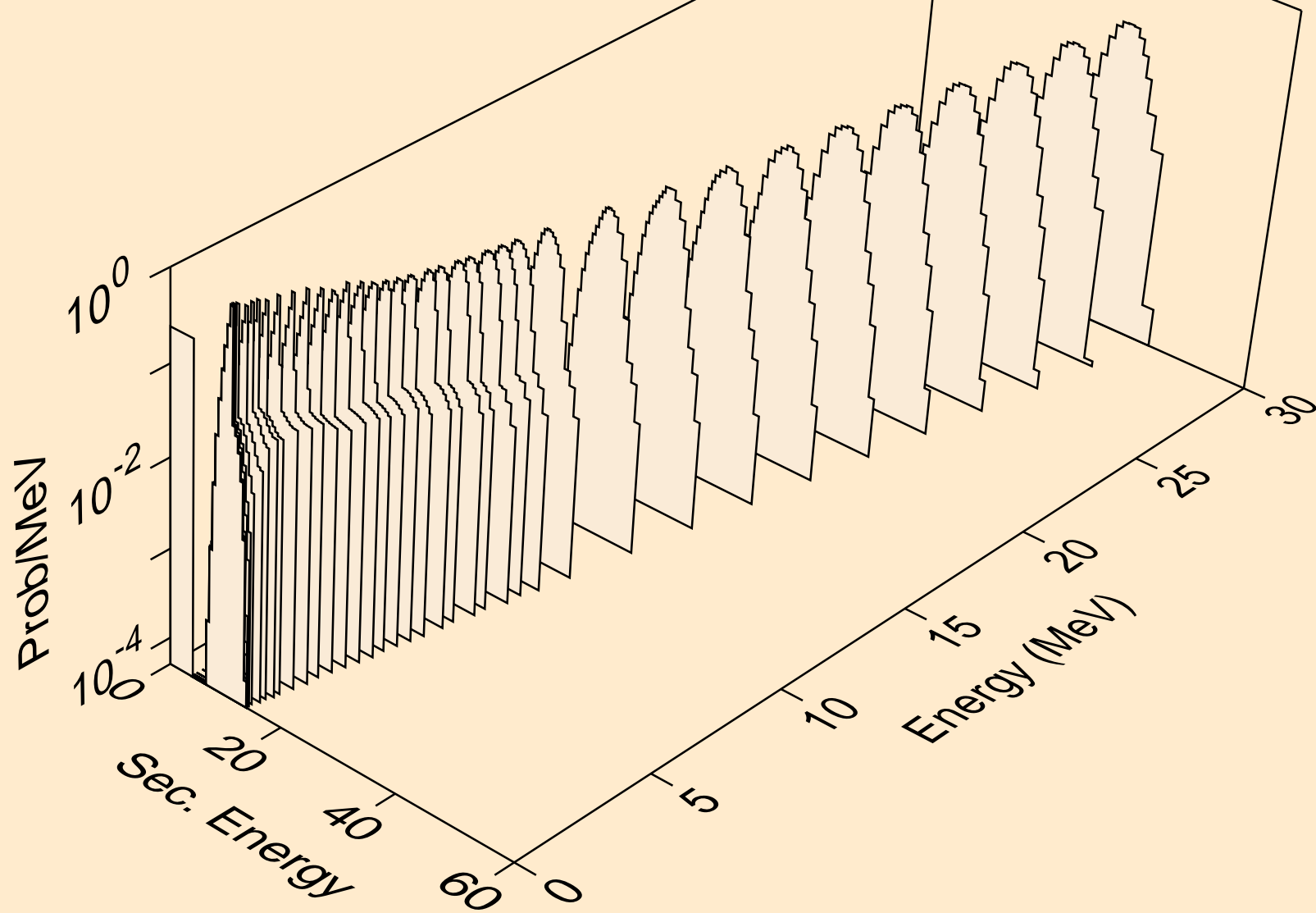

CE123 NEUTRON ACER TENDL-2021 LIBRARY; T=293.6K
alphas from (n,2a)

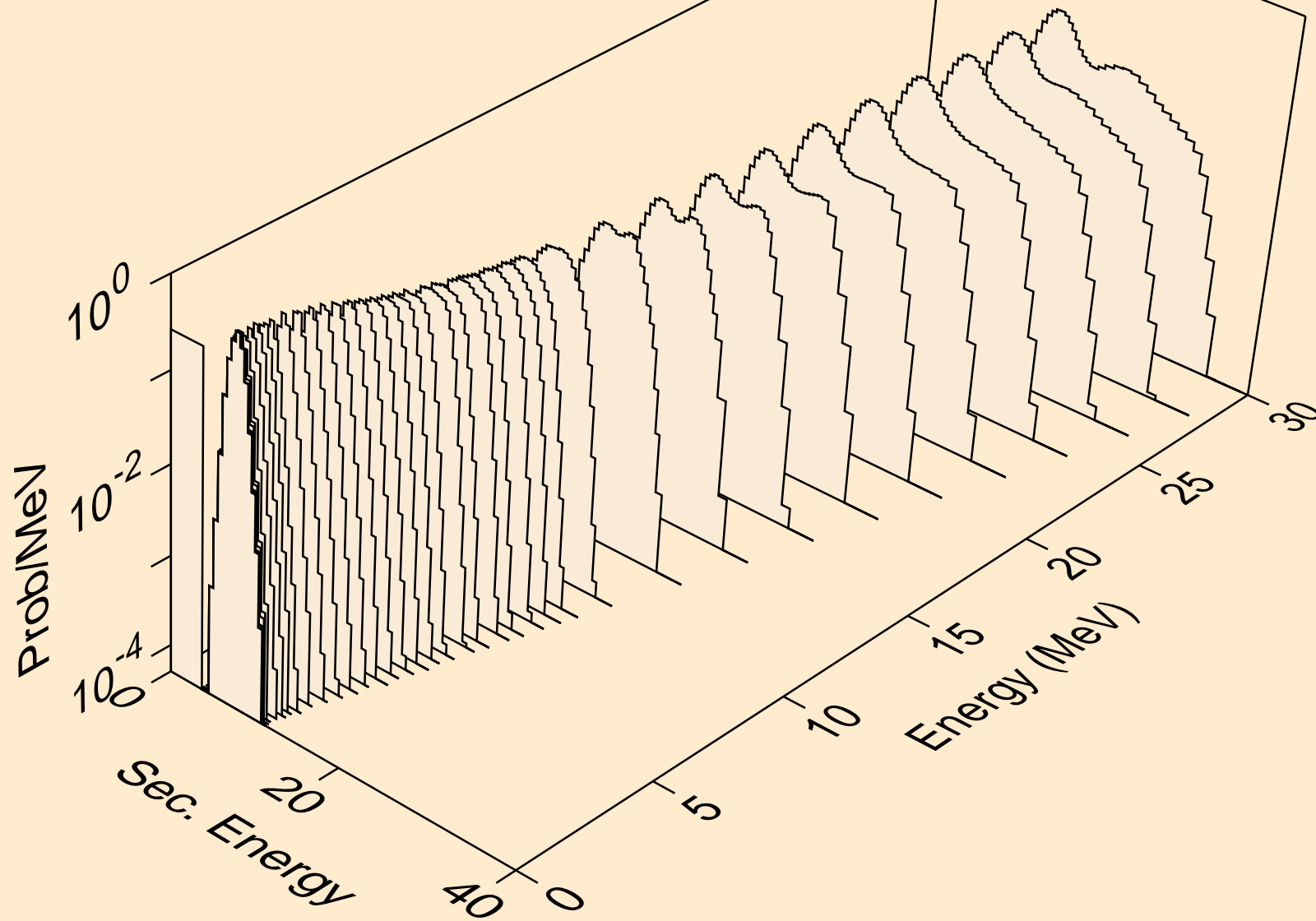

CE123 NEUTRON ACER TENDL-2021 LIBRARY; T=293.6K
alphas from (n,3a)

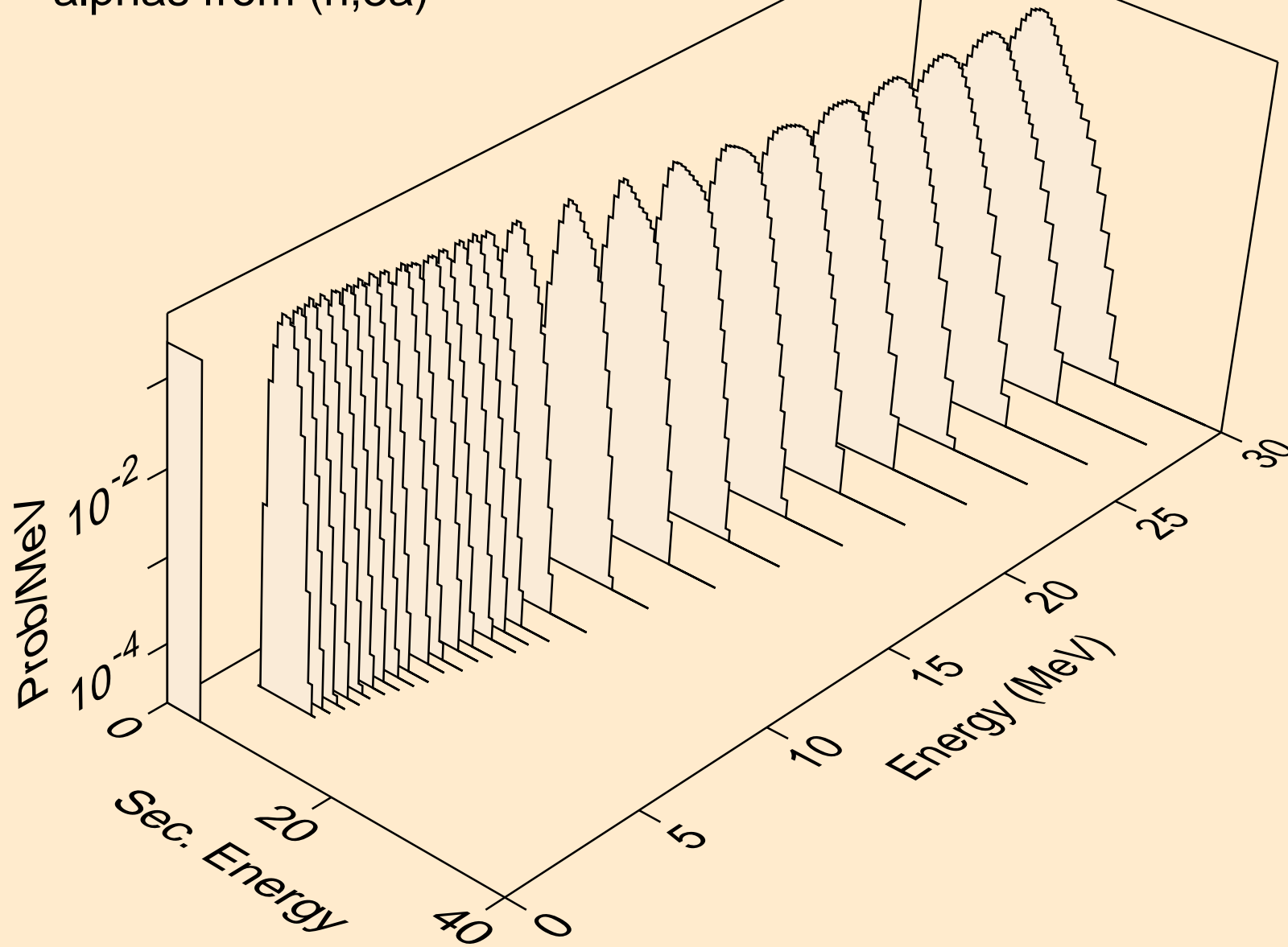

CE123 NEUTRON ACER TENDL-2021 LIBRARY; T=293.6K
alphas from (n,pa)

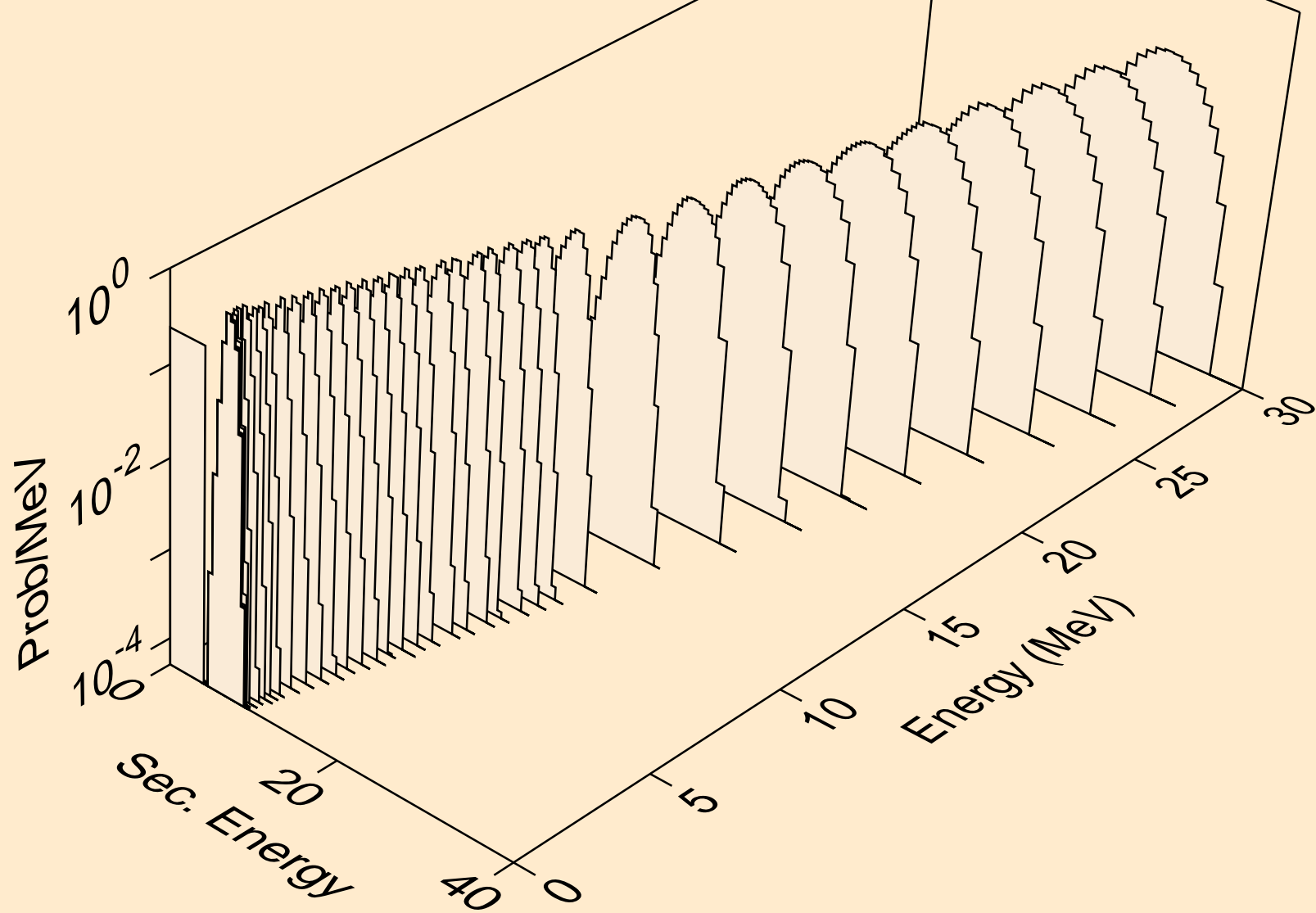

CE123 NEUTRON ACER TENDL-2021 LIBRARY; T=293.6K
alphas from (n,d2a)

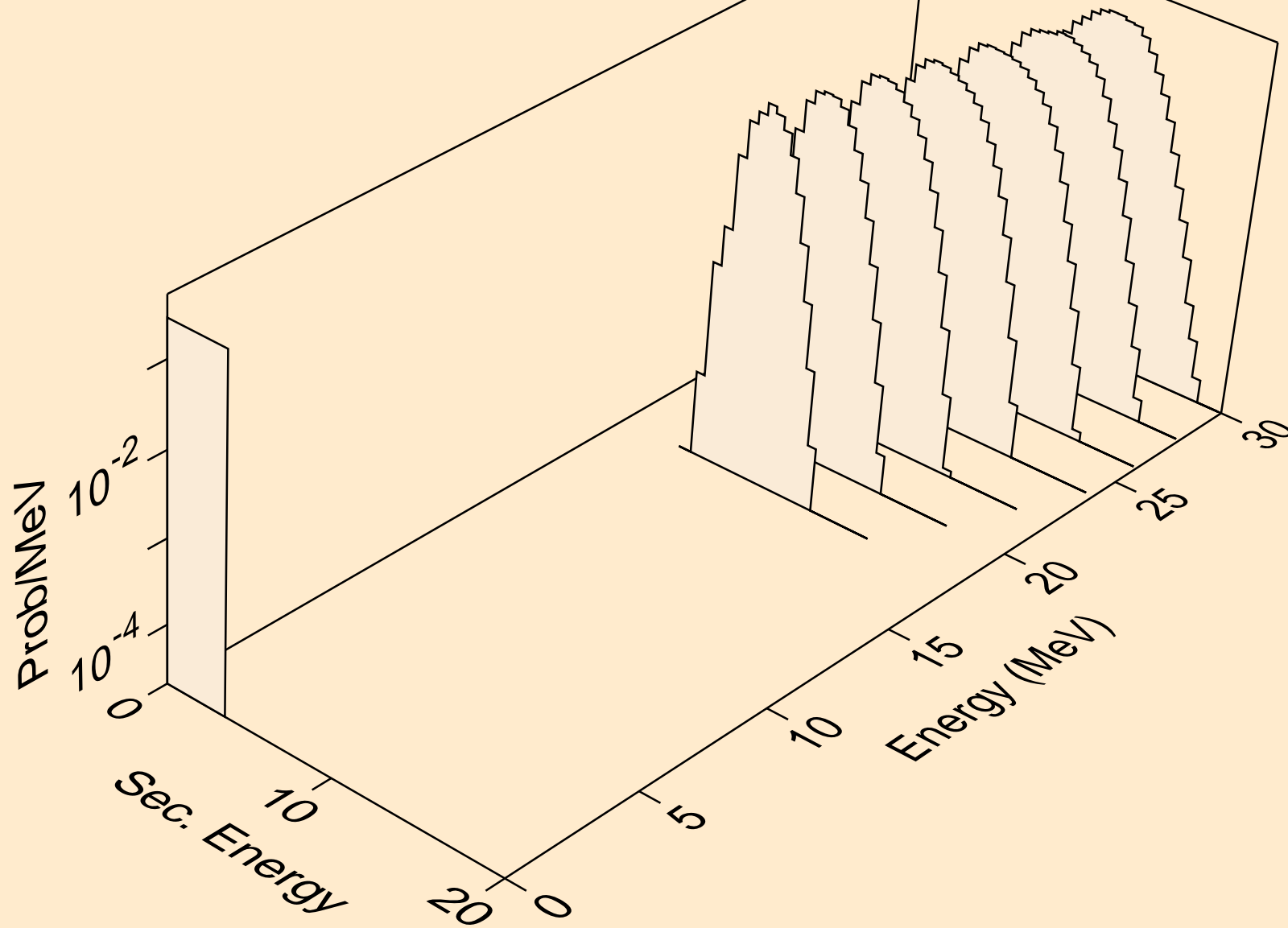

CE123 NEUTRON ACER TENDL-2021 LIBRARY; T=293.6K
alphas from (n,da)

