

CE127M NEUTRON ACER TENDL-2021 LIBRARY; T=293.6K  
Principal cross sections

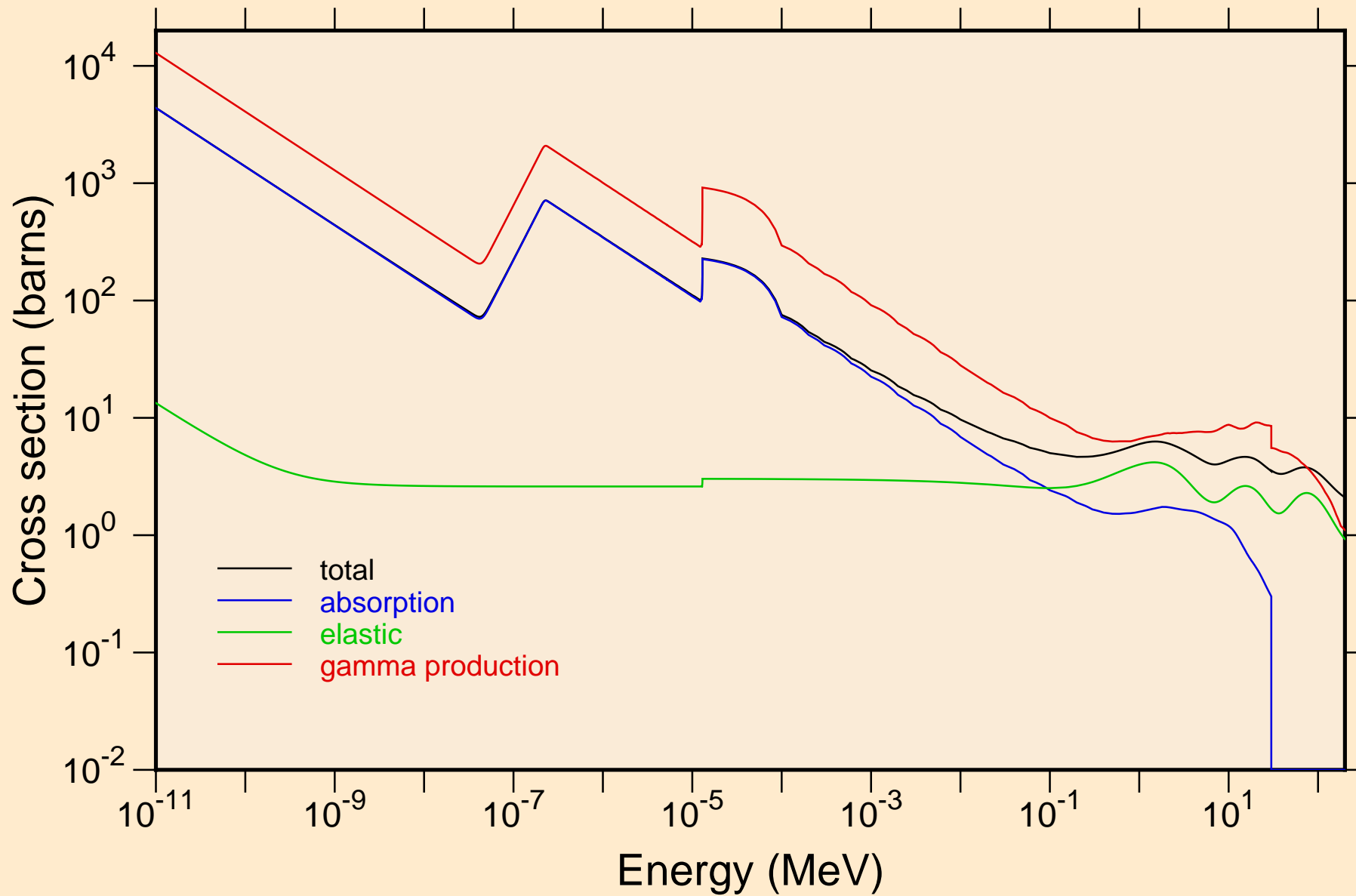

CE127M NEUTRON ACER TENDL-2021 LIBRARY; T=293.6K  
resonance total cross section

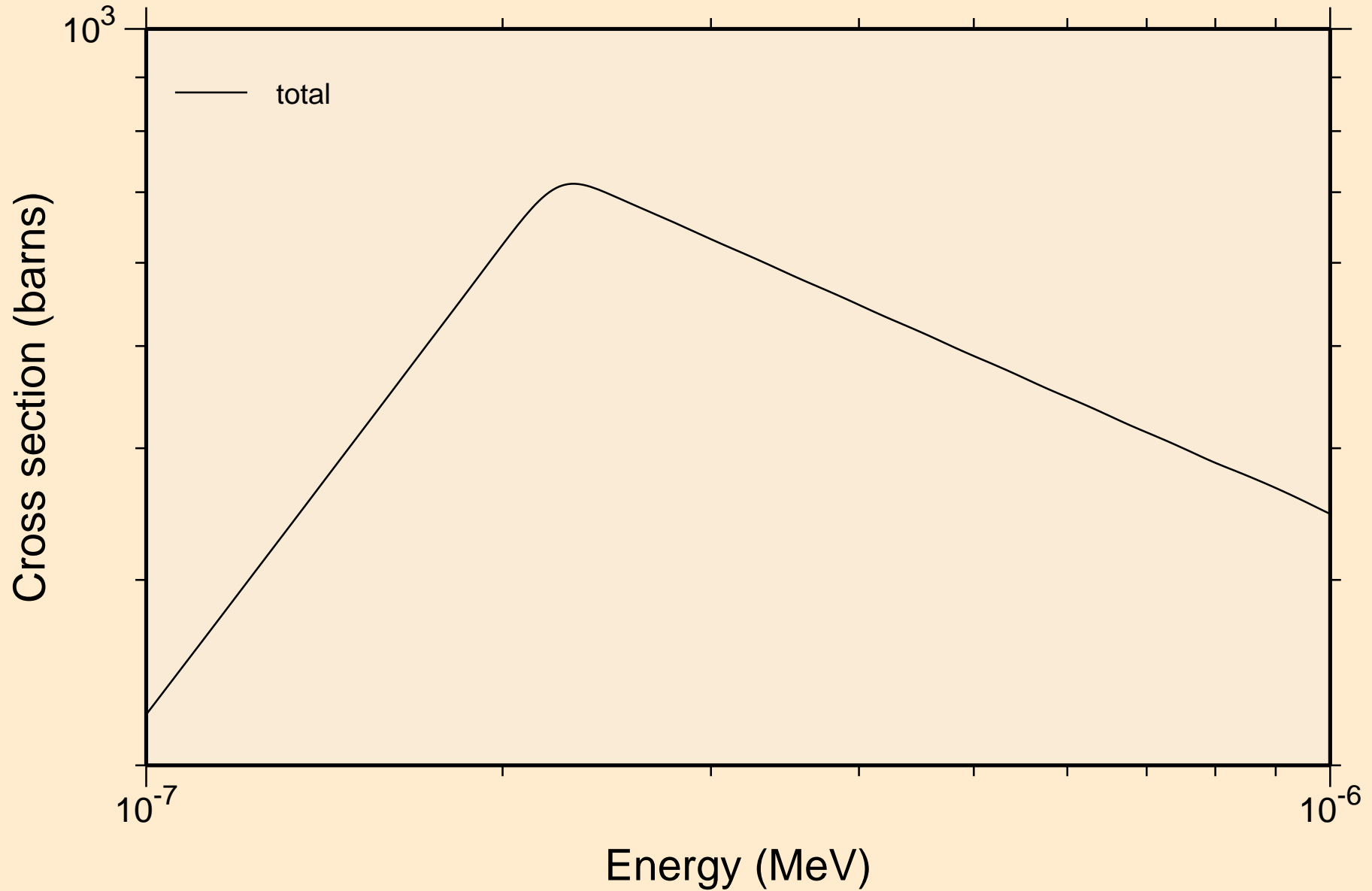

CE127M NEUTRON ACER TENDL-2021 LIBRARY; T=293.6K  
resonance total cross section

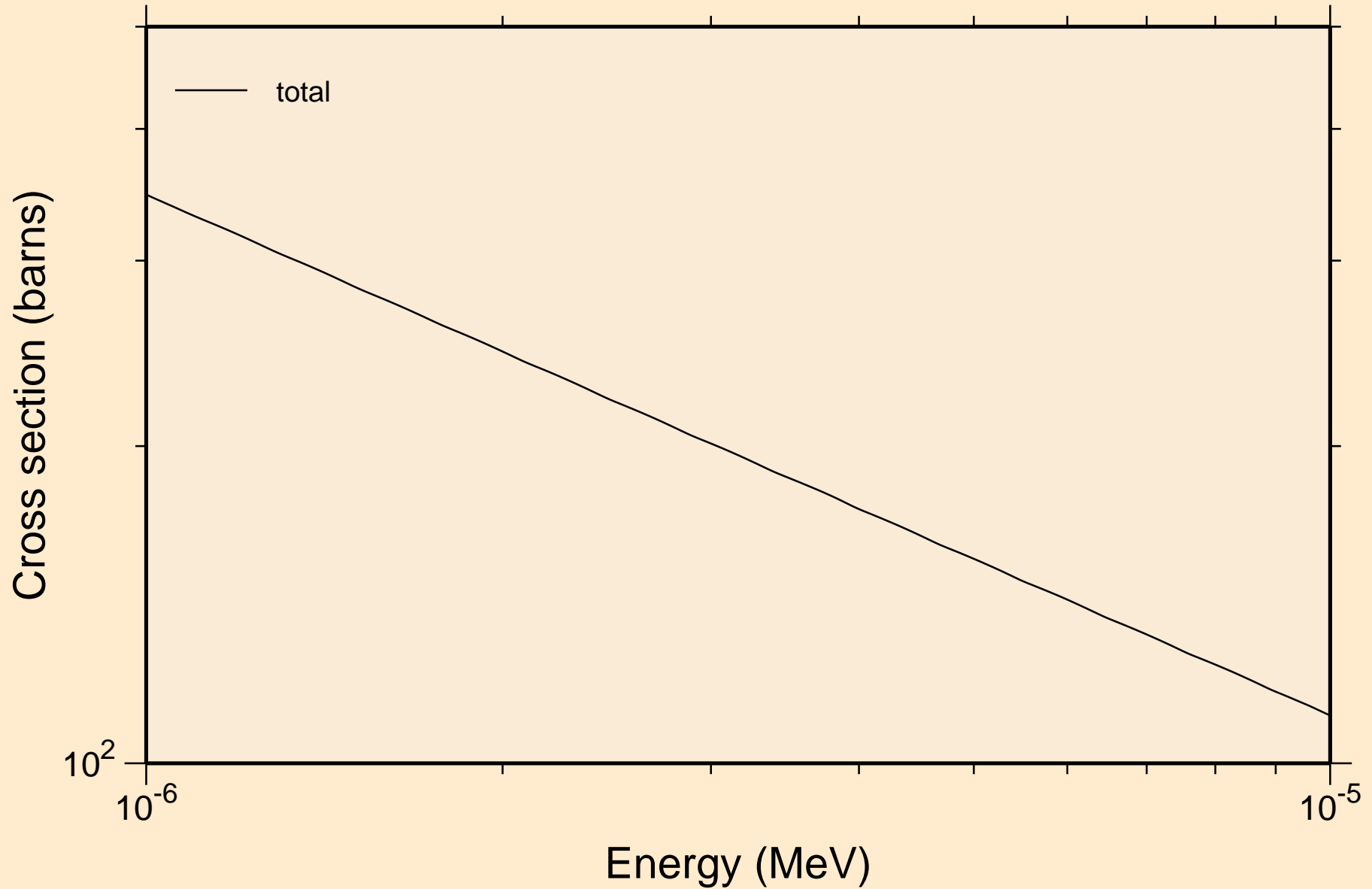

CE127M NEUTRON ACER TENDL-2021 LIBRARY; T=293.6K  
resonance total cross section

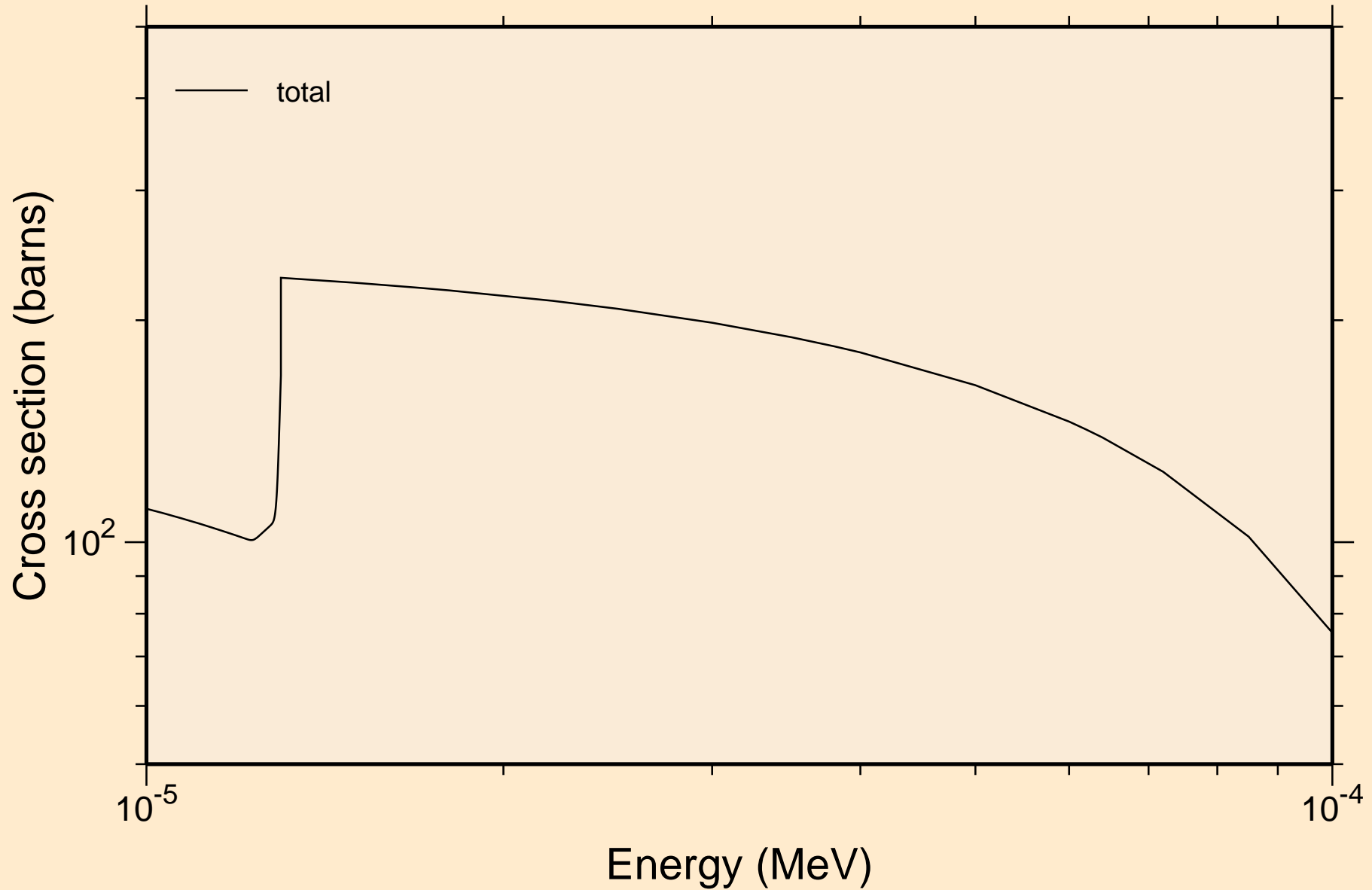

C<sup>127</sup>M NEUTRON ACER TENDL-2021 LIBRARY; T=293.6K  
resonance total cross section

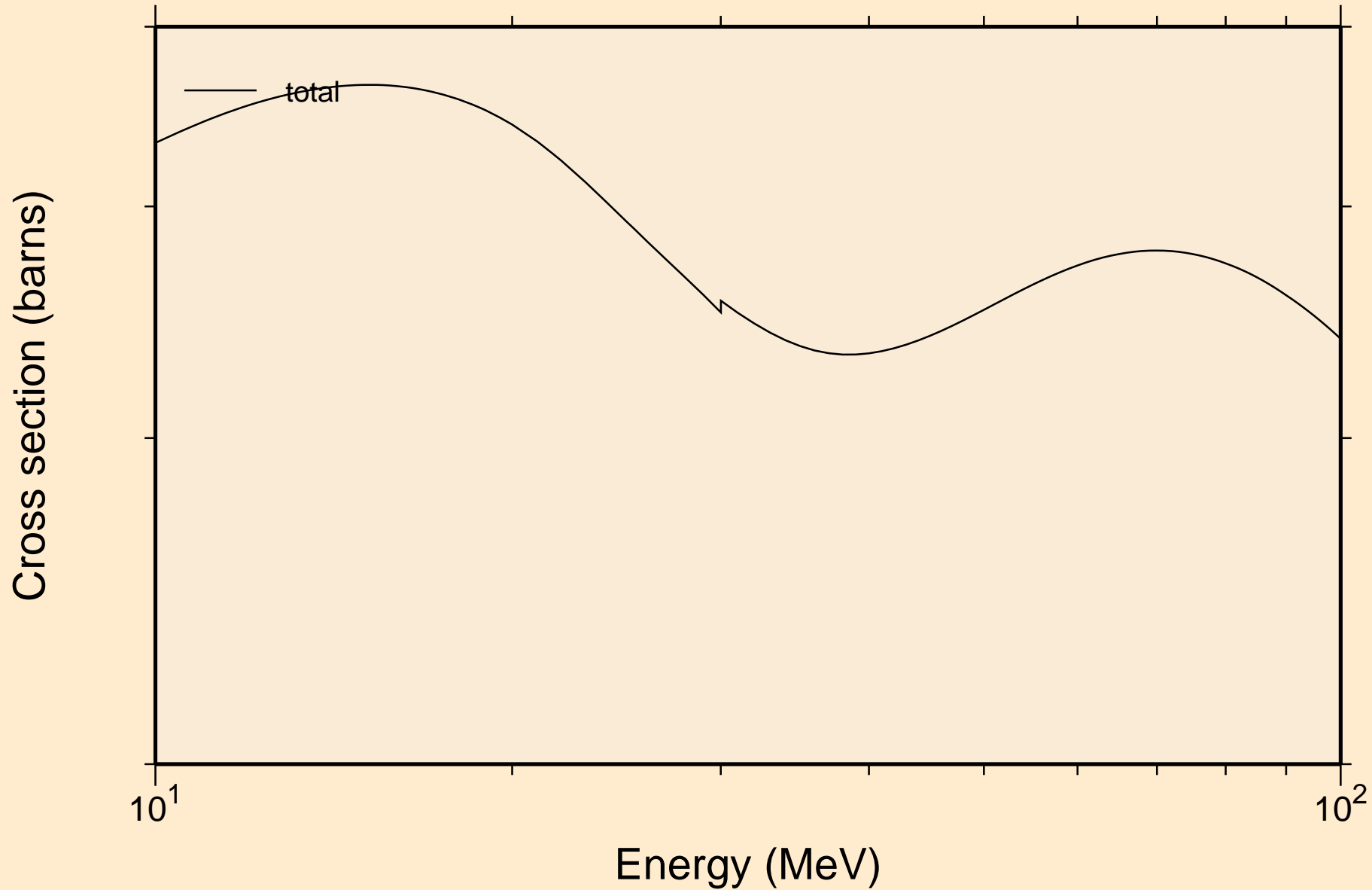

CE127M NEUTRON ACER TENDL-2021 LIBRARY; T=293.6K  
resonance absorption cross sections

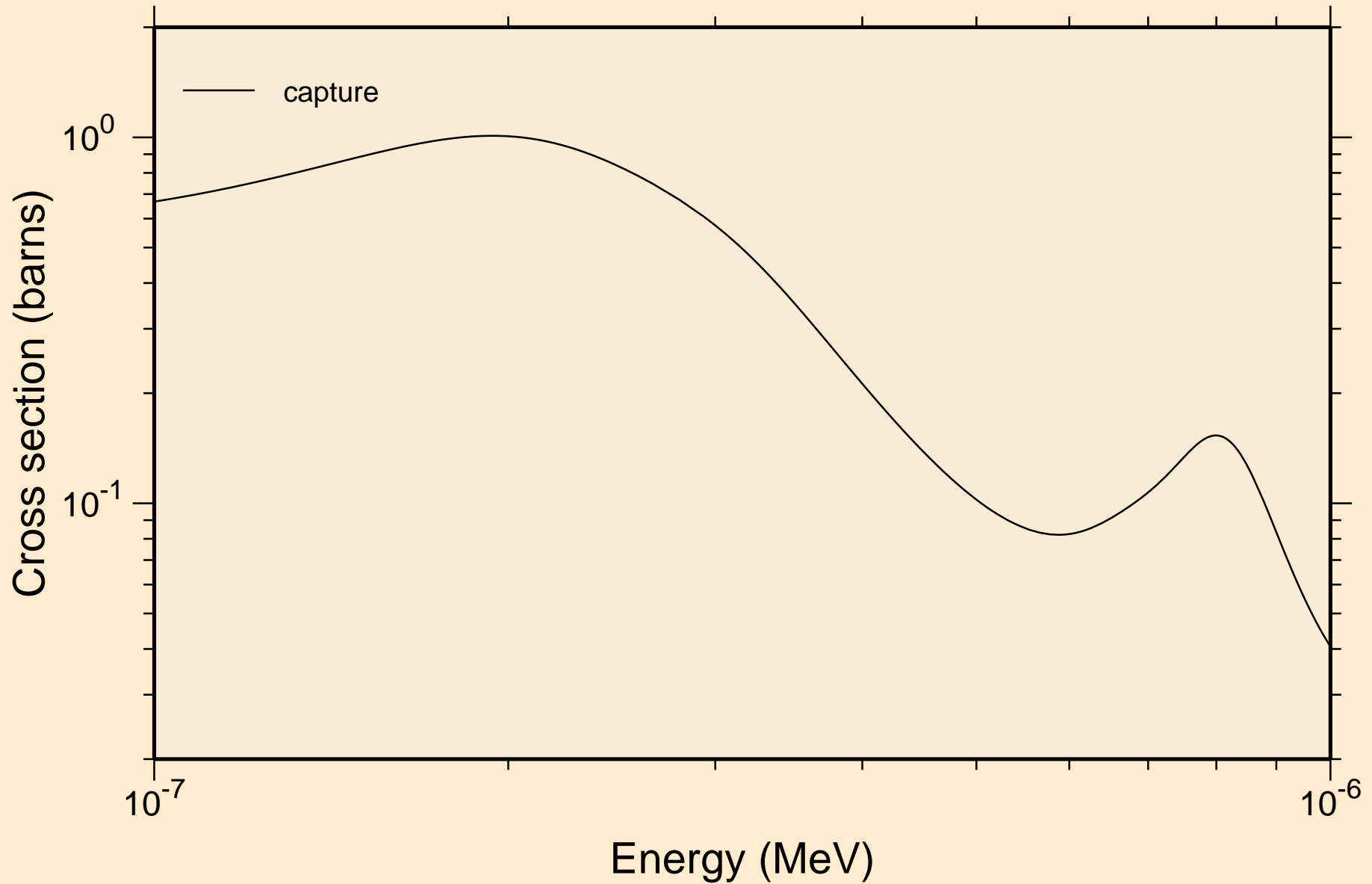

CE127M NEUTRON ACER TENDL-2021 LIBRARY; T=293.6K  
resonance absorption cross sections

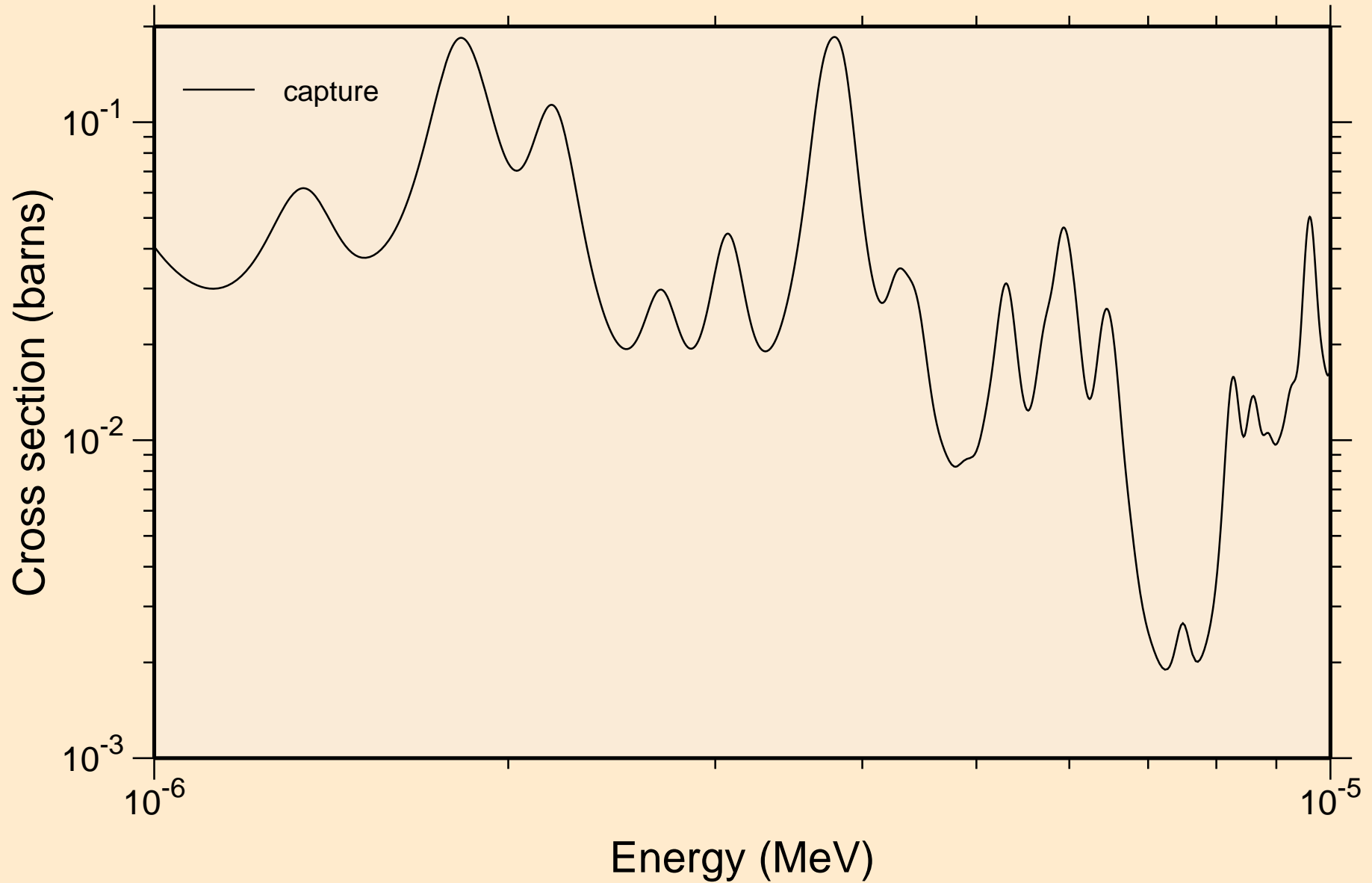

CE127M NEUTRON ACER TENDL-2021 LIBRARY; T=293.6K  
resonance absorption cross sections

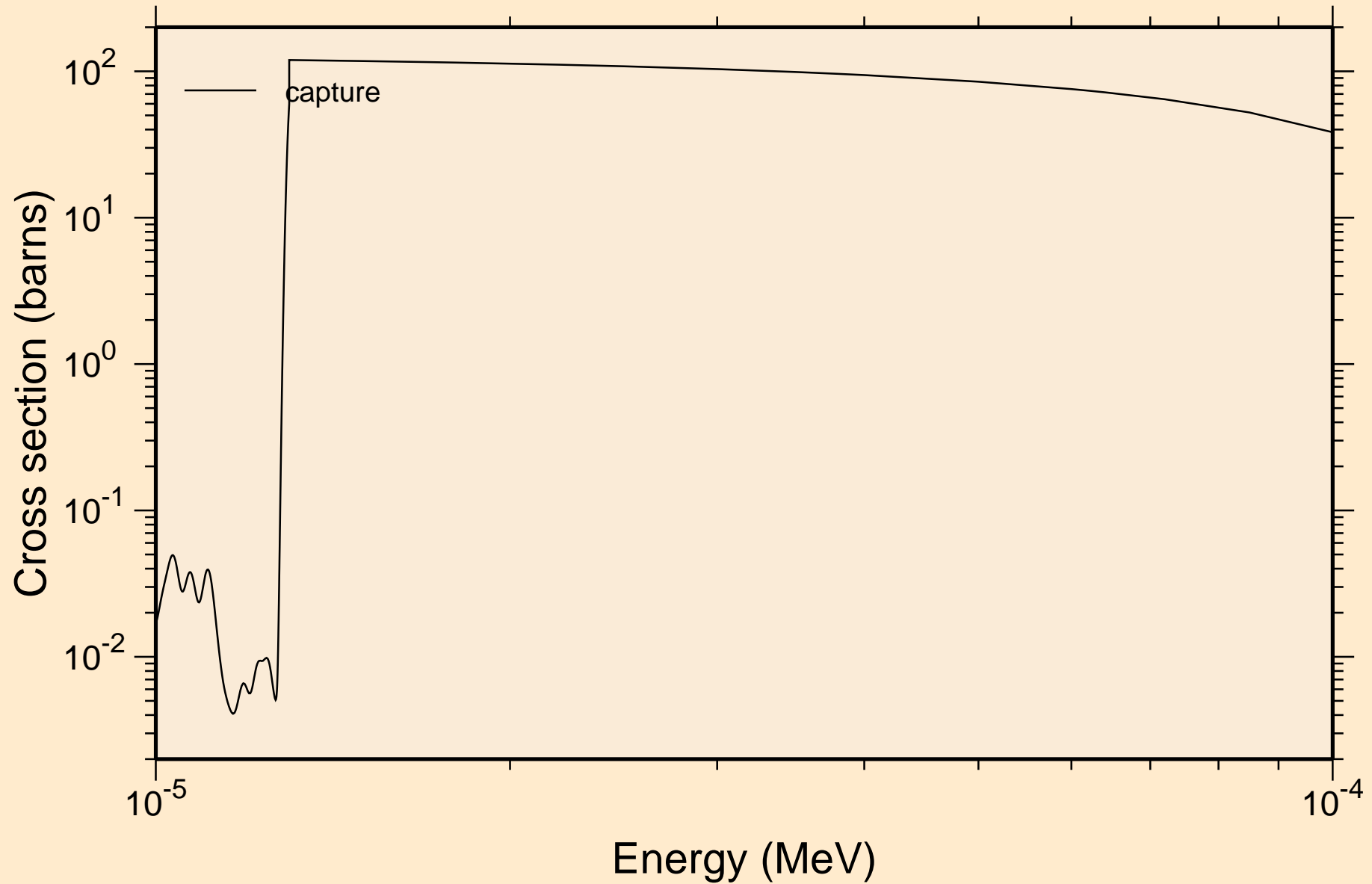



CE127M NEUTRON ACER TENDL-2021 LIBRARY; T=293.6K  
resonance absorption cross sections

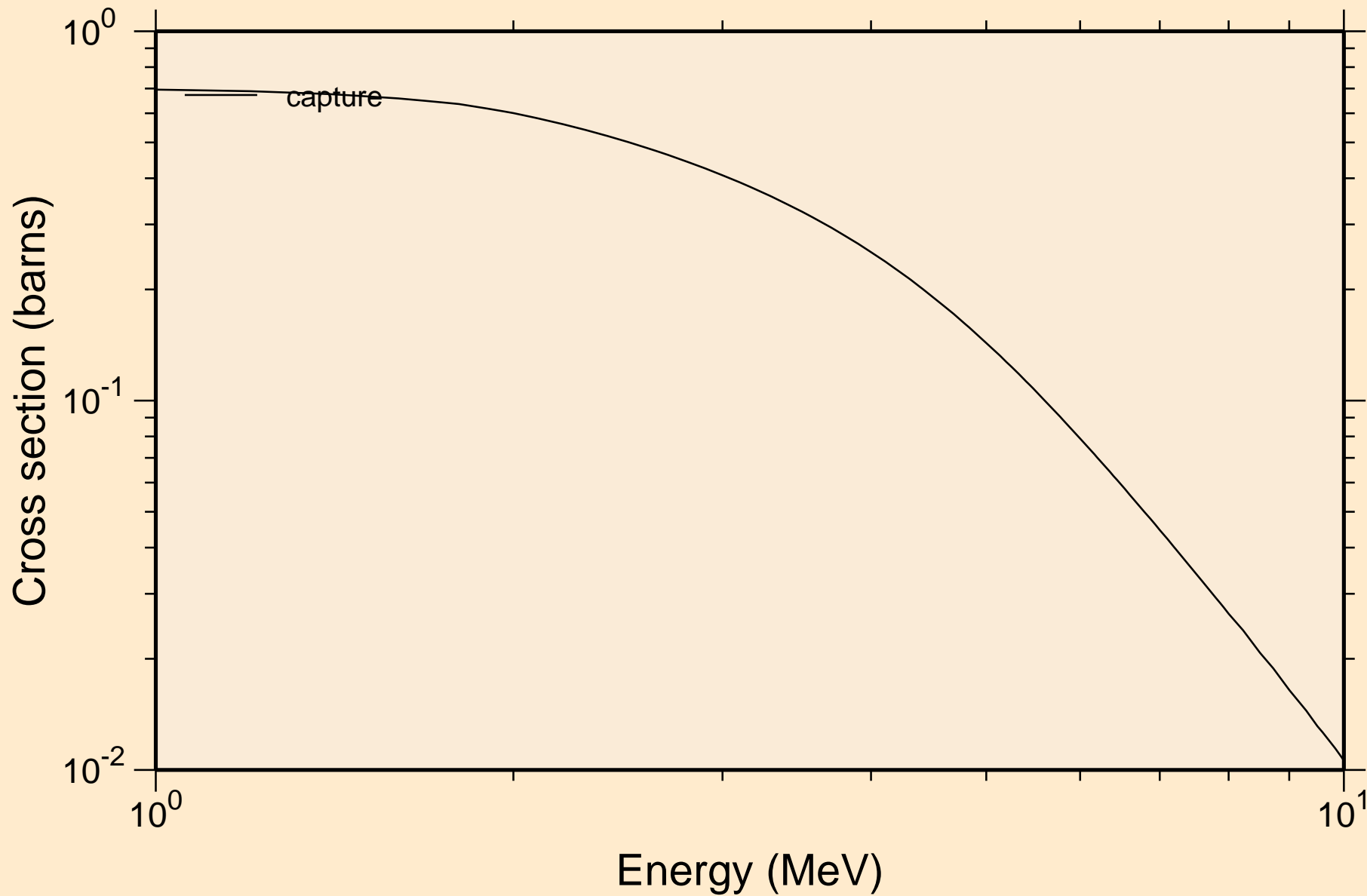

CE127M NEUTRON ACER TENDL-2021 LIBRARY; T=293.6K  
Heating

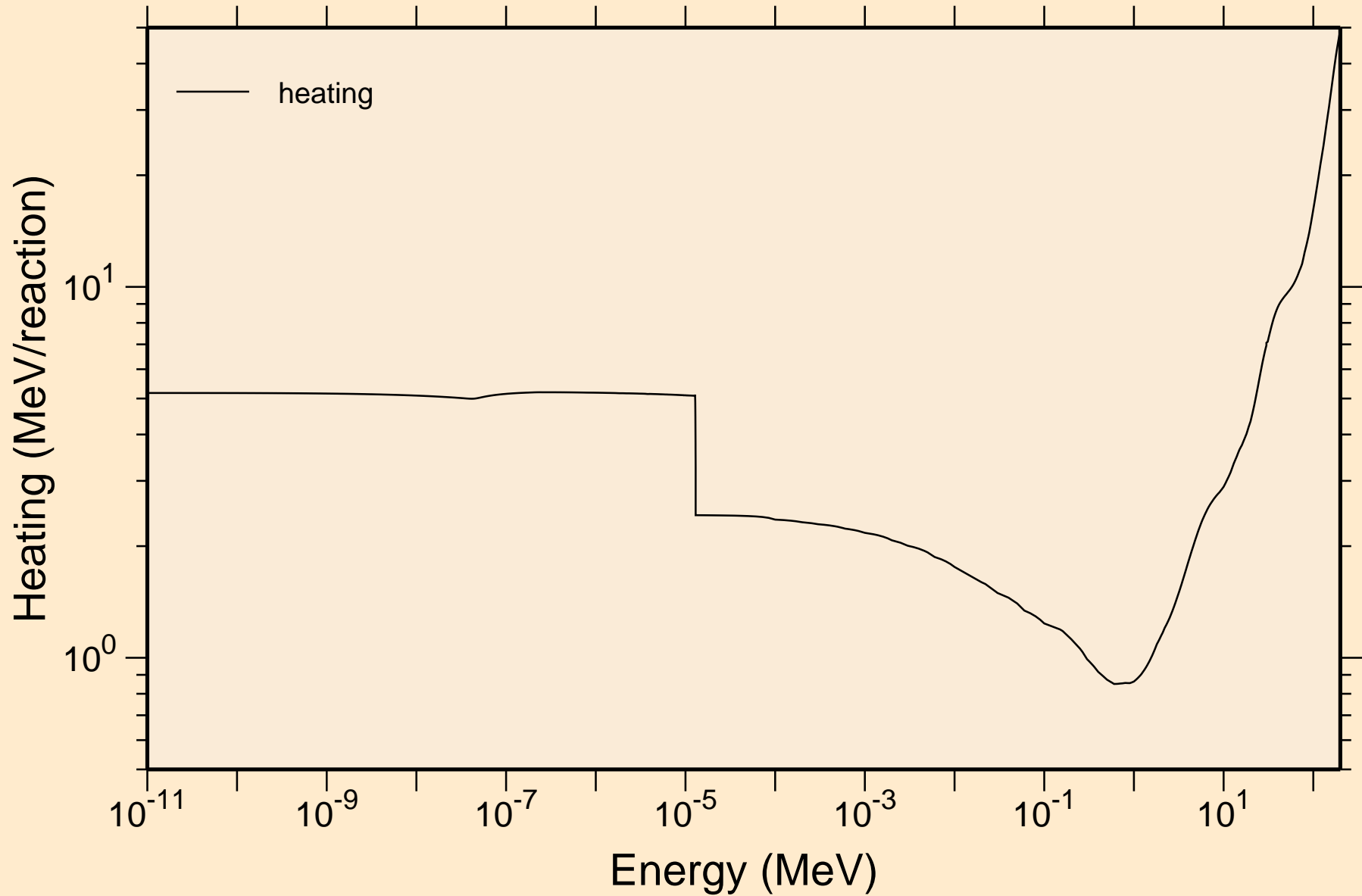

CE127M NEUTRON ACER TENDL-2021 LIBRARY; T=293.6K  
Damage

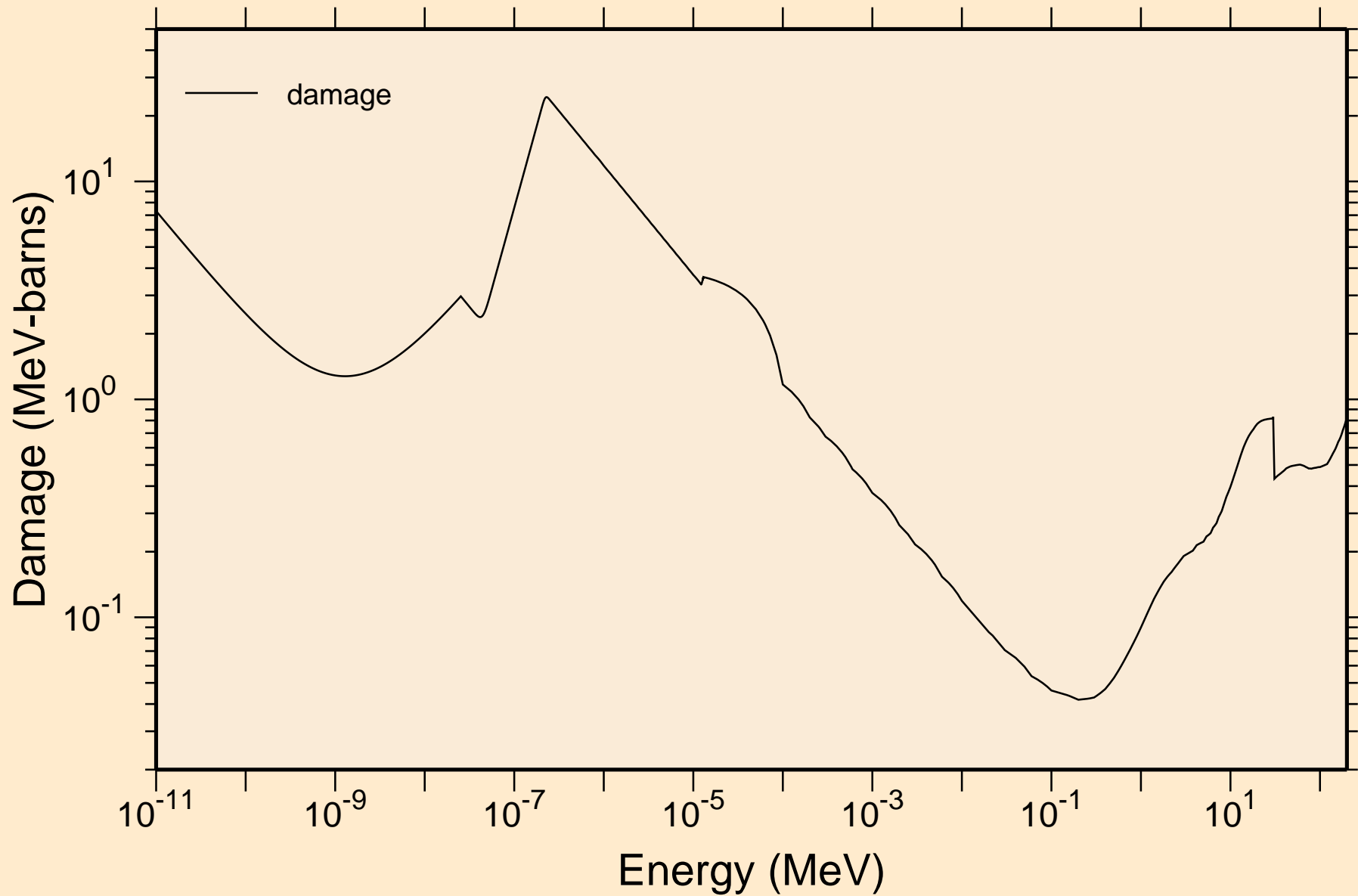

CE127M NEUTRON ACER TENDL-2021 LIBRARY; T=293.6K  
Non-threshold reactions

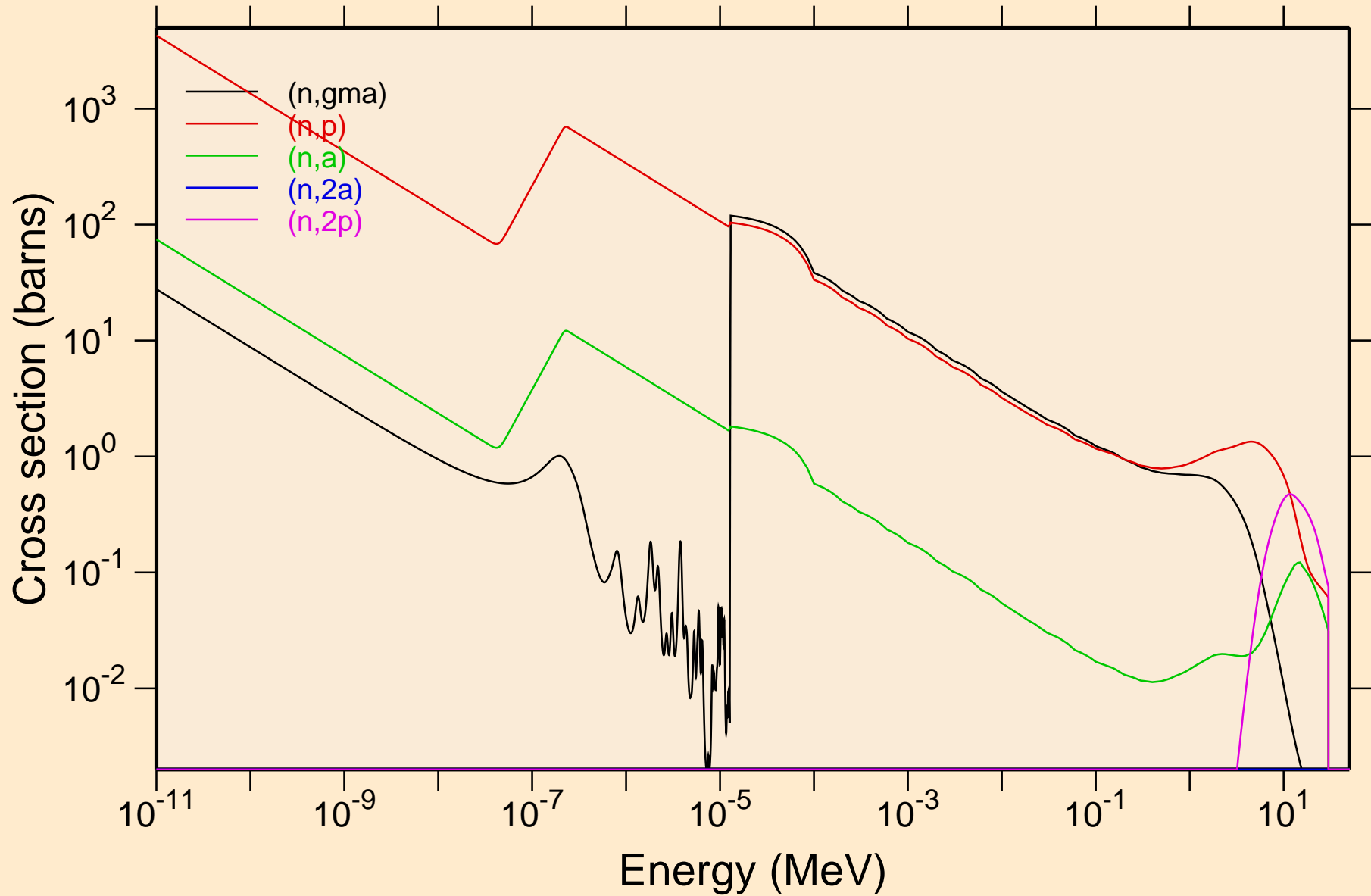

CE127M NEUTRON ACER TENDL-2021 LIBRARY; T=293.6K  
Non-threshold reactions

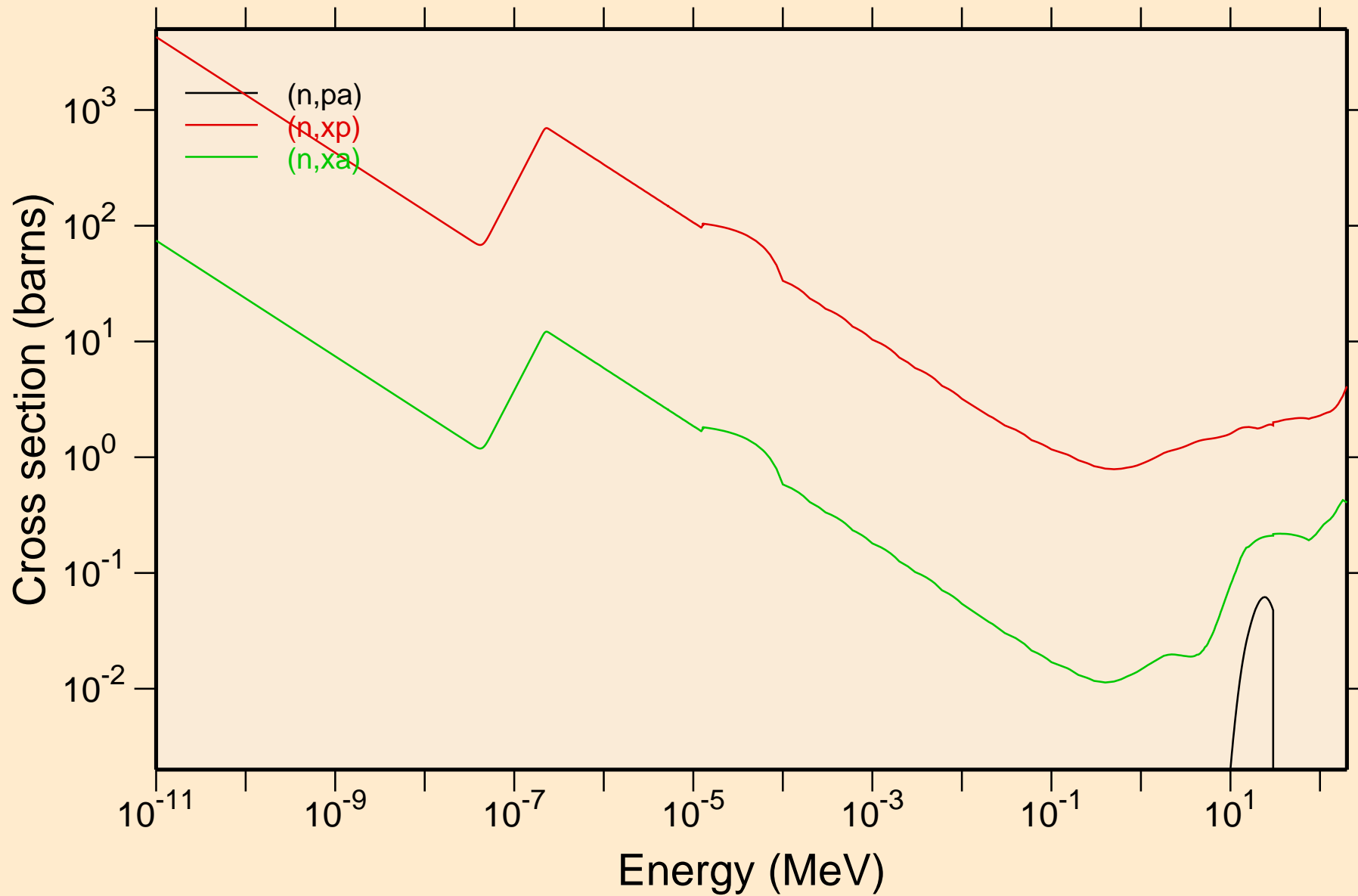

CE127M NEUTRON ACER TENDL-2021 LIBRARY; T=293.6K  
Principal cross sections

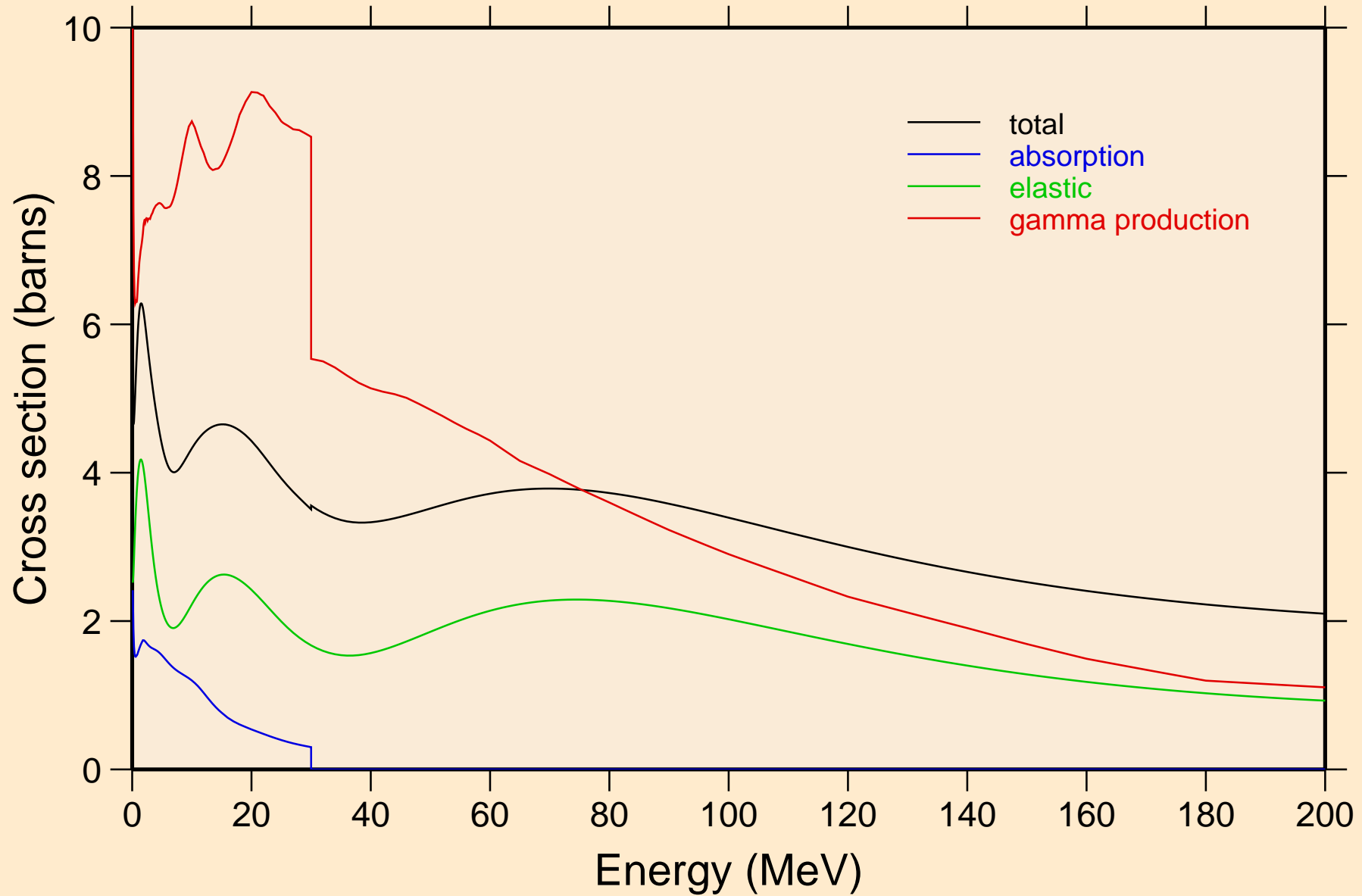

CE127M NEUTRON ACER TENDL-2021 LIBRARY; T=293.6K  
Heating

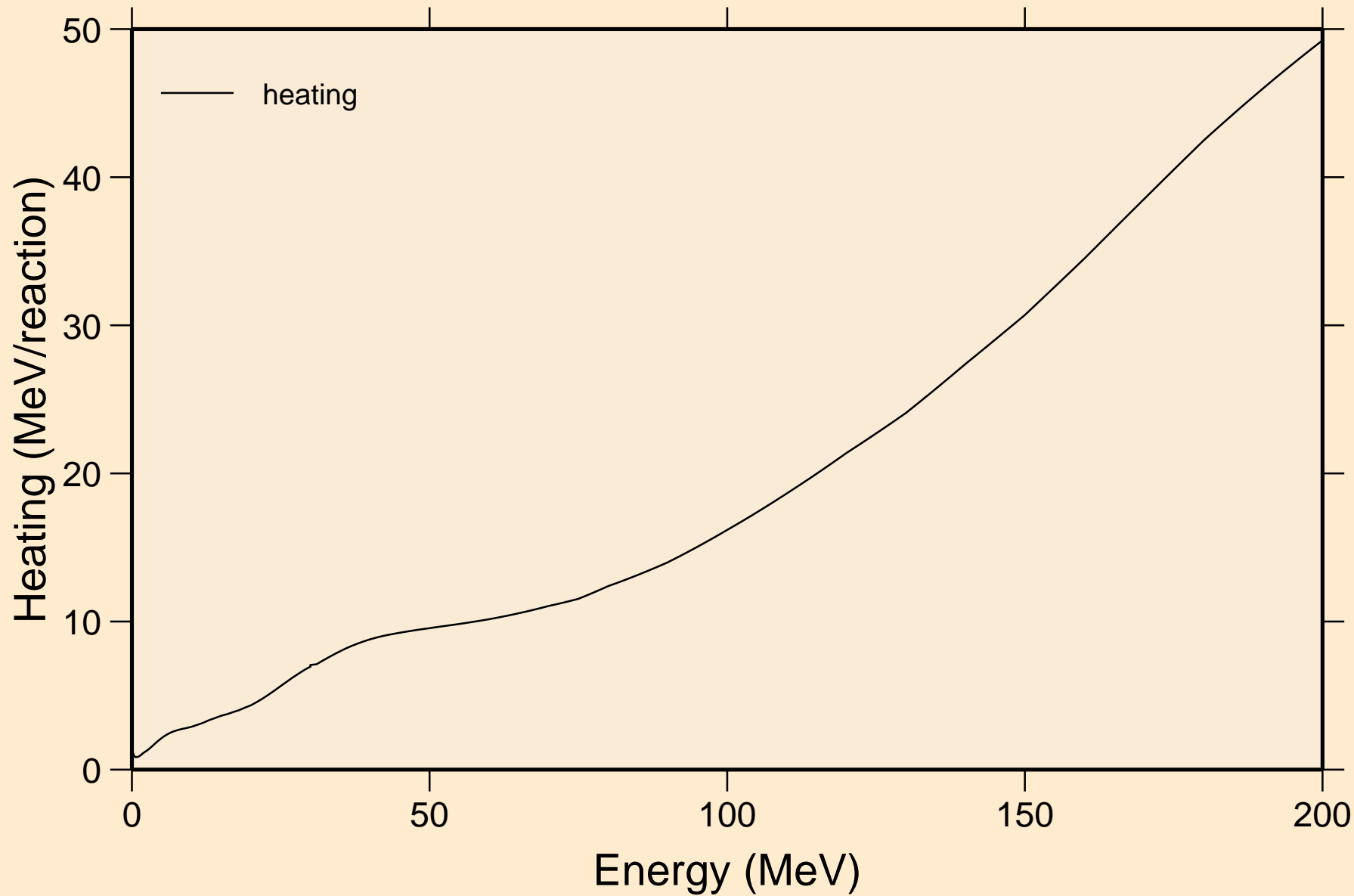

CE127M NEUTRON ACER TENDL-2021 LIBRARY; T=293.6K  
Damage

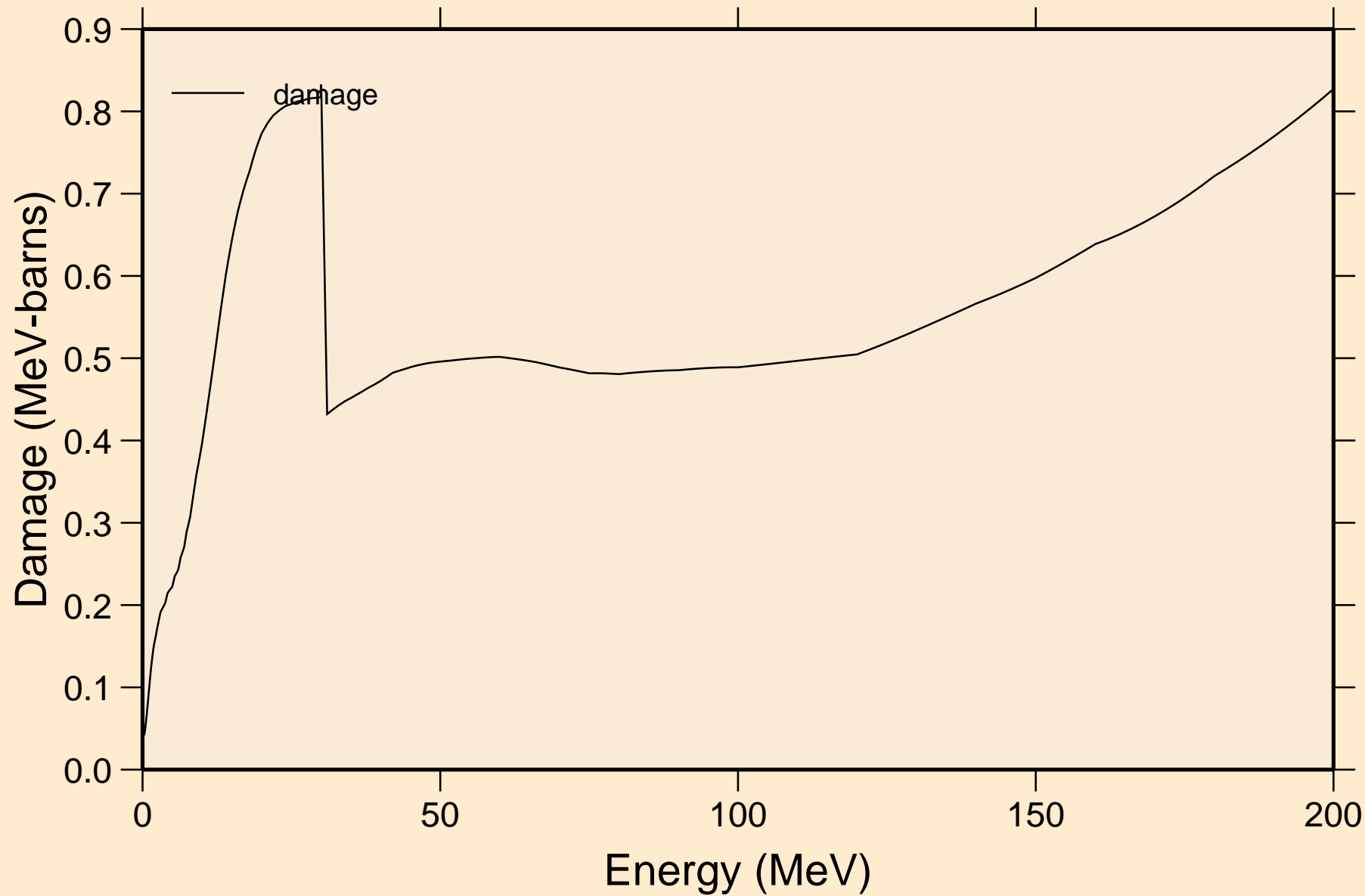



CE127M NEUTRON ACER TENDL-2021 LIBRARY; T=293.6K  
Non-threshold reactions

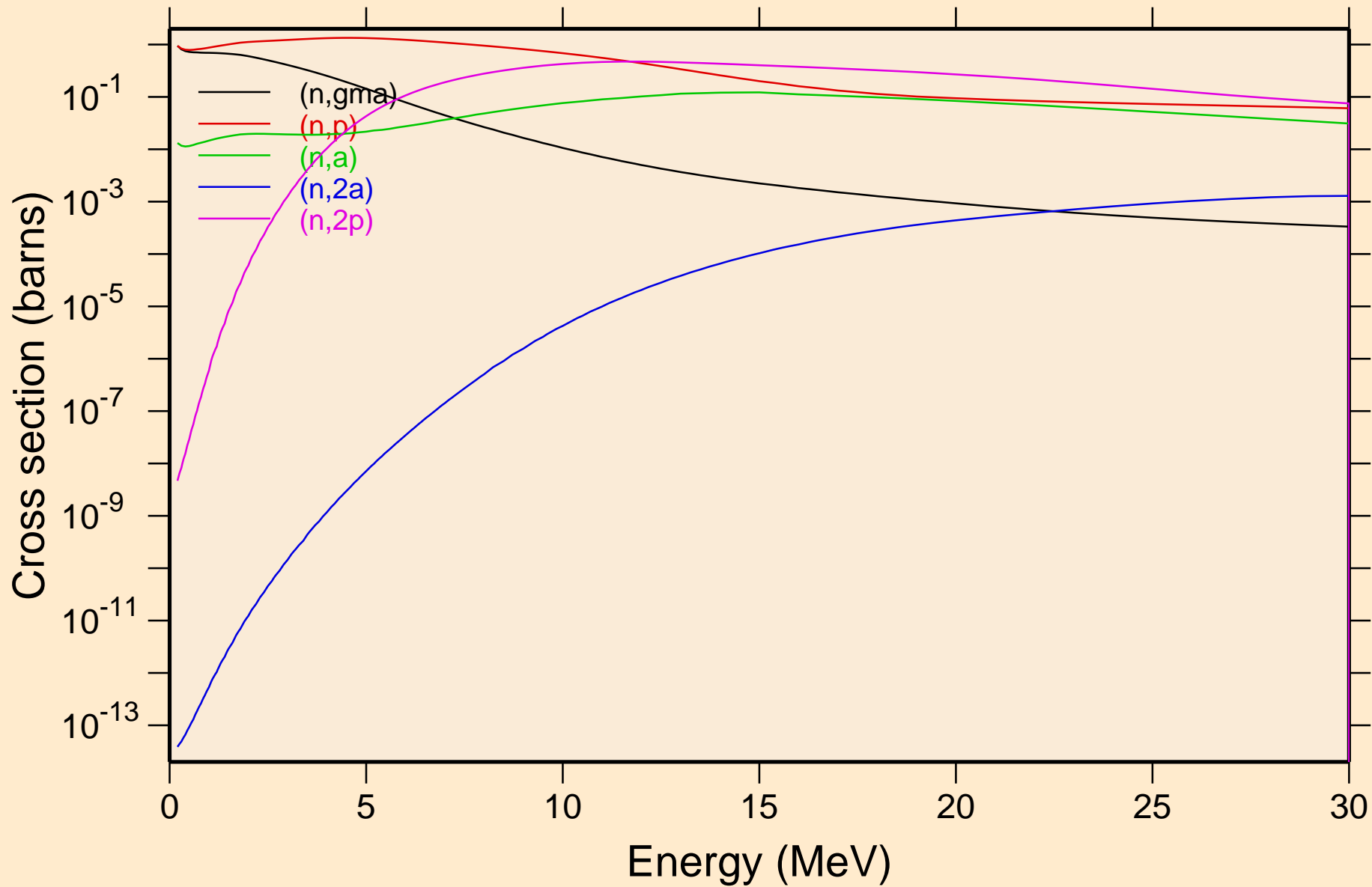

CE127M NEUTRON ACER TENDL-2021 LIBRARY; T=293.6K  
Non-threshold reactions

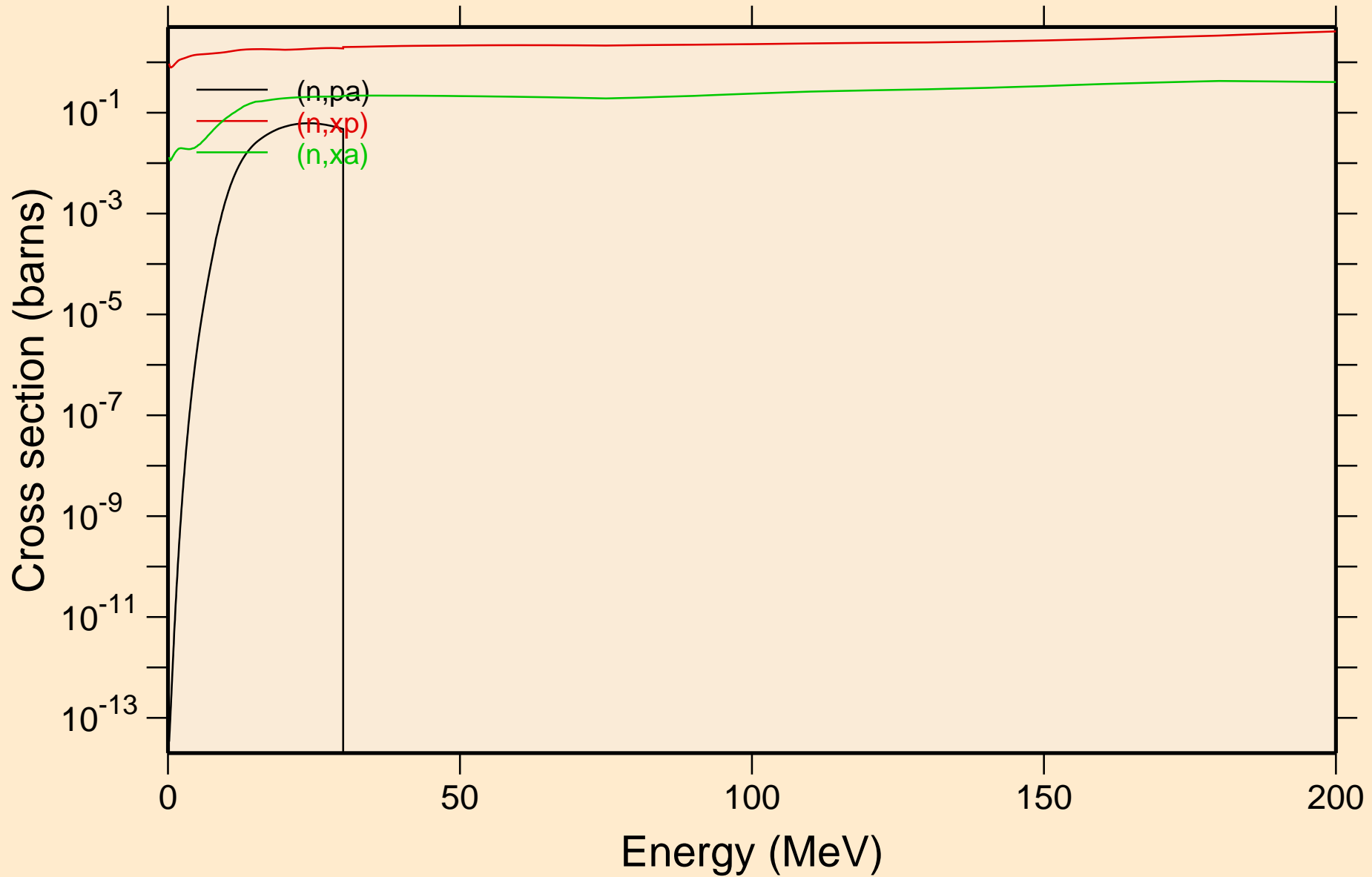

CE127M NEUTRON ACER TENDL-2021 LIBRARY; T=293.6K  
Inelastic levels

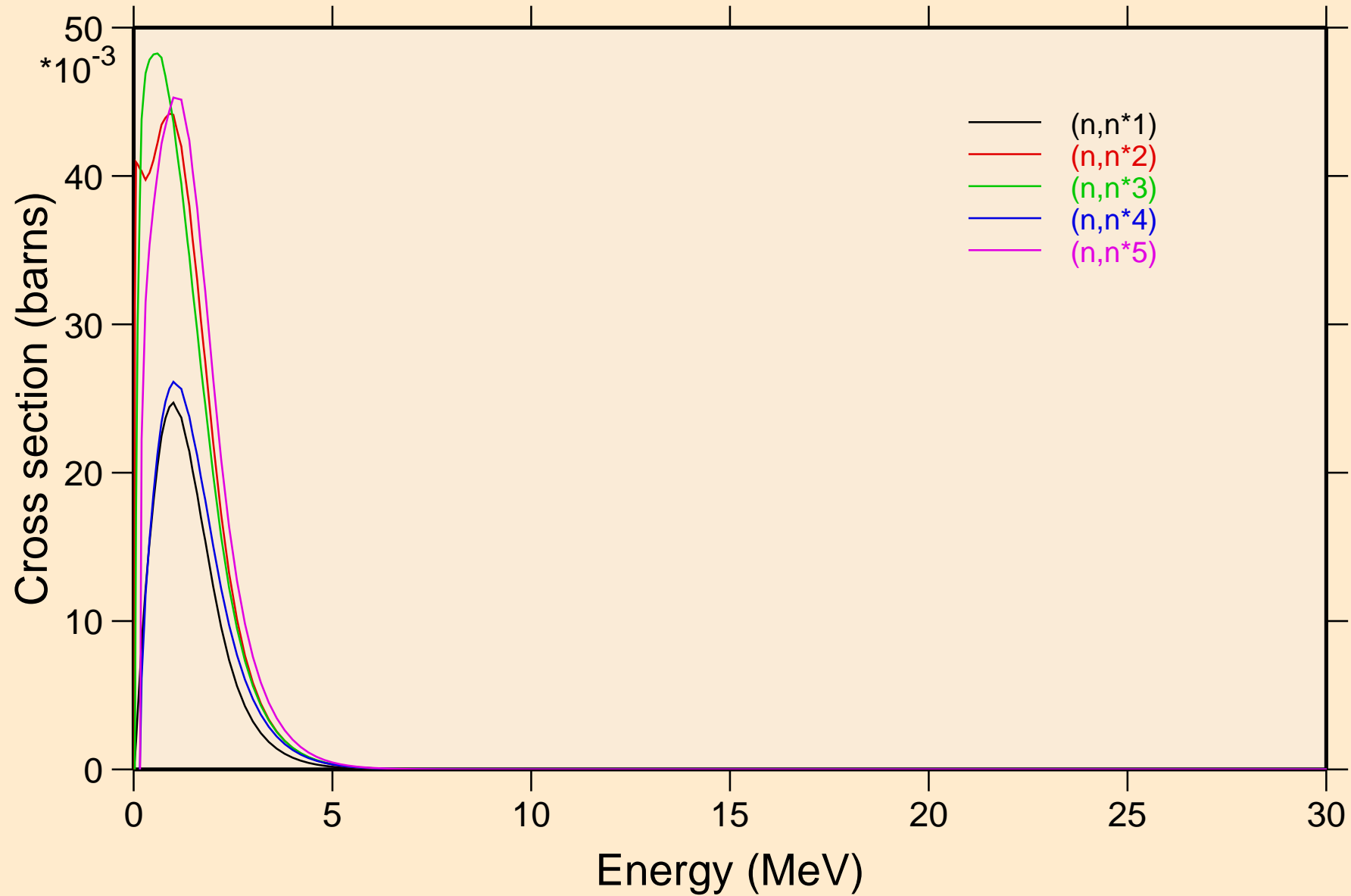

CE127M NEUTRON ACER TENDL-2021 LIBRARY; T=293.6K  
Inelastic levels

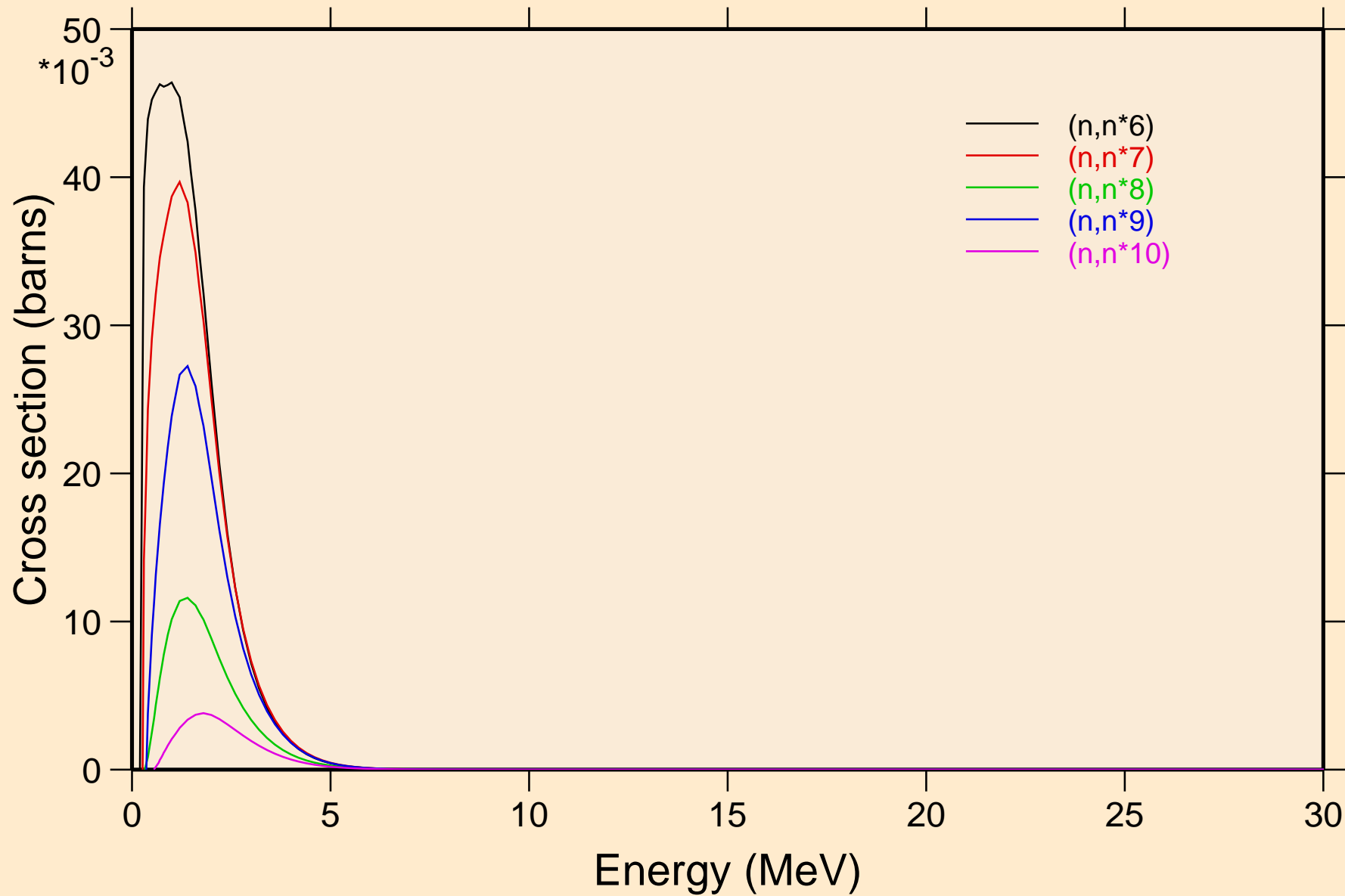

CE127M NEUTRON ACER TENDL-2021 LIBRARY; T=293.6K  
Inelastic levels

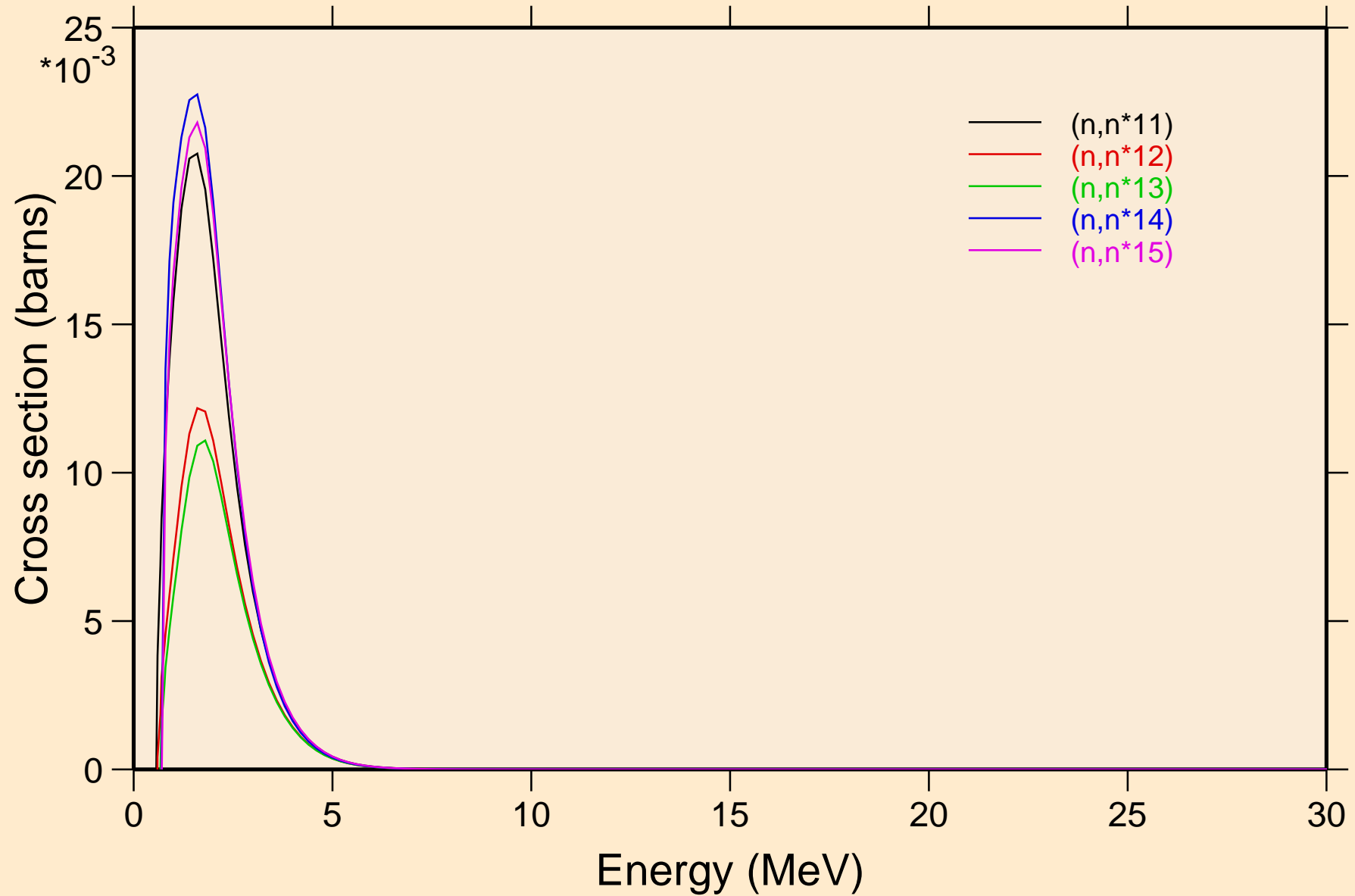

CE127M NEUTRON ACER TENDL-2021 LIBRARY; T=293.6K  
Inelastic levels

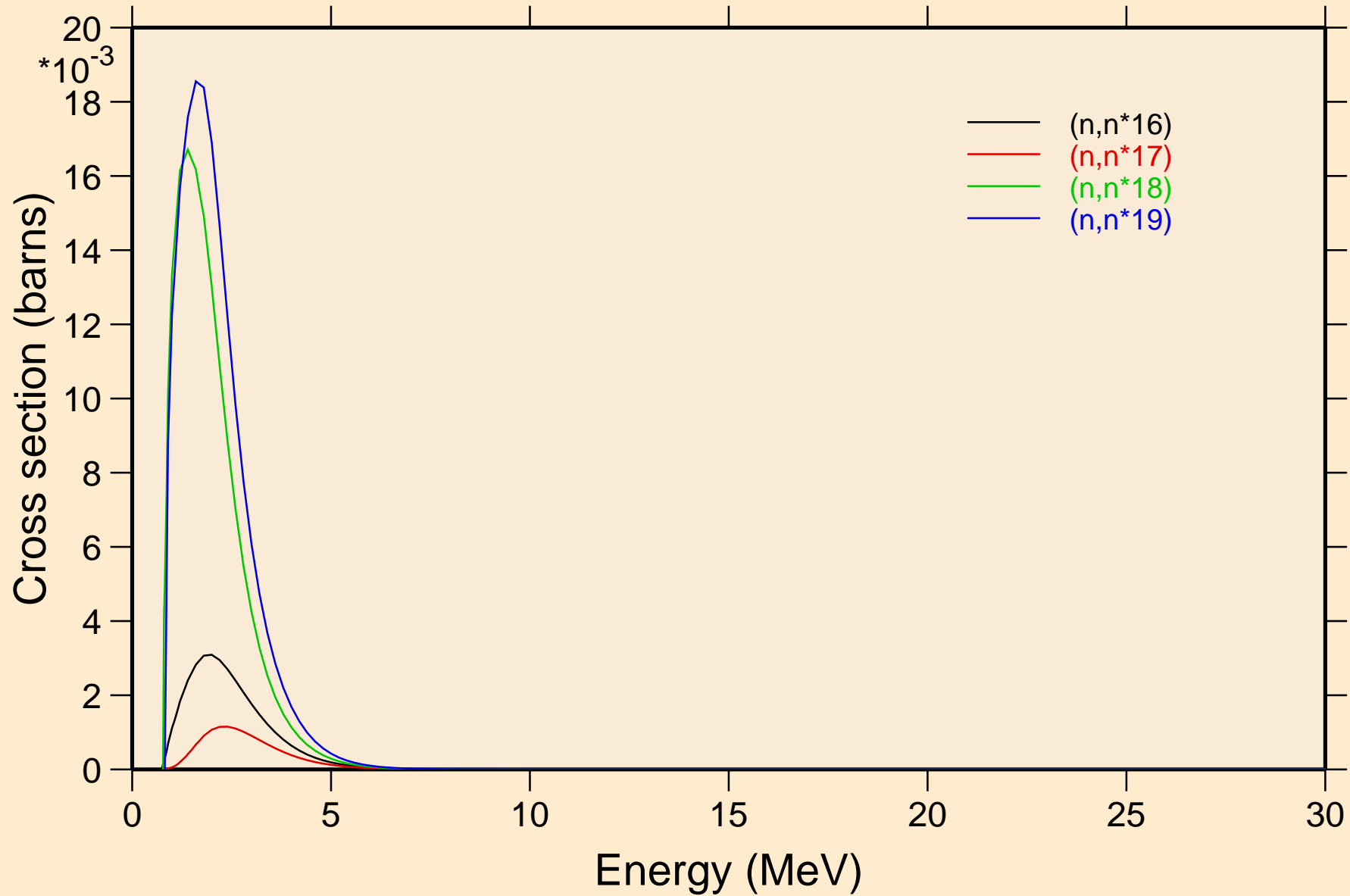

CE127M NEUTRON ACER TENDL-2021 LIBRARY; T=293.6K  
Threshold reactions

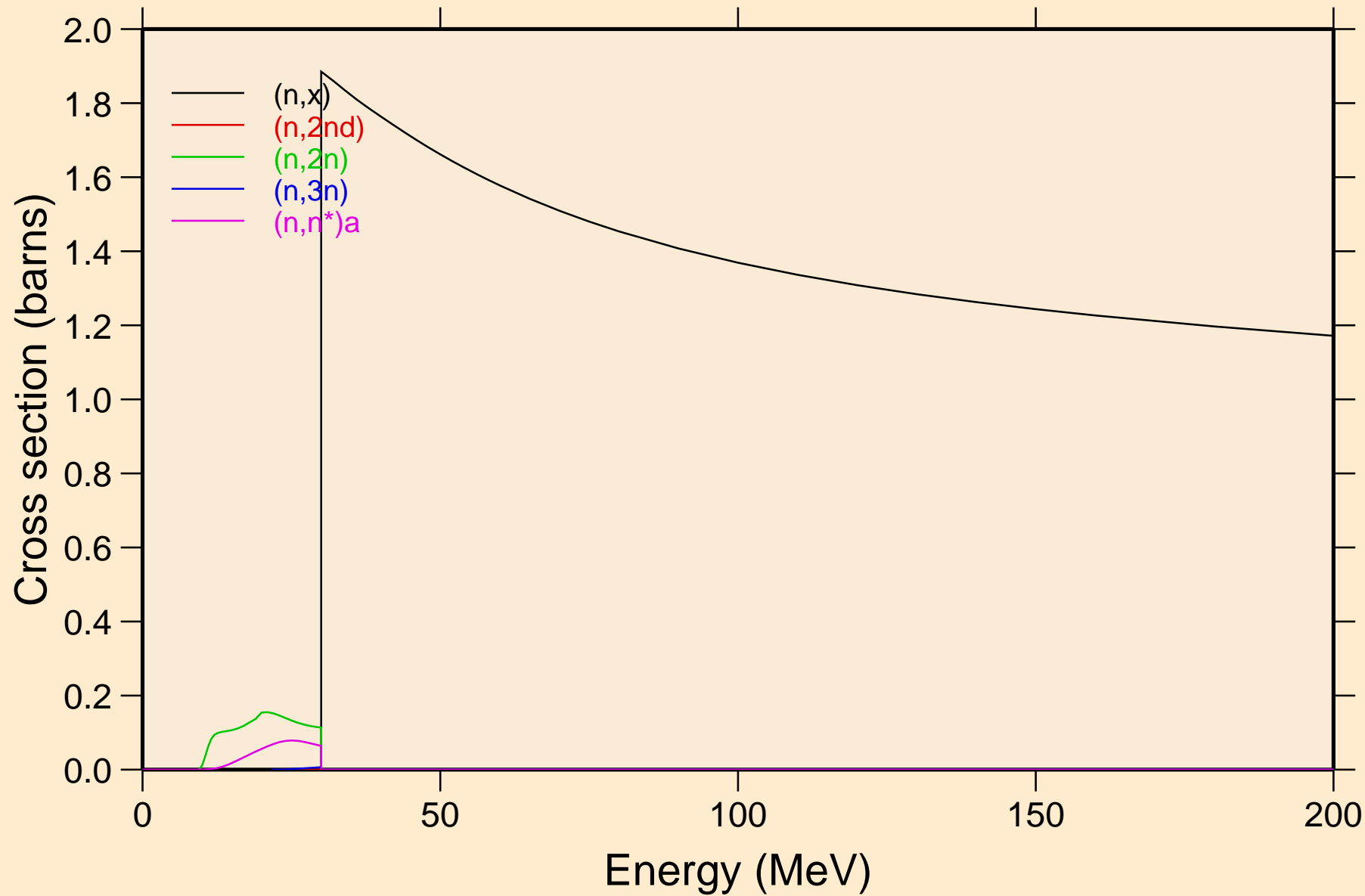

CE127M NEUTRON ACER TENDL-2021 LIBRARY; T=293.6K  
Threshold reactions

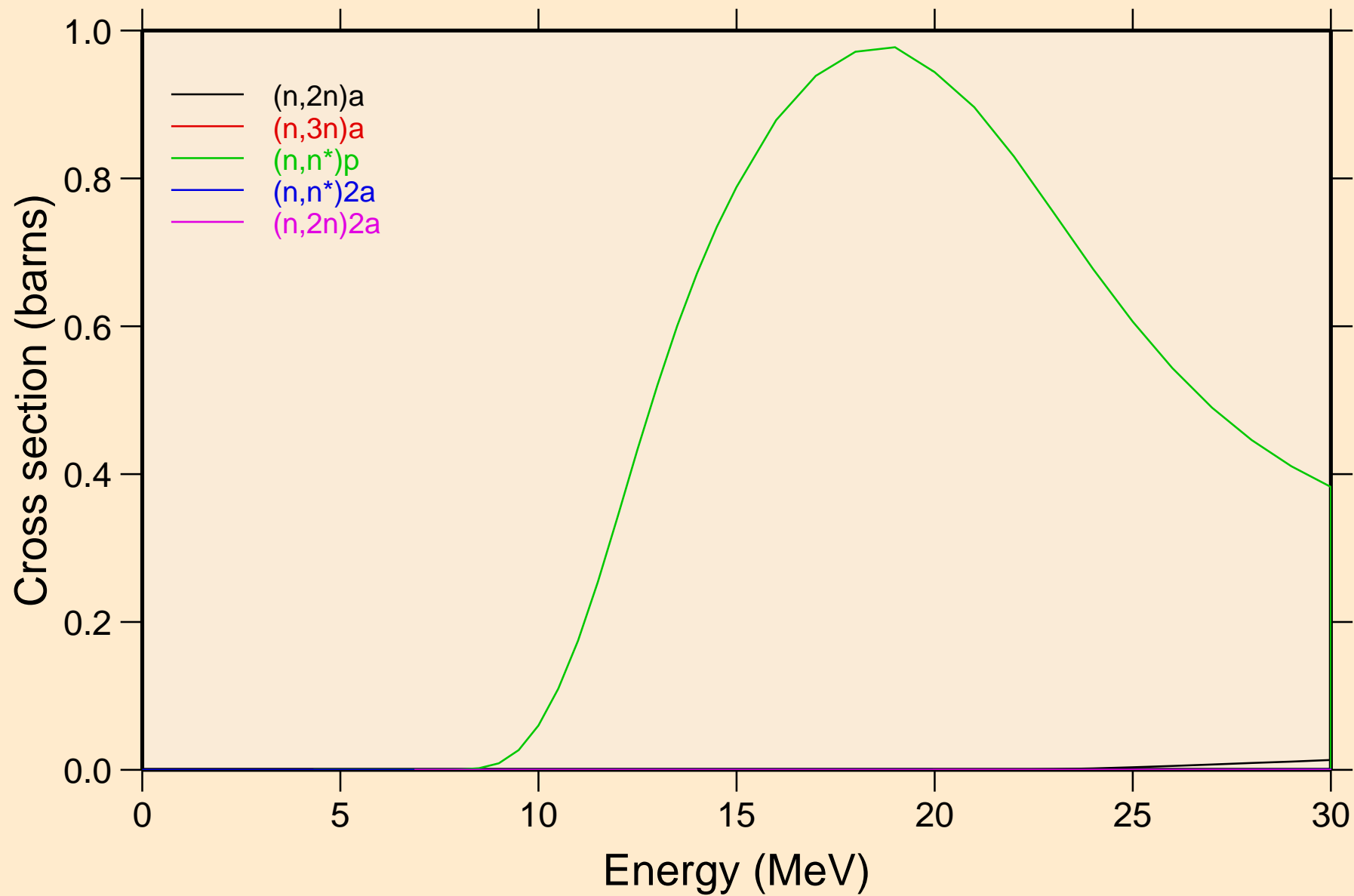



CE127M NEUTRON ACER TENDL-2021 LIBRARY; T=293.6K  
Threshold reactions

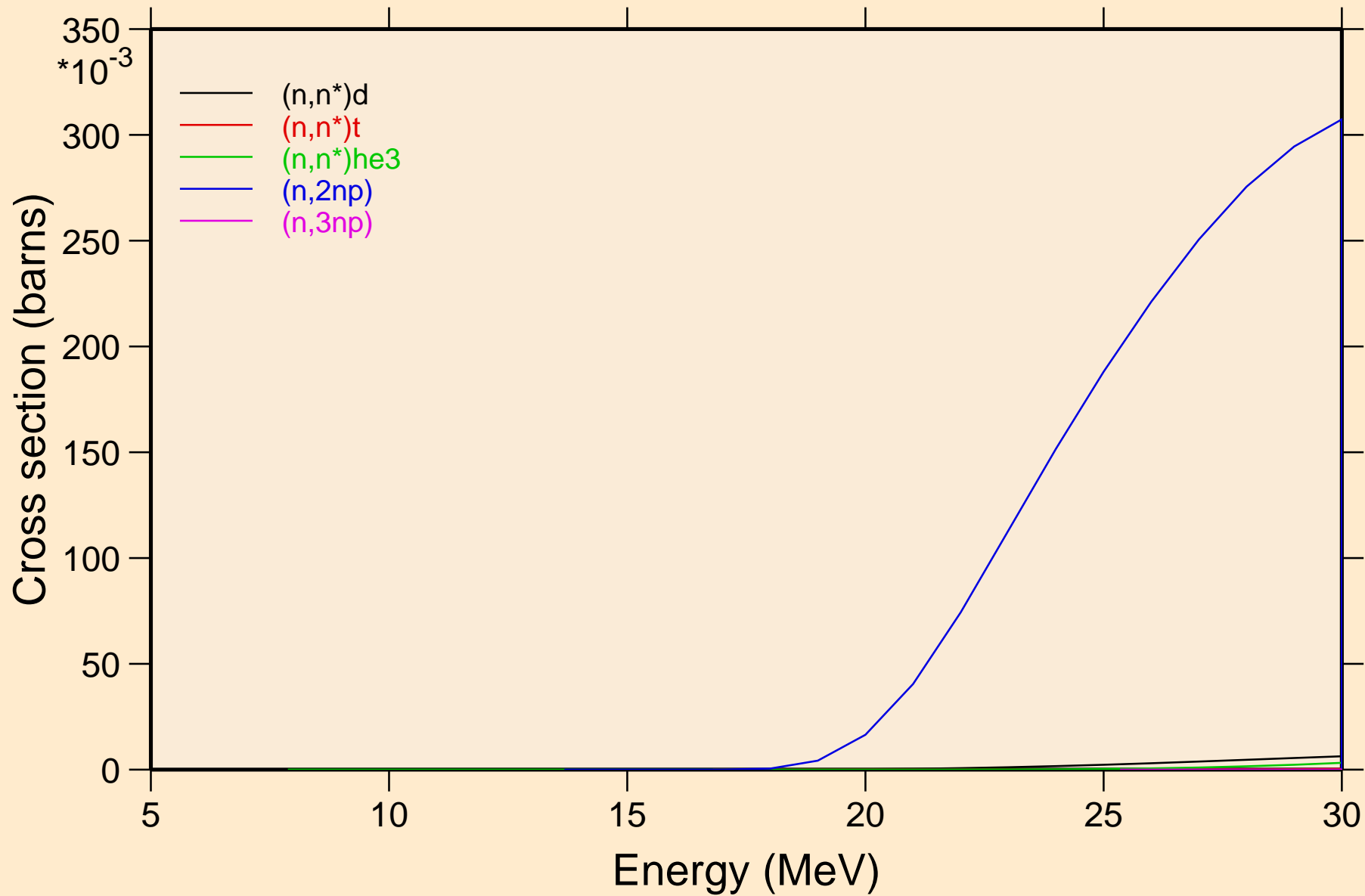

CE127M NEUTRON ACER TENDL-2021 LIBRARY; T=293.6K  
Threshold reactions

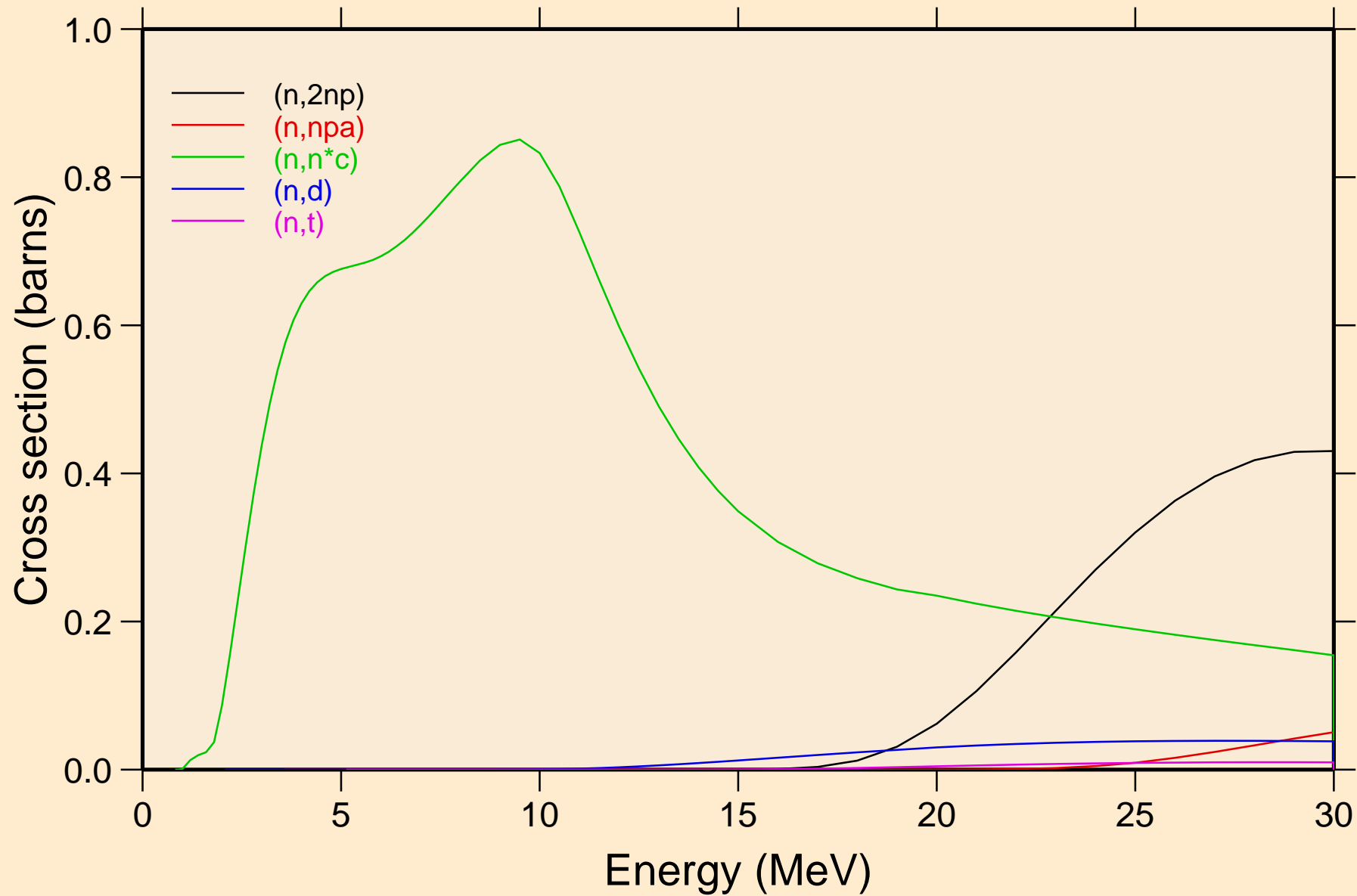

CE127M NEUTRON ACER TENDL-2021 LIBRARY; T=293.6K  
Threshold reactions

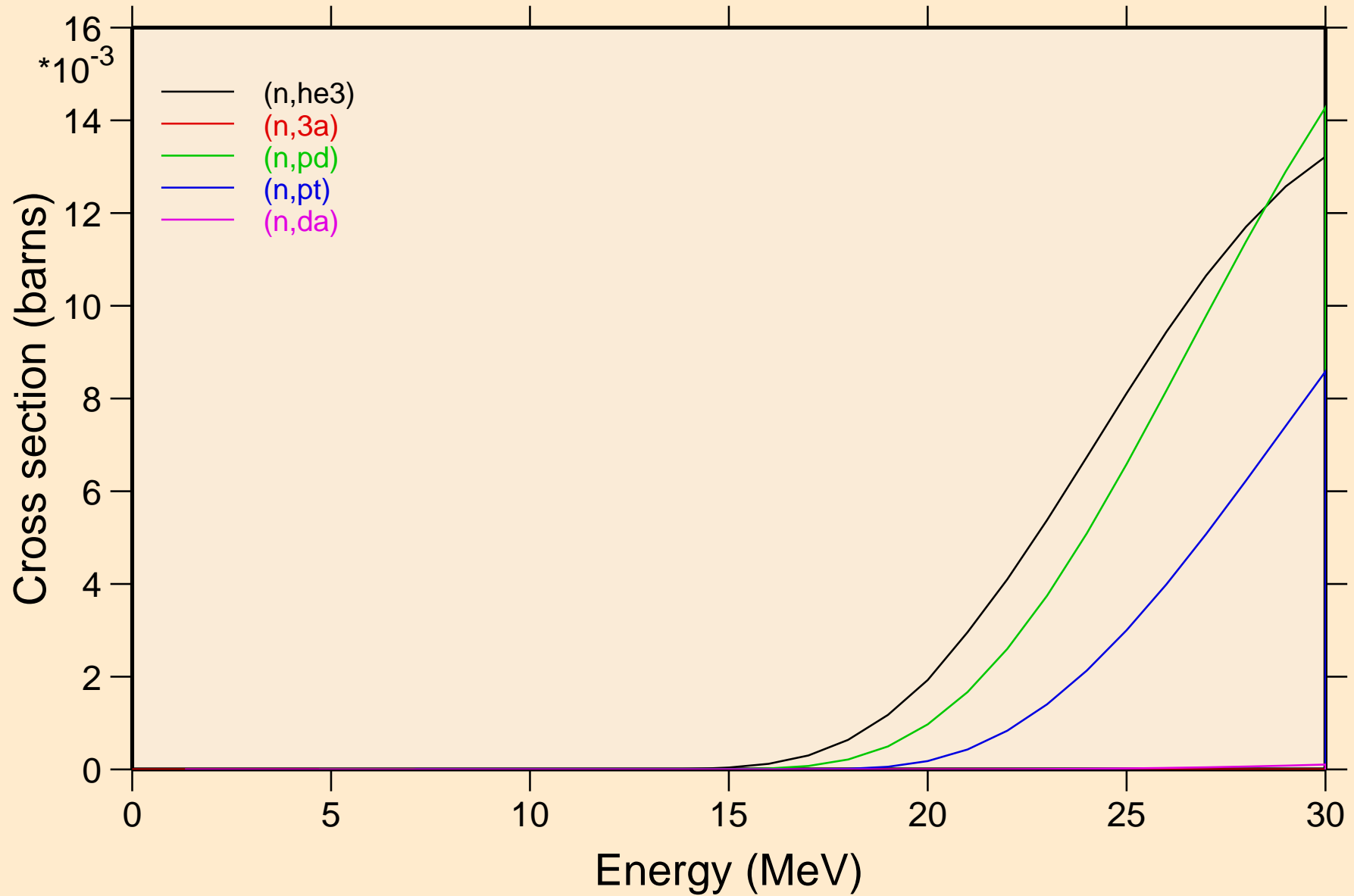

CE127M NEUTRON ACER TENDL-2021 LIBRARY; T=293.6K  
Threshold reactions

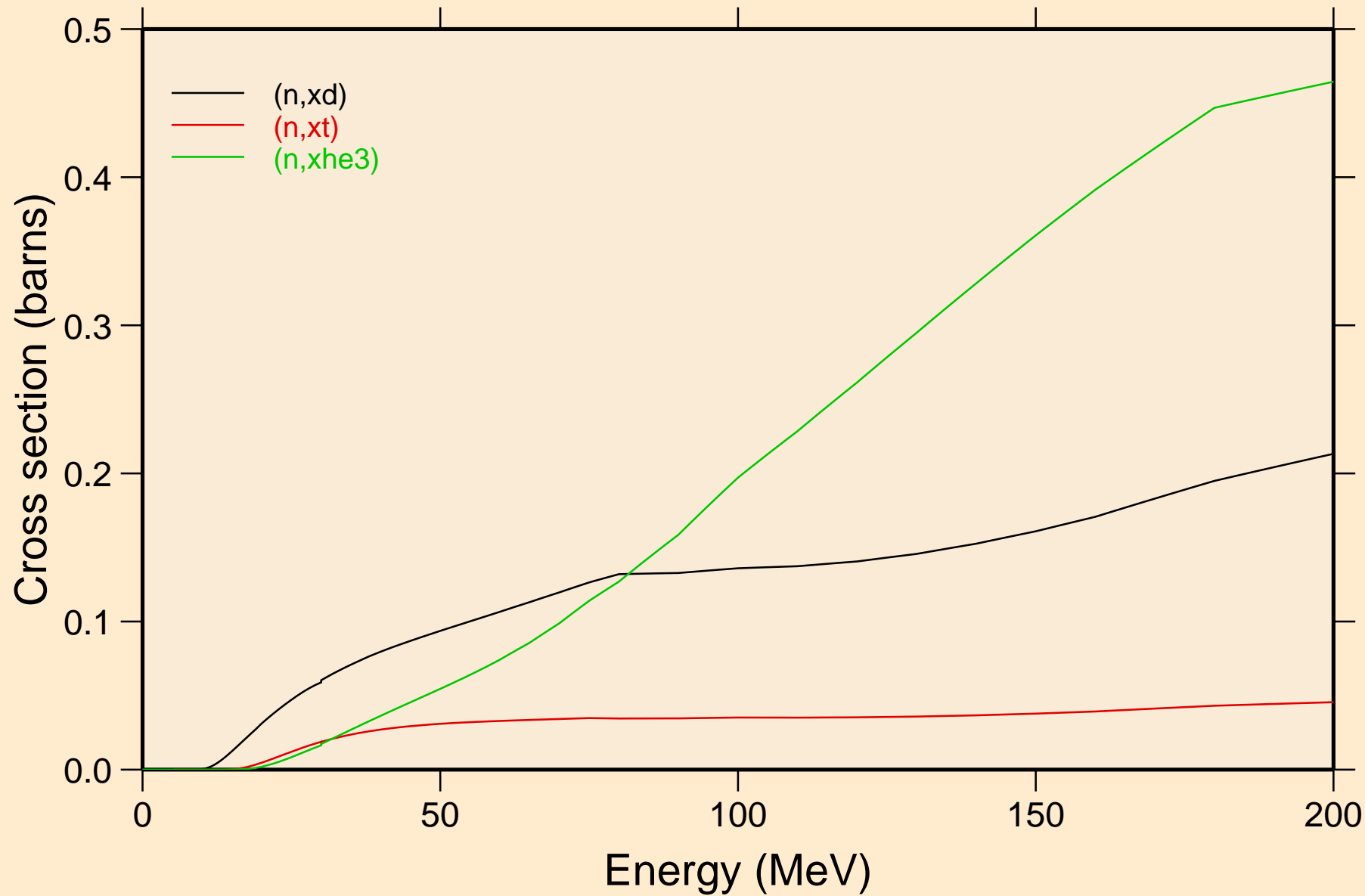

CE127M NEUTRON ACER TENDL-2021 LIBRARY; T=293.6K  
angular distribution for elastic

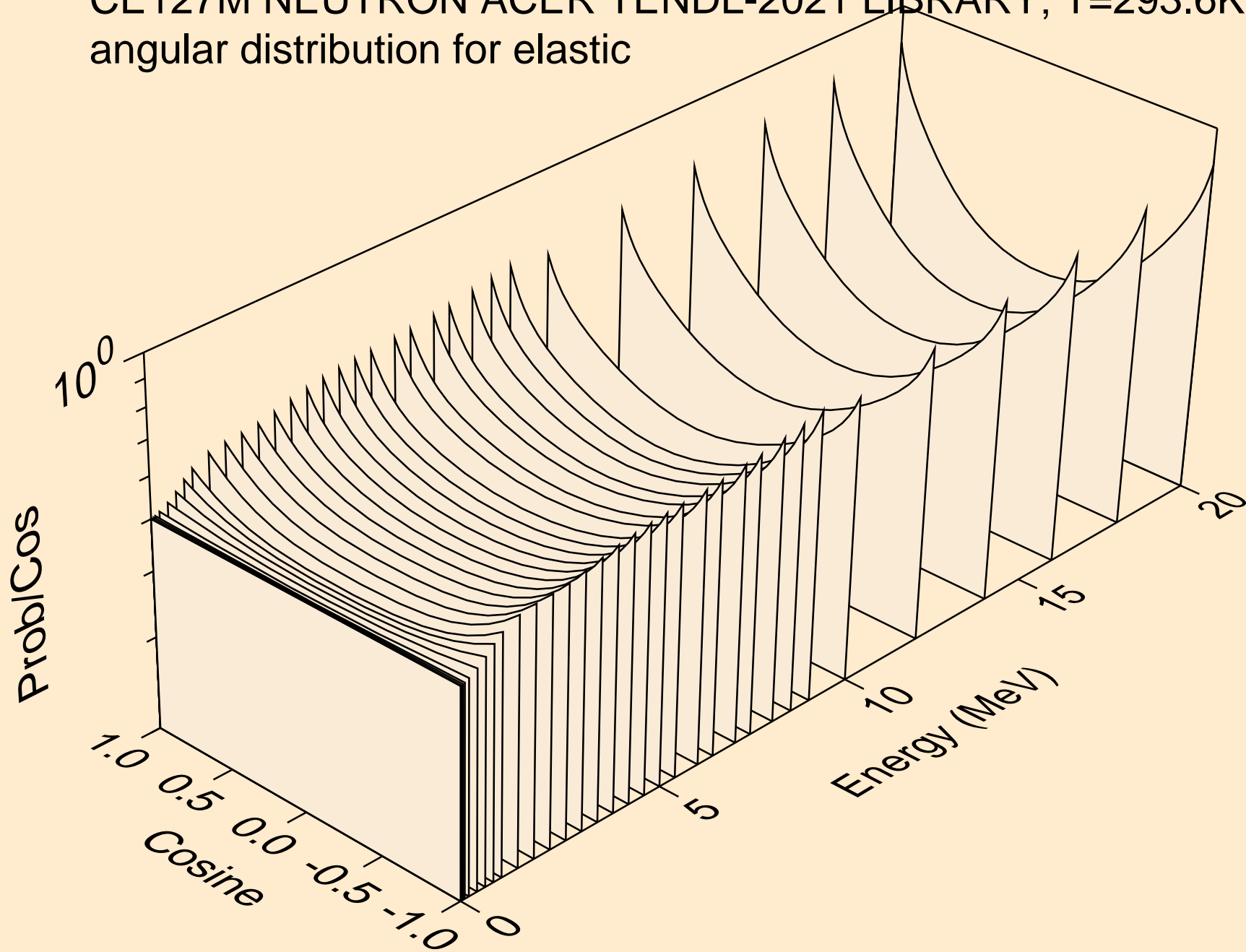

CE127M NEUTRON ACER TENDL-2021 LIBRARY; T=293.6K  
angular distribution for elastic

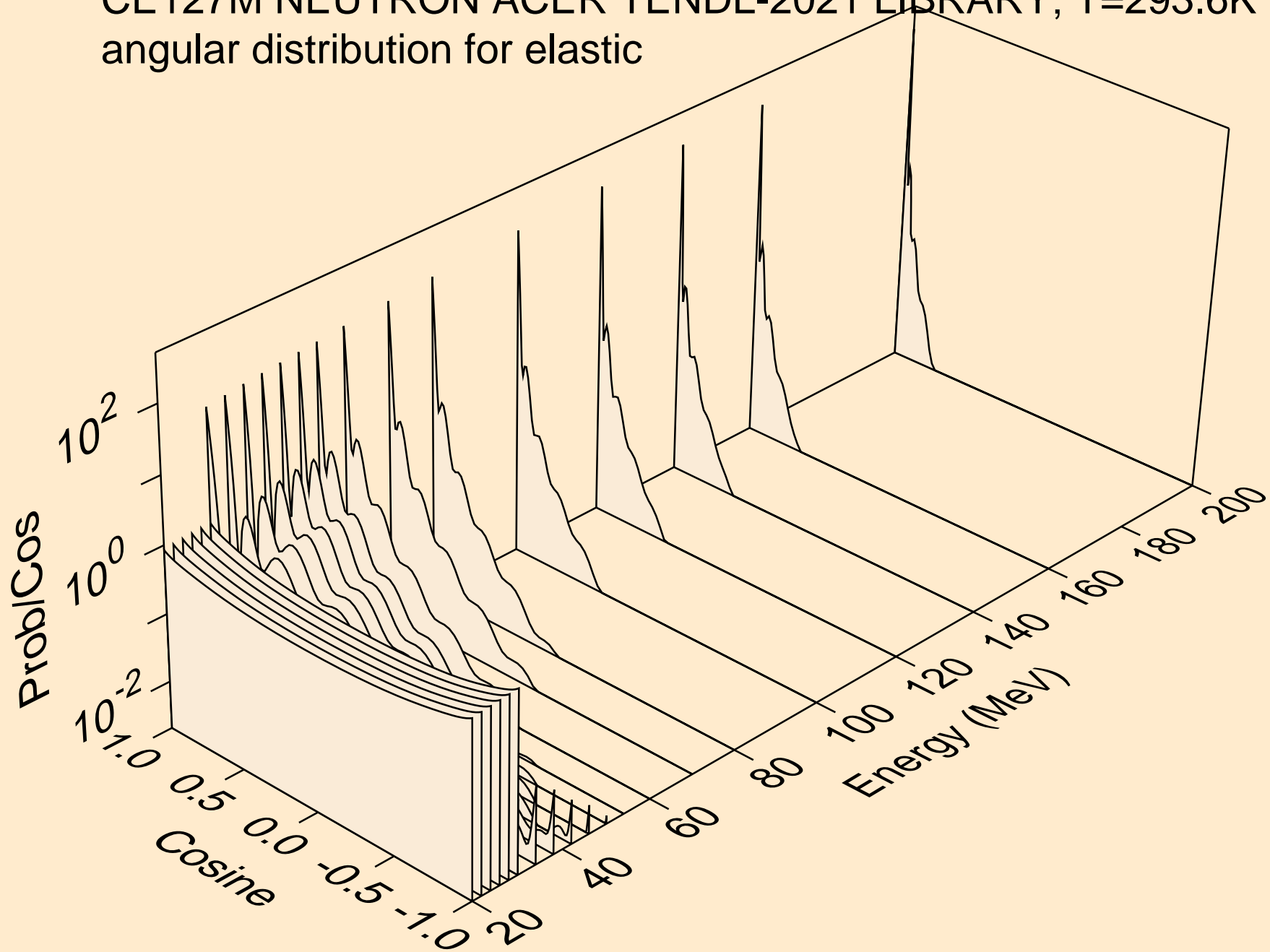

CE127M NEUTRON ACER TENDL-2021 LIBRARY; T=293.6K  
angular distribution for (n,n\*1)

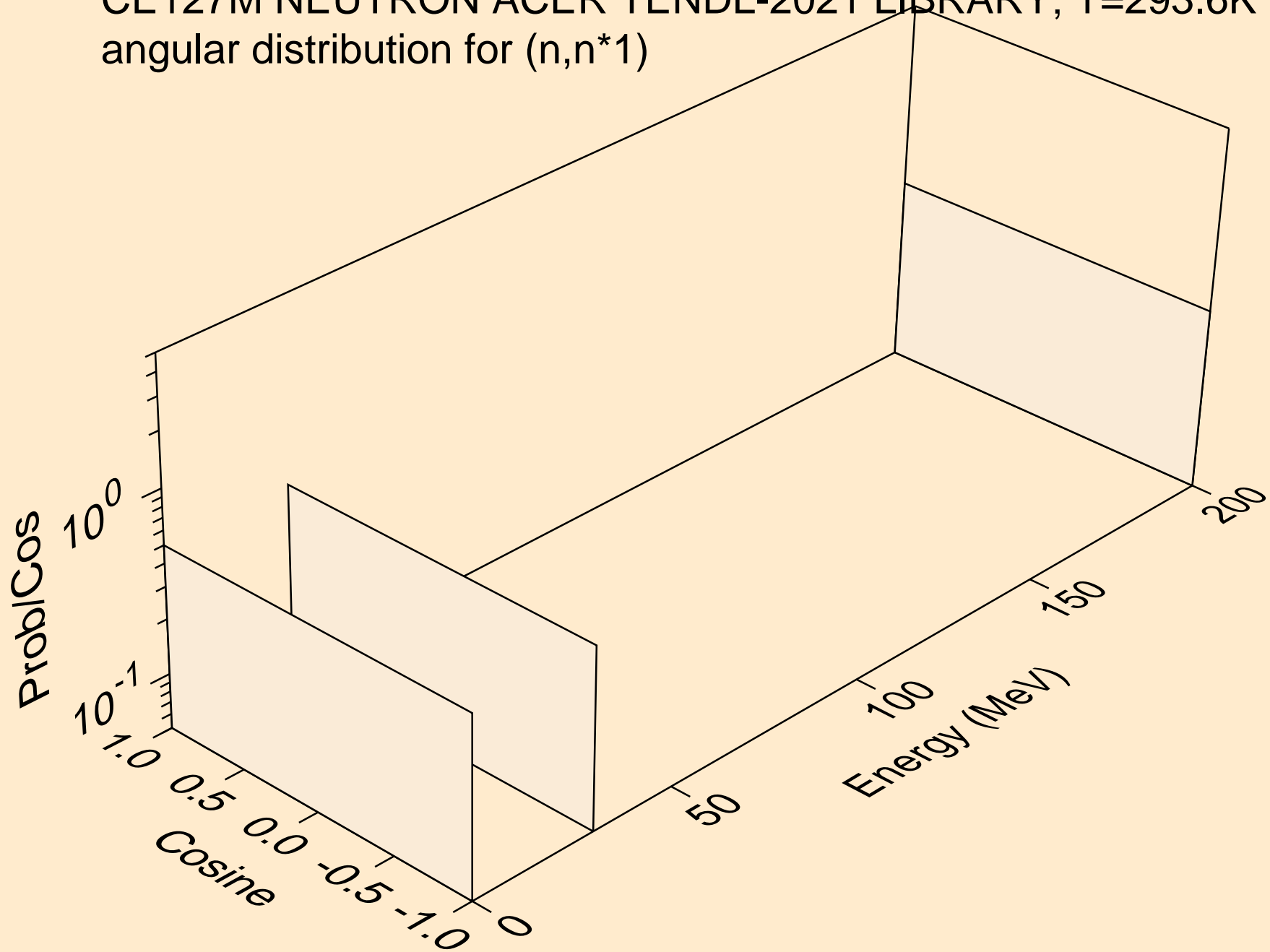

CE127M NEUTRON ACER TENDL-2021 LIBRARY; T=293.6K  
angular distribution for (n,n\*2)

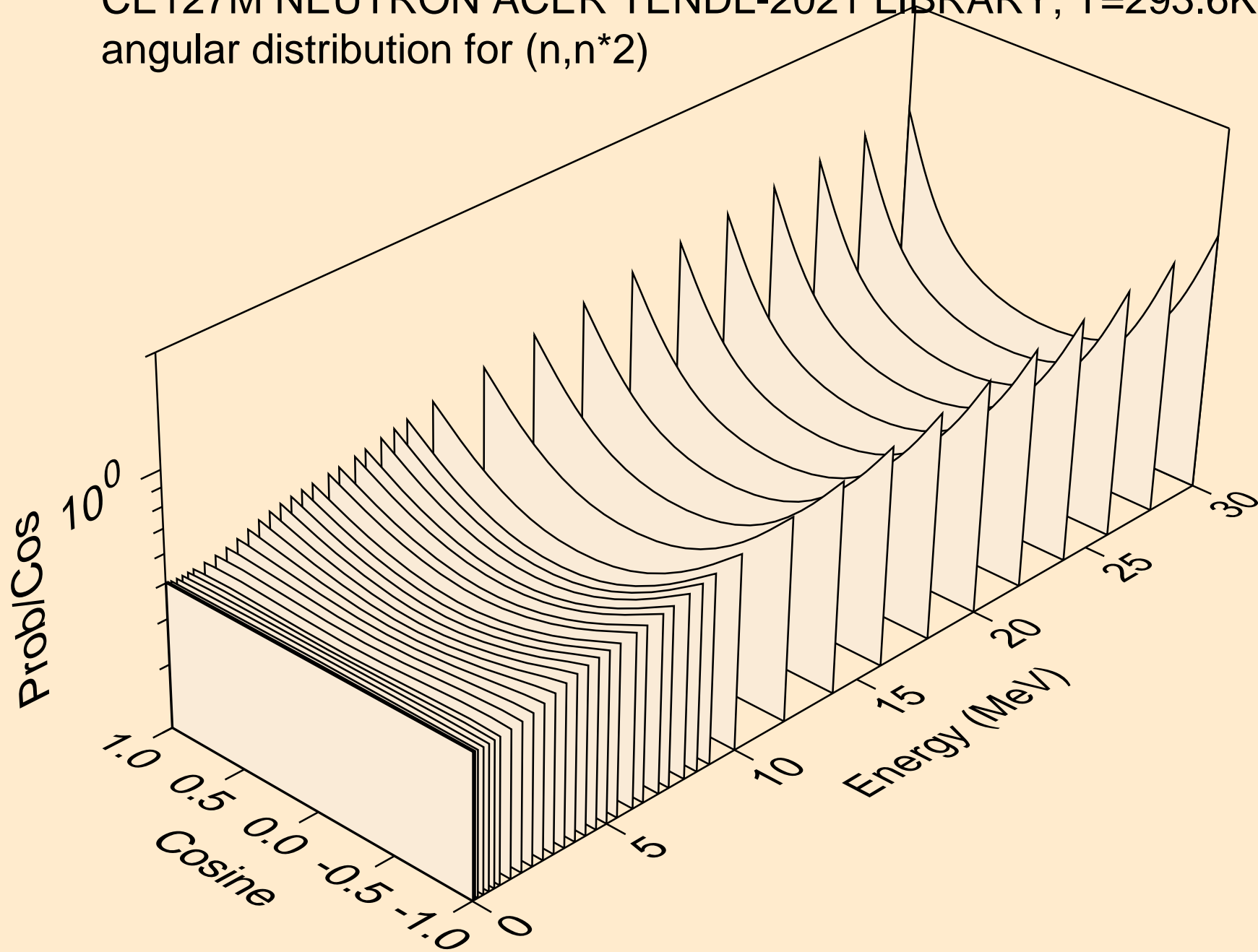



CE127M NEUTRON ACER TENDL-2021 LIBRARY; T=293.6K  
angular distribution for (n,n\*3)

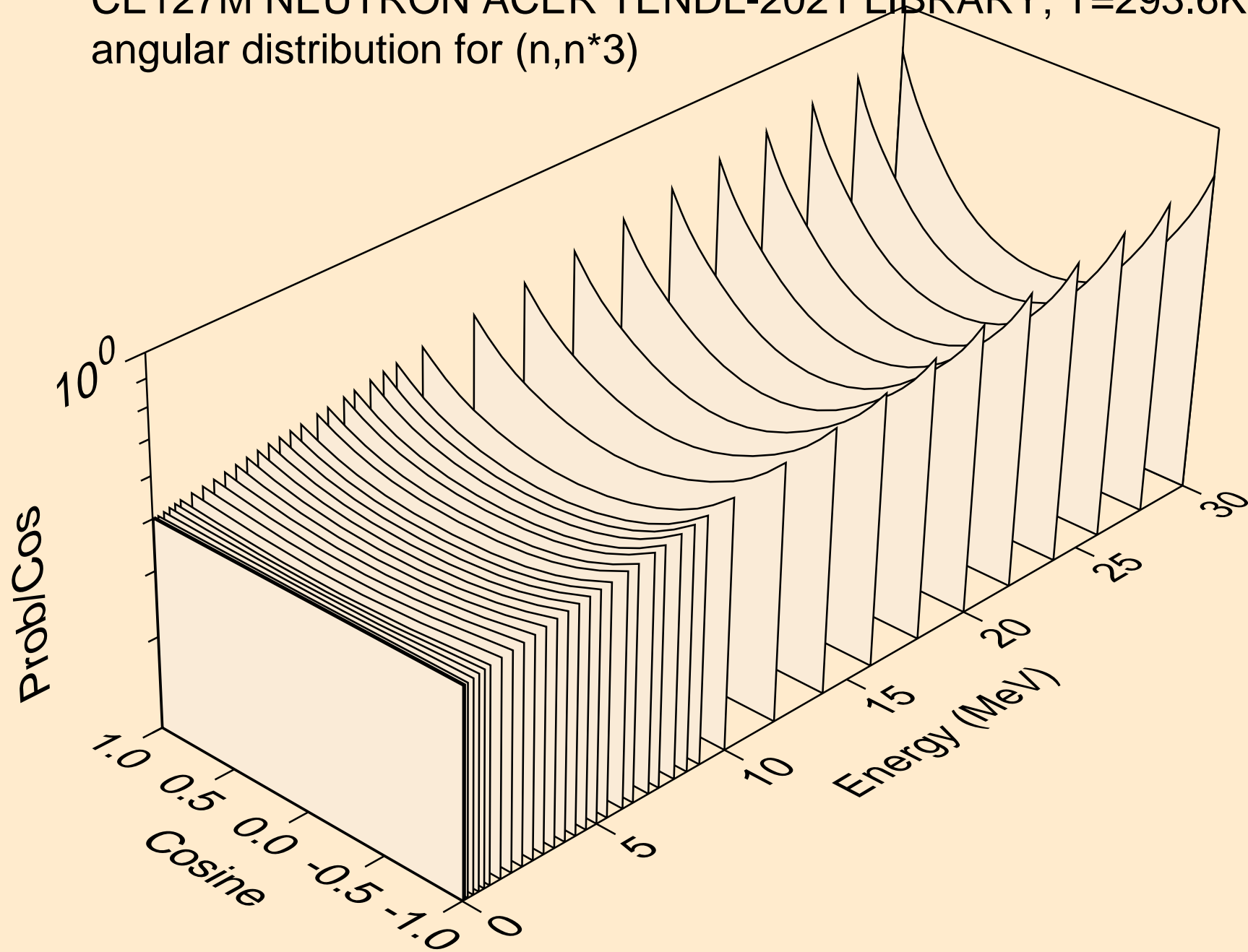

CE127M NEUTRON ACER TENDL-2021 LIBRARY; T=293.6K  
angular distribution for (n,n\*4)

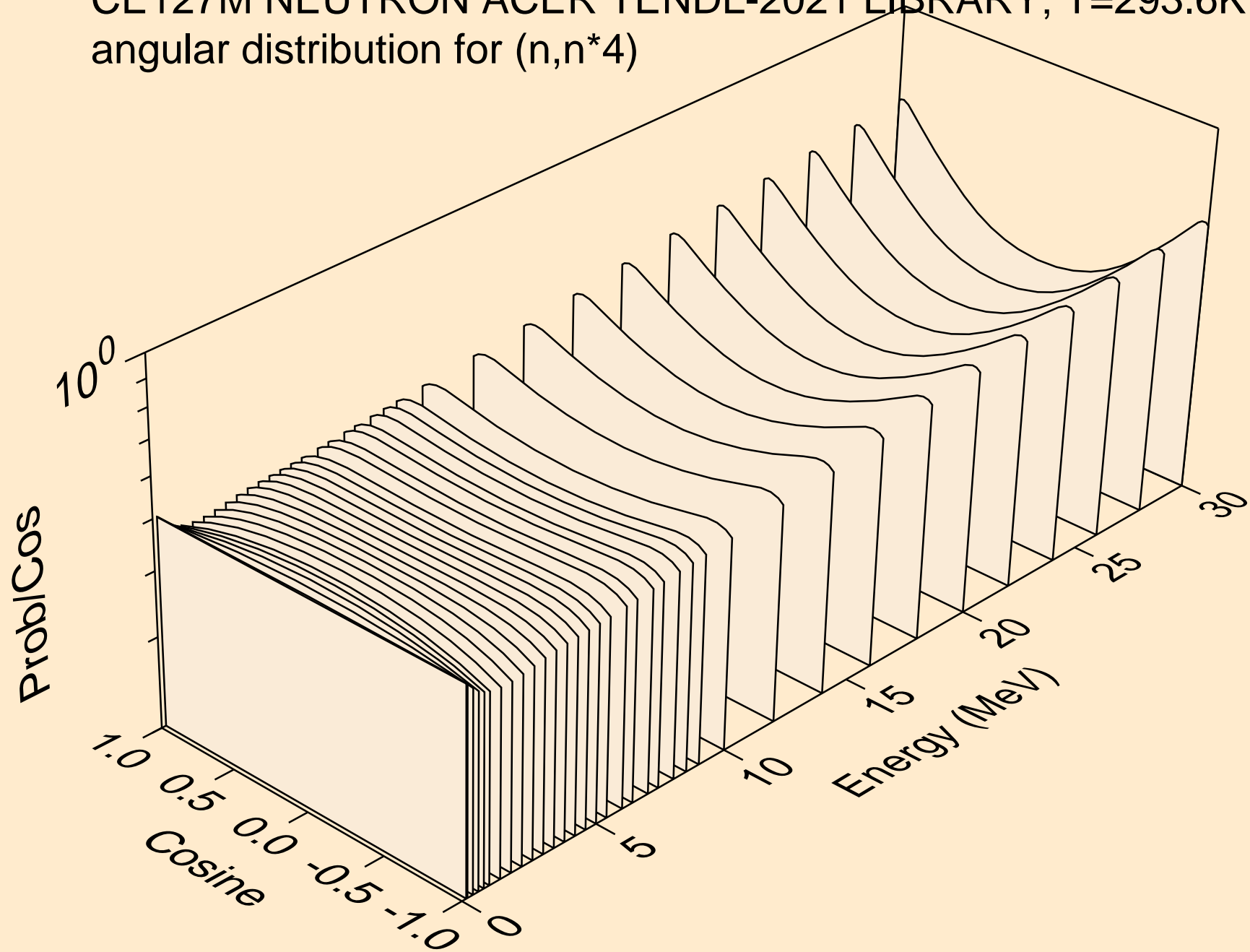

CE127M NEUTRON ACER TENDL-2021 LIBRARY; T=293.6K  
angular distribution for (n,n\*5)

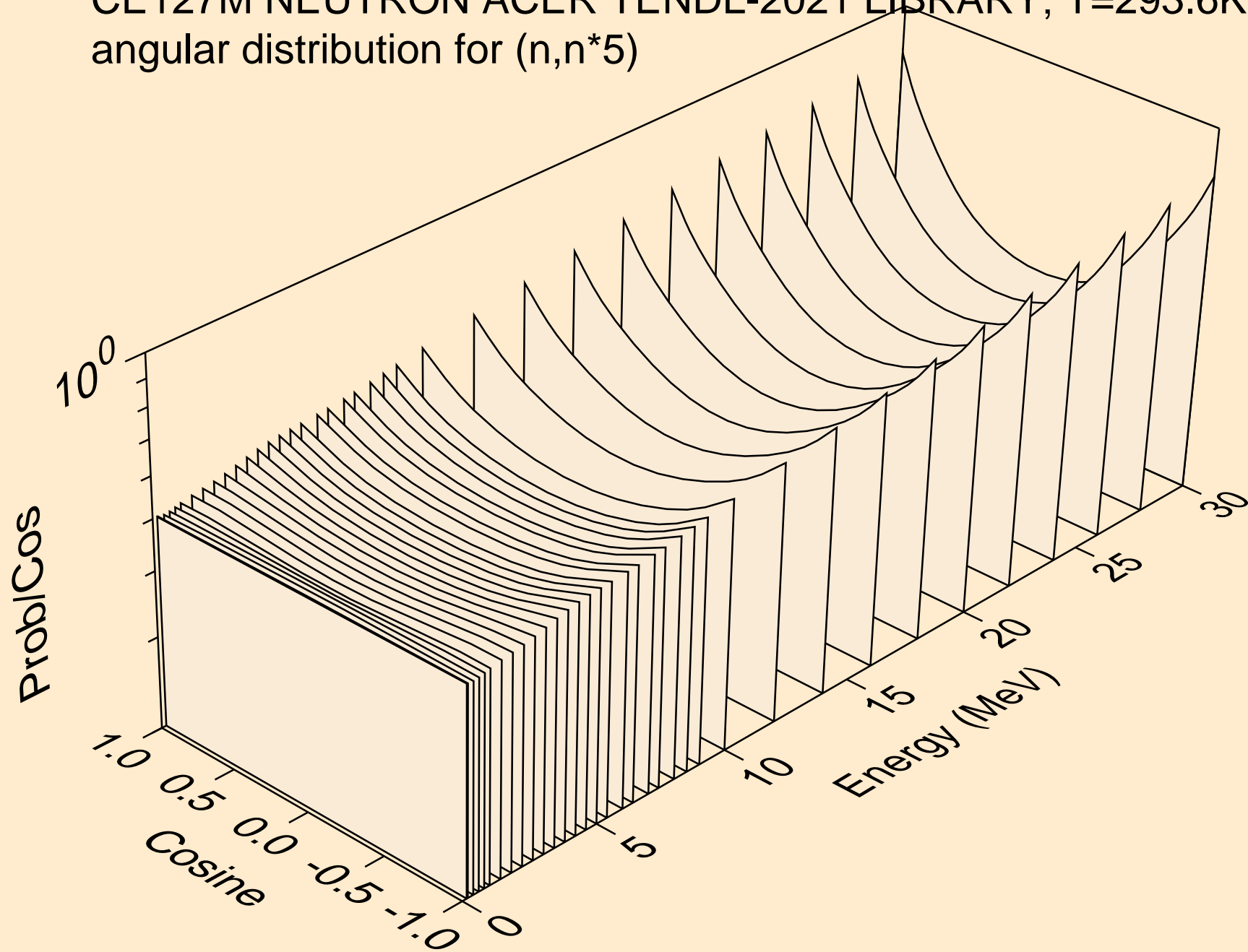

CE127M NEUTRON ACER TENDL-2021 LIBRARY; T=293.6K  
angular distribution for (n,n\*6)

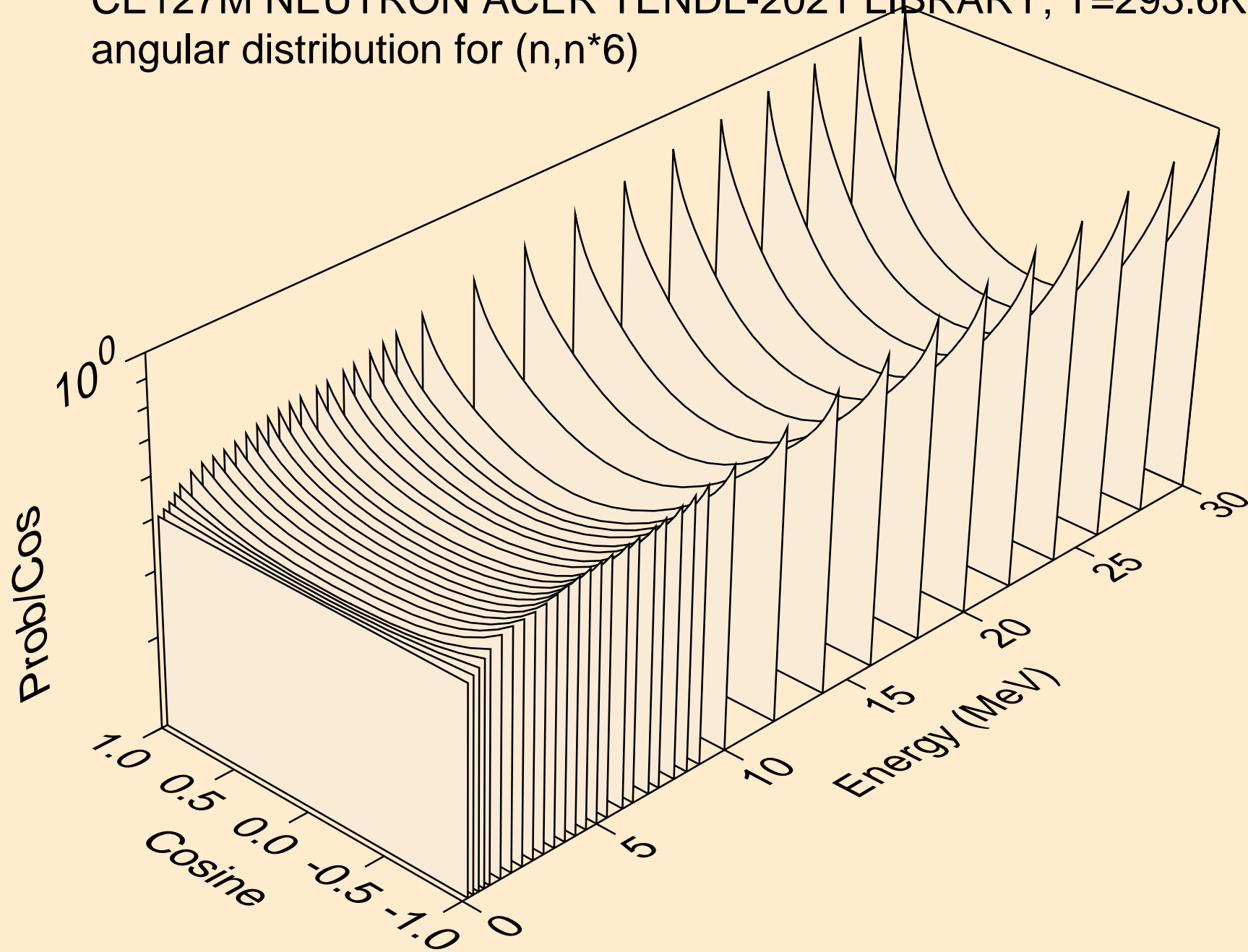

CE127M NEUTRON ACER TENDL-2021 LIBRARY; T=293.6K  
angular distribution for (n,n\*7)

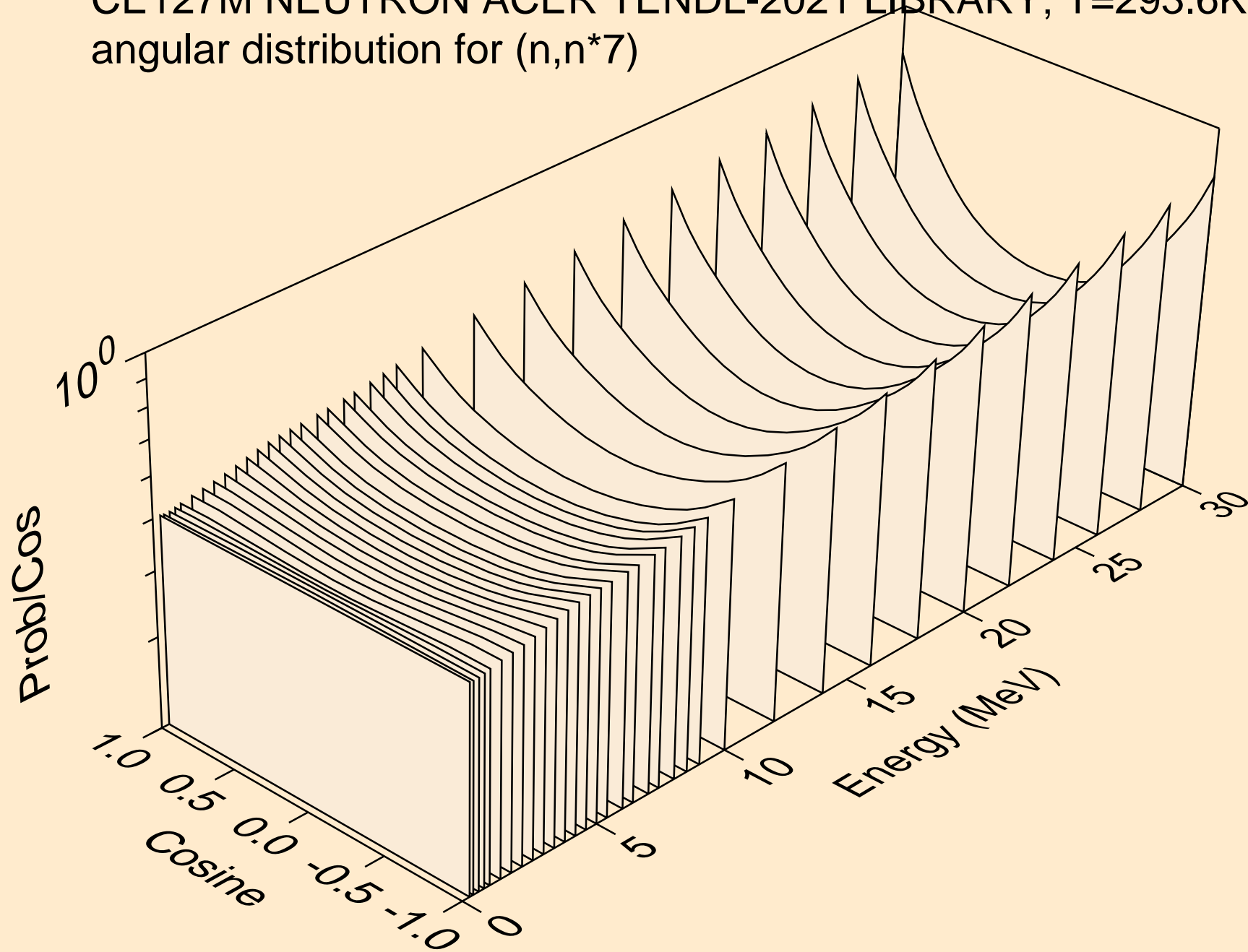

CE127M NEUTRON ACER TENDL-2021 LIBRARY; T=293.6K  
angular distribution for (n,n\*8)

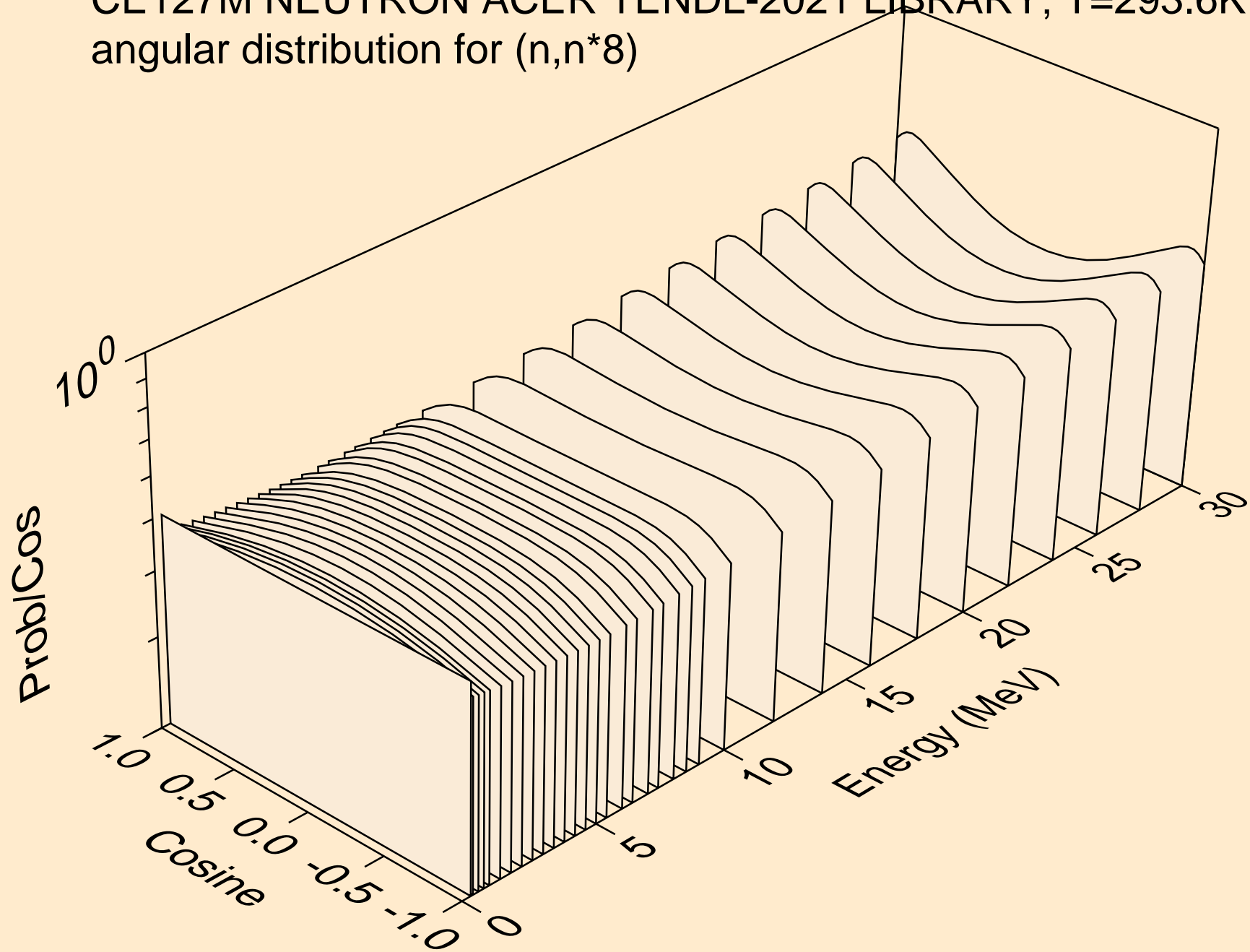

CE127M NEUTRON ACER TENDL-2021 LIBRARY; T=293.6K  
angular distribution for (n,n\*9)

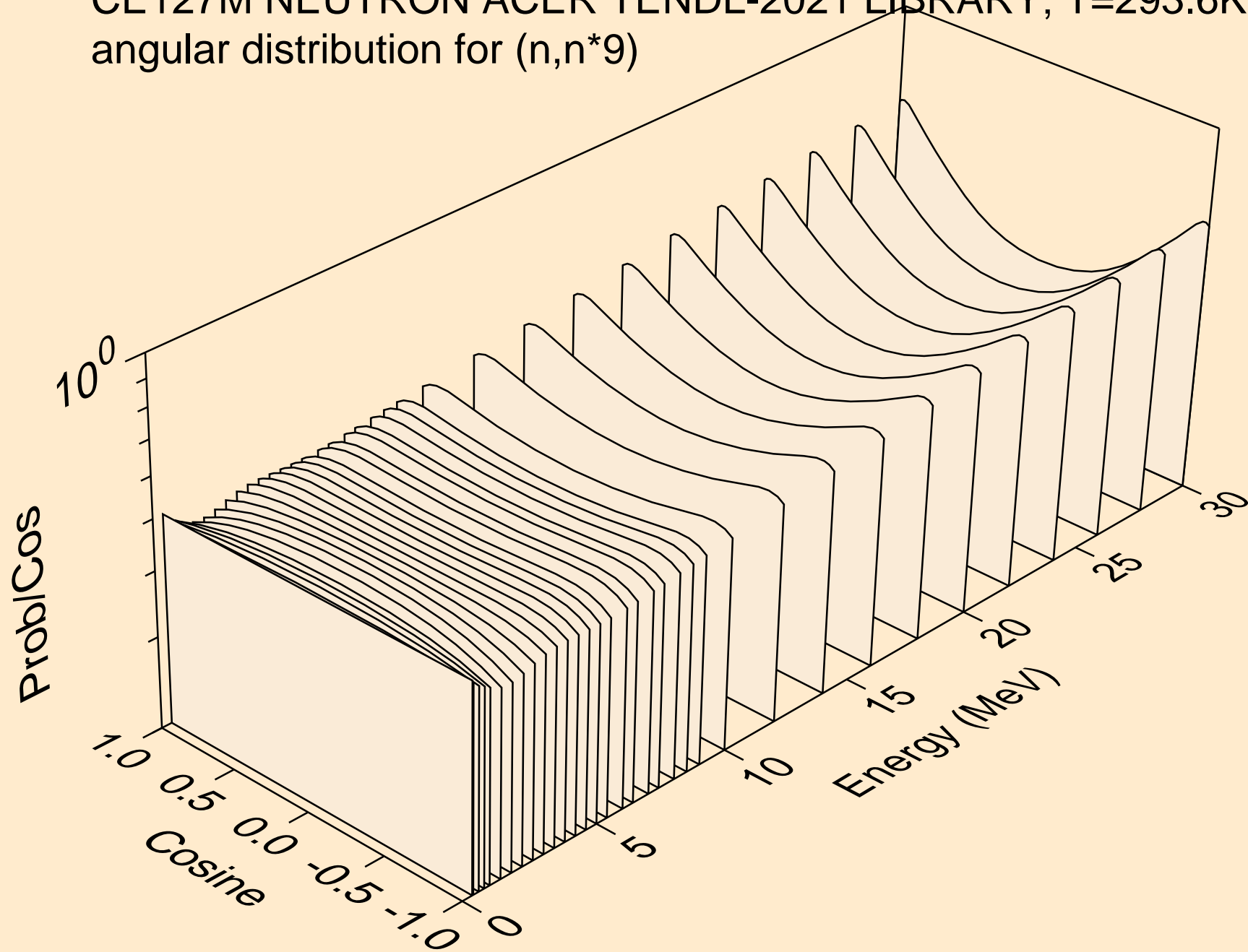

CE127M NEUTRON ACER TENDL-2021 LIBRARY; T=293.6K  
angular distribution for (n,n\*10)

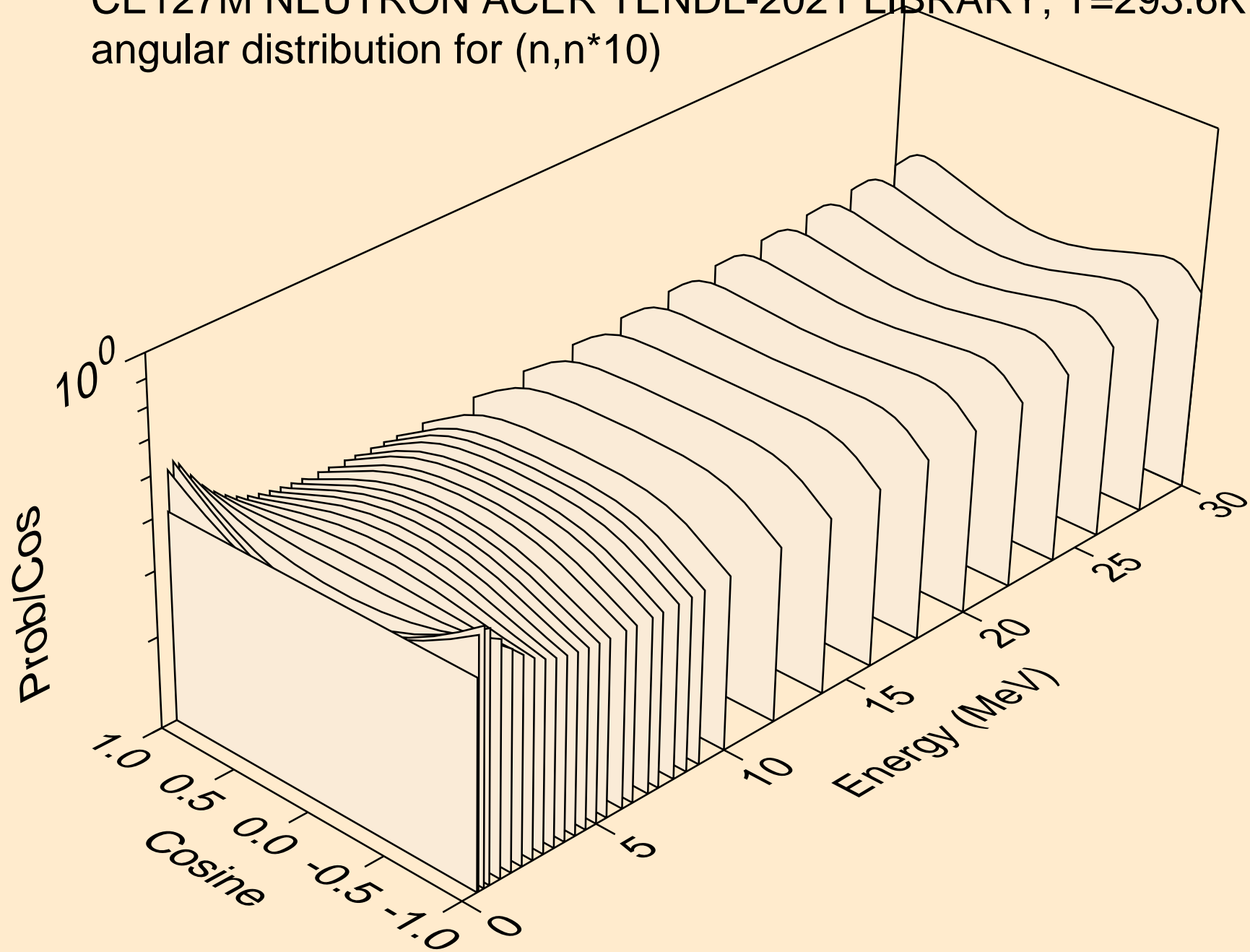



CE127M NEUTRON ACER TENDL-2021 LIBRARY; T=293.6K  
angular distribution for (n,n\*11)

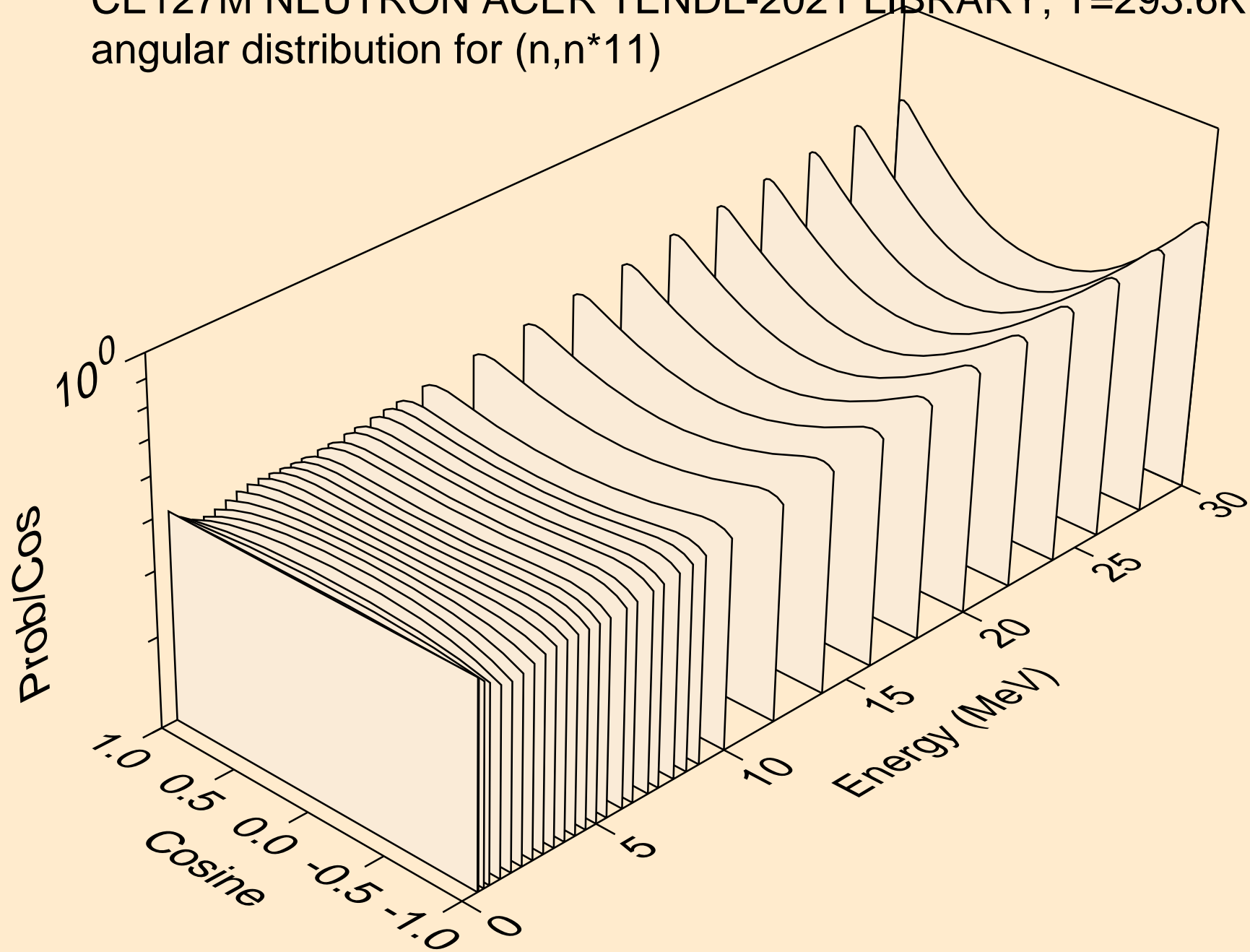

CE127M NEUTRON ACER TENDL-2021 LIBRARY; T=293.6K  
angular distribution for (n,n\*12)

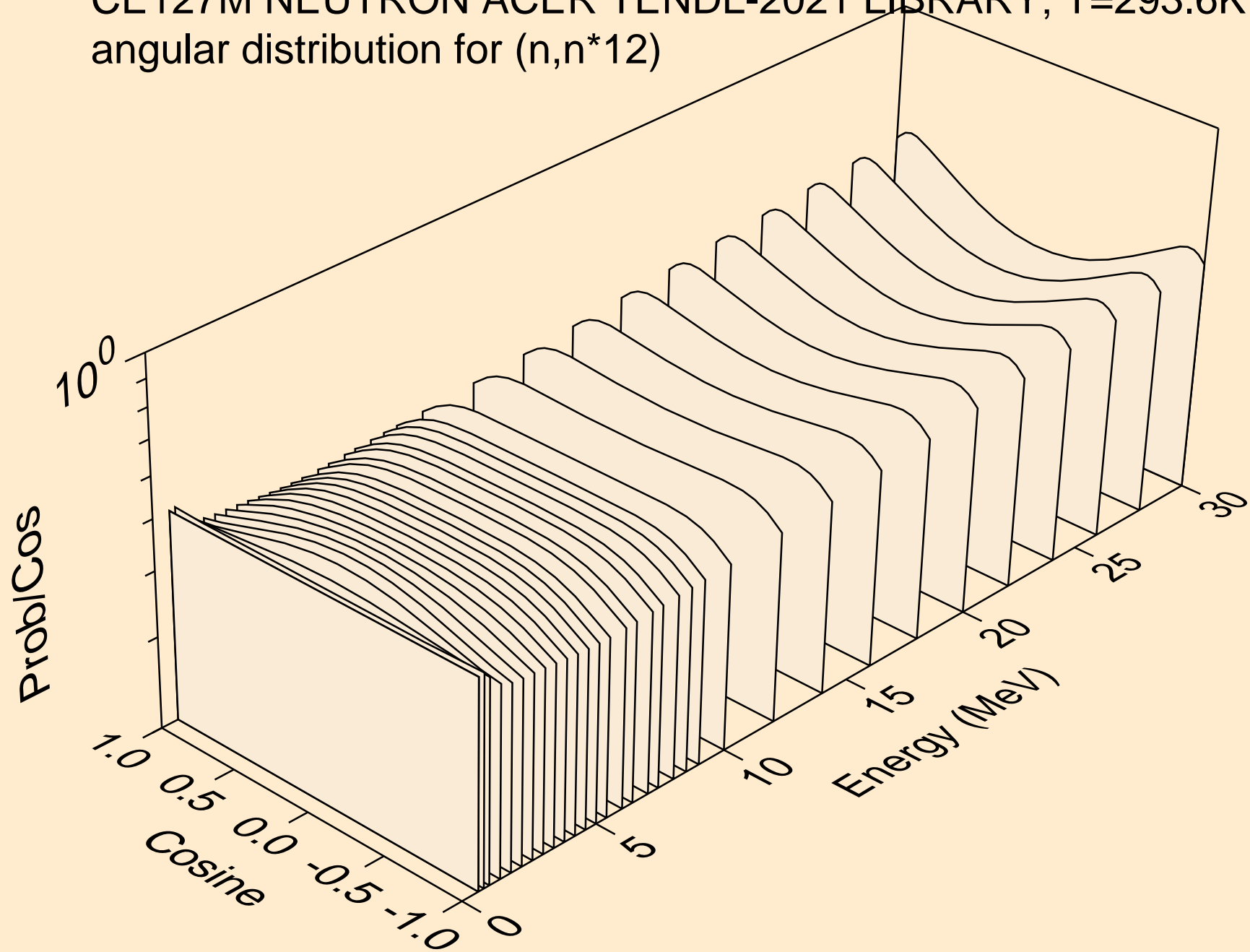

CE127M NEUTRON ACER TENDL-2021 LIBRARY; T=293.6K  
angular distribution for (n,n\*13)

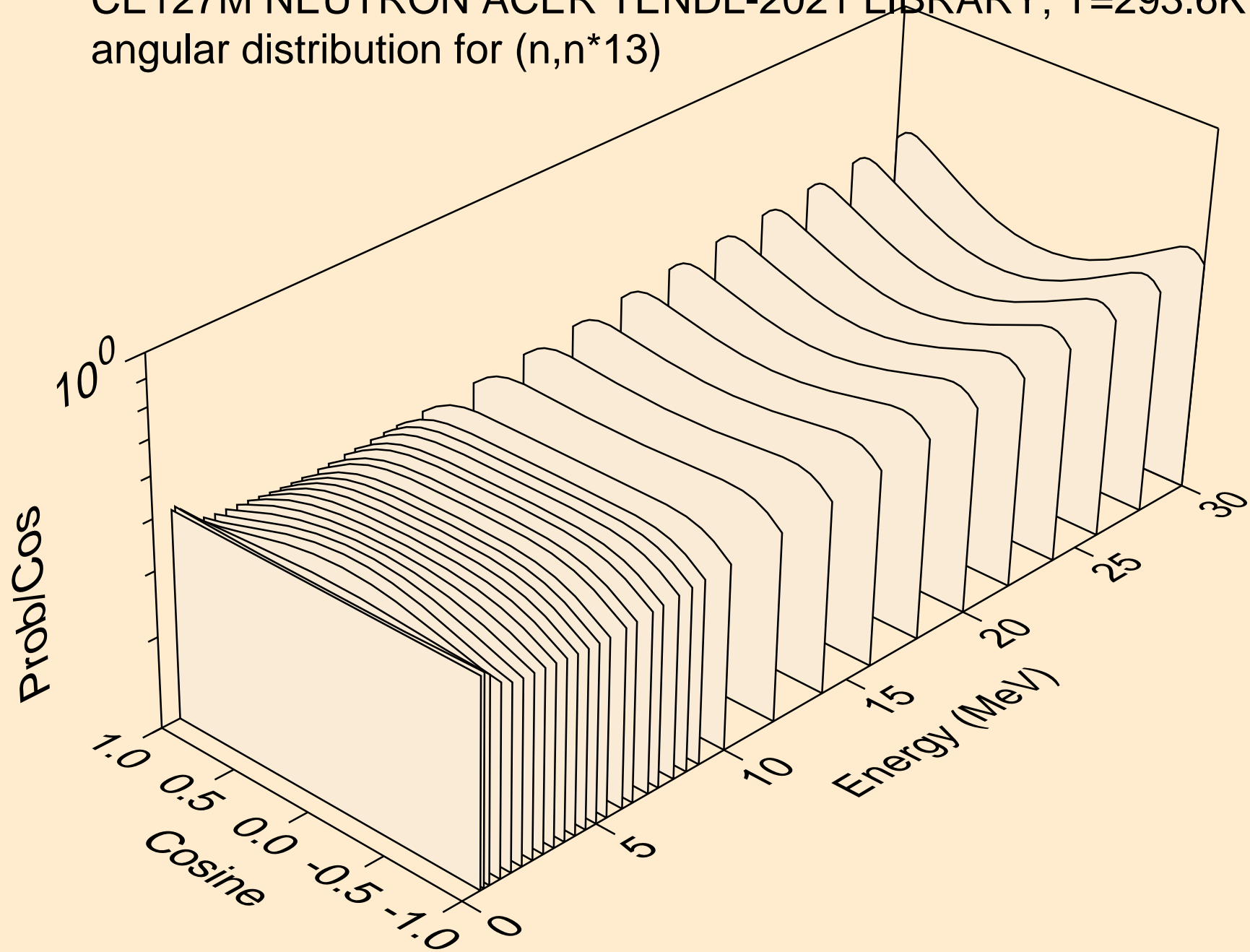

CE127M NEUTRON ACER TENDL-2021 LIBRARY; T=293.6K  
angular distribution for (n,n\*14)

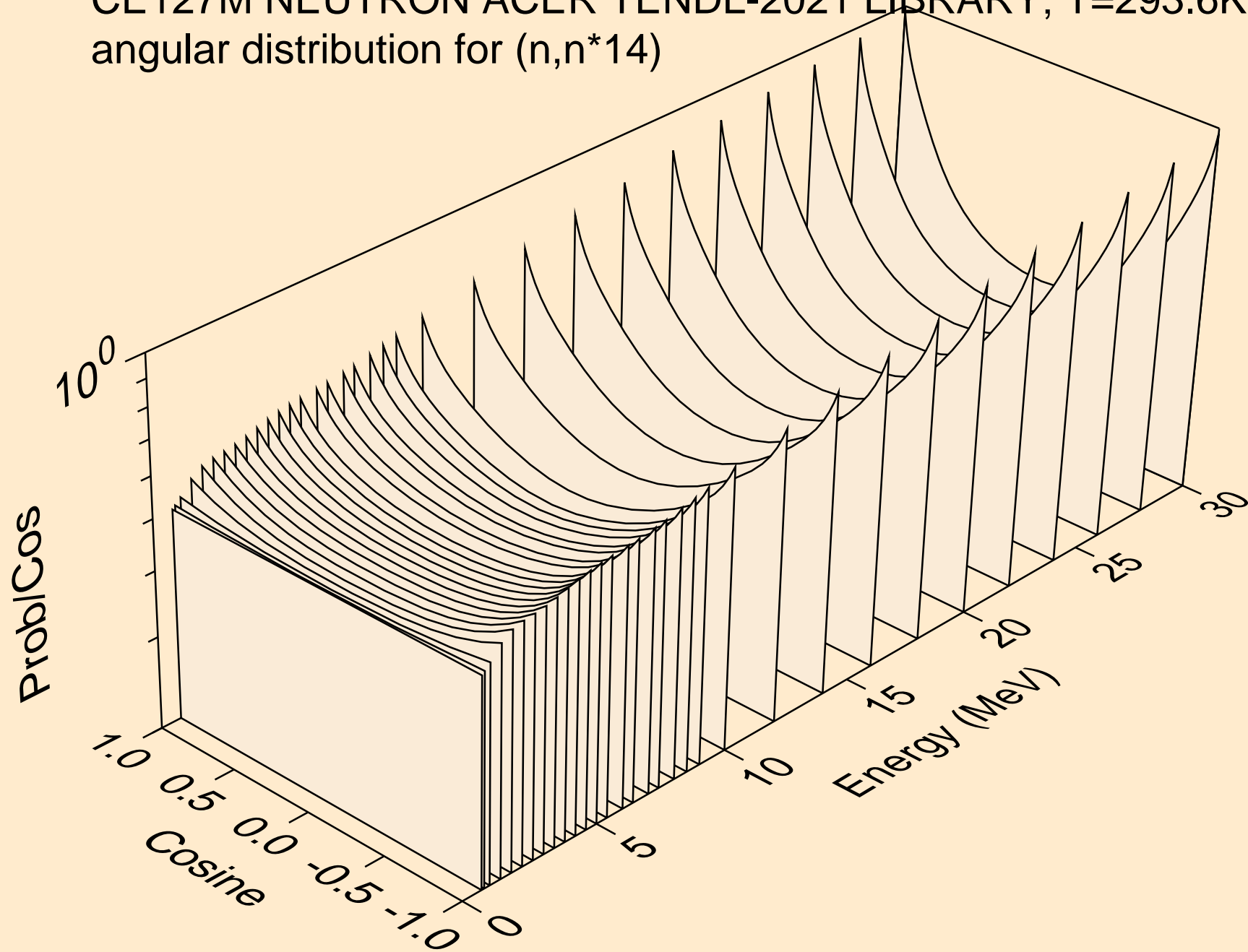

CE127M NEUTRON ACER TENDL-2021 LIBRARY; T=293.6K  
angular distribution for (n,n\*15)

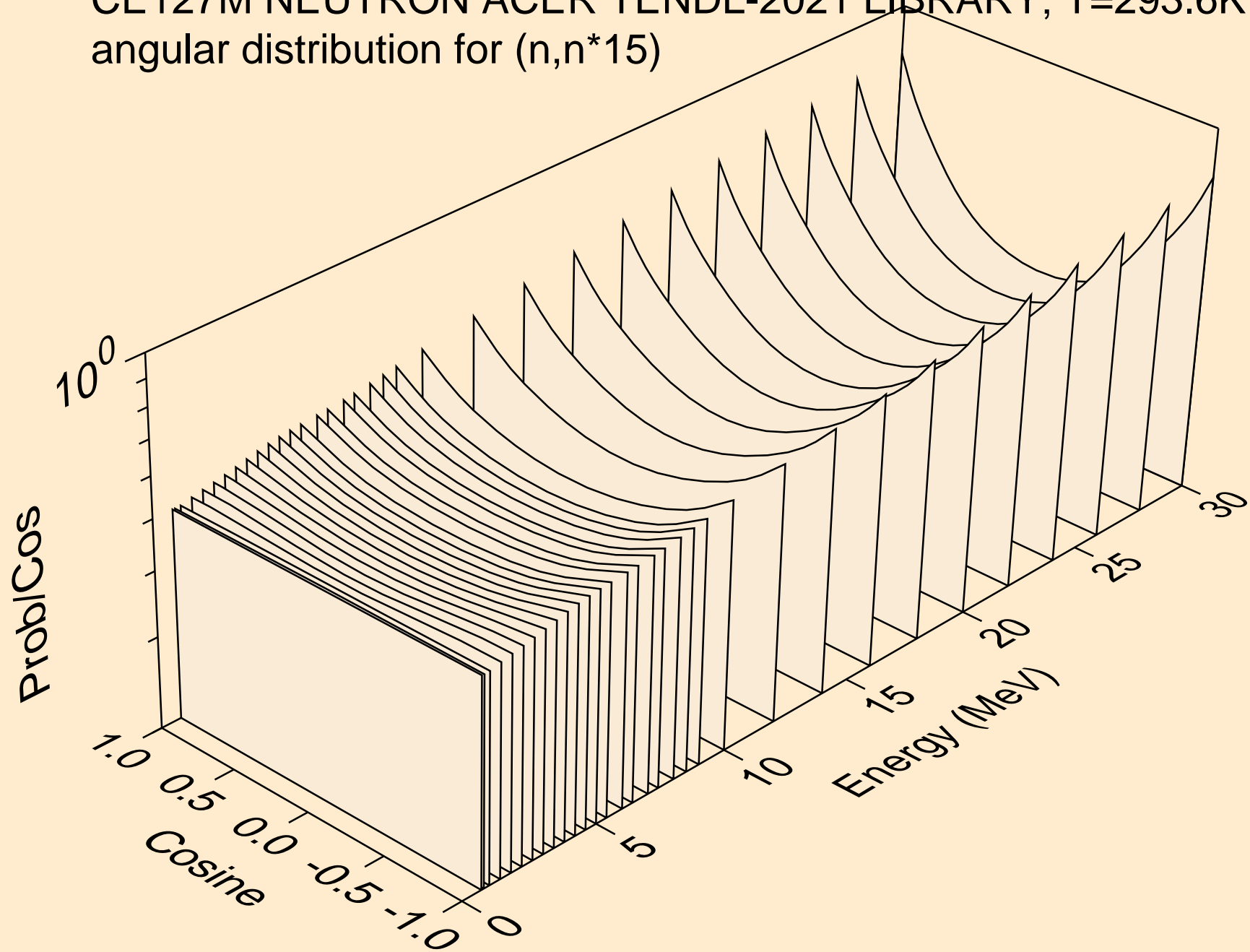

CE127M NEUTRON ACER TENDL-2021 LIBRARY; T=293.6K  
angular distribution for (n,n\*16)

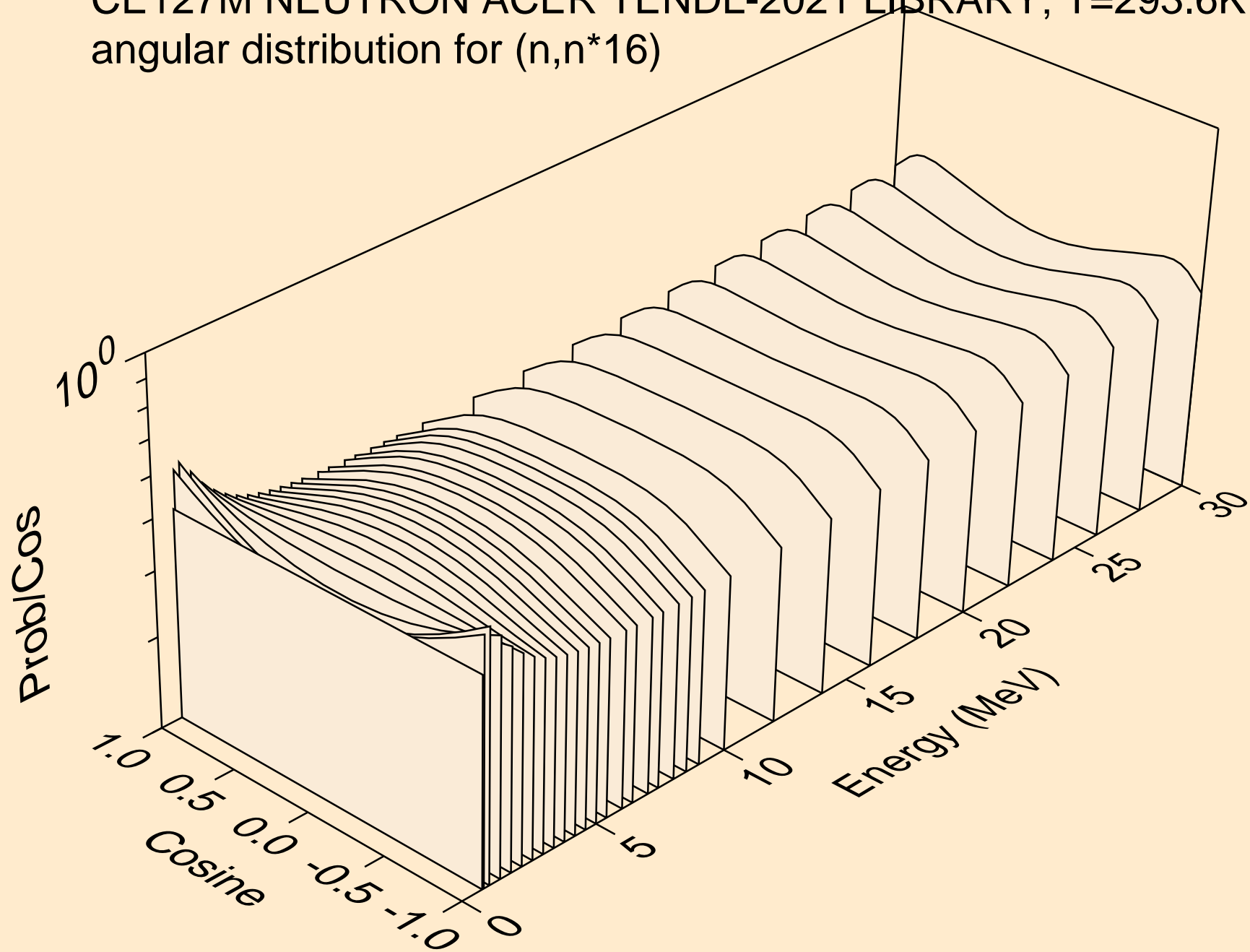

CE127M NEUTRON ACER TENDL-2021 LIBRARY; T=293.6K  
angular distribution for (n,n\*17)

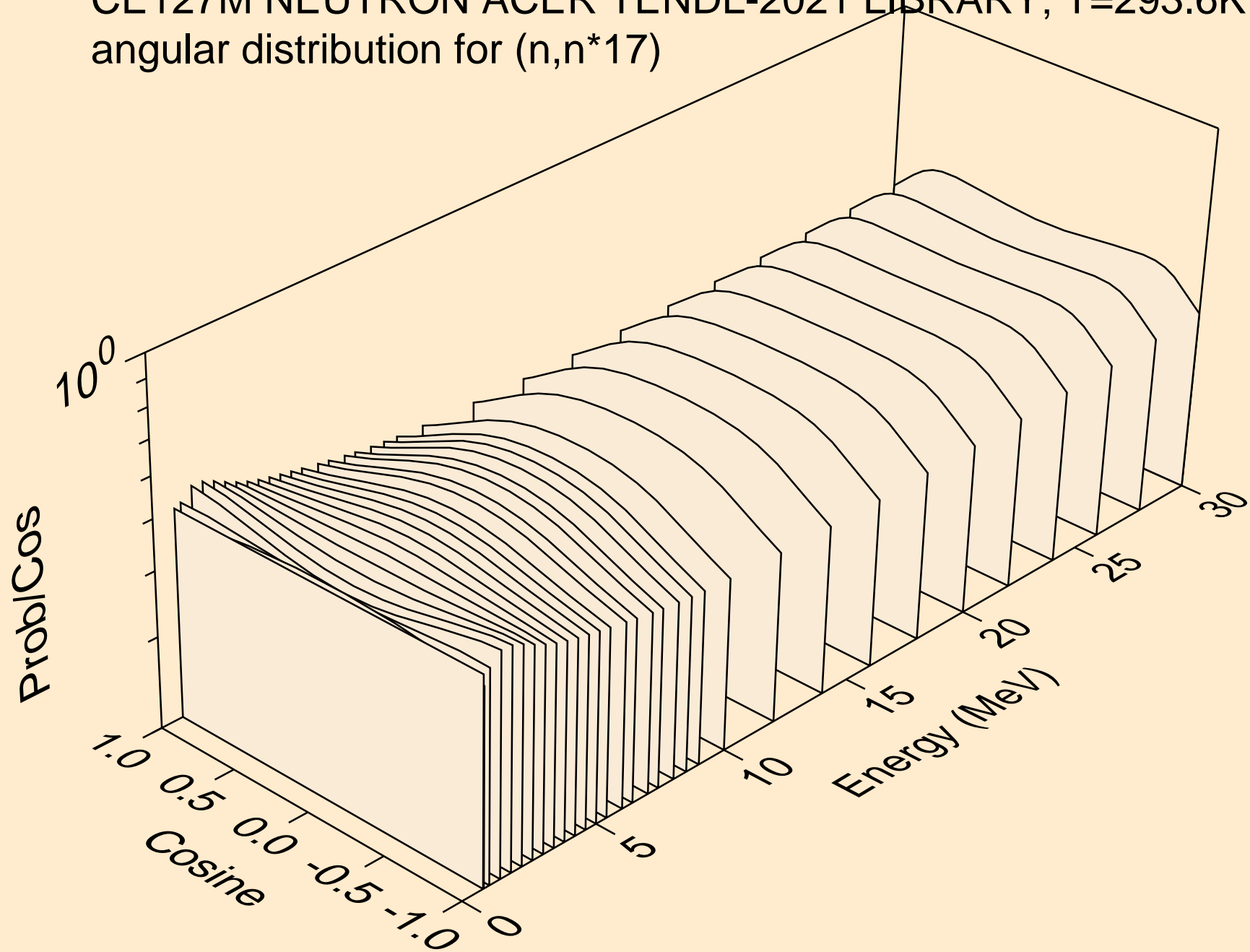

CE127M NEUTRON ACER TENDL-2021 LIBRARY; T=293.6K  
angular distribution for (n,n\*18)

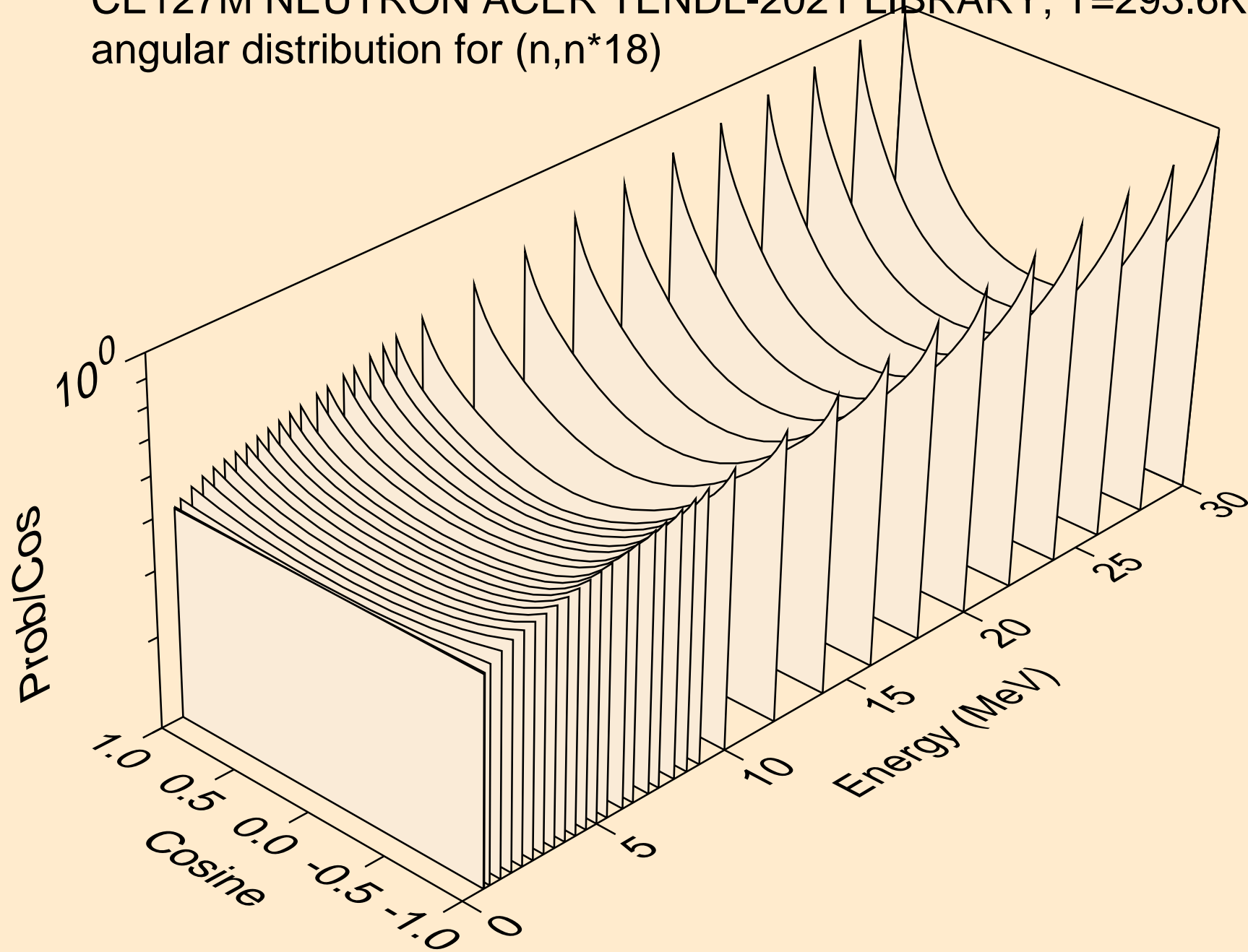



CE127M NEUTRON ACER TENDL-2021 LIBRARY; T=293.6K  
angular distribution for (n,n\*19)

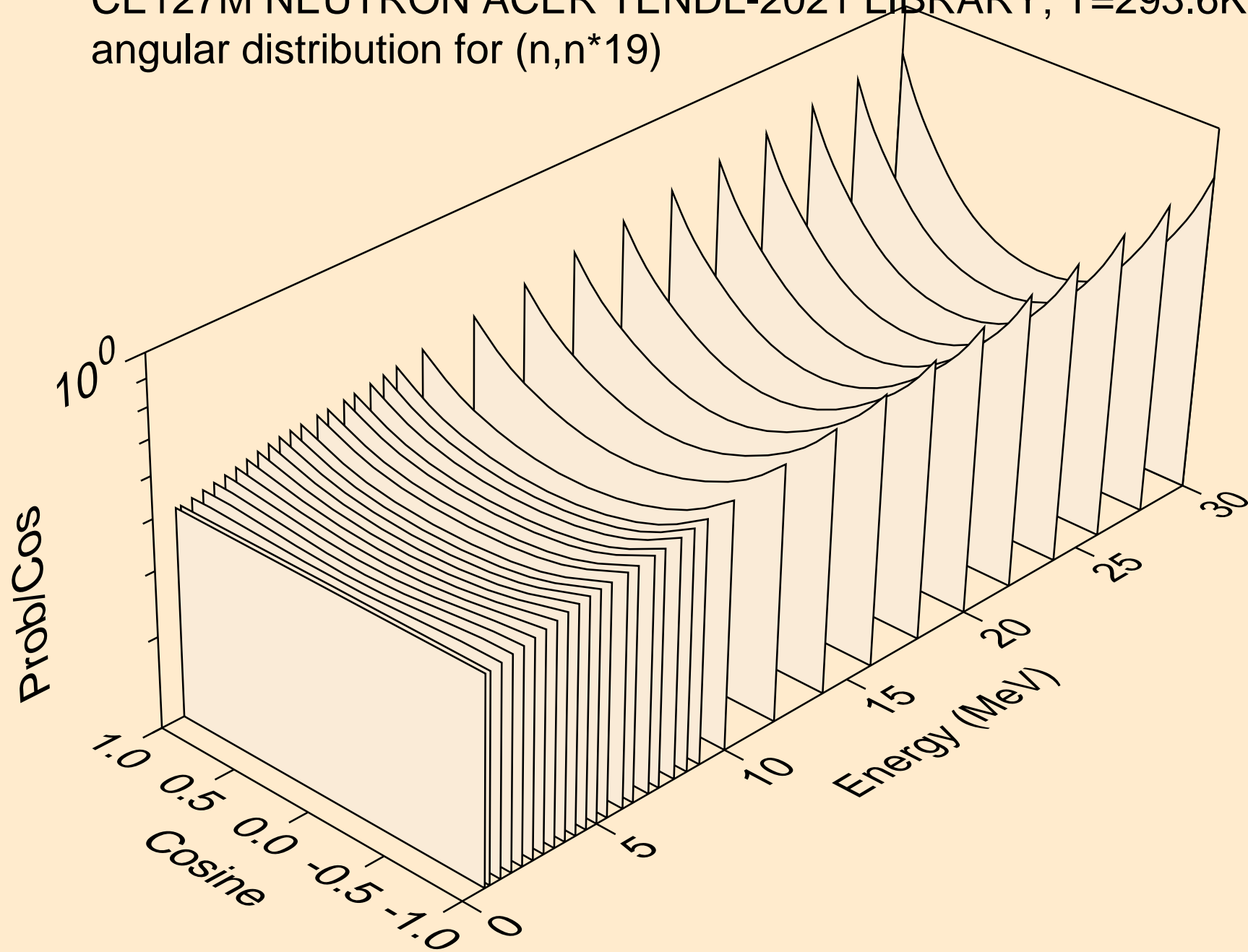

CE127M NEUTRON ACER TENDL-2021 LIBRARY; T=293.6K  
Neutron emission for (n,x)

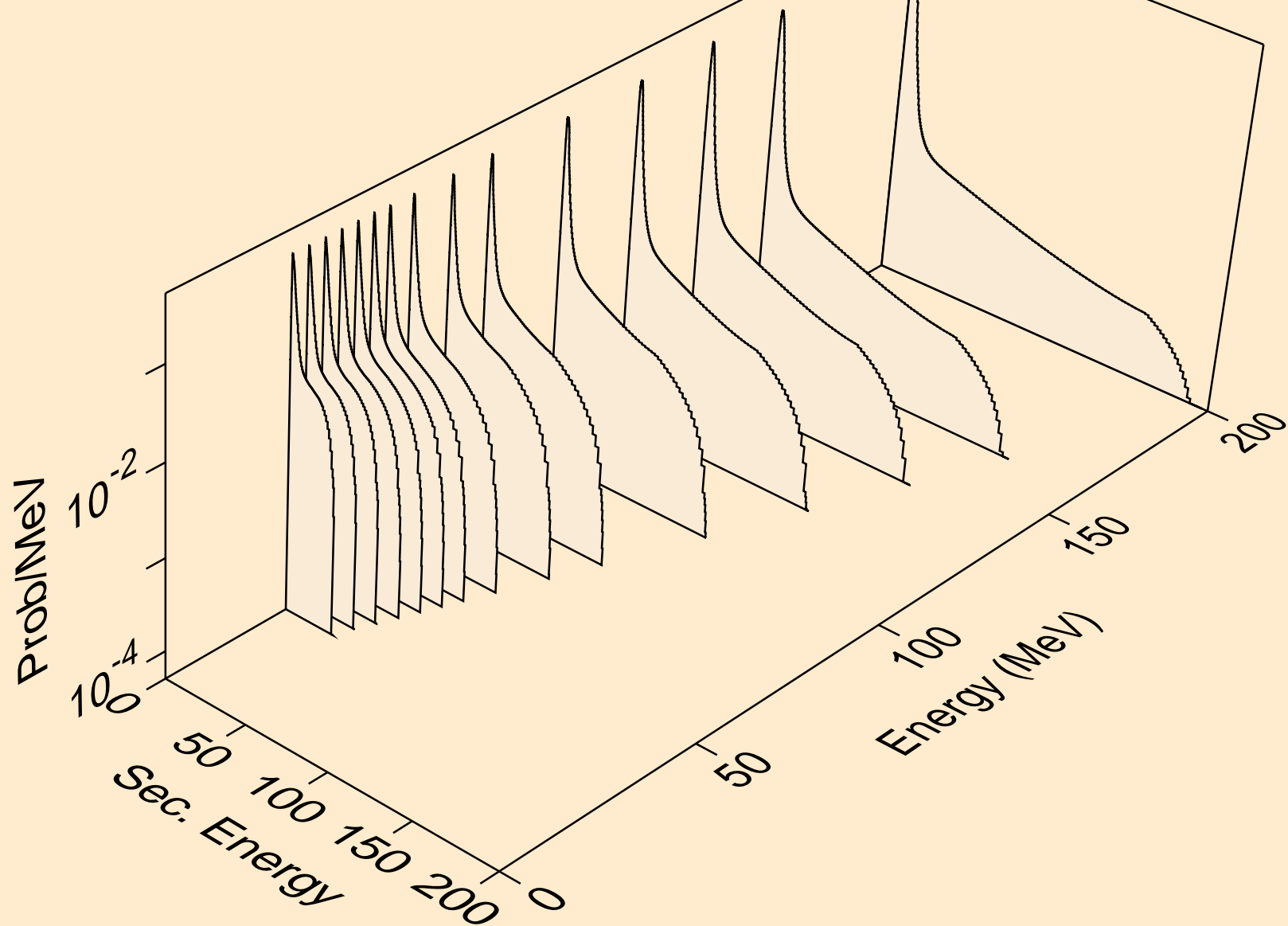

CE127M NEUTRON ACER TENDL-2021 LIBRARY; T=293.6K  
Neutron emission for (n,2nd)

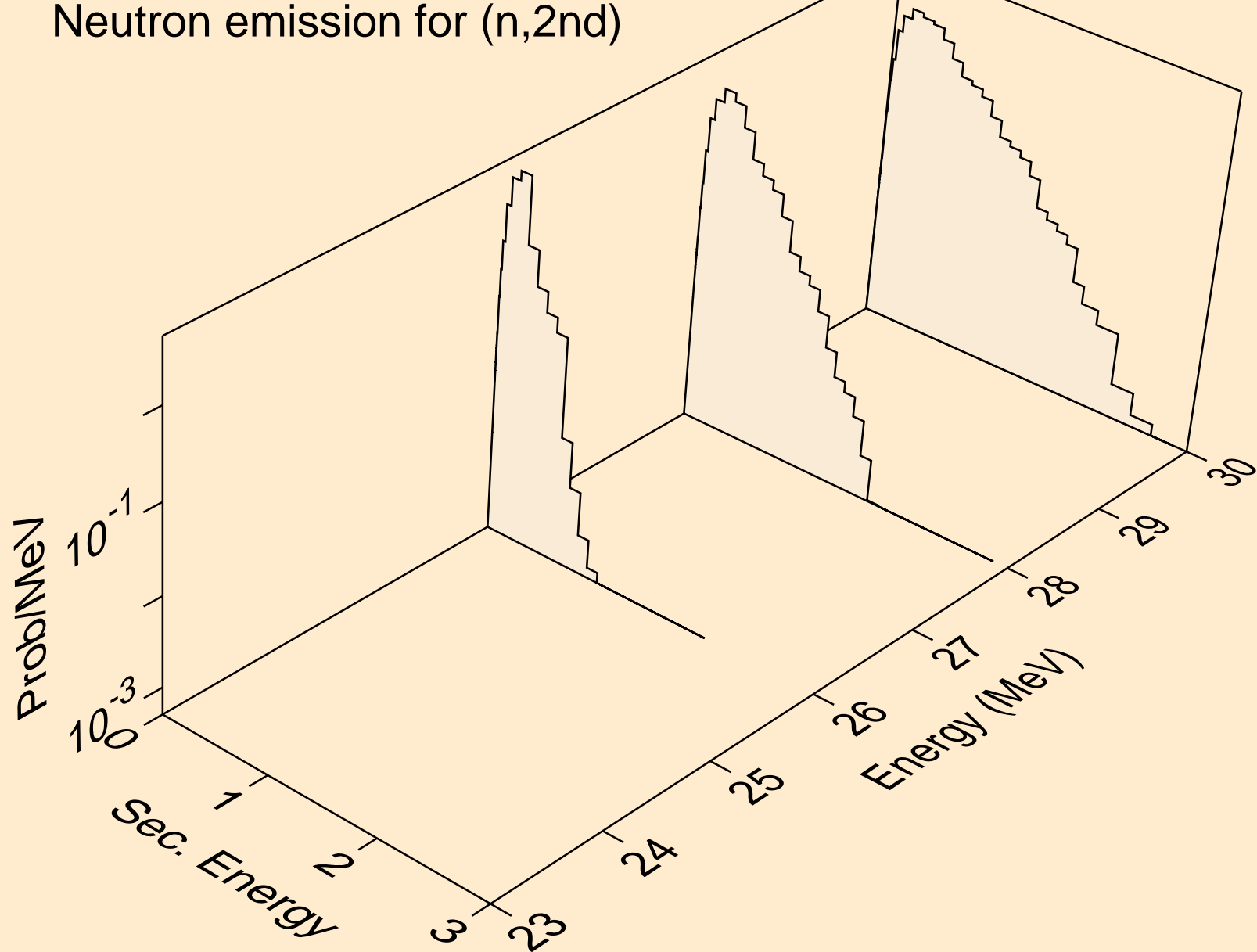

CE127M NEUTRON ACER TENDL-2021 LIBRARY; T=293.6K  
Neutron emission for (n,2n)

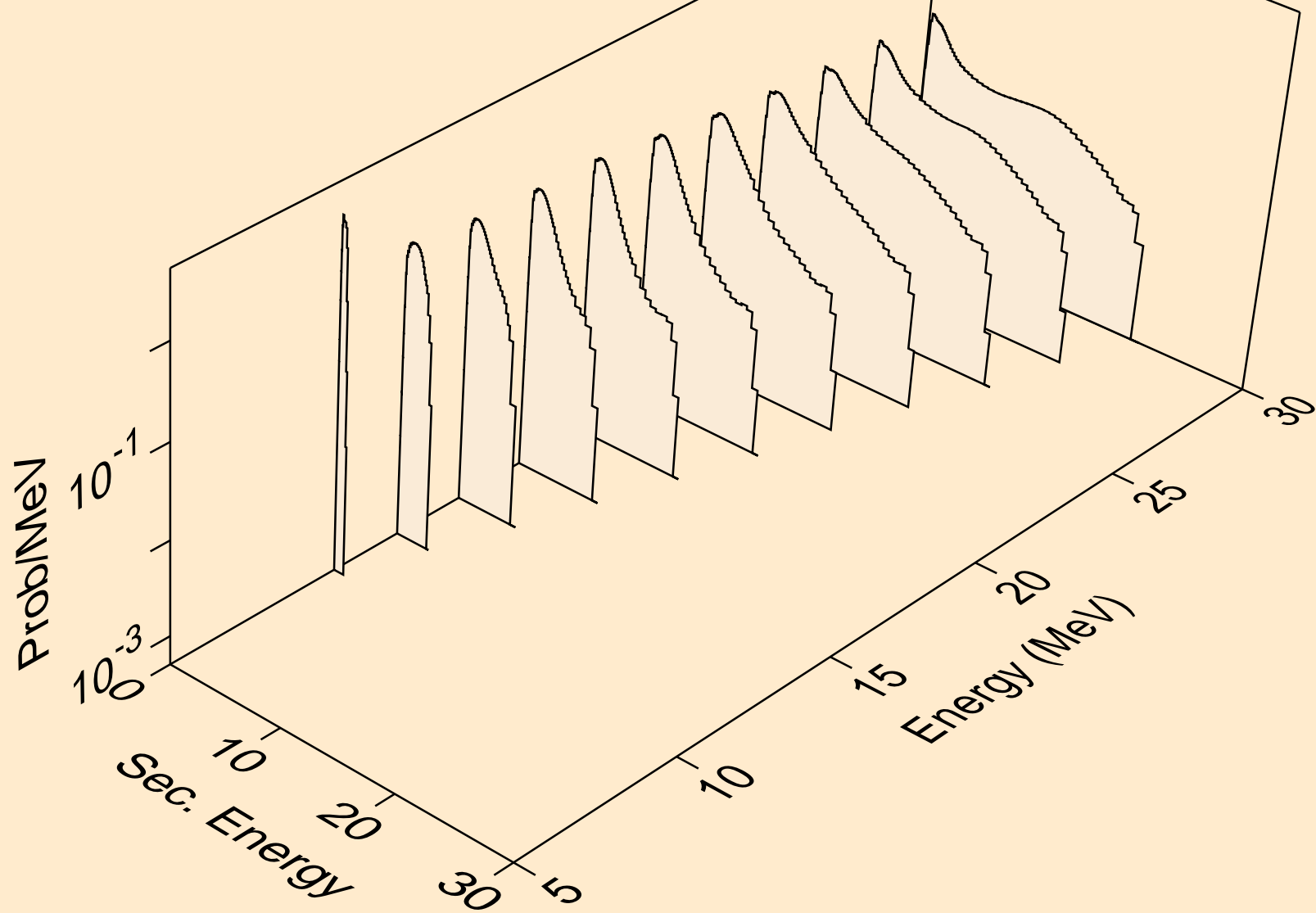

CE127M NEUTRON ACER TENDL-2021 LIBRARY; T=293.6K  
Neutron emission for (n,3n)

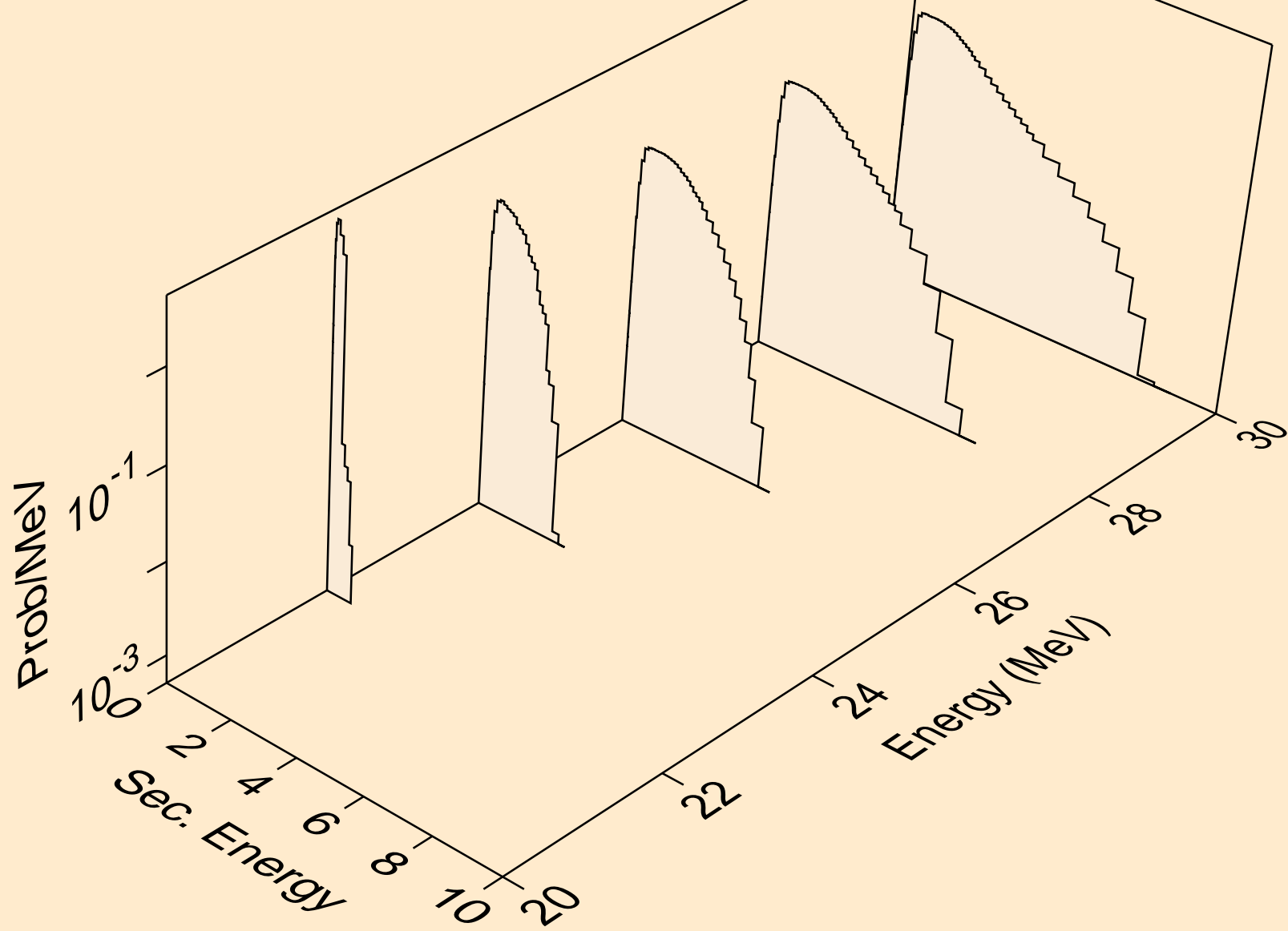

CE127M NEUTRON ACER TENDL-2021 LIBRARY; T=293.6K  
Neutron emission for (n,n\*)a

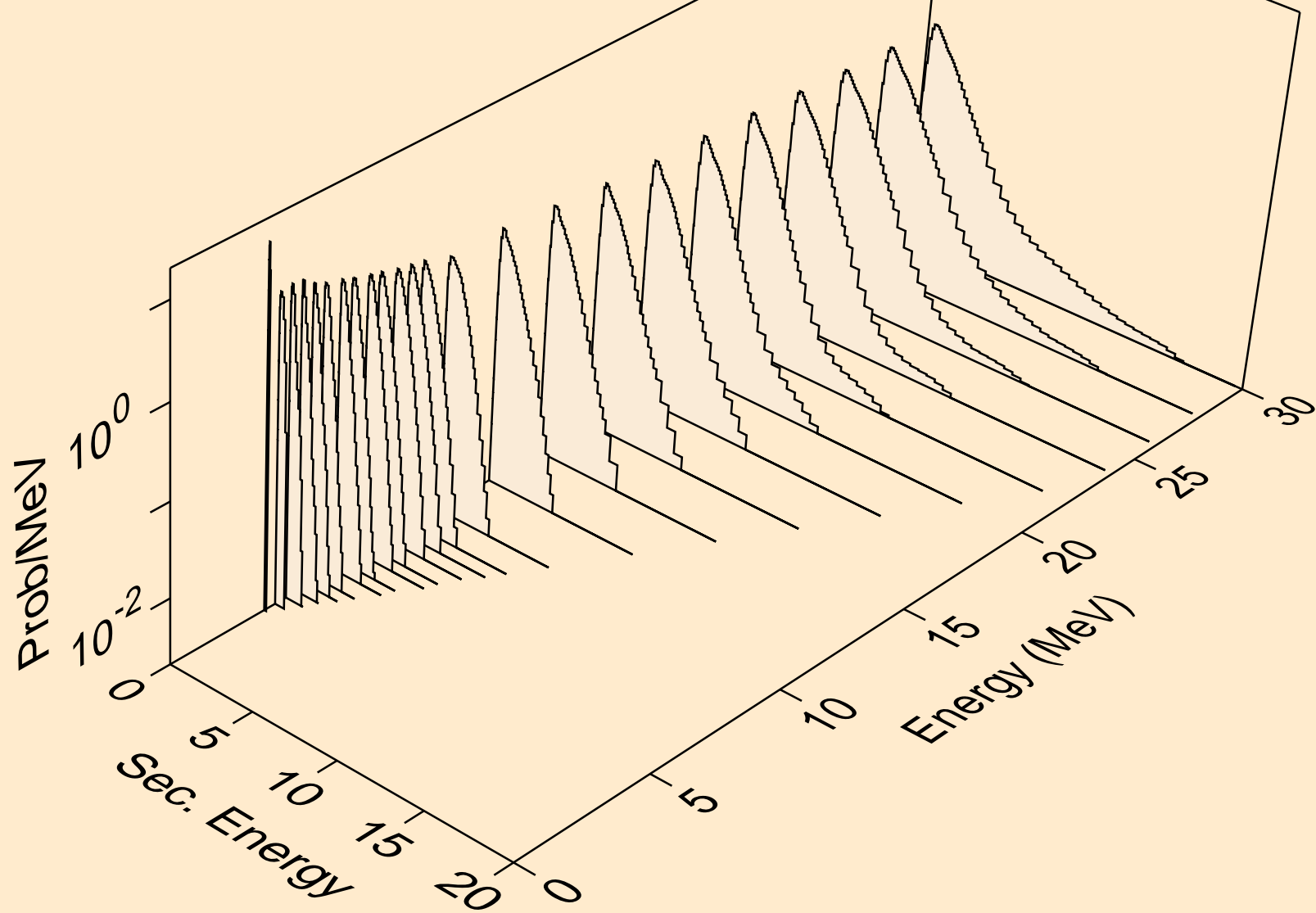

CE127M NEUTRON ACER TENDL-2021 LIBRARY; T=293.6K  
Neutron emission for (n,2n)a

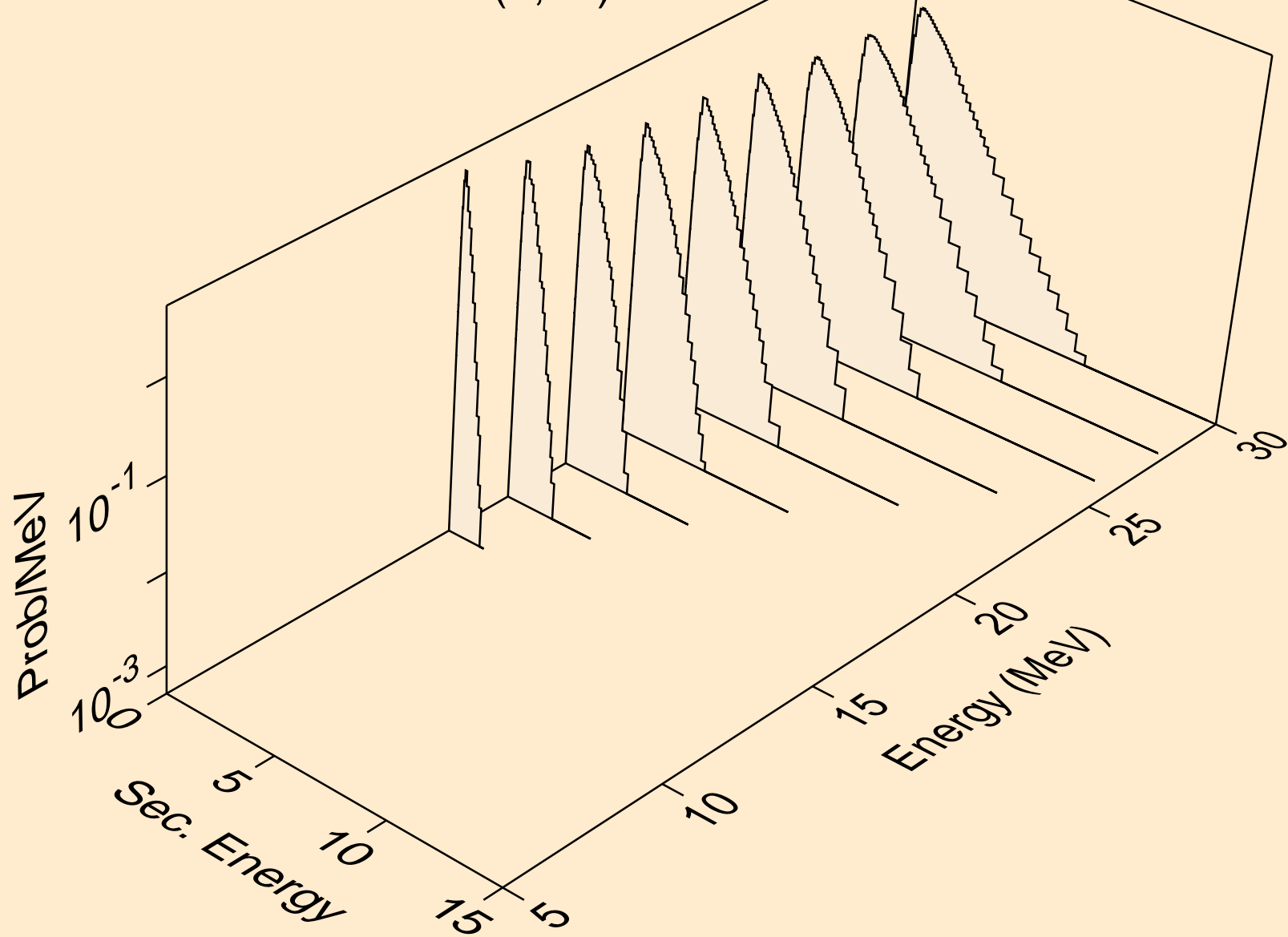

CE127M NEUTRON ACER TENDL-2021 LIBRARY; T=293.6K  
Neutron emission for (n,3n)a

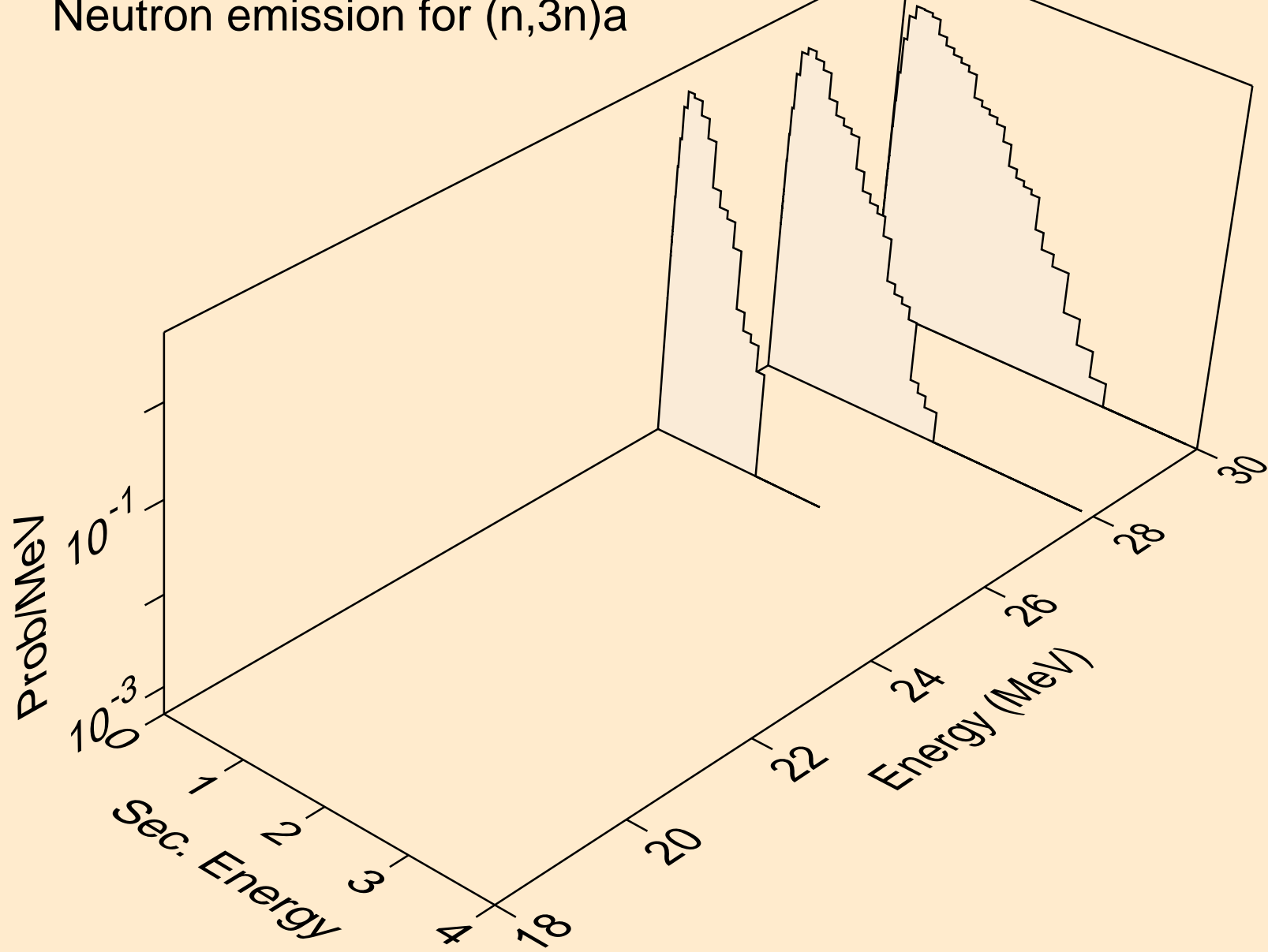



CE127M NEUTRON ACER TENDL-2021 LIBRARY; T=293.6K  
Neutron emission for (n,n\*)p

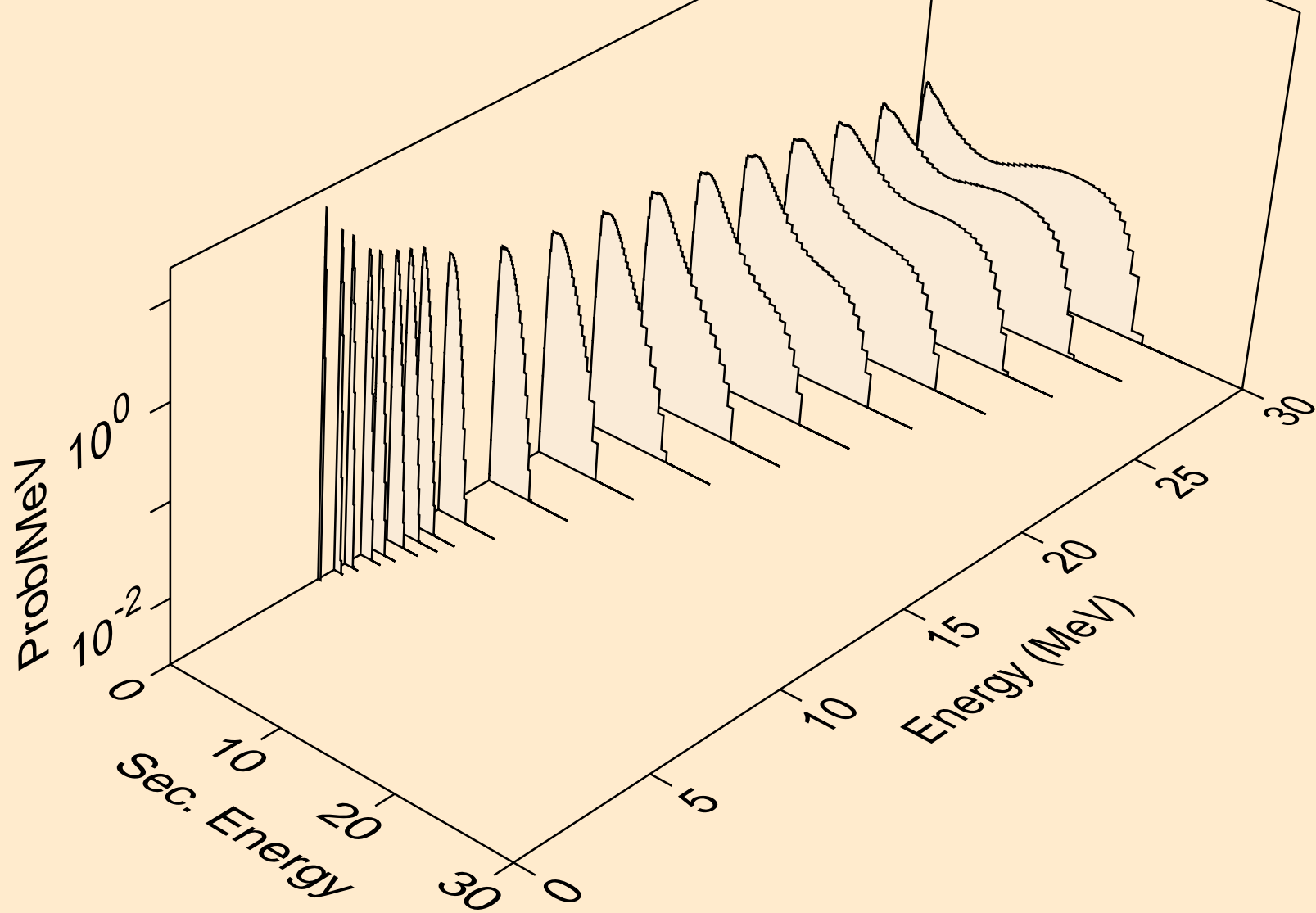

CE127M NEUTRON ACER TENDL-2021 LIBRARY; T=293.6K  
Neutron emission for (n,n\*)2a

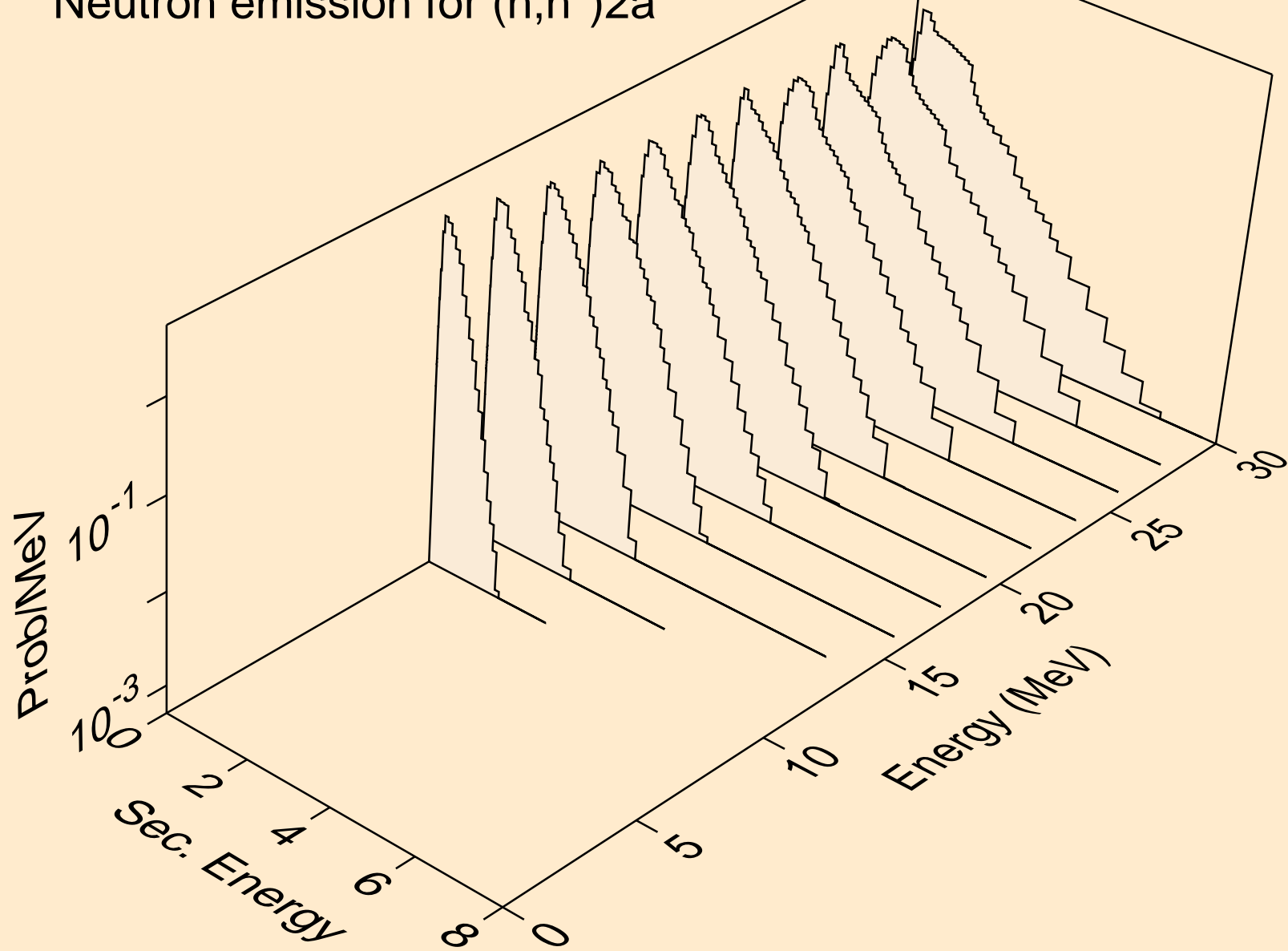

CE127M NEUTRON ACER TENDL-2021 LIBRARY; T=293.6K  
Neutron emission for (n,2n)2a

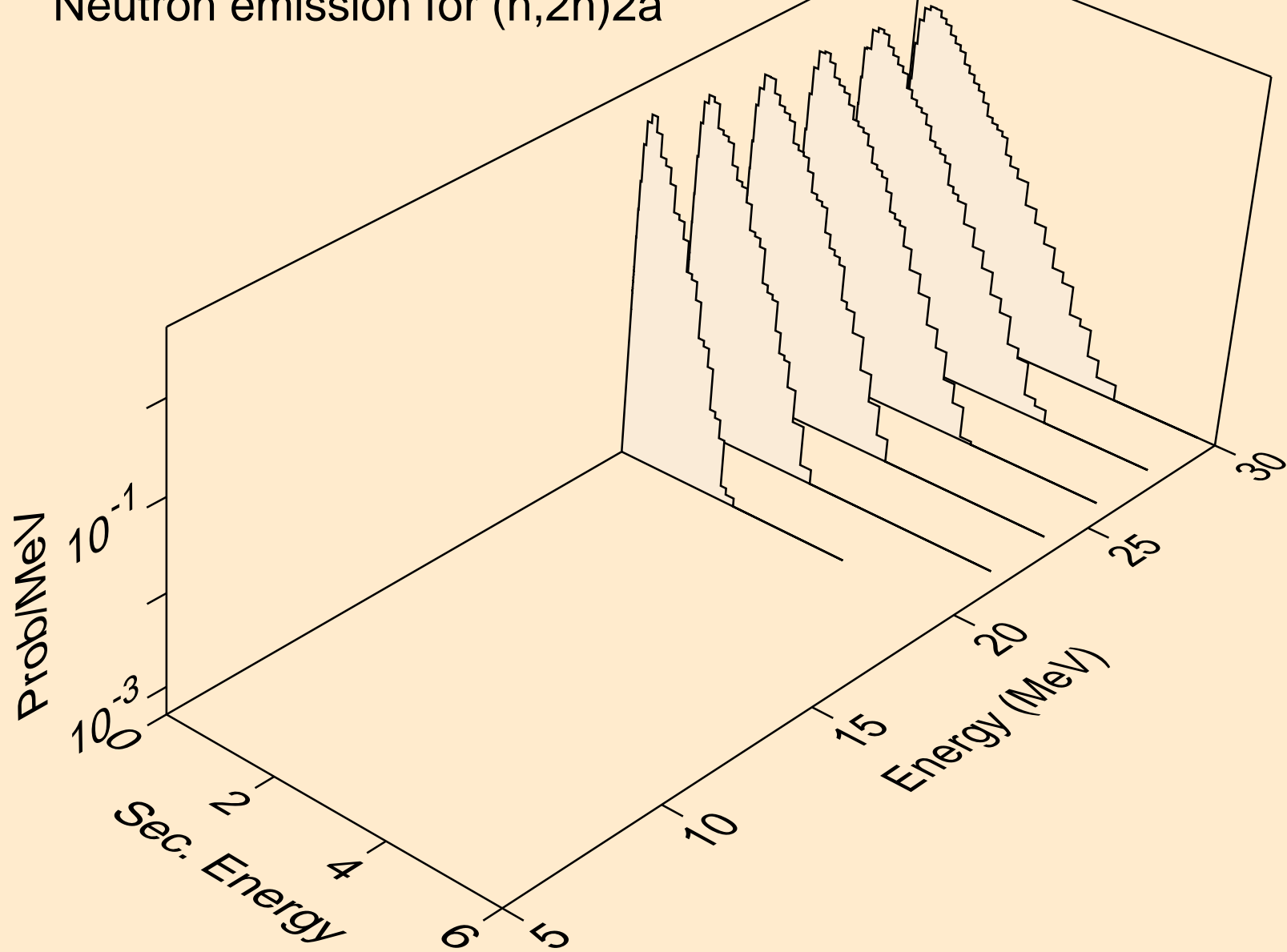

CE127M NEUTRON ACER TENDL-2021 LIBRARY; T=293.6K  
Neutron emission for (n,n\*)d

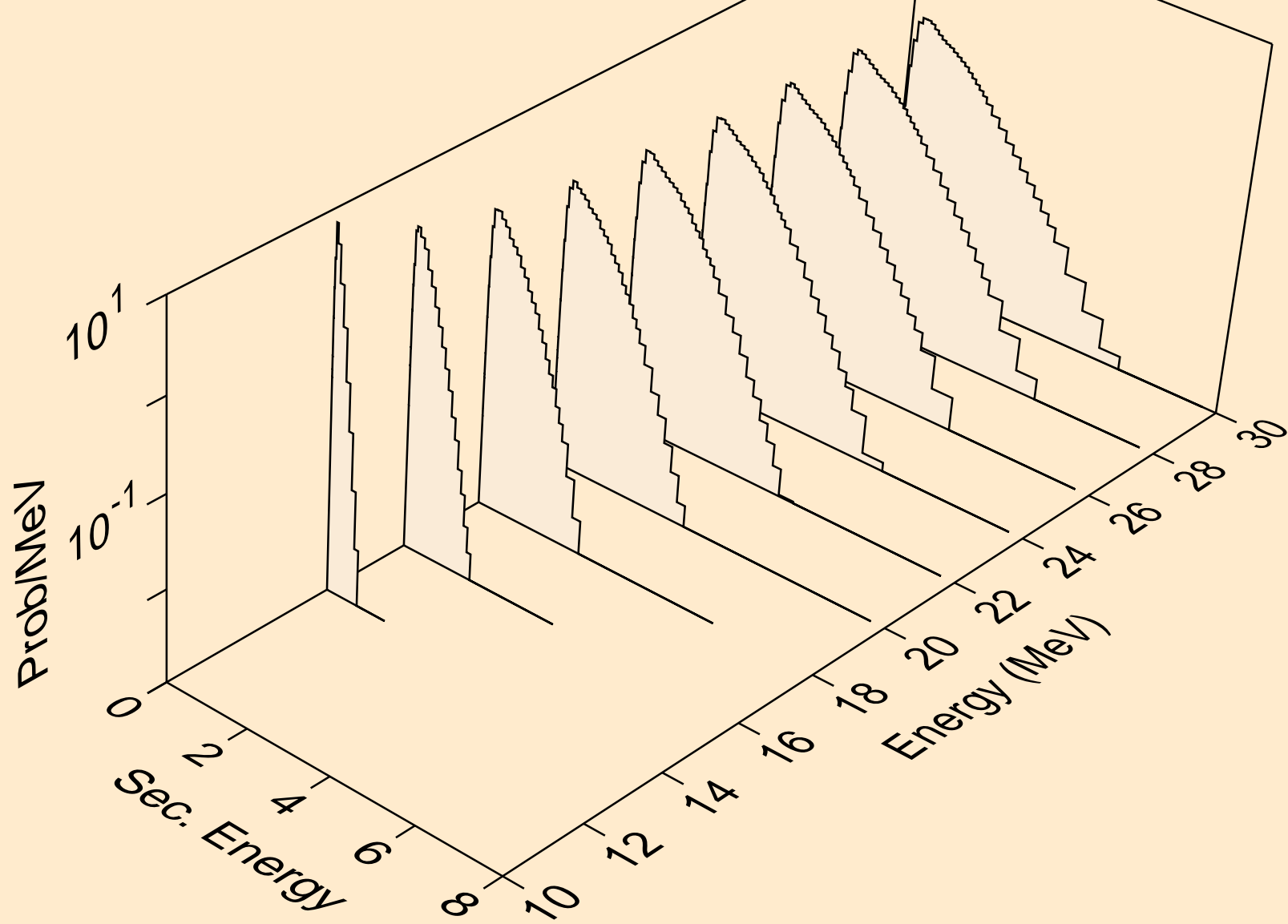

CE127M NEUTRON ACER TENDL-2021 LIBRARY; T=293.6K  
Neutron emission for (n,n\*)t

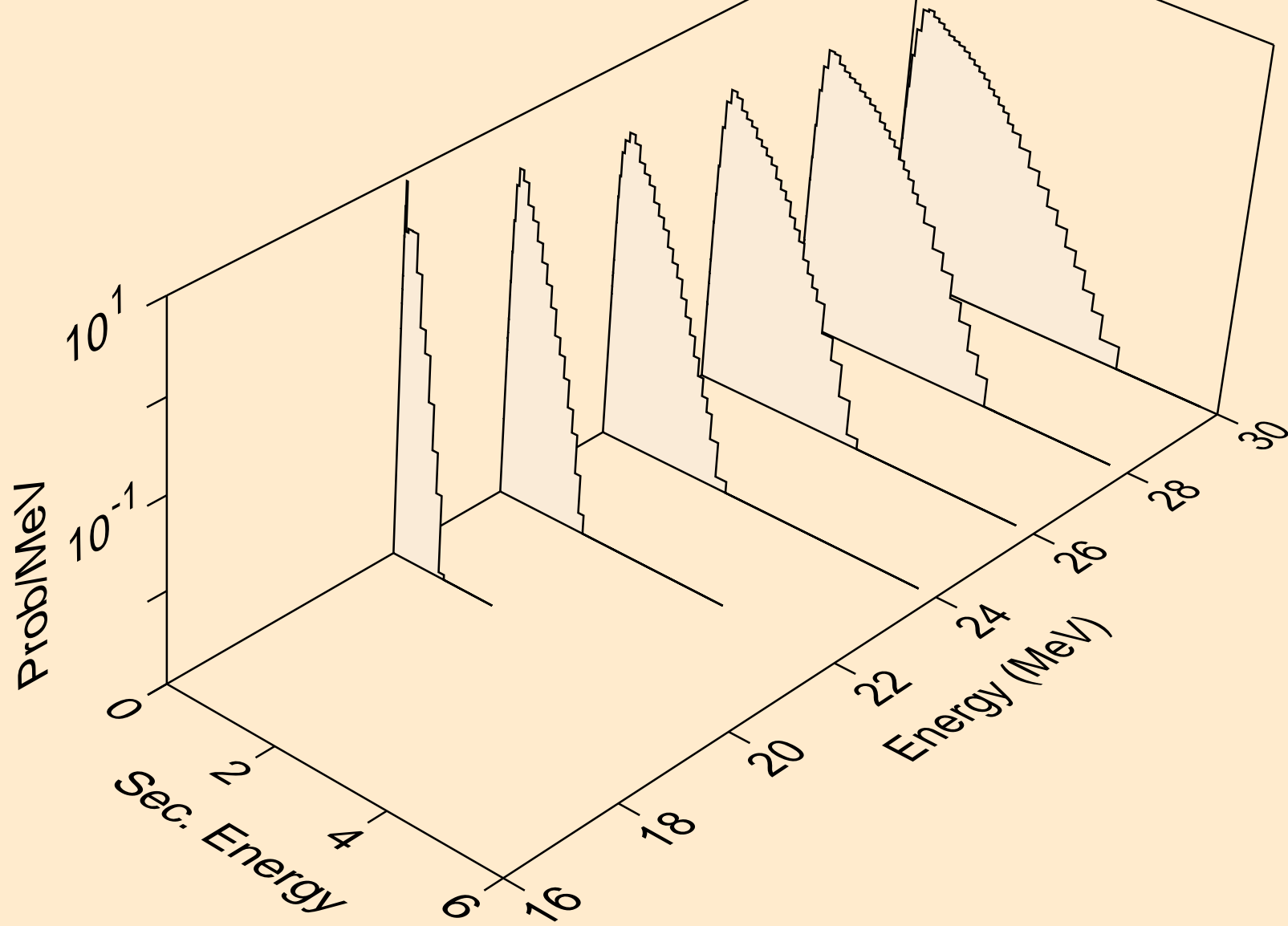

CE127M NEUTRON ACER TENDL-2021 LIBRARY; T=293.6K  
Neutron emission for (n,n\*)he3

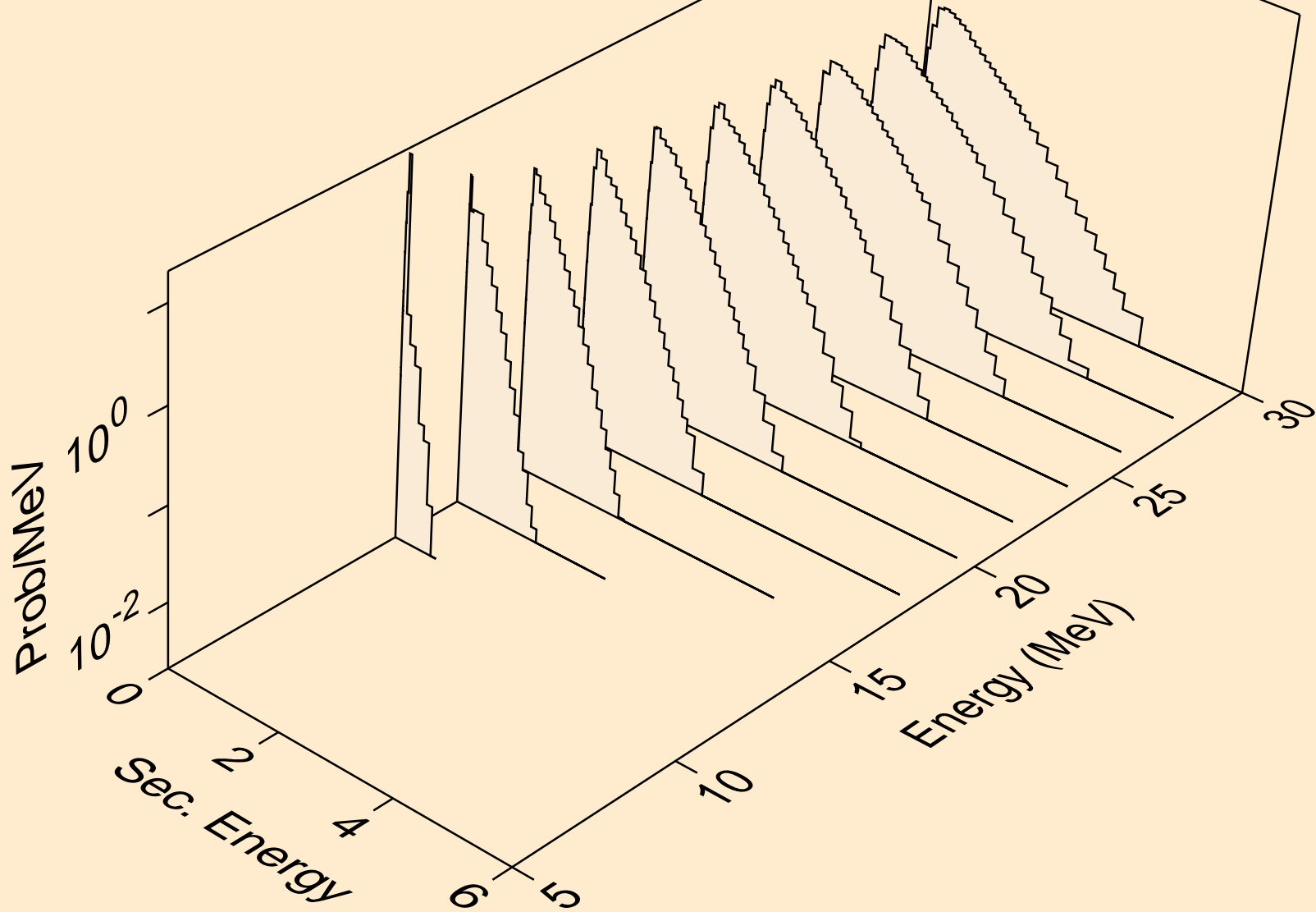

CE127M NEUTRON ACER TENDL-2021 LIBRARY; T=293.6K  
Neutron emission for (n,2np)

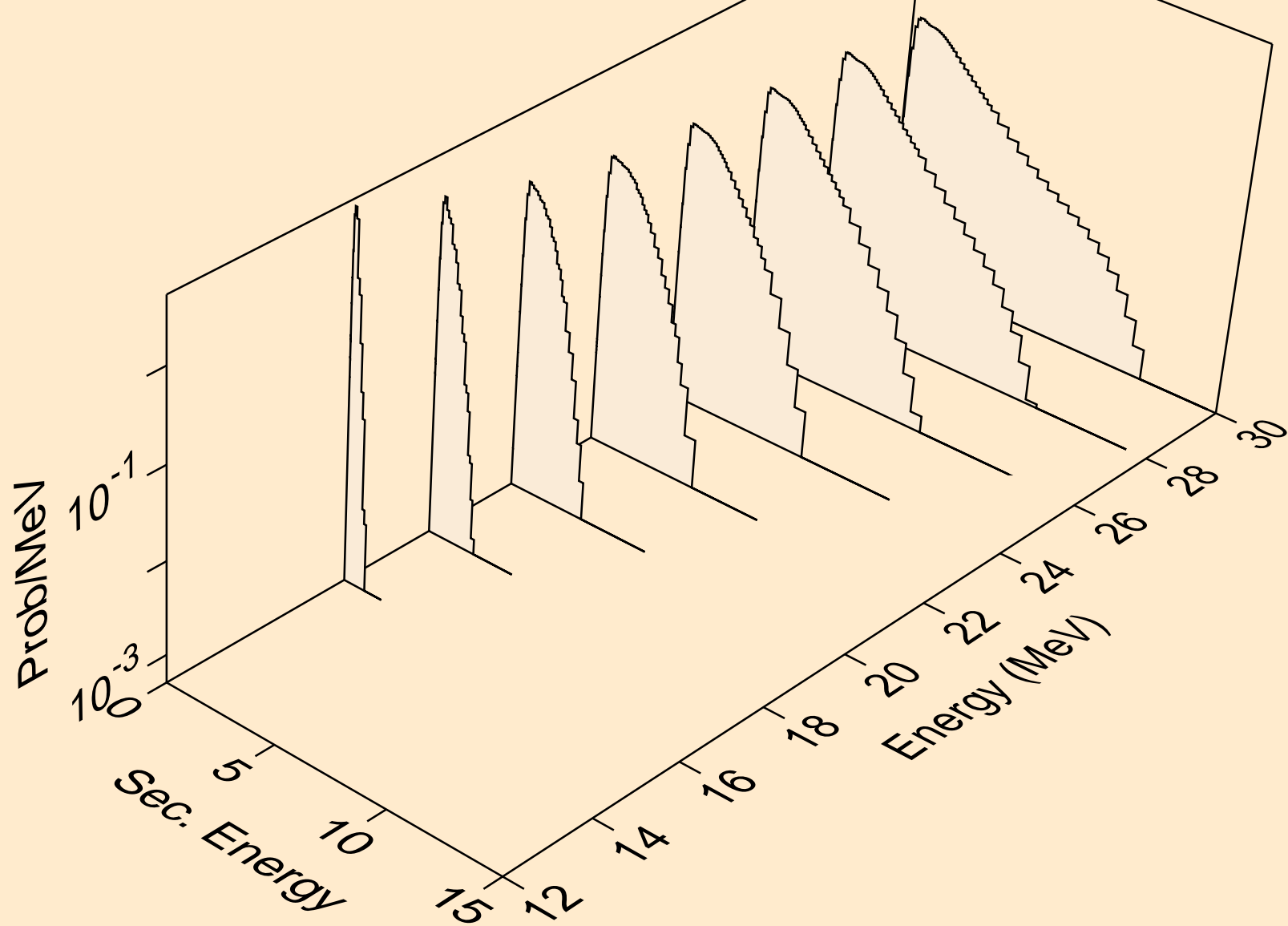

CE127M NEUTRON ACER TENDL-2021 LIBRARY; T=293.6K  
Neutron emission for (n,3np)

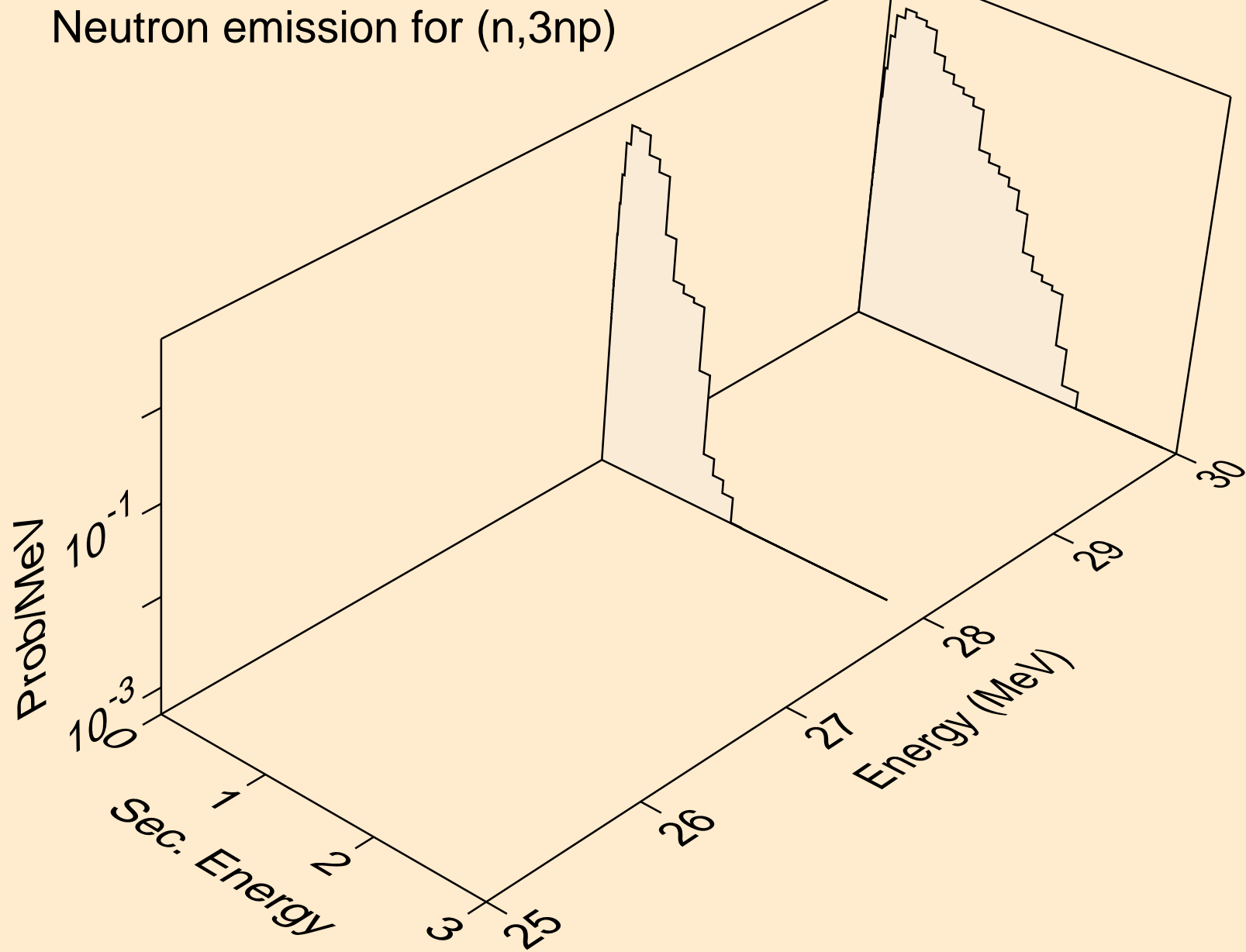



CE127M NEUTRON ACER TENDL-2021 LIBRARY; T=293.6K  
Neutron emission for (n,2np)

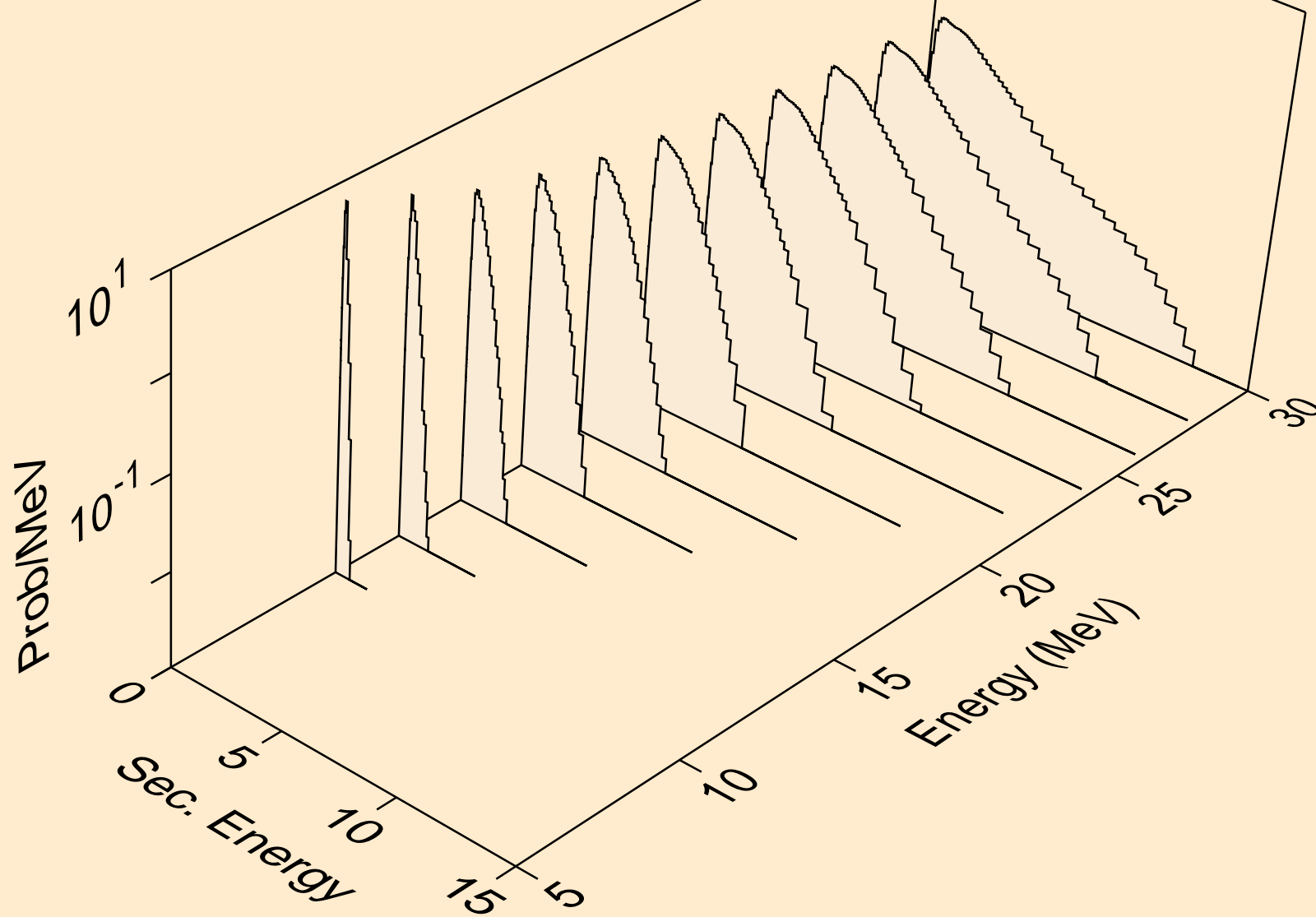

CE127M NEUTRON ACER TENDL-2021 LIBRARY; T=293.6K  
Neutron emission for (n,npa)

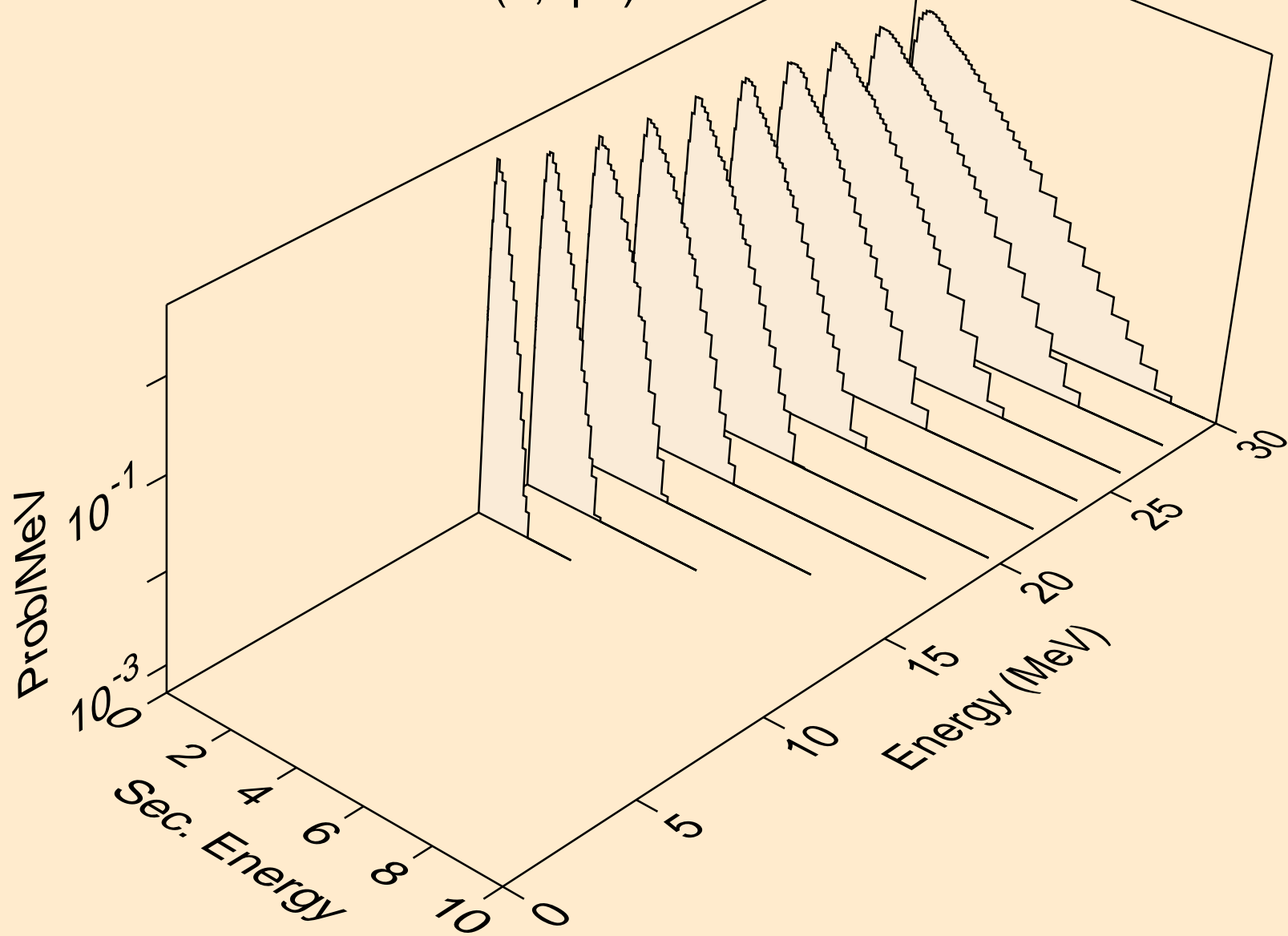

CE127M NEUTRON ACER TENDL-2021 LIBRARY; T=293.6K  
Neutron emission for (n,n\*c)

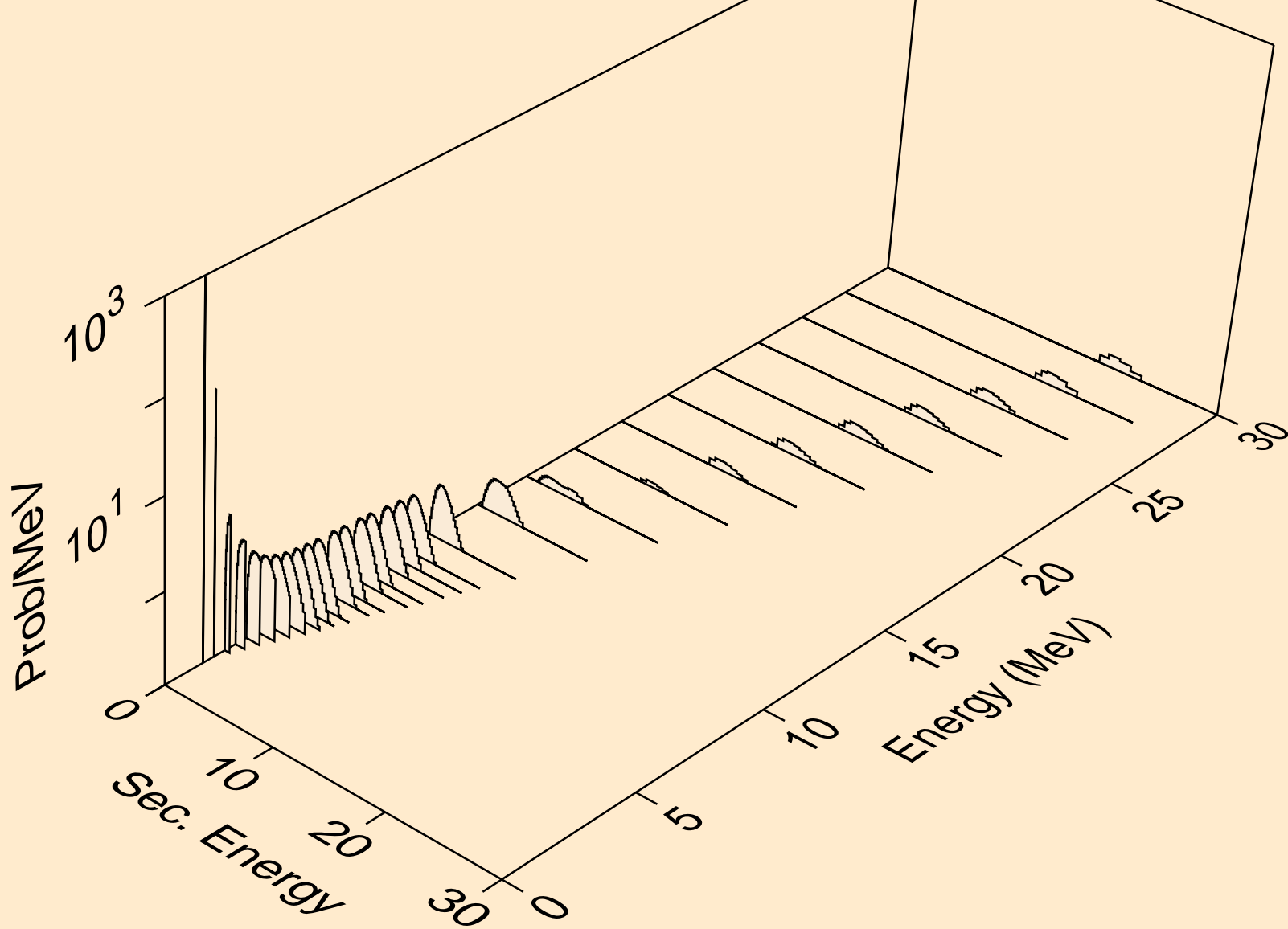

CE127M NEUTRON ACER TENDL-2021 LIBRARY; T=293.6K  
Photon emission for (n,x)

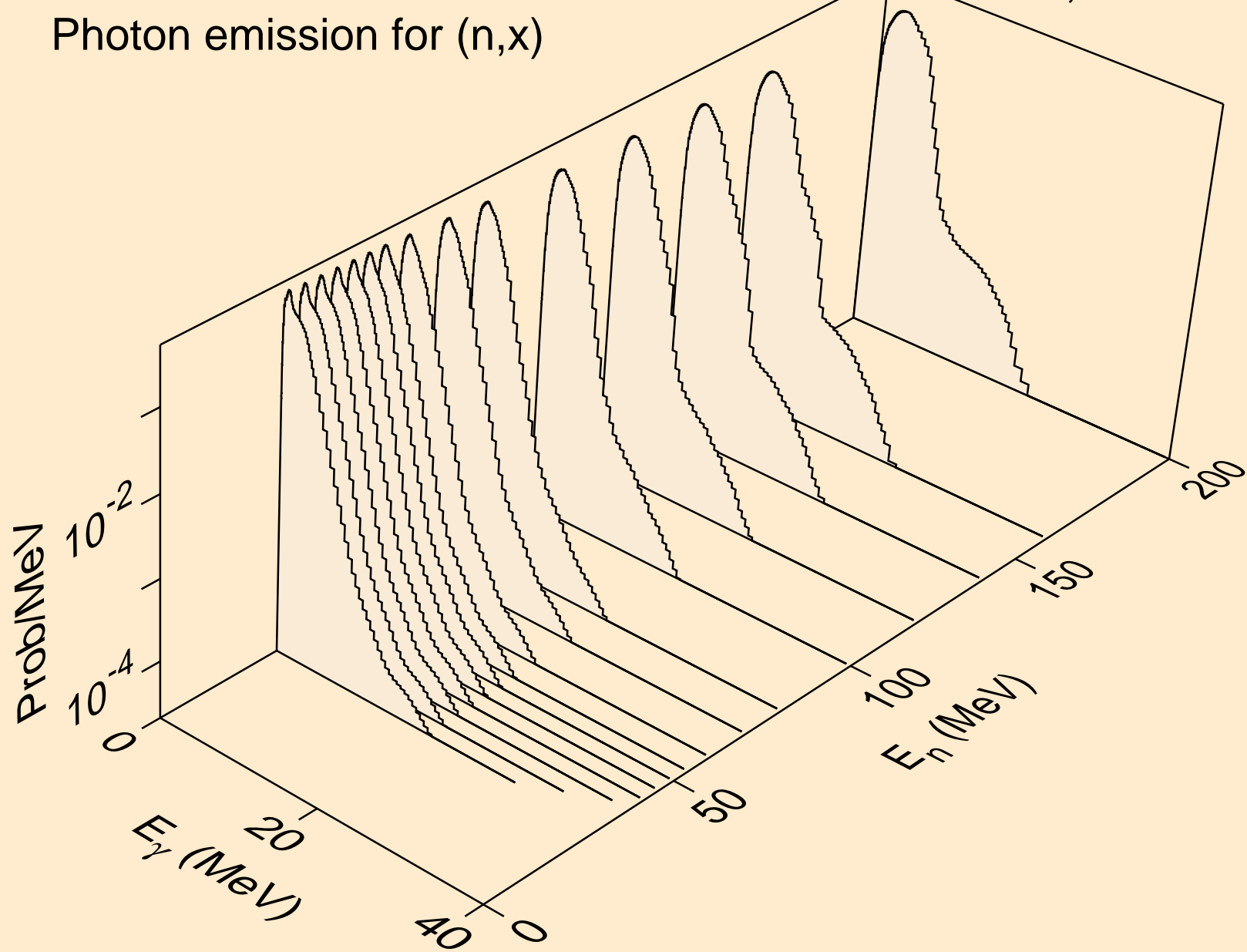

CE127M NEUTRON ACER TENDL-2021 LIBRARY; T=293.6K  
Photon emission for (n,2nd)

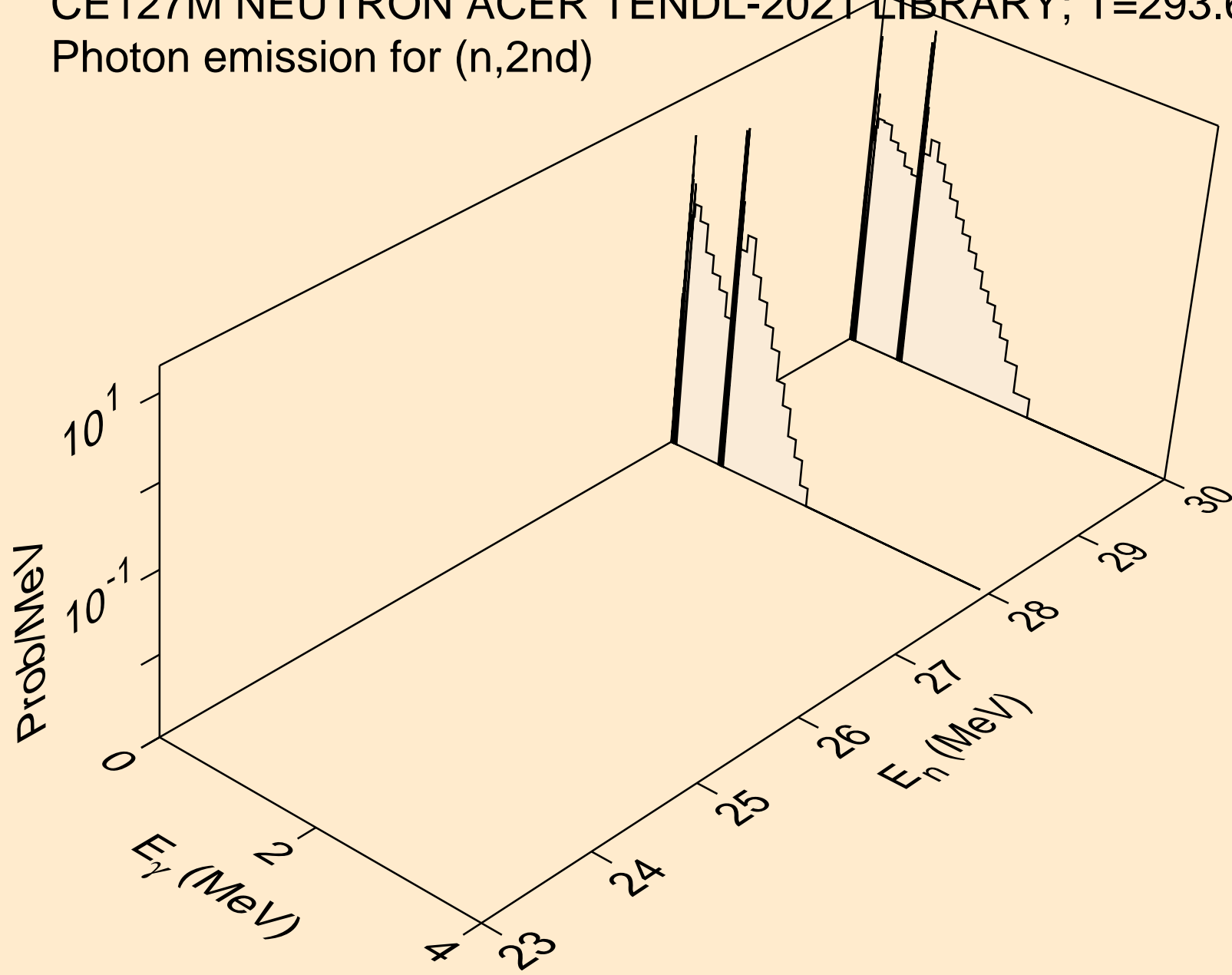

CE127M NEUTRON ACER TENDL-2021 LIBRARY; T=293.6K  
Photon emission for (n,2n)

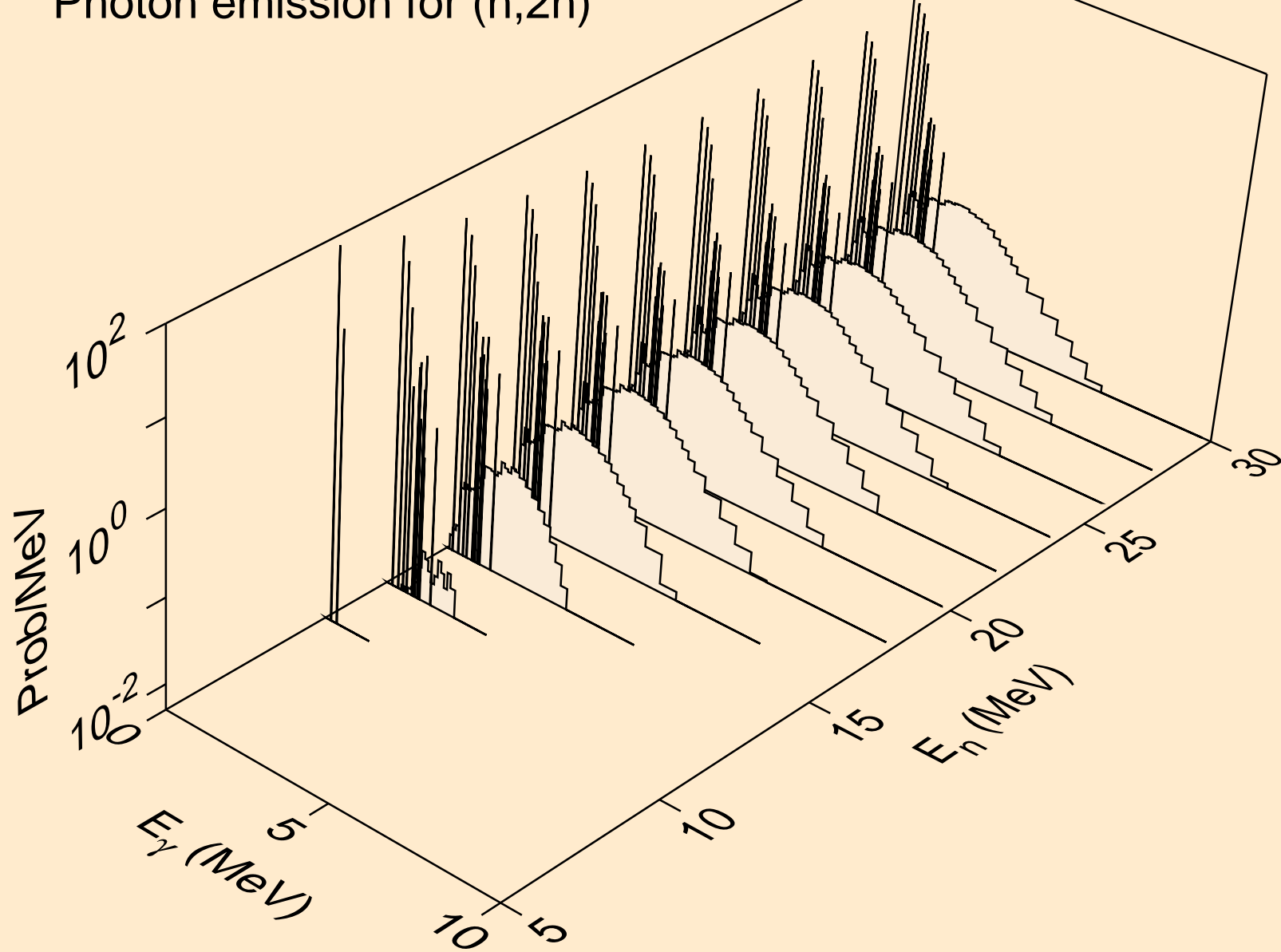

CE127M NEUTRON ACER TENDL-2021 LIBRARY; T=293.6K  
Photon emission for (n,3n)

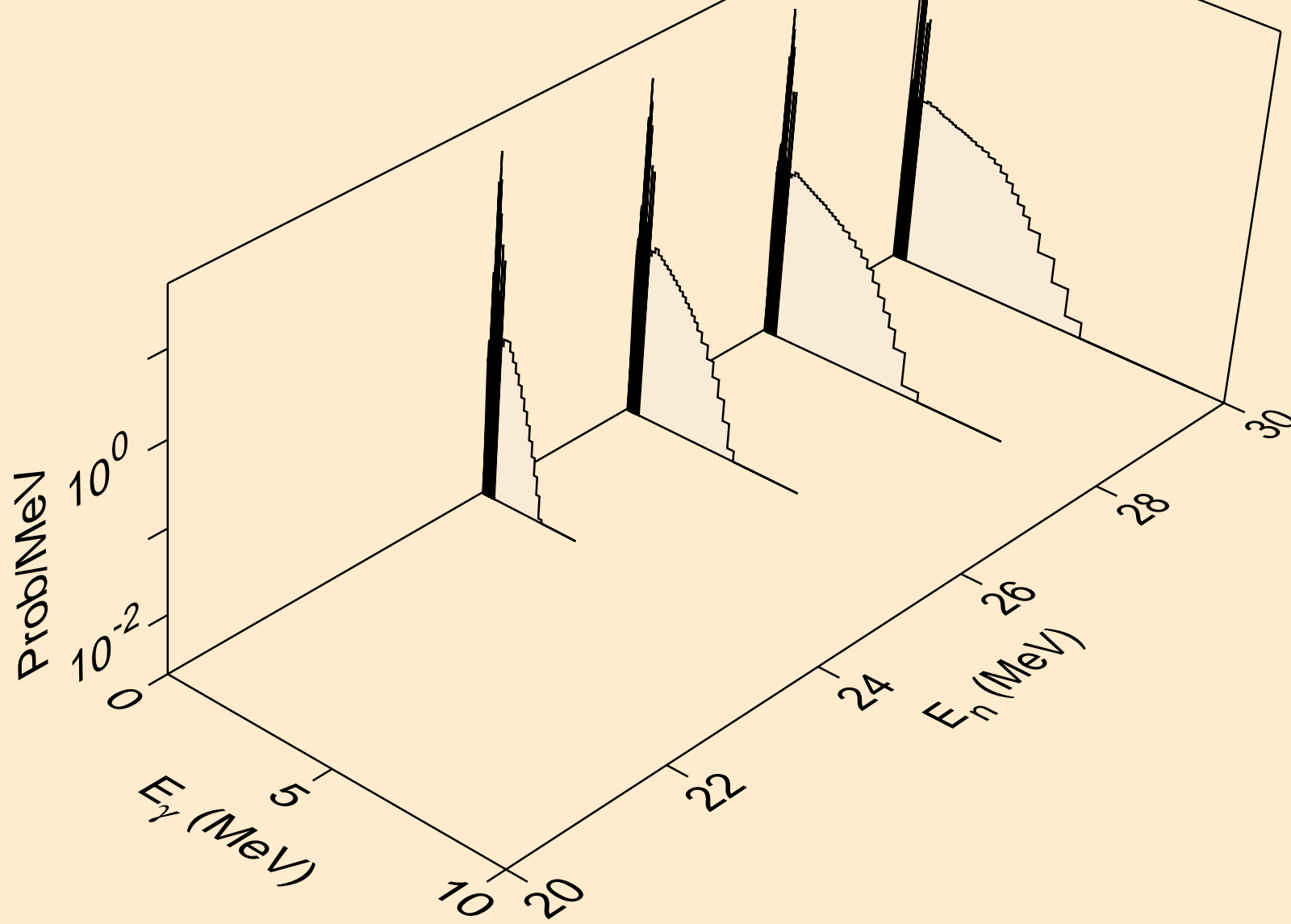

CE127M NEUTRON ACER TENDL-2021 LIBRARY; T=293.6K  
Photon emission for (n,n\*)a

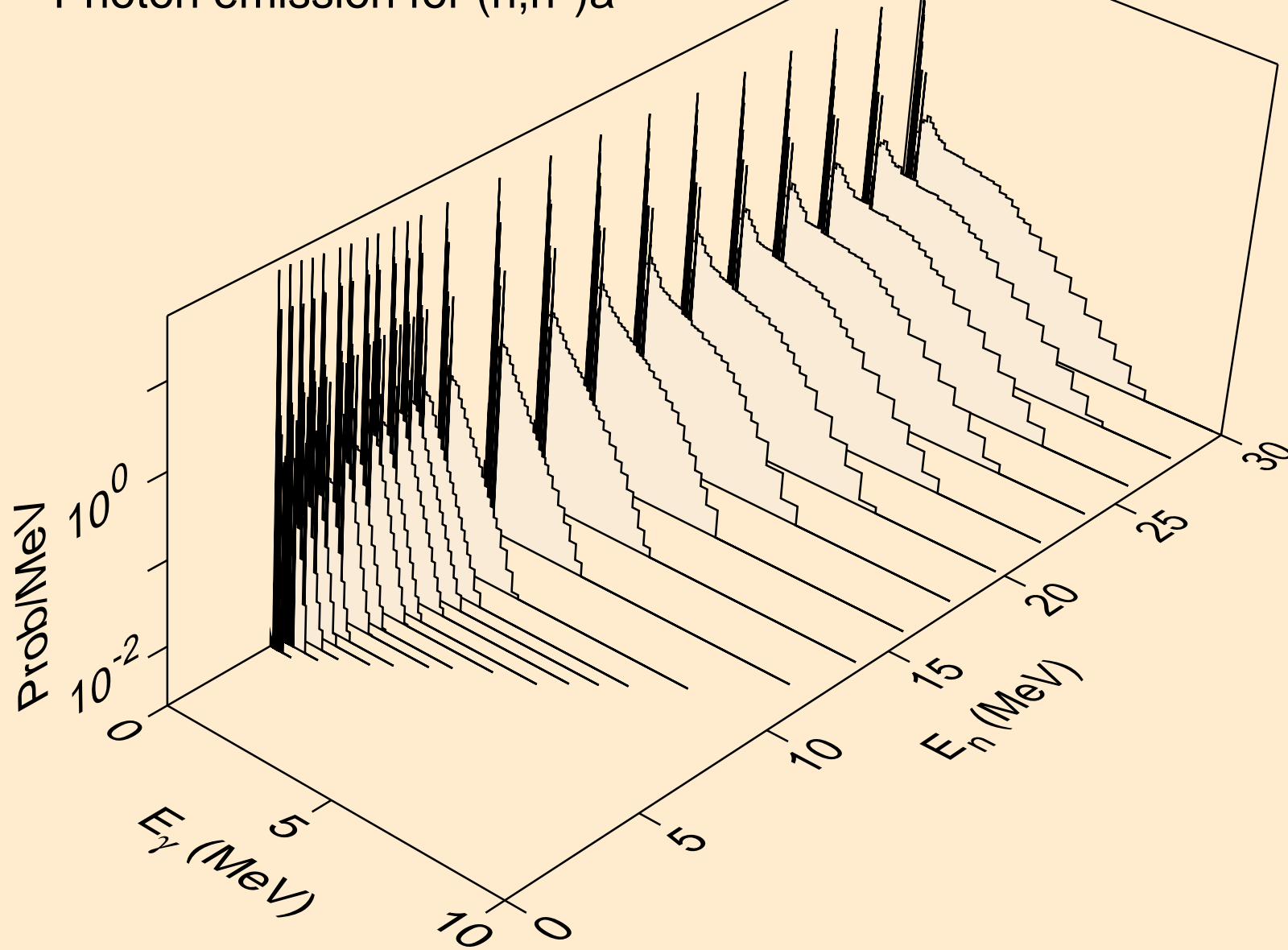



CE127M NEUTRON ACER TENDL-2021 LIBRARY; T=293.6K  
Photon emission for (n,2n)a

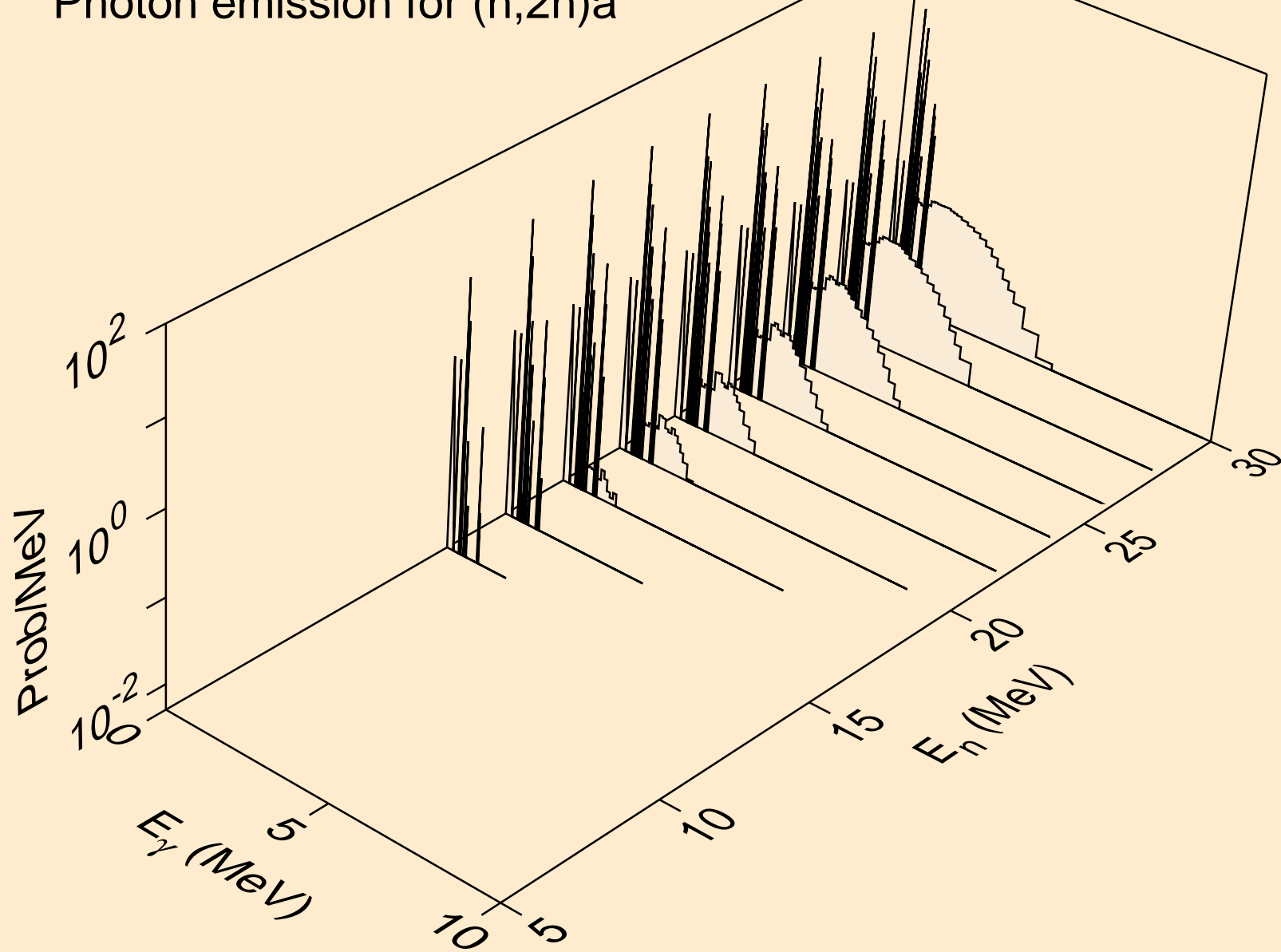

CE127M NEUTRON ACER TENDL-2021 LIBRARY; T=293.6K  
Photon emission for (n,3n)a

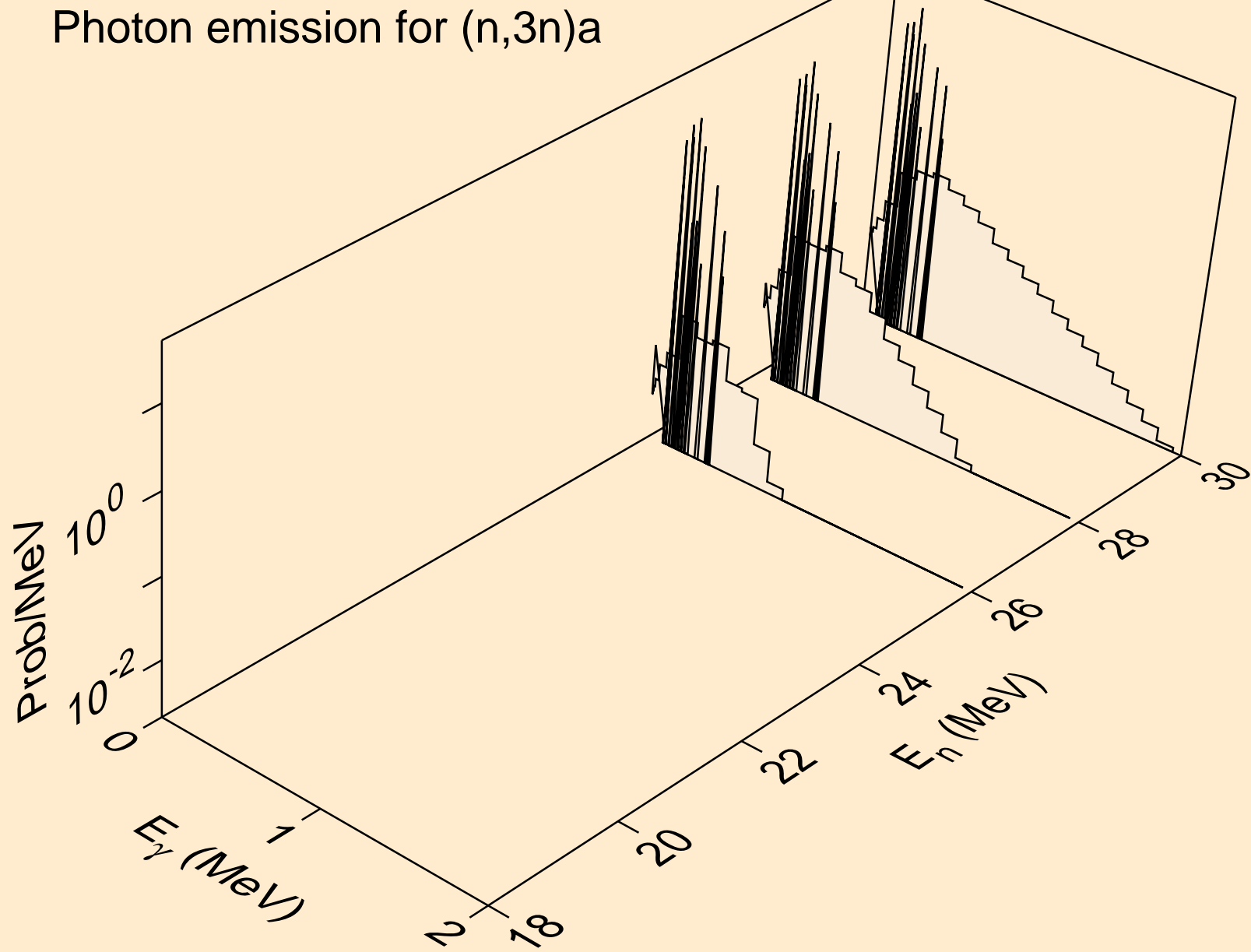

CE127M NEUTRON ACER TENDL-2021 LIBRARY; T=293.6K  
Photon emission for (n,n\*)p

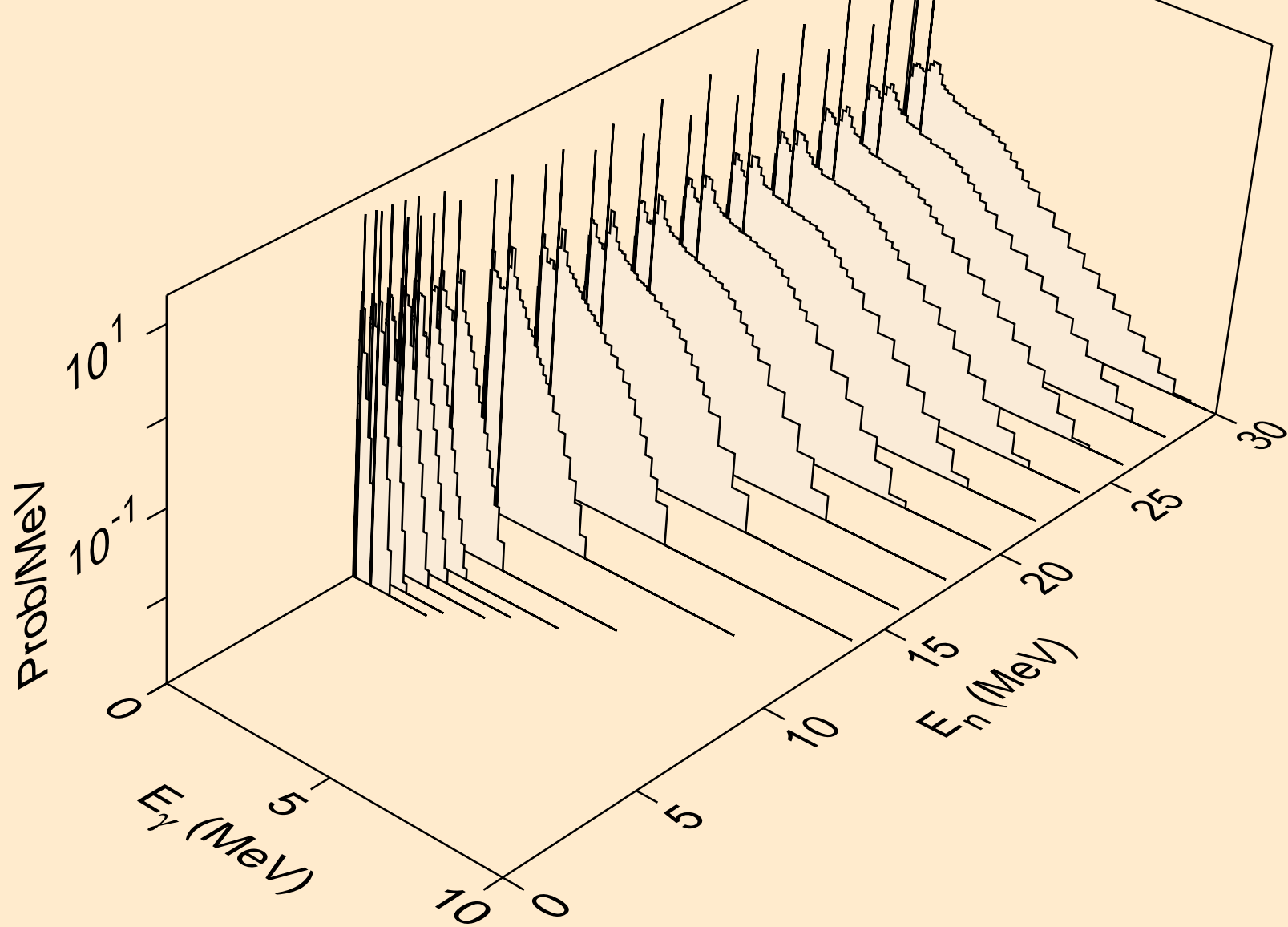

CE127M NEUTRON ACER TENDL-2021 LIBRARY; T=293.6K  
Photon emission for (n,n\*)2a

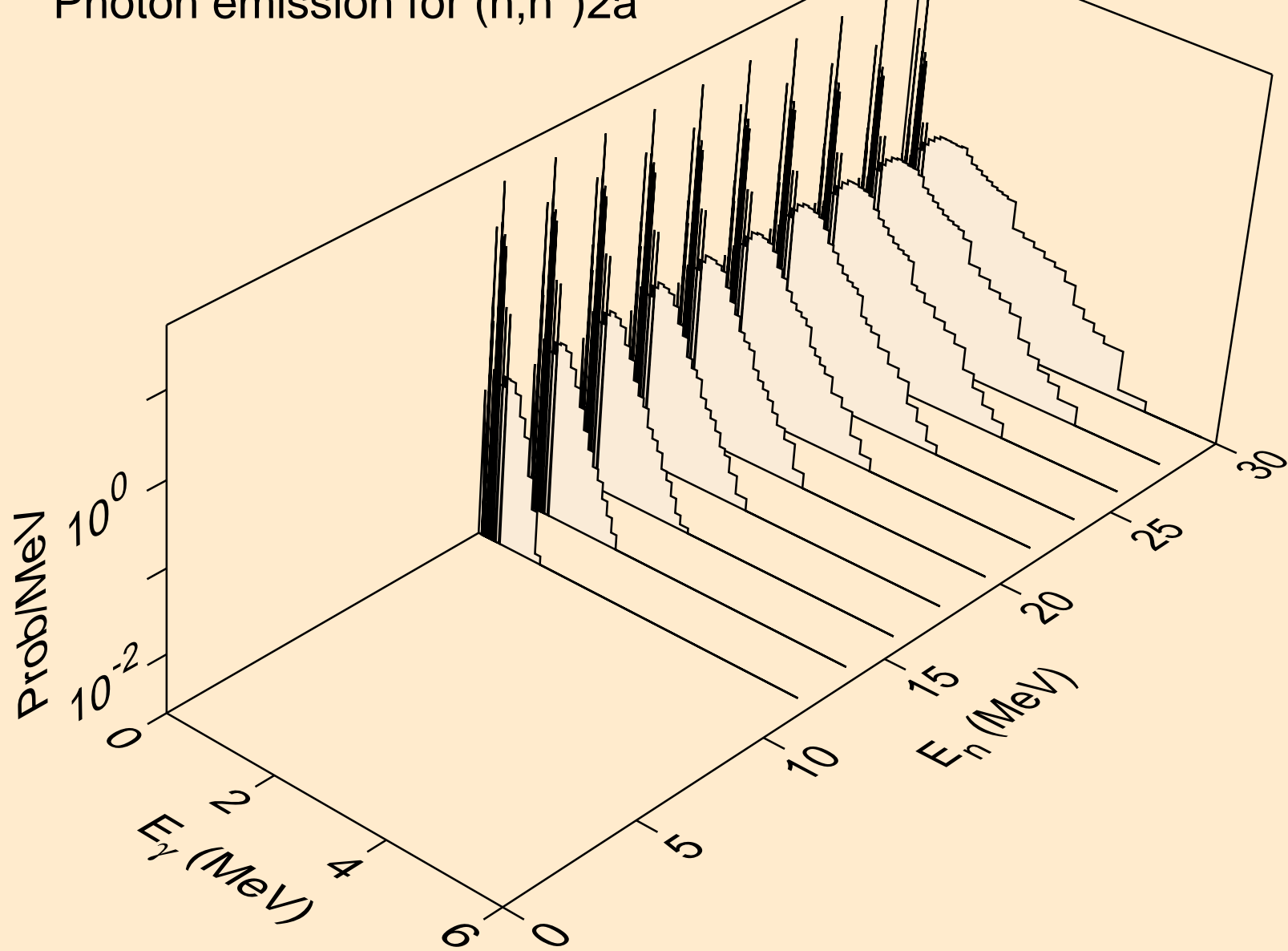

CE127M NEUTRON ACER TENDL-2021 LIBRARY; T=293.6K  
Photon emission for (n,2n)2a

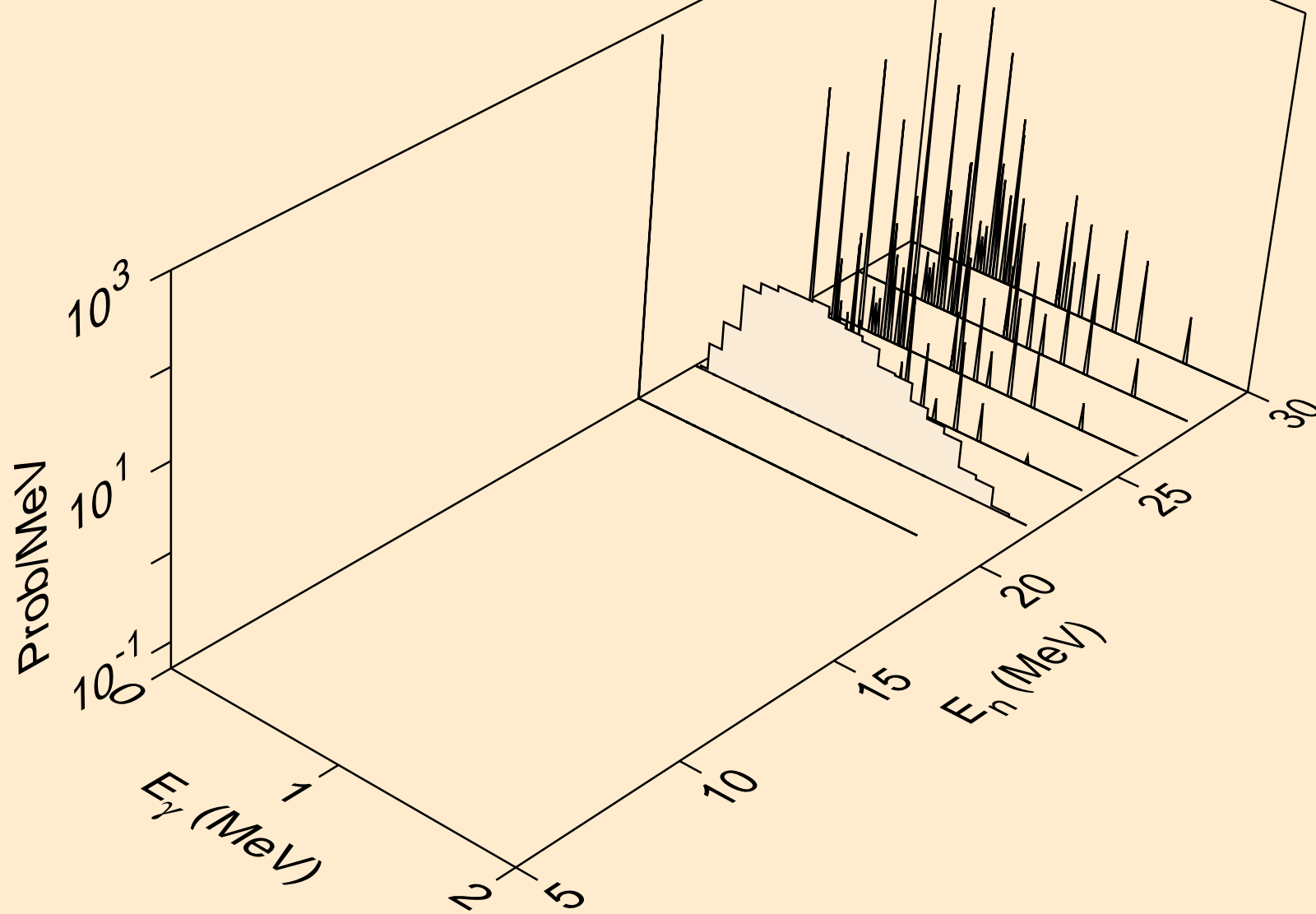

CE127M NEUTRON ACER TENDL-2021 LIBRARY; T=293.6K  
Photon emission for (n,n\*)d

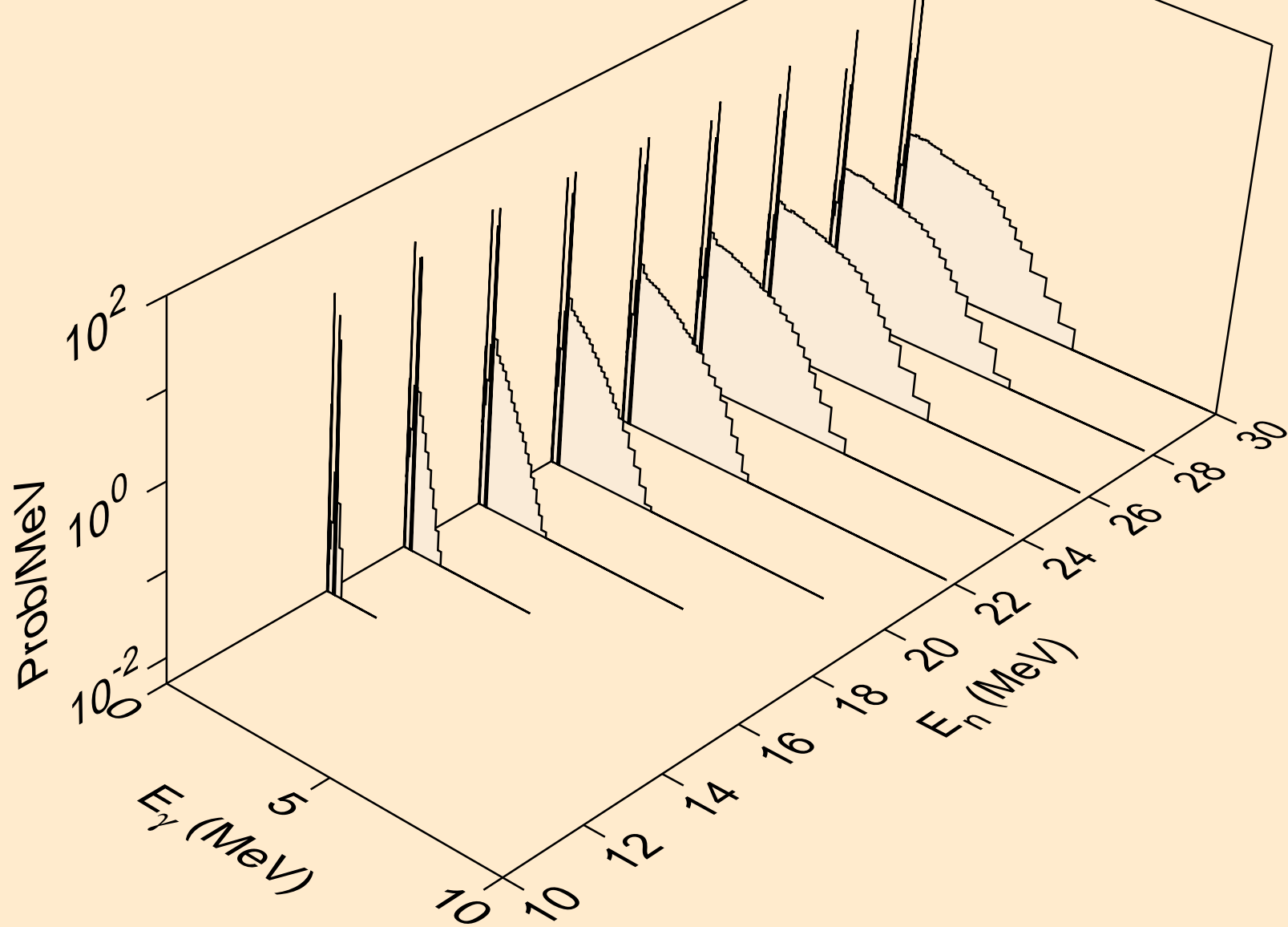

CE127M NEUTRON ACER TENDL-2021 LIBRARY; T=293.6K  
Photon emission for (n,n\*)t

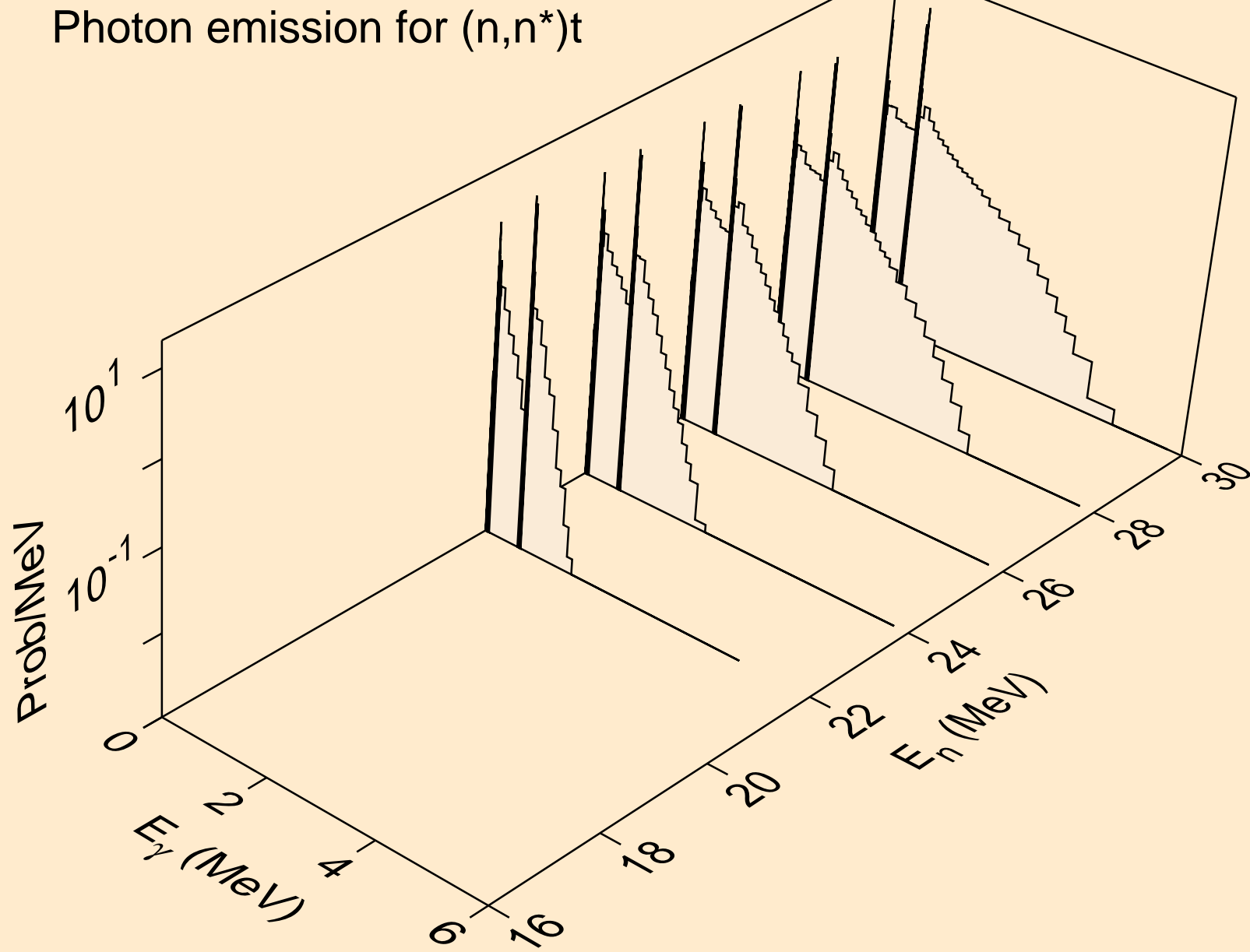

CE127M NEUTRON ACER TENDL-2021 LIBRARY; T=293.6K  
Photon emission for (n,n\*)he3

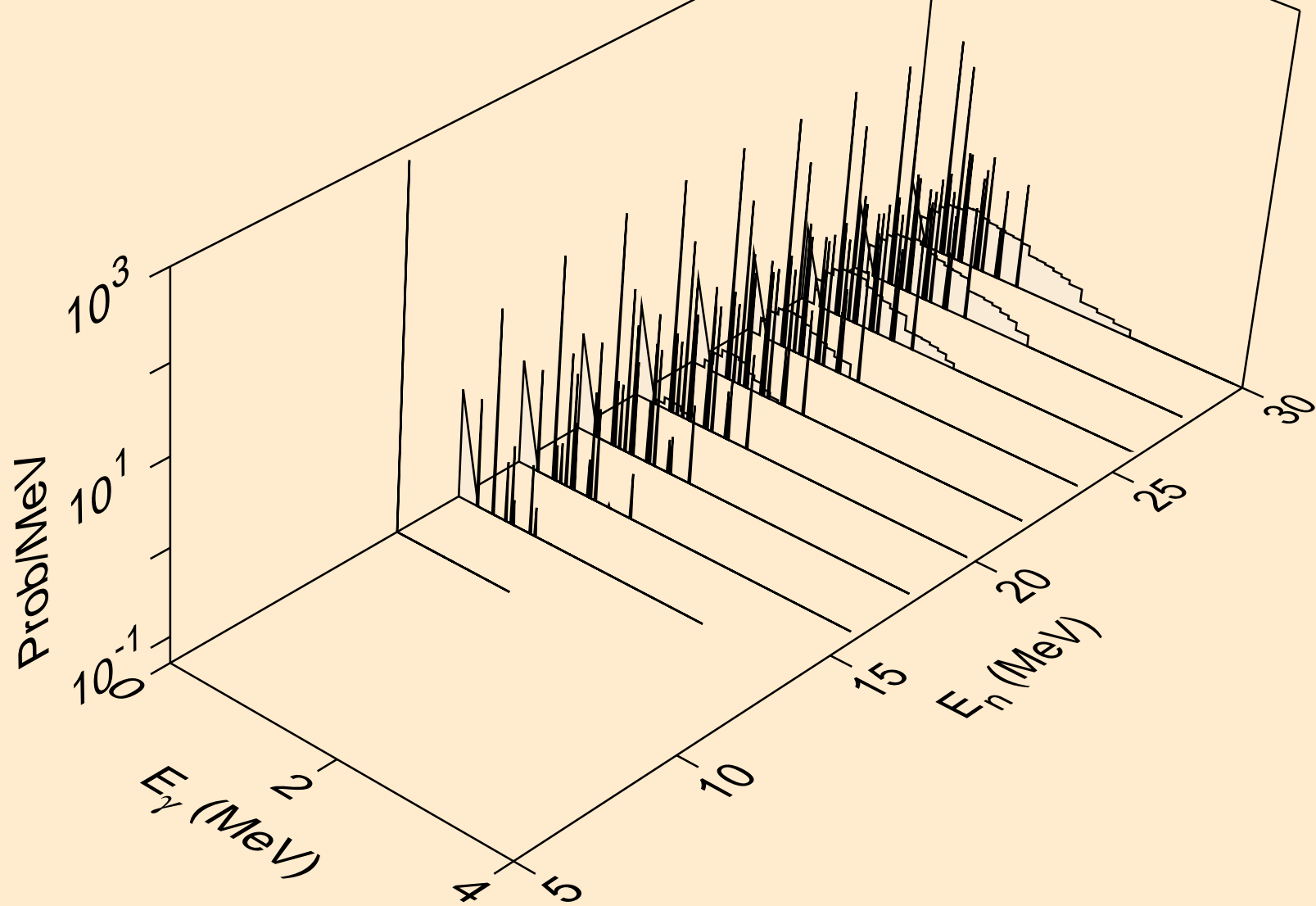



CE127M NEUTRON ACER TENDL-2021 LIBRARY; T=293.6K  
Photon emission for (n,2np)

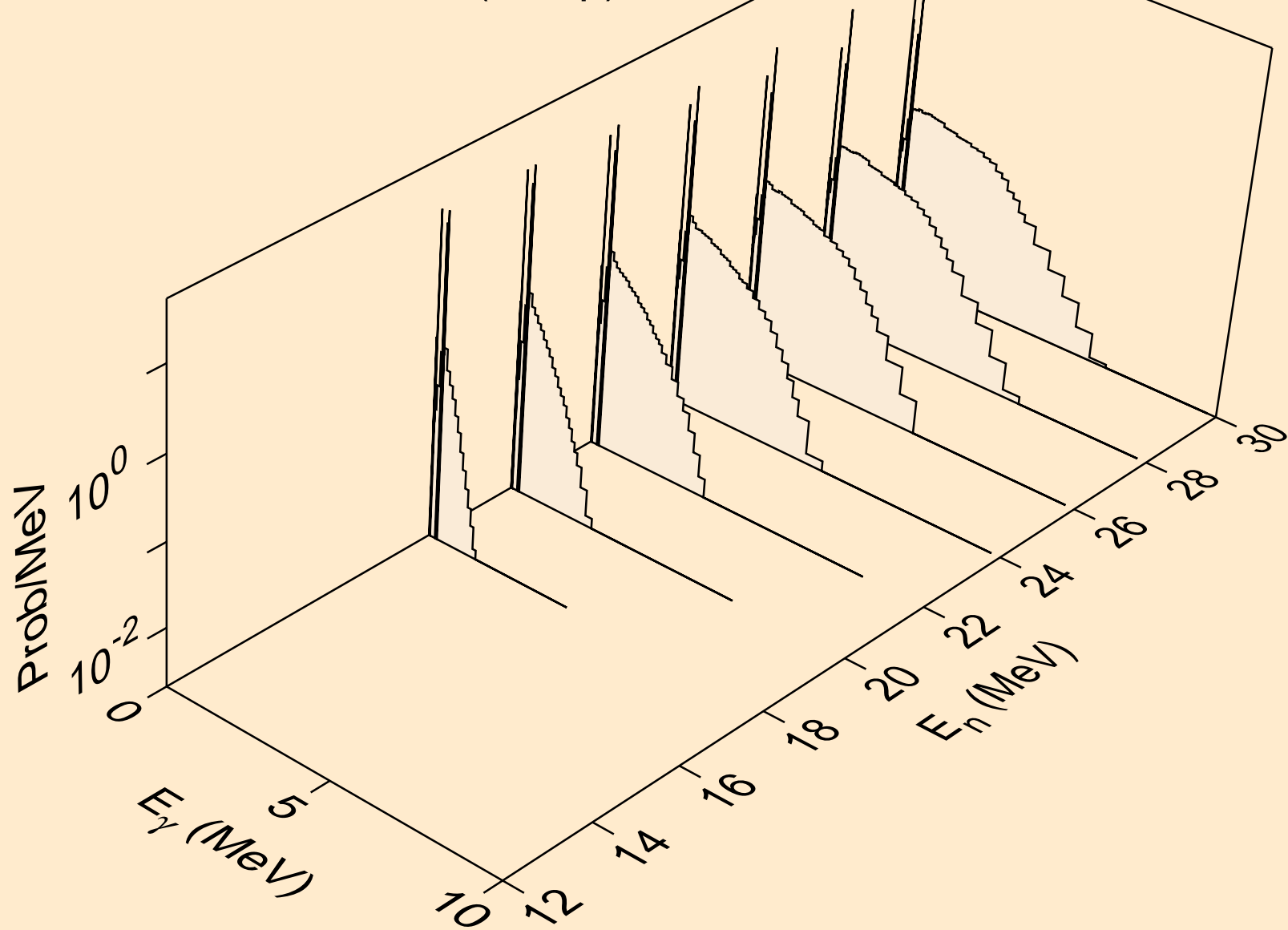

CE127M NEUTRON ACER TENDL-2021 LIBRARY; T=293.6K  
Photon emission for (n,3np)

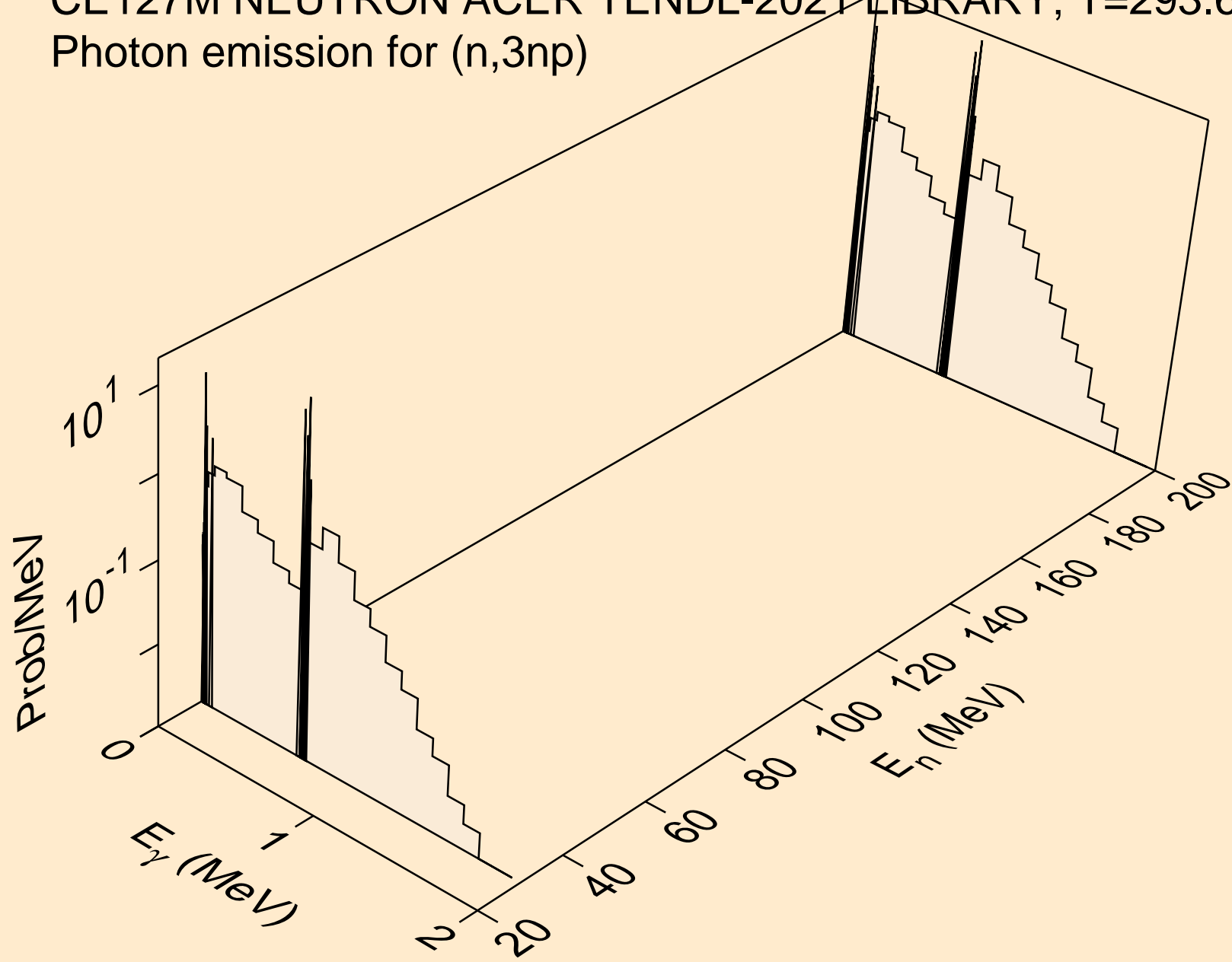

CE127M NEUTRON ACER TENDL-2021 LIBRARY; T=293.6K  
Photon emission for (n,2np)

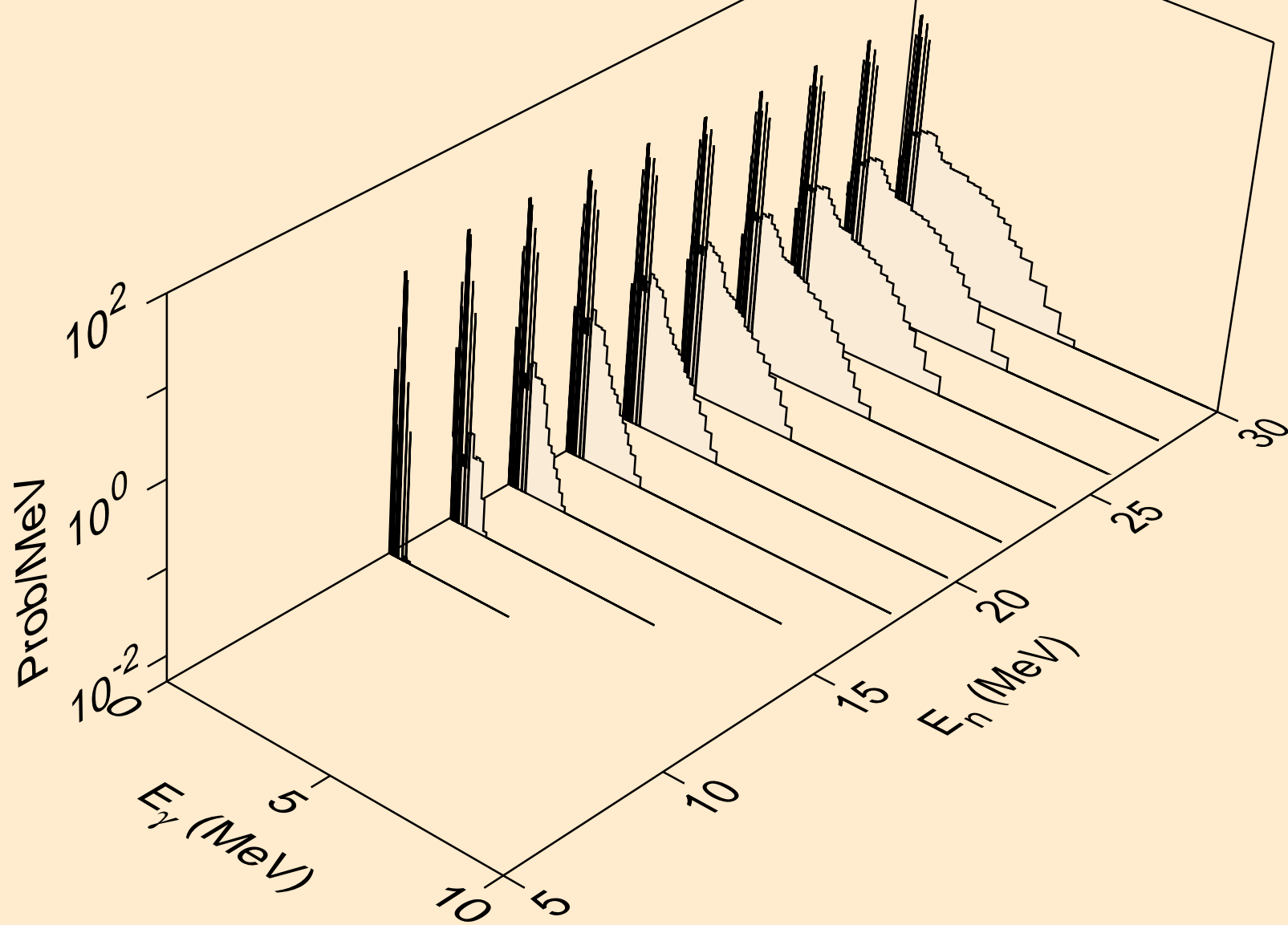

CE127M NEUTRON ACER TENDL-2021 LIBRARY; T=293.6K  
Photon emission for (n,npa)

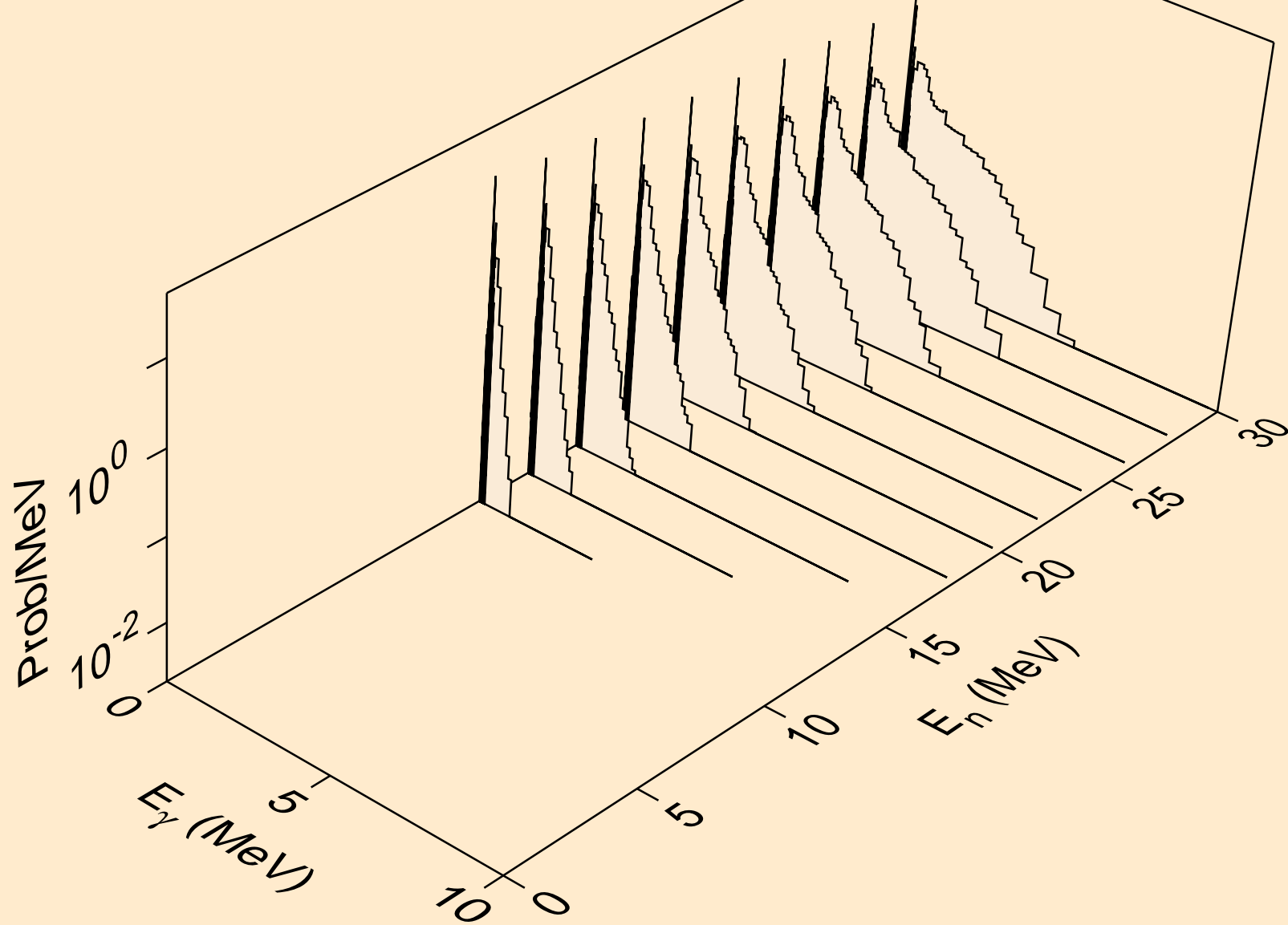

CE127M NEUTRON ACER TENDL-2021 LIBRARY; T=293.6K  
Photon emission for (n,n\*2)

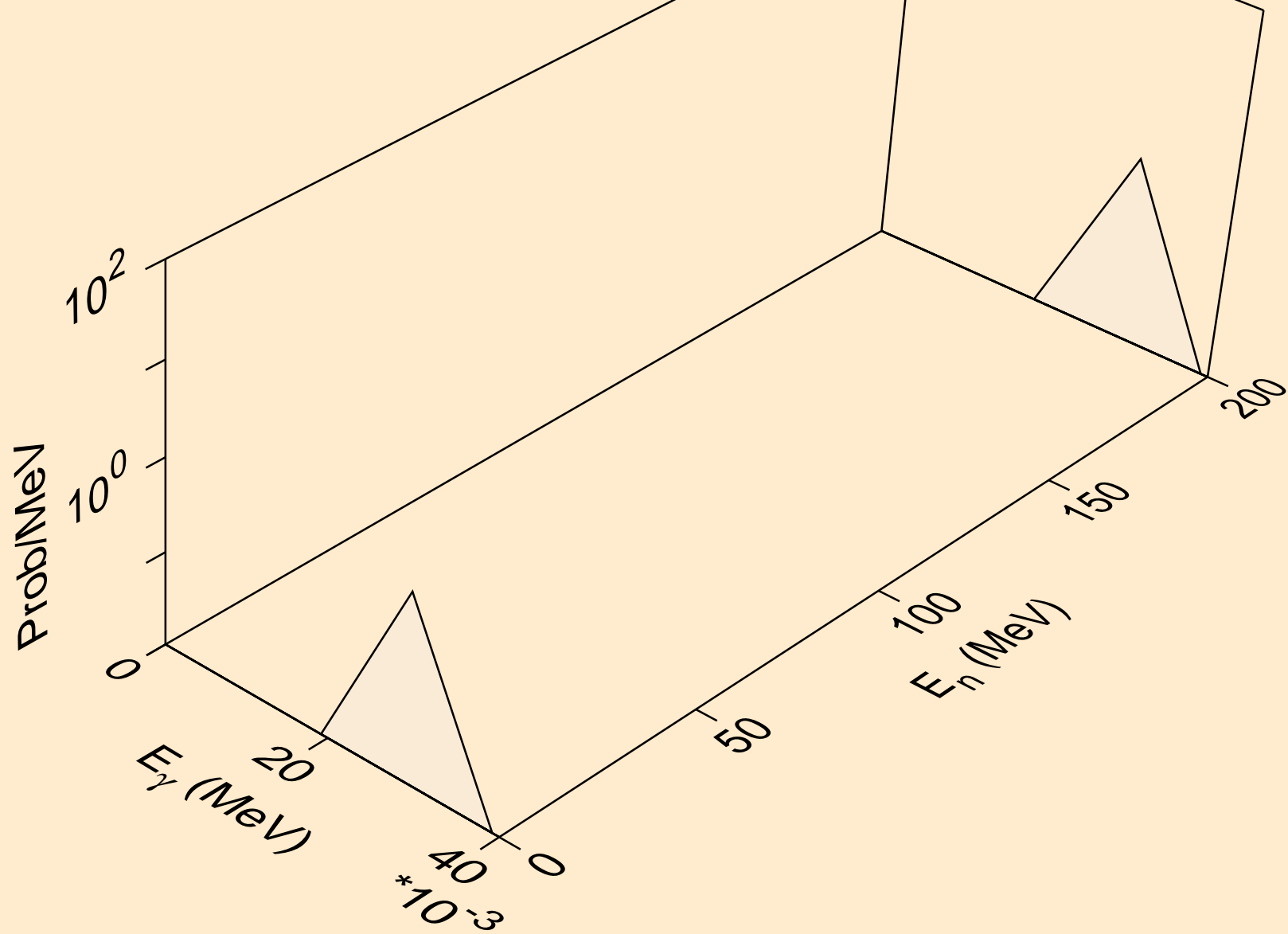

CE127M NEUTRON ACER TENDL-2021 LIBRARY; T=293.6K  
Photon emission for (n,n\*3)

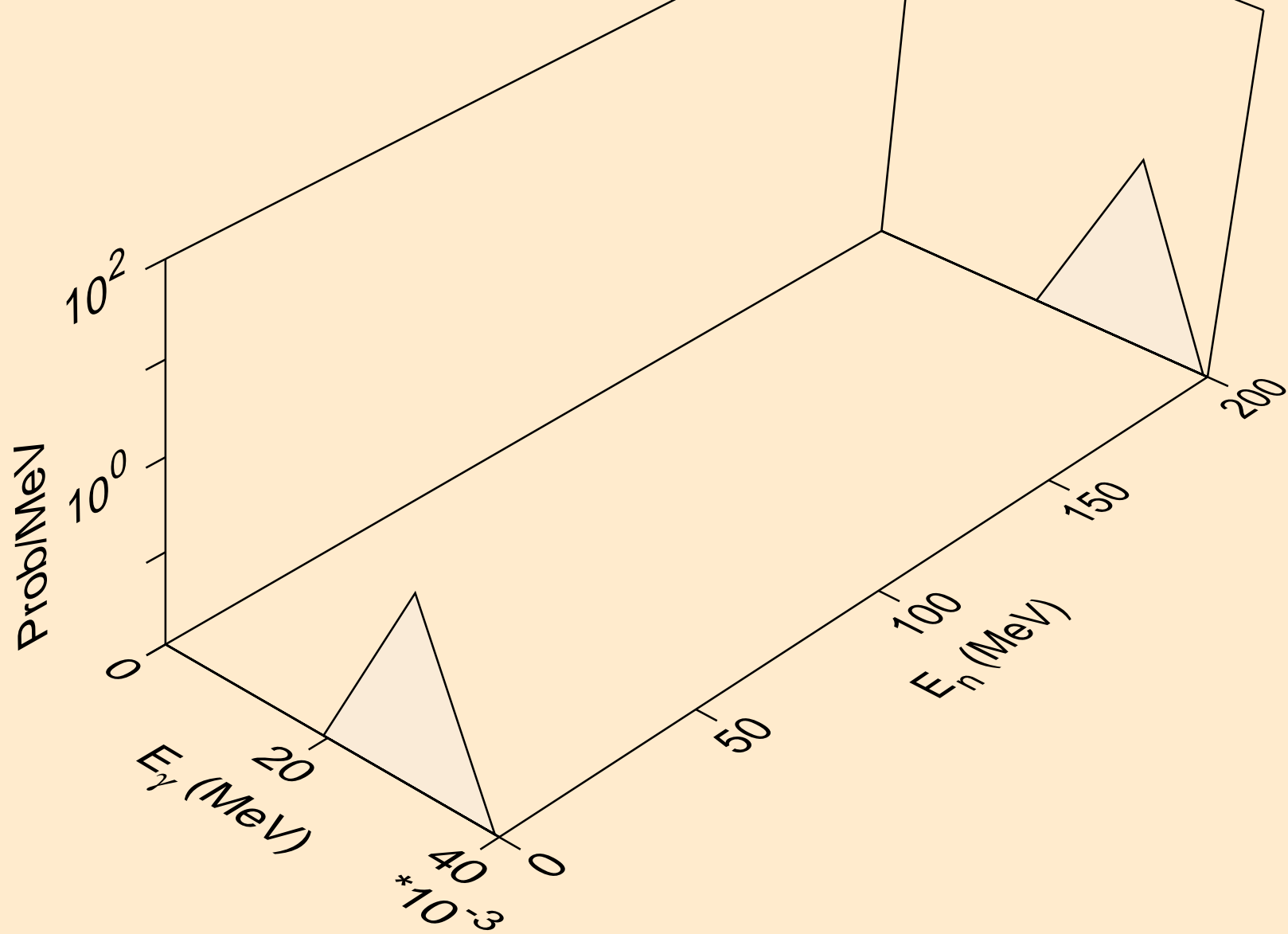

CE127M NEUTRON ACER TENDL-2021 LIBRARY; T=293.6K  
Photon emission for (n,n\*4)

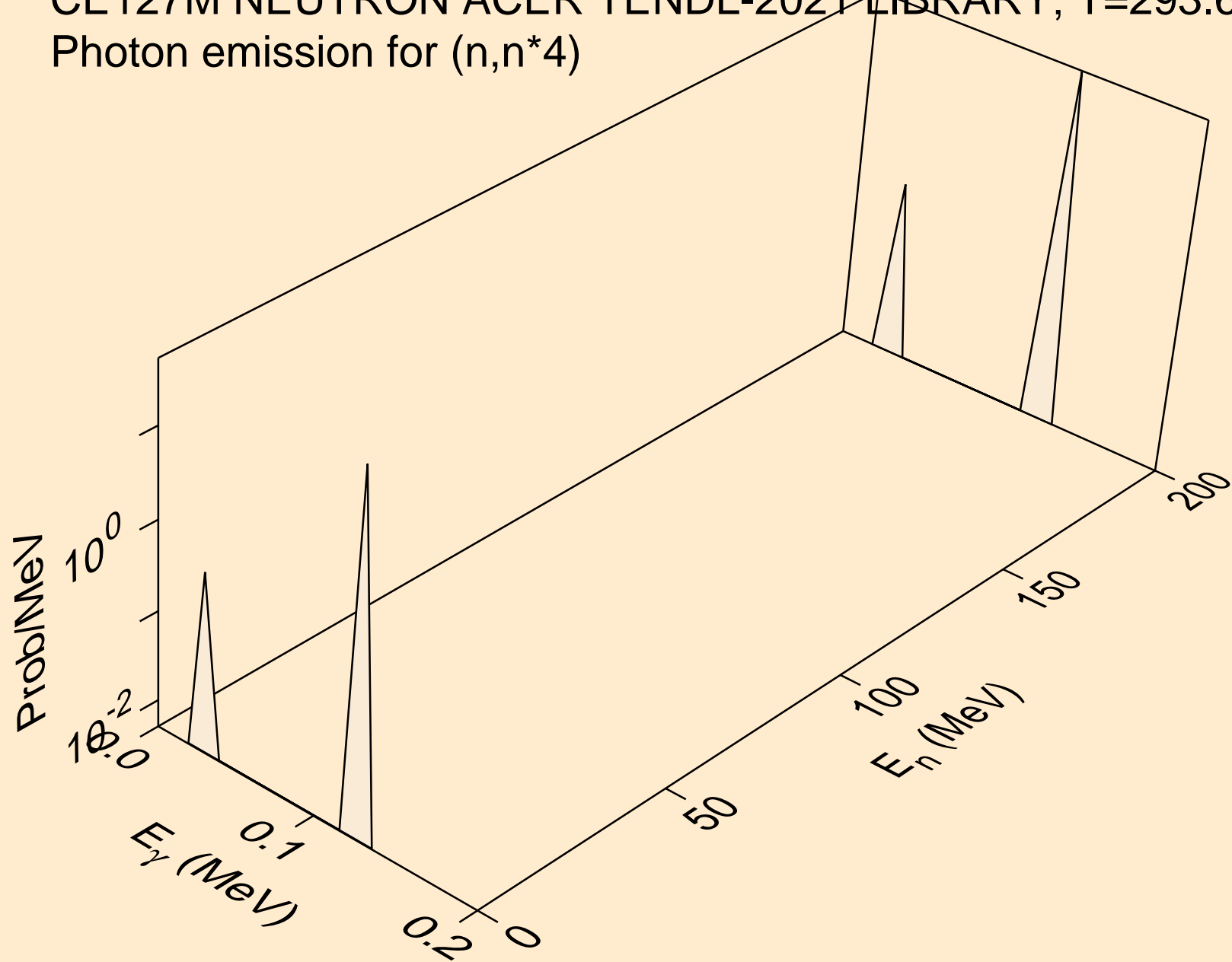

CE127M NEUTRON ACER TENDL-2021 LIBRARY; T=293.6K  
Photon emission for (n,n\*5)

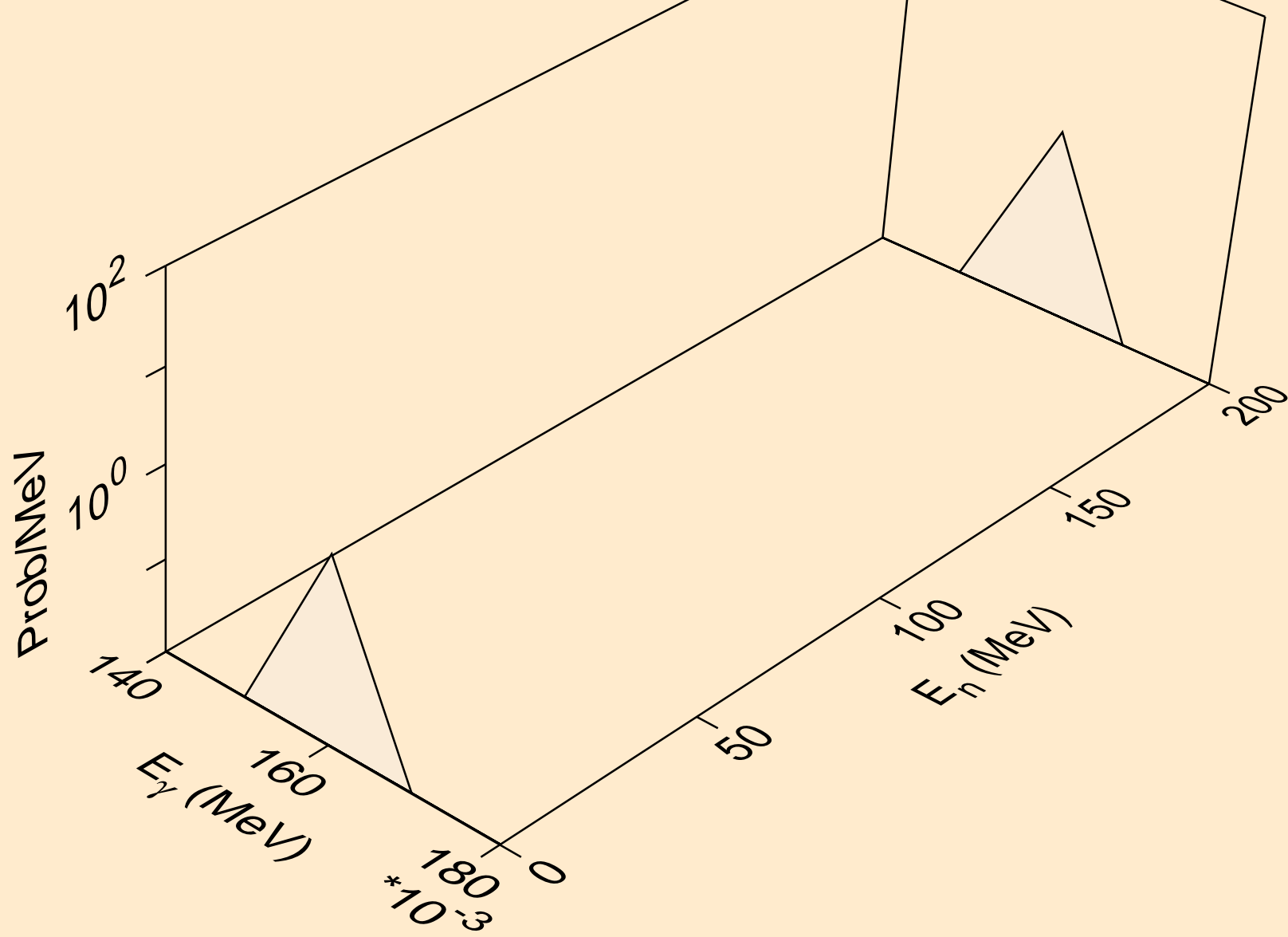



CE127M NEUTRON ACER TENDL-2021 LIBRARY; T=293.6K  
Photon emission for (n,n\*6)

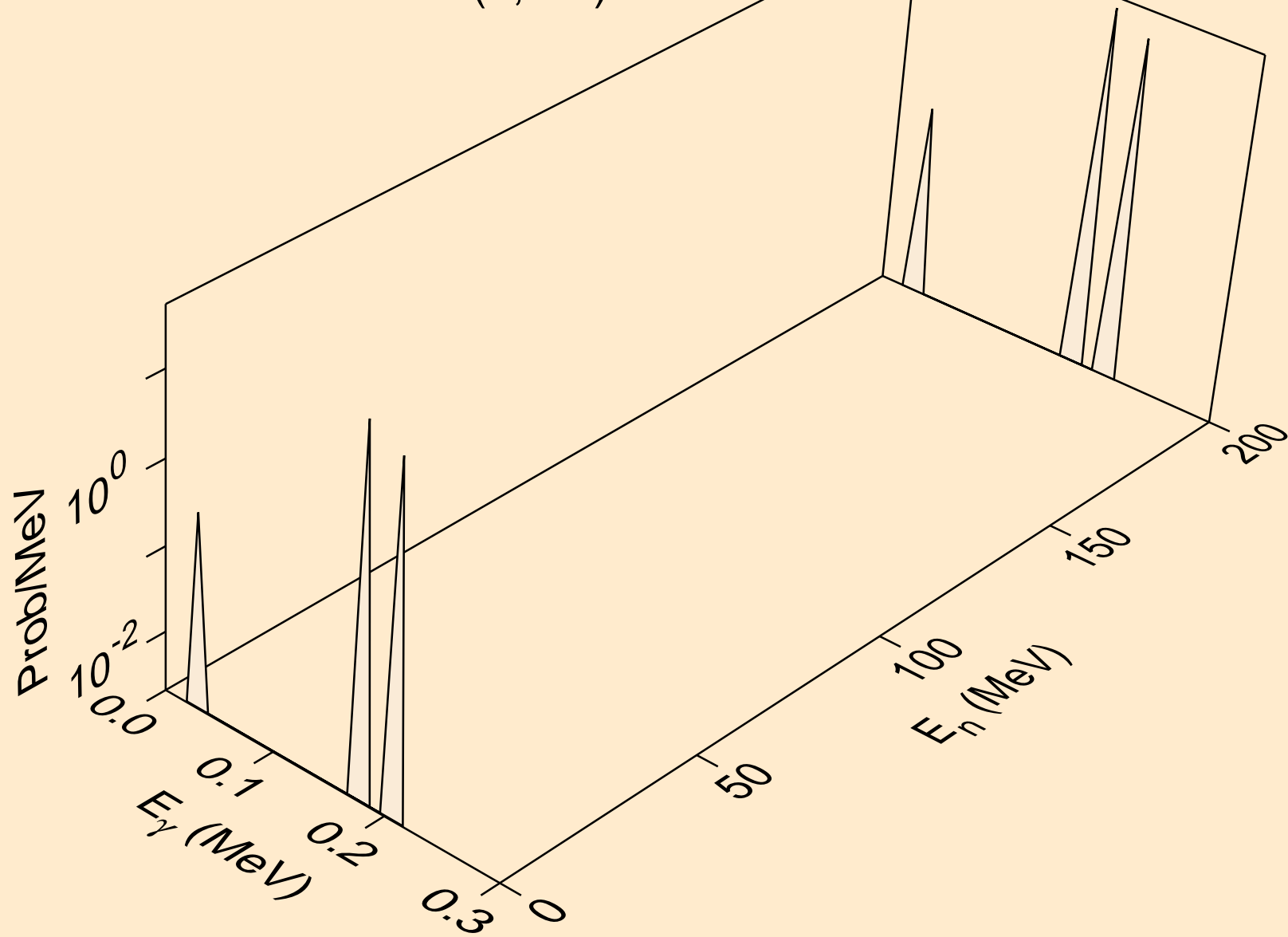

CE127M NEUTRON ACER TENDL-2021 LIBRARY; T=293.6K  
Photon emission for (n,n\*7)

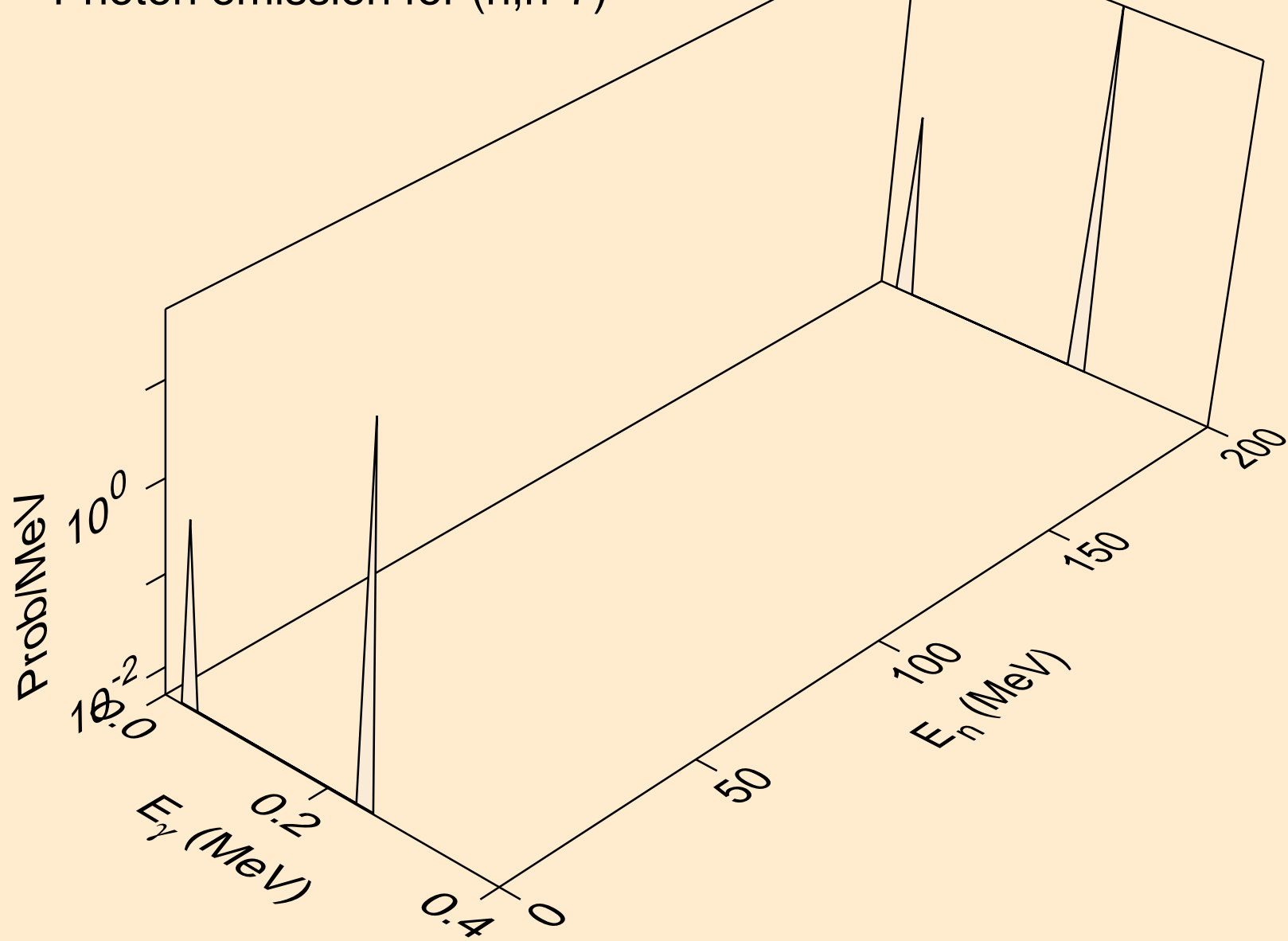

CE127M NEUTRON ACER TENDL-2021 LIBRARY; T=293.6K  
Photon emission for (n,n\*8)

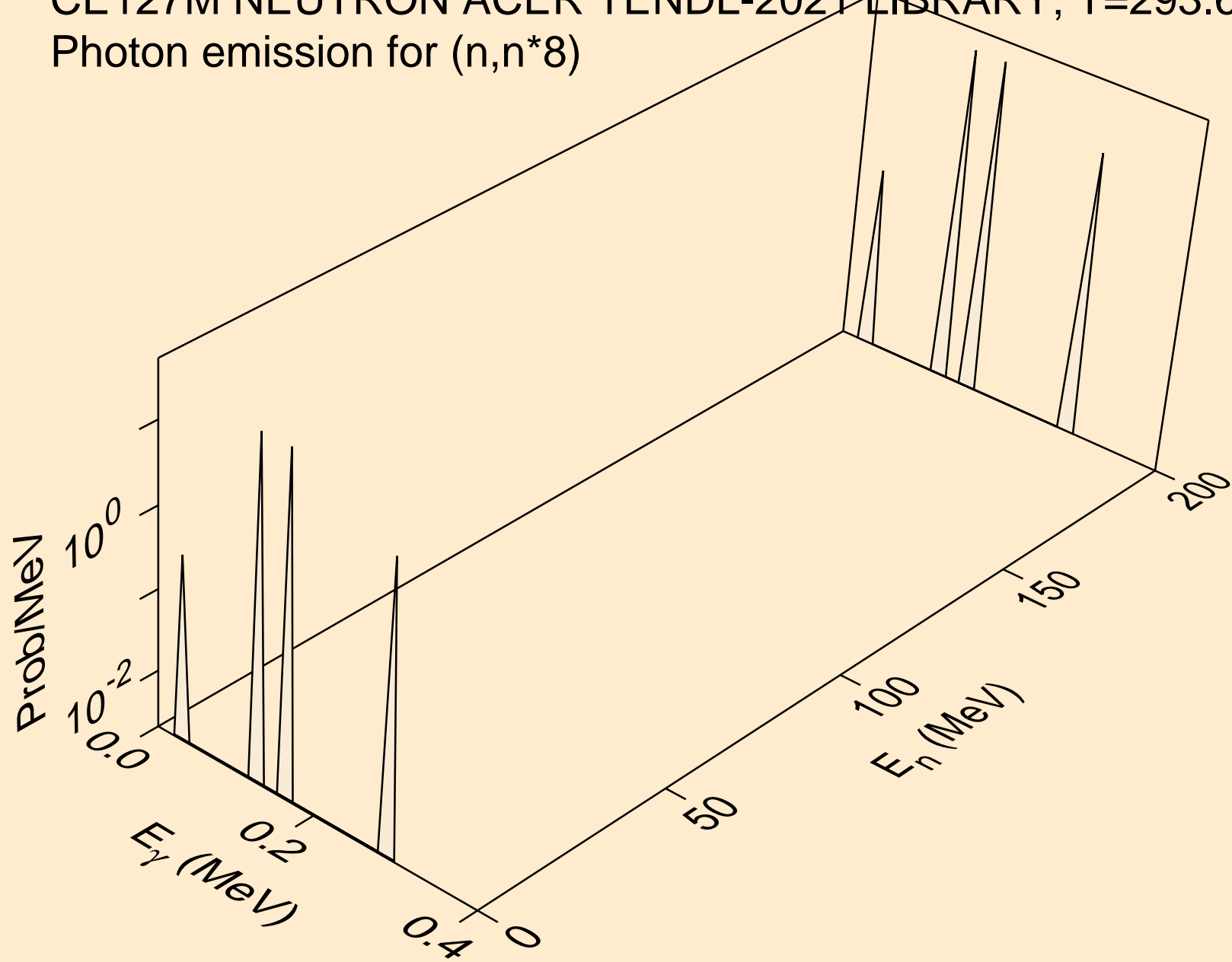

CE127M NEUTRON ACER TENDL-2021 LIBRARY; T=293.6K  
Photon emission for (n,n\*9)

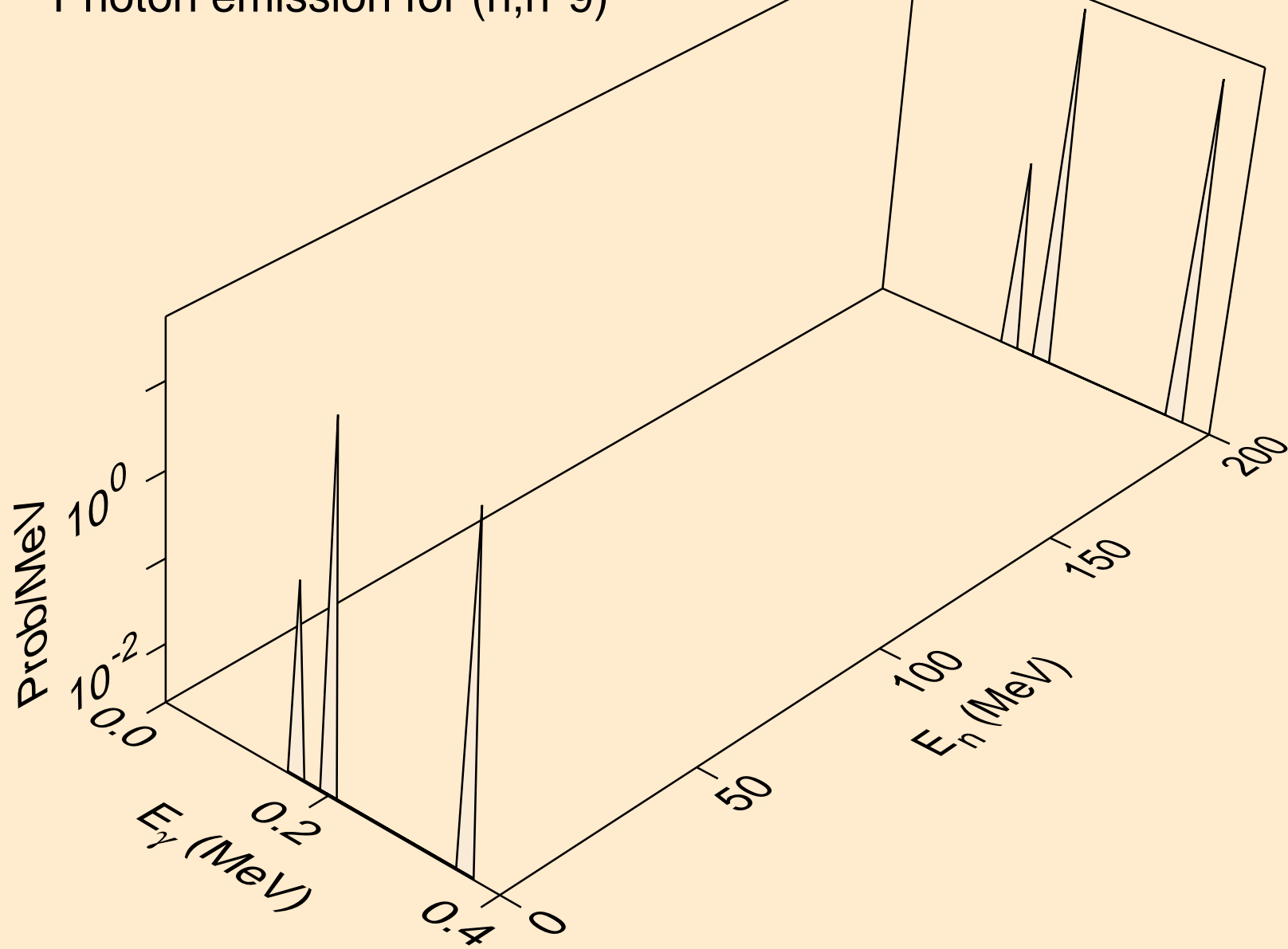

CE127M NEUTRON ACER TENDL-2021 LIBRARY; T=293.6K  
Photon emission for (n,n\*10)

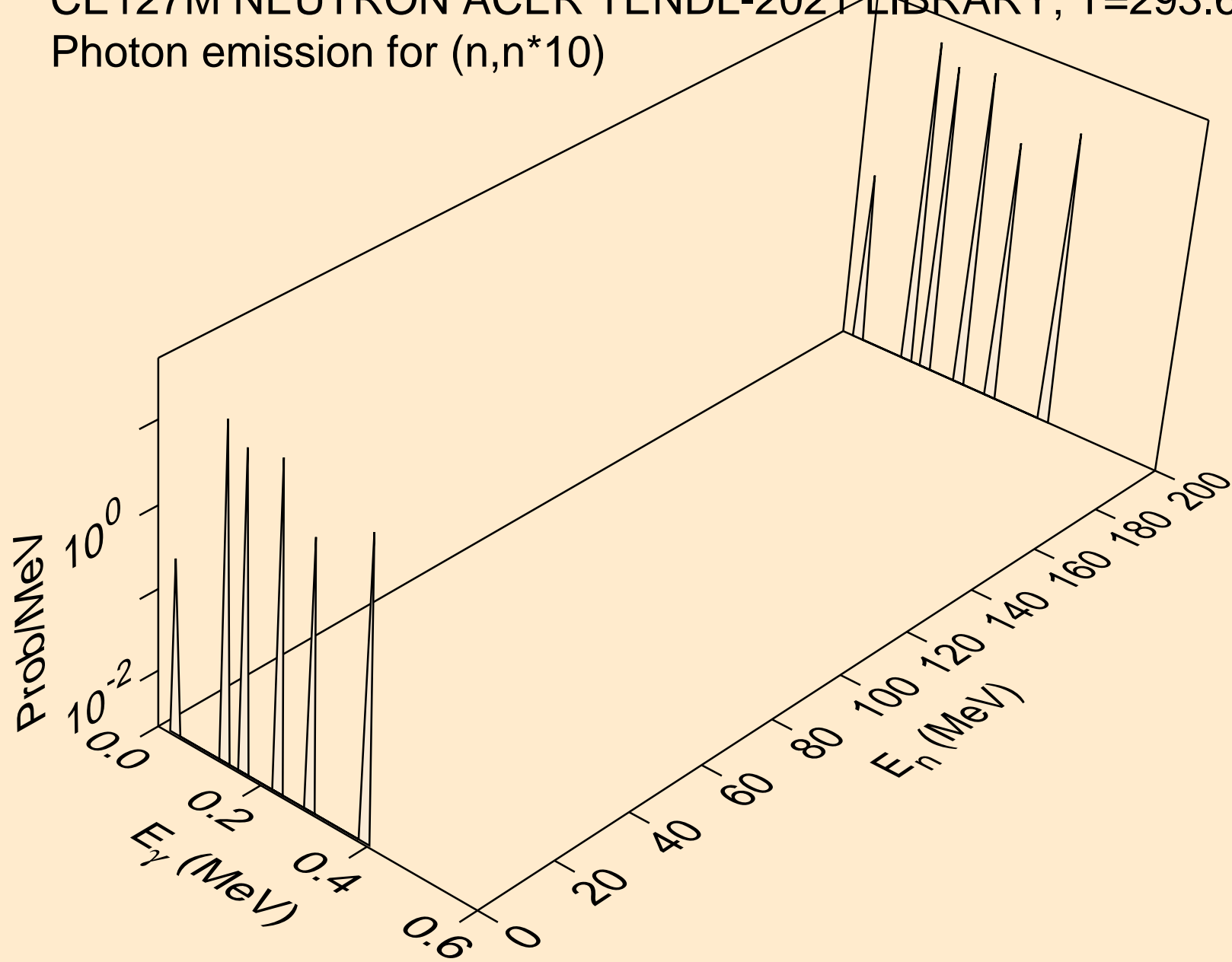

CE127M NEUTRON ACER TENDL-2021 LIBRARY; T=293.6K  
Photon emission for (n,n\*11)

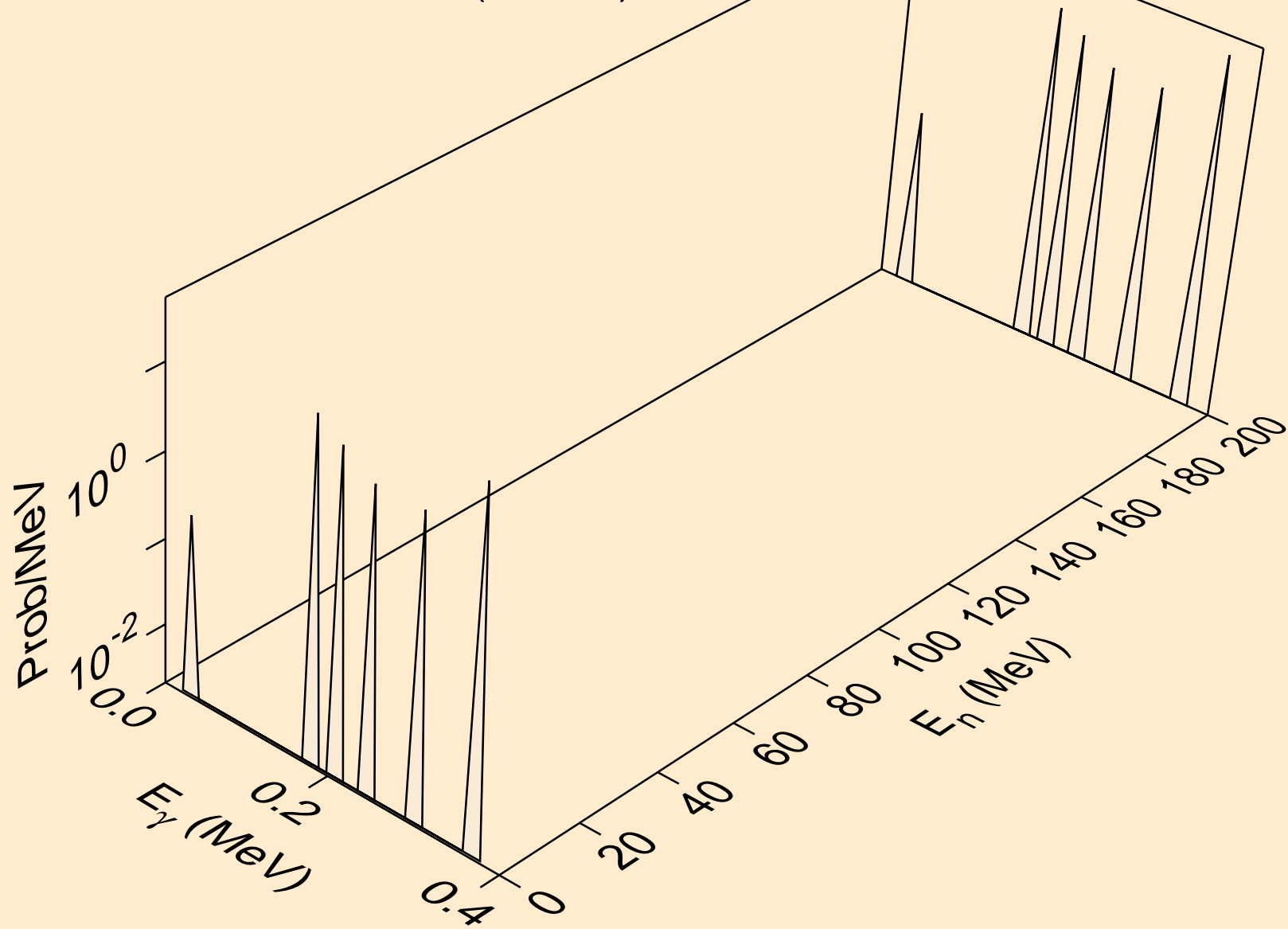

CE127M NEUTRON ACER TENDL-2021 LIBRARY; T=293.6K  
Photon emission for (n,n\*12)

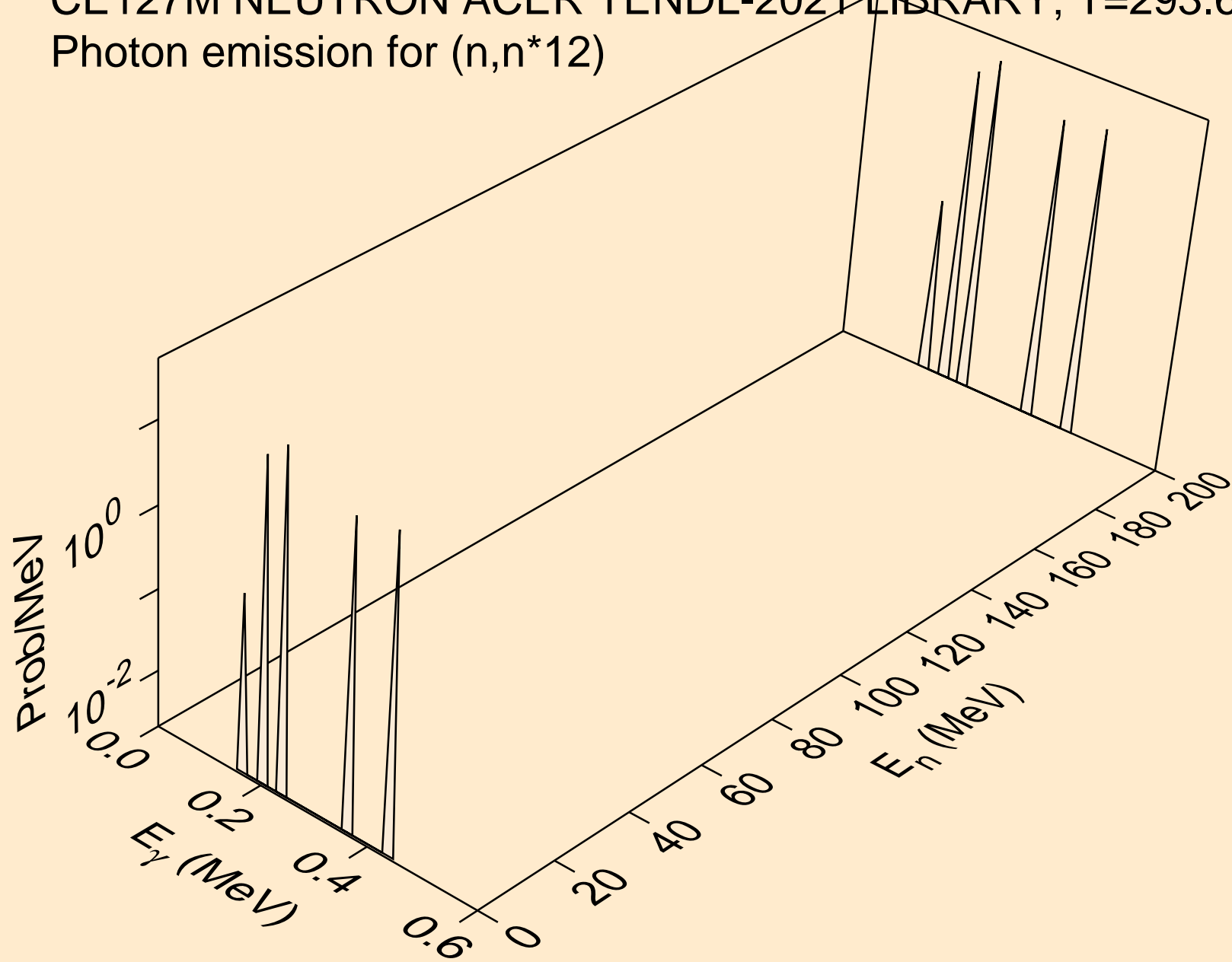

CE127M NEUTRON ACER TENDL-2021 LIBRARY; T=293.6K  
Photon emission for (n,n\*13)

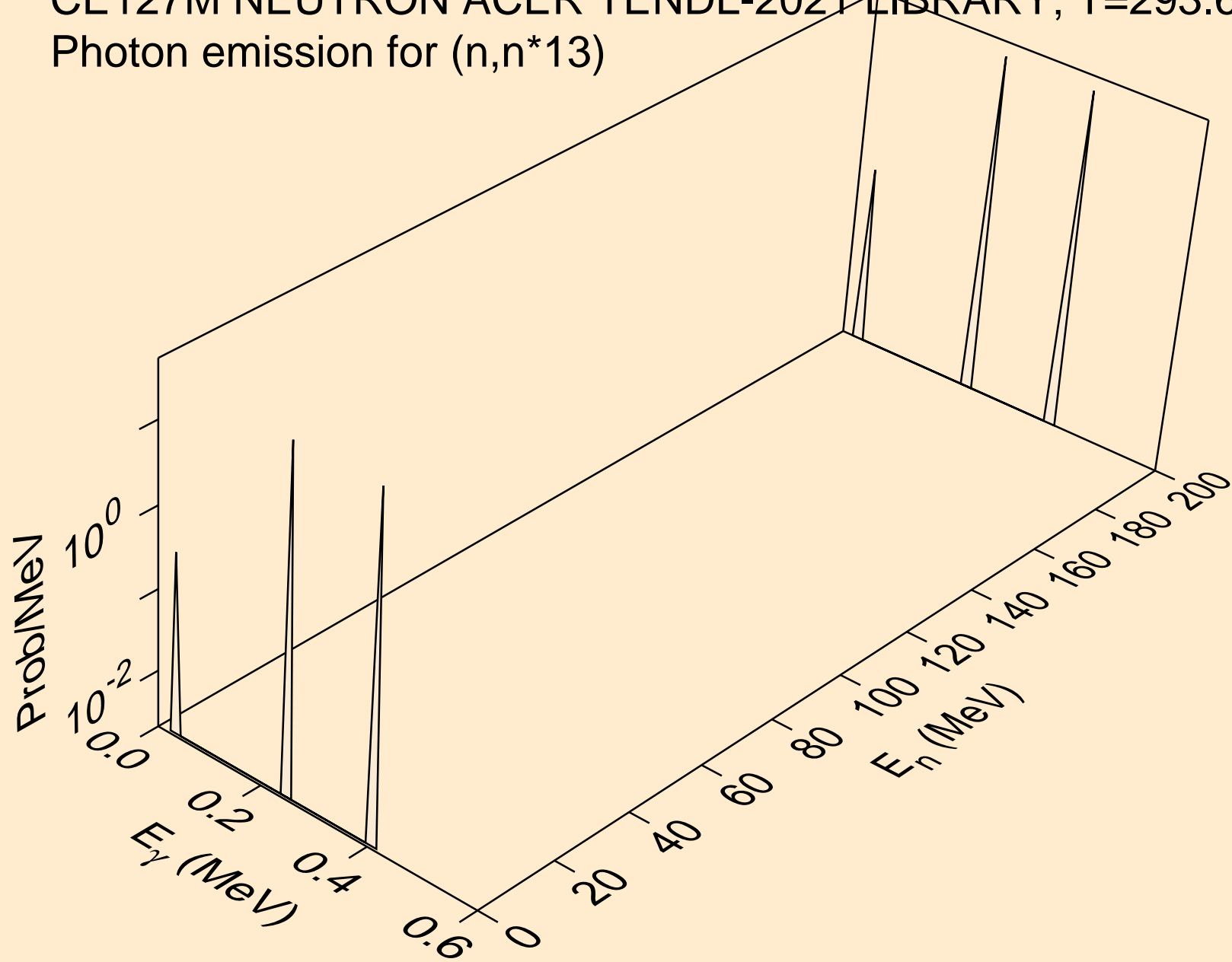



CE127M NEUTRON ACER TENDL-2021 LIBRARY; T=293.6K  
Photon emission for (n,n\*14)

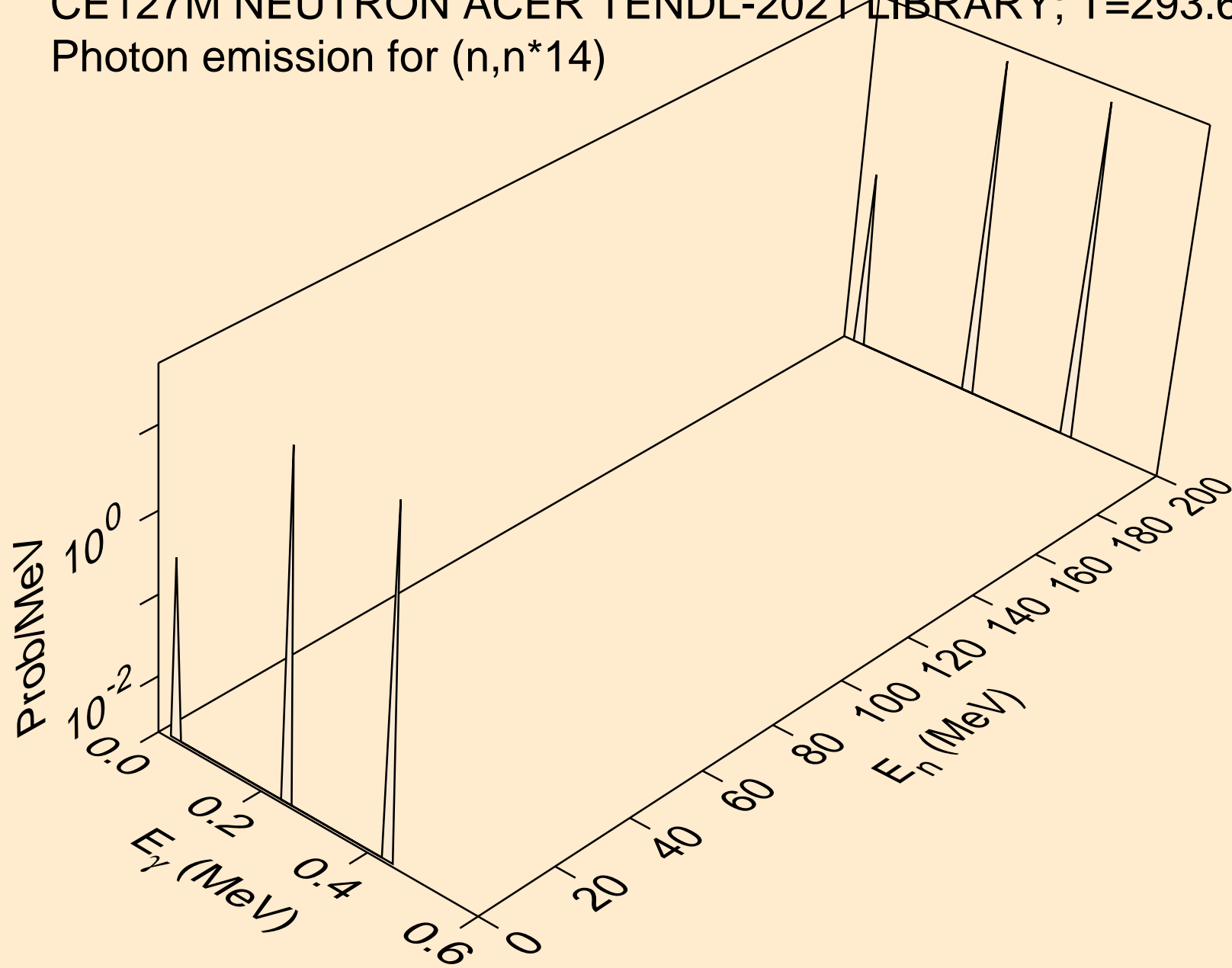

CE127M NEUTRON ACER TENDL-2021 LIBRARY; T=293.6K  
Photon emission for (n,n\*15)

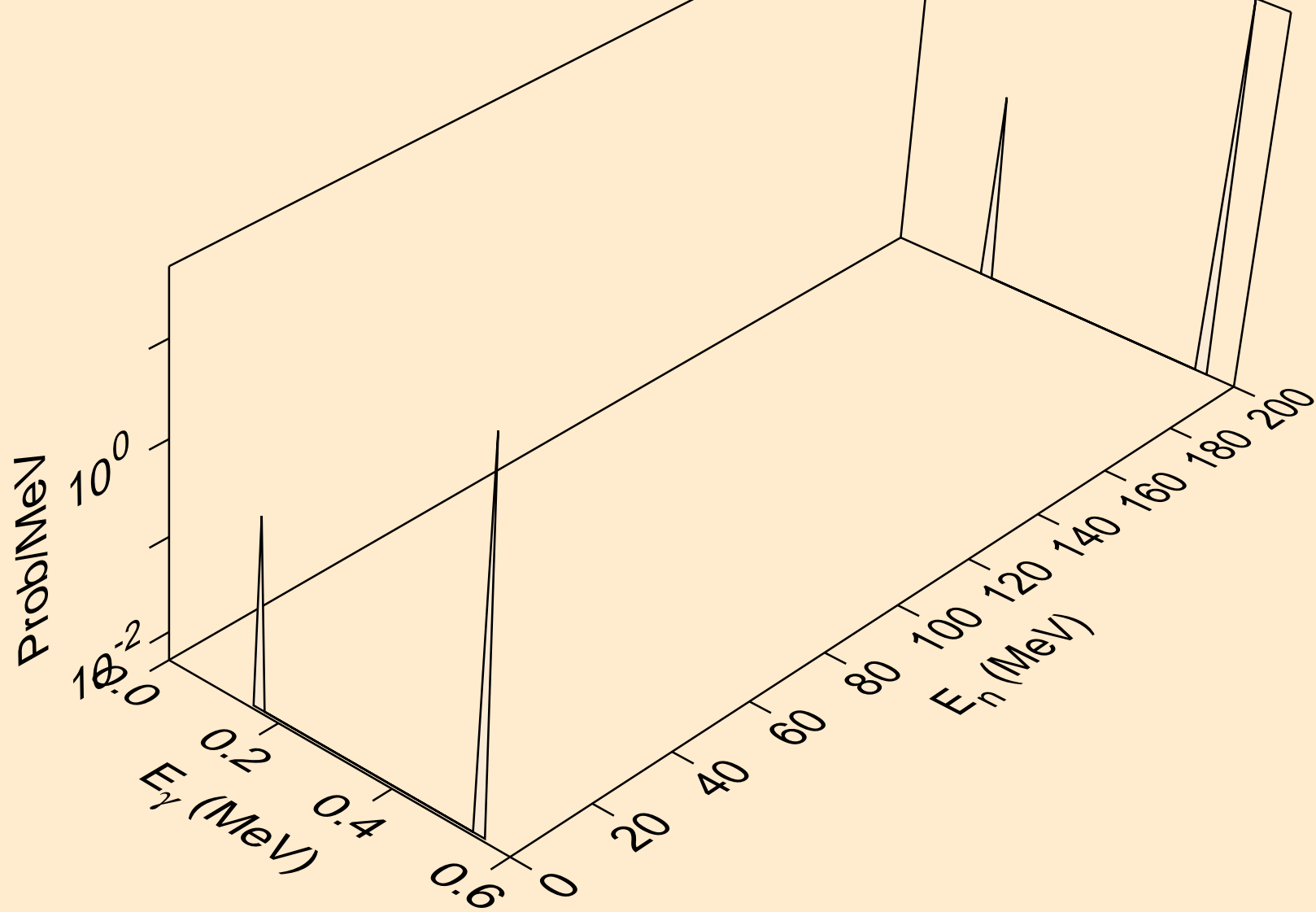

CE127M NEUTRON ACER TENDL-2021 LIBRARY; T=293.6K  
Photon emission for (n,n\*16)

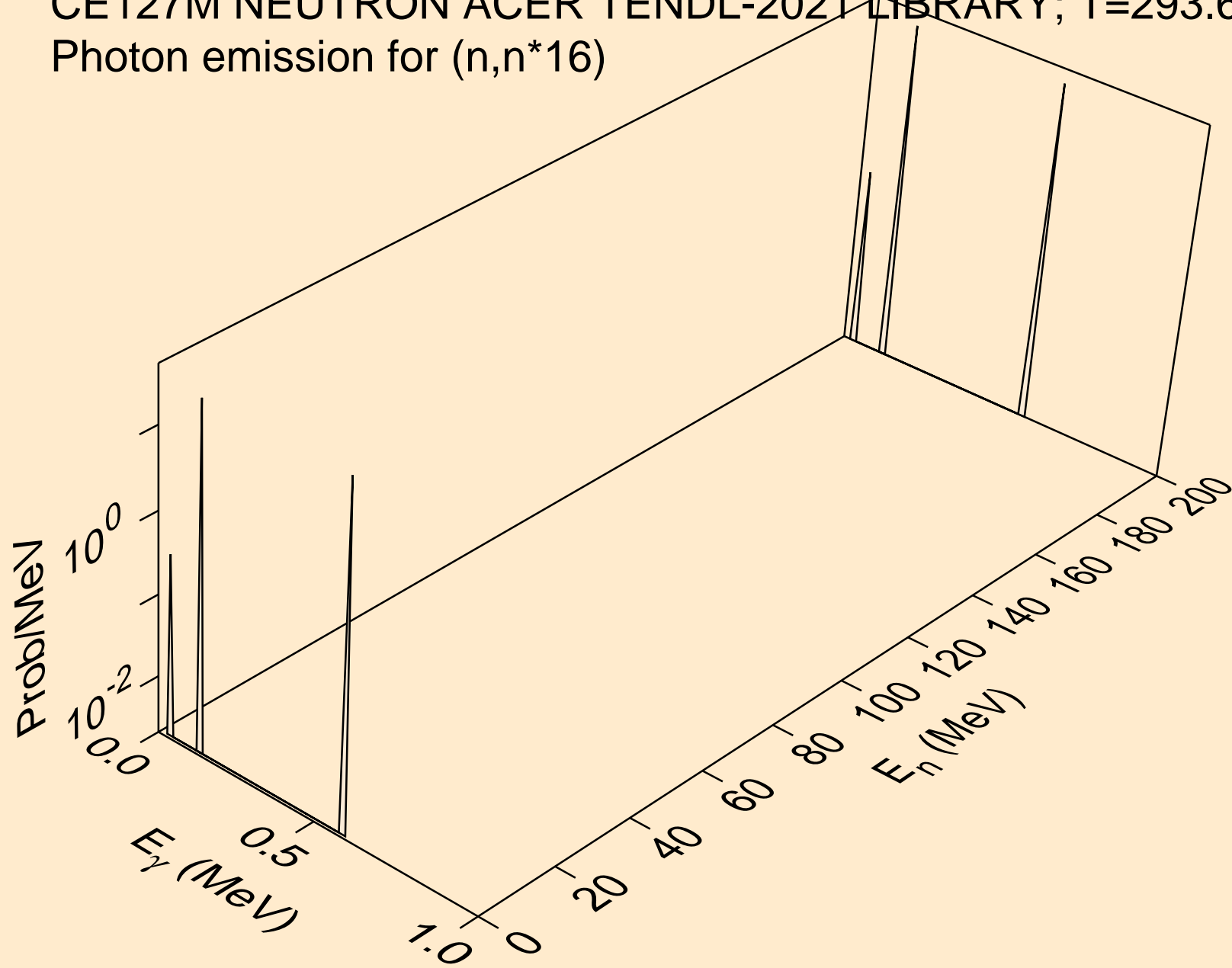

CE127M NEUTRON ACER TENDL-2021 LIBRARY; T=293.6K  
Photon emission for (n,n\*17)

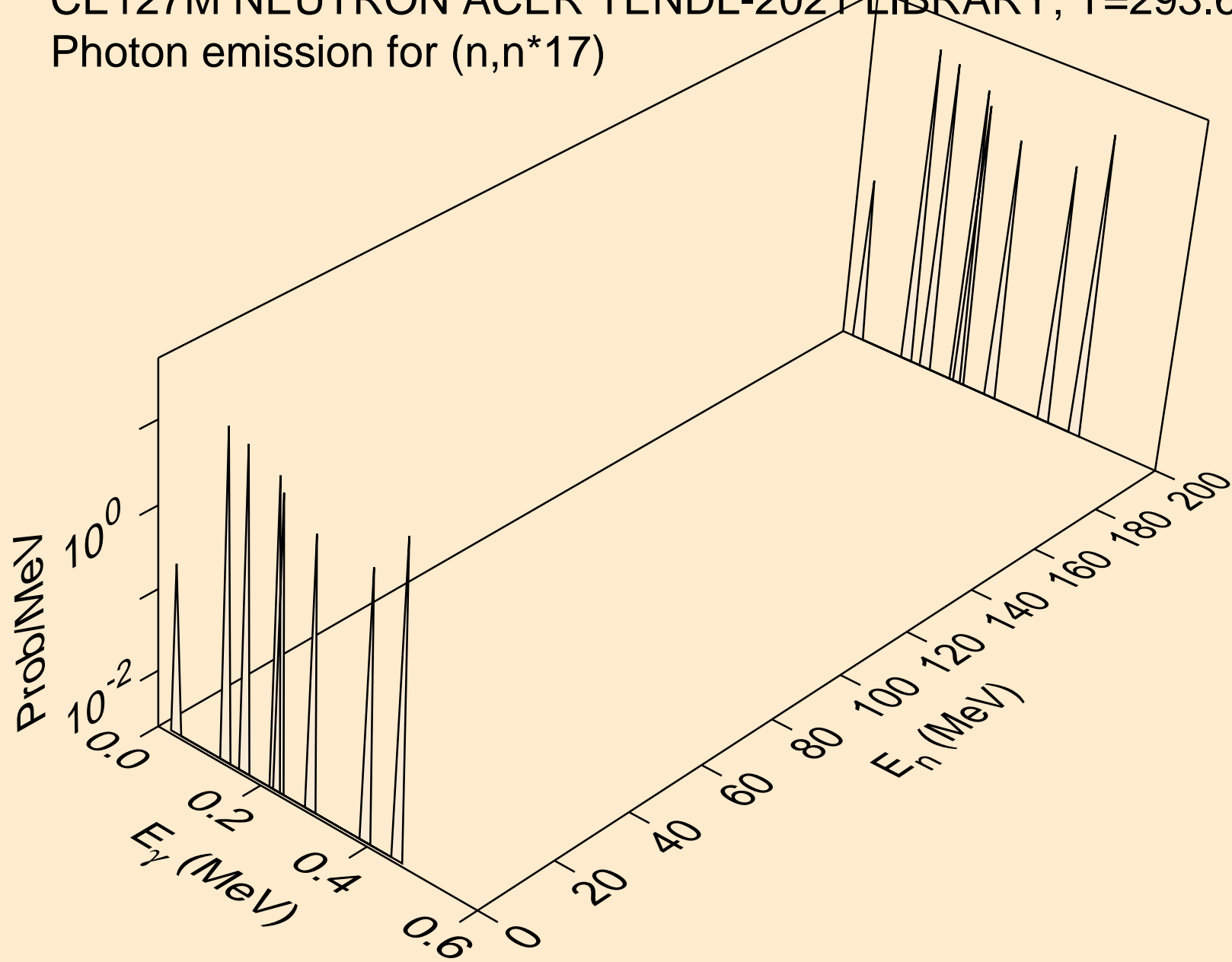

CE127M NEUTRON ACER TENDL-2021 LIBRARY; T=293.6K  
Photon emission for (n,n\*18)

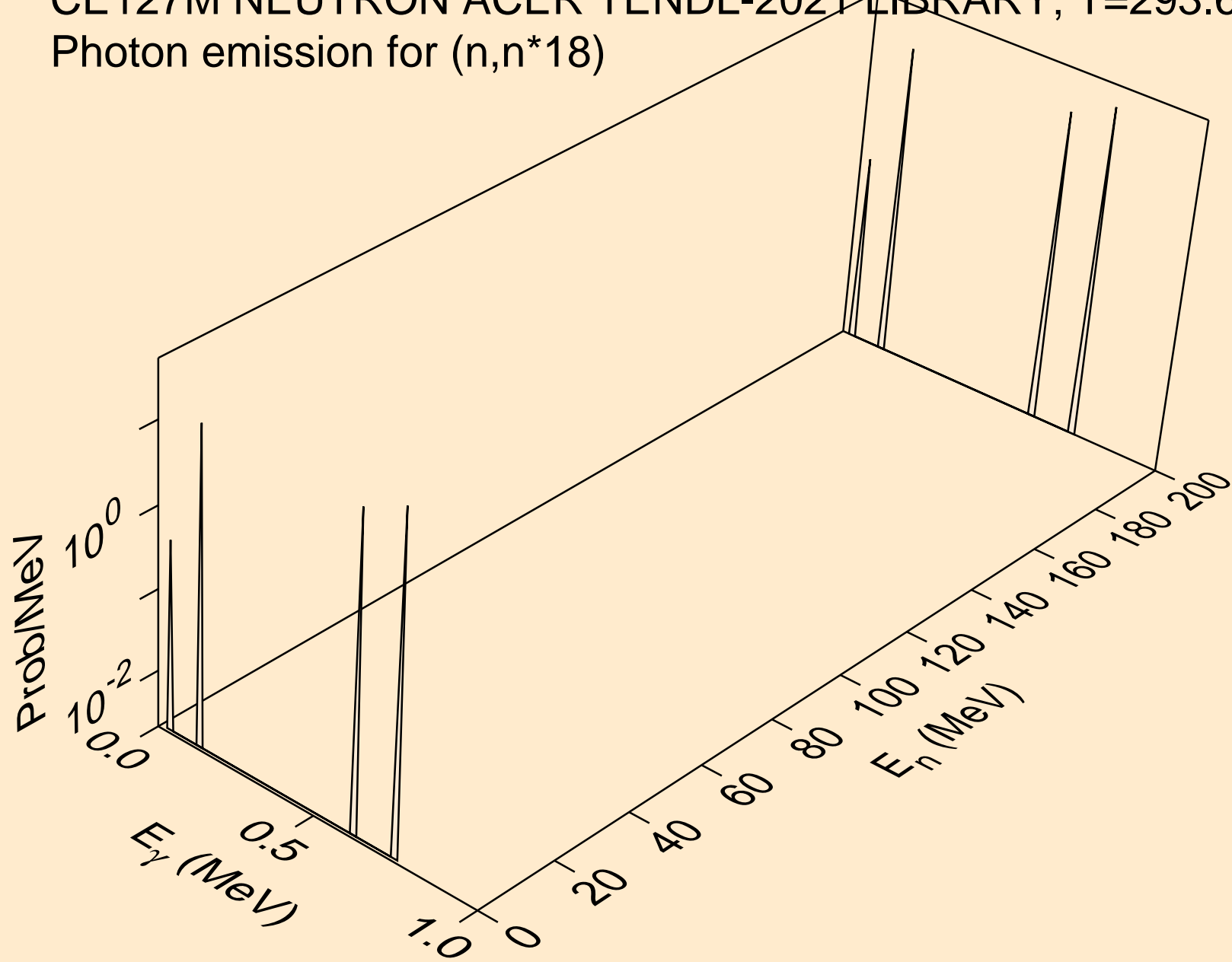

CE127M NEUTRON ACER TENDL-2021 LIBRARY; T=293.6K  
Photon emission for (n,n\*19)

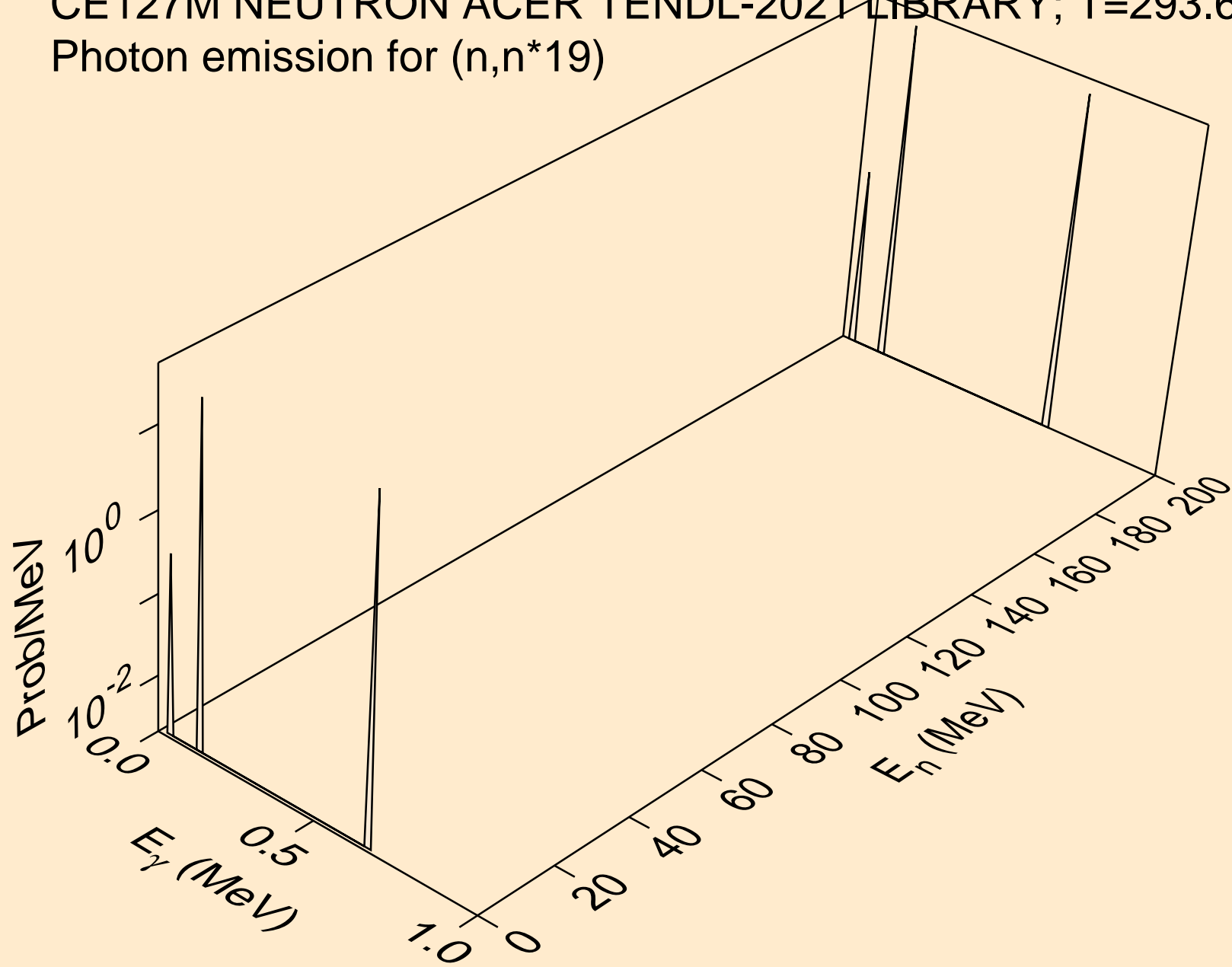

CE127M NEUTRON ACER TENDL-2021 LIBRARY; T=293.6K  
Photon emission for (n,n\*c)

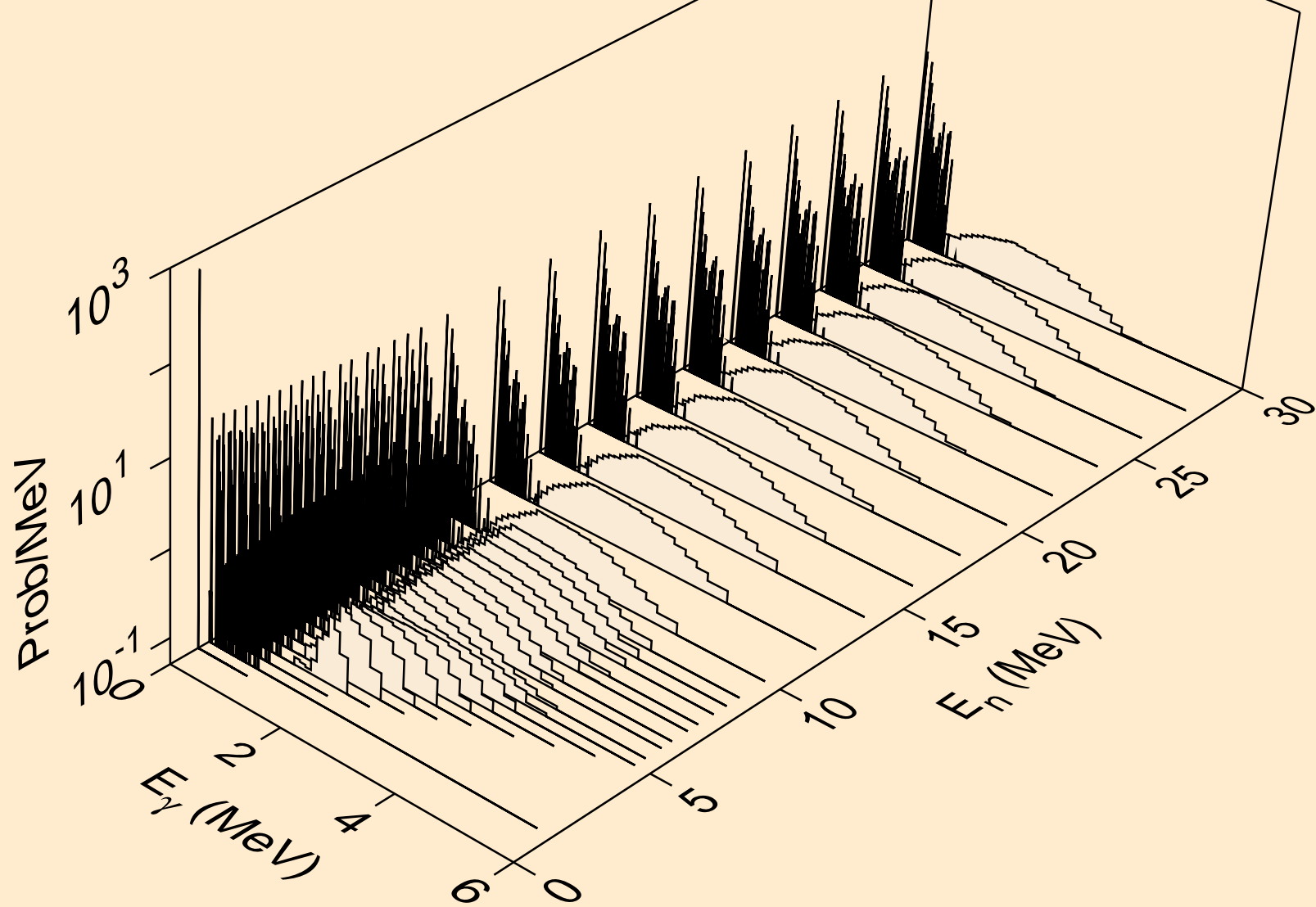

CE127M NEUTRON ACER TENDL-2021 LIBRARY; T=293.6K  
Photon emission for (n,gma)

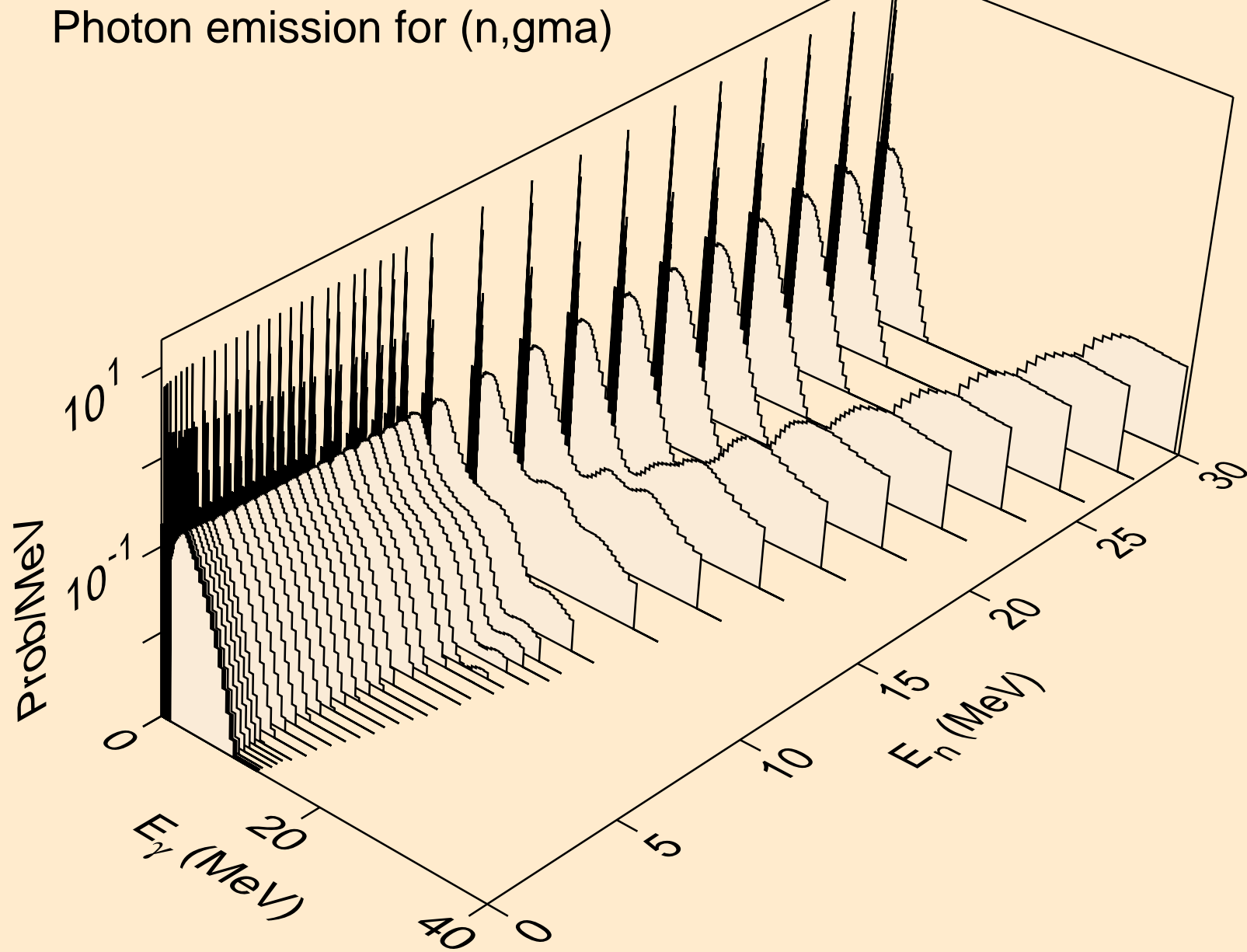



CE127M NEUTRON ACER TENDL-2021 LIBRARY; T=293.6K  
Photon emission for (n,p)

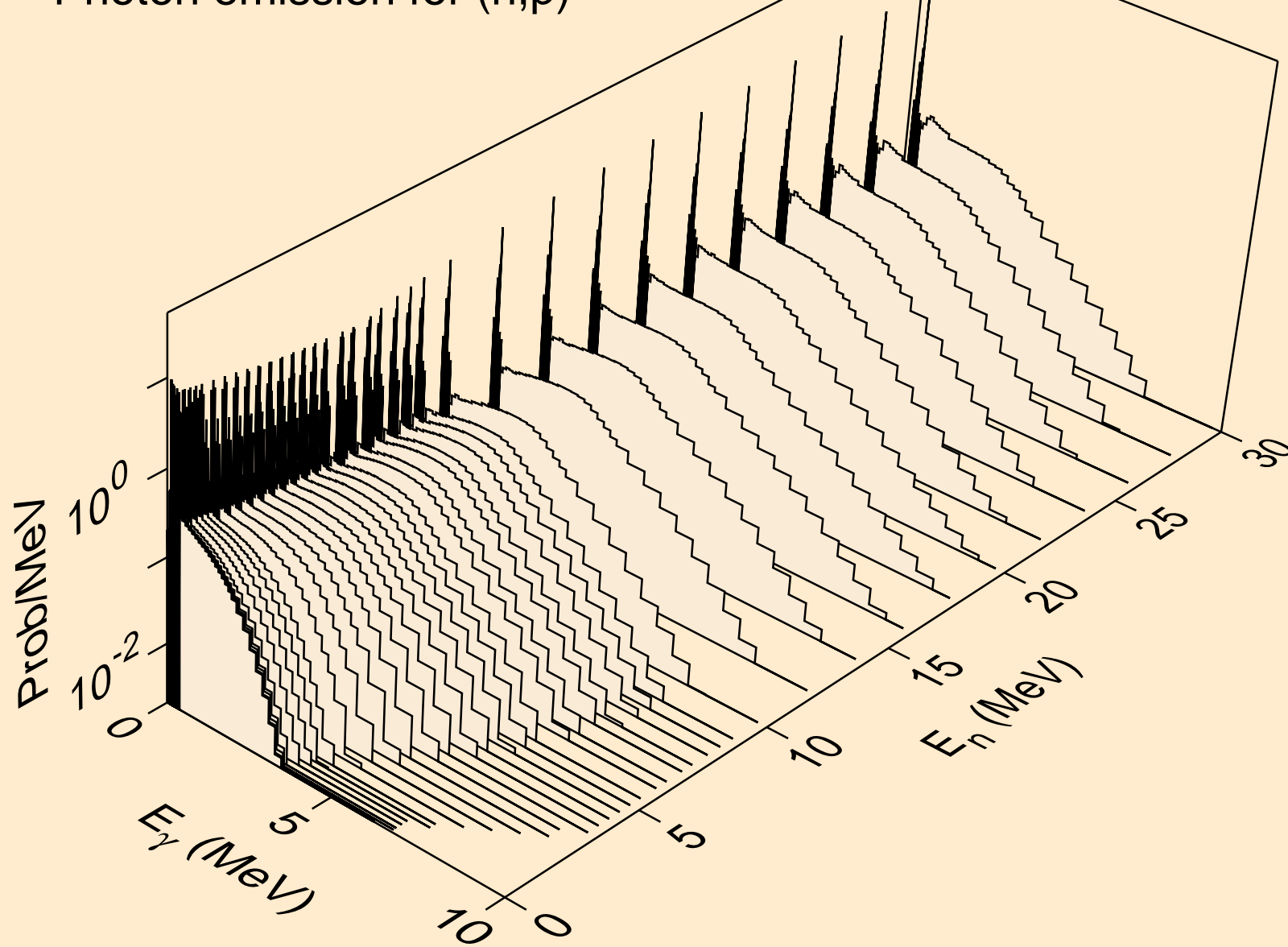

CE127M NEUTRON ACER TENDL-2021 LIBRARY; T=293.6K  
Photon emission for (n,d)

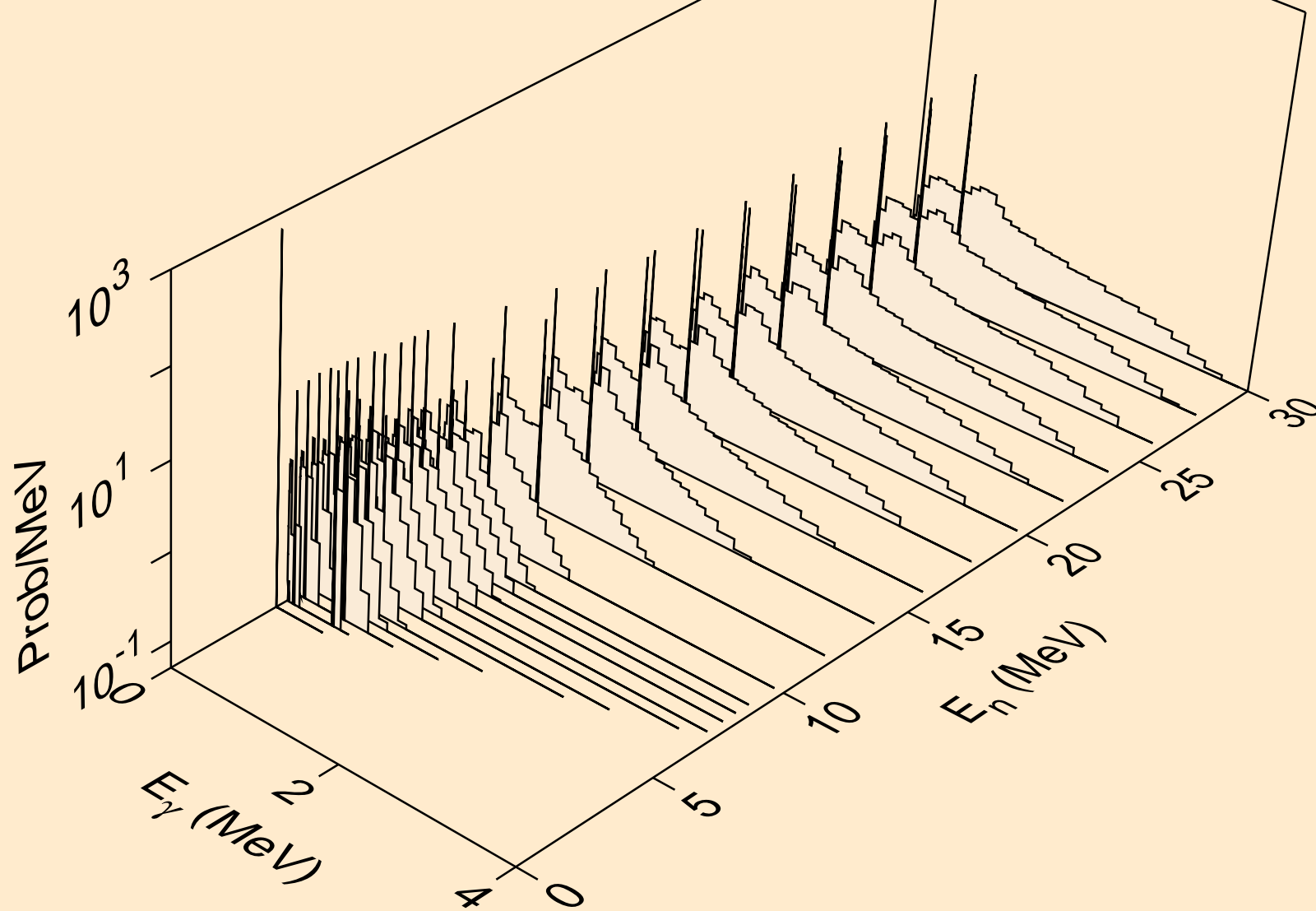

CE127M NEUTRON ACER TENDL-2021 LIBRARY; T=293.6K  
Photon emission for (n,t)

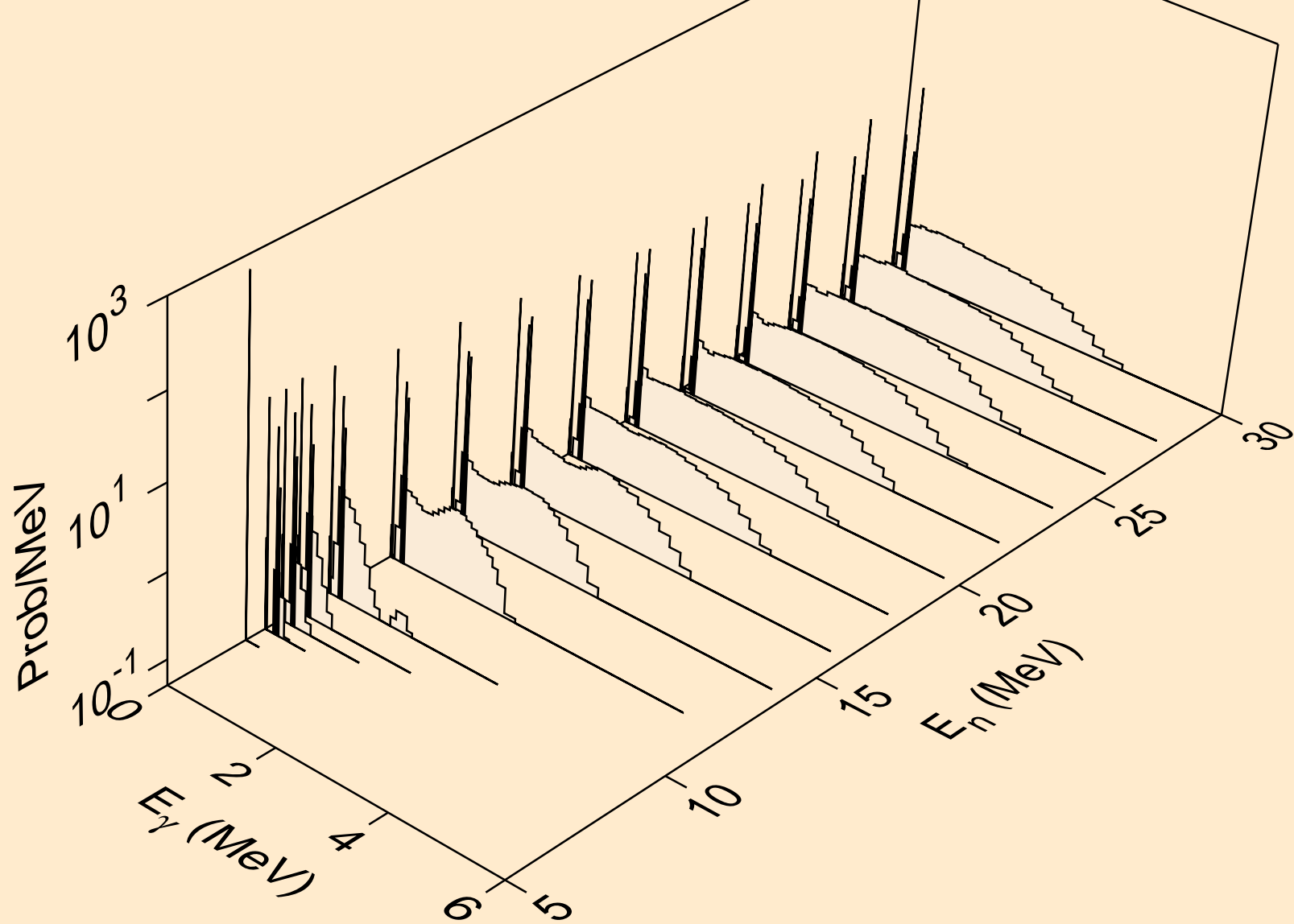

CE127M NEUTRON ACER TENDL-2021 LIBRARY; T=293.6K  
Photon emission for (n,he3)

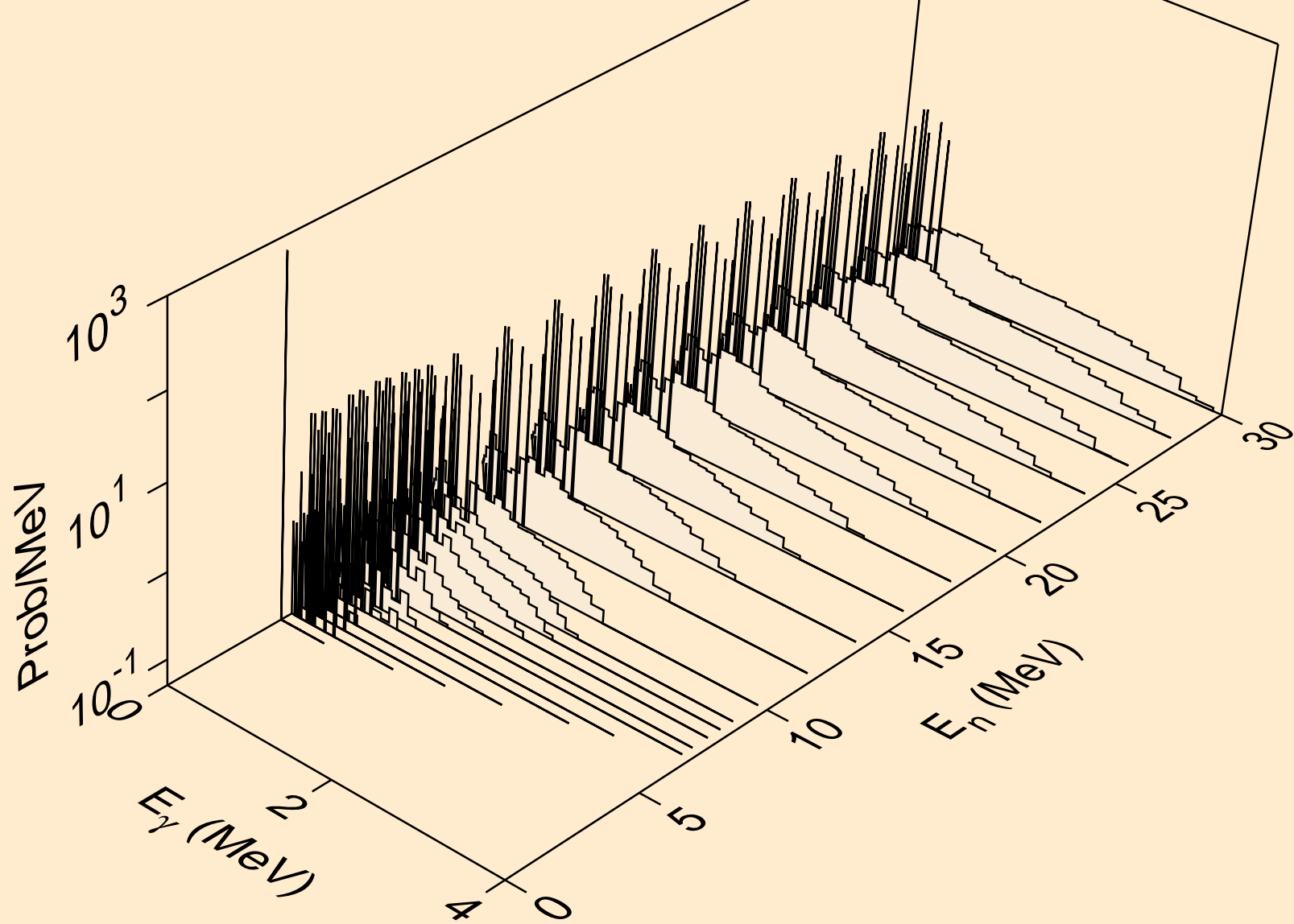

CE127M NEUTRON ACER TENDL-2021 LIBRARY; T=293.6K  
Photon emission for (n,a)

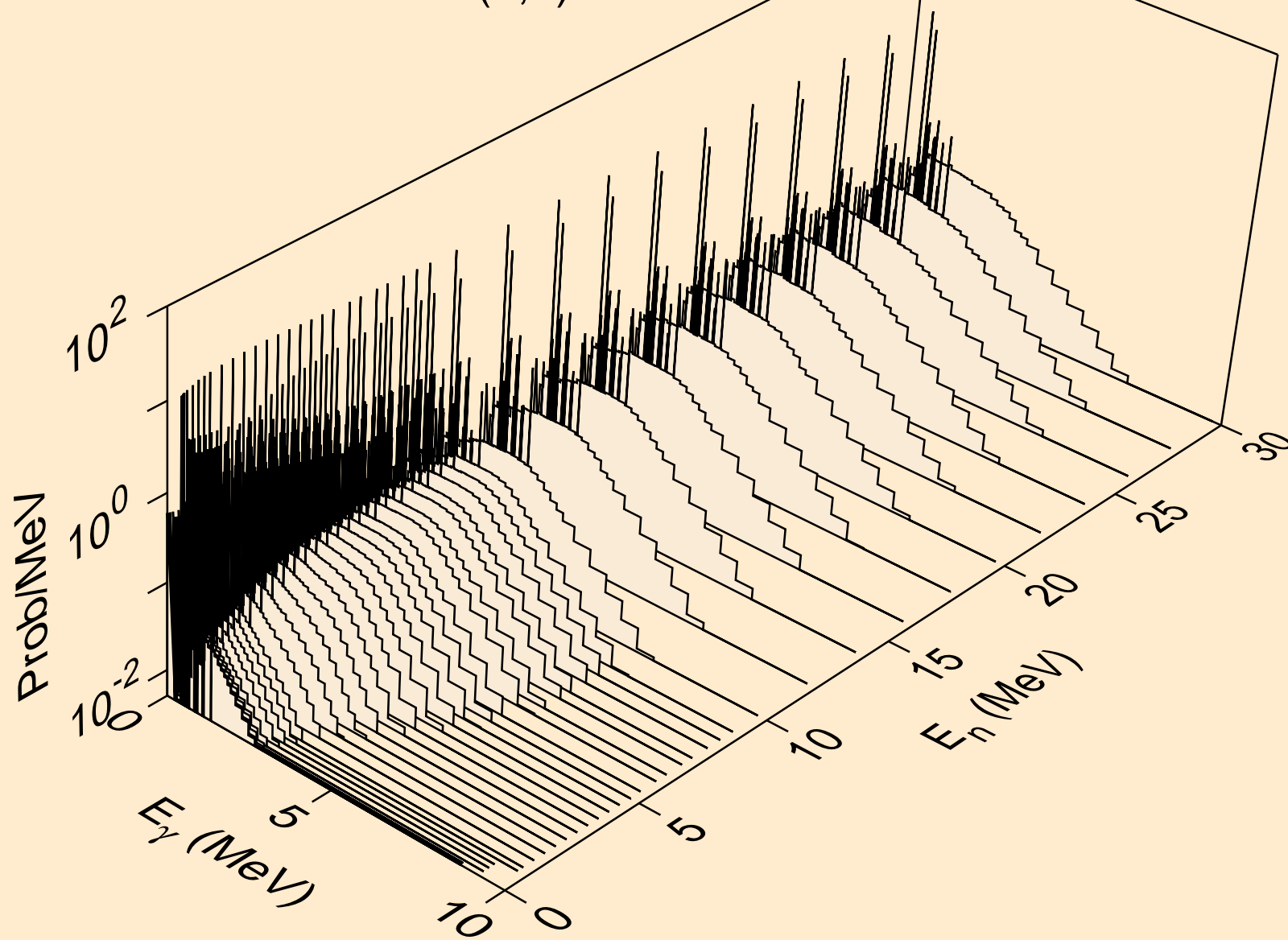

CE127M NEUTRON ACER TENDL-2021 LIBRARY; T=293.6K  
Photon emission for (n,2a)

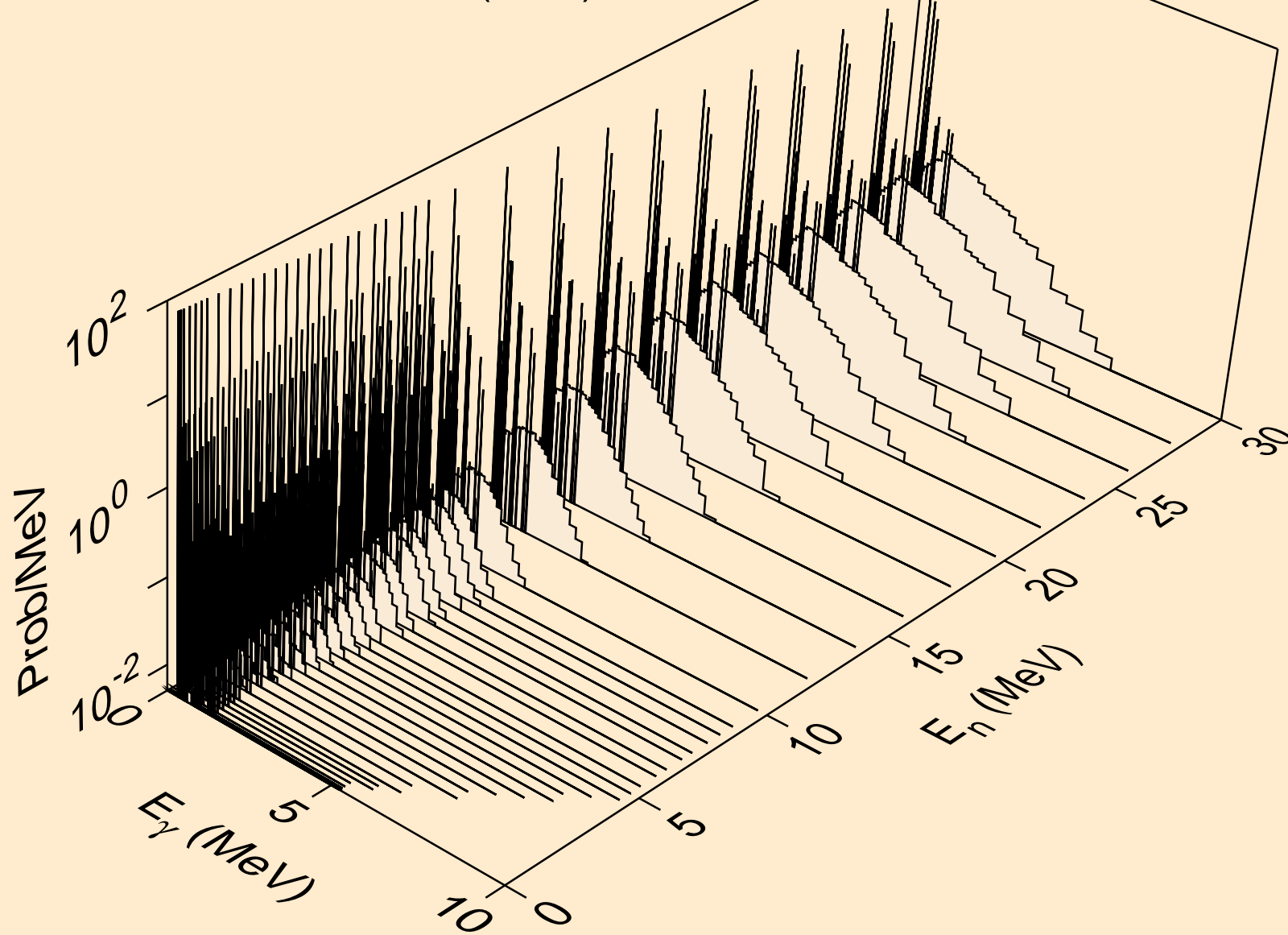

CE127M NEUTRON ACER TENDL-2021 LIBRARY; T=293.6K  
Photon emission for (n,3a)

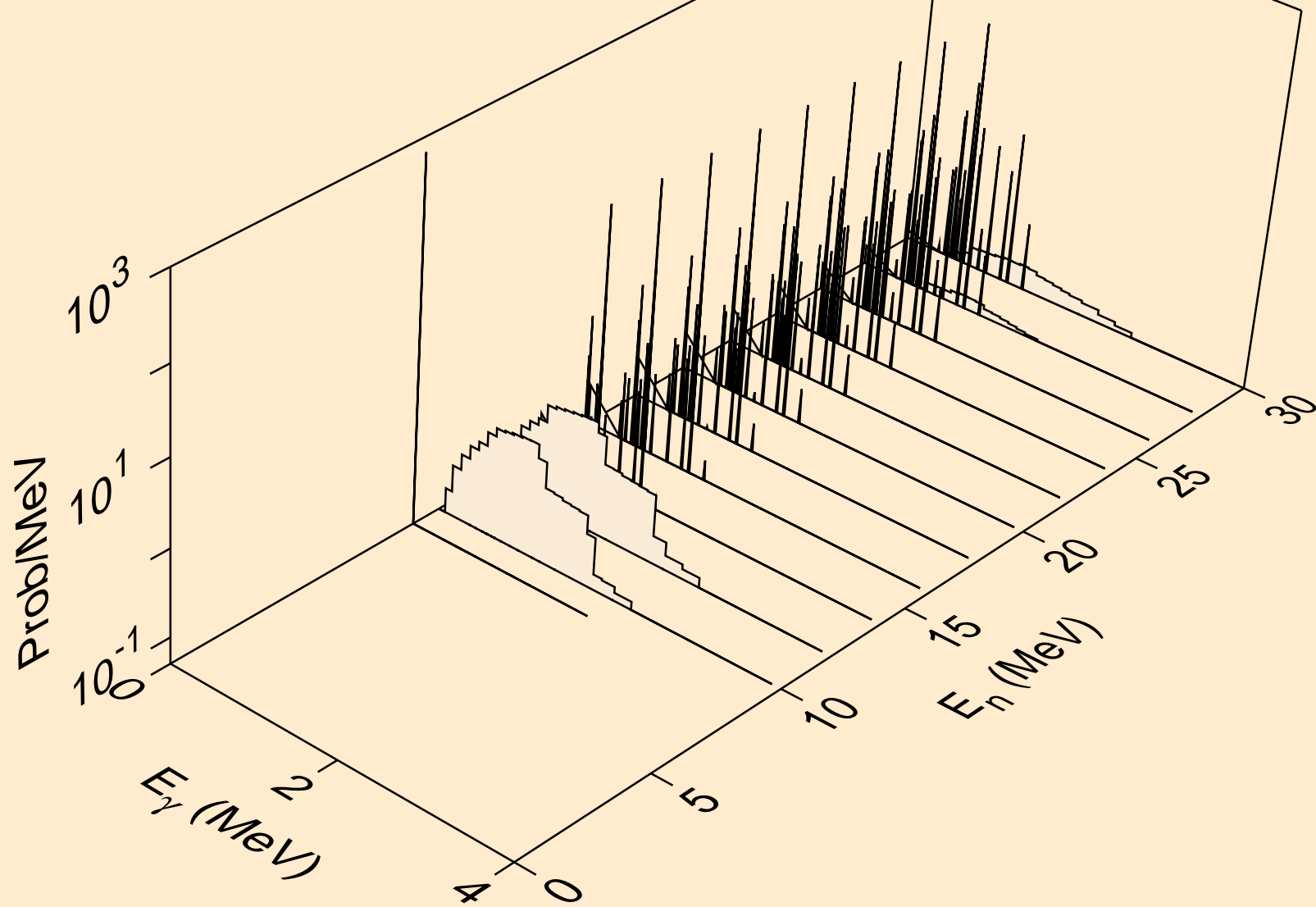

CE127M NEUTRON ACER TENDL-2021 LIBRARY; T=293.6K  
Photon emission for (n,2p)

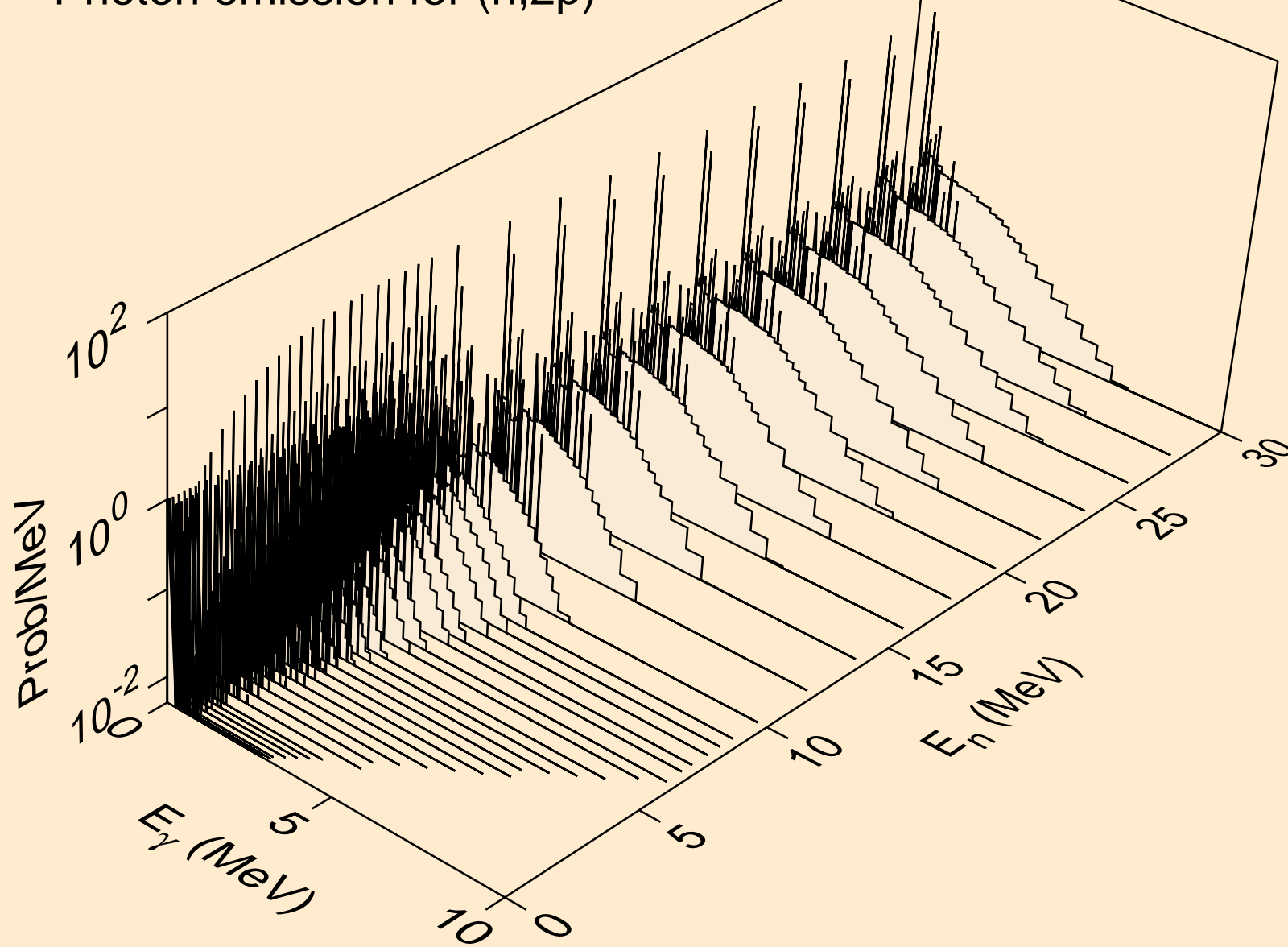



CE127M NEUTRON ACER TENDL-2021 LIBRARY; T=293.6K  
Photon emission for (n,p)

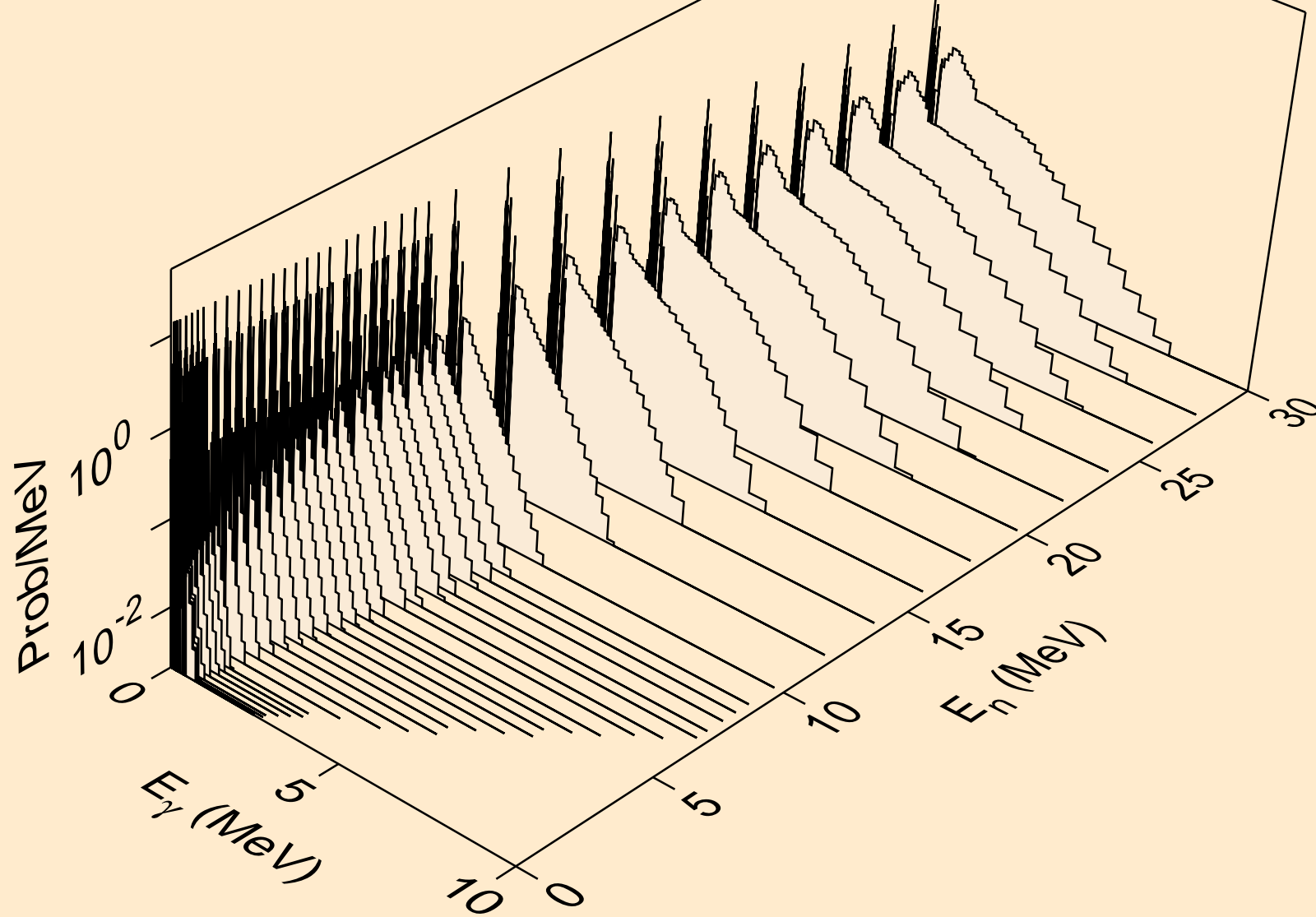

CE127M NEUTRON ACER TENDL-2021 LIBRARY; T=293.6K  
Photon emission for (n,pd)

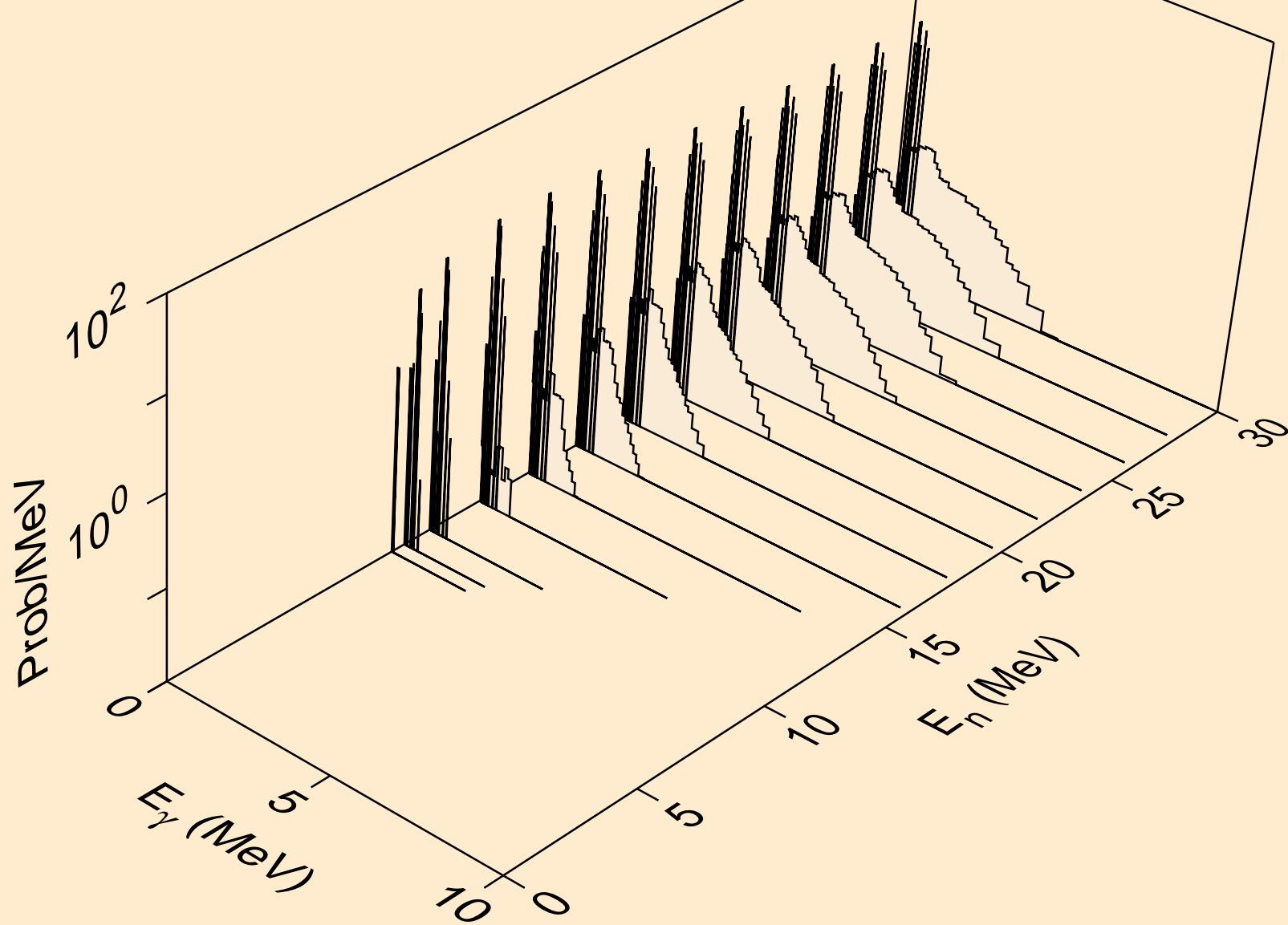

CE127M NEUTRON ACER TENDL-2021 LIBRARY; T=293.6K  
Photon emission for (n,pt)

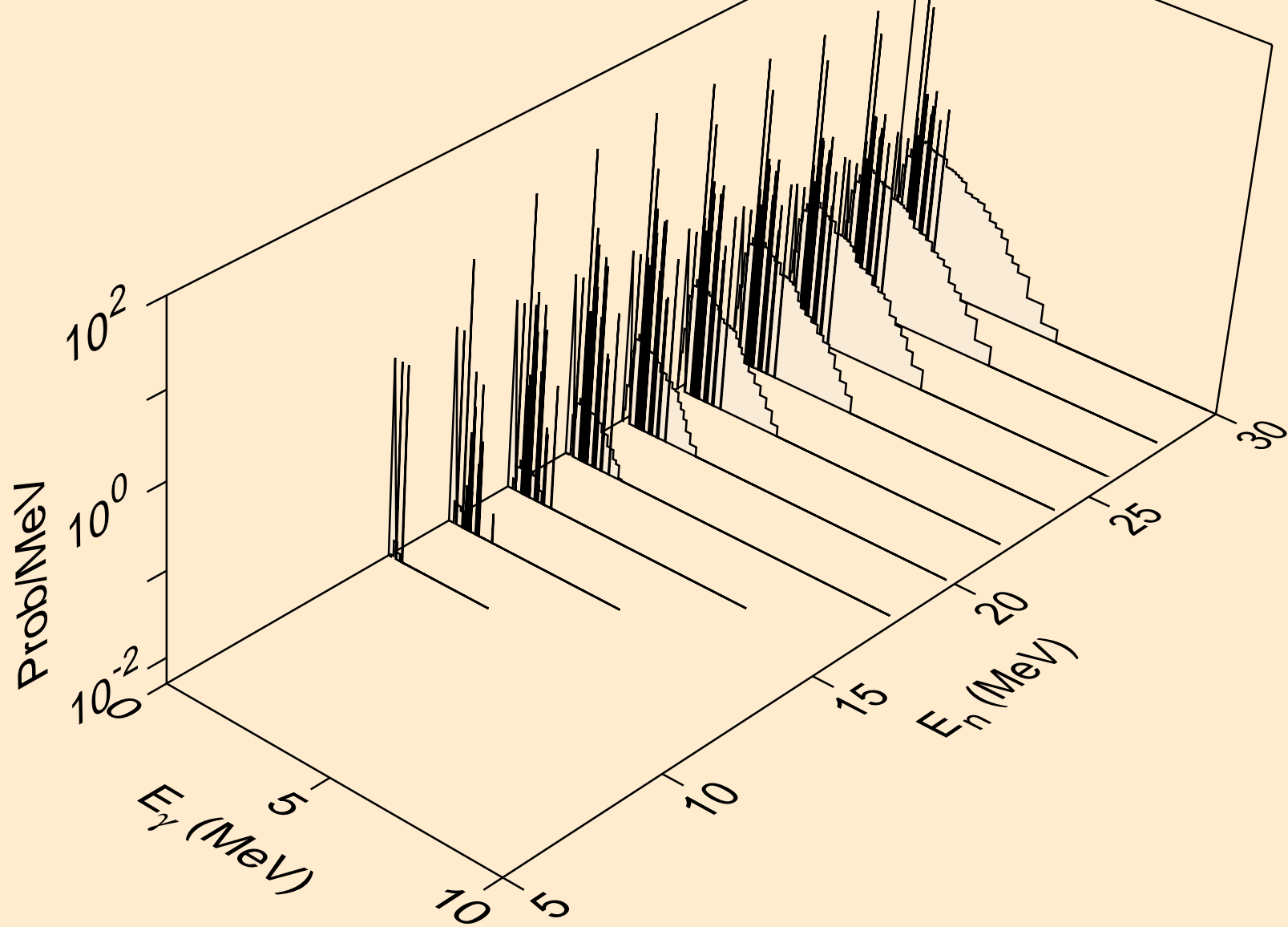

CE127M NEUTRON ACER TENDL-2021 LIBRARY; T=293.6K  
Photon emission for (n,da)

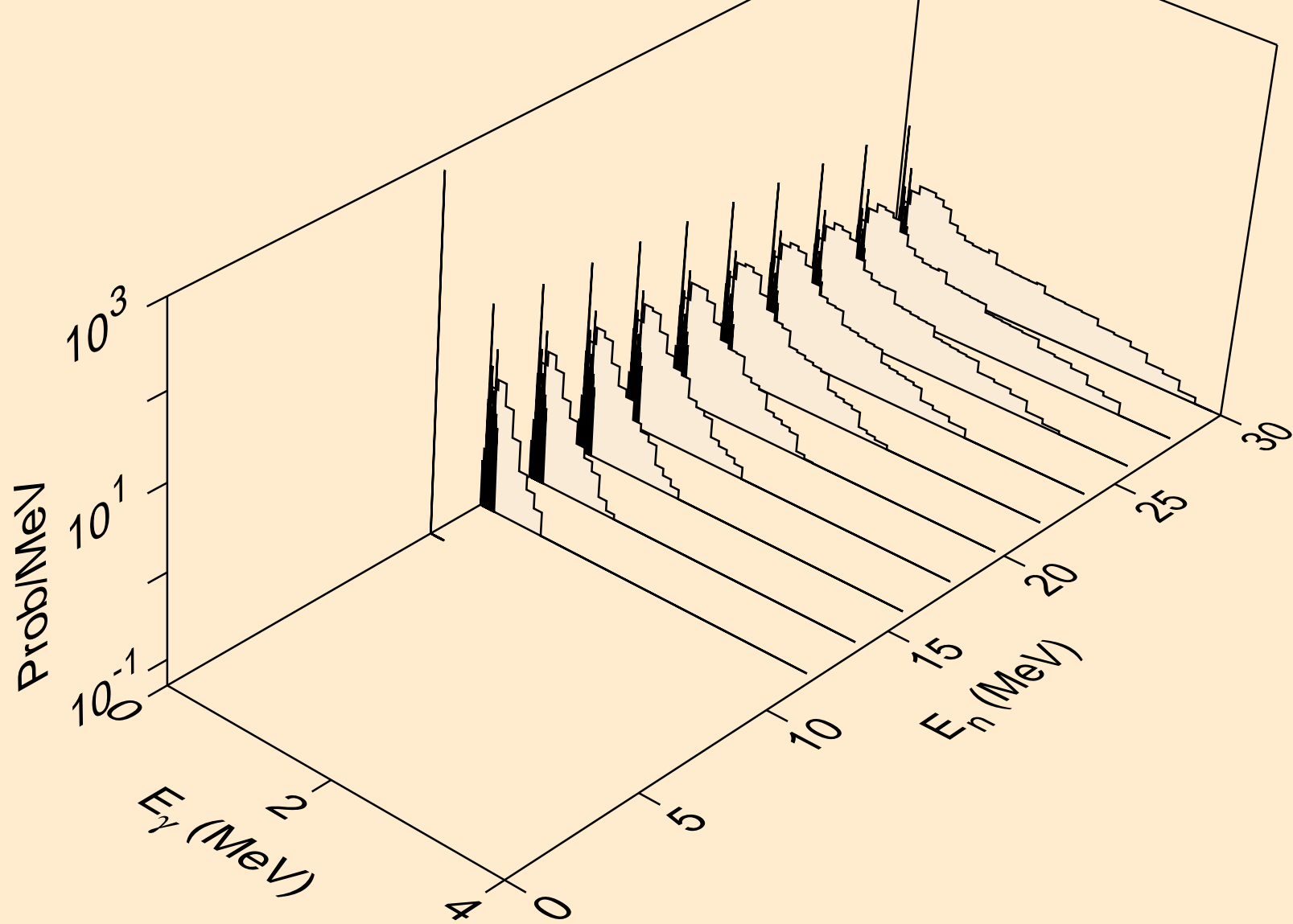

CE127M NEUTRON ACER TENDL-2021 LIBRARY; T=293.6K  
thermal capture photon spectrum

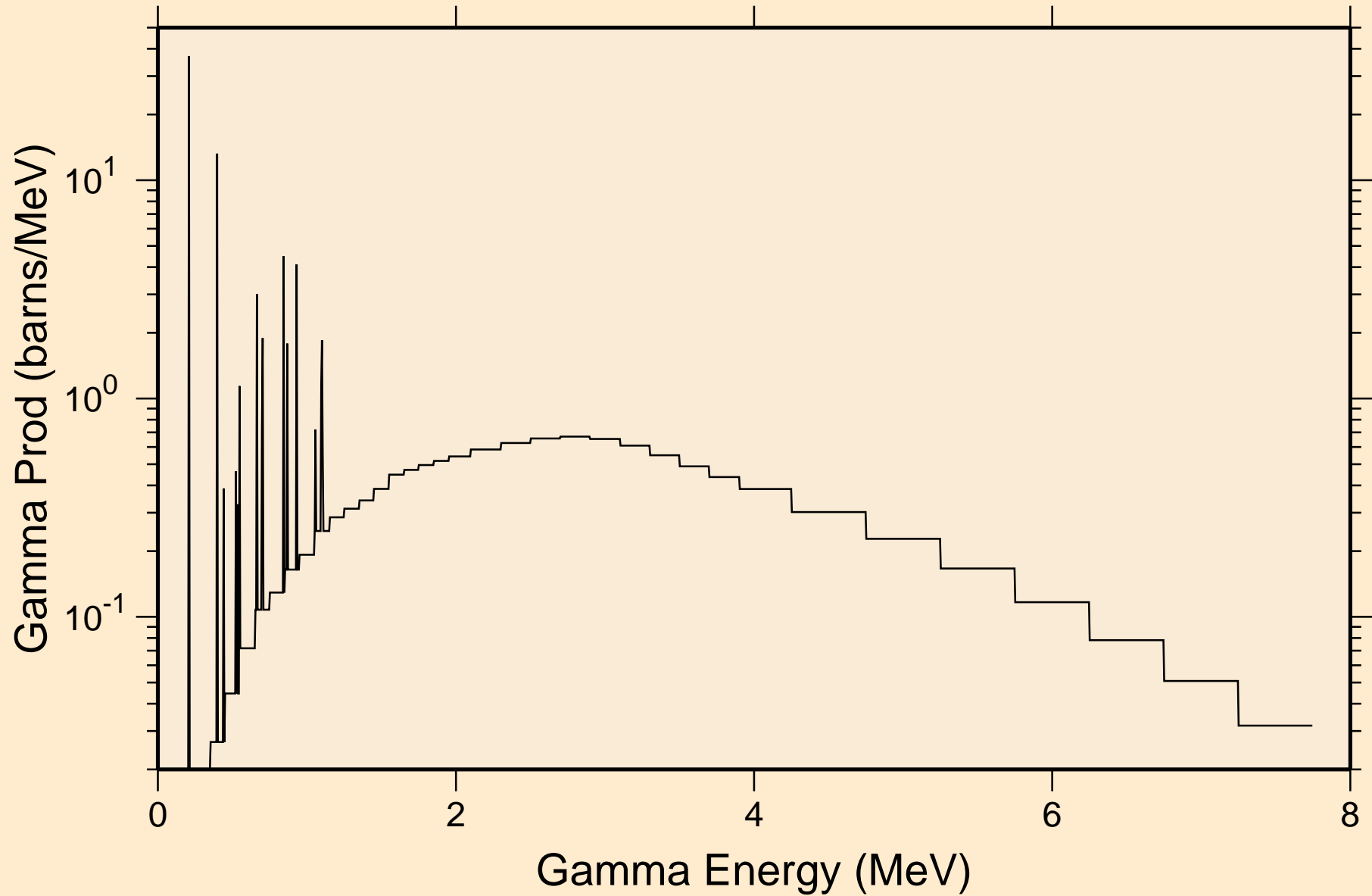

CE127M NEUTRON ACER TENDL-2021 LIBRARY; T=293.6K  
14 MeV photon spectrum

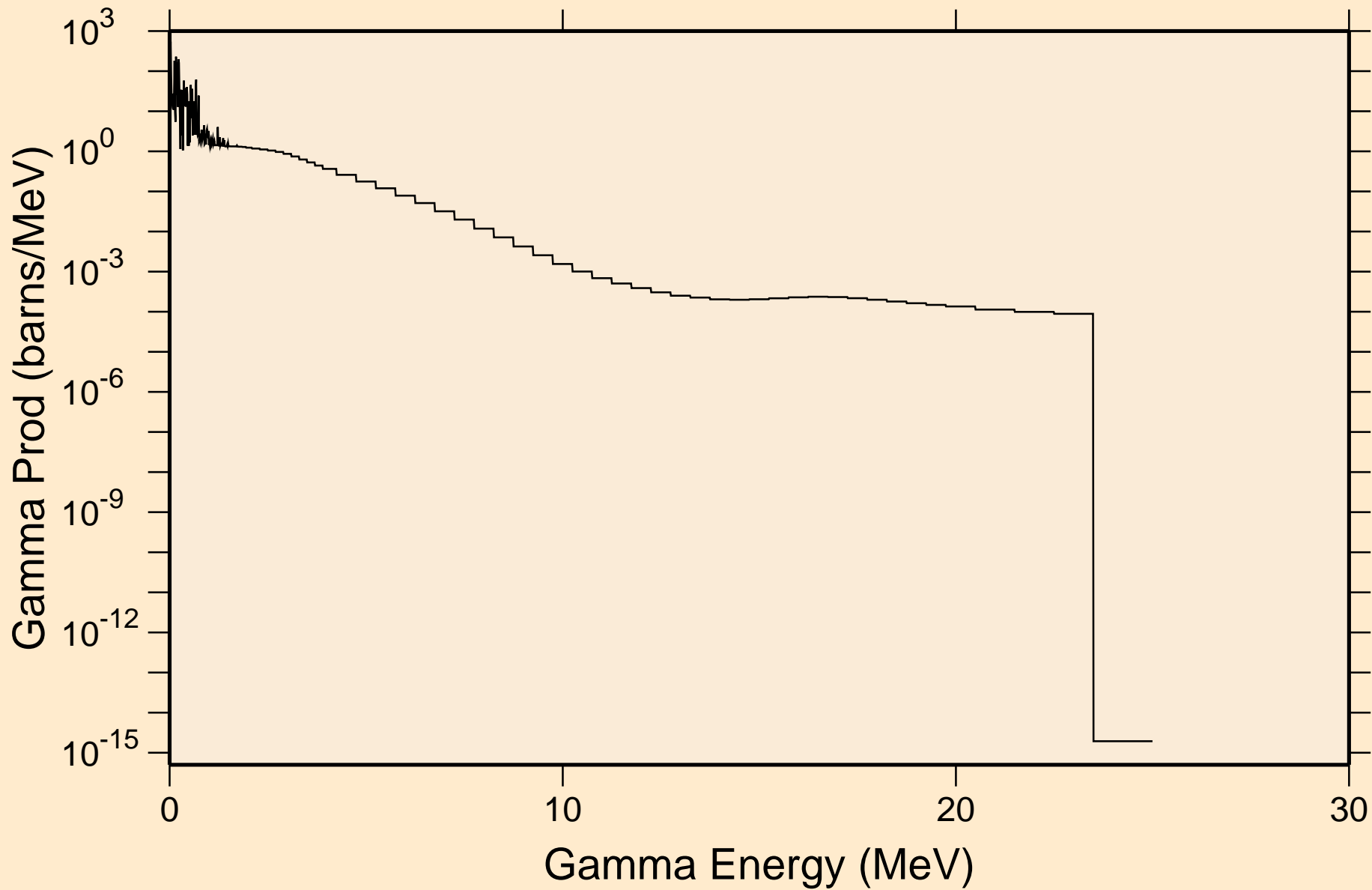

CE127M NEUTRON ACER TENDL-2021 LIBRARY; T=293.6K  
Particle heating contributions

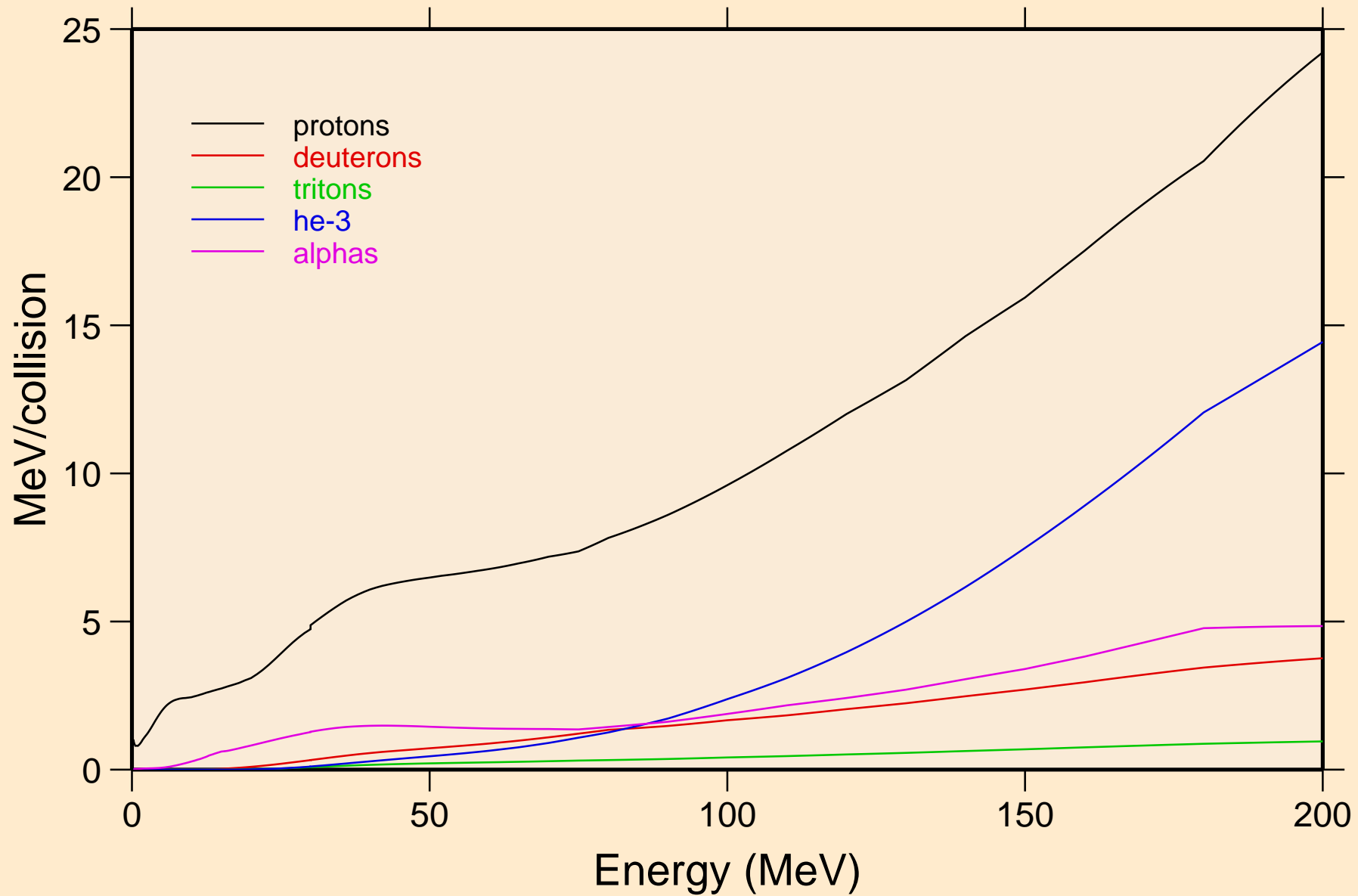

CE127M NEUTRON ACER TENDL-2021 LIBRARY; T=293.6K  
Recoil Heating

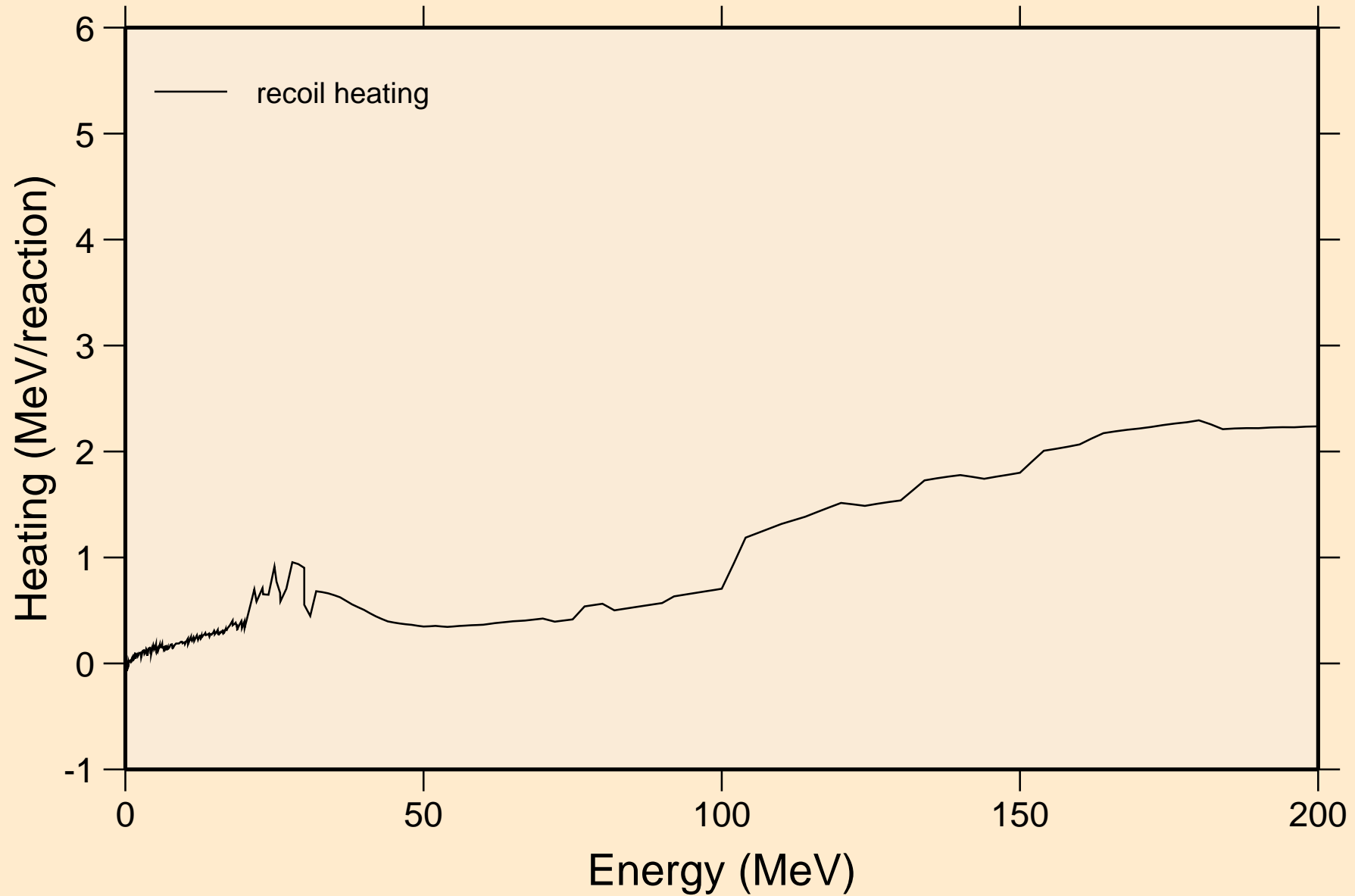



CE127M NEUTRON ACER TENDL-2021 LIBRARY; T=293.6K  
Particle production cross sections

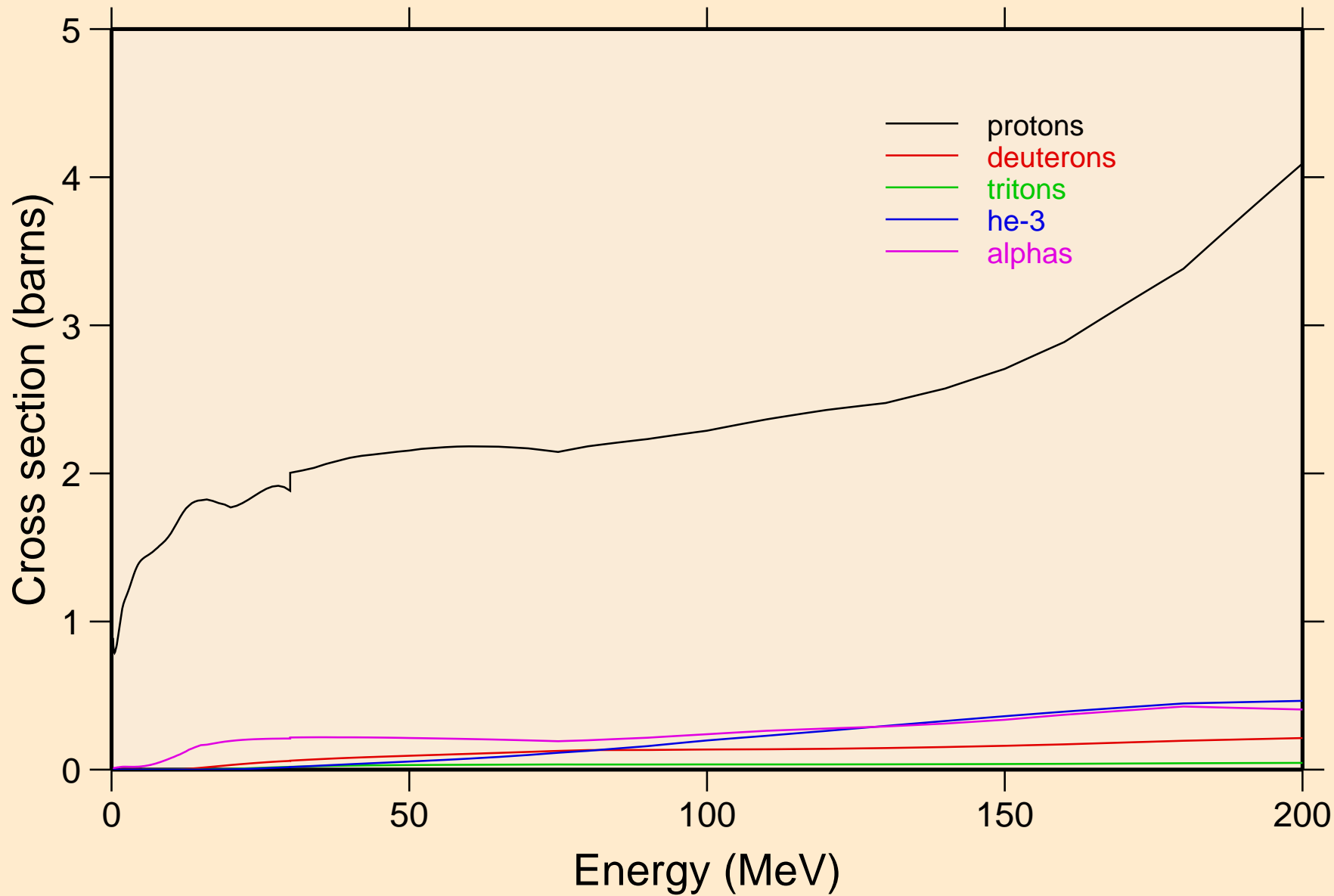

CE127M NEUTRON ACER TENDL-2021 LIBRARY; T=293.6K  
protons from (n,x)

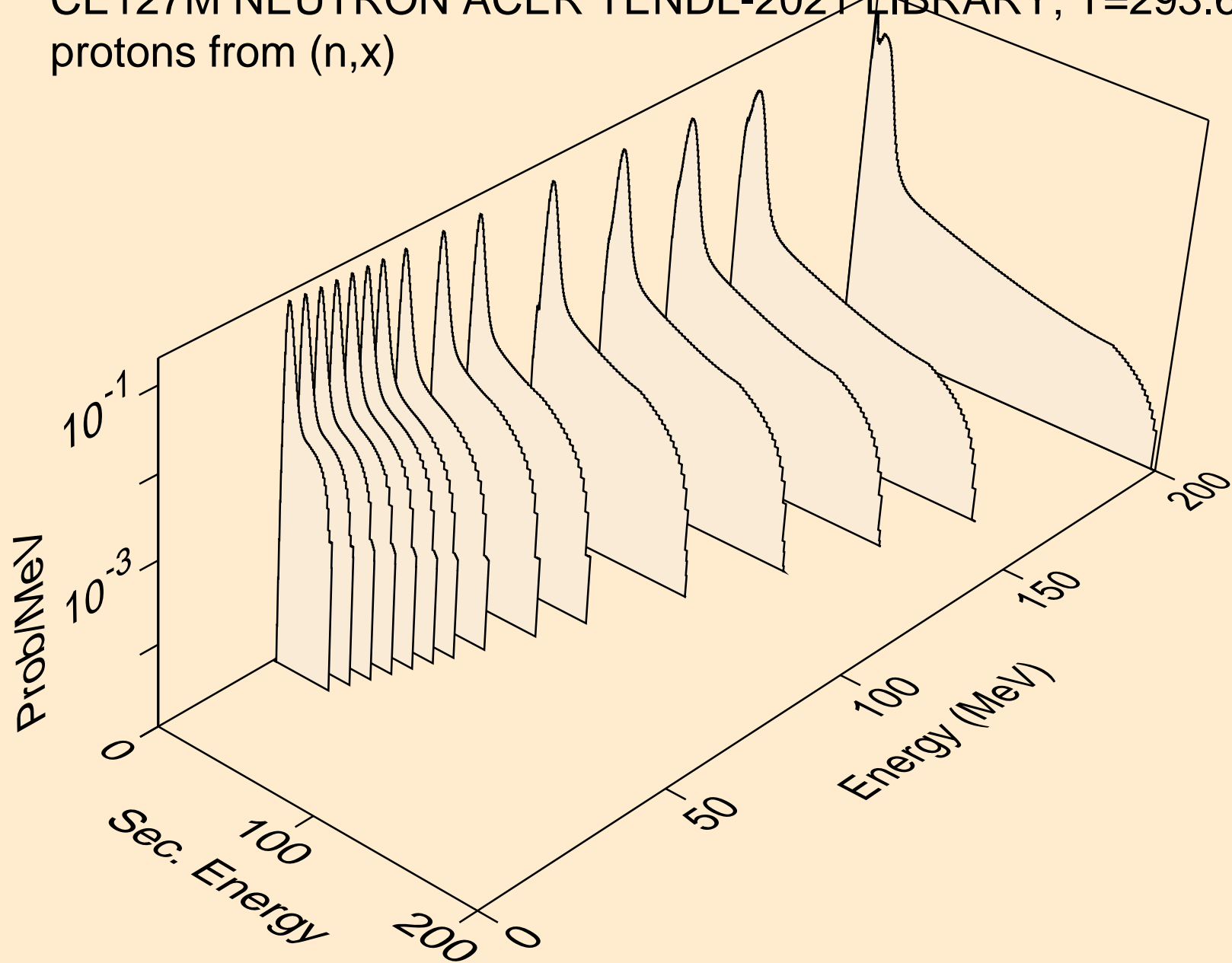

CE127M NEUTRON ACER TENDL-2021 LIBRARY; T=293.6K  
protons from (n,n\*)p

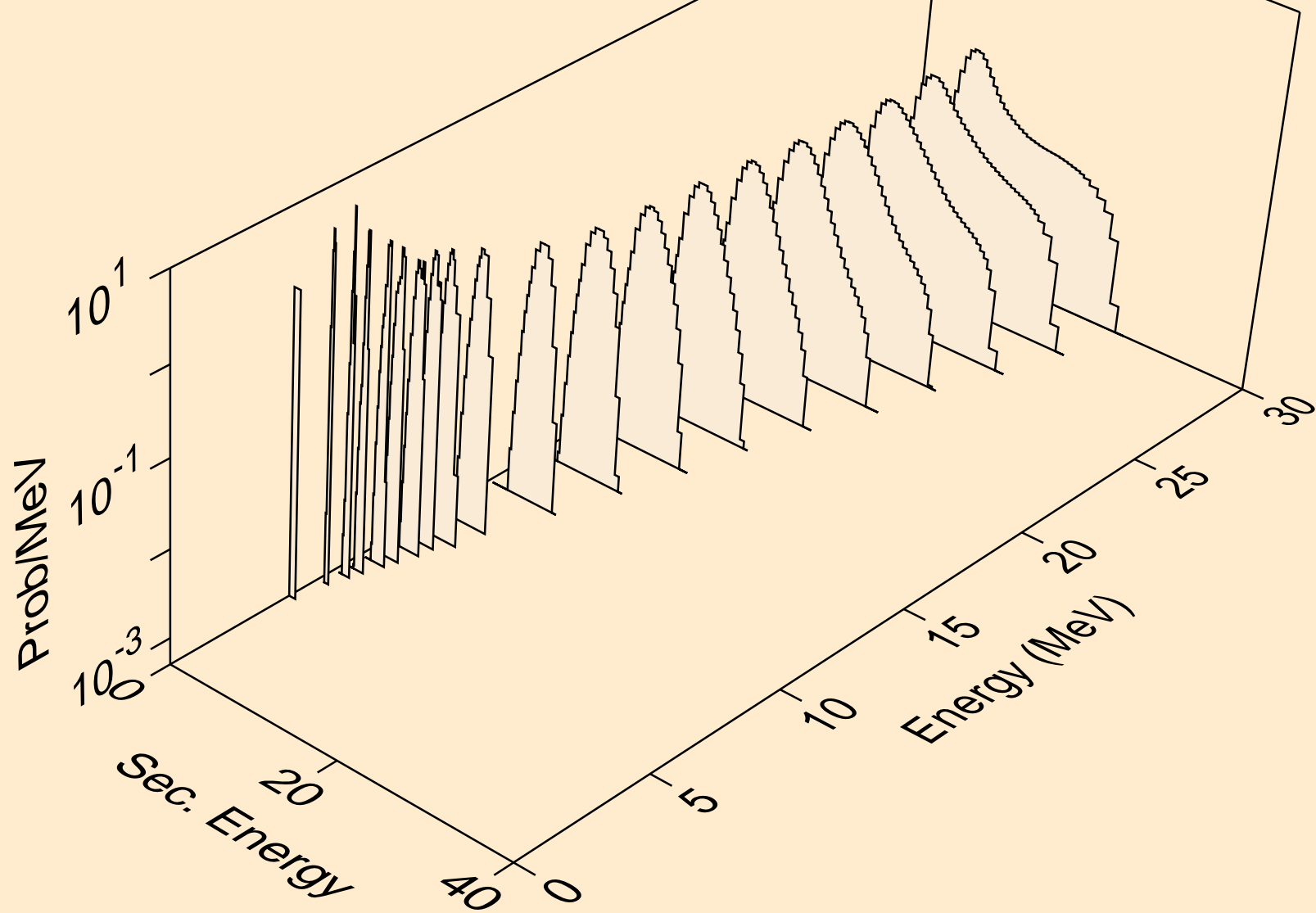

CE127M NEUTRON ACER TENDL-2021 LIBRARY; T=293.6K  
protons from (n,2np)

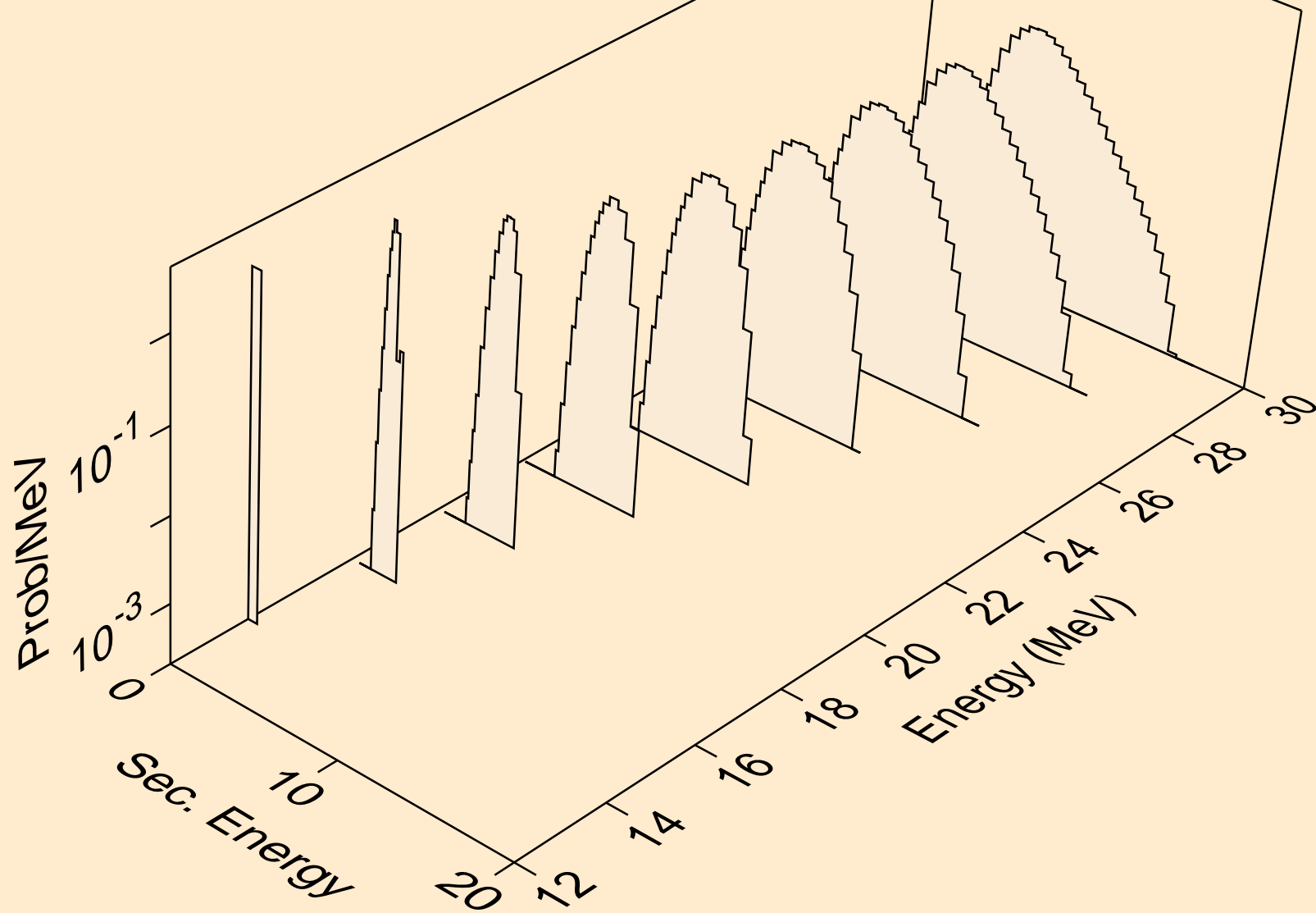

CE127M NEUTRON ACER TENDL-2021 LIBRARY; T=293.6K  
protons from (n,3np)

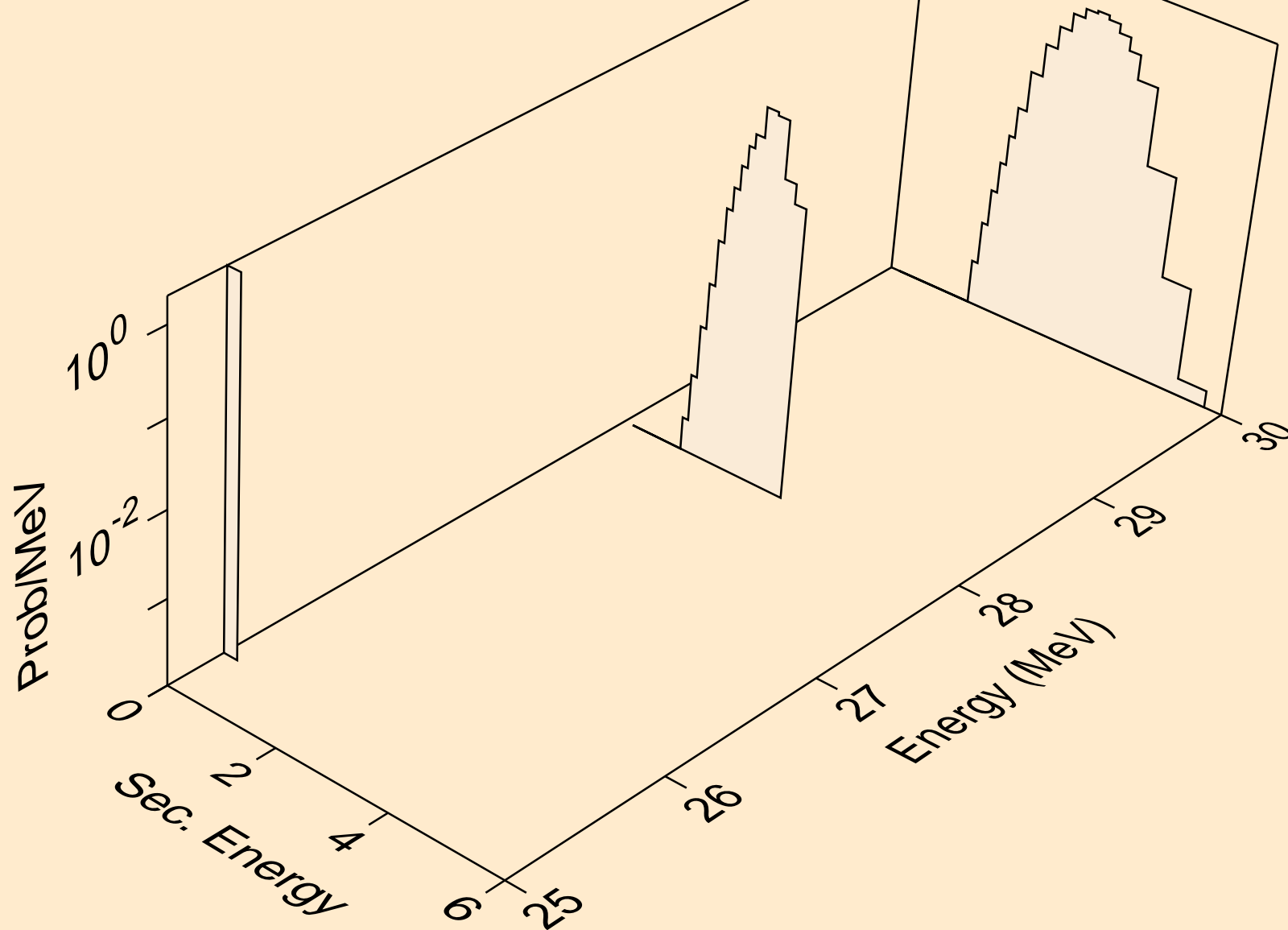

CE127M NEUTRON ACER TENDL-2021 LIBRARY; T=293.6K  
protons from (n,2np)

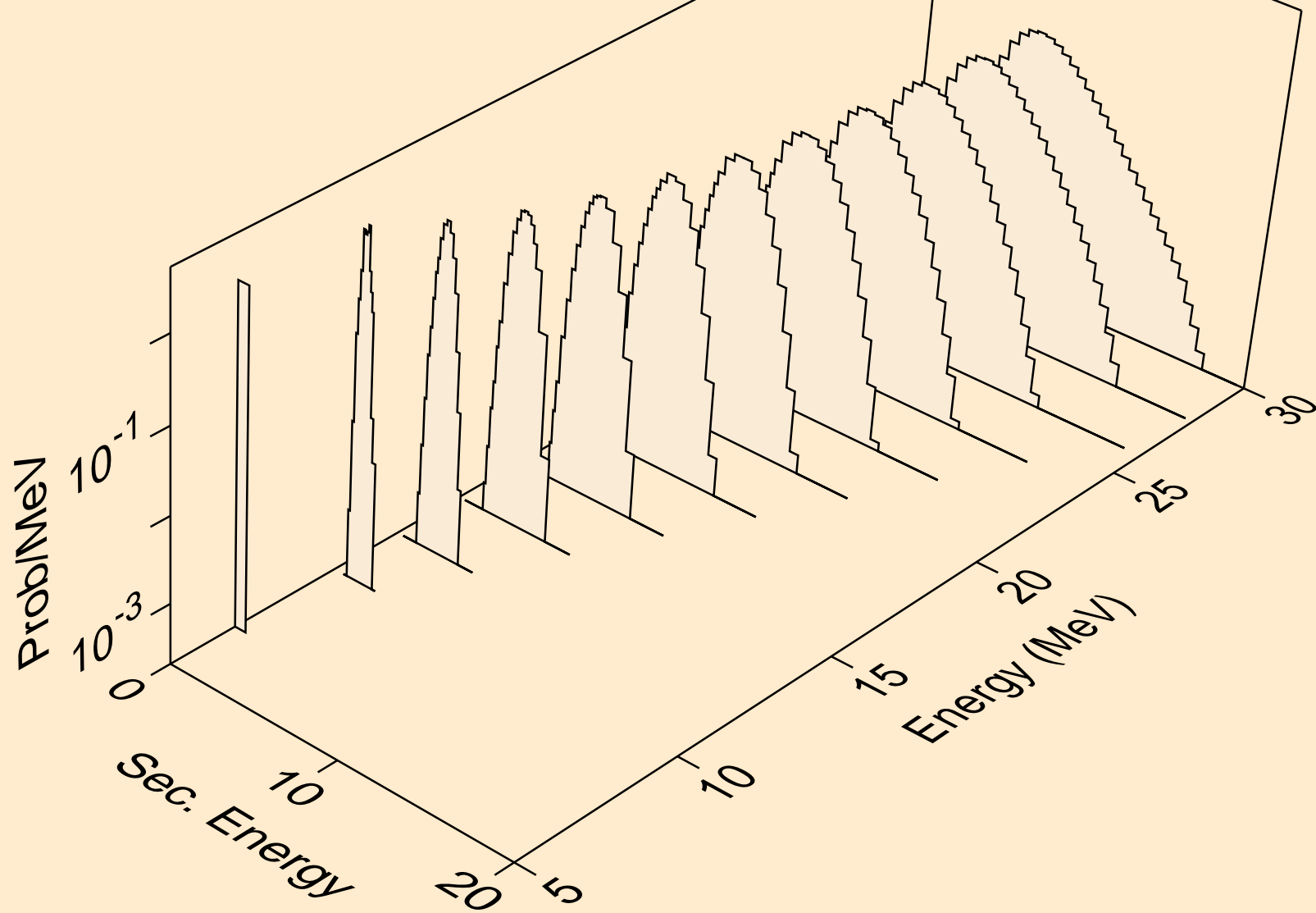

CE127M NEUTRON ACER TENDL-2021 LIBRARY; T=293.6K  
protons from (n,npa)

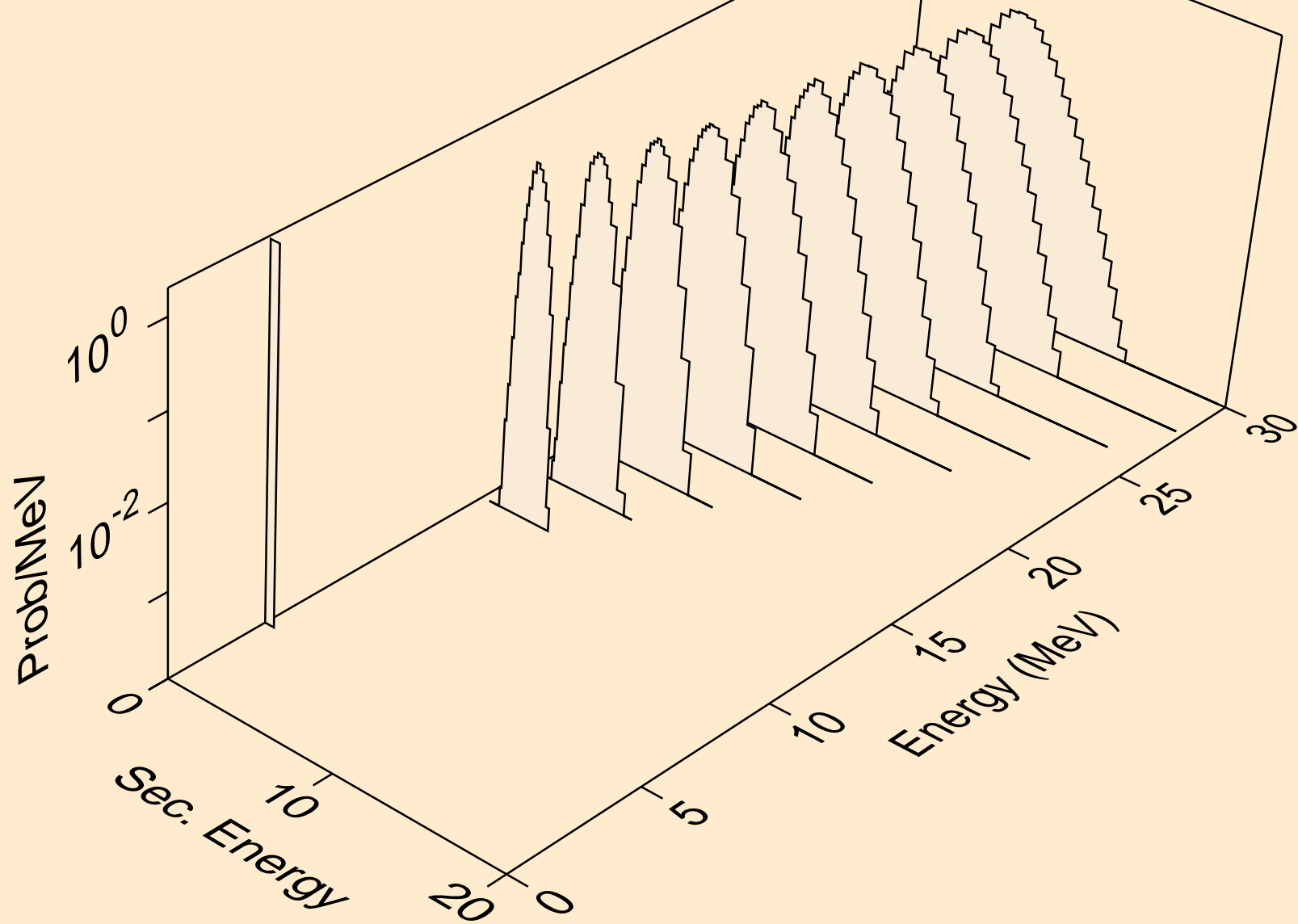

CE127M NEUTRON ACER TENDL-2021 LIBRARY; T=293.6K  
protons from (n,p)

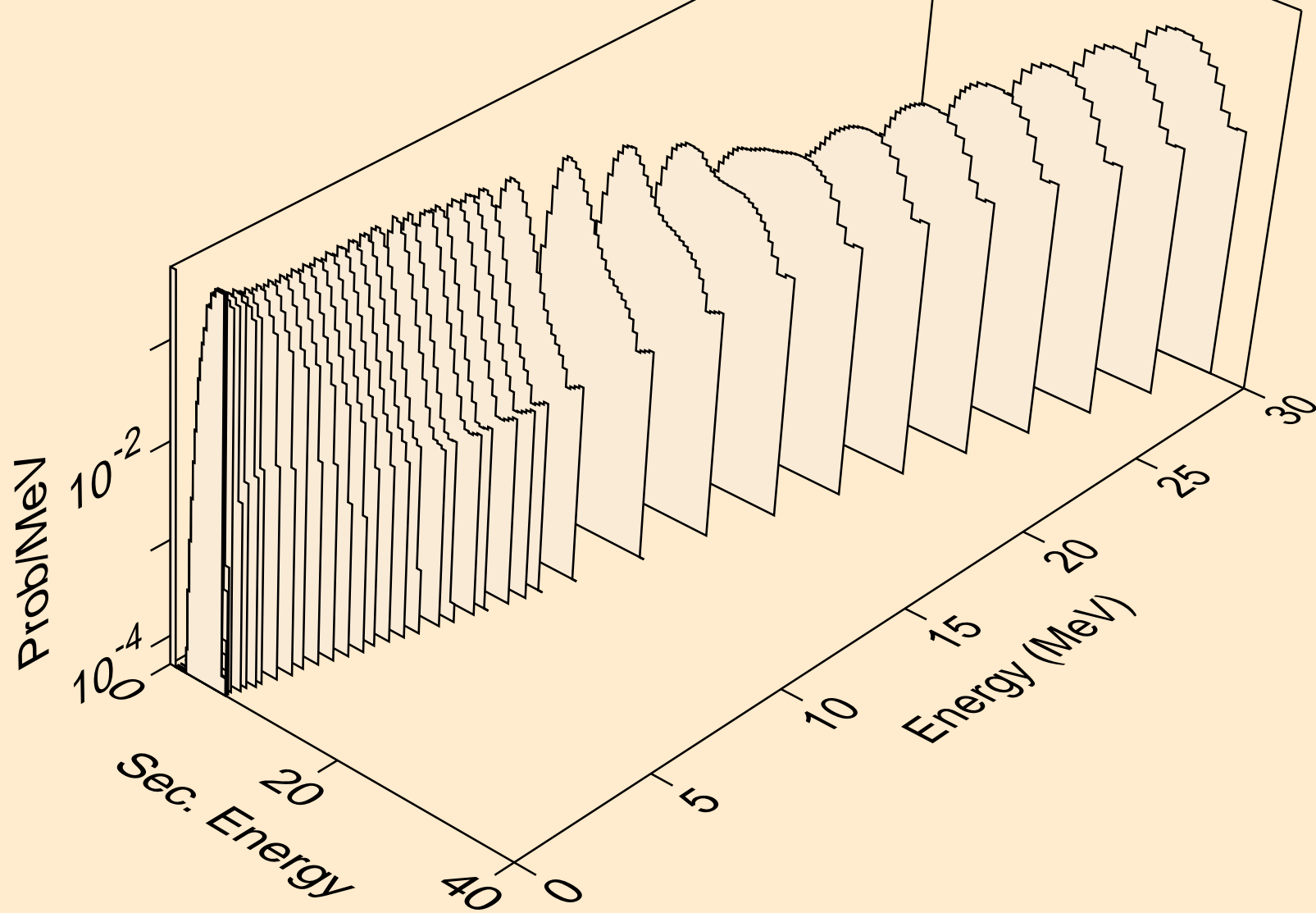



CE127M NEUTRON ACER TENDL-2021 LIBRARY; T=293.6K  
protons from (n,2p)

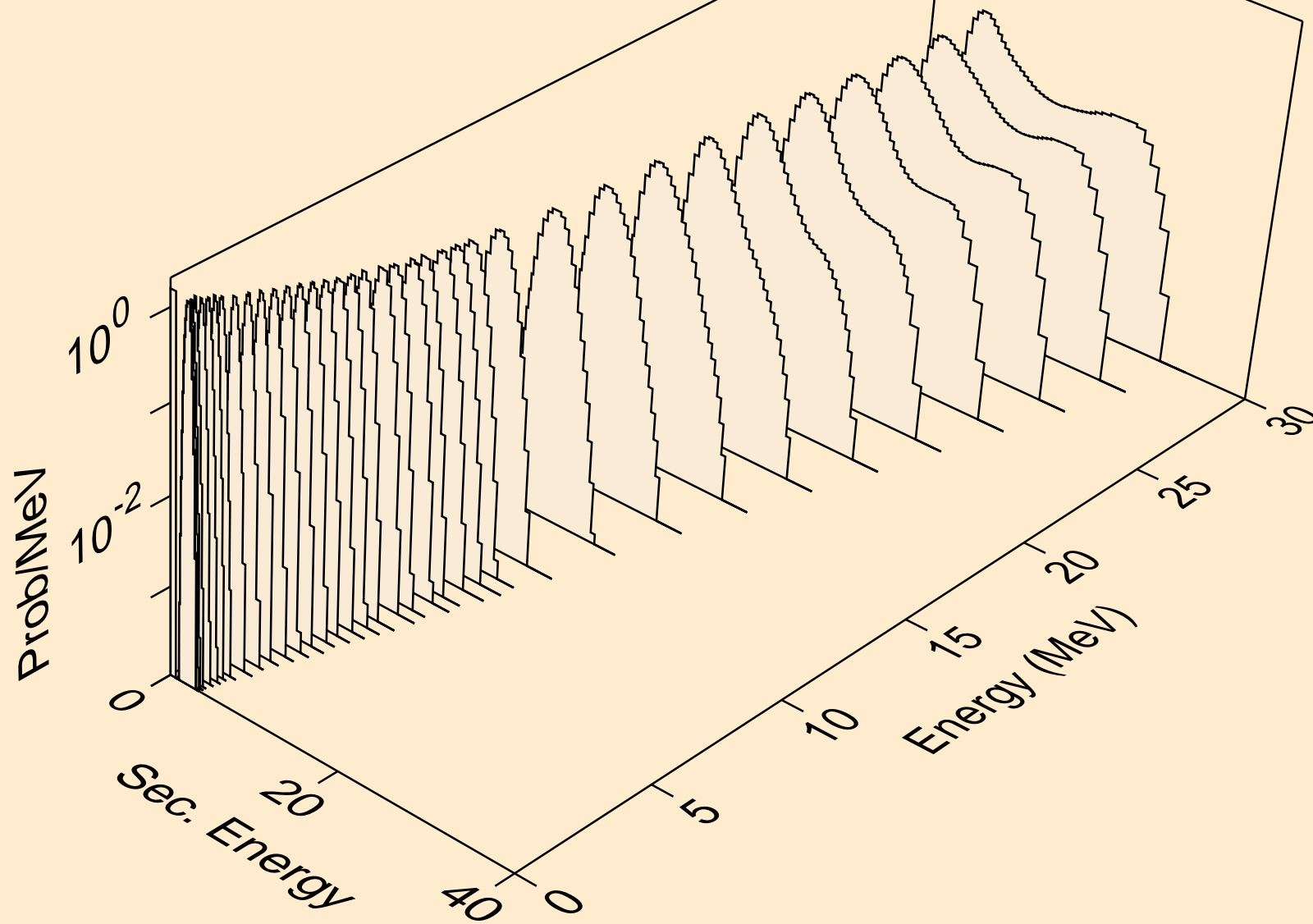

CE127M NEUTRON ACER TENDL-2021 LIBRARY; T=293.6K  
protons from (n,p)

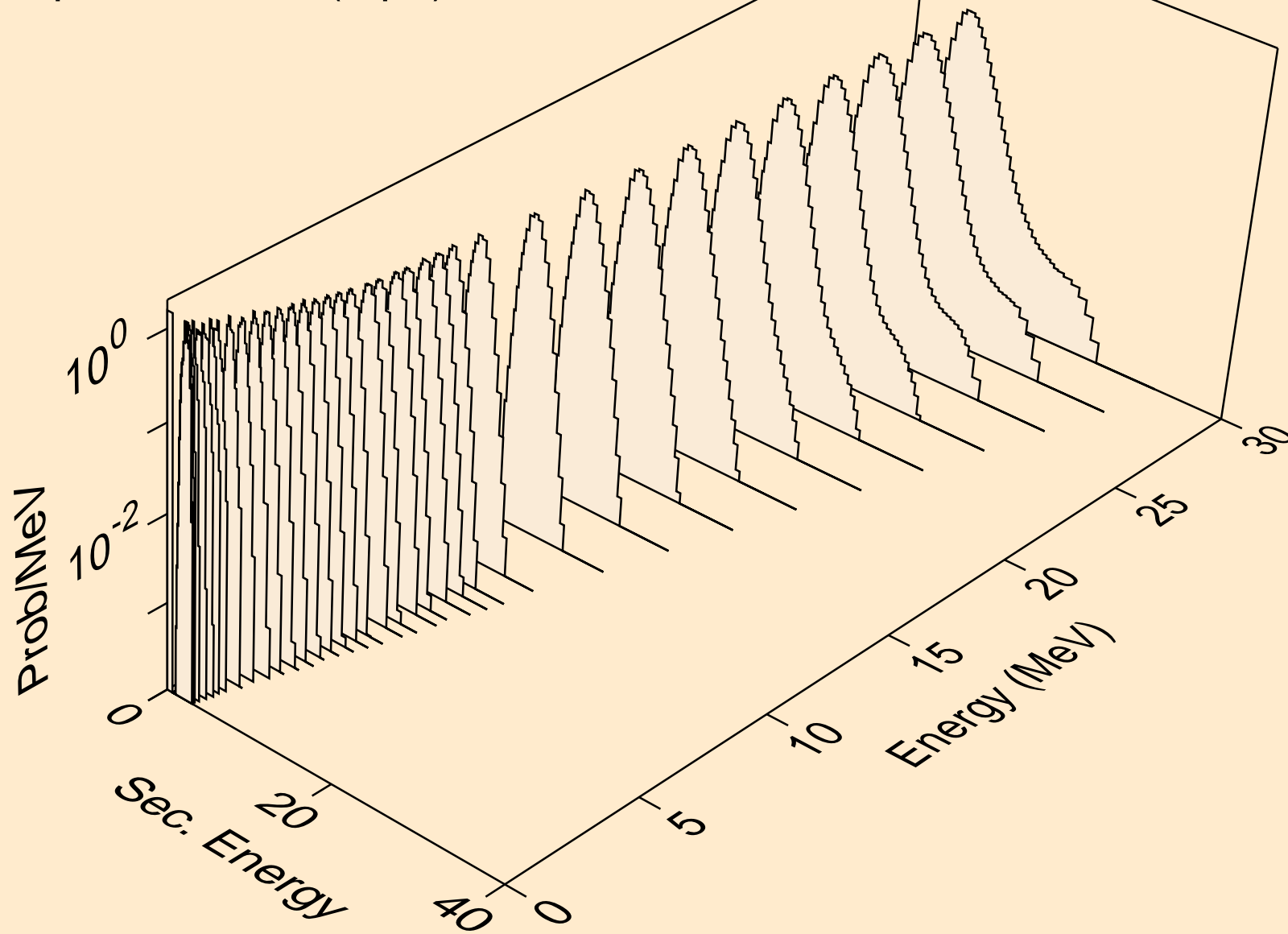

CE127M NEUTRON ACER TENDL-2021 LIBRARY; T=293.6K  
protons from (n,pd)

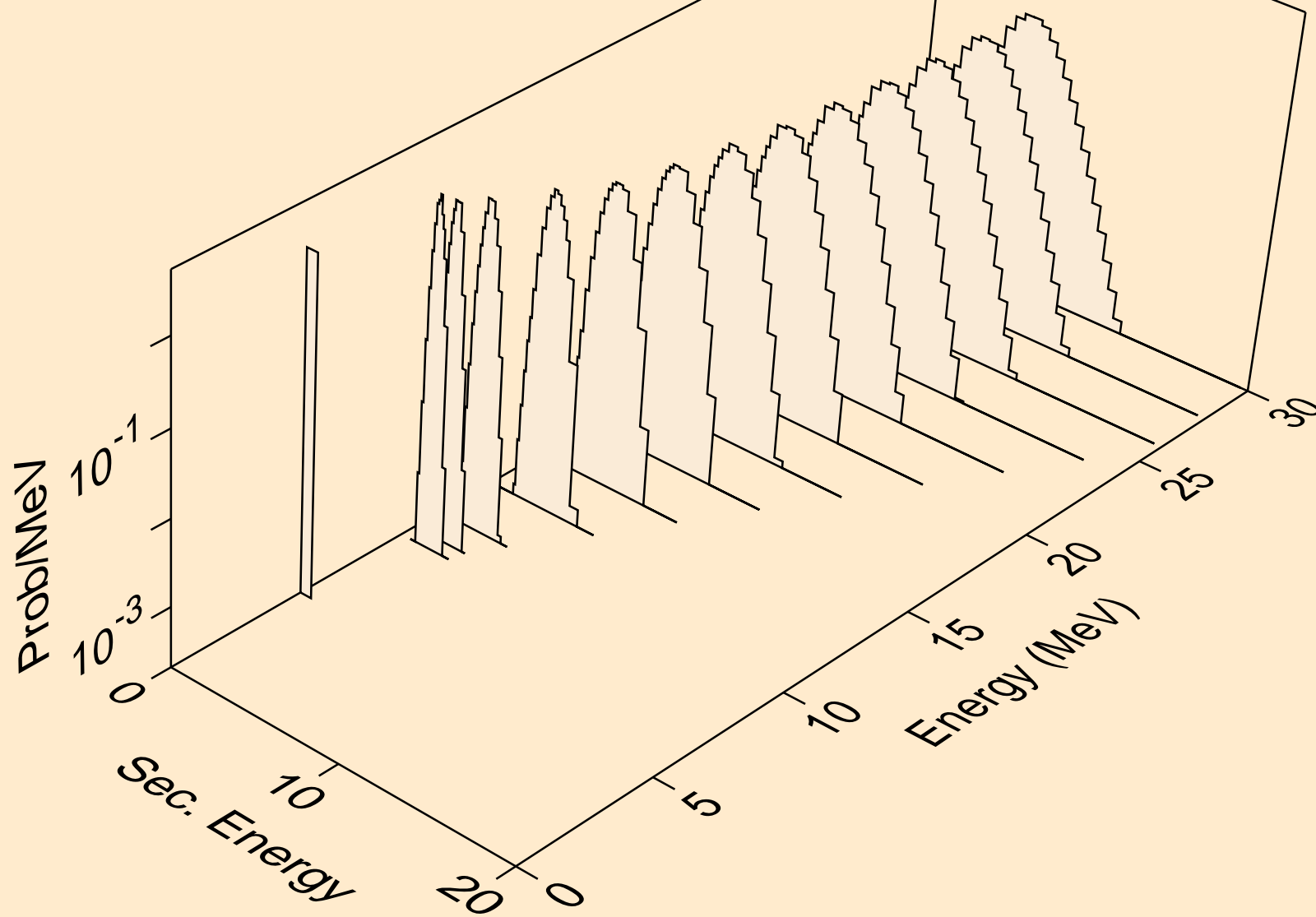

CE127M NEUTRON ACER TENDL-2021 LIBRARY; T=293.6K  
protons from (n,pt)

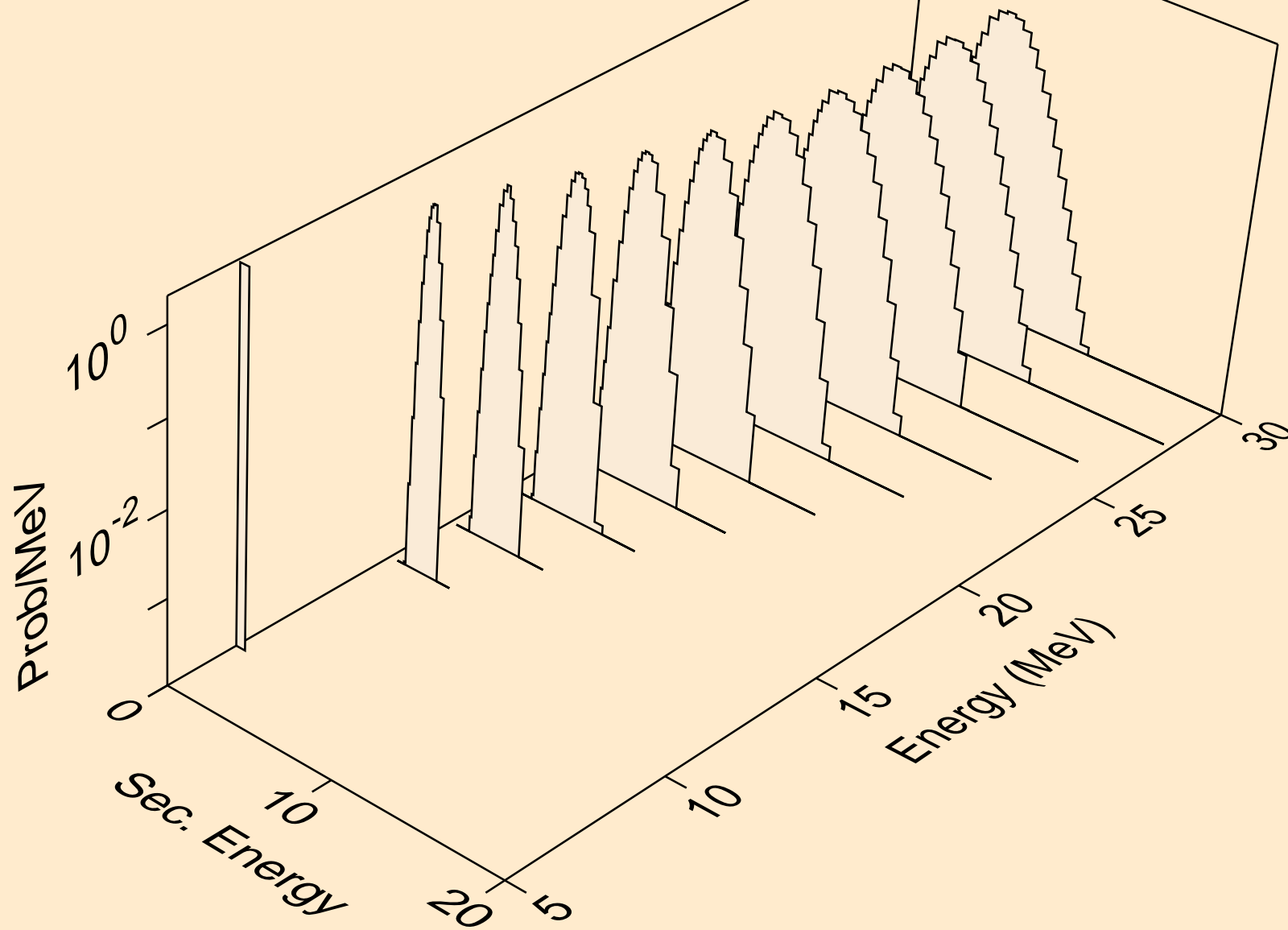

CE127M NEUTRON ACER TENDL-2021 LIBRARY; T=293.6K  
deuterons from (n,x)

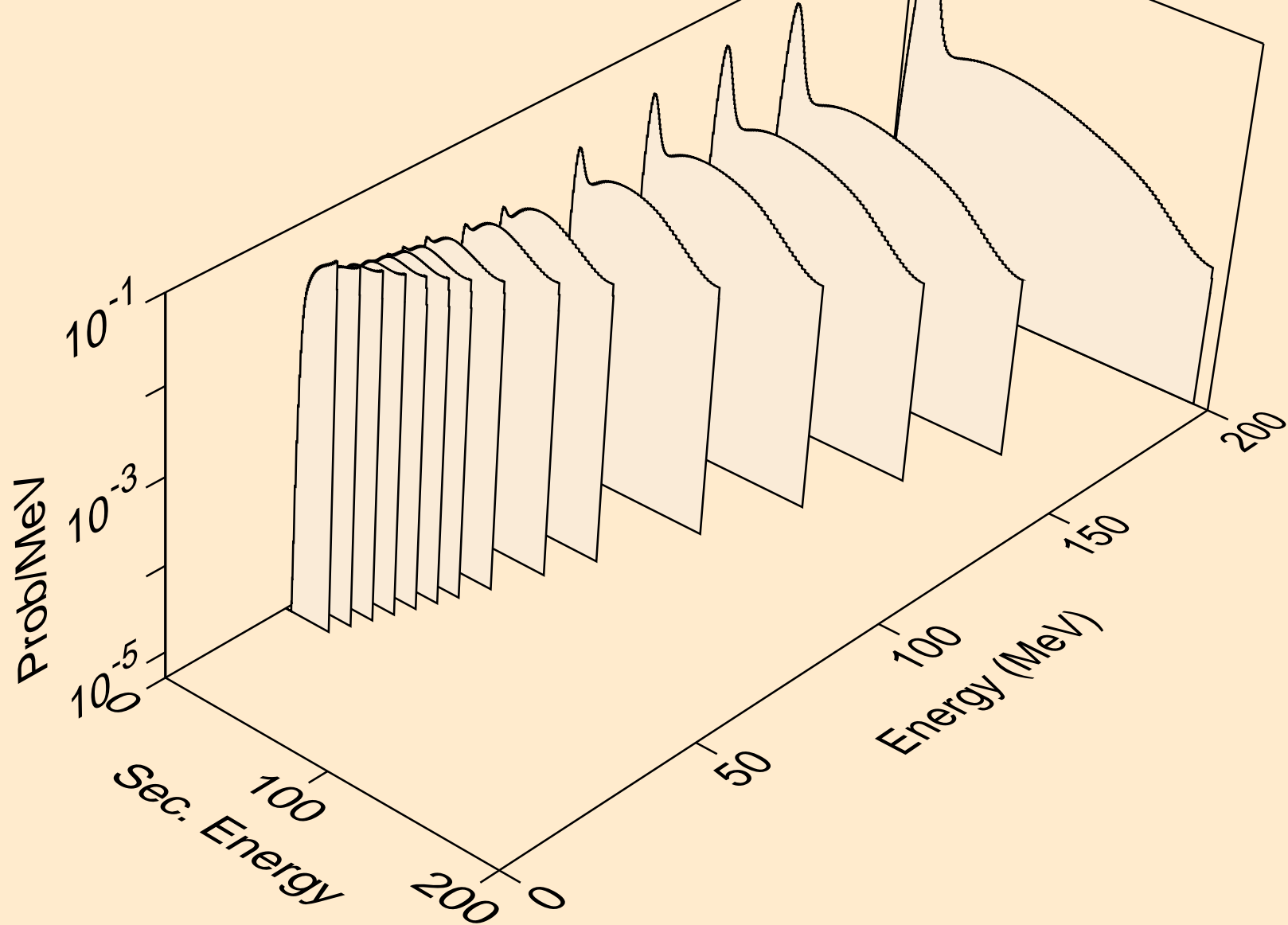

CE127M NEUTRON ACER TENDL-2021 LIBRARY; T=293.6K  
deuterons from (n,2nd)

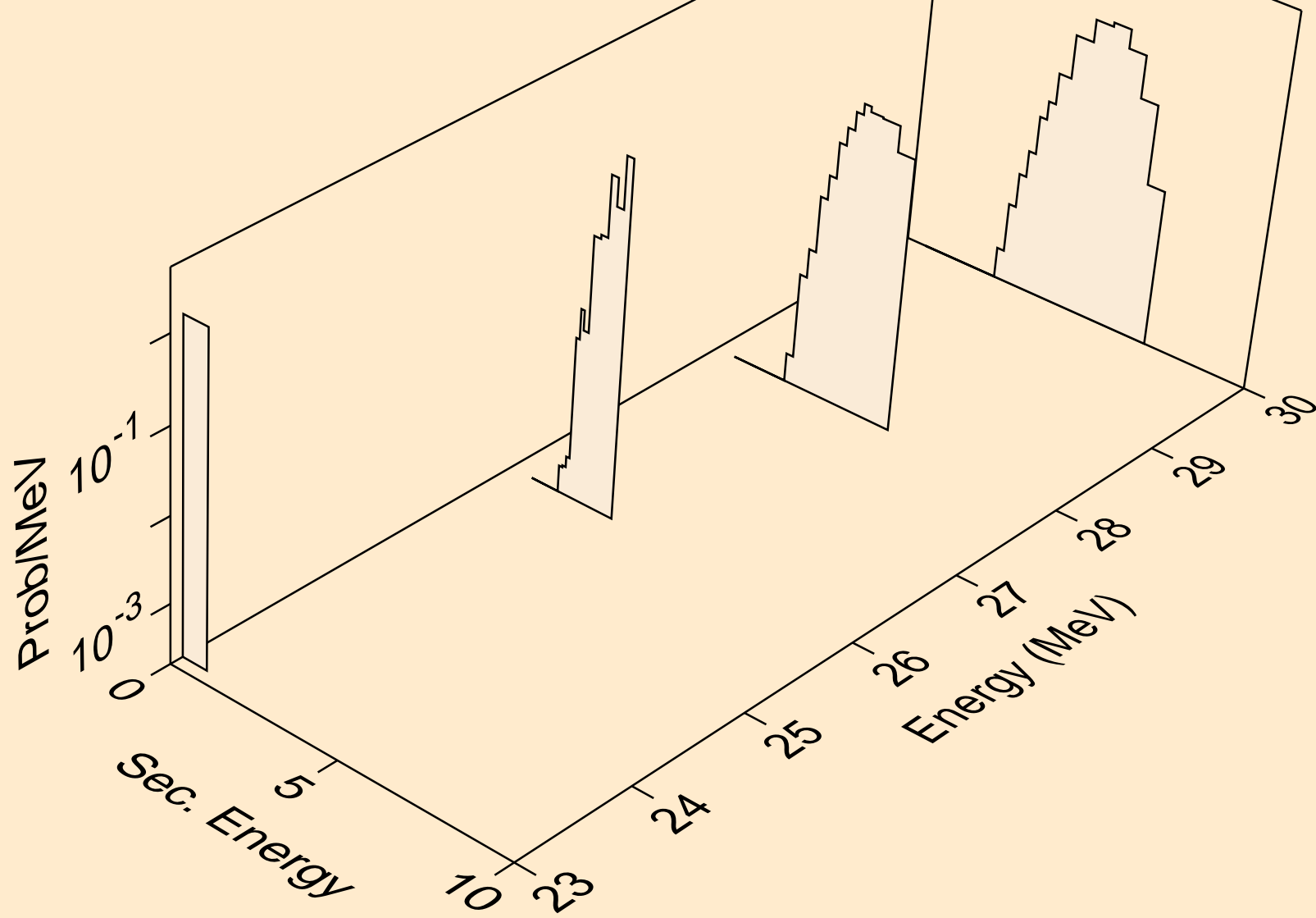

CE127M NEUTRON ACER TENDL-2021 LIBRARY; T=293.6K  
deuterons from (n,n\*)d

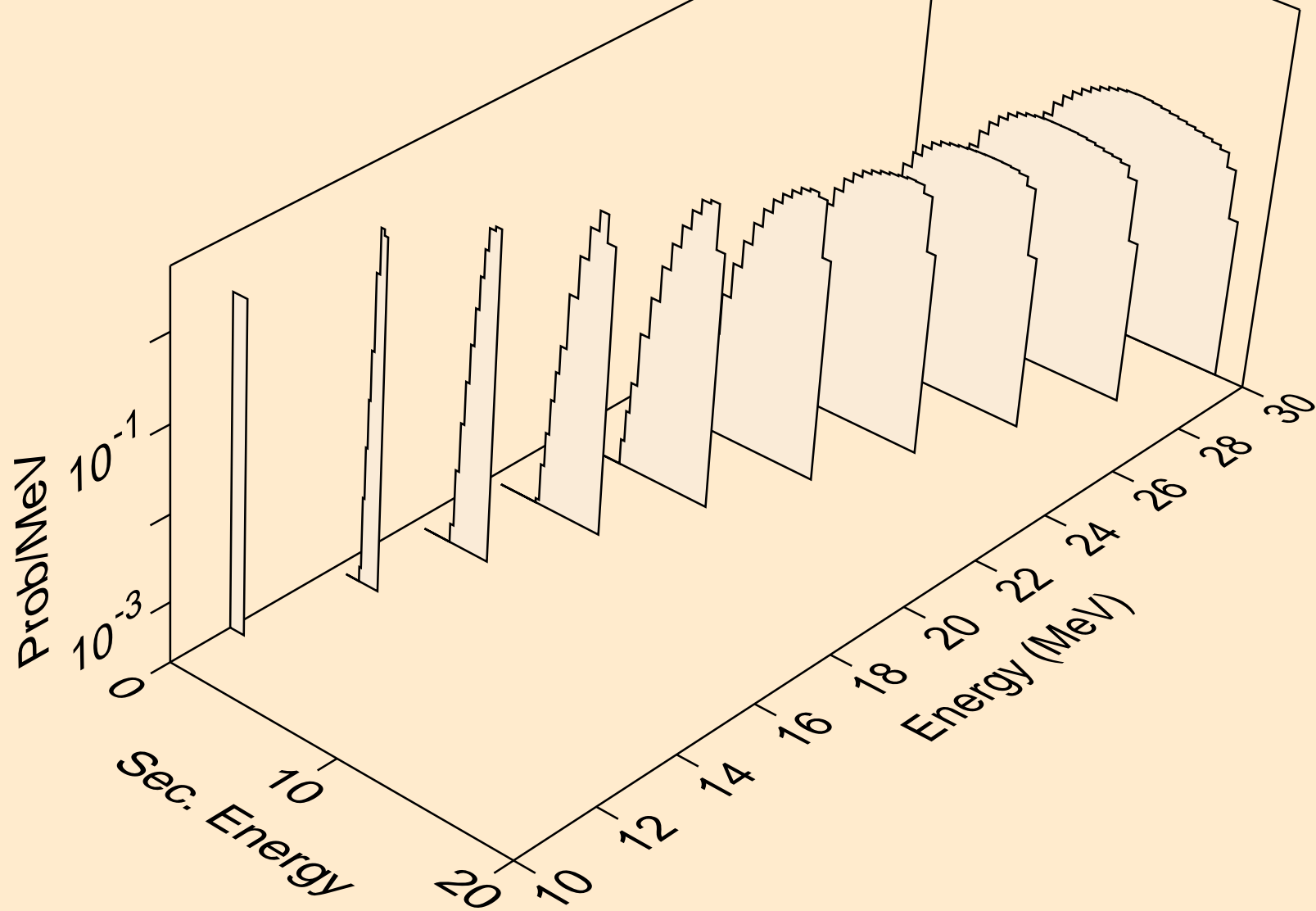

CE127M NEUTRON ACER TENDL-2021 LIBRARY; T=293.6K  
deuterons from (n,d)

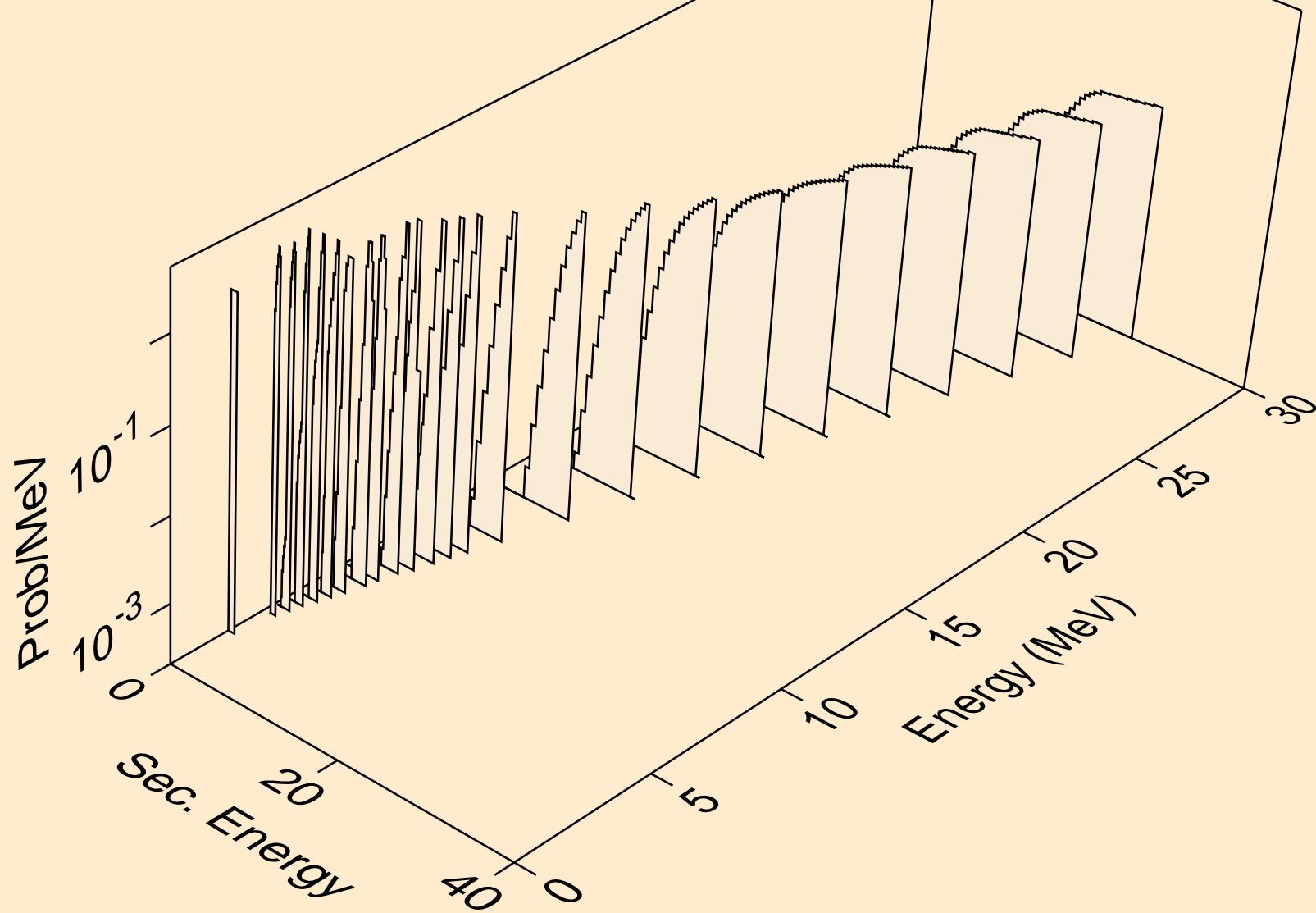



CE127M NEUTRON ACER TENDL-2021 LIBRARY; T=293.6K  
deuterons from (n,pd)

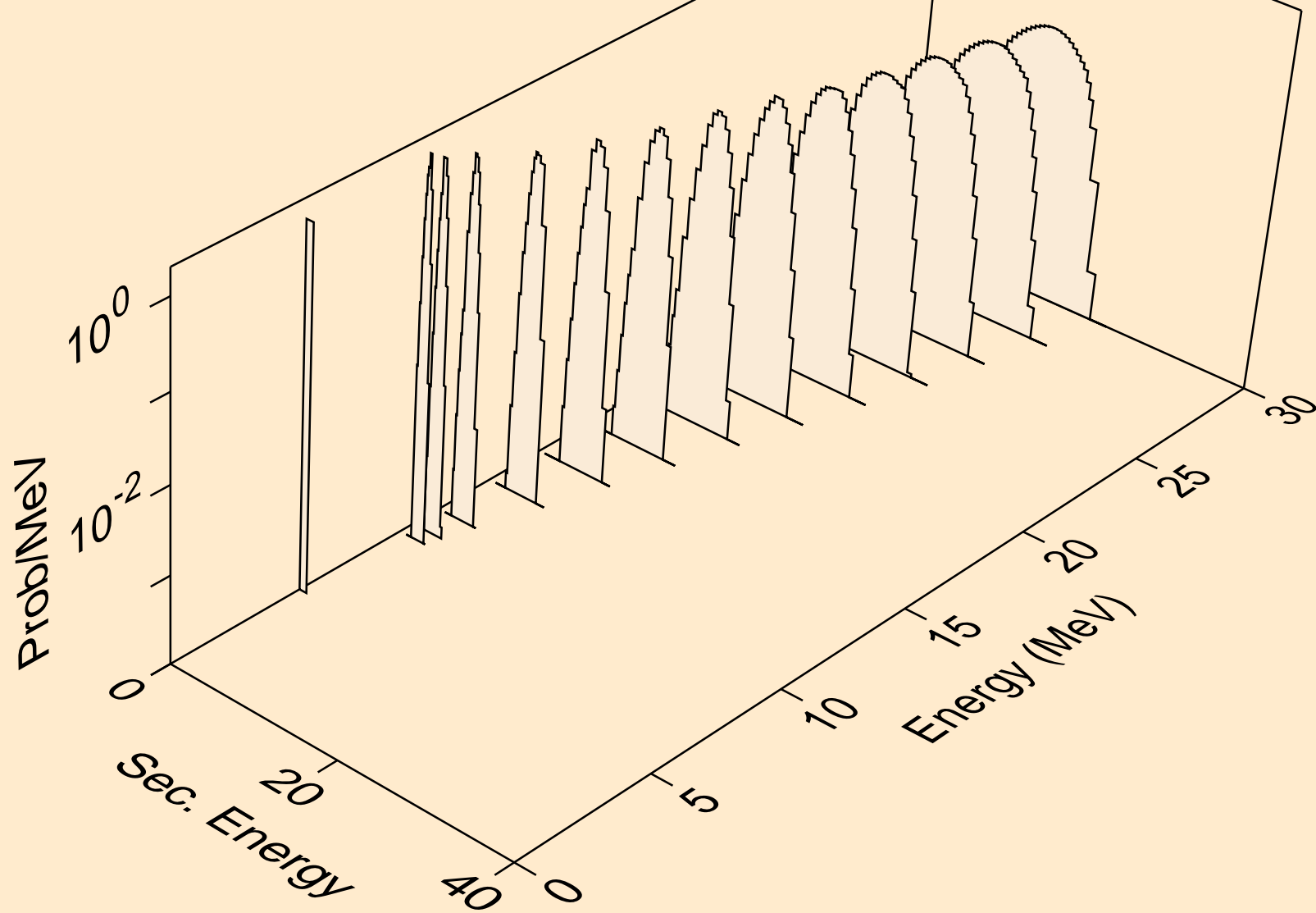

CE127M NEUTRON ACER TENDL-2021 LIBRARY; T=293.6K  
deuterons from (n,da)

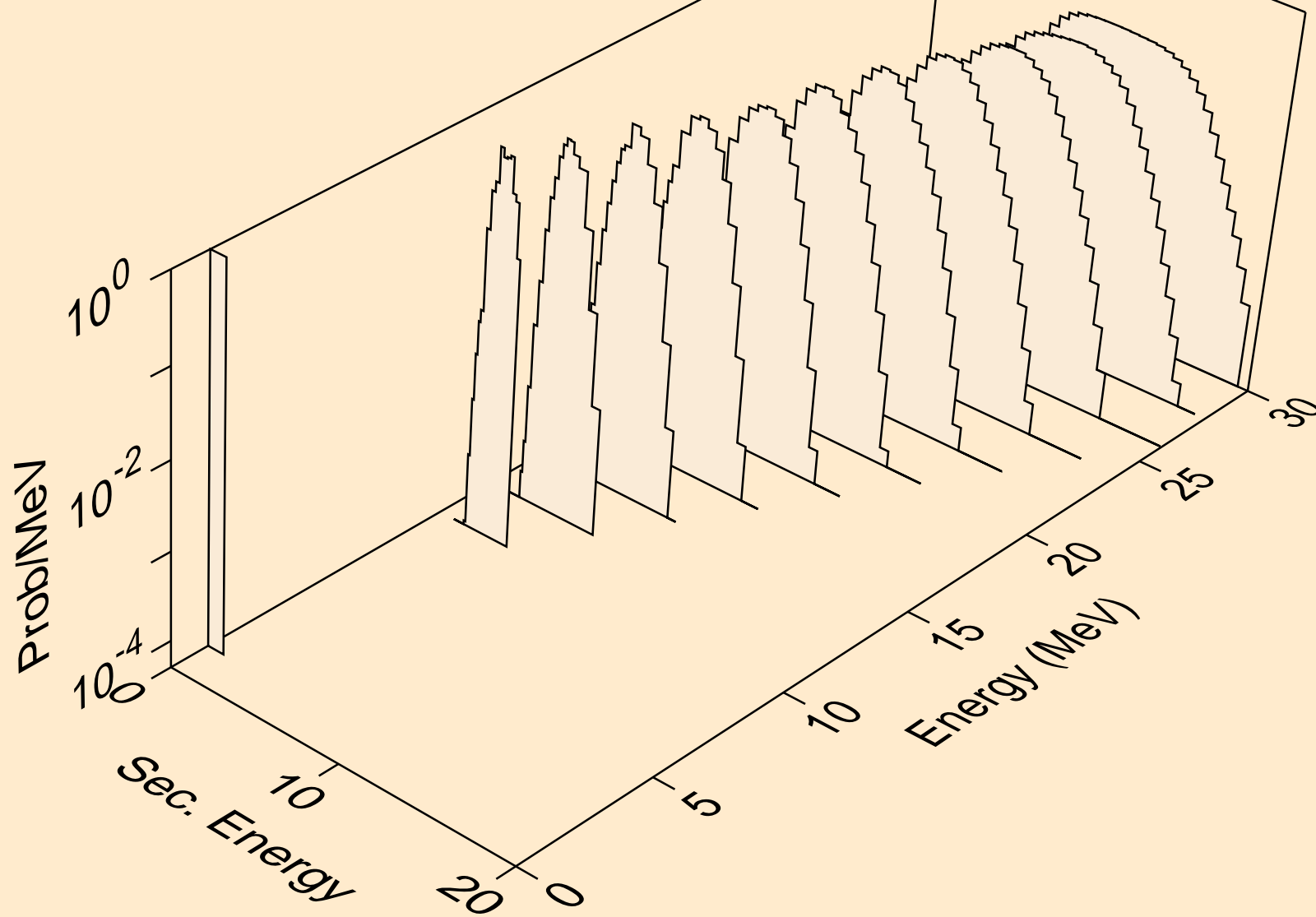

CE127M NEUTRON ACER TENDL-2021 LIBRARY; T=293.6K  
tritons from (n,x)

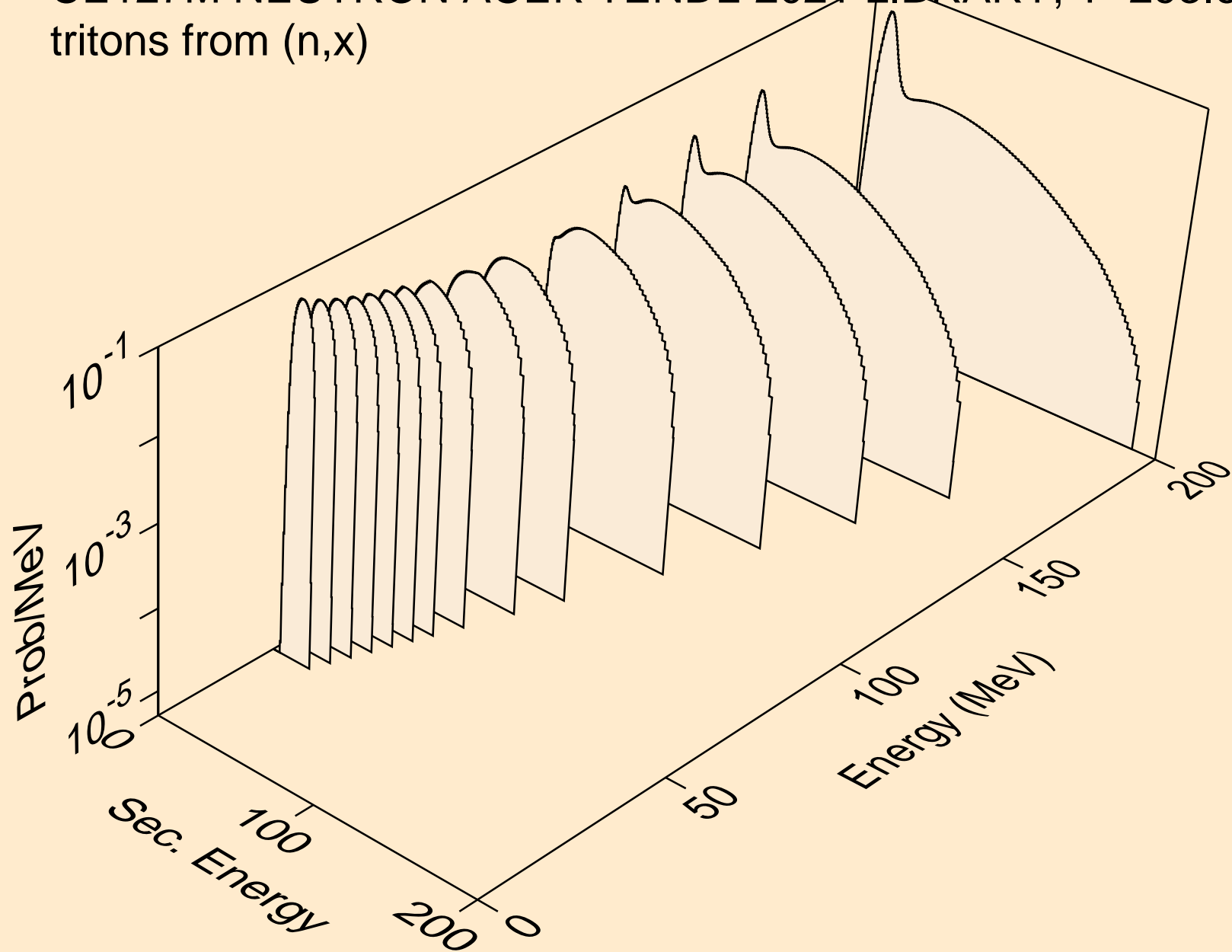

CE127M NEUTRON ACER TENDL-2021 LIBRARY; T=293.6K  
tritons from (n,n\*)t

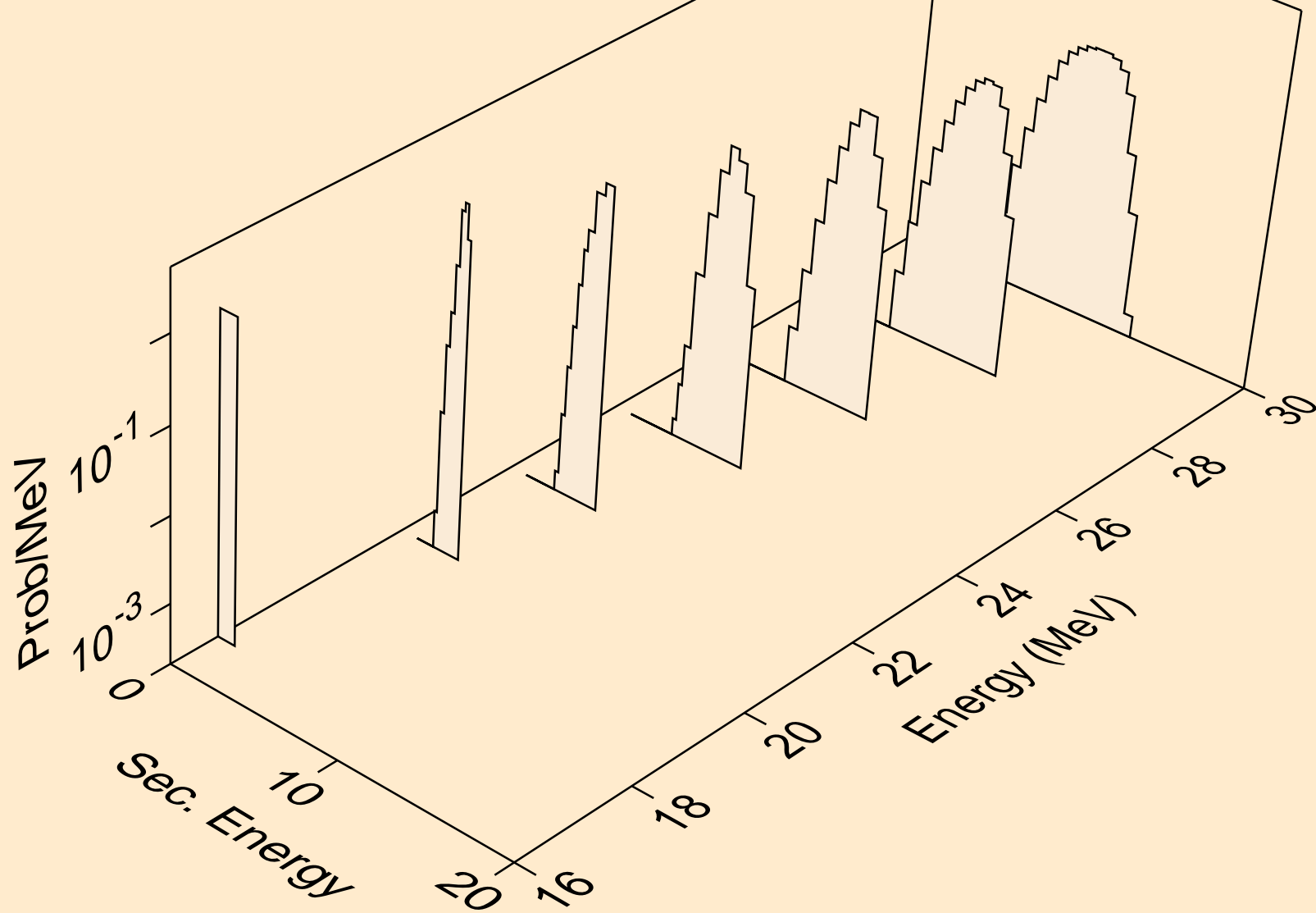

CE127M NEUTRON ACER TENDL-2021 LIBRARY; T=293.6K  
tritons from (n,t)

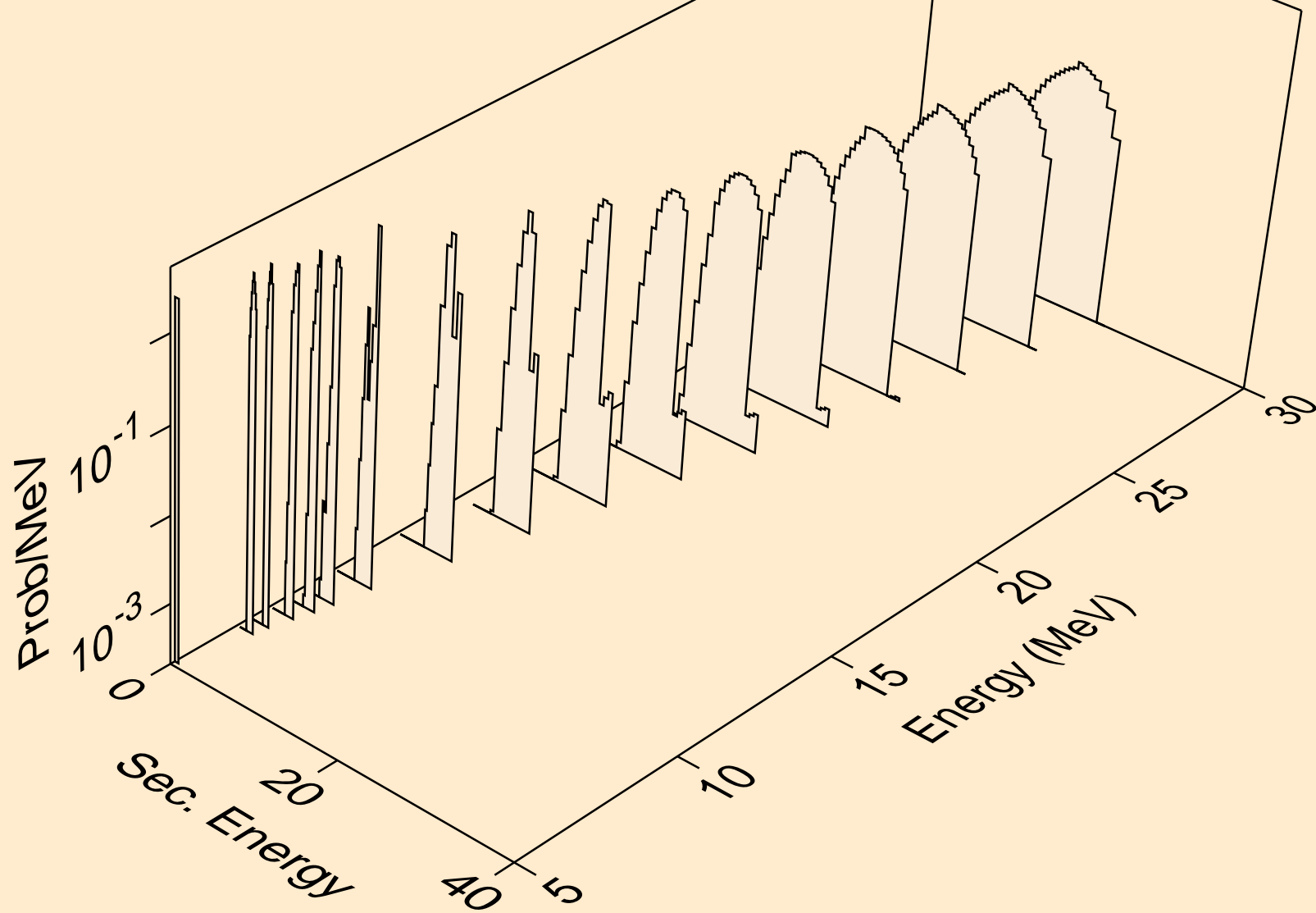

CE127M NEUTRON ACER TENDL-2021 LIBRARY; T=293.6K  
tritons from (n,pt)

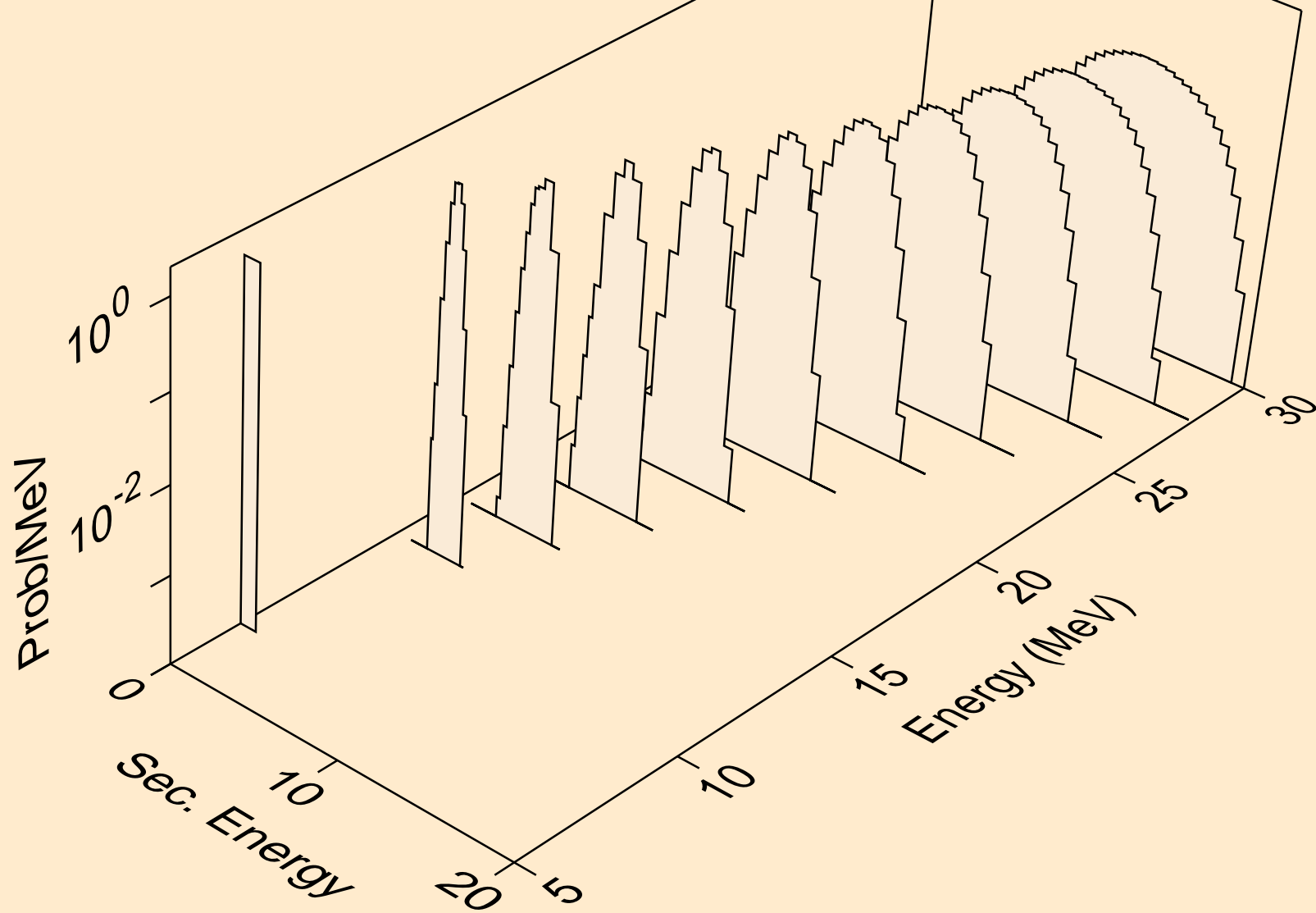

CE127M NEUTRON ACER TENDL-2021 LIBRARY; T=293.6K  
he3s from (n,x)

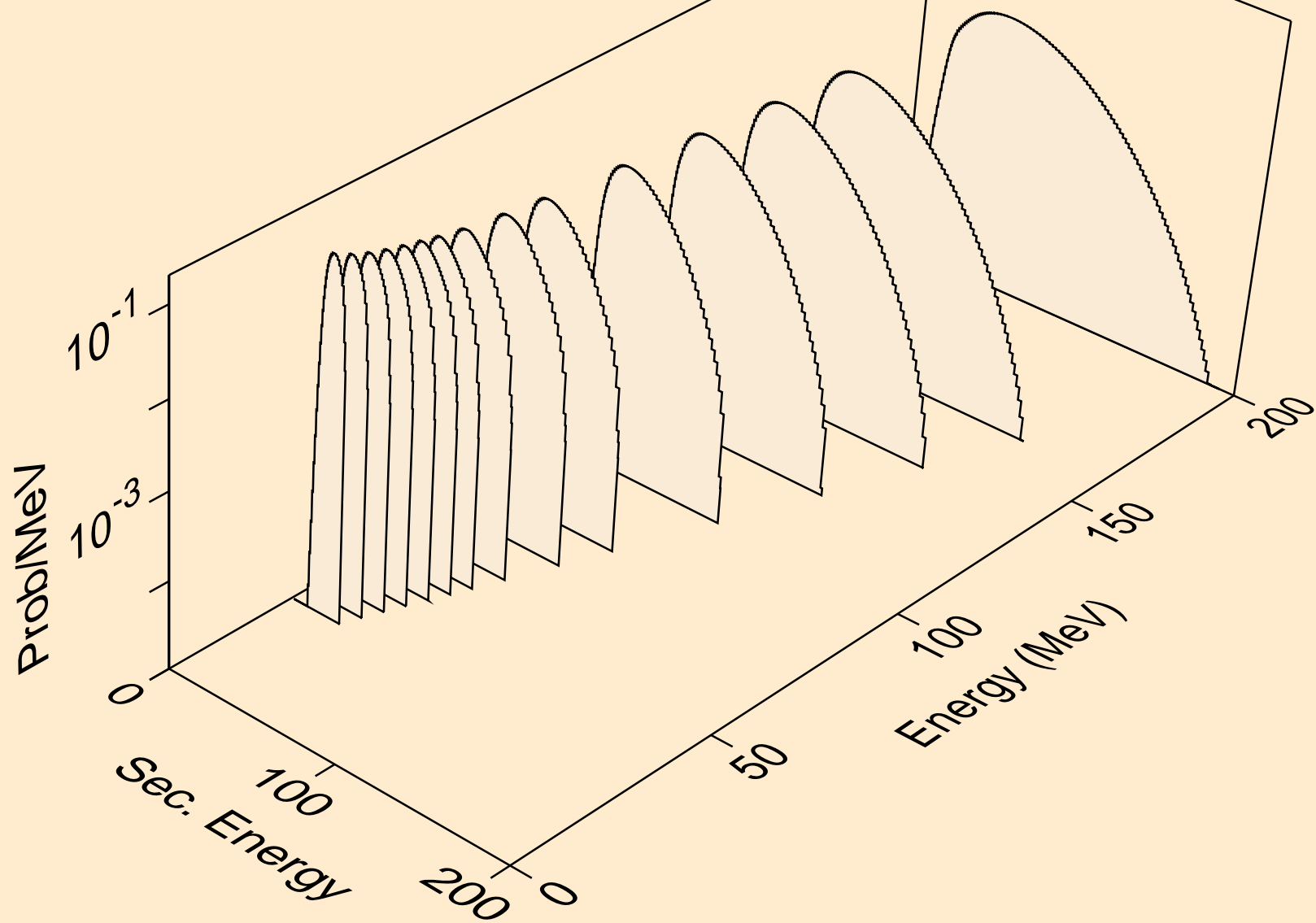

CE127M NEUTRON ACER TENDL-2021 LIBRARY; T=293.6K  
he3s from (n,n\*)he3

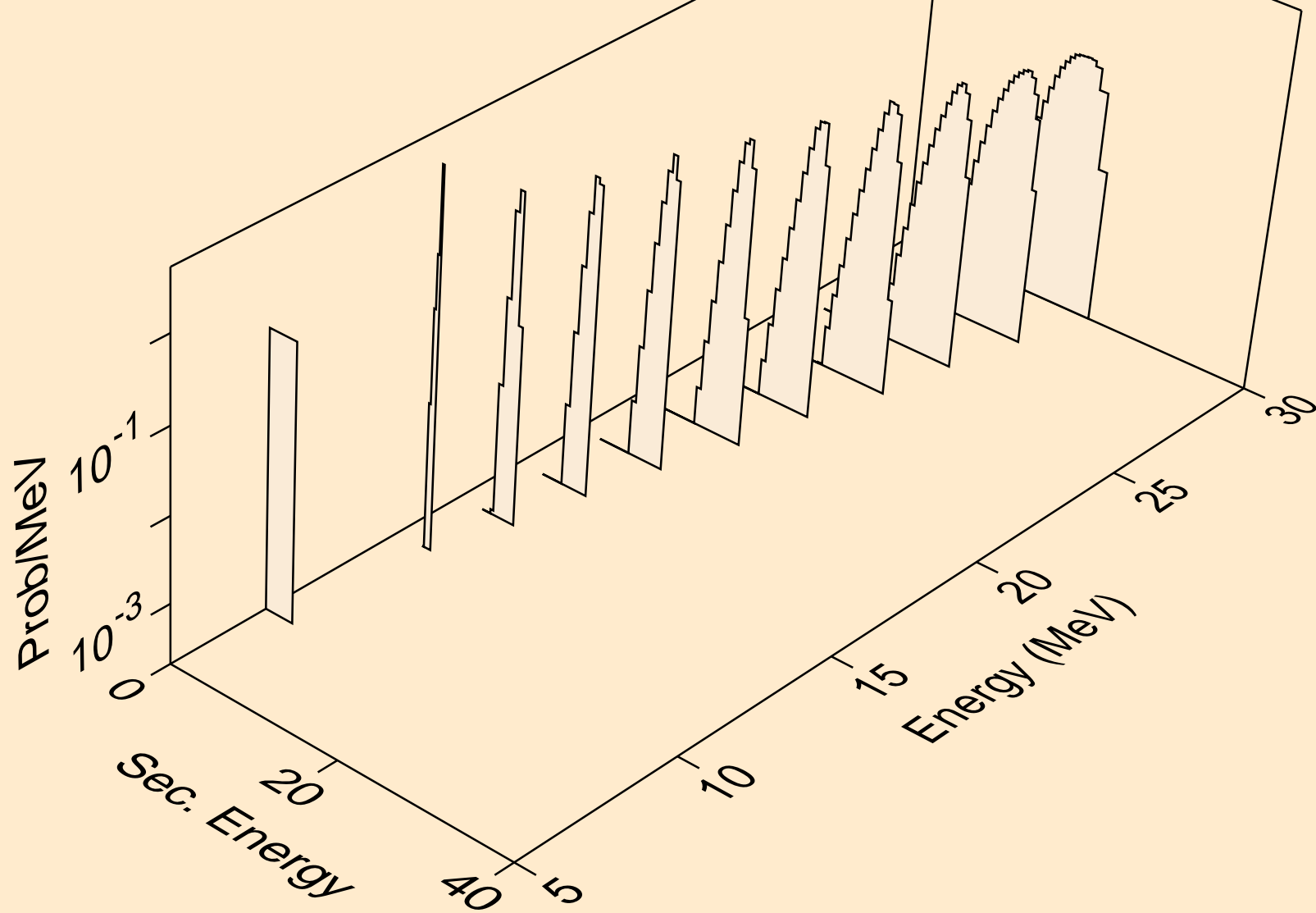



CE127M NEUTRON ACER TENDL-2021 LIBRARY; T=293.6K  
he3s from (n,he3)

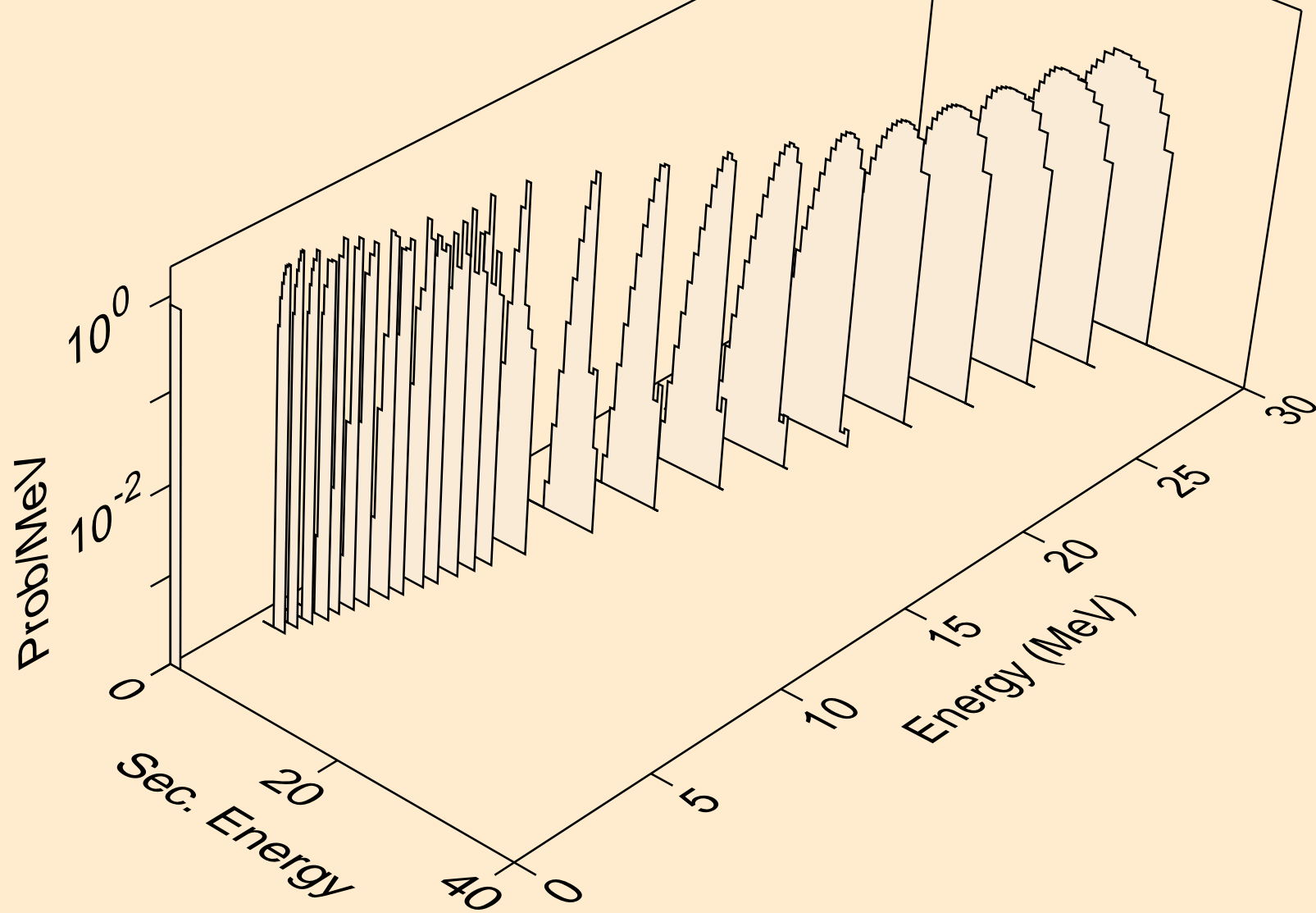

CE127M NEUTRON ACER TENDL-2021 LIBRARY; T=293.6K  
alphas from (n,x)

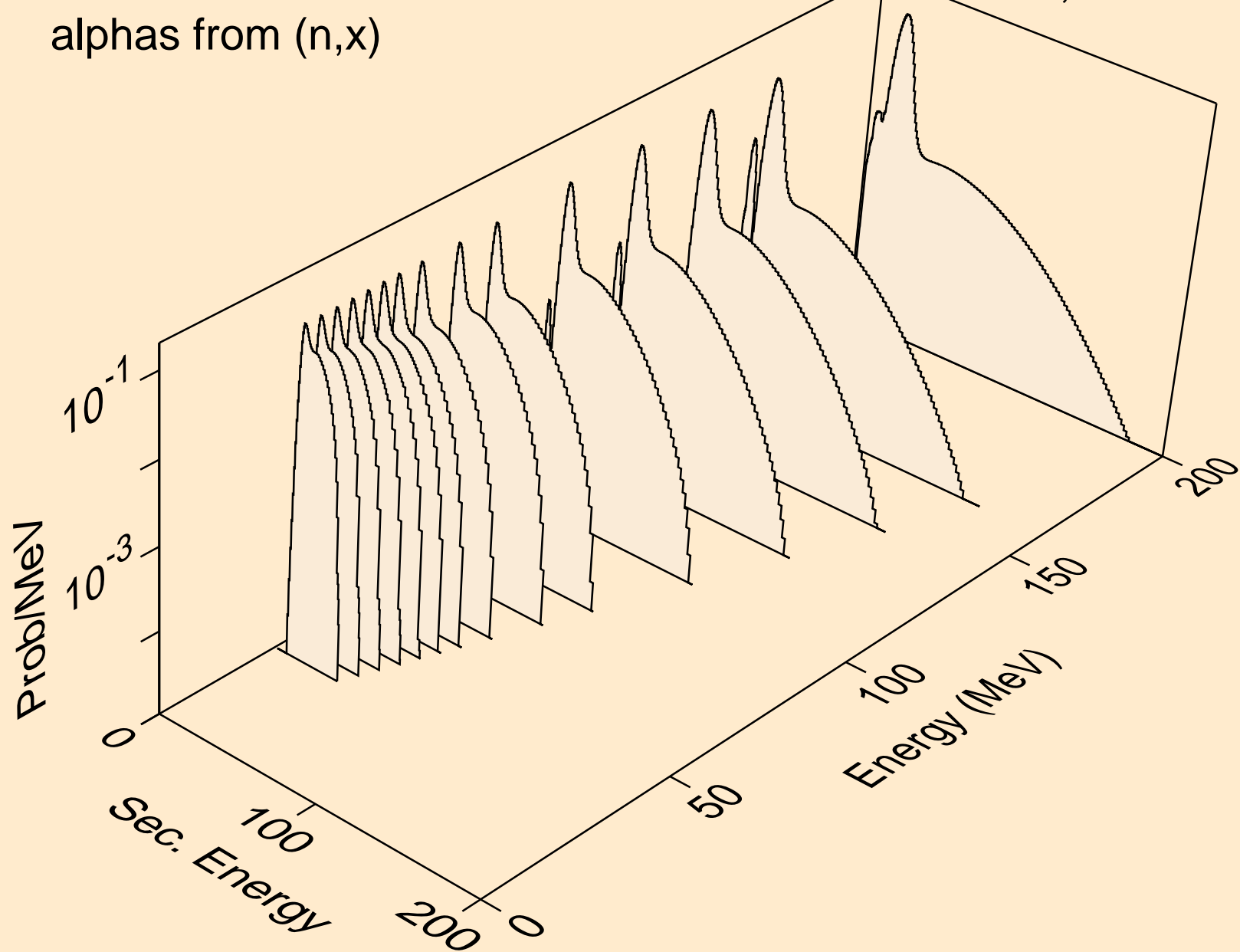

CE127M NEUTRON ACER TENDL-2021 LIBRARY; T=293.6K  
alphas from (n,n\*)a

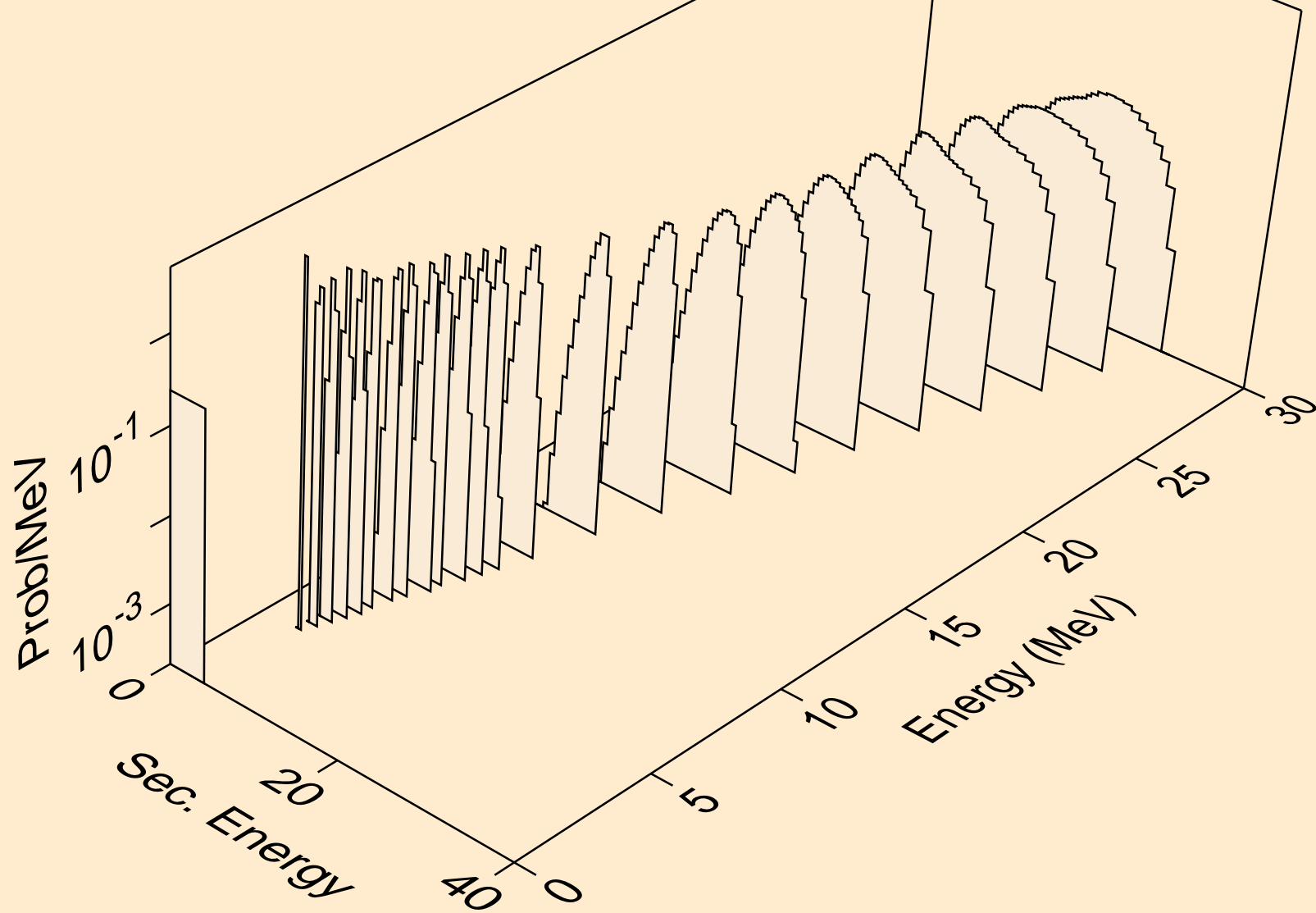

CE127M NEUTRON ACER TENDL-2021 LIBRARY; T=293.6K  
alphas from (n,2n)a

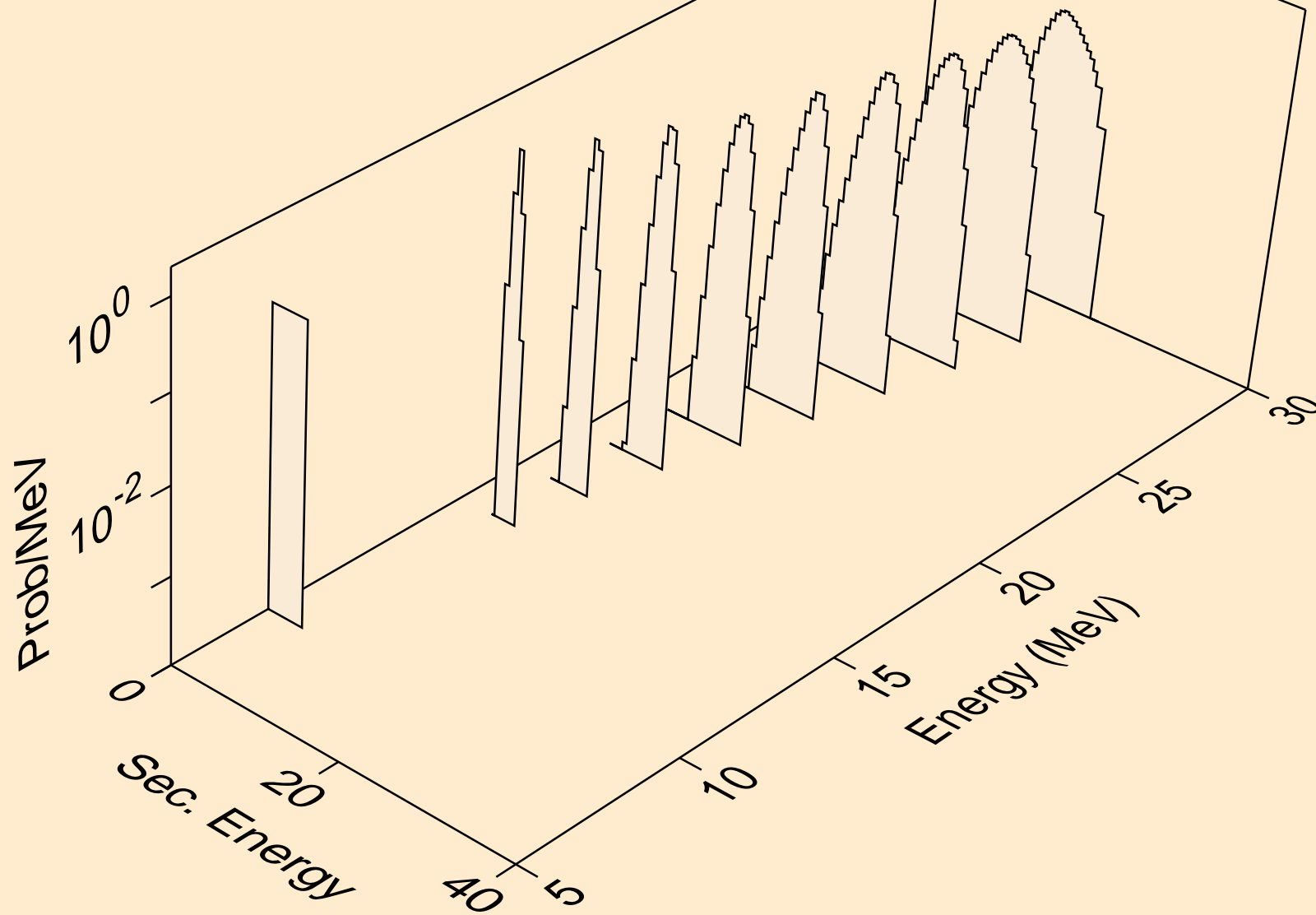

CE127M NEUTRON ACER TENDL-2021 LIBRARY; T=293.6K  
alphas from (n,3n)a

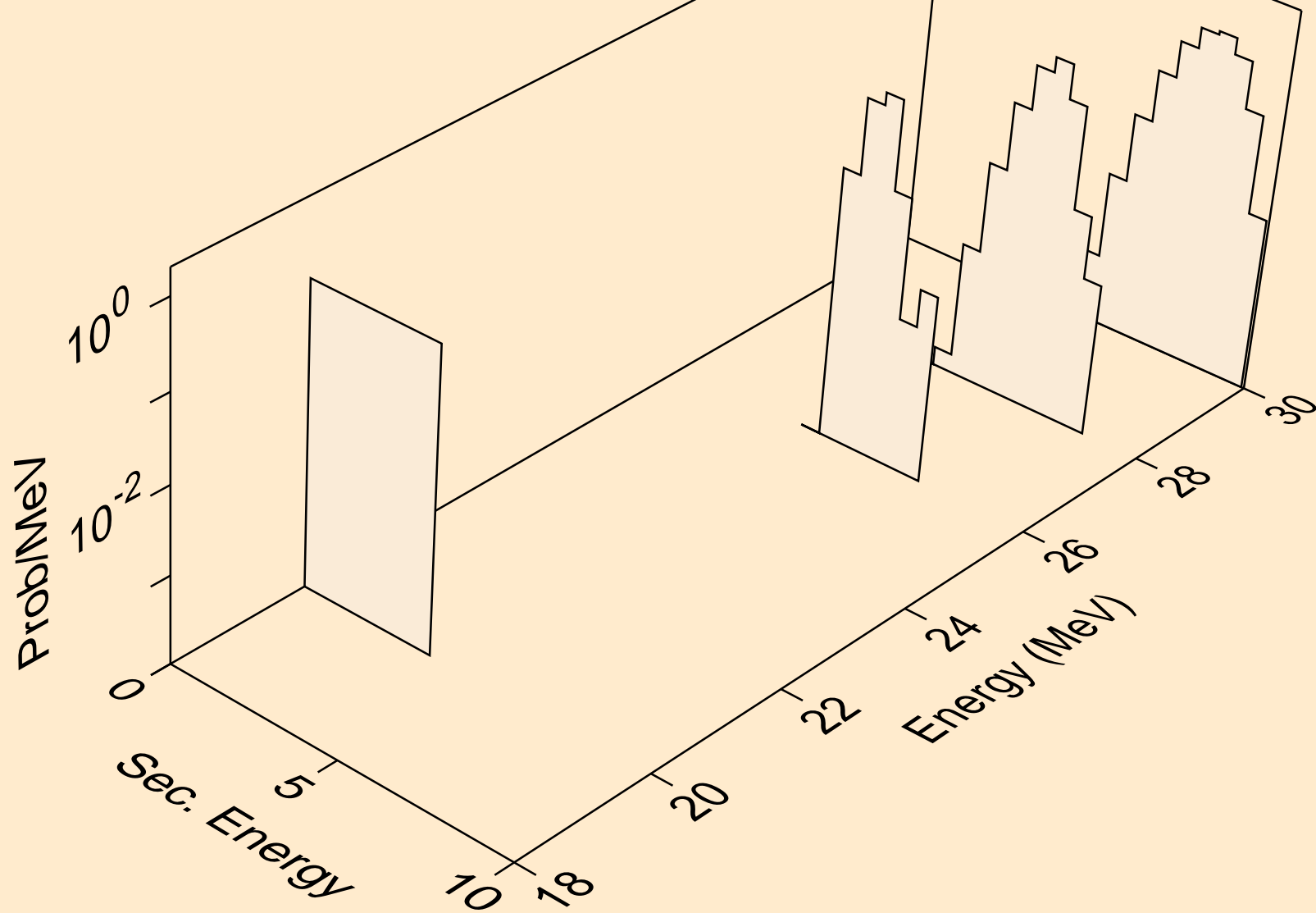

CE127M NEUTRON ACER TENDL-2021 LIBRARY; T=293.6K  
alphas from (n,n\*)2a

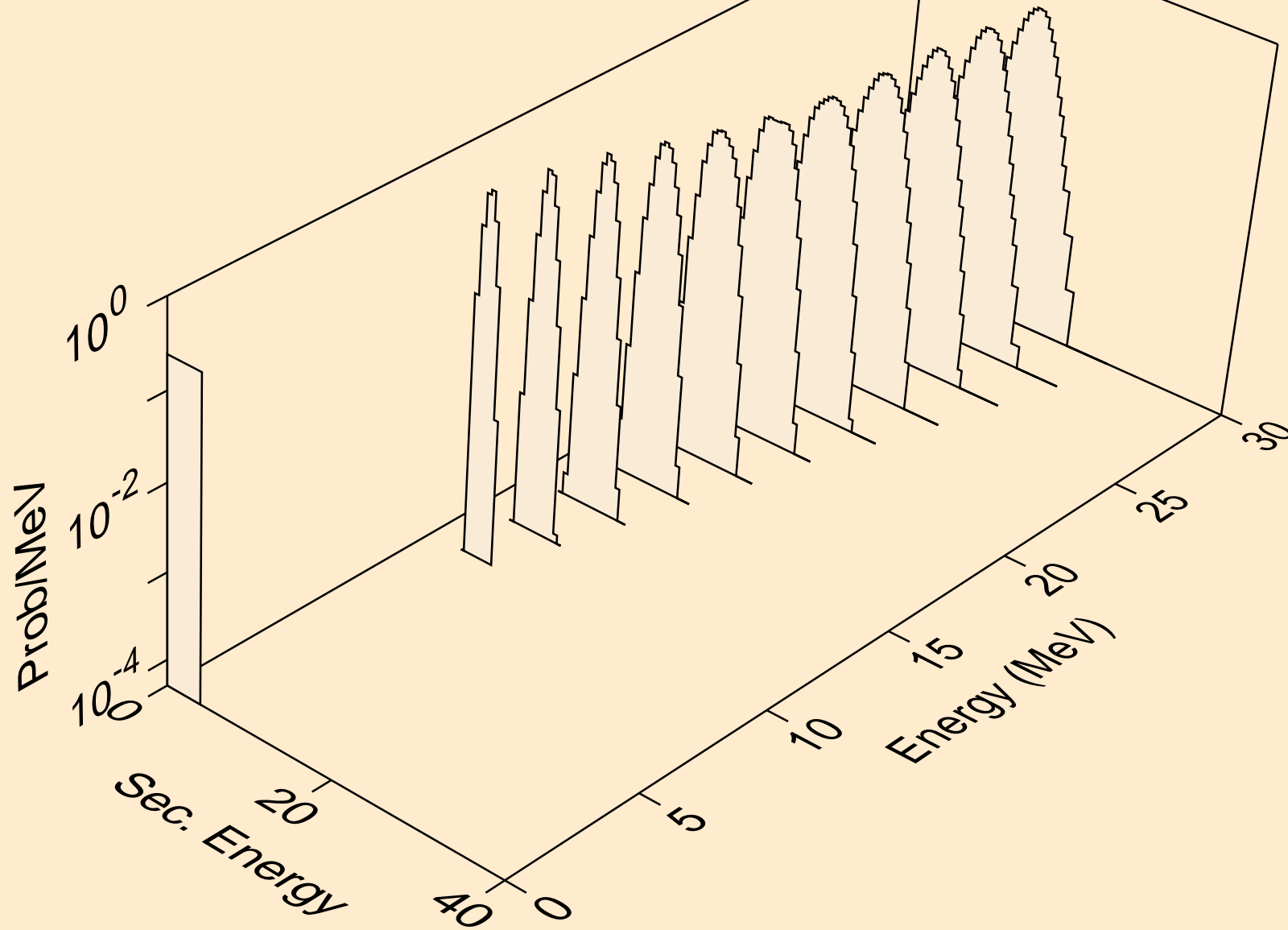

CE127M NEUTRON ACER TENDL-2021 LIBRARY; T=293.6K  
alphas from (n,2n)2a

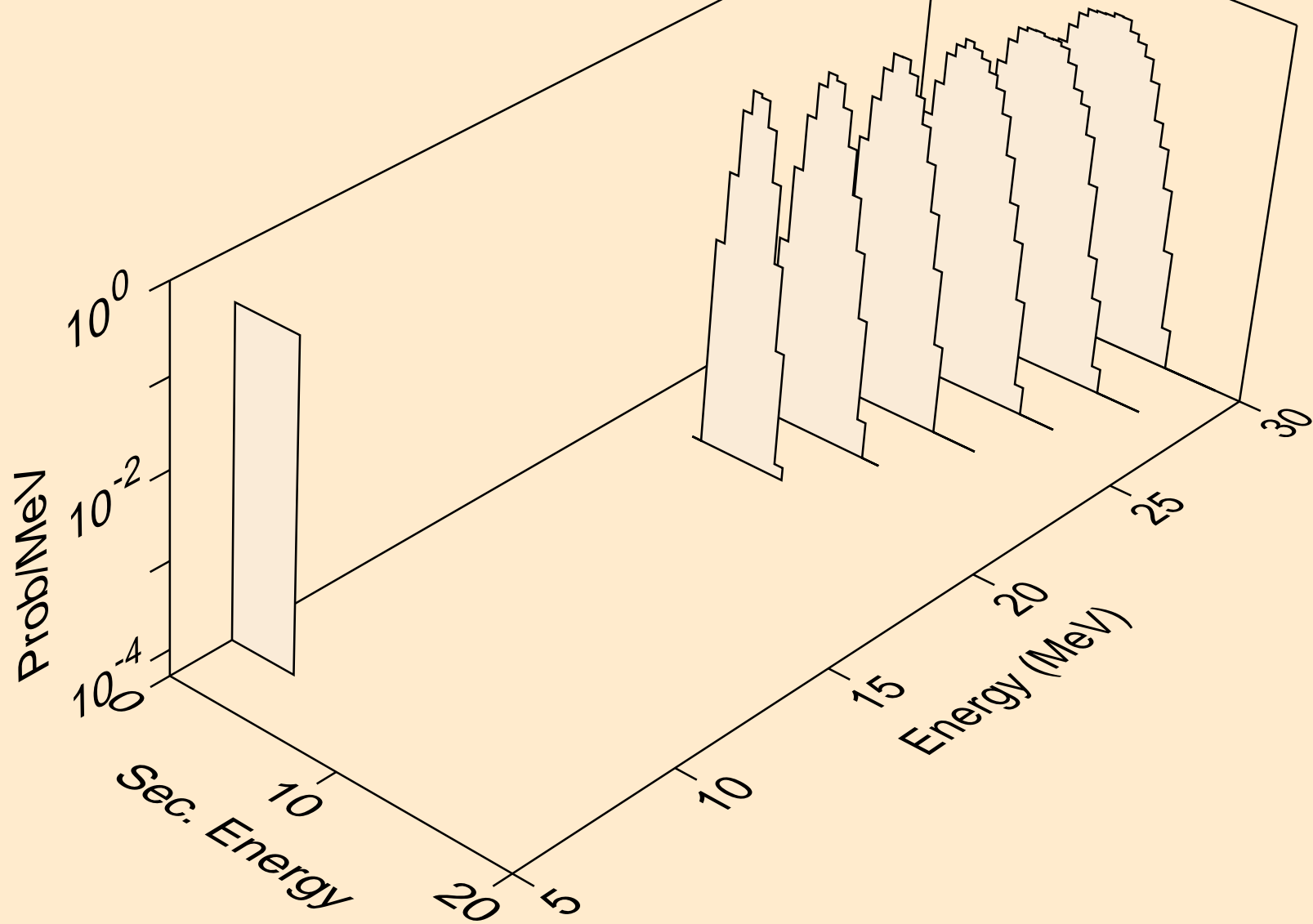

CE127M NEUTRON ACER TENDL-2021 LIBRARY; T=293.6K  
alphas from (n,npa)

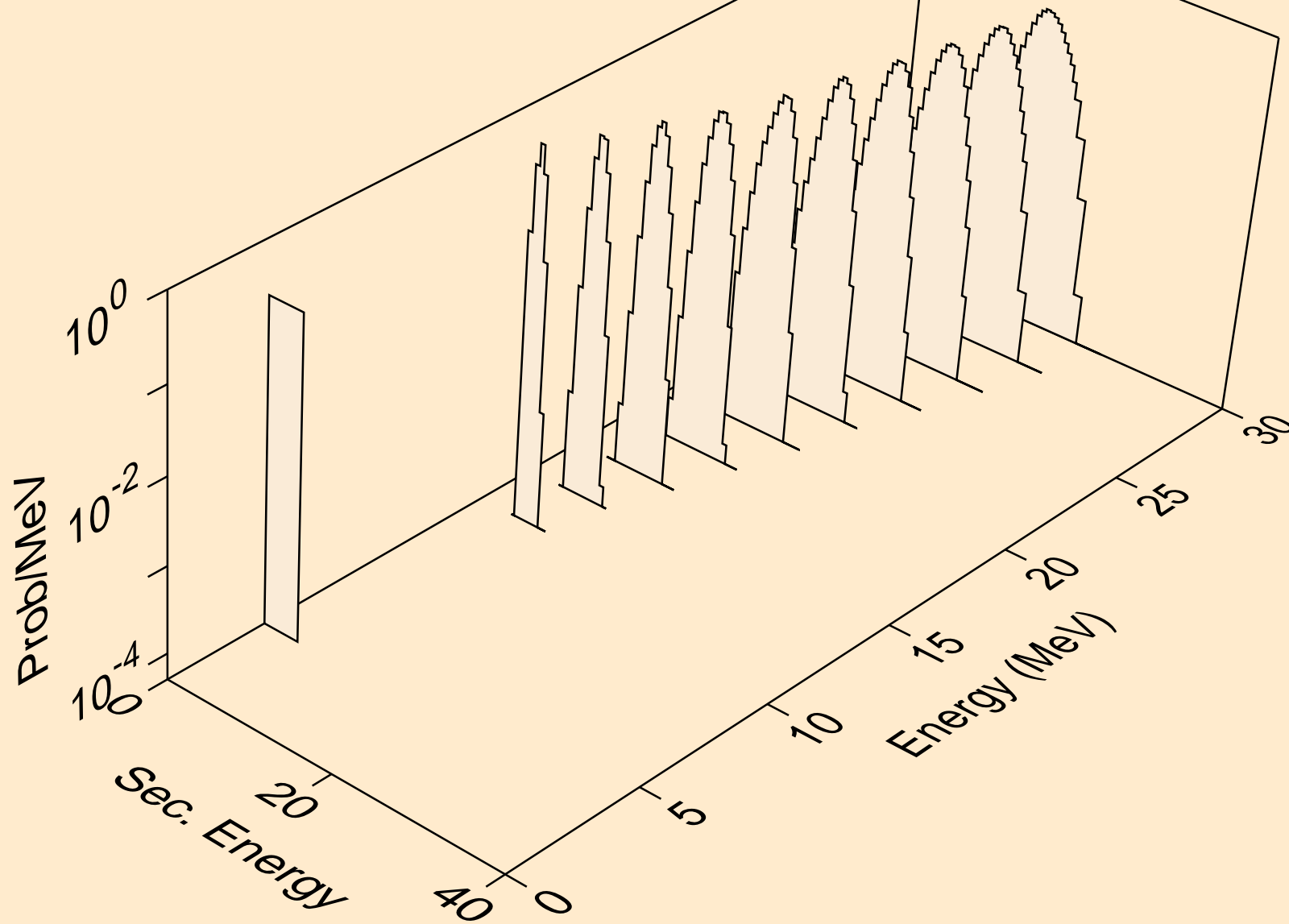



CE127M NEUTRON ACER TENDL-2021 LIBRARY; T=293.6K  
alphas from (n,a)

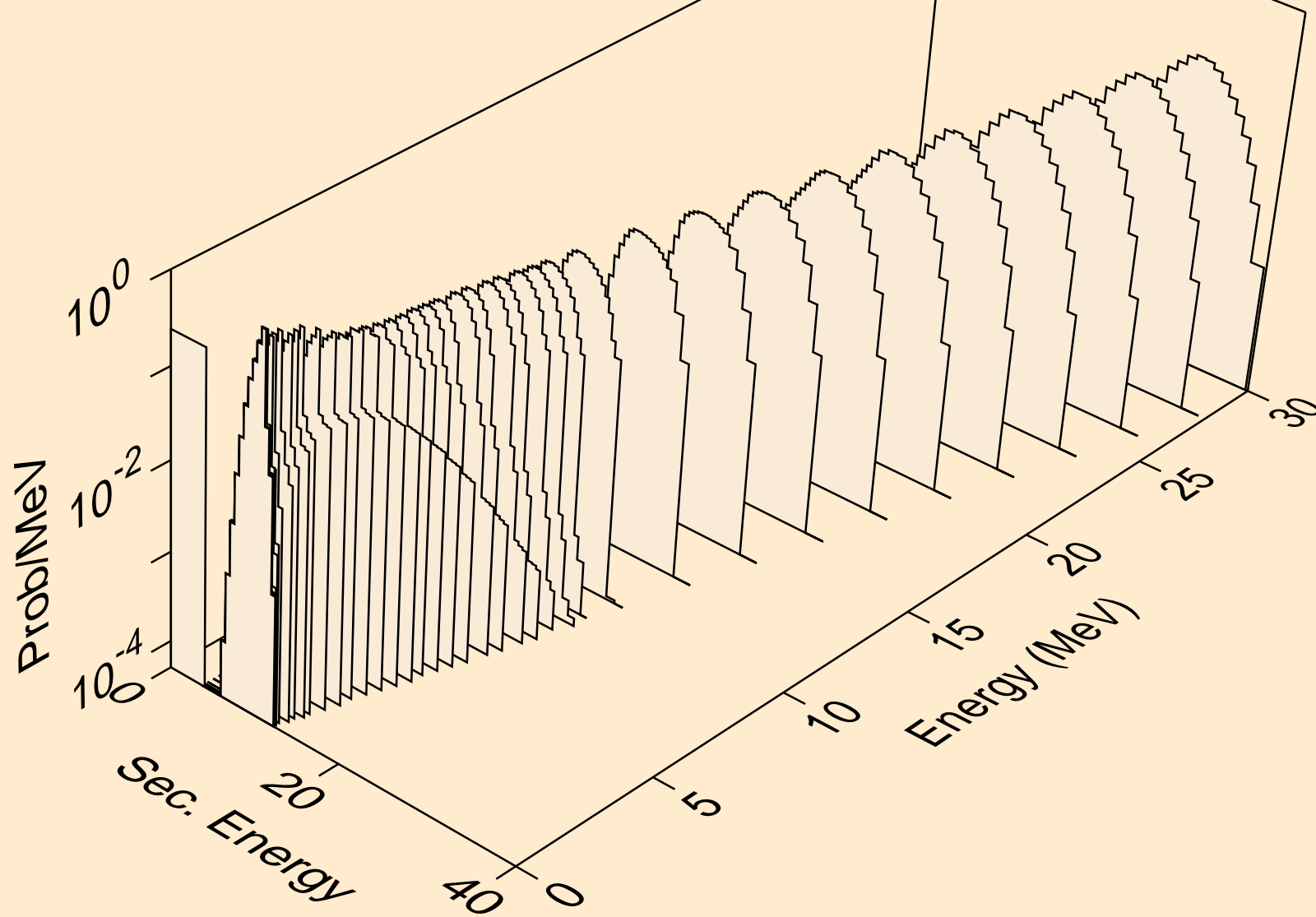

CE127M NEUTRON ACER TENDL-2021 LIBRARY; T=293.6K  
alphas from (n,2a)

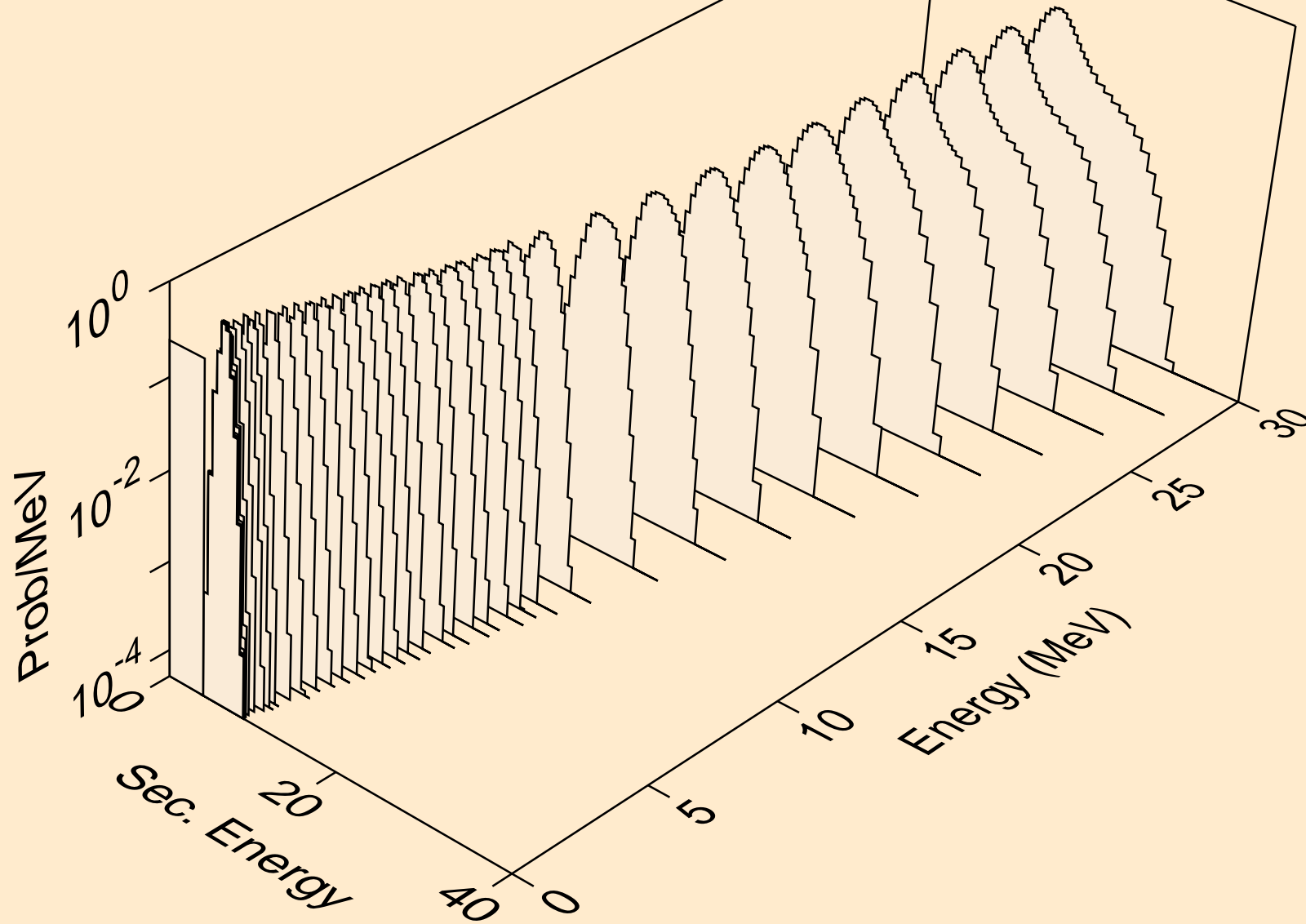

CE127M NEUTRON ACER TENDL-2021 LIBRARY; T=293.6K  
alphas from (n,3a)

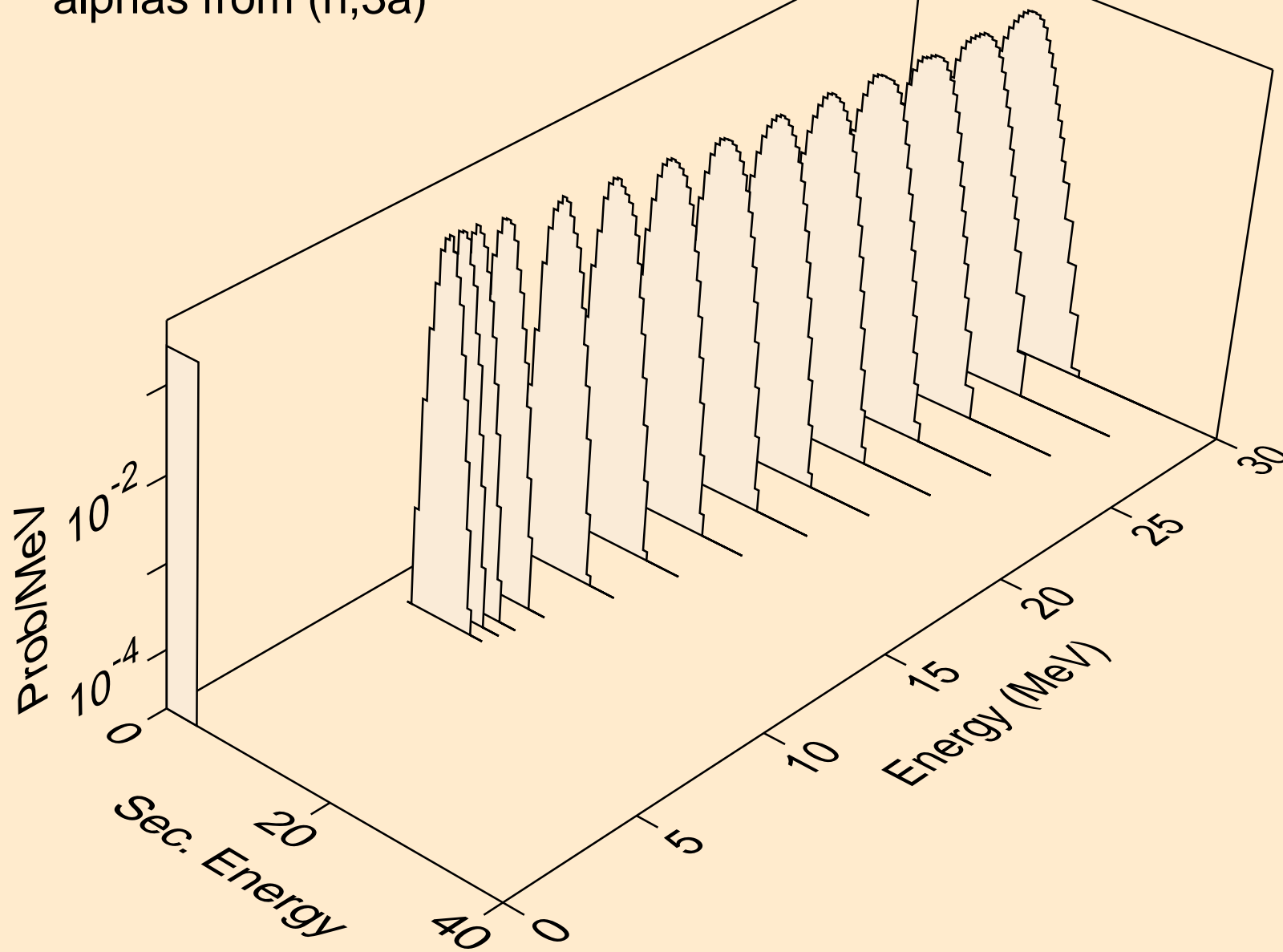

CE127M NEUTRON ACER TENDL-2021 LIBRARY; T=293.6K  
alphas from (n,pa)

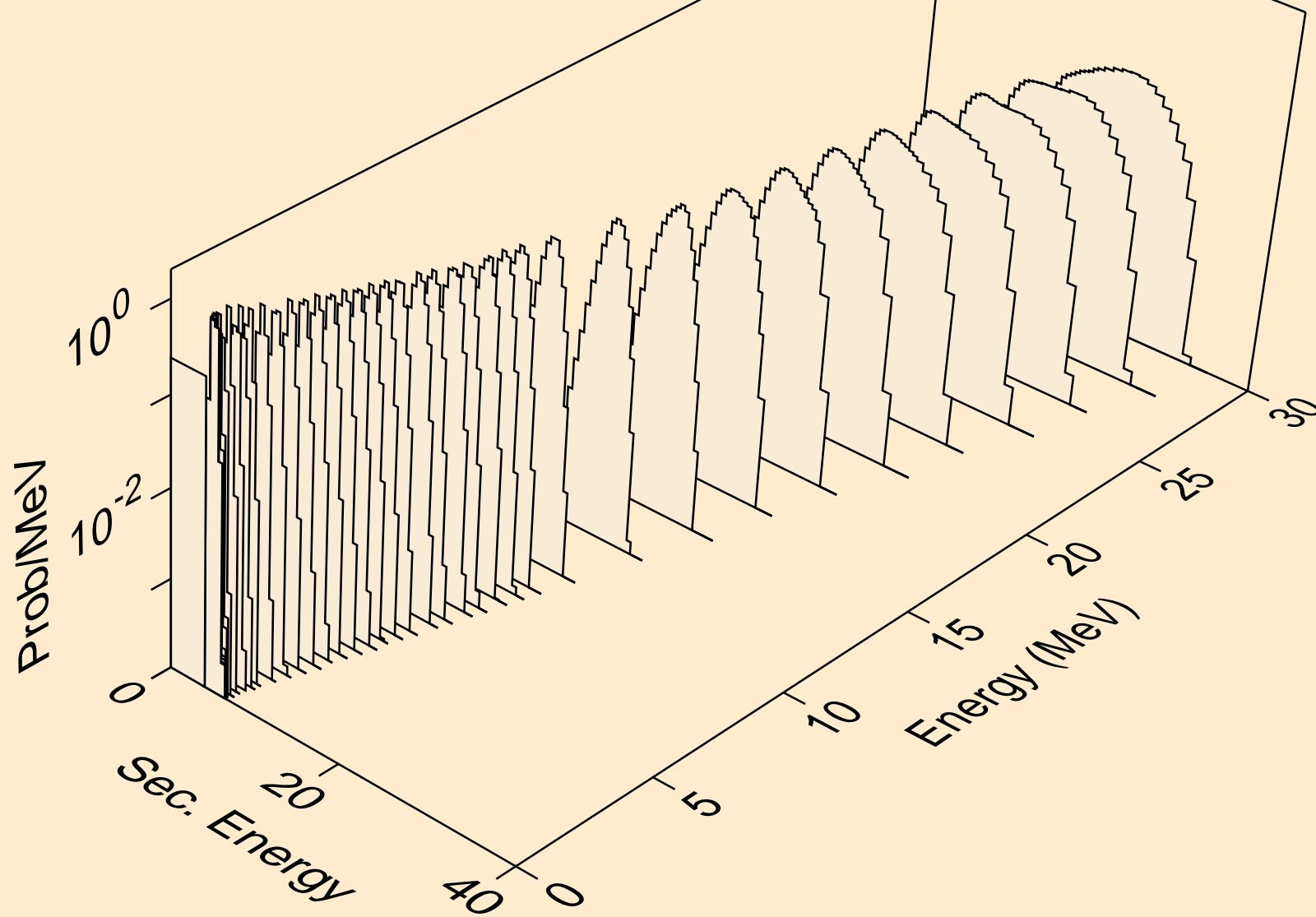

CE127M NEUTRON ACER TENDL-2021 LIBRARY; T=293.6K  
alphas from (n,da)

