

CE139 NEUTRON ACER TENDL-2021 LIBRARY; T=293.6K  
Principal cross sections

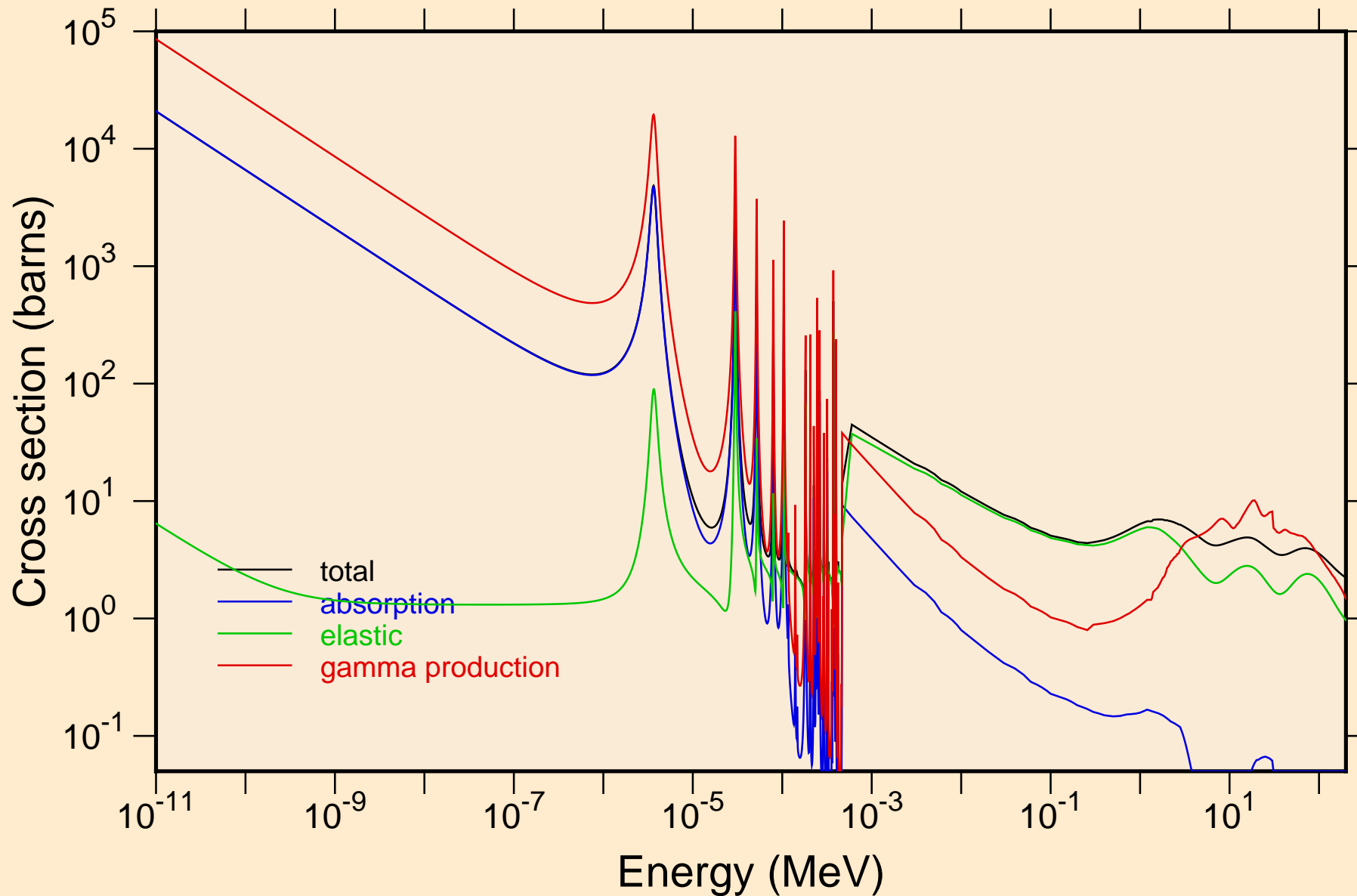

CE139 NEUTRON ACER TENDL-2021 LIBRARY; T=293.6K  
resonance total cross section

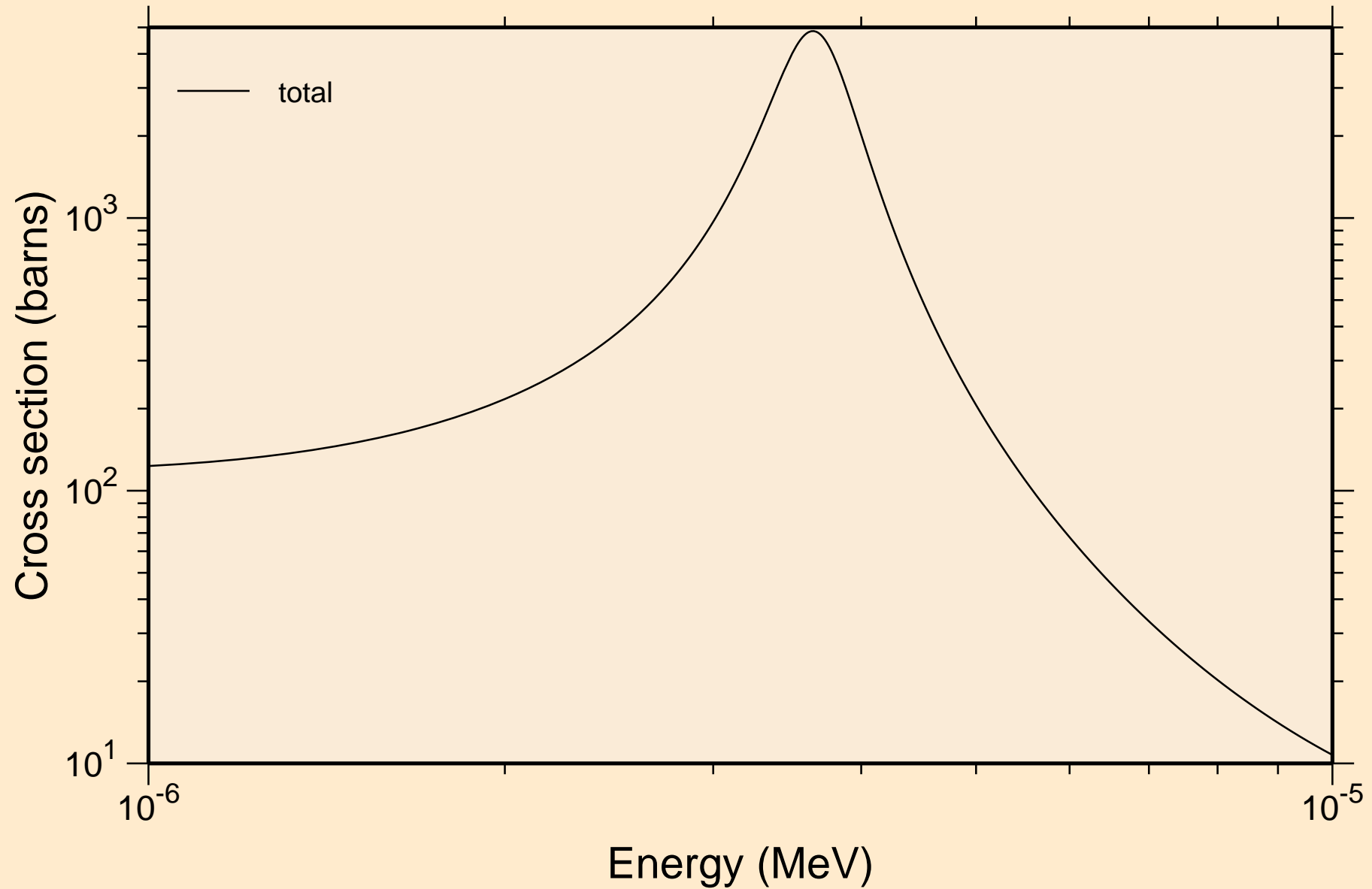

CE139 NEUTRON ACER TENDL-2021 LIBRARY; T=293.6K  
resonance total cross section

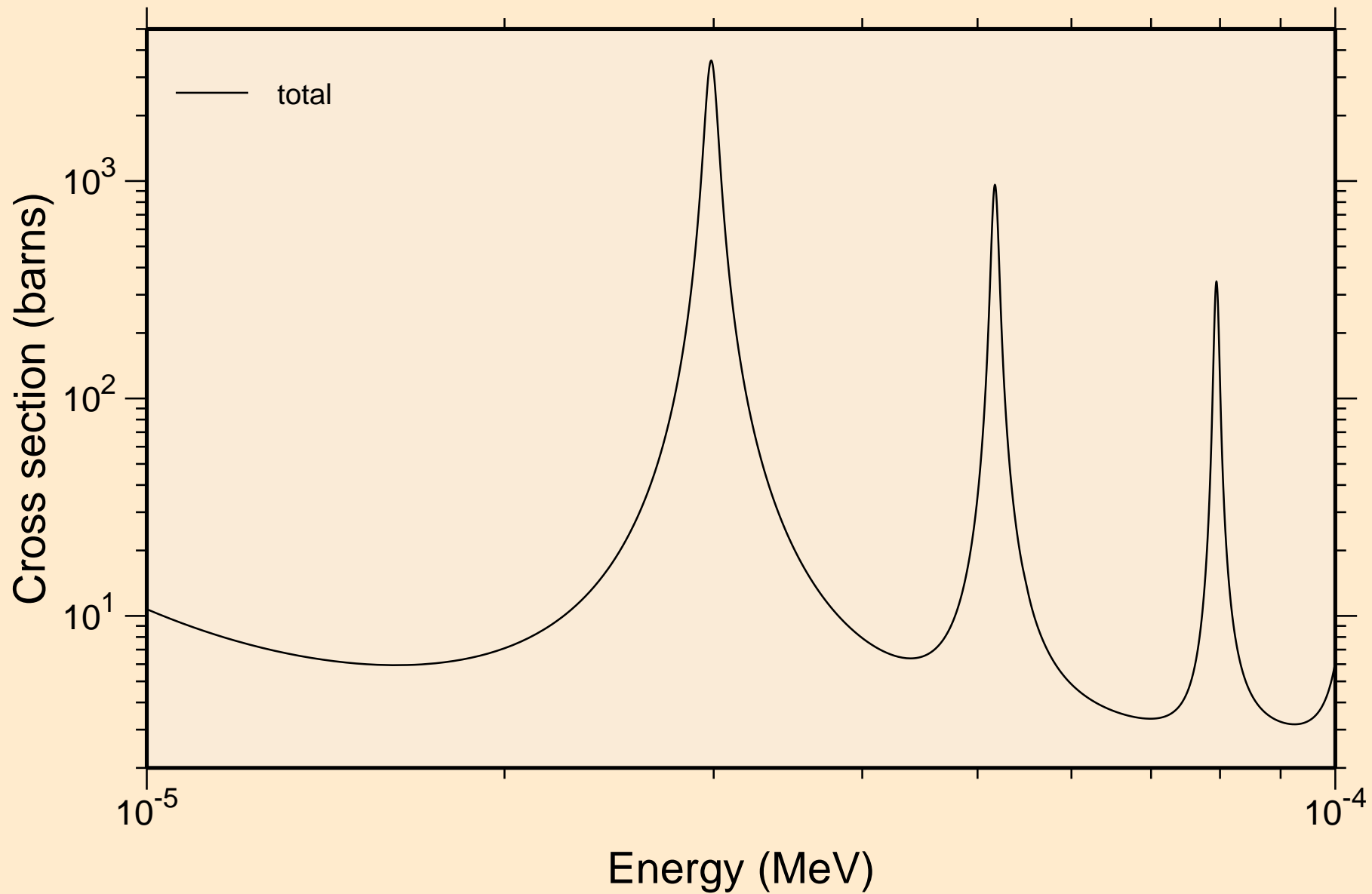

CE139 NEUTRON ACER TENDL-2021 LIBRARY; T=293.6K  
resonance total cross section

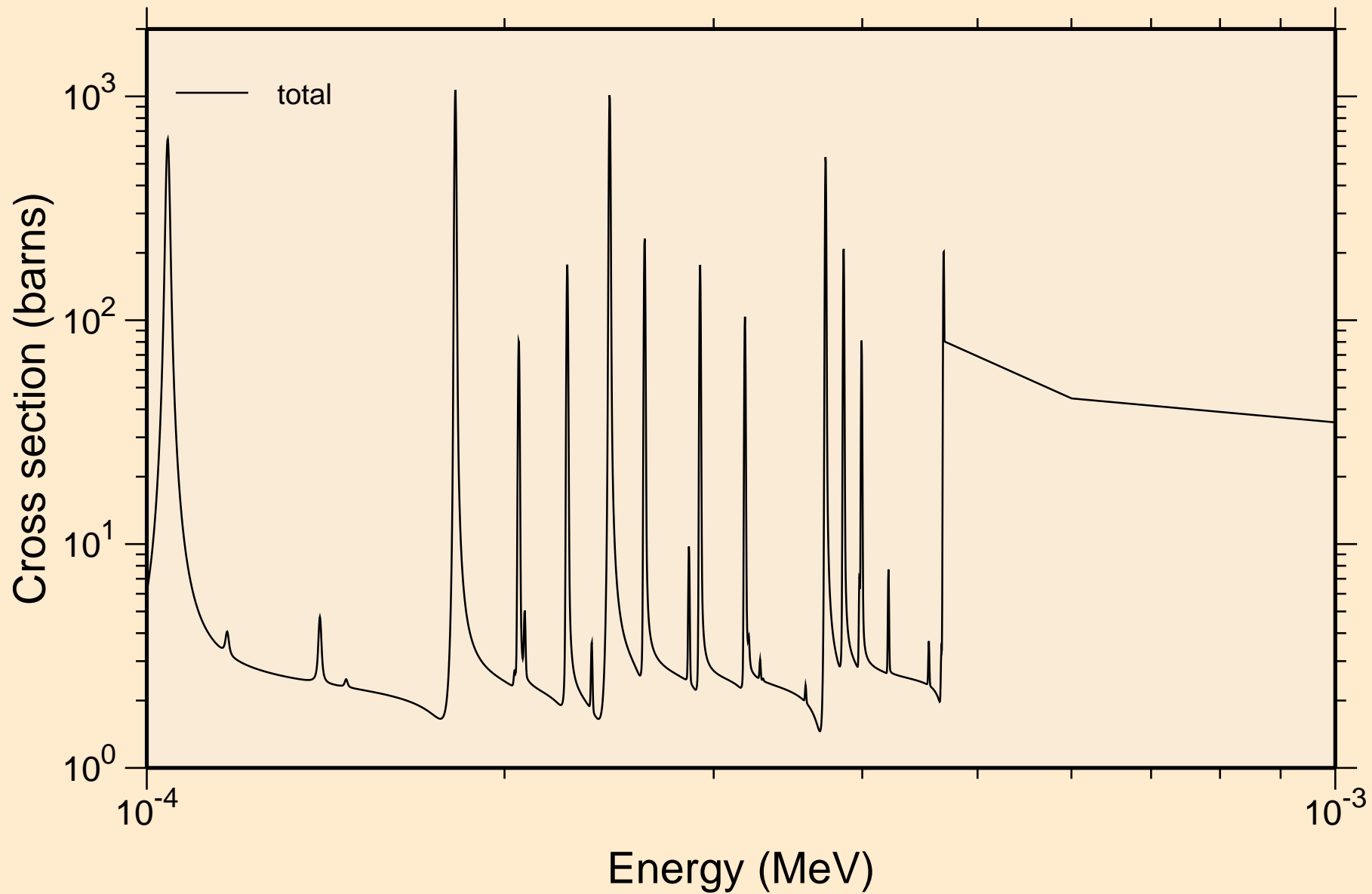

CE139 NEUTRON ACER TENDL-2021 LIBRARY; T=293.6K  
resonance total cross section

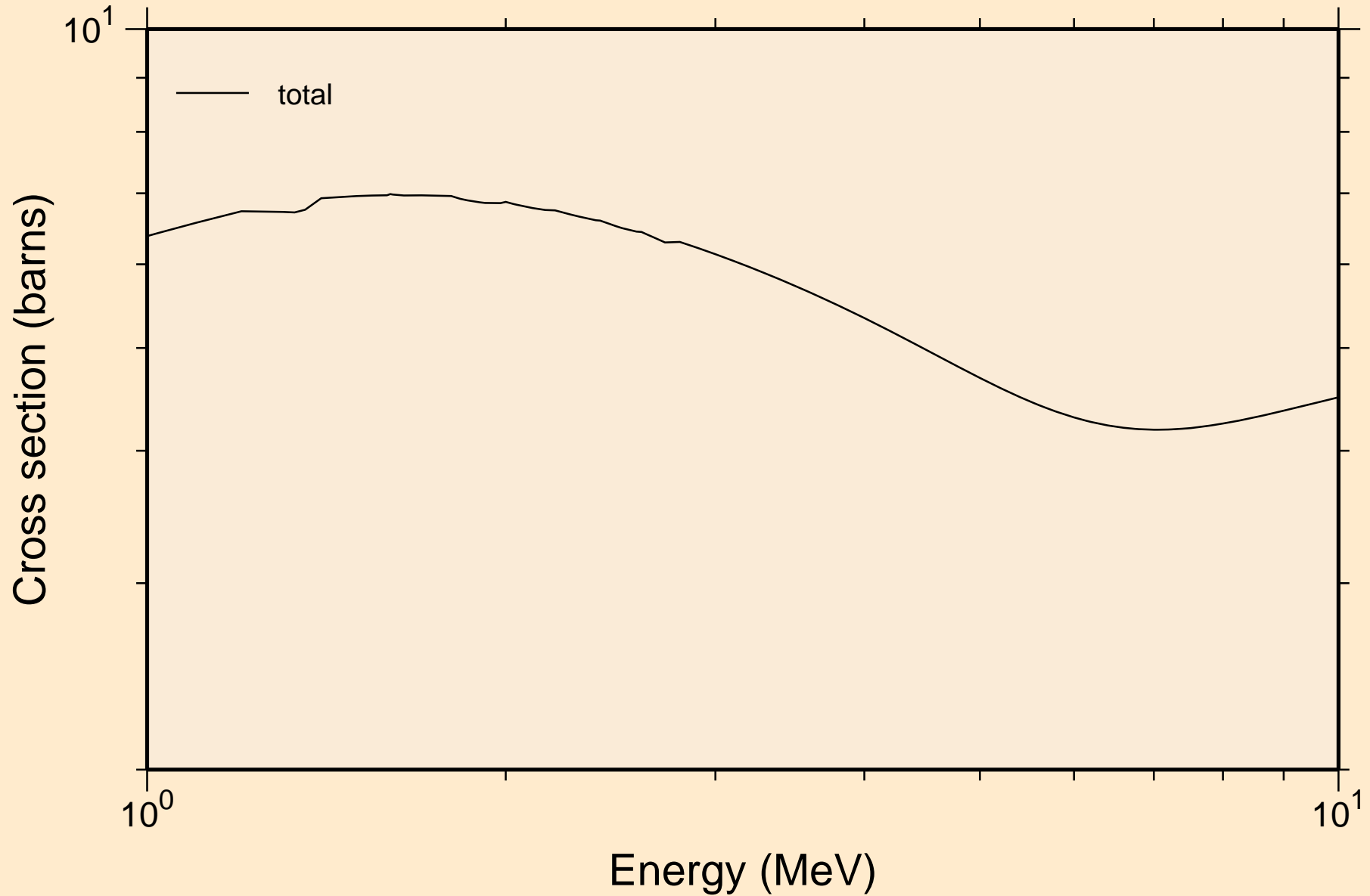

CE139 NEUTRON ACER TENDL-2021 LIBRARY; T=293.6K  
resonance absorption cross sections

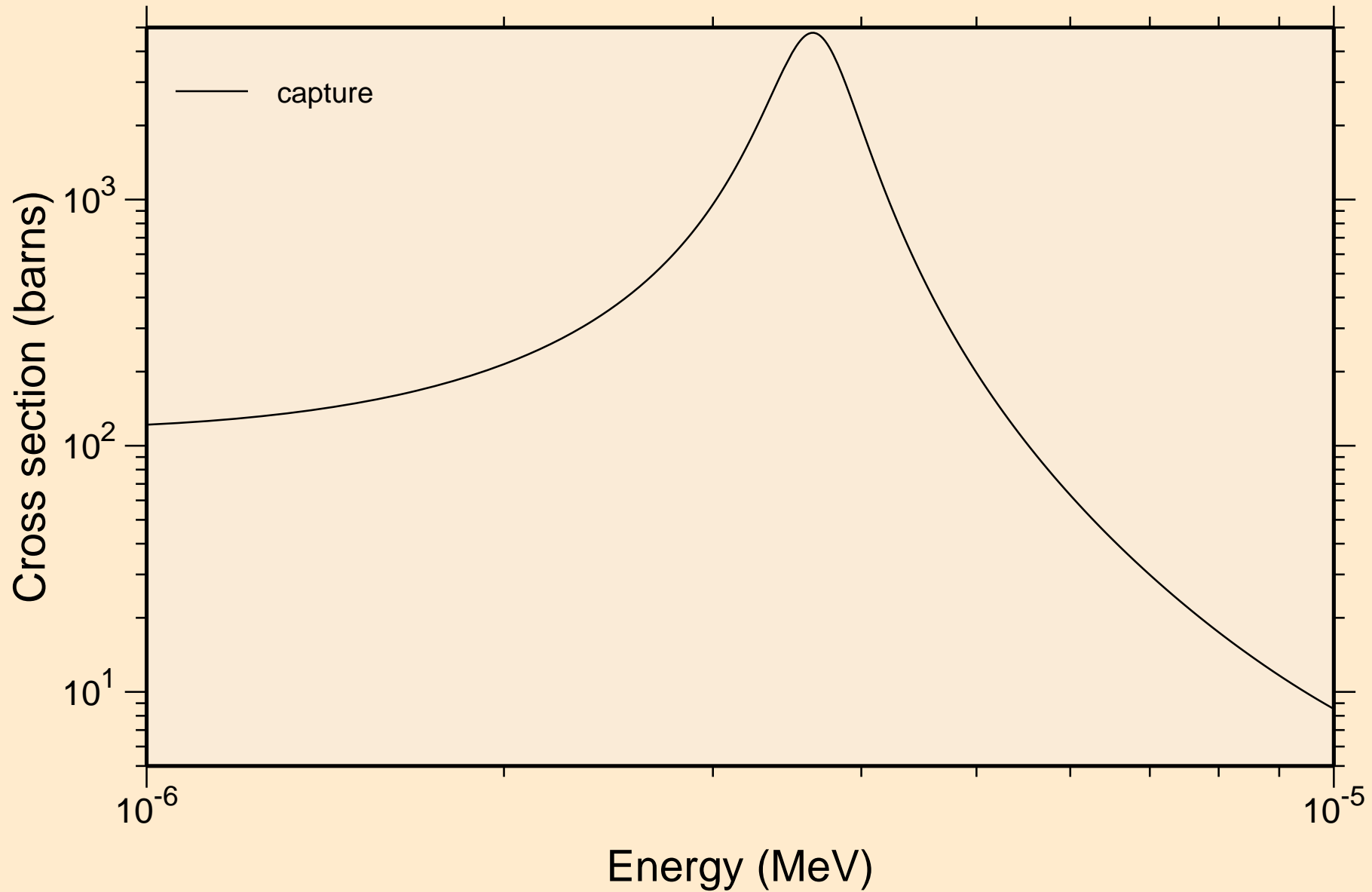

CE139 NEUTRON ACER TENDL-2021 LIBRARY; T=293.6K  
resonance absorption cross sections

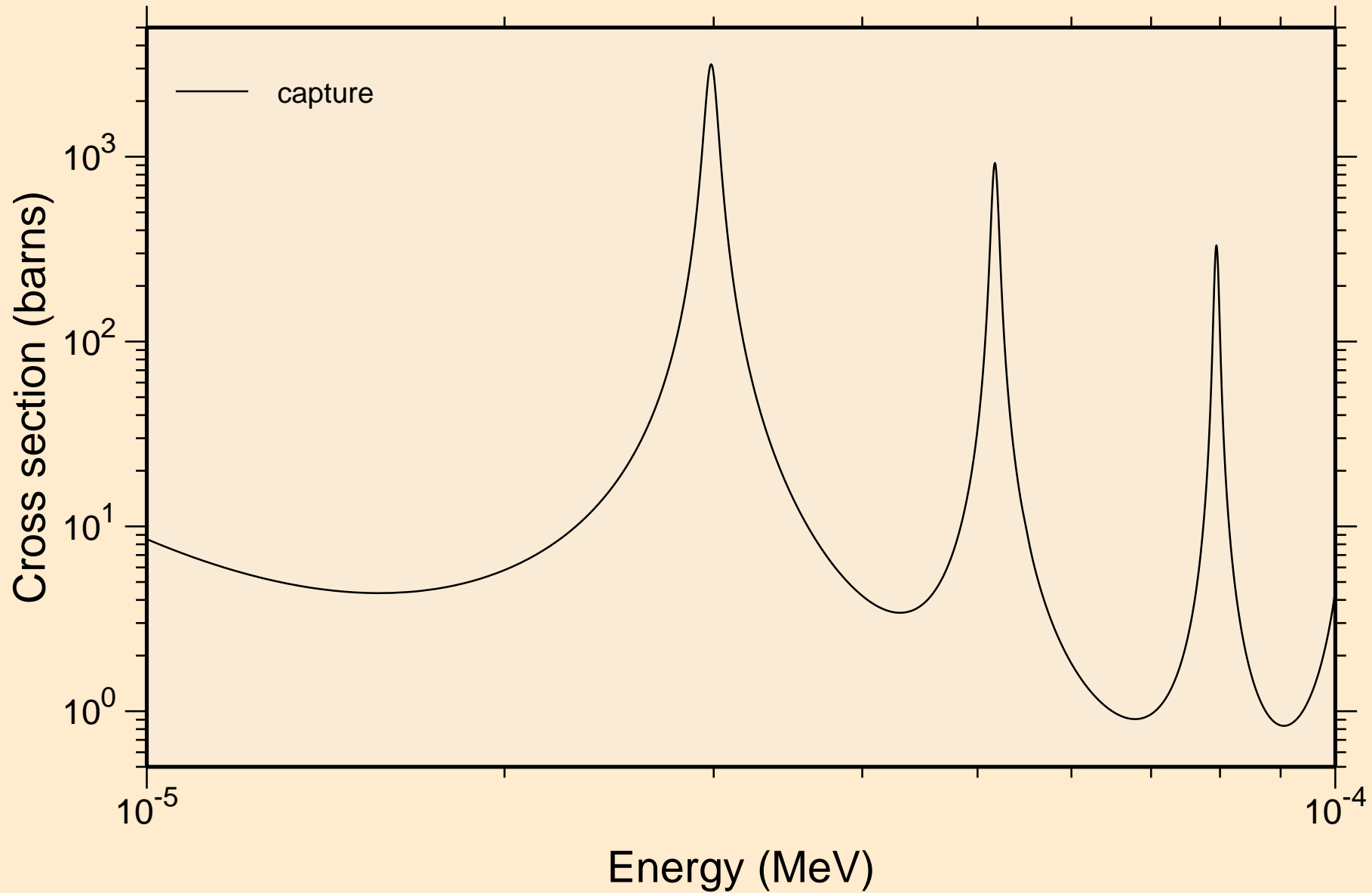

CE139 NEUTRON ACER TENDL-2021 LIBRARY; T=293.6K  
resonance absorption cross sections

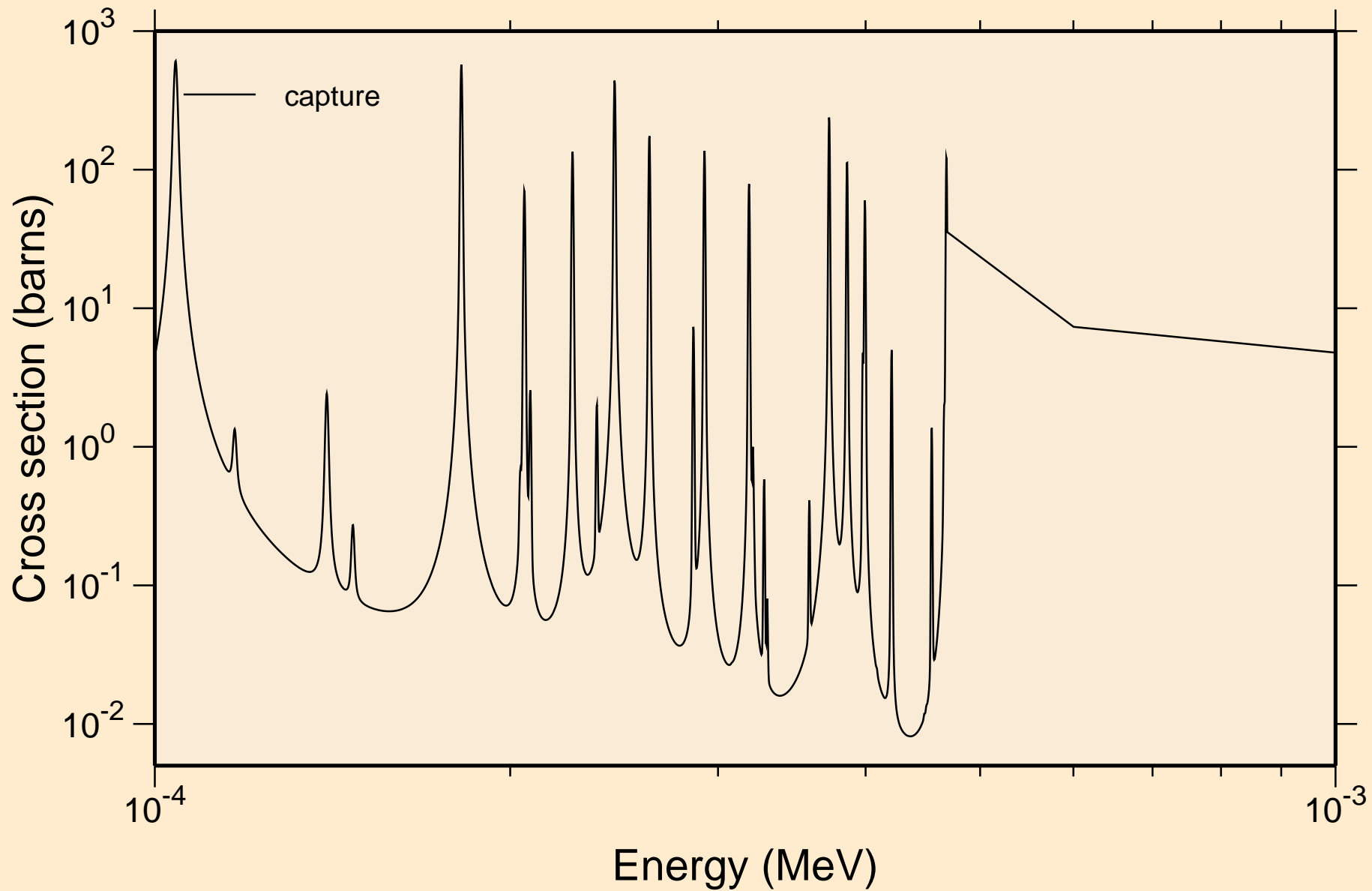



CE139 NEUTRON ACER TENDL-2021 LIBRARY; T=293.6K  
resonance absorption cross sections

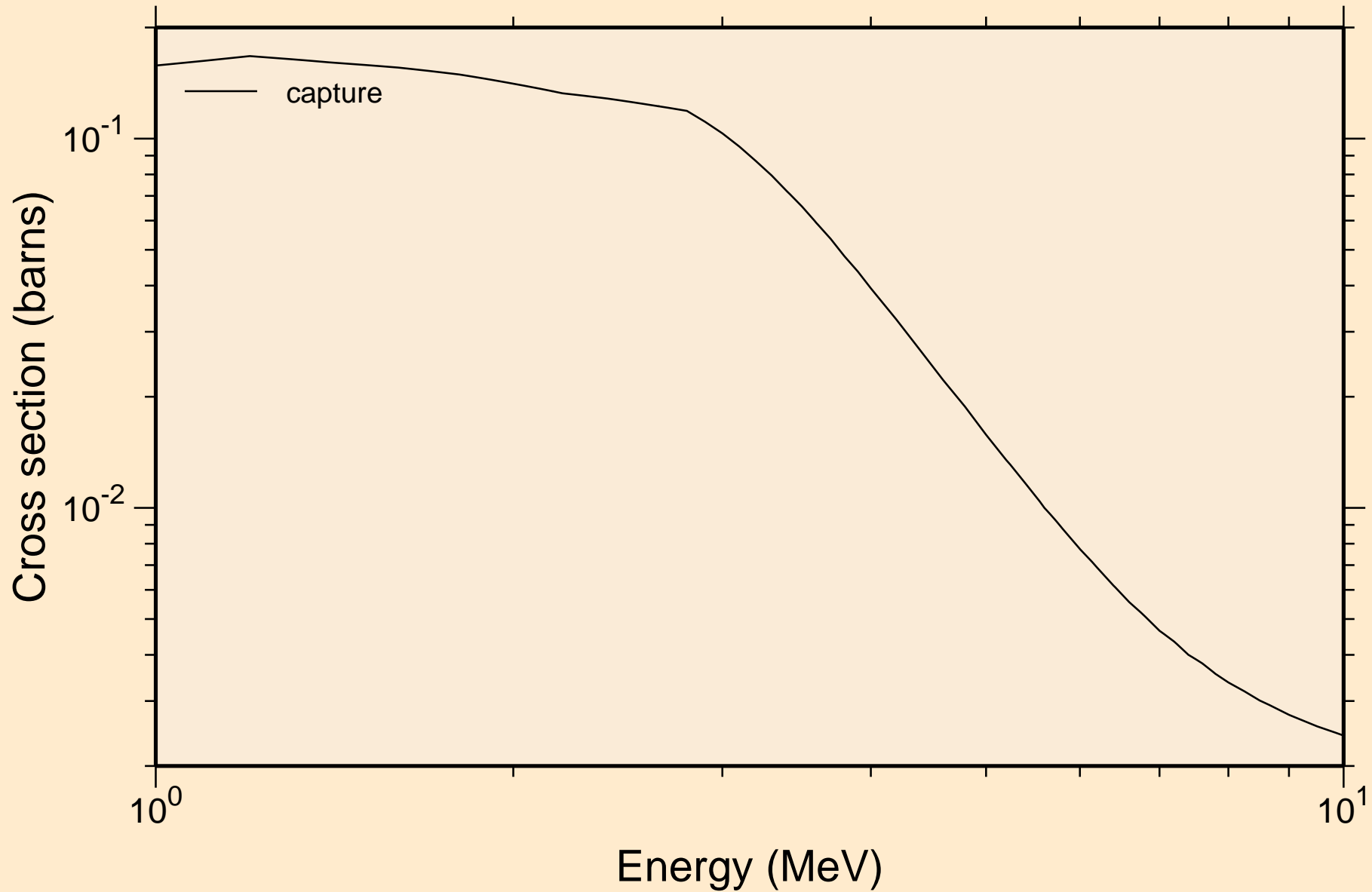

CE139 NEUTRON ACER TENDL-2021 LIBRARY; T=293.6K  
Heating

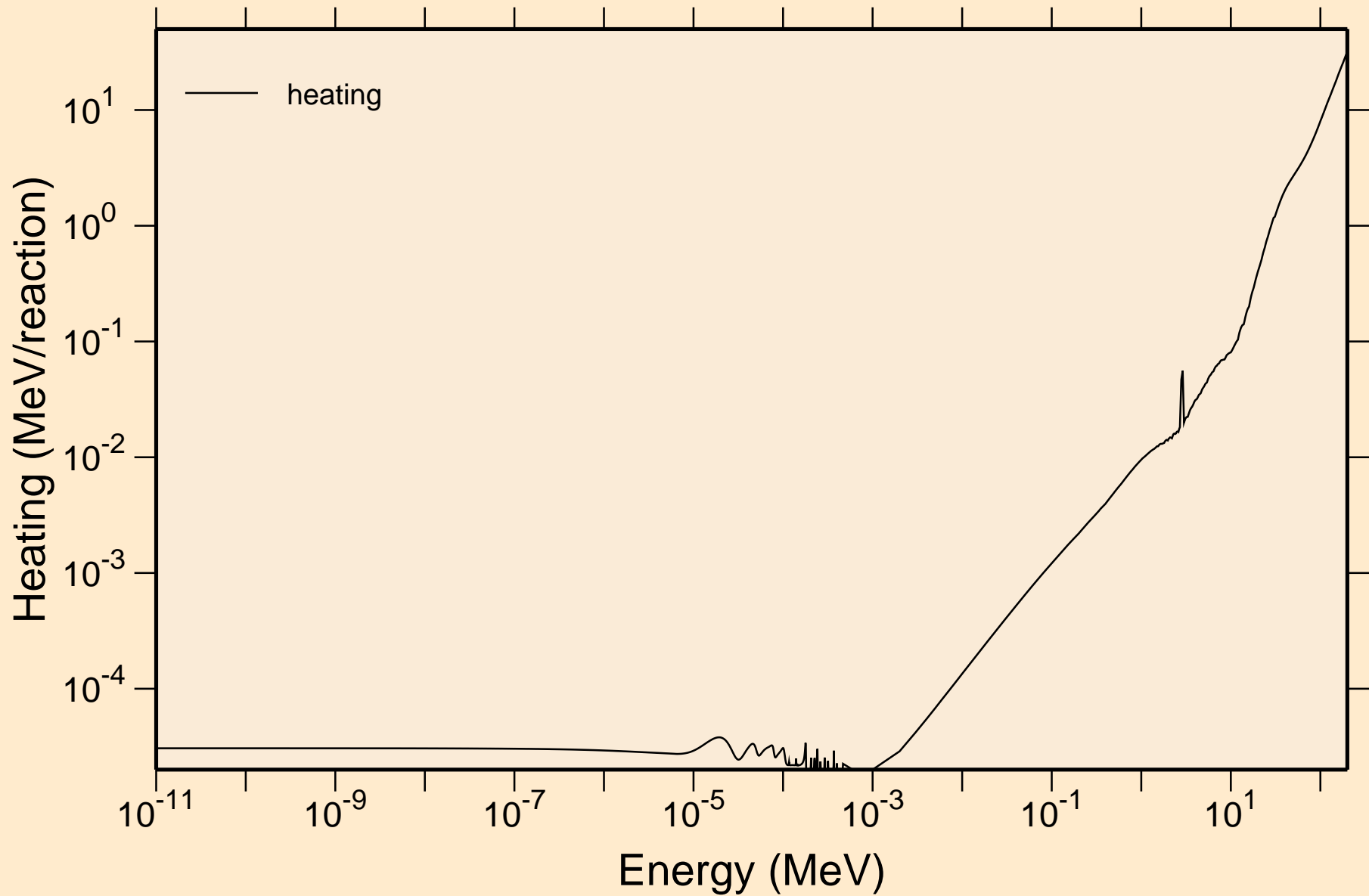

CE139 NEUTRON ACER TENDL-2021 LIBRARY; T=293.6K  
Damage

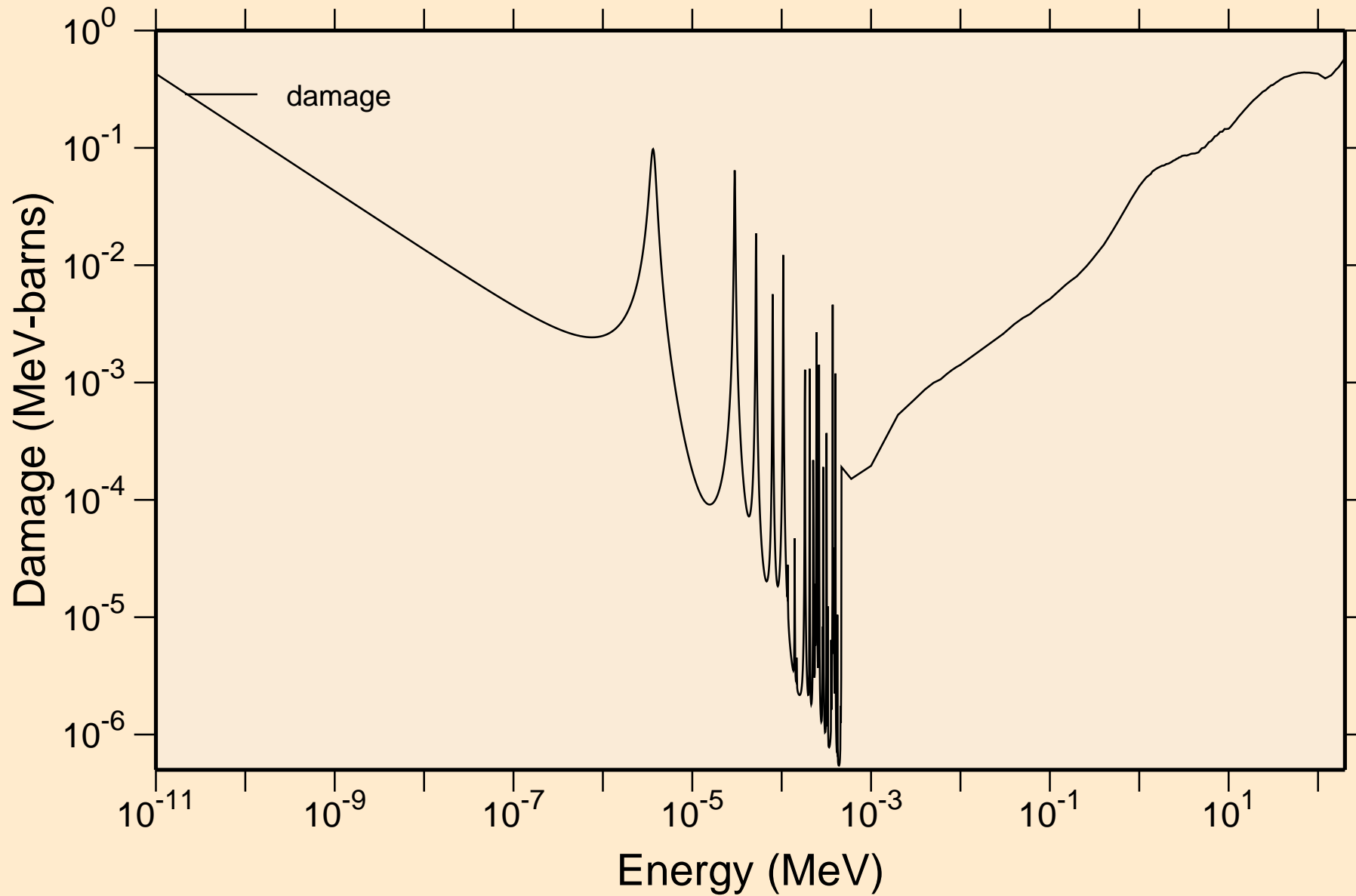

CE139 NEUTRON ACER TENDL-2021 LIBRARY; T=293.6K  
Non-threshold reactions

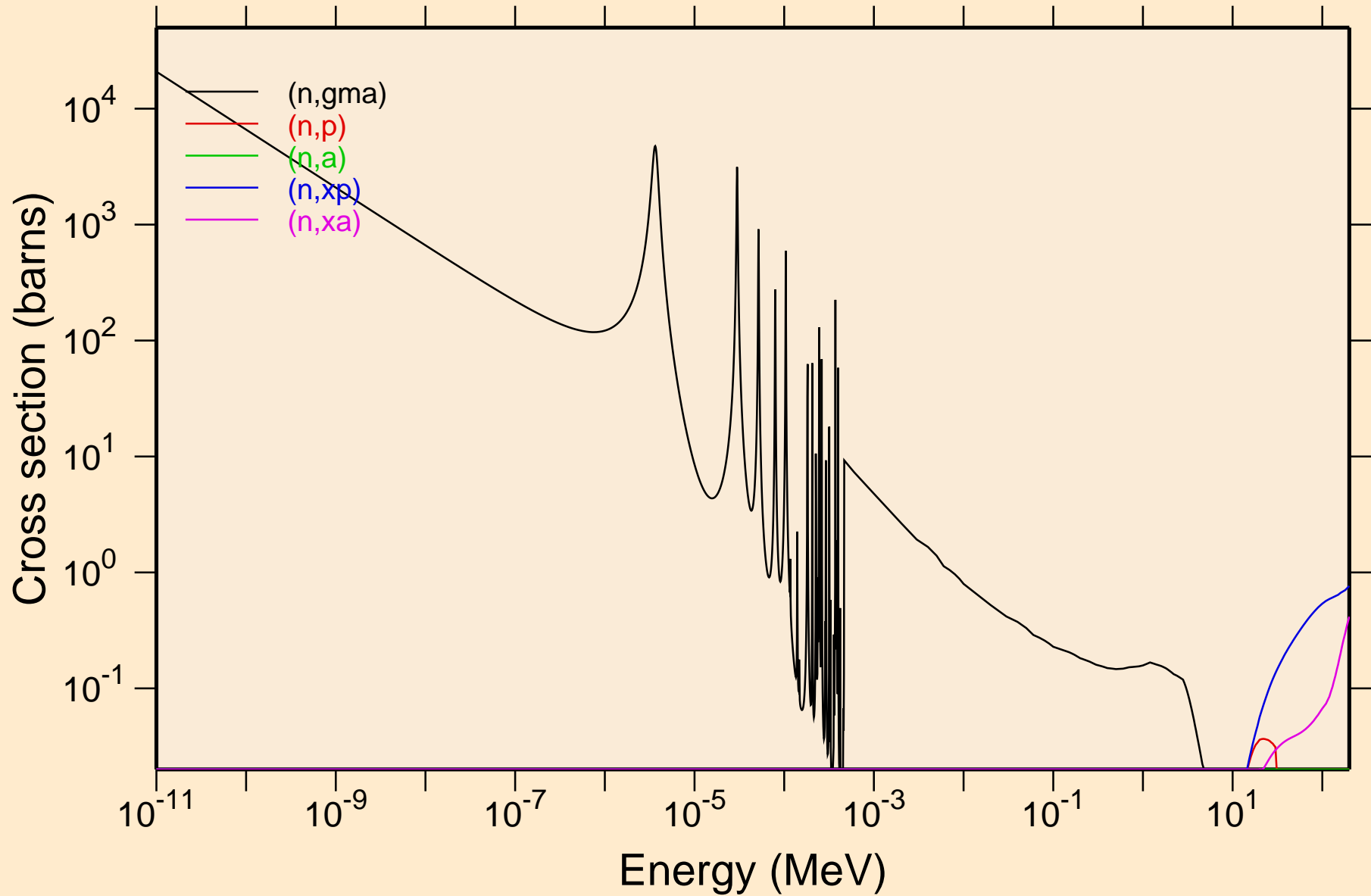

CE139 NEUTRON ACER TENDL-2021 LIBRARY; T=293.6K  
Principal cross sections

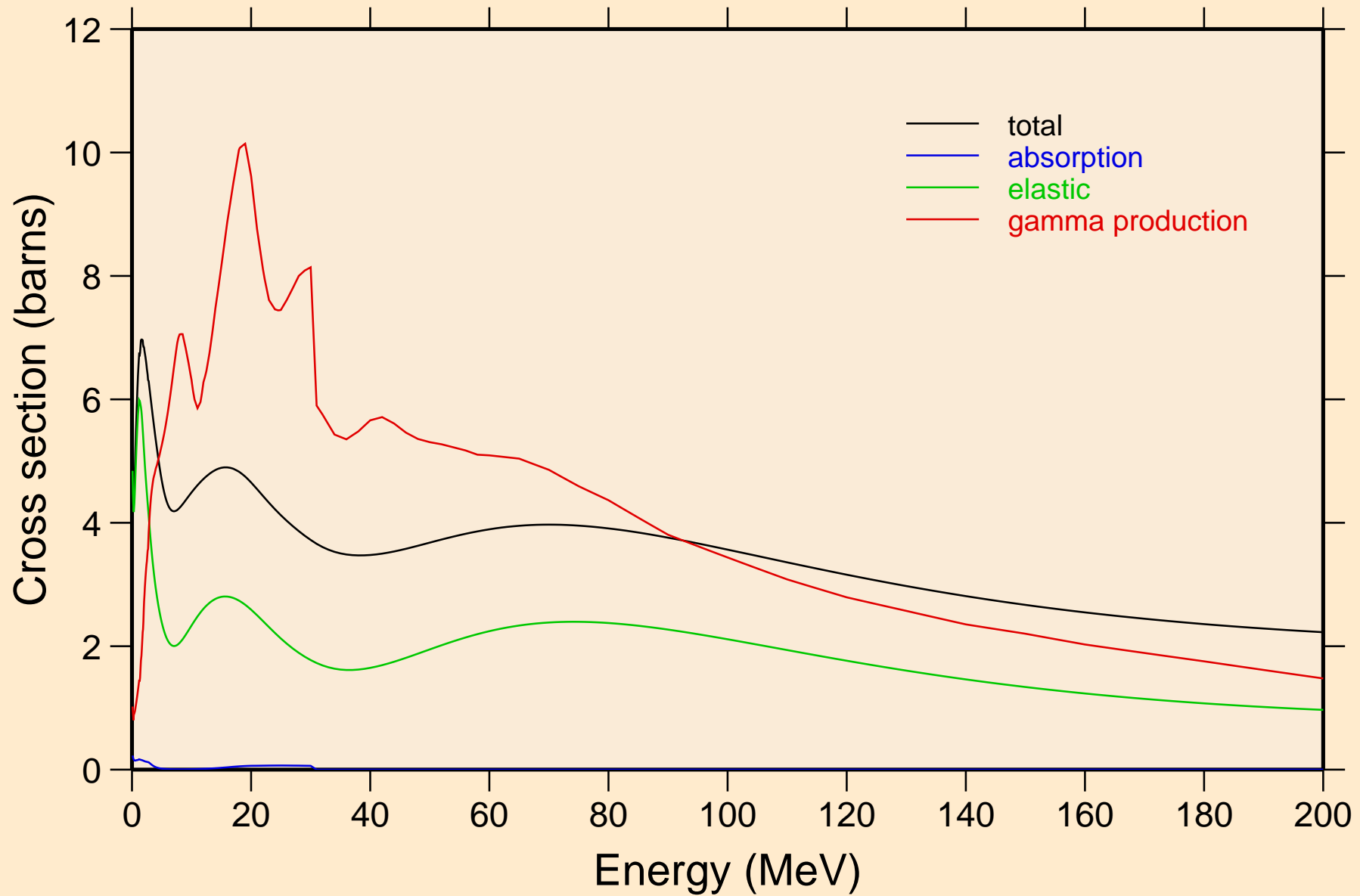

CE139 NEUTRON ACER TENDL-2021 LIBRARY; T=293.6K  
Heating

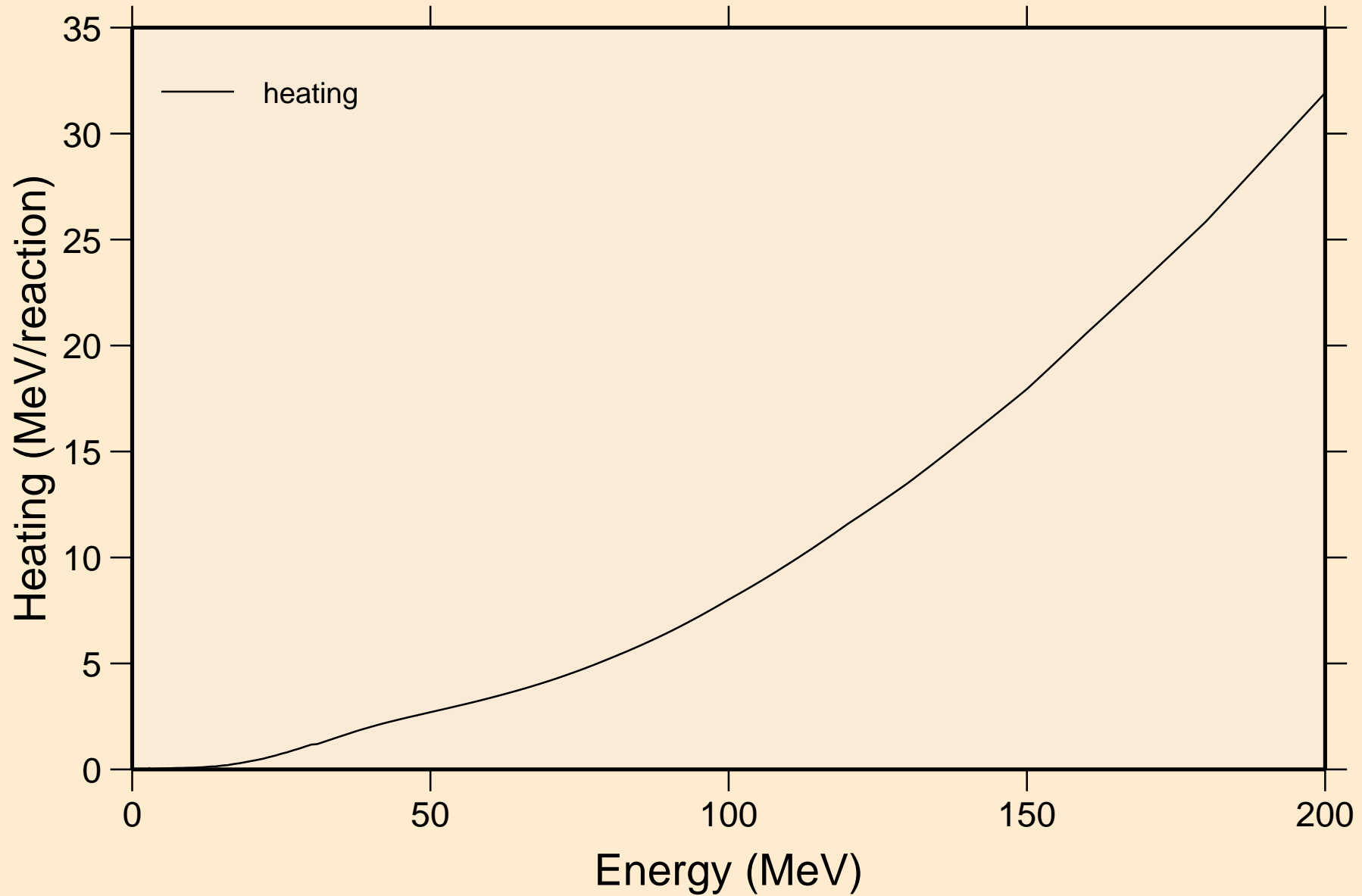

CE139 NEUTRON ACER TENDL-2021 LIBRARY; T=293.6K  
Damage

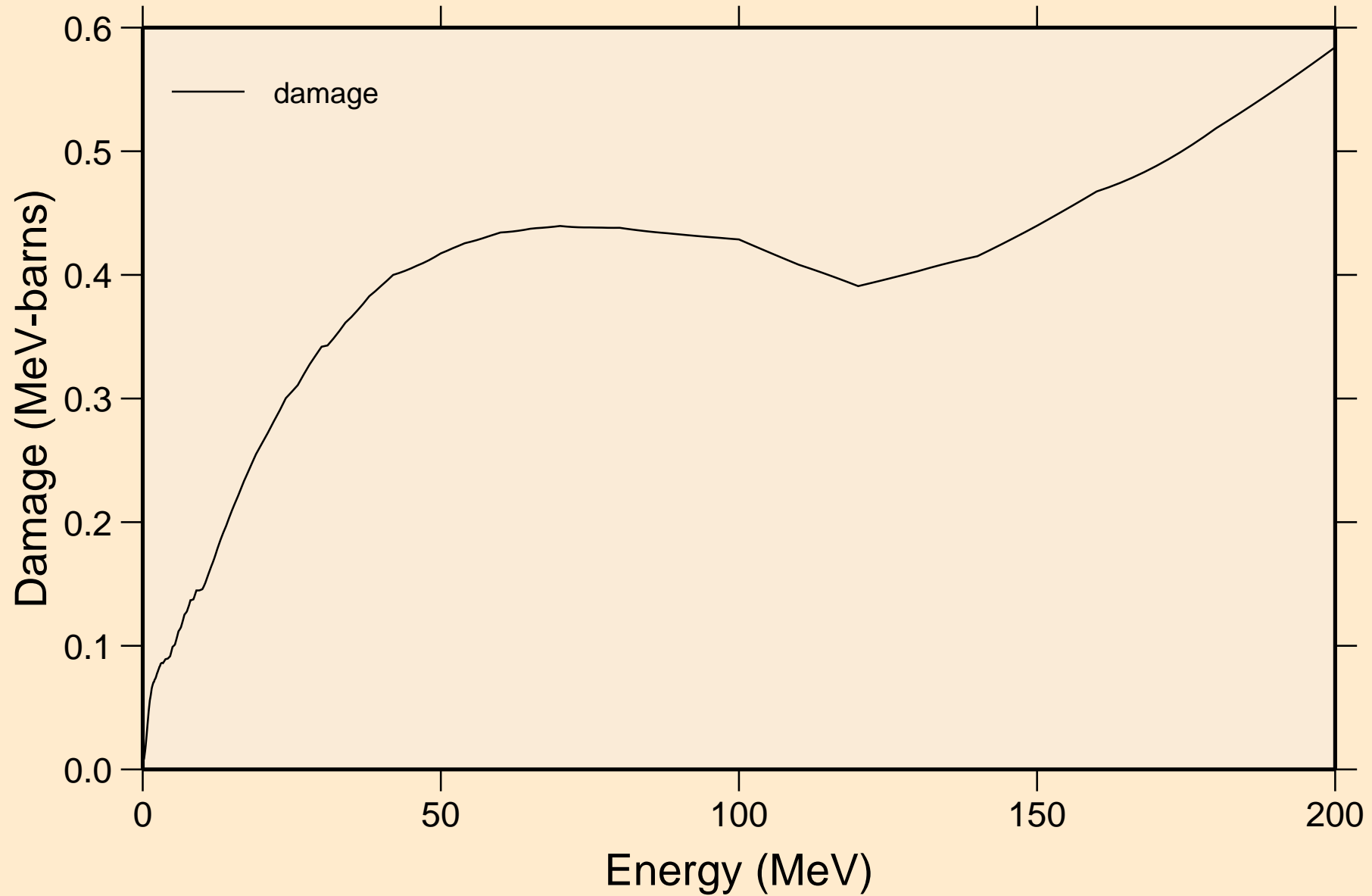

CE139 NEUTRON ACER TENDL-2021 LIBRARY; T=293.6K  
Non-threshold reactions

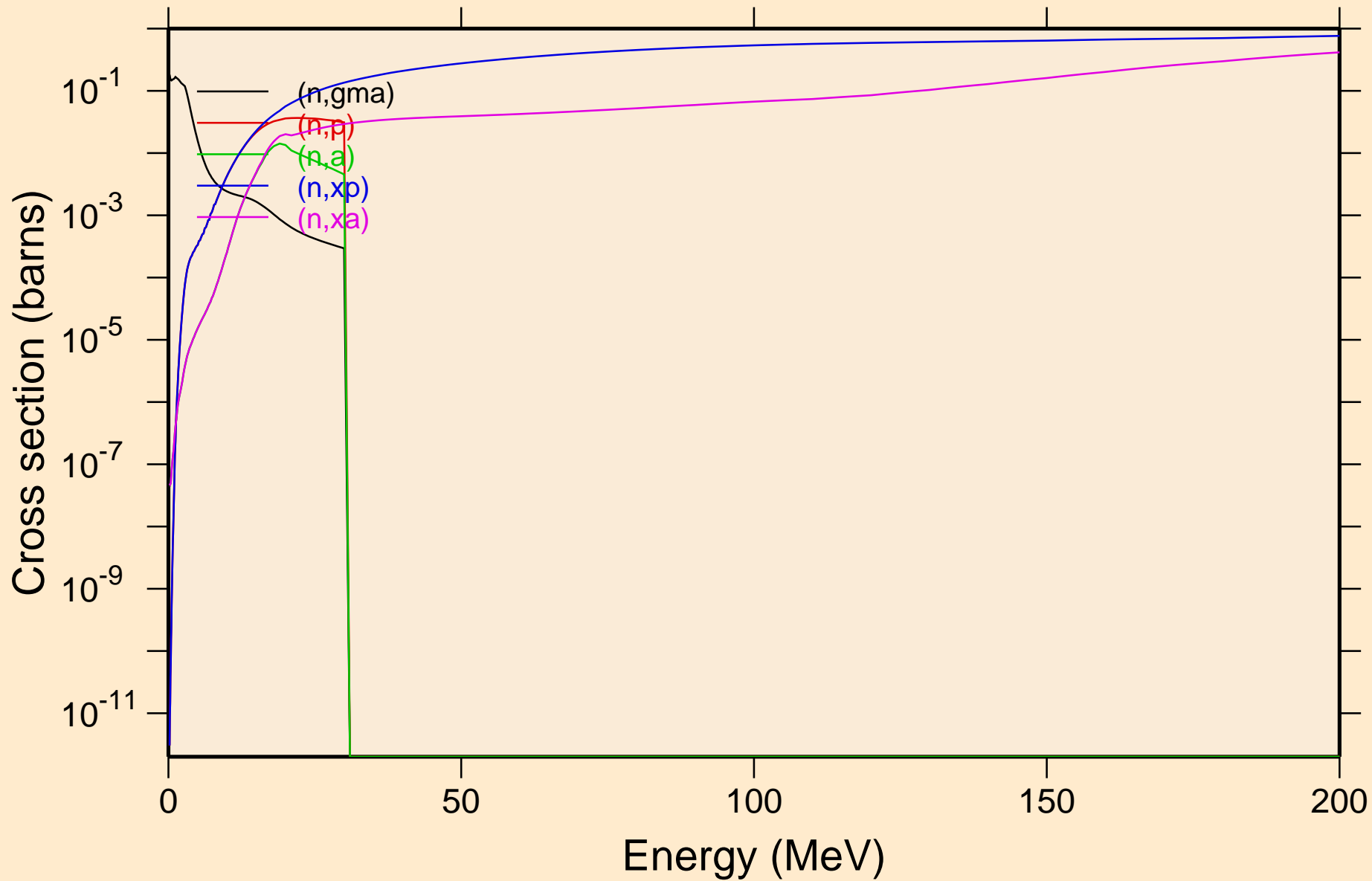



CE139 NEUTRON ACER TENDL-2021 LIBRARY; T=293.6K  
Inelastic levels

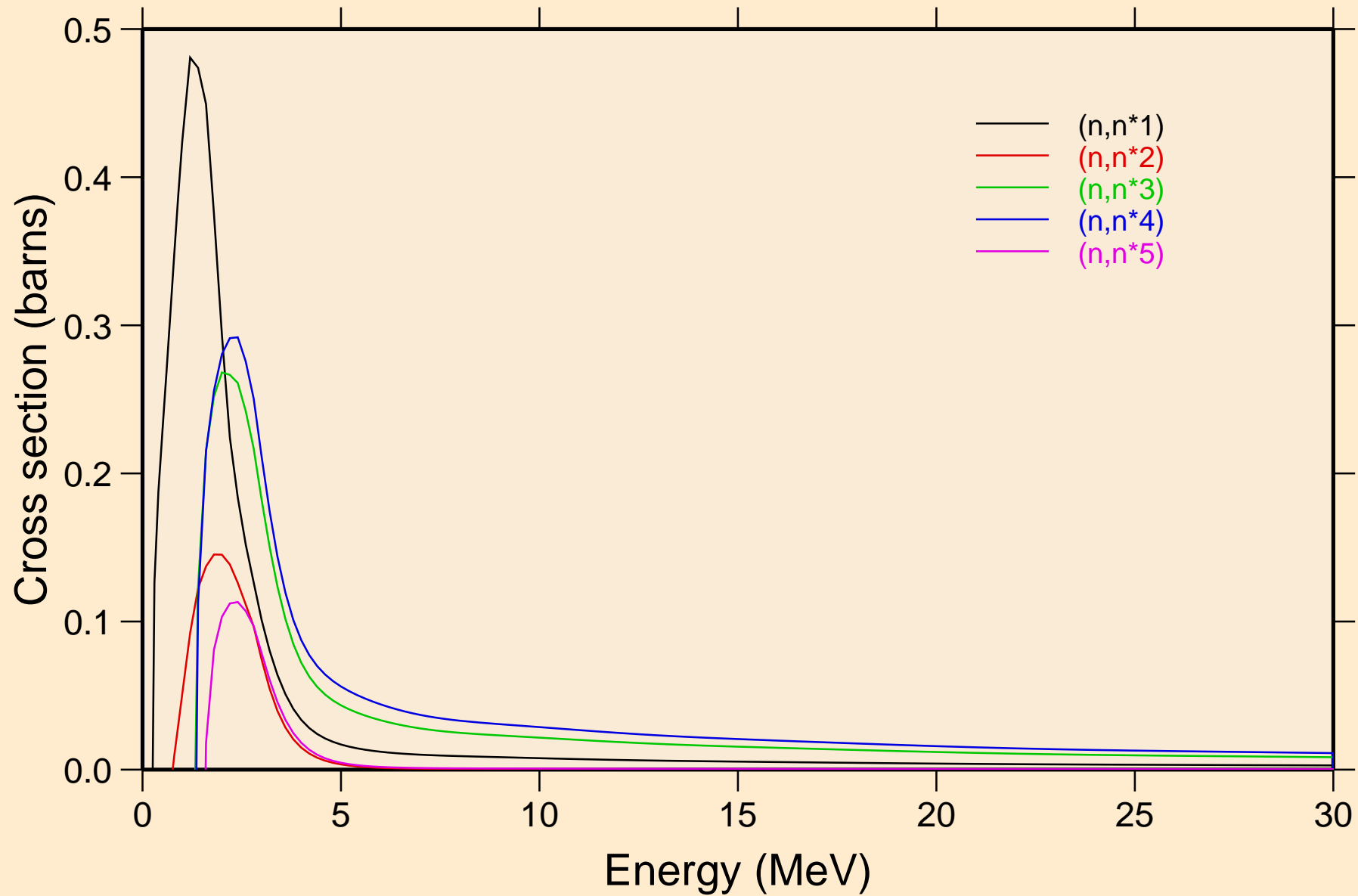

CE139 NEUTRON ACER TENDL-2021 LIBRARY; T=293.6K  
Inelastic levels

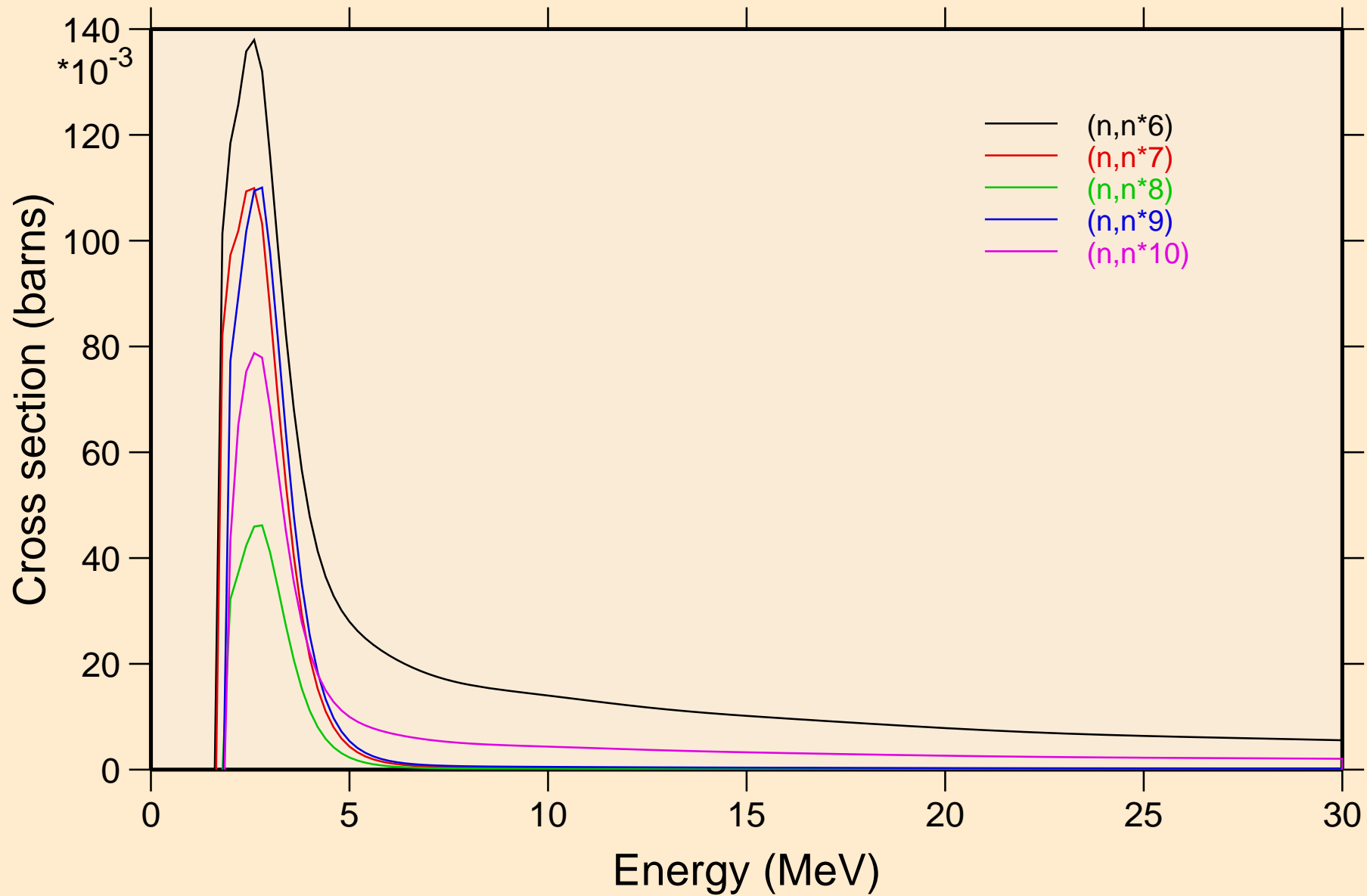

CE139 NEUTRON ACER TENDL-2021 LIBRARY; T=293.6K  
Inelastic levels

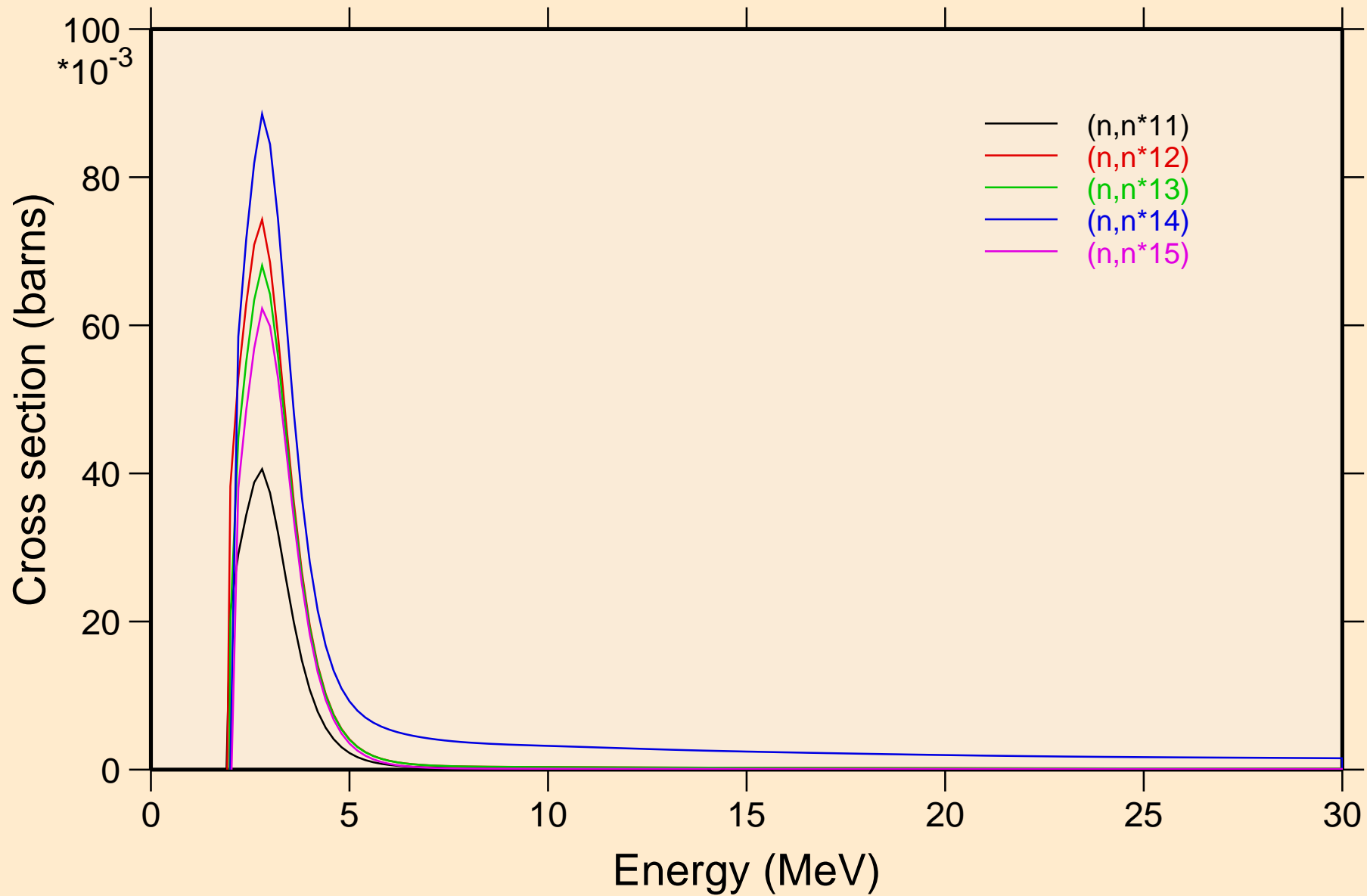

CE139 NEUTRON ACER TENDL-2021 LIBRARY; T=293.6K  
Inelastic levels

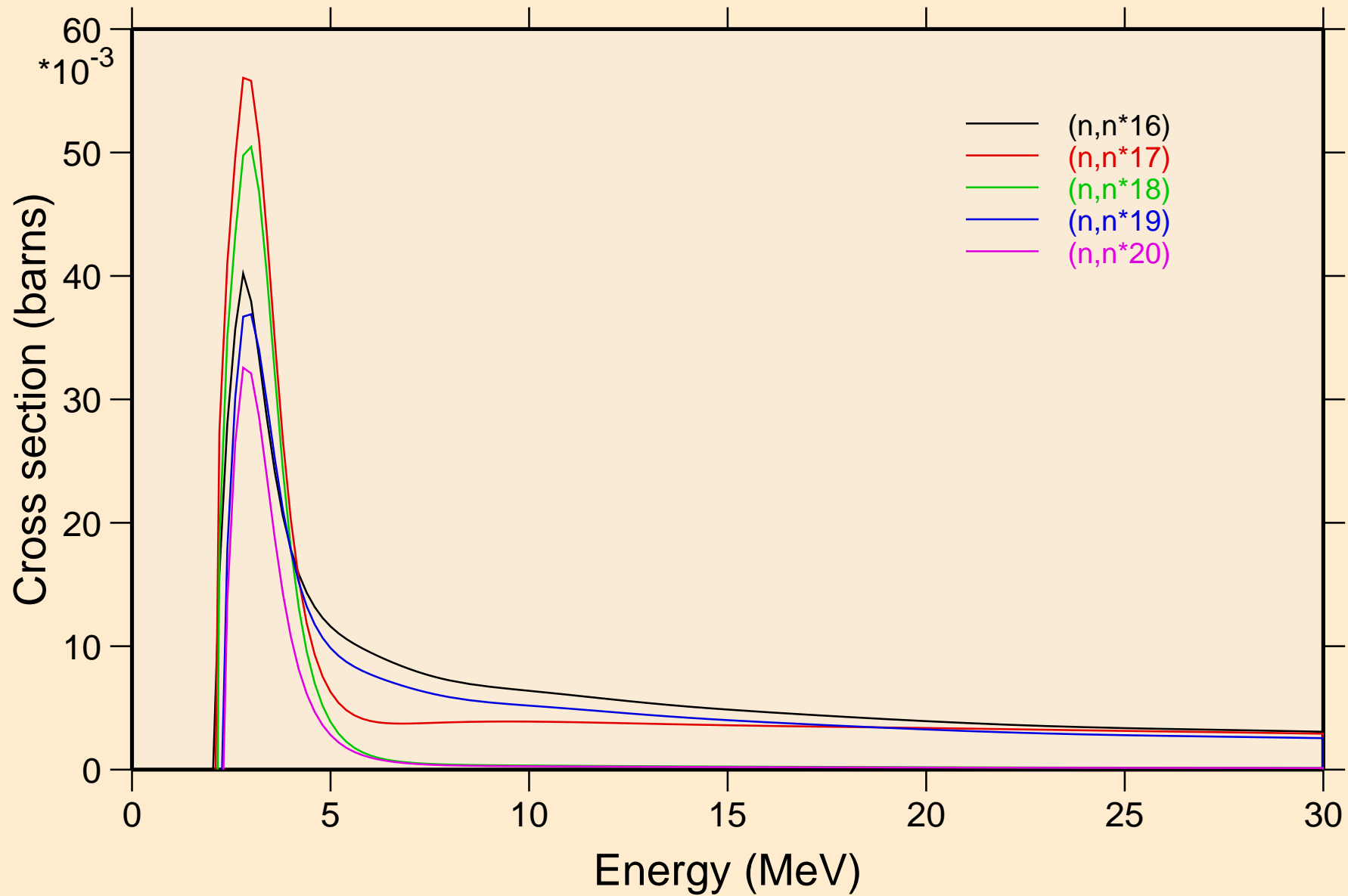

CE139 NEUTRON ACER TENDL-2021 LIBRARY; T=293.6K  
Inelastic levels

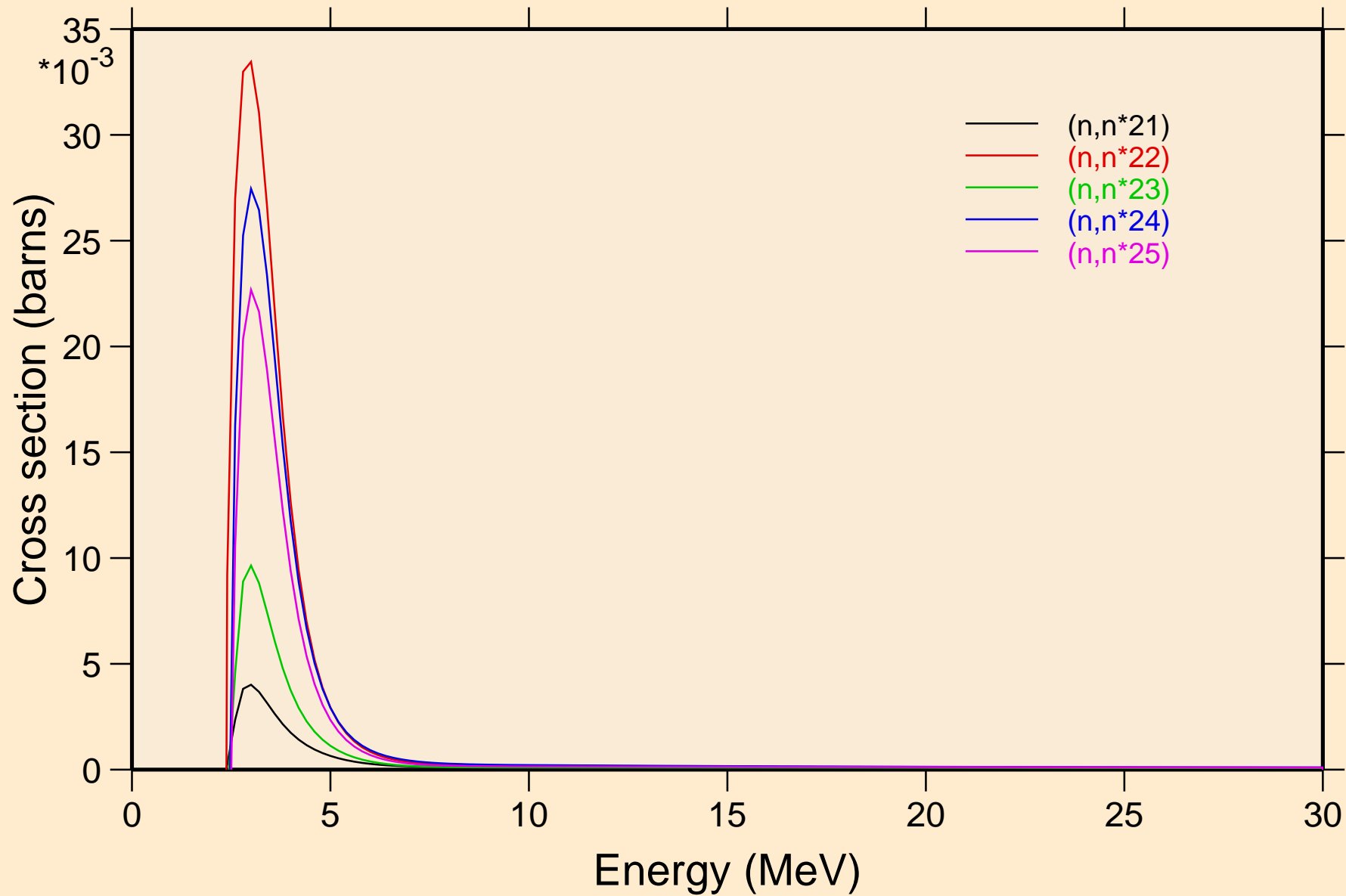

CE139 NEUTRON ACER TENDL-2021 LIBRARY; T=293.6K  
Inelastic levels

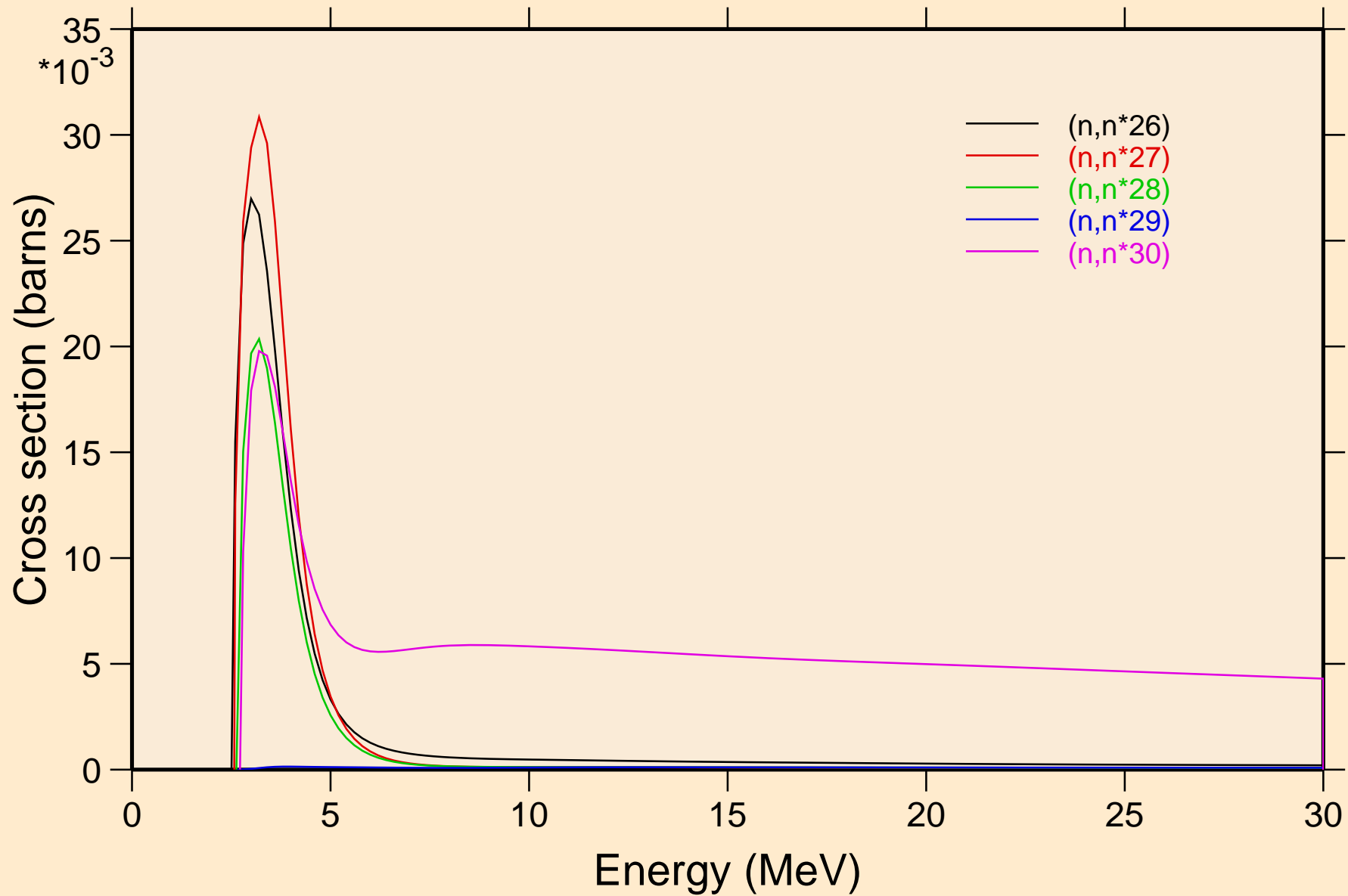

CE139 NEUTRON ACER TENDL-2021 LIBRARY; T=293.6K  
Threshold reactions

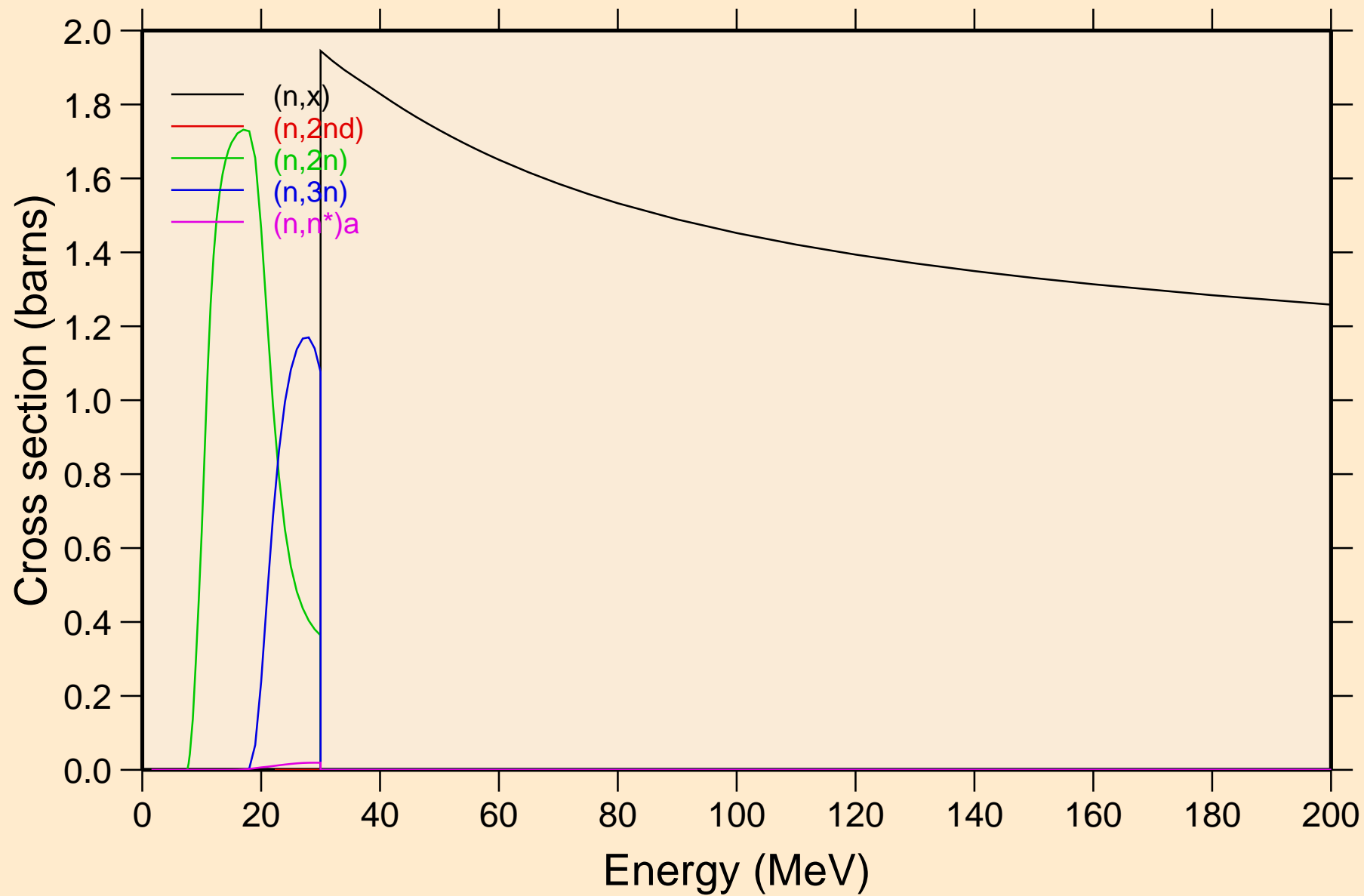

CE139 NEUTRON ACER TENDL-2021 LIBRARY; T=293.6K  
Threshold reactions

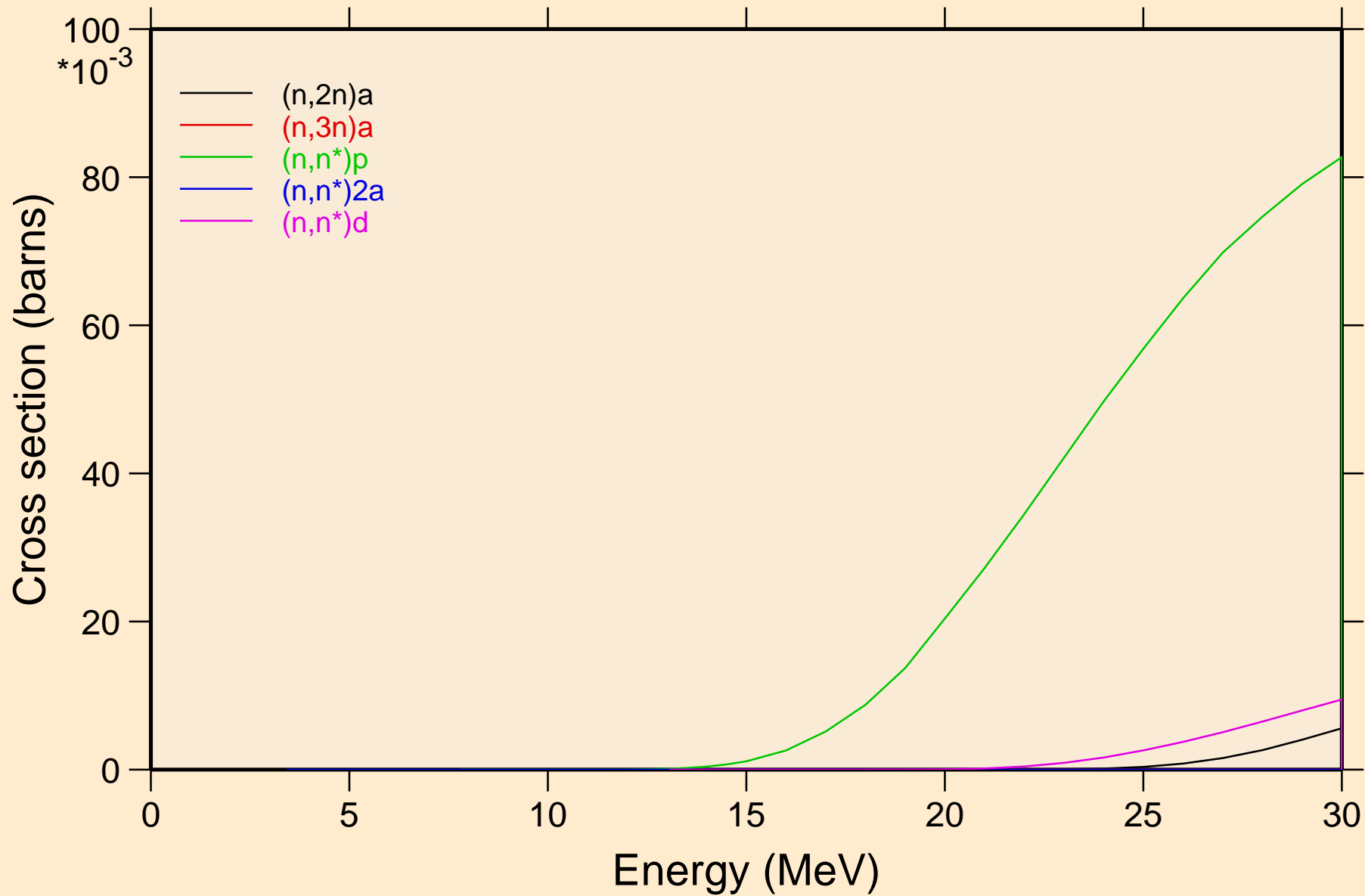



CE139 NEUTRON ACER TENDL-2021 LIBRARY; T=293.6K  
Threshold reactions

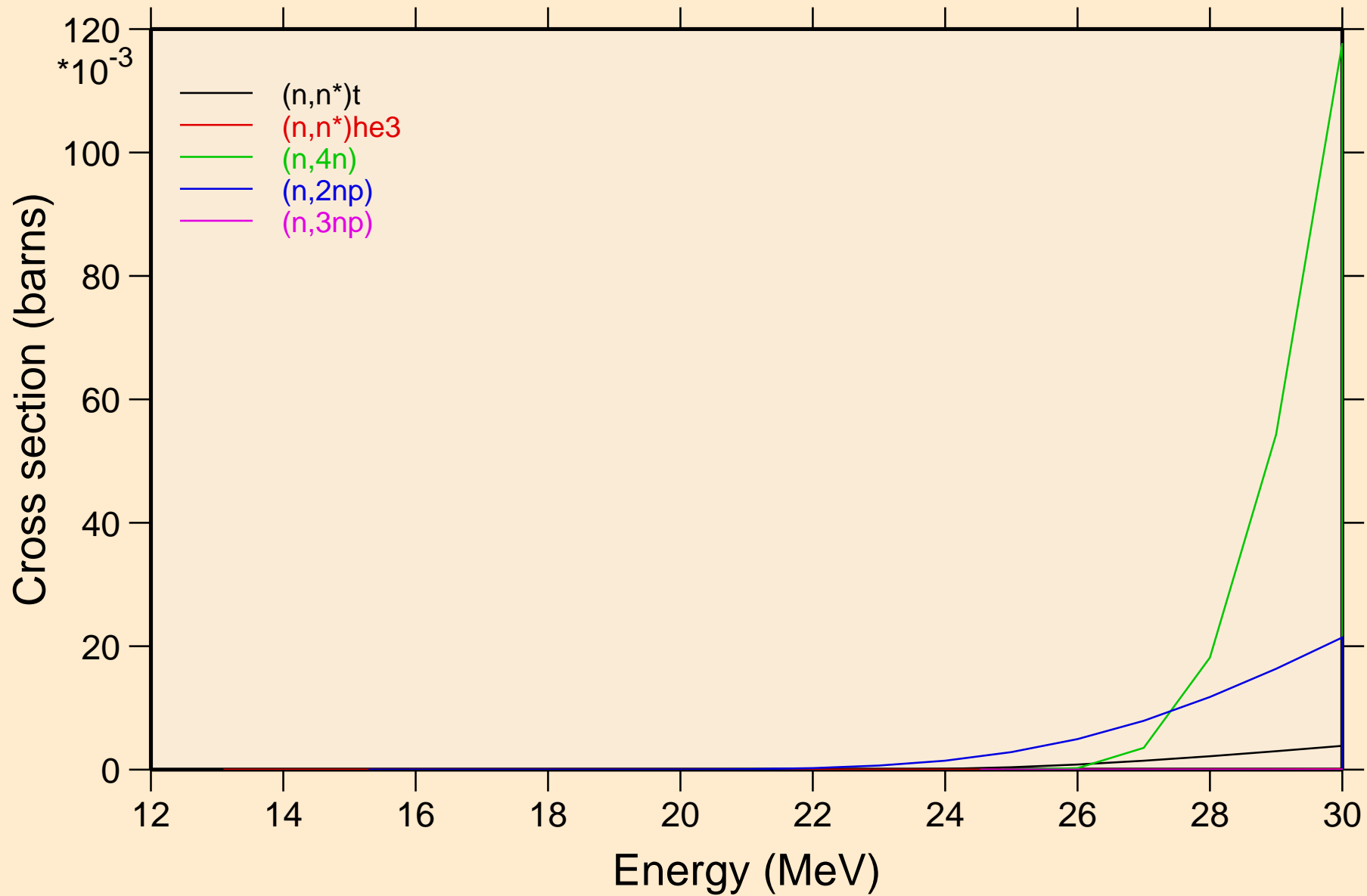

CE139 NEUTRON ACER TENDL-2021 LIBRARY; T=293.6K  
Threshold reactions

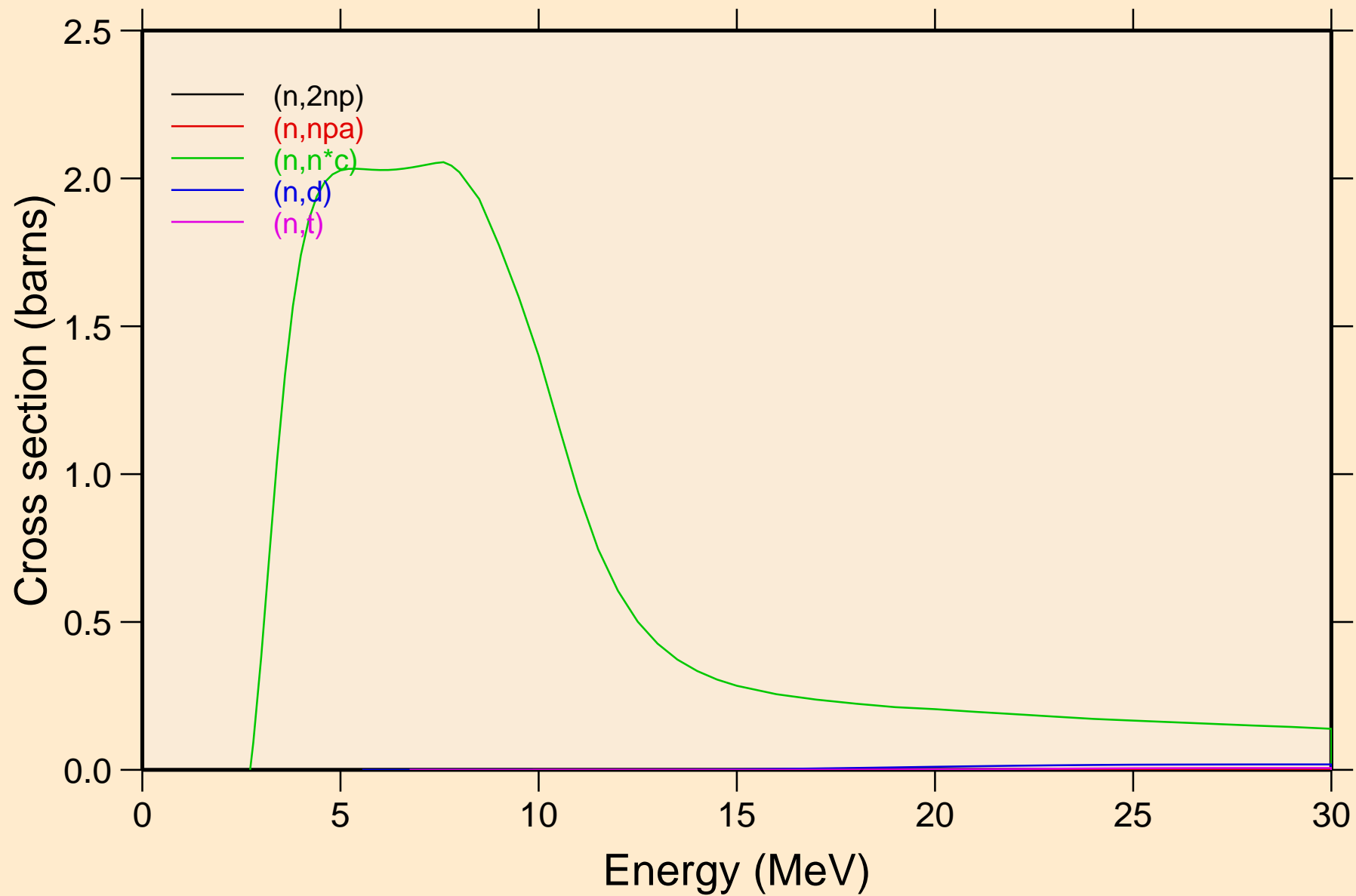

CE139 NEUTRON ACER TENDL-2021 LIBRARY; T=293.6K  
Threshold reactions

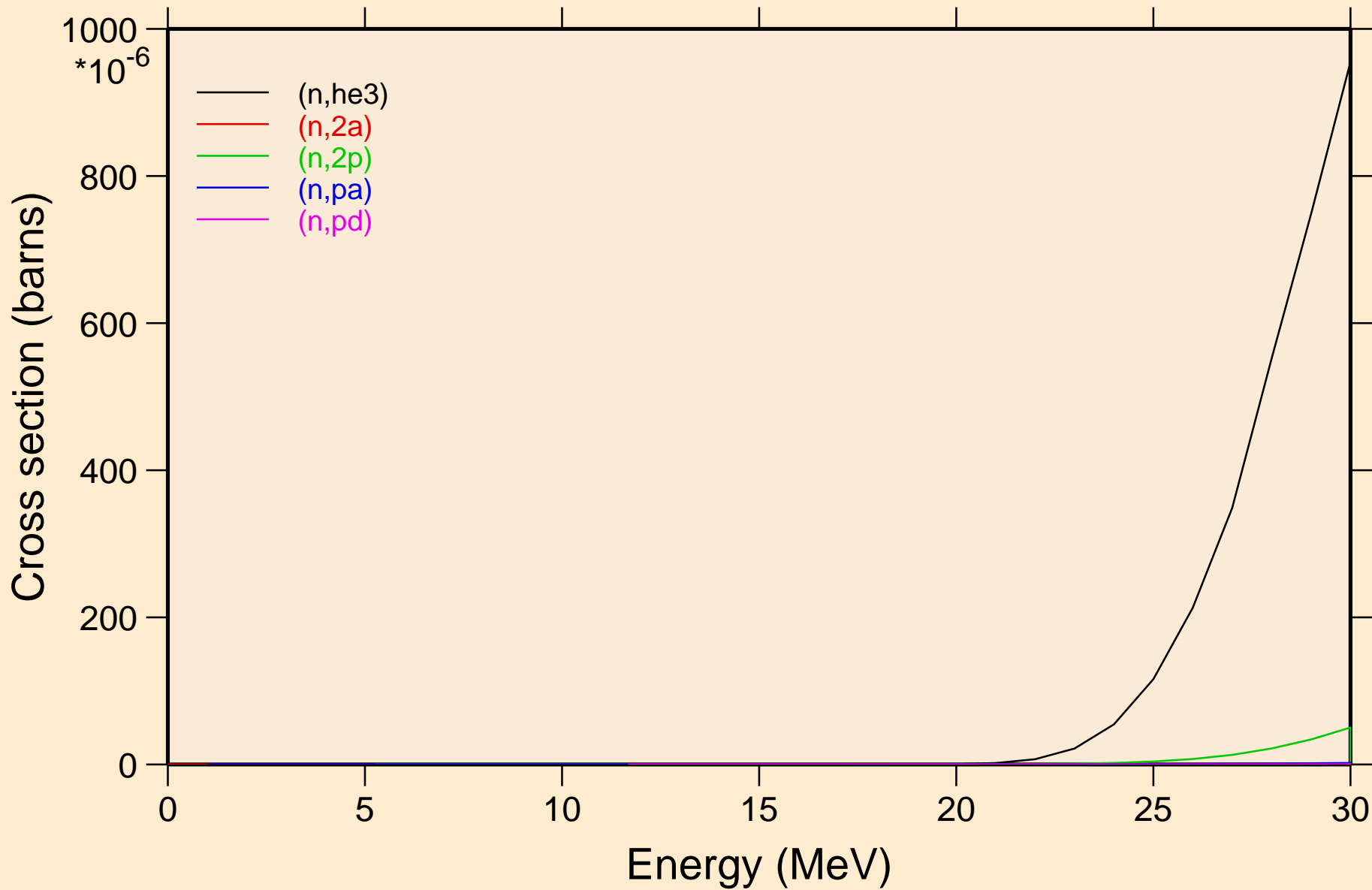

CE139 NEUTRON ACER TENDL-2021 LIBRARY; T=293.6K  
Threshold reactions

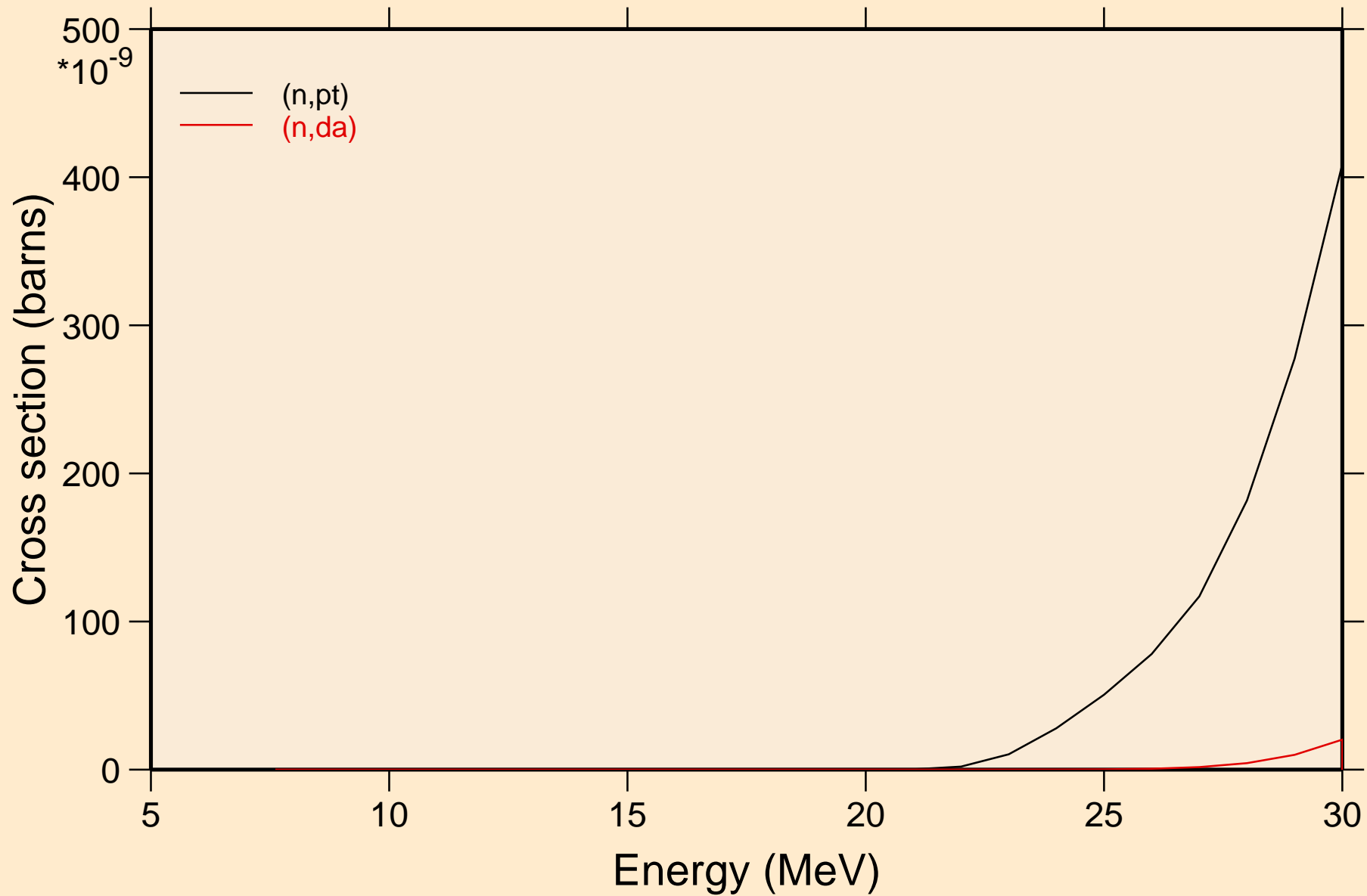

CE139 NEUTRON ACER TENDL-2021 LIBRARY; T=293.6K  
Threshold reactions

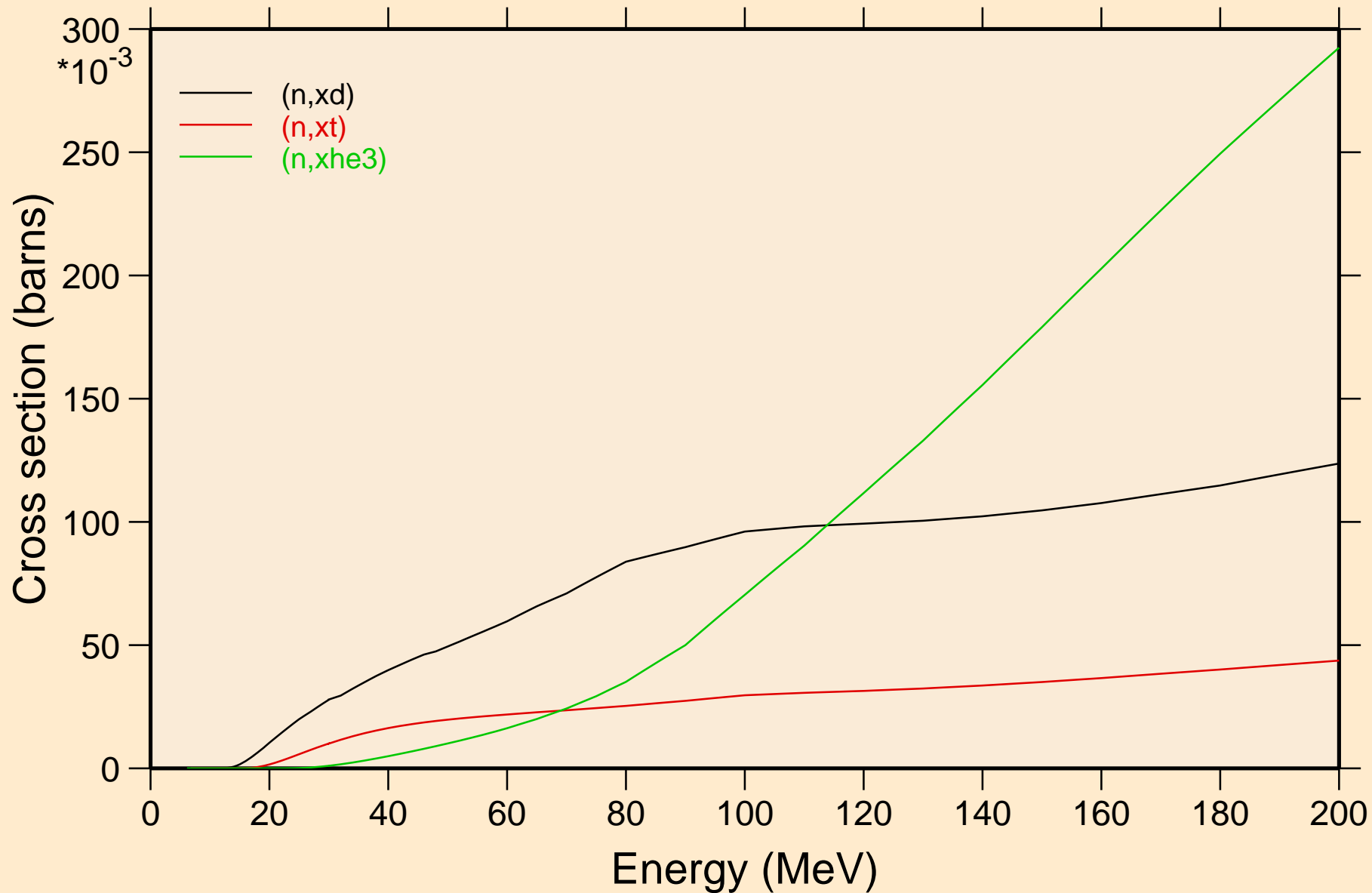

CE139 NEUTRON ACER TENDL-2021 LIBRARY; T=293.6K  
angular distribution for elastic

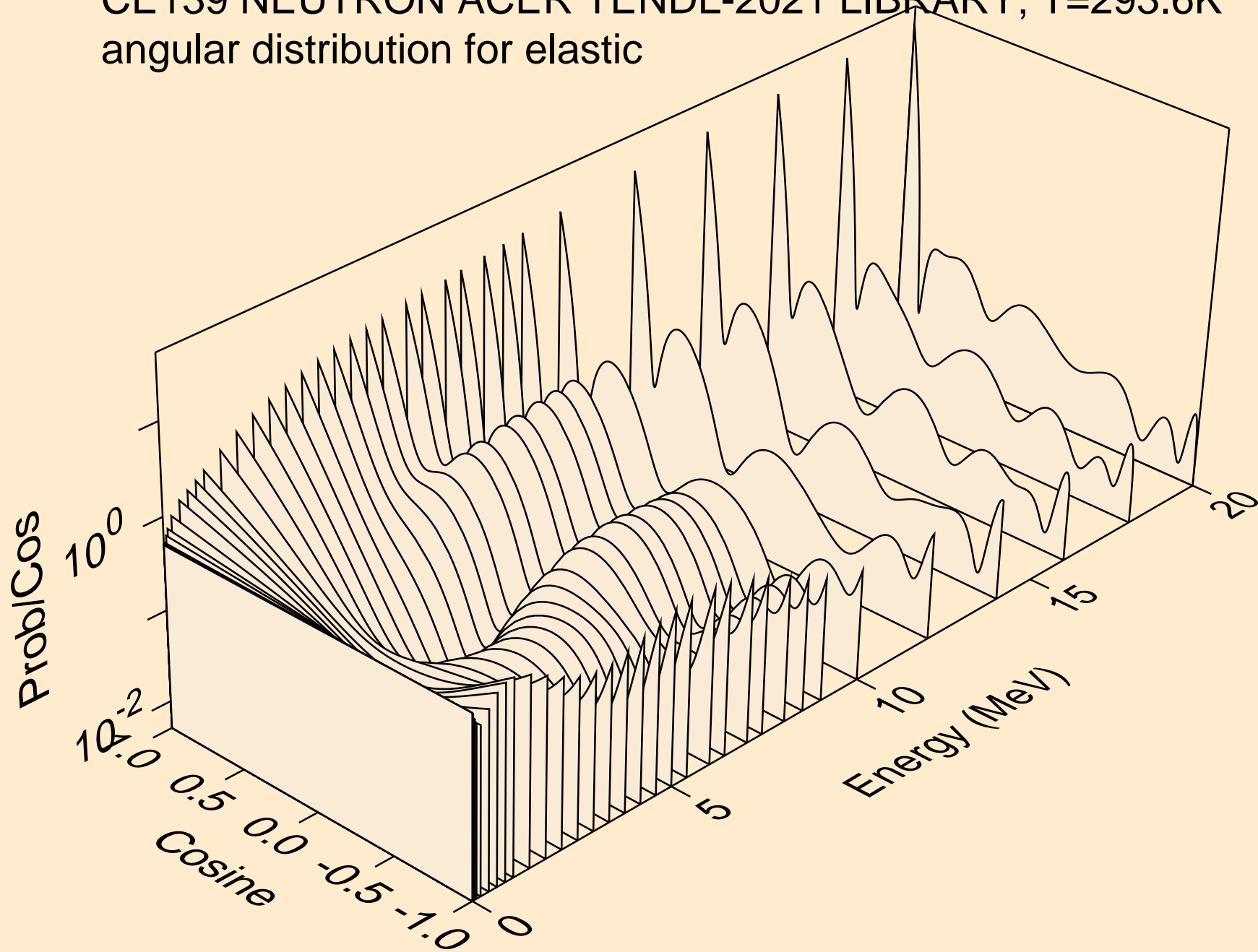

CE139 NEUTRON ACER TENDL-2021 LIBRARY; T=293.6K  
angular distribution for elastic

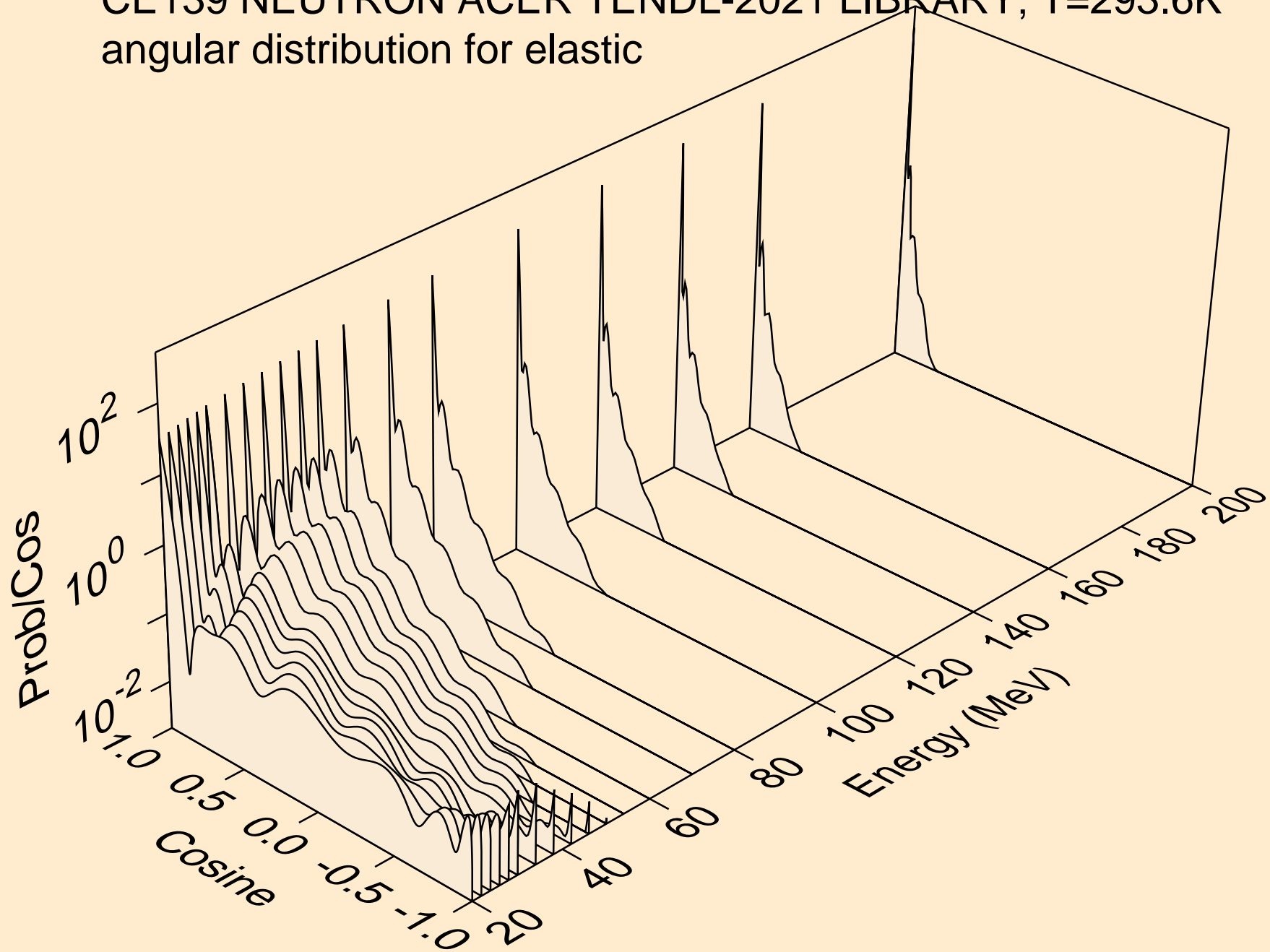

CE139 NEUTRON ACER TENDL-2021 LIBRARY; T=293.6K  
angular distribution for (n,n\*1)

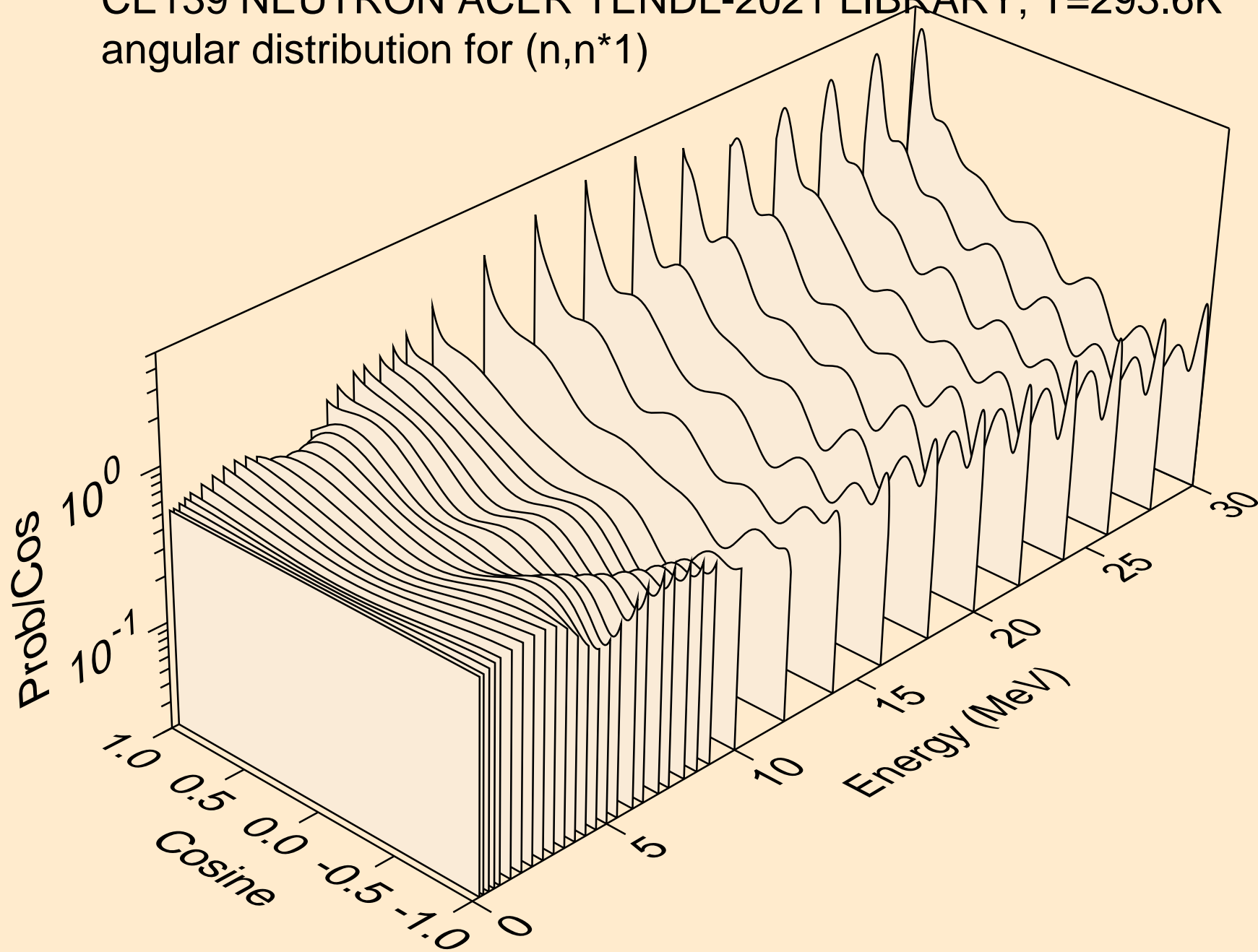



CE139 NEUTRON ACER TENDL-2021 LIBRARY; T=293.6K  
angular distribution for (n,n\*2)

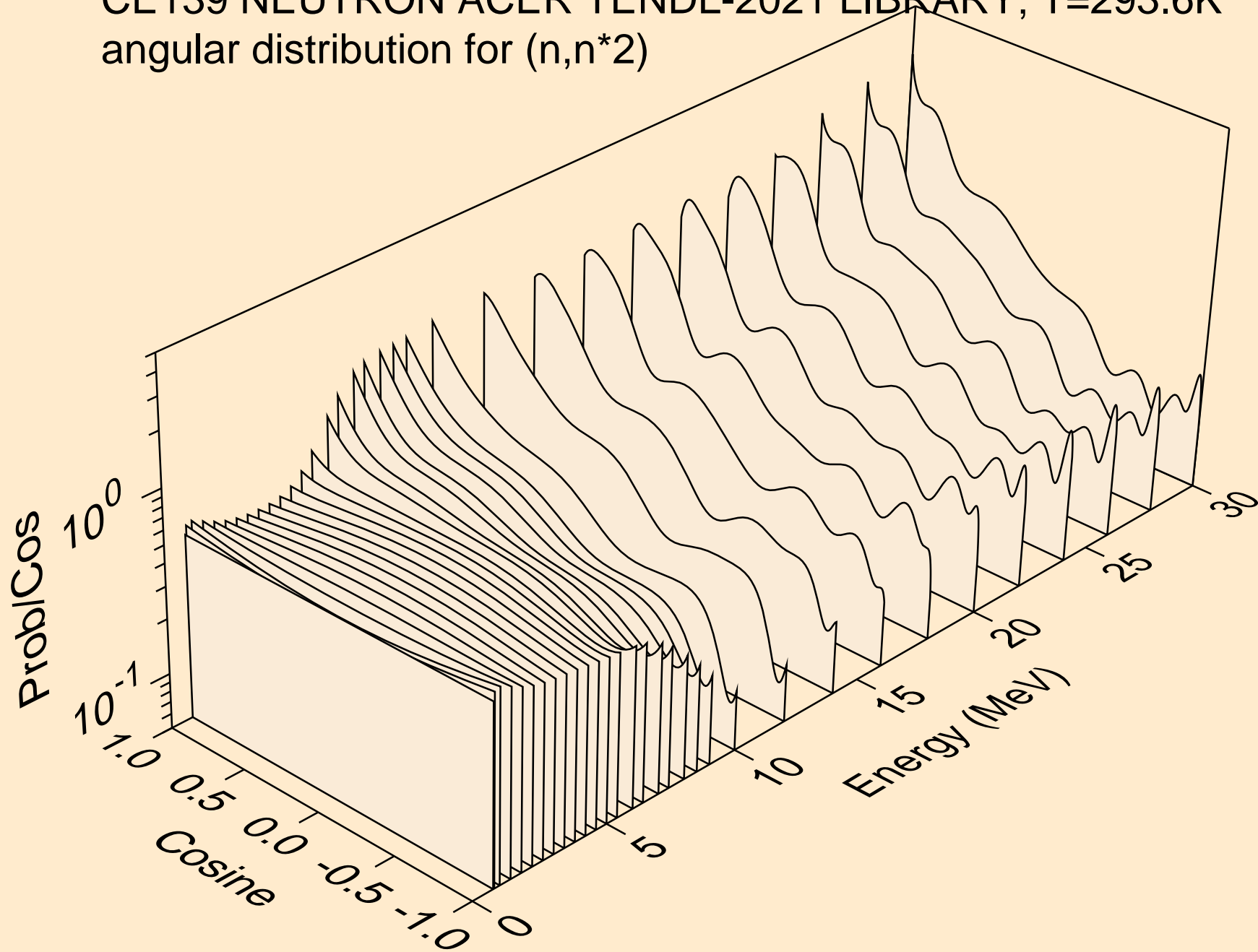

CE139 NEUTRON ACER TENDL-2021 LIBRARY; T=293.6K  
angular distribution for (n,n\*3)

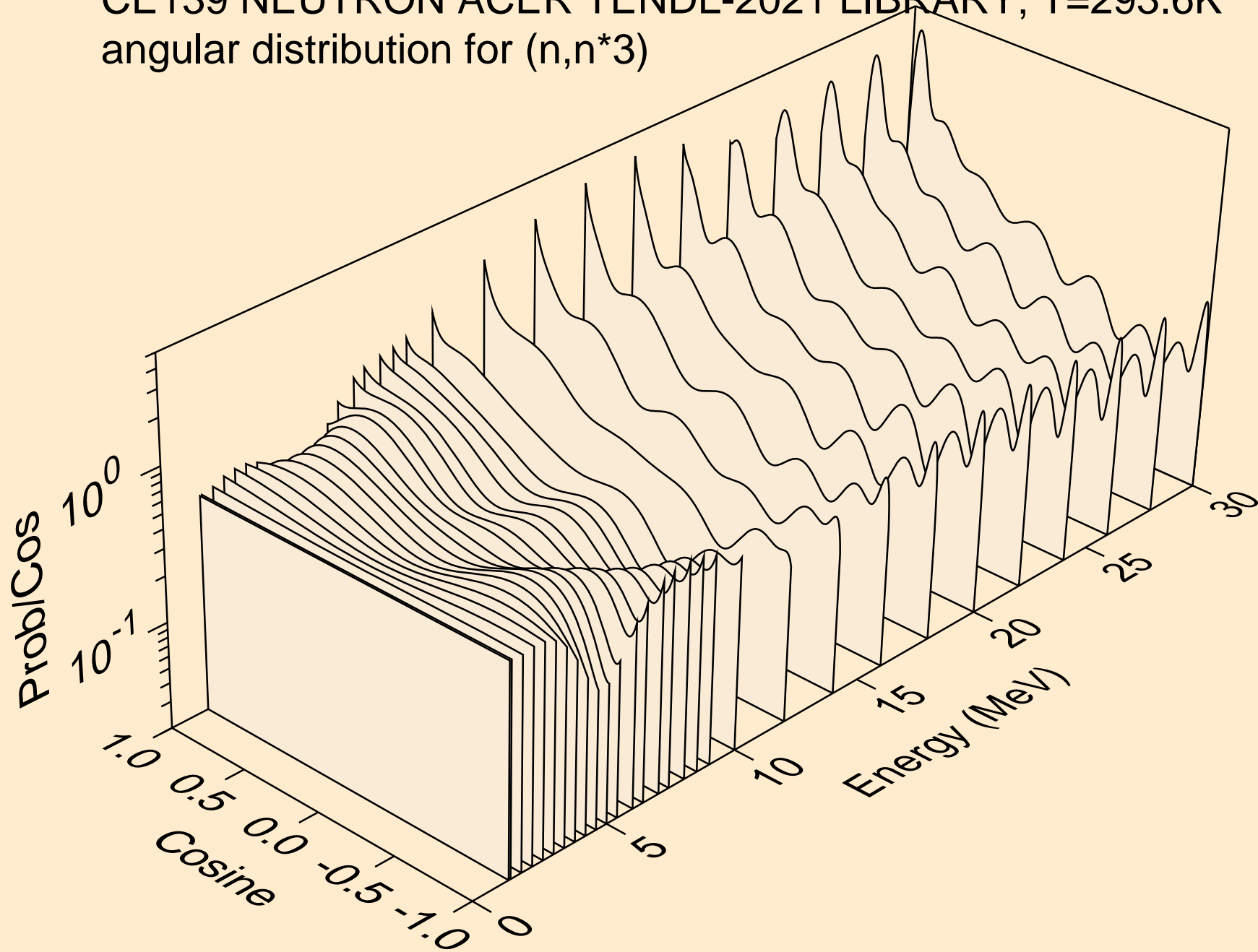

CE139 NEUTRON ACER TENDL-2021 LIBRARY; T=293.6K  
angular distribution for (n,n\*4)

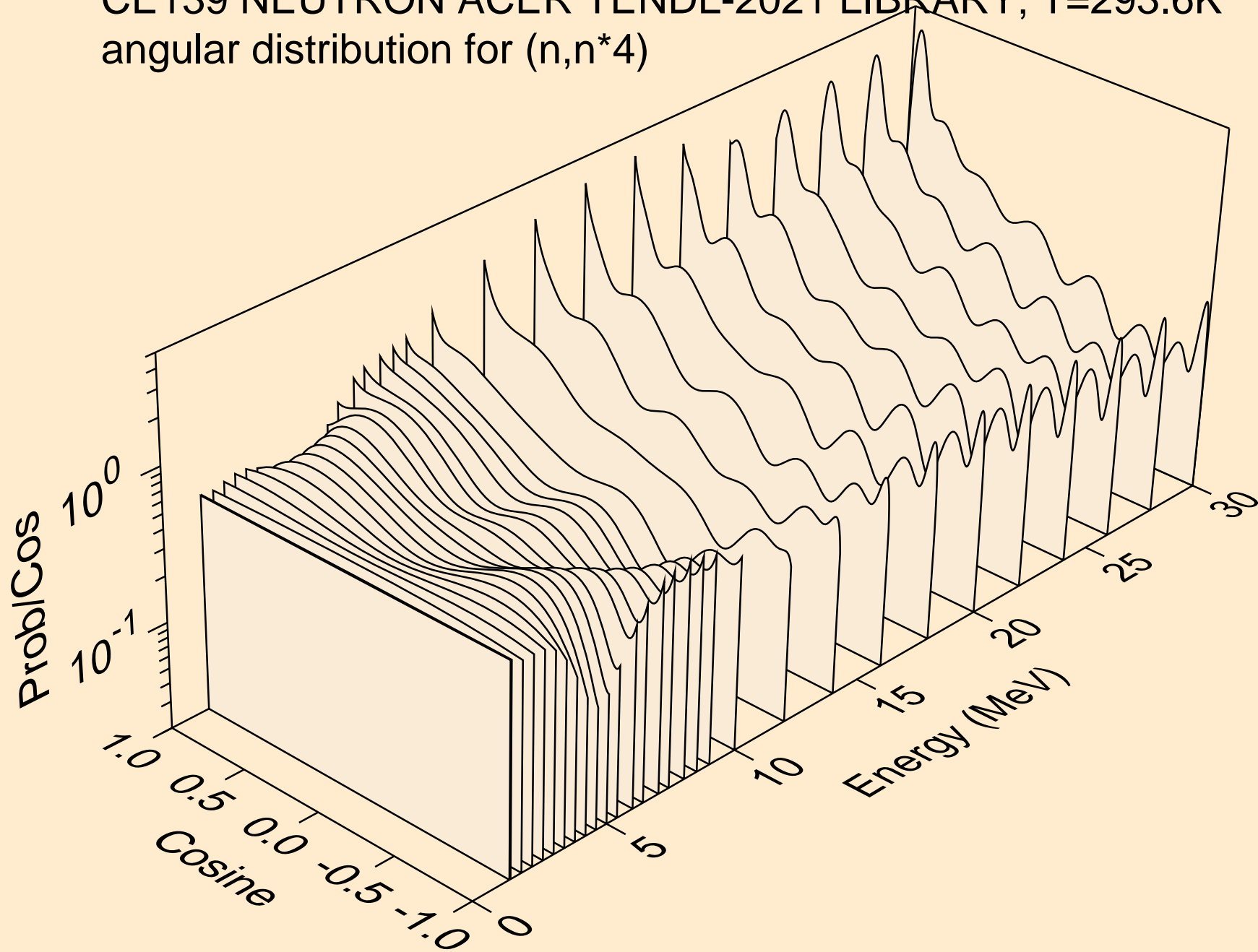

CE139 NEUTRON ACER TENDL-2021 LIBRARY; T=293.6K  
angular distribution for (n,n\*5)

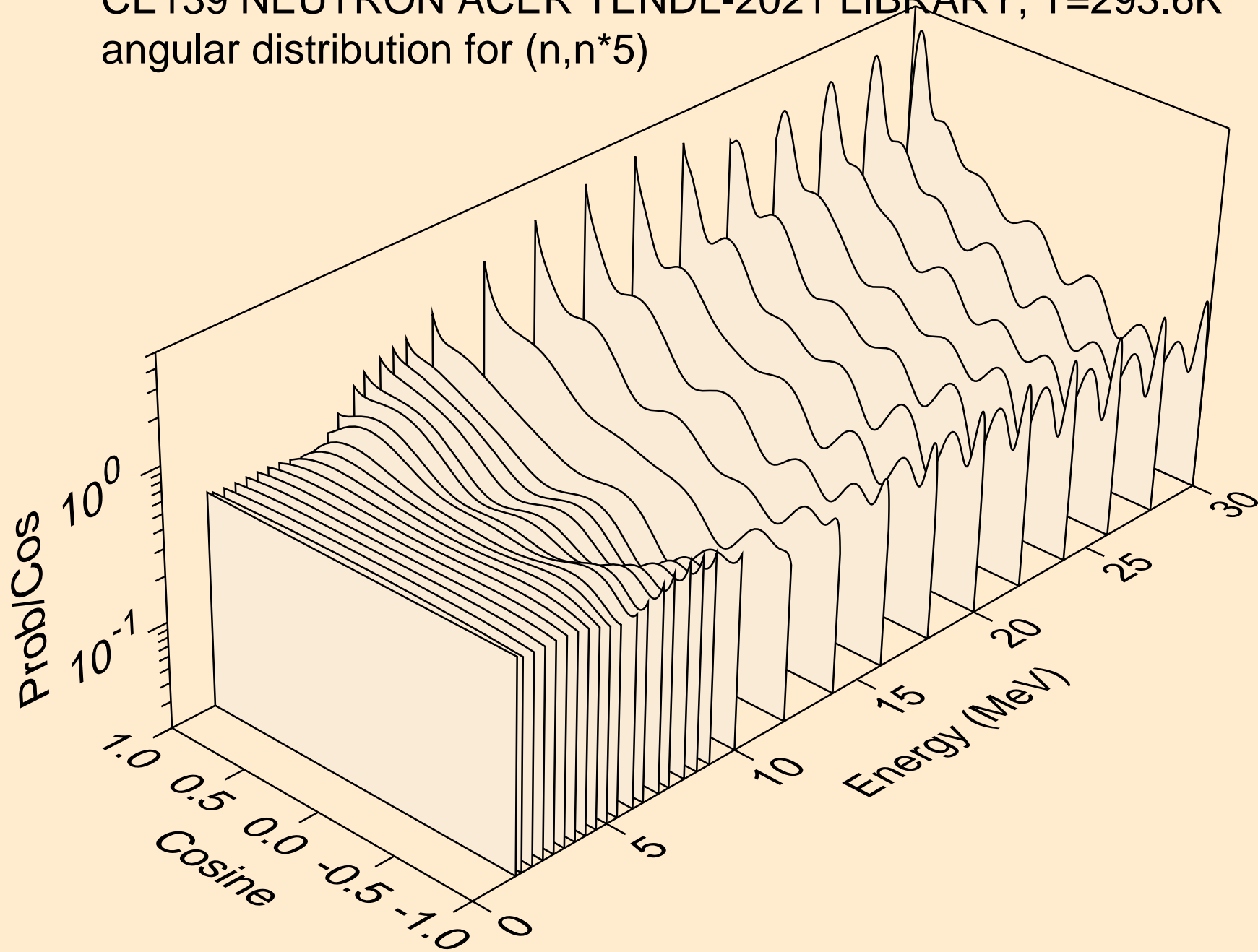

CE139 NEUTRON ACER TENDL-2021 LIBRARY; T=293.6K  
angular distribution for (n,n\*6)

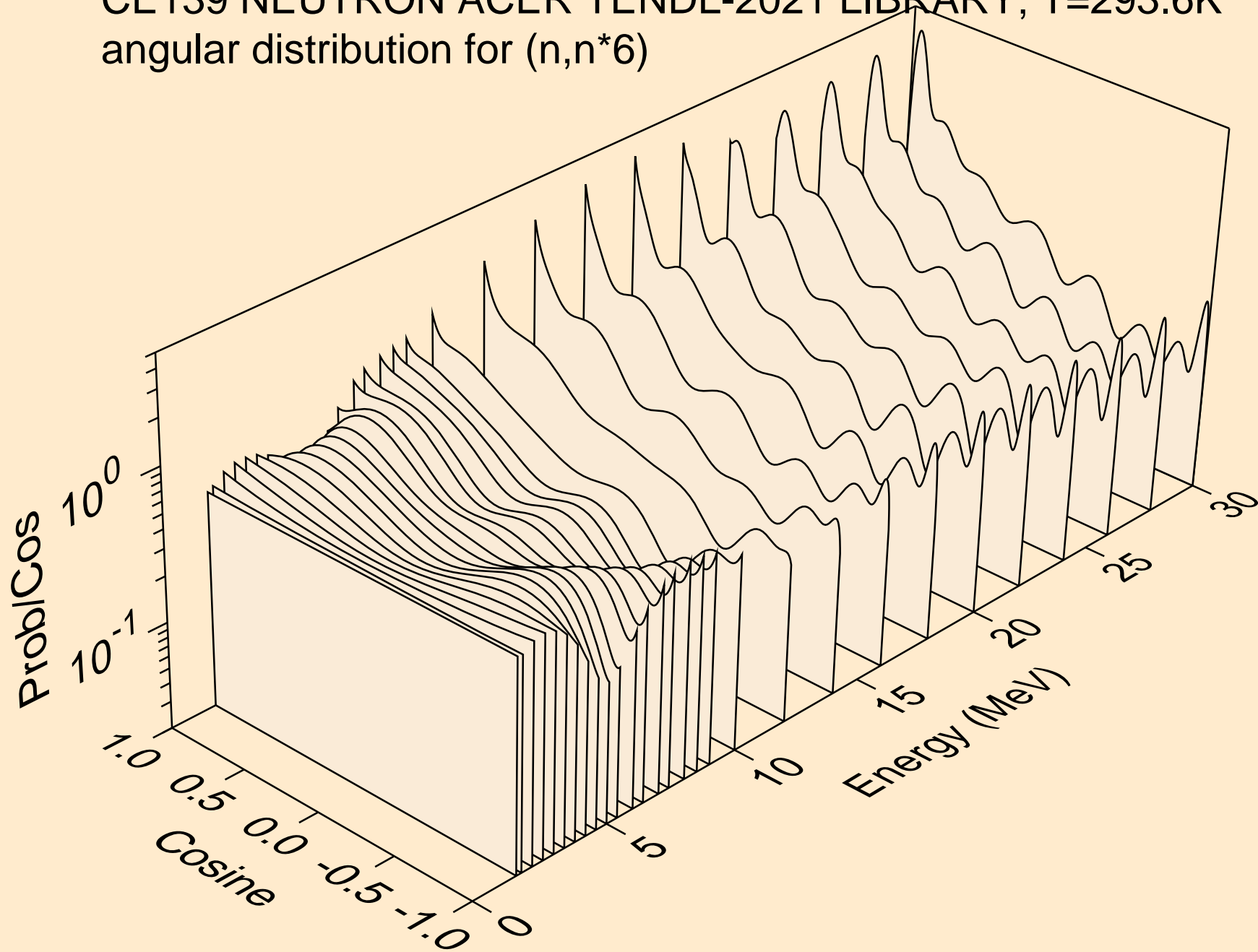

CE139 NEUTRON ACER TENDL-2021 LIBRARY; T=293.6K  
angular distribution for (n,n\*7)

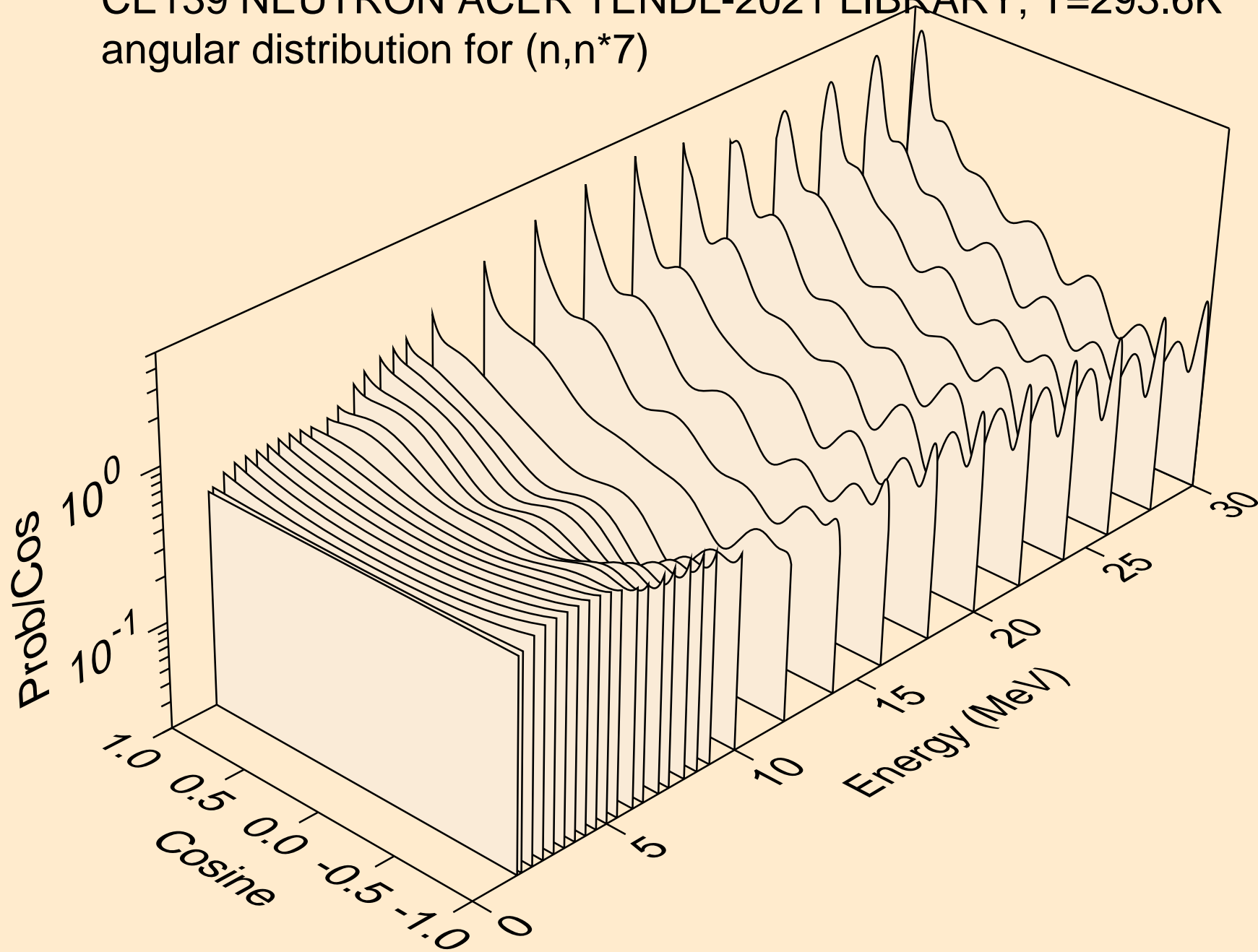

CE139 NEUTRON ACER TENDL-2021 LIBRARY; T=293.6K  
angular distribution for (n,n\*8)

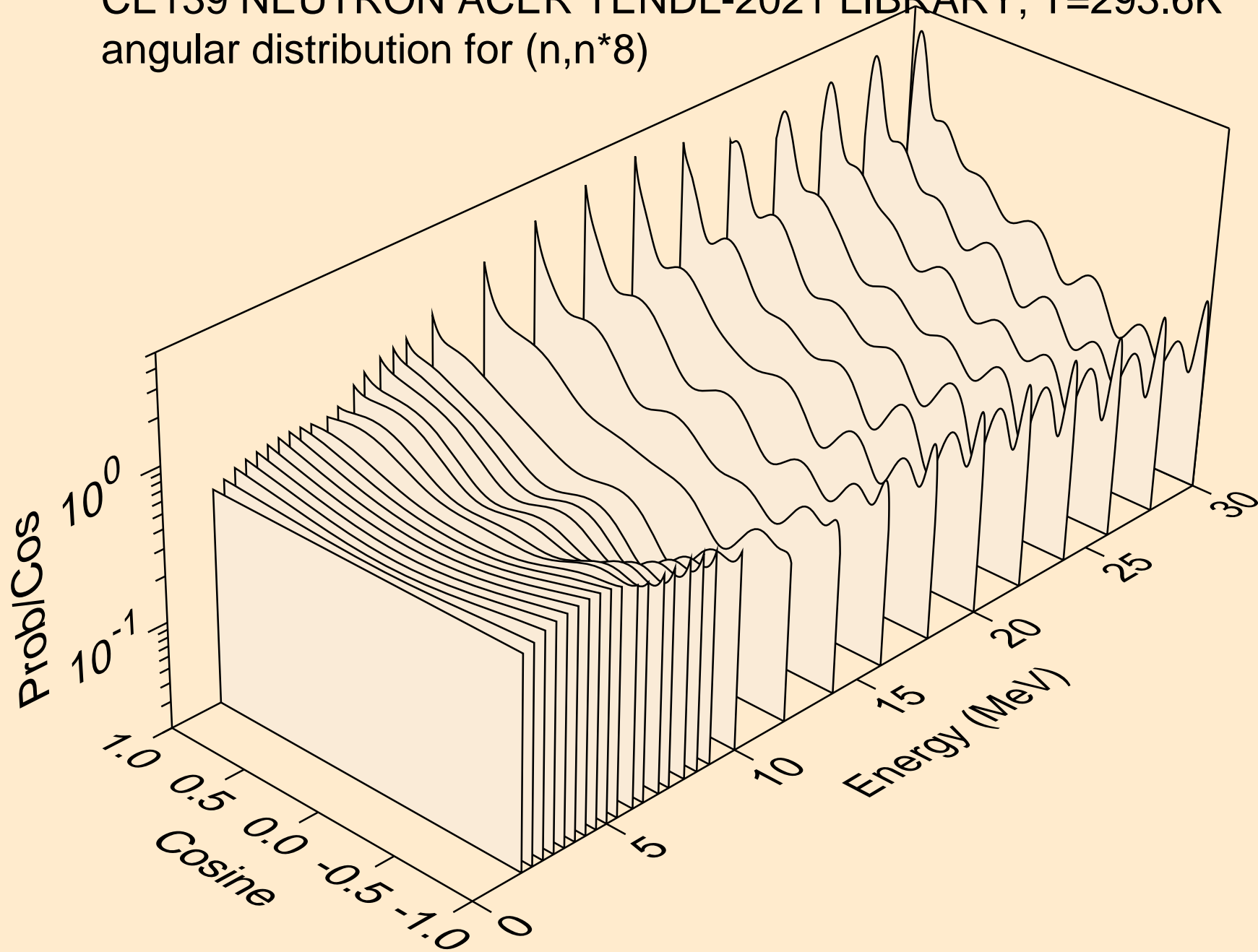

CE139 NEUTRON ACER TENDL-2021 LIBRARY; T=293.6K  
angular distribution for (n,n\*9)

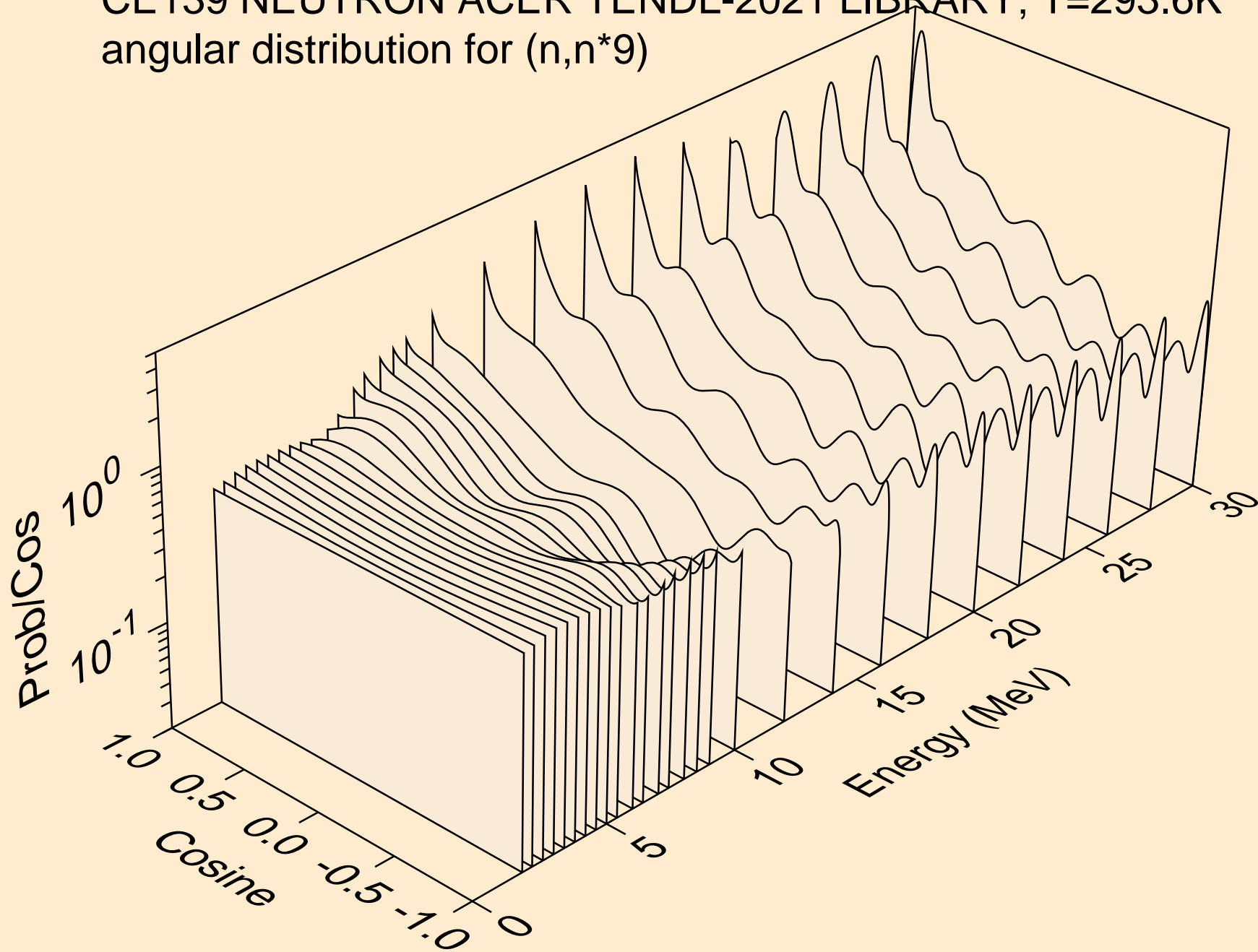



CE139 NEUTRON ACER TENDL-2021 LIBRARY; T=293.6K  
angular distribution for (n,n\*10)

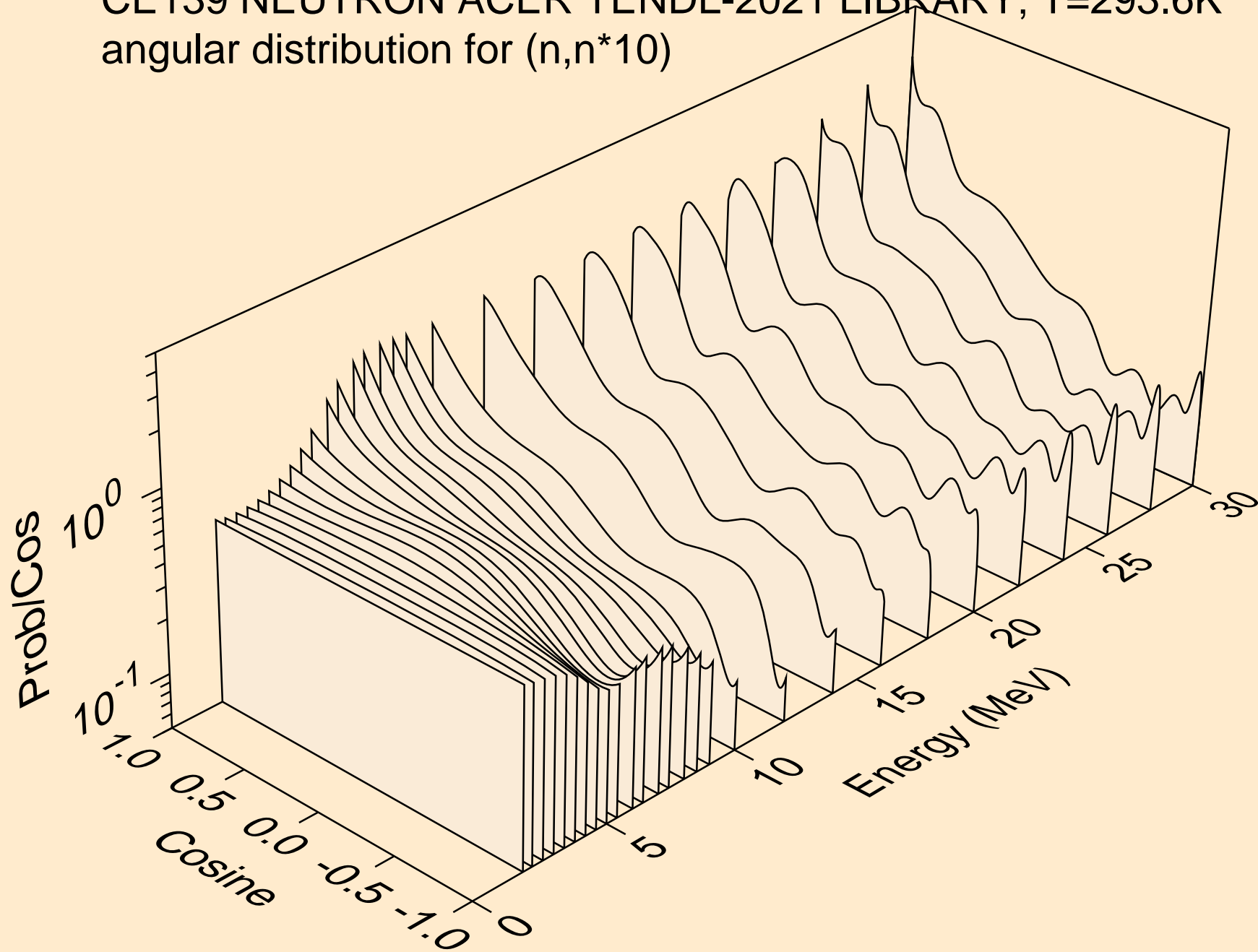

CE139 NEUTRON ACER TENDL-2021 LIBRARY; T=293.6K  
angular distribution for (n,n\*11)

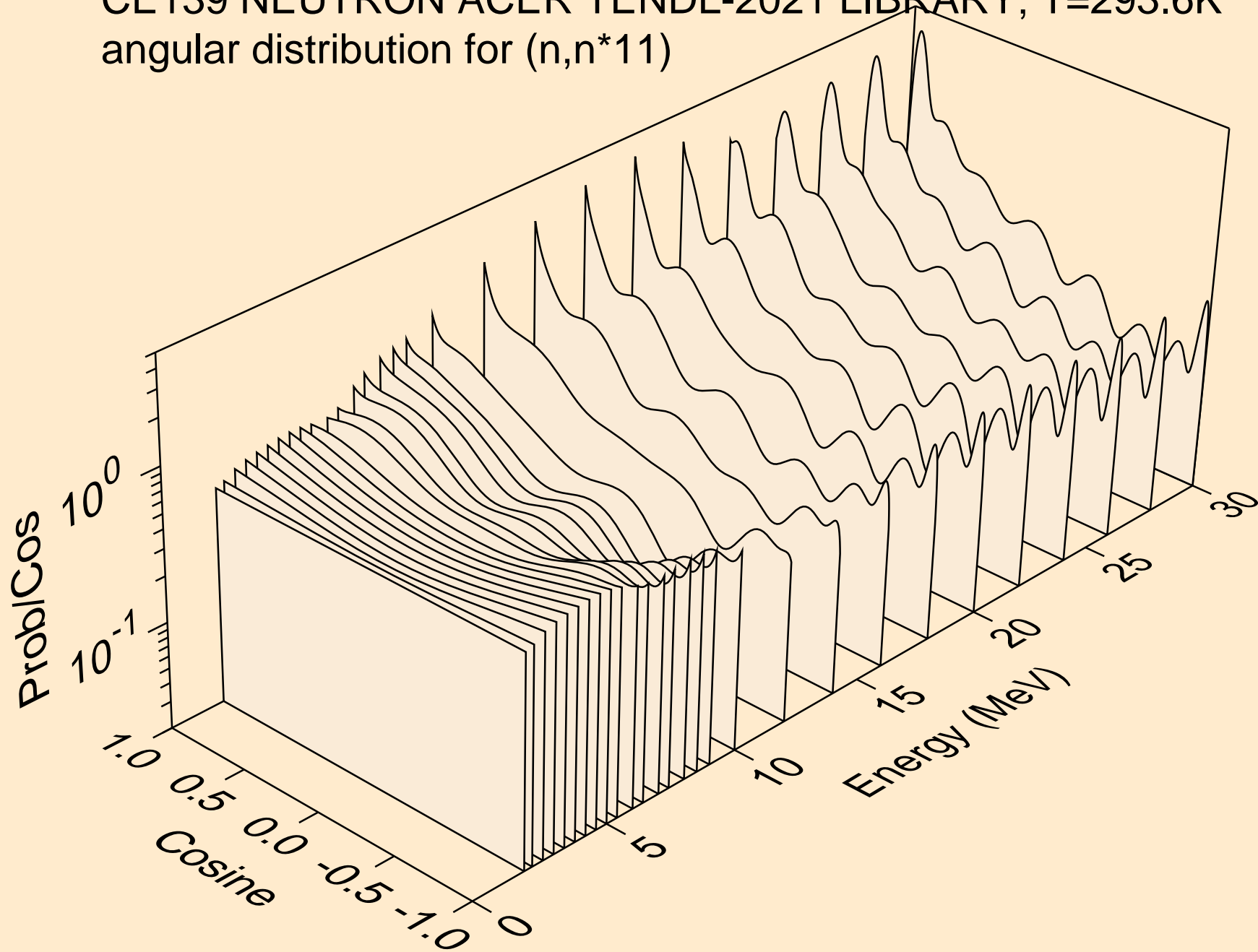

CE139 NEUTRON ACER TENDL-2021 LIBRARY; T=293.6K  
angular distribution for (n,n\*12)

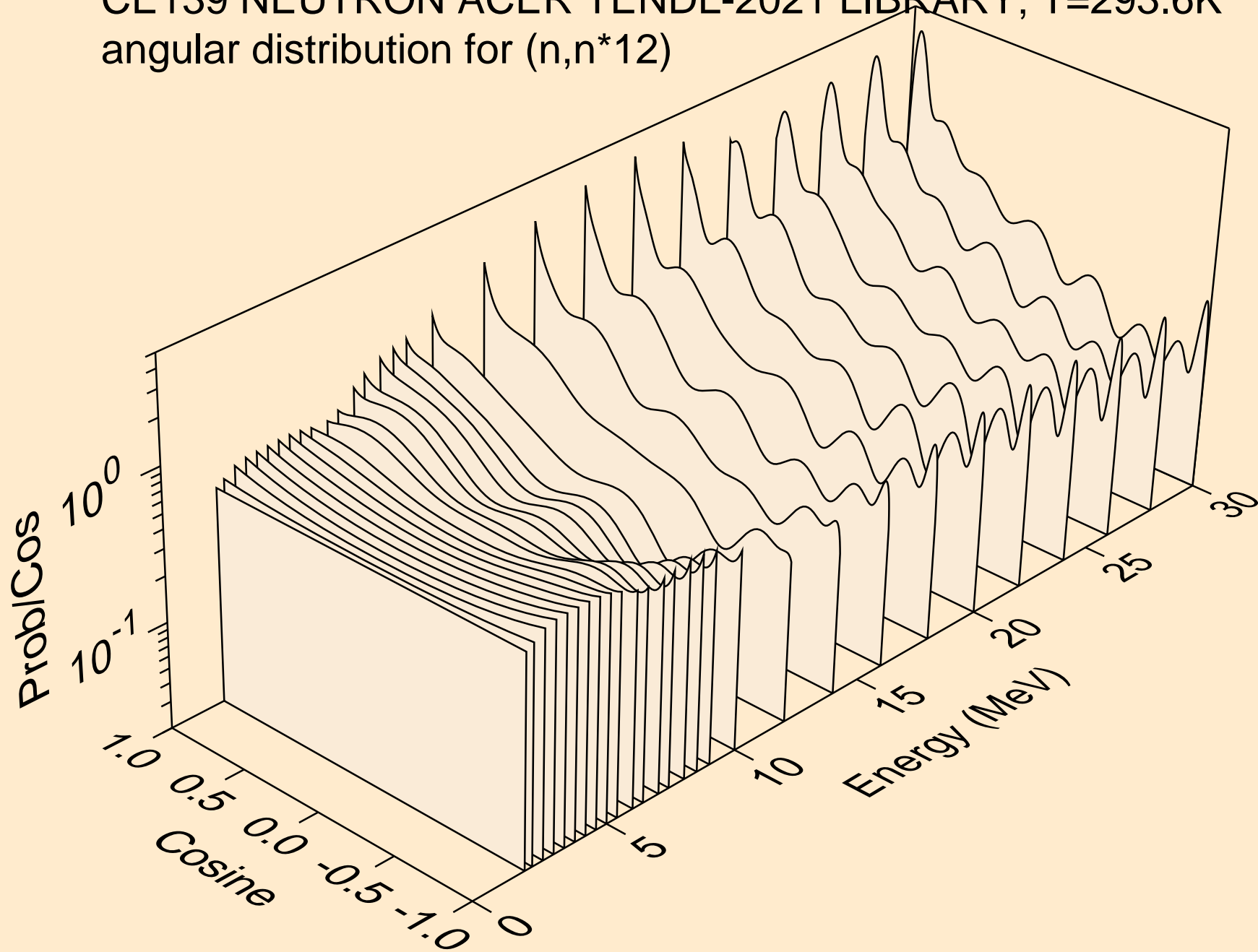

CE139 NEUTRON ACER TENDL-2021 LIBRARY; T=293.6K  
angular distribution for (n,n\*13)

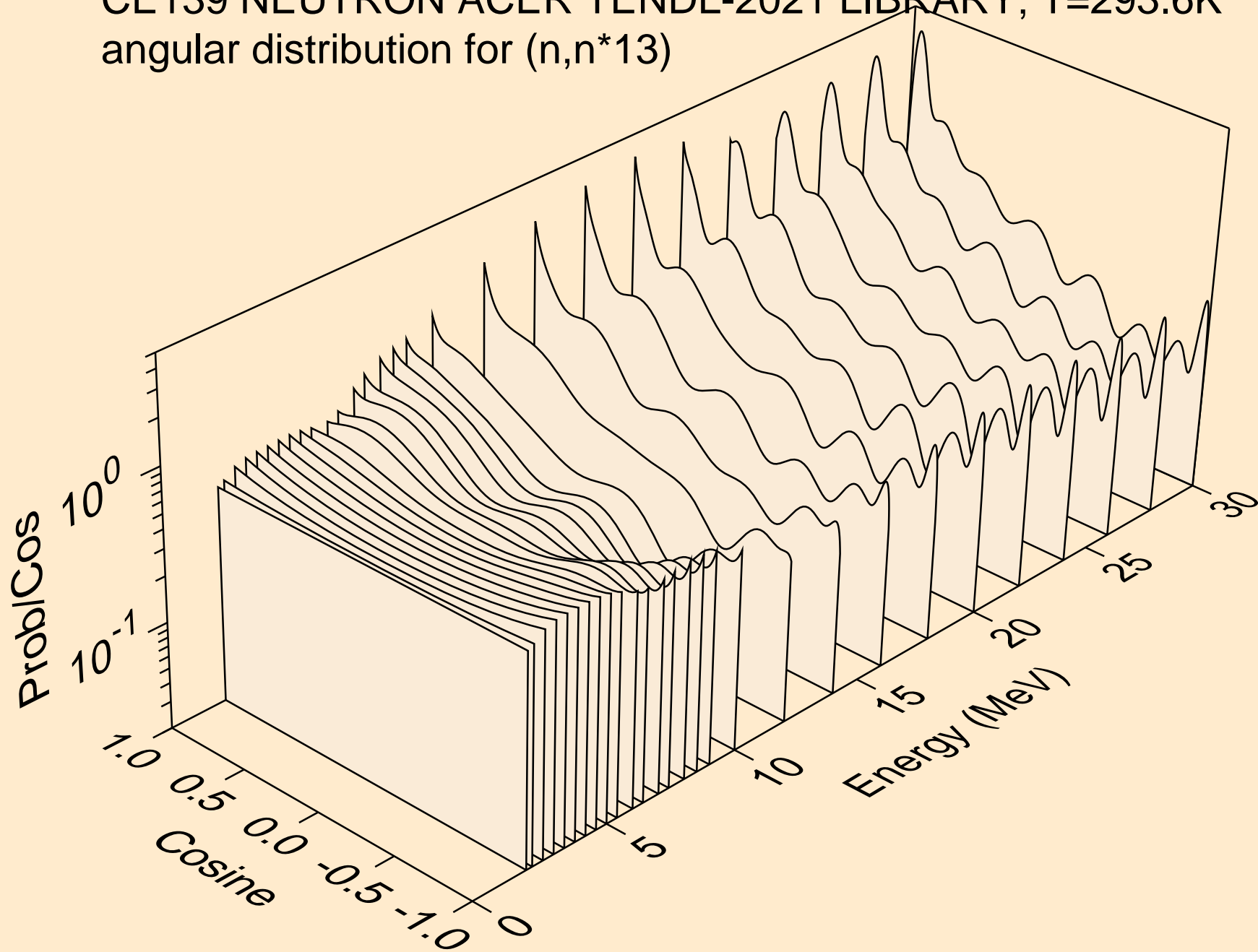

CE139 NEUTRON ACER TENDL-2021 LIBRARY; T=293.6K  
angular distribution for (n,n\*14)

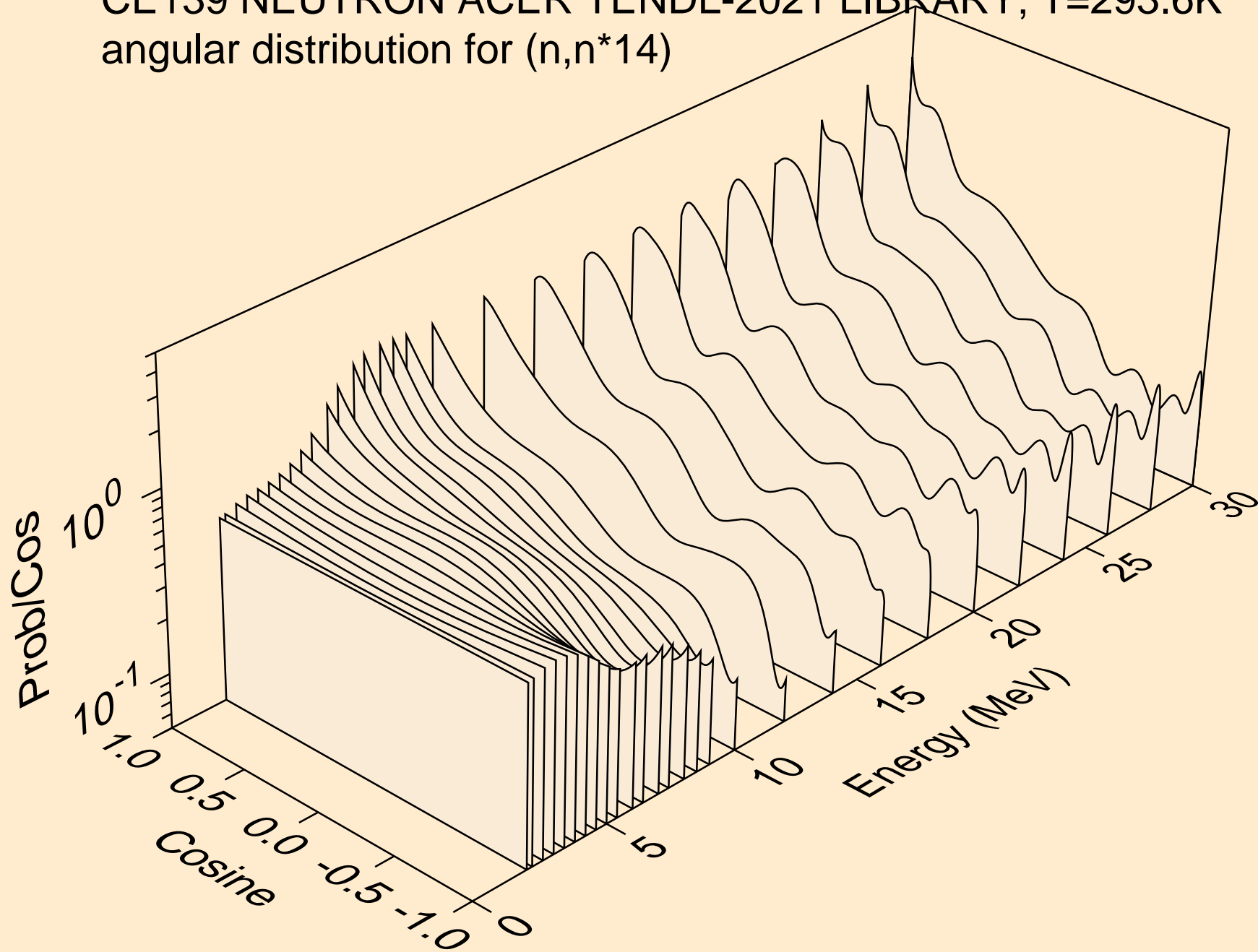

CE139 NEUTRON ACER TENDL-2021 LIBRARY; T=293.6K  
angular distribution for (n,n\*15)

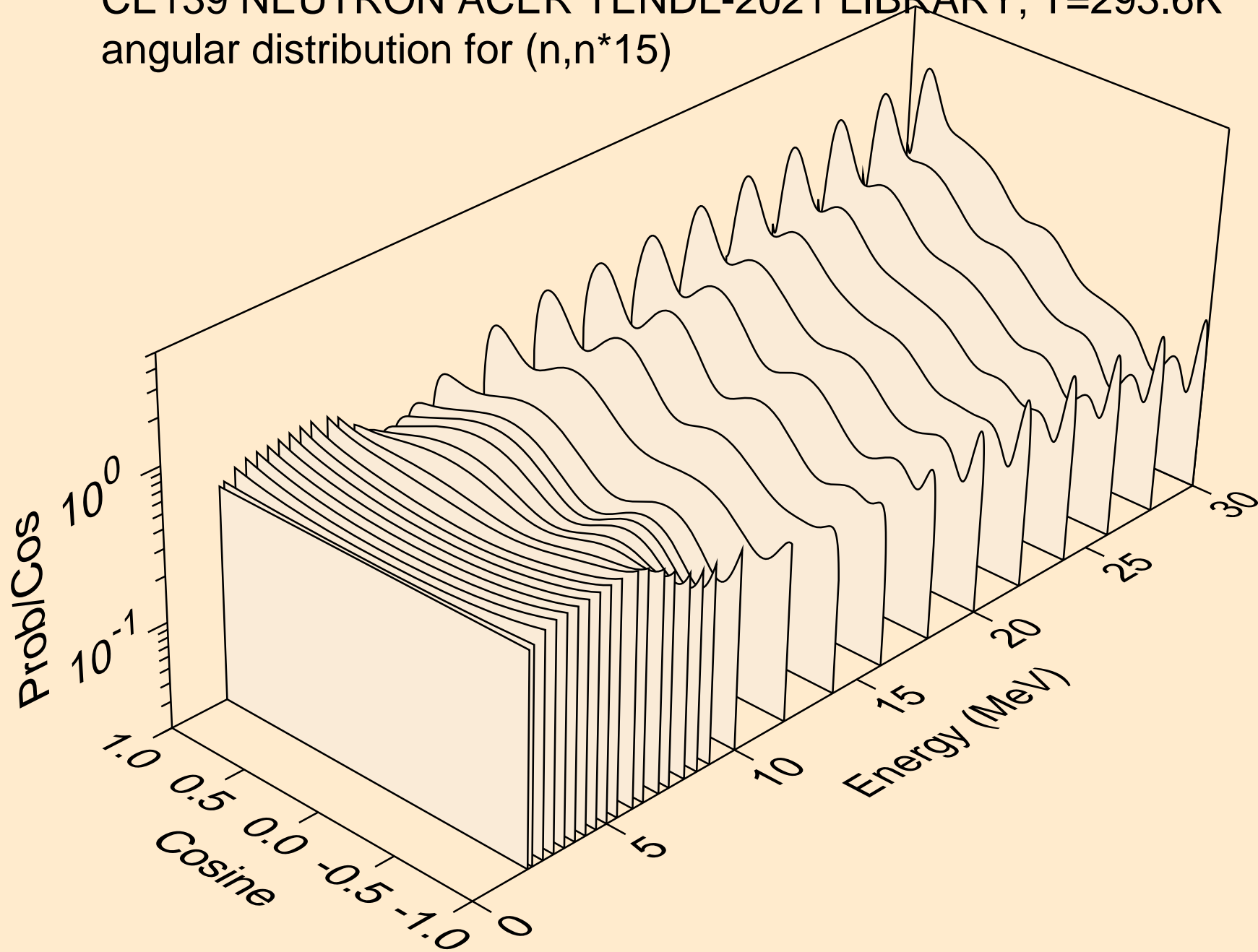

CE139 NEUTRON ACER TENDL-2021 LIBRARY; T=293.6K  
angular distribution for (n,n\*16)

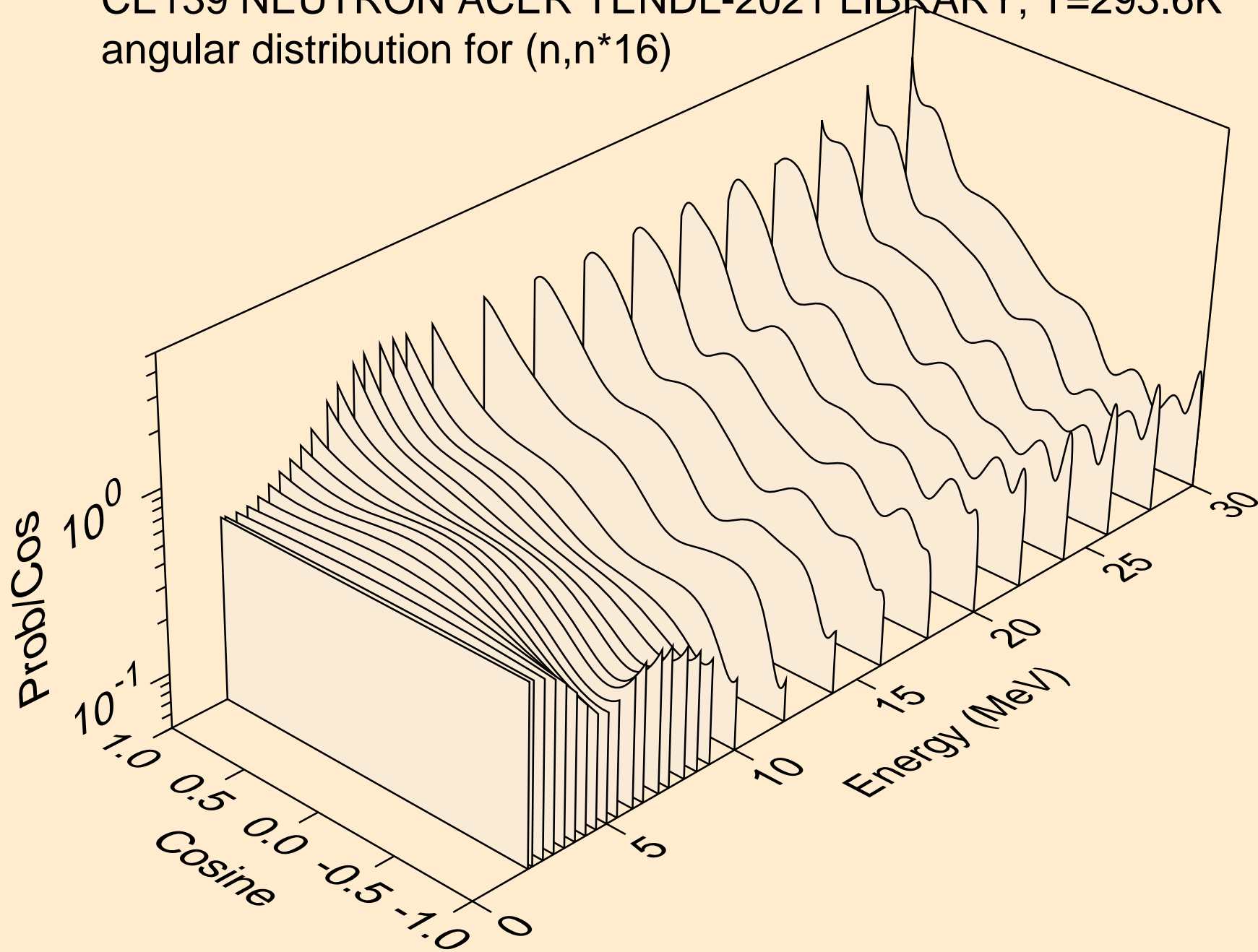

CE139 NEUTRON ACER TENDL-2021 LIBRARY; T=293.6K  
angular distribution for (n,n\*17)

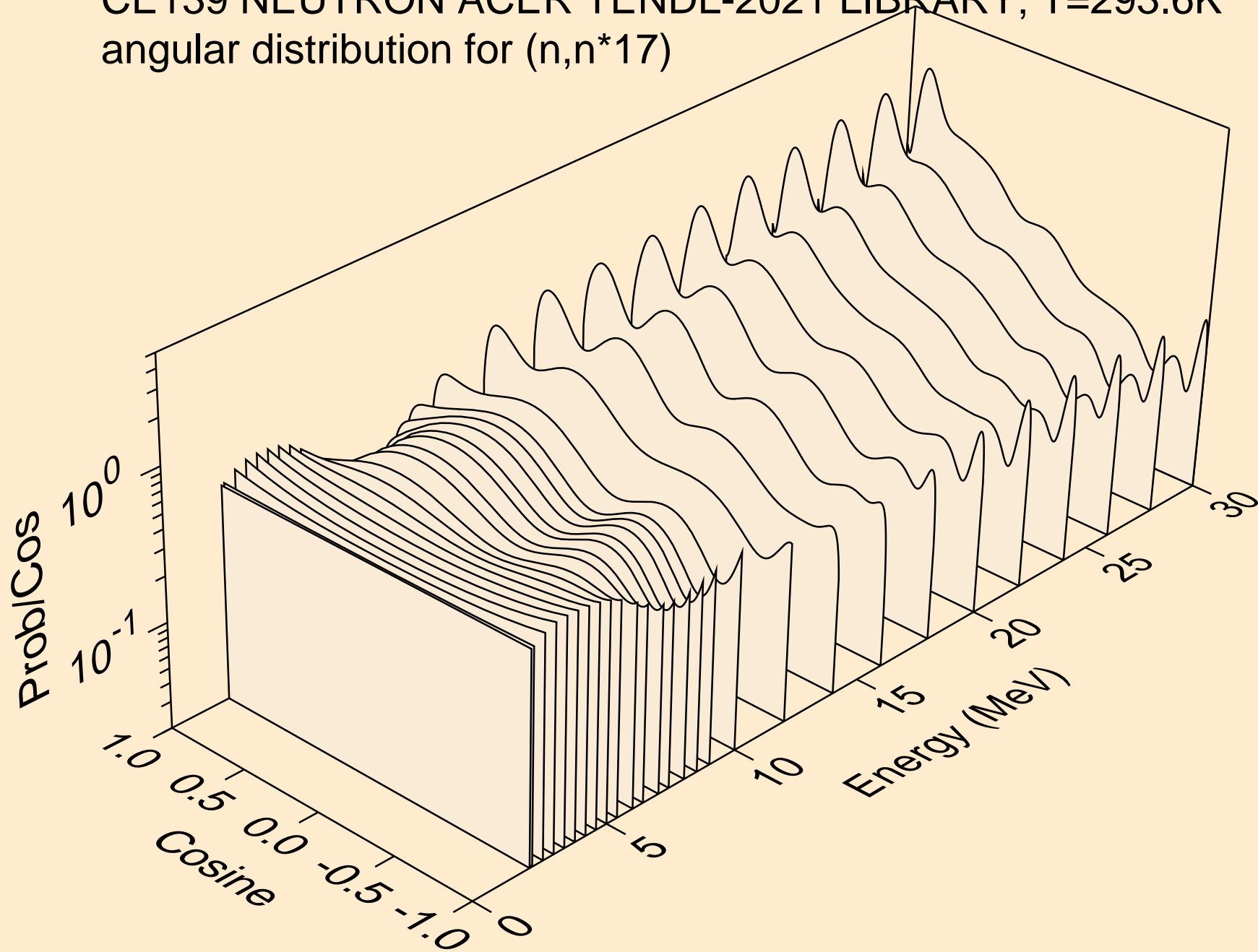



CE139 NEUTRON ACER TENDL-2021 LIBRARY; T=293.6K  
angular distribution for (n,n\*18)

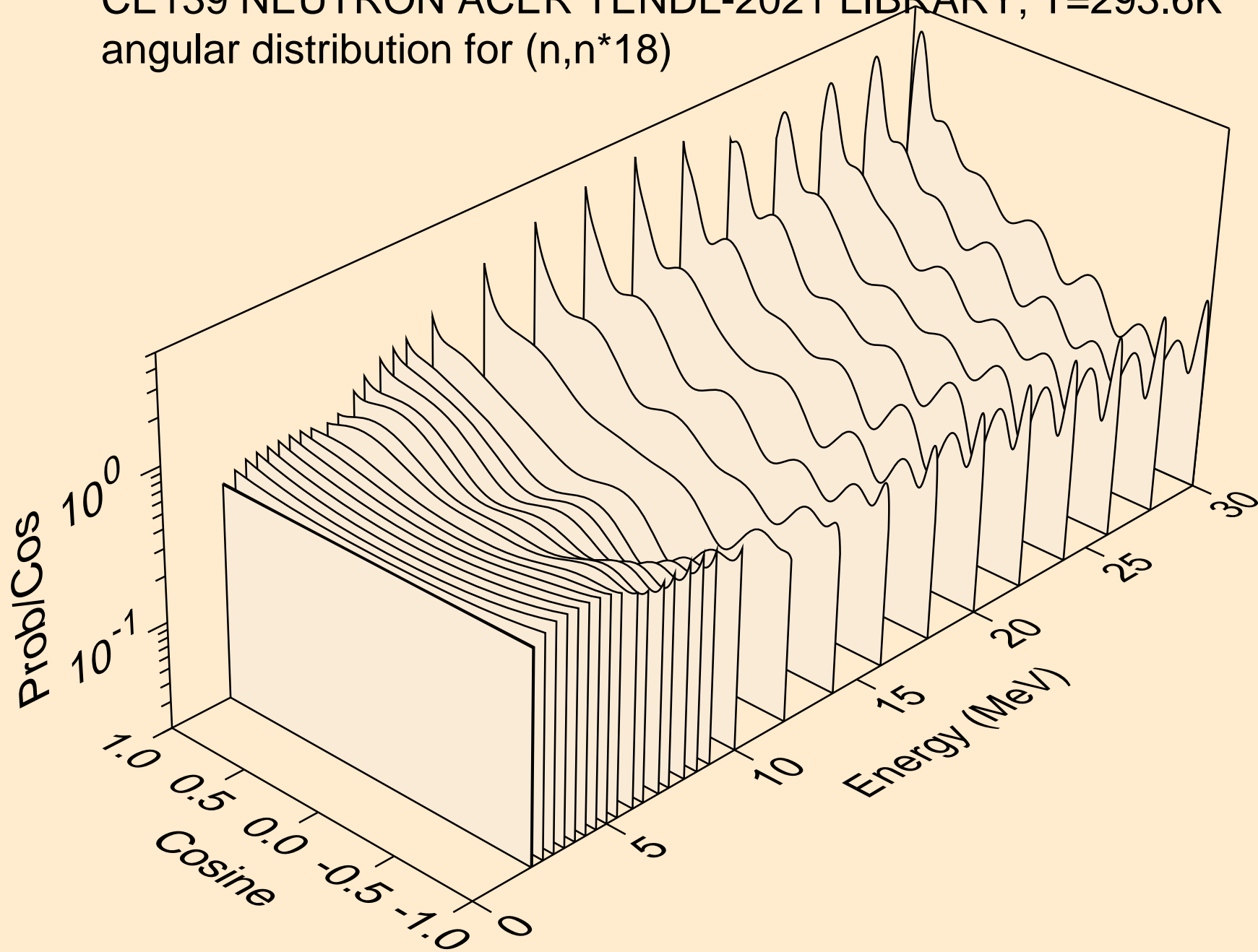

CE139 NEUTRON ACER TENDL-2021 LIBRARY; T=293.6K  
angular distribution for (n,n\*19)

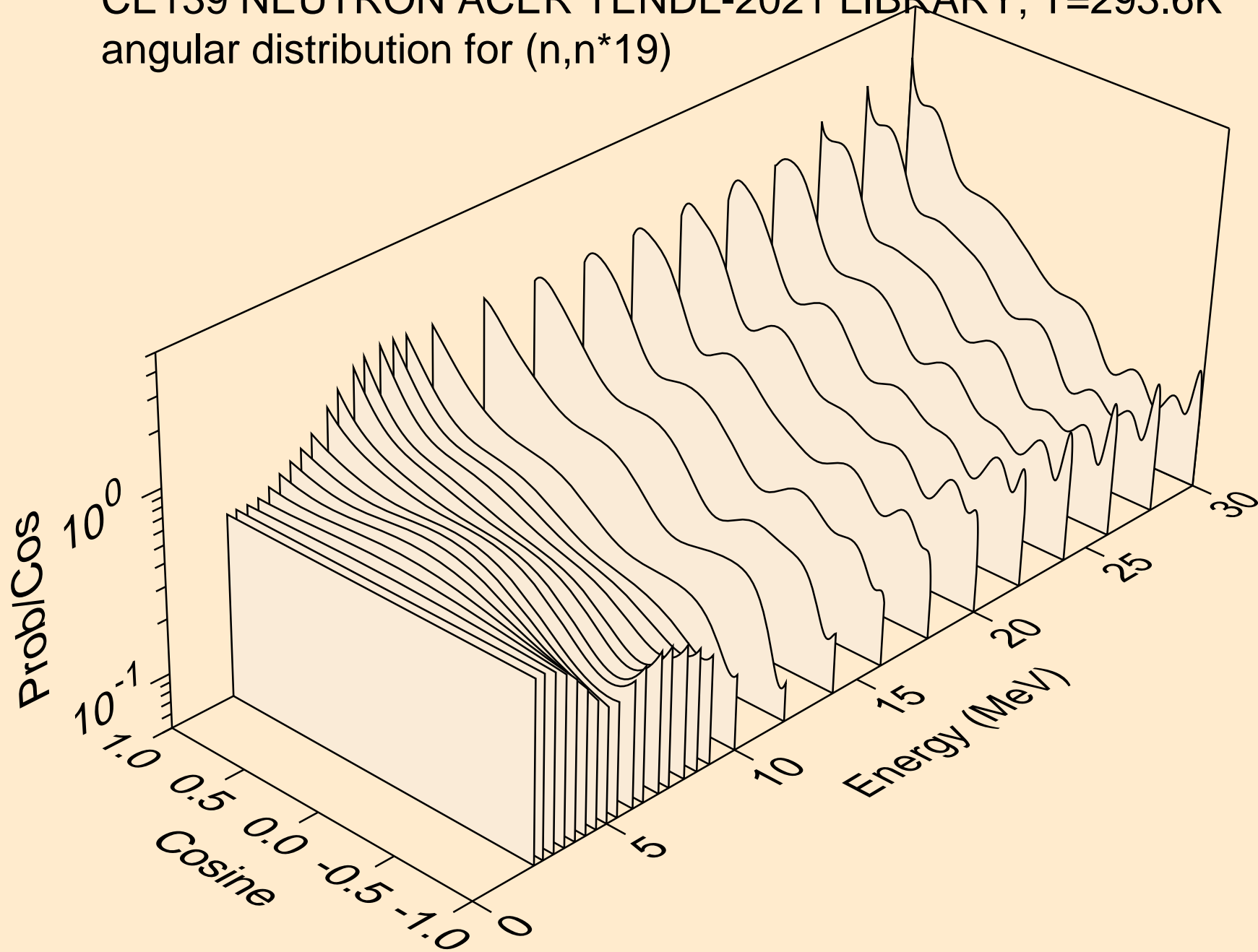

CE139 NEUTRON ACER TENDL-2021 LIBRARY; T=293.6K  
angular distribution for (n,n\*20)

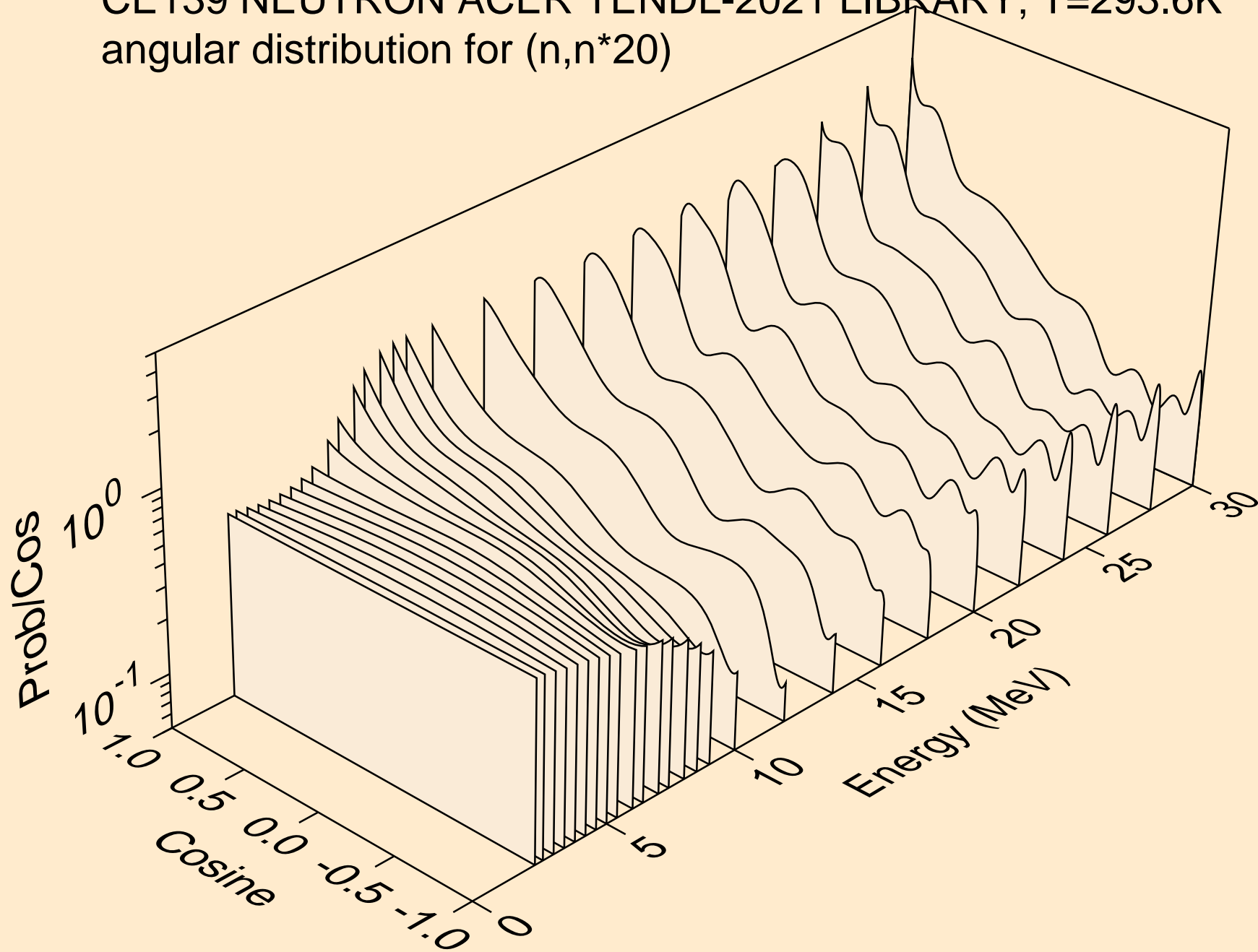

CE139 NEUTRON ACER TENDL-2021 LIBRARY; T=293.6K  
angular distribution for (n,n\*21)

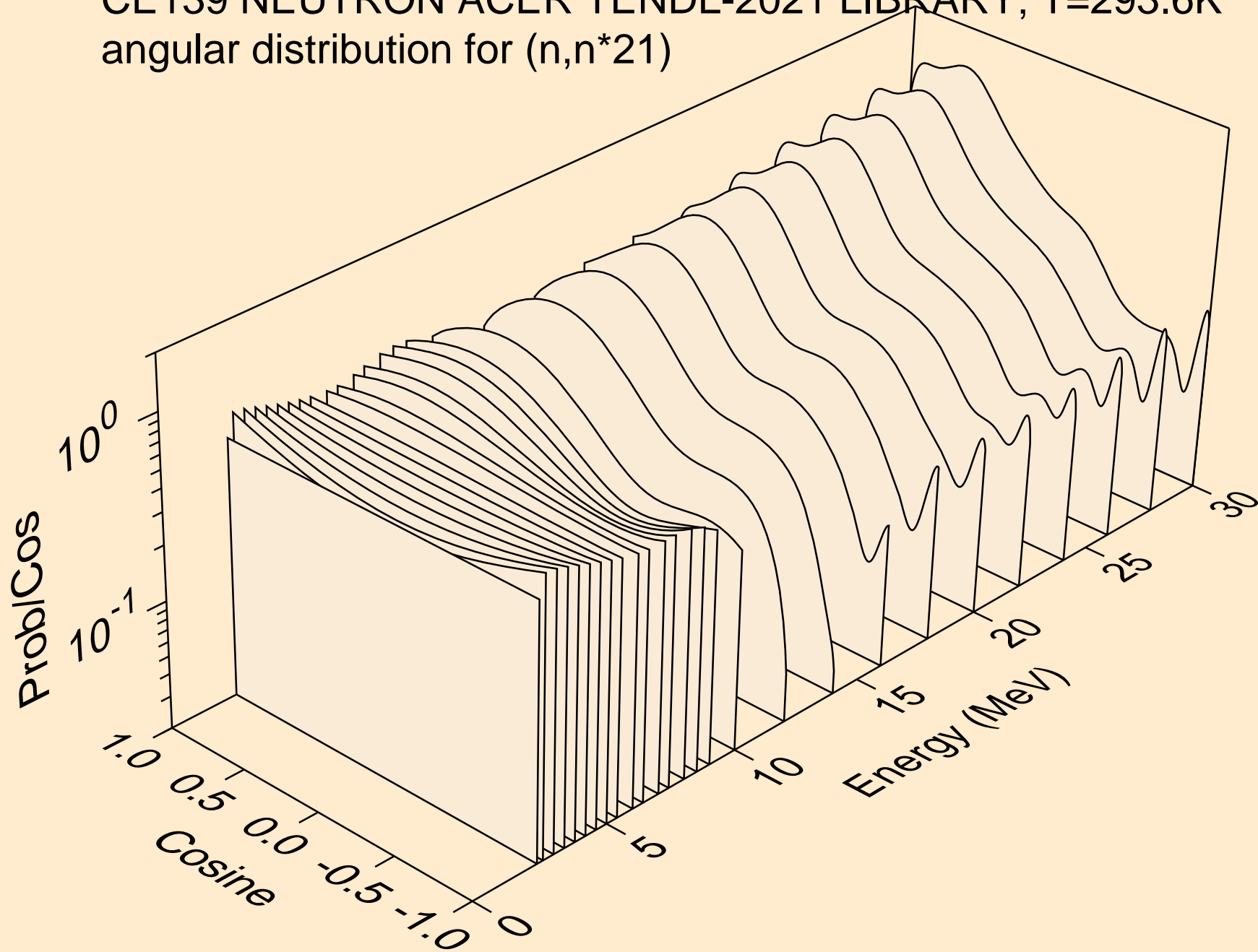

CE139 NEUTRON ACER TENDL-2021 LIBRARY; T=293.6K  
angular distribution for (n,n\*22)

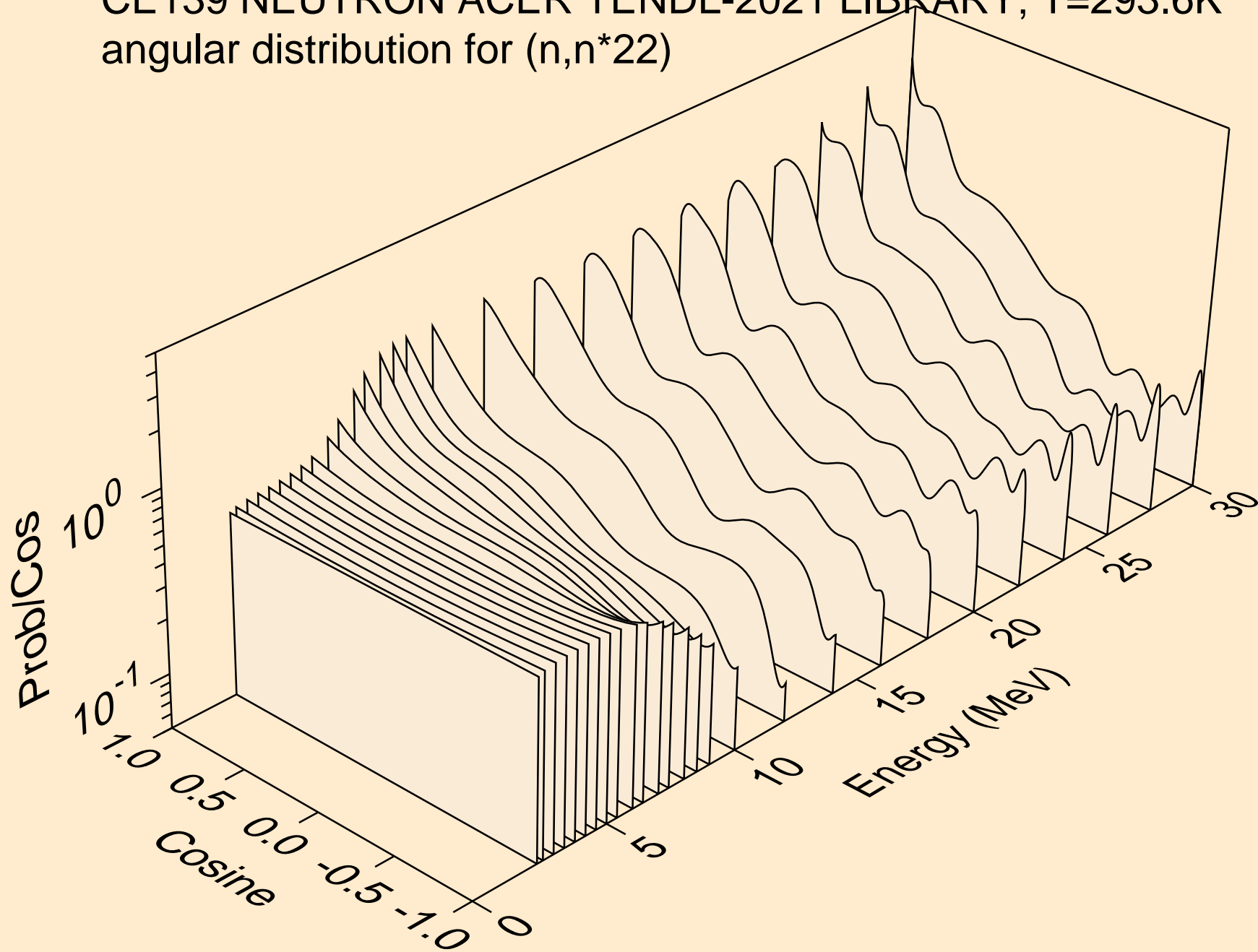

CE139 NEUTRON ACER TENDL-2021 LIBRARY; T=293.6K  
angular distribution for (n,n\*23)

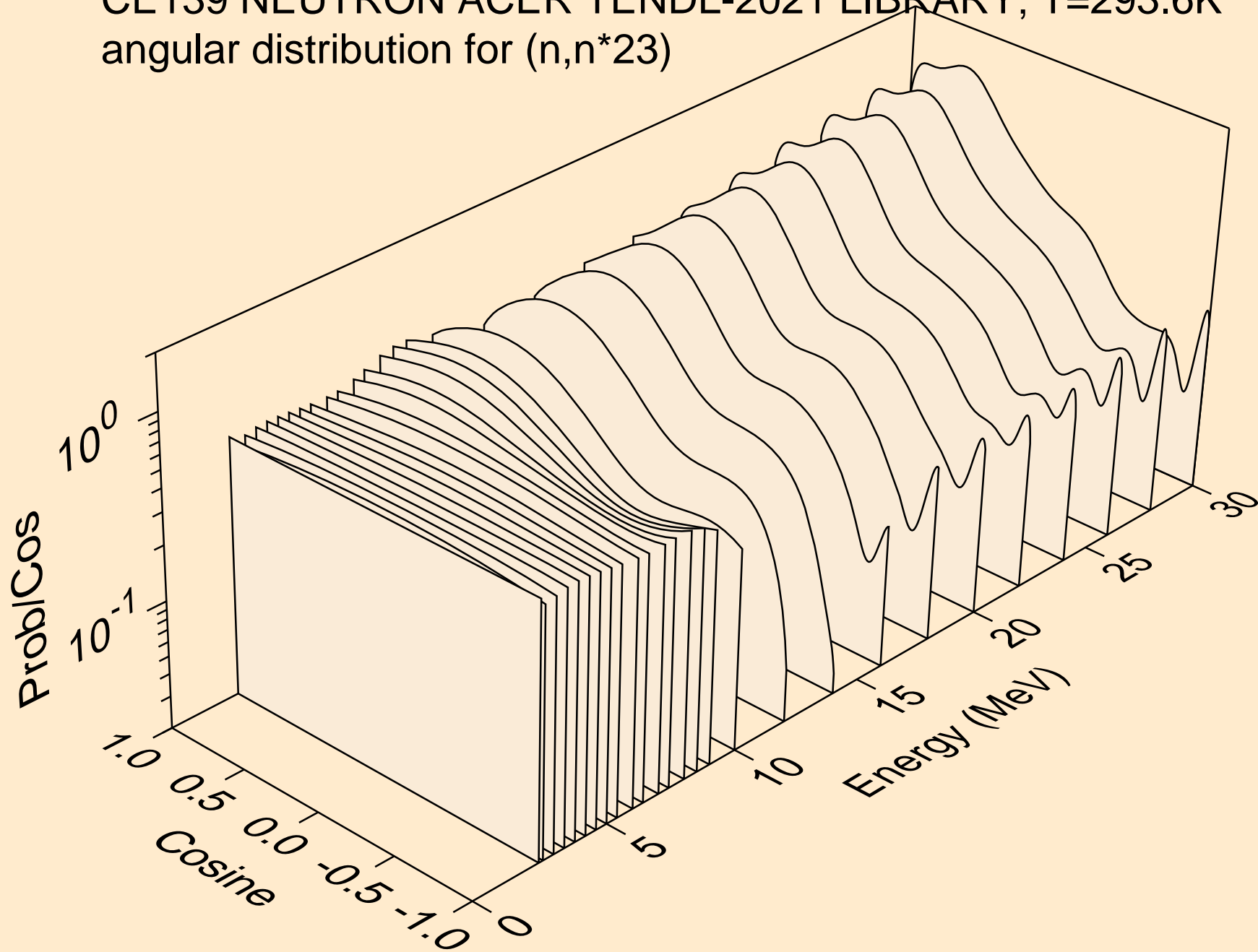

CE139 NEUTRON ACER TENDL-2021 LIBRARY; T=293.6K  
angular distribution for (n,n\*24)

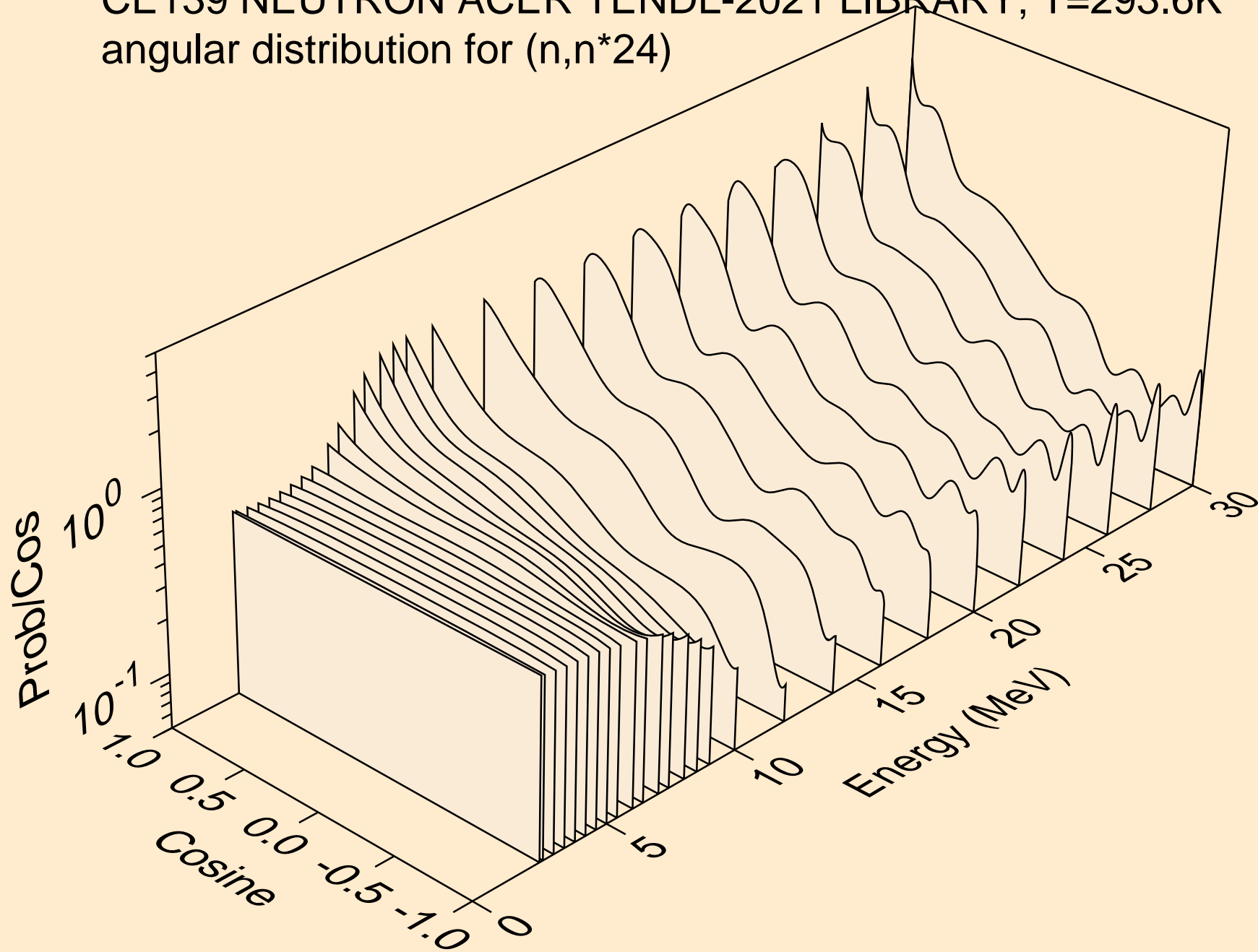

CE139 NEUTRON ACER TENDL-2021 LIBRARY; T=293.6K  
angular distribution for (n,n\*25)

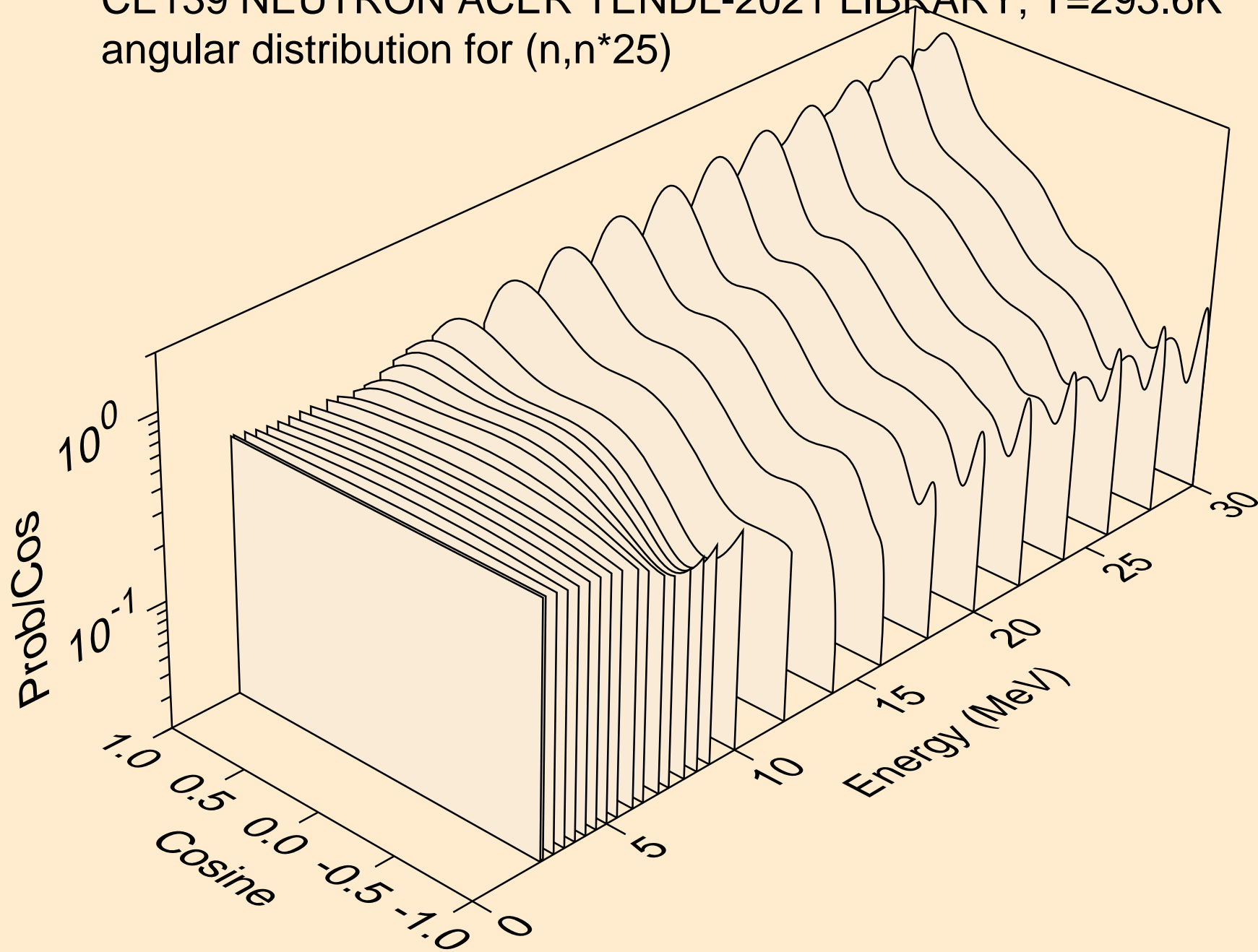



CE139 NEUTRON ACER TENDL-2021 LIBRARY; T=293.6K  
angular distribution for (n,n\*26)

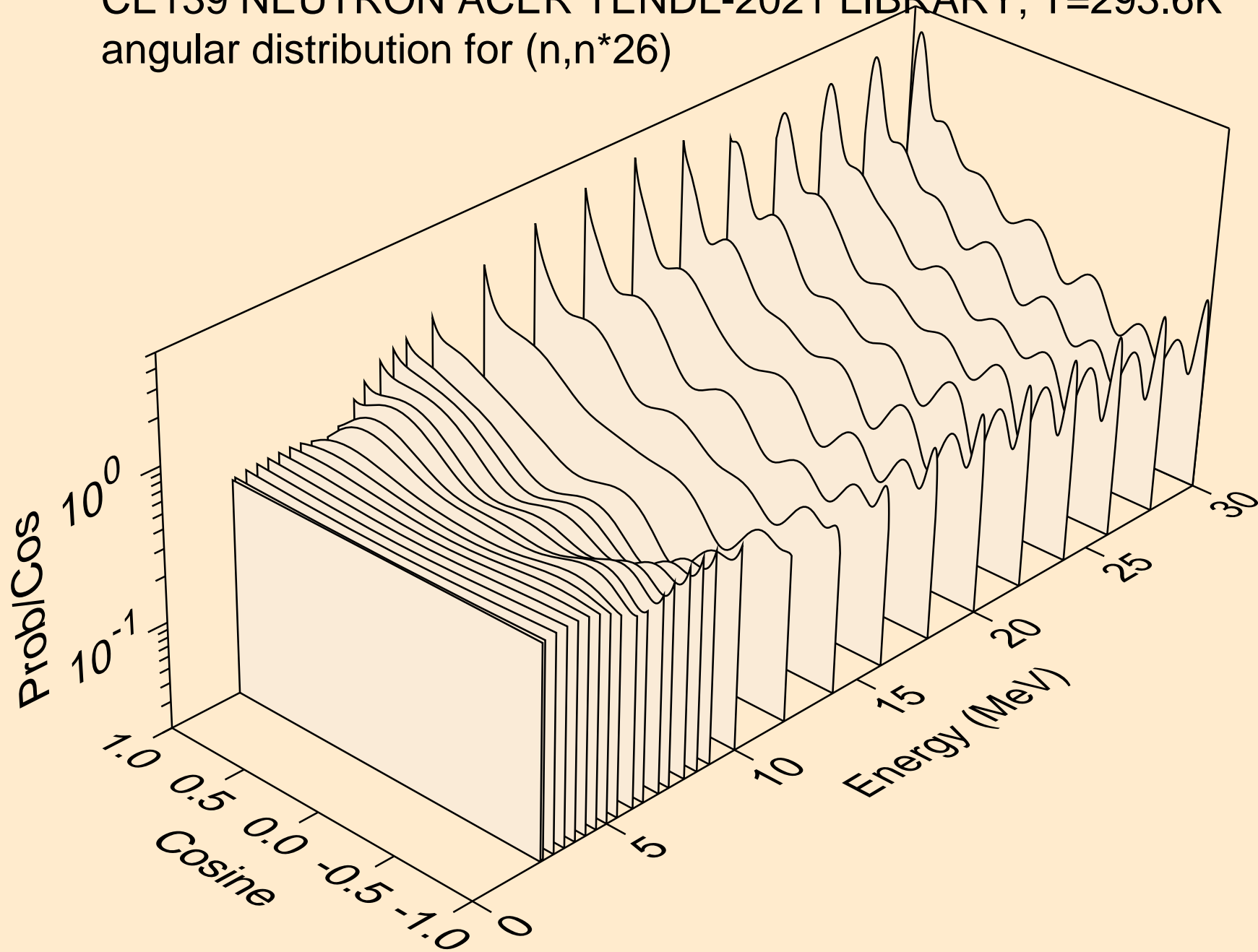

CE139 NEUTRON ACER TENDL-2021 LIBRARY; T=293.6K  
angular distribution for (n,n\*27)

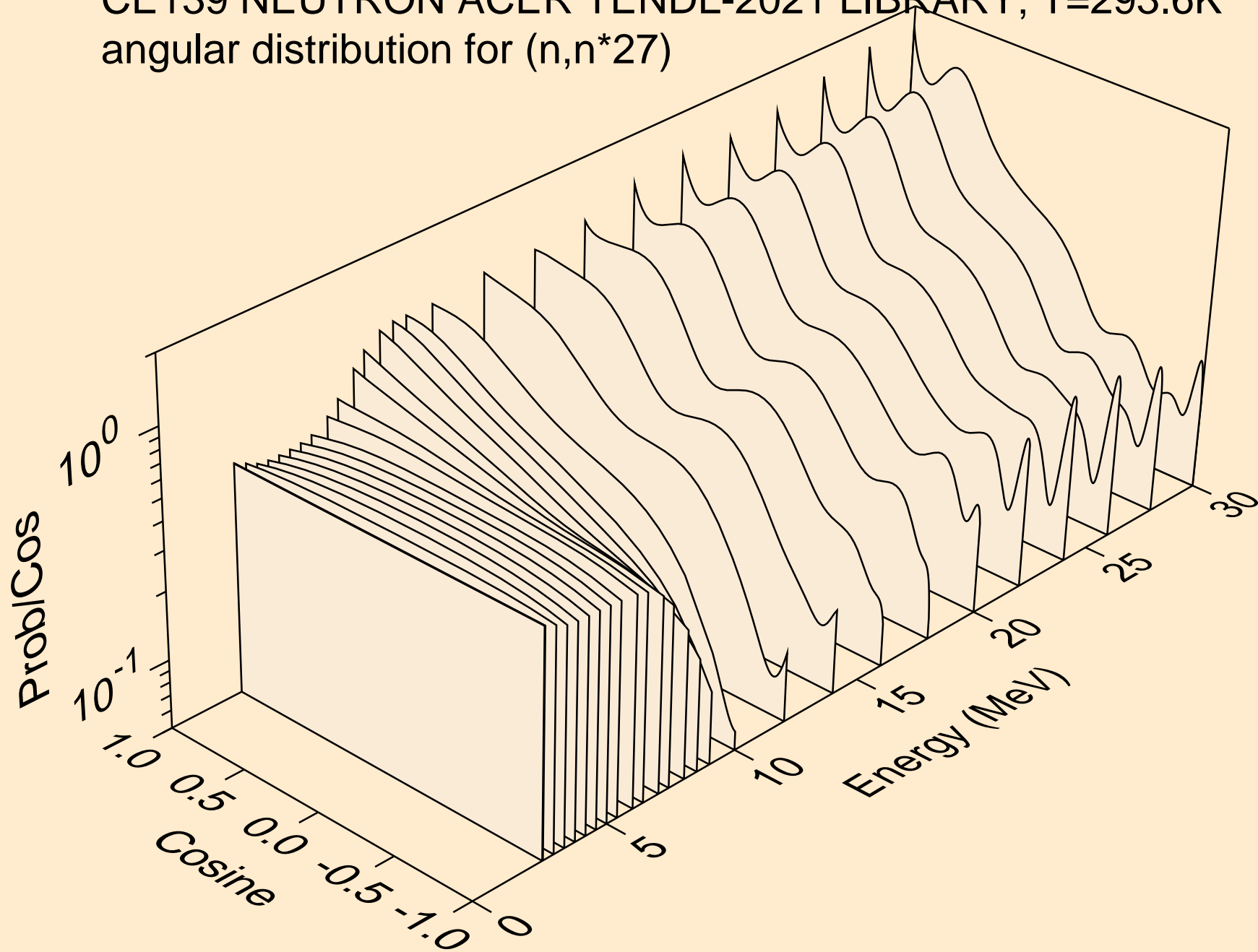

CE139 NEUTRON ACER TENDL-2021 LIBRARY; T=293.6K  
angular distribution for (n,n\*28)

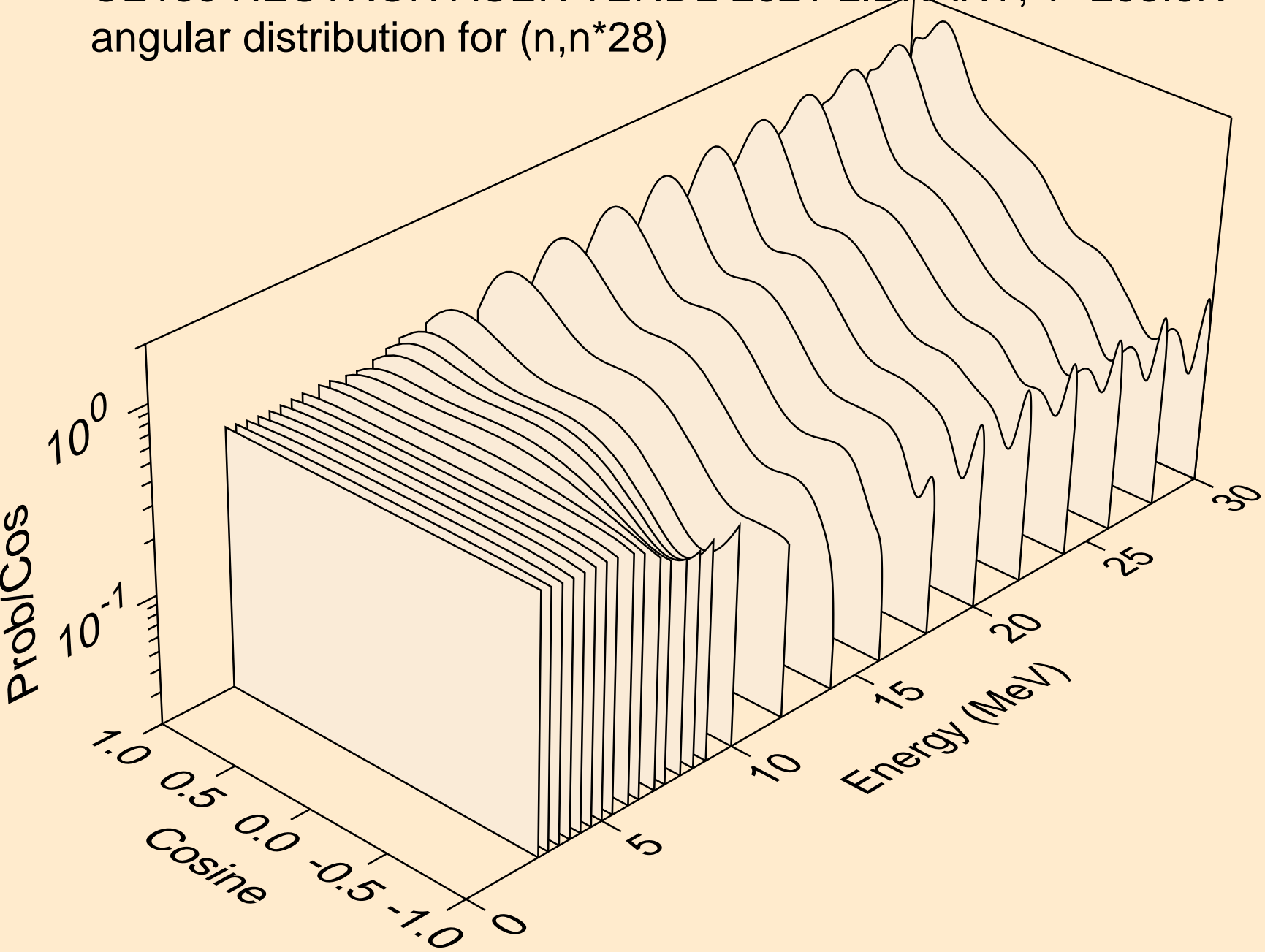

CE139 NEUTRON ACER TENDL-2021 LIBRARY; T=293.6K  
angular distribution for (n,n\*29)

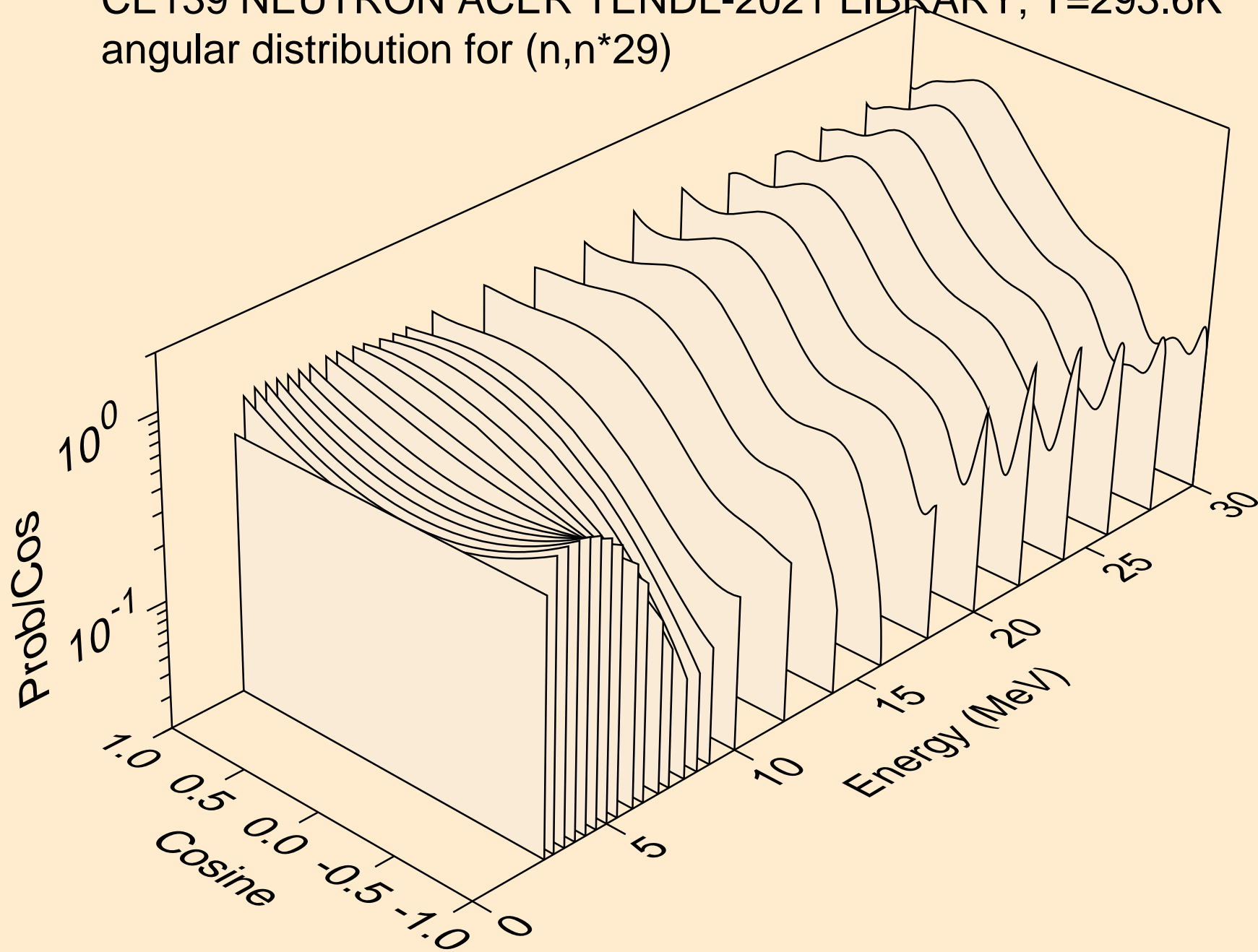

CE139 NEUTRON ACER TENDL-2021 LIBRARY; T=293.6K  
angular distribution for (n,n\*30)

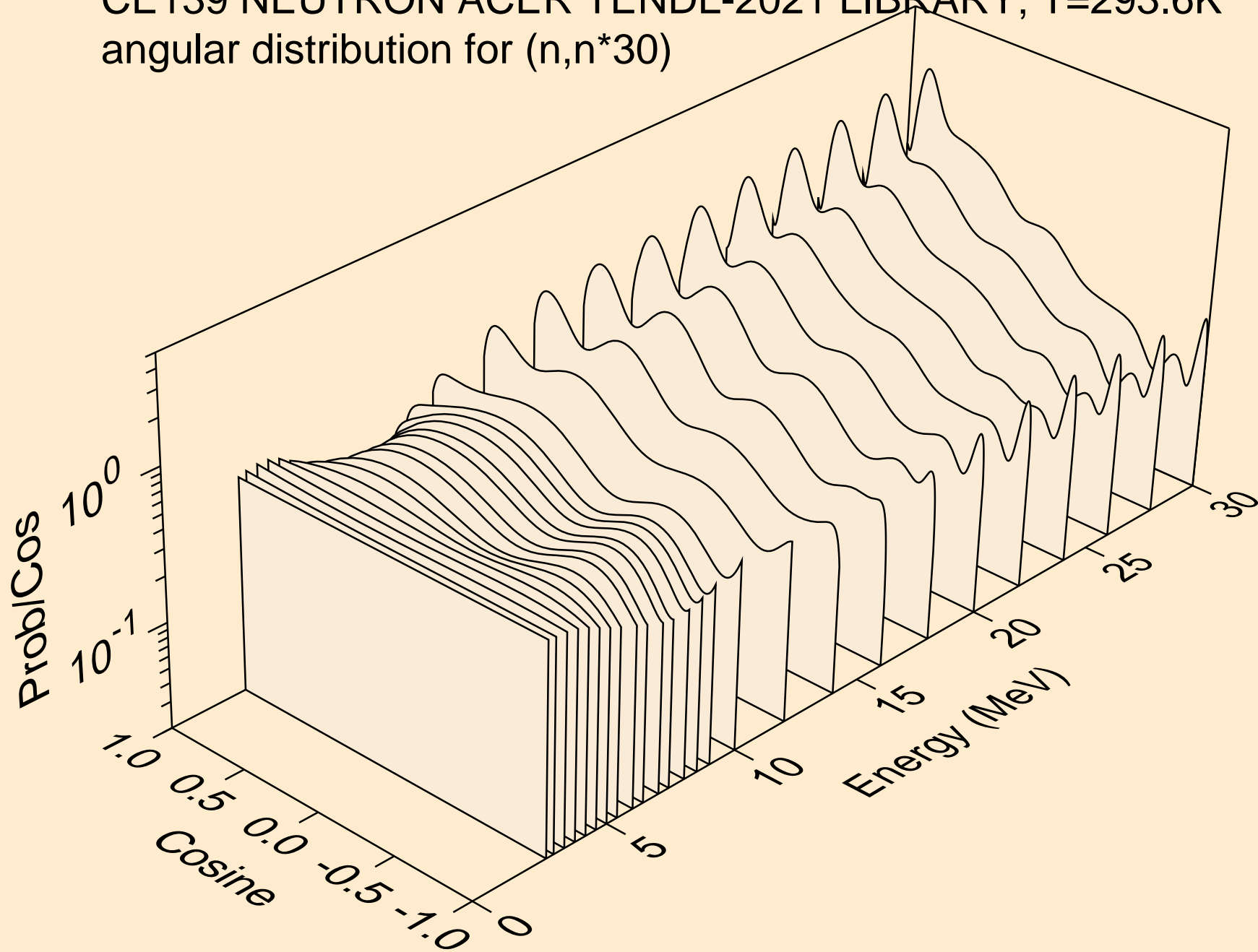

CE139 NEUTRON ACER TENDL-2021 LIBRARY; T=293.6K  
Neutron emission for (n,x)

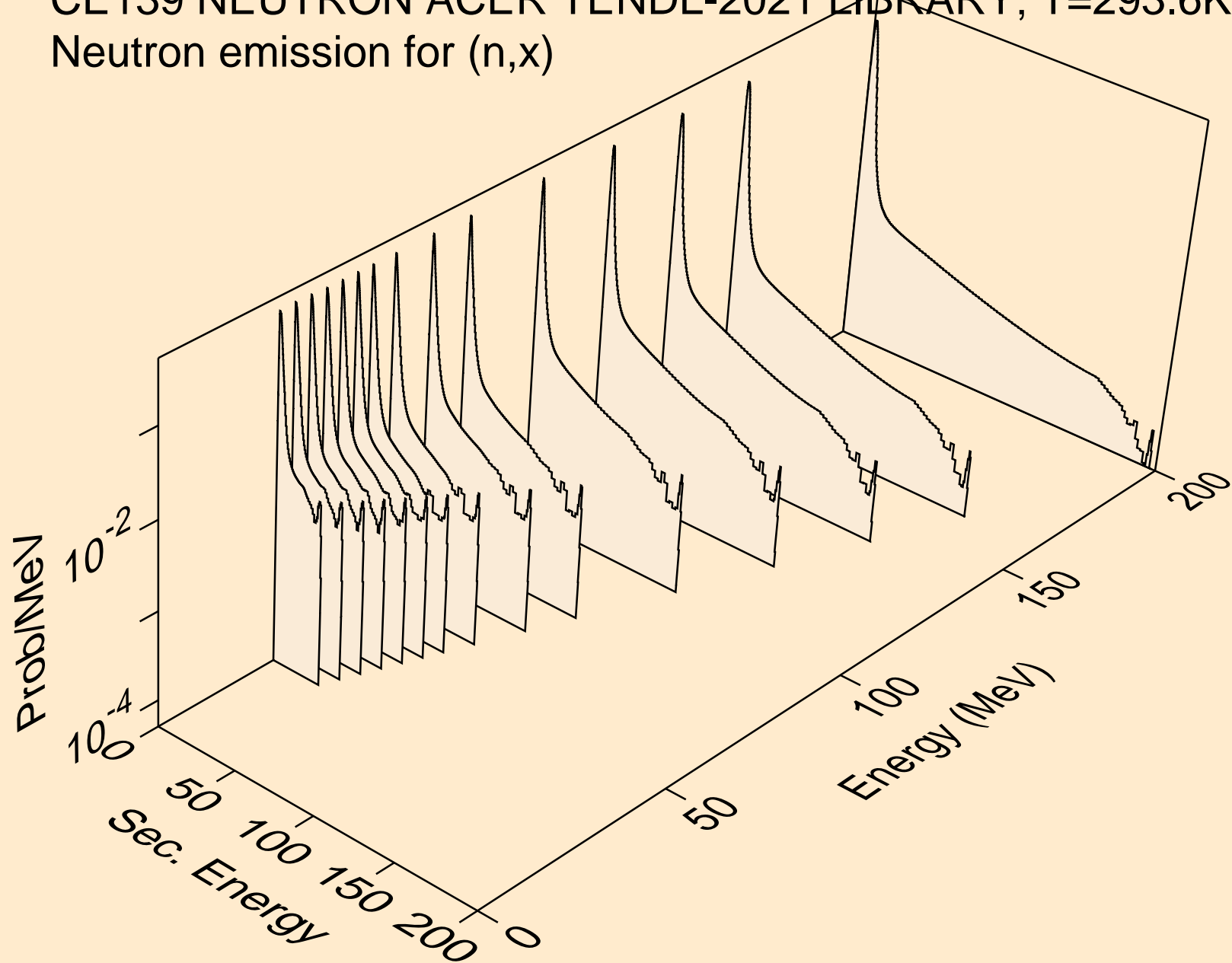

CE139 NEUTRON ACER TENDL-2021 LIBRARY; T=293.6K  
Neutron emission for (n,2nd)

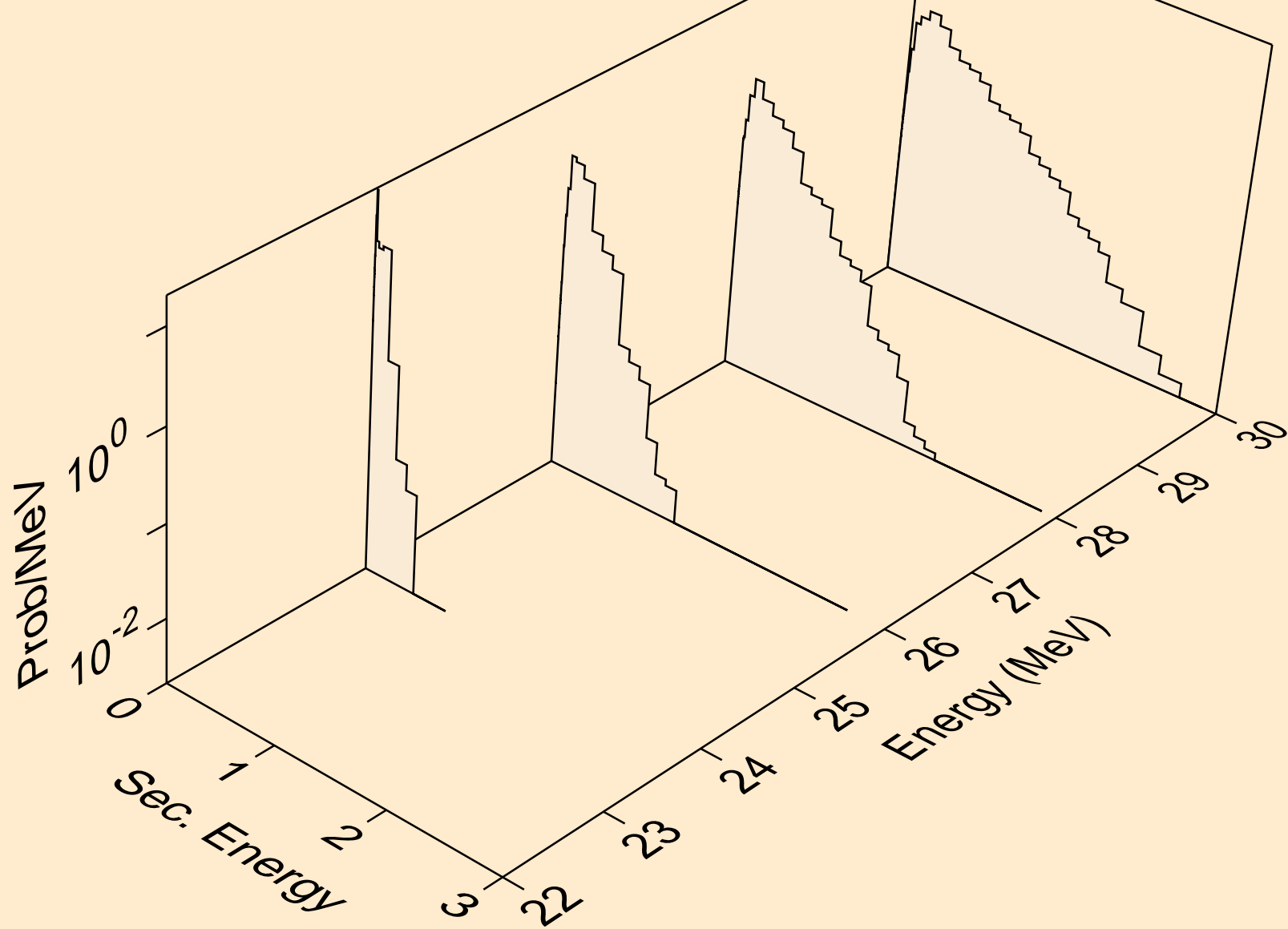

CE139 NEUTRON ACER TENDL-2021 LIBRARY; T=293.6K  
Neutron emission for (n,2n)

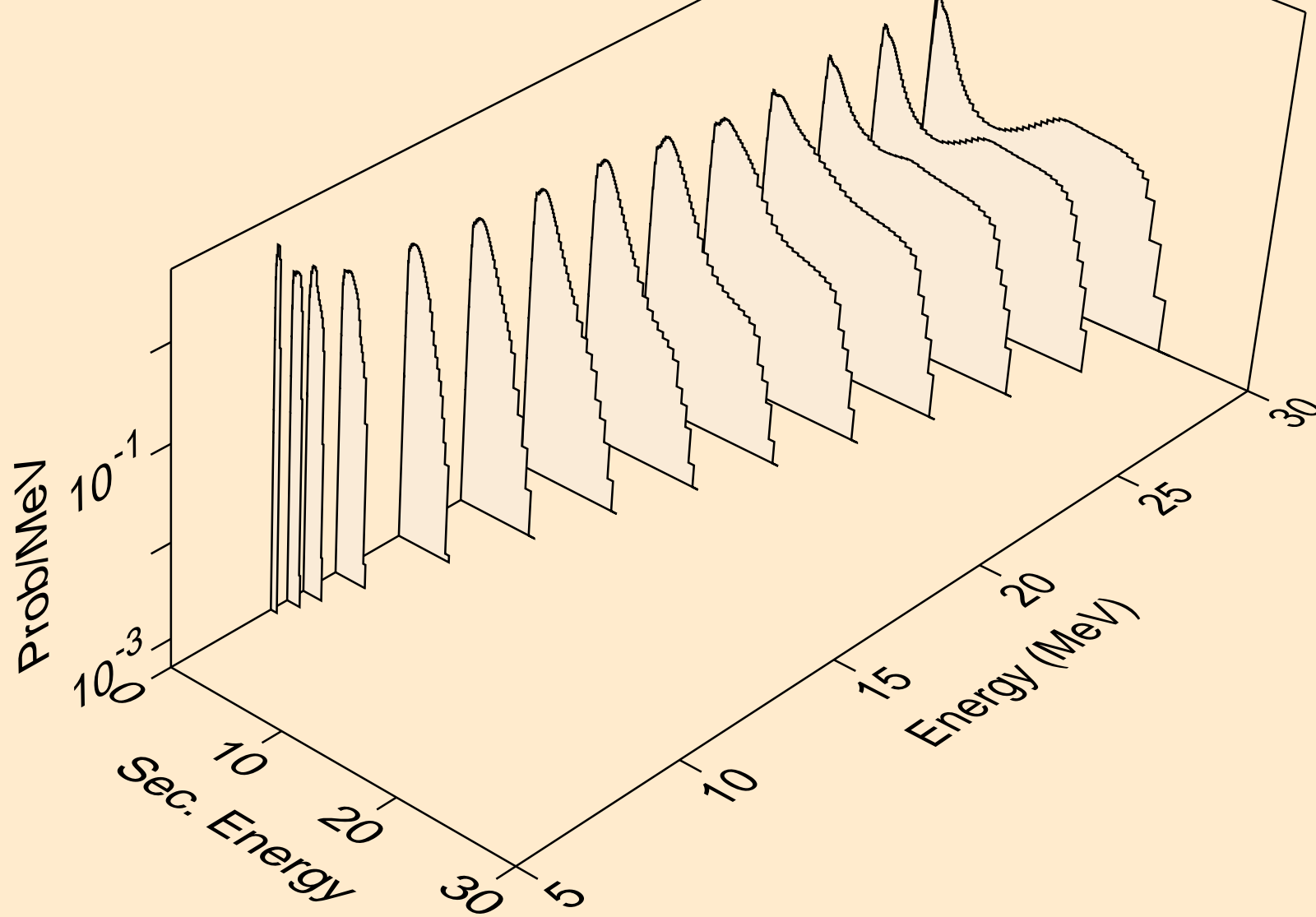



CE139 NEUTRON ACER TENDL-2021 LIBRARY; T=293.6K  
Neutron emission for (n,3n)

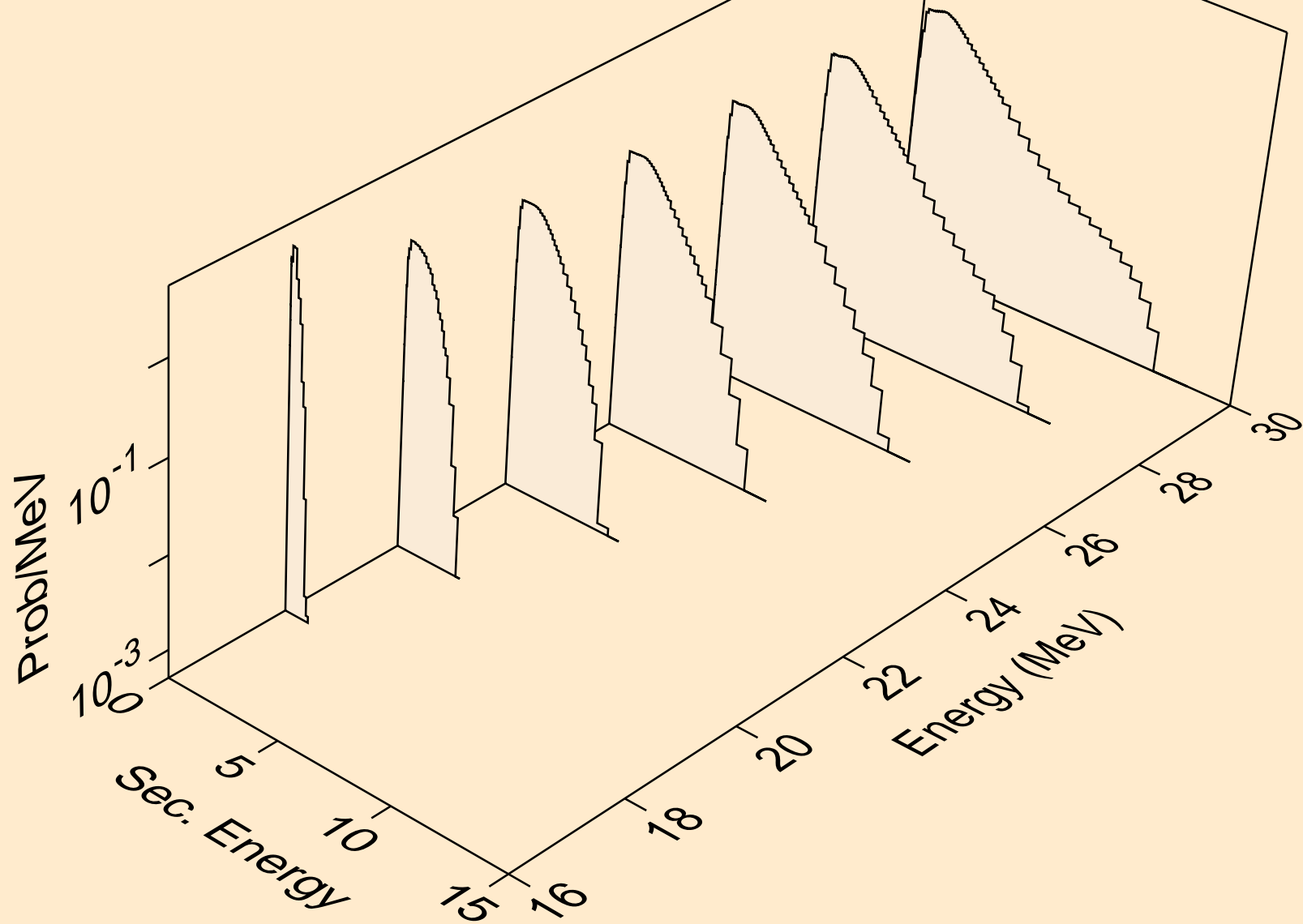

CE139 NEUTRON ACER TENDL-2021 LIBRARY; T=293.6K  
Neutron emission for (n,n\*)a

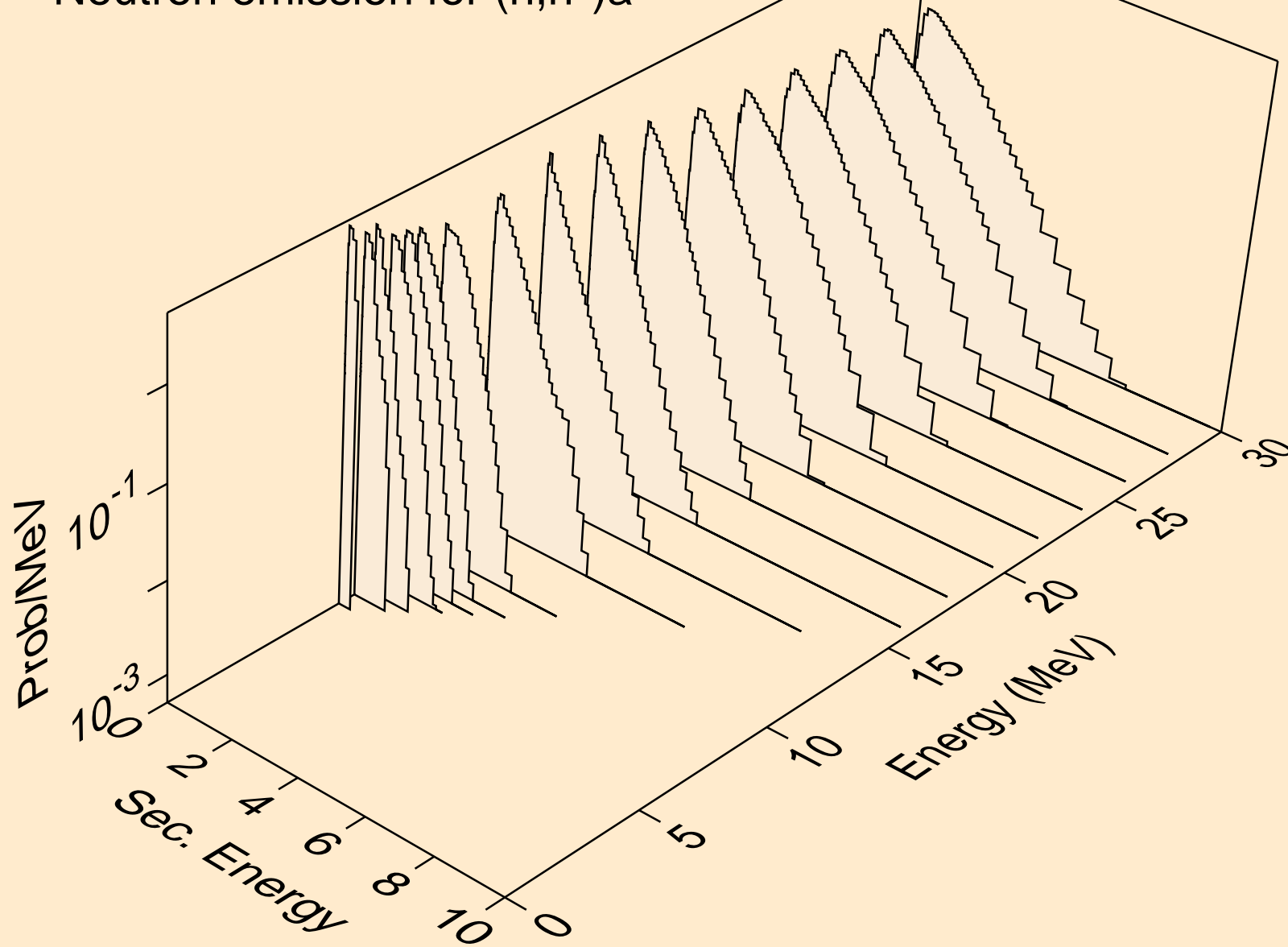

CE139 NEUTRON ACER TENDL-2021 LIBRARY; T=293.6K  
Neutron emission for (n,2n)a

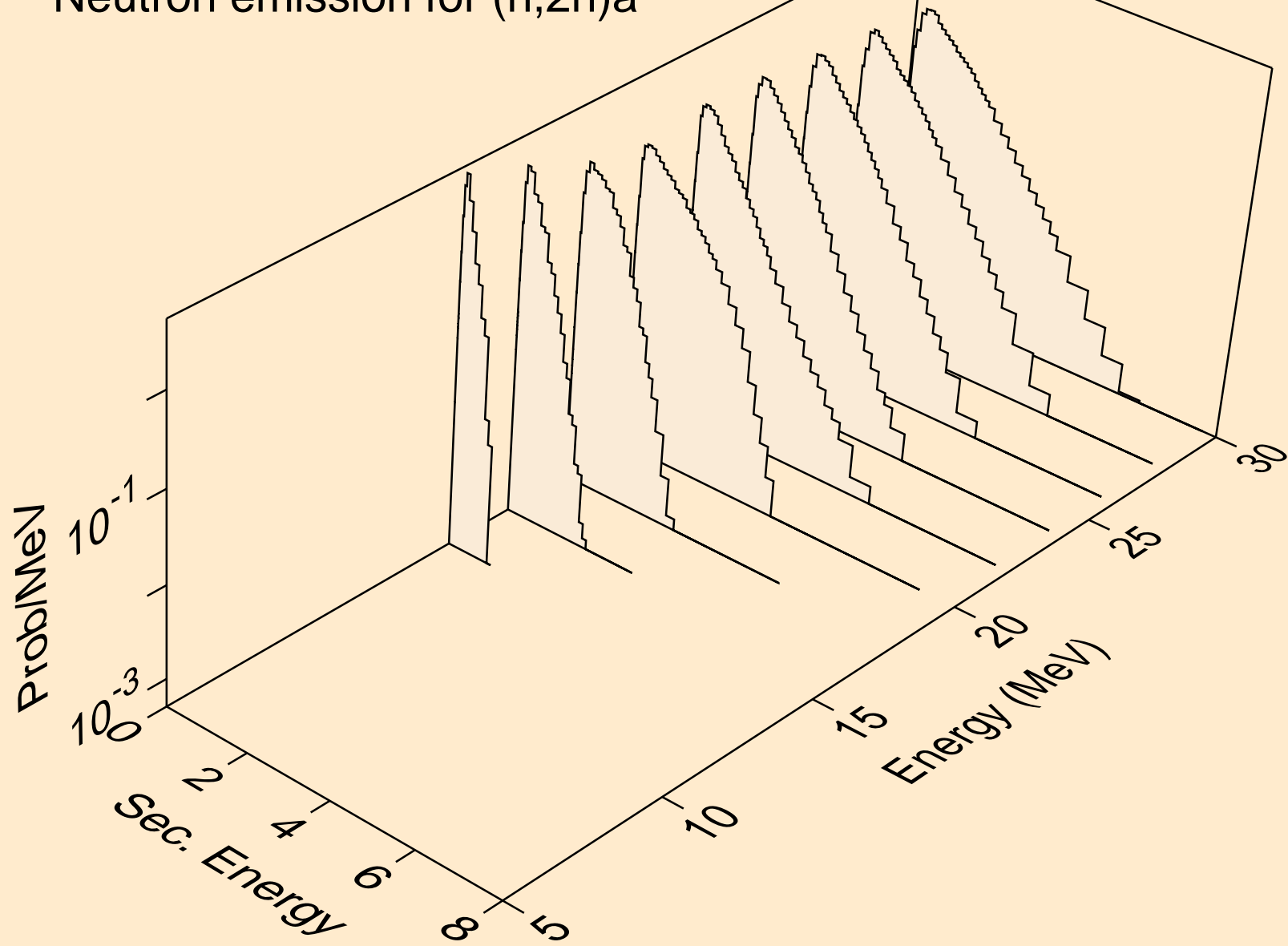

CE139 NEUTRON ACER TENDL-2021 LIBRARY; T=293.6K  
Neutron emission for (n,3n)a

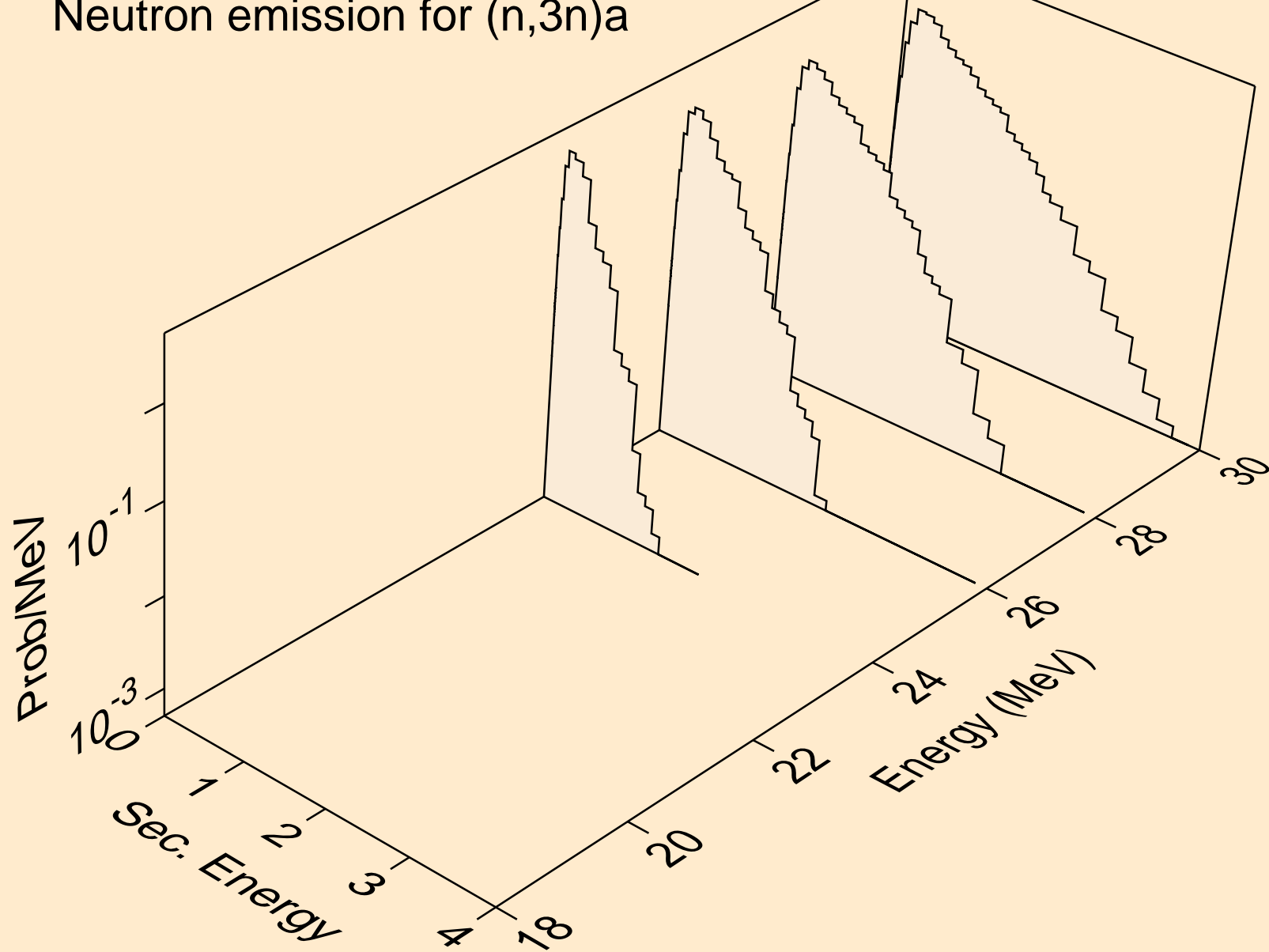

CE139 NEUTRON ACER TENDL-2021 LIBRARY; T=293.6K  
Neutron emission for (n,n\*)p

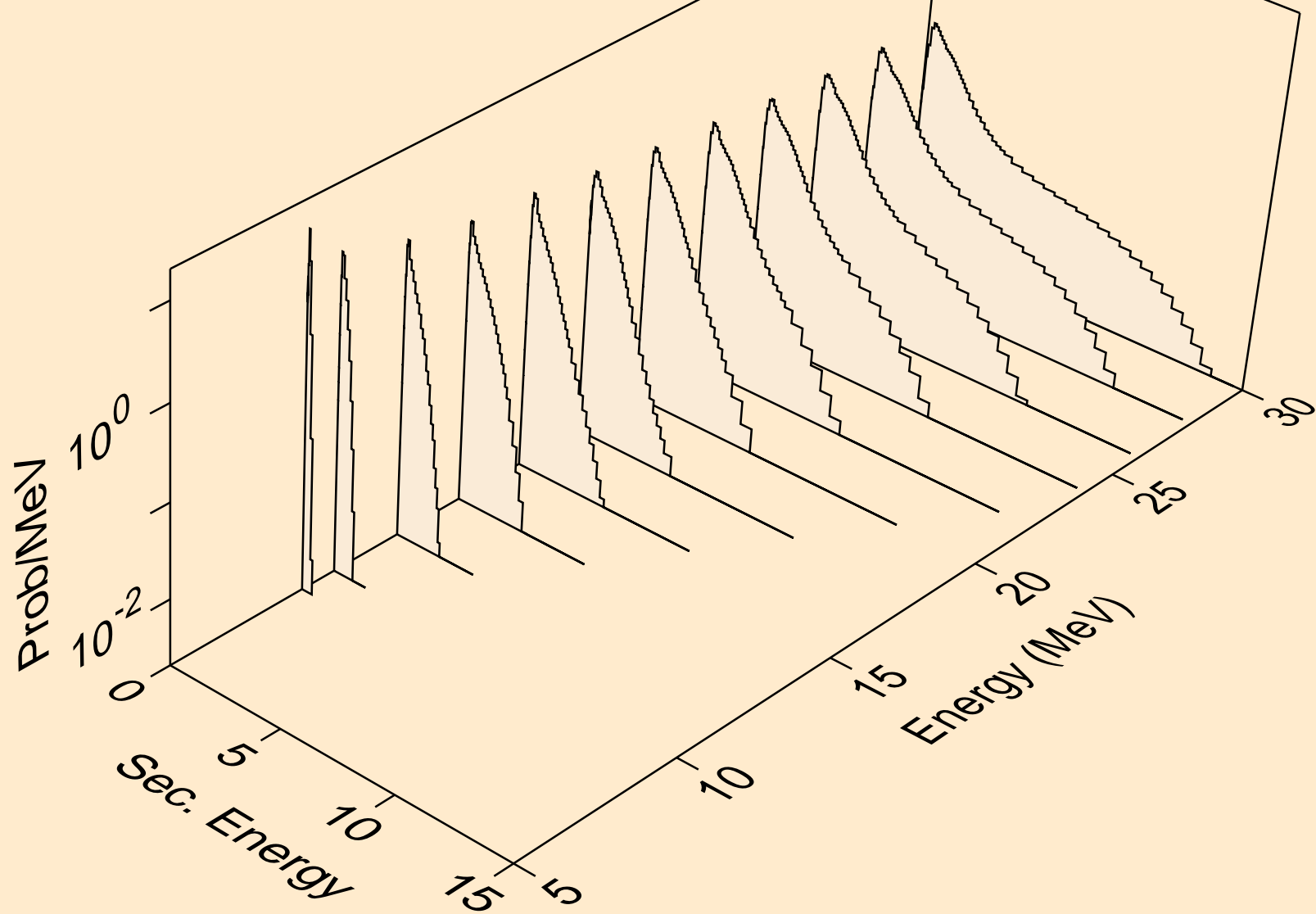

CE139 NEUTRON ACER TENDL-2021 LIBRARY; T=293.6K  
Neutron emission for (n,n\*)2a

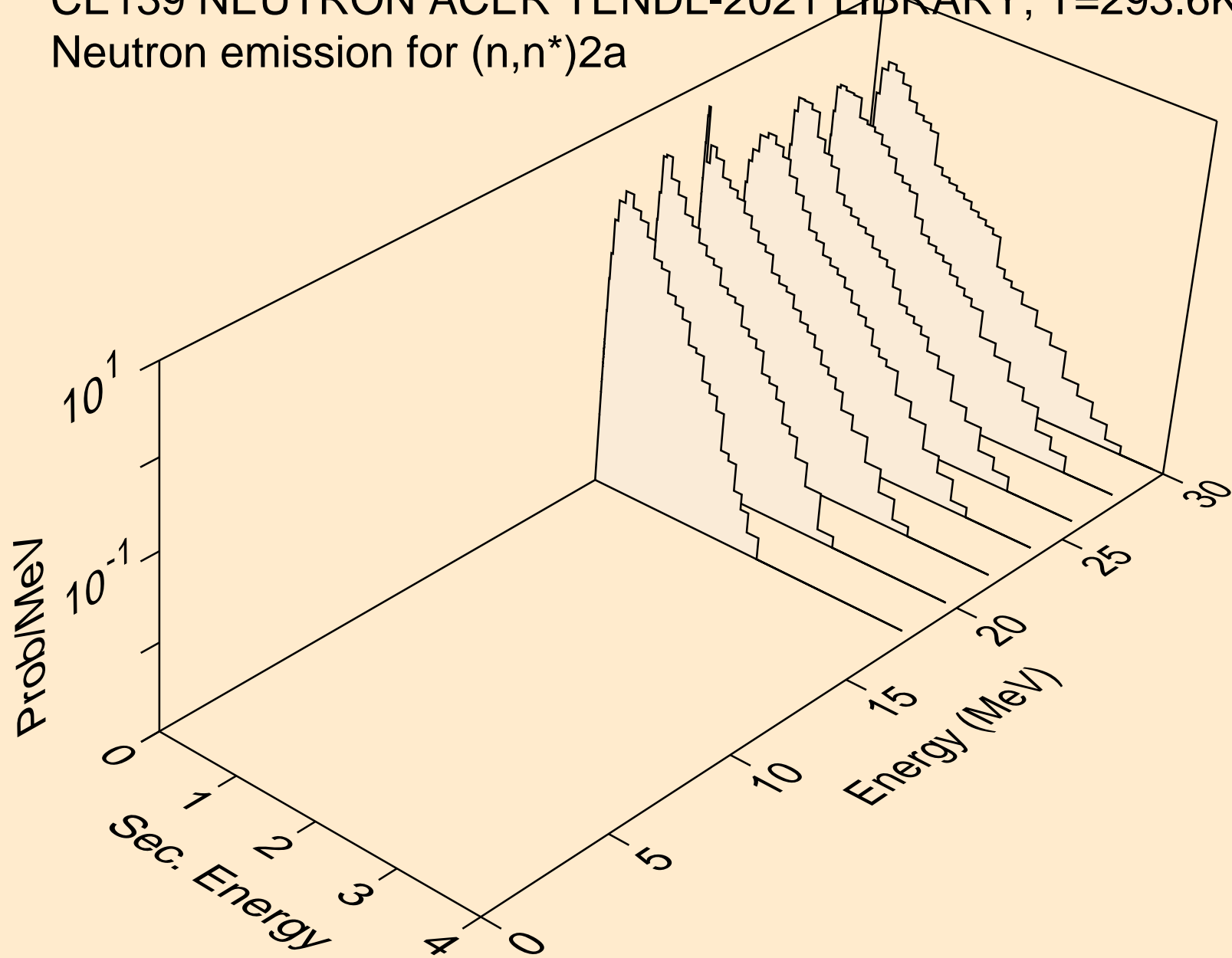

CE139 NEUTRON ACER TENDL-2021 LIBRARY; T=293.6K  
Neutron emission for (n,n\*)d

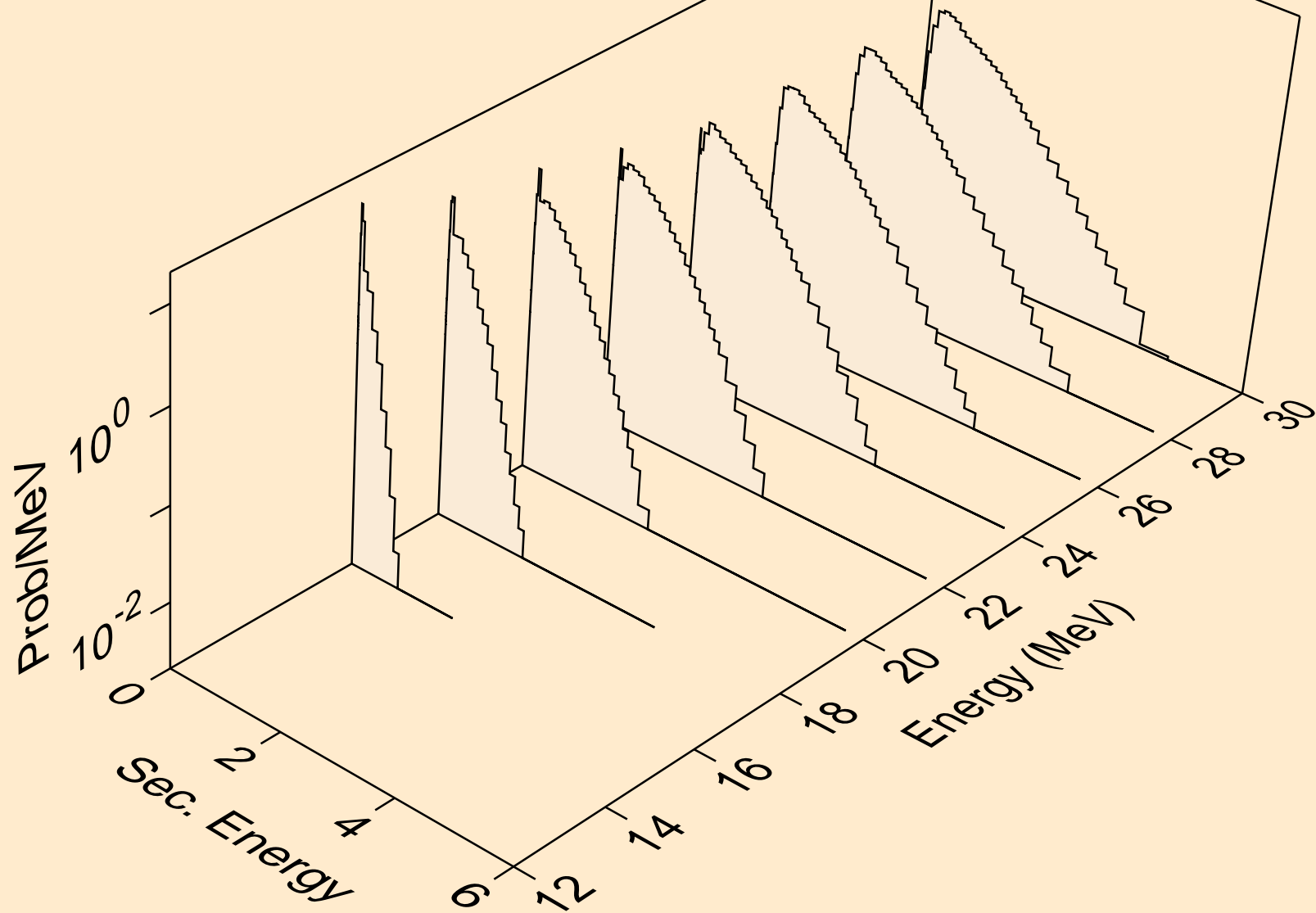

CE139 NEUTRON ACER TENDL-2021 LIBRARY; T=293.6K  
Neutron emission for (n,n\*)t

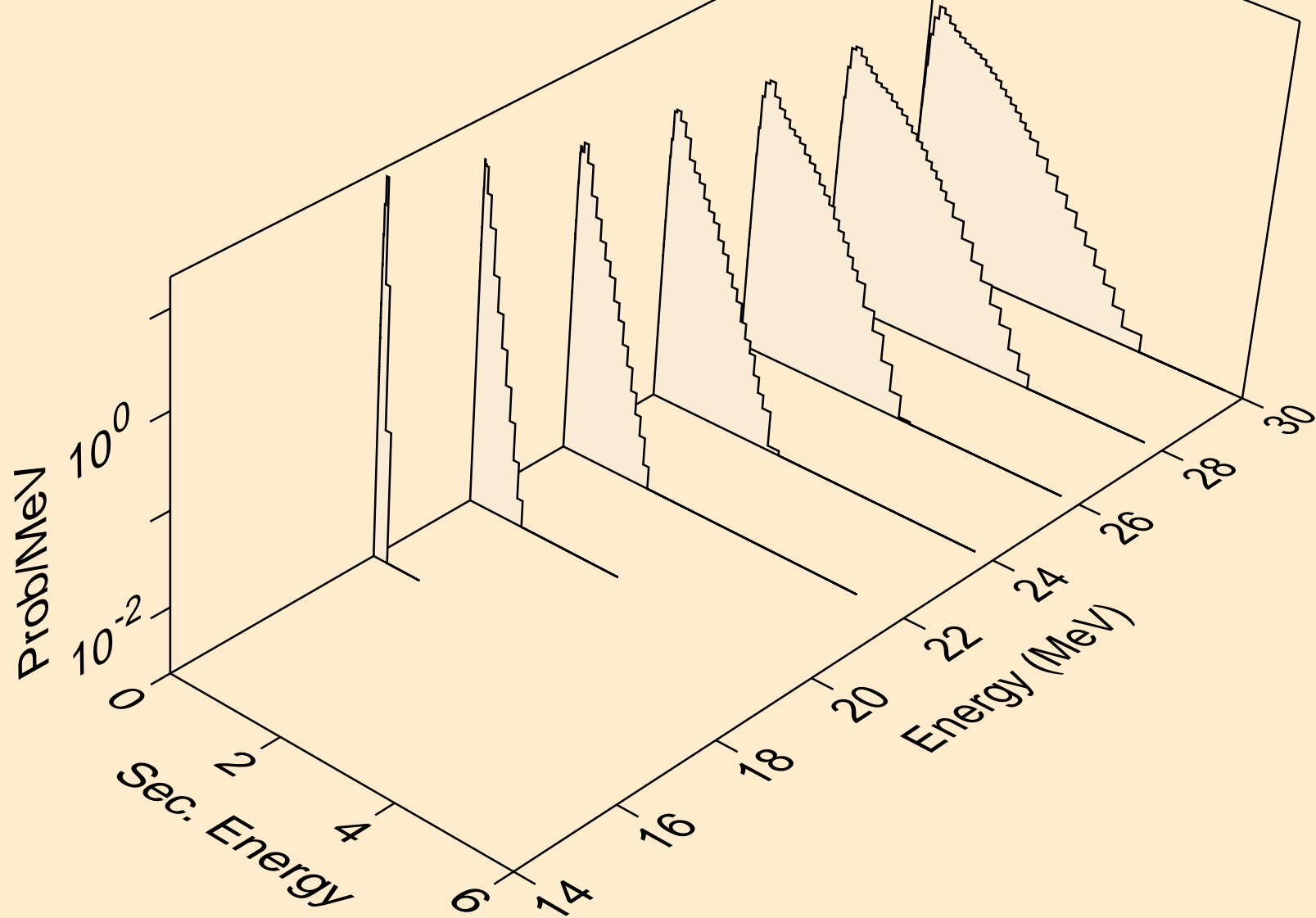



CE139 NEUTRON ACER TENDL-2021 LIBRARY; T=293.6K  
Neutron emission for (n,n\*)he3

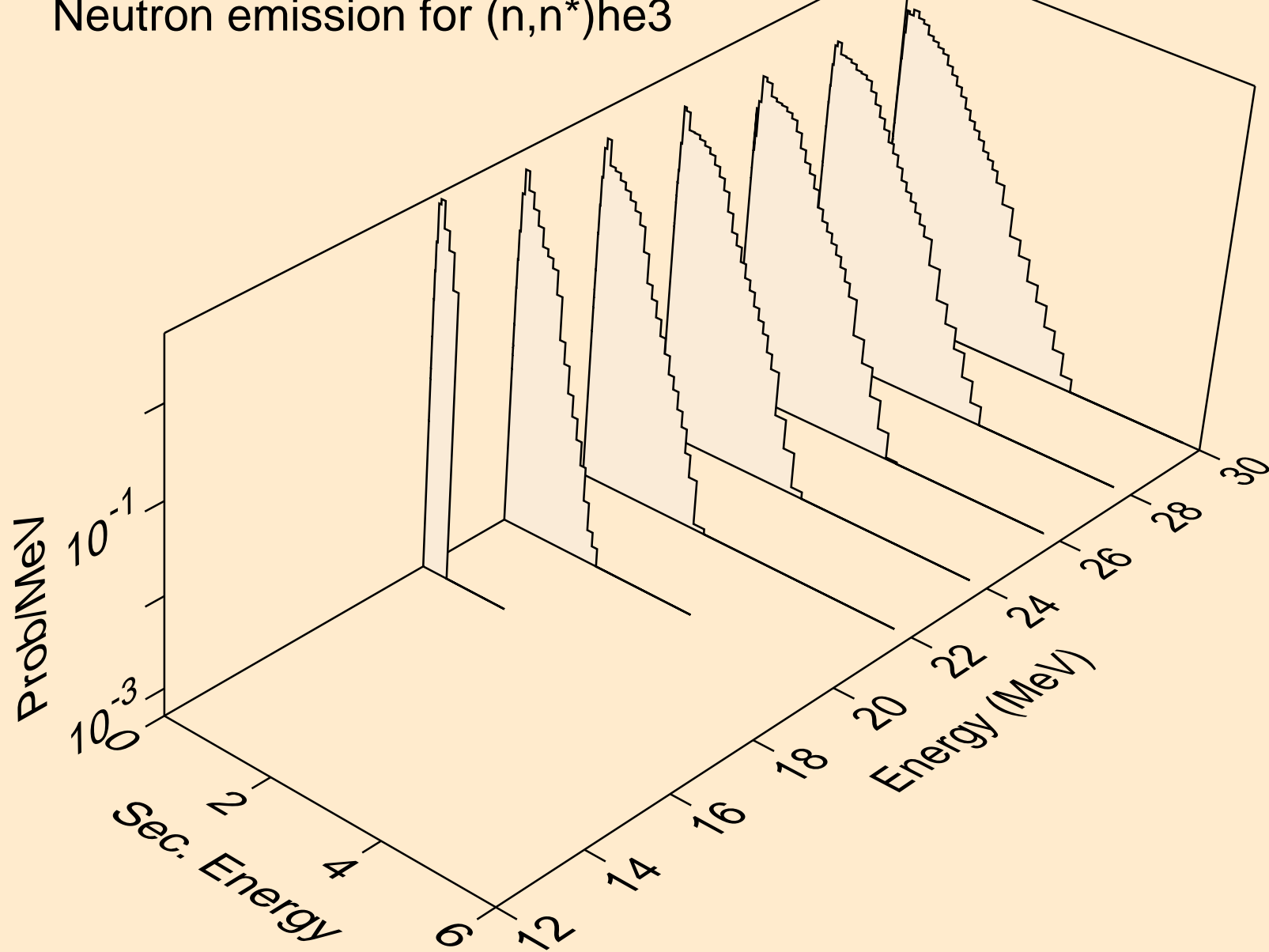

CE139 NEUTRON ACER TENDL-2021 LIBRARY; T=293.6K  
Neutron emission for (n,4n)

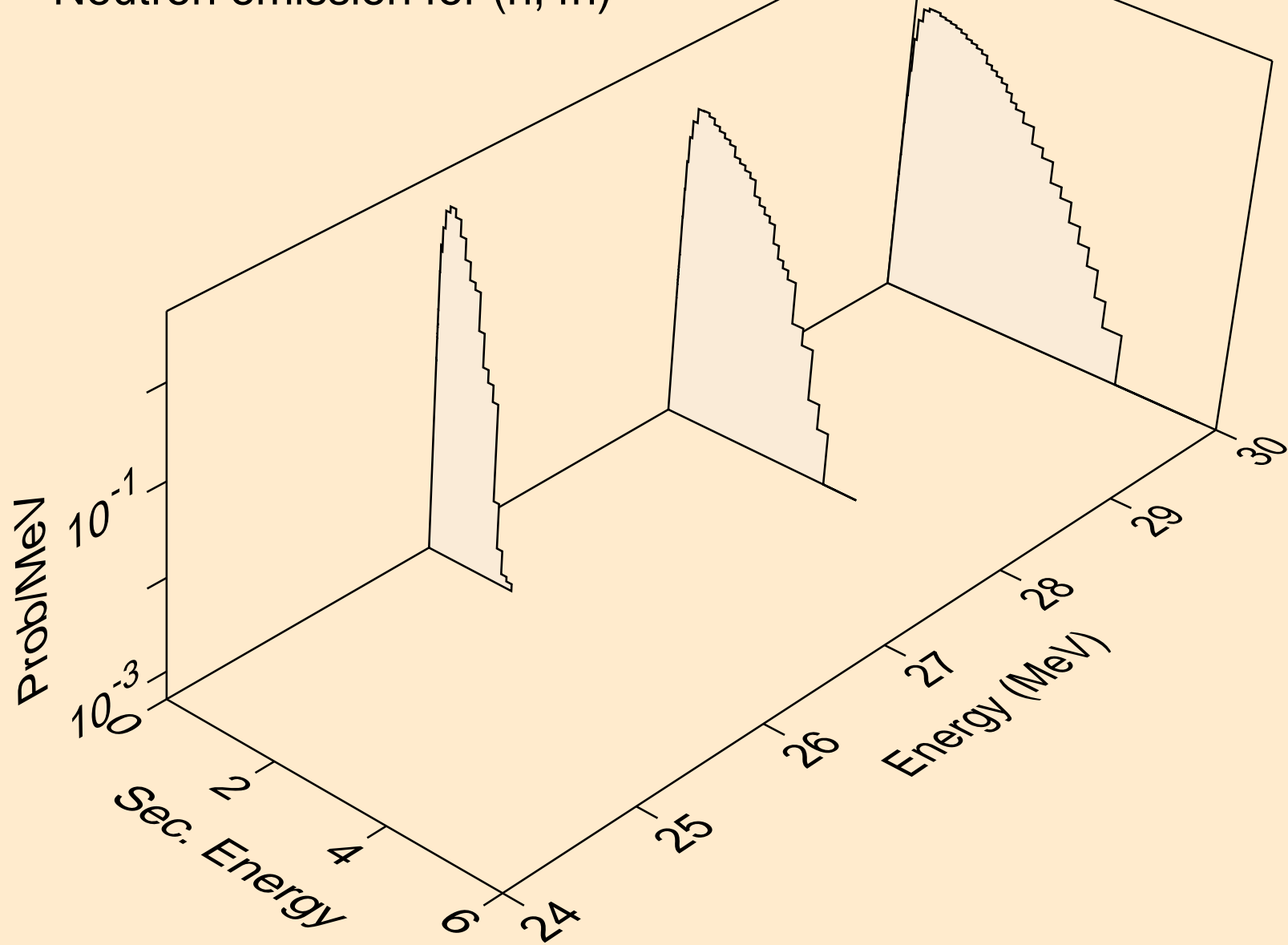

CE139 NEUTRON ACER TENDL-2021 LIBRARY; T=293.6K  
Neutron emission for (n,2np)

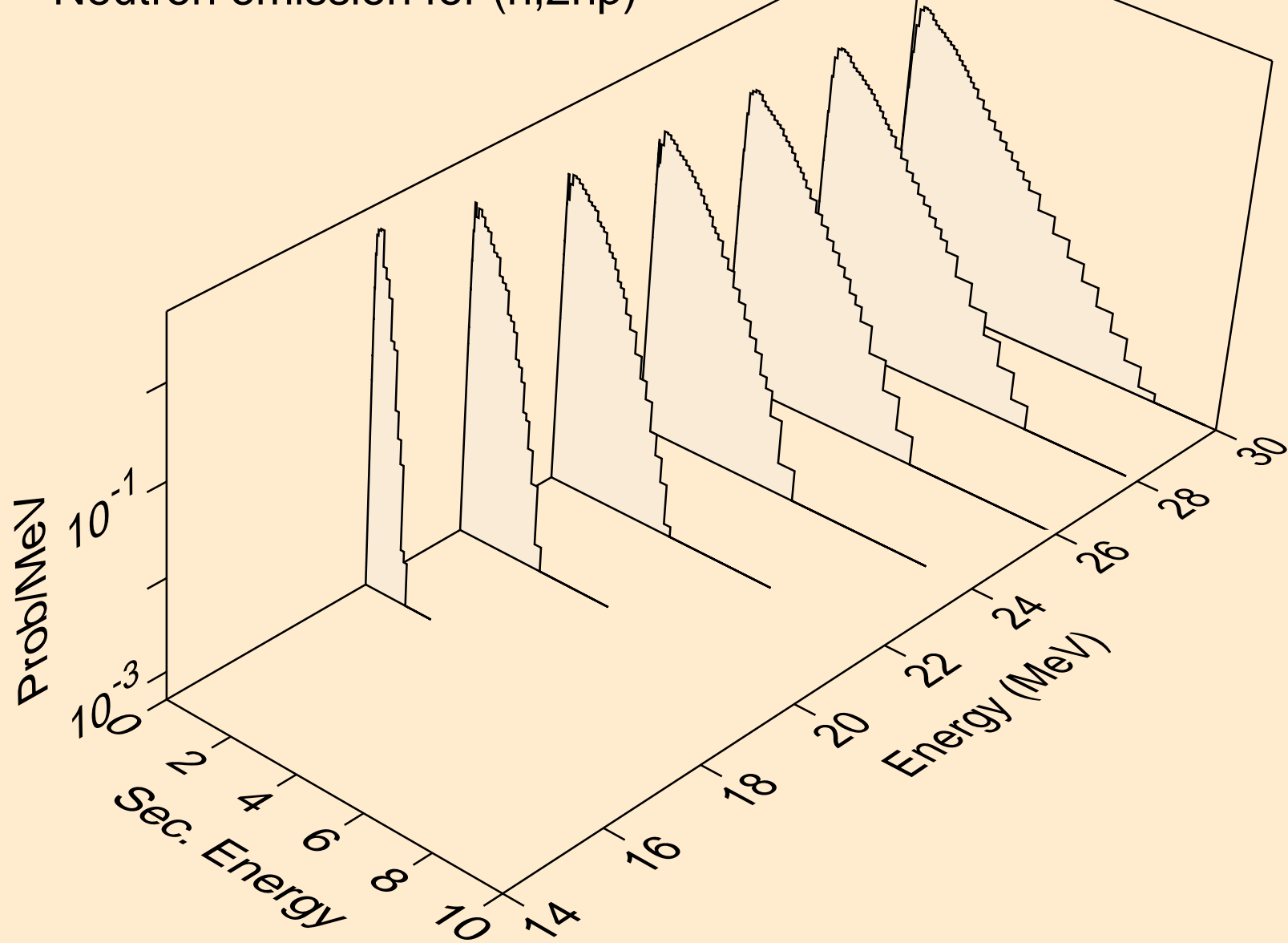

CE139 NEUTRON ACER TENDL-2021 LIBRARY; T=293.6K  
Neutron emission for (n,3np)

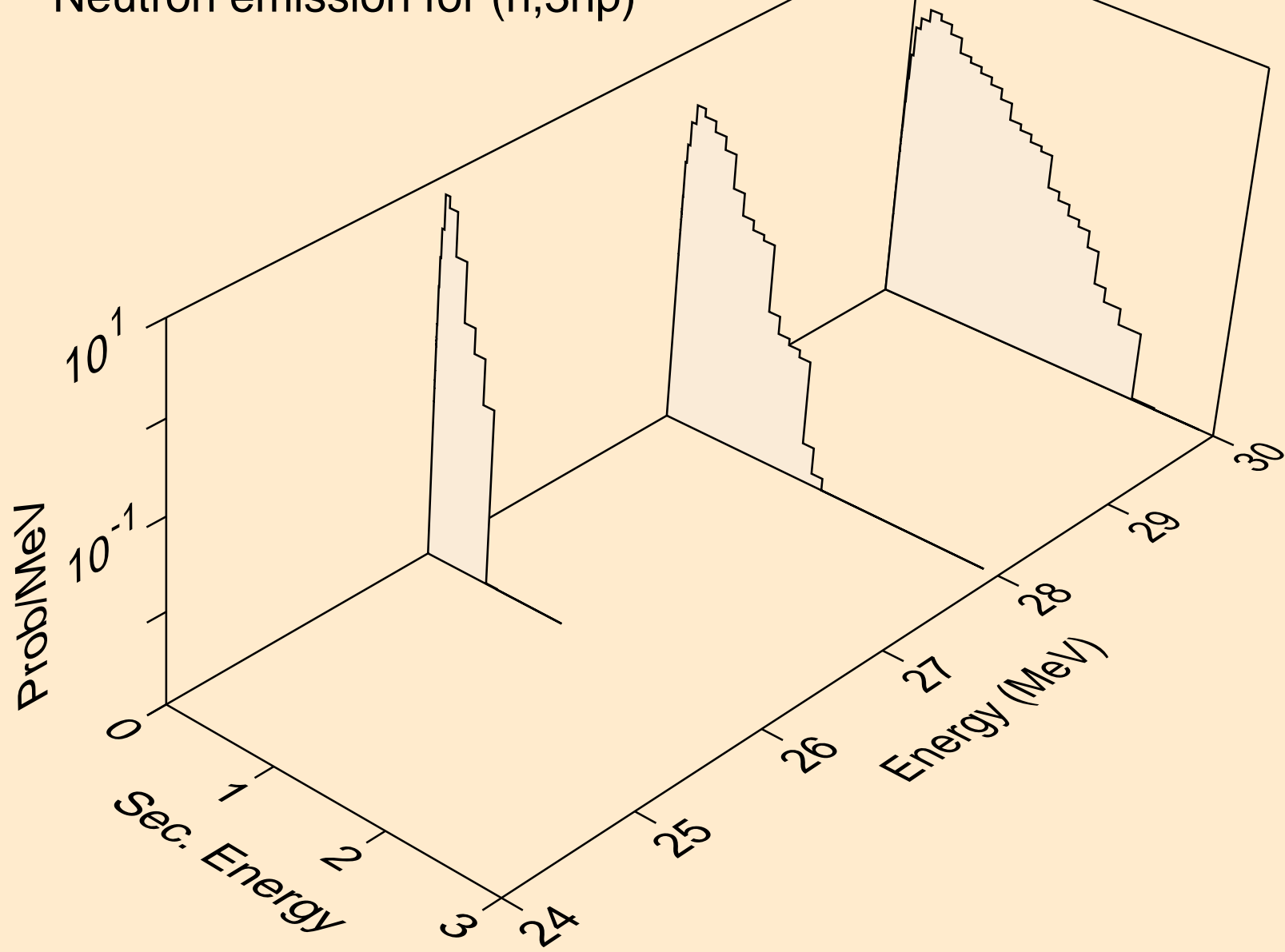

CE139 NEUTRON ACER TENDL-2021 LIBRARY; T=293.6K  
Neutron emission for (n,2np)

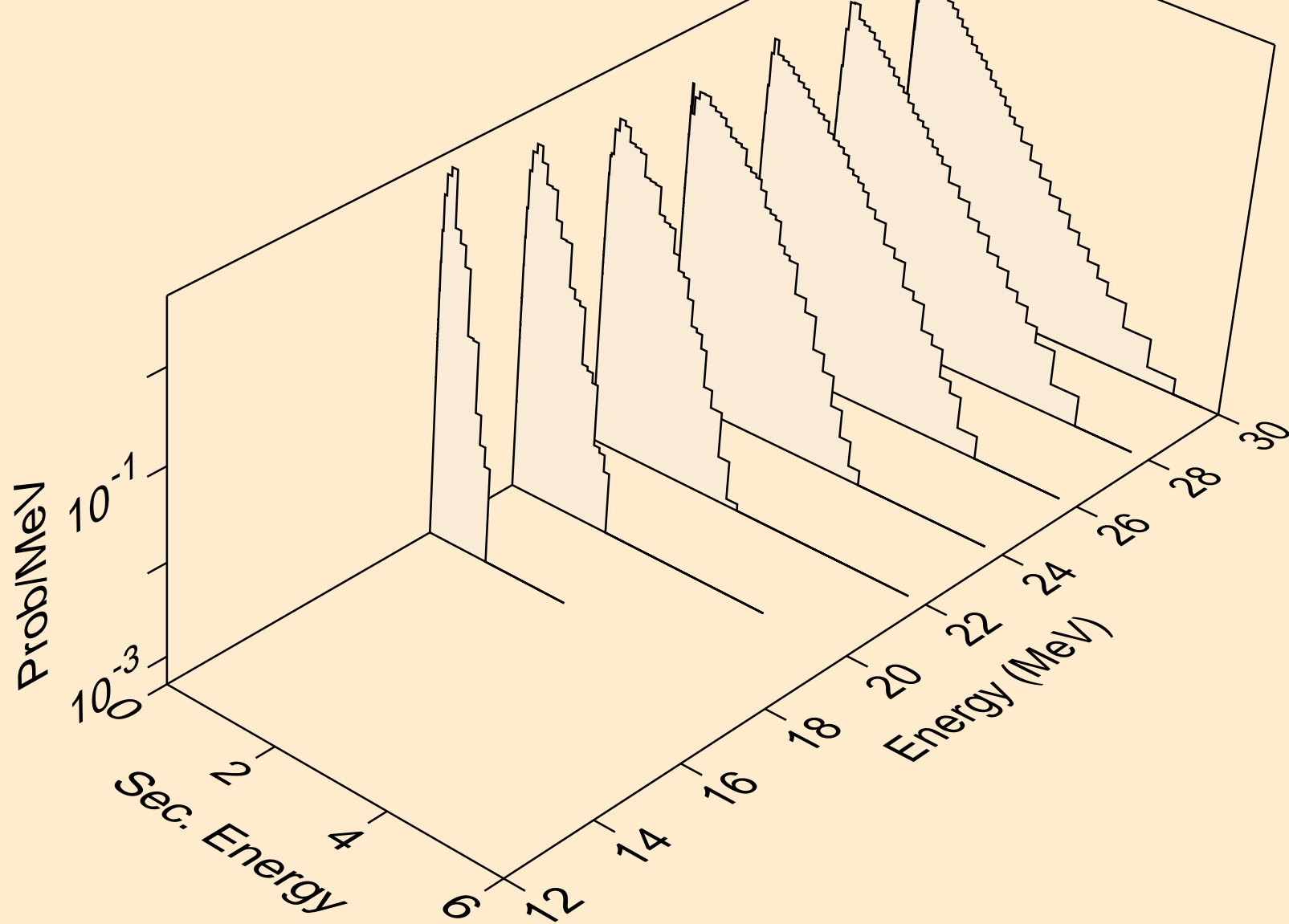

CE139 NEUTRON ACER TENDL-2021 LIBRARY; T=293.6K  
Neutron emission for (n,npa)

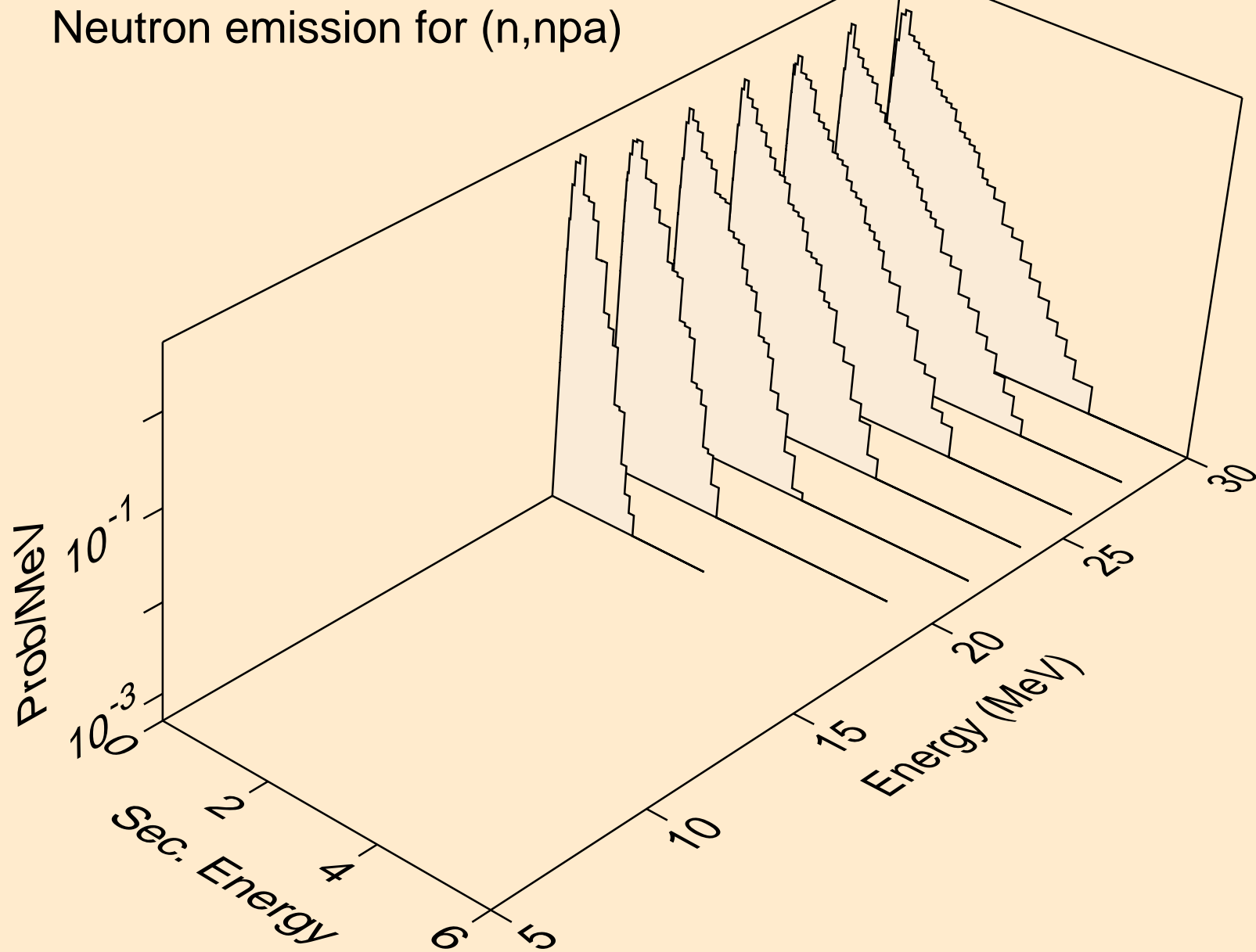

CE139 NEUTRON ACER TENDL-2021 LIBRARY; T=293.6K  
Neutron emission for (n,n\*c)

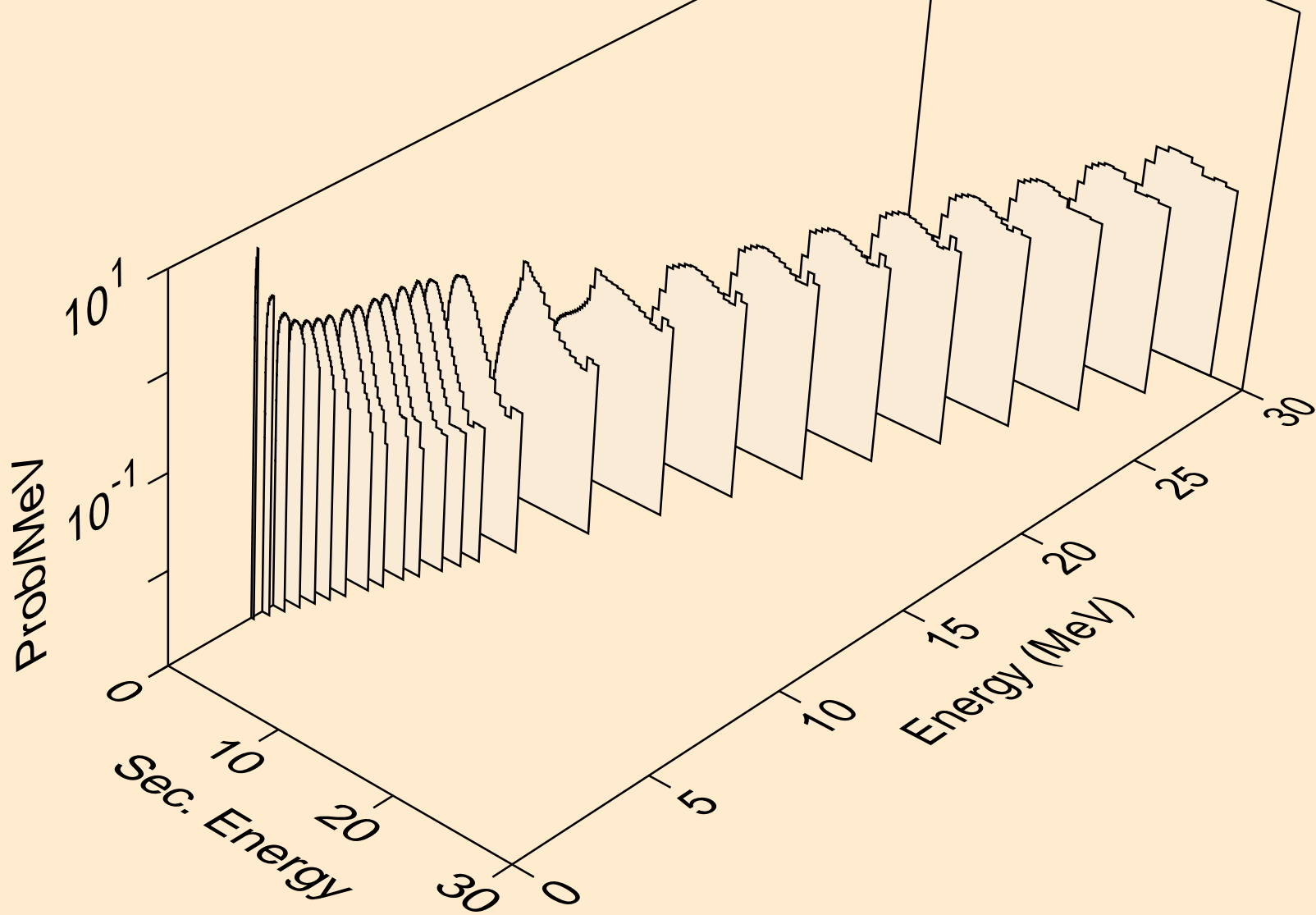

CE139 NEUTRON ACER TENDL-2021 LIBRARY; T=293.6K  
Photon emission for (n,x)

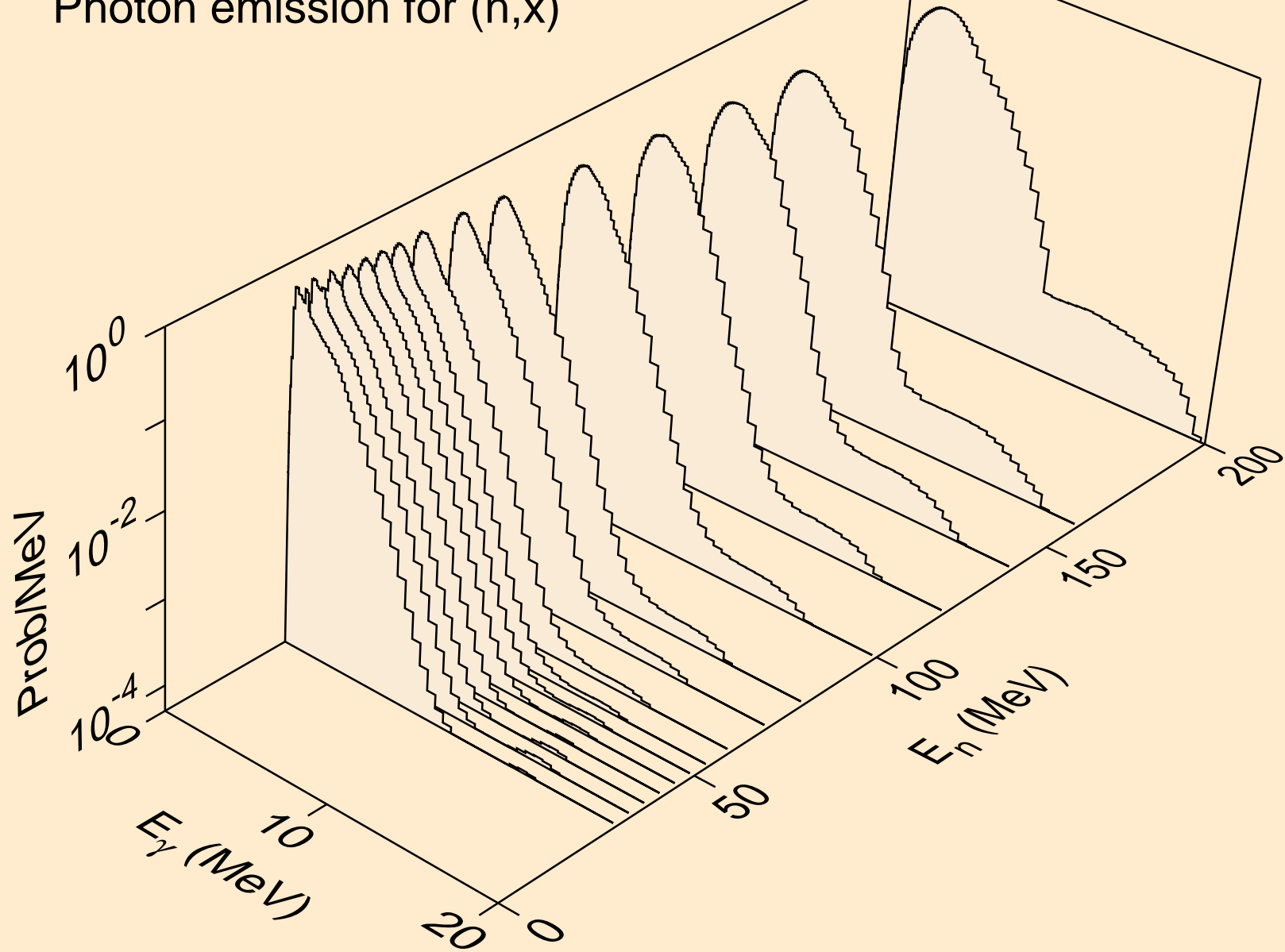



CE139 NEUTRON ACER TENDL-2021 LIBRARY; T=293.6K  
Photon emission for (n,2nd)

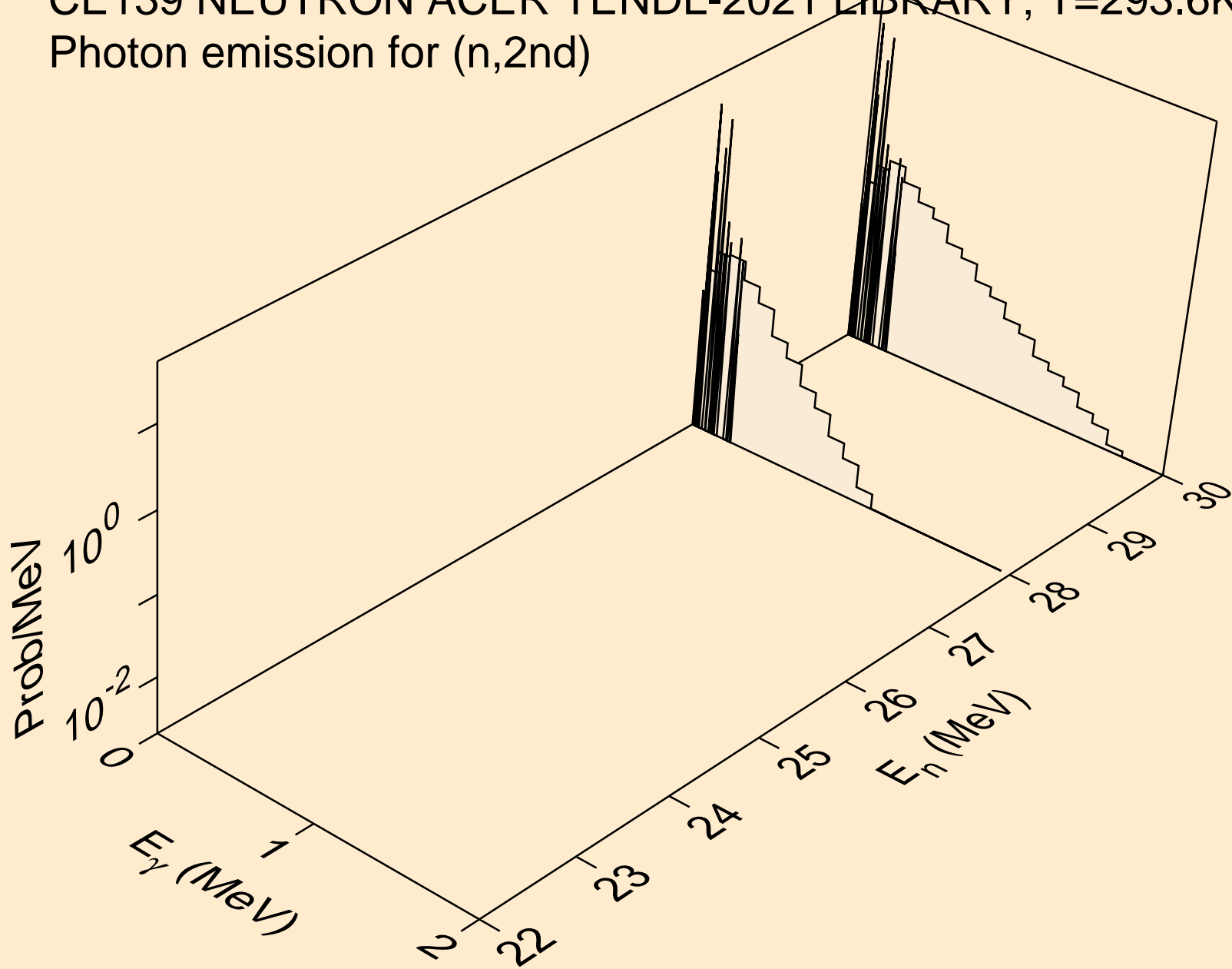

CE139 NEUTRON ACER TENDL-2021 LIBRARY; T=293.6K  
Photon emission for (n,2n)

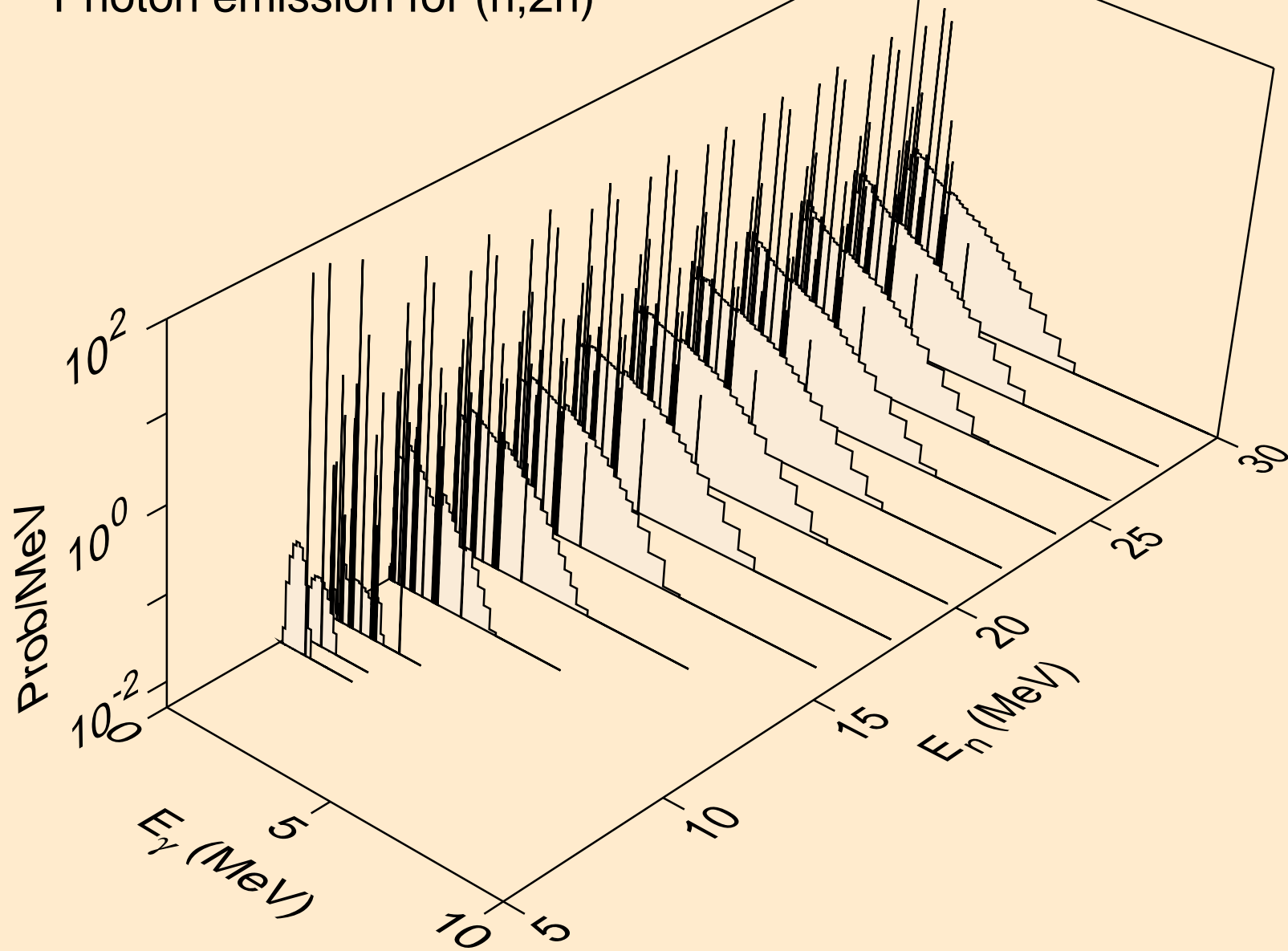

CE139 NEUTRON ACER TENDL-2021 LIBRARY; T=293.6K  
Photon emission for (n,3n)

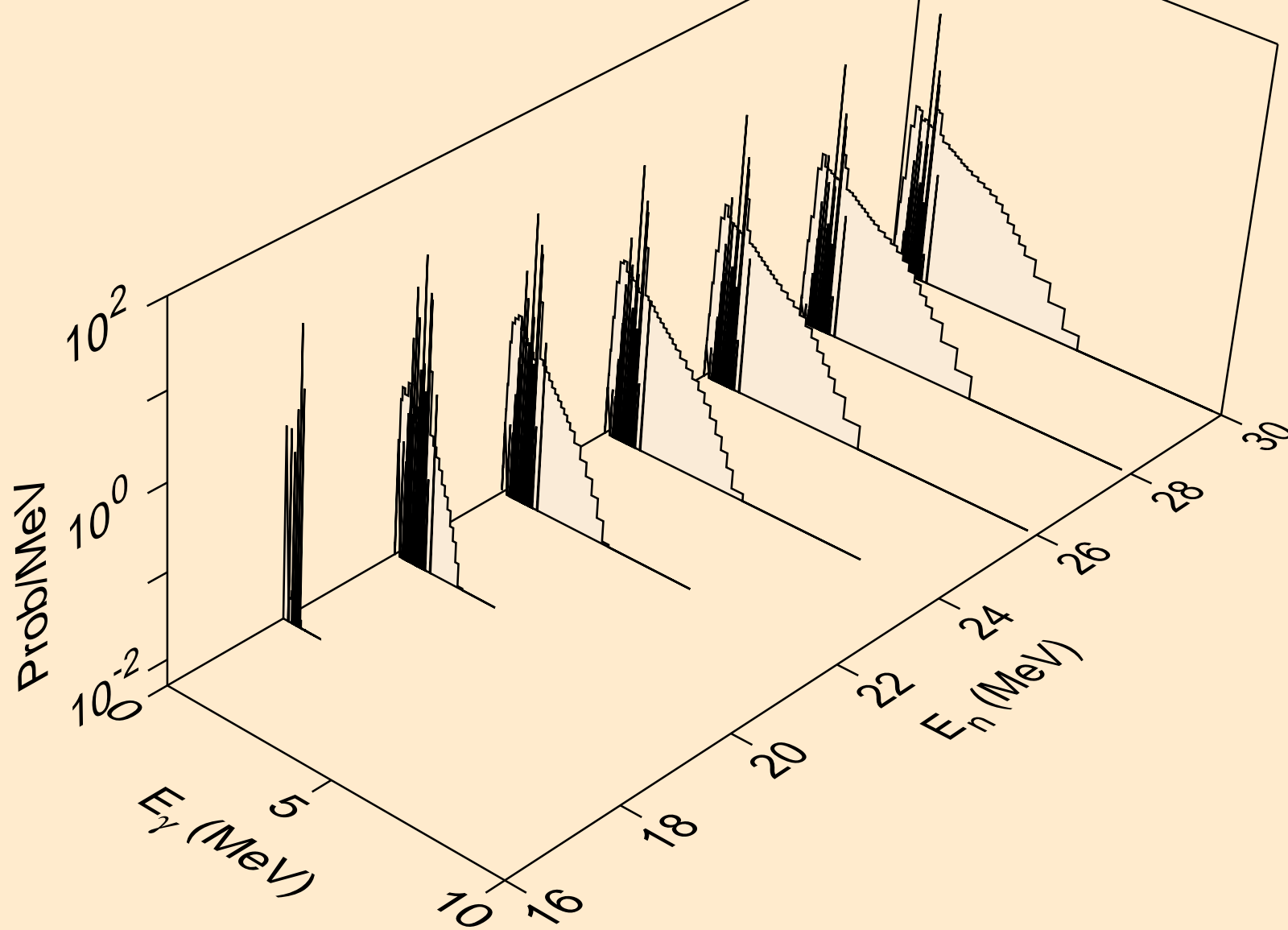

CE139 NEUTRON ACER TENDL-2021 LIBRARY; T=293.6K  
Photon emission for (n,n\*)a

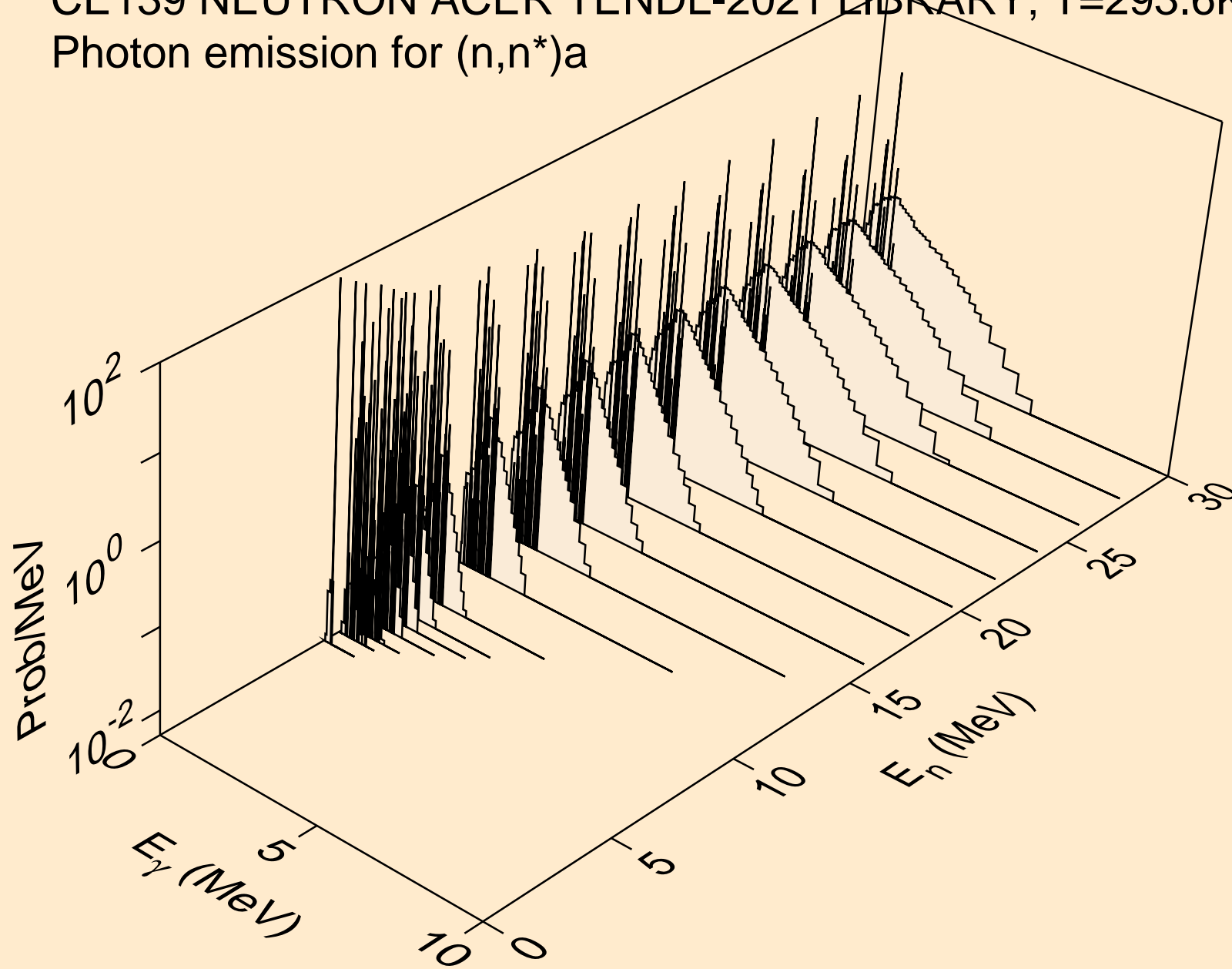

CE139 NEUTRON ACER TENDL-2021 LIBRARY; T=293.6K  
Photon emission for (n,2n)a

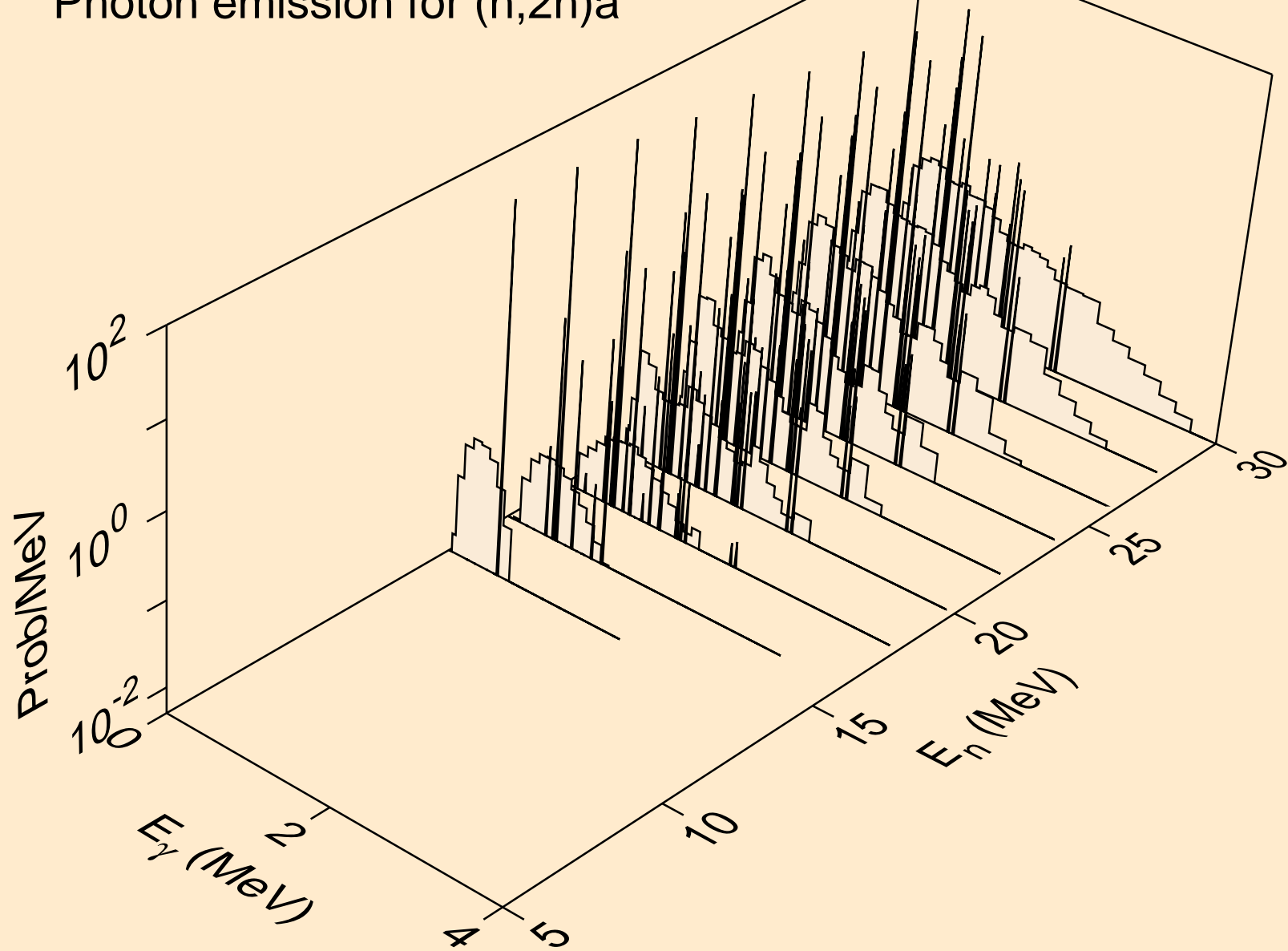

CE139 NEUTRON ACER TENDL-2021 LIBRARY; T=293.6K  
Photon emission for (n,3n)a

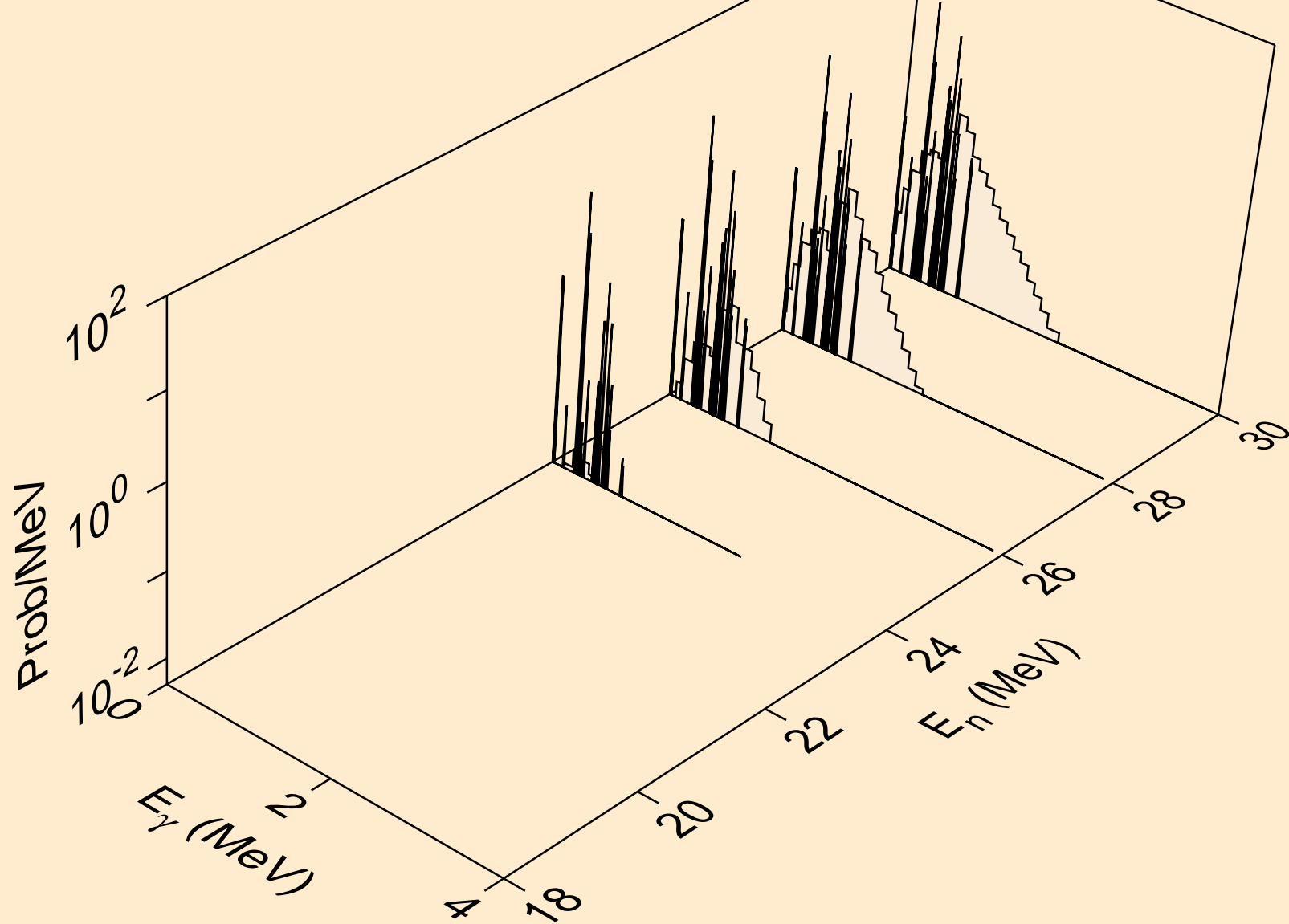

CE139 NEUTRON ACER TENDL-2021 LIBRARY; T=293.6K  
Photon emission for (n,n\*)p

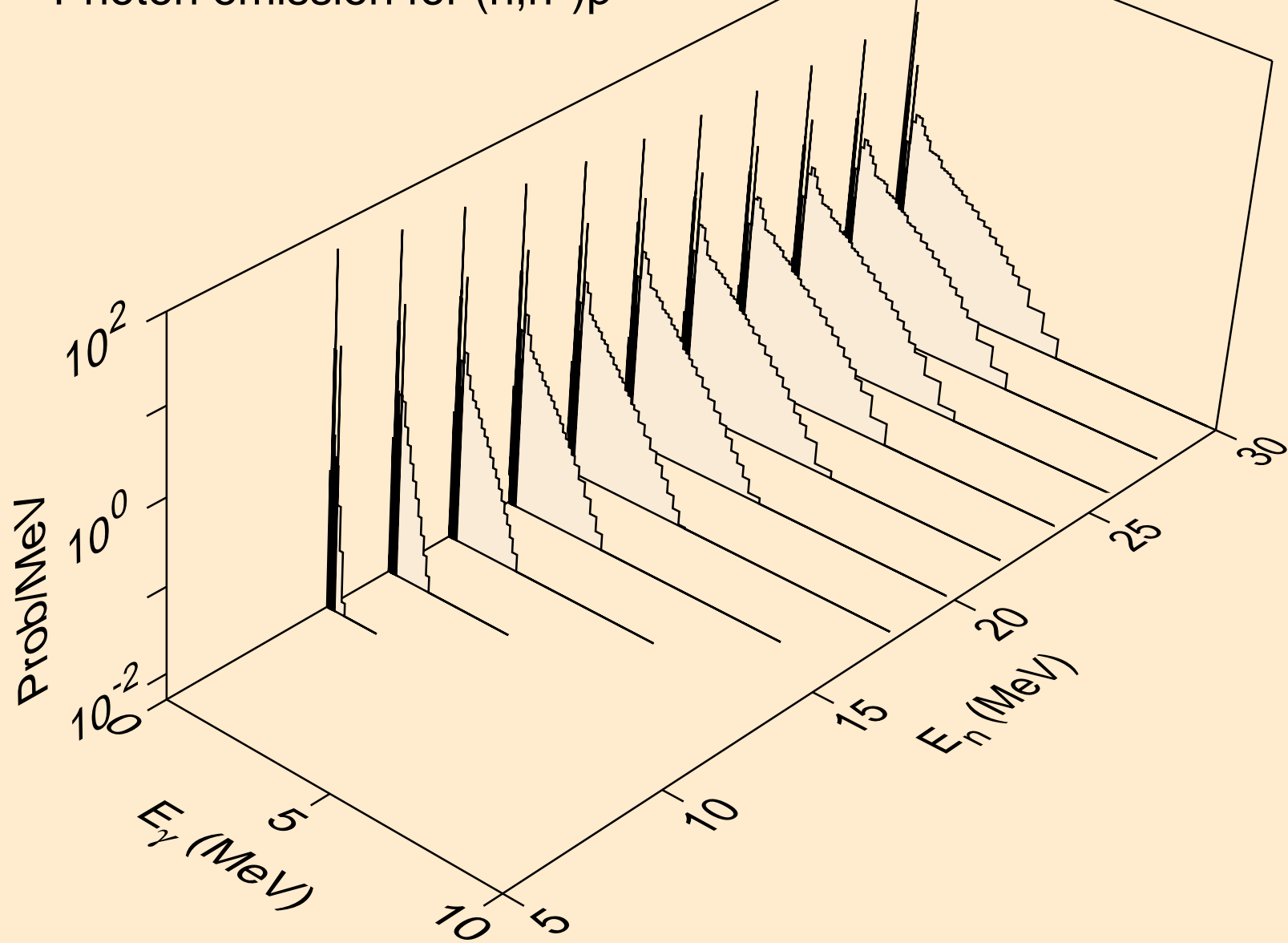

CE139 NEUTRON ACER TENDL-2021 LIBRARY; T=293.6K  
Photon emission for (n,n\*)2a

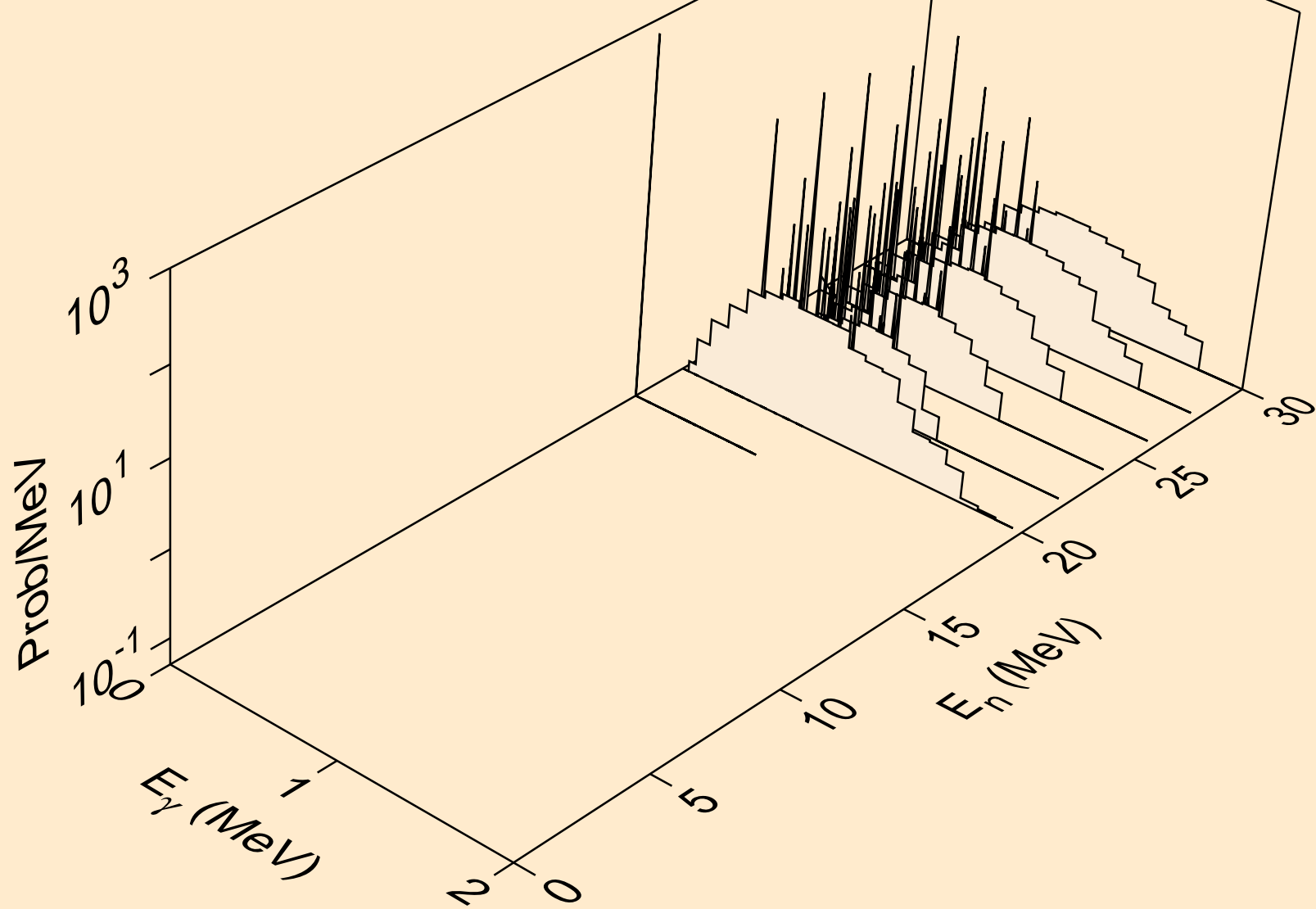



CE139 NEUTRON ACER TENDL-2021 LIBRARY; T=293.6K  
Photon emission for (n,n\*)d

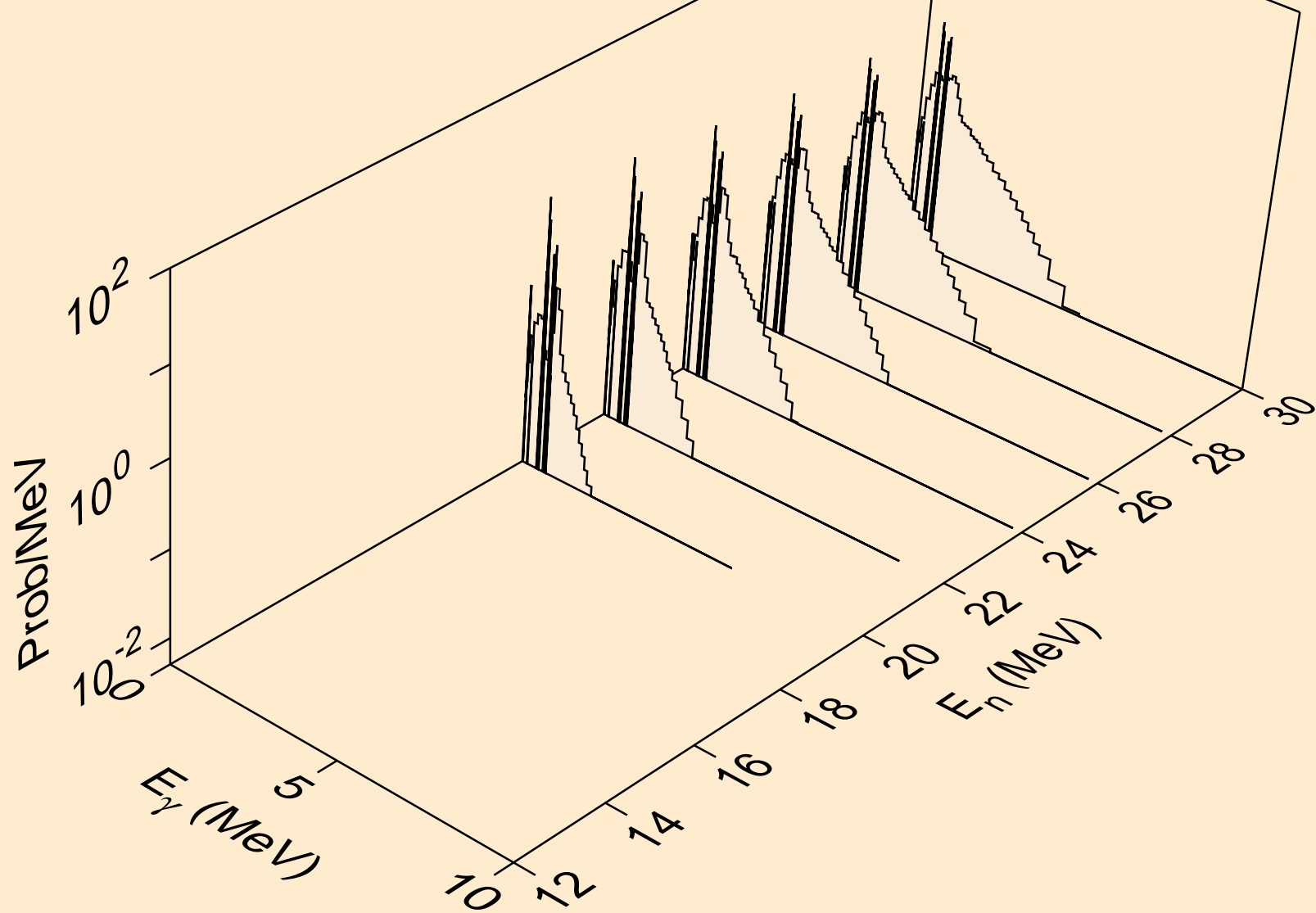

CE139 NEUTRON ACER TENDL-2021 LIBRARY; T=293.6K  
Photon emission for (n,n\*)t

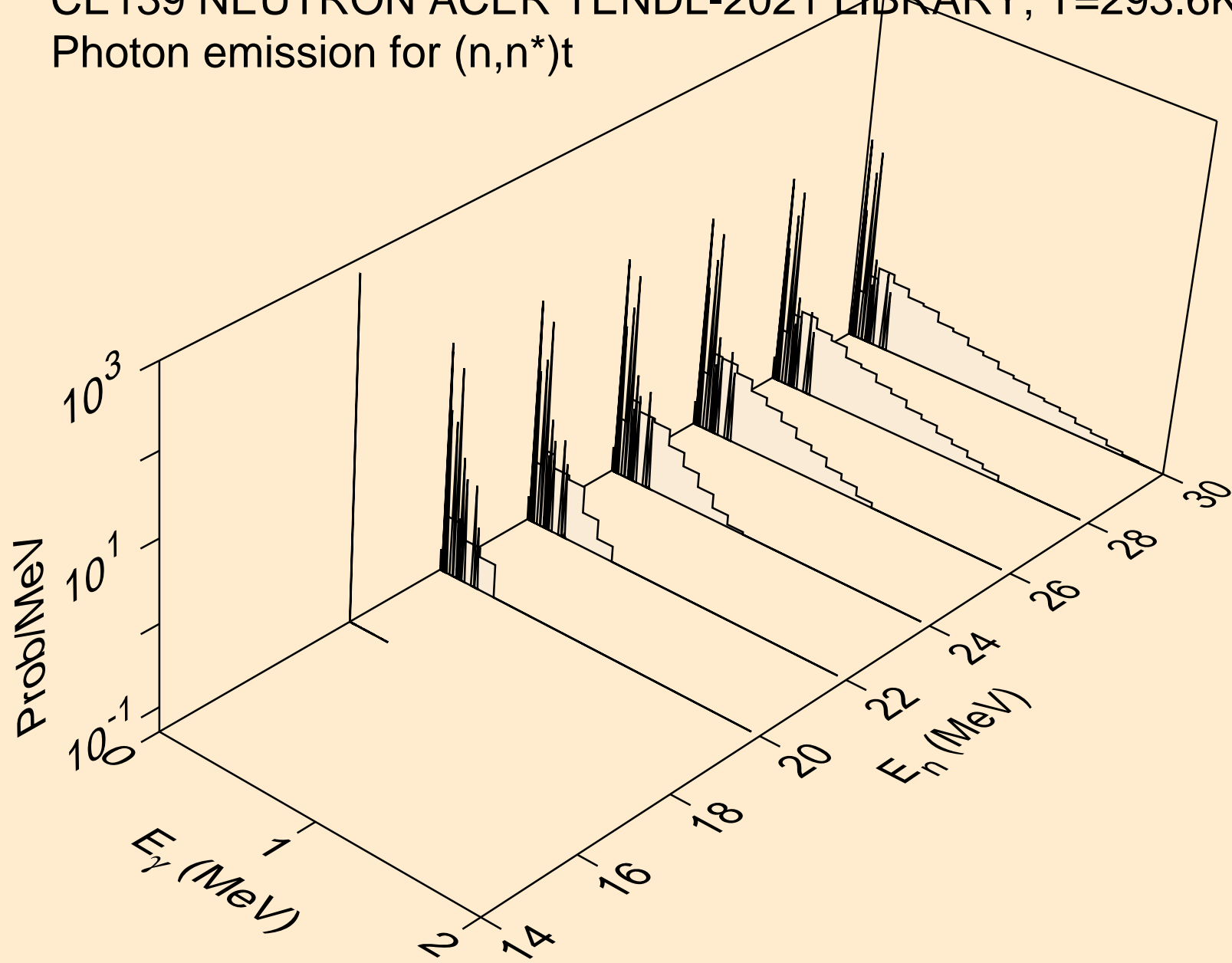

CE139 NEUTRON ACER TENDL-2021 LIBRARY; T=293.6K  
Photon emission for (n,n\*)he3

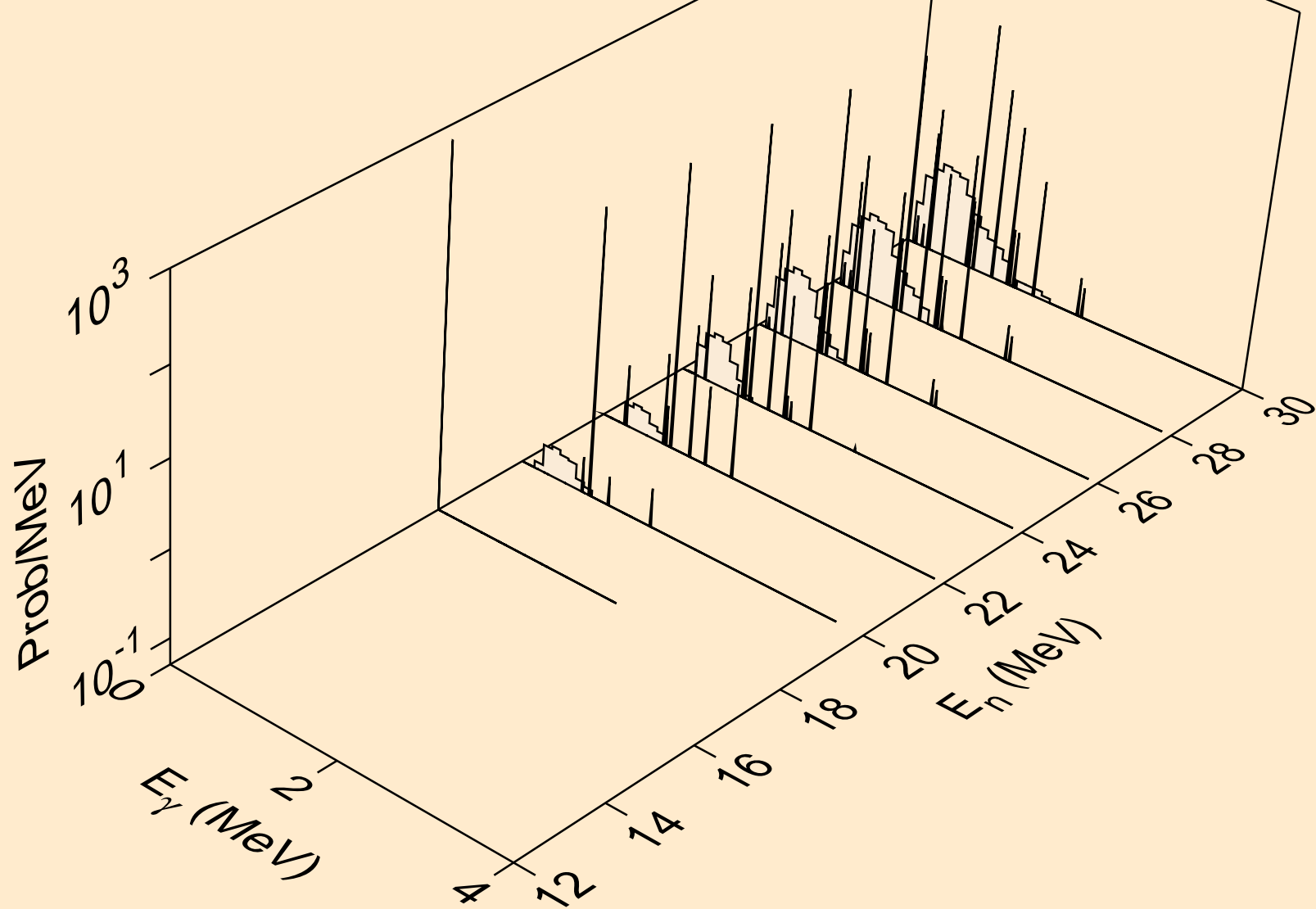

CE139 NEUTRON ACER TENDL-2021 LIBRARY; T=293.6K  
Photon emission for (n,4n)

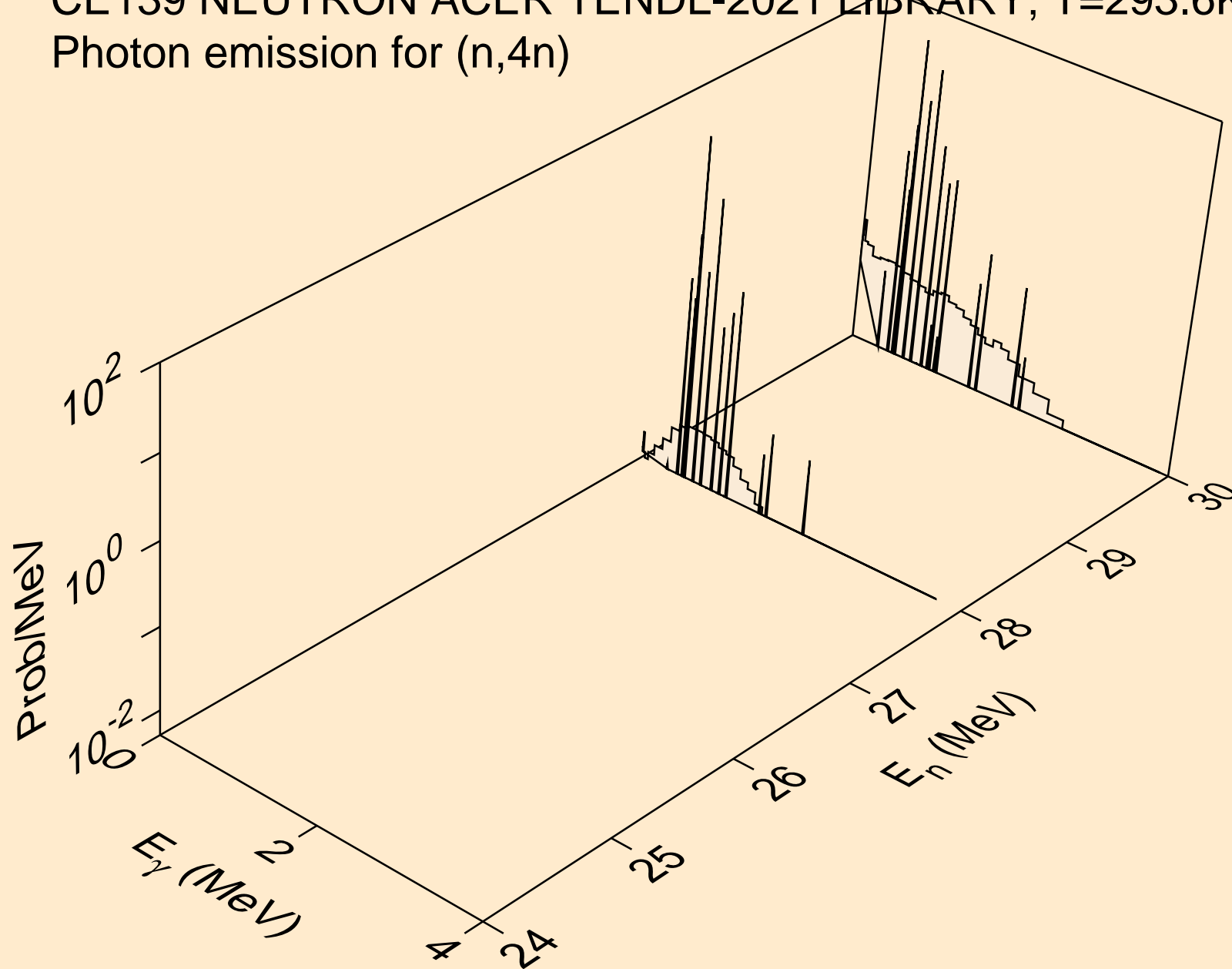

CE139 NEUTRON ACER TENDL-2021 LIBRARY; T=293.6K  
Photon emission for (n,2np)

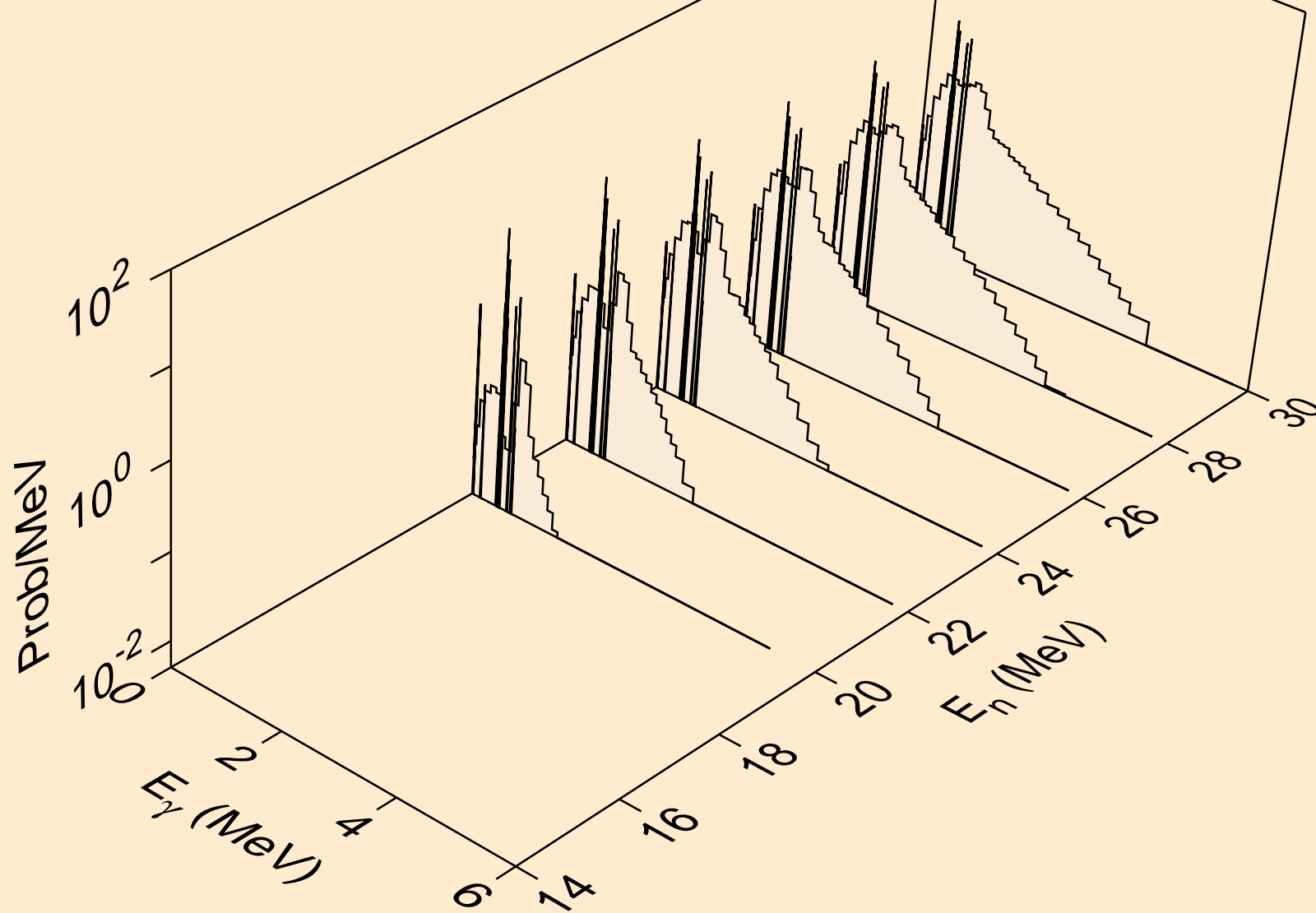

CE139 NEUTRON ACER TENDL-2021 LIBRARY; T=293.6K  
Photon emission for (n,3np)

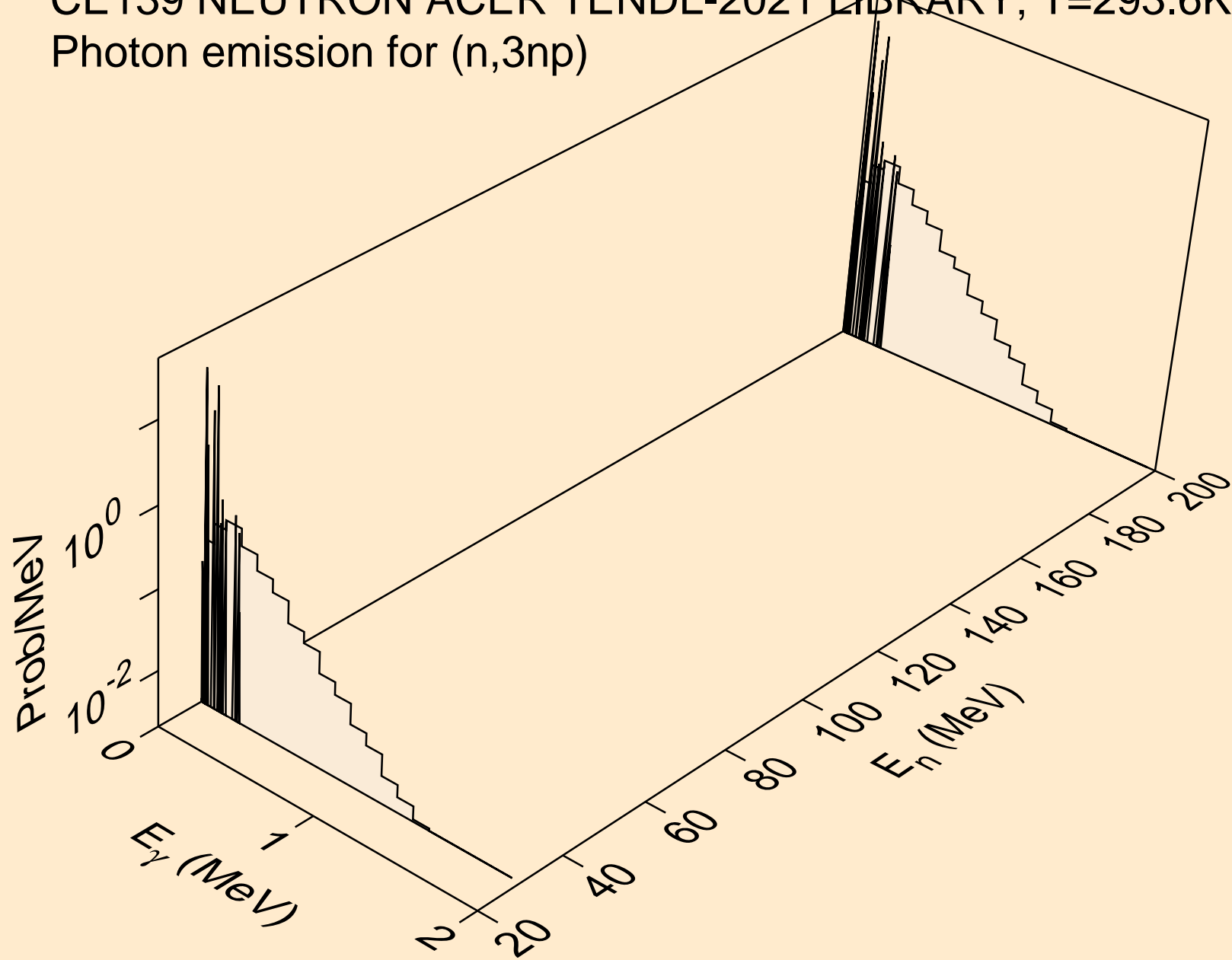

CE139 NEUTRON ACER TENDL-2021 LIBRARY; T=293.6K  
Photon emission for (n,2np)

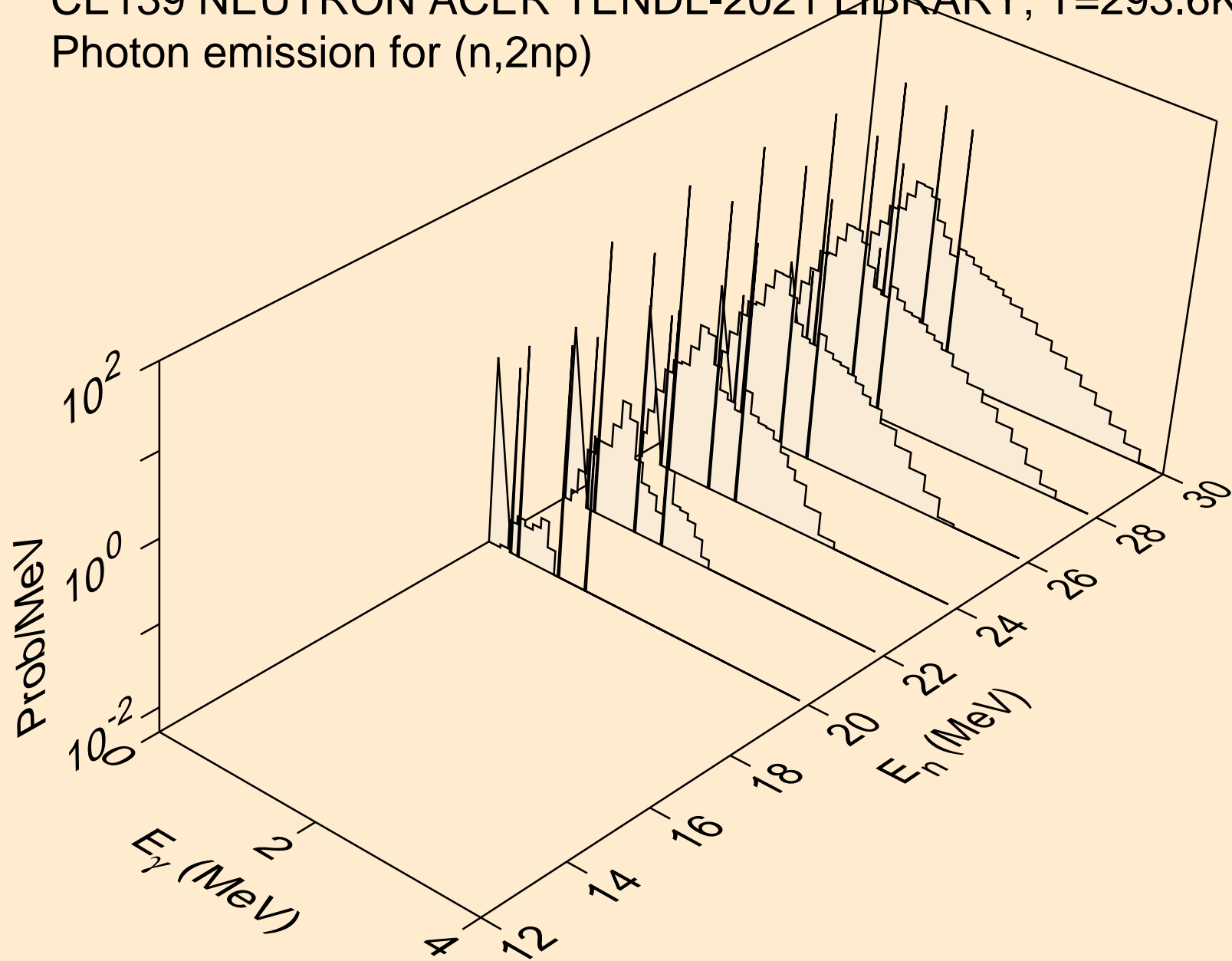

CE139 NEUTRON ACER TENDL-2021 LIBRARY; T=293.6K  
Photon emission for (n,npa)

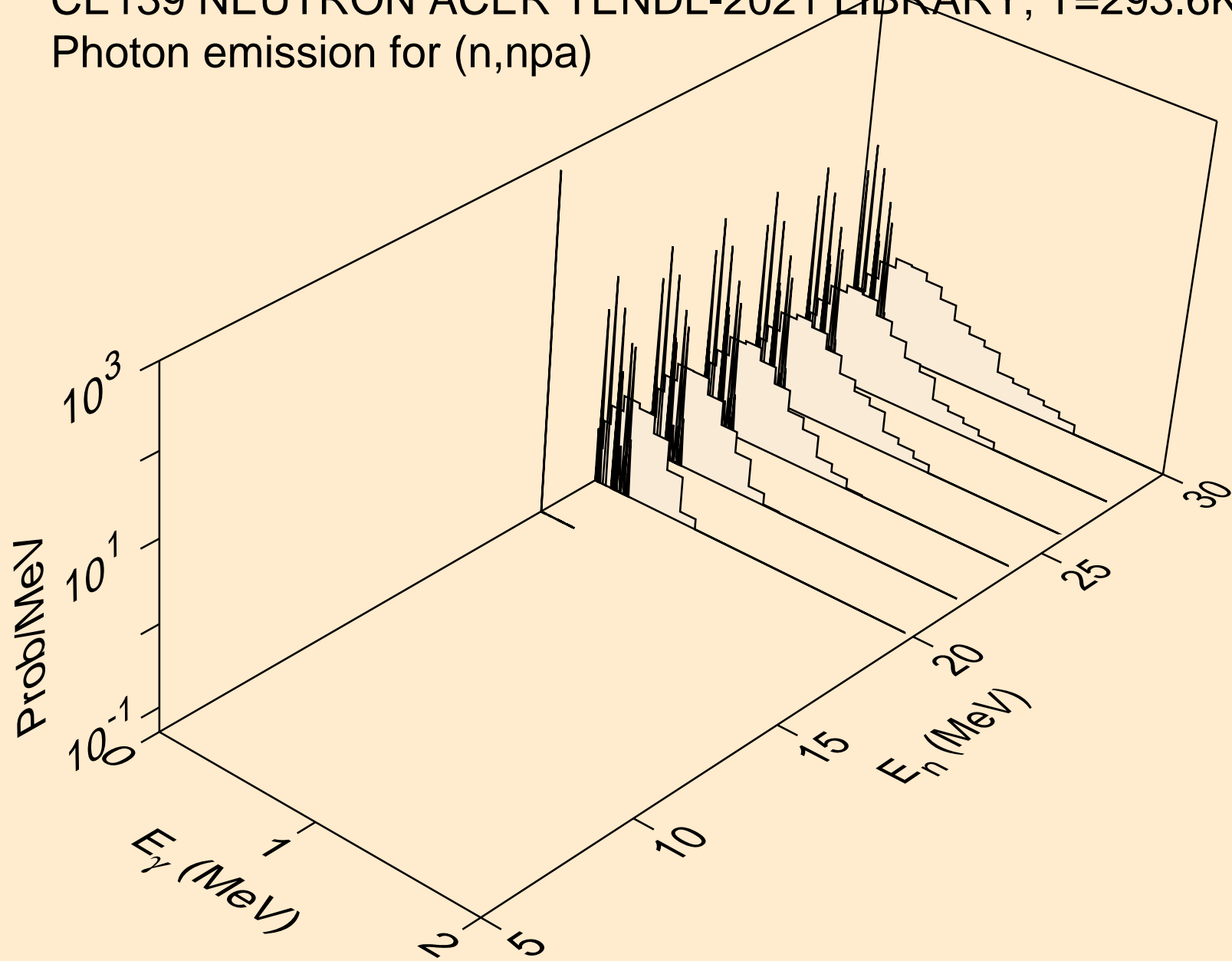



CE139 NEUTRON ACER TENDL-2021 LIBRARY; T=293.6K  
Photon emission for (n,n\*c)

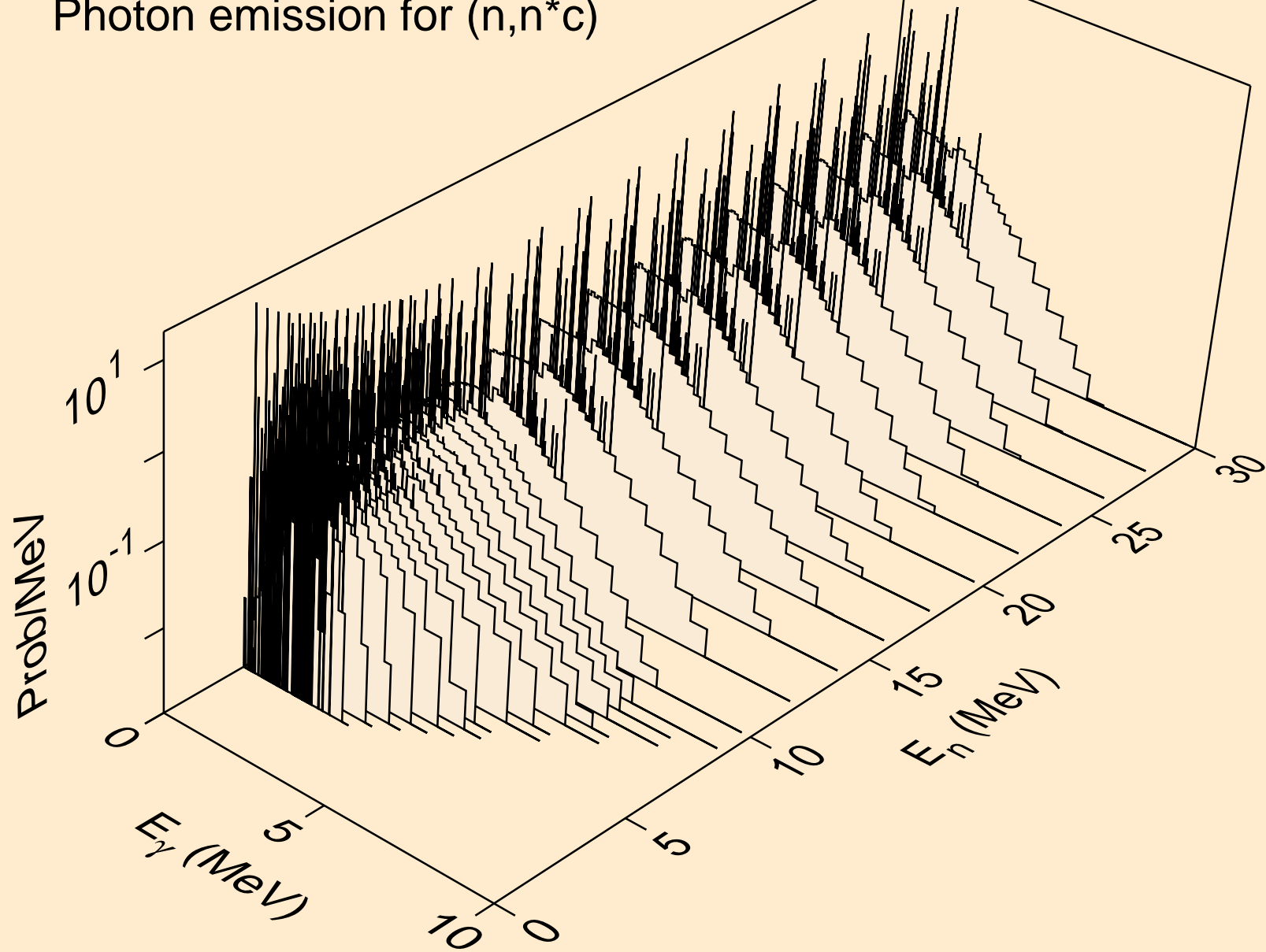

CE139 NEUTRON ACER TENDL-2021 LIBRARY; T=293.6K  
Photon emission for (n,gma)

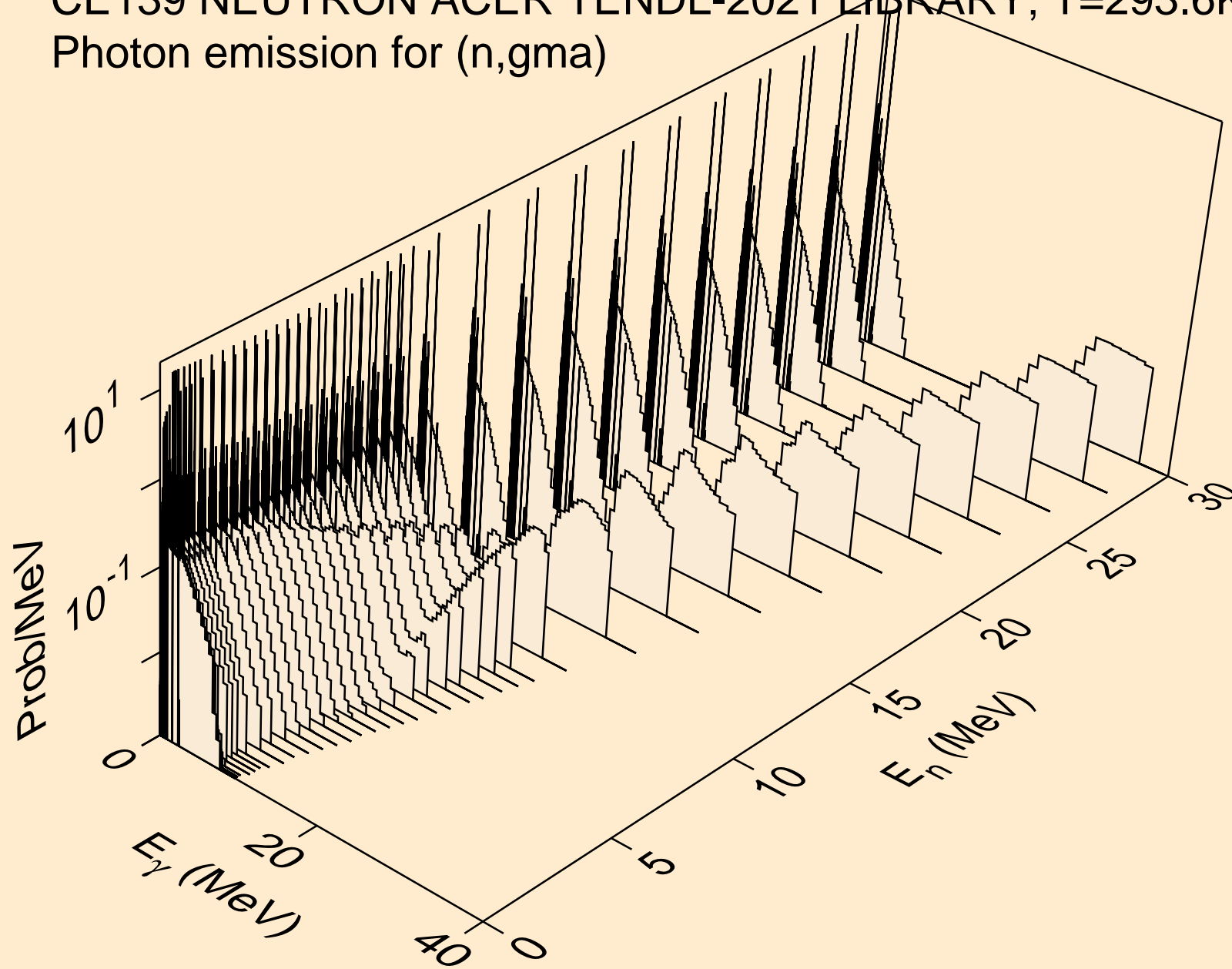

CE139 NEUTRON ACER TENDL-2021 LIBRARY; T=293.6K  
Photon emission for (n,p)

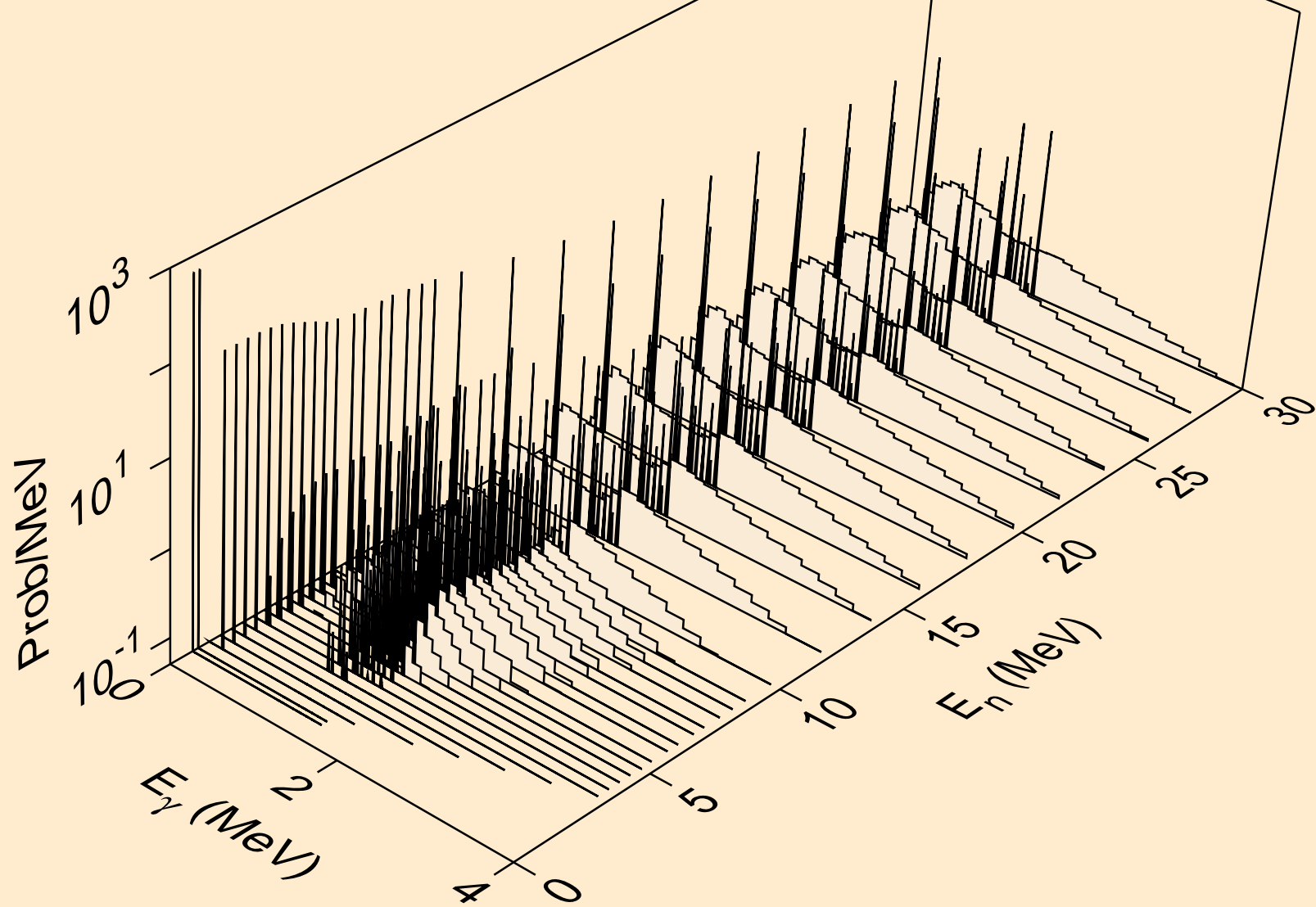

CE139 NEUTRON ACER TENDL-2021 LIBRARY; T=293.6K  
Photon emission for (n,d)

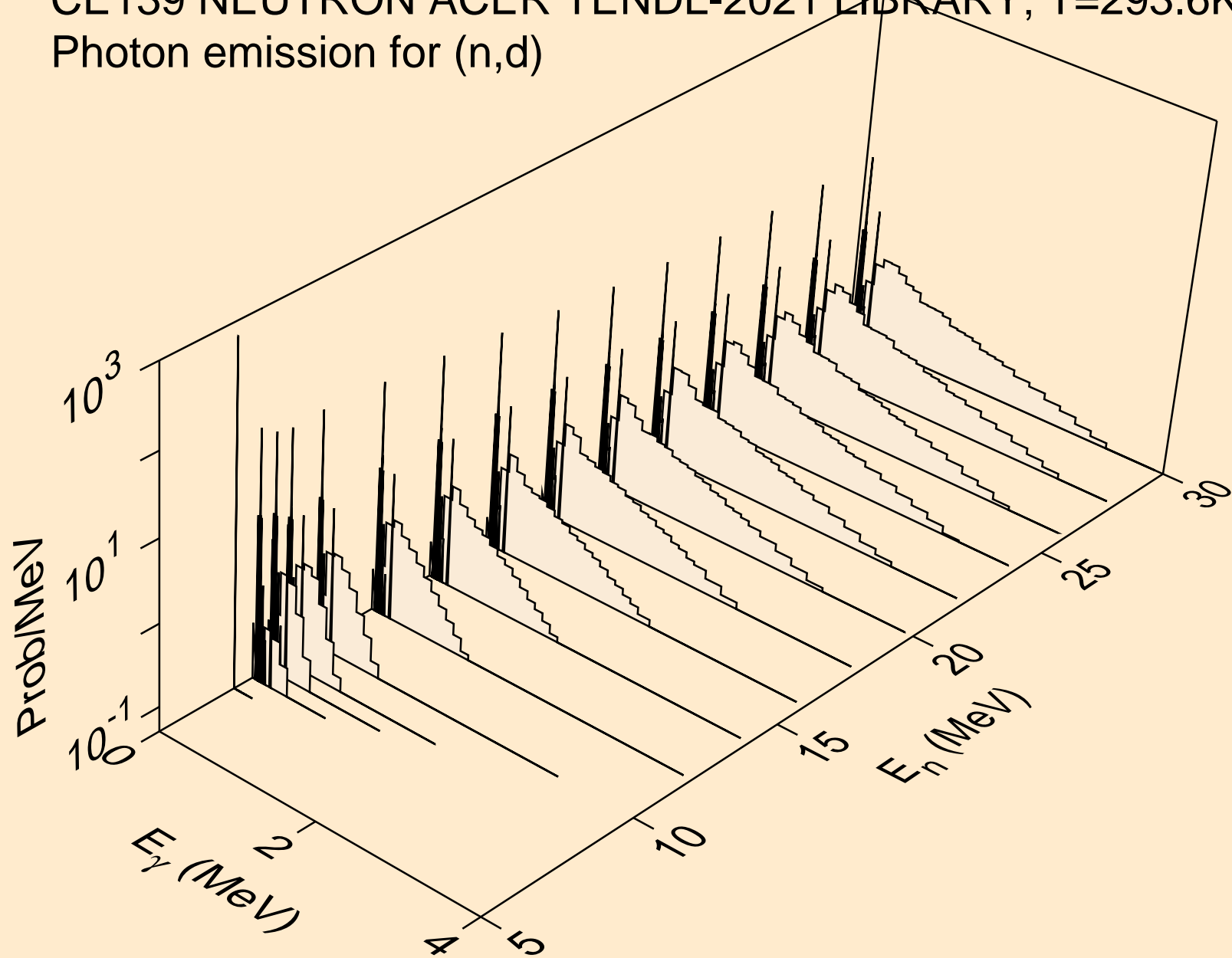

CE139 NEUTRON ACER TENDL-2021 LIBRARY; T=293.6K  
Photon emission for (n,t)

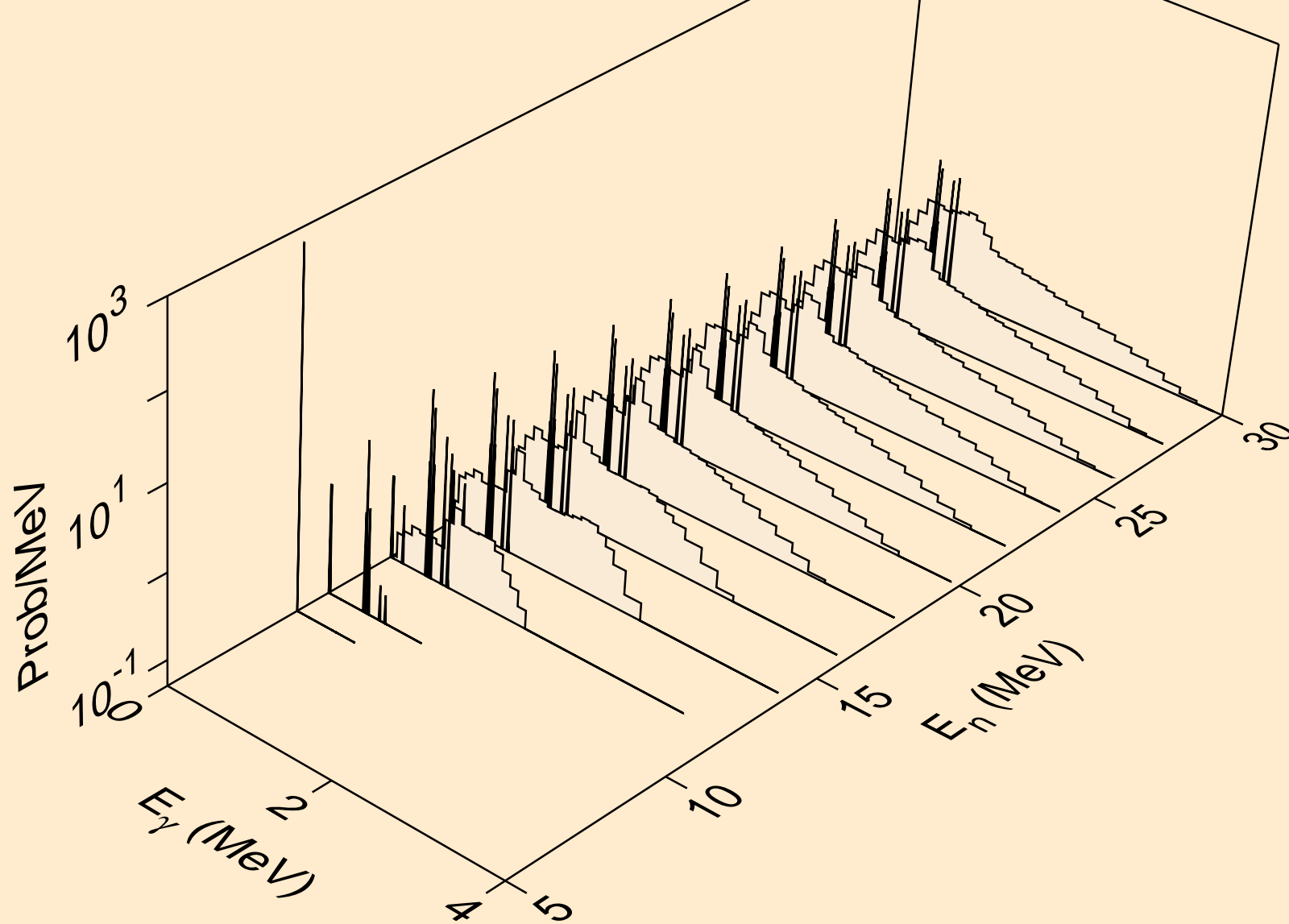

CE139 NEUTRON ACER TENDL-2021 LIBRARY; T=293.6K  
Photon emission for (n,he3)

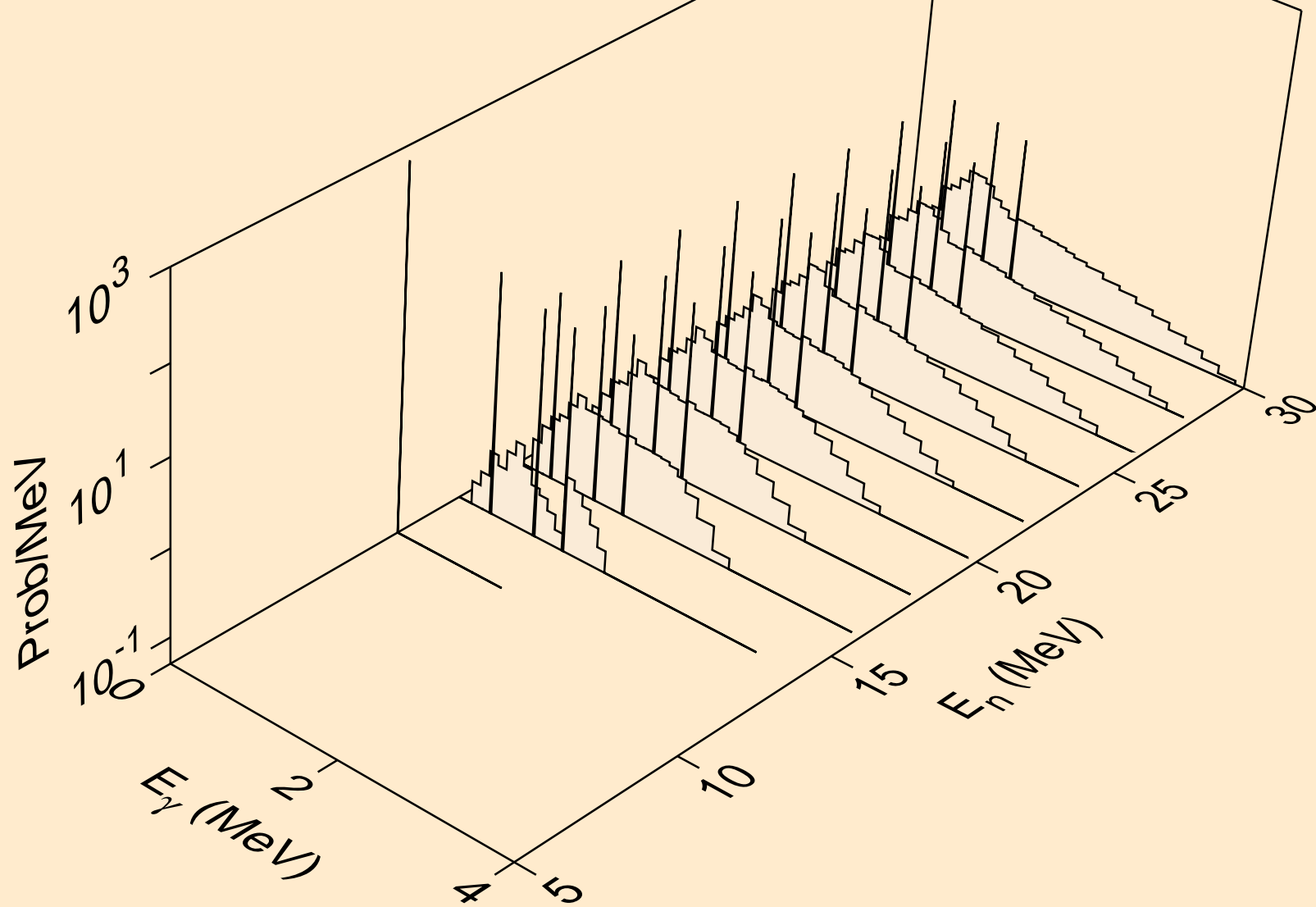

CE139 NEUTRON ACER TENDL-2021 LIBRARY; T=293.6K  
Photon emission for (n,a)

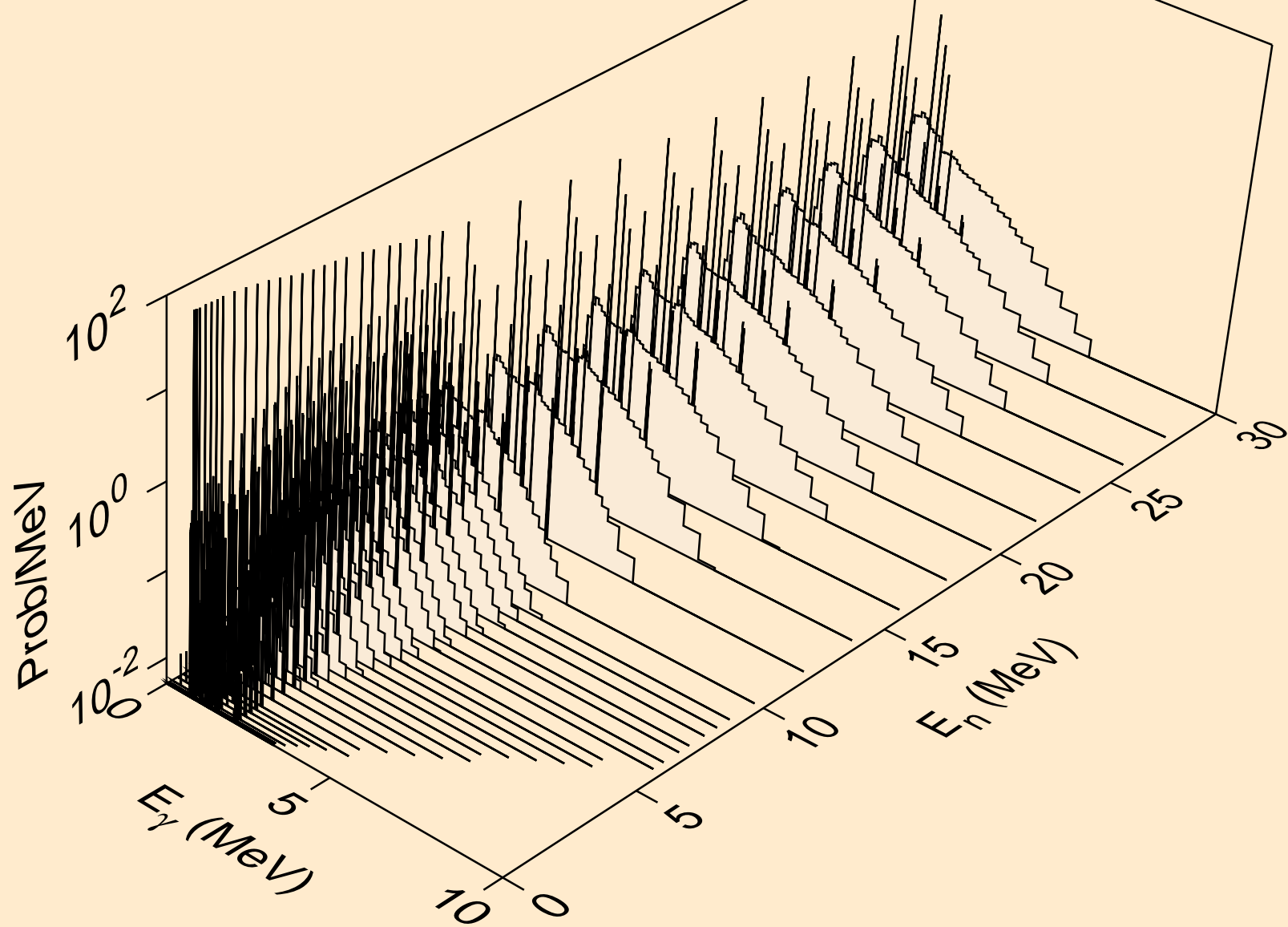

CE139 NEUTRON ACER TENDL-2021 LIBRARY; T=293.6K  
Photon emission for (n,2a)

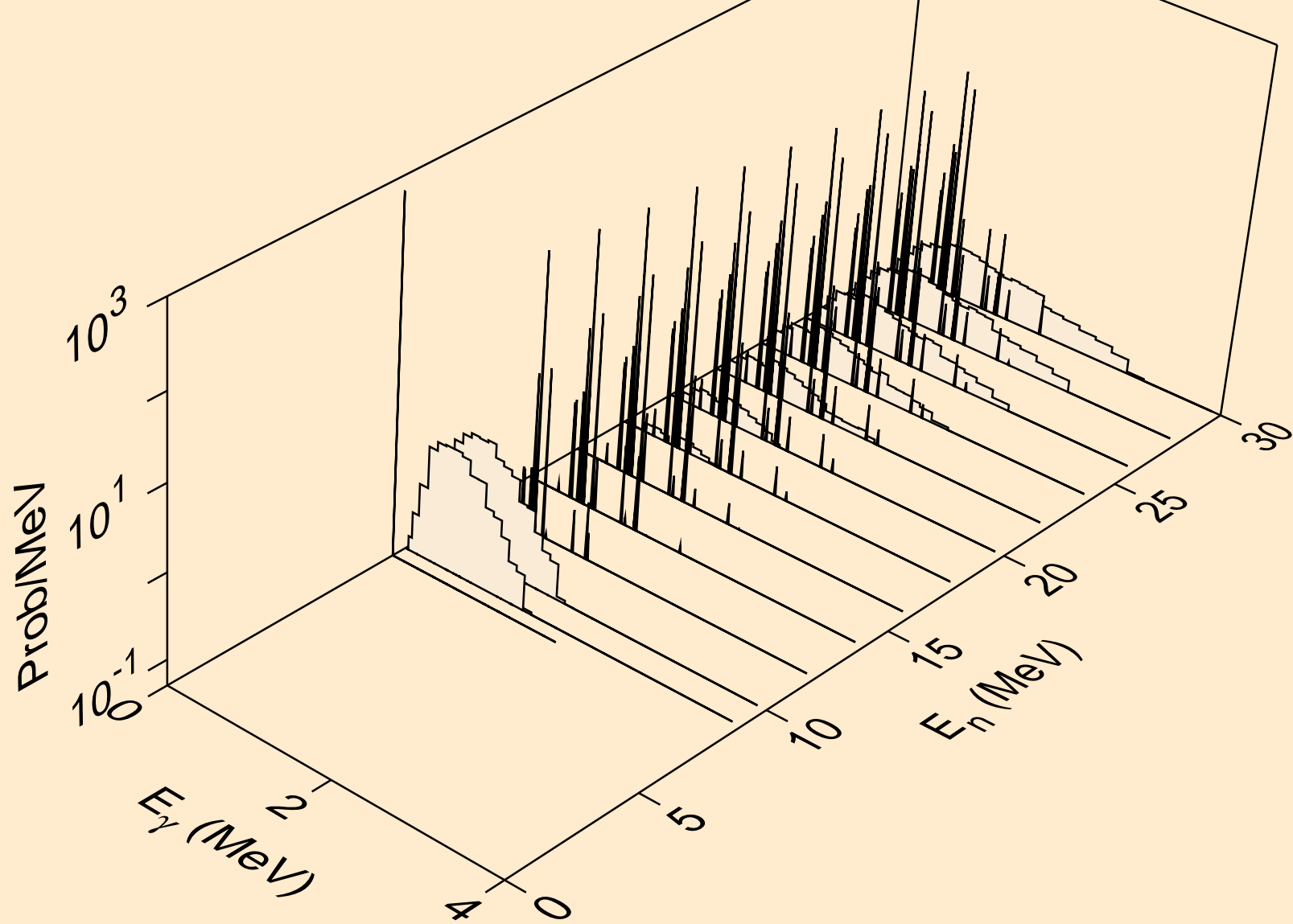



CE139 NEUTRON ACER TENDL-2021 LIBRARY; T=293.6K  
Photon emission for (n,2p)

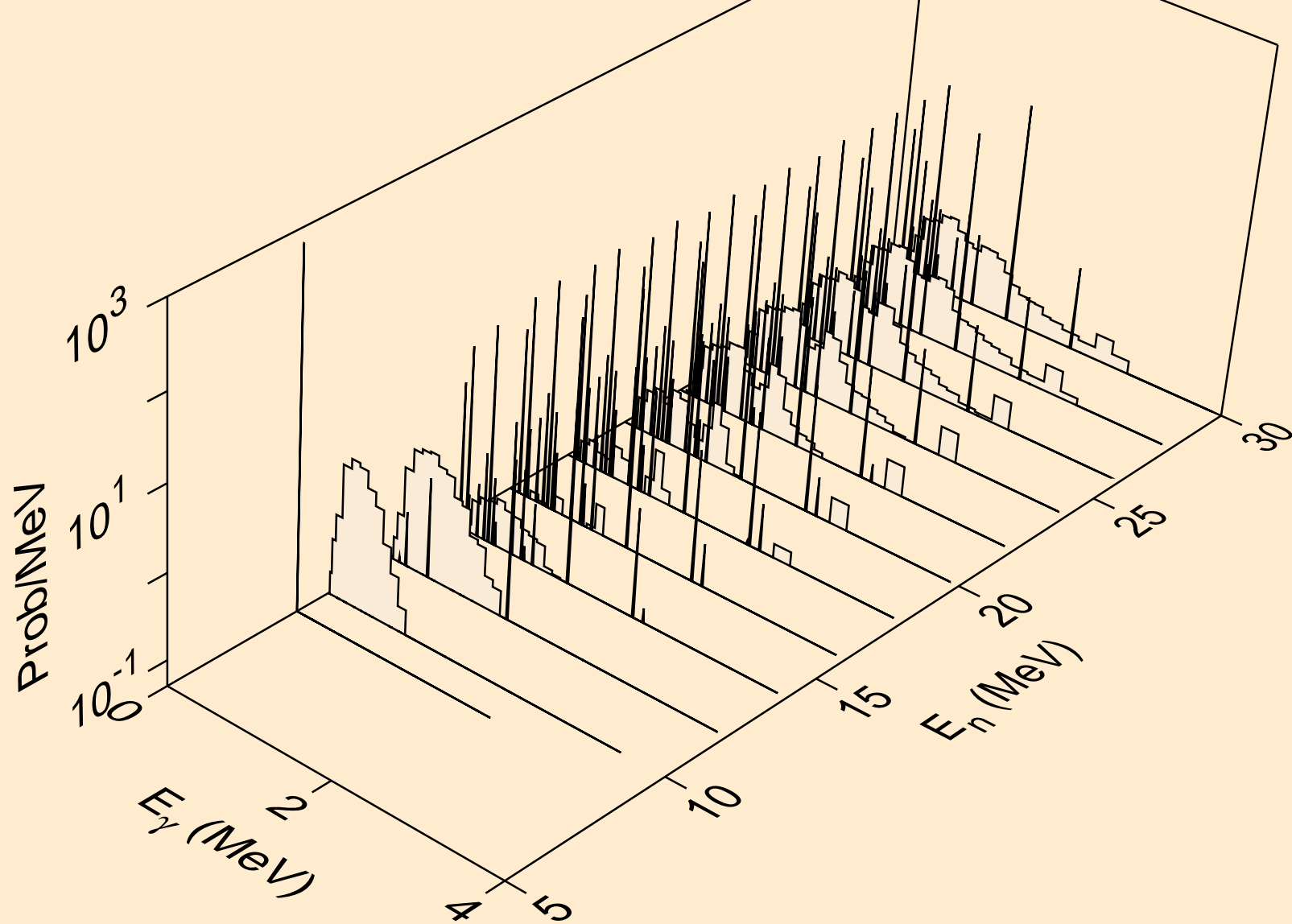

CE139 NEUTRON ACER TENDL-2021 LIBRARY; T=293.6K  
Photon emission for (n,p $\alpha$ )

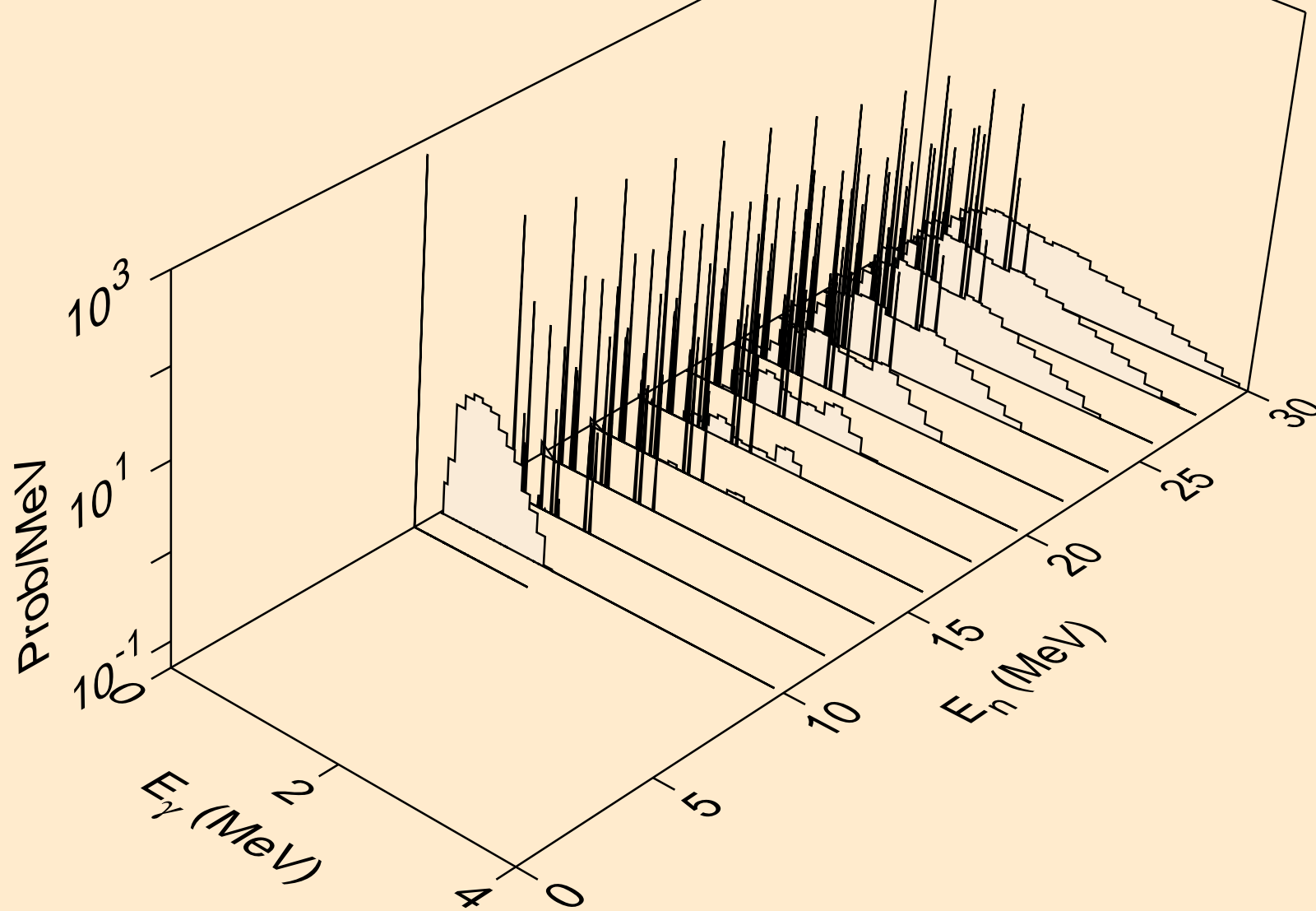

CE139 NEUTRON ACER TENDL-2021 LIBRARY; T=293.6K  
Photon emission for (n,pd)

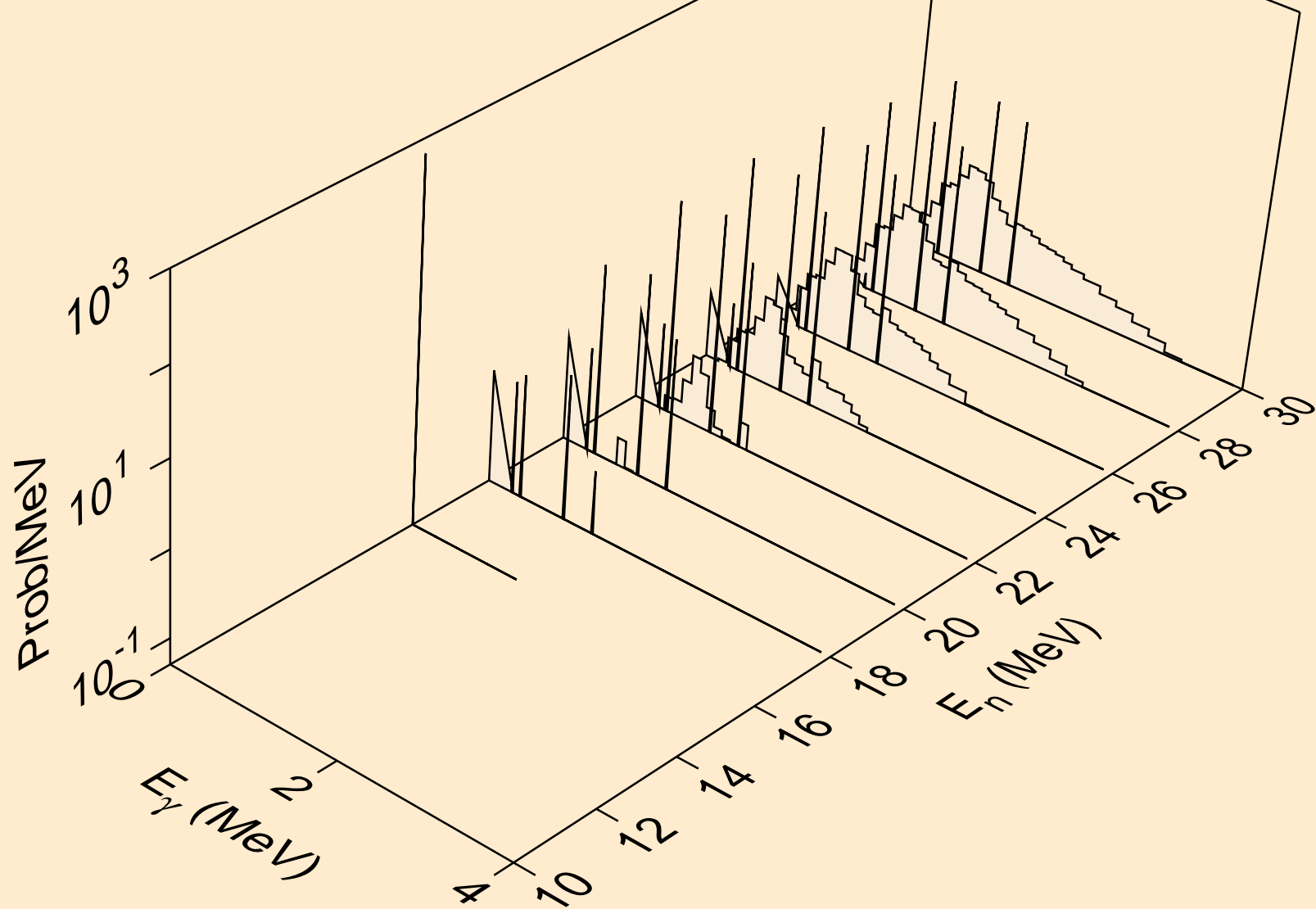

CE139 NEUTRON ACER TENDL-2021 LIBRARY; T=293.6K  
Photon emission for (n,pt)

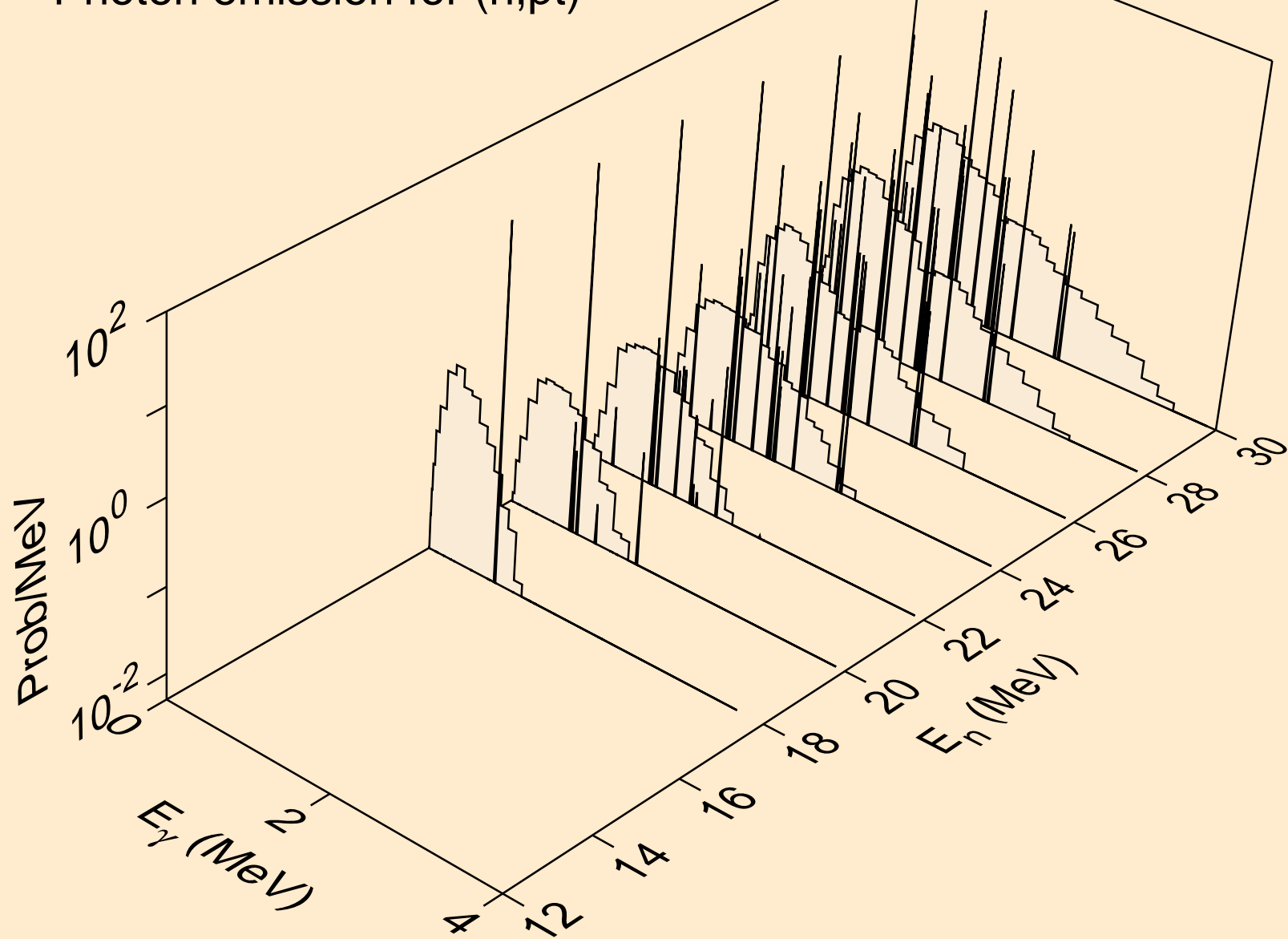

CE139 NEUTRON ACER TENDL-2021 LIBRARY; T=293.6K  
Photon emission for (n,da)

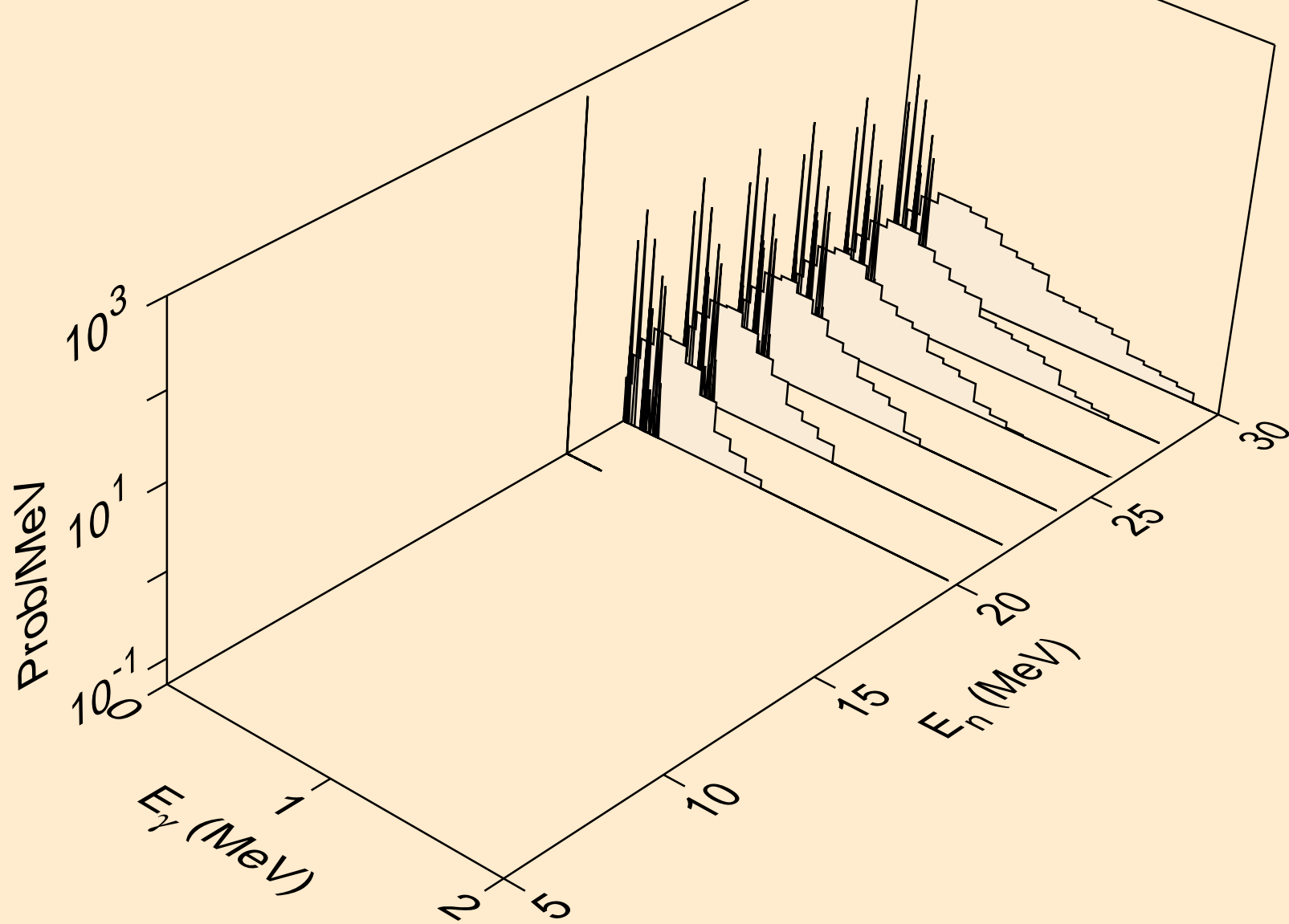

CE139 NEUTRON ACER TENDL-2021 LIBRARY; T=293.6K  
thermal capture photon spectrum

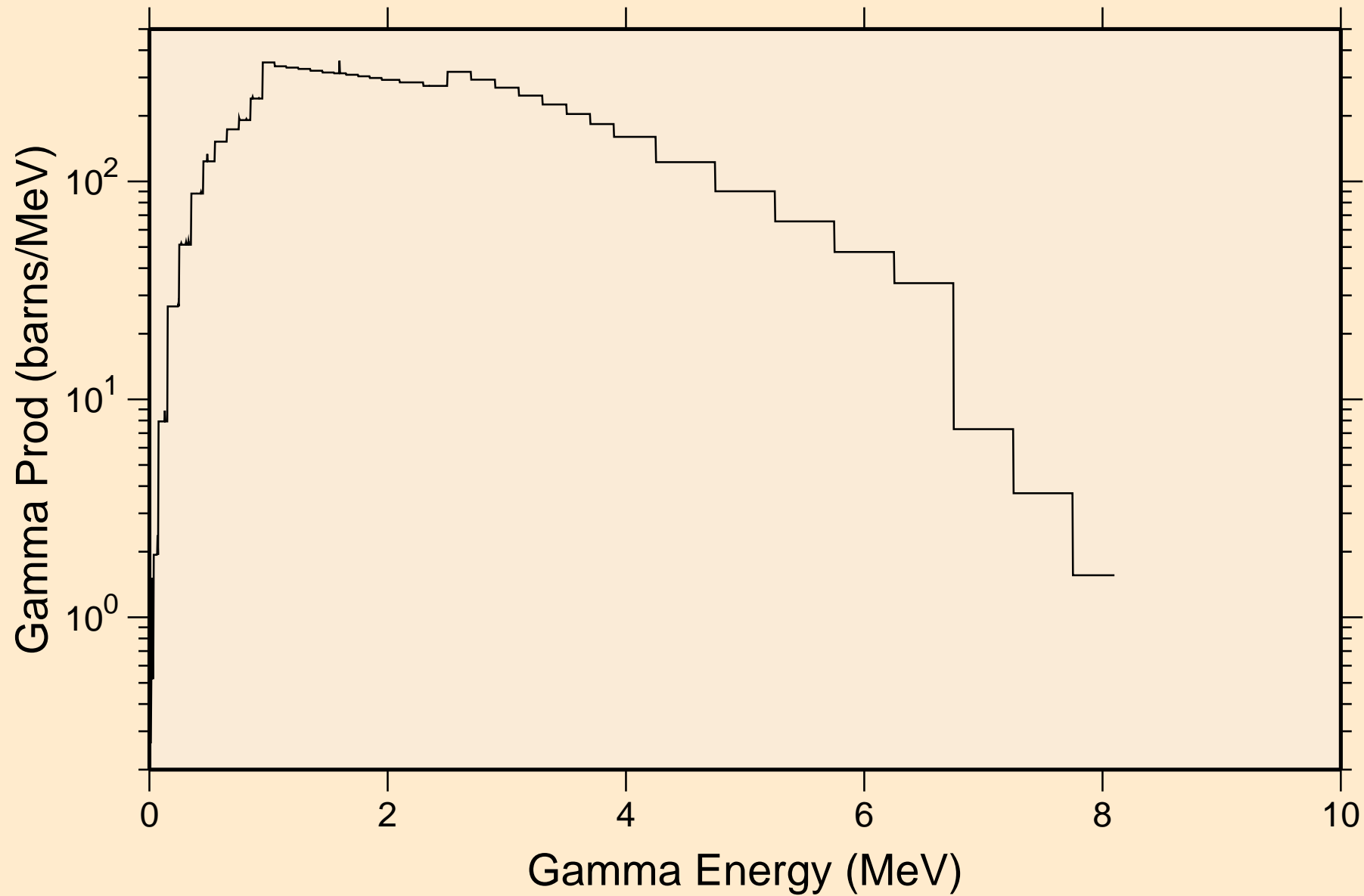

CE139 NEUTRON ACER TENDL-2021 LIBRARY; T=293.6K  
14 MeV photon spectrum

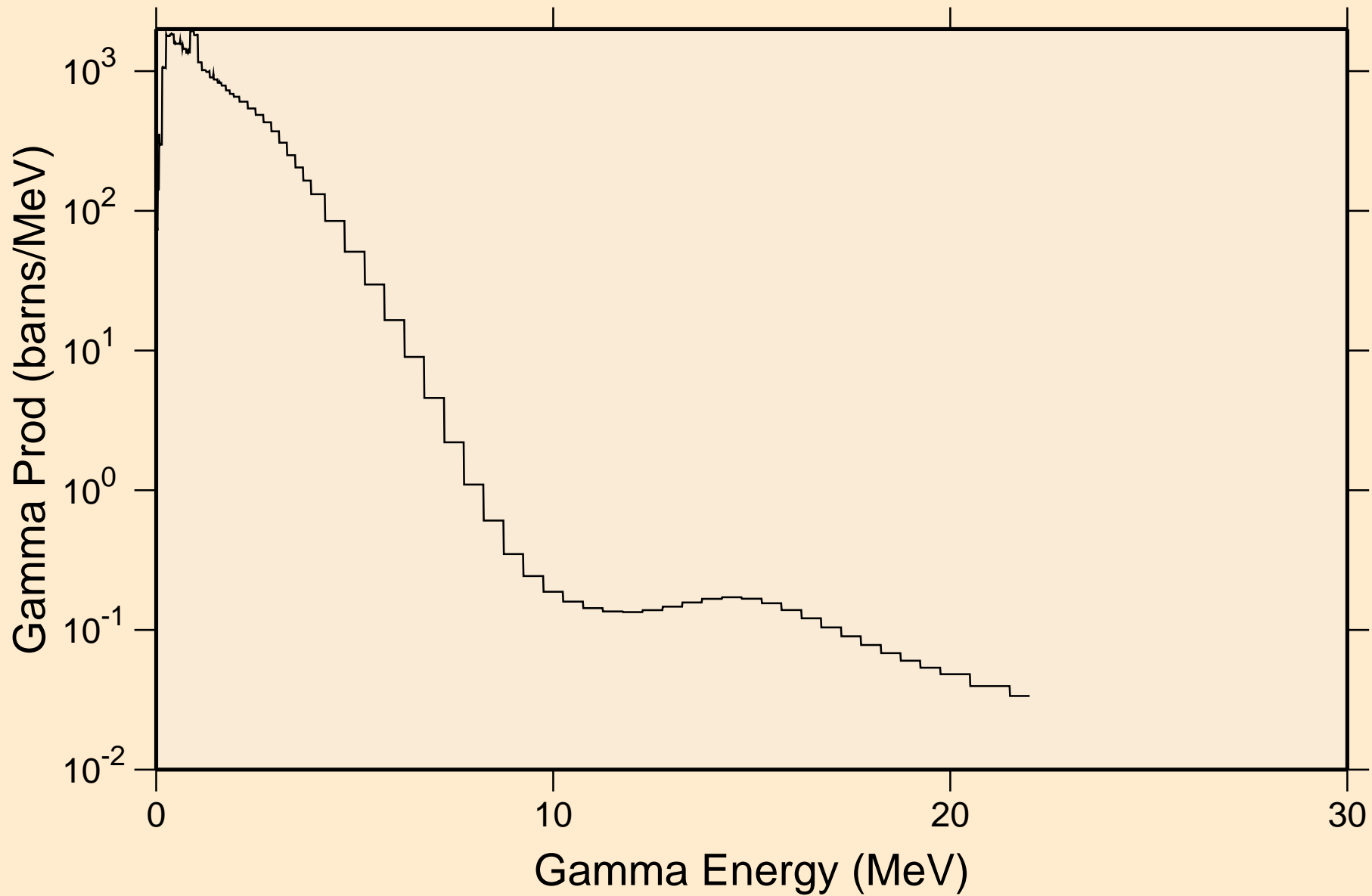

# CE139 NEUTRON ACER TENDL-2021 LIBRARY; T=293.6K

## Particle heating contributions

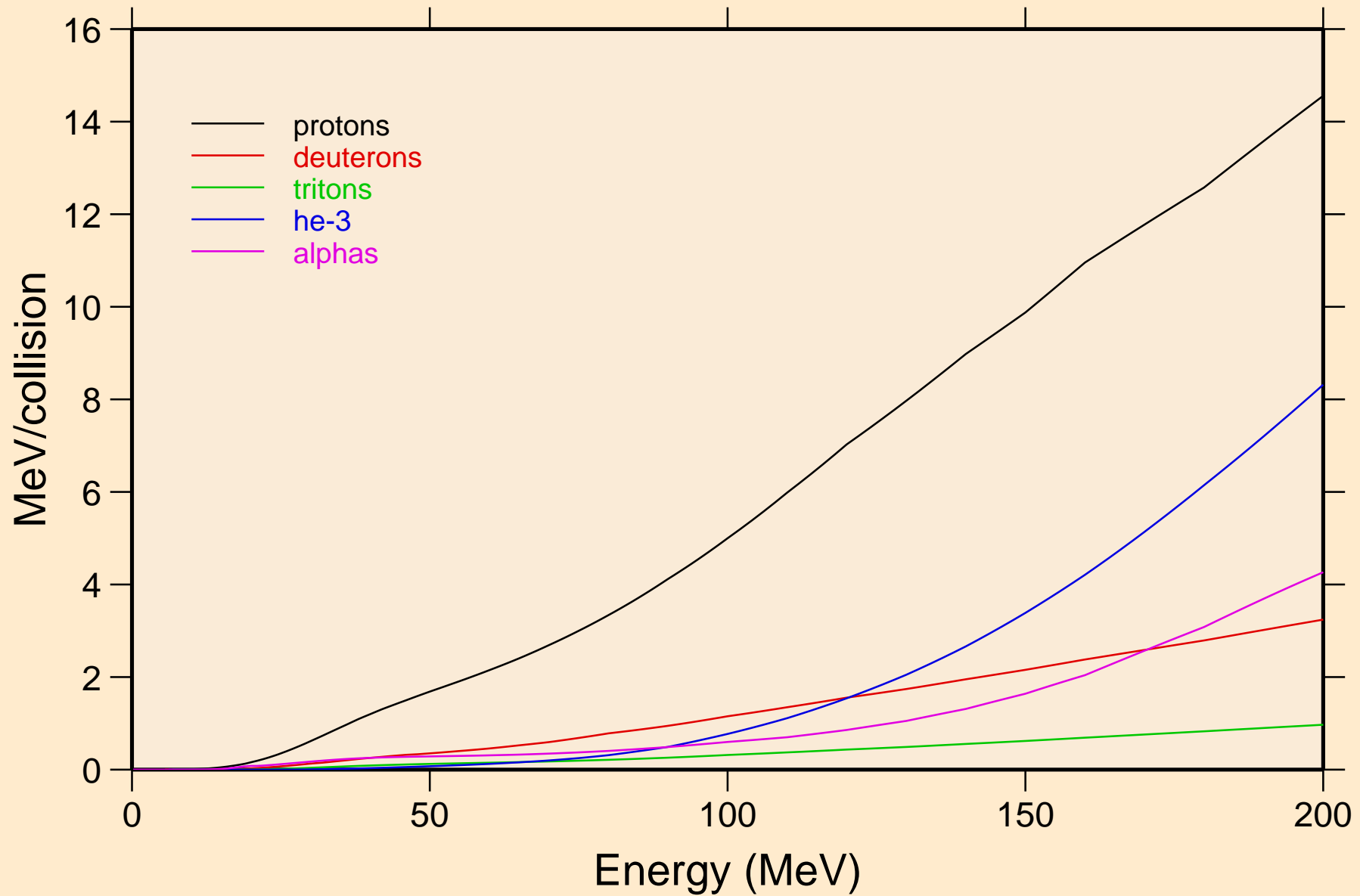



CE139 NEUTRON ACER TENDL-2021 LIBRARY; T=293.6K  
Recoil Heating

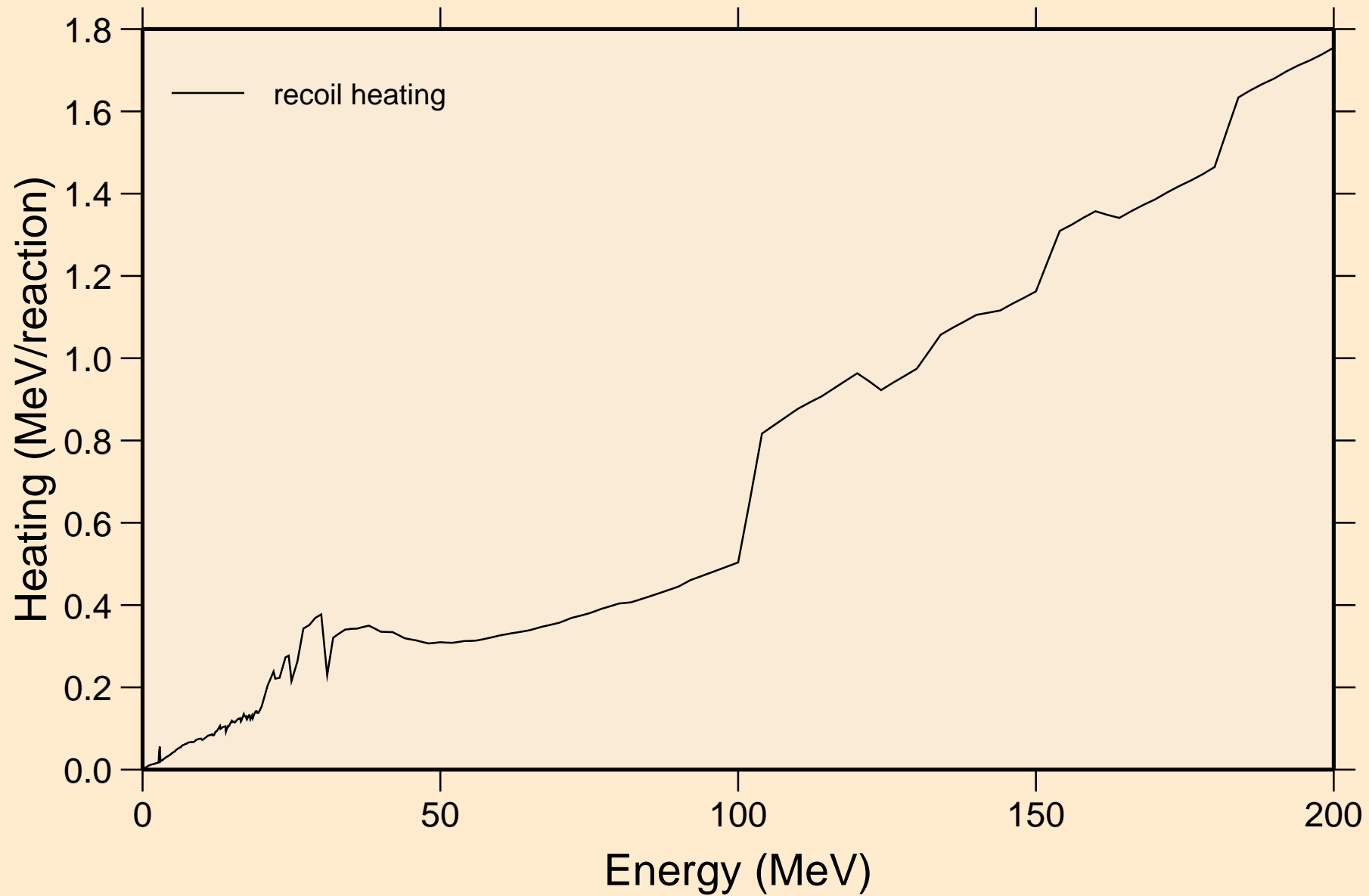

CE139 NEUTRON ACER TENDL-2021 LIBRARY; T=293.6K  
Particle production cross sections

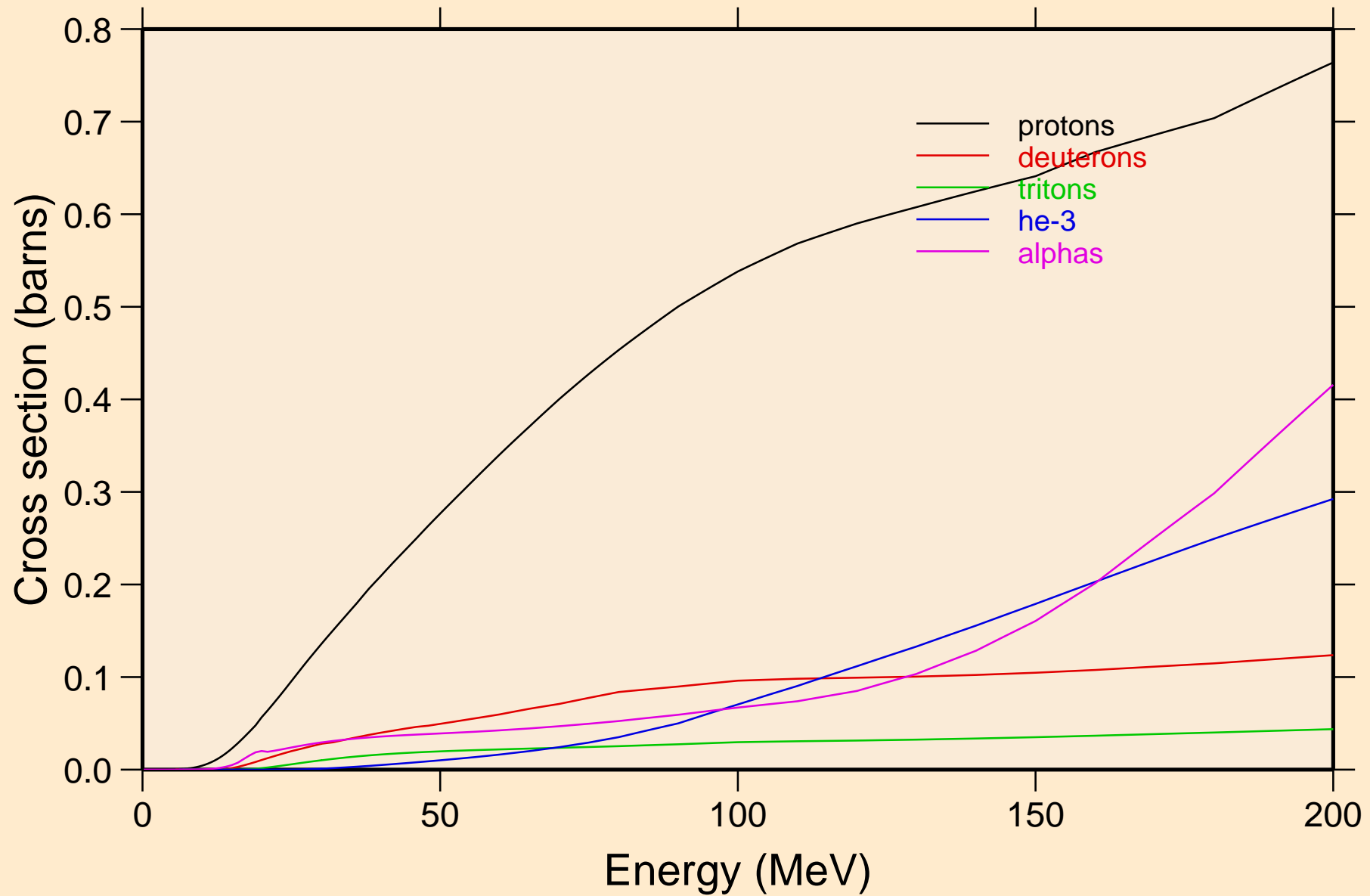

CE139 NEUTRON ACER TENDL-2021 LIBRARY; T=293.6K  
protons from (n,x)

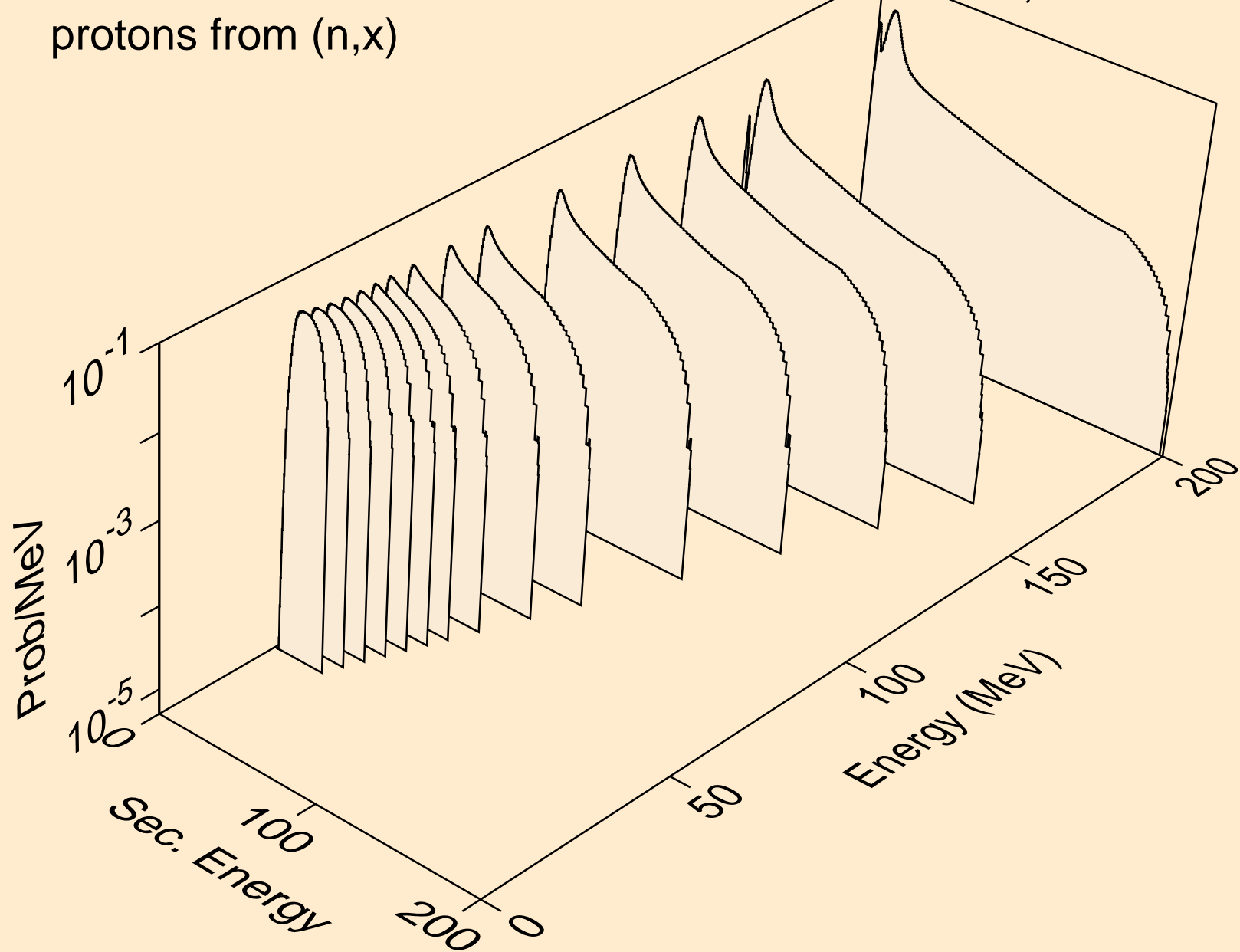

CE139 NEUTRON ACER TENDL-2021 LIBRARY; T=293.6K  
protons from (n,n\*)p

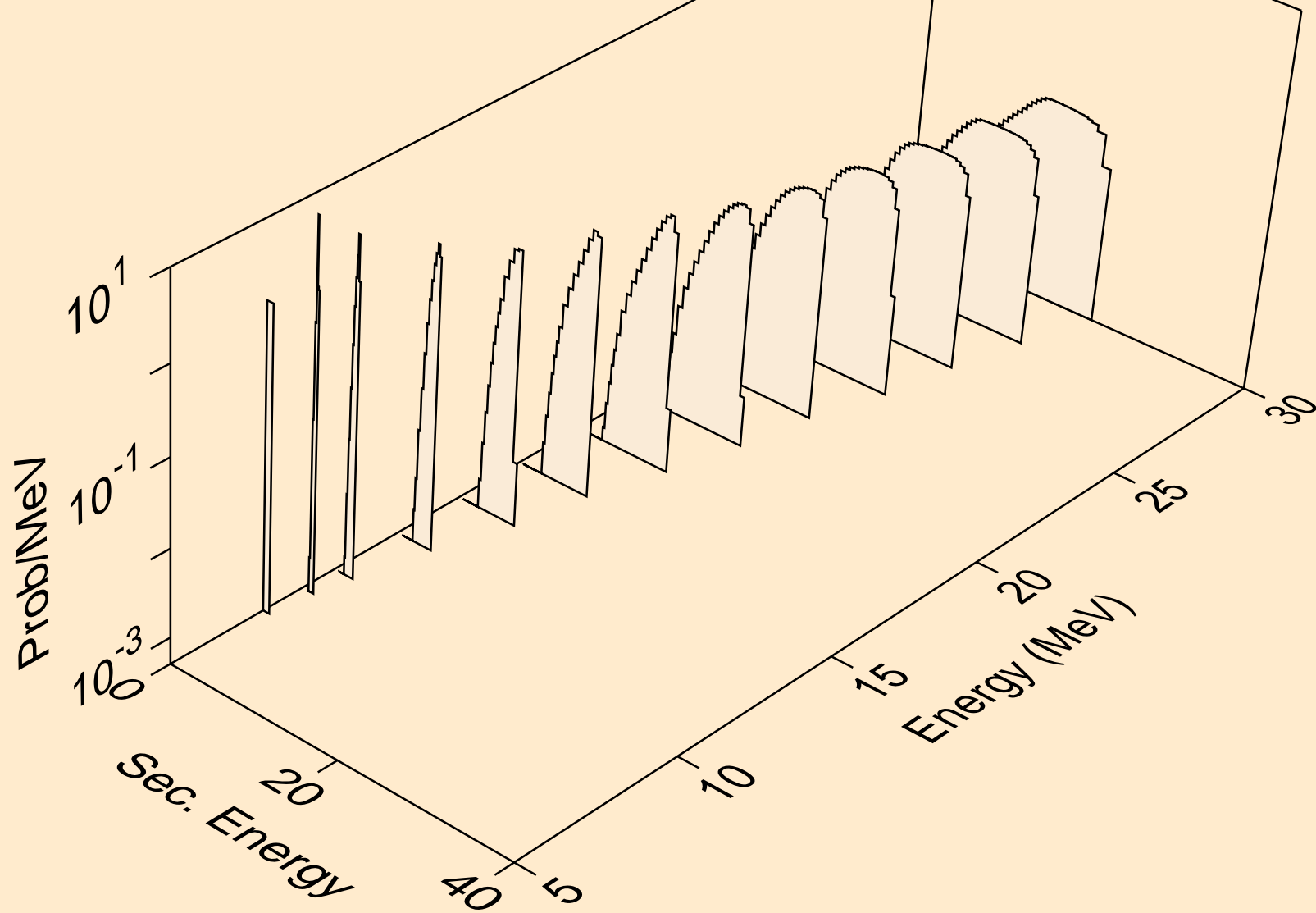

CE139 NEUTRON ACER TENDL-2021 LIBRARY; T=293.6K  
protons from (n,2np)

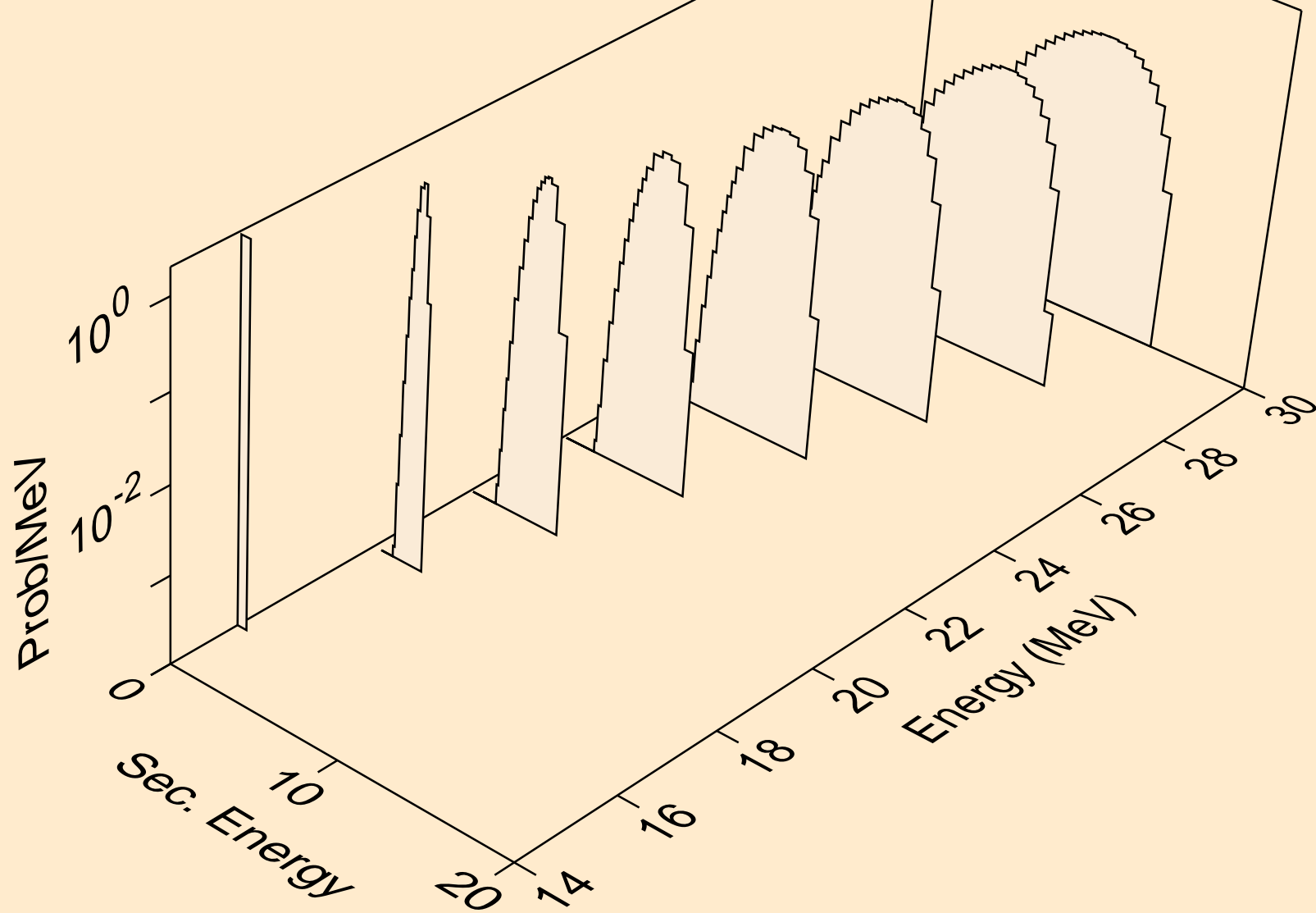

CE139 NEUTRON ACER TENDL-2021 LIBRARY; T=293.6K  
protons from (n,3np)

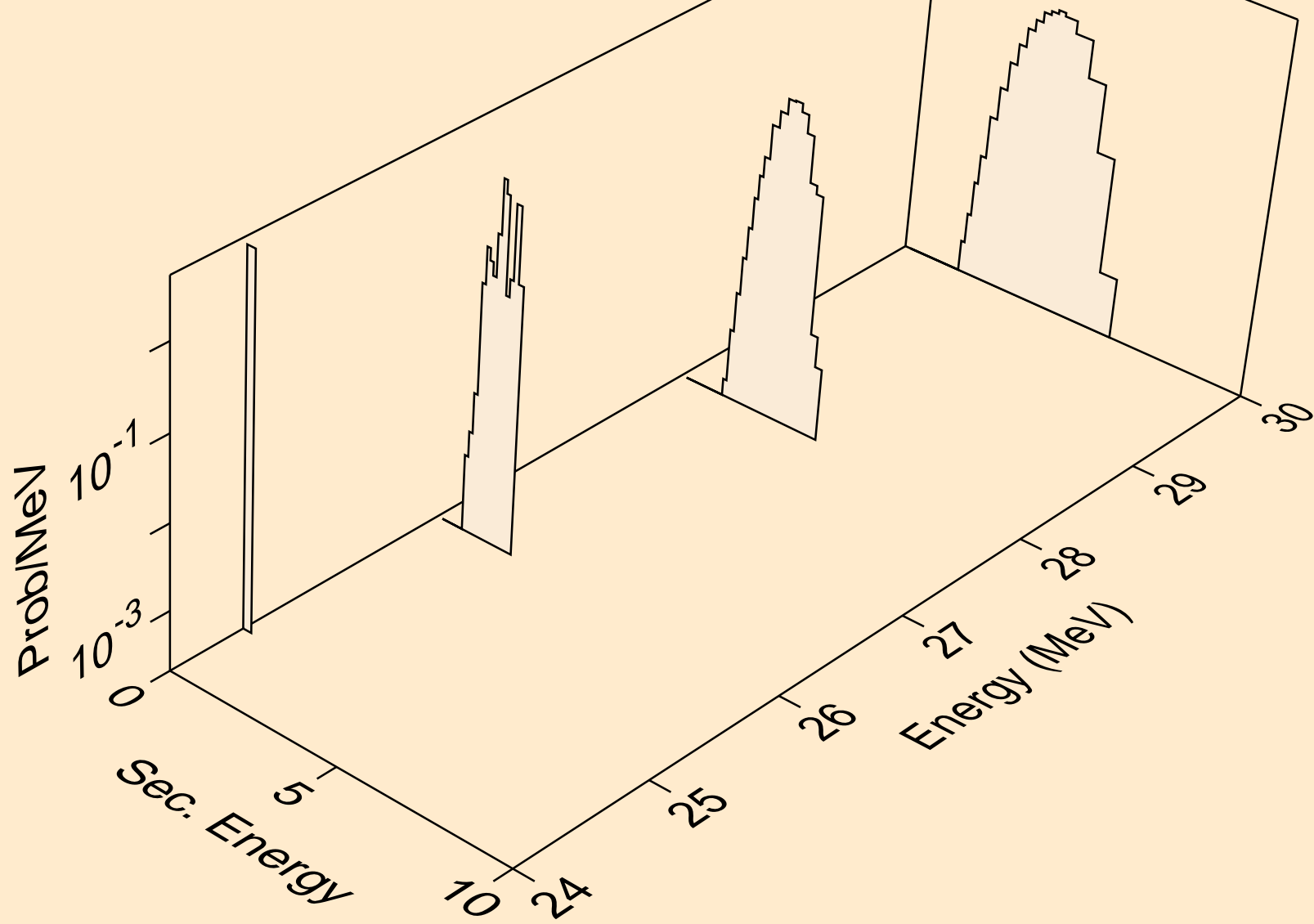

CE139 NEUTRON ACER TENDL-2021 LIBRARY; T=293.6K  
protons from (n,2np)

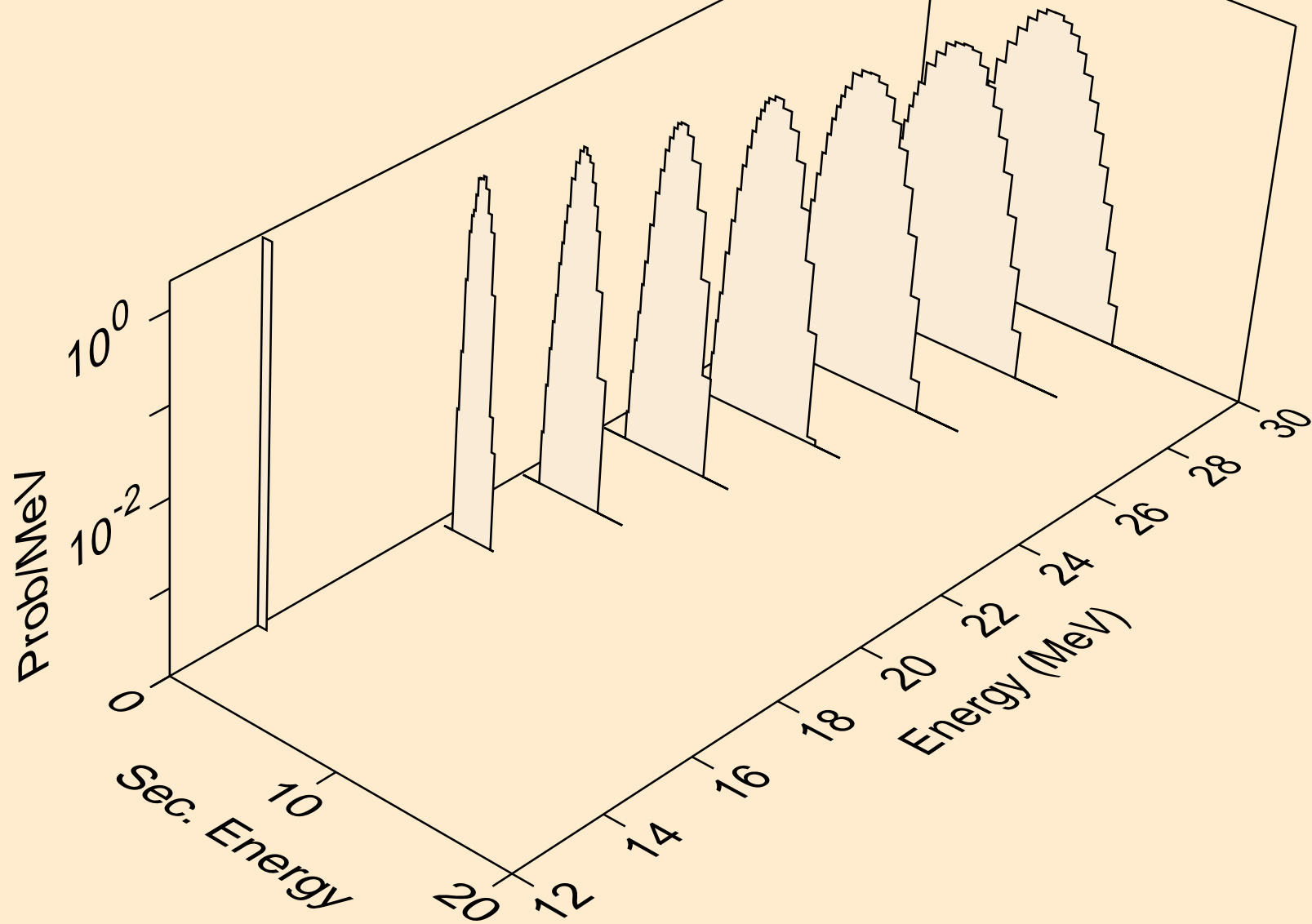

CE139 NEUTRON ACER TENDL-2021 LIBRARY; T=293.6K  
protons from (n,npa)

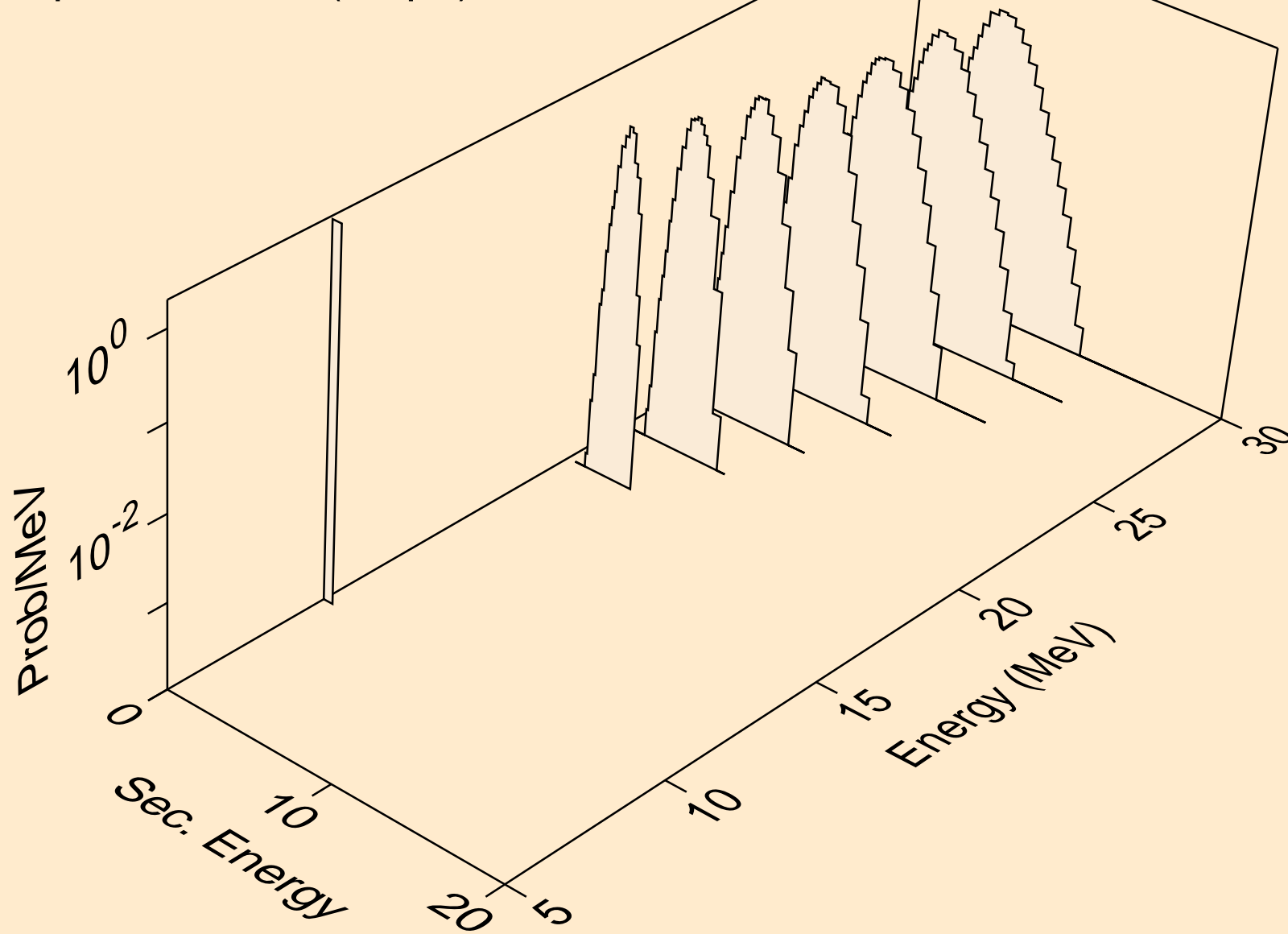



CE139 NEUTRON ACER TENDL-2021 LIBRARY; T=293.6K  
protons from (n,p)

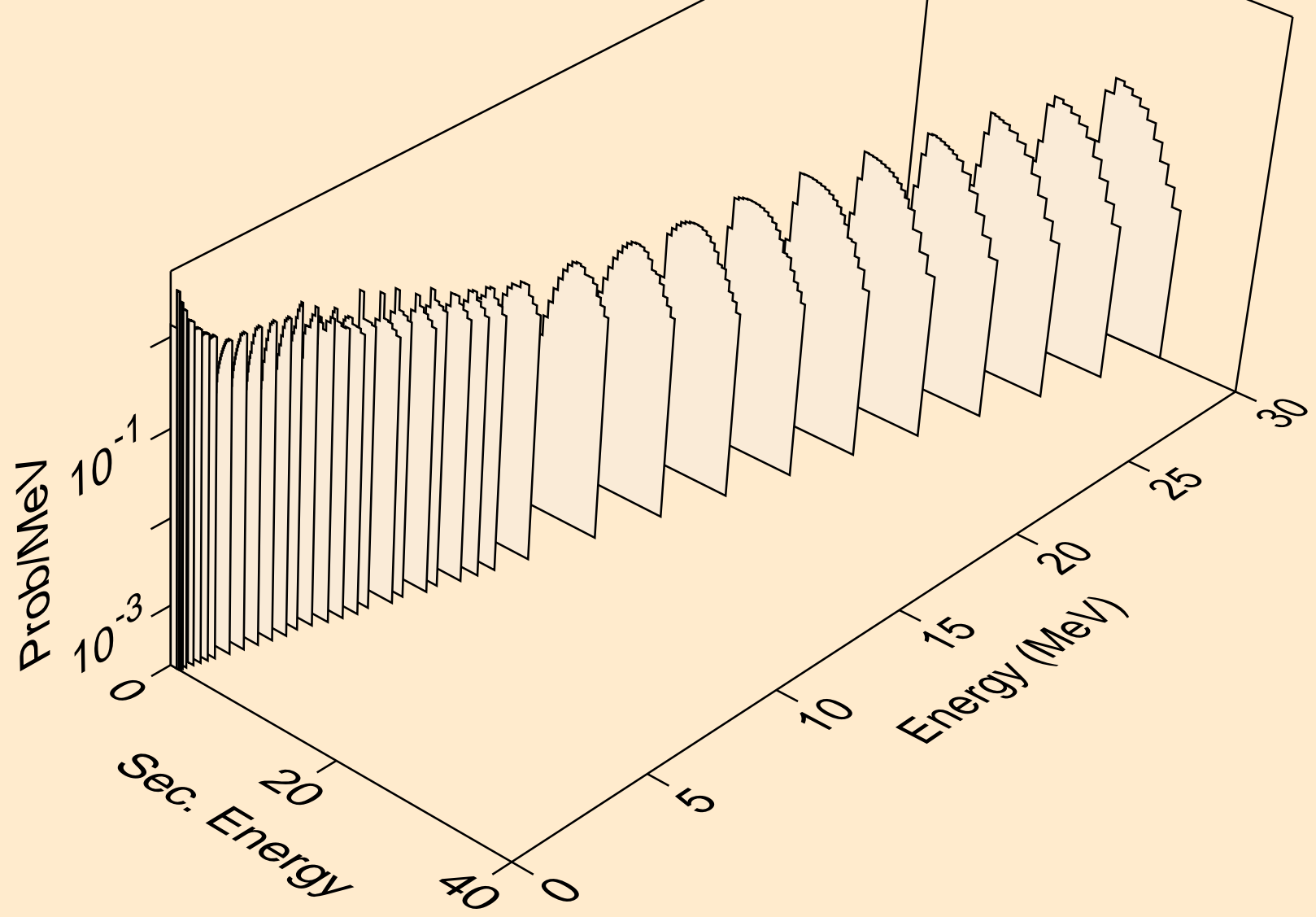

CE139 NEUTRON ACER TENDL-2021 LIBRARY; T=293.6K  
protons from (n,2p)

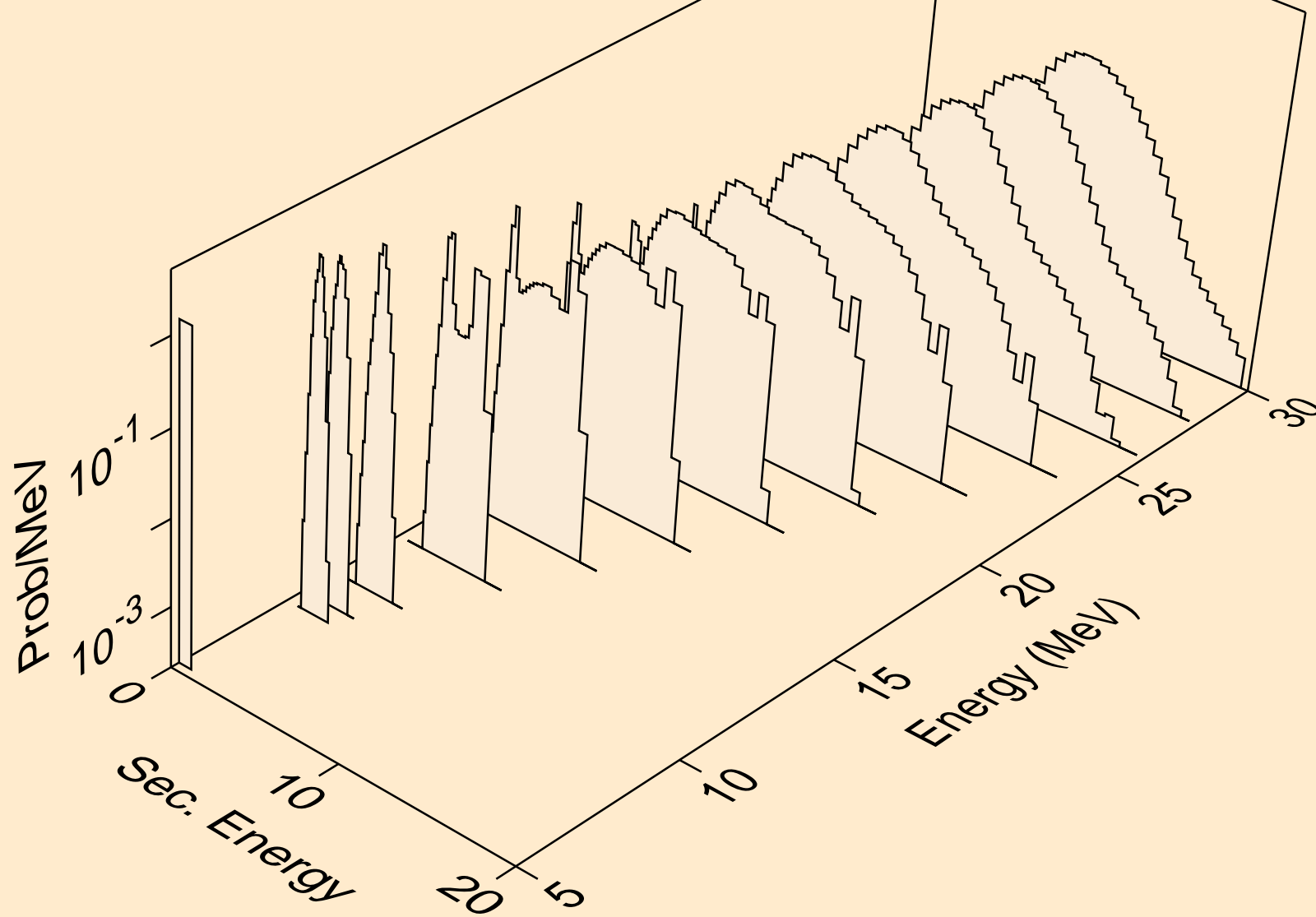

CE139 NEUTRON ACER TENDL-2021 LIBRARY; T=293.6K  
protons from (n,p)

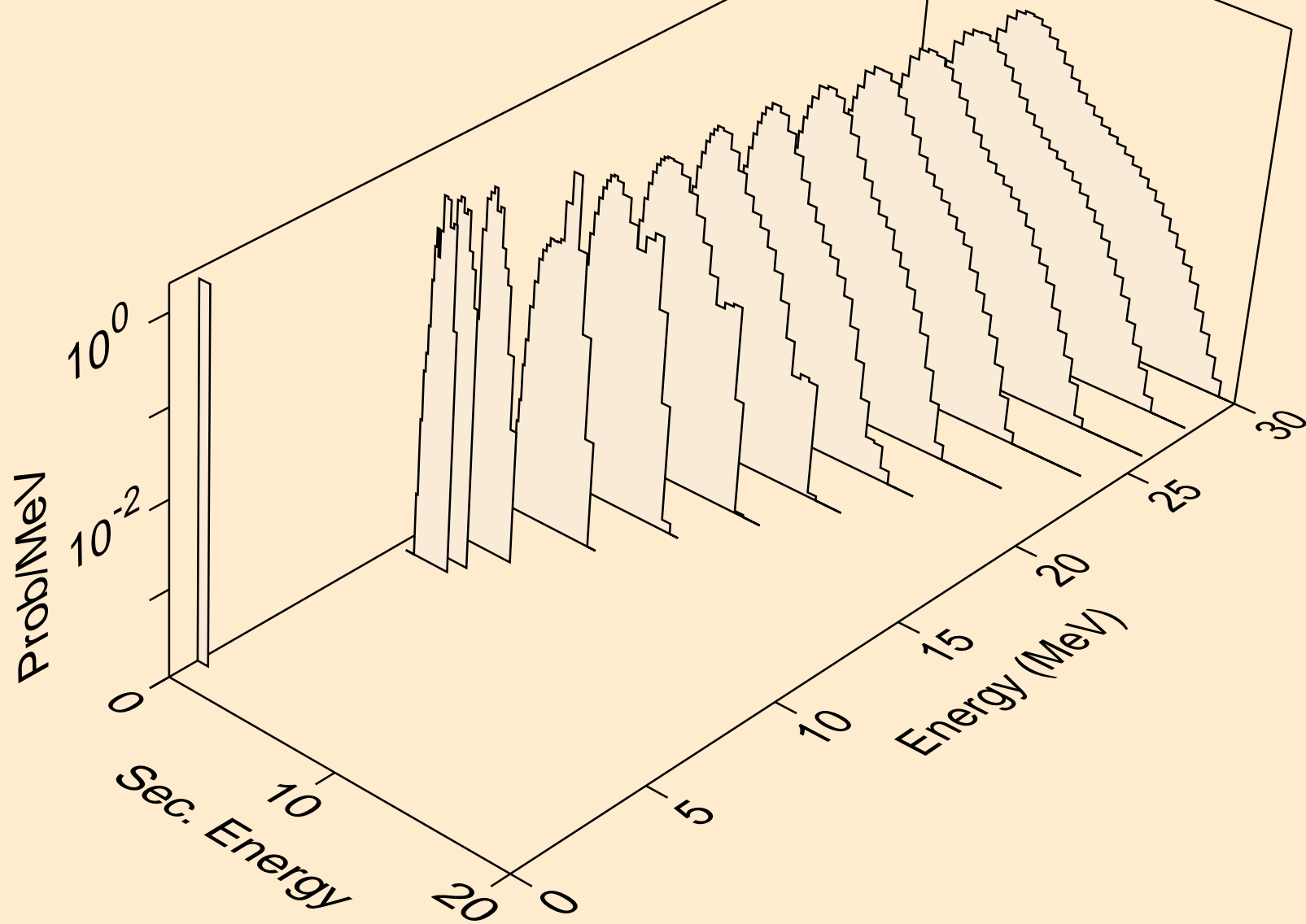

CE139 NEUTRON ACER TENDL-2021 LIBRARY; T=293.6K  
protons from (n,pd)

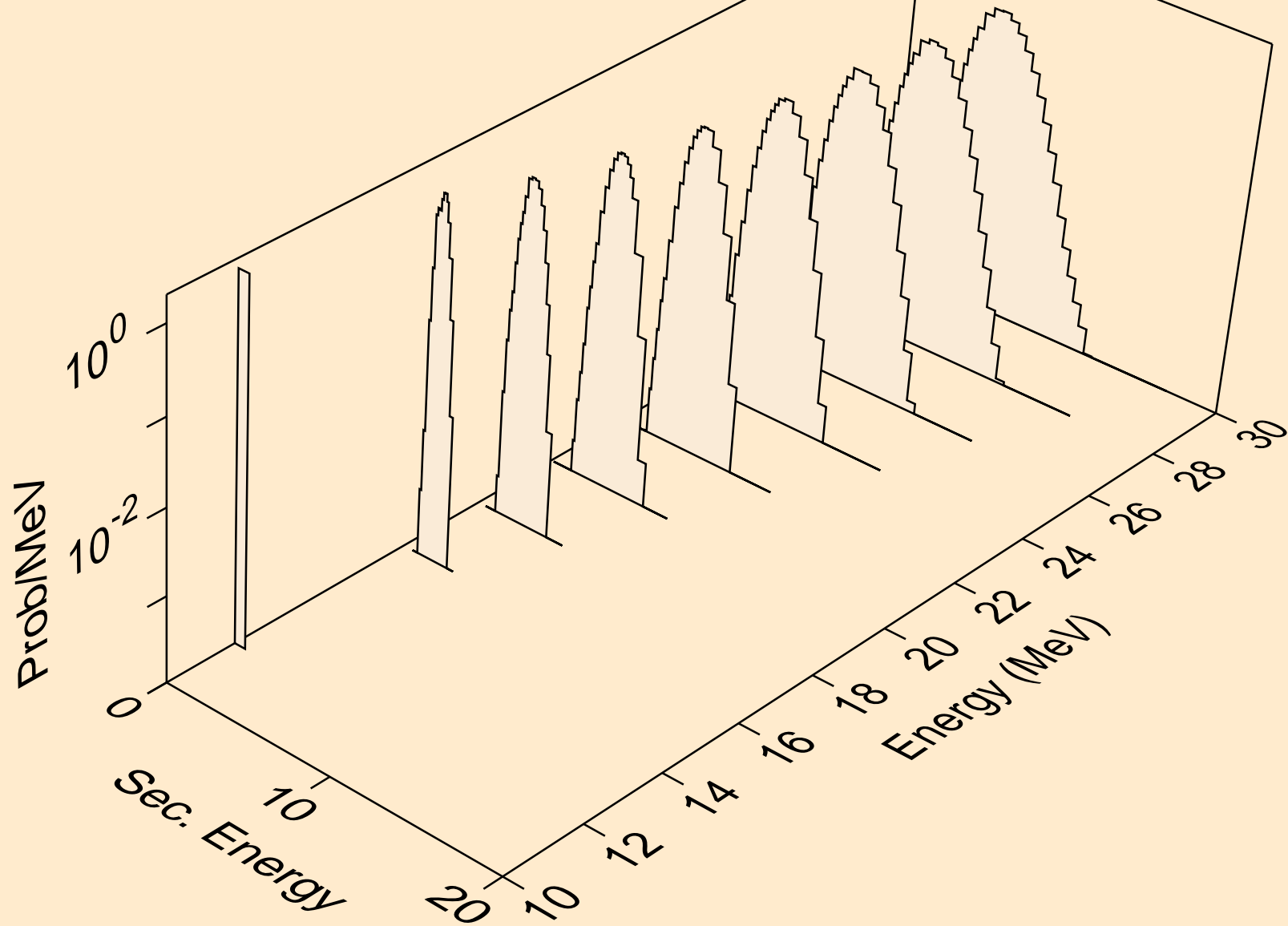

CE139 NEUTRON ACER TENDL-2021 LIBRARY; T=293.6K  
protons from (n,pt)

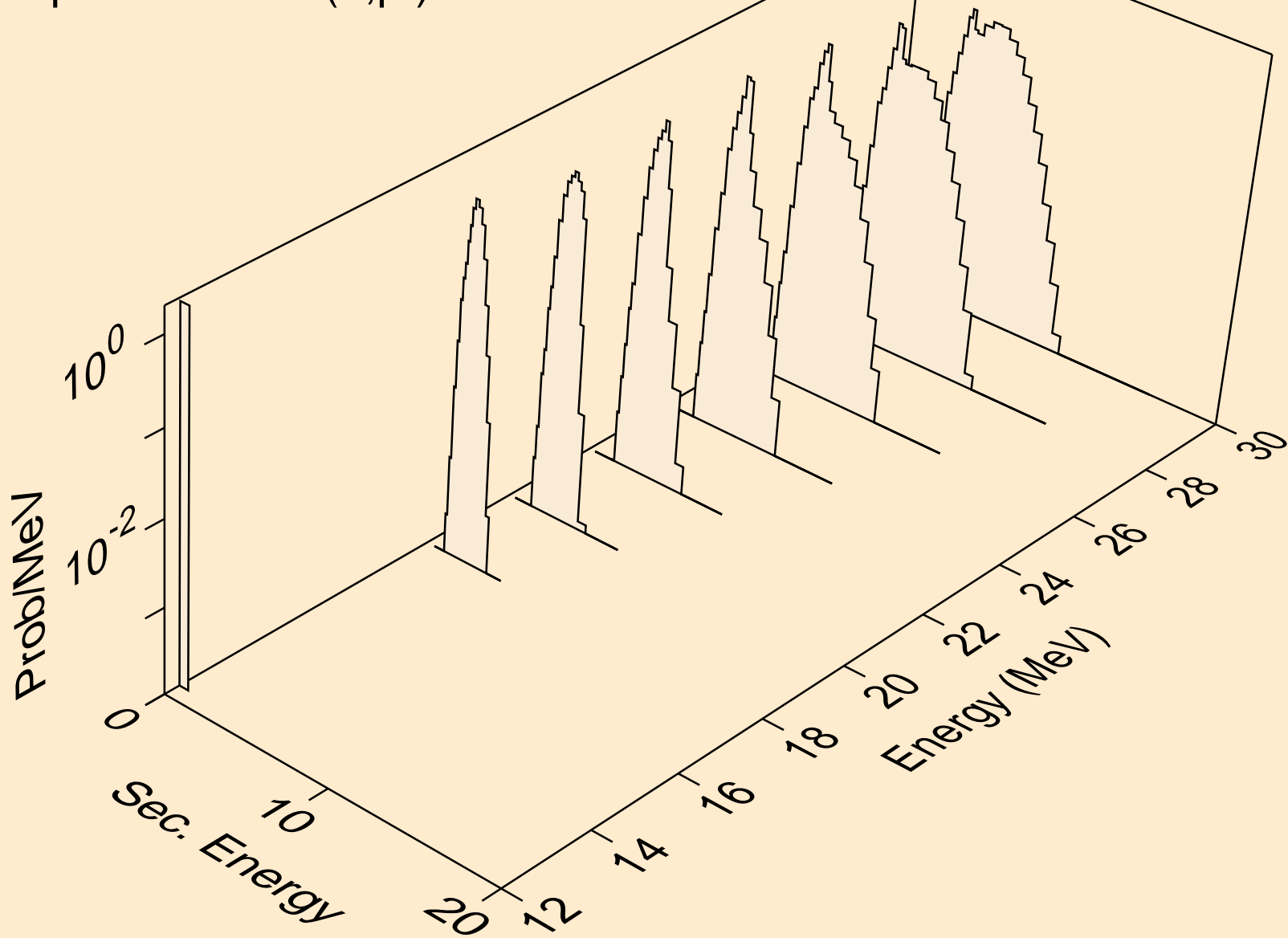

CE139 NEUTRON ACER TENDL-2021 LIBRARY; T=293.6K  
deuterons from (n,x)

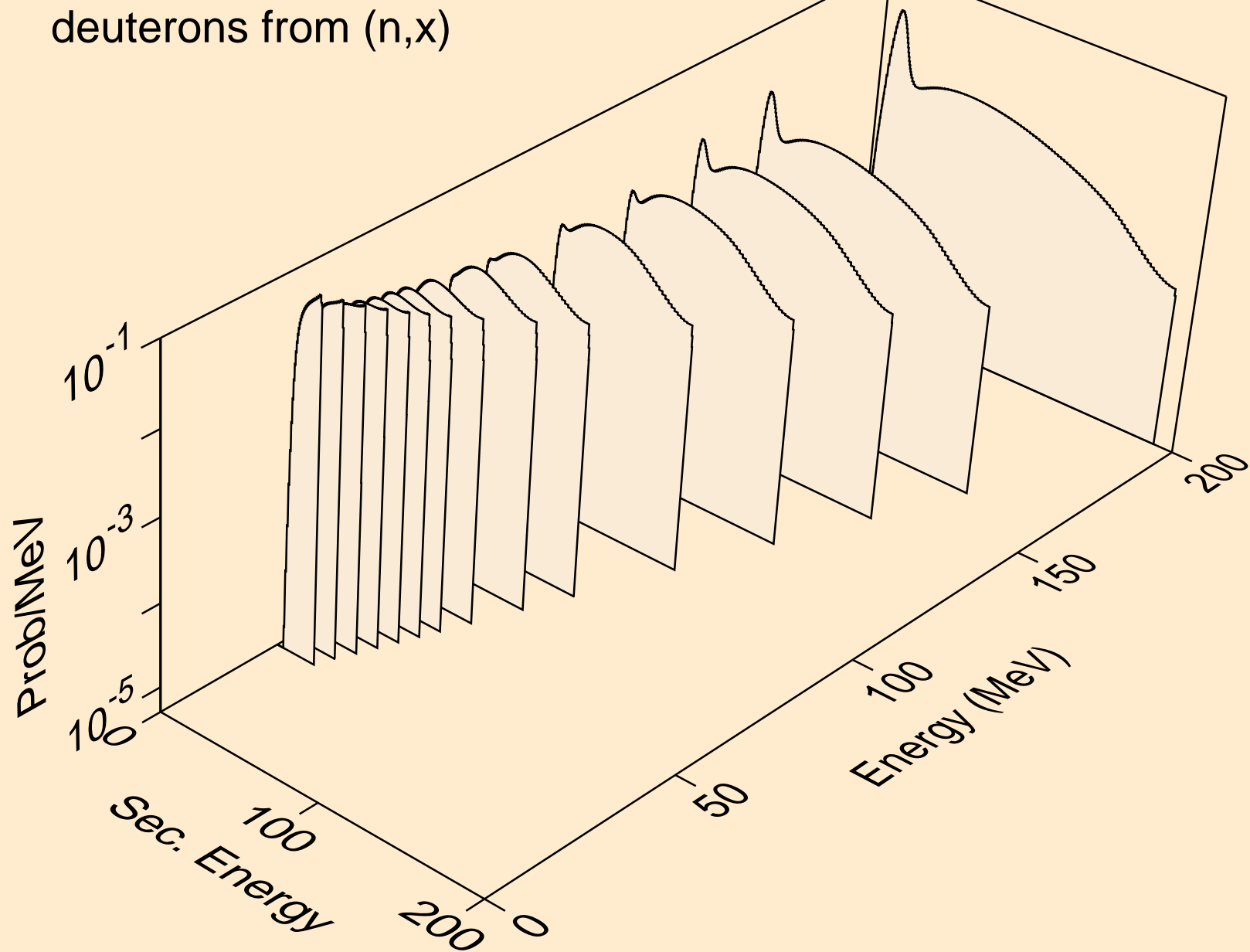

CE139 NEUTRON ACER TENDL-2021 LIBRARY; T=293.6K  
deuterons from (n,2nd)

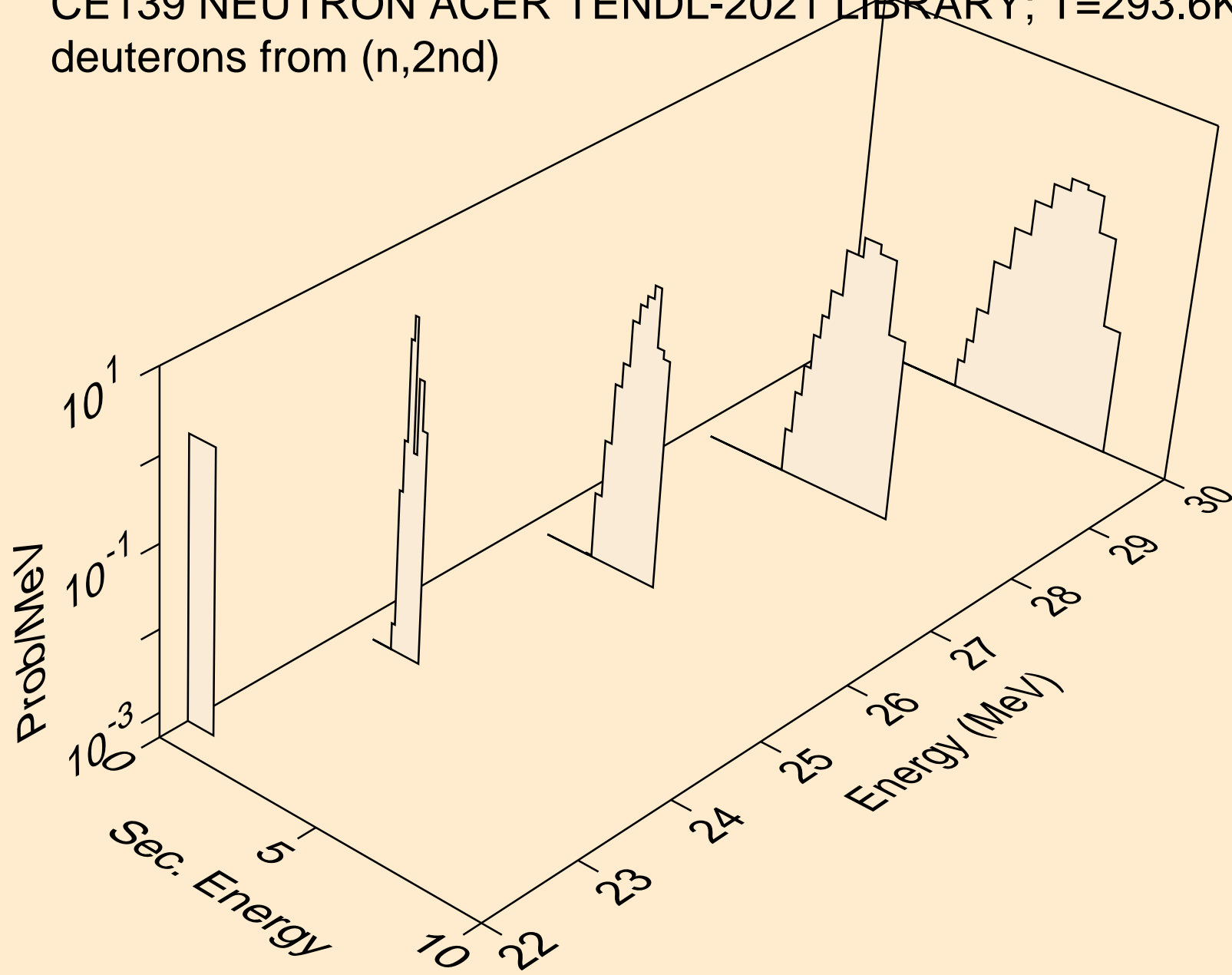

CE139 NEUTRON ACER TENDL-2021 LIBRARY; T=293.6K  
deuterons from (n,n\*)d

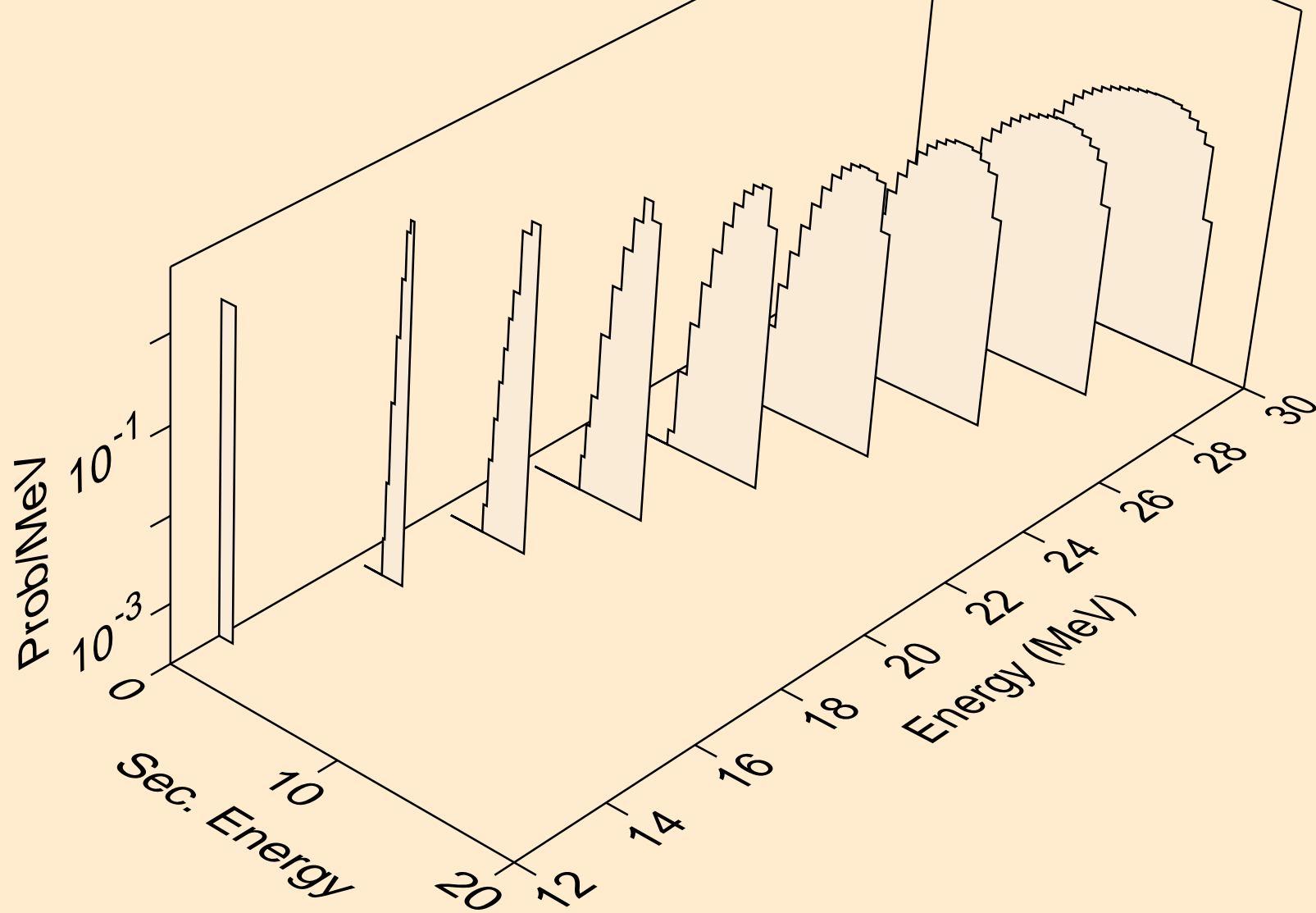



CE139 NEUTRON ACER TENDL-2021 LIBRARY; T=293.6K  
deuterons from (n,d)

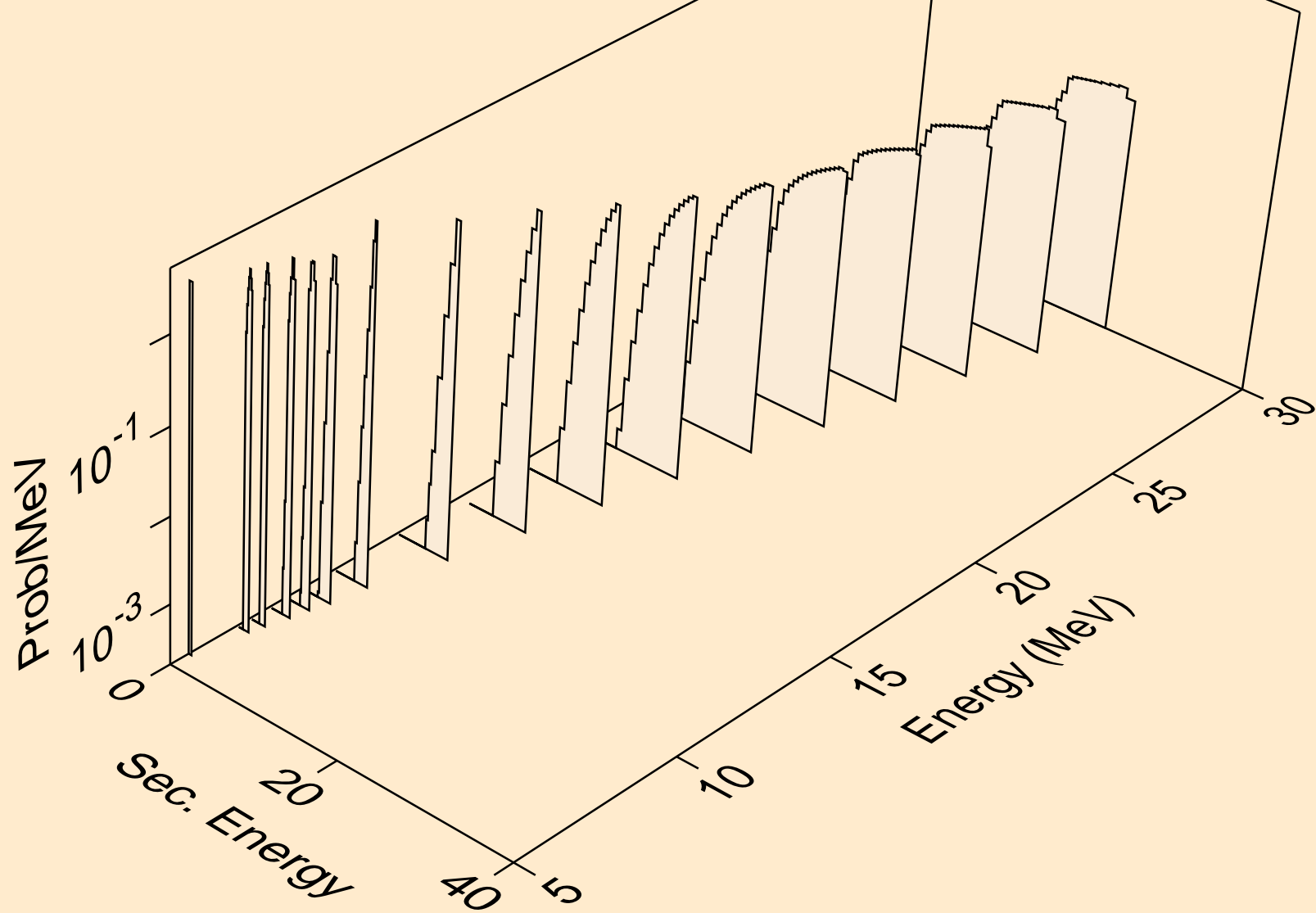

CE139 NEUTRON ACER TENDL-2021 LIBRARY; T=293.6K  
deuterons from (n,pd)

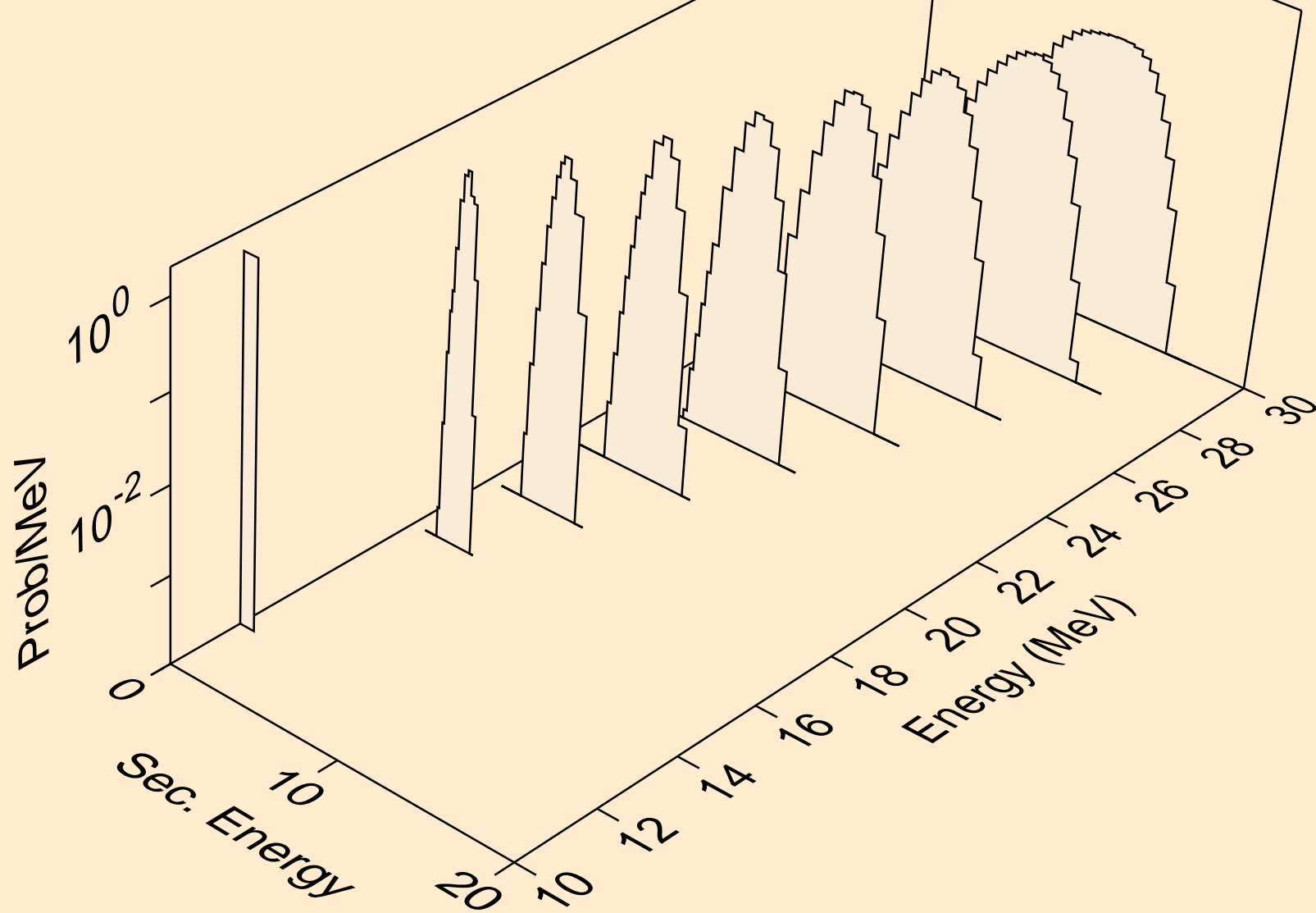

CE139 NEUTRON ACER TENDL-2021 LIBRARY; T=293.6K  
deuterons from (n,da)

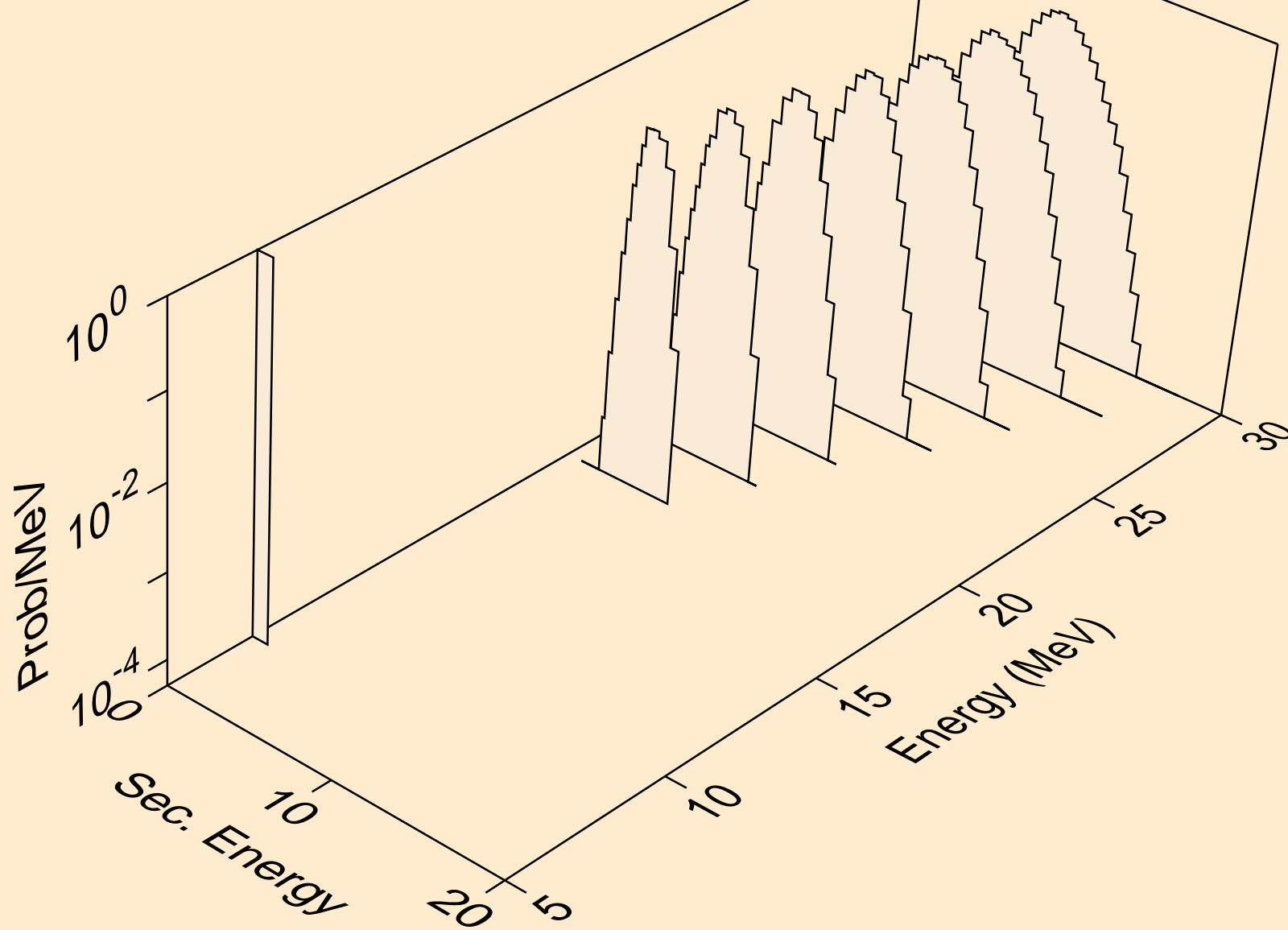

CE139 NEUTRON ACER TENDL-2021 LIBRARY; T=293.6K  
tritons from (n,x)

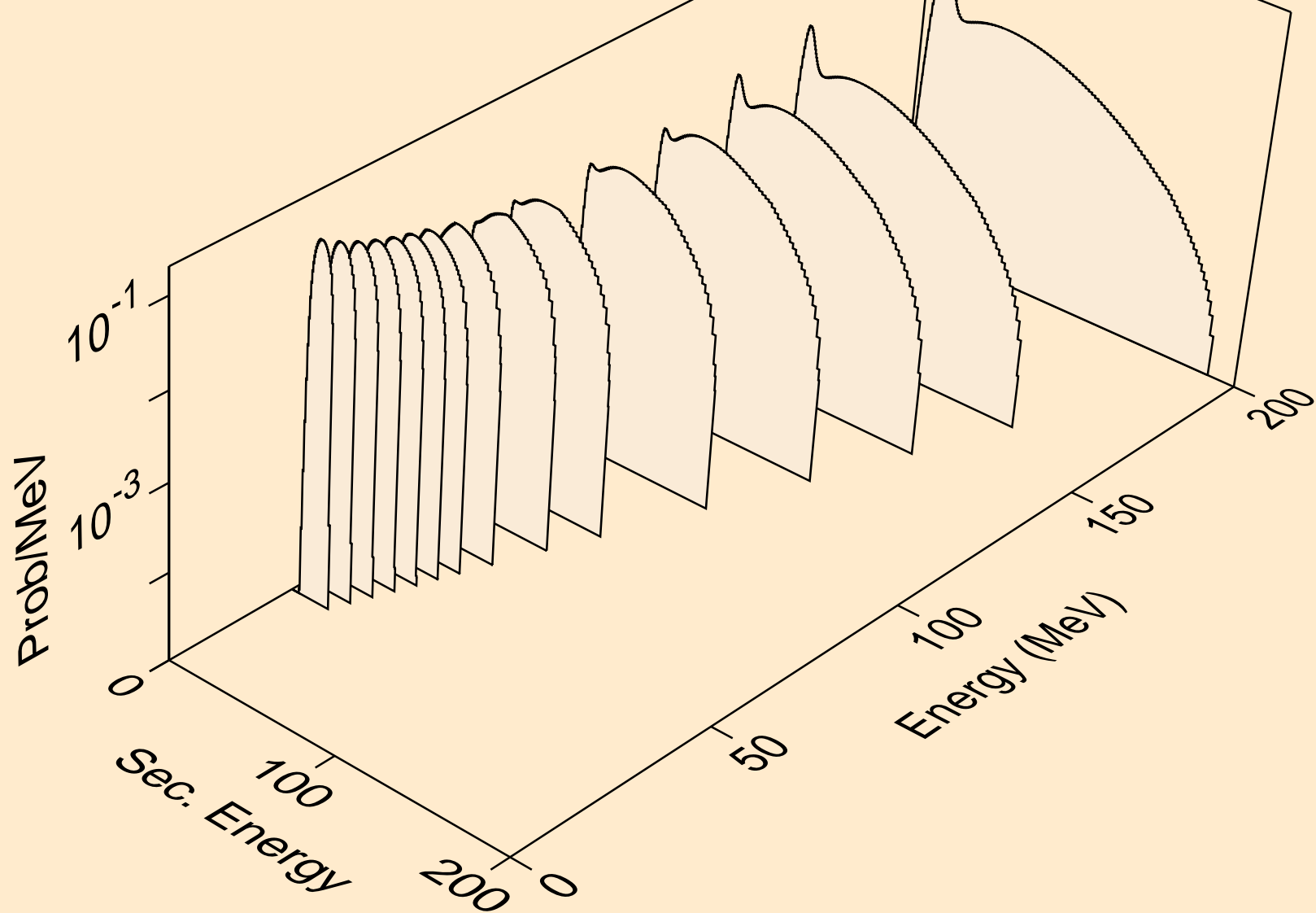

CE139 NEUTRON ACER TENDL-2021 LIBRARY; T=293.6K  
tritons from (n,n\*)t

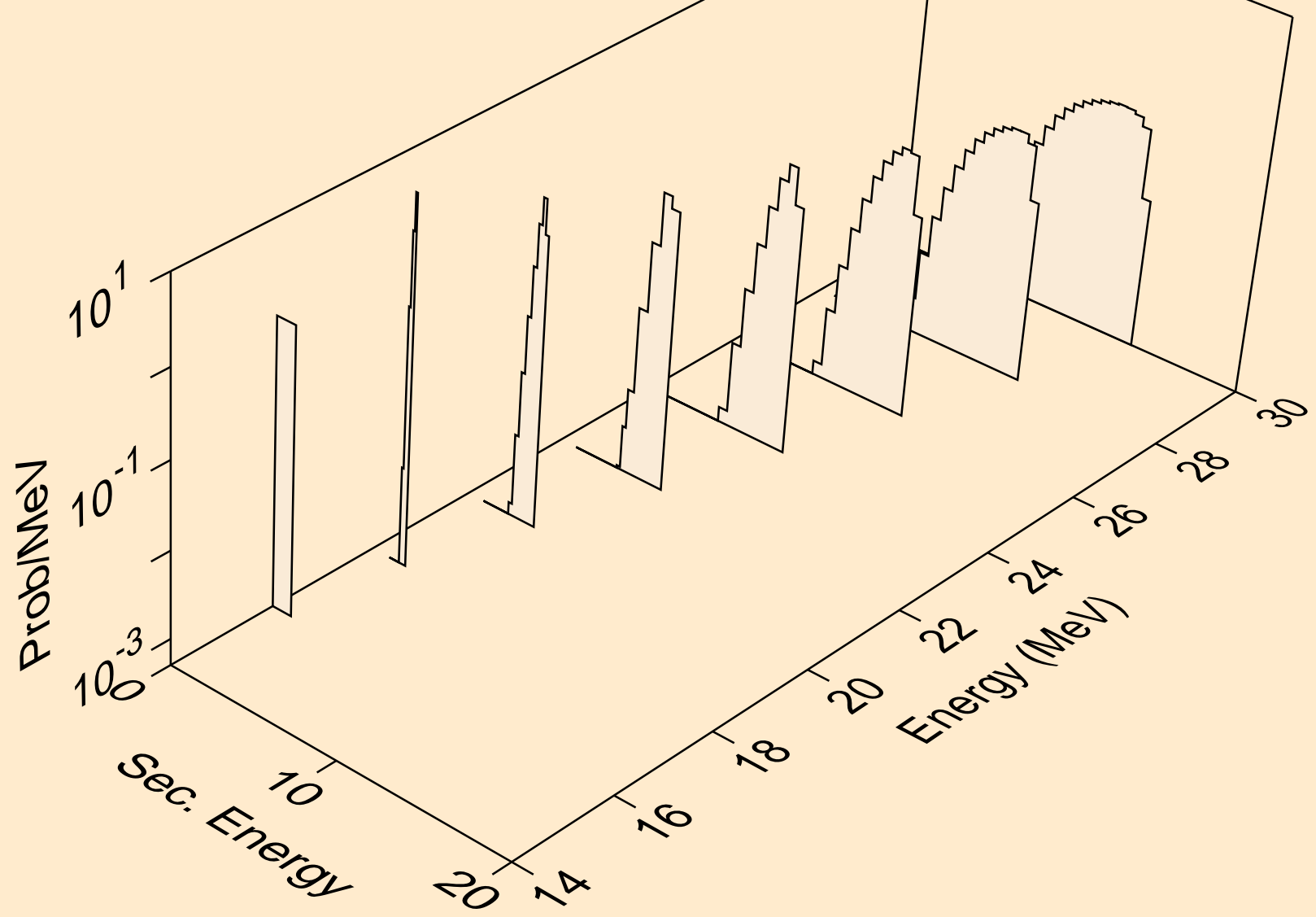

CE139 NEUTRON ACER TENDL-2021 LIBRARY; T=293.6K  
tritons from (n,t)

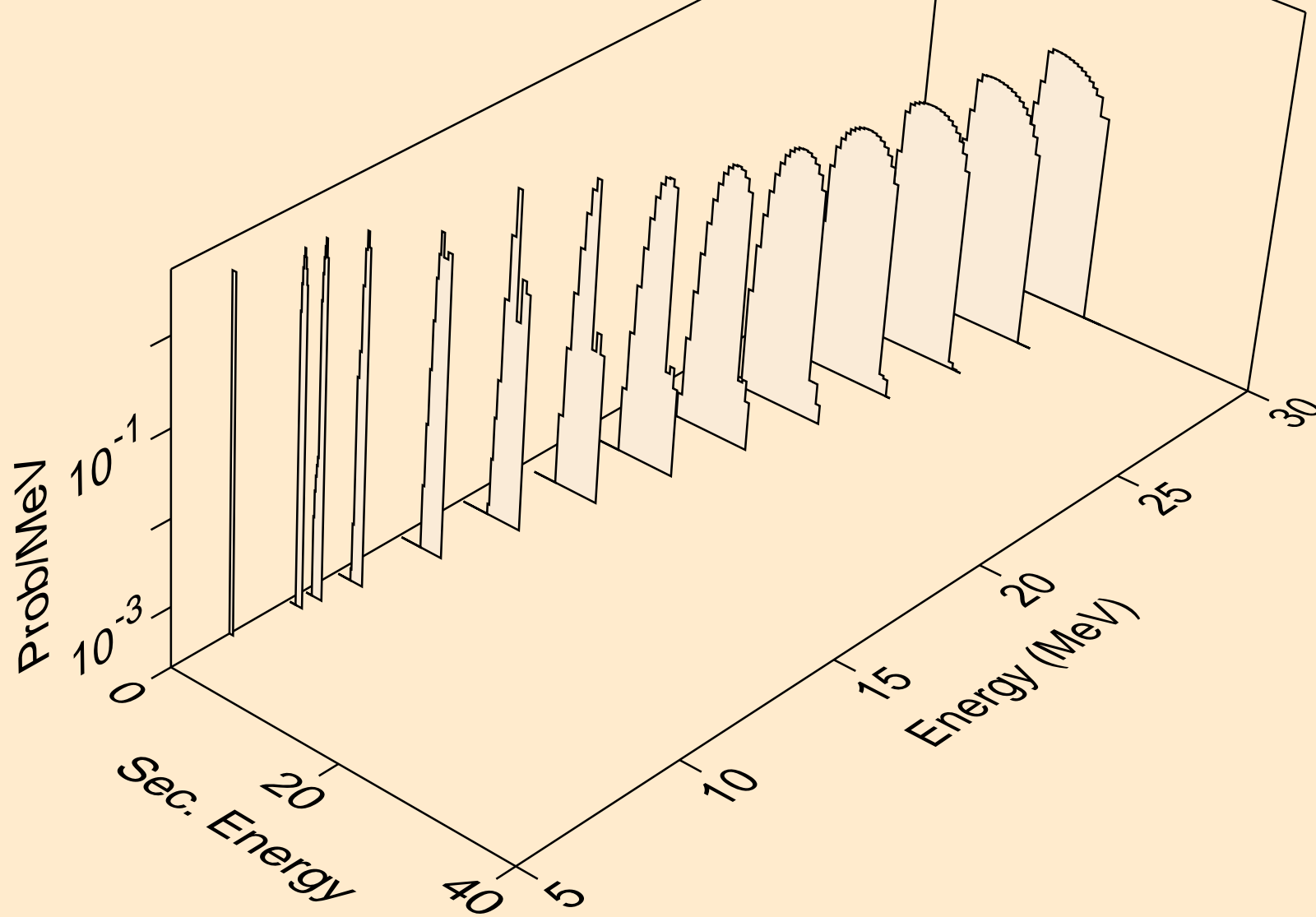

CE139 NEUTRON ACER TENDL-2021 LIBRARY; T=293.6K  
tritons from (n,pt)

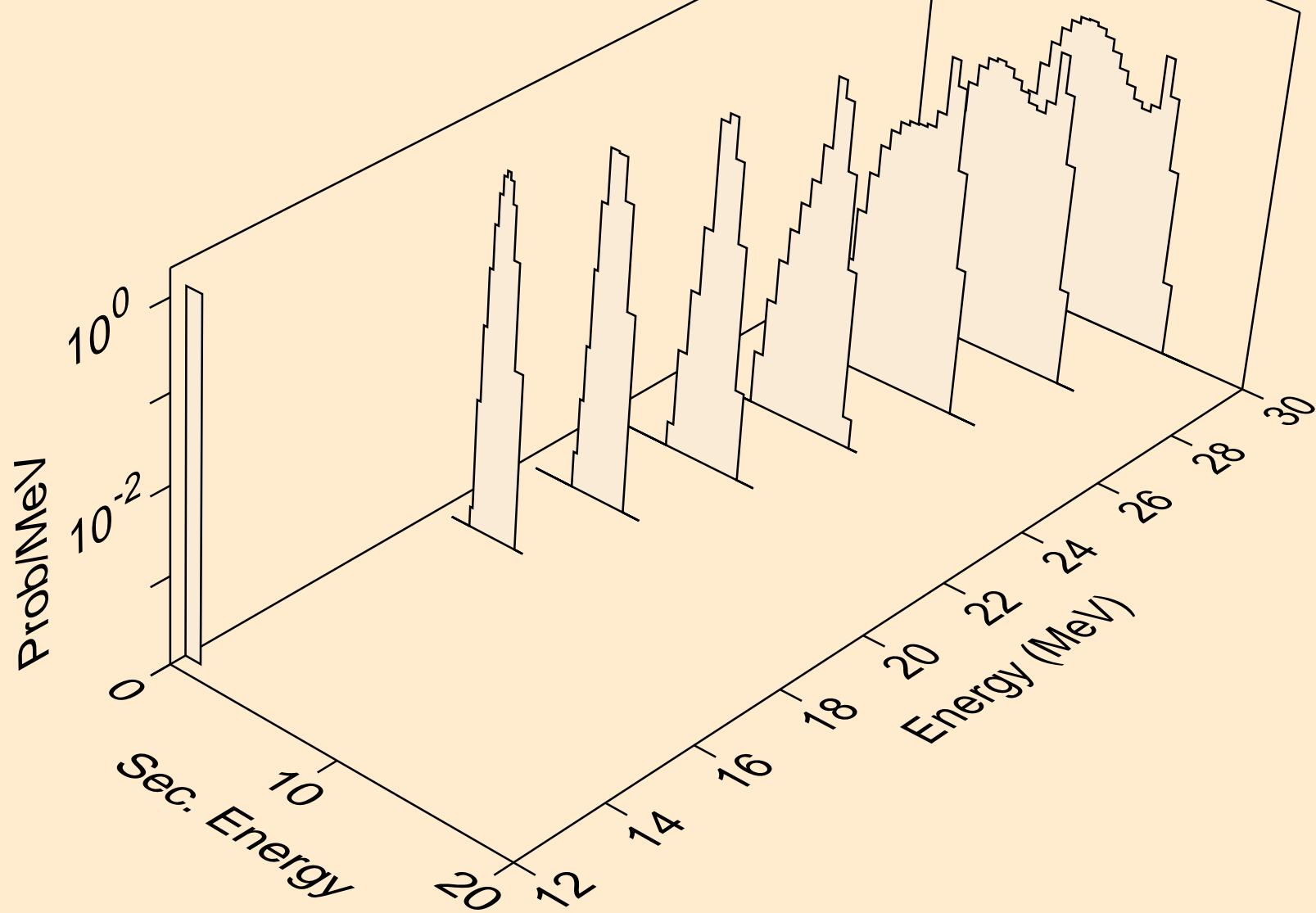

CE139 NEUTRON ACER TENDL-2021 LIBRARY; T=293.6K  
he3s from (n,x)

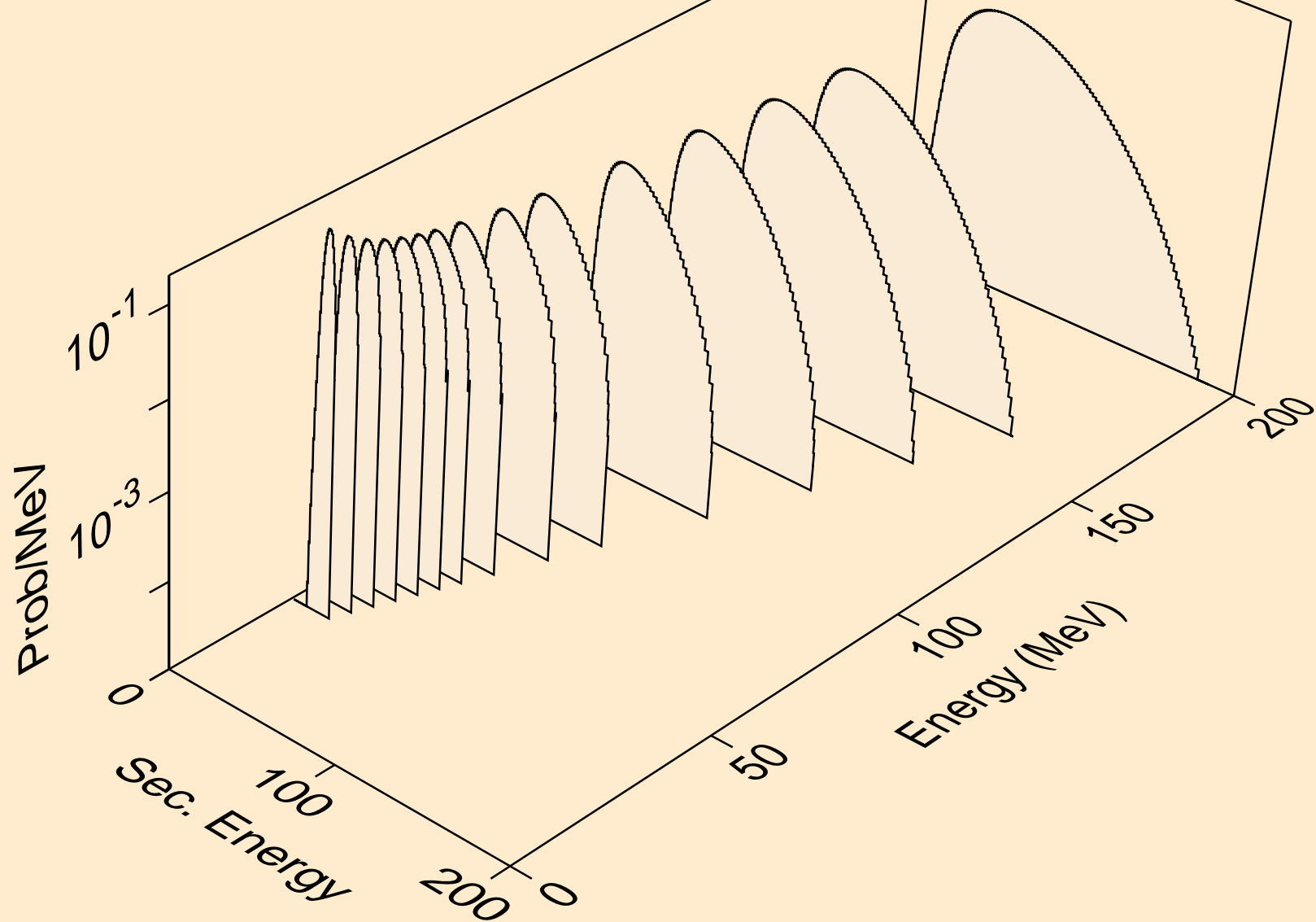



CE139 NEUTRON ACER TENDL-2021 LIBRARY; T=293.6K  
he3s from (n,n\*)he3

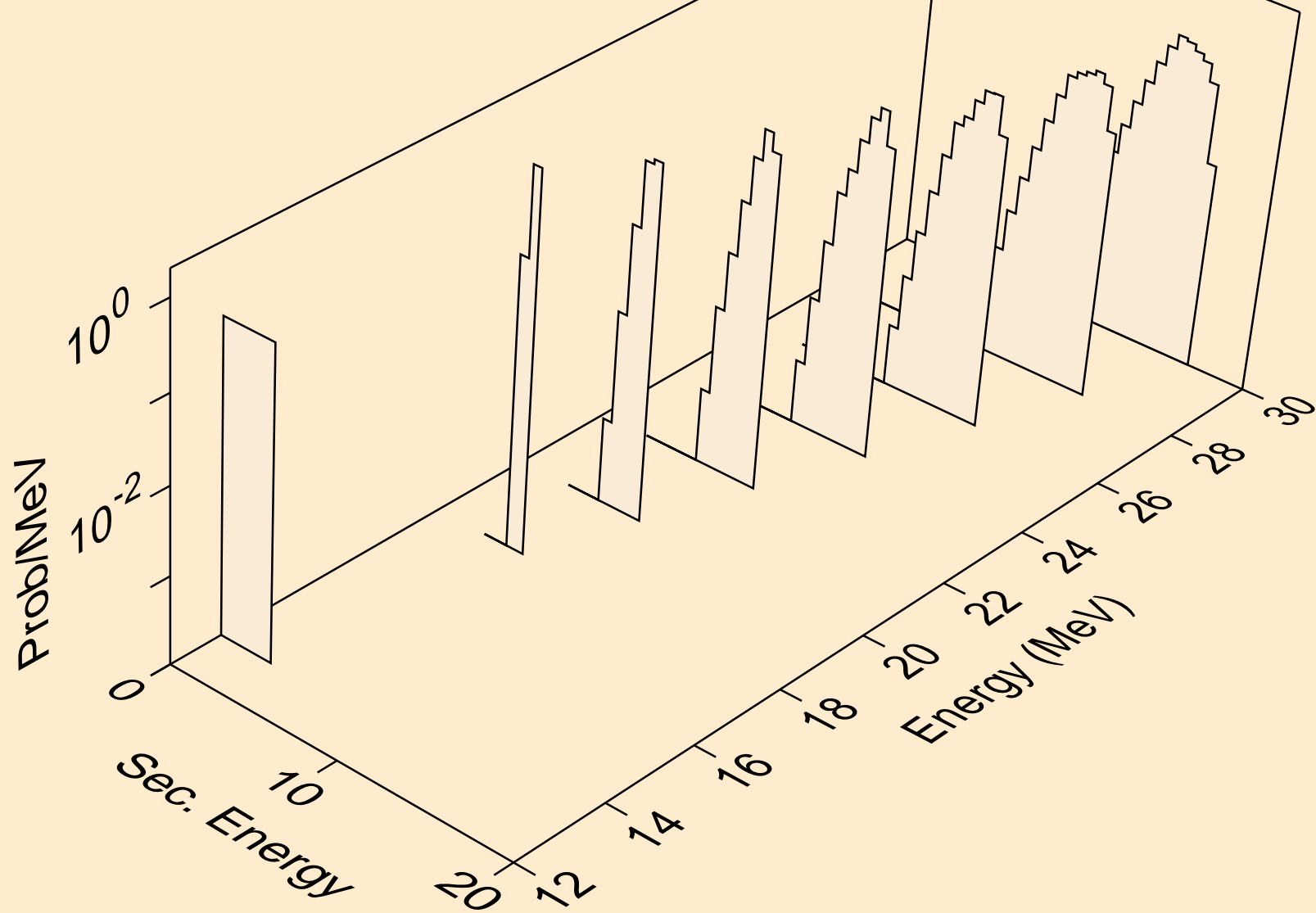

CE139 NEUTRON ACER TENDL-2021 LIBRARY; T=293.6K  
he3s from (n,he3)

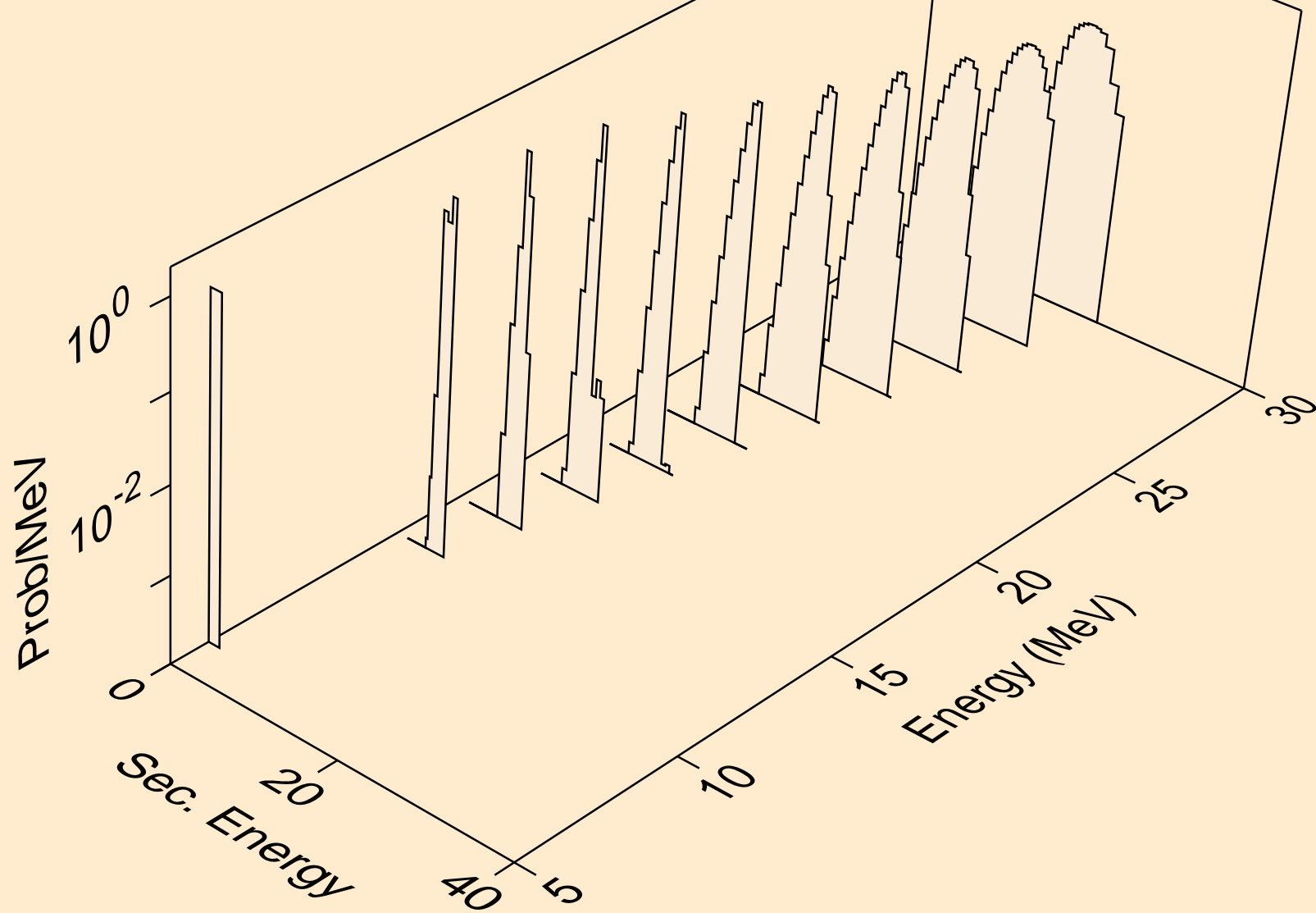

CE139 NEUTRON ACER TENDL-2021 LIBRARY; T=293.6K  
alphas from (n,x)

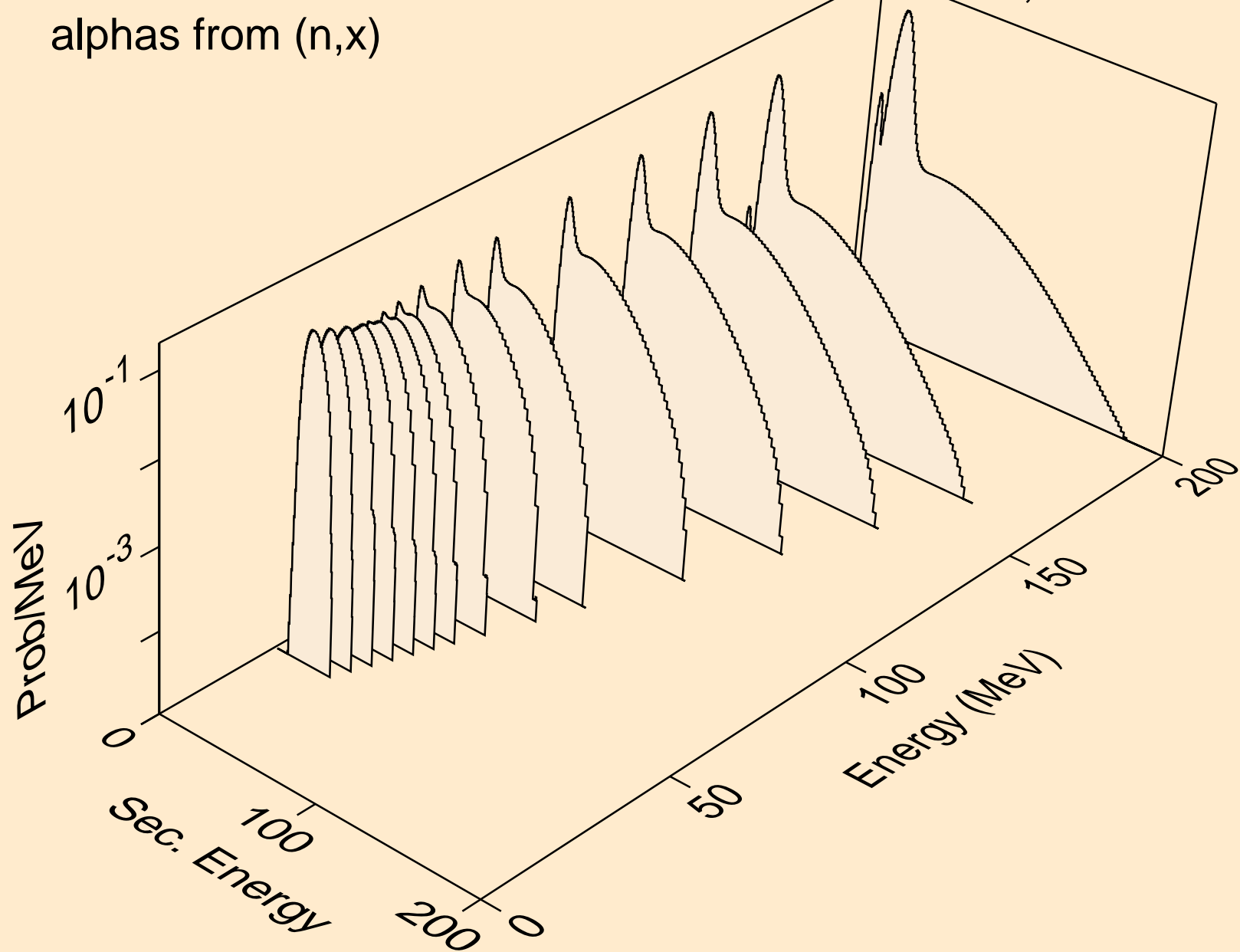

CE139 NEUTRON ACER TENDL-2021 LIBRARY; T=293.6K  
alphas from (n,n\*)a

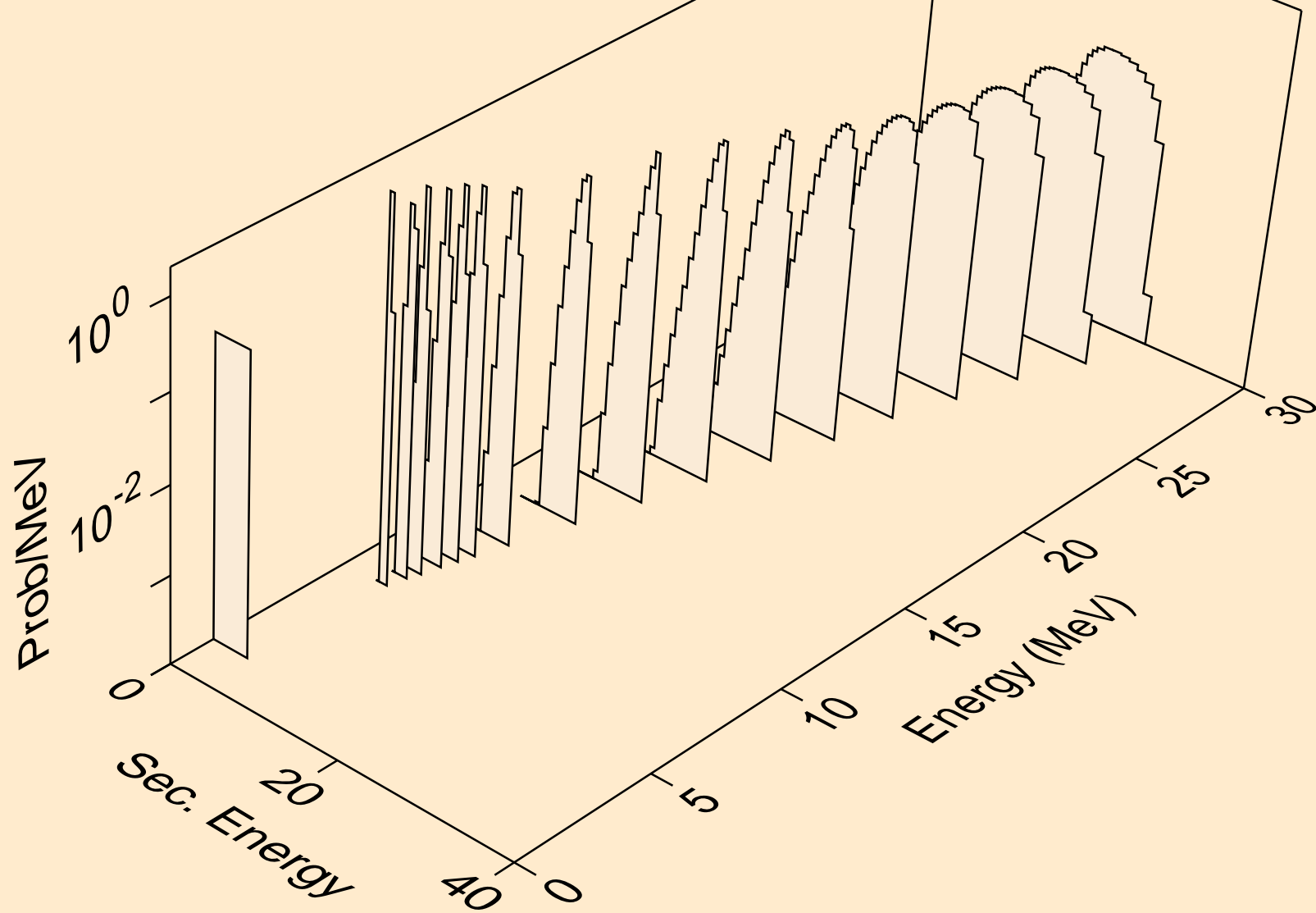

CE139 NEUTRON ACER TENDL-2021 LIBRARY; T=293.6K  
alphas from (n,2n)a

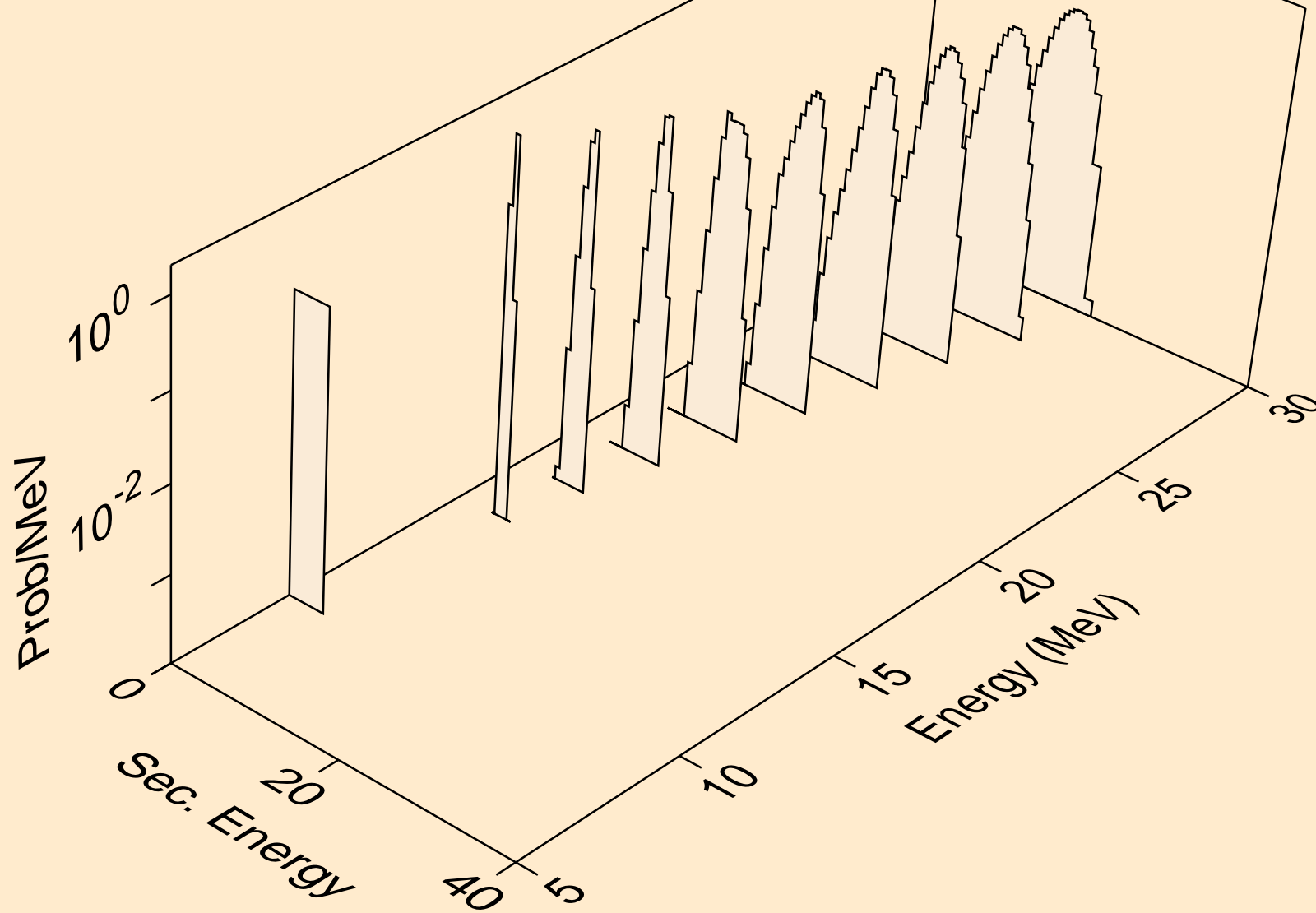

CE139 NEUTRON ACER TENDL-2021 LIBRARY; T=293.6K  
alphas from (n,3n)a

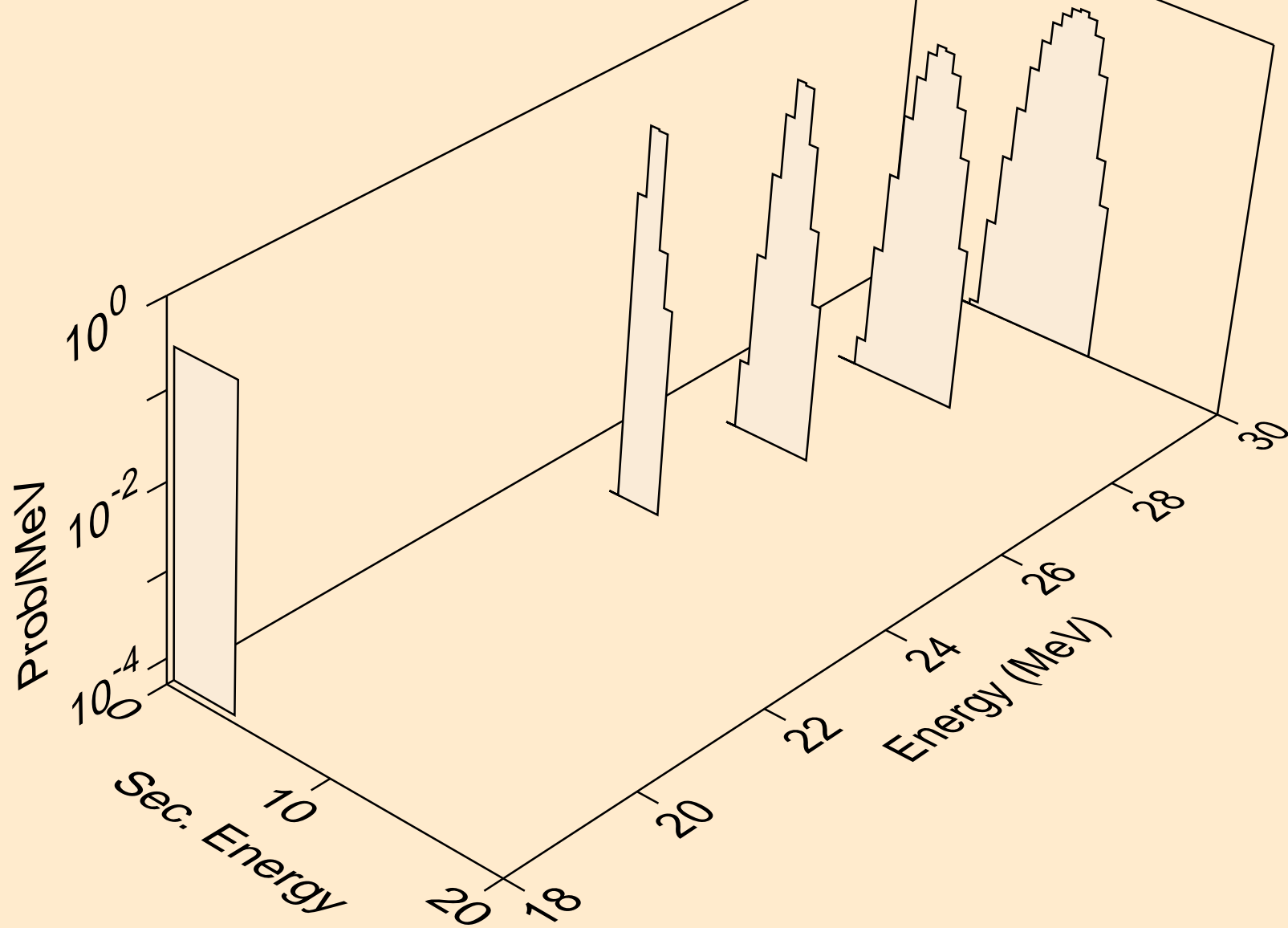

CE139 NEUTRON ACER TENDL-2021 LIBRARY; T=293.6K  
alphas from (n,n\*)2a

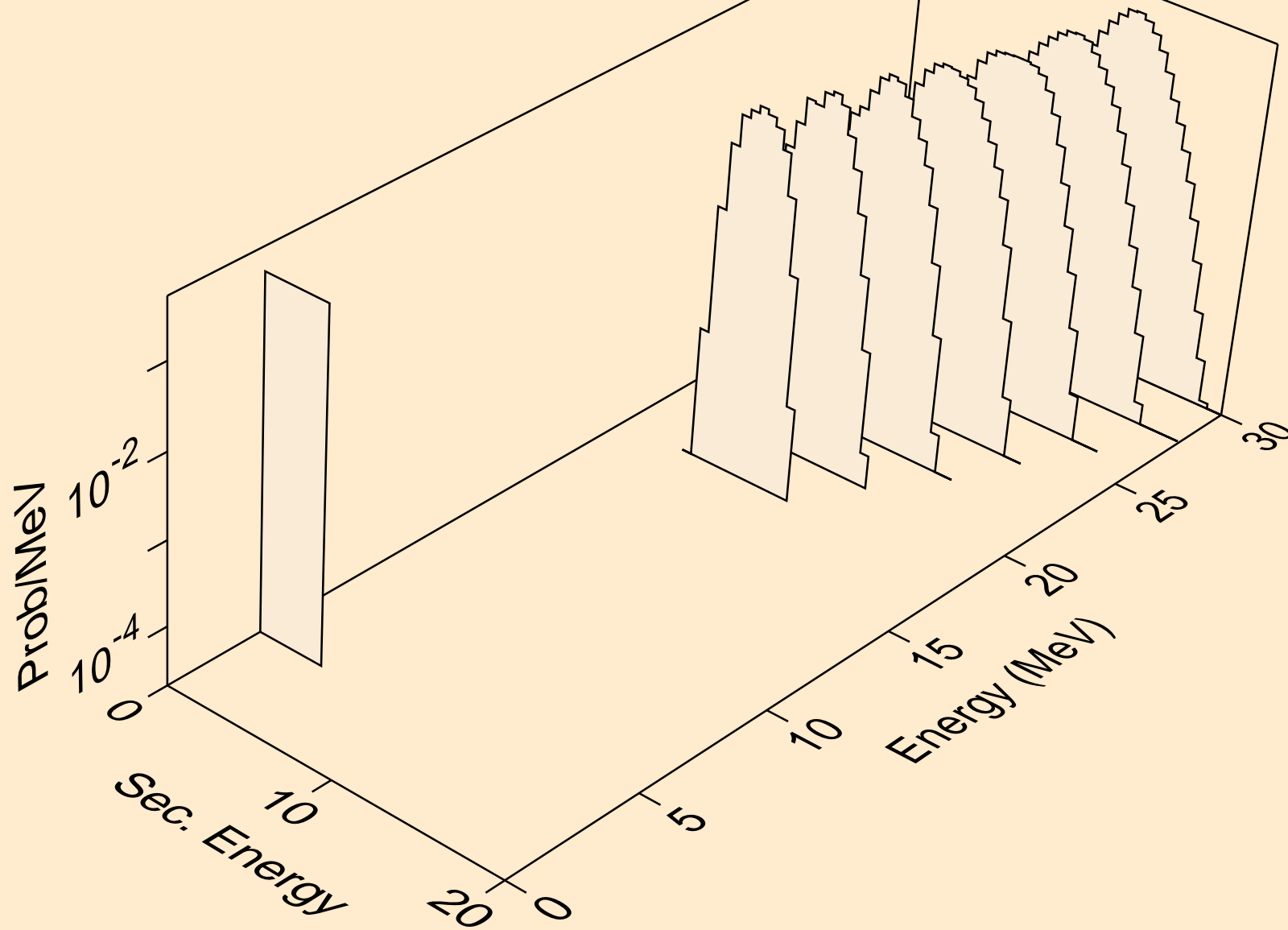

CE139 NEUTRON ACER TENDL-2021 LIBRARY; T=293.6K  
alphas from (n,npa)

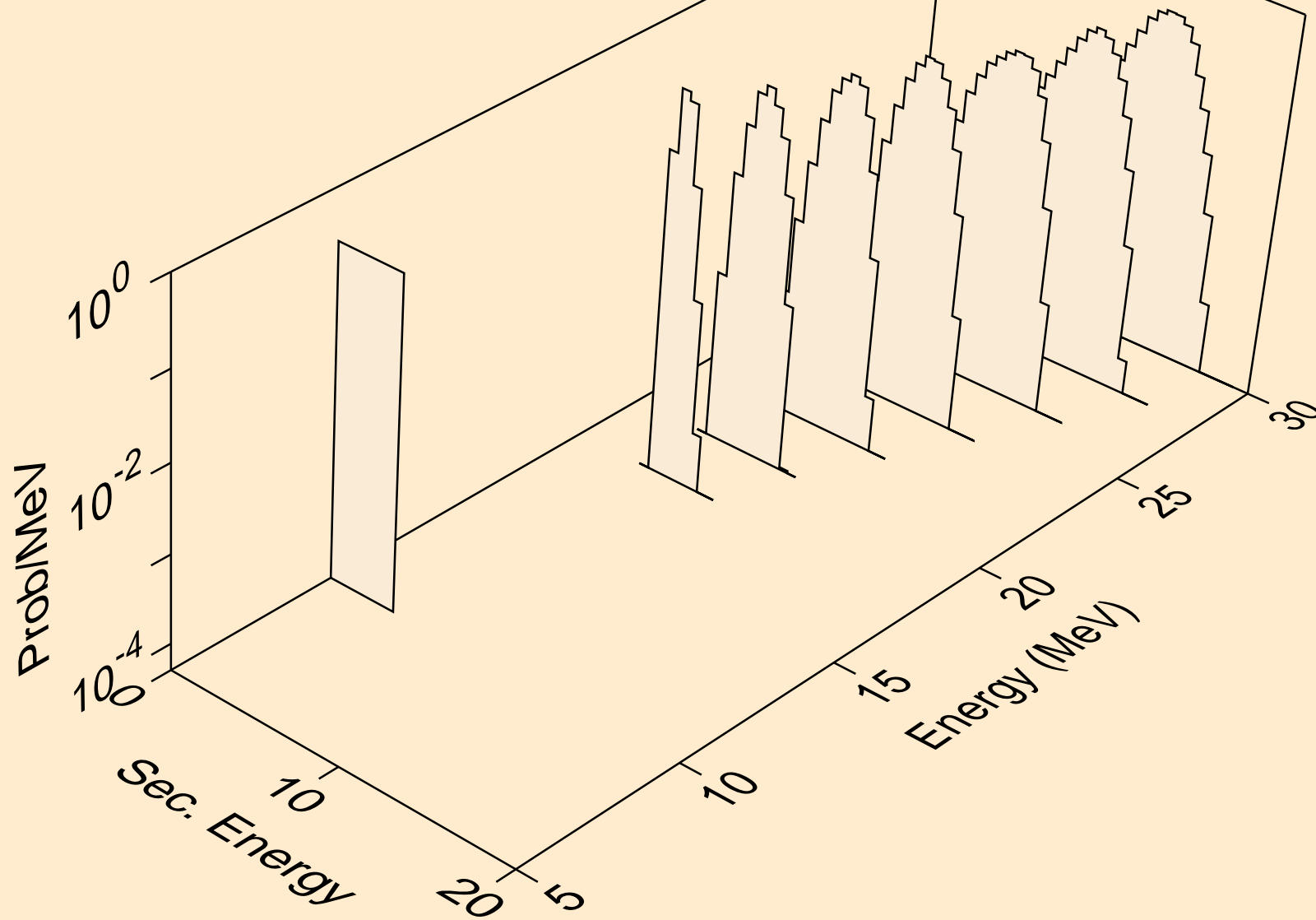



CE139 NEUTRON ACER TENDL-2021 LIBRARY; T=293.6K  
alphas from (n,a)

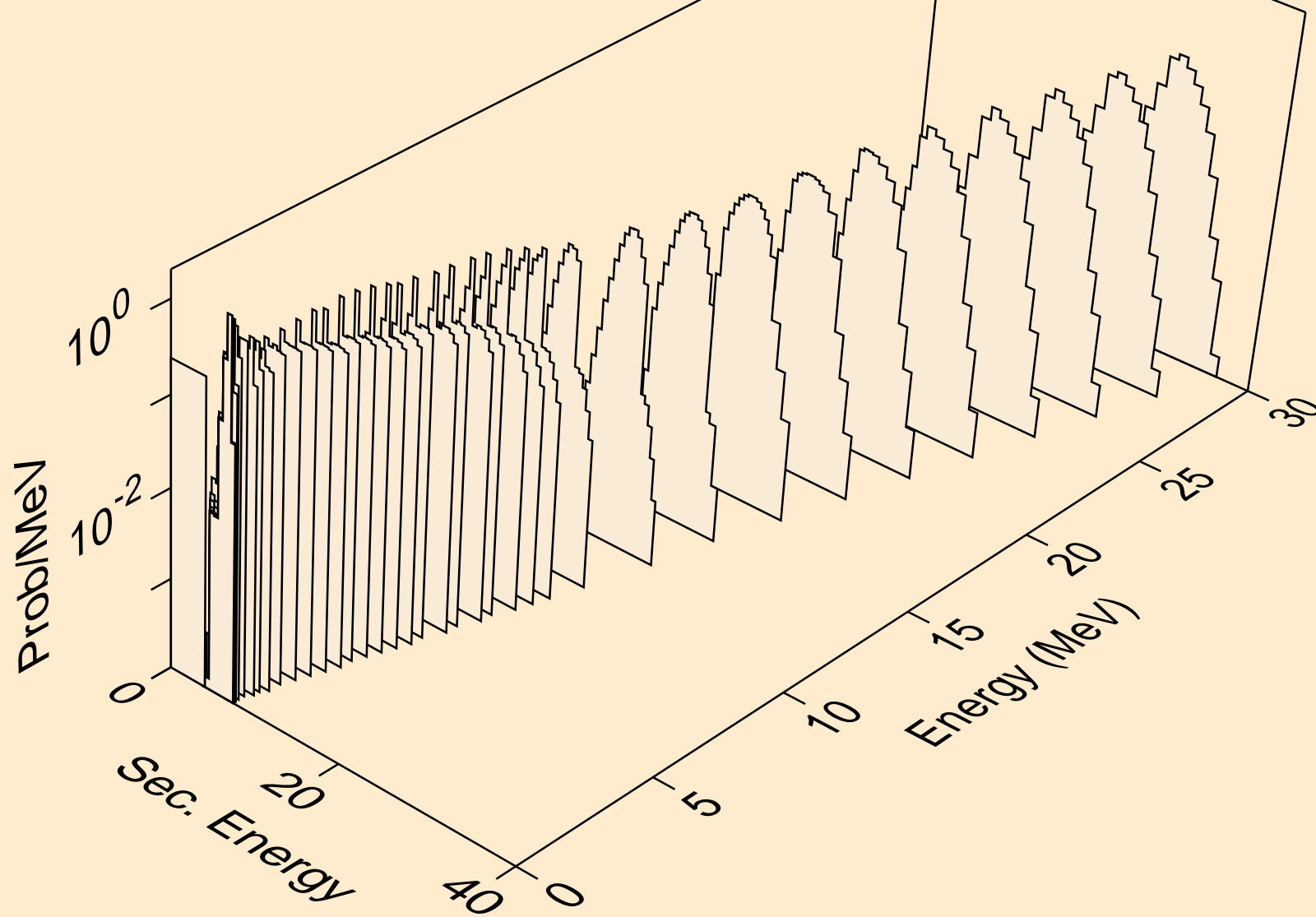

CE139 NEUTRON ACER TENDL-2021 LIBRARY; T=293.6K  
alphas from (n,2a)

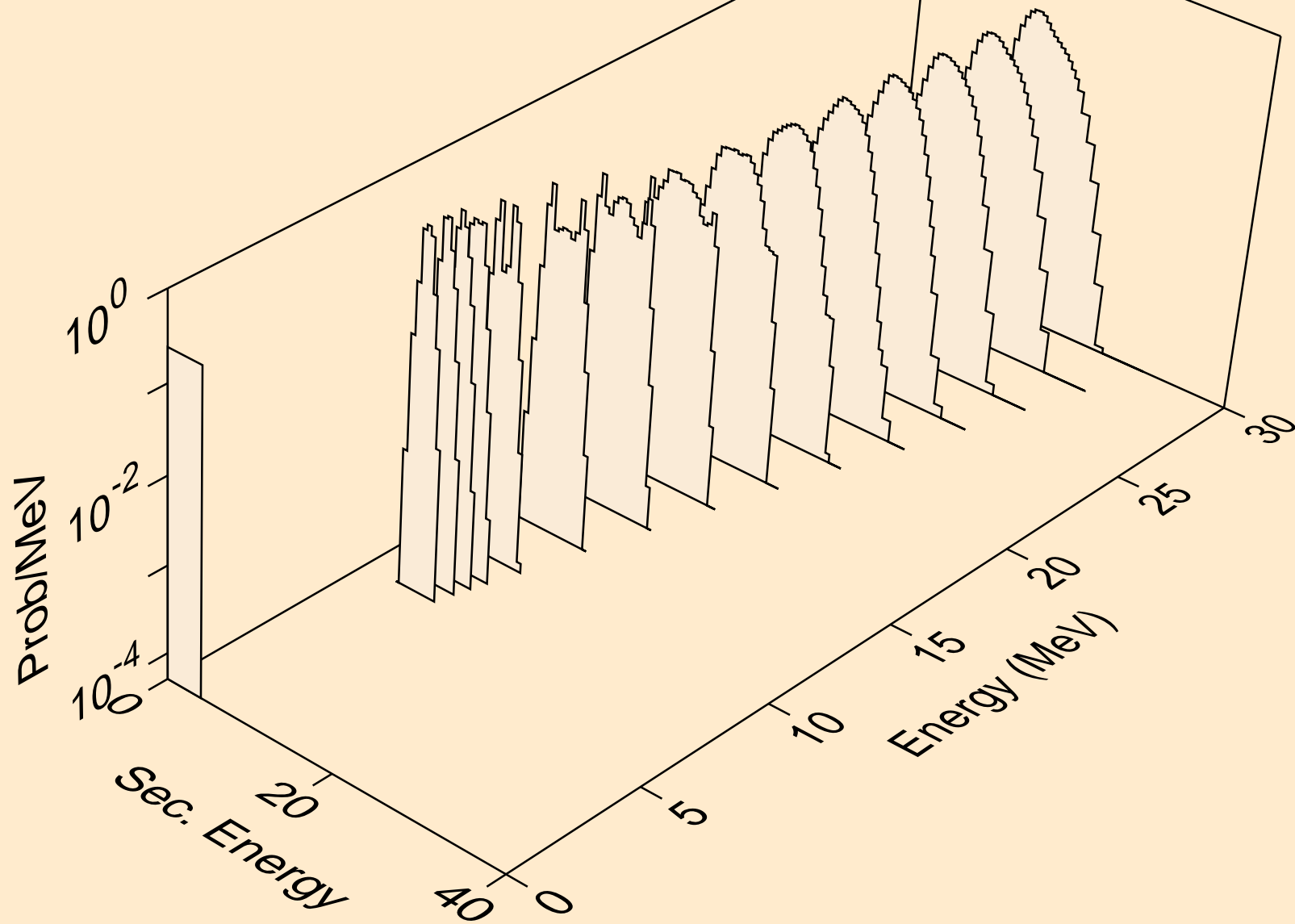

CE139 NEUTRON ACER TENDL-2021 LIBRARY; T=293.6K  
alphas from (n,pa)

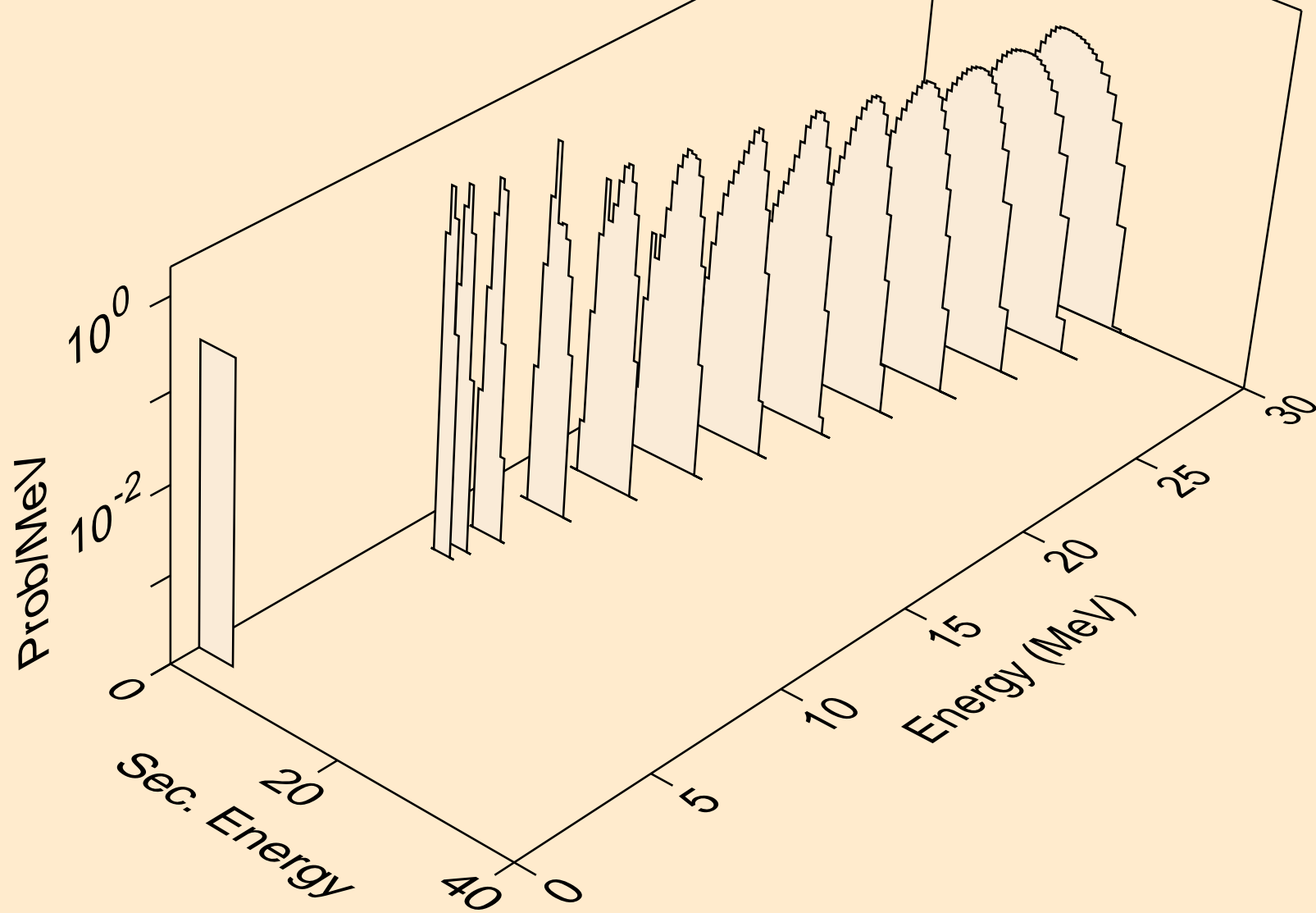

CE139 NEUTRON ACER TENDL-2021 LIBRARY; T=293.6K  
alphas from (n,da)

