

CF241 NEUTRON ACER TENDL-2021 LIBRARY; T=293.6K

Principal cross sections

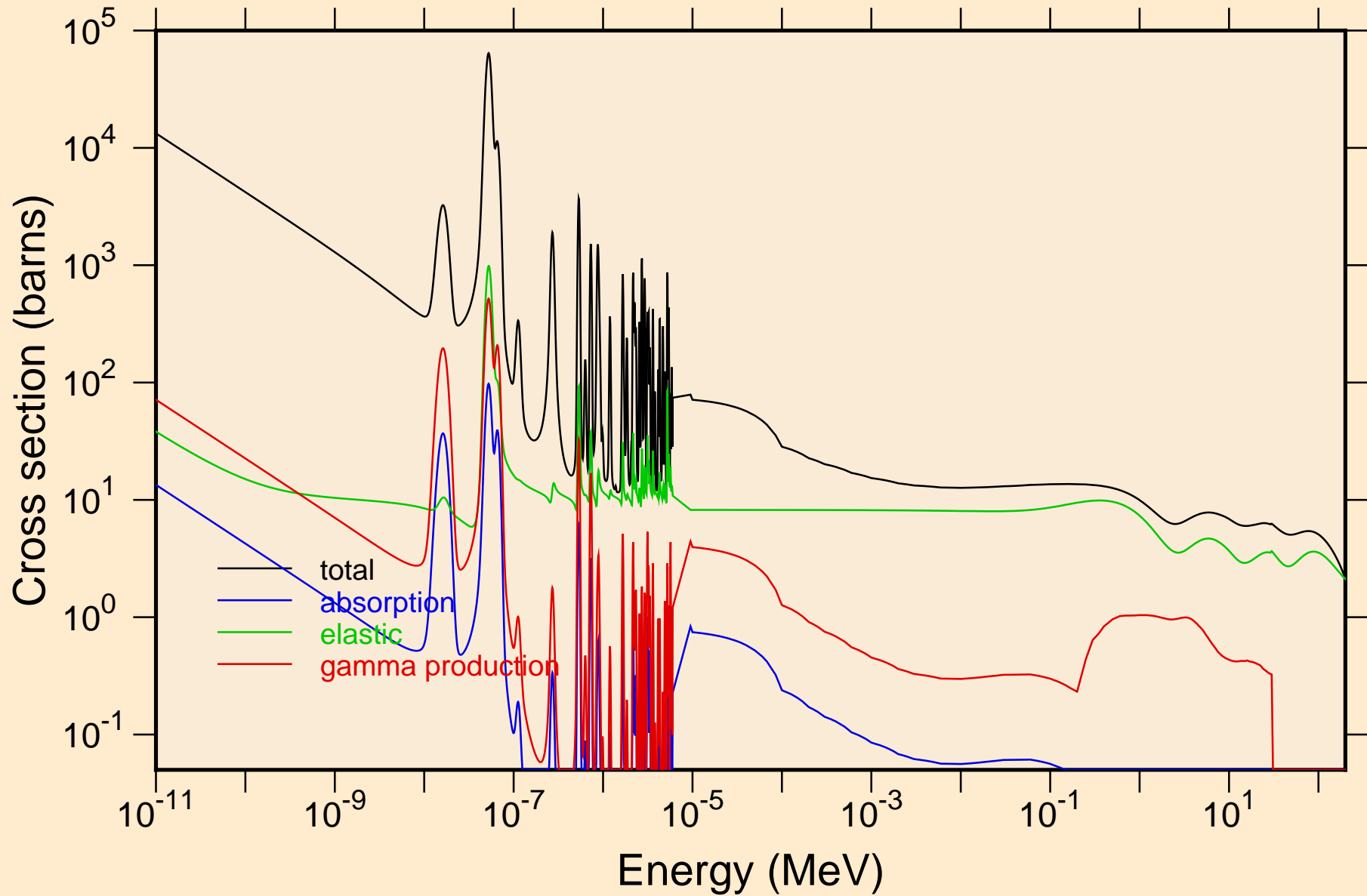

CF241 NEUTRON ACER TENDL-2021 LIBRARY; T=293.6K
resonance total cross section

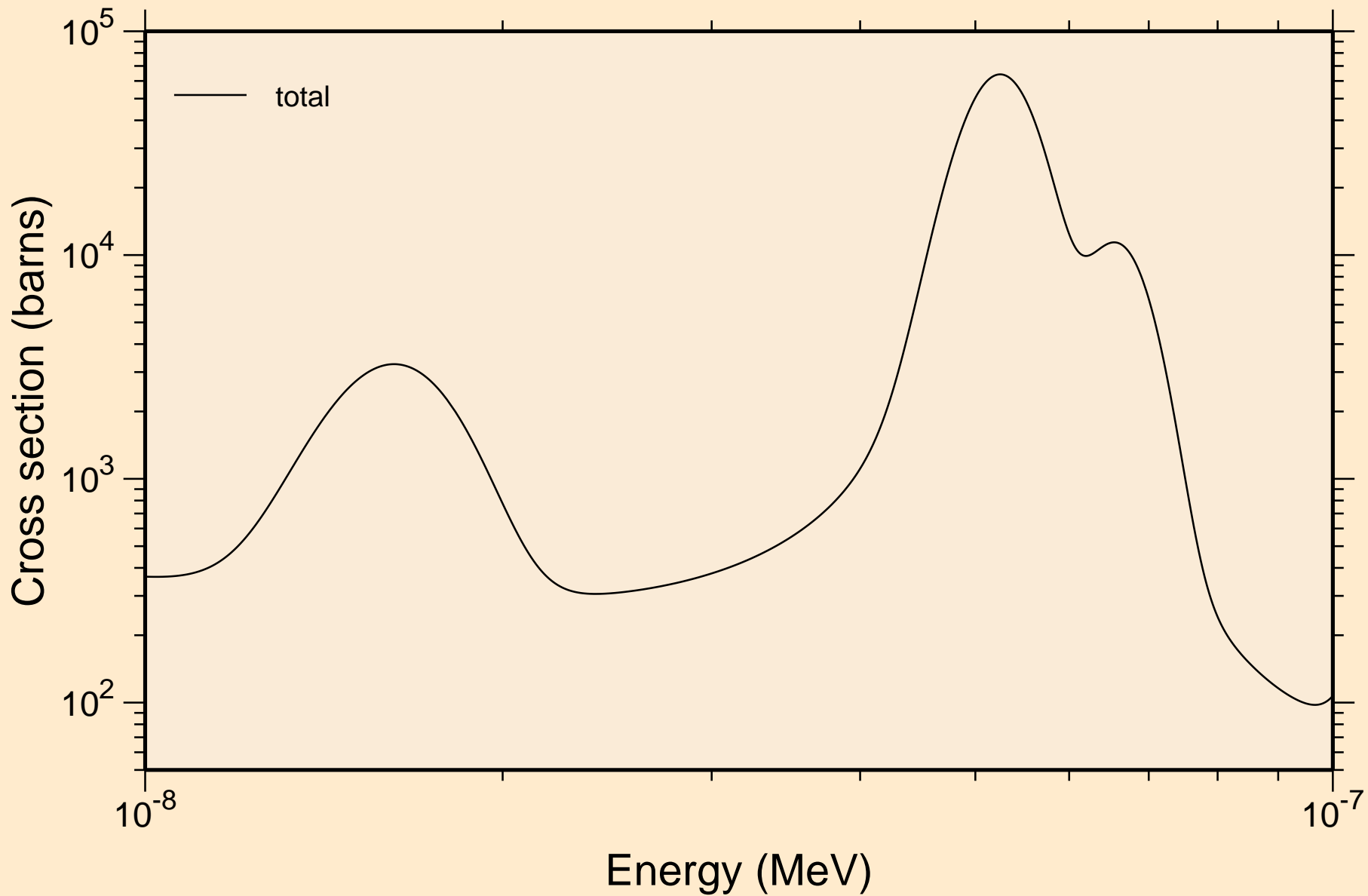

CF241 NEUTRON ACER TENDL-2021 LIBRARY; T=293.6K
resonance total cross section

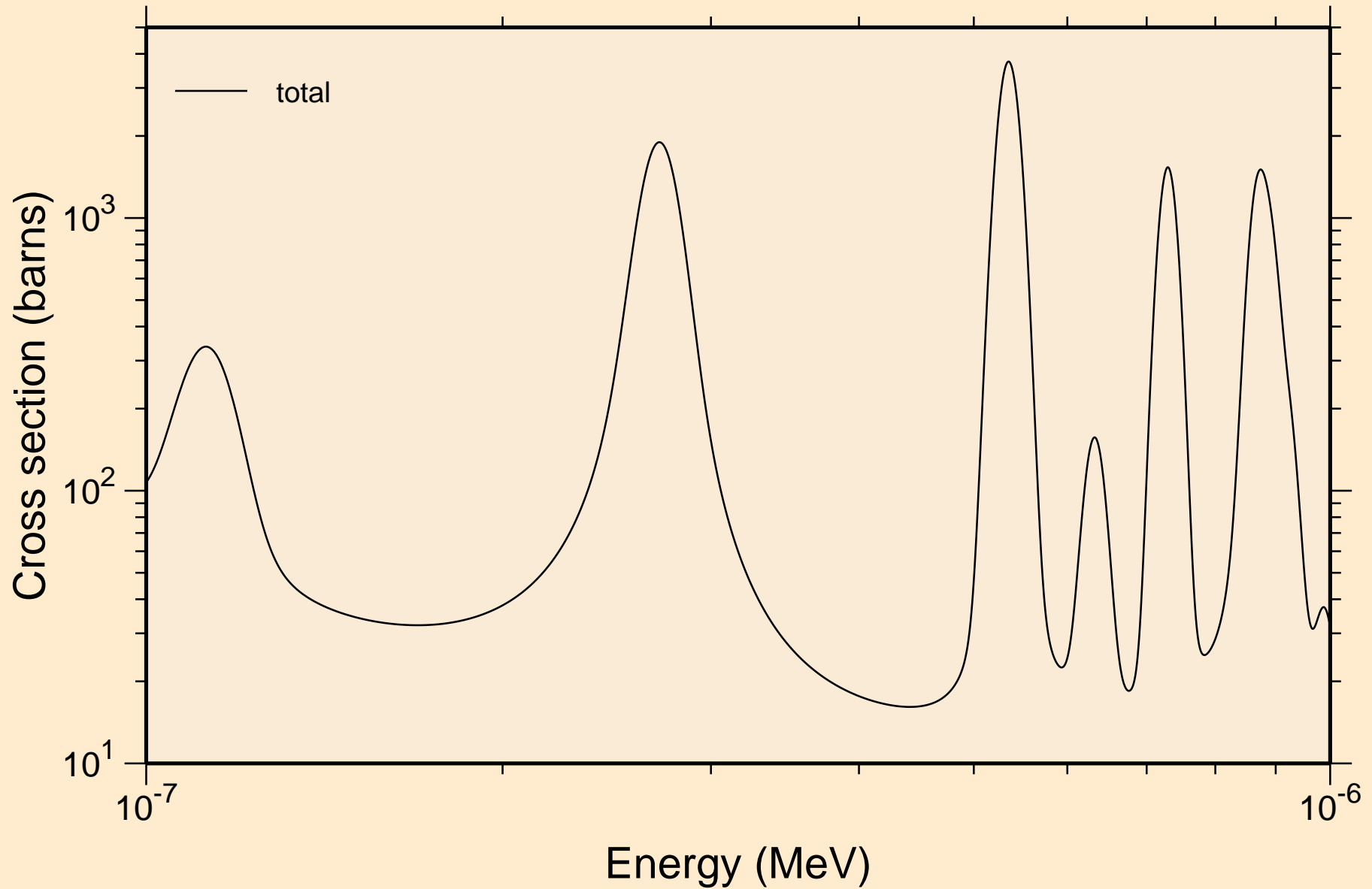

CF241 NEUTRON ACER TENDL-2021 LIBRARY; T=293.6K
resonance total cross section

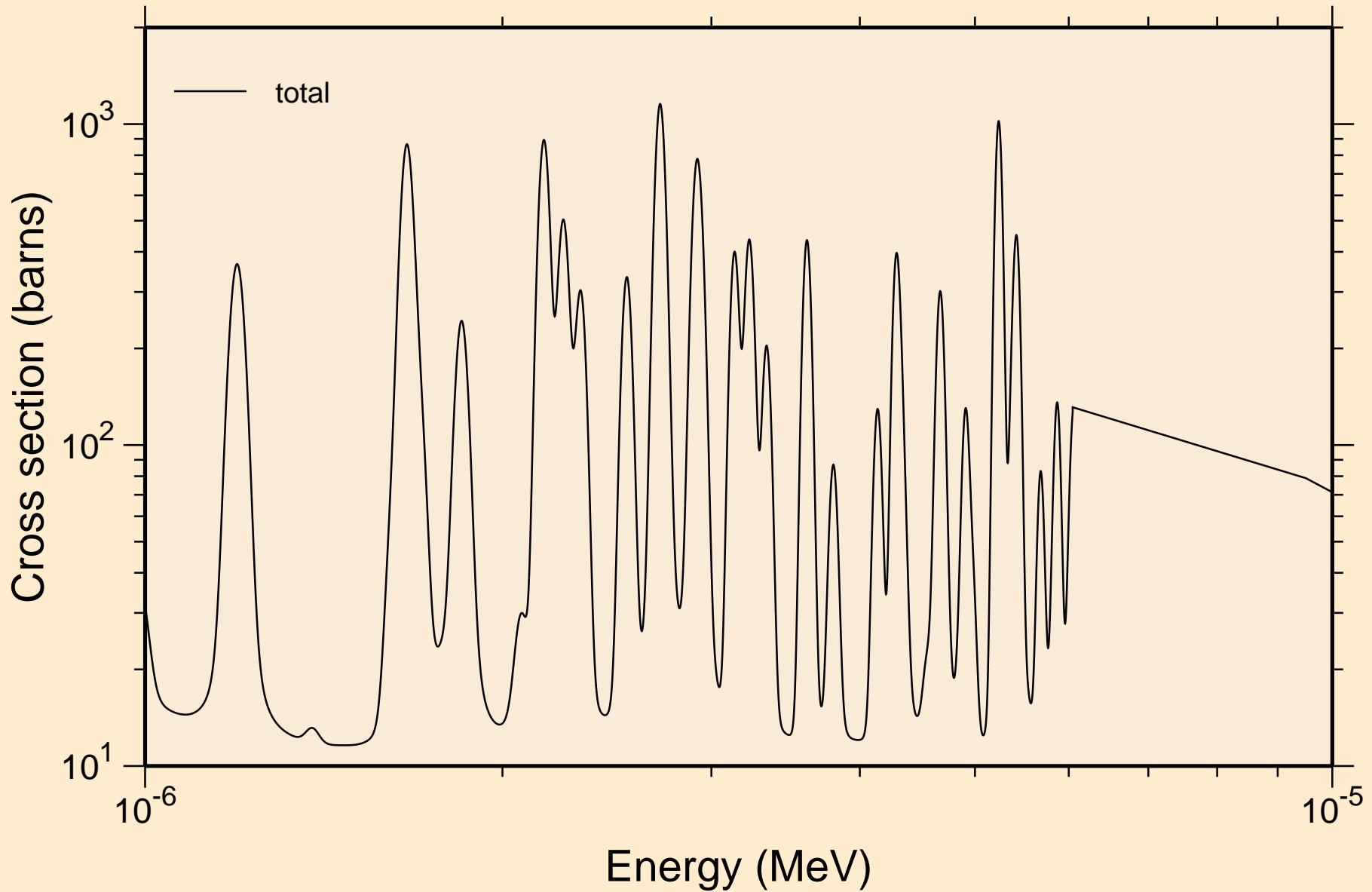

CF241 NEUTRON ACER TENDL-2021 LIBRARY; T=293.6K
resonance total cross section

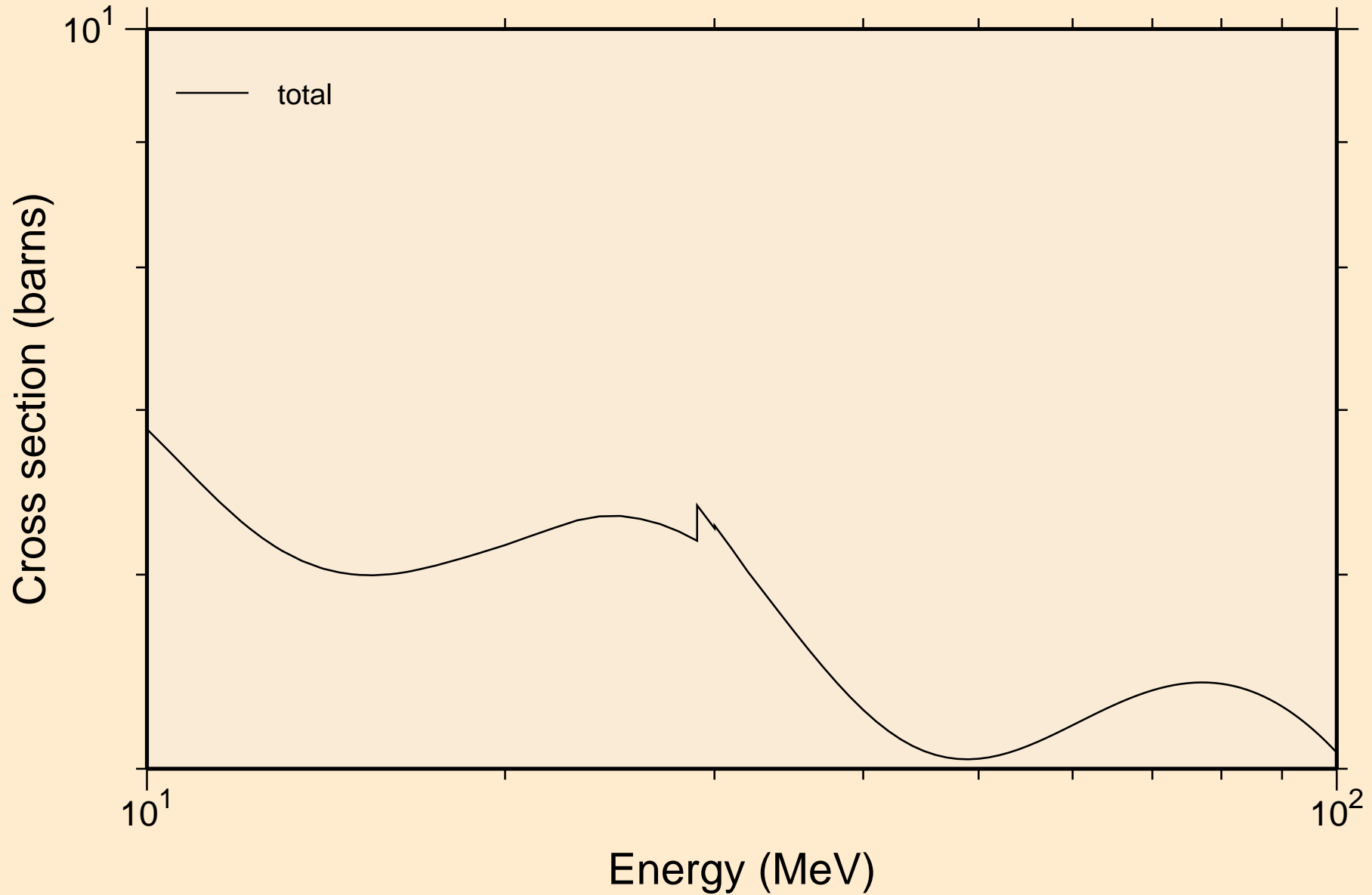

CF241 NEUTRON ACER TENDL-2021 LIBRARY; T=293.6K
resonance absorption cross sections

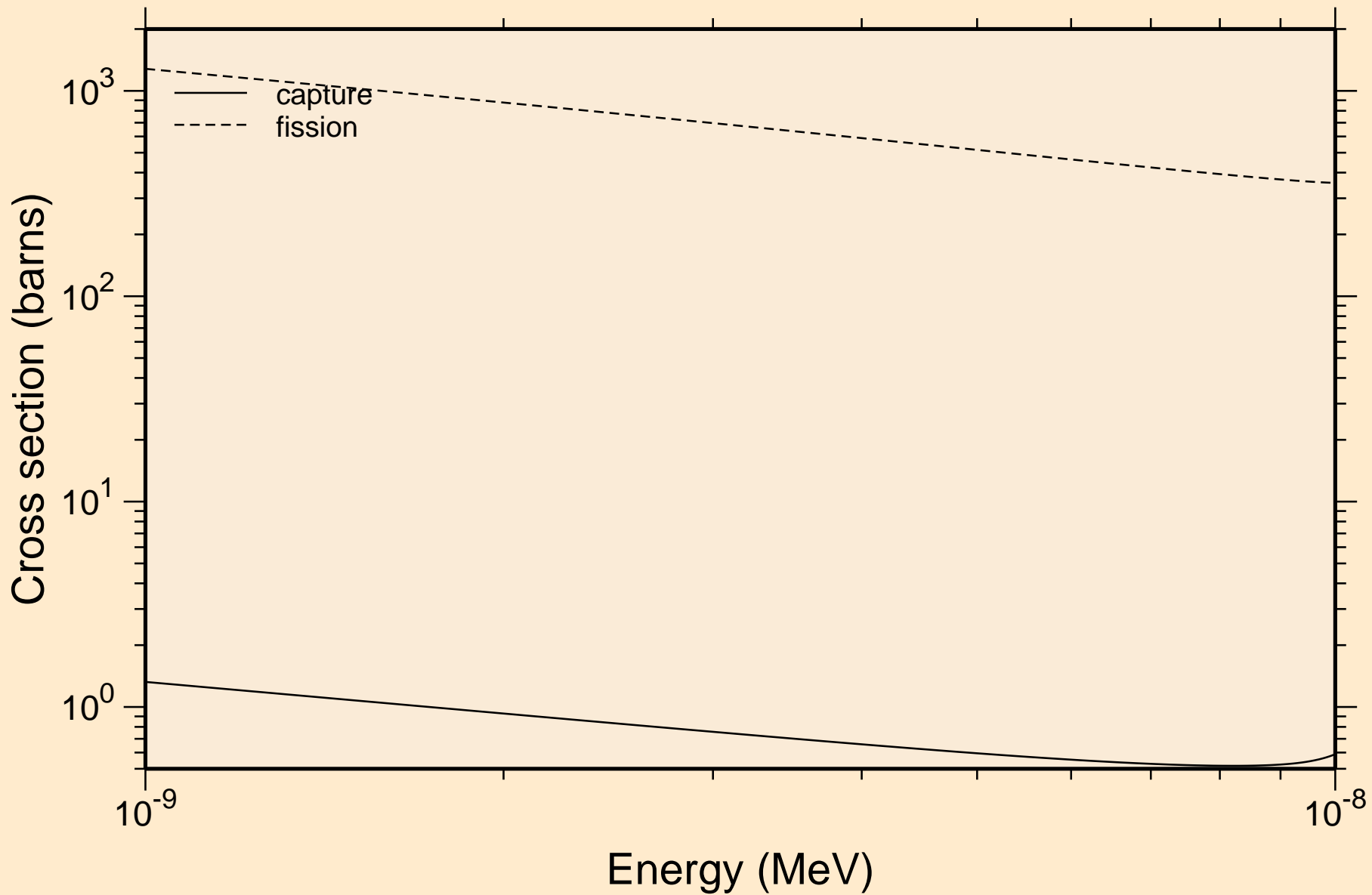

CF241 NEUTRON ACER TENDL-2021 LIBRARY; T=293.6K
resonance absorption cross sections

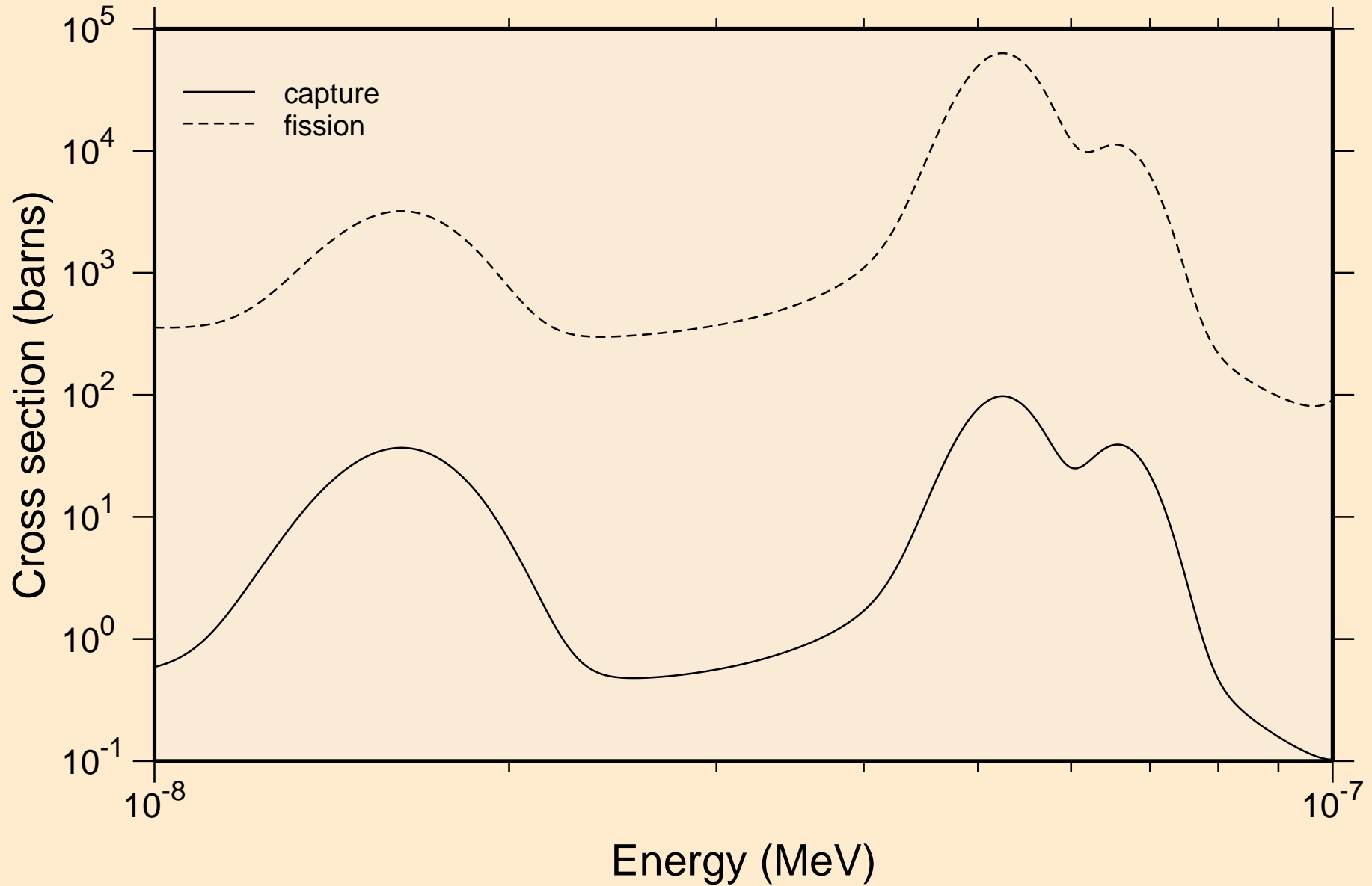

CF241 NEUTRON ACER TENDL-2021 LIBRARY; T=293.6K
resonance absorption cross sections

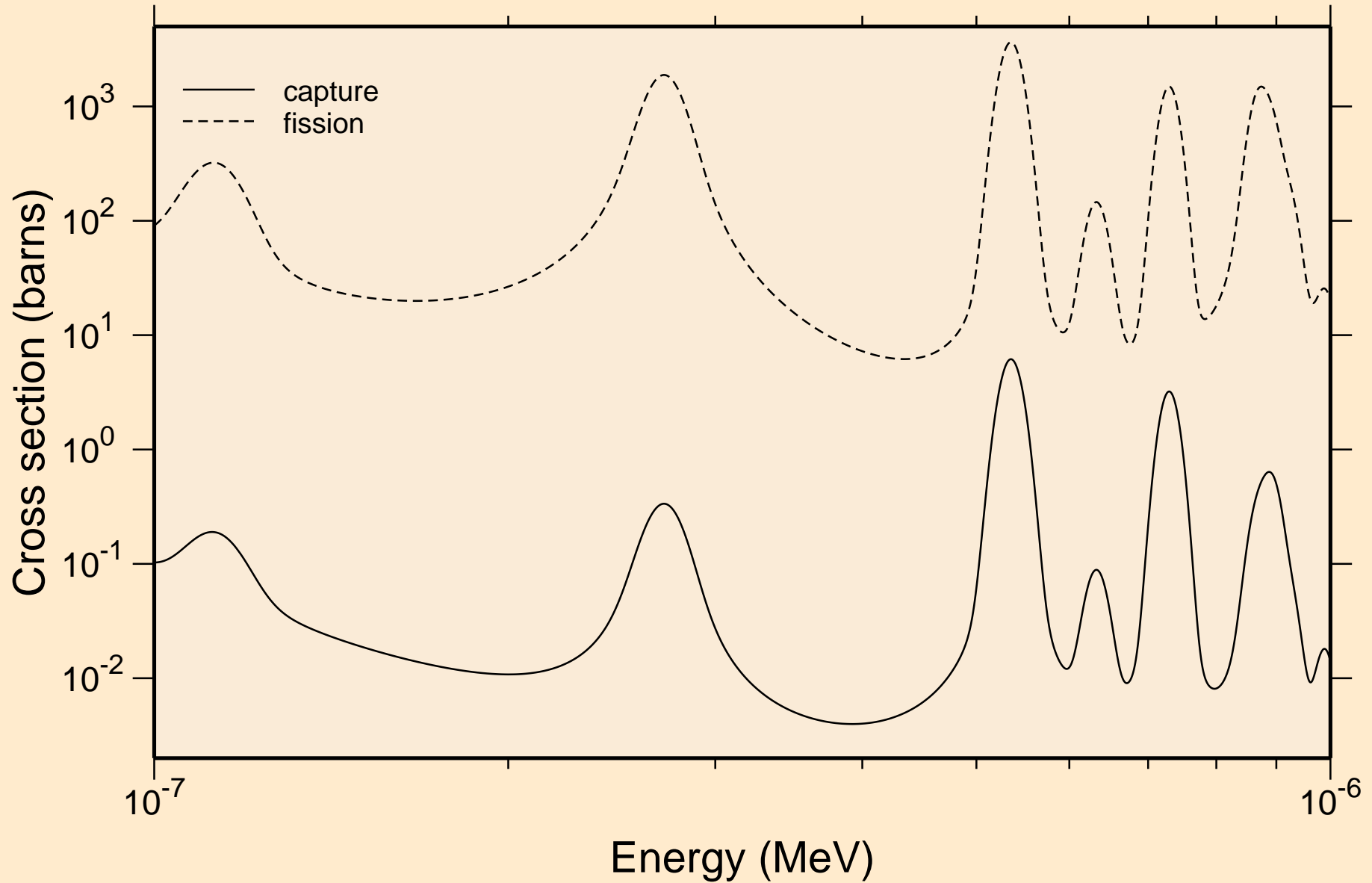

CF241 NEUTRON ACER TENDL-2021 LIBRARY; T=293.6K
resonance absorption cross sections

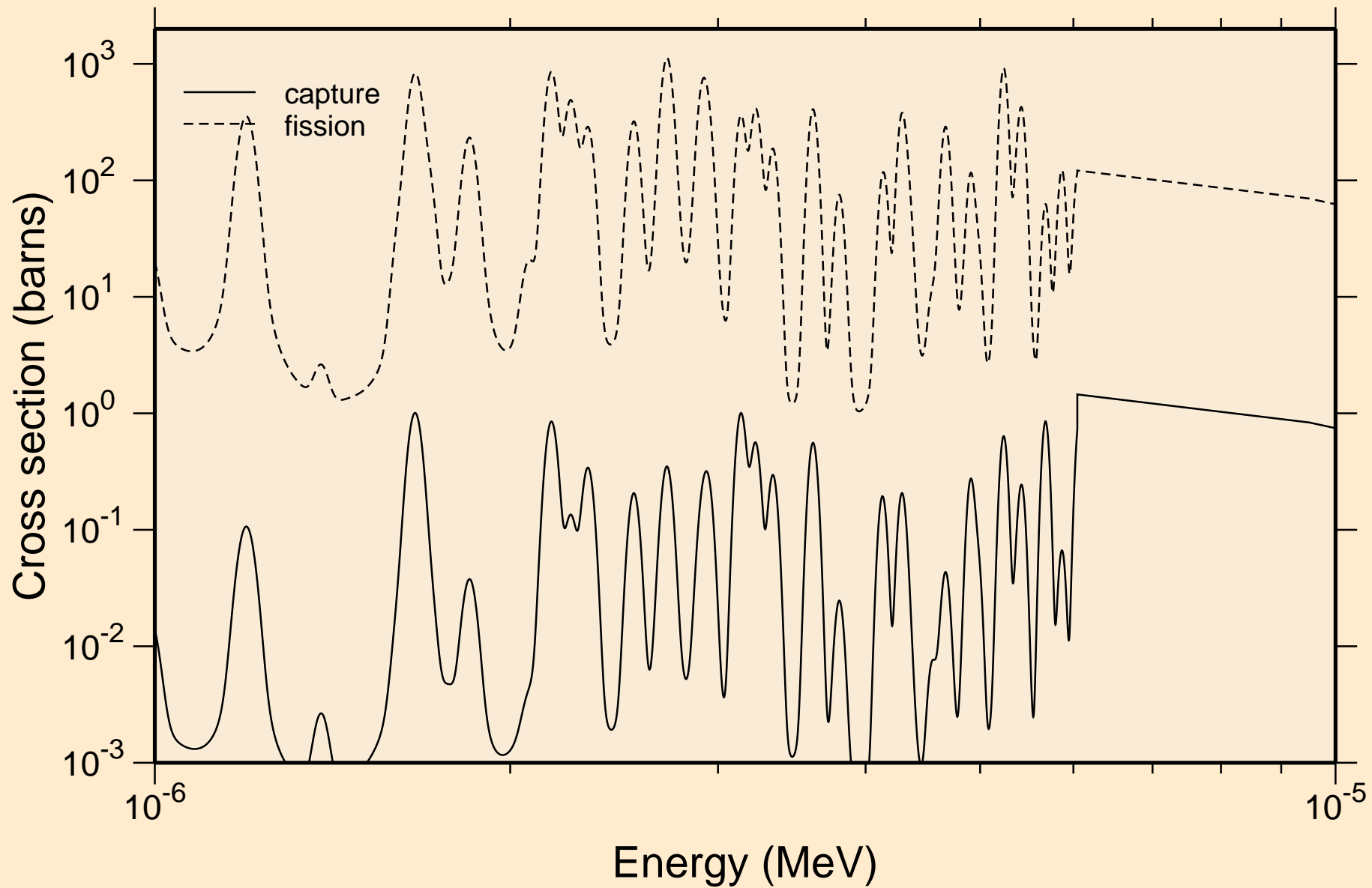

CF241 NEUTRON ACER TENDL-2021 LIBRARY; T=293.6K
resonance absorption cross sections

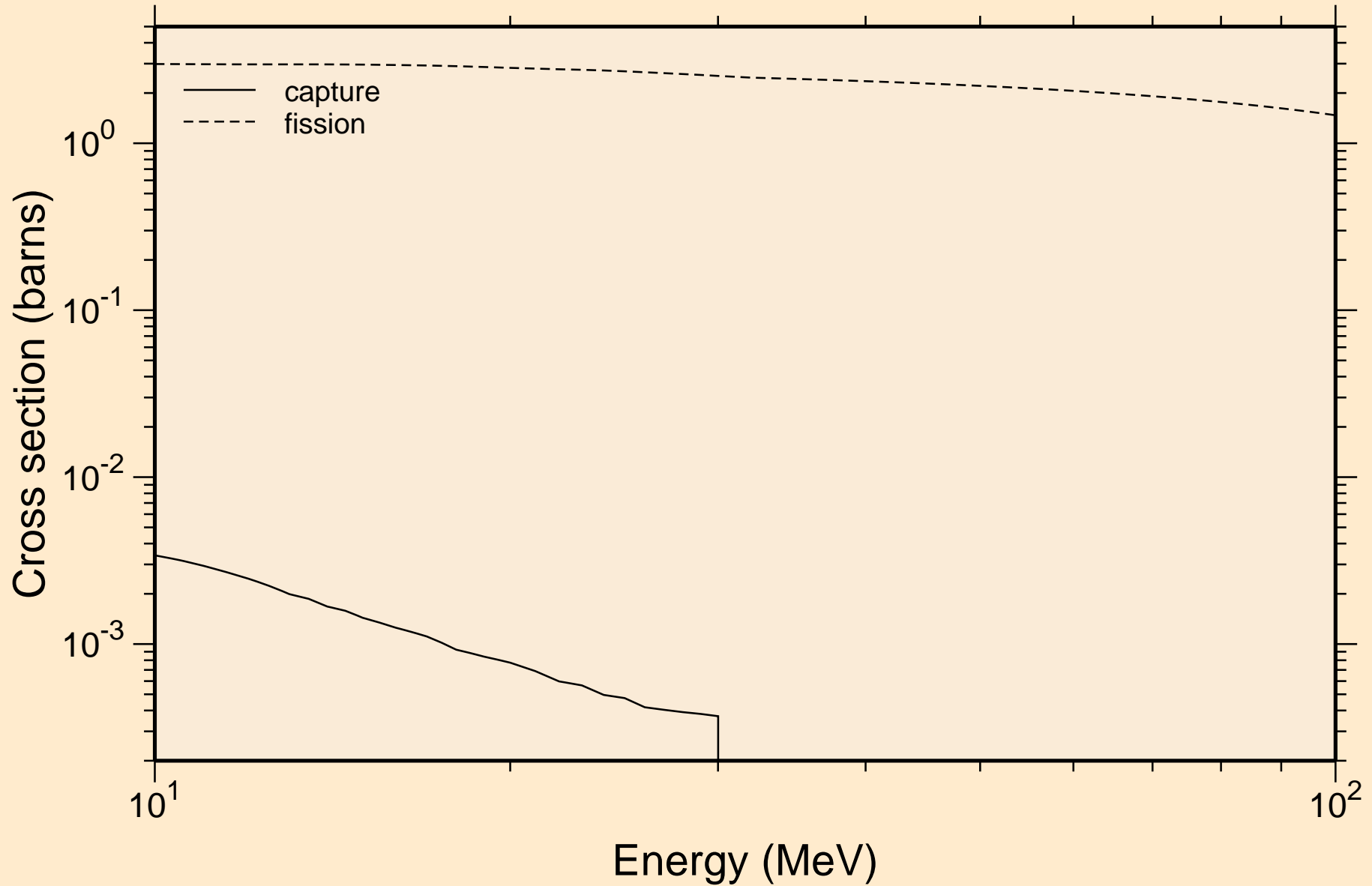

CF241 NEUTRON ACER TENDL-2021 LIBRARY; T=293.6K
Heating

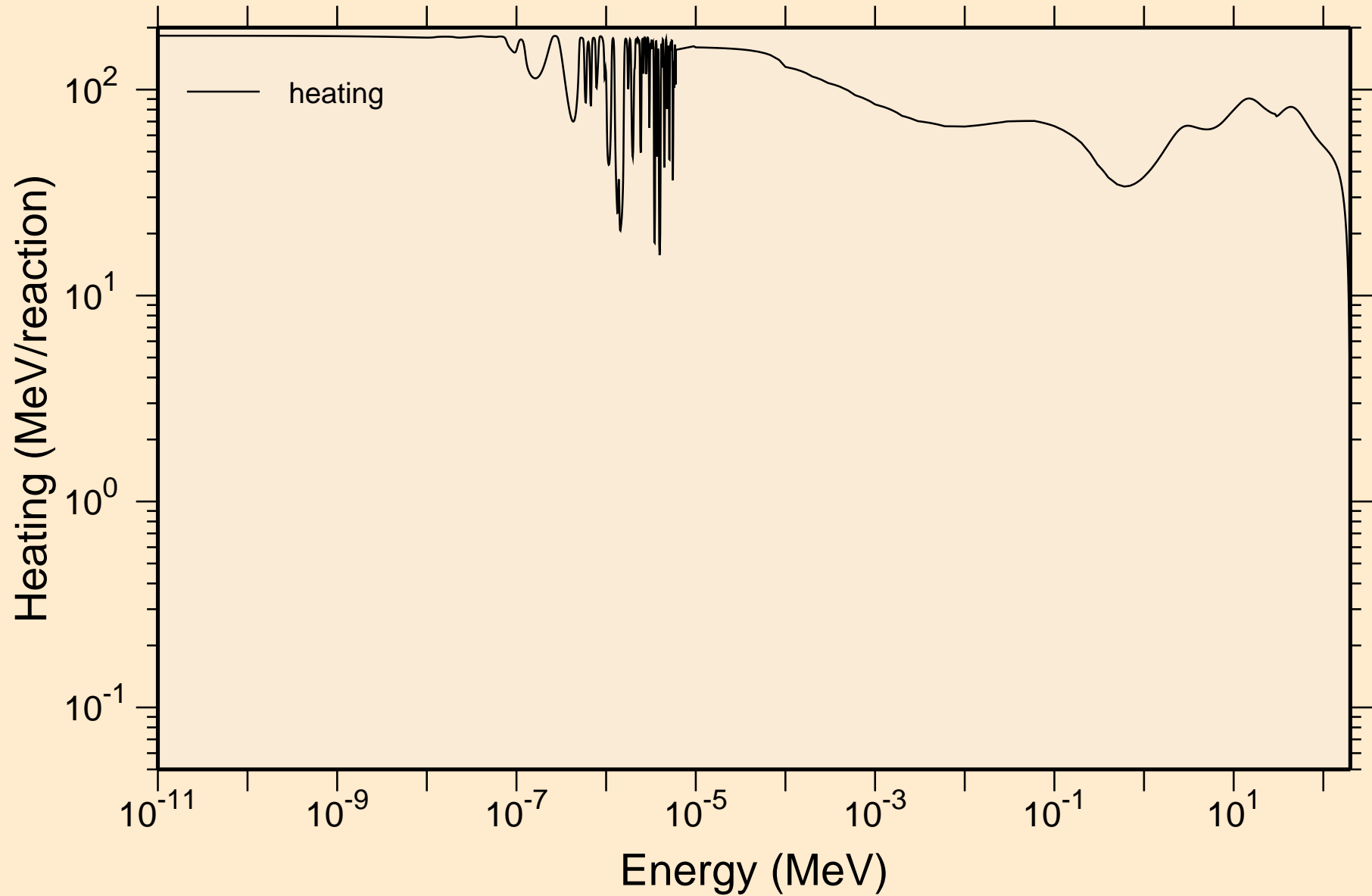

CF241 NEUTRON ACER TENDL-2021 LIBRARY; T=293.6K
Damage

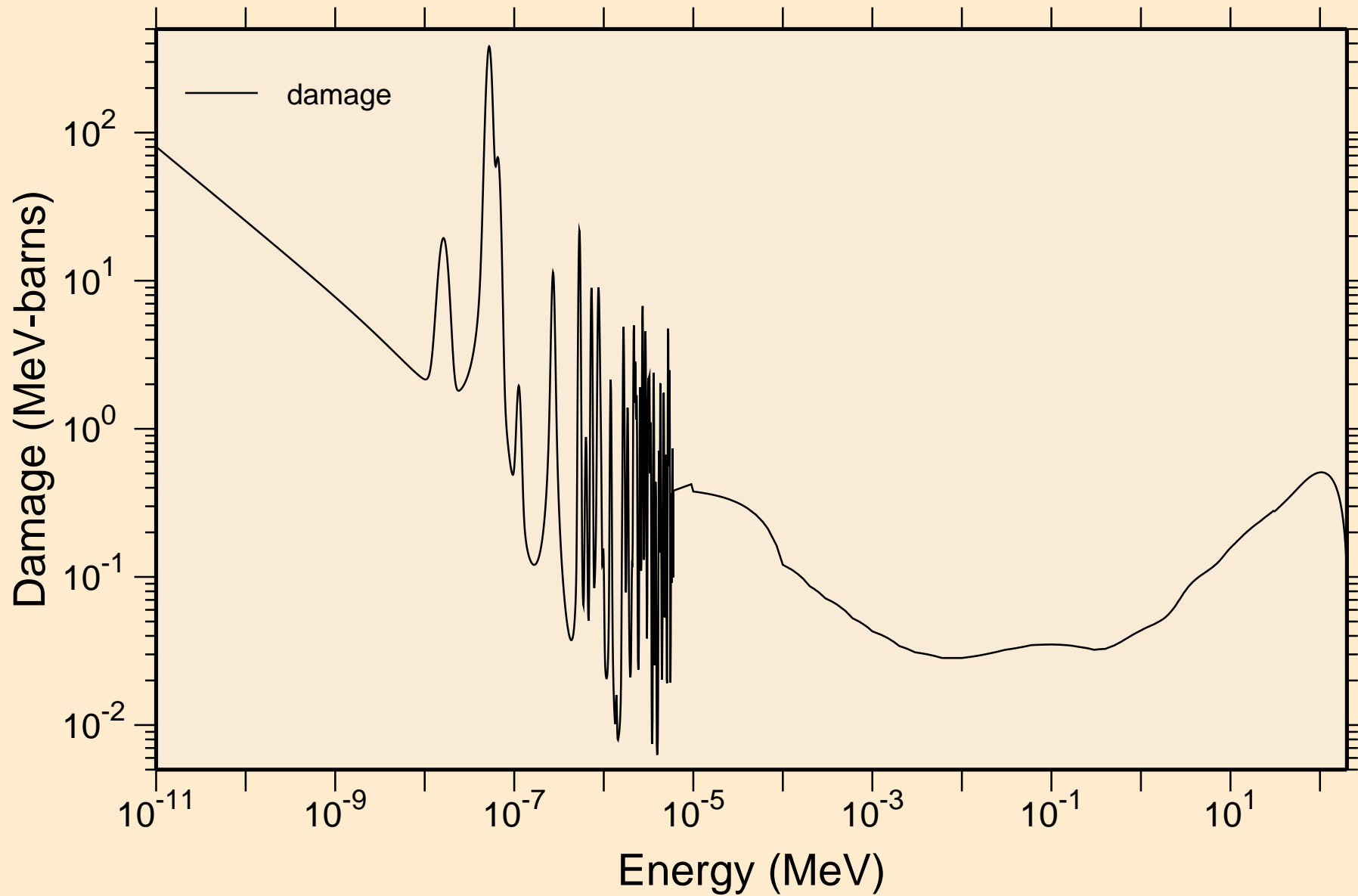

CF241 NEUTRON ACER TENDL-2021 LIBRARY; T=293.6K

Non-threshold reactions

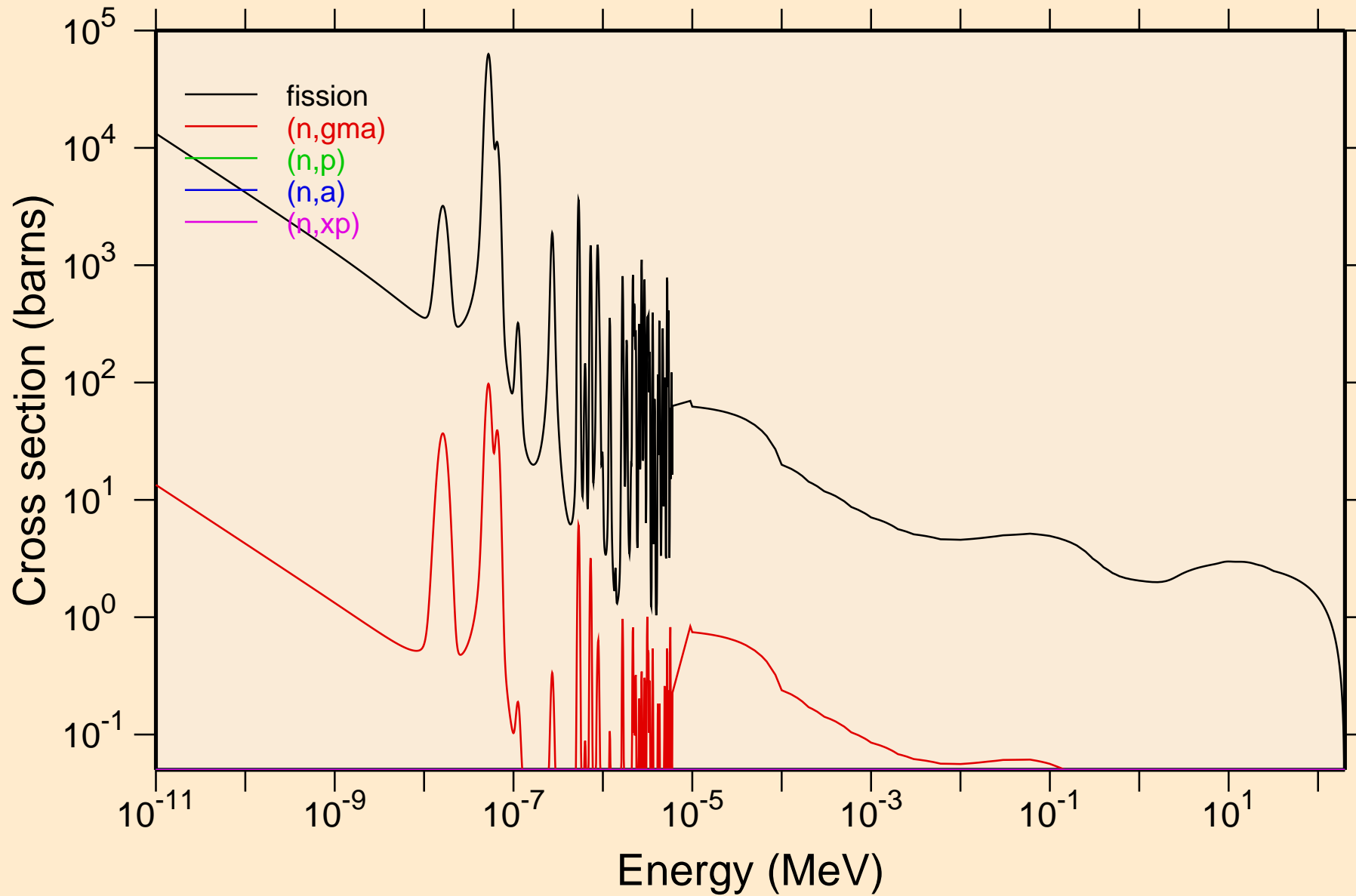

CF241 NEUTRON ACER TENDL-2021 LIBRARY; T=293.6K
Non-threshold reactions

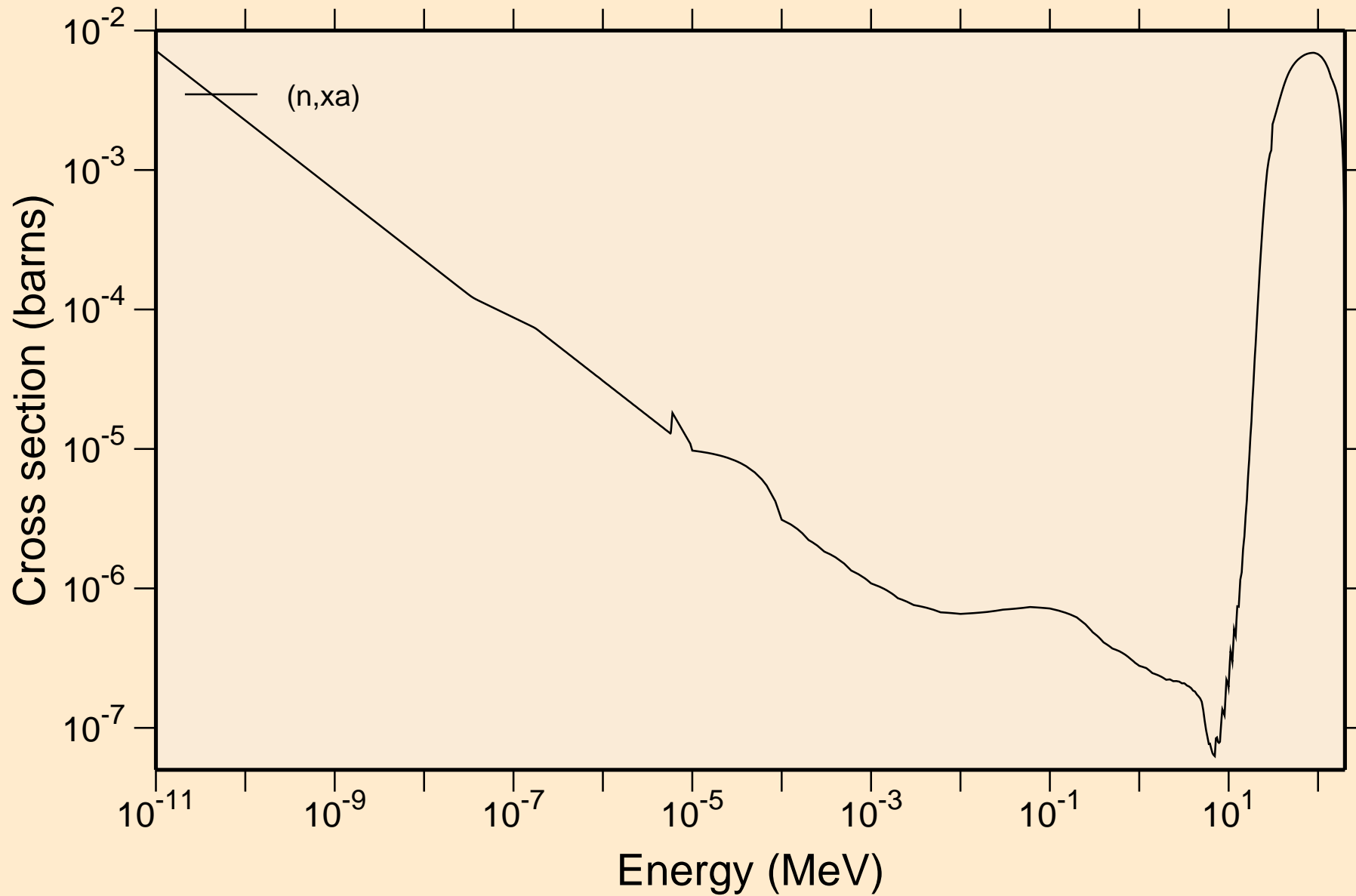

CF241 NEUTRON ACER TENDL-2021 LIBRARY; T=293.6K

Principal cross sections

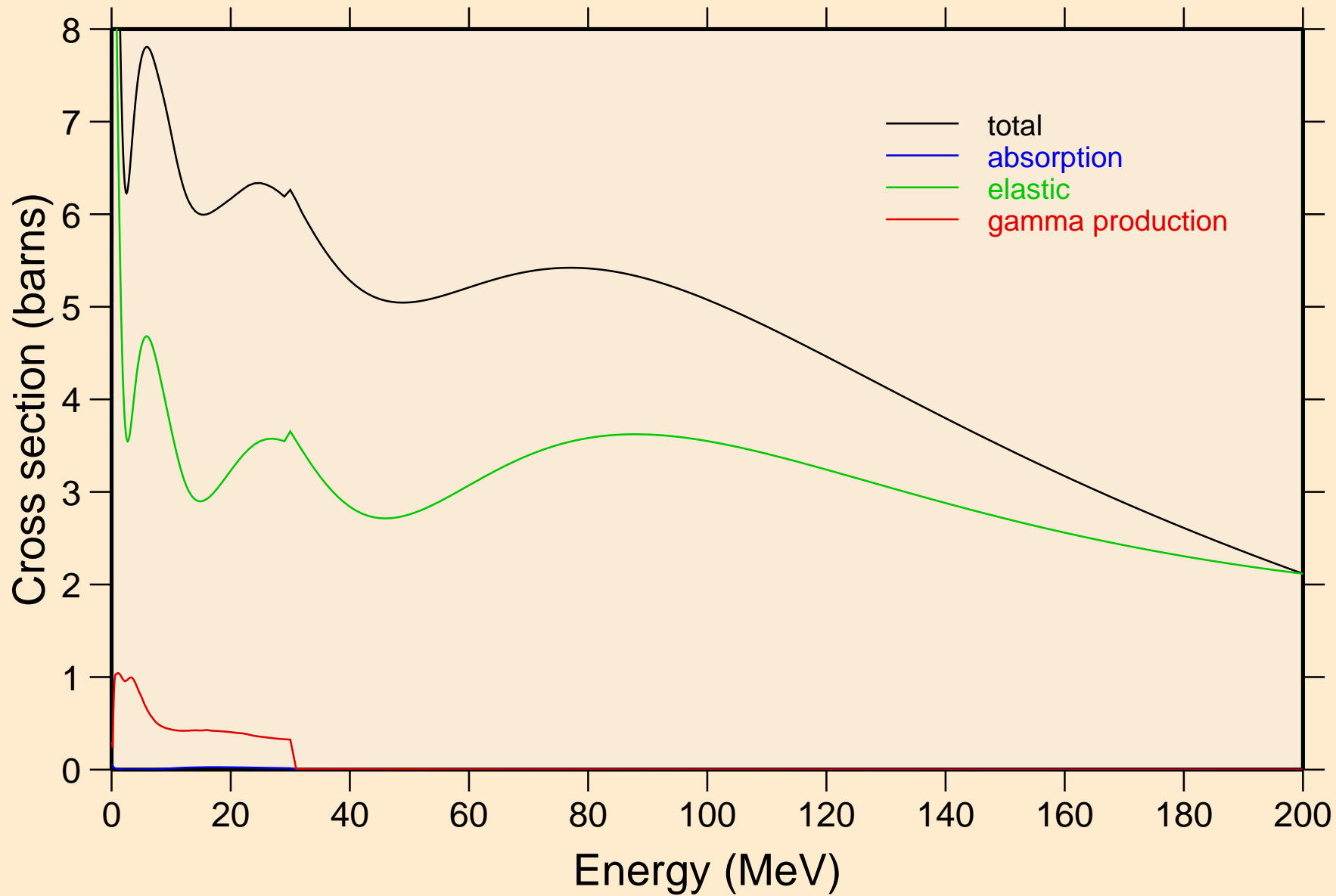

CF241 NEUTRON ACER TENDL-2021 LIBRARY; T=293.6K
Heating

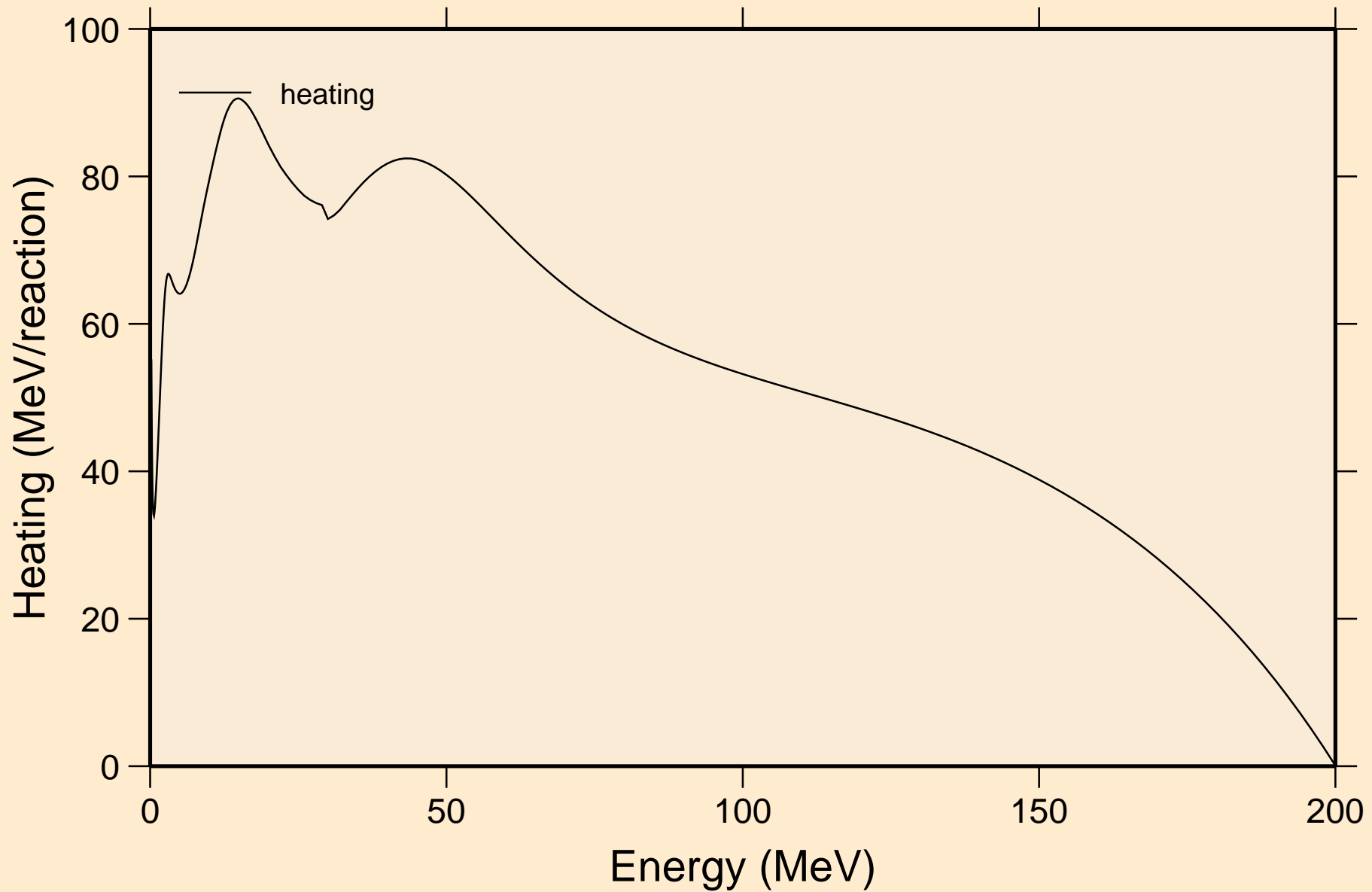

CF241 NEUTRON ACER TENDL-2021 LIBRARY; T=293.6K
Damage

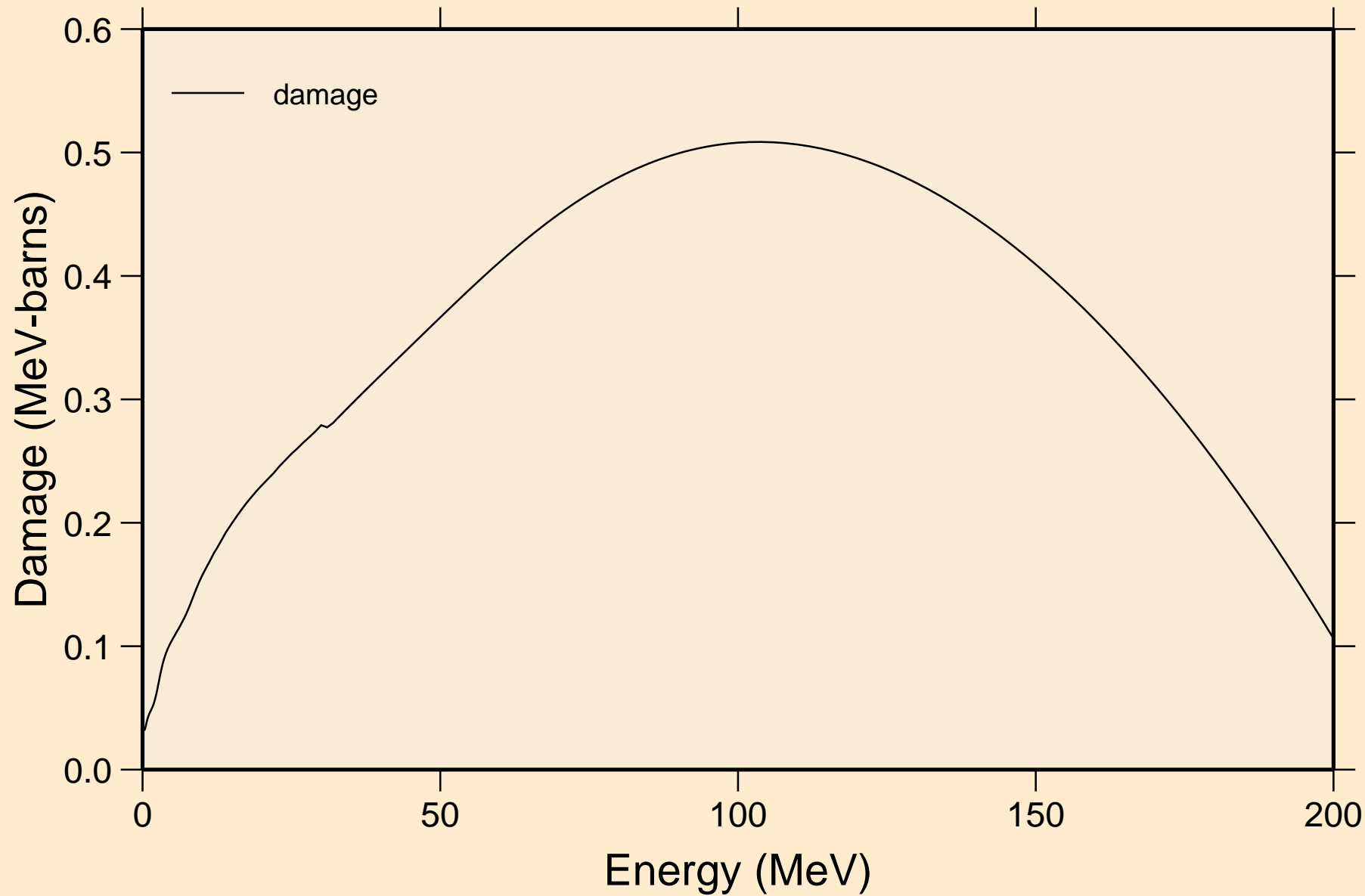

CF241 NEUTRON ACER TENDL-2021 LIBRARY; T=293.6K
Non-threshold reactions

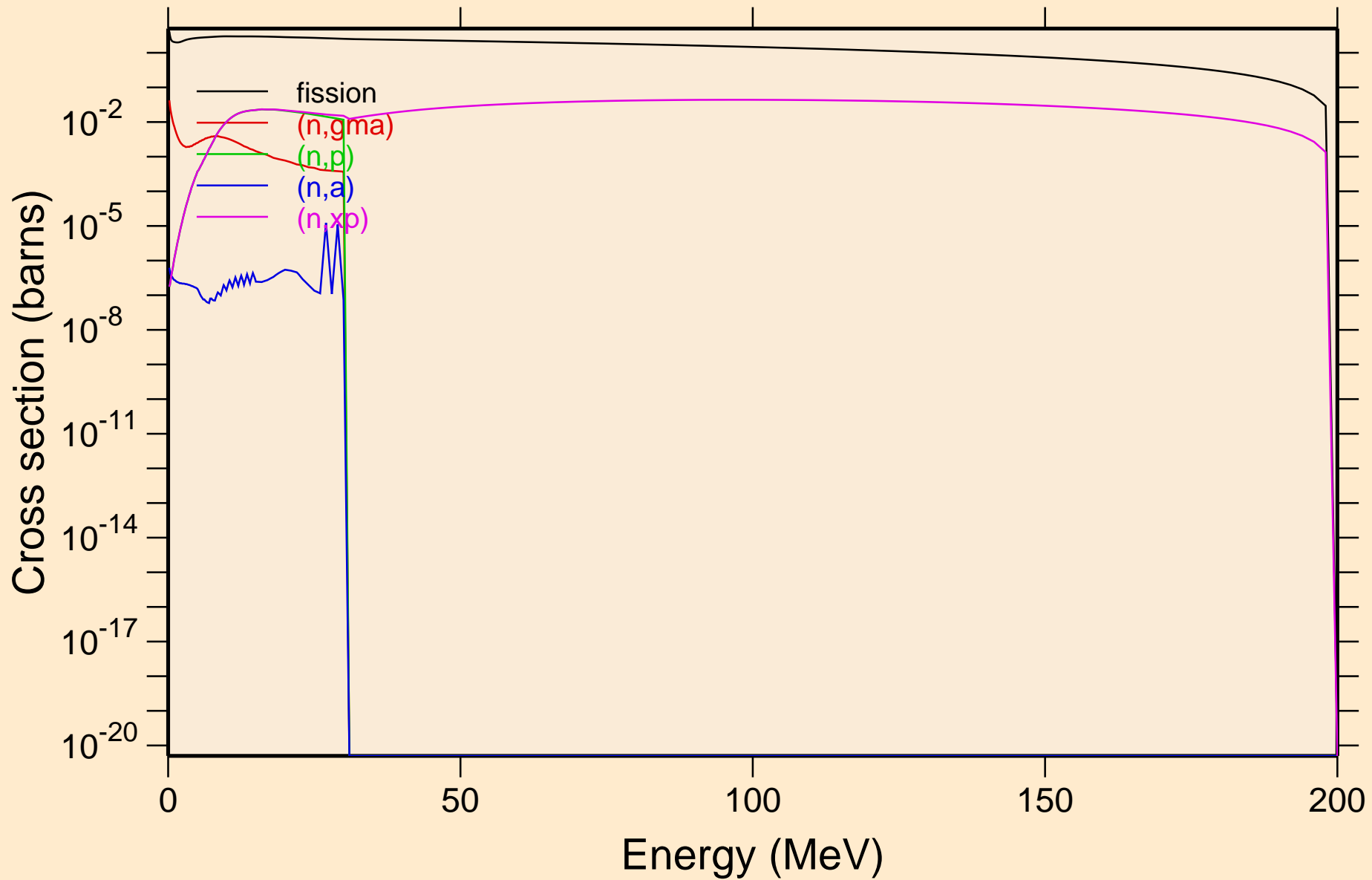

CF241 NEUTRON ACER TENDL-2021 LIBRARY; T=293.6K
Non-threshold reactions

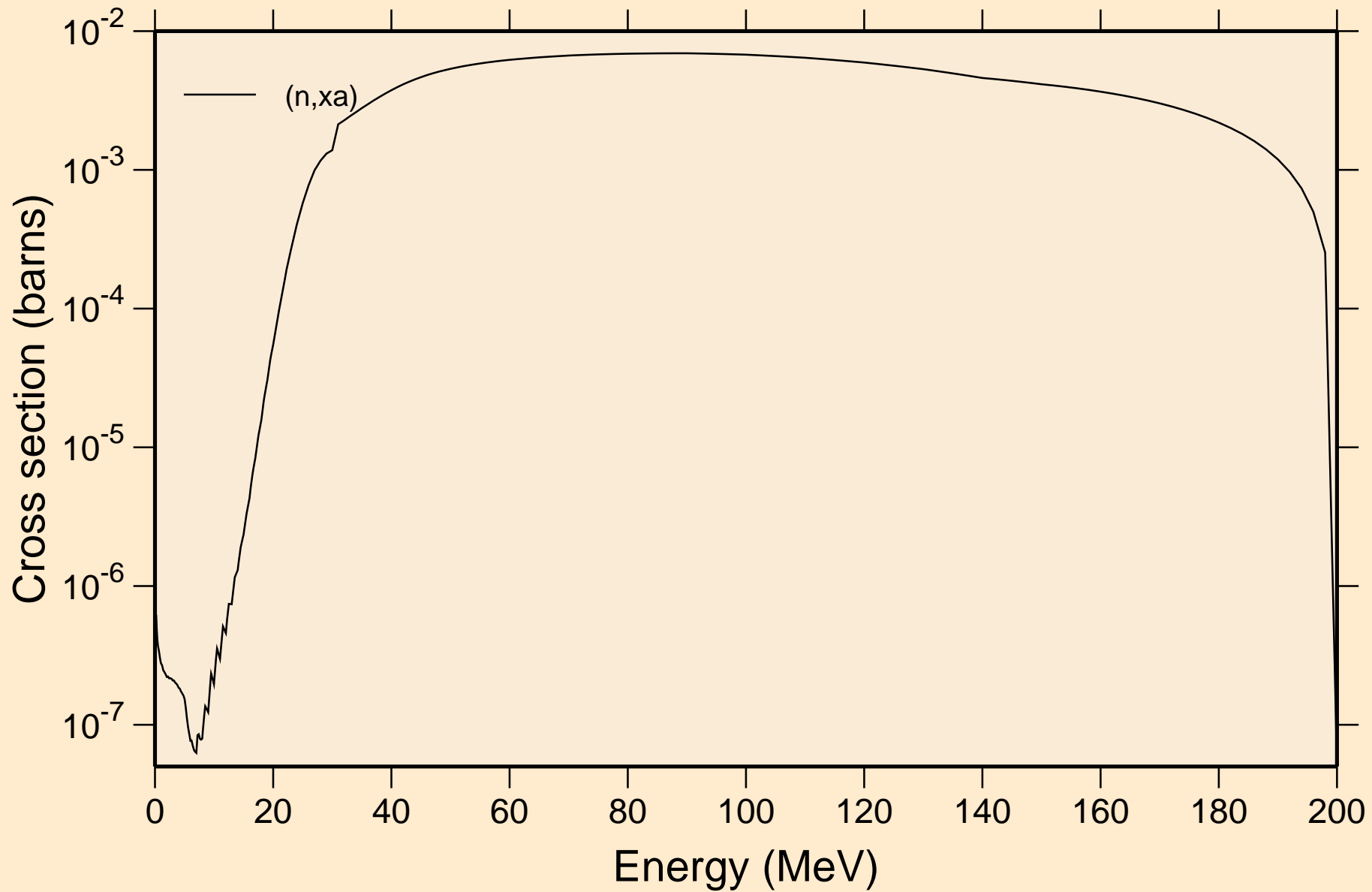

CF241 NEUTRON ACER TENDL-2021 LIBRARY; T=293.6K
Inelastic levels

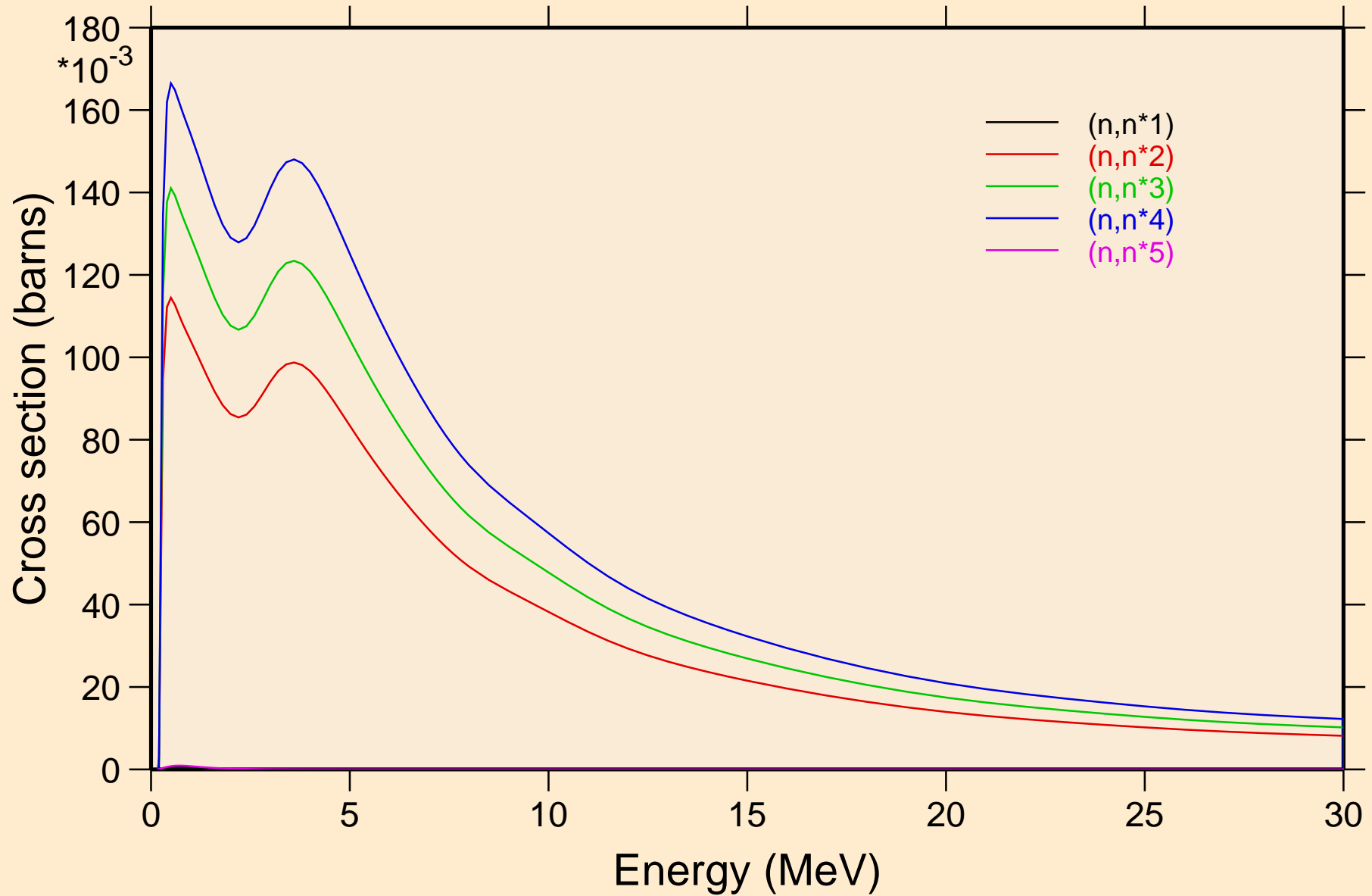

CF241 NEUTRON ACER TENDL-2021 LIBRARY; T=293.6K
Inelastic levels

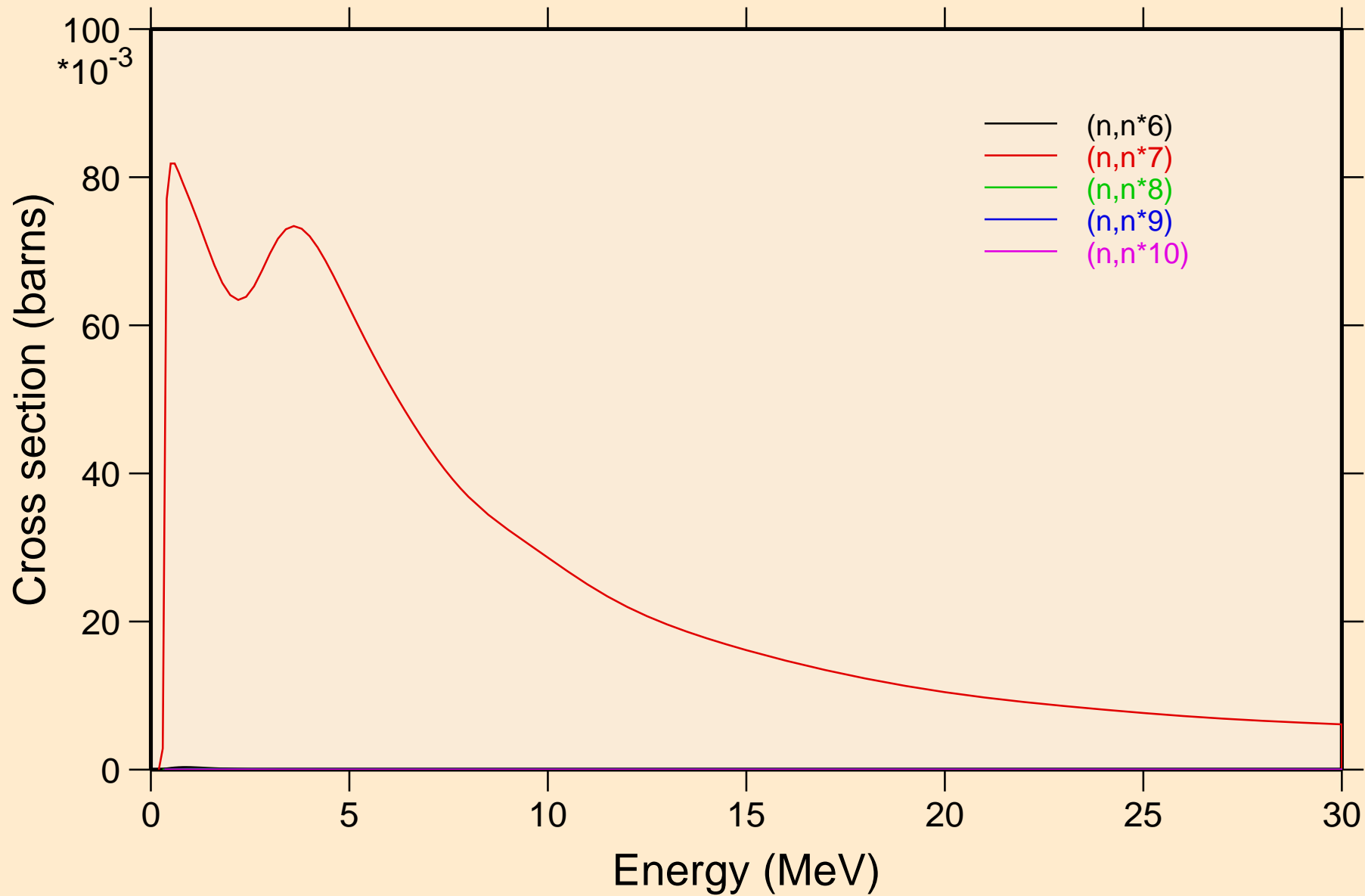

CF241 NEUTRON ACER TENDL-2021 LIBRARY; T=293.6K
Inelastic levels

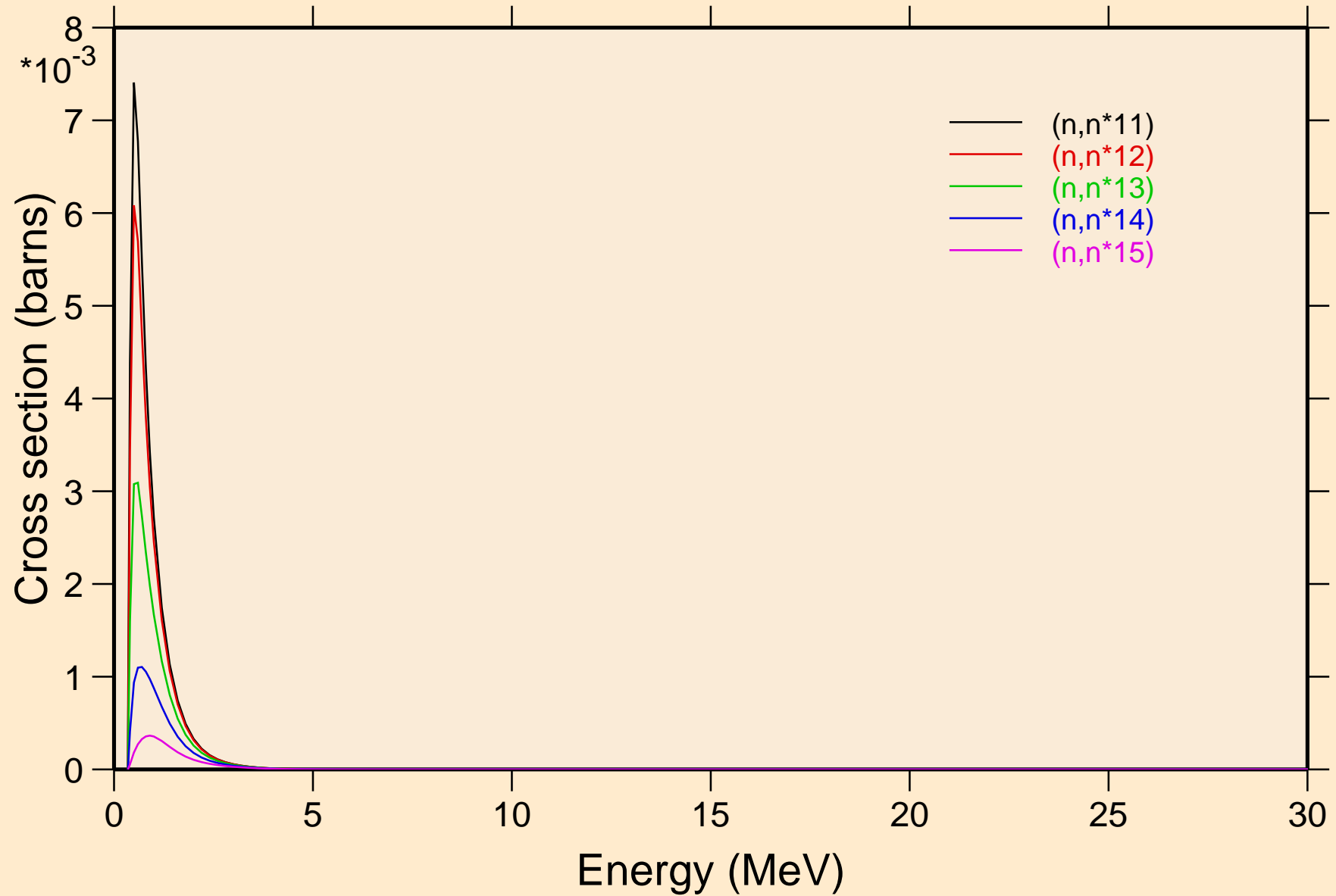

CF241 NEUTRON ACER TENDL-2021 LIBRARY; T=293.6K
Inelastic levels

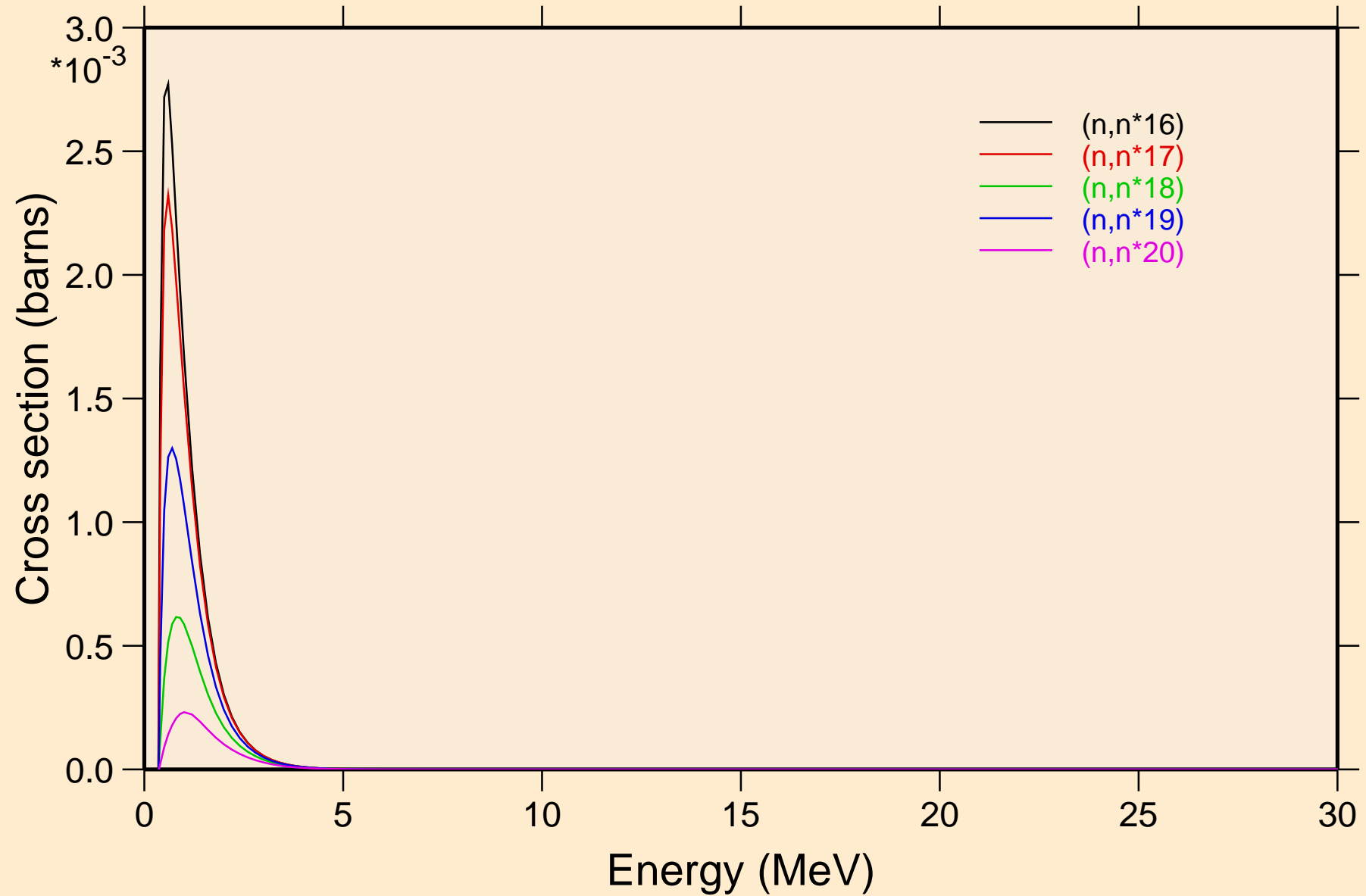

CF241 NEUTRON ACER TENDL-2021 LIBRARY; T=293.6K
Inelastic levels

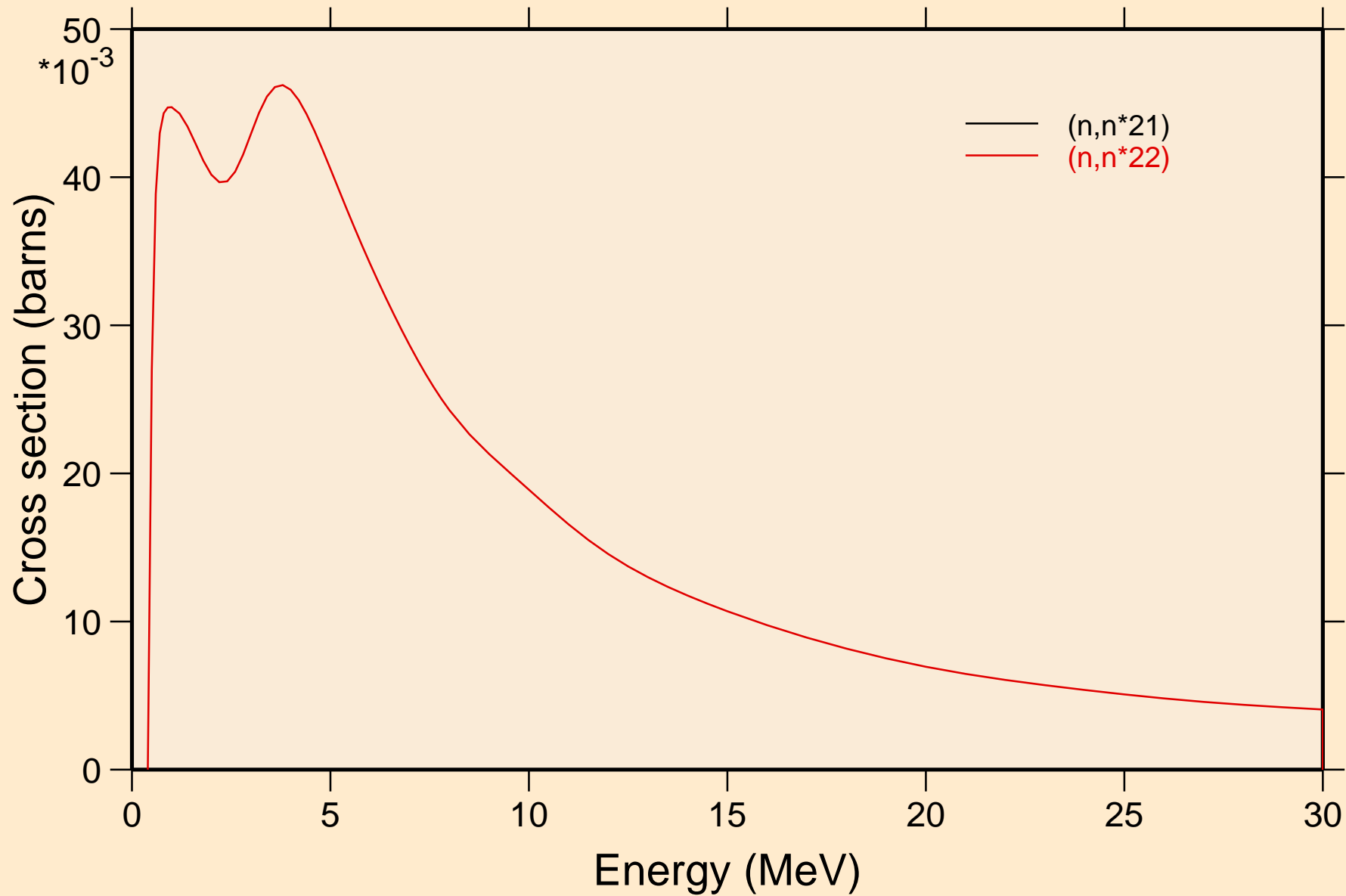

CF241 NEUTRON ACER TENDL-2021 LIBRARY; T=293.6K

Threshold reactions

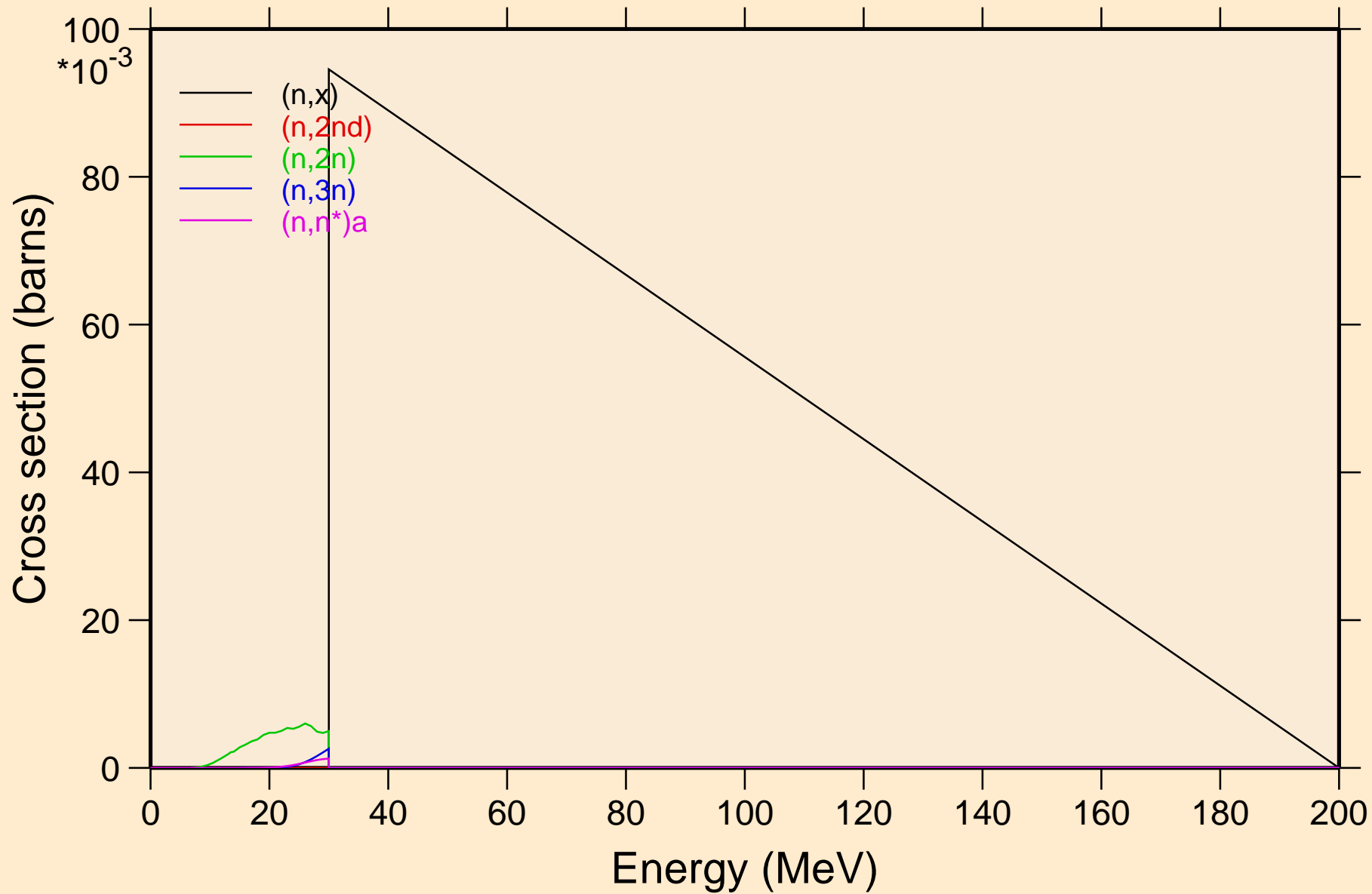

CF241 NEUTRON ACER TENDL-2021 LIBRARY; T=293.6K

Threshold reactions

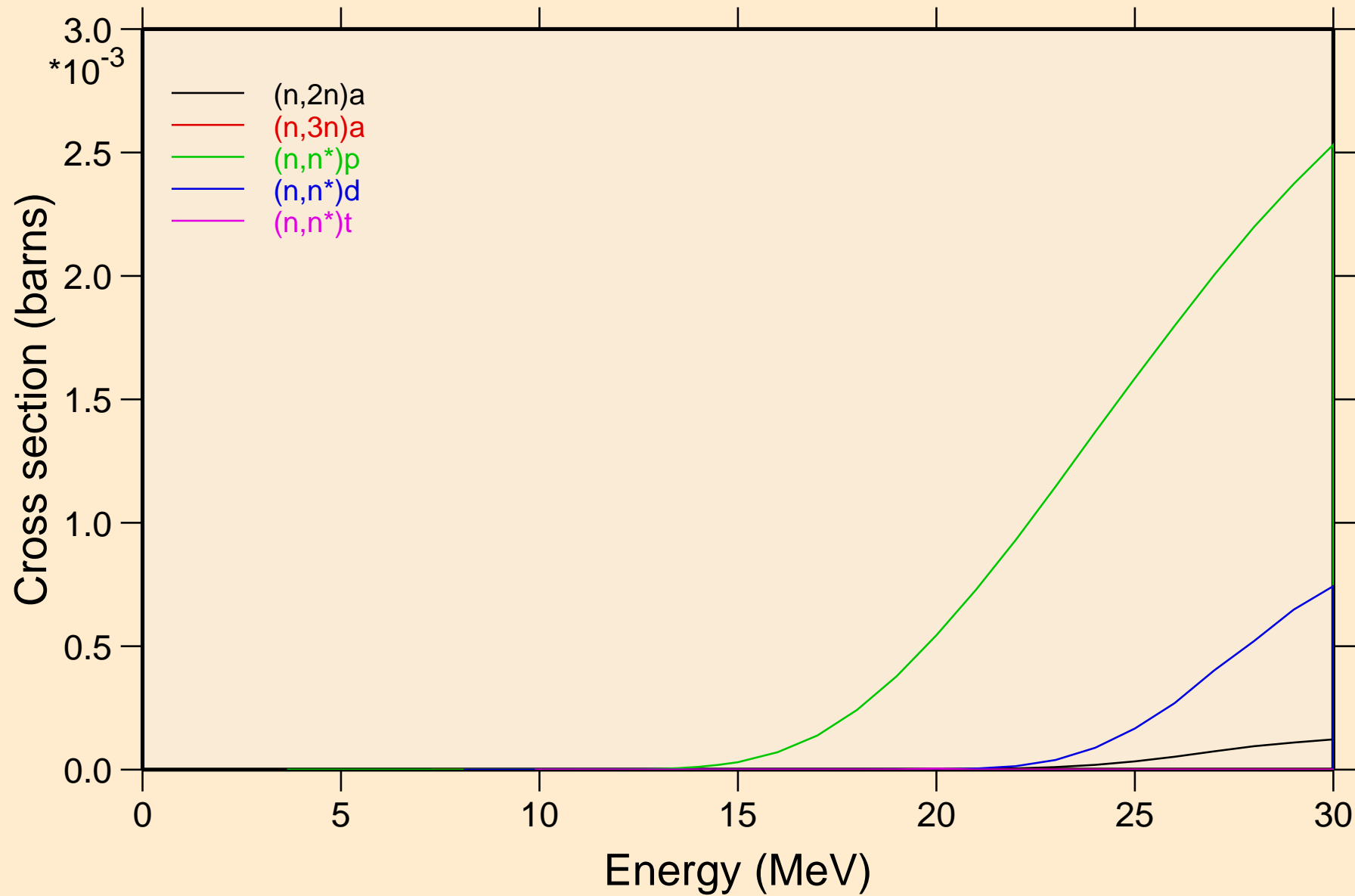

CF241 NEUTRON ACER TENDL-2021 LIBRARY; T=293.6K
Threshold reactions

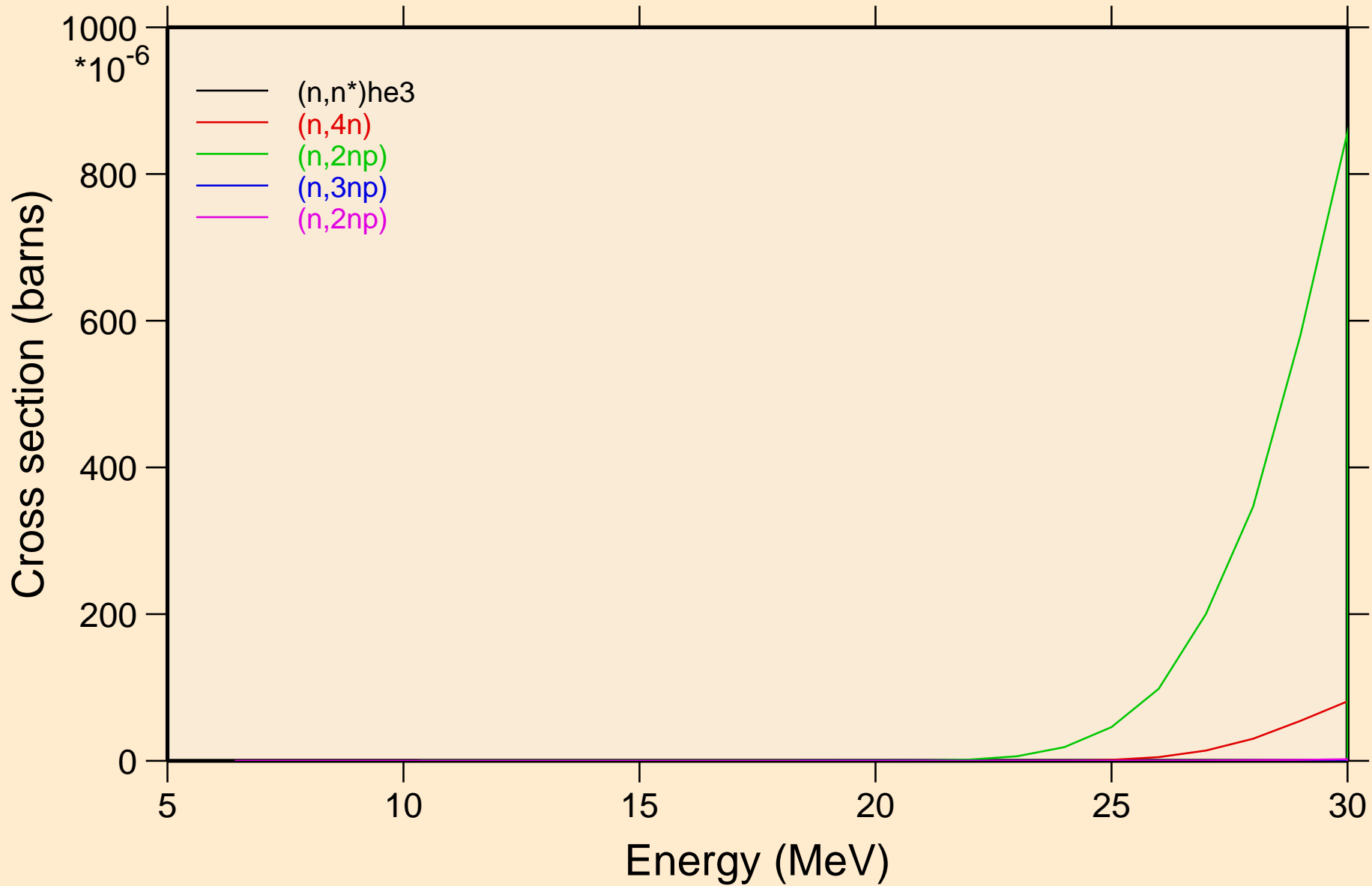

CF241 NEUTRON ACER TENDL-2021 LIBRARY; T=293.6K
Threshold reactions

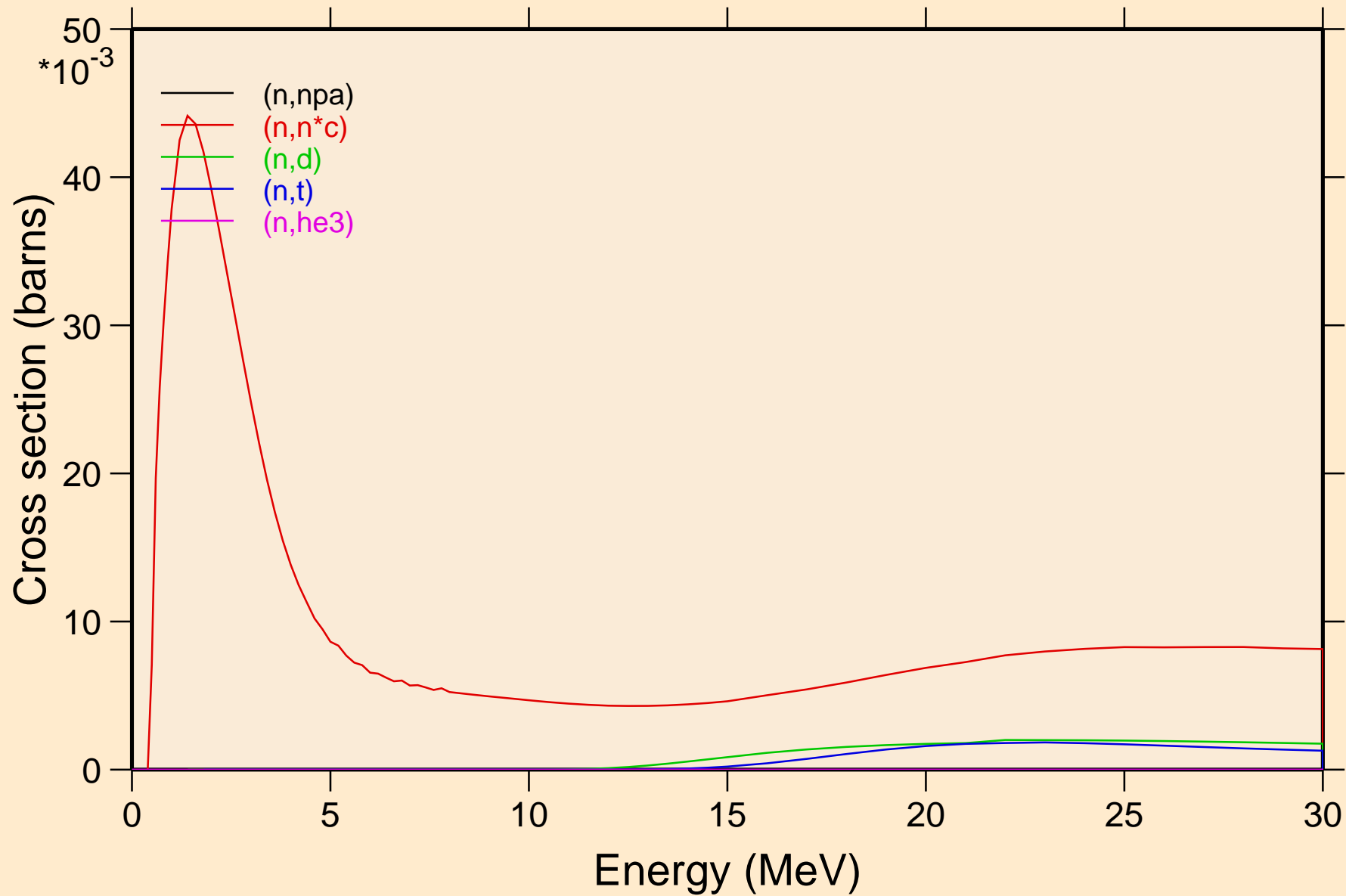

CF241 NEUTRON ACER TENDL-2021 LIBRARY; T=293.6K
Threshold reactions

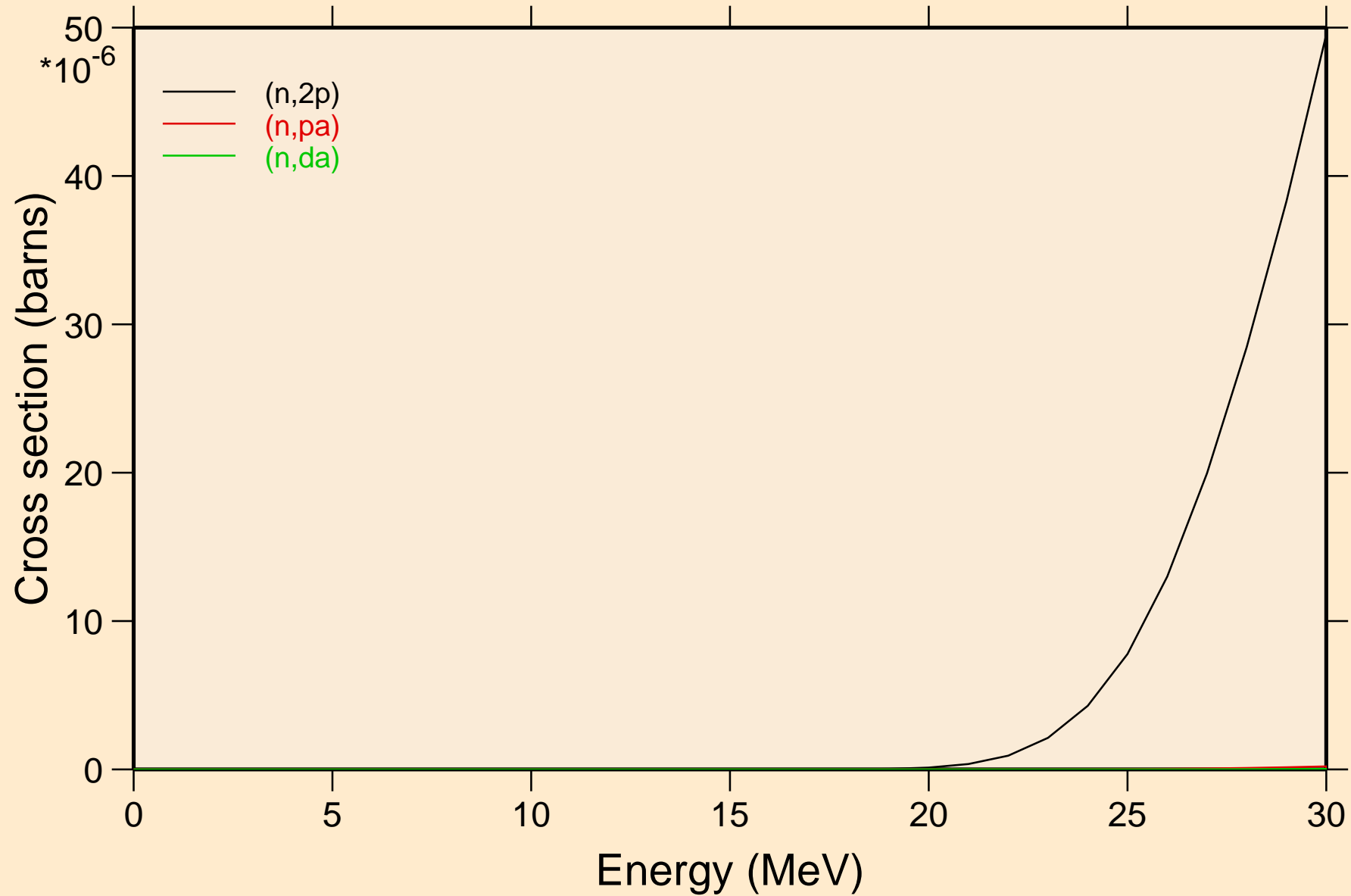

CF241 NEUTRON ACER TENDL-2021 LIBRARY; T=293.6K
Threshold reactions

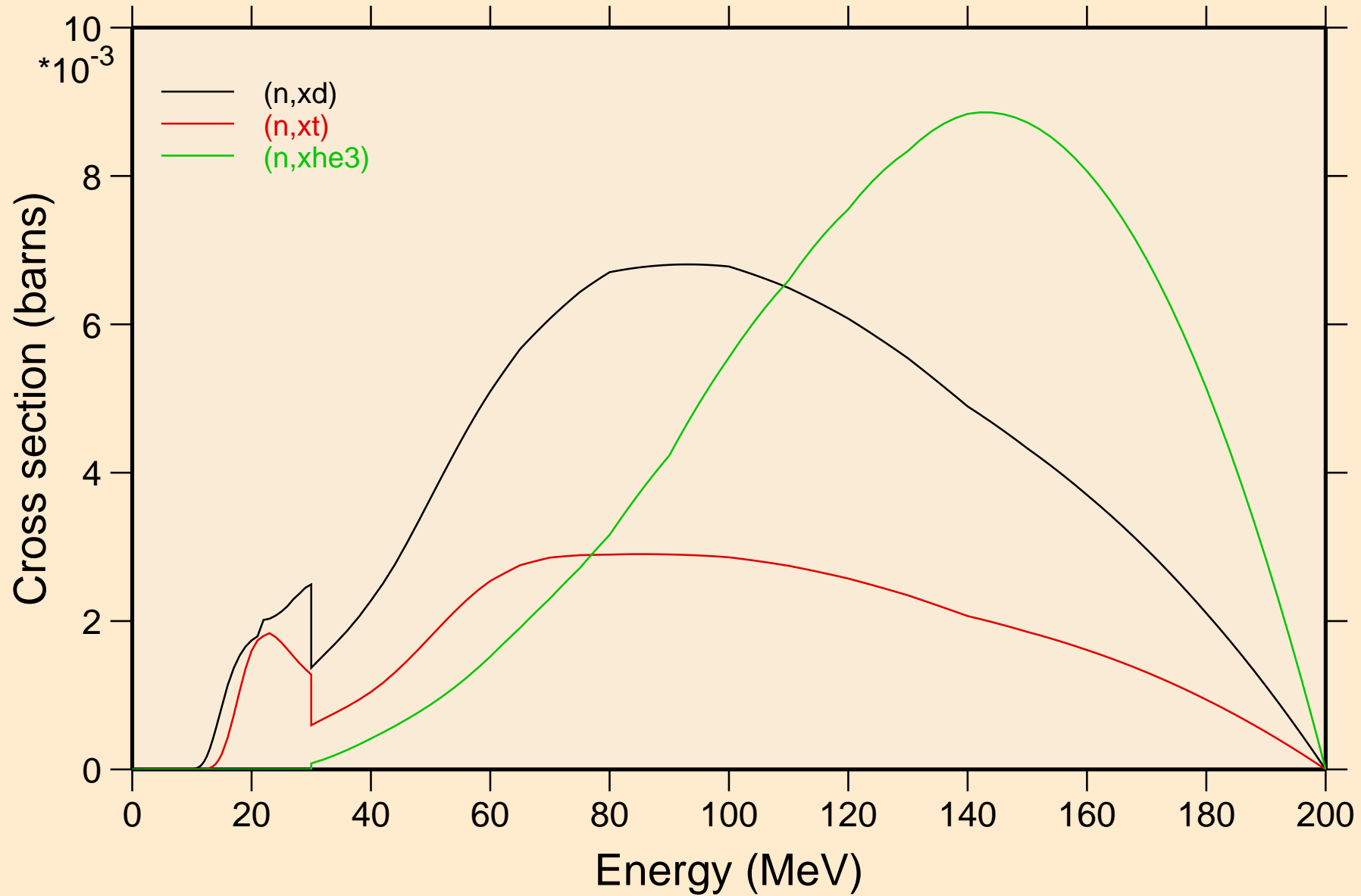

CF241 NEUTRON ACER TENDL-2021 LIBRARY; T=293.6K
angular distribution for elastic

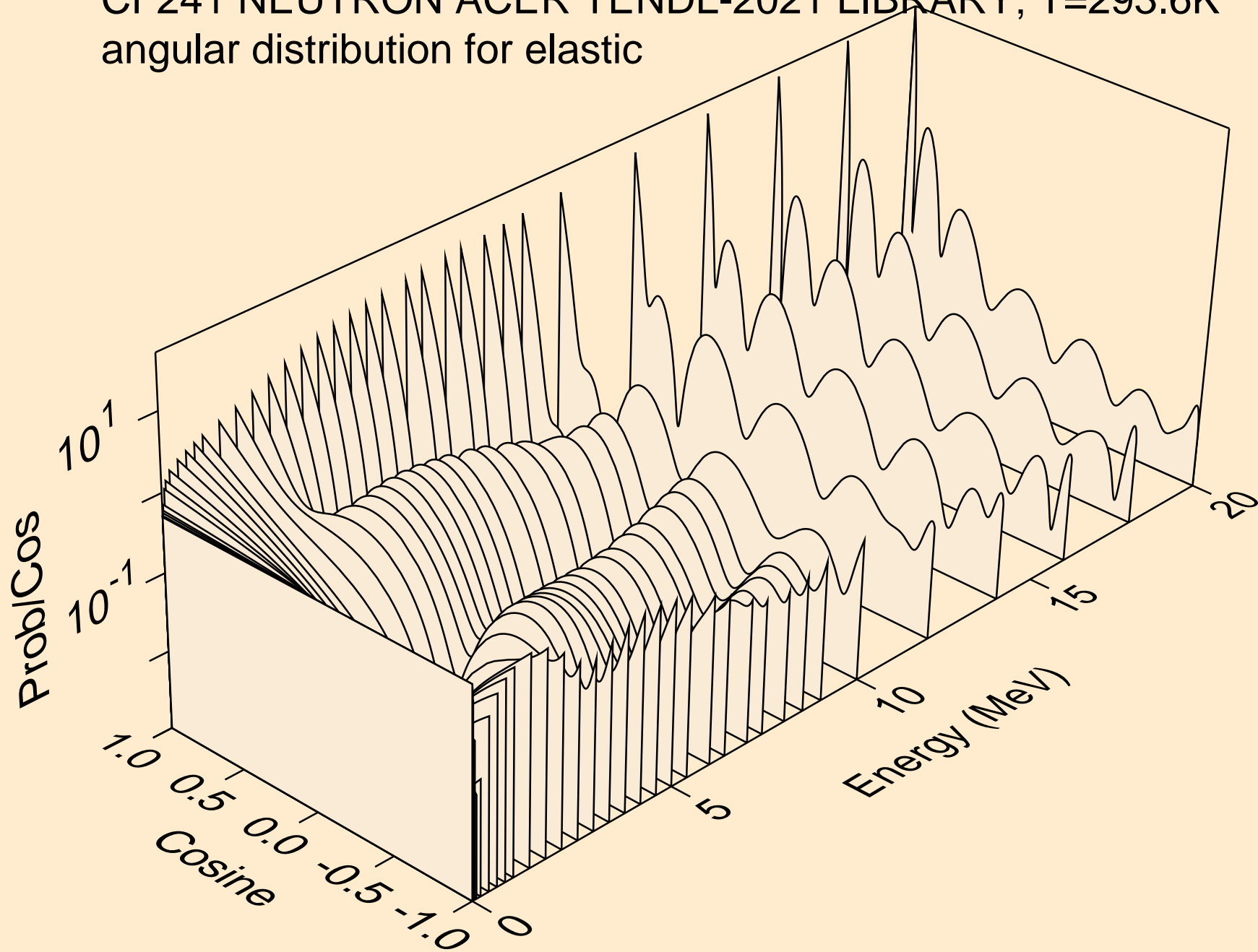

CF241 NEUTRON ACER TENDL-2021 LIBRARY; T=293.6K
angular distribution for elastic

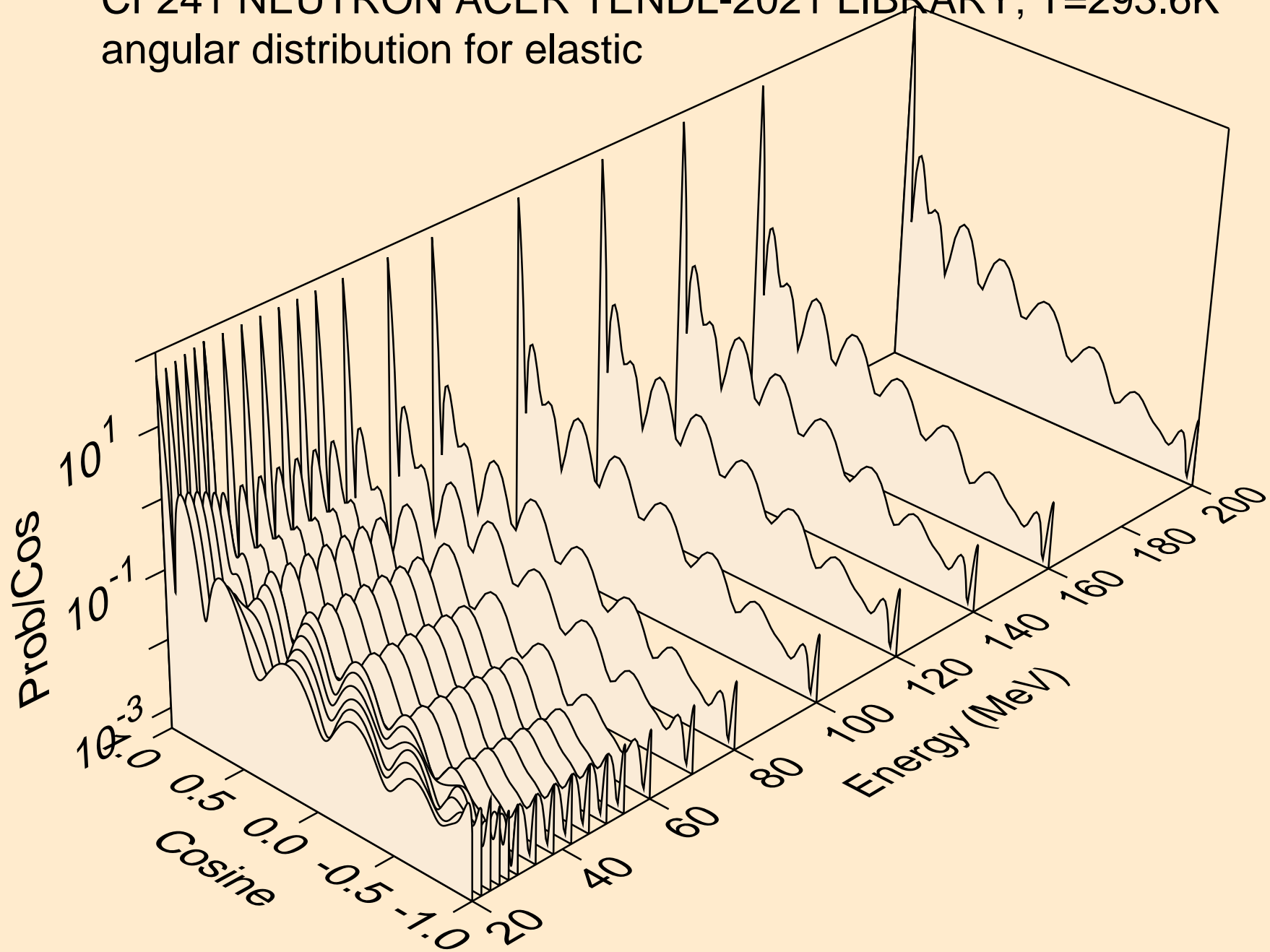

CF241 NEUTRON ACER TENDL-2021 LIBRARY; T=293.6K
angular distribution for (n,n*1)

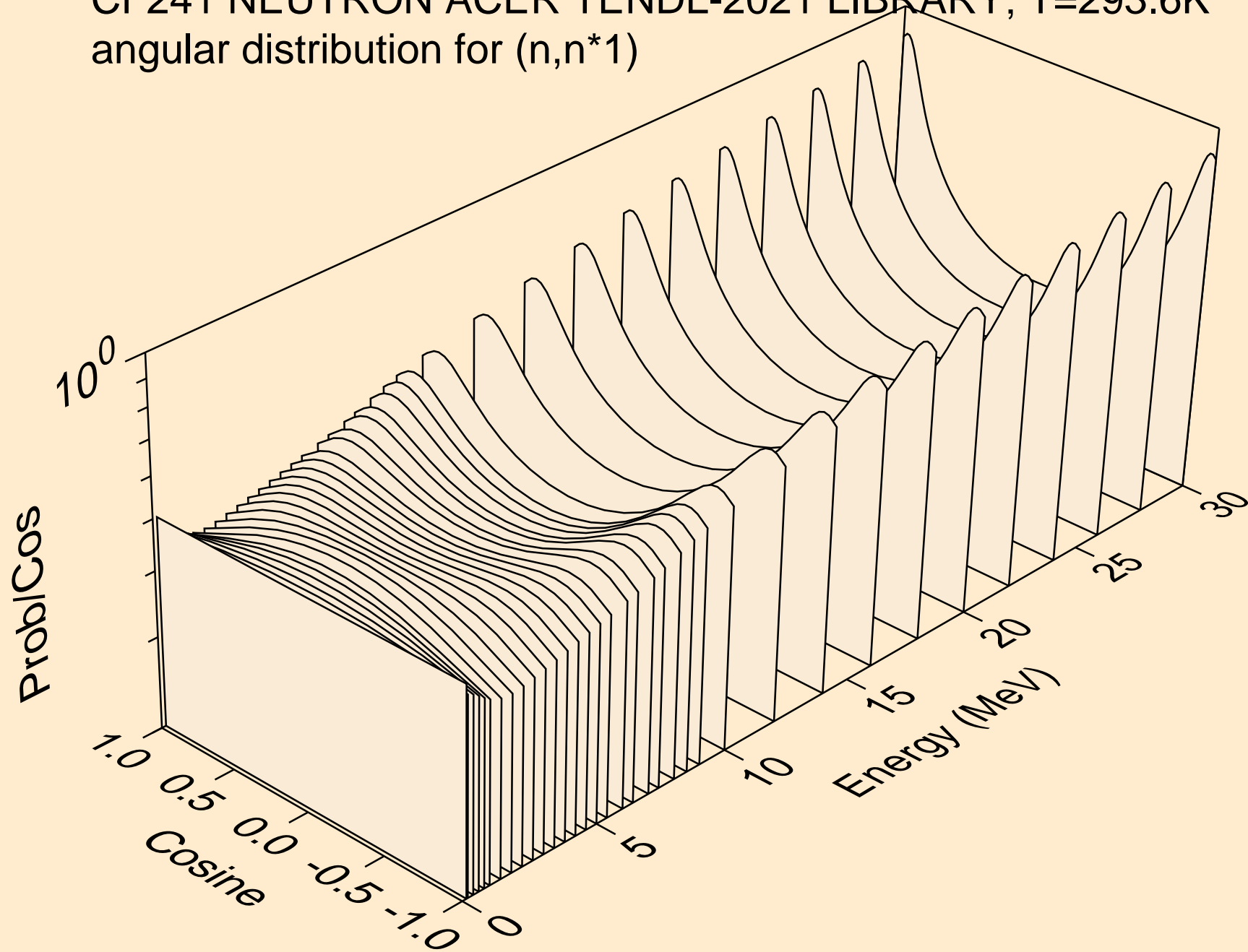

CF241 NEUTRON ACER TENDL-2021 LIBRARY; T=293.6K
angular distribution for (n,n*2)

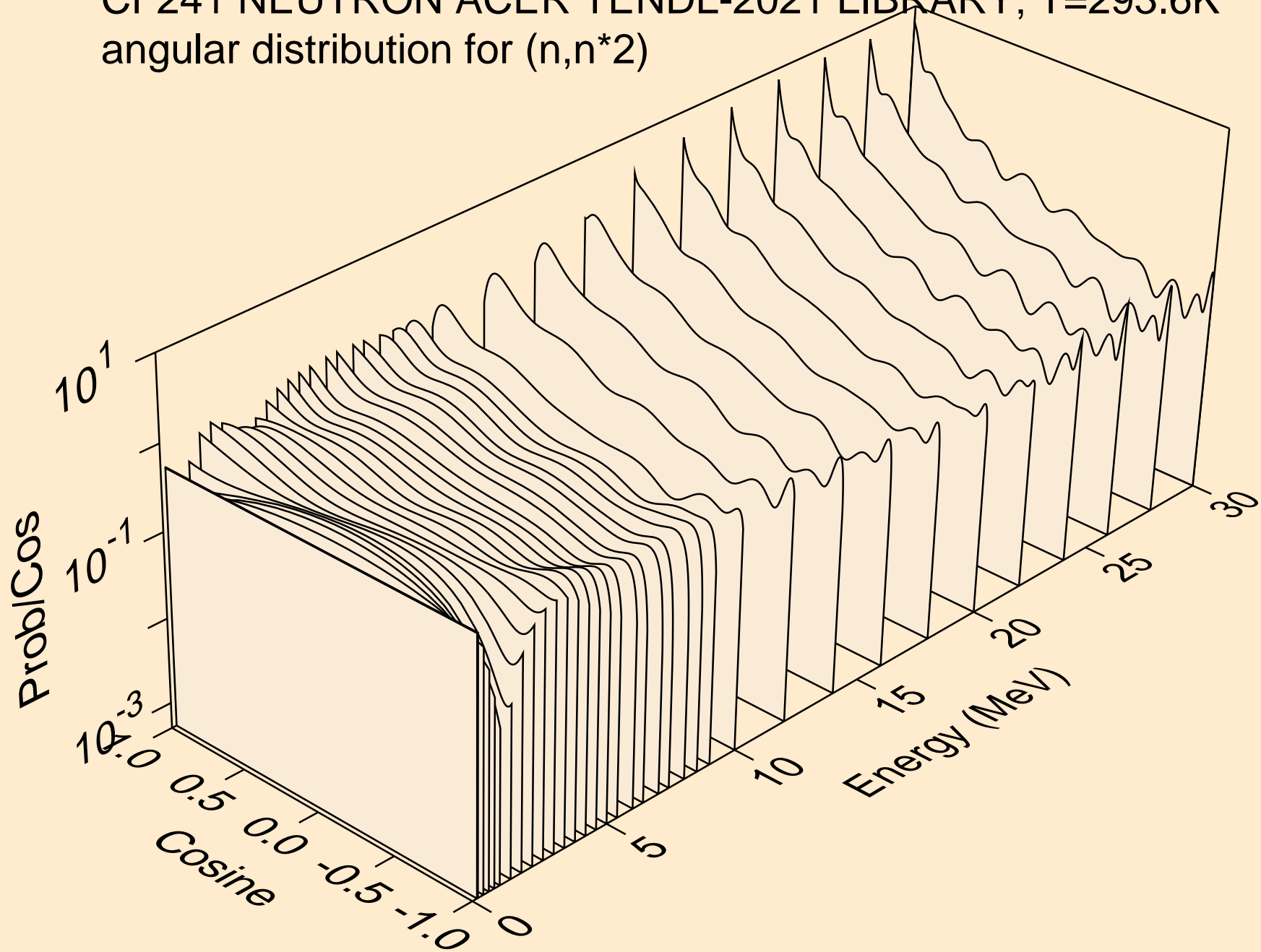

CF241 NEUTRON ACER TENDL-2021 LIBRARY; T=293.6K
angular distribution for (n,n*3)

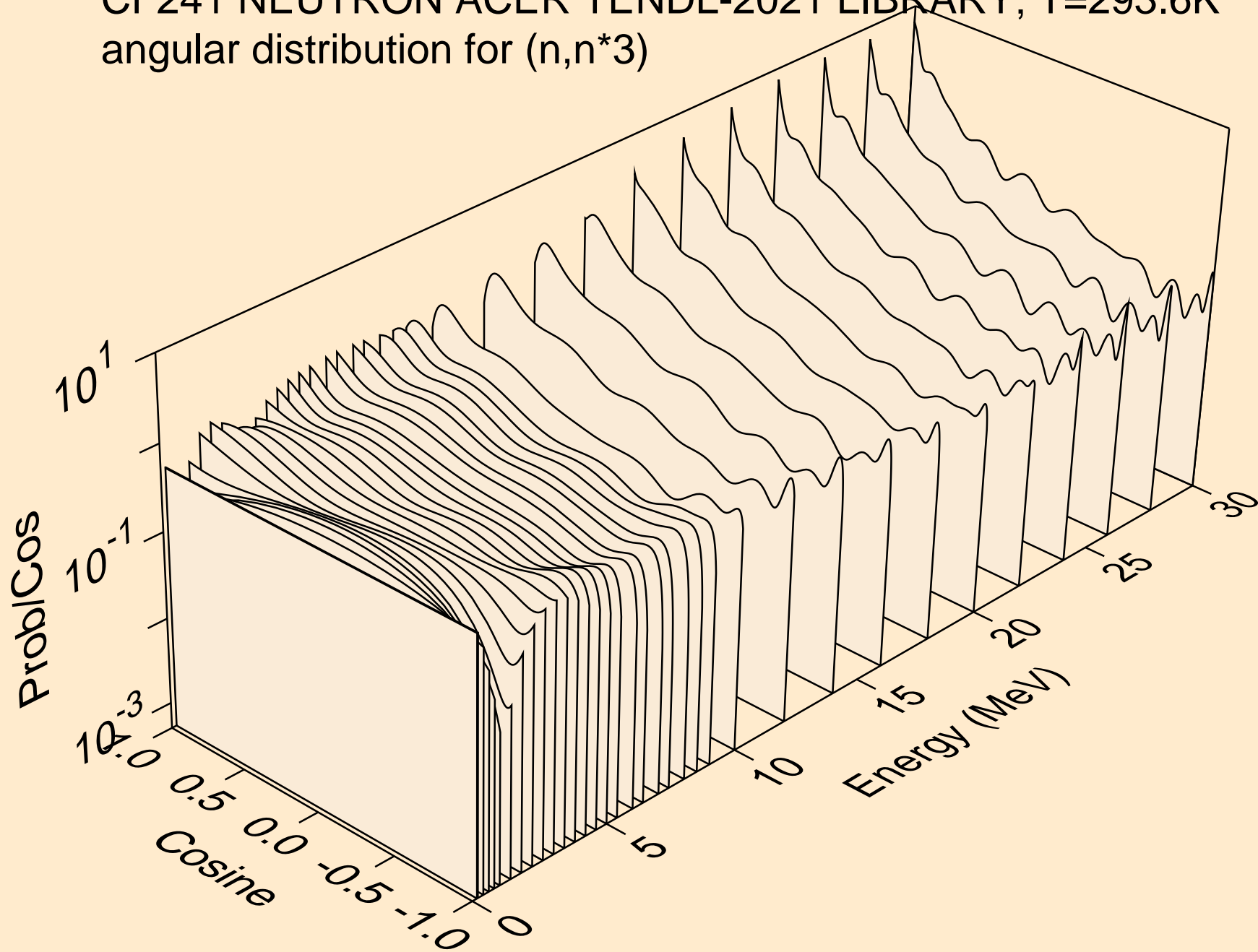

CF241 NEUTRON ACER TENDL-2021 LIBRARY; T=293.6K
angular distribution for (n,n*4)

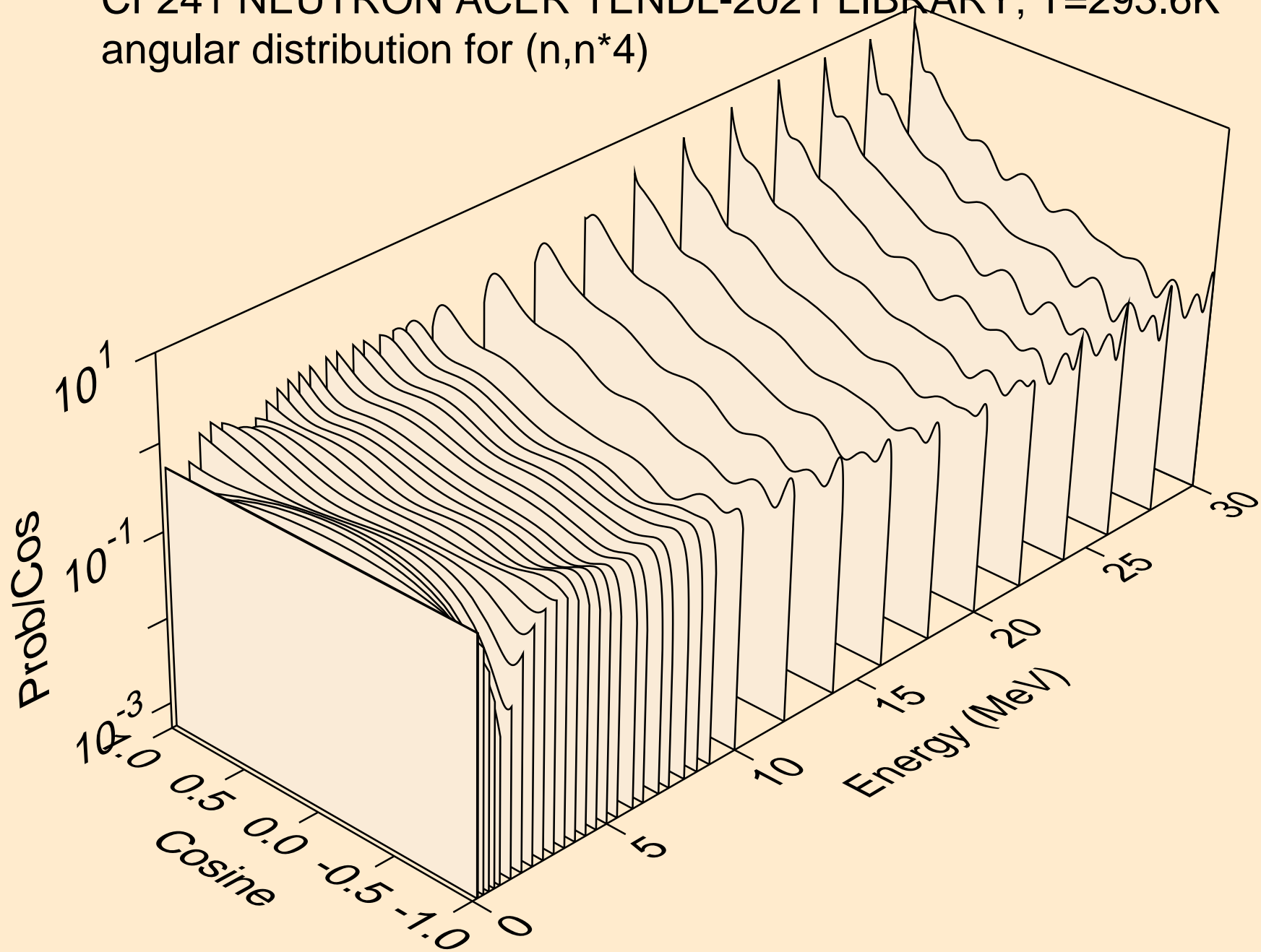

CF241 NEUTRON ACER TENDL-2021 LIBRARY; T=293.6K
angular distribution for (n,n*5)

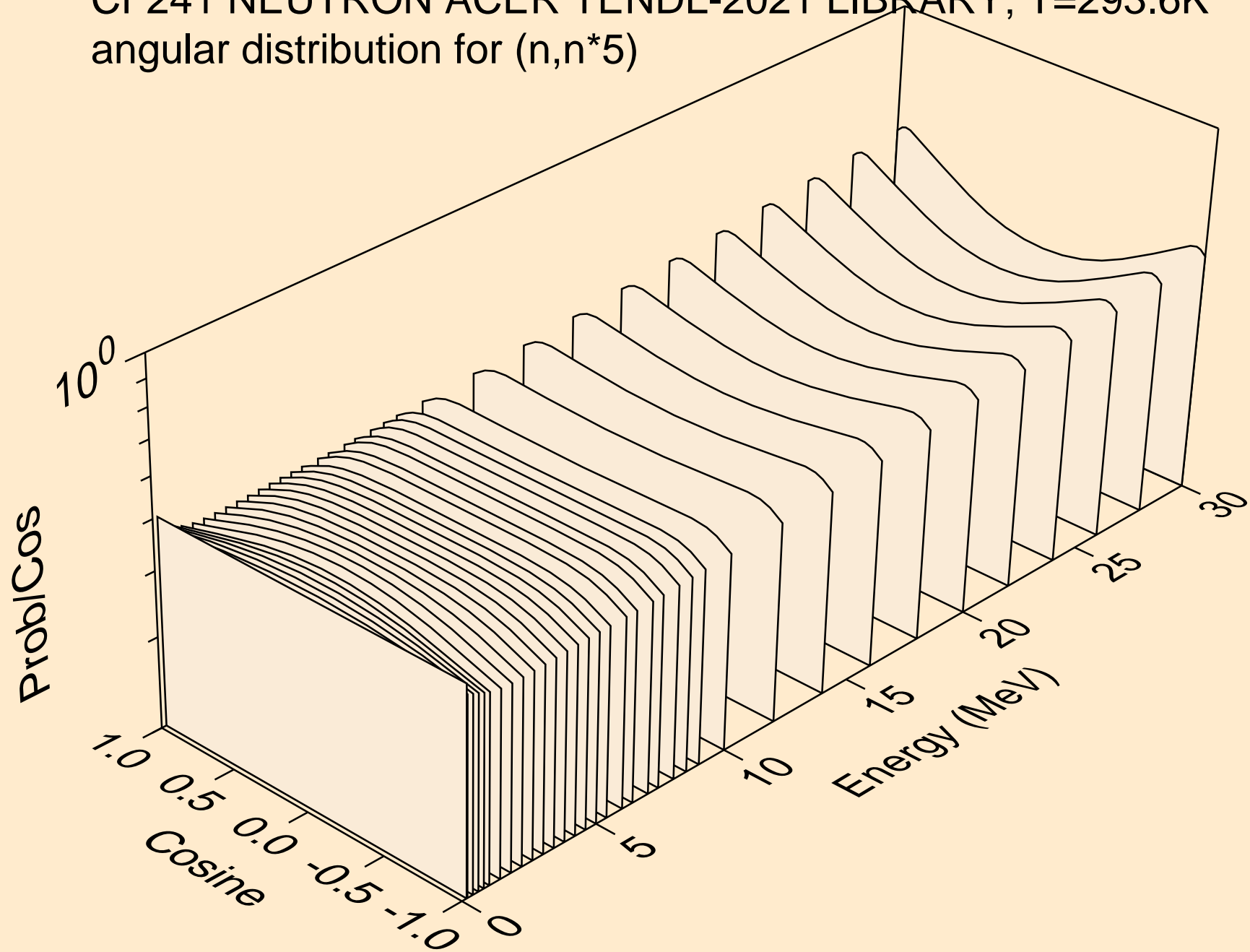

CF241 NEUTRON ACER TENDL-2021 LIBRARY; T=293.6K
angular distribution for (n,n*6)

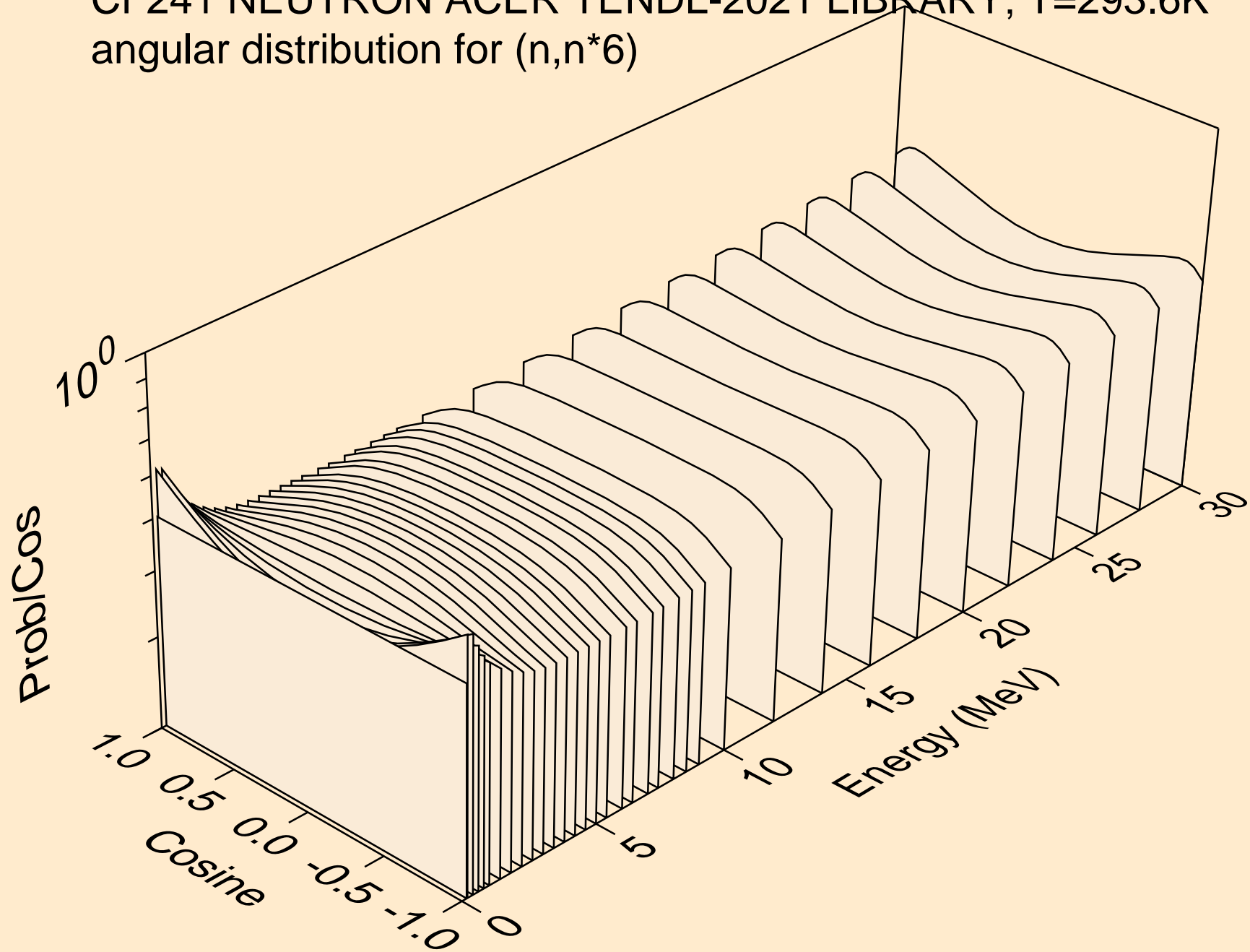

CF241 NEUTRON ACER TENDL-2021 LIBRARY; T=293.6K
angular distribution for (n,n*7)

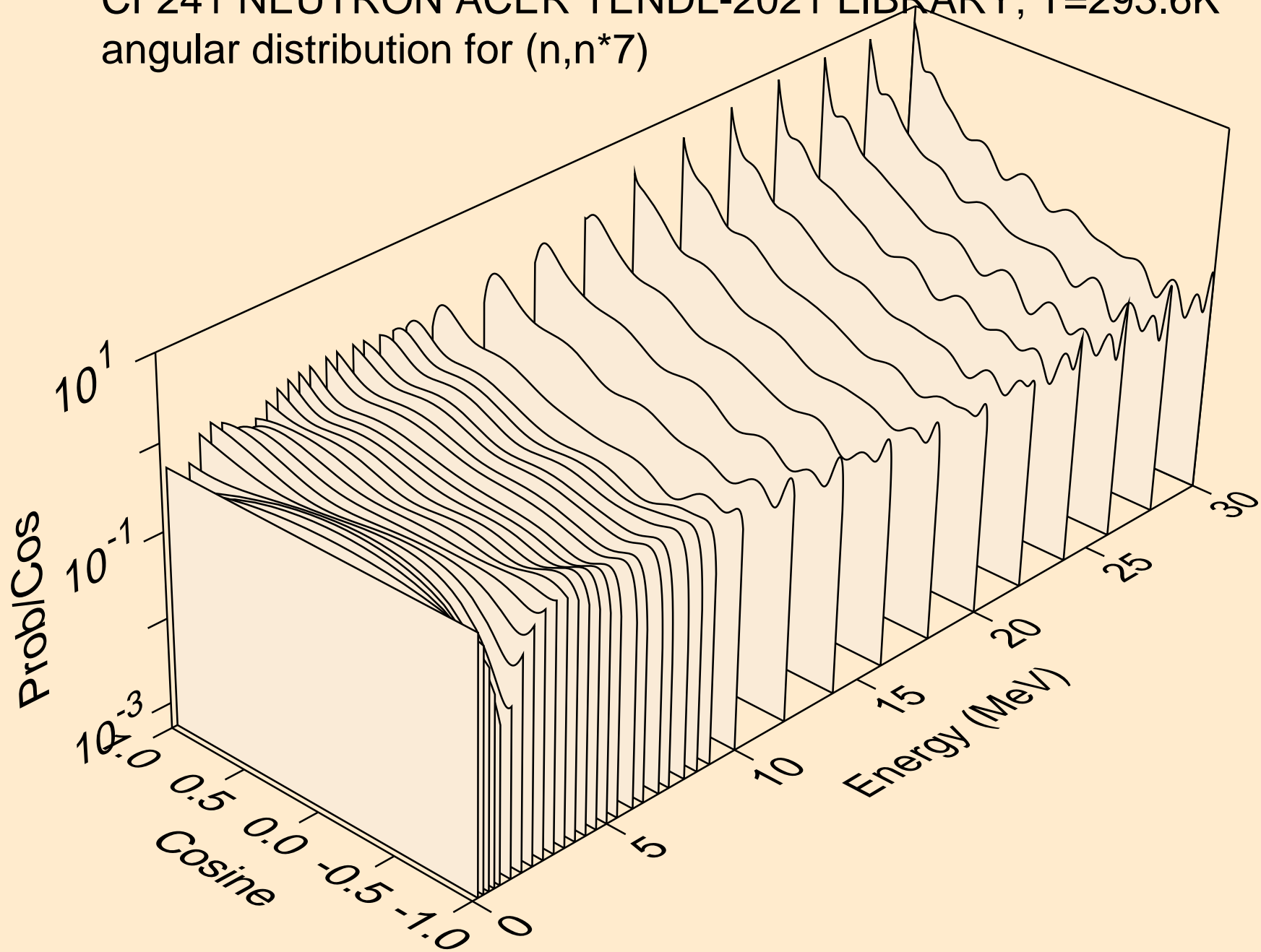

CF241 NEUTRON ACER TENDL-2021 LIBRARY; T=293.6K
angular distribution for (n,n*8)

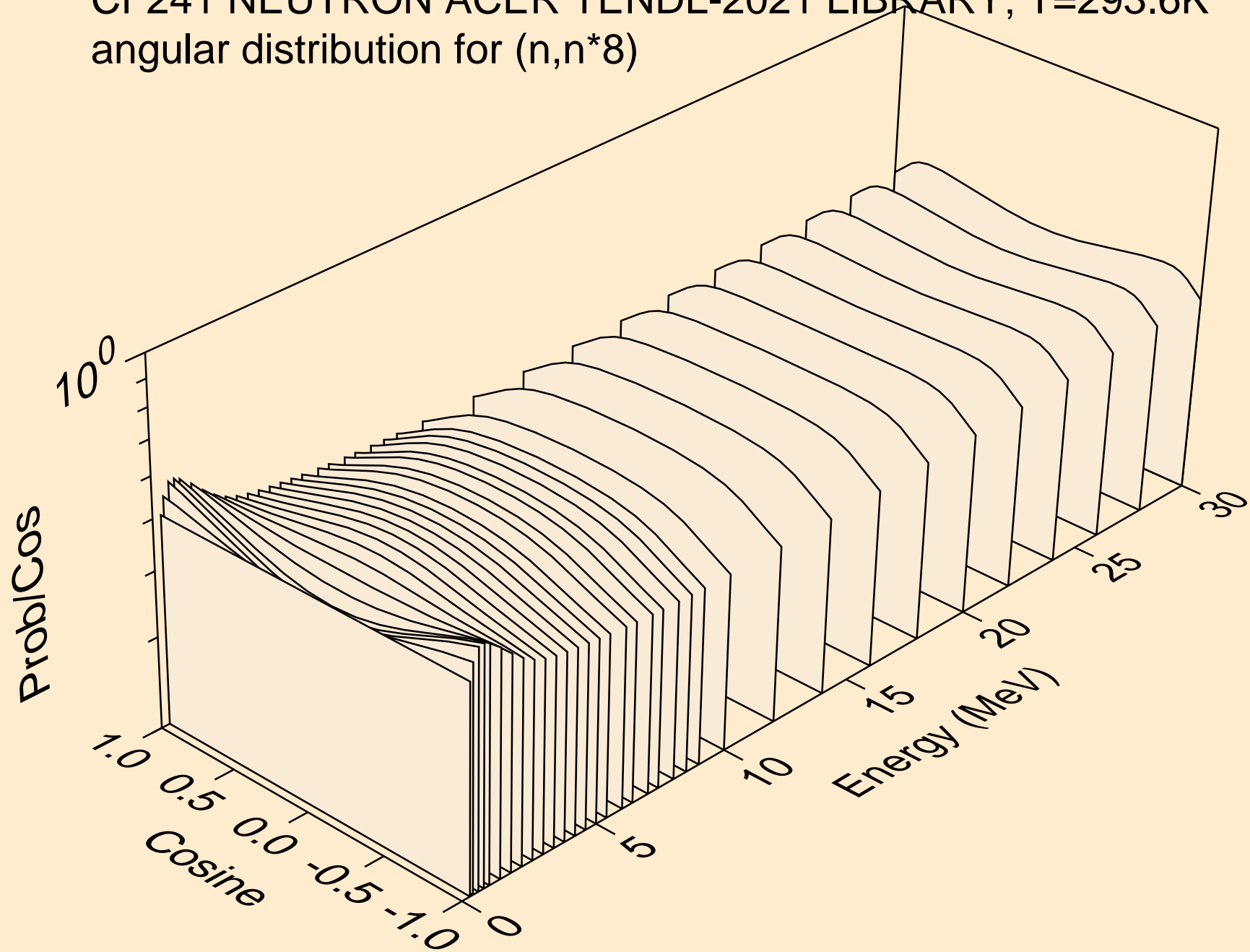

CF241 NEUTRON ACER TENDL-2021 LIBRARY; T=293.6K
angular distribution for (n,n*9)

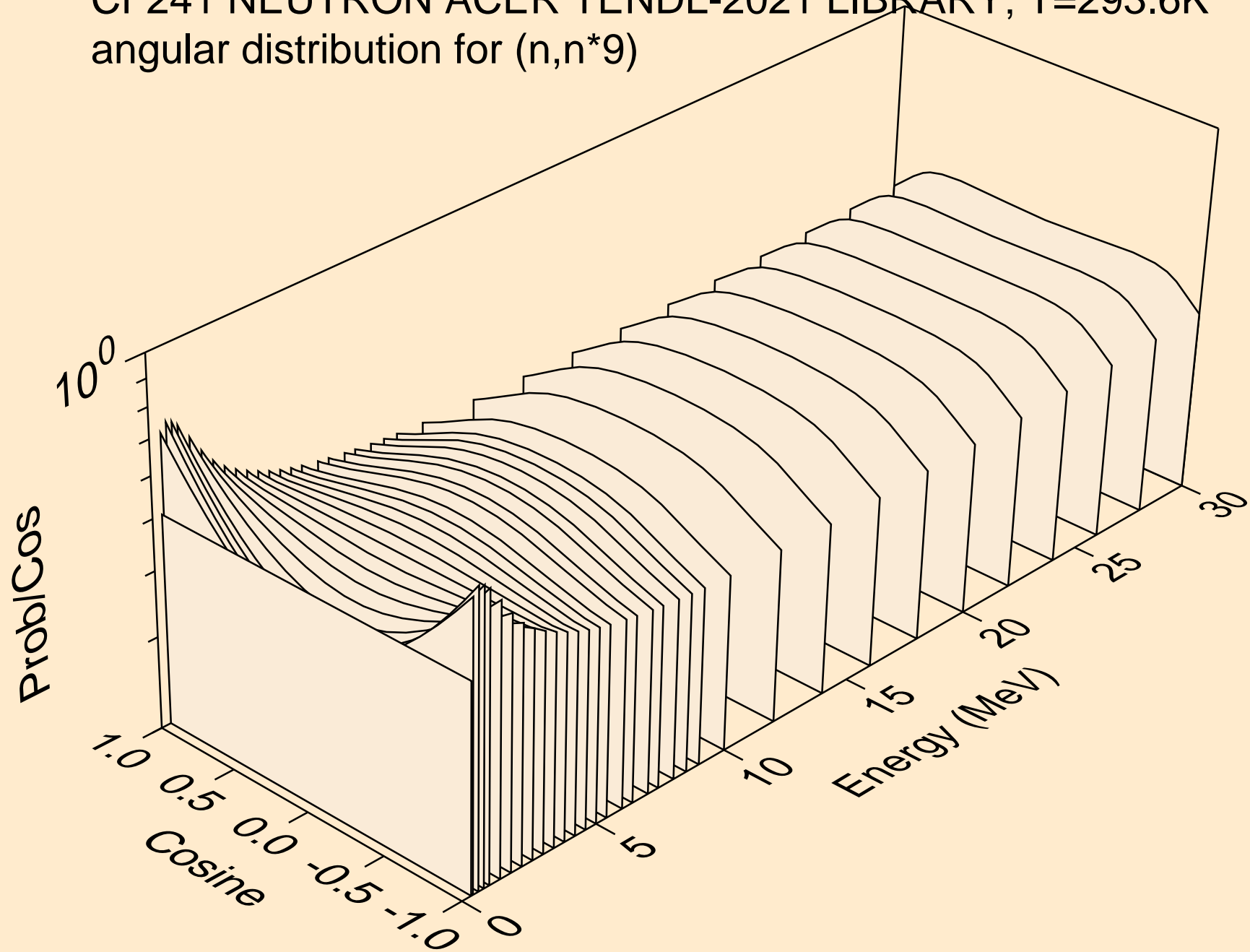

CF241 NEUTRON ACER TENDL-2021 LIBRARY; T=293.6K
angular distribution for (n,n*10)

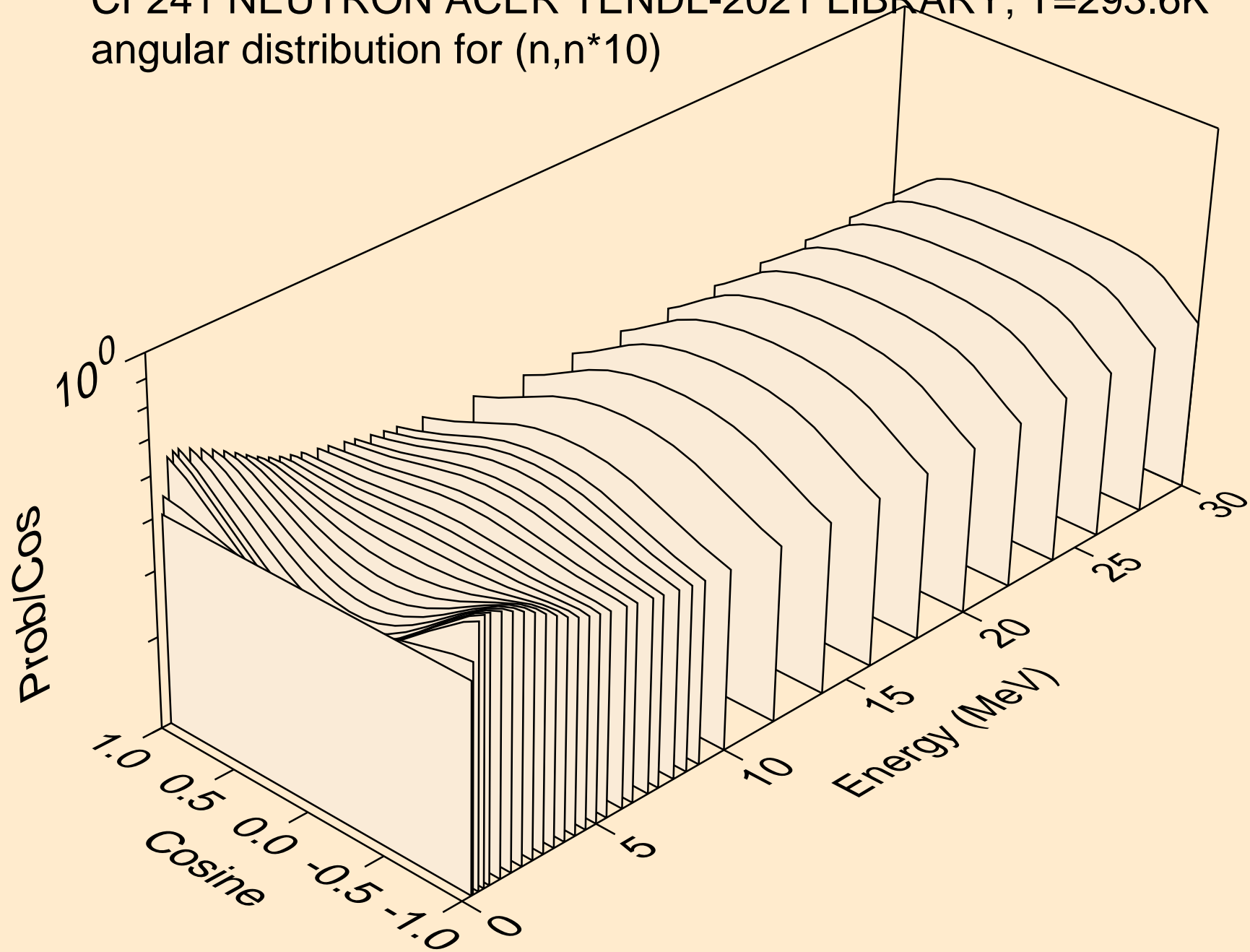

CF241 NEUTRON ACER TENDL-2021 LIBRARY; T=293.6K
angular distribution for (n,n*11)

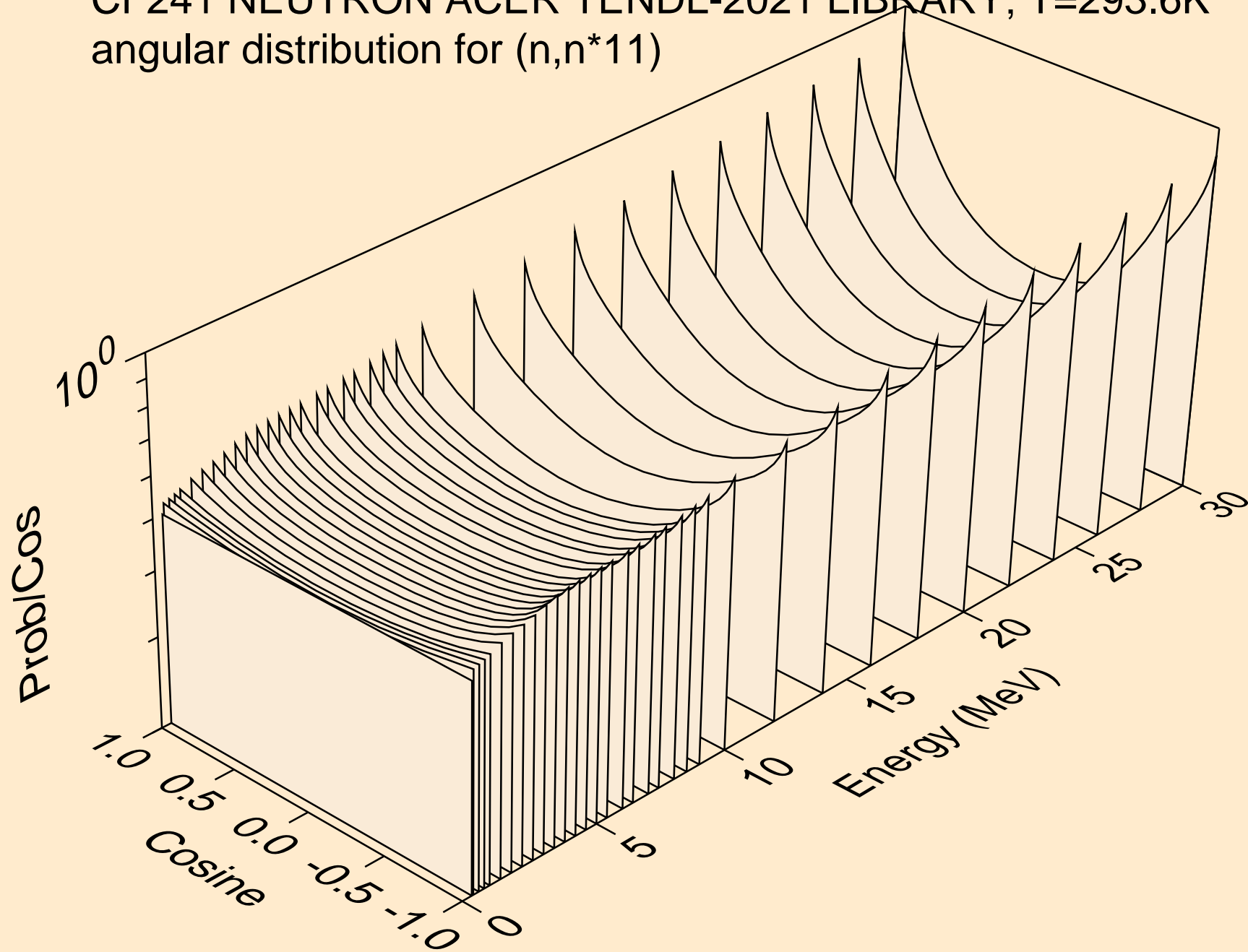

CF241 NEUTRON ACER TENDL-2021 LIBRARY; T=293.6K
angular distribution for (n,n*12)

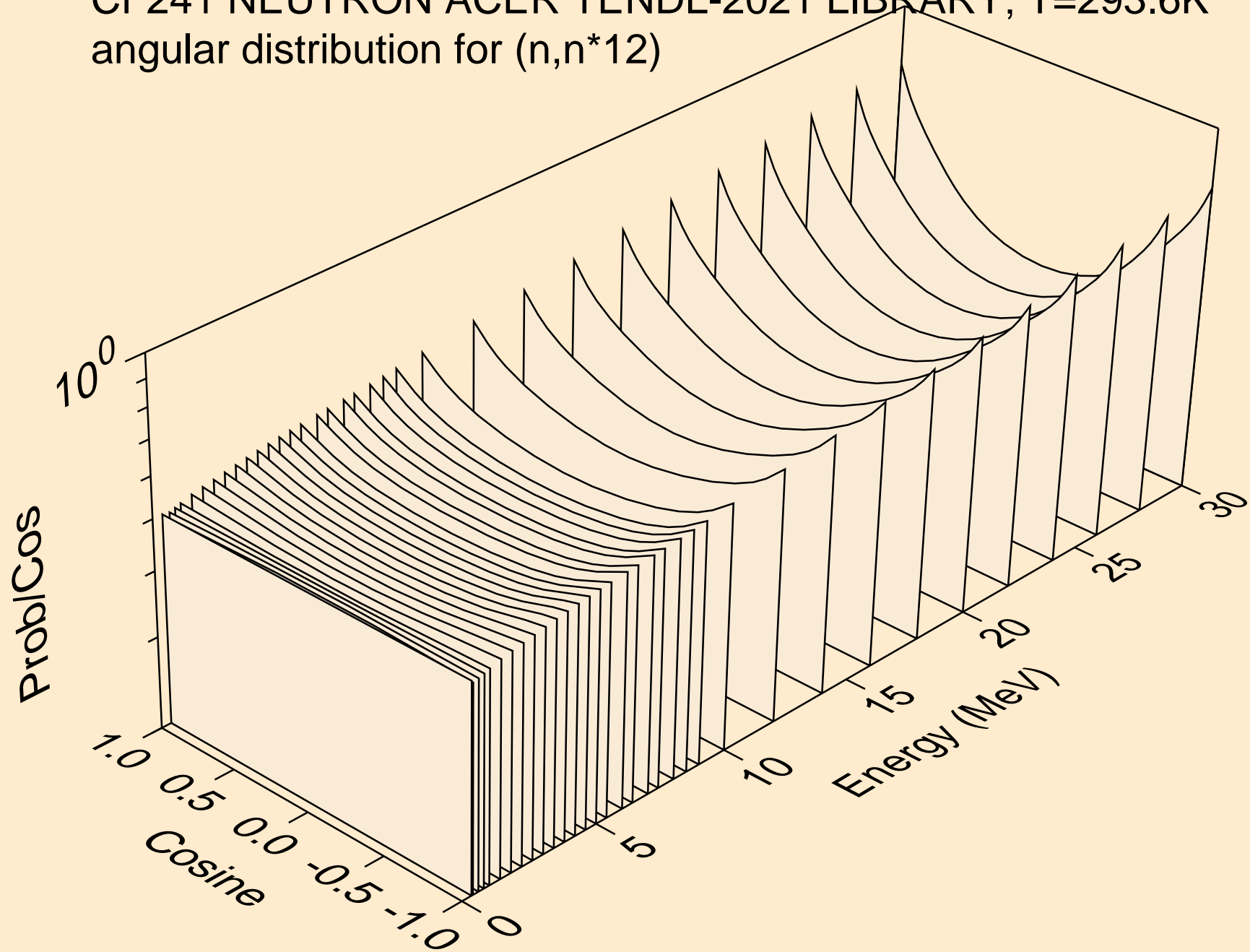

CF241 NEUTRON ACER TENDL-2021 LIBRARY; T=293.6K
angular distribution for (n,n*13)

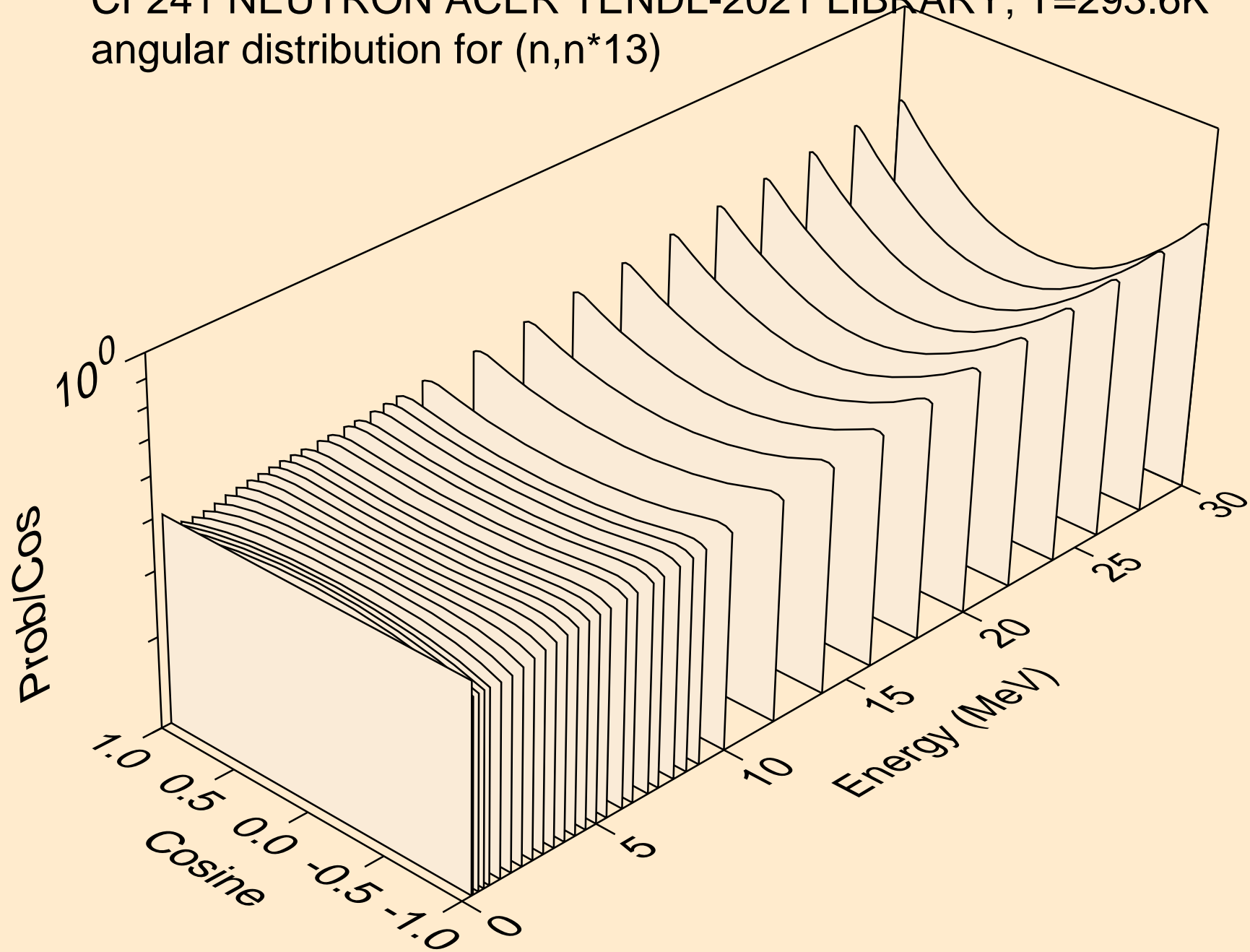

CF241 NEUTRON ACER TENDL-2021 LIBRARY; T=293.6K
angular distribution for (n,n*14)

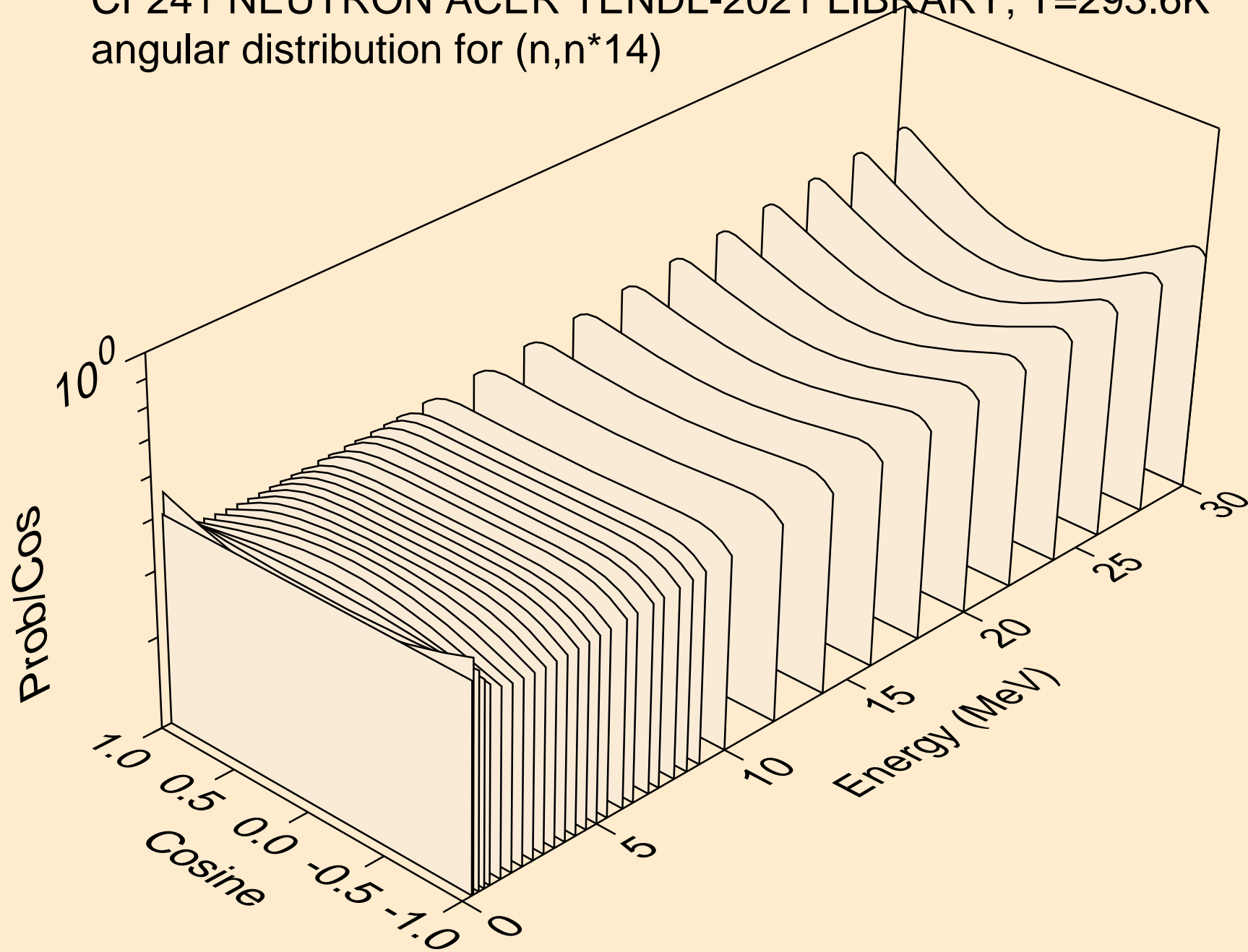

CF241 NEUTRON ACER TENDL-2021 LIBRARY; T=293.6K
angular distribution for (n,n*15)

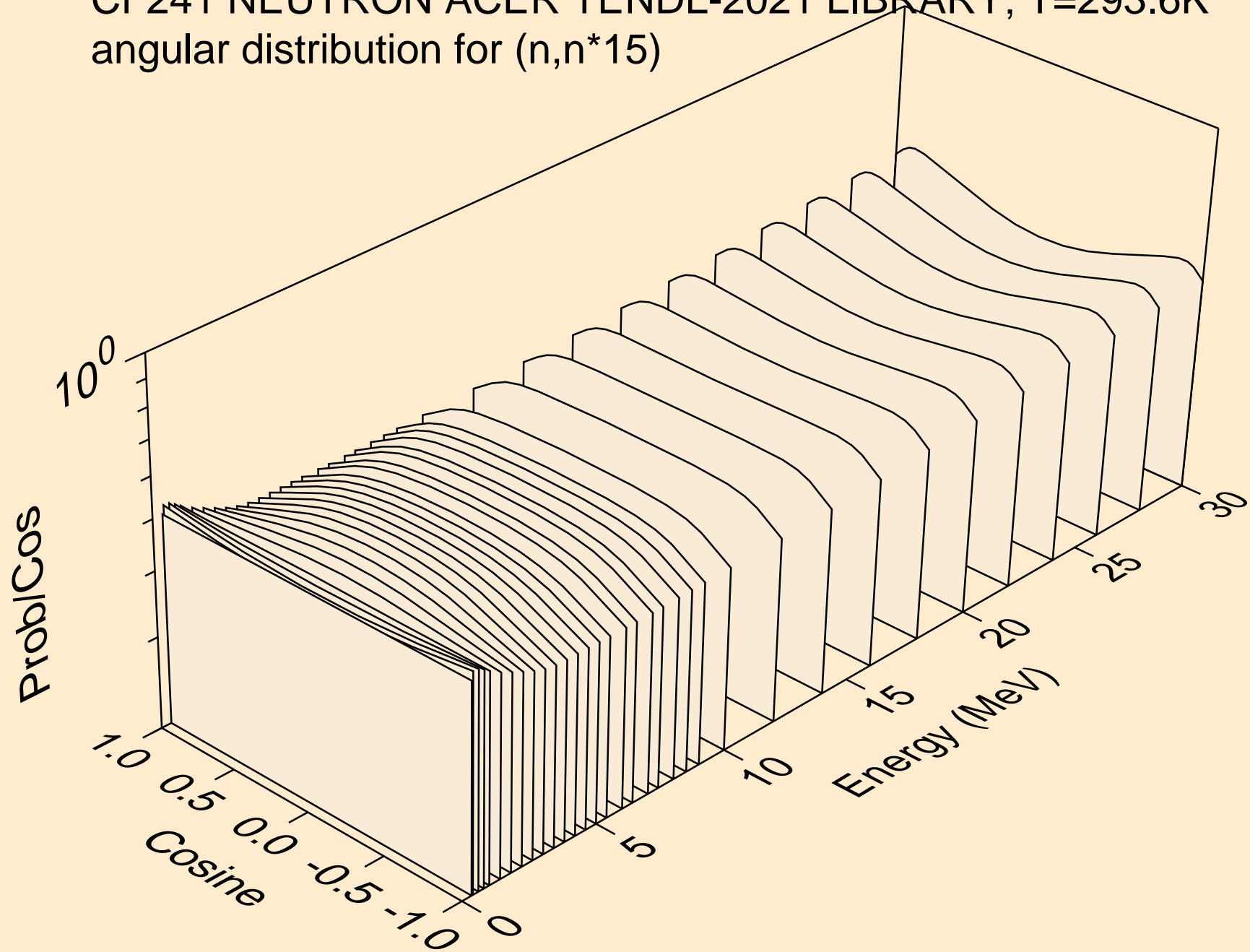

CF241 NEUTRON ACER TENDL-2021 LIBRARY; T=293.6K
angular distribution for (n,n*16)

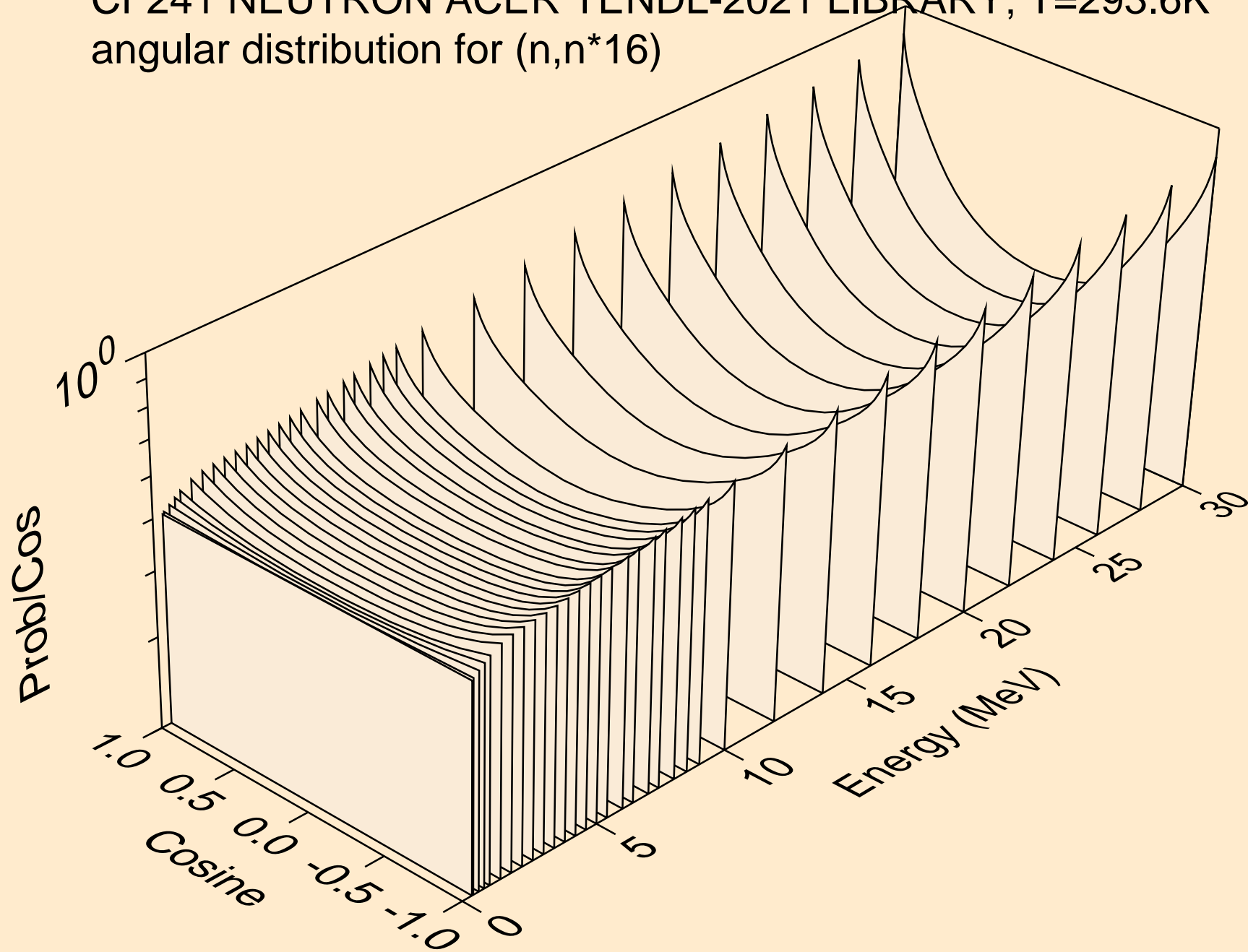

CF241 NEUTRON ACER TENDL-2021 LIBRARY; T=293.6K
angular distribution for (n,n*17)

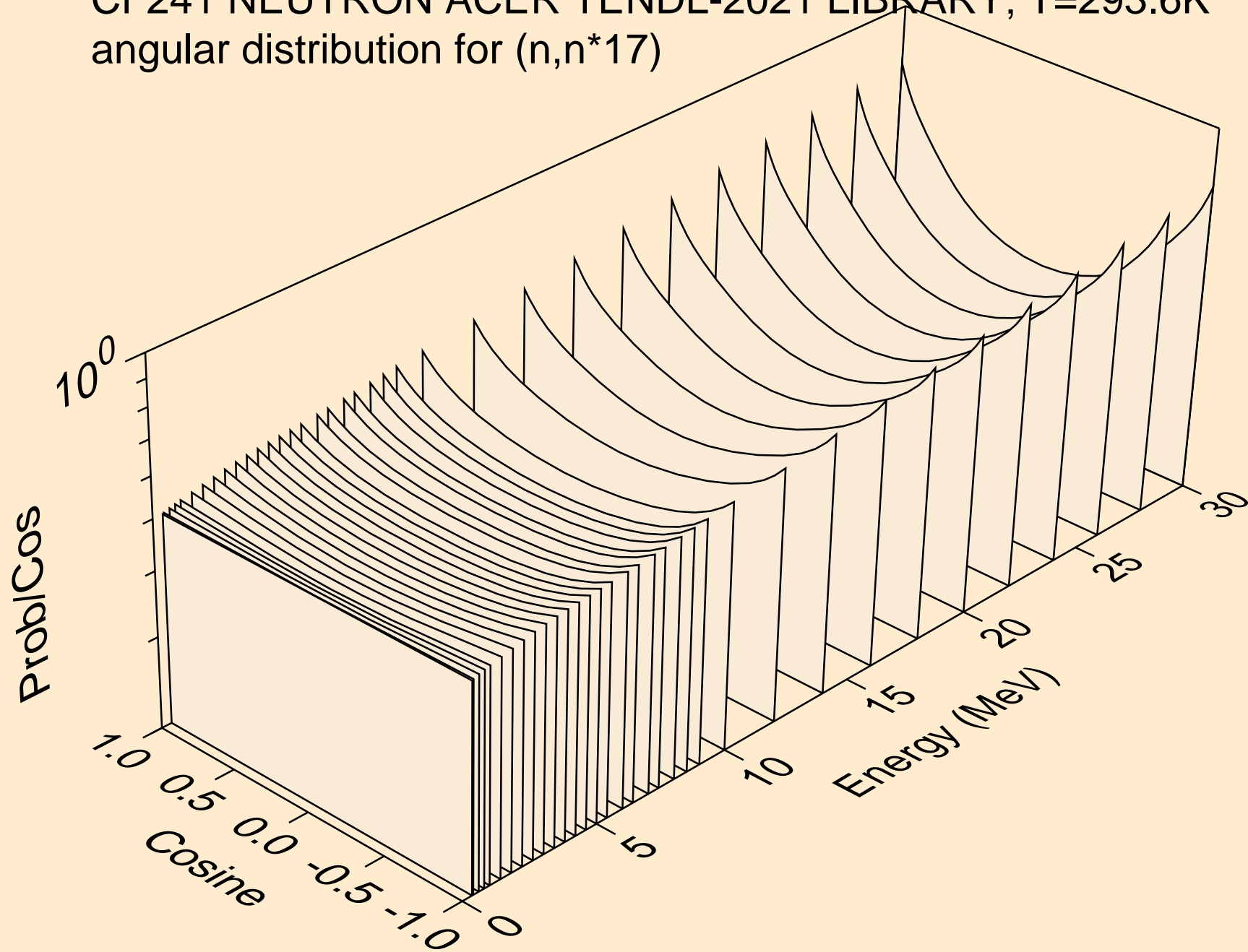

CF241 NEUTRON ACER TENDL-2021 LIBRARY; T=293.6K
angular distribution for (n,n*18)

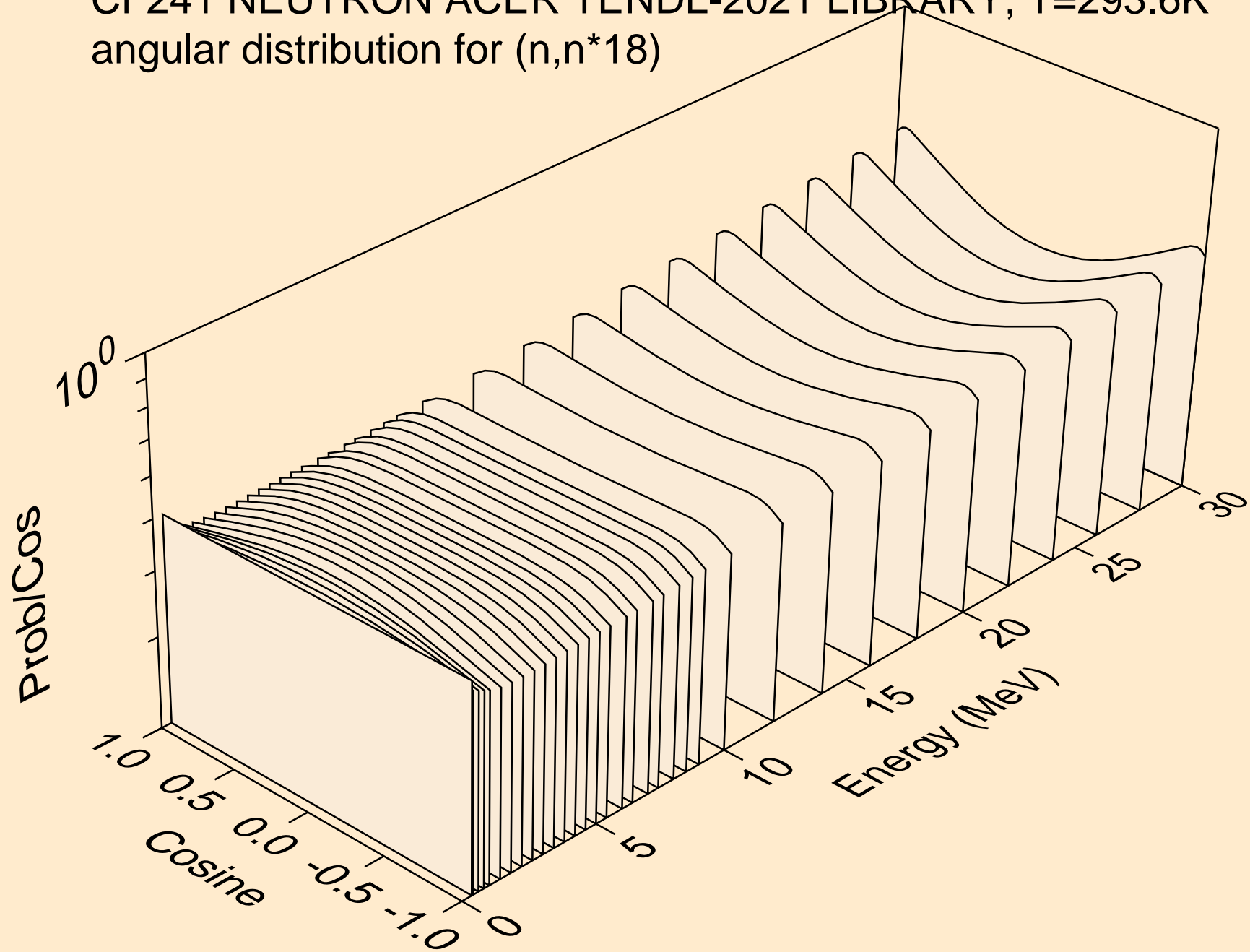

CF241 NEUTRON ACER TENDL-2021 LIBRARY; T=293.6K
angular distribution for (n,n*19)

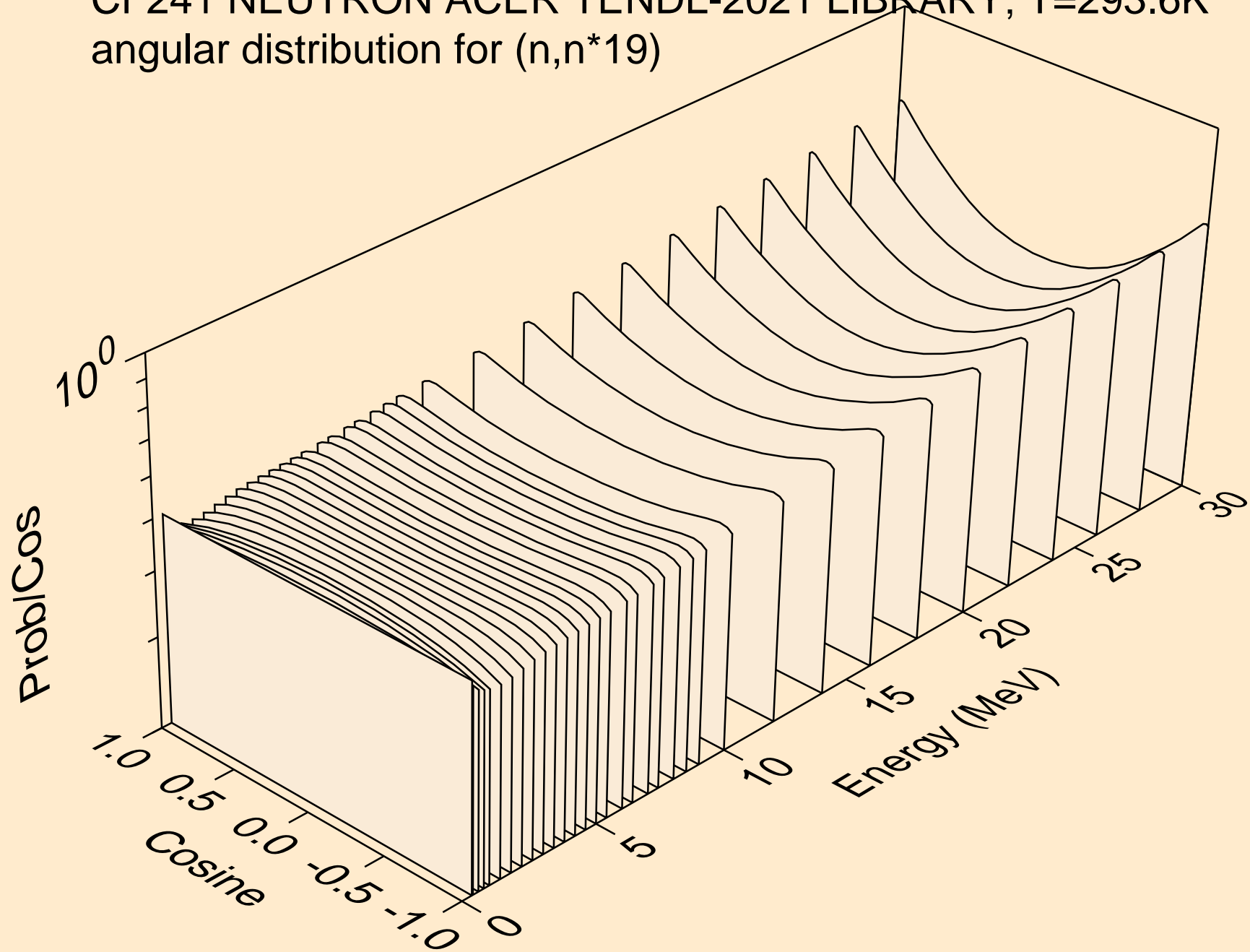

CF241 NEUTRON ACER TENDL-2021 LIBRARY; T=293.6K
angular distribution for (n,n*20)

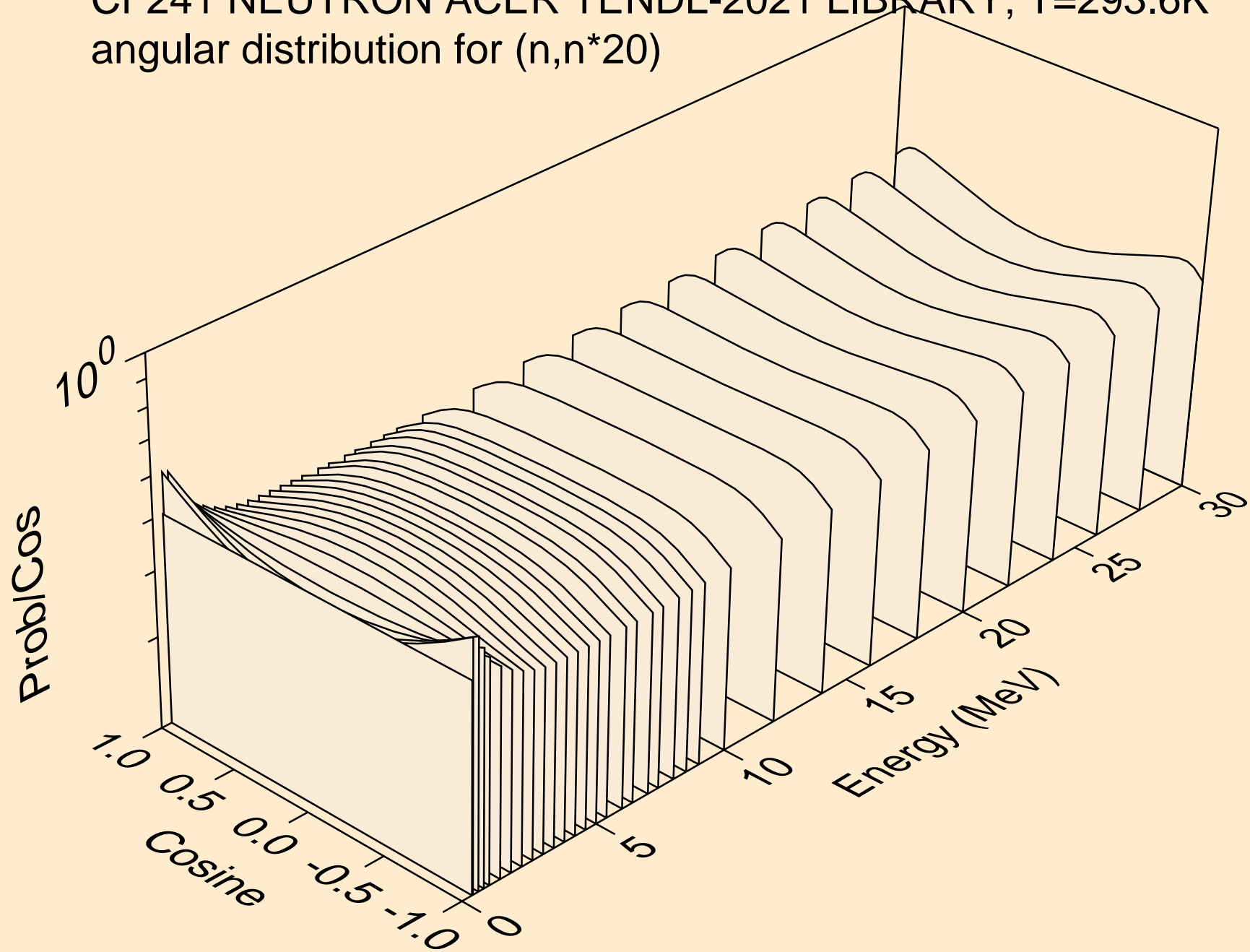

CF241 NEUTRON ACER TENDL-2021 LIBRARY; T=293.6K
angular distribution for (n,n*21)

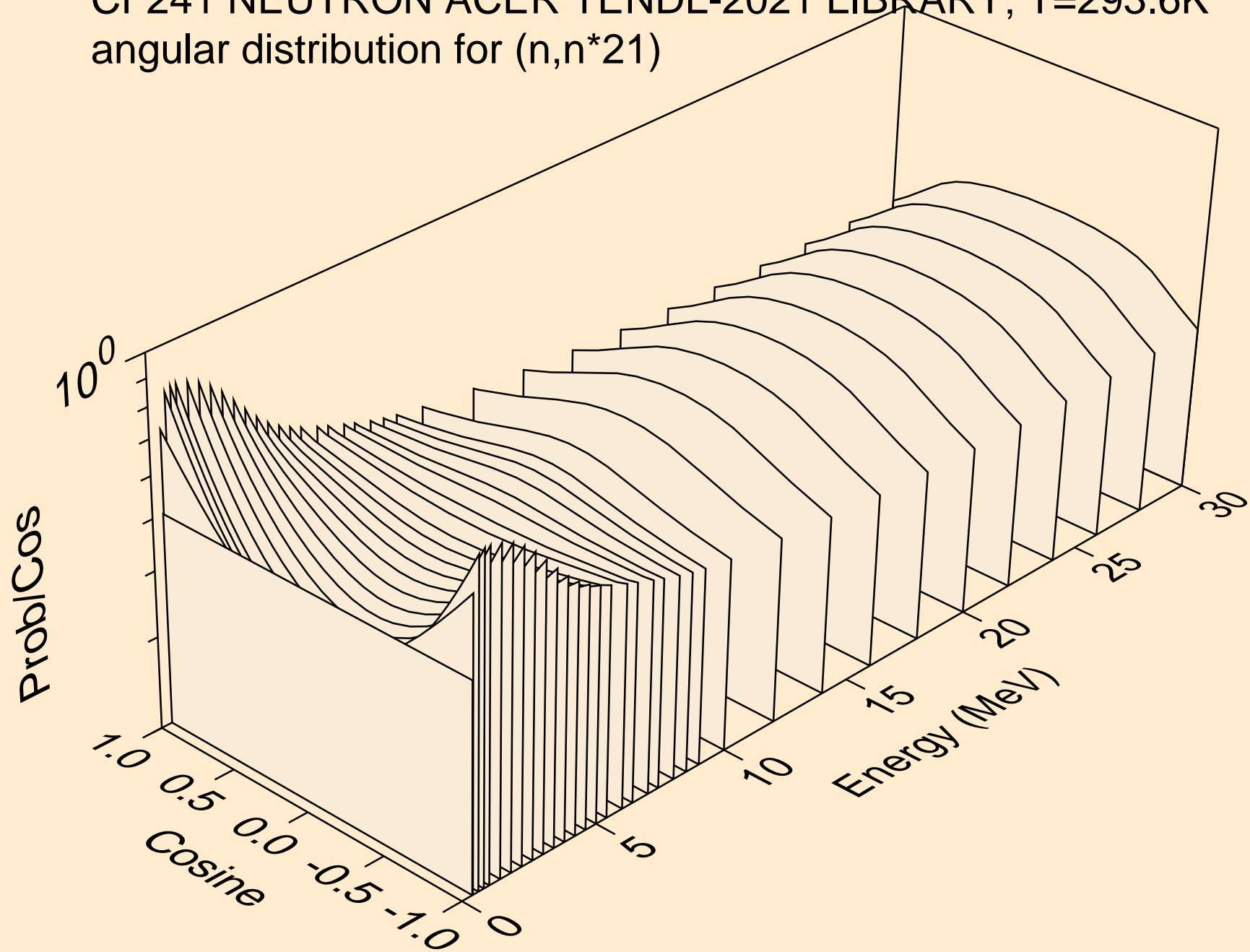

CF241 NEUTRON ACER TENDL-2021 LIBRARY; T=293.6K
angular distribution for (n,n*22)

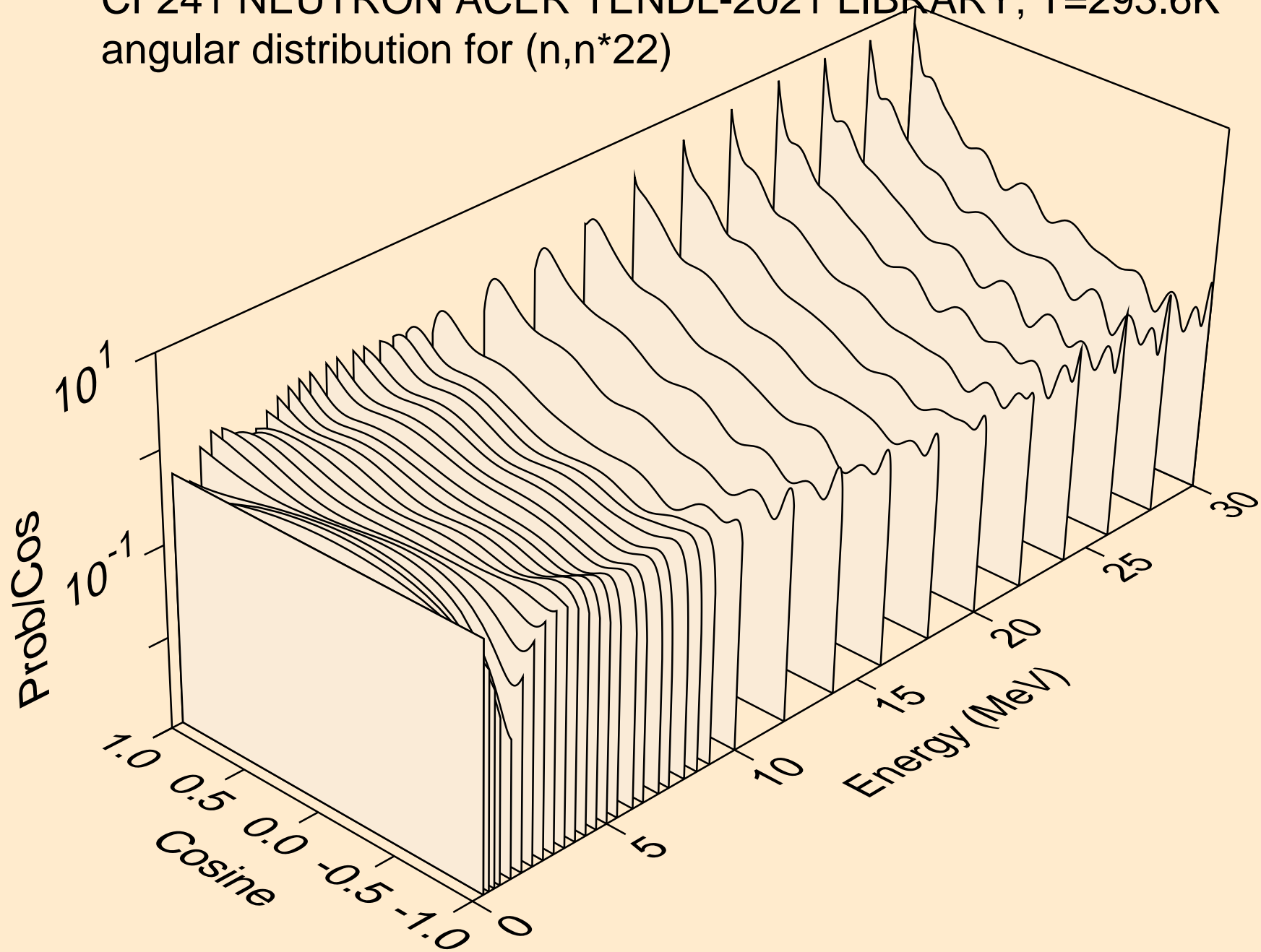

CF241 NEUTRON ACER TENDL-2021 LIBRARY; T=293.6K
Total fission nubar

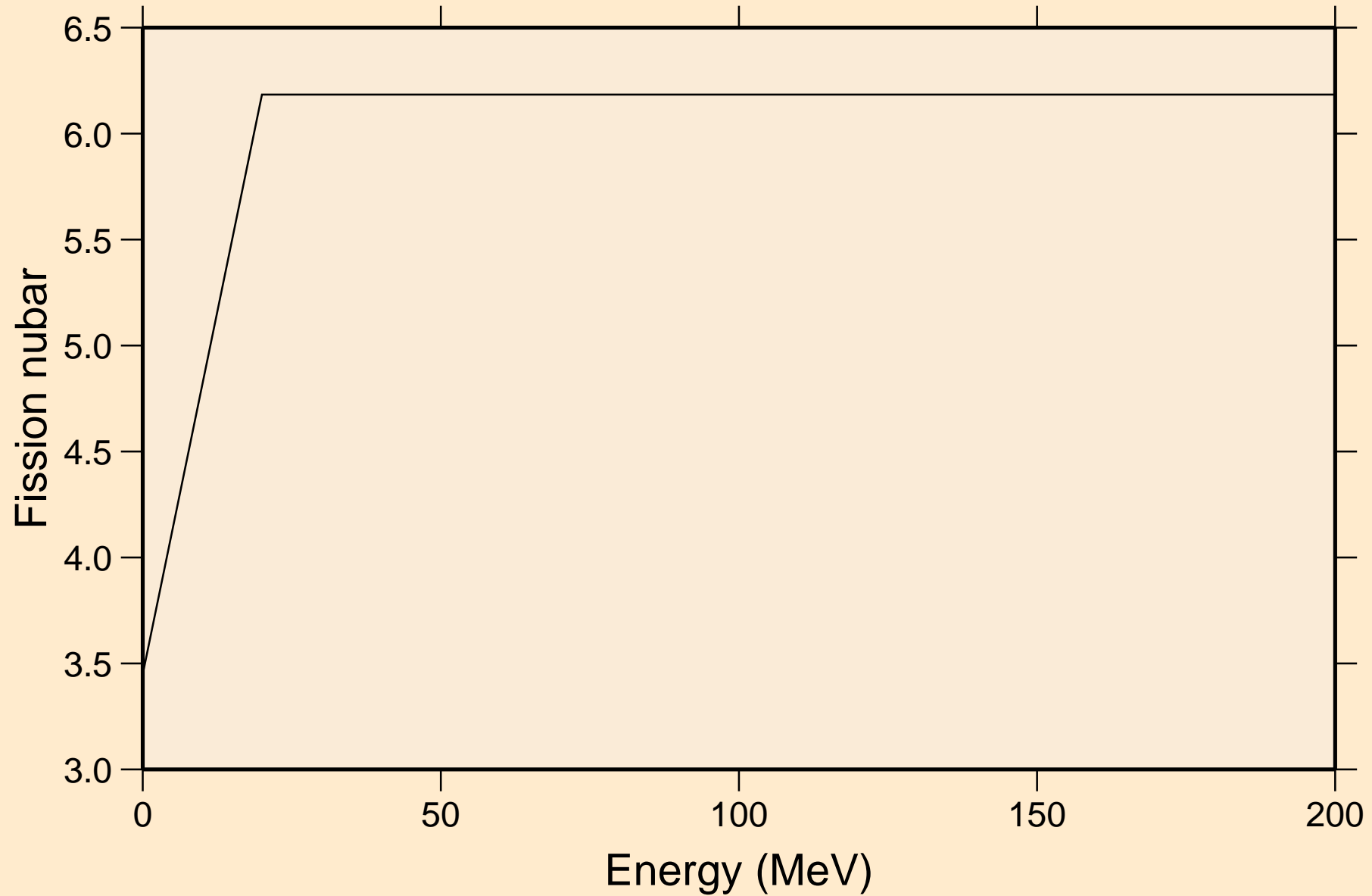

CF241 NEUTRON ACER TENDL-2021 LIBRARY; T=293.6K
Neutron emission for (n,x)

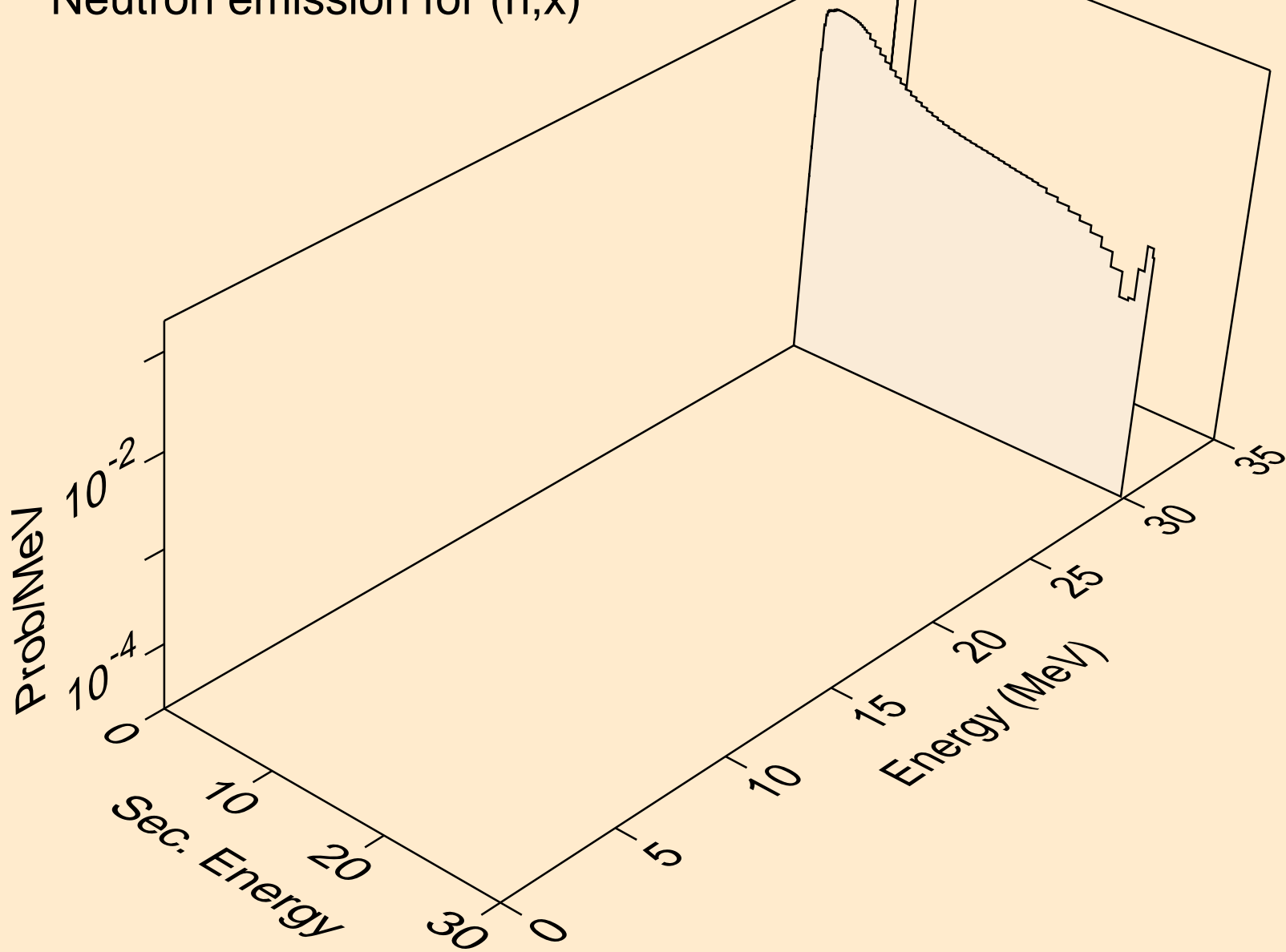

CF241 NEUTRON ACER TENDL-2021 LIBRARY; T=293.6K
Neutron emission for (n,2nd)

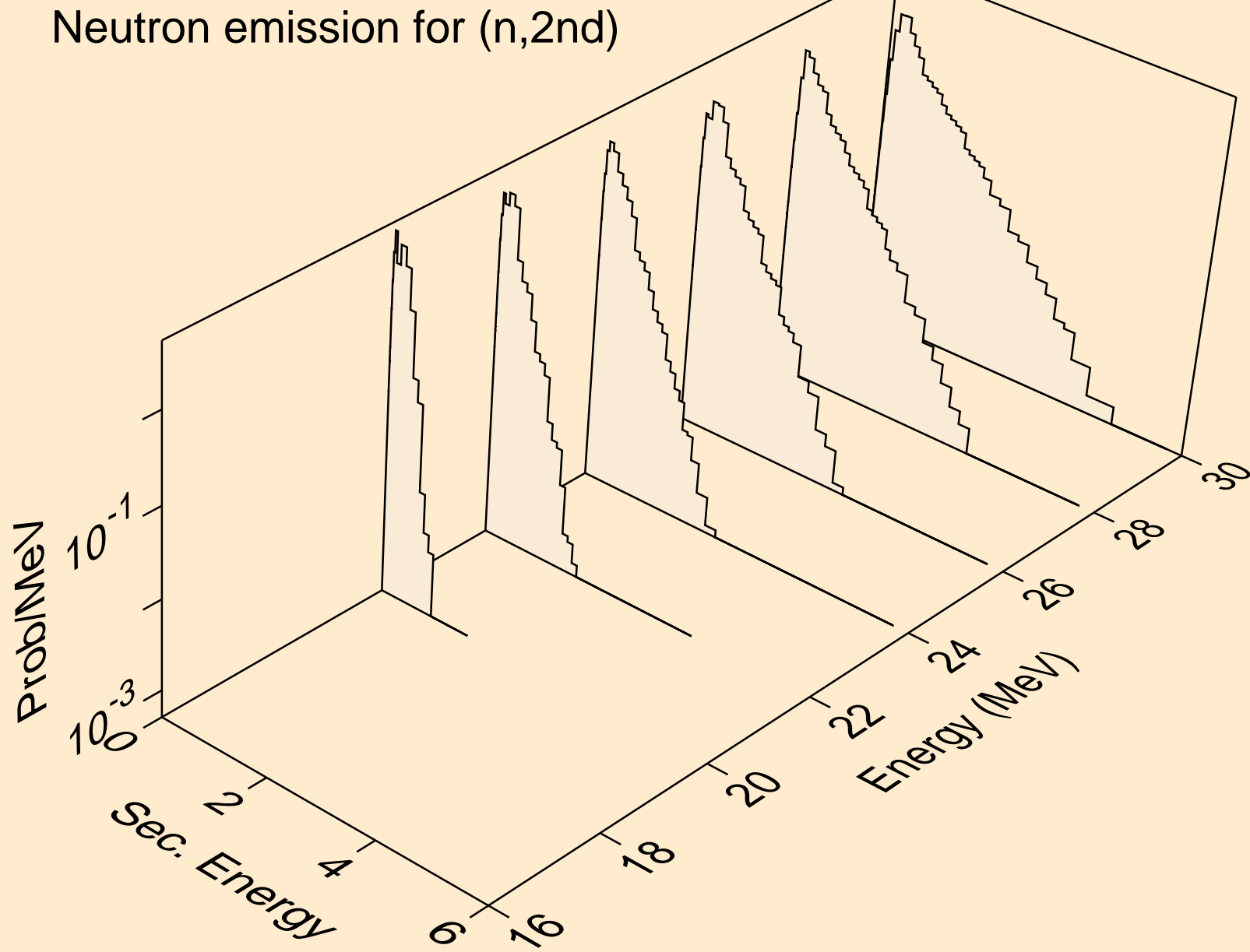

CF241 NEUTRON ACER TENDL-2021 LIBRARY; T=293.6K
Neutron emission for (n,2n)

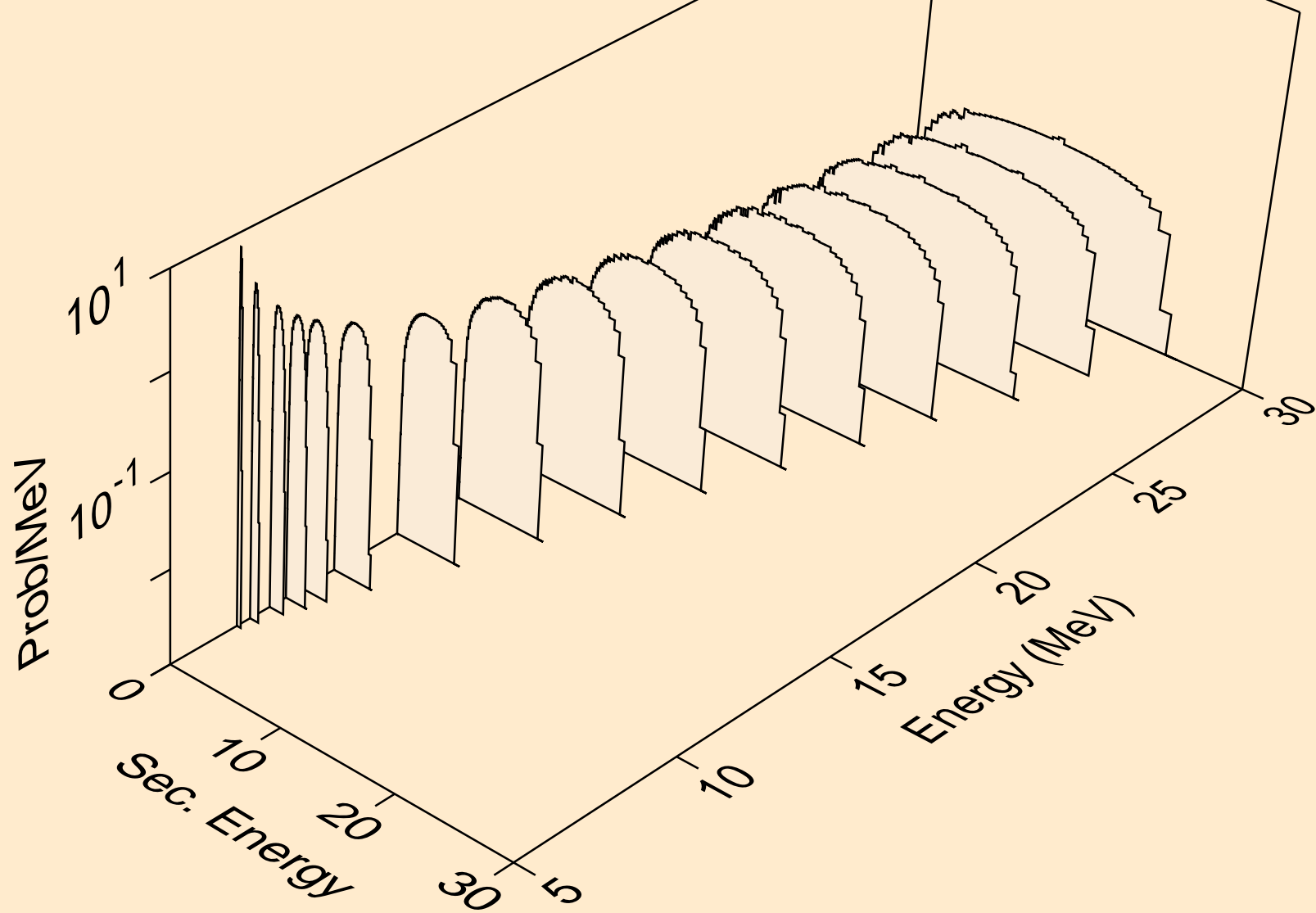

CF241 NEUTRON ACER TENDL-2021 LIBRARY; T=293.6K
Neutron emission for (n,3n)

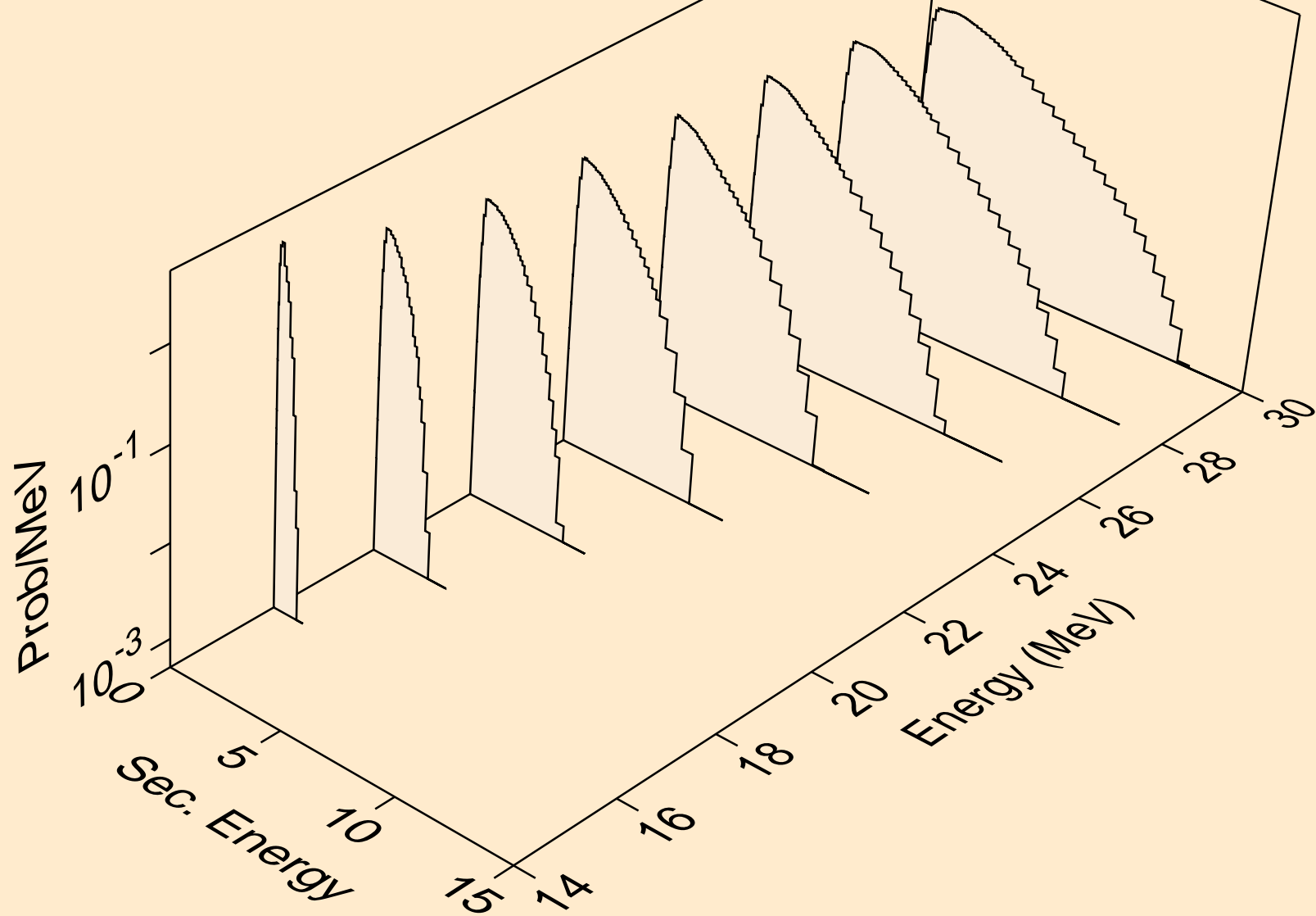

CF241 NEUTRON ACER TENDL-2021 LIBRARY; T=293.6K
Neutron emission for fission

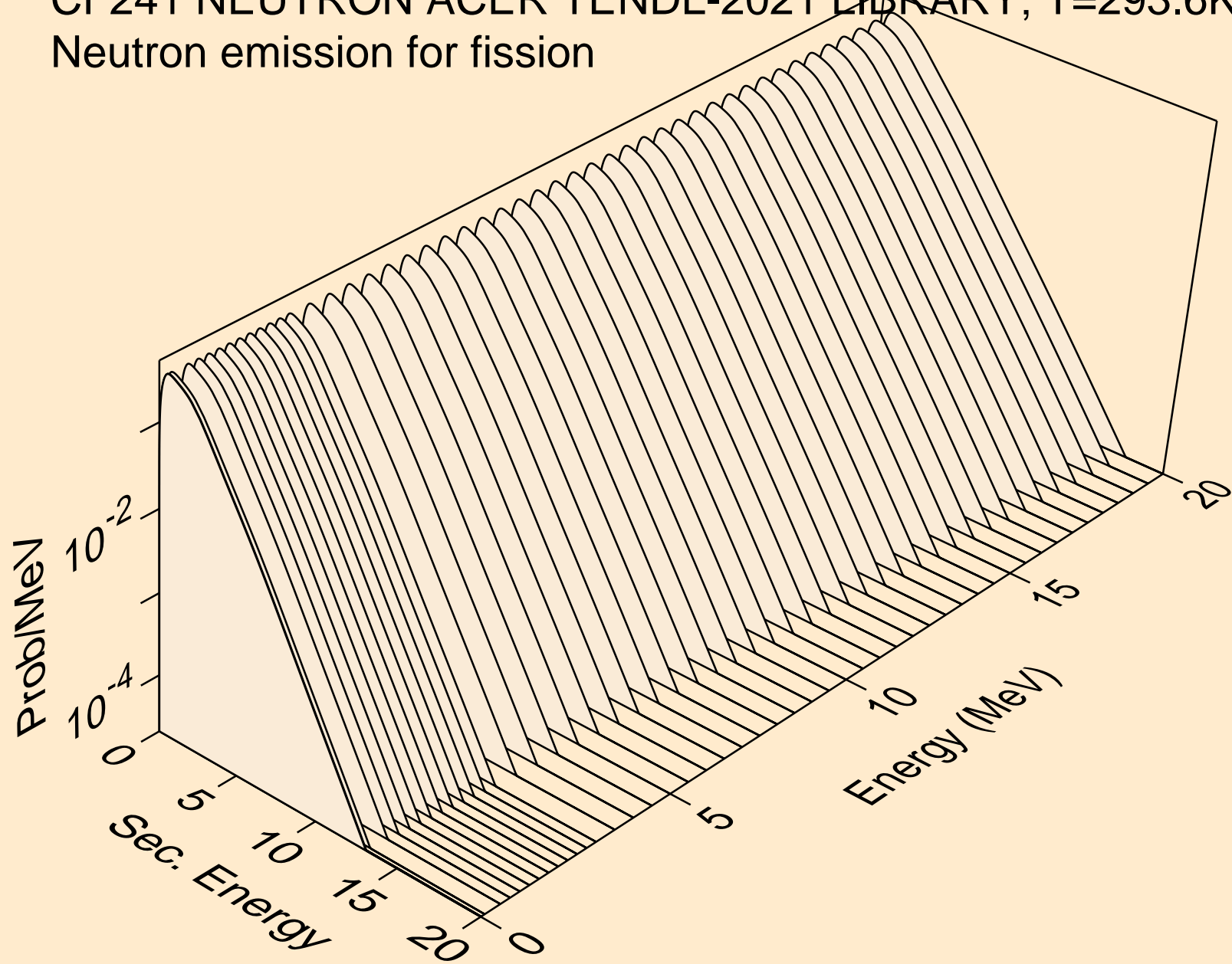

CF241 NEUTRON ACER TENDL-2021 LIBRARY; T=293.6K
Neutron emission for (n,n*)a

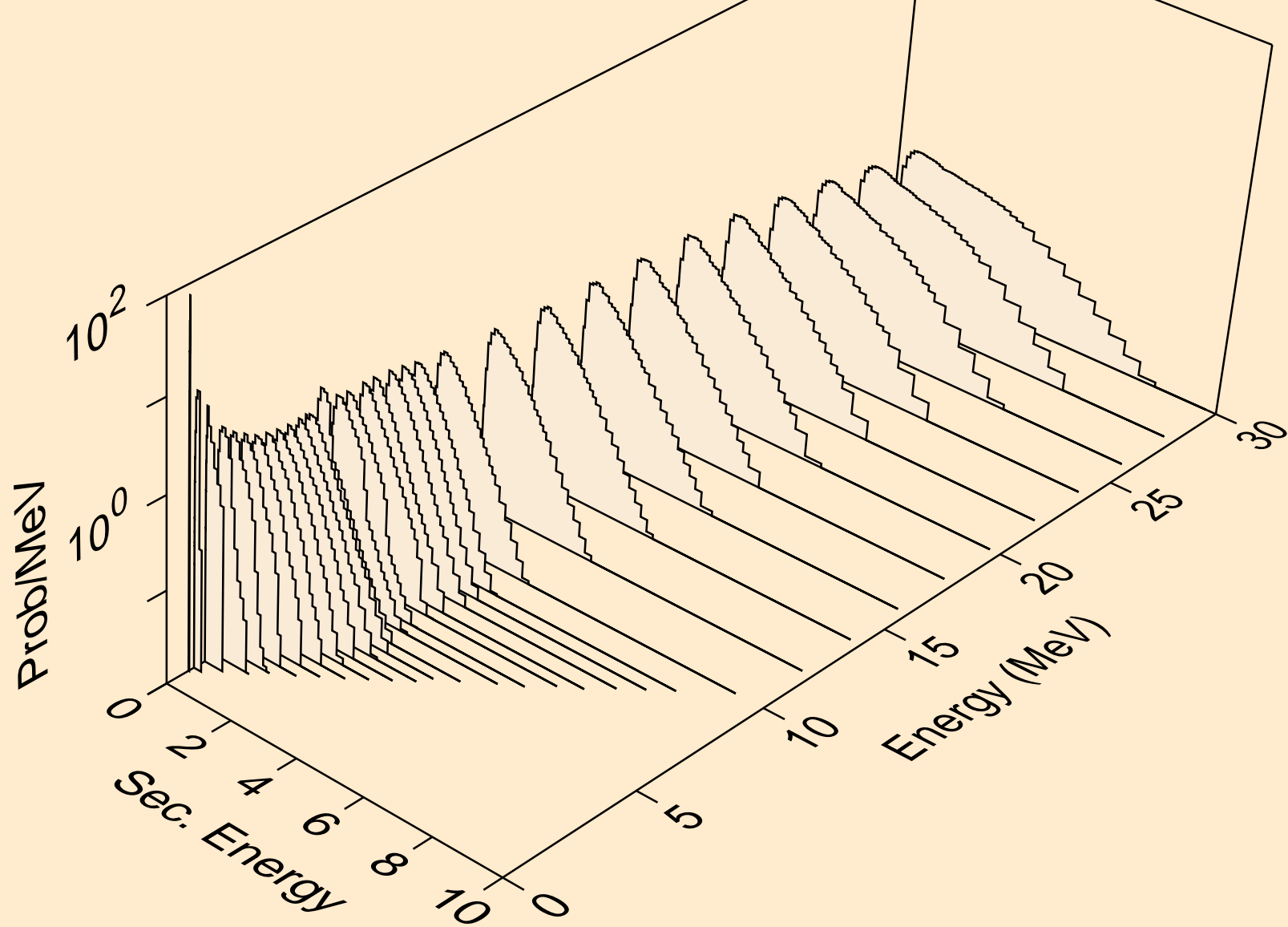

CF241 NEUTRON ACER TENDL-2021 LIBRARY; T=293.6K
Neutron emission for (n,2n)_a

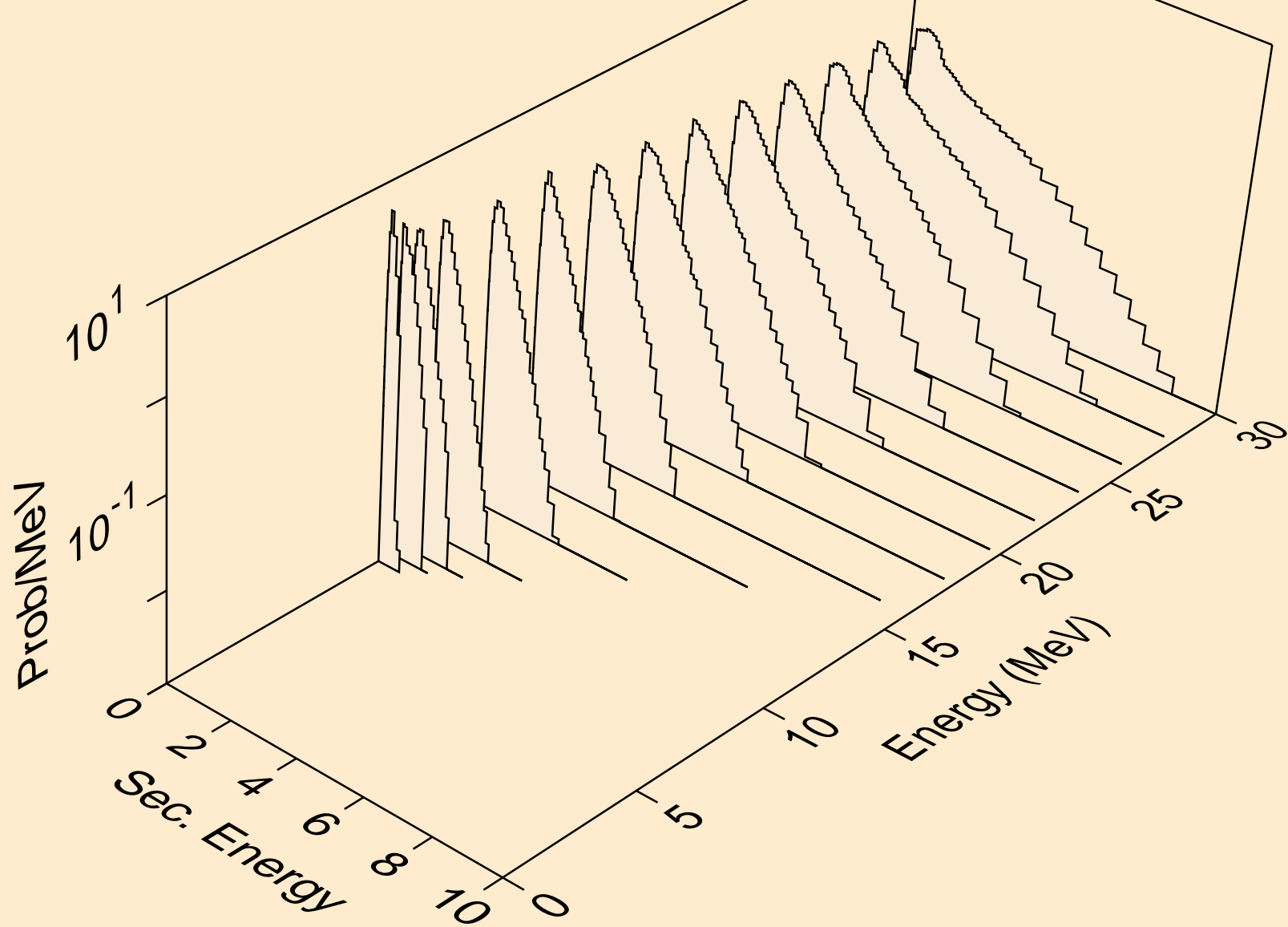

CF241 NEUTRON ACER TENDL-2021 LIBRARY; T=293.6K
Neutron emission for (n,3n)a

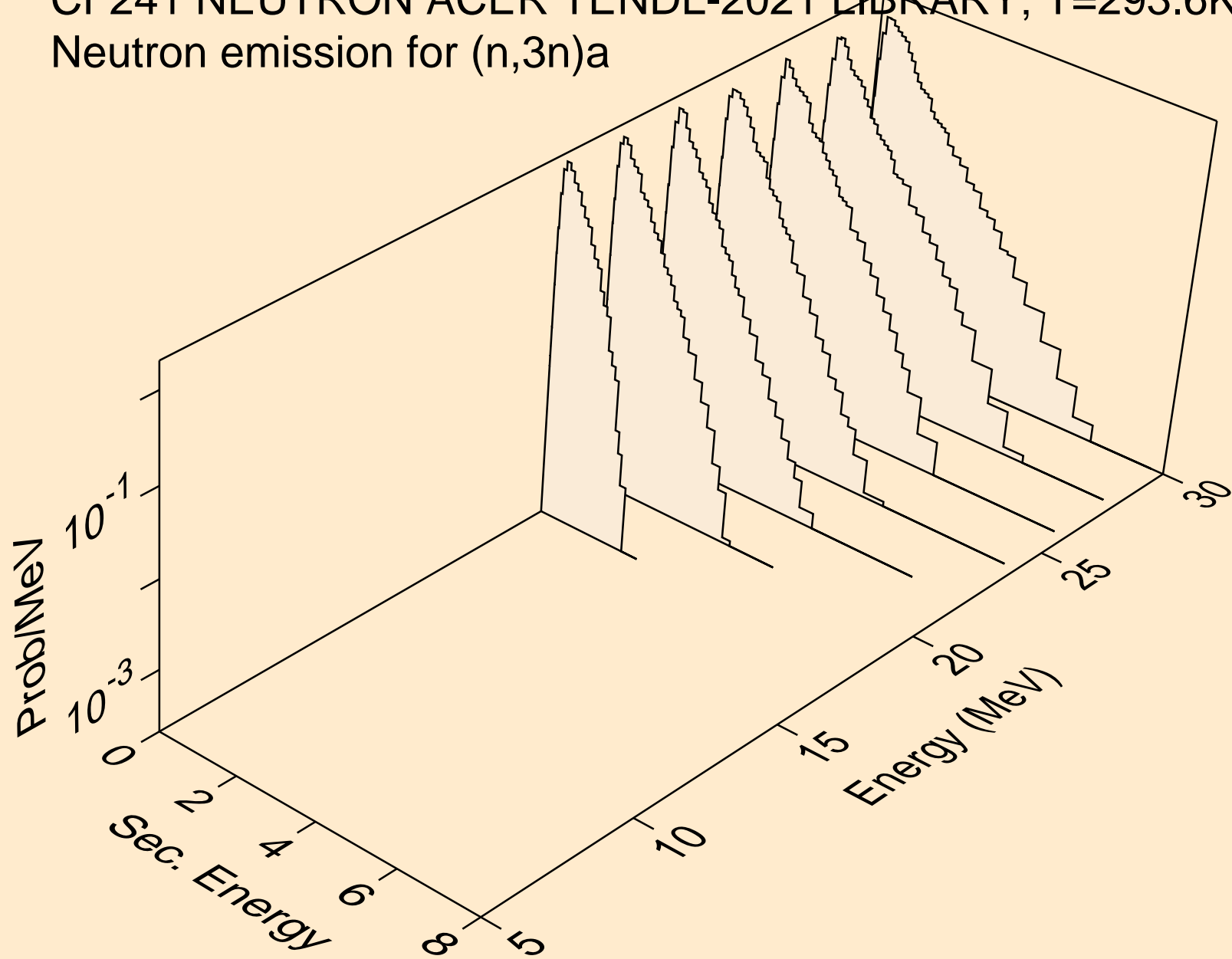

CF241 NEUTRON ACER TENDL-2021 LIBRARY; T=293.6K
Neutron emission for (n,n*)p

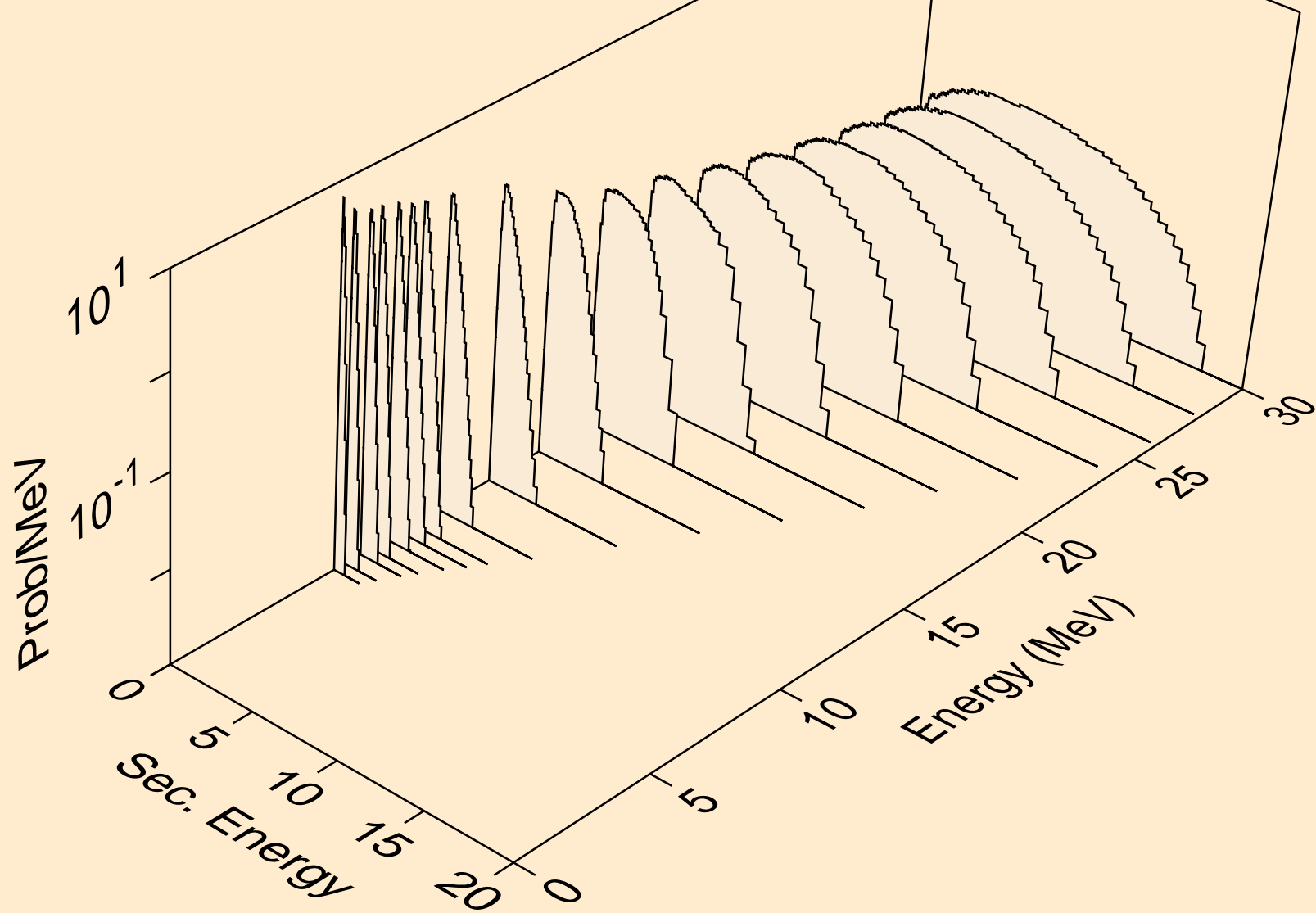

CF241 NEUTRON ACER TENDL-2021 LIBRARY; T=293.6K
Neutron emission for (n,n*)d

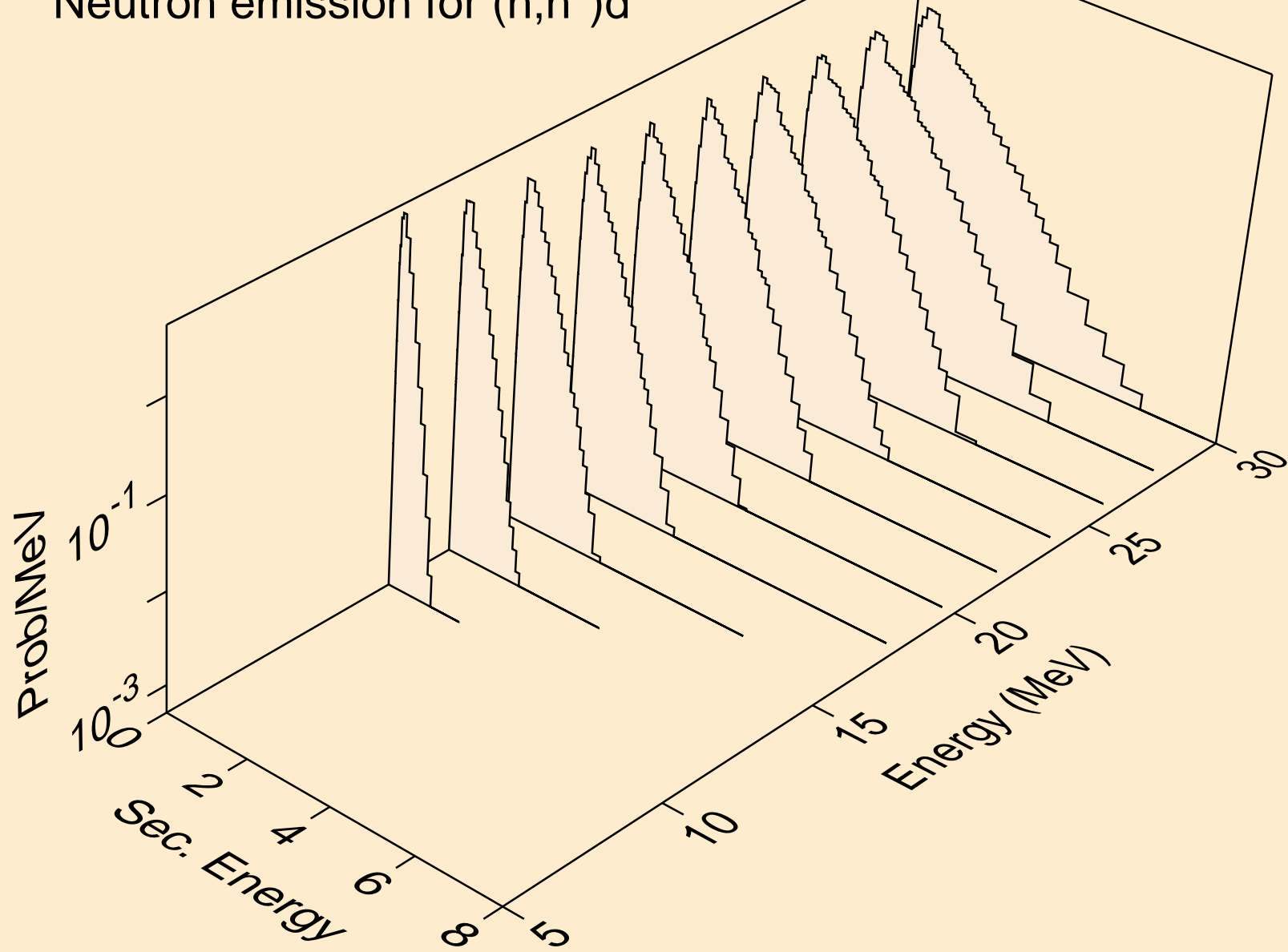

CF241 NEUTRON ACER TENDL-2021 LIBRARY; T=293.6K
Neutron emission for (n,n*)t

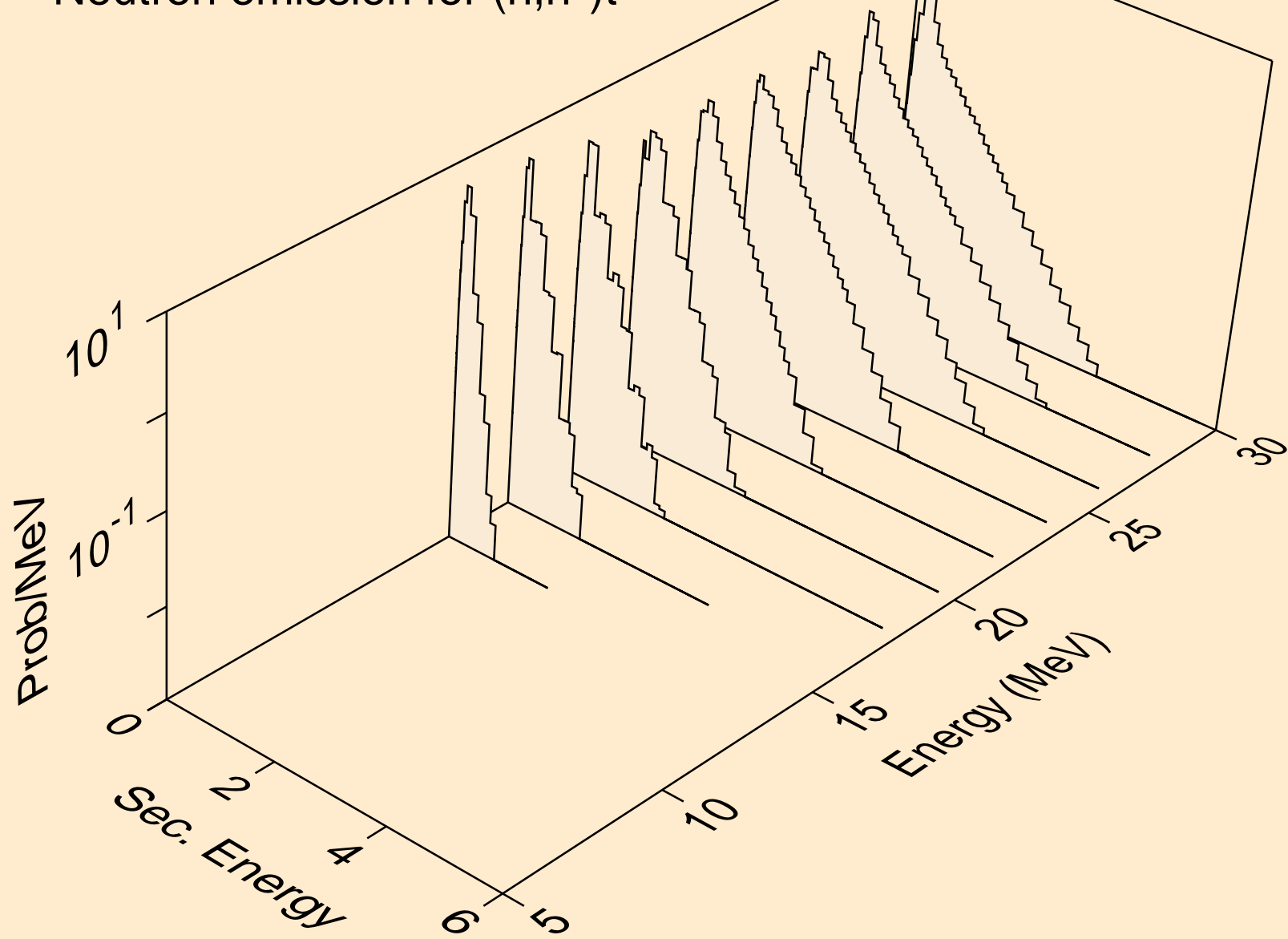

CF241 NEUTRON ACER TENDL-2021 LIBRARY; T=293.6K
Neutron emission for (n,n*)he3

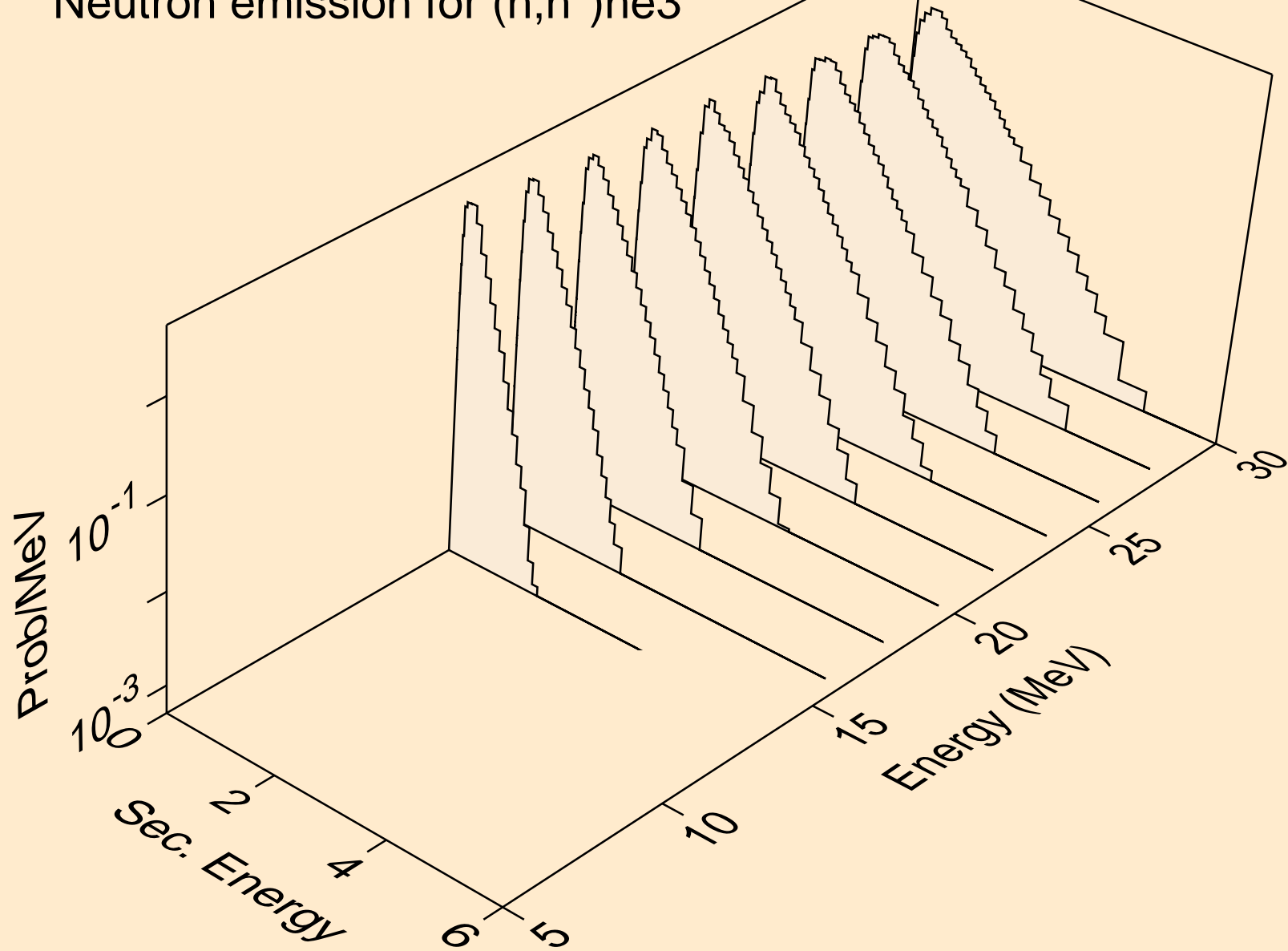

CF241 NEUTRON ACER TENDL-2021 LIBRARY; T=293.6K
Neutron emission for (n,4n)

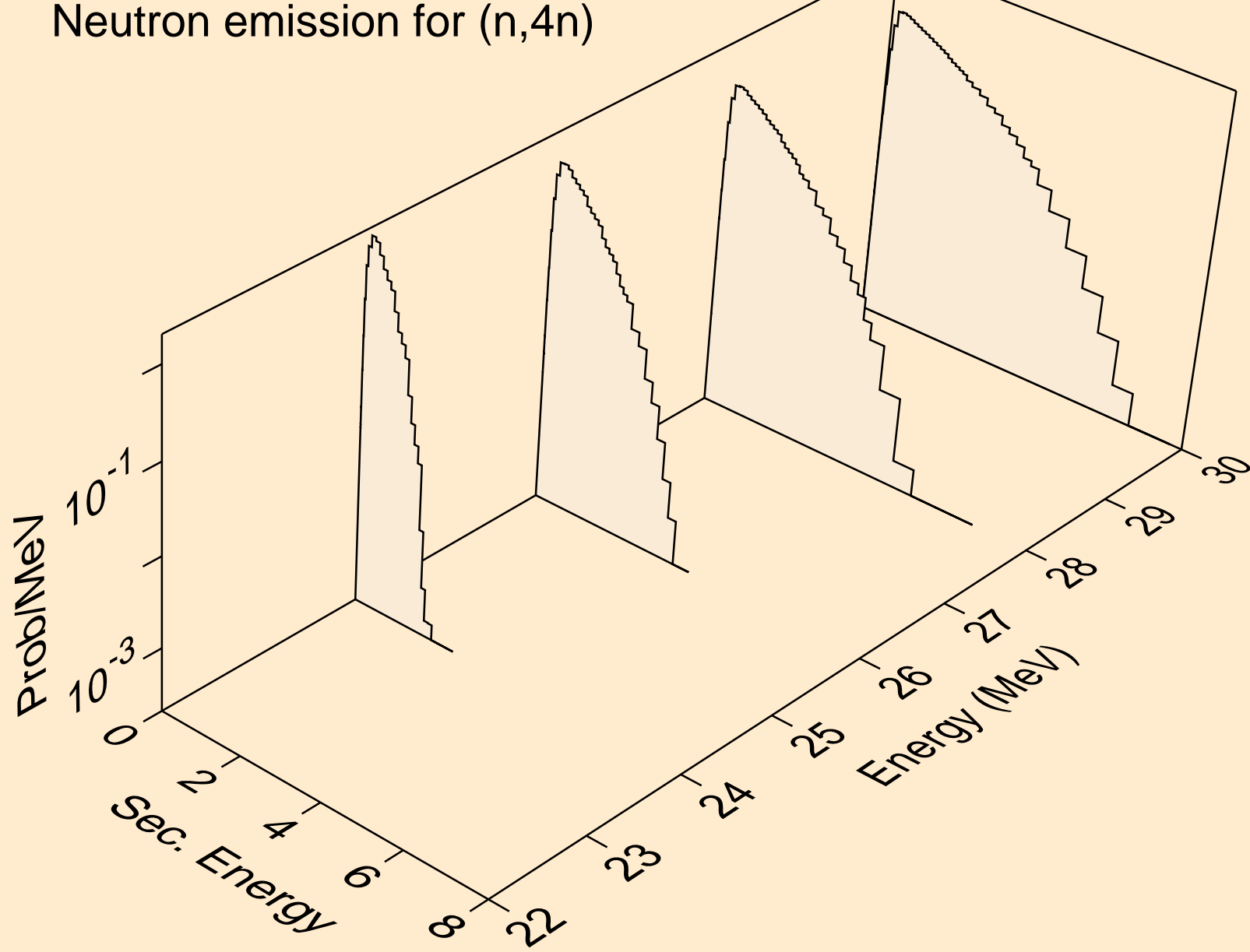

CF241 NEUTRON ACER TENDL-2021 LIBRARY; T=293.6K
Neutron emission for (n,2np)

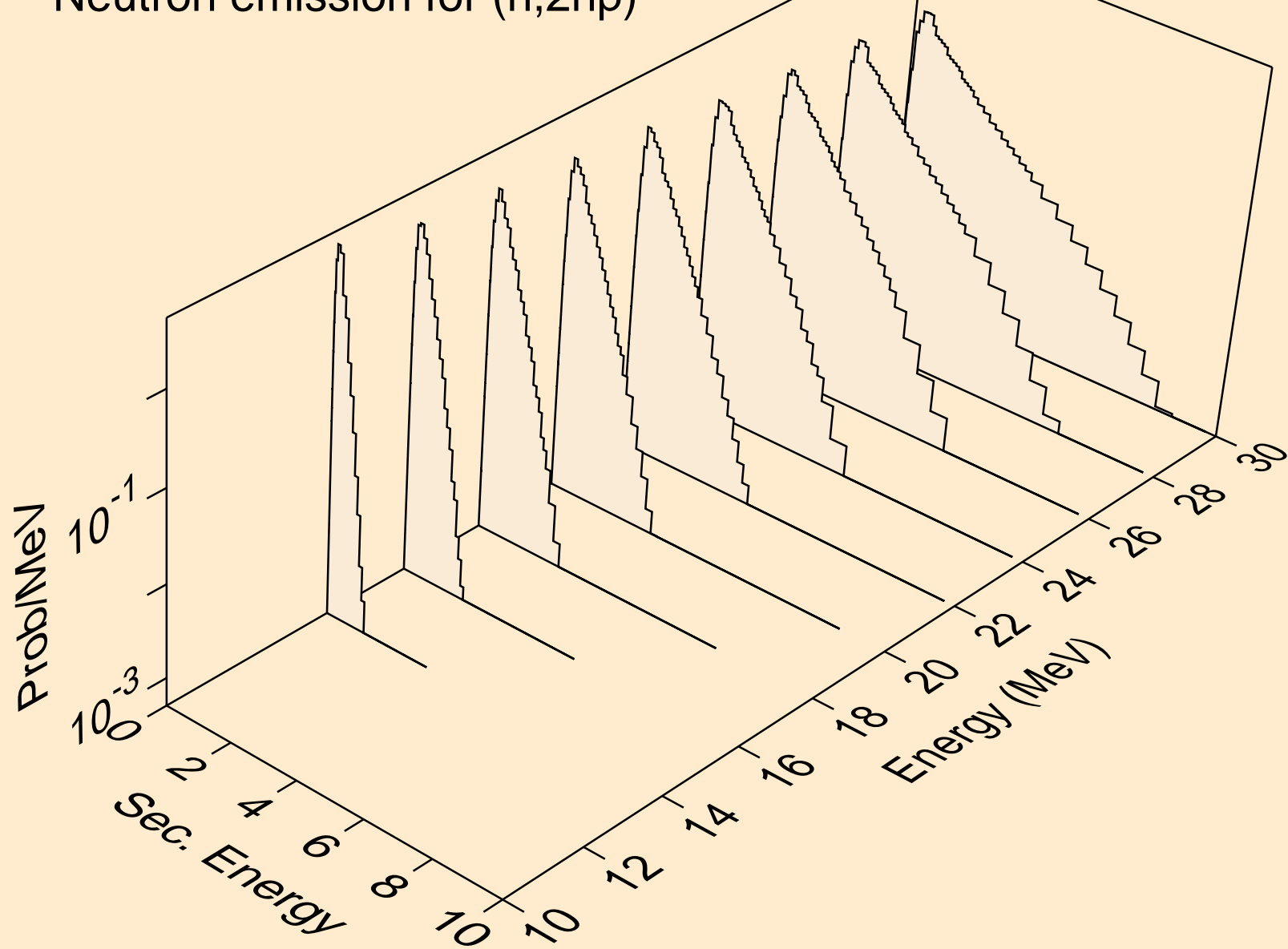

CF241 NEUTRON ACER TENDL-2021 LIBRARY; T=293.6K
Neutron emission for (n,3np)

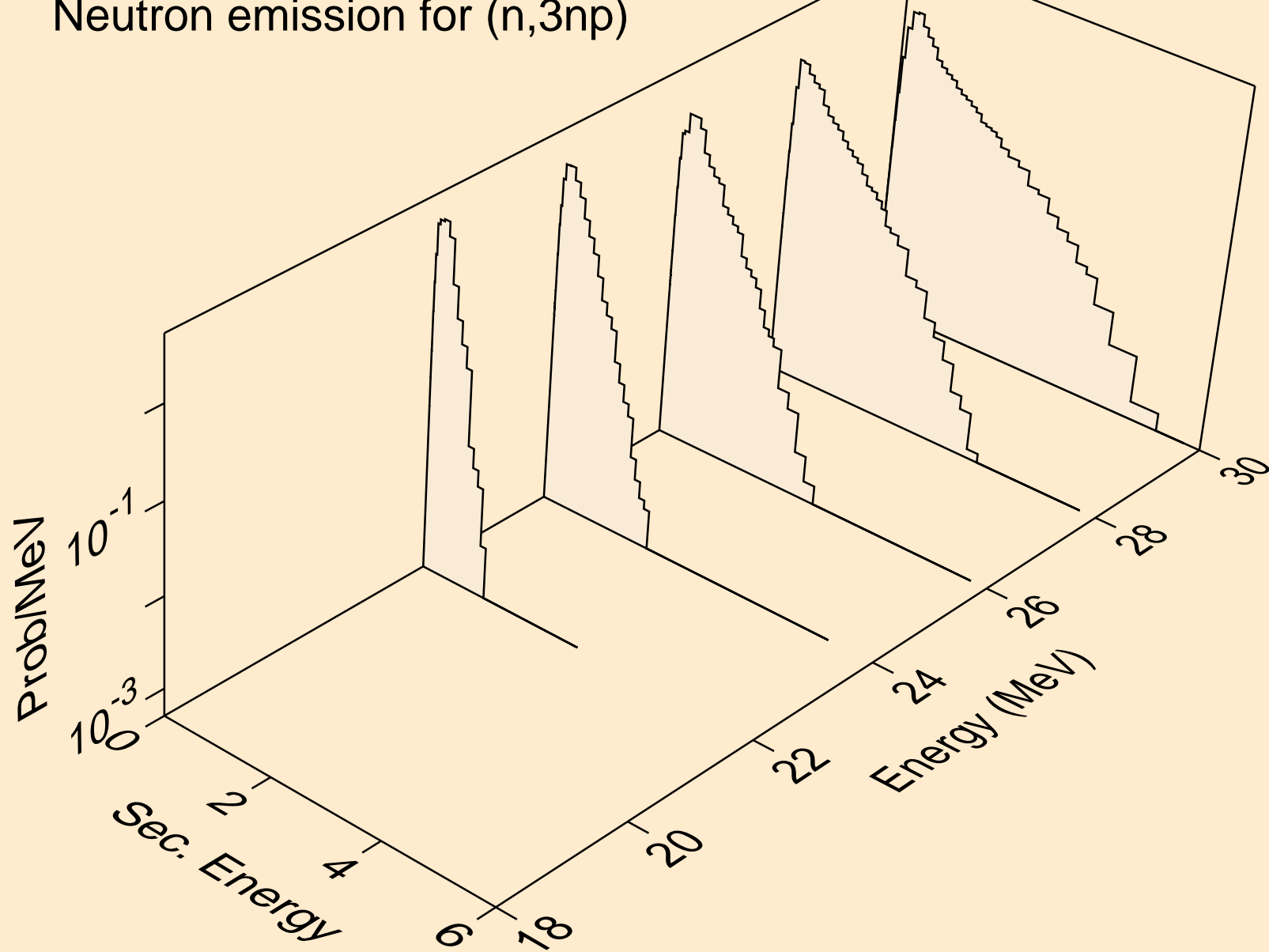

CF241 NEUTRON ACER TENDL-2021 LIBRARY; T=293.6K
Neutron emission for (n,2np)

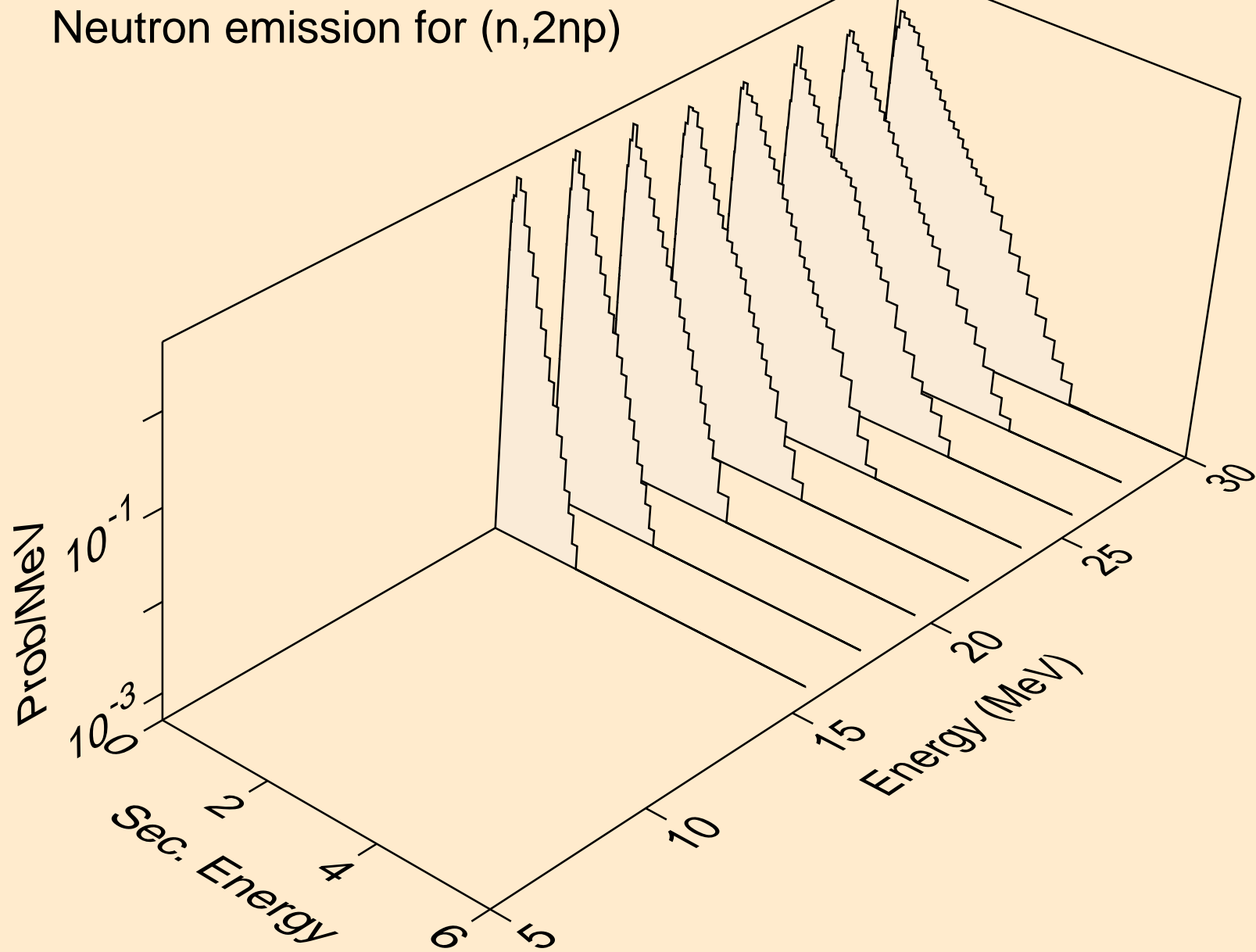

CF241 NEUTRON ACER TENDL-2021 LIBRARY; T=293.6K
Neutron emission for (n,npa)

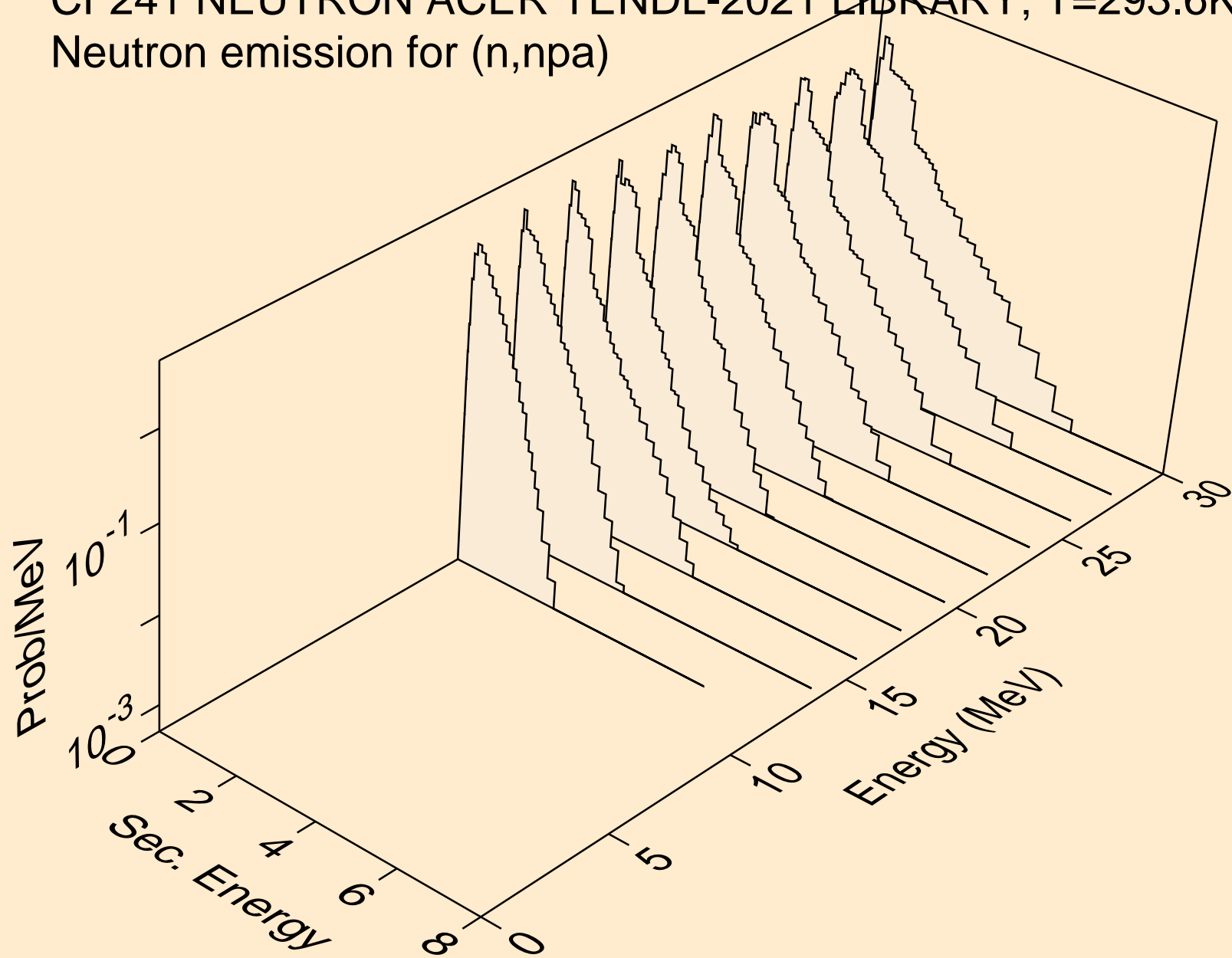

CF241 NEUTRON ACER TENDL-2021 LIBRARY; T=293.6K
Neutron emission for (n,n*c)

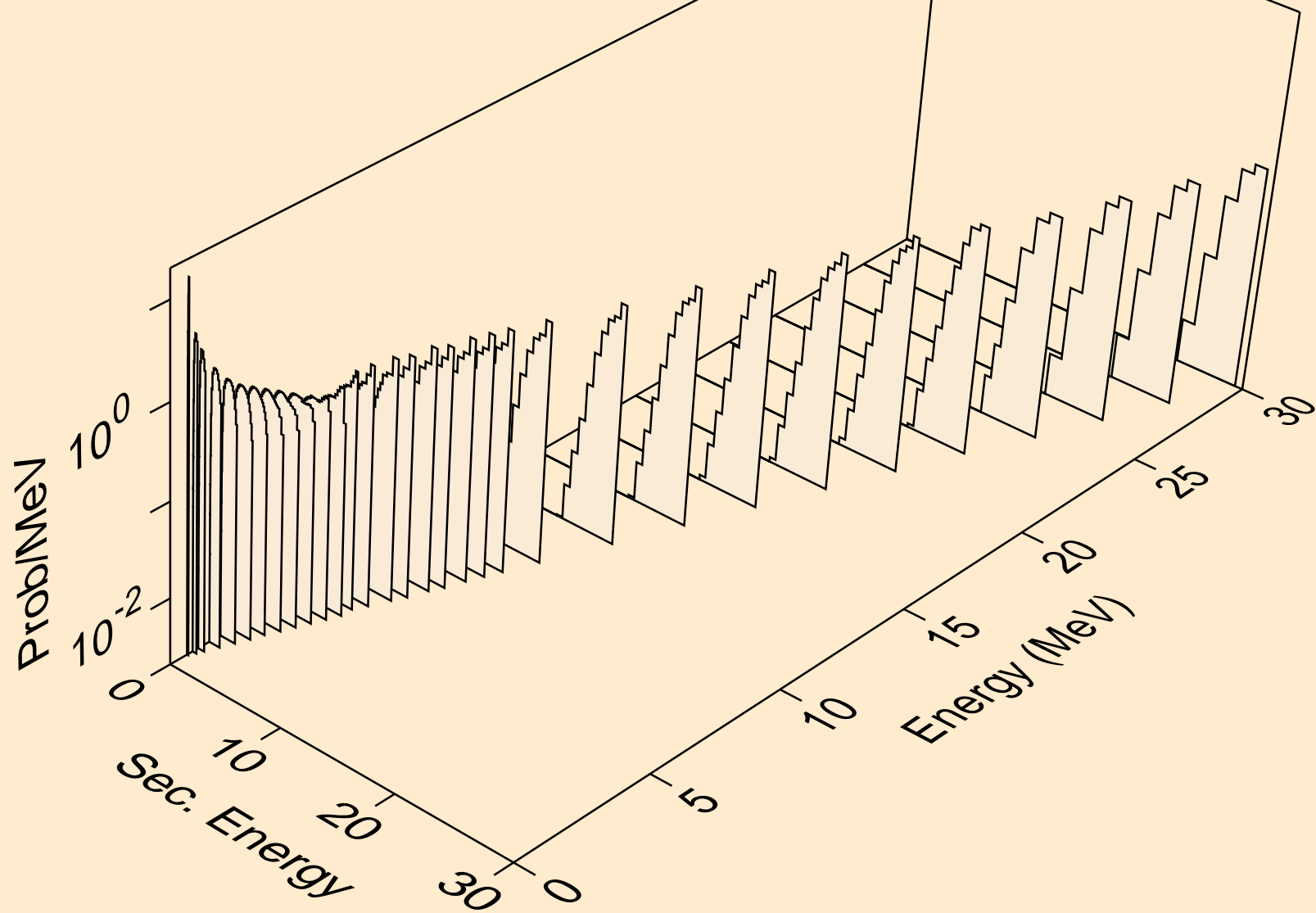

CF241 NEUTRON ACER TENDL-2021 LIBRARY; T=293.6K

Delayed nubar

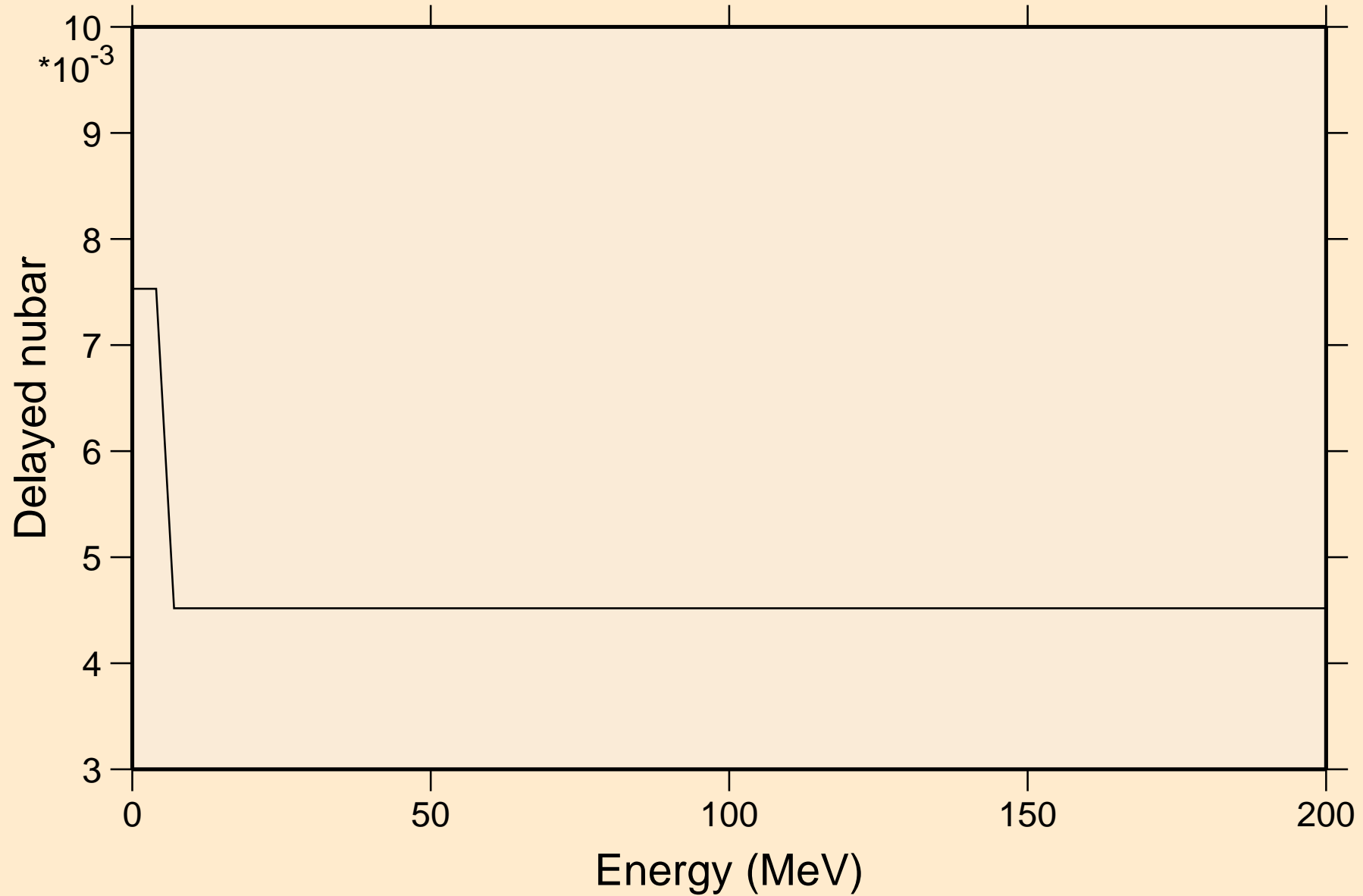

CF241 NEUTRON ACER TENDL-2021 LIBRARY; T=293.6K

Delayed neutron spectra

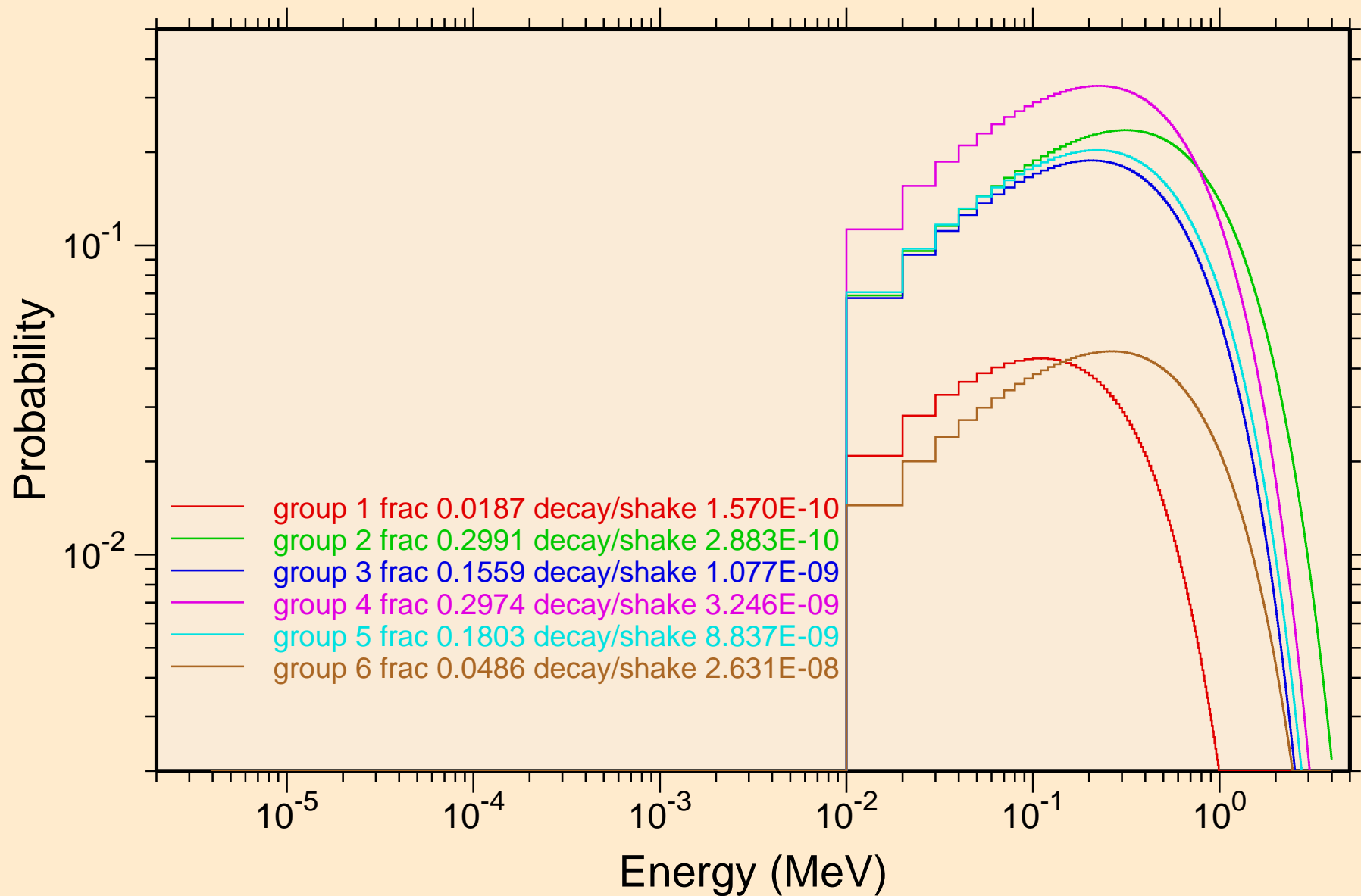

CF241 NEUTRON ACER TENDL-2021 LIBRARY; T=293.6K
Photon emission for (n,x)

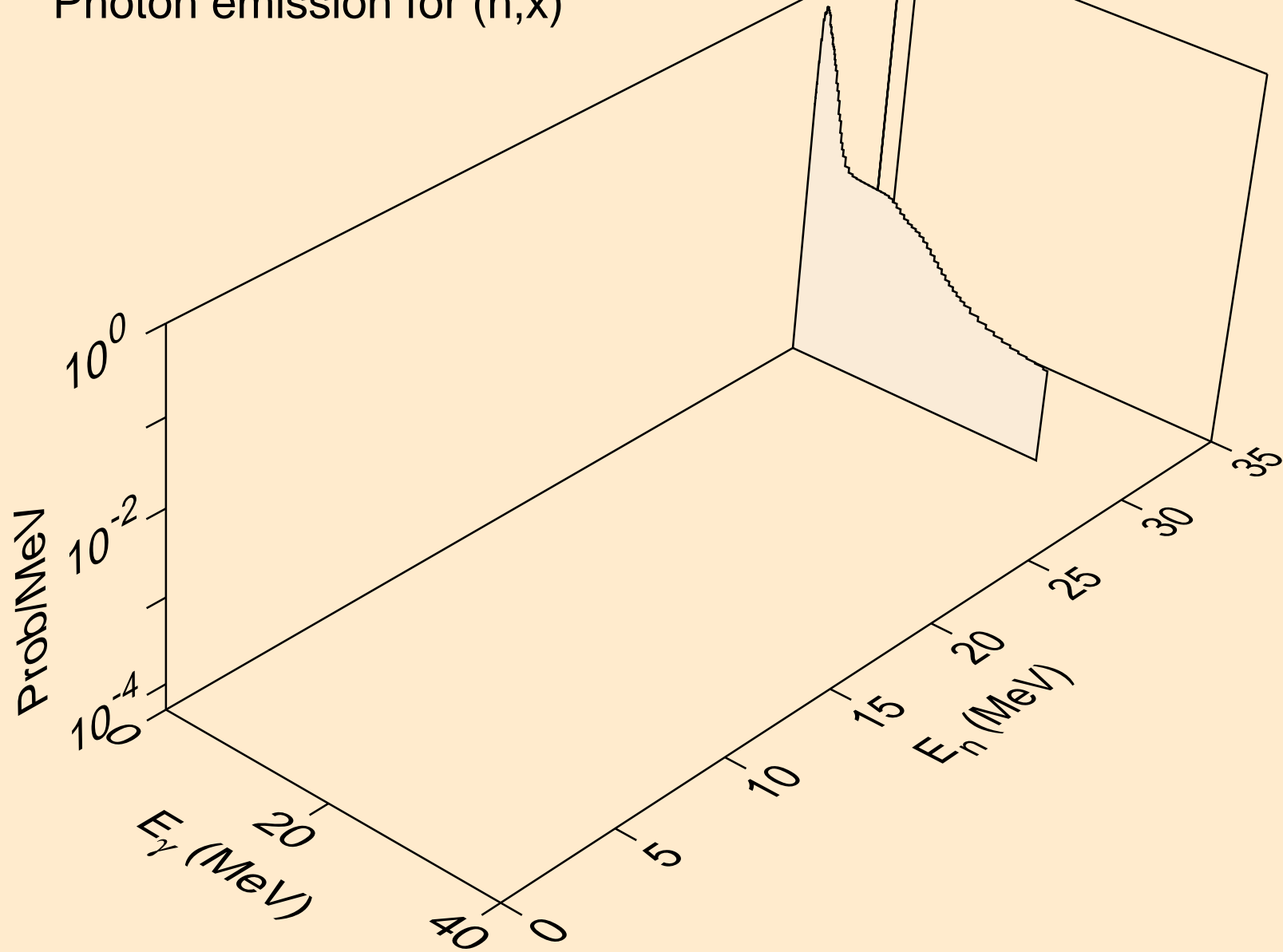

CF241 NEUTRON ACER TENDL-2021 LIBRARY; T=293.6K
Photon emission for (n,2nd)

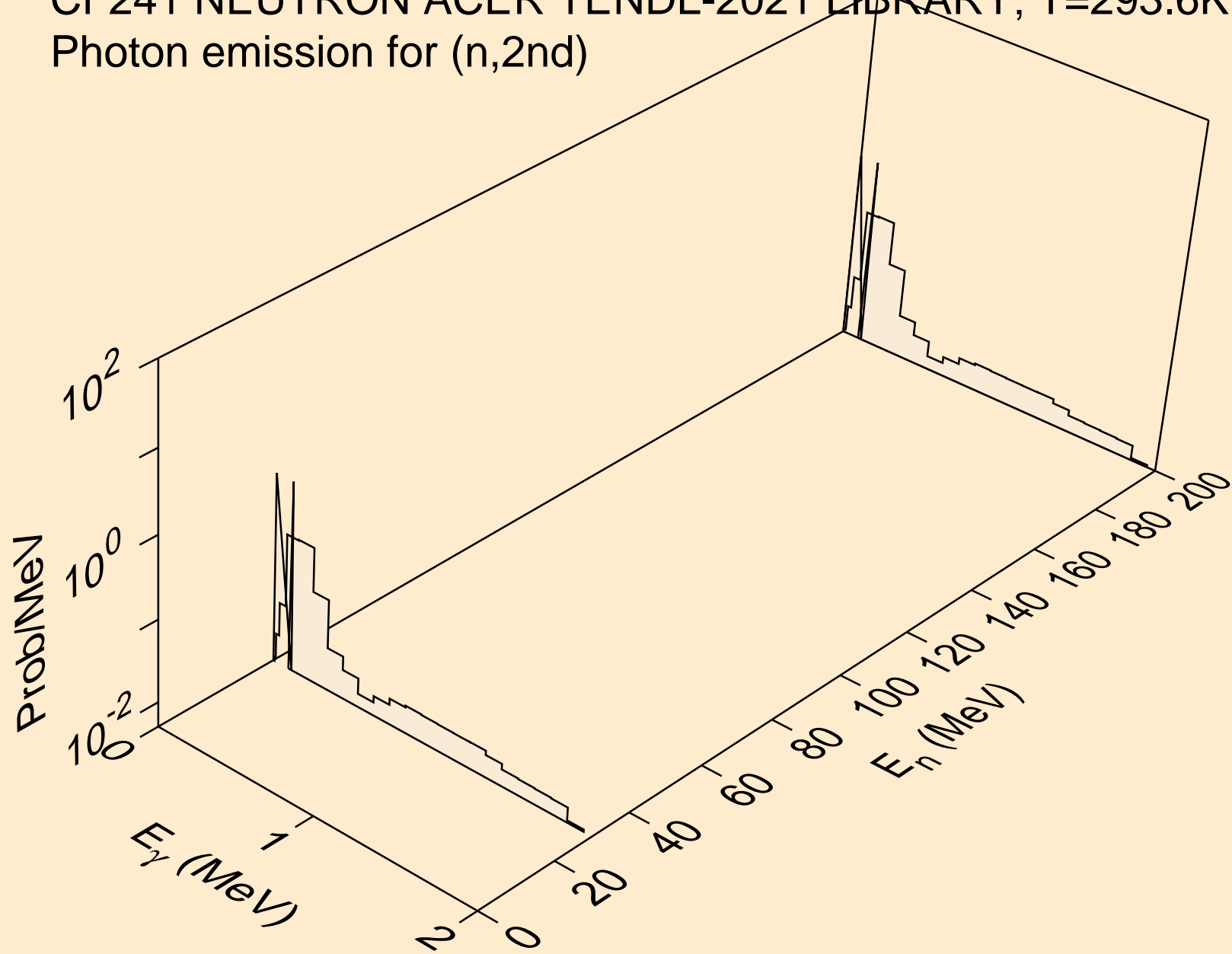

CF241 NEUTRON ACER TENDL-2021 LIBRARY; T=293.6K
Photon emission for (n,2n)

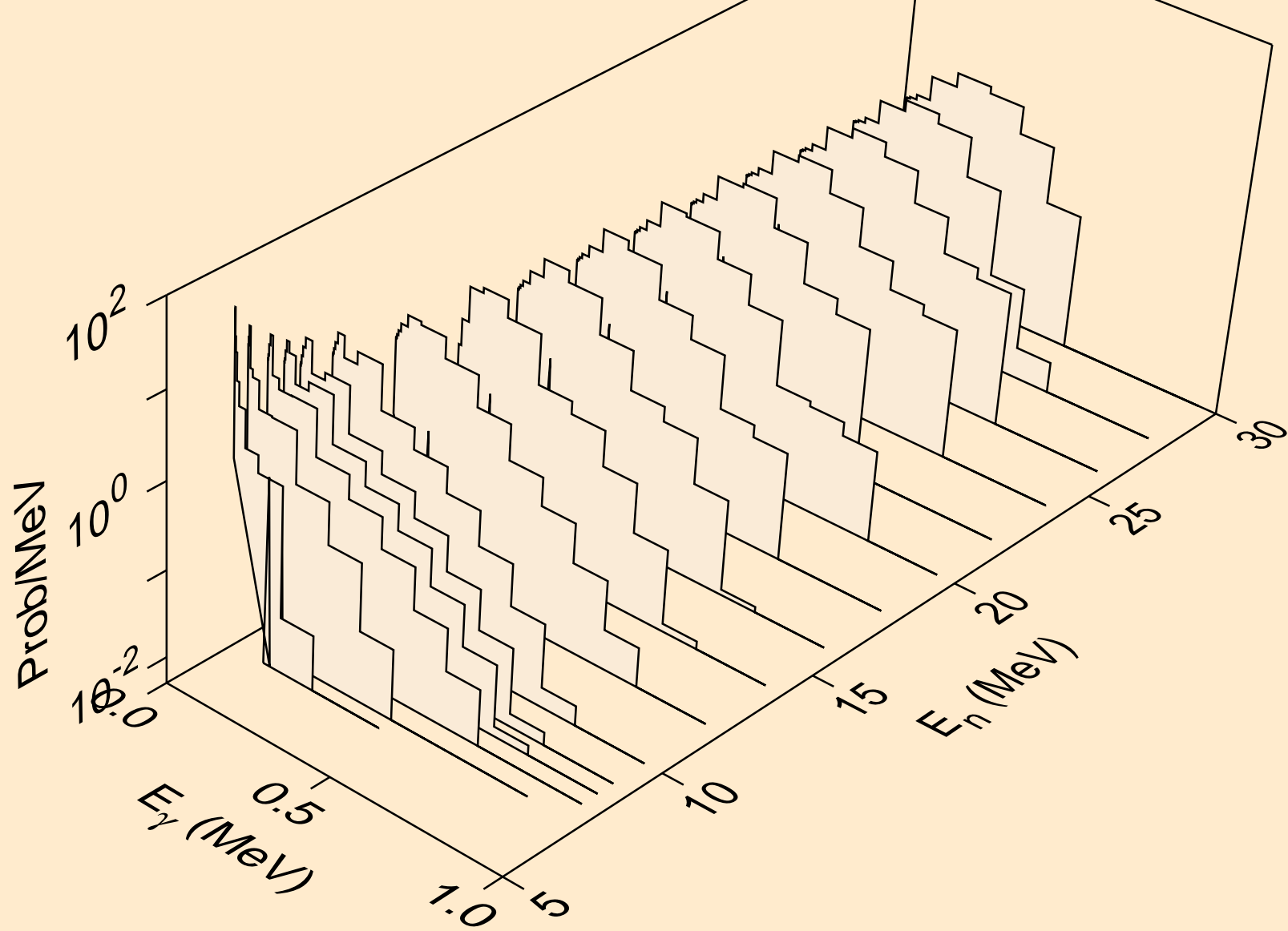

CF241 NEUTRON ACER TENDL-2021 LIBRARY; T=293.6K
Photon emission for (n,3n)

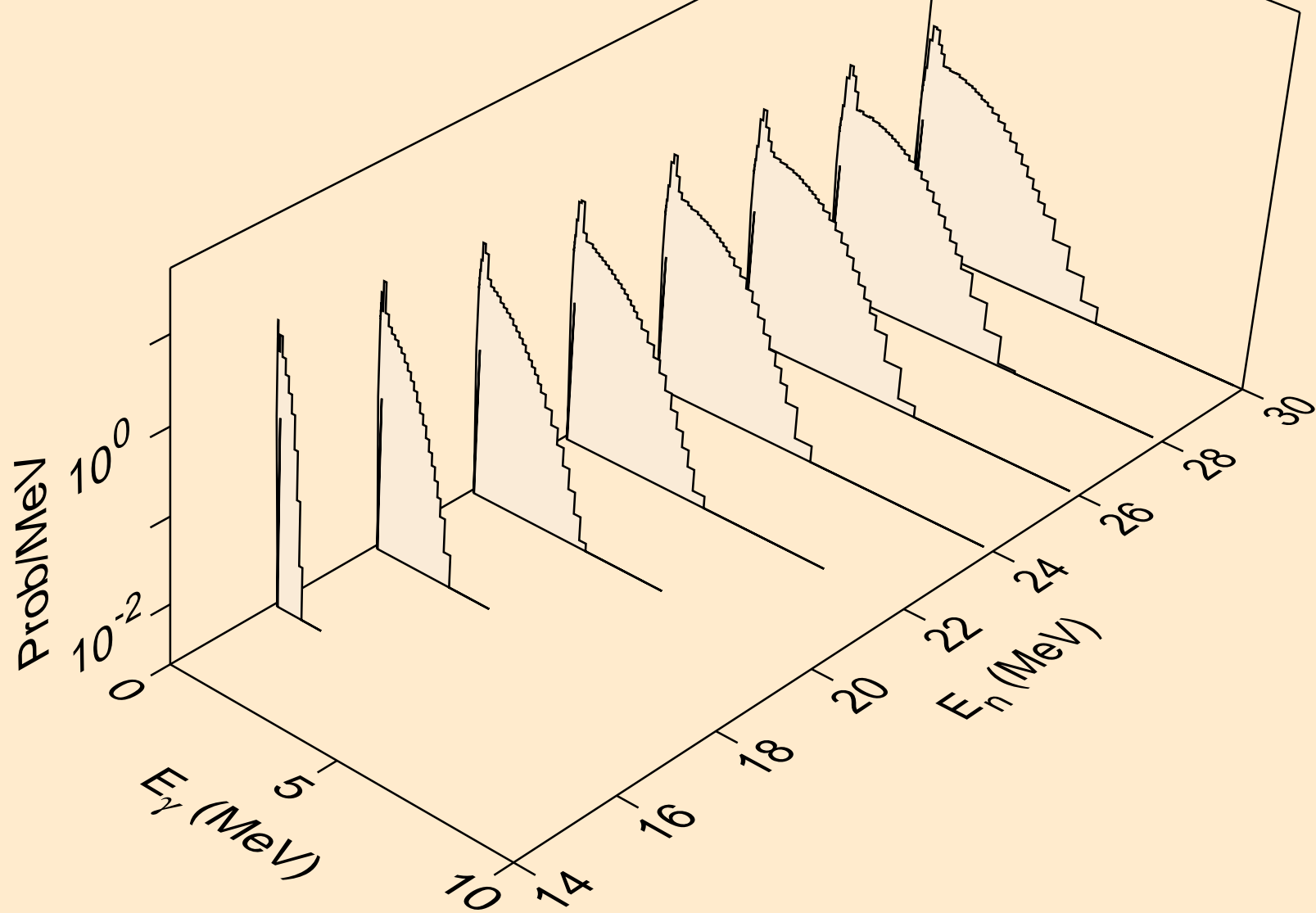

CF241 NEUTRON ACER TENDL-2021 LIBRARY; T=293.6K
Photon emission for (n,n*)a

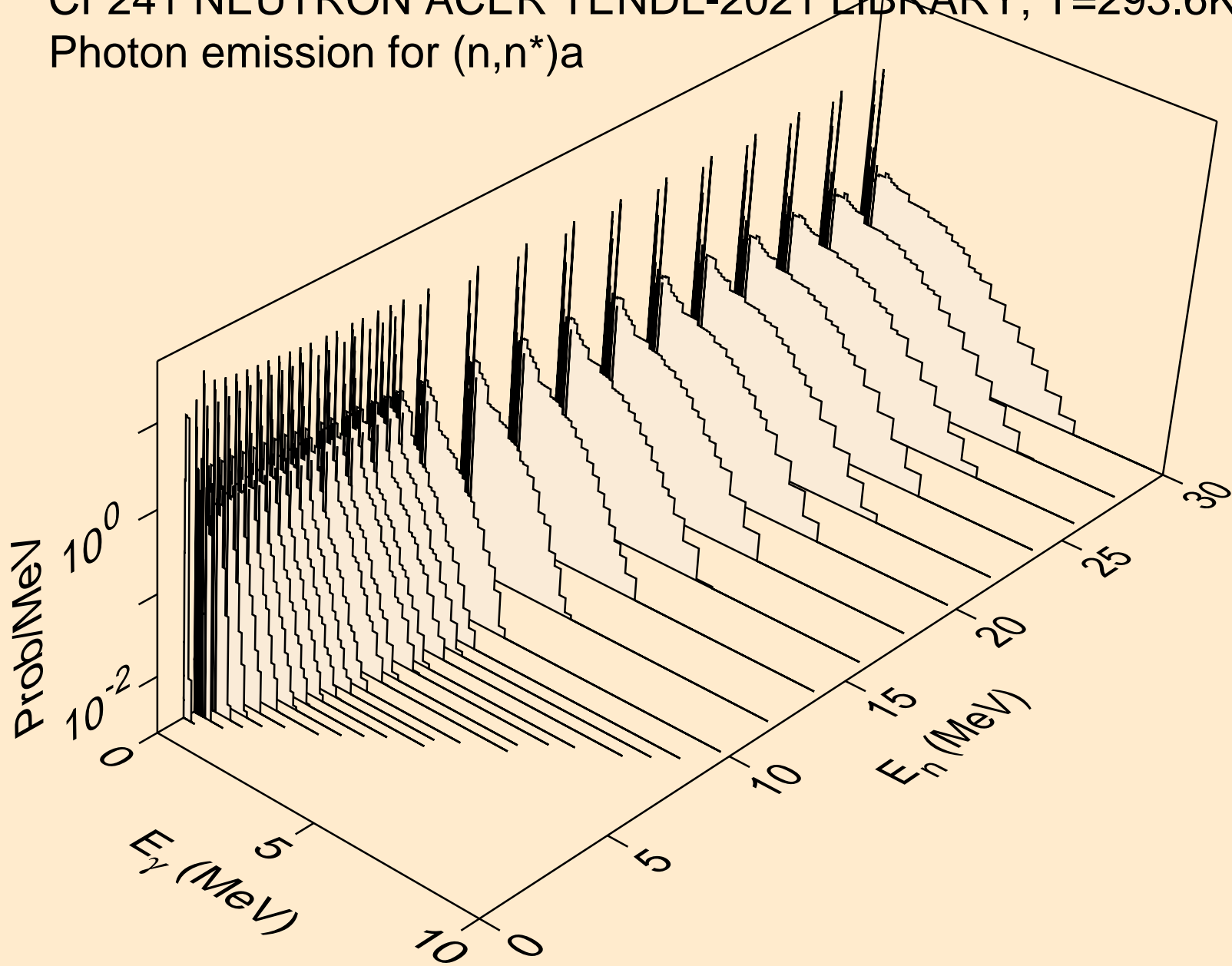

CF241 NEUTRON ACER TENDL-2021 LIBRARY; T=293.6K
Photon emission for (n,2n)a

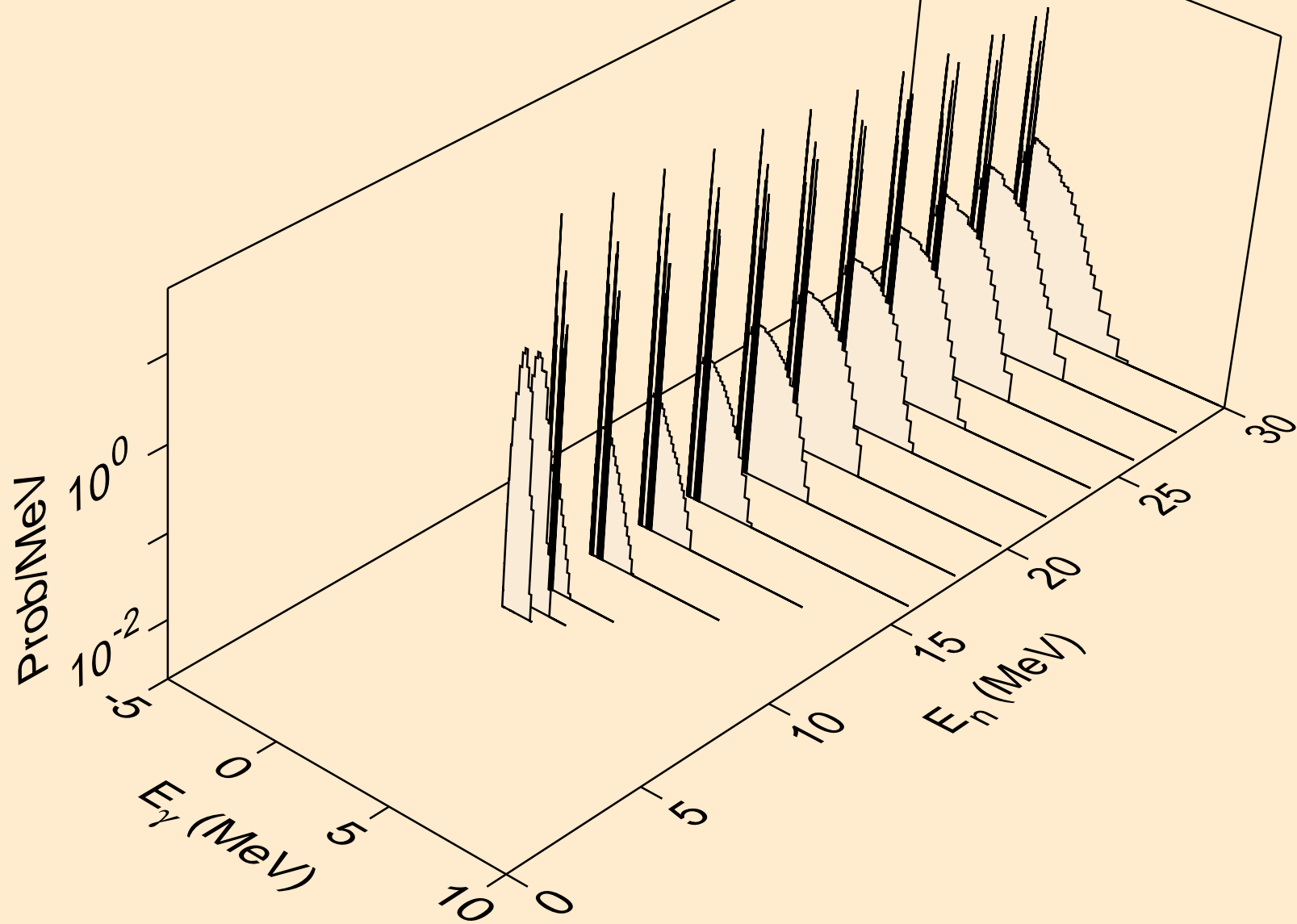

CF241 NEUTRON ACER TENDL-2021 LIBRARY; T=293.6K
Photon emission for (n,3n)a

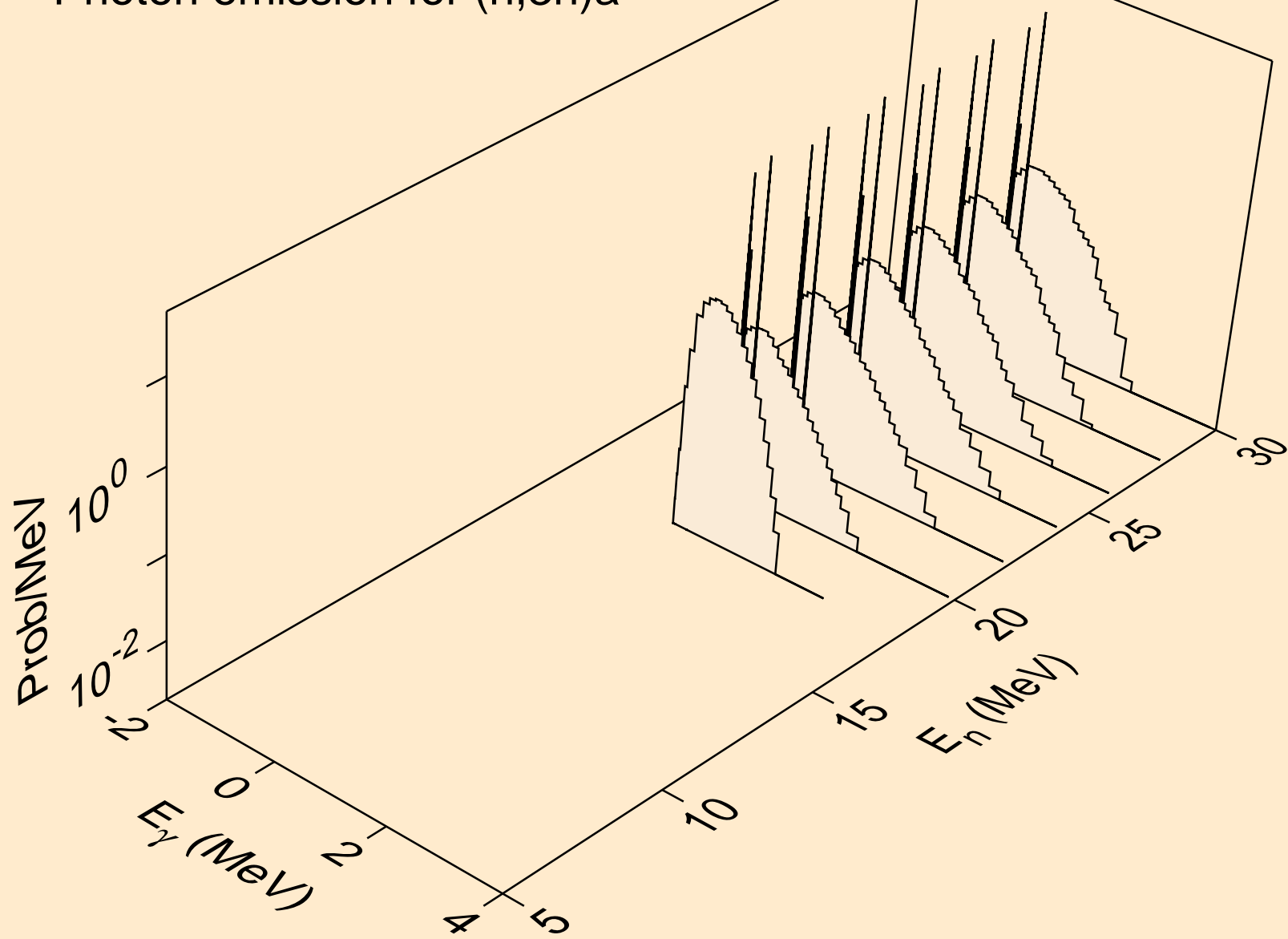

CF241 NEUTRON ACER TENDL-2021 LIBRARY; T=293.6K
Photon emission for (n,n*)p

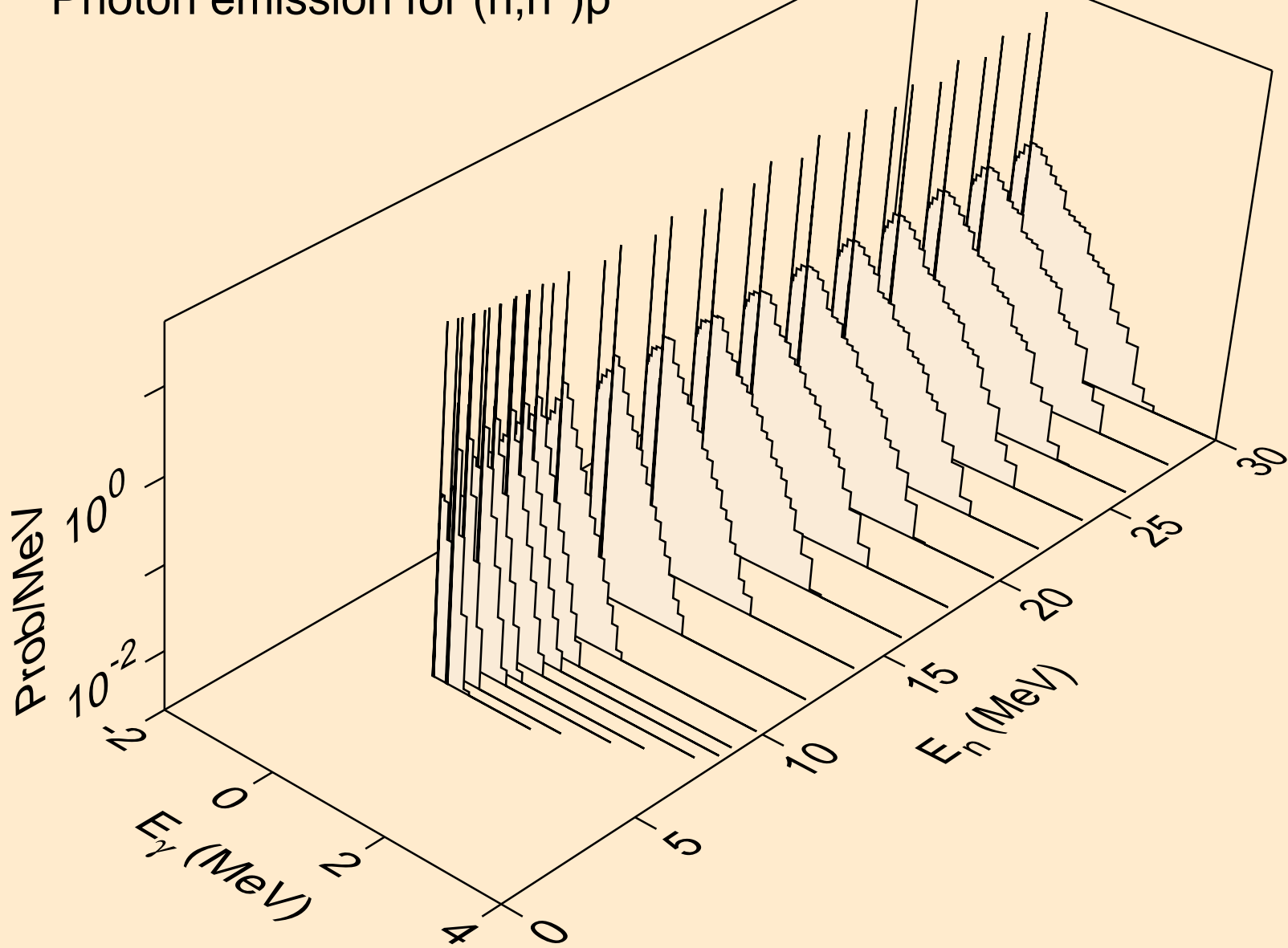

CF241 NEUTRON ACER TENDL-2021 LIBRARY; T=293.6K
Photon emission for (n,n*)d

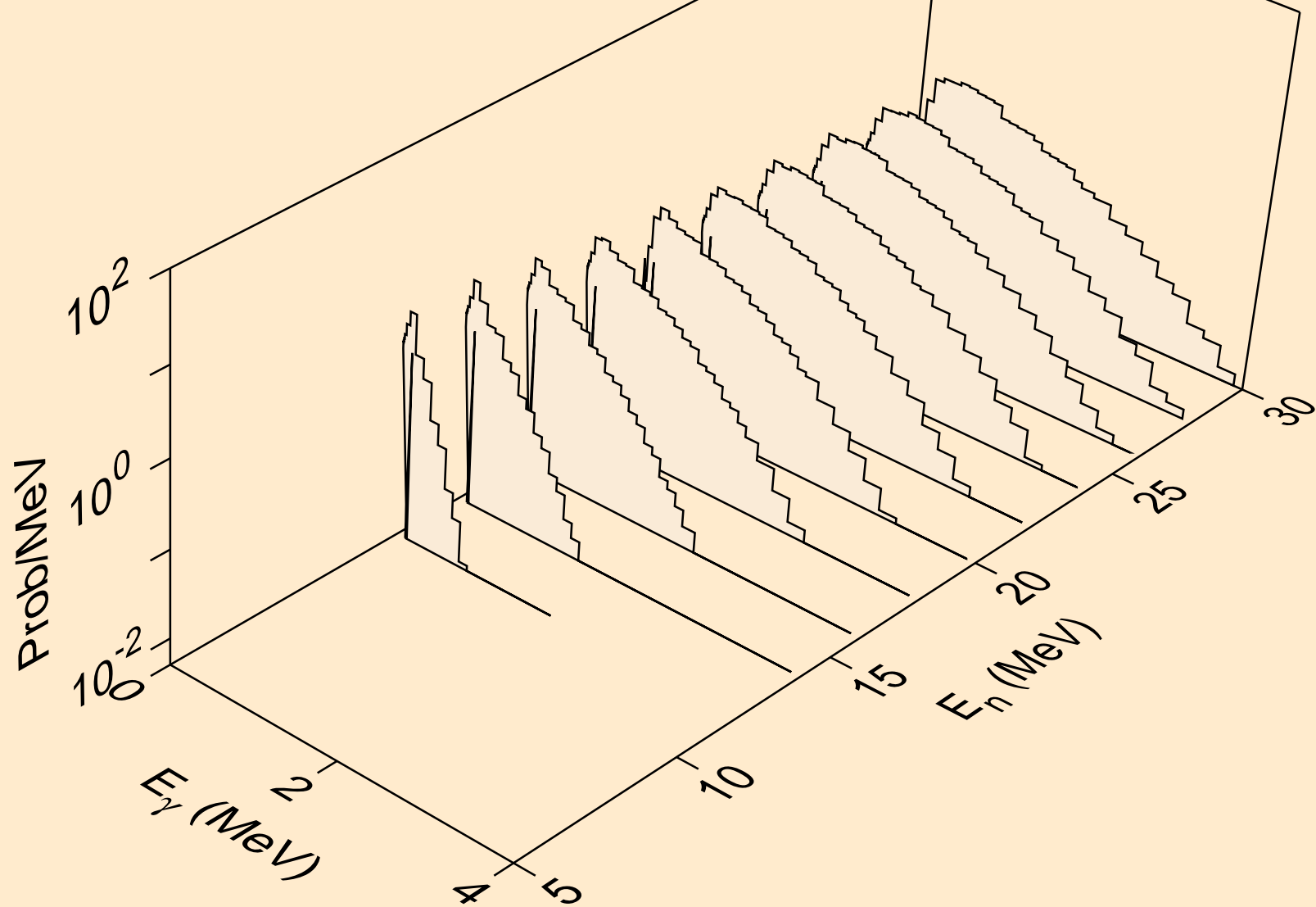

CF241 NEUTRON ACER TENDL-2021 LIBRARY; T=293.6K
Photon emission for (n,n*)t

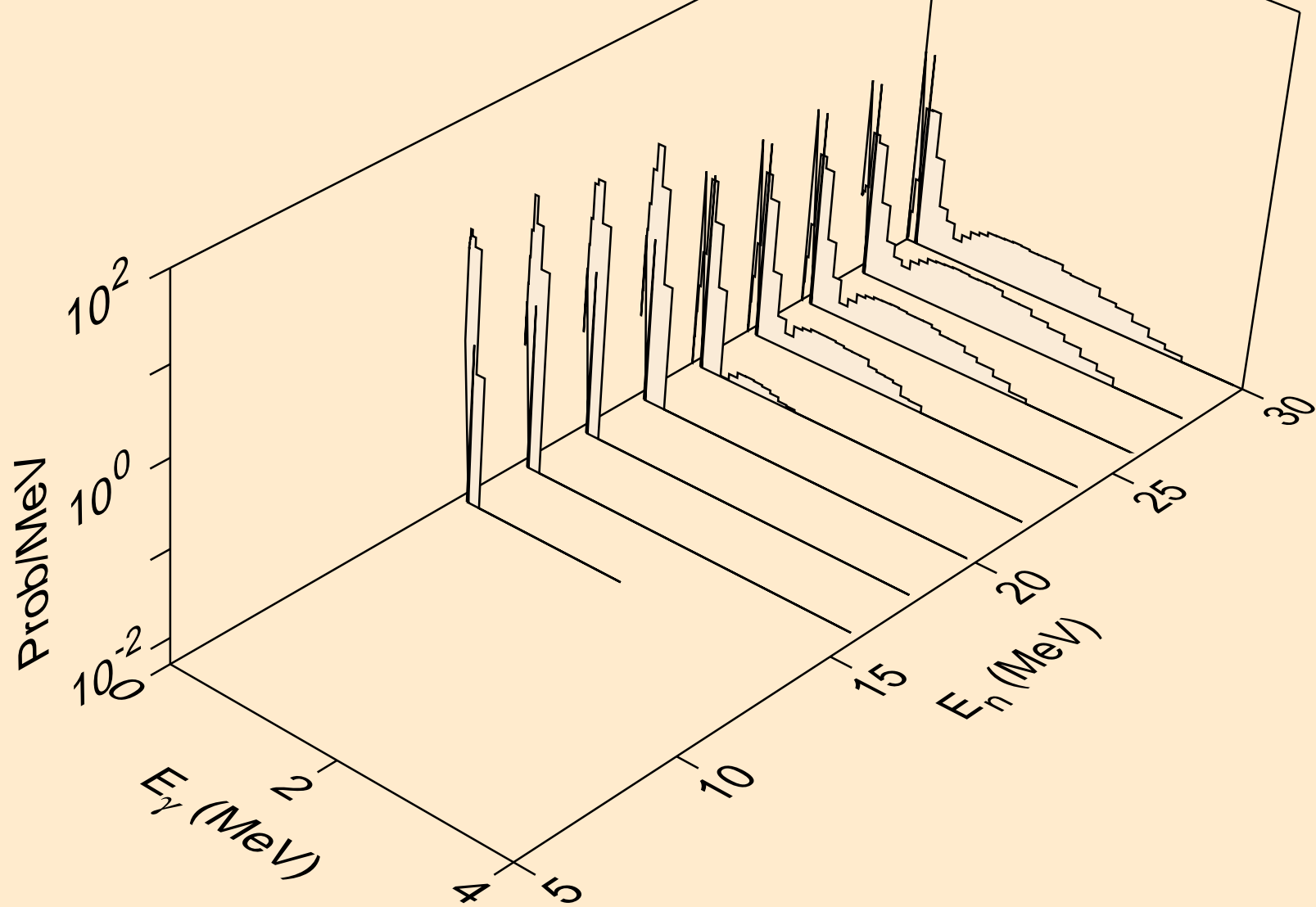

CF241 NEUTRON ACER TENDL-2021 LIBRARY; T=293.6K
Photon emission for (n,n*)he3

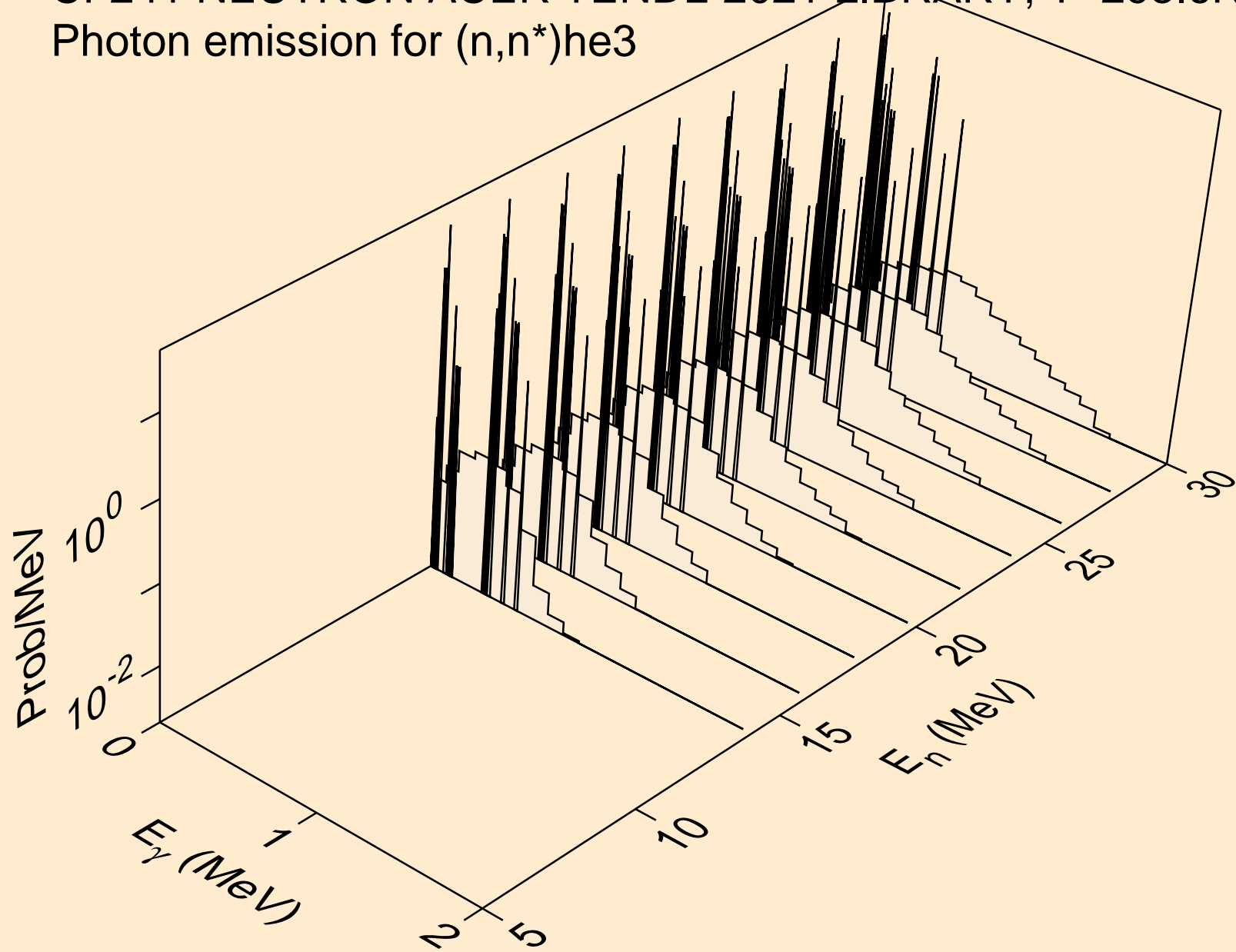

CF241 NEUTRON ACER TENDL-2021 LIBRARY; T=293.6K
Photon emission for (n,4n)

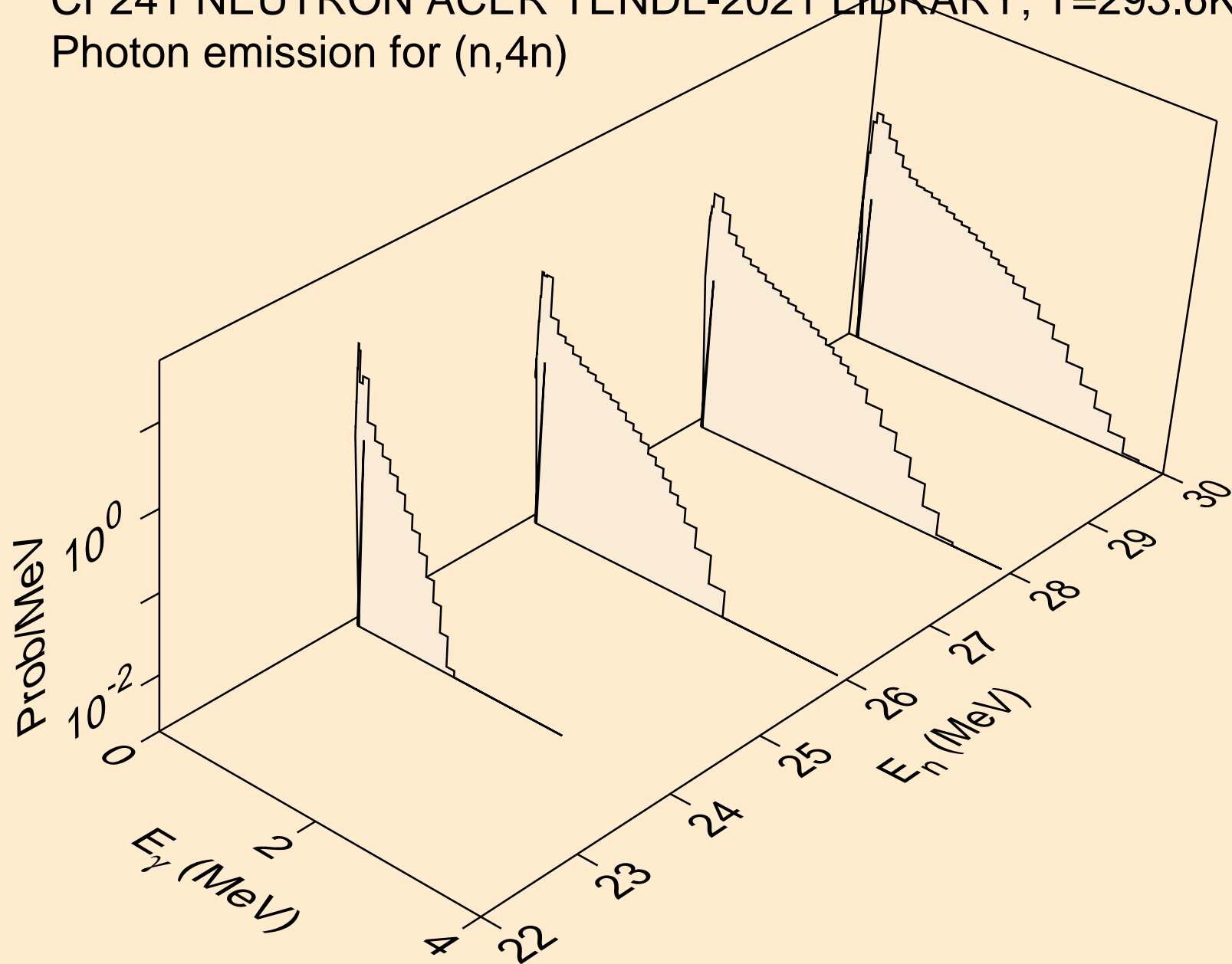

CF241 NEUTRON ACER TENDL-2021 LIBRARY; T=293.6K
Photon emission for (n,2np)

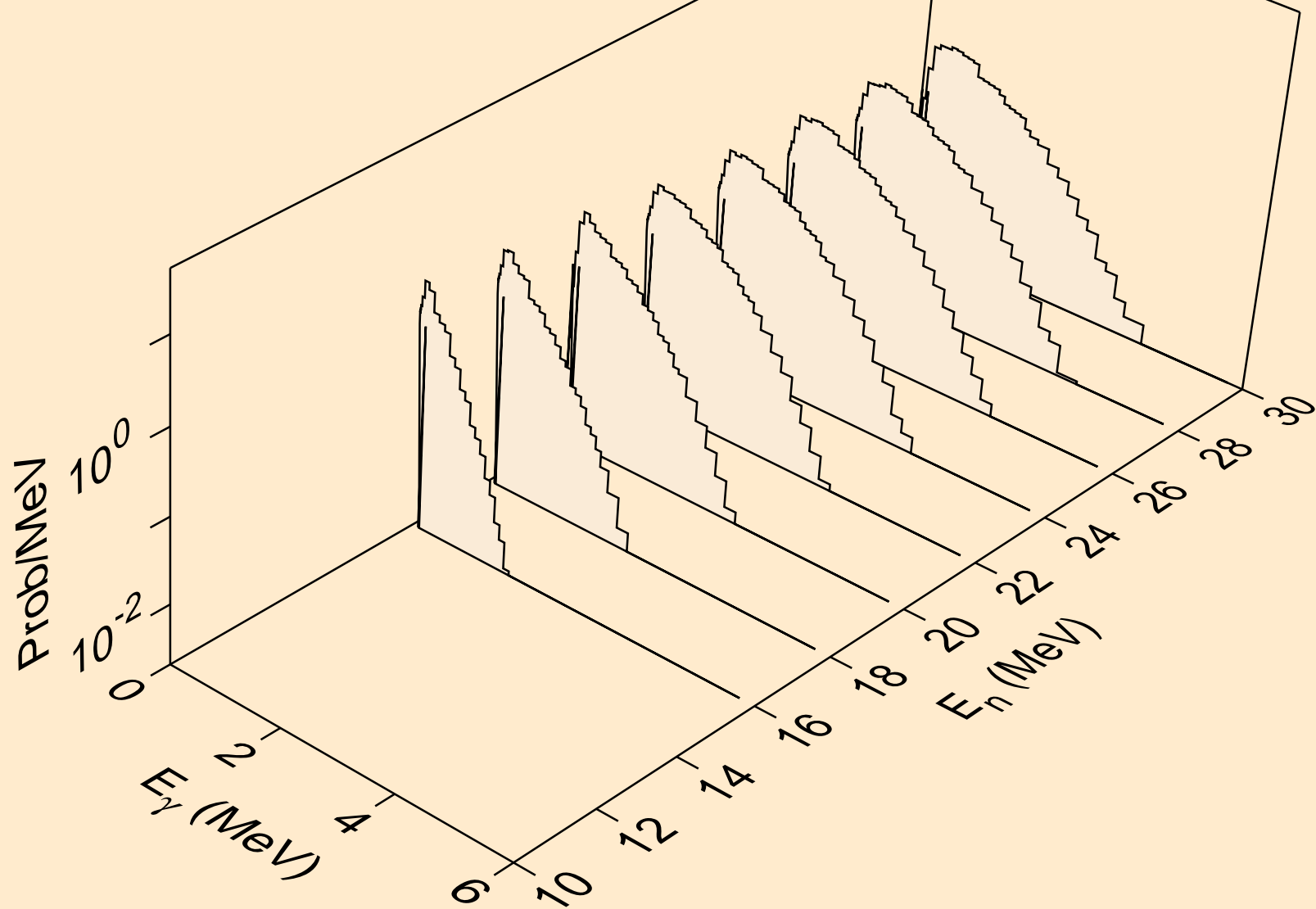

CF241 NEUTRON ACER TENDL-2021 LIBRARY; T=293.6K
Photon emission for (n,3np)

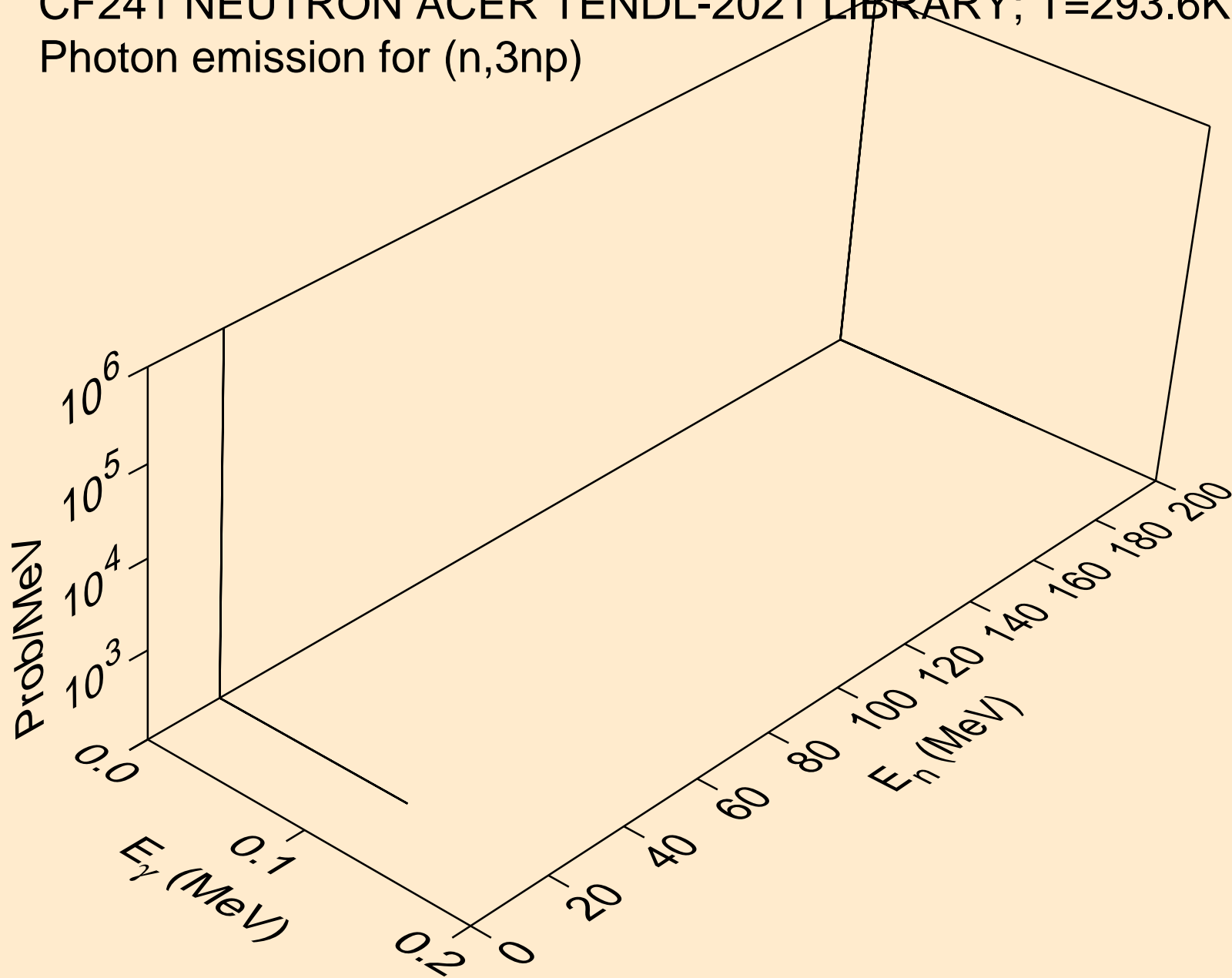

CF241 NEUTRON ACER TENDL-2021 LIBRARY; T=293.6K
Photon emission for (n,2np)

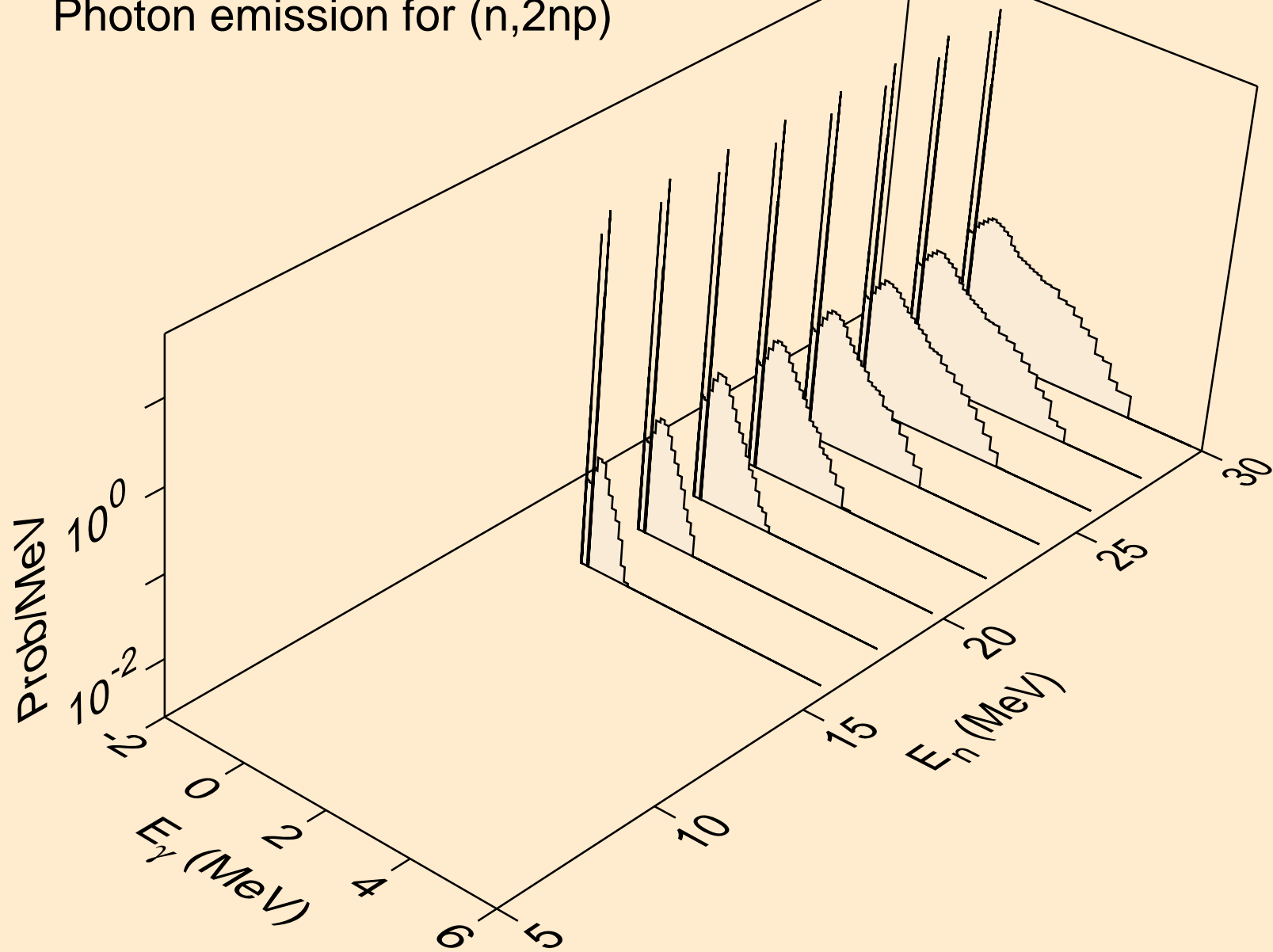

CF241 NEUTRON ACER TENDL-2021 LIBRARY; T=293.6K
Photon emission for (n,npa)

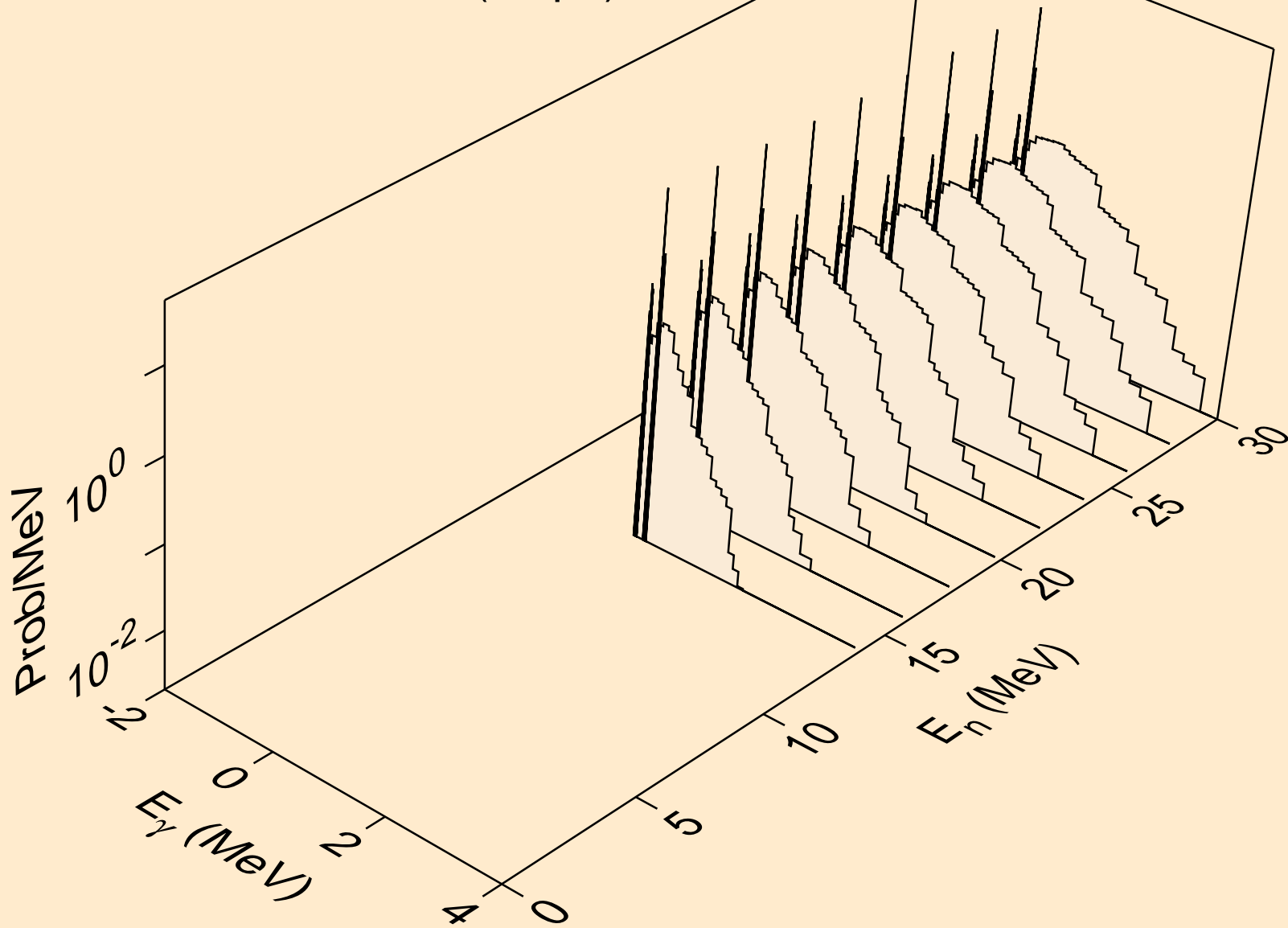

CF241 NEUTRON ACER TENDL-2021 LIBRARY; T=293.6K
Photon emission for (n,n*c)

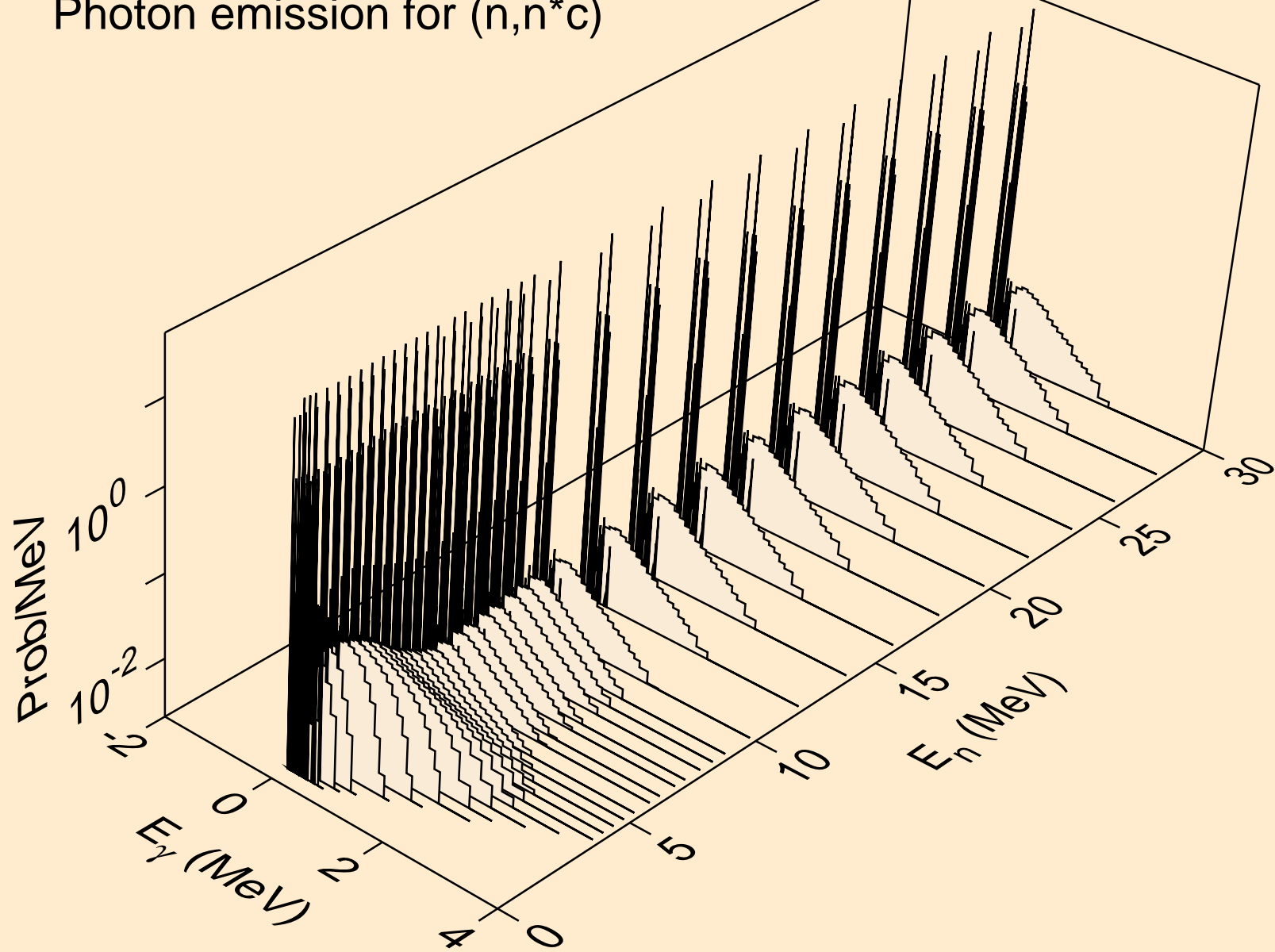

CF241 NEUTRON ACER TENDL-2021 LIBRARY; T=293.6K
Photon emission for (n,gma)

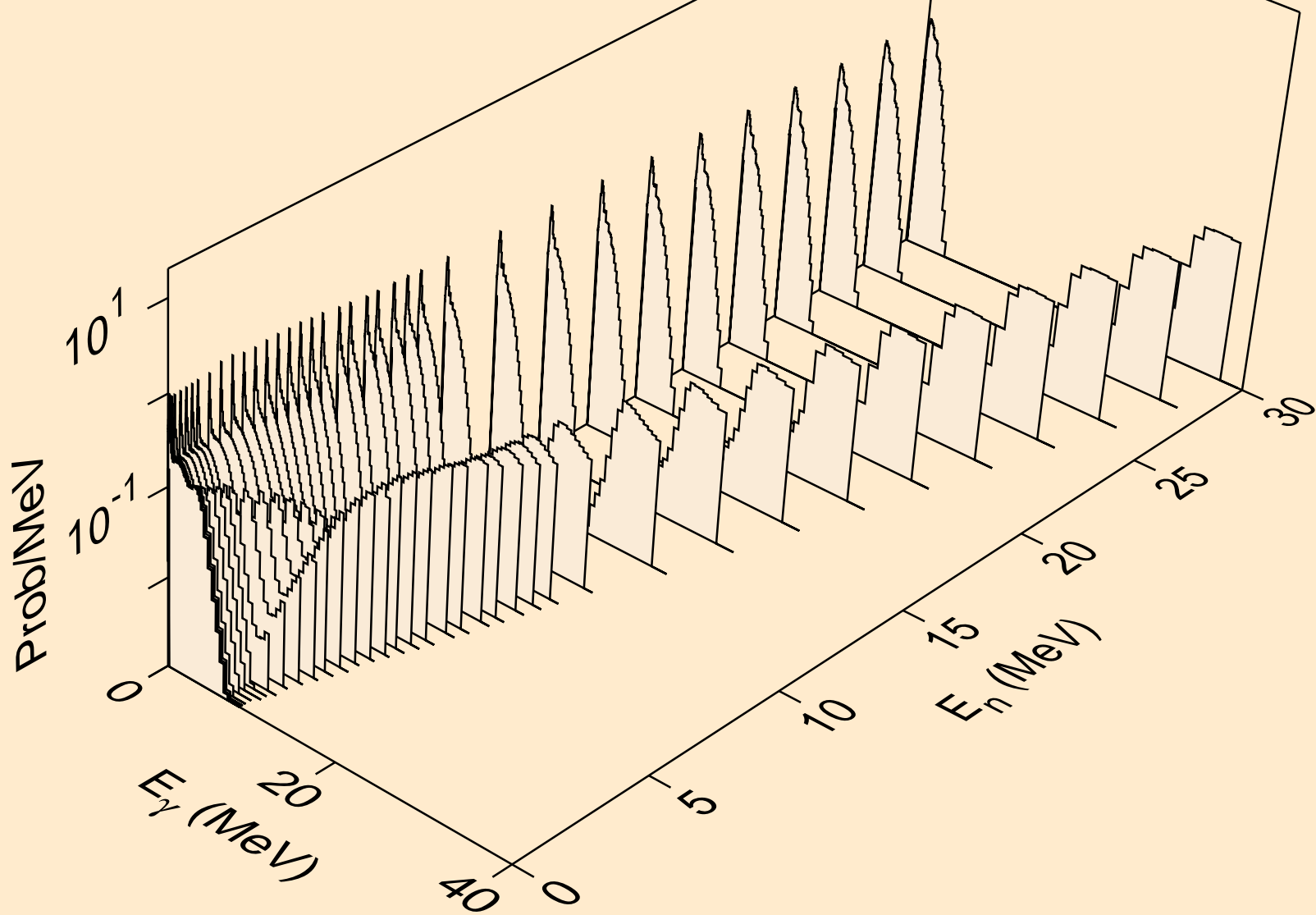

CF241 NEUTRON ACER TENDL-2021 LIBRARY; T=293.6K
Photon emission for (n,p)

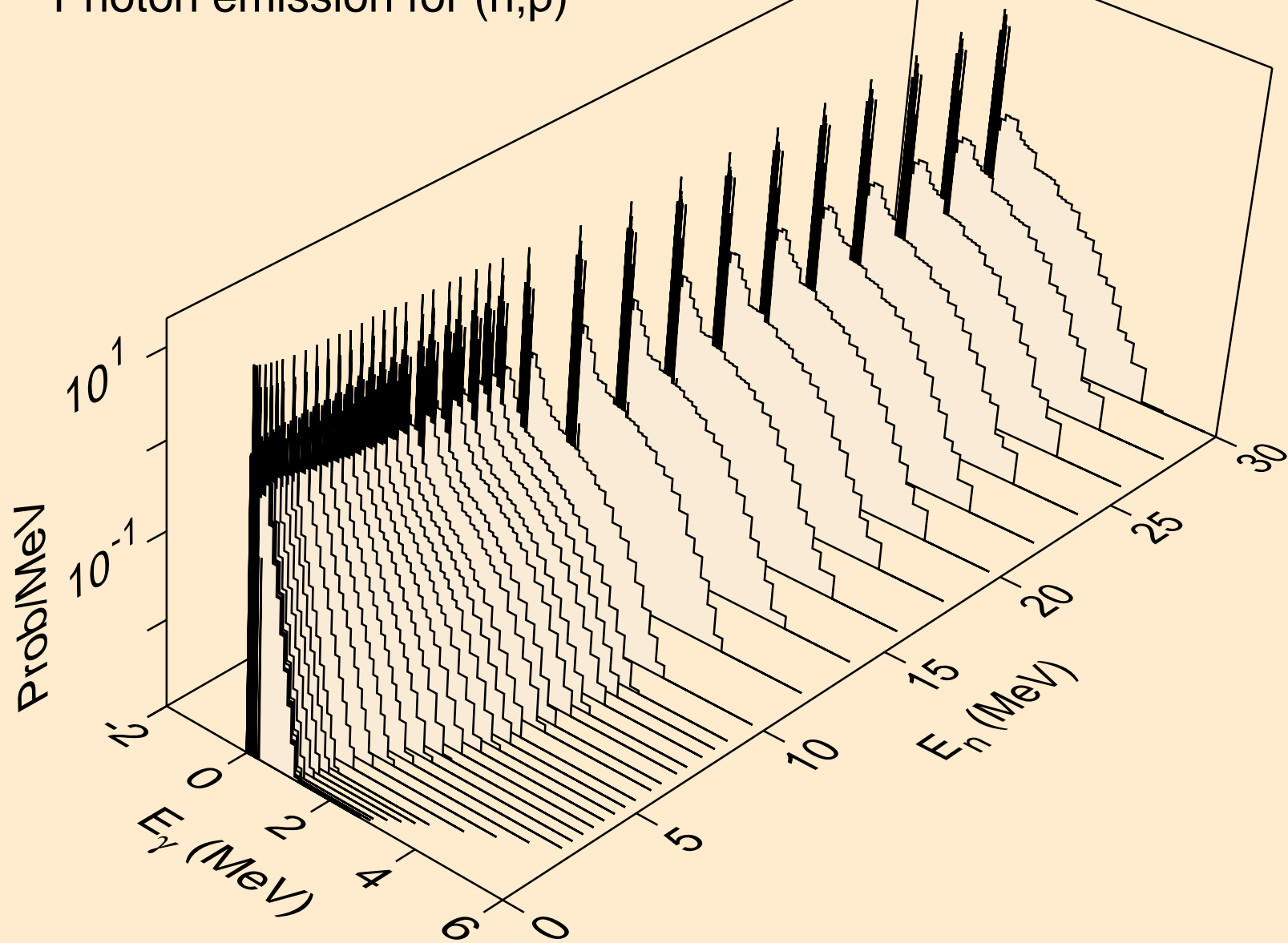

CF241 NEUTRON ACER TENDL-2021 LIBRARY; T=293.6K
Photon emission for (n,d)

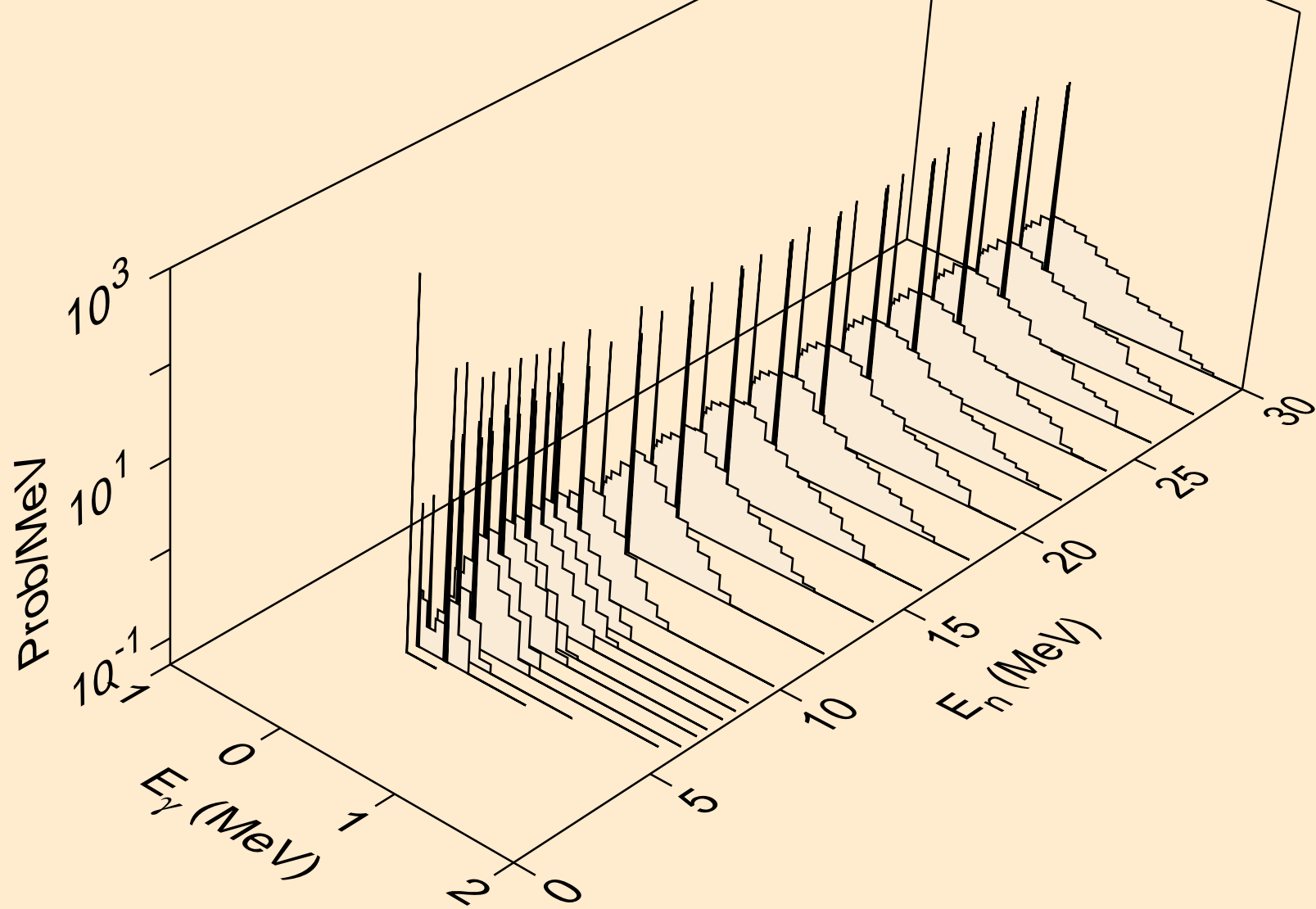

CF241 NEUTRON ACER TENDL-2021 LIBRARY; T=293.6K
Photon emission for (n,t)

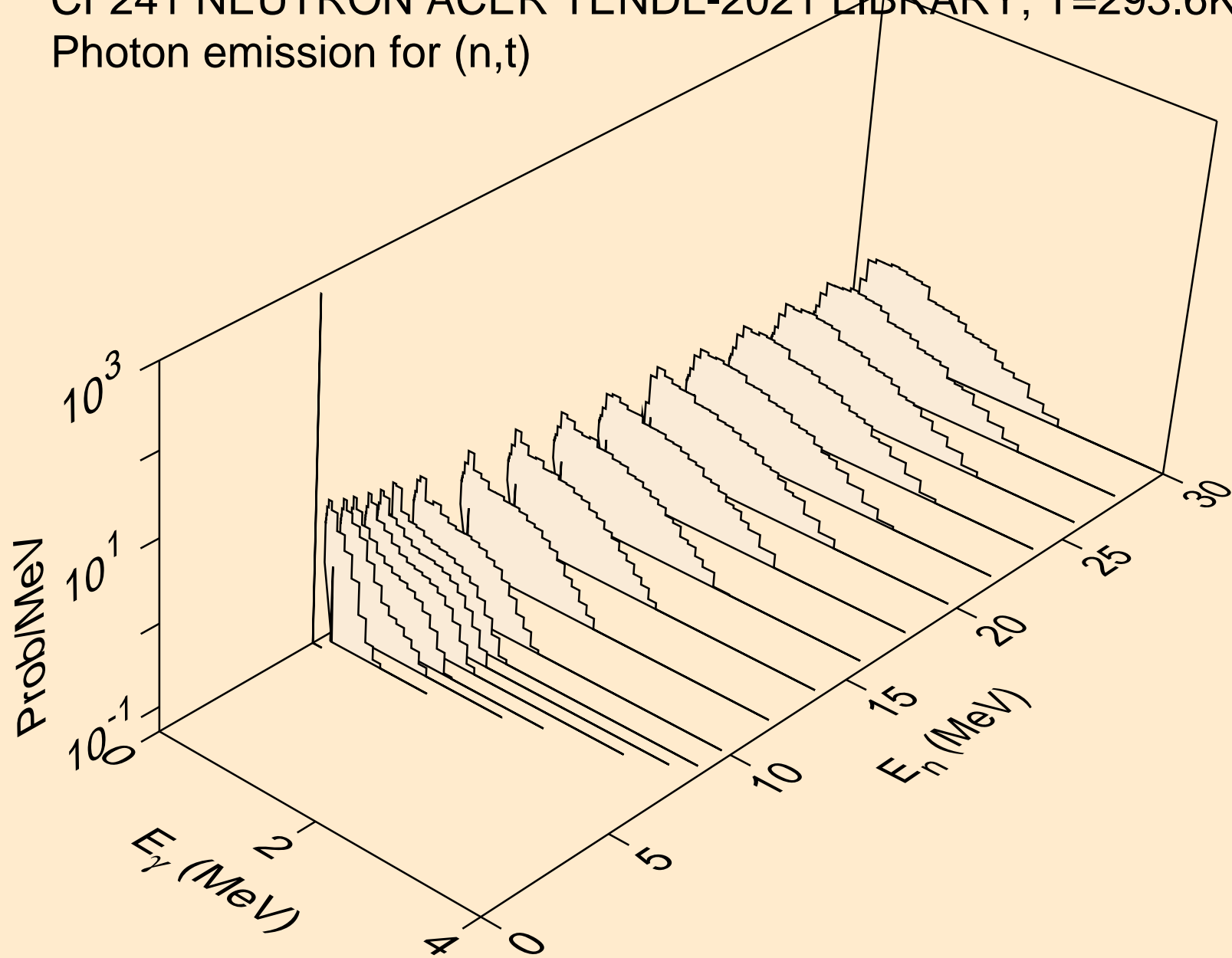

CF241 NEUTRON ACER TENDL-2021 LIBRARY; T=293.6K
Photon emission for (n,he3)

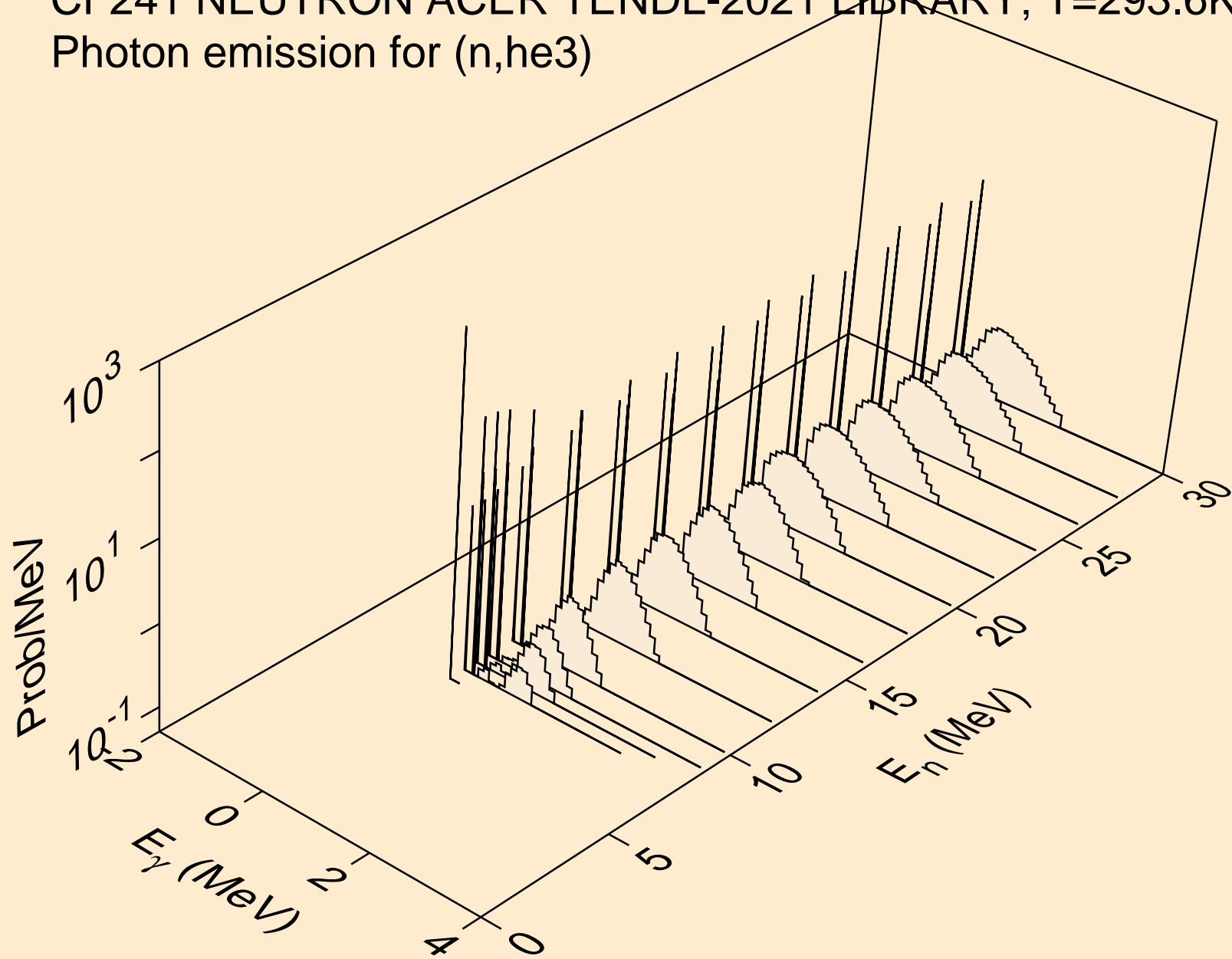

CF241 NEUTRON ACER TENDL-2021 LIBRARY; T=293.6K
Photon emission for (n,a)

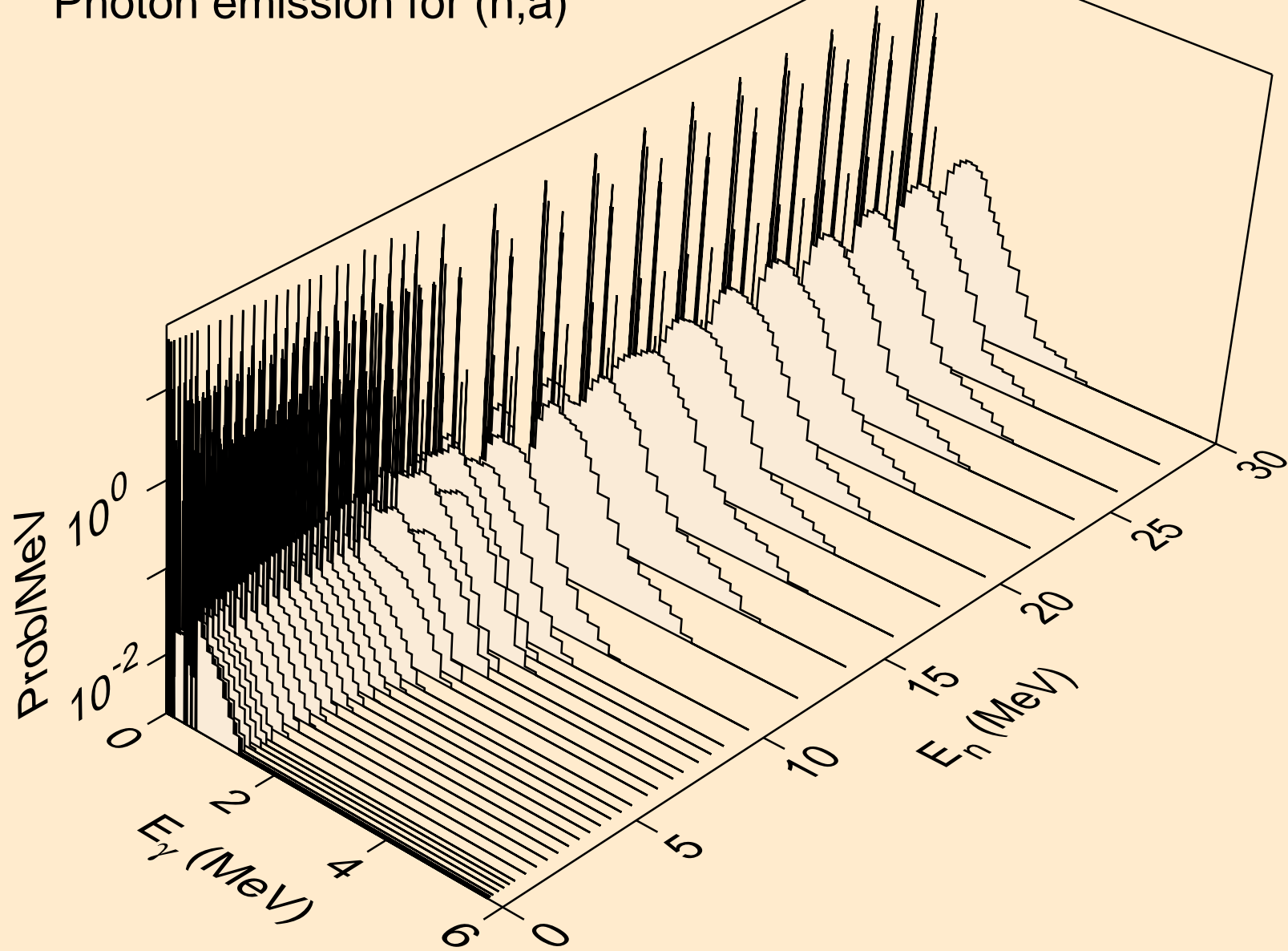

CF241 NEUTRON ACER TENDL-2021 LIBRARY; T=293.6K
Photon emission for (n,2p)

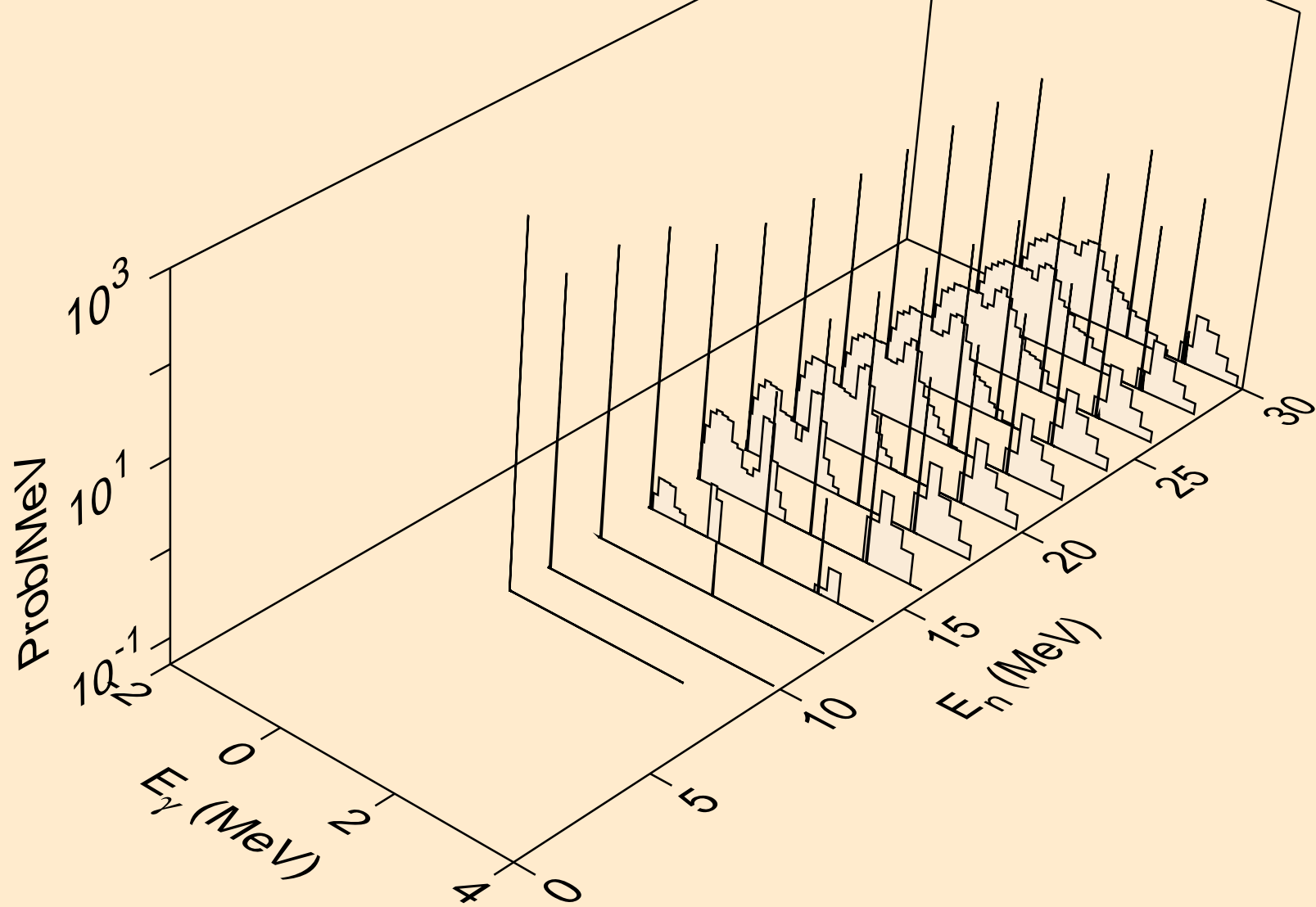

CF241 NEUTRON ACER TENDL-2021 LIBRARY; T=293.6K
Photon emission for (n,p α)

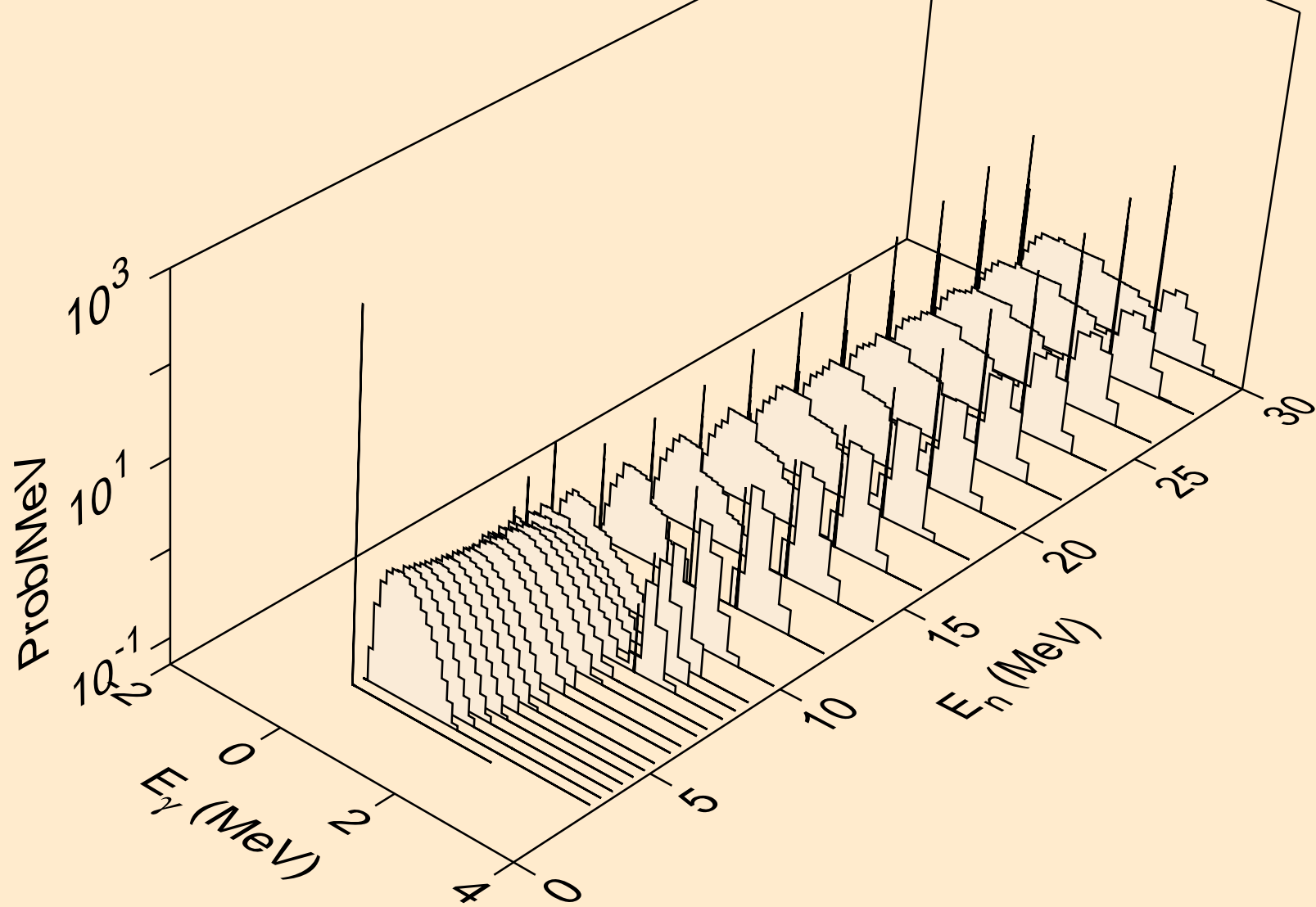

CF241 NEUTRON ACER TENDL-2021 LIBRARY; T=293.6K
Photon emission for (n,da)

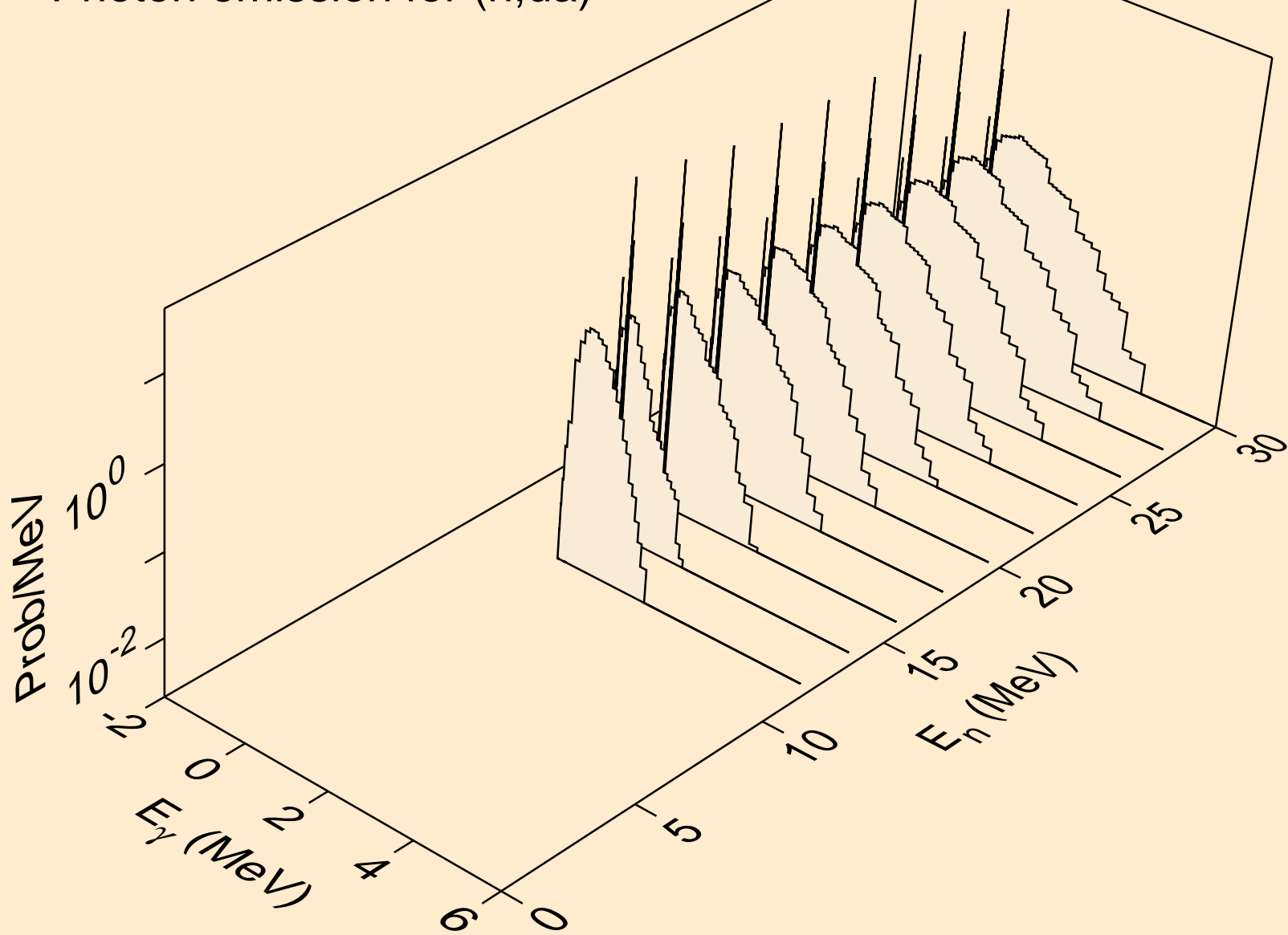

CF241 NEUTRON ACER TENDL-2021 LIBRARY; T=293.6K
thermal capture photon spectrum

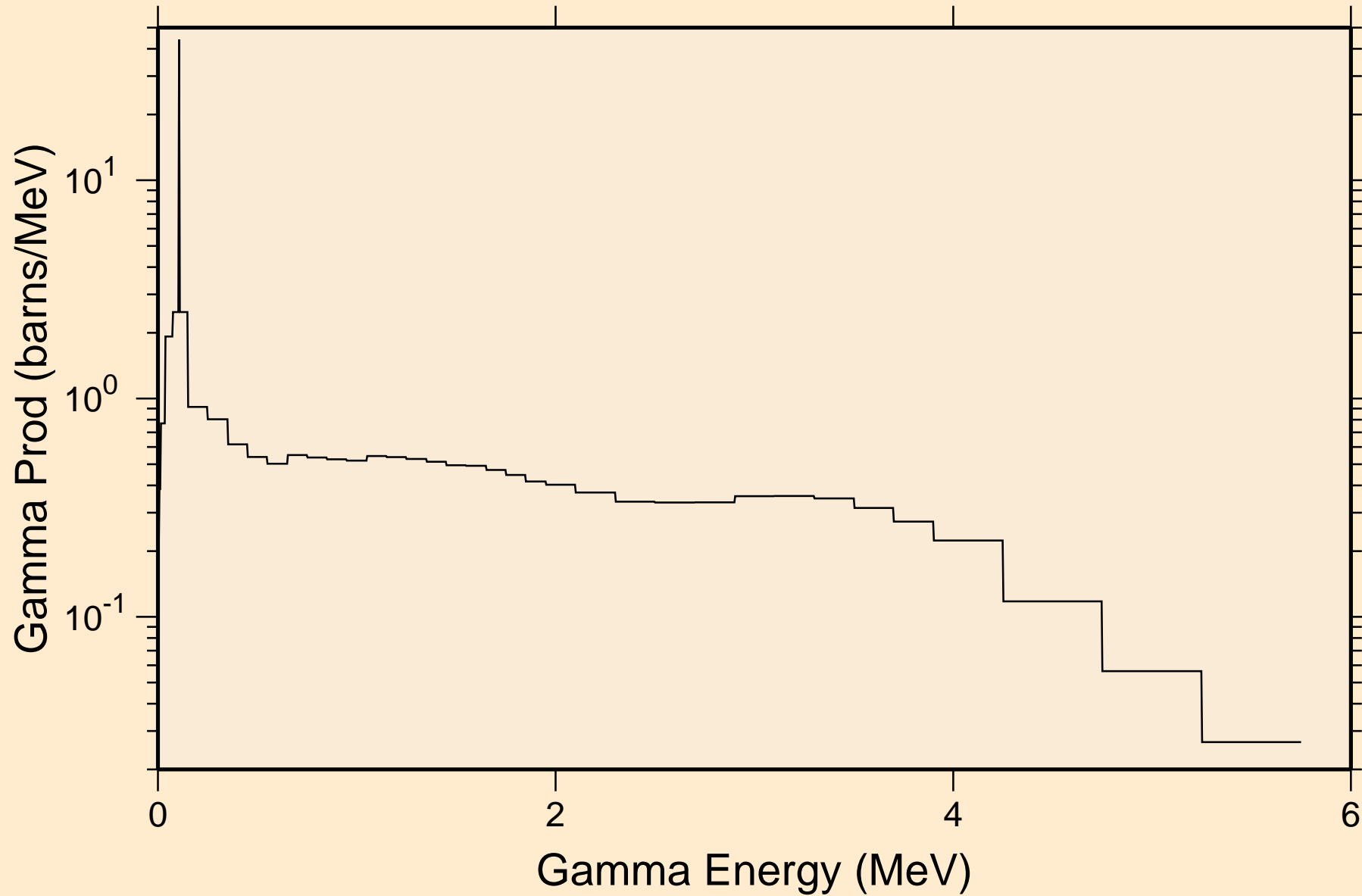

CF241 NEUTRON ACER TENDL-2021 LIBRARY; T=293.6K
14 MeV photon spectrum

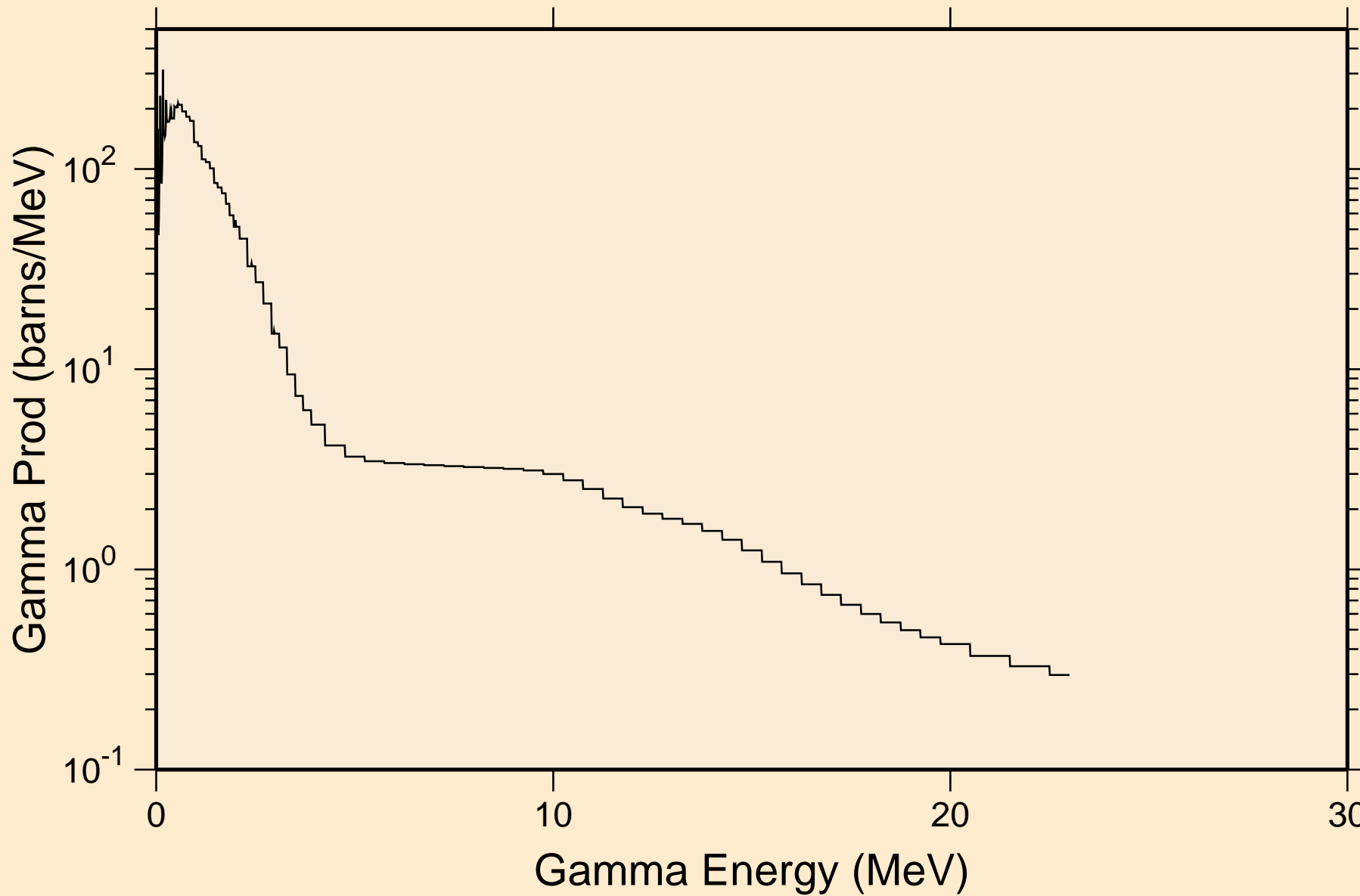

CF241 NEUTRON ACER TENDL-2021 LIBRARY; T=293.6K

Particle heating contributions

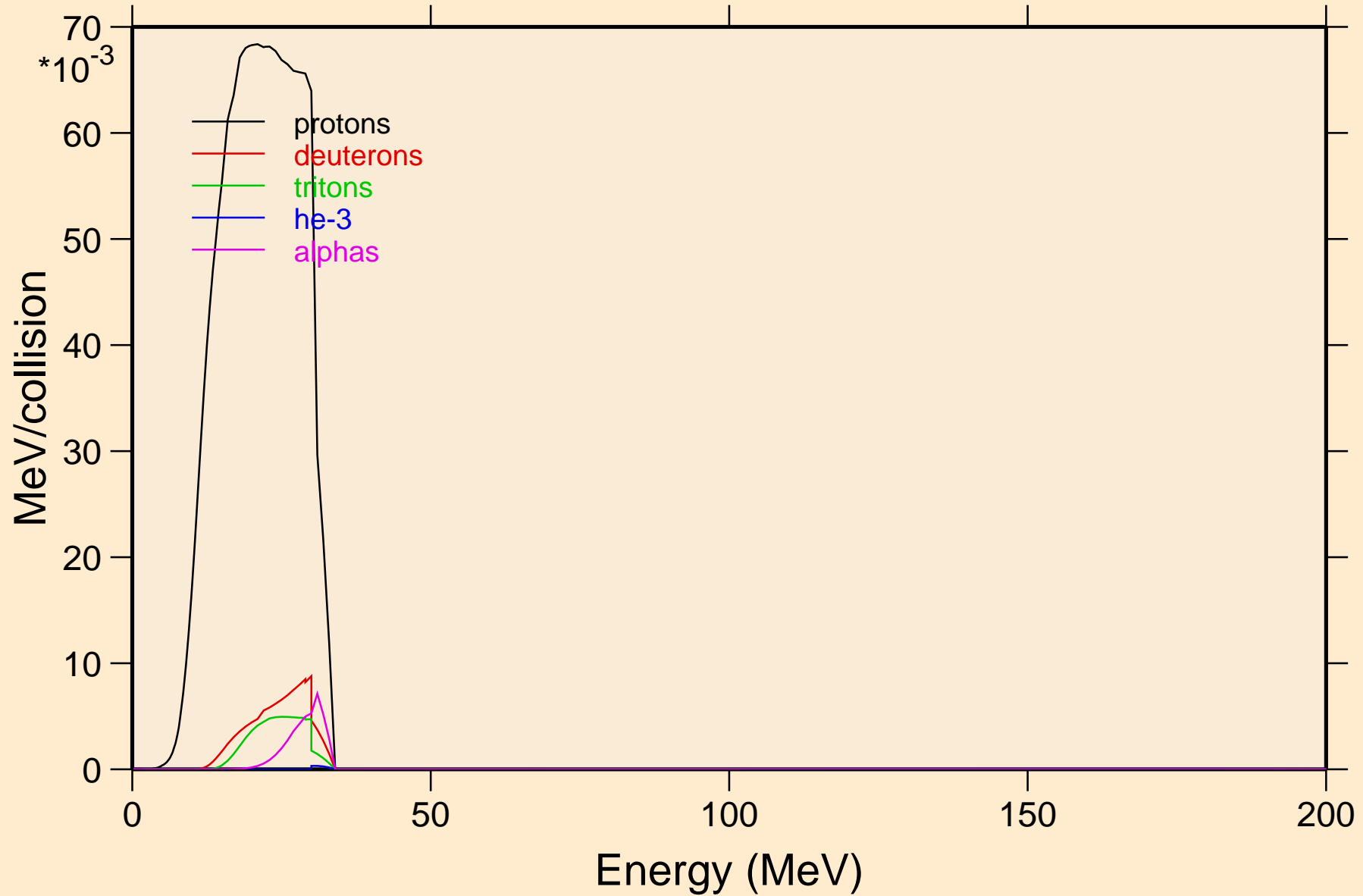

CF241 NEUTRON ACER TENDL-2021 LIBRARY; T=293.6K
Recoil Heating

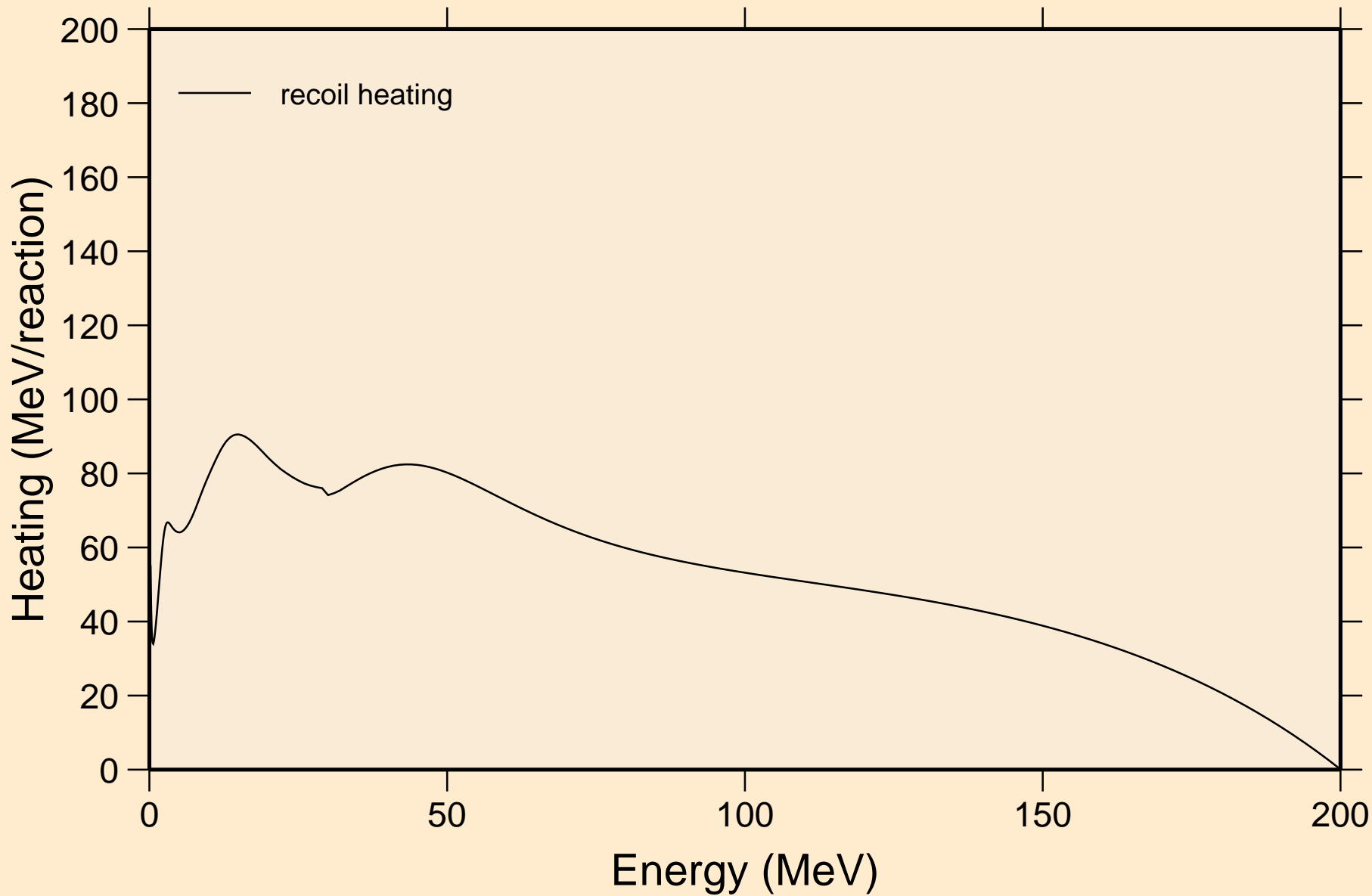

CF241 NEUTRON ACER TENDL-2021 LIBRARY; T=293.6K

Particle production cross sections

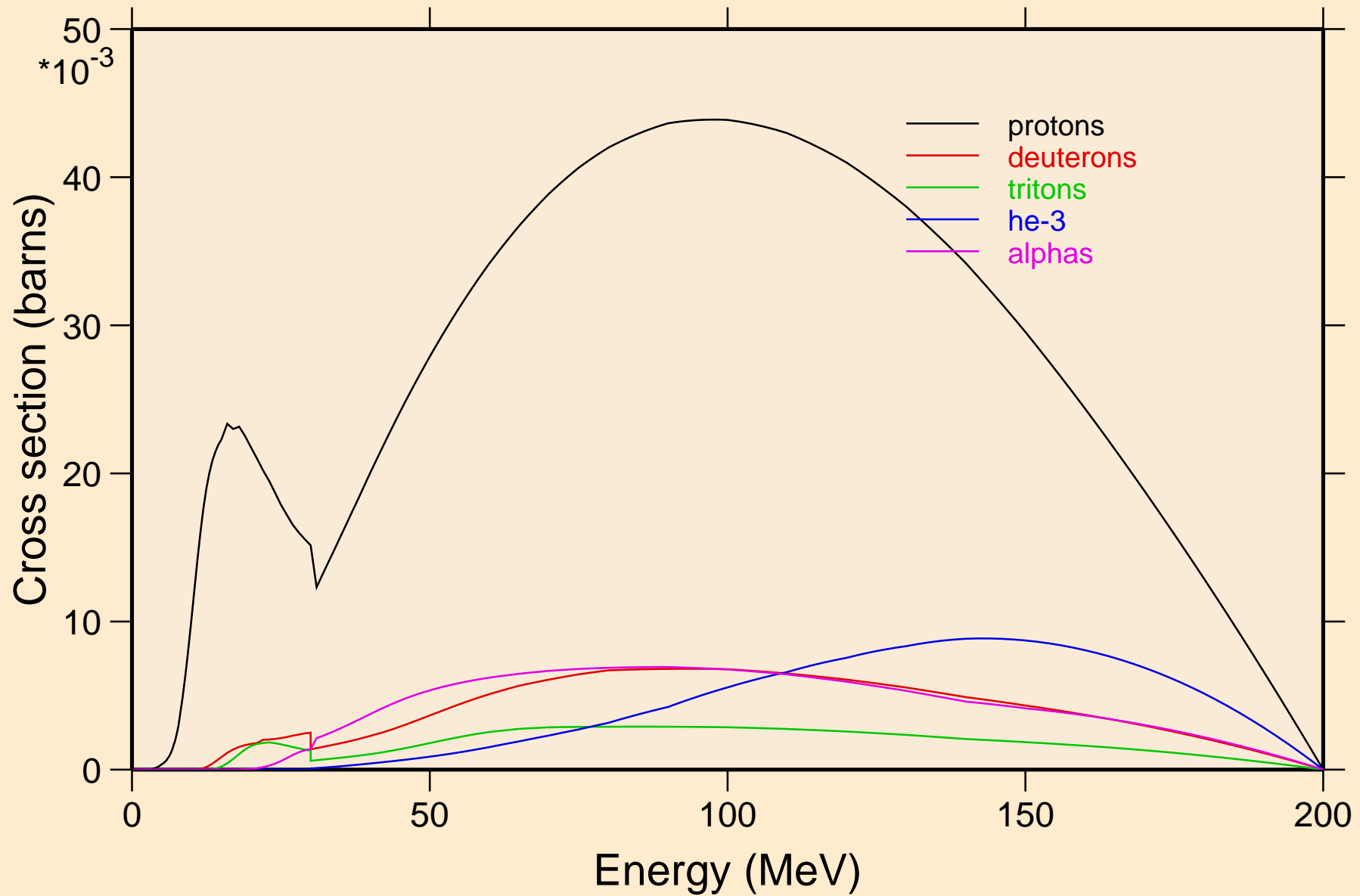

CF241 NEUTRON ACER TENDL-2021 LIBRARY; T=293.6K
protons from (n,x)

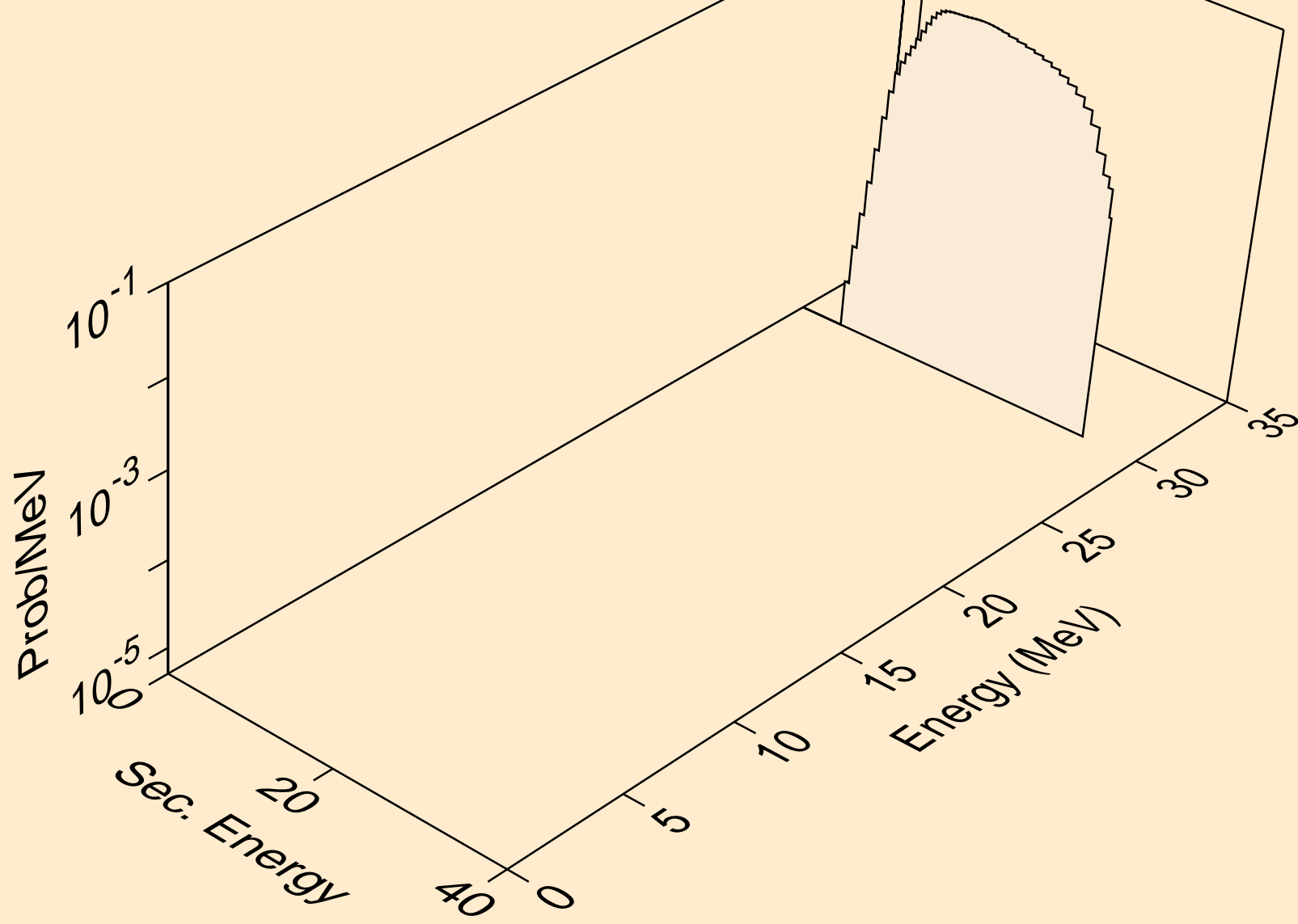

CF241 NEUTRON ACER TENDL-2021 LIBRARY; T=293.6K
protons from (n,n*)p

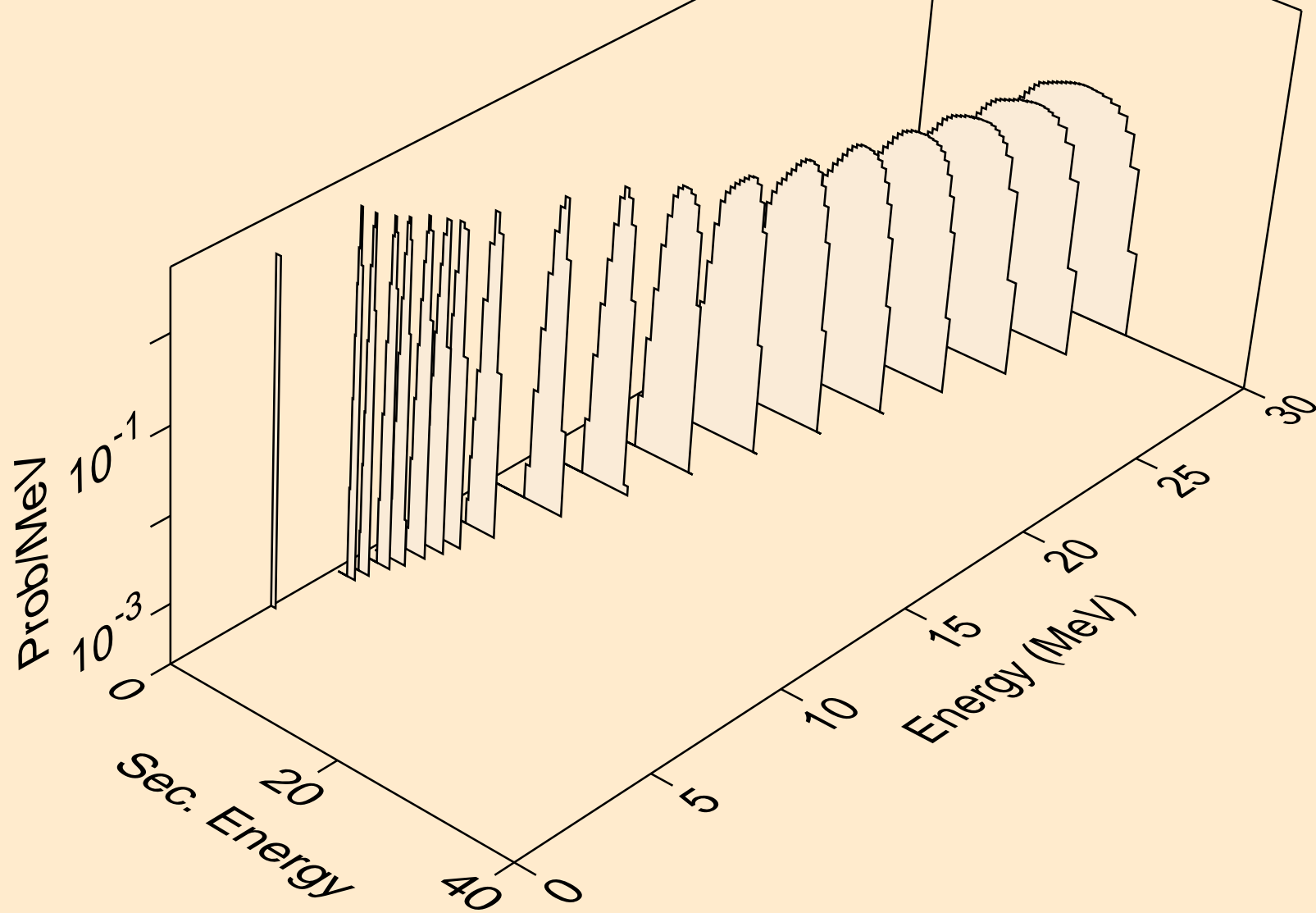

CF241 NEUTRON ACER TENDL-2021 LIBRARY; T=293.6K
protons from (n,2np)

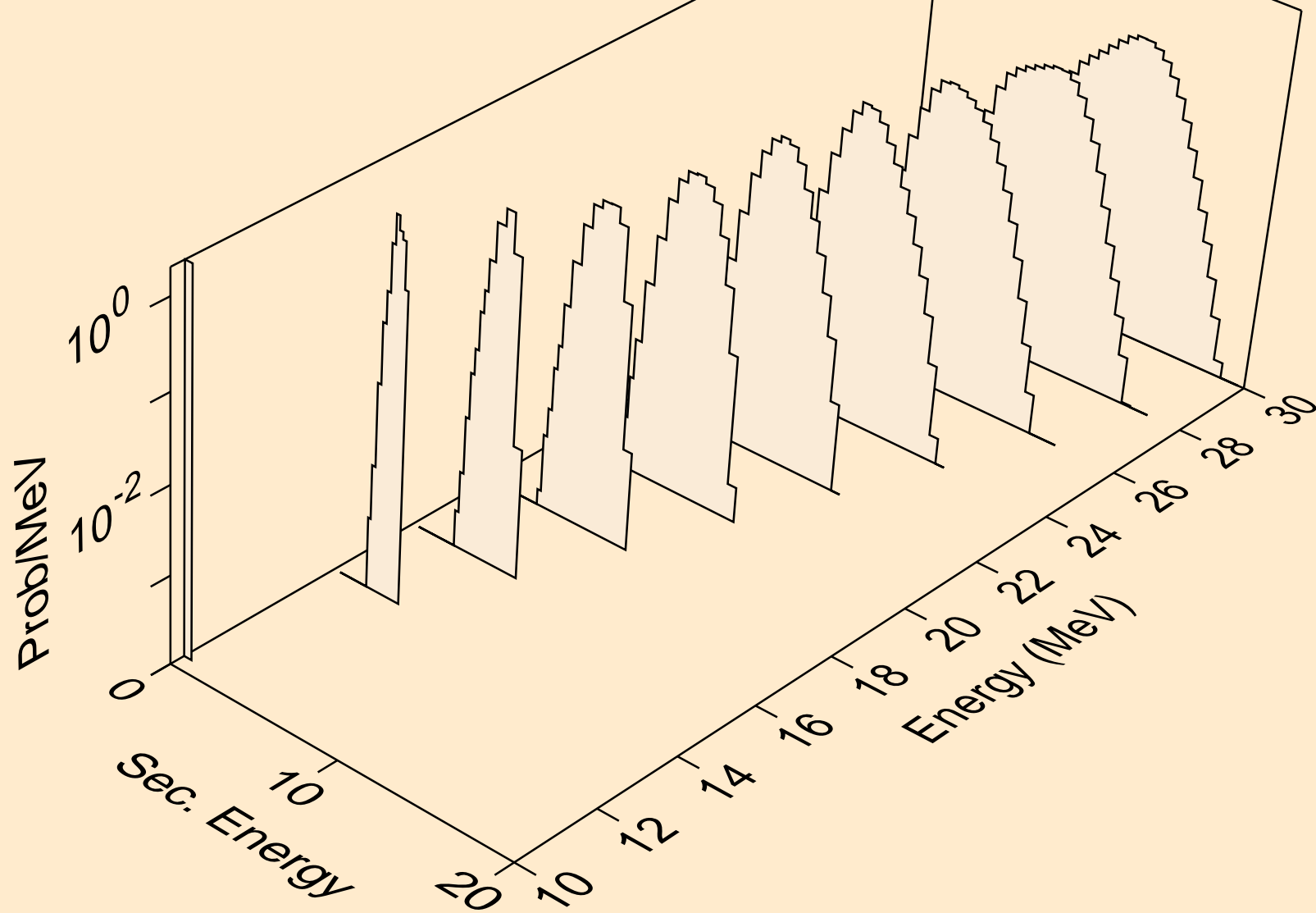

CF241 NEUTRON ACER TENDL-2021 LIBRARY; T=293.6K
protons from (n,3np)

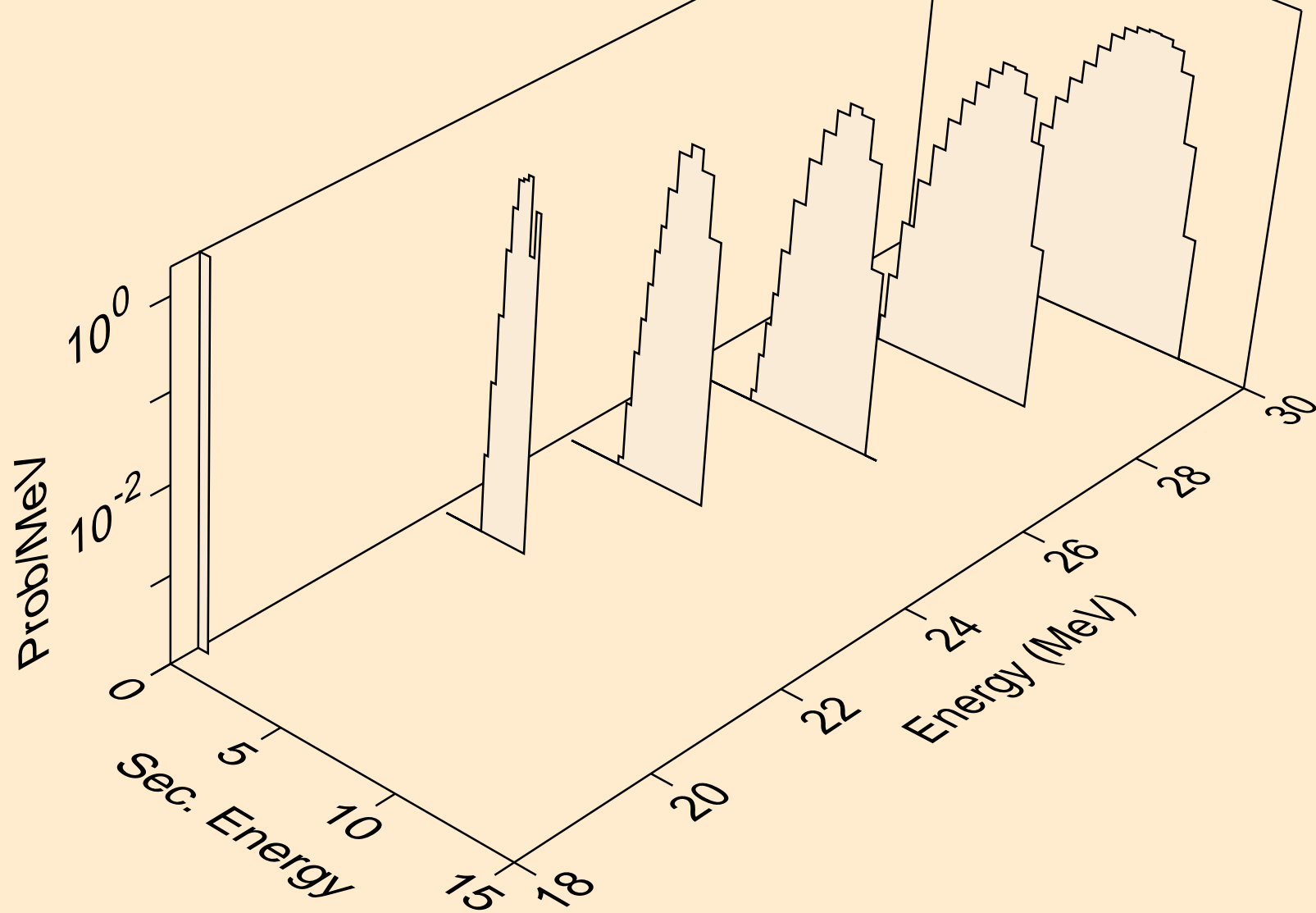

CF241 NEUTRON ACER TENDL-2021 LIBRARY; T=293.6K
protons from (n,2np)

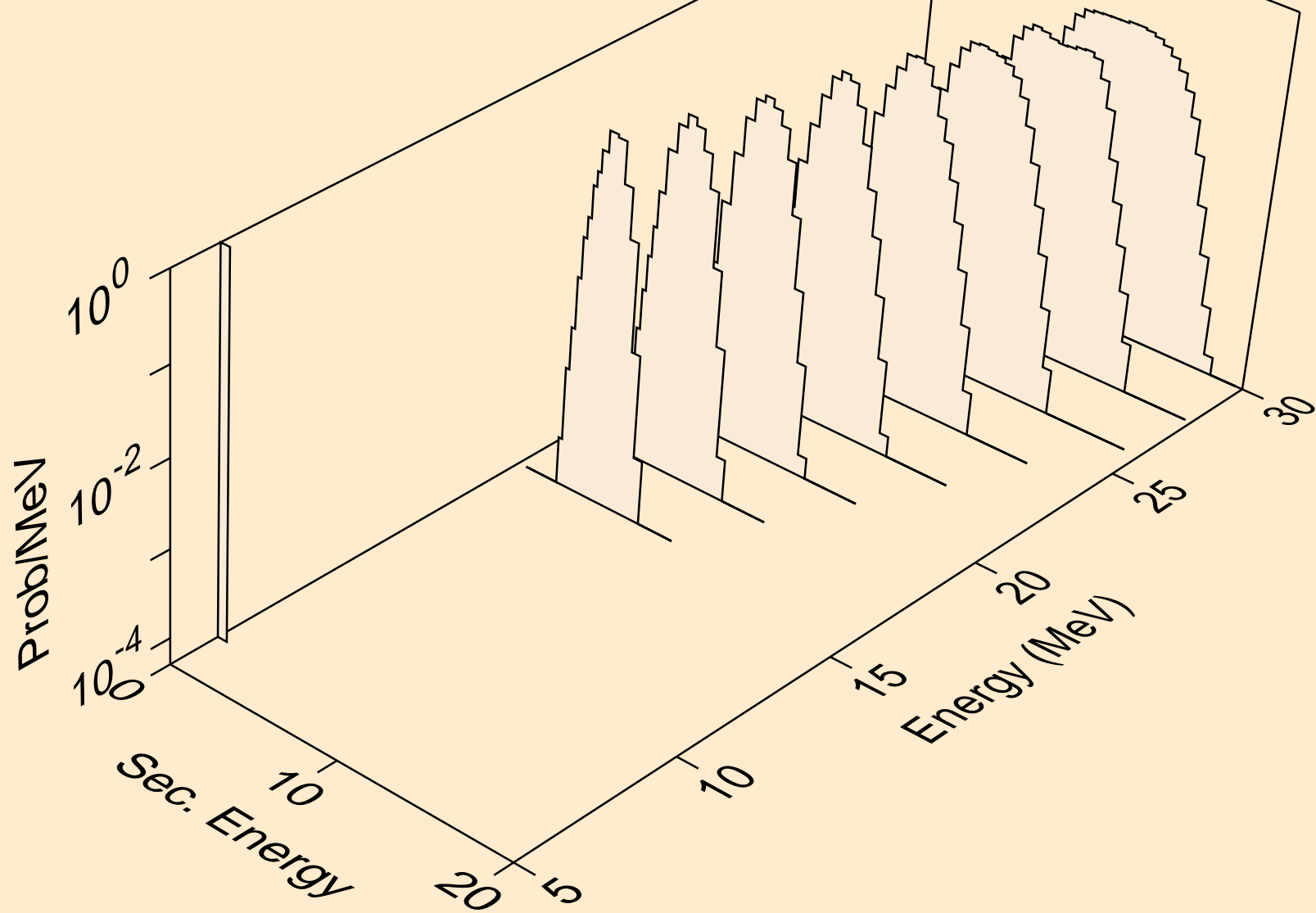

CF241 NEUTRON ACER TENDL-2021 LIBRARY; T=293.6K
protons from (n,npa)

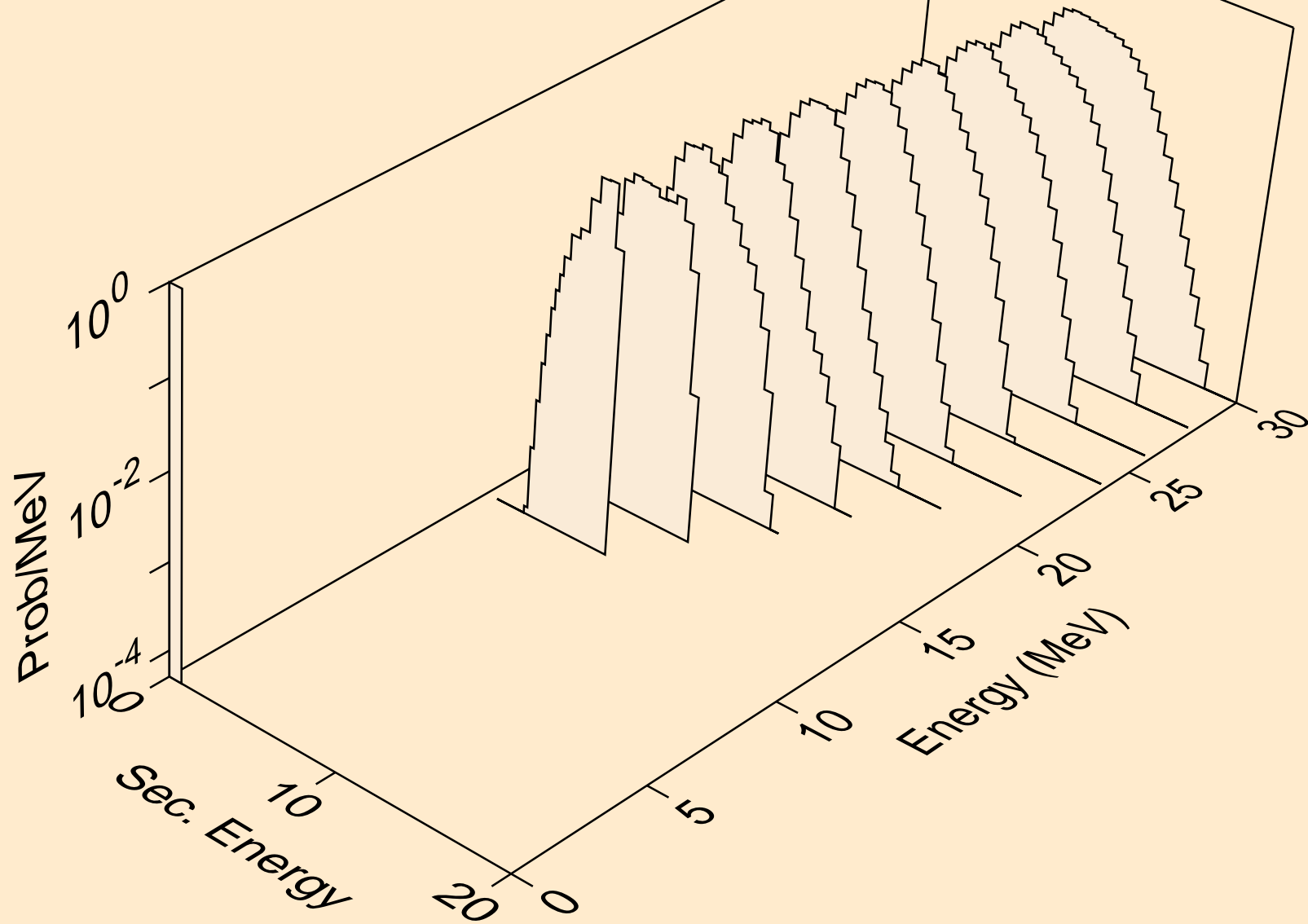

CF241 NEUTRON ACER TENDL-2021 LIBRARY; T=293.6K
protons from (n,p)

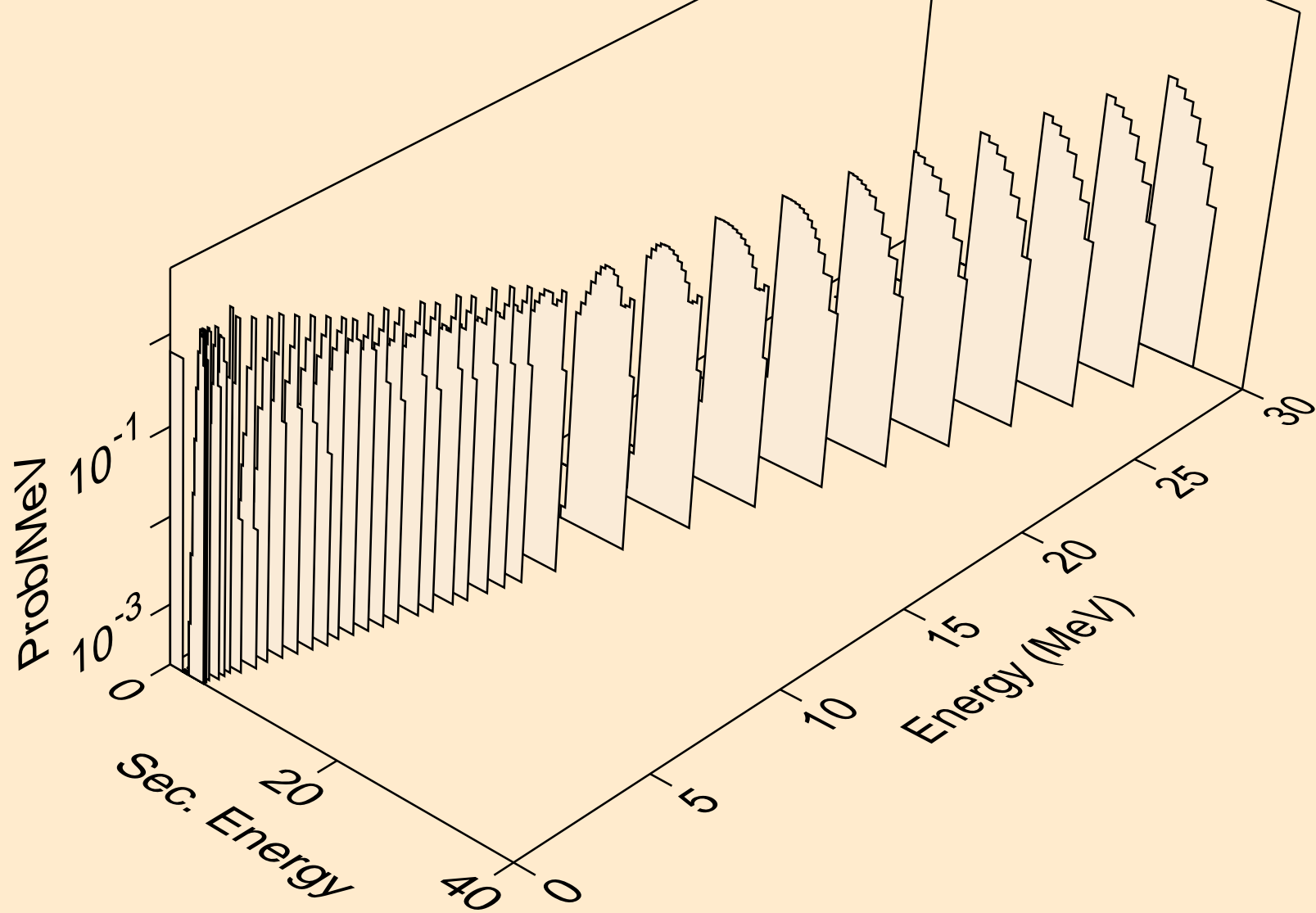

CF241 NEUTRON ACER TENDL-2021 LIBRARY; T=293.6K
protons from (n,2p)

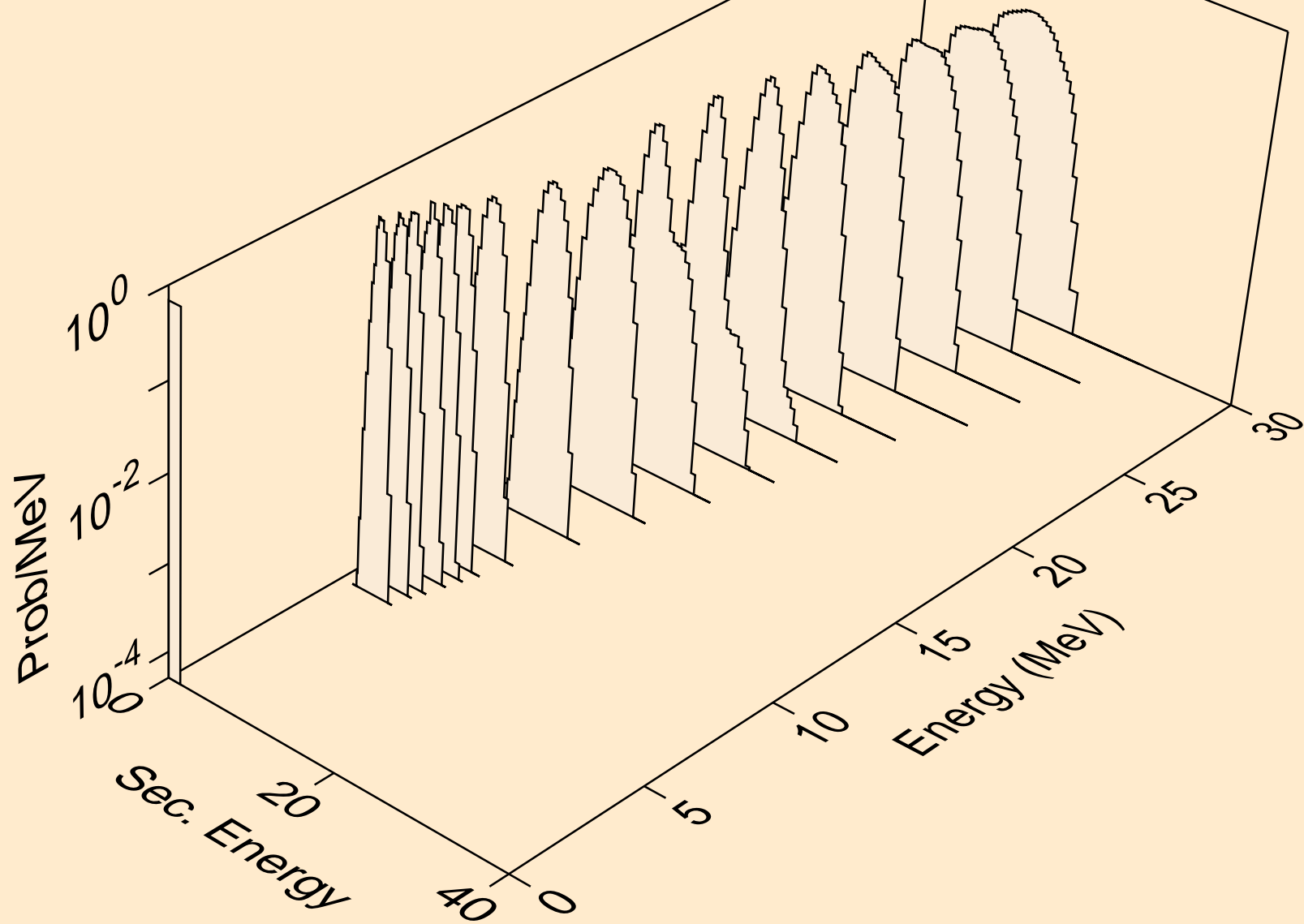

CF241 NEUTRON ACER TENDL-2021 LIBRARY; T=293.6K
protons from (n,p)

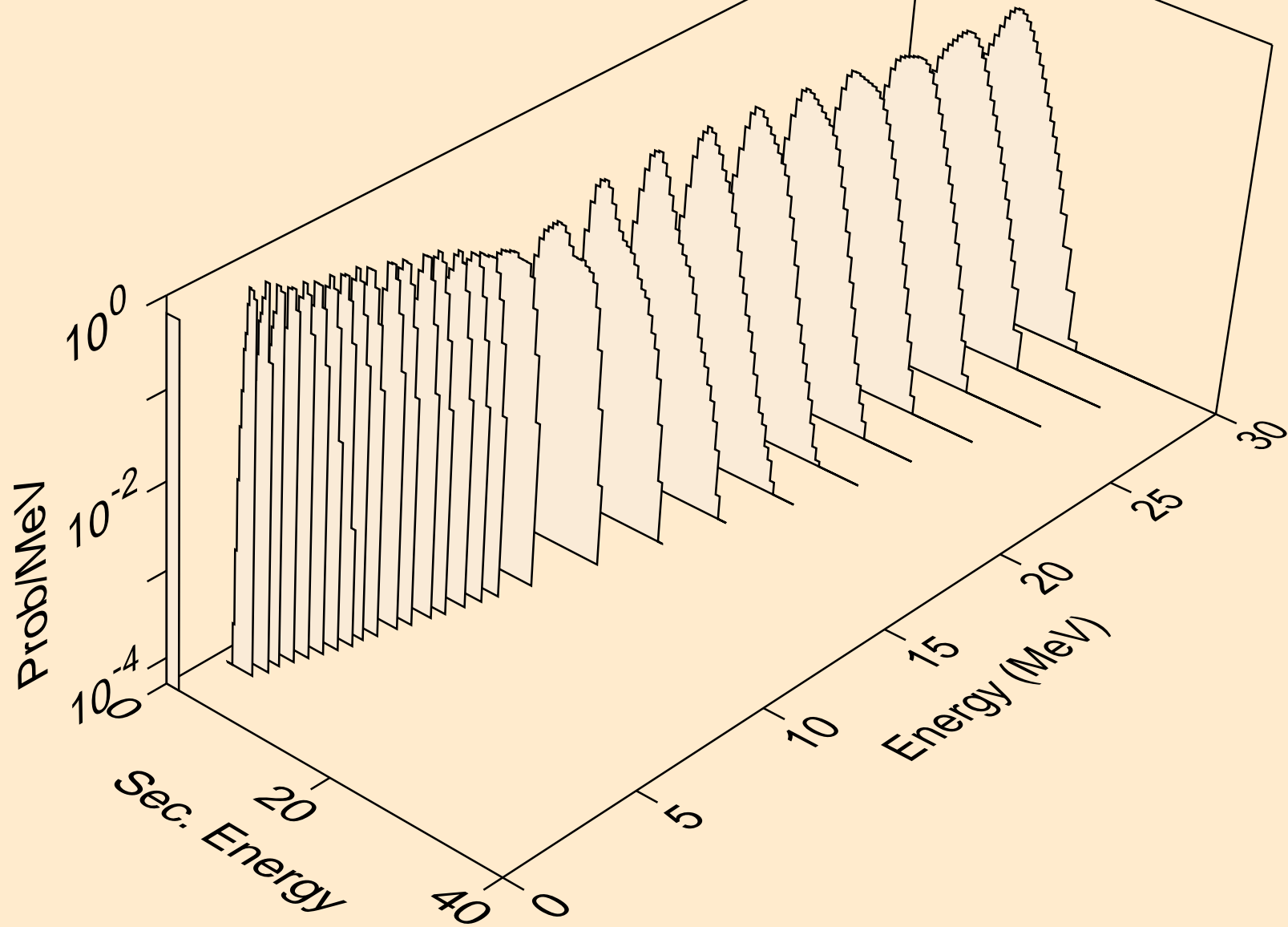

CF241 NEUTRON ACER TENDL-2021 LIBRARY; T=293.6K
deuterons from (n,x)

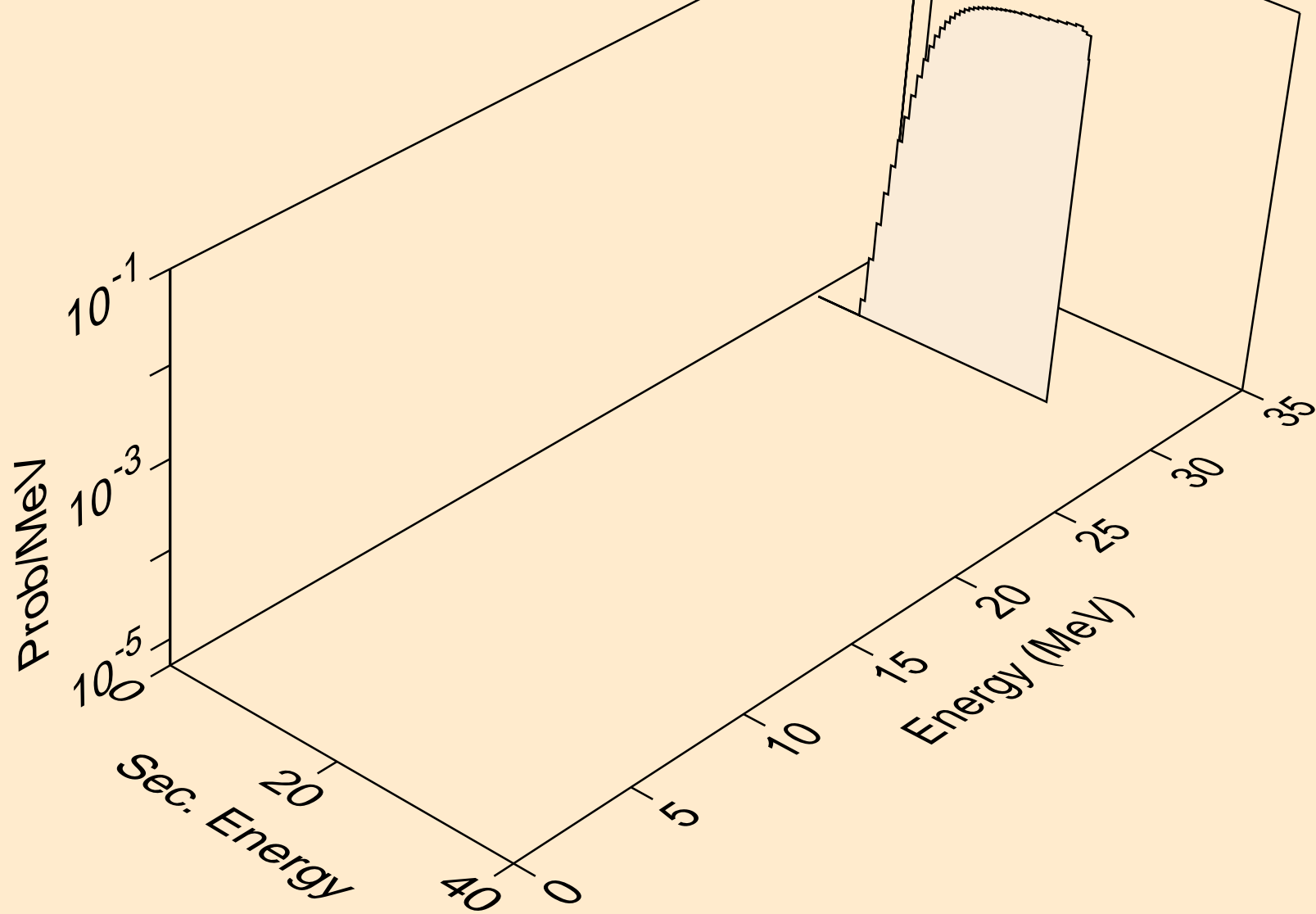

CF241 NEUTRON ACER TENDL-2021 LIBRARY; T=293.6K
deuterons from (n,2nd)

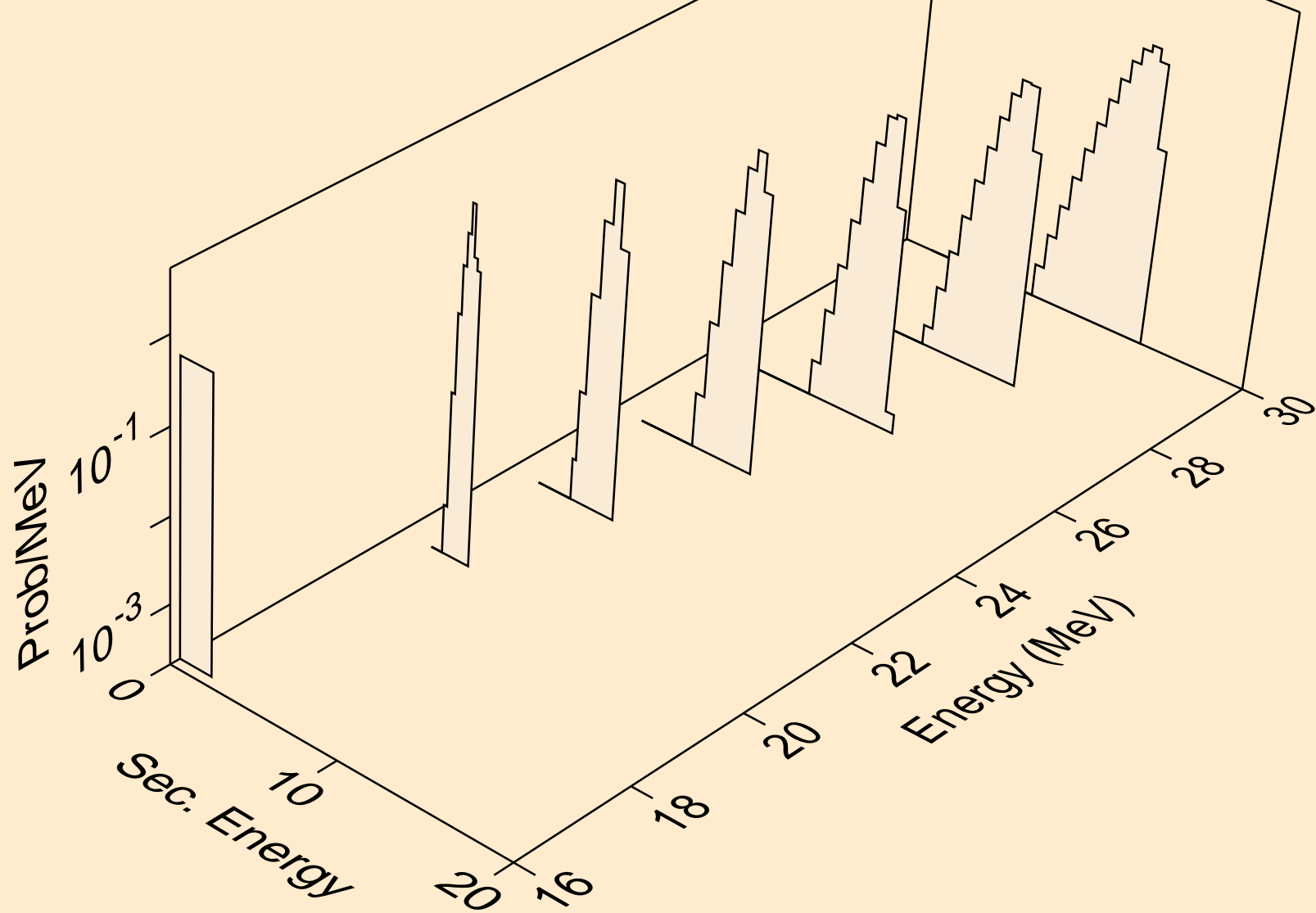

CF241 NEUTRON ACER TENDL-2021 LIBRARY; T=293.6K
deuterons from (n,n*)d

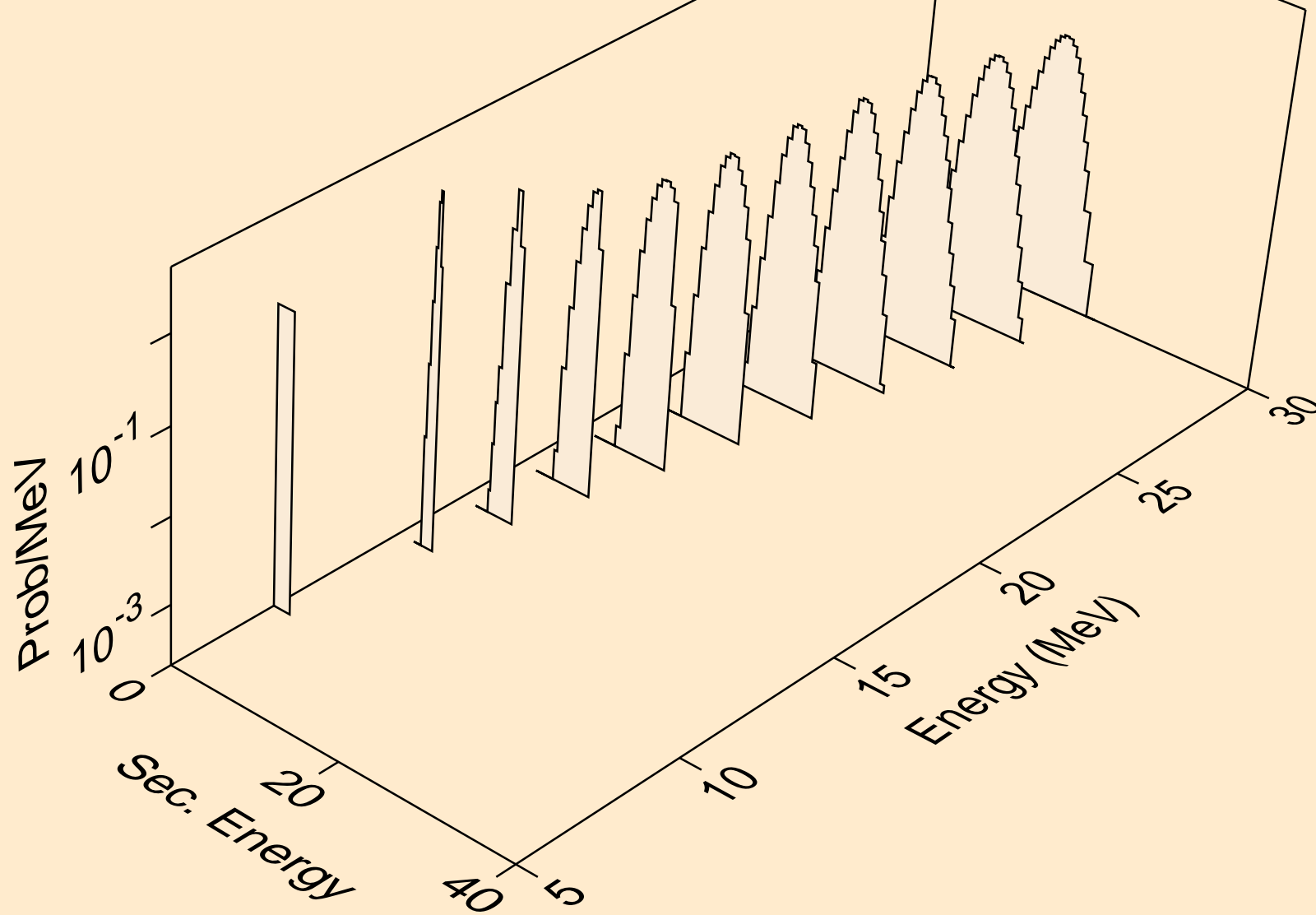

CF241 NEUTRON ACER TENDL-2021 LIBRARY; T=293.6K
deuterons from (n,d)

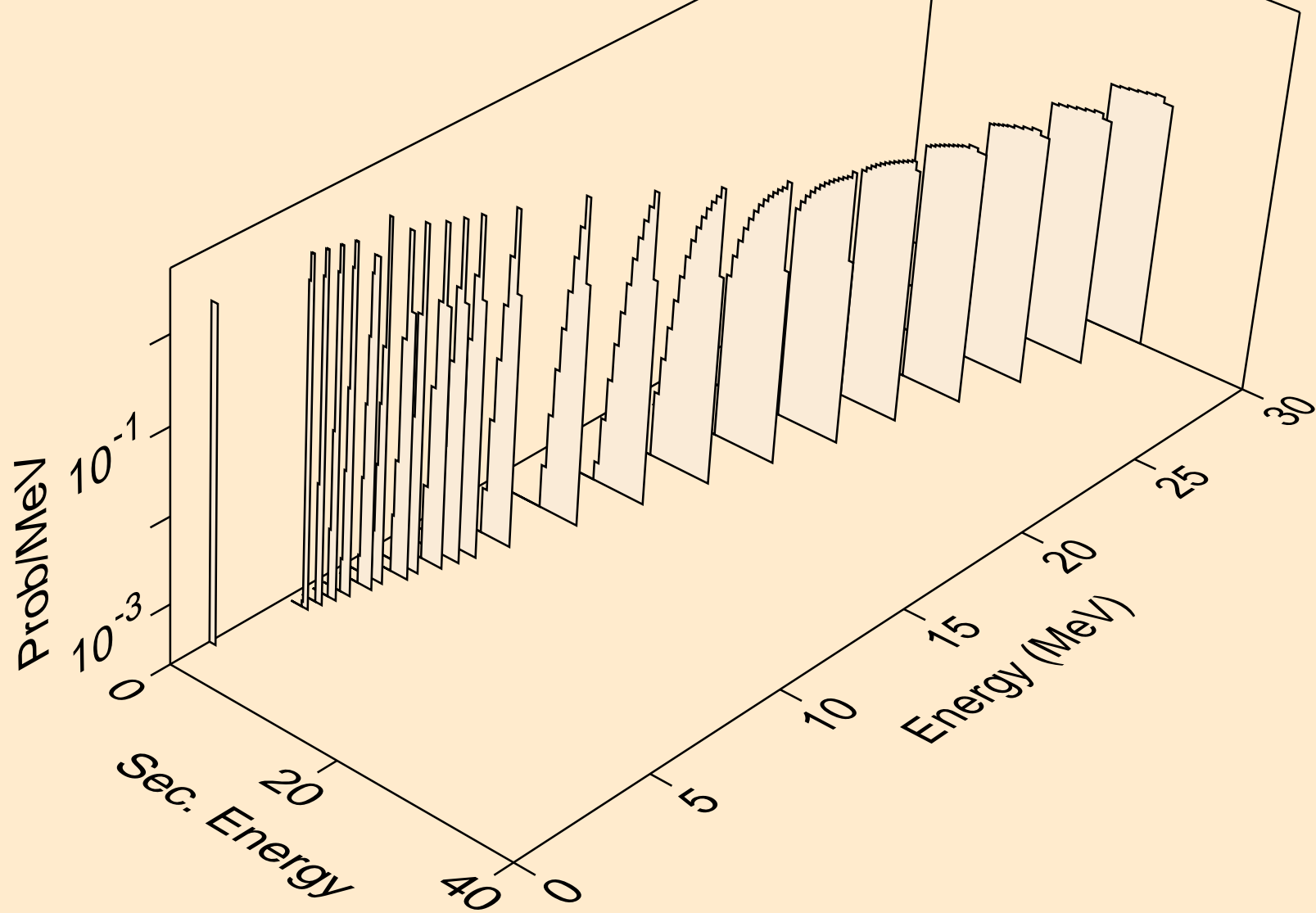

CF241 NEUTRON ACER TENDL-2021 LIBRARY; T=293.6K
deuterons from (n,da)

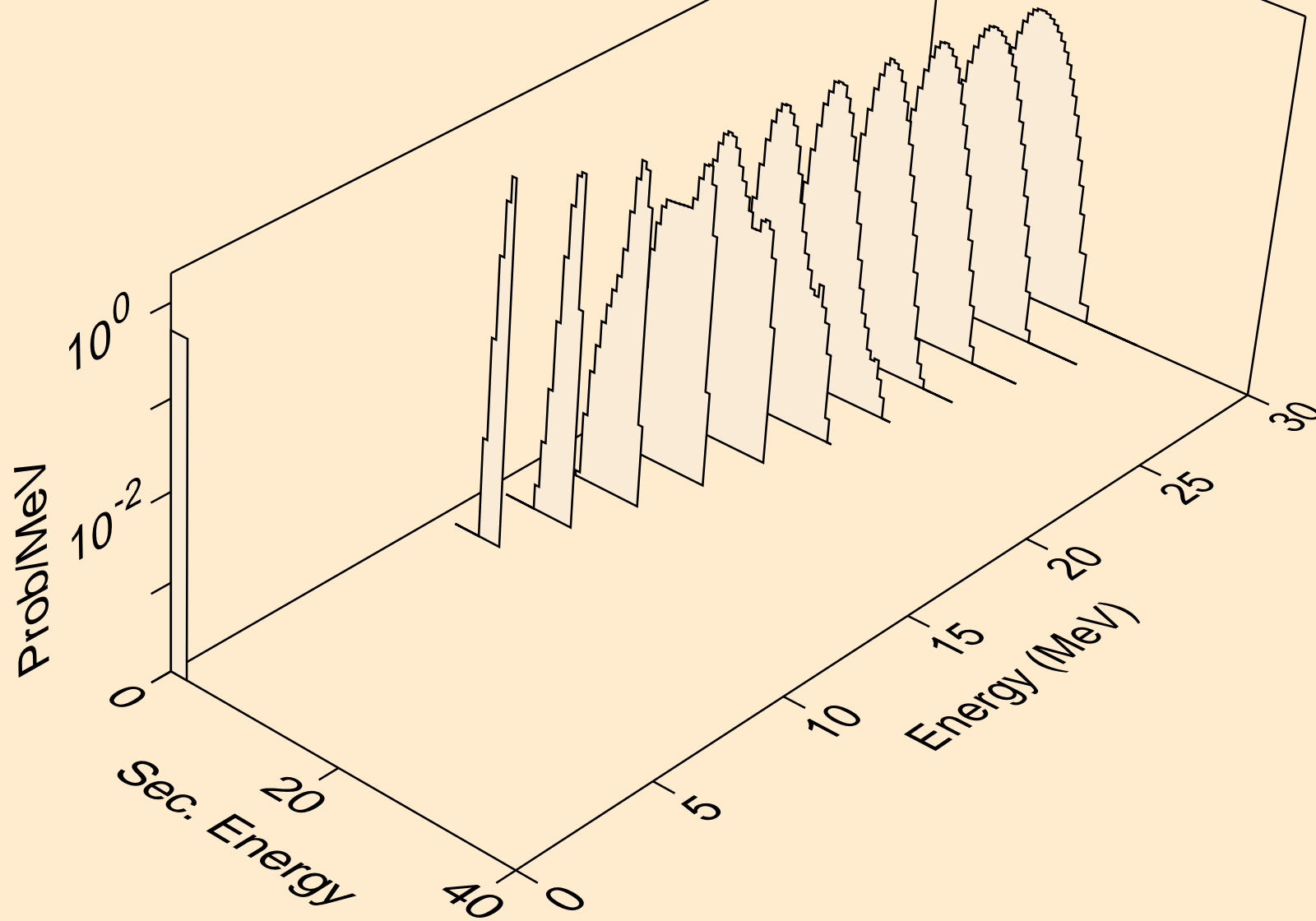

CF241 NEUTRON ACER TENDL-2021 LIBRARY; T=293.6K
tritons from (n,x)

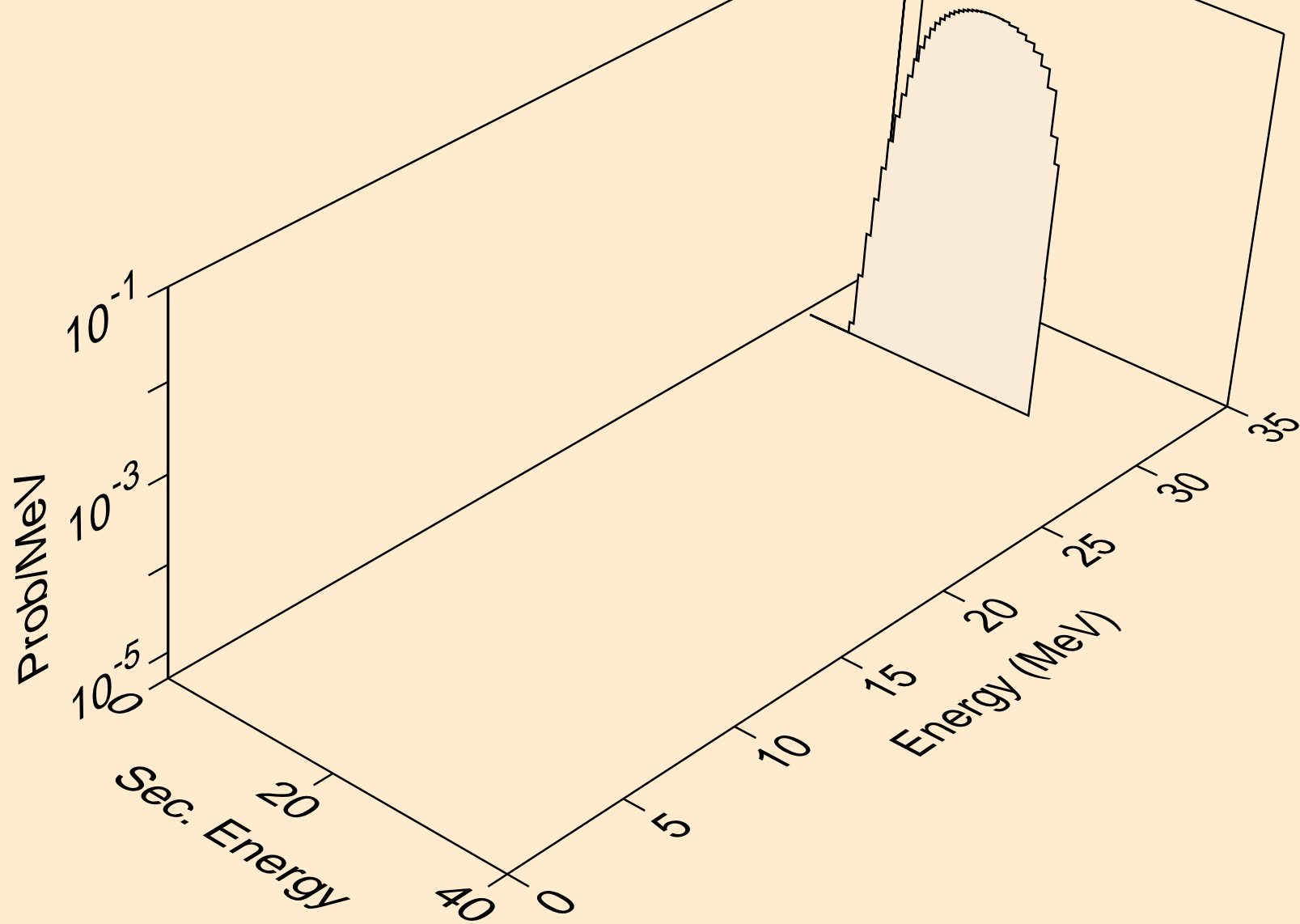

CF241 NEUTRON ACER TENDL-2021 LIBRARY; T=293.6K
tritons from (n,n*)t

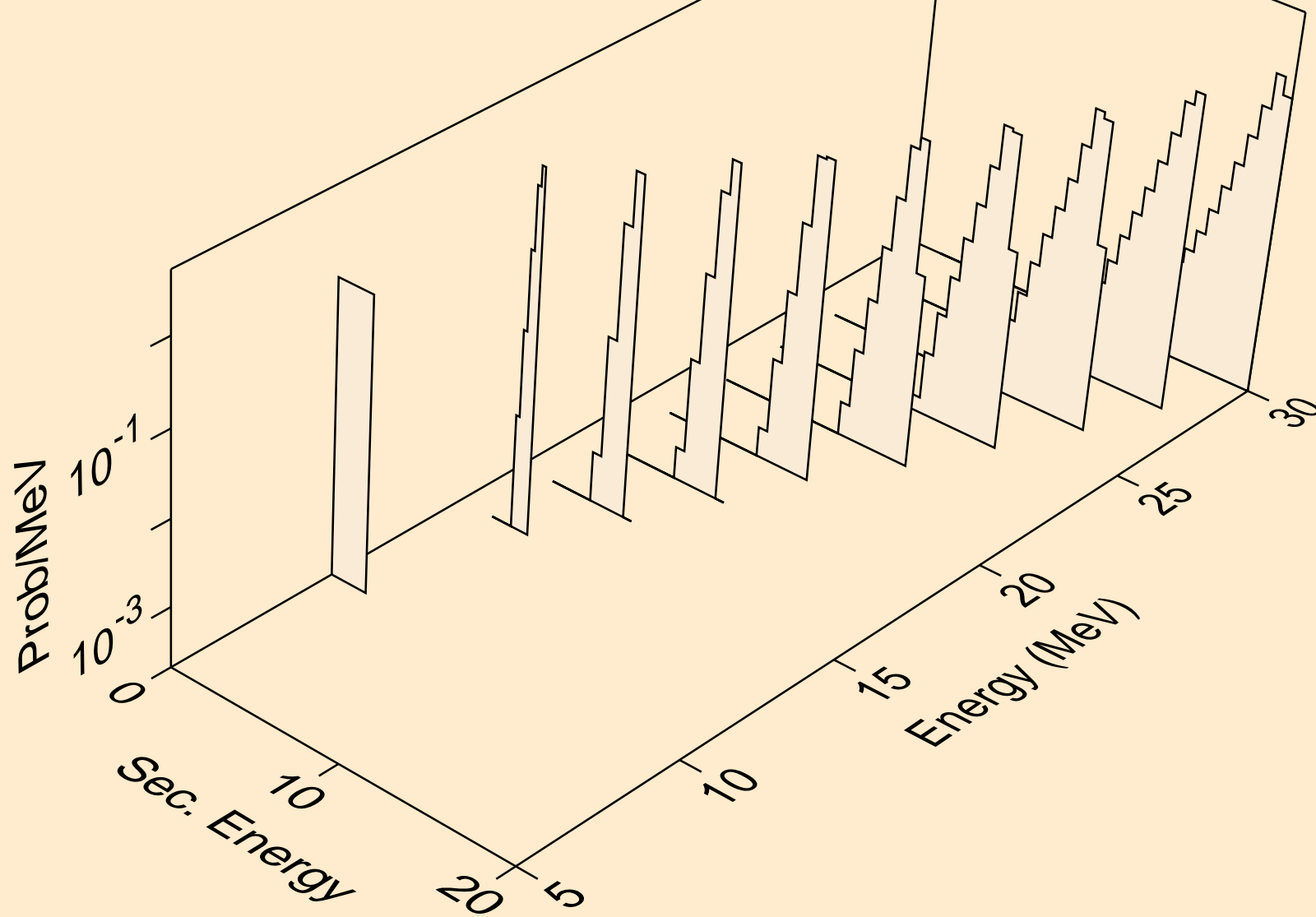

CF241 NEUTRON ACER TENDL-2021 LIBRARY; T=293.6K
tritons from (n,t)

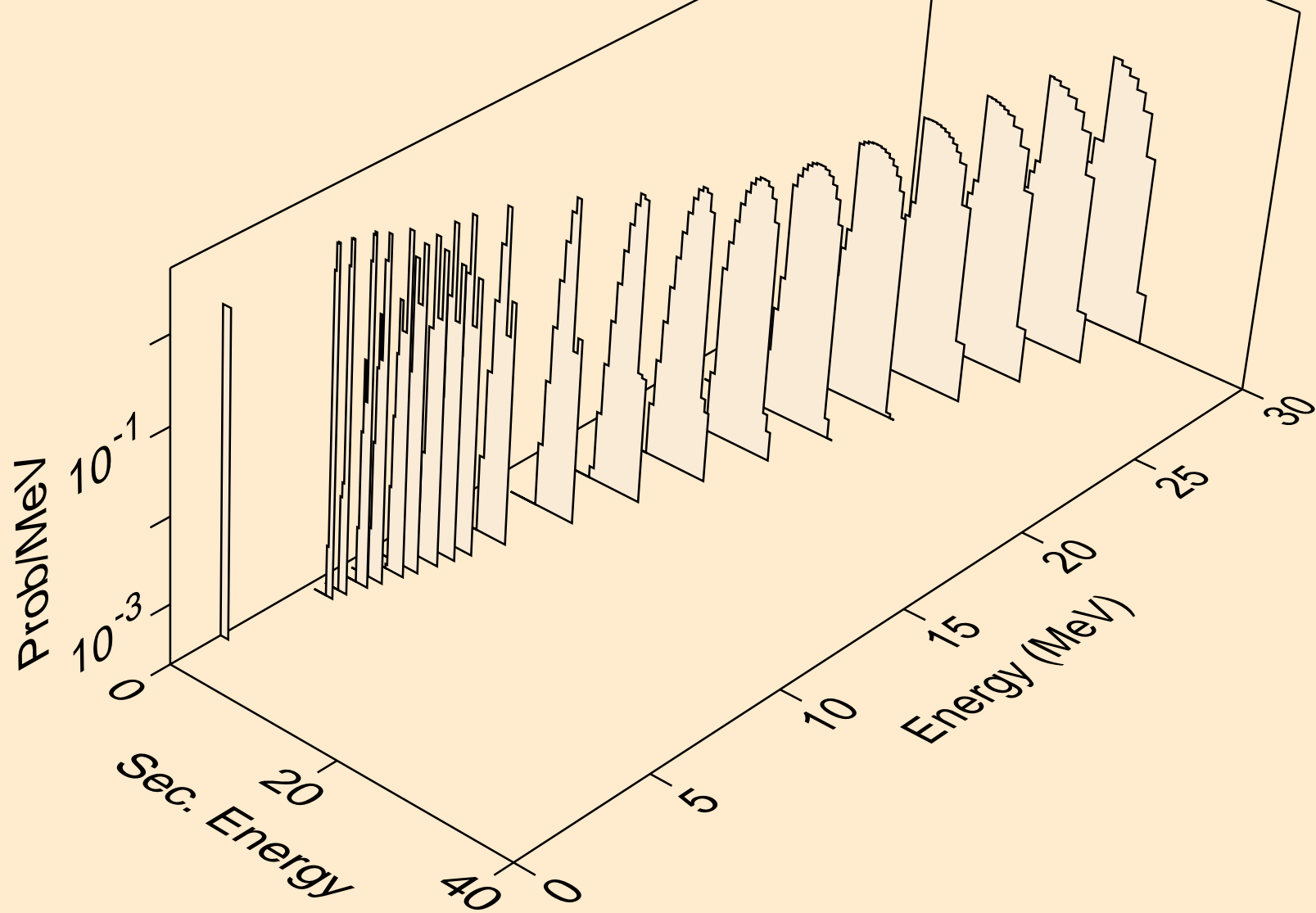

CF241 NEUTRON ACER TENDL-2021 LIBRARY; T=293.6K
he3s from (n,x)

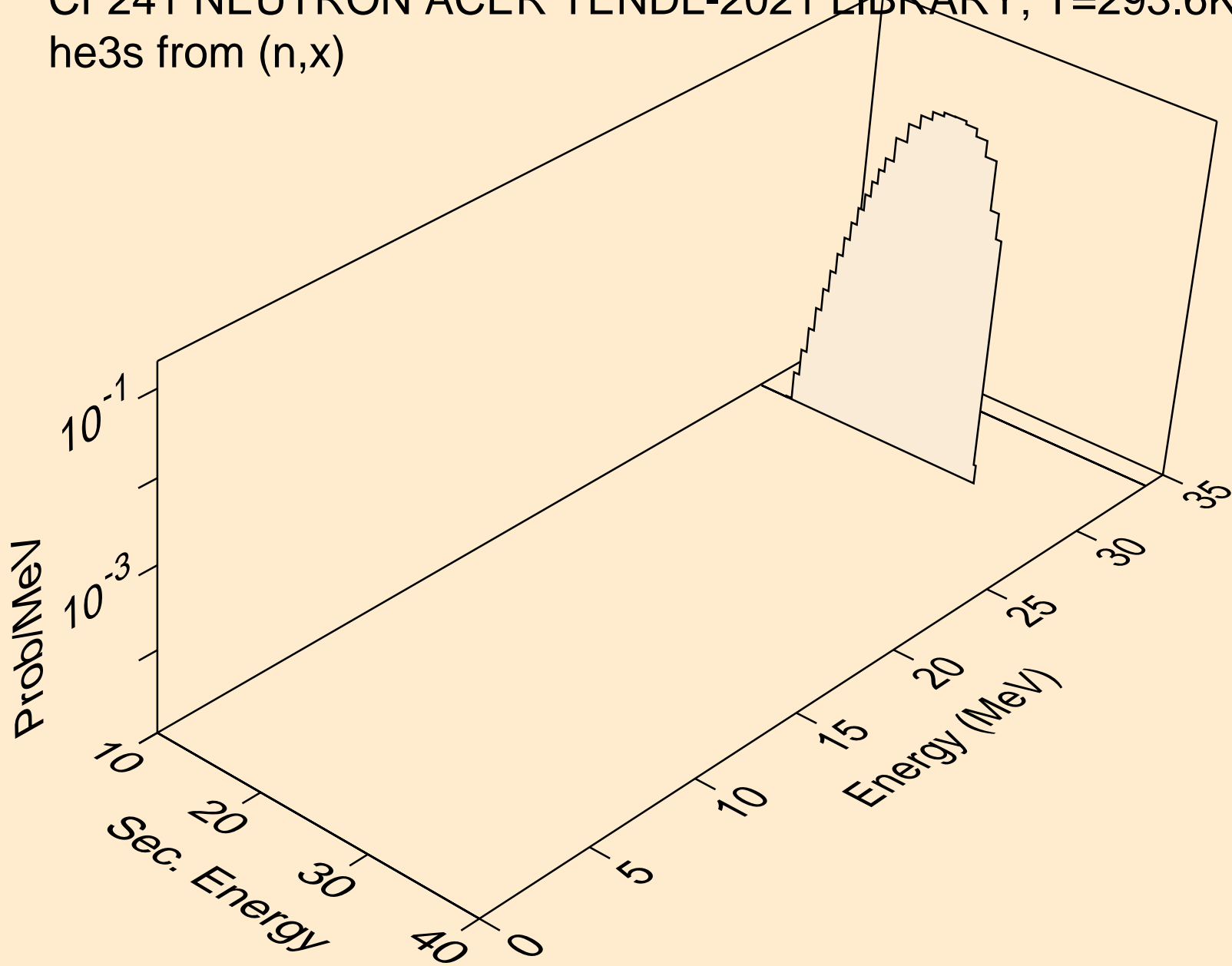

CF241 NEUTRON ACER TENDL-2021 LIBRARY; T=293.6K
he3s from (n,n*)he3

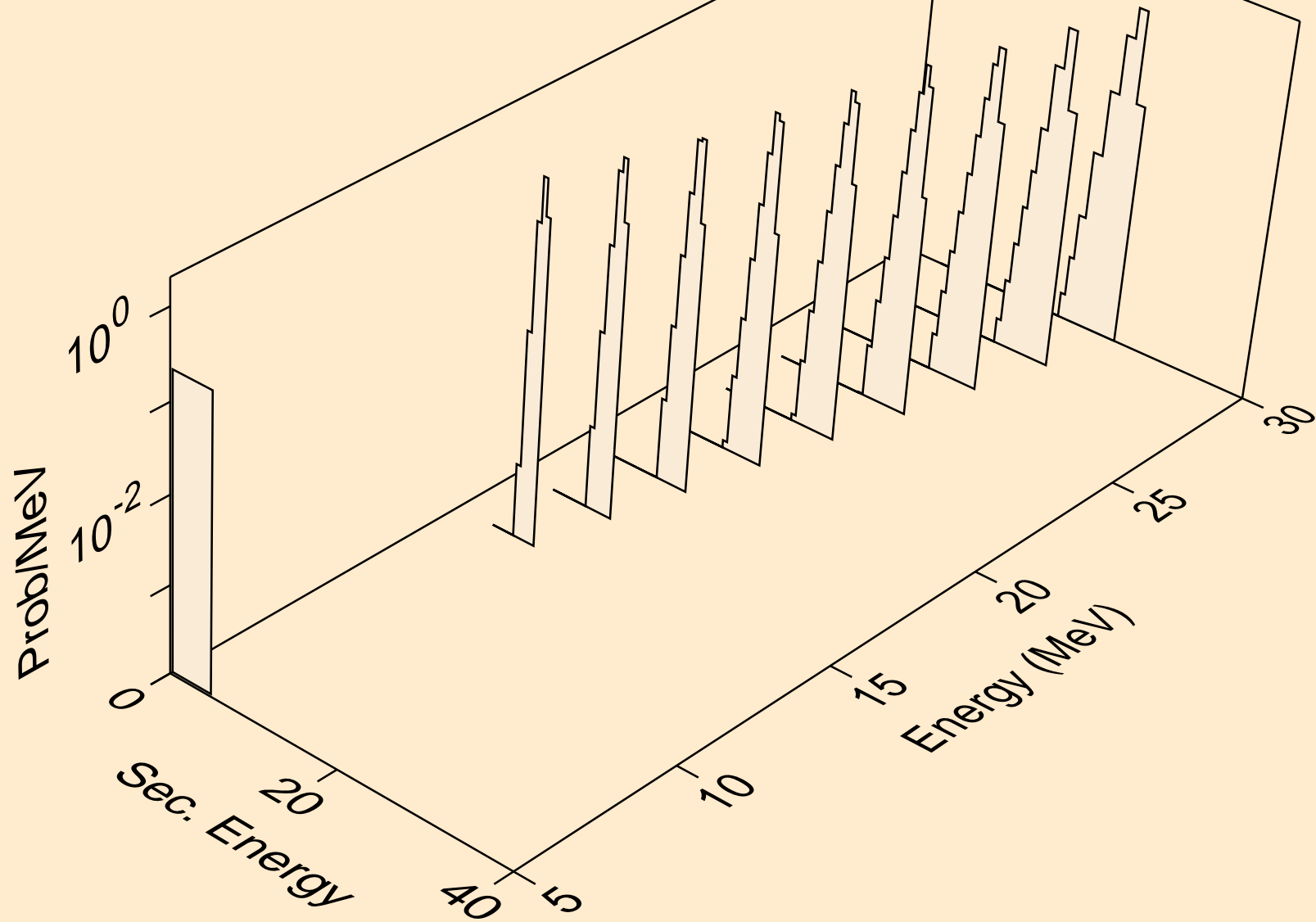

CF241 NEUTRON ACER TENDL-2021 LIBRARY; T=293.6K
he3s from (n,he3)

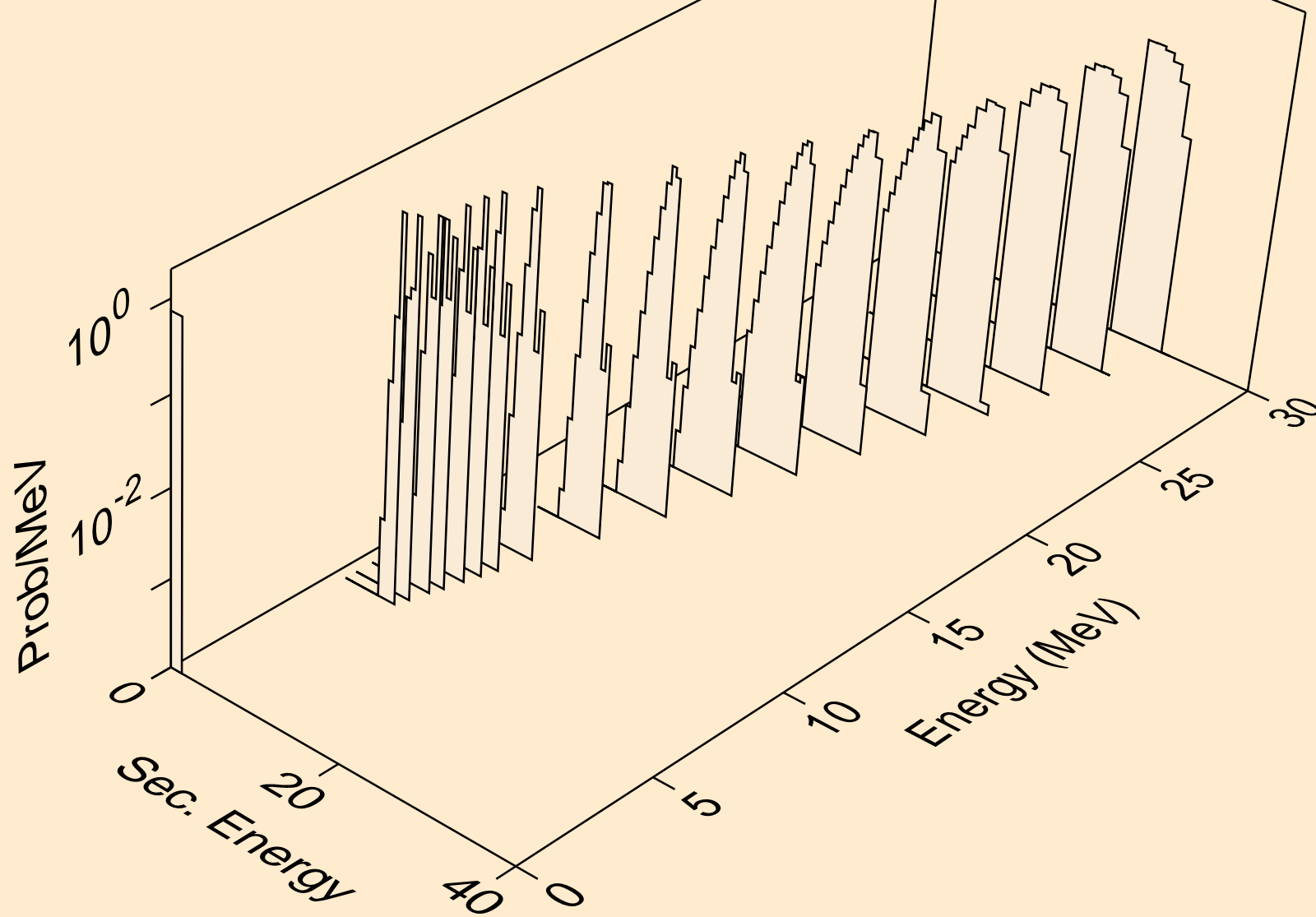

CF241 NEUTRON ACER TENDL-2021 LIBRARY; T=293.6K
alphas from (n,x)

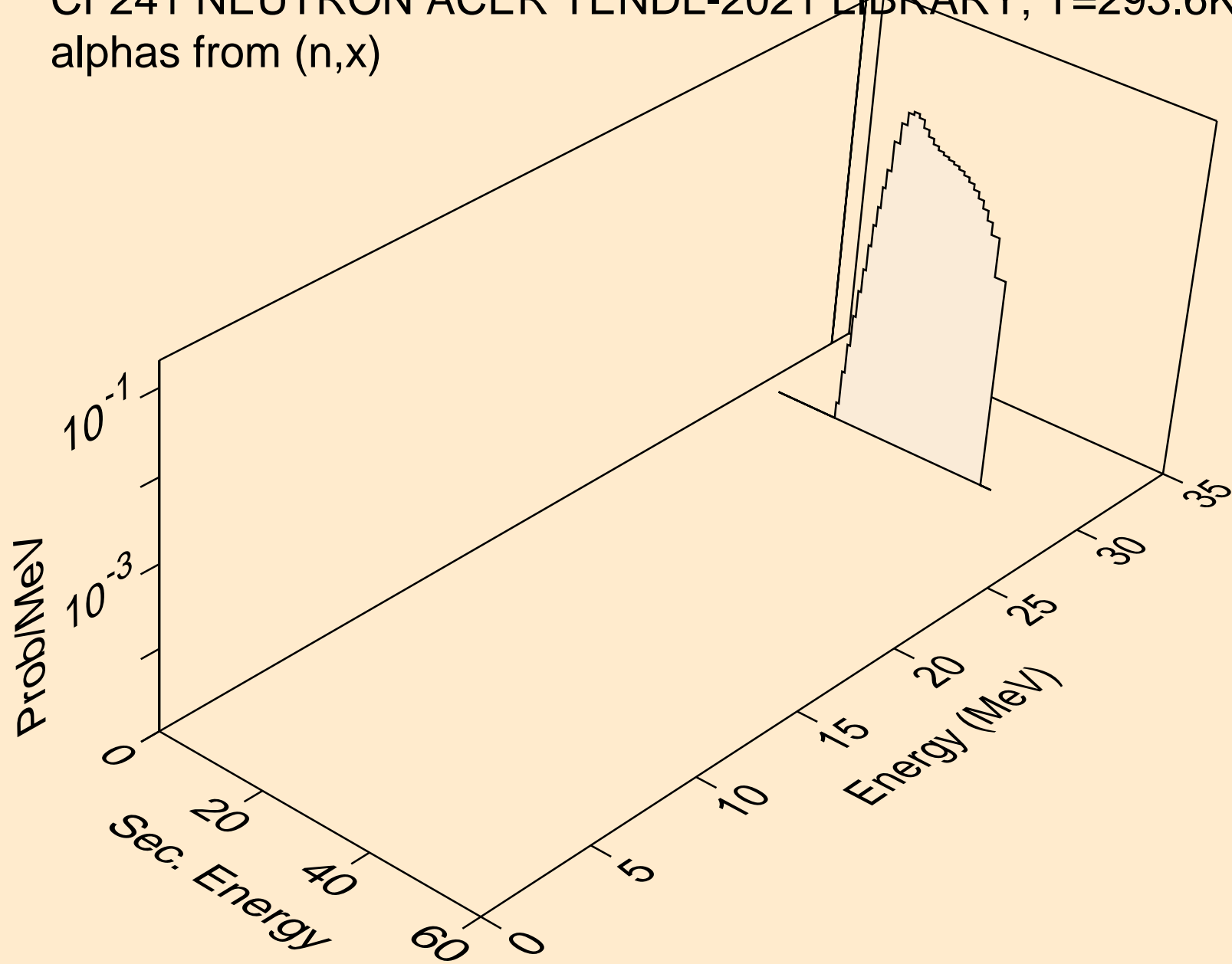

CF241 NEUTRON ACER TENDL-2021 LIBRARY; T=293.6K
alphas from (n,n*)a

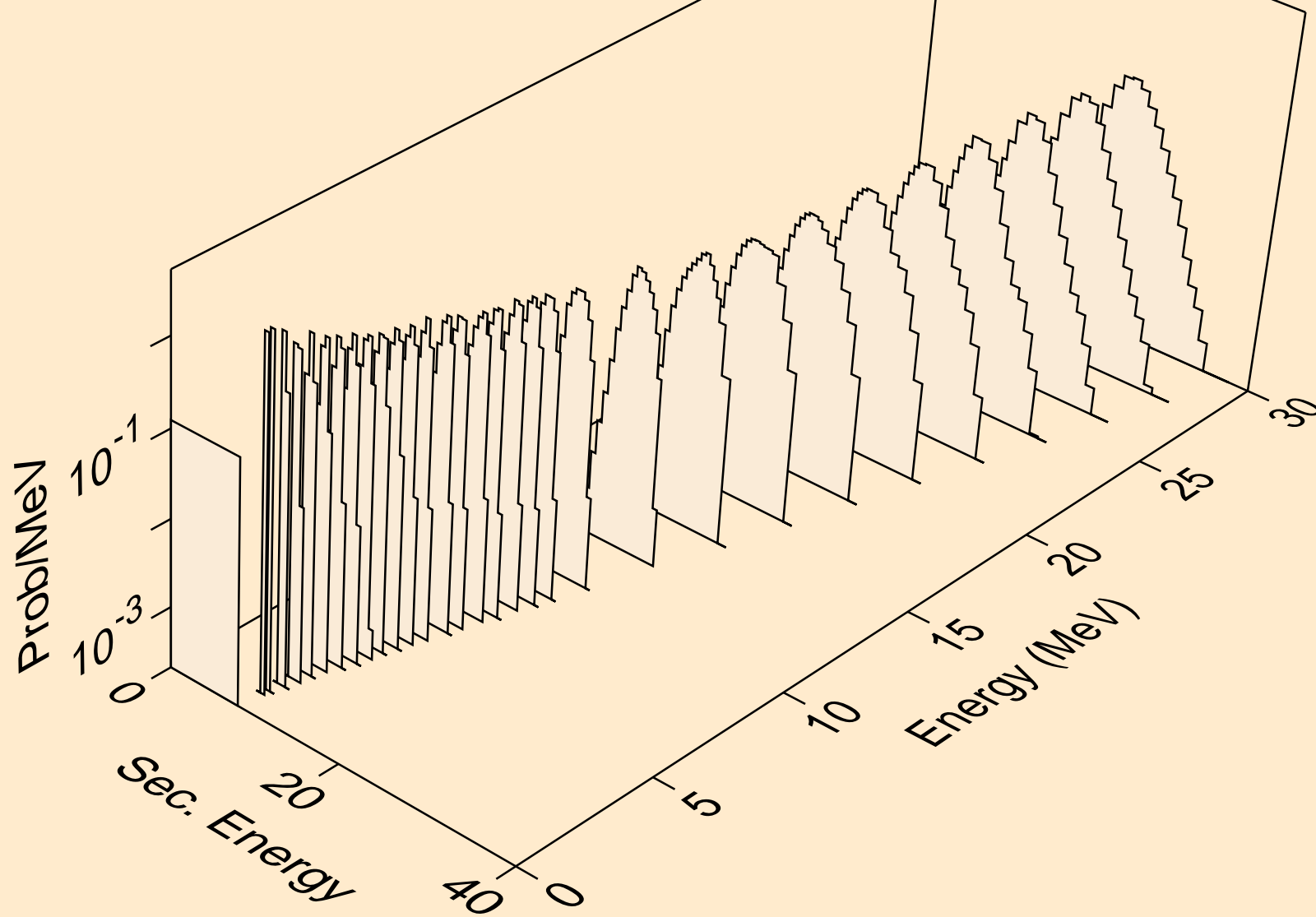

CF241 NEUTRON ACER TENDL-2021 LIBRARY; T=293.6K
alphas from (n,2n)a

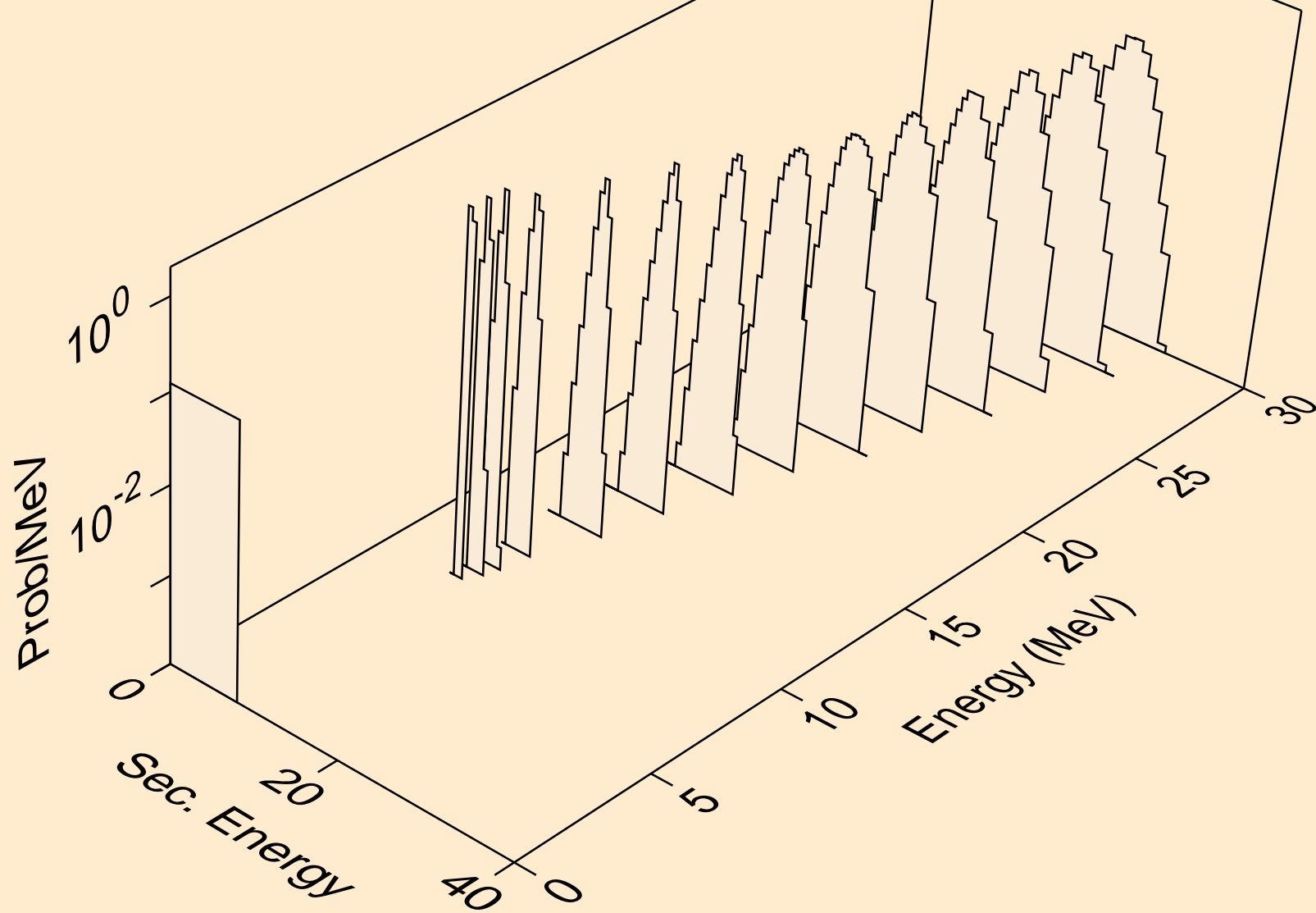

CF241 NEUTRON ACER TENDL-2021 LIBRARY; T=293.6K
alphas from (n,3n)a

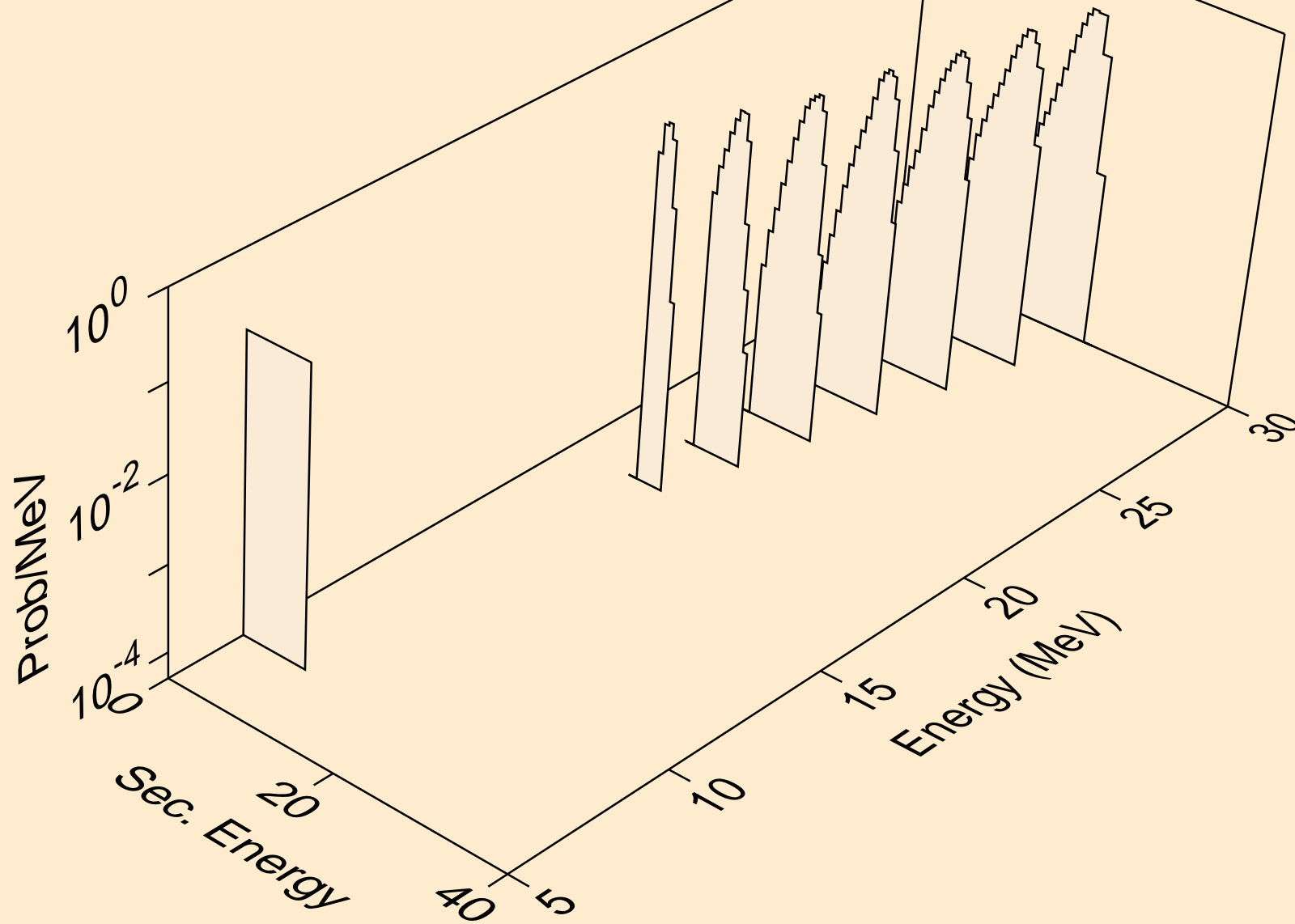

CF241 NEUTRON ACER TENDL-2021 LIBRARY; T=293.6K
alphas from (n,npa)

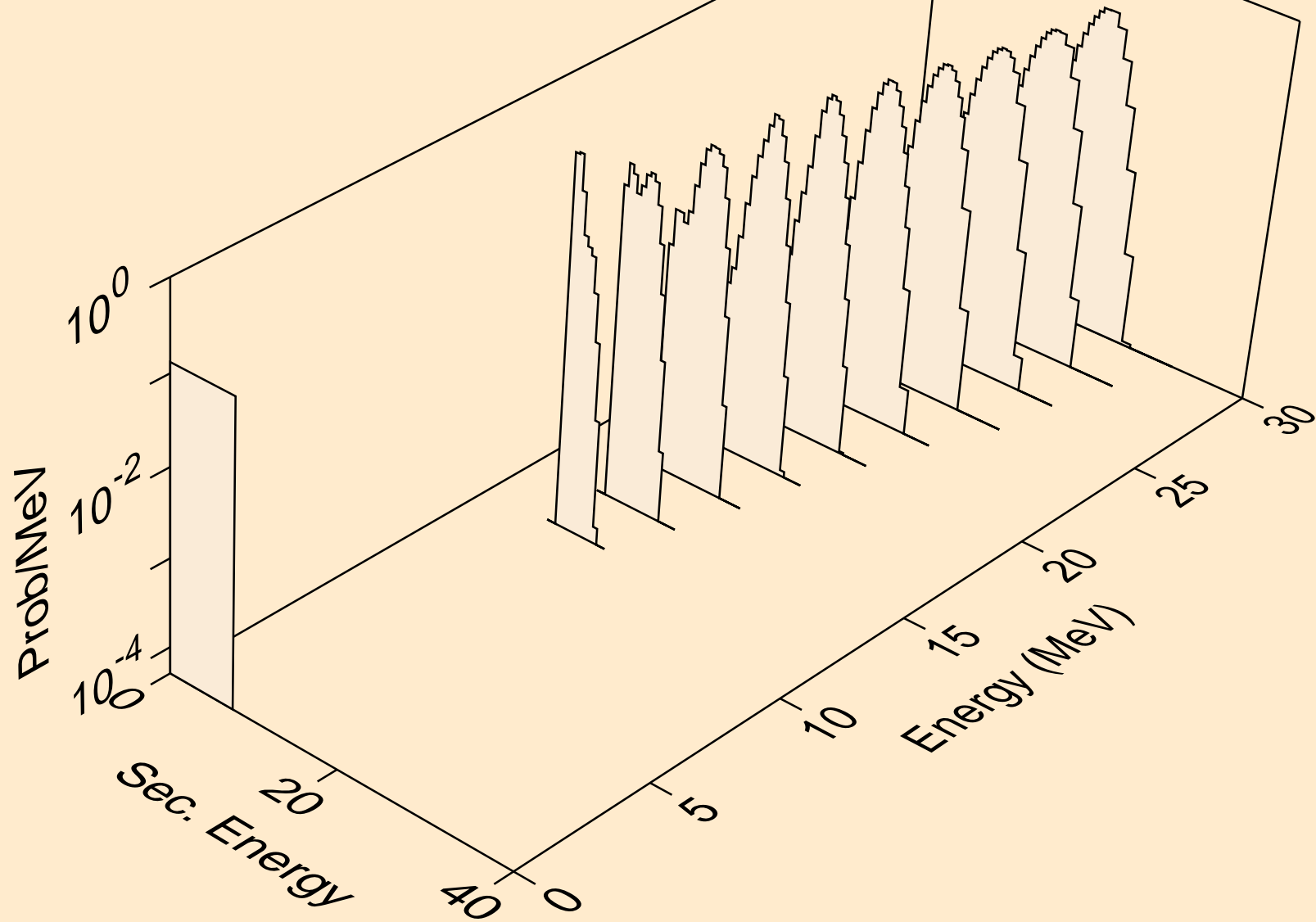

CF241 NEUTRON ACER TENDL-2021 LIBRARY; T=293.6K
alphas from (n,a)

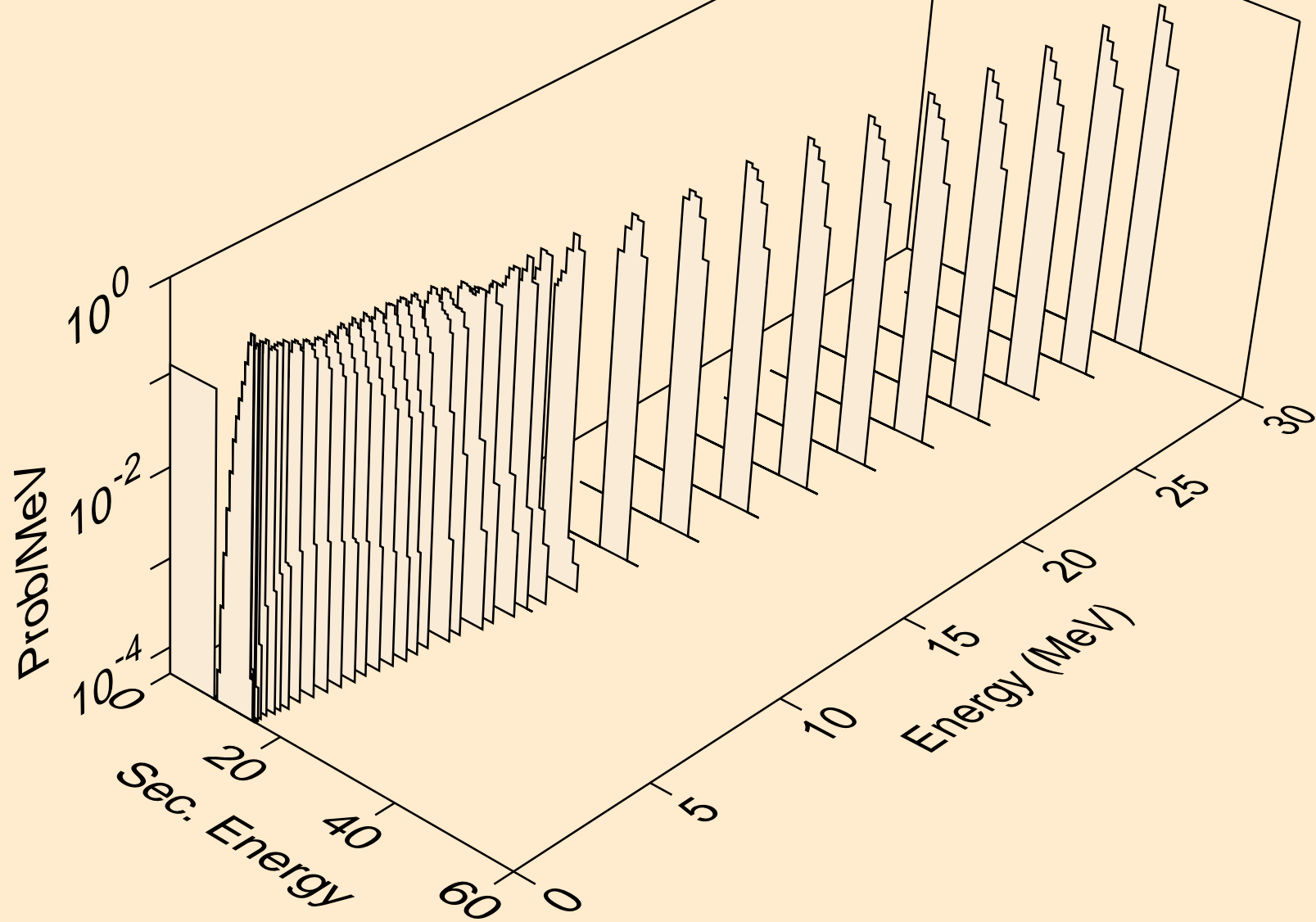

CF241 NEUTRON ACER TENDL-2021 LIBRARY; T=293.6K
alphas from (n,pa)

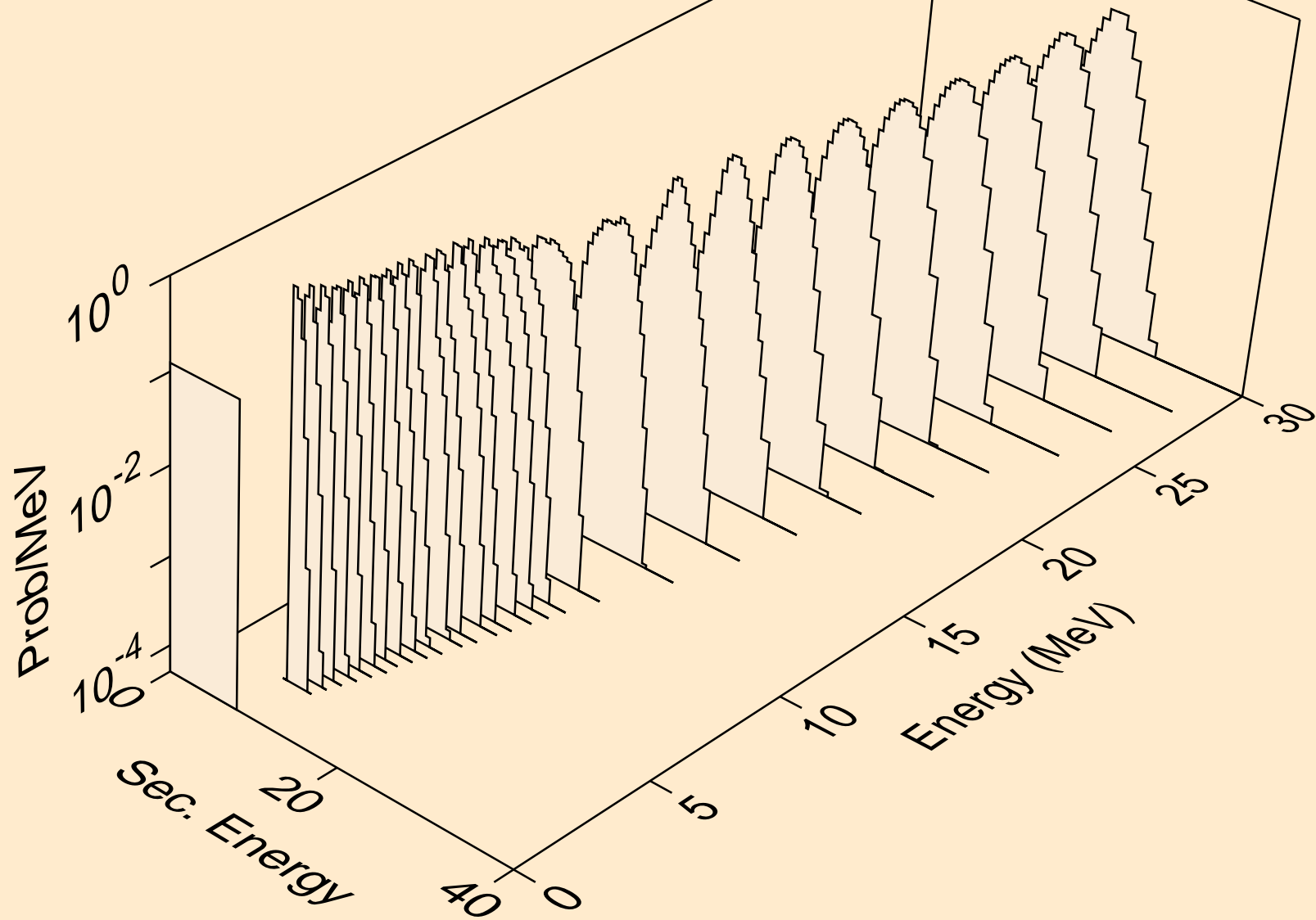

CF241 NEUTRON ACER TENDL-2021 LIBRARY; T=293.6K
alphas from (n,da)

