

CF246 NEUTRON ACER TENDL-2021 LIBRARY; T=293.6K

Principal cross sections

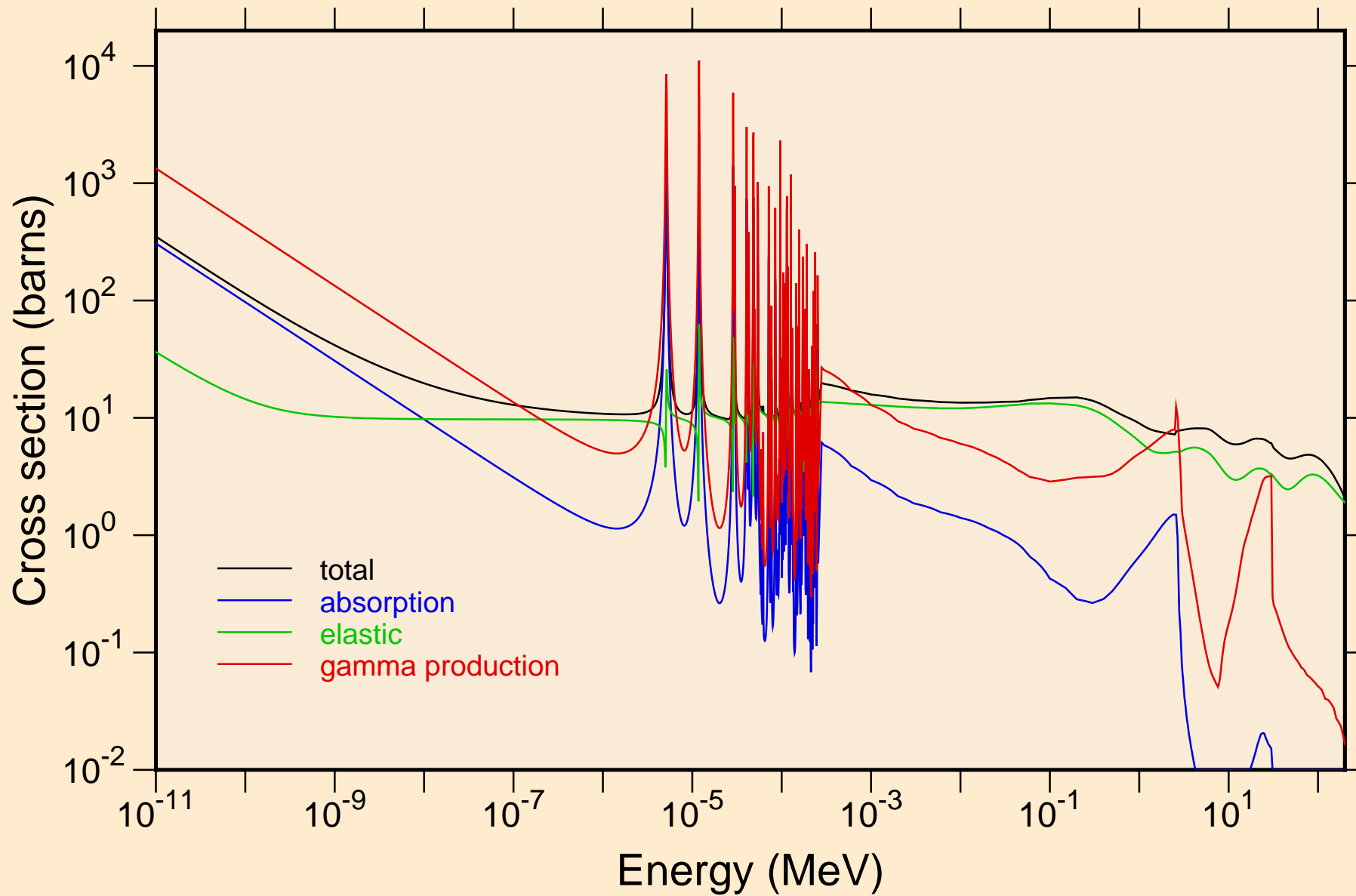

CF246 NEUTRON ACER TENDL-2021 LIBRARY; T=293.6K
resonance total cross section

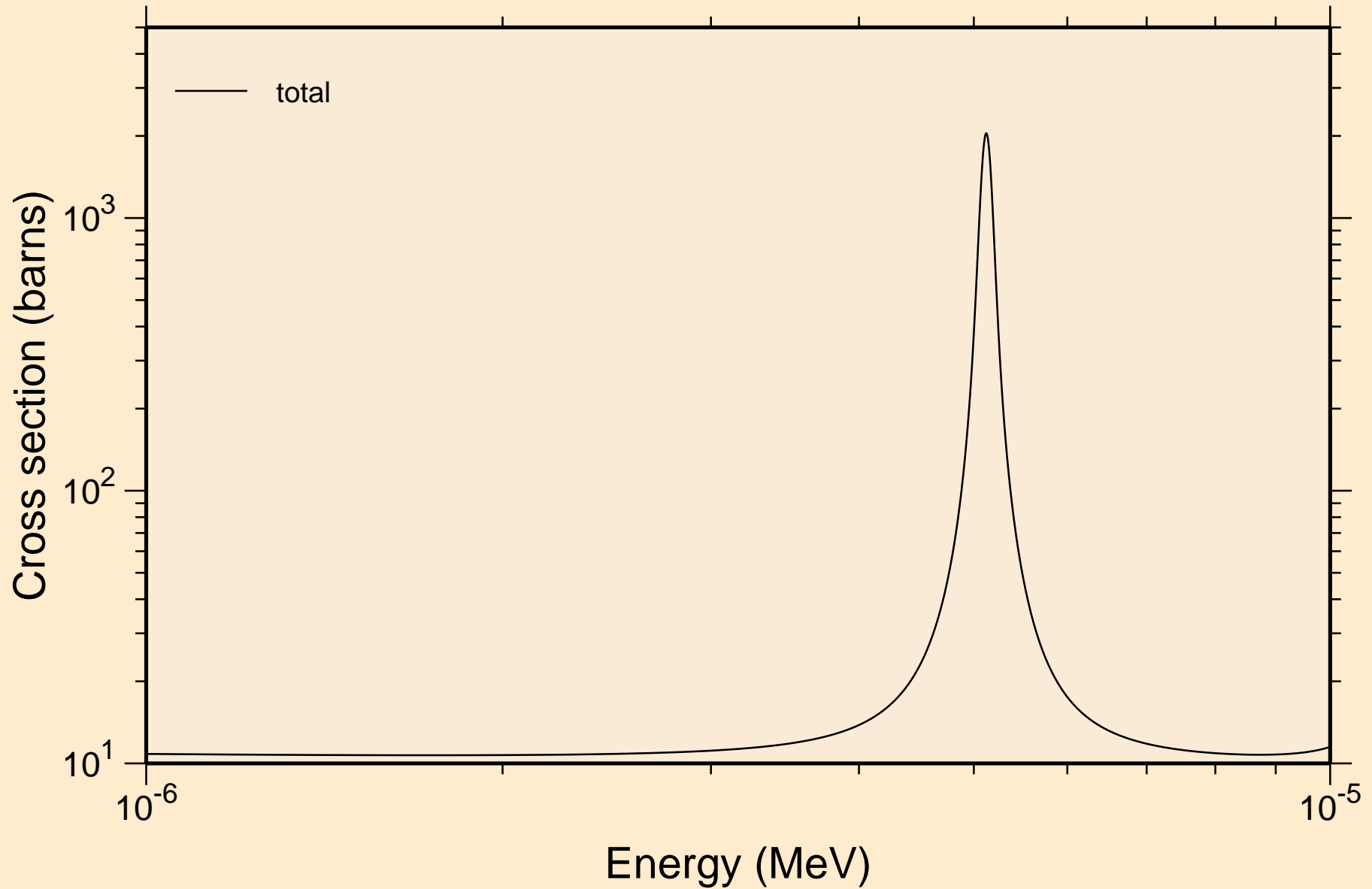

CF246 NEUTRON ACER TENDL-2021 LIBRARY; T=293.6K
resonance total cross section

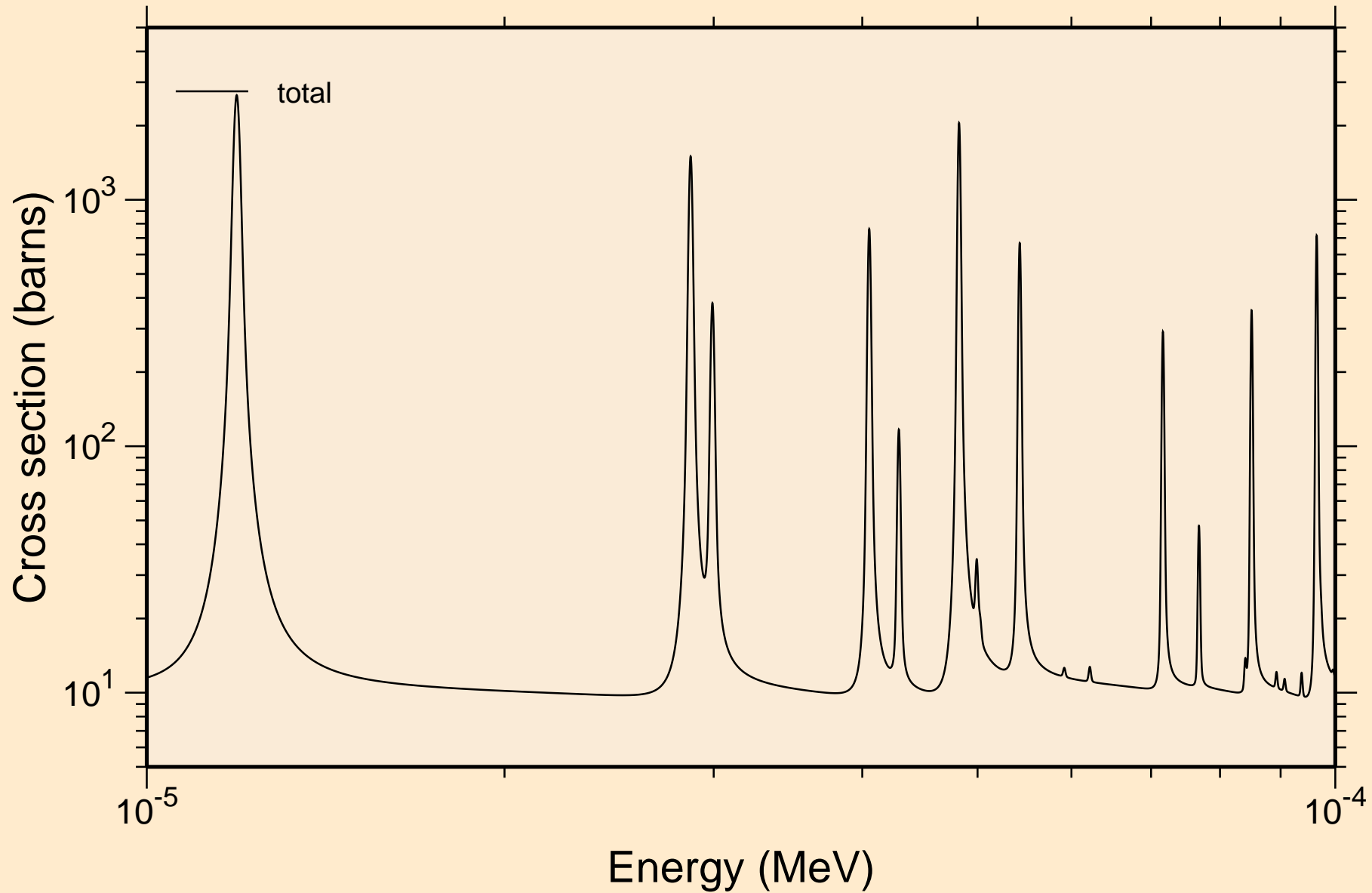

CF246 NEUTRON ACER TENDL-2021 LIBRARY; T=293.6K
resonance total cross section

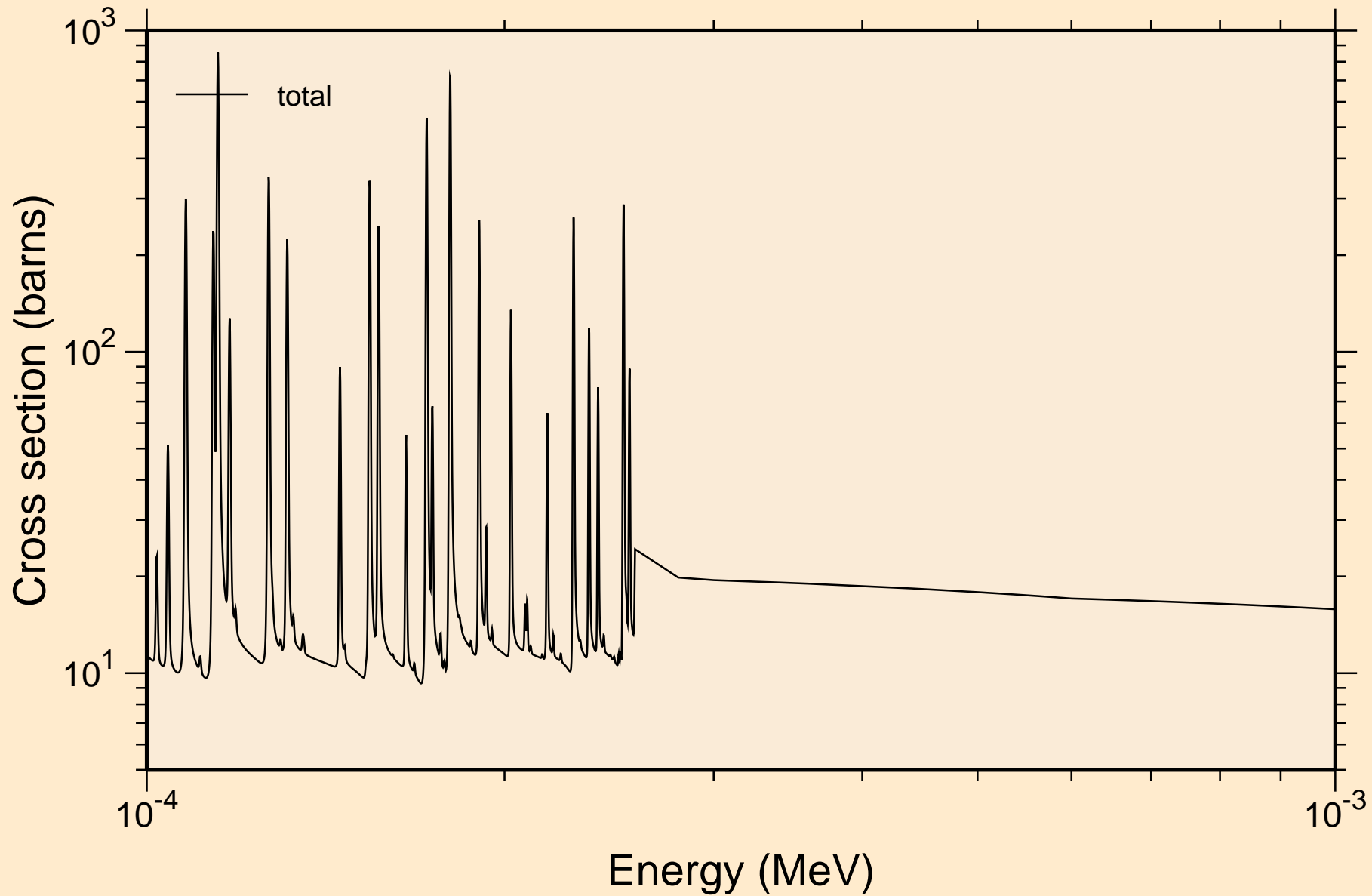

CF246 NEUTRON ACER TENDL-2021 LIBRARY; T=293.6K
resonance total cross section

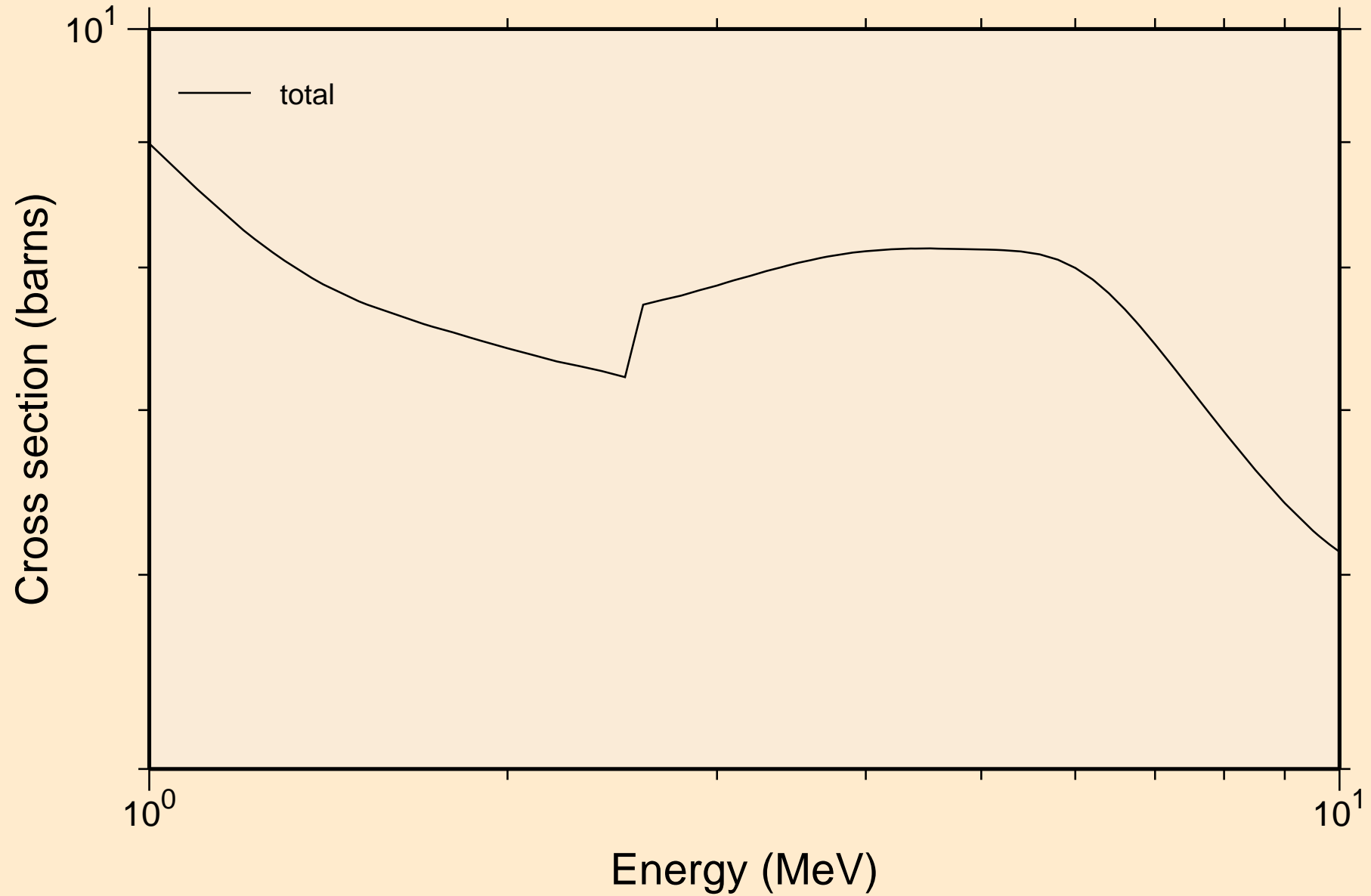

CF246 NEUTRON ACER TENDL-2021 LIBRARY; T=293.6K
resonance absorption cross sections

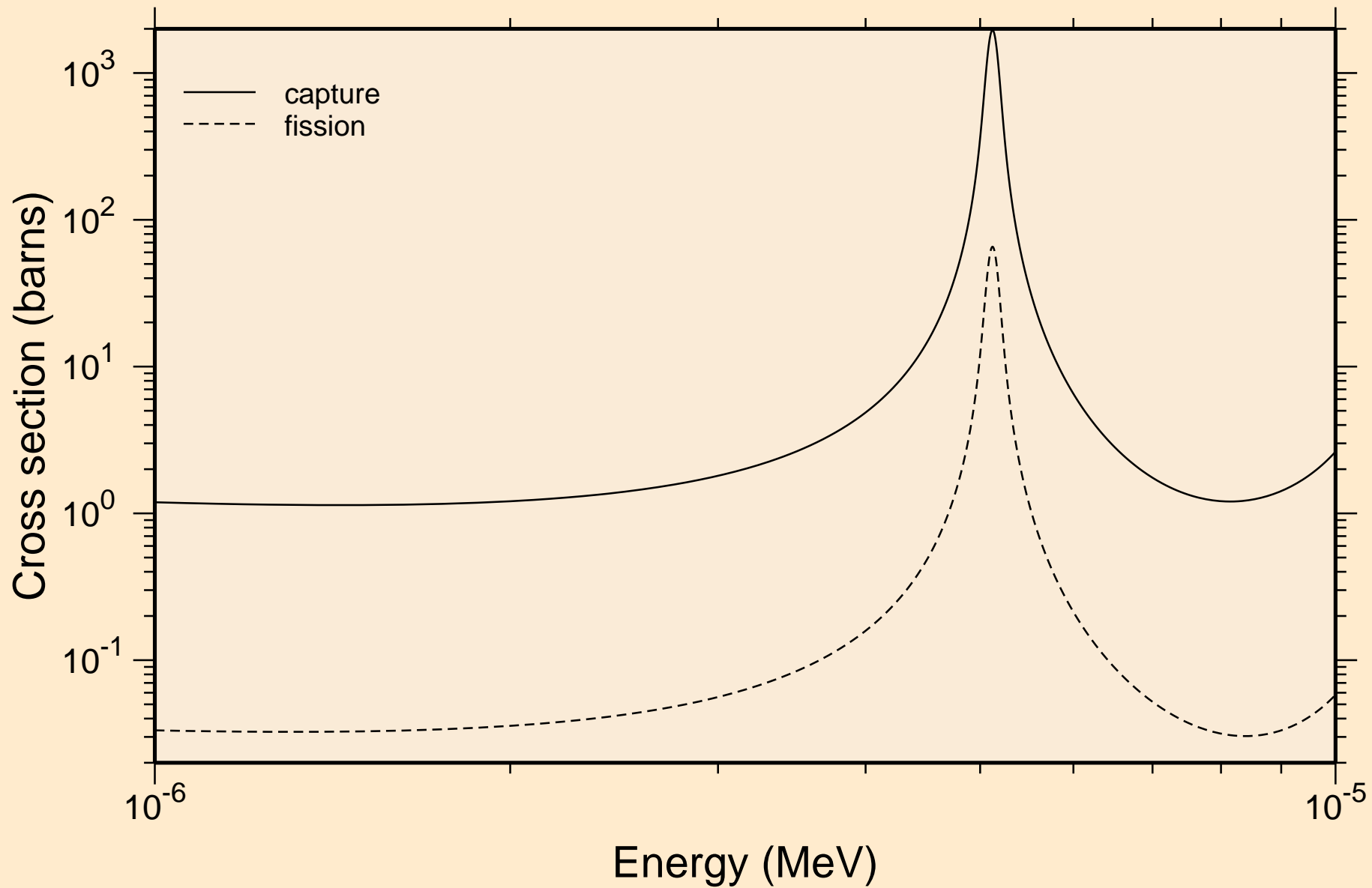

CF246 NEUTRON ACER TENDL-2021 LIBRARY; T=293.6K
resonance absorption cross sections

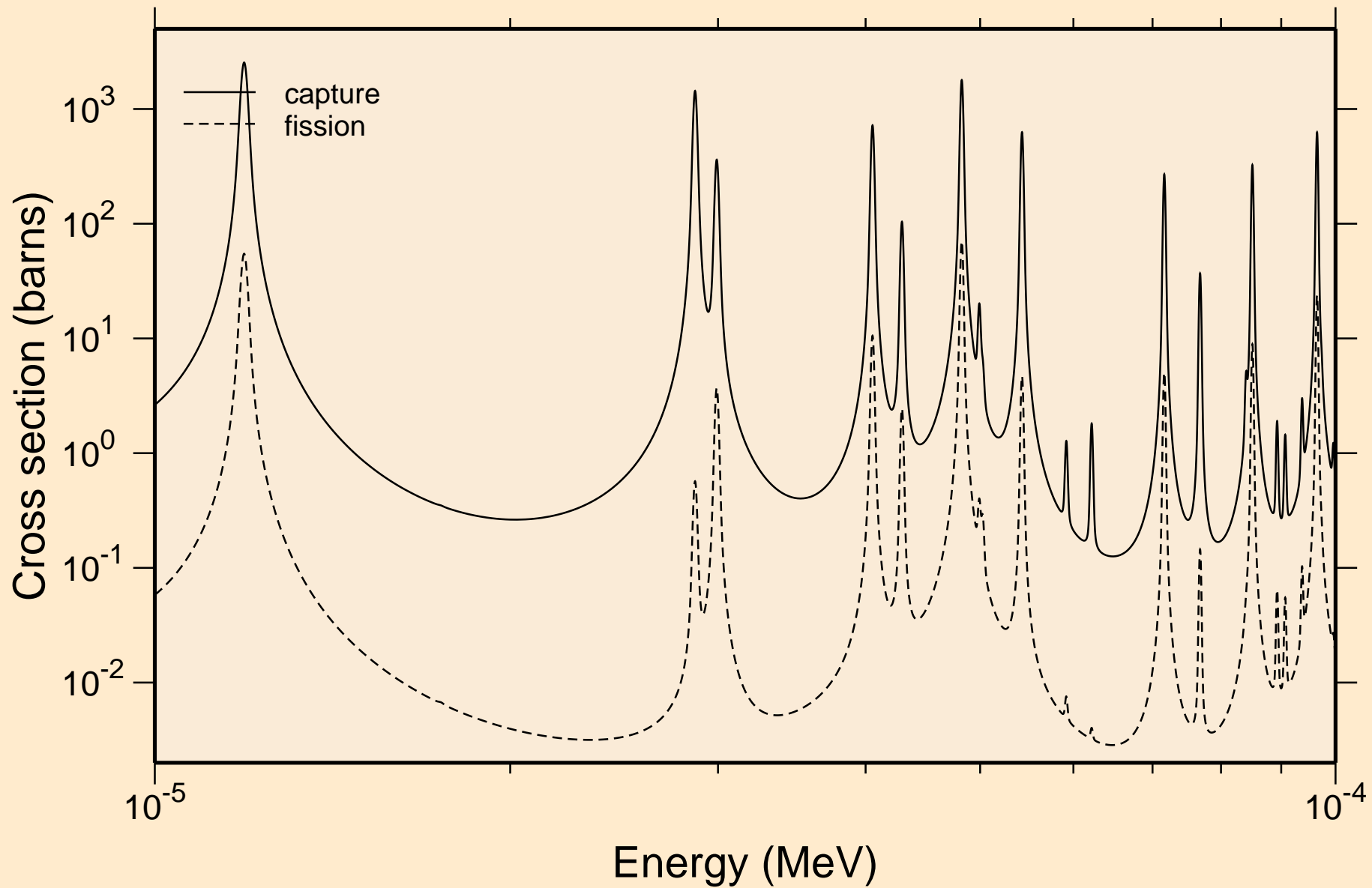

CF246 NEUTRON ACER TENDL-2021 LIBRARY; T=293.6K
resonance absorption cross sections

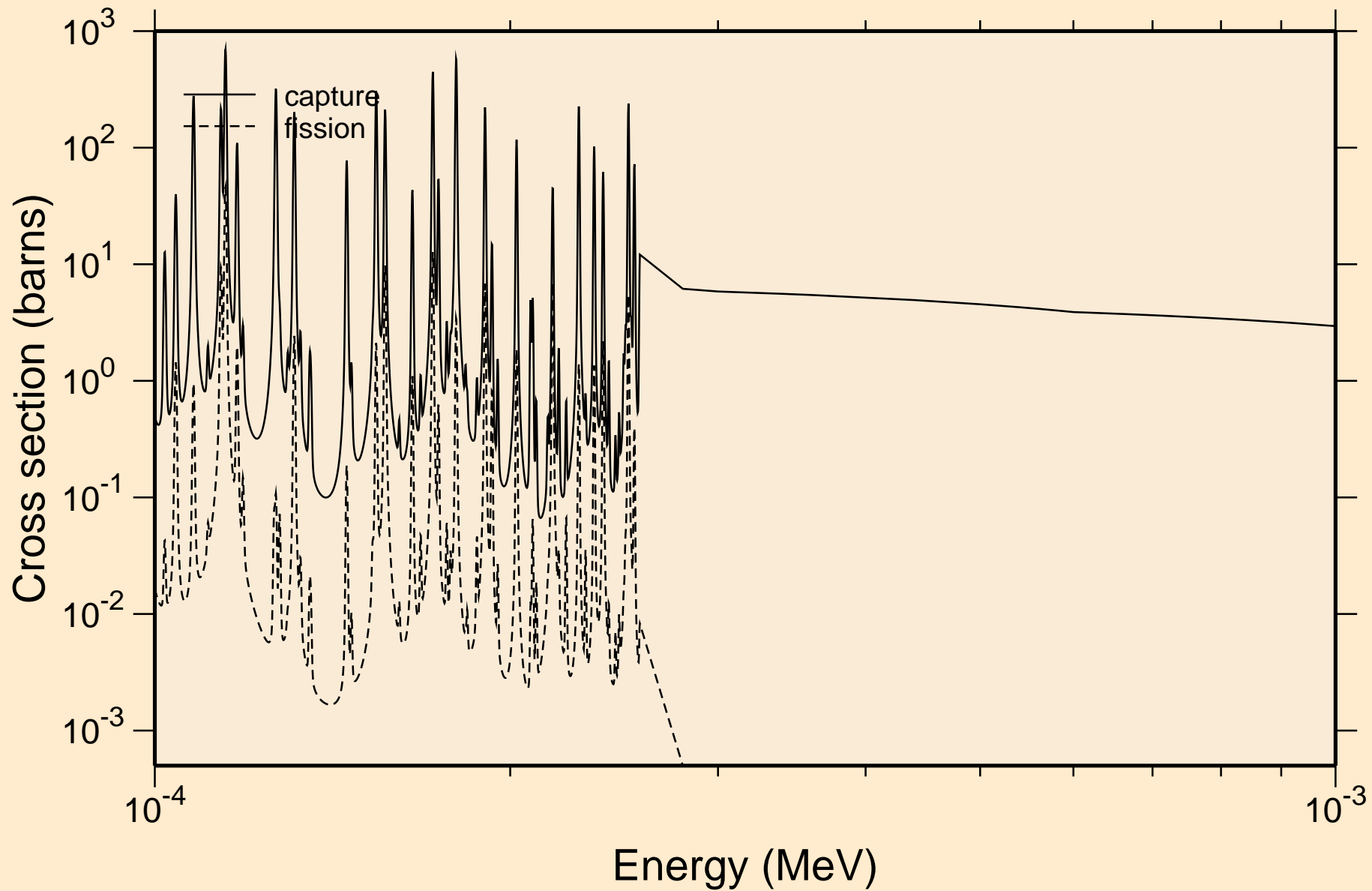

CF246 NEUTRON ACER TENDL-2021 LIBRARY; T=293.6K
resonance absorption cross sections

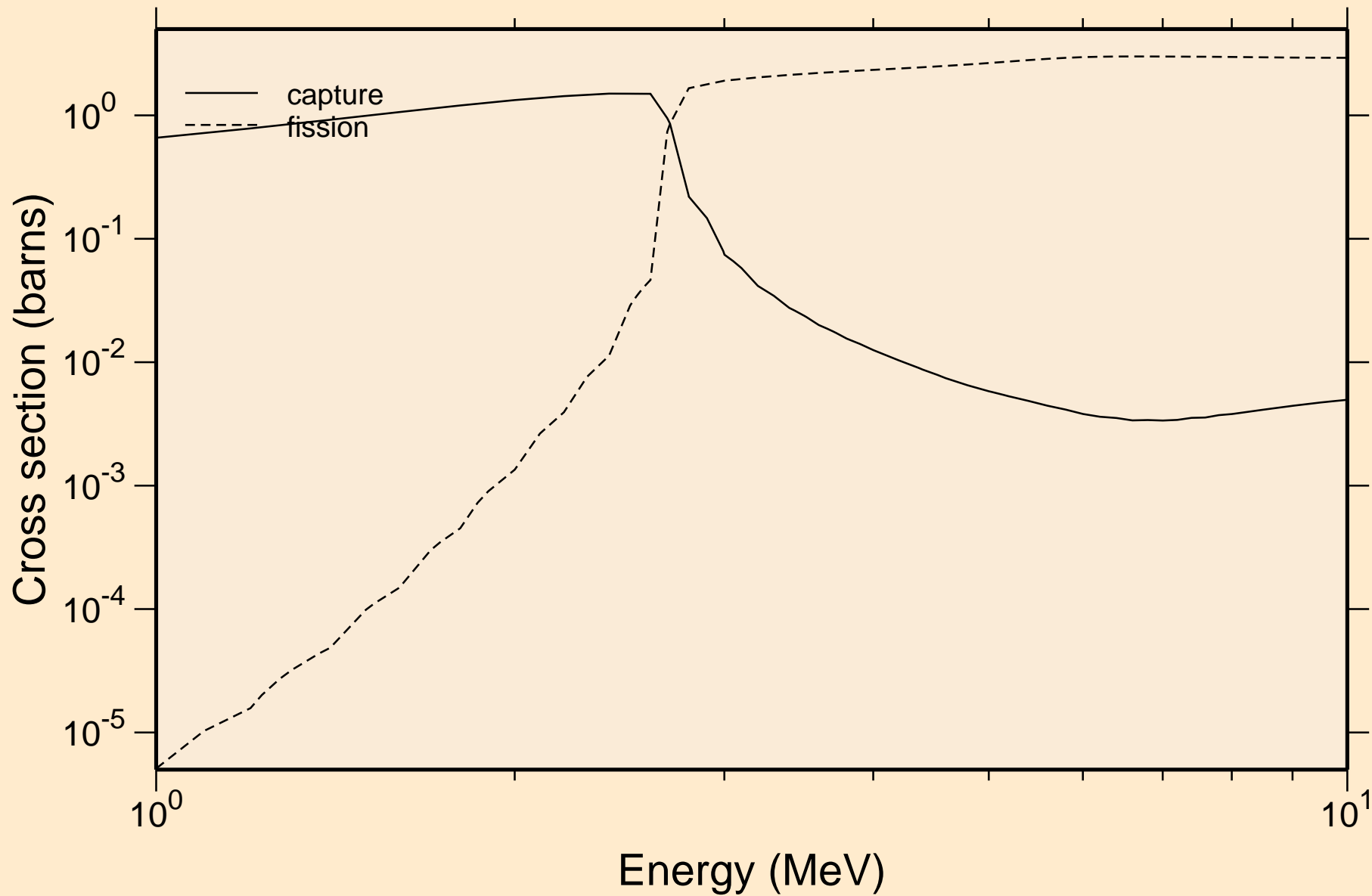

CF246 NEUTRON ACER TENDL-2021 LIBRARY; T=293.6K
Heating

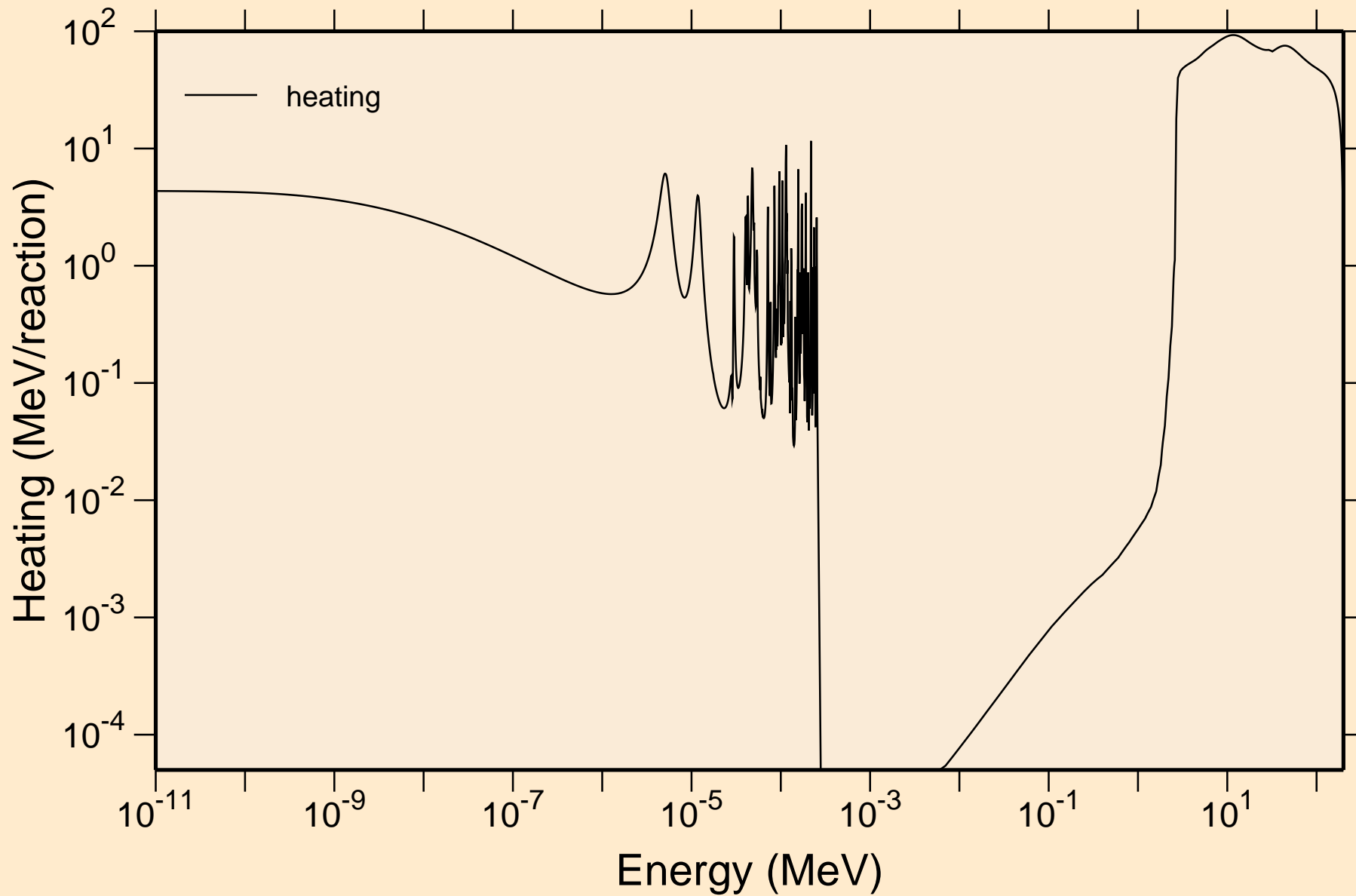

CF246 NEUTRON ACER TENDL-2021 LIBRARY; T=293.6K

Damage

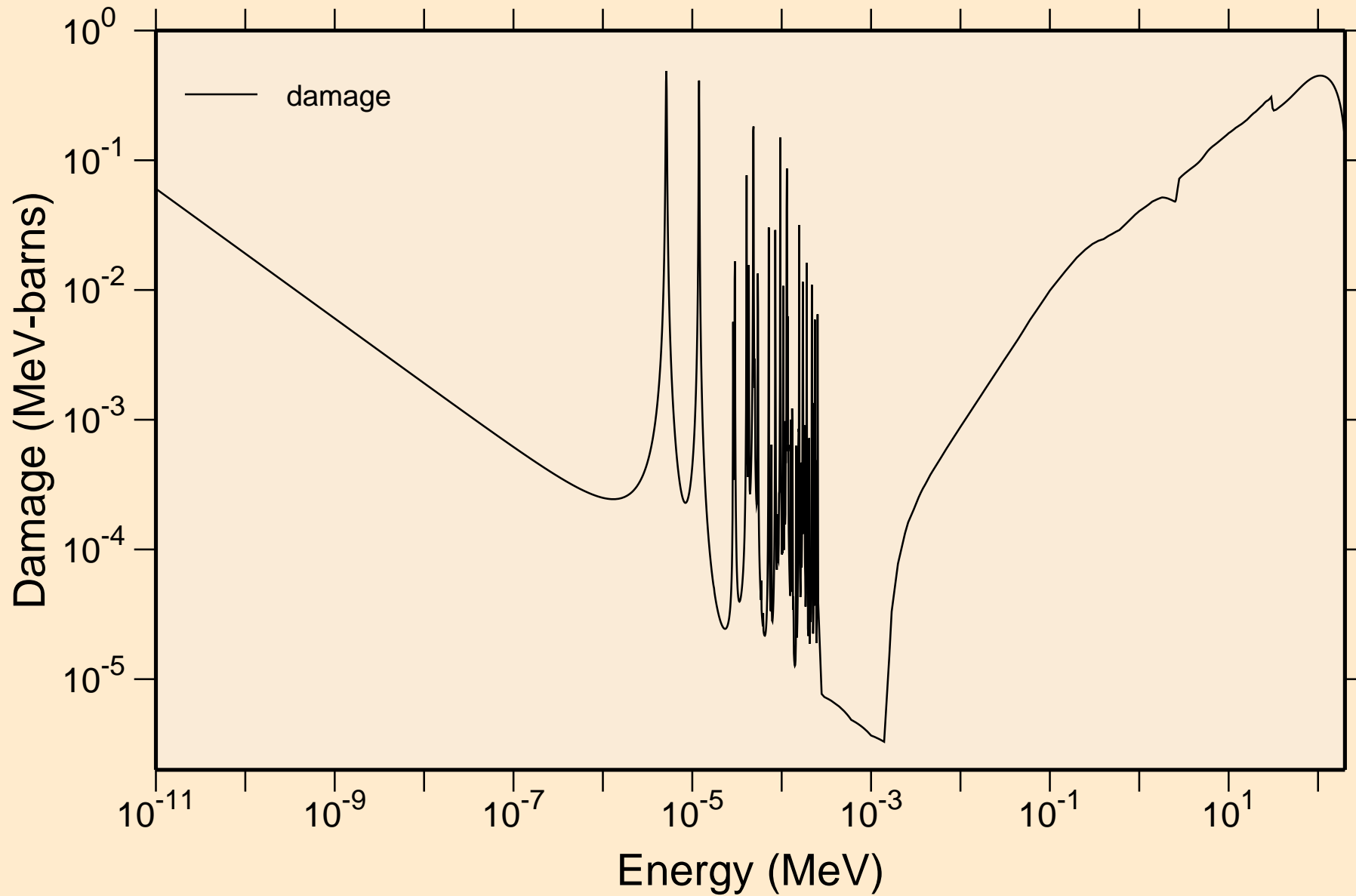

CF246 NEUTRON ACER TENDL-2021 LIBRARY; T=293.6K

Non-threshold reactions

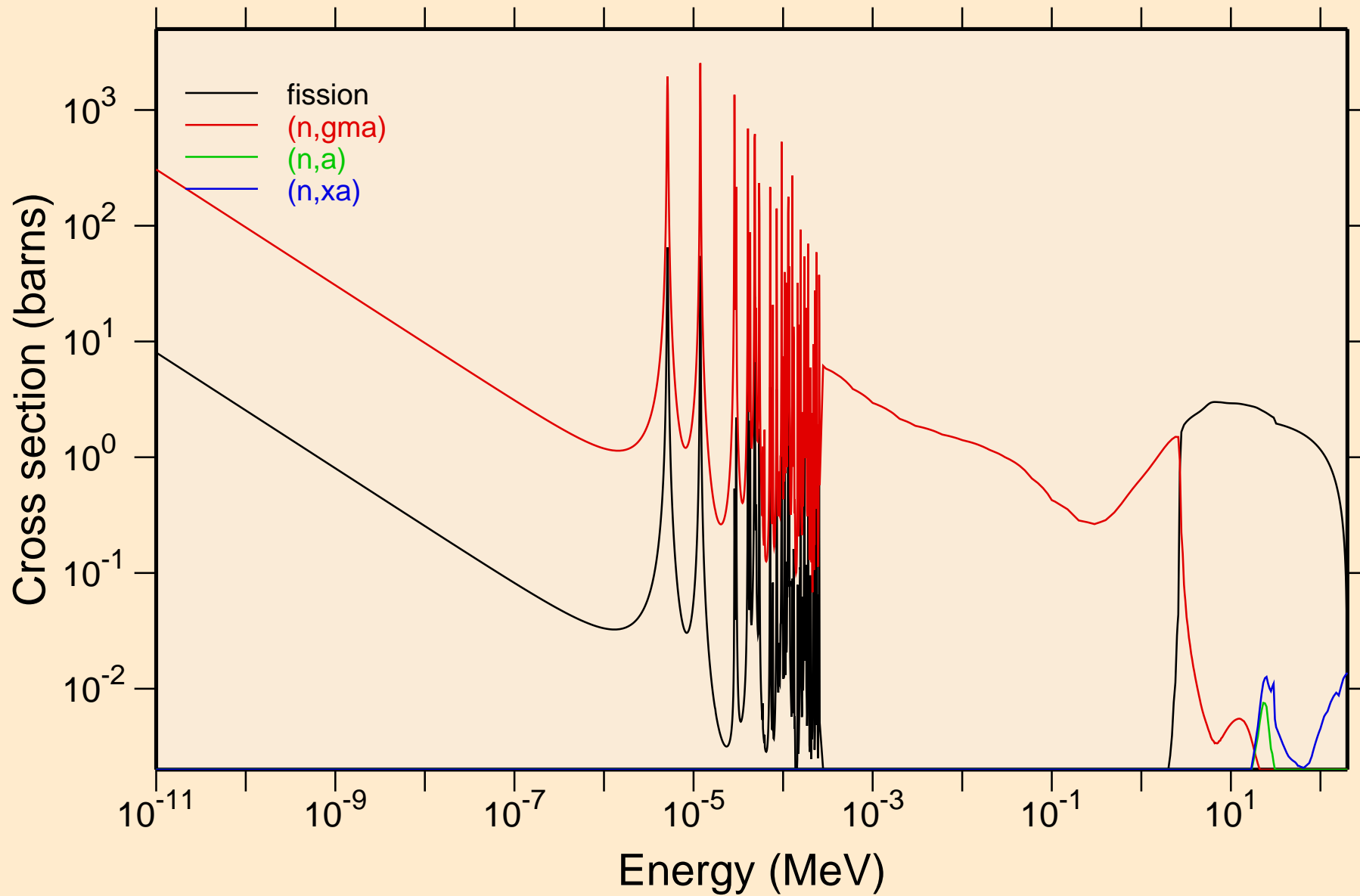

CF246 NEUTRON ACER TENDL-2021 LIBRARY; T=293.6K

Principal cross sections

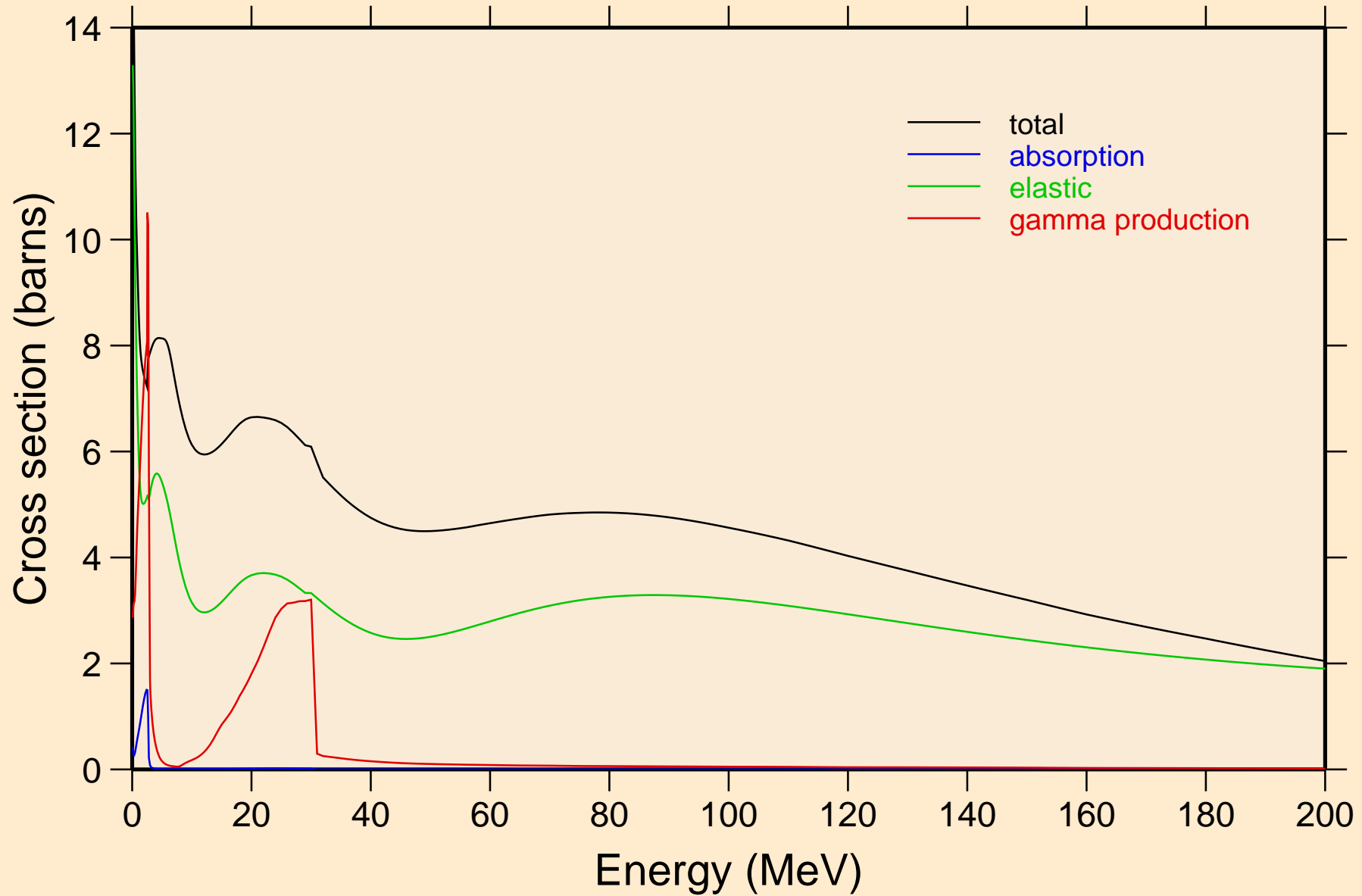

CF246 NEUTRON ACER TENDL-2021 LIBRARY; T=293.6K
Heating

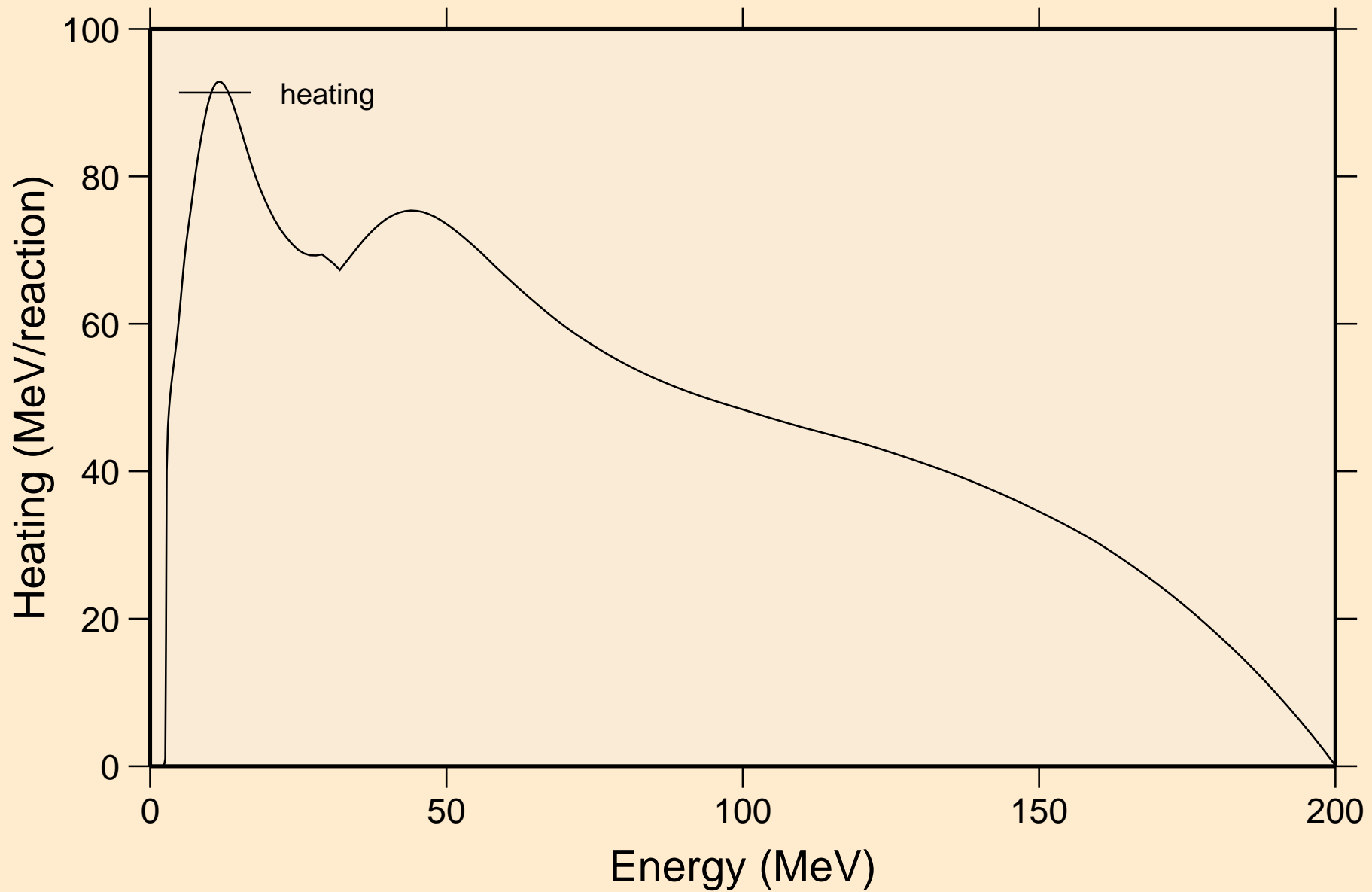

CF246 NEUTRON ACER TENDL-2021 LIBRARY; T=293.6K
Damage

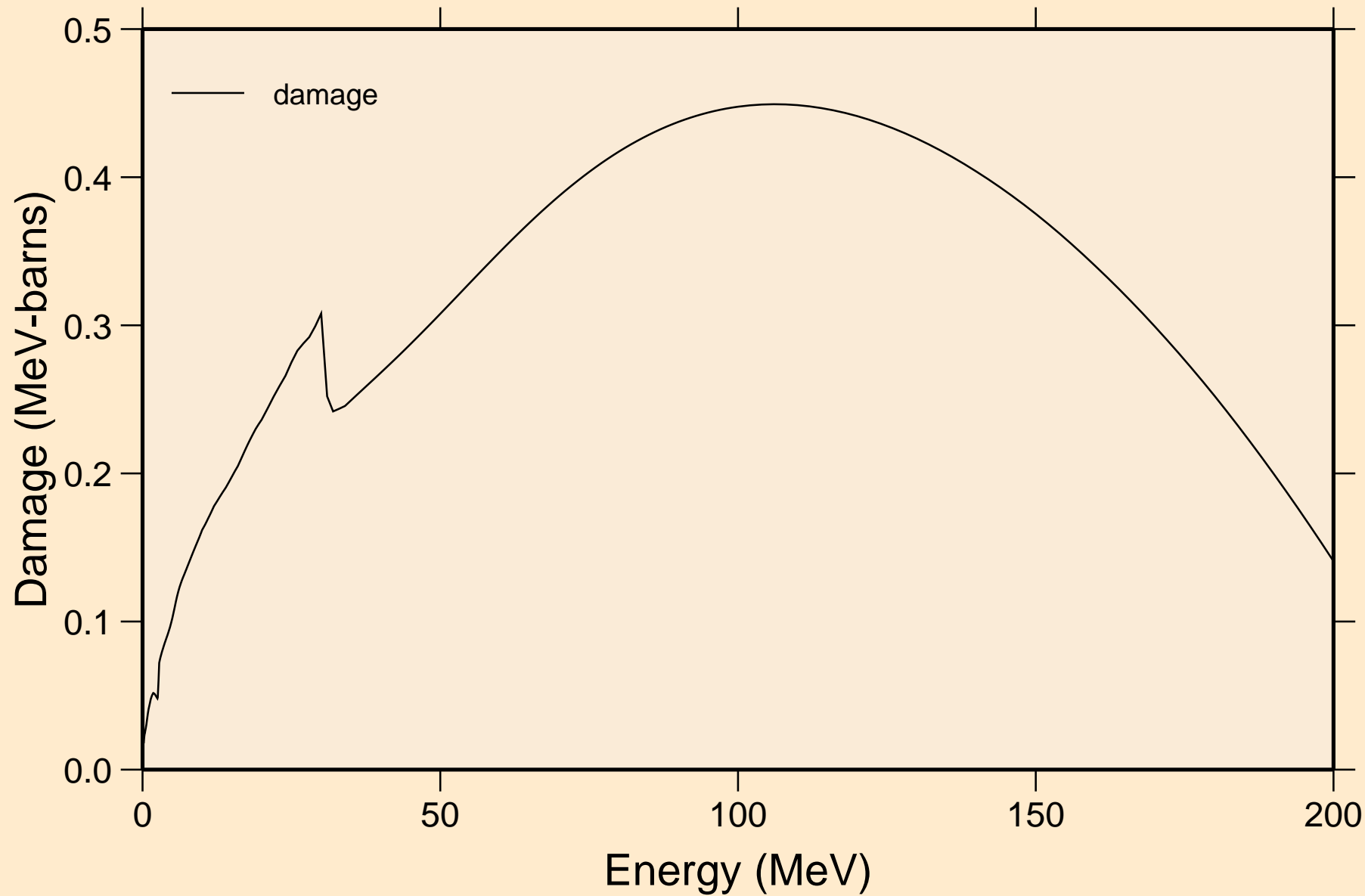

CF246 NEUTRON ACER TENDL-2021 LIBRARY; T=293.6K

Non-threshold reactions

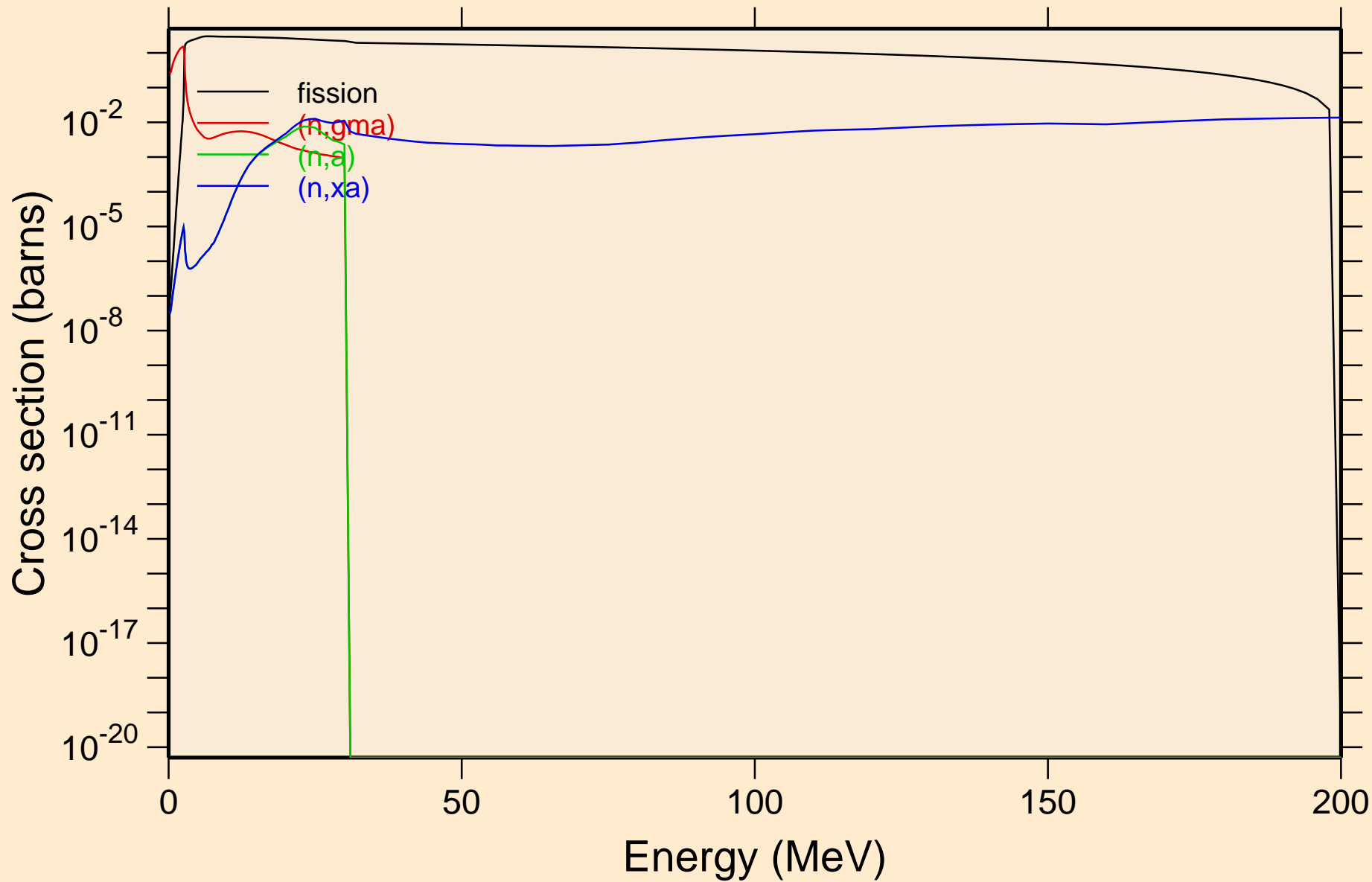

CF246 NEUTRON ACER TENDL-2021 LIBRARY; T=293.6K
Inelastic levels

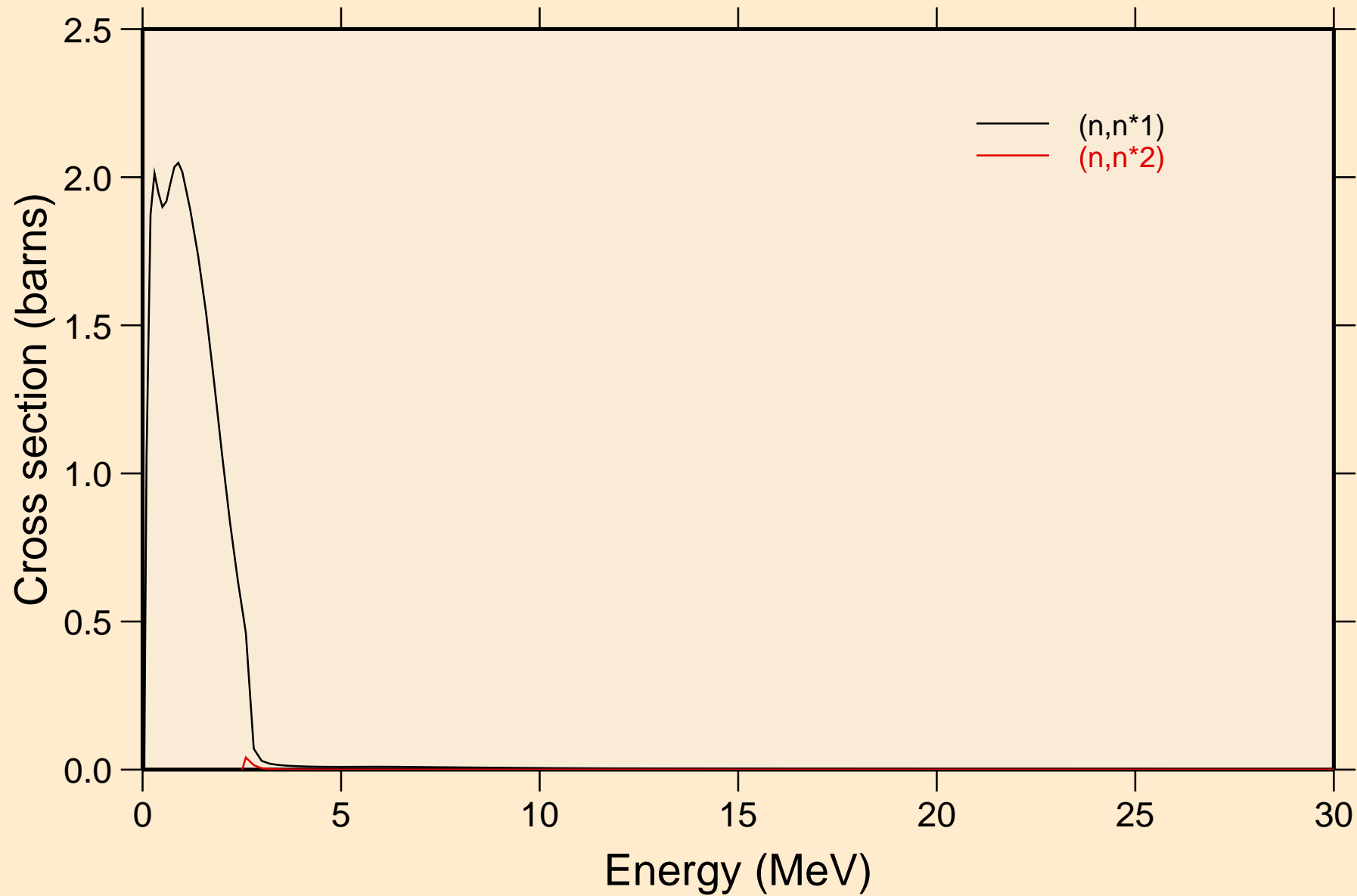

CF246 NEUTRON ACER TENDL-2021 LIBRARY; T=293.6K

Threshold reactions

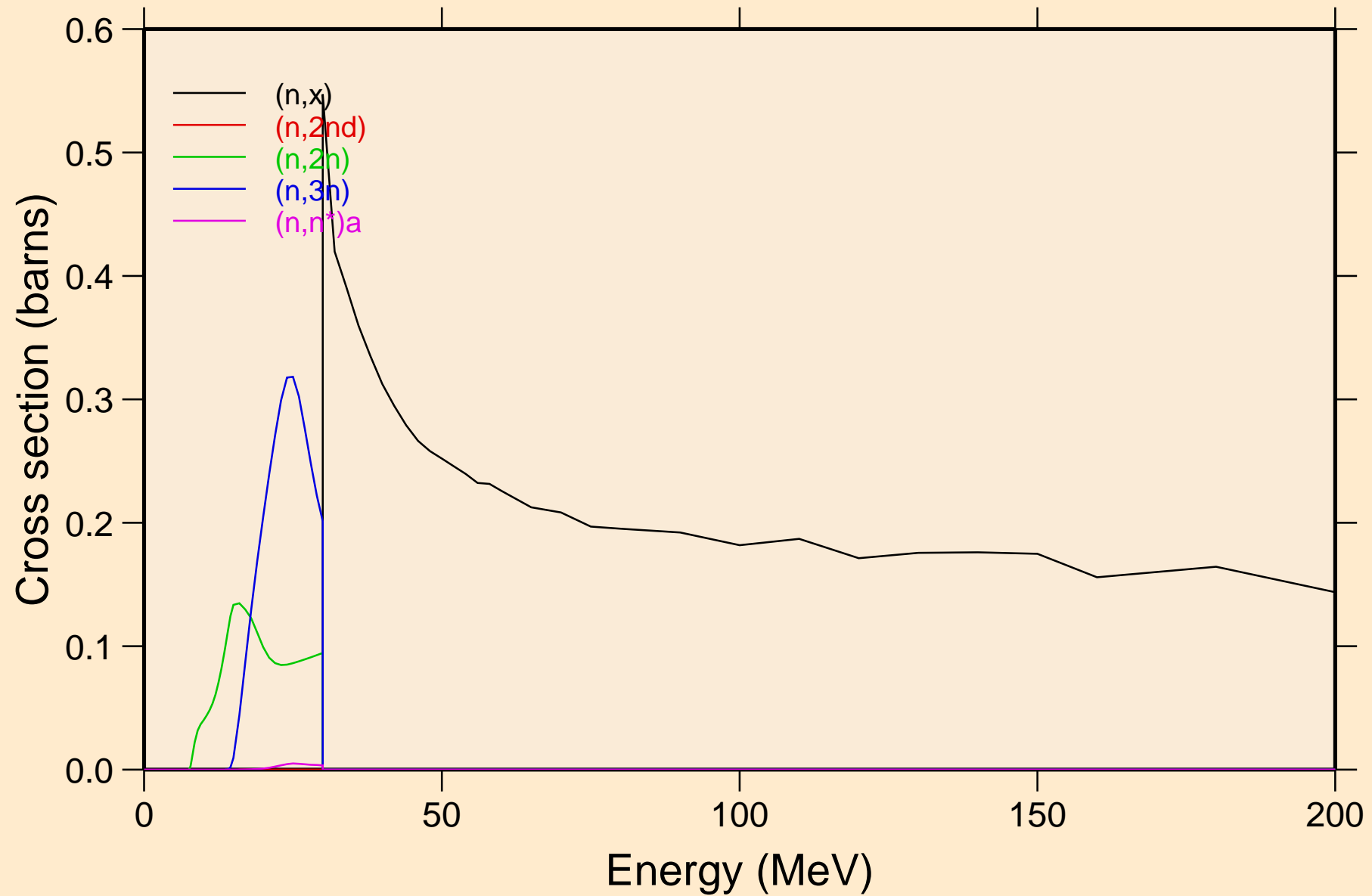

CF246 NEUTRON ACER TENDL-2021 LIBRARY; T=293.6K
Threshold reactions

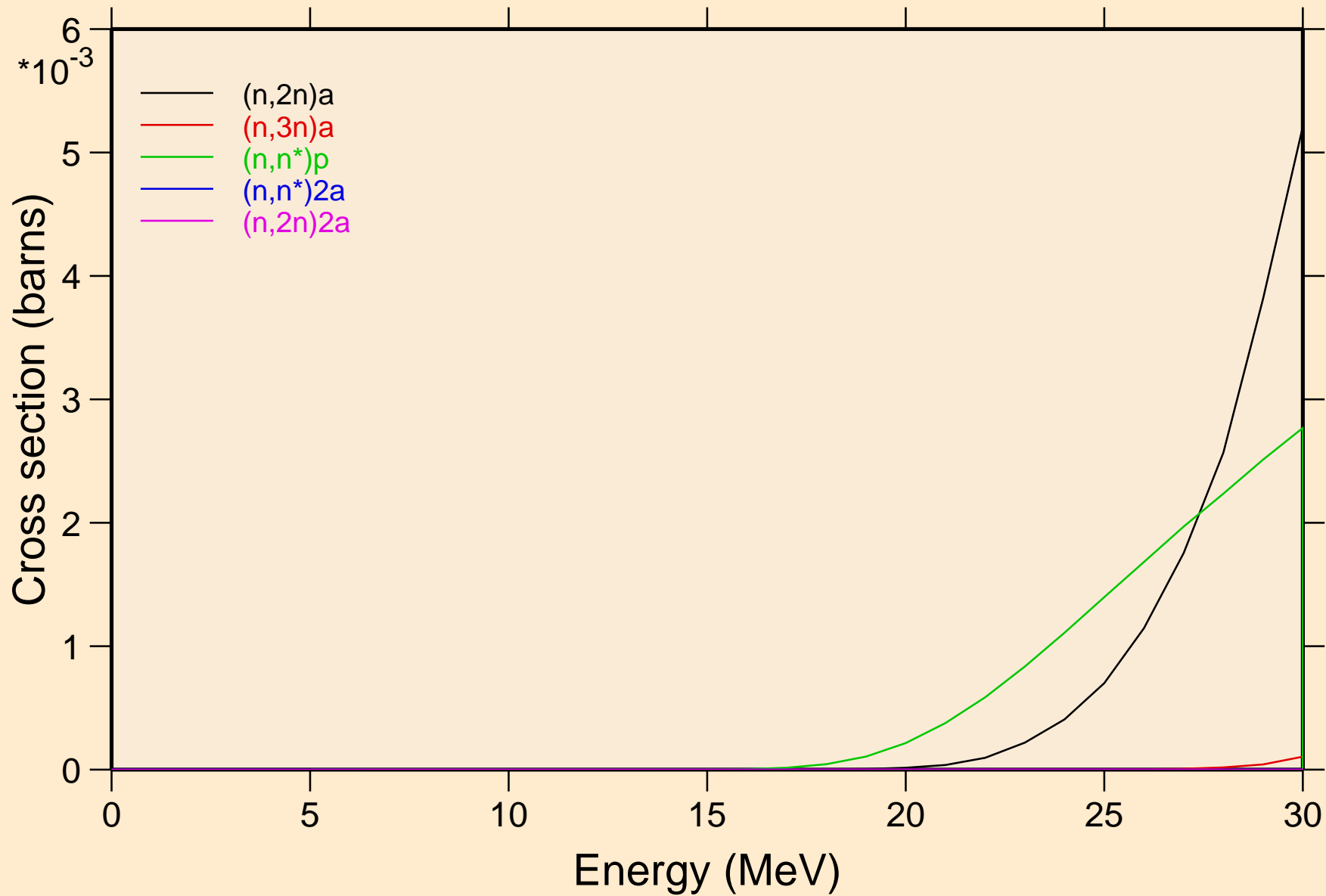

CF246 NEUTRON ACER TENDL-2021 LIBRARY; T=293.6K

Threshold reactions

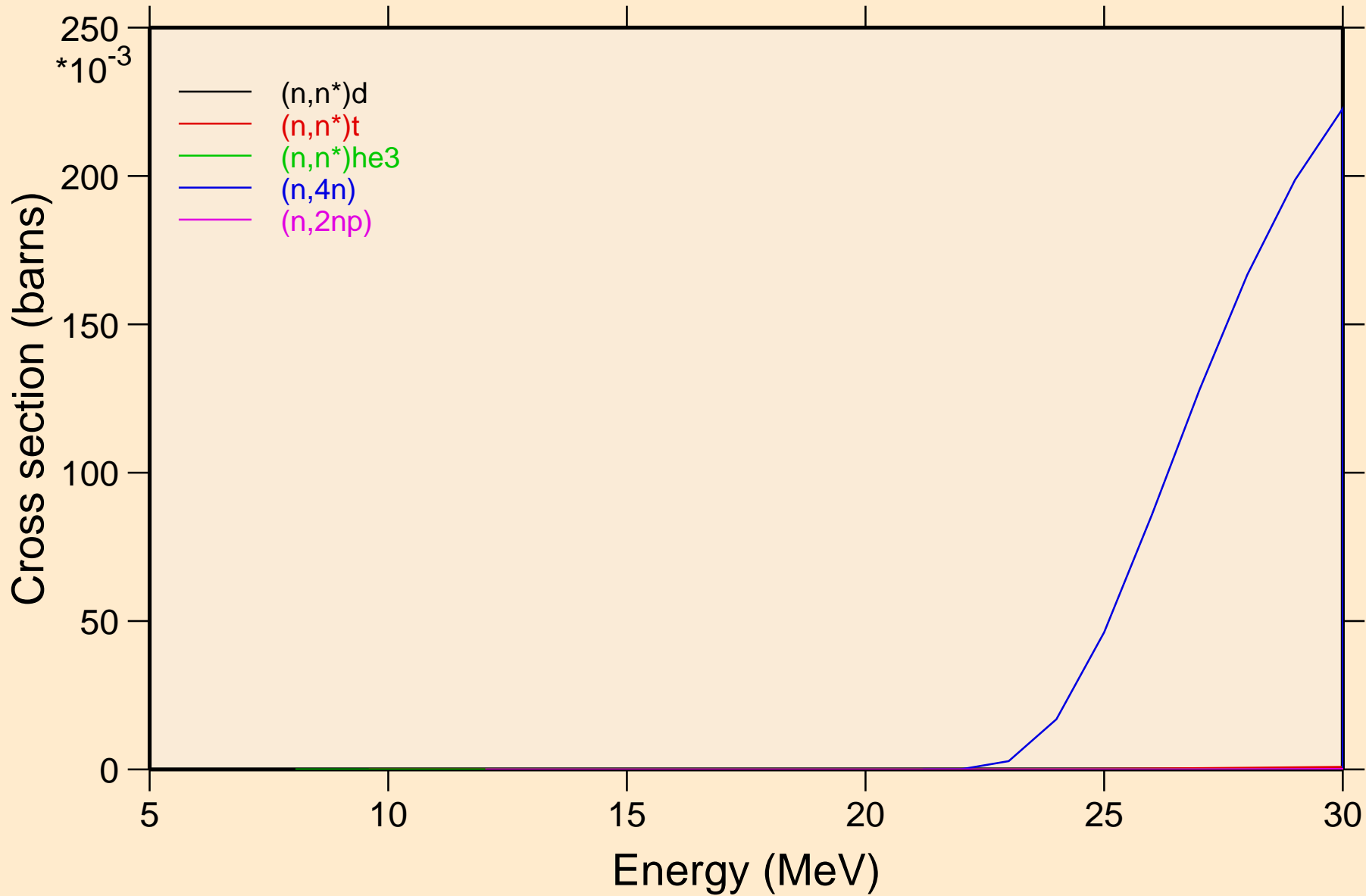

CF246 NEUTRON ACER TENDL-2021 LIBRARY; T=293.6K

Threshold reactions

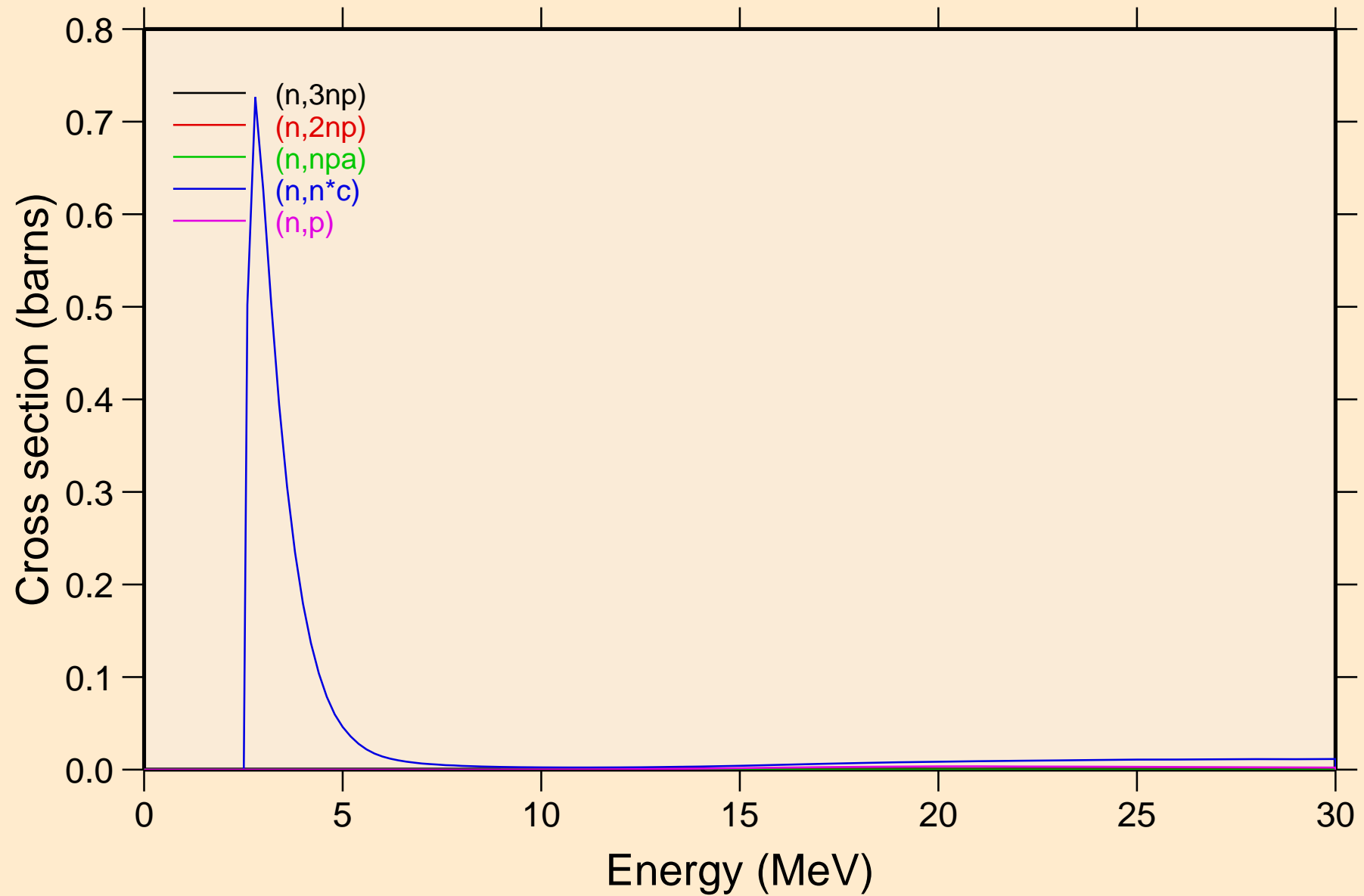

CF246 NEUTRON ACER TENDL-2021 LIBRARY; T=293.6K
Threshold reactions

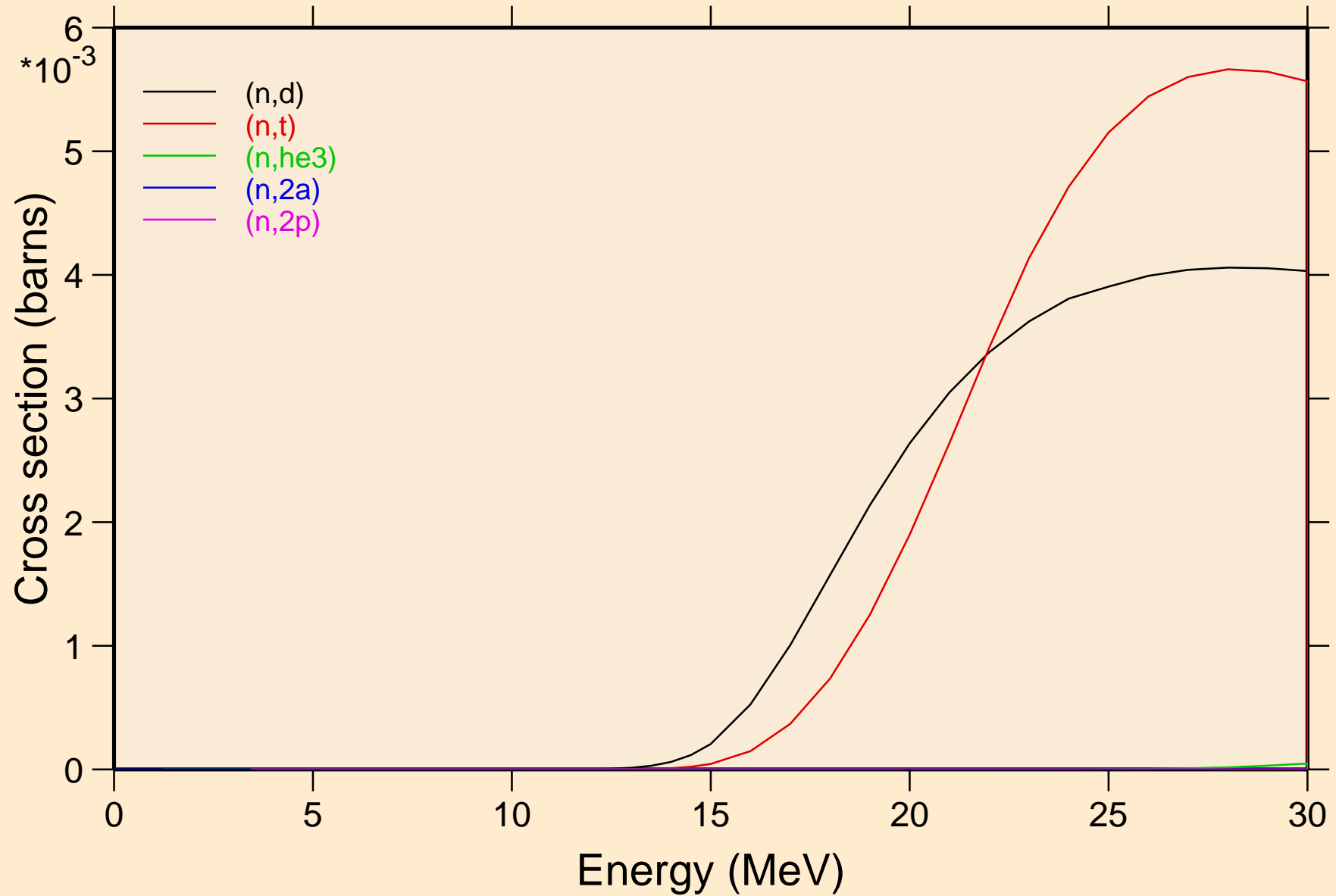

CF246 NEUTRON ACER TENDL-2021 LIBRARY; T=293.6K
Threshold reactions

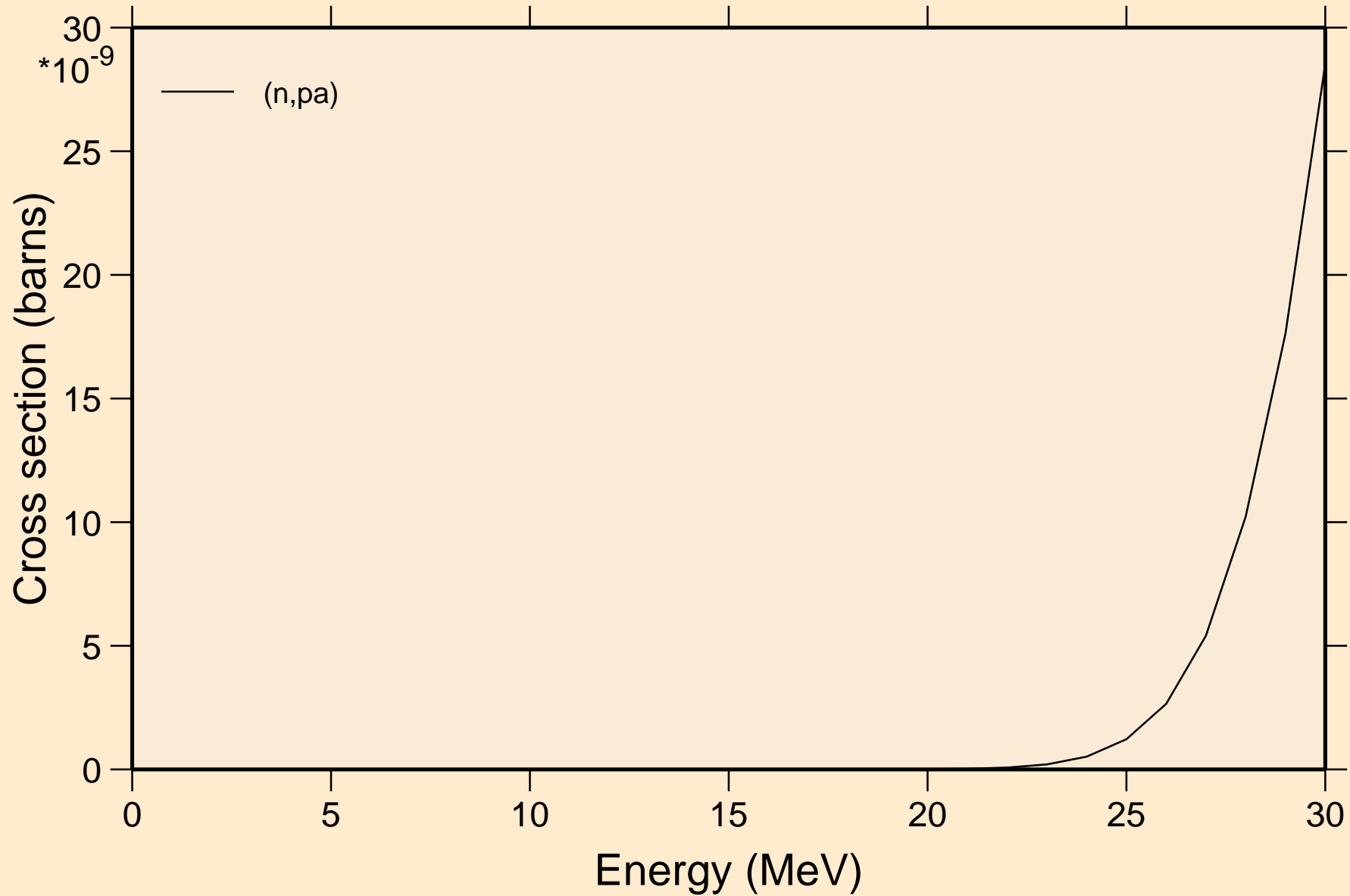

CF246 NEUTRON ACER TENDL-2021 LIBRARY; T=293.6K

Threshold reactions

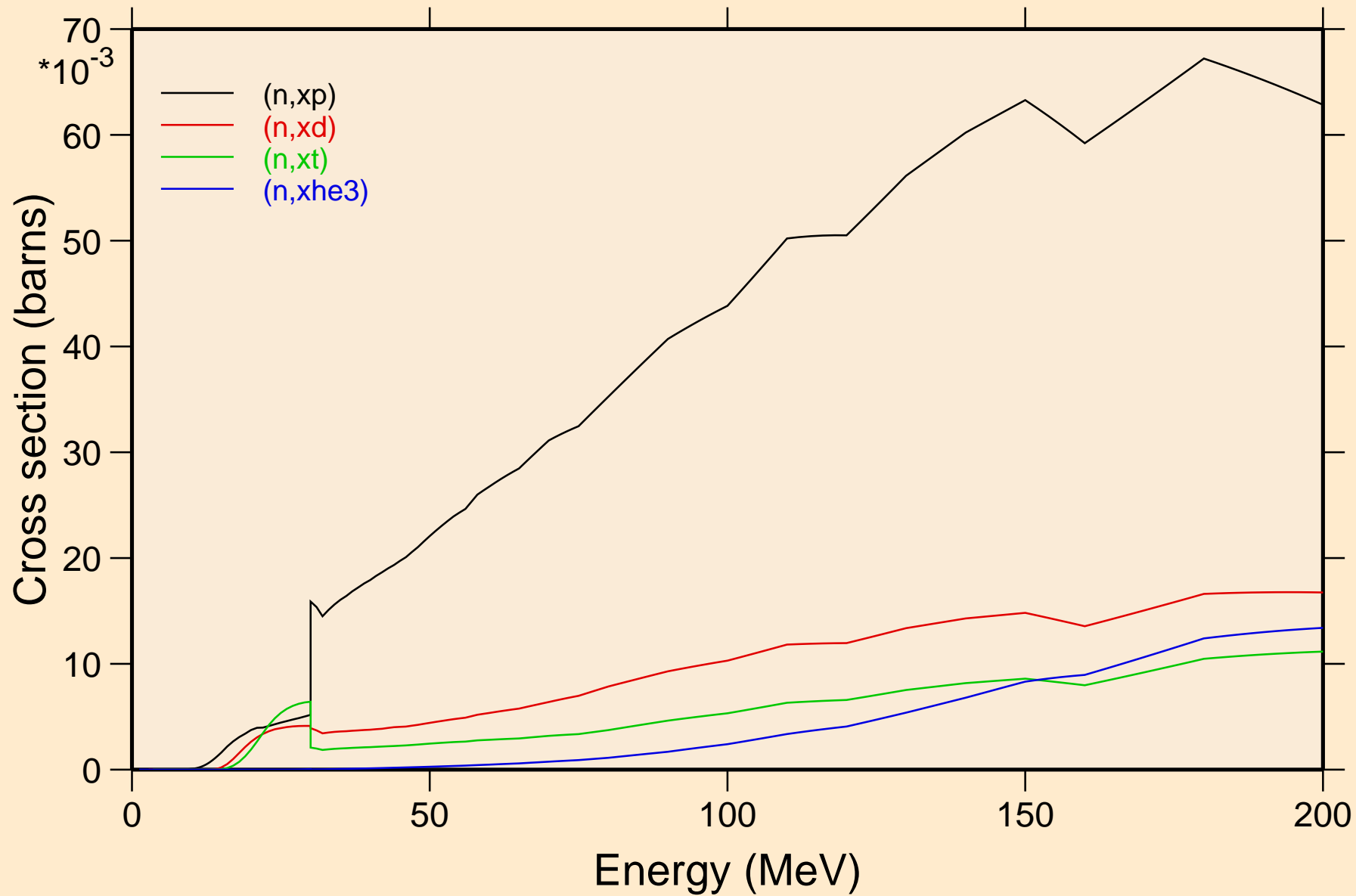

CF246 NEUTRON ACER TENDL-2021 LIBRARY; T=293.6K
angular distribution for elastic

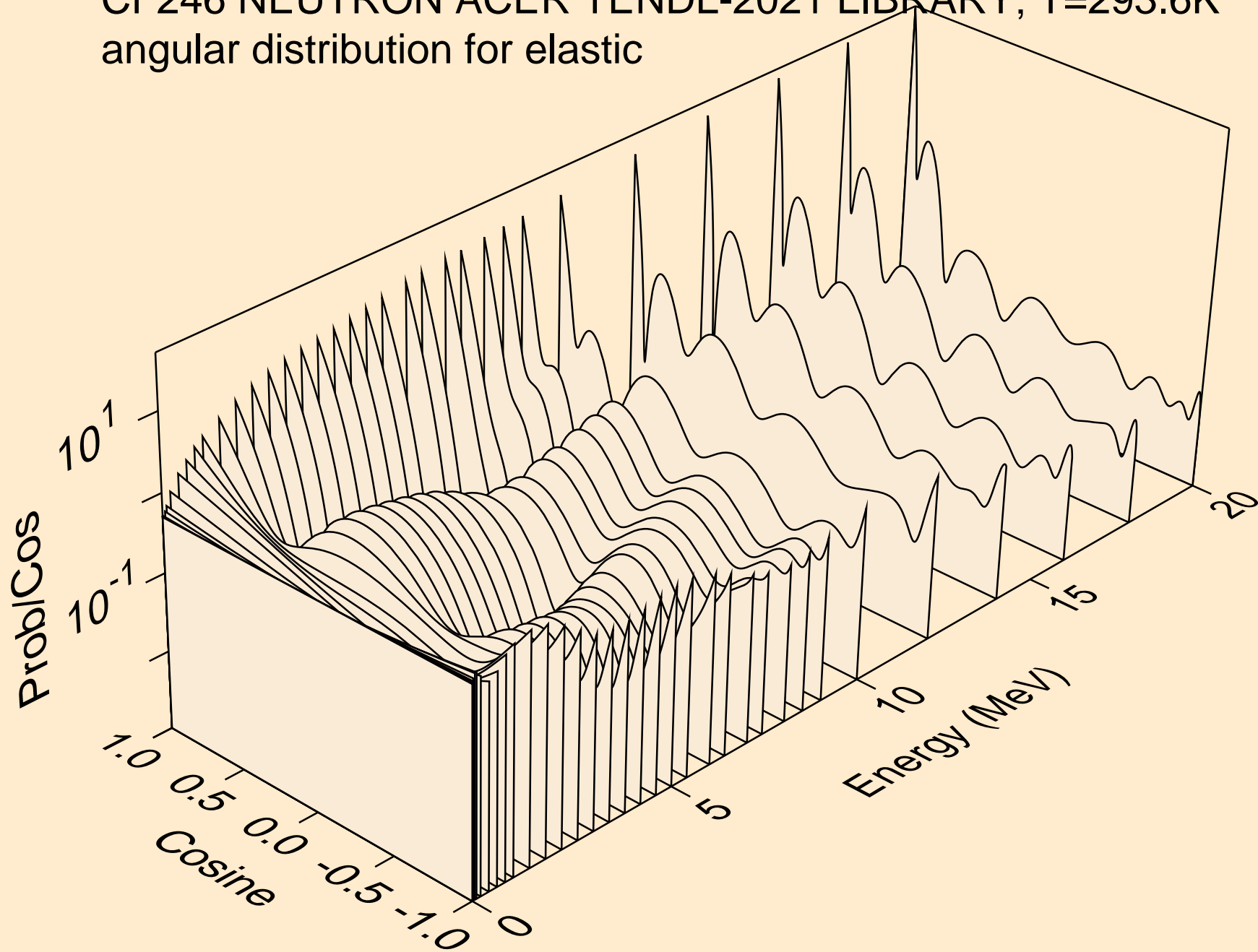

CF246 NEUTRON ACER TENDL-2021 LIBRARY; T=293.6K
angular distribution for elastic

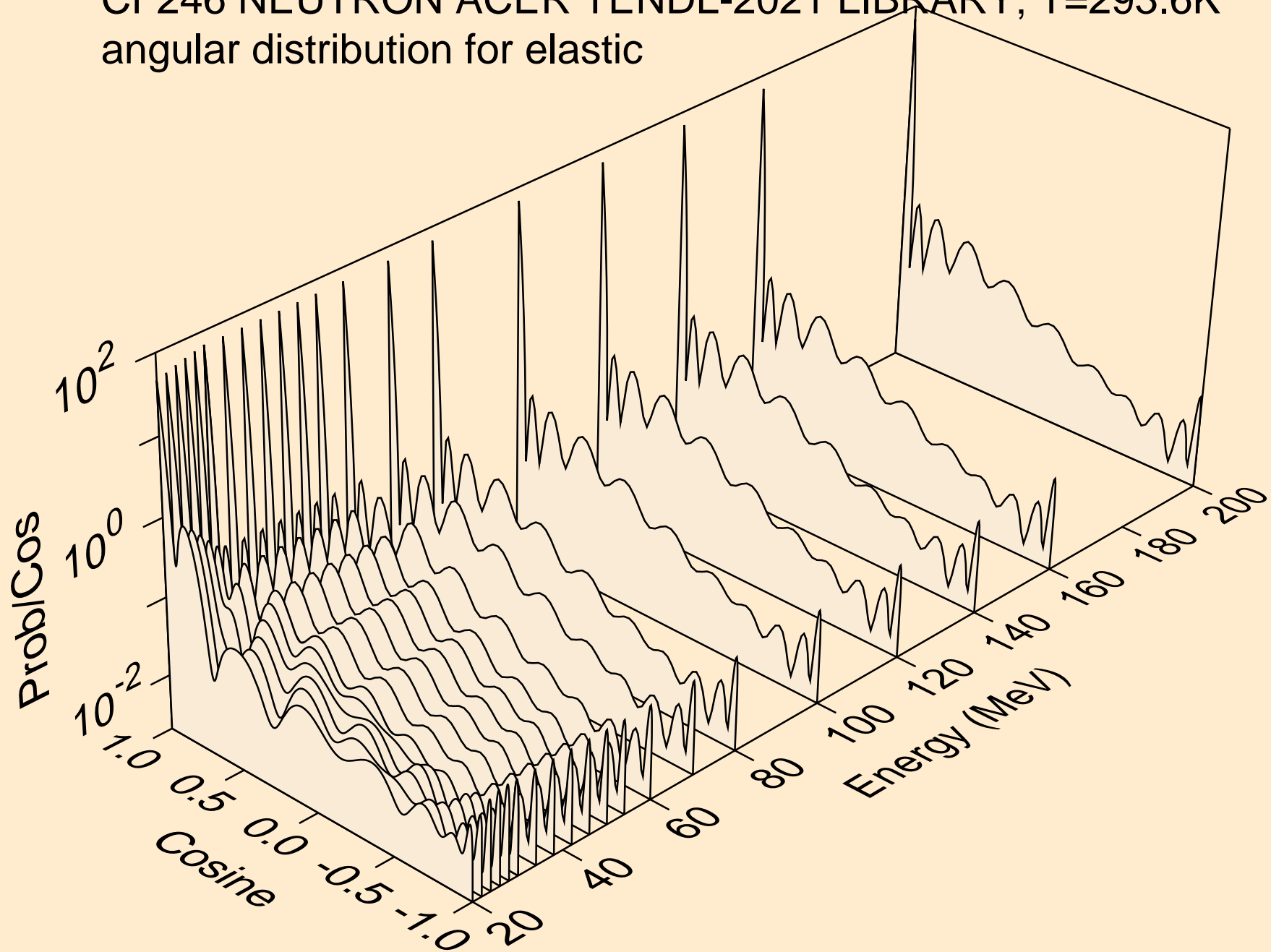

CF246 NEUTRON ACER TENDL-2021 LIBRARY; T=293.6K
angular distribution for (n,n*1)

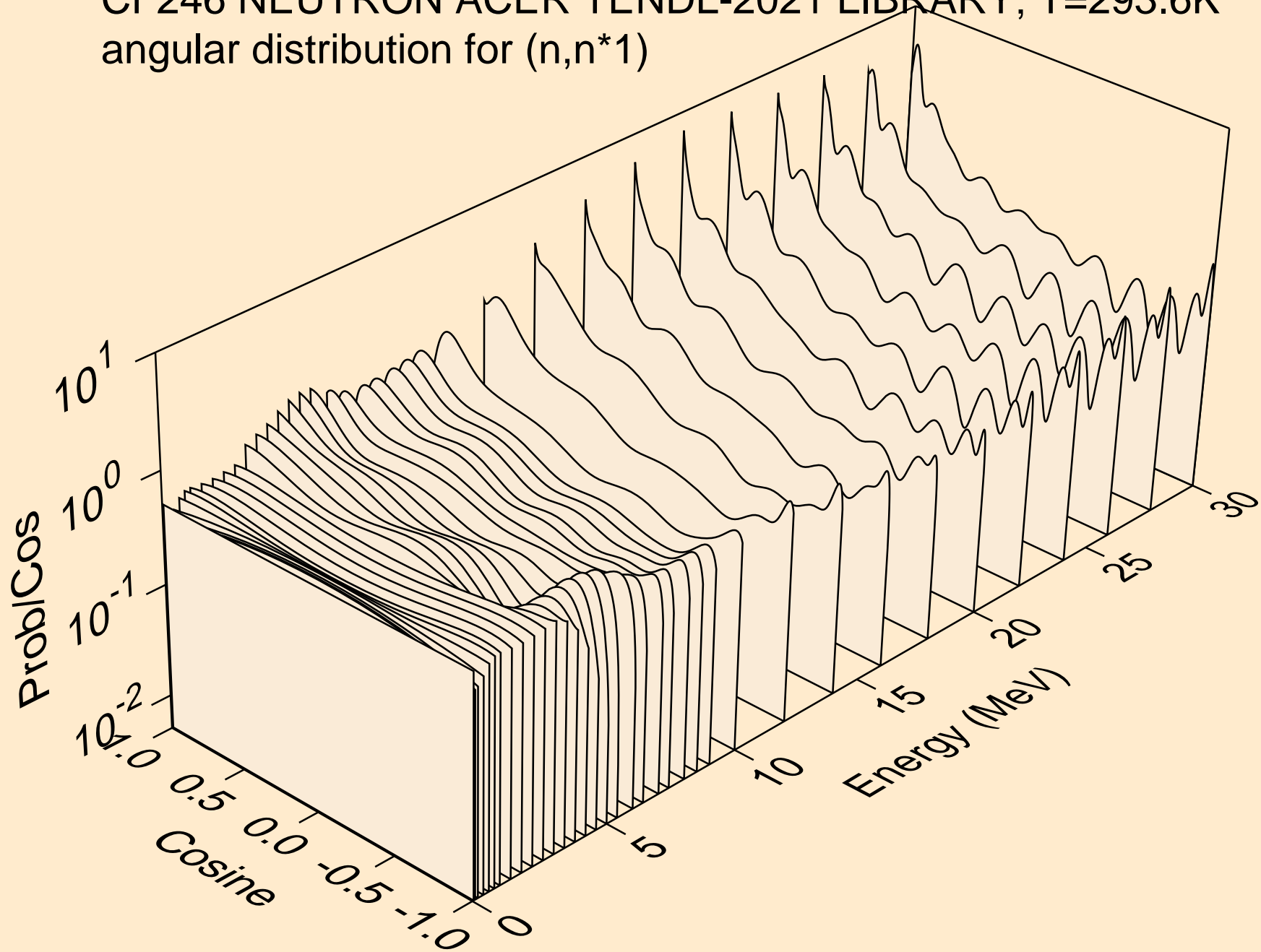

CF246 NEUTRON ACER TENDL-2021 LIBRARY; T=293.6K
angular distribution for (n,n*2)

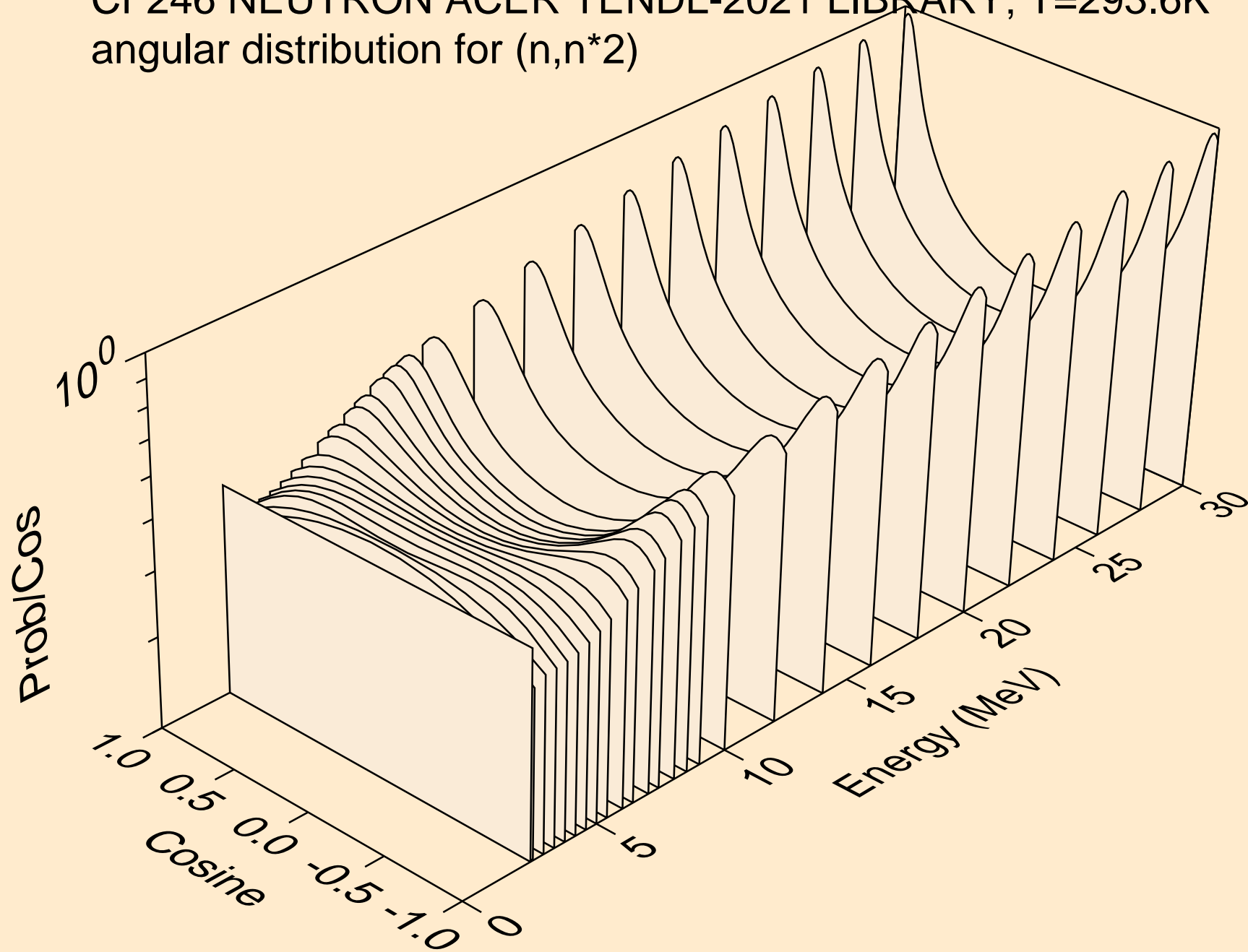

CF246 NEUTRON ACER TENDL-2021 LIBRARY; T=293.6K
Total fission nubar

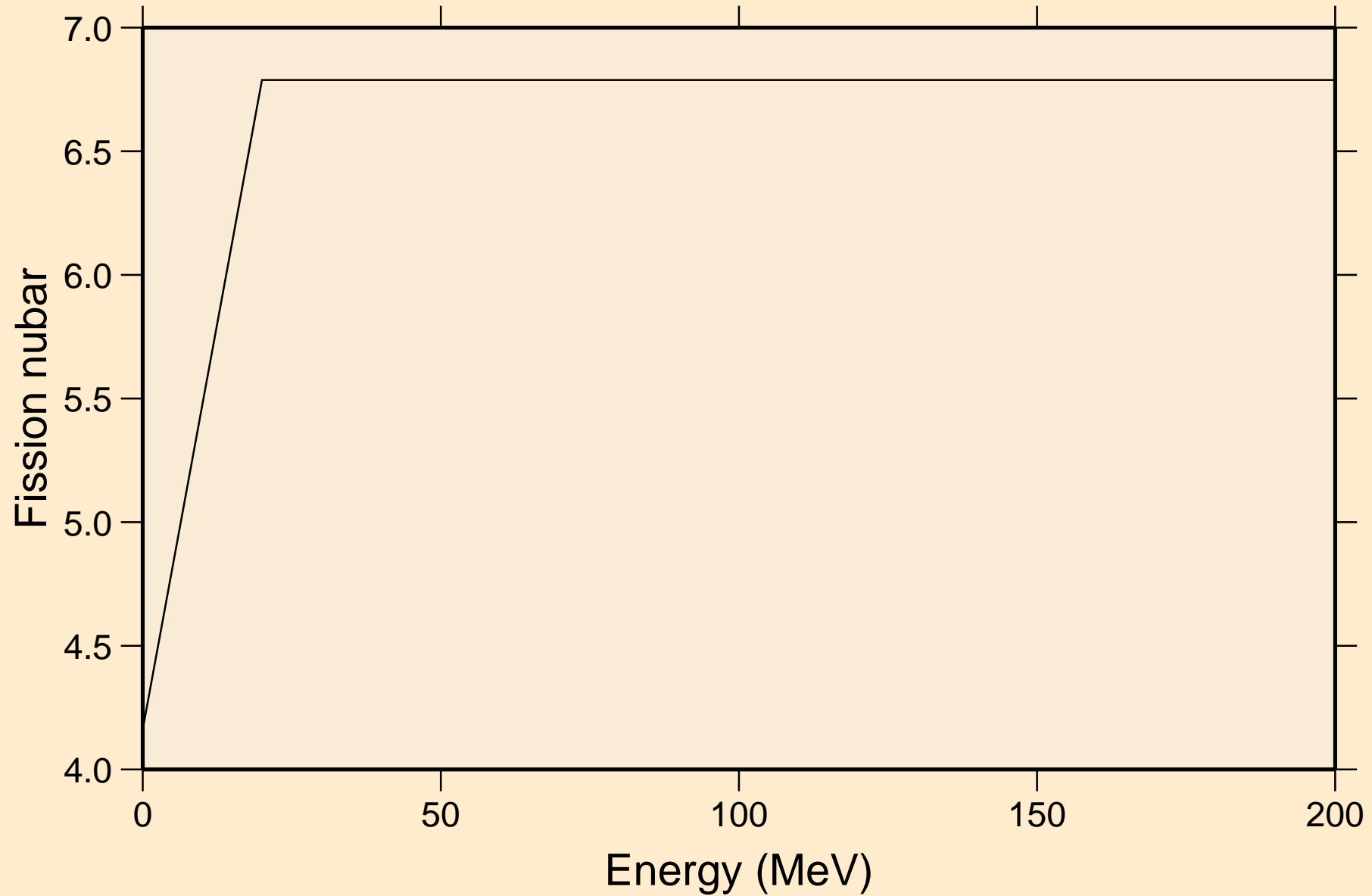

CF246 NEUTRON ACER TENDL-2021 LIBRARY; T=293.6K
Neutron emission for (n,x)

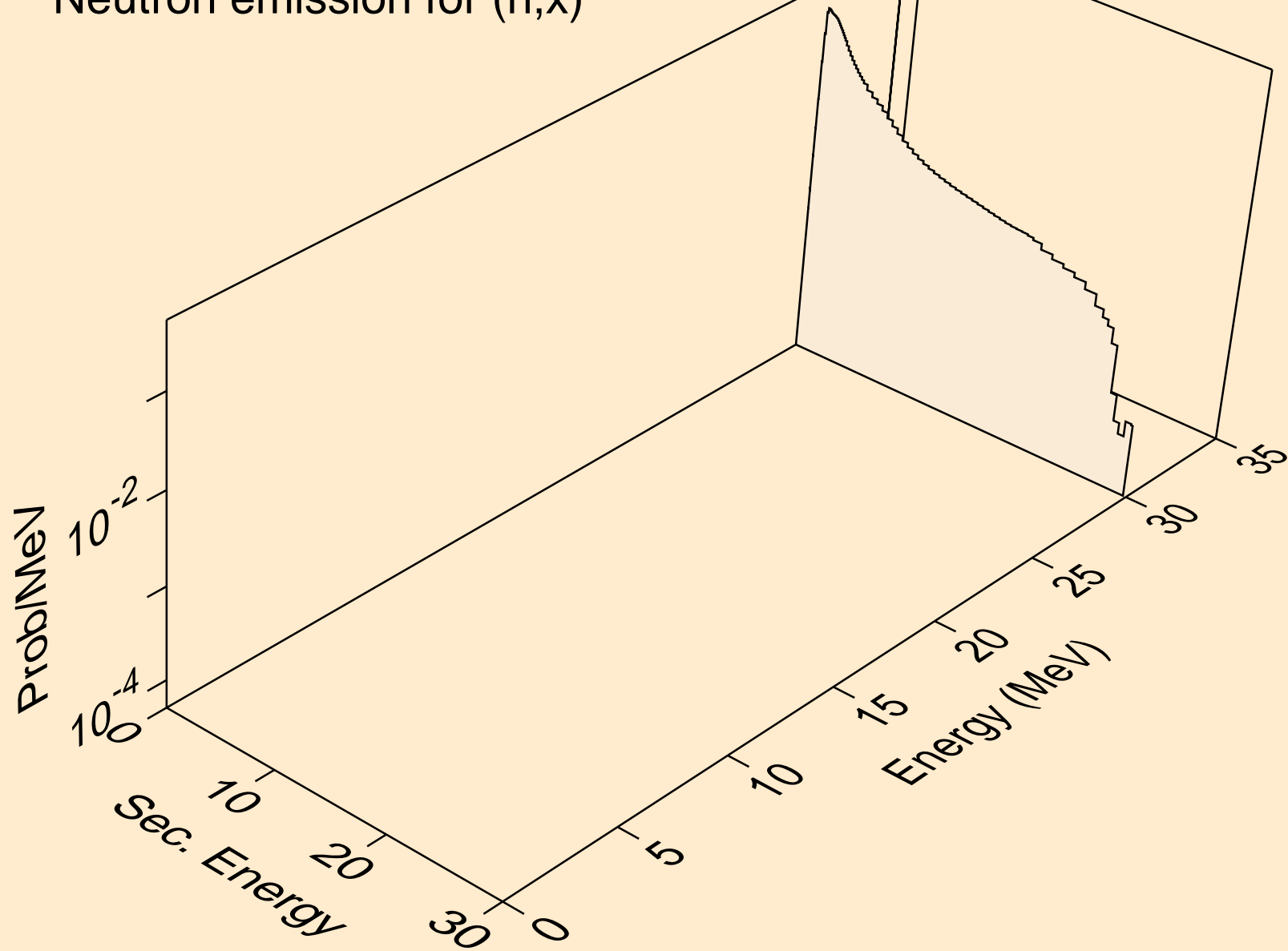

CF246 NEUTRON ACER TENDL-2021 LIBRARY; T=293.6K
Neutron emission for (n,2nd)

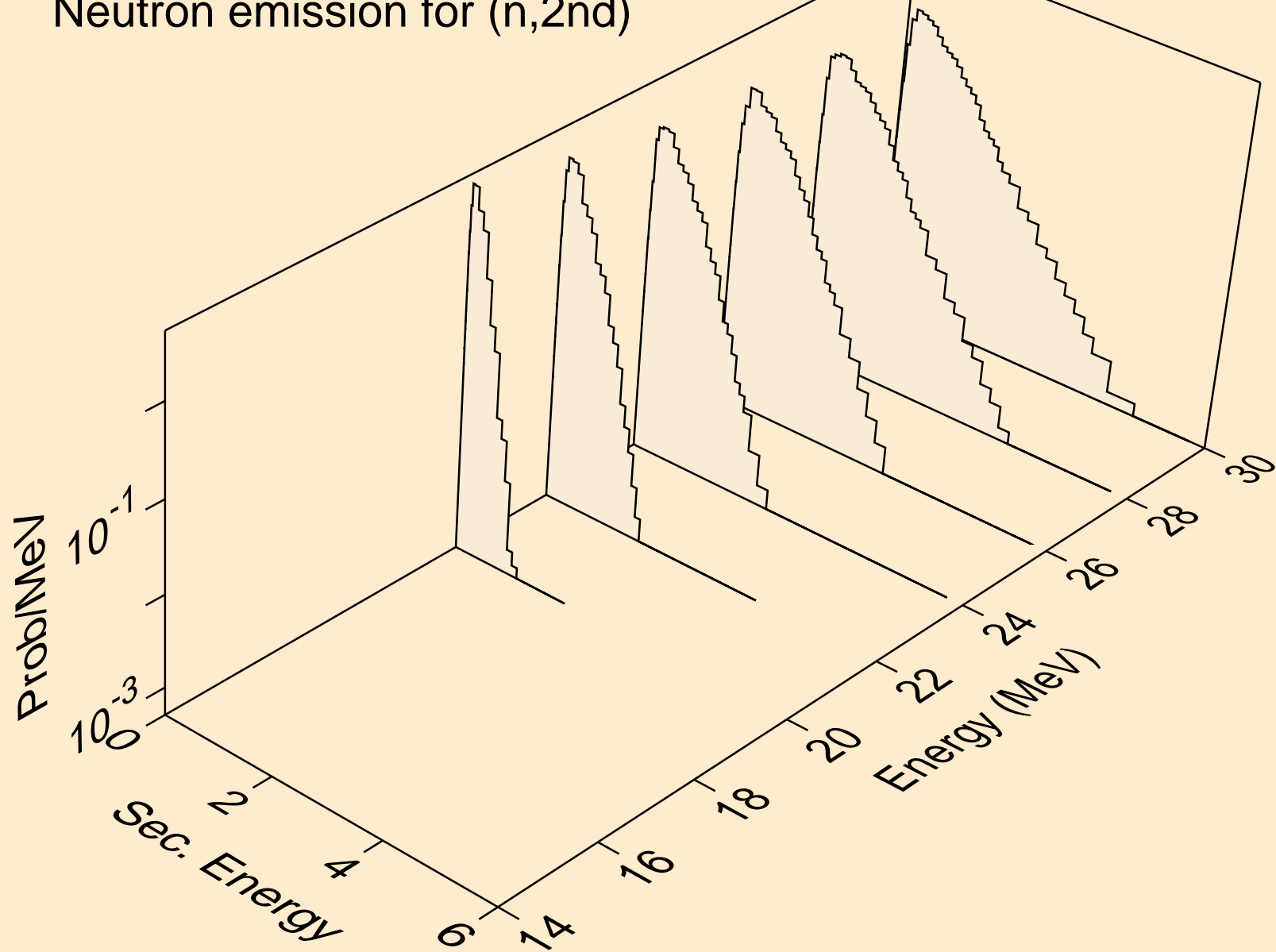

CF246 NEUTRON ACER TENDL-2021 LIBRARY; T=293.6K
Neutron emission for (n,2n)

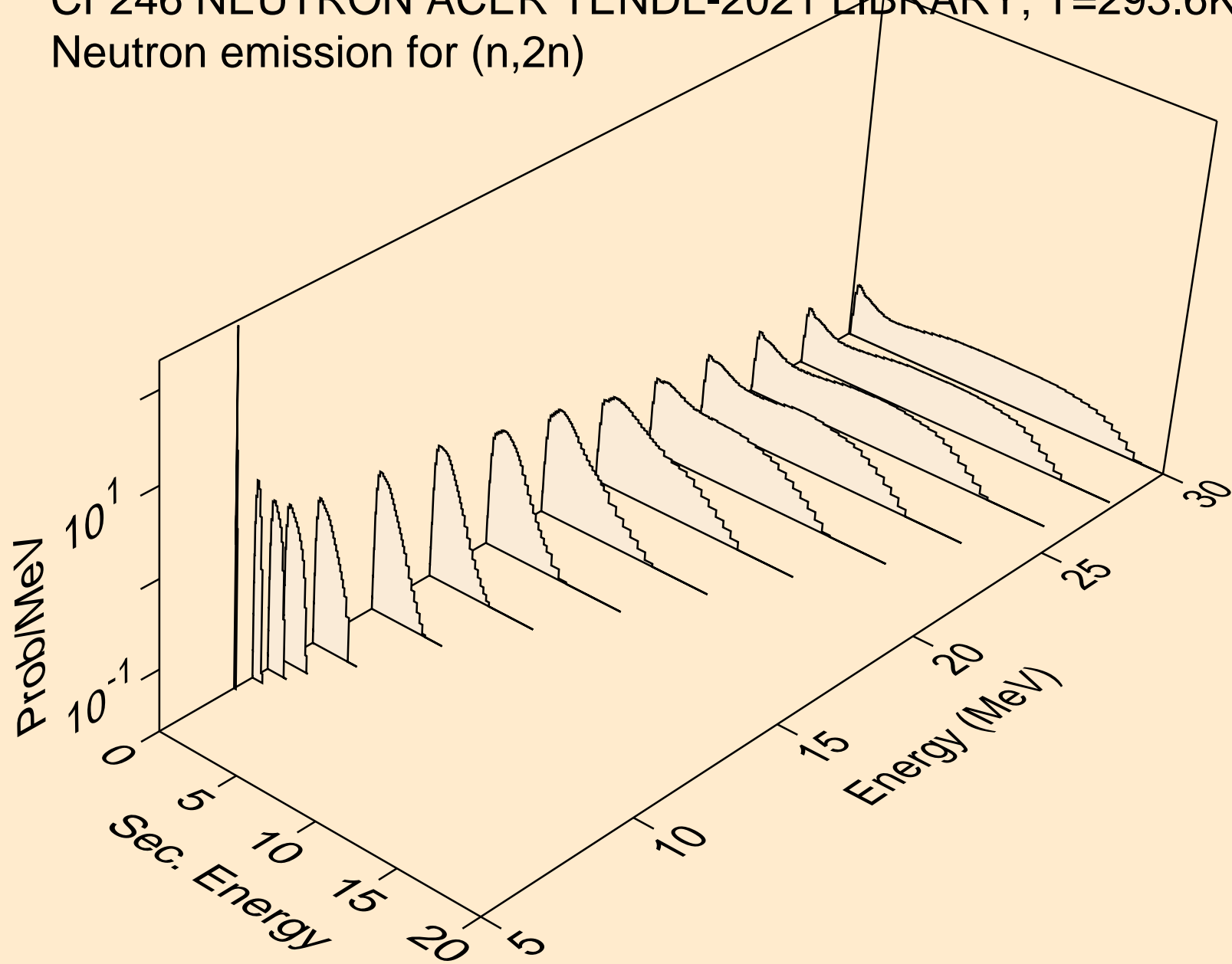

CF246 NEUTRON ACER TENDL-2021 LIBRARY; T=293.6K
Neutron emission for (n,3n)

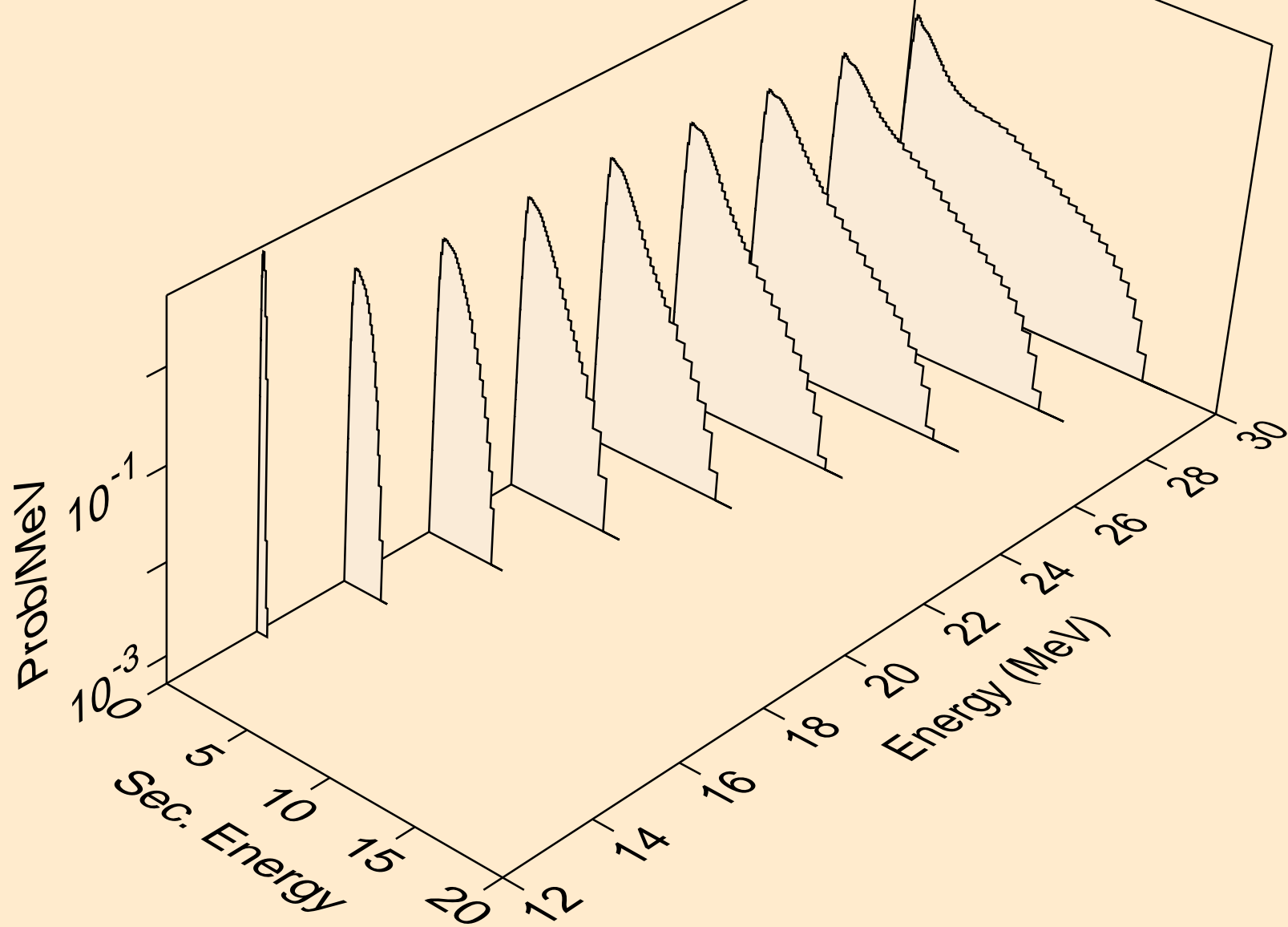

CF246 NEUTRON ACER TENDL-2021 LIBRARY; T=293.6K
Neutron emission for fission

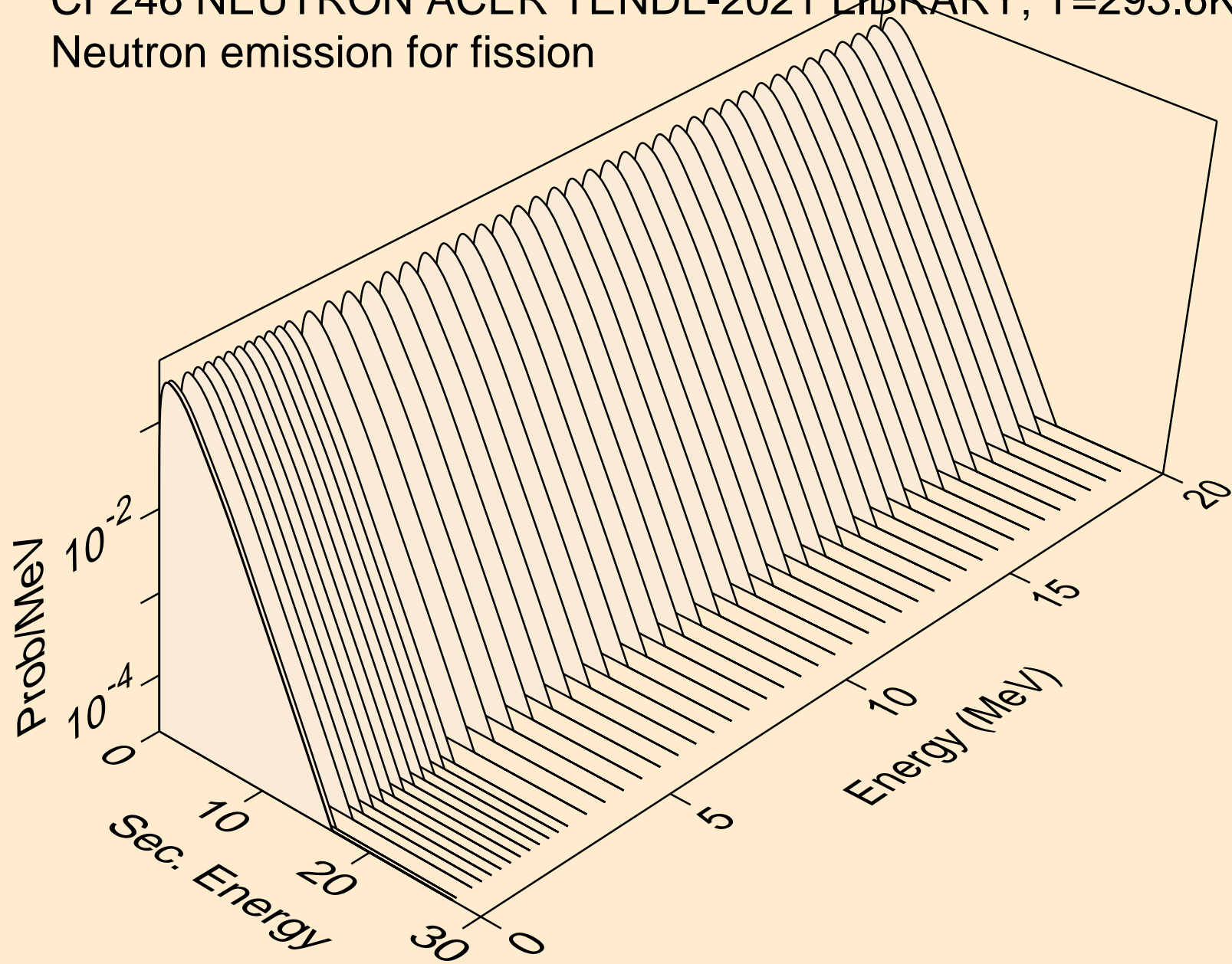

CF246 NEUTRON ACER TENDL-2021 LIBRARY; T=293.6K
Neutron emission for (n,n*)a

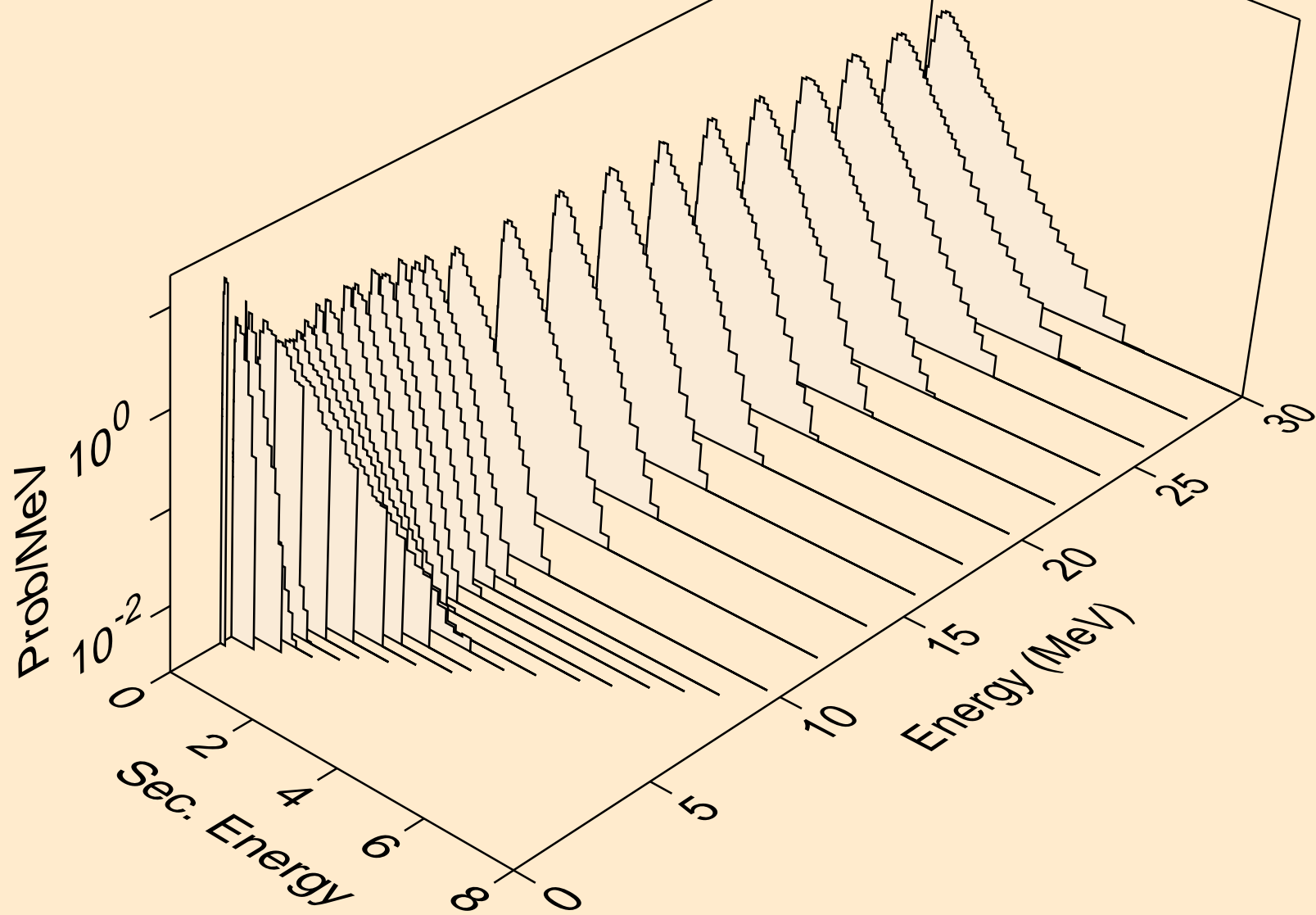

CF246 NEUTRON ACER TENDL-2021 LIBRARY; T=293.6K
Neutron emission for (n,2n)a

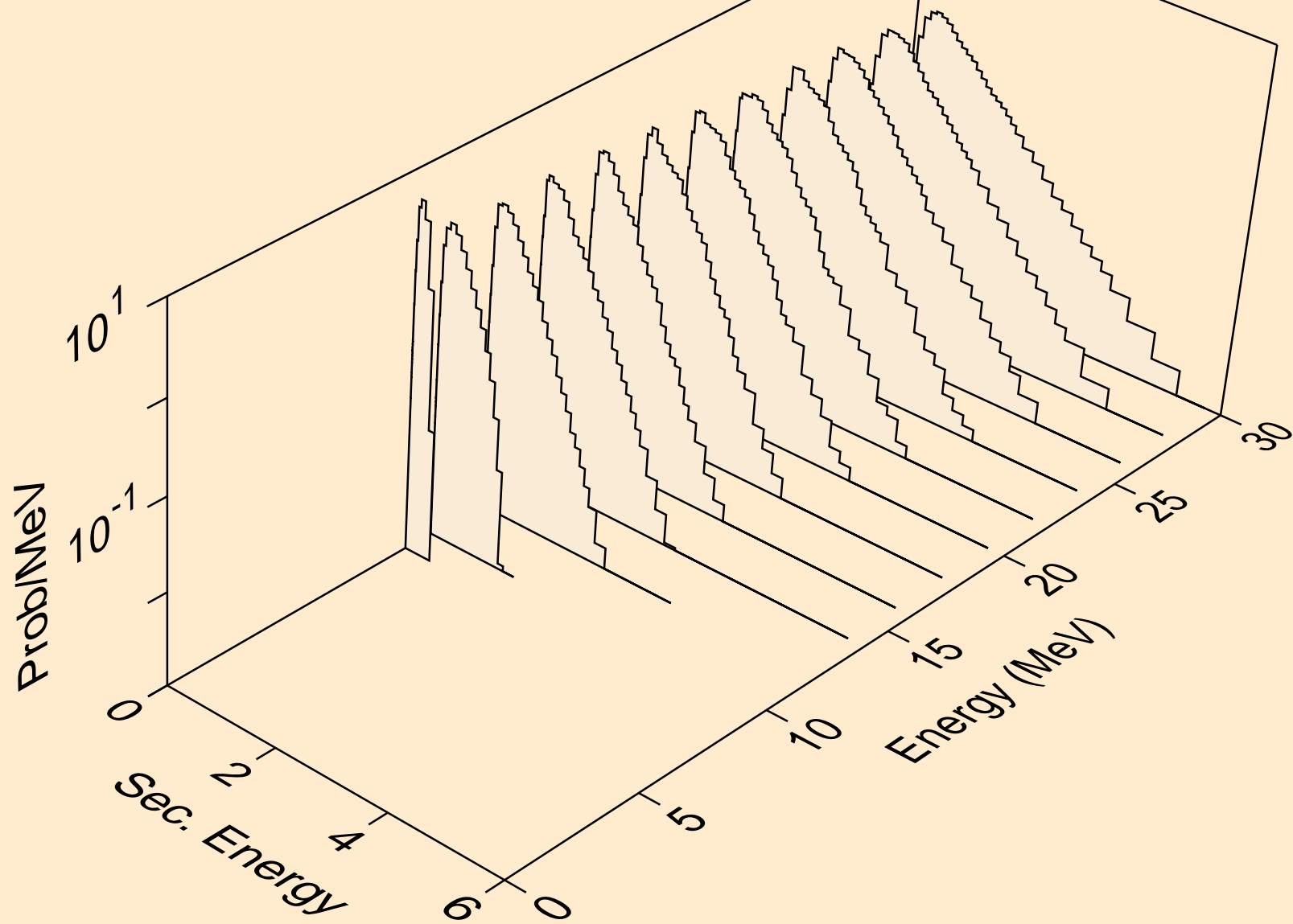

CF246 NEUTRON ACER TENDL-2021 LIBRARY; T=293.6K
Neutron emission for (n,3n)a

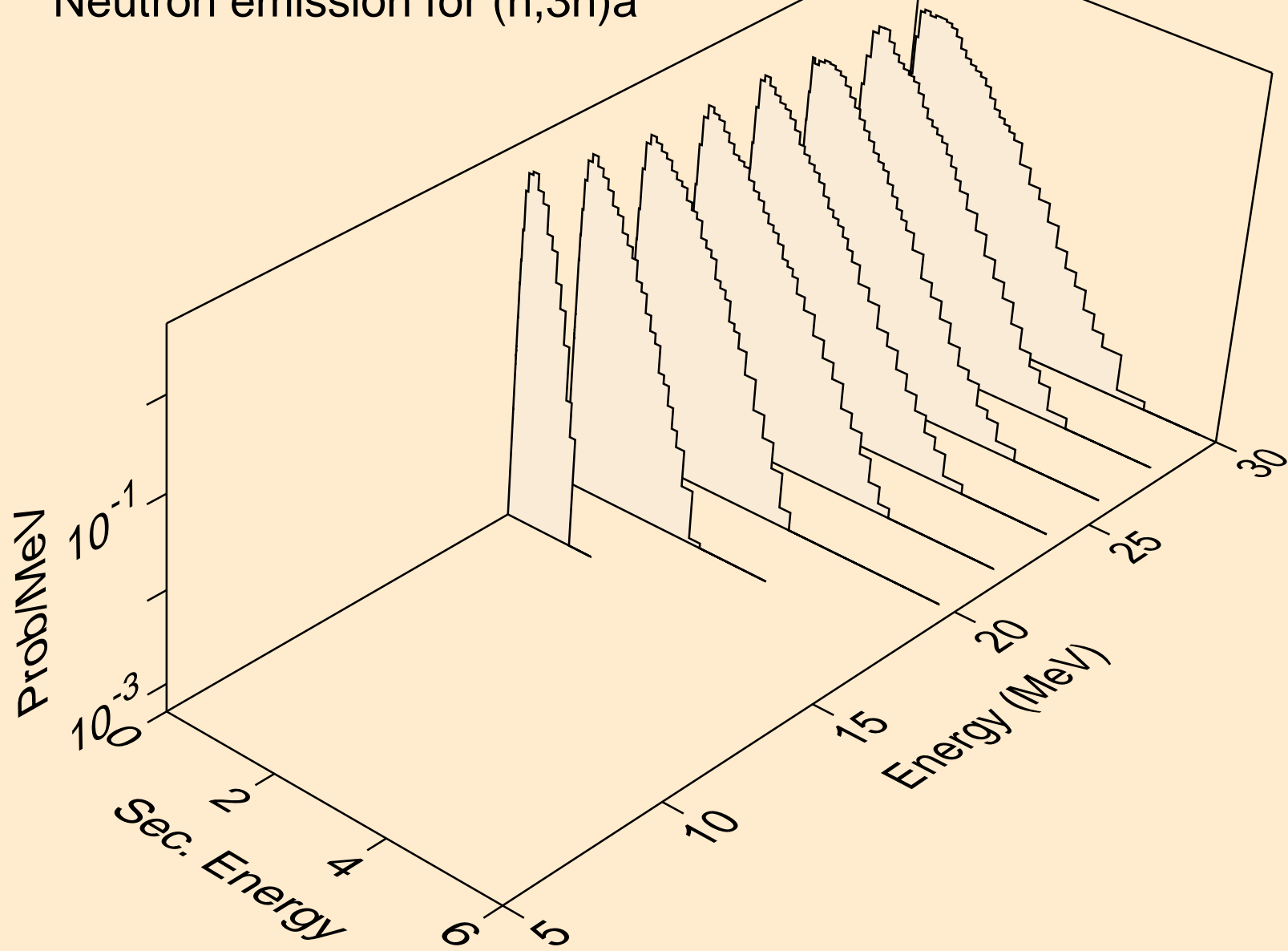

CF246 NEUTRON ACER TENDL-2021 LIBRARY; T=293.6K
Neutron emission for (n,n*)p

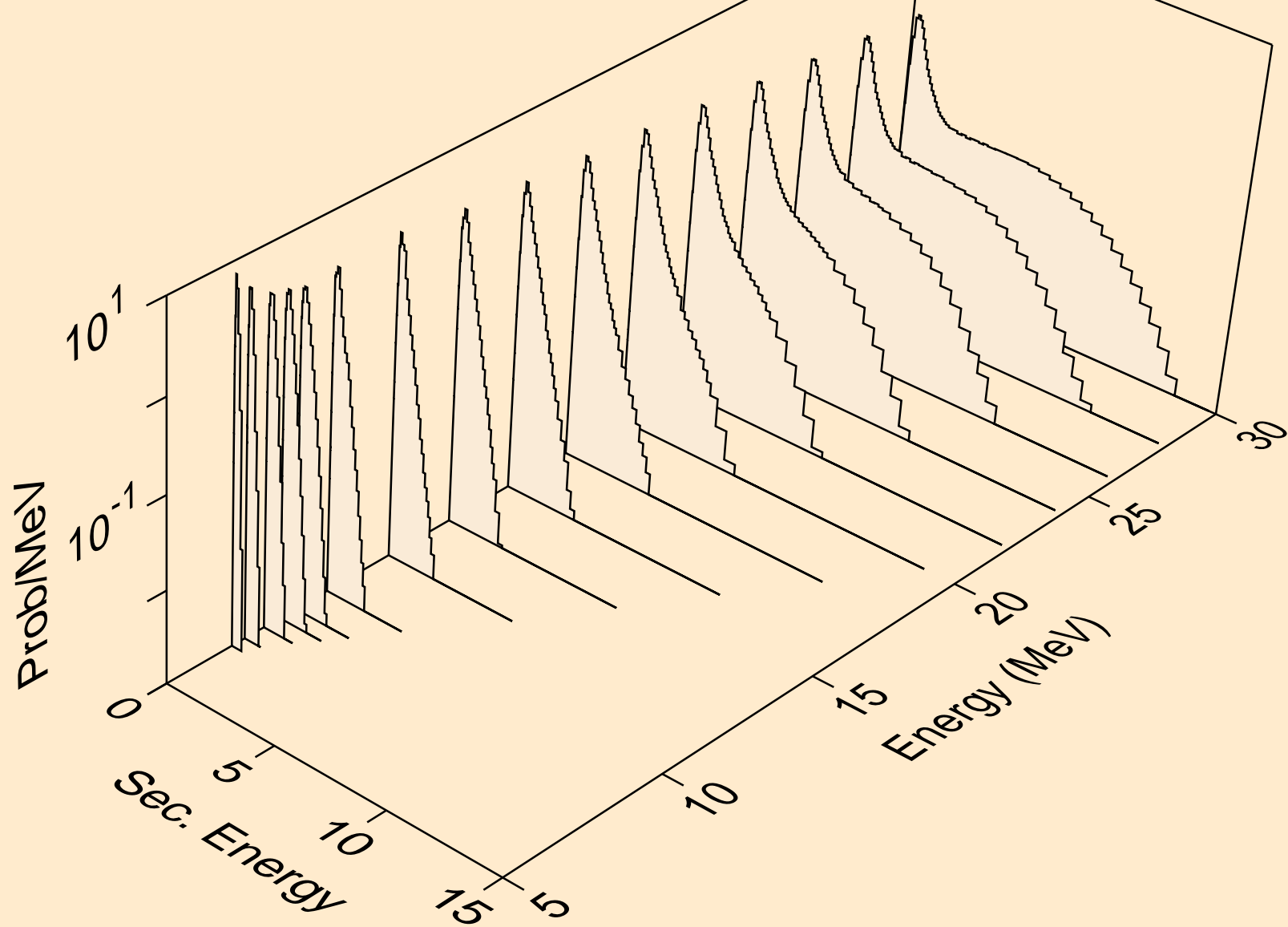

CF246 NEUTRON ACER TENDL-2021 LIBRARY; T=293.6K
Neutron emission for (n,n*)2a

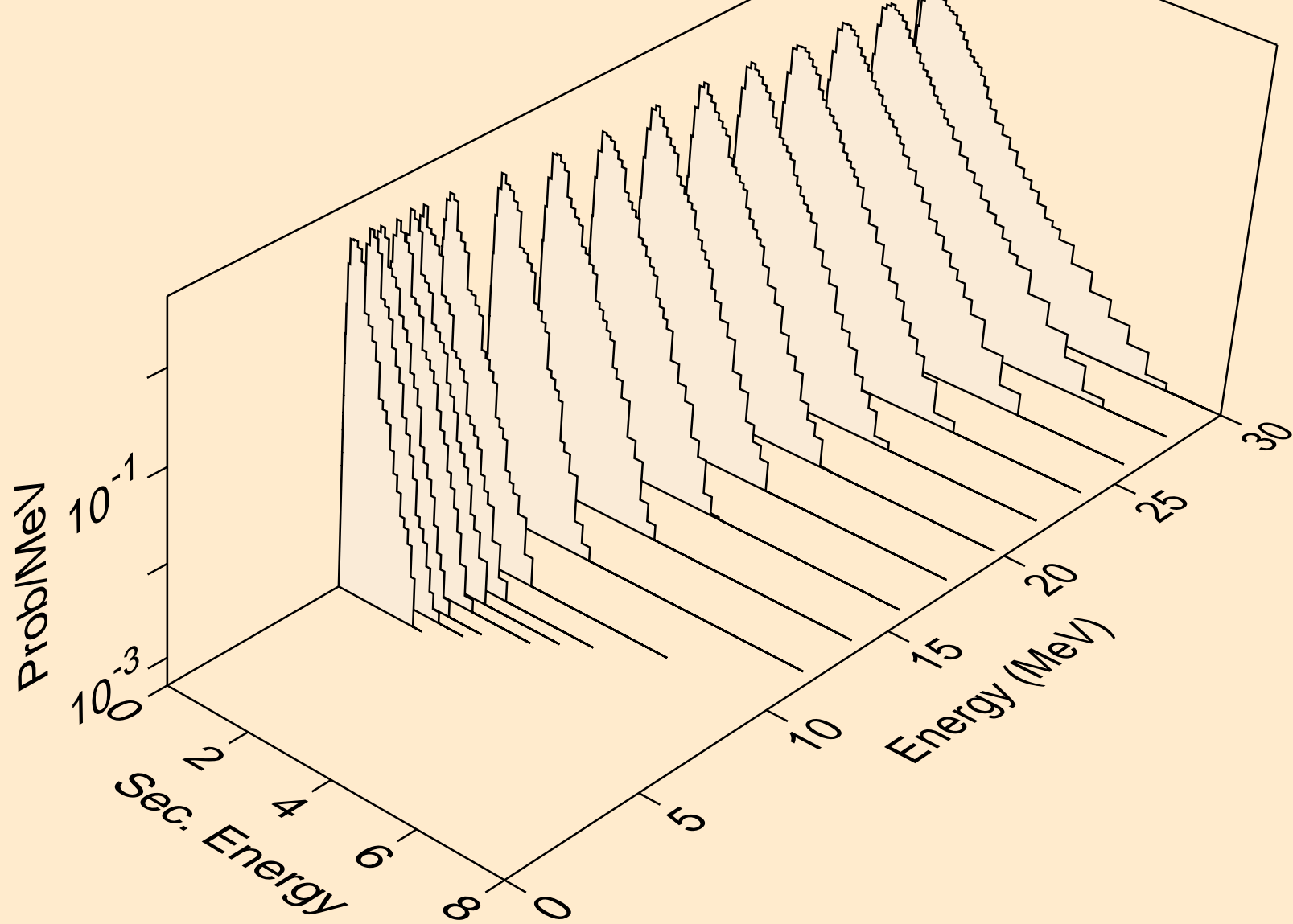

CF246 NEUTRON ACER TENDL-2021 LIBRARY; T=293.6K
Neutron emission for (n,2n)2a

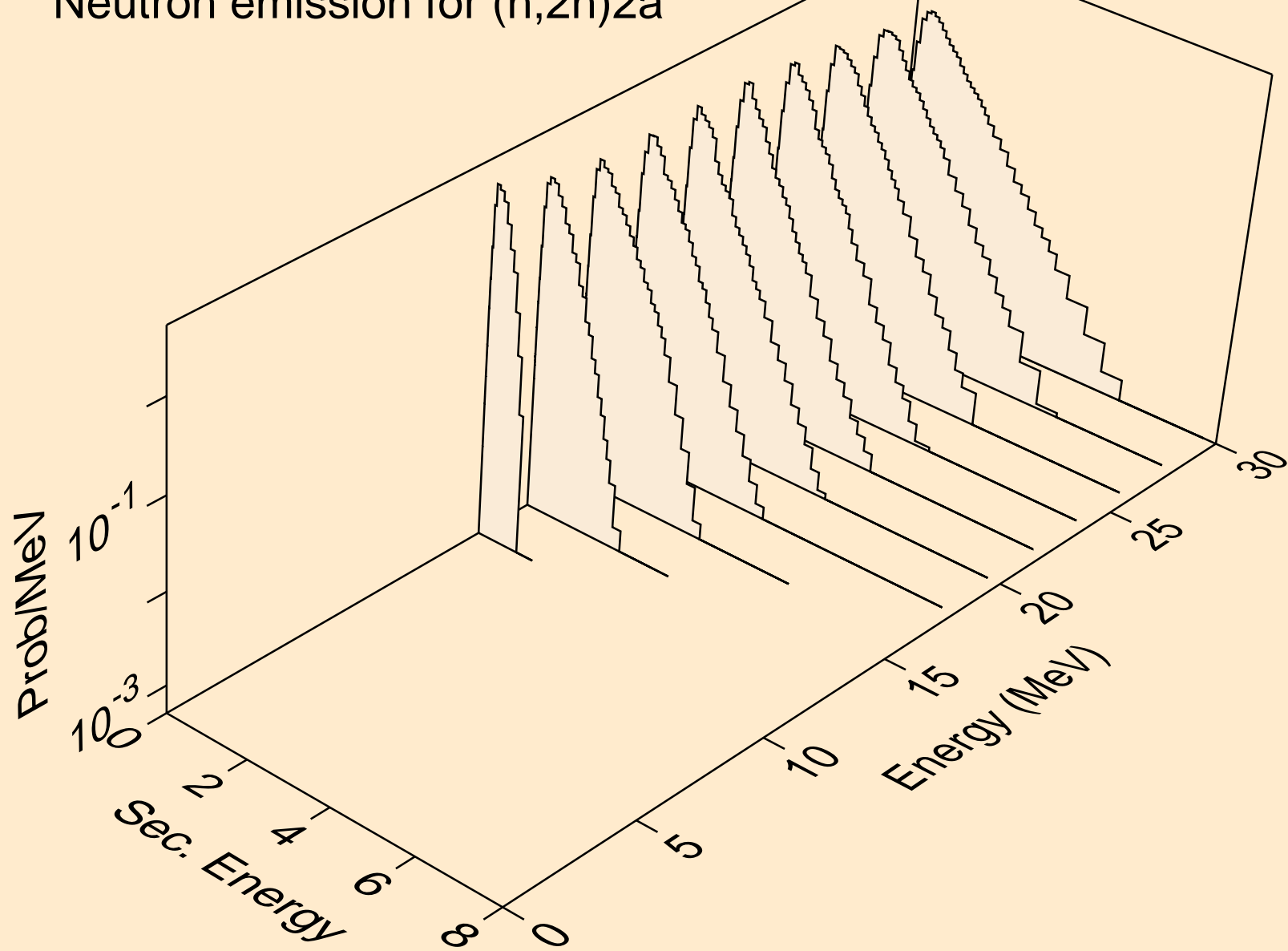

CF246 NEUTRON ACER TENDL-2021 LIBRARY; T=293.6K
Neutron emission for (n,n*)d

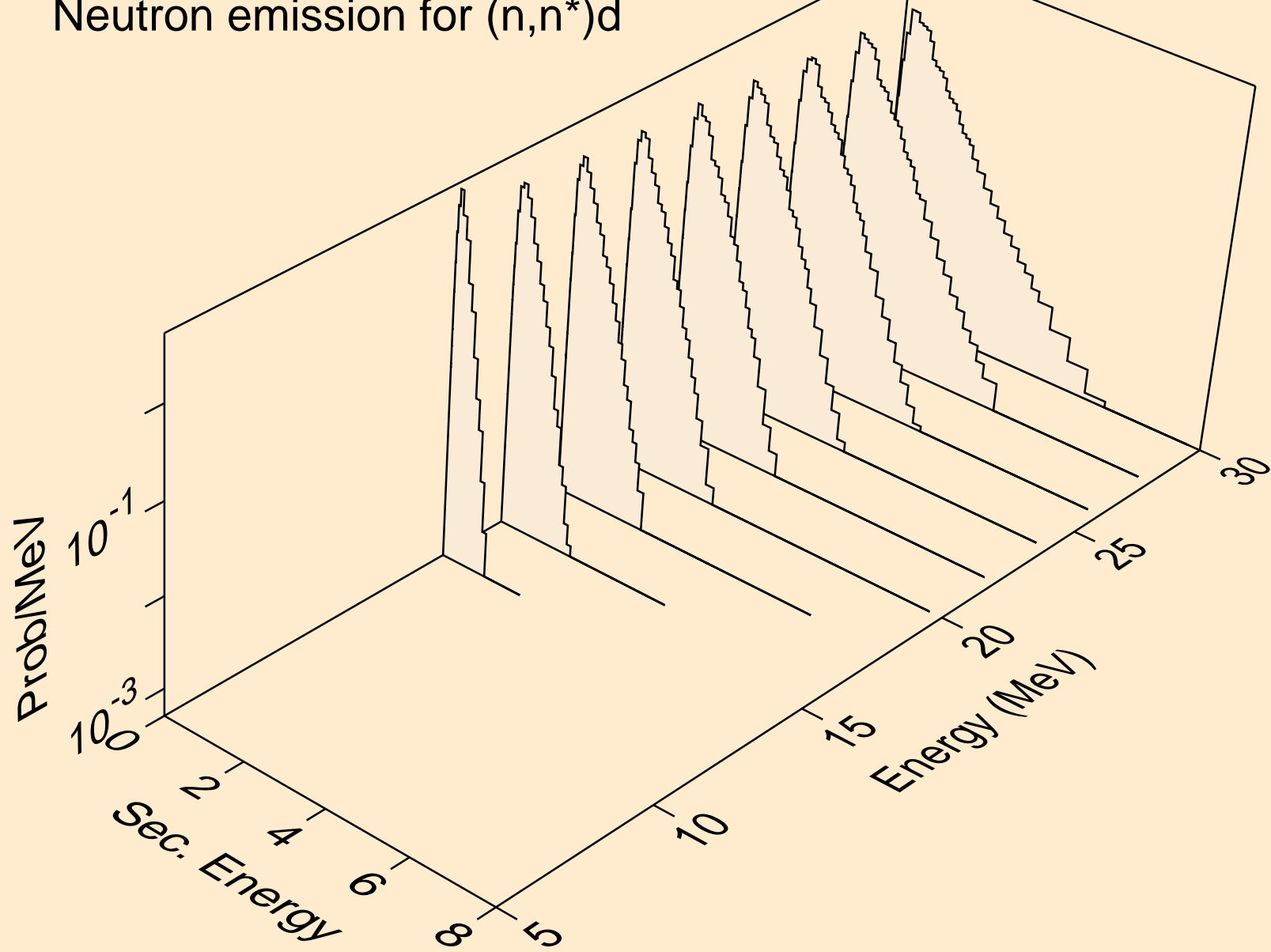

CF246 NEUTRON ACER TENDL-2021 LIBRARY; T=293.6K
Neutron emission for (n,n*)t

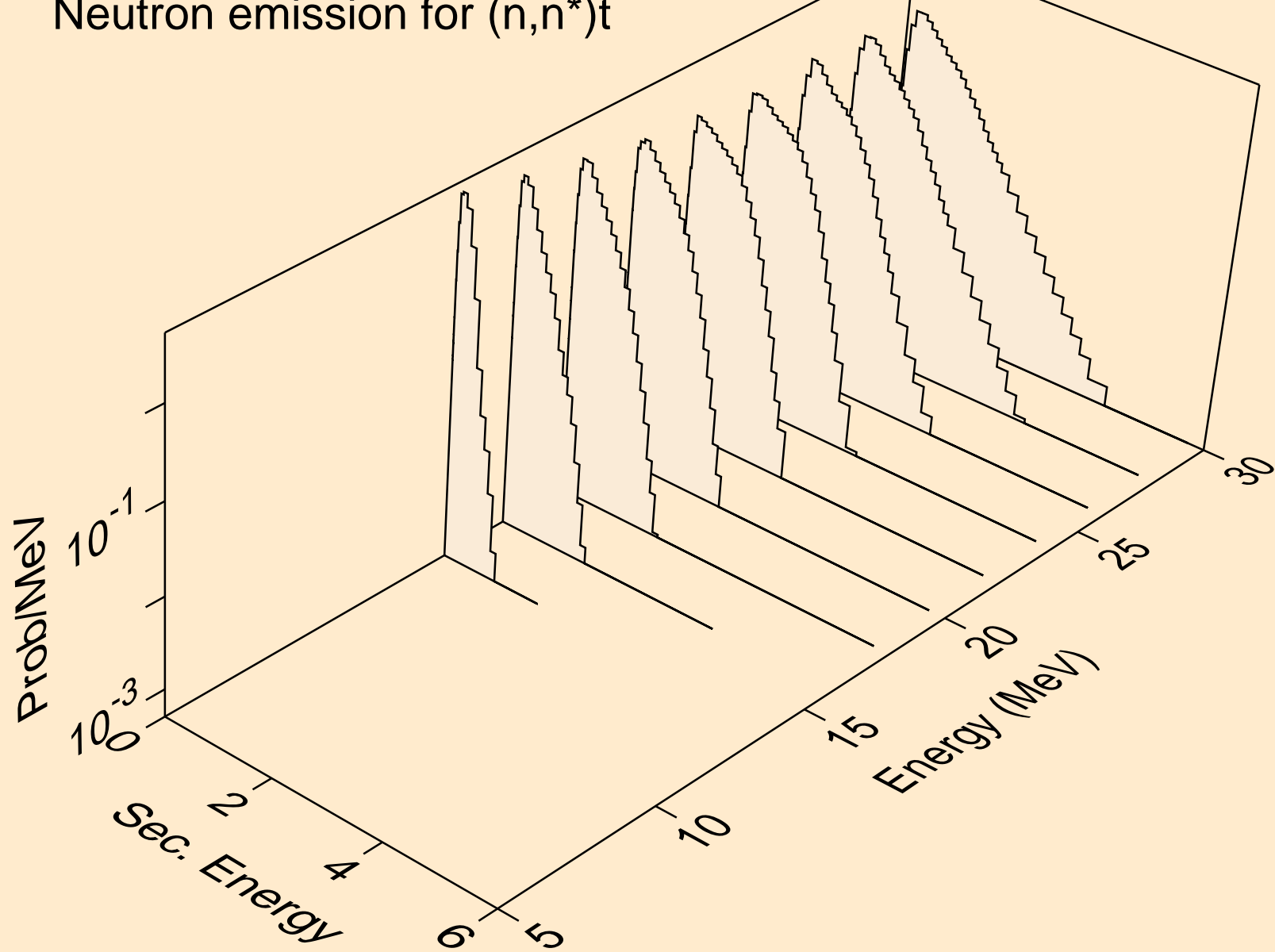

CF246 NEUTRON ACER TENDL-2021 LIBRARY; T=293.6K
Neutron emission for (n,n*)he3

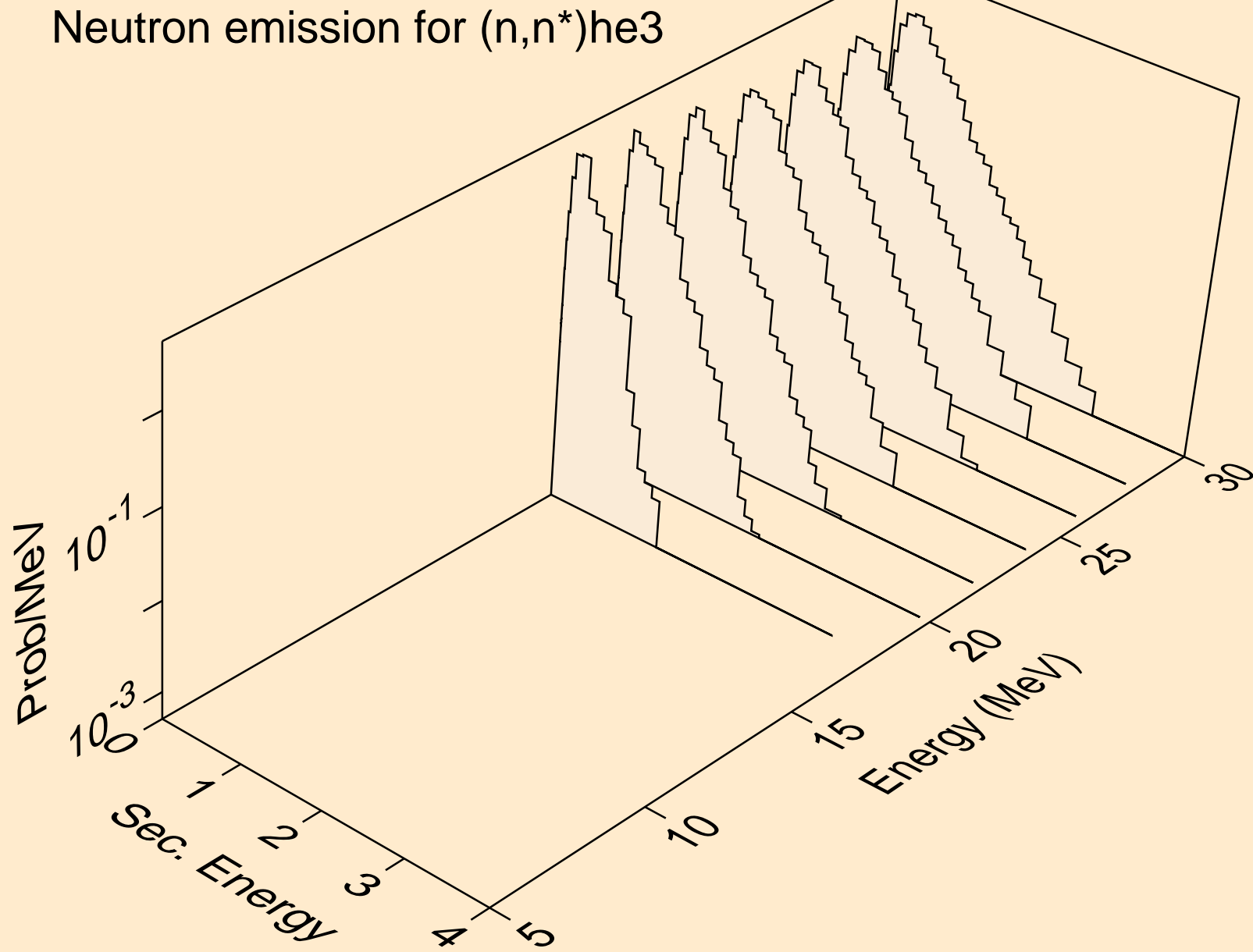

CF246 NEUTRON ACER TENDL-2021 LIBRARY; T=293.6K
Neutron emission for (n,4n)

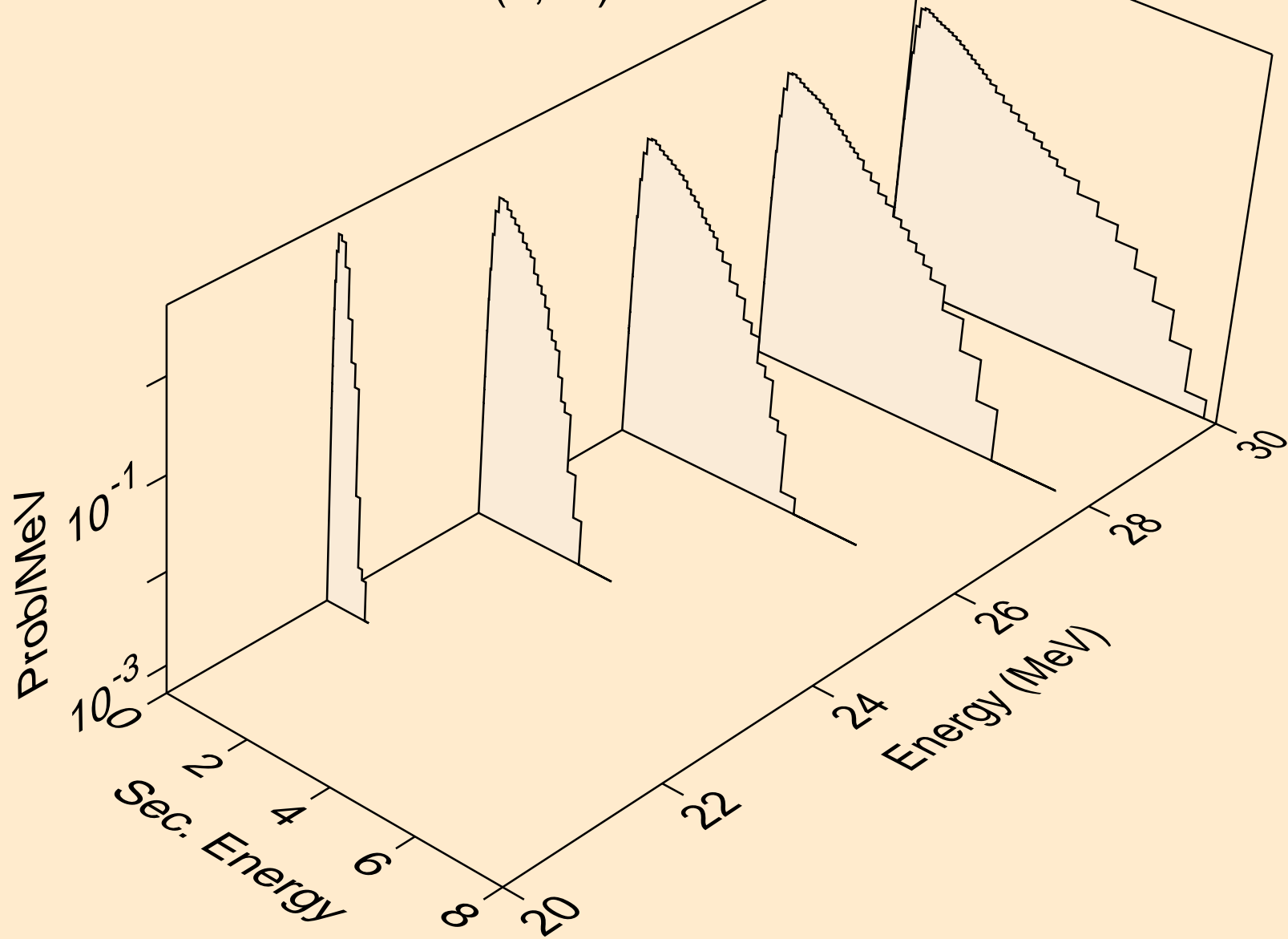

CF246 NEUTRON ACER TENDL-2021 LIBRARY; T=293.6K
Neutron emission for (n,2np)

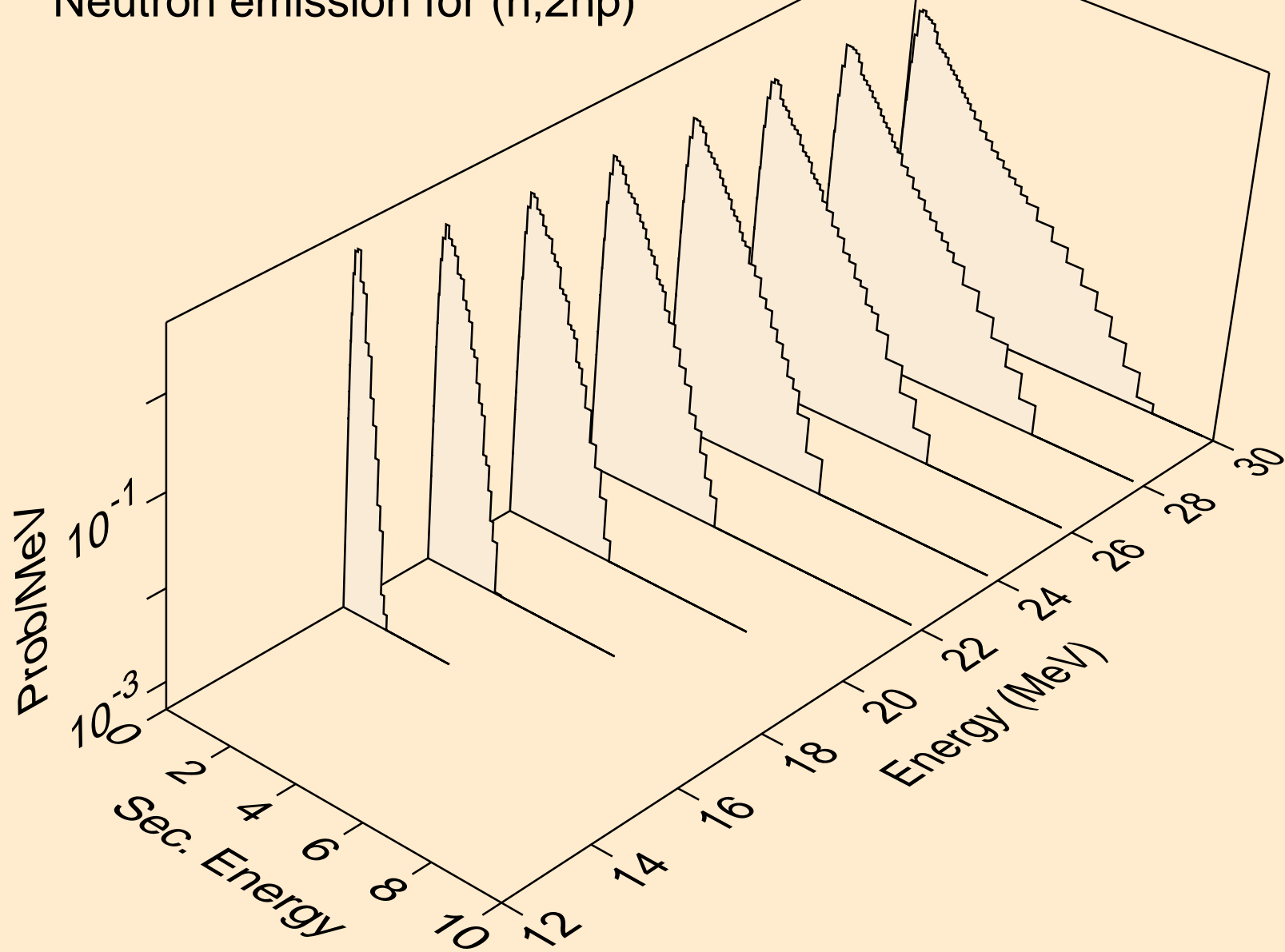

CF246 NEUTRON ACER TENDL-2021 LIBRARY; T=293.6K
Neutron emission for (n,3np)

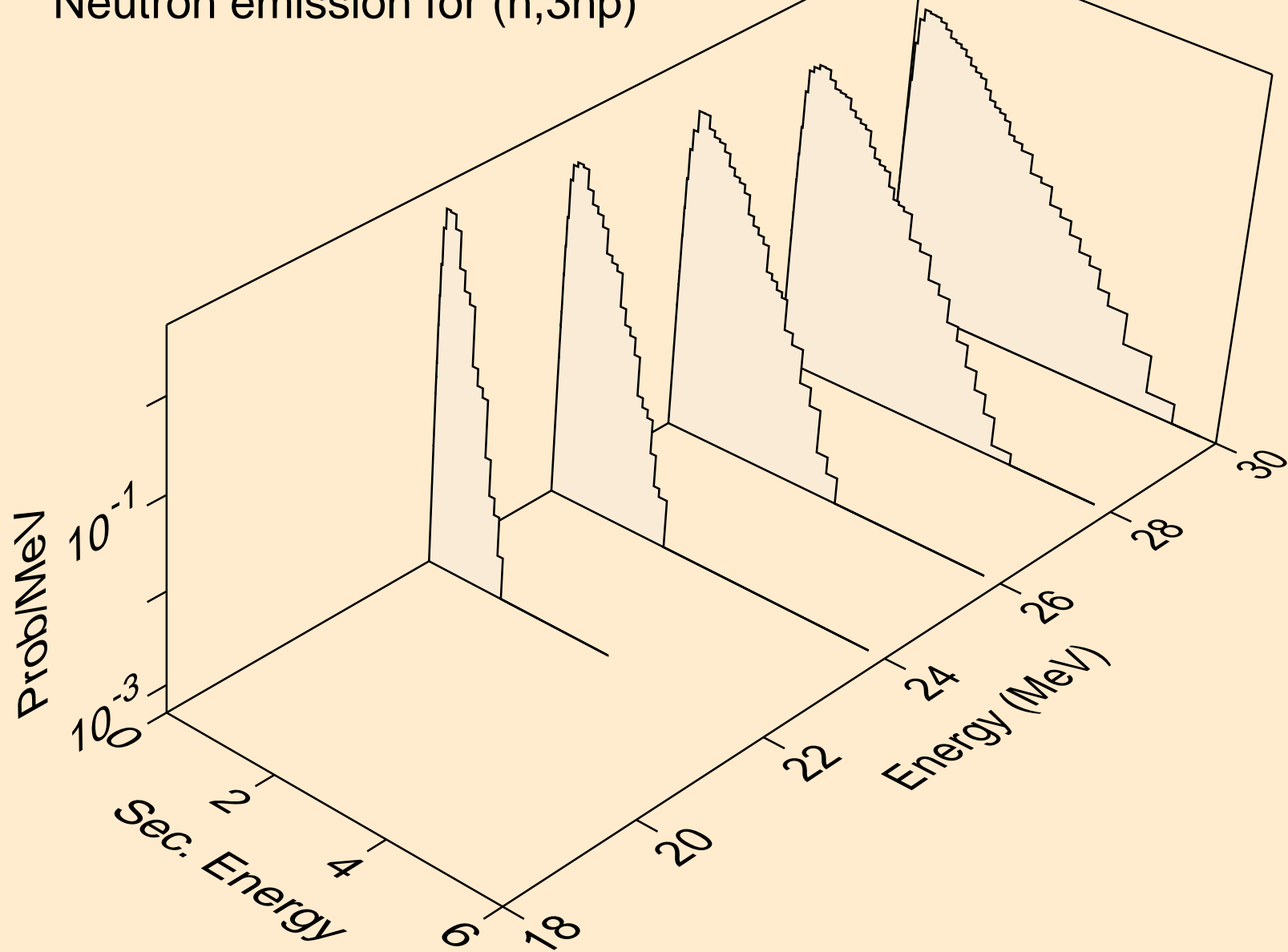

CF246 NEUTRON ACER TENDL-2021 LIBRARY; T=293.6K
Neutron emission for (n,2np)

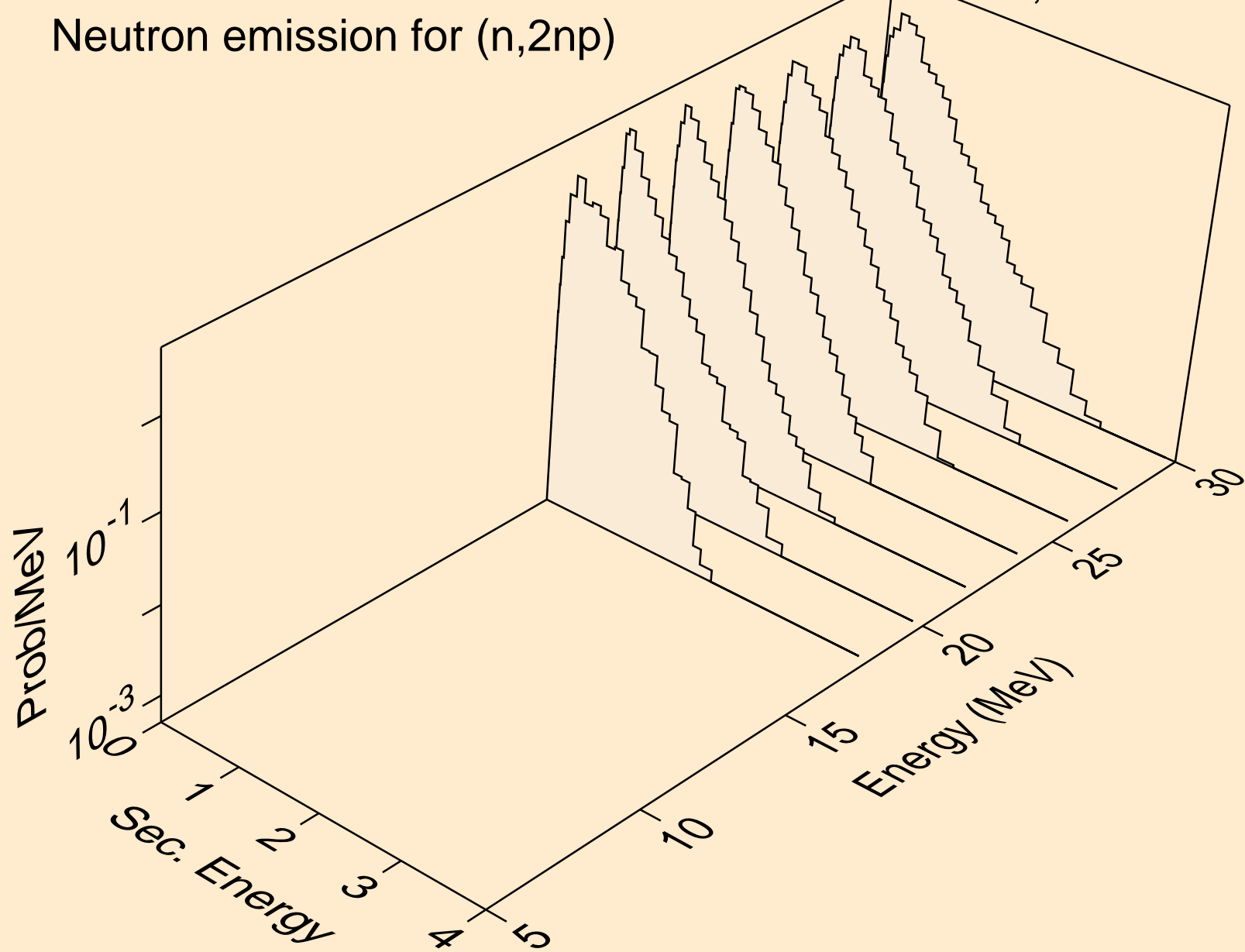

CF246 NEUTRON ACER TENDL-2021 LIBRARY; T=293.6K
Neutron emission for (n,npa)

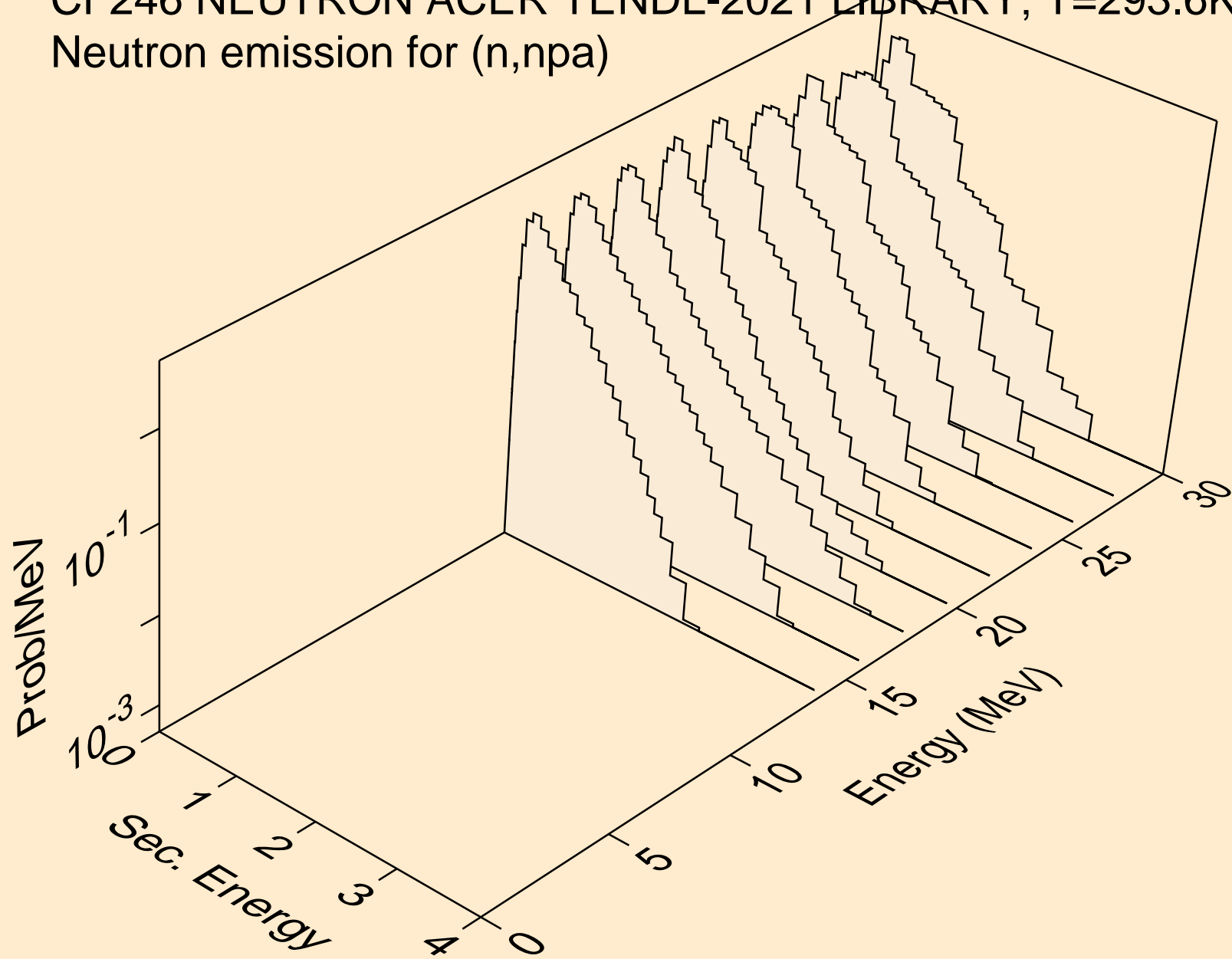

CF246 NEUTRON ACER TENDL-2021 LIBRARY; T=293.6K
Neutron emission for (n,n*c)

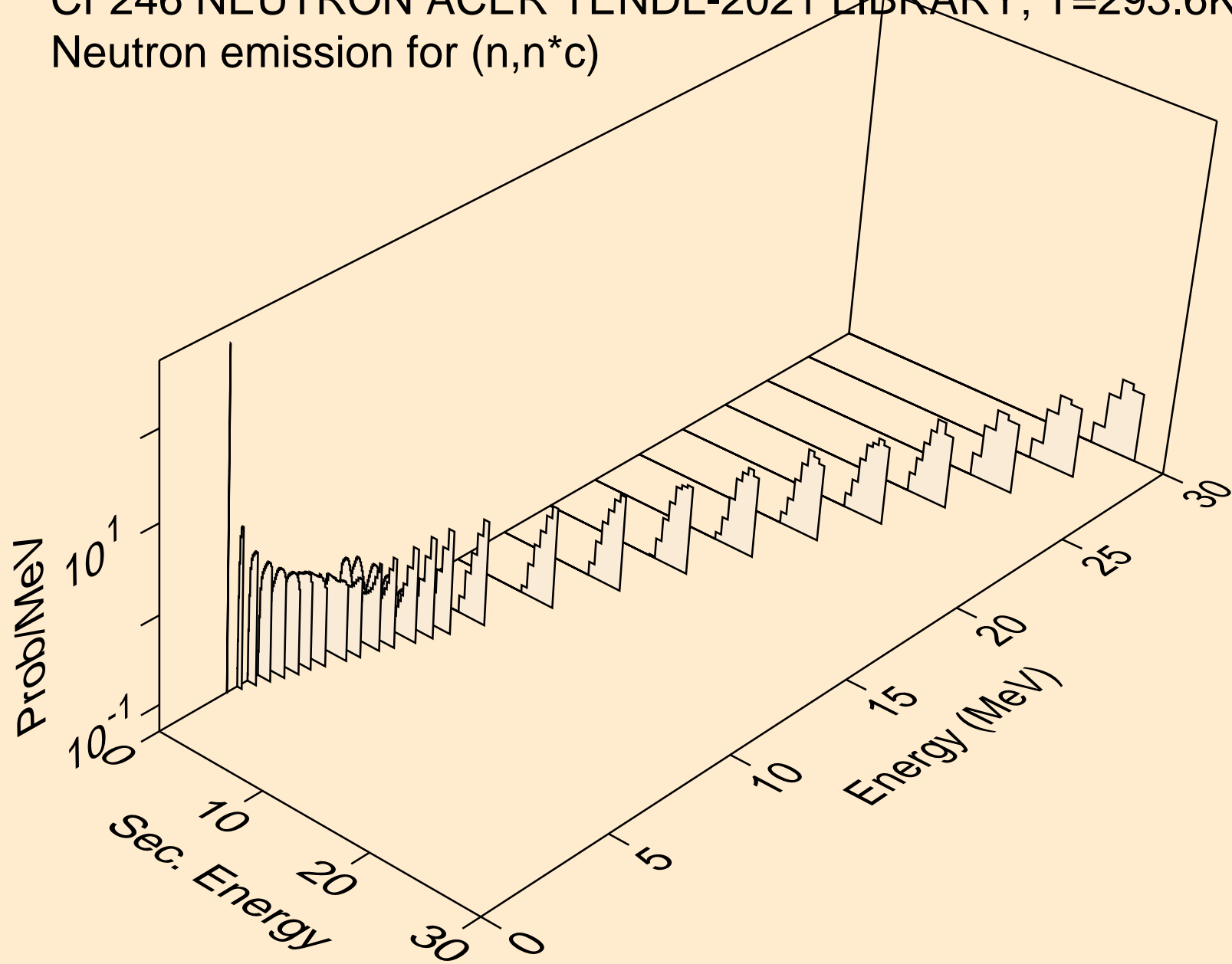

CF246 NEUTRON ACER TENDL-2021 LIBRARY; T=293.6K
Delayed nubar

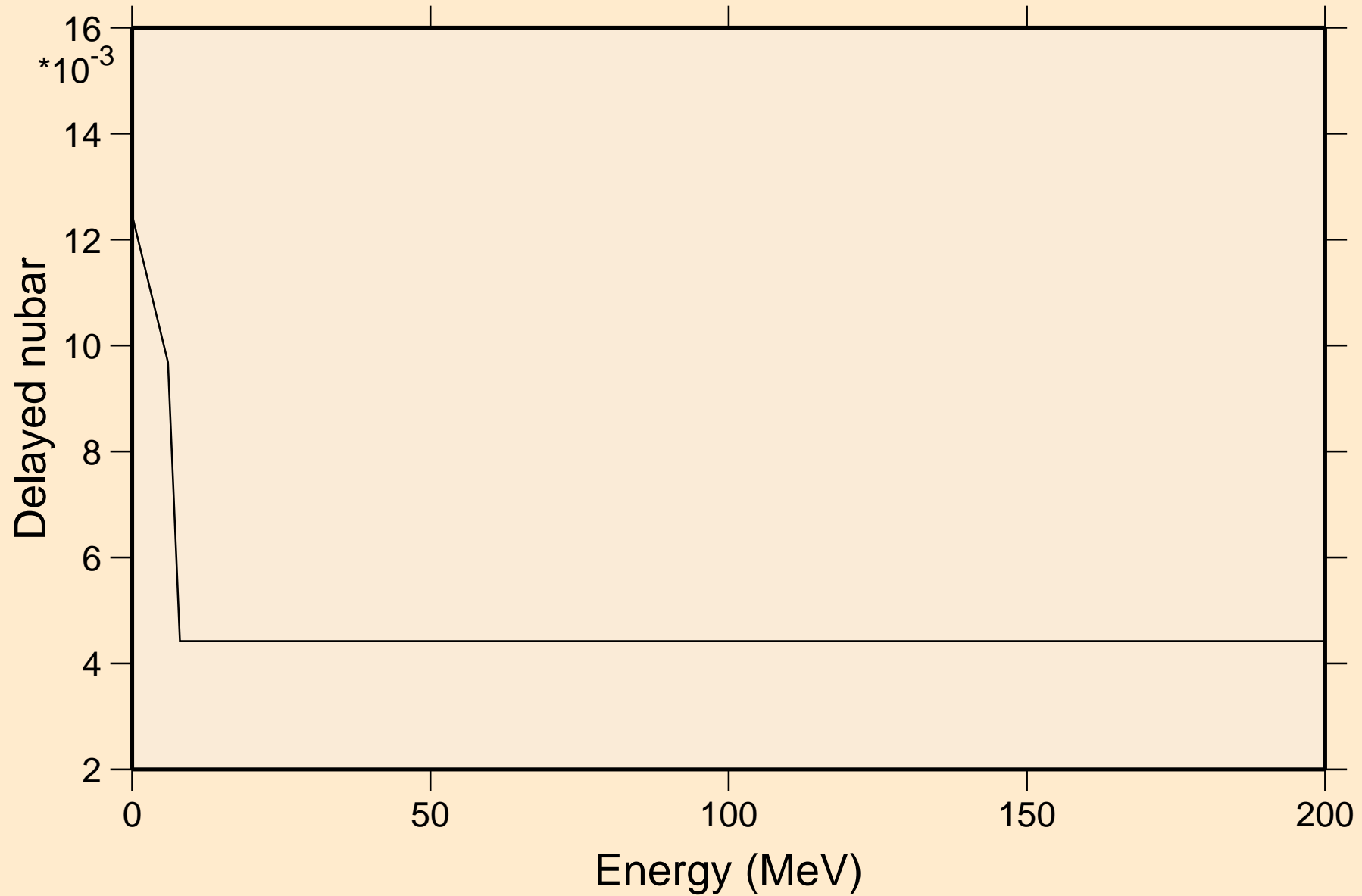

CF246 NEUTRON ACER TENDL-2021 LIBRARY; T=293.6K

Delayed neutron spectra

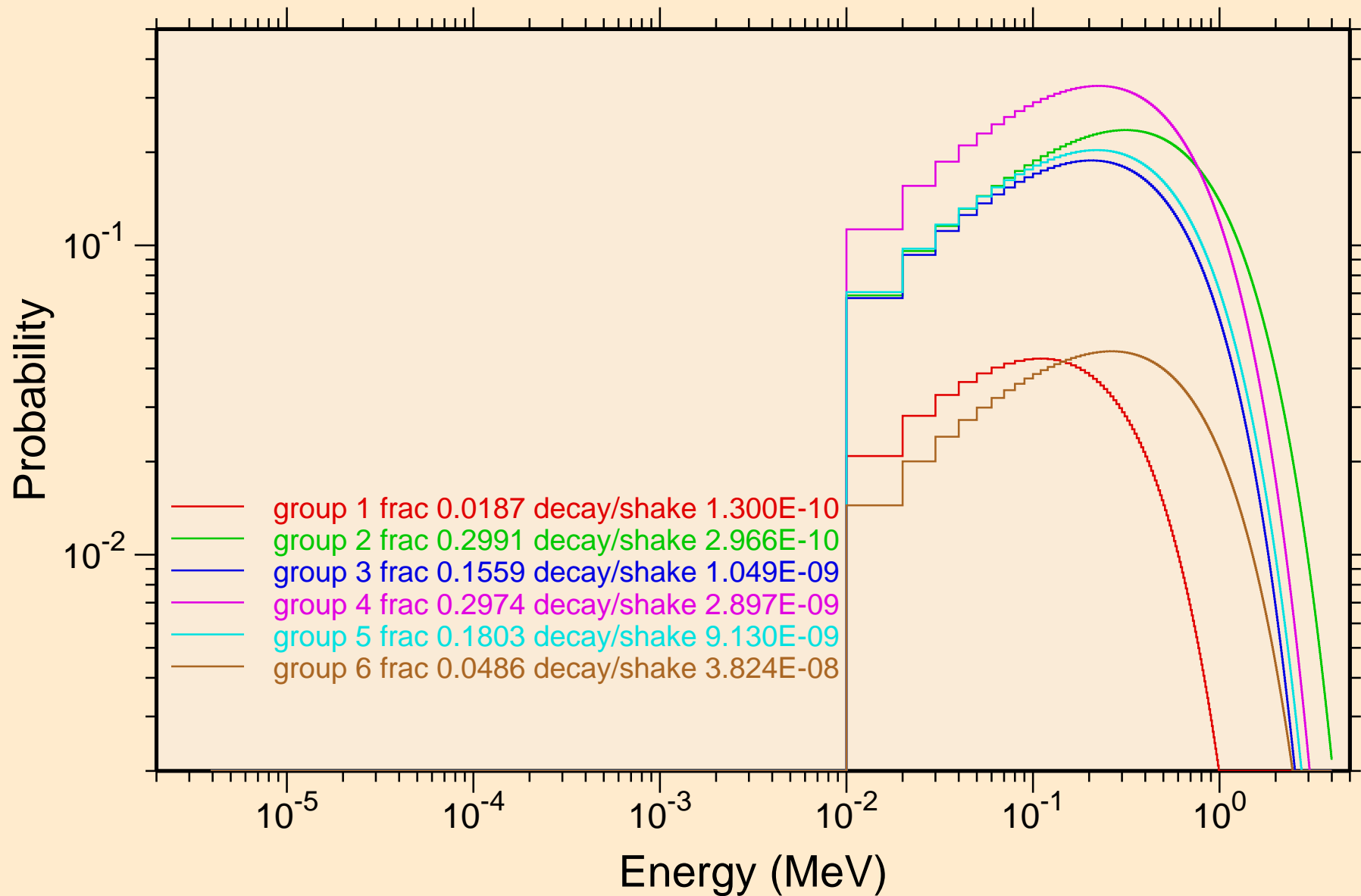

CF246 NEUTRON ACER TENDL-2021 LIBRARY; T=293.6K
Photon emission for (n,x)

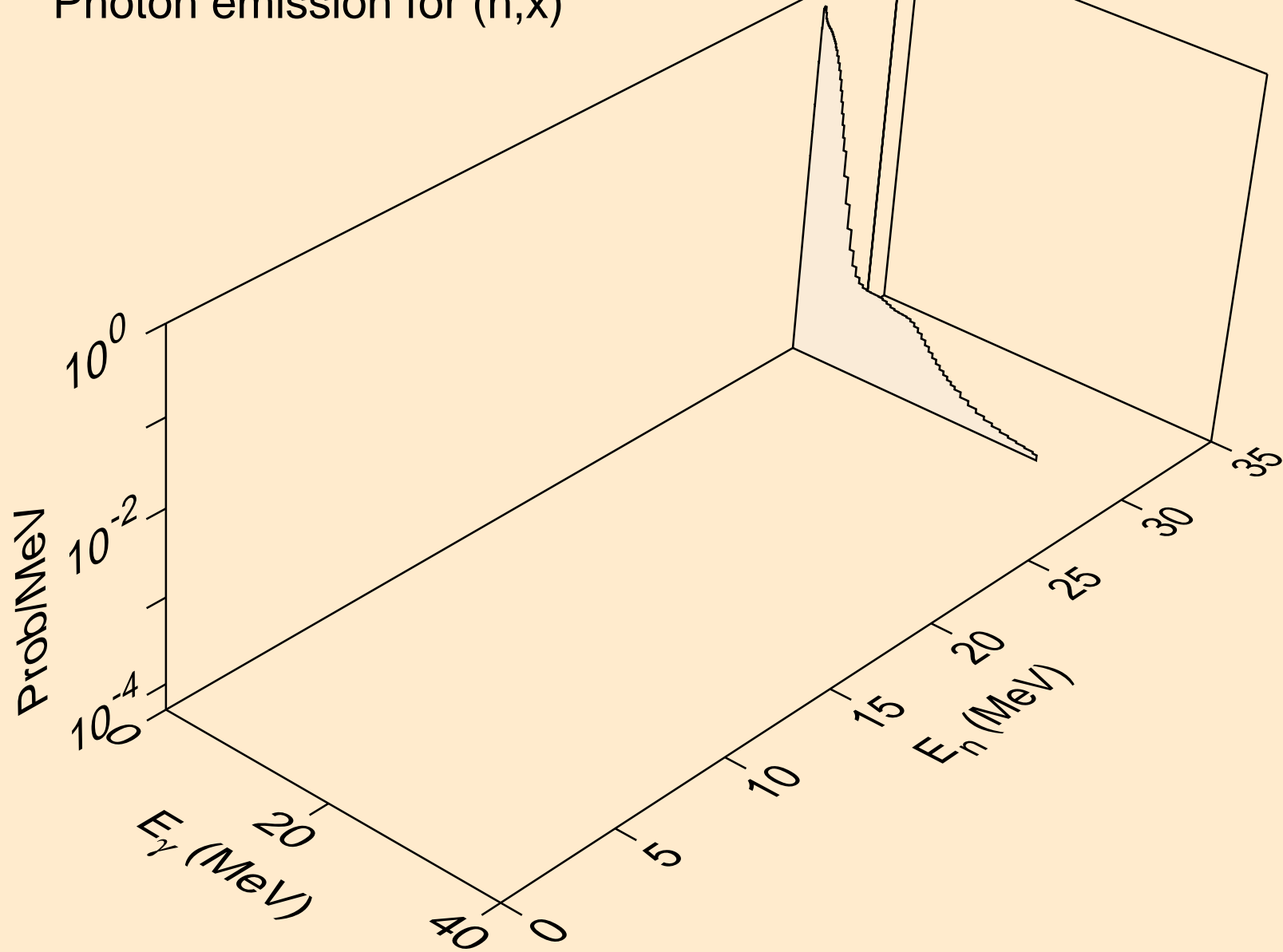

CF246 NEUTRON ACER TENDL-2021 LIBRARY; T=293.6K
Photon emission for (n,2nd)

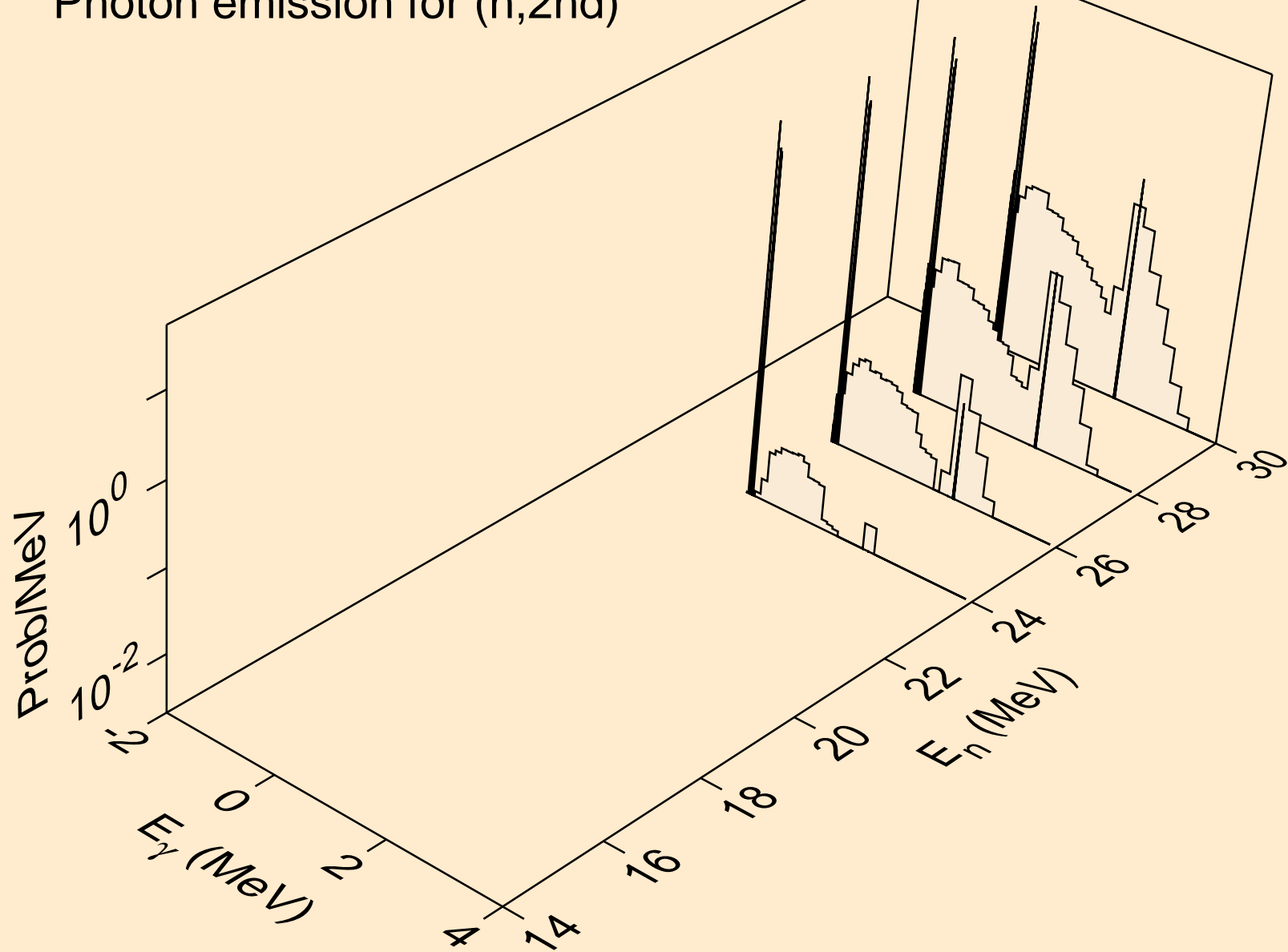

CF246 NEUTRON ACER TENDL-2021 LIBRARY; T=293.6K
Photon emission for (n,2n)

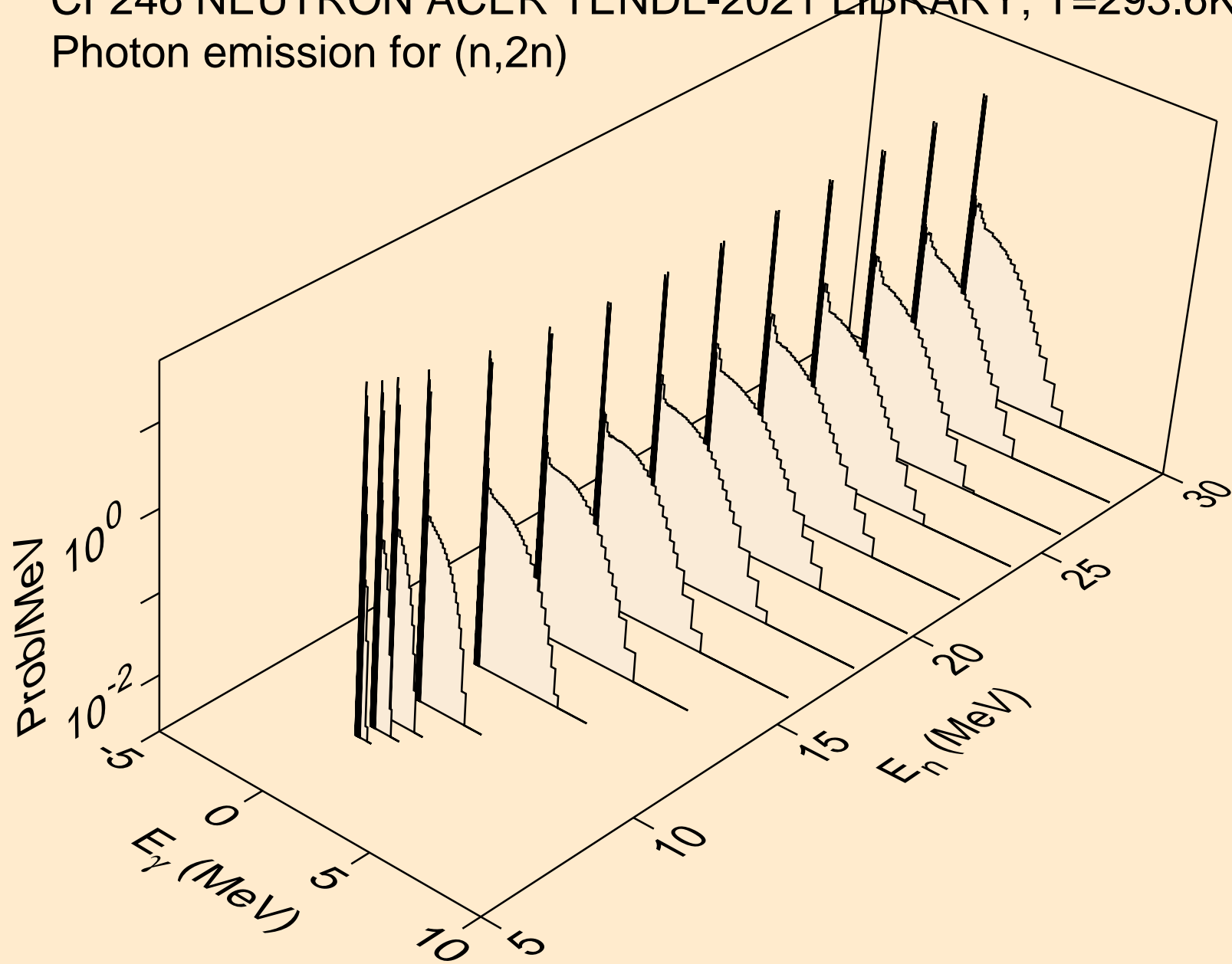

CF246 NEUTRON ACER TENDL-2021 LIBRARY; T=293.6K
Photon emission for (n,3n)

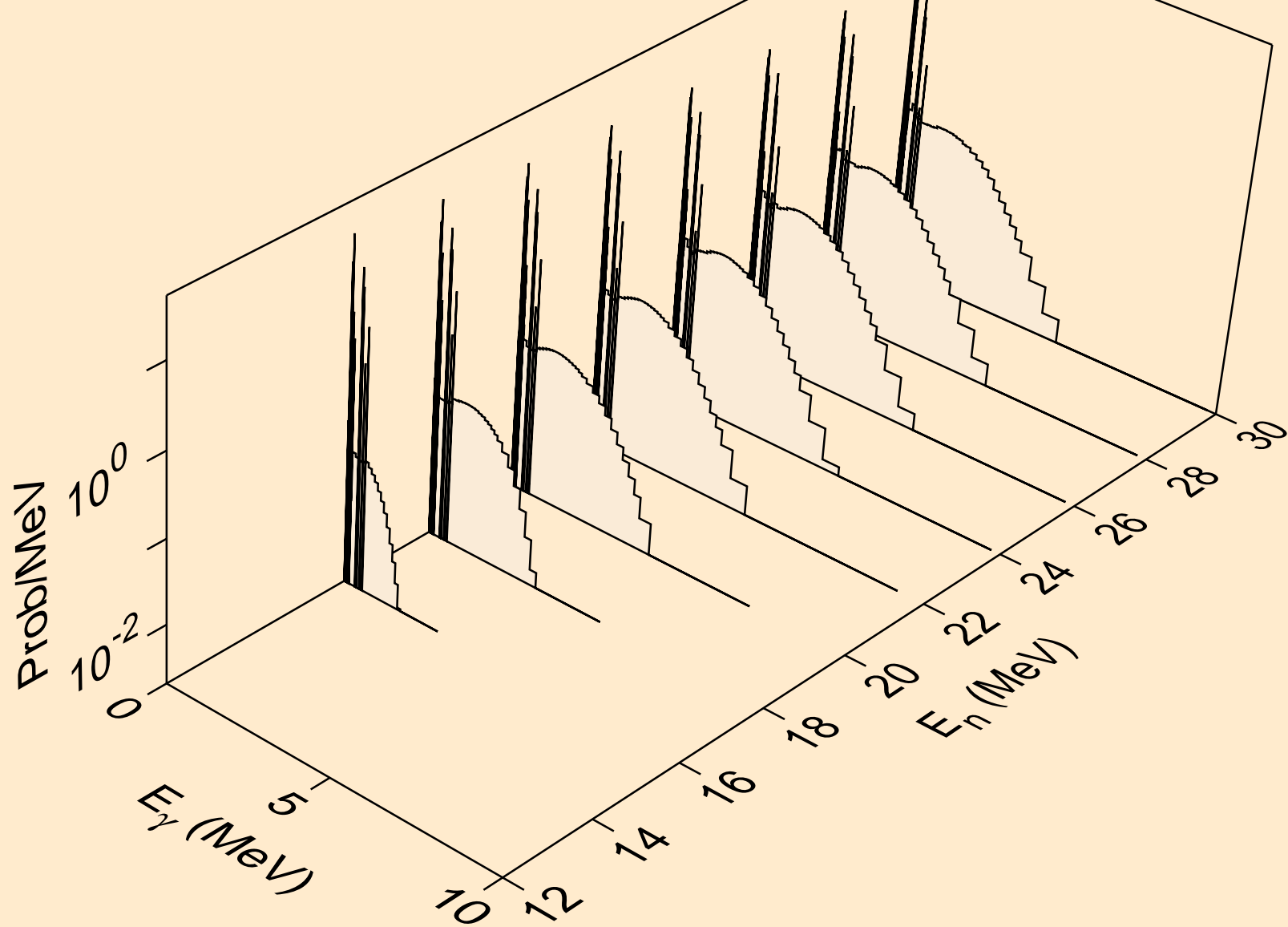

CF246 NEUTRON ACER TENDL-2021 LIBRARY; T=293.6K
Photon emission for (n,n*)a

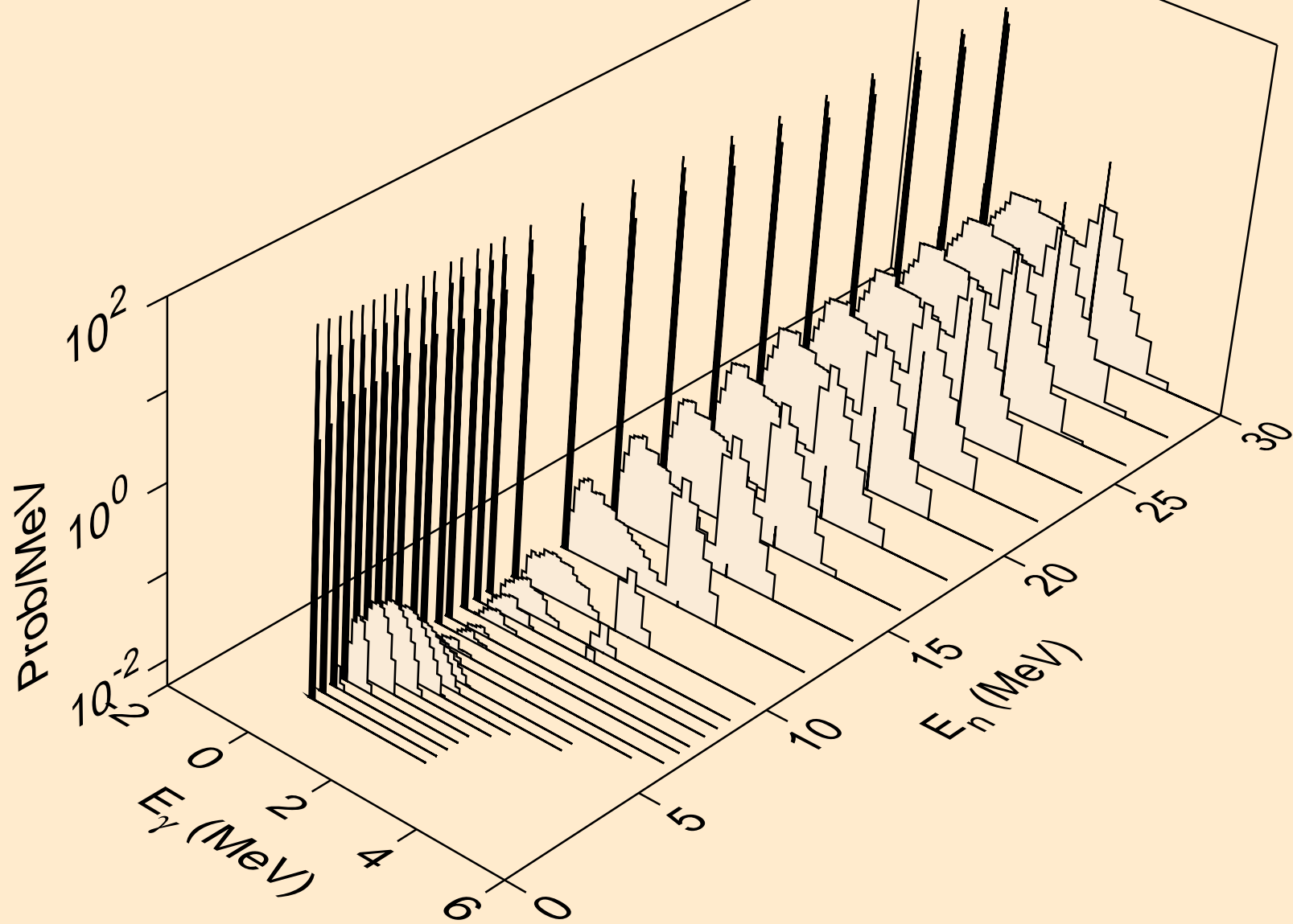

CF246 NEUTRON ACER TENDL-2021 LIBRARY; T=293.6K
Photon emission for (n,2n)a

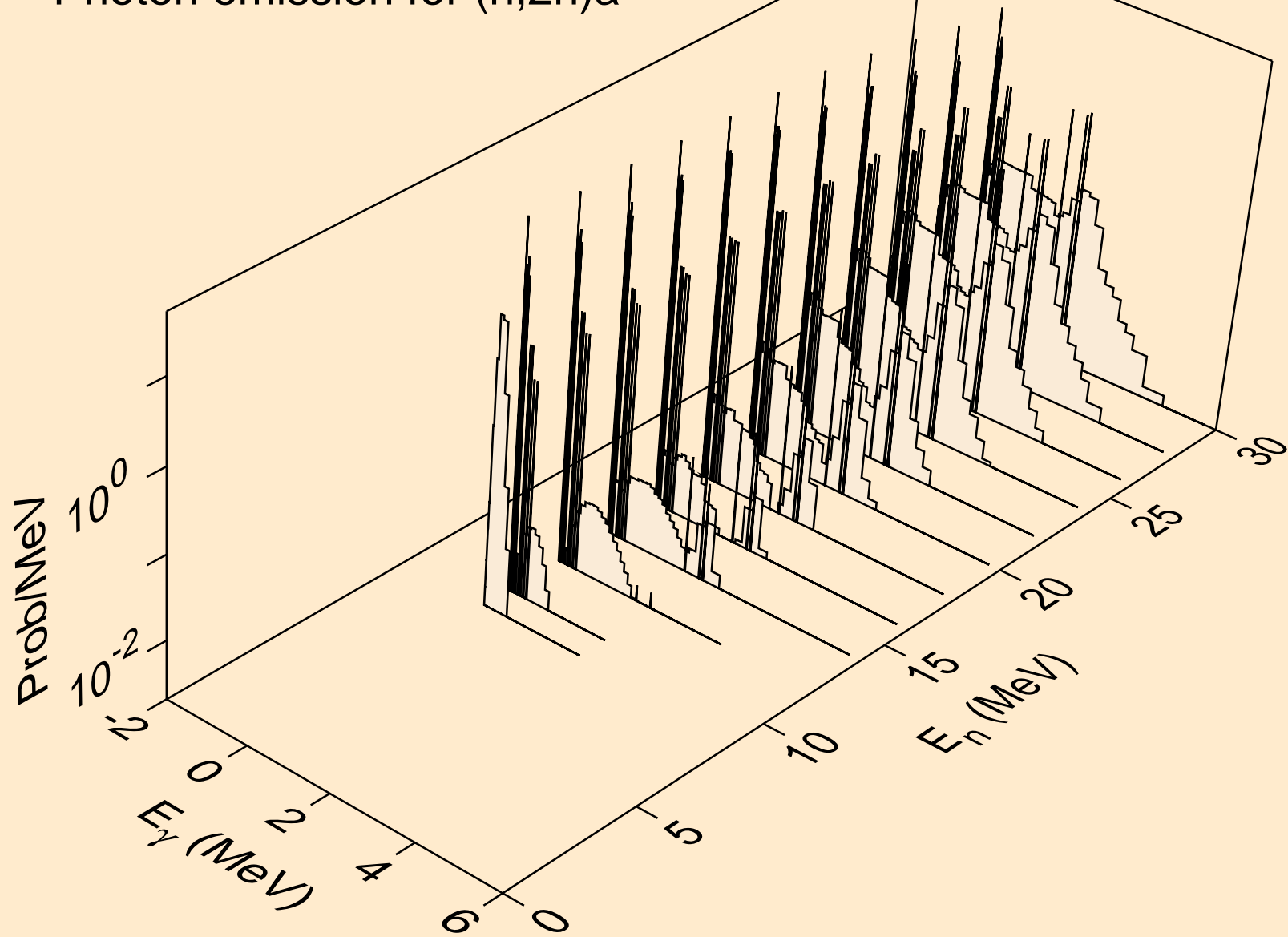

CF246 NEUTRON ACER TENDL-2021 LIBRARY; T=293.6K
Photon emission for (n,3n)a

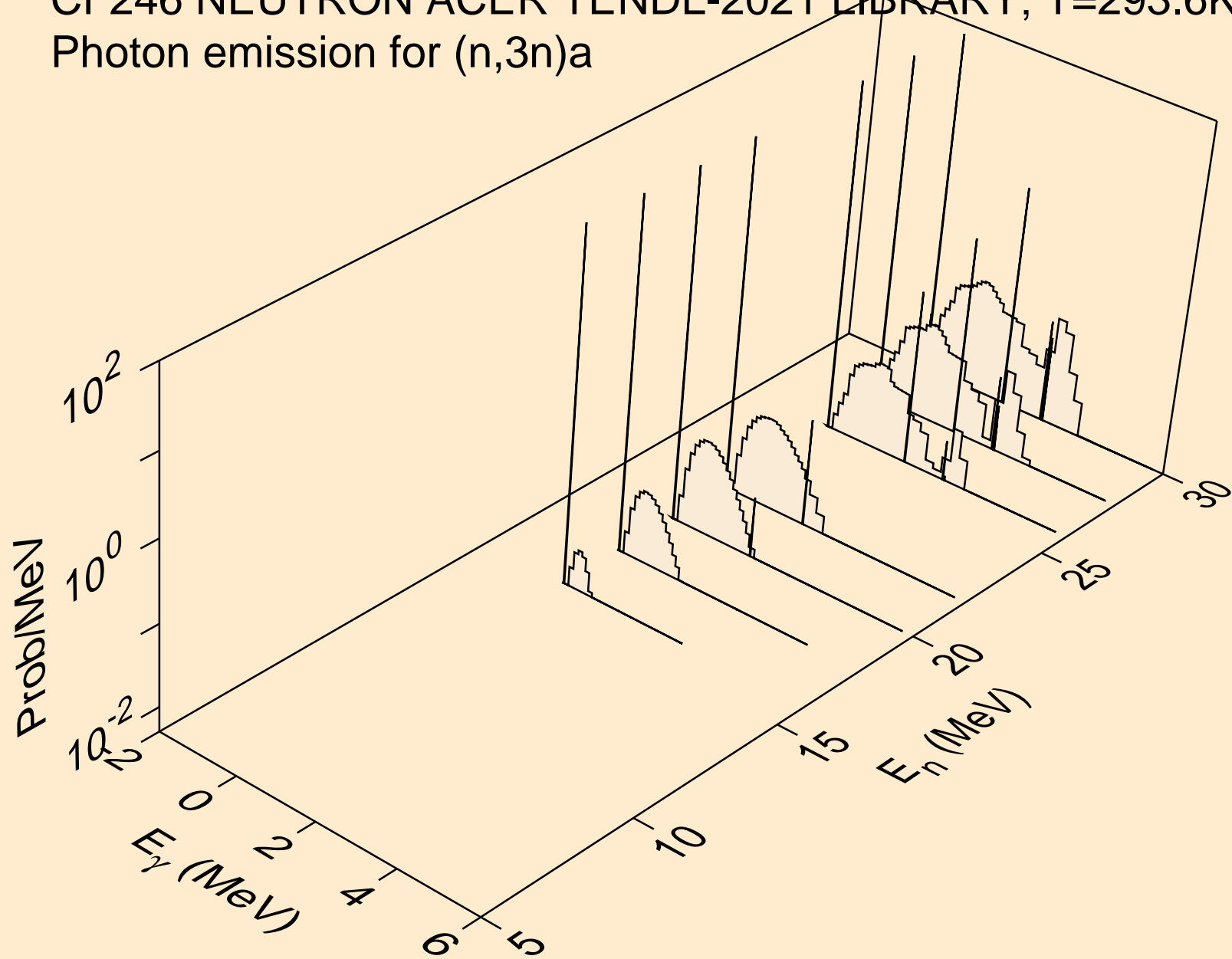

CF246 NEUTRON ACER TENDL-2021 LIBRARY; T=293.6K
Photon emission for (n,n*)p

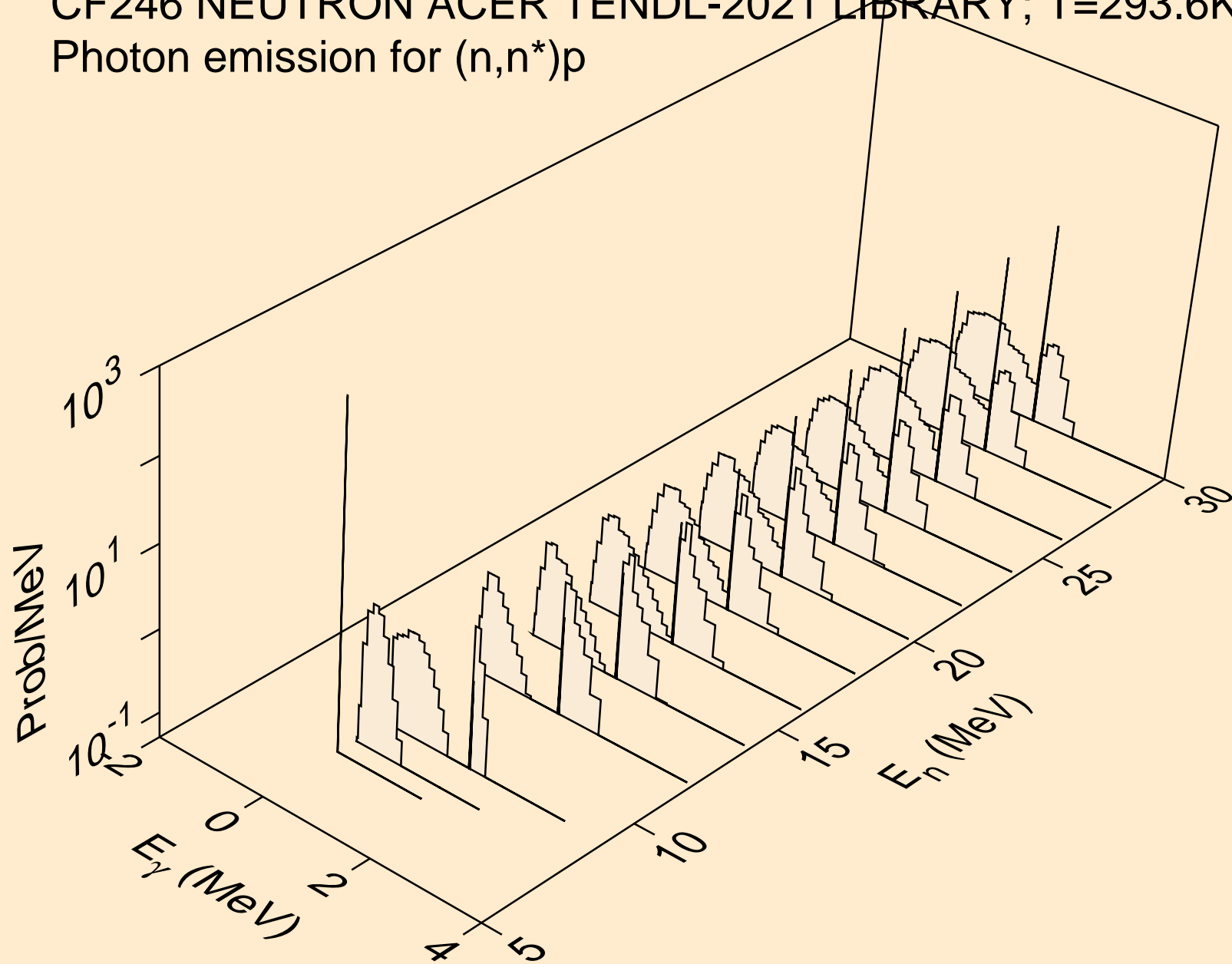

CF246 NEUTRON ACER TENDL-2021 LIBRARY; T=293.6K
Photon emission for (n,n*)2a

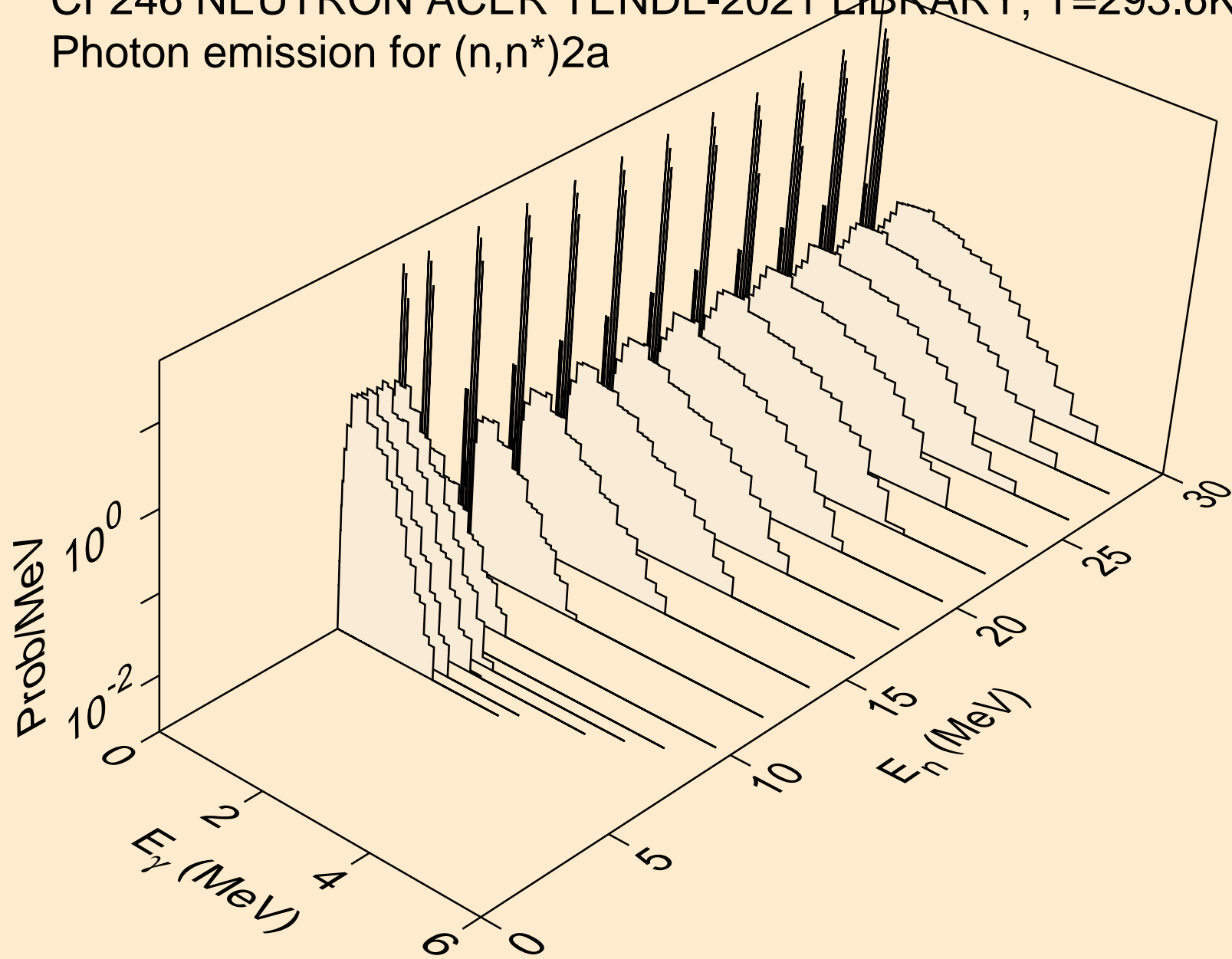

CF246 NEUTRON ACER TENDL-2021 LIBRARY; T=293.6K
Photon emission for (n,2n)2a

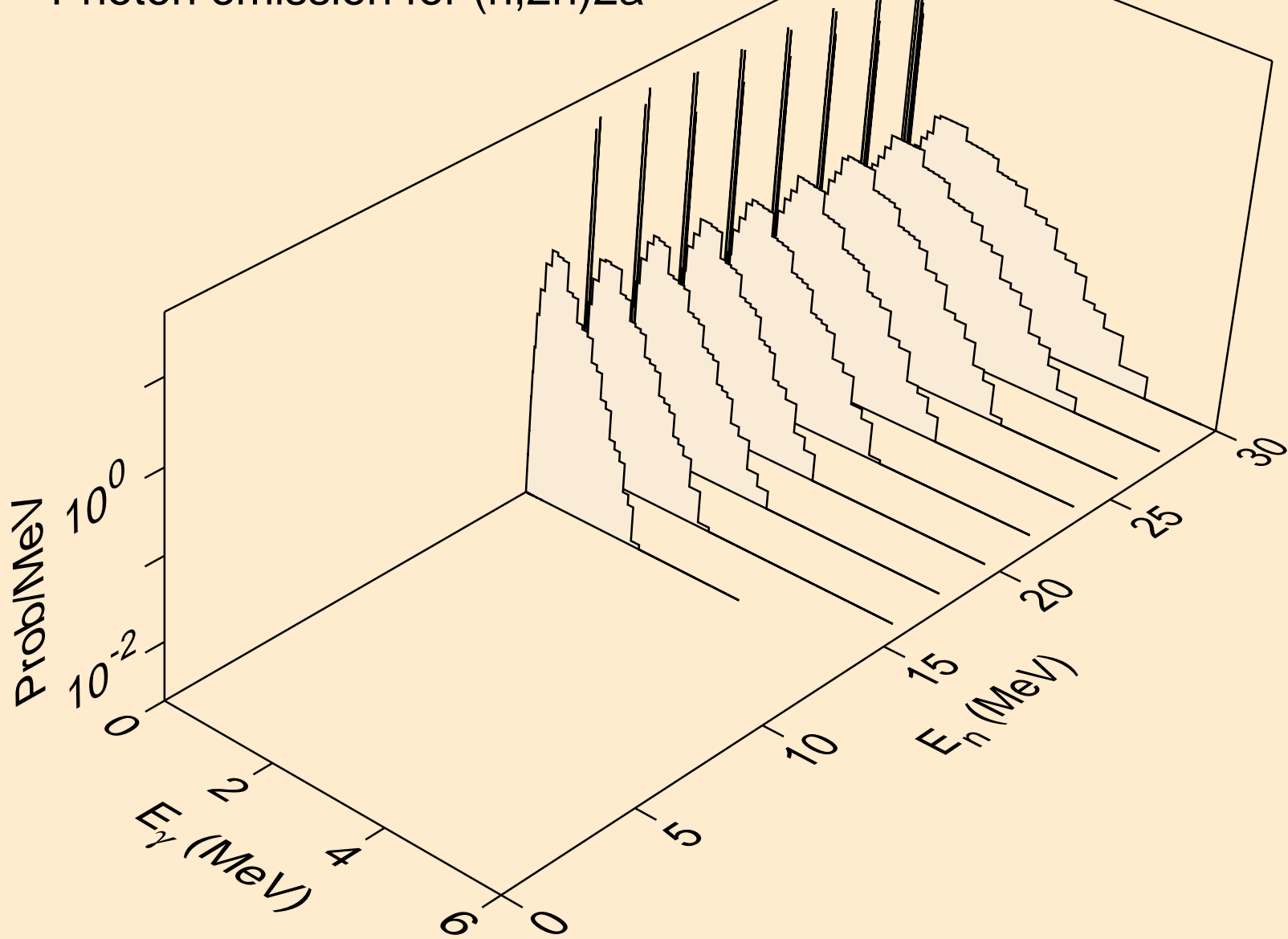

CF246 NEUTRON ACER TENDL-2021 LIBRARY; T=293.6K
Photon emission for (n,n*)d

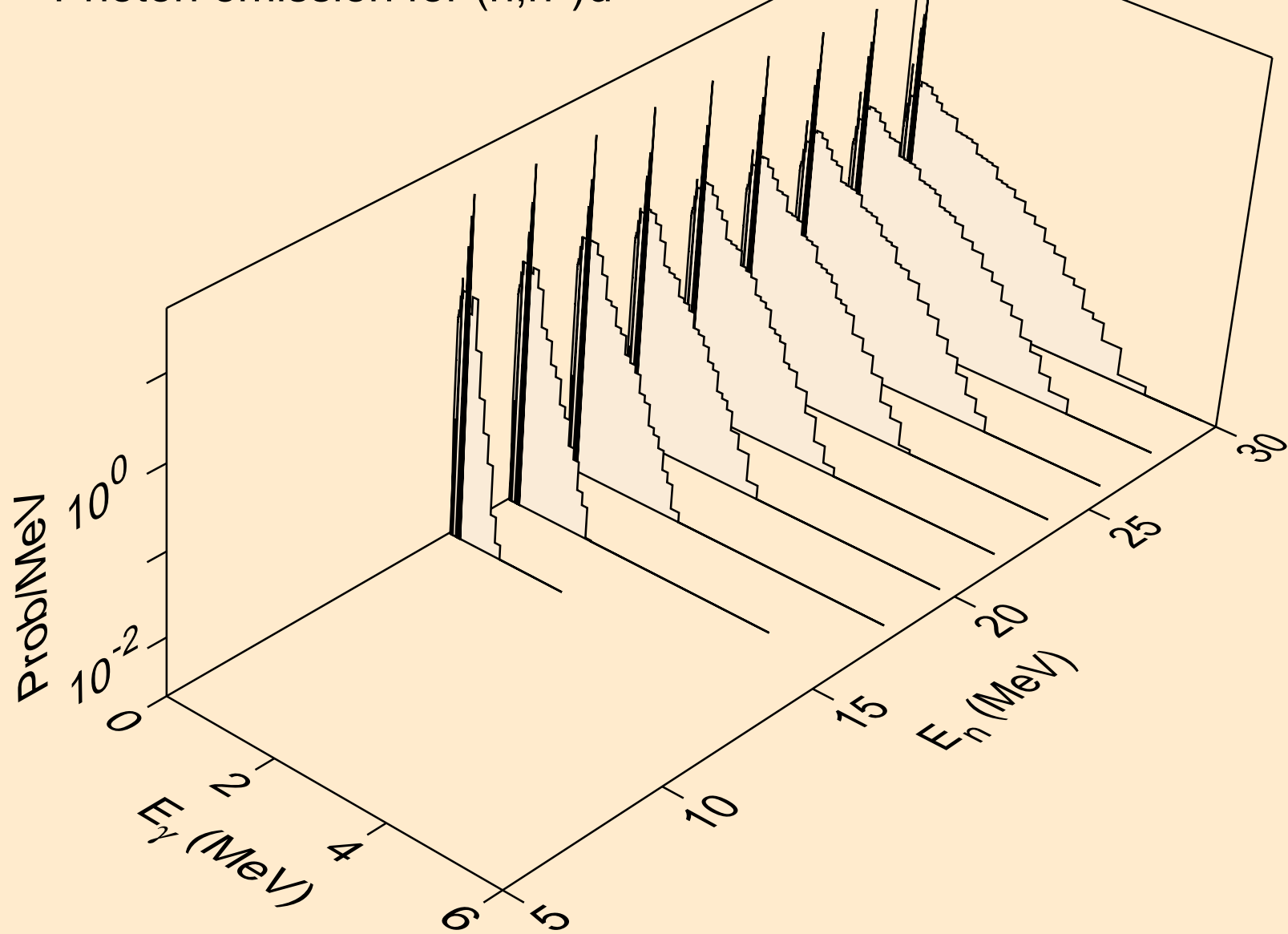

CF246 NEUTRON ACER TENDL-2021 LIBRARY; T=293.6K
Photon emission for (n,n*)t

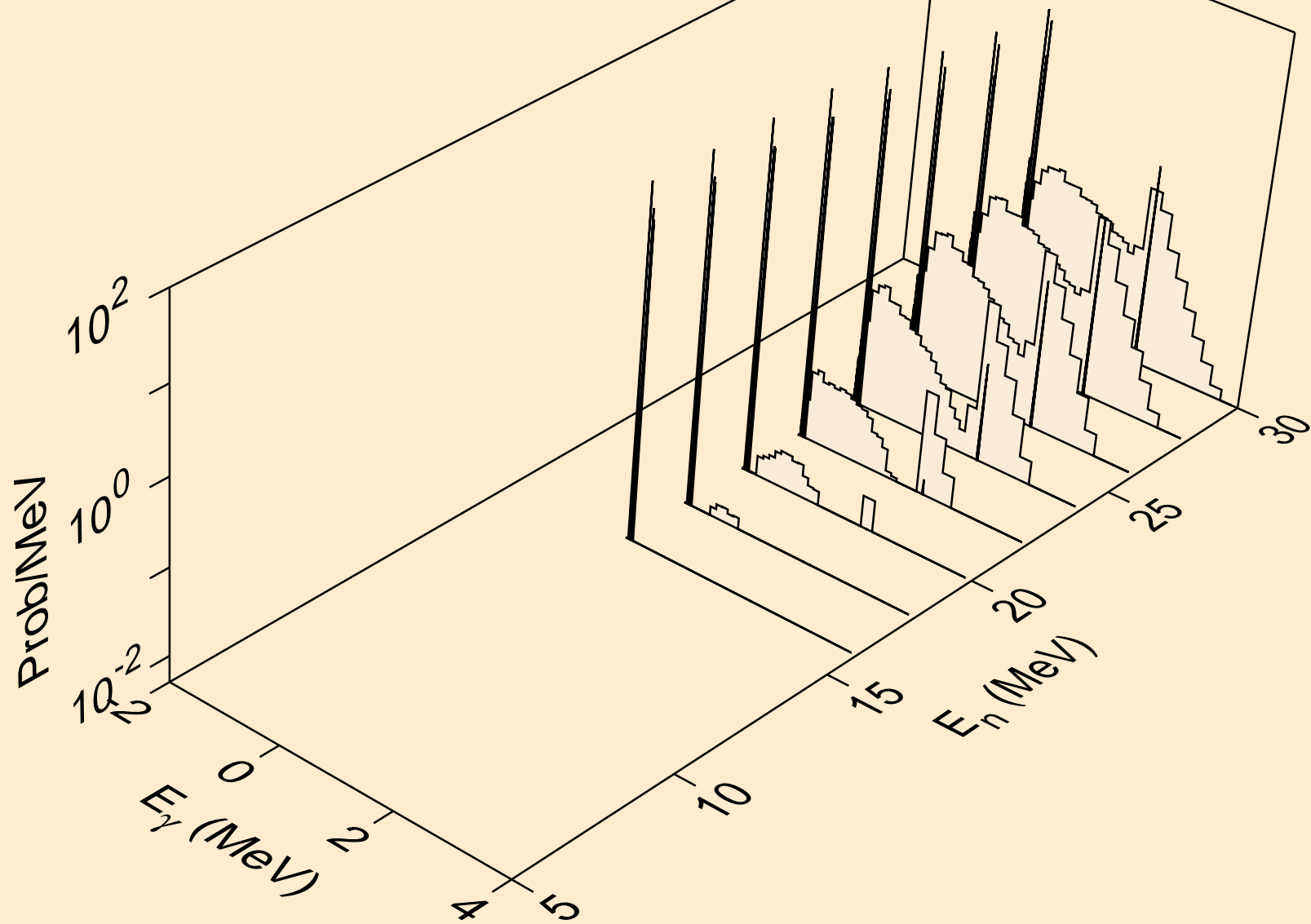

CF246 NEUTRON ACER TENDL-2021 LIBRARY; T=293.6K
Photon emission for (n,n*)he3

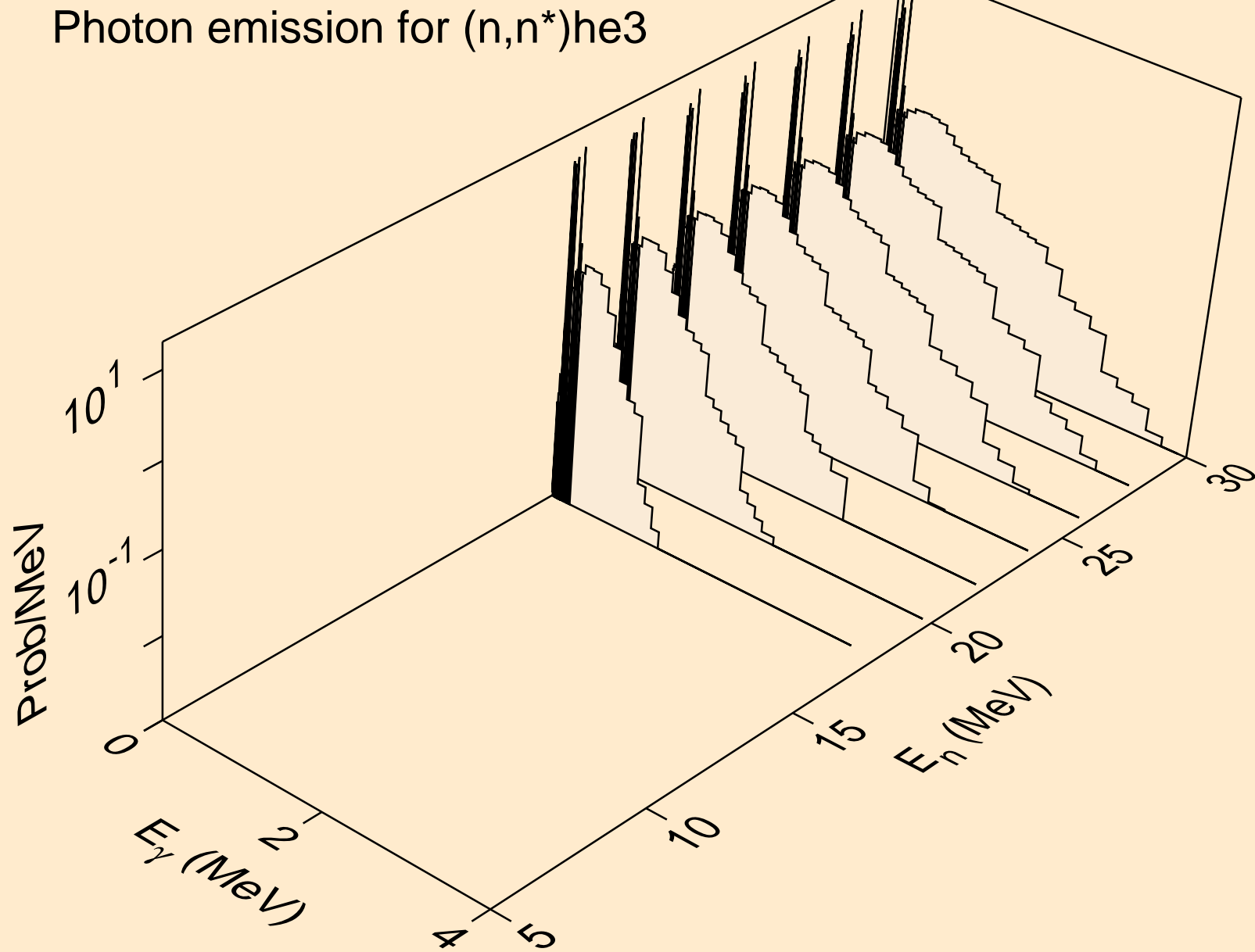

CF246 NEUTRON ACER TENDL-2021 LIBRARY; T=293.6K
Photon emission for (n,4n)

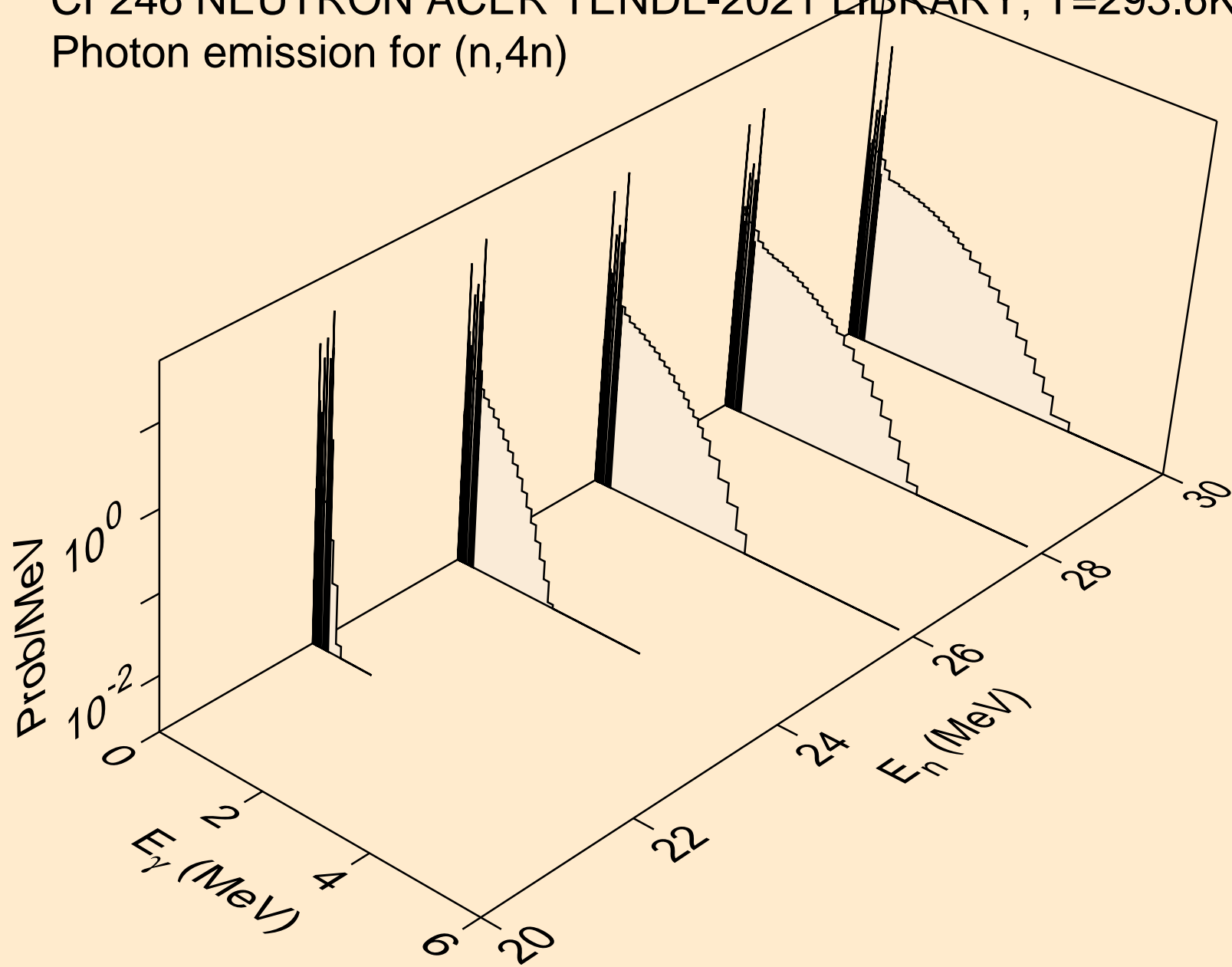

CF246 NEUTRON ACER TENDL-2021 LIBRARY; T=293.6K
Photon emission for (n,2np)

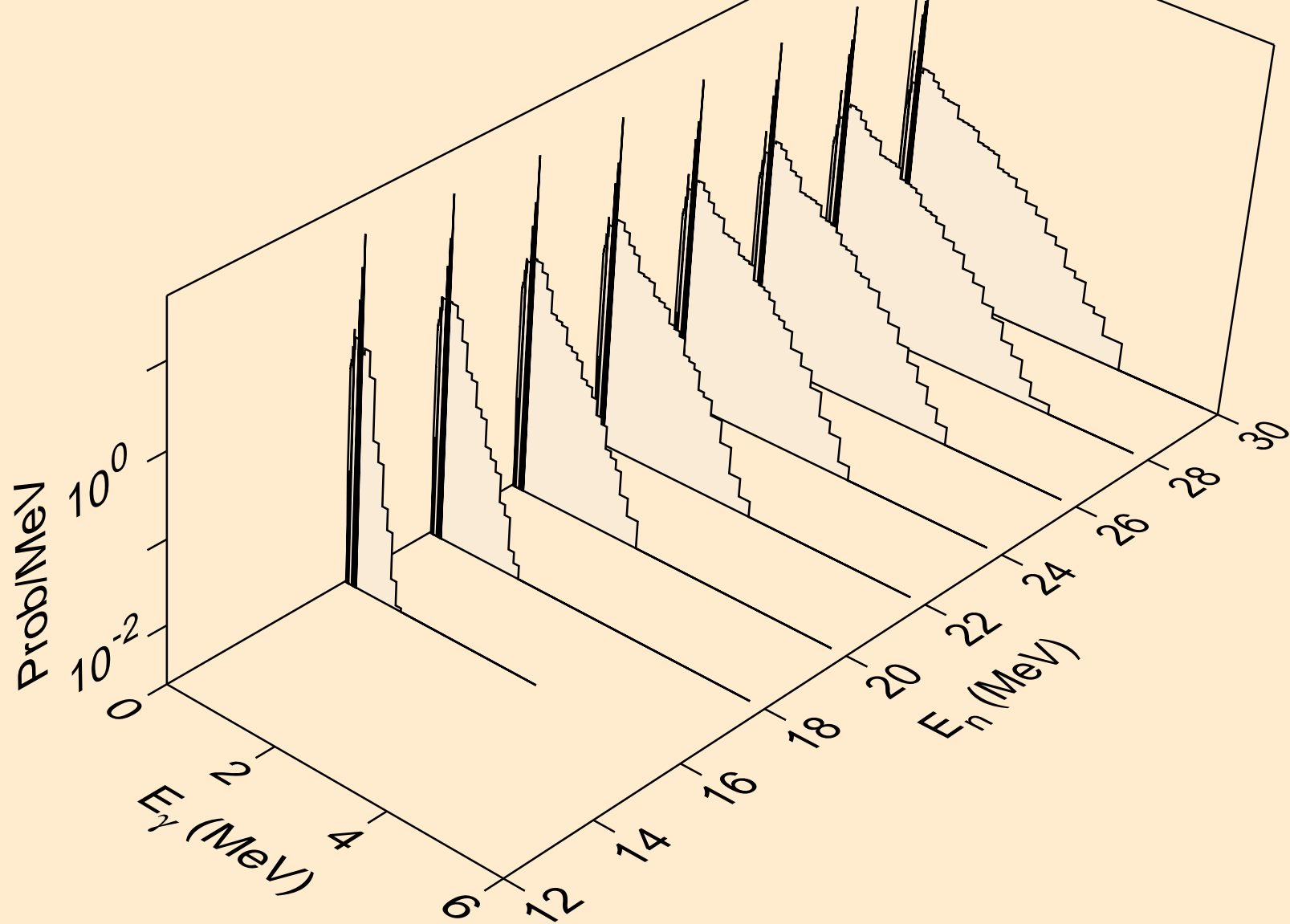

CF246 NEUTRON ACER TENDL-2021 LIBRARY; T=293.6K
Photon emission for (n,3np)

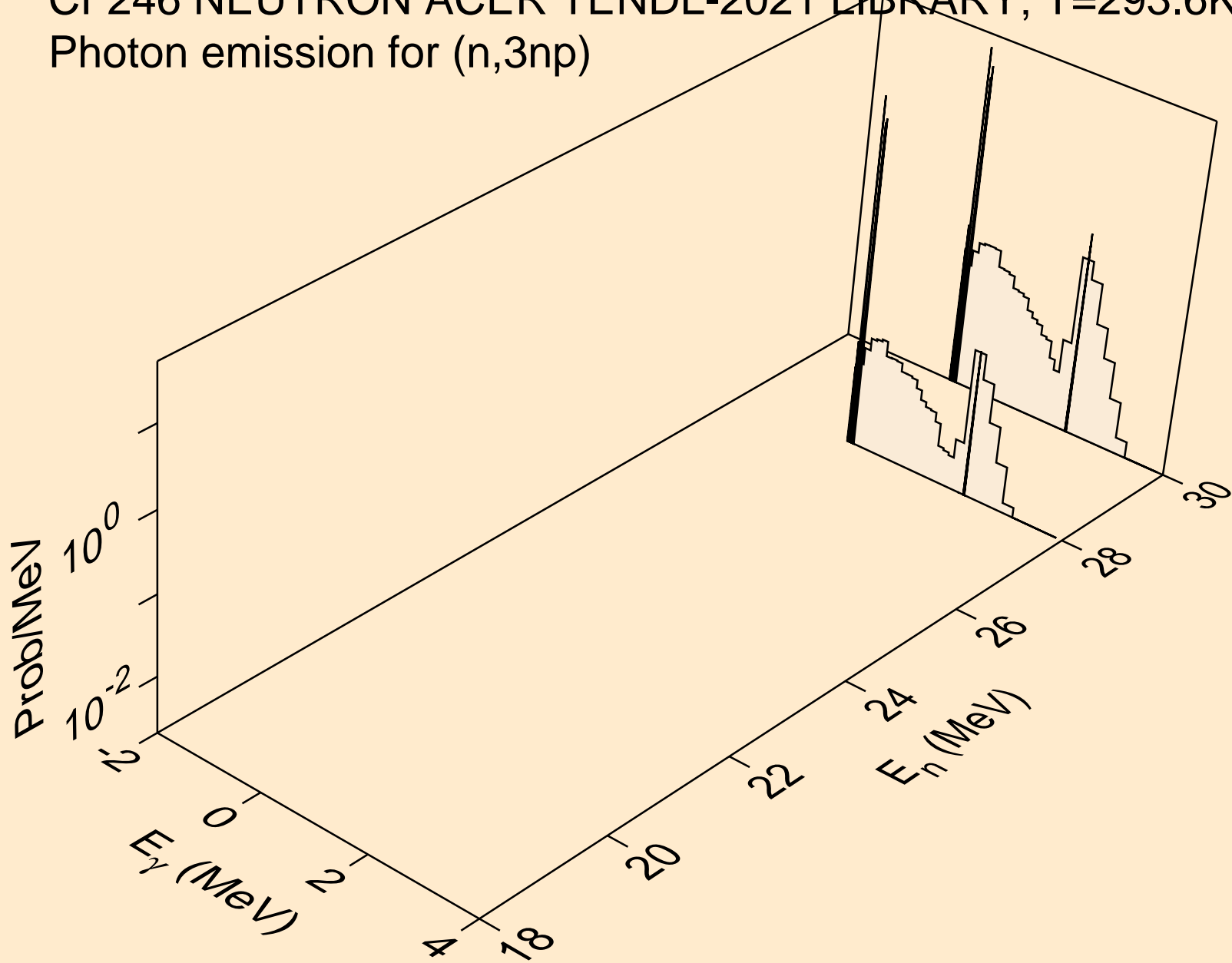

CF246 NEUTRON ACER TENDL-2021 LIBRARY; T=293.6K
Photon emission for (n,2np)

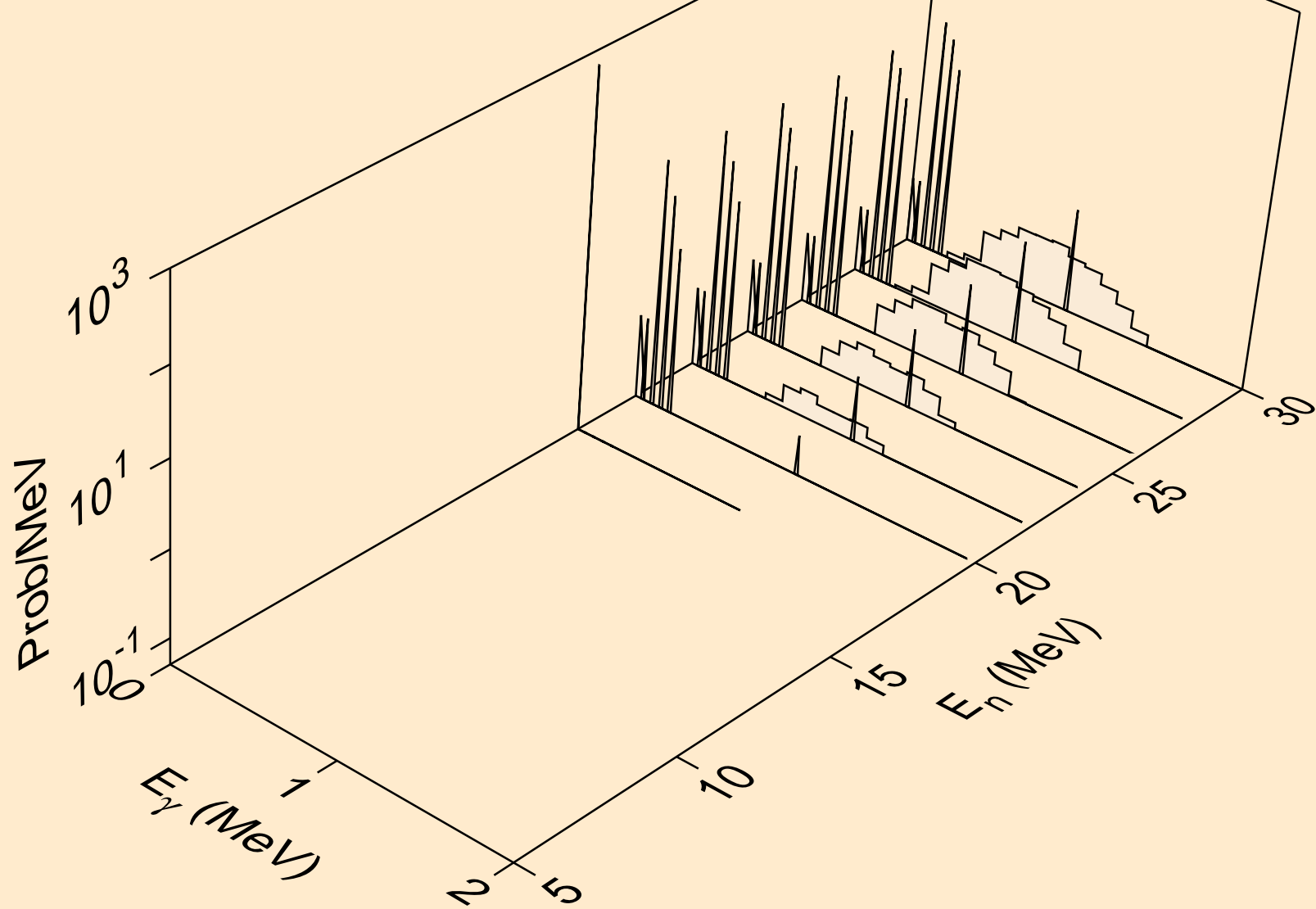

CF246 NEUTRON ACER TENDL-2021 LIBRARY; T=293.6K
Photon emission for (n,npa)

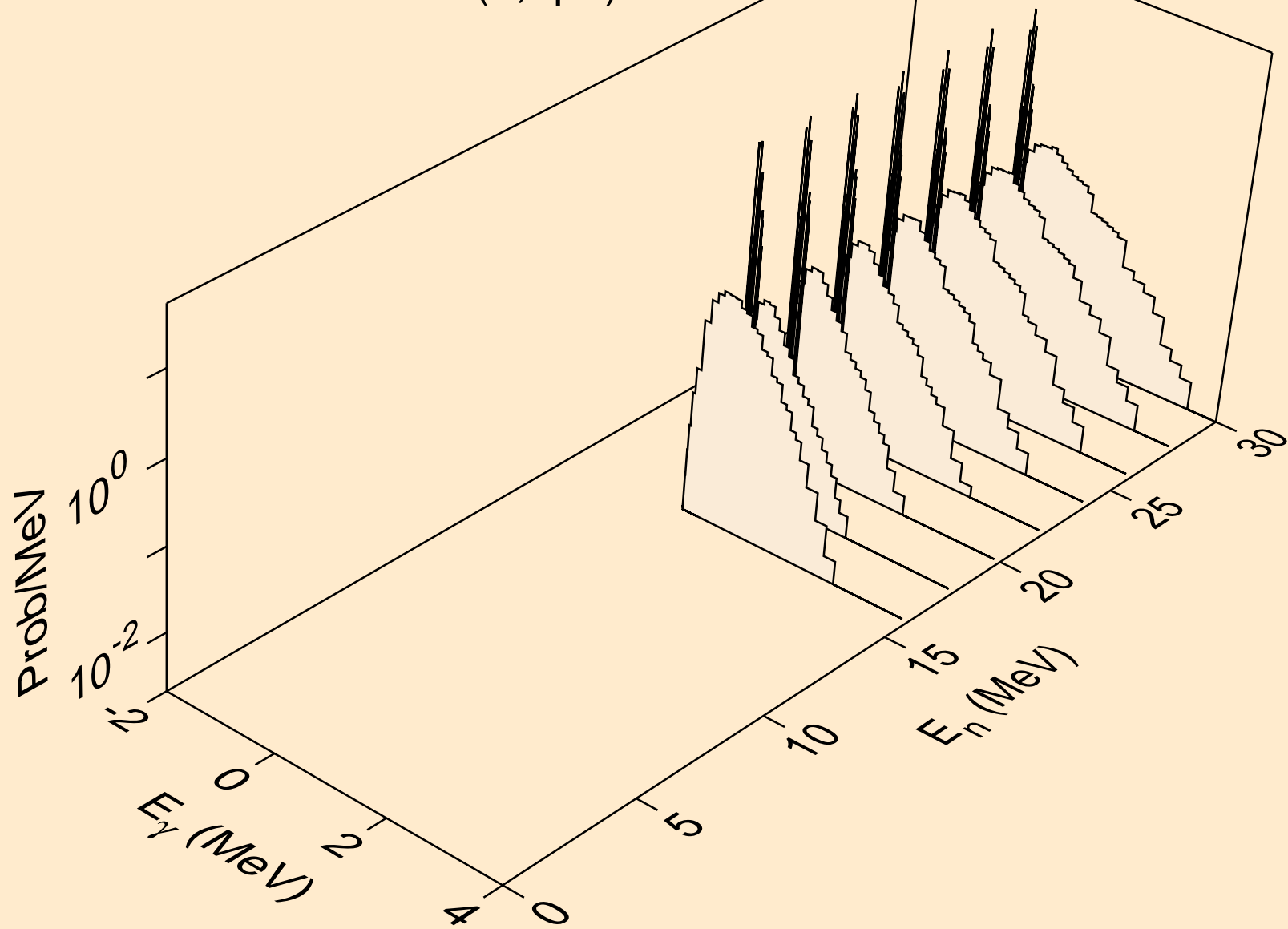

CF246 NEUTRON ACER TENDL-2021 LIBRARY; T=293.6K
Photon emission for (n,n*c)

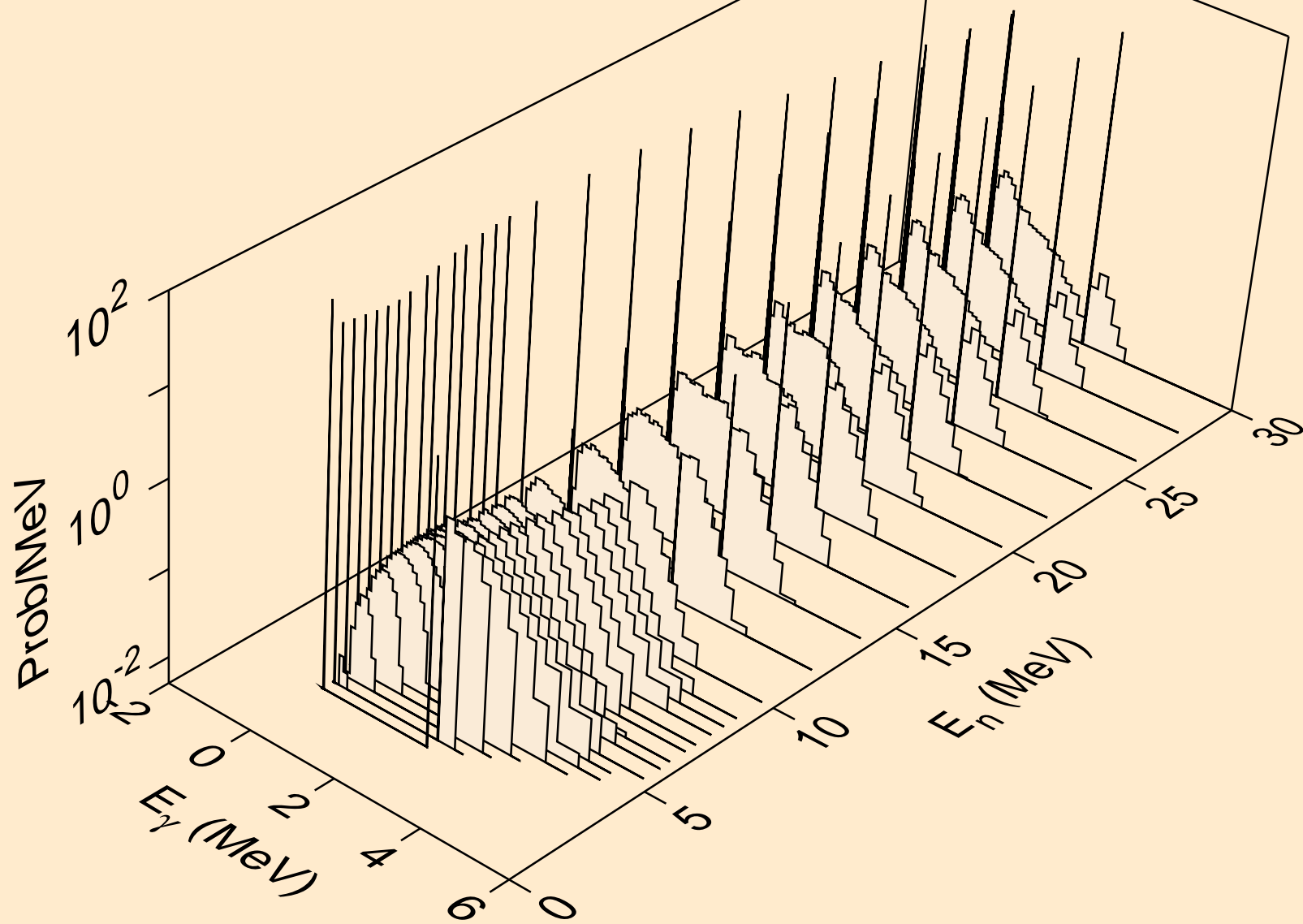

CF246 NEUTRON ACER TENDL-2021 LIBRARY; T=293.6K
Photon emission for (n,gma)

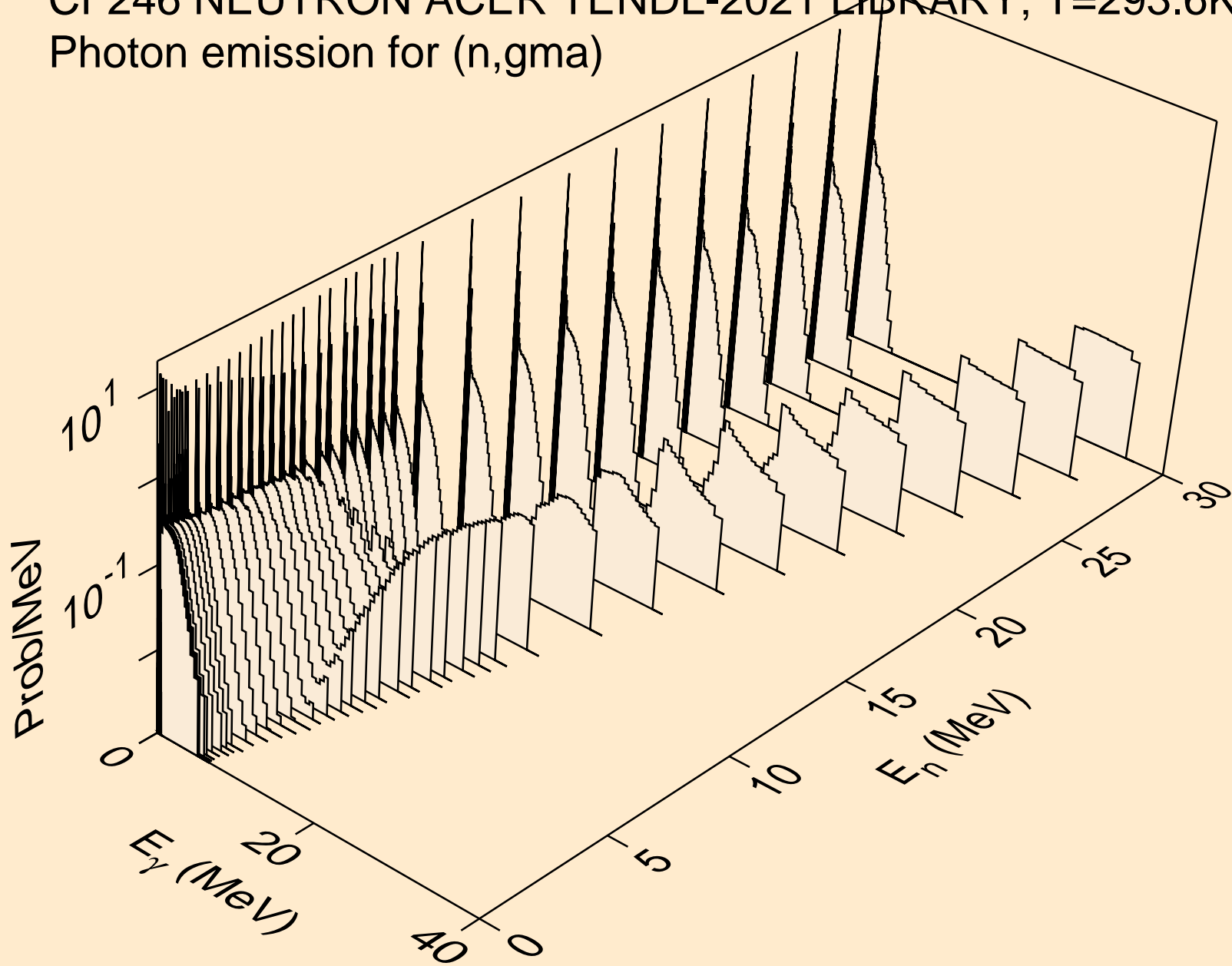

CF246 NEUTRON ACER TENDL-2021 LIBRARY; T=293.6K
Photon emission for (n,p)

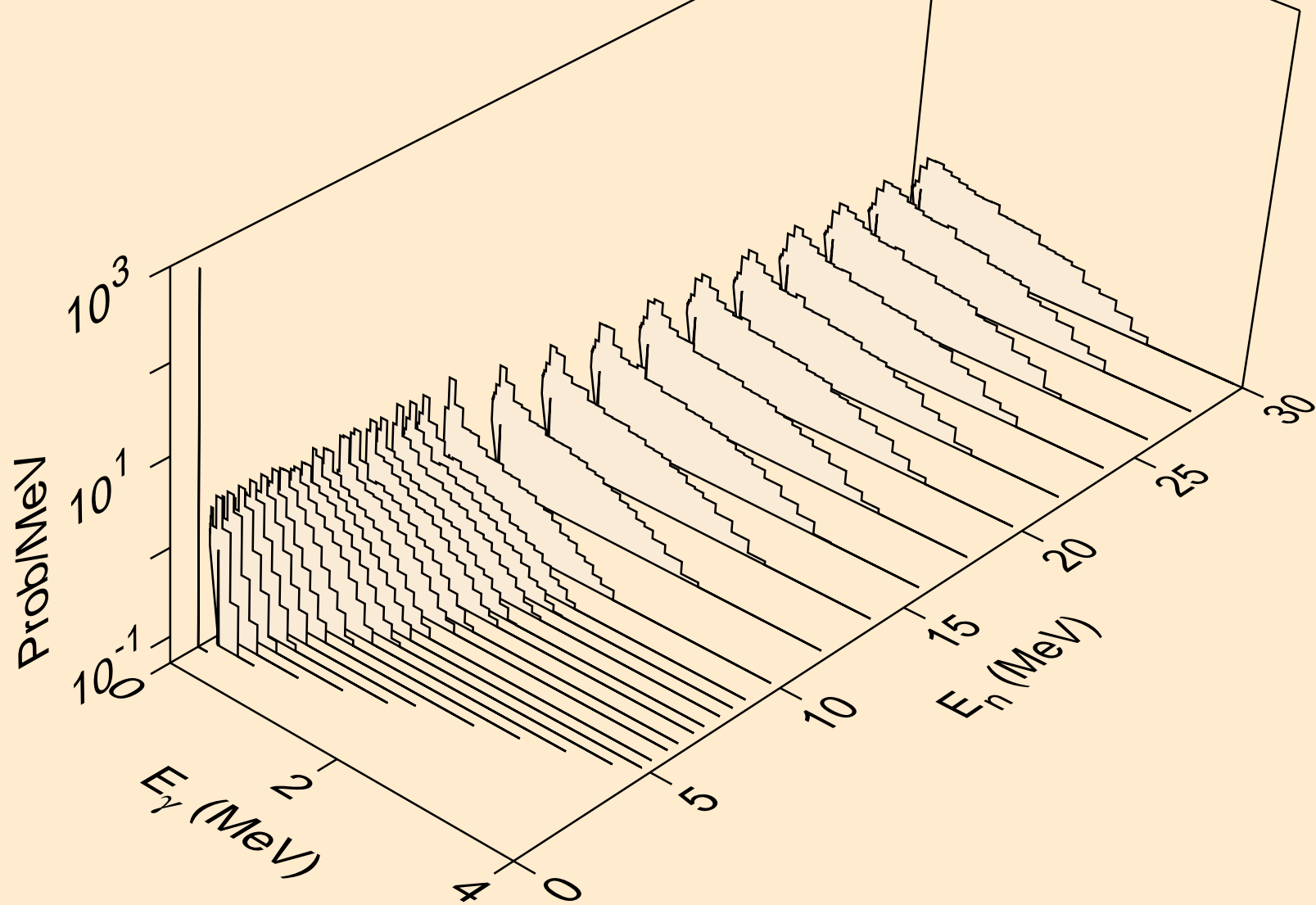

CF246 NEUTRON ACER TENDL-2021 LIBRARY; T=293.6K
Photon emission for (n,d)

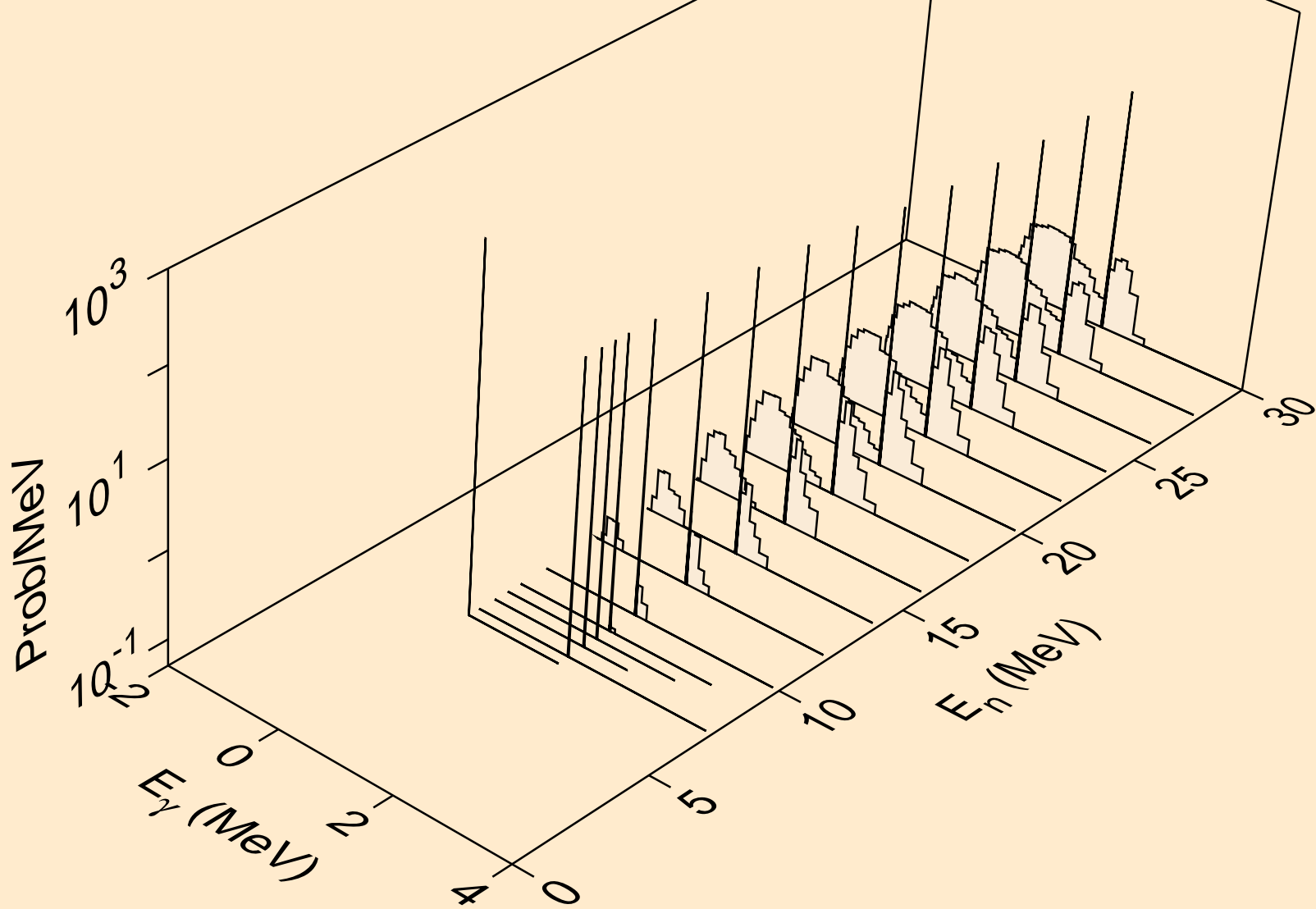

CF246 NEUTRON ACER TENDL-2021 LIBRARY; T=293.6K
Photon emission for (n,t)

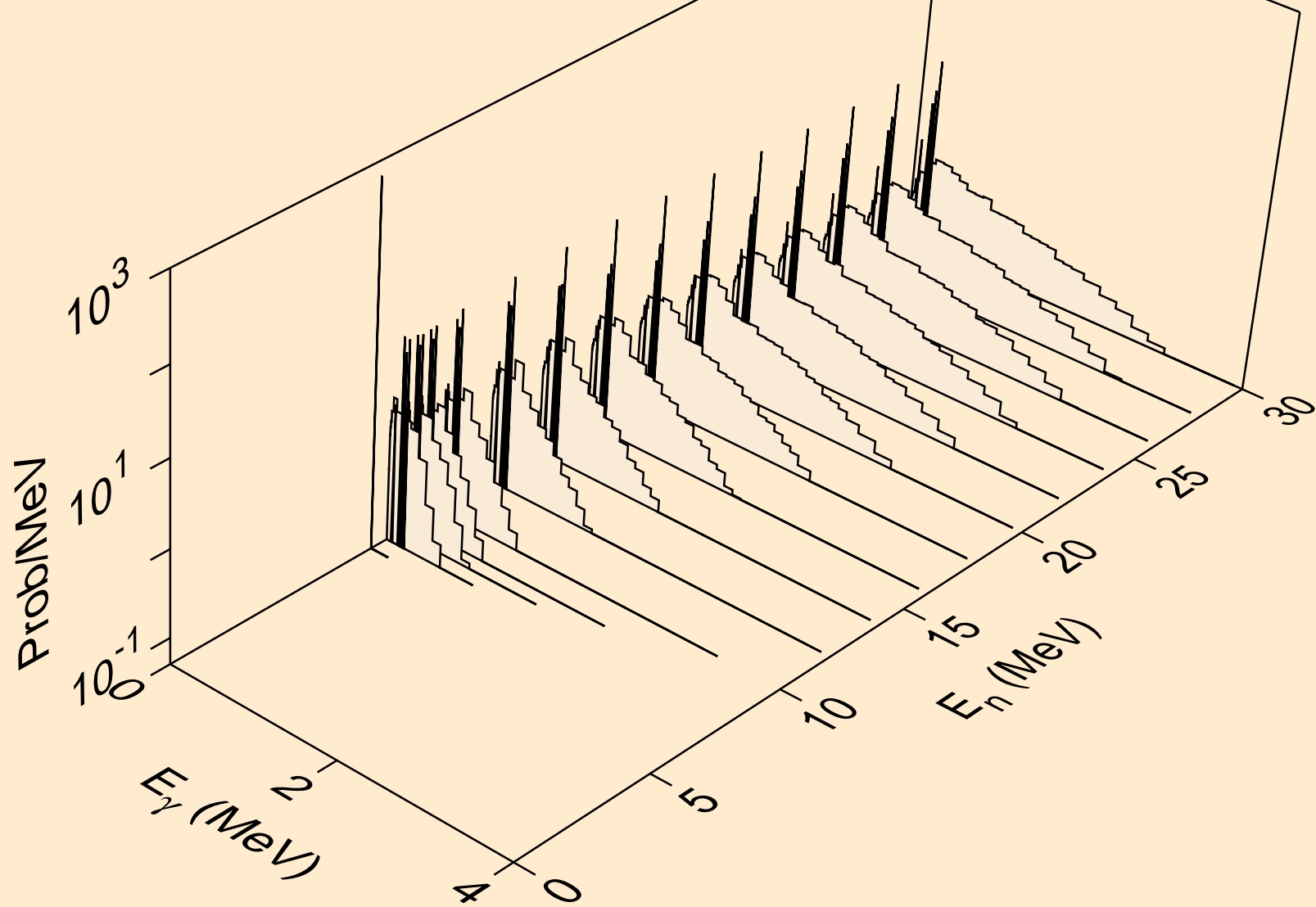

CF246 NEUTRON ACER TENDL-2021 LIBRARY; T=293.6K
Photon emission for (n,he3)

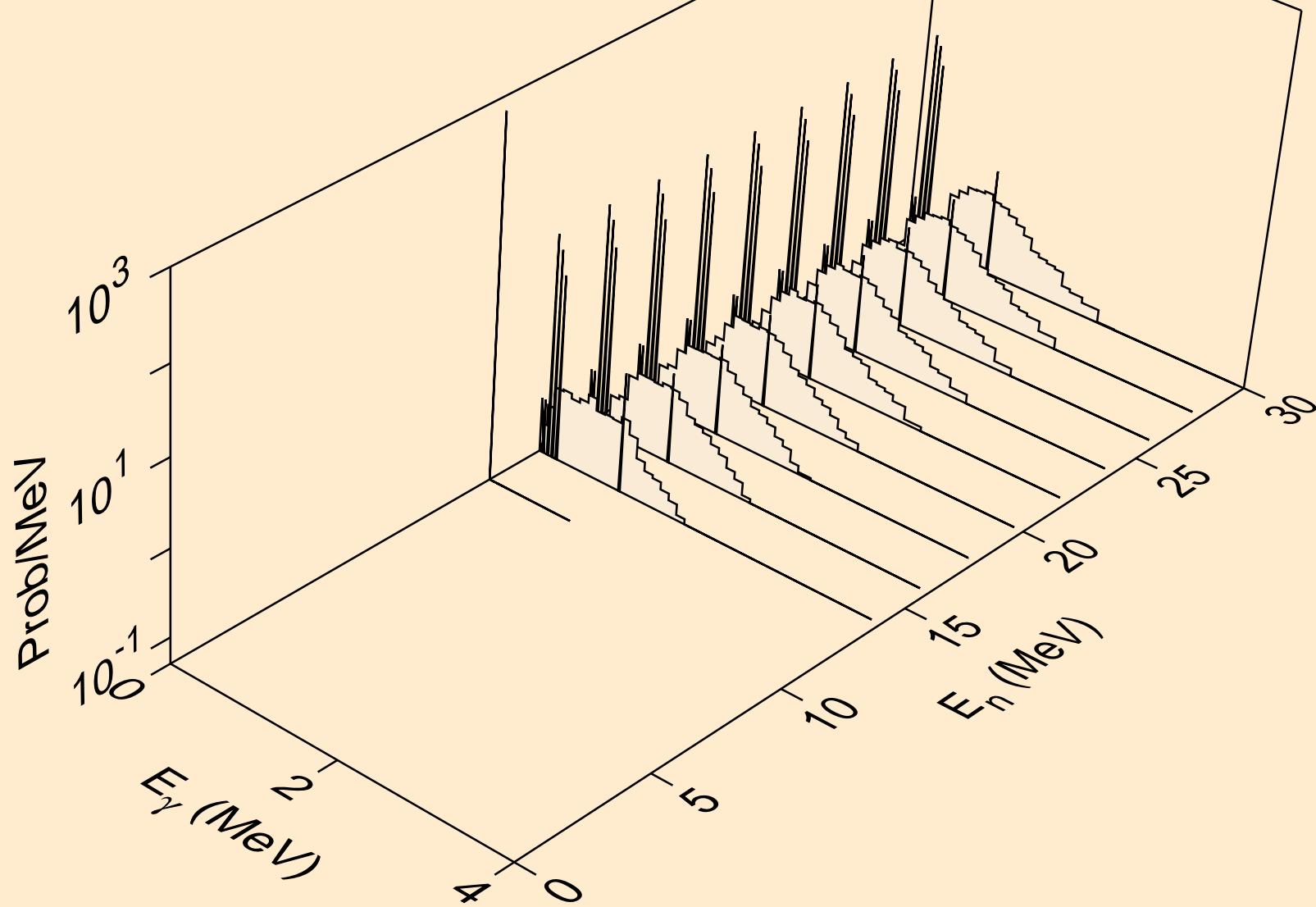

CF246 NEUTRON ACER TENDL-2021 LIBRARY; T=293.6K
Photon emission for (n,a)

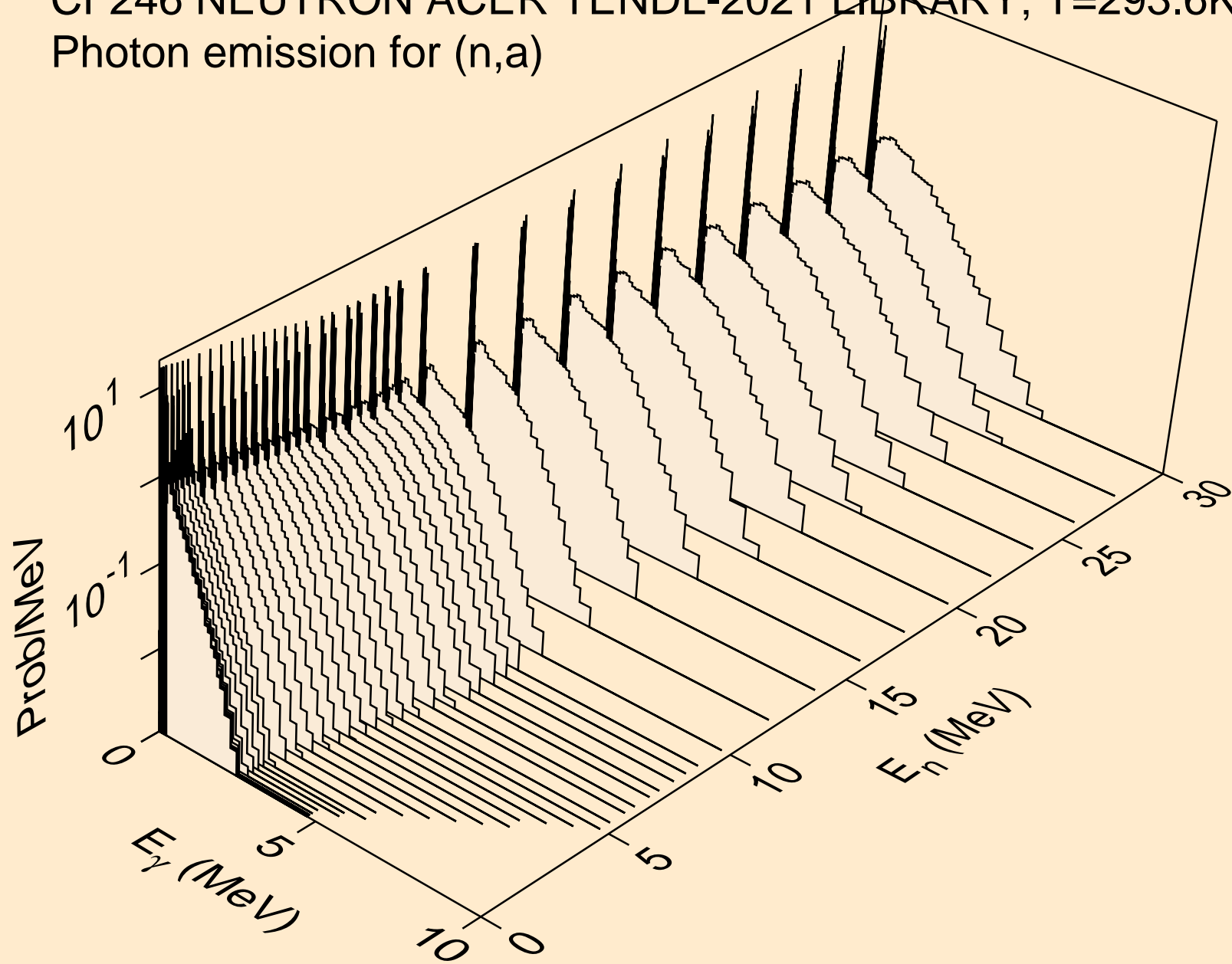

CF246 NEUTRON ACER TENDL-2021 LIBRARY; T=293.6K
Photon emission for (n,2a)

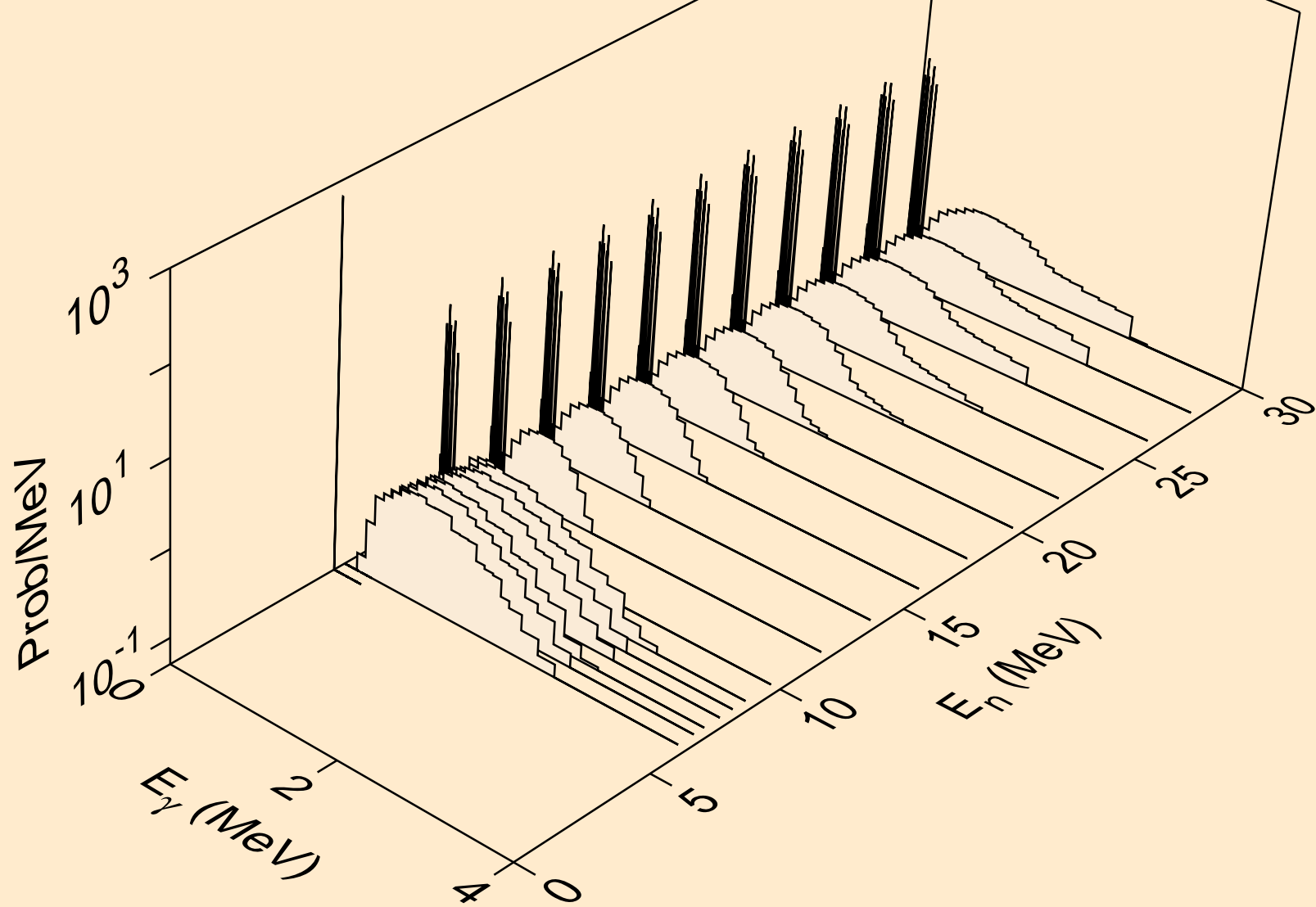

CF246 NEUTRON ACER TENDL-2021 LIBRARY; T=293.6K
Photon emission for (n,2p)

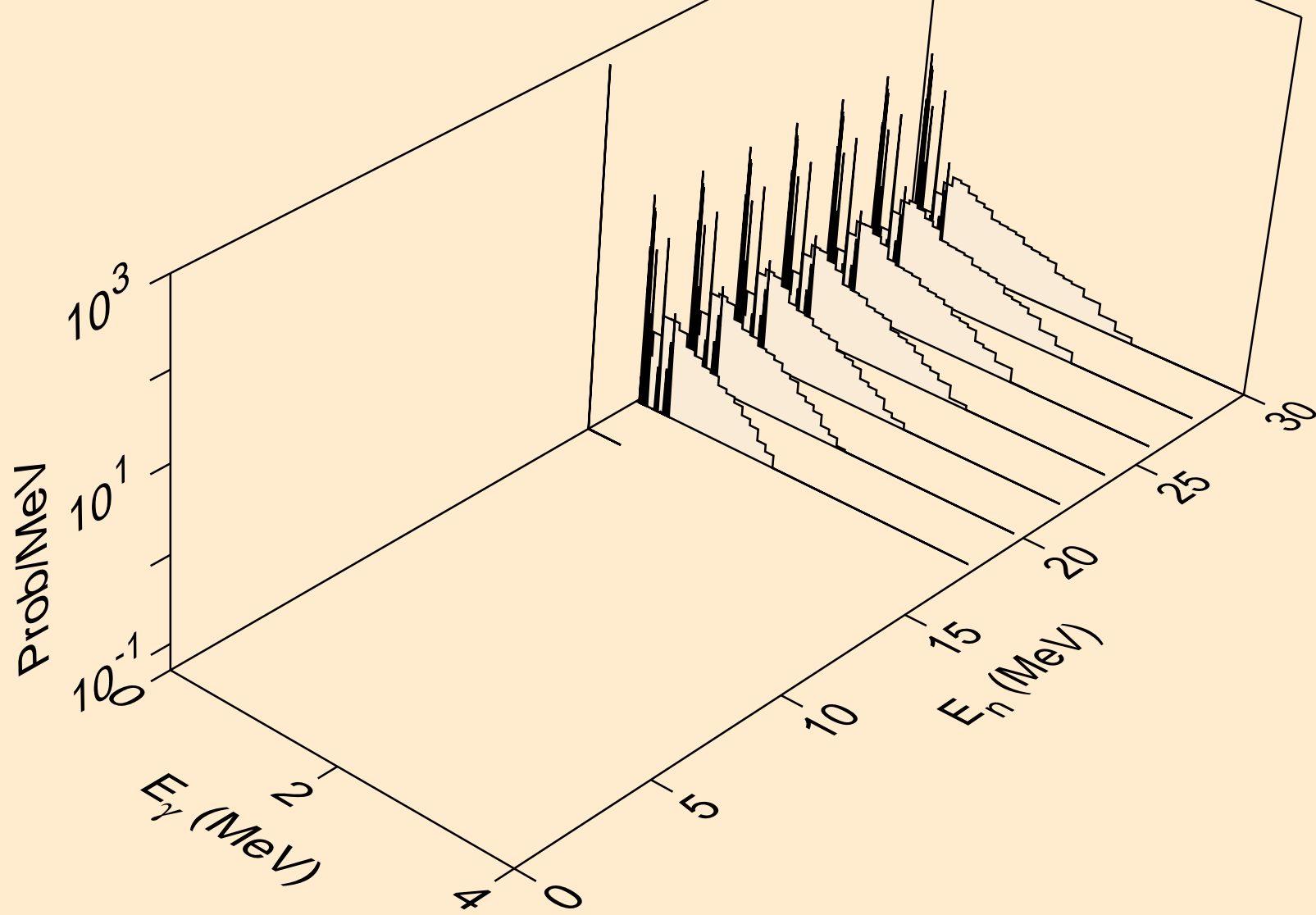

CF246 NEUTRON ACER TENDL-2021 LIBRARY; T=293.6K
Photon emission for (n,p)

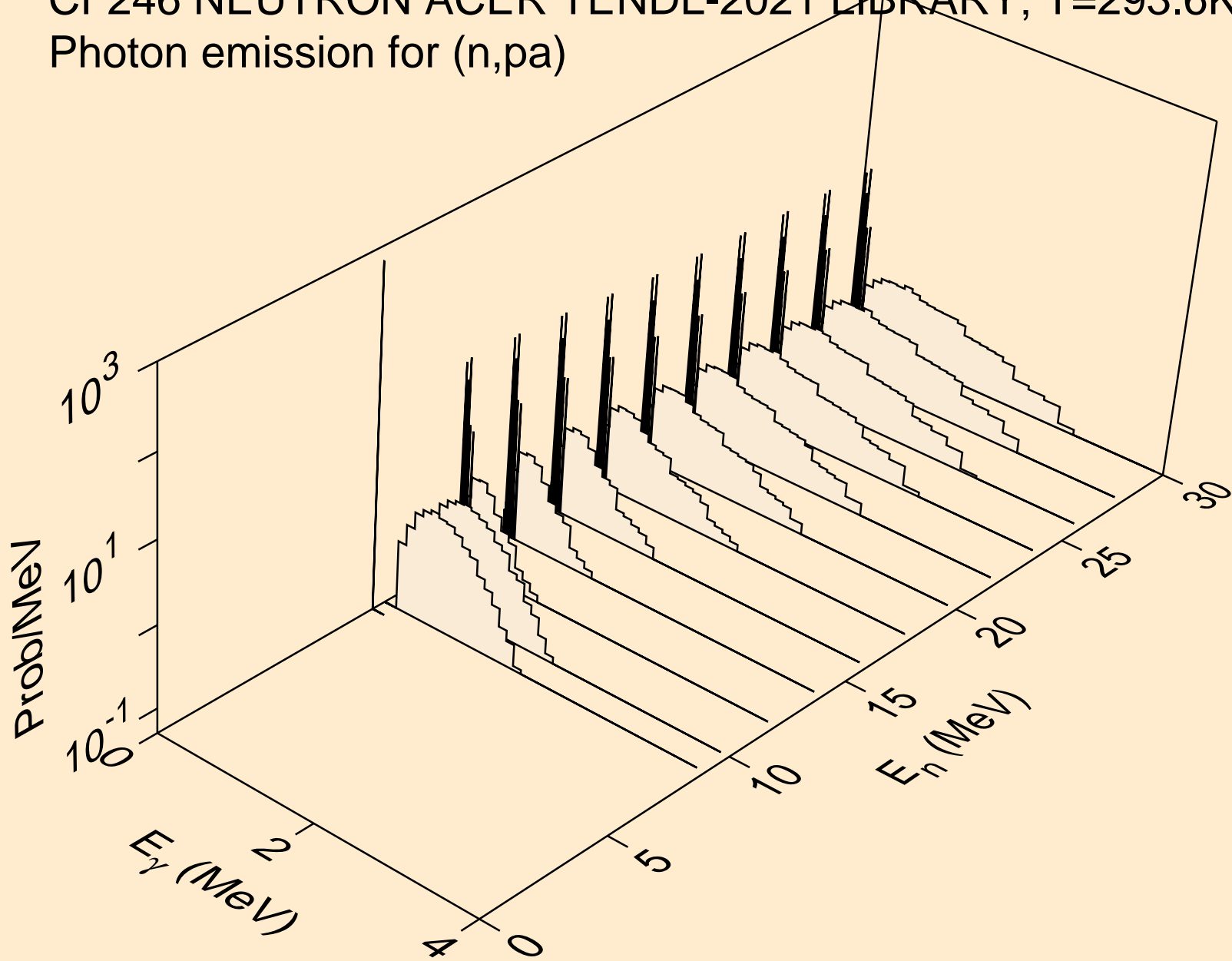

CF246 NEUTRON ACER TENDL-2021 LIBRARY; T=293.6K
thermal capture photon spectrum

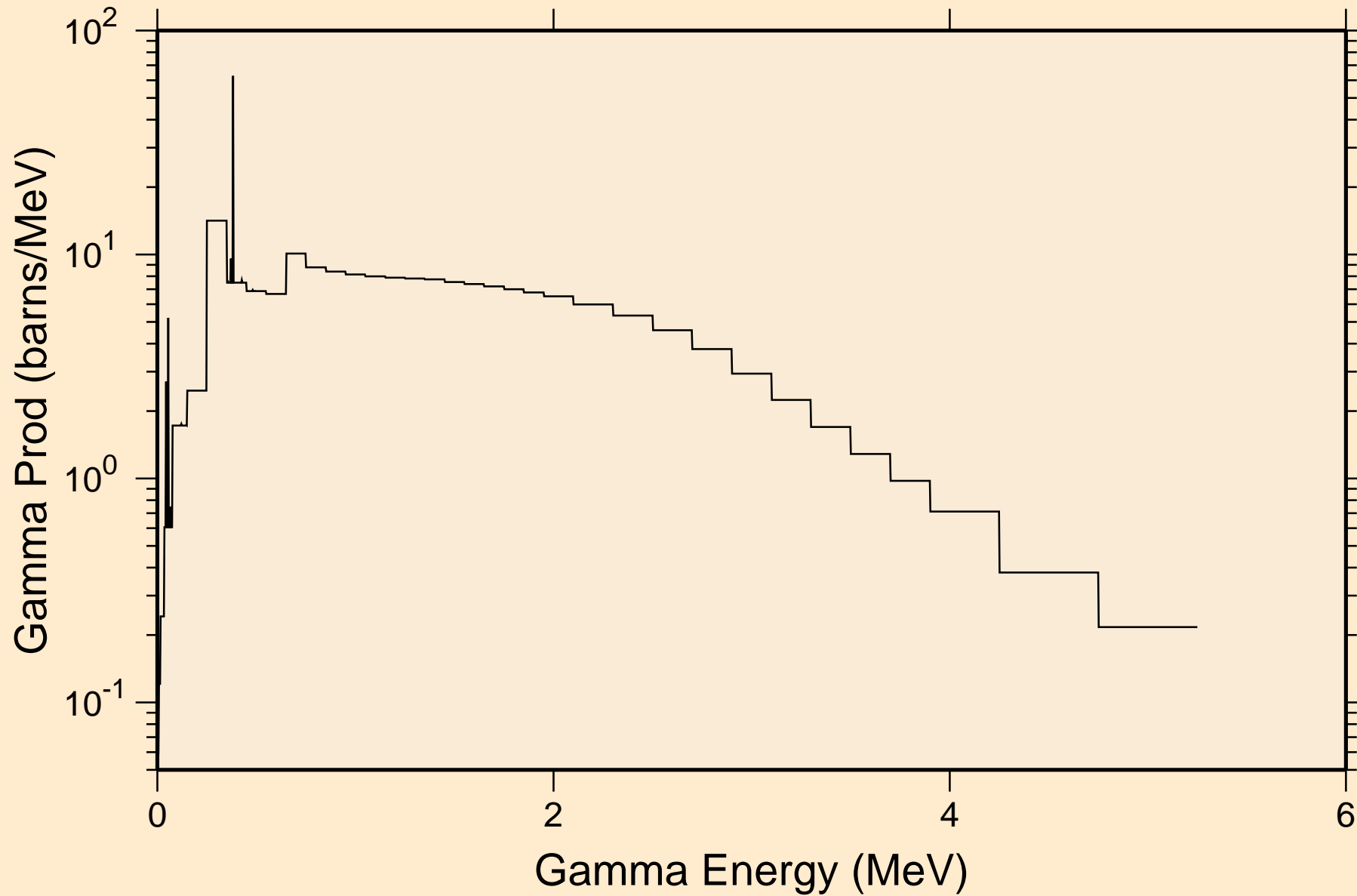

CF246 NEUTRON ACER TENDL-2021 LIBRARY; T=293.6K
14 MeV photon spectrum

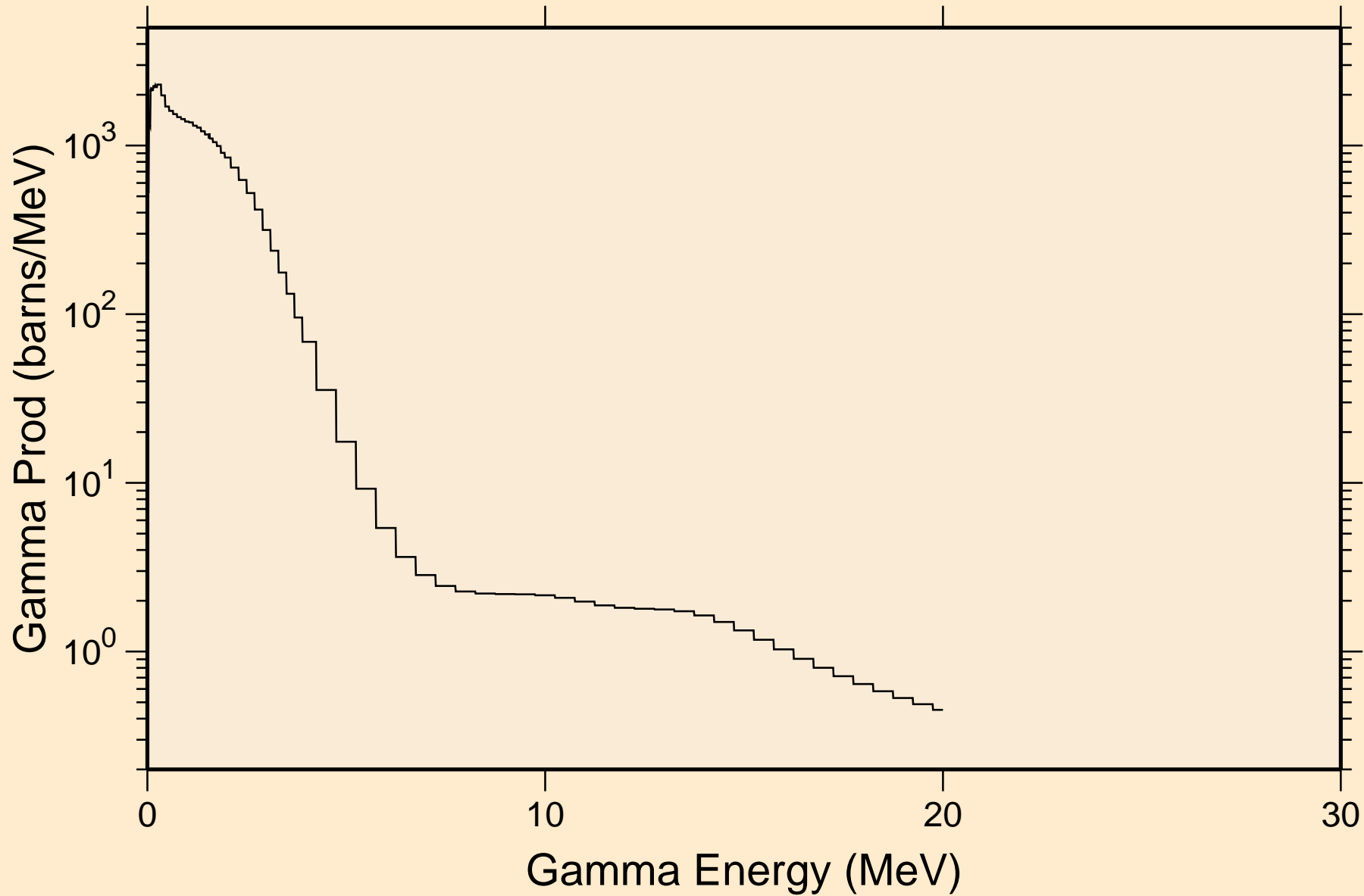

CF246 NEUTRON ACER TENDL-2021 LIBRARY; T=293.6K

Particle heating contributions

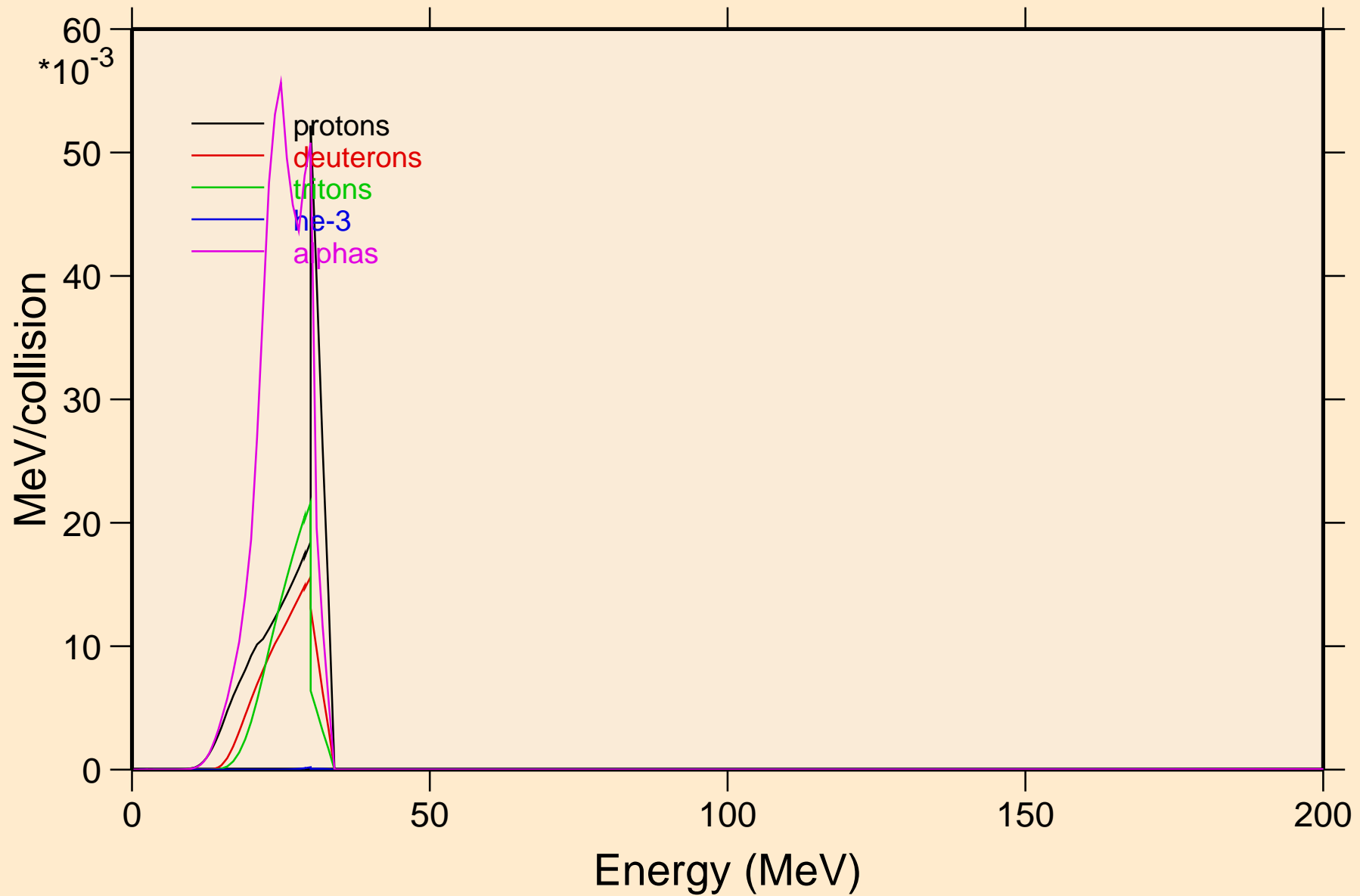

CF246 NEUTRON ACER TENDL-2021 LIBRARY; T=293.6K
Recoil Heating

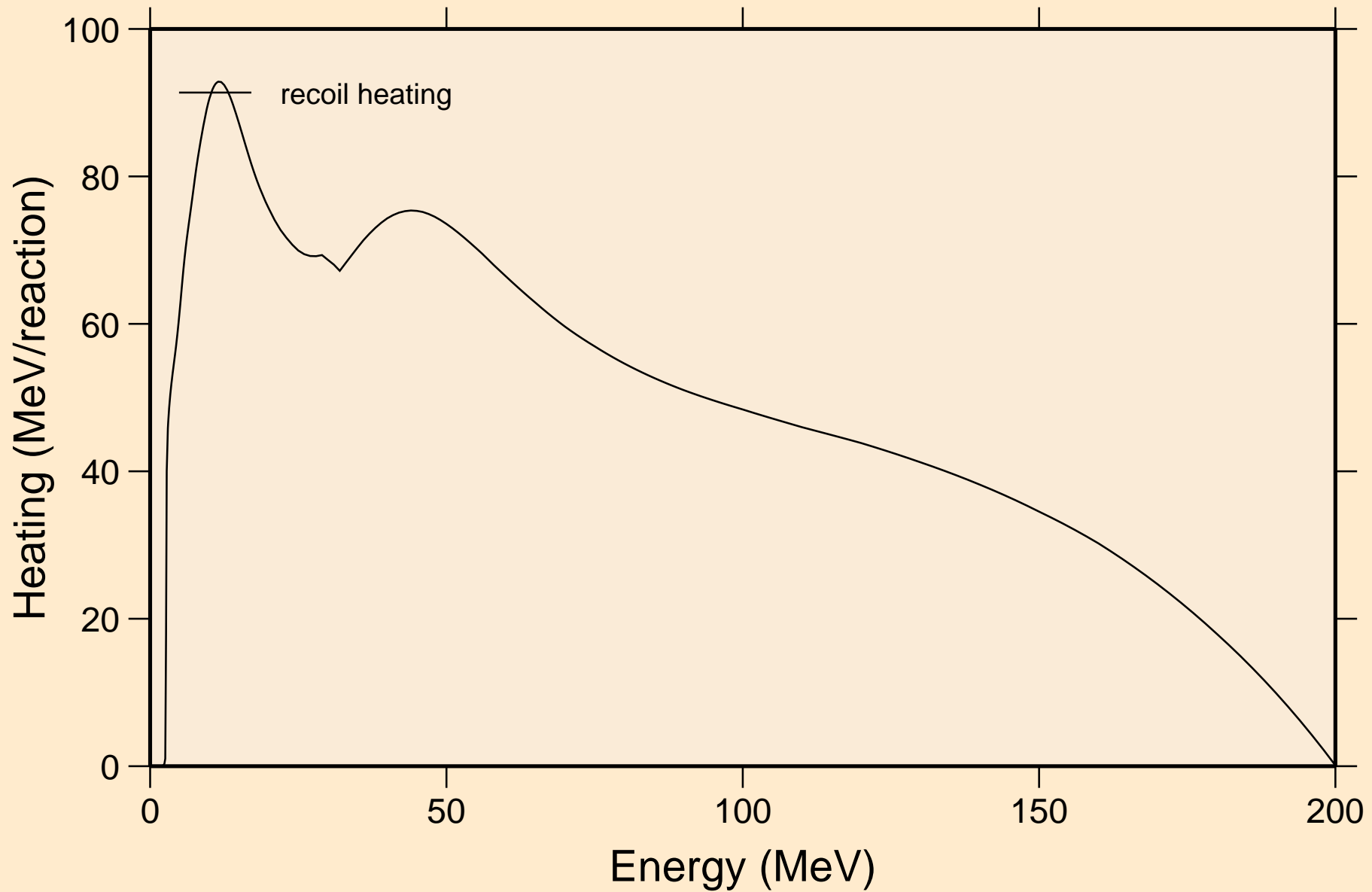

CF246 NEUTRON ACER TENDL-2021 LIBRARY; T=293.6K

Particle production cross sections

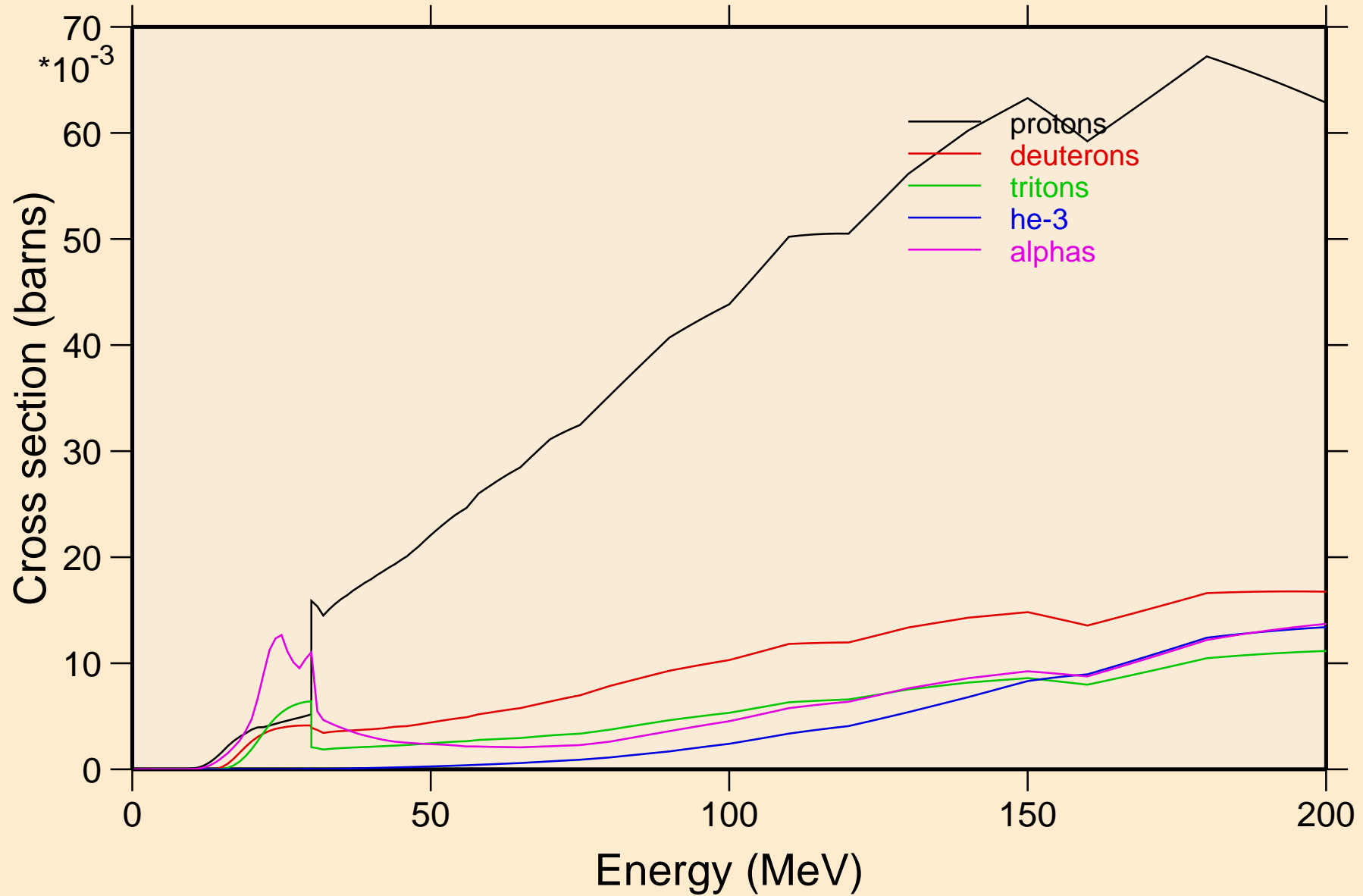

CF246 NEUTRON ACER TENDL-2021 LIBRARY; T=293.6K
protons from (n,x)

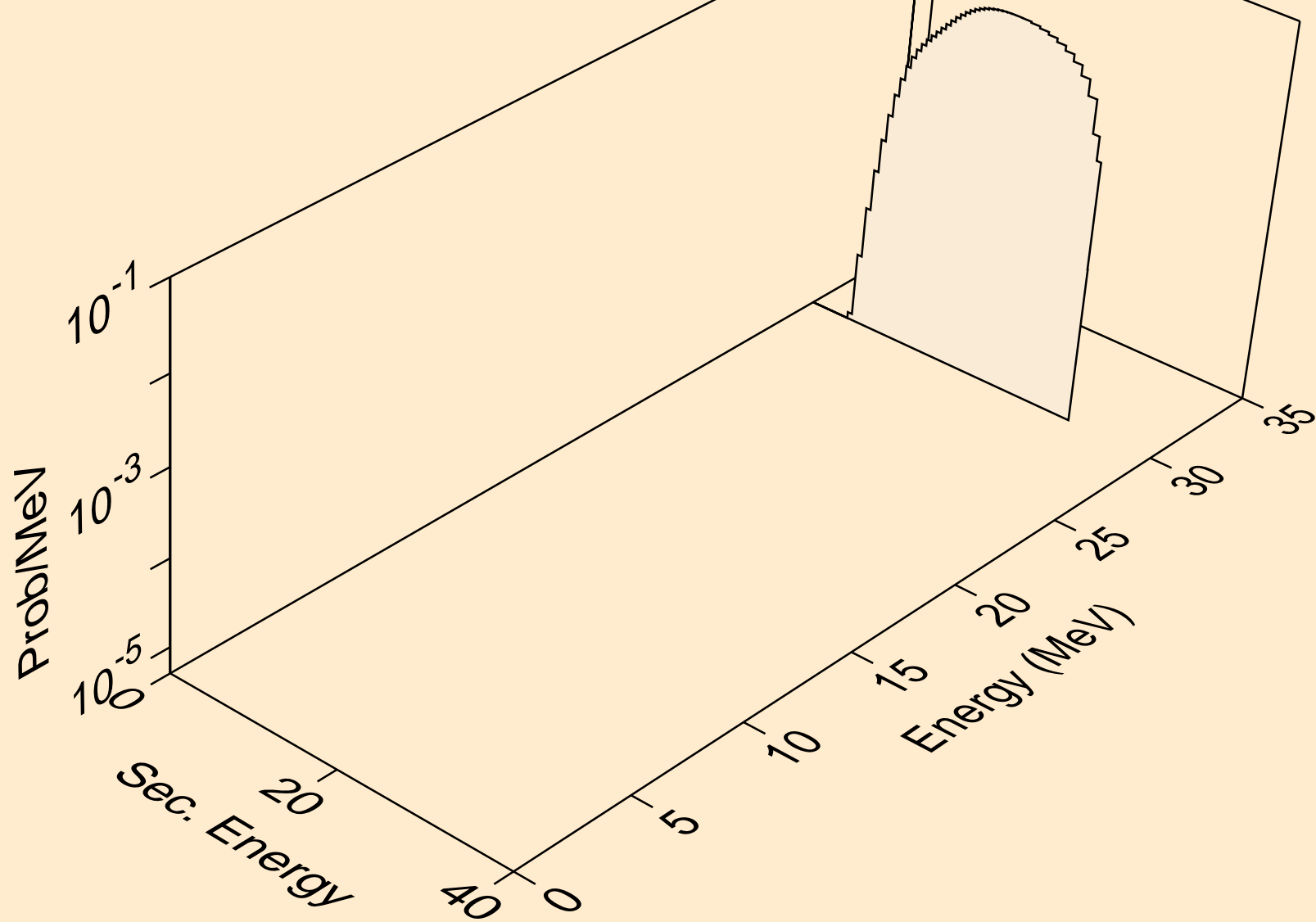

CF246 NEUTRON ACER TENDL-2021 LIBRARY; T=293.6K
protons from (n,n*)p

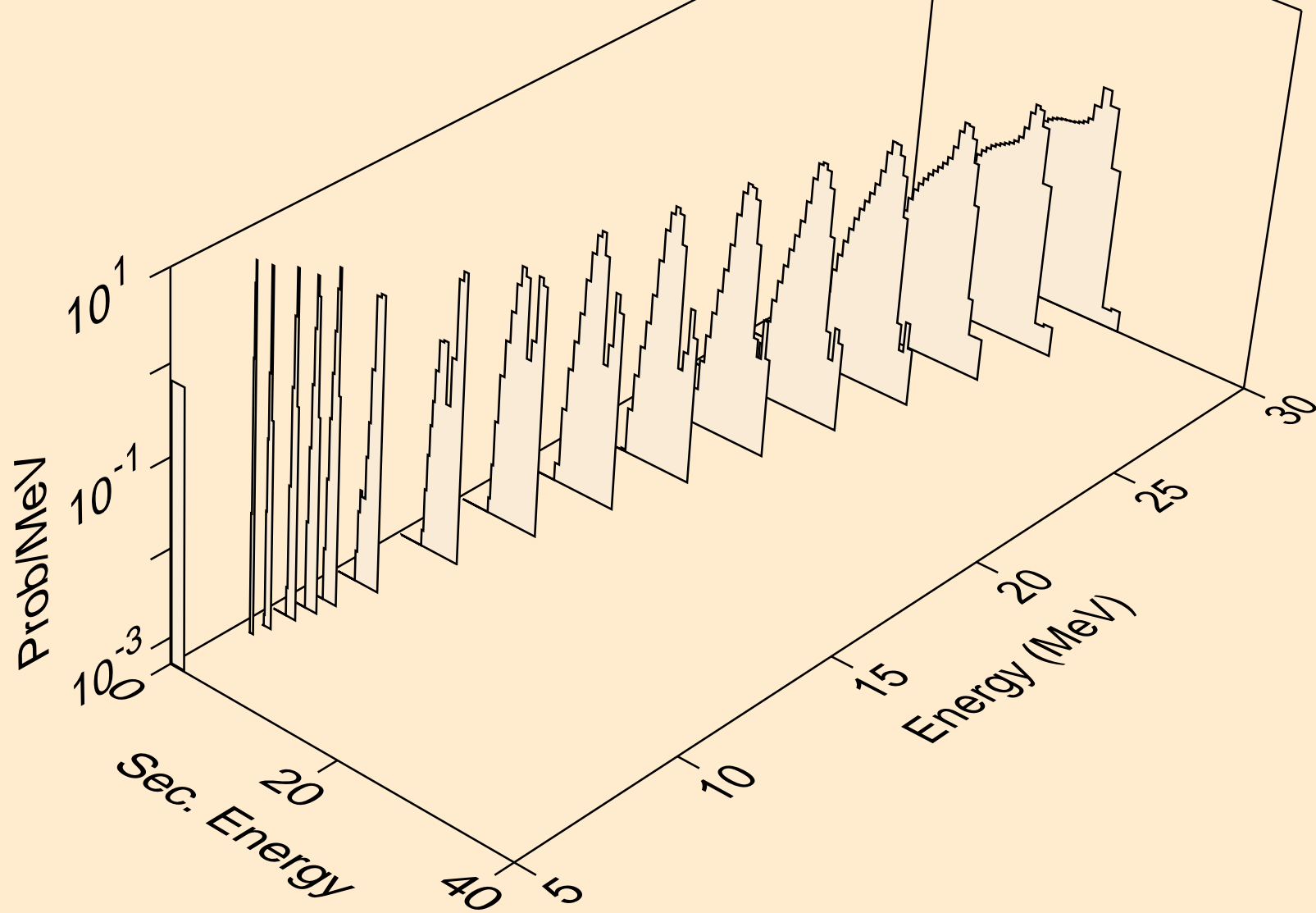

CF246 NEUTRON ACER TENDL-2021 LIBRARY; T=293.6K
protons from (n,2np)

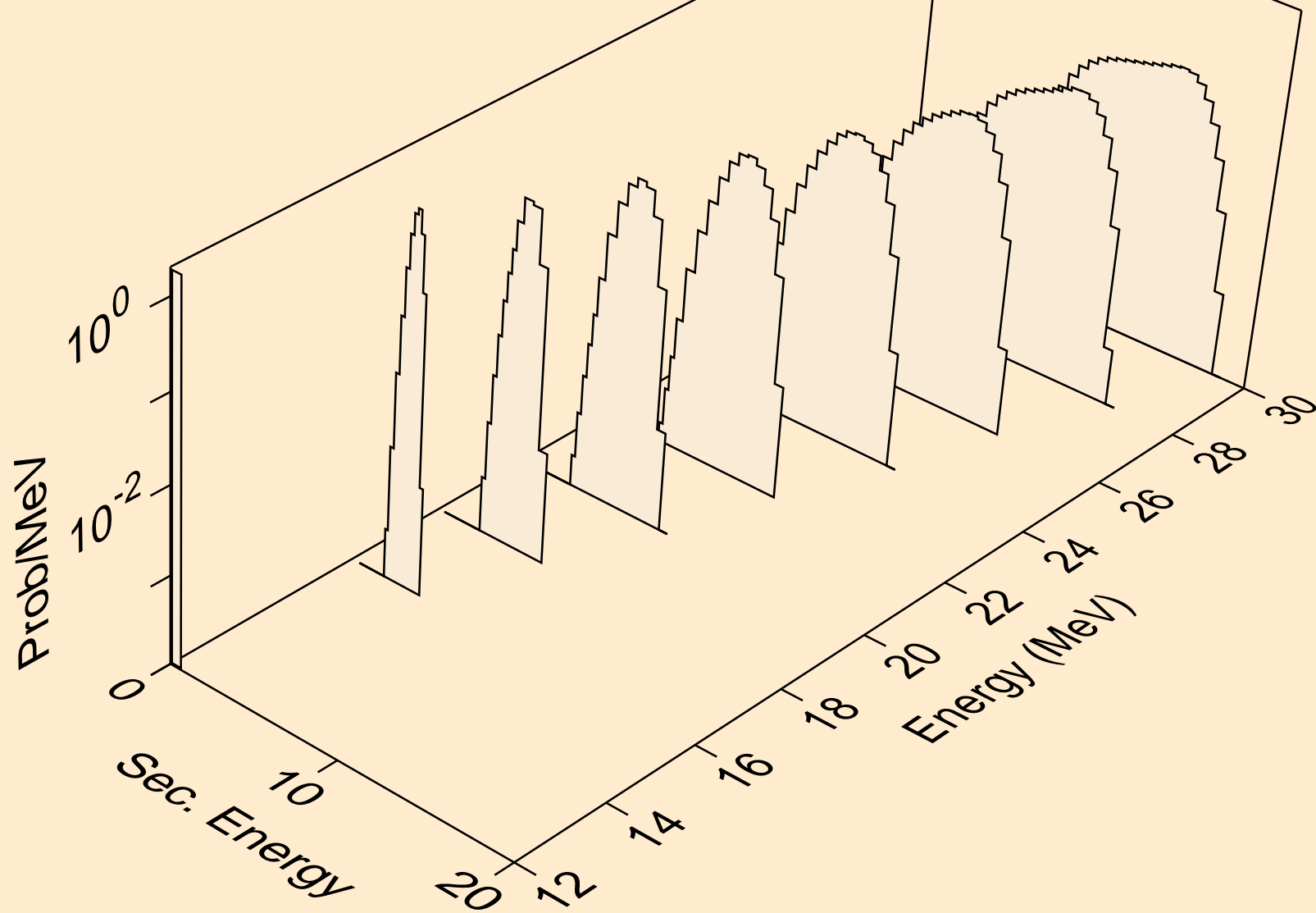

CF246 NEUTRON ACER TENDL-2021 LIBRARY; T=293.6K
protons from (n,3np)

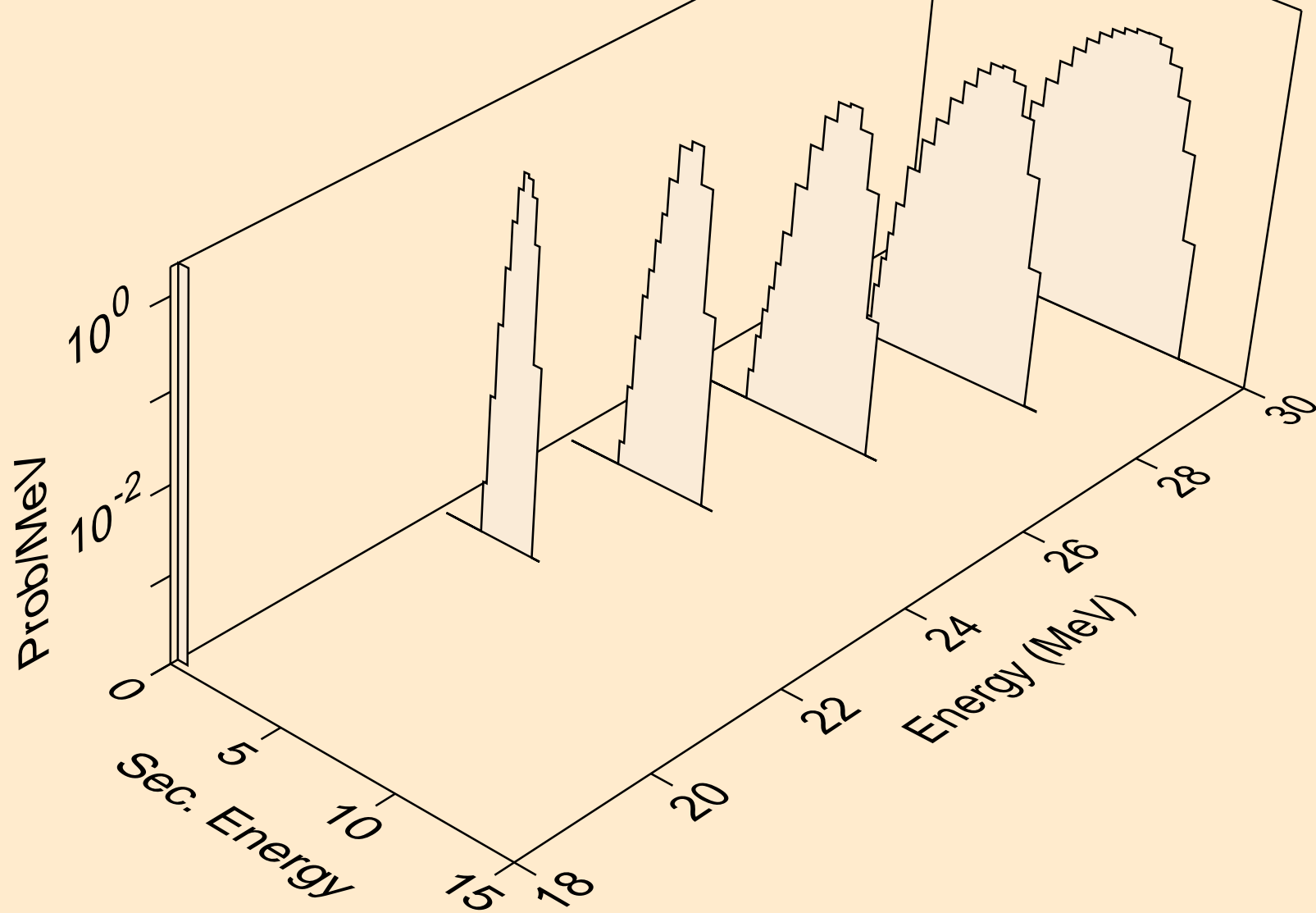

CF246 NEUTRON ACER TENDL-2021 LIBRARY; T=293.6K
protons from (n,2np)

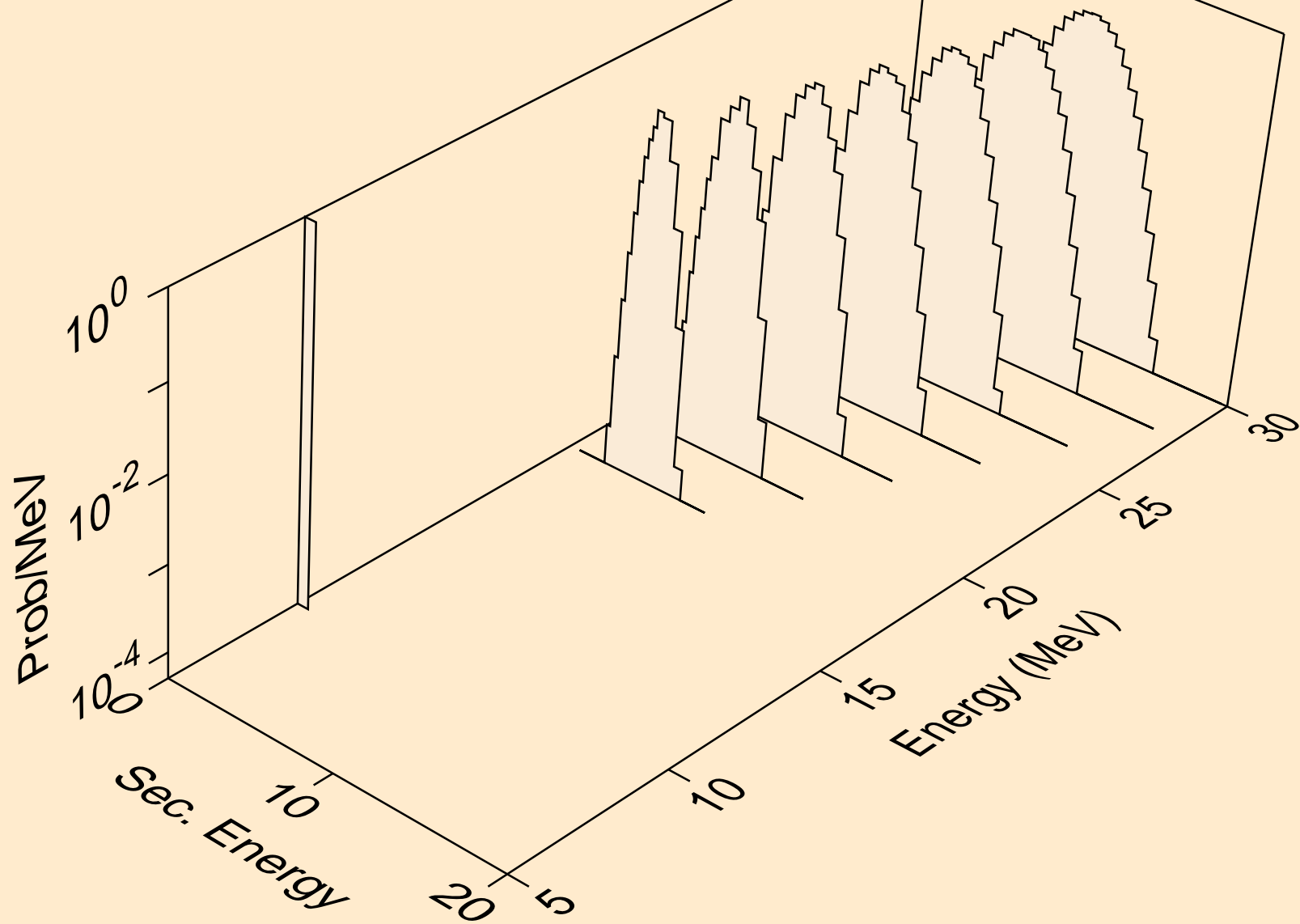

CF246 NEUTRON ACER TENDL-2021 LIBRARY; T=293.6K
protons from (n,npa)

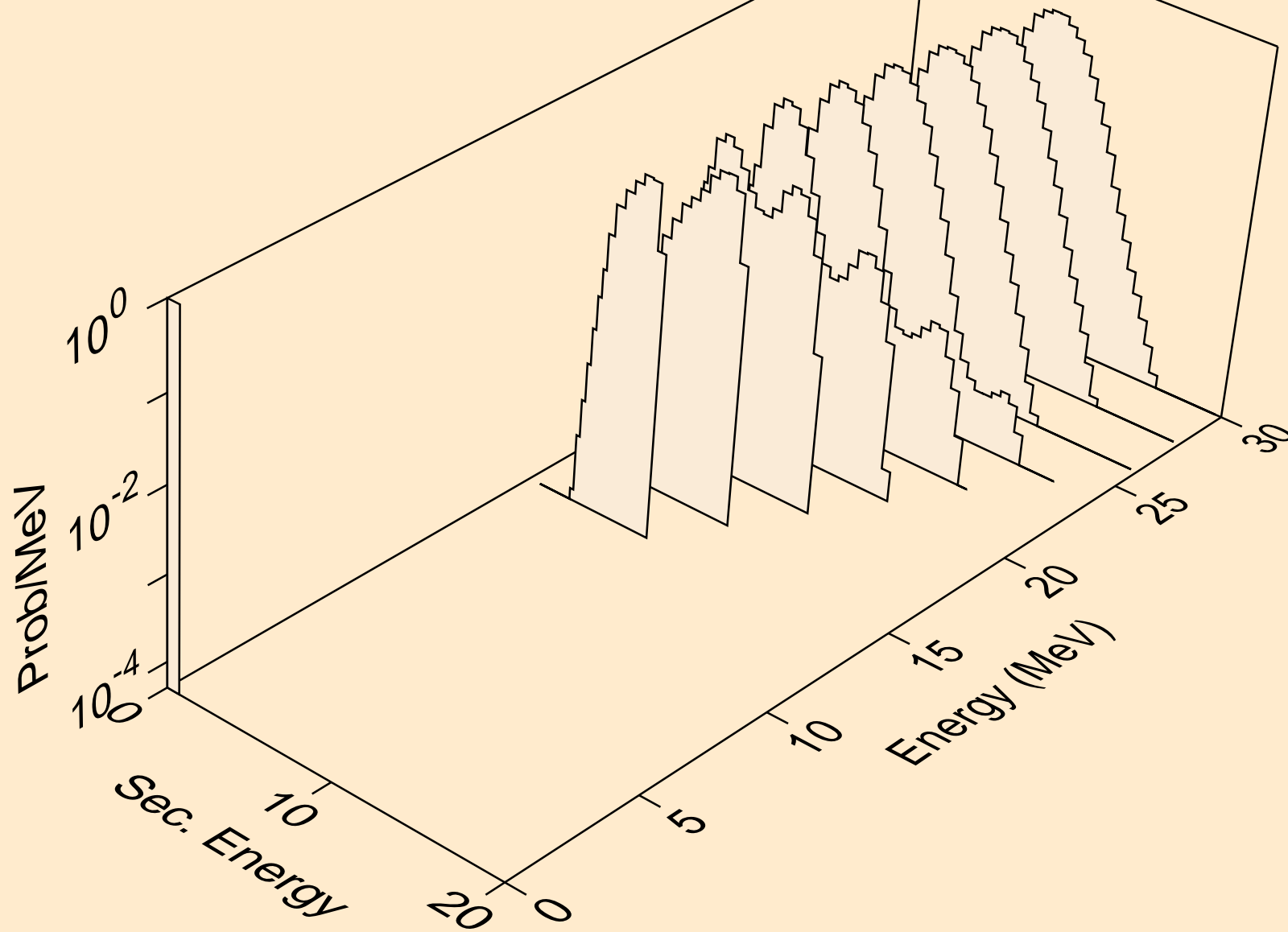

CF246 NEUTRON ACER TENDL-2021 LIBRARY; T=293.6K
protons from (n,p)

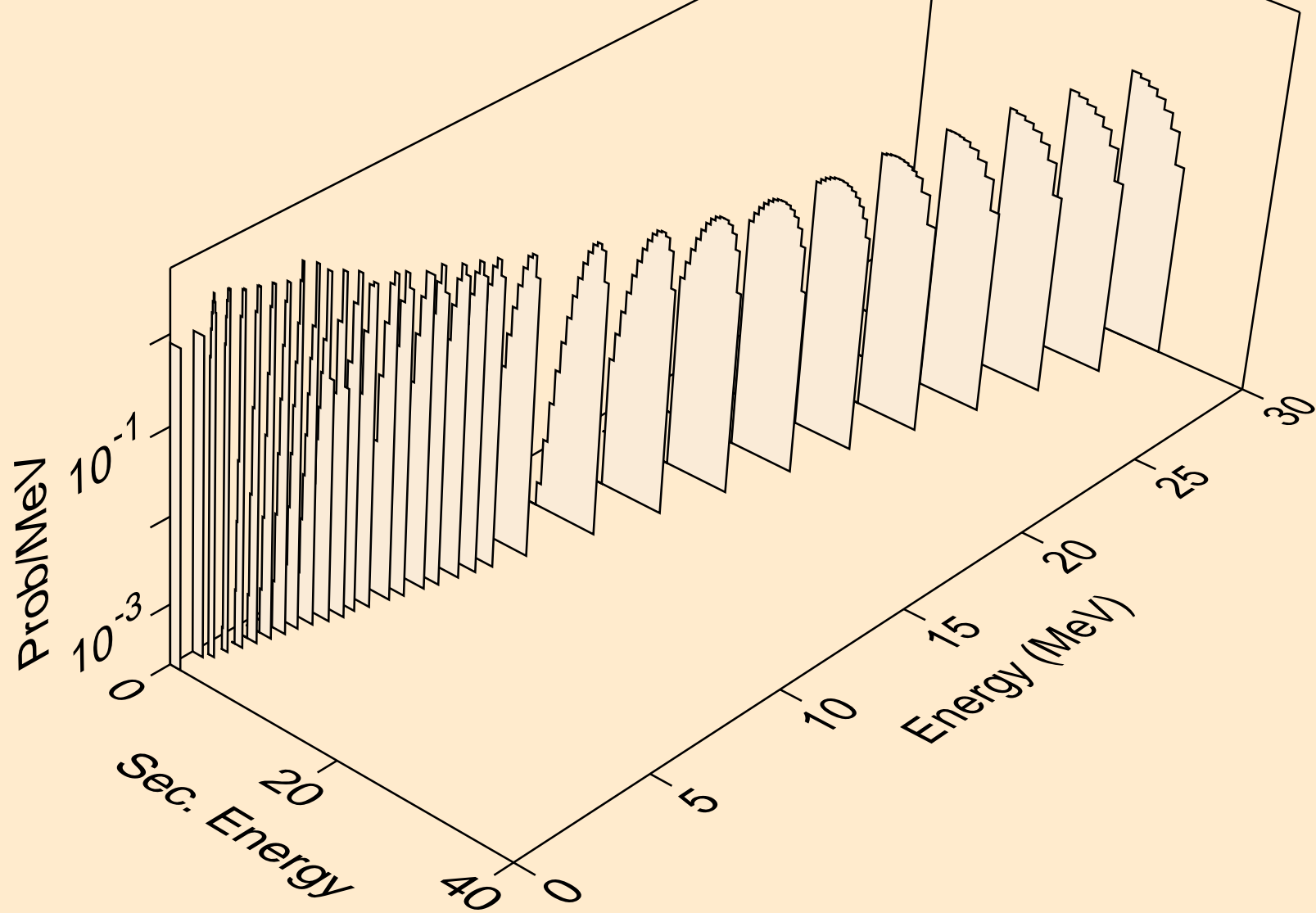

CF246 NEUTRON ACER TENDL-2021 LIBRARY; T=293.6K
protons from (n,2p)

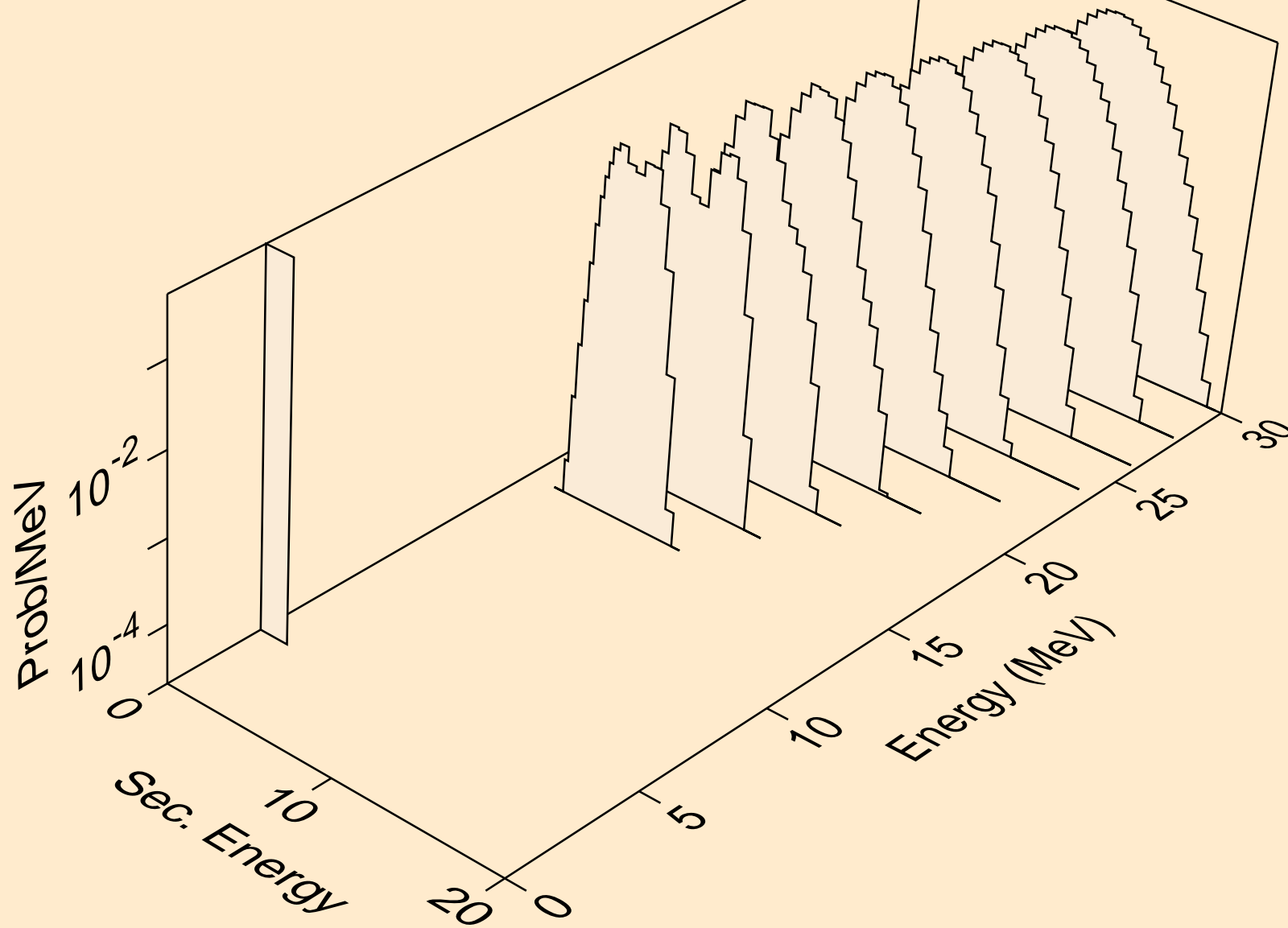

CF246 NEUTRON ACER TENDL-2021 LIBRARY; T=293.6K
protons from (n,p)

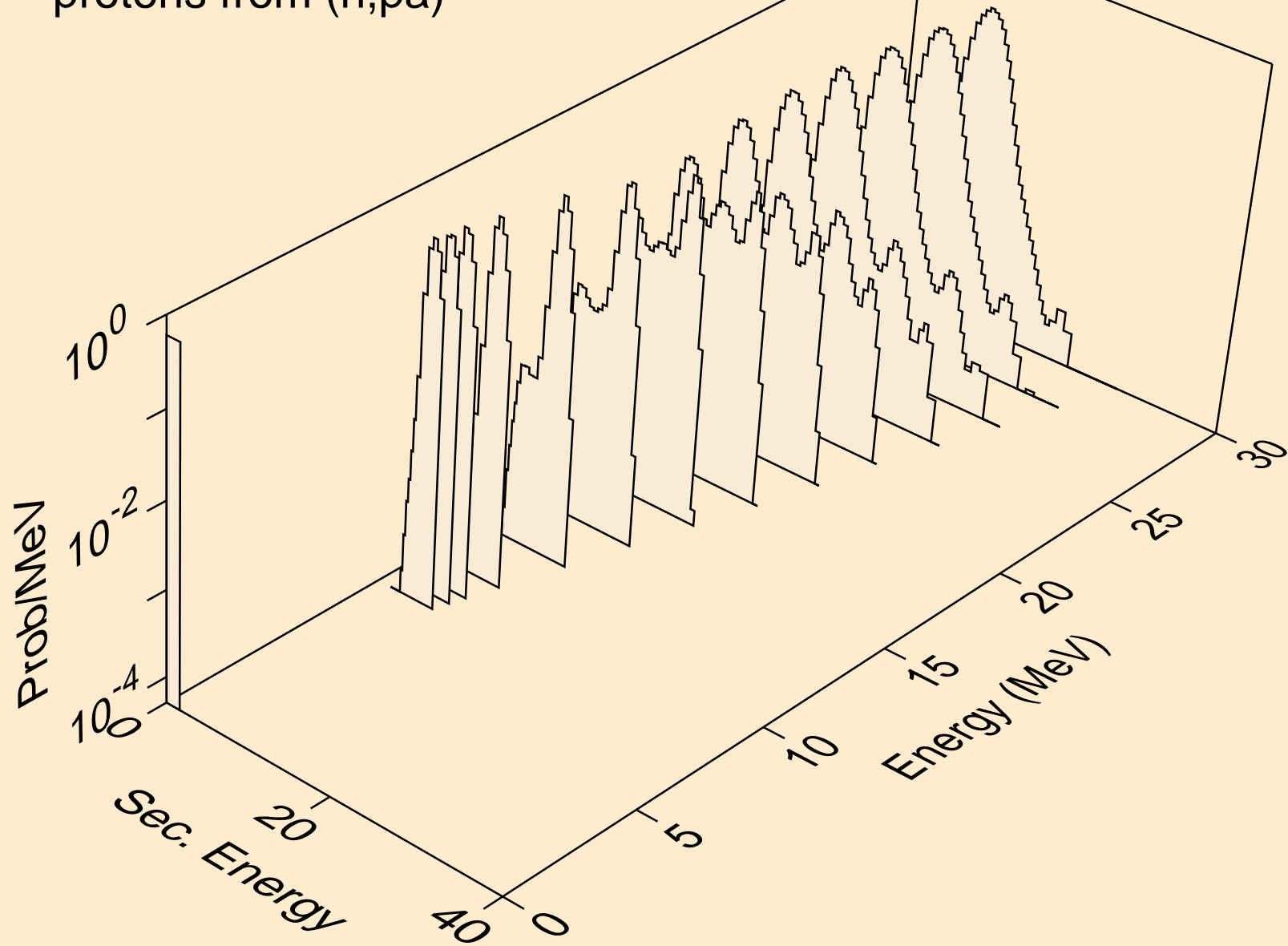

CF246 NEUTRON ACER TENDL-2021 LIBRARY; T=293.6K
deuterons from (n,x)

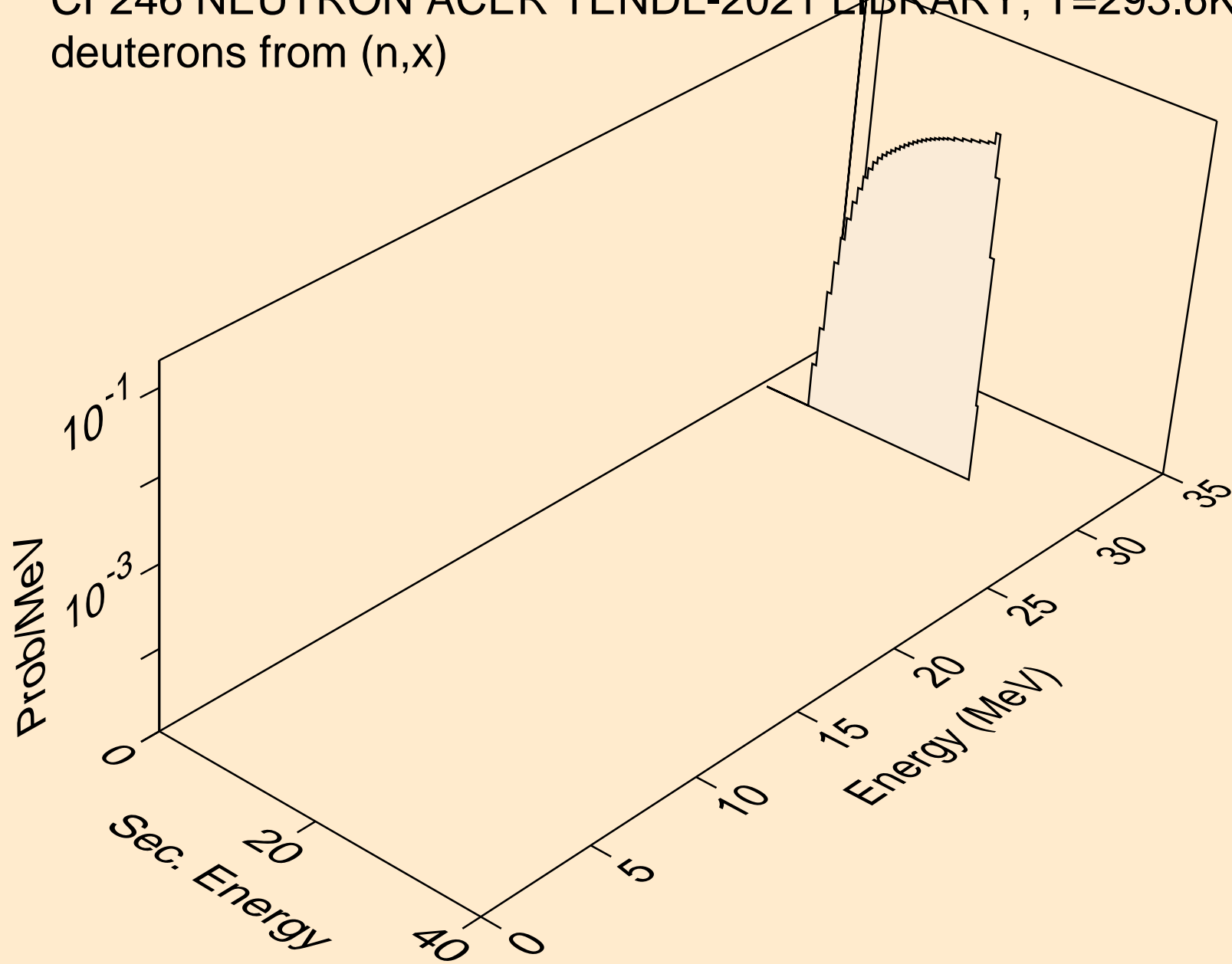

CF246 NEUTRON ACER TENDL-2021 LIBRARY; T=293.6K
deuterons from (n,2nd)

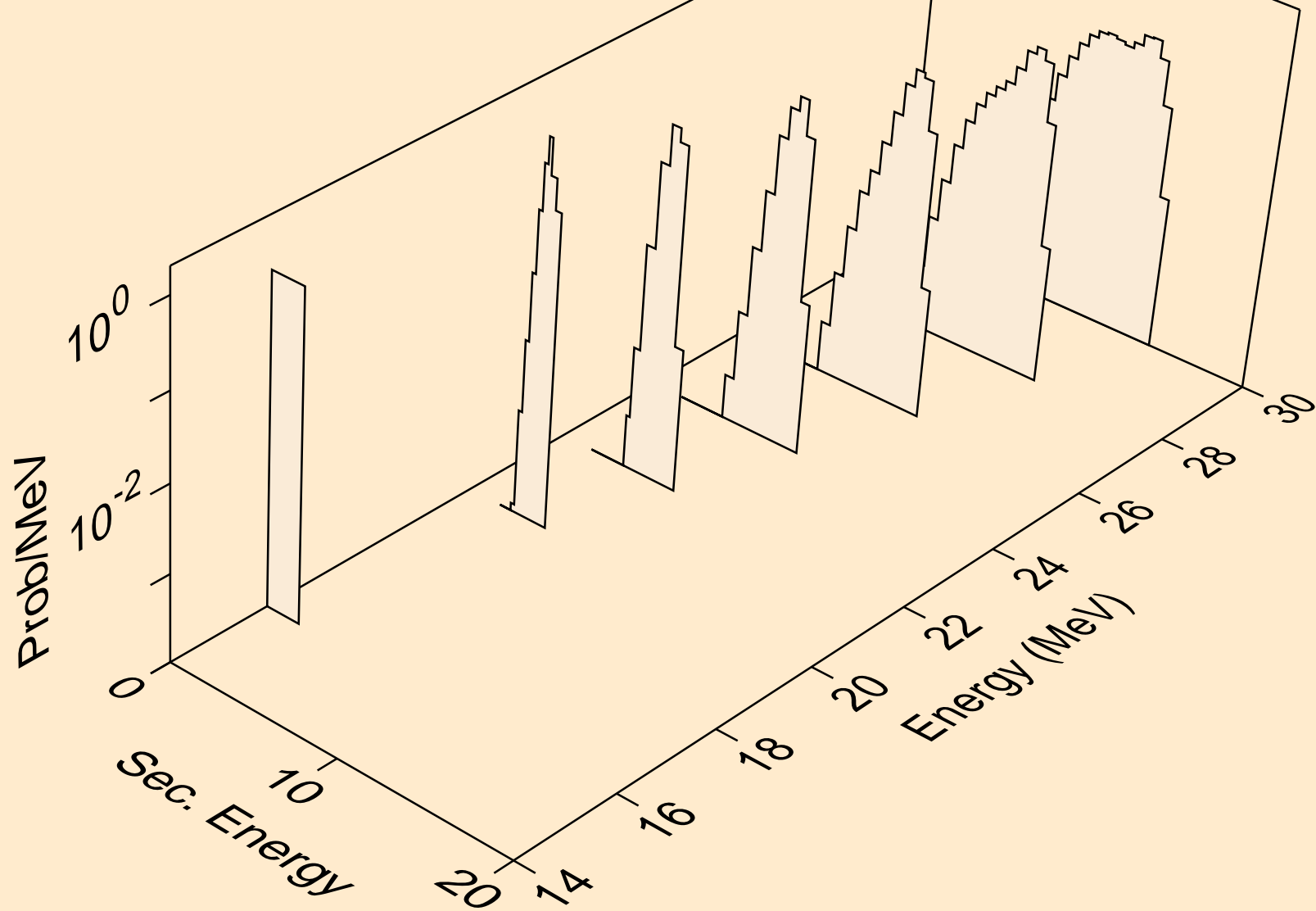

CF246 NEUTRON ACER TENDL-2021 LIBRARY; T=293.6K
deuterons from (n,n*)d

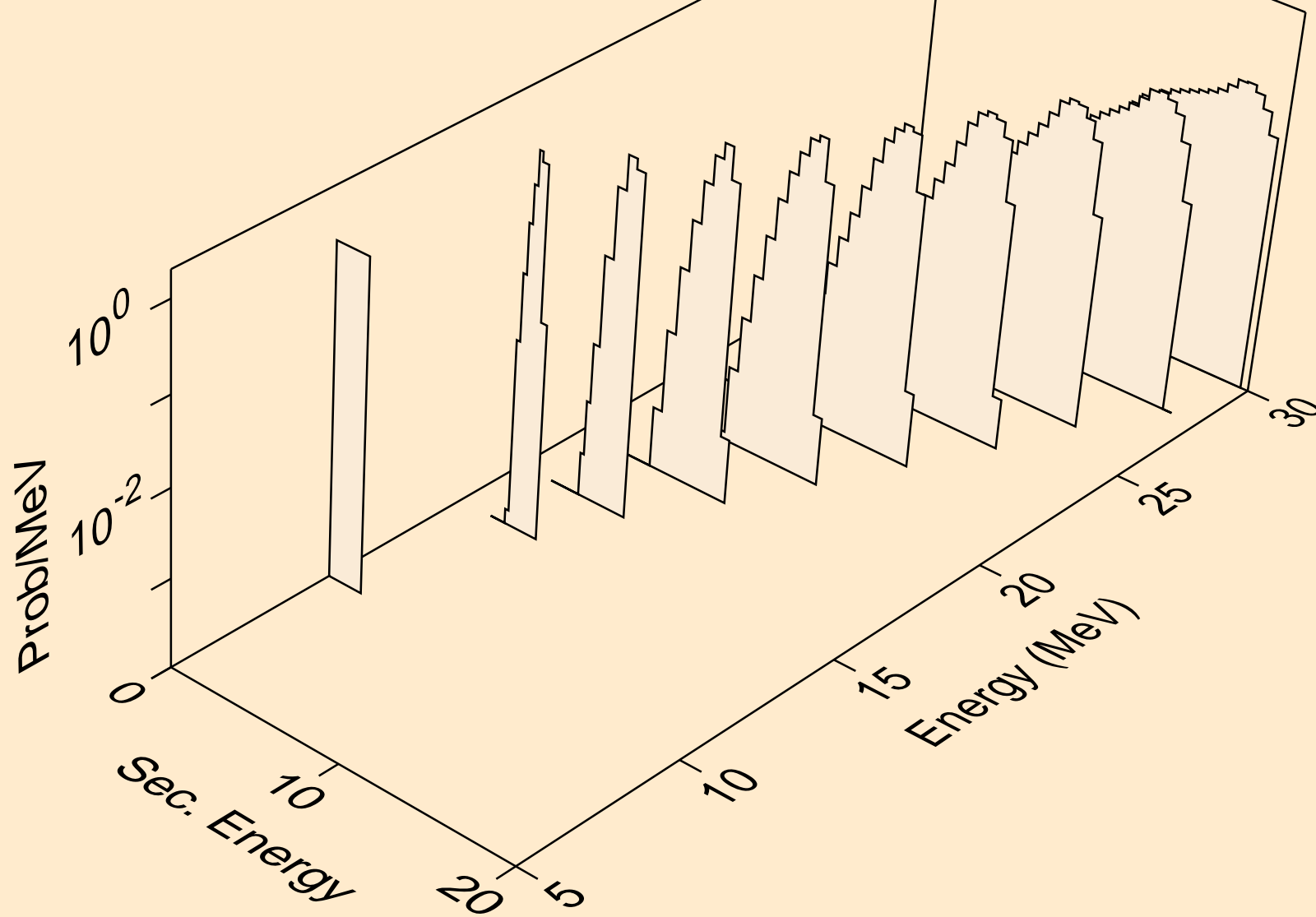

CF246 NEUTRON ACER TENDL-2021 LIBRARY; T=293.6K
deuterons from (n,d)

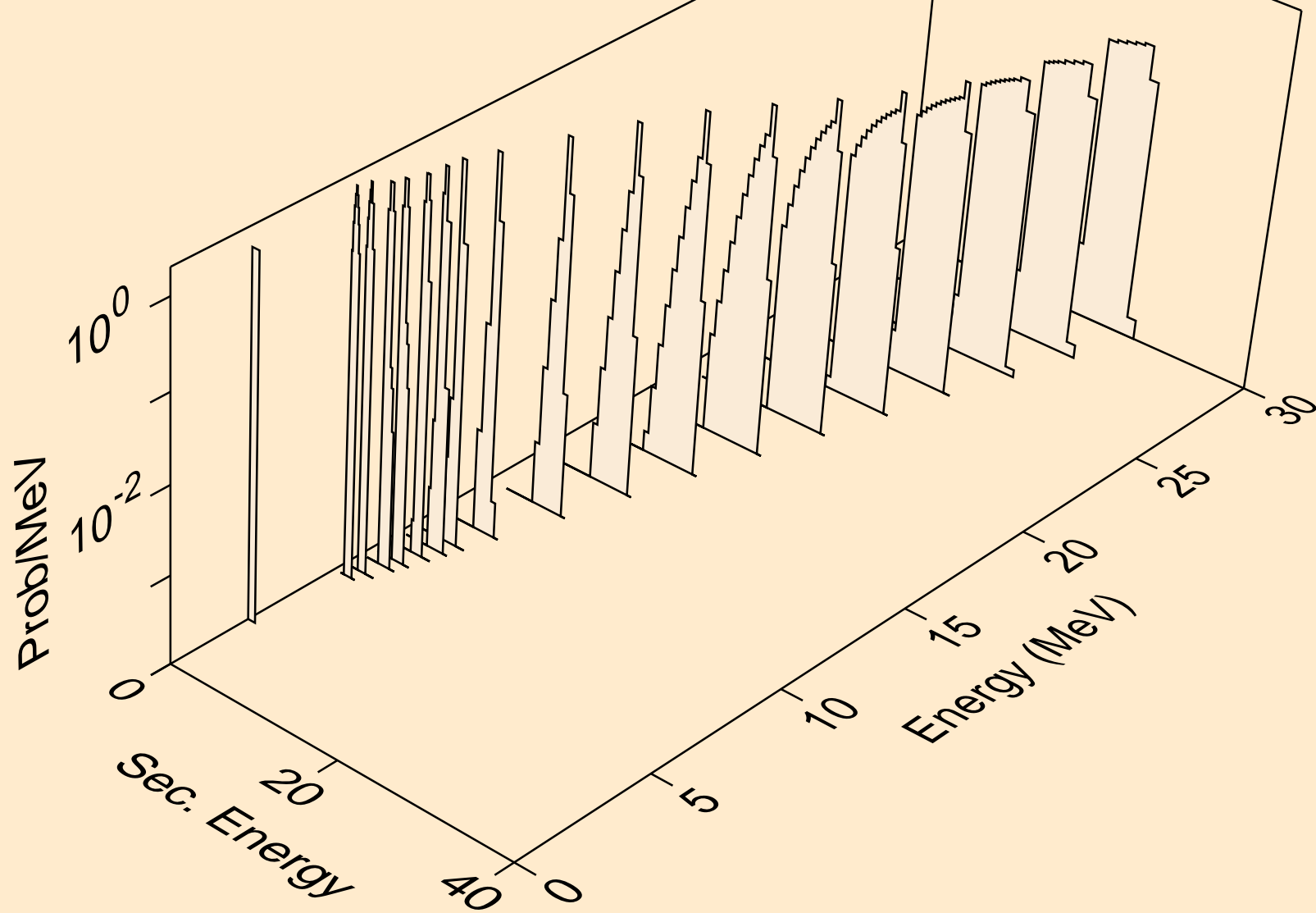

CF246 NEUTRON ACER TENDL-2021 LIBRARY; T=293.6K
tritons from (n,x)

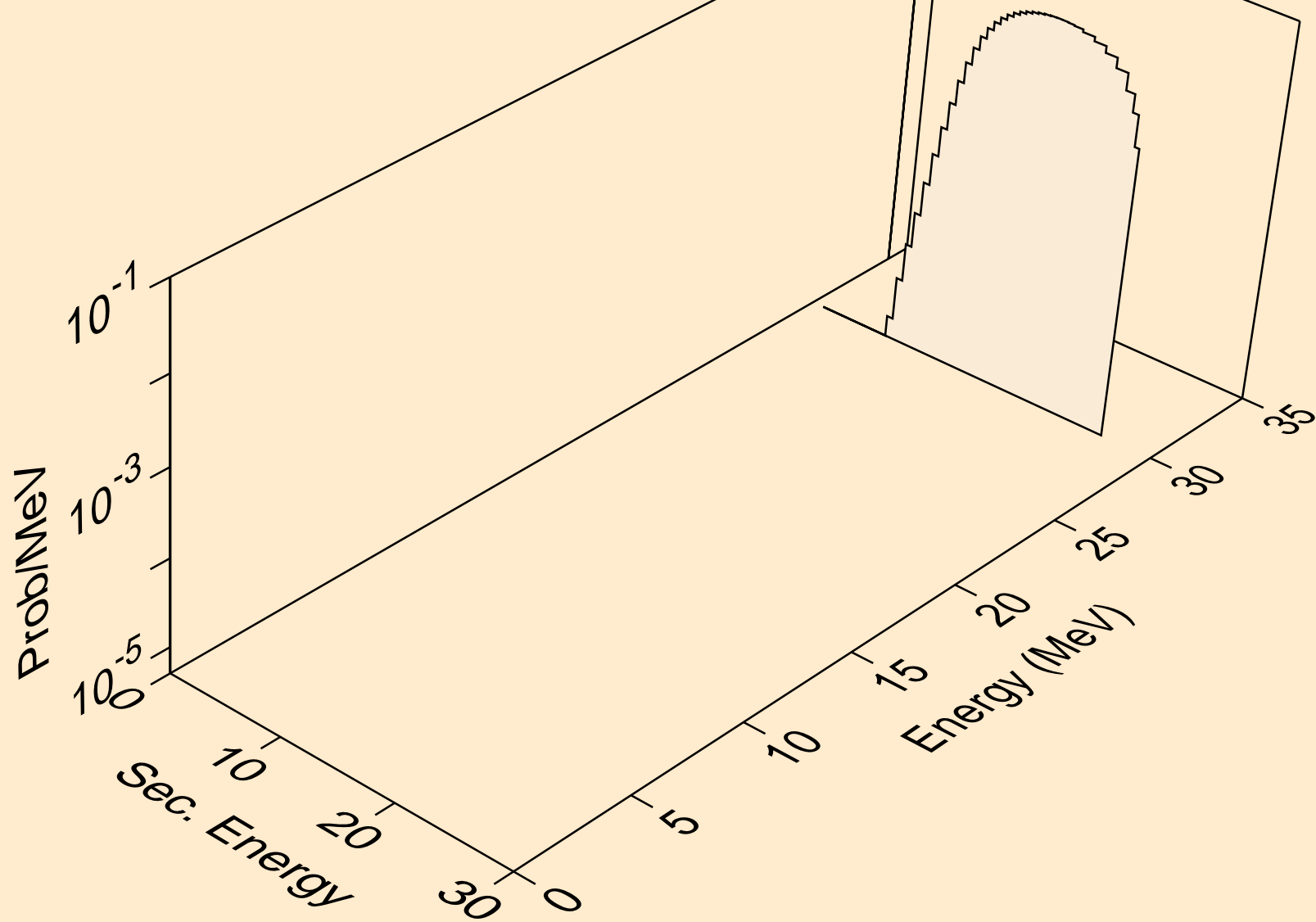

CF246 NEUTRON ACER TENDL-2021 LIBRARY; T=293.6K
tritons from (n,n*)t

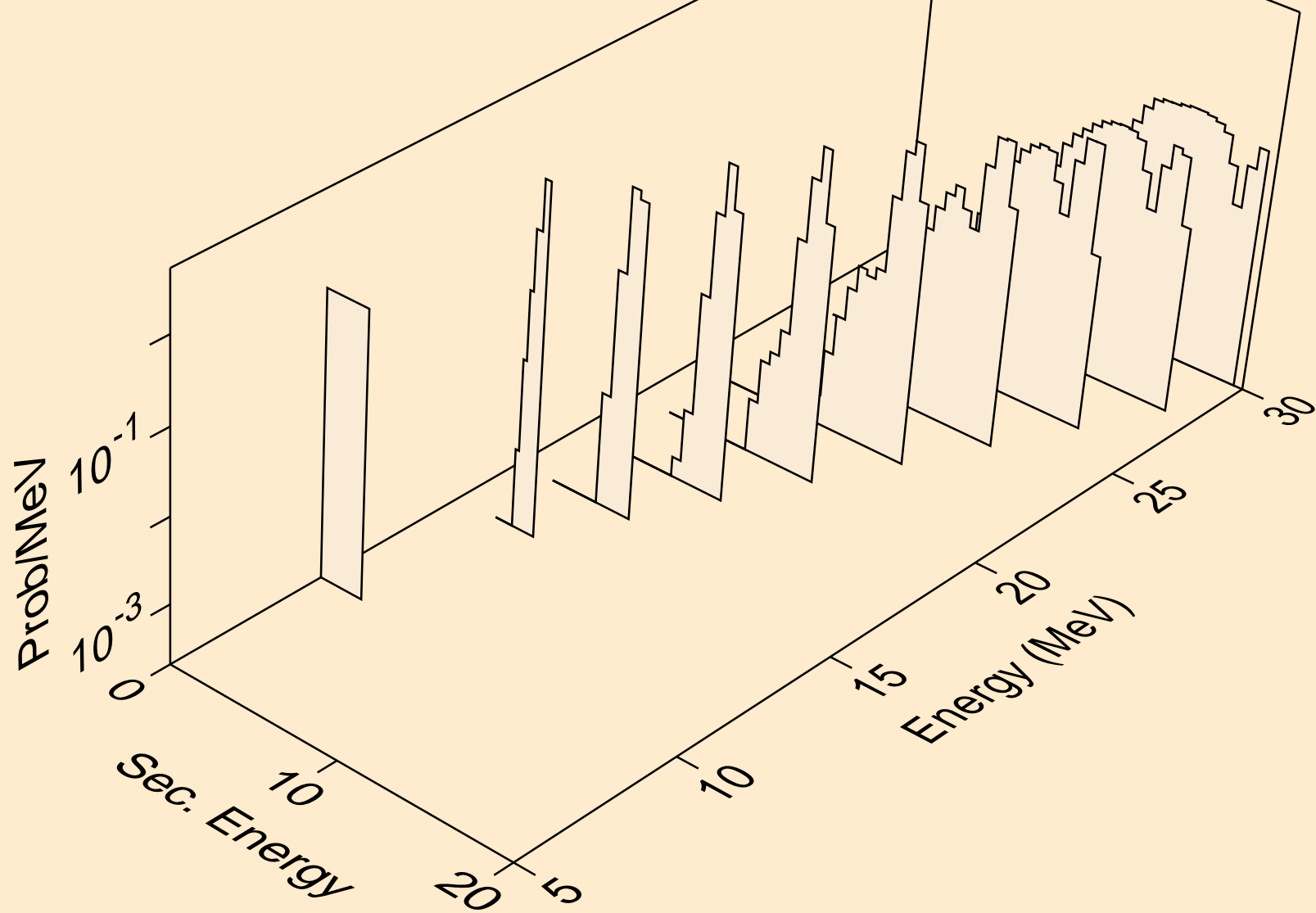

CF246 NEUTRON ACER TENDL-2021 LIBRARY; T=293.6K
tritons from (n,t)

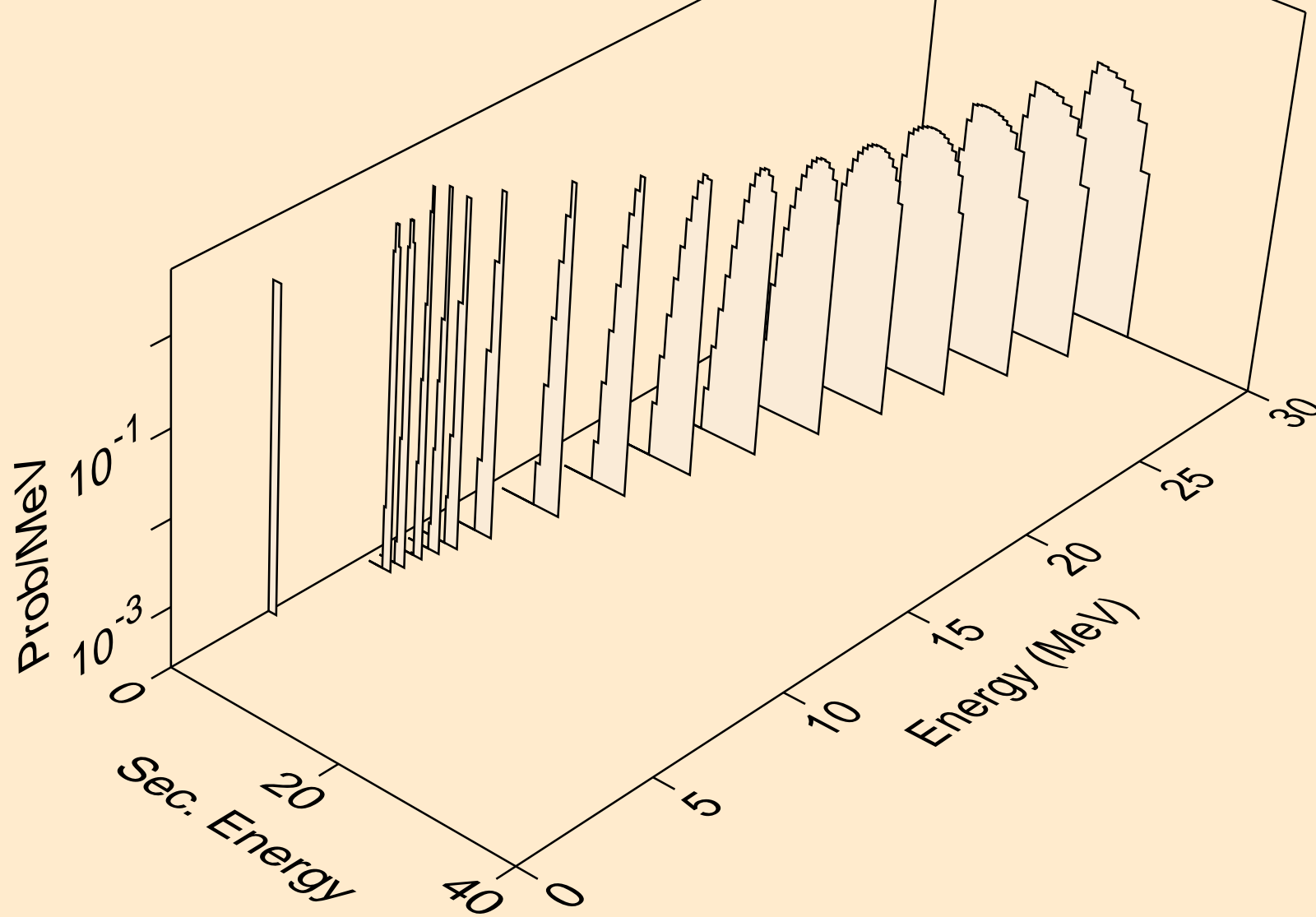

CF246 NEUTRON ACER TENDL-2021 LIBRARY; T=293.6K
he3s from (n,x)

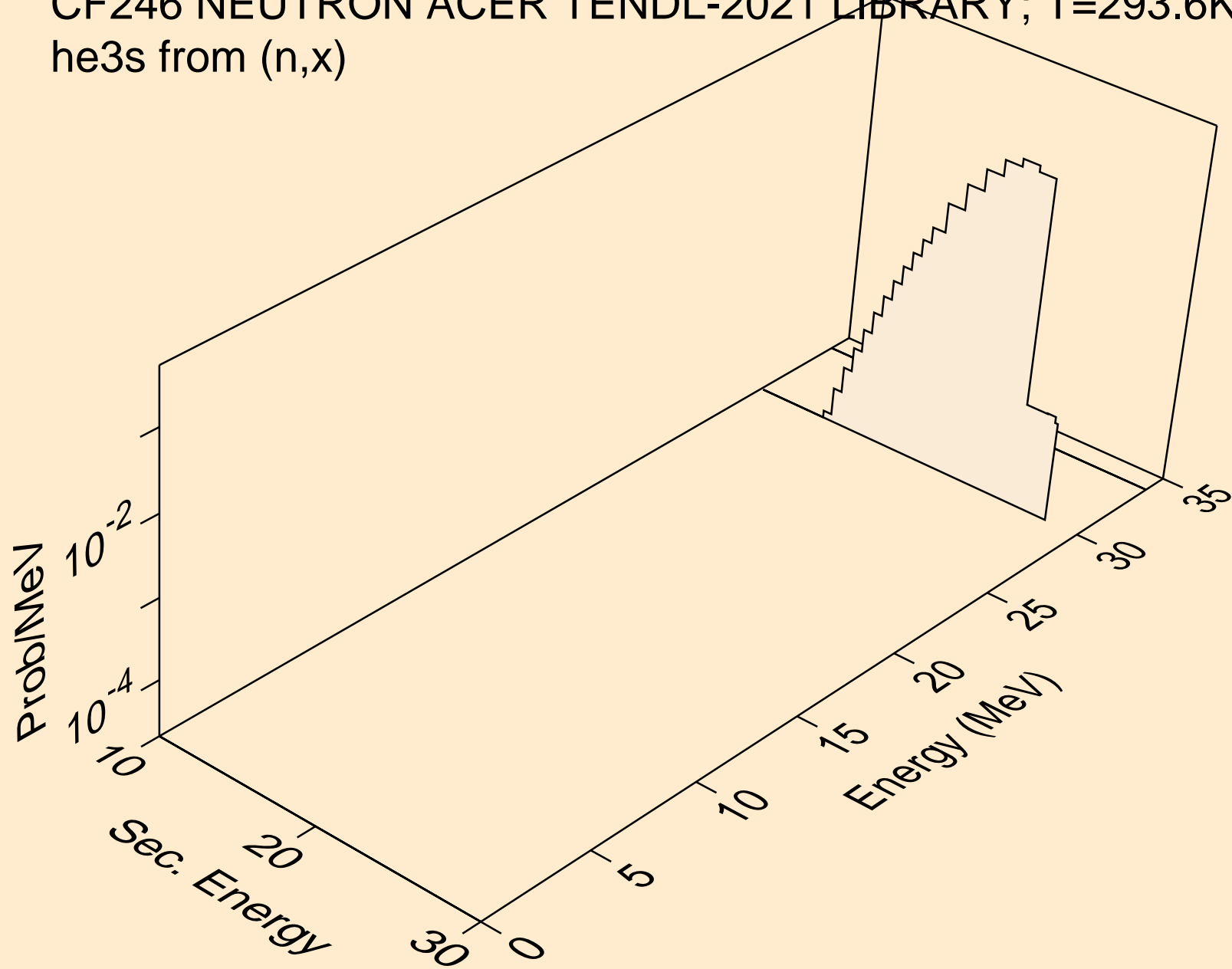

CF246 NEUTRON ACER TENDL-2021 LIBRARY; T=293.6K
he3s from (n,n*)he3

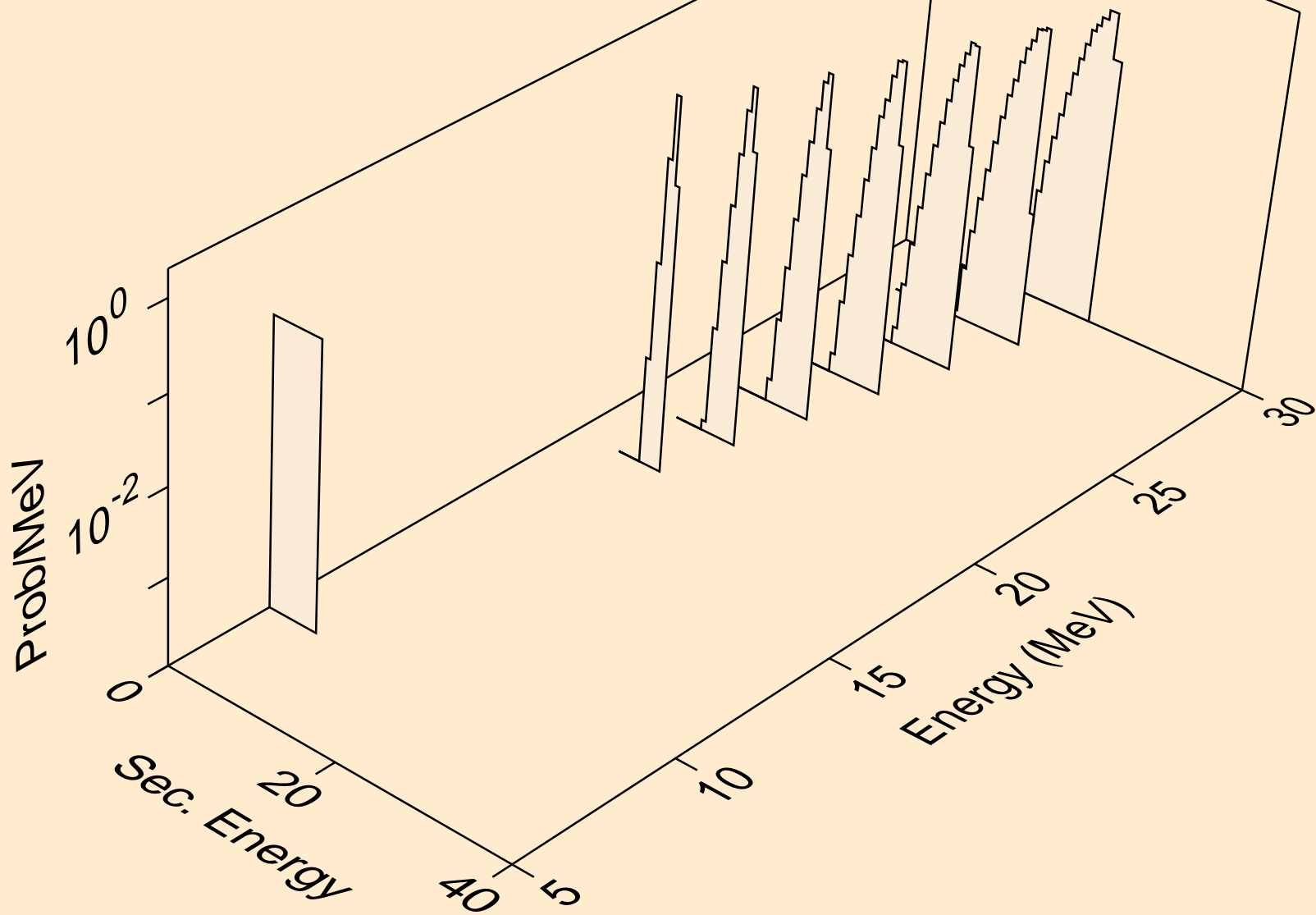

CF246 NEUTRON ACER TENDL-2021 LIBRARY; T=293.6K
he3s from (n,he3)

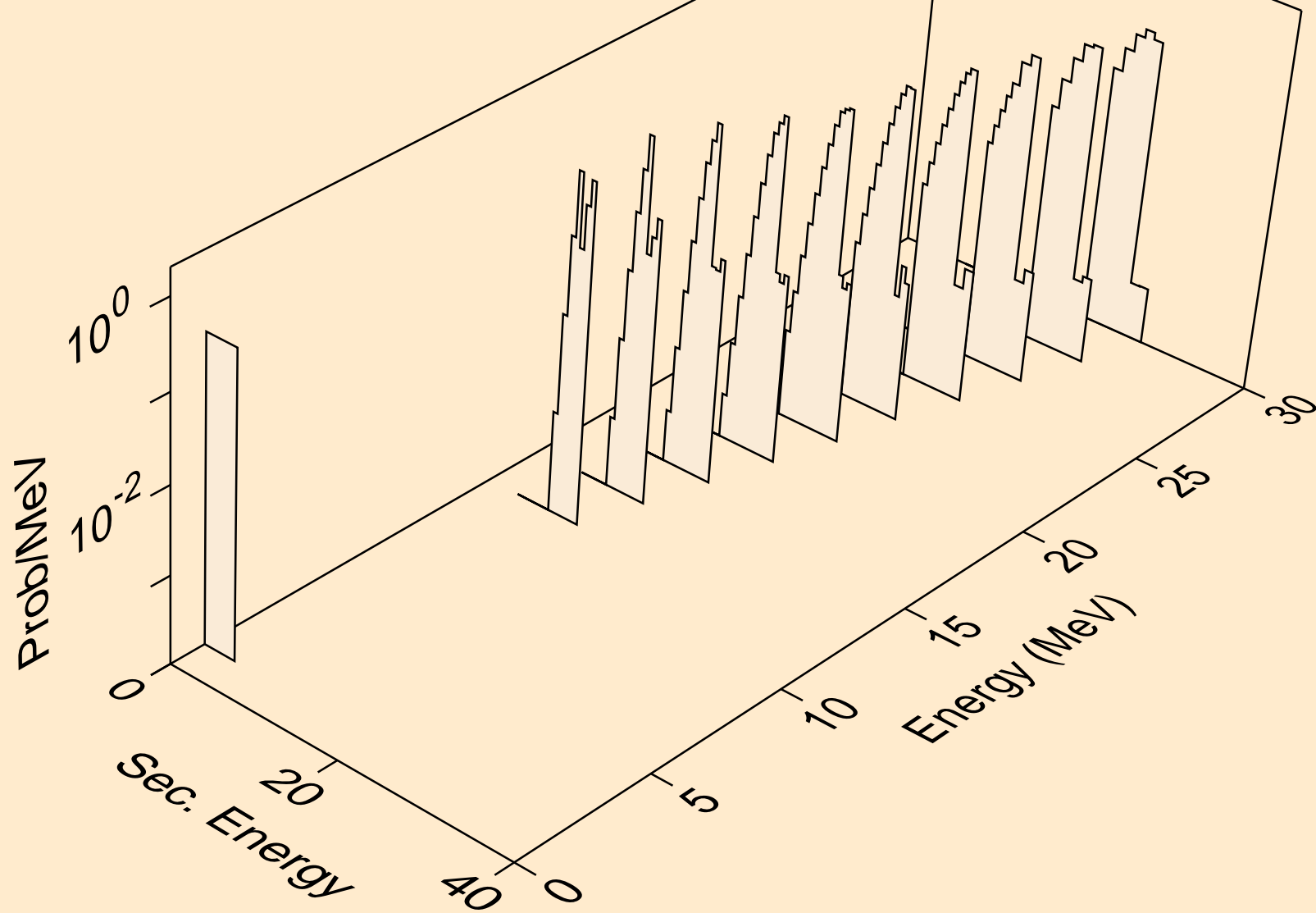

CF246 NEUTRON ACER TENDL-2021 LIBRARY; T=293.6K
alphas from (n,x)

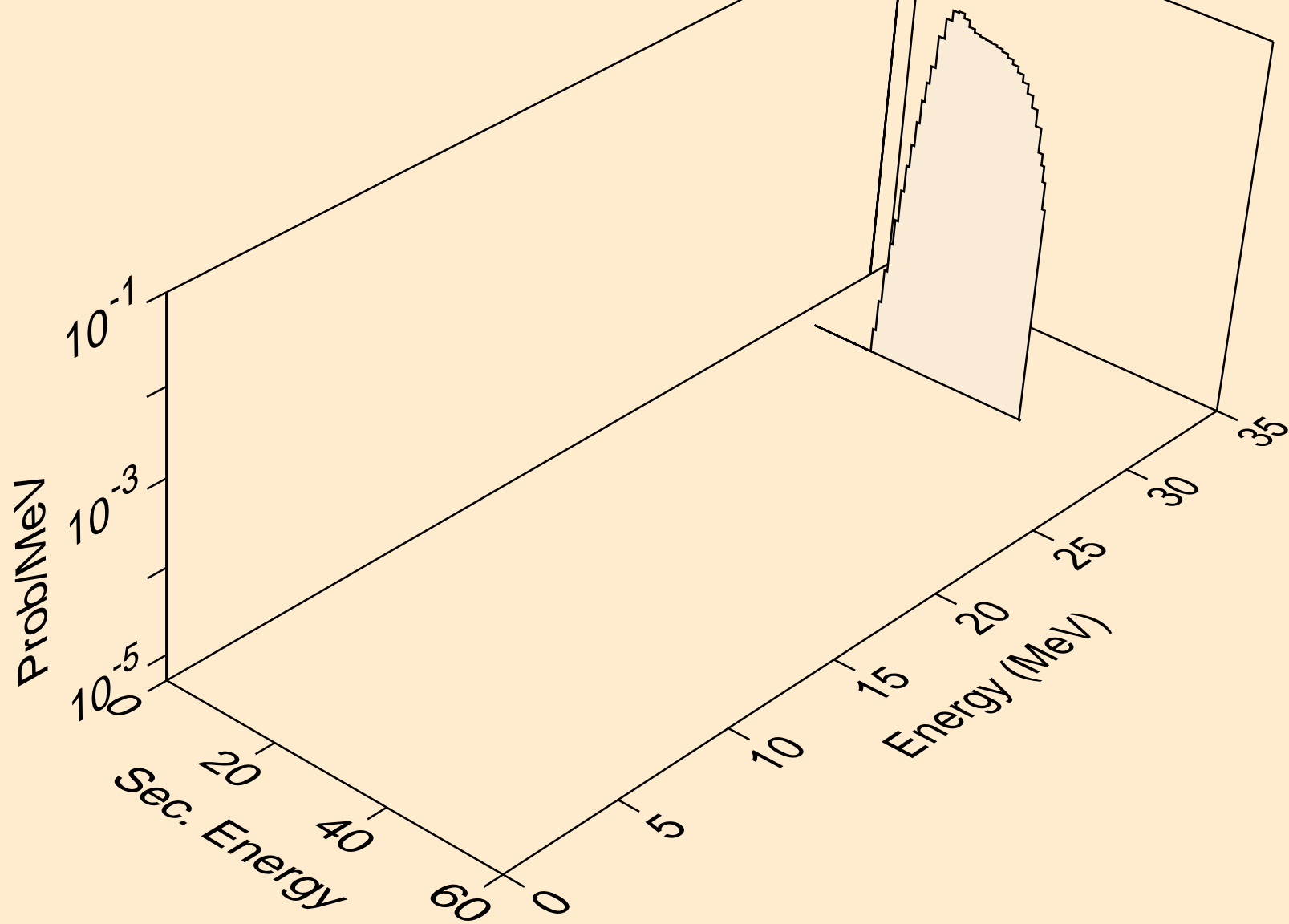

CF246 NEUTRON ACER TENDL-2021 LIBRARY; T=293.6K
alphas from (n,n*)a

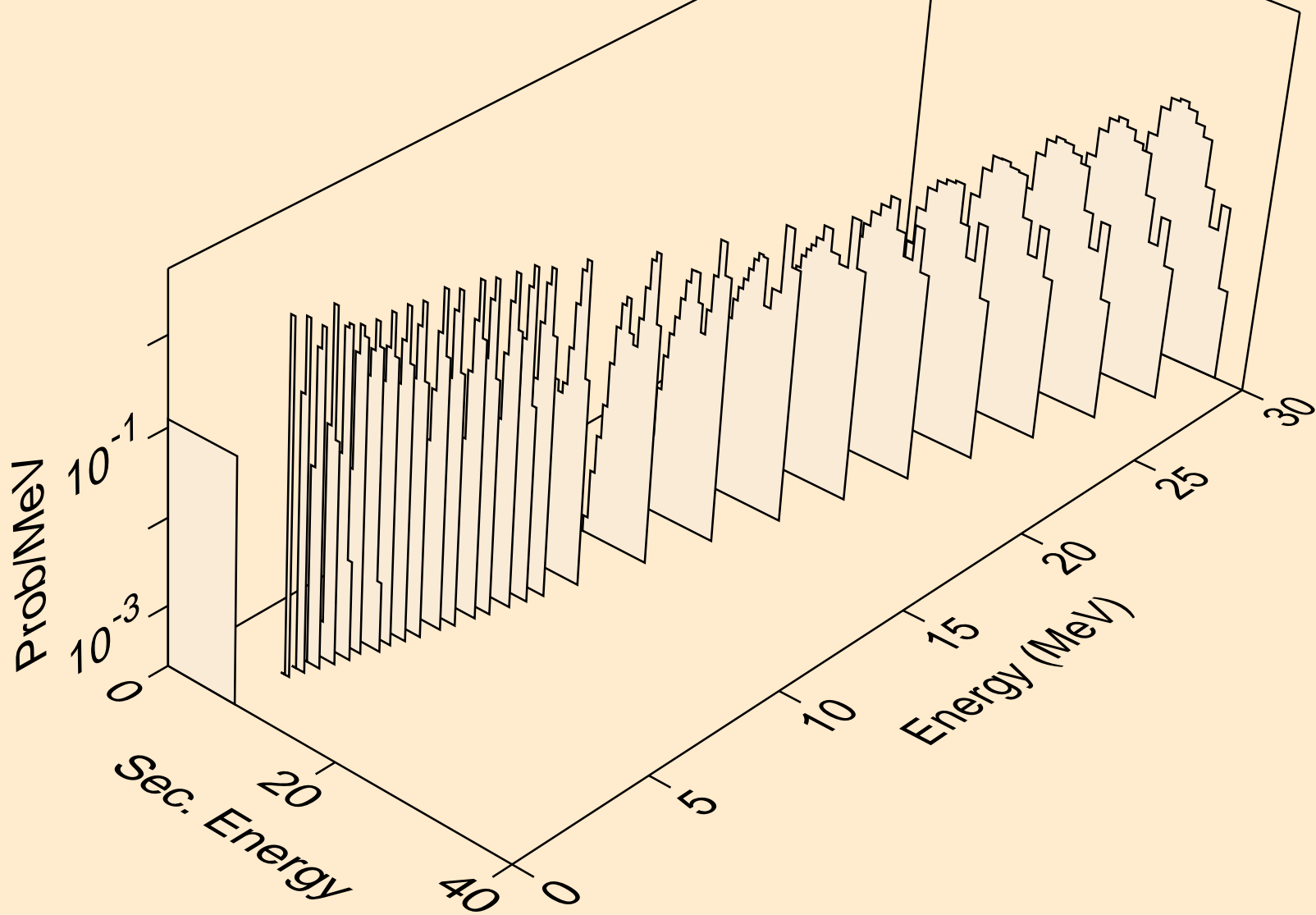

CF246 NEUTRON ACER TENDL-2021 LIBRARY; T=293.6K
alphas from (n,2n)a

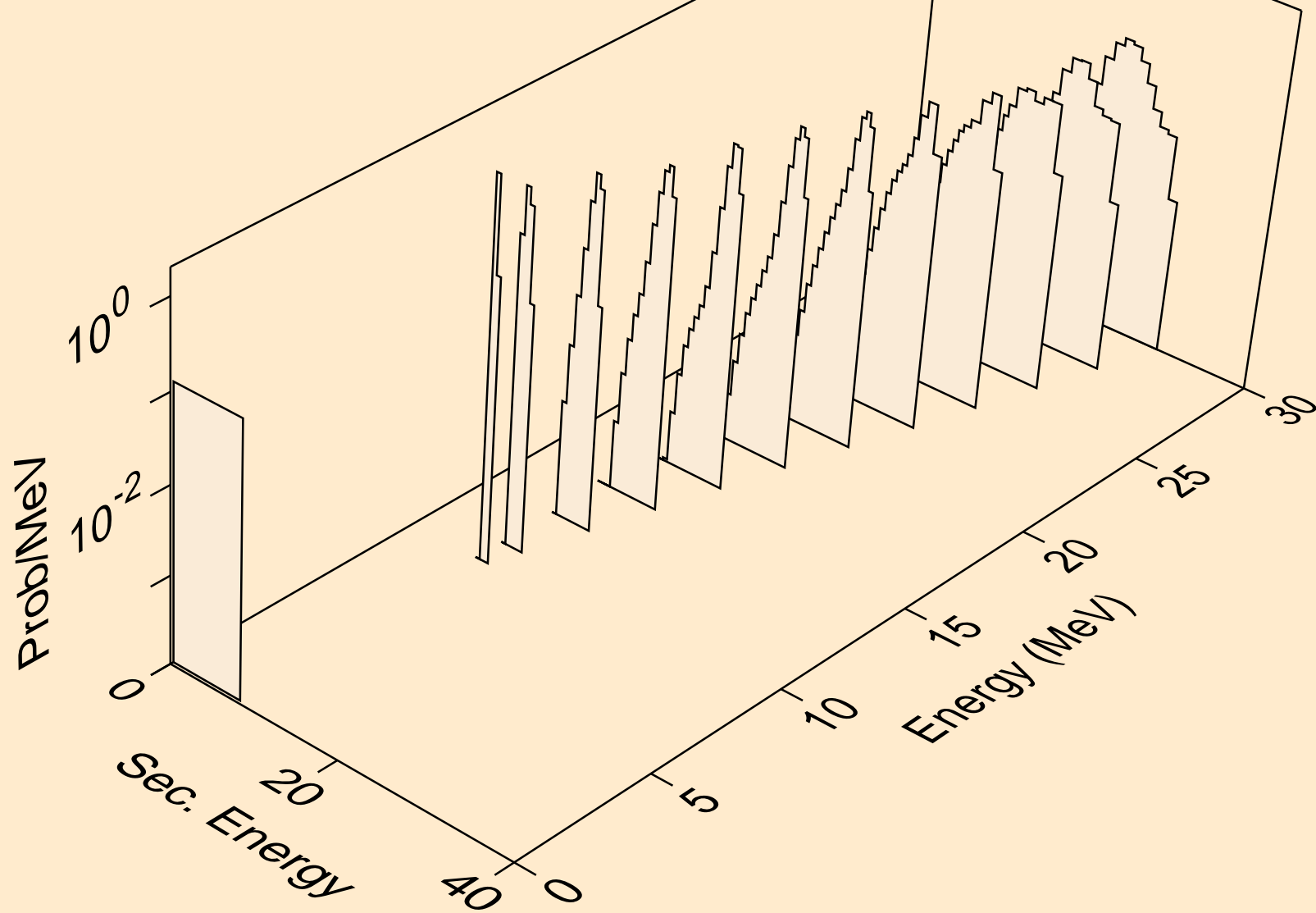

CF246 NEUTRON ACER TENDL-2021 LIBRARY; T=293.6K
alphas from (n,3n)a

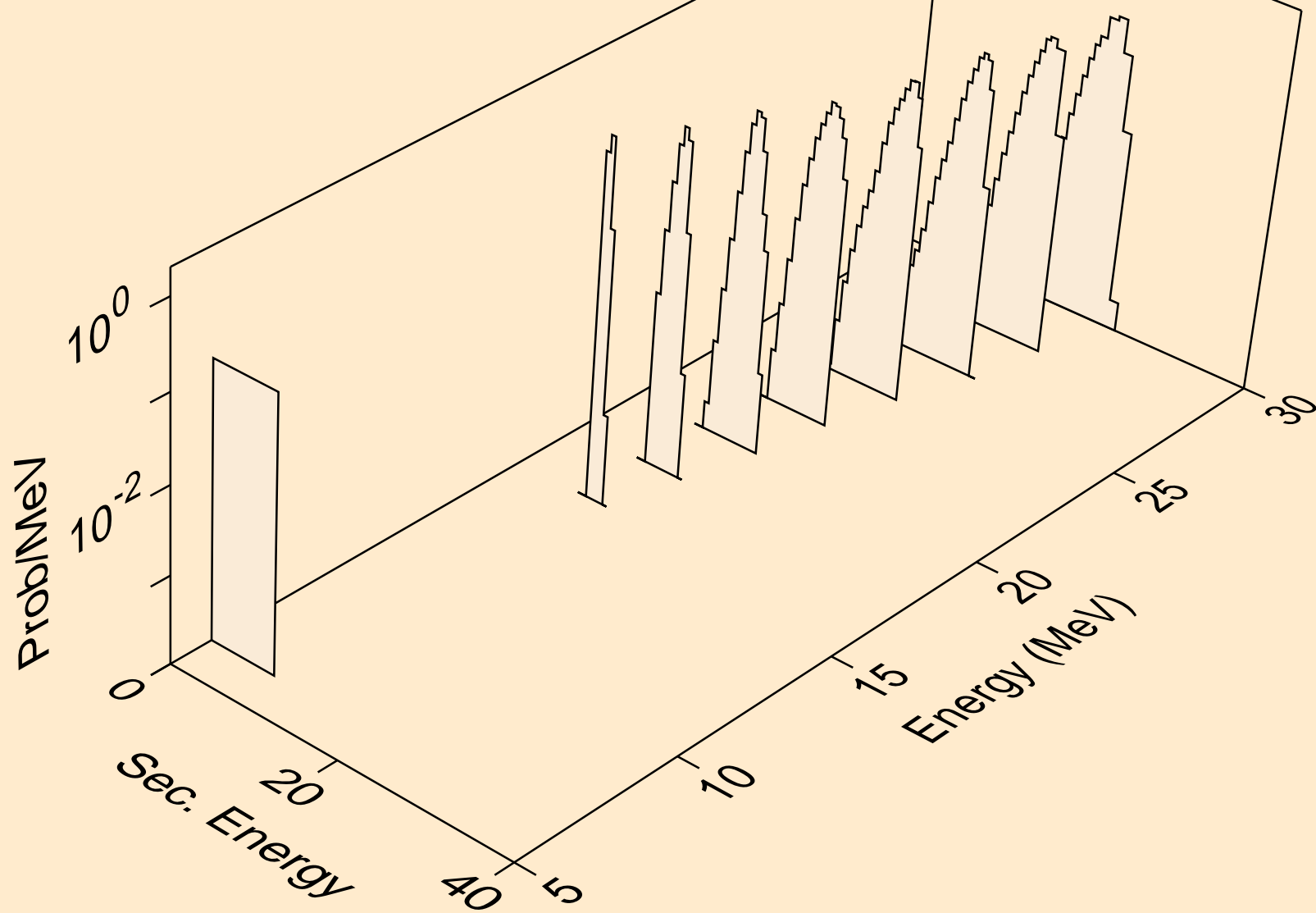

CF246 NEUTRON ACER TENDL-2021 LIBRARY; T=293.6K
alphas from (n,n*)2a

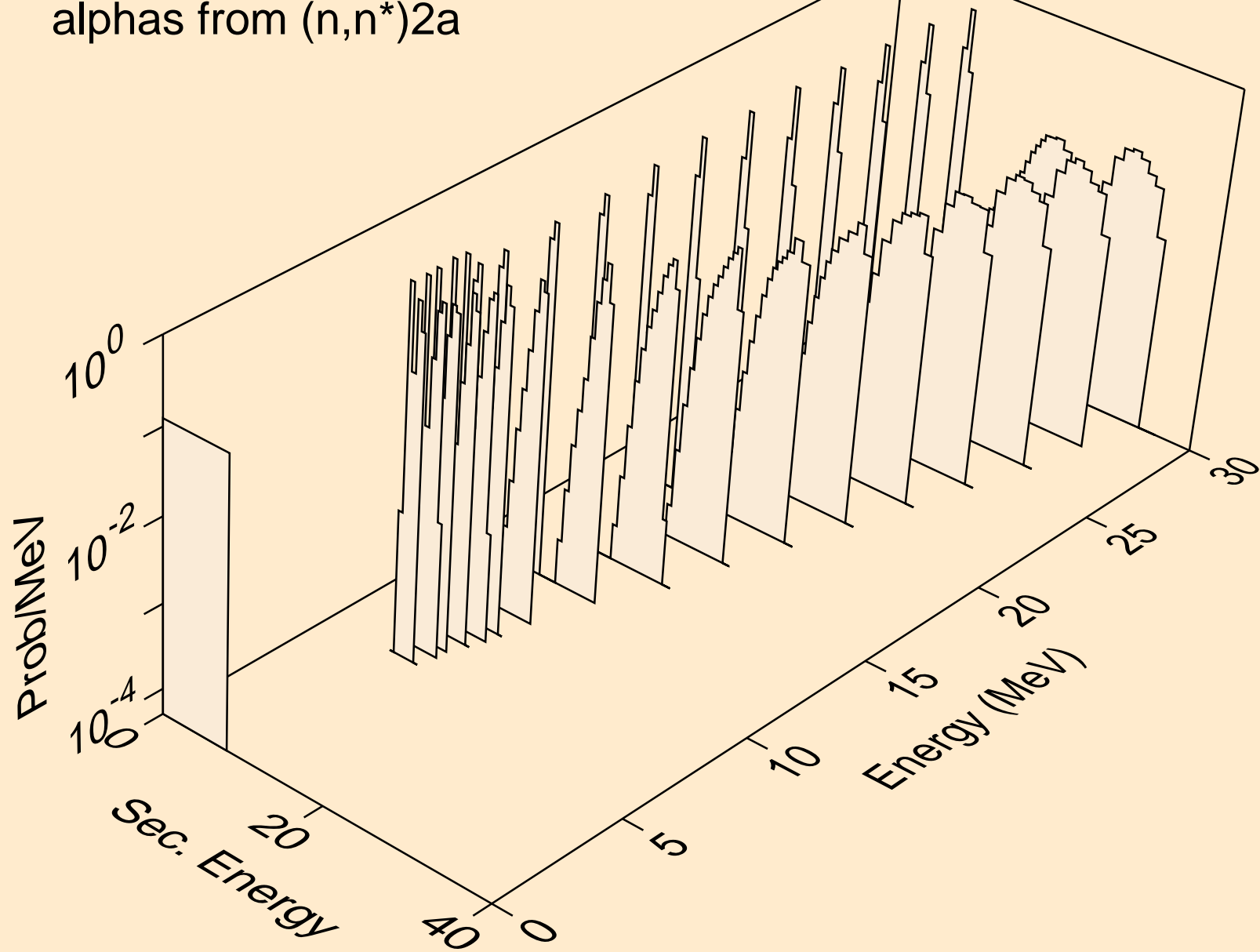

CF246 NEUTRON ACER TENDL-2021 LIBRARY; T=293.6K
alphas from (n,2n)2a

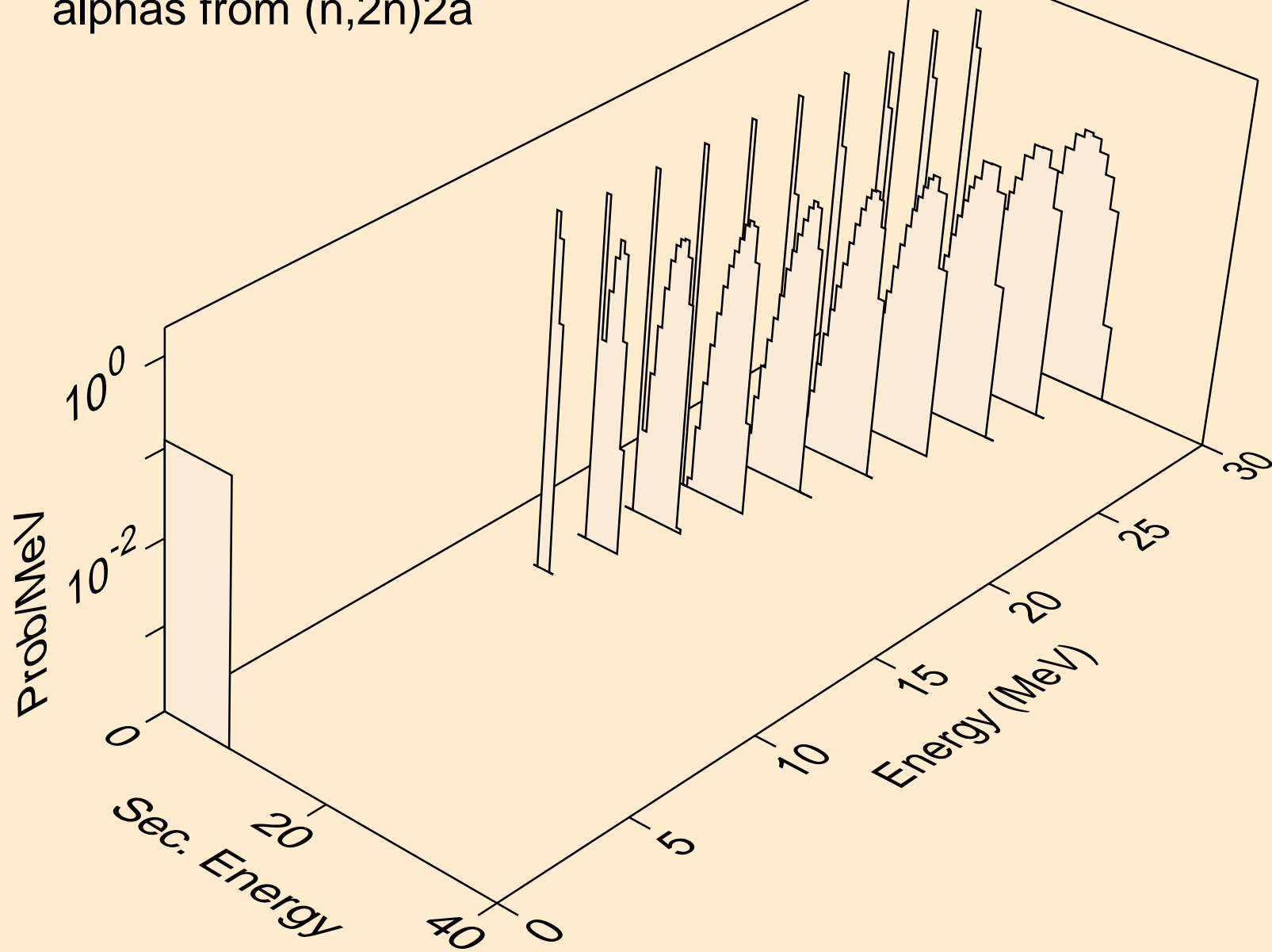

CF246 NEUTRON ACER TENDL-2021 LIBRARY; T=293.6K
alphas from (n,npa)

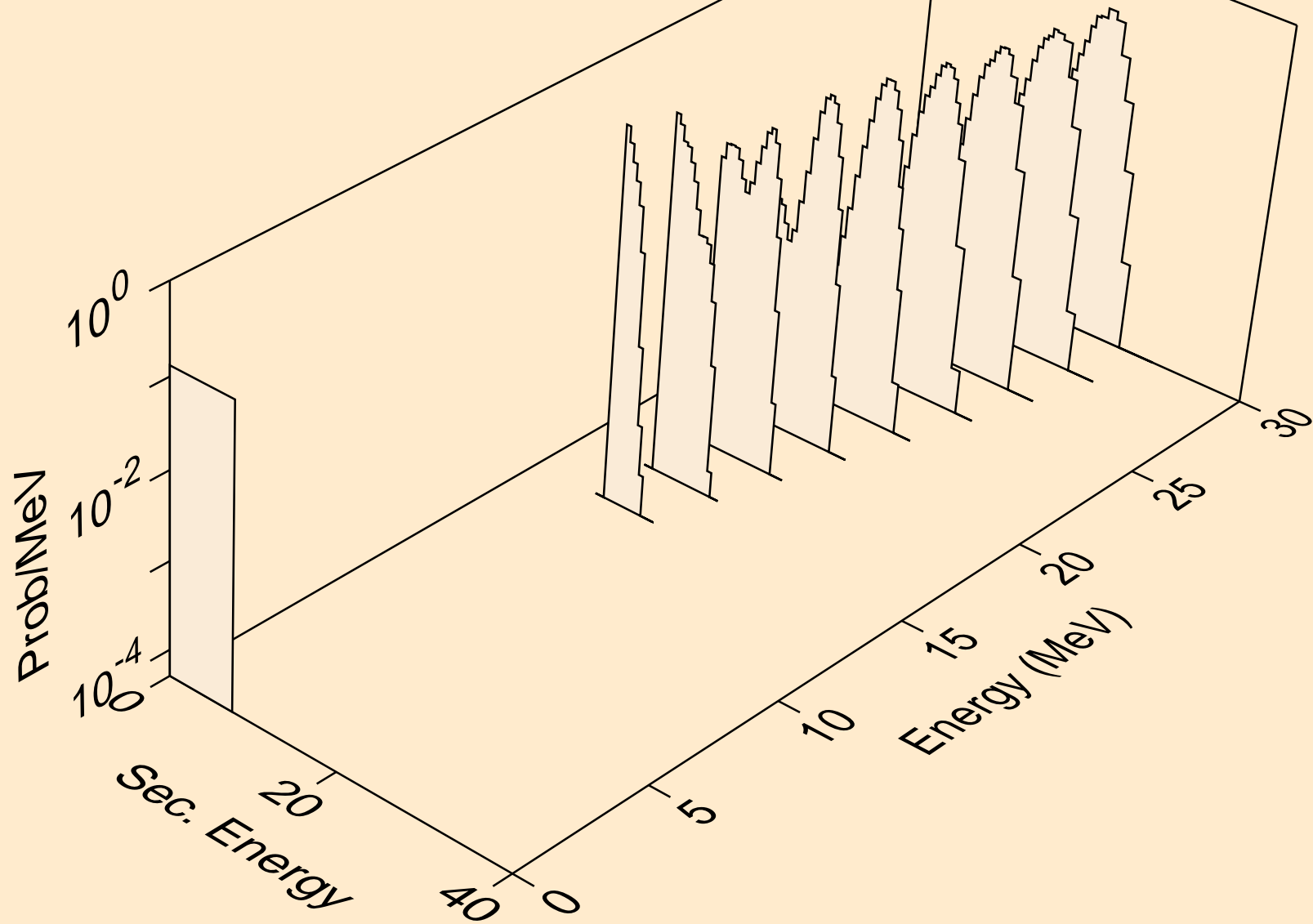

CF246 NEUTRON ACER TENDL-2021 LIBRARY; T=293.6K
alphas from (n,a)

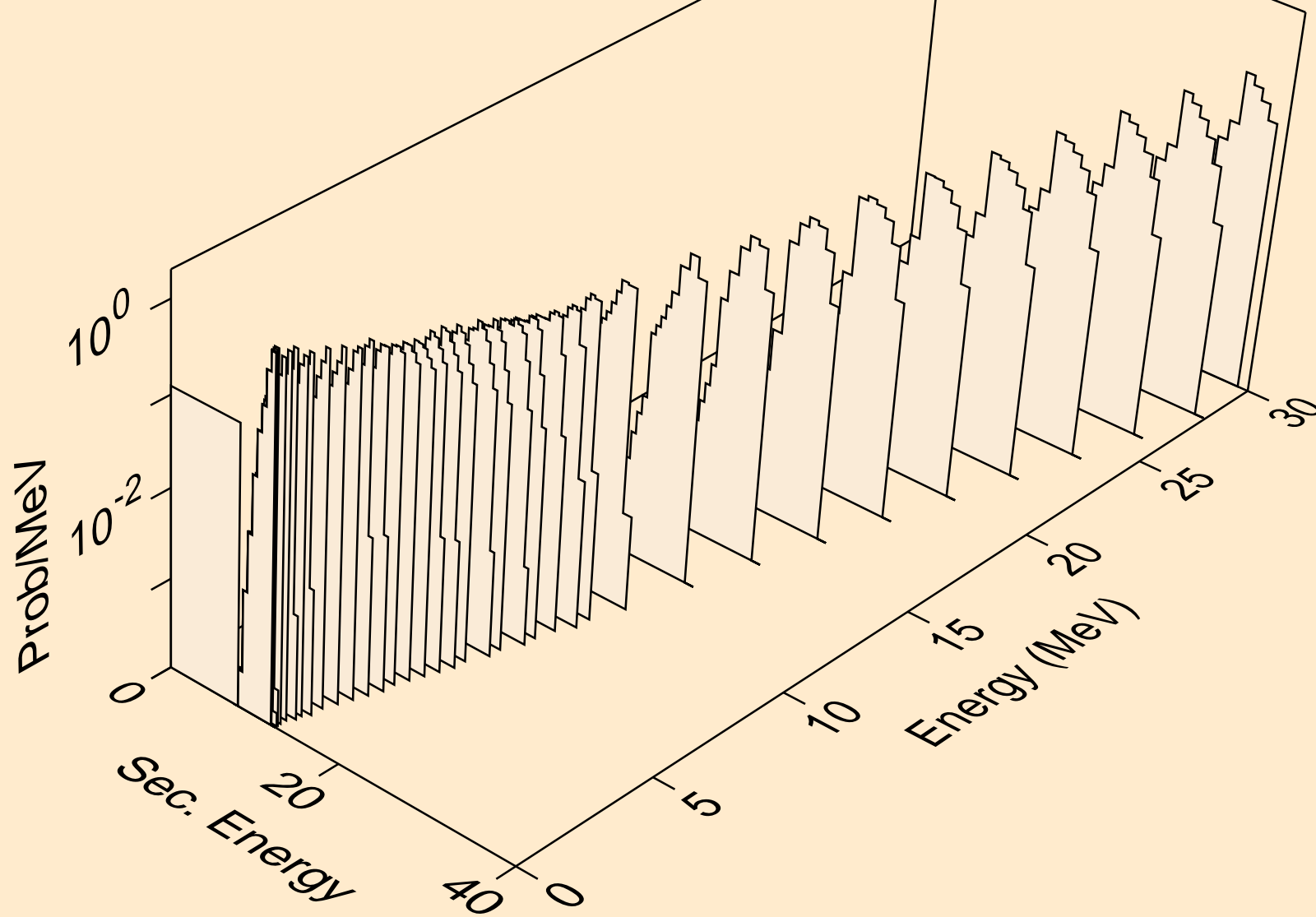

CF246 NEUTRON ACER TENDL-2021 LIBRARY; T=293.6K
alphas from (n,2a)

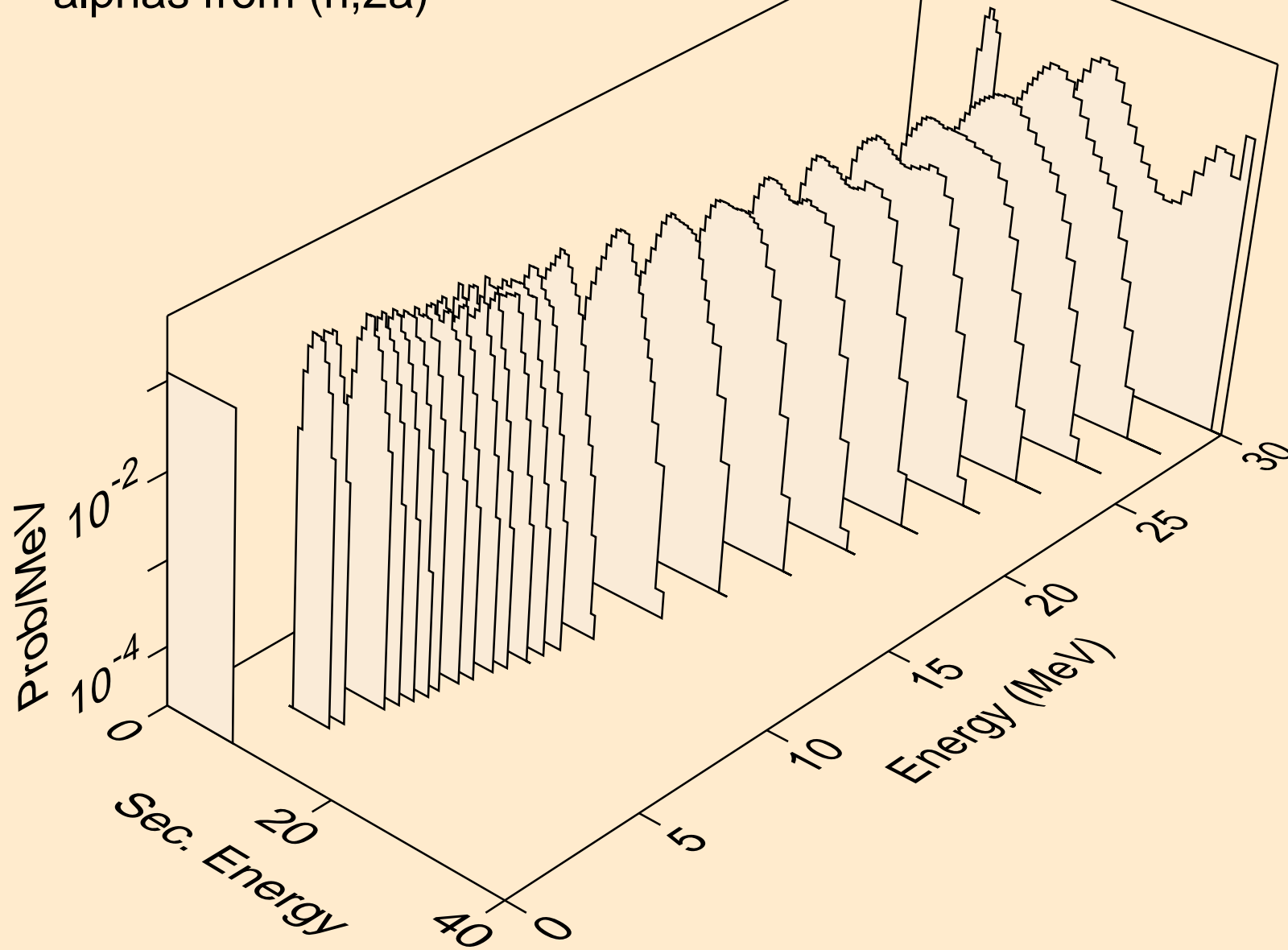

CF246 NEUTRON ACER TENDL-2021 LIBRARY; T=293.6K
alphas from (n,pa)

