

CL037 NEUTRON ACER TENDL-2021 LIBRARY; T=293.6K
Principal cross sections

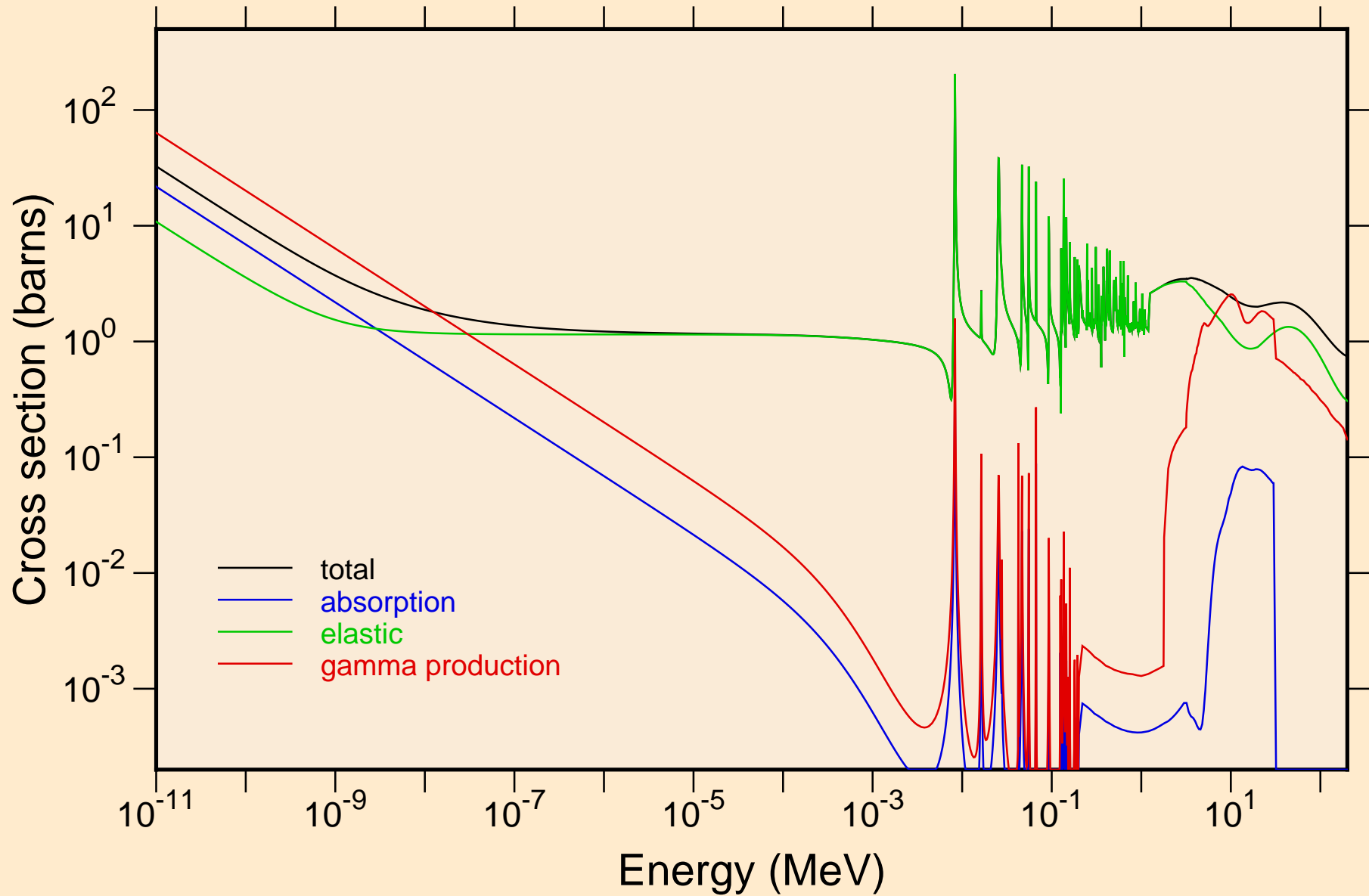

CL037 NEUTRON ACER TENDL-2021 LIBRARY; T=293.6K
resonance total cross section

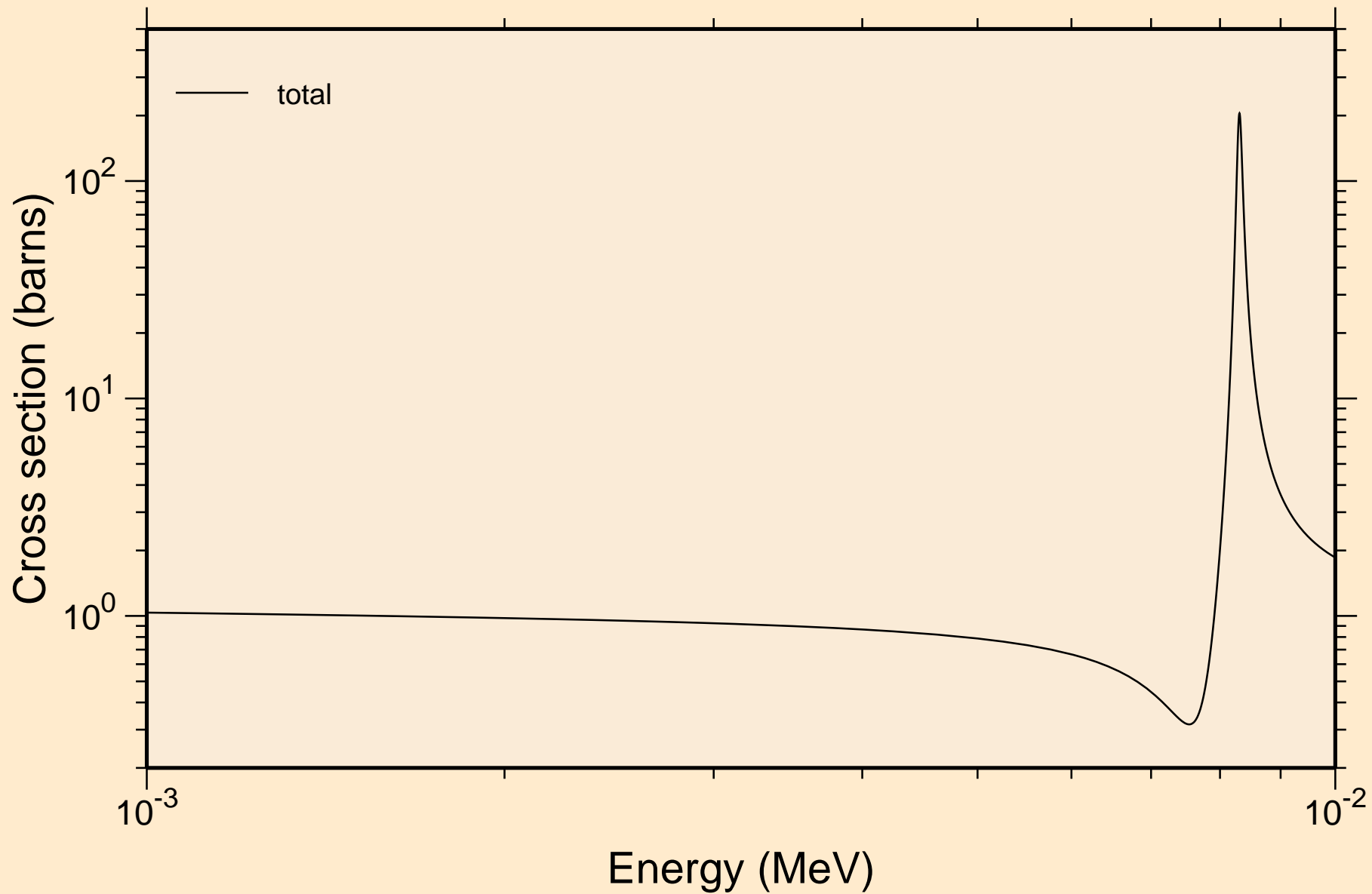

CL037 NEUTRON ACER TENDL-2021 LIBRARY; T=293.6K
resonance total cross section

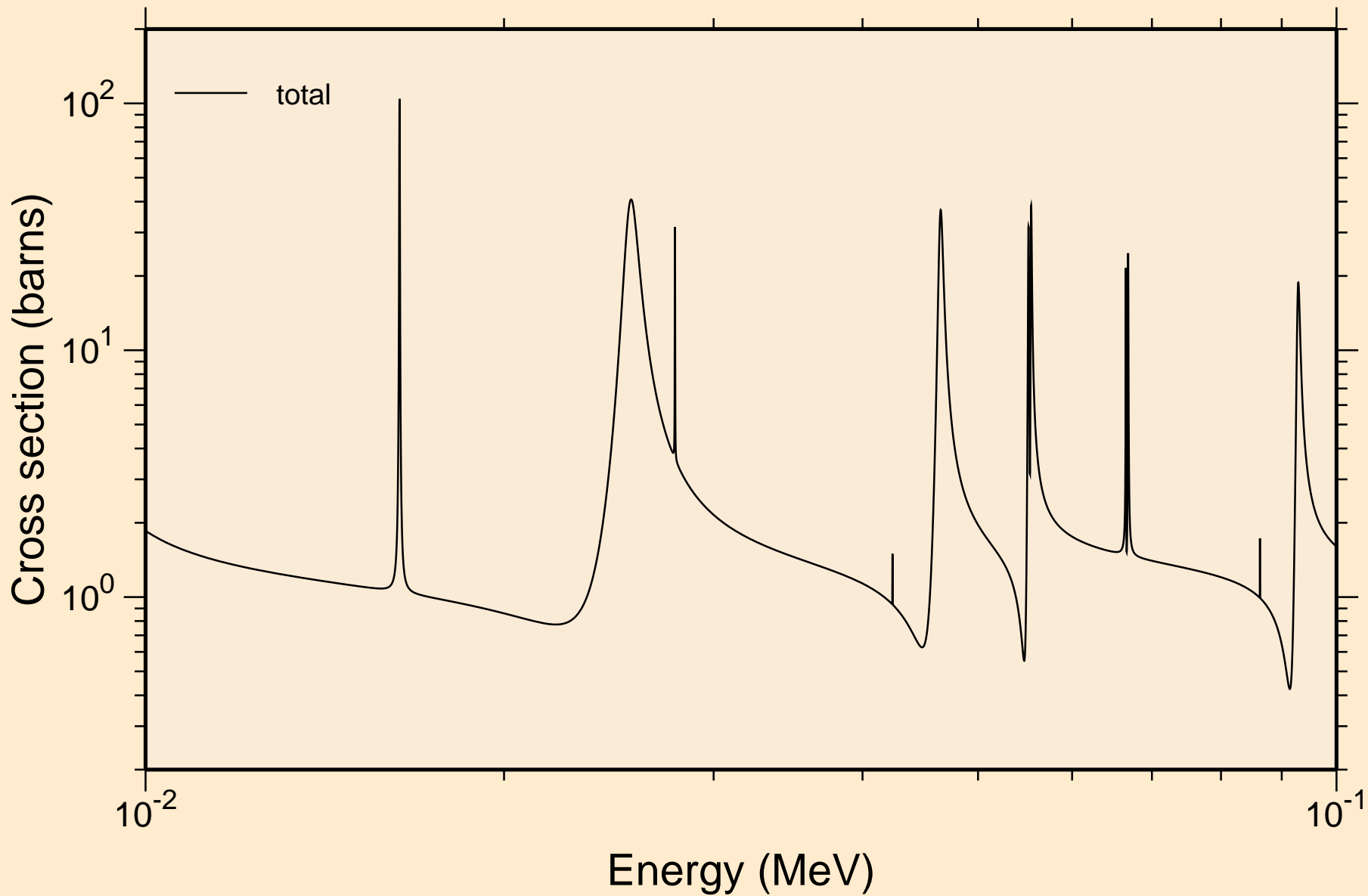

CL037 NEUTRON ACER TENDL-2021 LIBRARY; T=293.6K
resonance total cross section

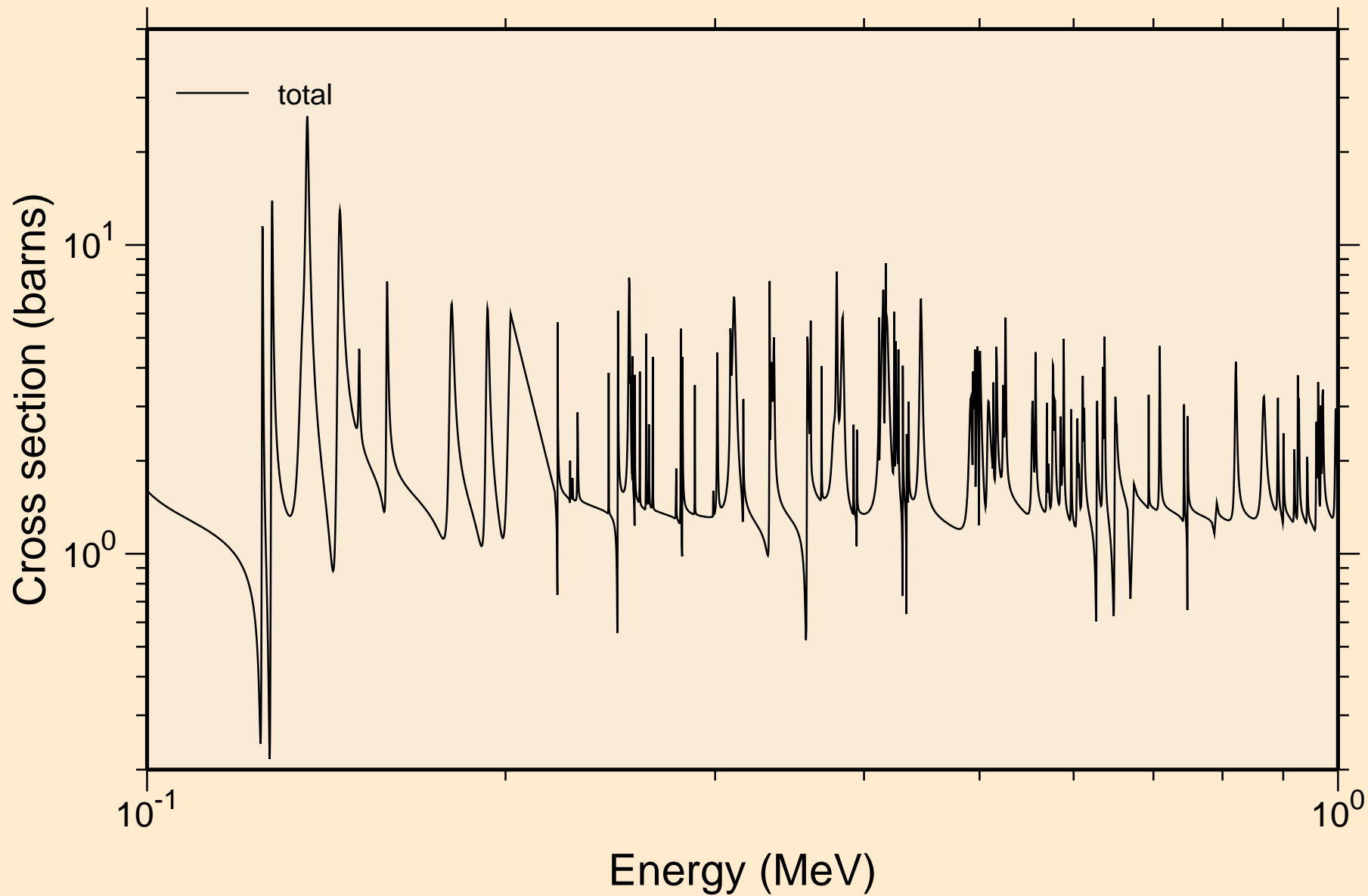

CL037 NEUTRON ACER TENDL-2021 LIBRARY; T=293.6K
resonance total cross section

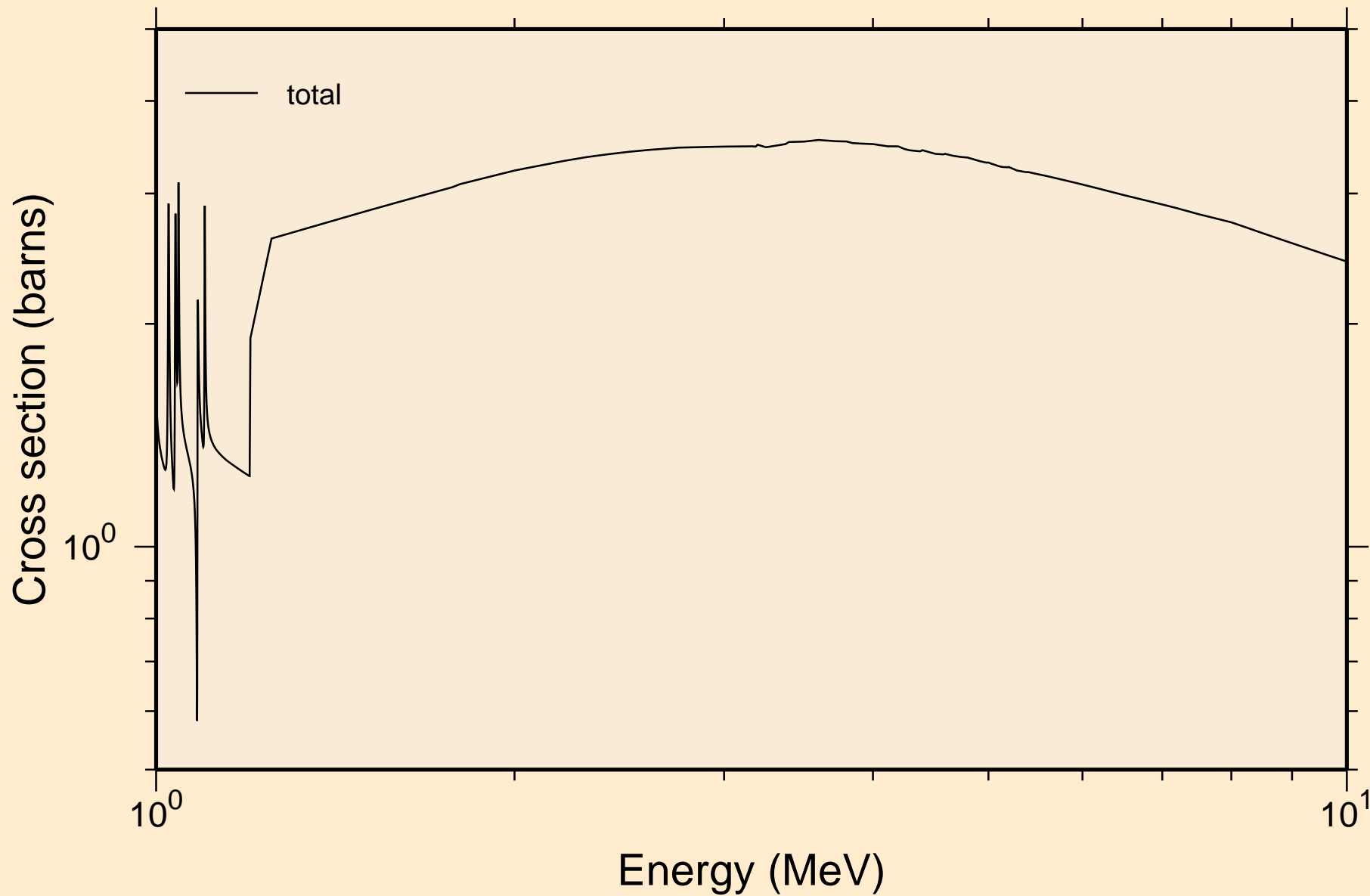

CL037 NEUTRON ACER TENDL-2021 LIBRARY; T=293.6K
resonance absorption cross sections

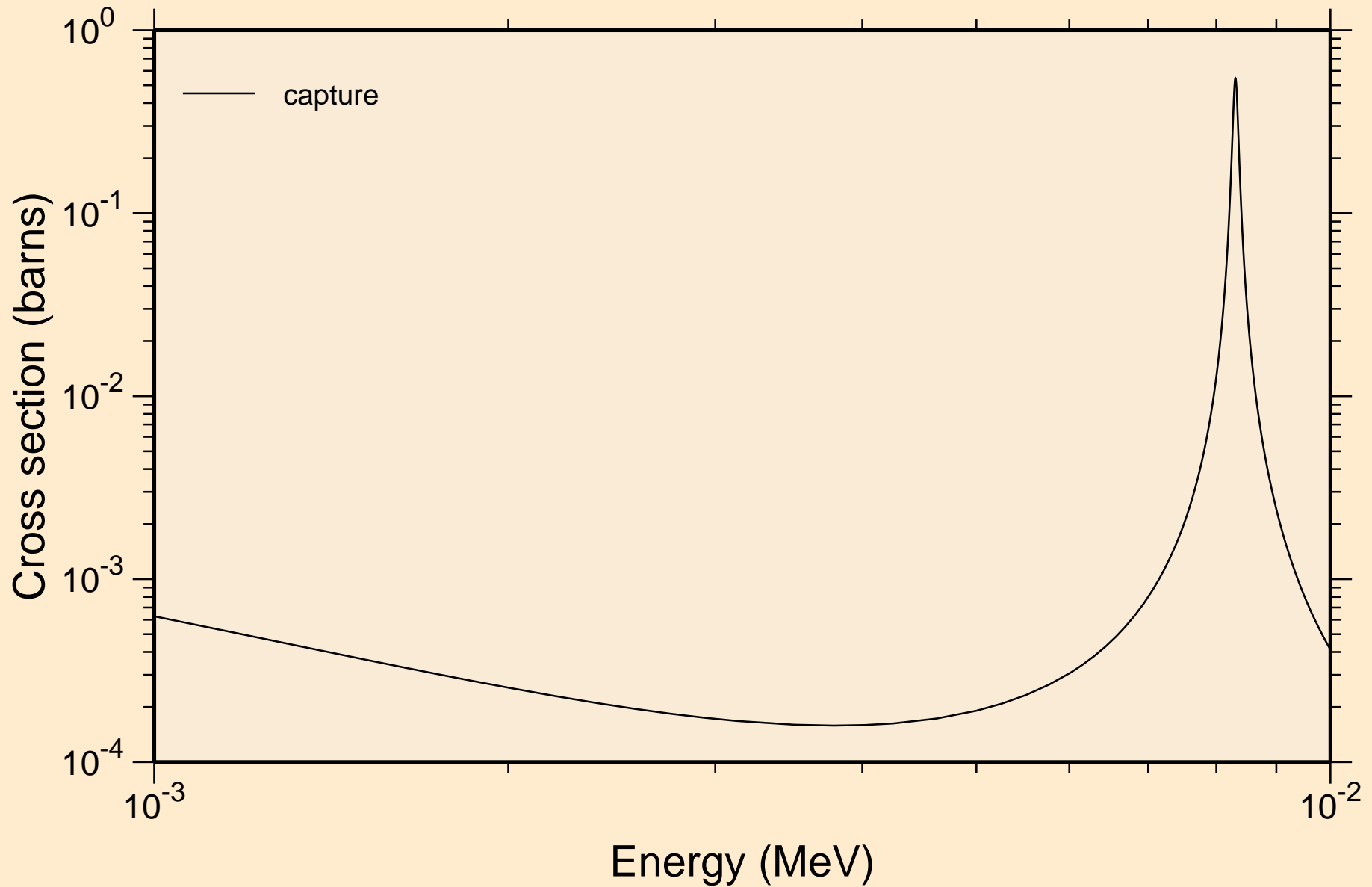

CL037 NEUTRON ACER TENDL-2021 LIBRARY; T=293.6K
resonance absorption cross sections

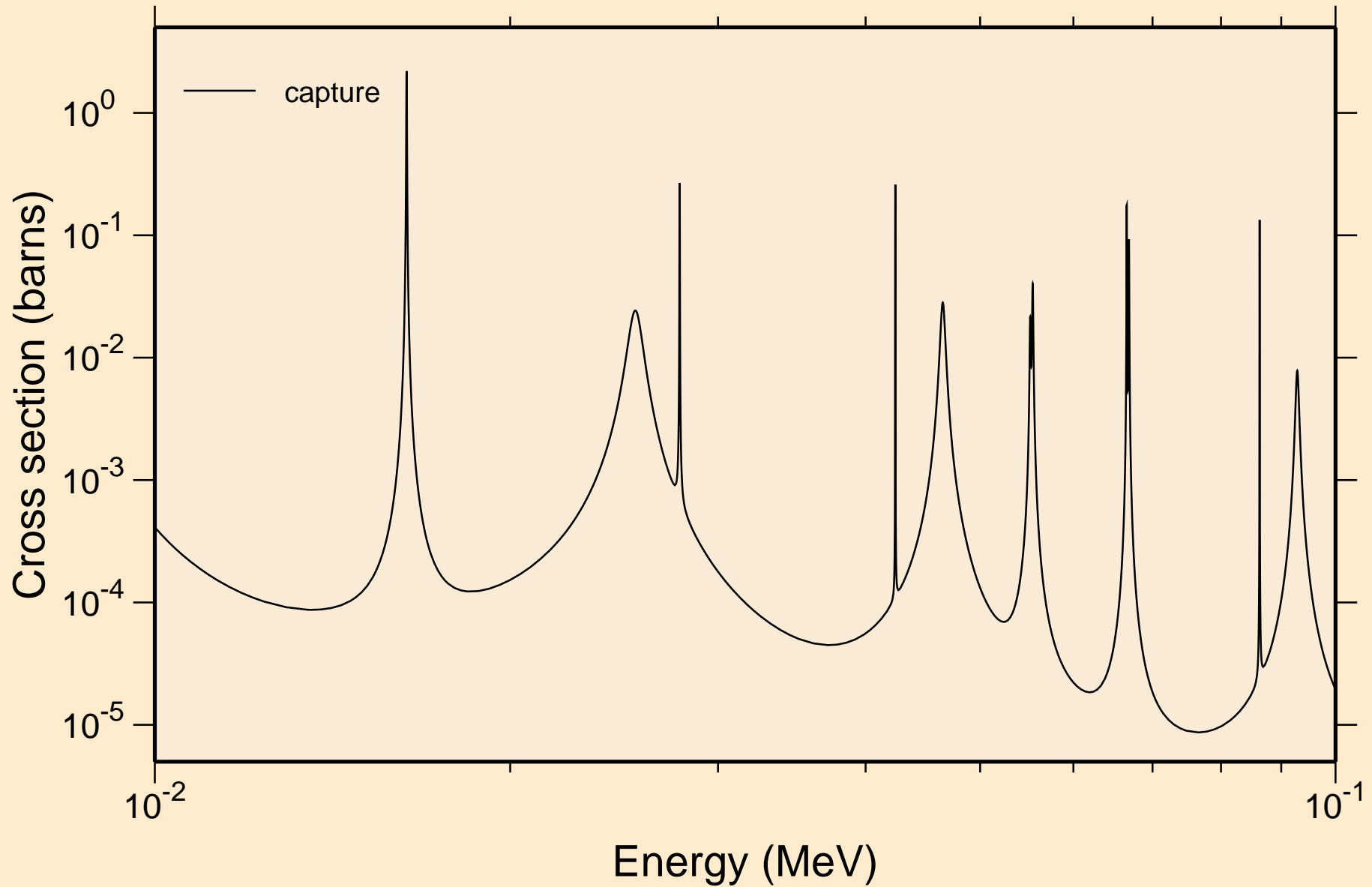

CL037 NEUTRON ACER TENDL-2021 LIBRARY; T=293.6K
resonance absorption cross sections

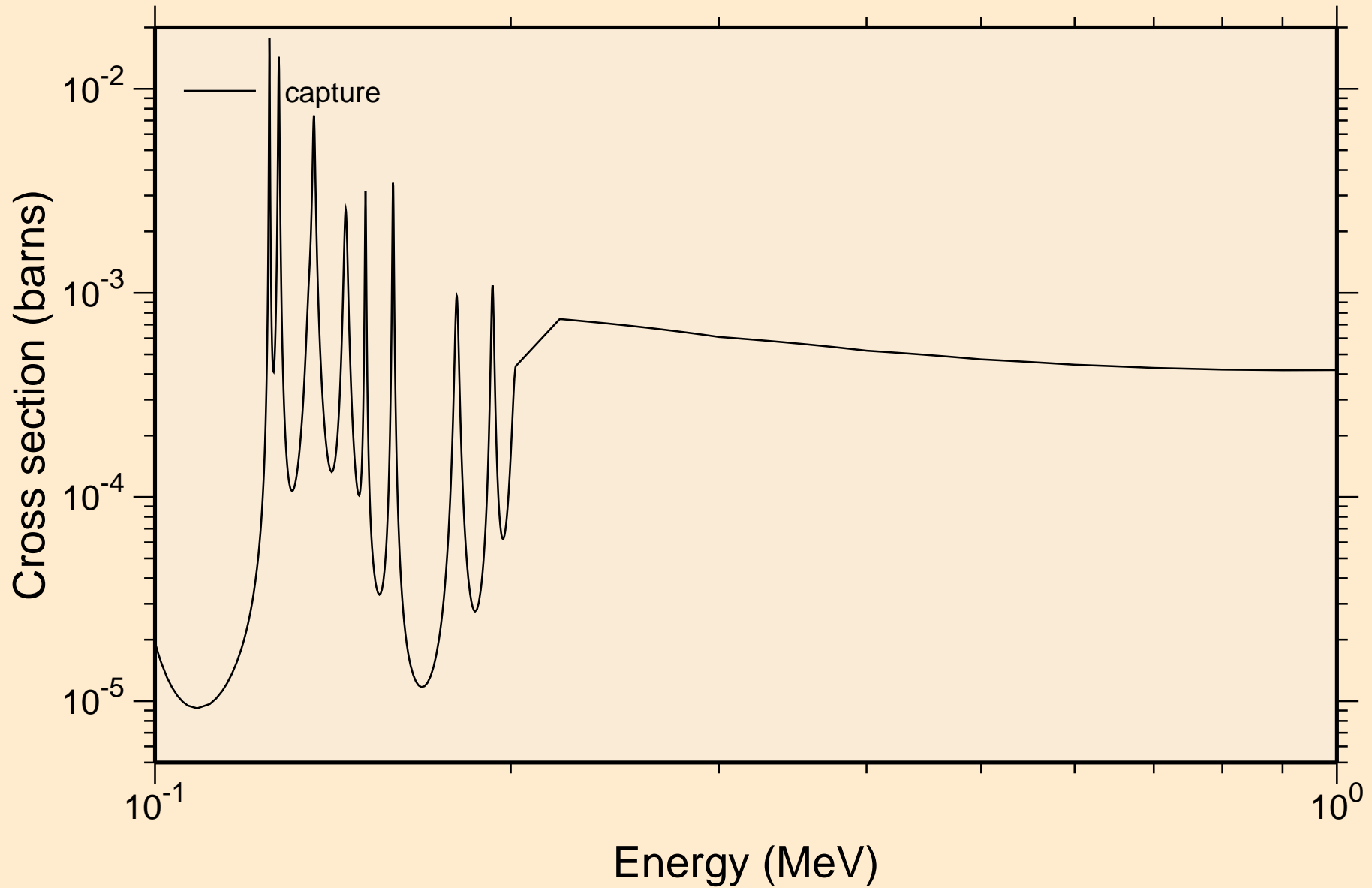

CL037 NEUTRON ACER TENDL-2021 LIBRARY; T=293.6K
resonance absorption cross sections

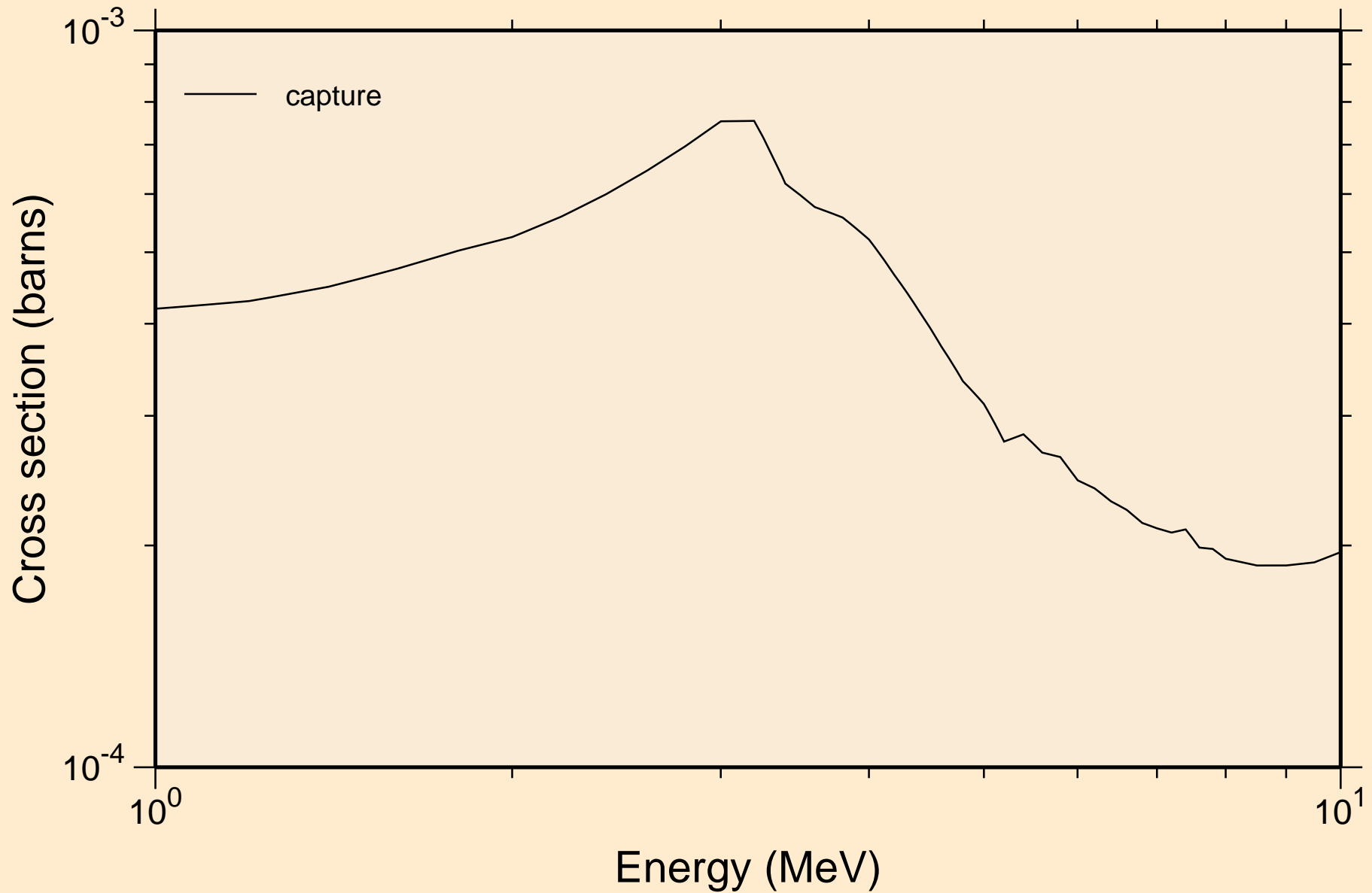

CL037 NEUTRON ACER TENDL-2021 LIBRARY; T=293.6K
Heating

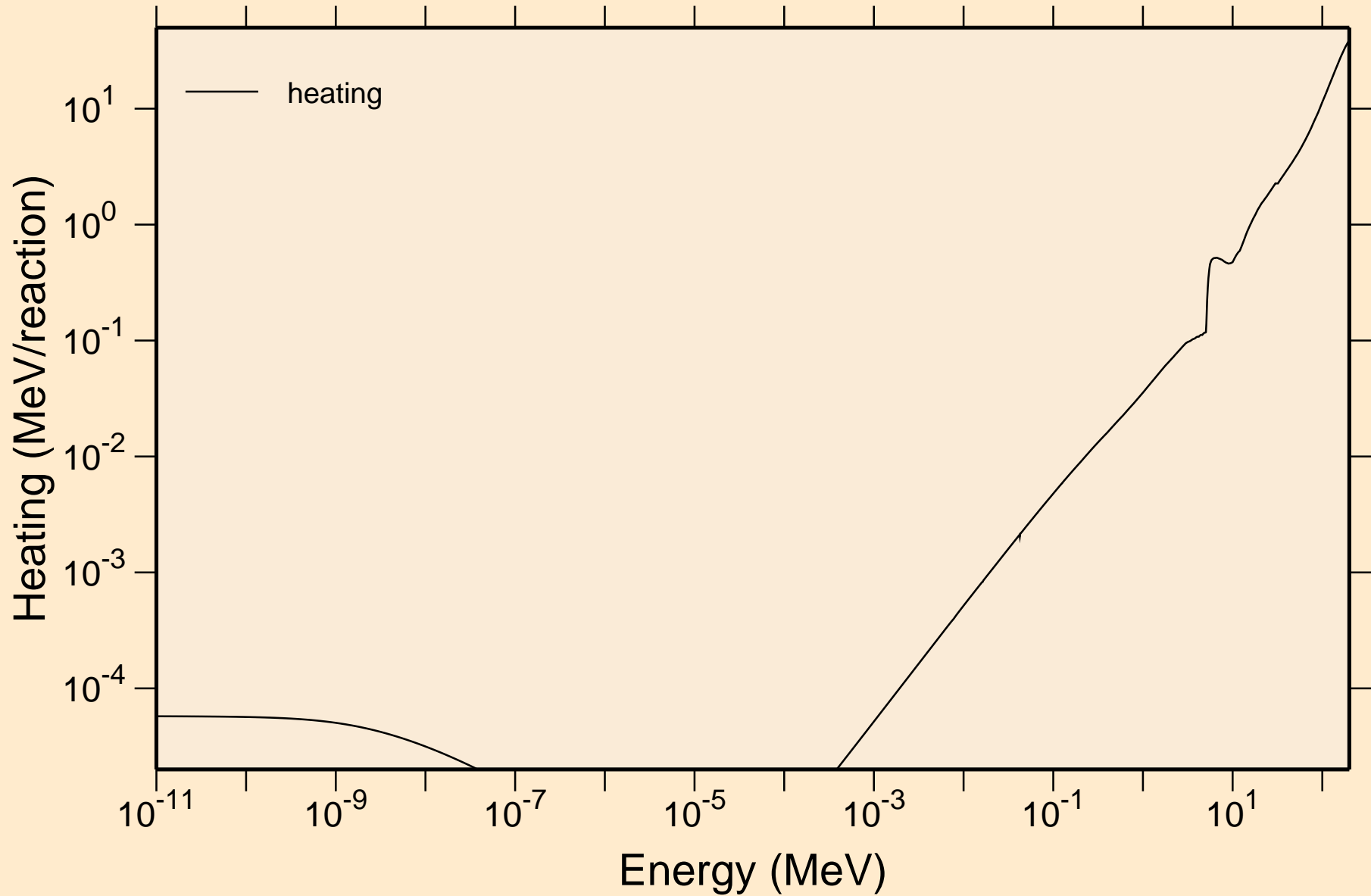

CL037 NEUTRON ACER TENDL-2021 LIBRARY; T=293.6K
Damage

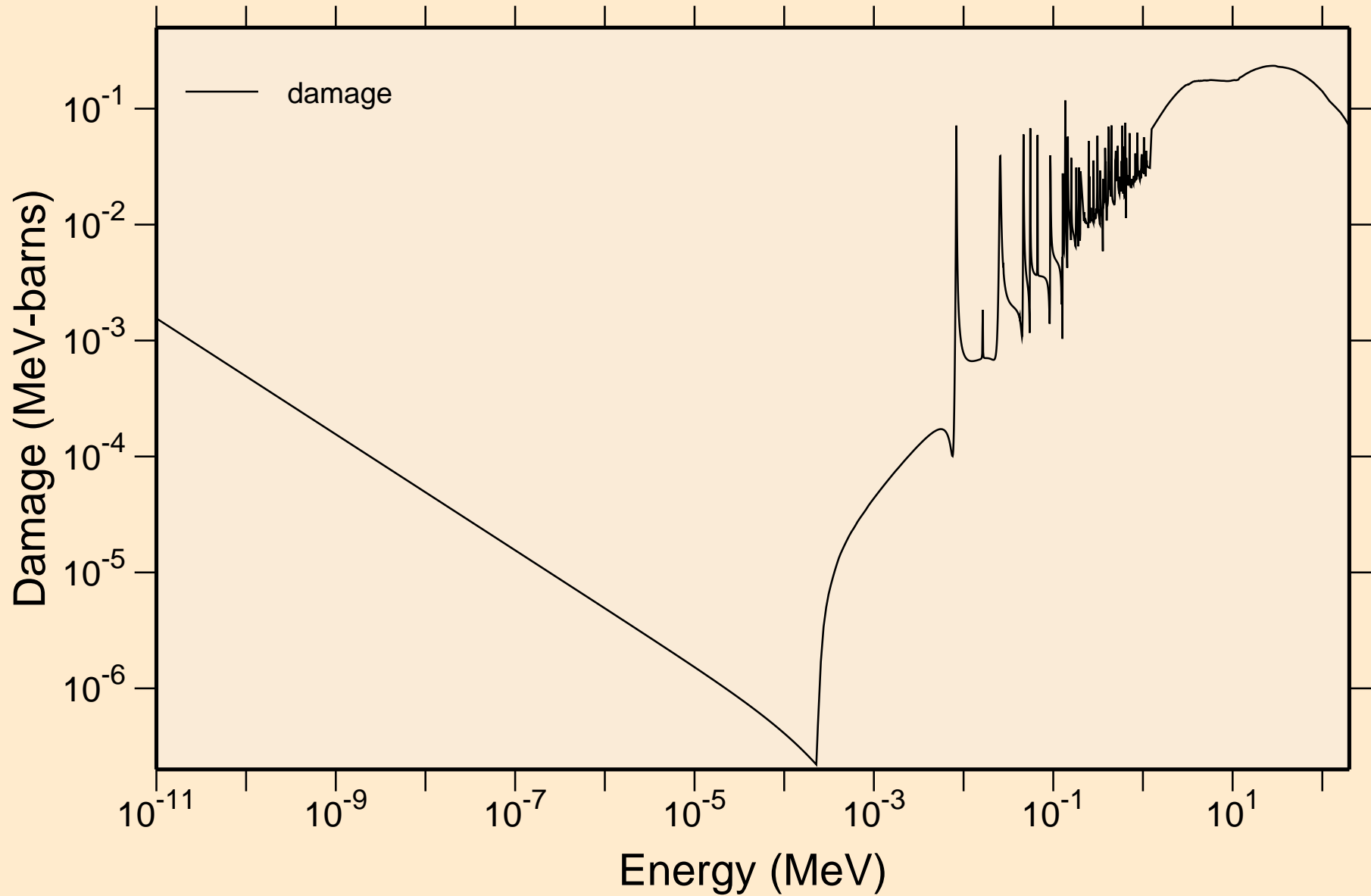

CL037 NEUTRON ACER TENDL-2021 LIBRARY; T=293.6K
Non-threshold reactions

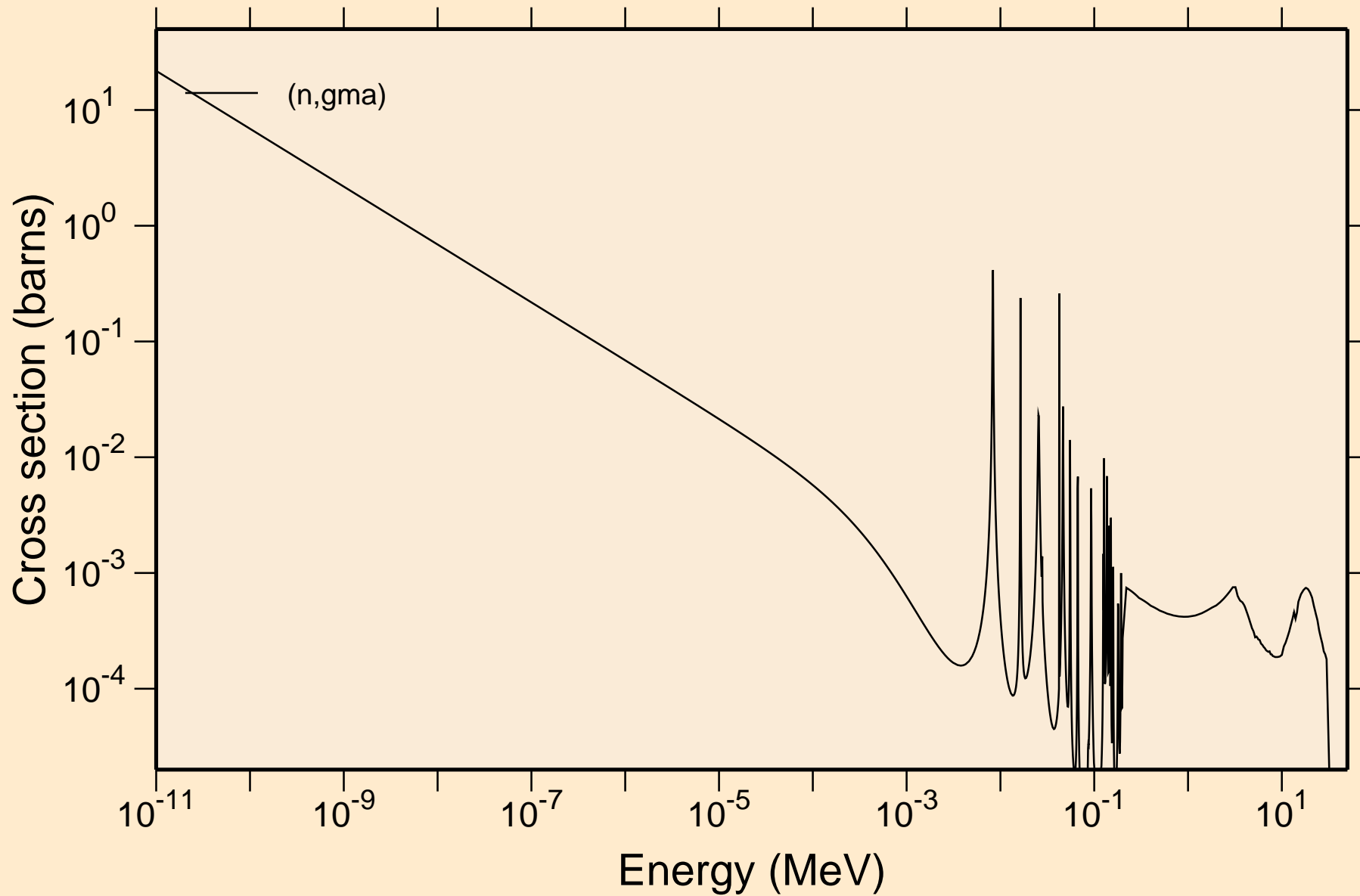

CL037 NEUTRON ACER TENDL-2021 LIBRARY; T=293.6K
Principal cross sections

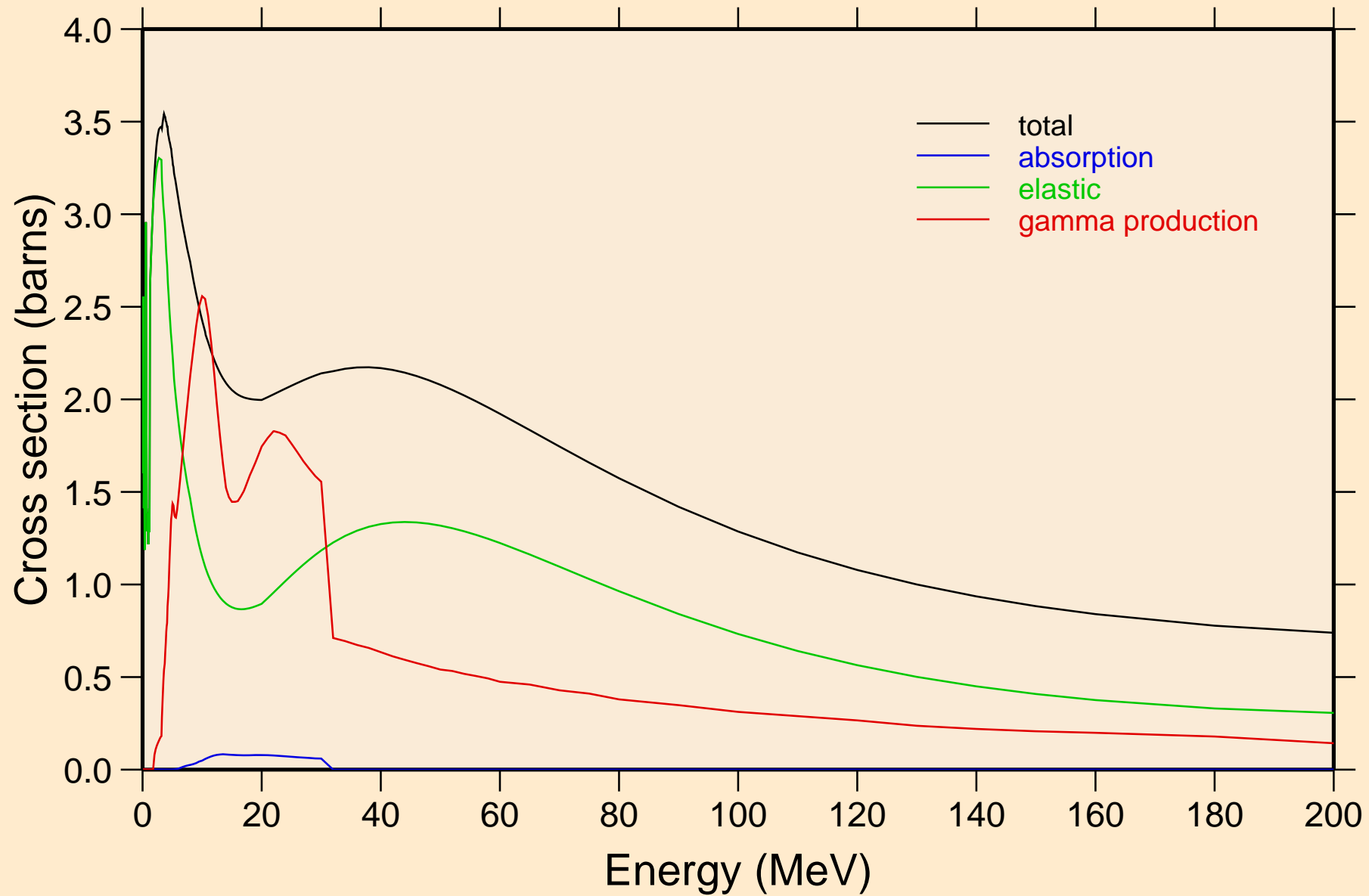

CL037 NEUTRON ACER TENDL-2021 LIBRARY; T=293.6K

Heating

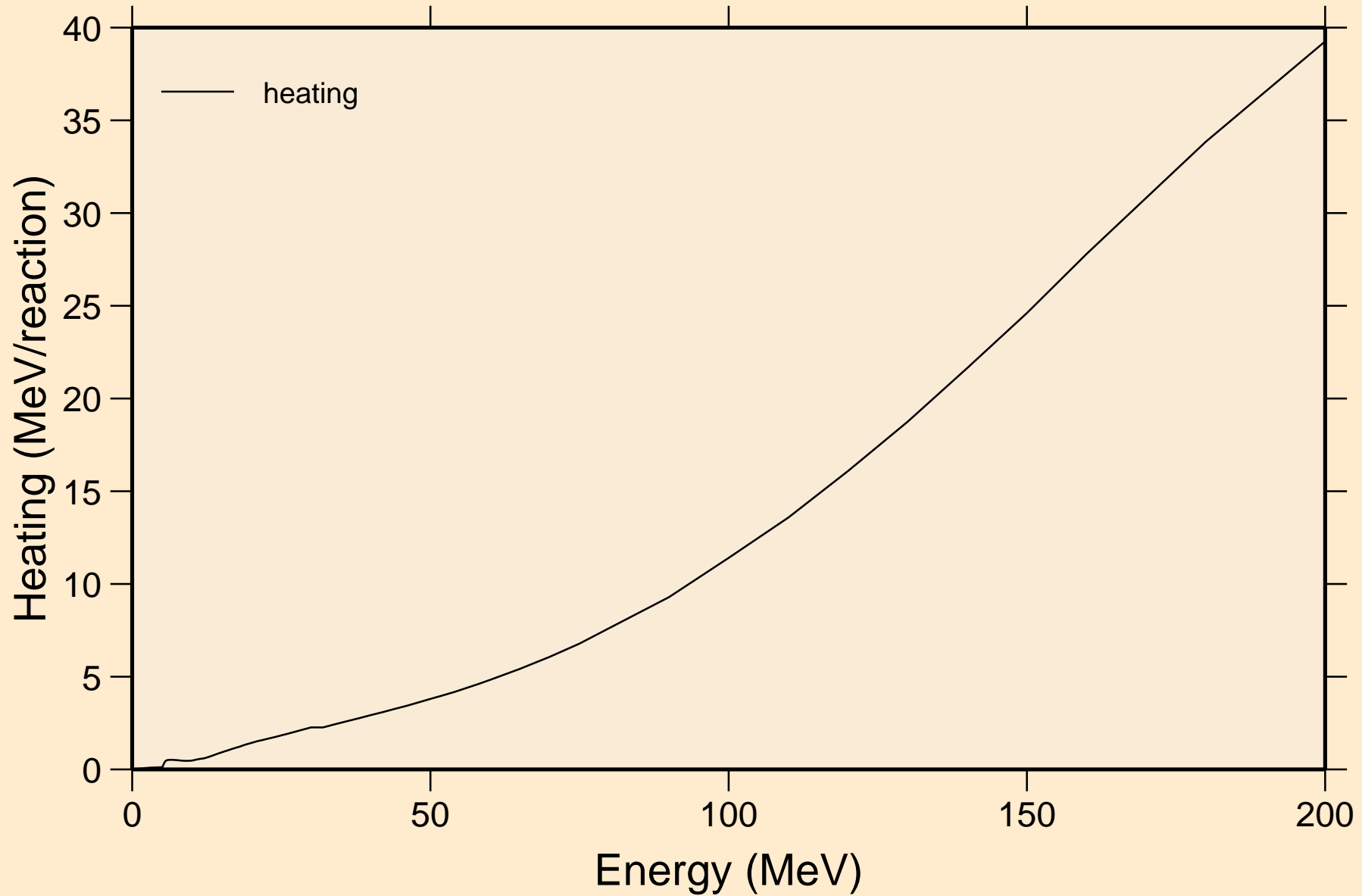

CL037 NEUTRON ACER TENDL-2021 LIBRARY; T=293.6K
Damage

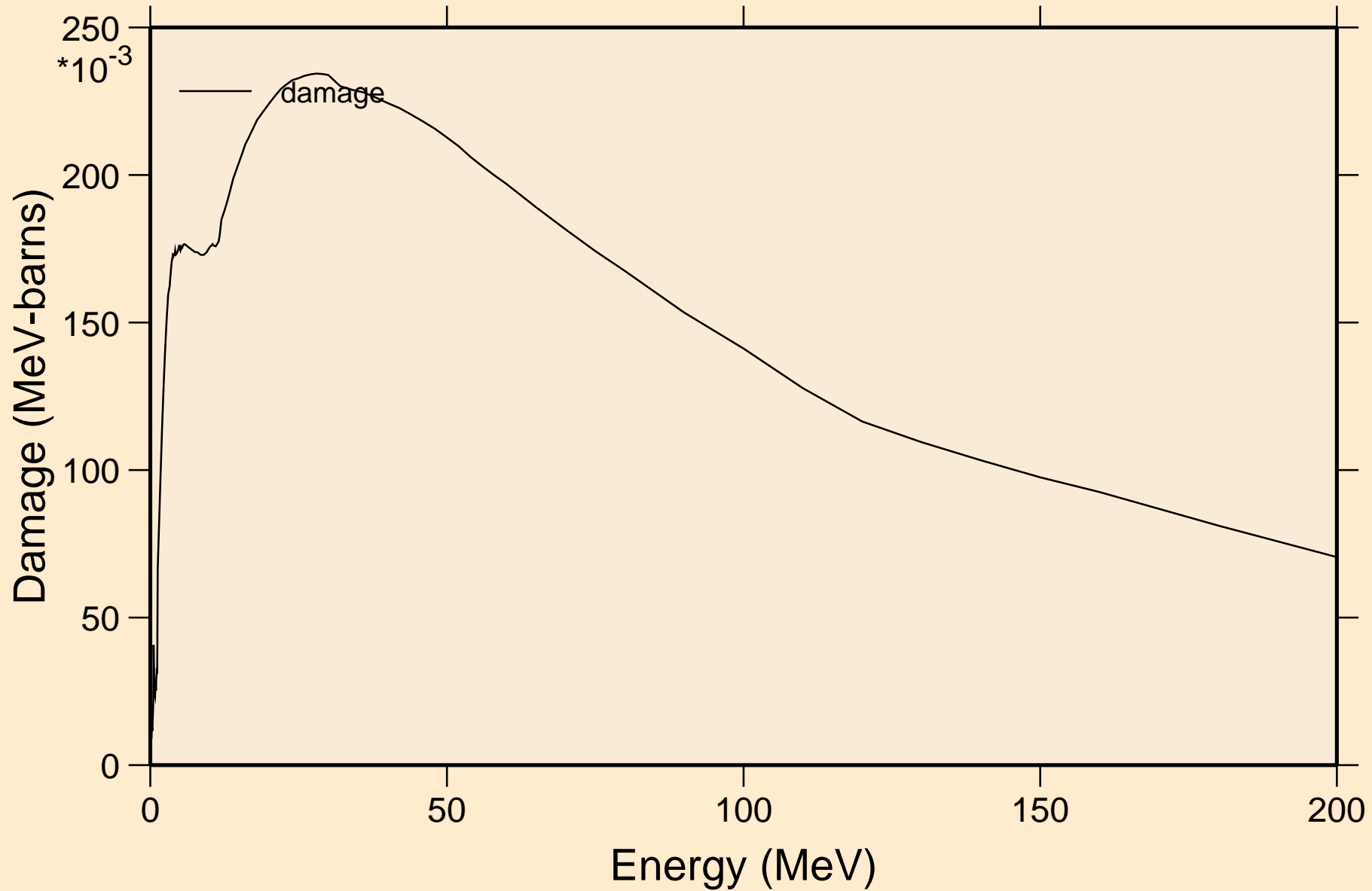

CL037 NEUTRON ACER TENDL-2021 LIBRARY; T=293.6K
Non-threshold reactions

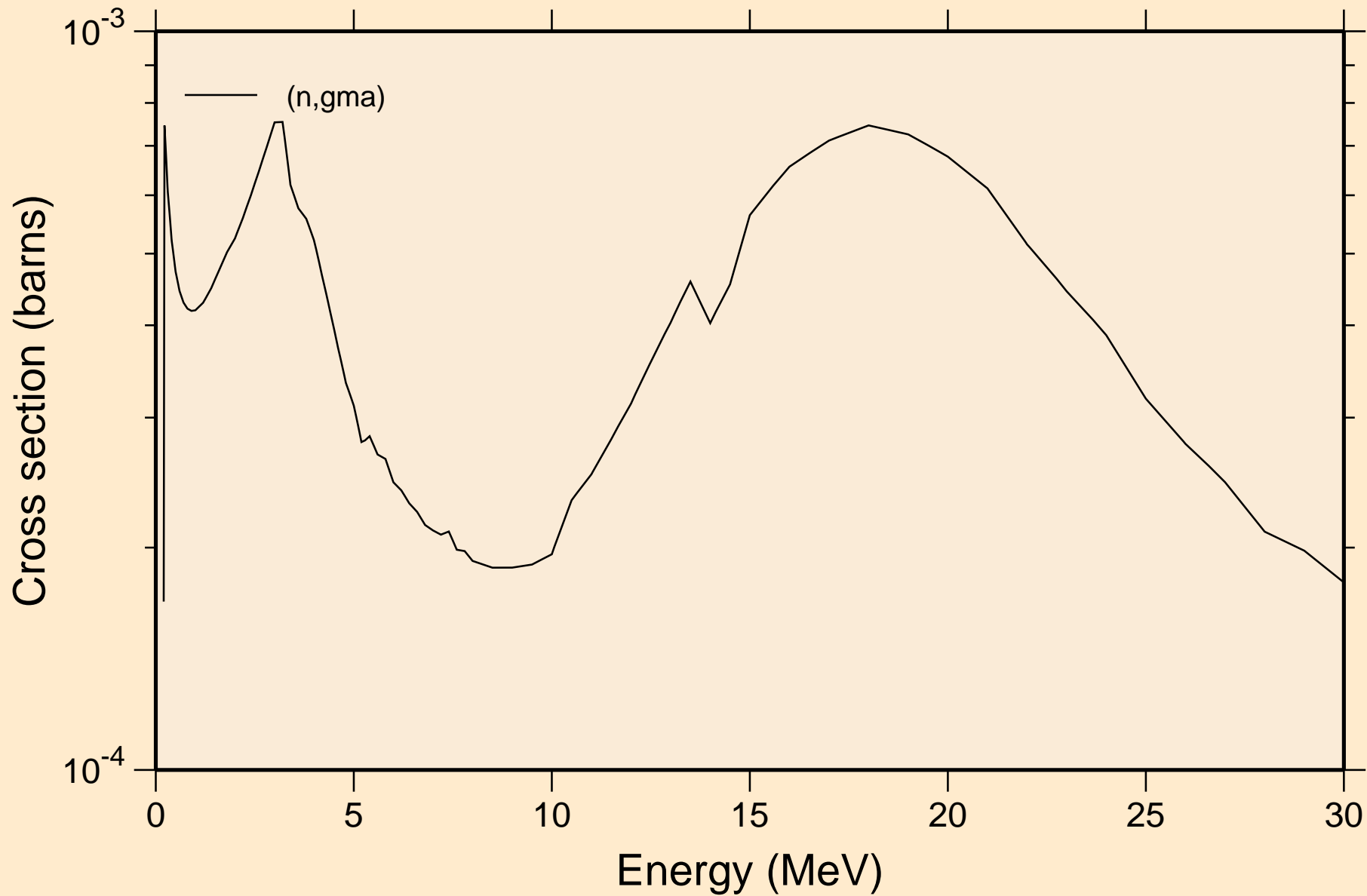

CL037 NEUTRON ACER TENDL-2021 LIBRARY; T=293.6K
Inelastic levels

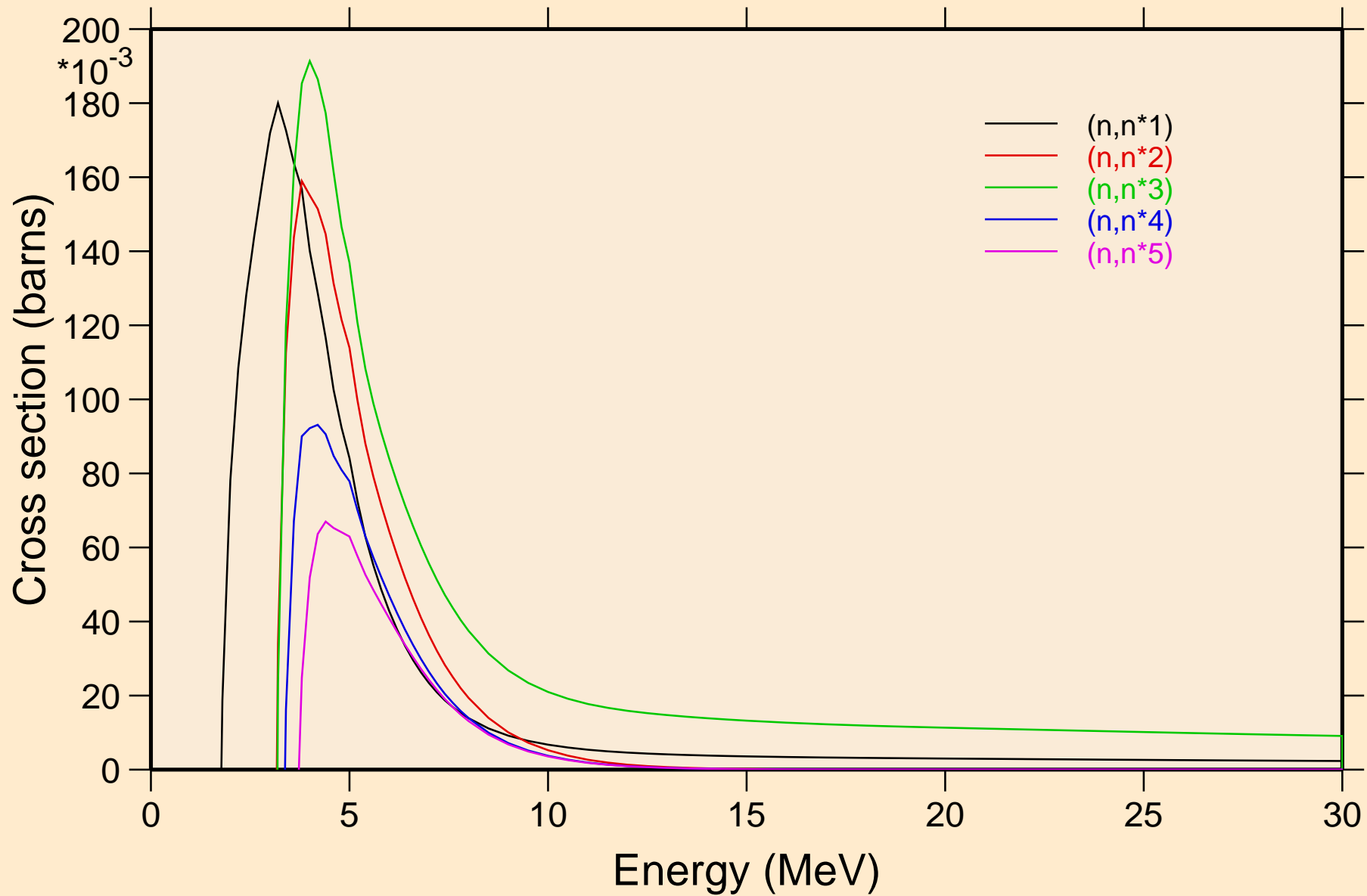

CL037 NEUTRON ACER TENDL-2021 LIBRARY; T=293.6K
Inelastic levels

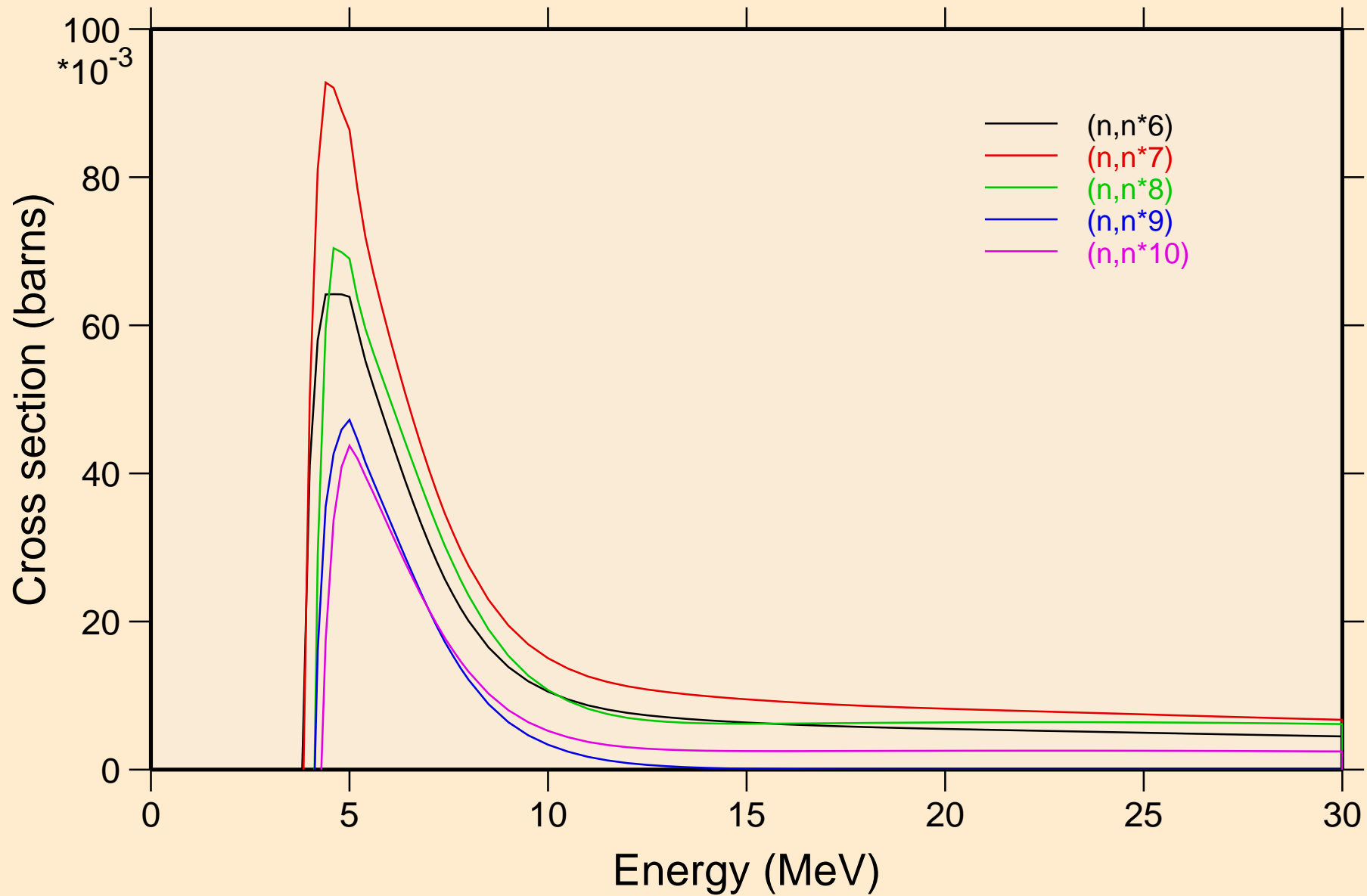

CL037 NEUTRON ACER TENDL-2021 LIBRARY; T=293.6K
Inelastic levels

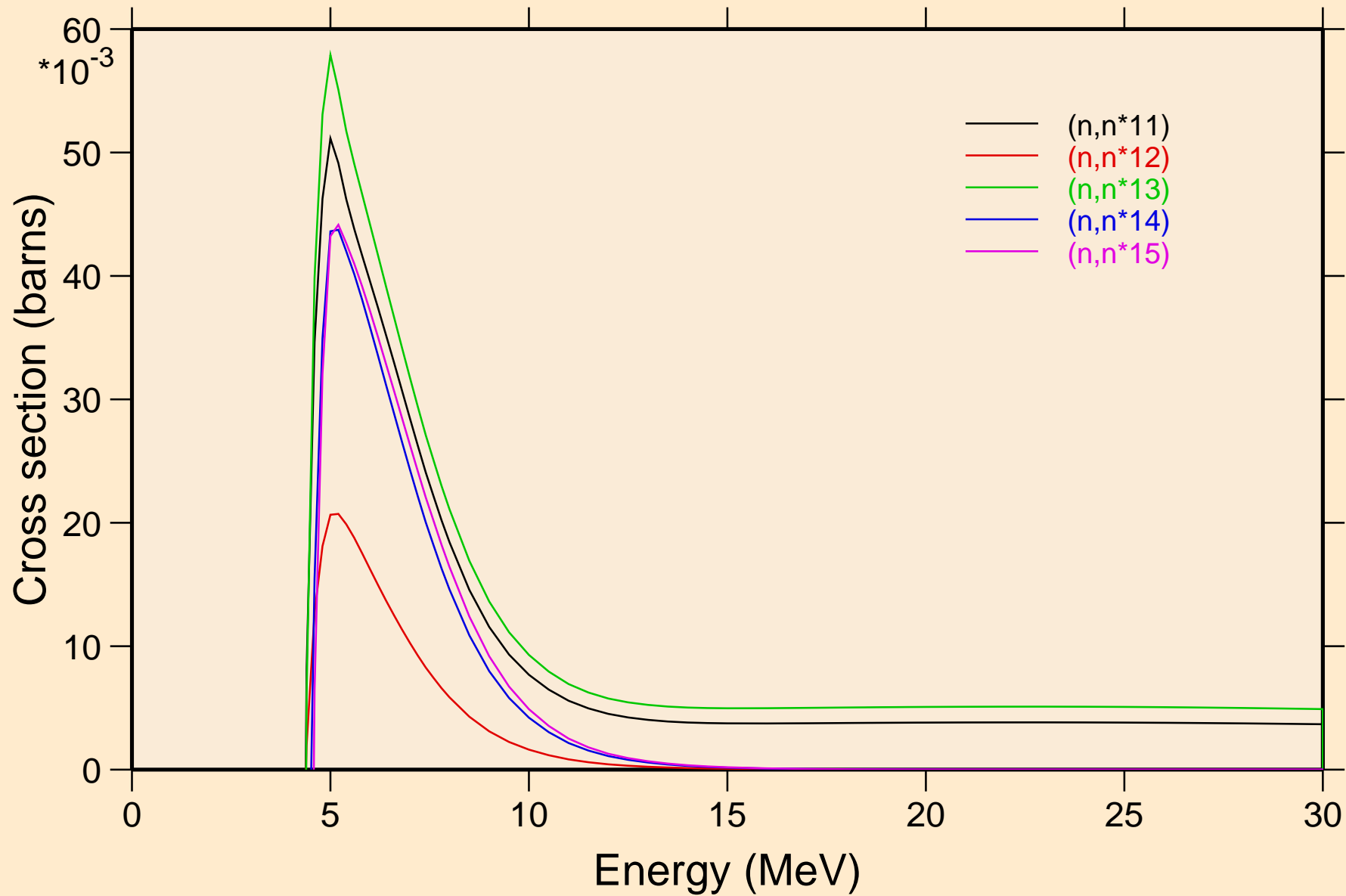

CL037 NEUTRON ACER TENDL-2021 LIBRARY; T=293.6K
Inelastic levels

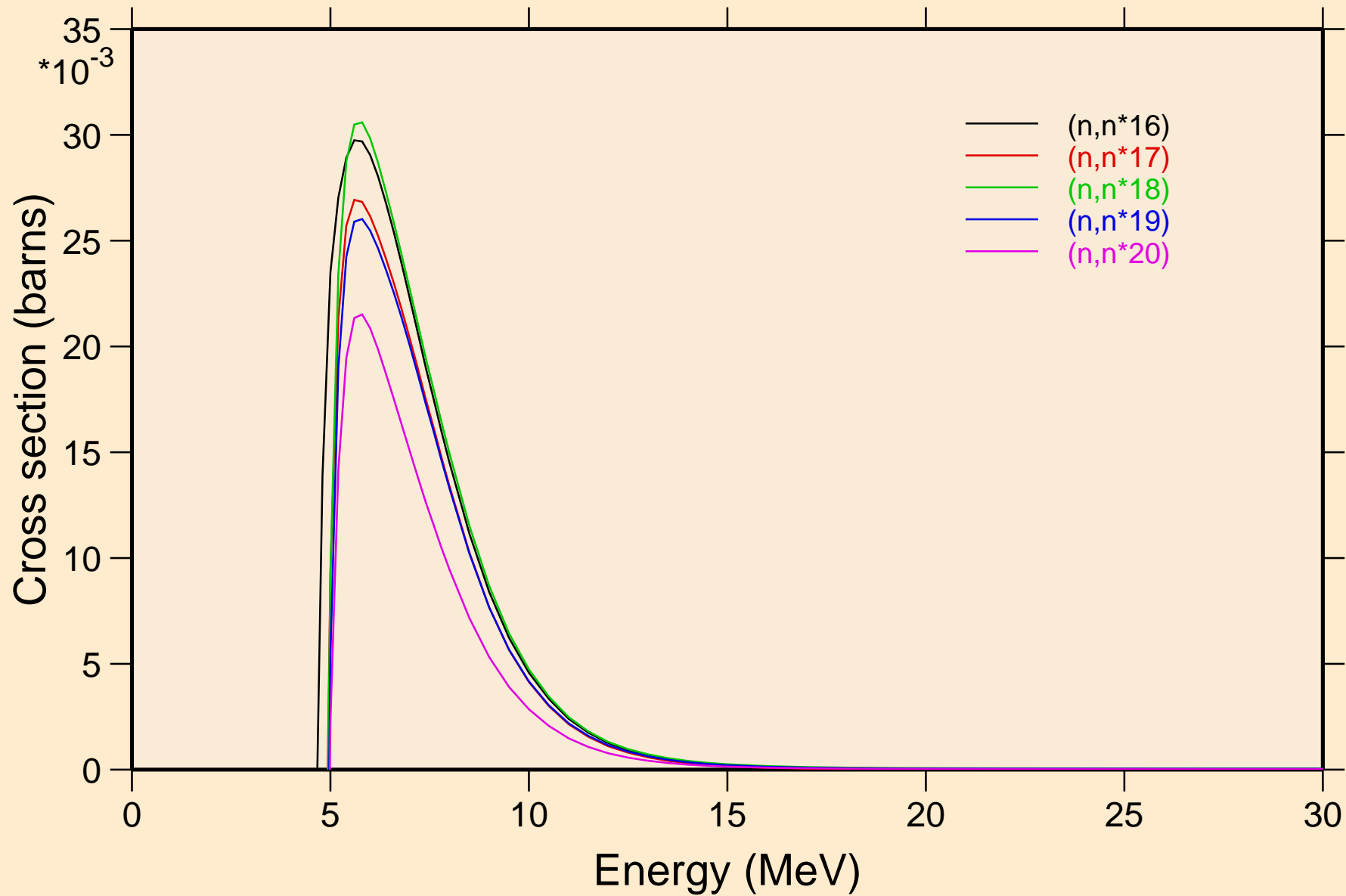

CL037 NEUTRON ACER TENDL-2021 LIBRARY; T=293.6K
Inelastic levels

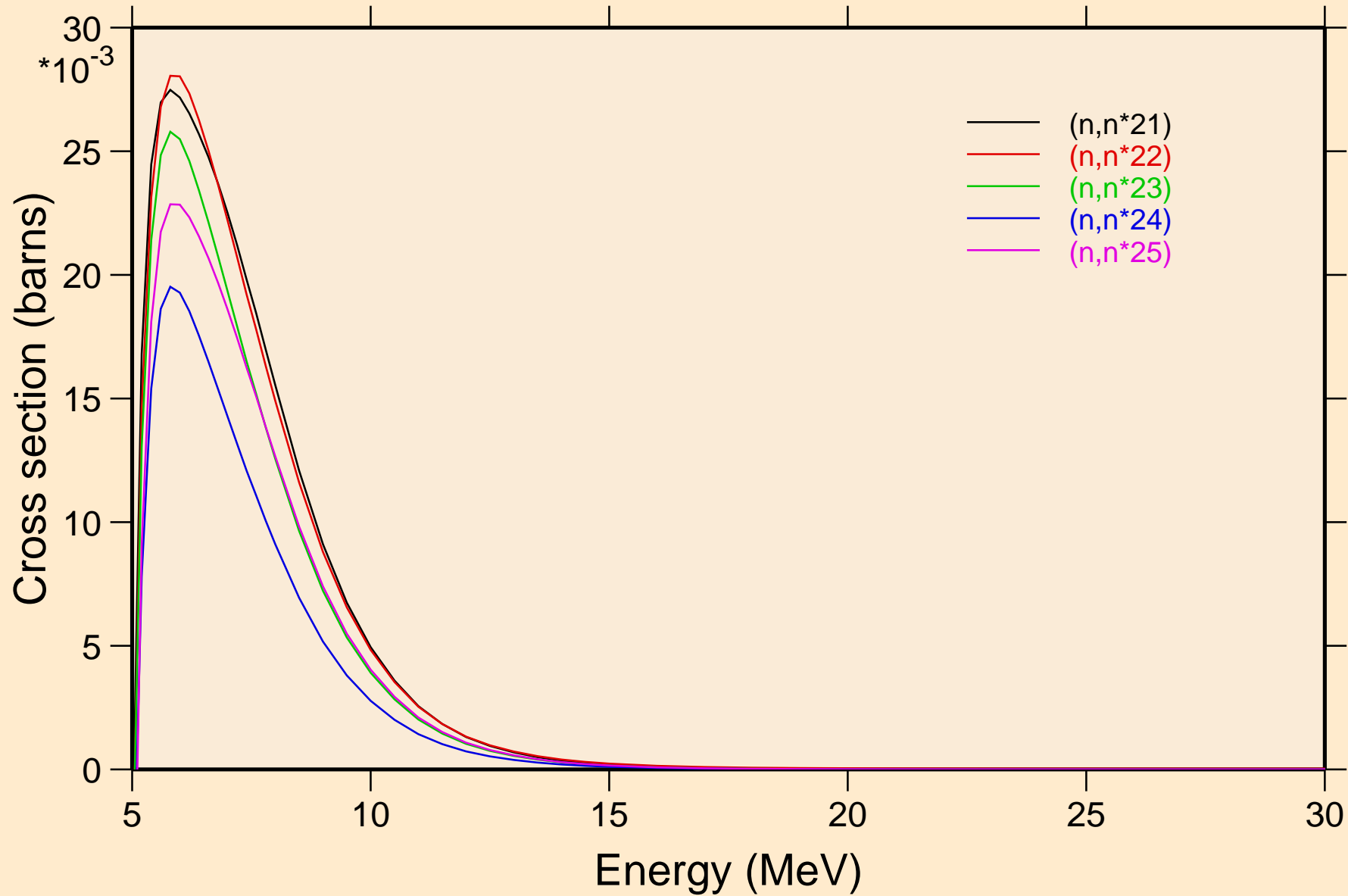

CL037 NEUTRON ACER TENDL-2021 LIBRARY; T=293.6K
Inelastic levels

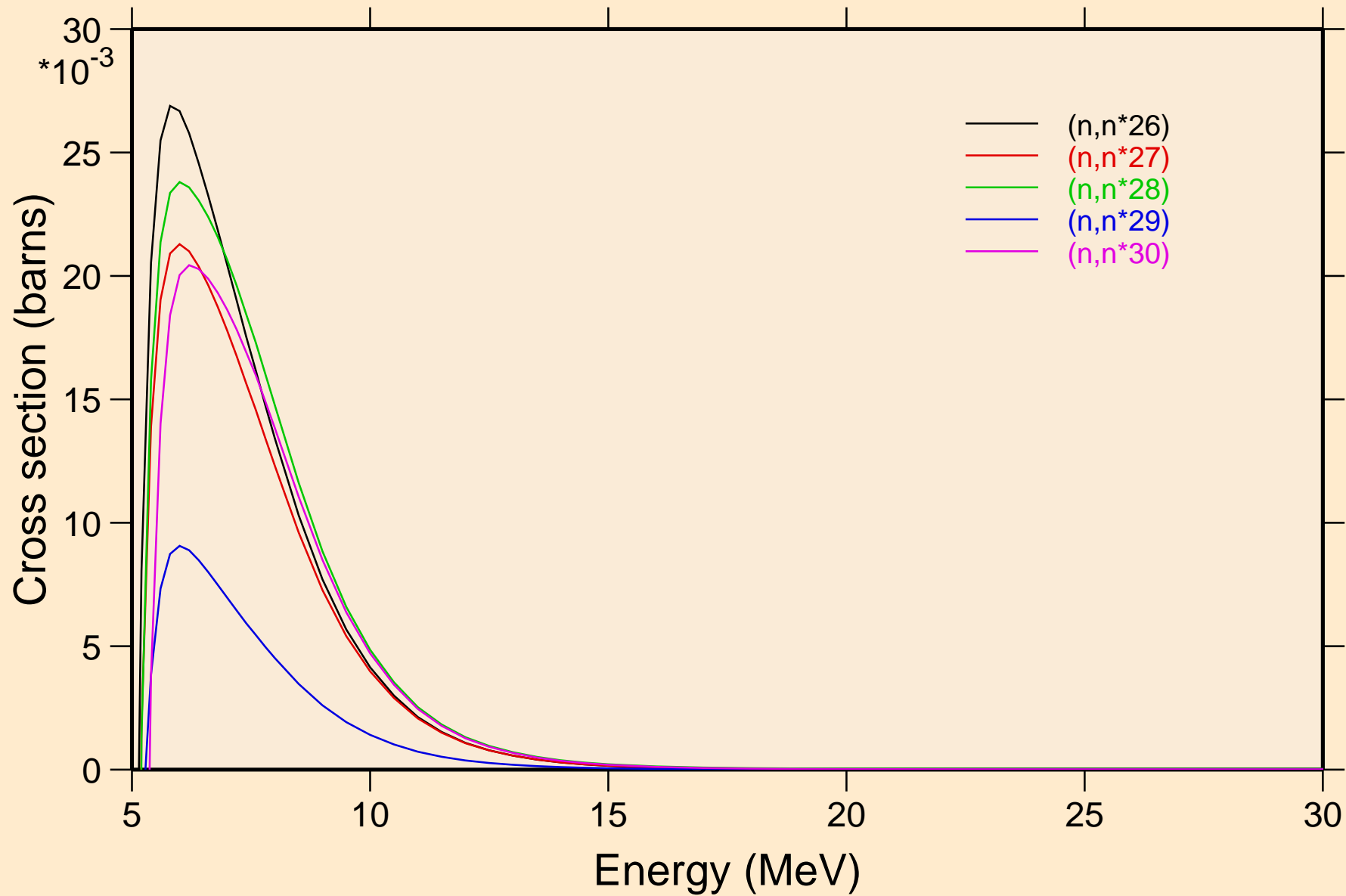

CL037 NEUTRON ACER TENDL-2021 LIBRARY; T=293.6K
Threshold reactions

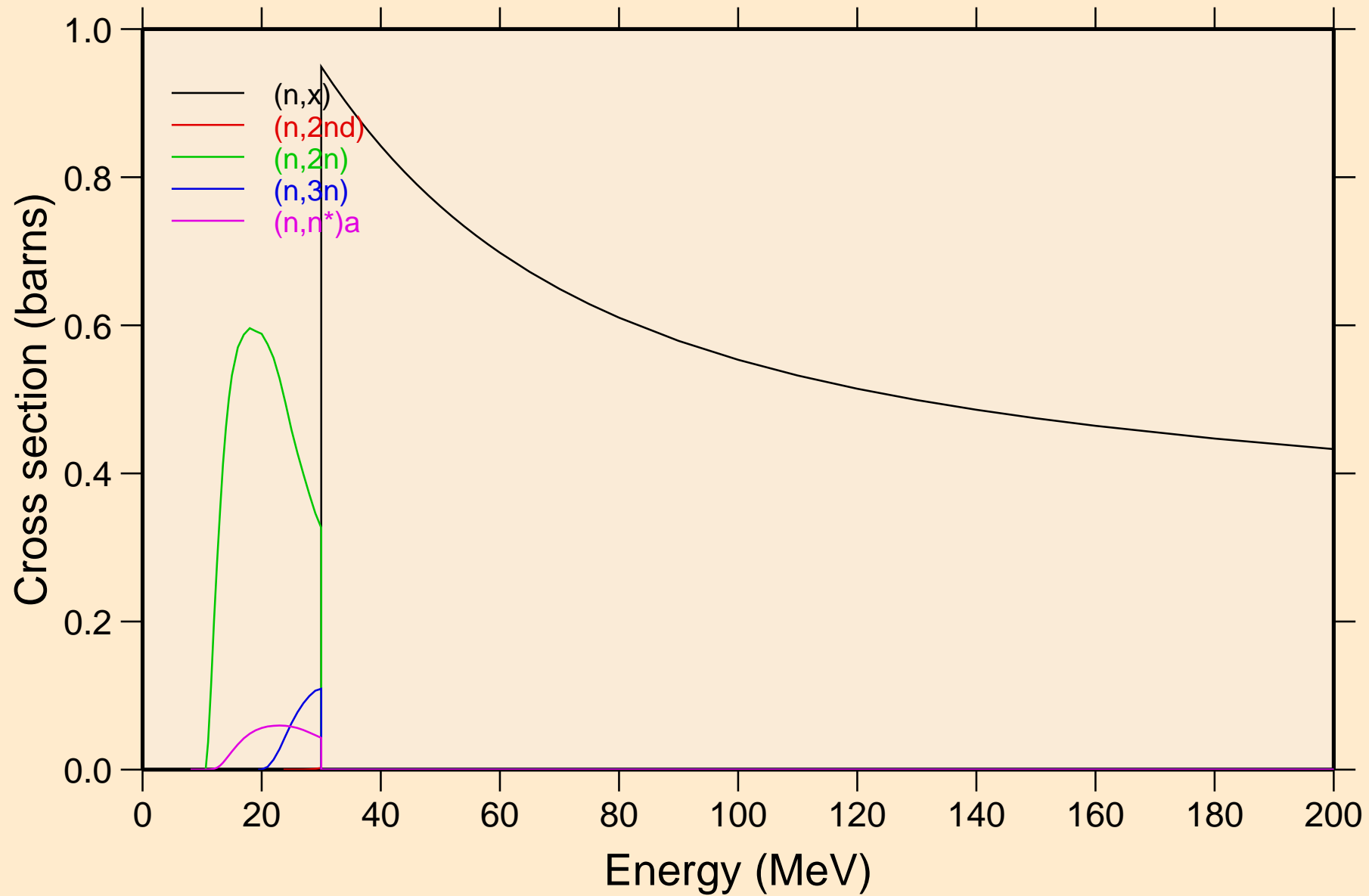

CL037 NEUTRON ACER TENDL-2021 LIBRARY; T=293.6K
Threshold reactions

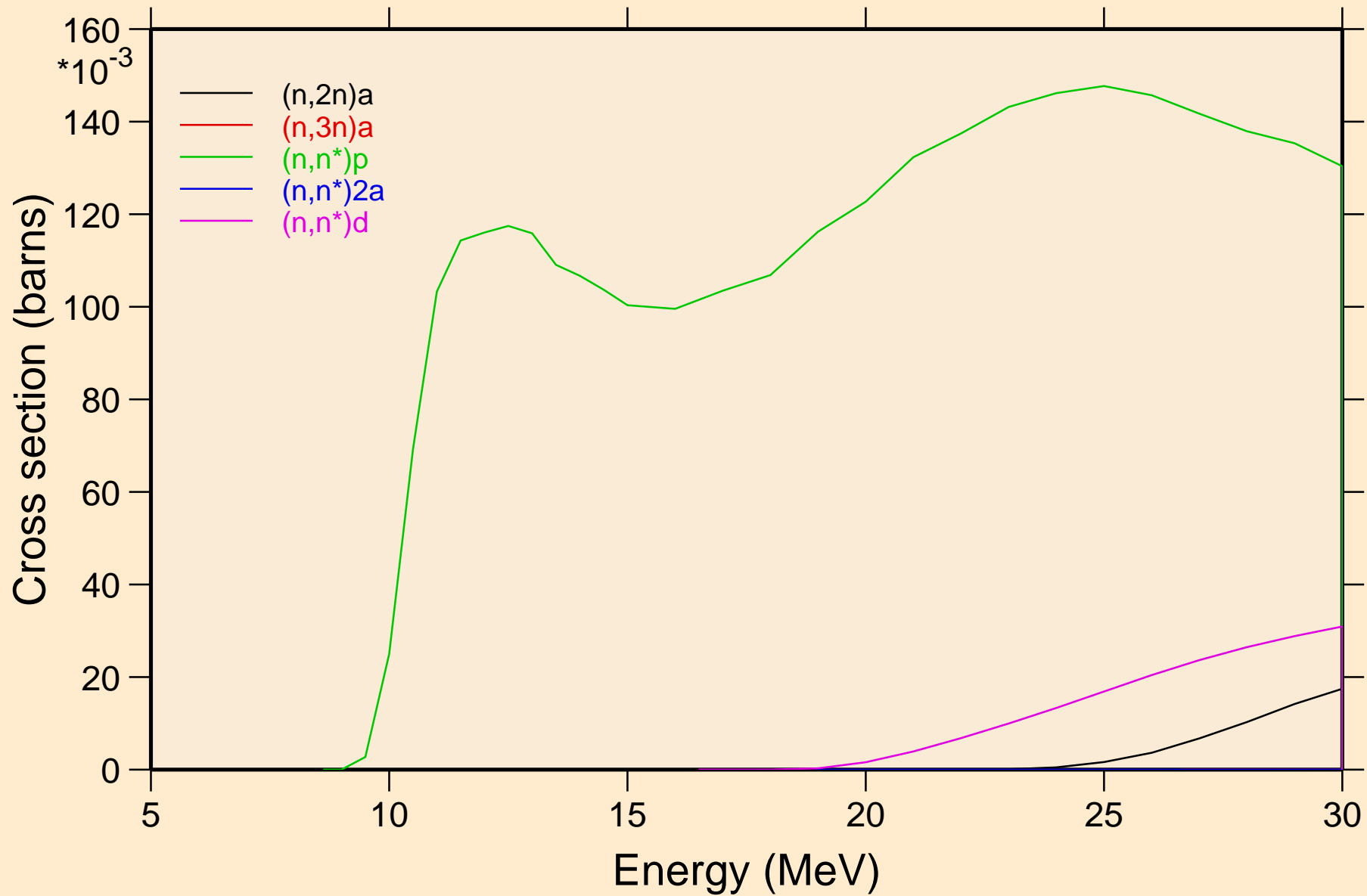

CL037 NEUTRON ACER TENDL-2021 LIBRARY; T=293.6K
Threshold reactions

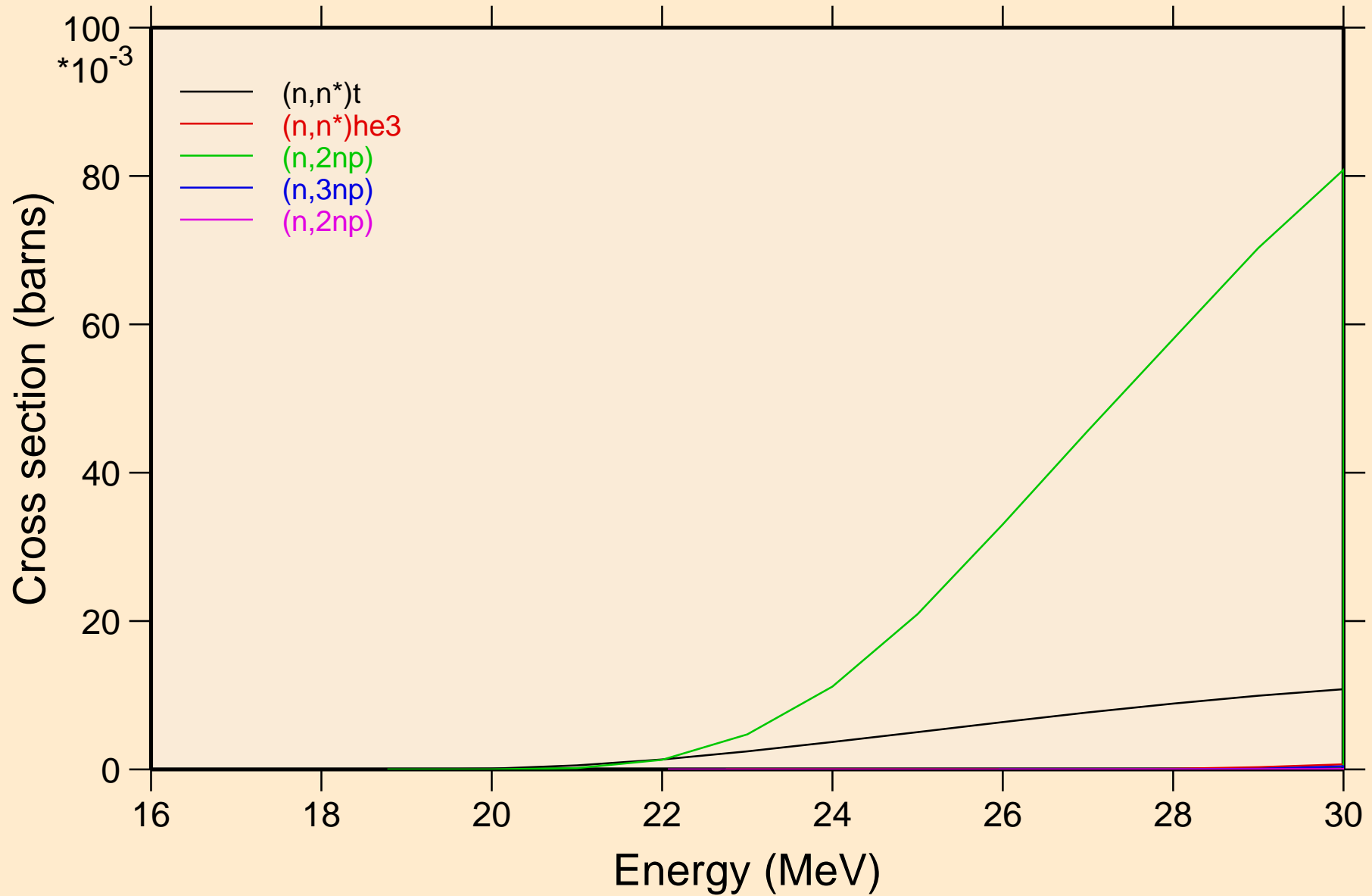

CL037 NEUTRON ACER TENDL-2021 LIBRARY; T=293.6K
Threshold reactions

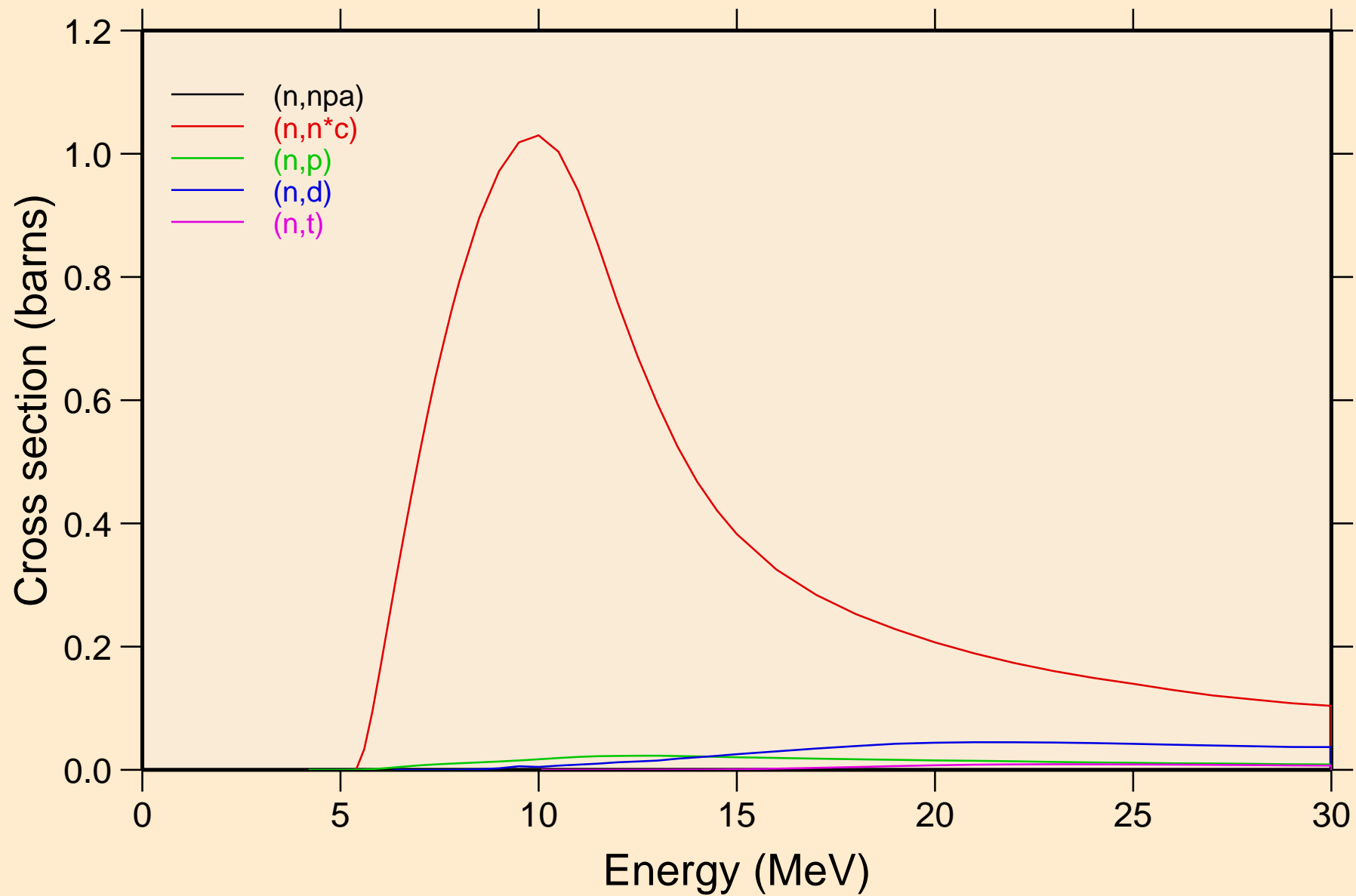

CL037 NEUTRON ACER TENDL-2021 LIBRARY; T=293.6K
Threshold reactions

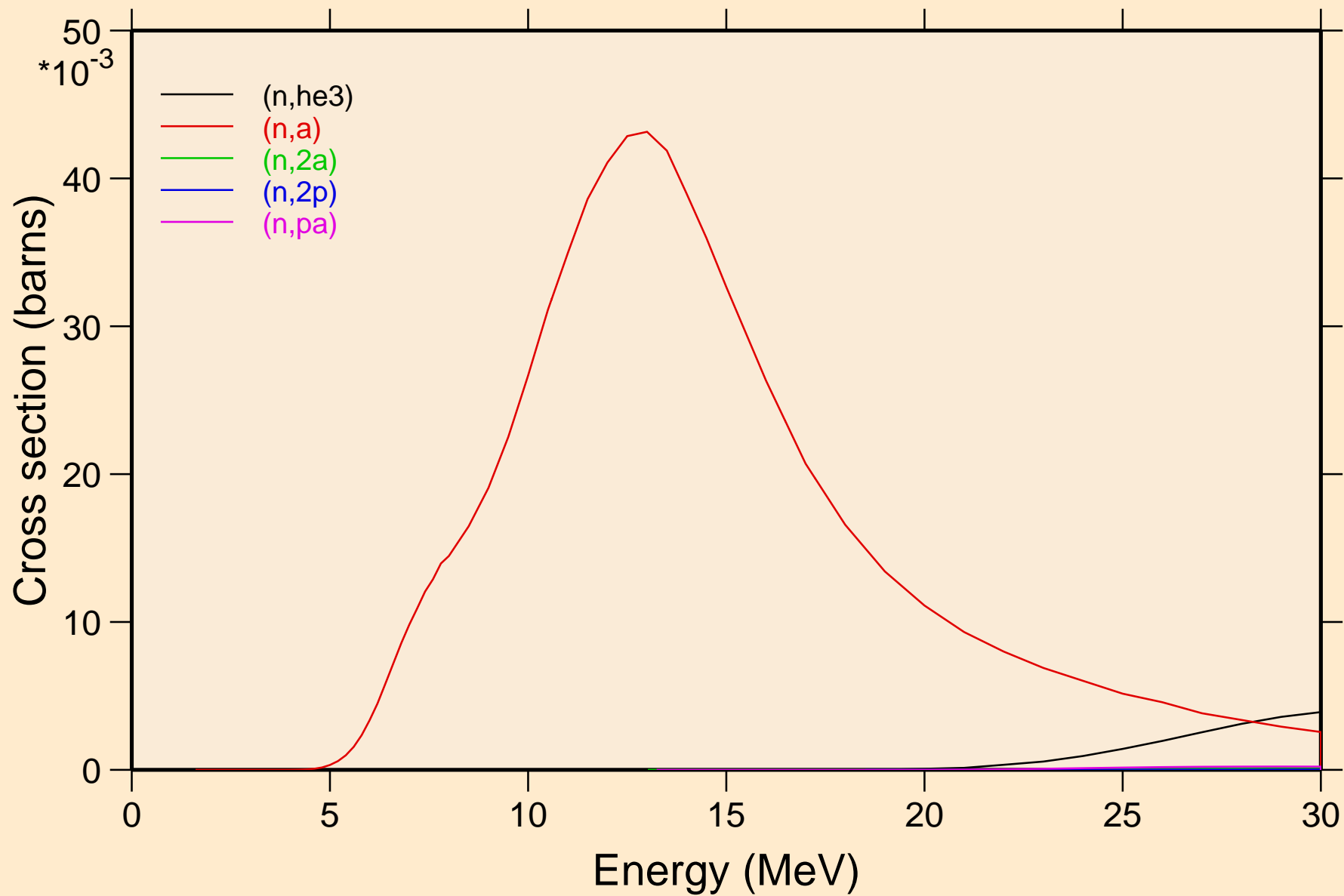

CL037 NEUTRON ACER TENDL-2021 LIBRARY; T=293.6K

Threshold reactions

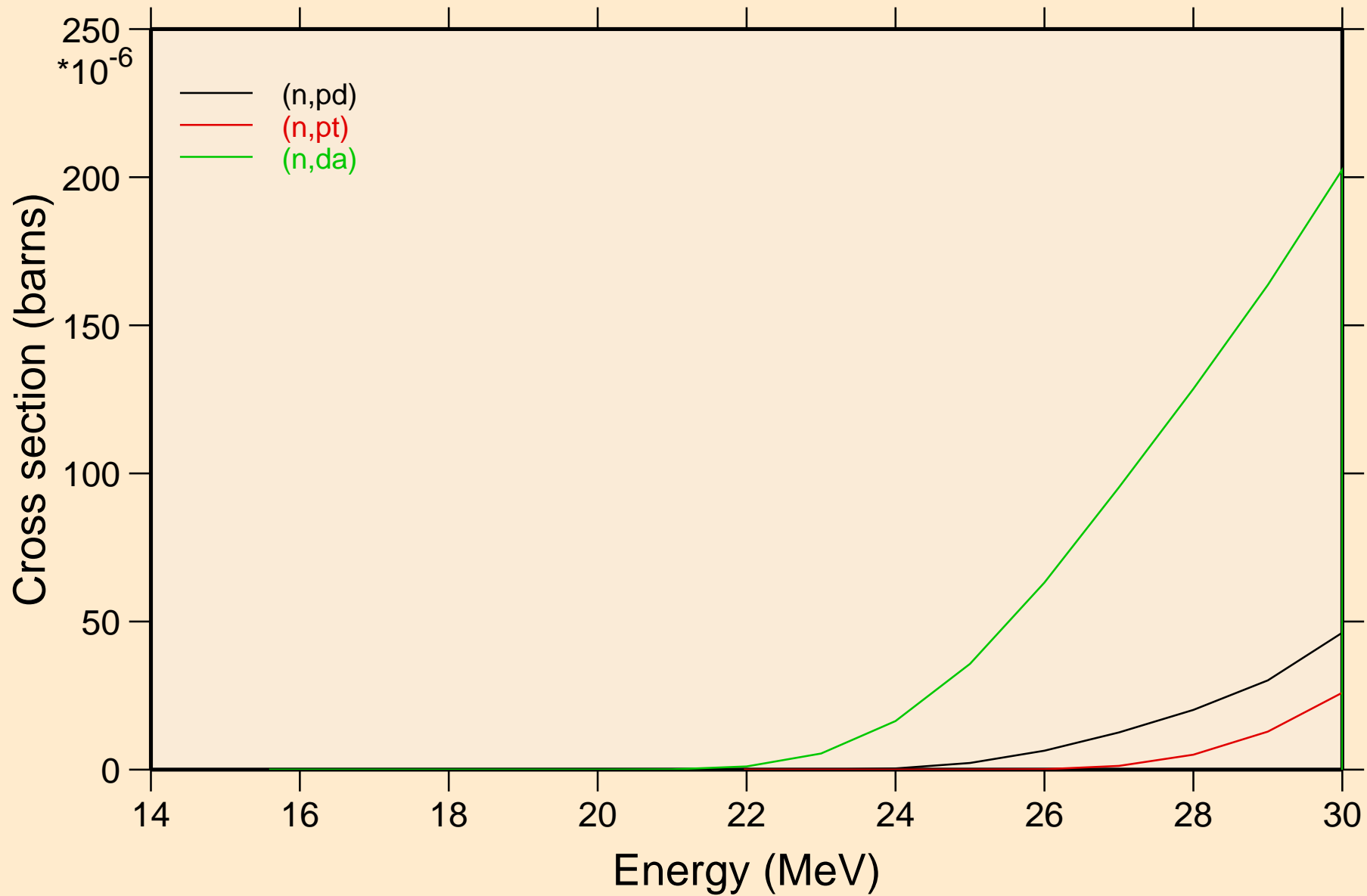

CL037 NEUTRON ACER TENDL-2021 LIBRARY; T=293.6K
Threshold reactions

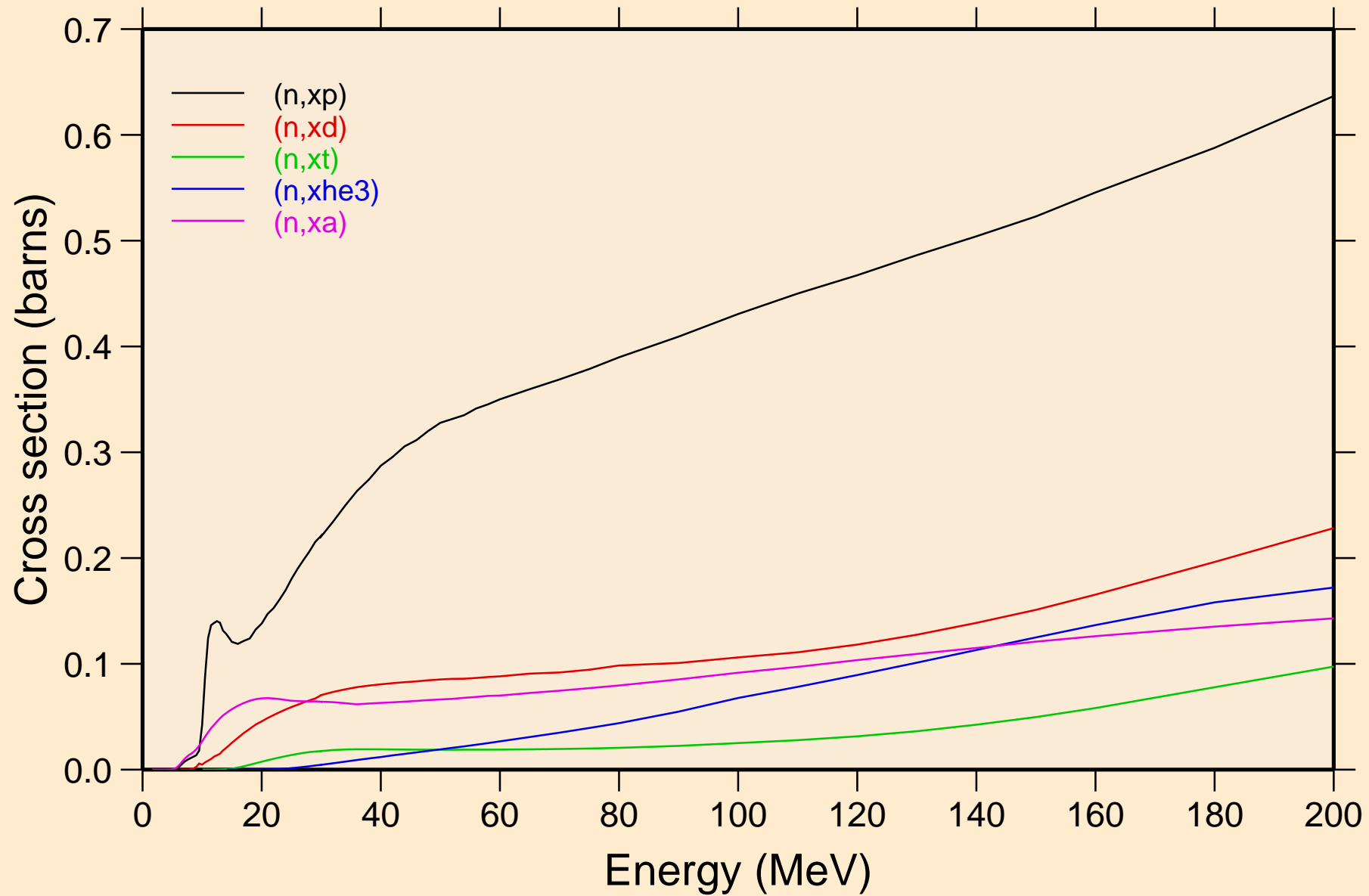

CL037 NEUTRON ACER TENDL-2021 LIBRARY; T=293.6K
angular distribution for elastic

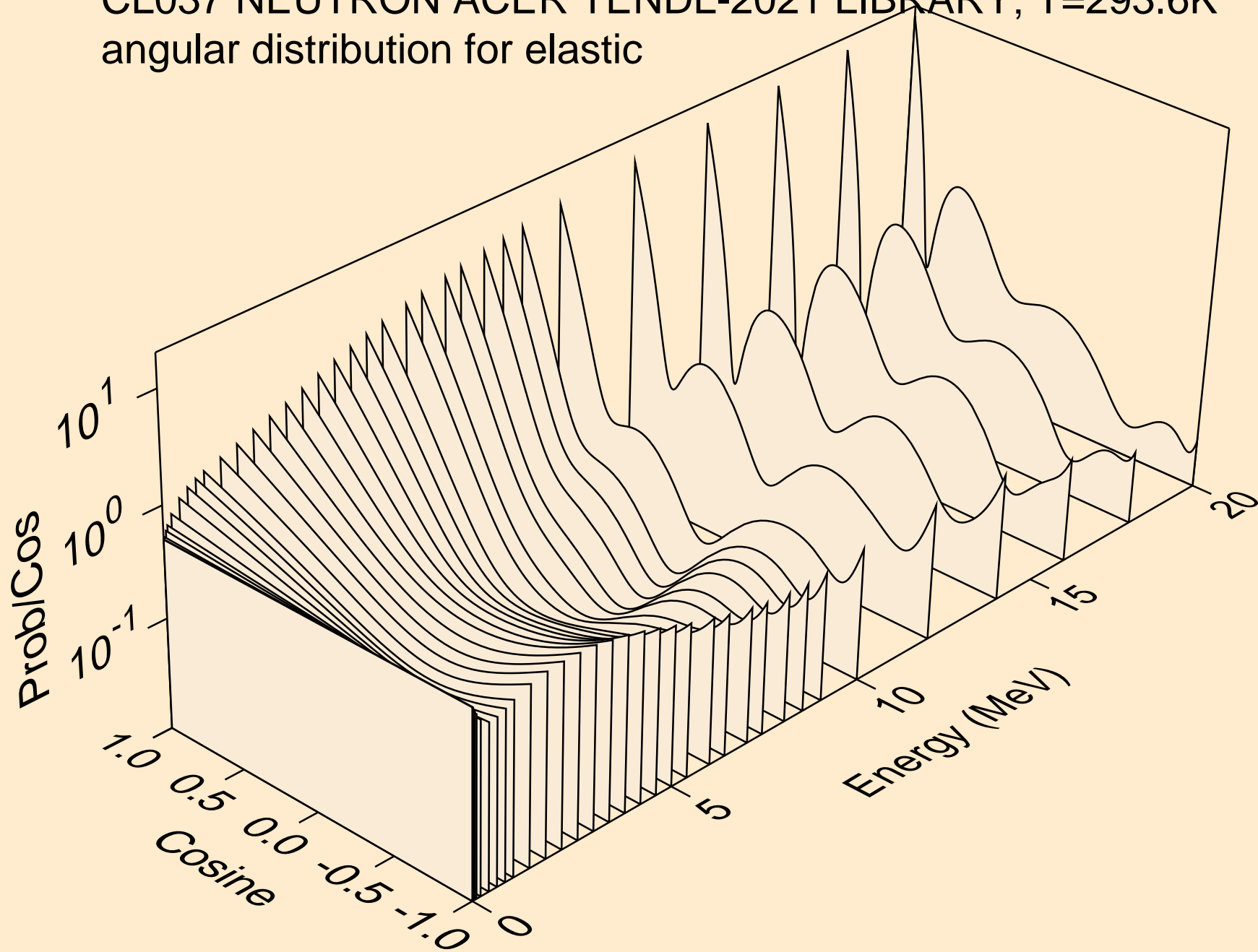

CL037 NEUTRON ACER TENDL-2021 LIBRARY; T=293.6K
angular distribution for elastic

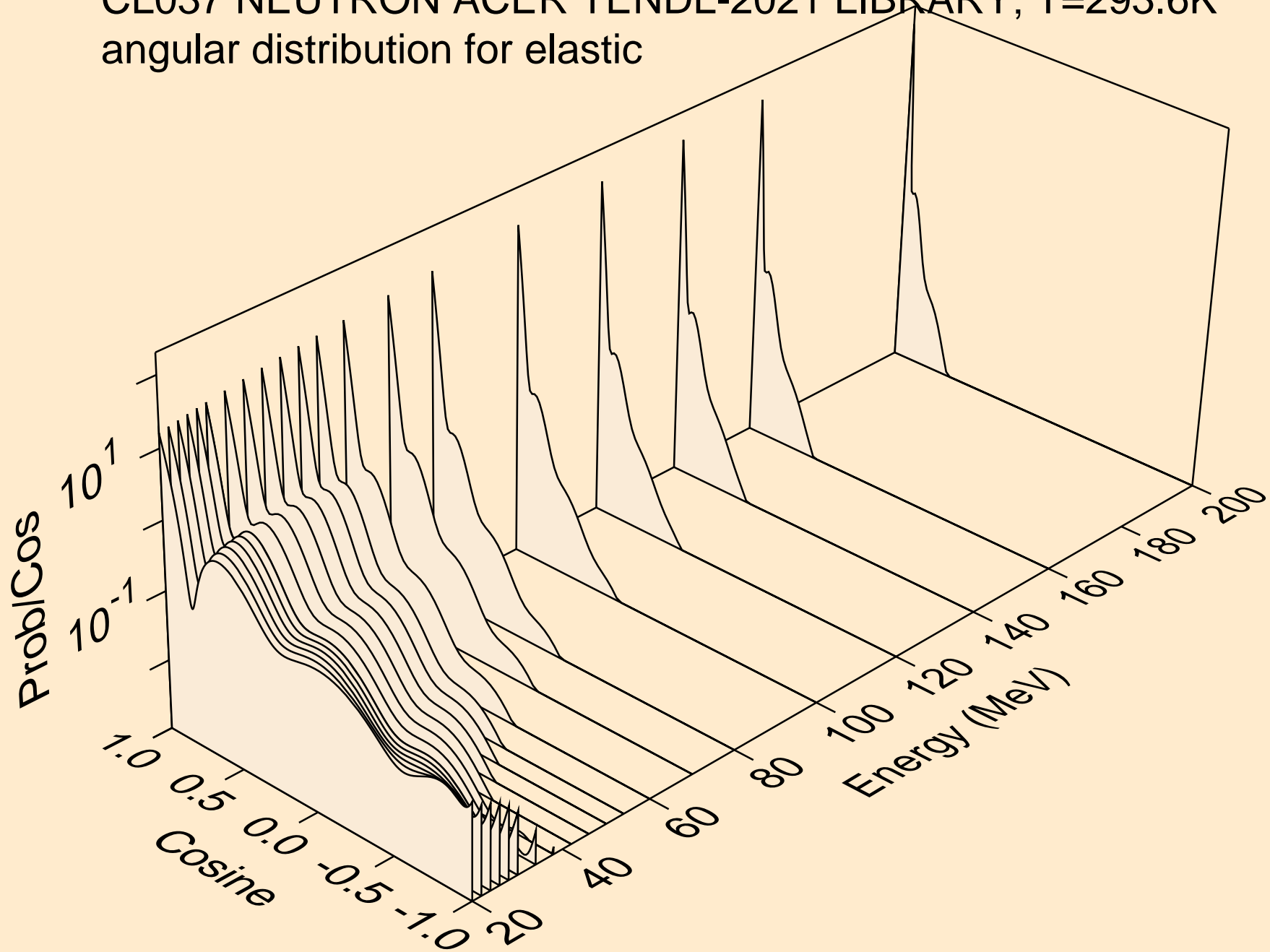

CL037 NEUTRON ACER TENDL-2021 LIBRARY; T=293.6K
angular distribution for (n,n*1)

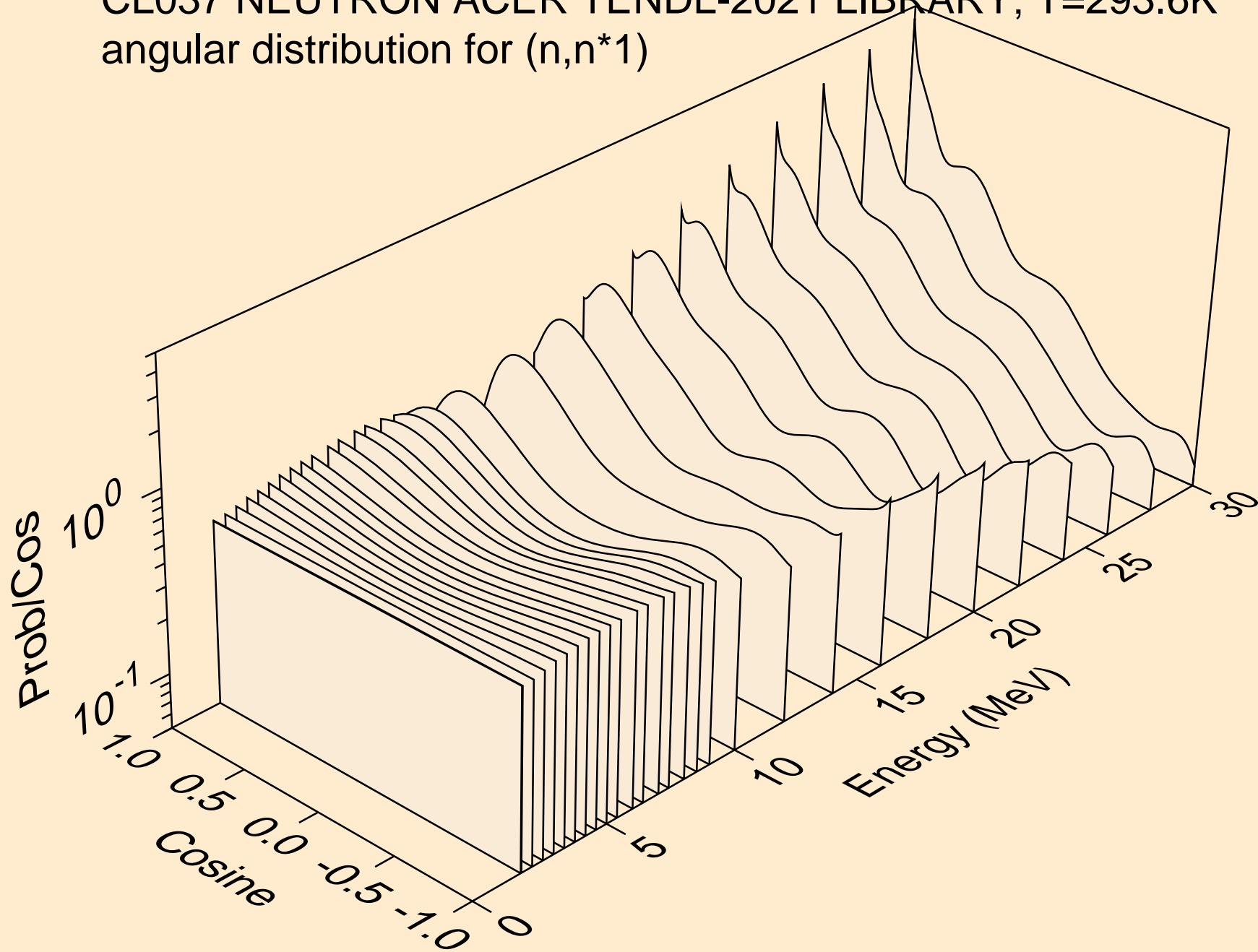

CL037 NEUTRON ACER TENDL-2021 LIBRARY; T=293.6K
angular distribution for (n,n*2)

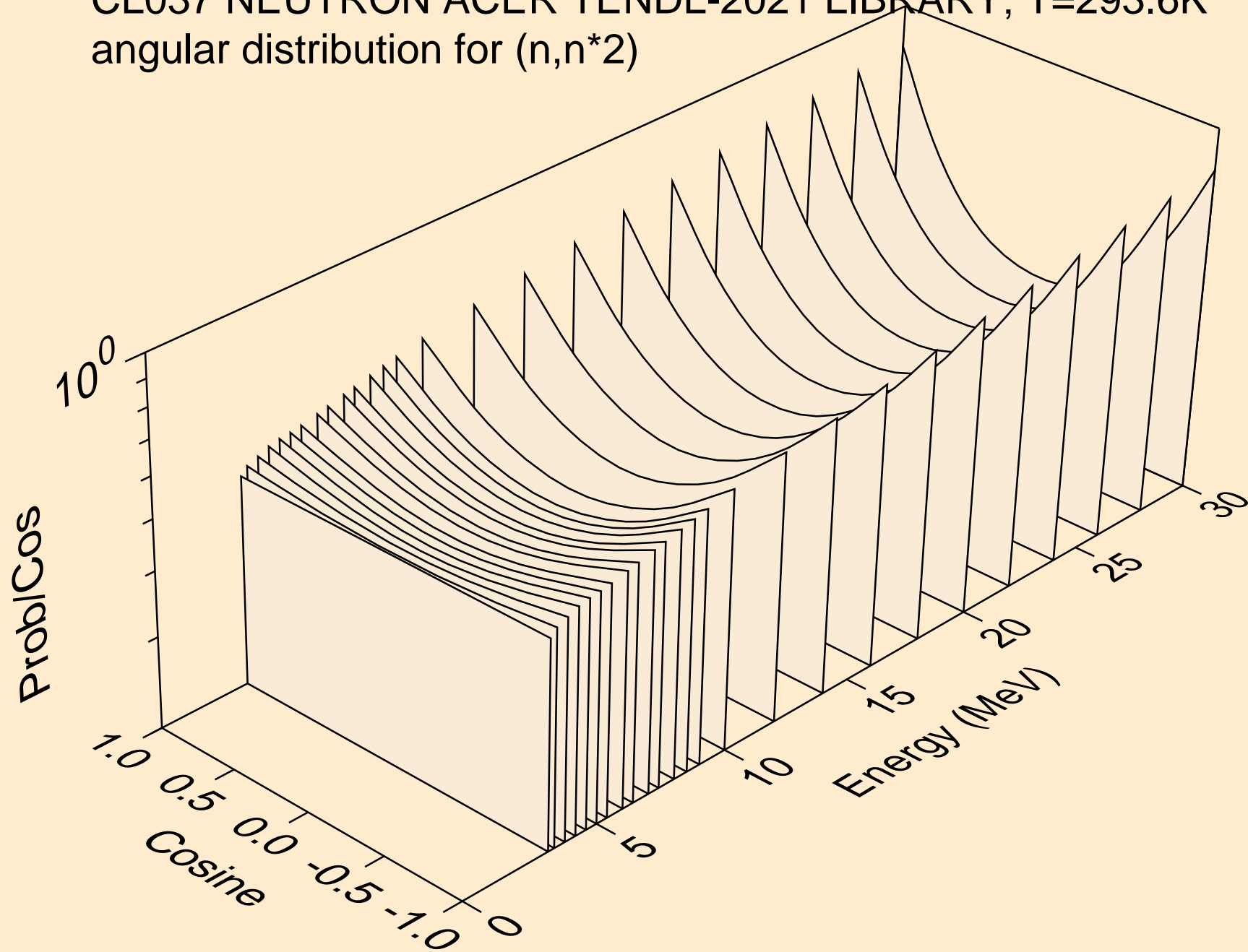

CL037 NEUTRON ACER TENDL-2021 LIBRARY; T=293.6K
angular distribution for (n,n*3)

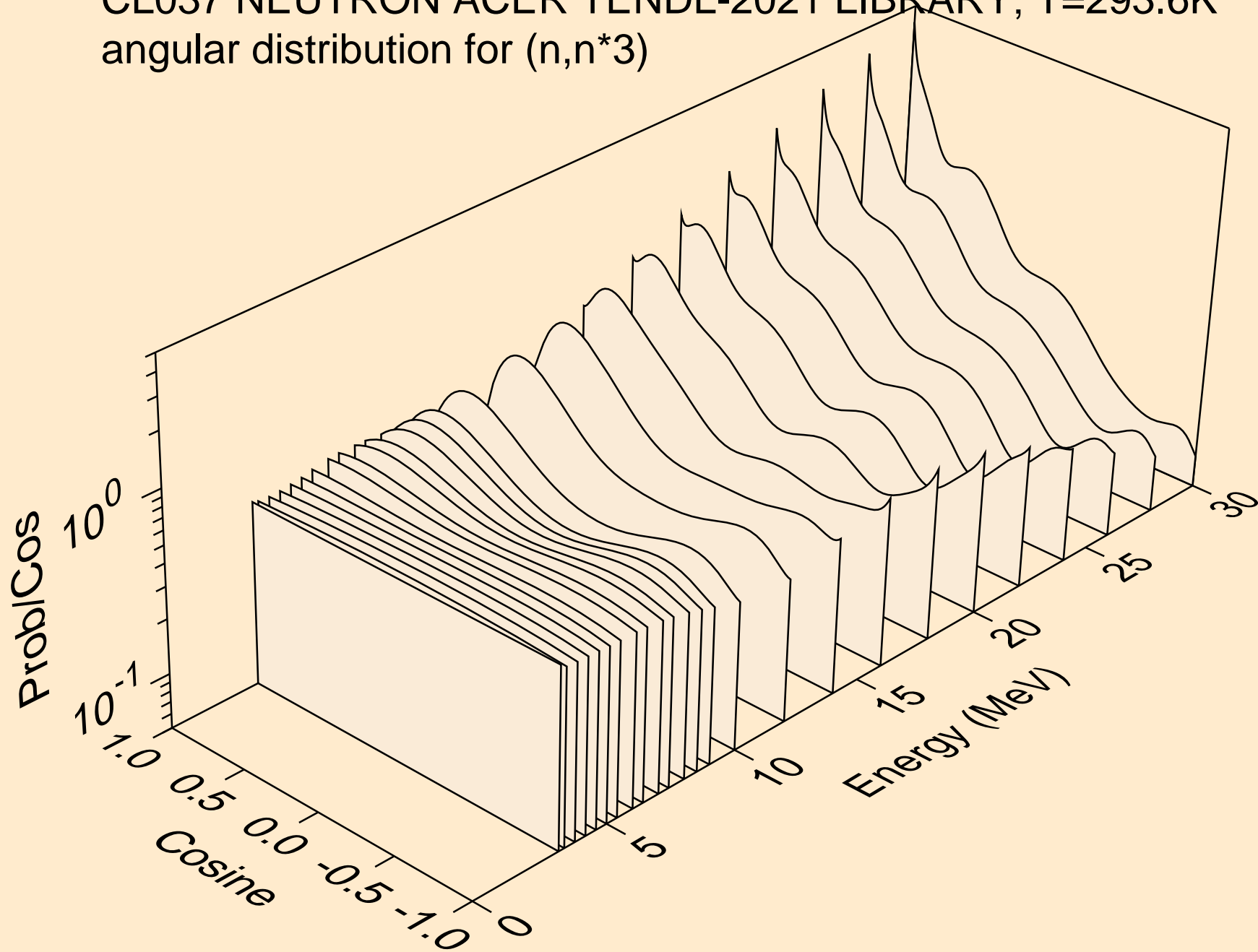

CL037 NEUTRON ACER TENDL-2021 LIBRARY; T=293.6K
angular distribution for (n,n*4)

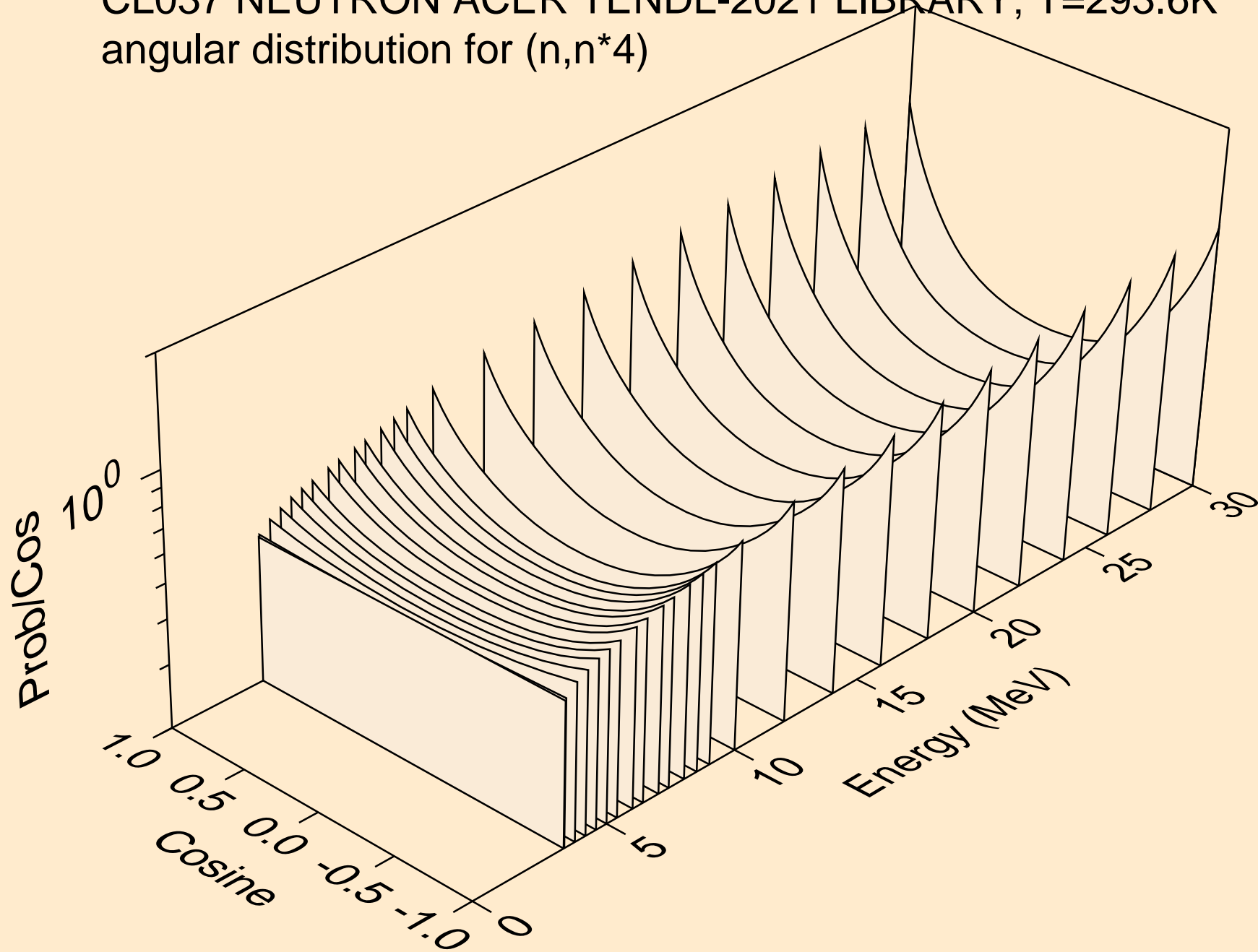

CL037 NEUTRON ACER TENDL-2021 LIBRARY; T=293.6K
angular distribution for (n,n*5)

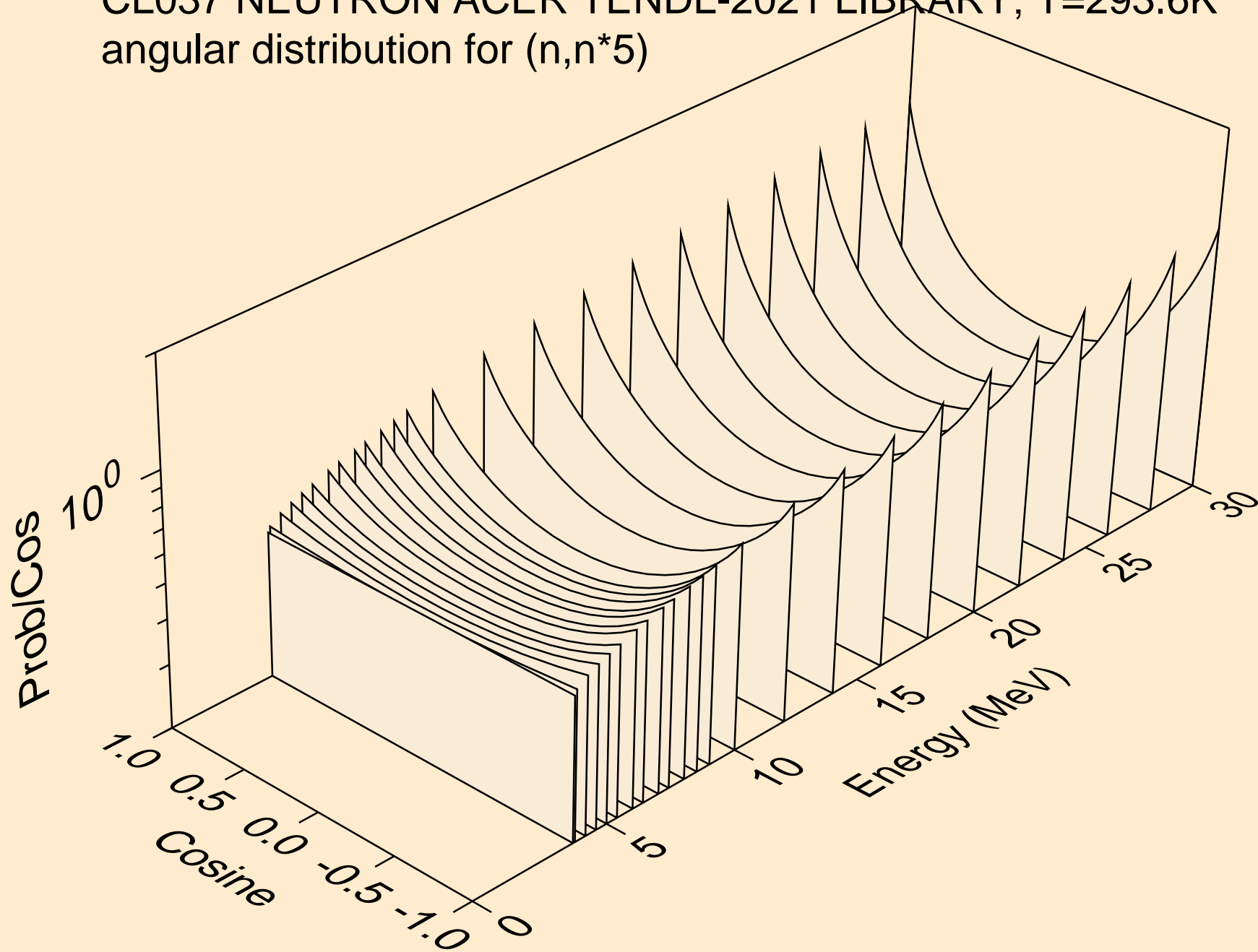

CL037 NEUTRON ACER TENDL-2021 LIBRARY; T=293.6K
angular distribution for (n,n*6)

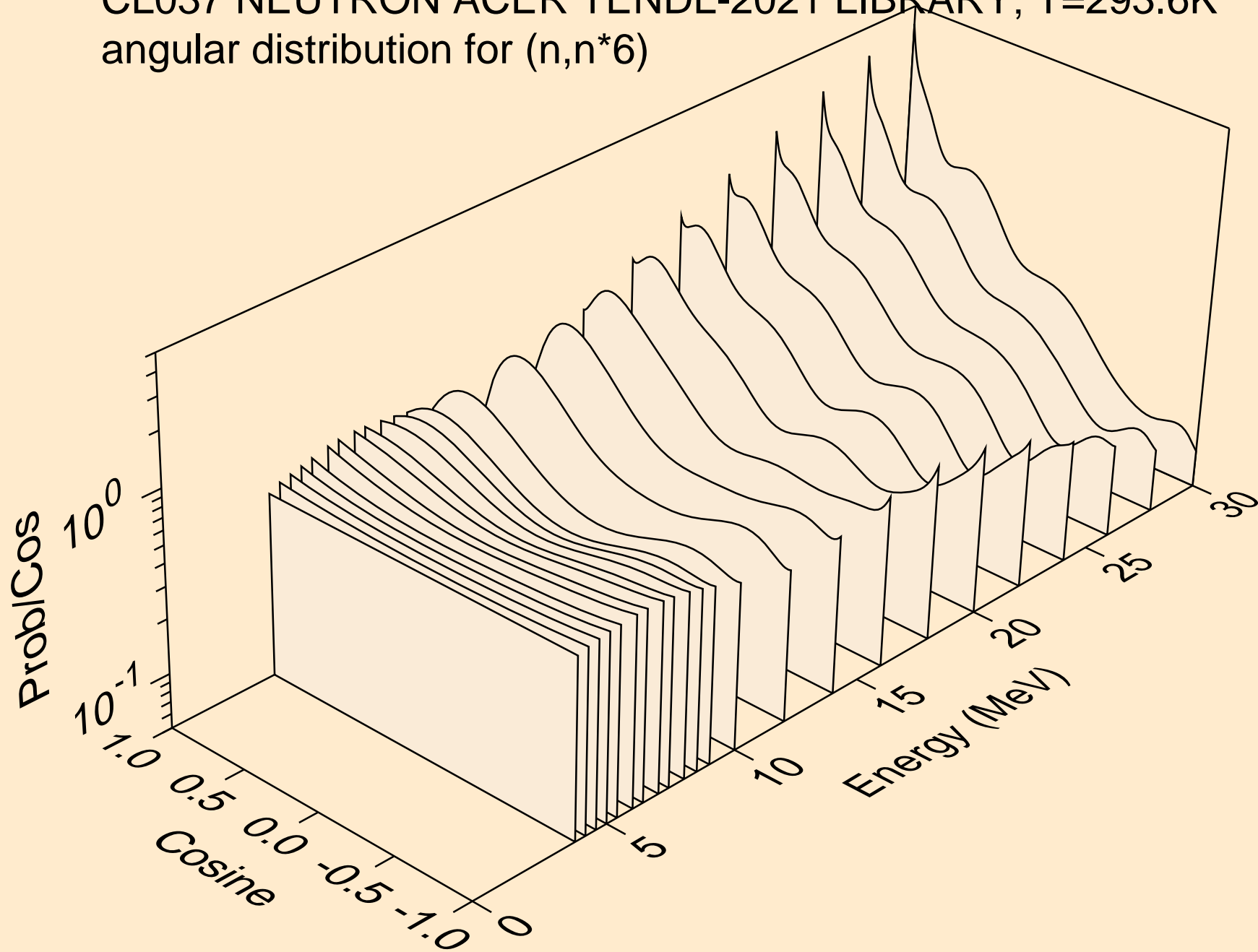

CL037 NEUTRON ACER TENDL-2021 LIBRARY; T=293.6K
angular distribution for (n,n*7)

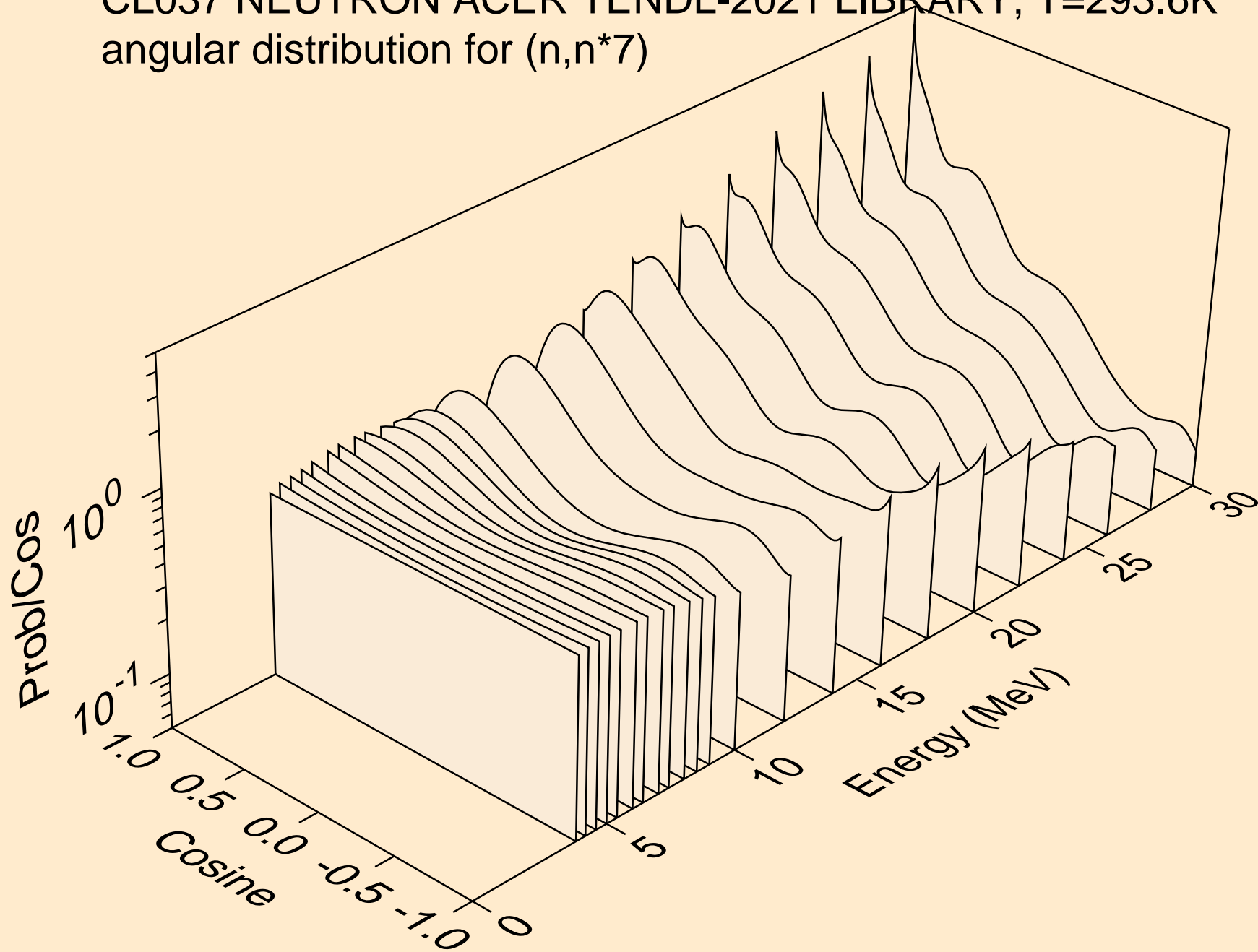

CL037 NEUTRON ACER TENDL-2021 LIBRARY; T=293.6K
angular distribution for (n,n*8)

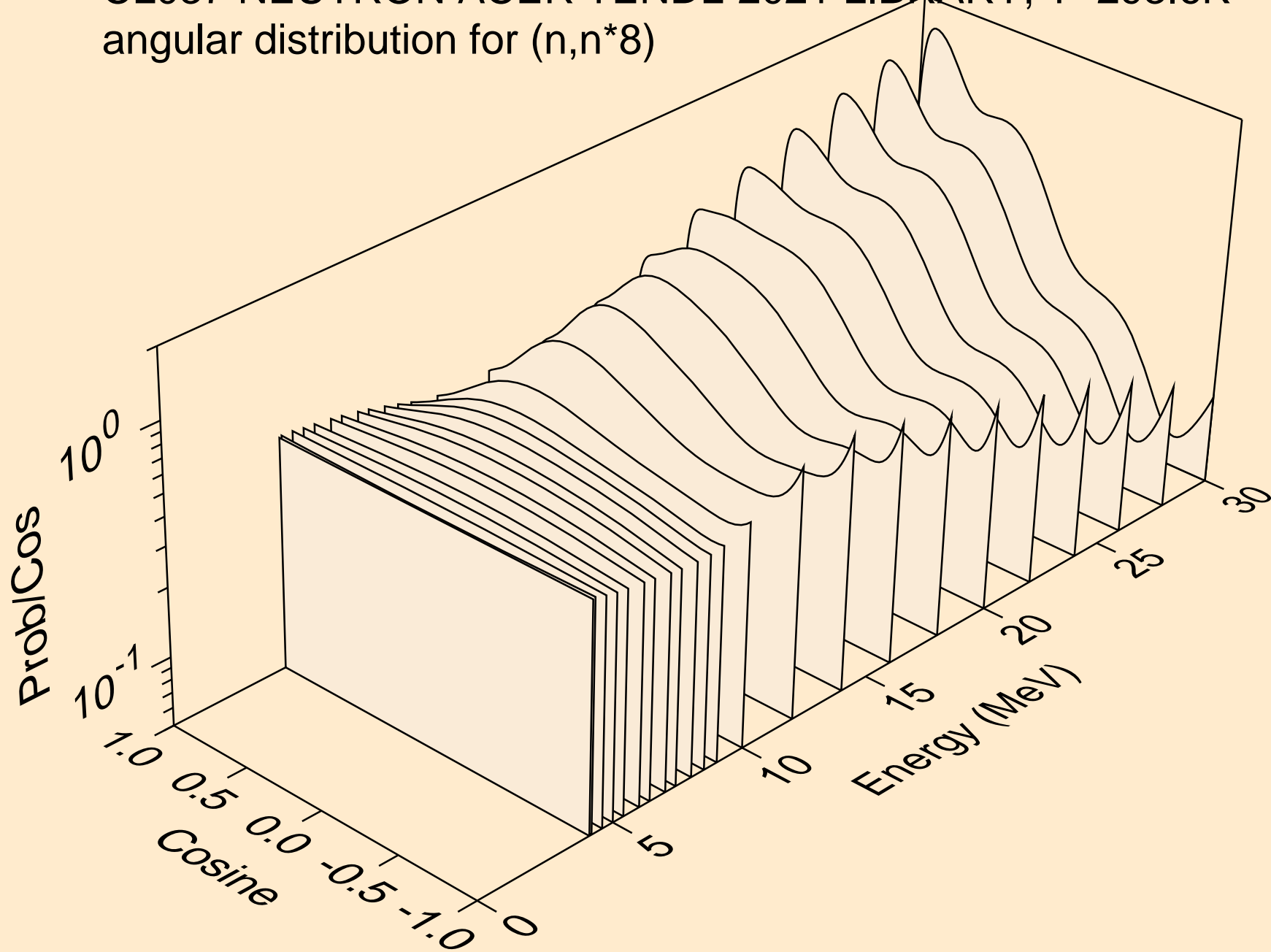

CL037 NEUTRON ACER TENDL-2021 LIBRARY; T=293.6K
angular distribution for (n,n*9)

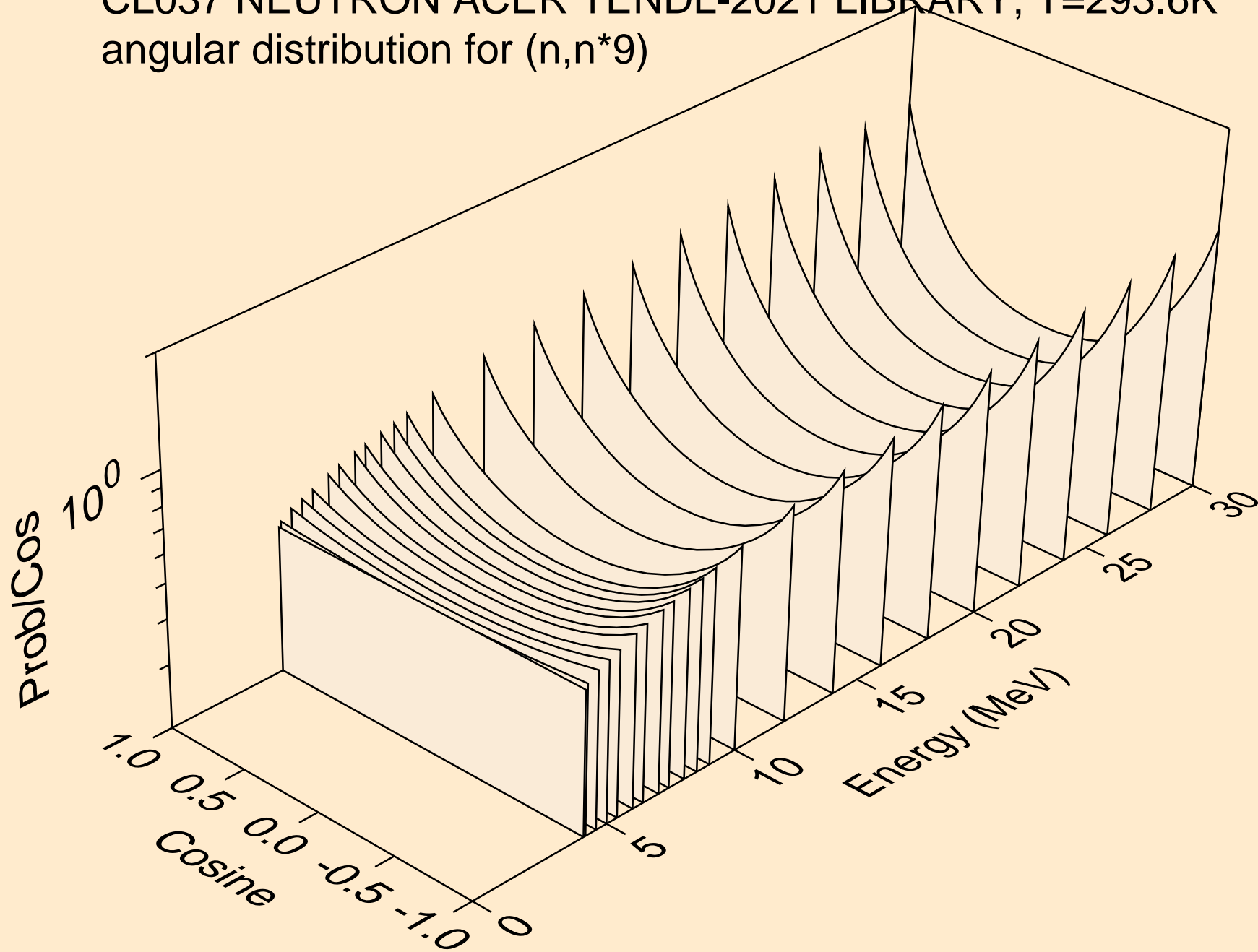

CL037 NEUTRON ACER TENDL-2021 LIBRARY; T=293.6K
angular distribution for (n,n*10)

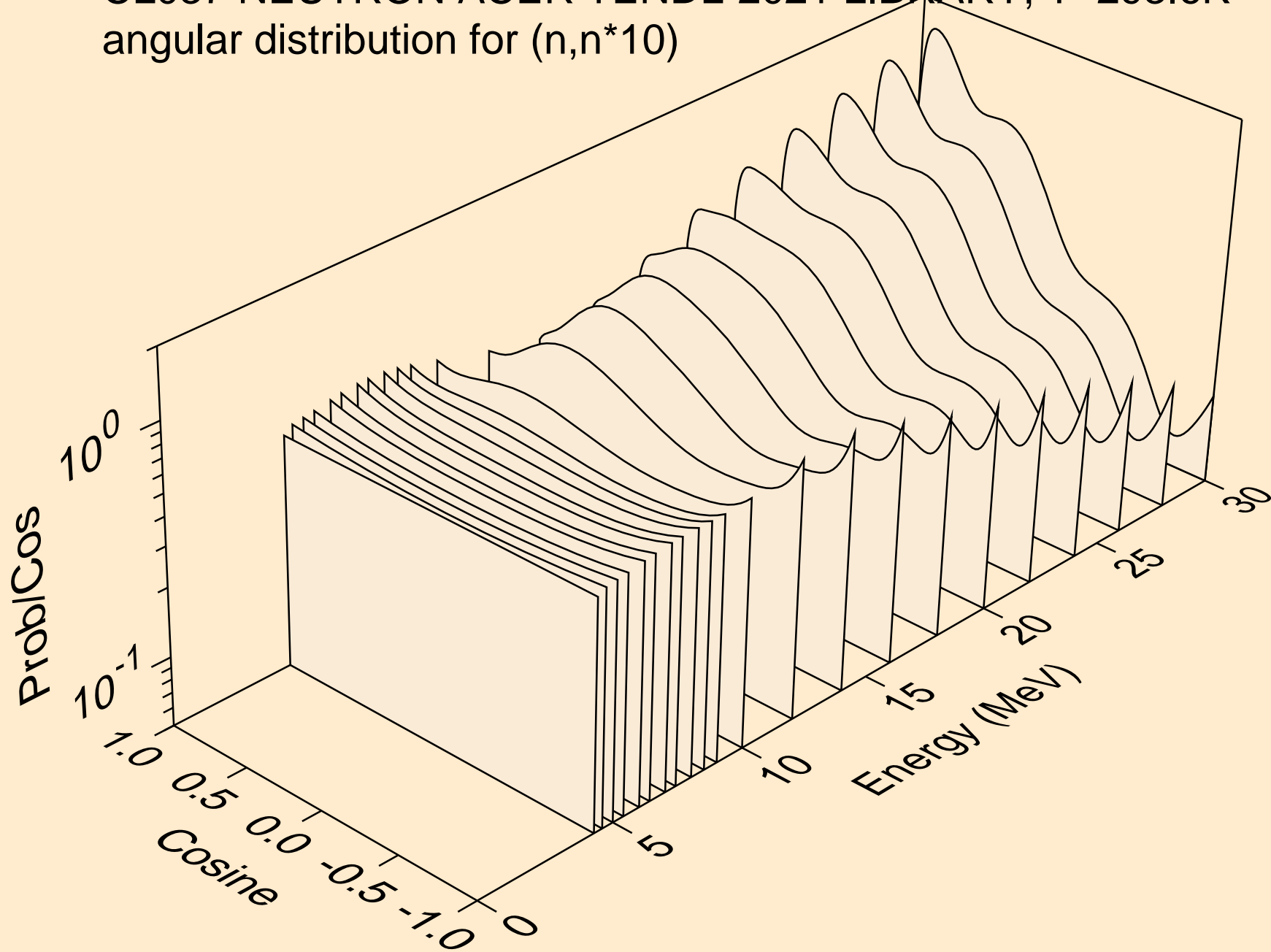

CL037 NEUTRON ACER TENDL-2021 LIBRARY; T=293.6K
angular distribution for (n,n*11)

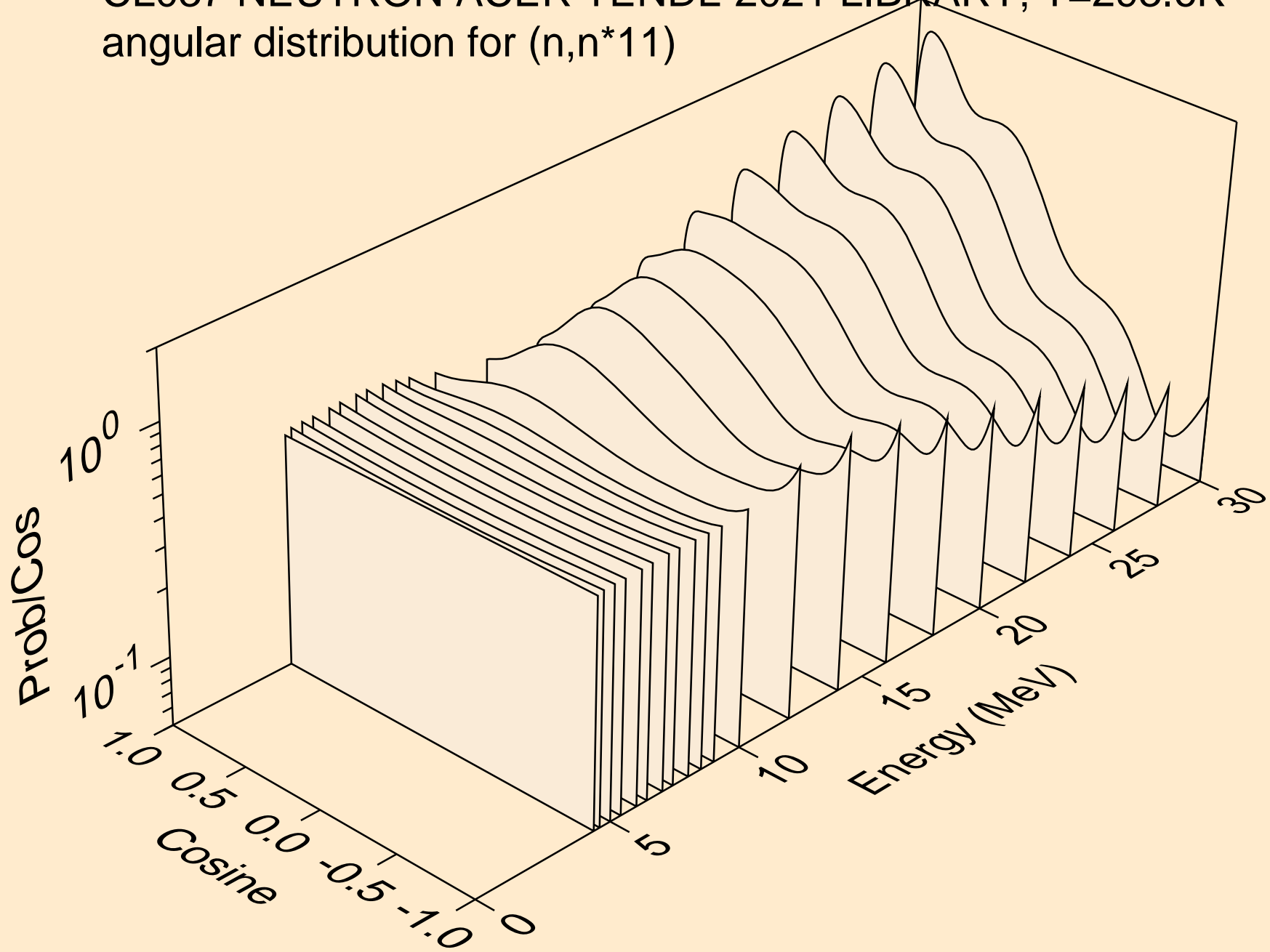

CL037 NEUTRON ACER TENDL-2021 LIBRARY; T=293.6K
angular distribution for (n,n*12)

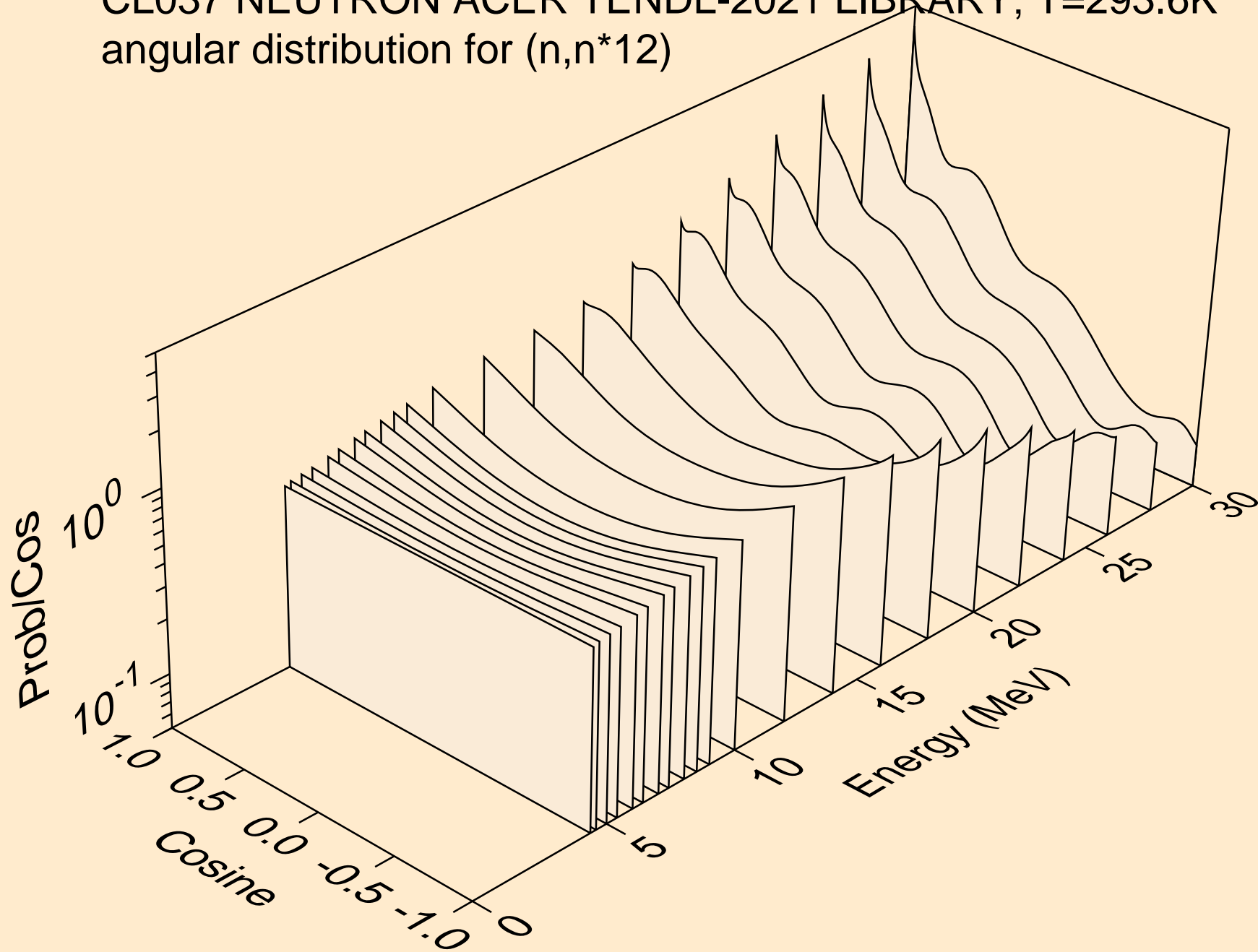

CL037 NEUTRON ACER TENDL-2021 LIBRARY; T=293.6K
angular distribution for (n,n*13)

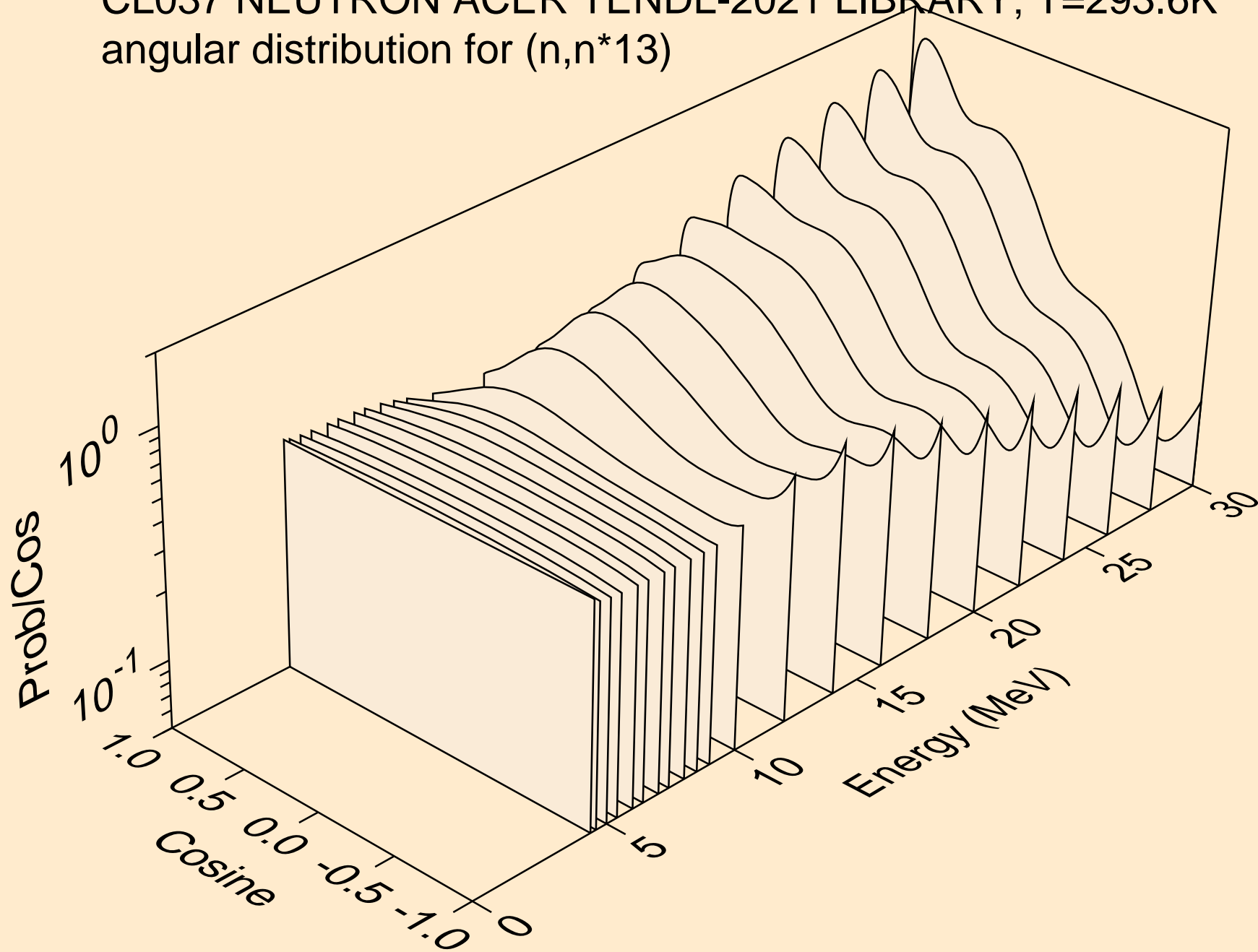

CL037 NEUTRON ACER TENDL-2021 LIBRARY; T=293.6K
angular distribution for (n,n*14)

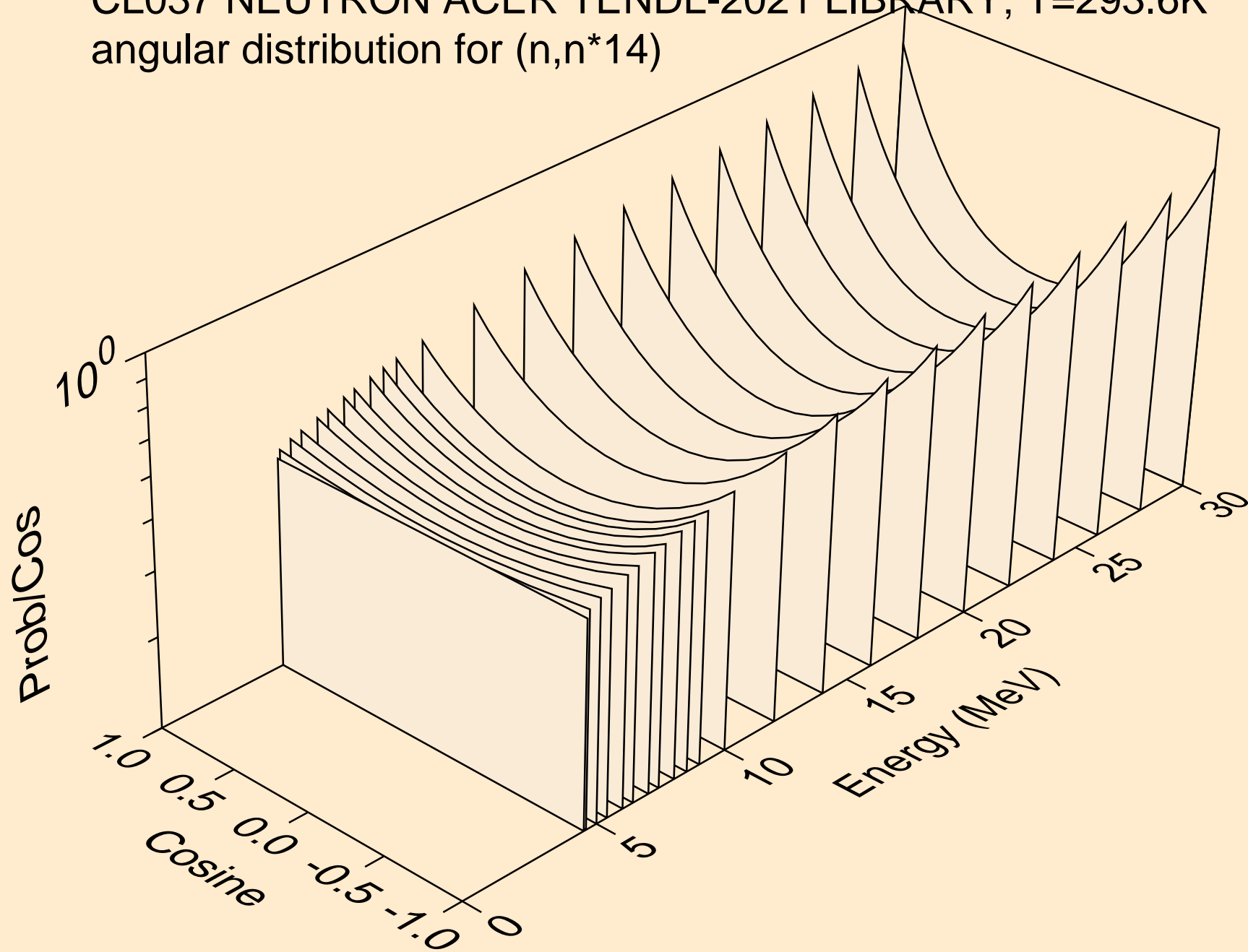

CL037 NEUTRON ACER TENDL-2021 LIBRARY; T=293.6K
angular distribution for (n,n*15)

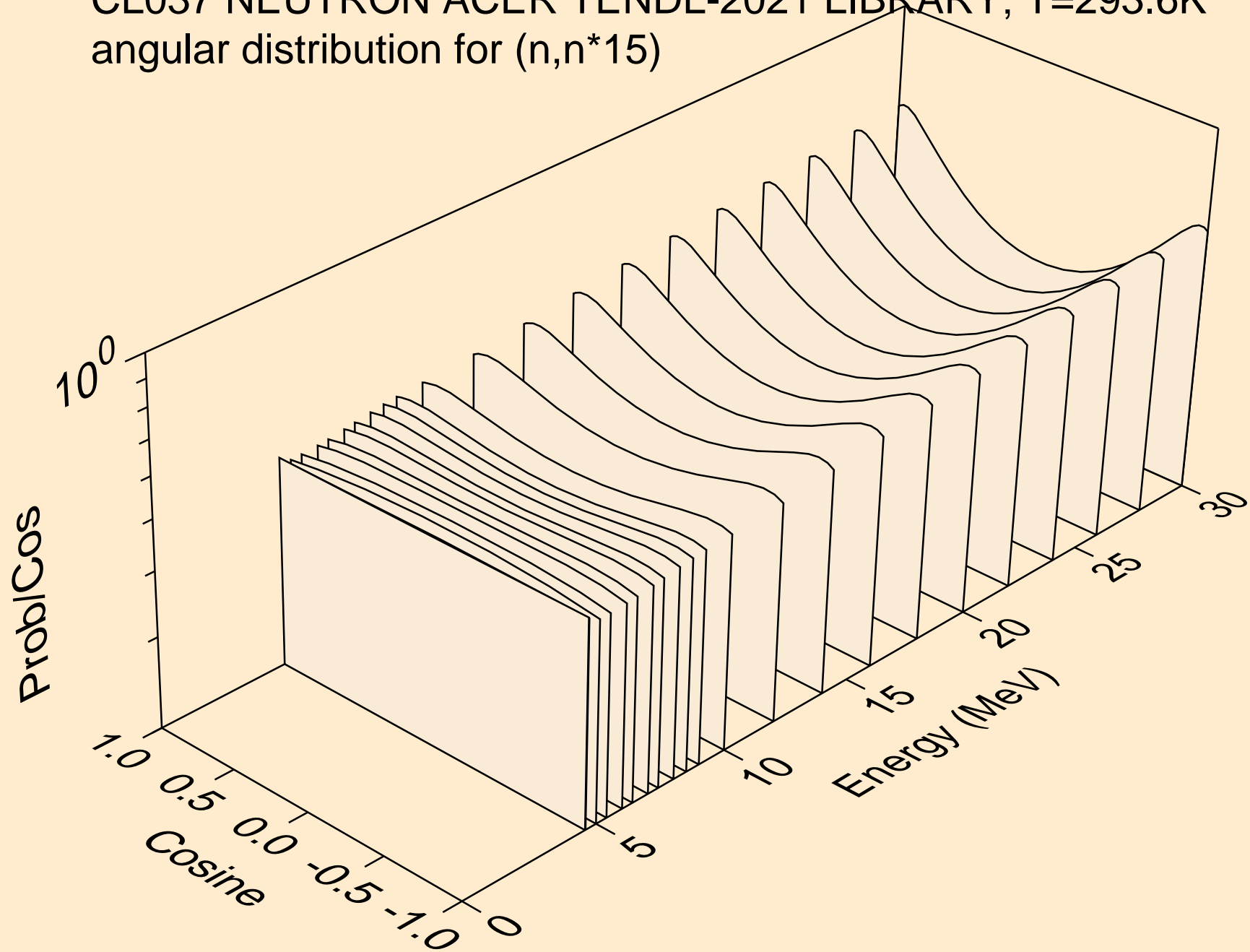

CL037 NEUTRON ACER TENDL-2021 LIBRARY; T=293.6K
angular distribution for (n,n*16)

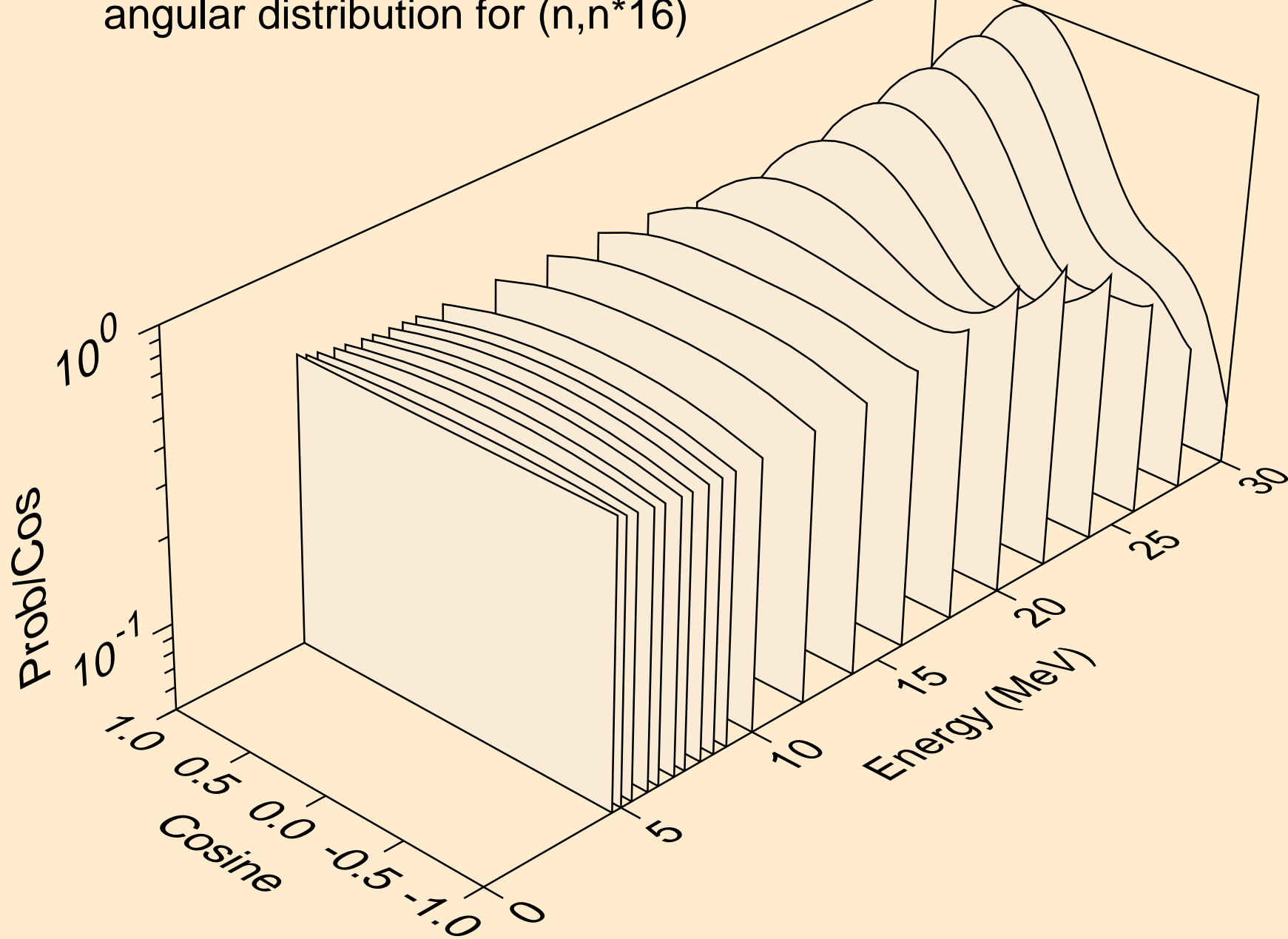

CL037 NEUTRON ACER TENDL-2021 LIBRARY; T=293.6K
angular distribution for (n,n*17)

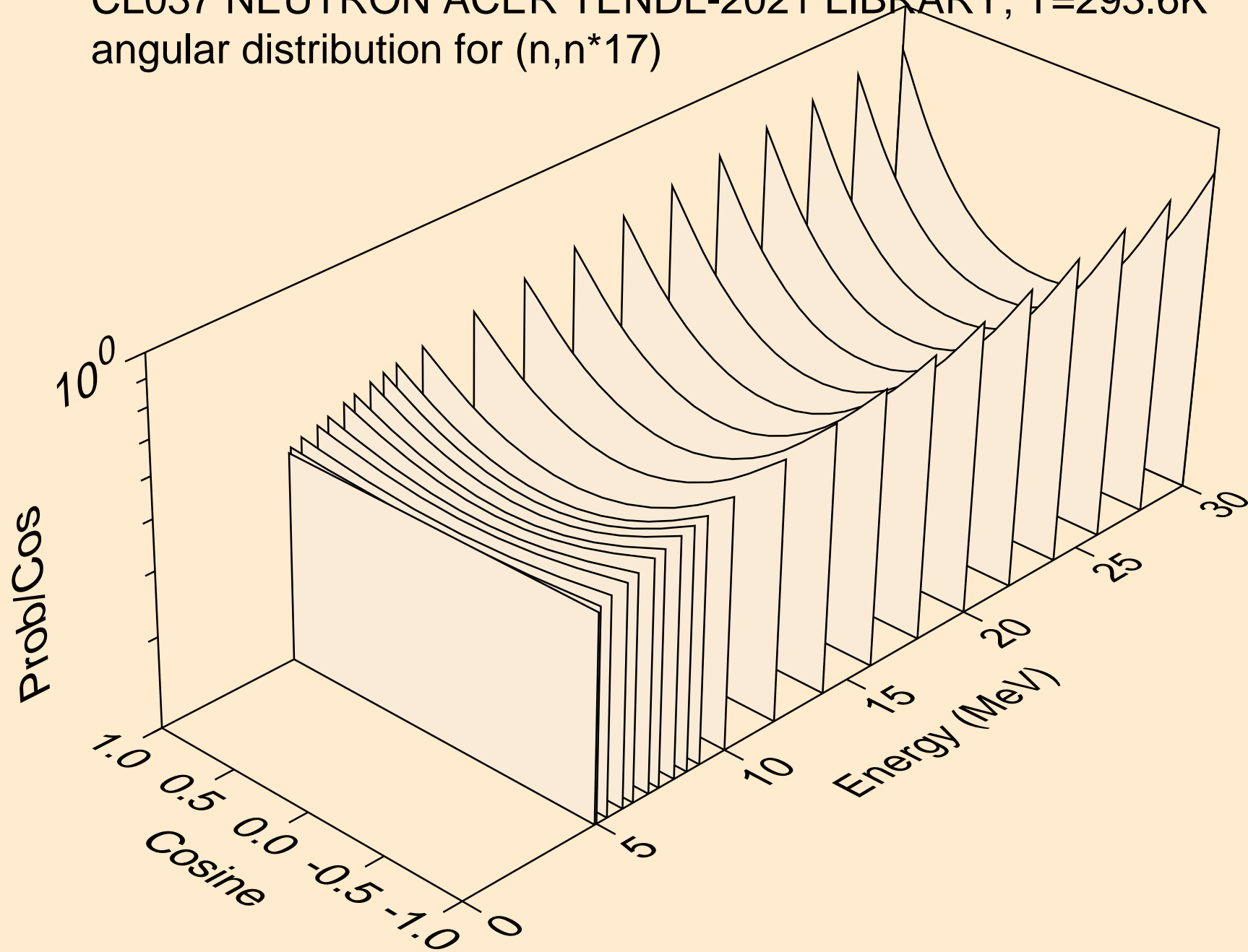

CL037 NEUTRON ACER TENDL-2021 LIBRARY; T=293.6K
angular distribution for (n,n*18)

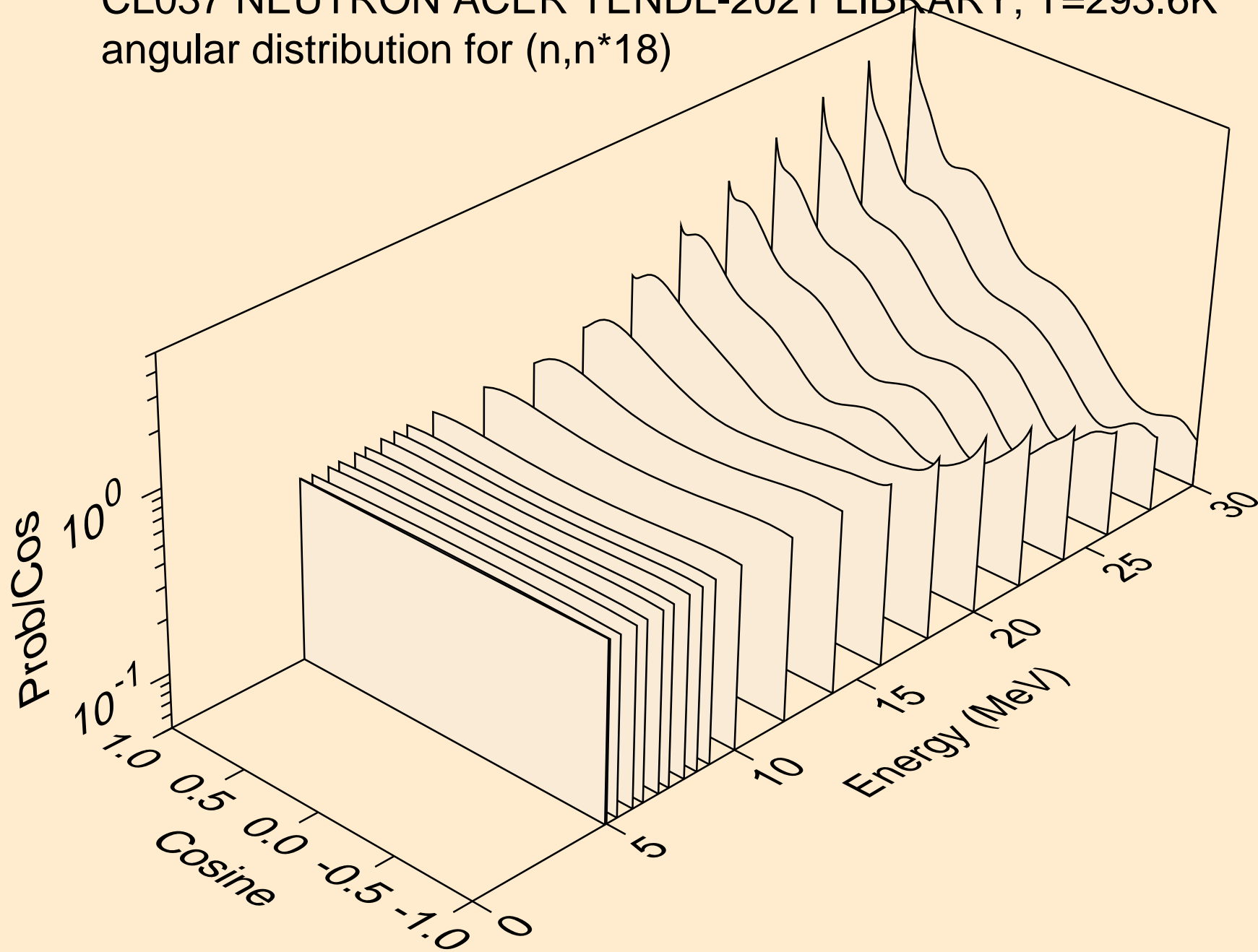

CL037 NEUTRON ACER TENDL-2021 LIBRARY; T=293.6K
angular distribution for (n,n*19)

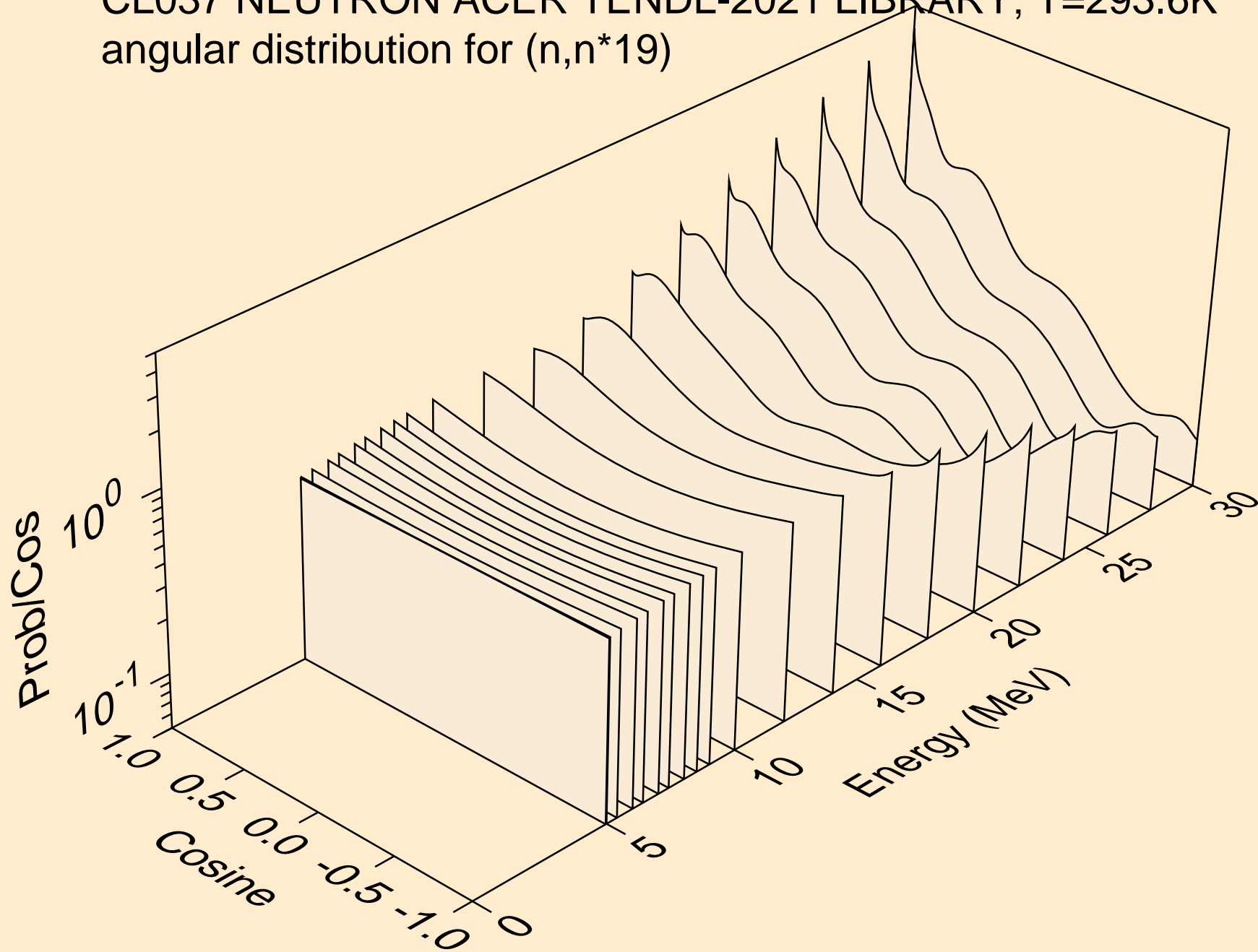

CL037 NEUTRON ACER TENDL-2021 LIBRARY; T=293.6K
angular distribution for (n,n*20)

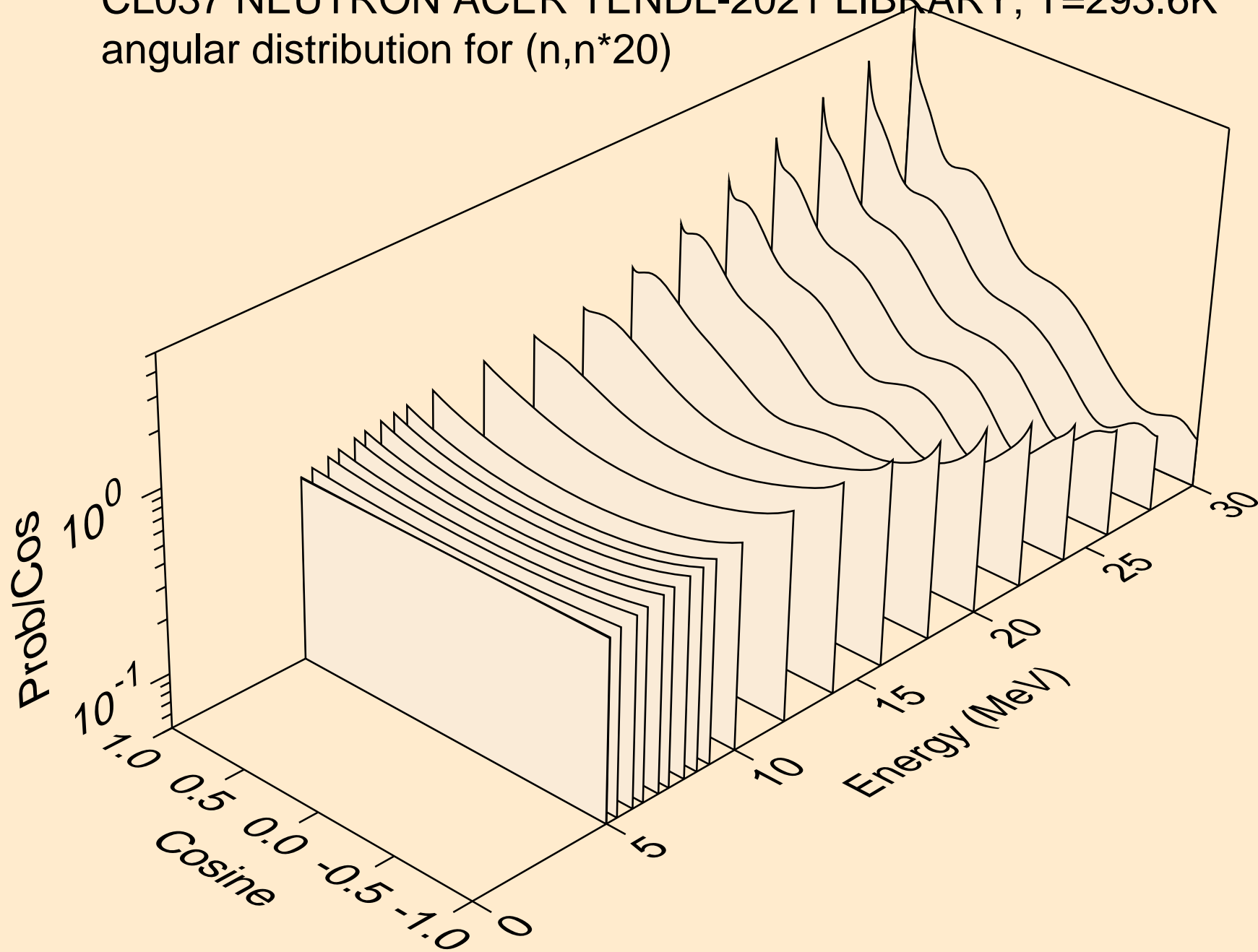

CL037 NEUTRON ACER TENDL-2021 LIBRARY; T=293.6K
angular distribution for (n,n*21)

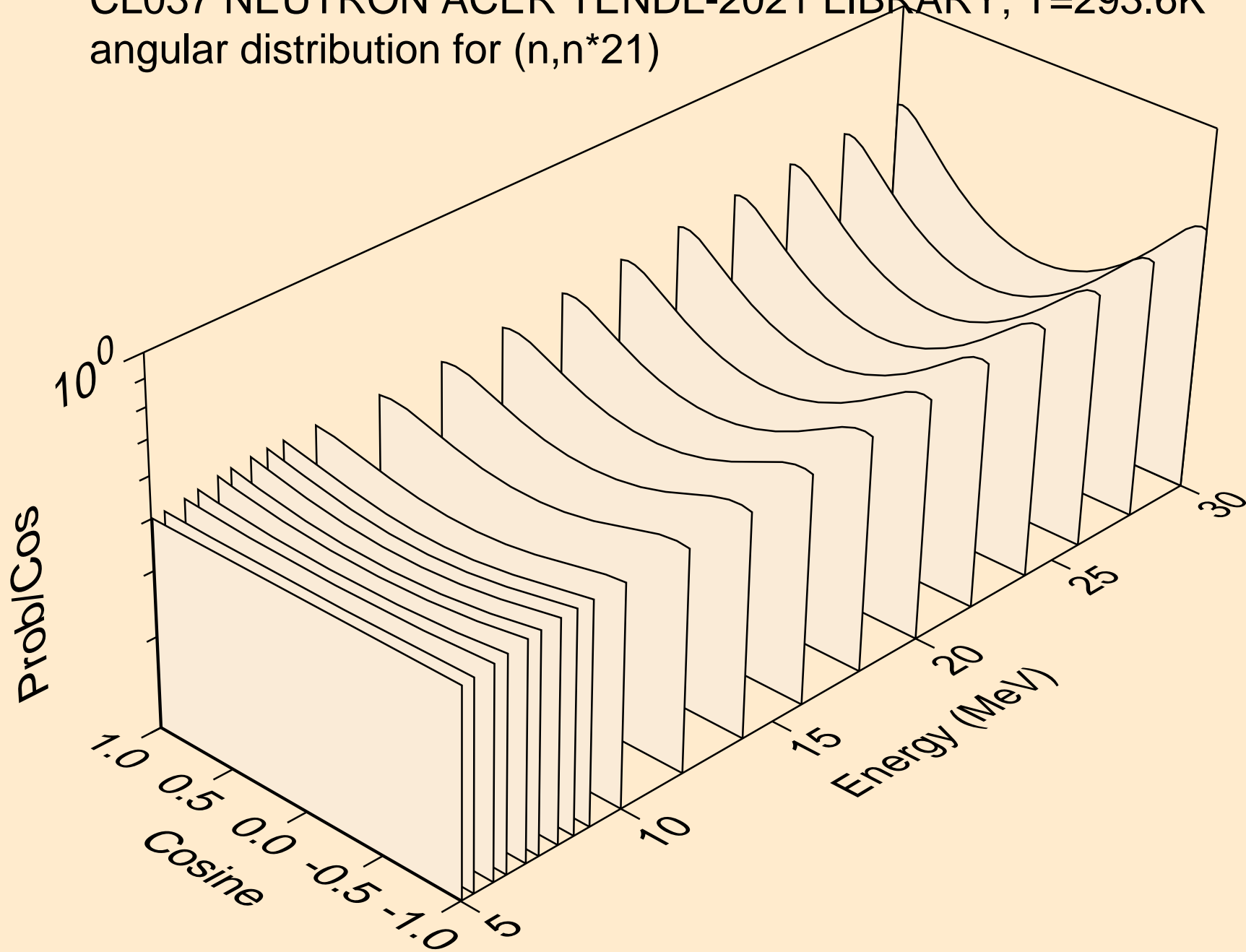

CL037 NEUTRON ACER TENDL-2021 LIBRARY; T=293.6K
angular distribution for (n,n*22)

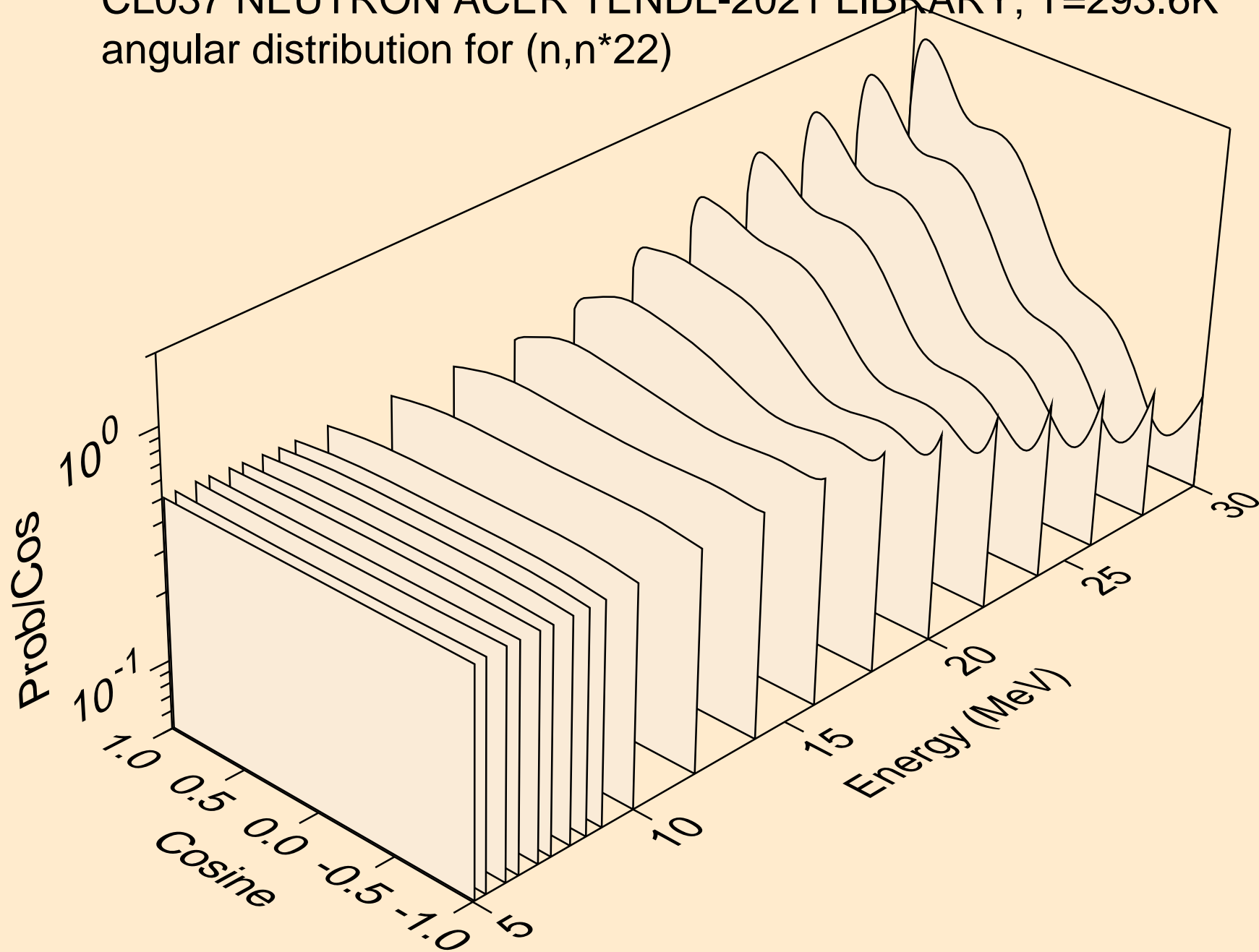

CL037 NEUTRON ACER TENDL-2021 LIBRARY; T=293.6K
angular distribution for (n,n*23)

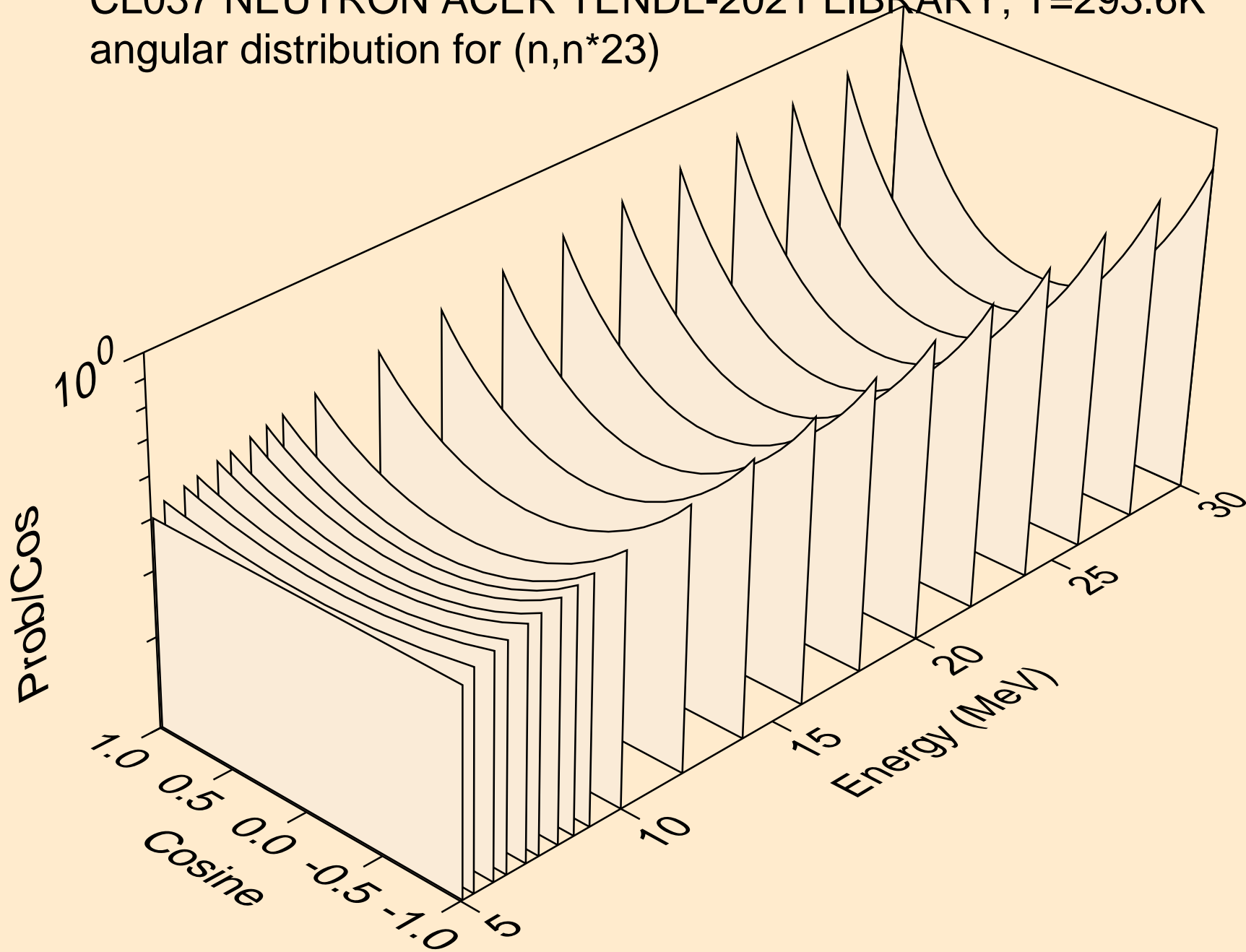

CL037 NEUTRON ACER TENDL-2021 LIBRARY; T=293.6K
angular distribution for (n,n*24)

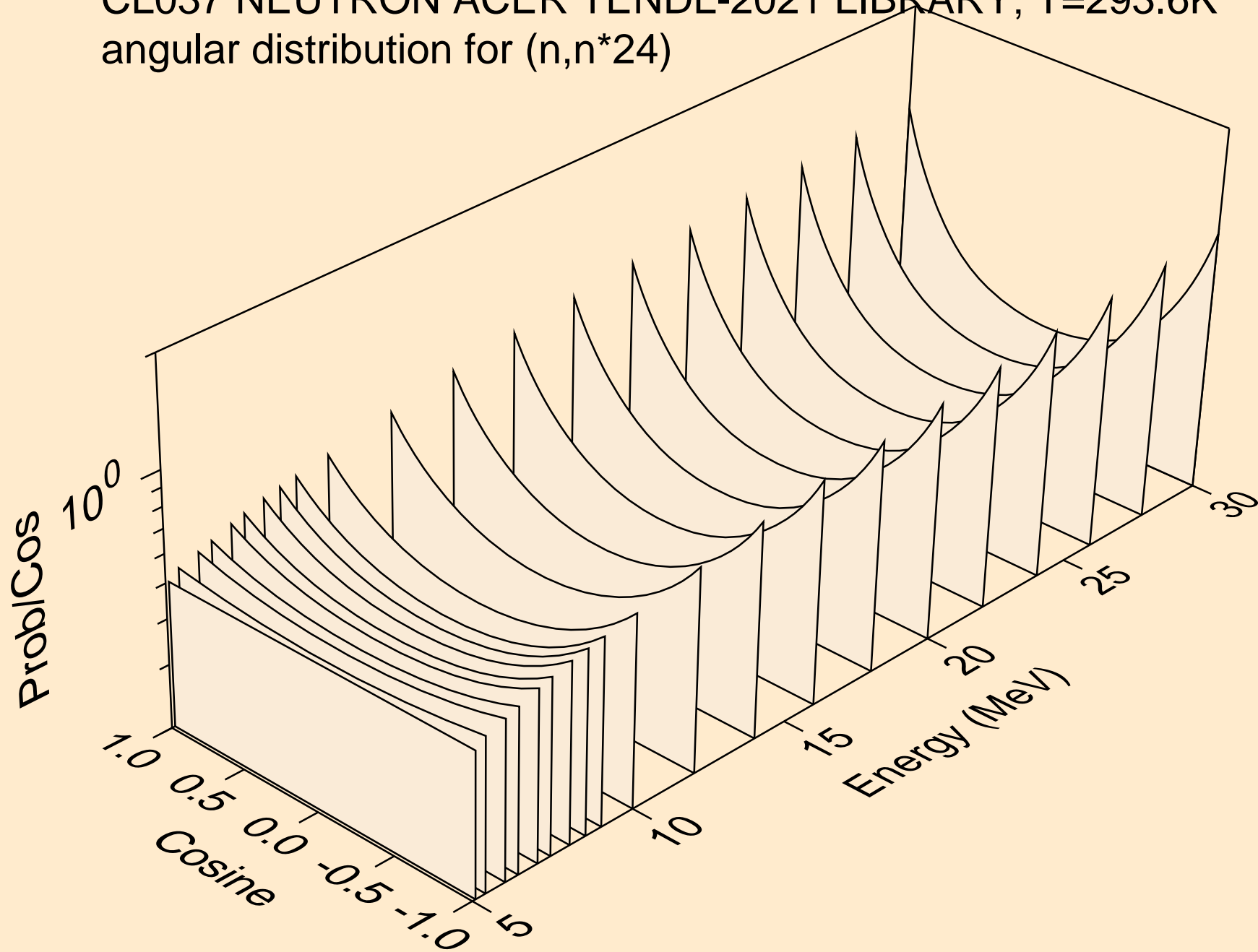

CL037 NEUTRON ACER TENDL-2021 LIBRARY; T=293.6K
angular distribution for (n,n*25)

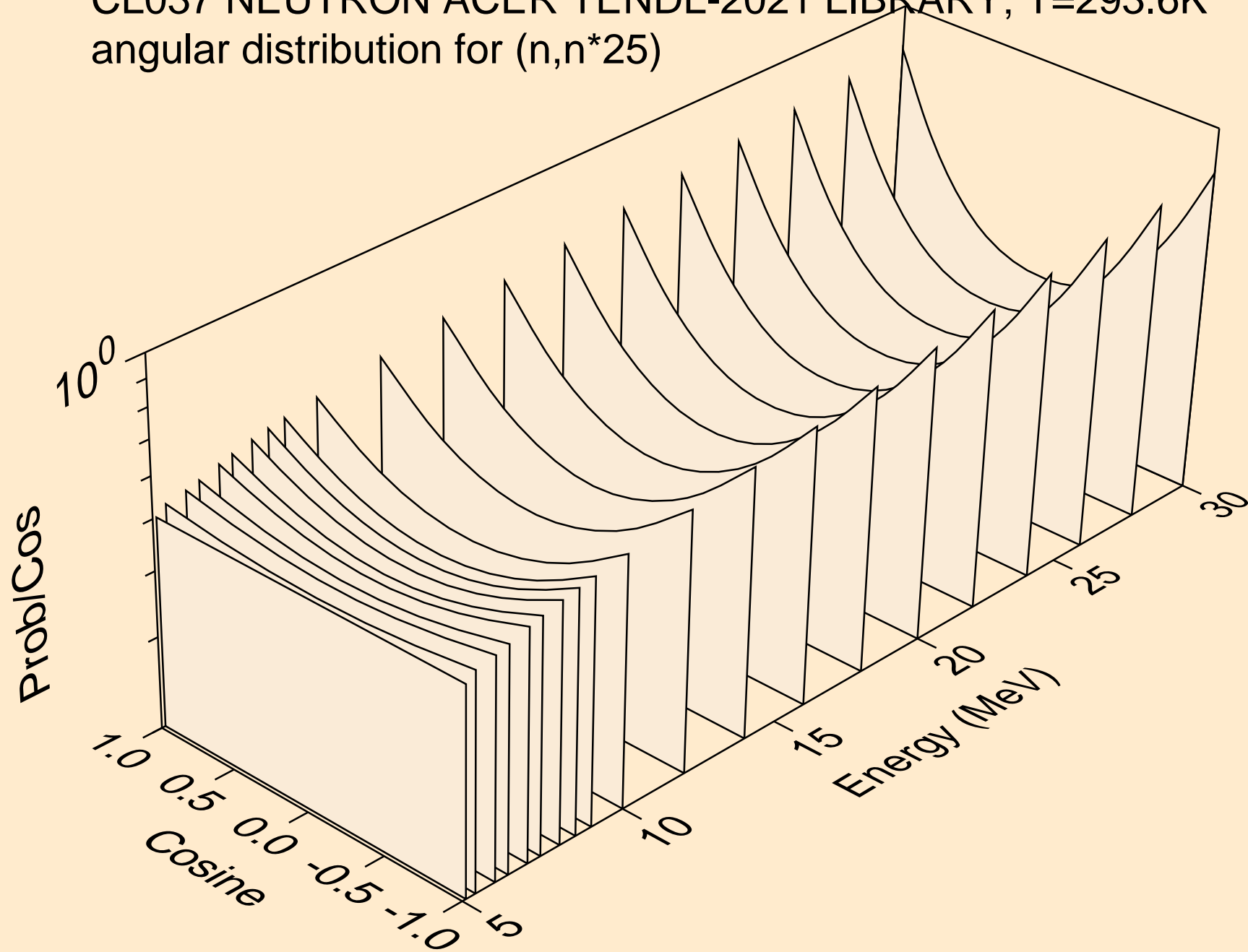

CL037 NEUTRON ACER TENDL-2021 LIBRARY; T=293.6K
angular distribution for (n,n*26)

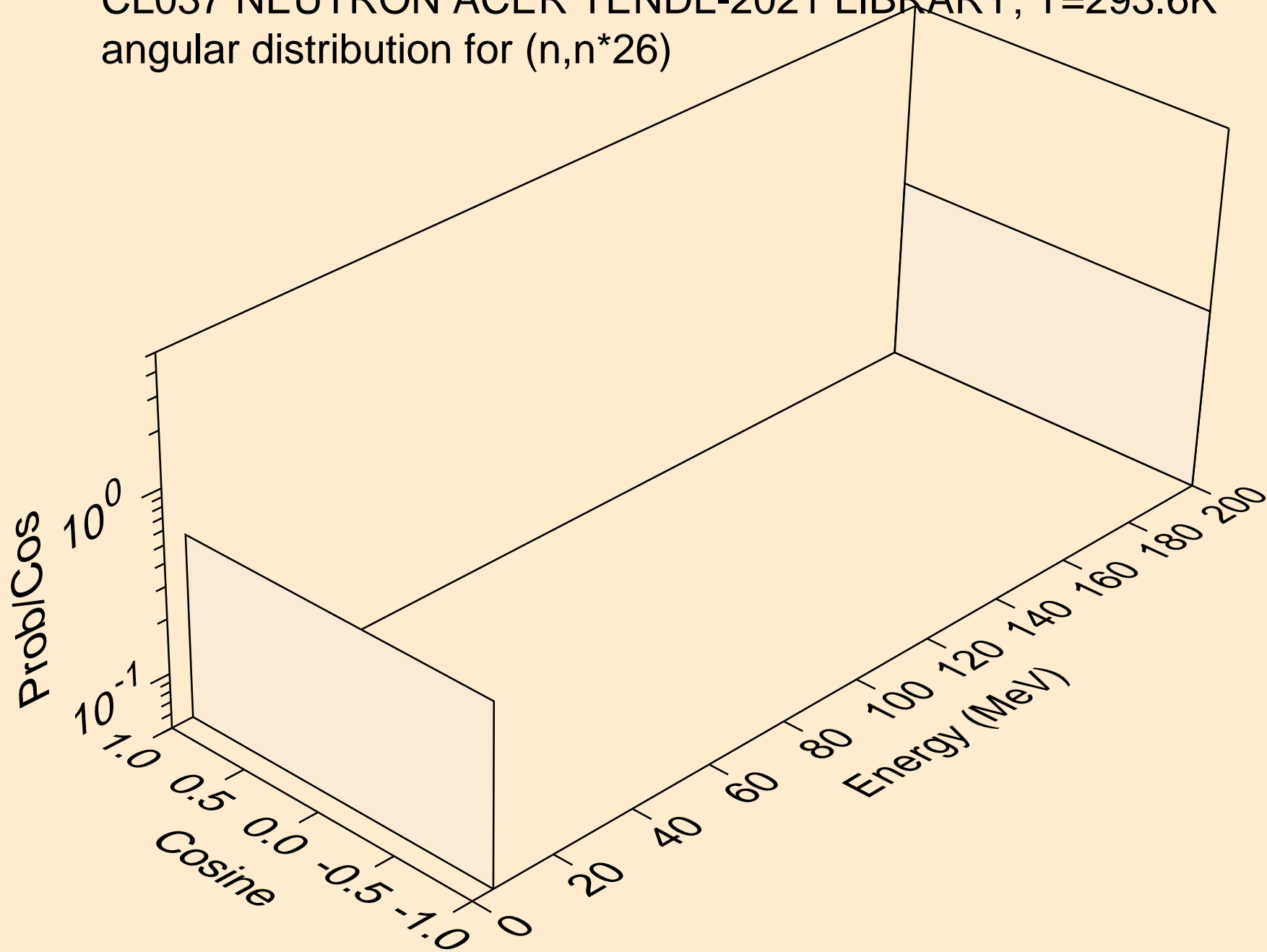

CL037 NEUTRON ACER TENDL-2021 LIBRARY; T=293.6K
angular distribution for (n,n*27)

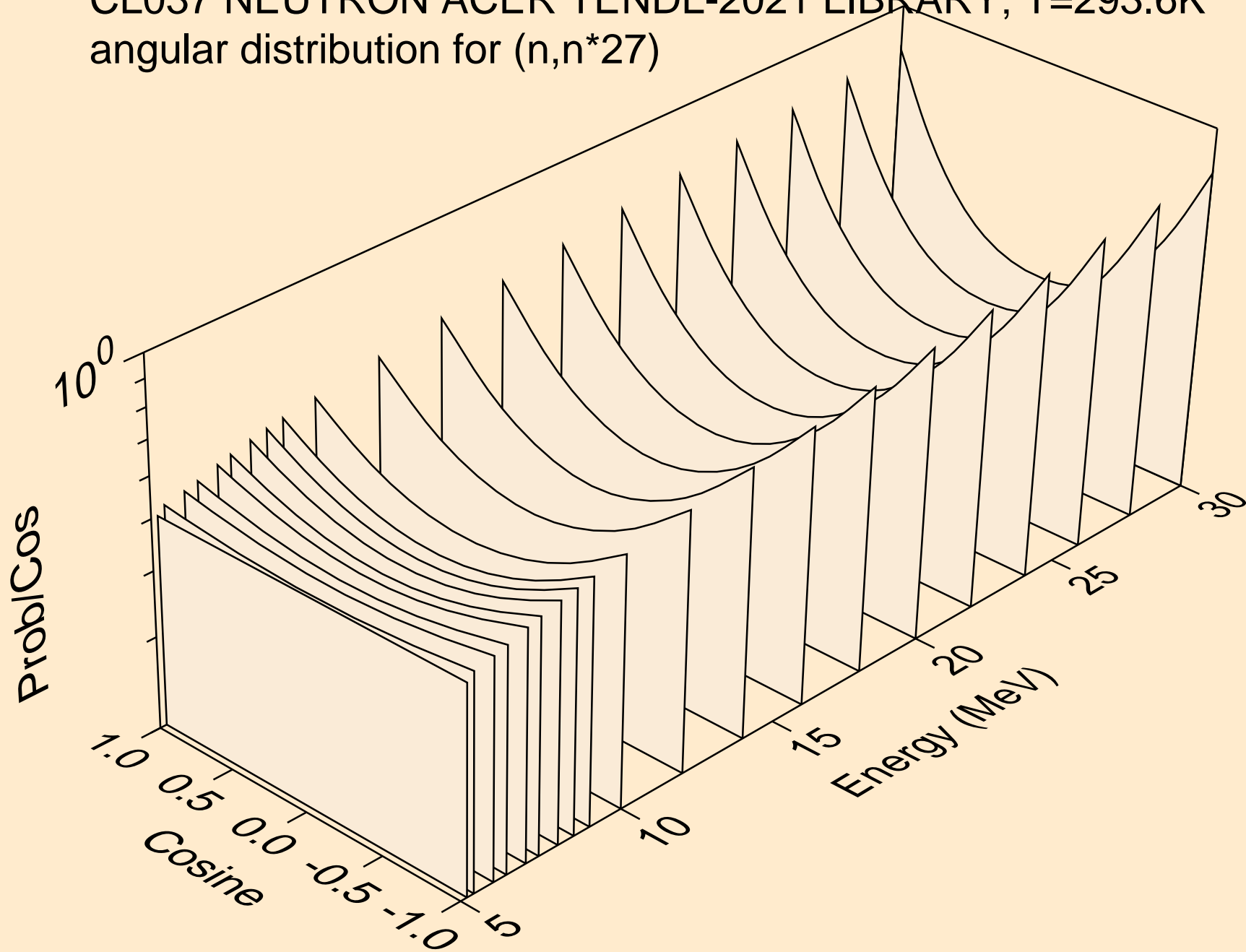

CL037 NEUTRON ACER TENDL-2021 LIBRARY; T=293.6K
angular distribution for (n,n*28)

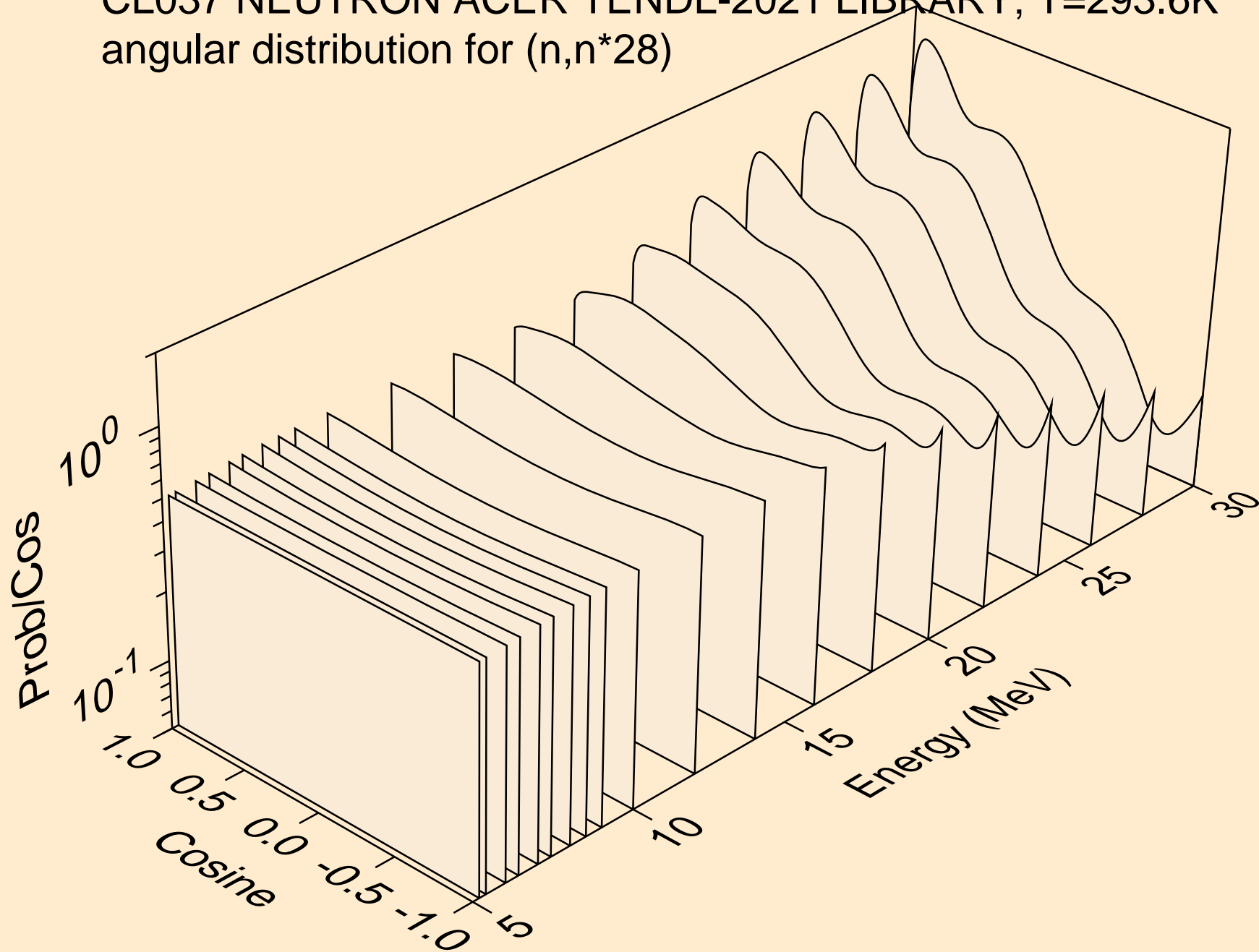

CL037 NEUTRON ACER TENDL-2021 LIBRARY; T=293.6K
angular distribution for (n,n*29)

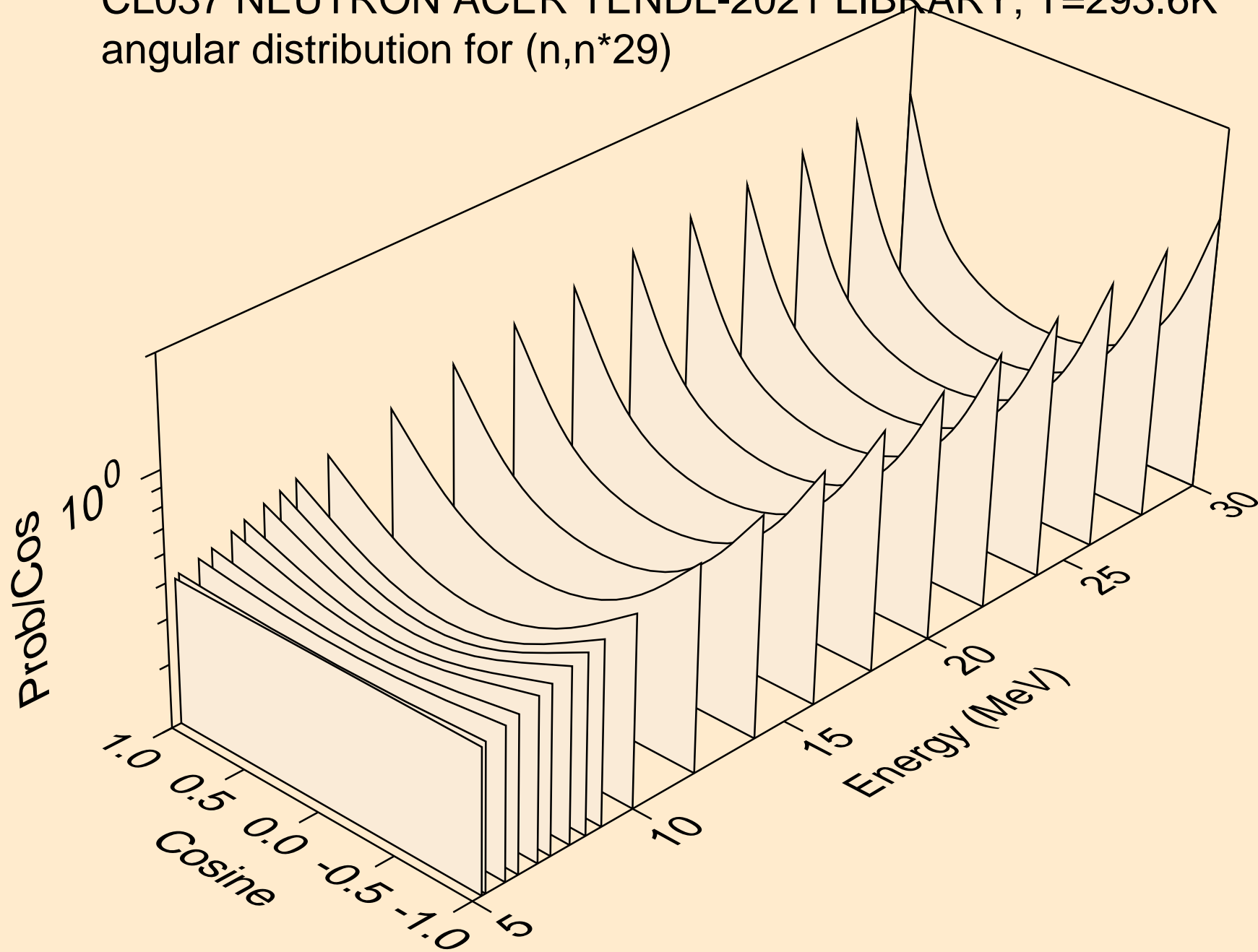

CL037 NEUTRON ACER TENDL-2021 LIBRARY; T=293.6K
angular distribution for (n,n*30)

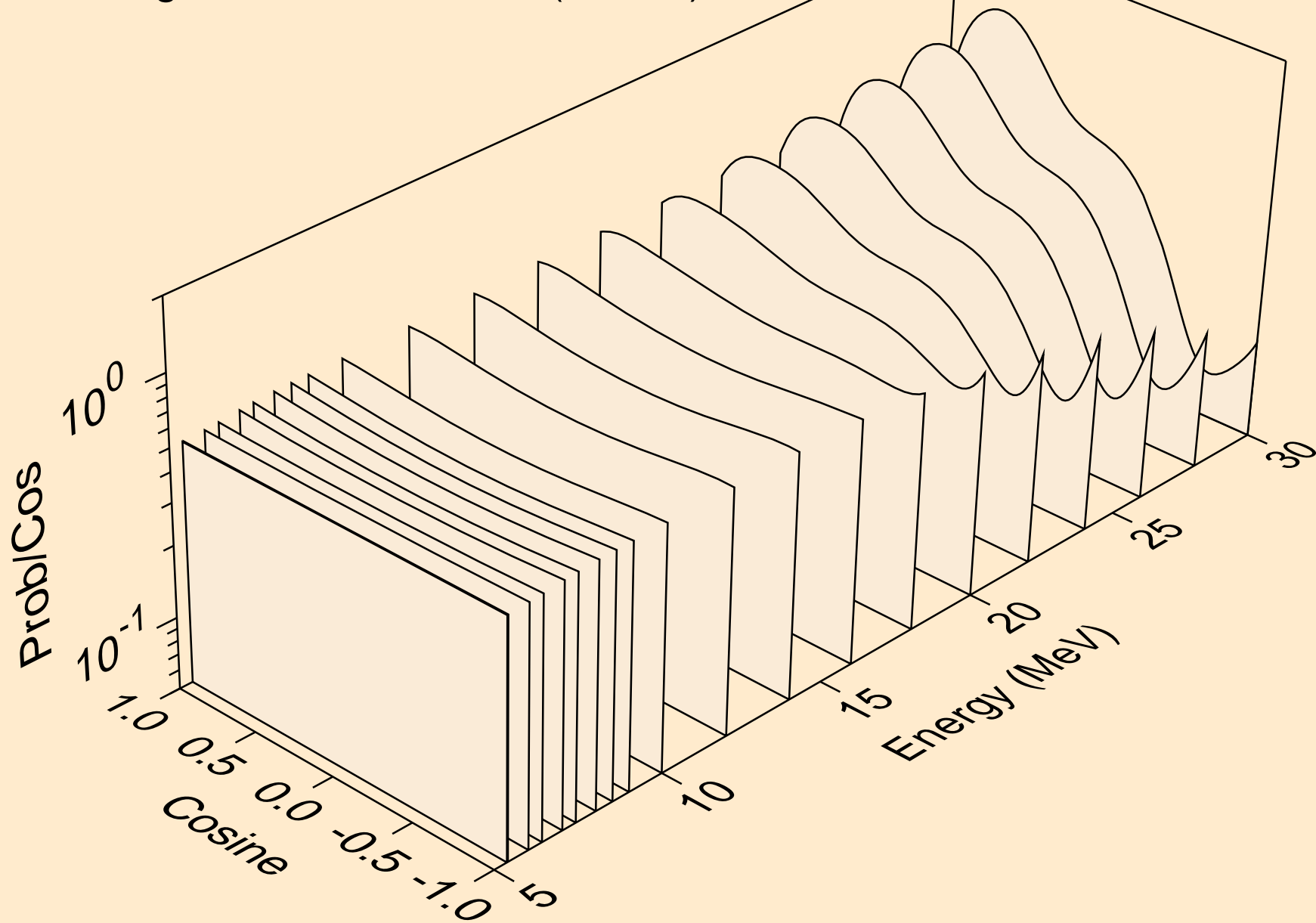

CL037 NEUTRON ACER TENDL-2021 LIBRARY; T=293.6K
Neutron emission for (n,x)

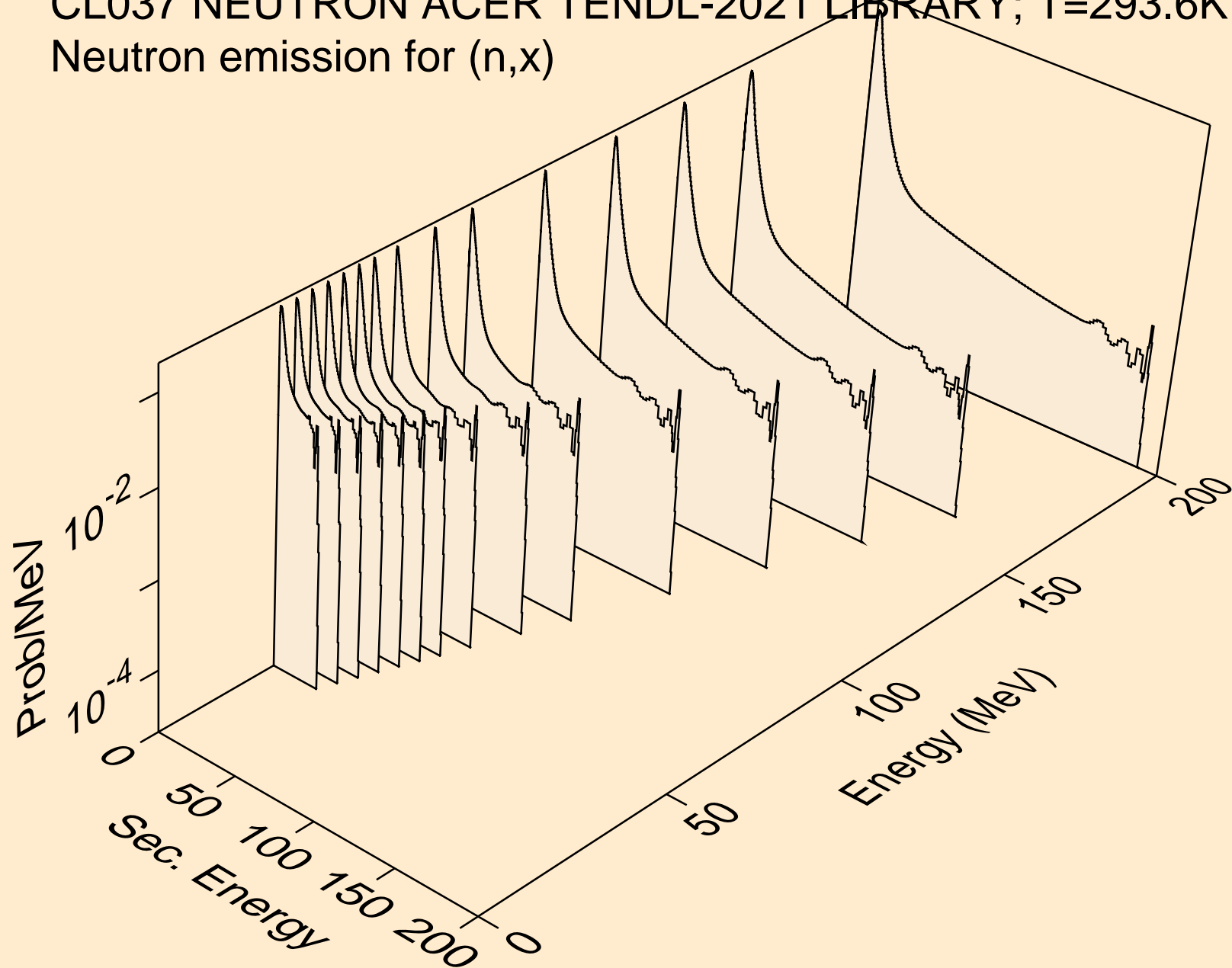

CL037 NEUTRON ACER TENDL-2021 LIBRARY; T=293.6K
Neutron emission for (n,2nd)

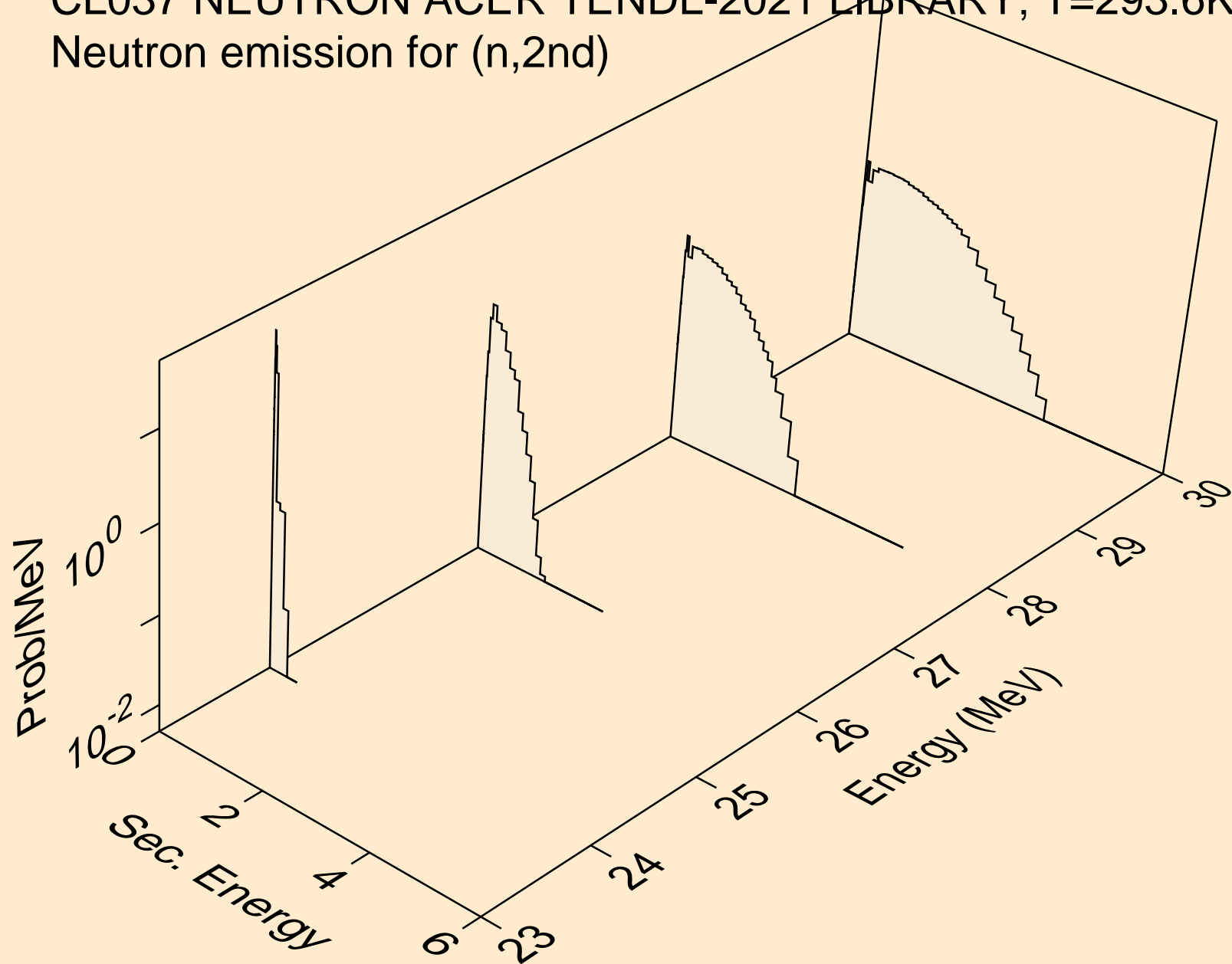

CL037 NEUTRON ACER TENDL-2021 LIBRARY; T=293.6K
Neutron emission for (n,2n)

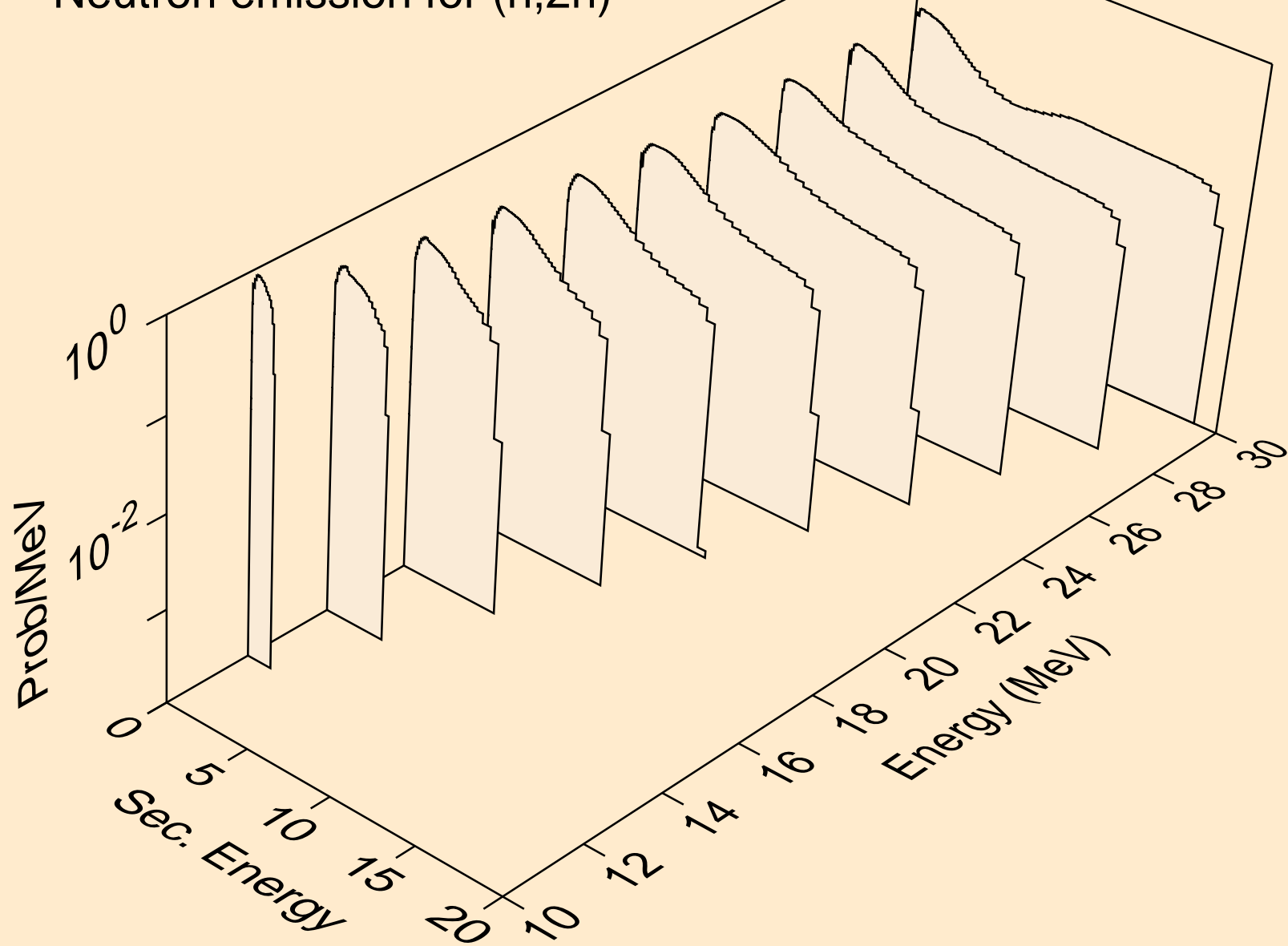

CL037 NEUTRON ACER TENDL-2021 LIBRARY; T=293.6K
Neutron emission for (n,3n)

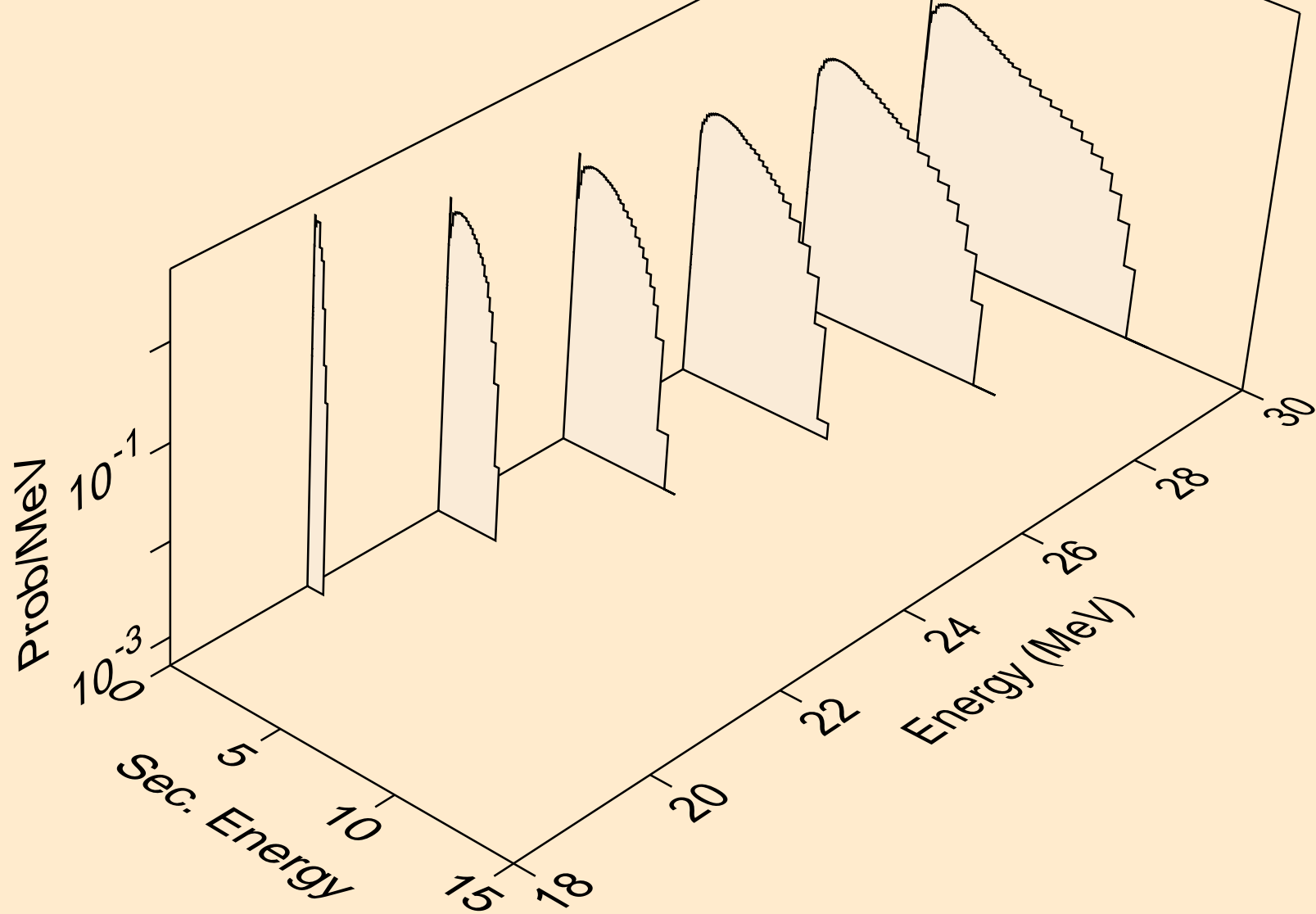

CL037 NEUTRON ACER TENDL-2021 LIBRARY; T=293.6K
Neutron emission for (n,n*)a

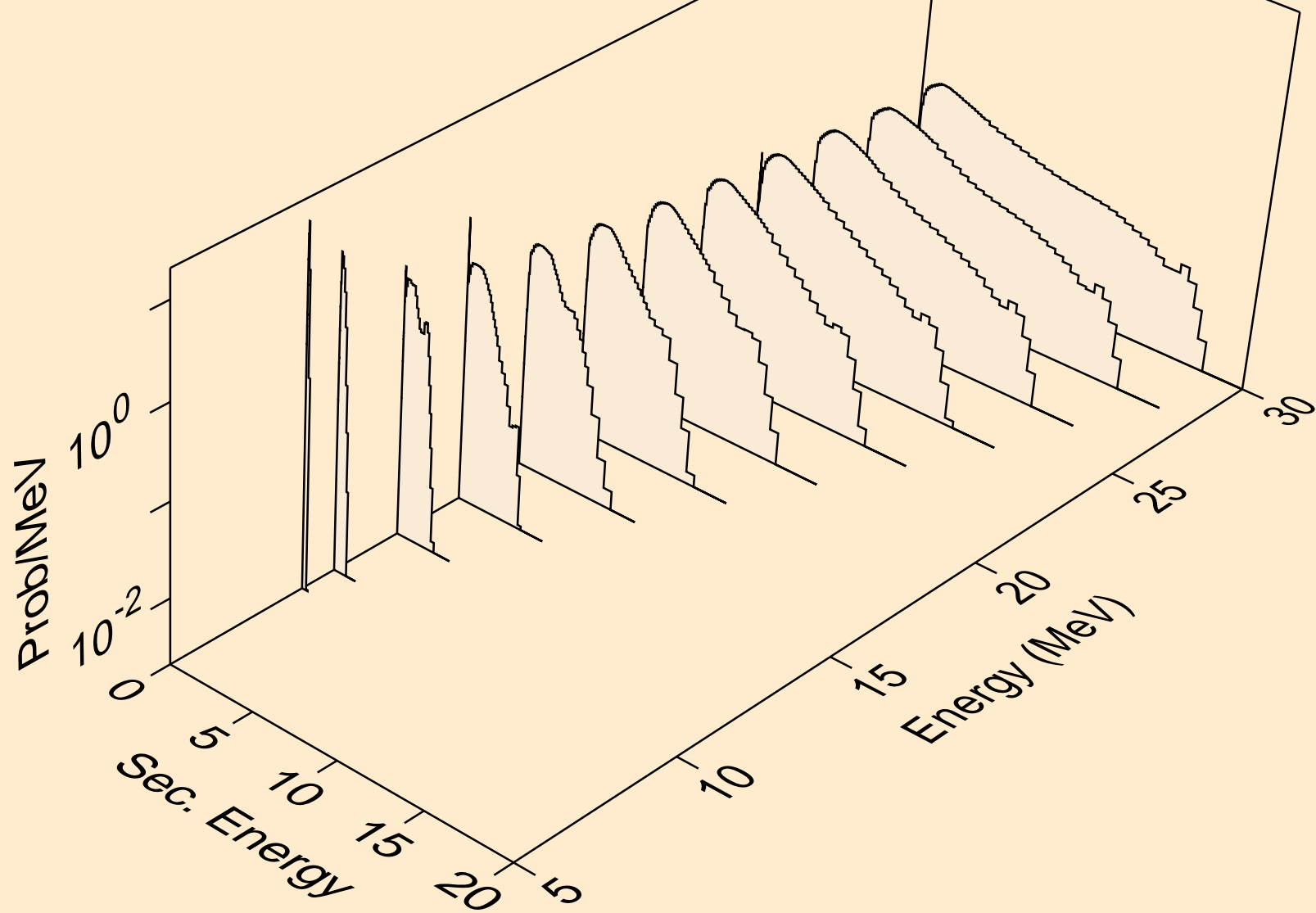

CL037 NEUTRON ACER TENDL-2021 LIBRARY; T=293.6K
Neutron emission for (n,2n)a

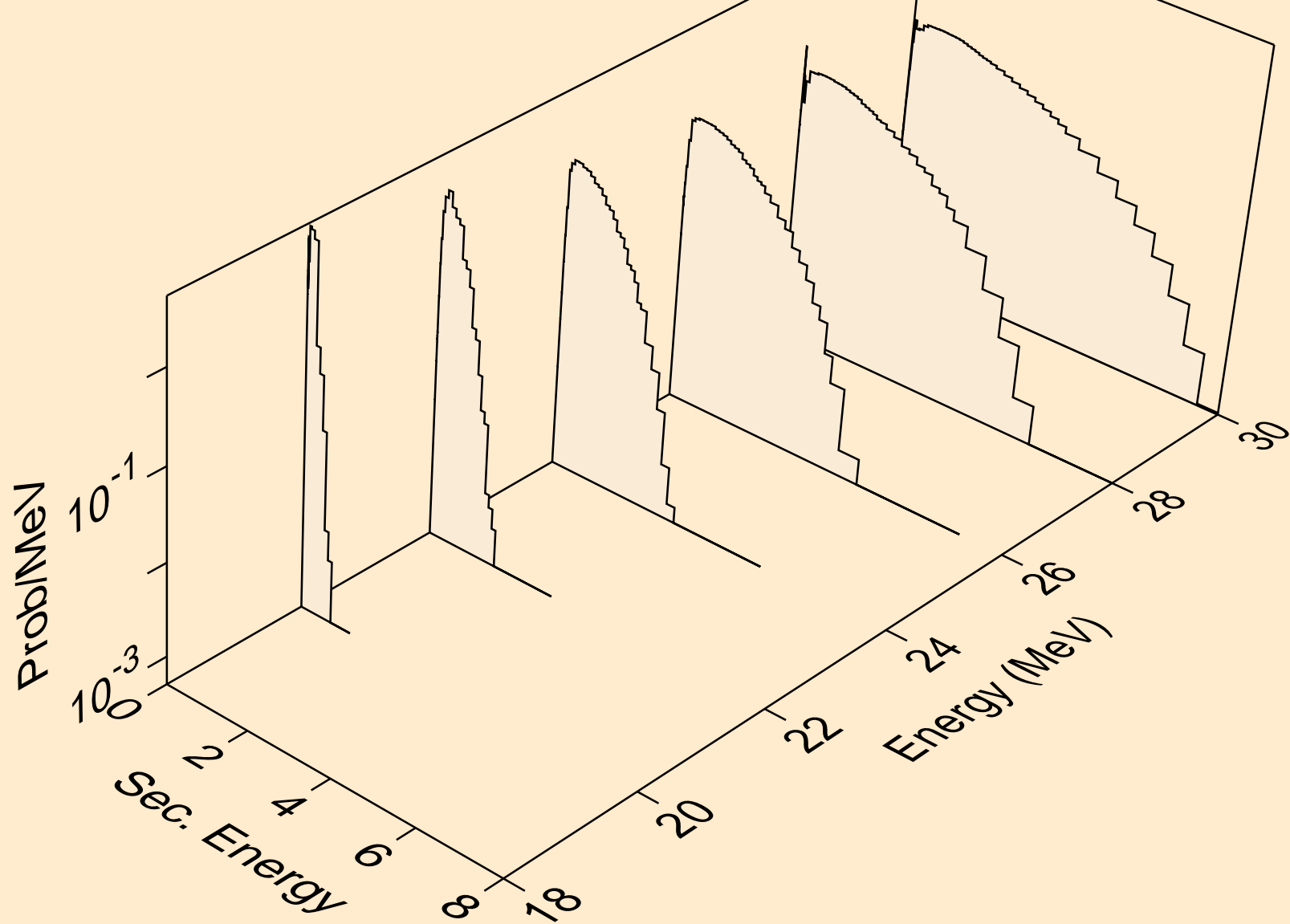

CL037 NEUTRON ACER TENDL-2021 LIBRARY; T=293.6K
Neutron emission for (n,3n)a

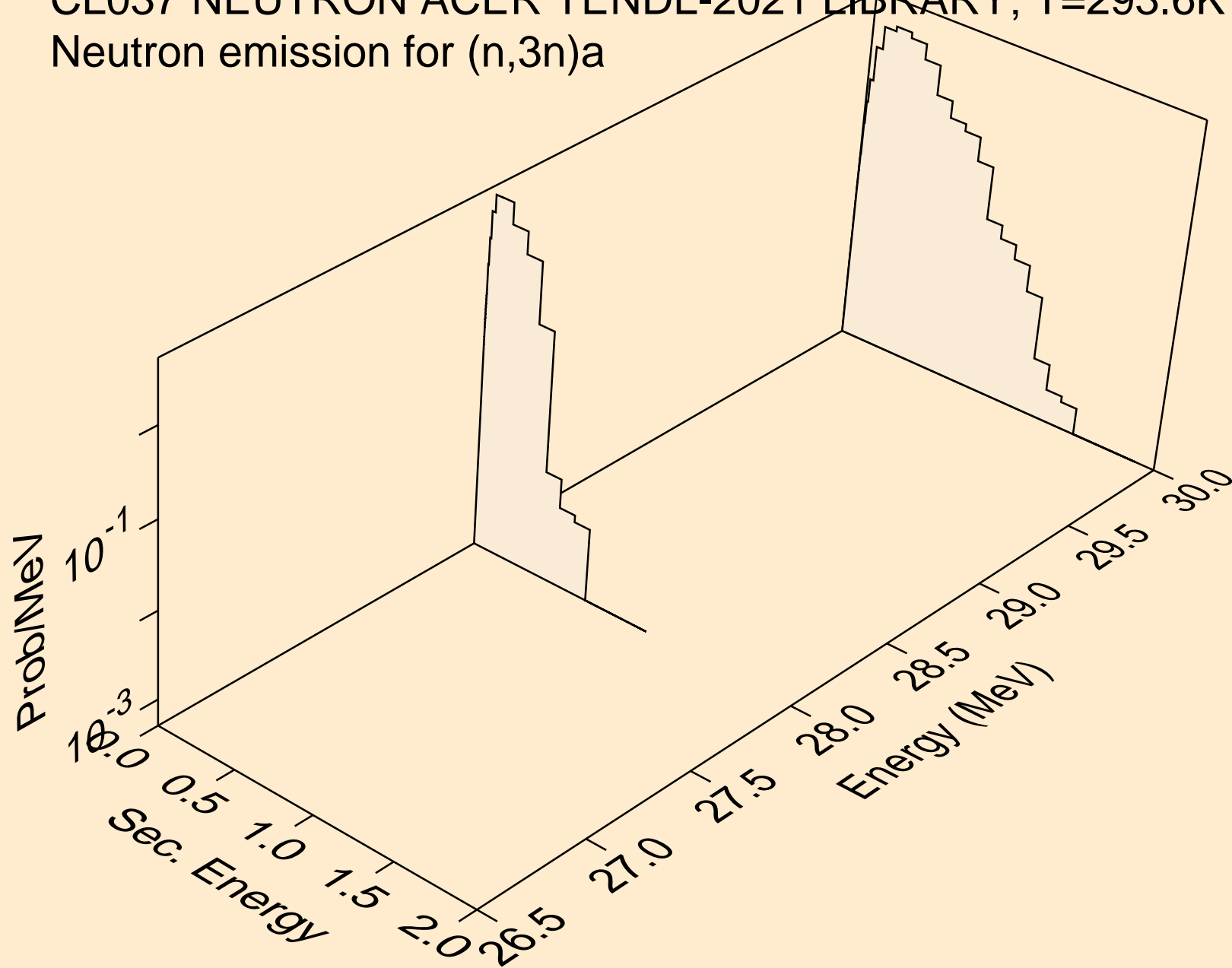

CL037 NEUTRON ACER TENDL-2021 LIBRARY; T=293.6K
Neutron emission for (n,n*)p

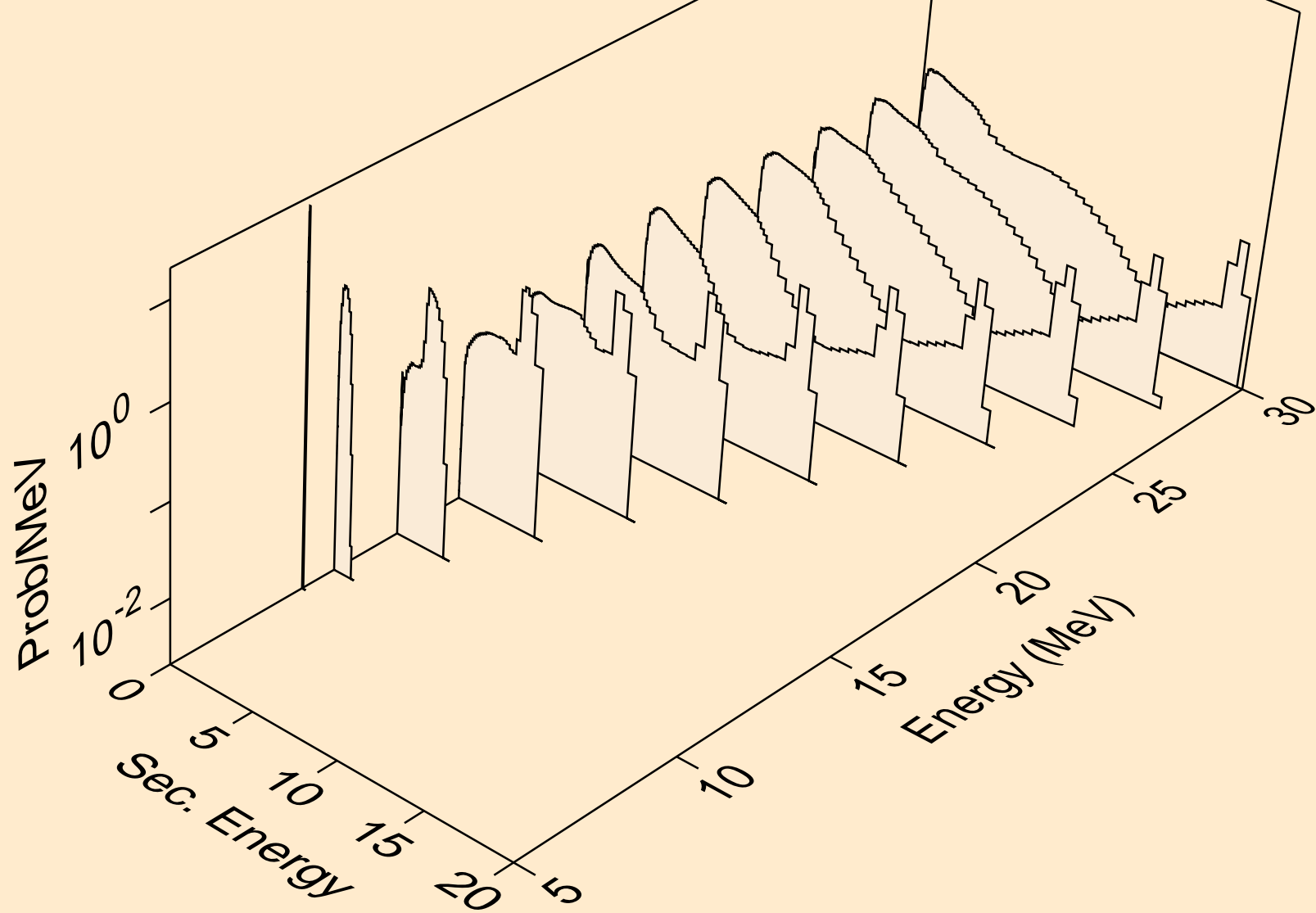

CL037 NEUTRON ACER TENDL-2021 LIBRARY; T=293.6K
Neutron emission for (n,n*)2a

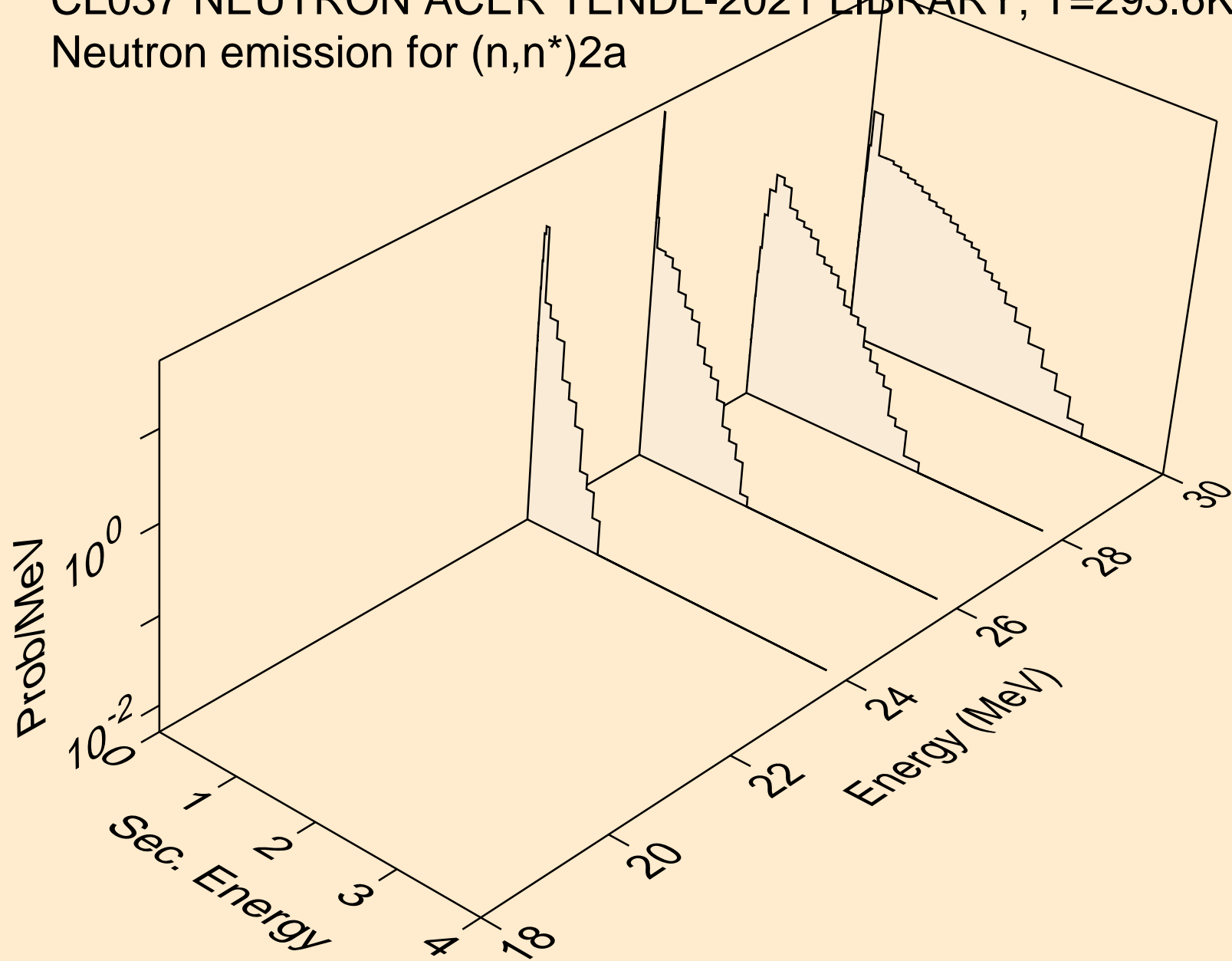

CL037 NEUTRON ACER TENDL-2021 LIBRARY; T=293.6K
Neutron emission for (n,n*)d

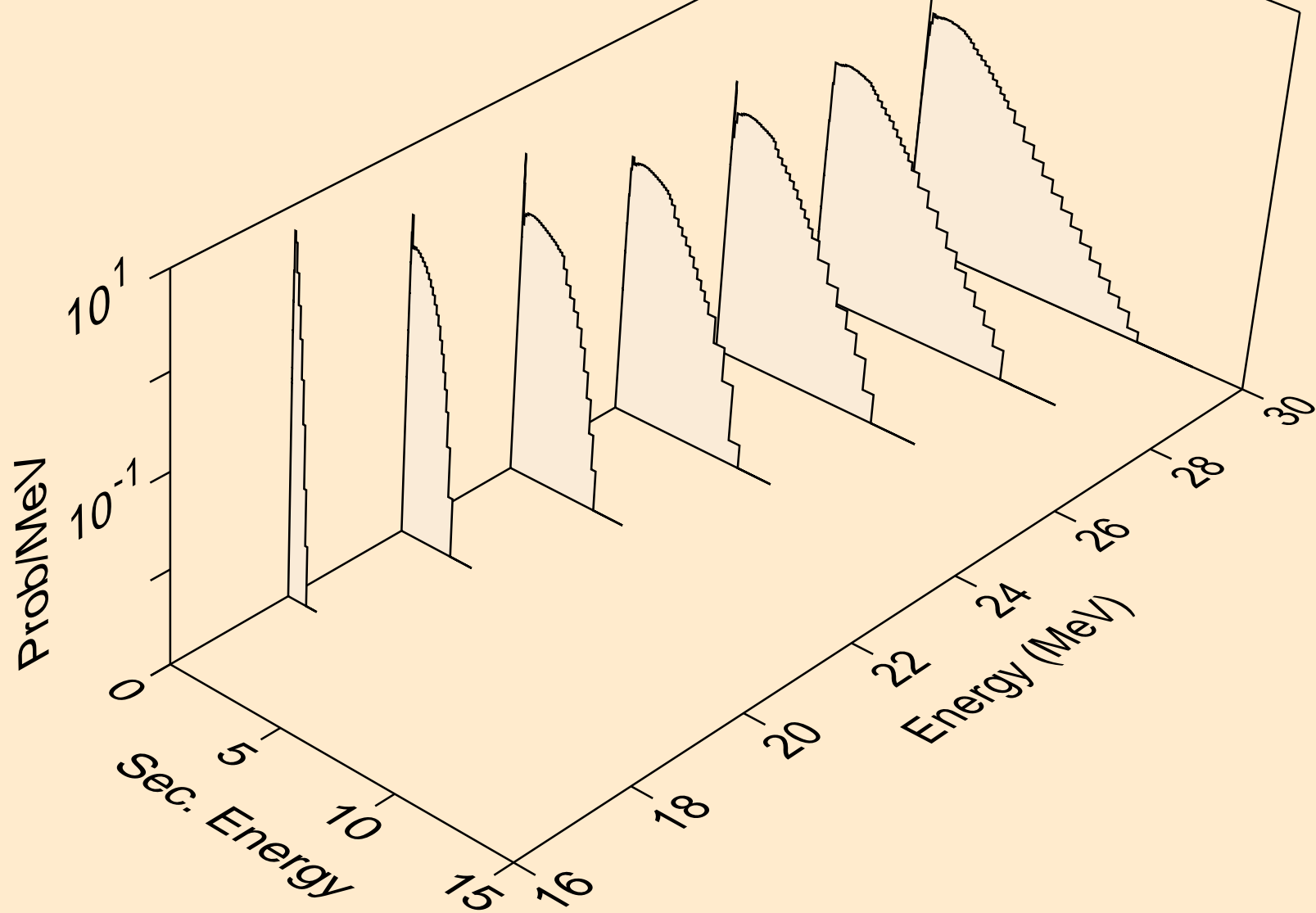

CL037 NEUTRON ACER TENDL-2021 LIBRARY; T=293.6K
Neutron emission for (n,n*)t

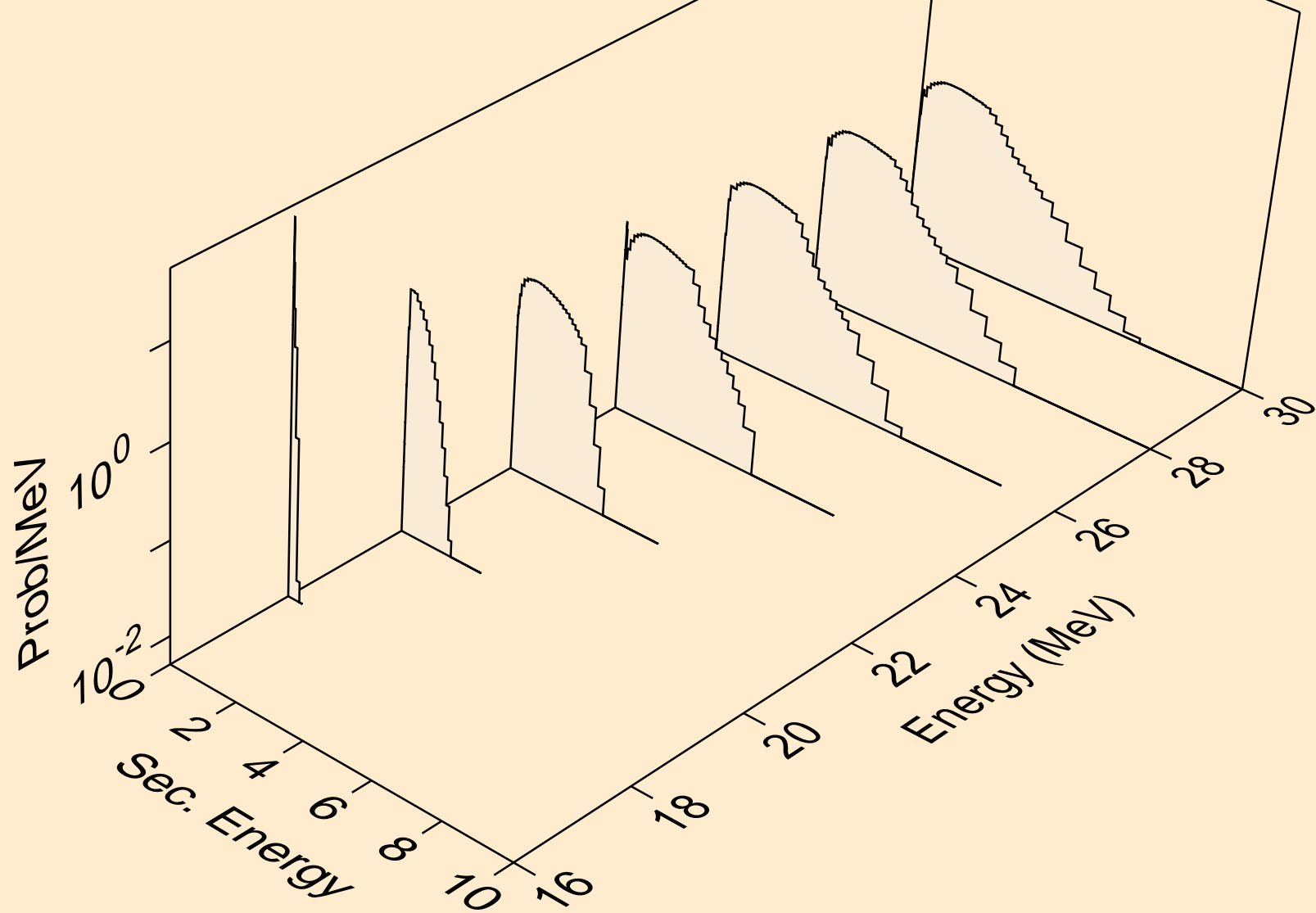

CL037 NEUTRON ACER TENDL-2021 LIBRARY; T=293.6K
Neutron emission for (n,n*)he3

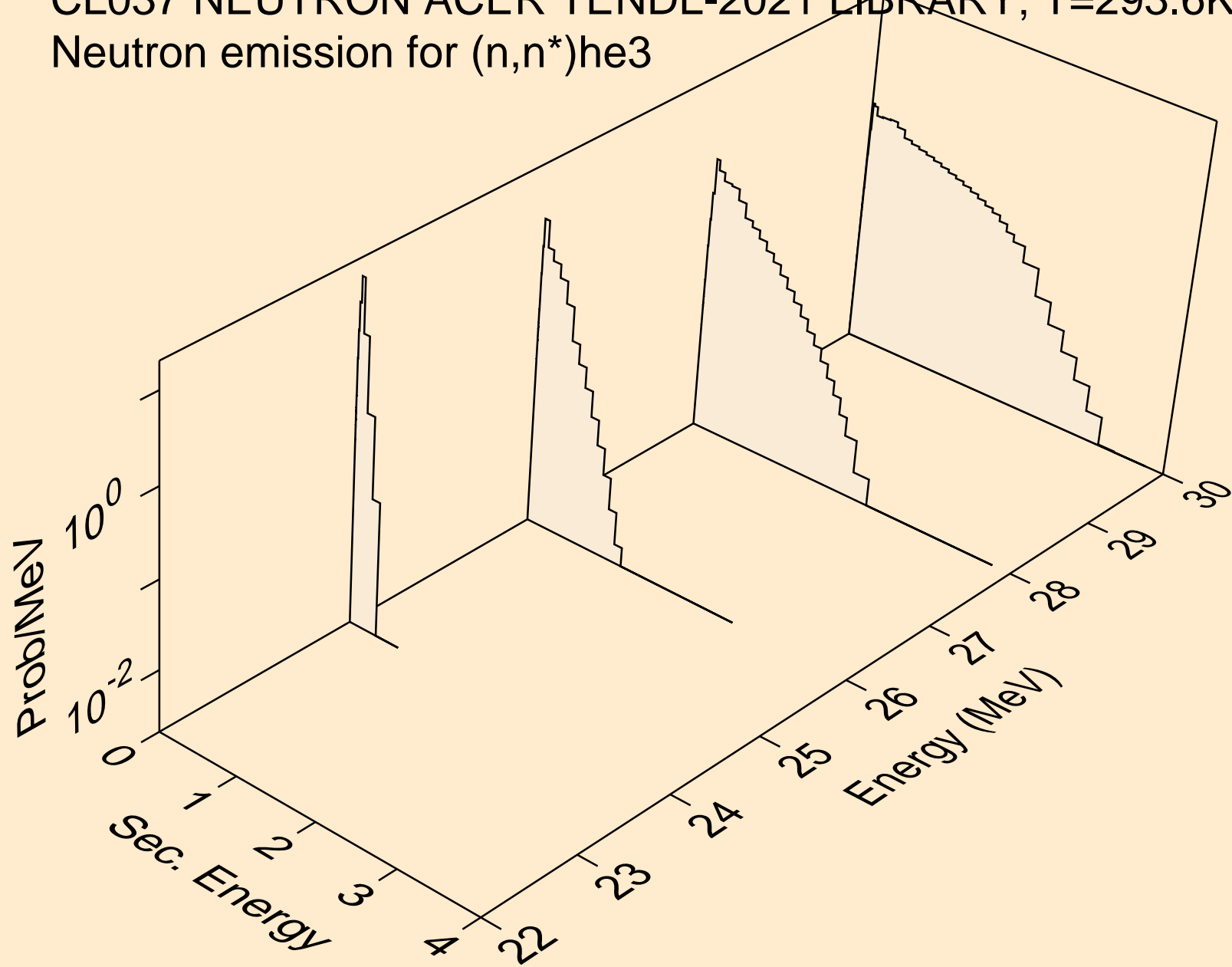

CL037 NEUTRON ACER TENDL-2021 LIBRARY; T=293.6K
Neutron emission for (n,2np)

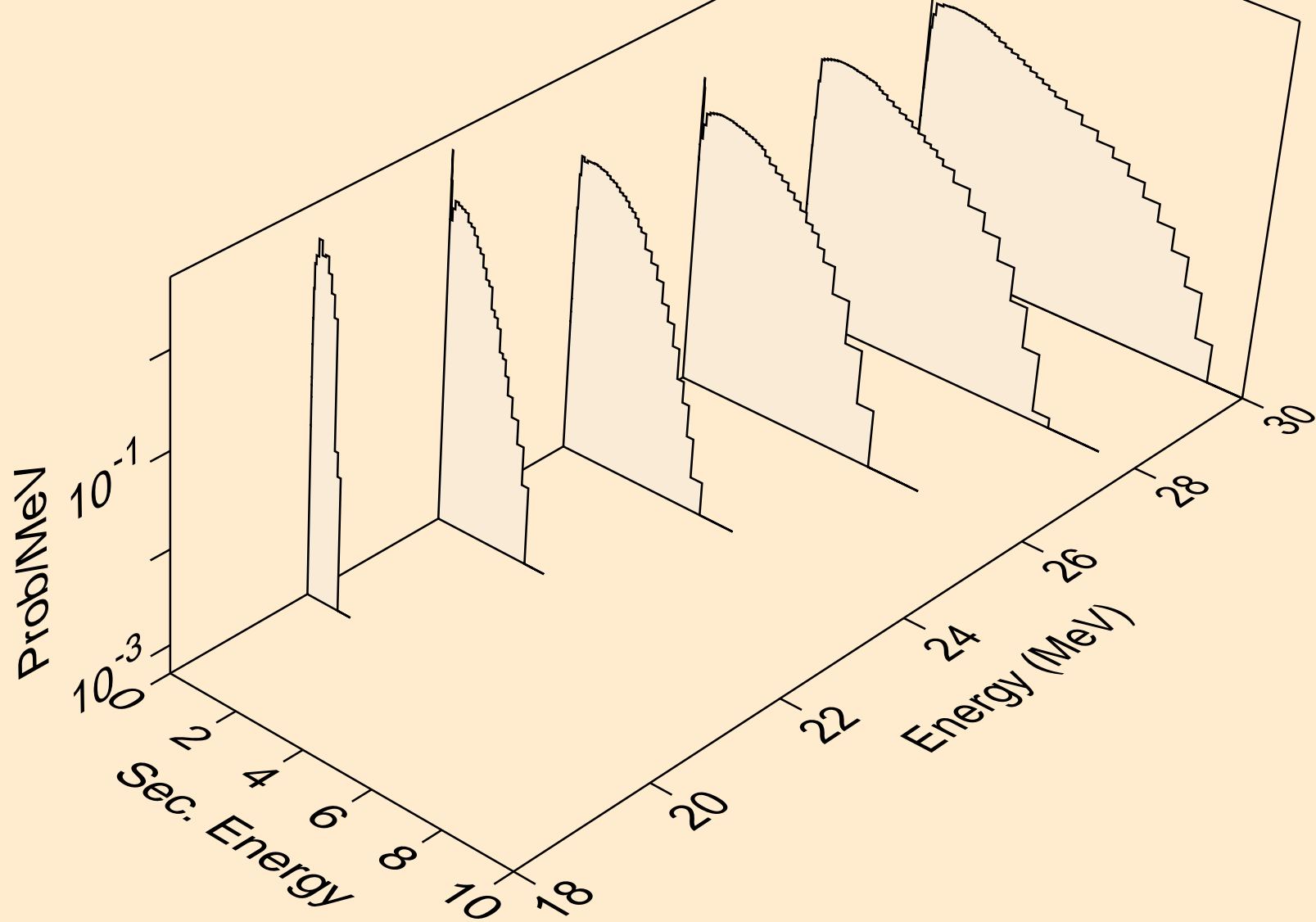

CL037 NEUTRON ACER TENDL-2021 LIBRARY; T=293.6K
Neutron emission for (n,3np)

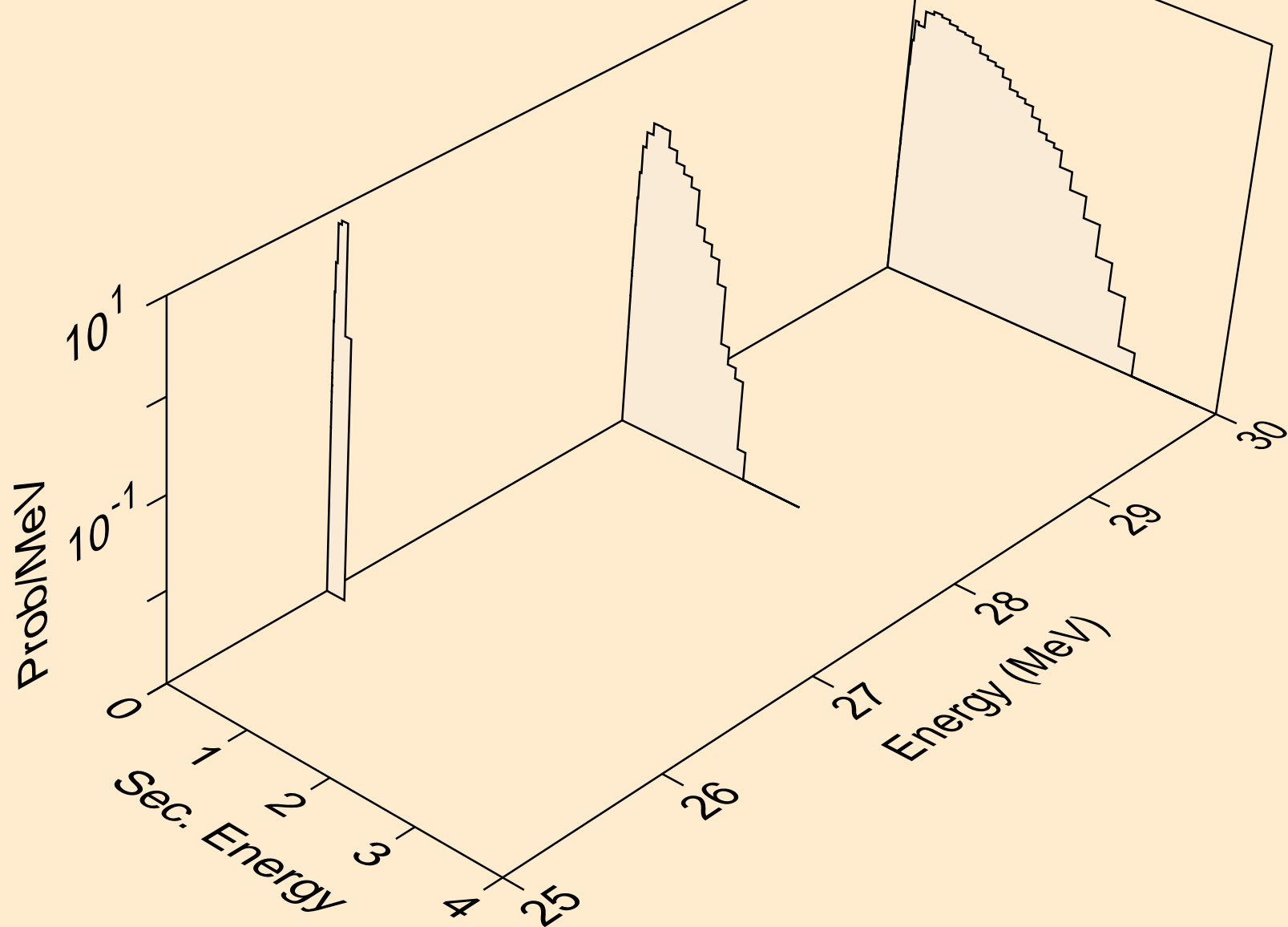

CL037 NEUTRON ACER TENDL-2021 LIBRARY; T=293.6K
Neutron emission for (n,2np)

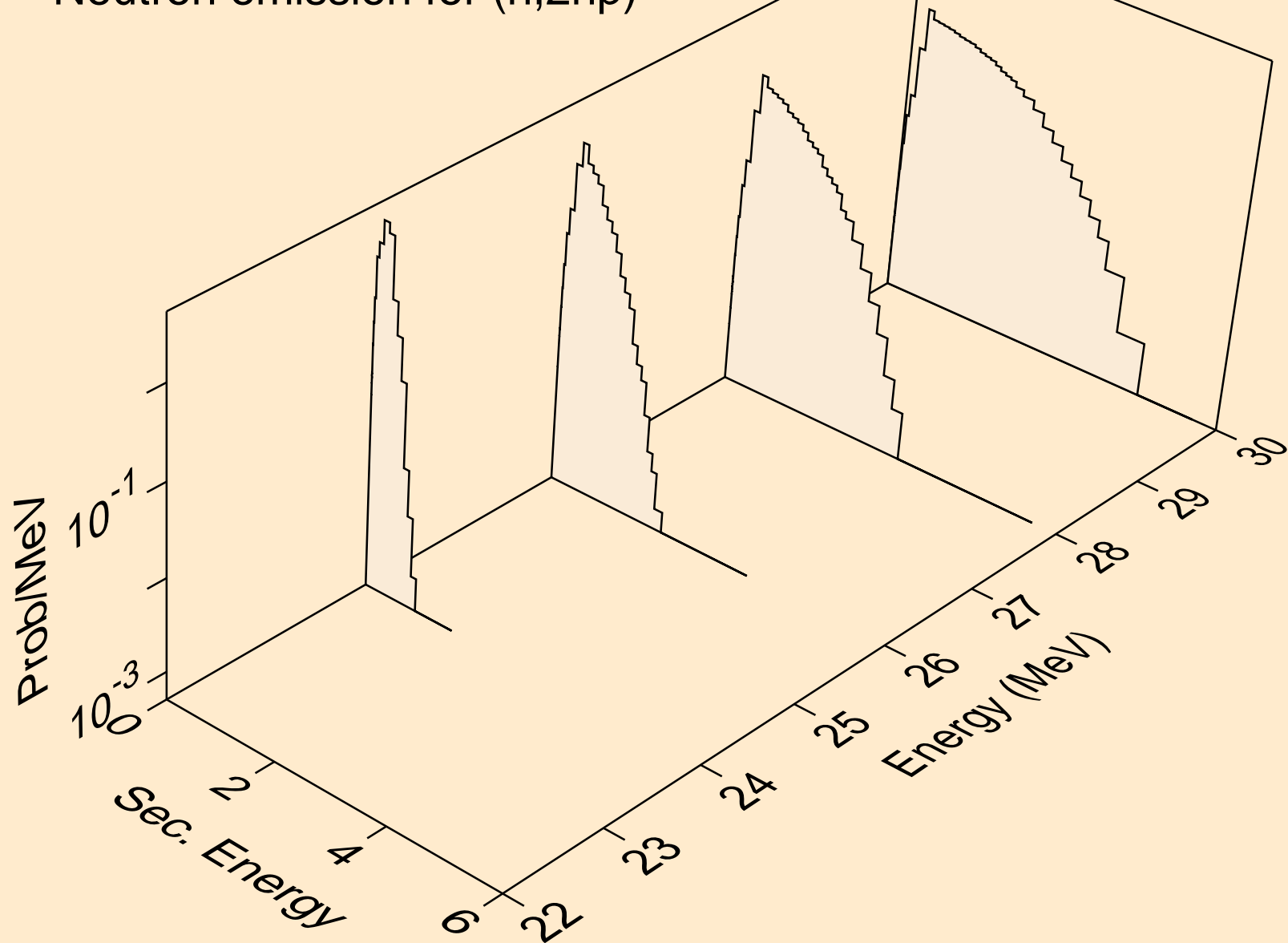

CL037 NEUTRON ACER TENDL-2021 LIBRARY; T=293.6K
Neutron emission for (n,npa)

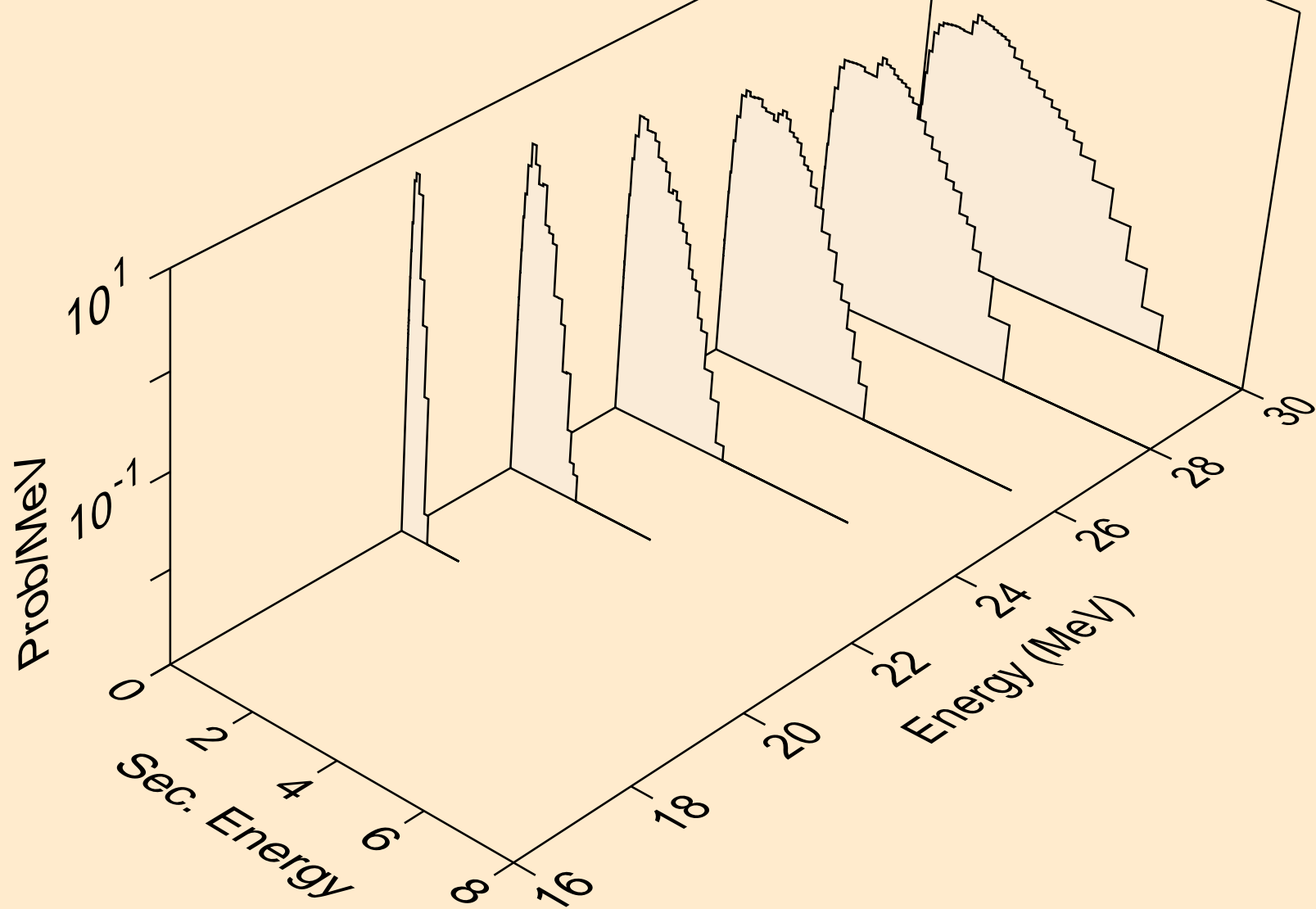

CL037 NEUTRON ACER TENDL-2021 LIBRARY; T=293.6K
Neutron emission for (n,n*c)

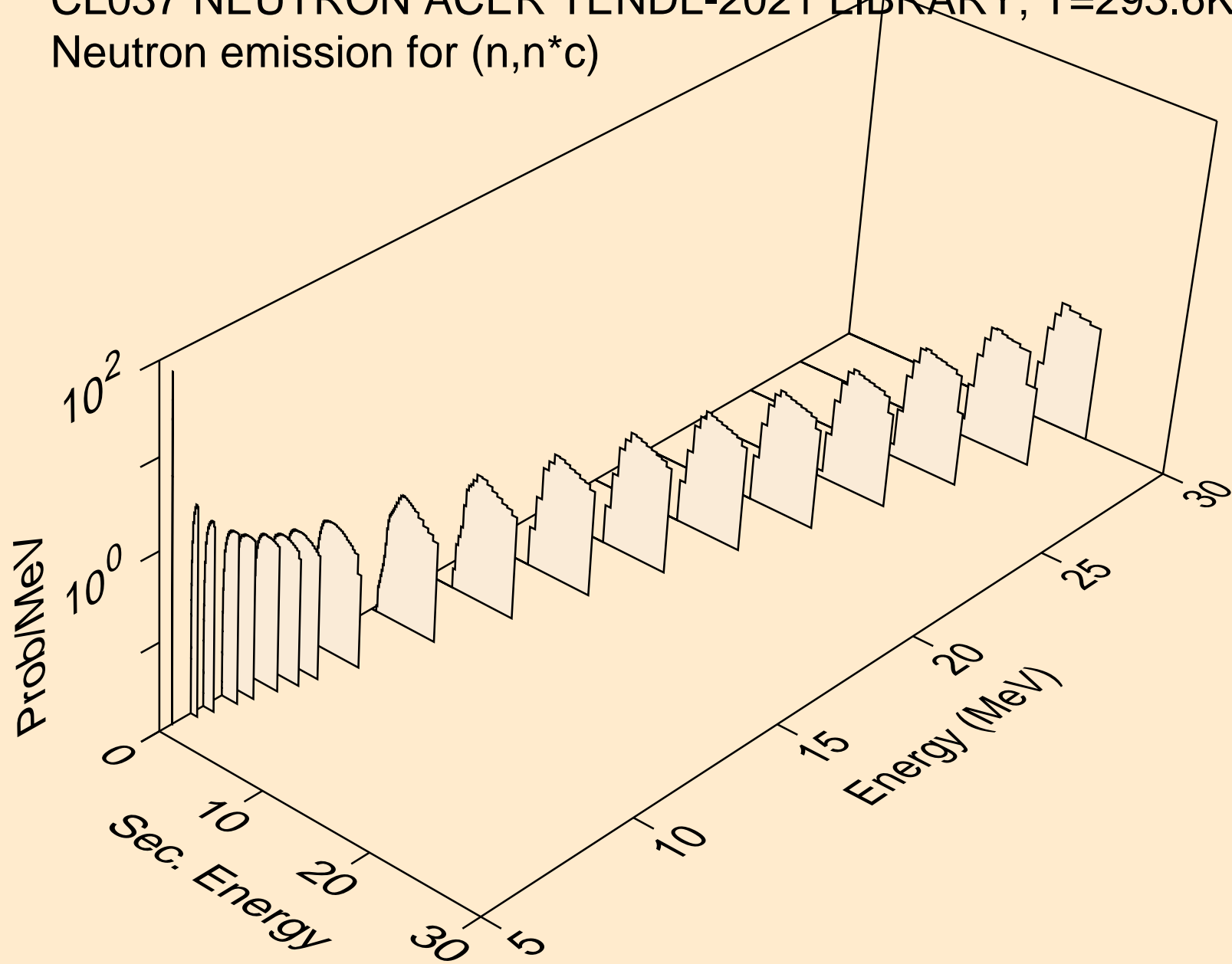

CL037 NEUTRON ACER TENDL-2021 LIBRARY; T=293.6K
Photon emission for (n,x)

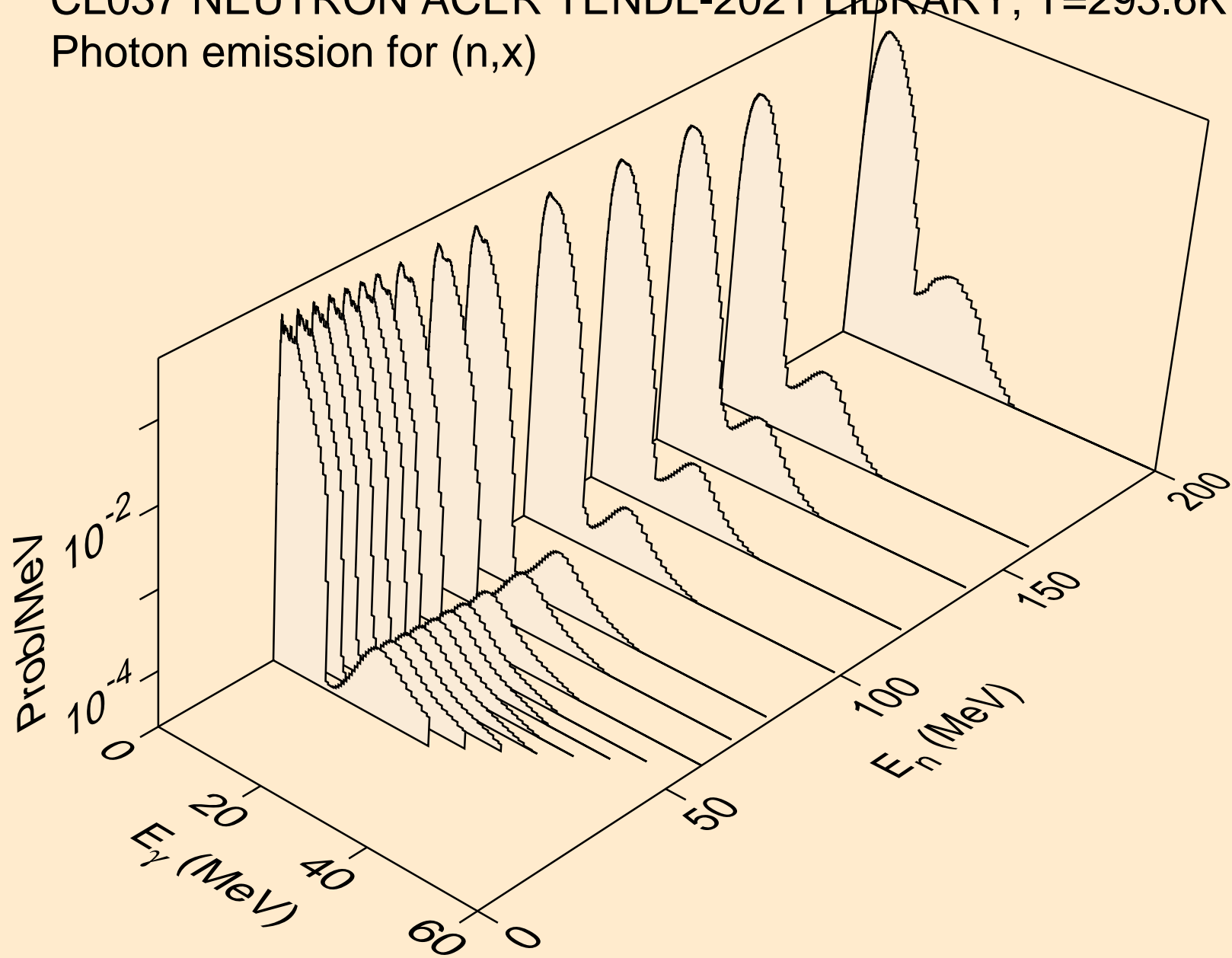

CL037 NEUTRON ACER TENDL-2021 LIBRARY; T=293.6K
Photon emission for (n,2nd)

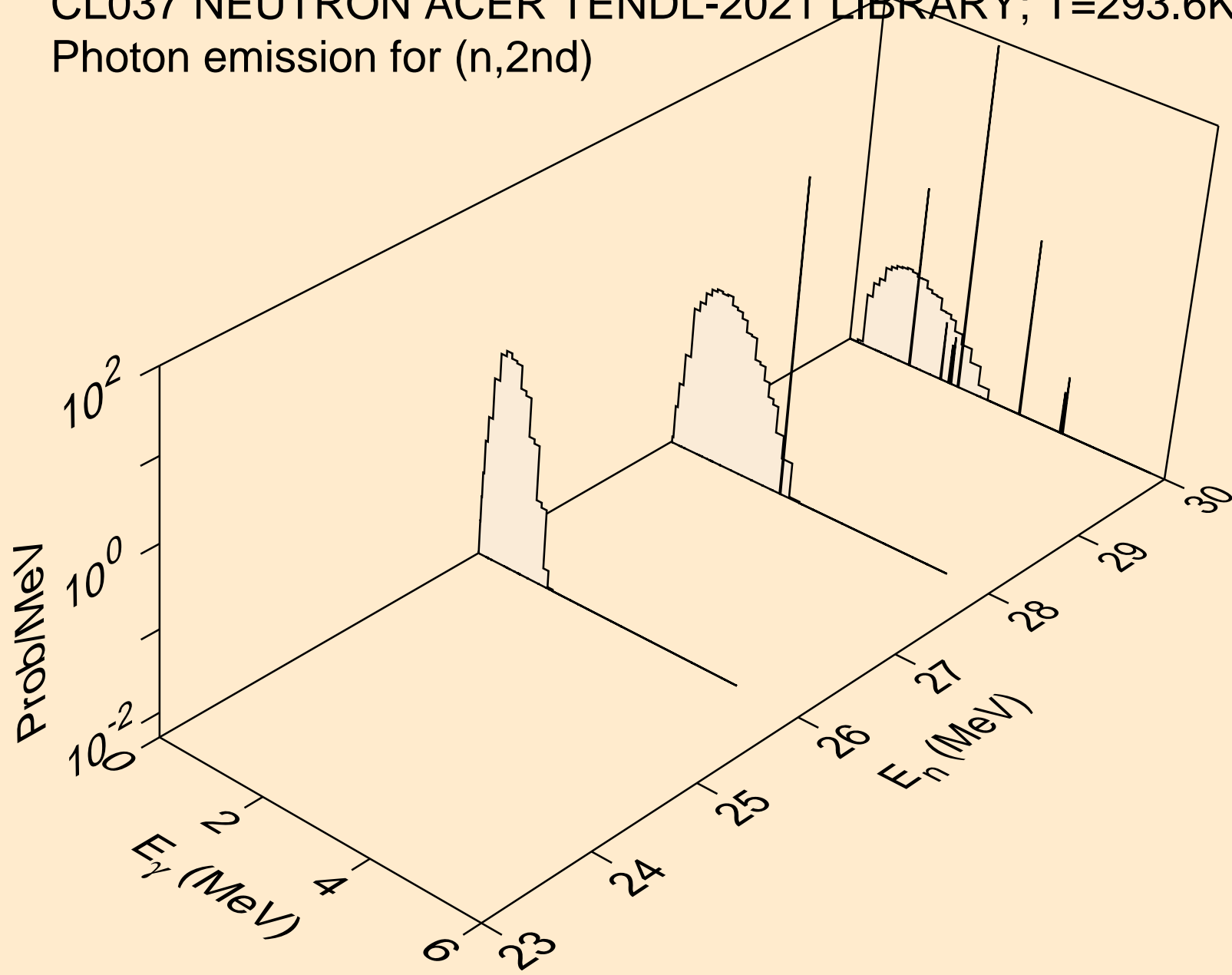

CL037 NEUTRON ACER TENDL-2021 LIBRARY; T=293.6K
Photon emission for (n,2n)

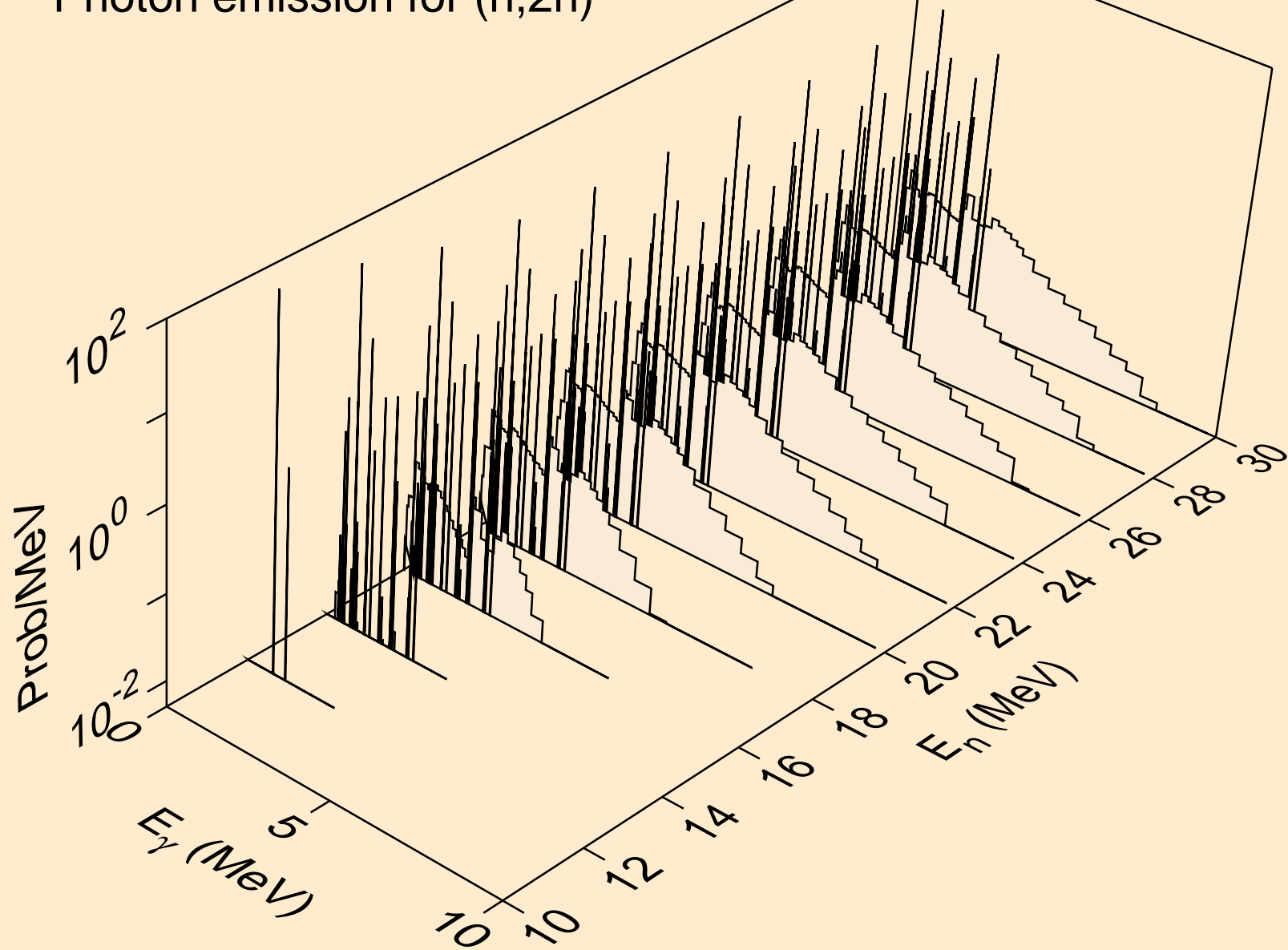

CL037 NEUTRON ACER TENDL-2021 LIBRARY; T=293.6K
Photon emission for (n,3n)

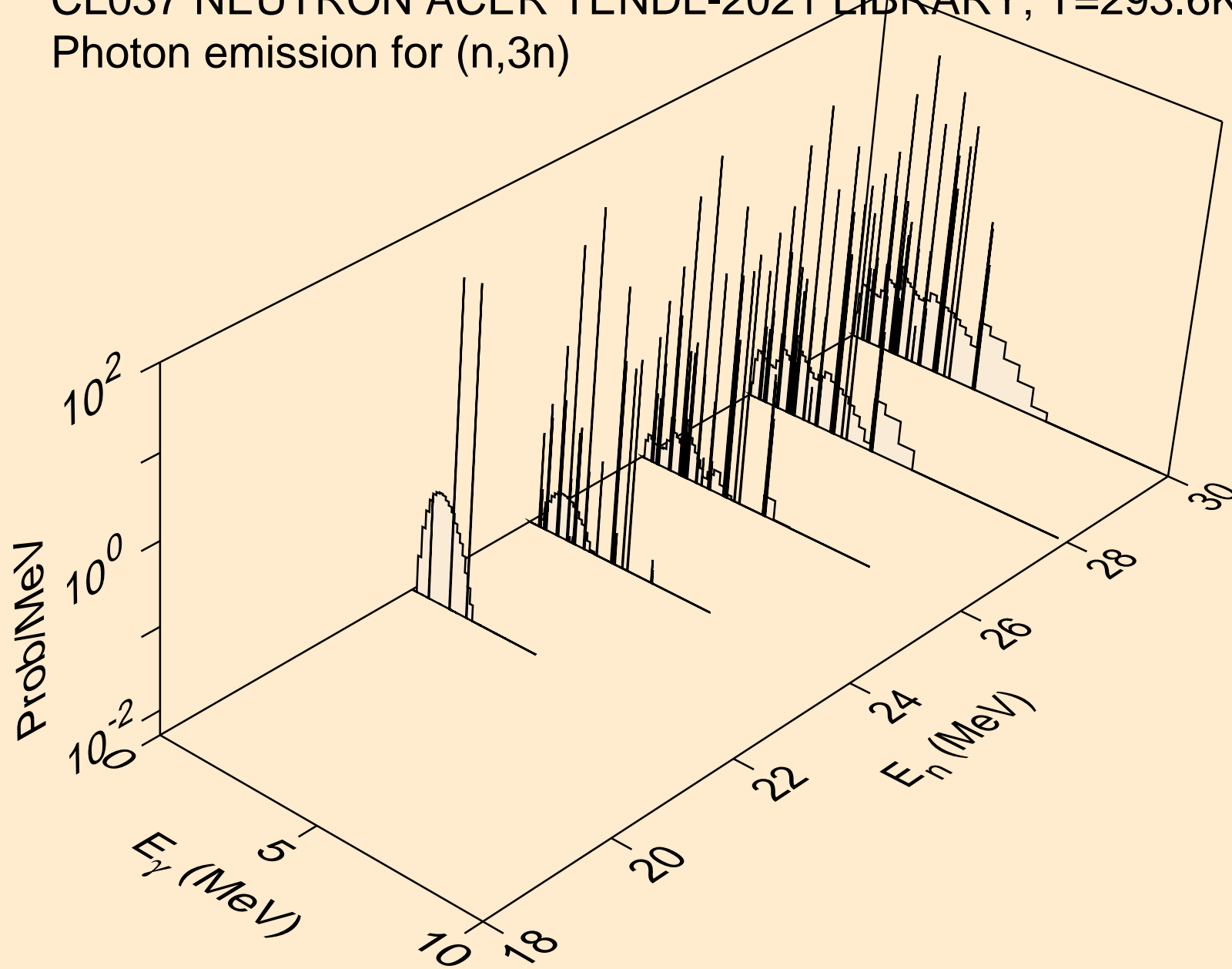

CL037 NEUTRON ACER TENDL-2021 LIBRARY; T=293.6K
Photon emission for (n,n*)a

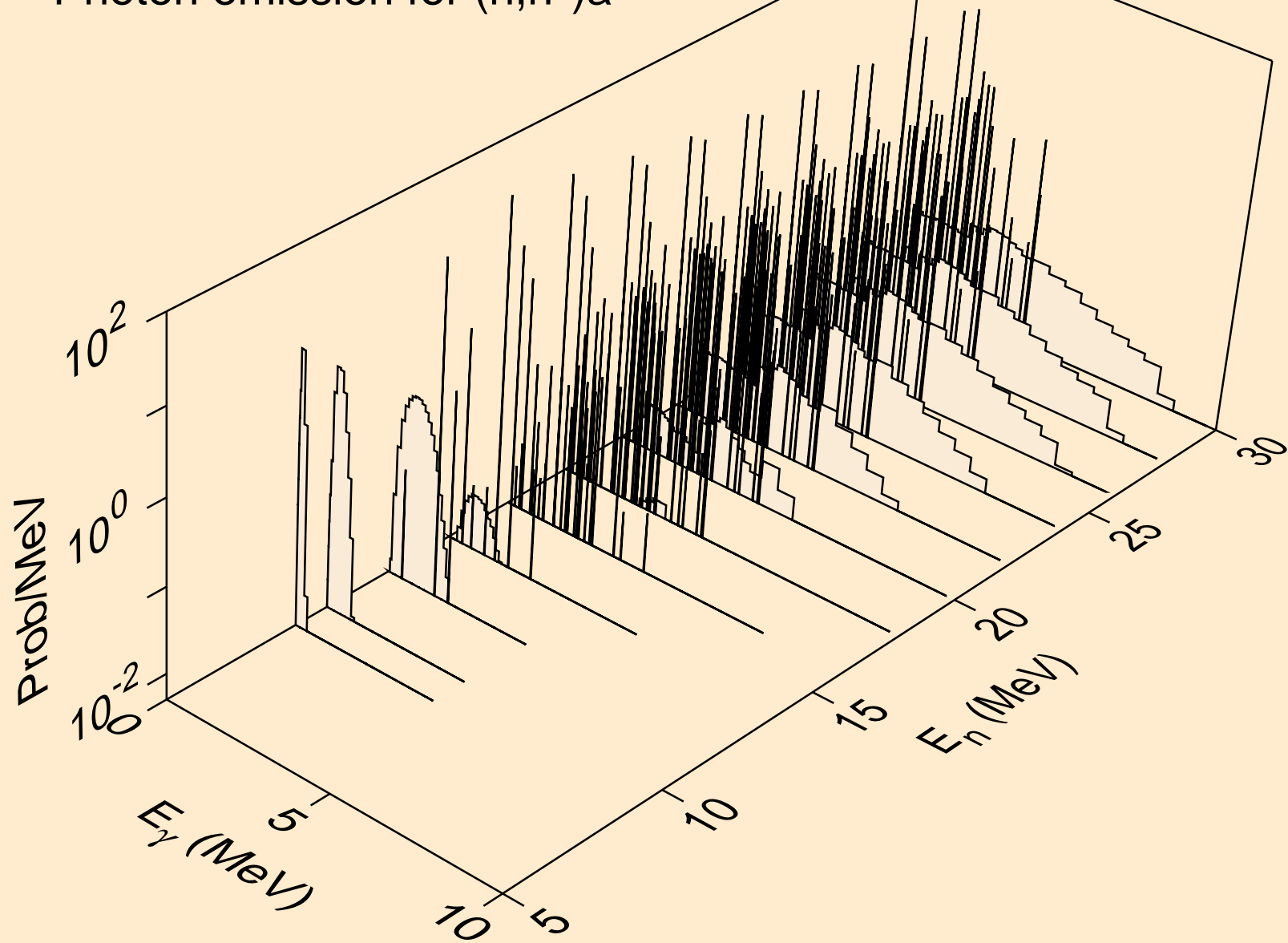

CL037 NEUTRON ACER TENDL-2021 LIBRARY; T=293.6K
Photon emission for (n,2n)a

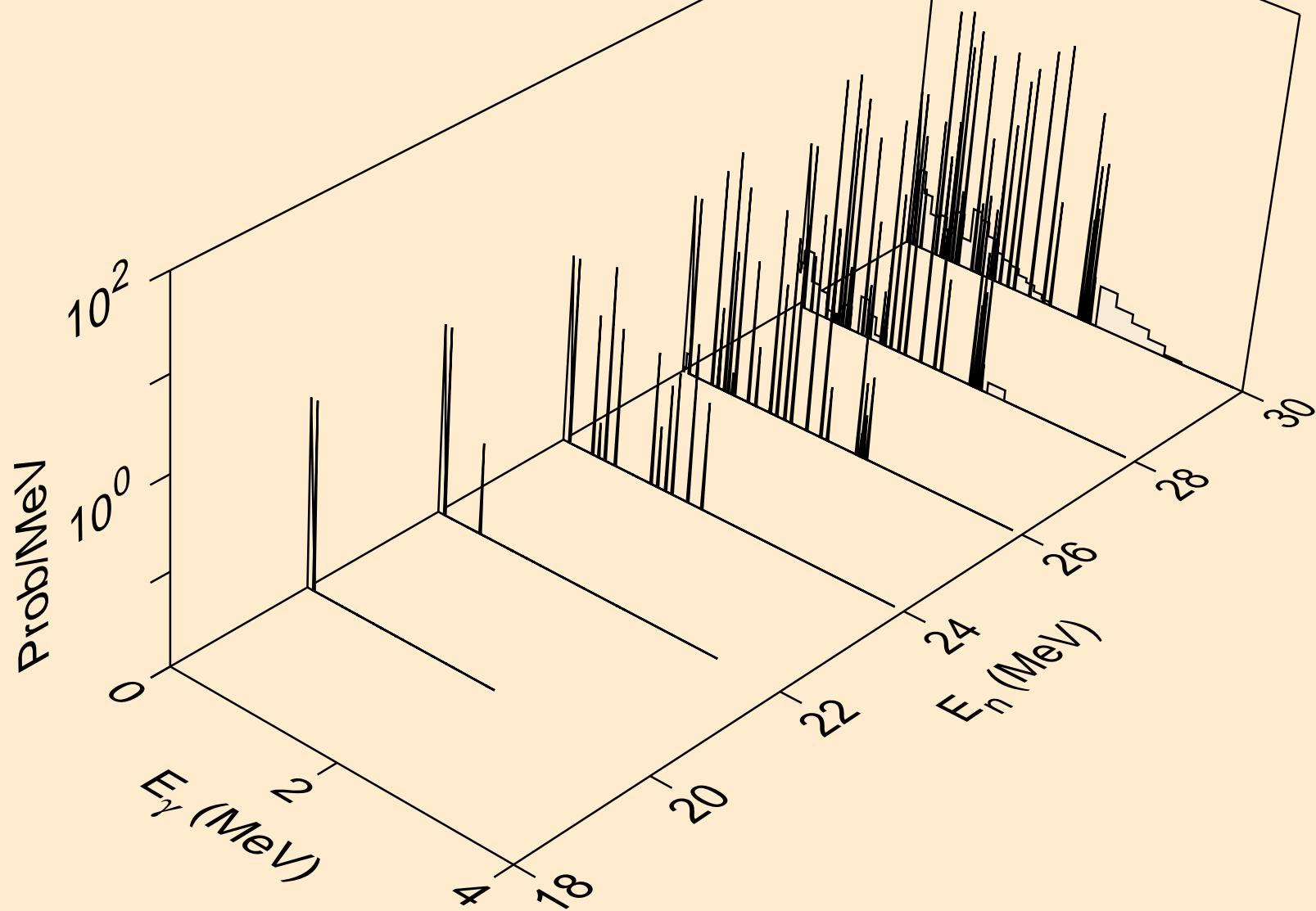

CL037 NEUTRON ACER TENDL-2021 LIBRARY; T=293.6K
Photon emission for (n,3n)a

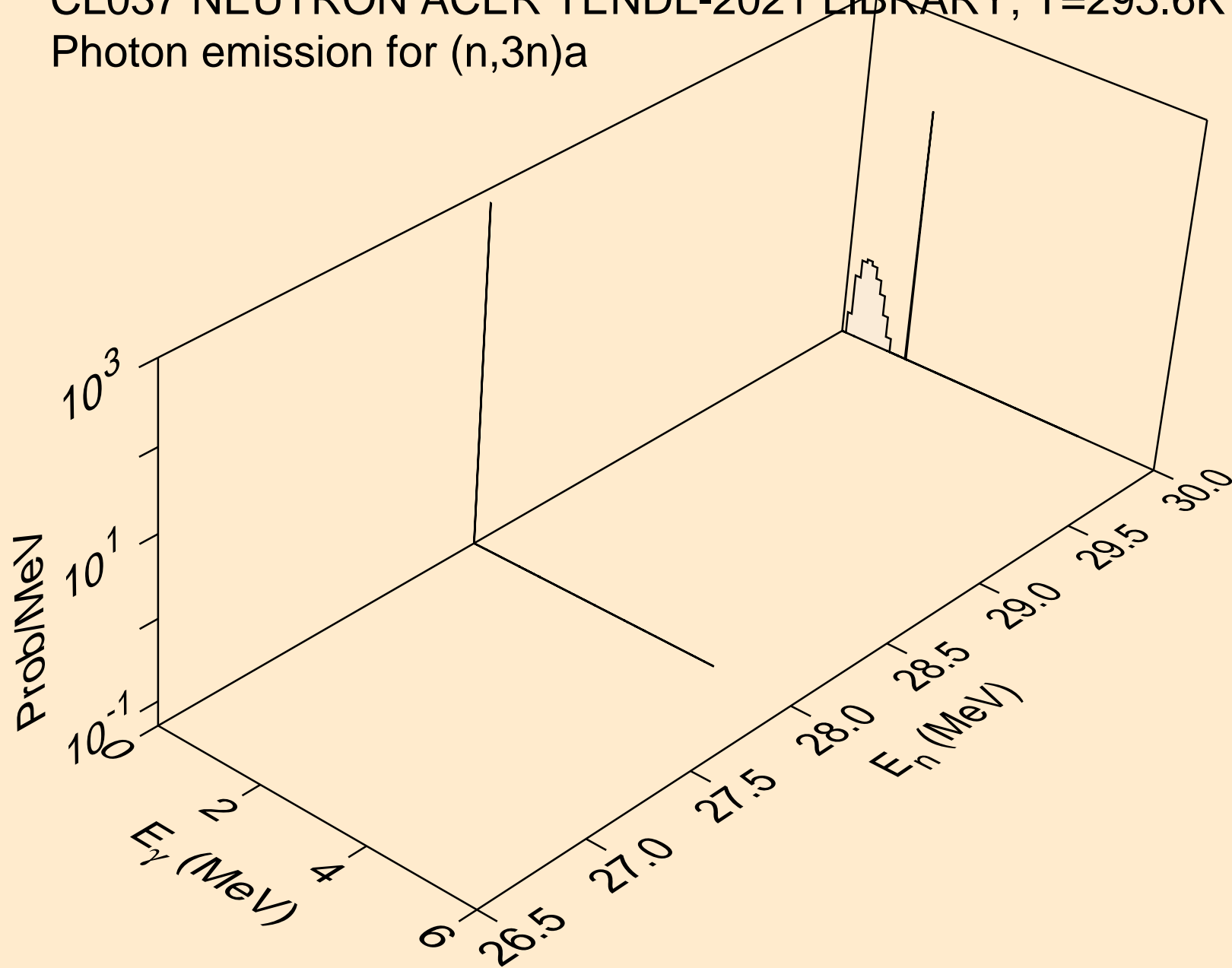

CL037 NEUTRON ACER TENDL-2021 LIBRARY; T=293.6K
Photon emission for (n,n*)p

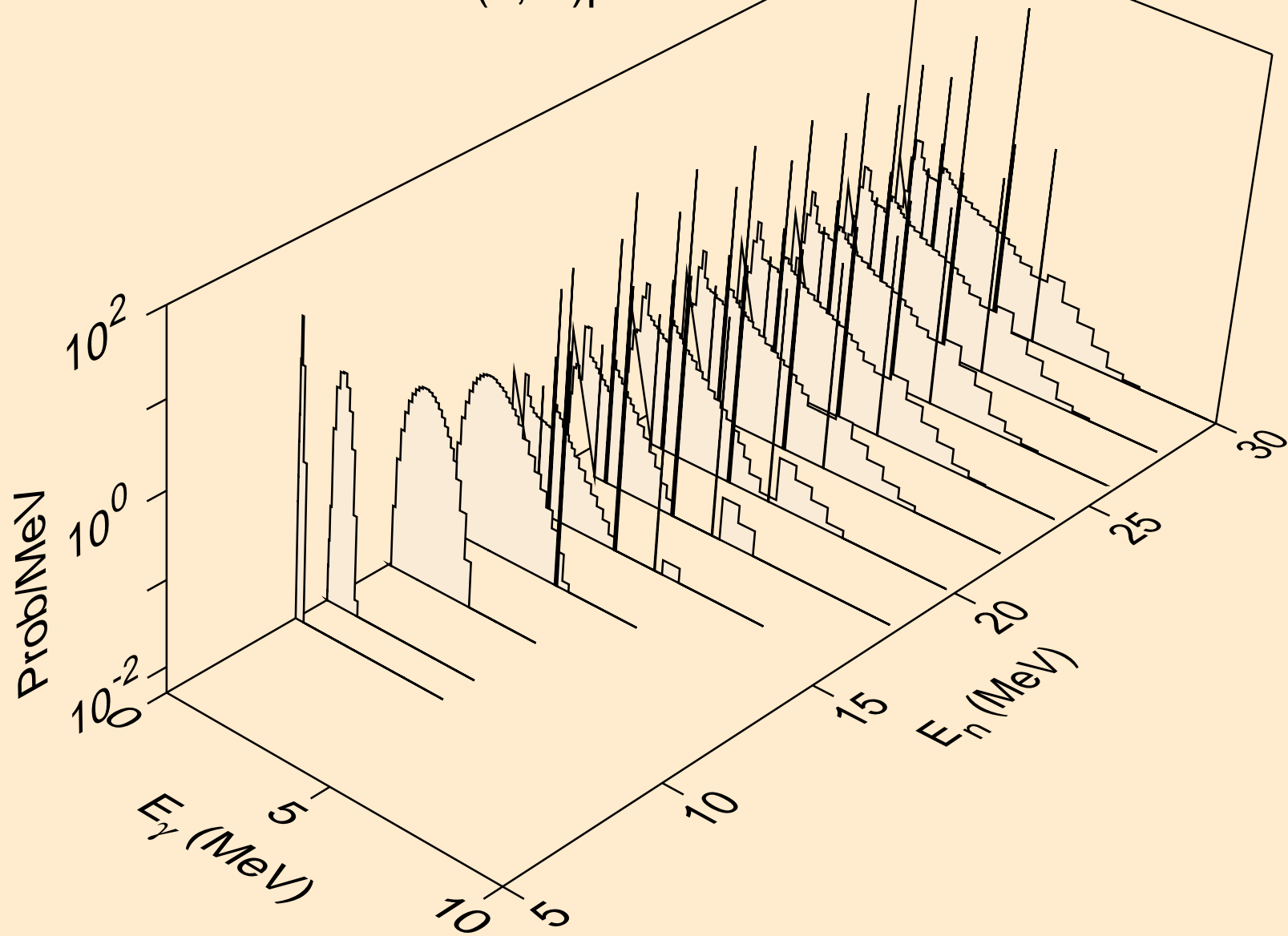

CL037 NEUTRON ACER TENDL-2021 LIBRARY; T=293.6K
Photon emission for (n,n*)2a

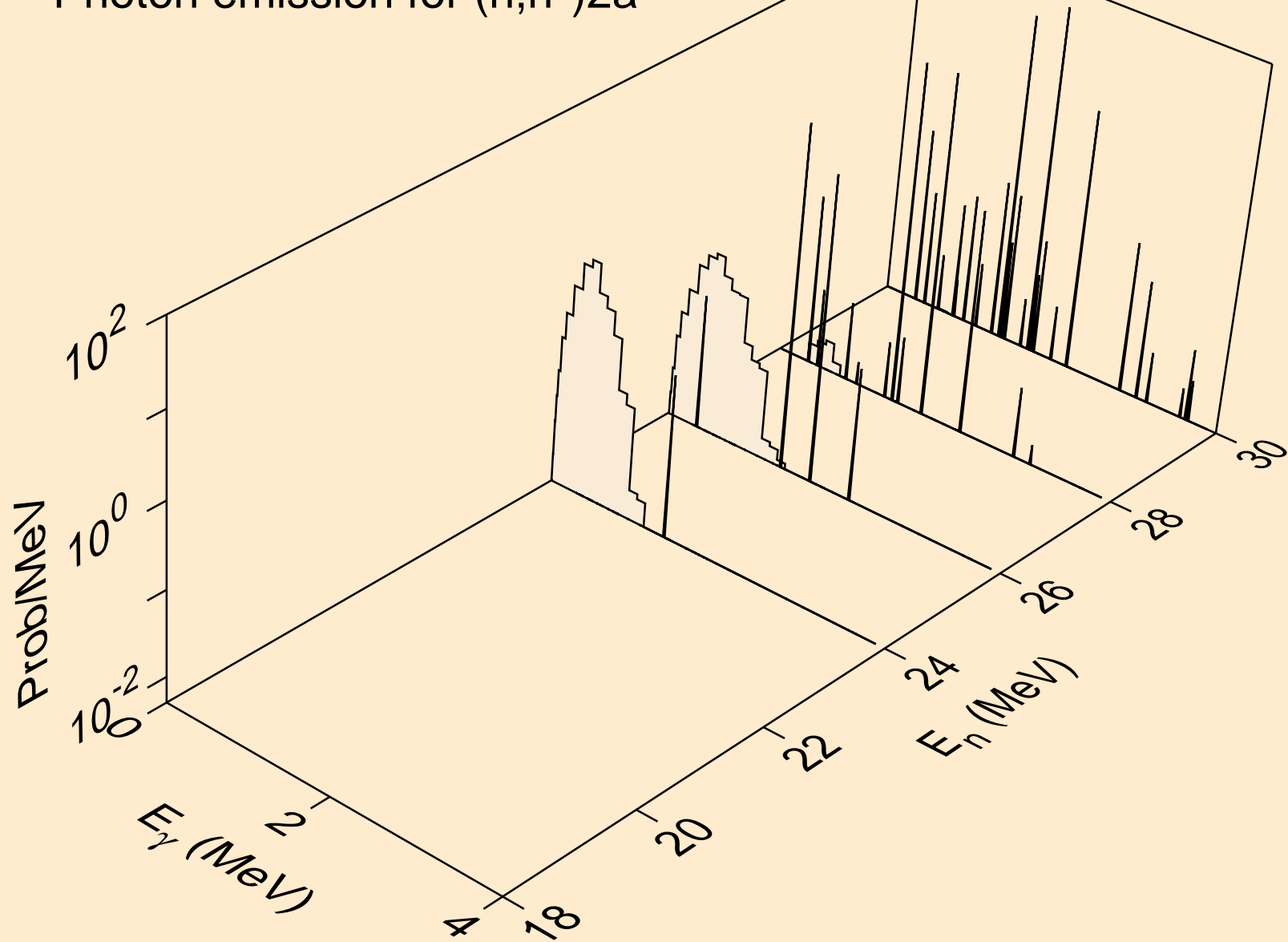

CL037 NEUTRON ACER TENDL-2021 LIBRARY; T=293.6K
Photon emission for (n,n*)d

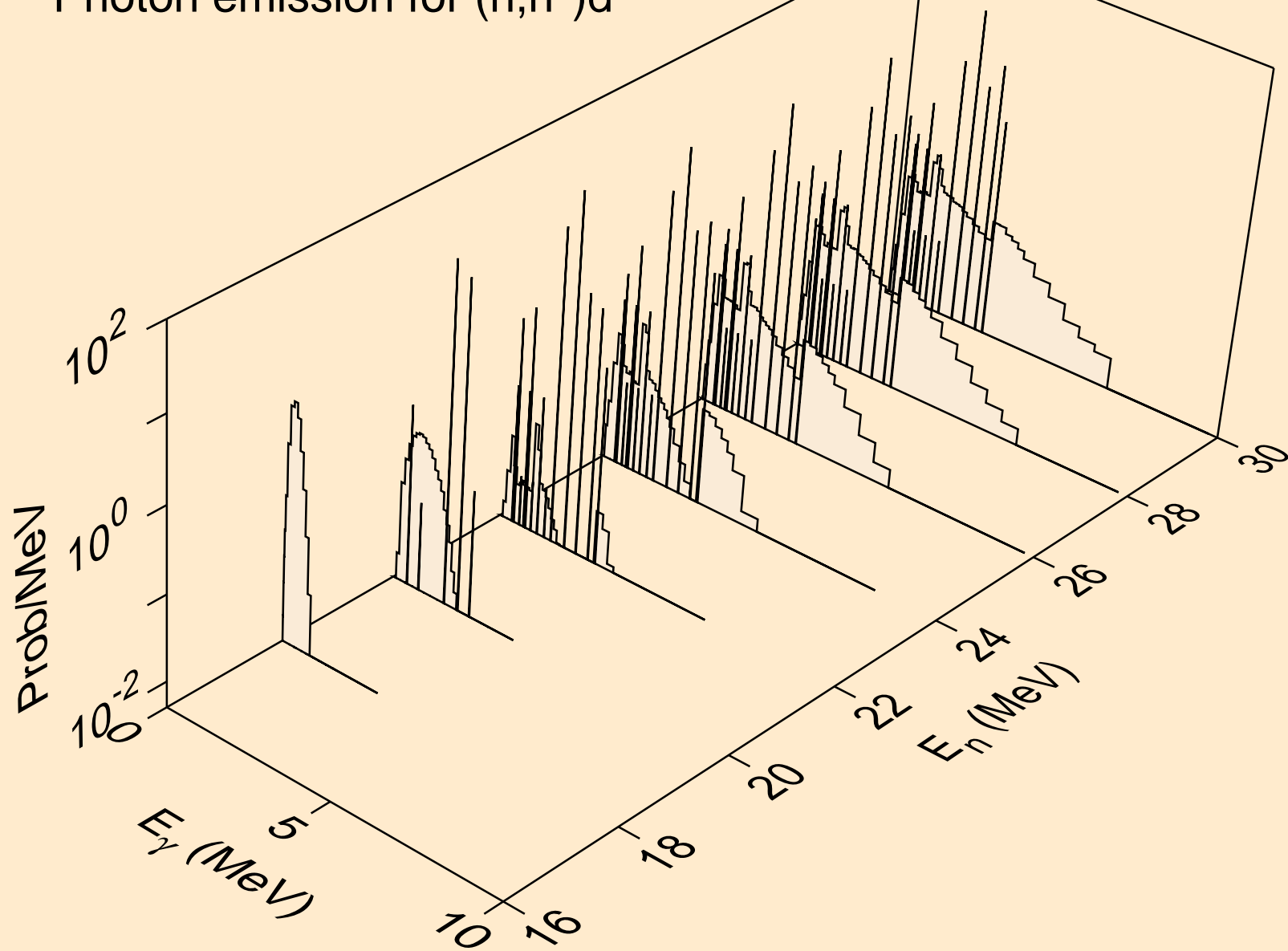

CL037 NEUTRON ACER TENDL-2021 LIBRARY; T=293.6K
Photon emission for (n,n*)t

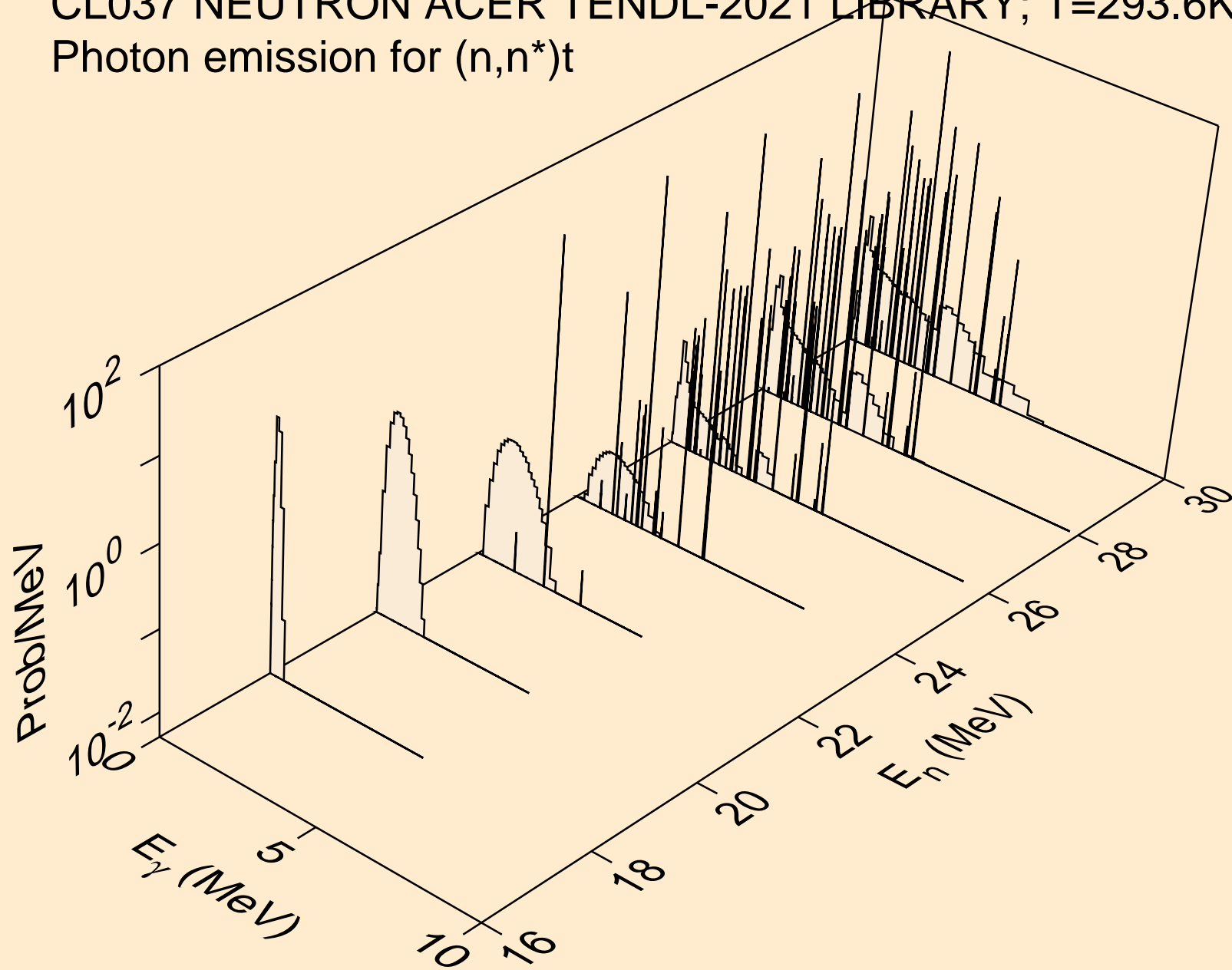

CL037 NEUTRON ACER TENDL-2021 LIBRARY; T=293.6K
Photon emission for (n,n*)he3

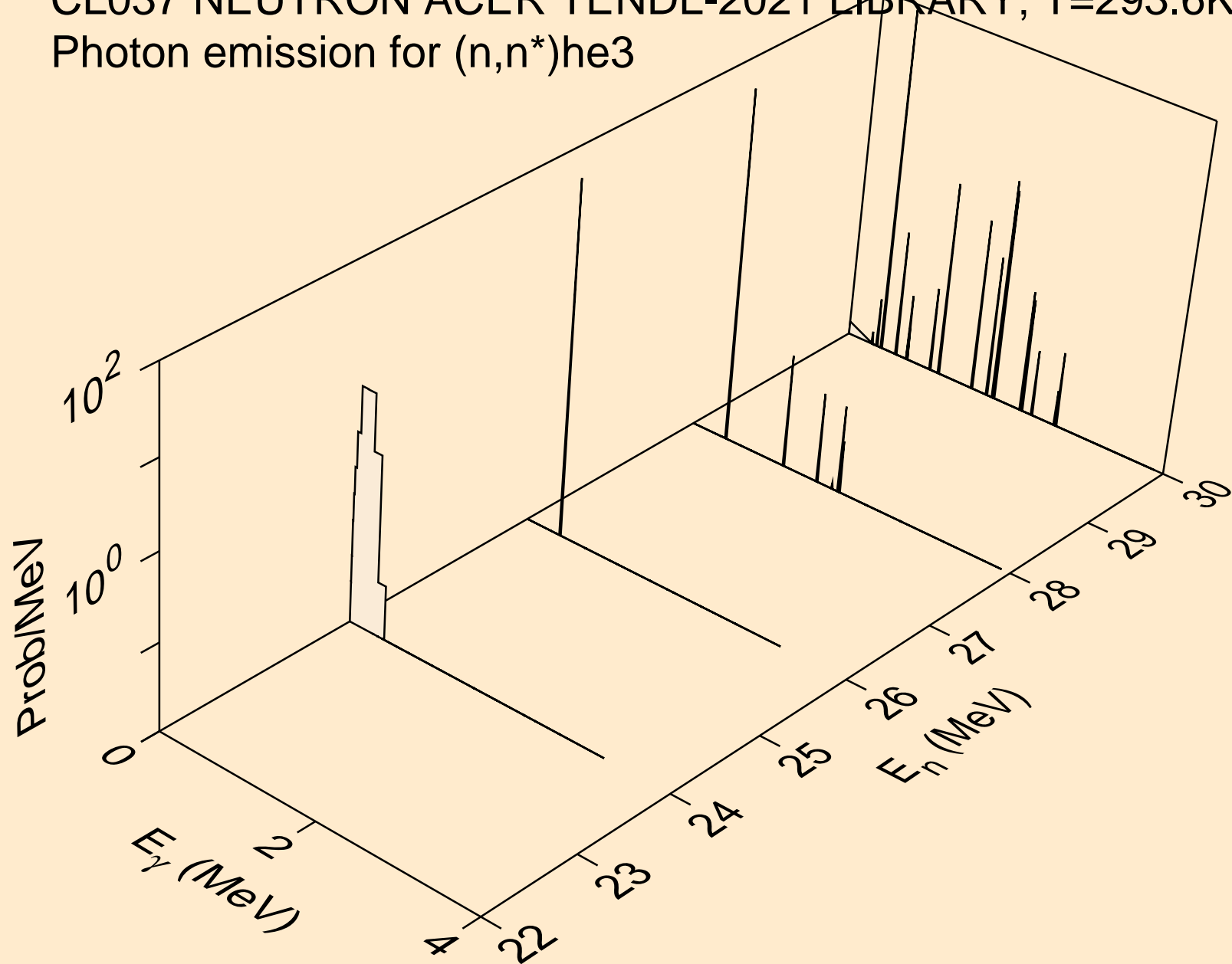

CL037 NEUTRON ACER TENDL-2021 LIBRARY; T=293.6K
Photon emission for (n,2np)

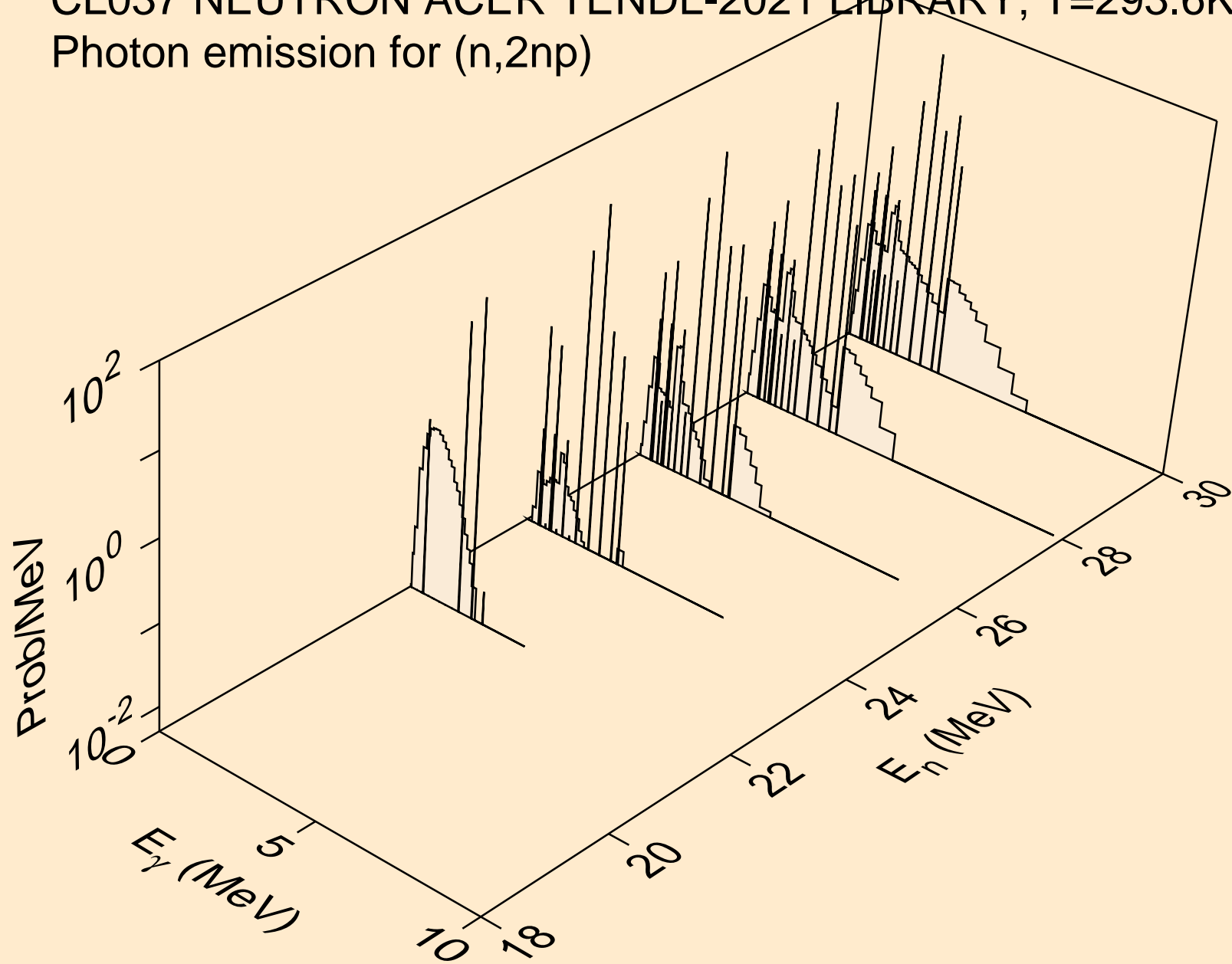

CL037 NEUTRON ACER TENDL-2021 LIBRARY; T=293.6K
Photon emission for (n,3np)

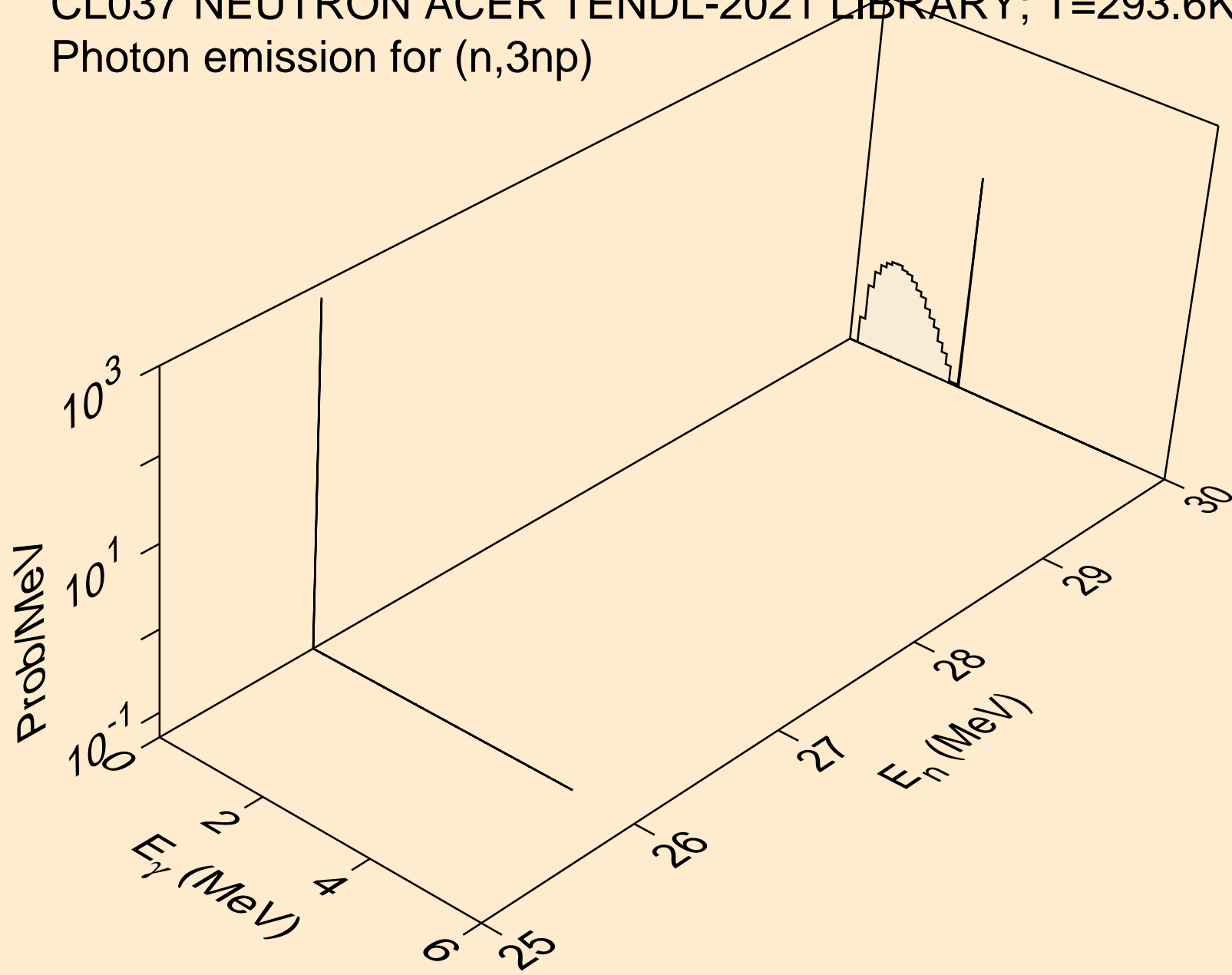

CL037 NEUTRON ACER TENDL-2021 LIBRARY; T=293.6K
Photon emission for (n,2np)

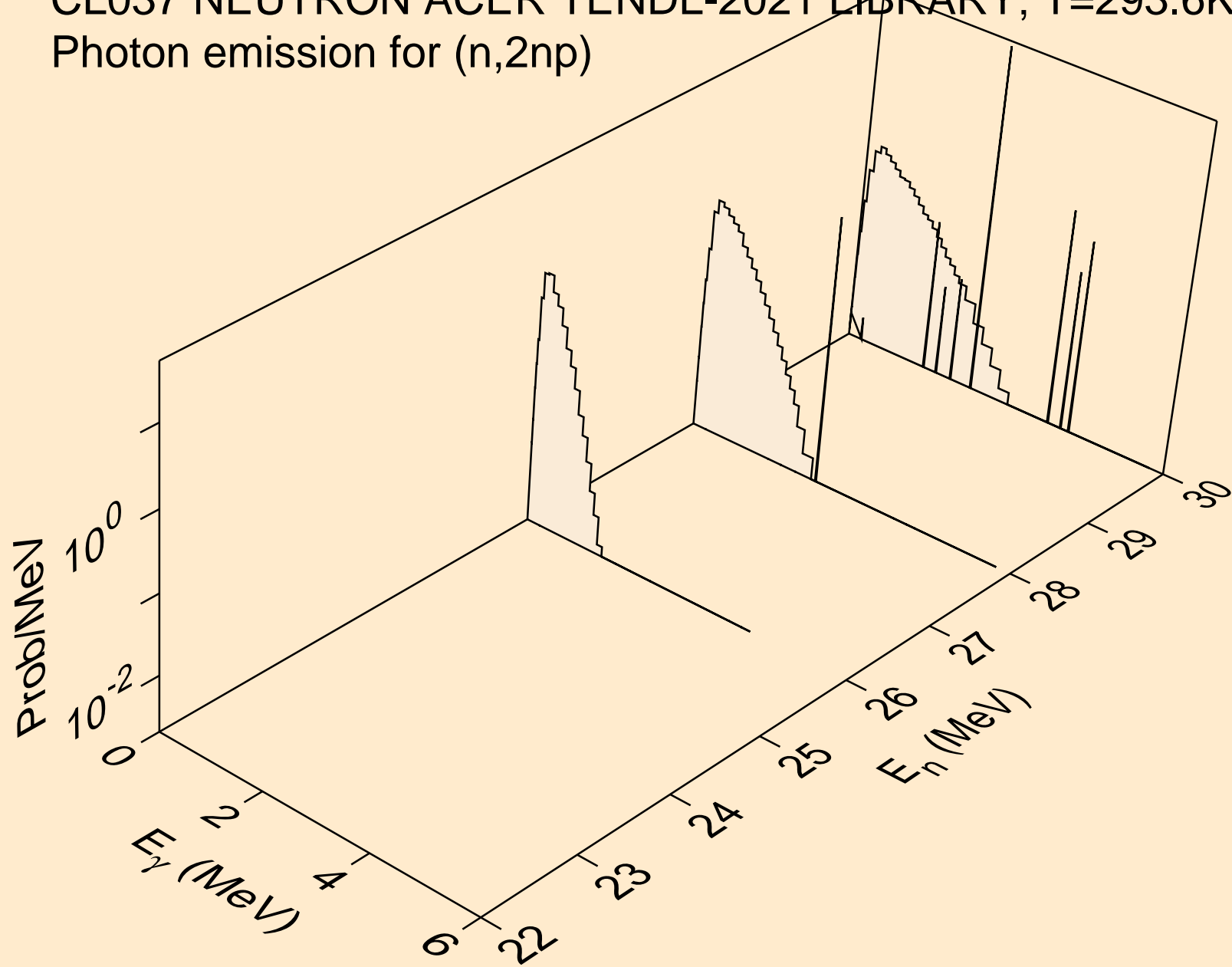

CL037 NEUTRON ACER TENDL-2021 LIBRARY; T=293.6K
Photon emission for (n,npa)

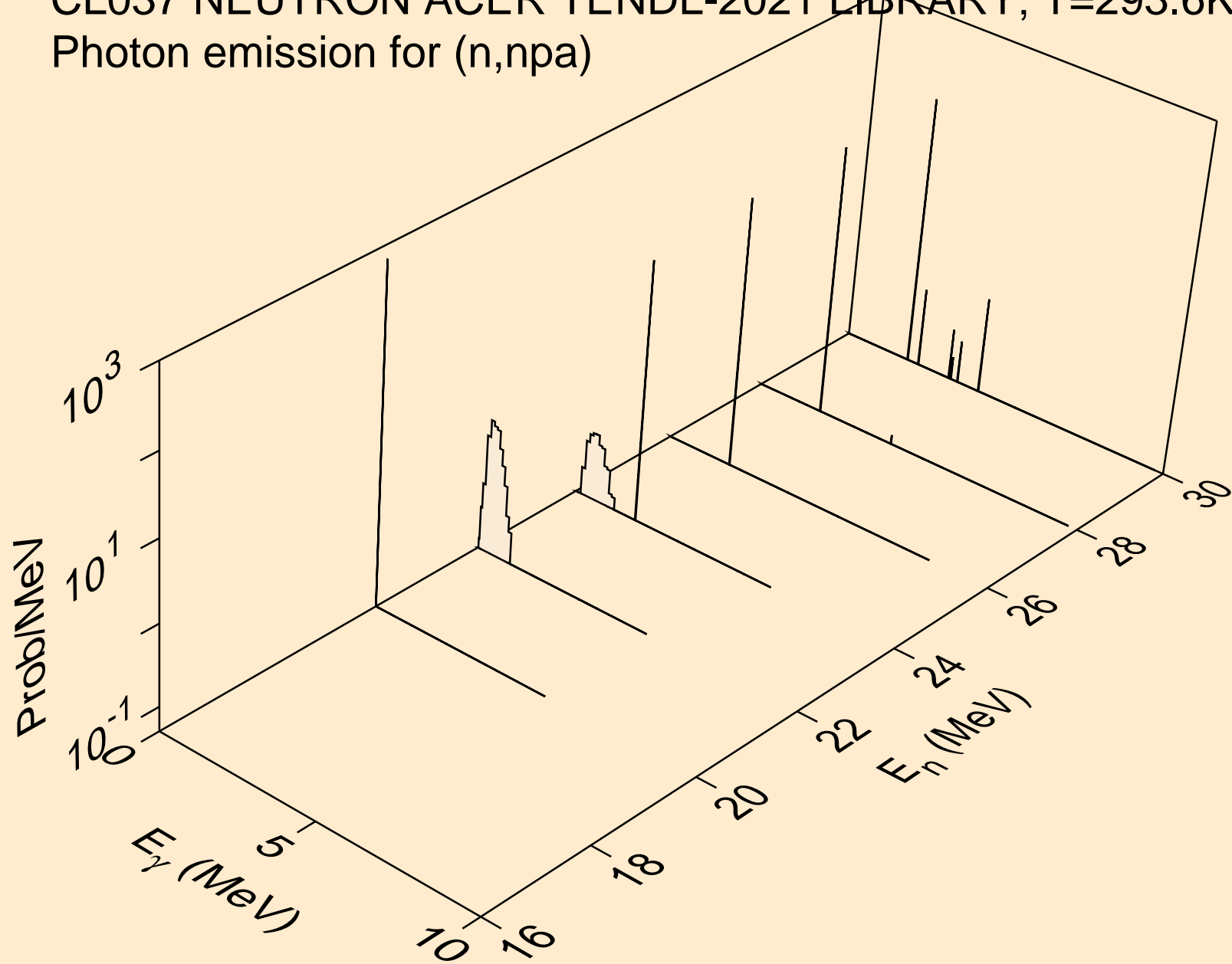

CL037 NEUTRON ACER TENDL-2021 LIBRARY; T=293.6K
Photon emission for (n,n*c)

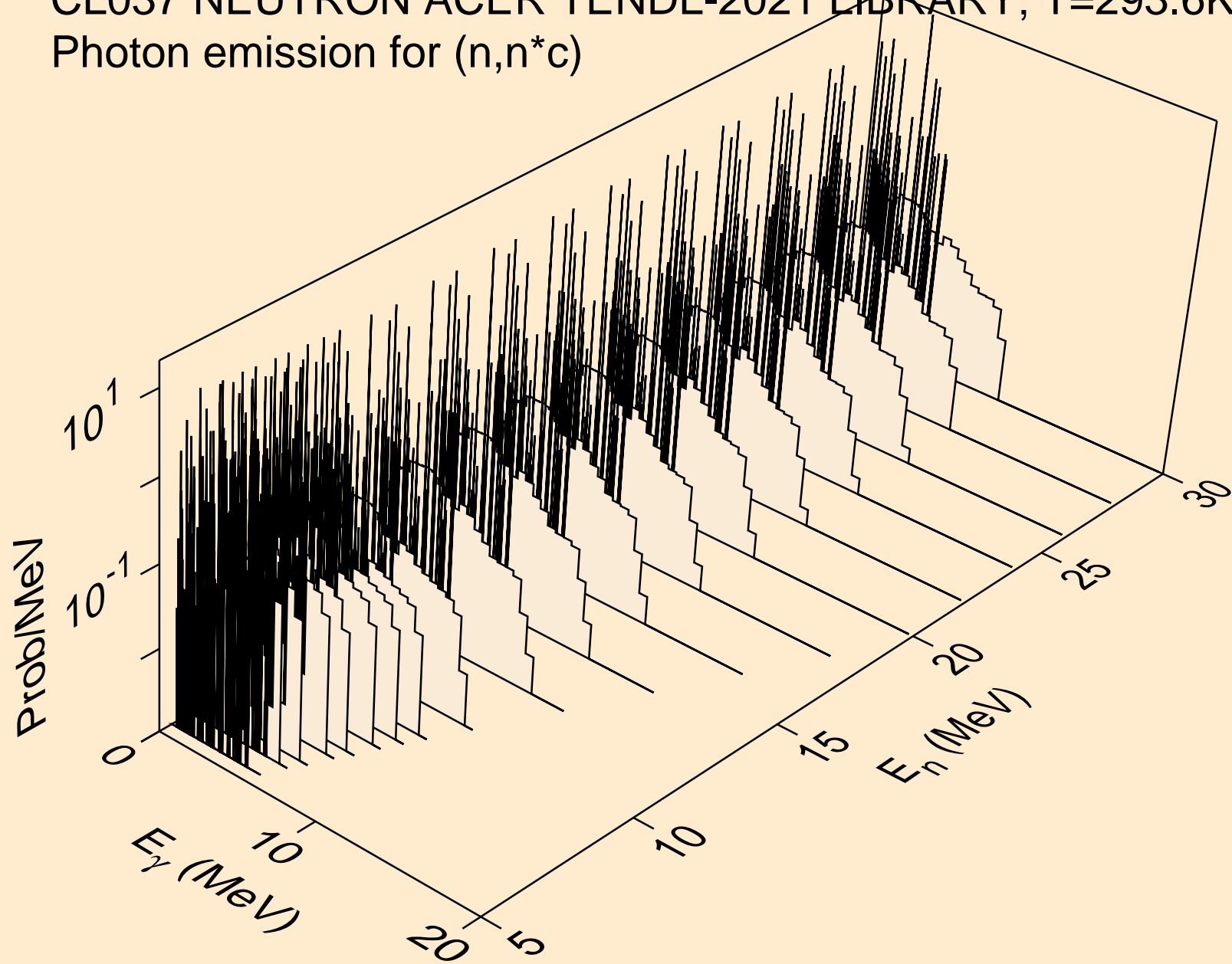

CL037 NEUTRON ACER TENDL-2021 LIBRARY; T=293.6K
Photon emission for (n,gma)

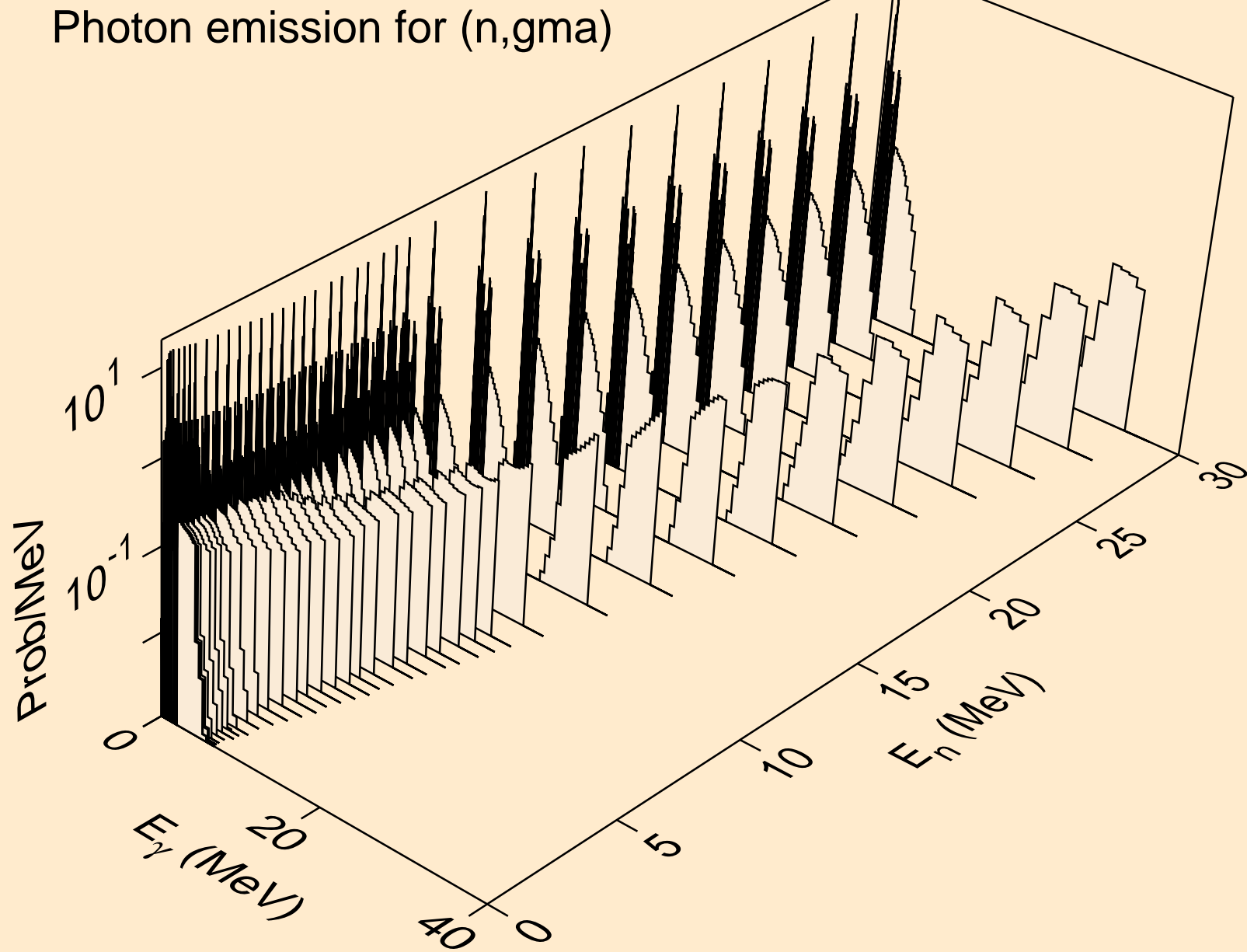

CL037 NEUTRON ACER TENDL-2021 LIBRARY; T=293.6K
Photon emission for (n,p)

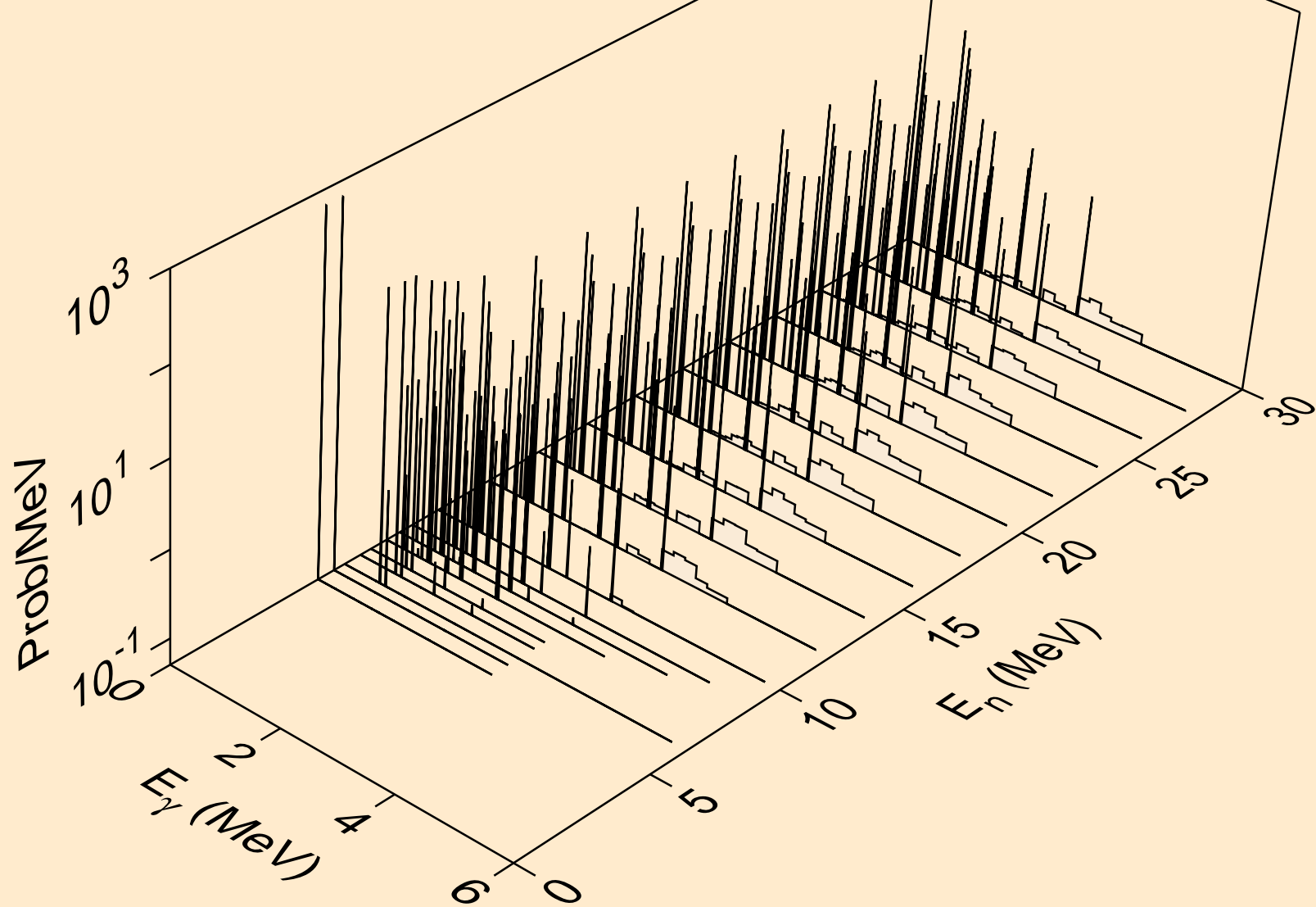

CL037 NEUTRON ACER TENDL-2021 LIBRARY; T=293.6K
Photon emission for (n,d)

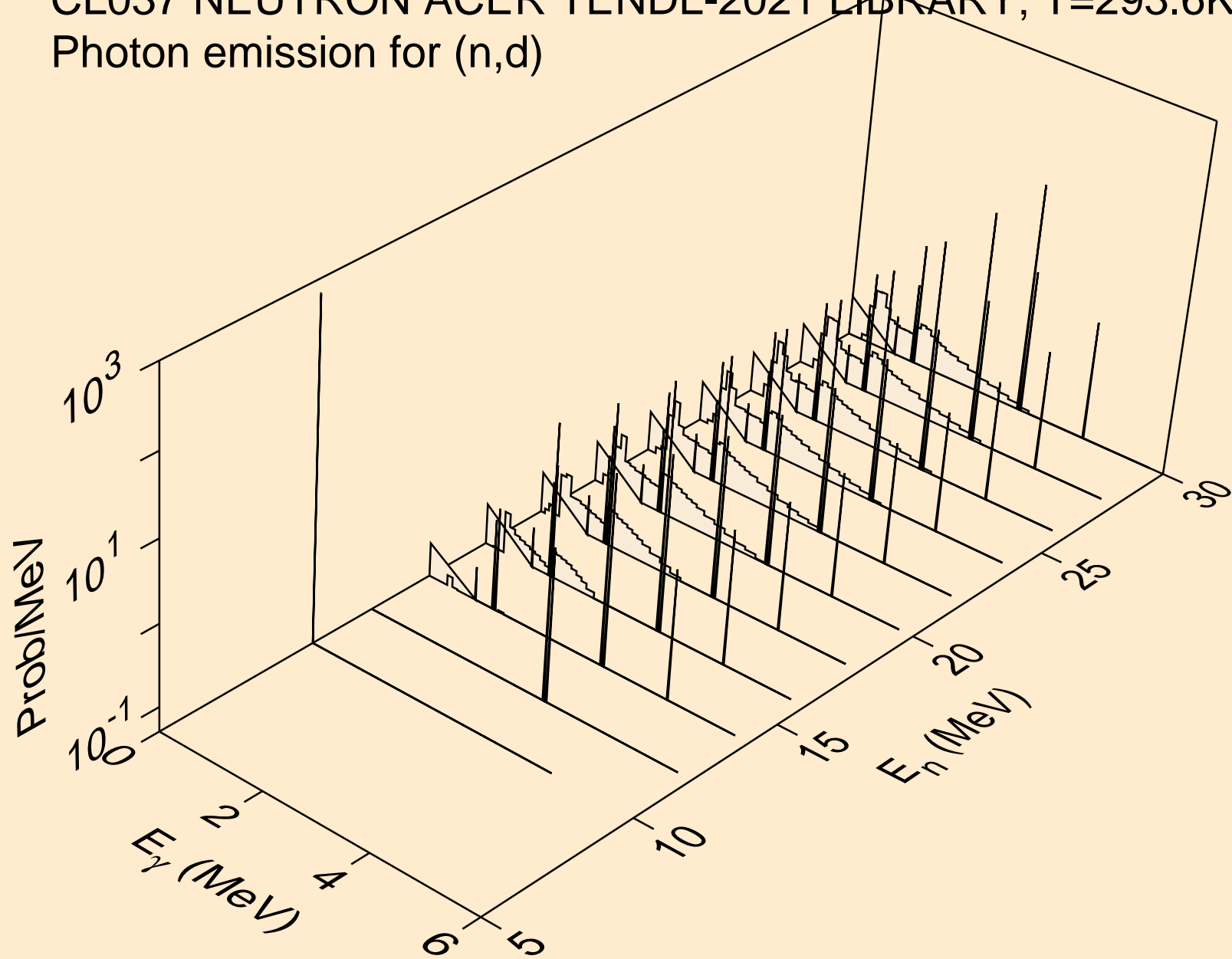

CL037 NEUTRON ACER TENDL-2021 LIBRARY; T=293.6K
Photon emission for (n,t)

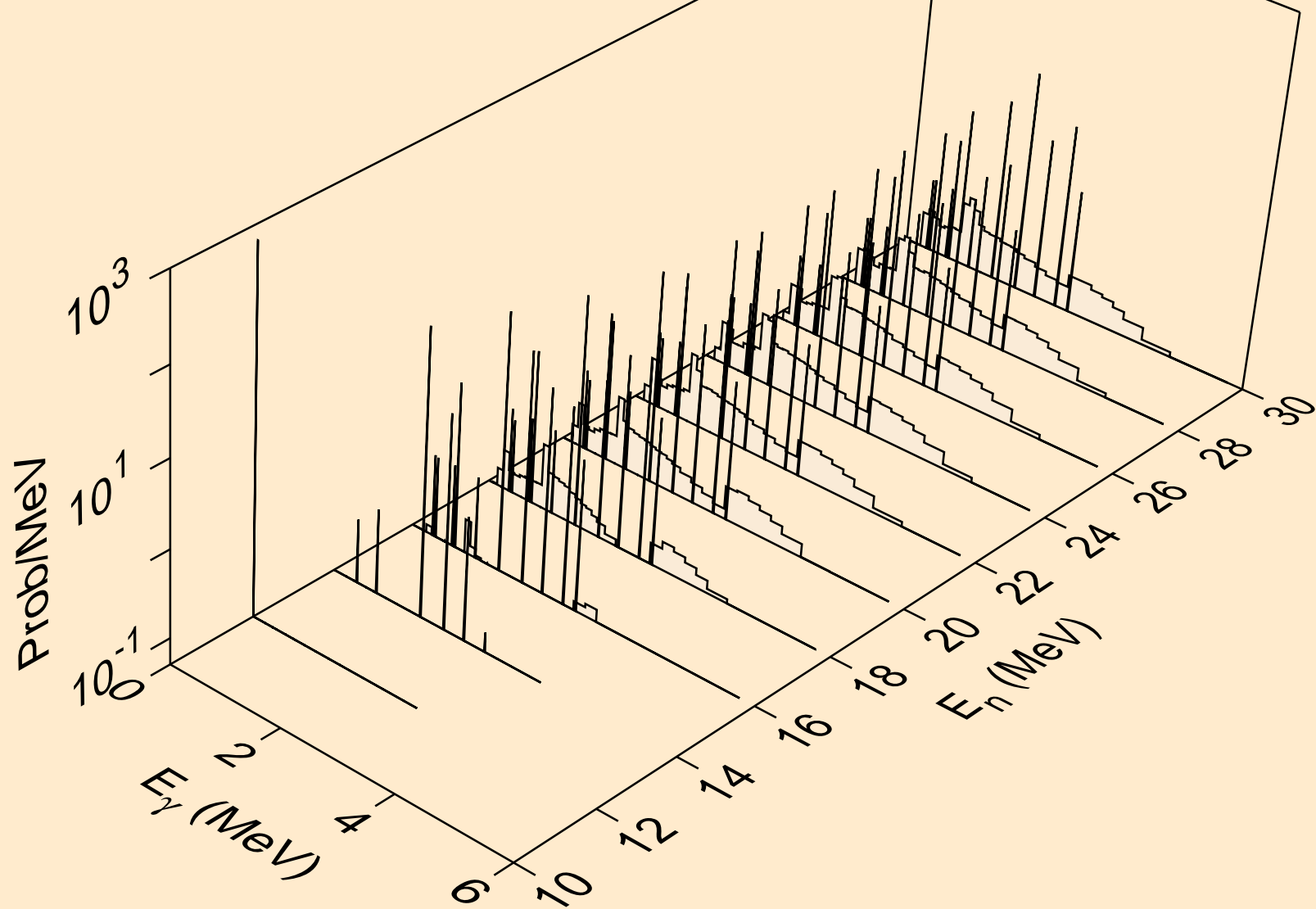

CL037 NEUTRON ACER TENDL-2021 LIBRARY; T=293.6K
Photon emission for (n,he3)

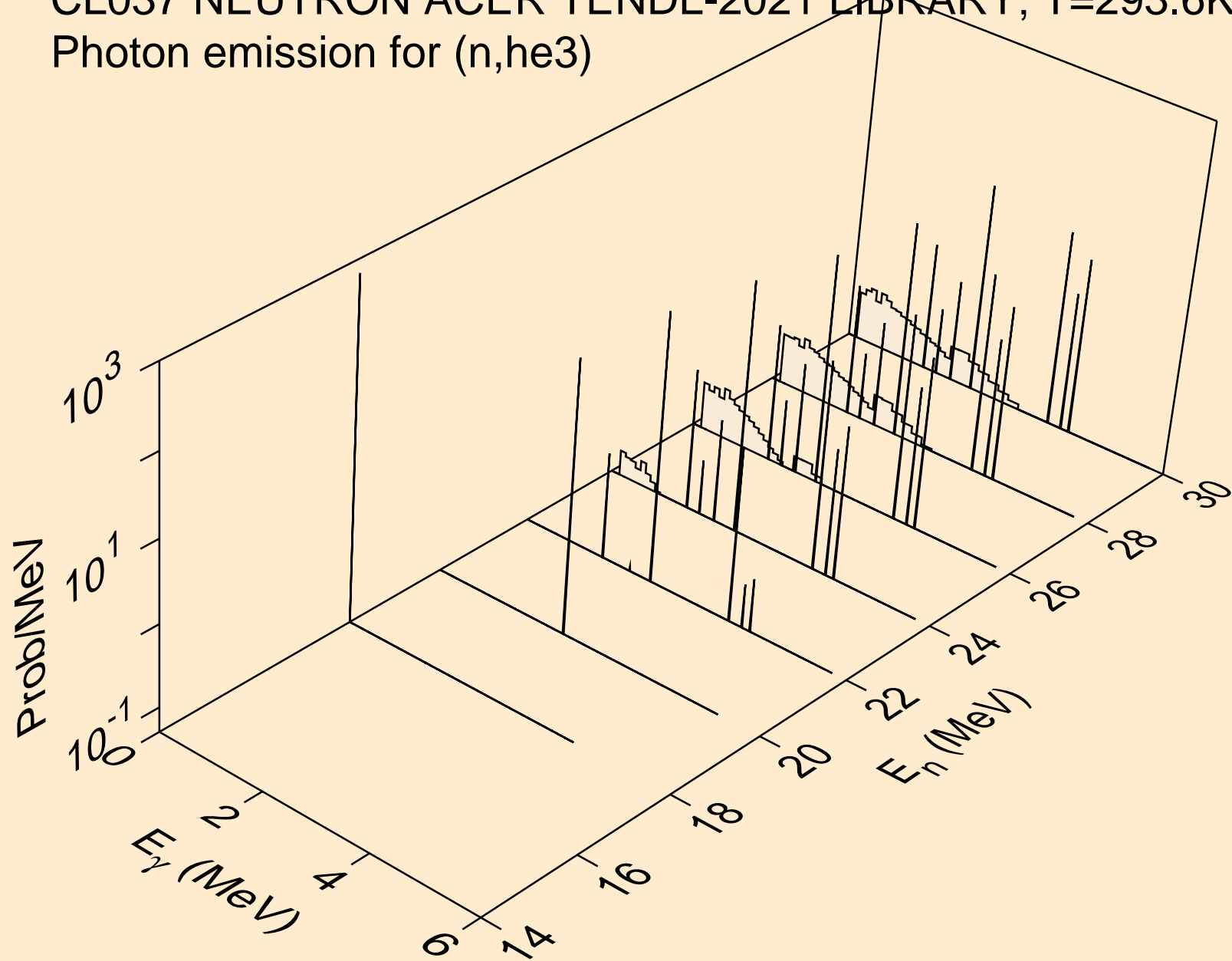

CL037 NEUTRON ACER TENDL-2021 LIBRARY; T=293.6K
Photon emission for (n,a)

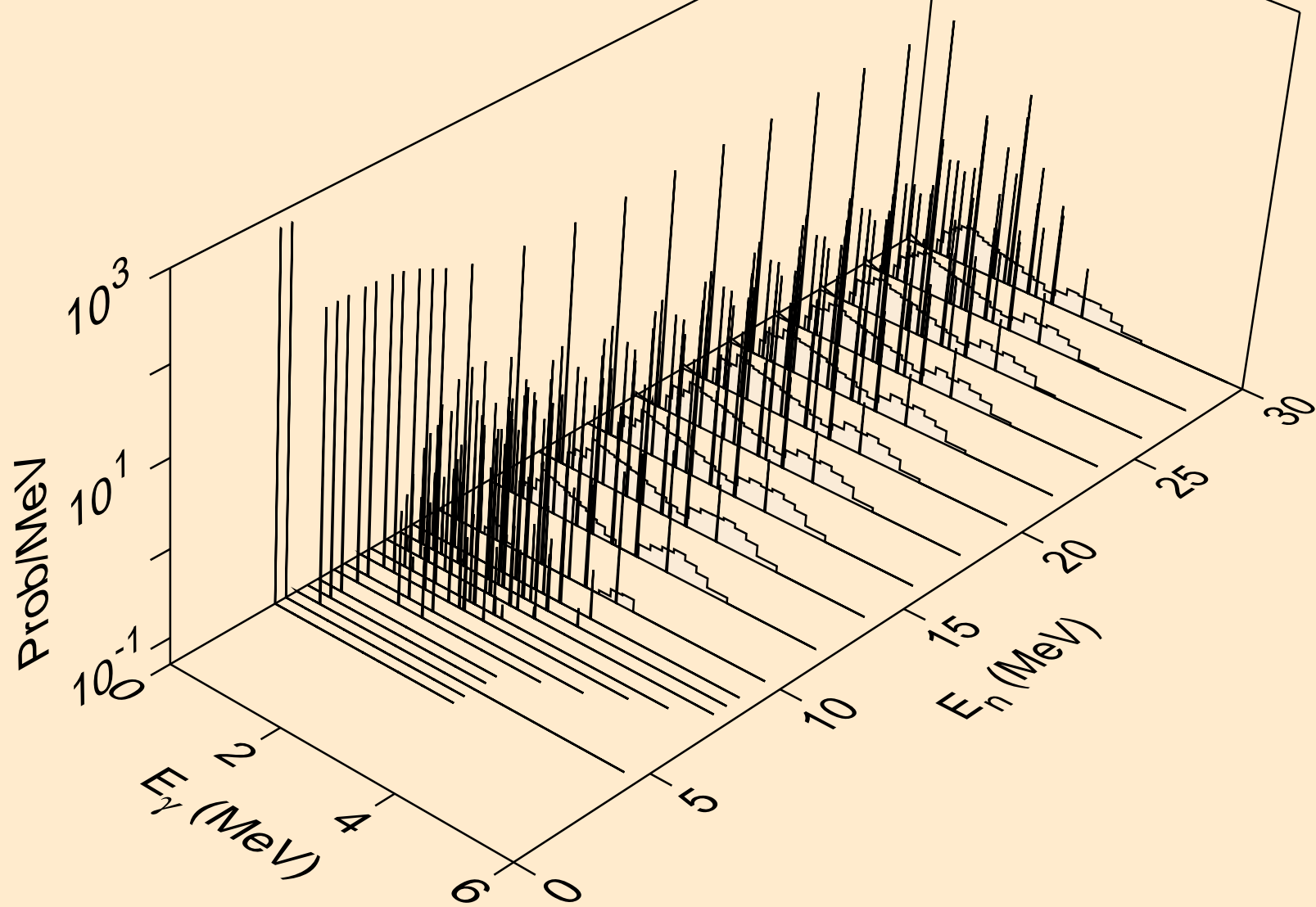

CL037 NEUTRON ACER TENDL-2021 LIBRARY; T=293.6K
Photon emission for (n,2a)

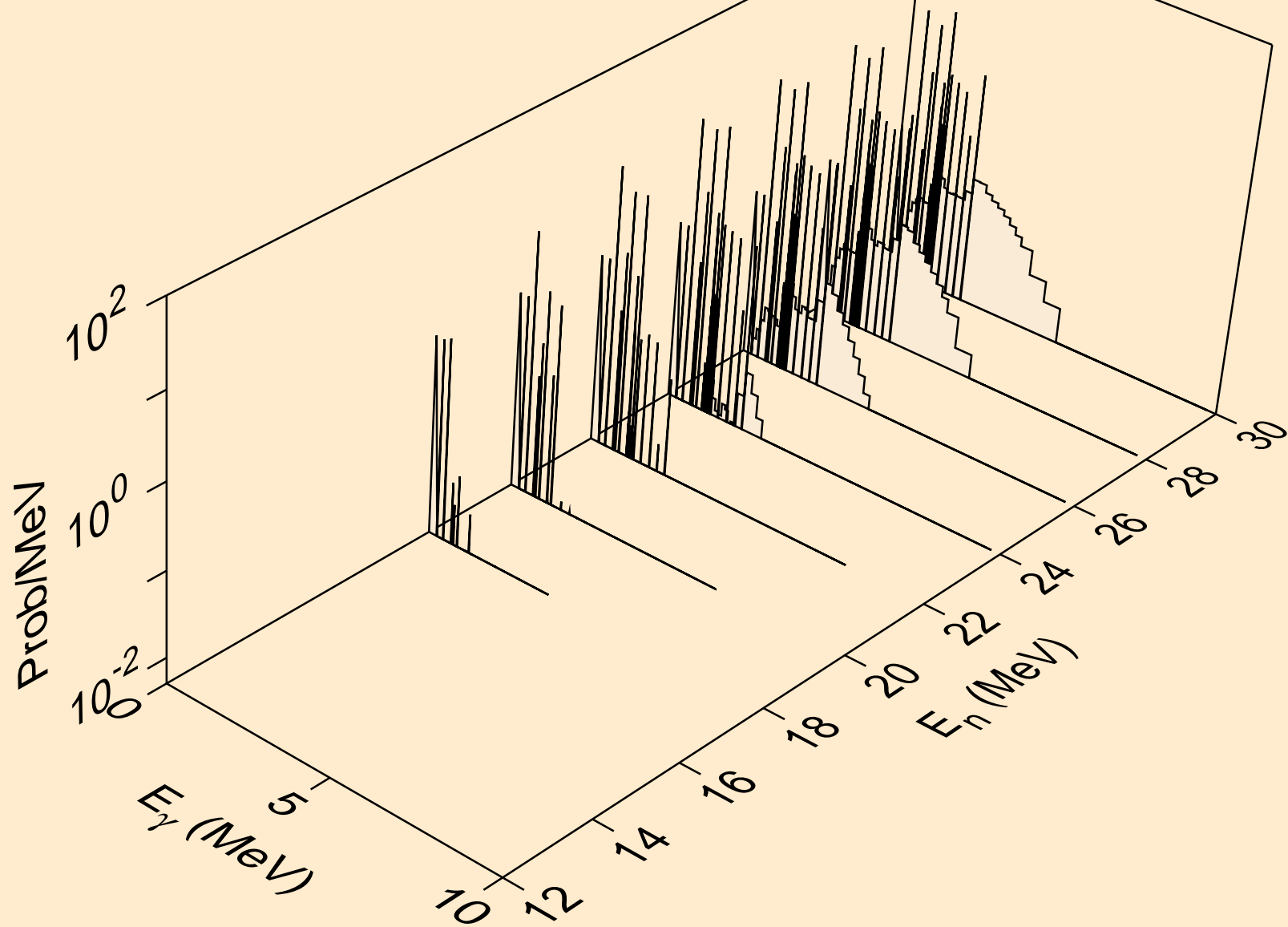

CL037 NEUTRON ACER TENDL-2021 LIBRARY; T=293.6K
Photon emission for (n,2p)

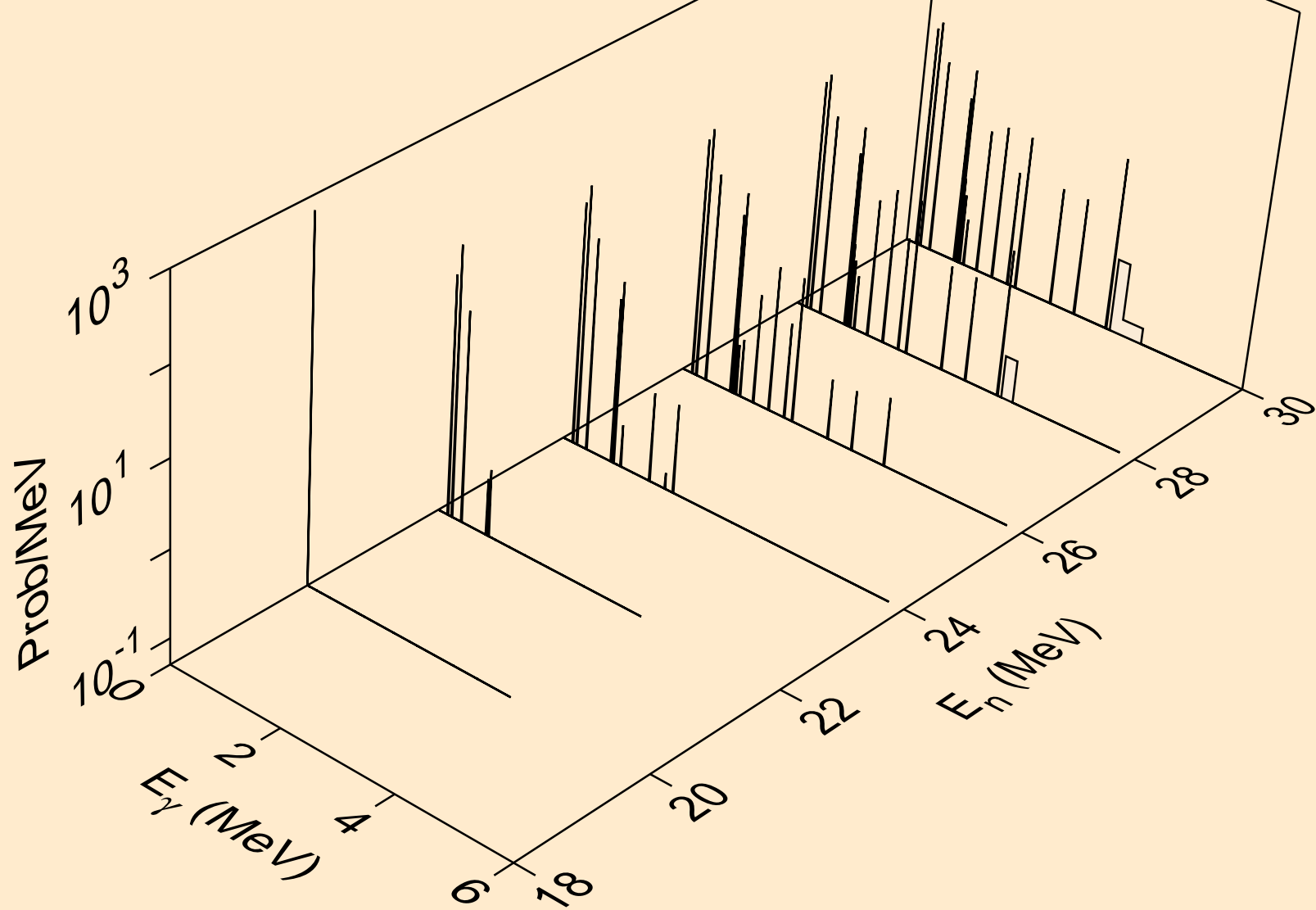

CL037 NEUTRON ACER TENDL-2021 LIBRARY; T=293.6K
Photon emission for (n,p α)

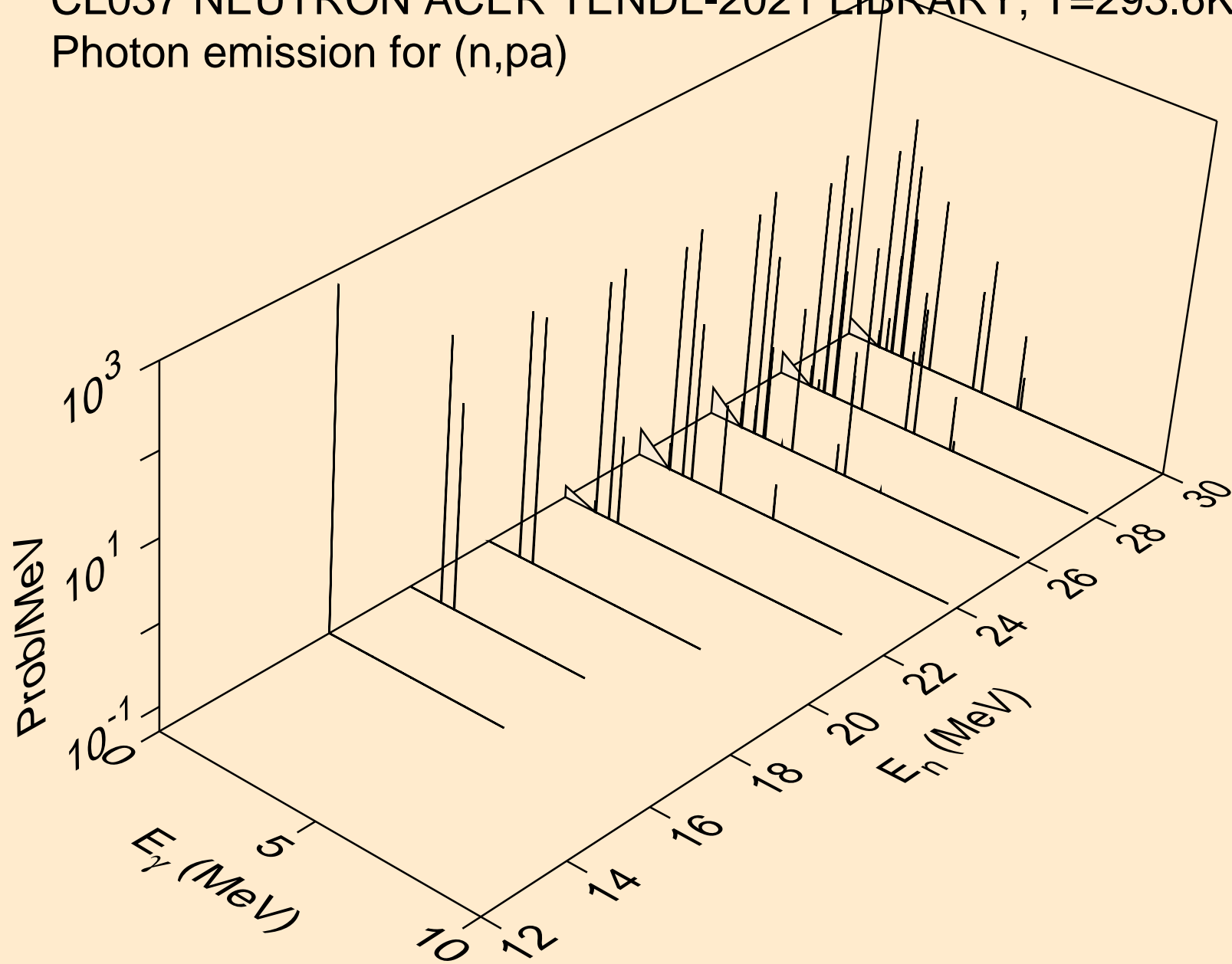

CL037 NEUTRON ACER TENDL-2021 LIBRARY; T=293.6K
Photon emission for (n,pd)

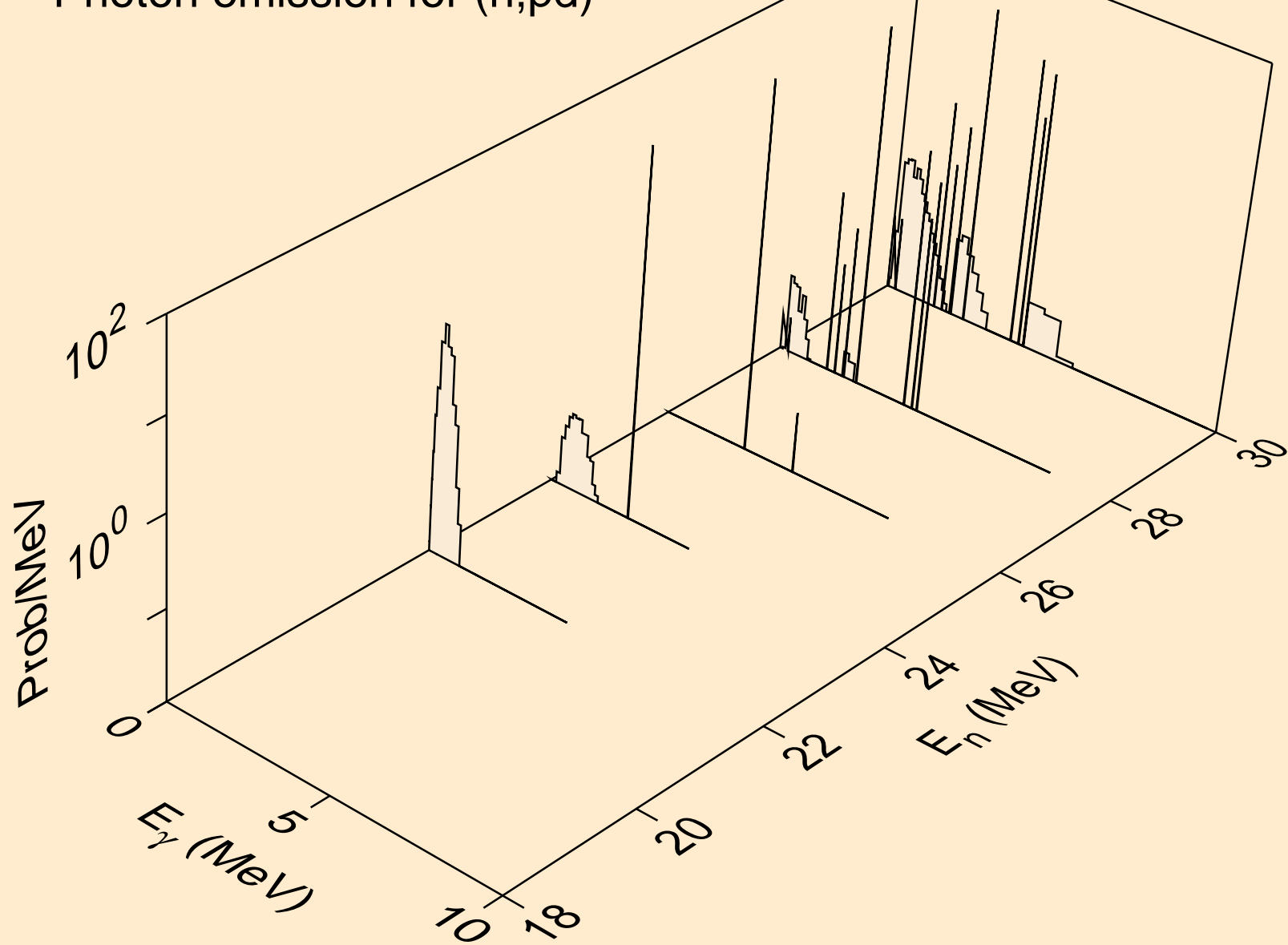

CL037 NEUTRON ACER TENDL-2021 LIBRARY; T=293.6K
Photon emission for (n,pt)

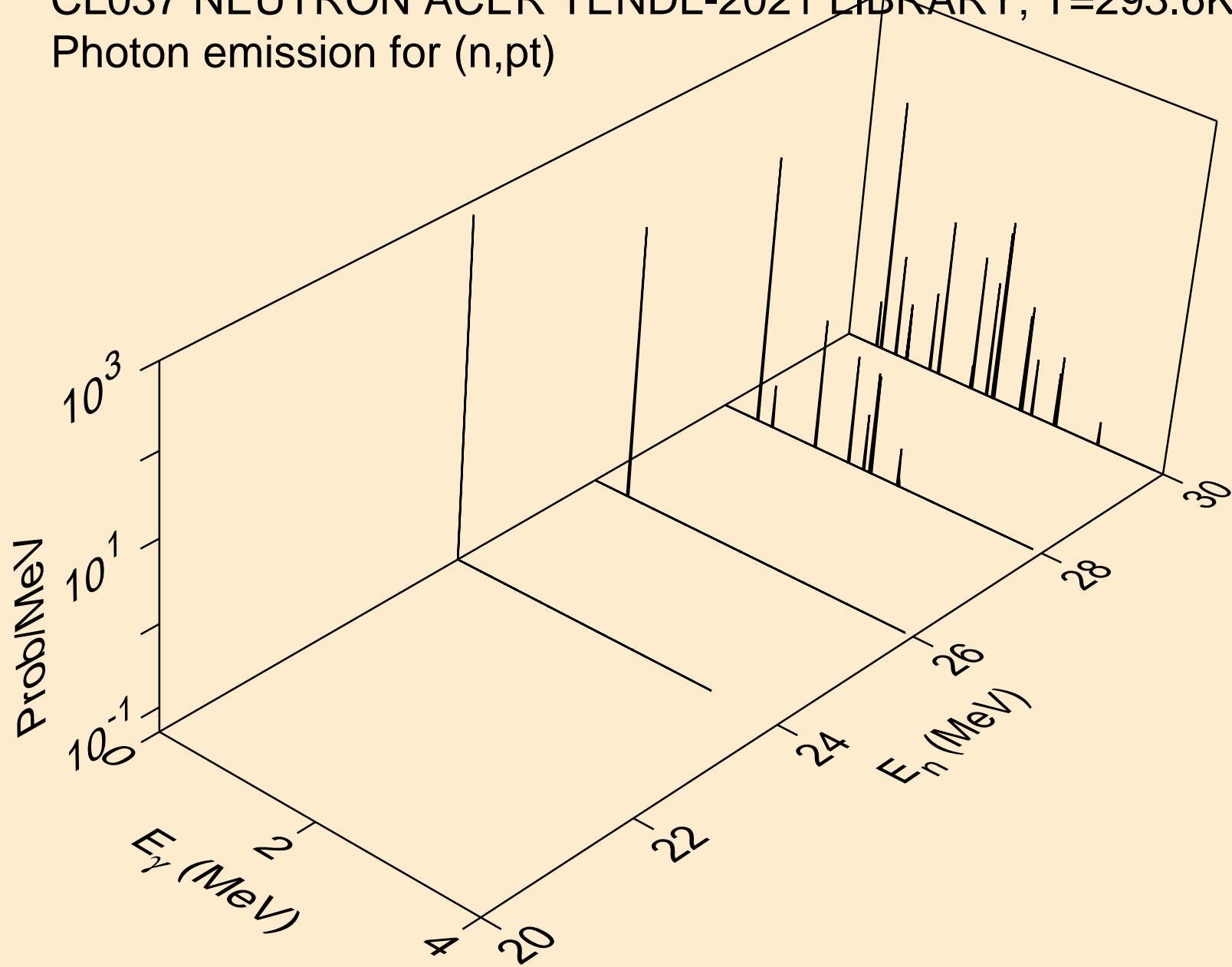

CL037 NEUTRON ACER TENDL-2021 LIBRARY; T=293.6K
Photon emission for (n,da)

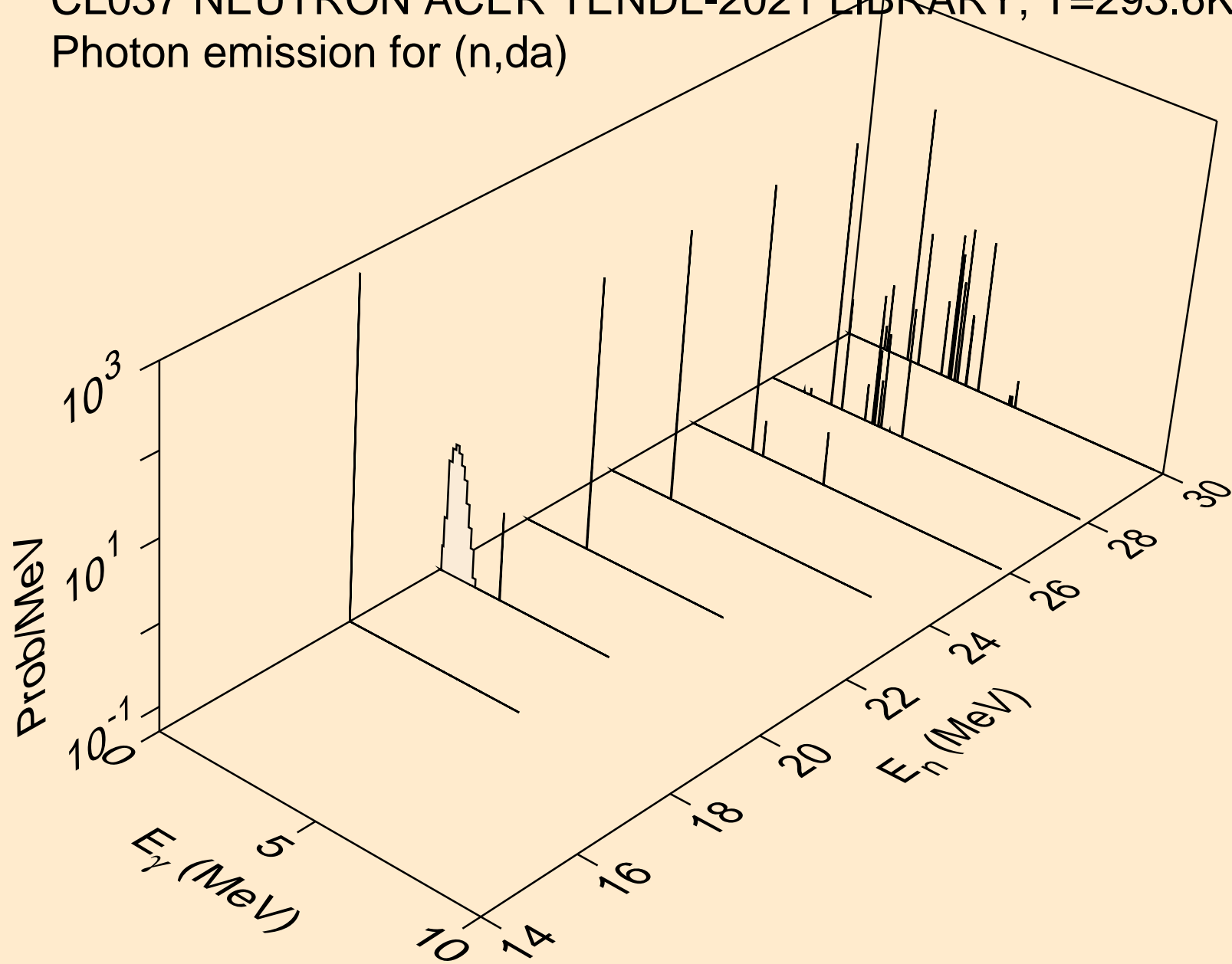

CL037 NEUTRON ACER TENDL-2021 LIBRARY; T=293.6K
thermal capture photon spectrum

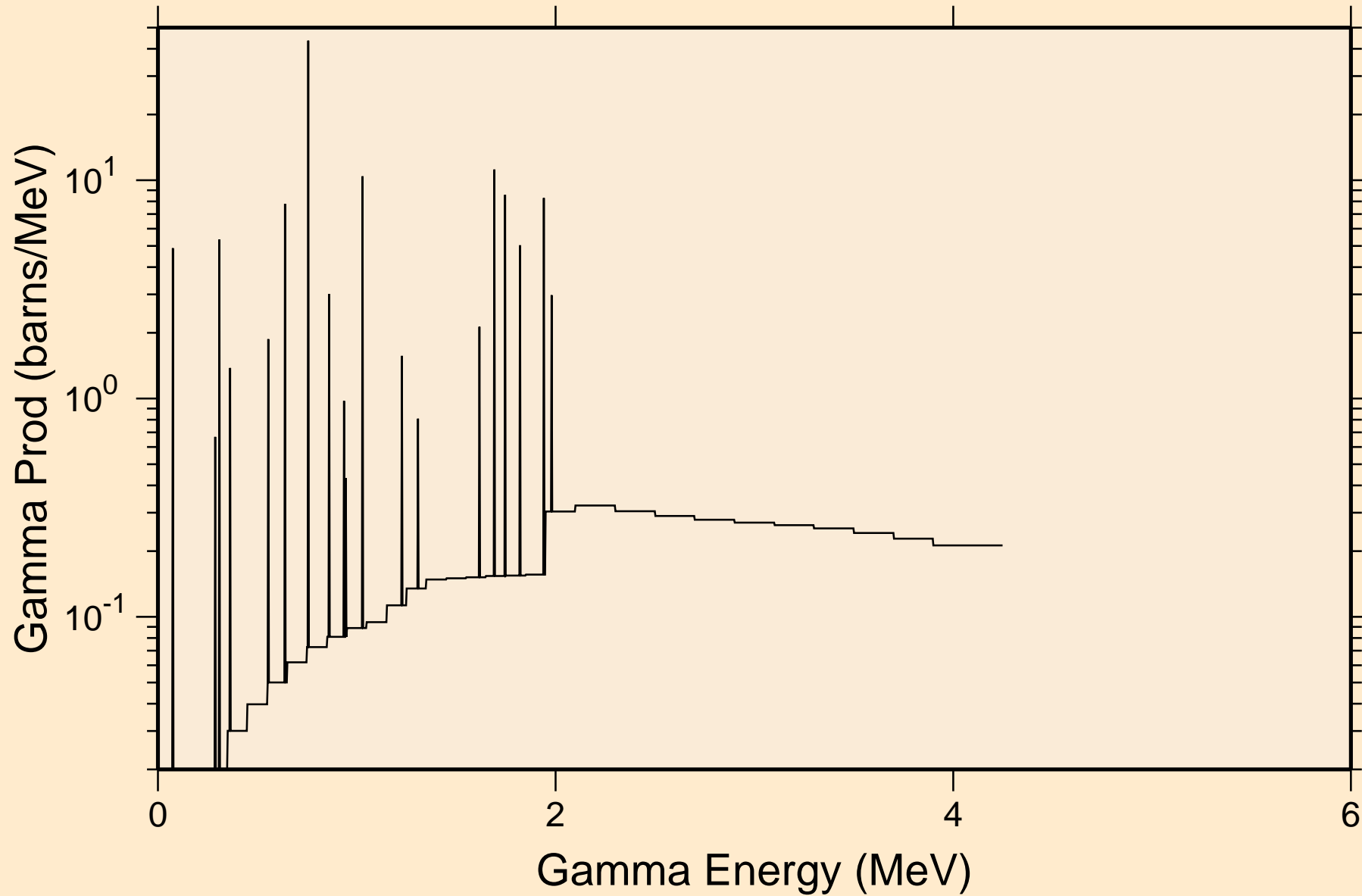

CL037 NEUTRON ACER TENDL-2021 LIBRARY; T=293.6K
14 MeV photon spectrum

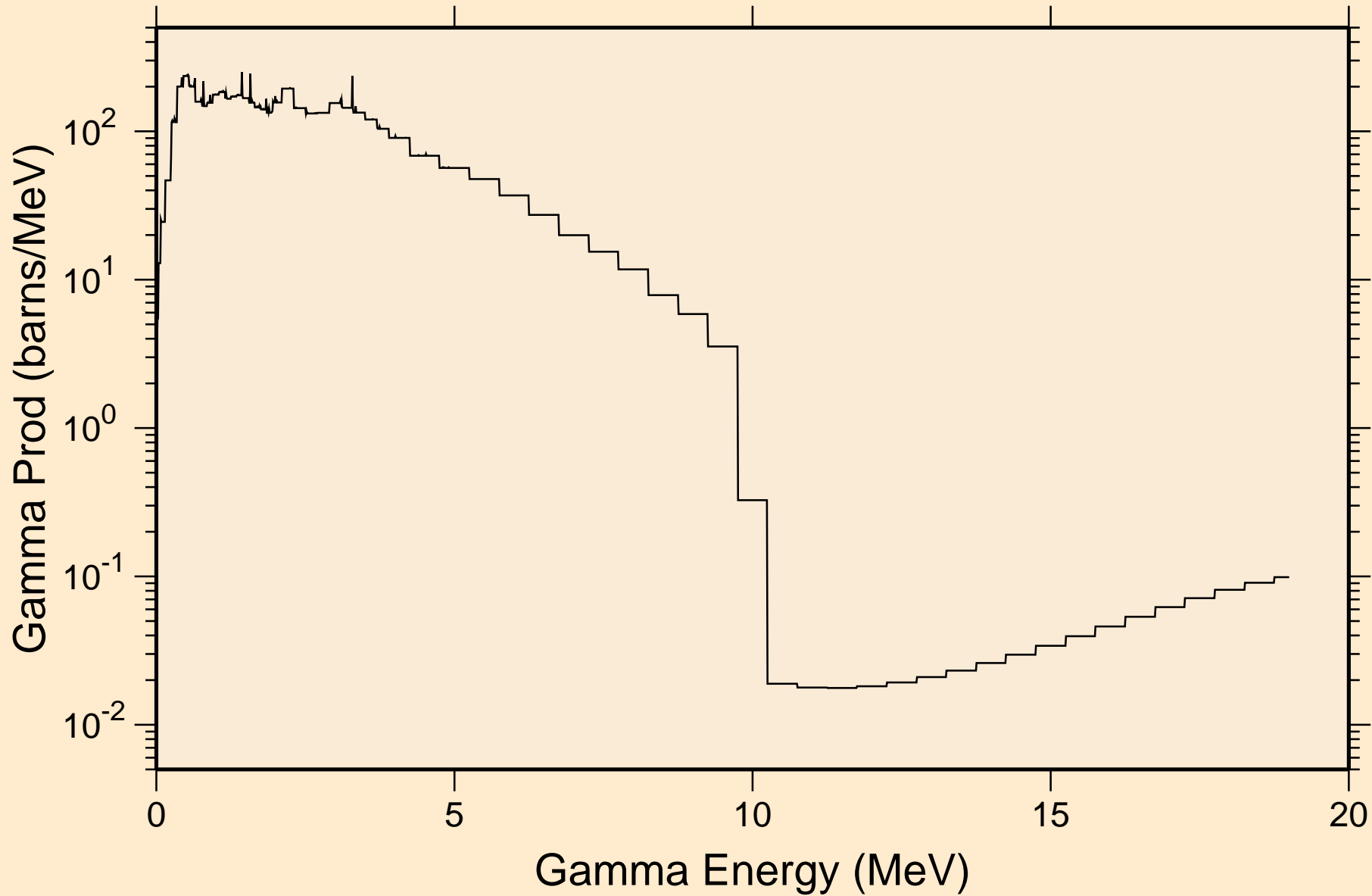

CL037 NEUTRON ACER TENDL-2021 LIBRARY; T=293.6K
Particle heating contributions

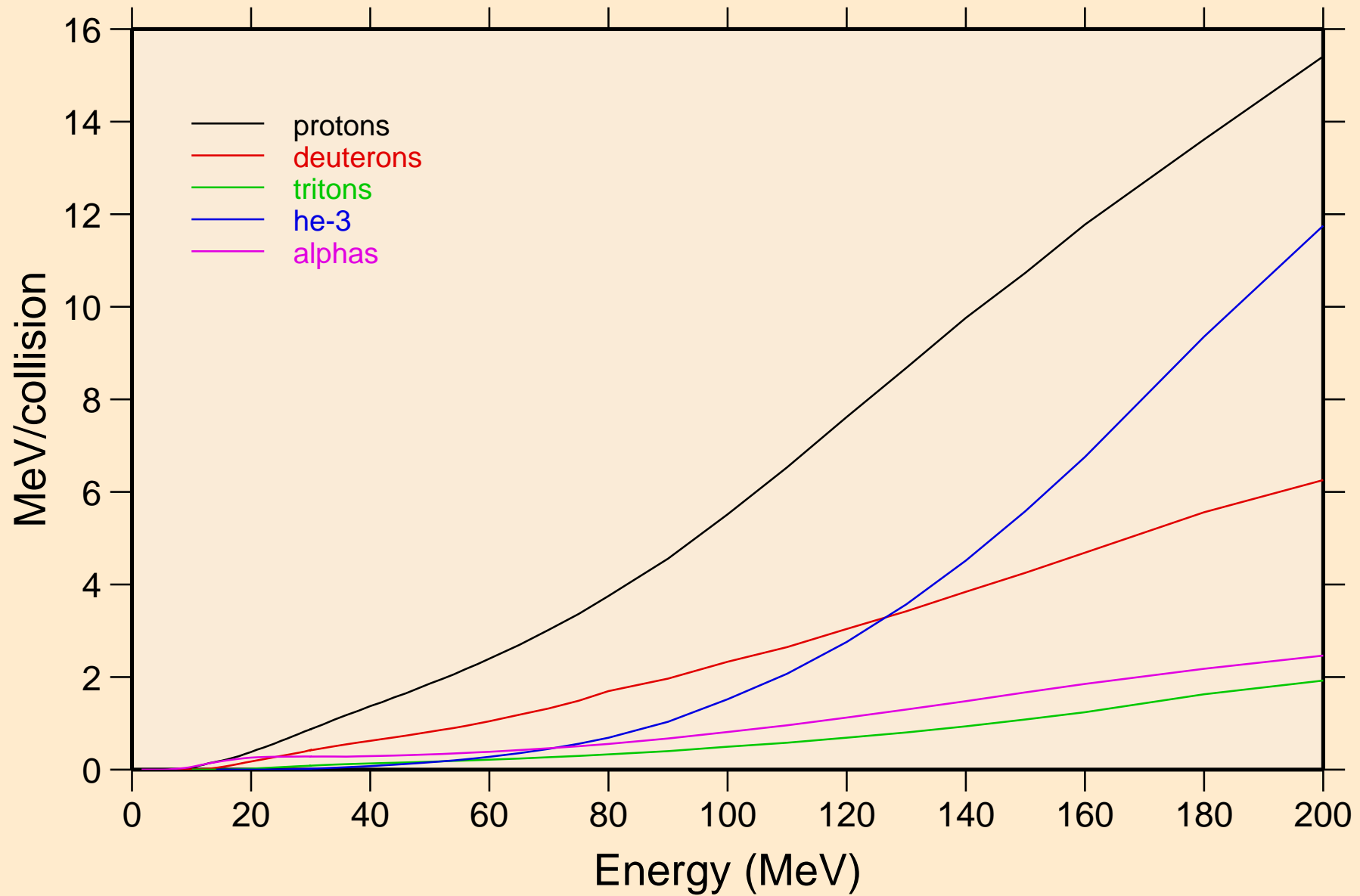

CL037 NEUTRON ACER TENDL-2021 LIBRARY; T=293.6K
Recoil Heating

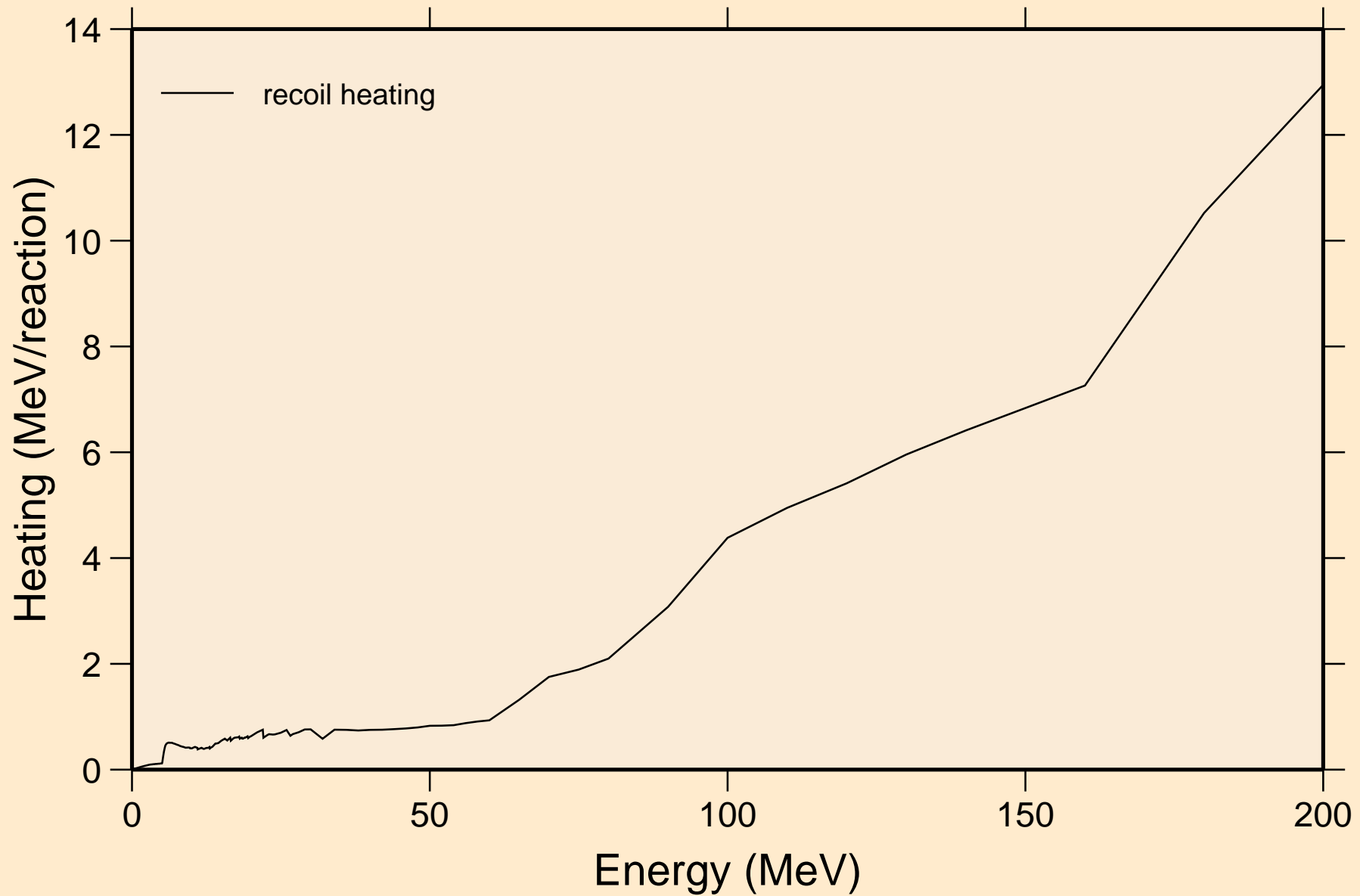

CL037 NEUTRON ACER TENDL-2021 LIBRARY; T=293.6K
Particle production cross sections

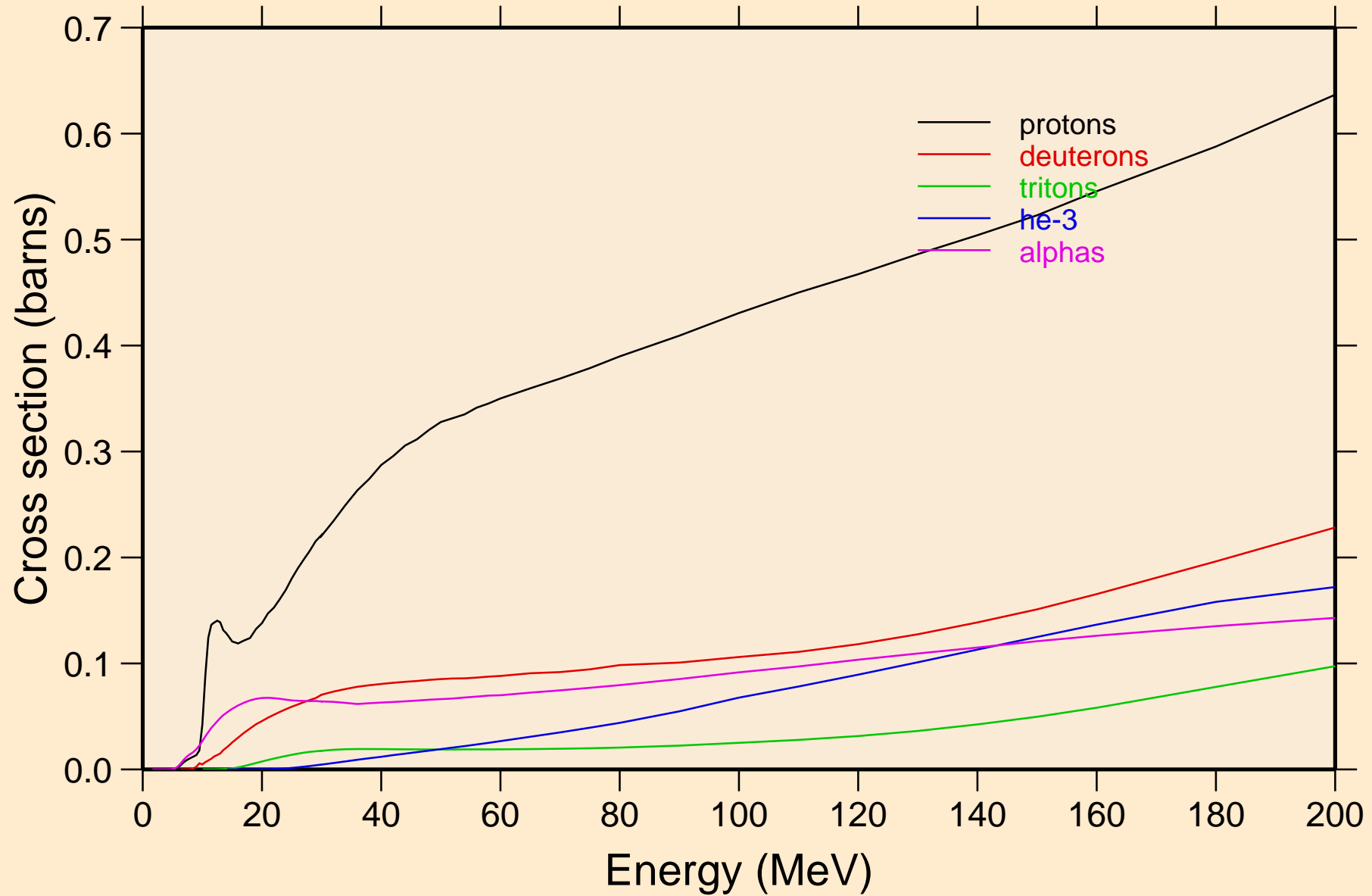

CL037 NEUTRON ACER TENDL-2021 LIBRARY; T=293.6K
protons from (n,x)

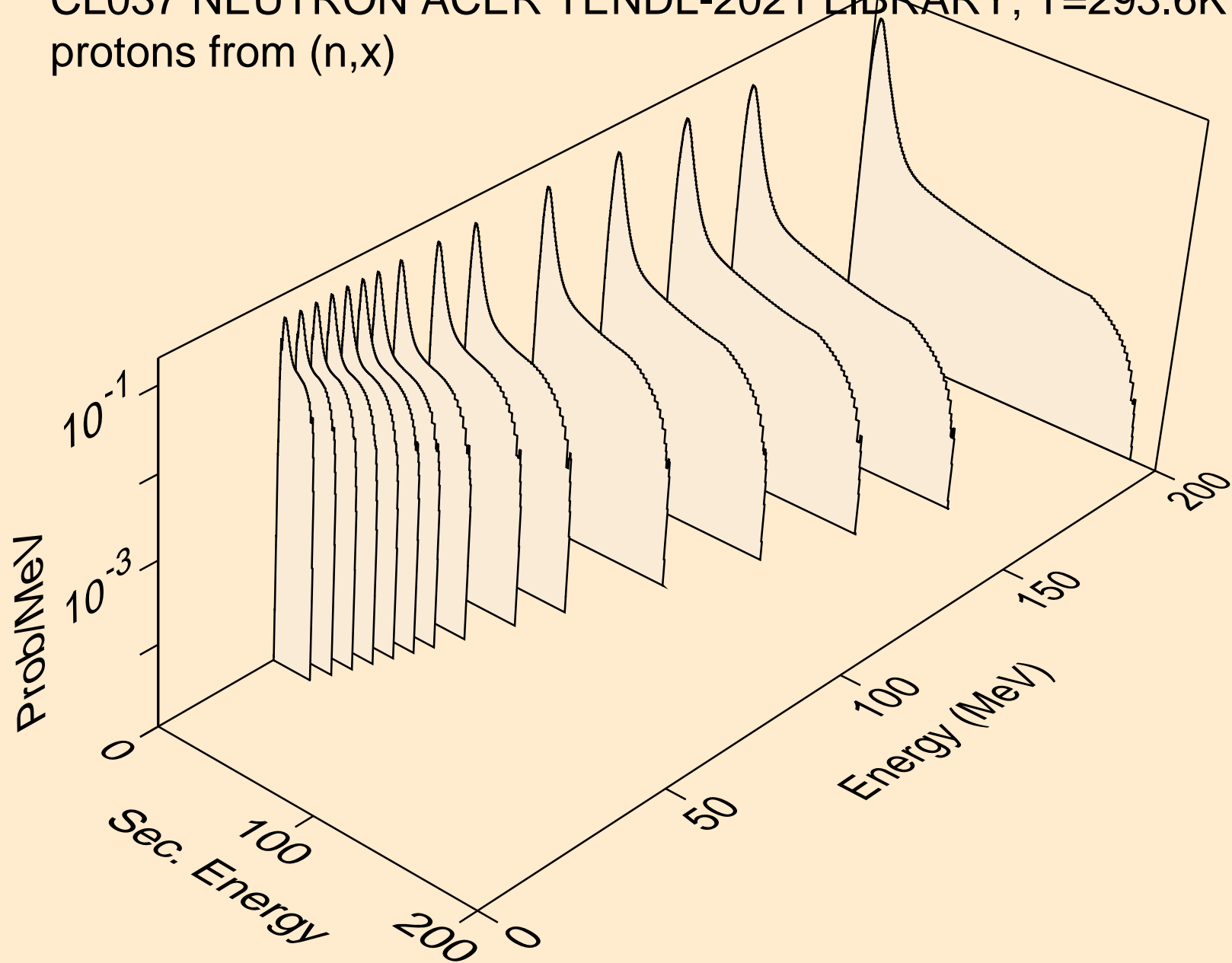

CL037 NEUTRON ACER TENDL-2021 LIBRARY; T=293.6K
protons from (n,n*)p

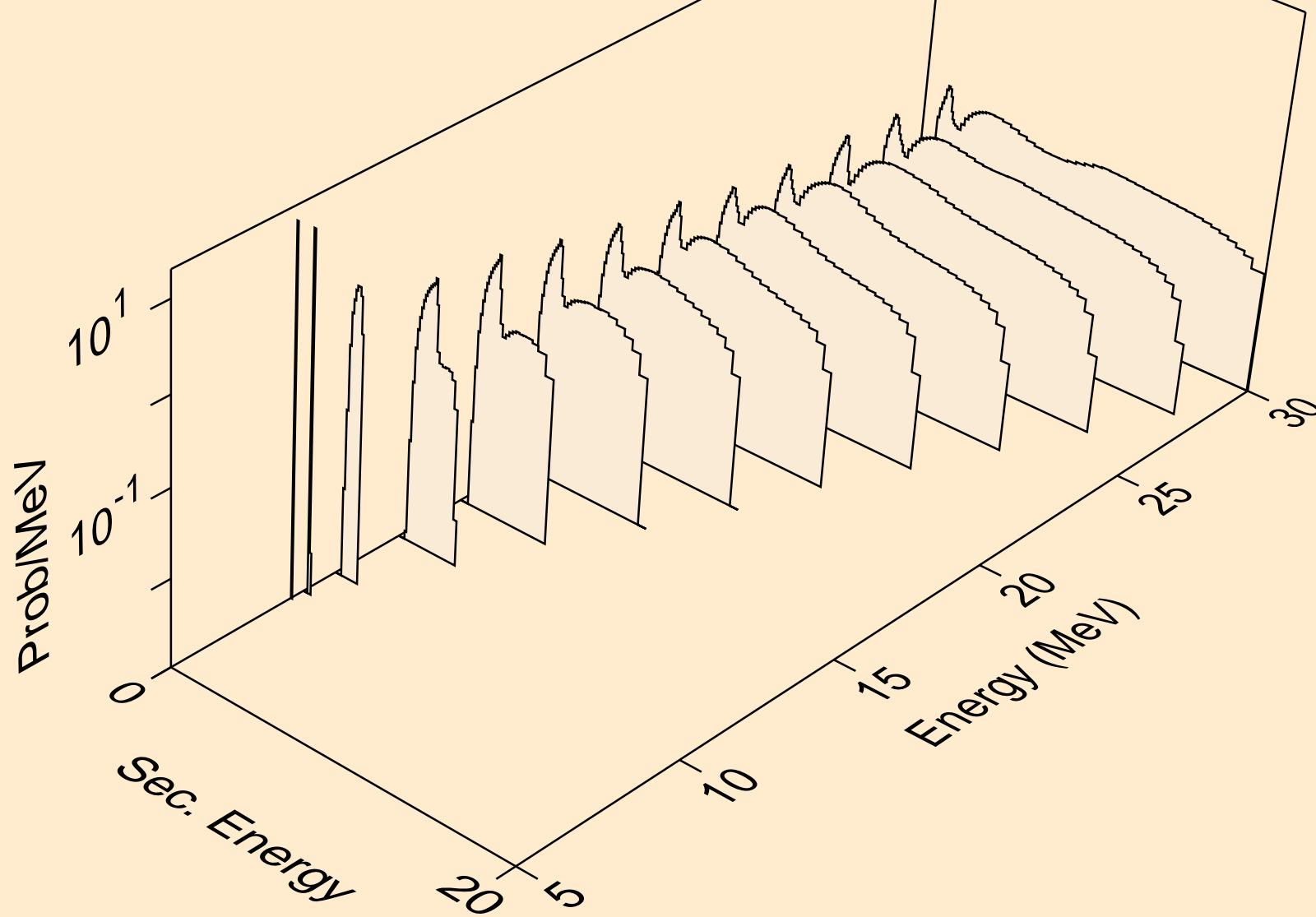

CL037 NEUTRON ACER TENDL-2021 LIBRARY; T=293.6K
protons from (n,2np)

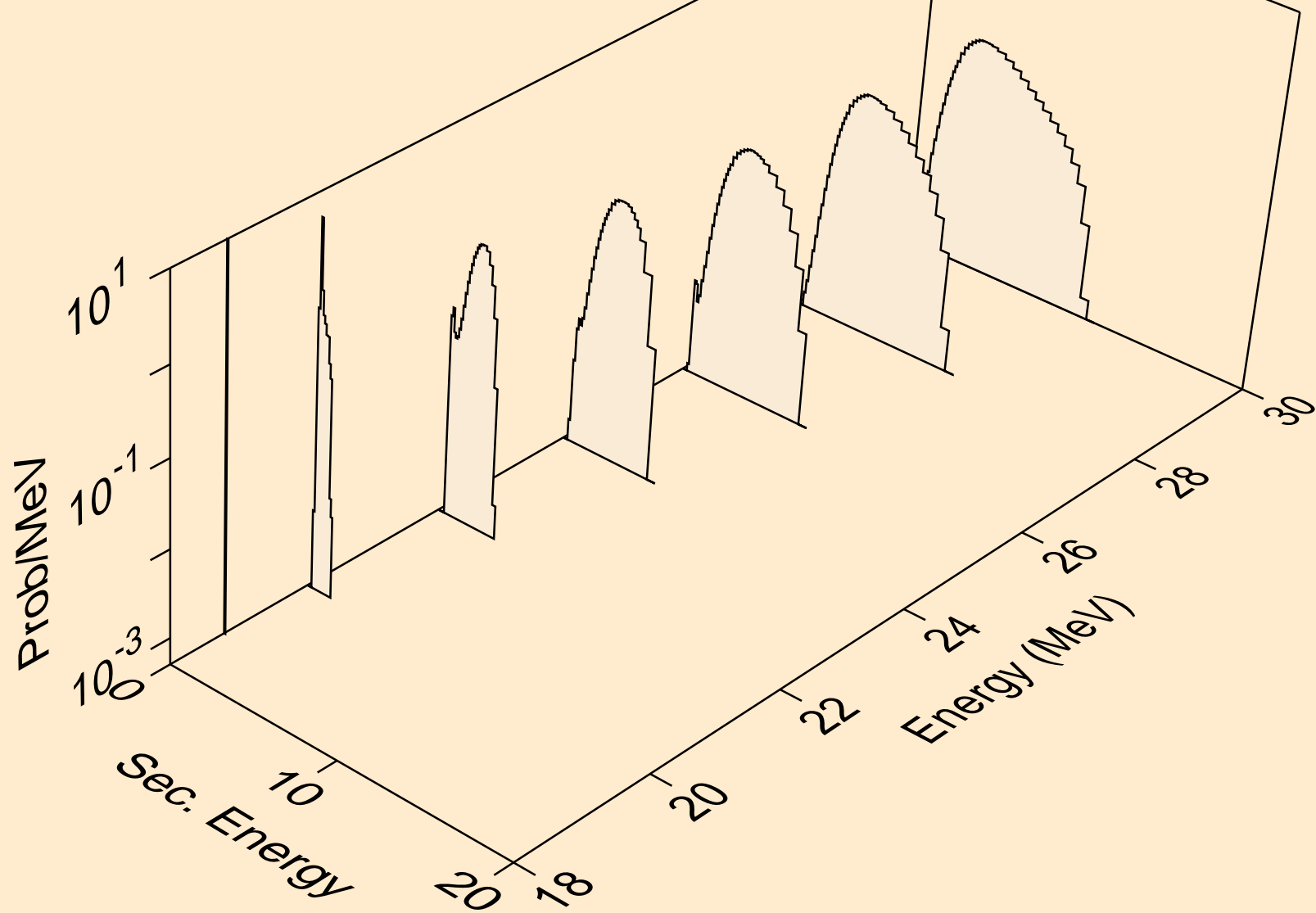

CL037 NEUTRON ACER TENDL-2021 LIBRARY; T=293.6K
protons from (n,3np)

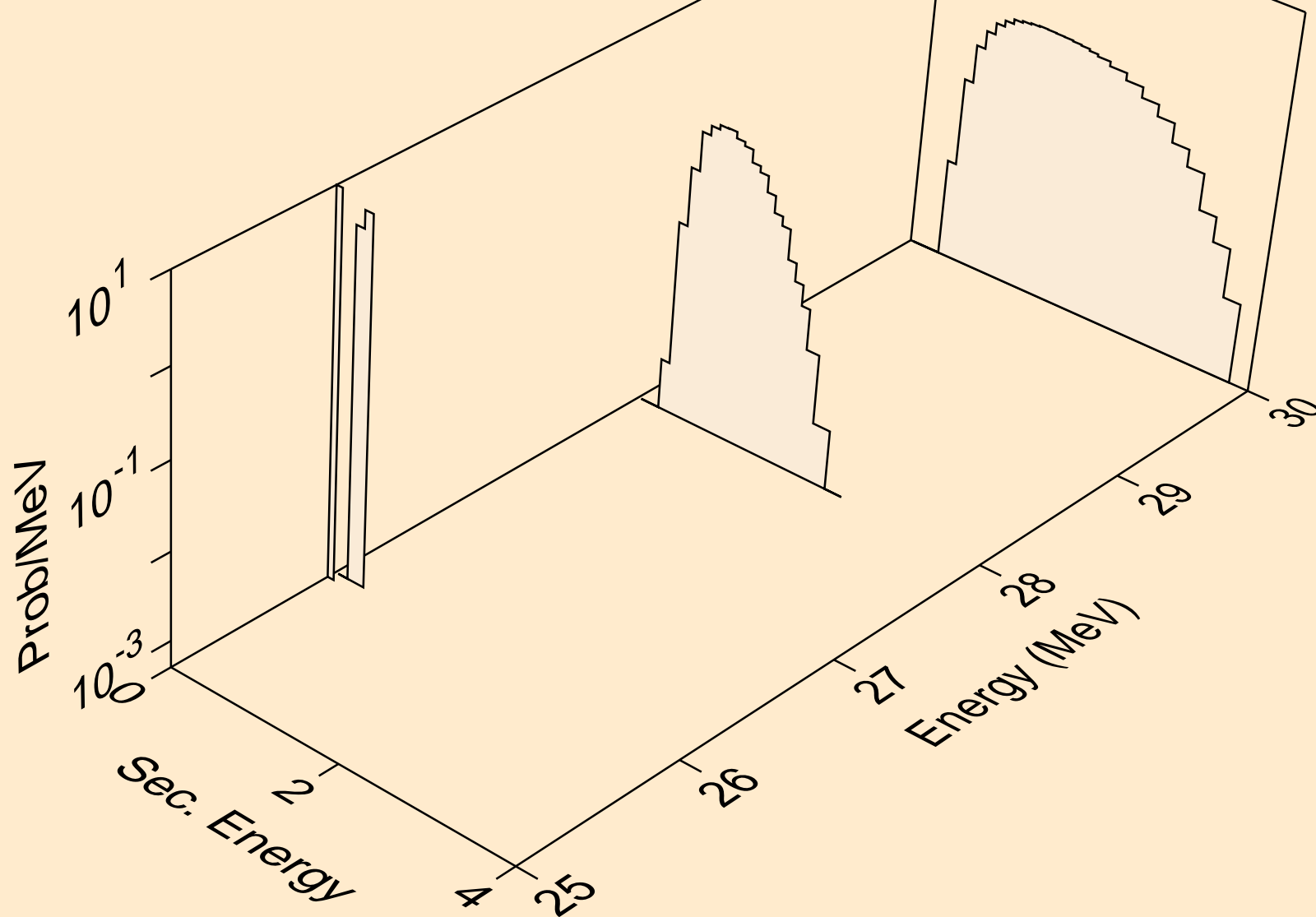

CL037 NEUTRON ACER TENDL-2021 LIBRARY; T=293.6K
protons from (n,2np)

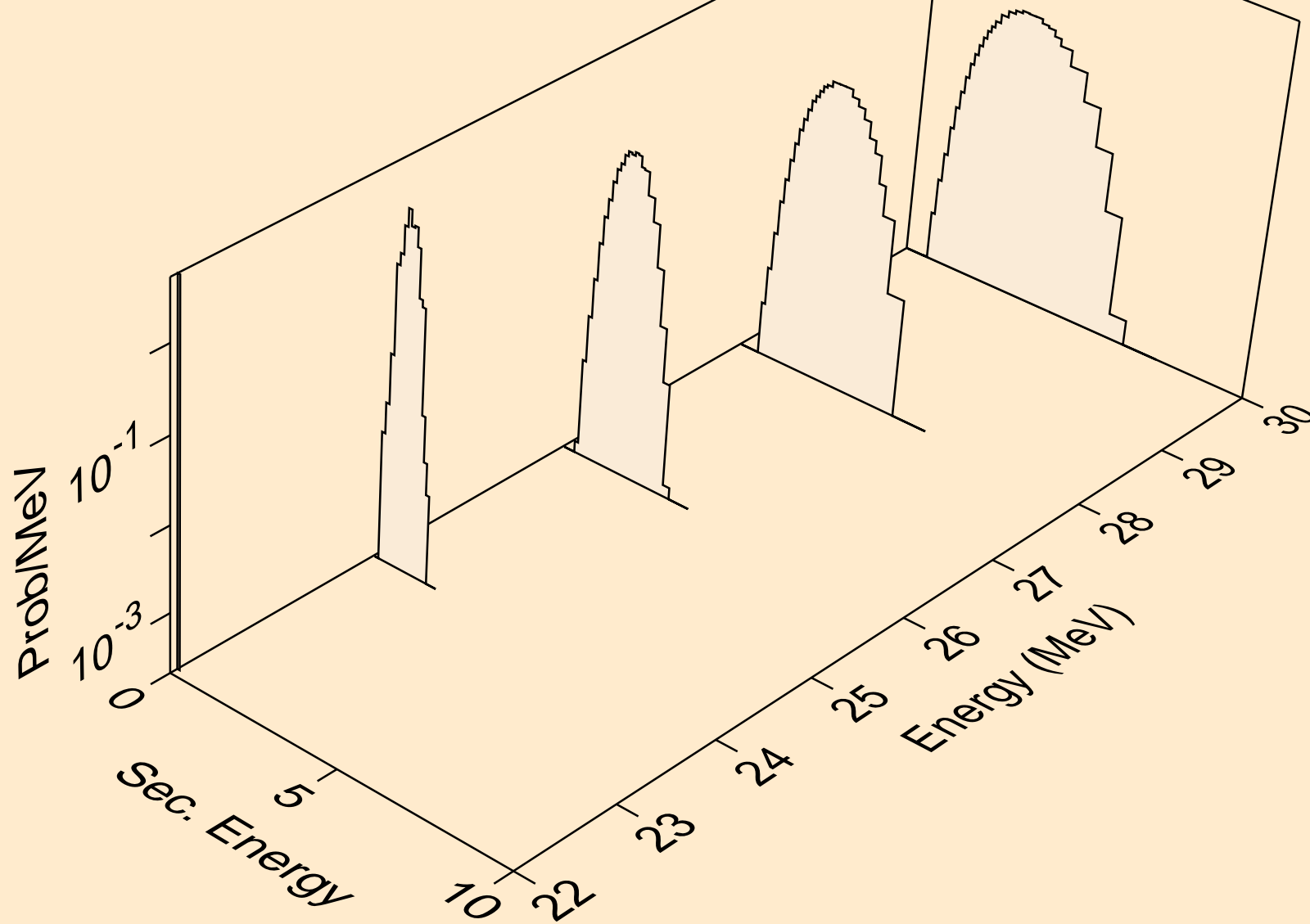

CL037 NEUTRON ACER TENDL-2021 LIBRARY; T=293.6K
protons from (n,npa)

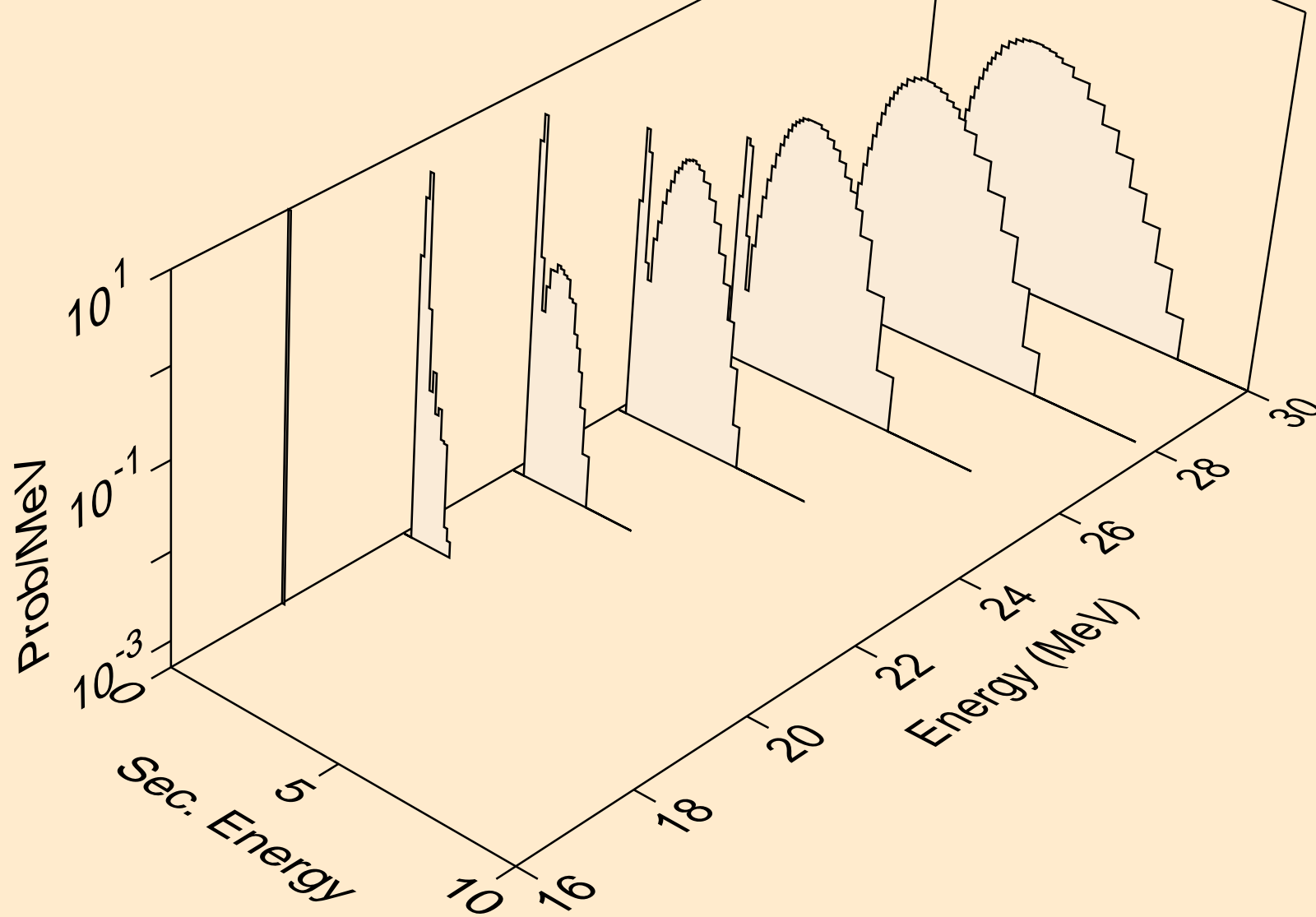

CL037 NEUTRON ACER TENDL-2021 LIBRARY; T=293.6K
protons from (n,p)

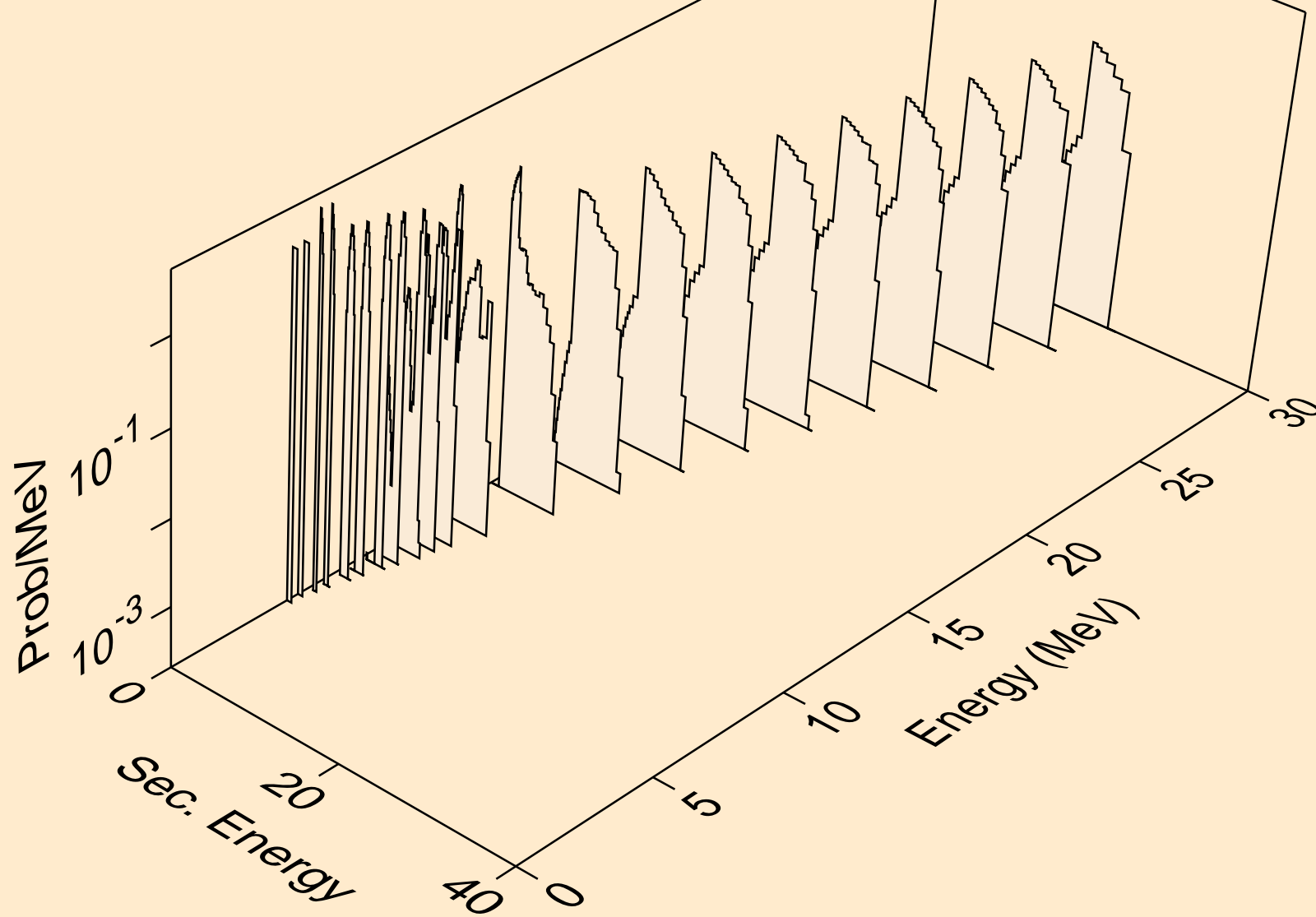

CL037 NEUTRON ACER TENDL-2021 LIBRARY; T=293.6K
protons from (n,2p)

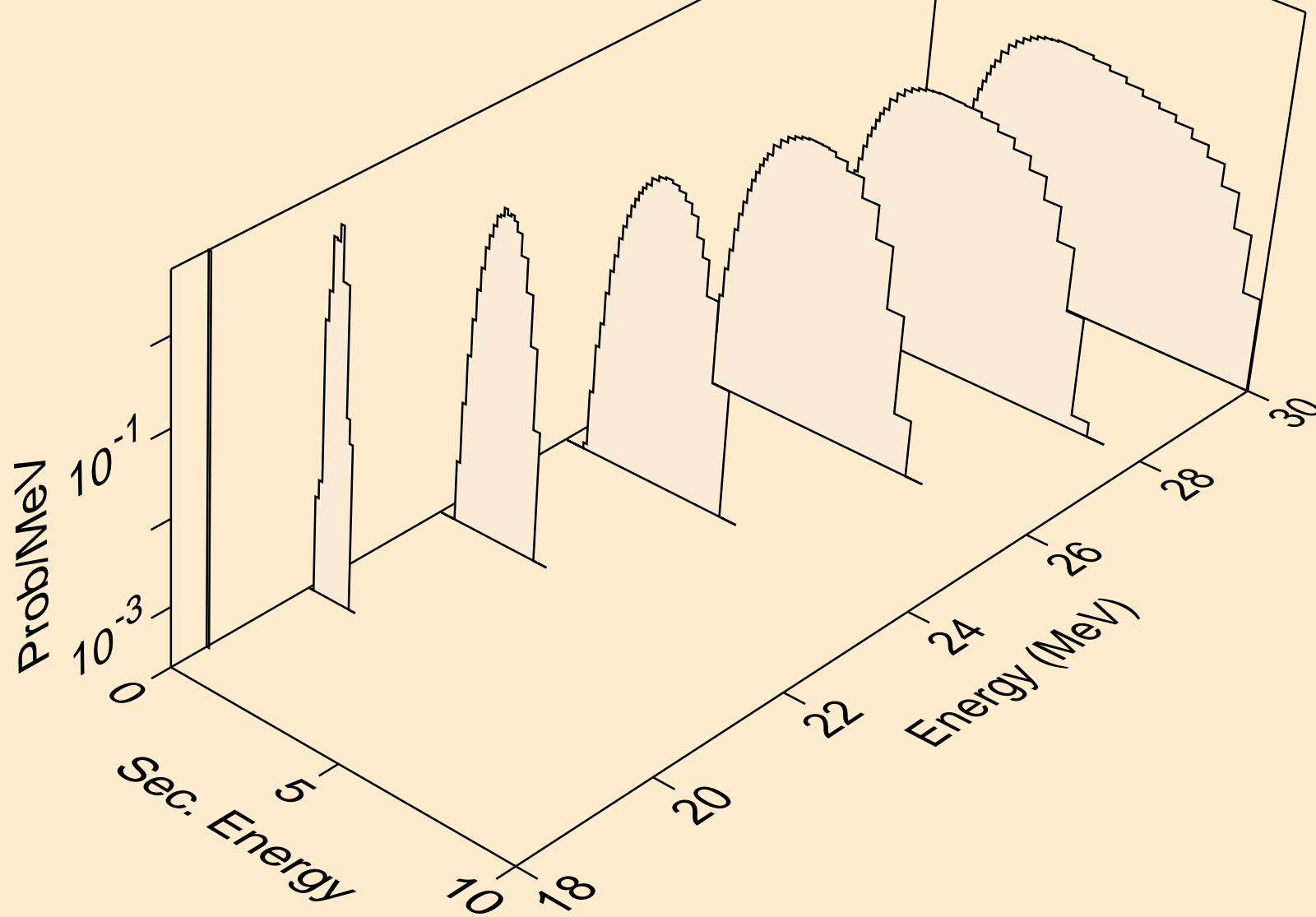

CL037 NEUTRON ACER TENDL-2021 LIBRARY; T=293.6K
protons from (n,p)

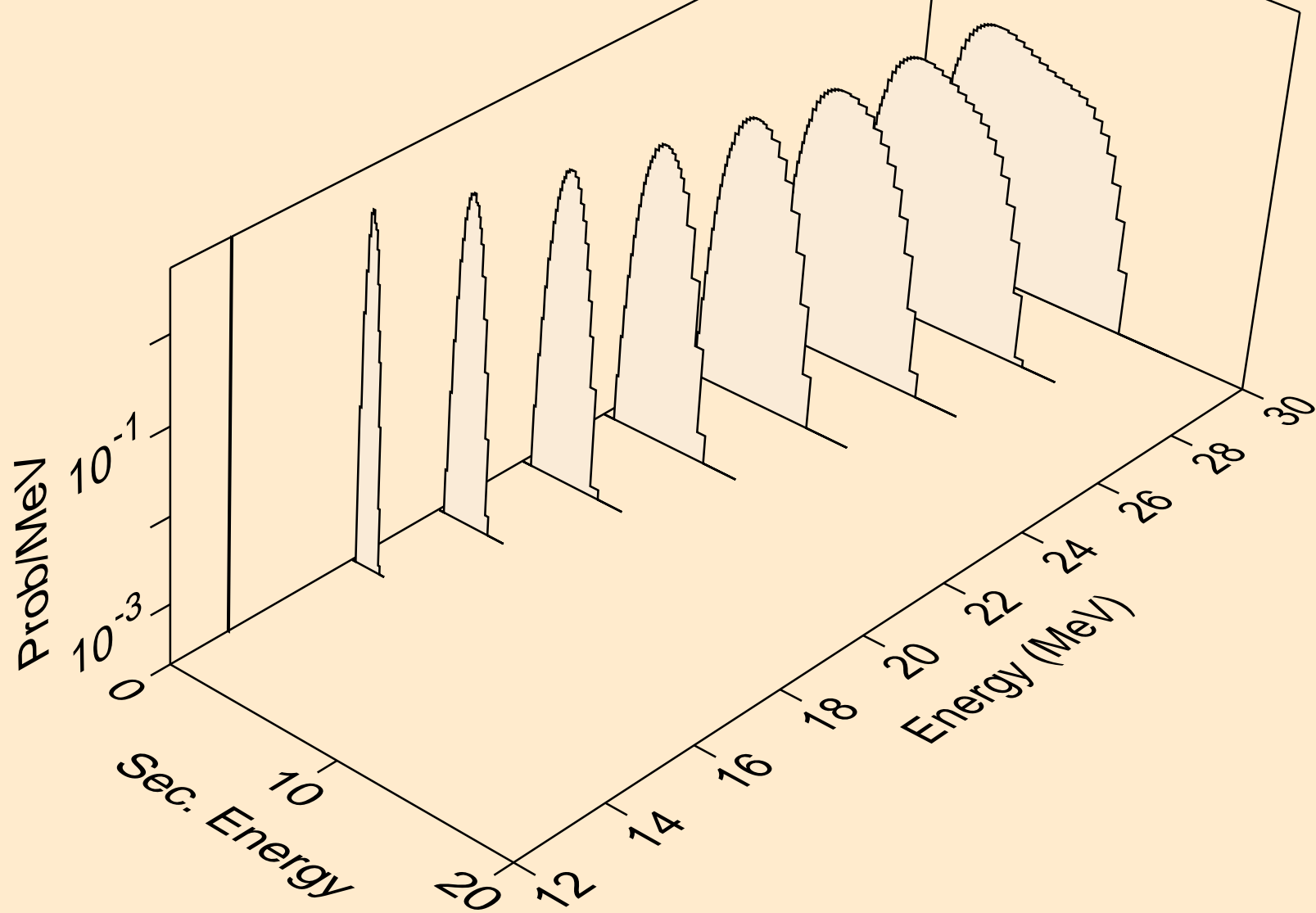

CL037 NEUTRON ACER TENDL-2021 LIBRARY; T=293.6K
protons from (n,pd)

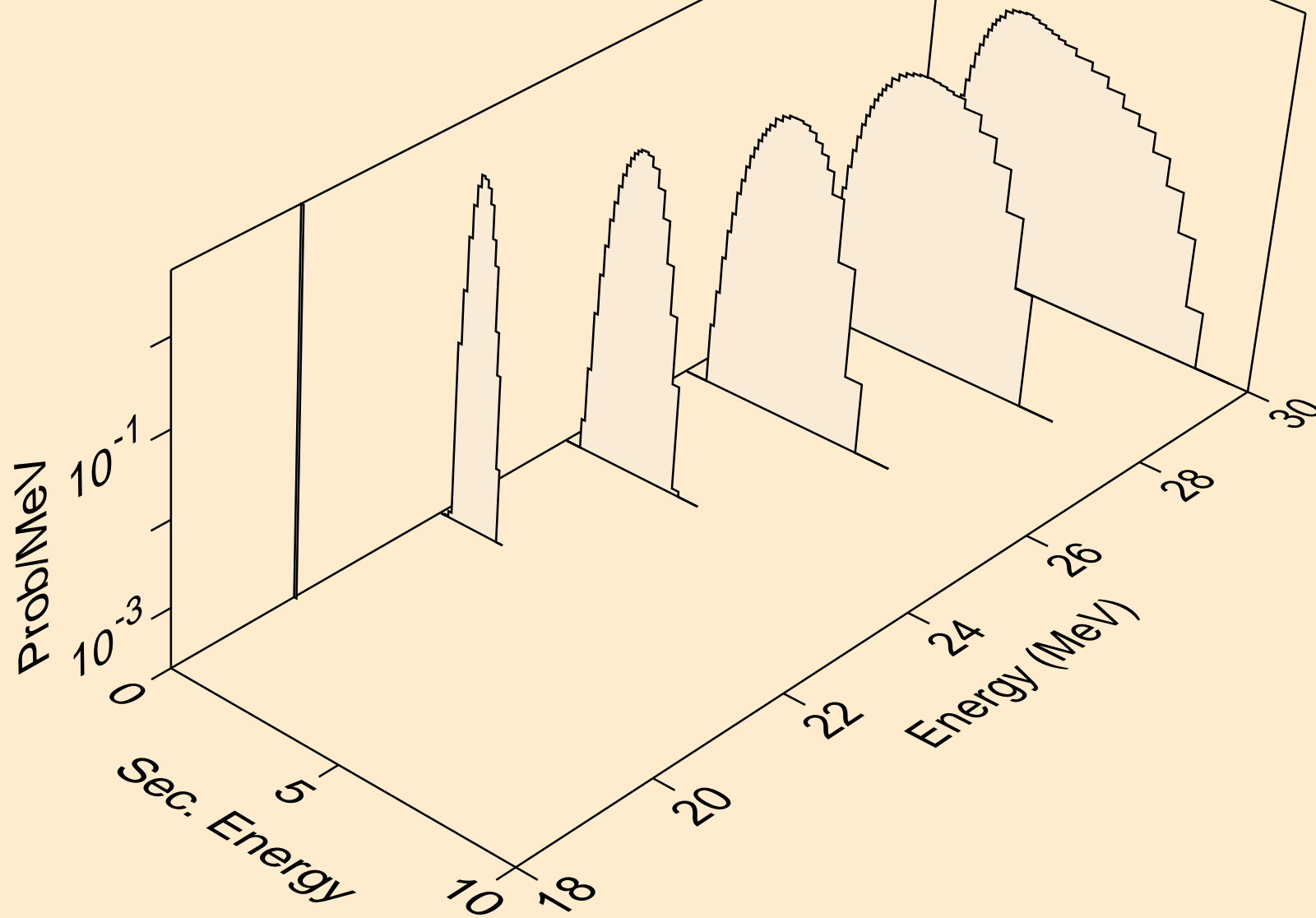

CL037 NEUTRON ACER TENDL-2021 LIBRARY; T=293.6K
protons from (n,pt)

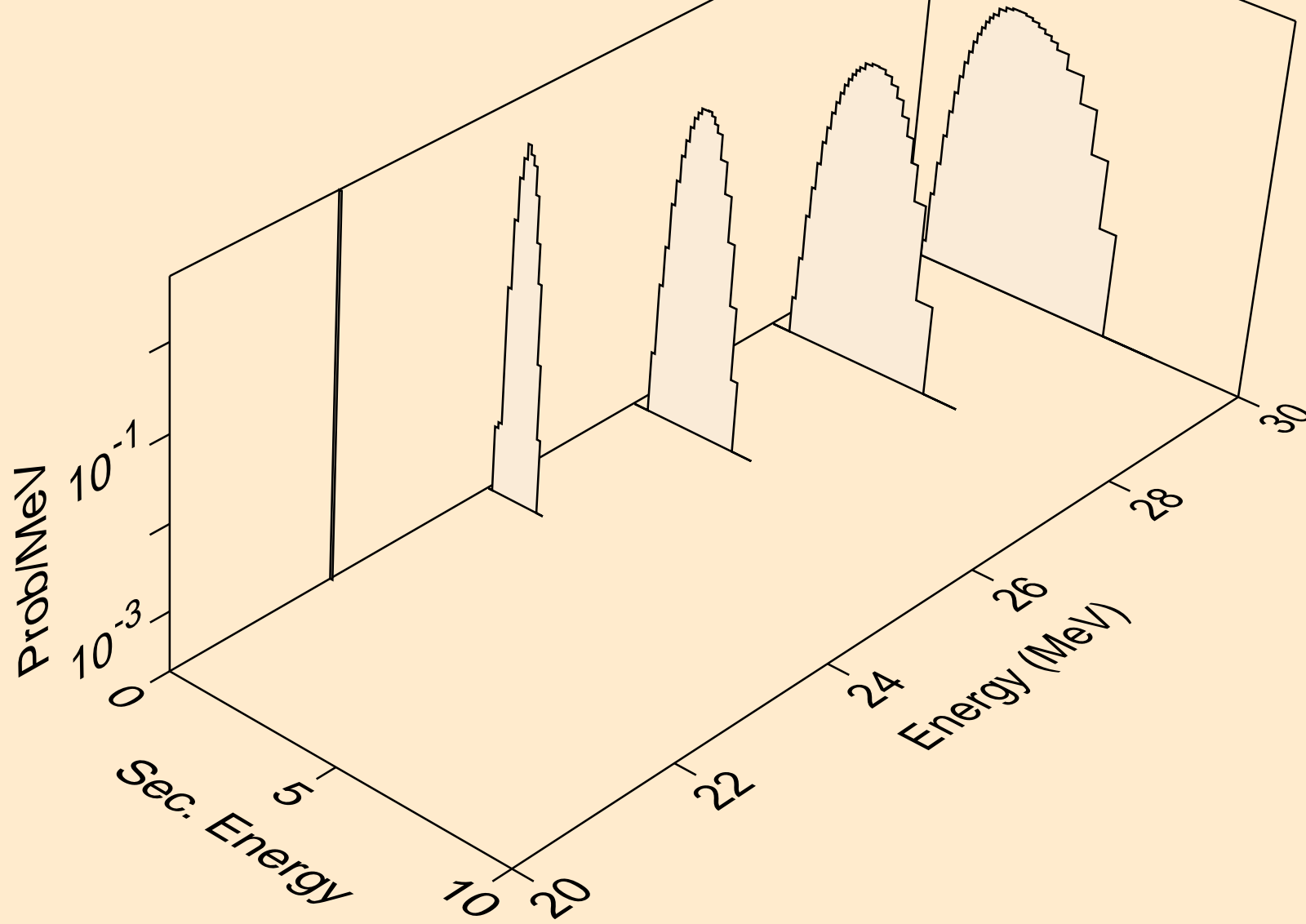

CL037 NEUTRON ACER TENDL-2021 LIBRARY; T=293.6K
deuterons from (n,x)

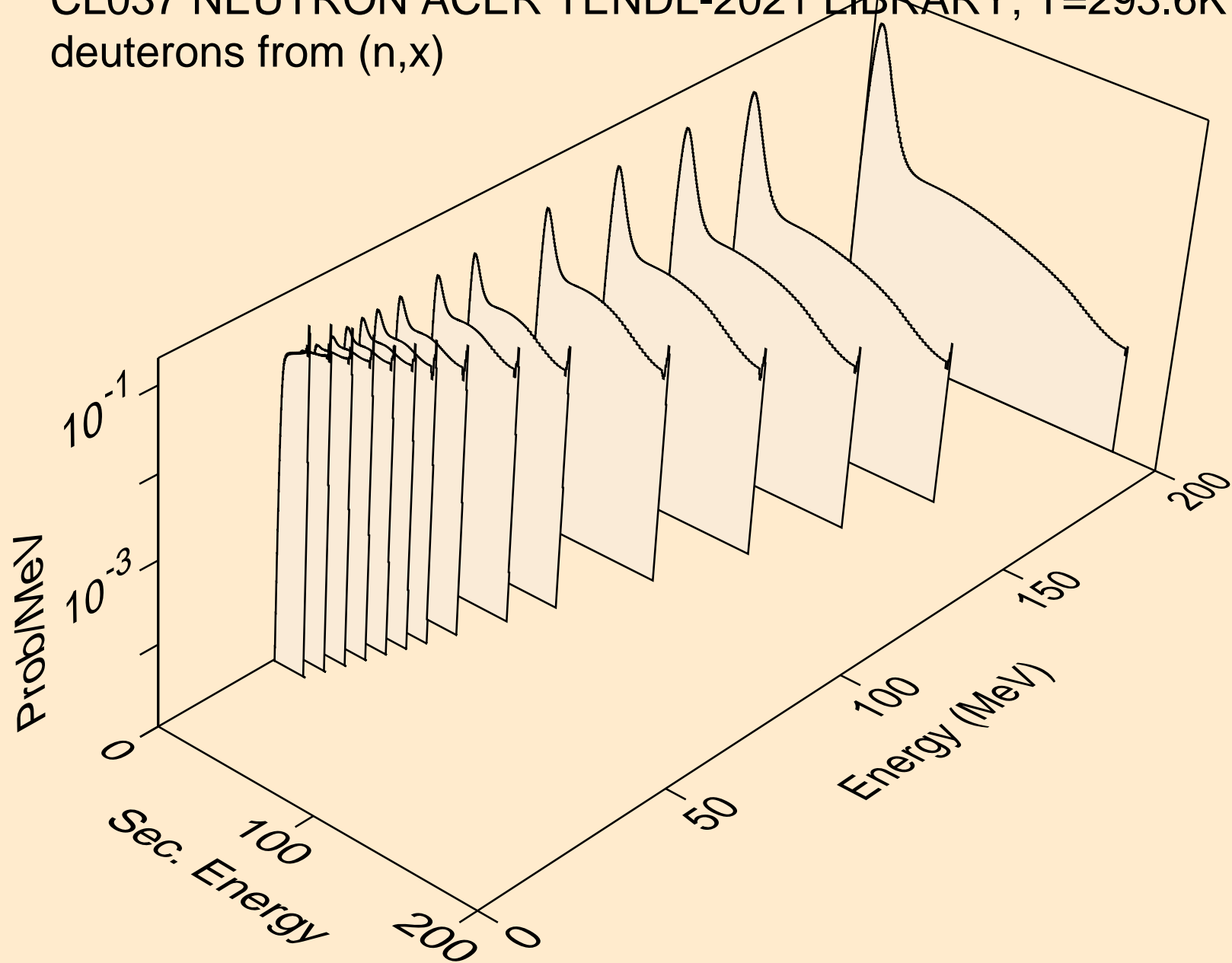

CL037 NEUTRON ACER TENDL-2021 LIBRARY; T=293.6K
deuterons from (n,2nd)

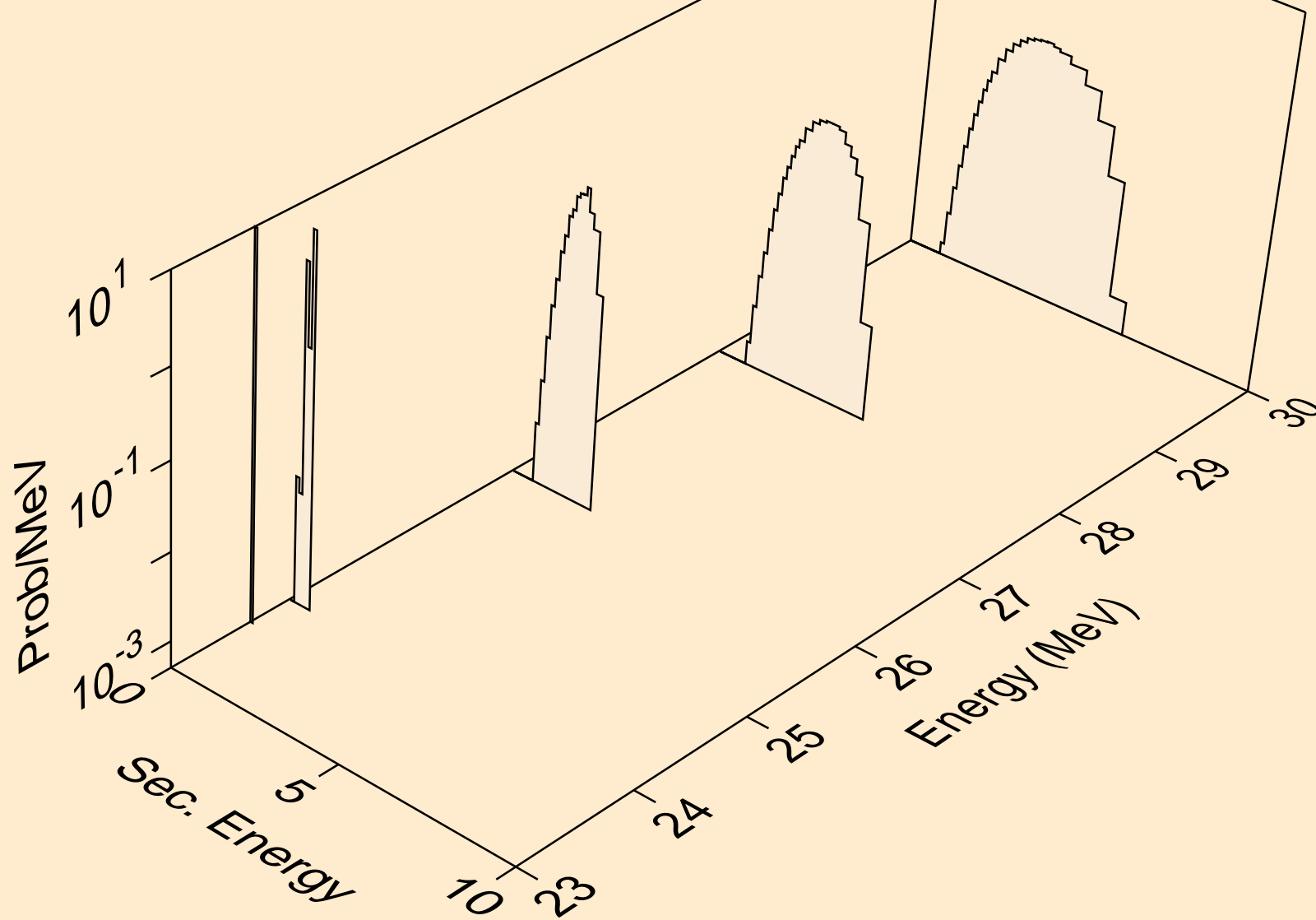

CL037 NEUTRON ACER TENDL-2021 LIBRARY; T=293.6K
deuterons from (n,n*)d

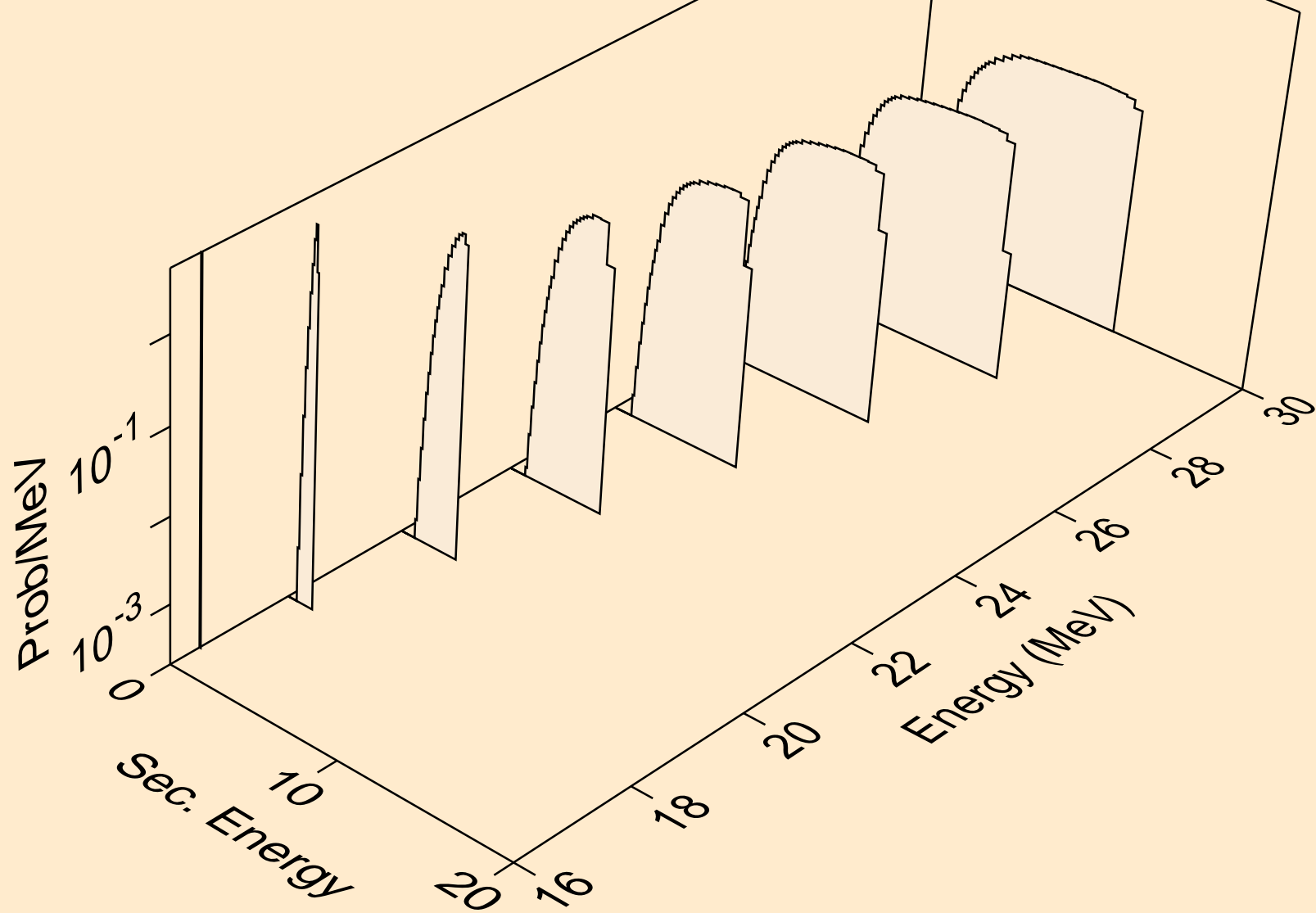

CL037 NEUTRON ACER TENDL-2021 LIBRARY; T=293.6K
deuterons from (n,d)

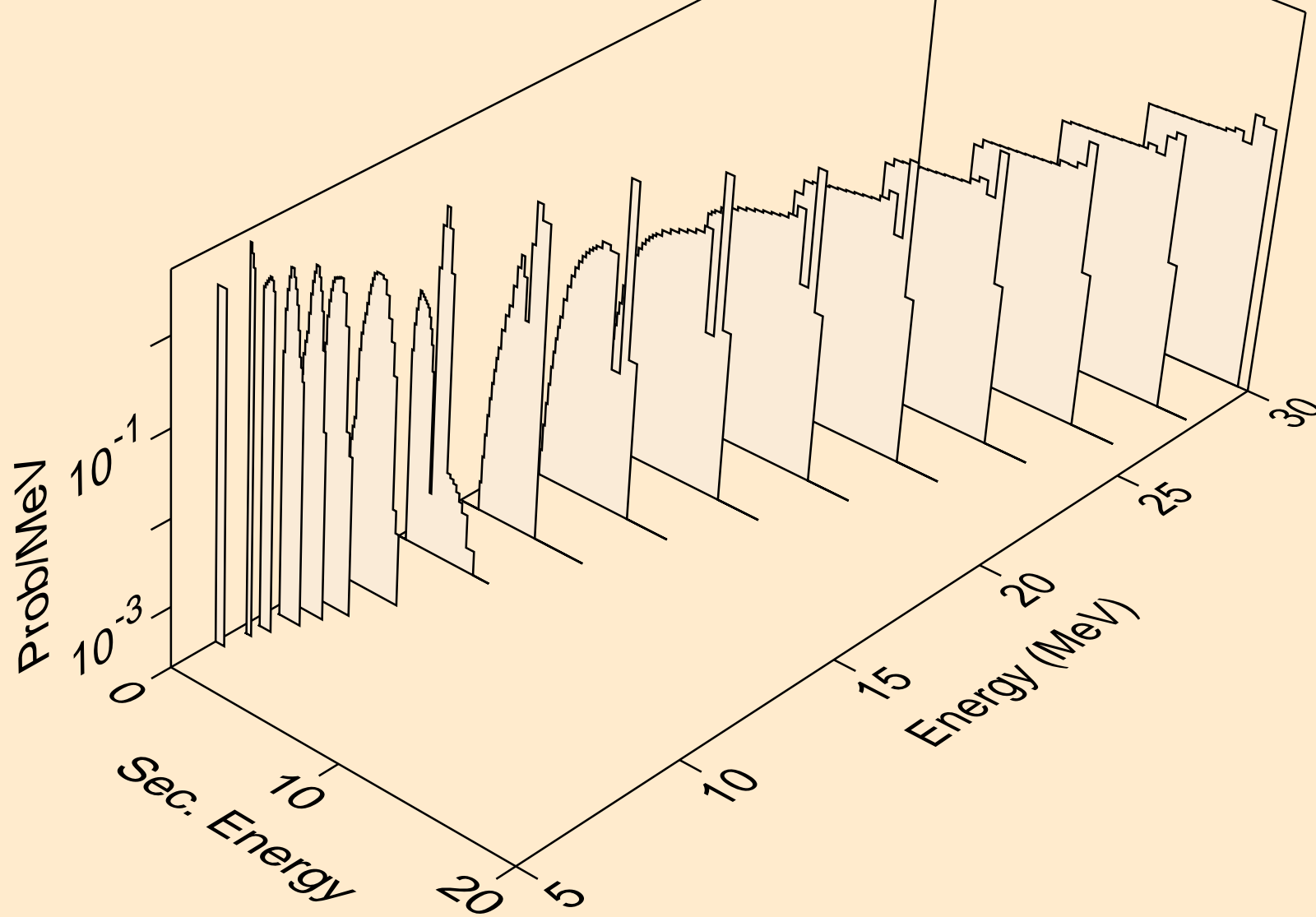

CL037 NEUTRON ACER TENDL-2021 LIBRARY; T=293.6K
deuterons from (n,pd)

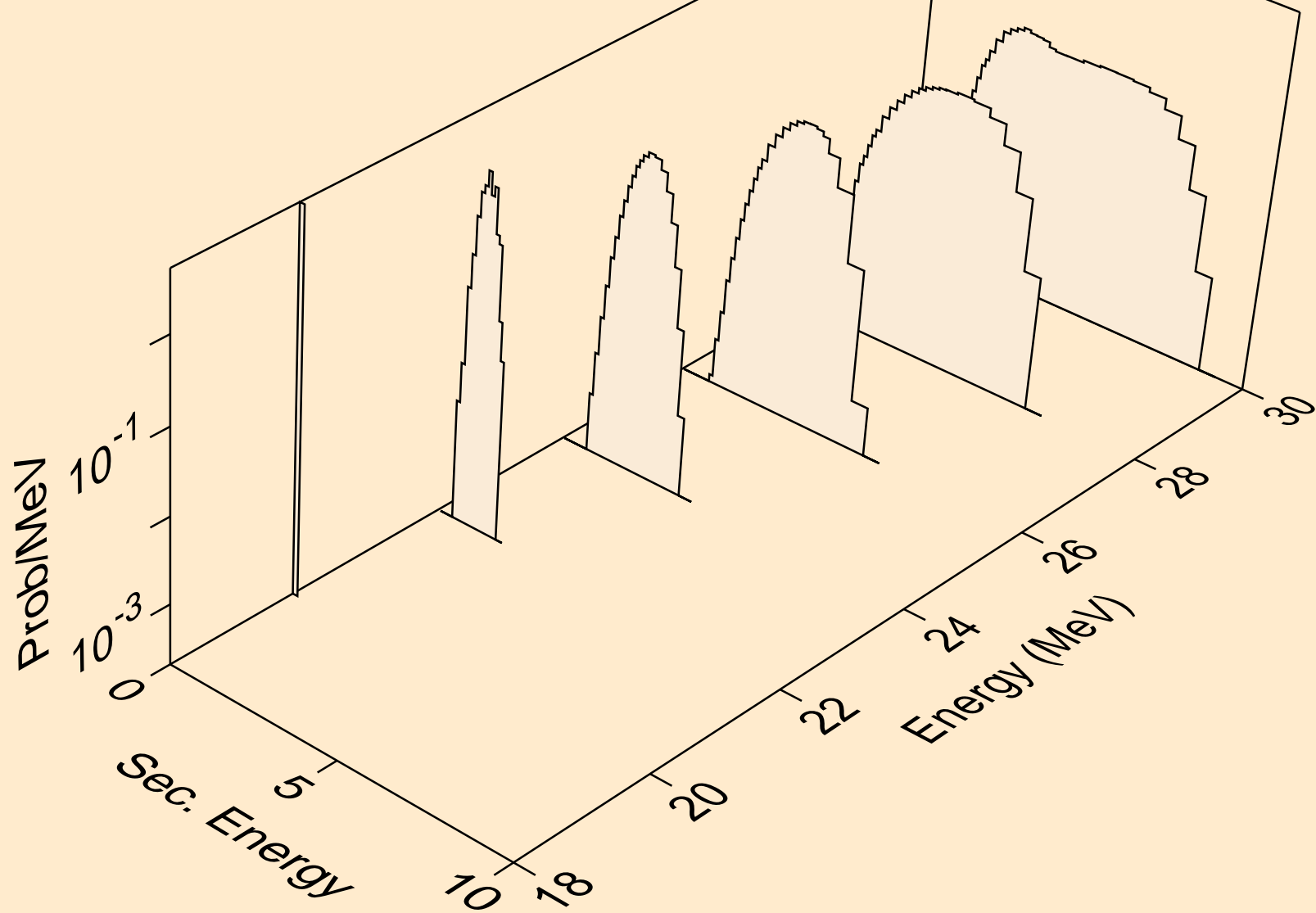

CL037 NEUTRON ACER TENDL-2021 LIBRARY; T=293.6K
deuterons from (n,da)

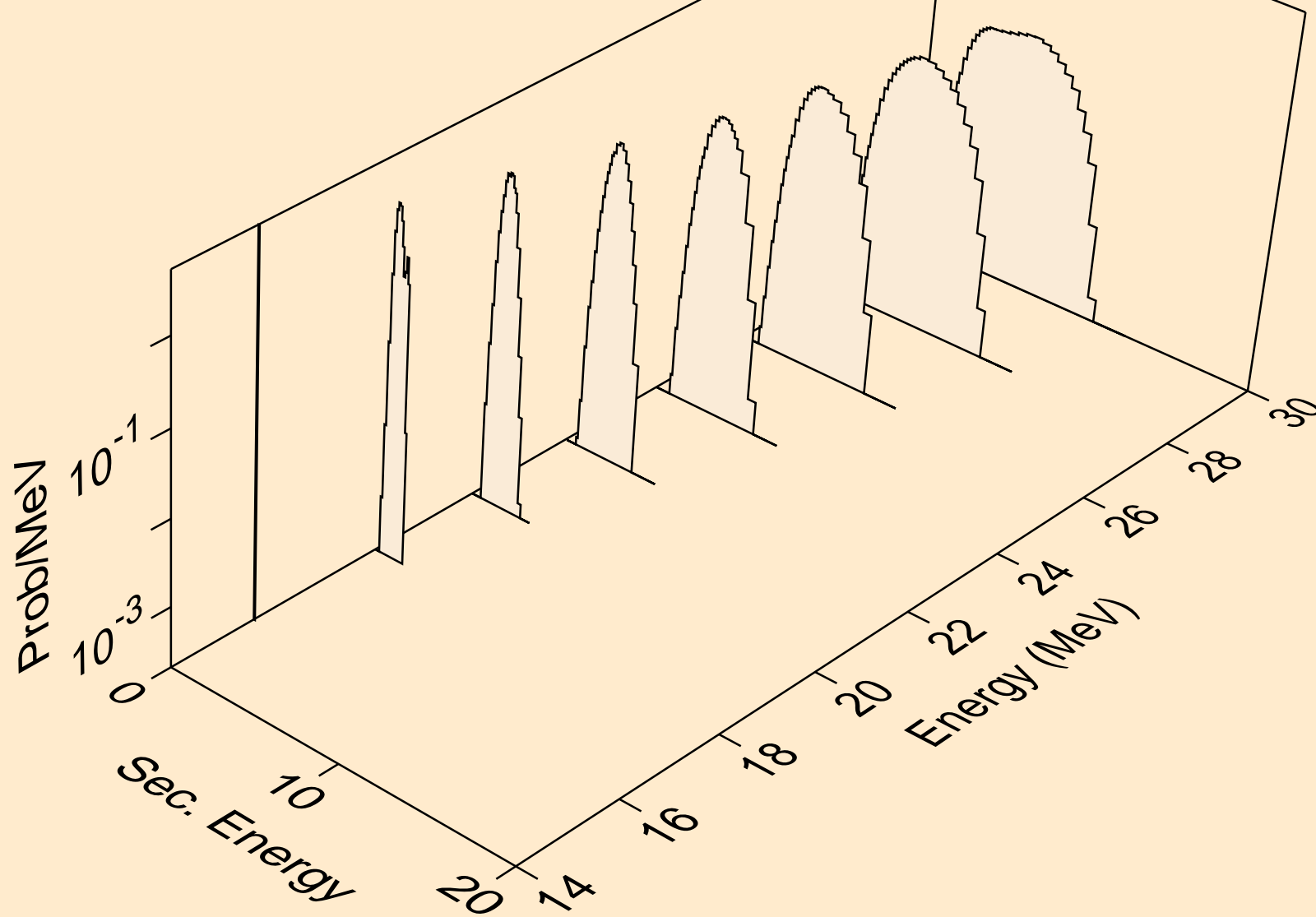

CL037 NEUTRON ACER TENDL-2021 LIBRARY; T=293.6K
tritons from (n,x)

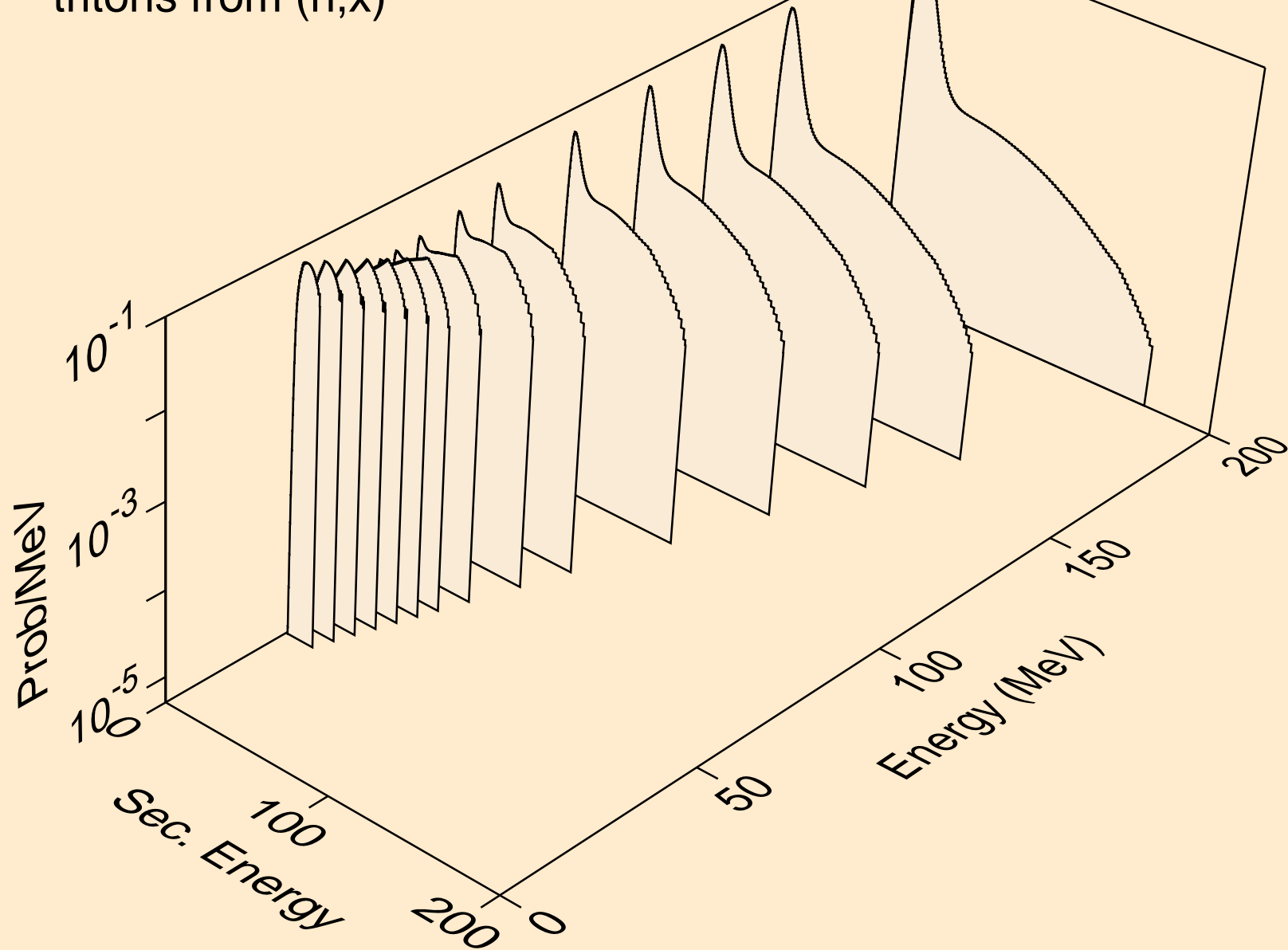

CL037 NEUTRON ACER TENDL-2021 LIBRARY; T=293.6K
tritons from (n,n*)t

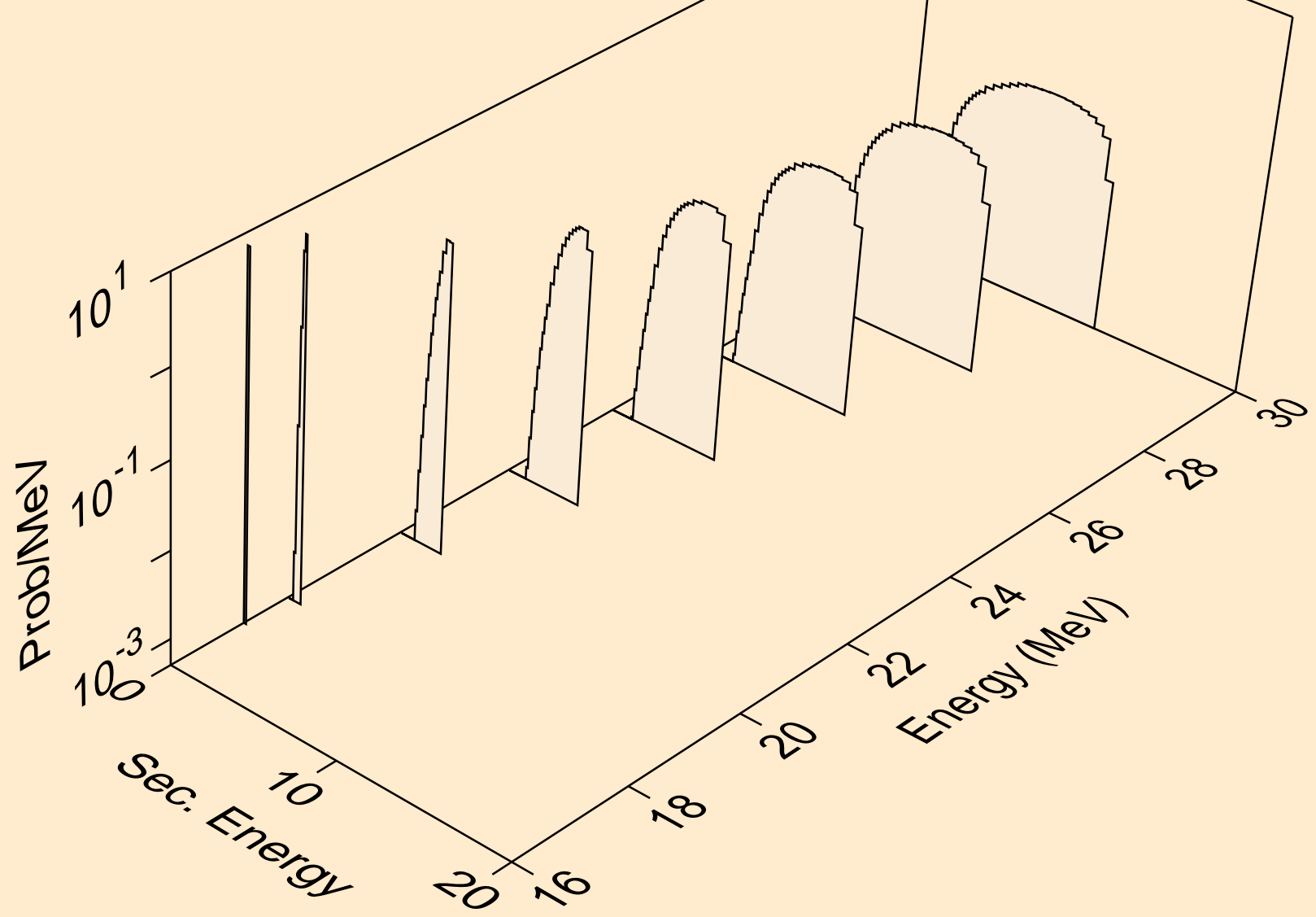

CL037 NEUTRON ACER TENDL-2021 LIBRARY; T=293.6K
tritons from (n,t)

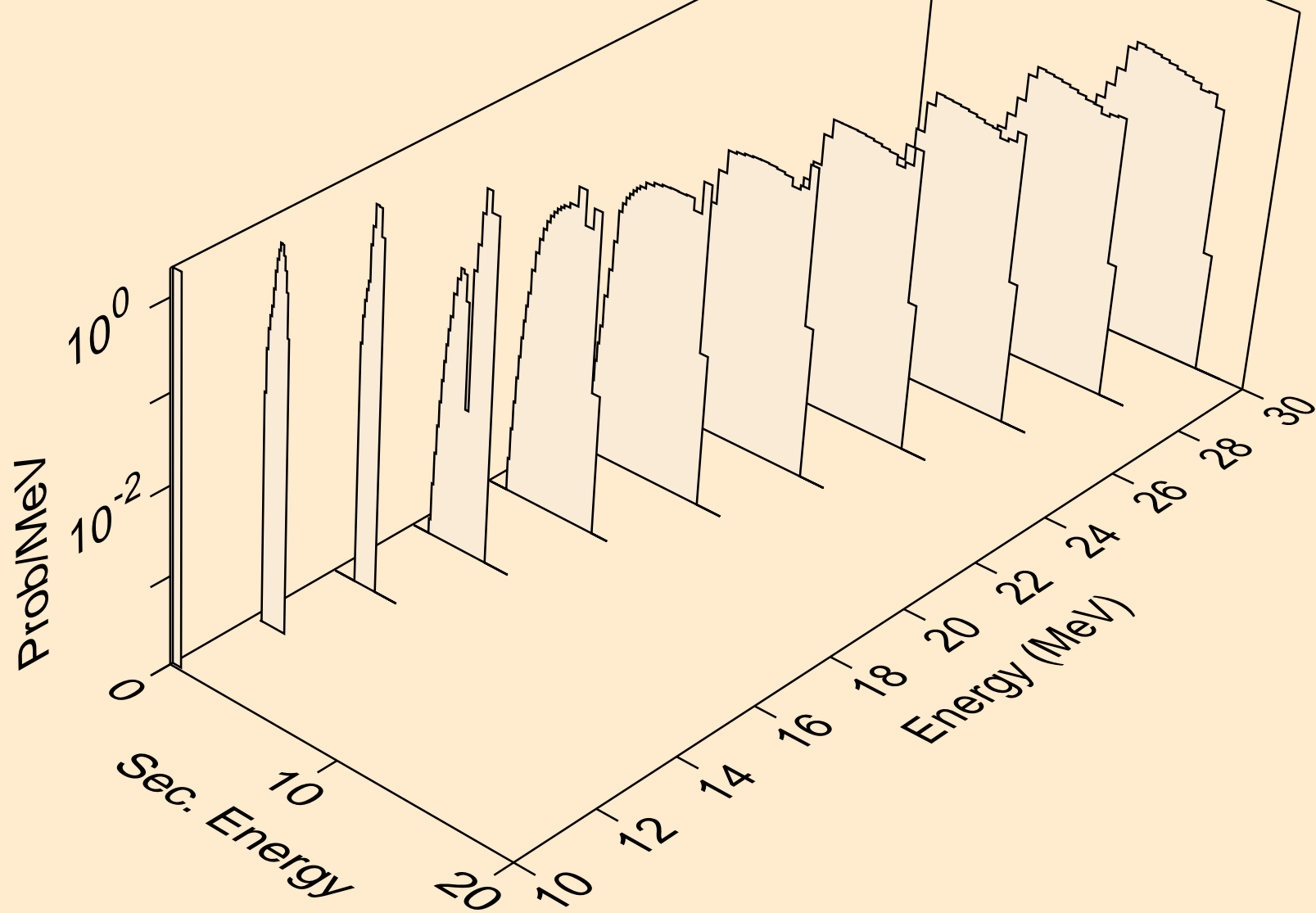

CL037 NEUTRON ACER TENDL-2021 LIBRARY; T=293.6K
tritons from (n,pt)

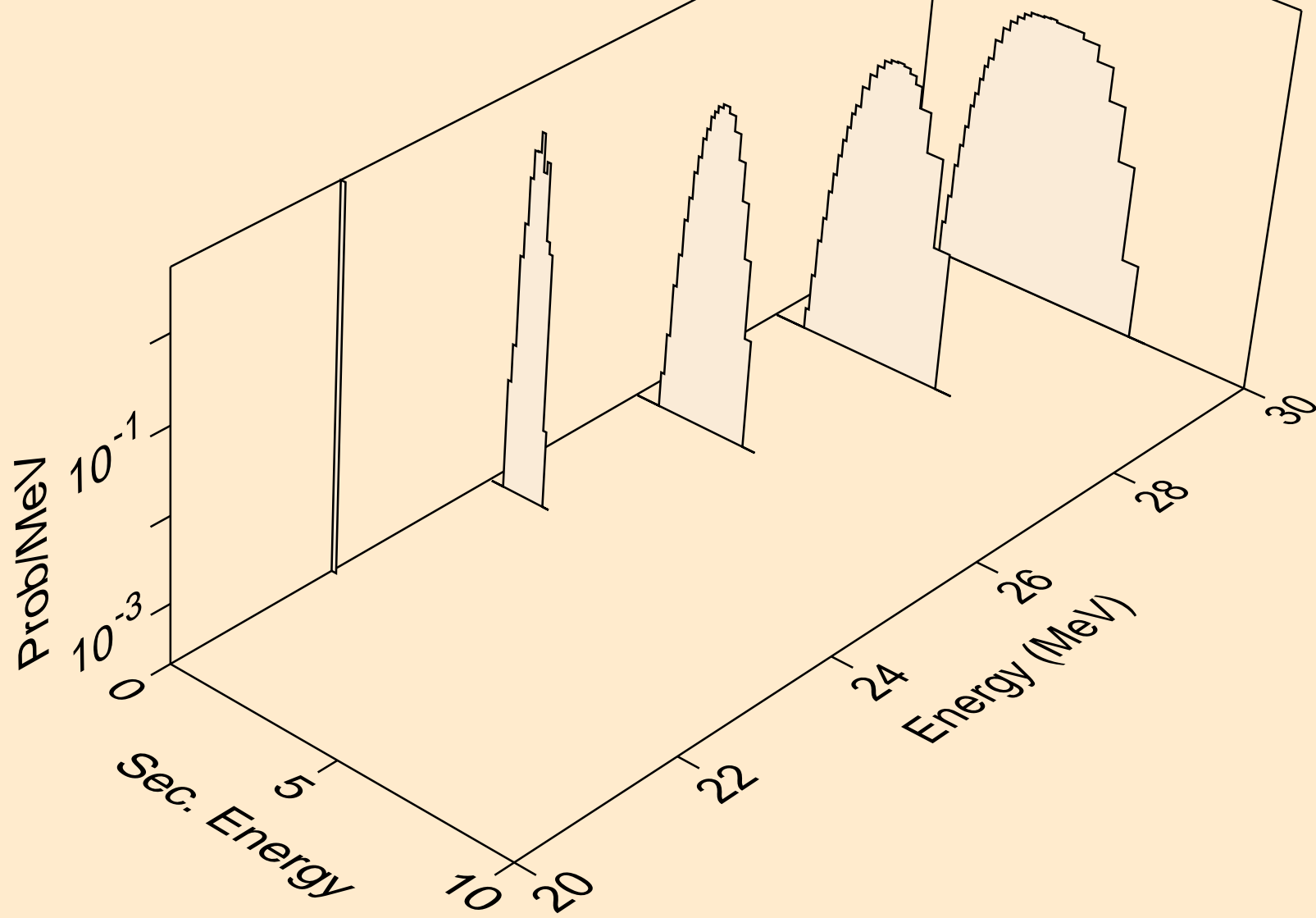

CL037 NEUTRON ACER TENDL-2021 LIBRARY; T=293.6K
he3s from (n,x)

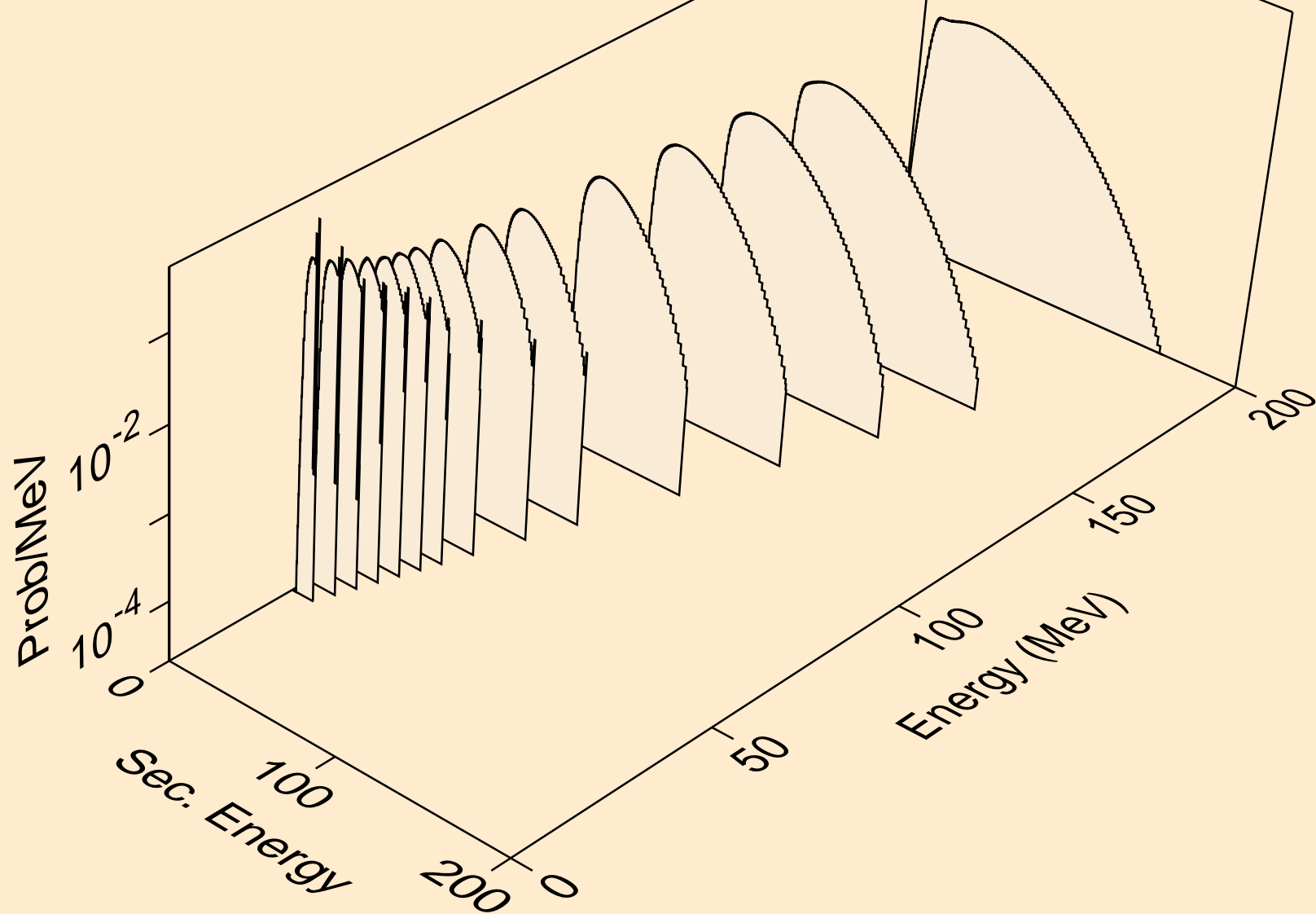

CL037 NEUTRON ACER TENDL-2021 LIBRARY; T=293.6K
he3s from (n,n*)he3

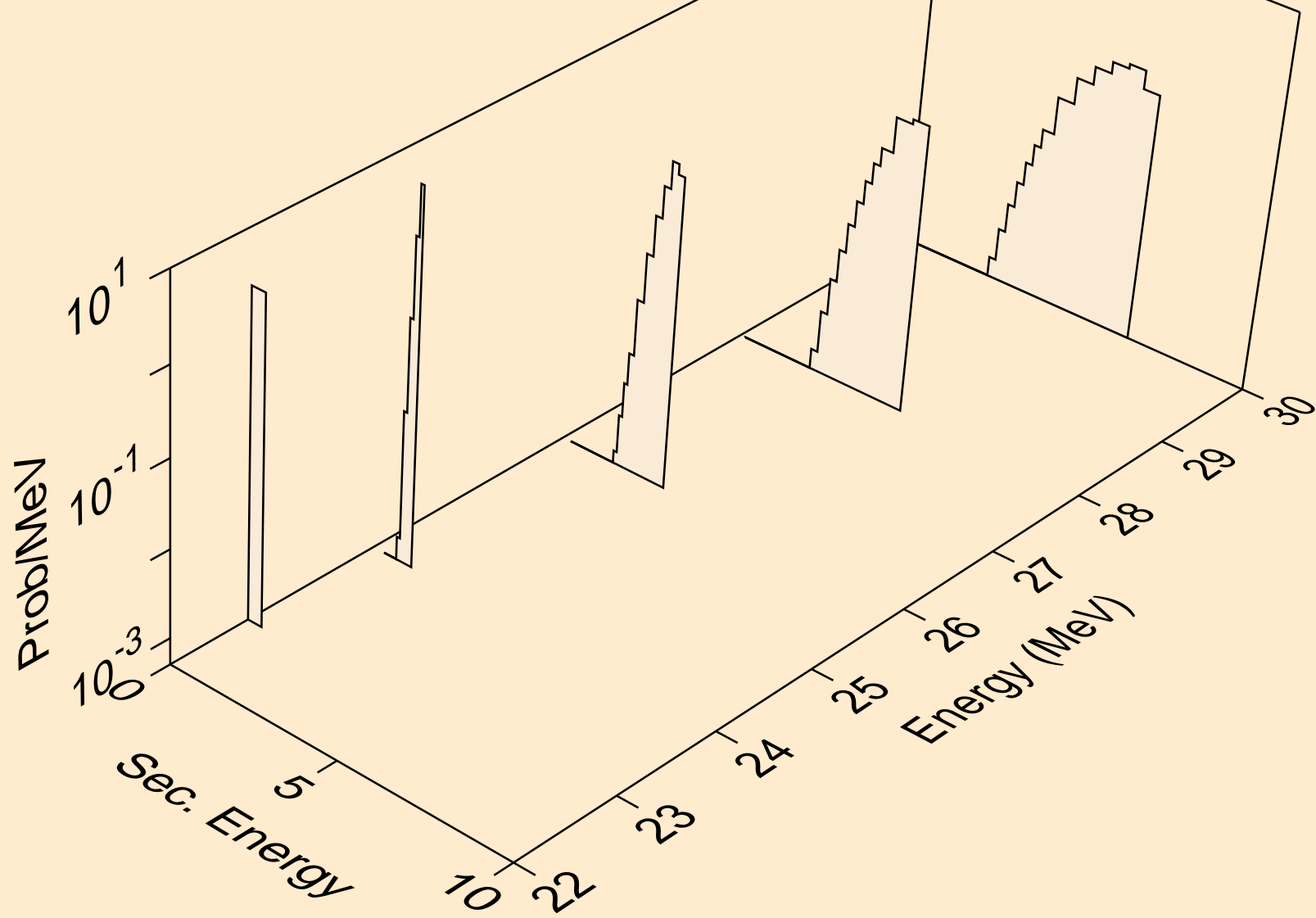

CL037 NEUTRON ACER TENDL-2021 LIBRARY; T=293.6K
he3s from (n,he3)

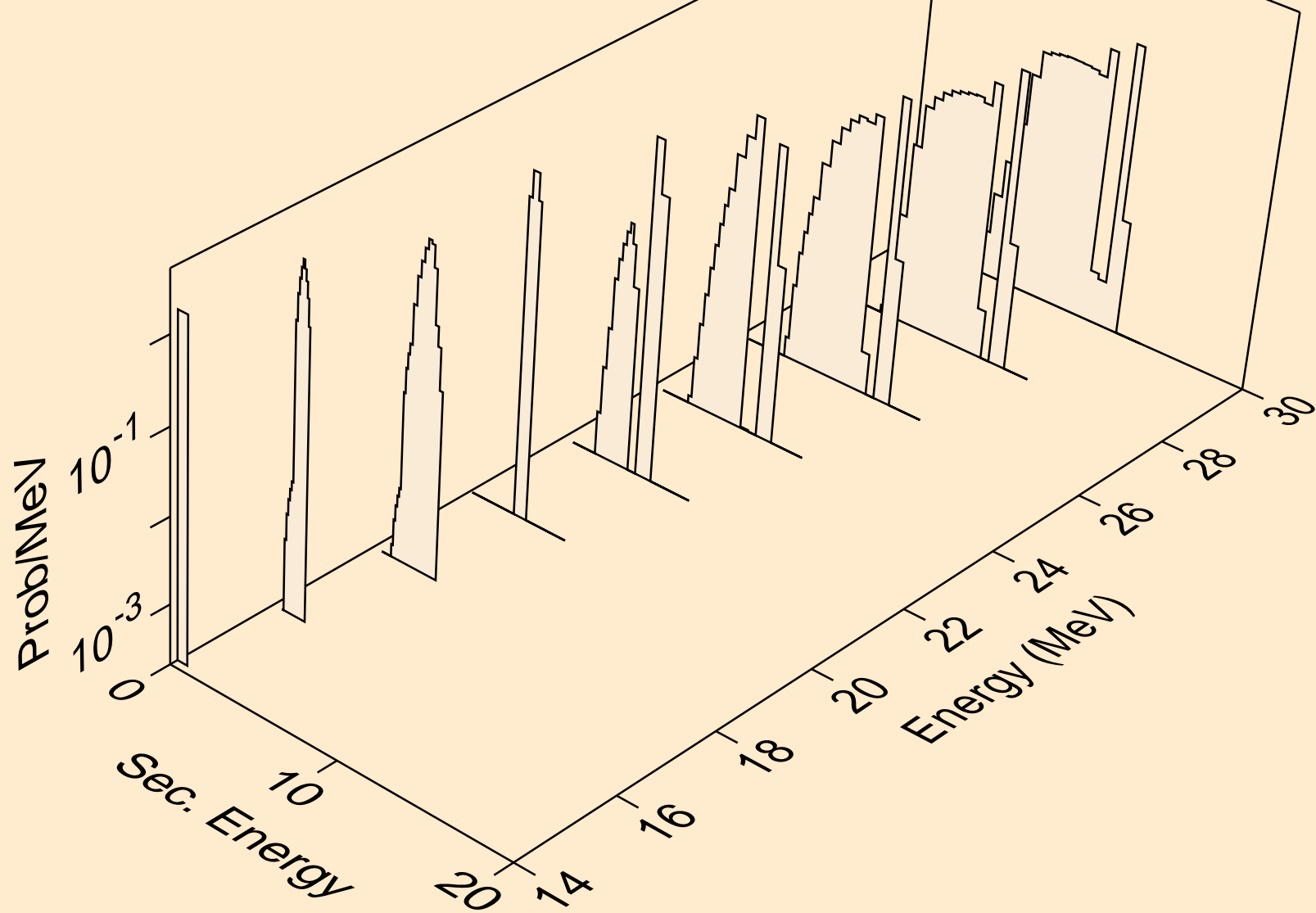

CL037 NEUTRON ACER TENDL-2021 LIBRARY; T=293.6K
alphas from (n,x)

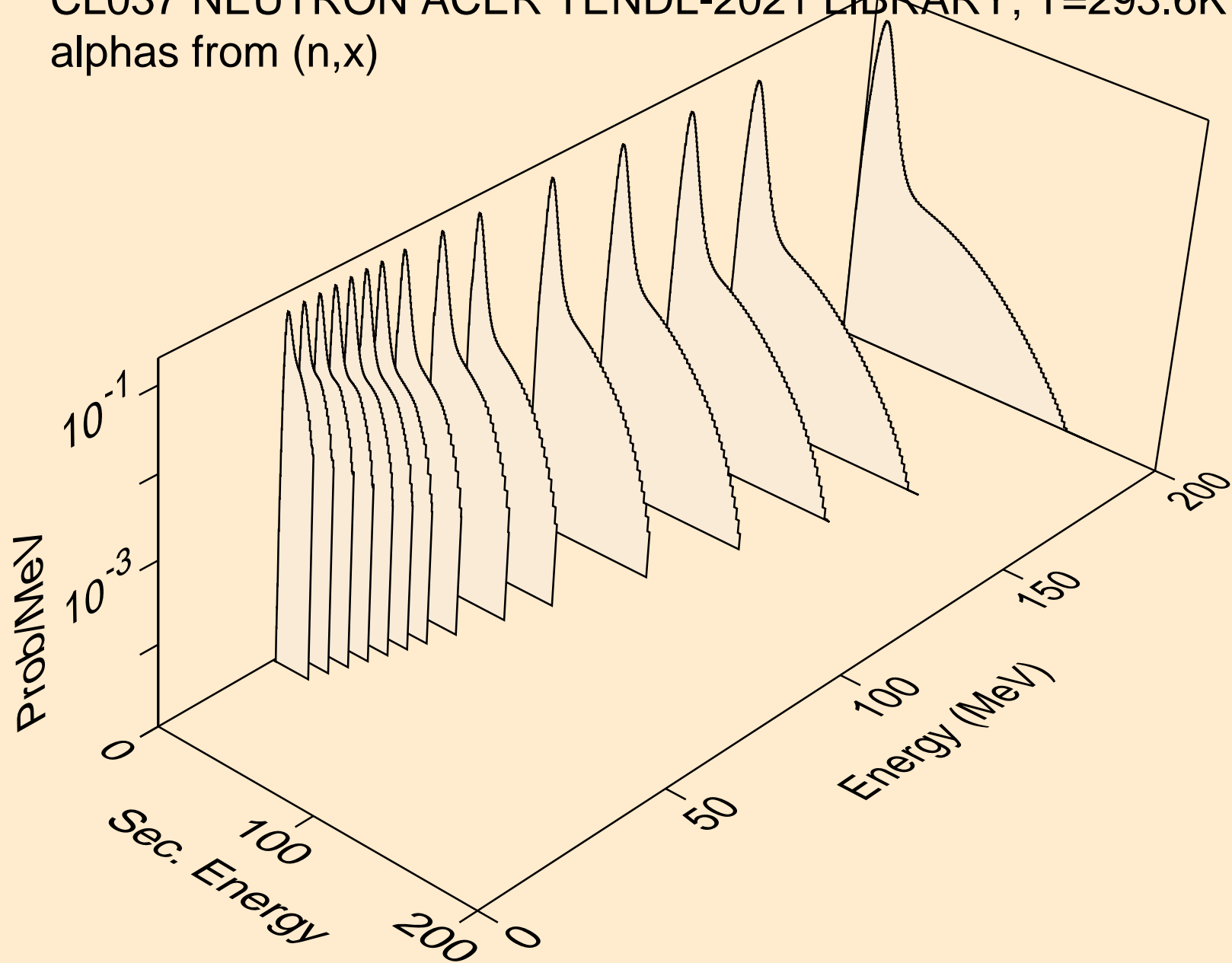

CL037 NEUTRON ACER TENDL-2021 LIBRARY; T=293.6K
alphas from (n,n*)a

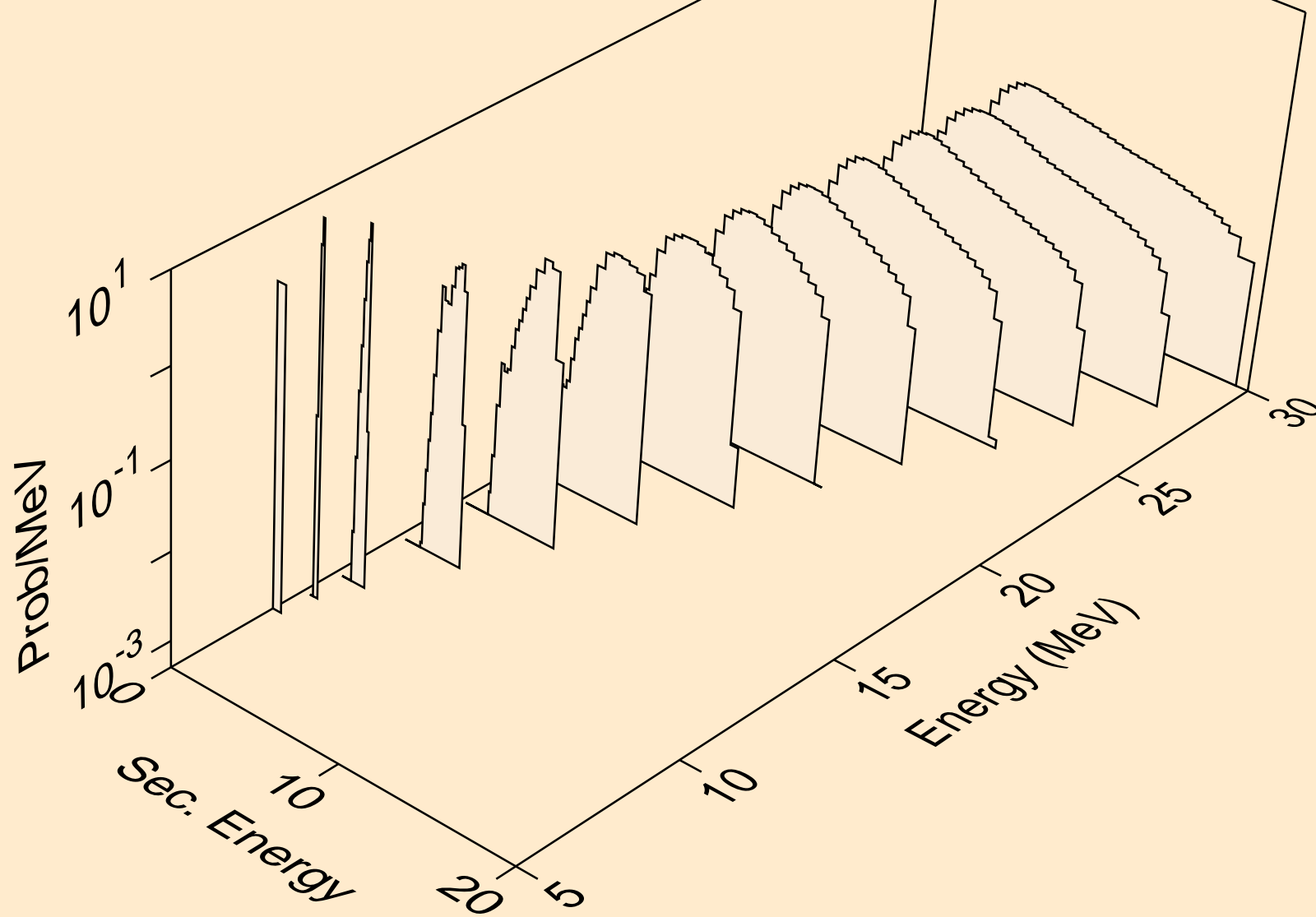

CL037 NEUTRON ACER TENDL-2021 LIBRARY; T=293.6K
alphas from (n,2n)a

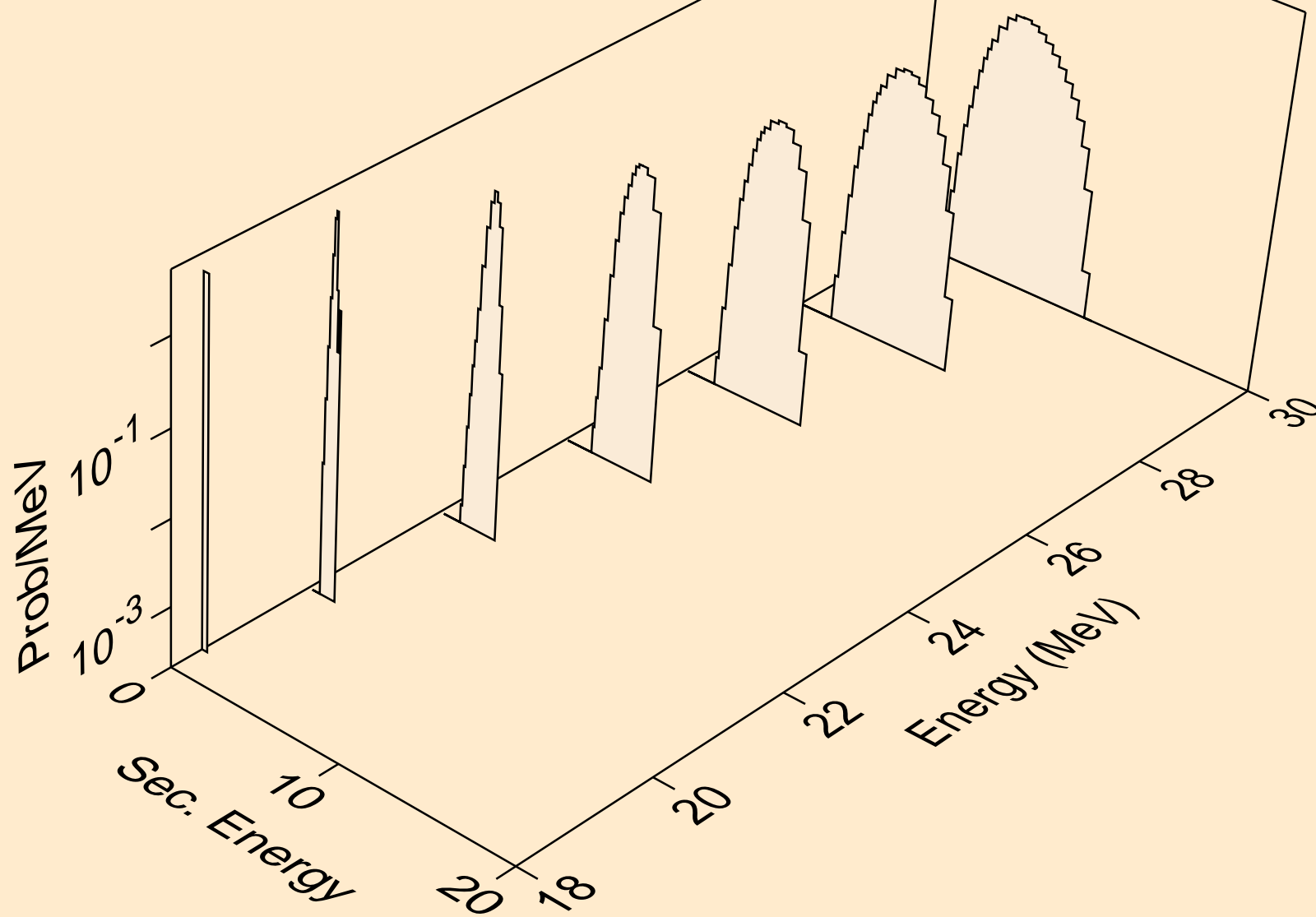

CL037 NEUTRON ACER TENDL-2021 LIBRARY; T=293.6K
alphas from (n,3n)a

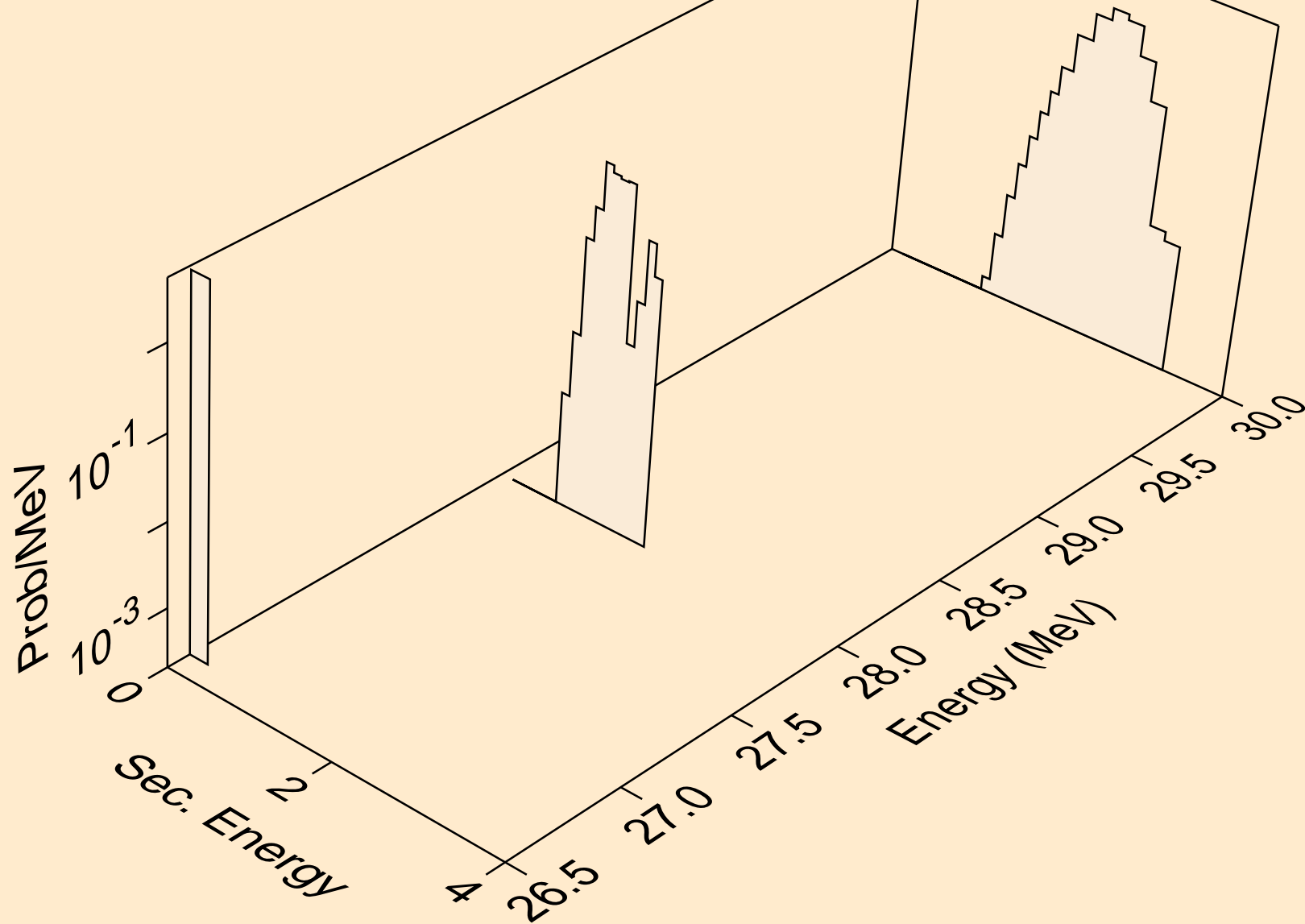

CL037 NEUTRON ACER TENDL-2021 LIBRARY; T=293.6K
alphas from (n,n*)2a

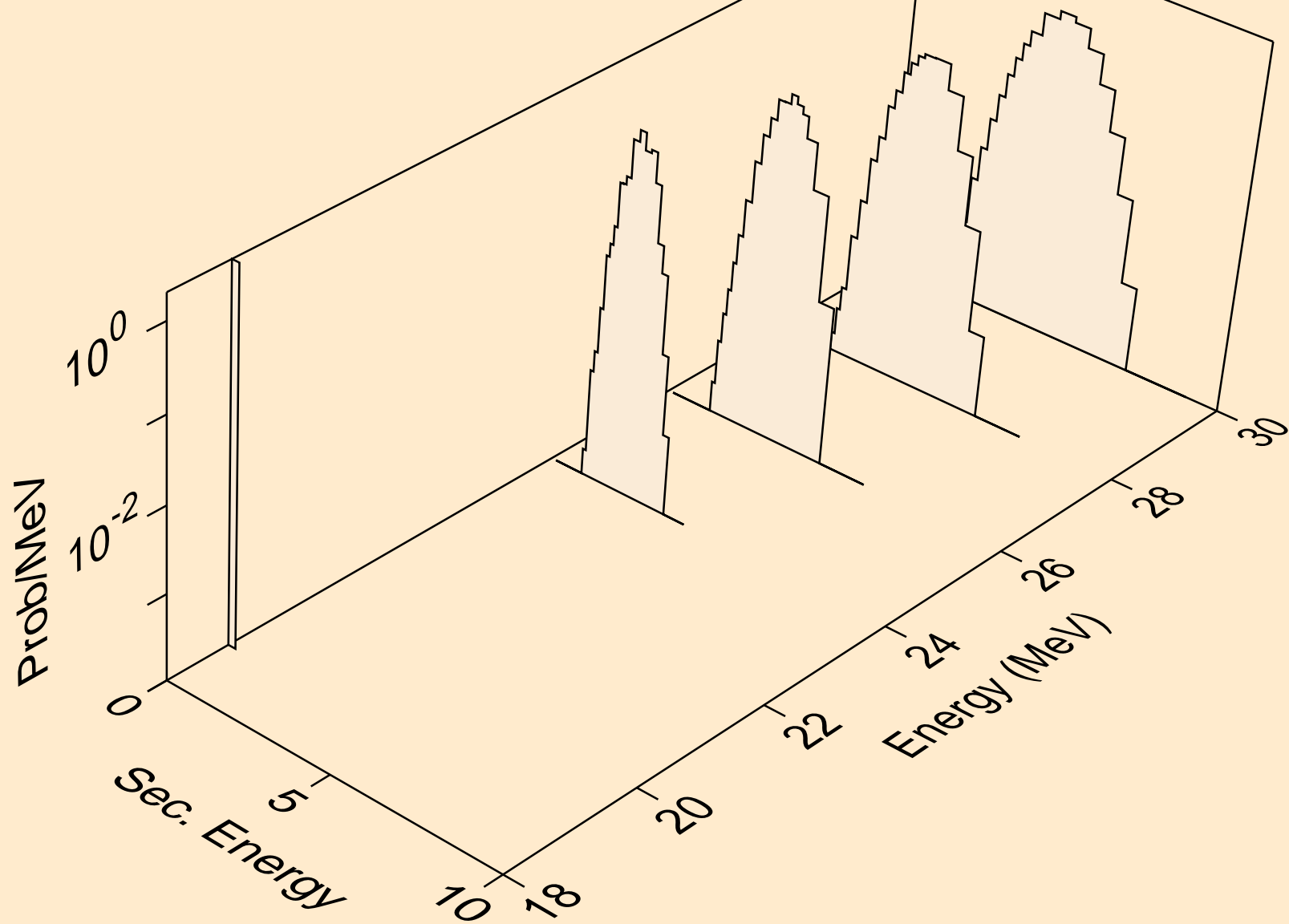

CL037 NEUTRON ACER TENDL-2021 LIBRARY; T=293.6K
alphas from (n,npa)

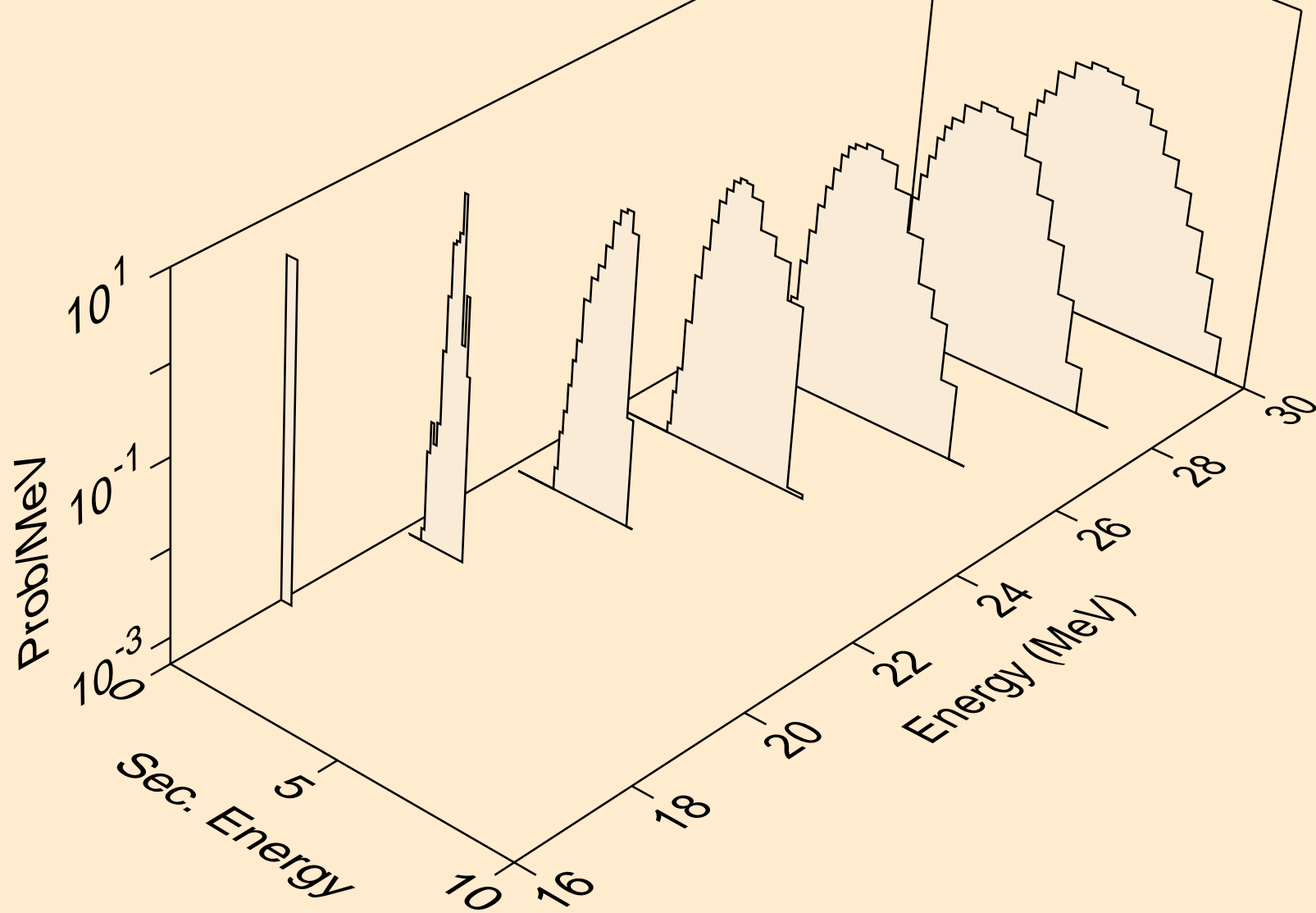

CL037 NEUTRON ACER TENDL-2021 LIBRARY; T=293.6K
alphas from (n,a)

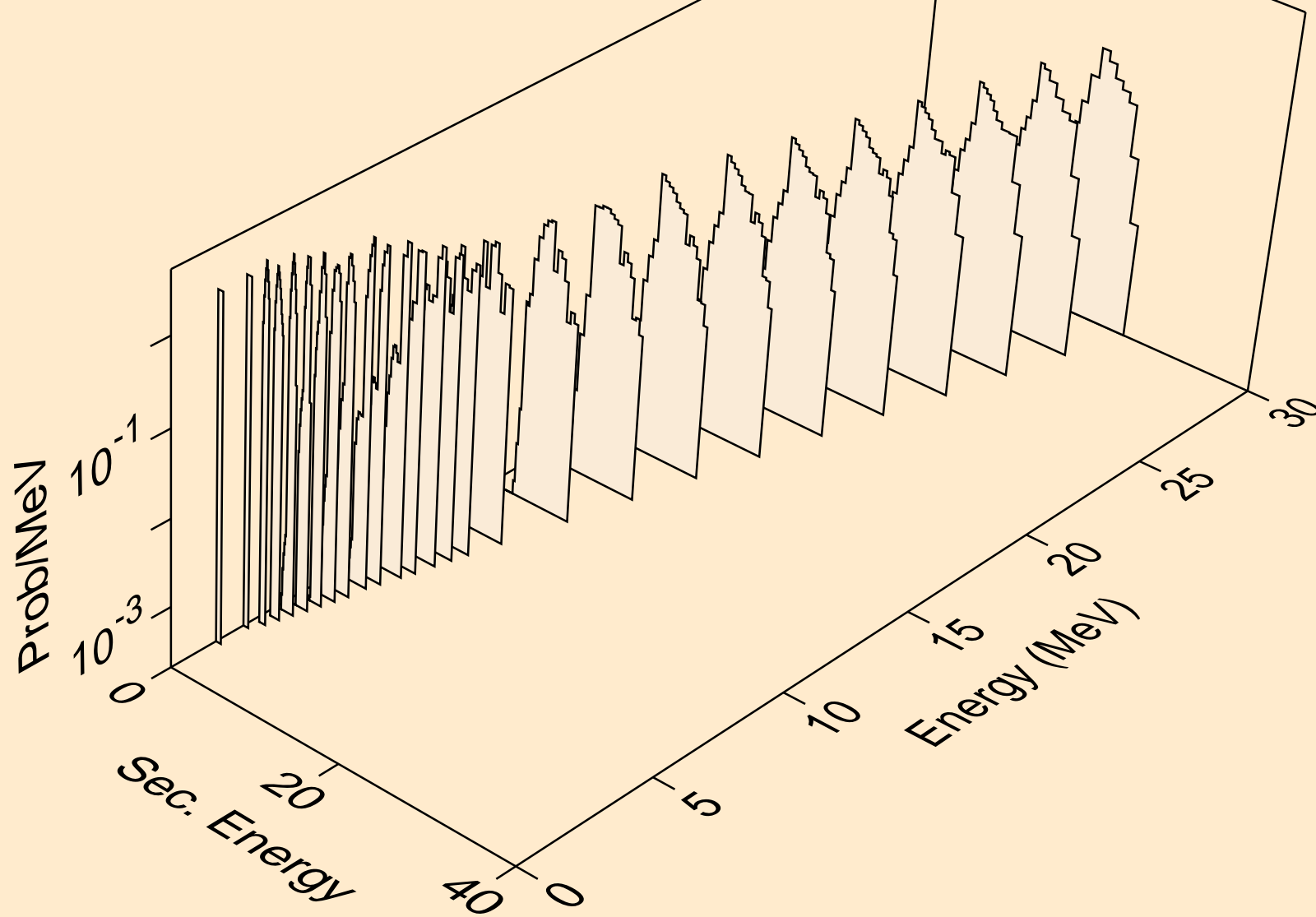

CL037 NEUTRON ACER TENDL-2021 LIBRARY; T=293.6K
alphas from (n,2a)

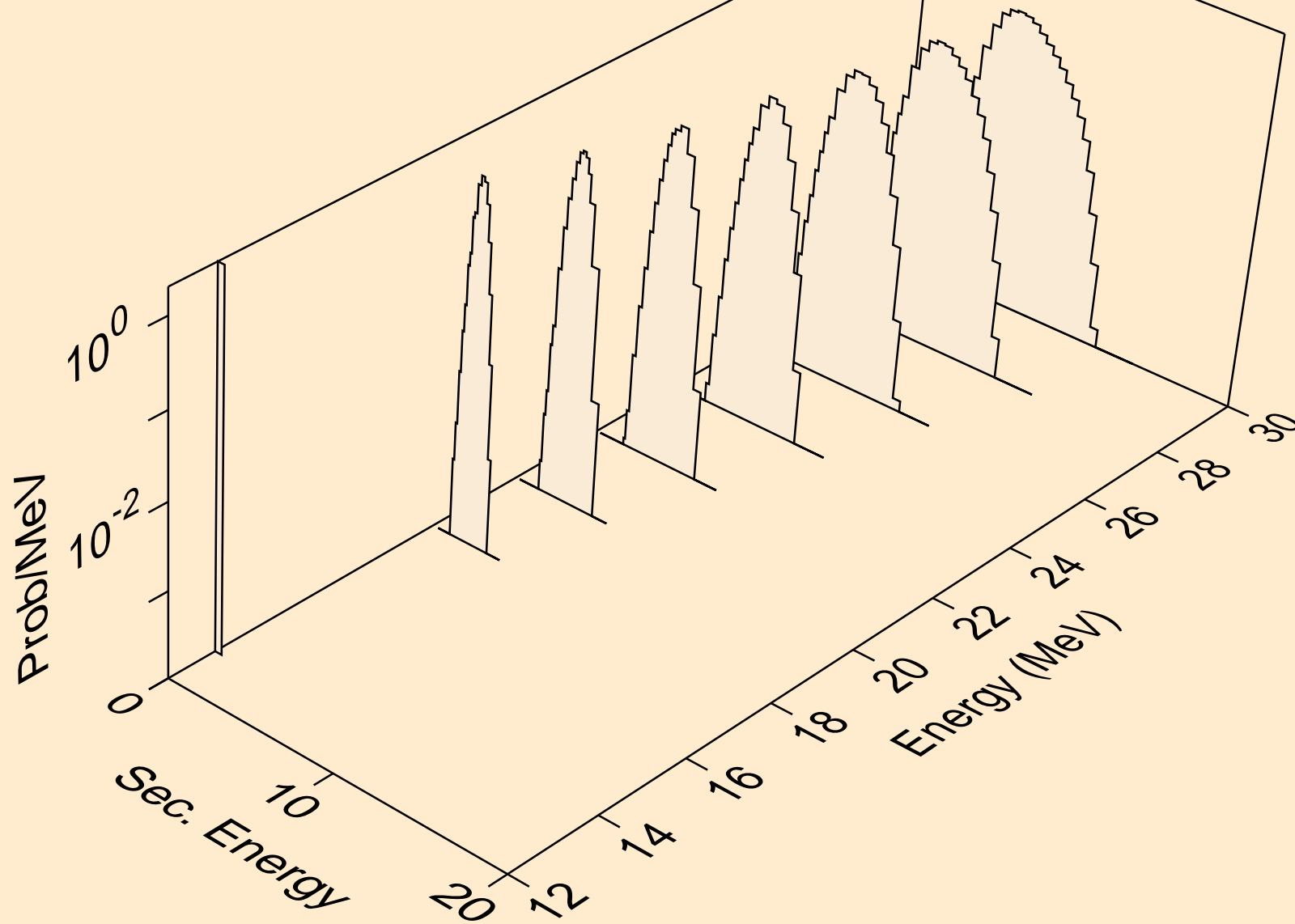

CL037 NEUTRON ACER TENDL-2021 LIBRARY; T=293.6K
alphas from (n,pa)

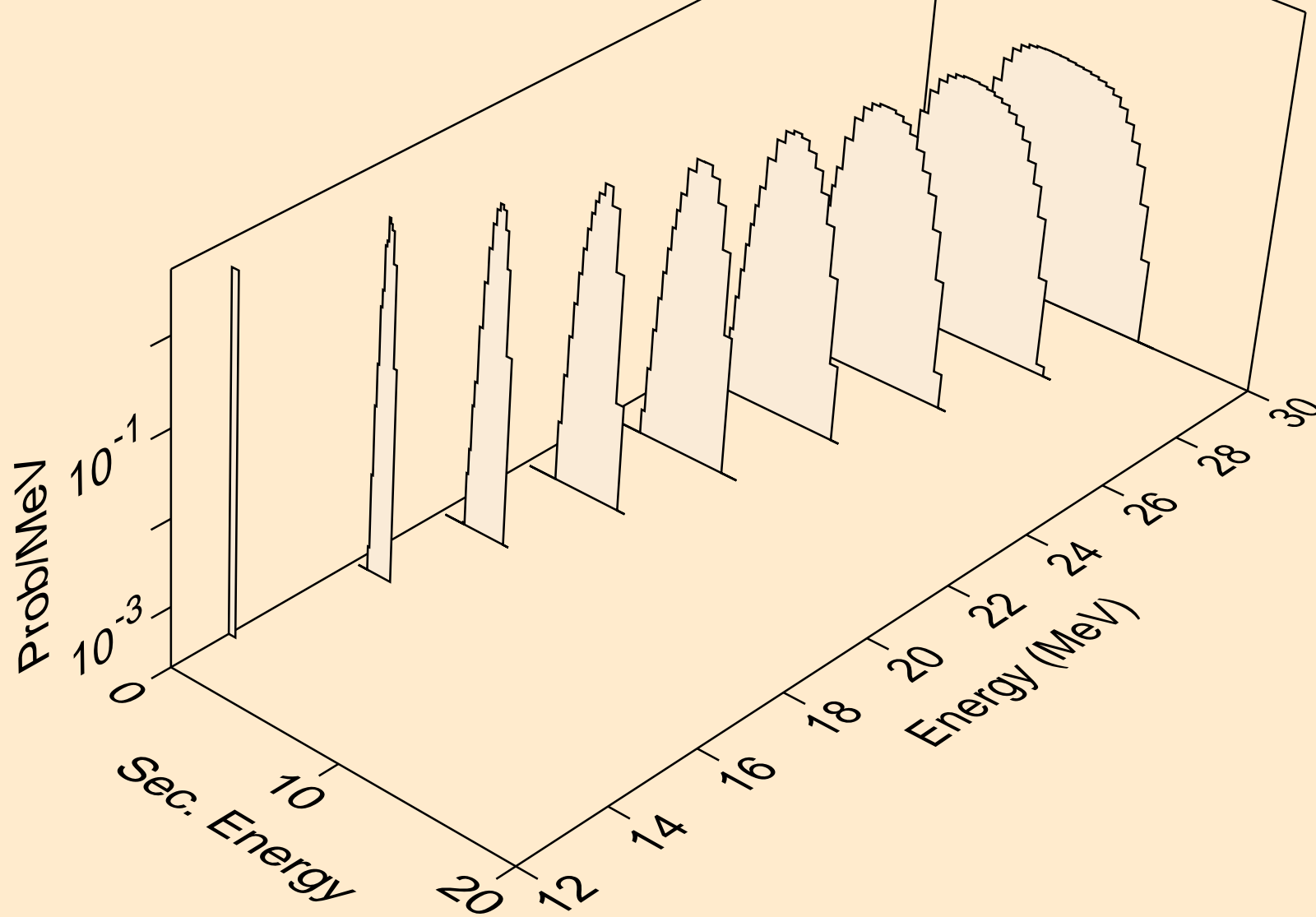

CL037 NEUTRON ACER TENDL-2021 LIBRARY; T=293.6K
alphas from (n,da)

