

CL040 NEUTRON ACER TENDL-2021 LIBRARY; T=293.6K

Principal cross sections

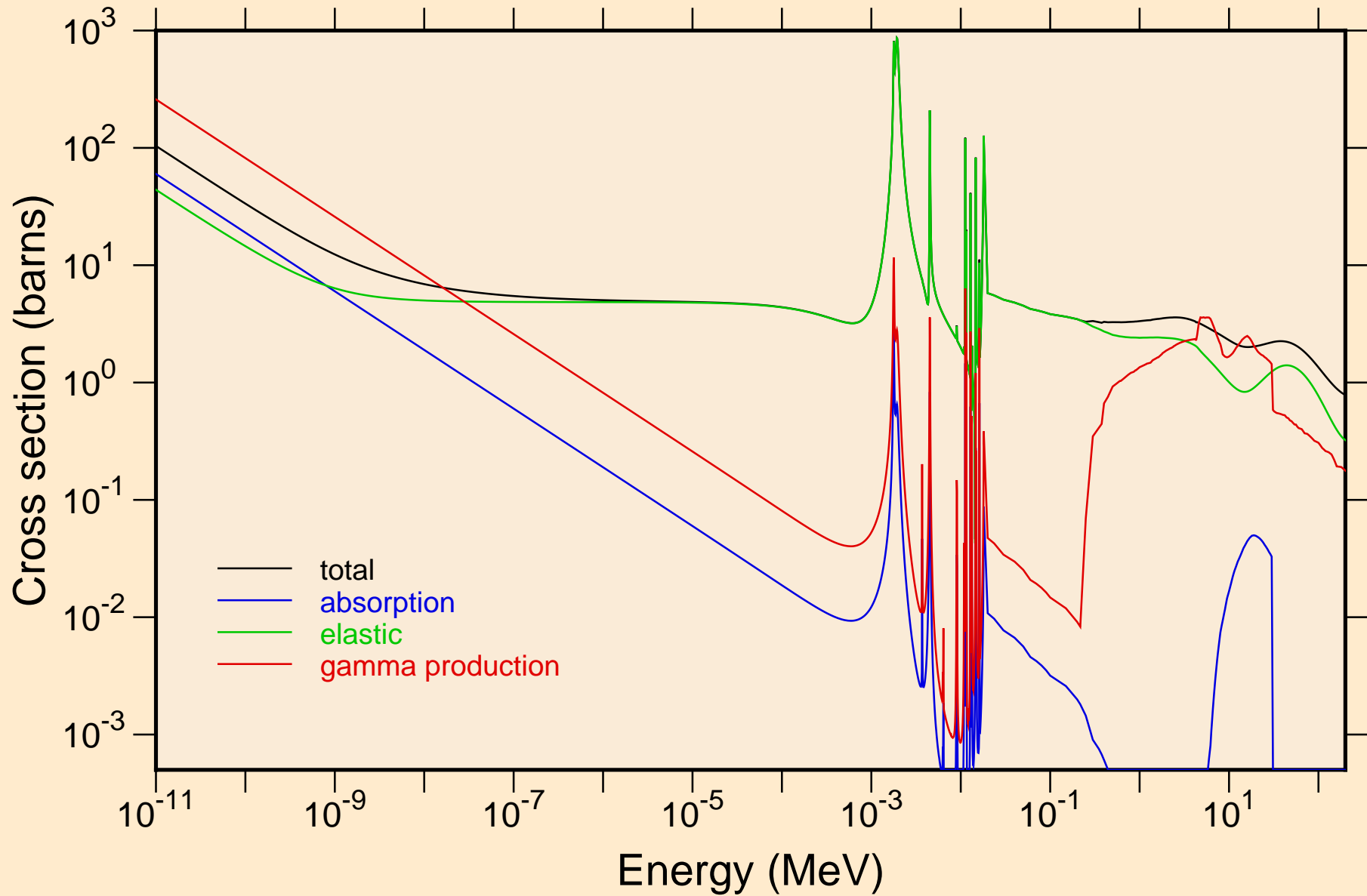

CL040 NEUTRON ACER TENDL-2021 LIBRARY; T=293.6K
resonance total cross section

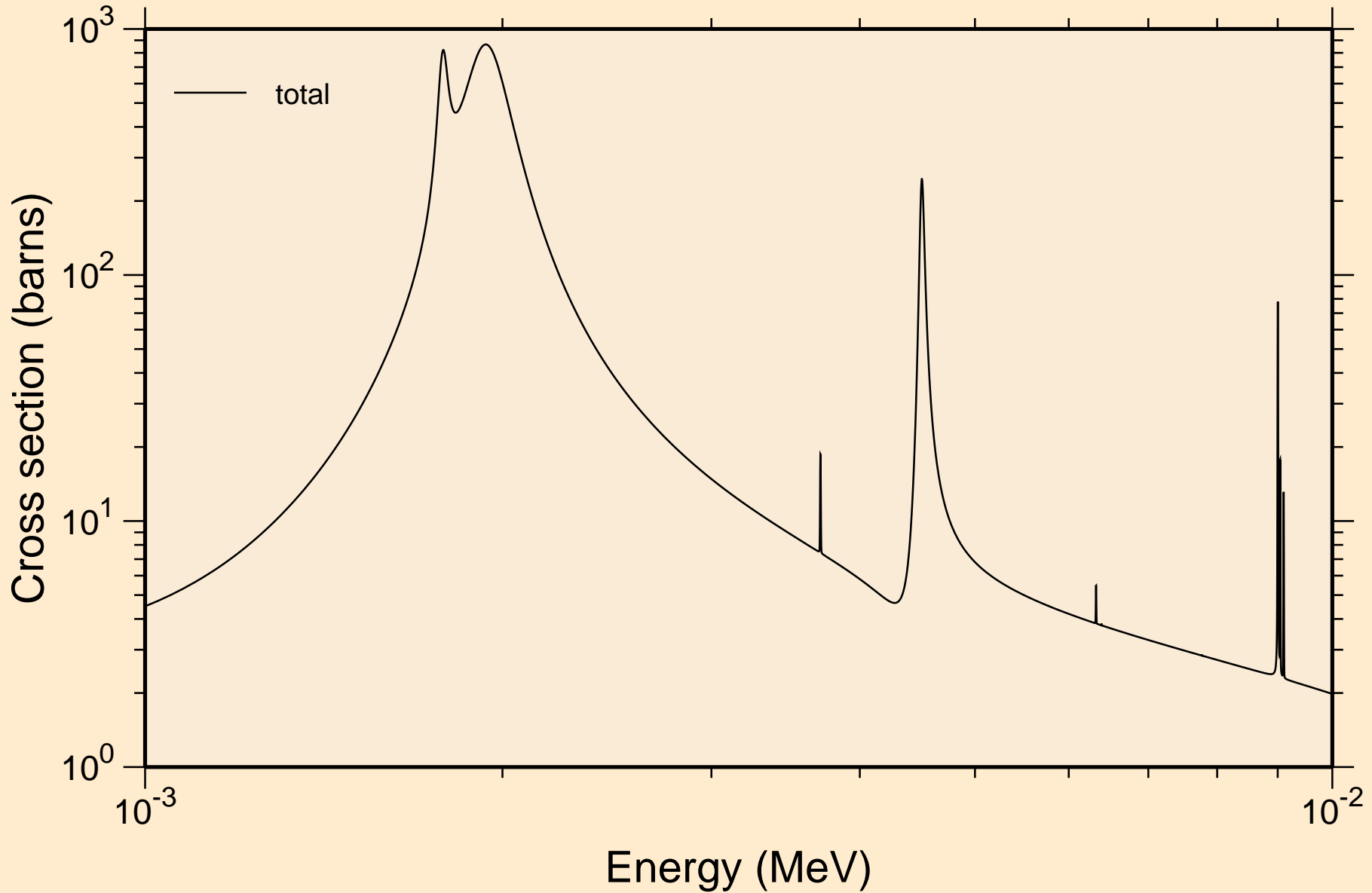

CL040 NEUTRON ACER TENDL-2021 LIBRARY; T=293.6K
resonance total cross section

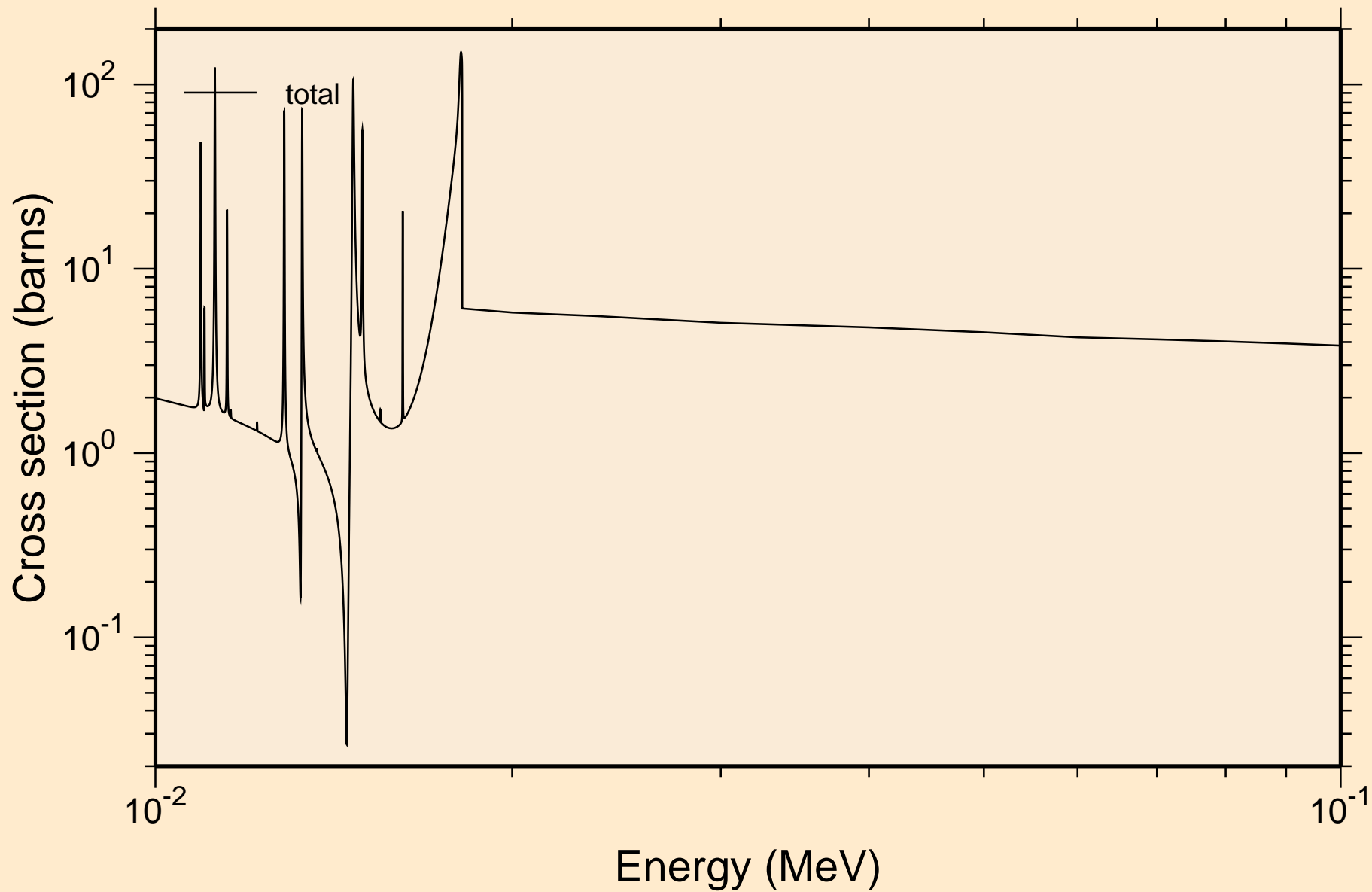

CL040 NEUTRON ACER TENDL-2021 LIBRARY; T=293.6K
resonance total cross section

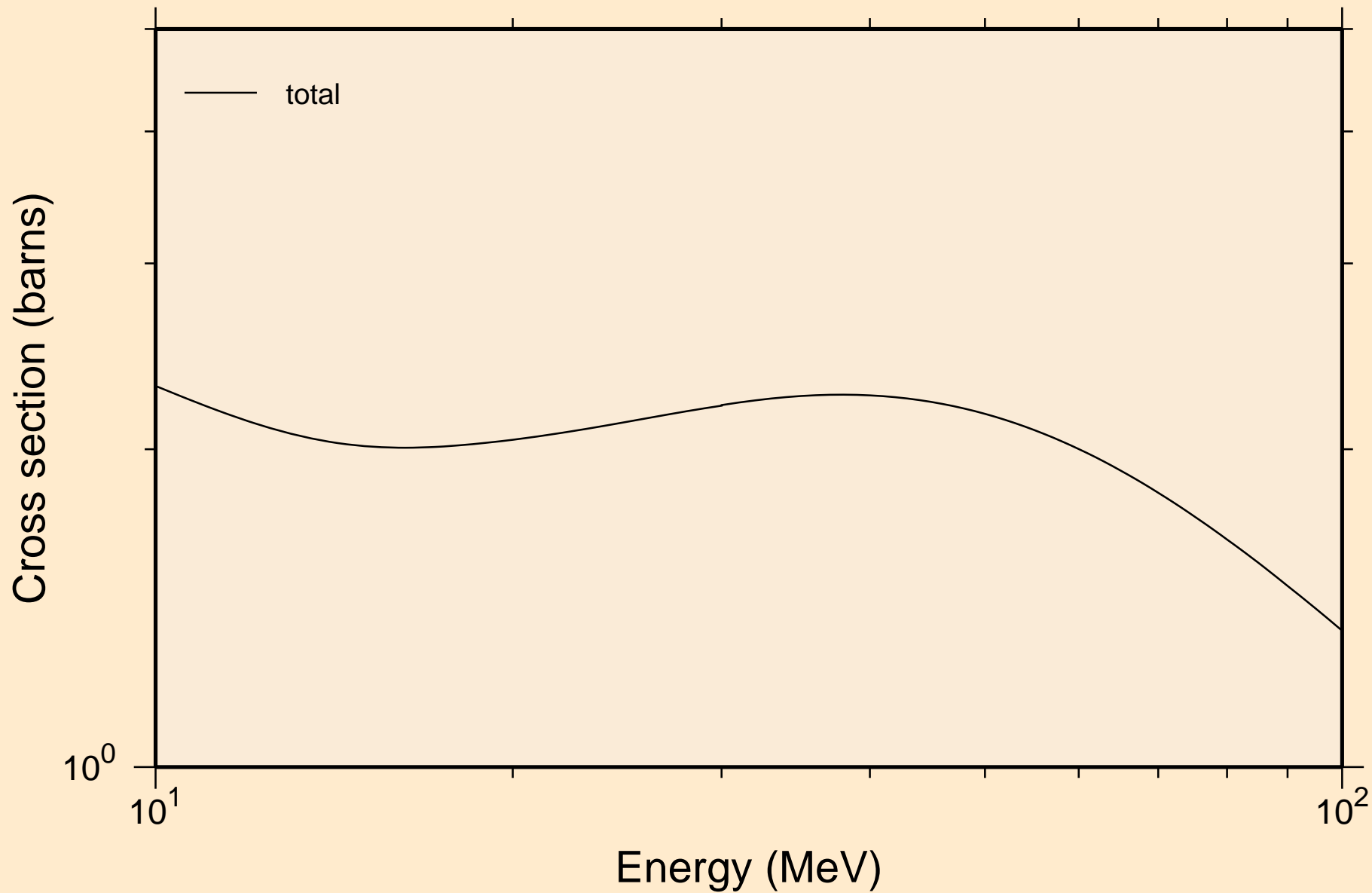

CL040 NEUTRON ACER TENDL-2021 LIBRARY; T=293.6K
resonance absorption cross sections

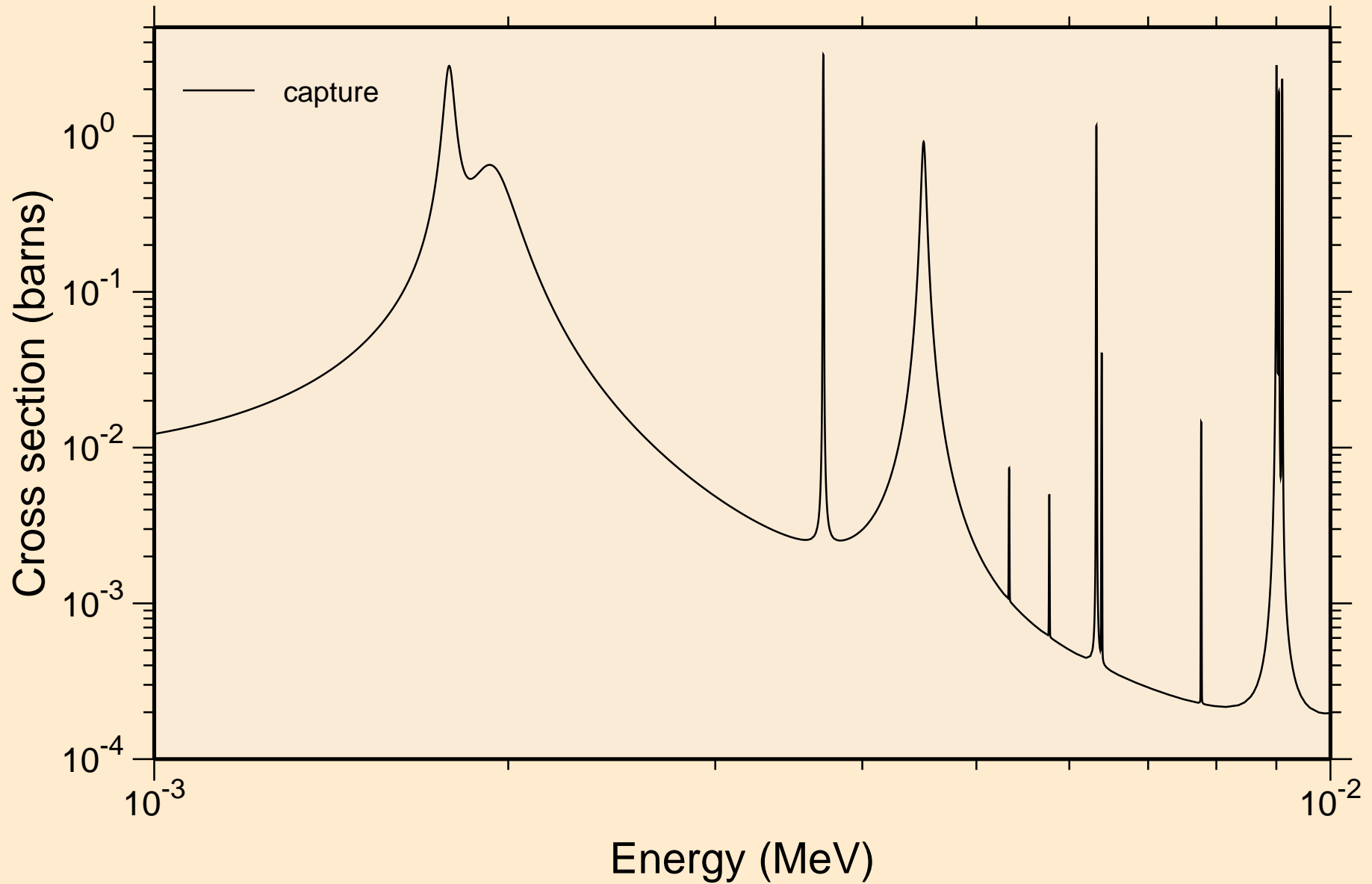

CL040 NEUTRON ACER TENDL-2021 LIBRARY; T=293.6K
resonance absorption cross sections

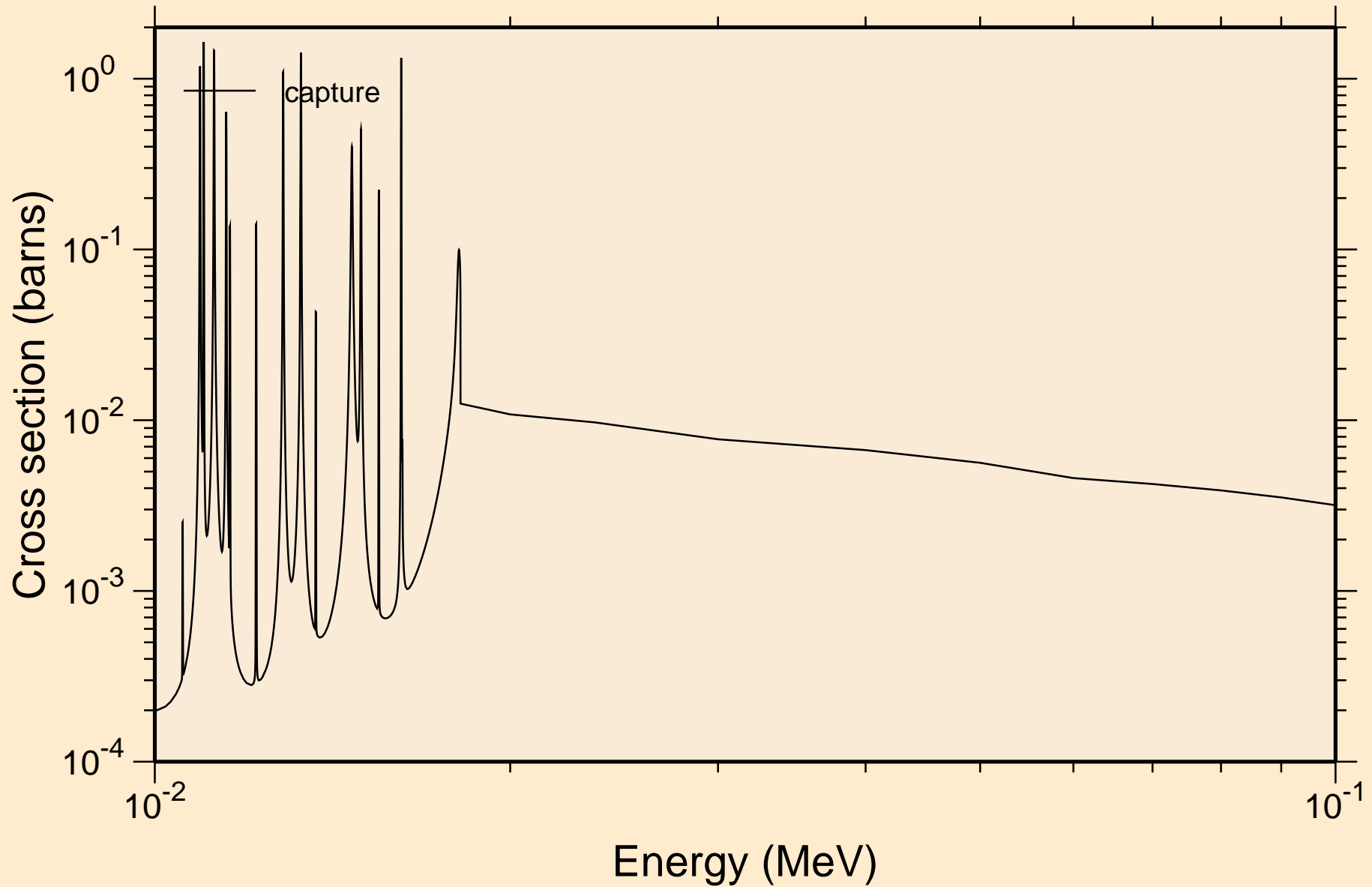

CL040 NEUTRON ACER TENDL-2021 LIBRARY; T=293.6K
resonance absorption cross sections

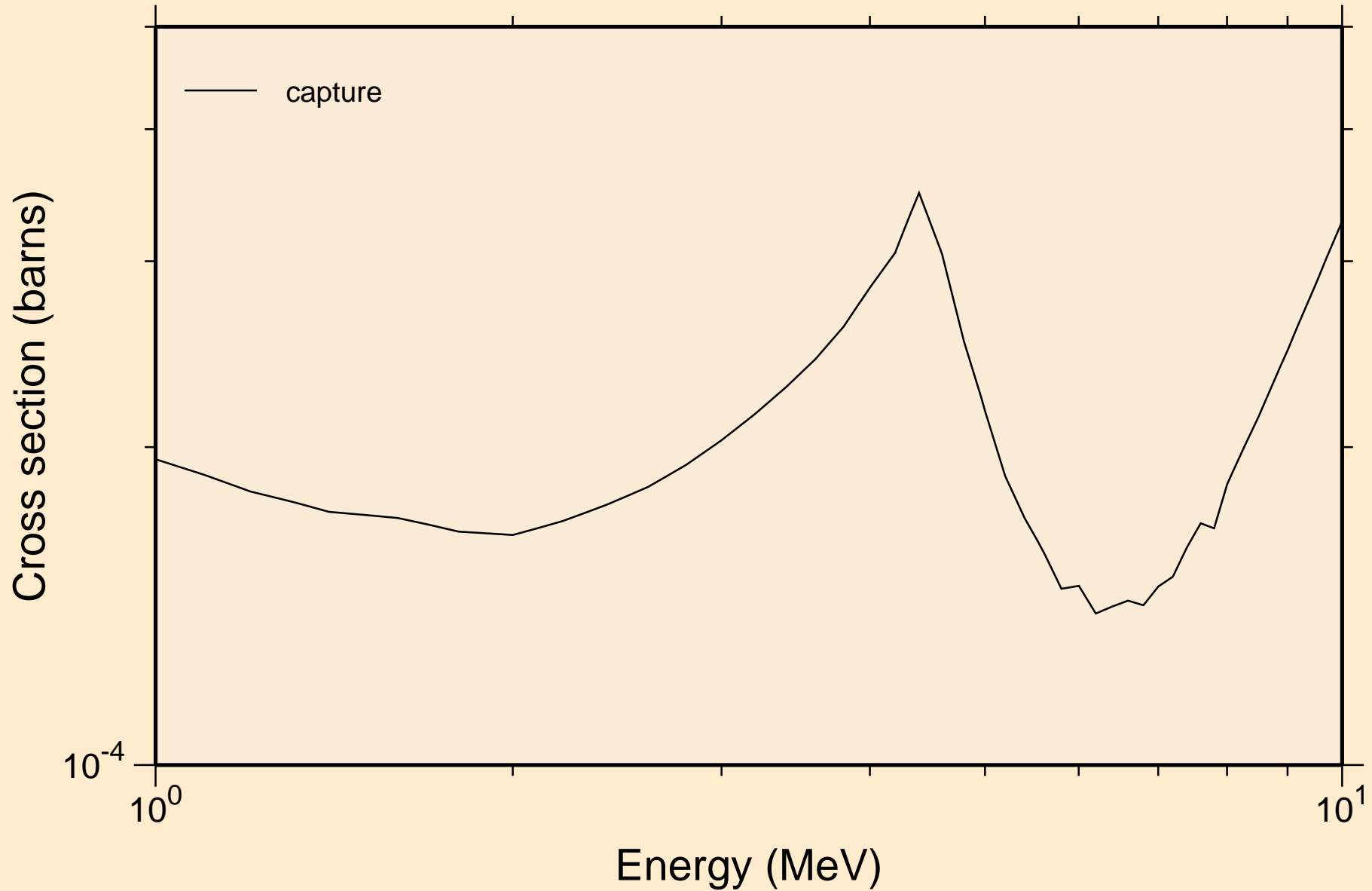

CL040 NEUTRON ACER TENDL-2021 LIBRARY; T=293.6K
Heating

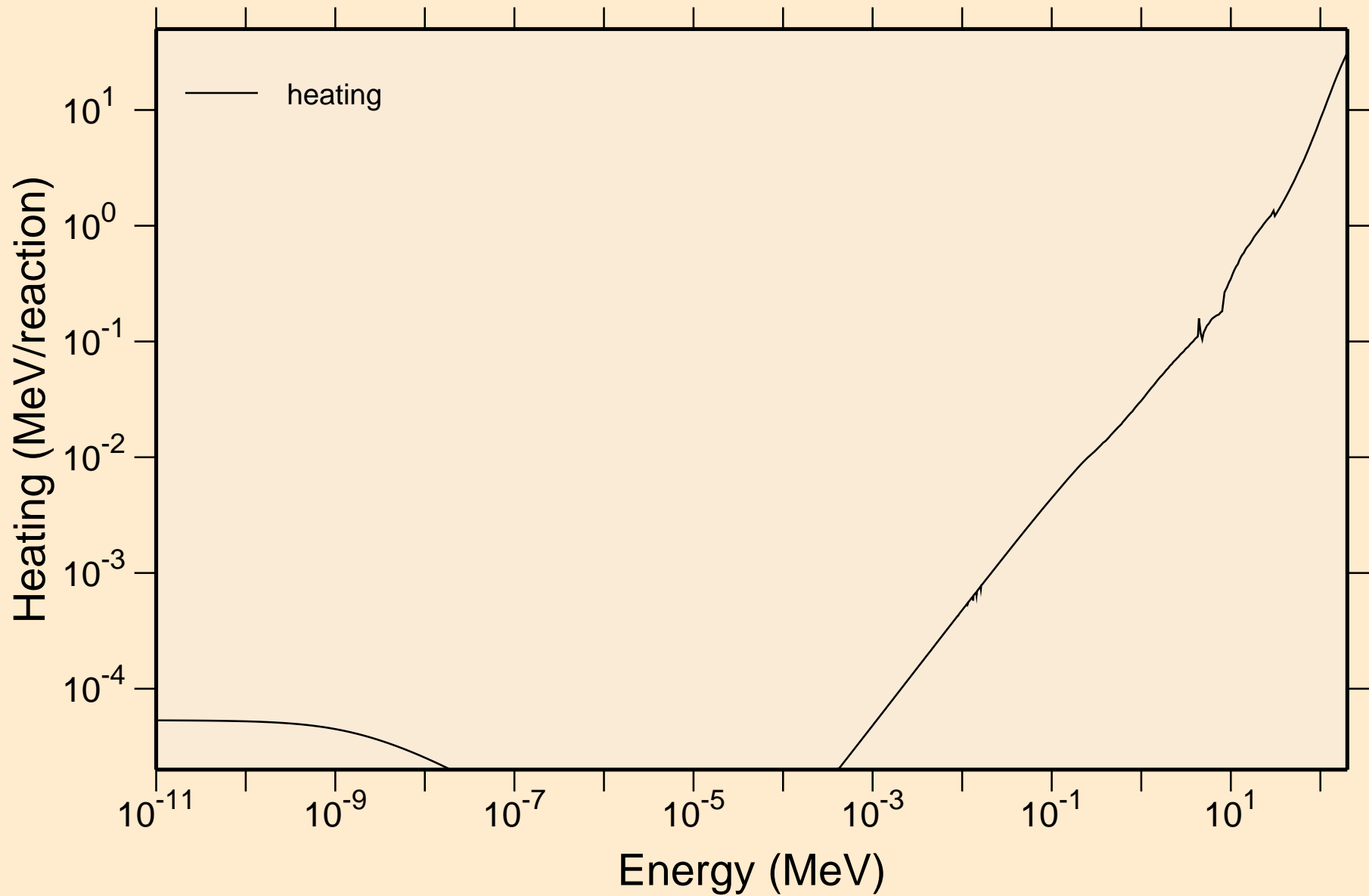

CL040 NEUTRON ACER TENDL-2021 LIBRARY; T=293.6K
Damage

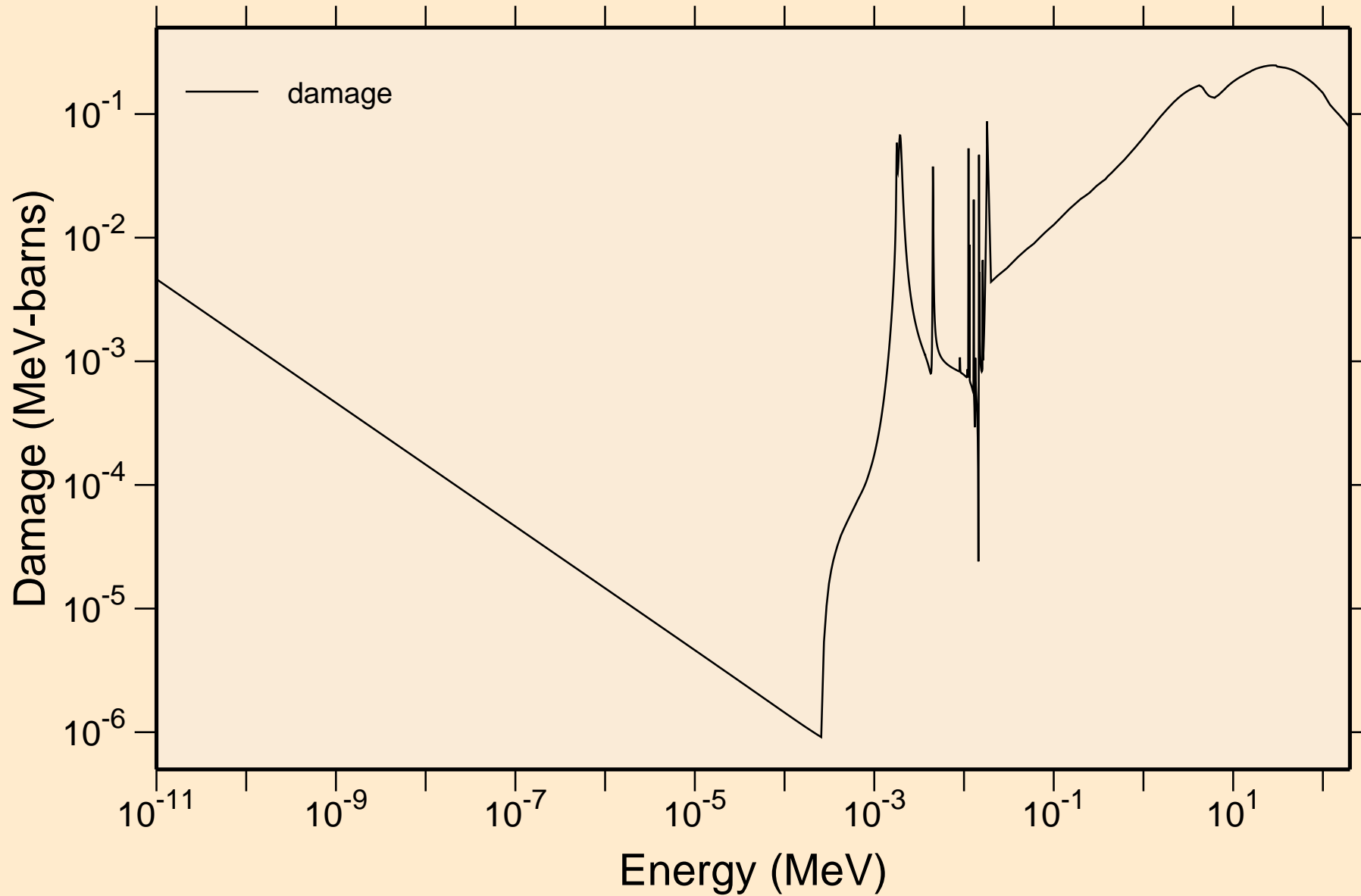

CL040 NEUTRON ACER TENDL-2021 LIBRARY; T=293.6K
Non-threshold reactions

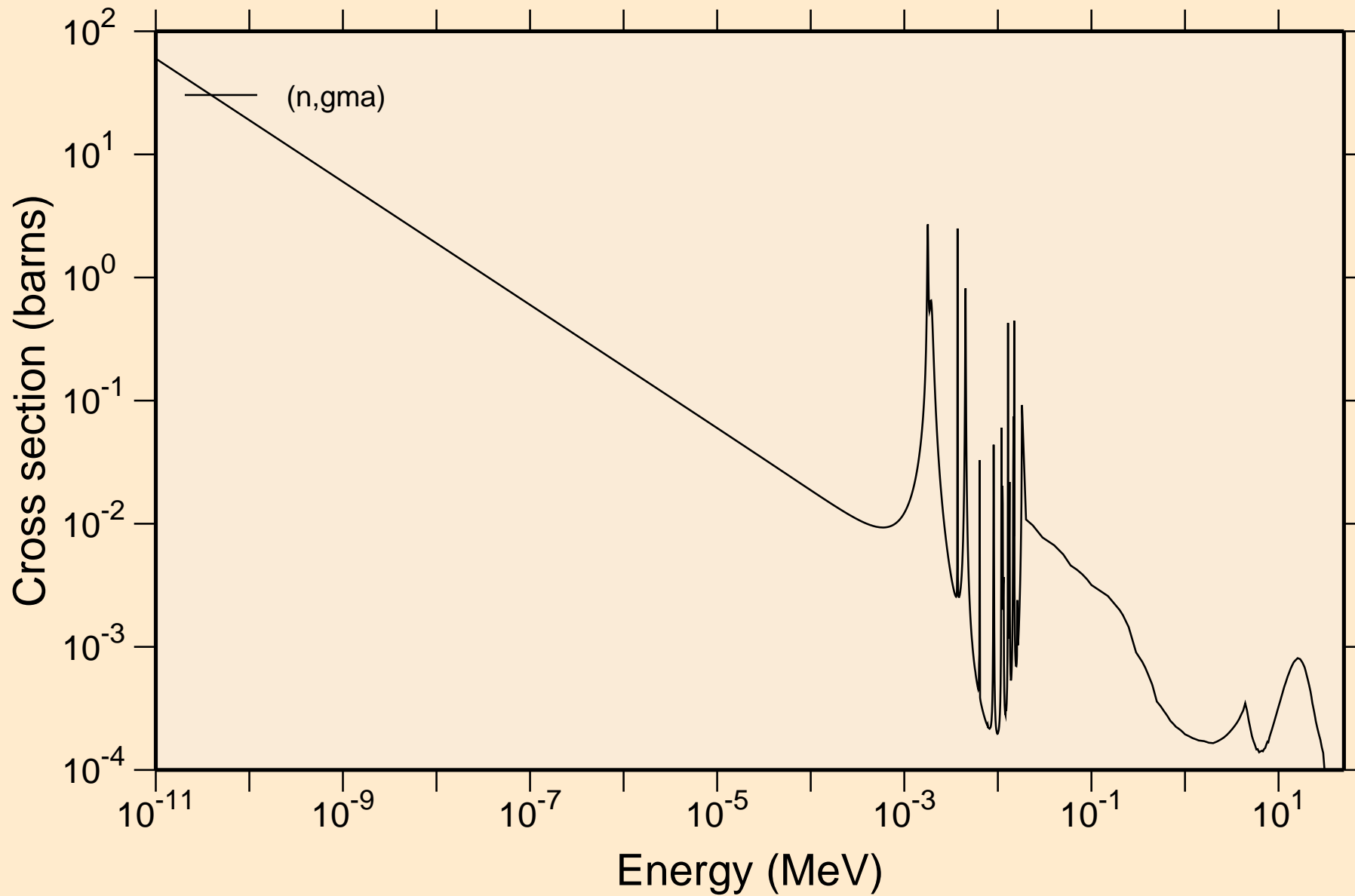

CL040 NEUTRON ACER TENDL-2021 LIBRARY; T=293.6K

Principal cross sections

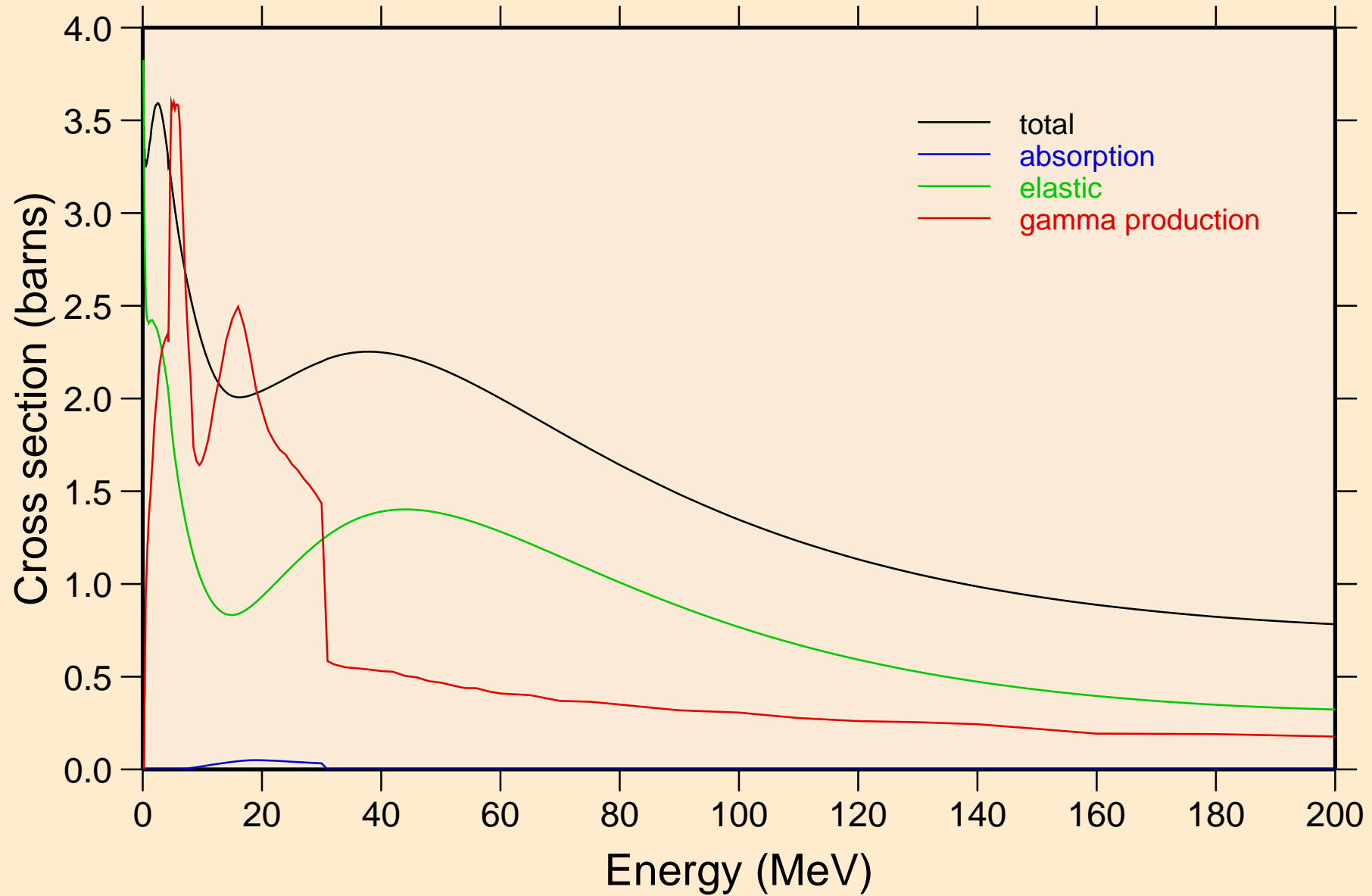

CL040 NEUTRON ACER TENDL-2021 LIBRARY; T=293.6K
Heating

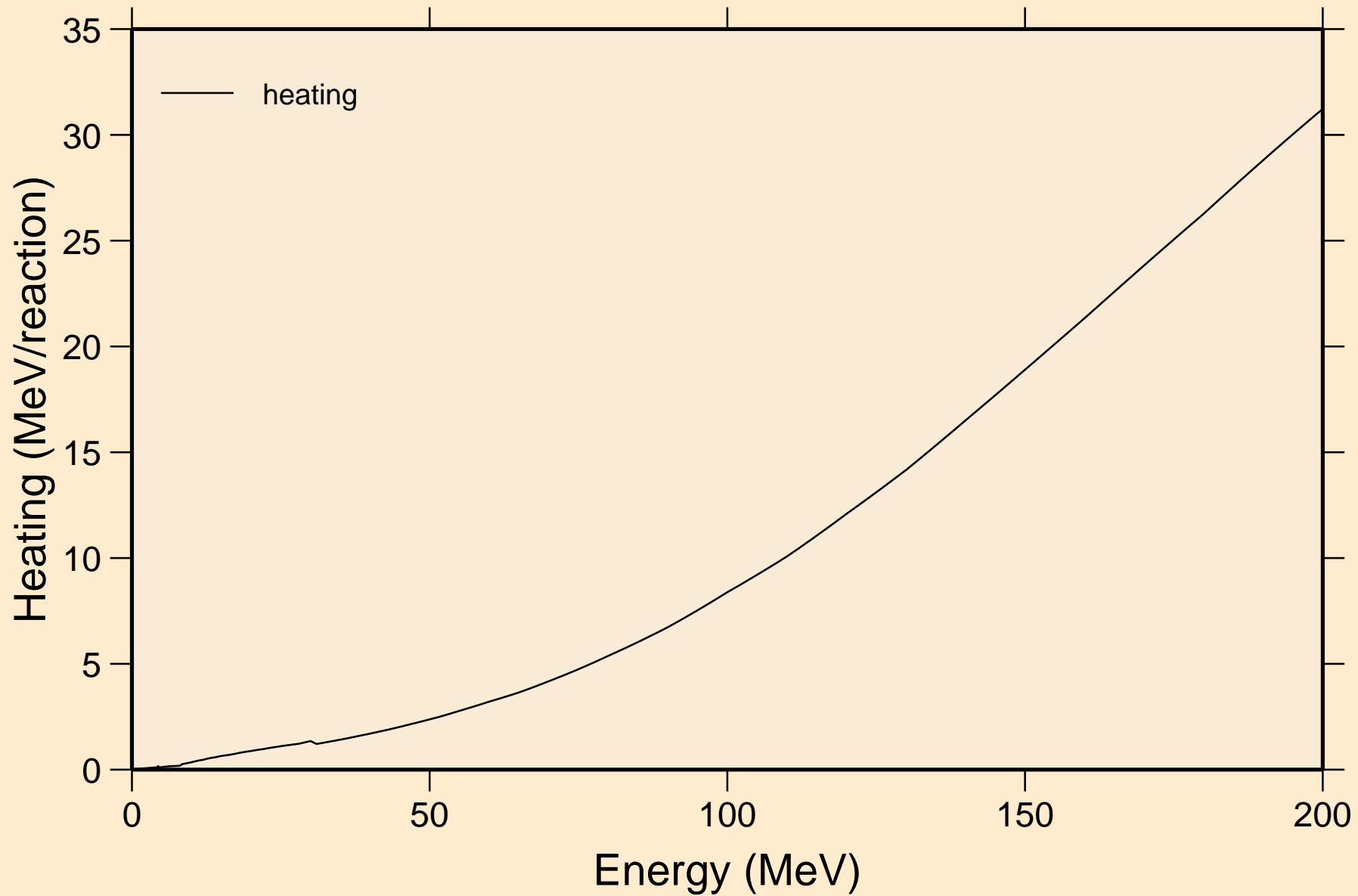

CL040 NEUTRON ACER TENDL-2021 LIBRARY; T=293.6K
Damage

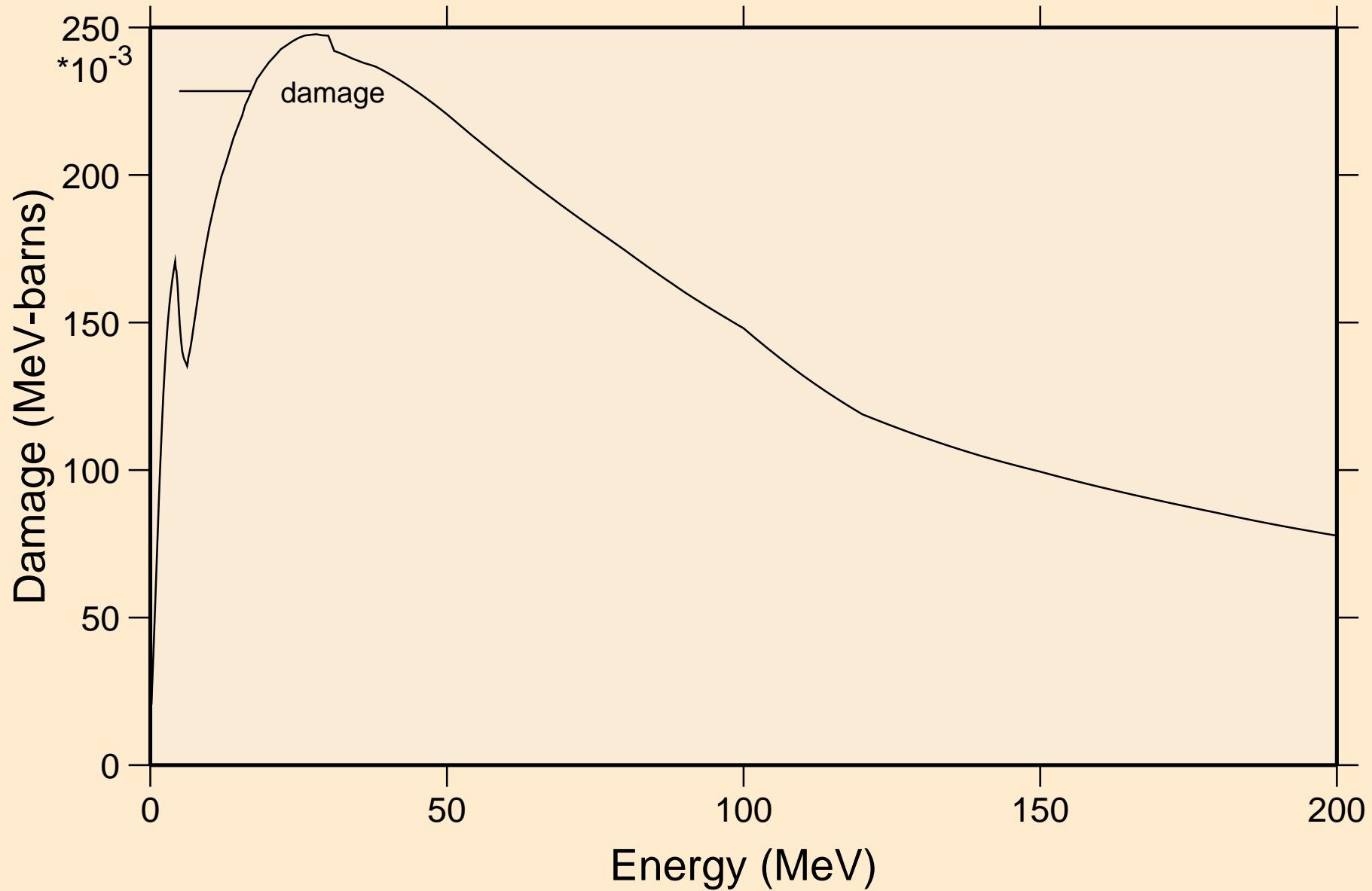

CL040 NEUTRON ACER TENDL-2021 LIBRARY; T=293.6K
Non-threshold reactions

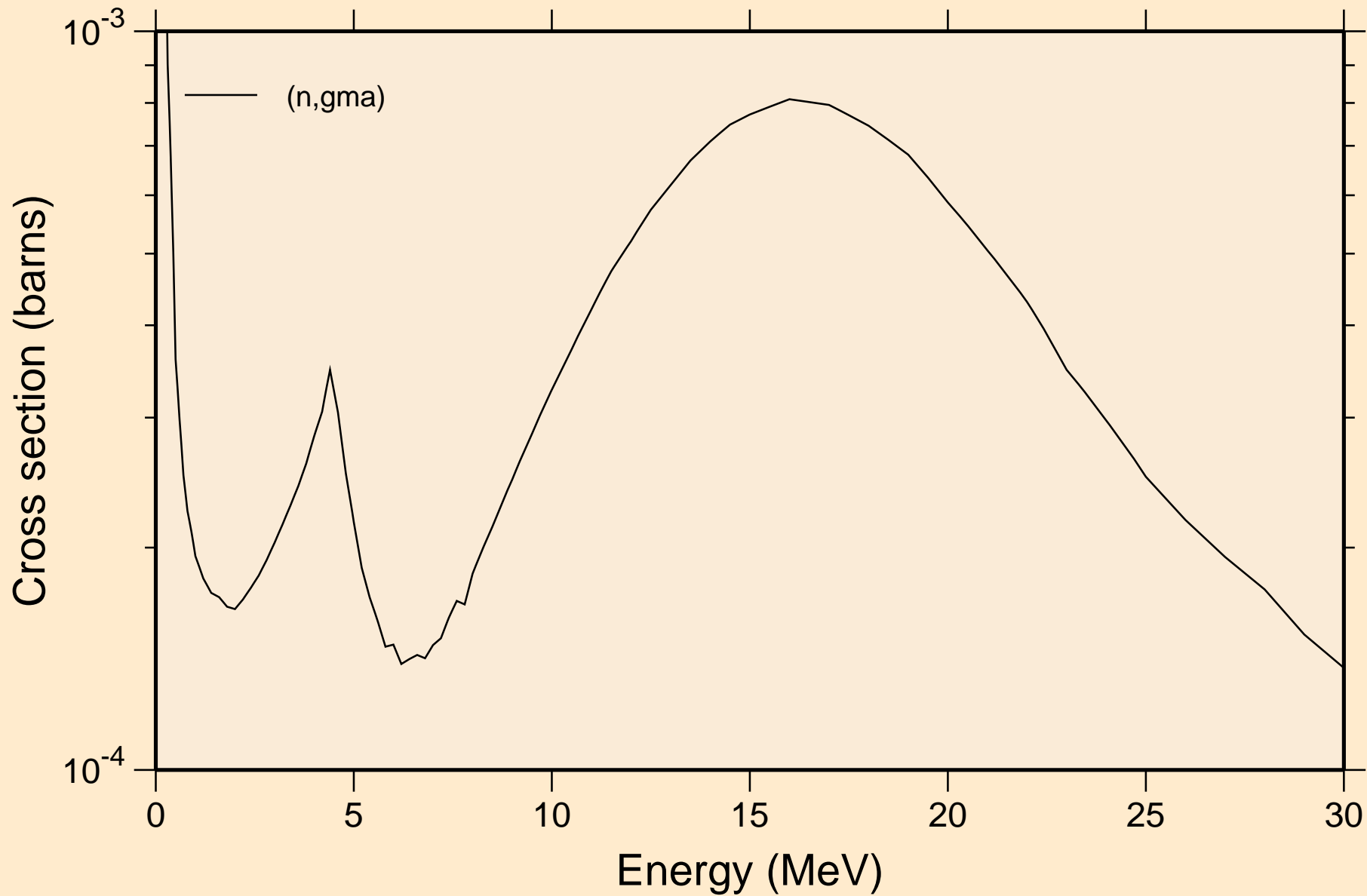

CL040 NEUTRON ACER TENDL-2021 LIBRARY; T=293.6K
Inelastic levels

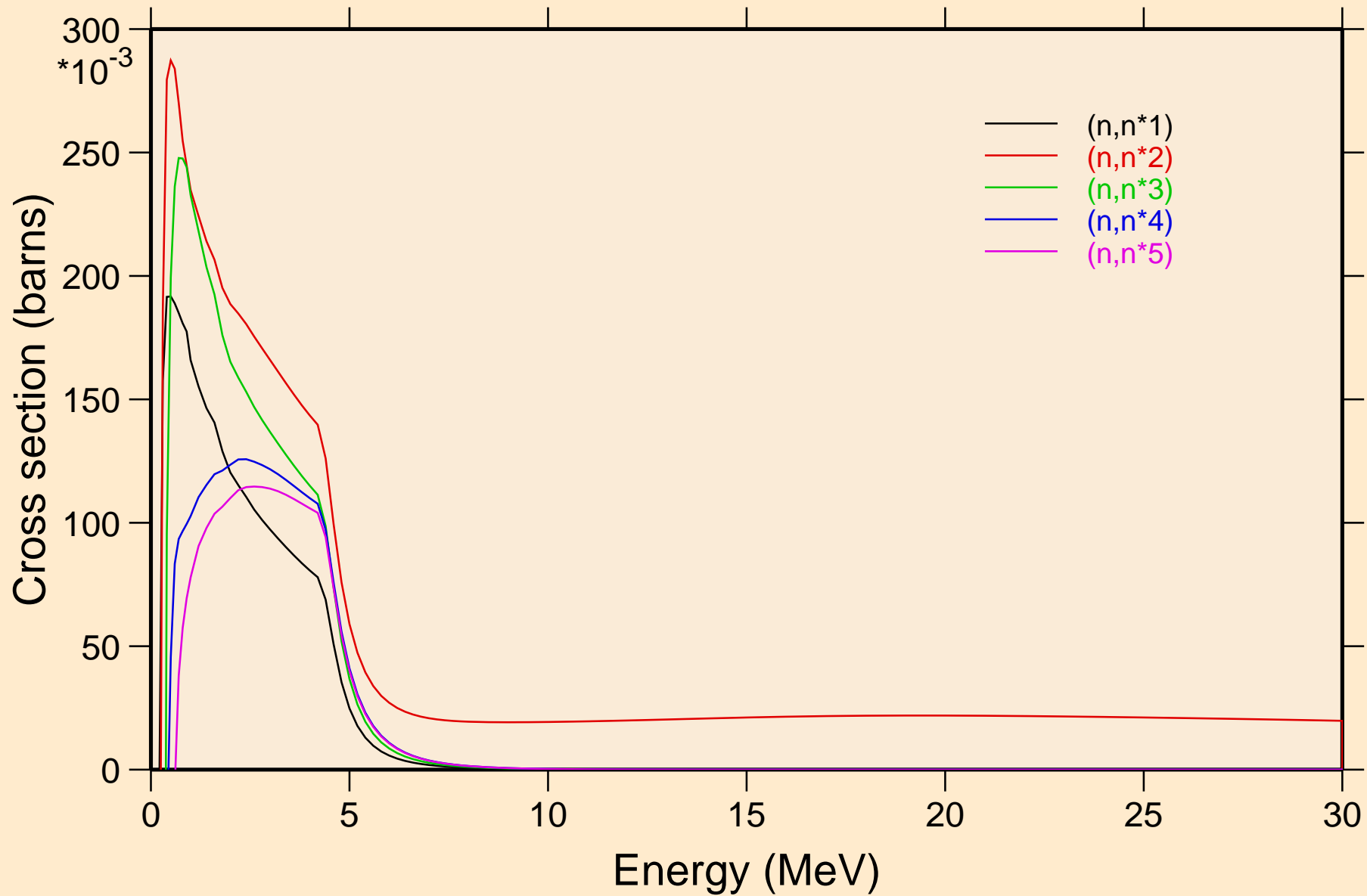

CL040 NEUTRON ACER TENDL-2021 LIBRARY; T=293.6K
Inelastic levels

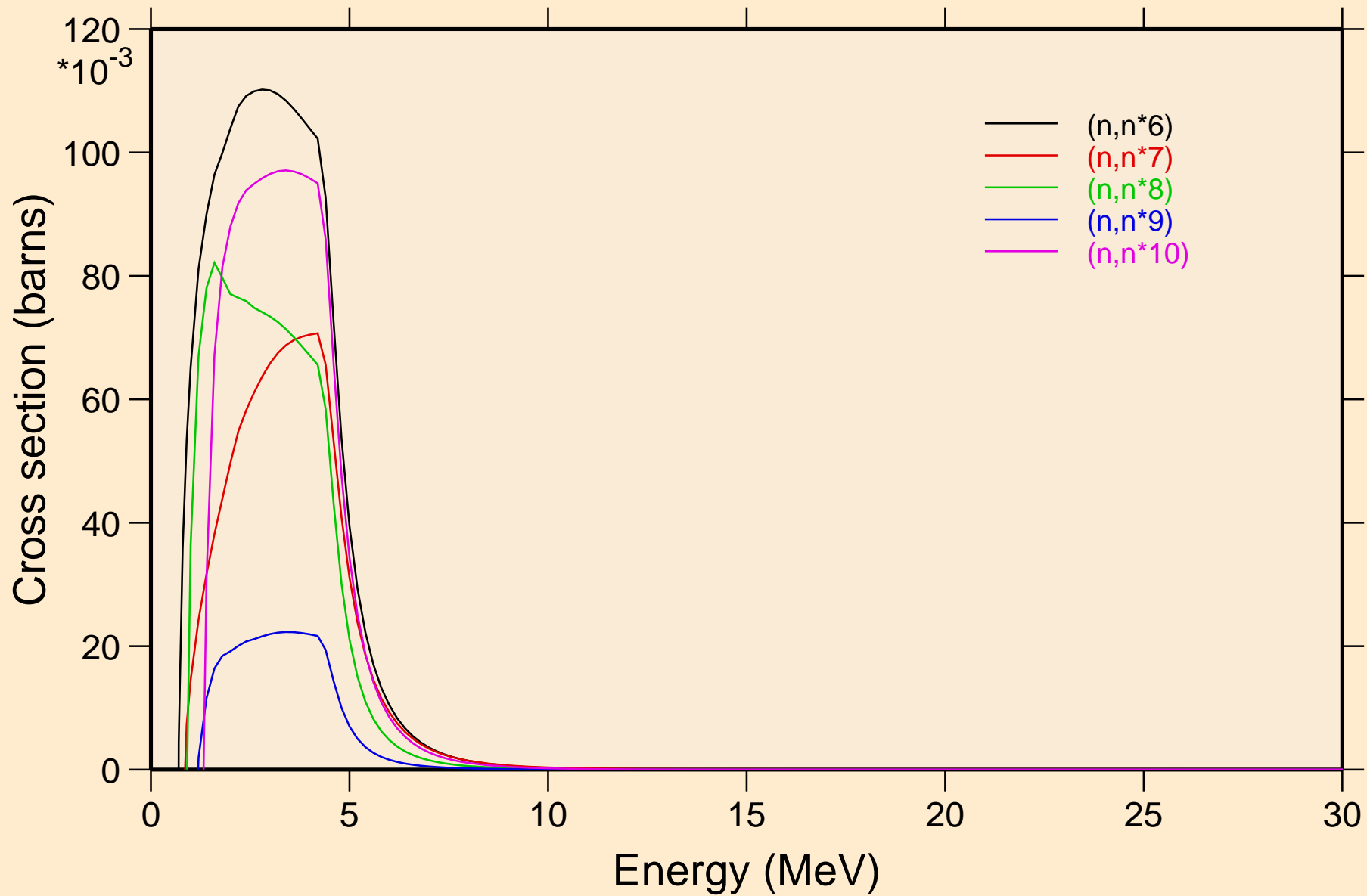

CL040 NEUTRON ACER TENDL-2021 LIBRARY; T=293.6K
Inelastic levels

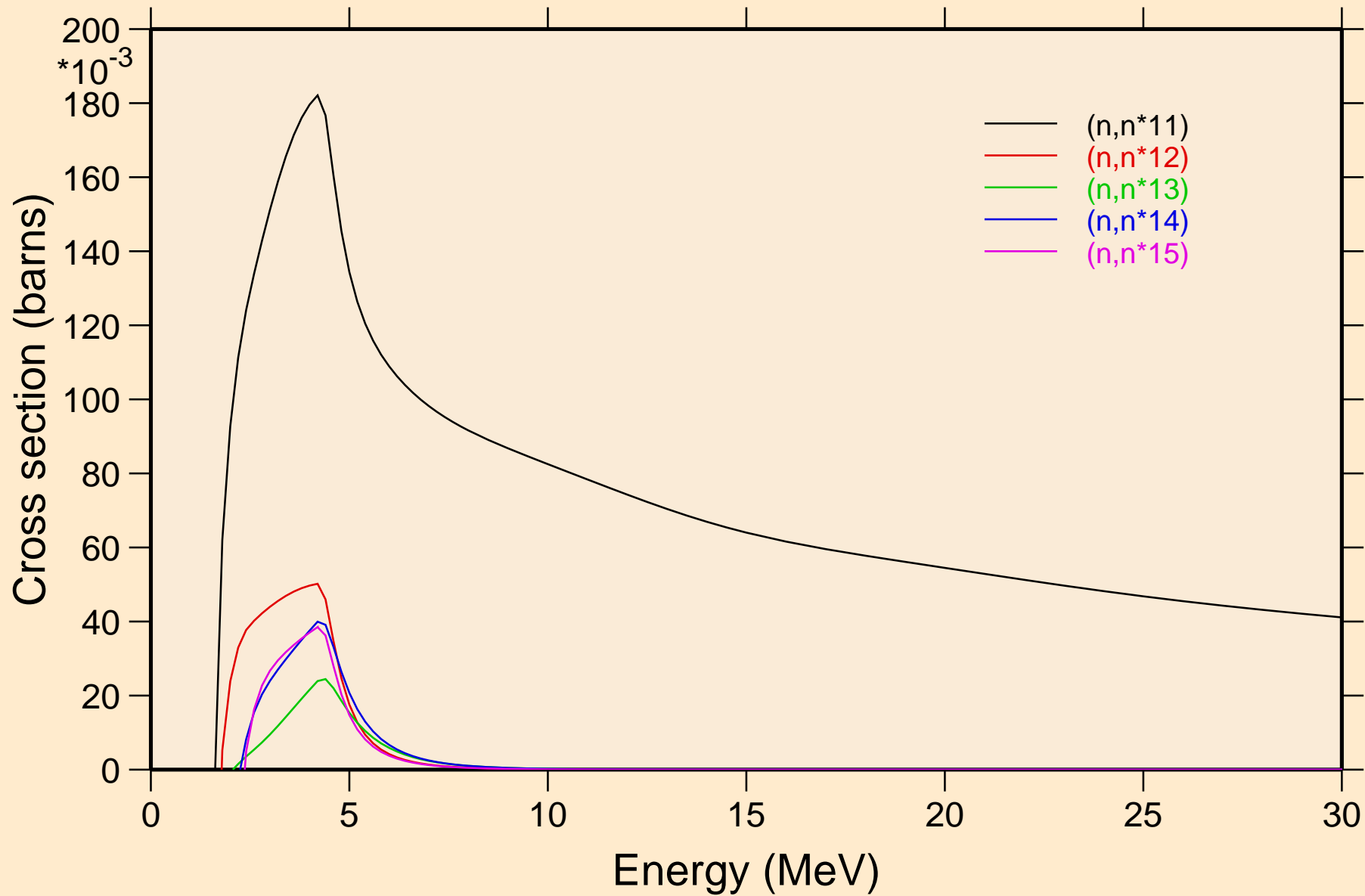

CL040 NEUTRON ACER TENDL-2021 LIBRARY; T=293.6K
Inelastic levels

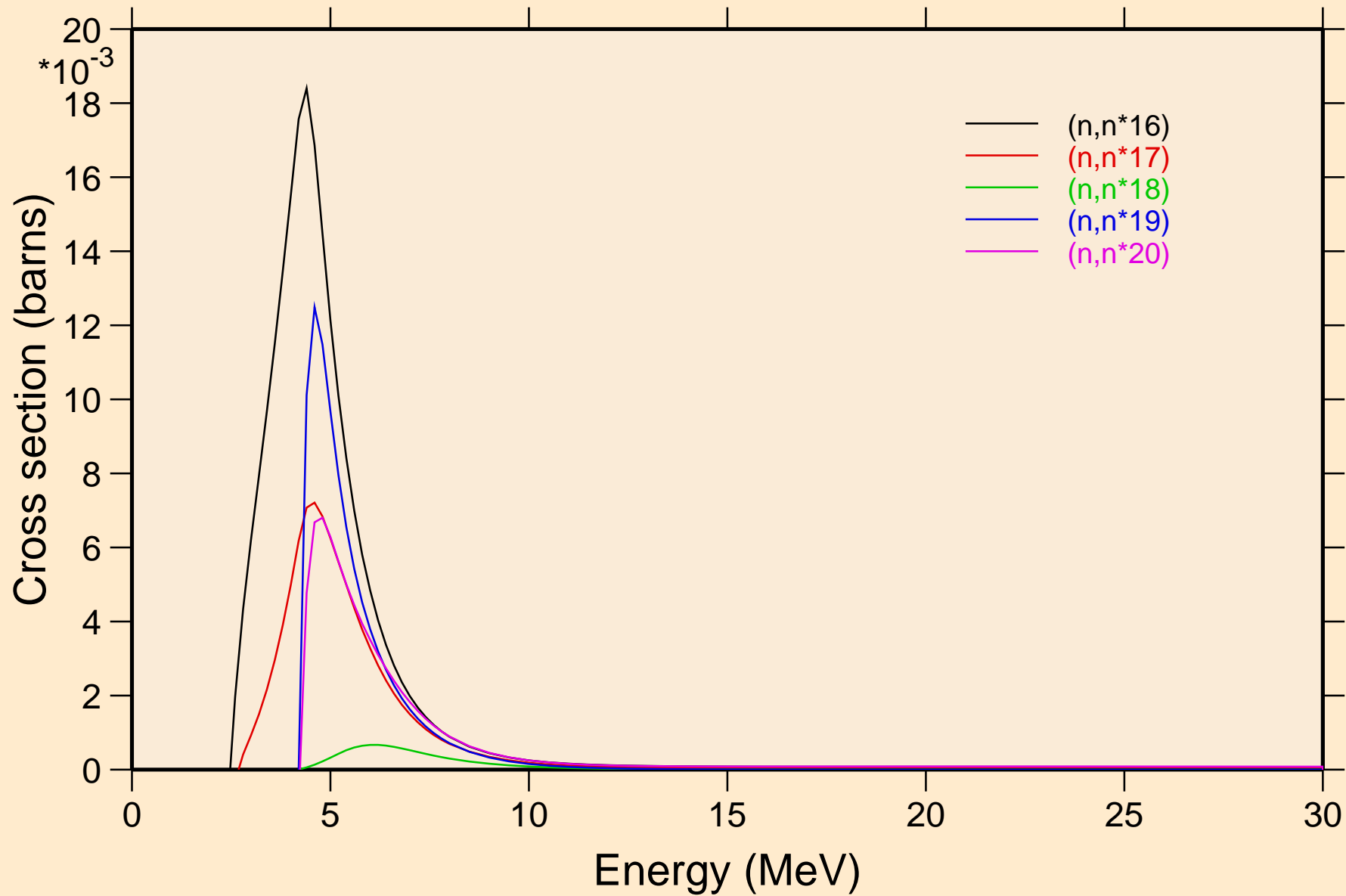

CL040 NEUTRON ACER TENDL-2021 LIBRARY; T=293.6K
Inelastic levels

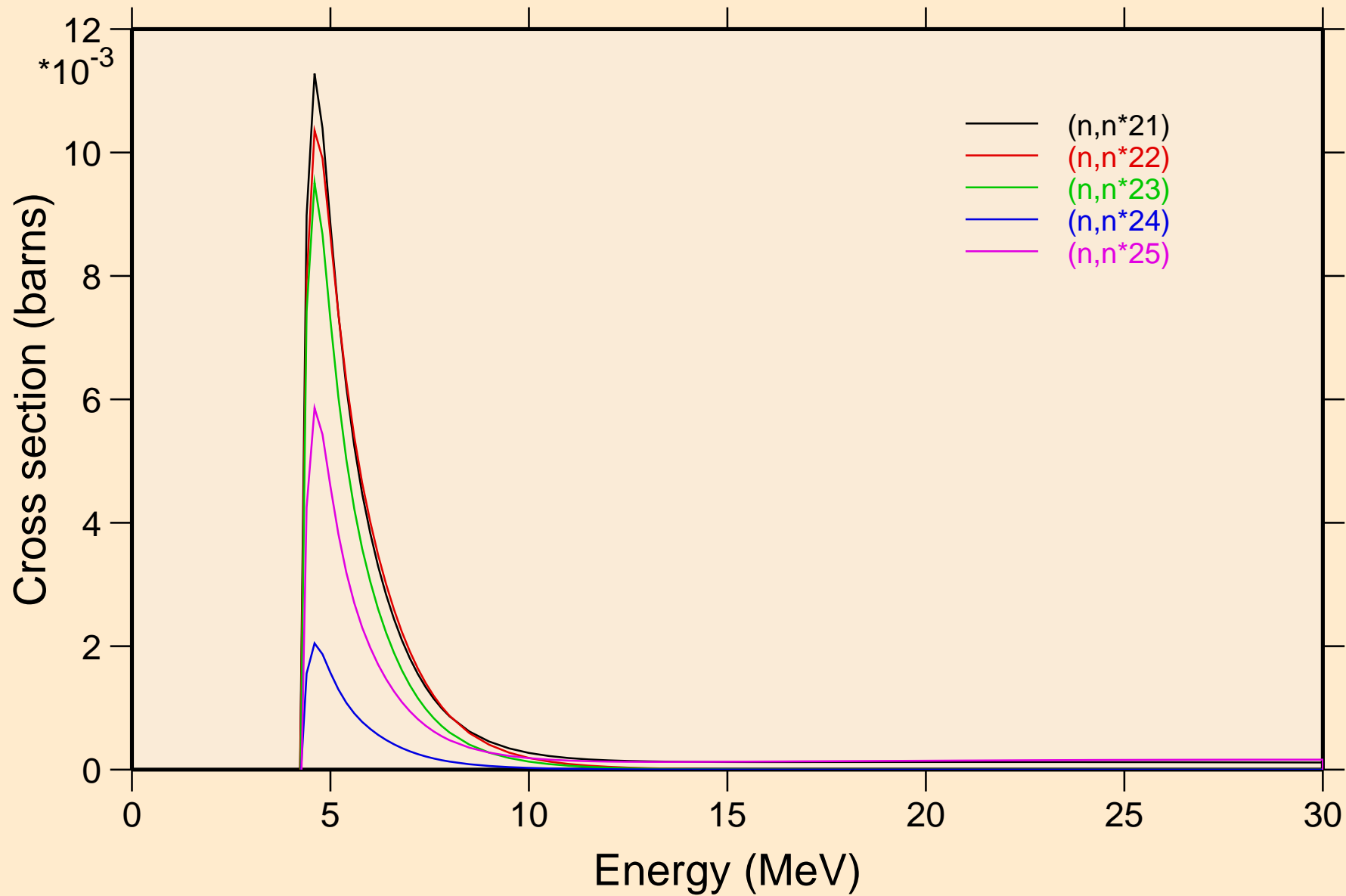

CL040 NEUTRON ACER TENDL-2021 LIBRARY; T=293.6K
Inelastic levels

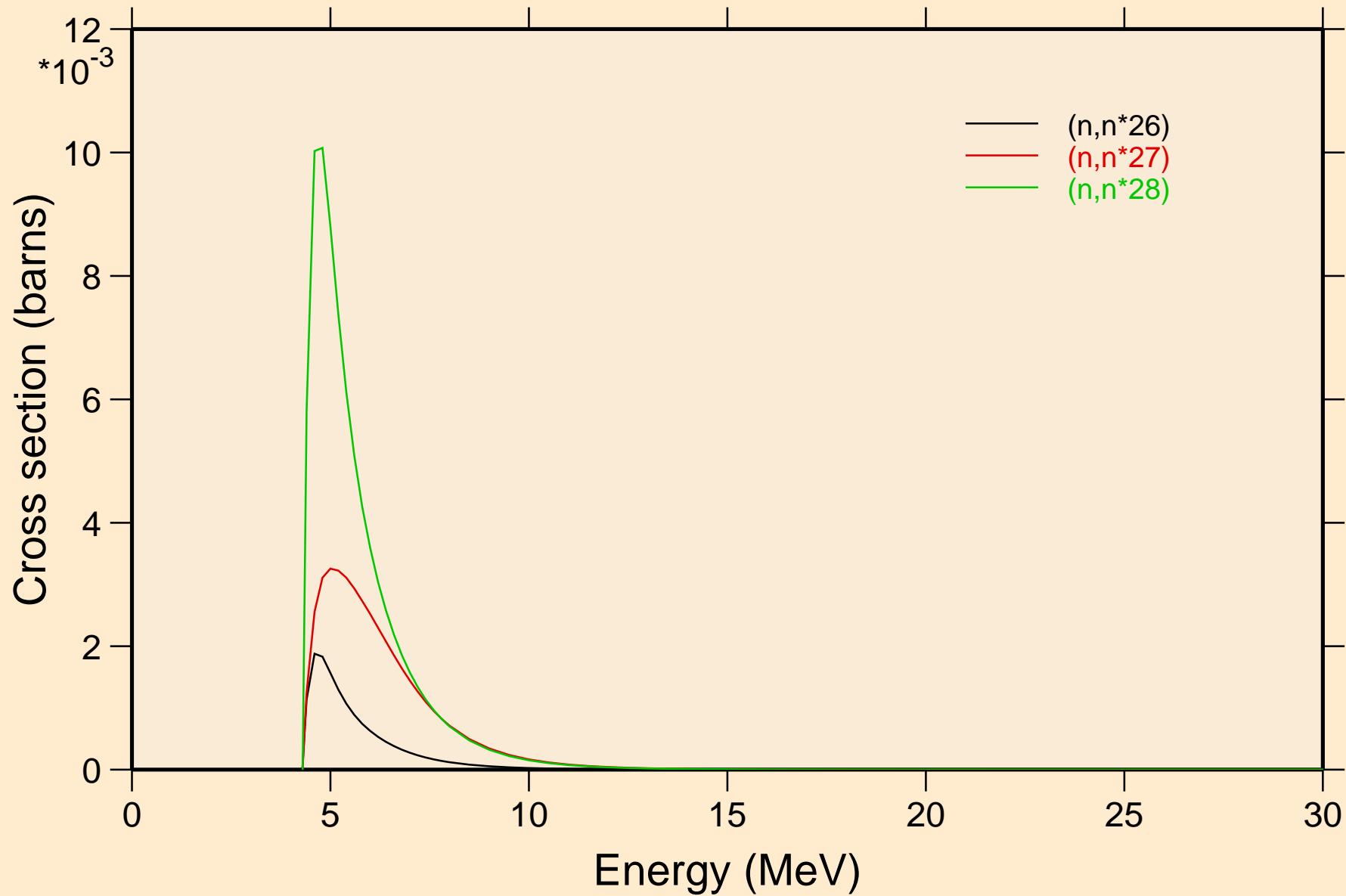

CL040 NEUTRON ACER TENDL-2021 LIBRARY; T=293.6K
Threshold reactions

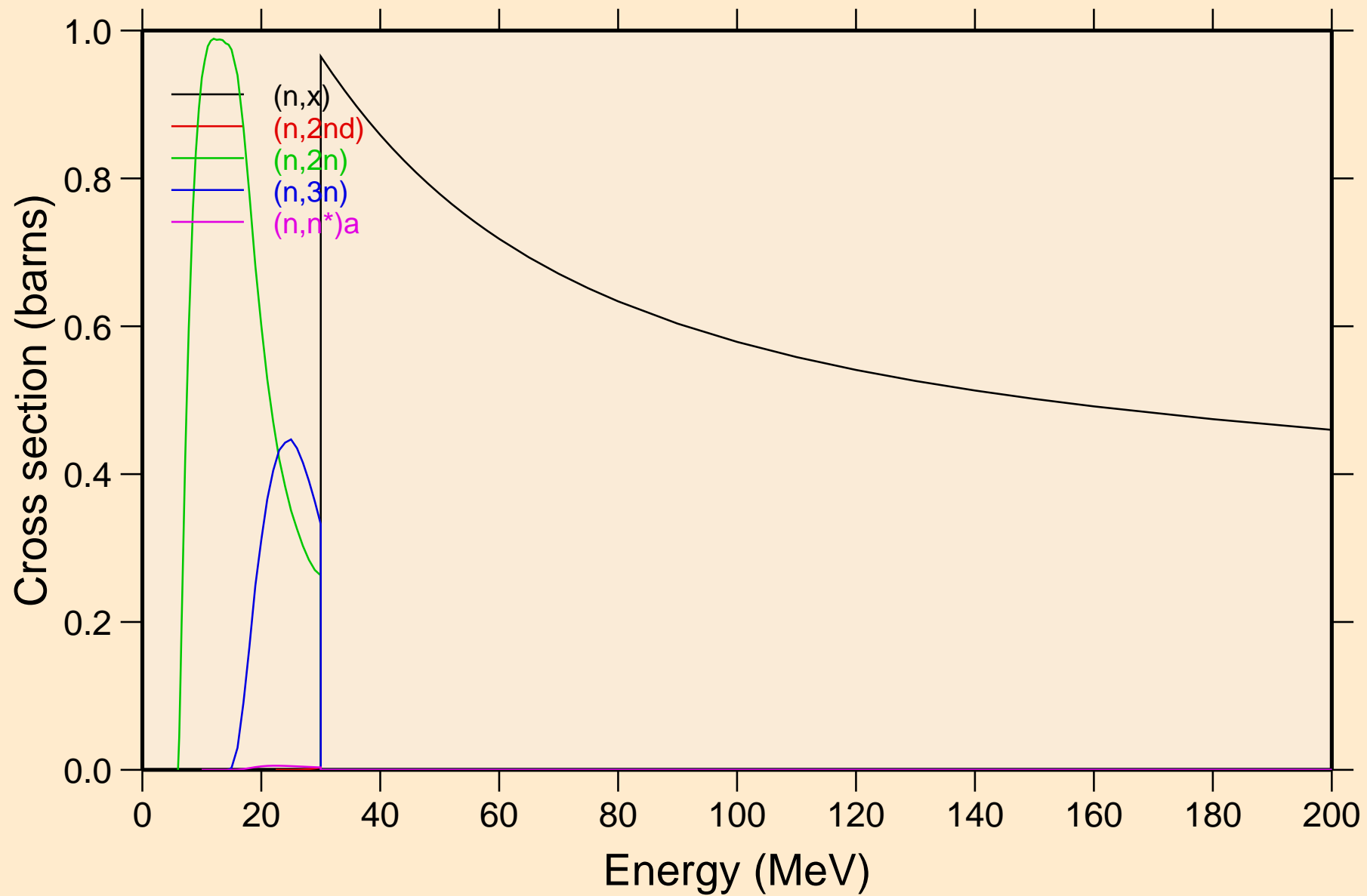

CL040 NEUTRON ACER TENDL-2021 LIBRARY; T=293.6K
Threshold reactions

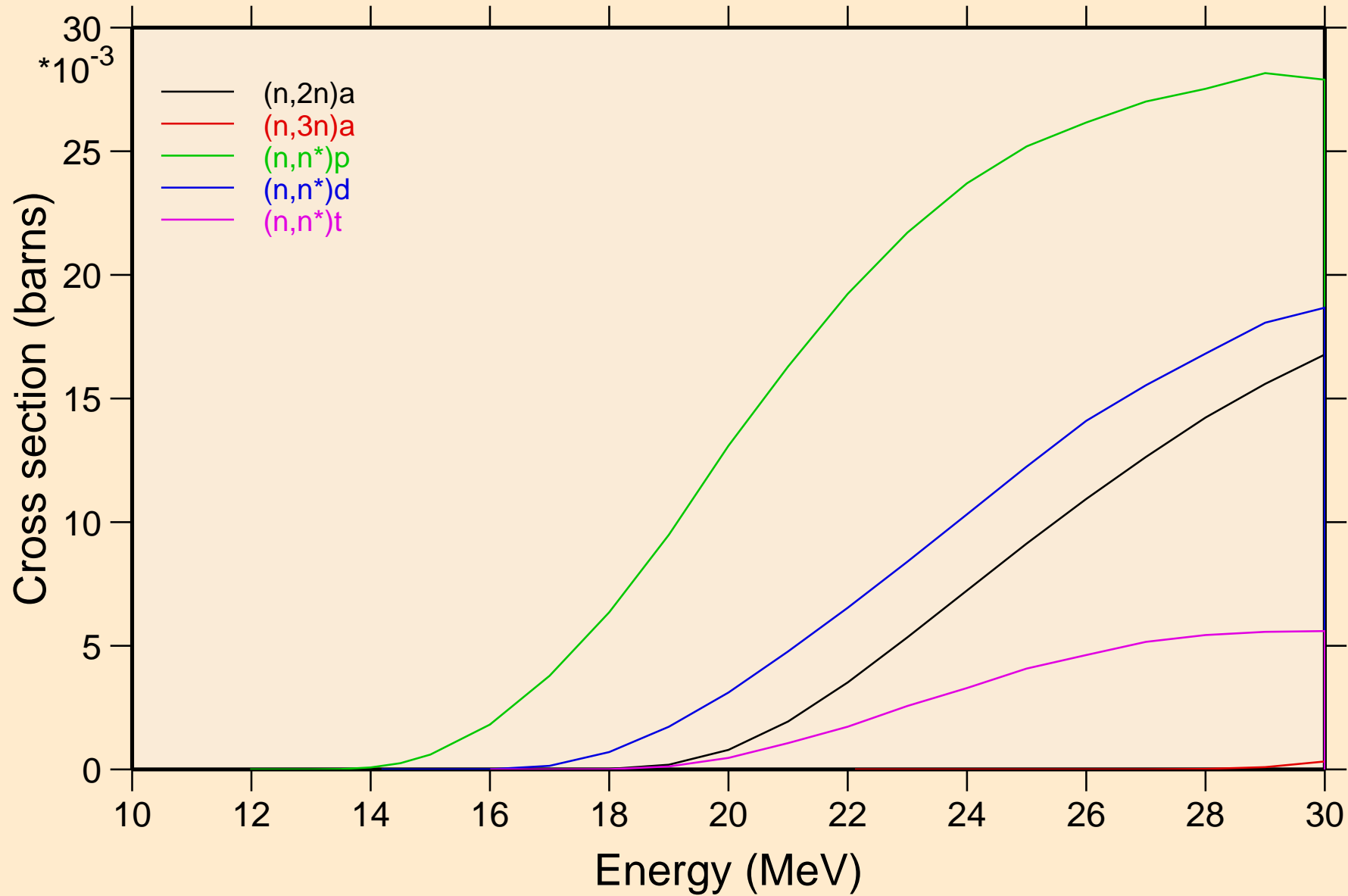

CL040 NEUTRON ACER TENDL-2021 LIBRARY; T=293.6K
Threshold reactions

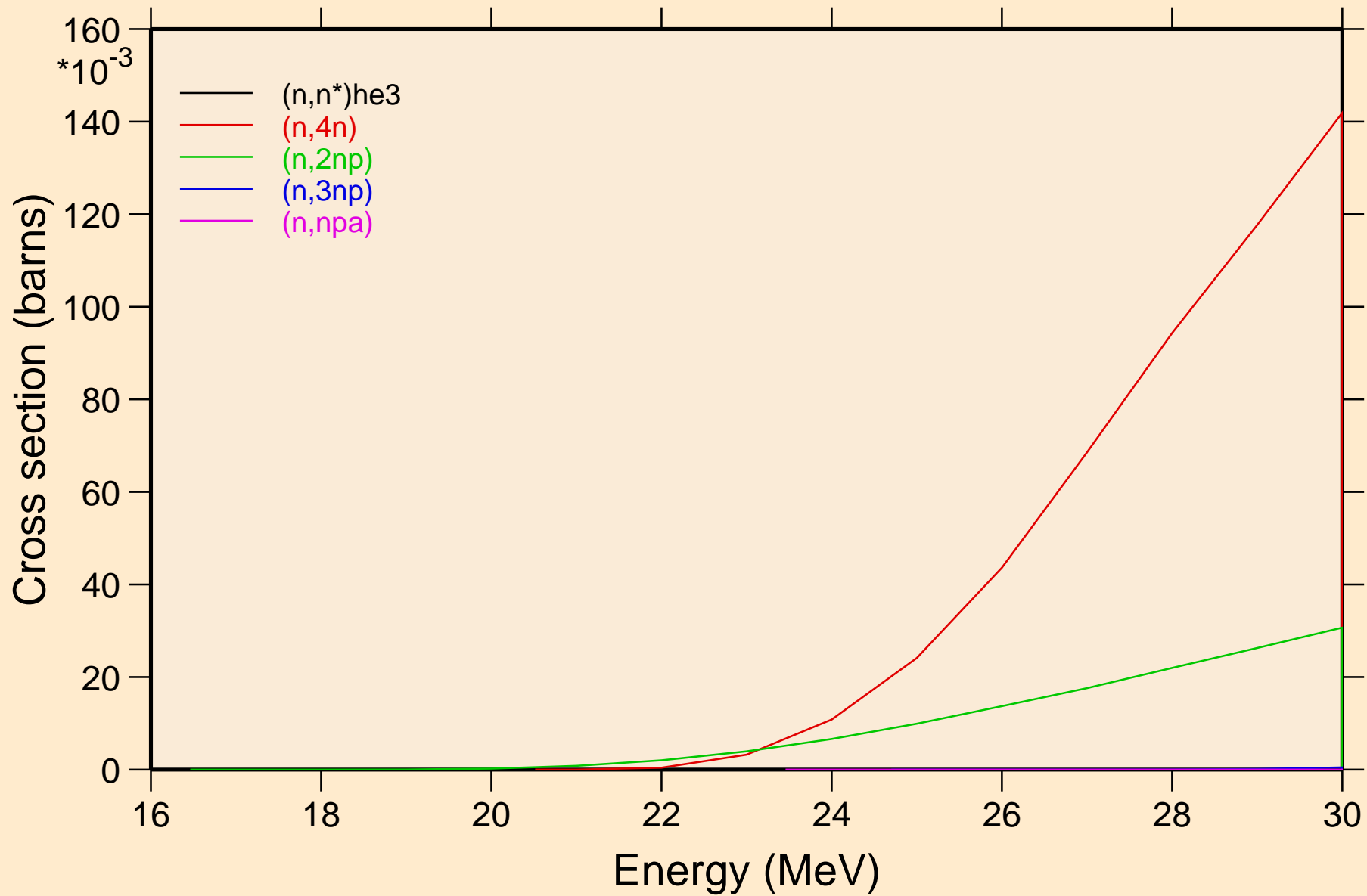

CL040 NEUTRON ACER TENDL-2021 LIBRARY; T=293.6K
Threshold reactions

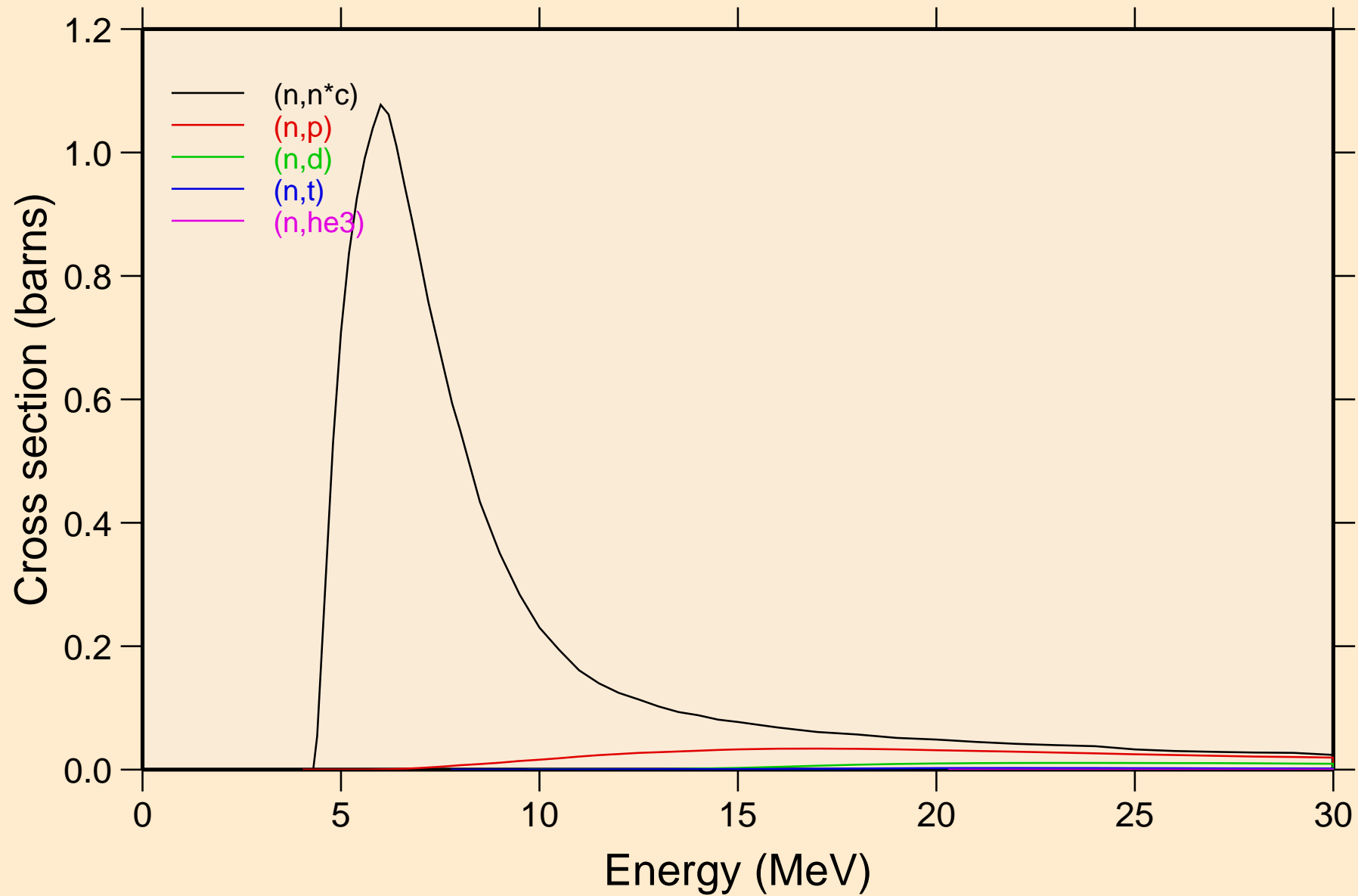

CL040 NEUTRON ACER TENDL-2021 LIBRARY; T=293.6K
Threshold reactions

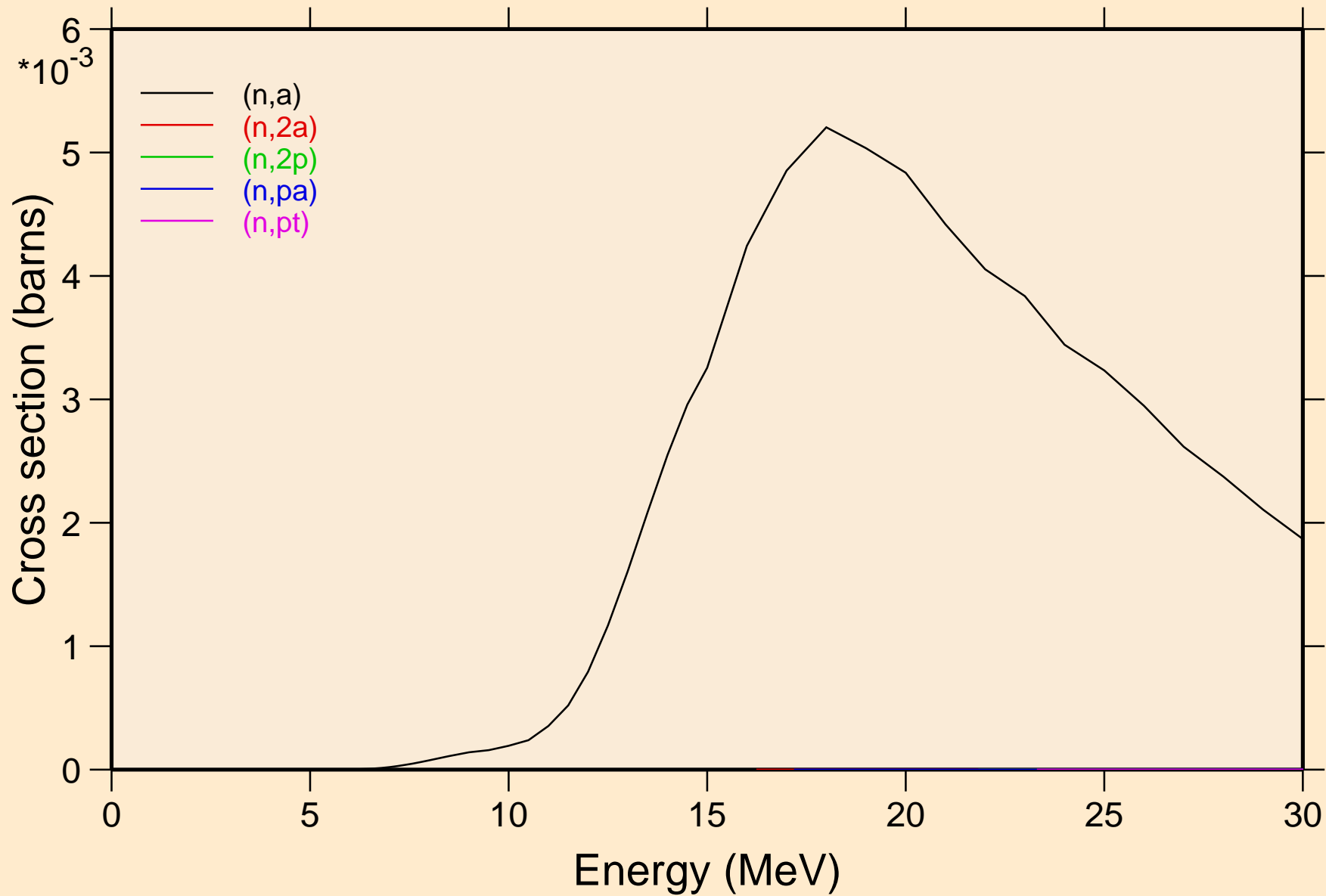

CL040 NEUTRON ACER TENDL-2021 LIBRARY; T=293.6K
Threshold reactions

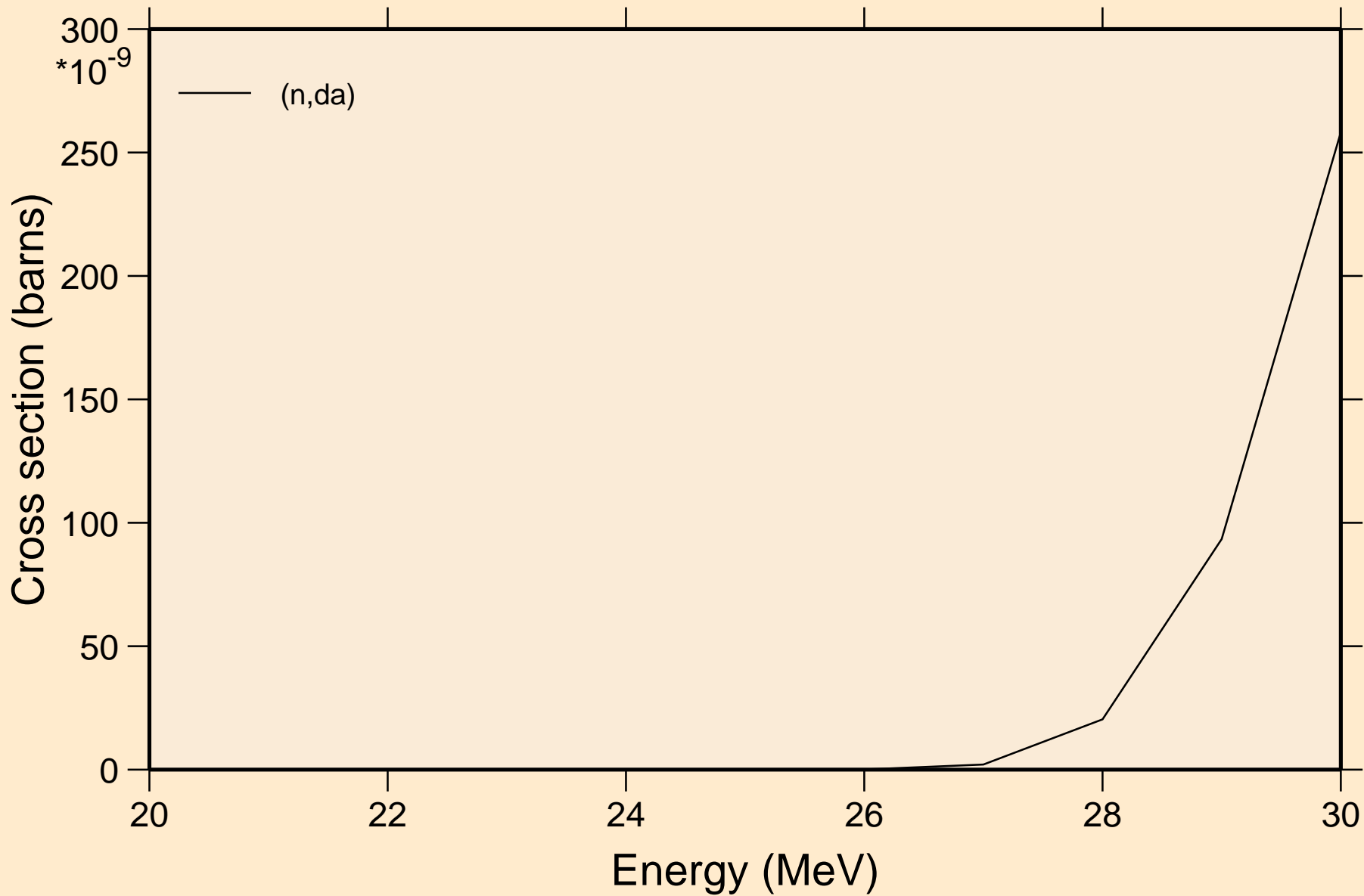

CL040 NEUTRON ACER TENDL-2021 LIBRARY; T=293.6K
Threshold reactions

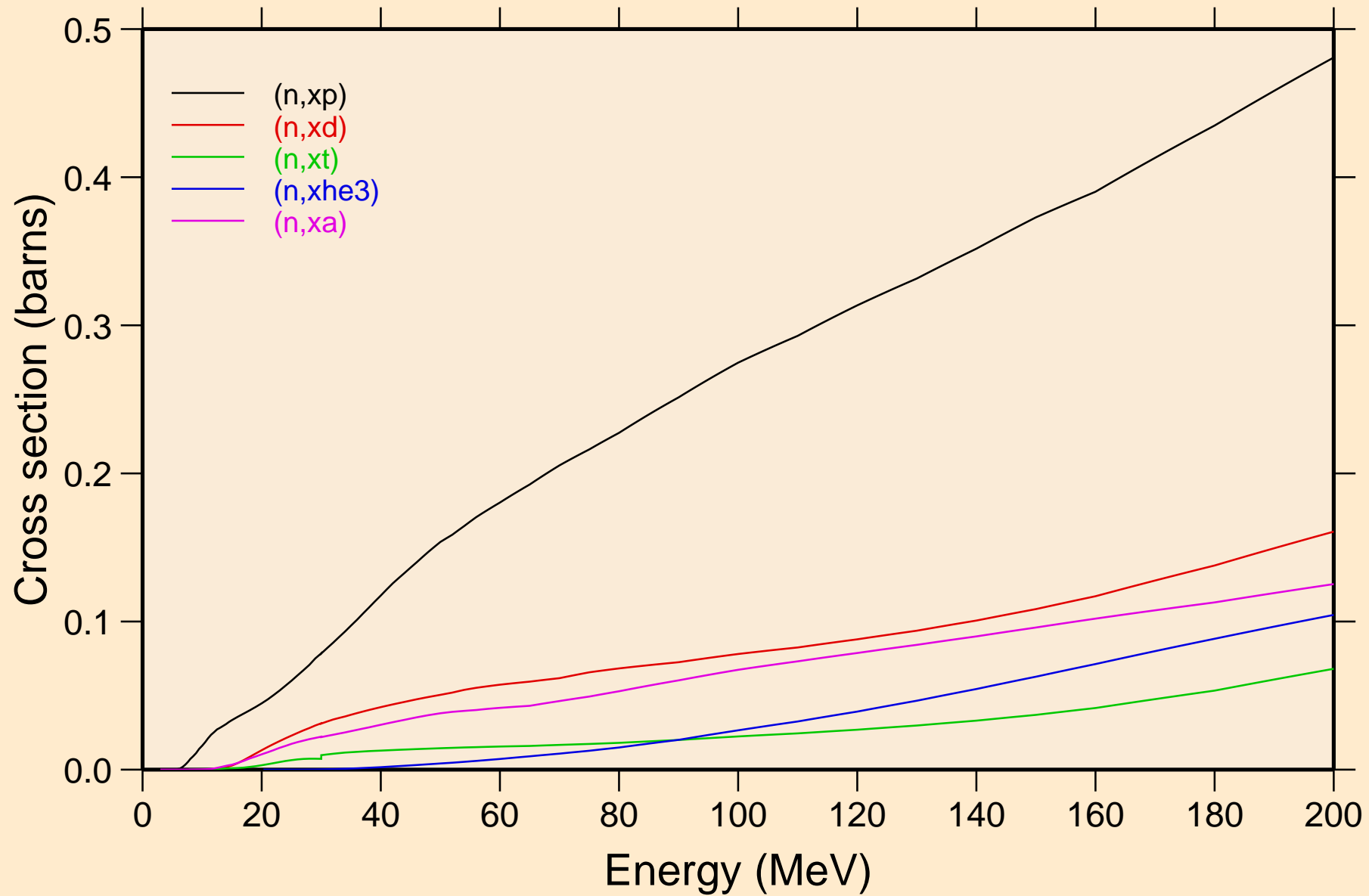

CL040 NEUTRON ACER TENDL-2021 LIBRARY; T=293.6K
angular distribution for elastic

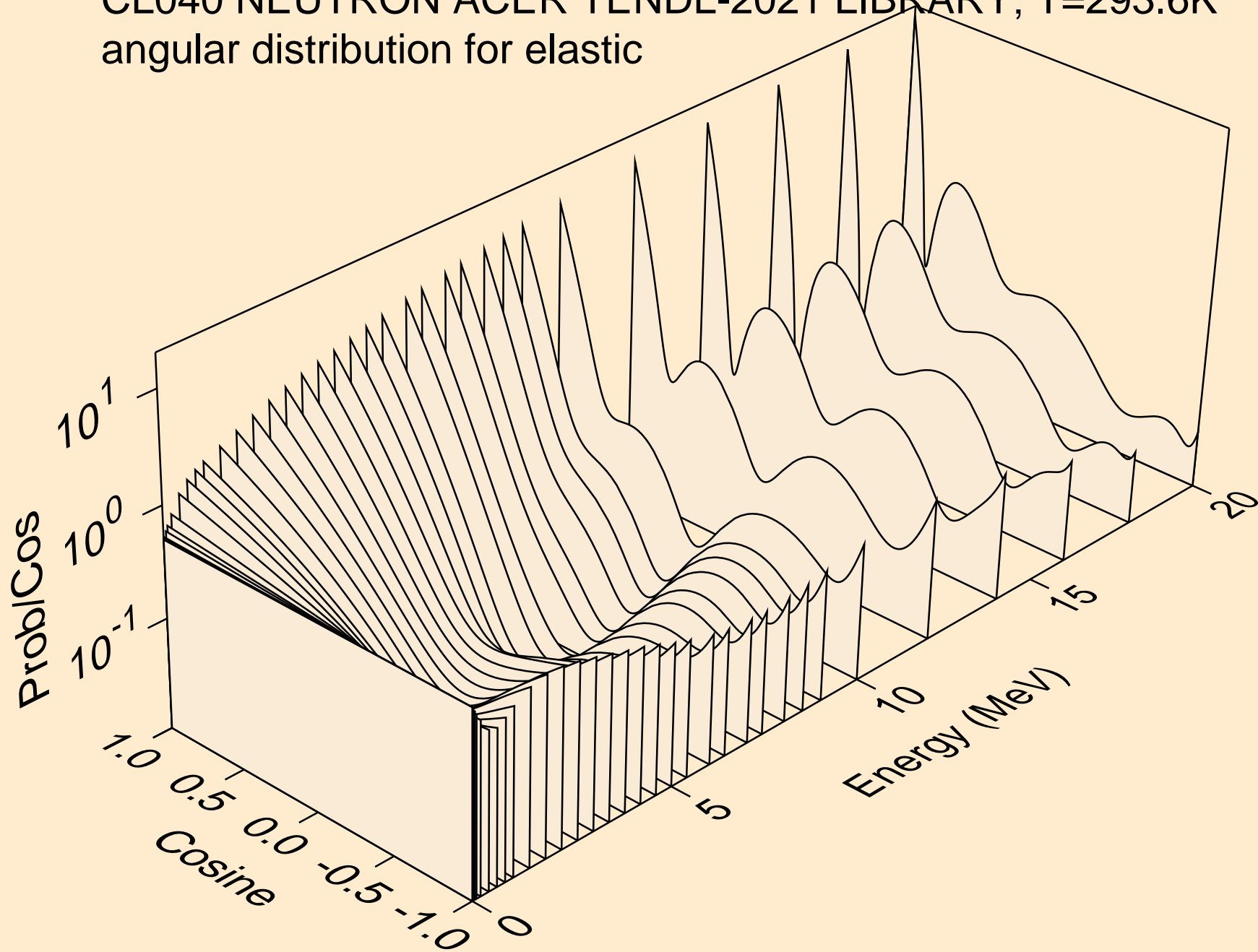

CL040 NEUTRON ACER TENDL-2021 LIBRARY; T=293.6K
angular distribution for elastic

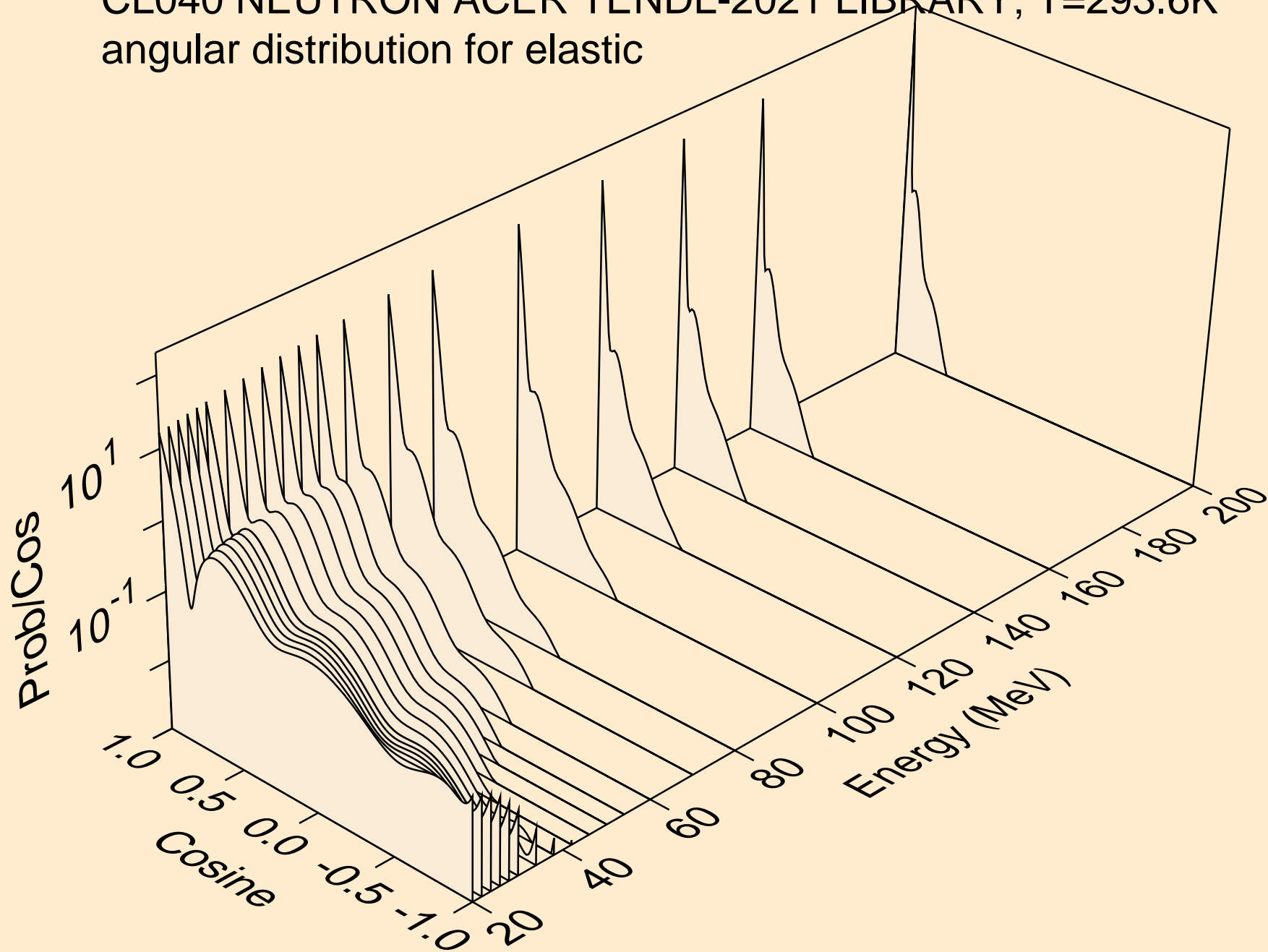

CL040 NEUTRON ACER TENDL-2021 LIBRARY; T=293.6K
angular distribution for (n,n*1)

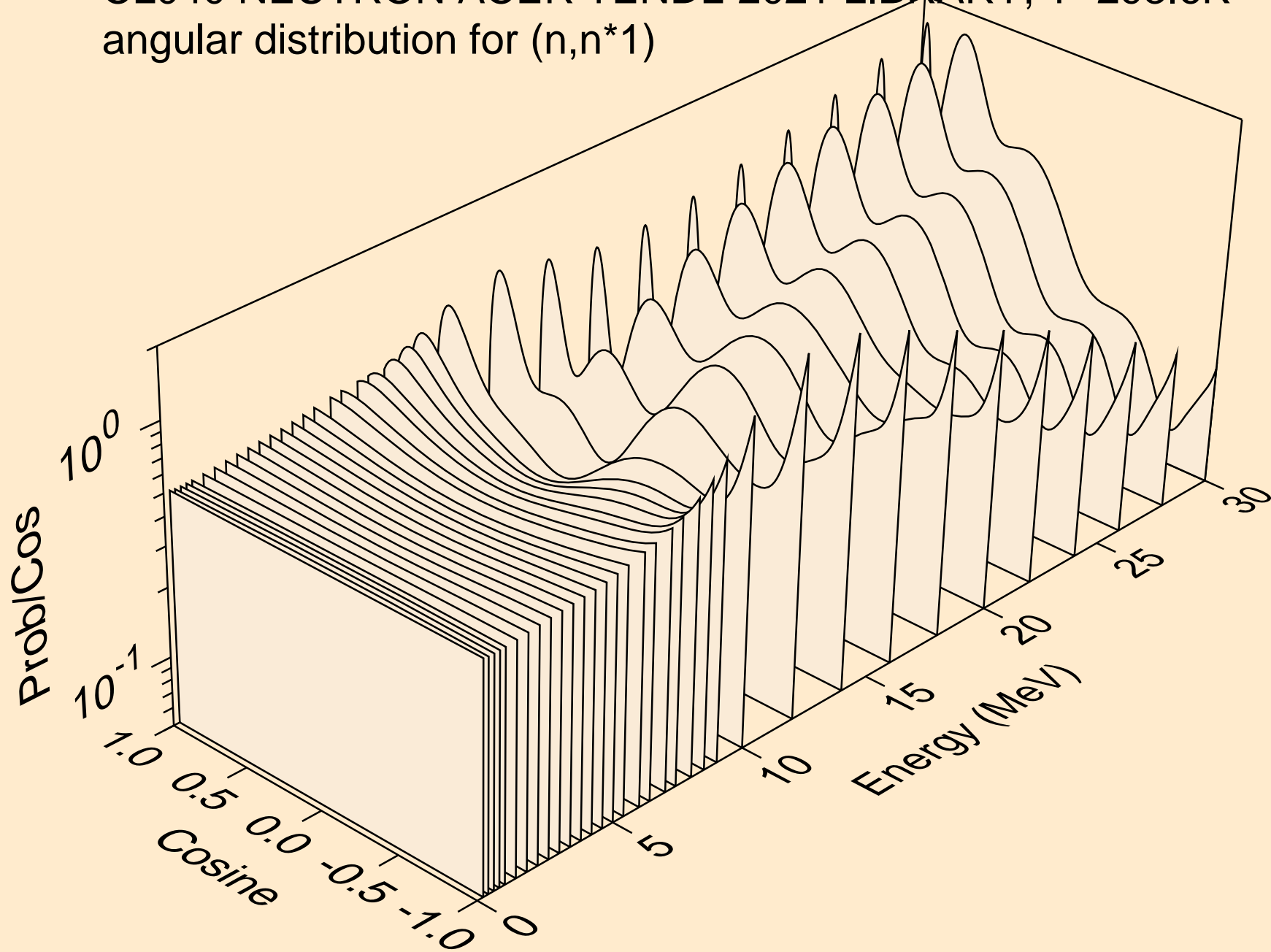

CL040 NEUTRON ACER TENDL-2021 LIBRARY; T=293.6K
angular distribution for (n,n*2)

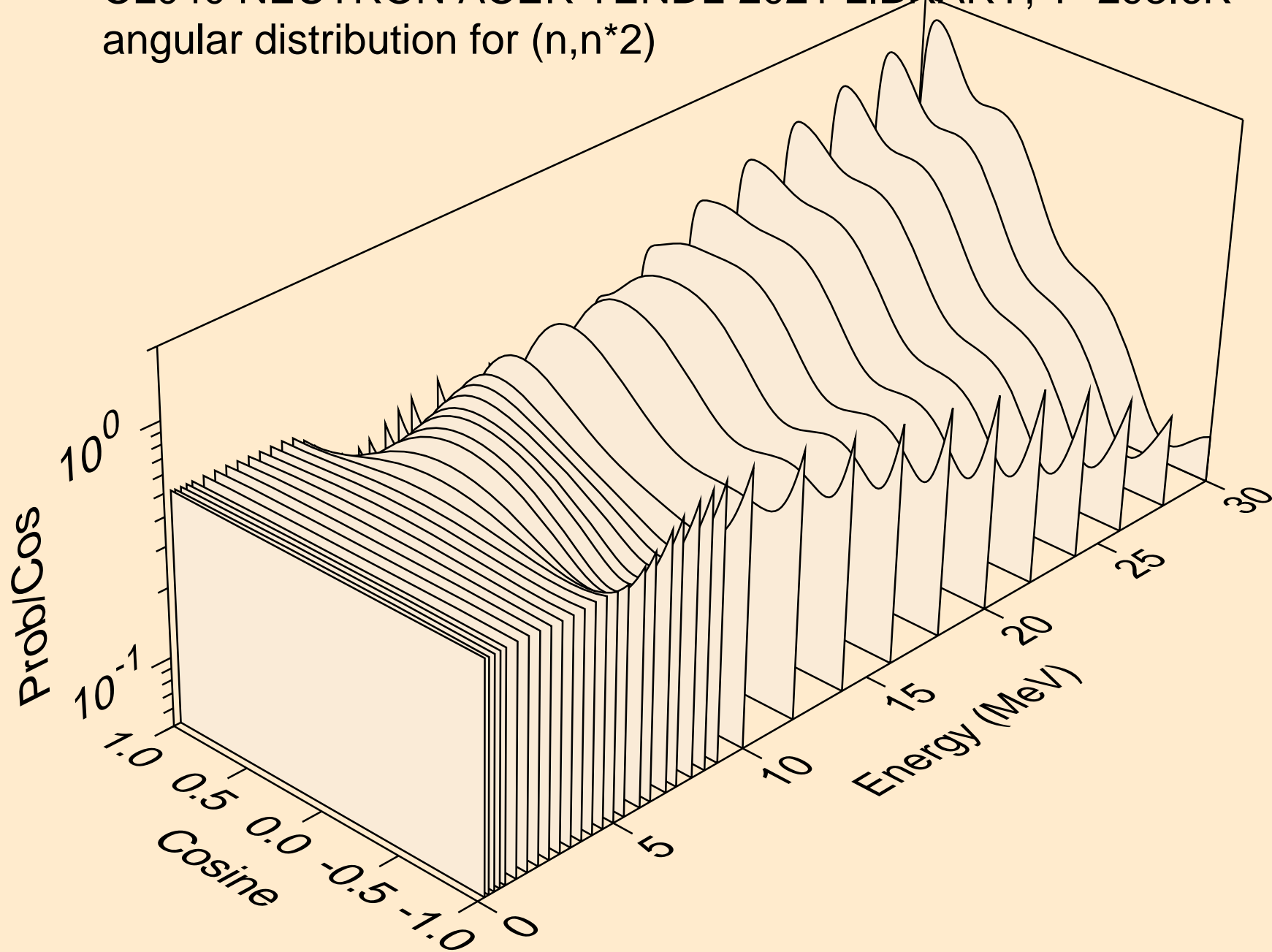

CL040 NEUTRON ACER TENDL-2021 LIBRARY; T=293.6K
angular distribution for (n,n*3)

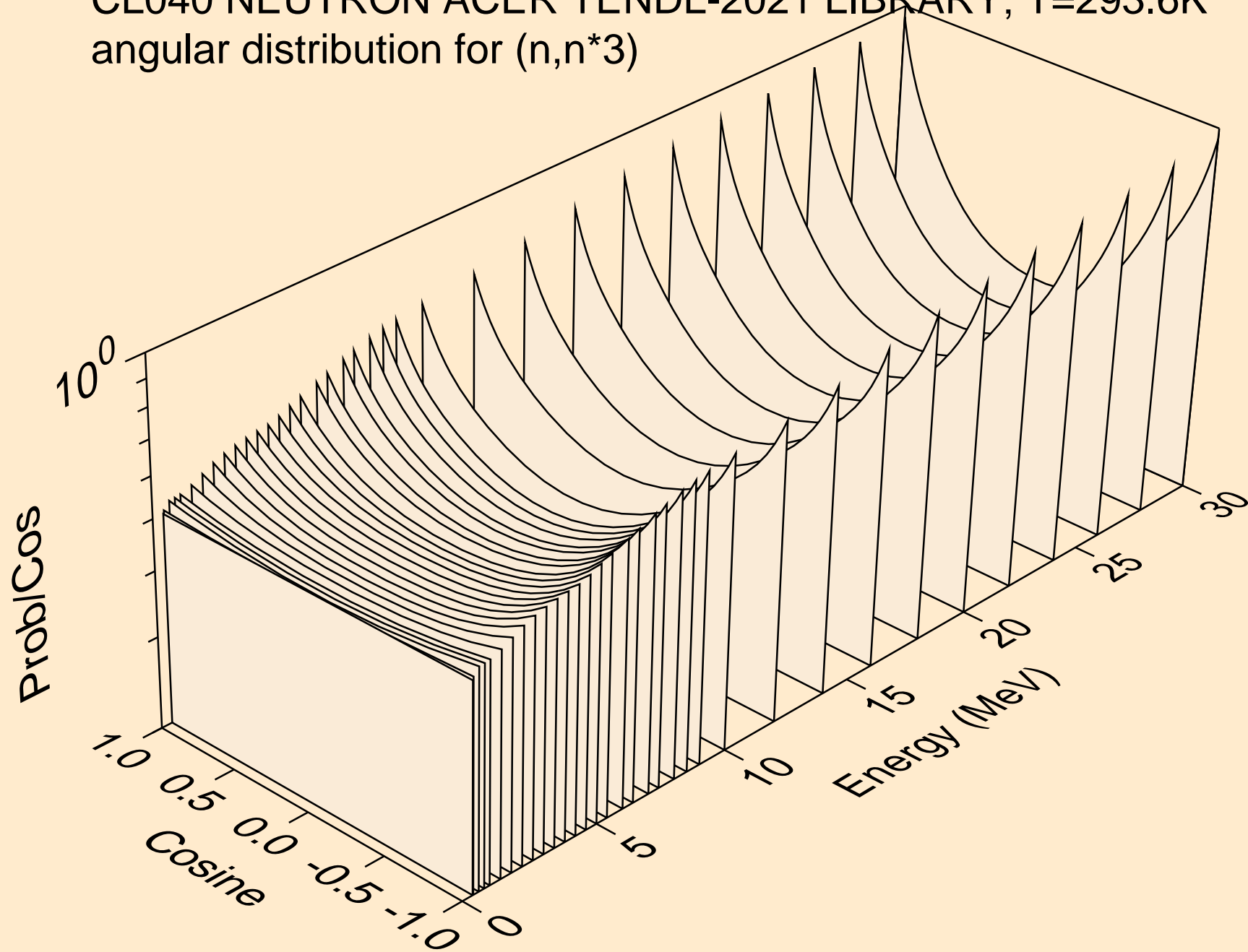

CL040 NEUTRON ACER TENDL-2021 LIBRARY; T=293.6K
angular distribution for (n,n*4)

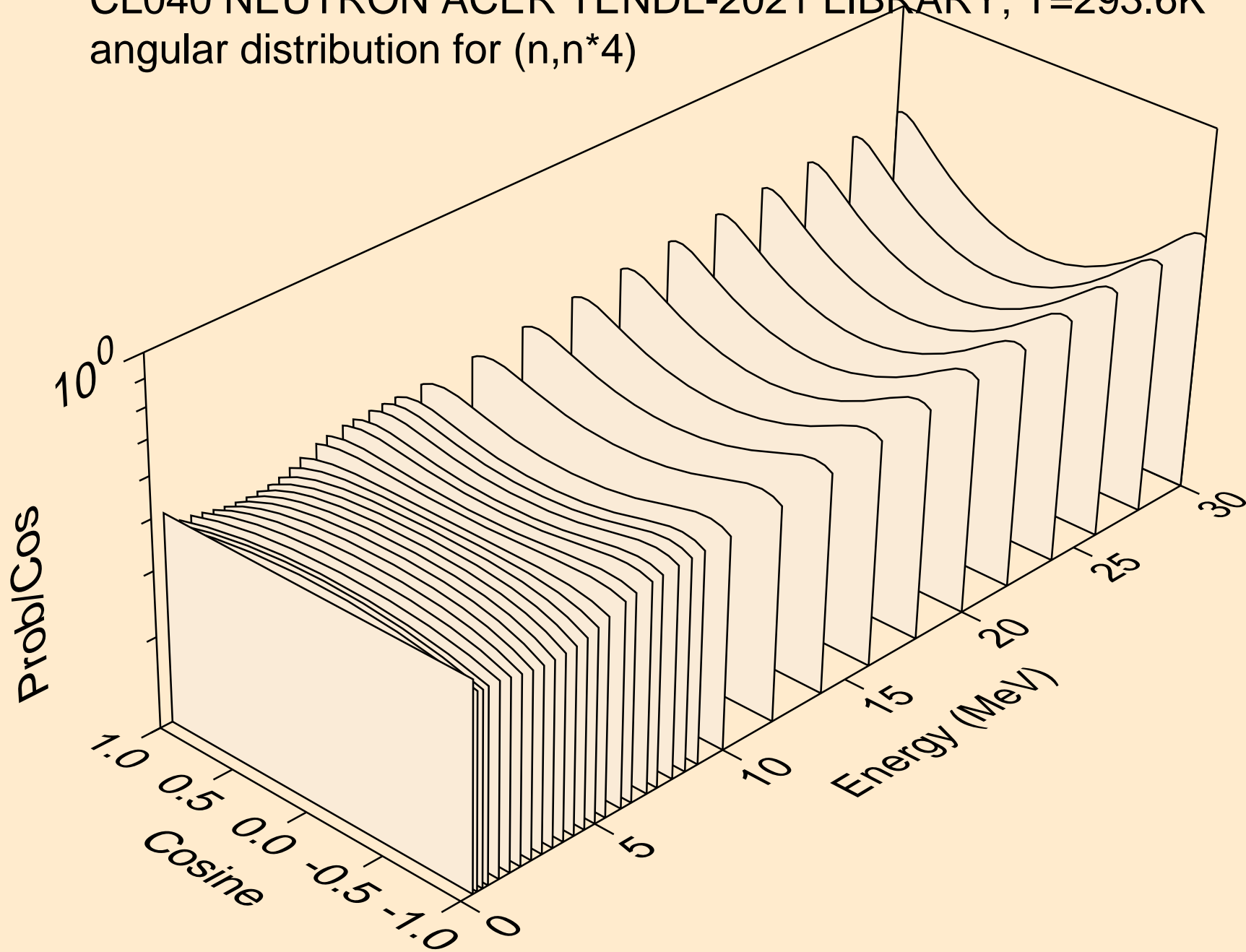

CL040 NEUTRON ACER TENDL-2021 LIBRARY; T=293.6K
angular distribution for (n,n*5)

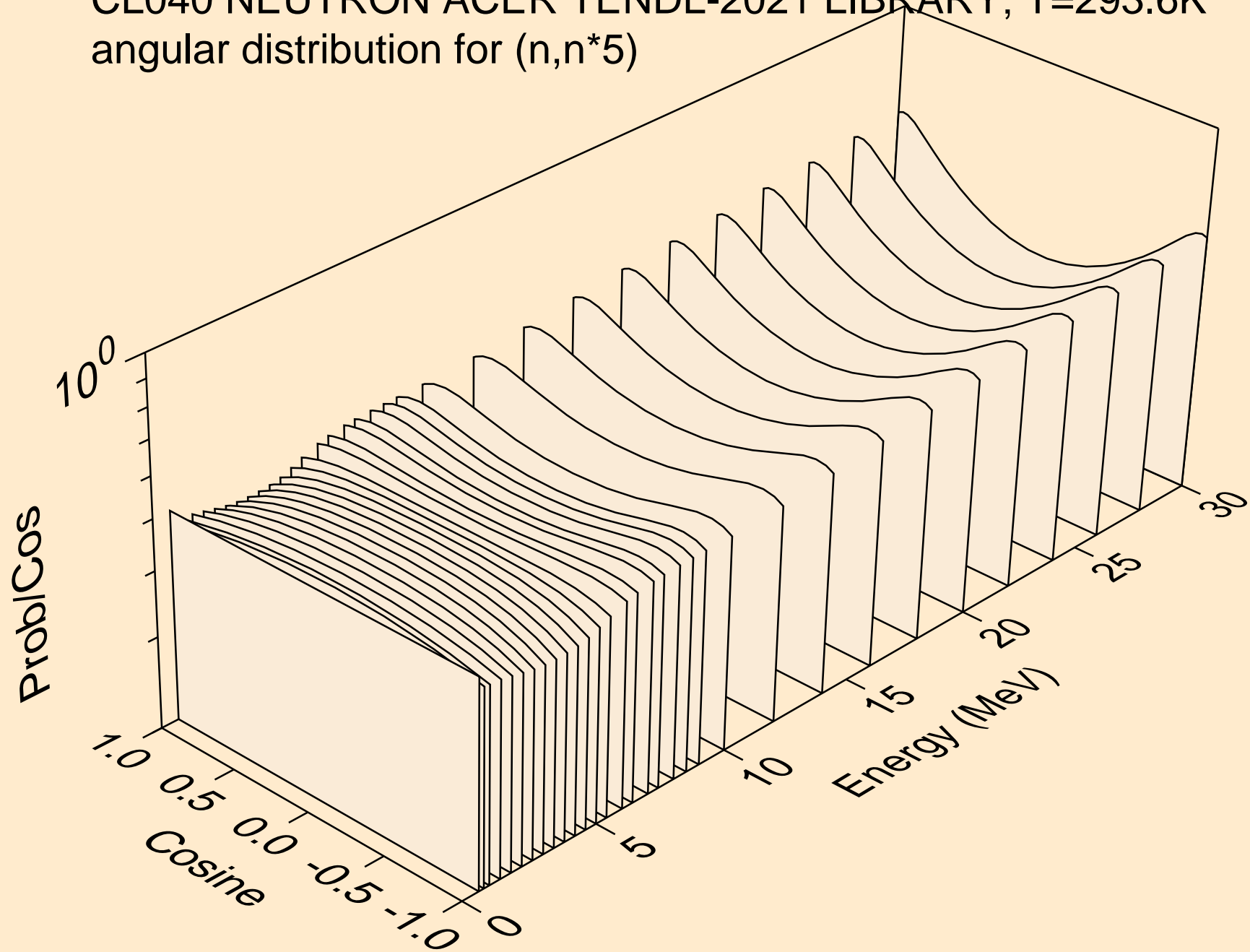

CL040 NEUTRON ACER TENDL-2021 LIBRARY; T=293.6K
angular distribution for (n,n*6)

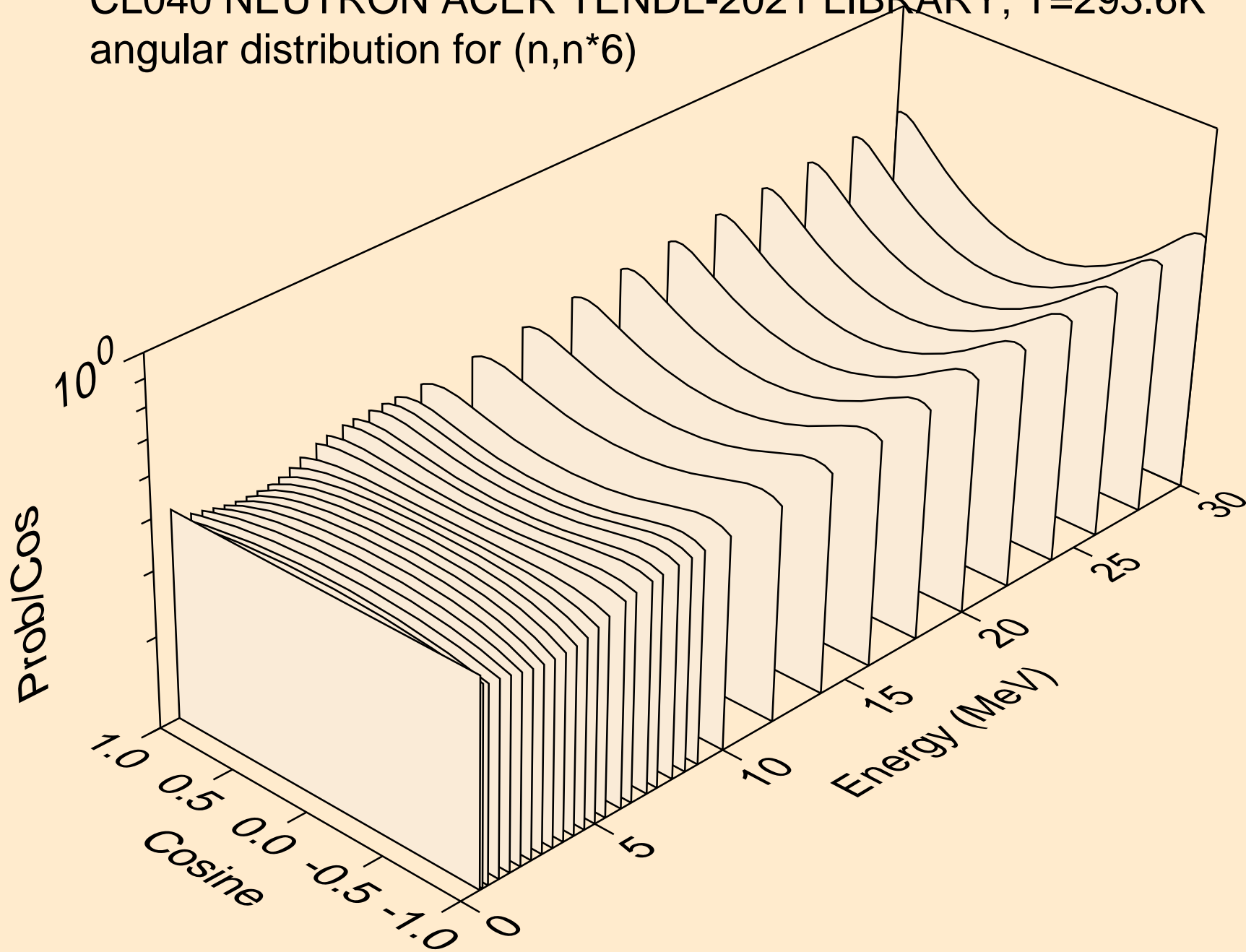

CL040 NEUTRON ACER TENDL-2021 LIBRARY; T=293.6K
angular distribution for (n,n*7)

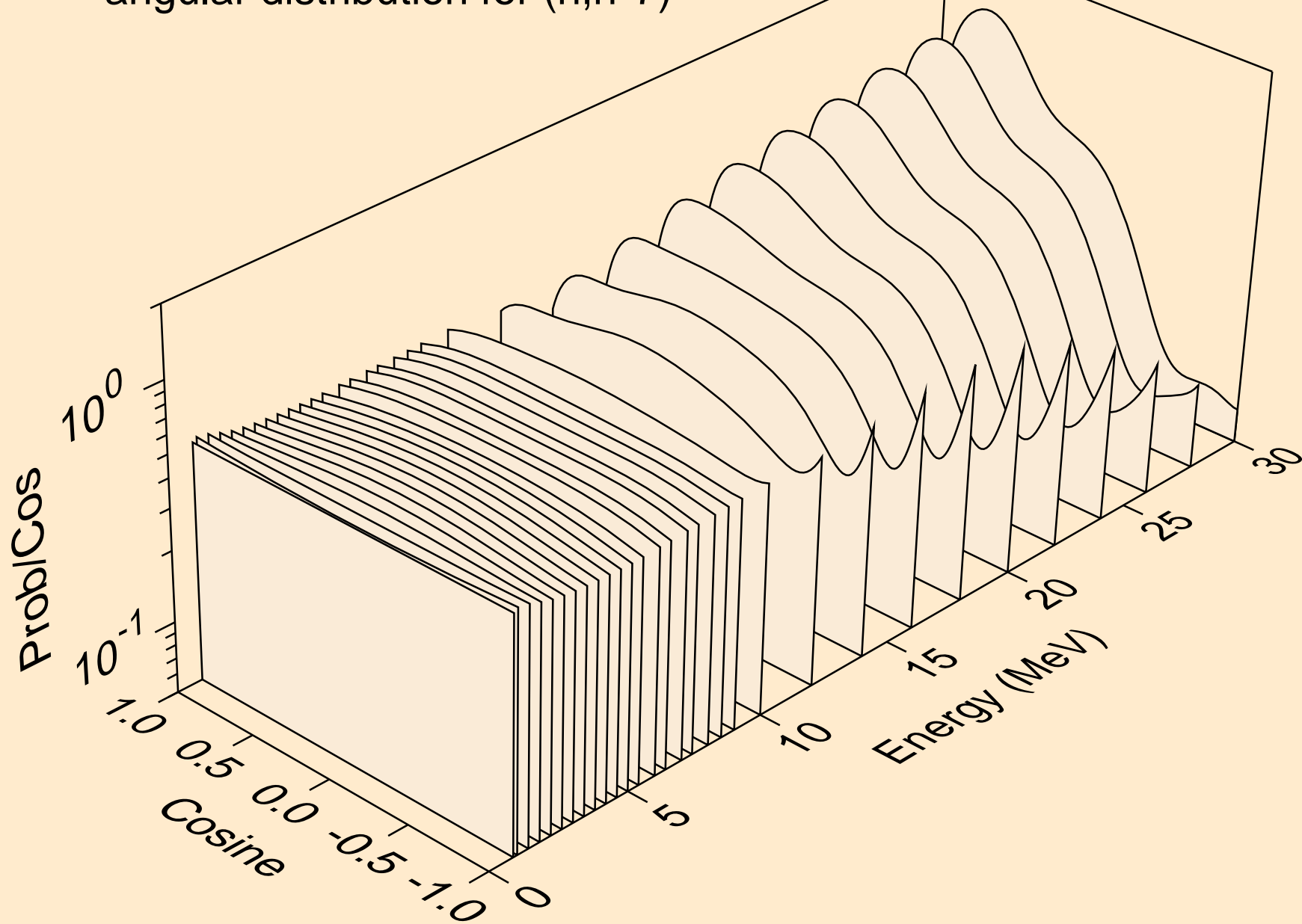

CL040 NEUTRON ACER TENDL-2021 LIBRARY; T=293.6K
angular distribution for (n,n*8)

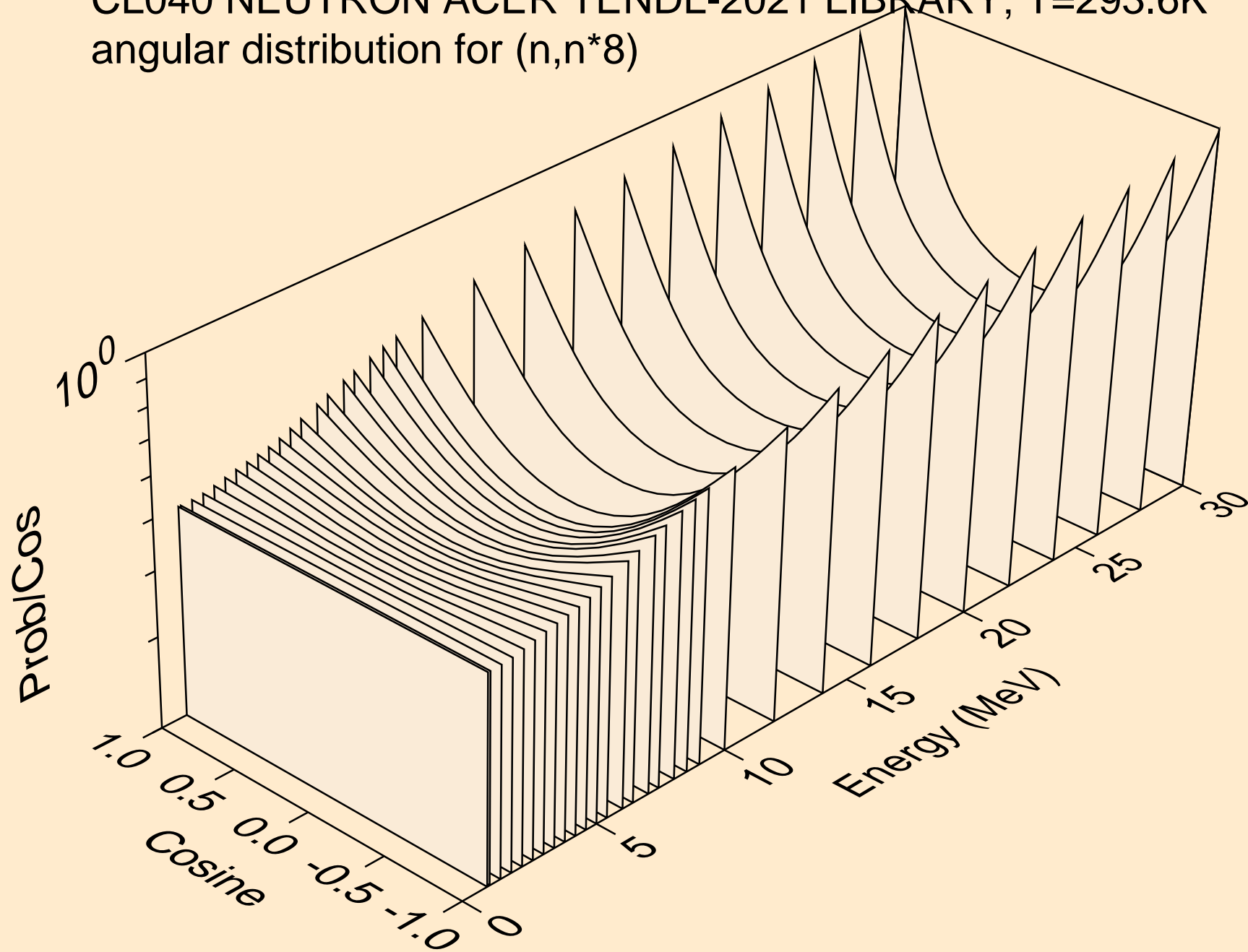

CL040 NEUTRON ACER TENDL-2021 LIBRARY; T=293.6K
angular distribution for (n,n*9)

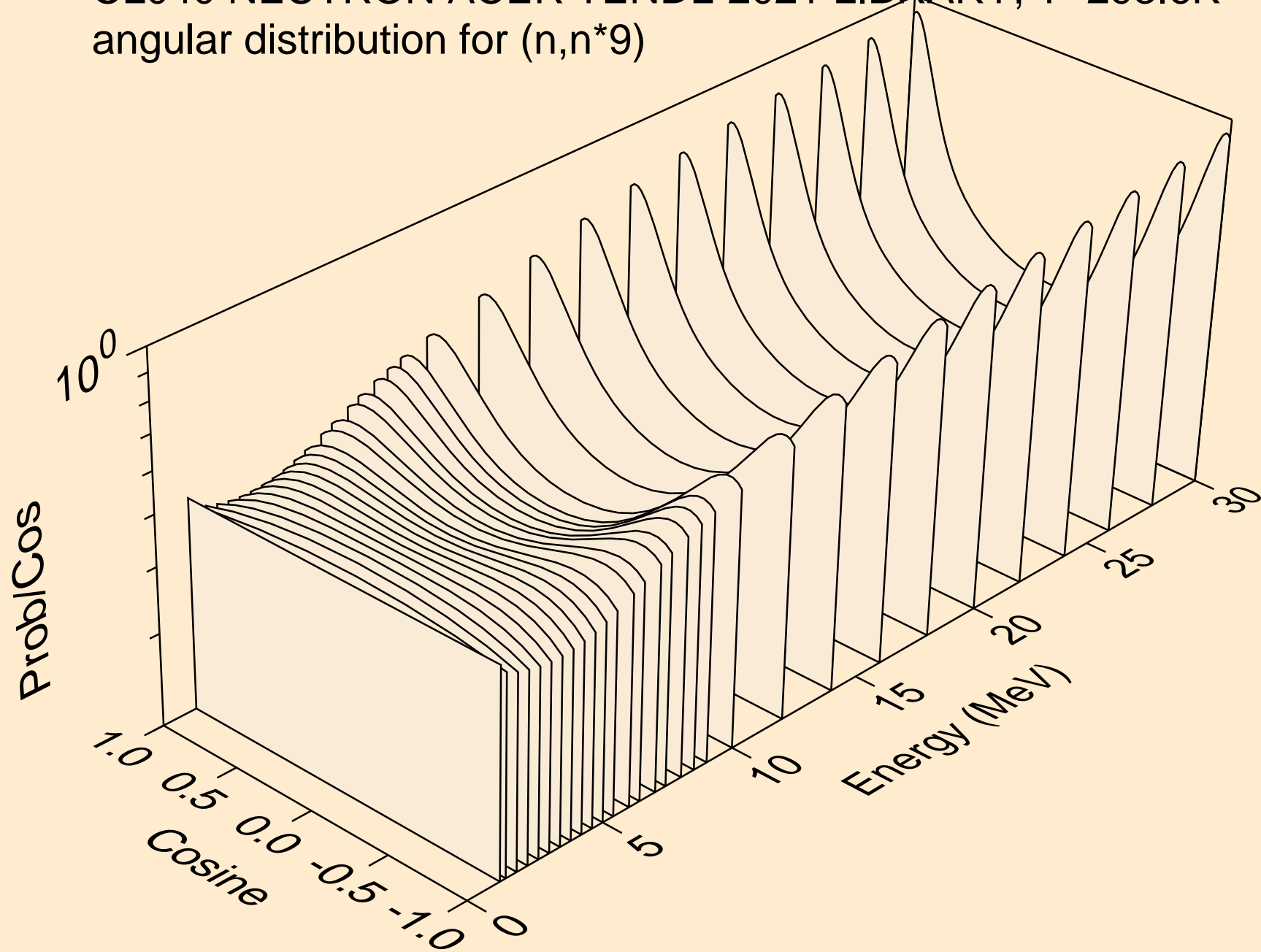

CL040 NEUTRON ACER TENDL-2021 LIBRARY; T=293.6K
angular distribution for (n,n*10)

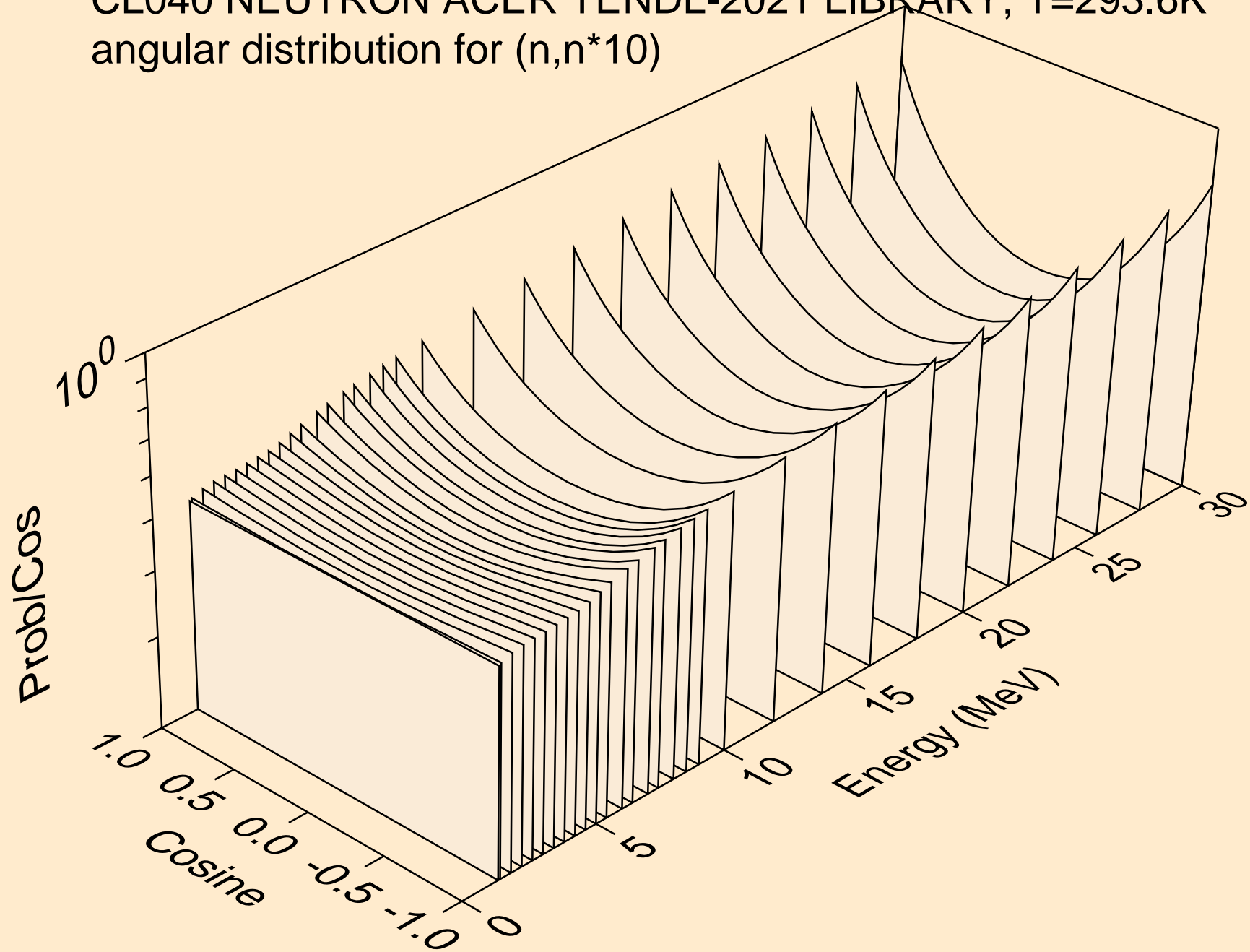

CL040 NEUTRON ACER TENDL-2021 LIBRARY; T=293.6K
angular distribution for (n,n*11)

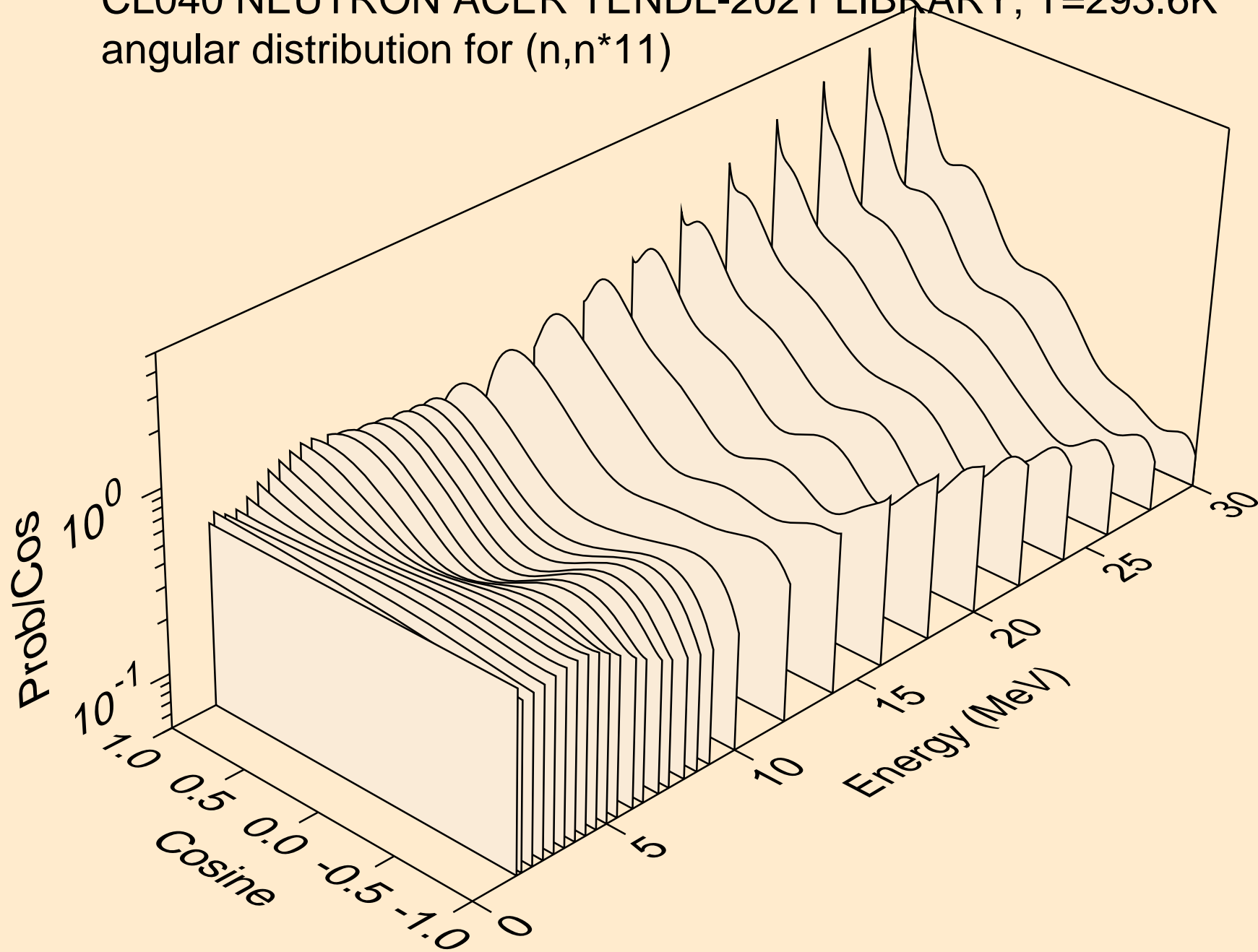

CL040 NEUTRON ACER TENDL-2021 LIBRARY; T=293.6K
angular distribution for (n,n*12)

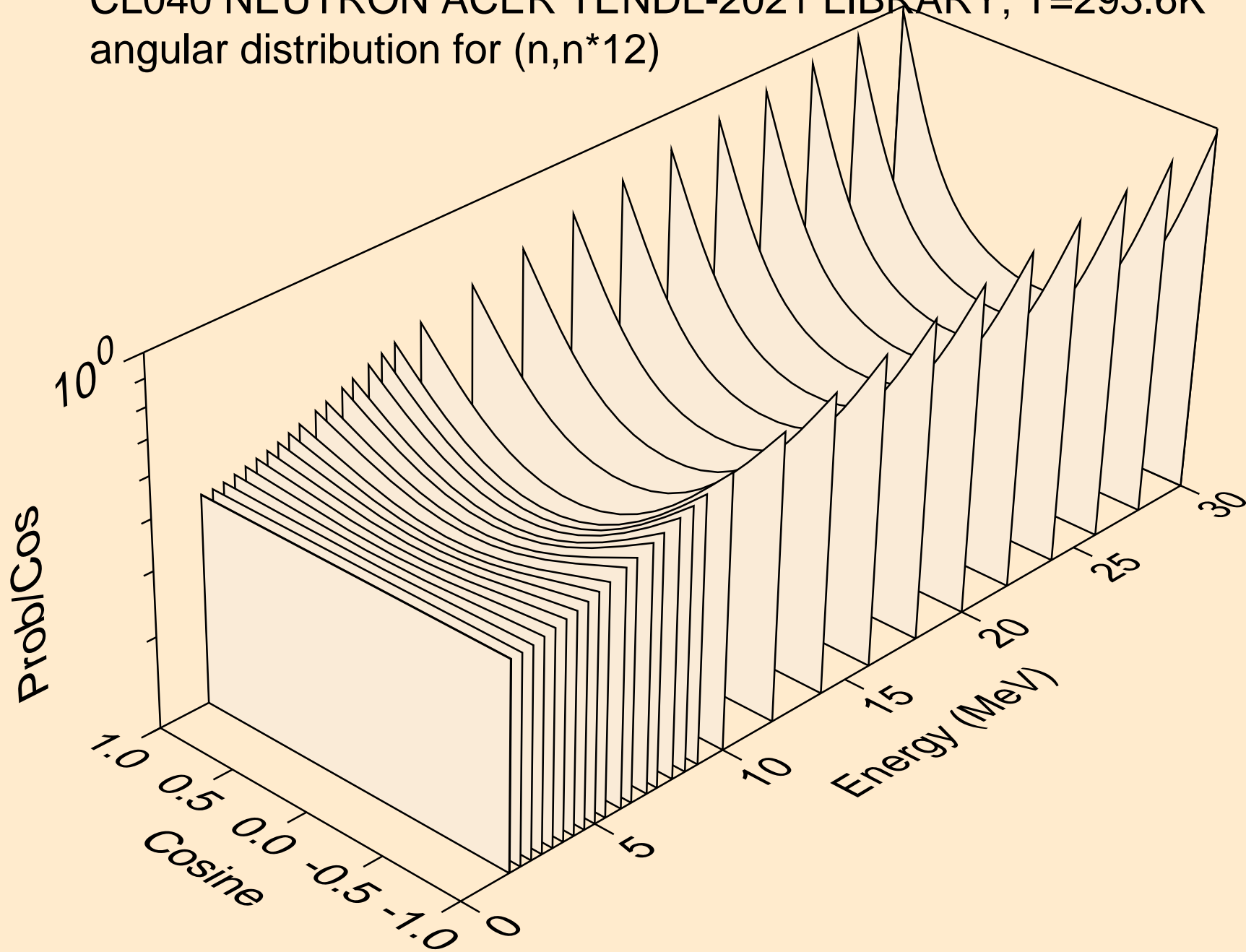

CL040 NEUTRON ACER TENDL-2021 LIBRARY; T=293.6K
angular distribution for (n,n*13)

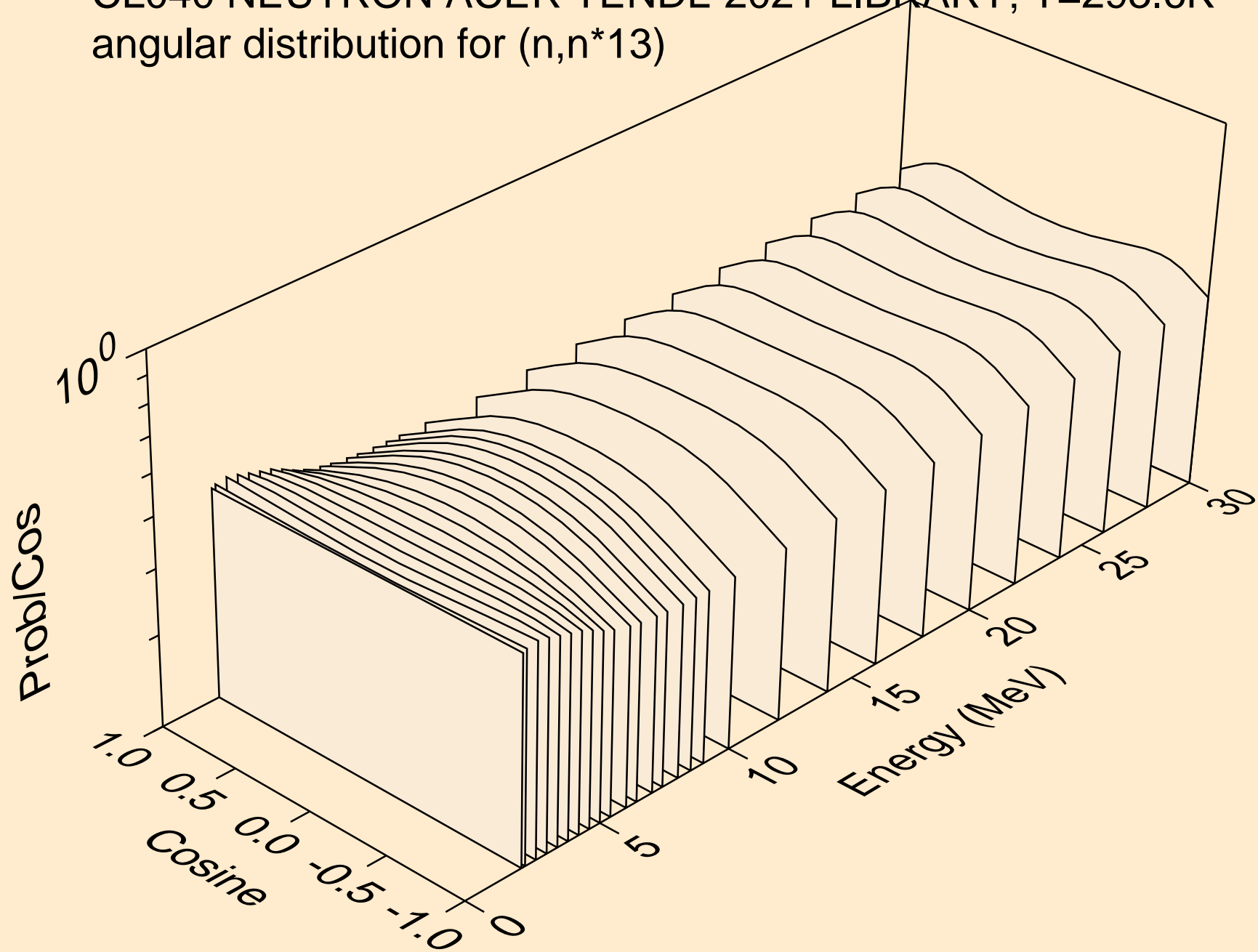

CL040 NEUTRON ACER TENDL-2021 LIBRARY; T=293.6K
angular distribution for (n,n*14)

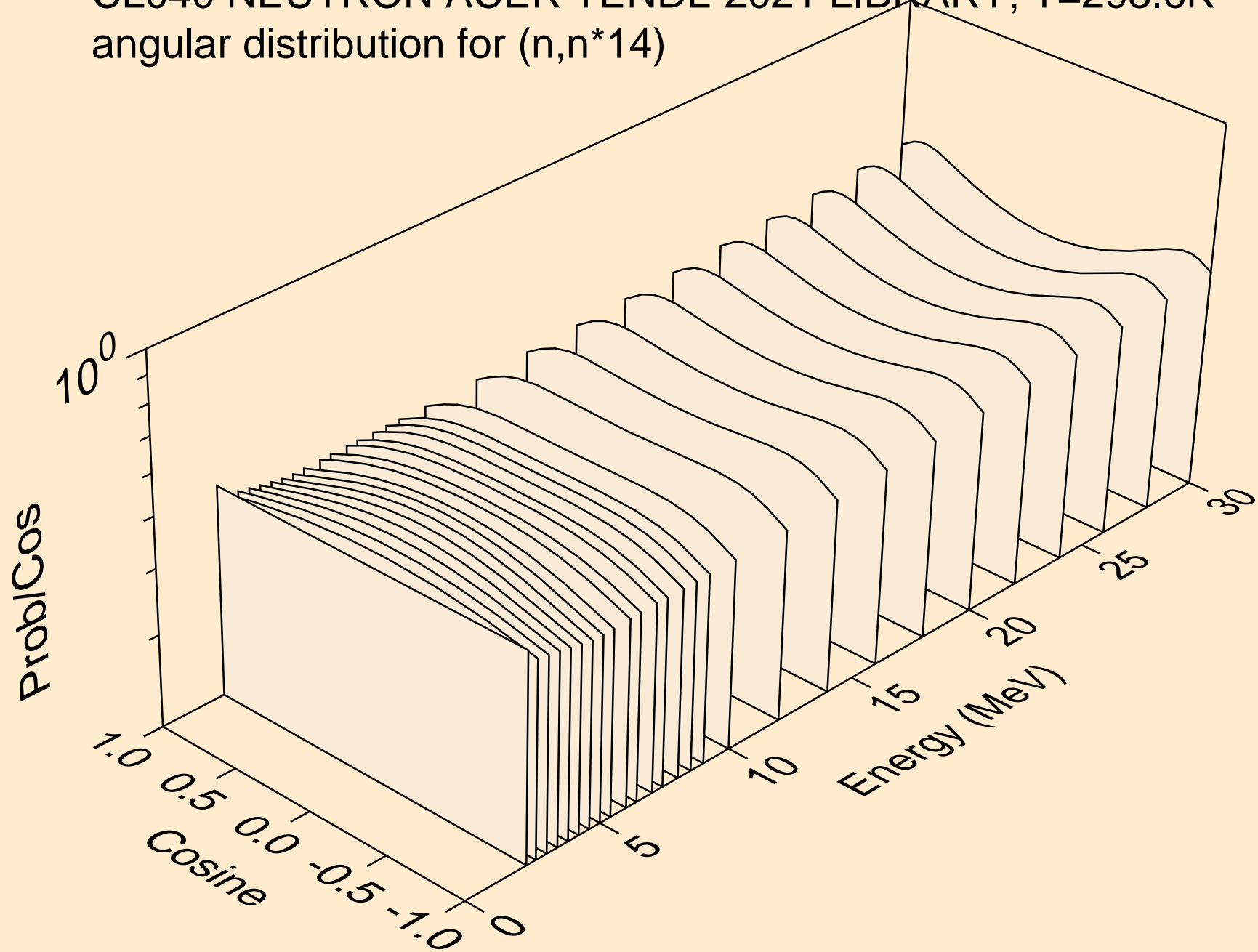

CL040 NEUTRON ACER TENDL-2021 LIBRARY; T=293.6K
angular distribution for (n,n*15)

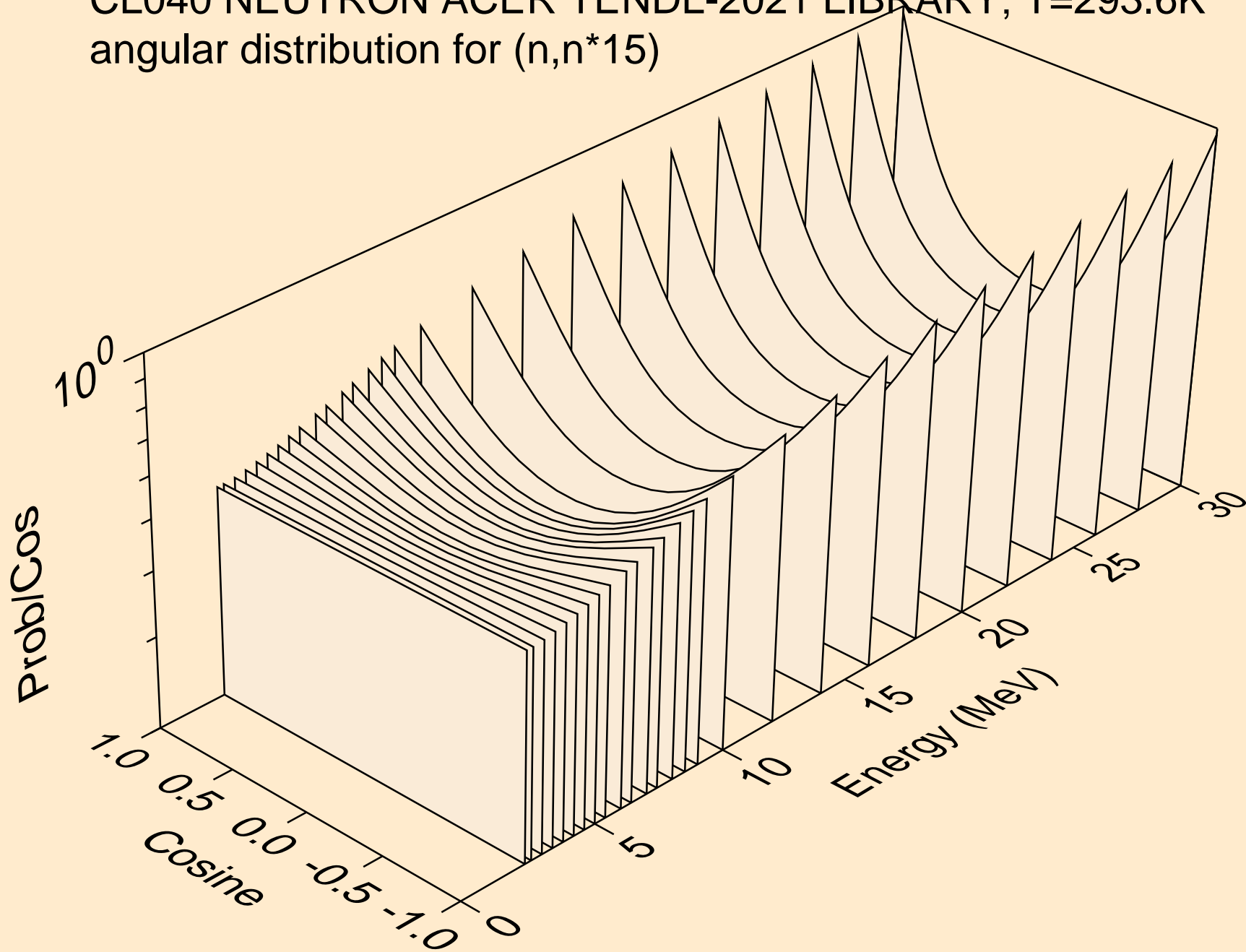

CL040 NEUTRON ACER TENDL-2021 LIBRARY; T=293.6K
angular distribution for (n,n*16)

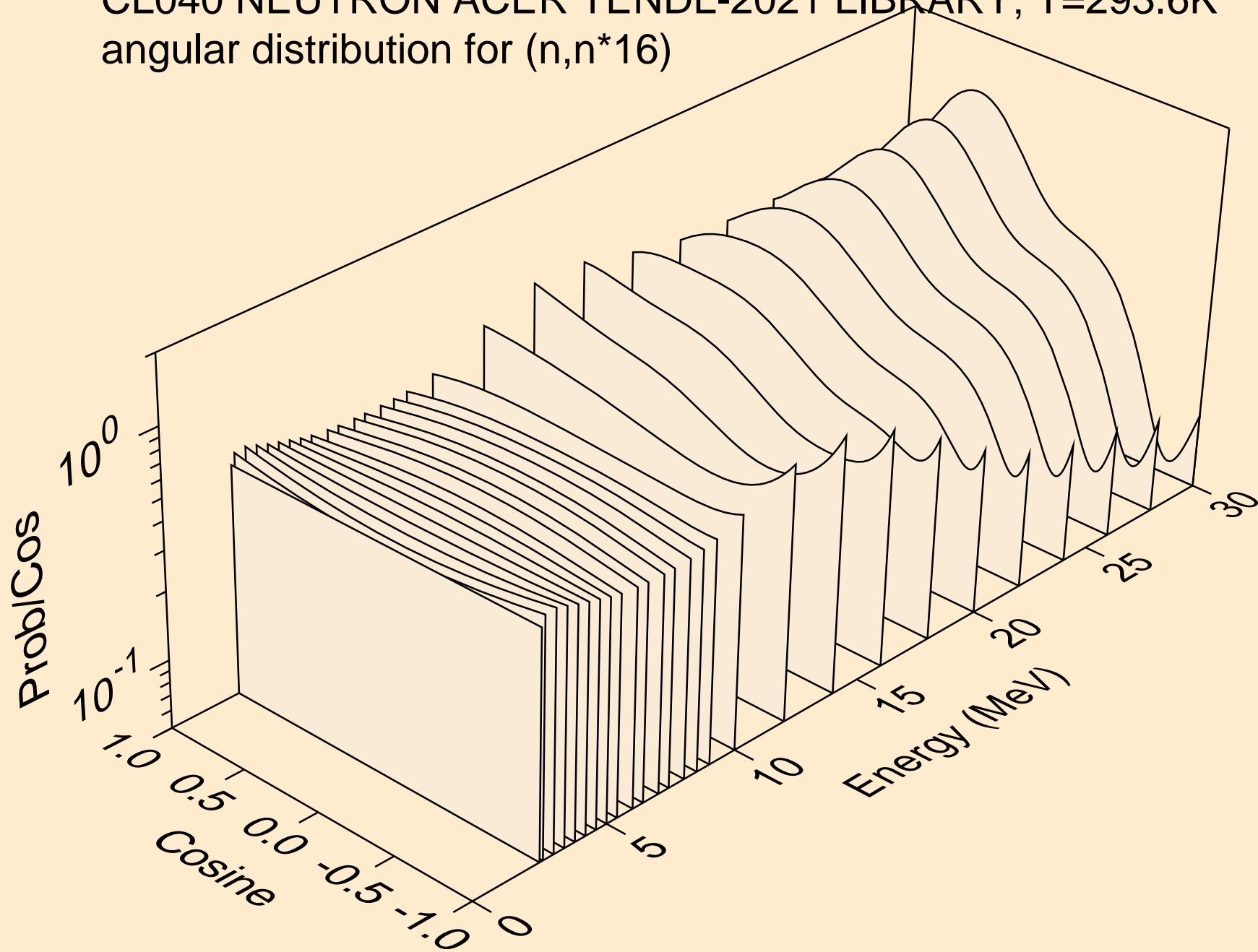

CL040 NEUTRON ACER TENDL-2021 LIBRARY; T=293.6K
angular distribution for (n,n*17)

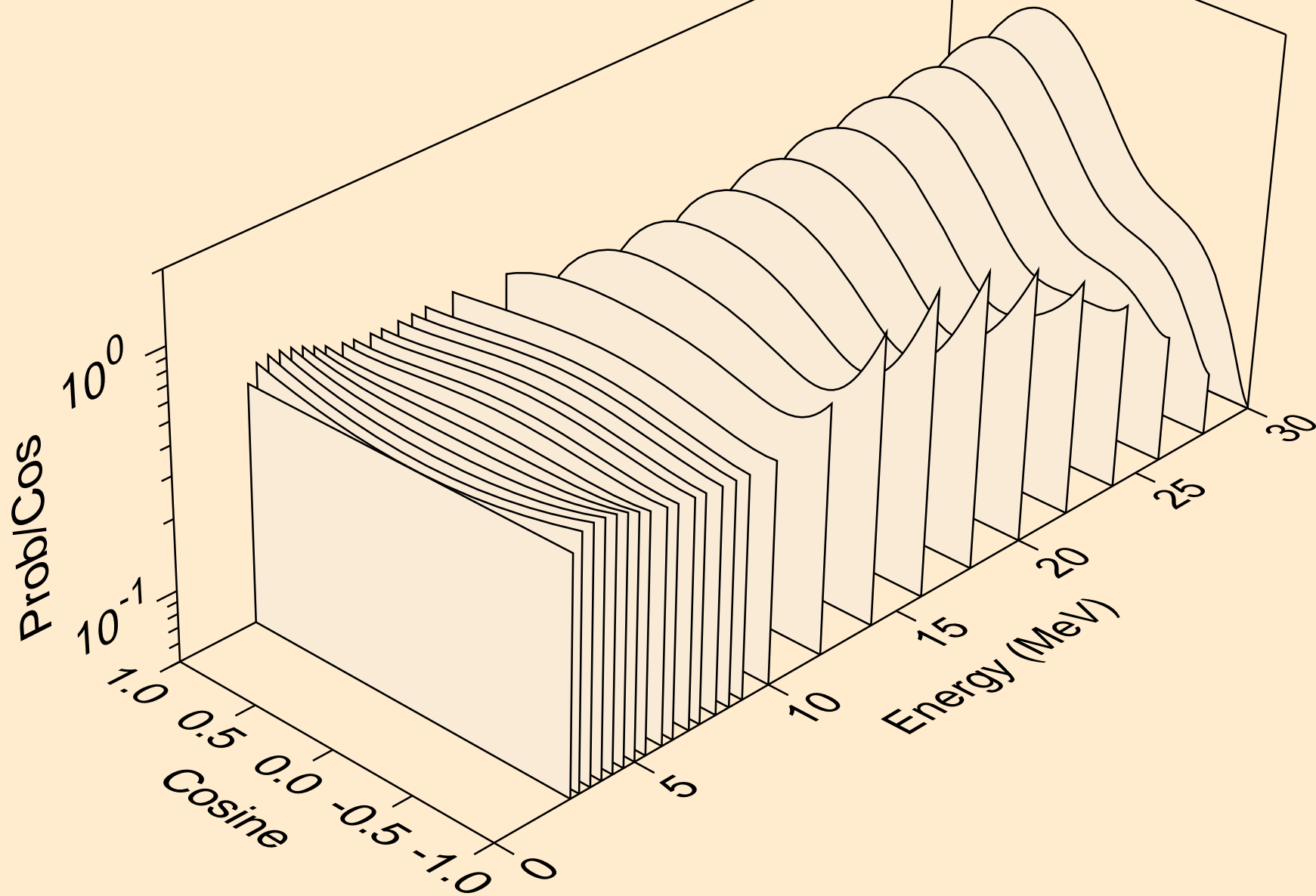

CL040 NEUTRON ACER TENDL-2021 LIBRARY; T=293.6K
angular distribution for (n,n*18)

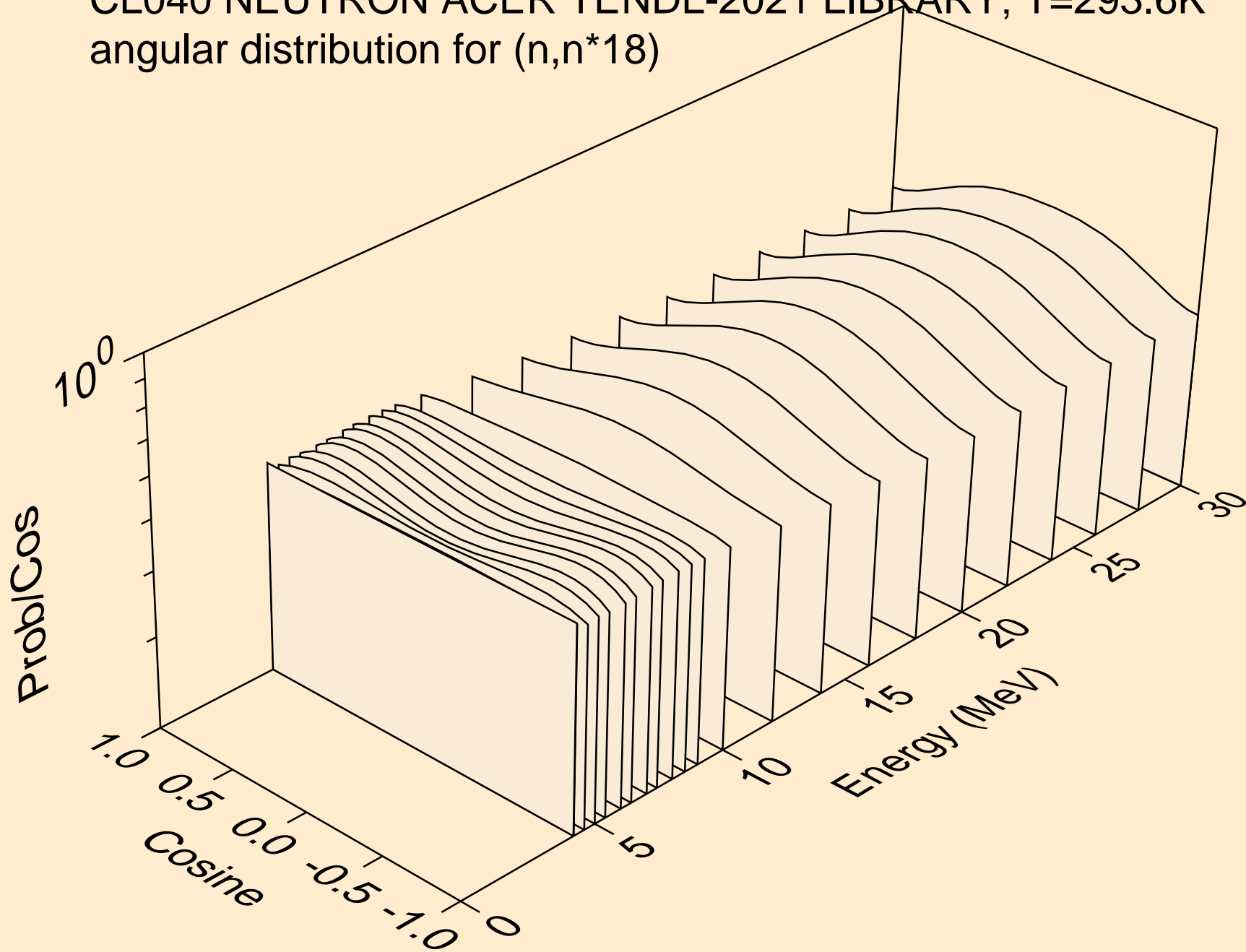

CL040 NEUTRON ACER TENDL-2021 LIBRARY; T=293.6K
angular distribution for (n,n*19)

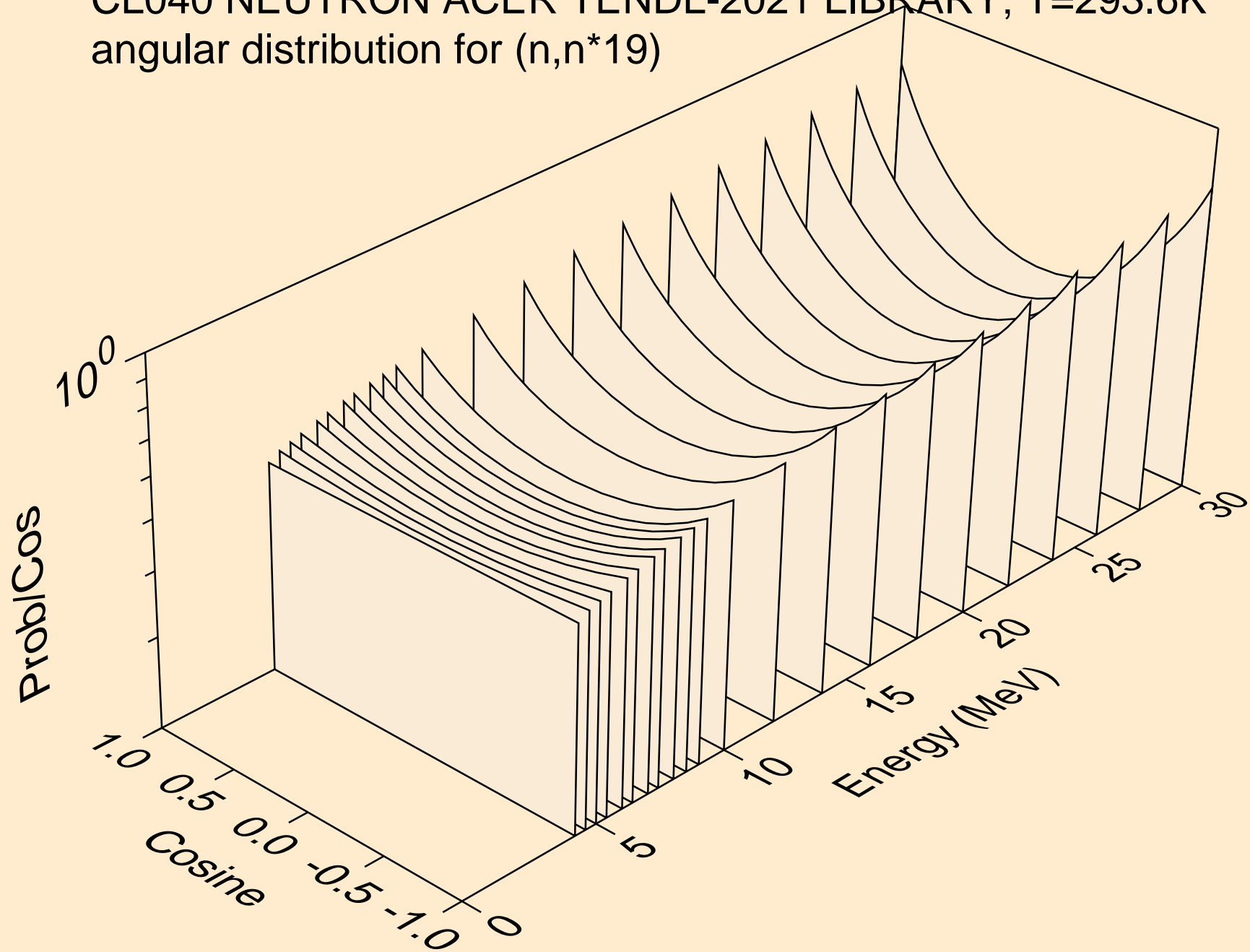

CL040 NEUTRON ACER TENDL-2021 LIBRARY; T=293.6K
angular distribution for (n,n*20)

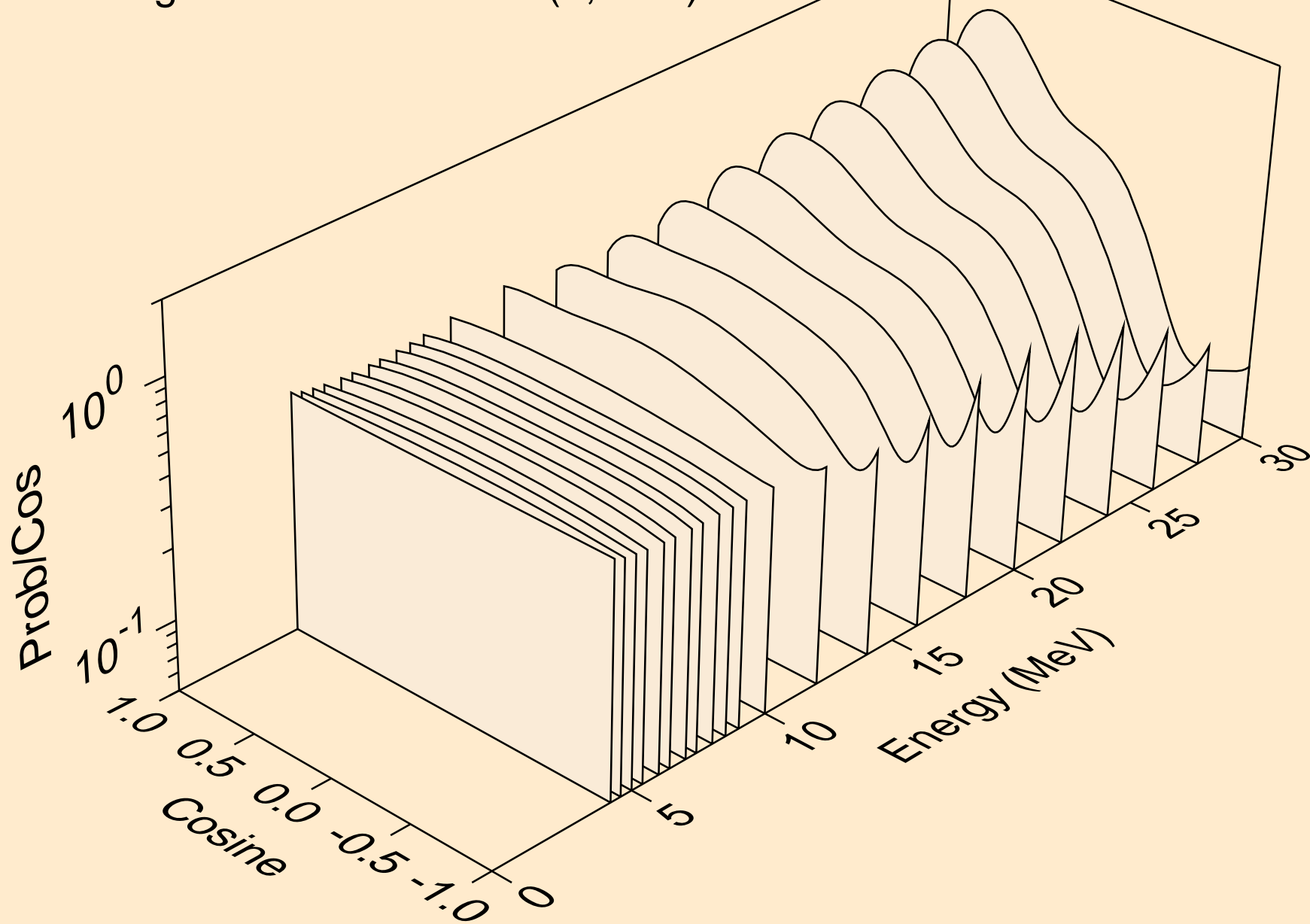

CL040 NEUTRON ACER TENDL-2021 LIBRARY; T=293.6K
angular distribution for (n,n*21)

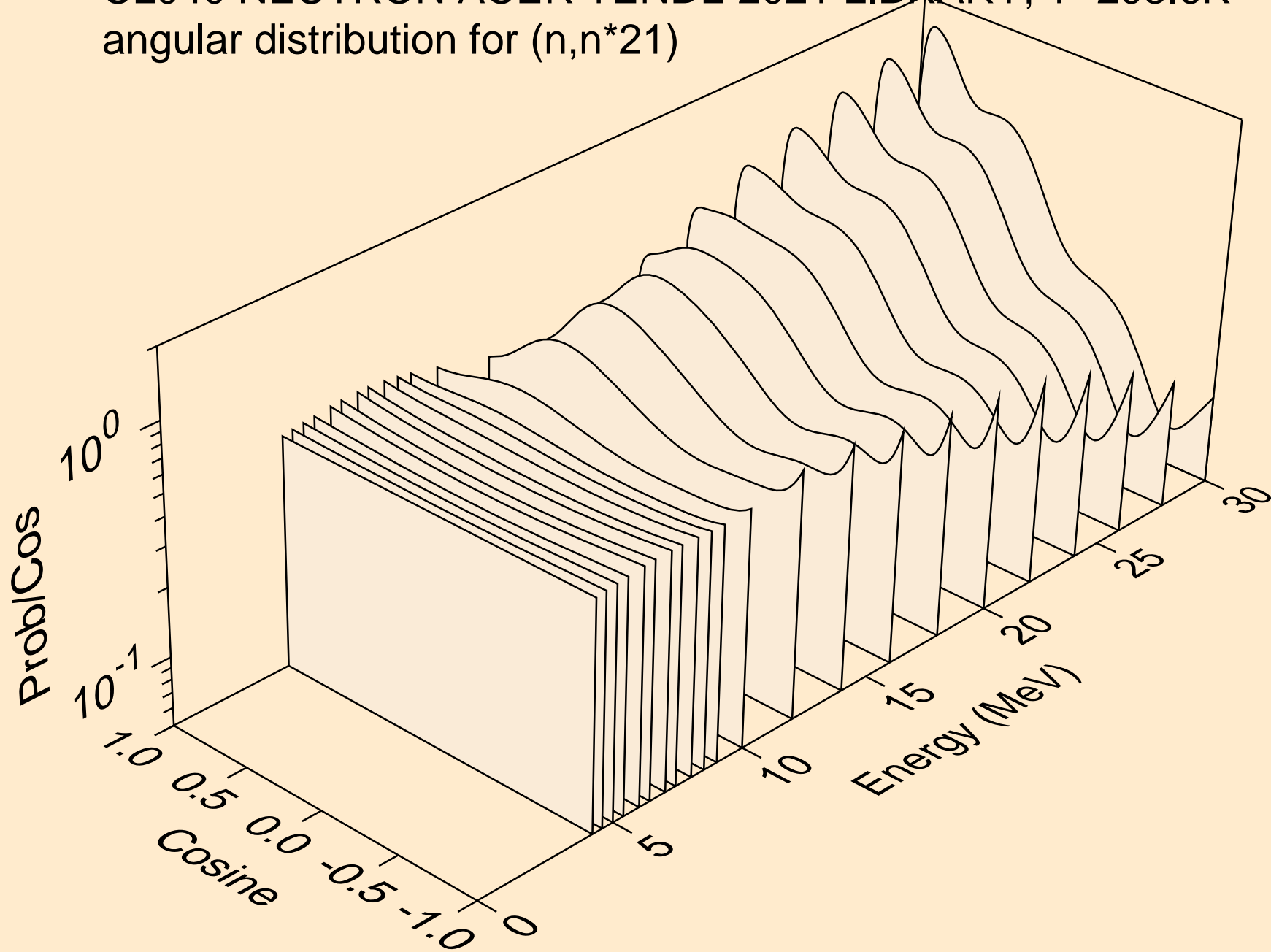

CL040 NEUTRON ACER TENDL-2021 LIBRARY; T=293.6K
angular distribution for (n,n*22)

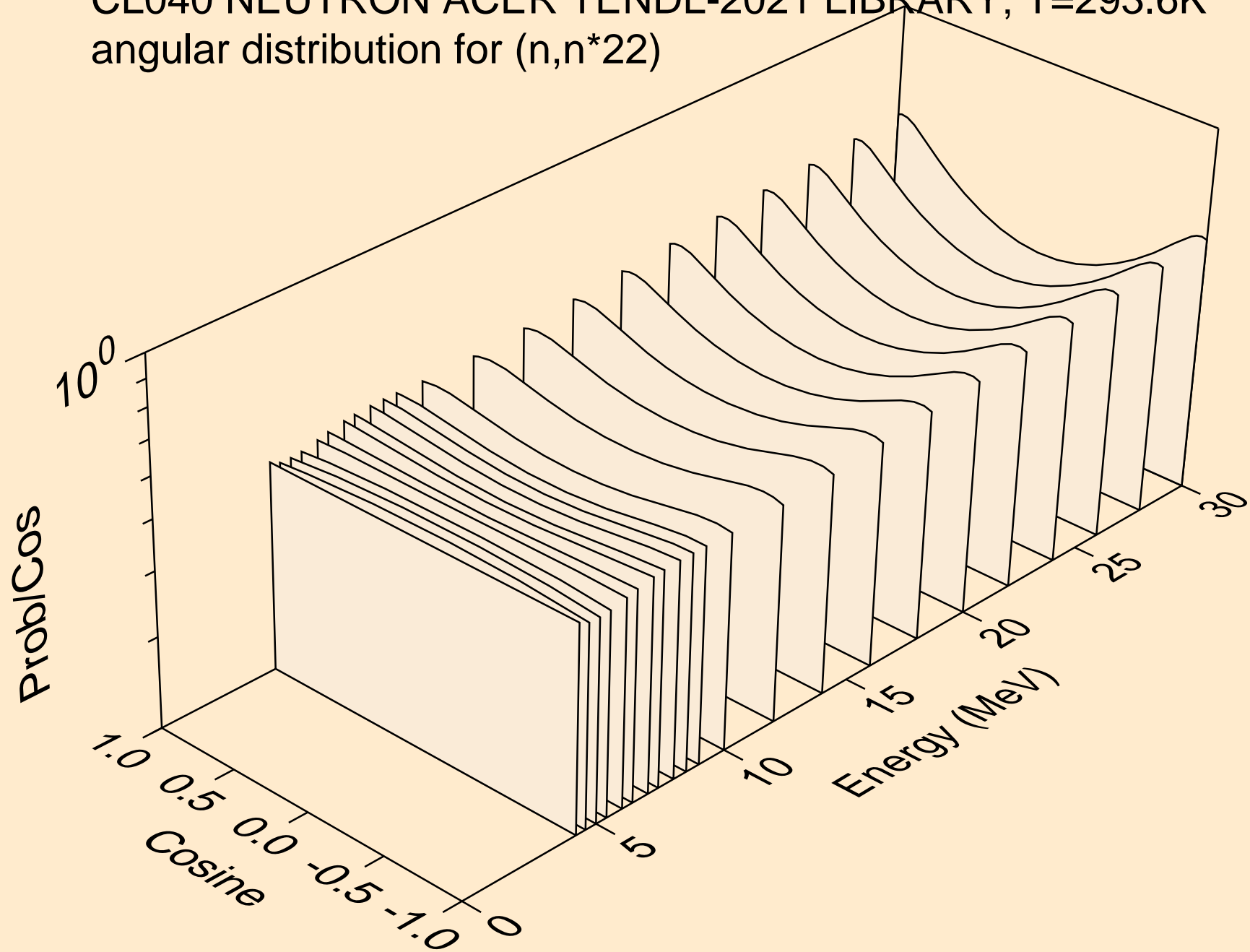

CL040 NEUTRON ACER TENDL-2021 LIBRARY; T=293.6K
angular distribution for (n,n*23)

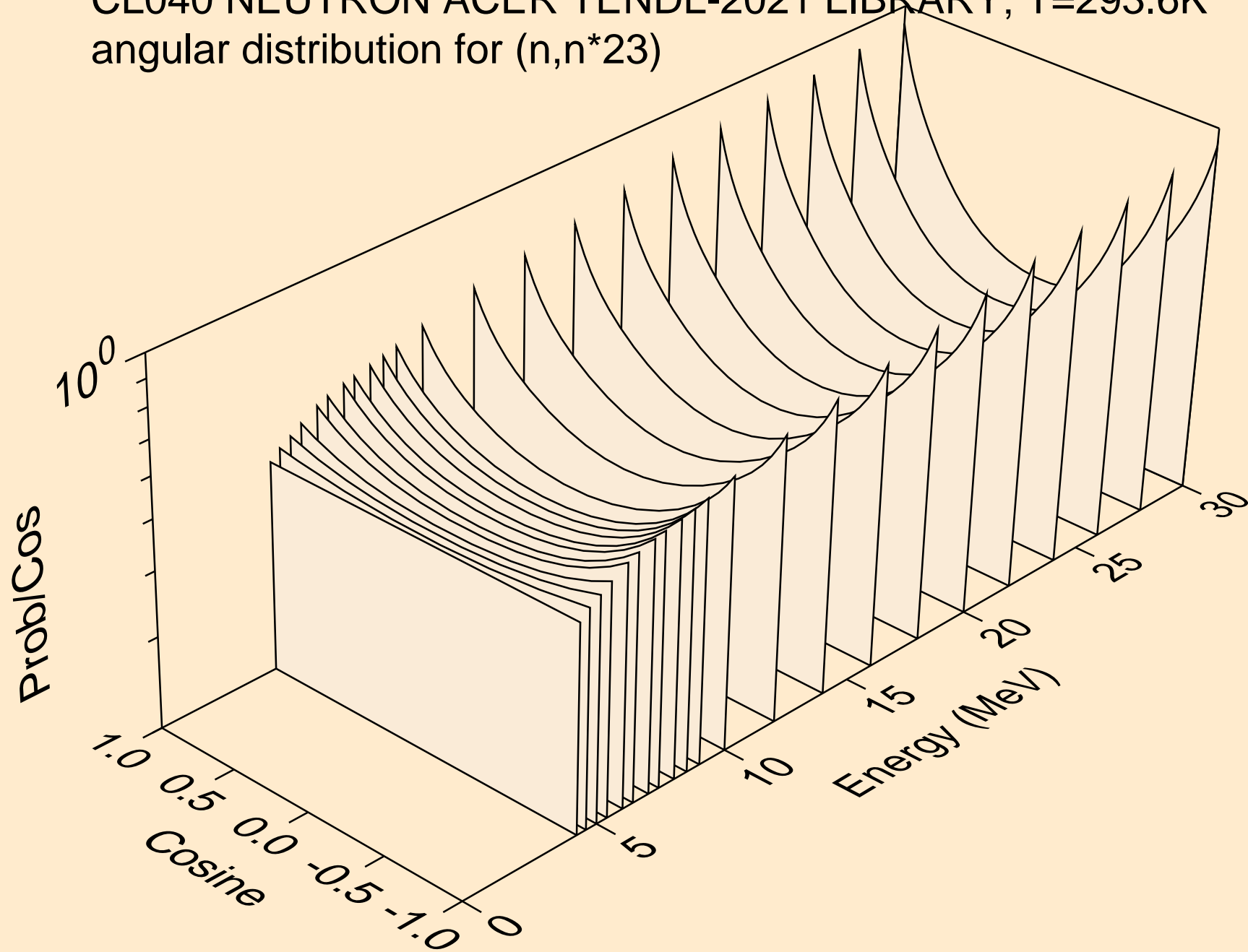

CL040 NEUTRON ACER TENDL-2021 LIBRARY; T=293.6K
angular distribution for (n,n*24)

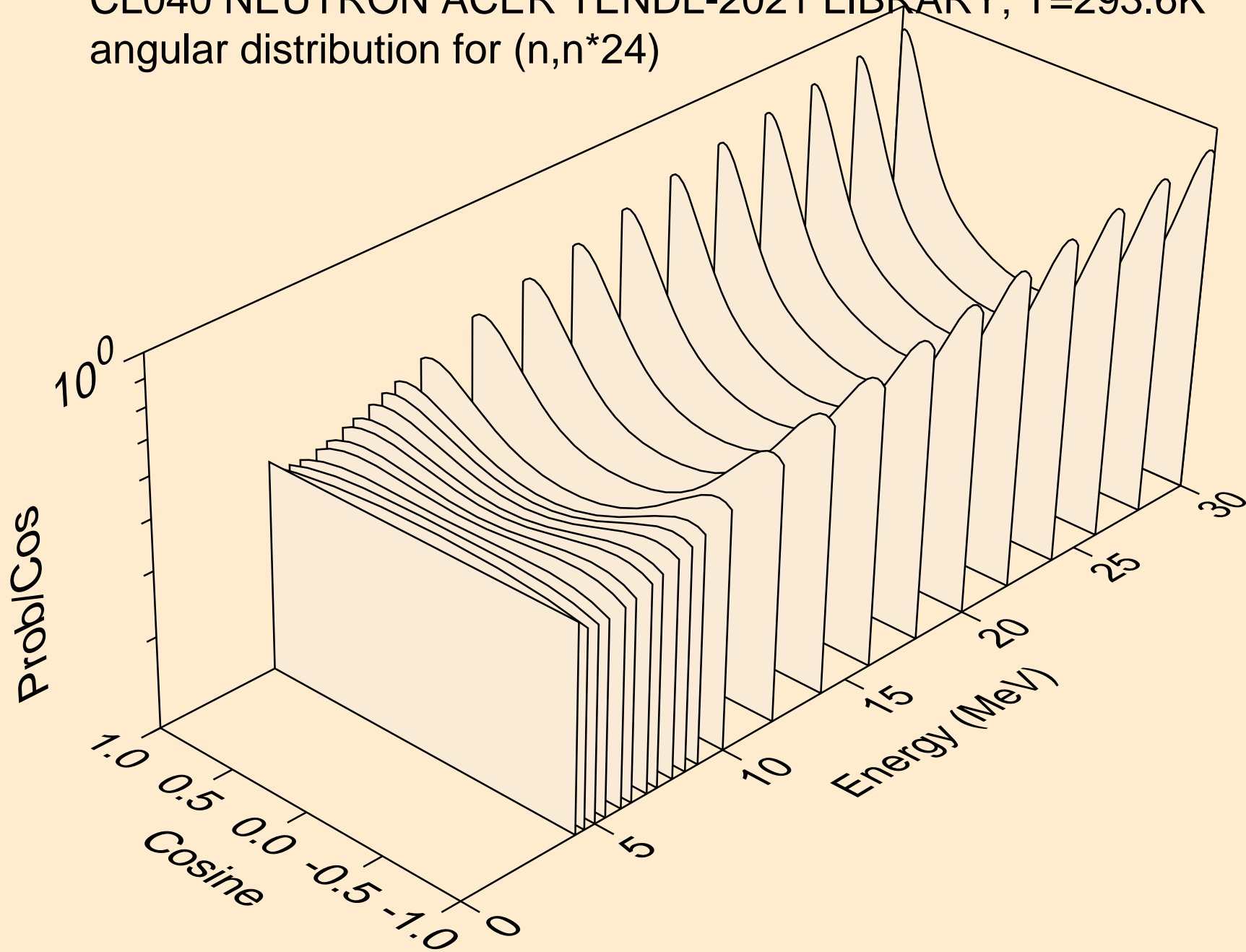

CL040 NEUTRON ACER TENDL-2021 LIBRARY; T=293.6K
angular distribution for (n,n*25)

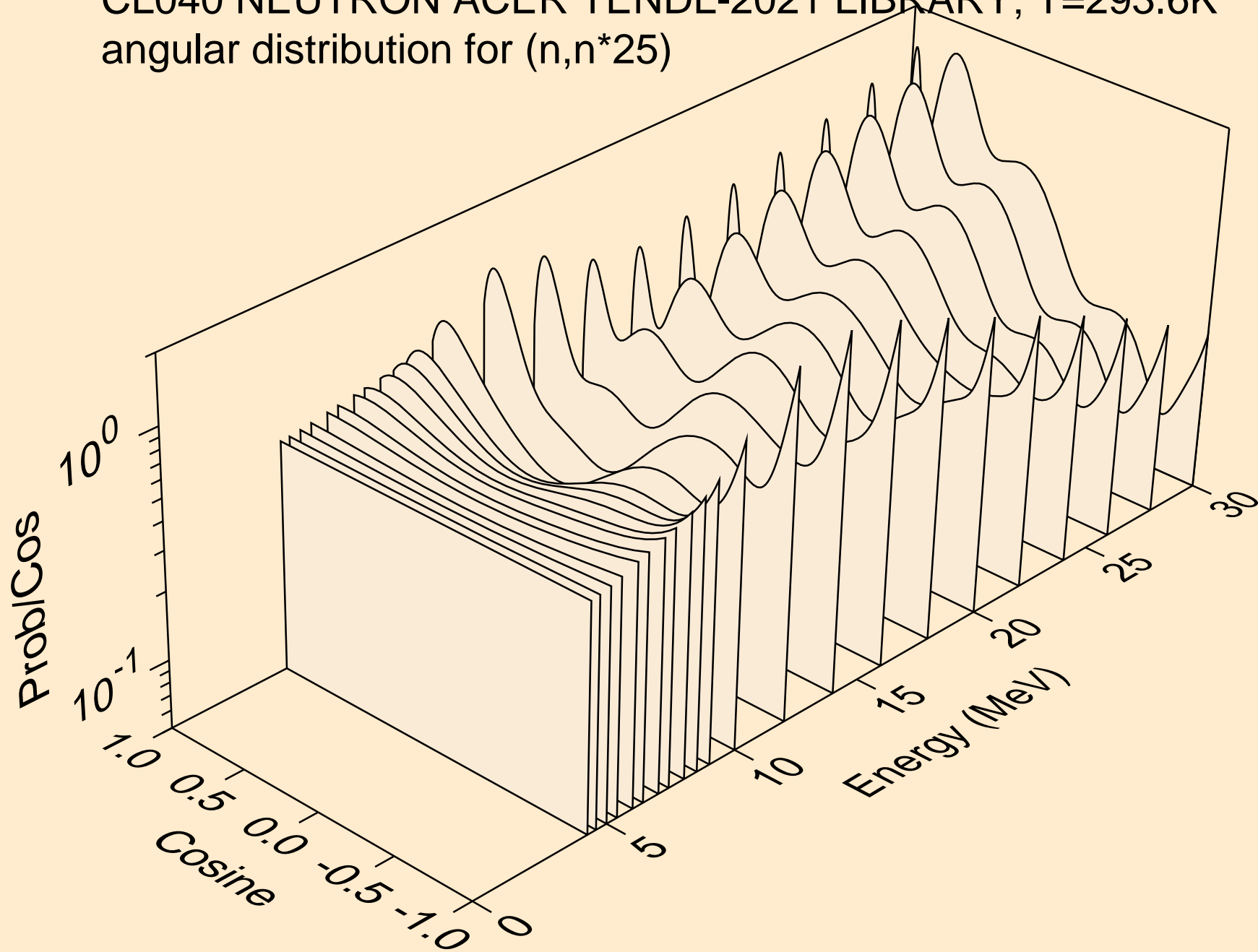

CL040 NEUTRON ACER TENDL-2021 LIBRARY; T=293.6K
angular distribution for (n,n*26)

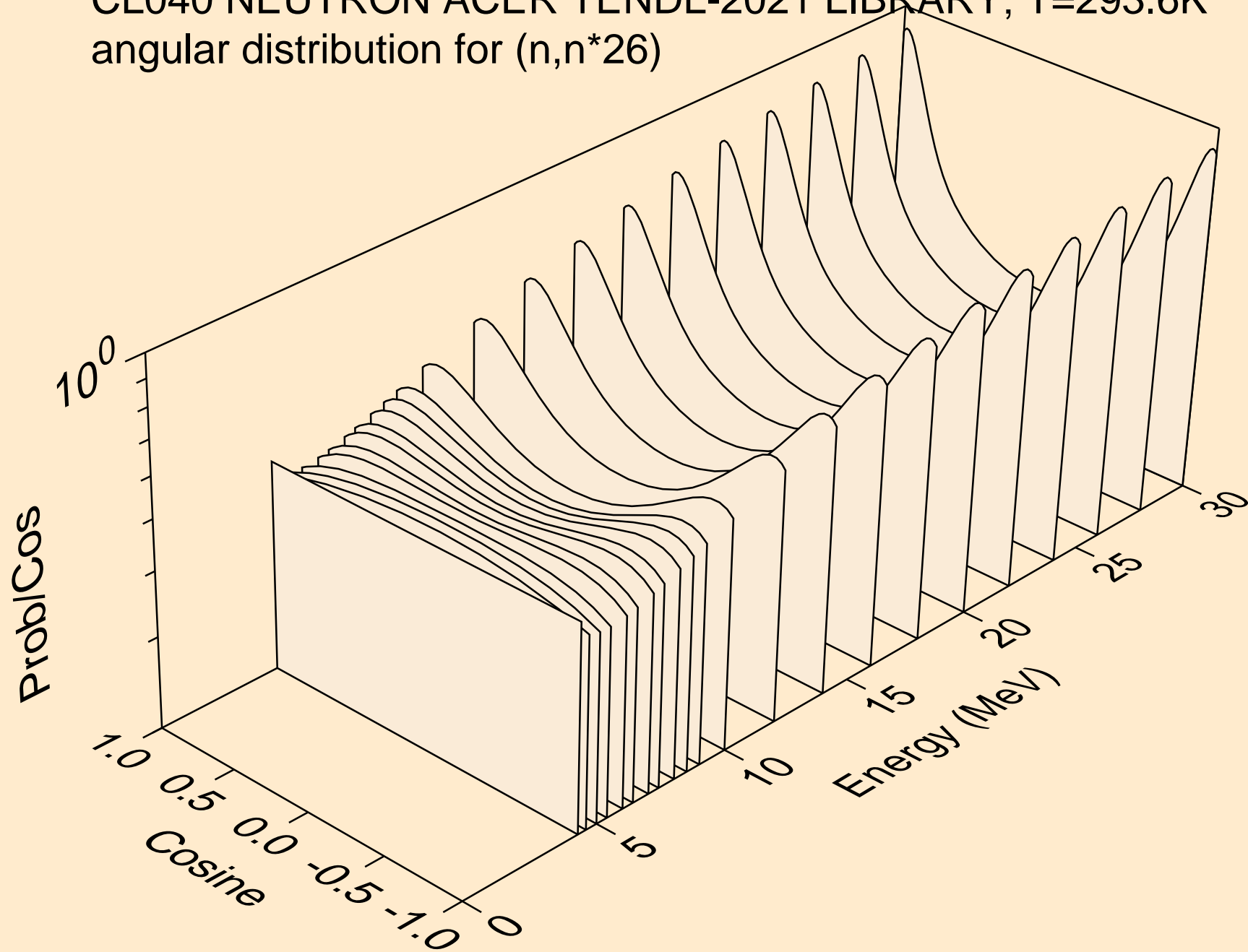

CL040 NEUTRON ACER TENDL-2021 LIBRARY; T=293.6K
angular distribution for (n,n*27)

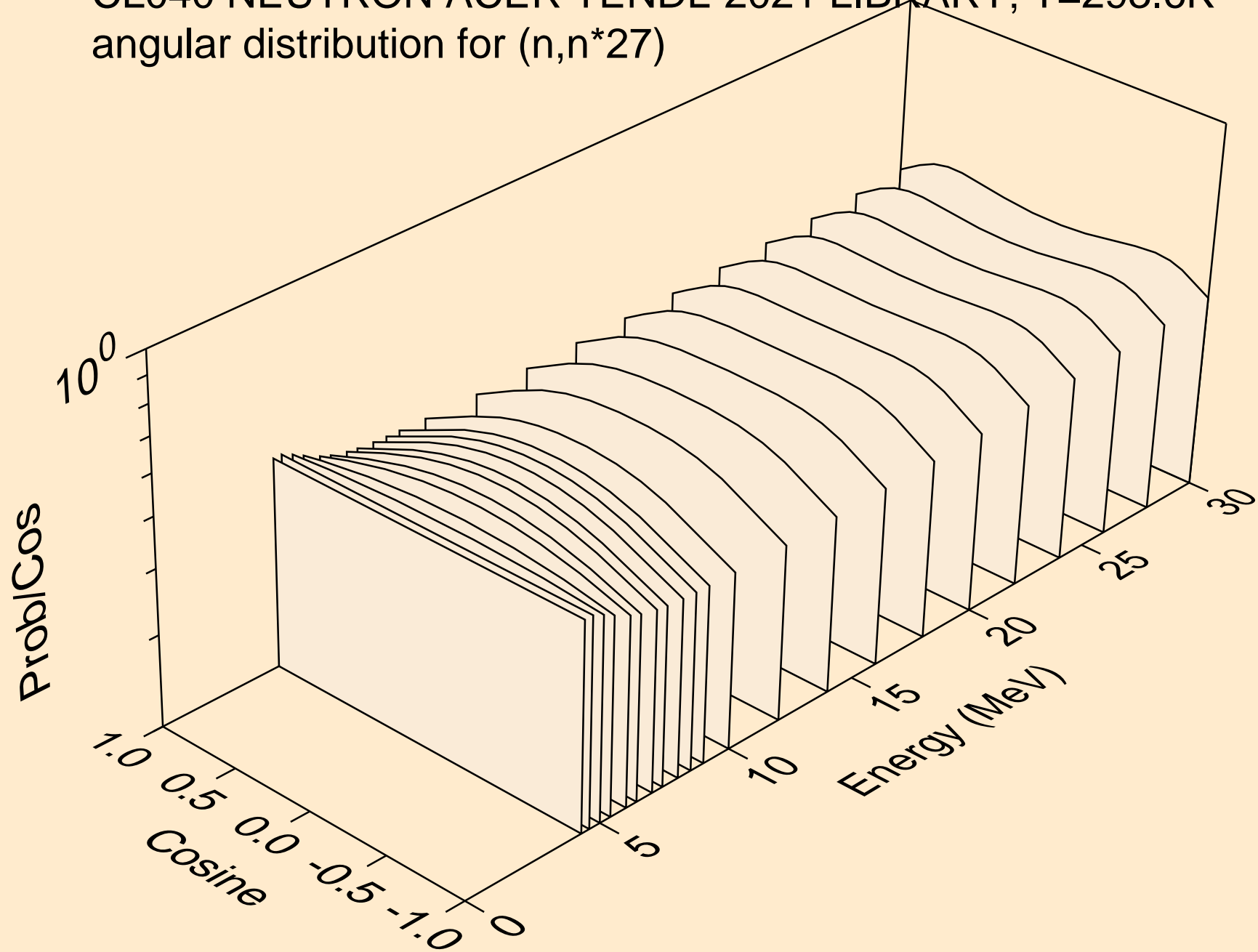

CL040 NEUTRON ACER TENDL-2021 LIBRARY; T=293.6K
angular distribution for (n,n*28)

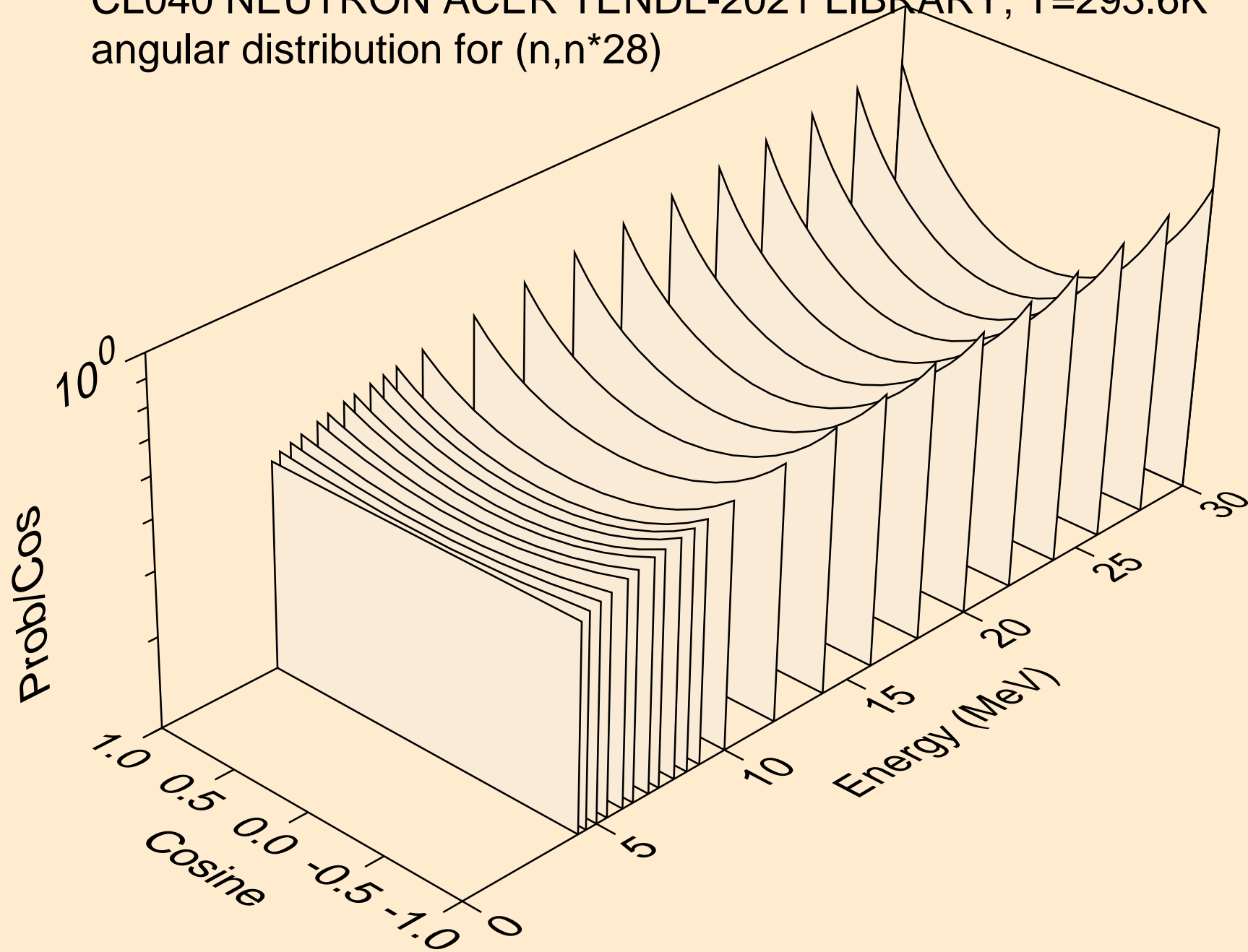

CL040 NEUTRON ACER TENDL-2021 LIBRARY; T=293.6K
Neutron emission for (n,x)

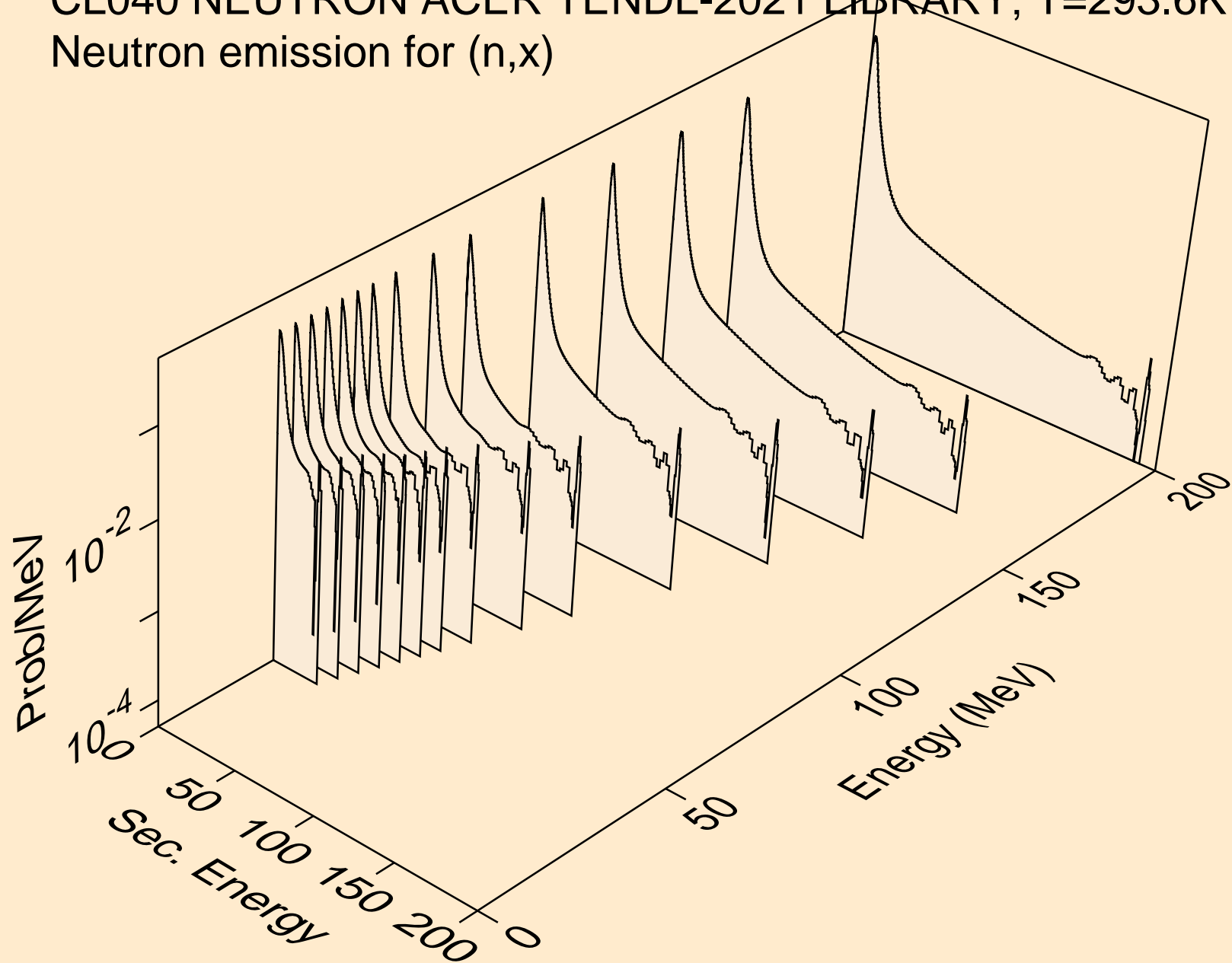

CL040 NEUTRON ACER TENDL-2021 LIBRARY; T=293.6K
Neutron emission for (n,2nd)

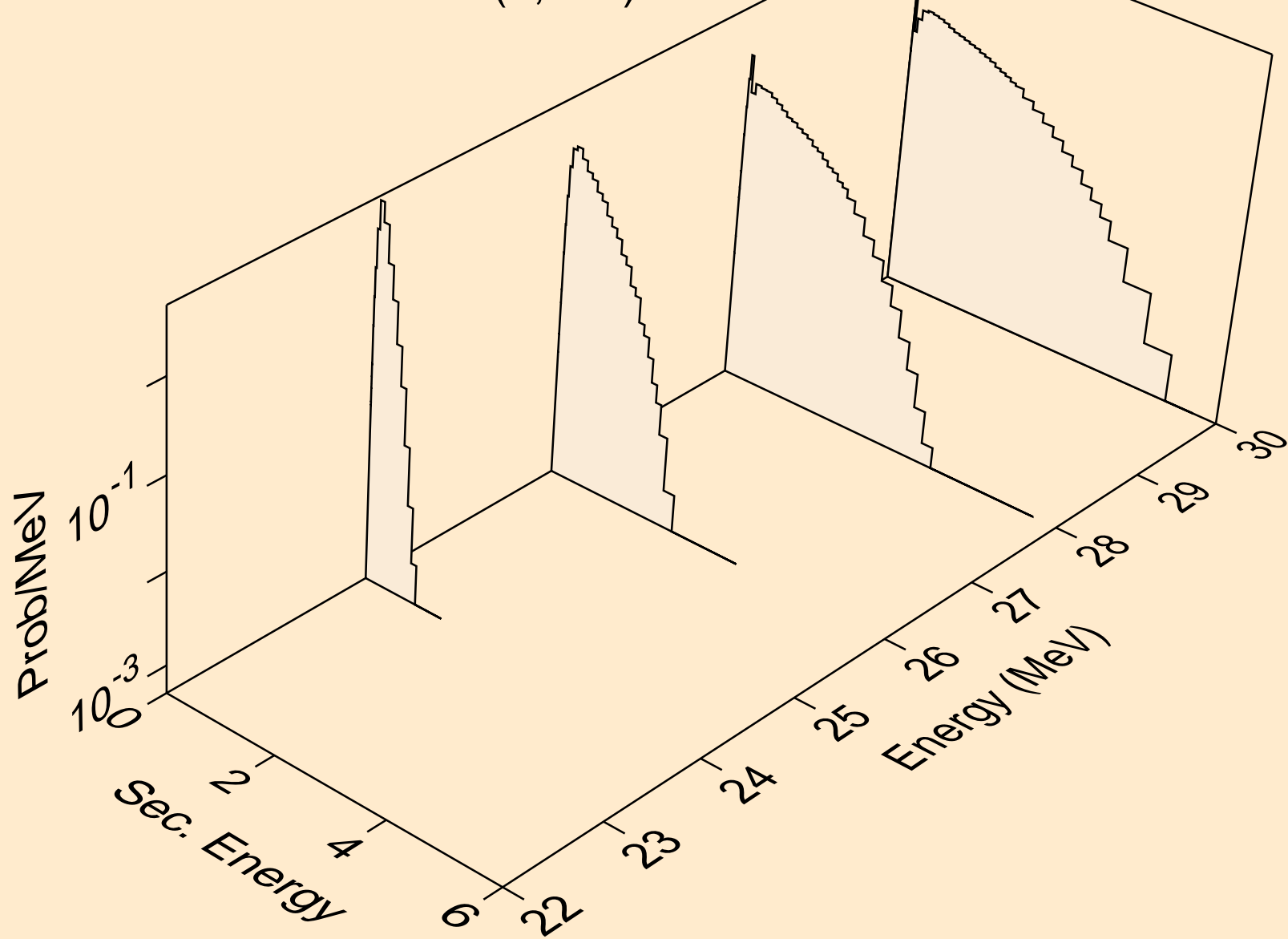

CL040 NEUTRON ACER TENDL-2021 LIBRARY; T=293.6K
Neutron emission for (n,2n)

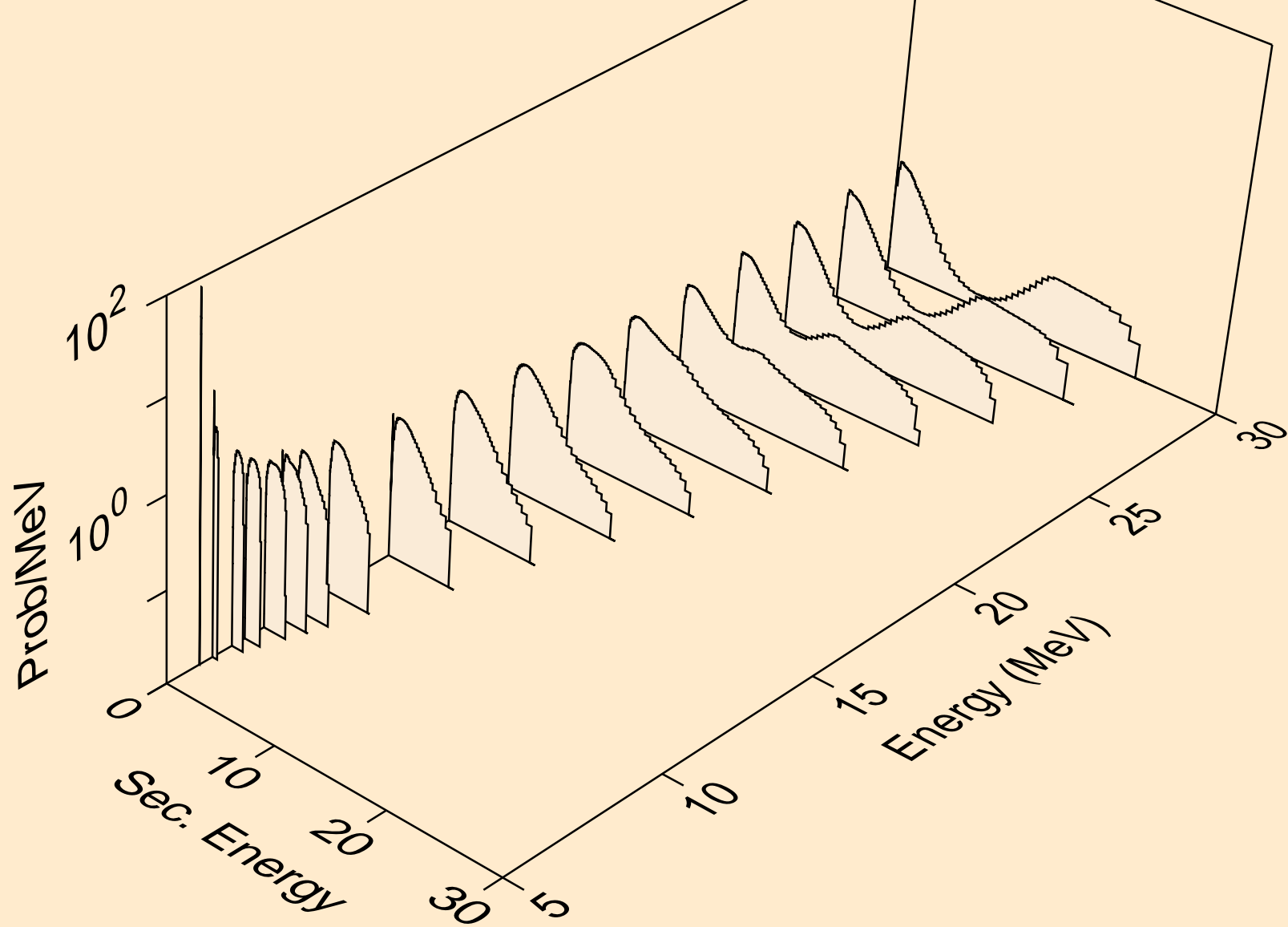

CL040 NEUTRON ACER TENDL-2021 LIBRARY; T=293.6K
Neutron emission for (n,3n)

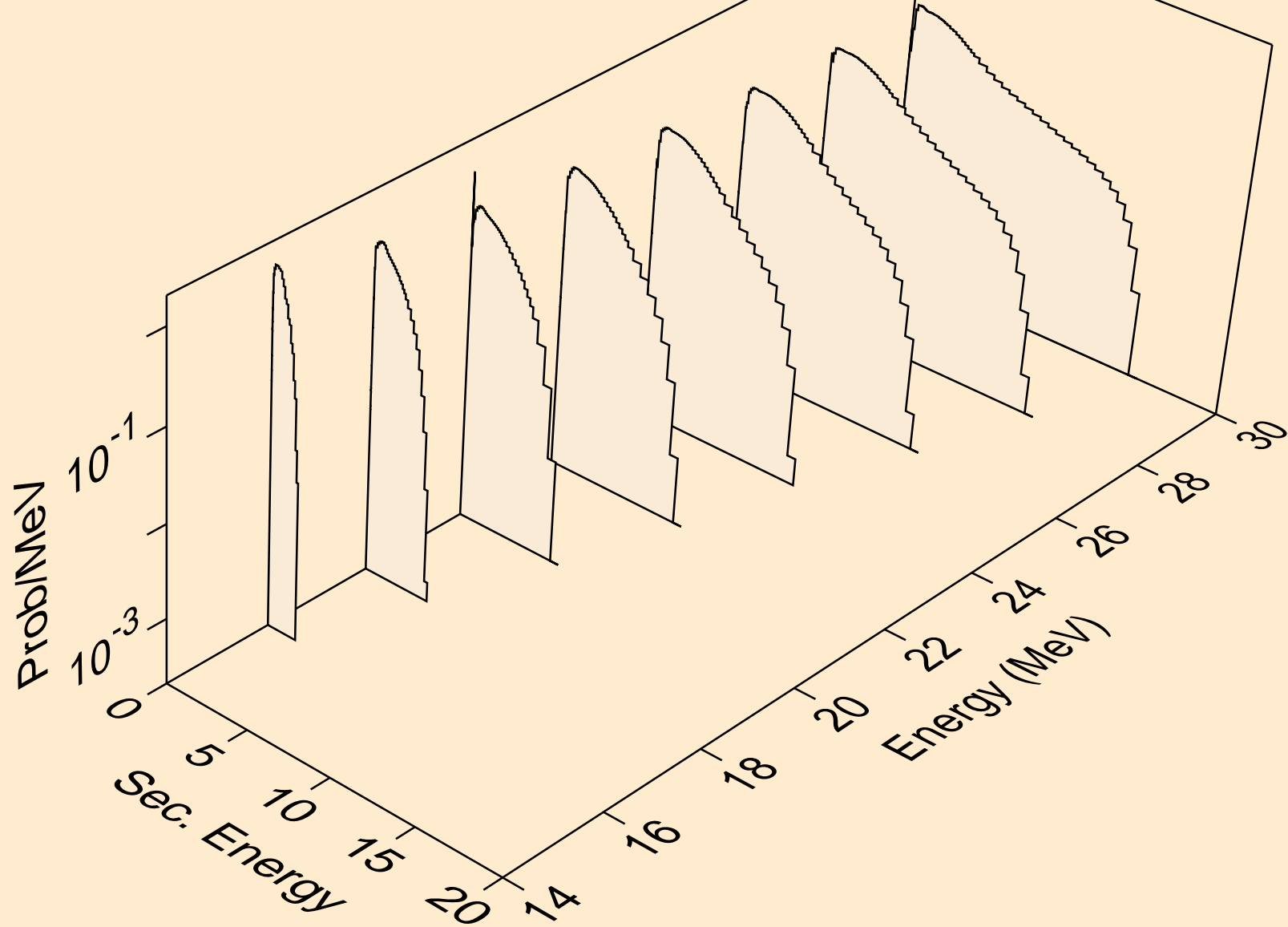

CL040 NEUTRON ACER TENDL-2021 LIBRARY; T=293.6K
Neutron emission for (n,n*)a

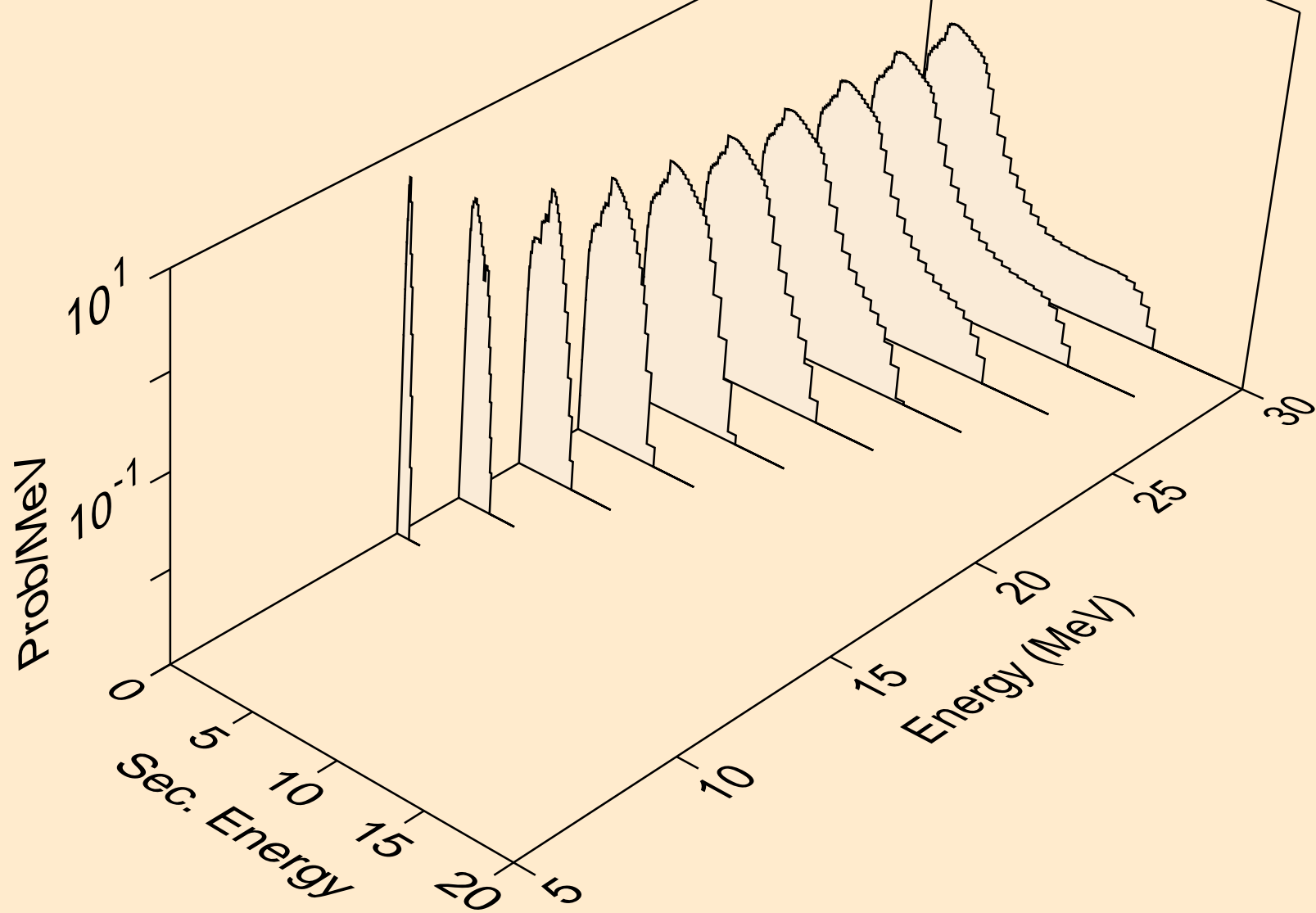

CL040 NEUTRON ACER TENDL-2021 LIBRARY; T=293.6K
Neutron emission for (n,2n)a

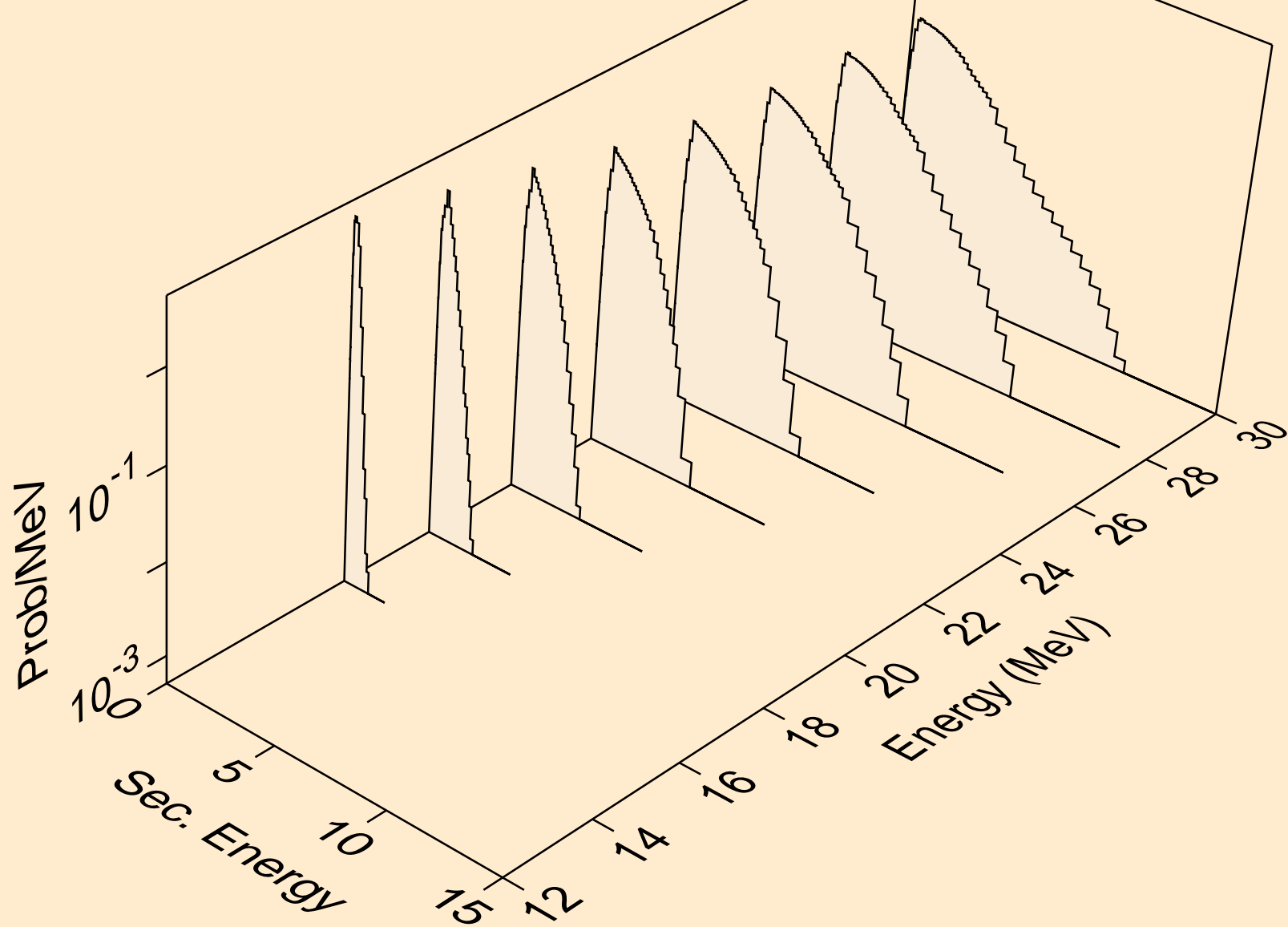

CL040 NEUTRON ACER TENDL-2021 LIBRARY; T=293.6K
Neutron emission for (n,3n)a

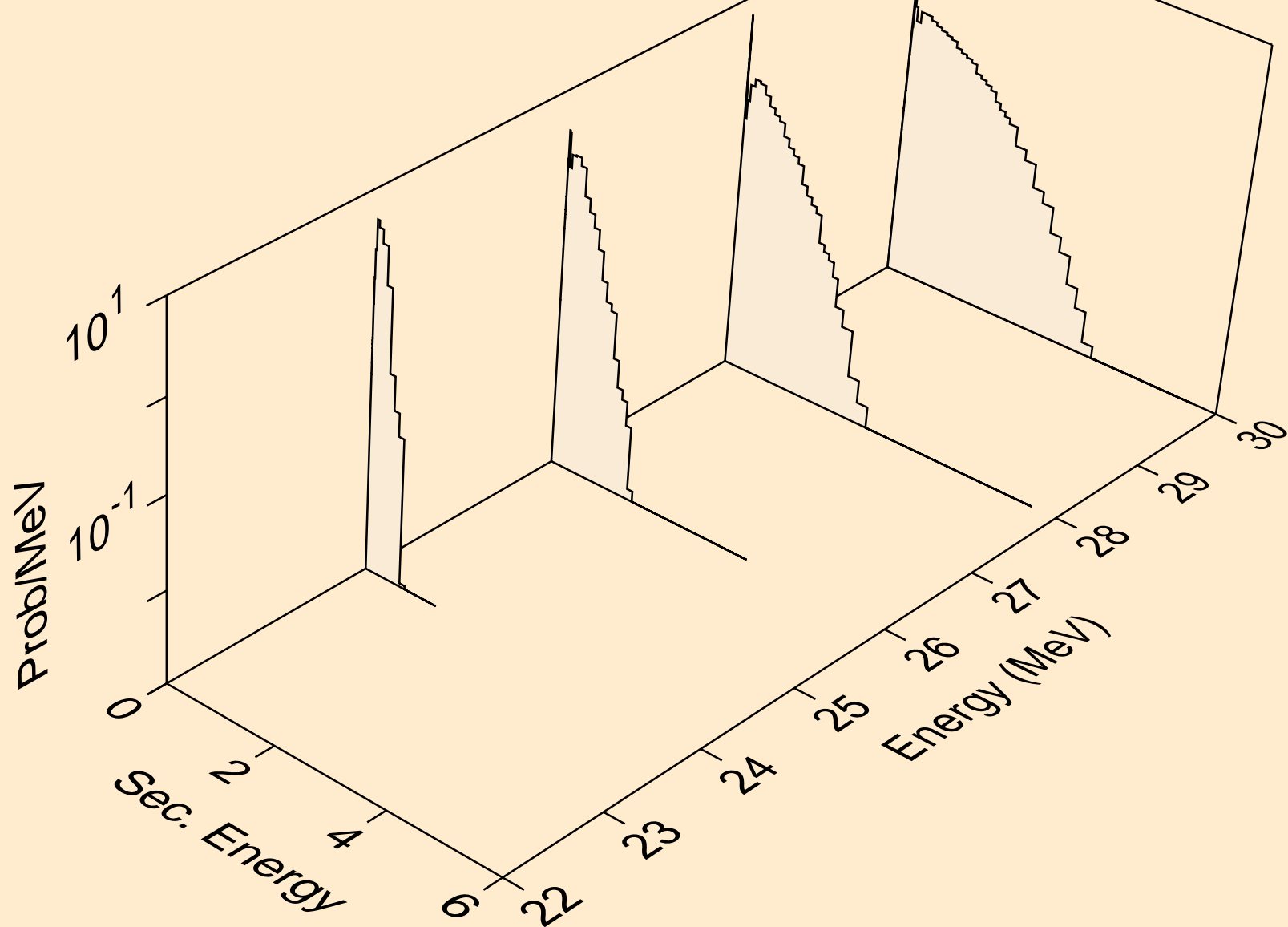

CL040 NEUTRON ACER TENDL-2021 LIBRARY; T=293.6K
Neutron emission for (n,n*)p

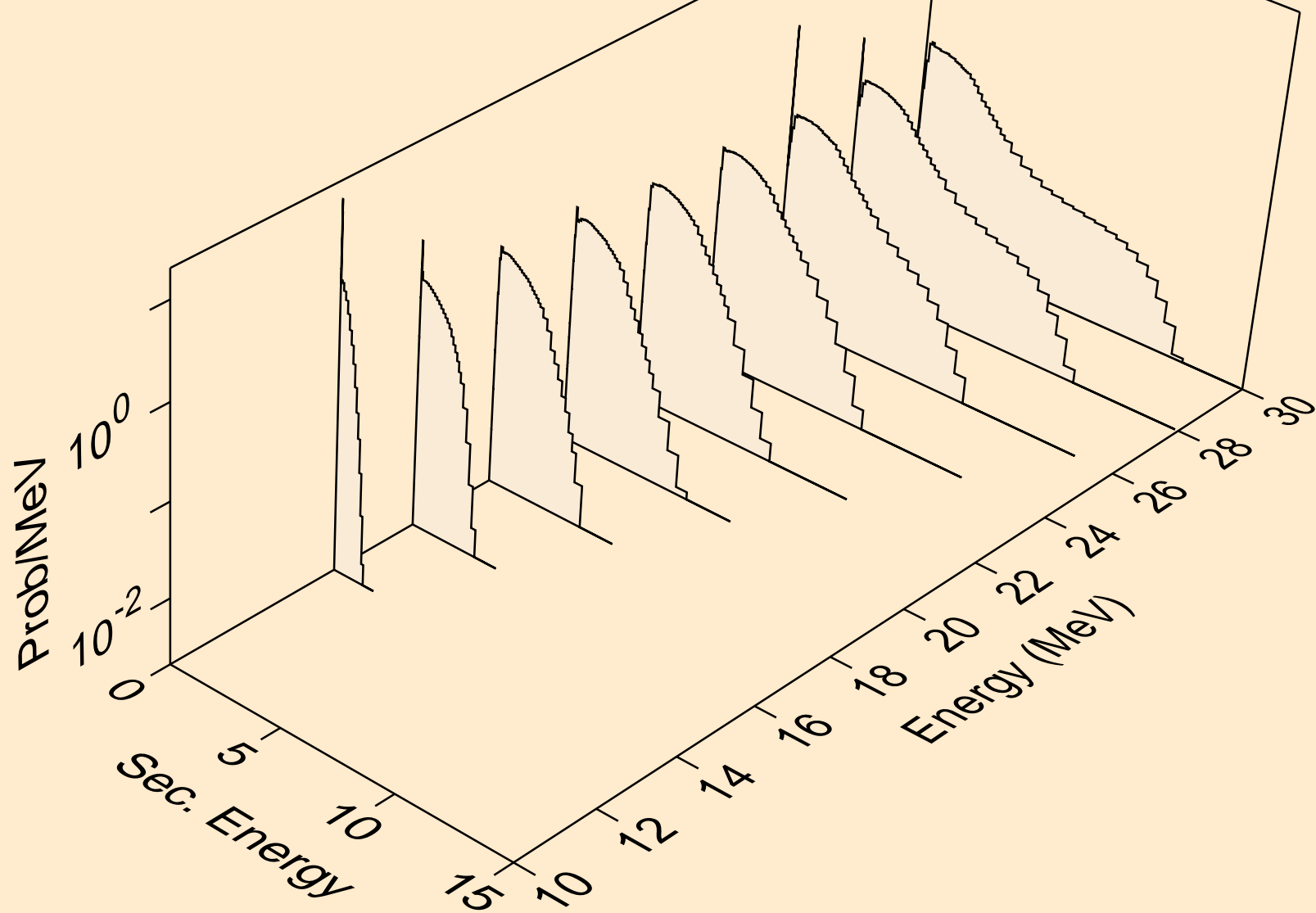

CL040 NEUTRON ACER TENDL-2021 LIBRARY; T=293.6K
Neutron emission for (n,n*)d

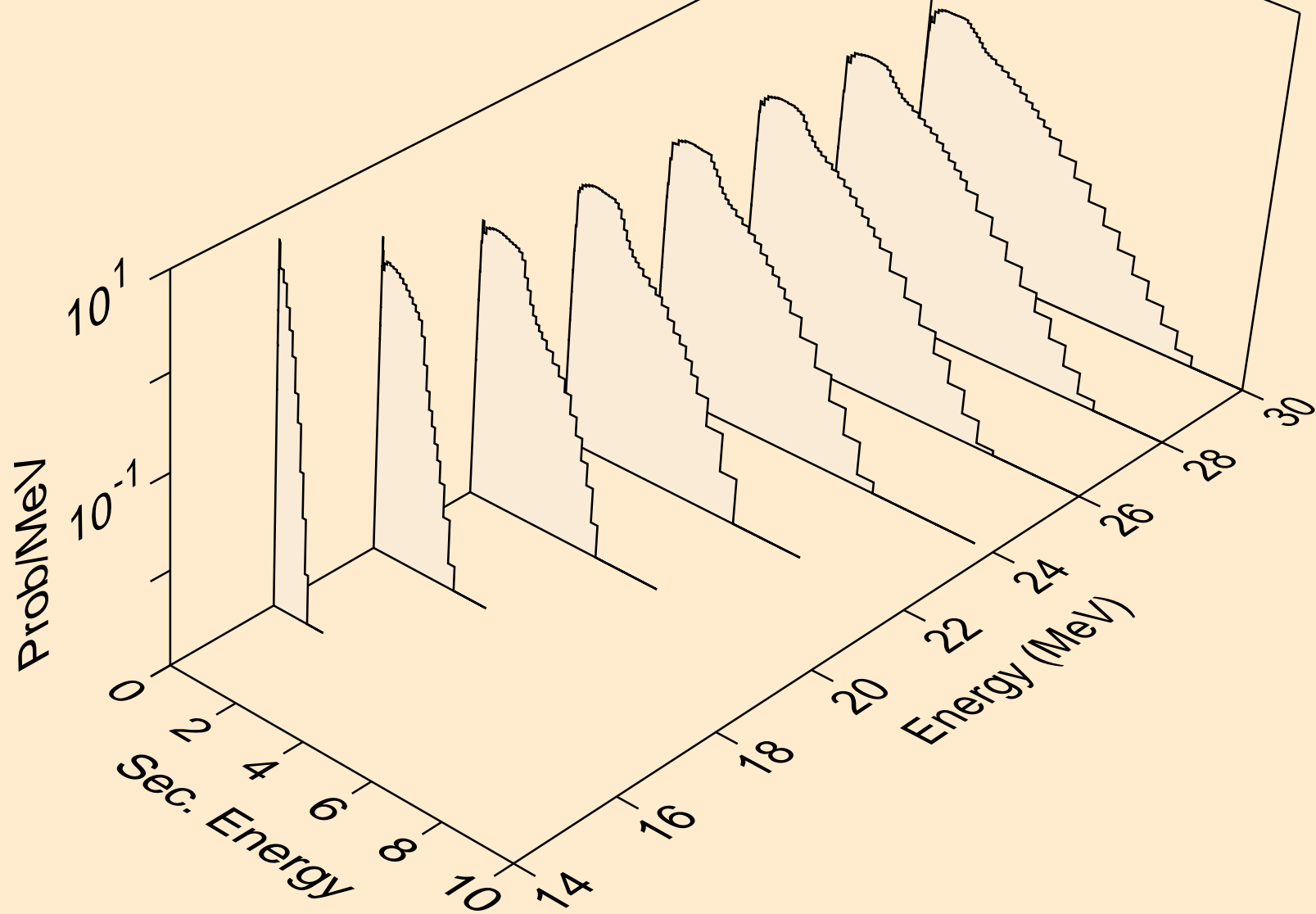

CL040 NEUTRON ACER TENDL-2021 LIBRARY; T=293.6K
Neutron emission for (n,n*)t

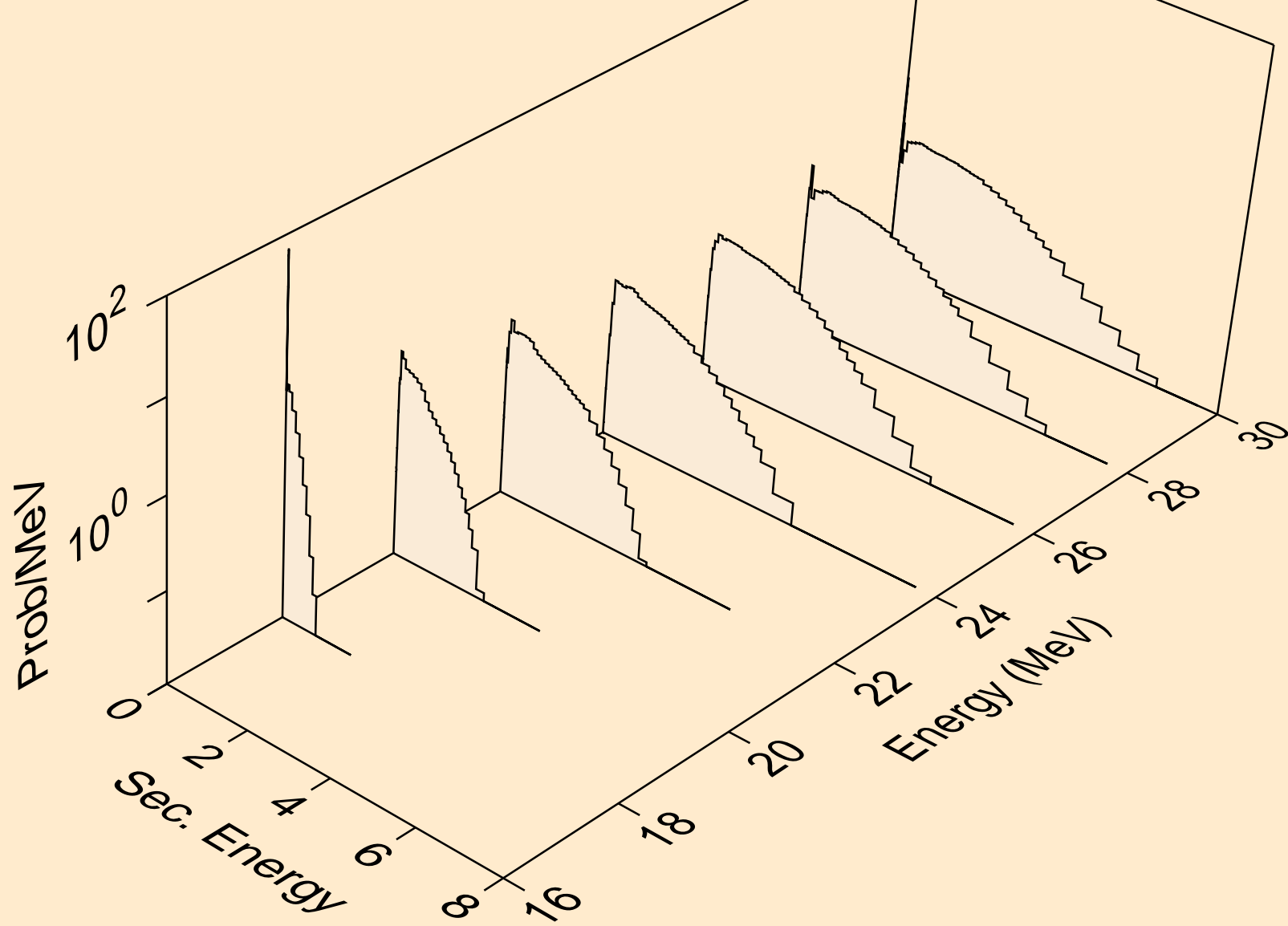

CL040 NEUTRON ACER TENDL-2021 LIBRARY; T=293.6K
Neutron emission for (n,n*)he3

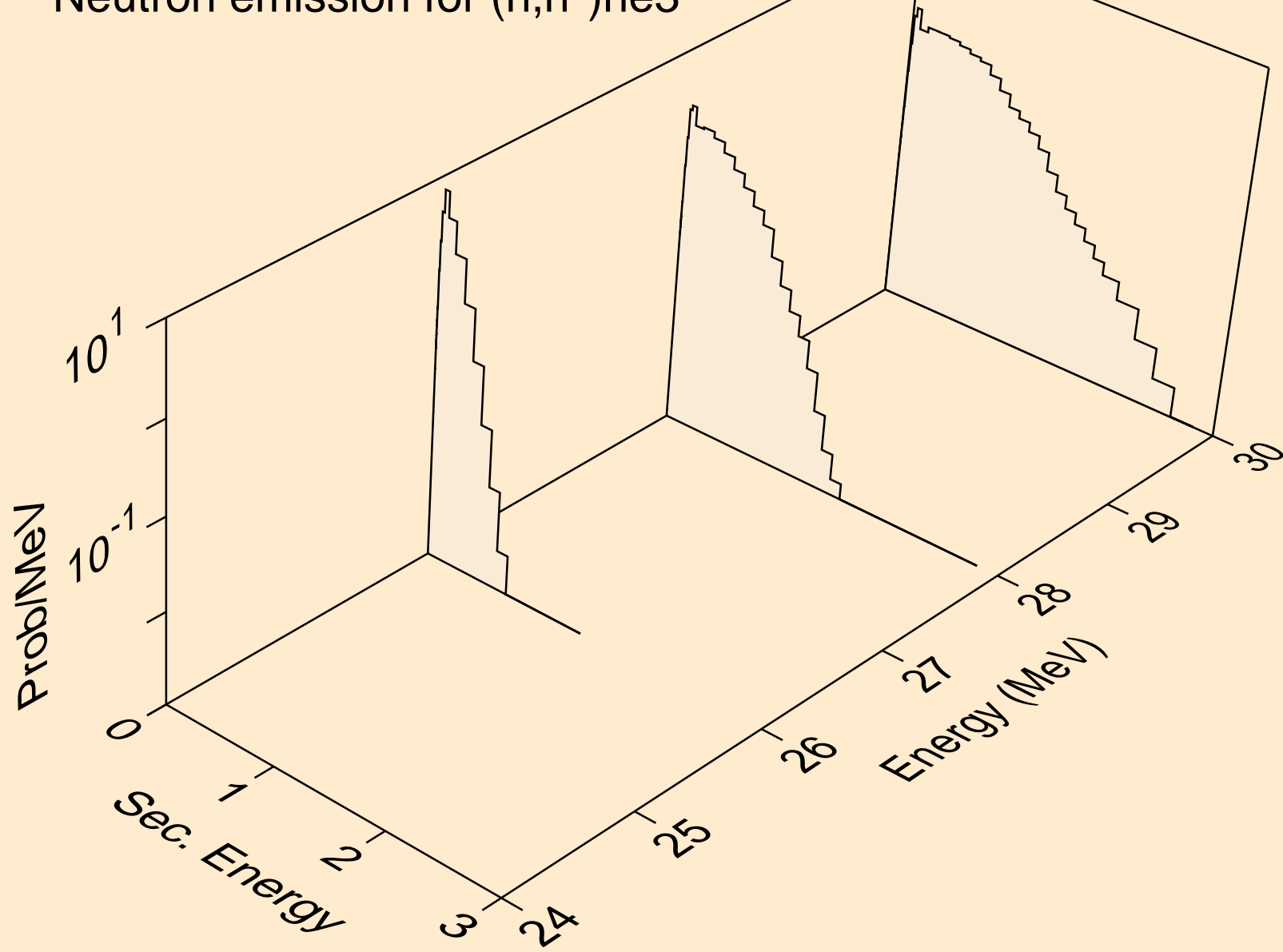

CL040 NEUTRON ACER TENDL-2021 LIBRARY; T=293.6K
Neutron emission for (n,4n)

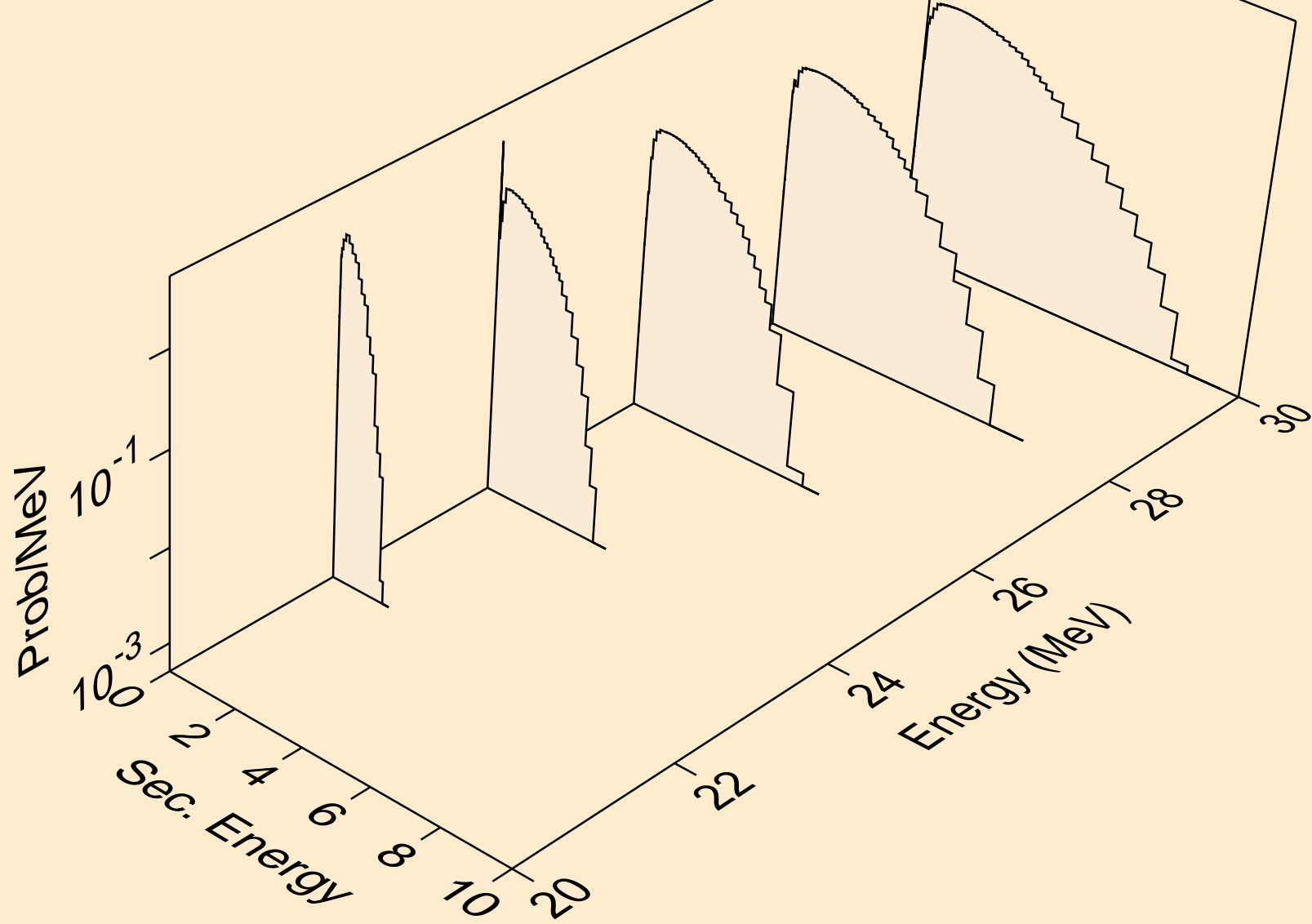

CL040 NEUTRON ACER TENDL-2021 LIBRARY; T=293.6K
Neutron emission for (n,2np)

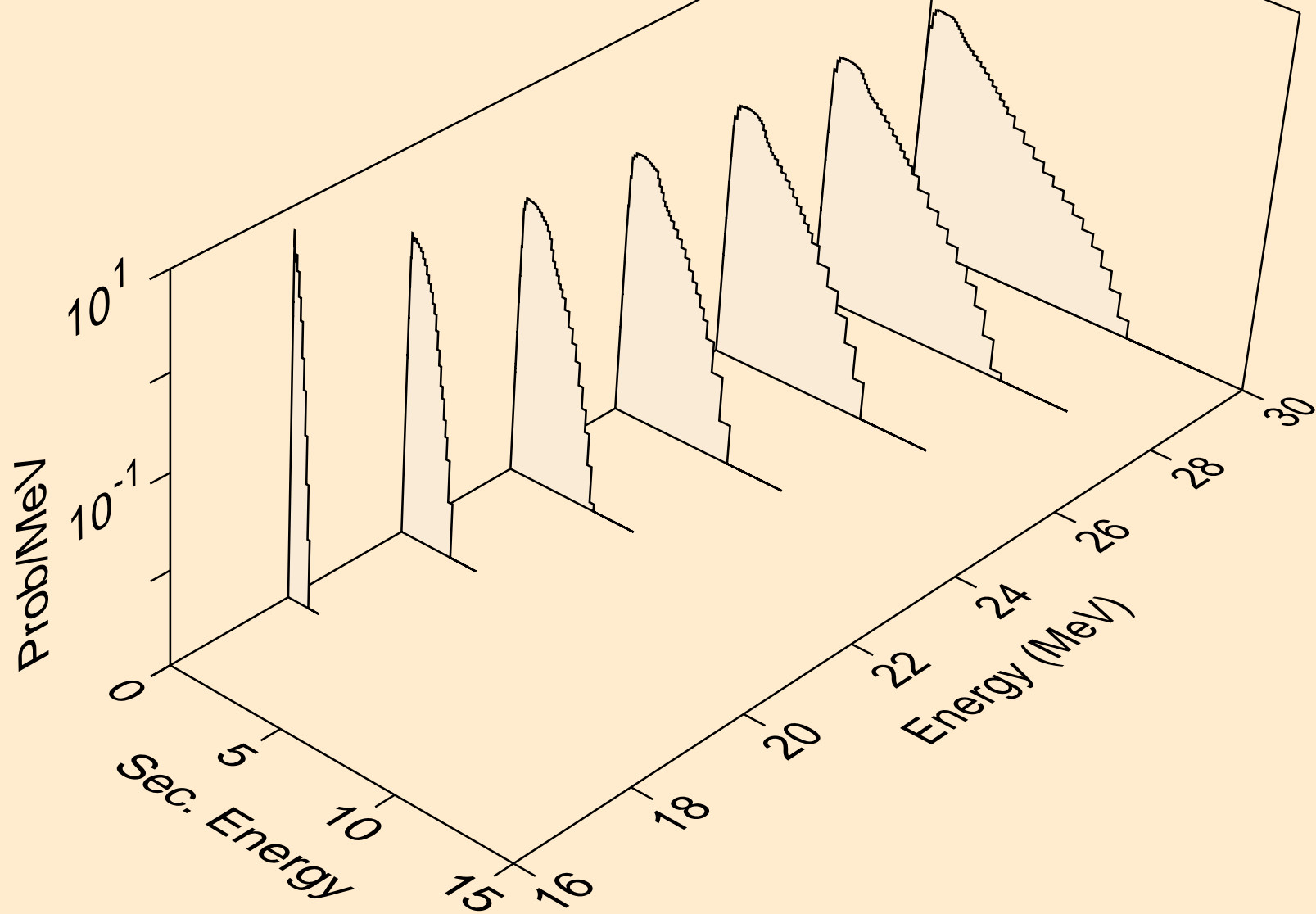

CL040 NEUTRON ACER TENDL-2021 LIBRARY; T=293.6K
Neutron emission for (n,3np)

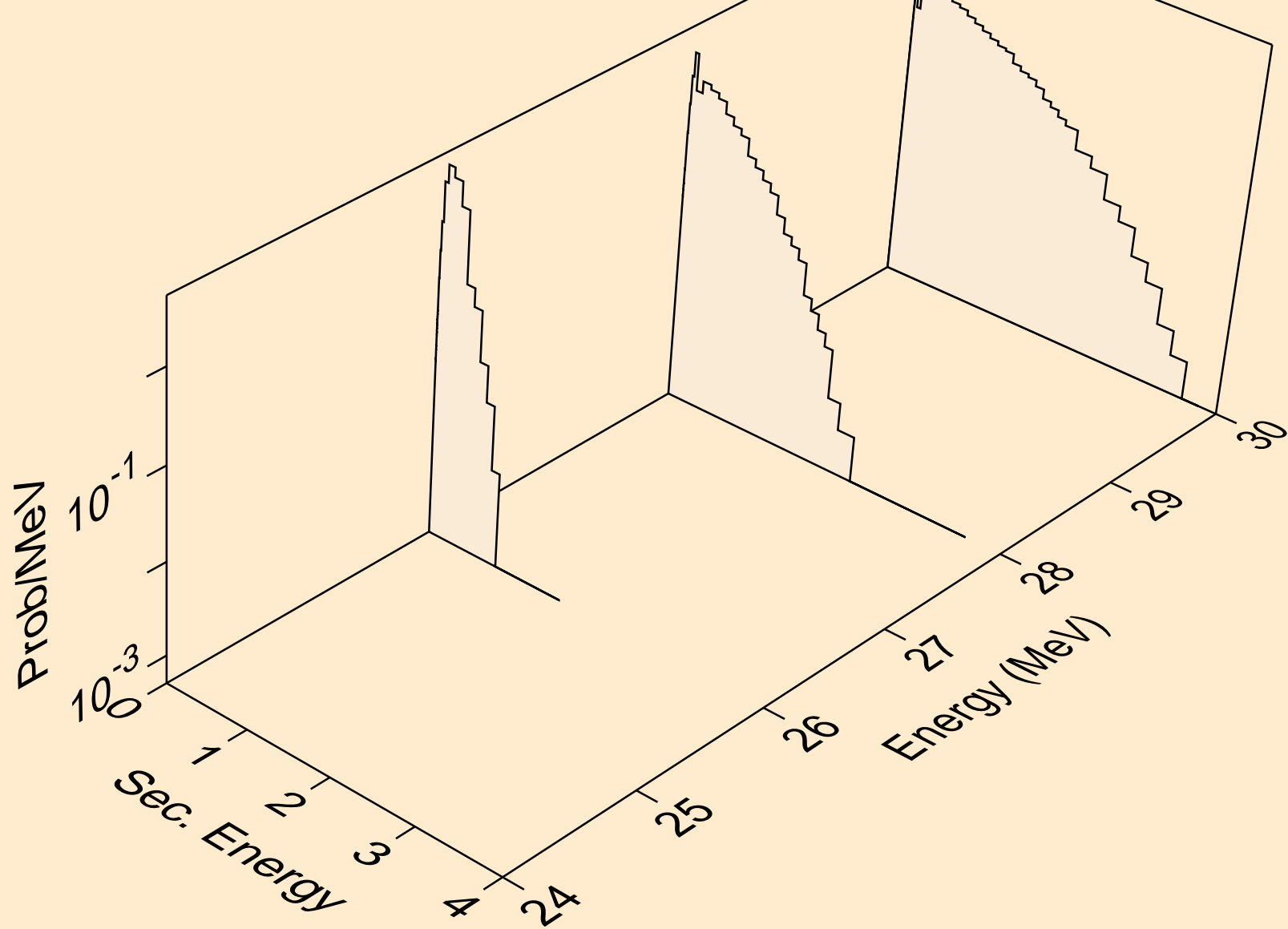

CL040 NEUTRON ACER TENDL-2021 LIBRARY; T=293.6K
Neutron emission for (n,npa)

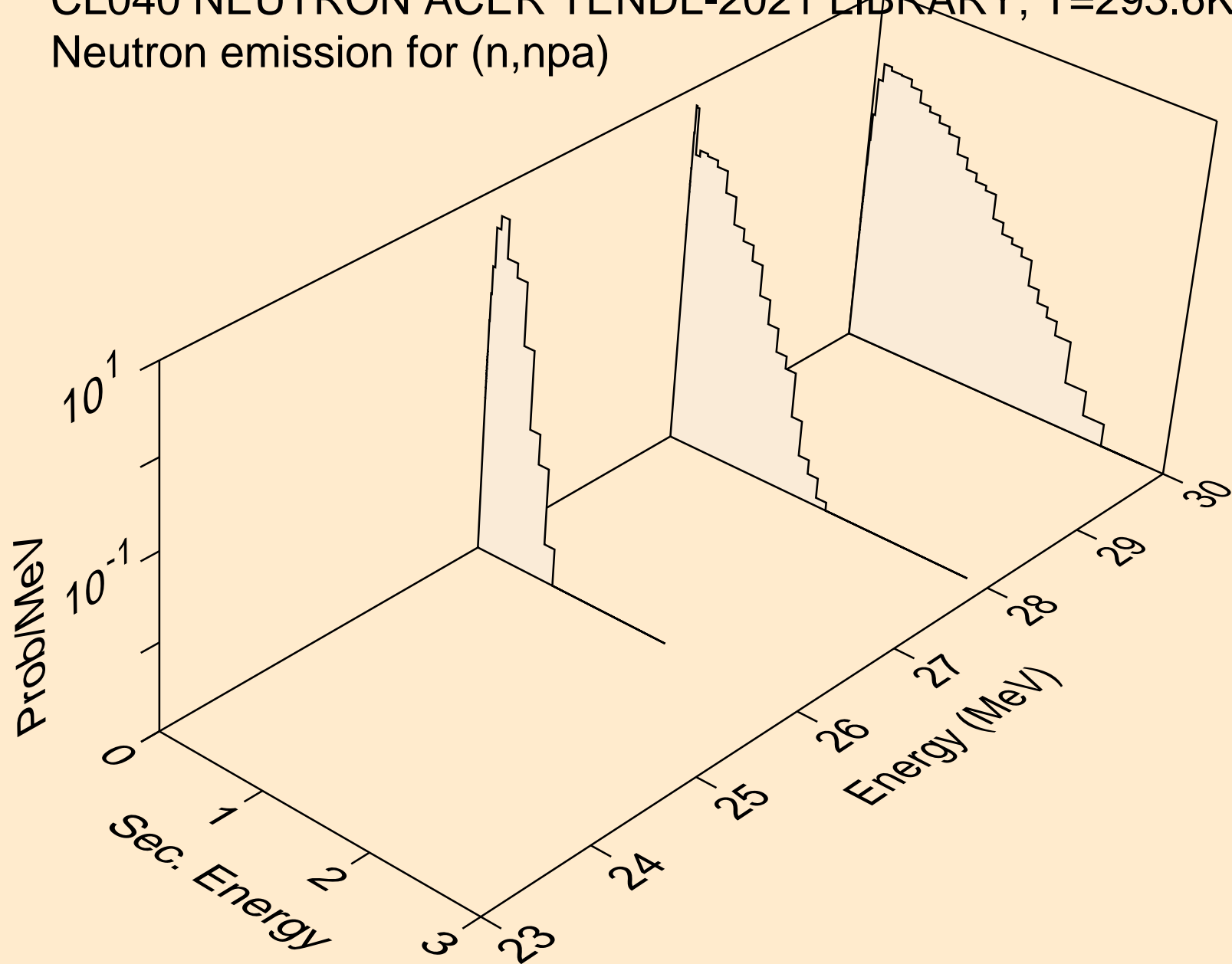

CL040 NEUTRON ACER TENDL-2021 LIBRARY; T=293.6K
Neutron emission for (n,n*c)

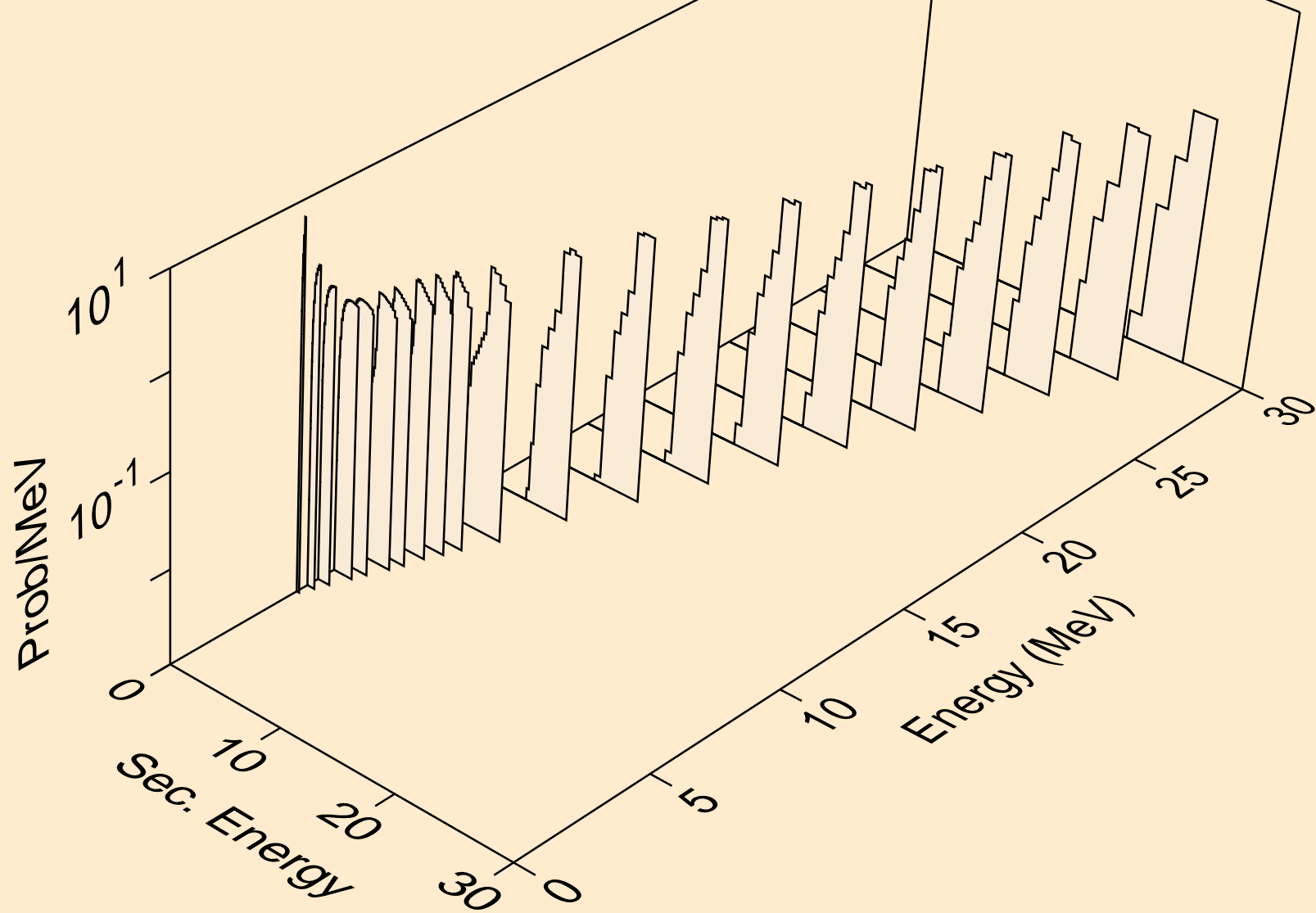

CL040 NEUTRON ACER TENDL-2021 LIBRARY; T=293.6K
Photon emission for (n,x)

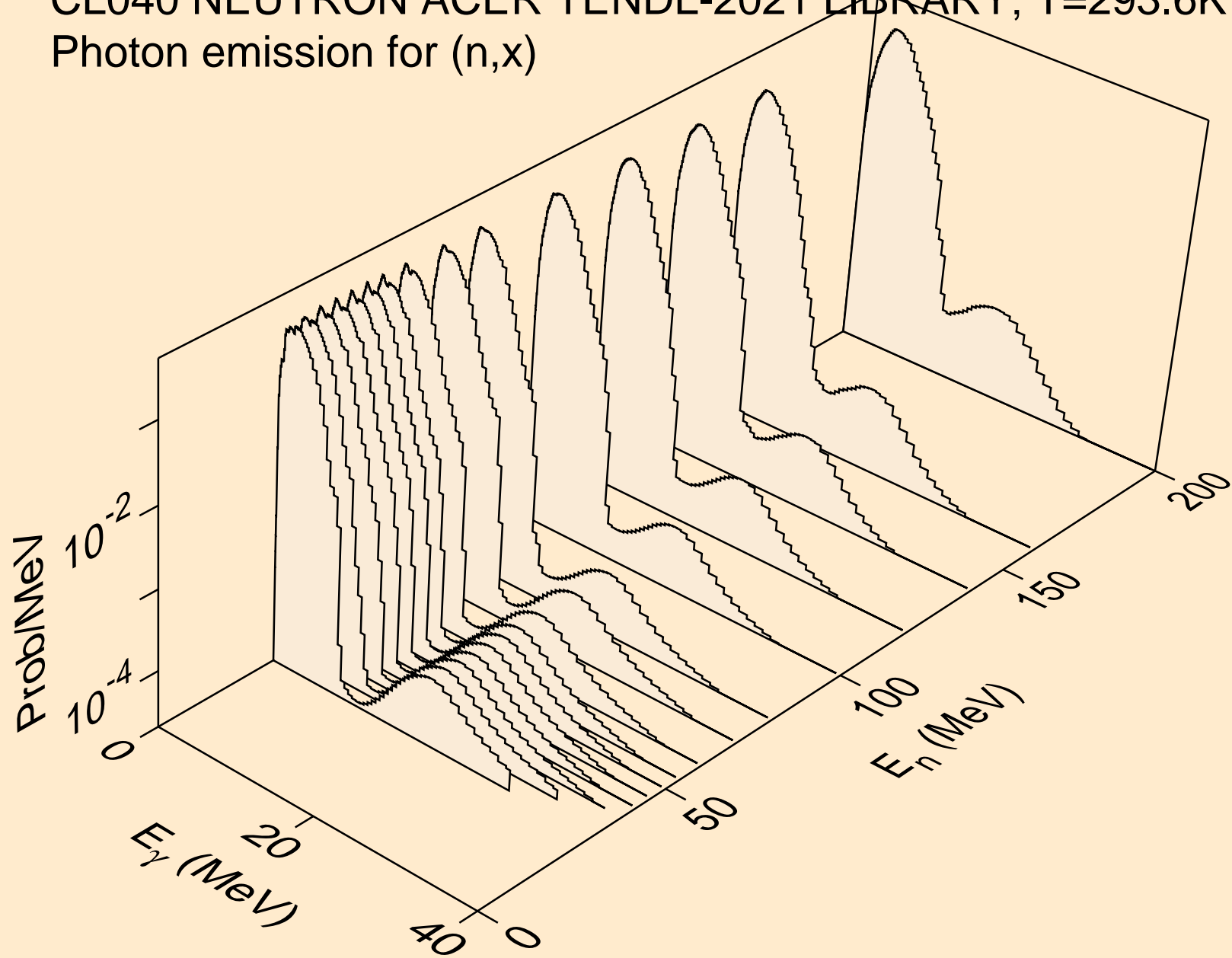

CL040 NEUTRON ACER TENDL-2021 LIBRARY; T=293.6K
Photon emission for (n,2nd)

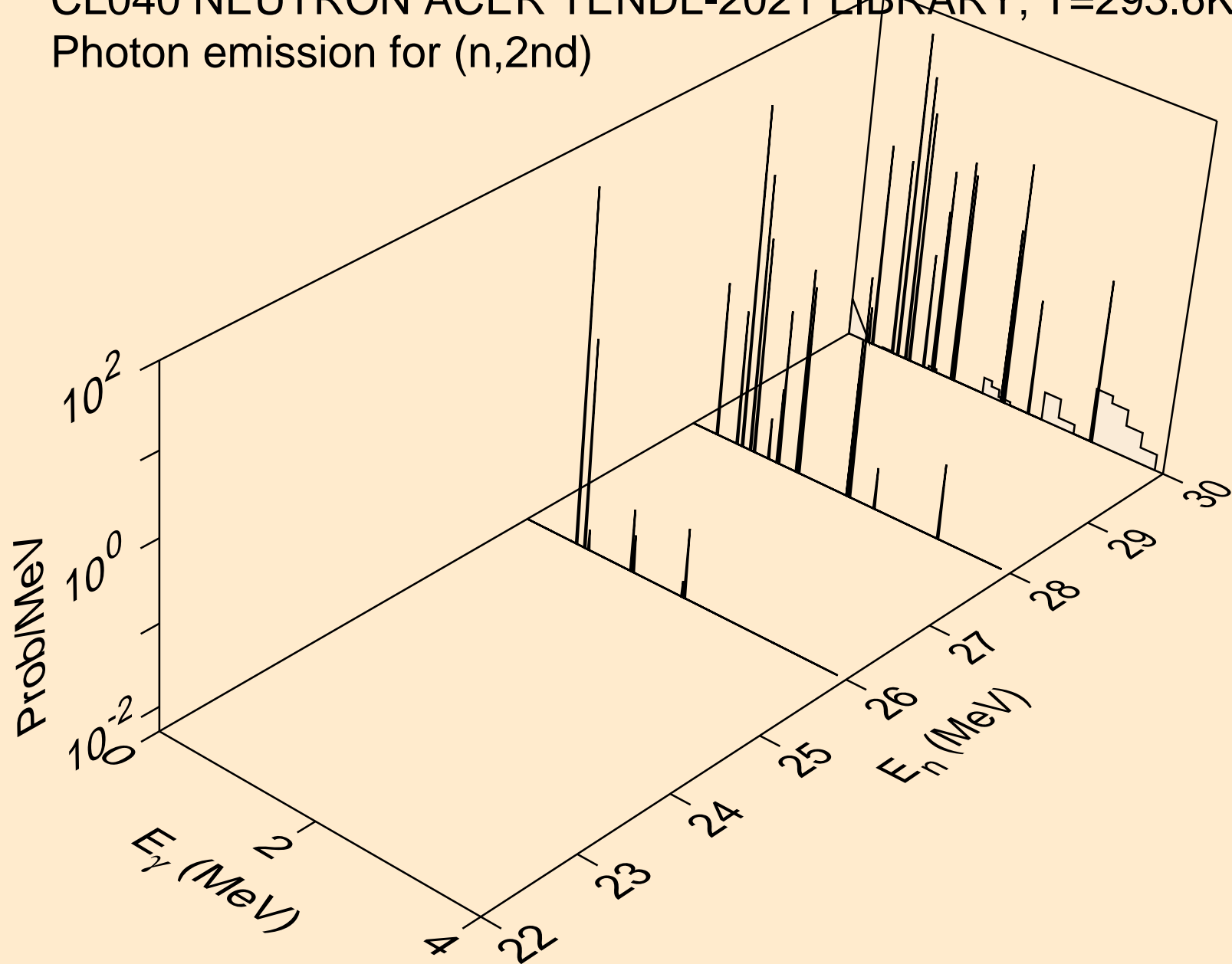

CL040 NEUTRON ACER TENDL-2021 LIBRARY; T=293.6K
Photon emission for (n,2n)

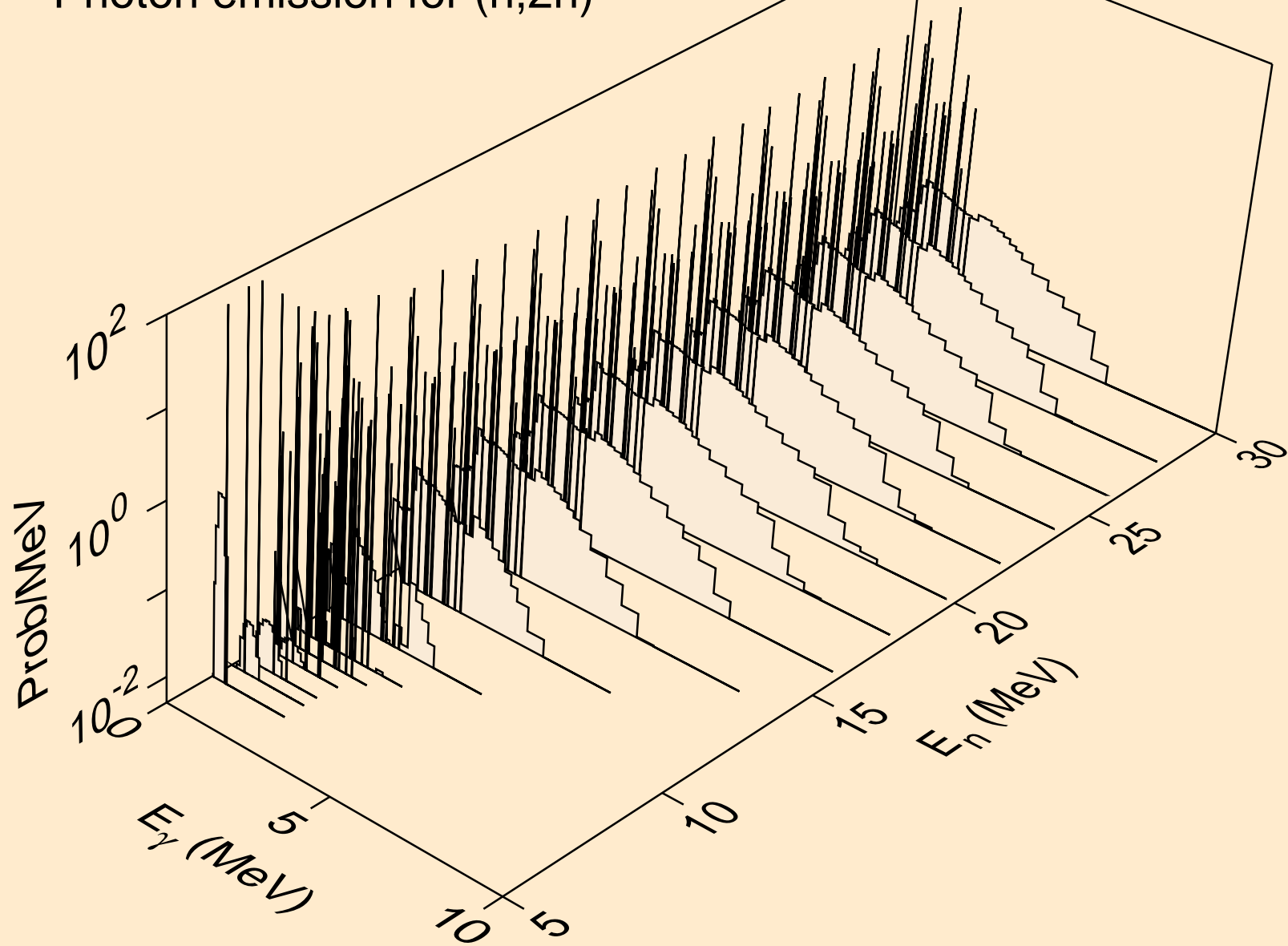

CL040 NEUTRON ACER TENDL-2021 LIBRARY; T=293.6K
Photon emission for (n,3n)

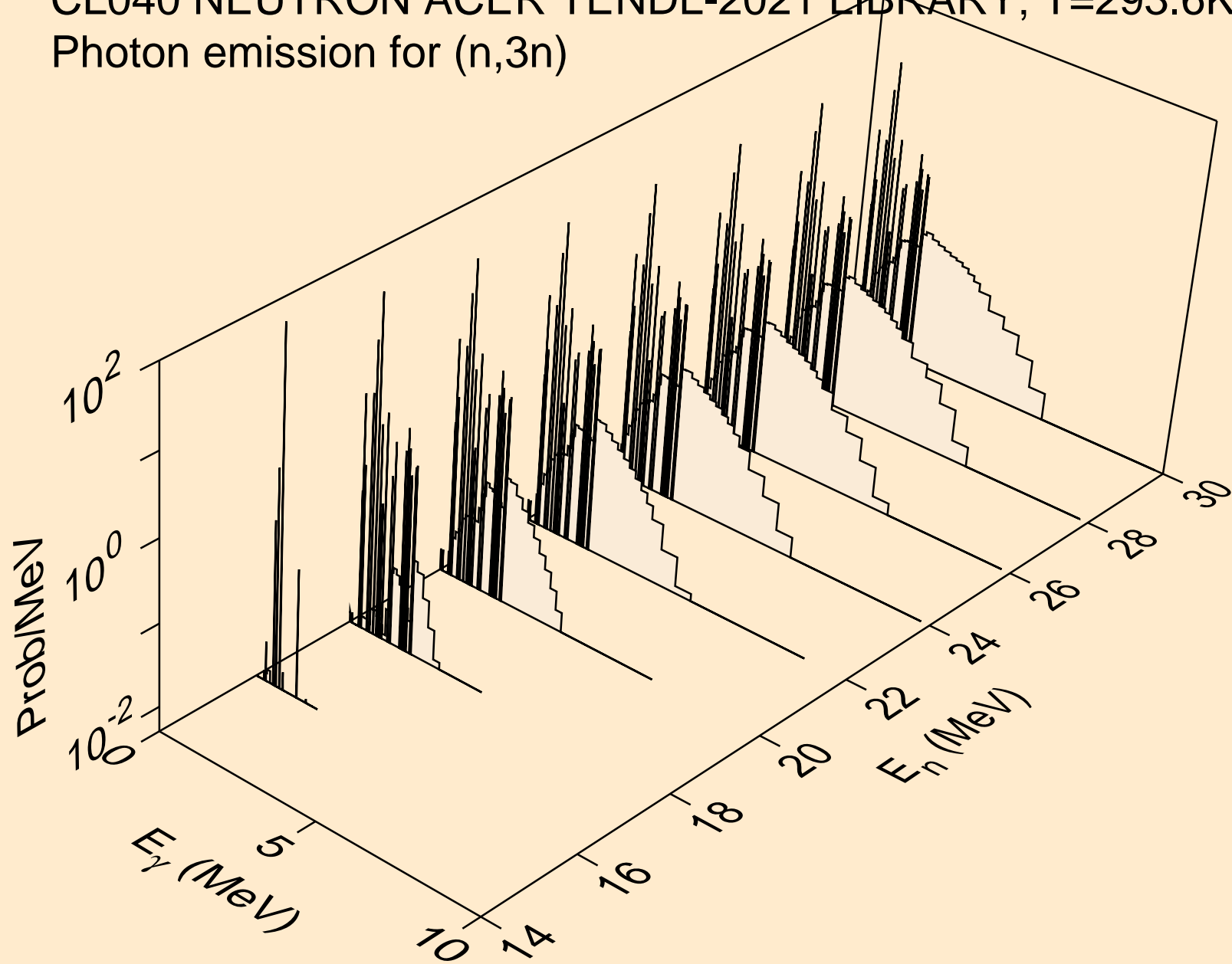

CL040 NEUTRON ACER TENDL-2021 LIBRARY; T=293.6K
Photon emission for (n,n*)a

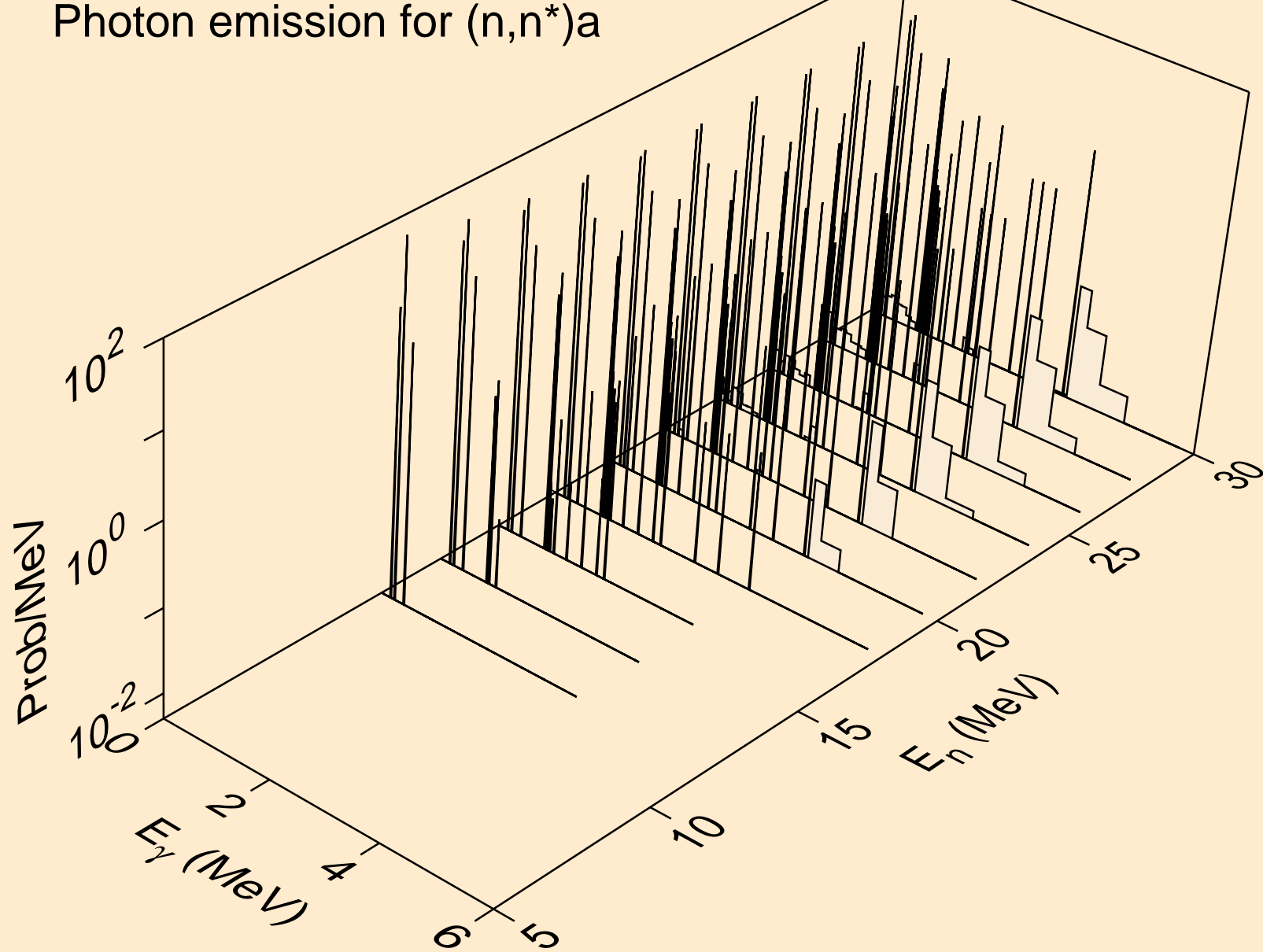

CL040 NEUTRON ACER TENDL-2021 LIBRARY; T=293.6K
Photon emission for (n,2n)a

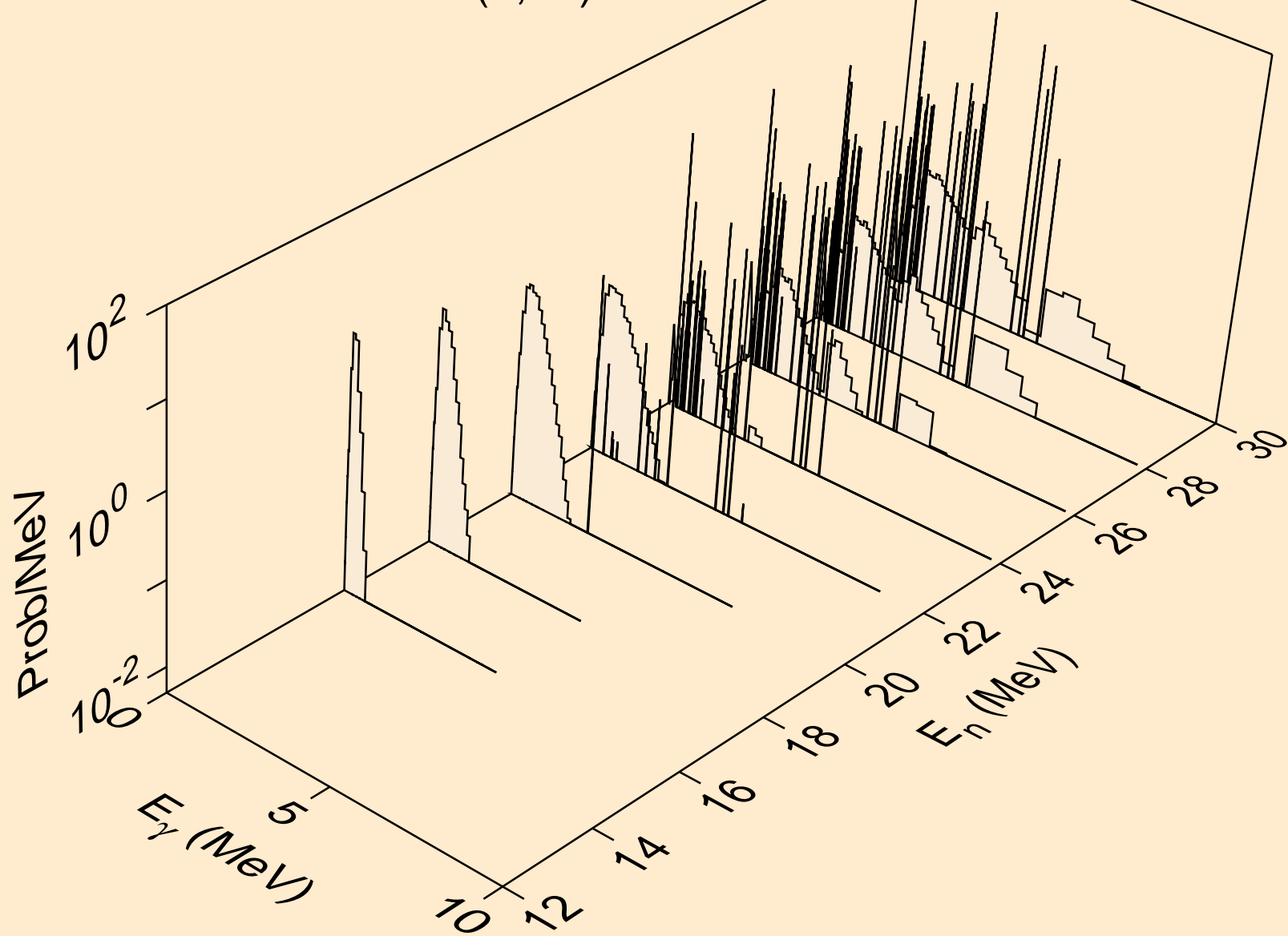

CL040 NEUTRON ACER TENDL-2021 LIBRARY; T=293.6K
Photon emission for (n,3n)a

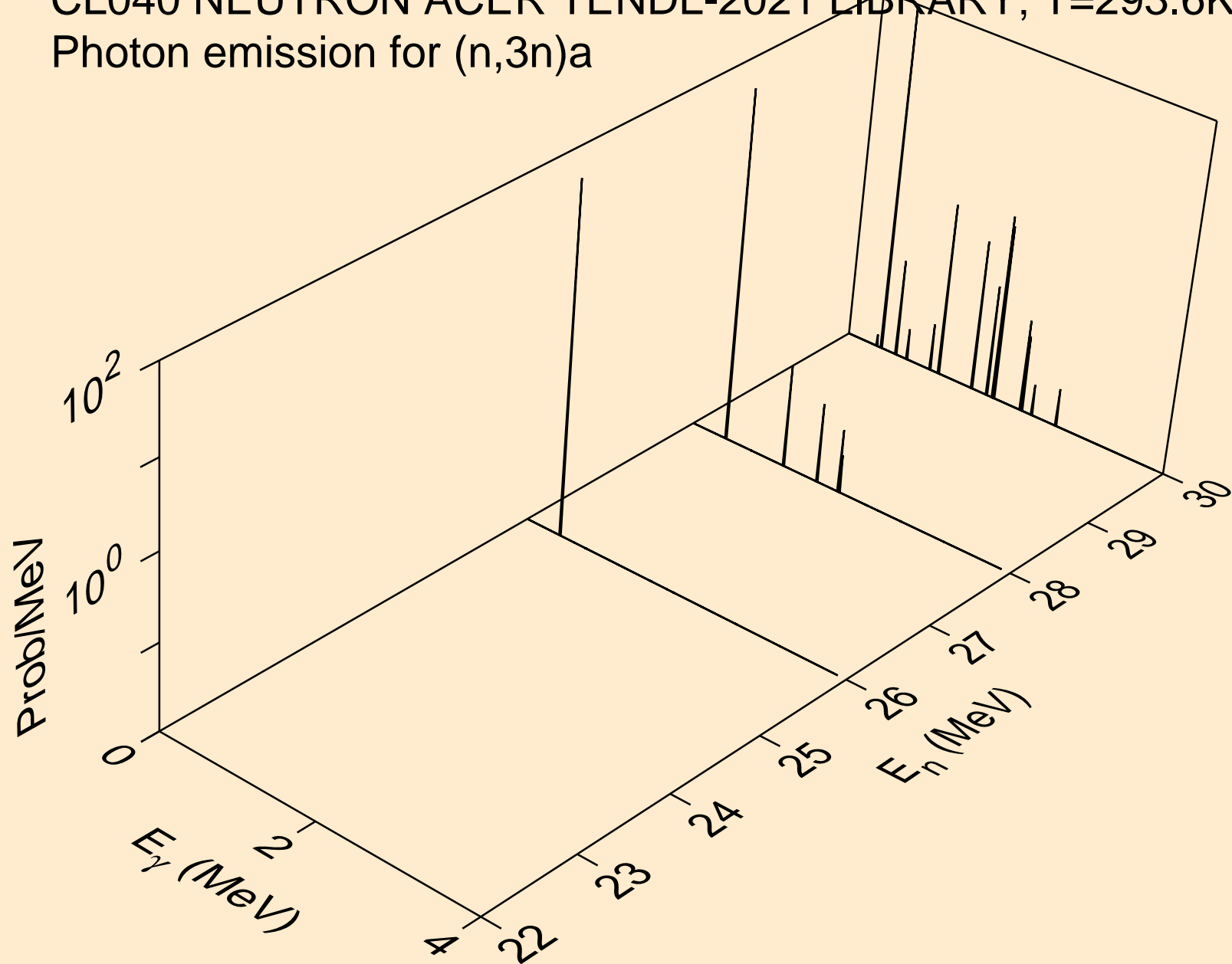

CL040 NEUTRON ACER TENDL-2021 LIBRARY; T=293.6K
Photon emission for (n,n*)p

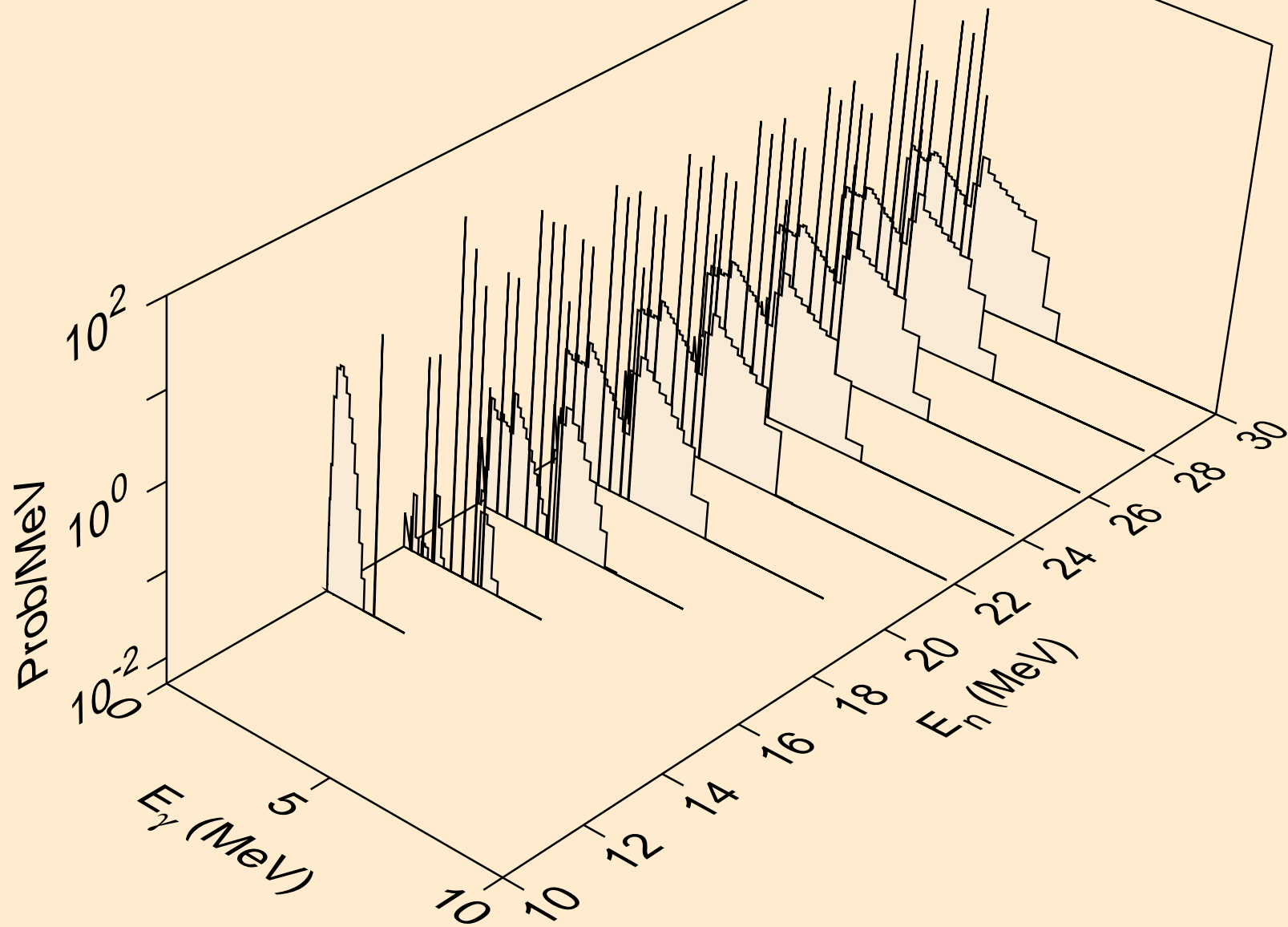

CL040 NEUTRON ACER TENDL-2021 LIBRARY; T=293.6K
Photon emission for (n,n*)d

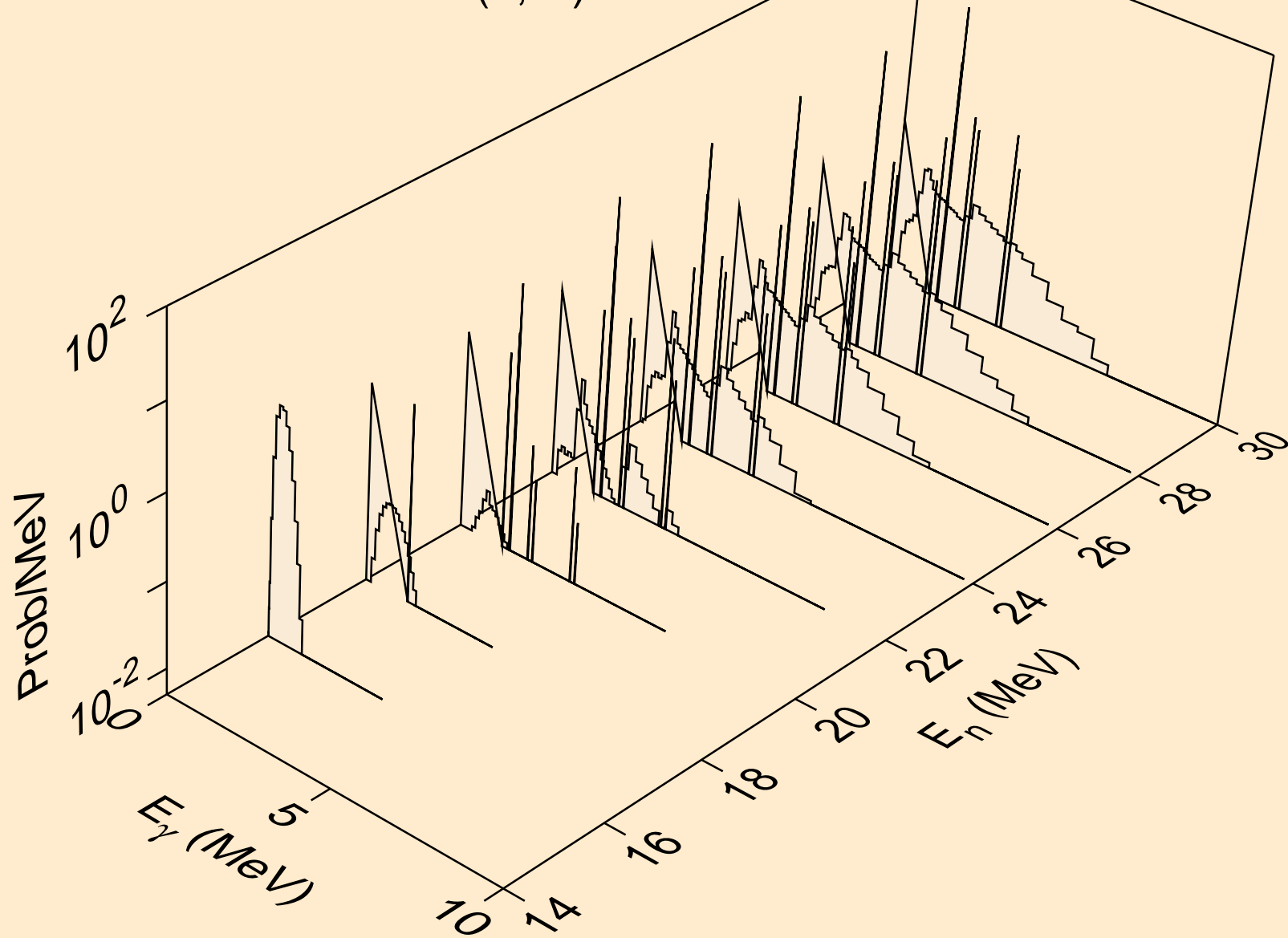

CL040 NEUTRON ACER TENDL-2021 LIBRARY; T=293.6K
Photon emission for (n,n*)t

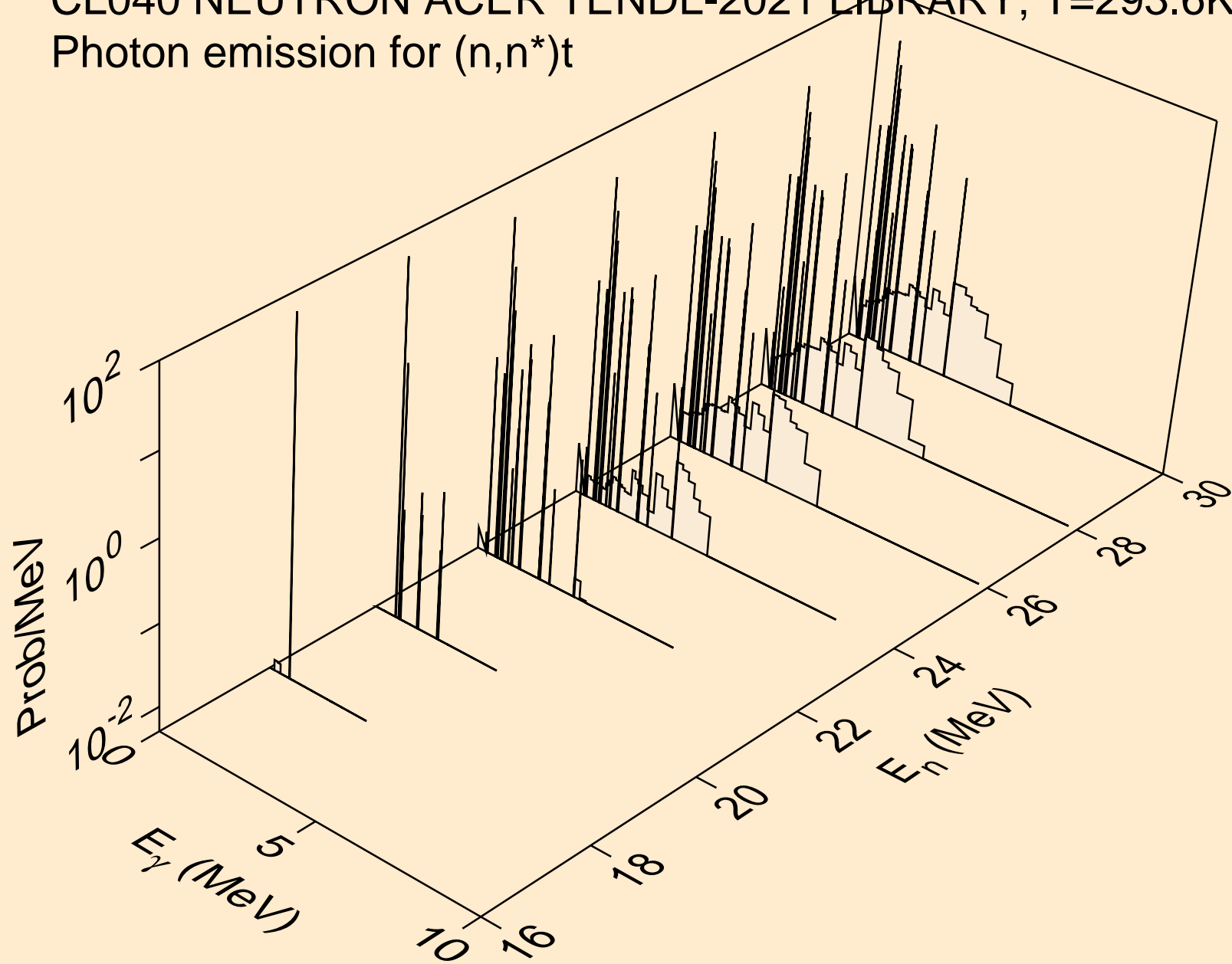

CL040 NEUTRON ACER TENDL-2021 LIBRARY; T=293.6K
Photon emission for (n,n*)he3

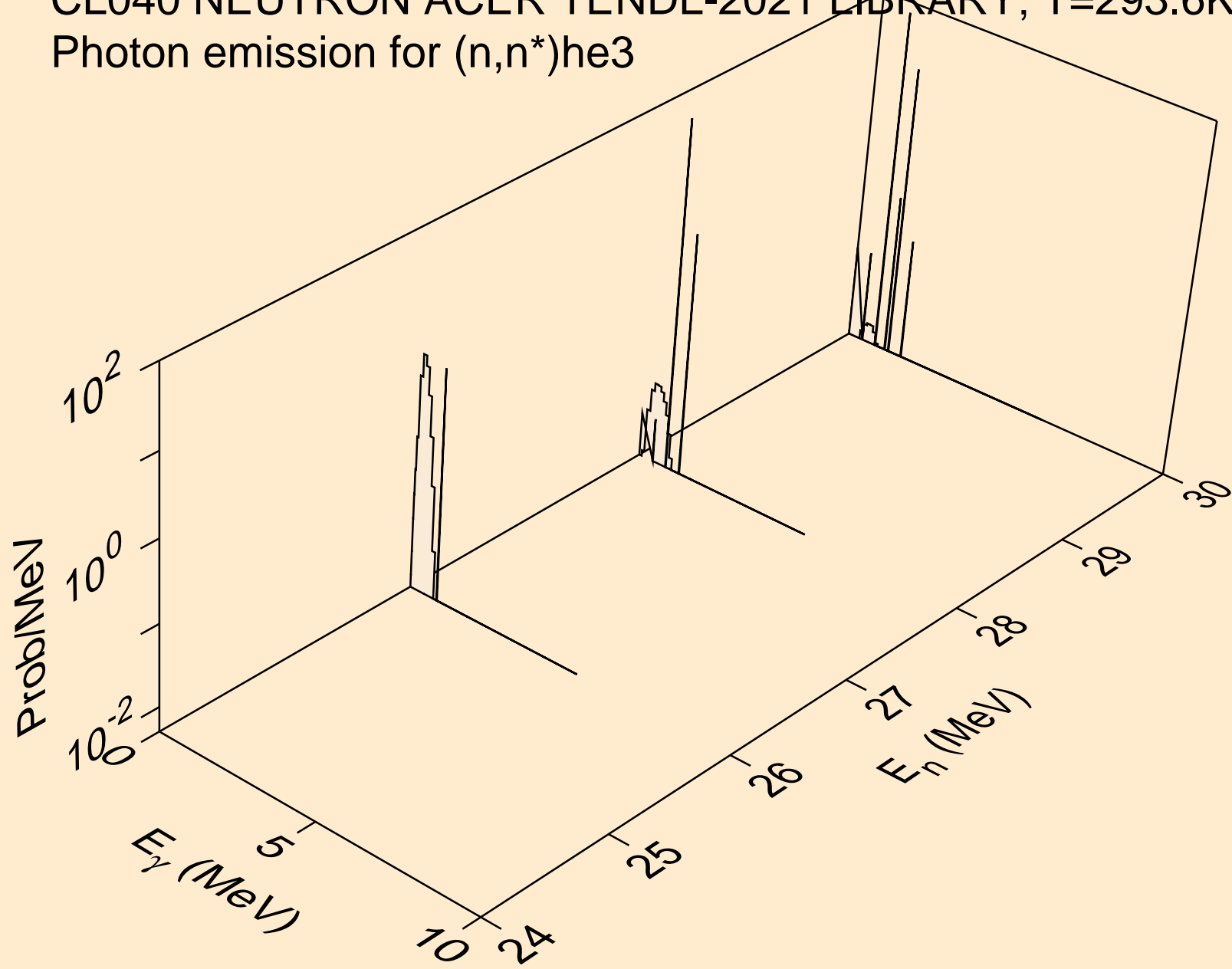

CL040 NEUTRON ACER TENDL-2021 LIBRARY; T=293.6K
Photon emission for (n,4n)

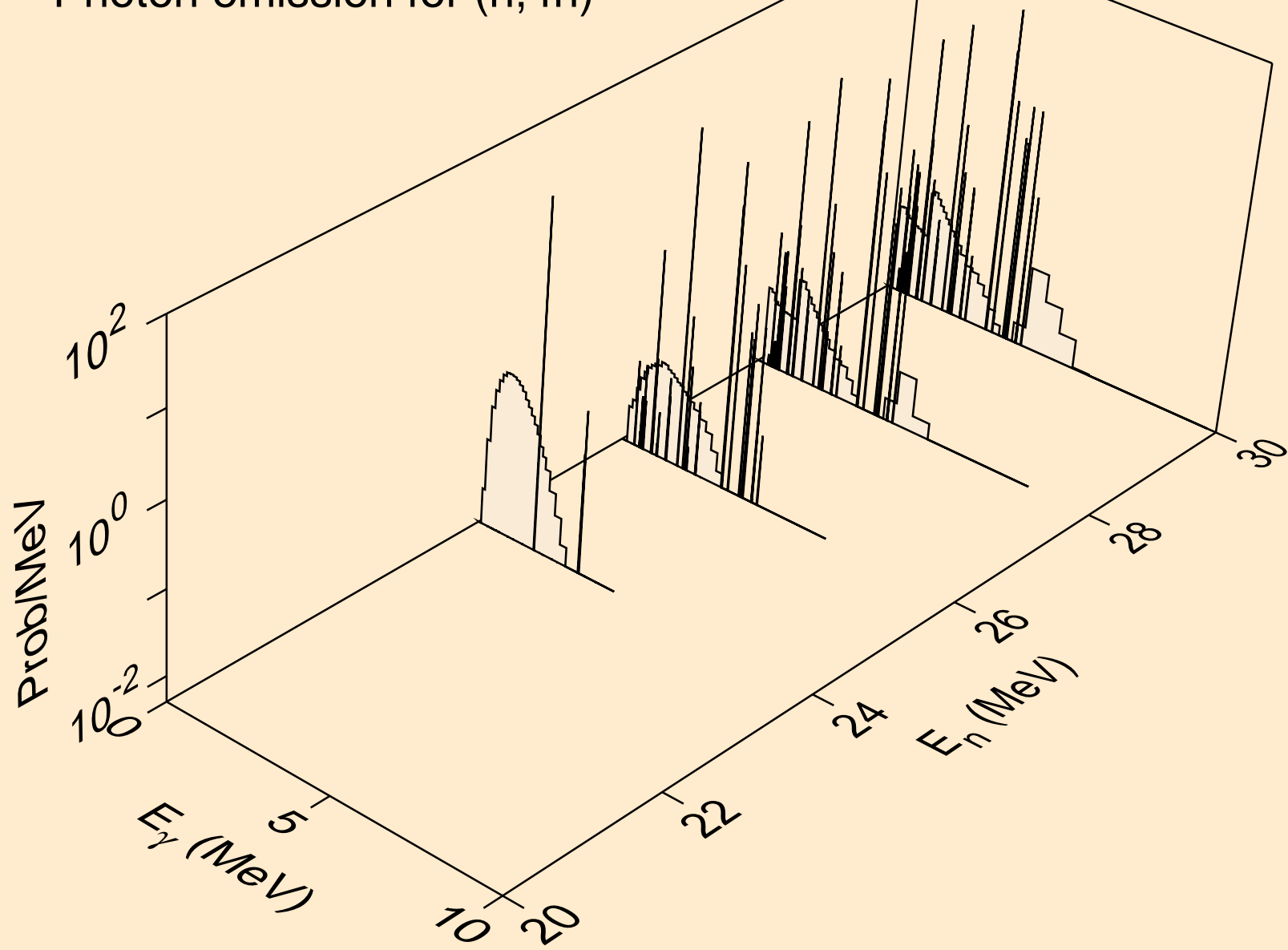

CL040 NEUTRON ACER TENDL-2021 LIBRARY; T=293.6K
Photon emission for (n,2np)

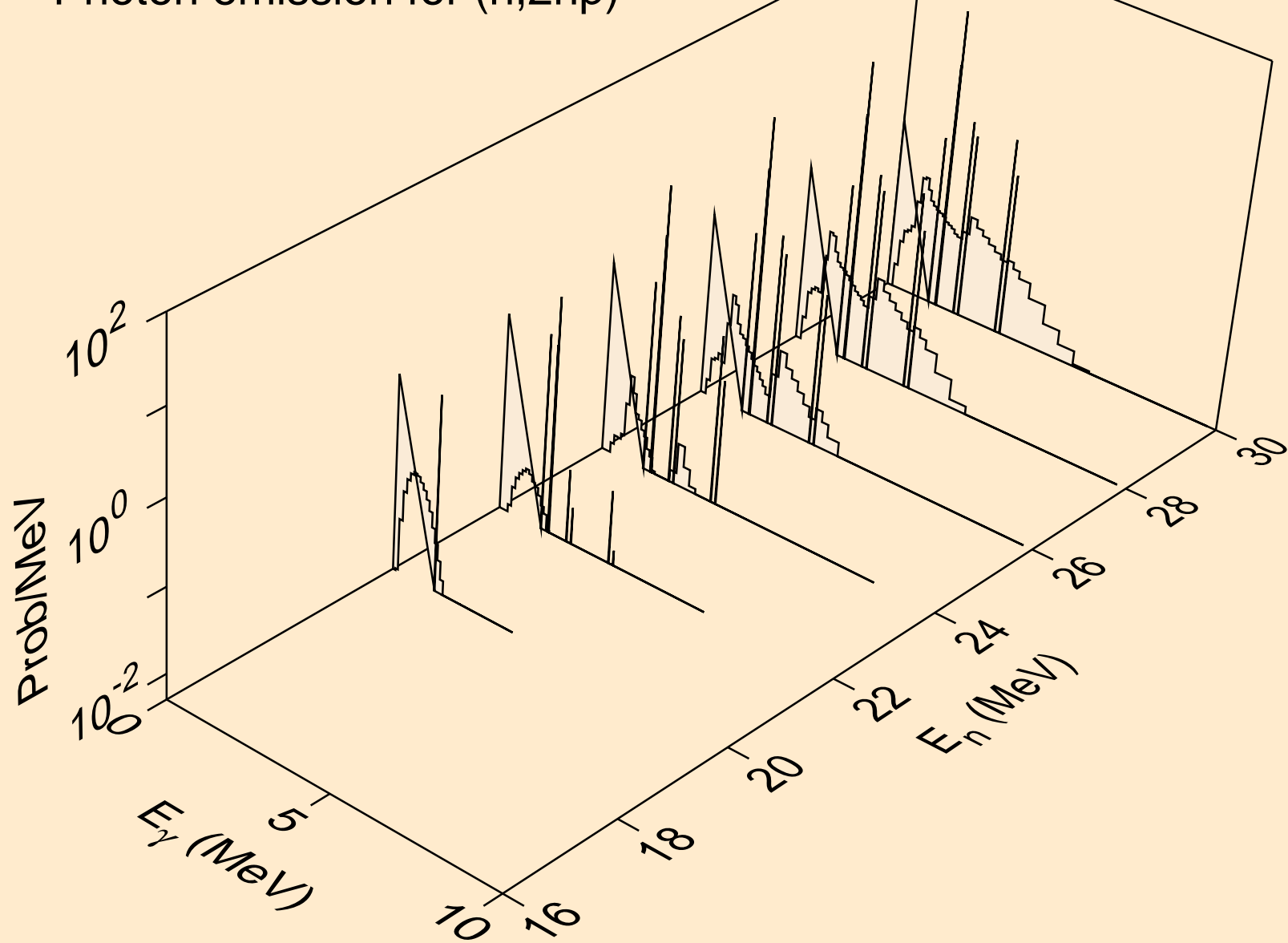

CL040 NEUTRON ACER TENDL-2021 LIBRARY; T=293.6K
Photon emission for (n,3np)

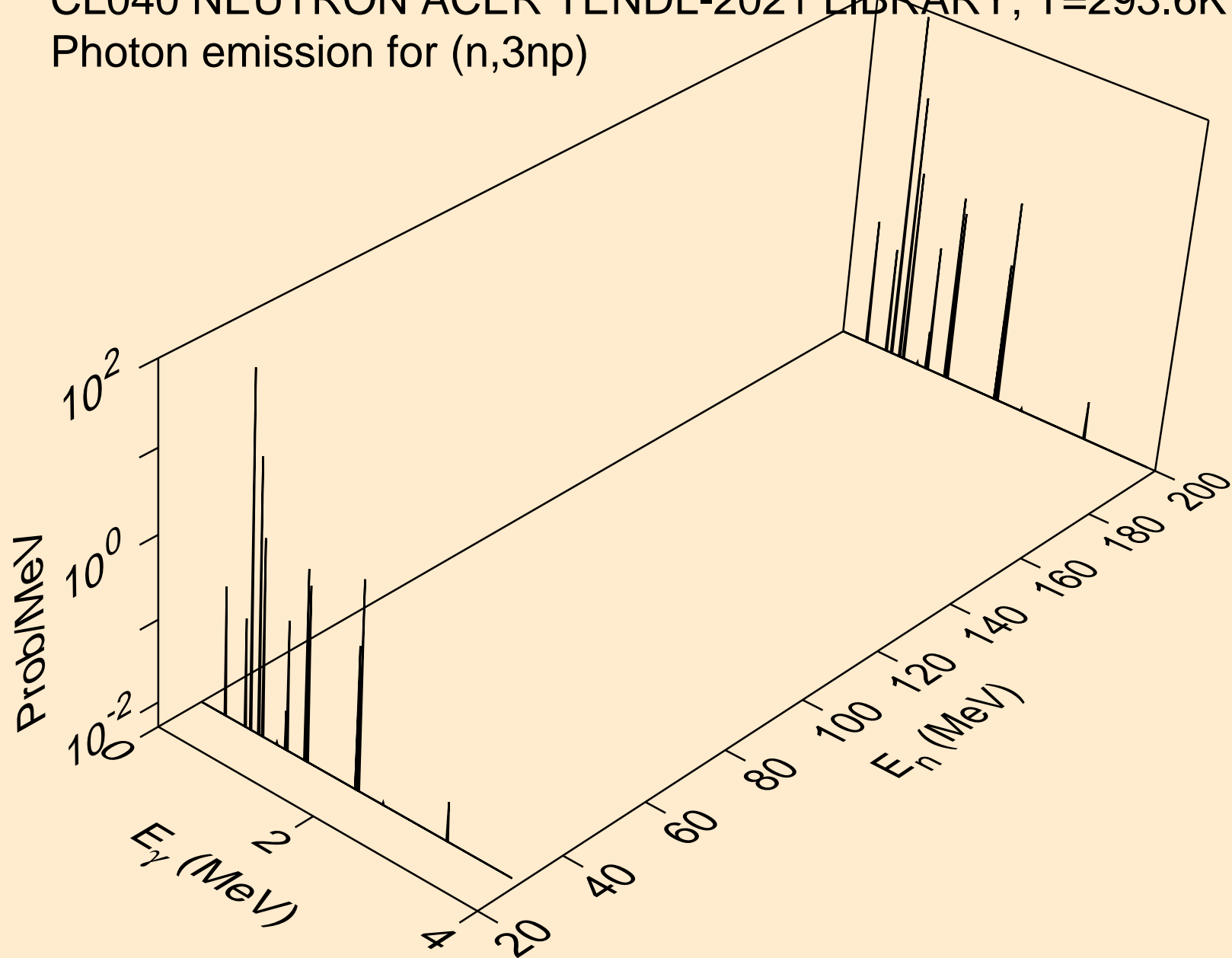

CL040 NEUTRON ACER TENDL-2021 LIBRARY; T=293.6K
Photon emission for (n,npa)

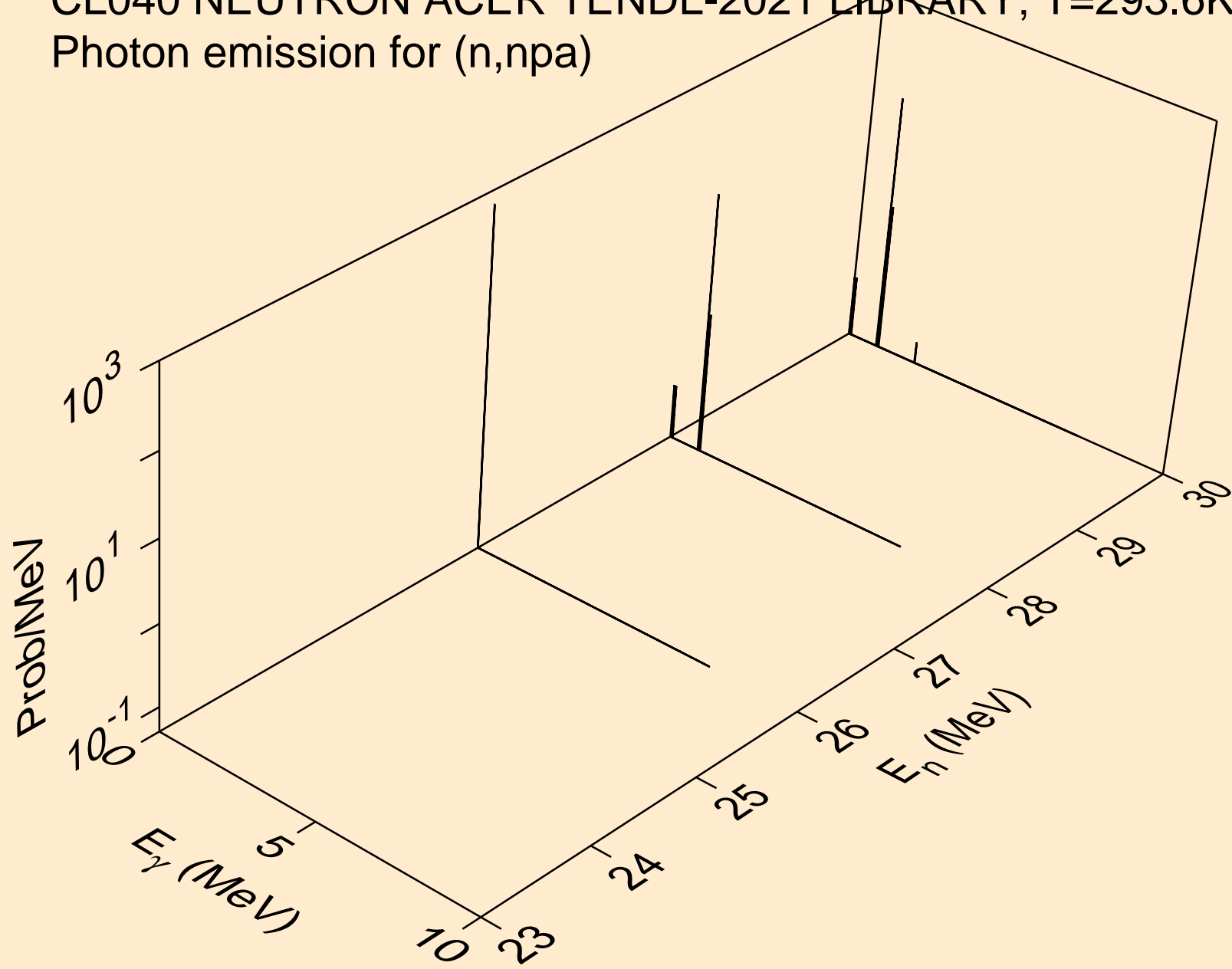

CL040 NEUTRON ACER TENDL-2021 LIBRARY; T=293.6K
Photon emission for (n,n*c)

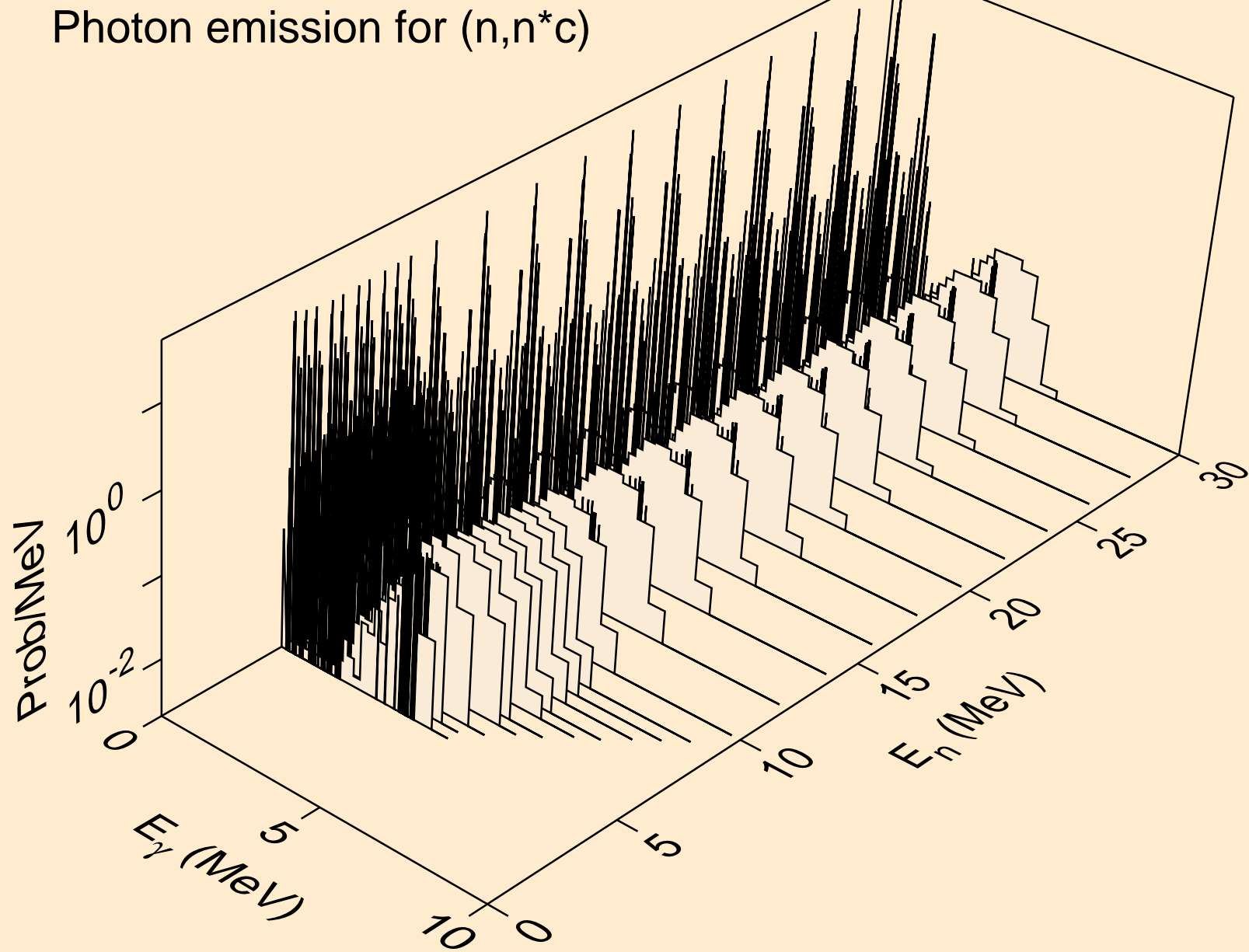

CL040 NEUTRON ACER TENDL-2021 LIBRARY; T=293.6K
Photon emission for (n,gma)

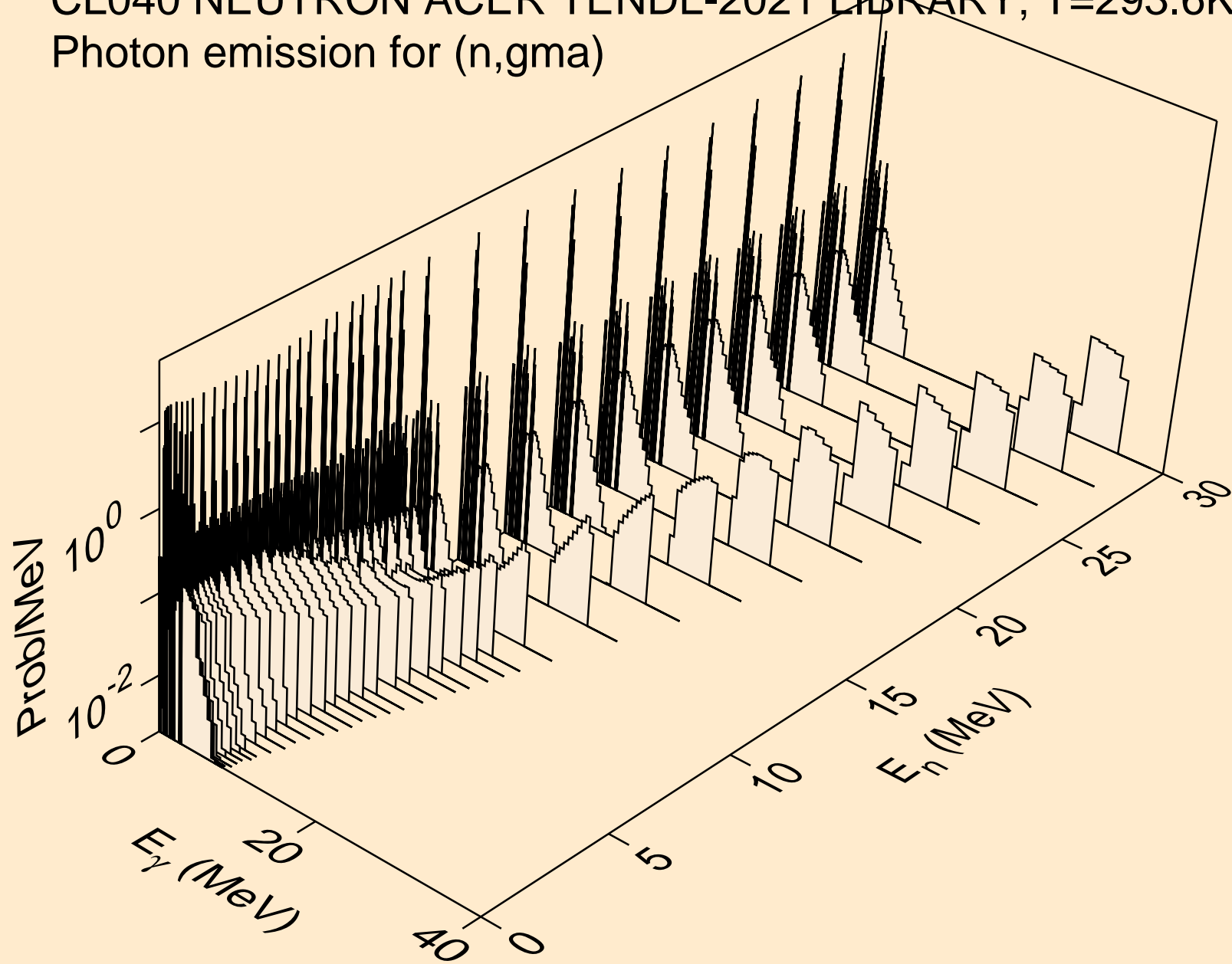

CL040 NEUTRON ACER TENDL-2021 LIBRARY; T=293.6K
Photon emission for (n,p)

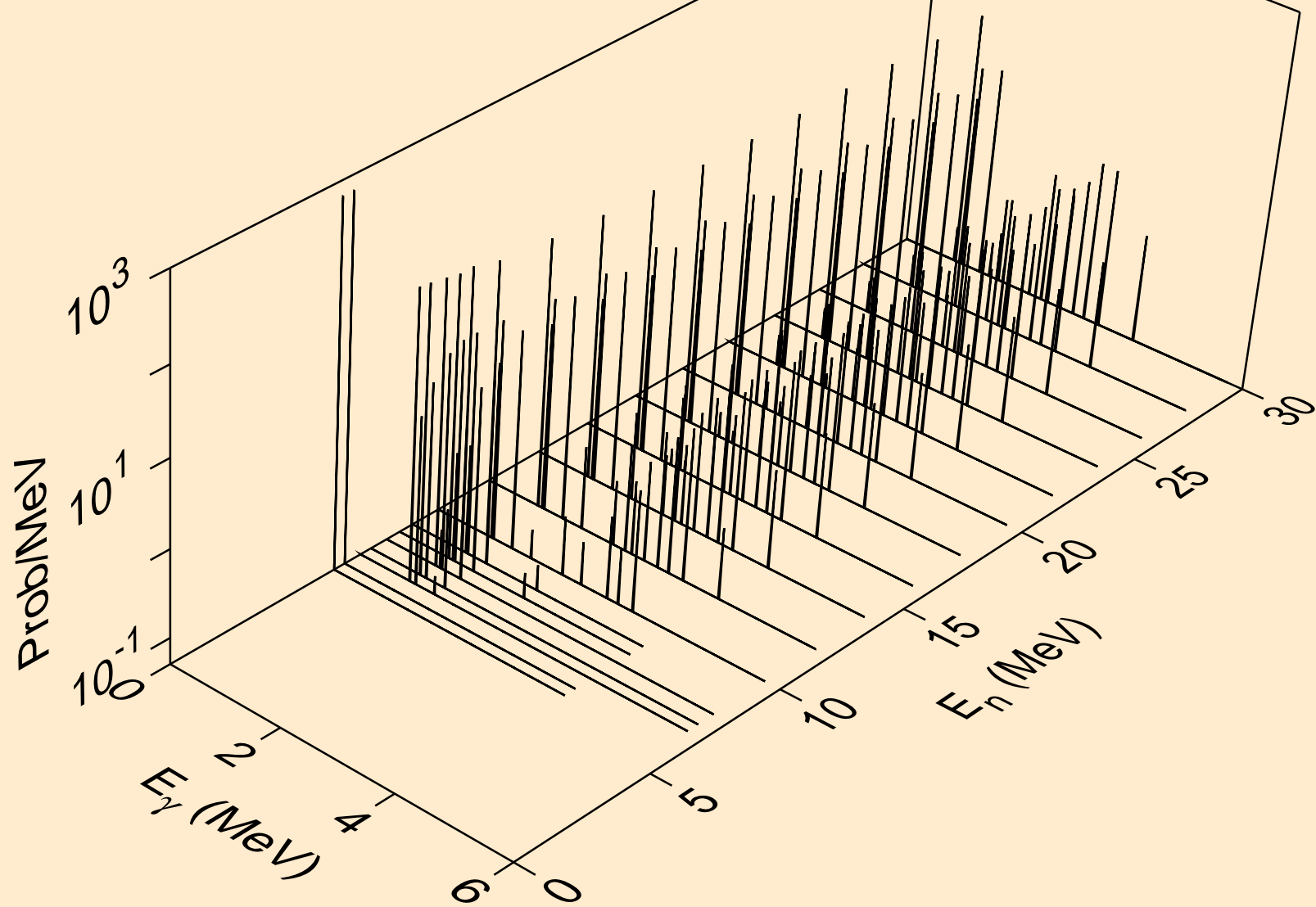

CL040 NEUTRON ACER TENDL-2021 LIBRARY; T=293.6K
Photon emission for (n,d)

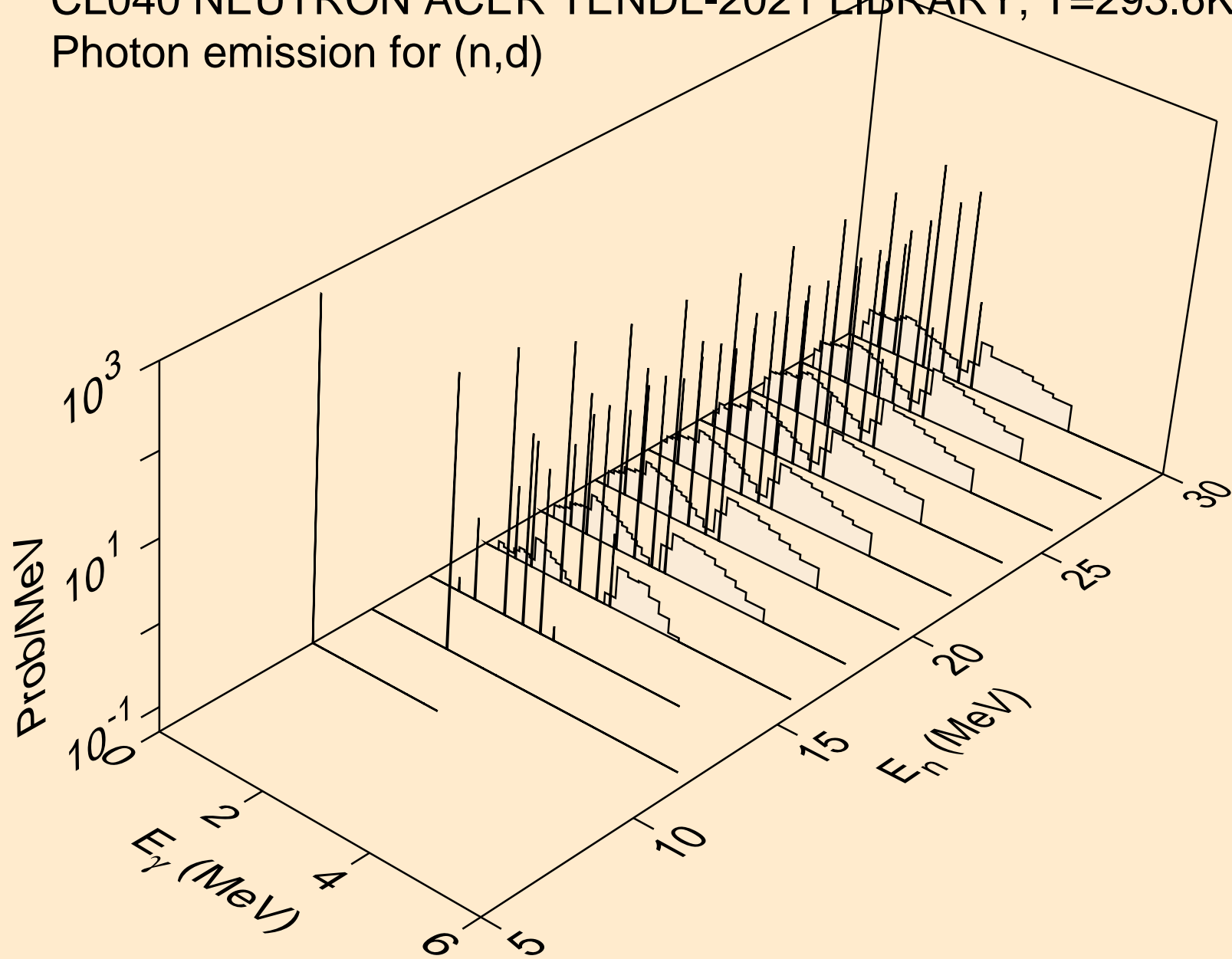

CL040 NEUTRON ACER TENDL-2021 LIBRARY; T=293.6K
Photon emission for (n,t)

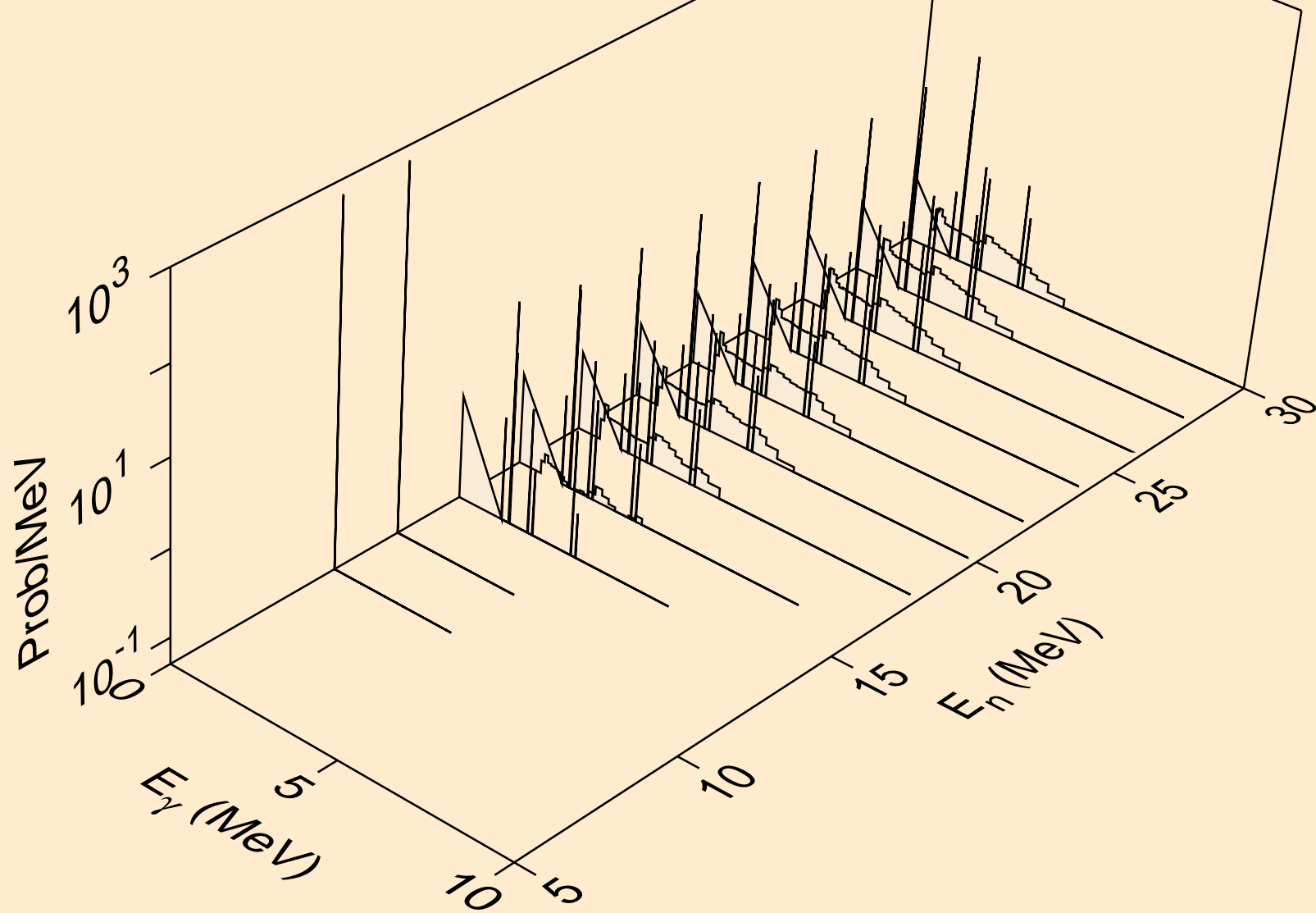

CL040 NEUTRON ACER TENDL-2021 LIBRARY; T=293.6K
Photon emission for (n,he3)

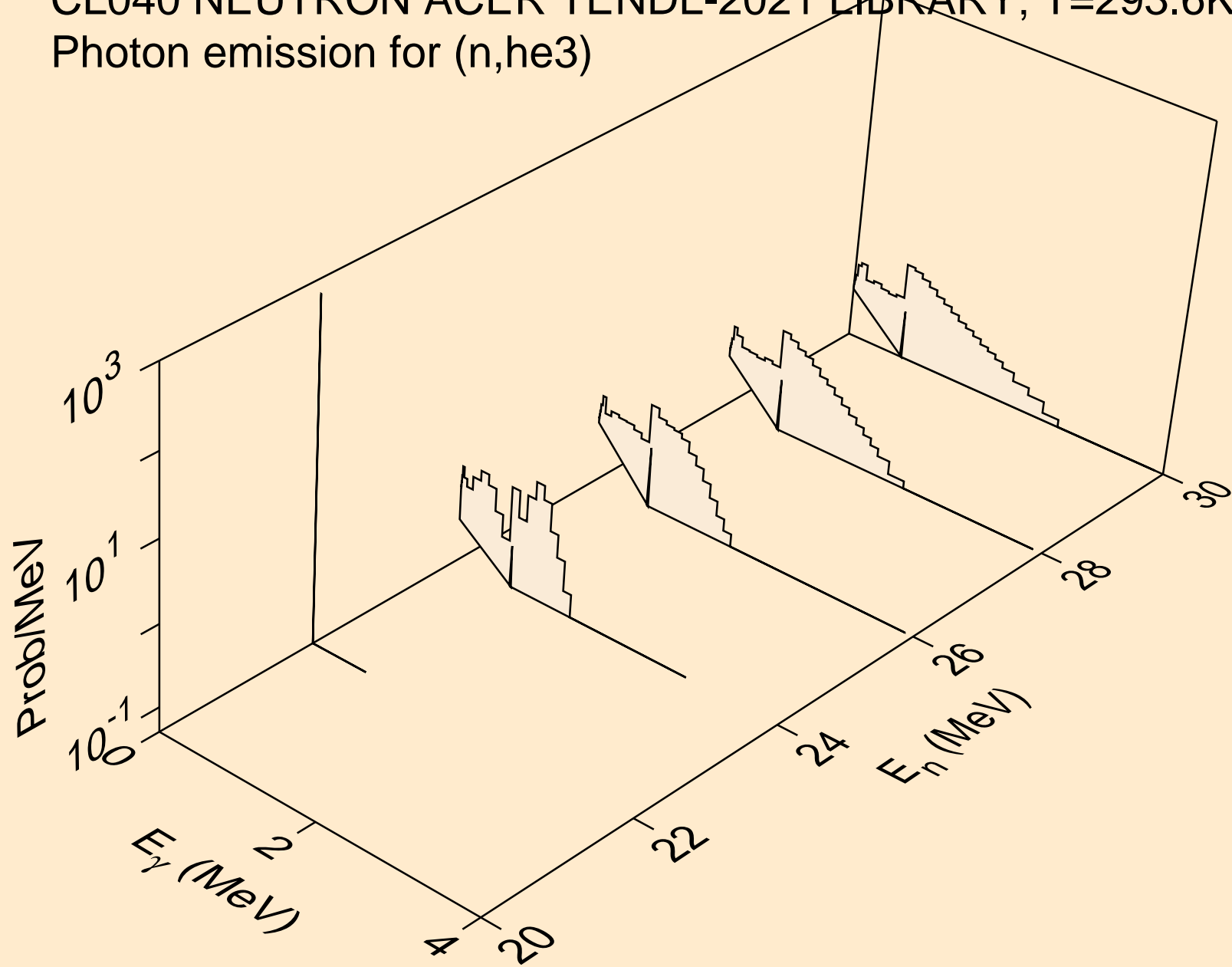

CL040 NEUTRON ACER TENDL-2021 LIBRARY; T=293.6K
Photon emission for (n,a)

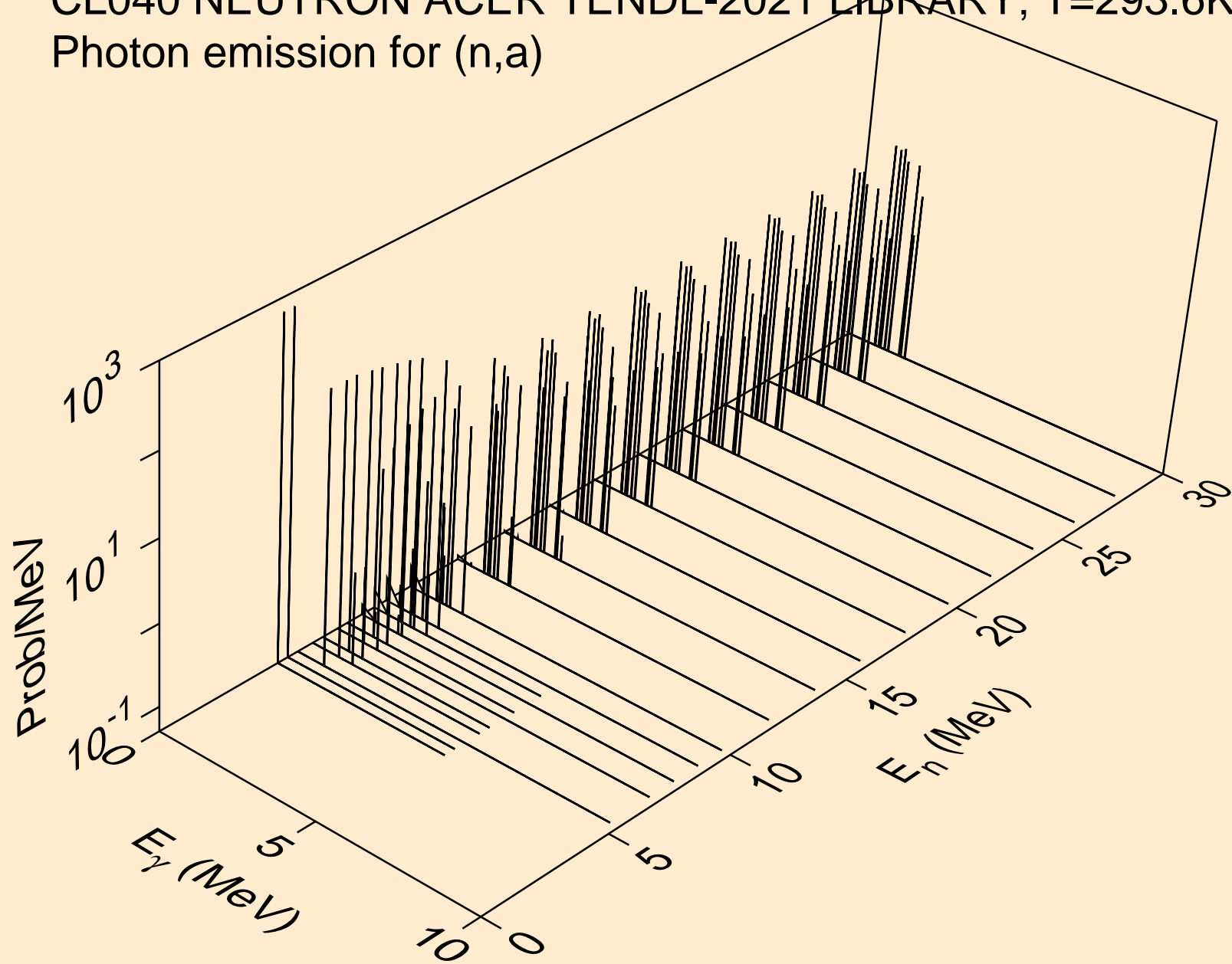

CL040 NEUTRON ACER TENDL-2021 LIBRARY; T=293.6K
Photon emission for (n,2a)

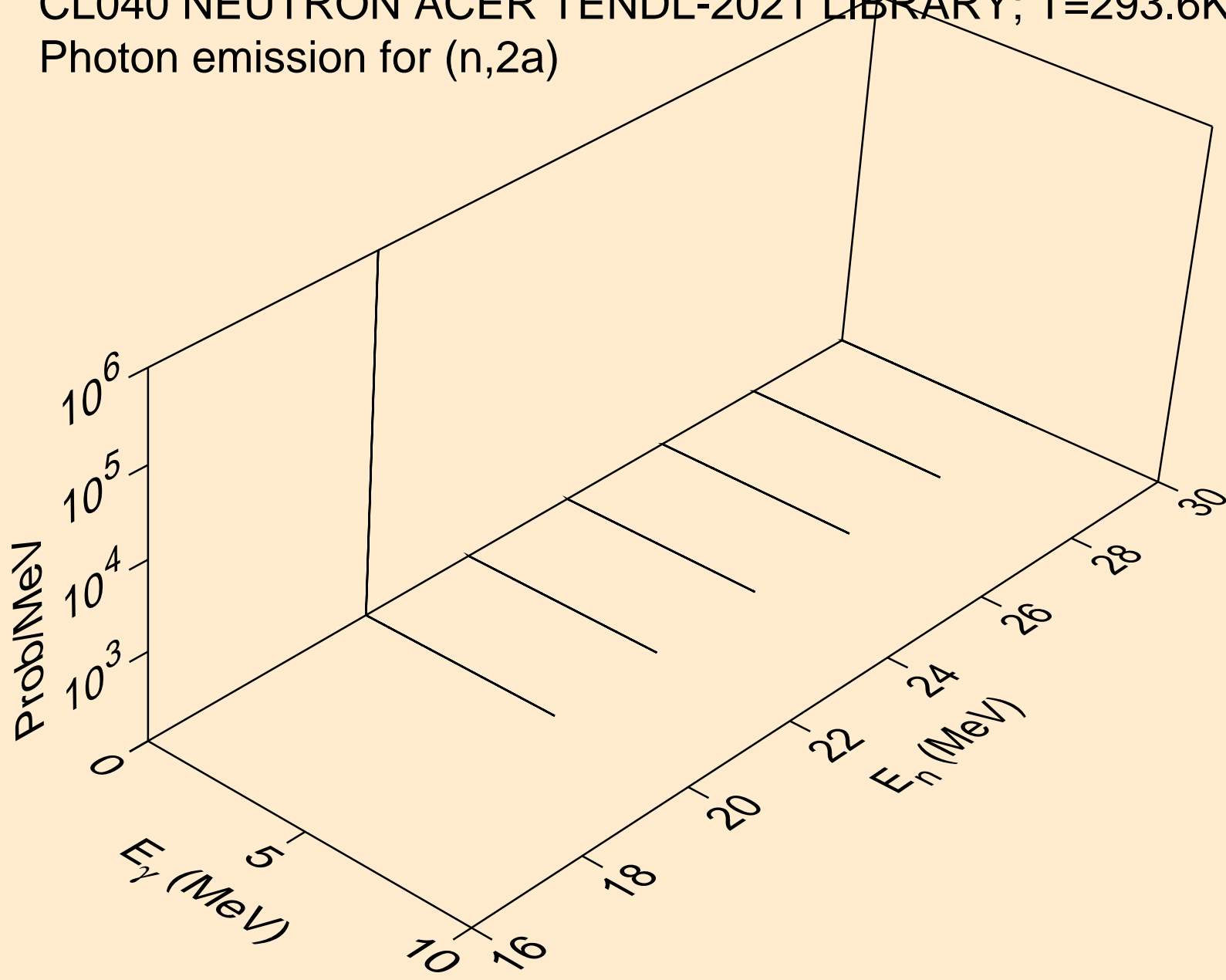

CL040 NEUTRON ACER TENDL-2021 LIBRARY; T=293.6K
Photon emission for (n,2p)

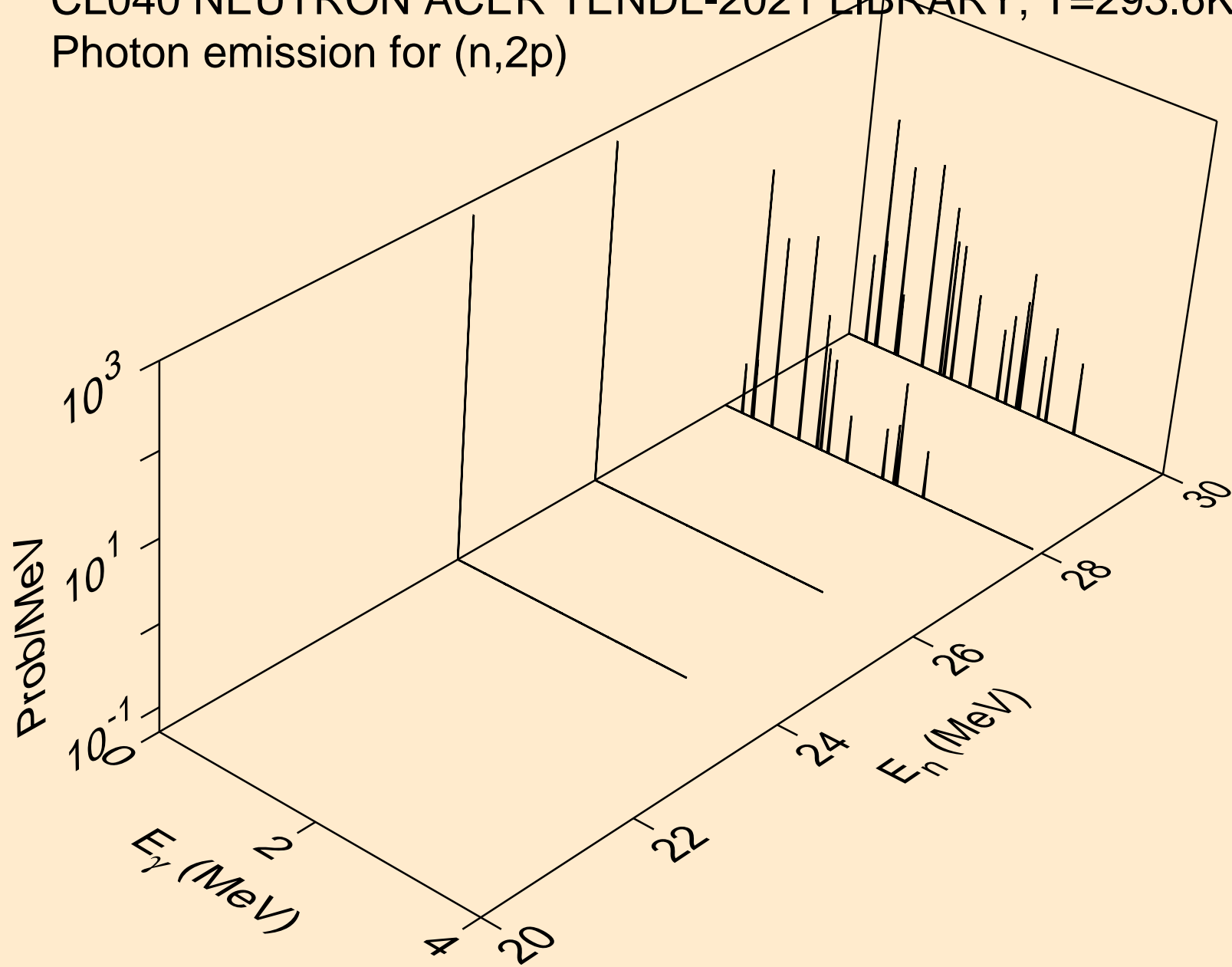

CL040 NEUTRON ACER TENDL-2021 LIBRARY; T=293.6K
Photon emission for (n,p)

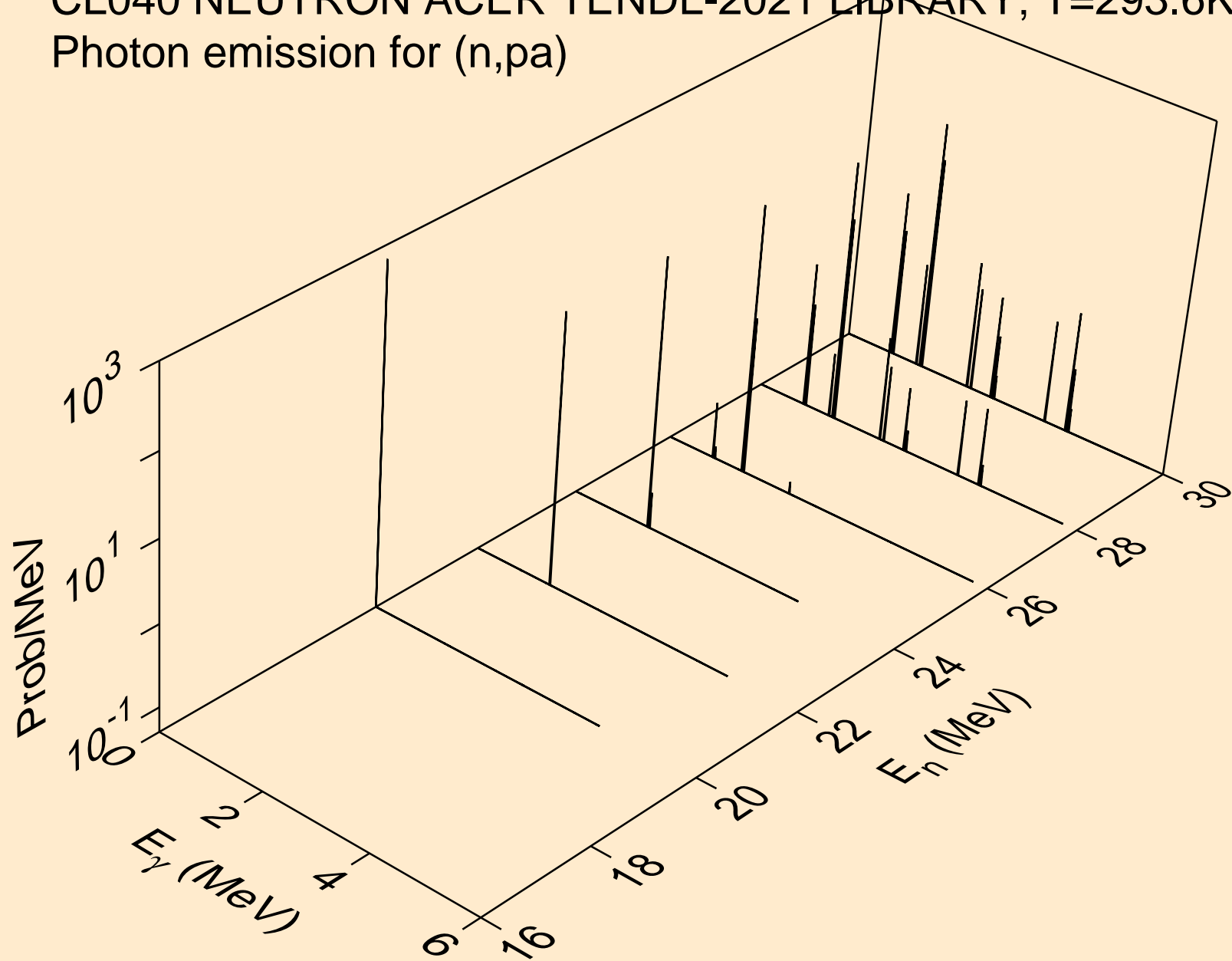

CL040 NEUTRON ACER TENDL-2021 LIBRARY; T=293.6K
Photon emission for (n,pt)

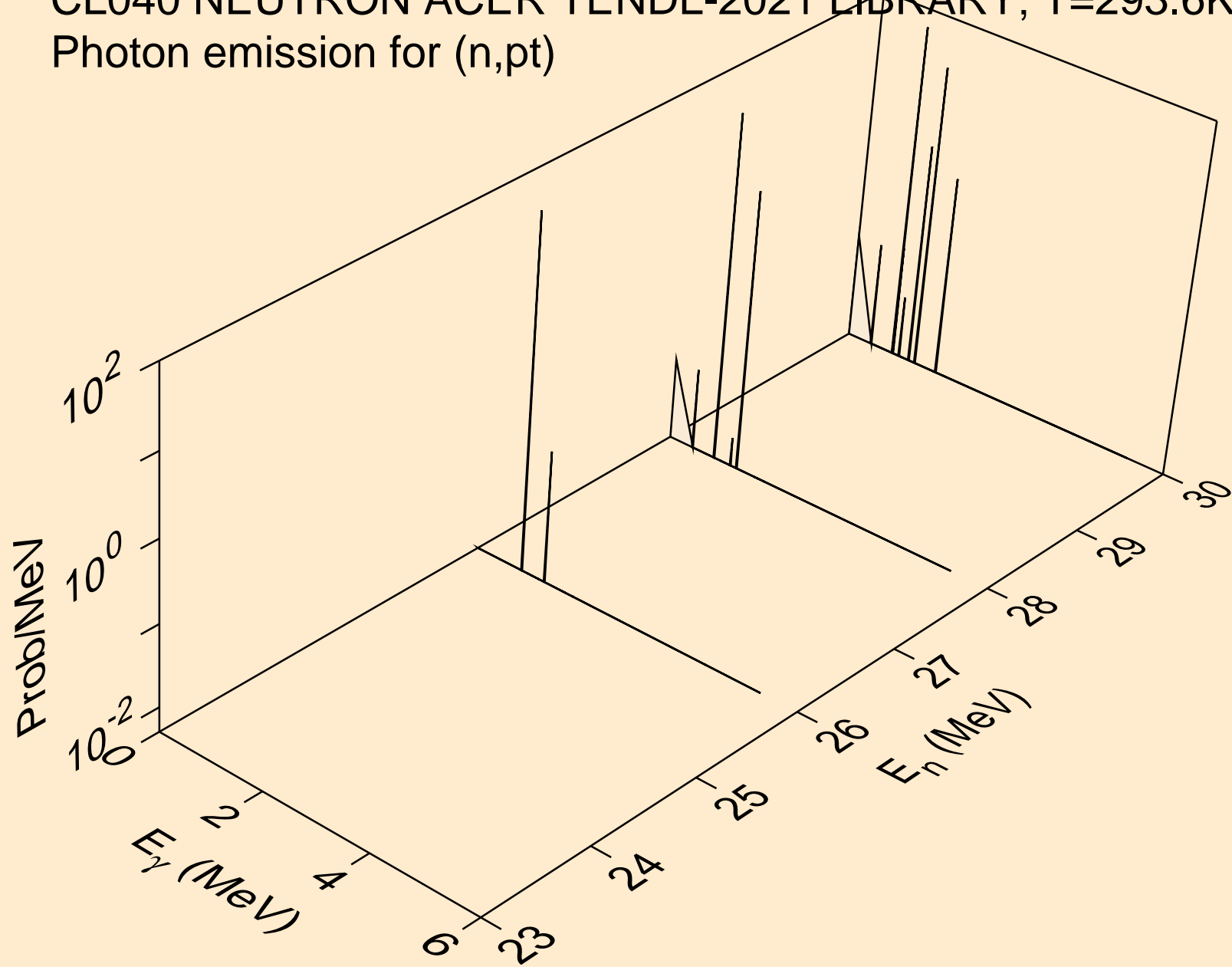

CL040 NEUTRON ACER TENDL-2021 LIBRARY; T=293.6K
Photon emission for (n,da)

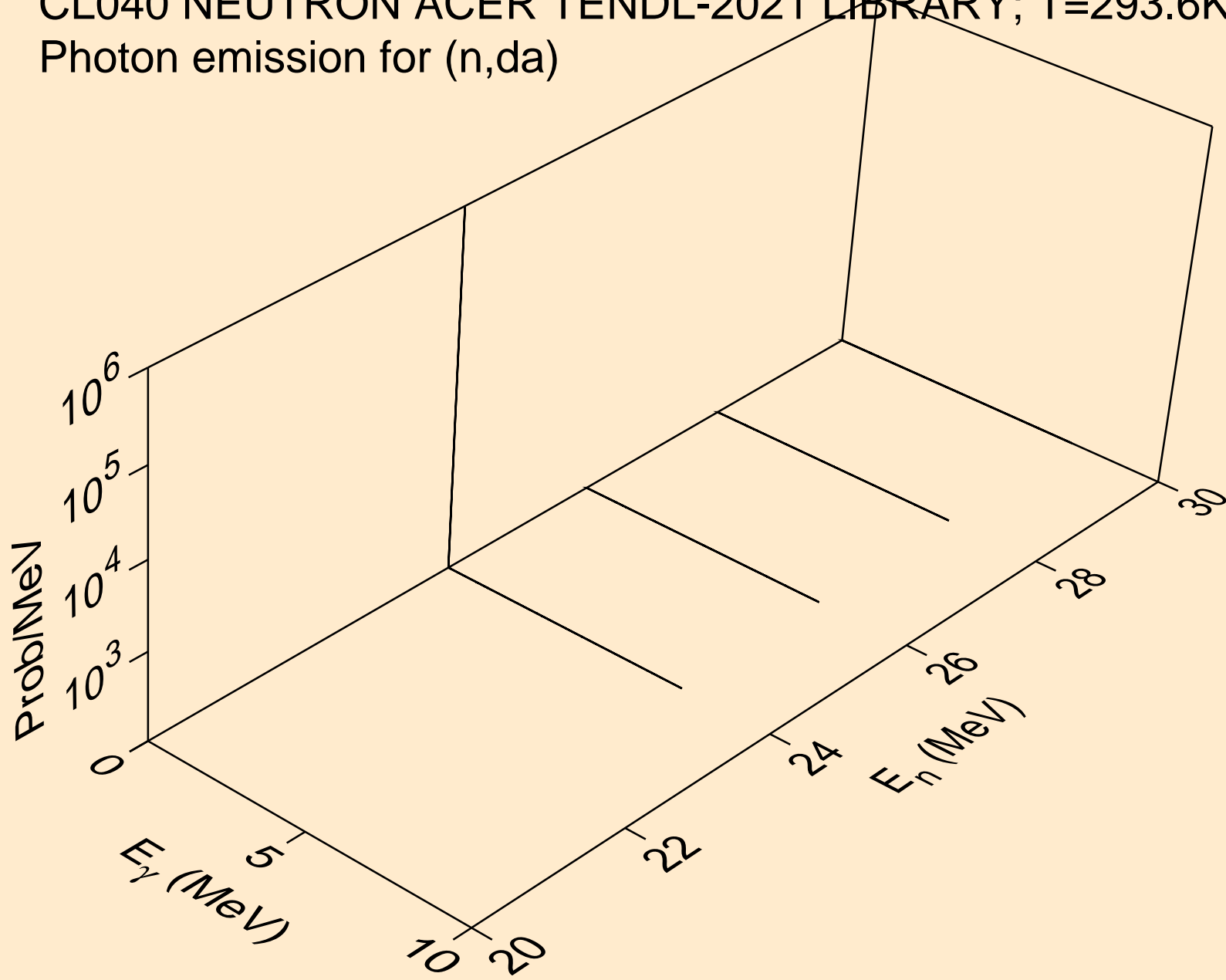

CL040 NEUTRON ACER TENDL-2021 LIBRARY; T=293.6K
thermal capture photon spectrum

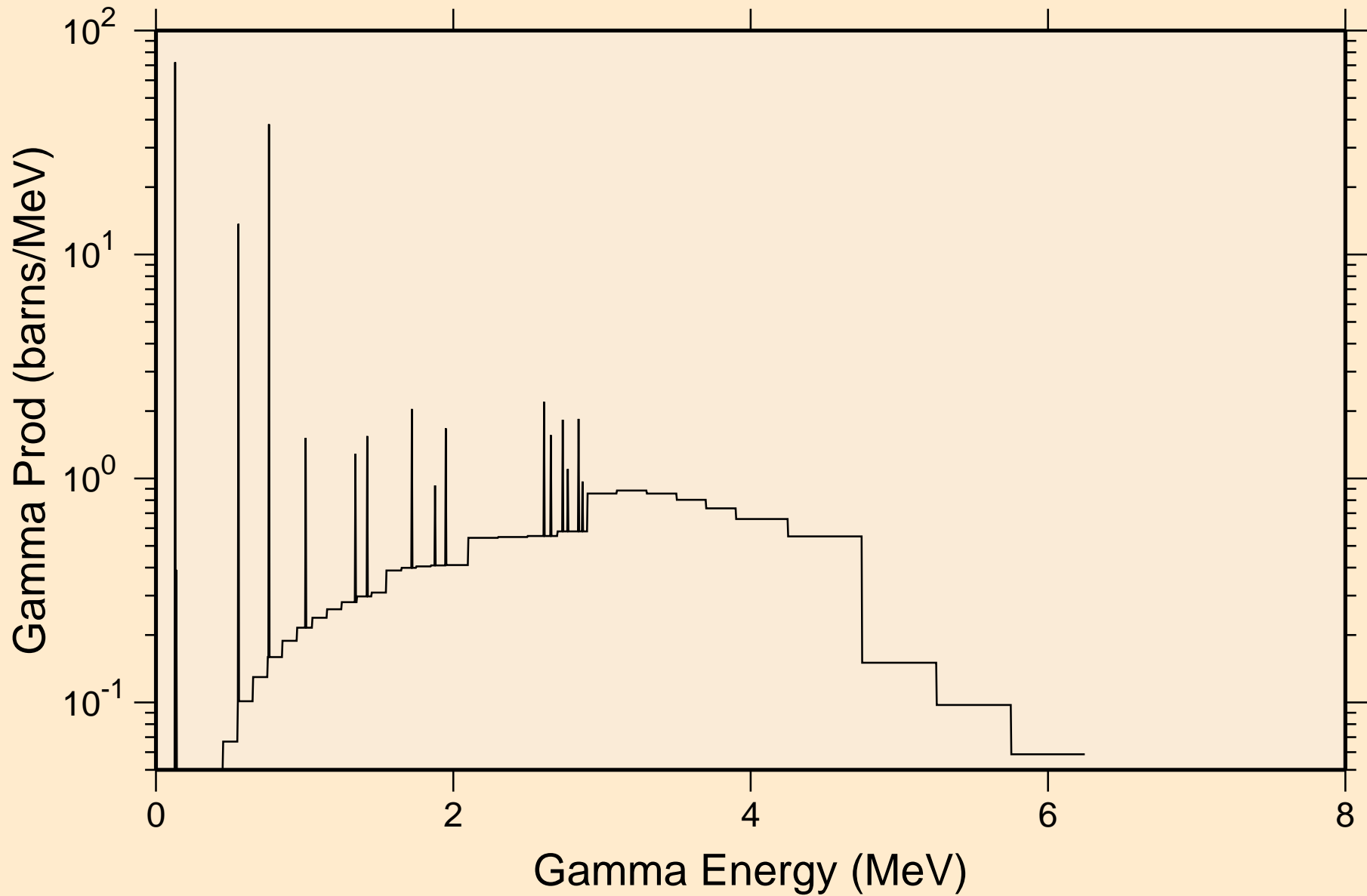

CL040 NEUTRON ACER TENDL-2021 LIBRARY; T=293.6K
14 MeV photon spectrum

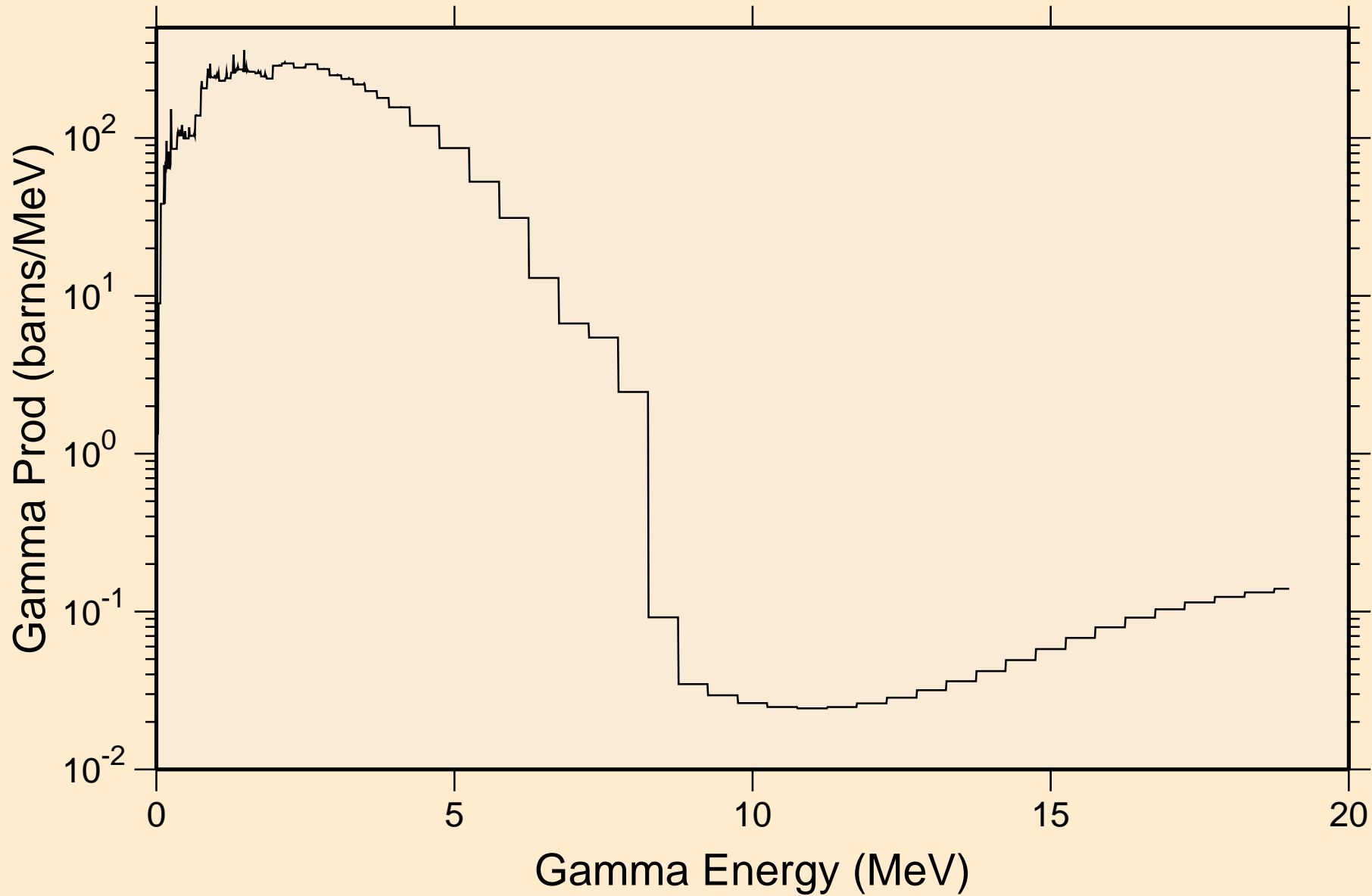

CL040 NEUTRON ACER TENDL-2021 LIBRARY; T=293.6K

Particle heating contributions

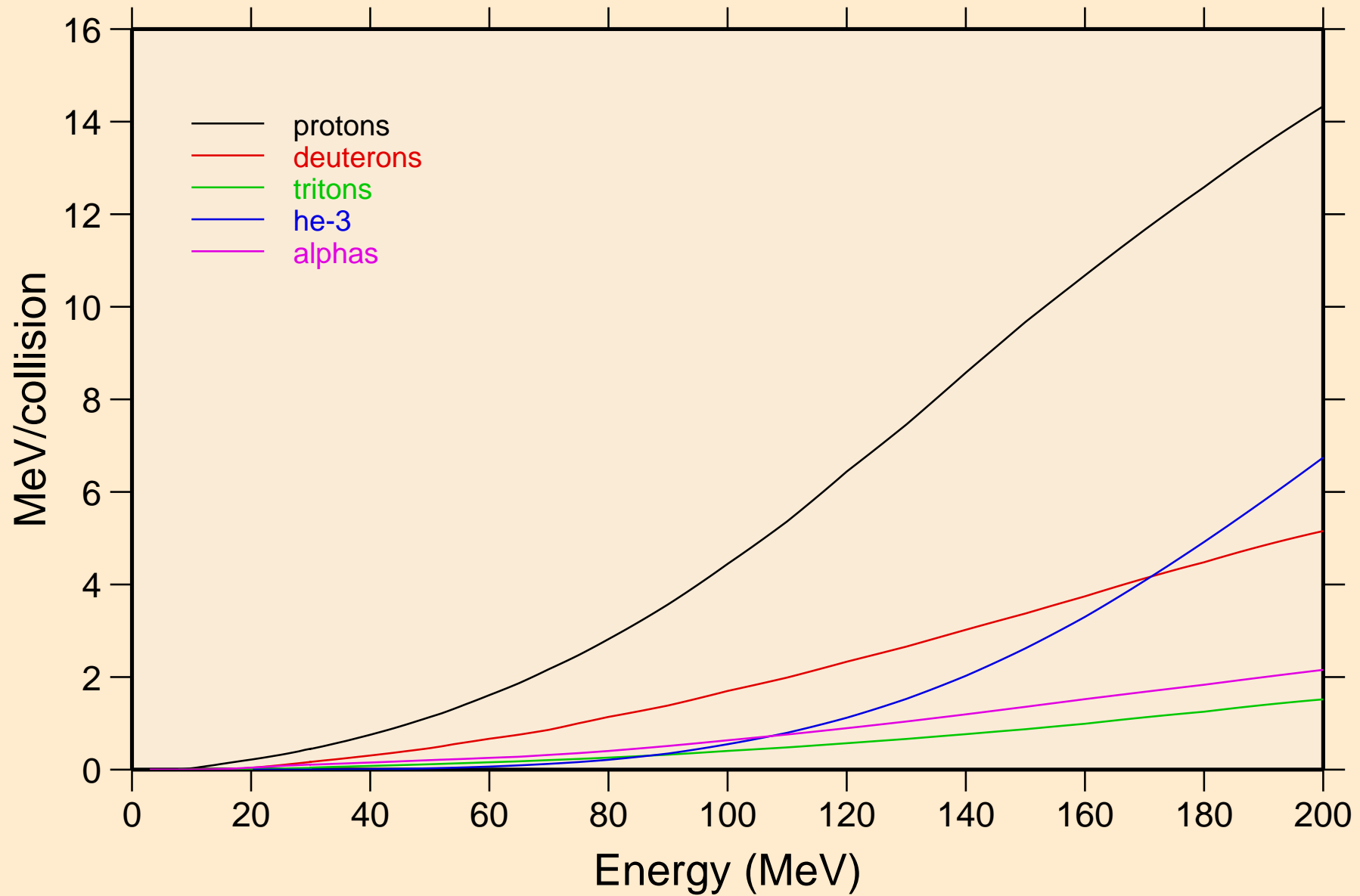

CL040 NEUTRON ACER TENDL-2021 LIBRARY; T=293.6K
Recoil Heating

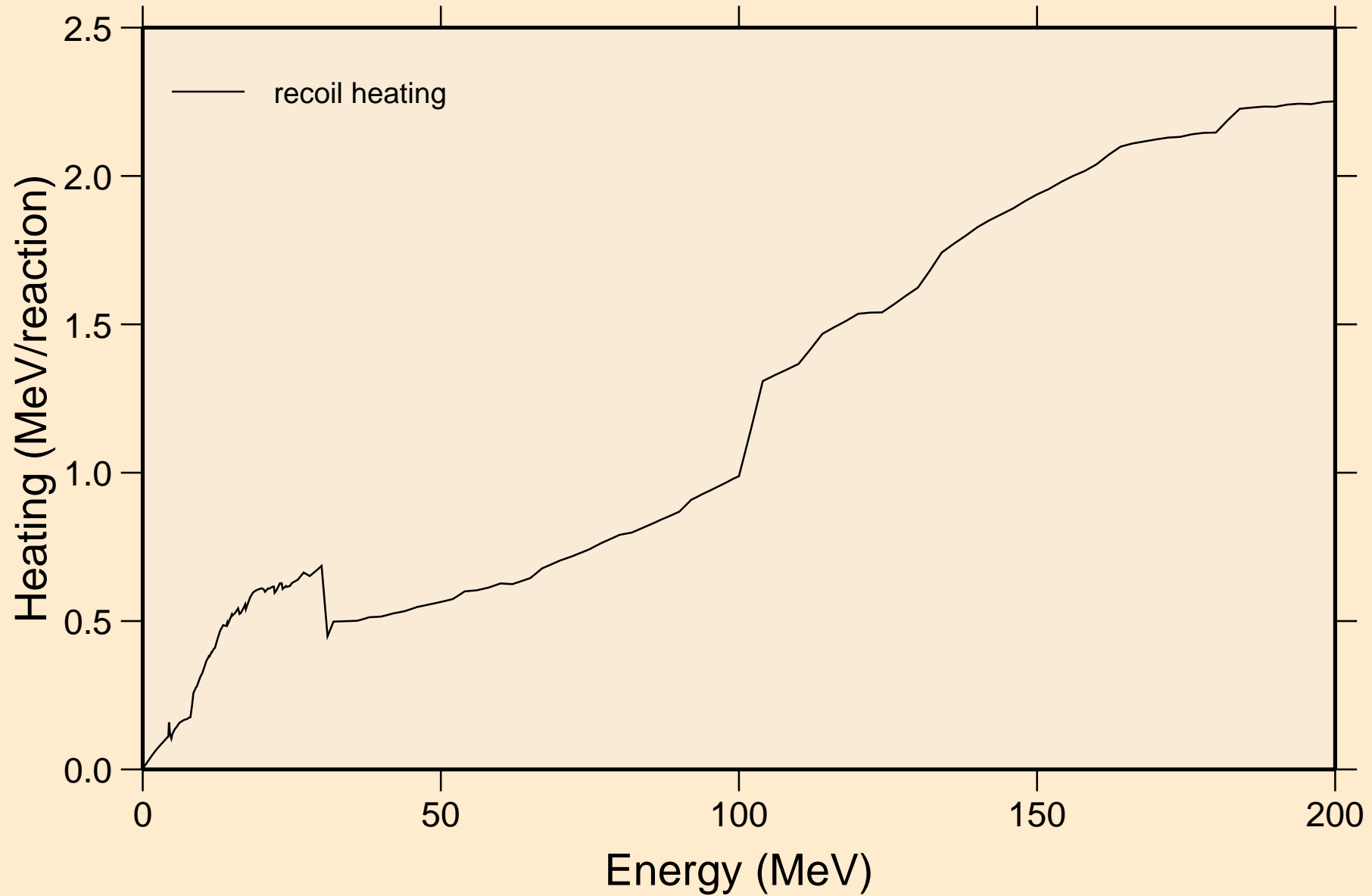

CL040 NEUTRON ACER TENDL-2021 LIBRARY; T=293.6K
Particle production cross sections

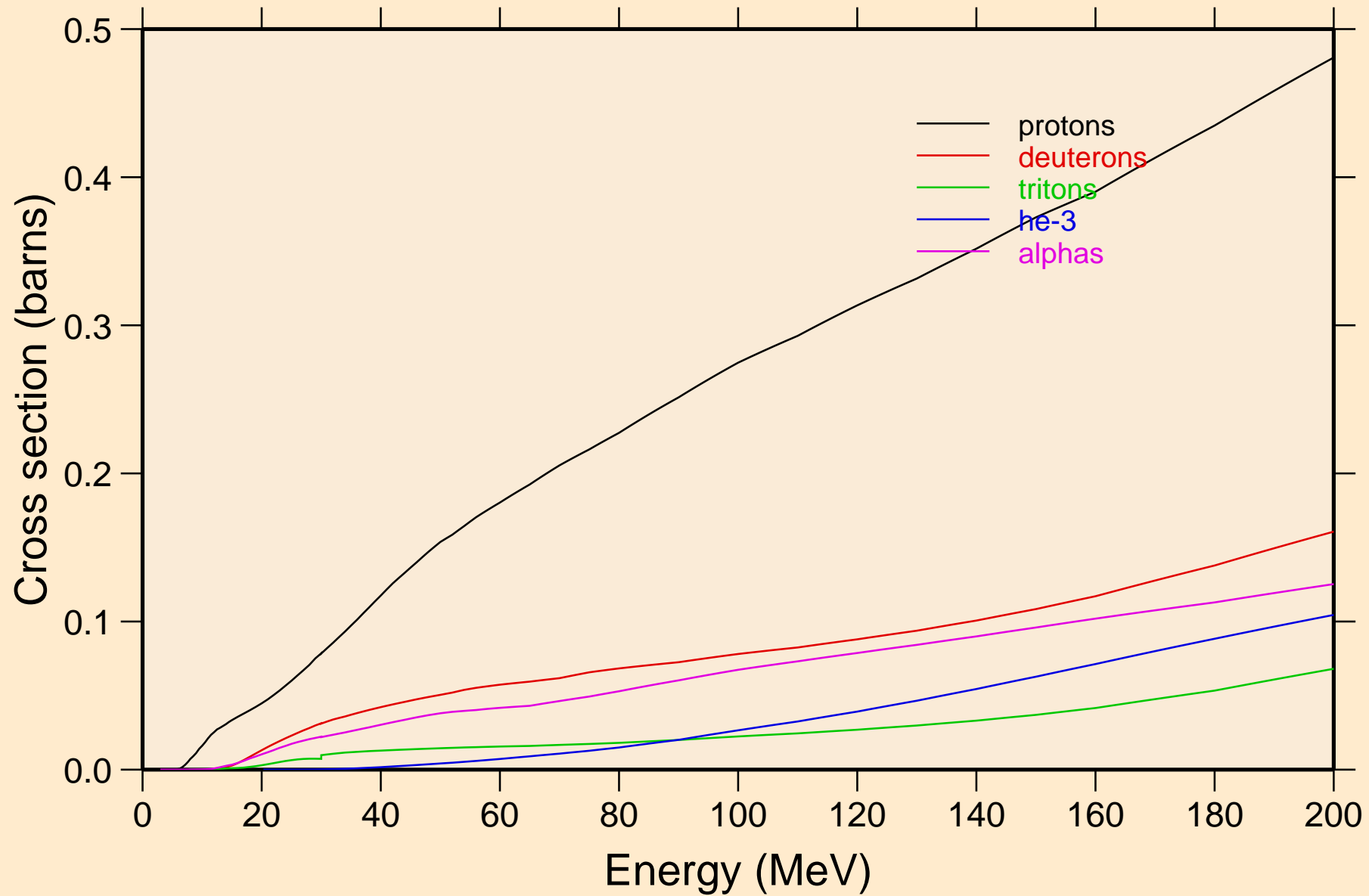

CL040 NEUTRON ACER TENDL-2021 LIBRARY; T=293.6K
protons from (n,x)

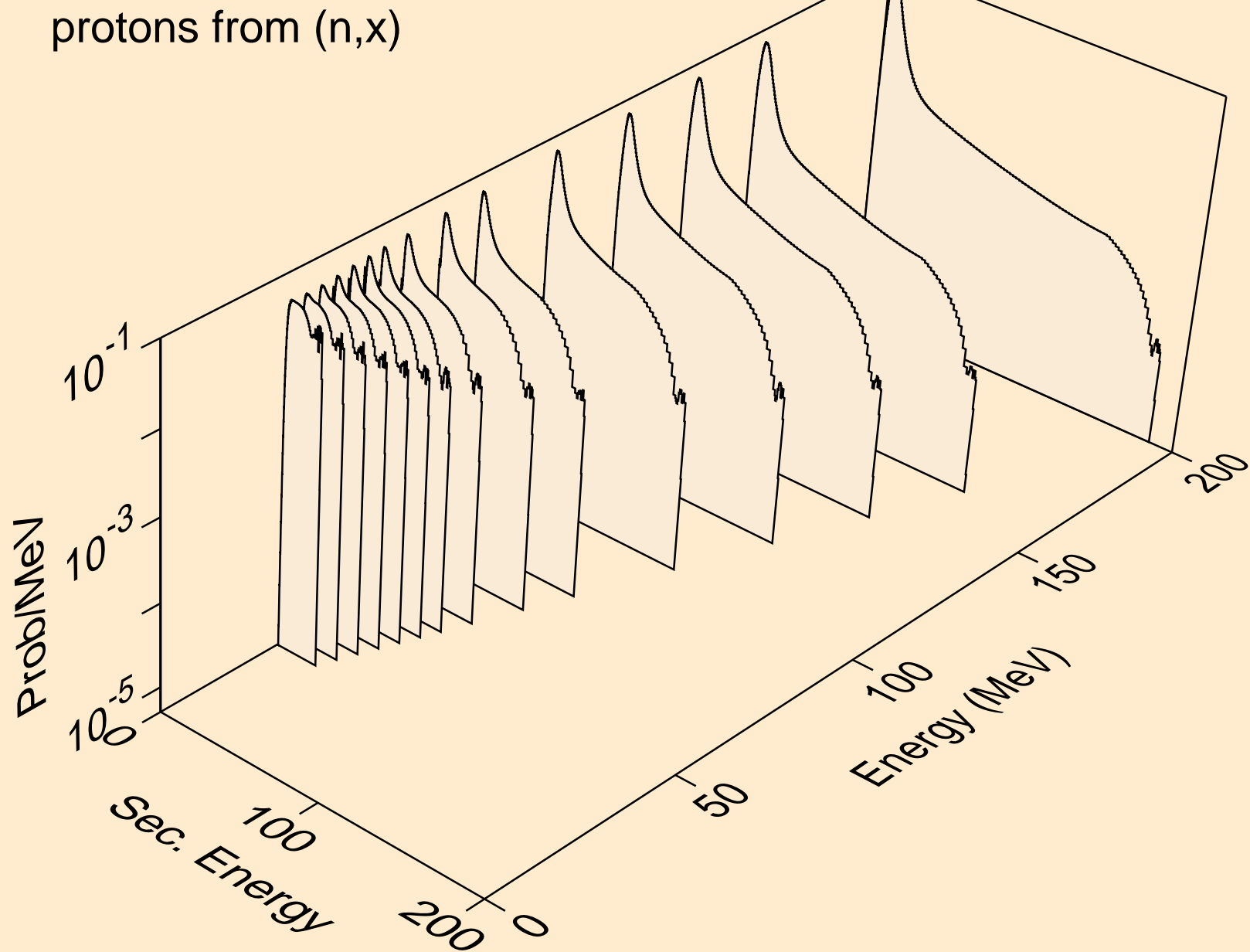

CL040 NEUTRON ACER TENDL-2021 LIBRARY; T=293.6K
protons from (n,n*)p

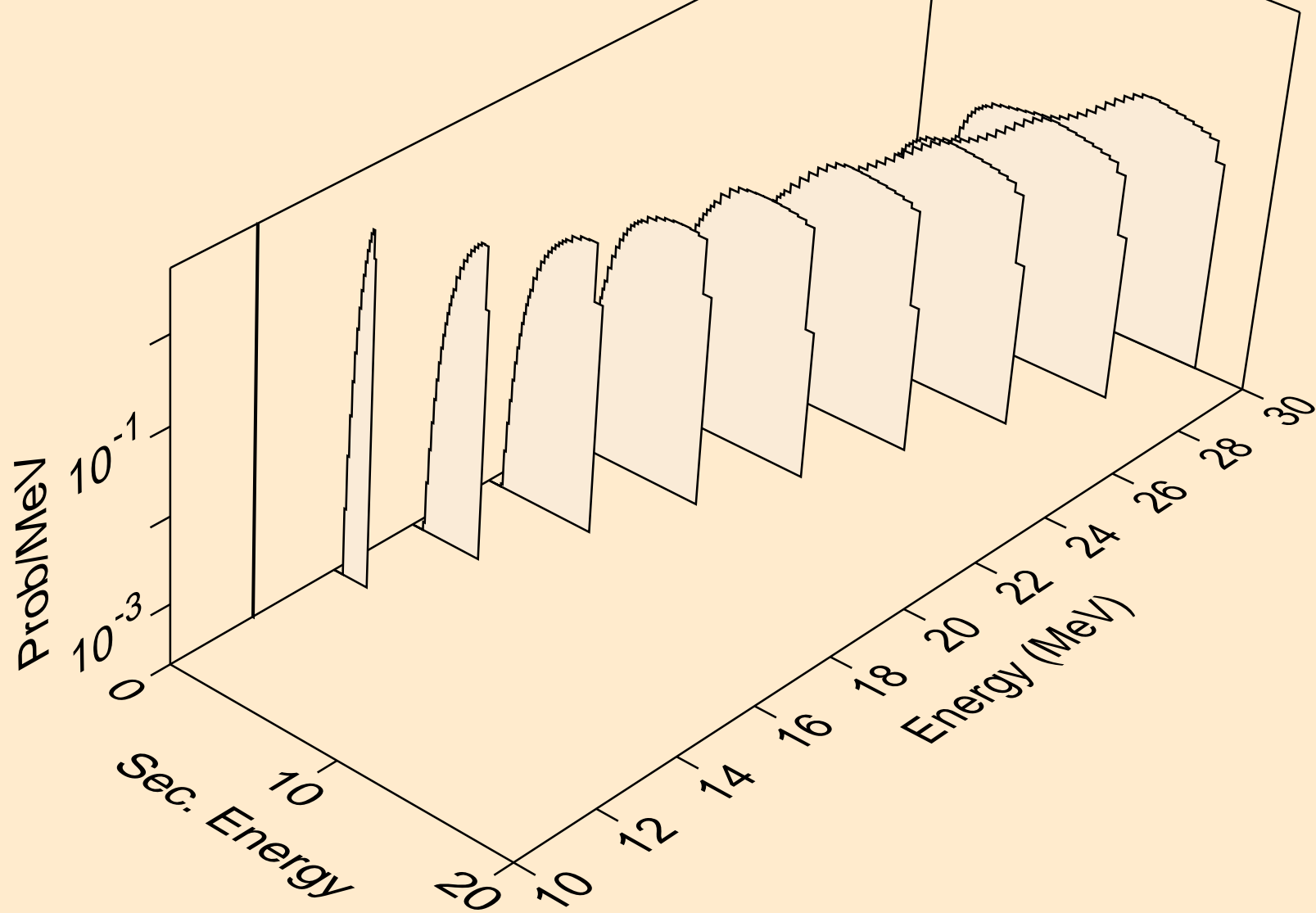

CL040 NEUTRON ACER TENDL-2021 LIBRARY; T=293.6K
protons from (n,2np)

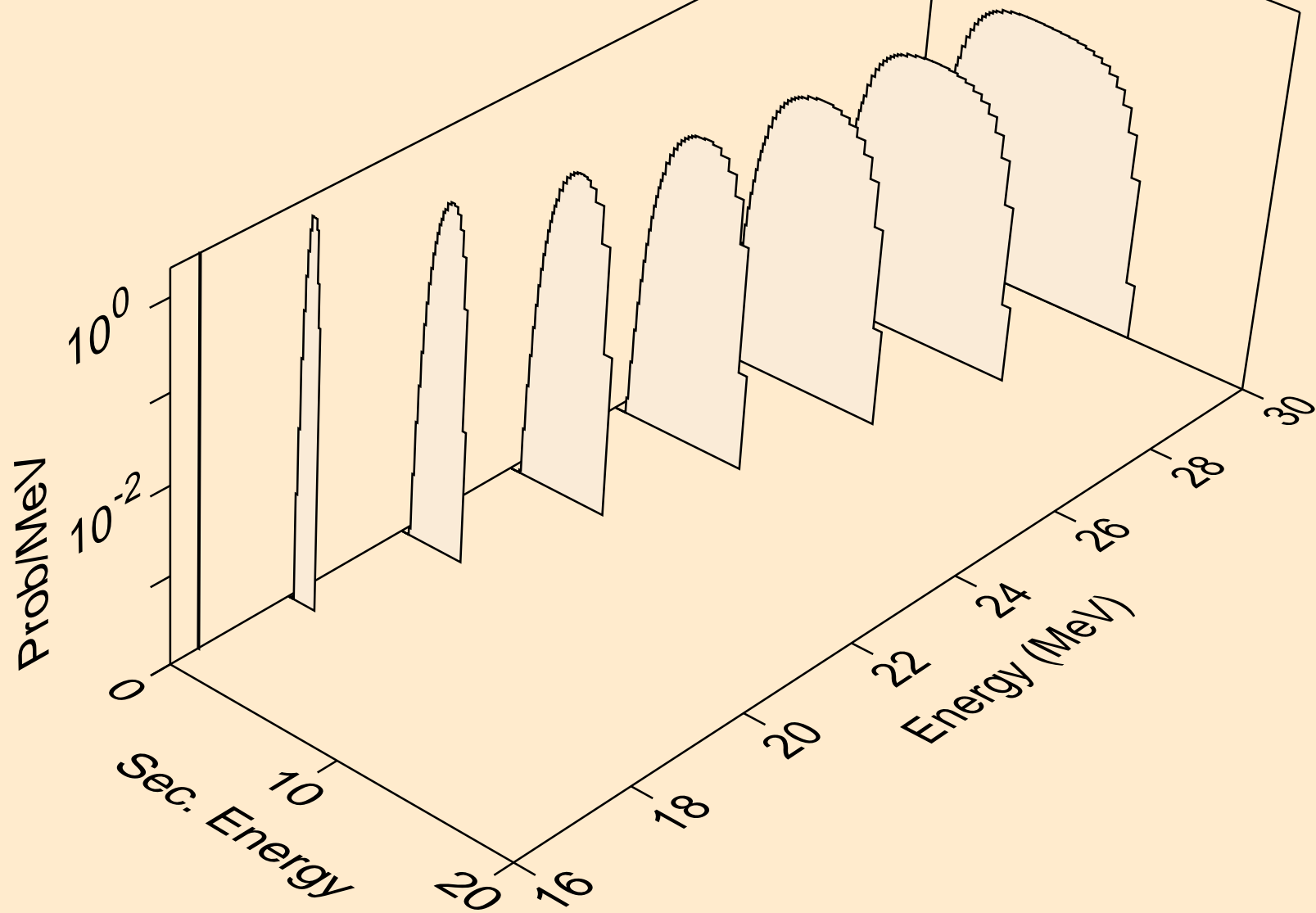

CL040 NEUTRON ACER TENDL-2021 LIBRARY; T=293.6K
protons from (n,3np)

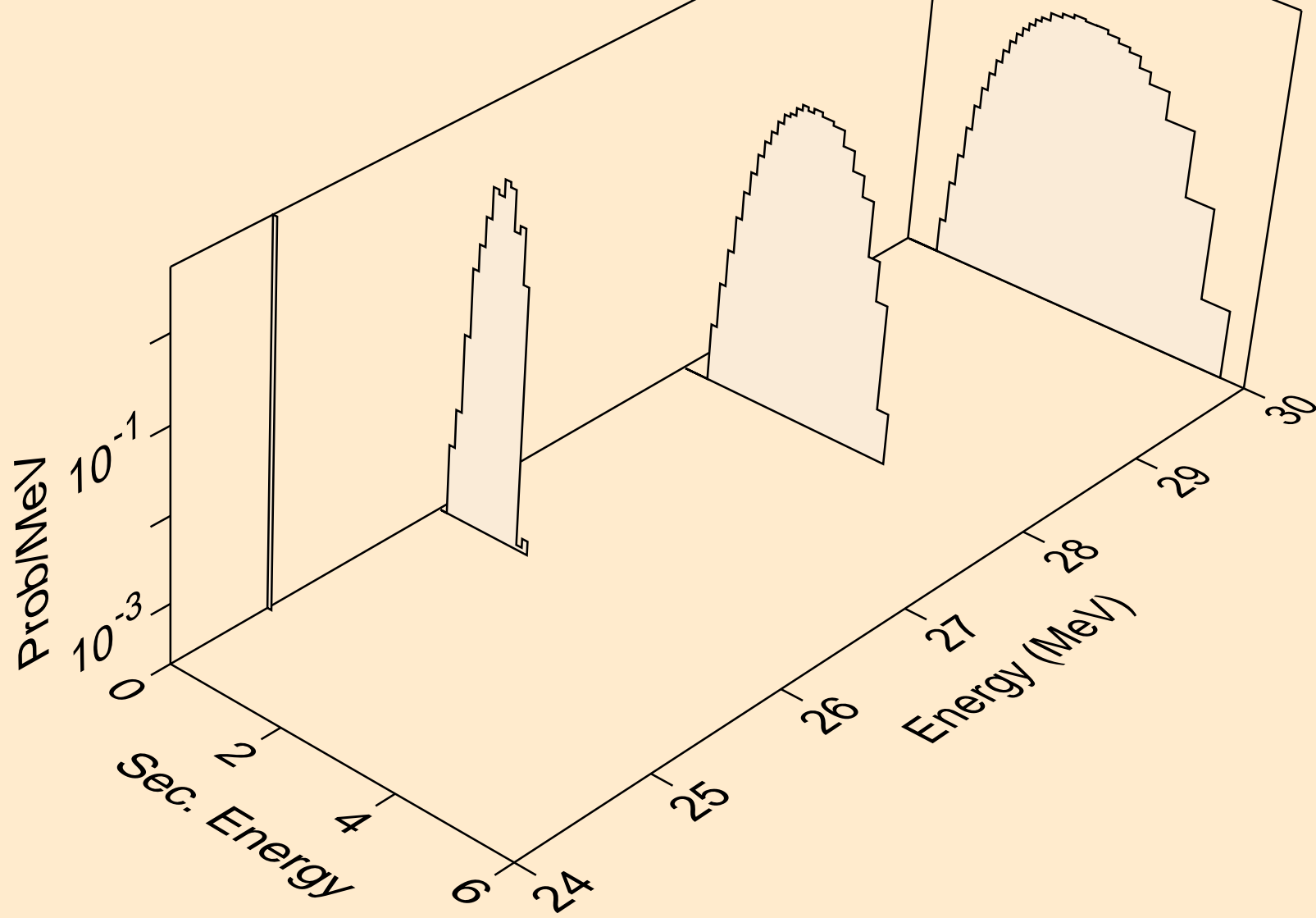

CL040 NEUTRON ACER TENDL-2021 LIBRARY; T=293.6K
protons from (n,npa)

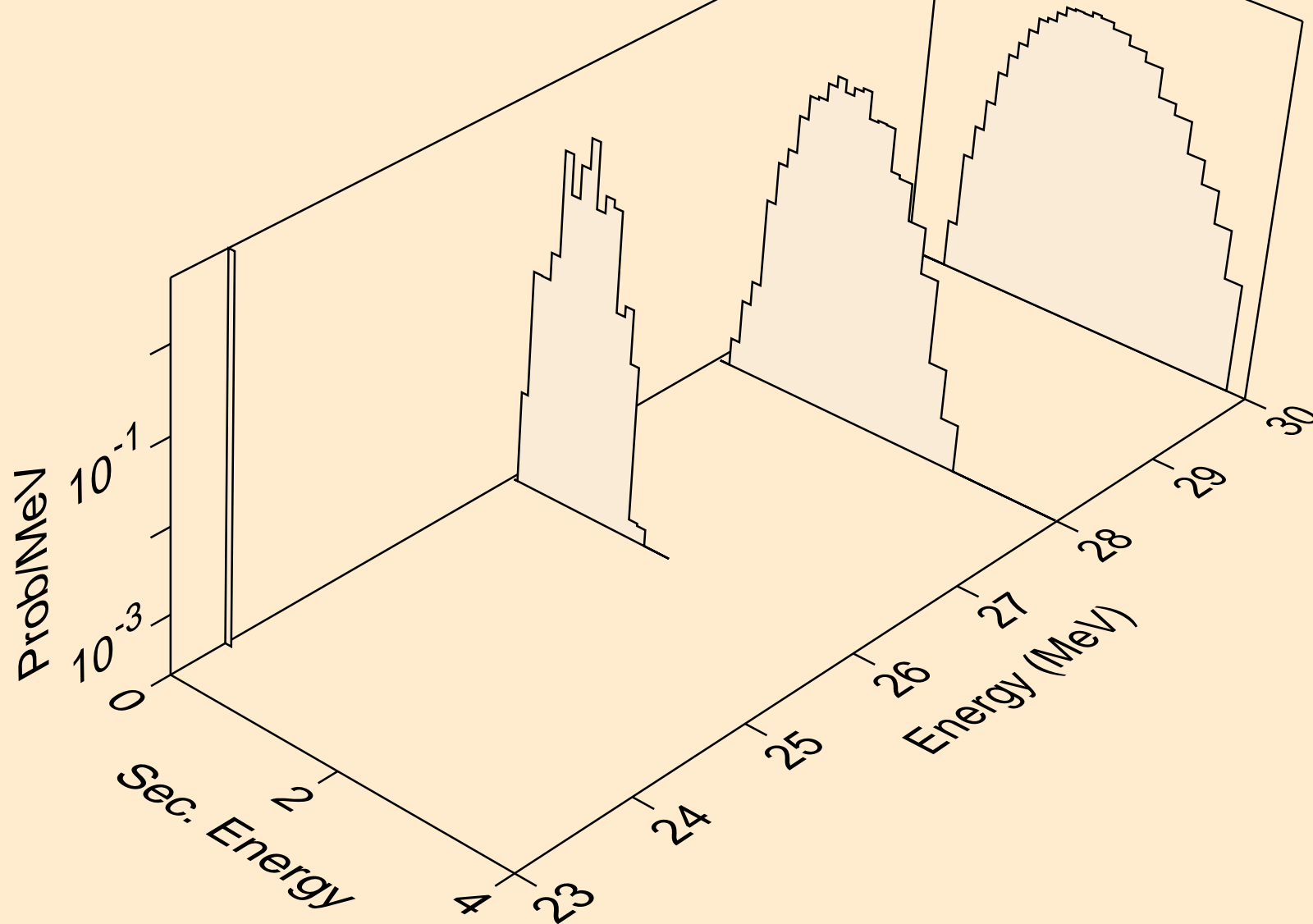

CL040 NEUTRON ACER TENDL-2021 LIBRARY; T=293.6K
protons from (n,p)

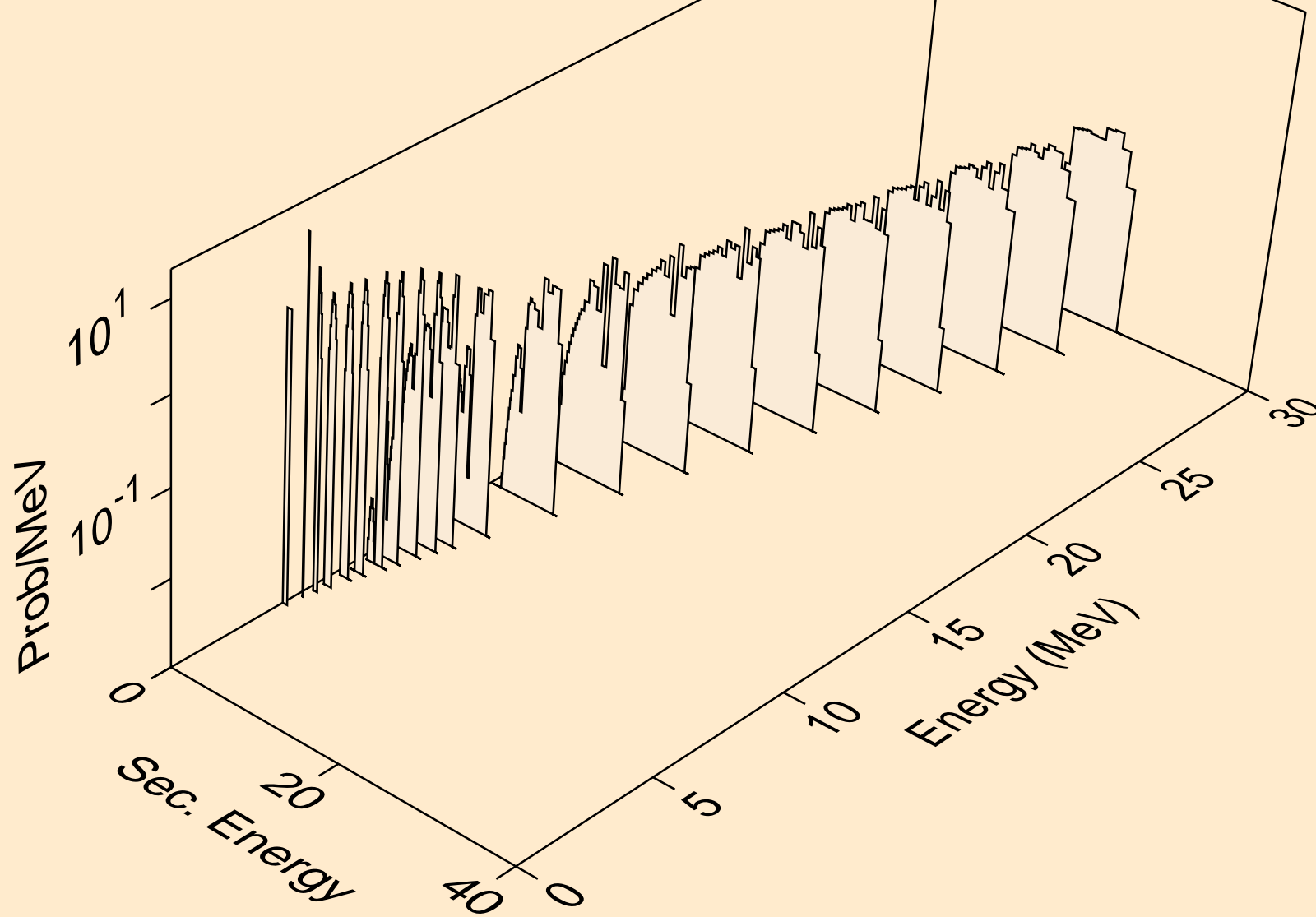

CL040 NEUTRON ACER TENDL-2021 LIBRARY; T=293.6K
protons from (n,2p)

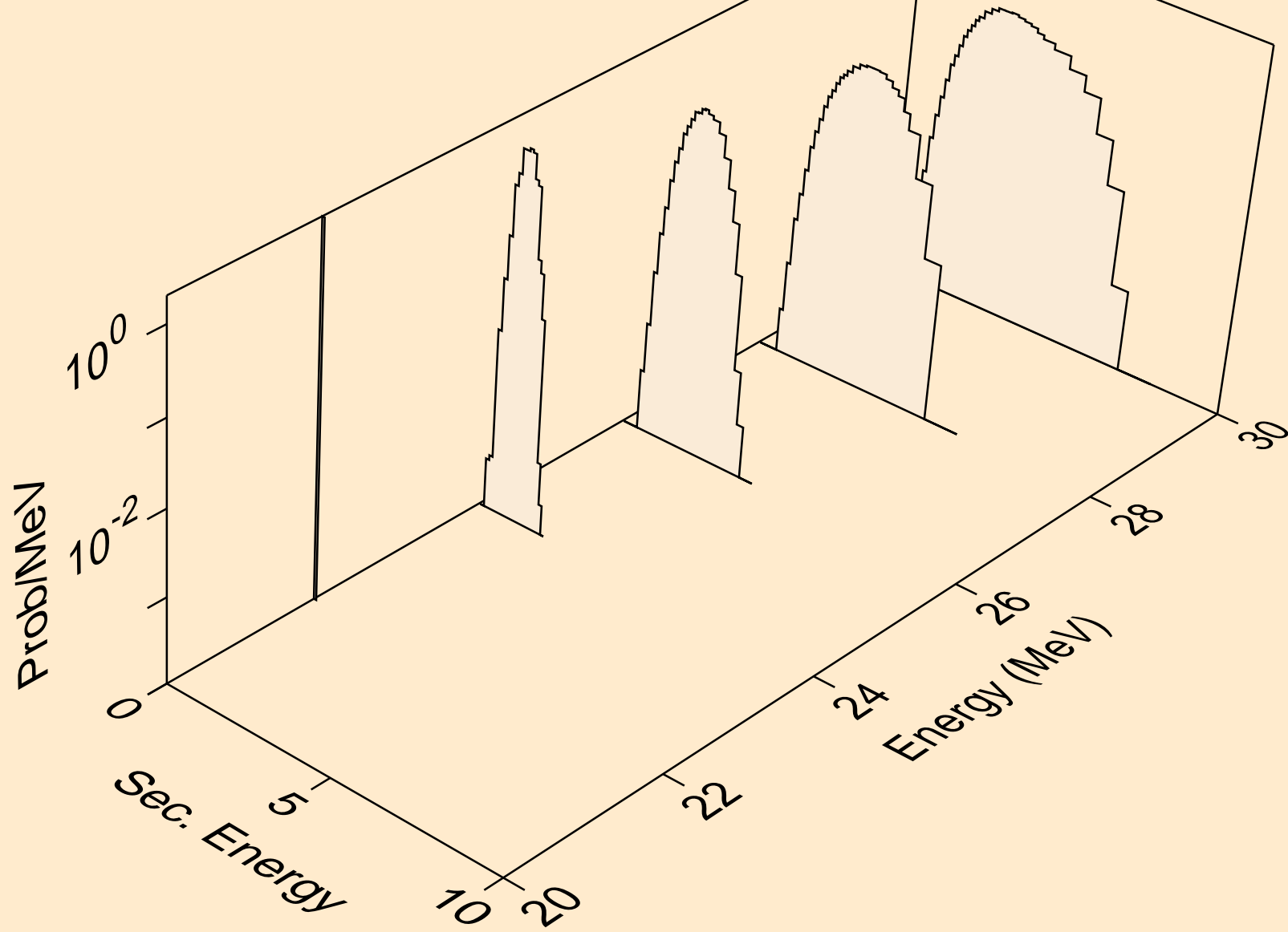

CL040 NEUTRON ACER TENDL-2021 LIBRARY; T=293.6K
protons from (n,p)

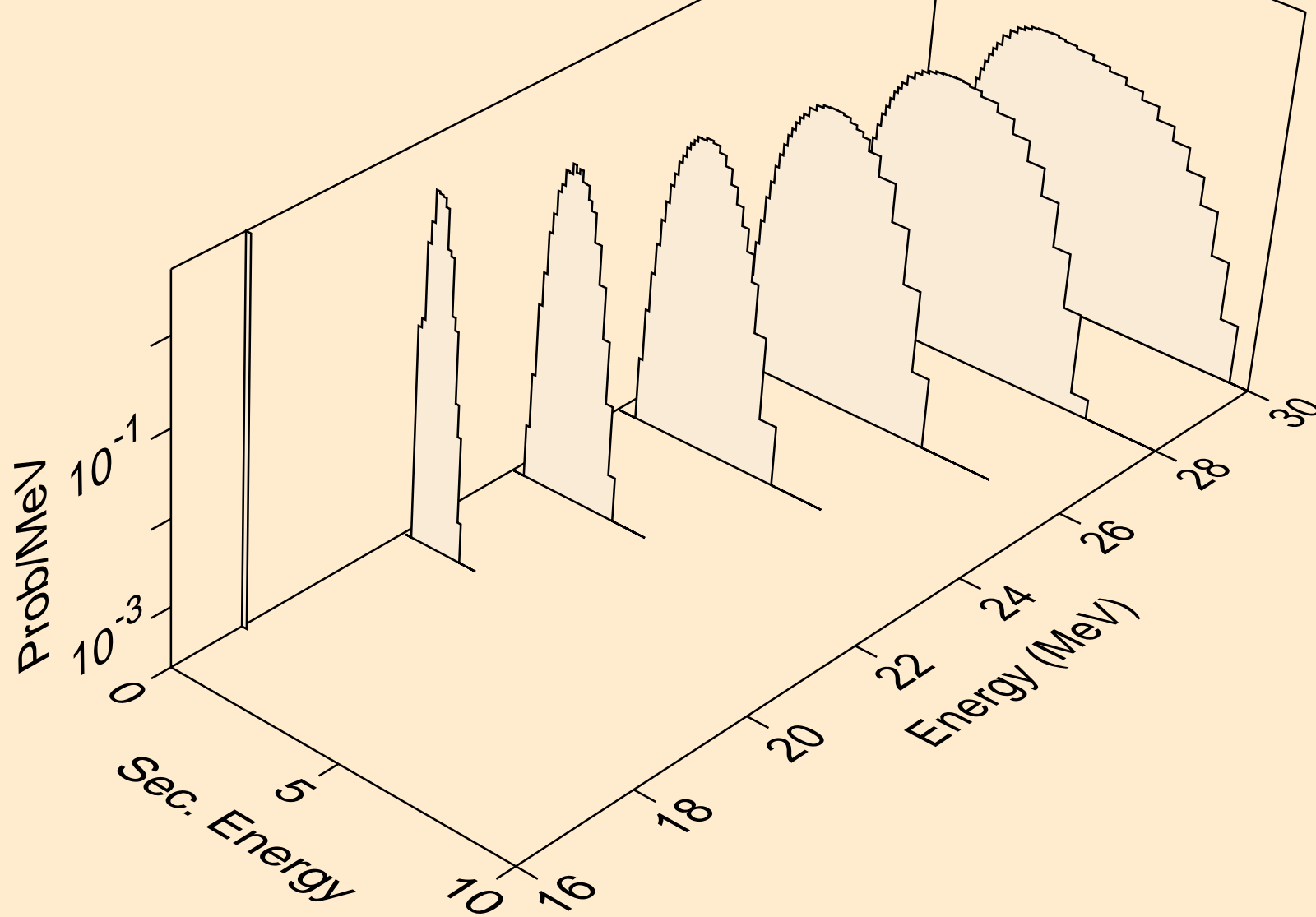

CL040 NEUTRON ACER TENDL-2021 LIBRARY; T=293.6K
protons from (n,pt)

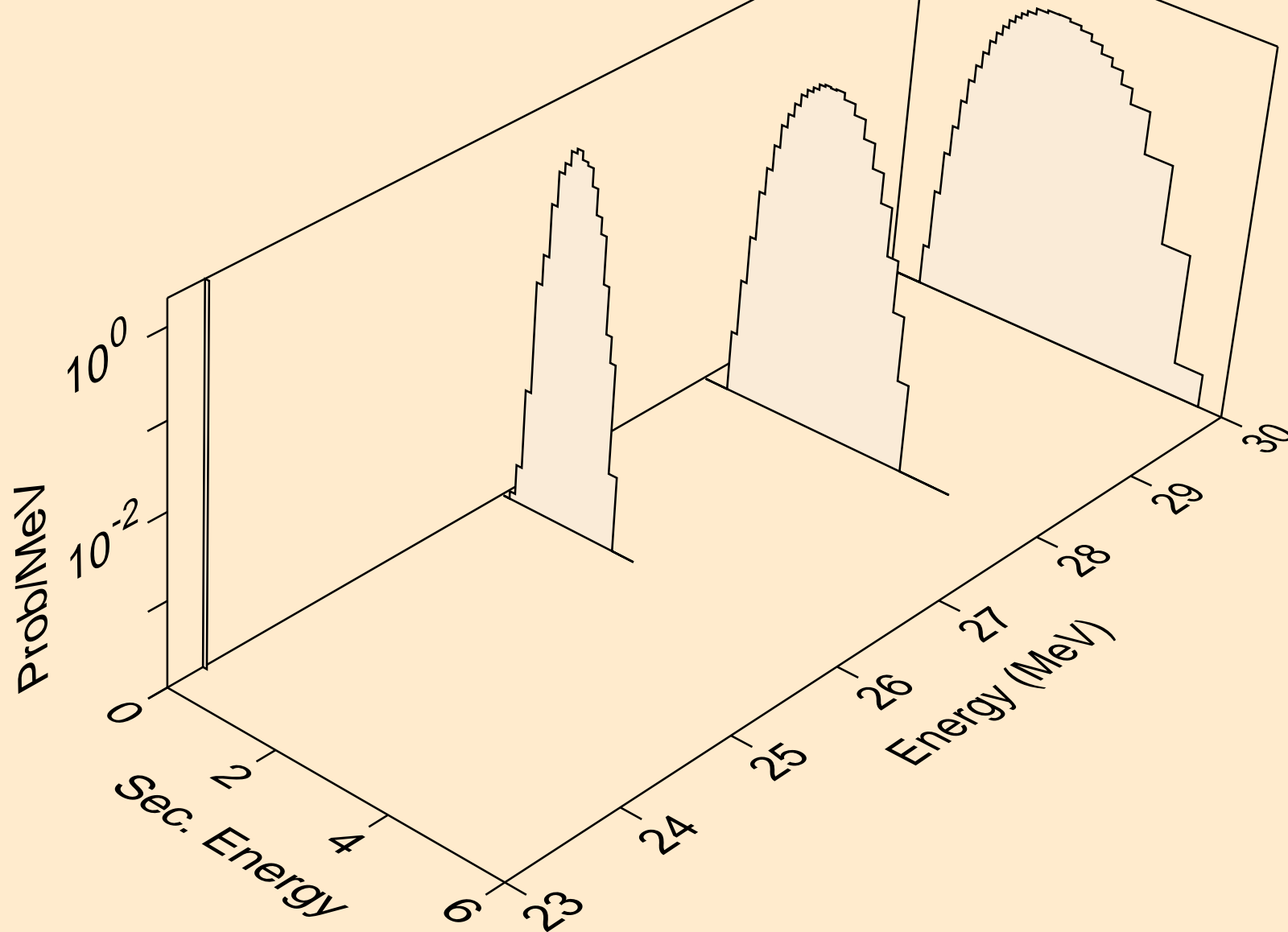

CL040 NEUTRON ACER TENDL-2021 LIBRARY; T=293.6K
deuterons from (n,x)

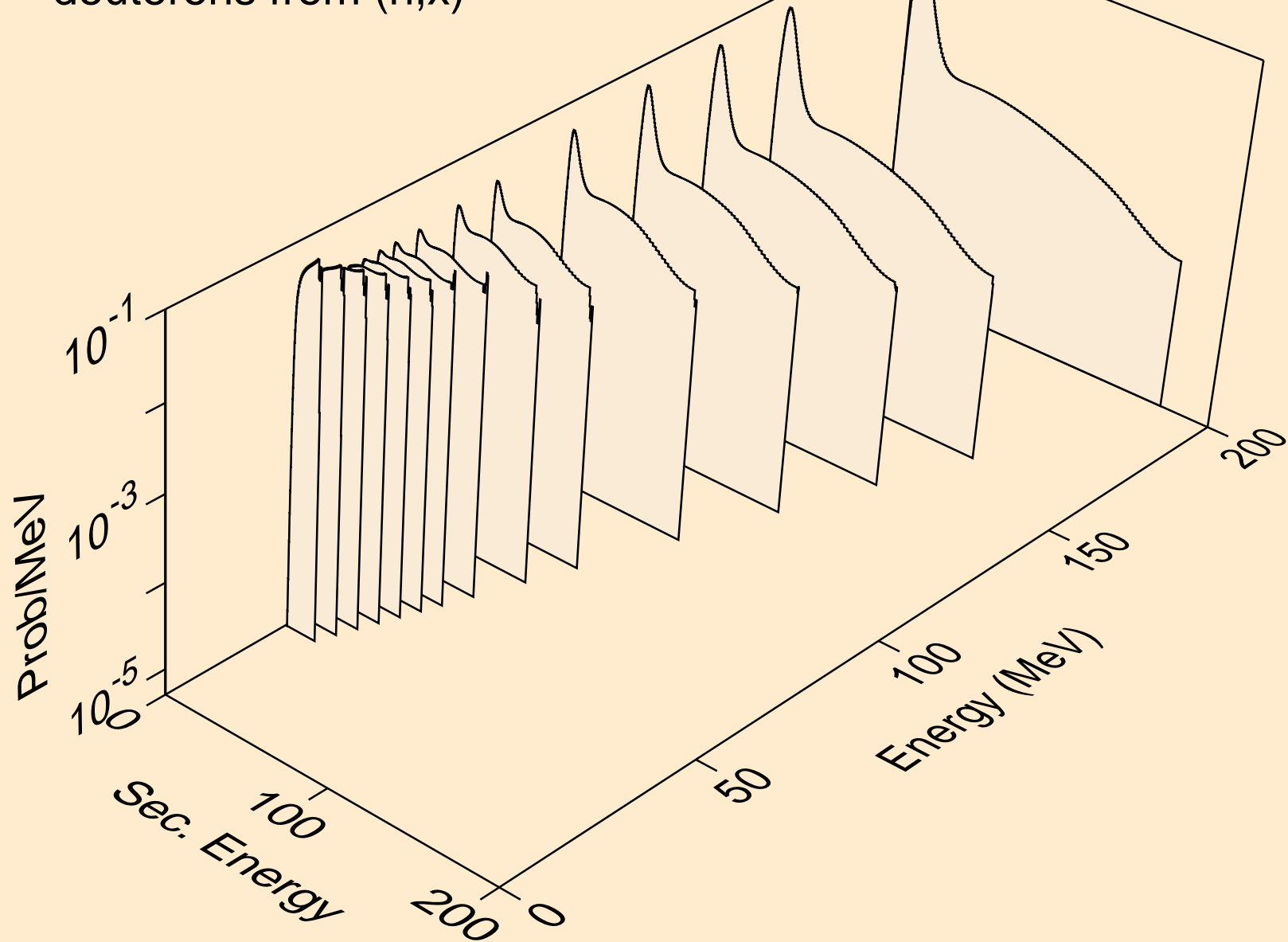

CL040 NEUTRON ACER TENDL-2021 LIBRARY; T=293.6K
deuterons from (n,2nd)

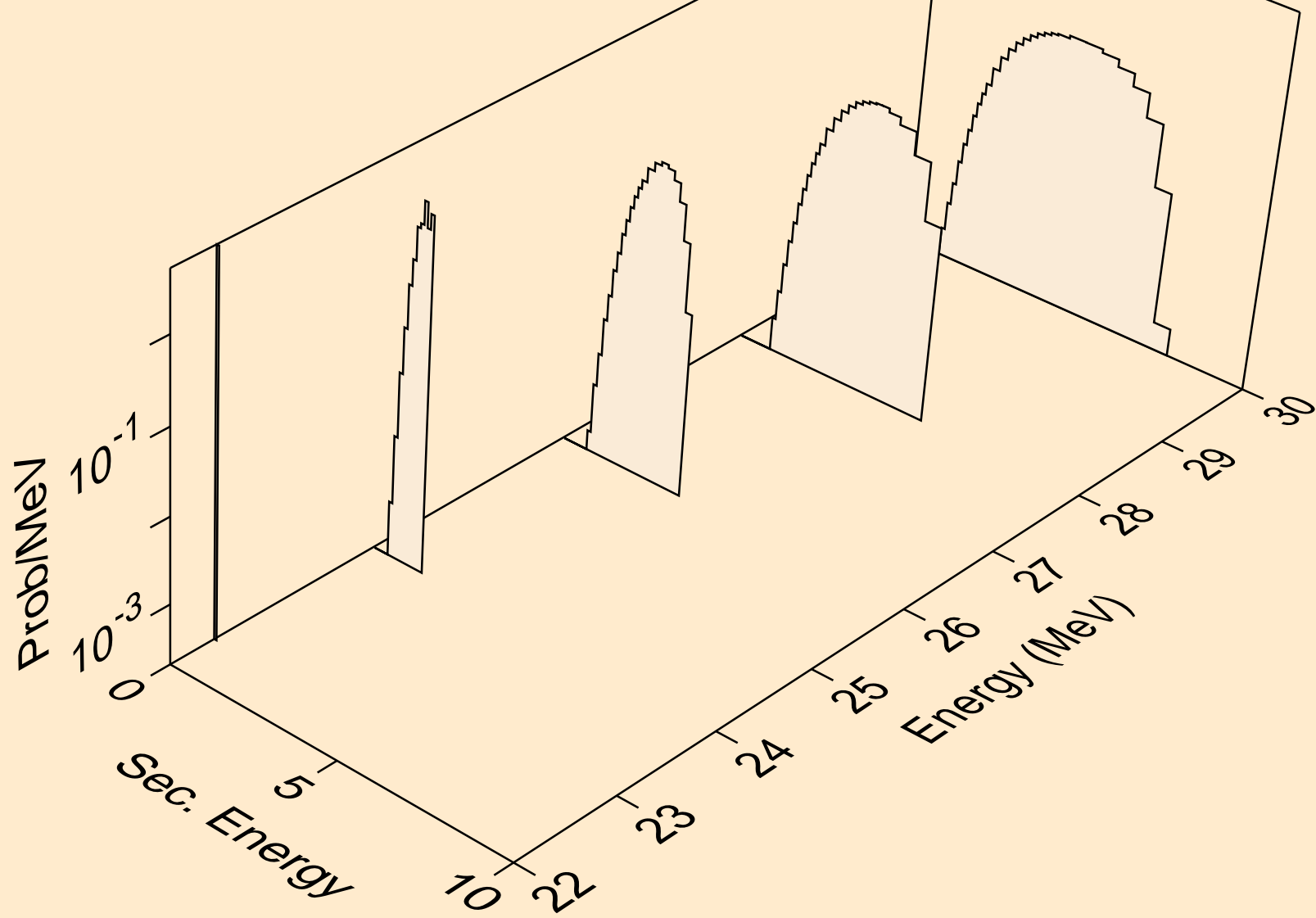

CL040 NEUTRON ACER TENDL-2021 LIBRARY; T=293.6K
deuterons from (n,n*)d

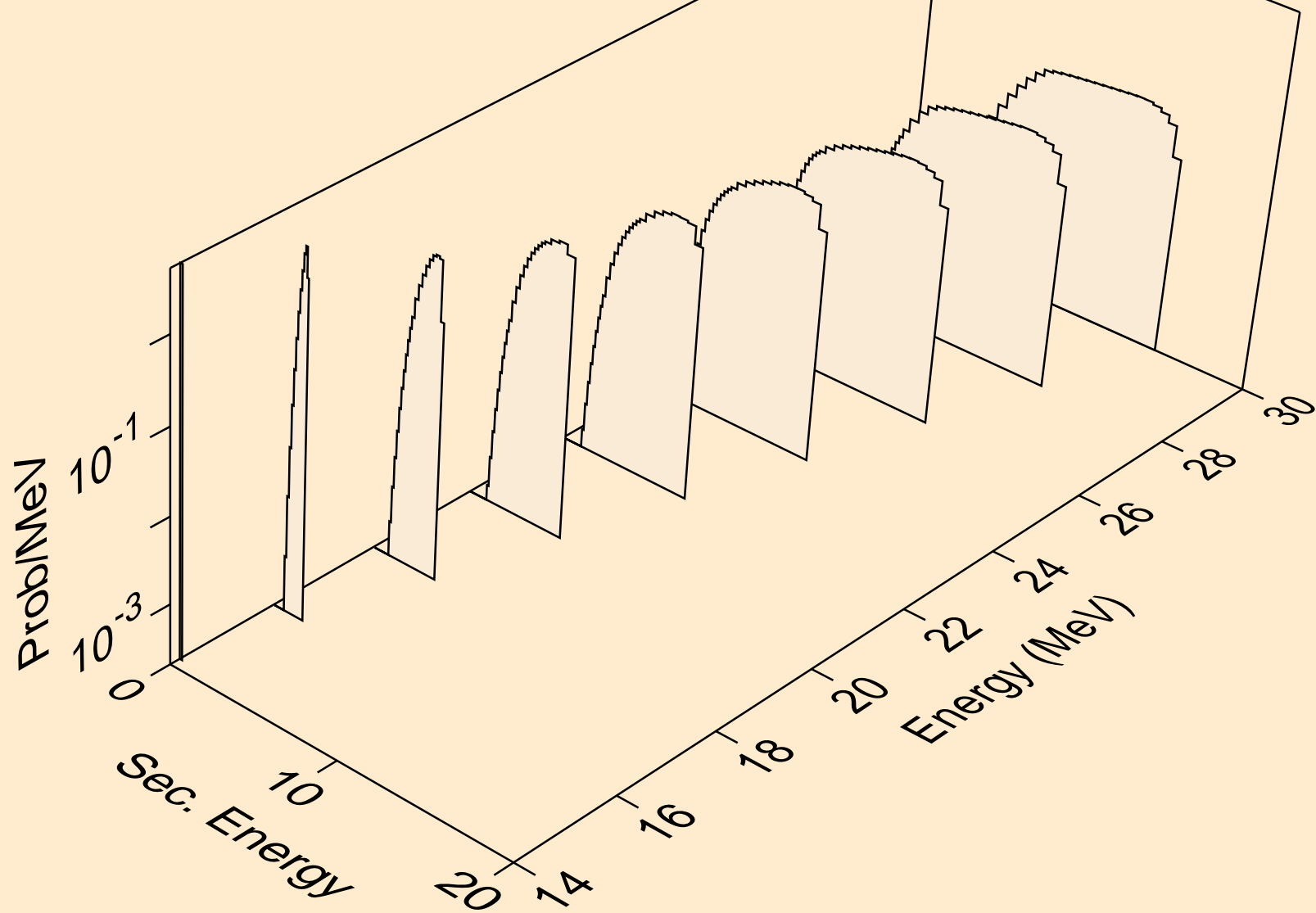

CL040 NEUTRON ACER TENDL-2021 LIBRARY; T=293.6K
deuterons from (n,d)

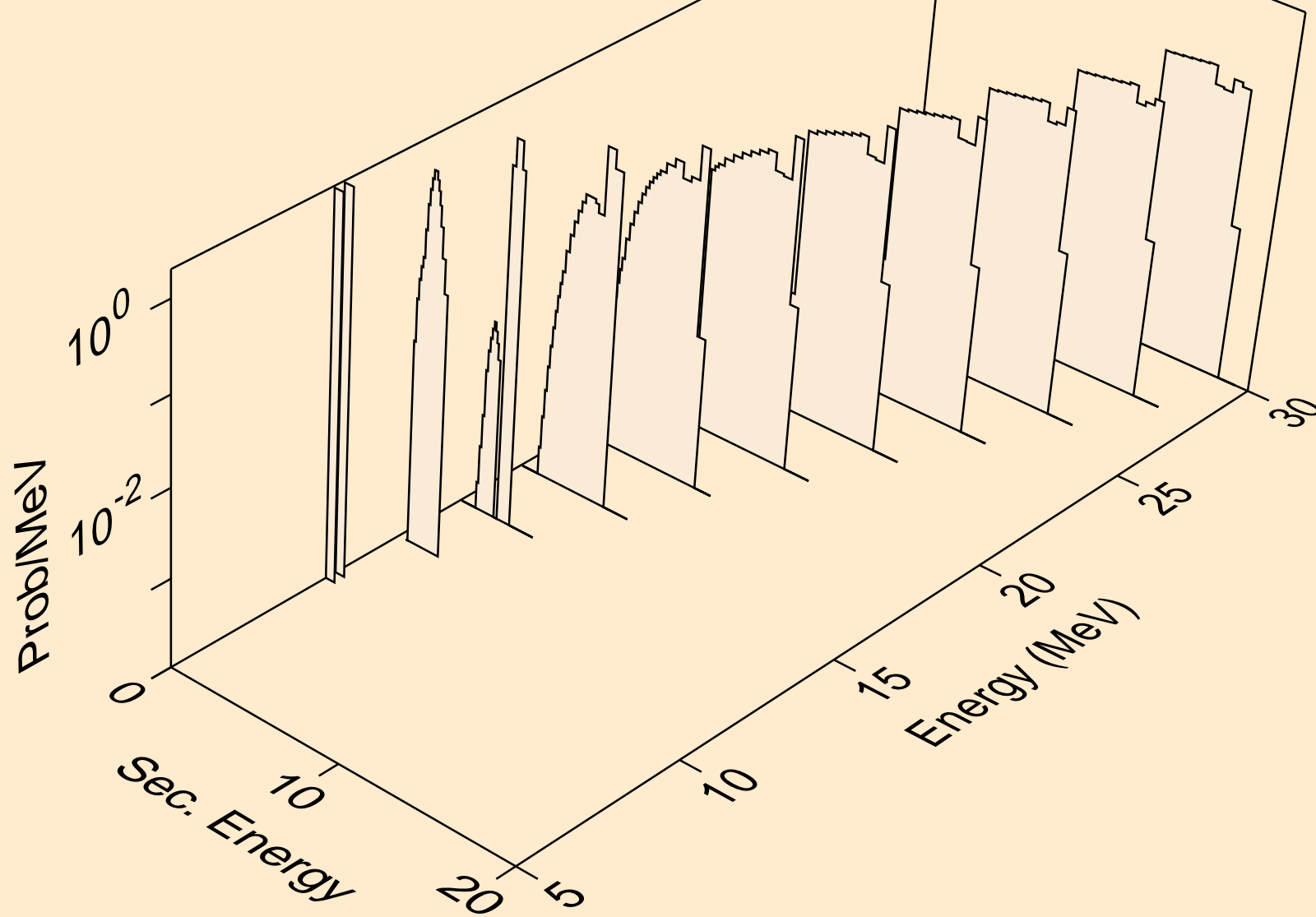

CL040 NEUTRON ACER TENDL-2021 LIBRARY; T=293.6K
deuterons from (n,da)

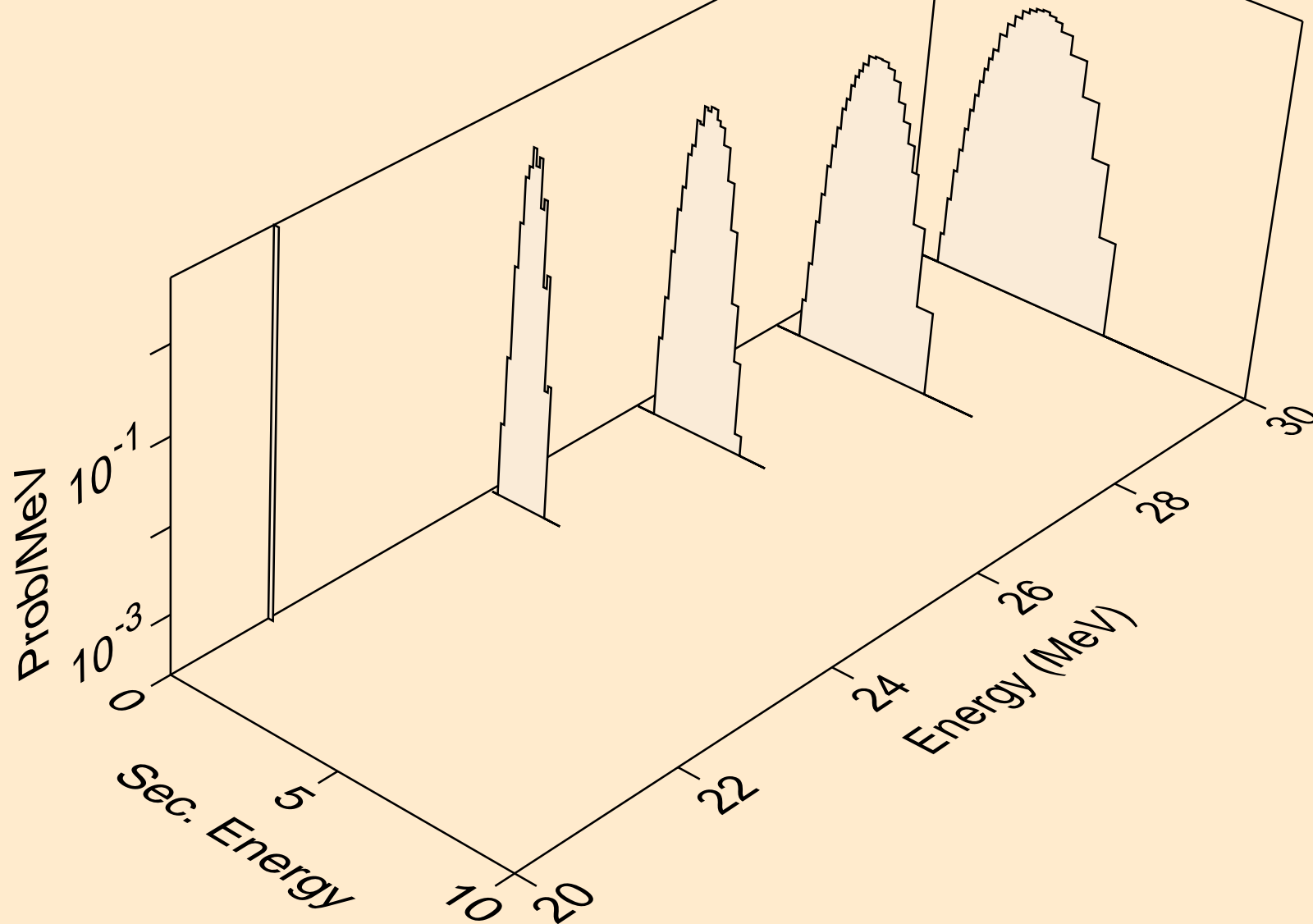

CL040 NEUTRON ACER TENDL-2021 LIBRARY; T=293.6K
tritons from (n,x)

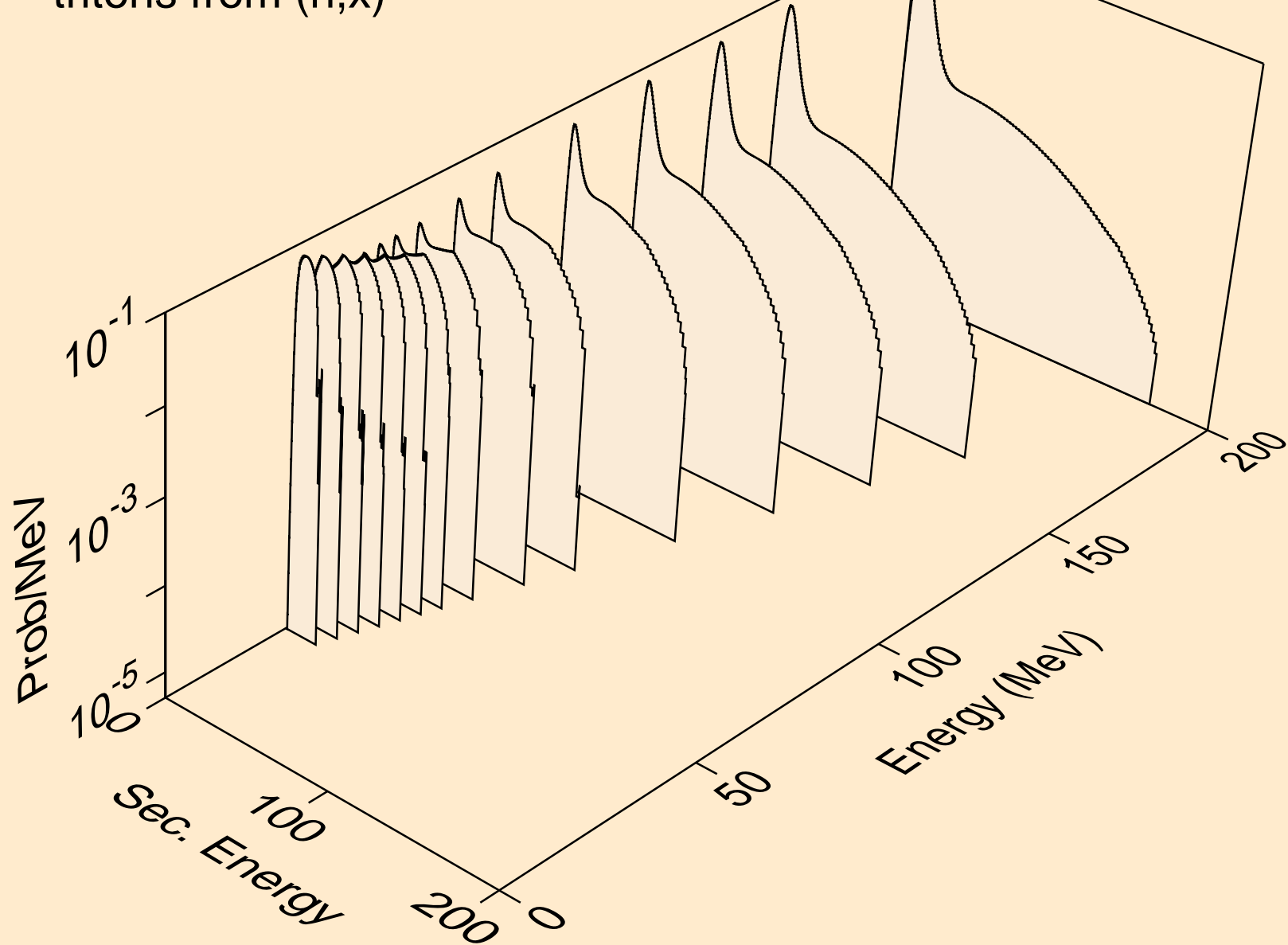

CL040 NEUTRON ACER TENDL-2021 LIBRARY; T=293.6K
tritons from (n,n*)t

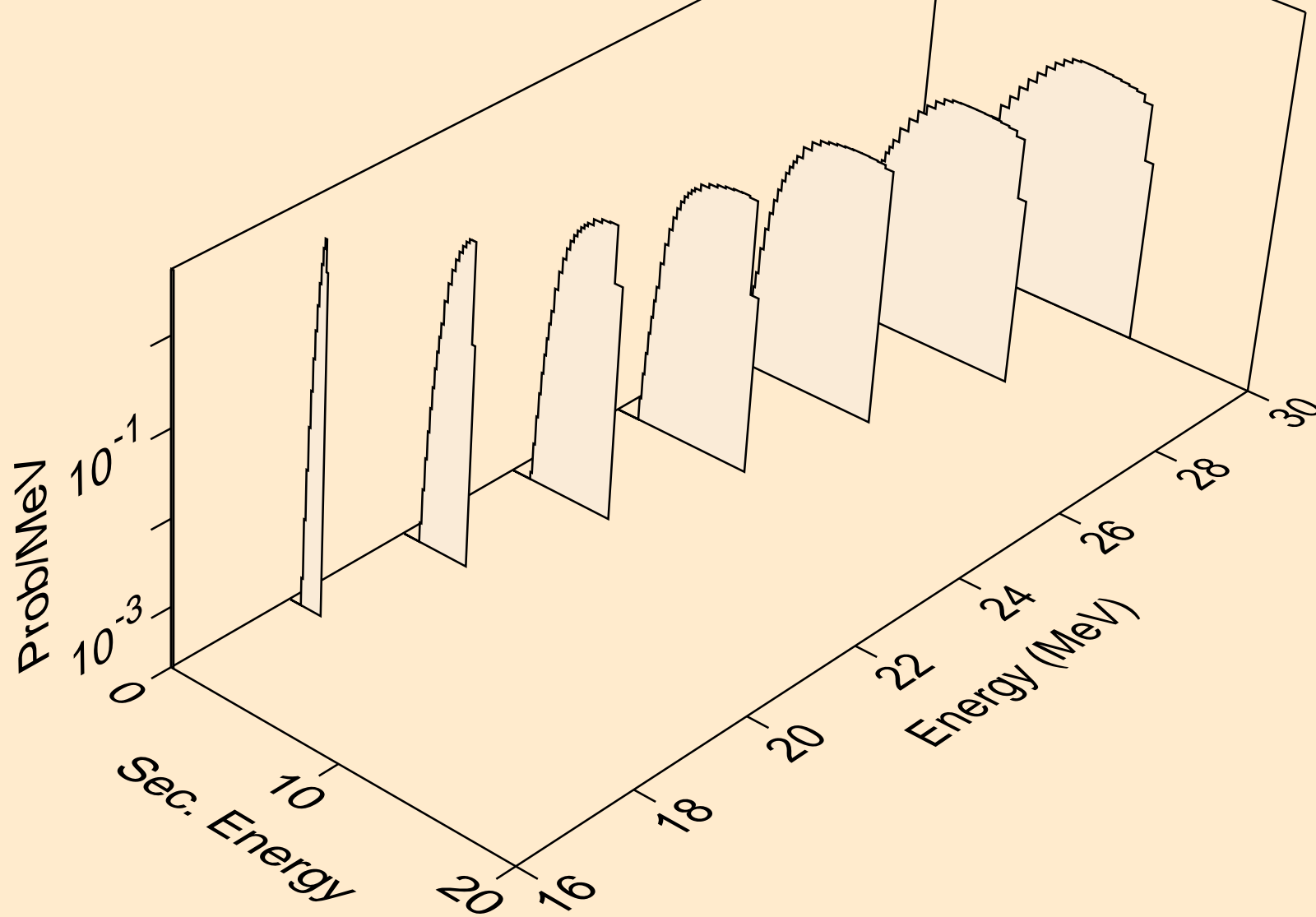

CL040 NEUTRON ACER TENDL-2021 LIBRARY; T=293.6K
tritons from (n,t)

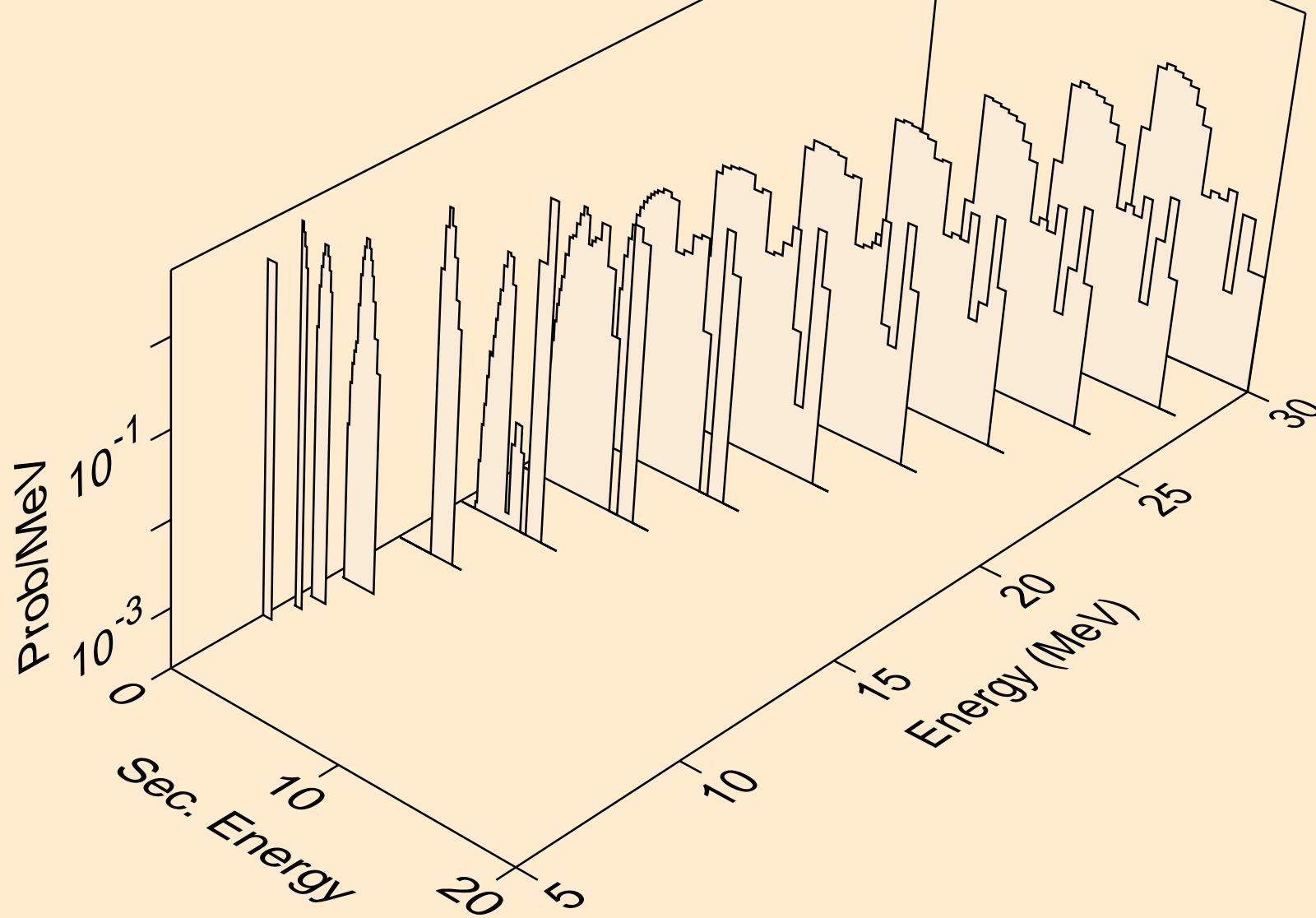

CL040 NEUTRON ACER TENDL-2021 LIBRARY; T=293.6K
tritons from (n,pt)

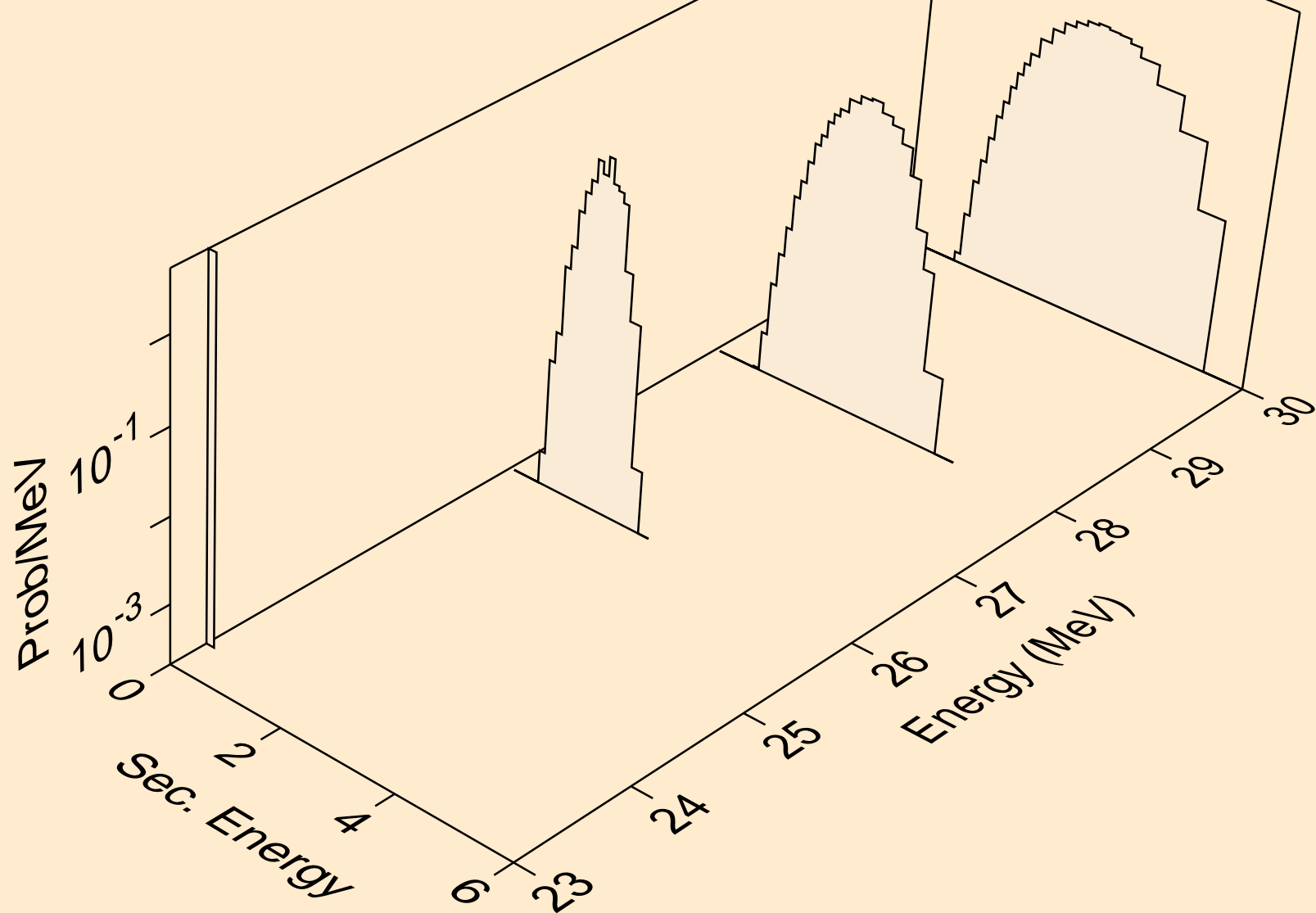

CL040 NEUTRON ACER TENDL-2021 LIBRARY; T=293.6K
he3s from (n,x)

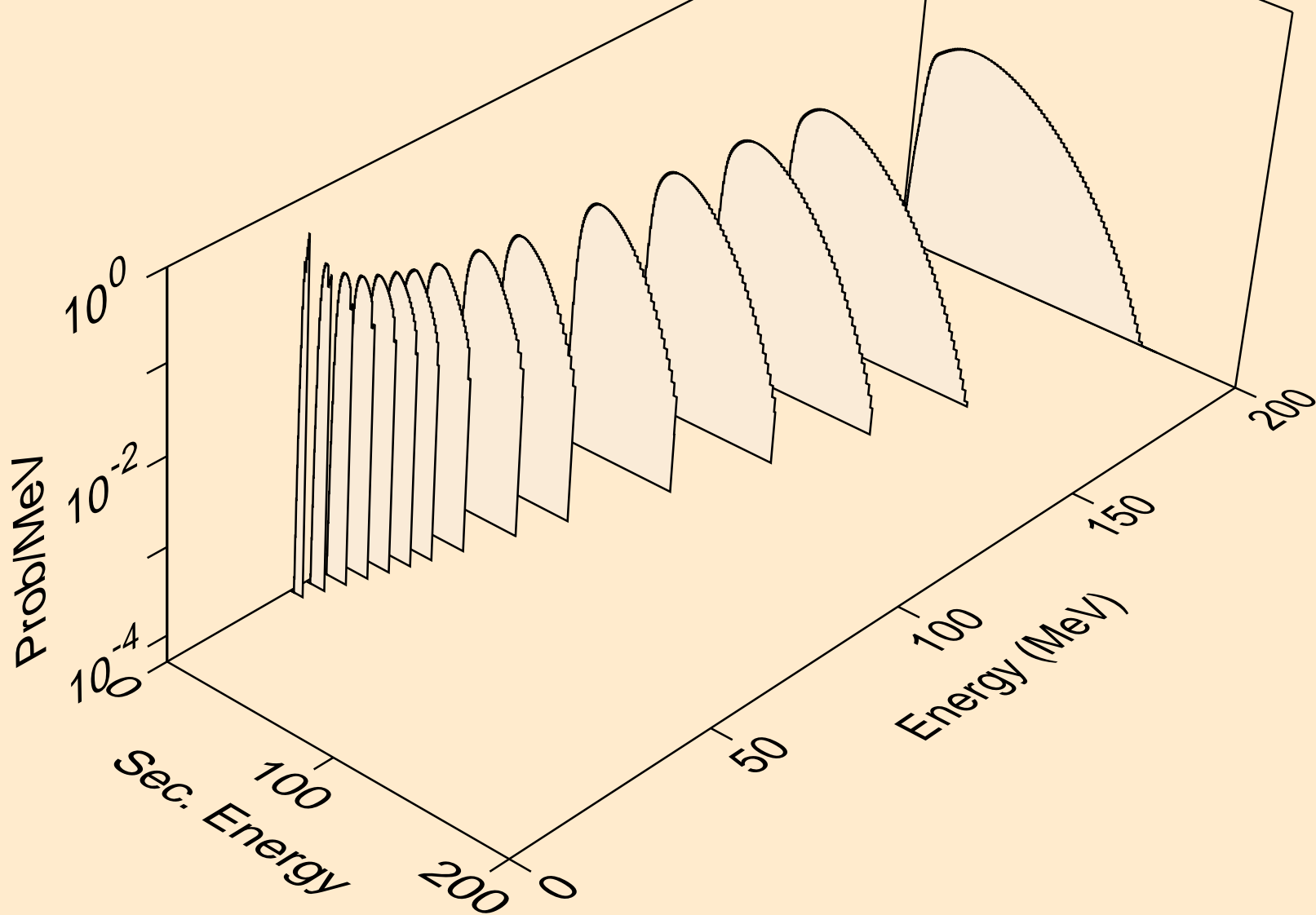

CL040 NEUTRON ACER TENDL-2021 LIBRARY; T=293.6K
he3s from (n,n*)he3

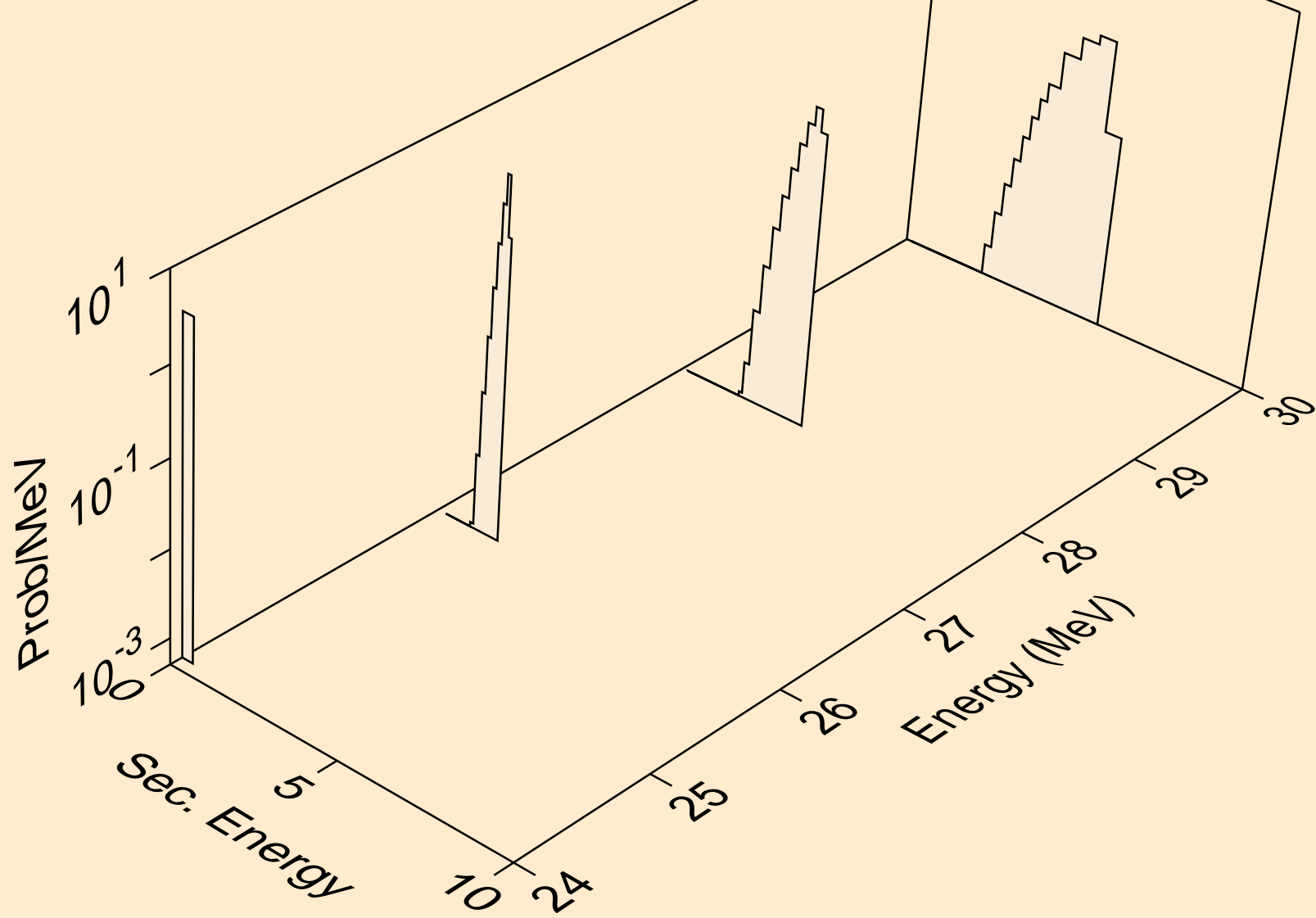

CL040 NEUTRON ACER TENDL-2021 LIBRARY; T=293.6K
he3s from (n,he3)

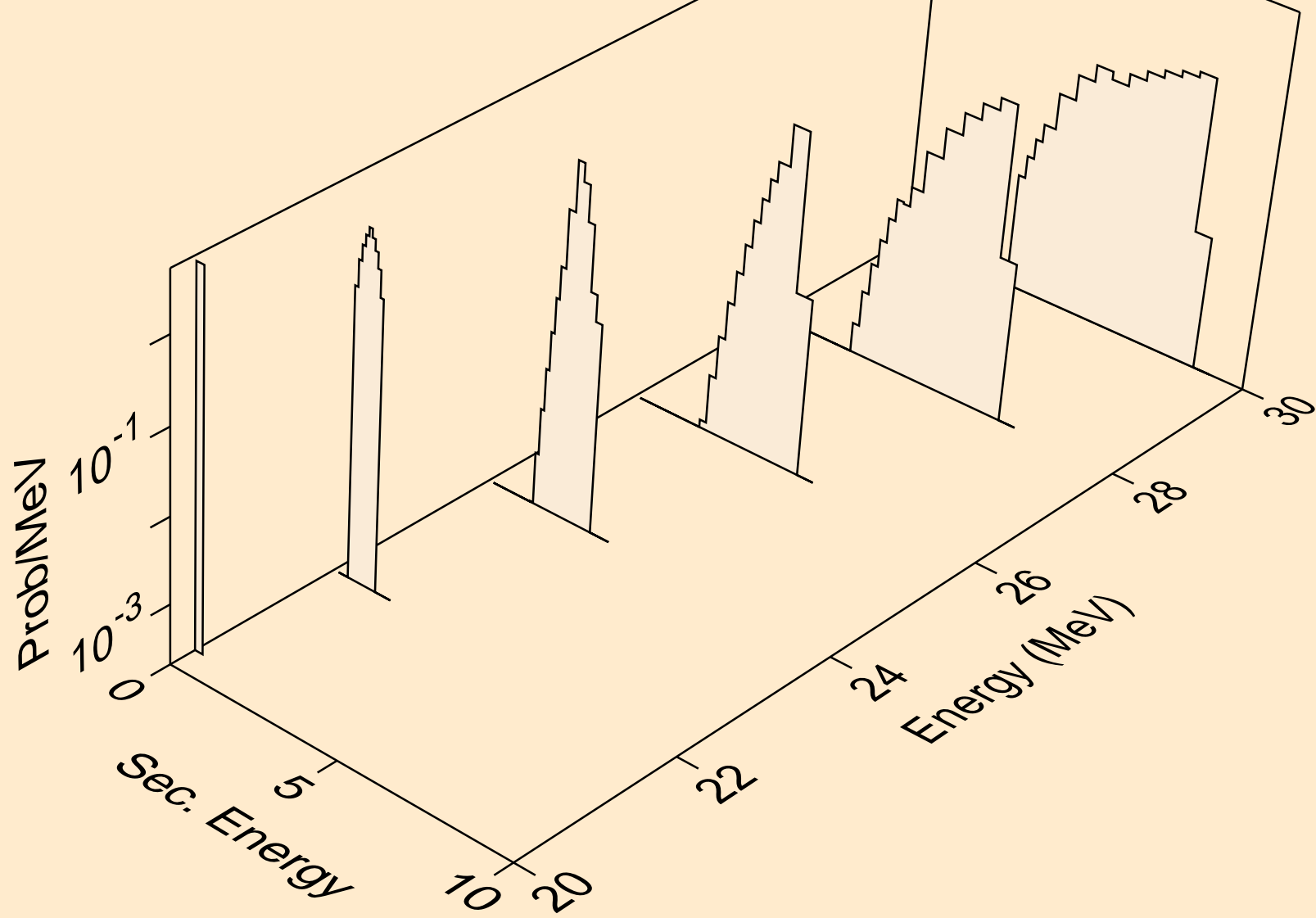

CL040 NEUTRON ACER TENDL-2021 LIBRARY; T=293.6K
alphas from (n,x)

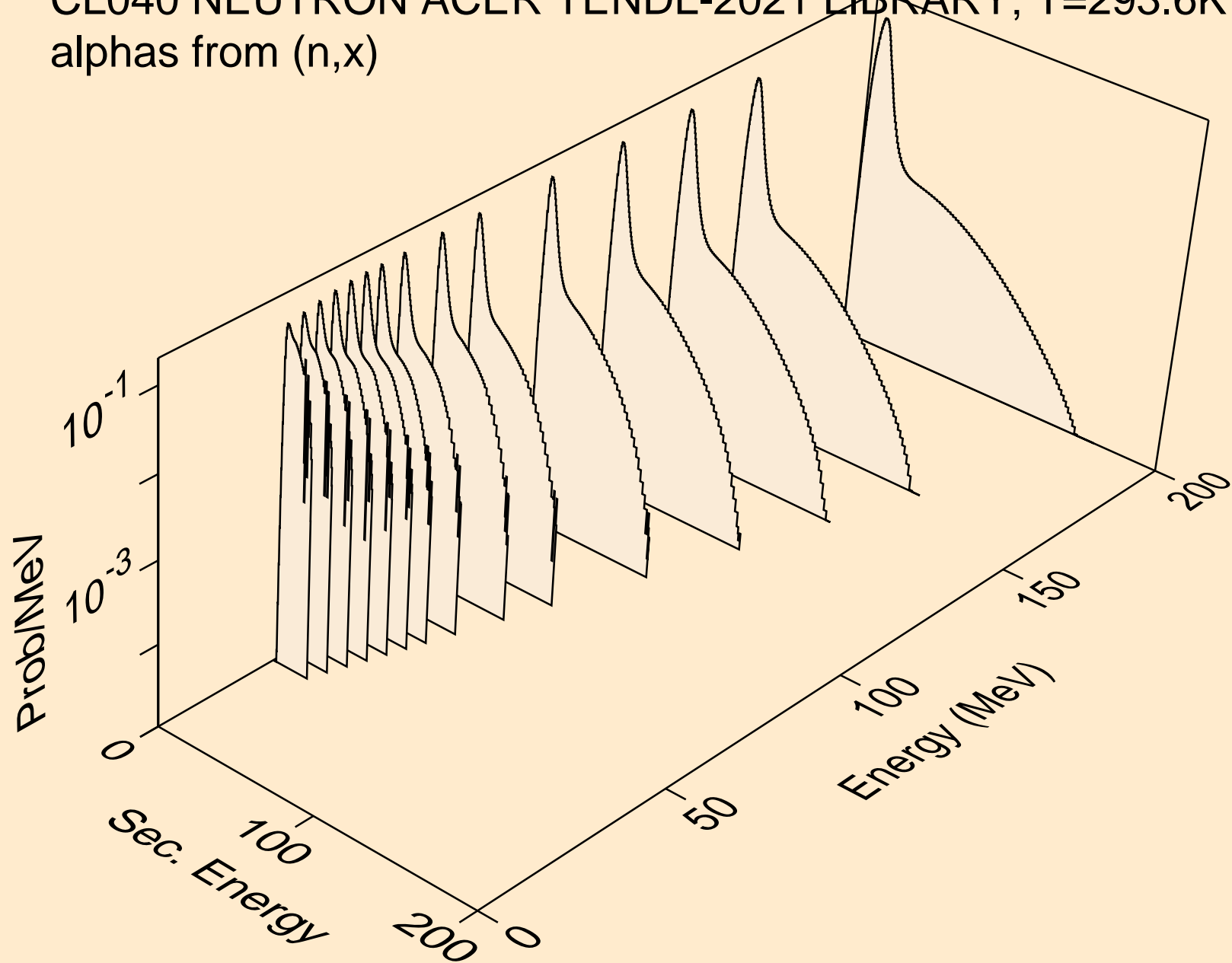

CL040 NEUTRON ACER TENDL-2021 LIBRARY; T=293.6K
alphas from (n,n*)a

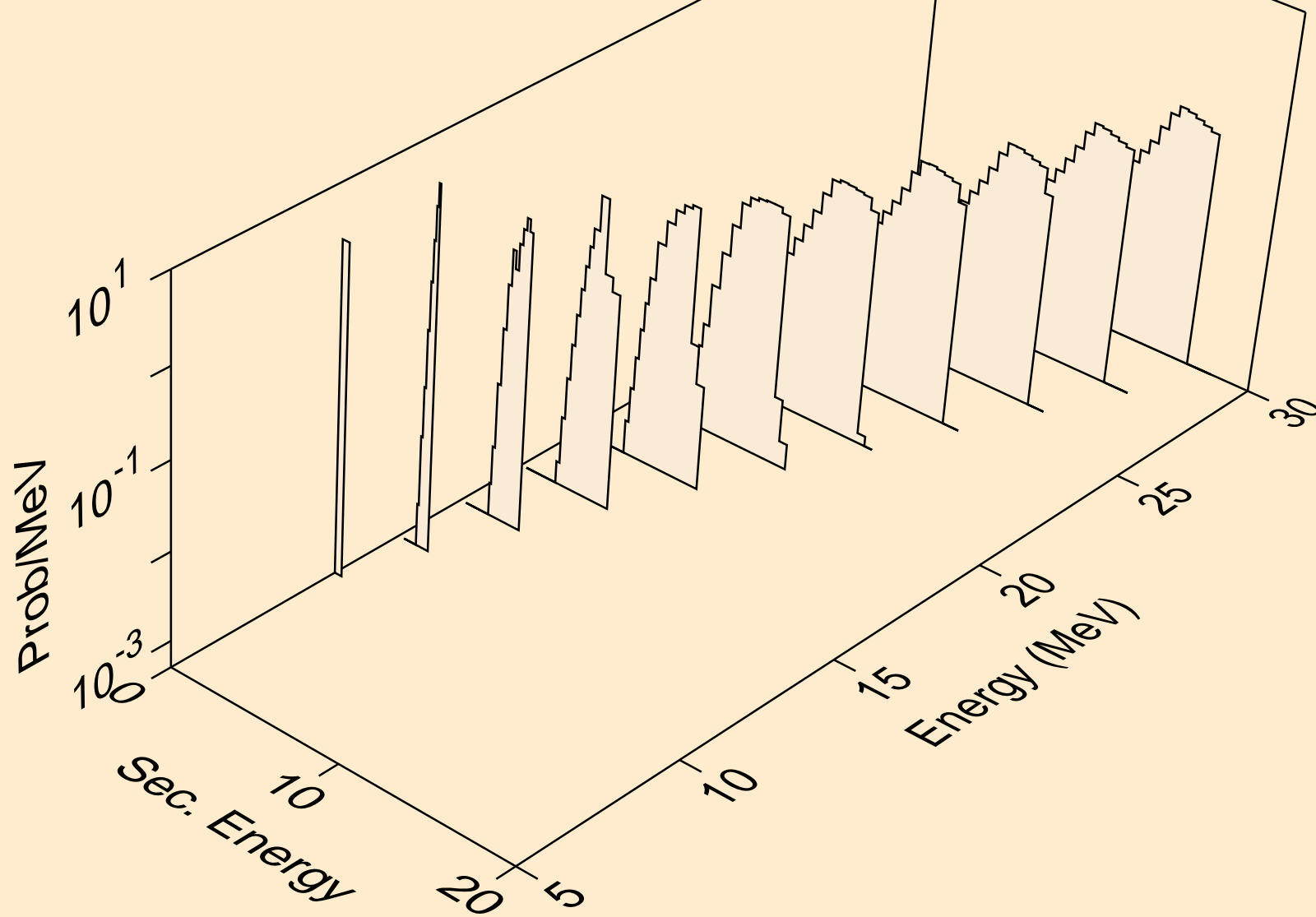

CL040 NEUTRON ACER TENDL-2021 LIBRARY; T=293.6K
alphas from (n,2n)a

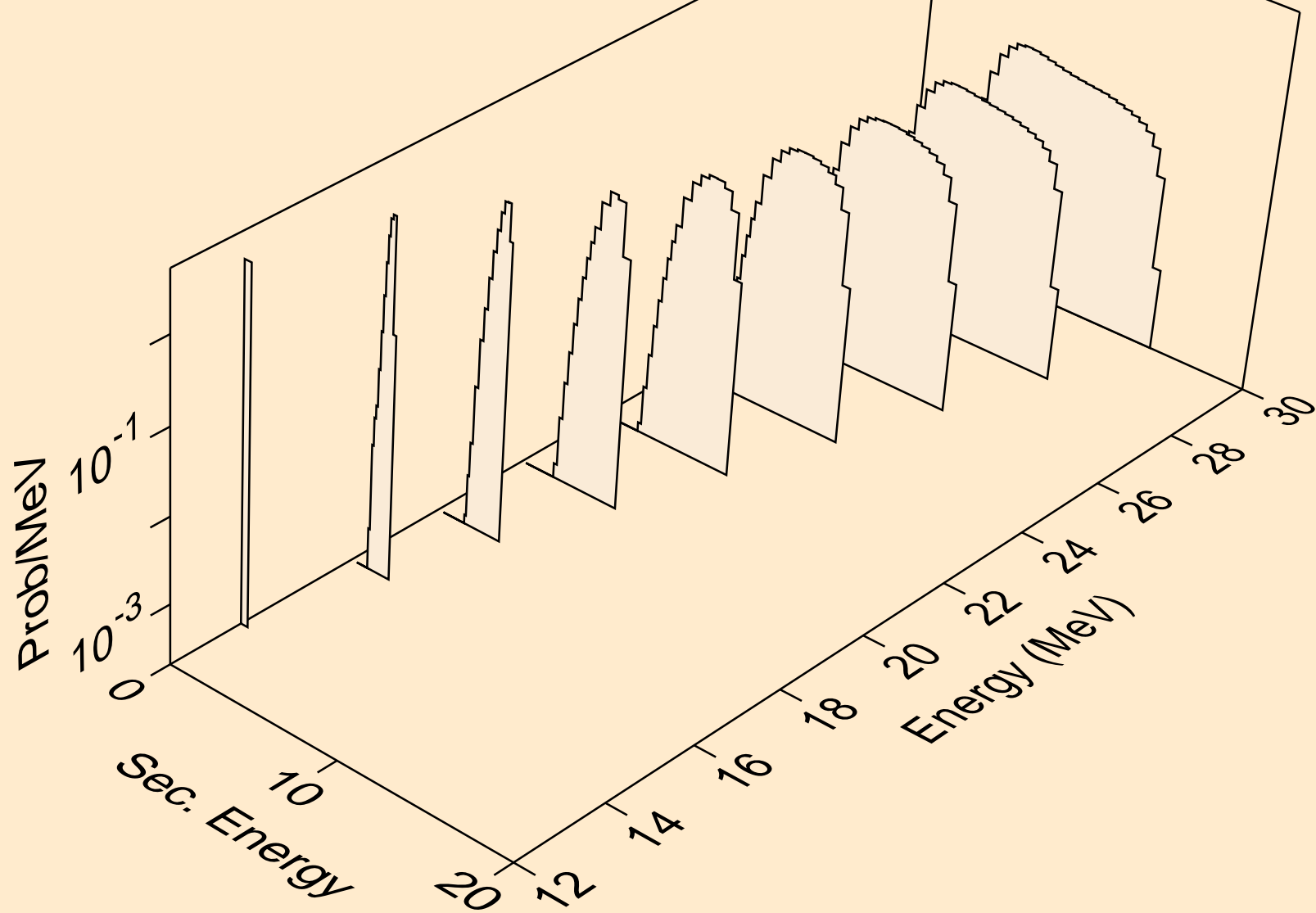

CL040 NEUTRON ACER TENDL-2021 LIBRARY; T=293.6K
alphas from (n,3n)a

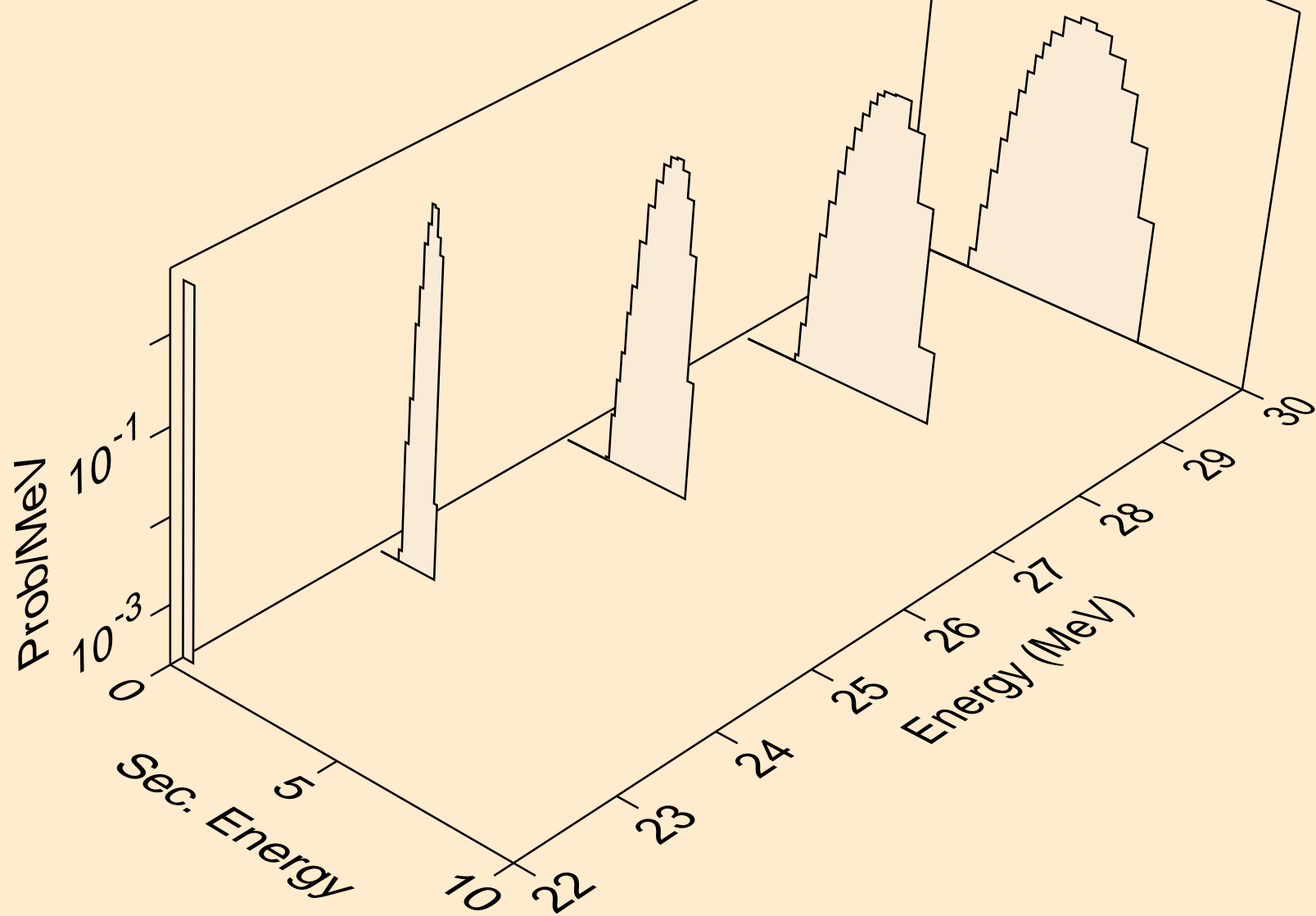

CL040 NEUTRON ACER TENDL-2021 LIBRARY; T=293.6K
alphas from (n,npa)

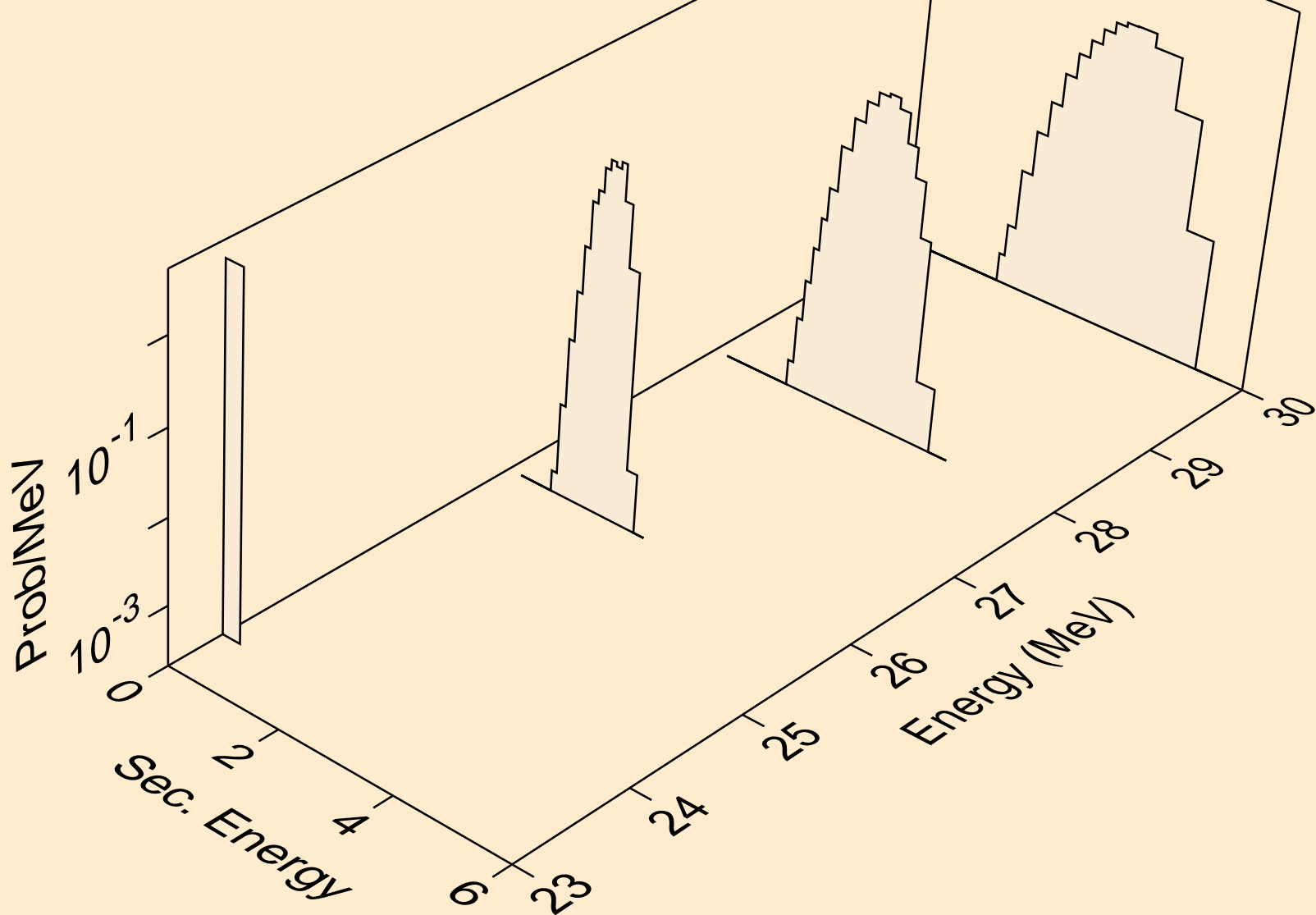

CL040 NEUTRON ACER TENDL-2021 LIBRARY; T=293.6K
alphas from (n,a)

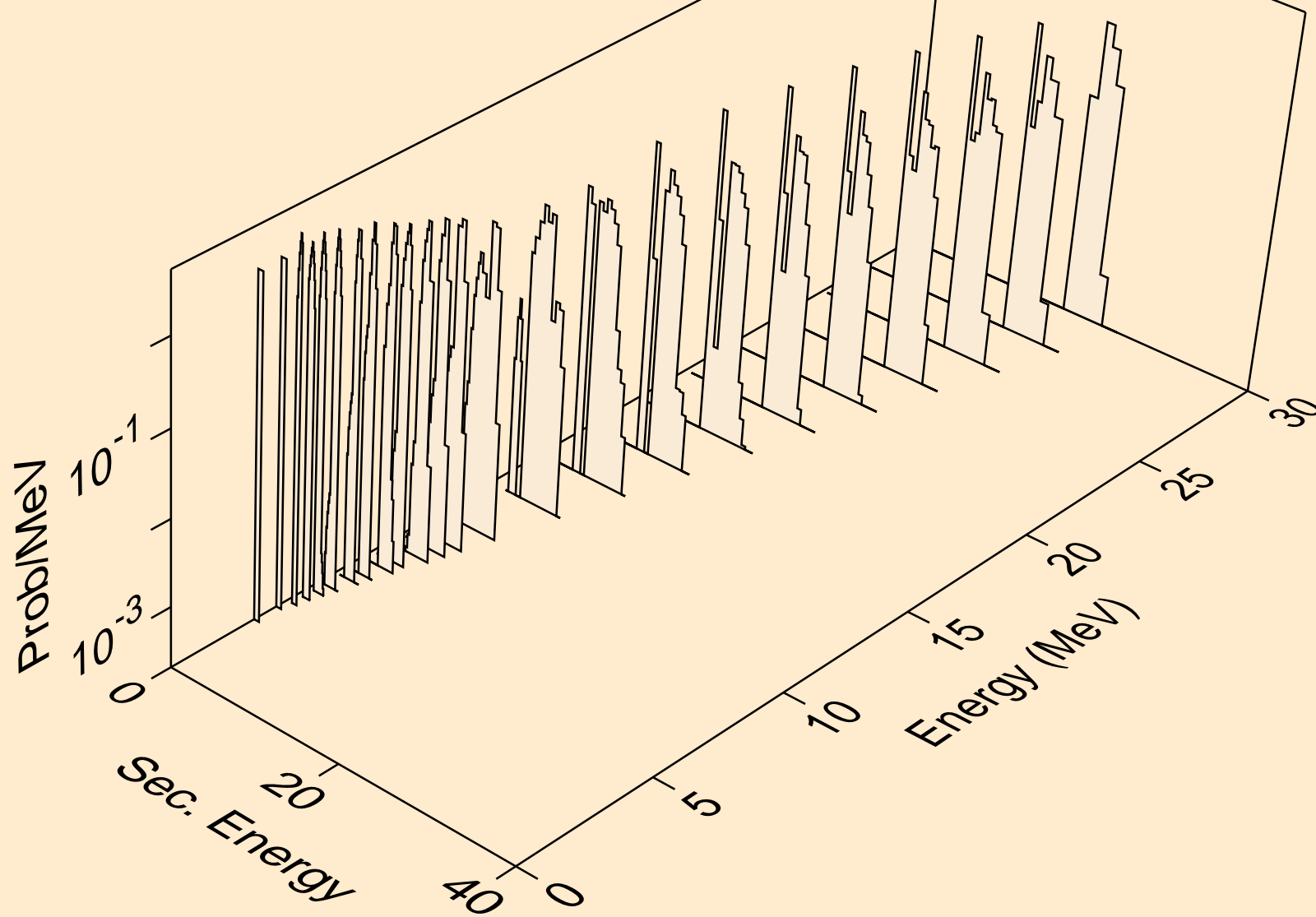

CL040 NEUTRON ACER TENDL-2021 LIBRARY; T=293.6K
alphas from (n,2a)

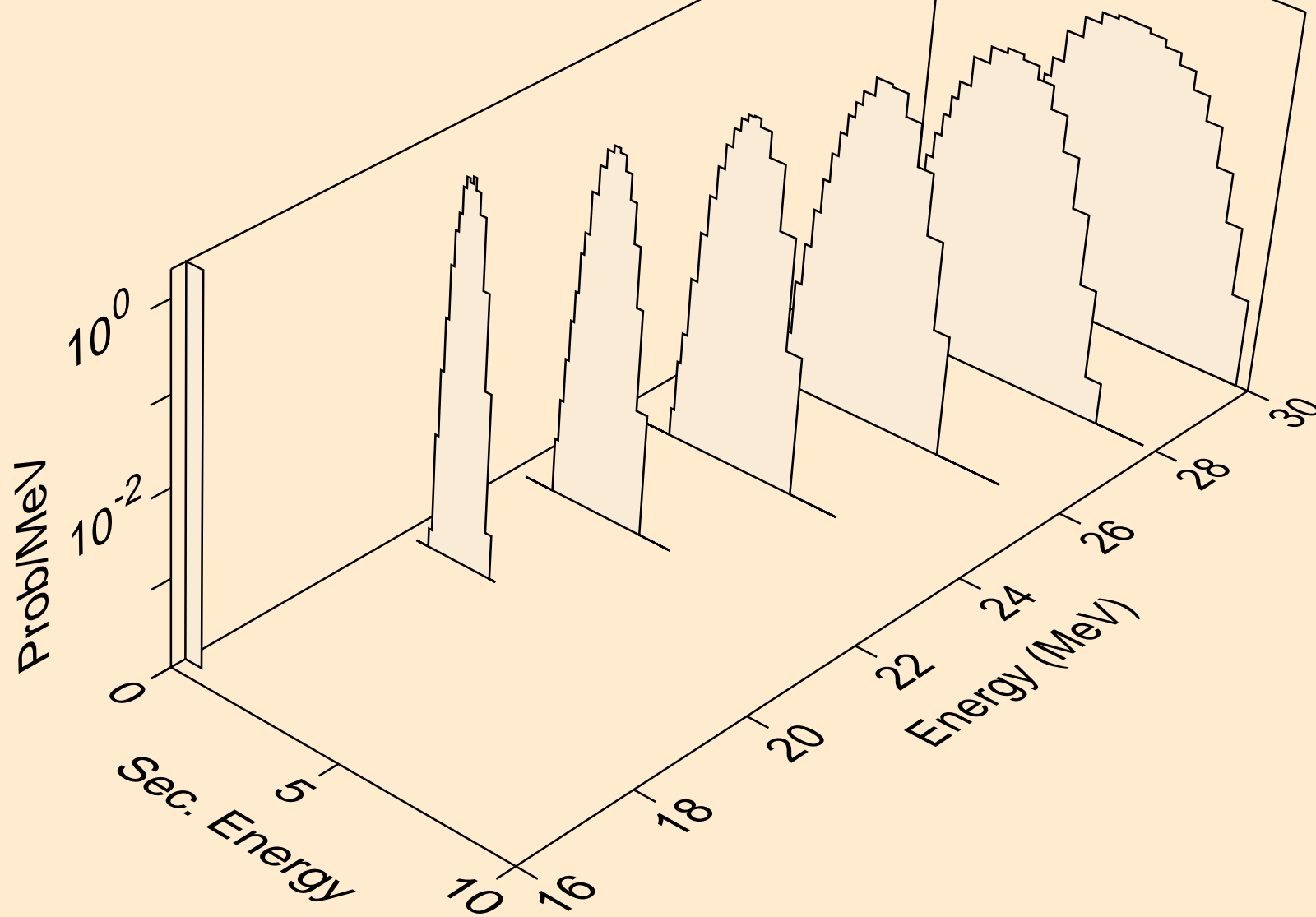

CL040 NEUTRON ACER TENDL-2021 LIBRARY; T=293.6K
alphas from (n,pa)

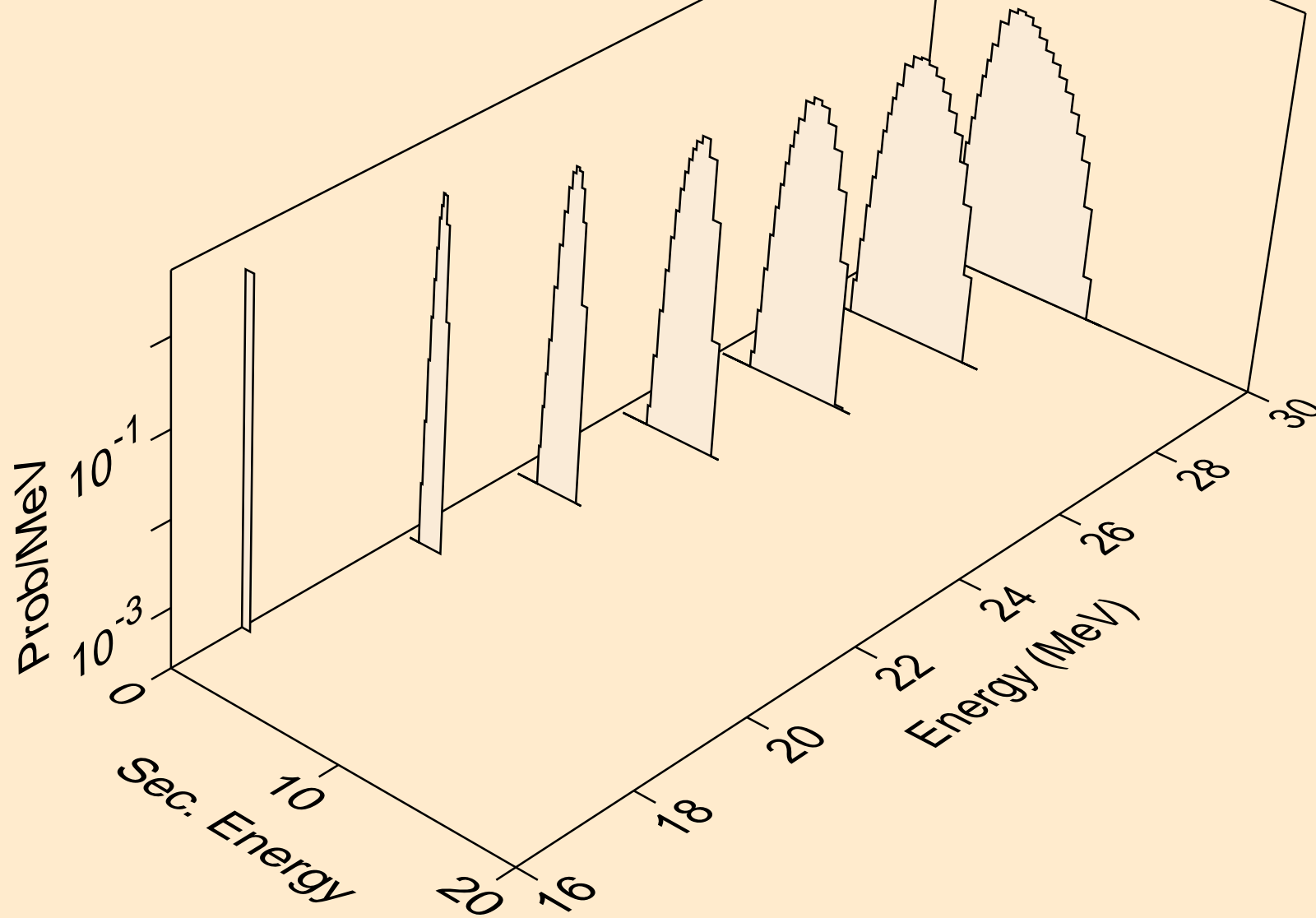

CL040 NEUTRON ACER TENDL-2021 LIBRARY; T=293.6K
alphas from (n,da)

