

# CL043 NEUTRON ACER TENDL-2021 LIBRARY; T=293.6K

## Principal cross sections

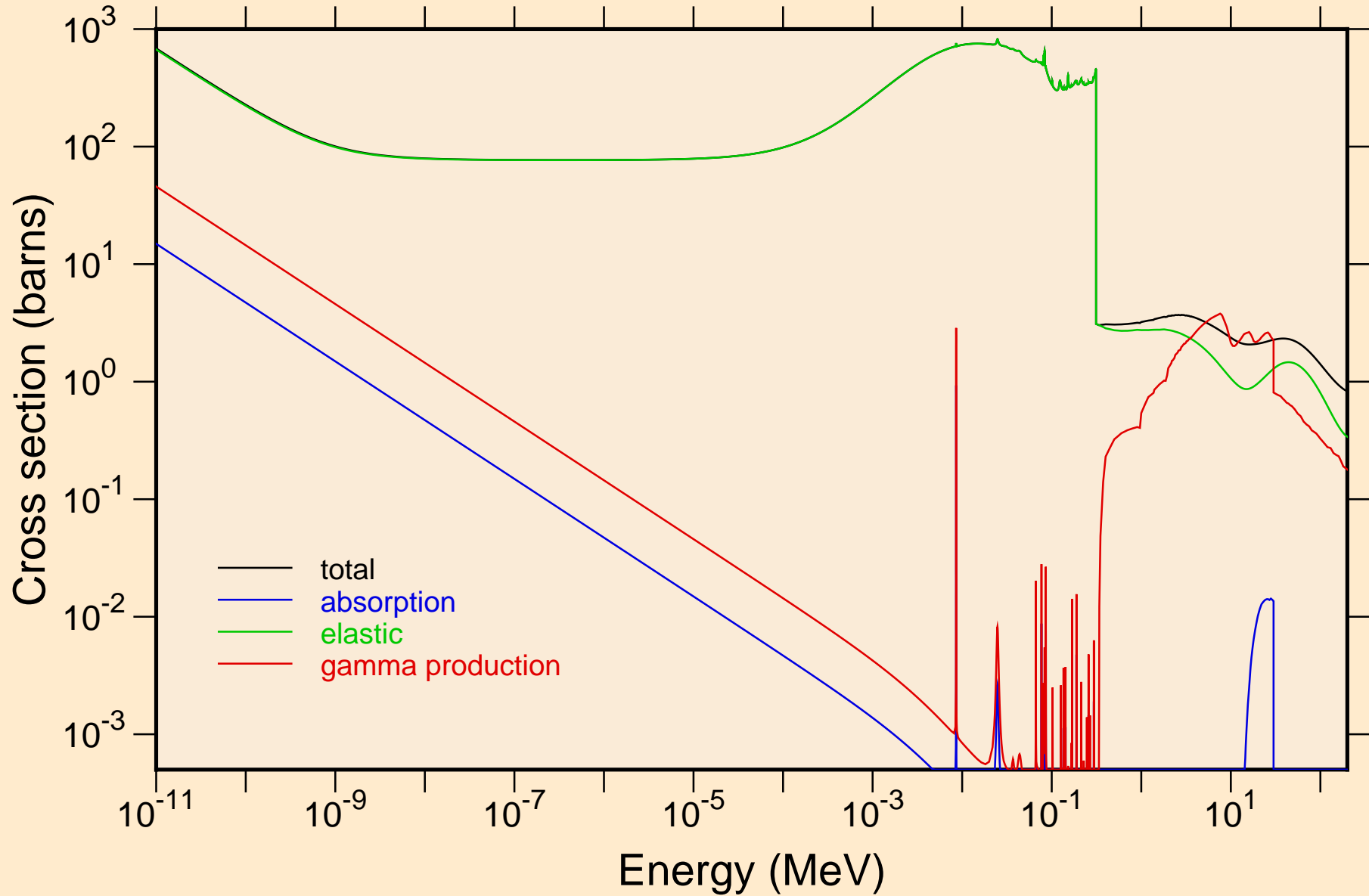

CL043 NEUTRON ACER TENDL-2021 LIBRARY; T=293.6K  
resonance total cross section

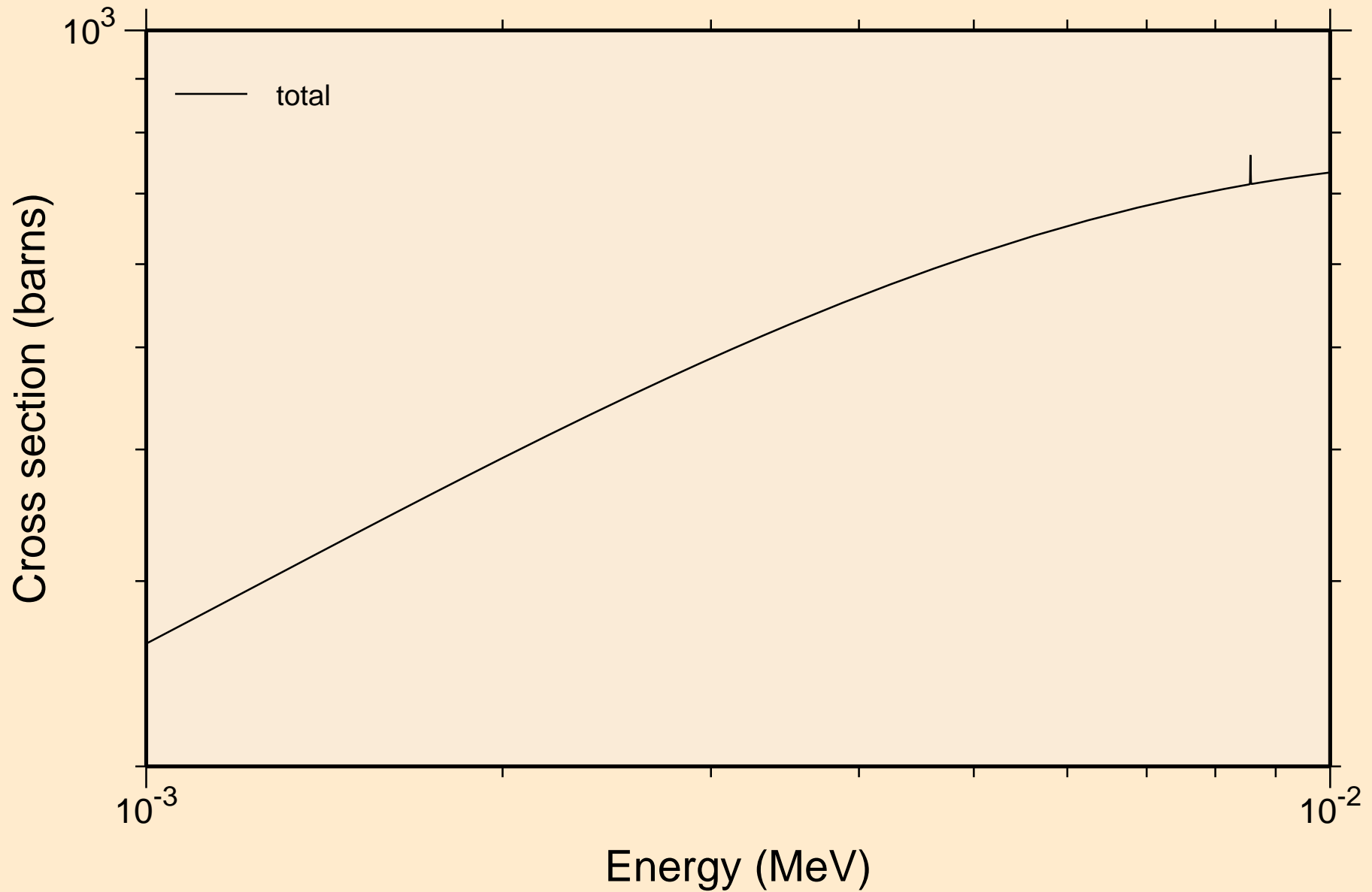

CL043 NEUTRON ACER TENDL-2021 LIBRARY; T=293.6K  
resonance total cross section

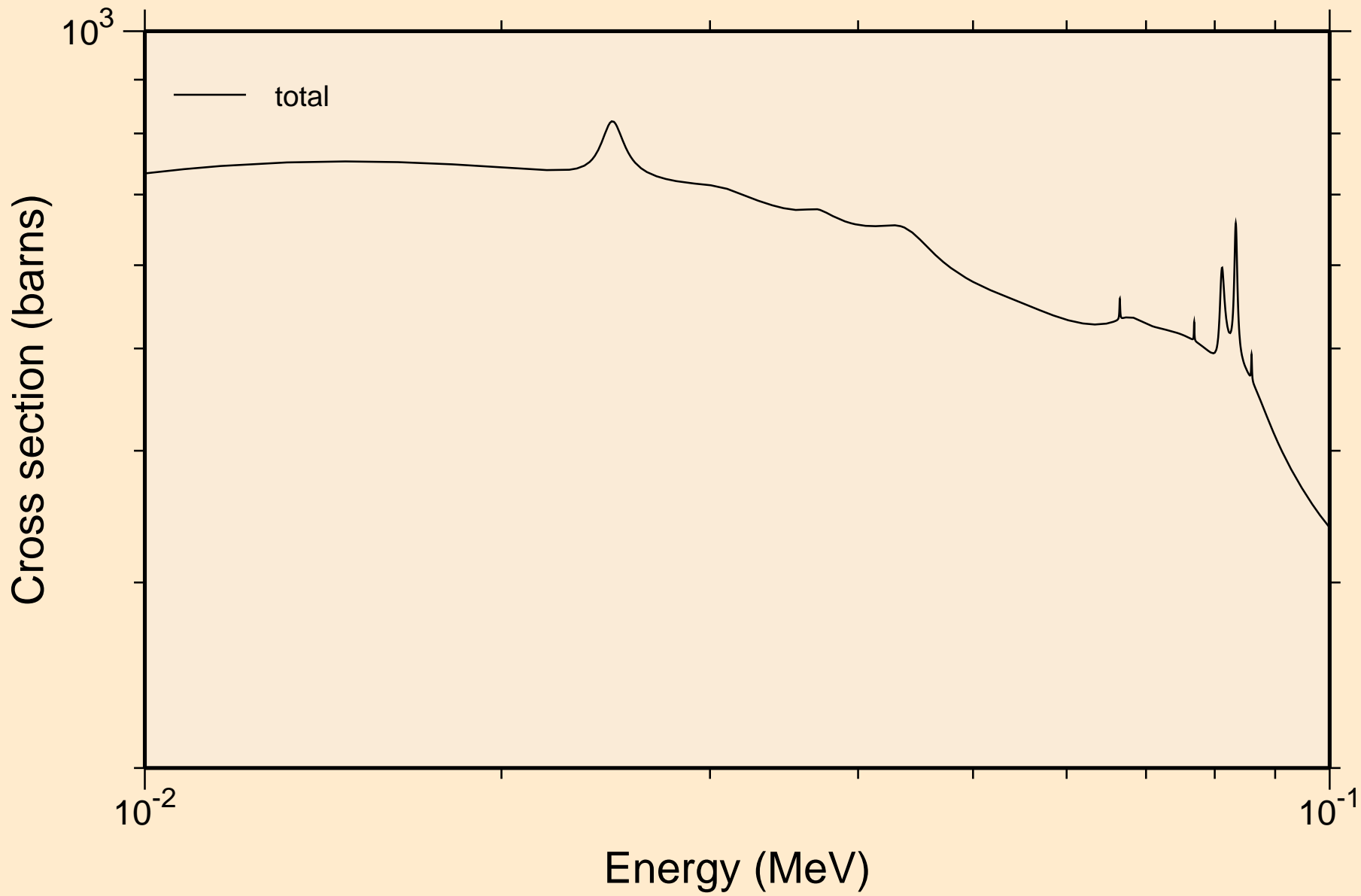

CL043 NEUTRON ACER TENDL-2021 LIBRARY; T=293.6K  
resonance total cross section

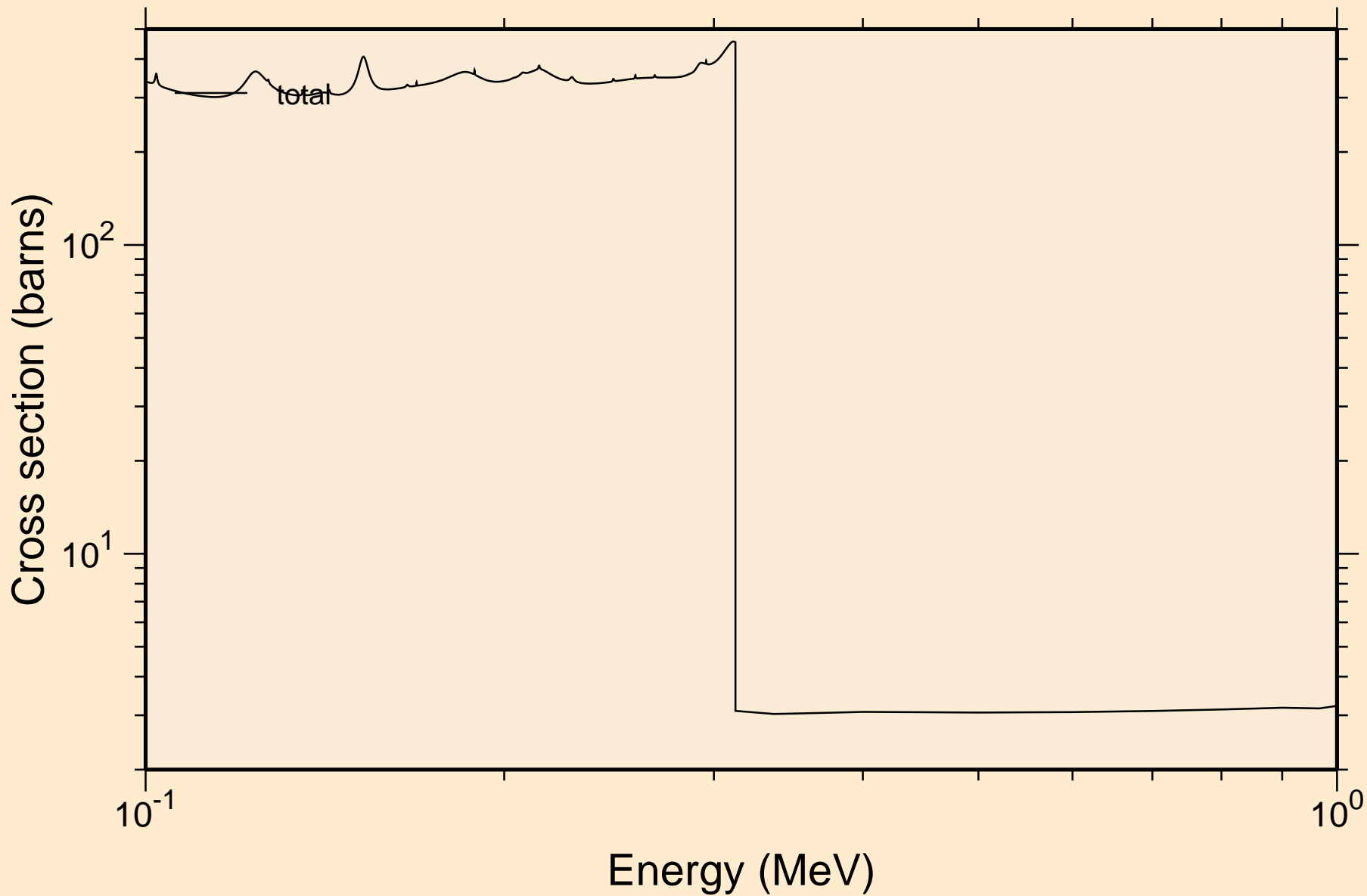

CL043 NEUTRON ACER TENDL-2021 LIBRARY; T=293.6K  
resonance total cross section

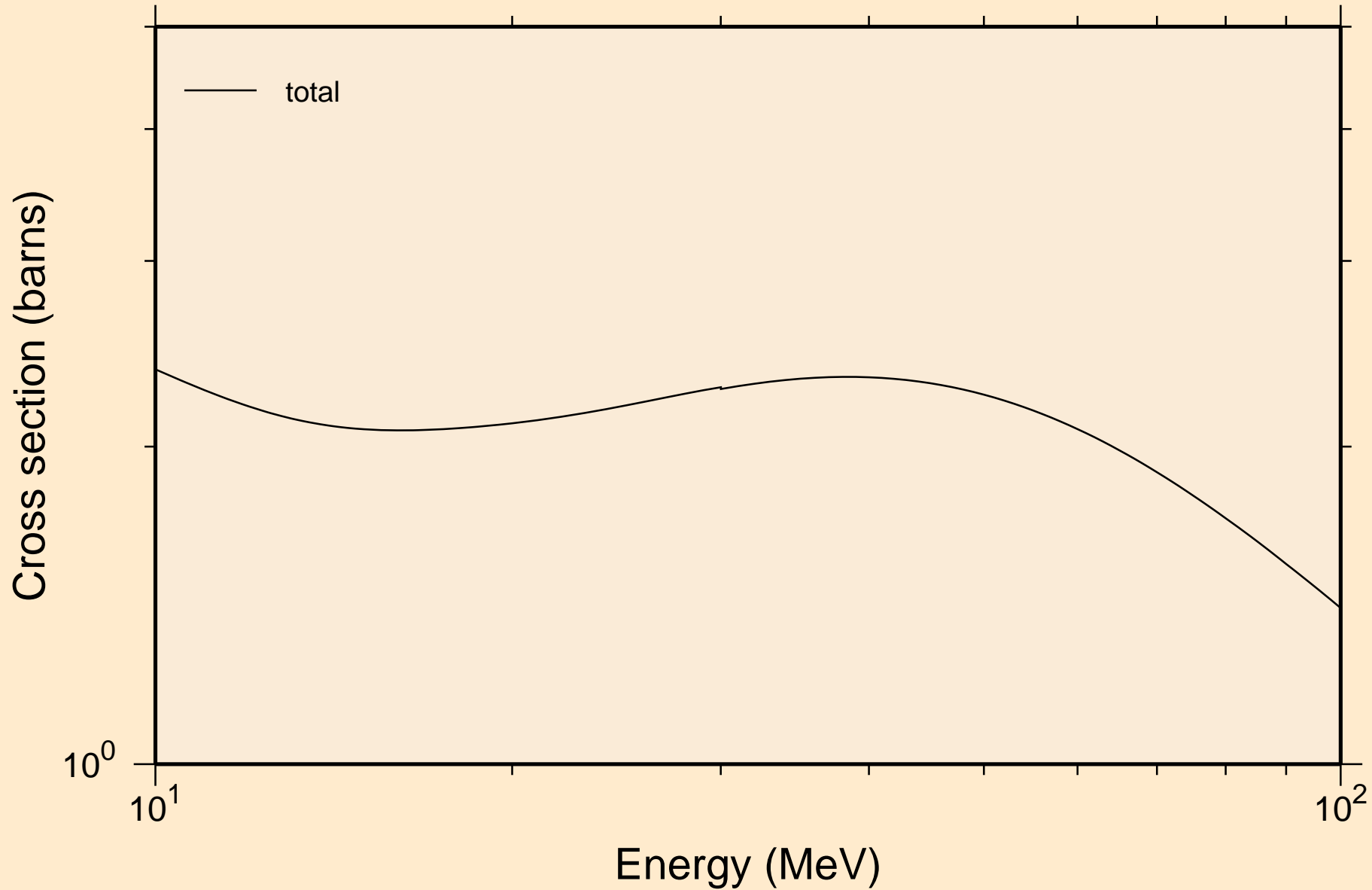

CL043 NEUTRON ACER TENDL-2021 LIBRARY; T=293.6K  
resonance absorption cross sections

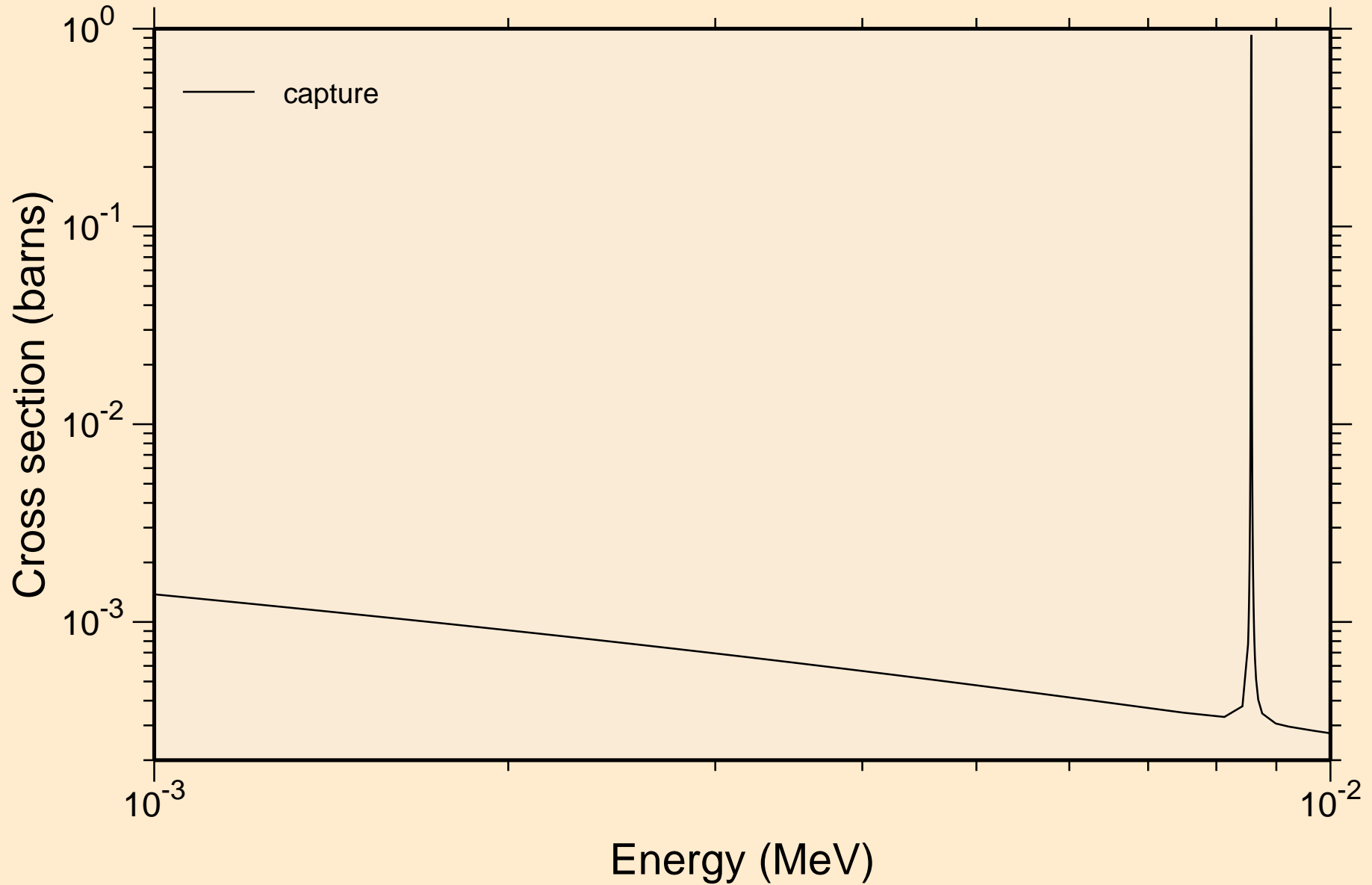

CL043 NEUTRON ACER TENDL-2021 LIBRARY; T=293.6K  
resonance absorption cross sections

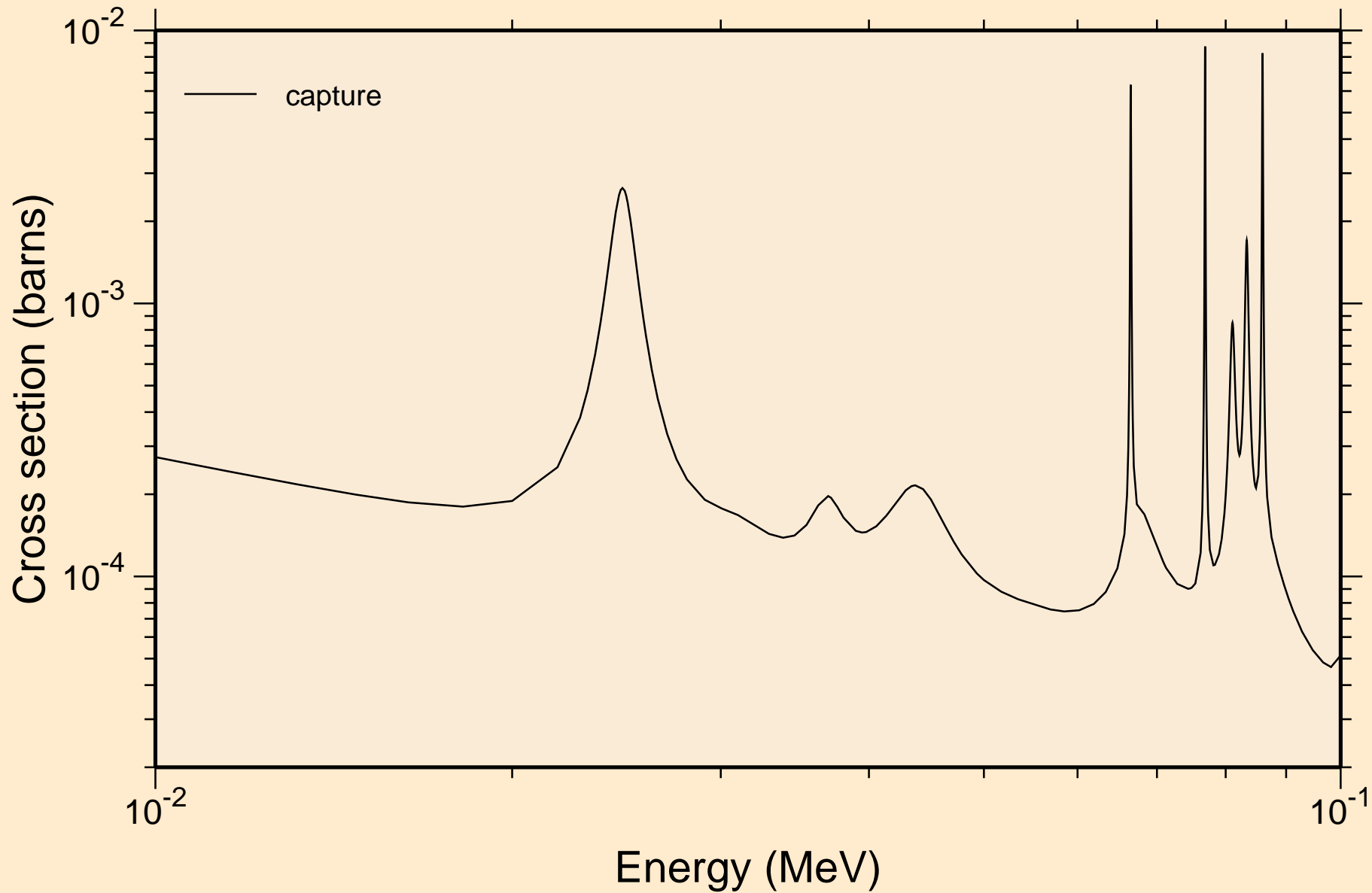

CL043 NEUTRON ACER TENDL-2021 LIBRARY; T=293.6K  
resonance absorption cross sections

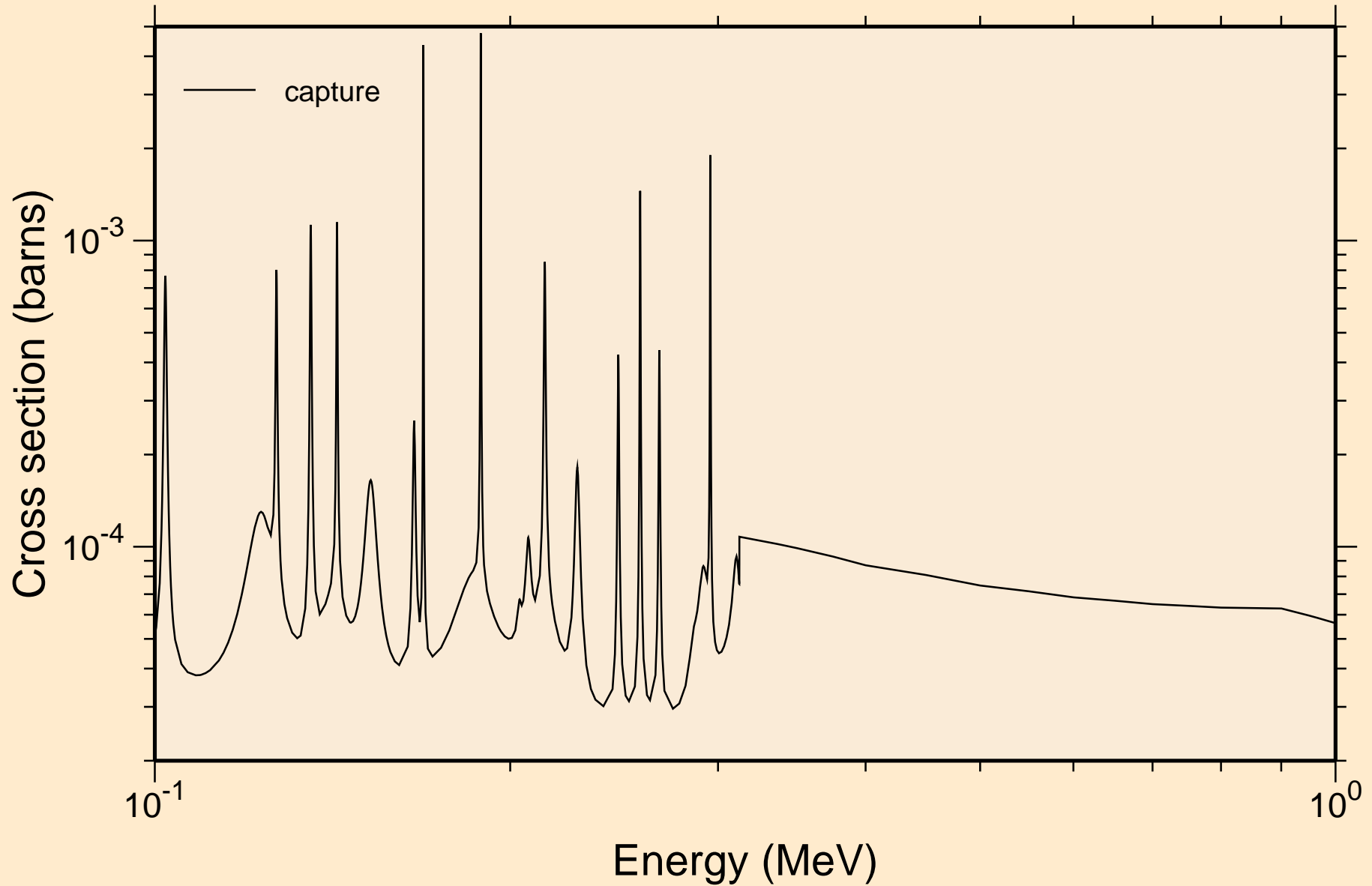



CL043 NEUTRON ACER TENDL-2021 LIBRARY; T=293.6K  
resonance absorption cross sections

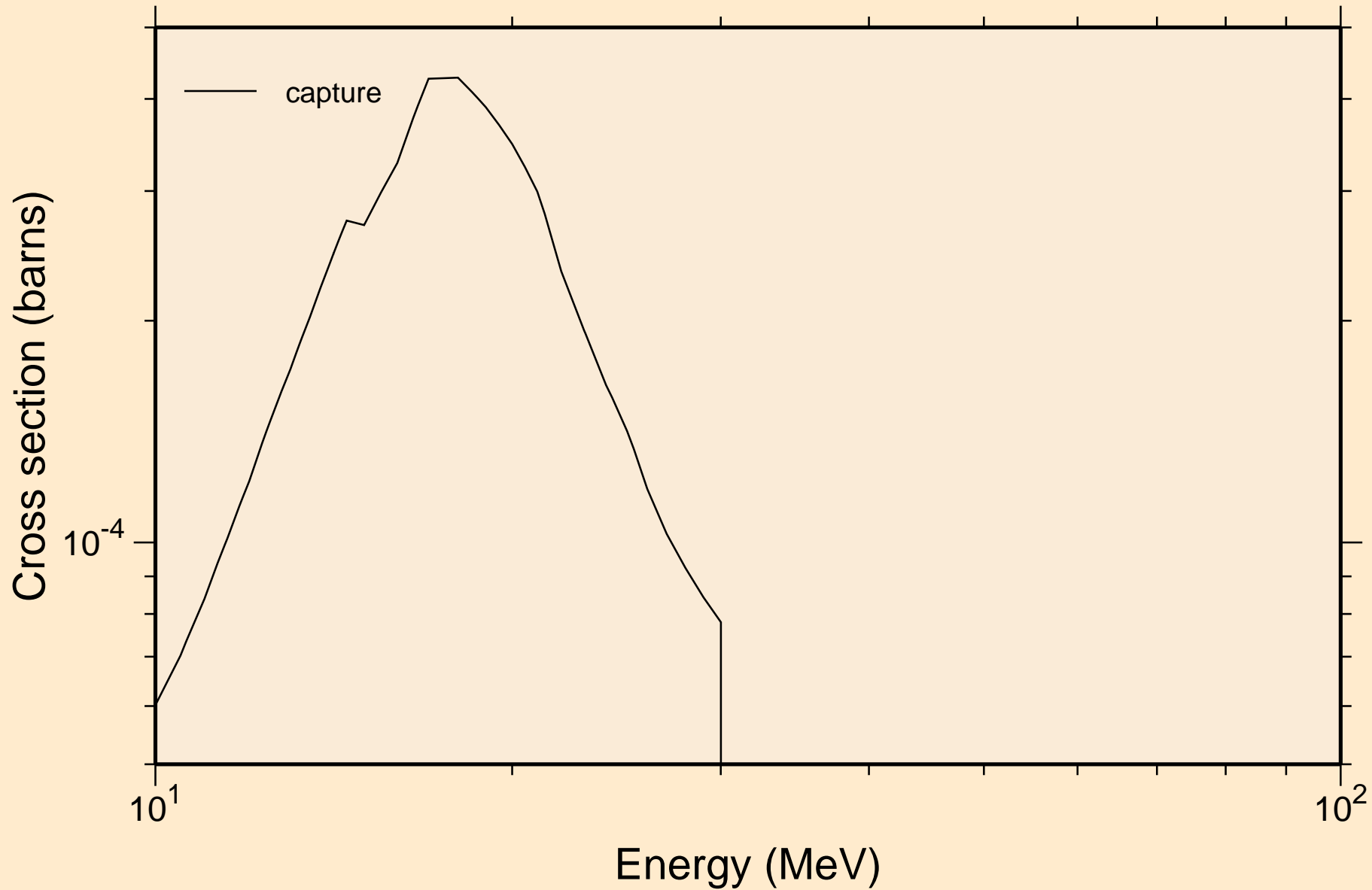

CL043 NEUTRON ACER TENDL-2021 LIBRARY; T=293.6K  
Heating

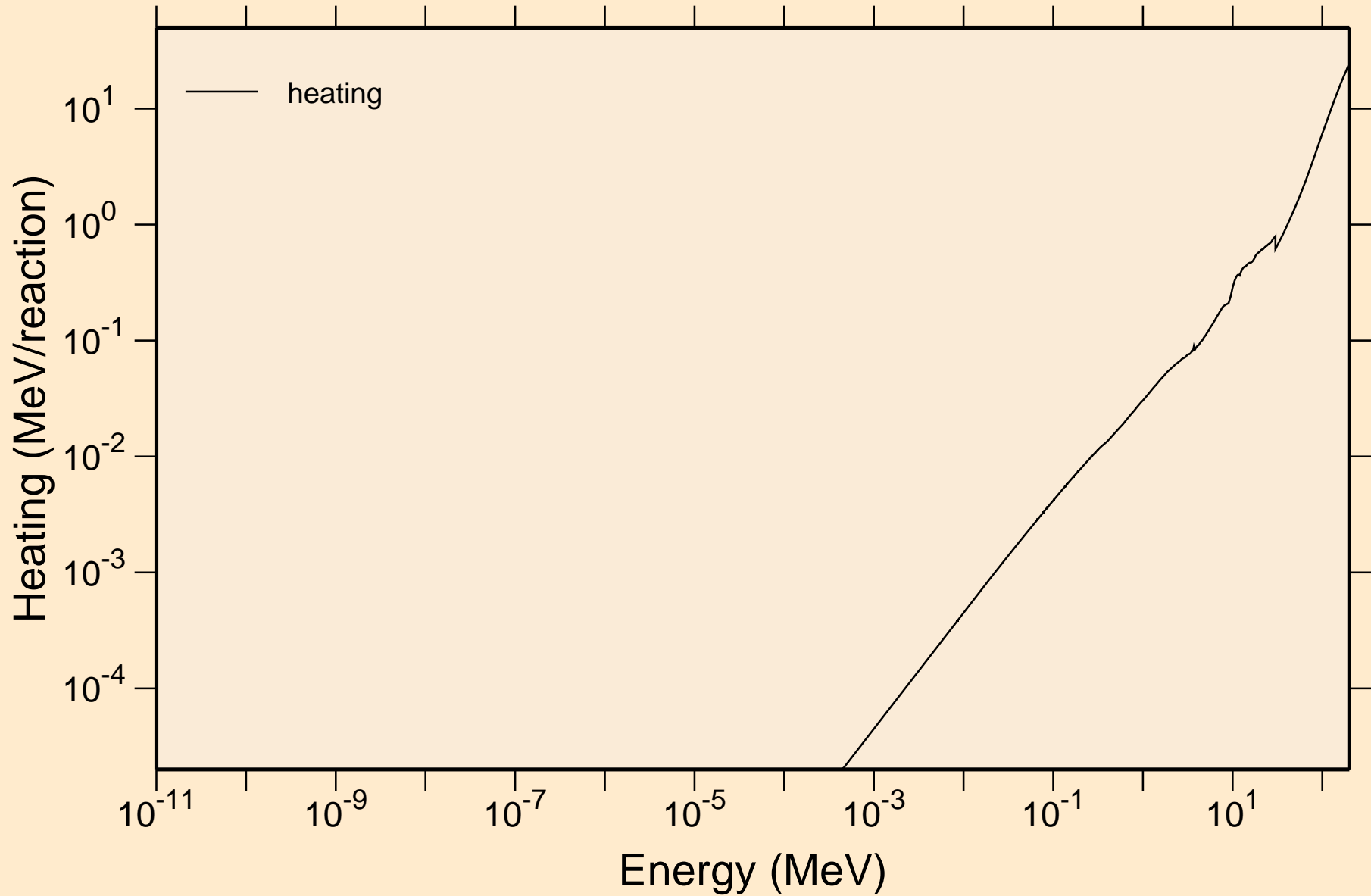

CL043 NEUTRON ACER TENDL-2021 LIBRARY; T=293.6K  
Damage

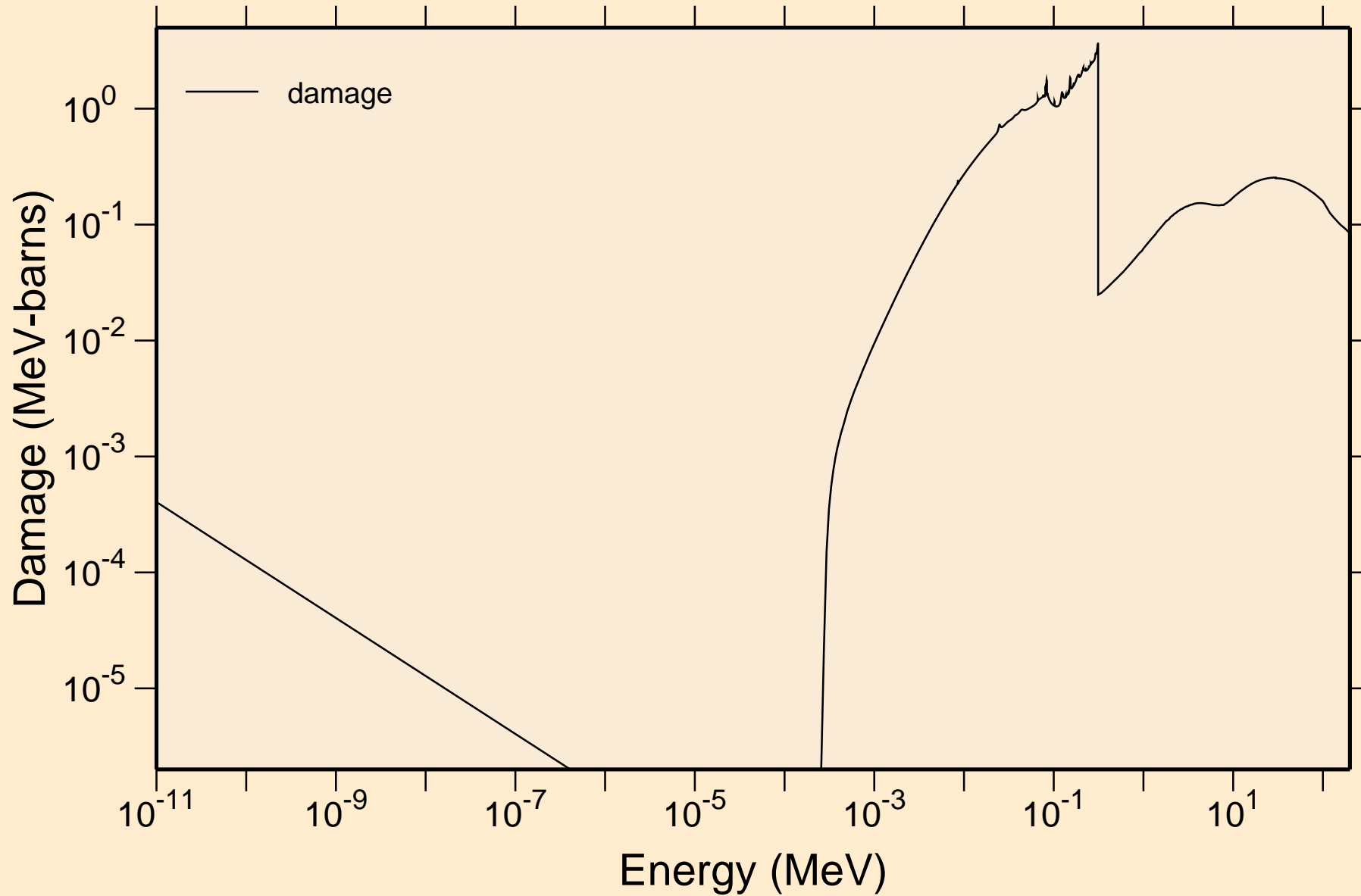

CL043 NEUTRON ACER TENDL-2021 LIBRARY; T=293.6K  
Non-threshold reactions

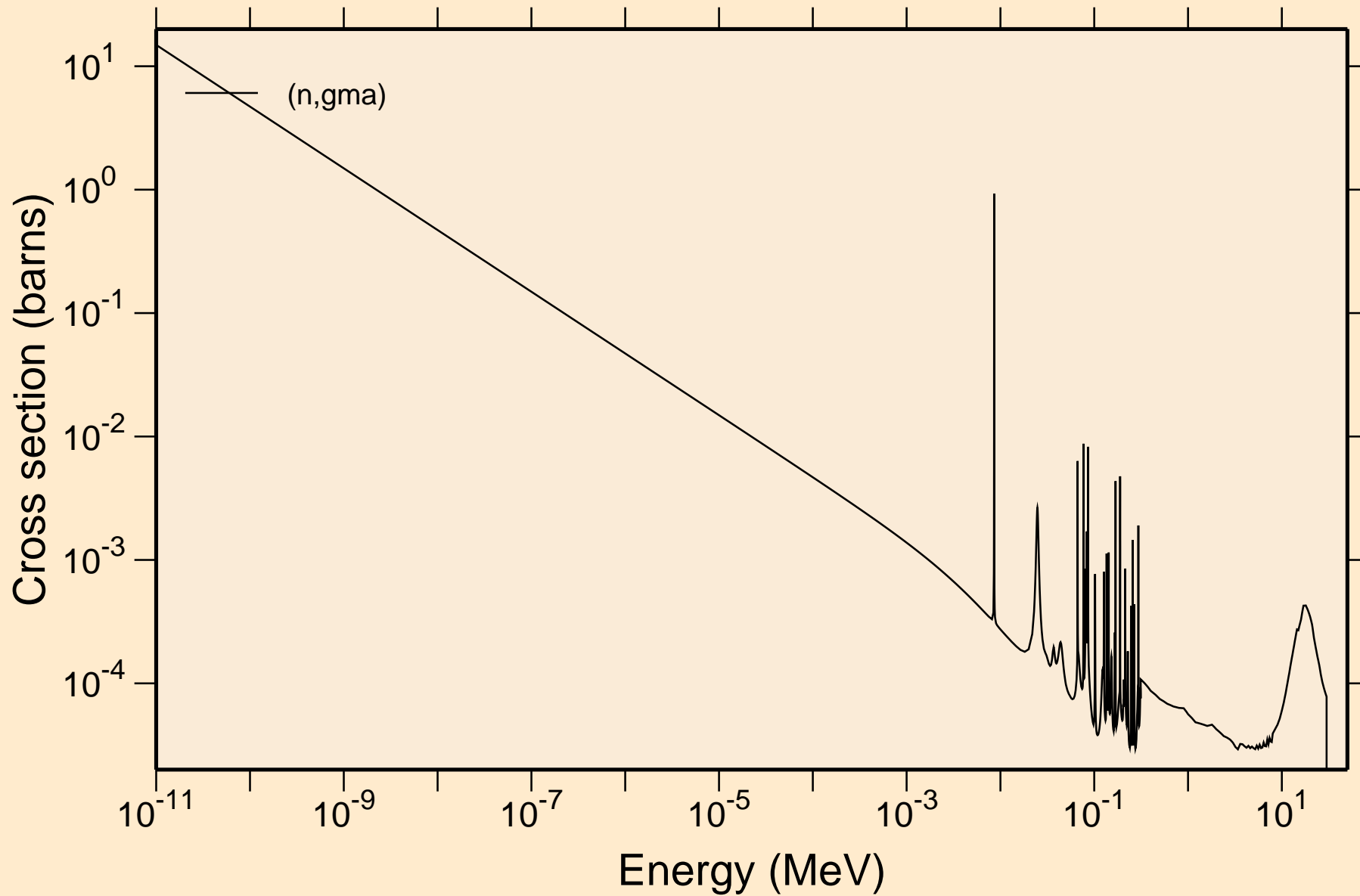

CL043 NEUTRON ACER TENDL-2021 LIBRARY; T=293.6K  
Principal cross sections

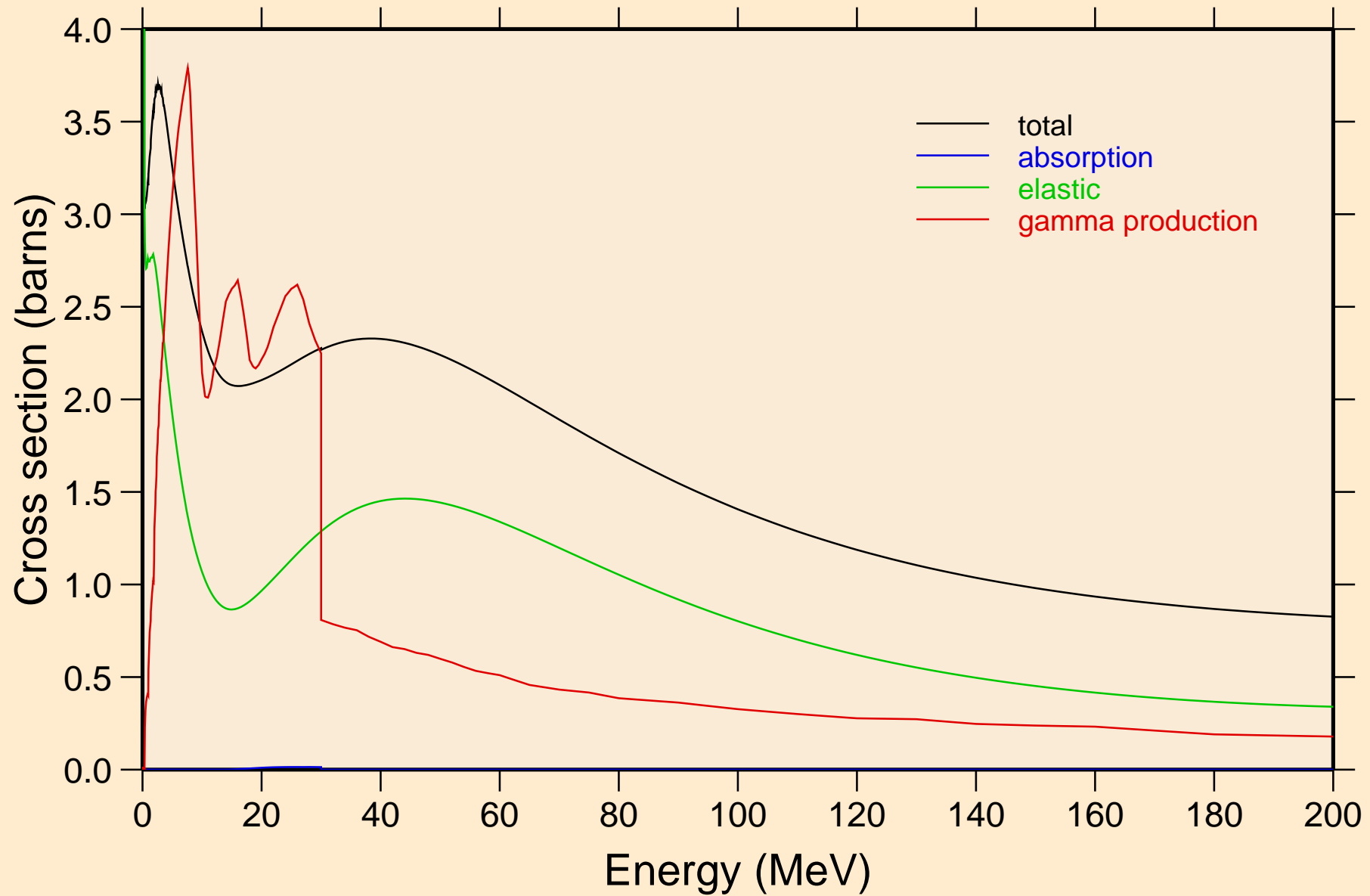

CL043 NEUTRON ACER TENDL-2021 LIBRARY; T=293.6K

Heating

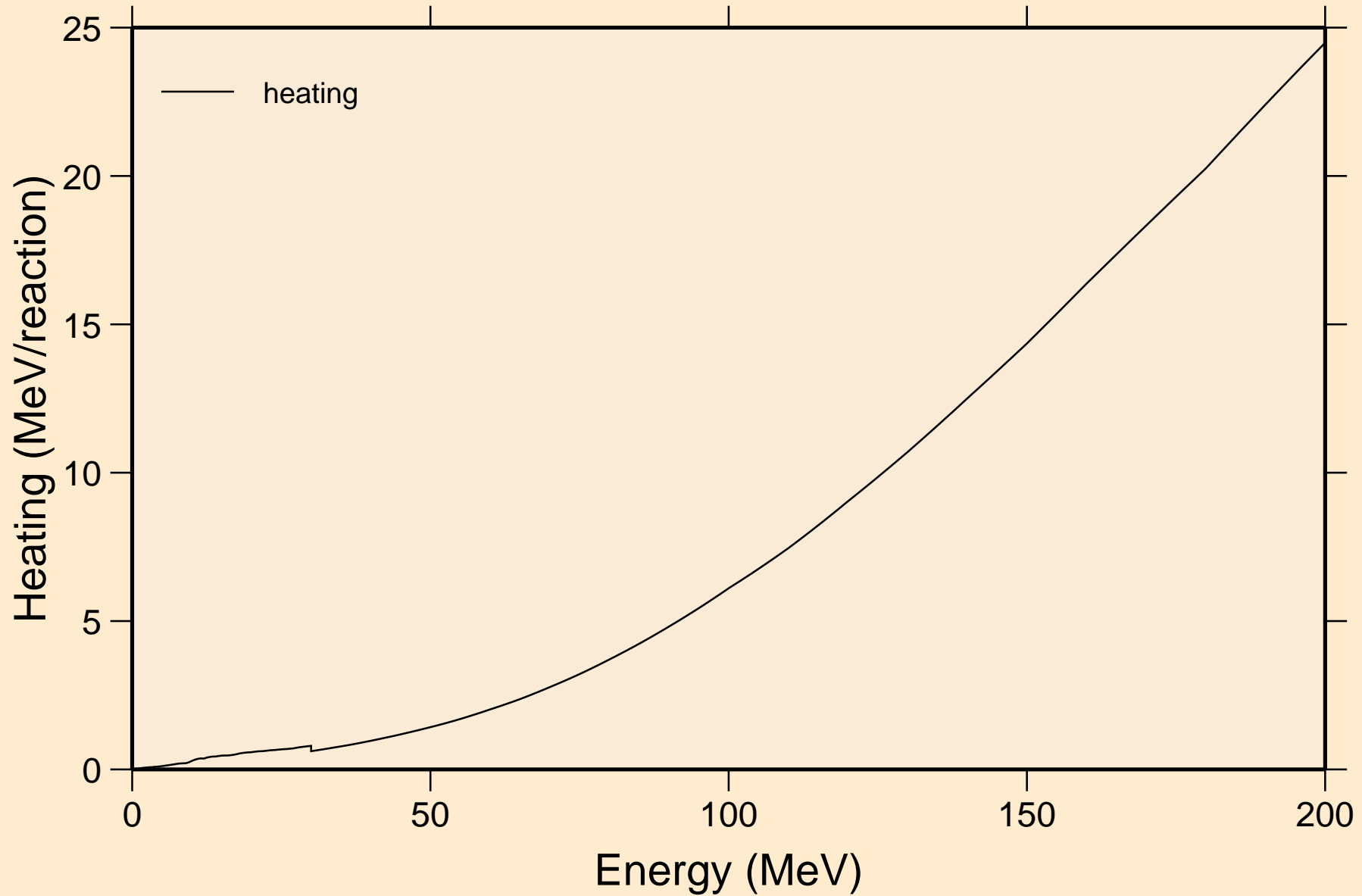

CL043 NEUTRON ACER TENDL-2021 LIBRARY; T=293.6K  
Damage

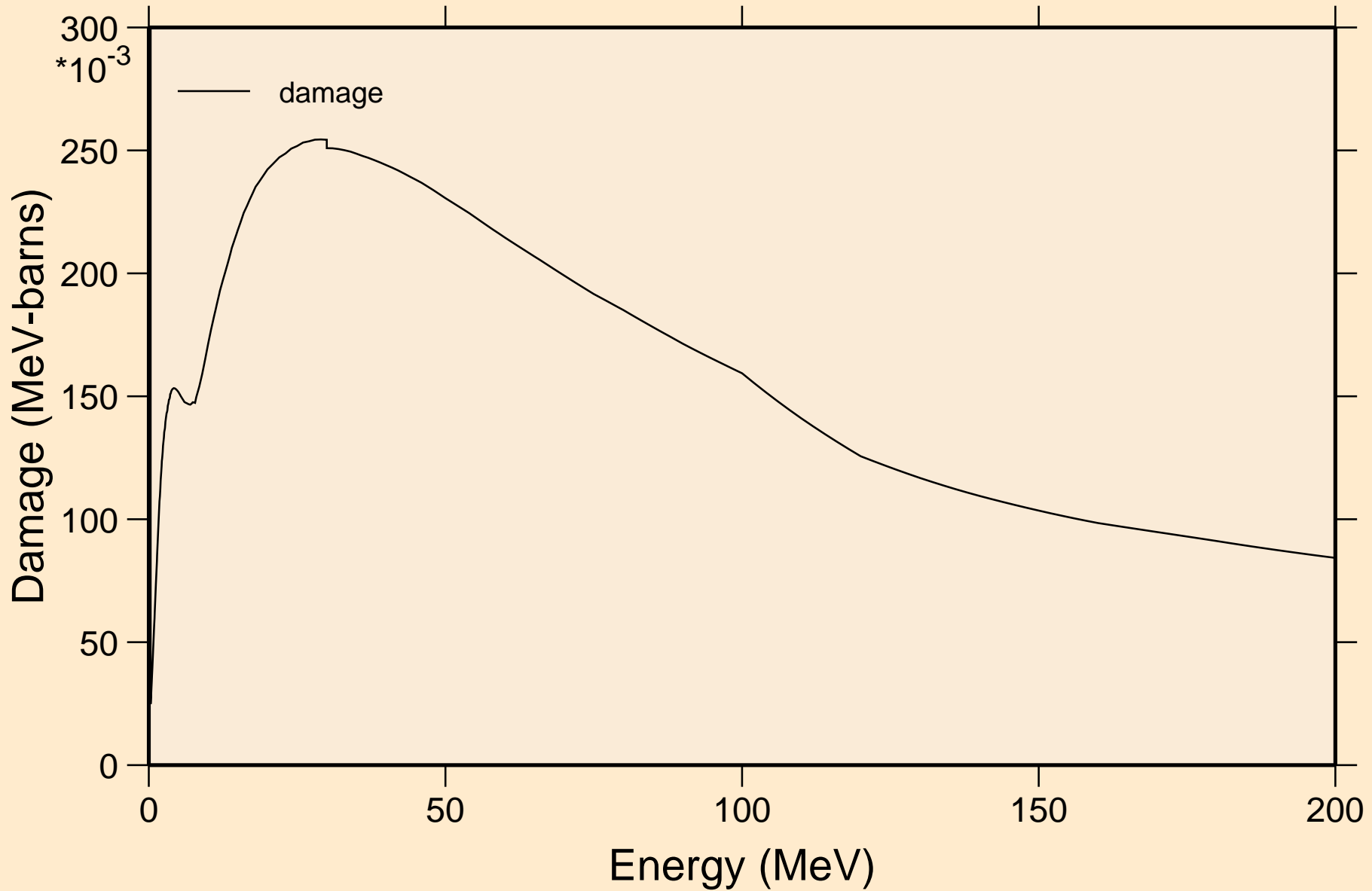

CL043 NEUTRON ACER TENDL-2021 LIBRARY; T=293.6K  
Non-threshold reactions

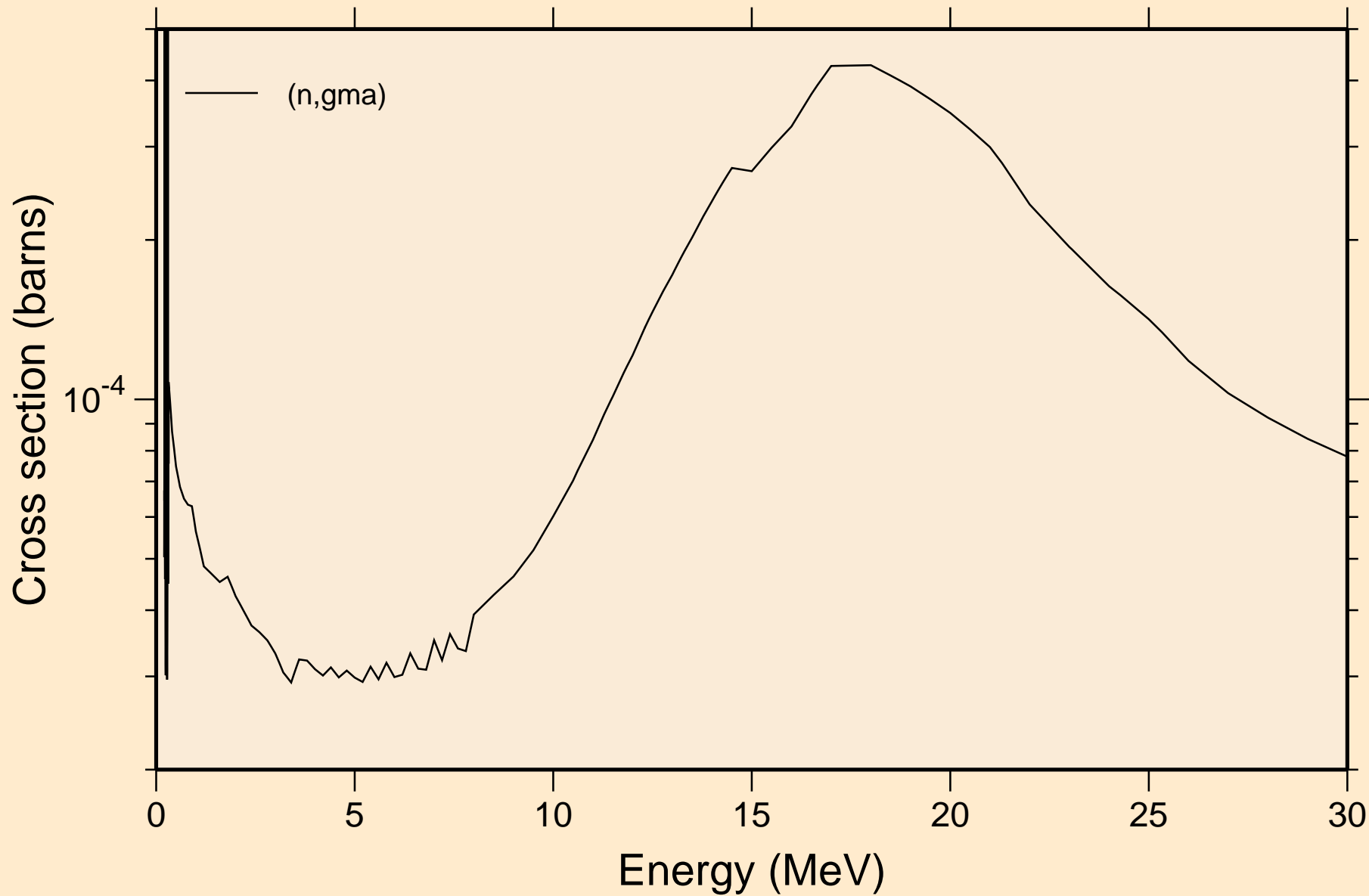



CL043 NEUTRON ACER TENDL-2021 LIBRARY; T=293.6K  
Inelastic levels

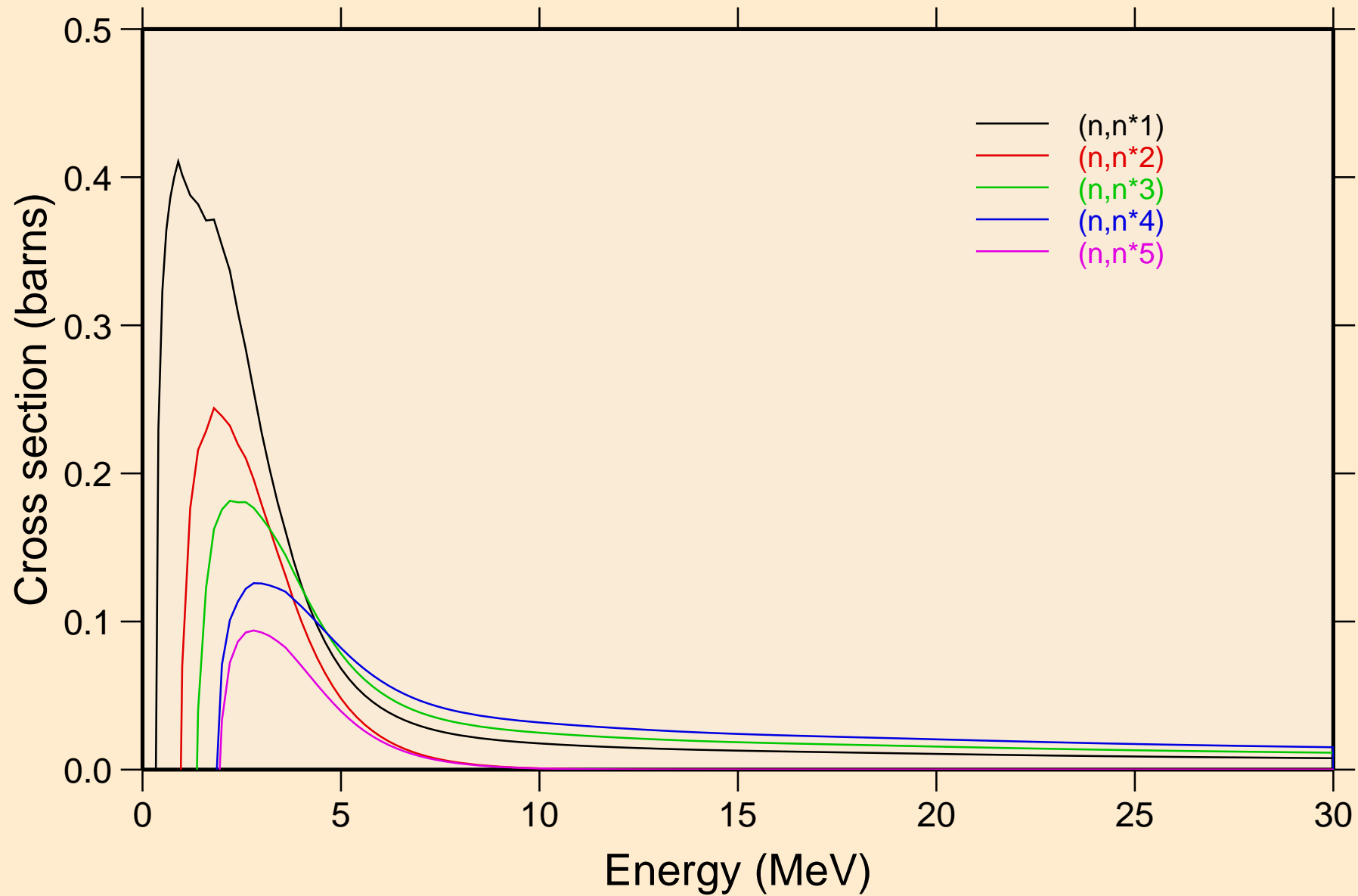

CL043 NEUTRON ACER TENDL-2021 LIBRARY; T=293.6K  
Inelastic levels

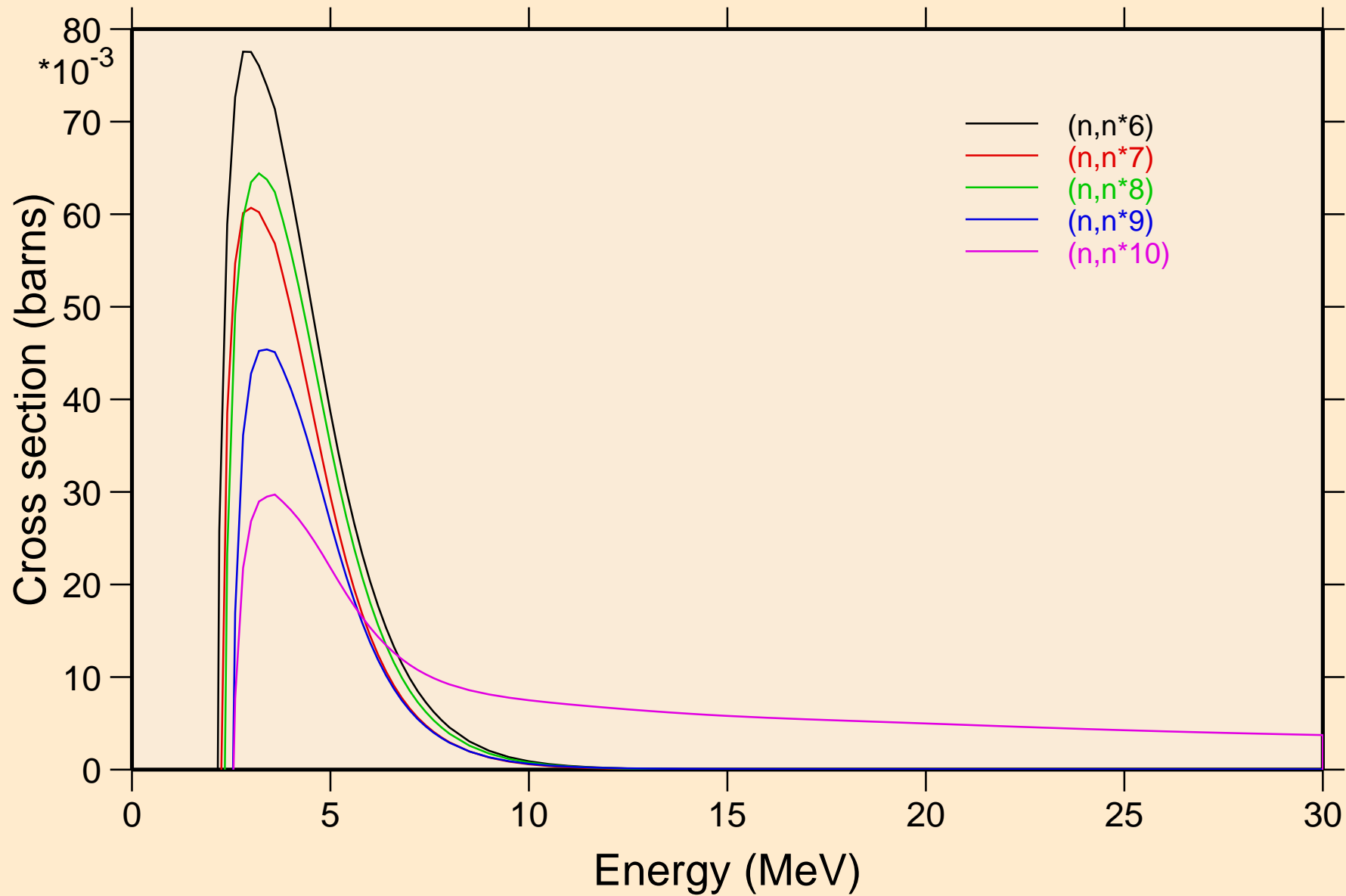

CL043 NEUTRON ACER TENDL-2021 LIBRARY; T=293.6K  
Inelastic levels

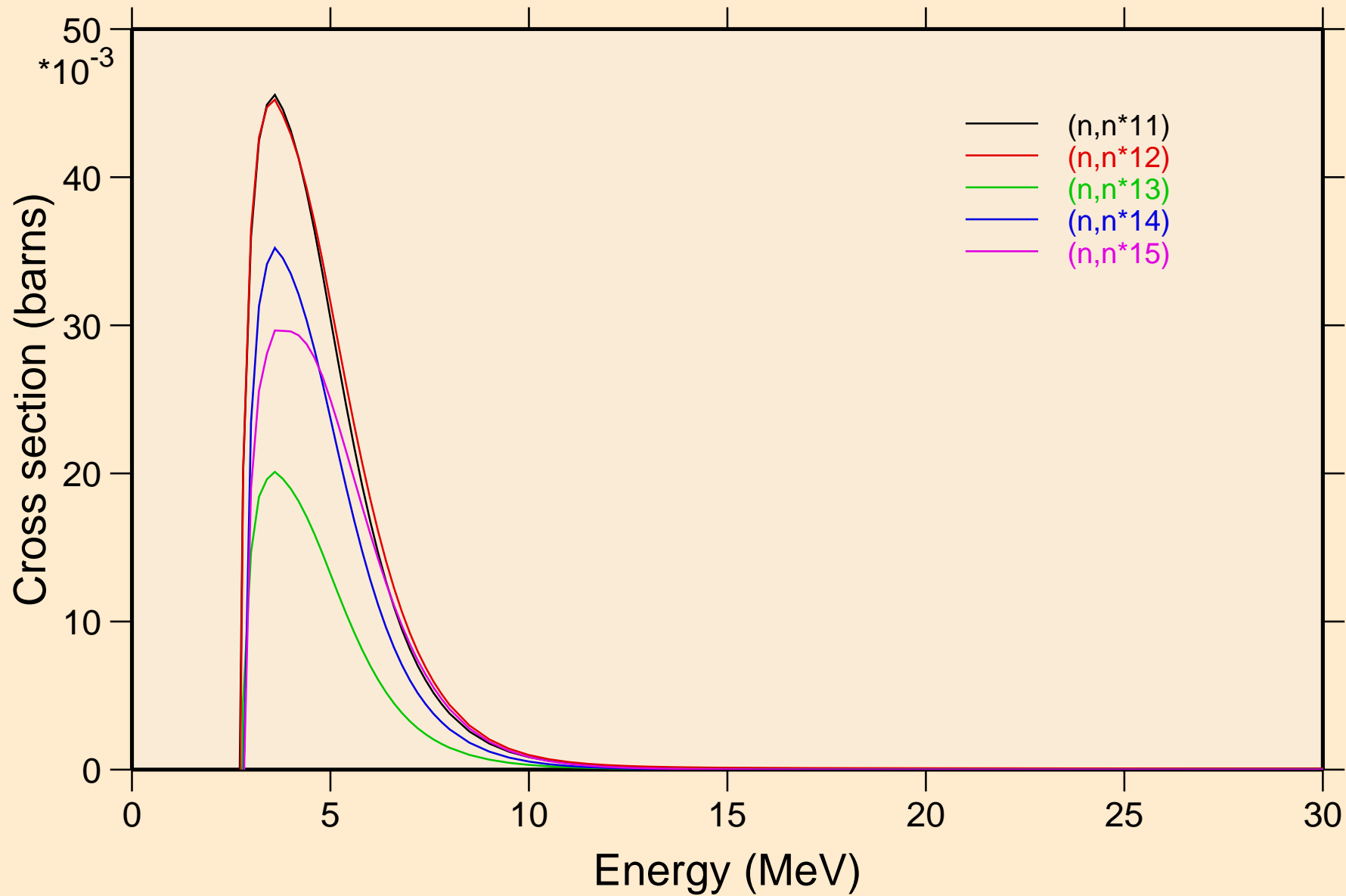

CL043 NEUTRON ACER TENDL-2021 LIBRARY; T=293.6K  
Inelastic levels

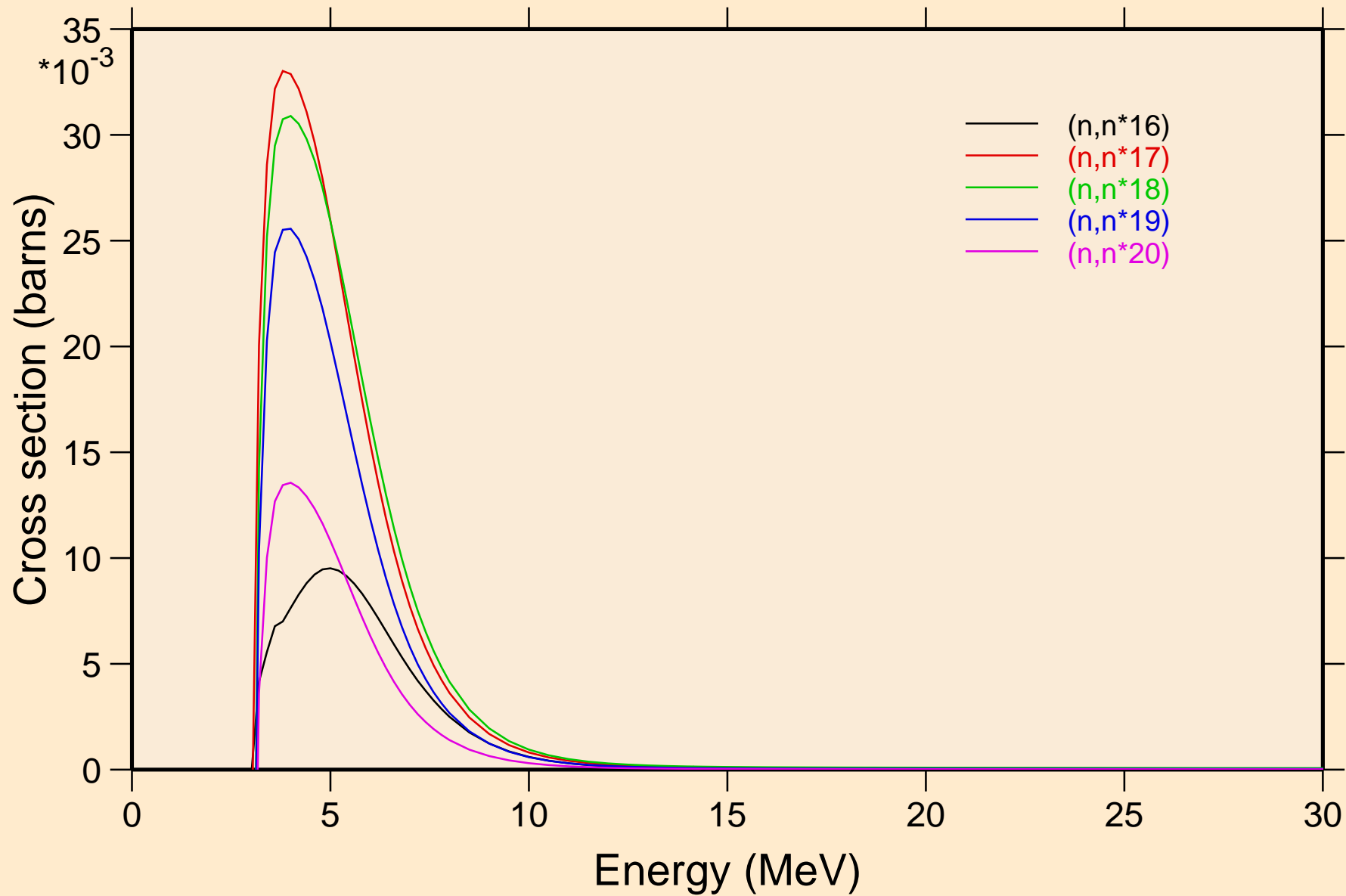

CL043 NEUTRON ACER TENDL-2021 LIBRARY; T=293.6K  
Inelastic levels

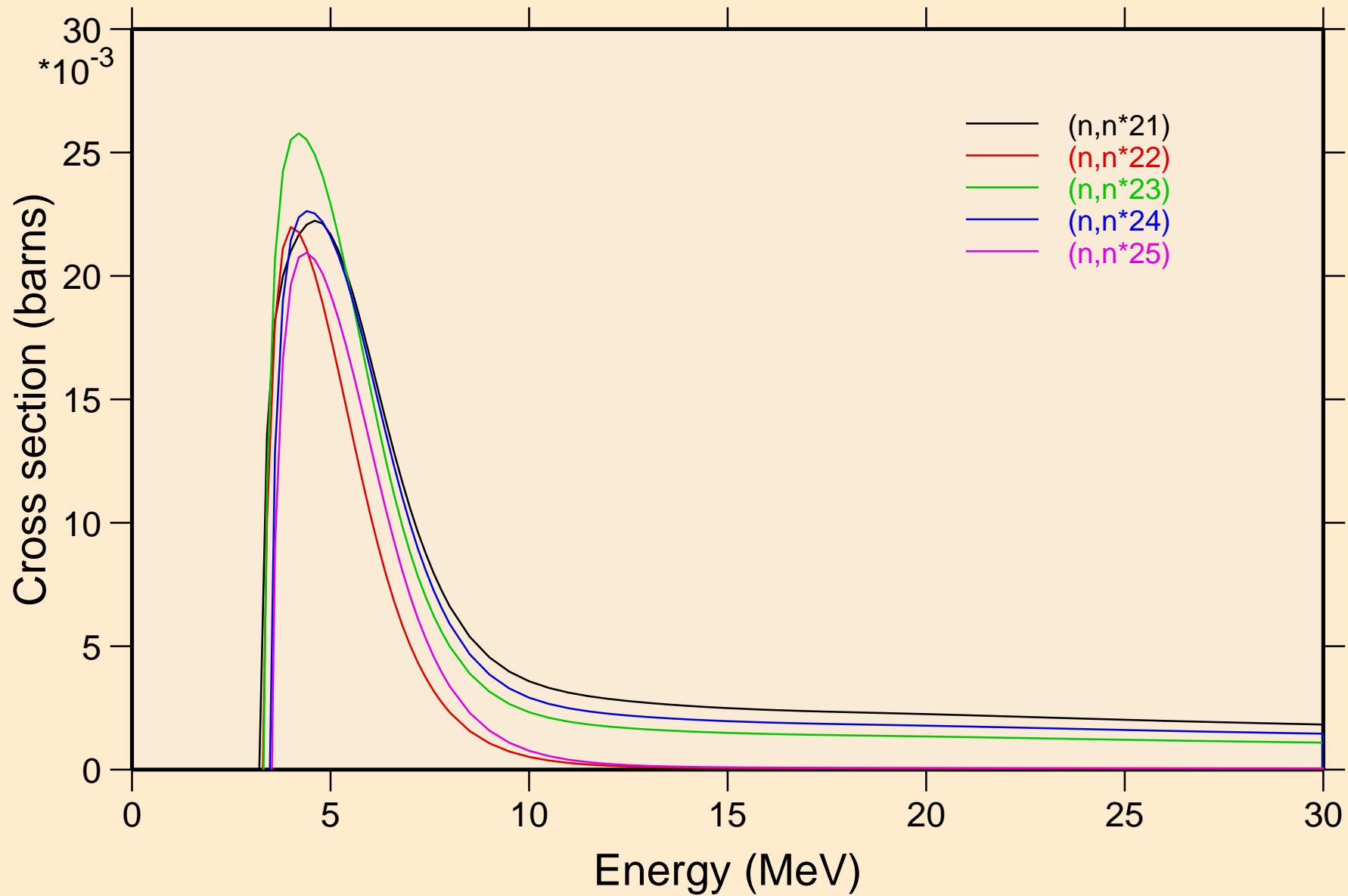

CL043 NEUTRON ACER TENDL-2021 LIBRARY; T=293.6K  
Inelastic levels

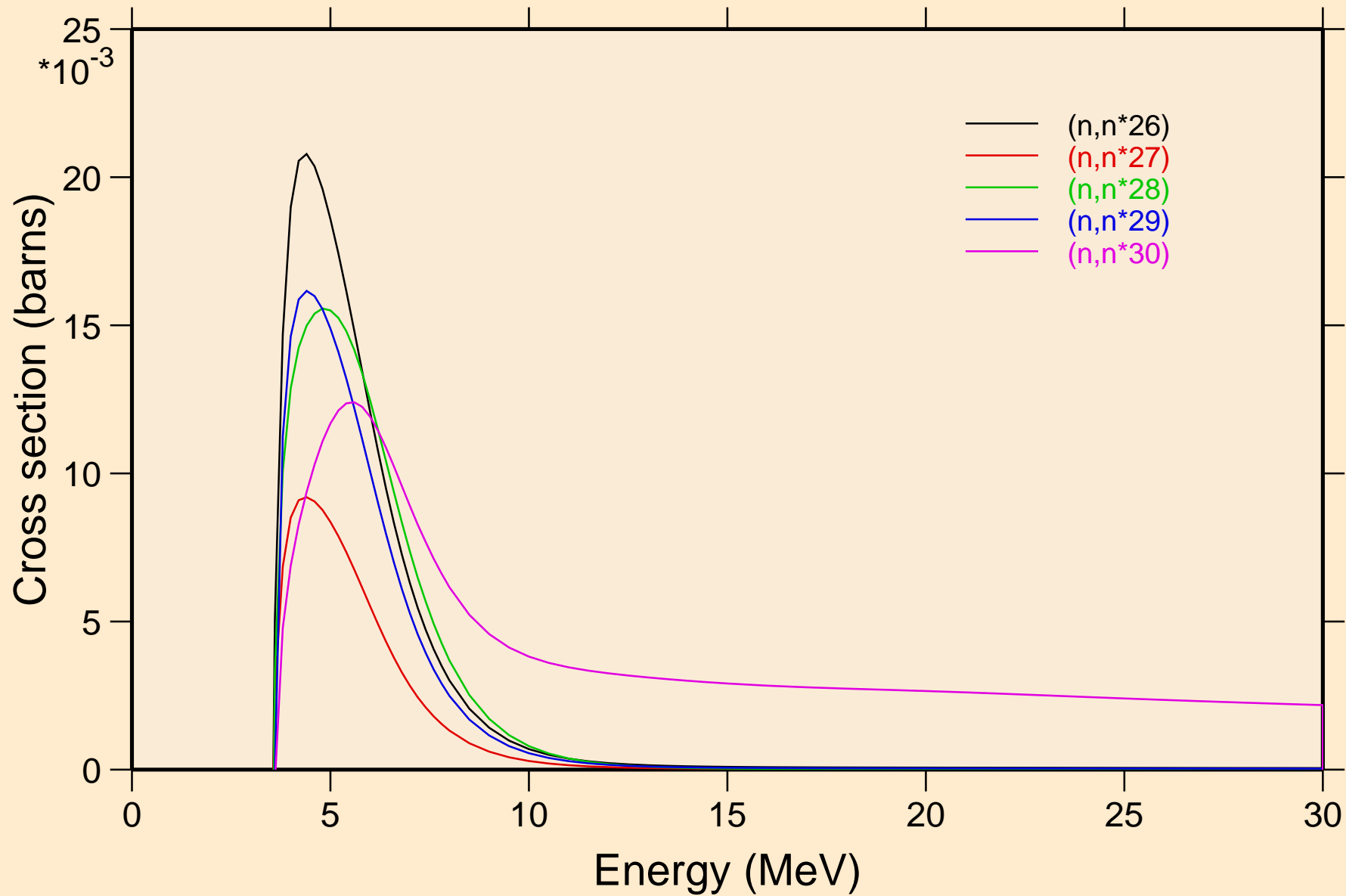

CL043 NEUTRON ACER TENDL-2021 LIBRARY; T=293.6K  
Threshold reactions

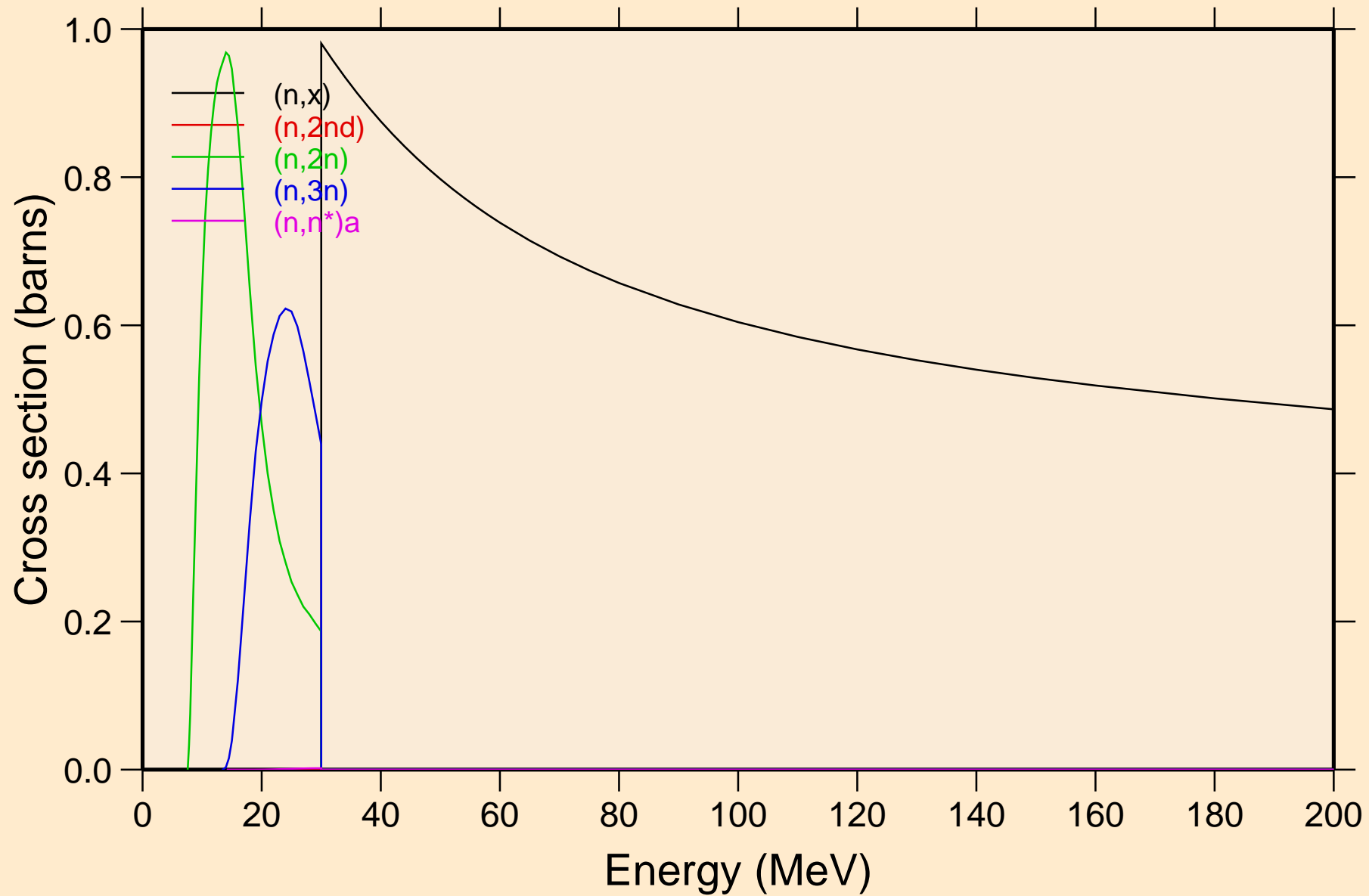

CL043 NEUTRON ACER TENDL-2021 LIBRARY; T=293.6K  
Threshold reactions

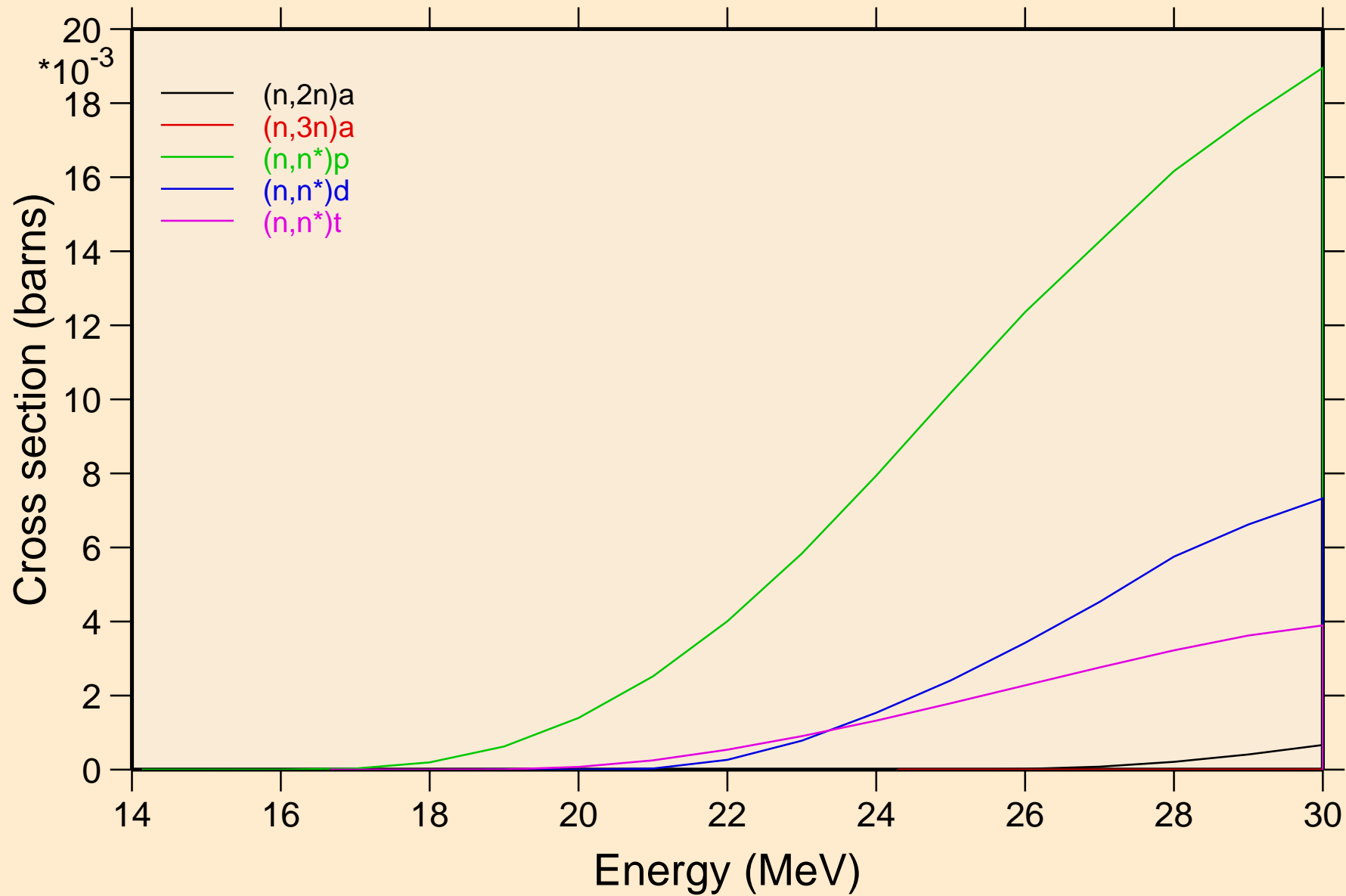



CL043 NEUTRON ACER TENDL-2021 LIBRARY; T=293.6K  
Threshold reactions

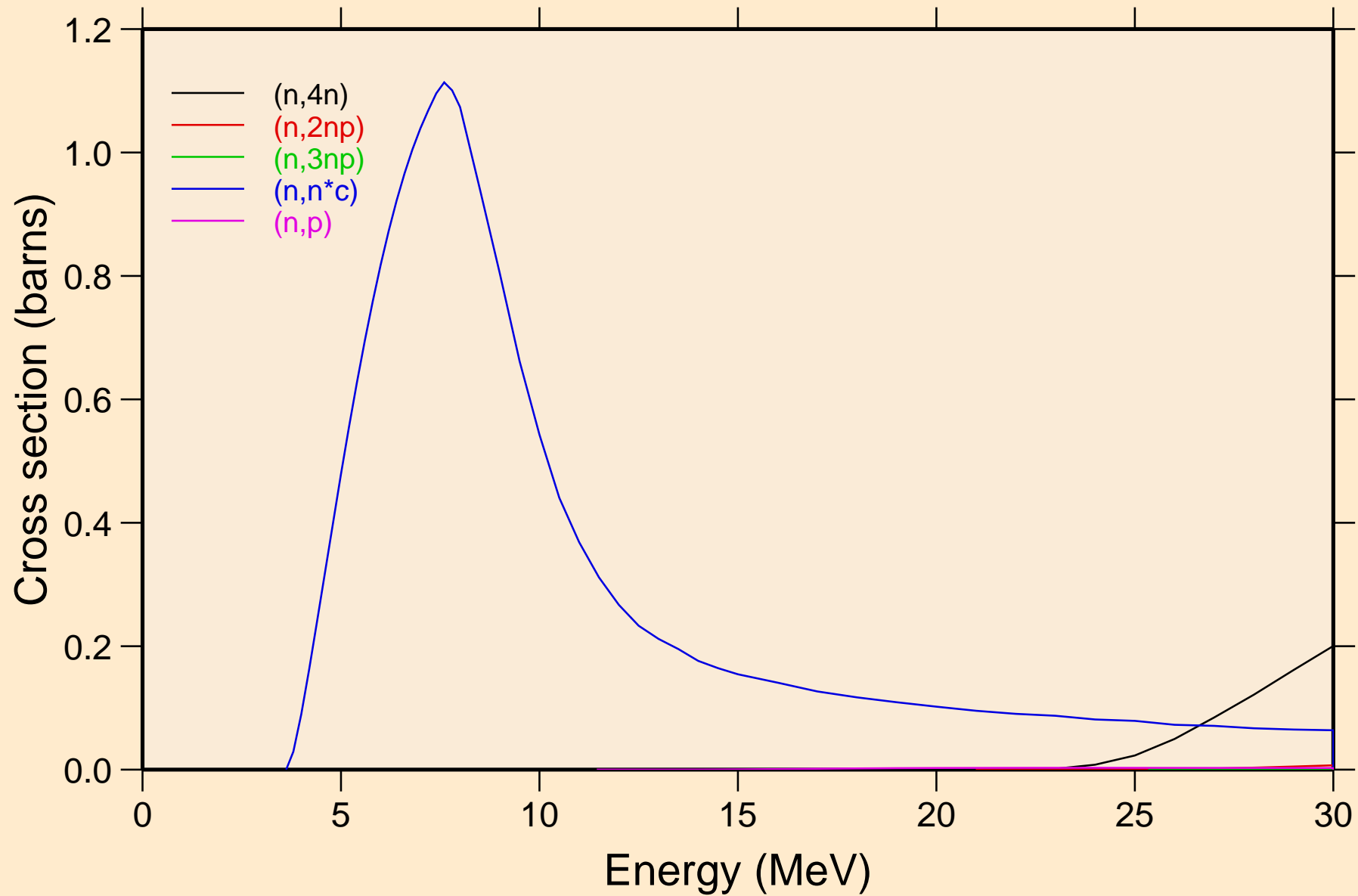

CL043 NEUTRON ACER TENDL-2021 LIBRARY; T=293.6K  
Threshold reactions

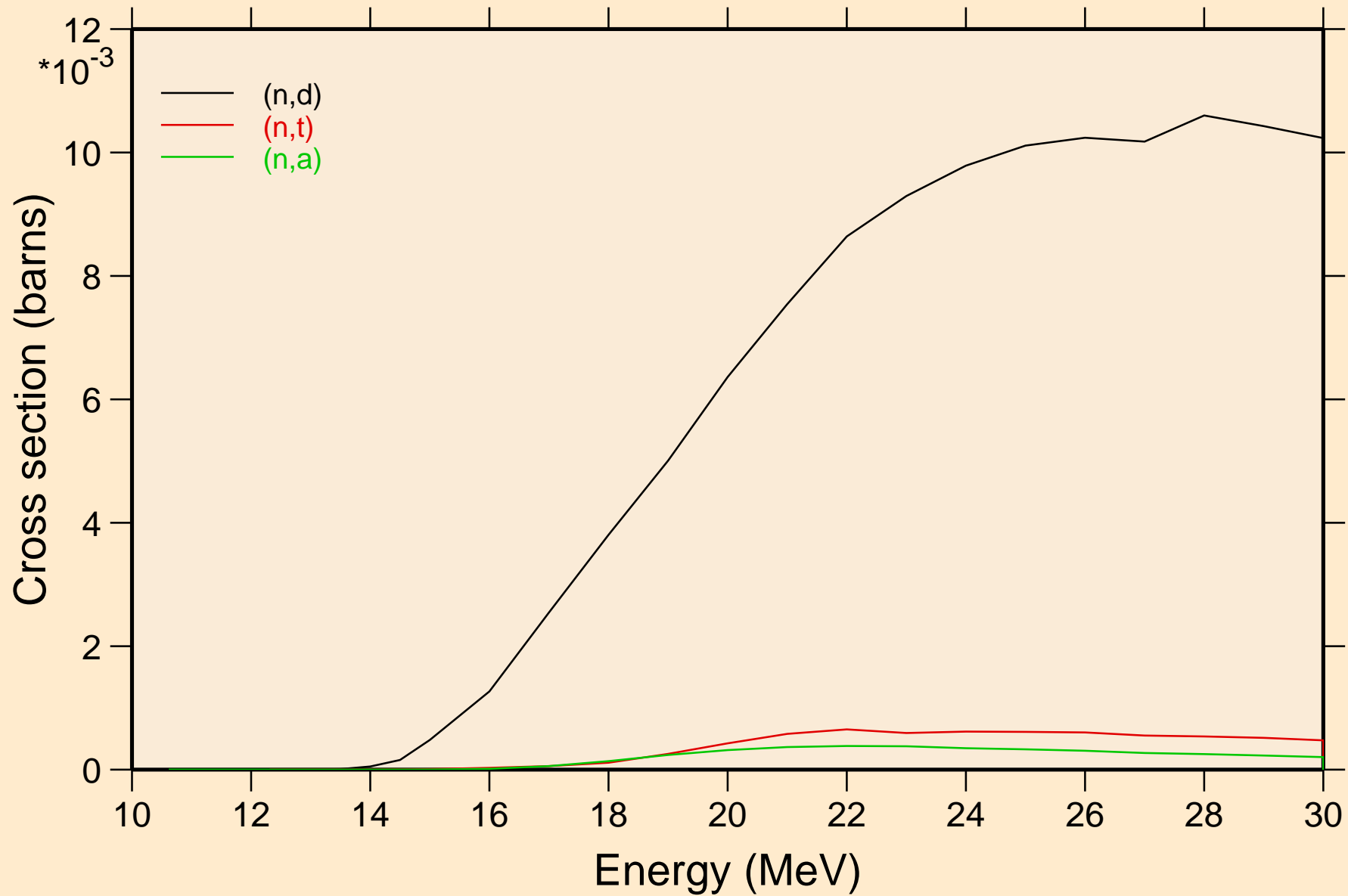

# CL043 NEUTRON ACER TENDL-2021 LIBRARY; T=293.6K

## Threshold reactions

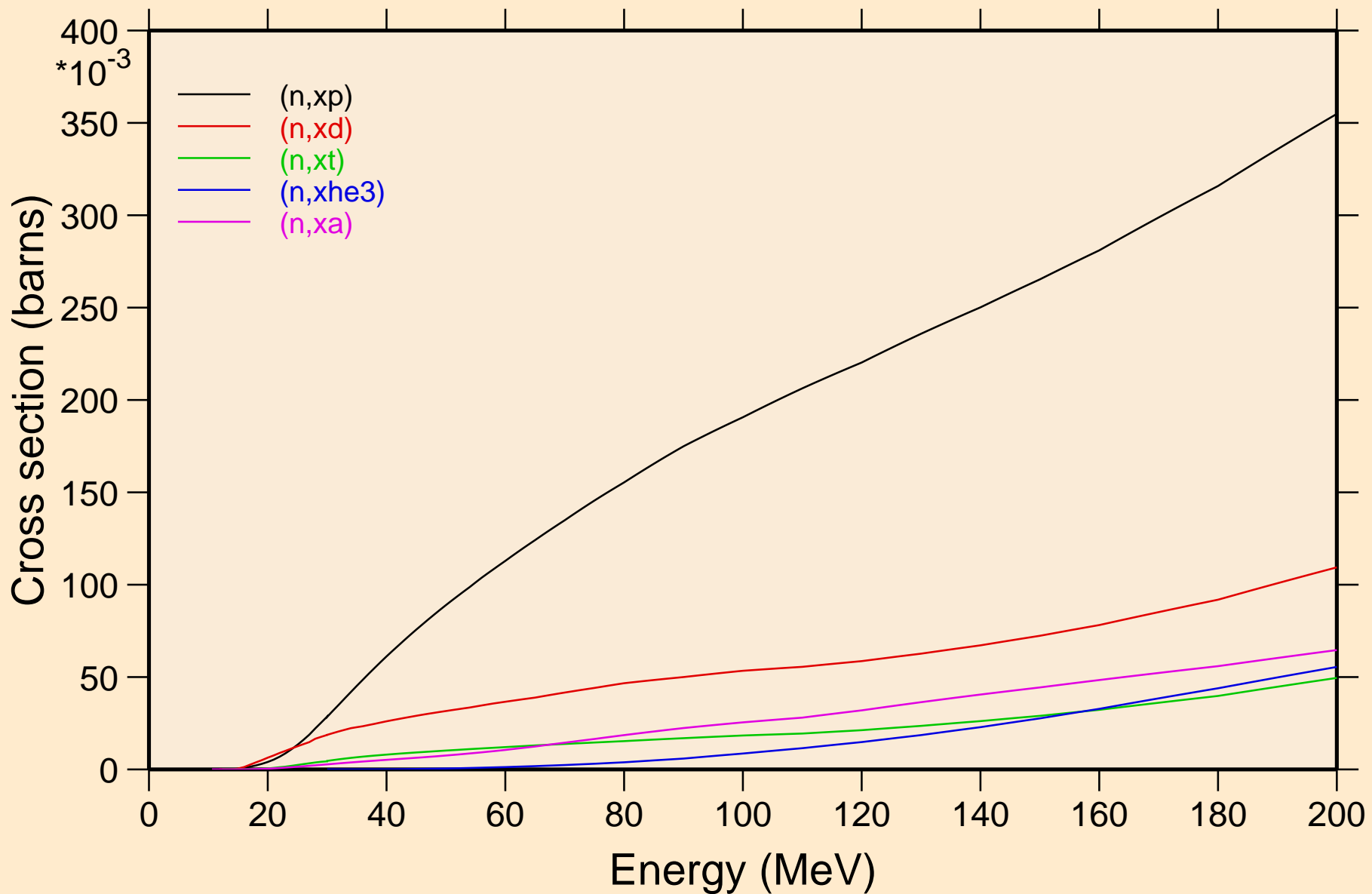

CL043 NEUTRON ACER TENDL-2021 LIBRARY; T=293.6K  
angular distribution for elastic

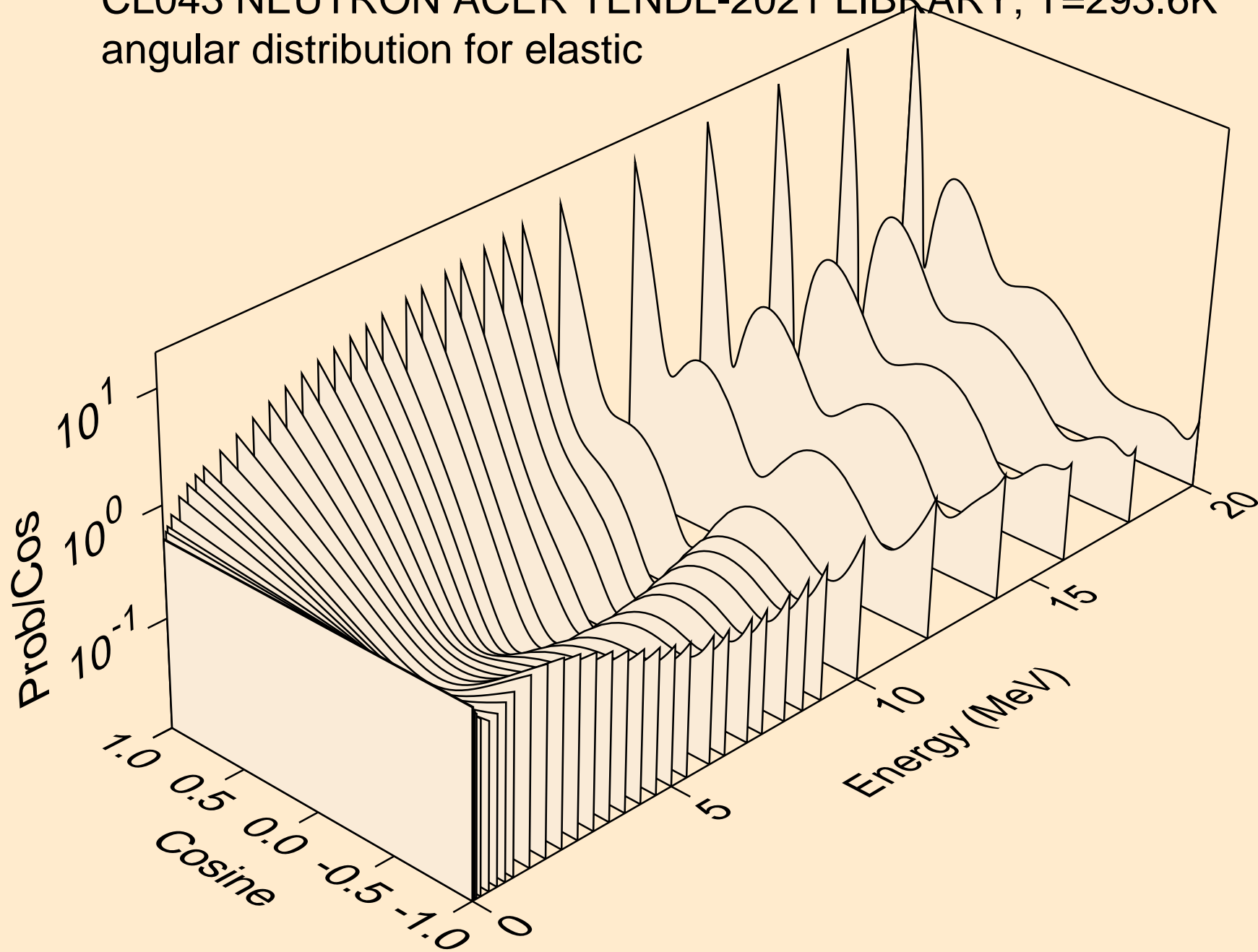

CL043 NEUTRON ACER TENDL-2021 LIBRARY; T=293.6K  
angular distribution for elastic

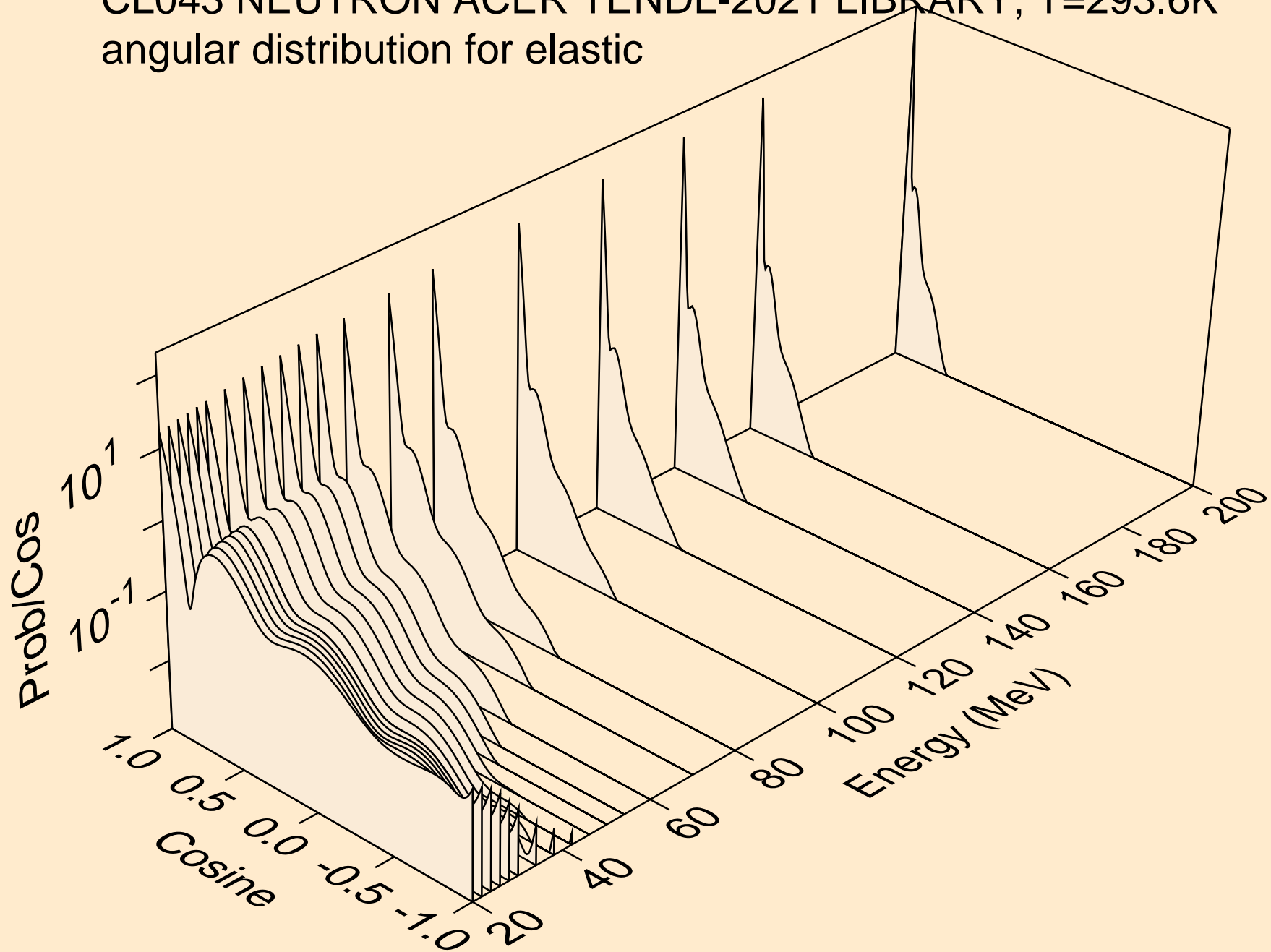

CL043 NEUTRON ACER TENDL-2021 LIBRARY; T=293.6K  
angular distribution for (n,n\*1)

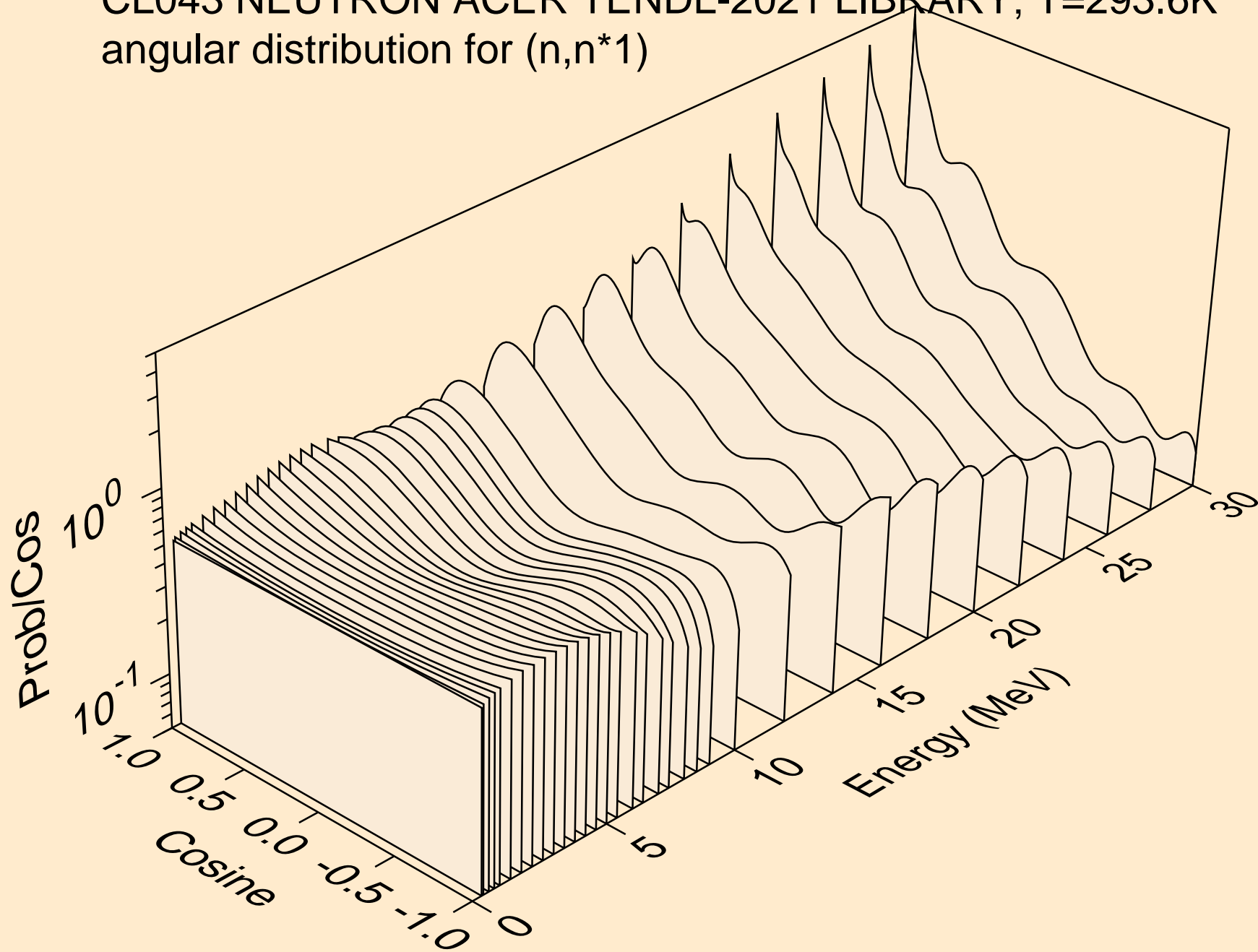

CL043 NEUTRON ACER TENDL-2021 LIBRARY; T=293.6K  
angular distribution for (n,n\*2)

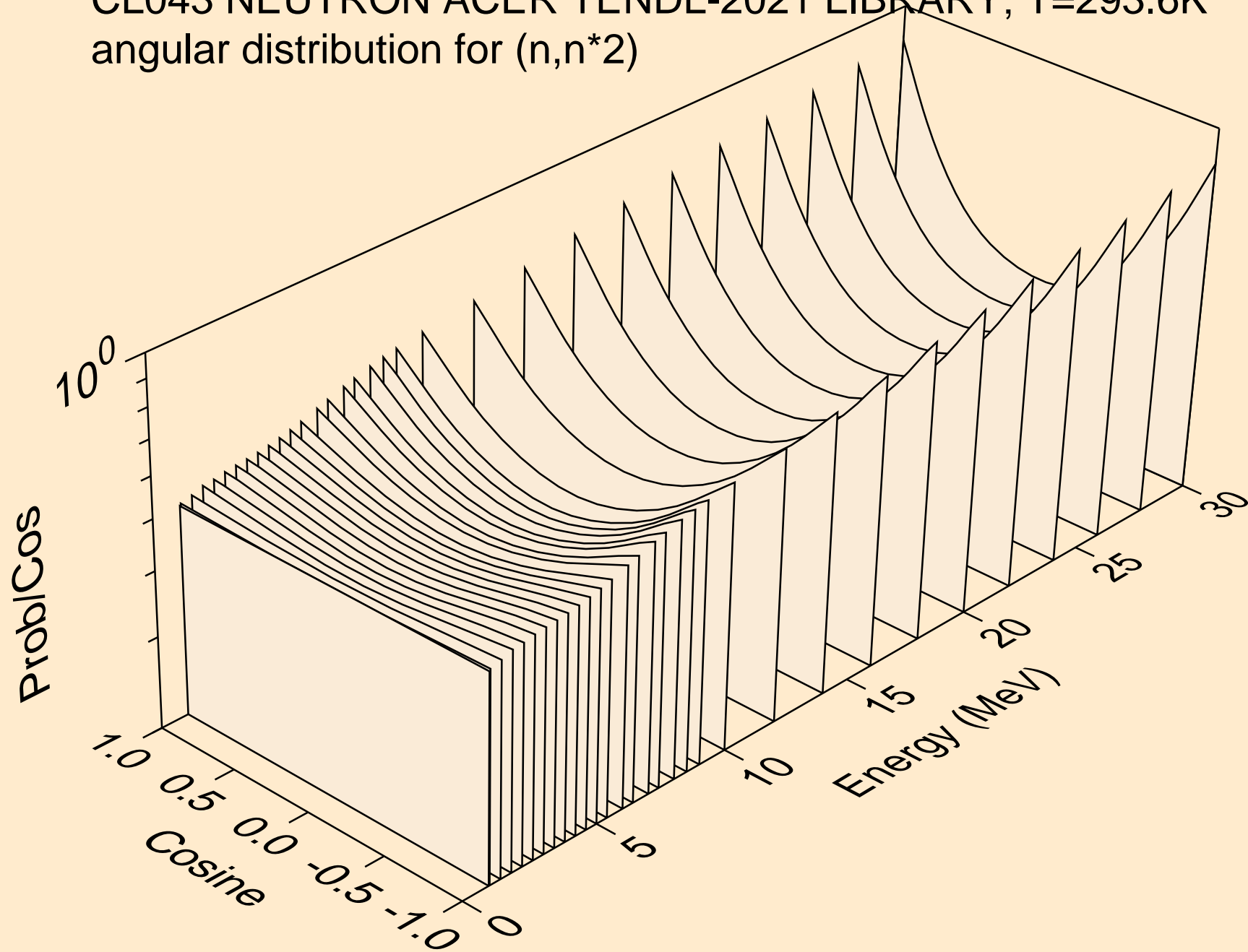

CL043 NEUTRON ACER TENDL-2021 LIBRARY; T=293.6K  
angular distribution for (n,n\*3)

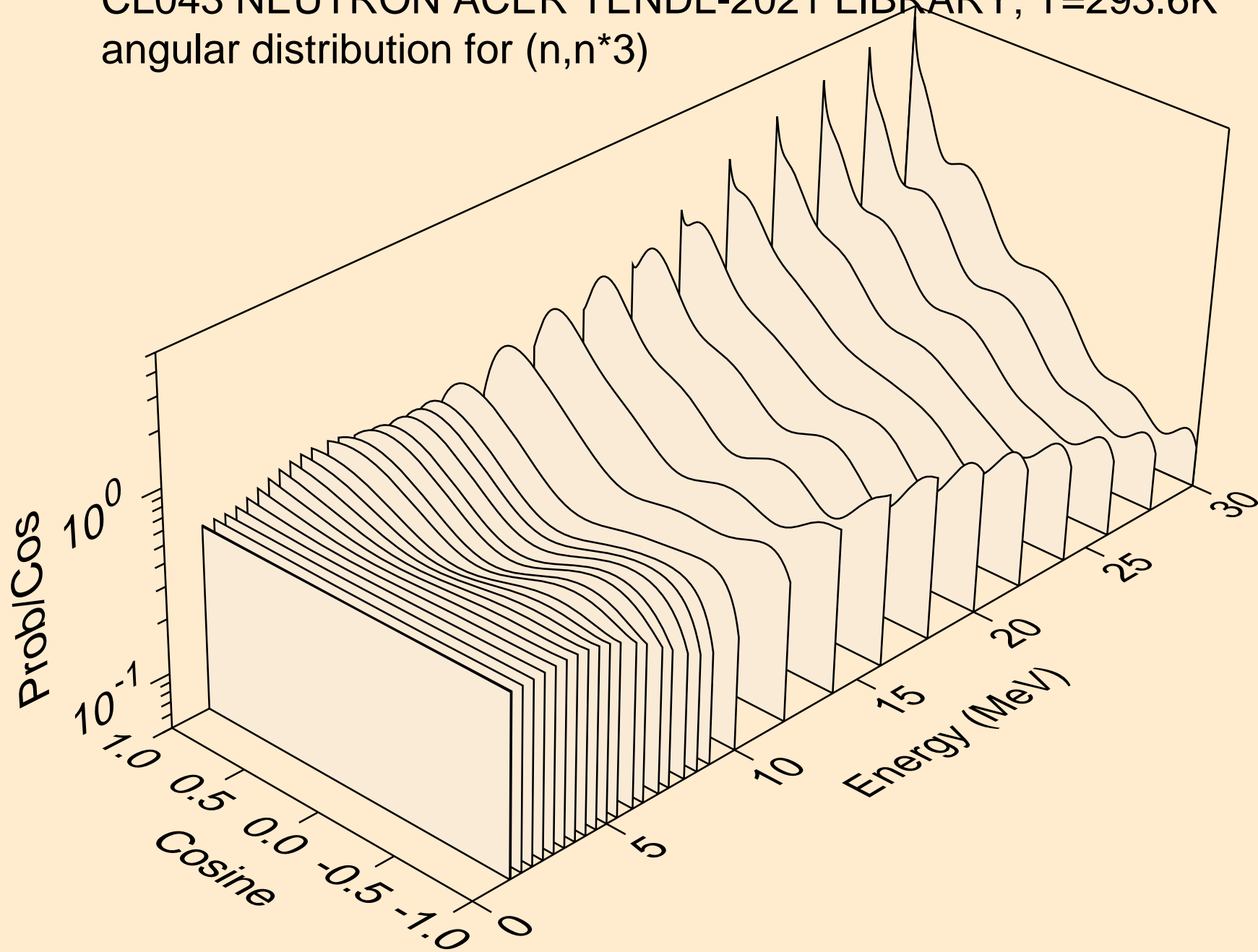



CL043 NEUTRON ACER TENDL-2021 LIBRARY; T=293.6K  
angular distribution for (n,n\*4)

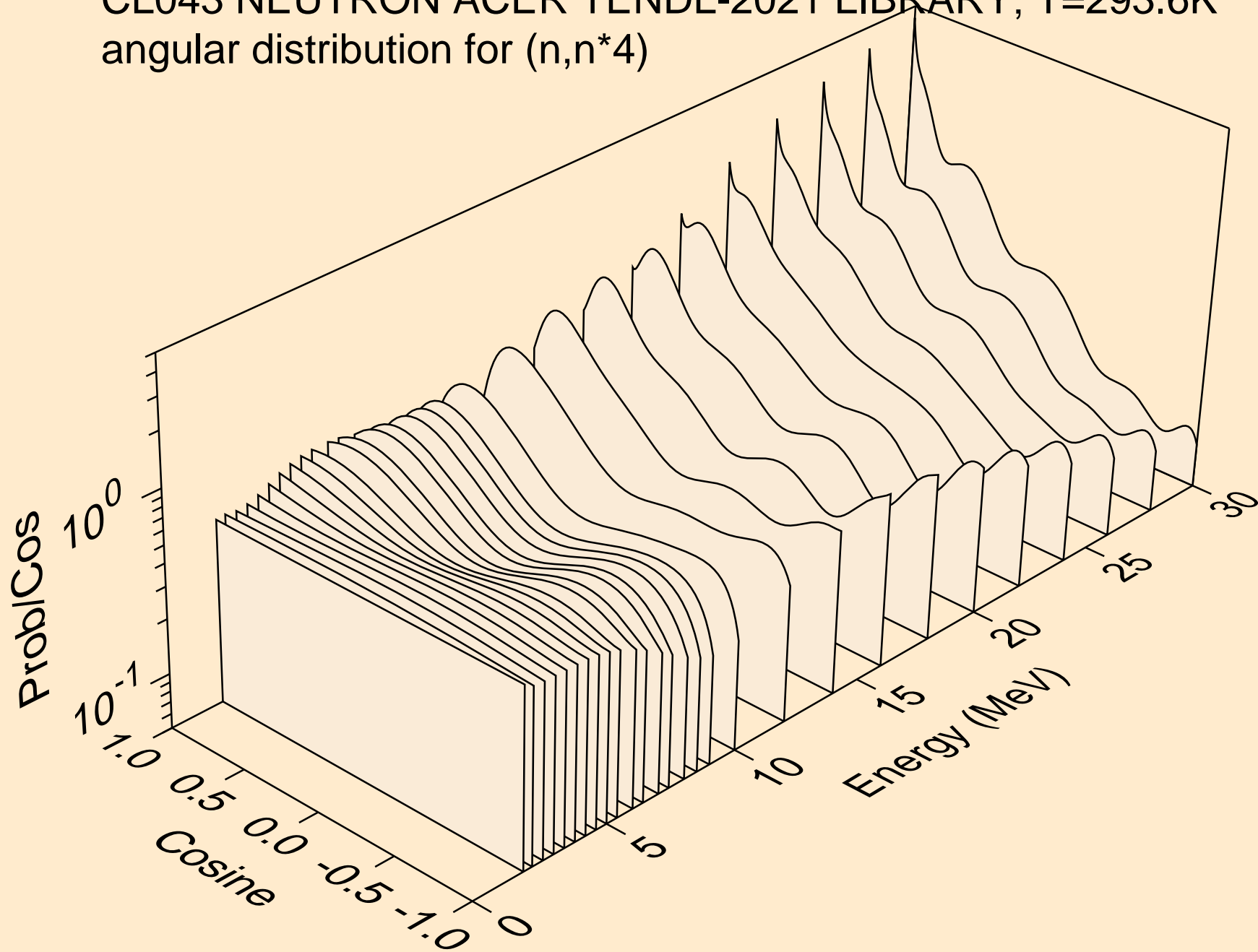

CL043 NEUTRON ACER TENDL-2021 LIBRARY; T=293.6K  
angular distribution for (n,n\*5)

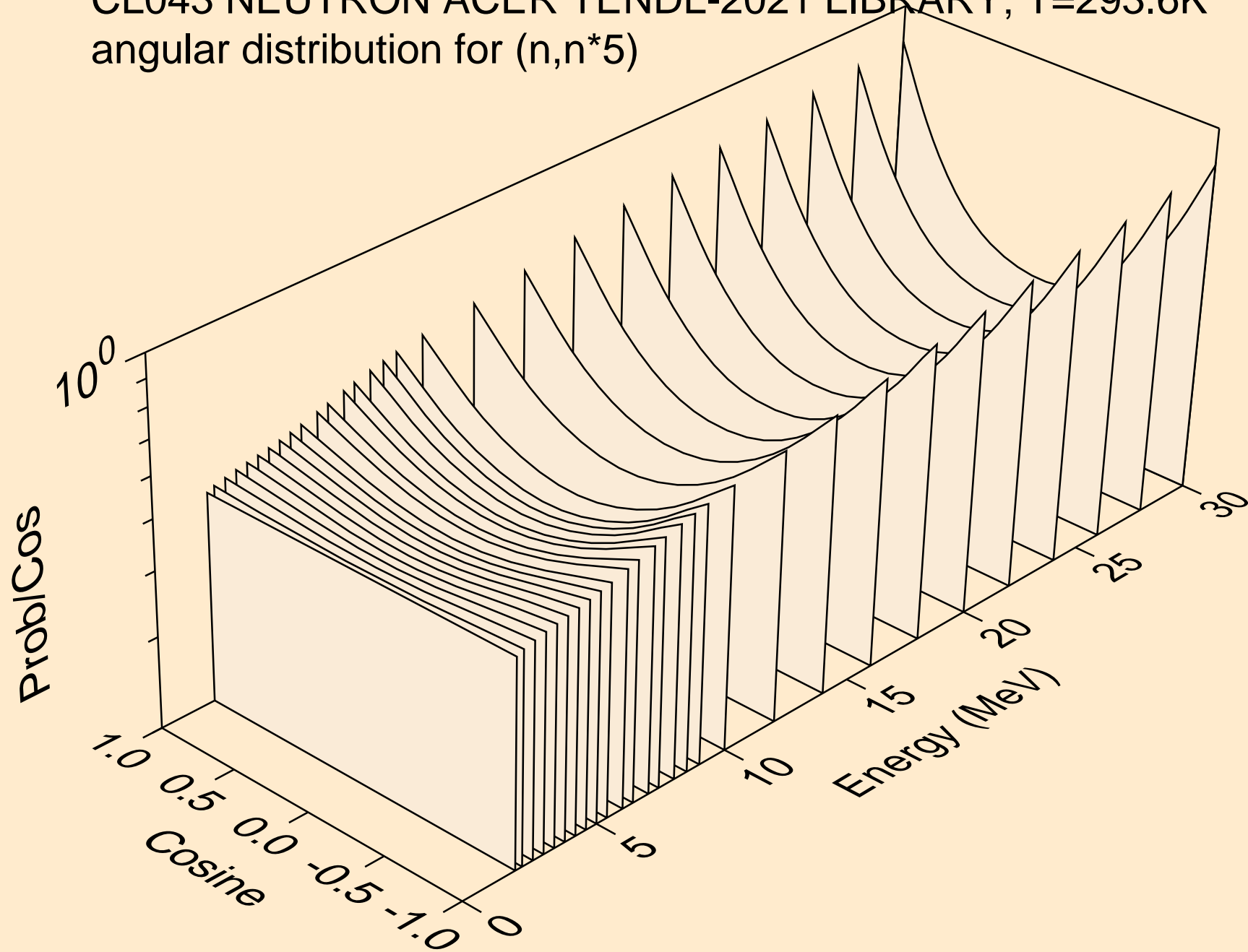

CL043 NEUTRON ACER TENDL-2021 LIBRARY; T=293.6K  
angular distribution for (n,n\*6)

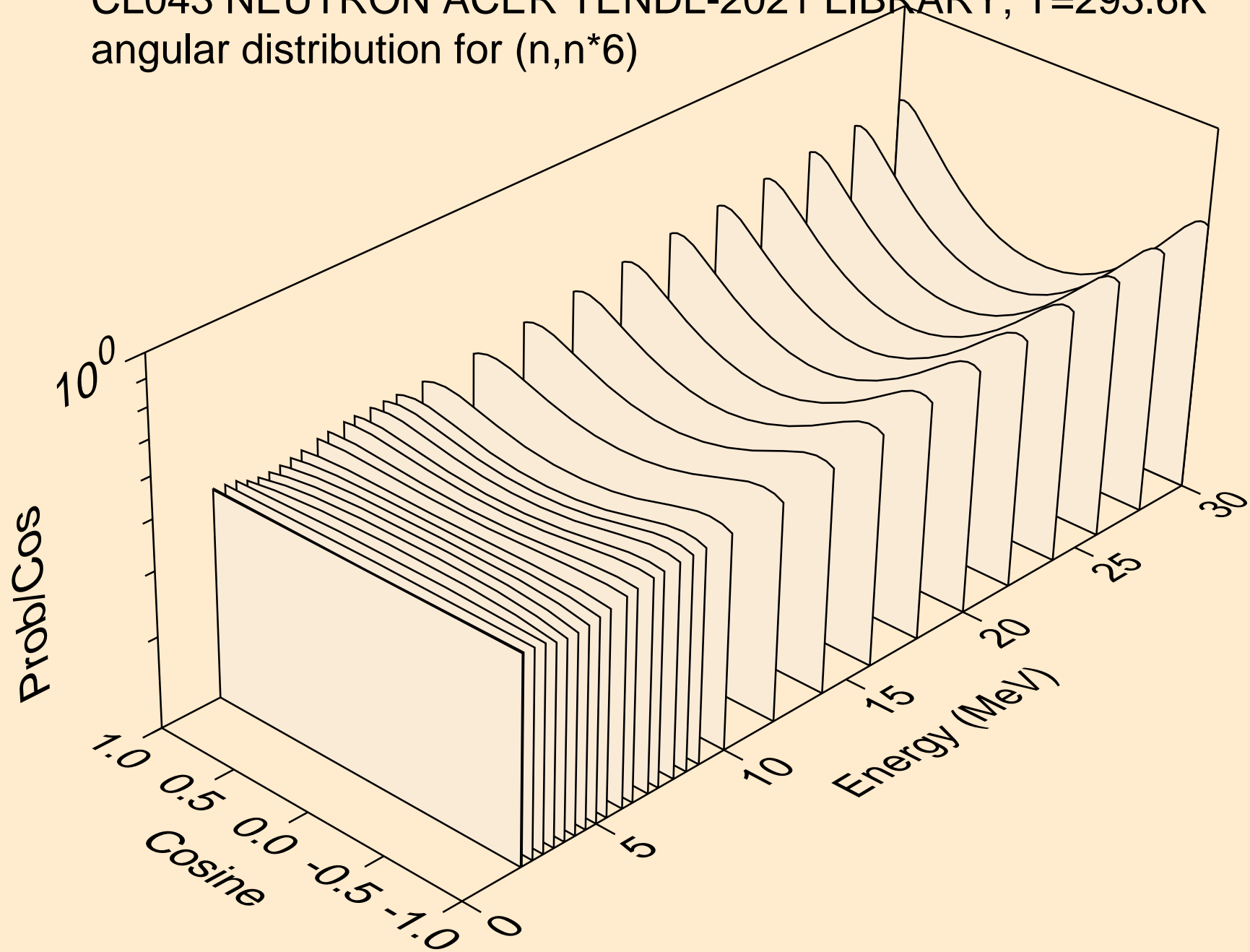

CL043 NEUTRON ACER TENDL-2021 LIBRARY; T=293.6K  
angular distribution for (n,n\*7)

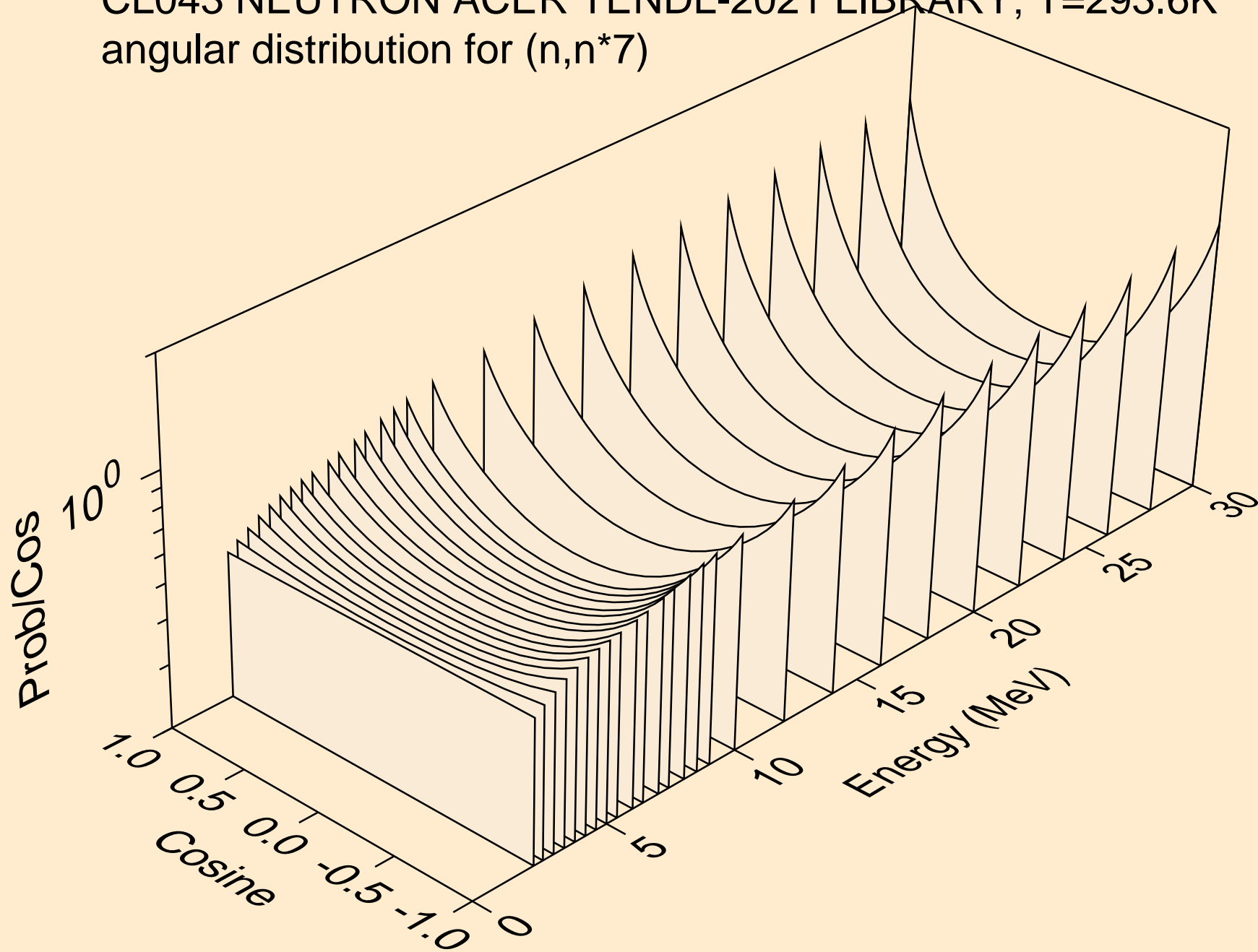

CL043 NEUTRON ACER TENDL-2021 LIBRARY; T=293.6K  
angular distribution for (n,n\*8)

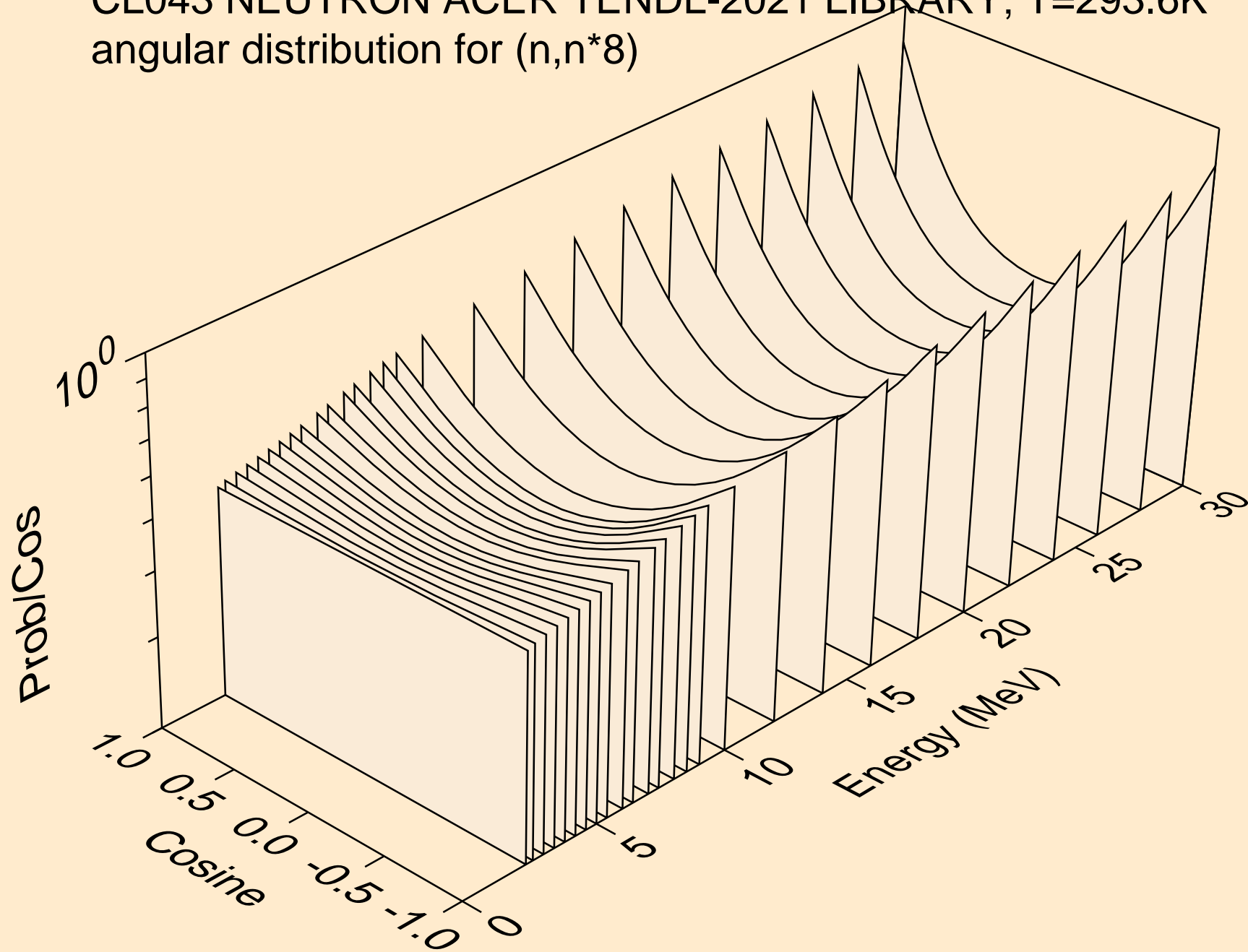

CL043 NEUTRON ACER TENDL-2021 LIBRARY; T=293.6K  
angular distribution for (n,n\*9)

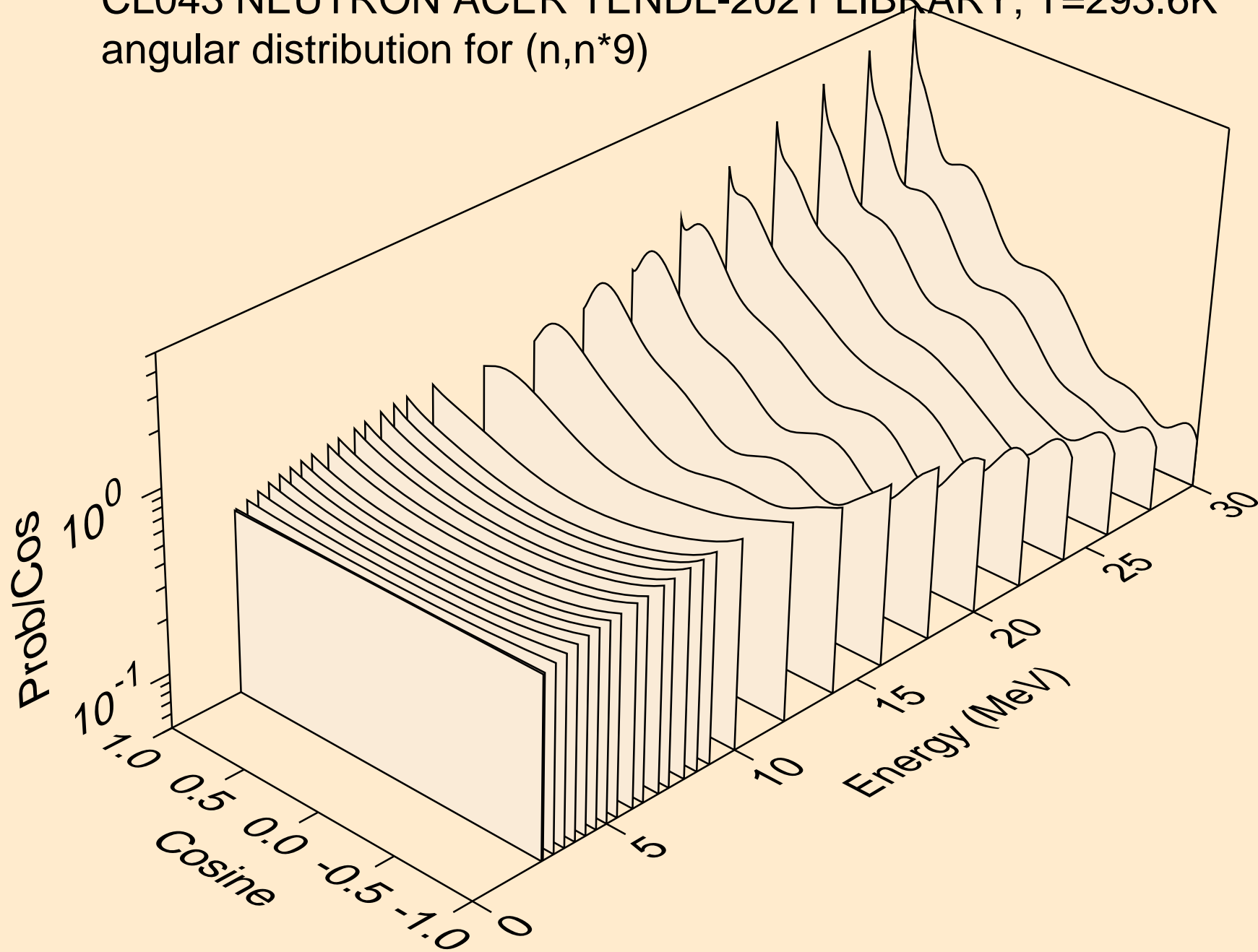

CL043 NEUTRON ACER TENDL-2021 LIBRARY; T=293.6K  
angular distribution for (n,n\*10)

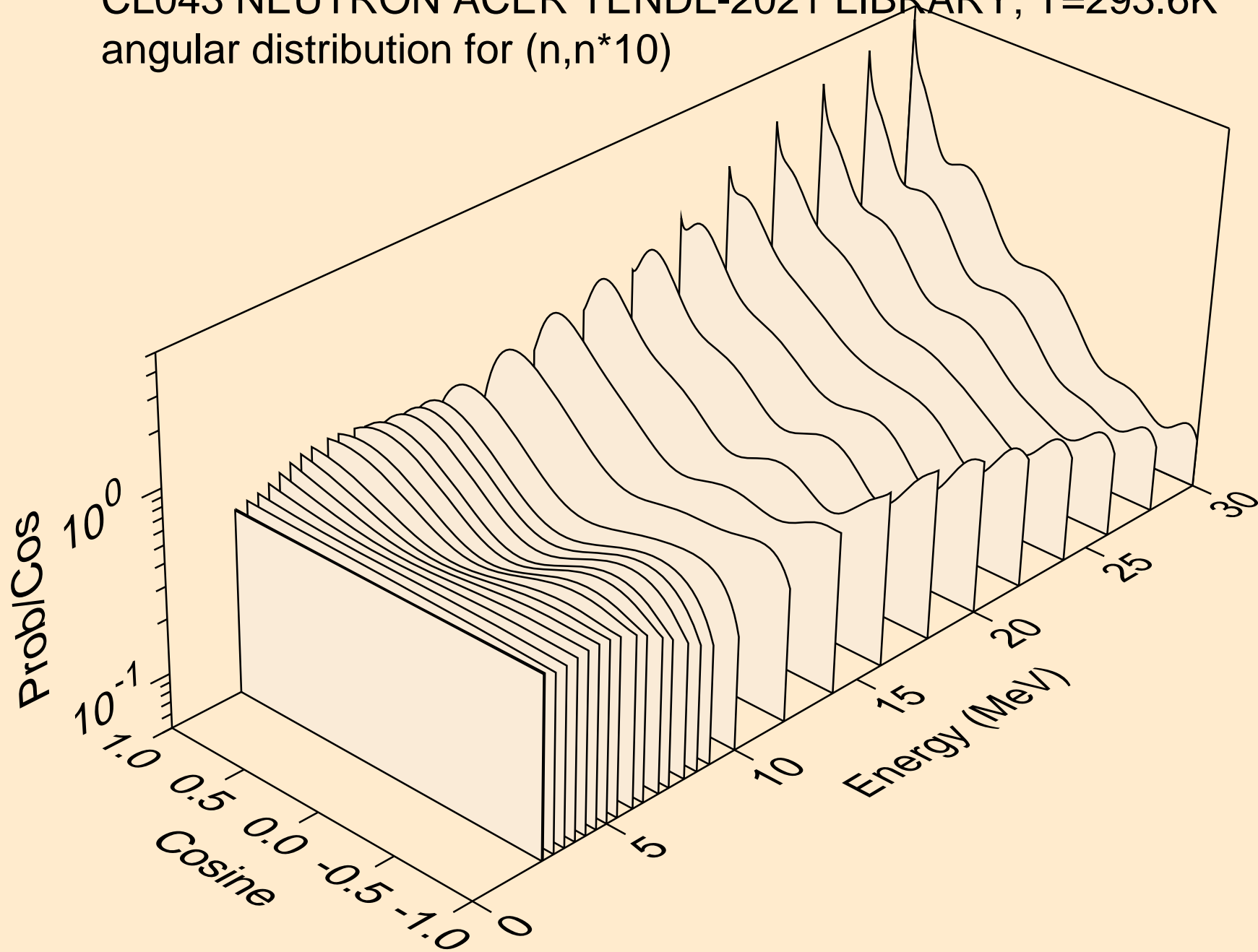

CL043 NEUTRON ACER TENDL-2021 LIBRARY; T=293.6K  
angular distribution for (n,n\*11)

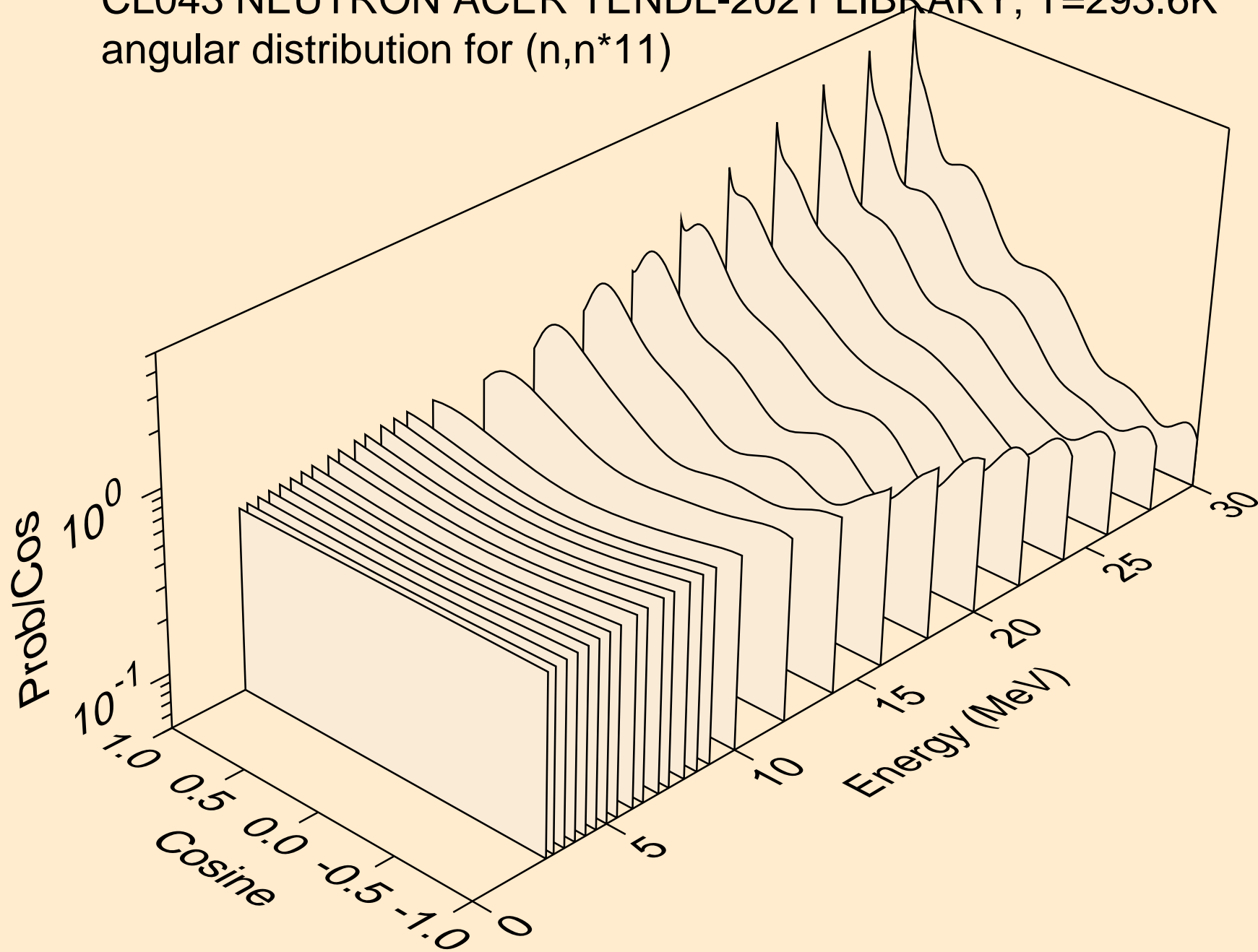



CL043 NEUTRON ACER TENDL-2021 LIBRARY; T=293.6K  
angular distribution for (n,n\*12)

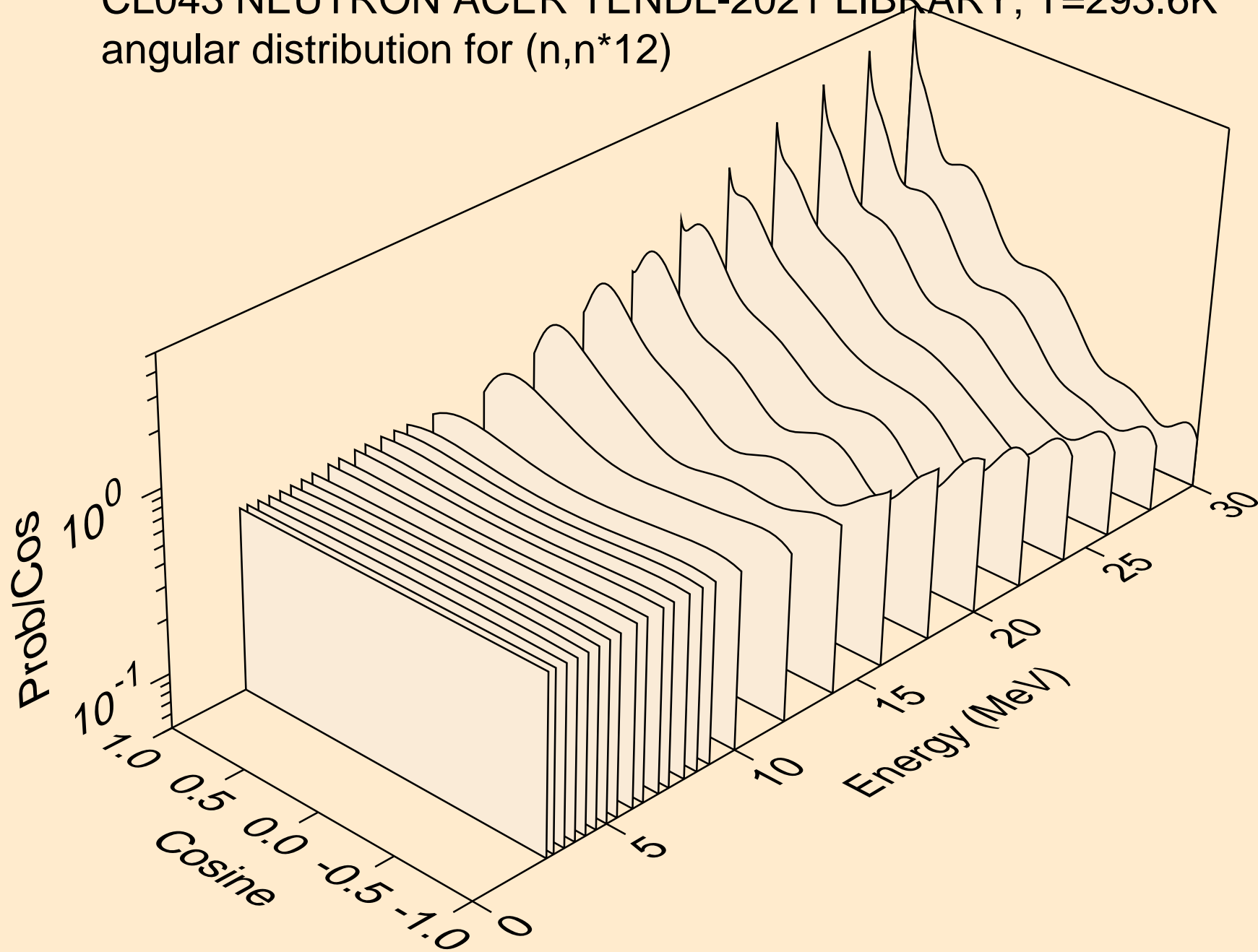

CL043 NEUTRON ACER TENDL-2021 LIBRARY; T=293.6K  
angular distribution for (n,n\*13)

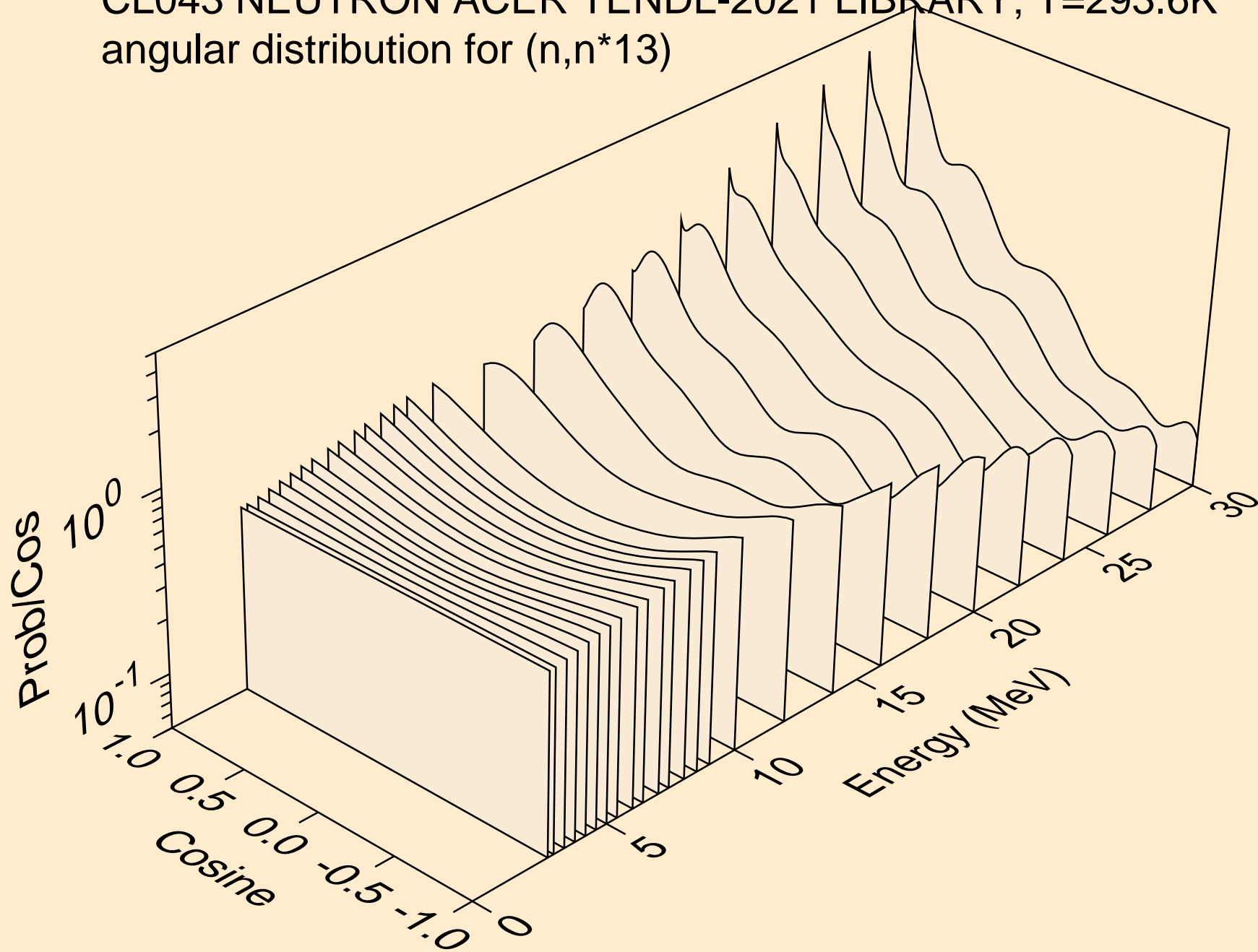

CL043 NEUTRON ACER TENDL-2021 LIBRARY; T=293.6K  
angular distribution for (n,n\*14)

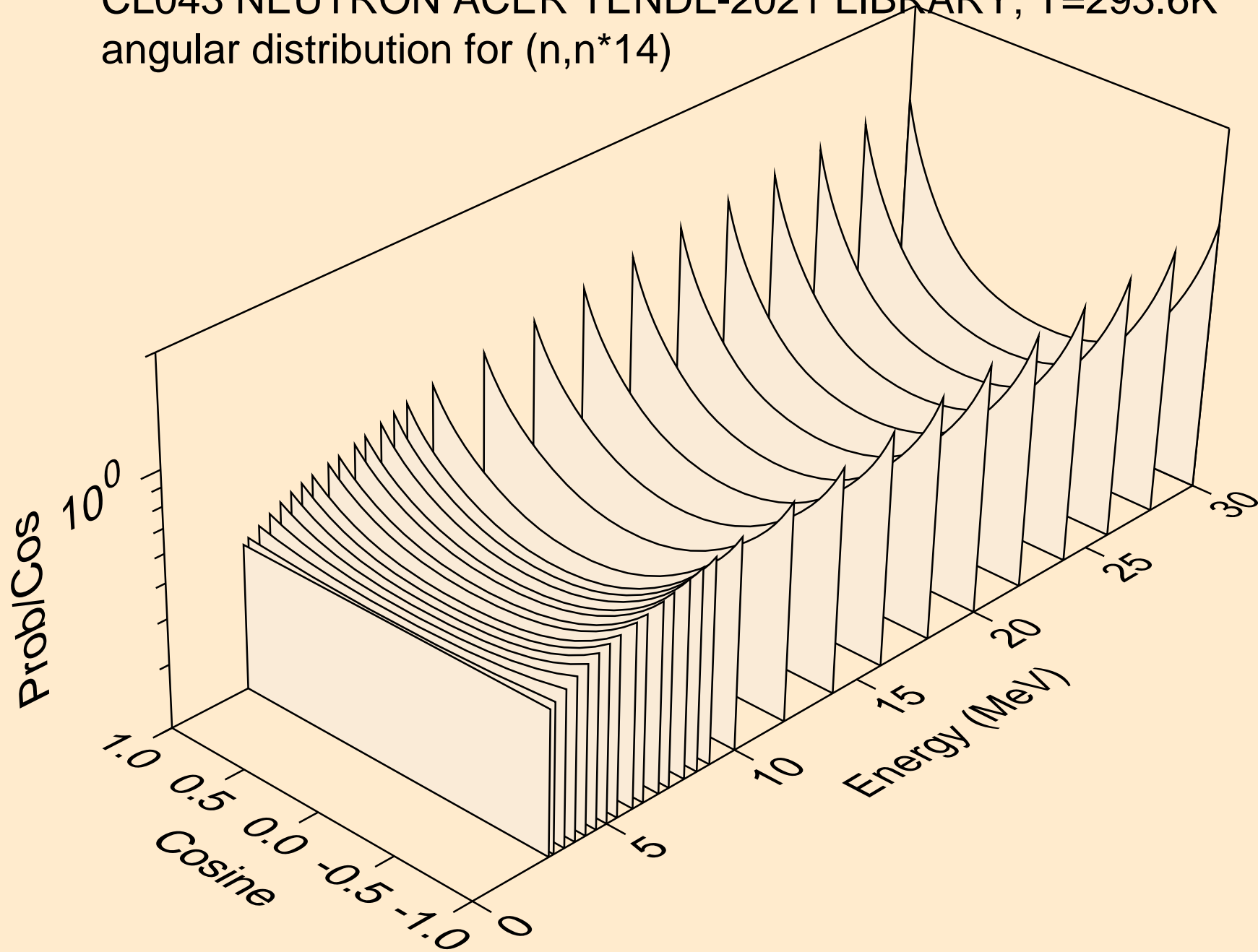

CL043 NEUTRON ACER TENDL-2021 LIBRARY; T=293.6K  
angular distribution for (n,n\*15)

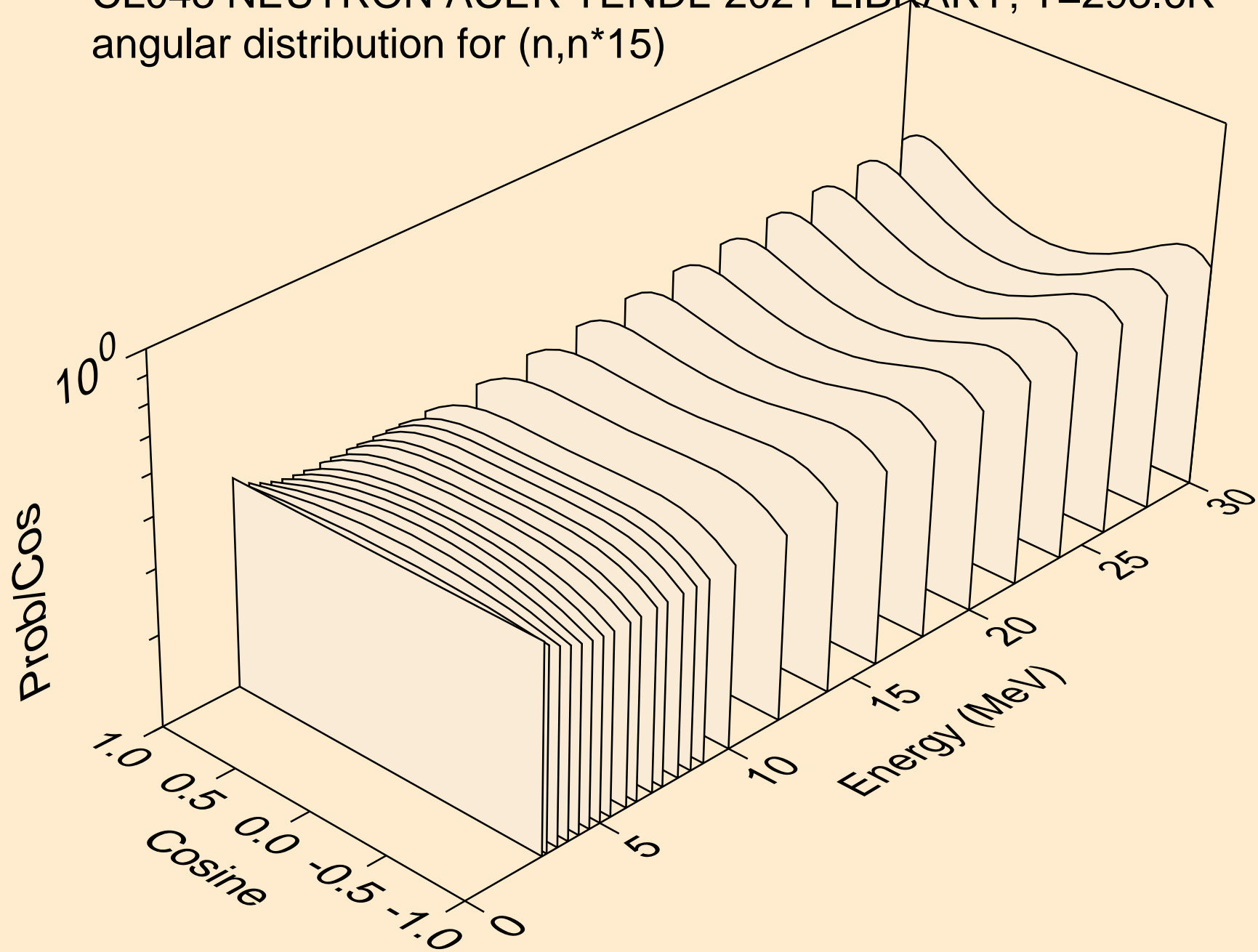

CL043 NEUTRON ACER TENDL-2021 LIBRARY; T=293.6K  
angular distribution for (n,n\*16)

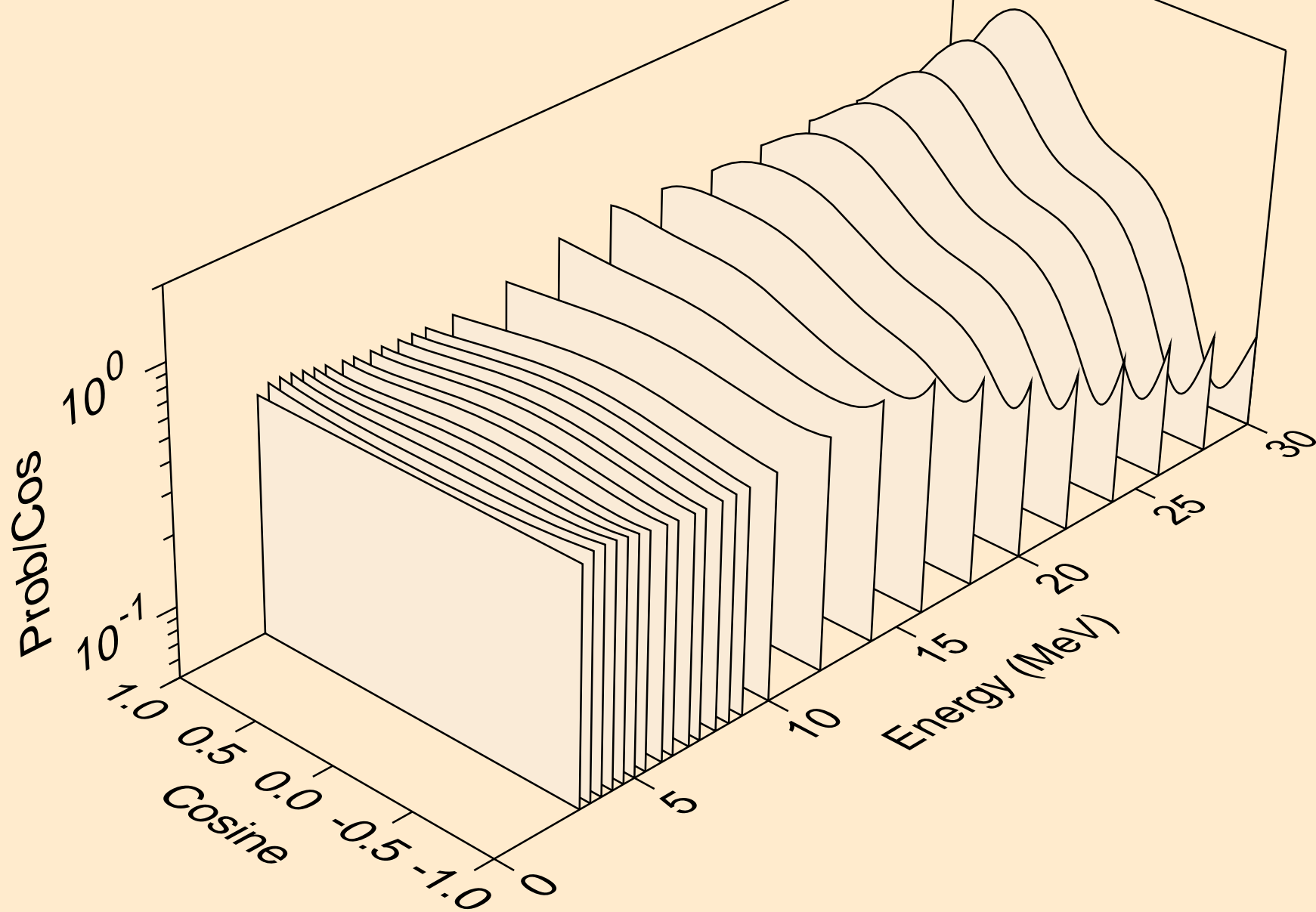

CL043 NEUTRON ACER TENDL-2021 LIBRARY; T=293.6K  
angular distribution for (n,n\*17)

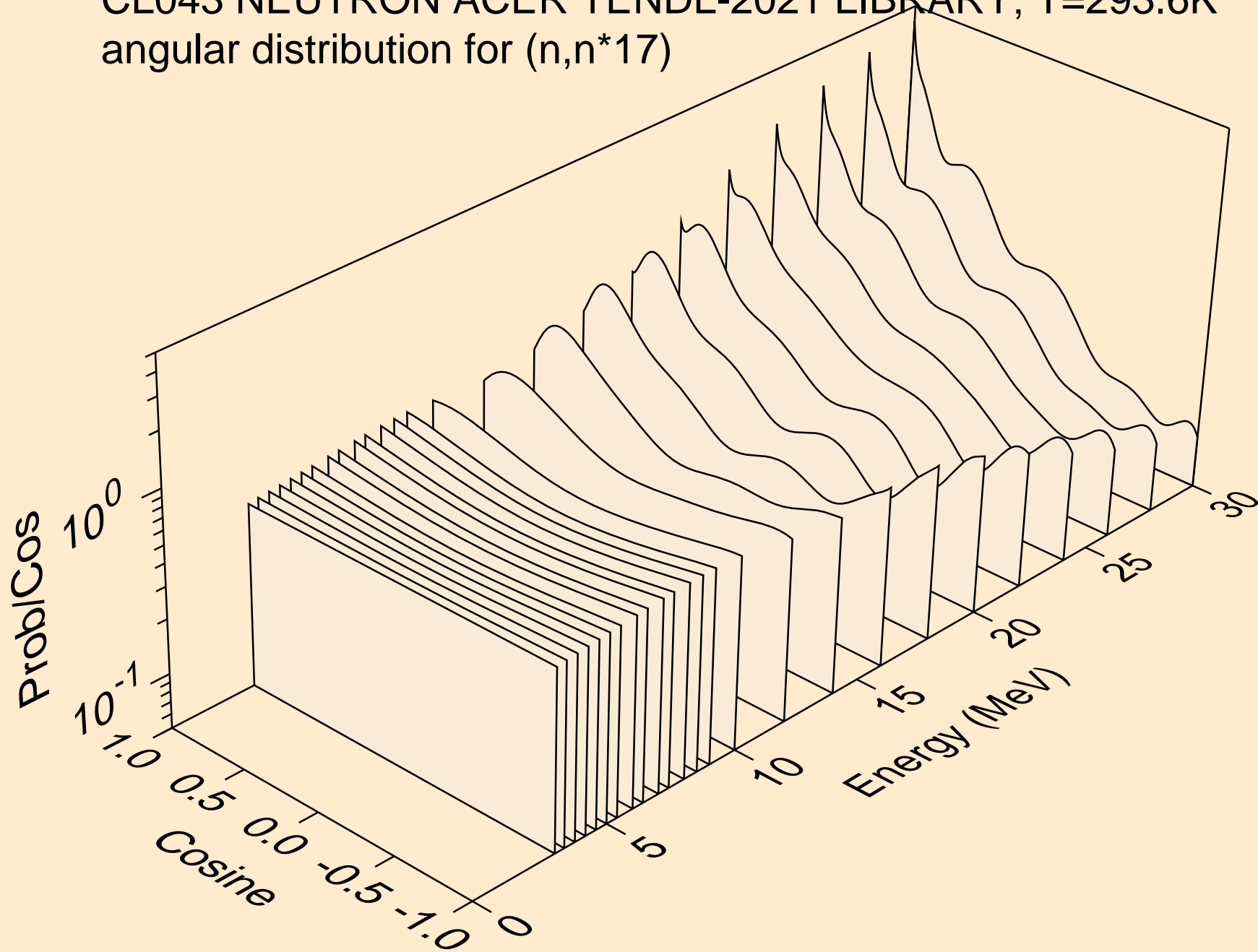

CL043 NEUTRON ACER TENDL-2021 LIBRARY; T=293.6K  
angular distribution for (n,n\*18)

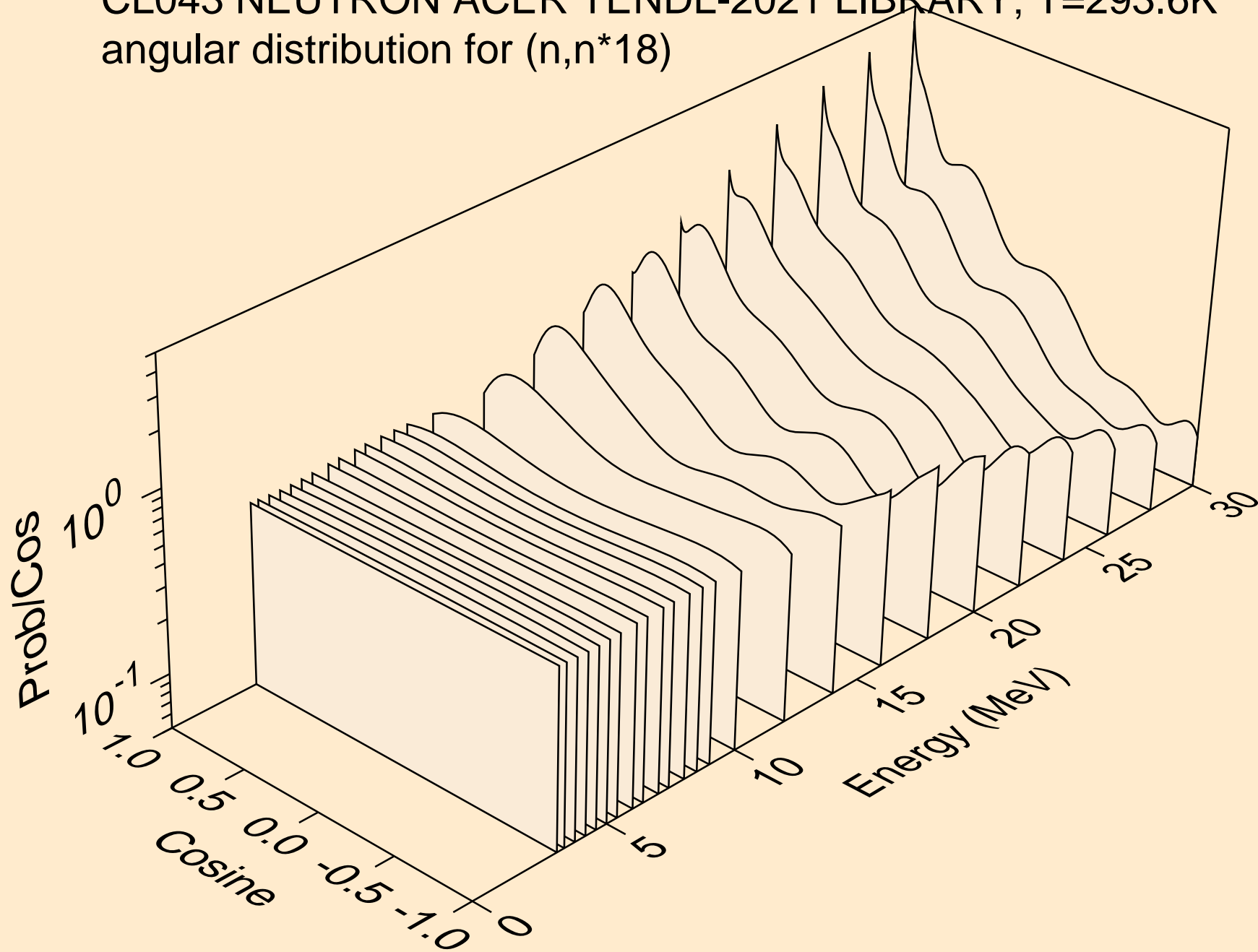

CL043 NEUTRON ACER TENDL-2021 LIBRARY; T=293.6K  
angular distribution for (n,n\*19)

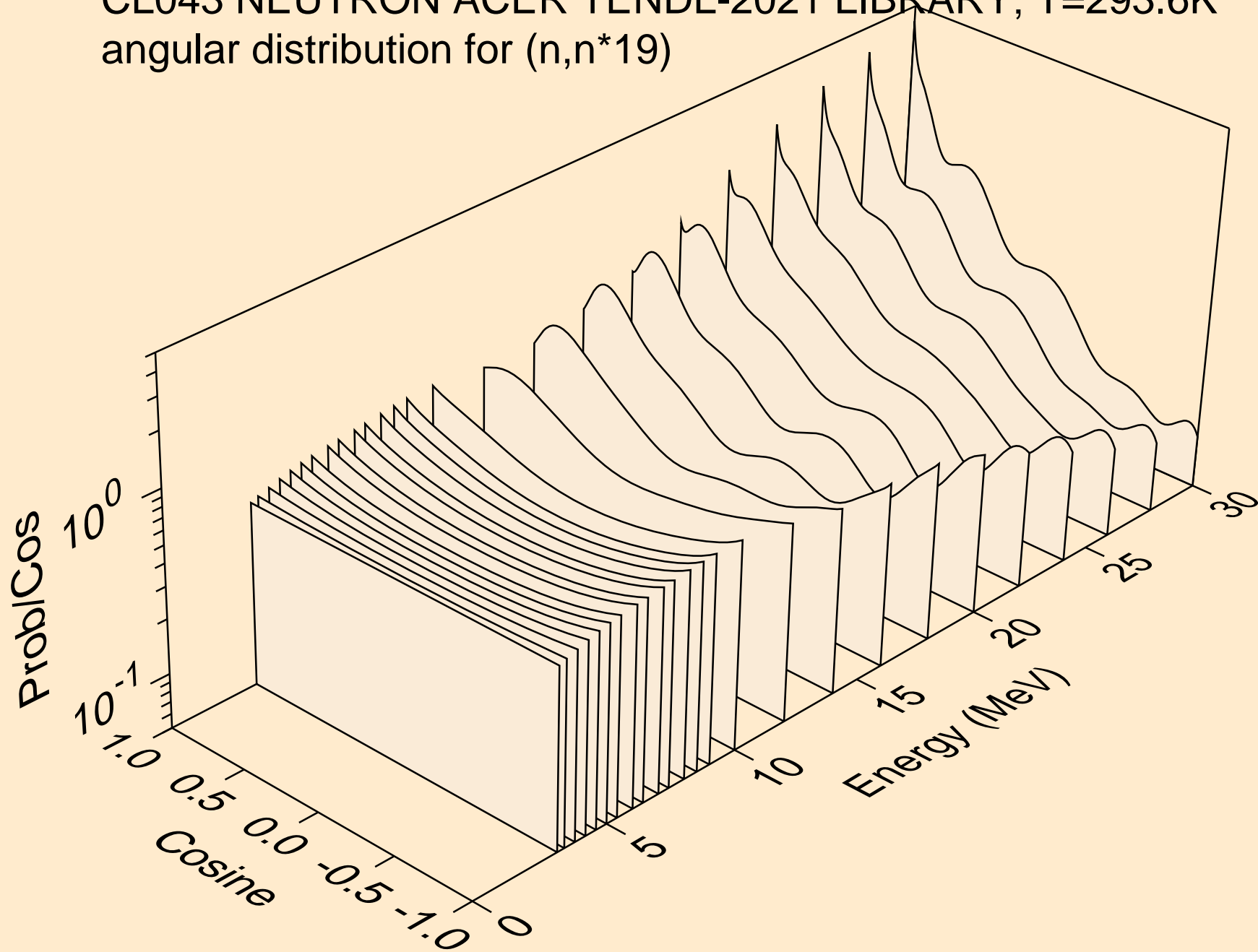



CL043 NEUTRON ACER TENDL-2021 LIBRARY; T=293.6K  
angular distribution for (n,n\*20)

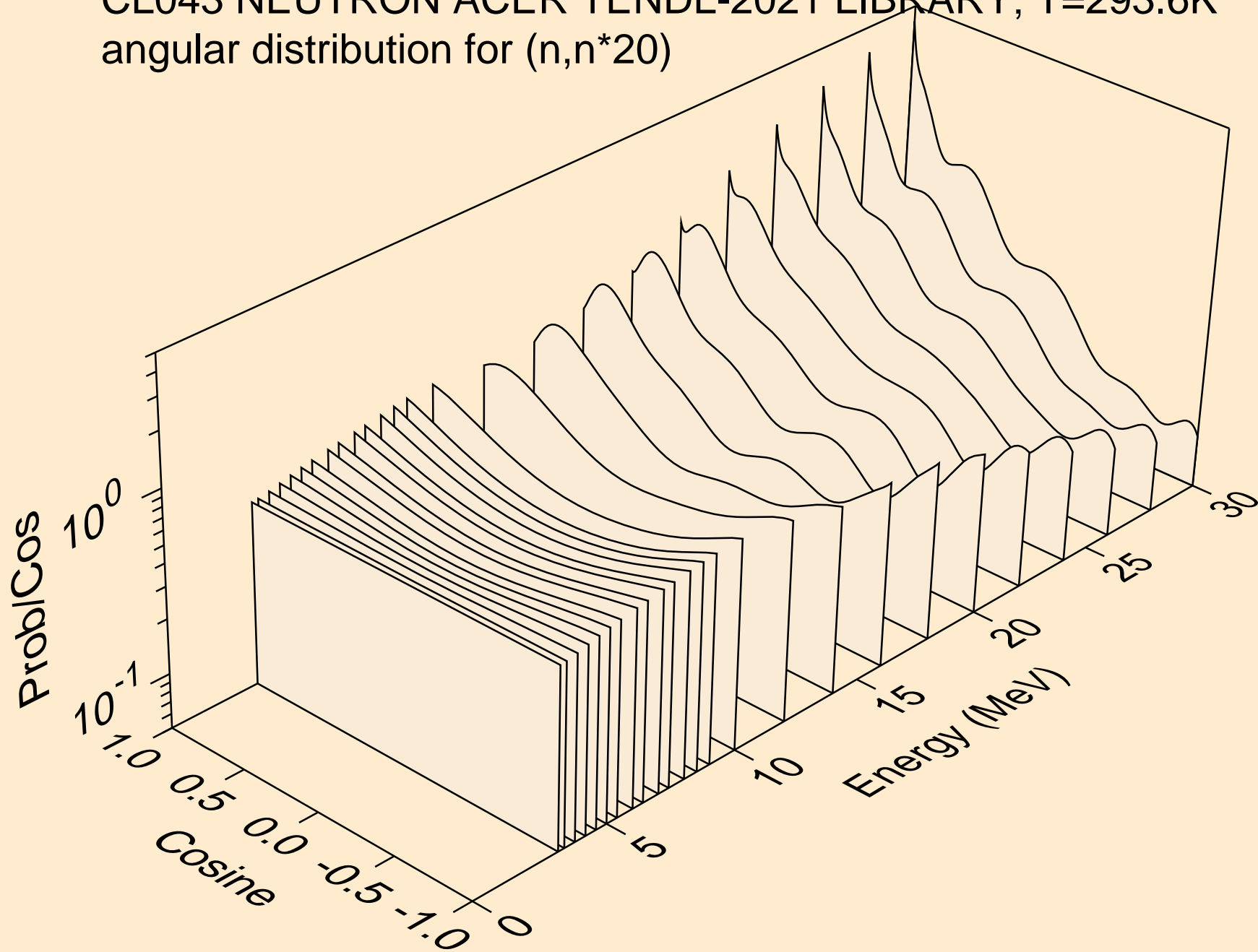

CL043 NEUTRON ACER TENDL-2021 LIBRARY; T=293.6K  
angular distribution for (n,n\*21)

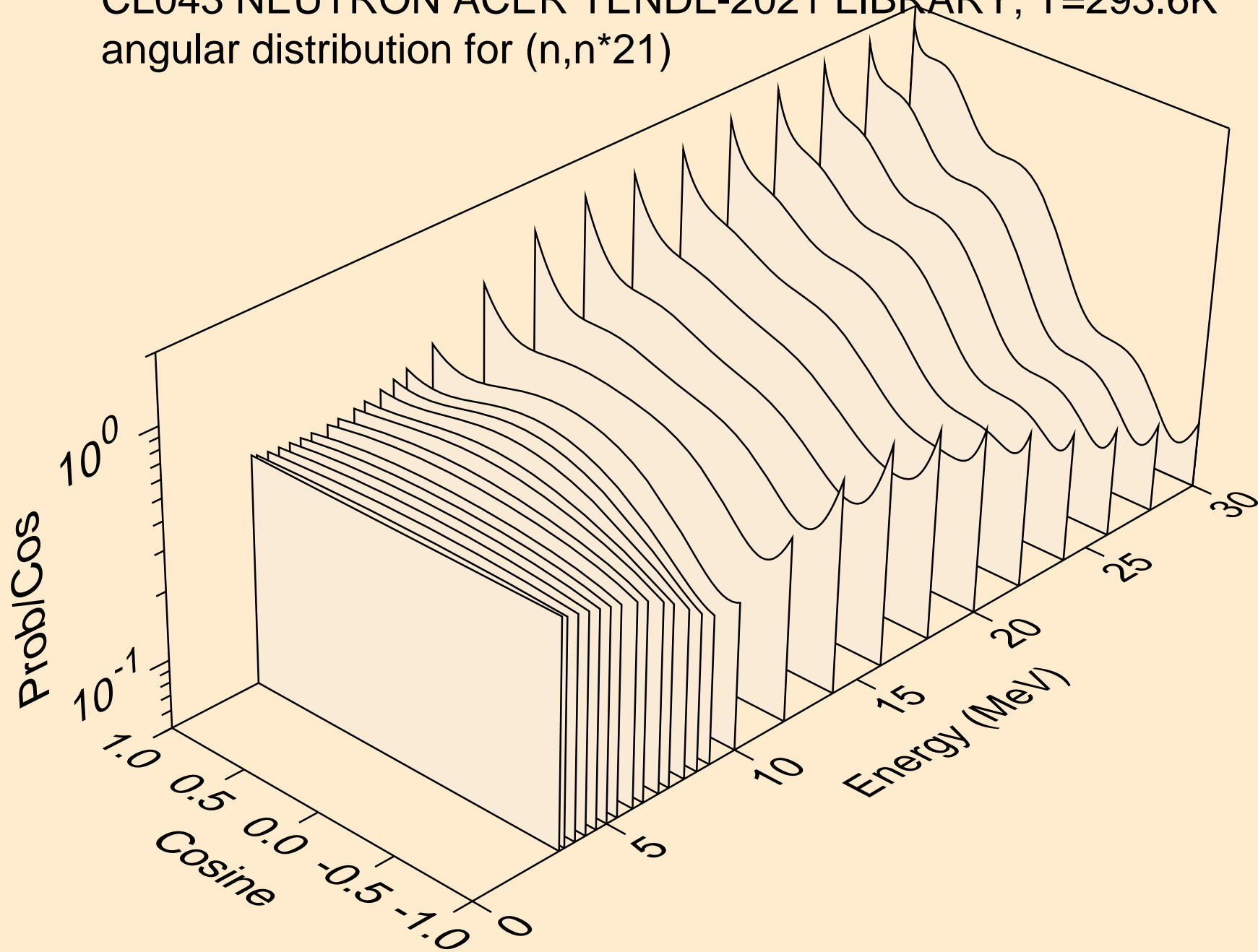

CL043 NEUTRON ACER TENDL-2021 LIBRARY; T=293.6K  
angular distribution for (n,n\*22)

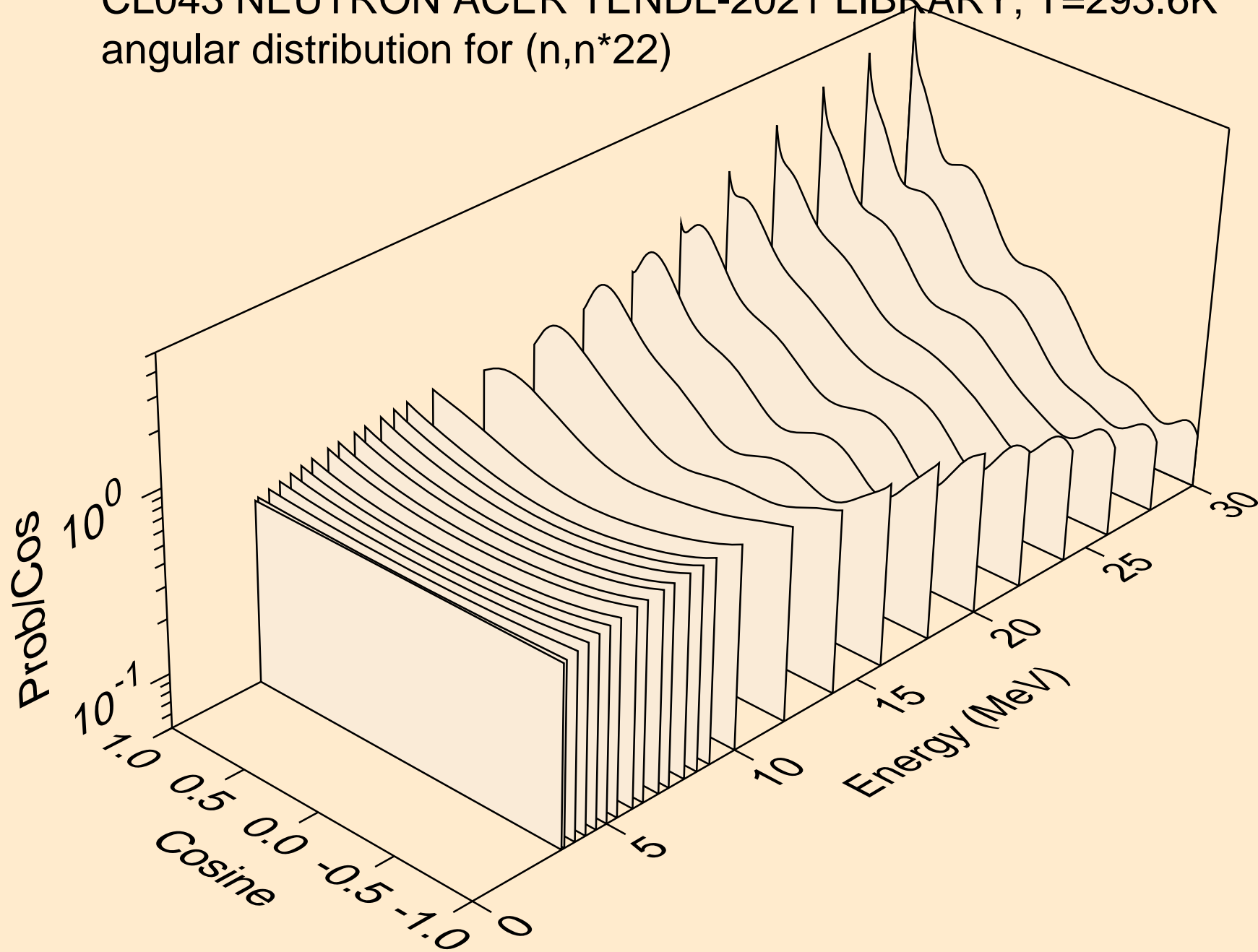

CL043 NEUTRON ACER TENDL-2021 LIBRARY; T=293.6K  
angular distribution for (n,n\*23)

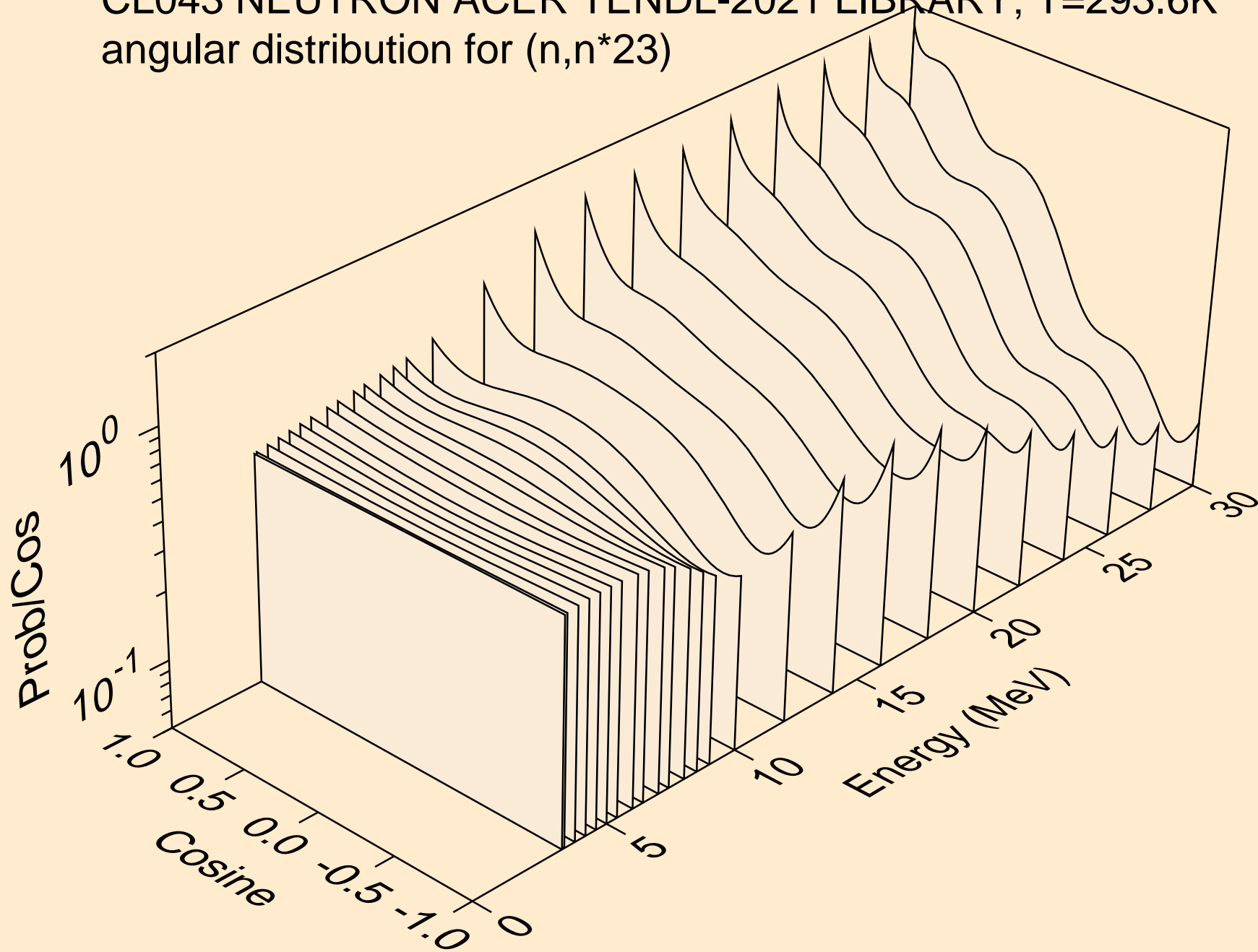

CL043 NEUTRON ACER TENDL-2021 LIBRARY; T=293.6K  
angular distribution for (n,n\*24)

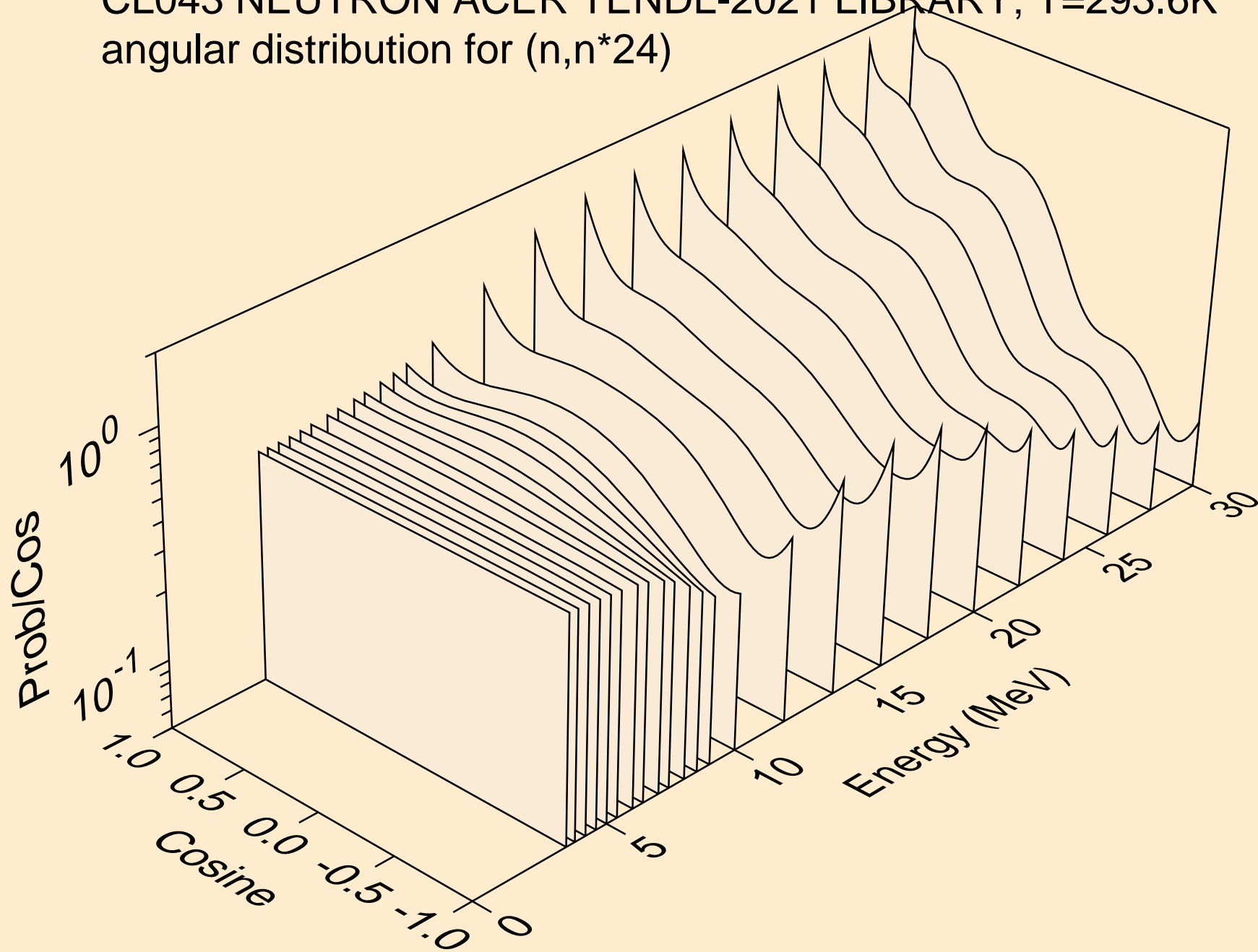

CL043 NEUTRON ACER TENDL-2021 LIBRARY; T=293.6K  
angular distribution for (n,n\*25)

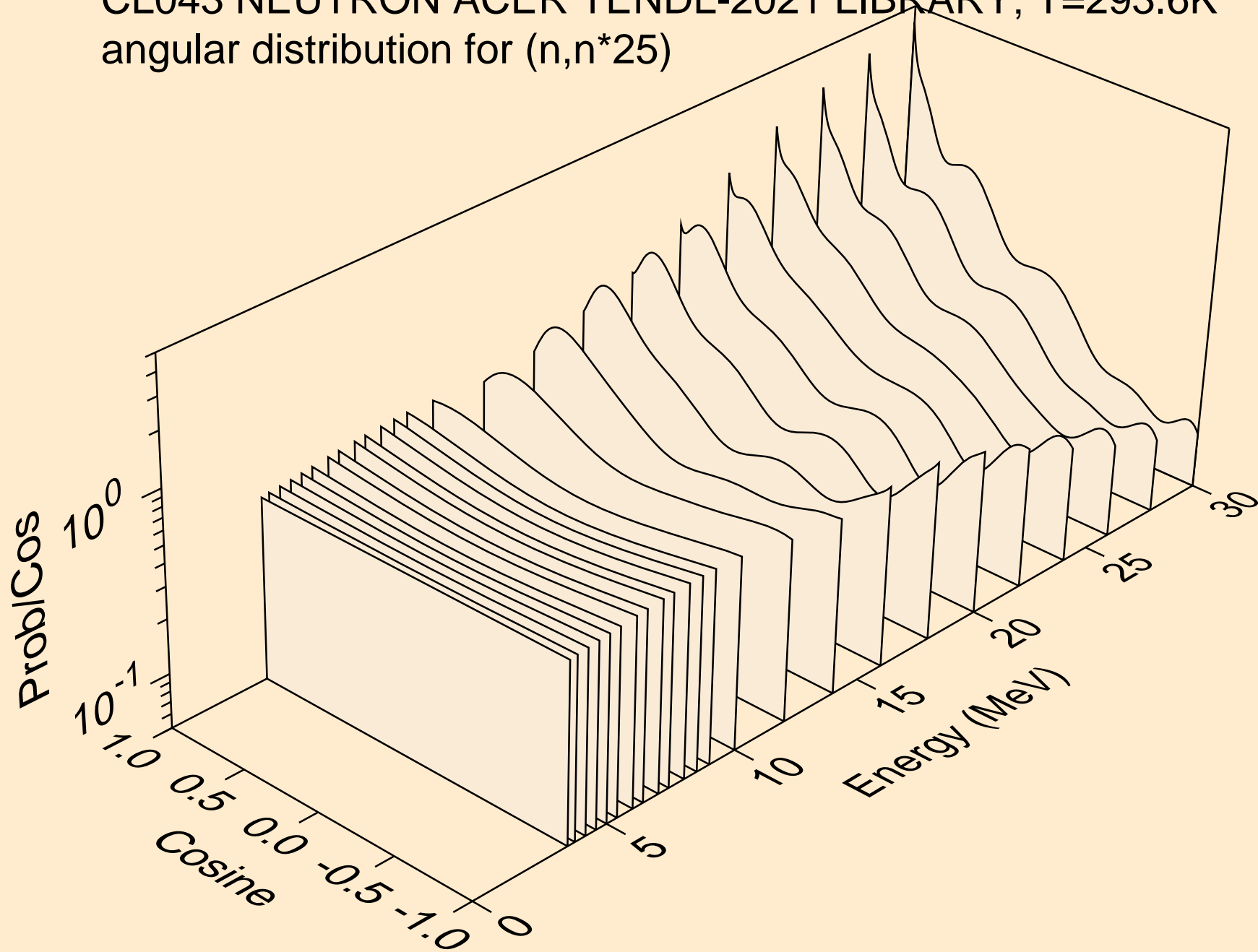

CL043 NEUTRON ACER TENDL-2021 LIBRARY; T=293.6K  
angular distribution for (n,n\*26)

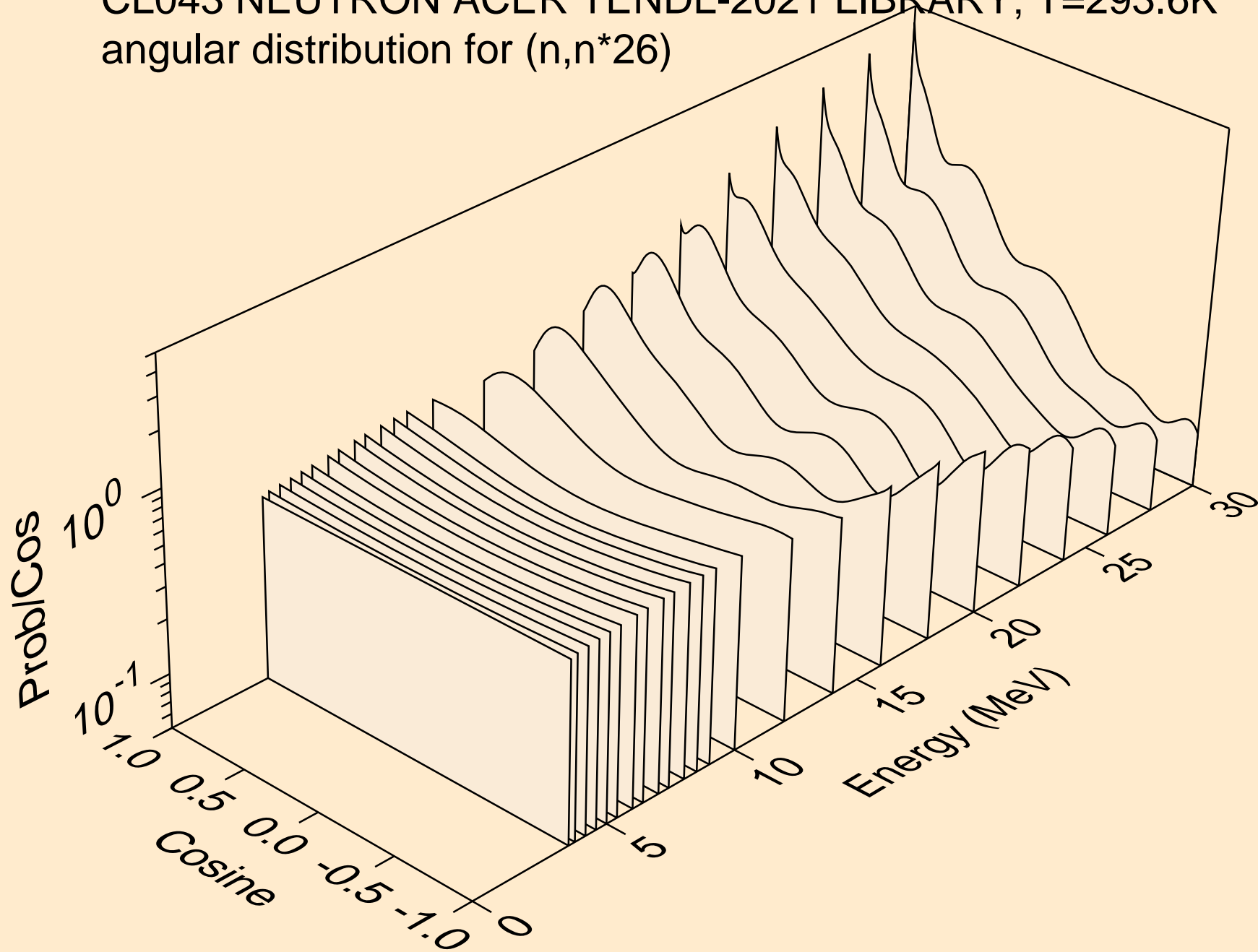

CL043 NEUTRON ACER TENDL-2021 LIBRARY; T=293.6K  
angular distribution for (n,n\*27)

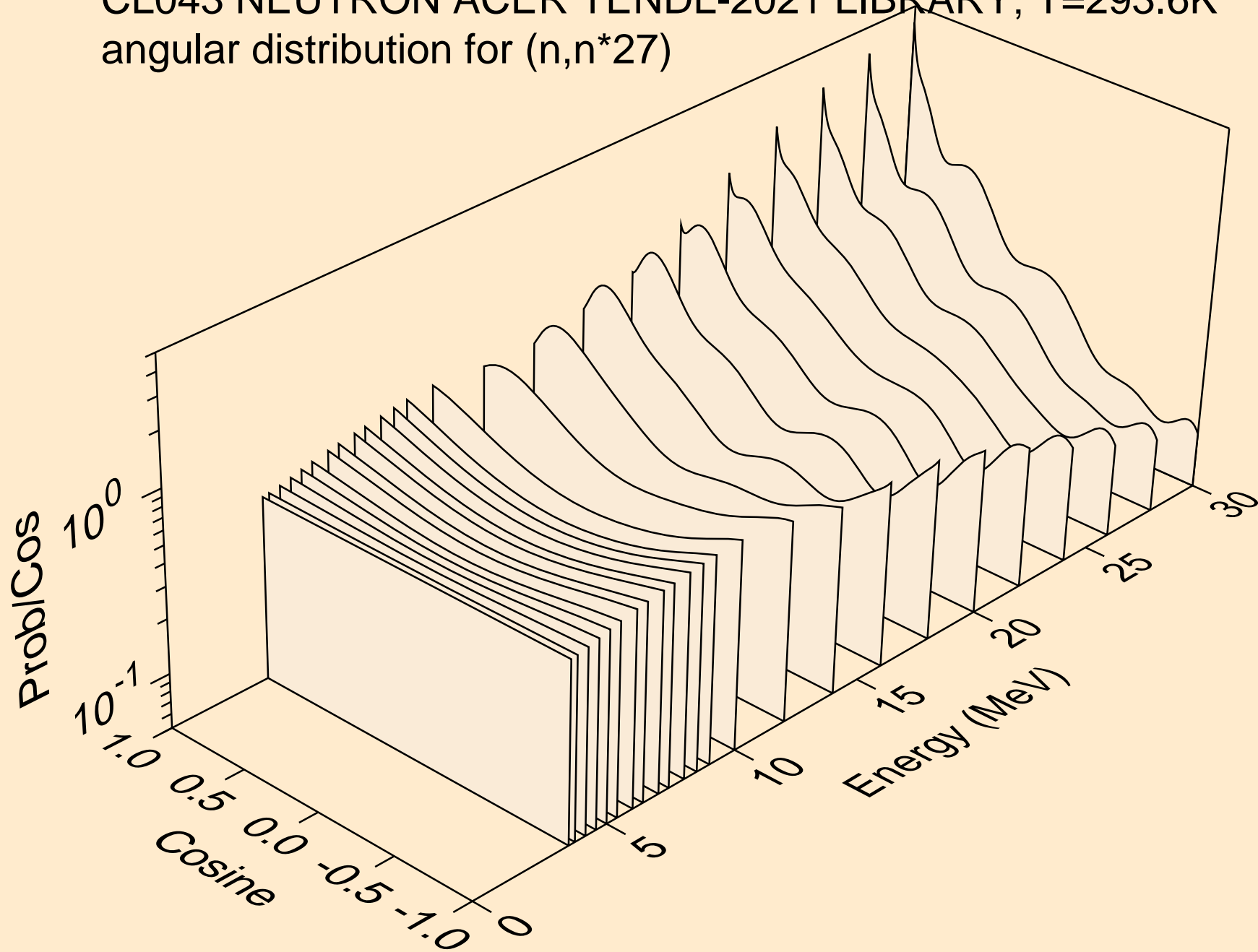



CL043 NEUTRON ACER TENDL-2021 LIBRARY; T=293.6K  
angular distribution for (n,n\*28)

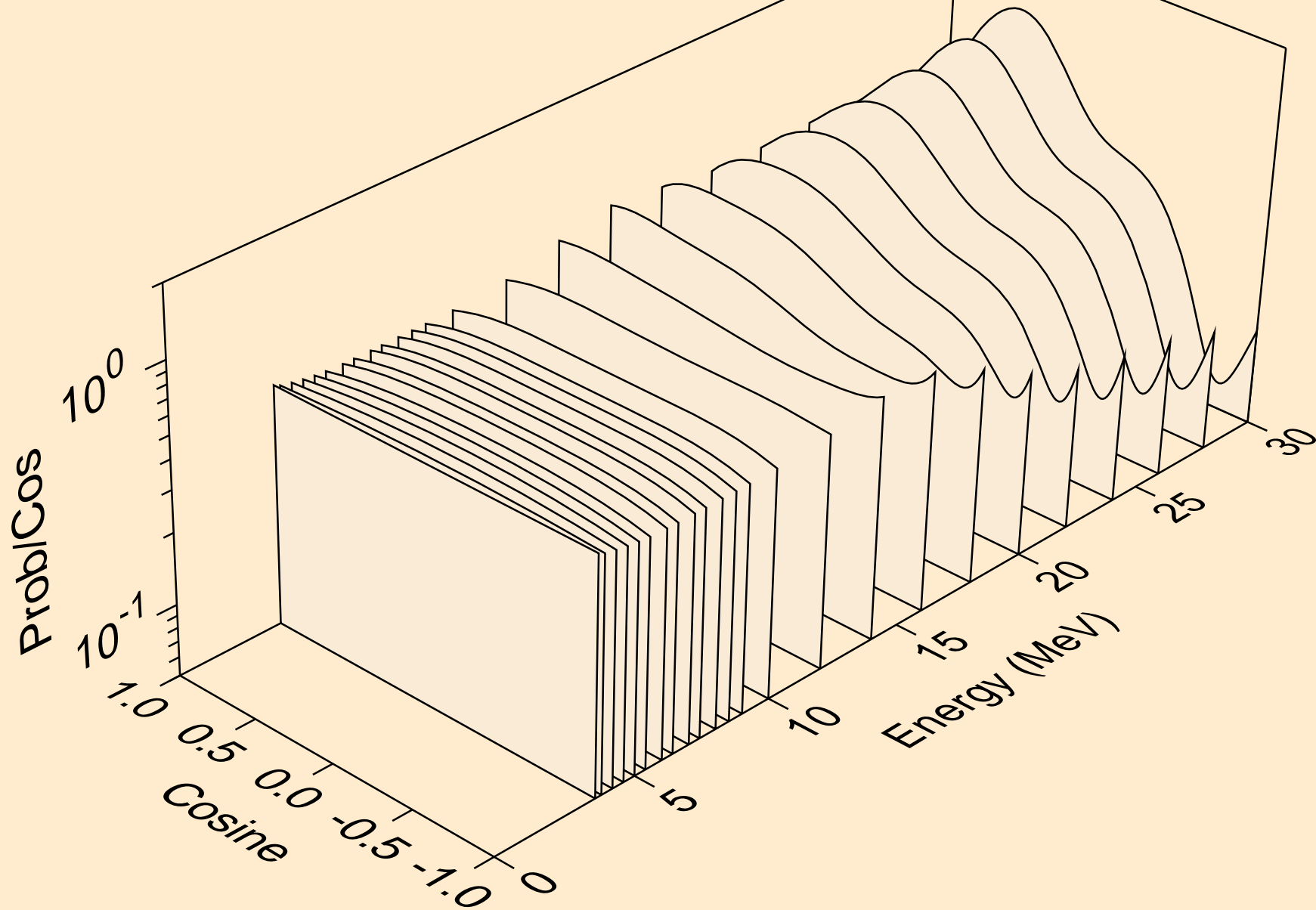

CL043 NEUTRON ACER TENDL-2021 LIBRARY; T=293.6K  
angular distribution for (n,n\*29)

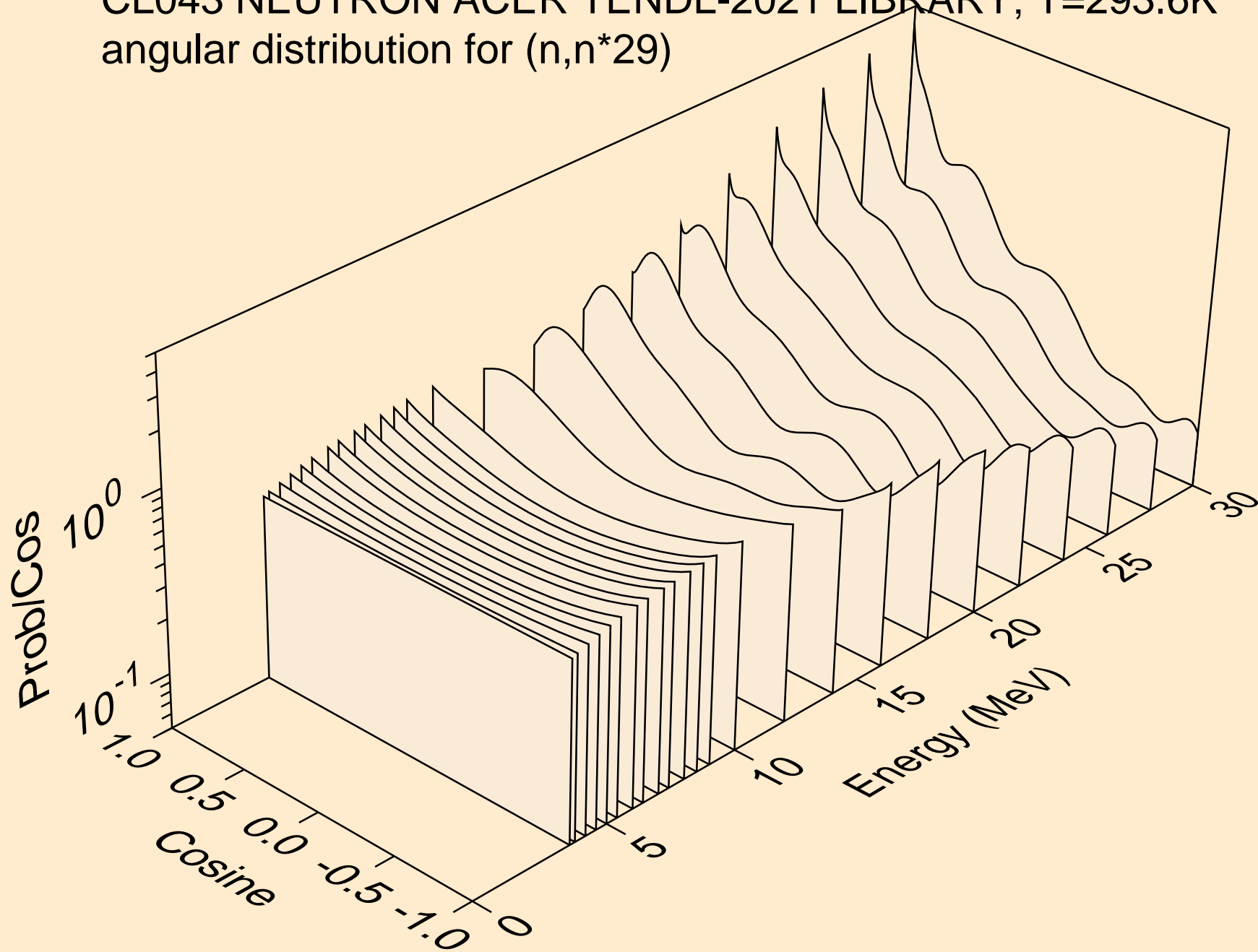

CL043 NEUTRON ACER TENDL-2021 LIBRARY; T=293.6K  
angular distribution for (n,n\*30)

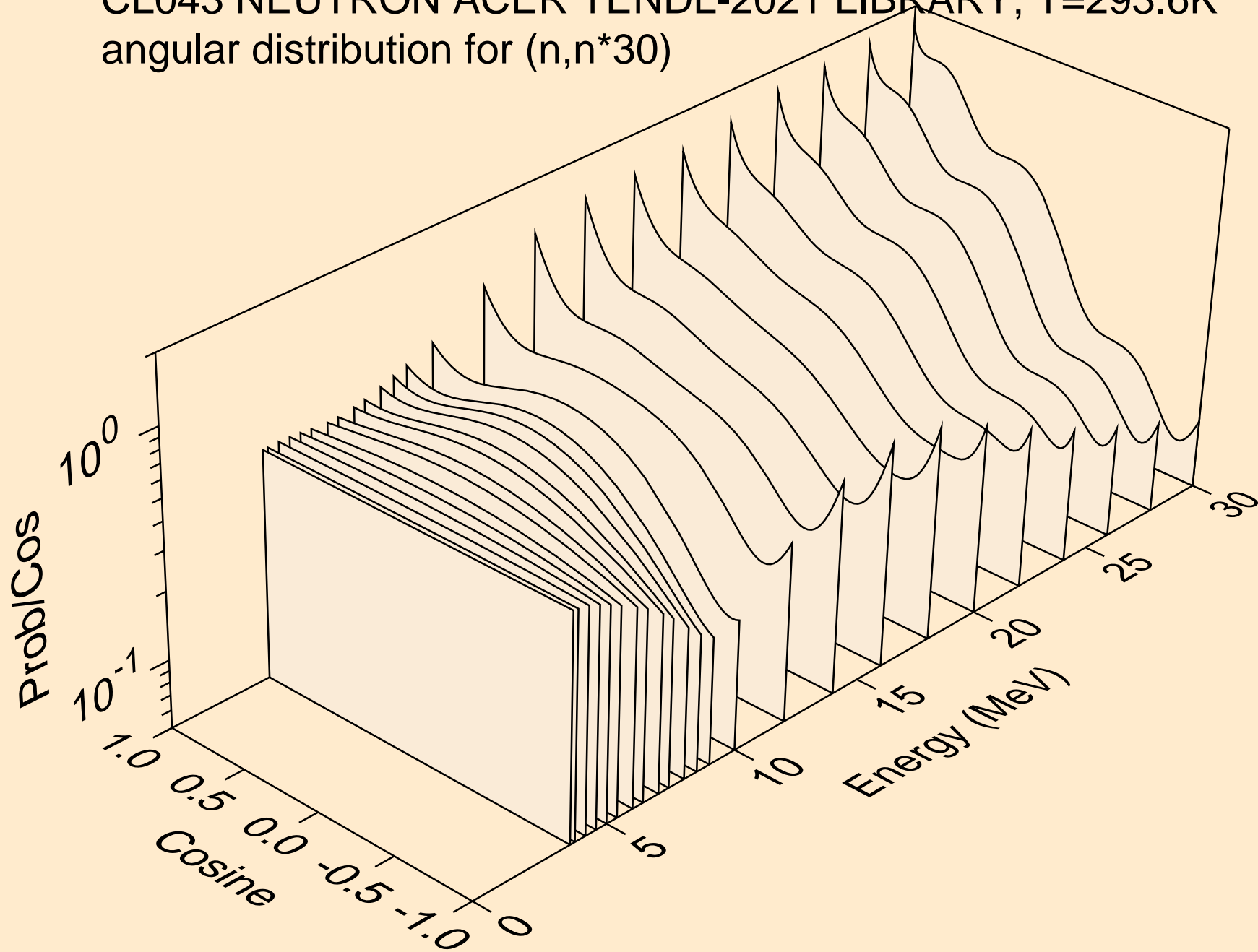

CL043 NEUTRON ACER TENDL-2021 LIBRARY; T=293.6K  
Neutron emission for (n,x)

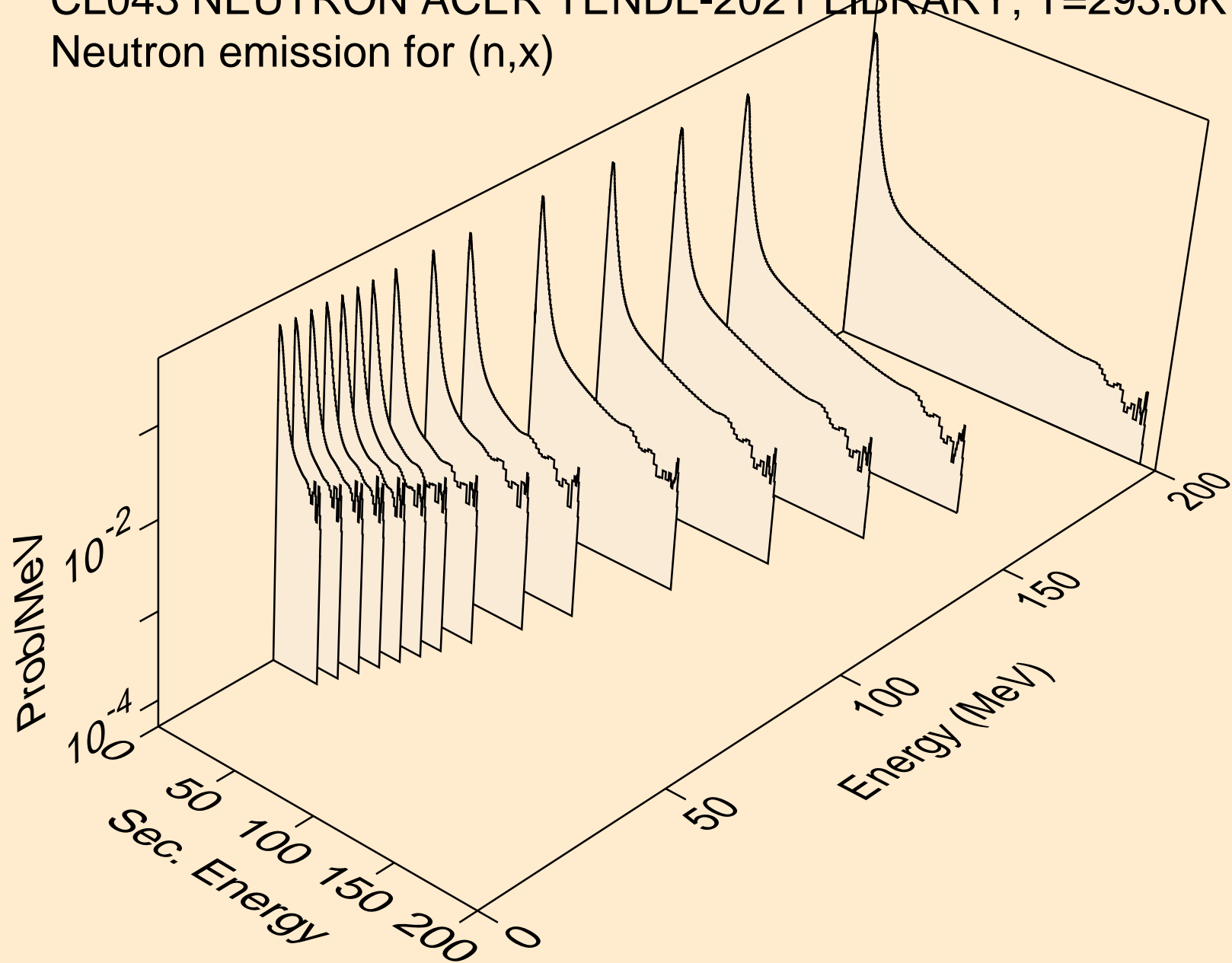

CL043 NEUTRON ACER TENDL-2021 LIBRARY; T=293.6K  
Neutron emission for (n,2nd)

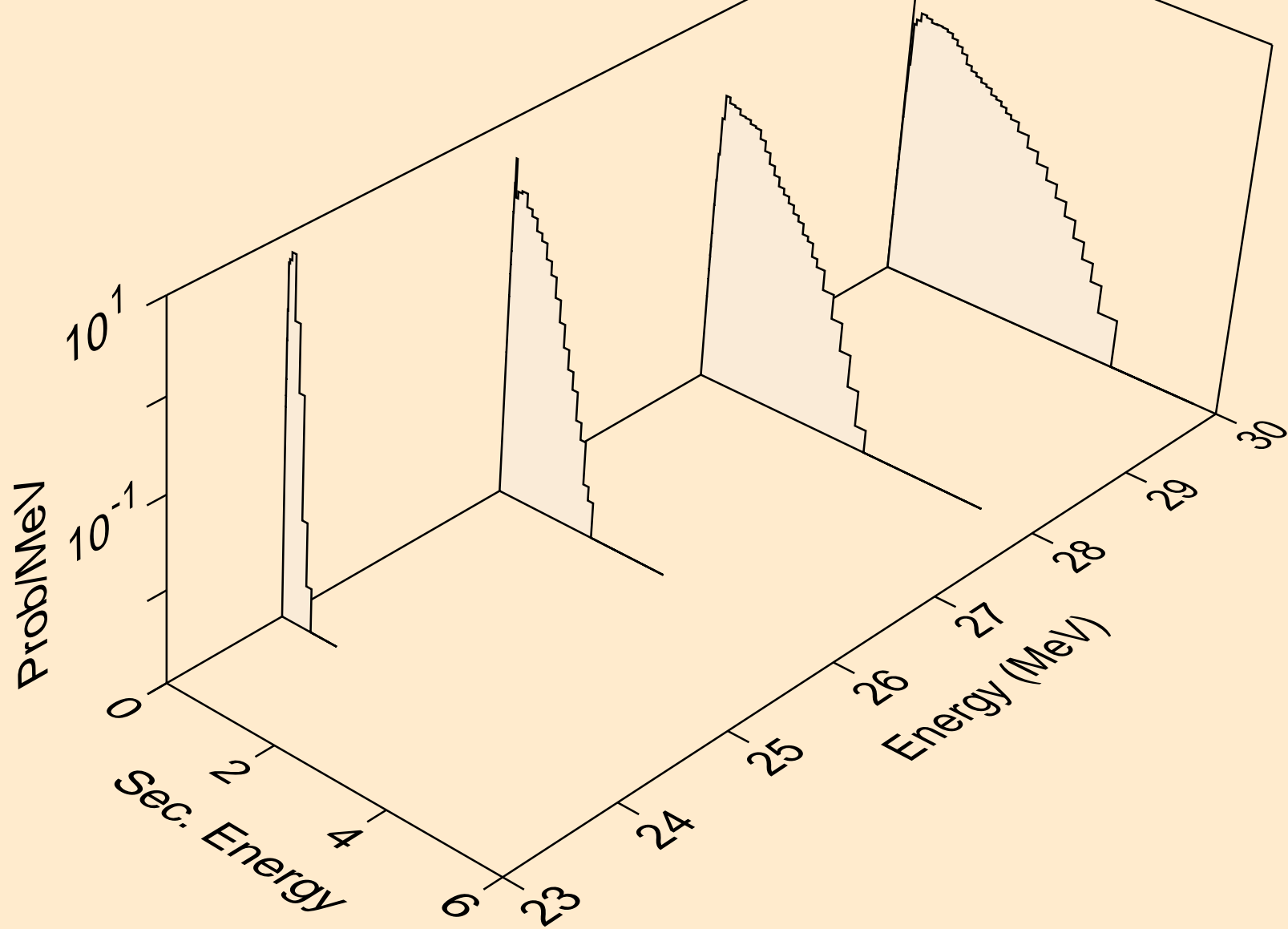

CL043 NEUTRON ACER TENDL-2021 LIBRARY; T=293.6K  
Neutron emission for (n,2n)

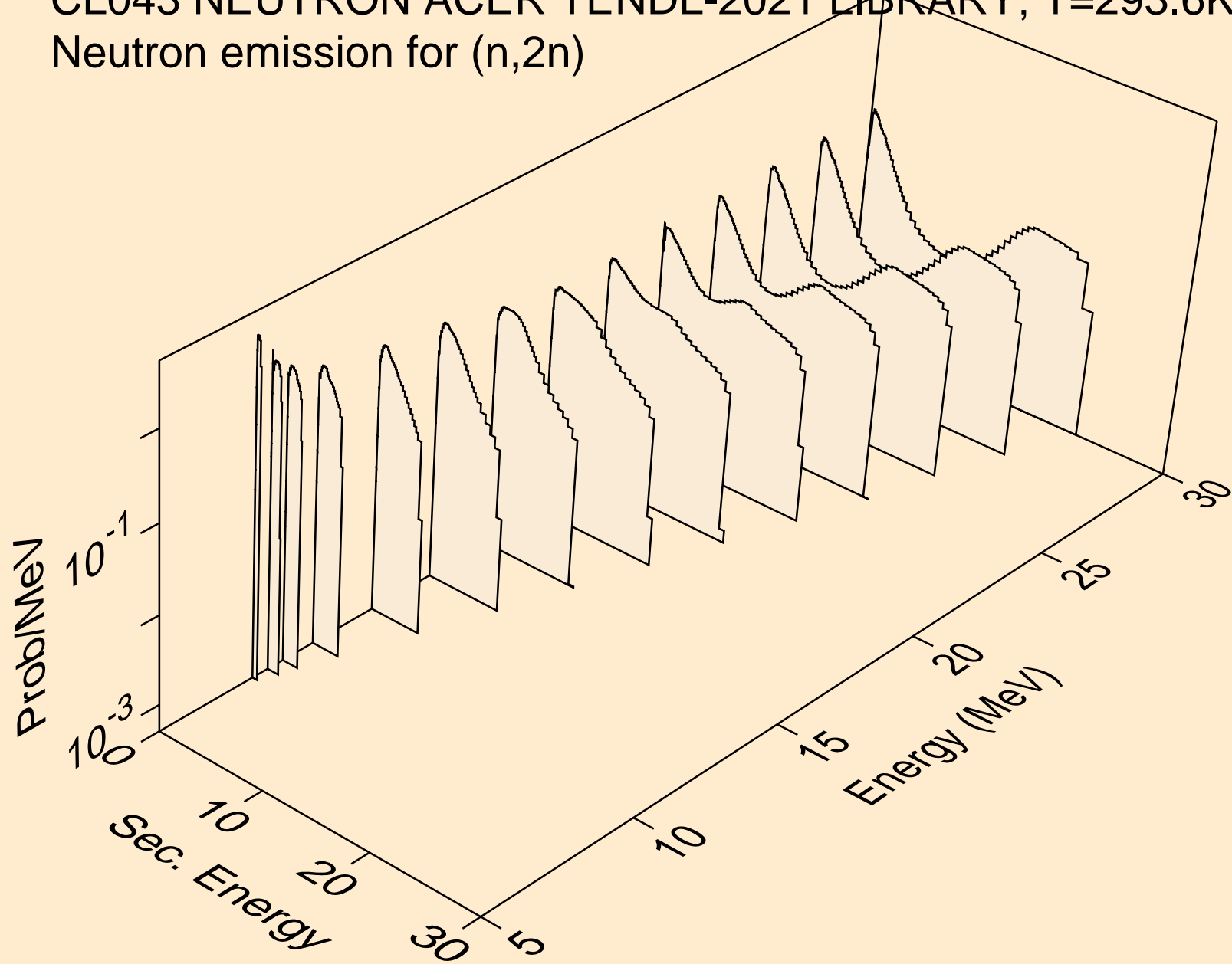

CL043 NEUTRON ACER TENDL-2021 LIBRARY; T=293.6K  
Neutron emission for (n,3n)

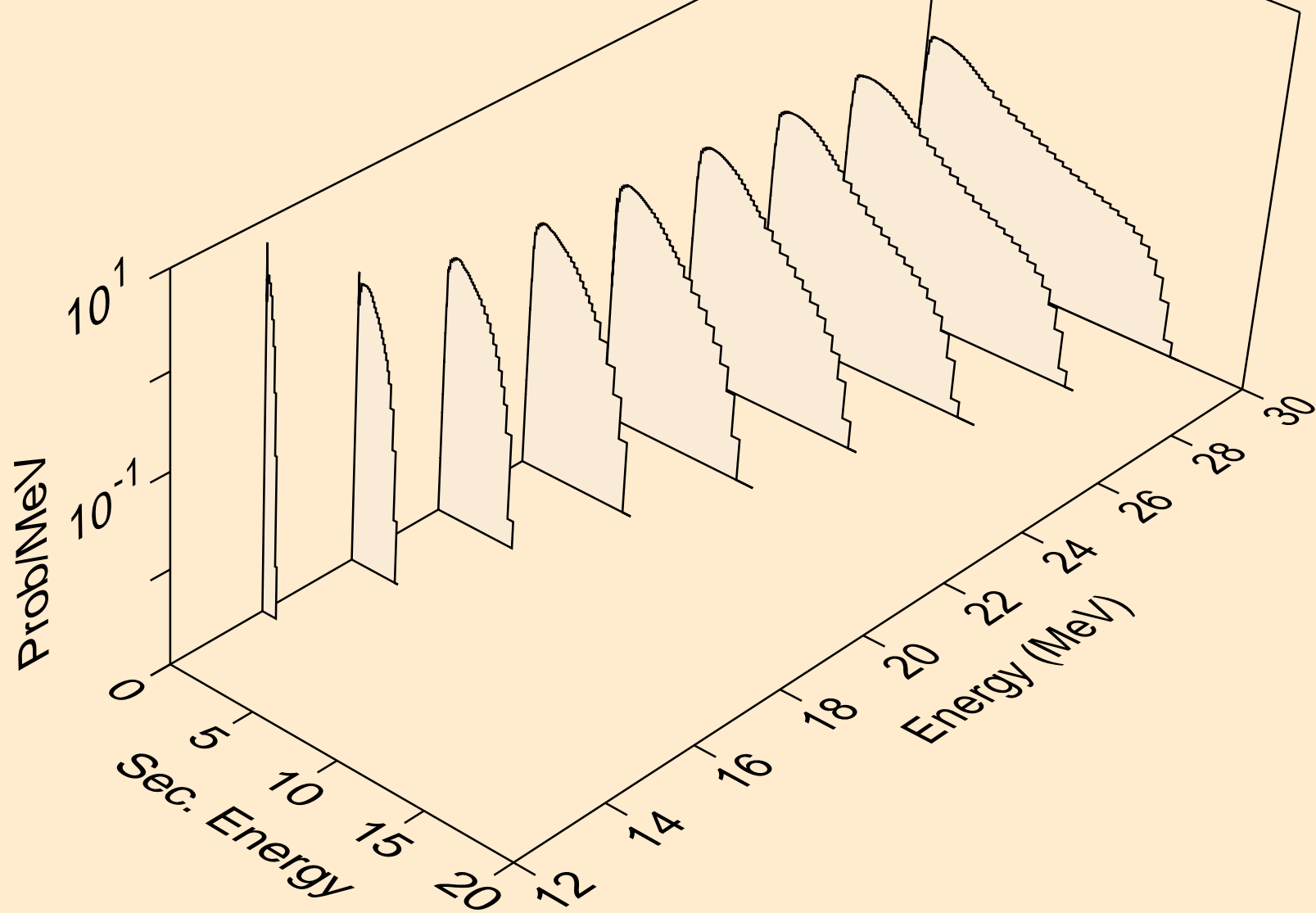

CL043 NEUTRON ACER TENDL-2021 LIBRARY; T=293.6K  
Neutron emission for (n,n\*)a

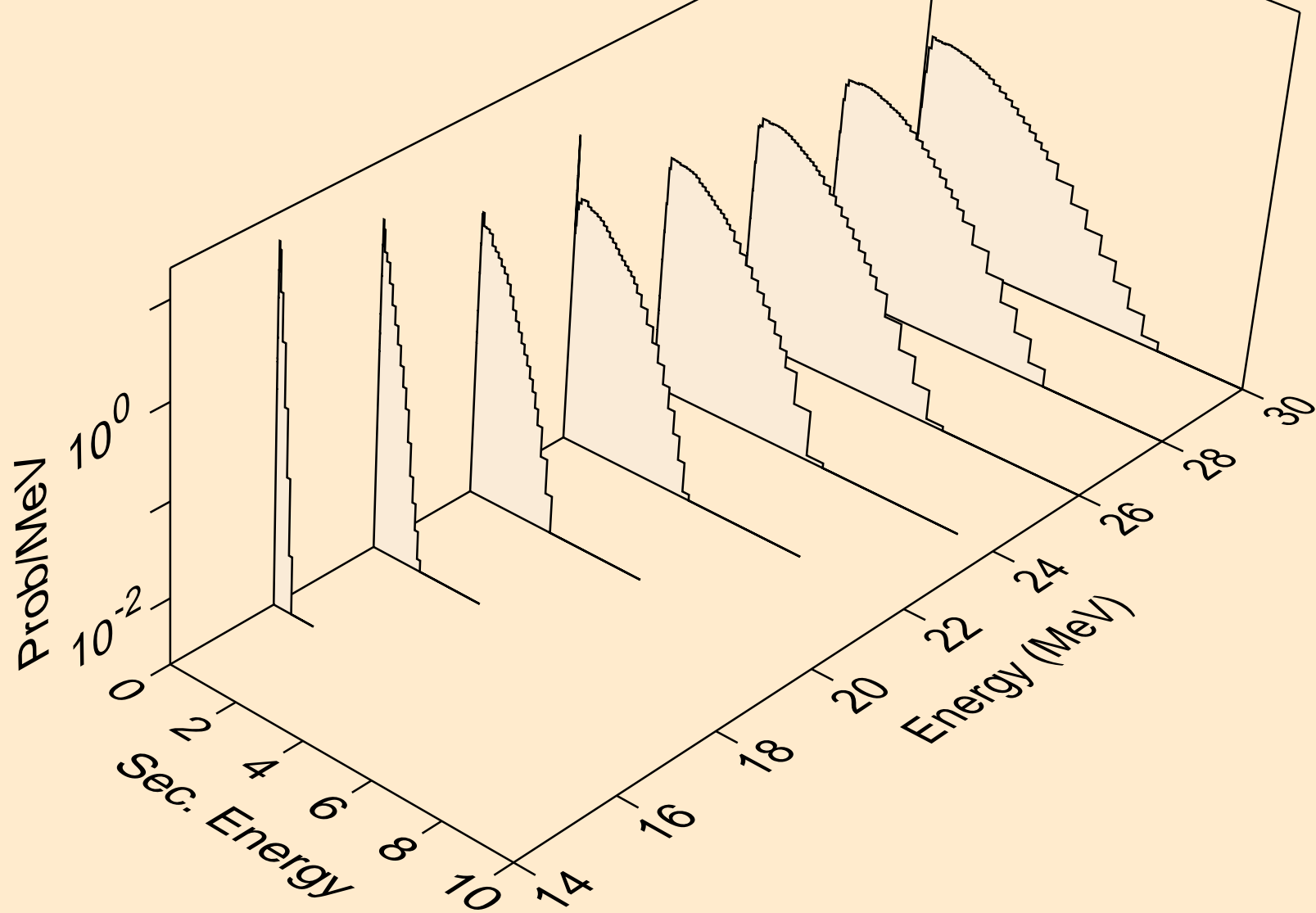



CL043 NEUTRON ACER TENDL-2021 LIBRARY; T=293.6K  
Neutron emission for (n,2n)a

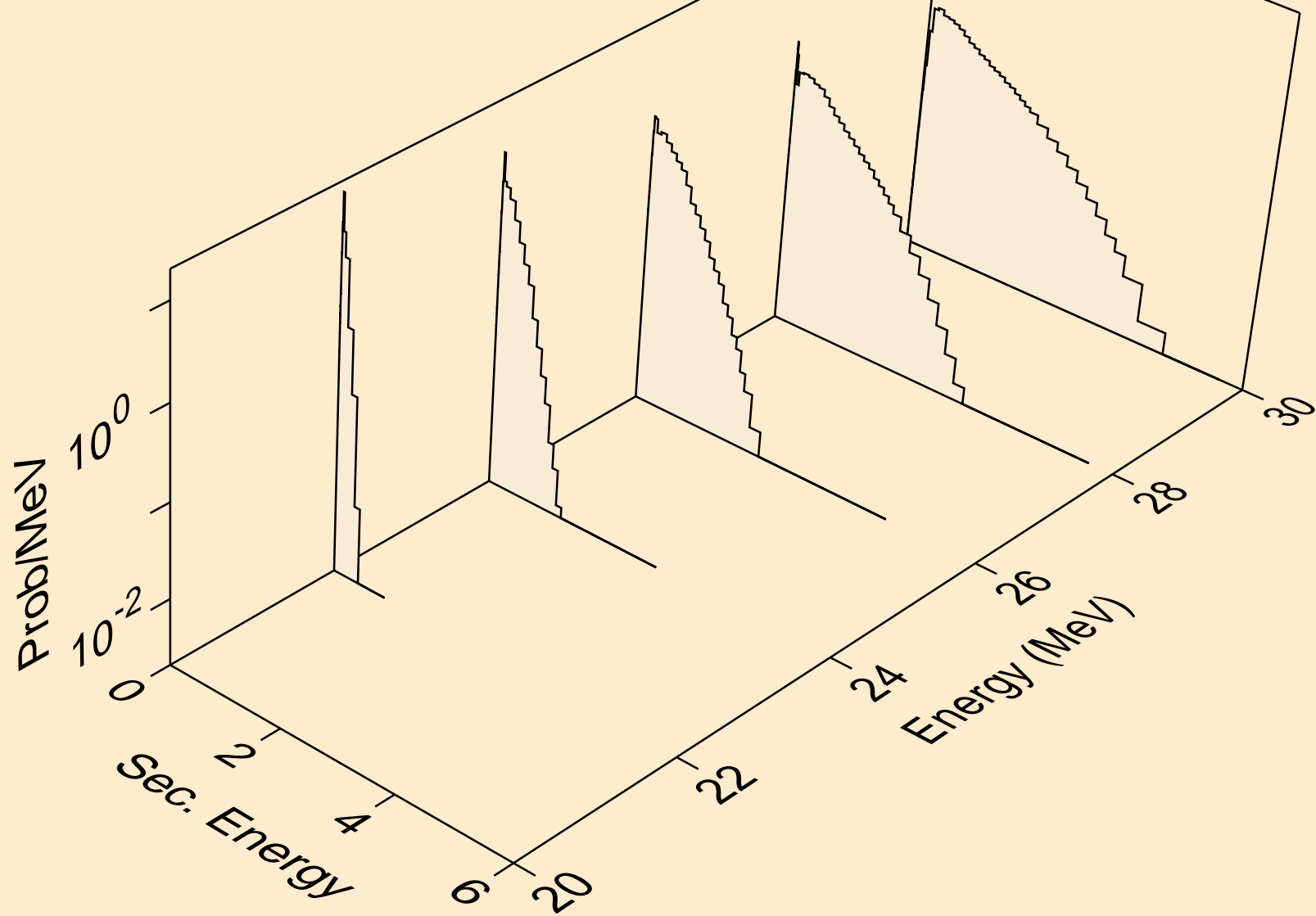

CL043 NEUTRON ACER TENDL-2021 LIBRARY; T=293.6K  
Neutron emission for (n,3n)a

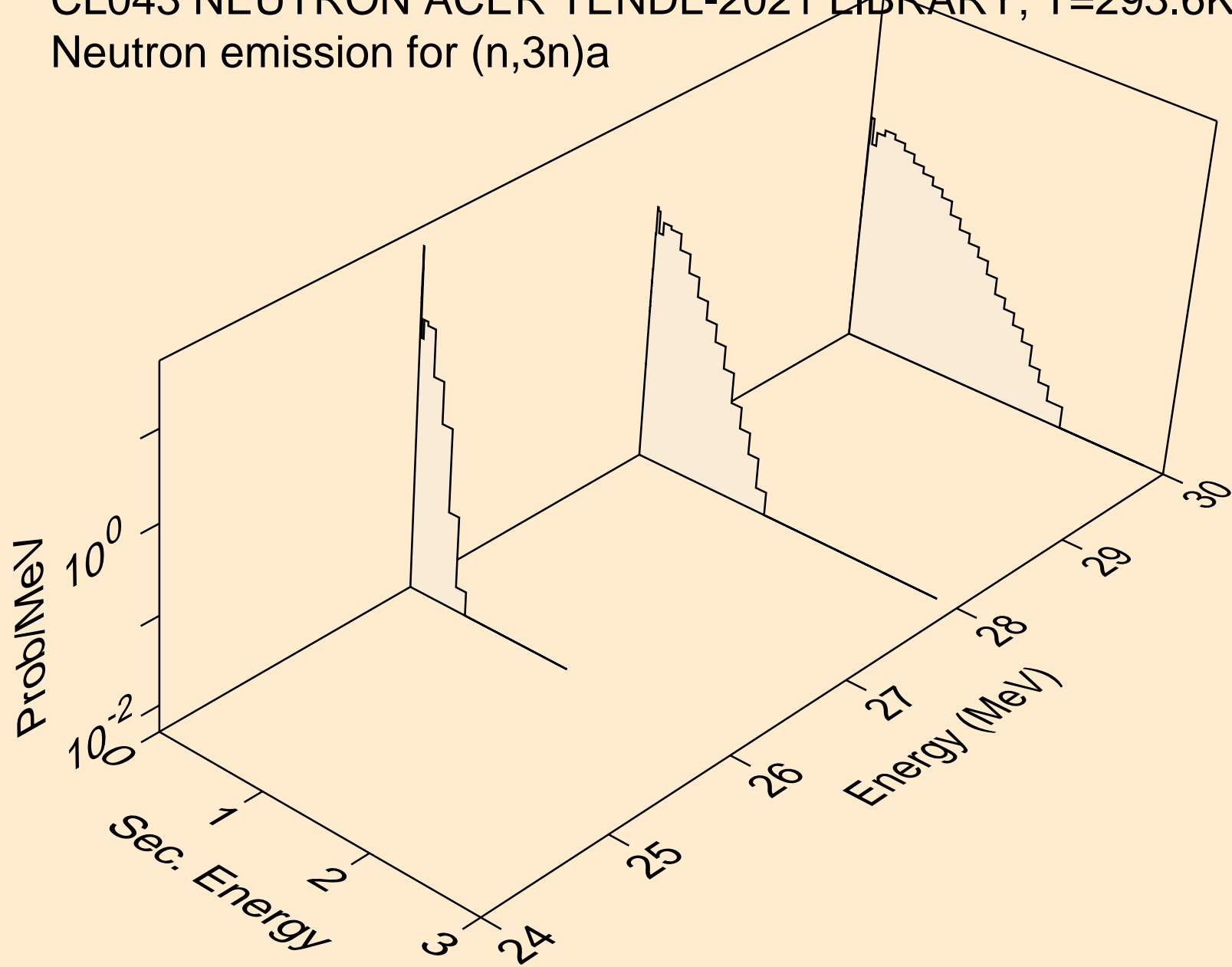

CL043 NEUTRON ACER TENDL-2021 LIBRARY; T=293.6K  
Neutron emission for (n,n\*)p

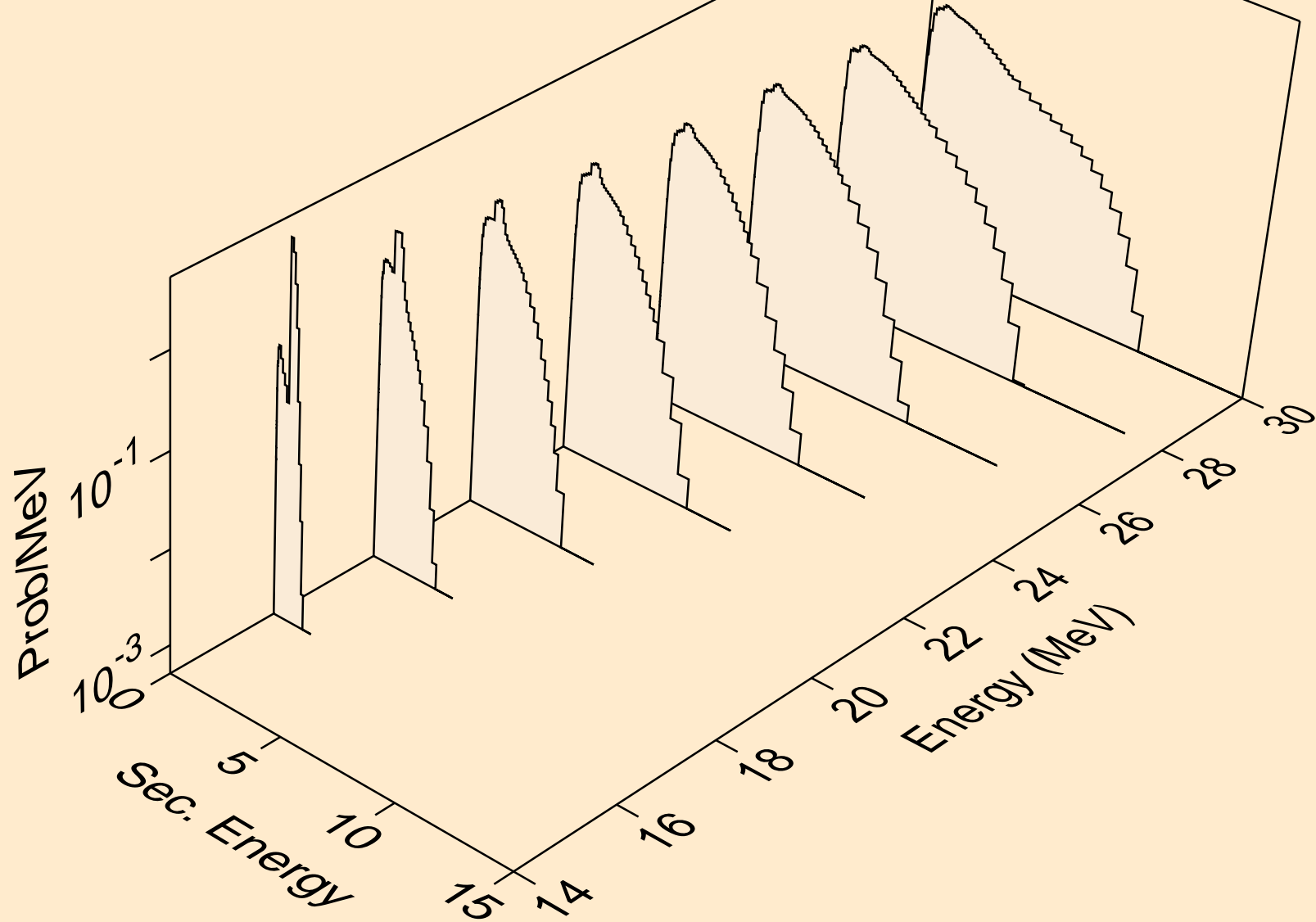

CL043 NEUTRON ACER TENDL-2021 LIBRARY; T=293.6K  
Neutron emission for (n,n\*)d

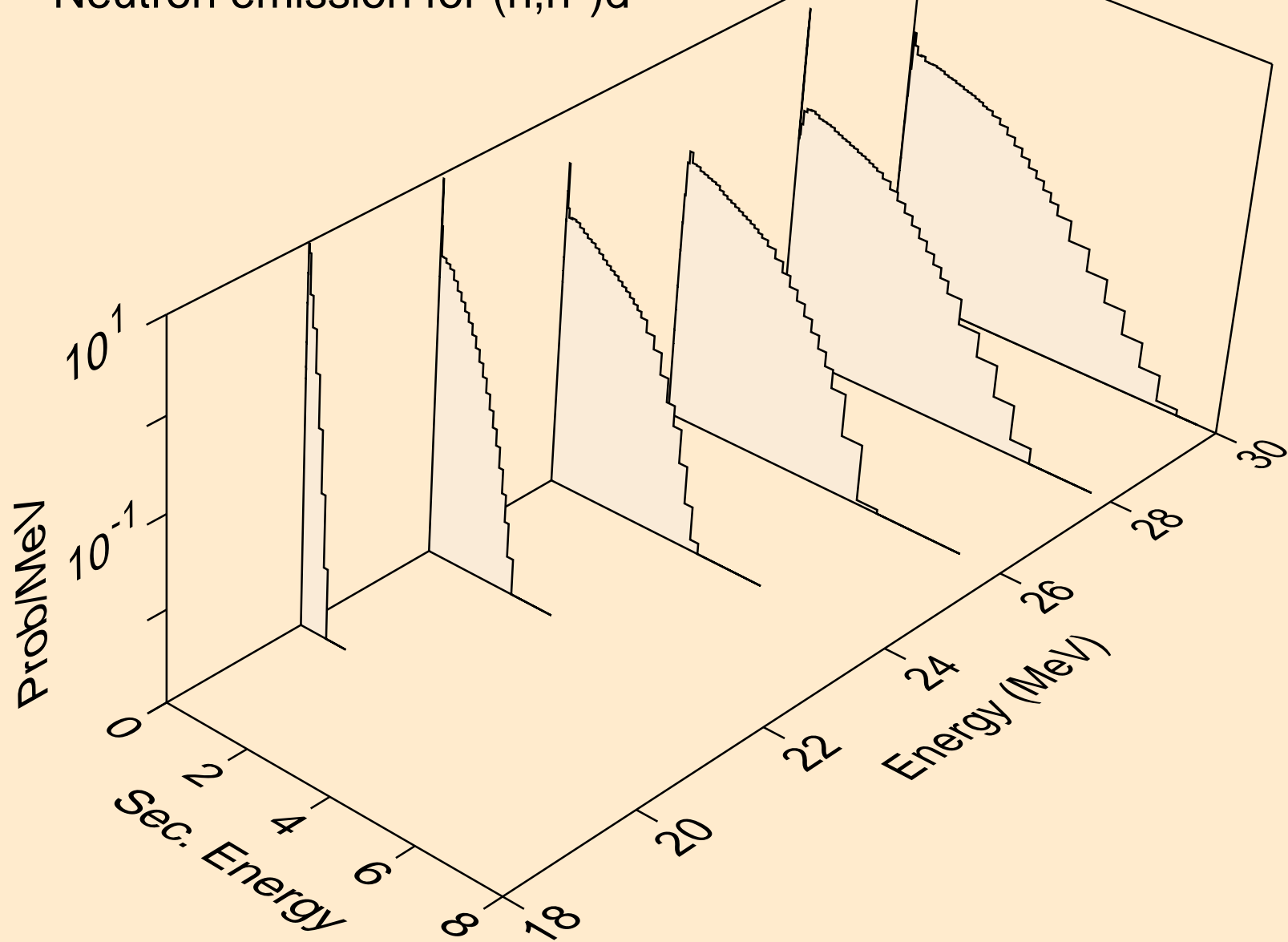

CL043 NEUTRON ACER TENDL-2021 LIBRARY; T=293.6K  
Neutron emission for (n,n\*)t

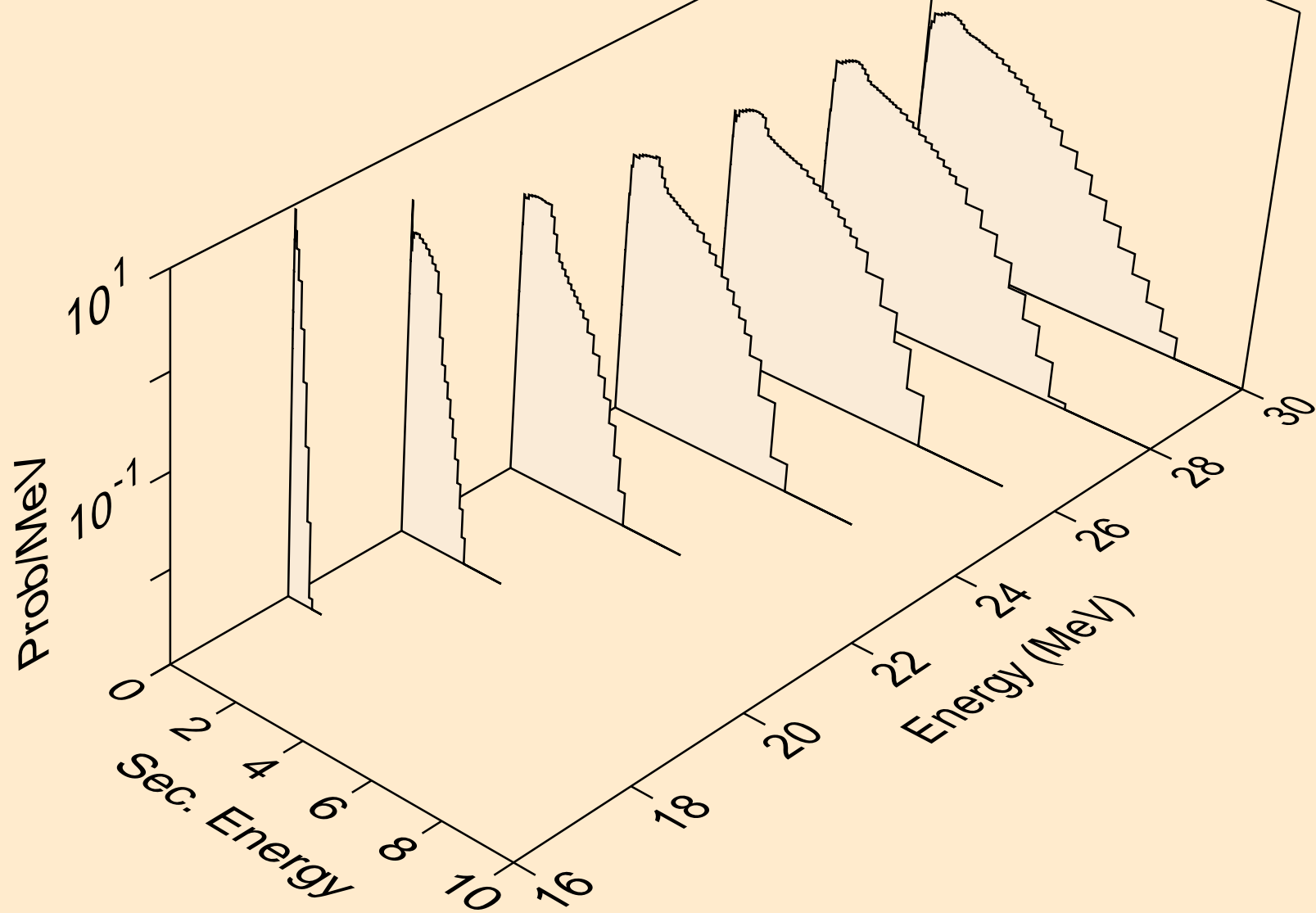

CL043 NEUTRON ACER TENDL-2021 LIBRARY; T=293.6K  
Neutron emission for (n,4n)

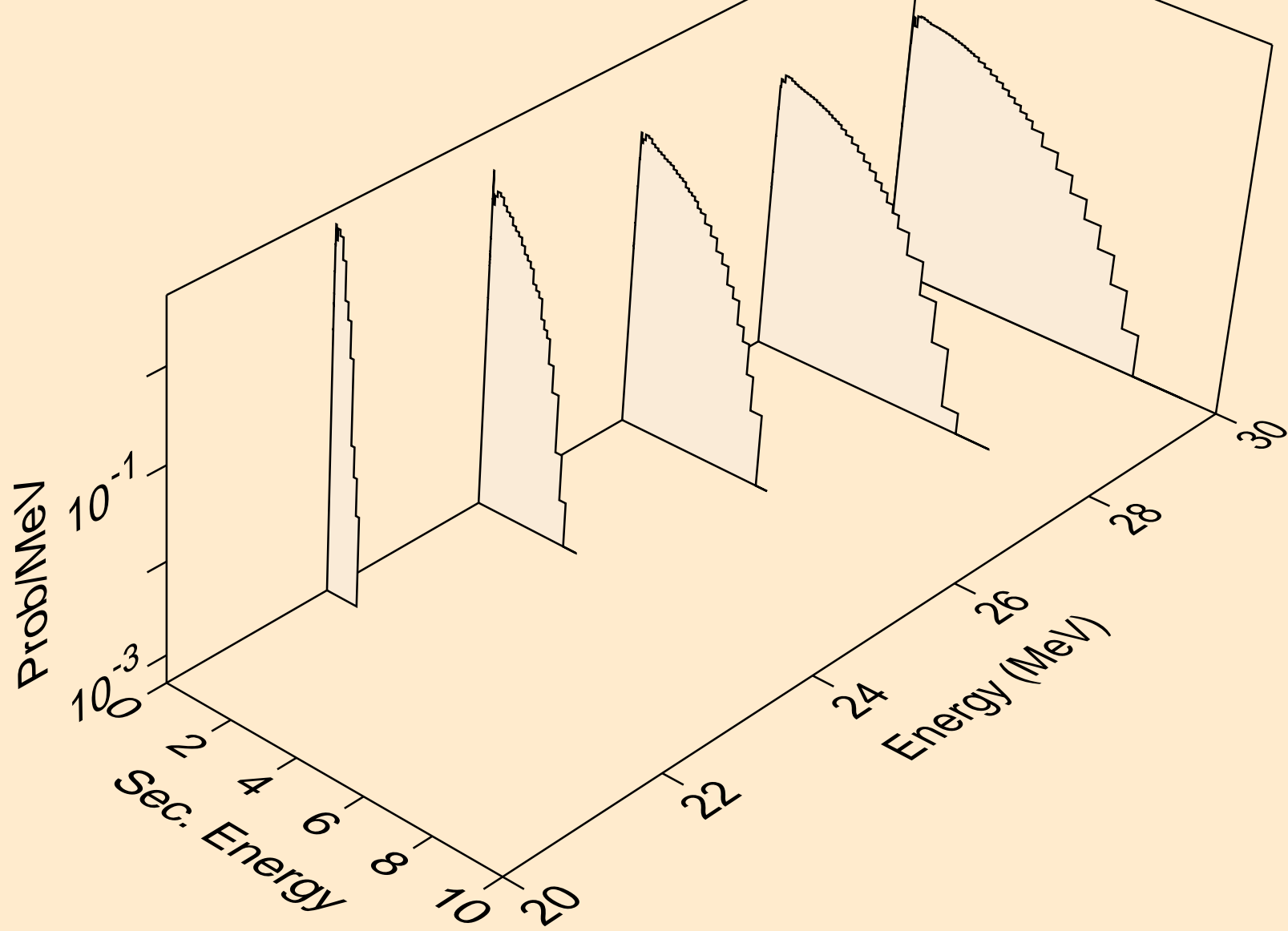

CL043 NEUTRON ACER TENDL-2021 LIBRARY; T=293.6K  
Neutron emission for (n,2np)

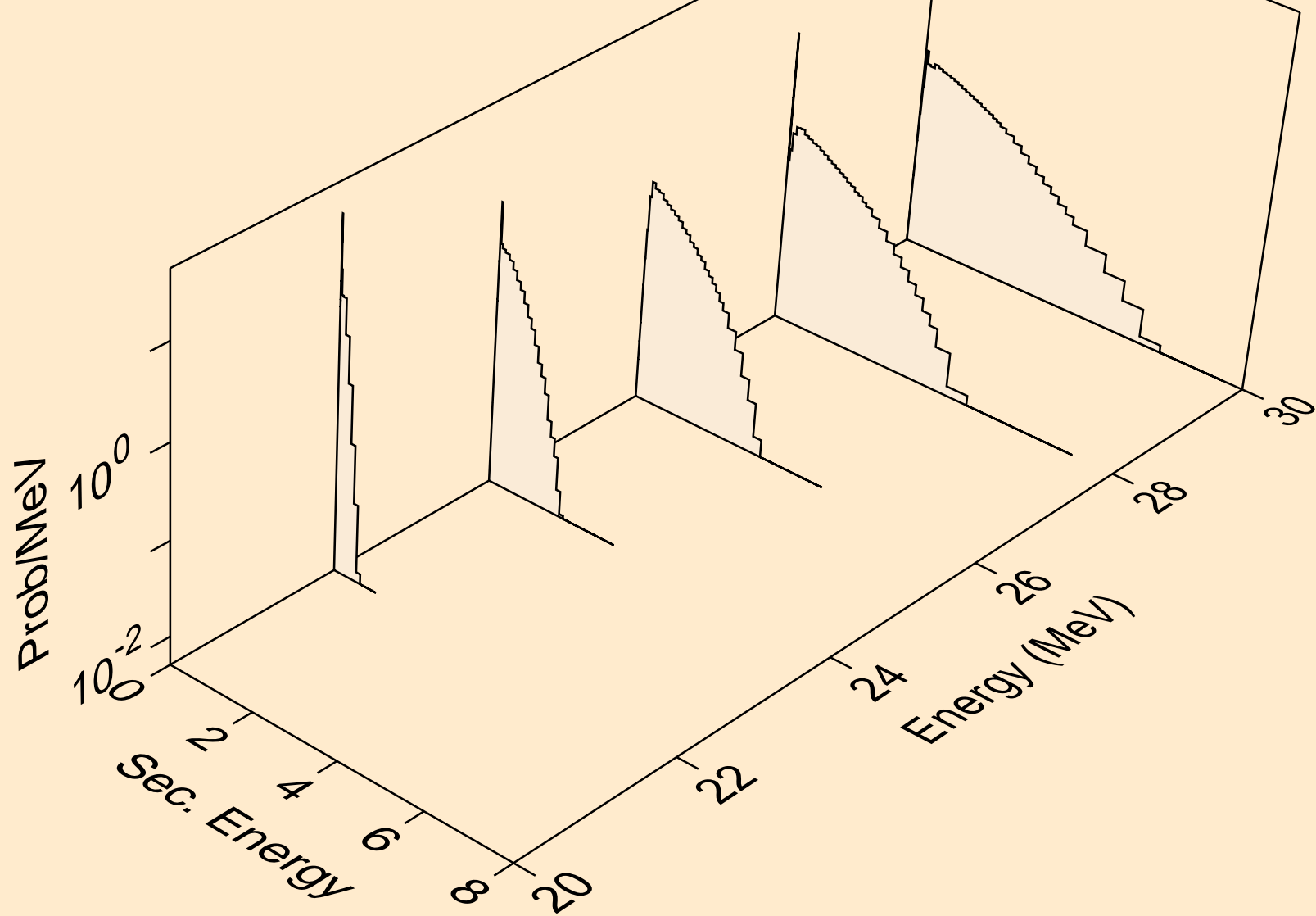

CL043 NEUTRON ACER TENDL-2021 LIBRARY; T=293.6K  
Neutron emission for (n,3np)

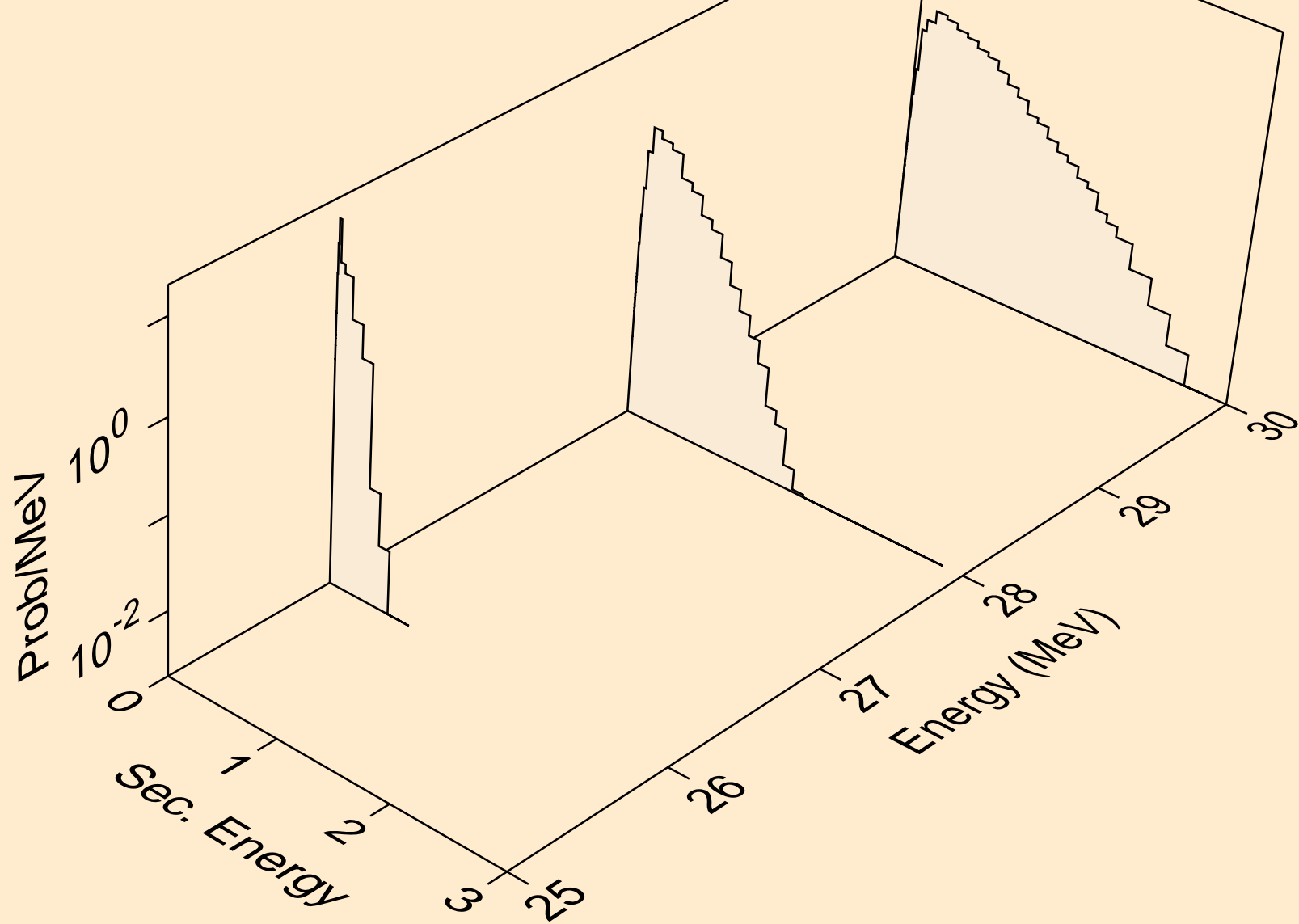



CL043 NEUTRON ACER TENDL-2021 LIBRARY; T=293.6K  
Neutron emission for (n,n\*c)

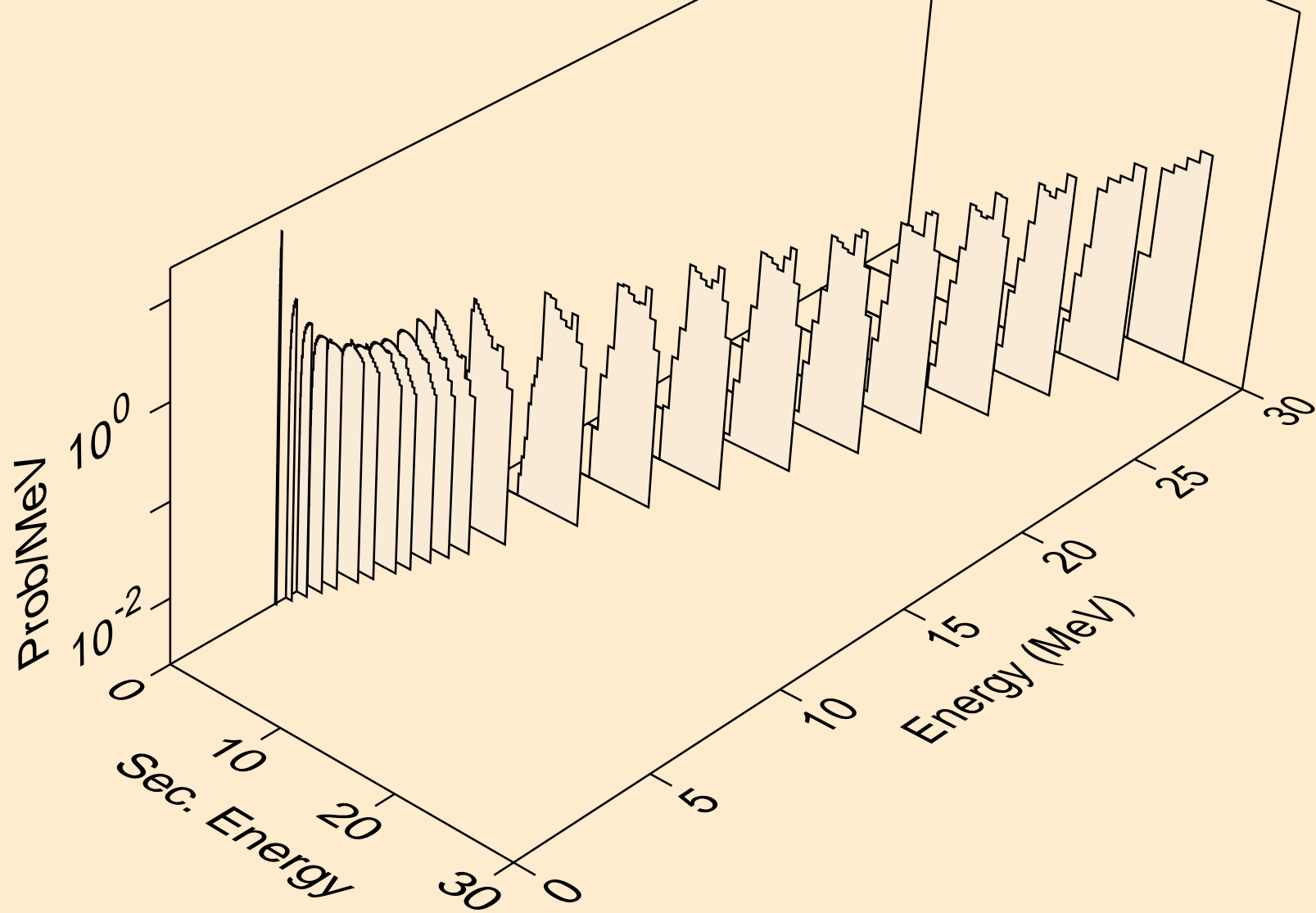

CL043 NEUTRON ACER TENDL-2021 LIBRARY; T=293.6K  
Photon emission for (n,x)

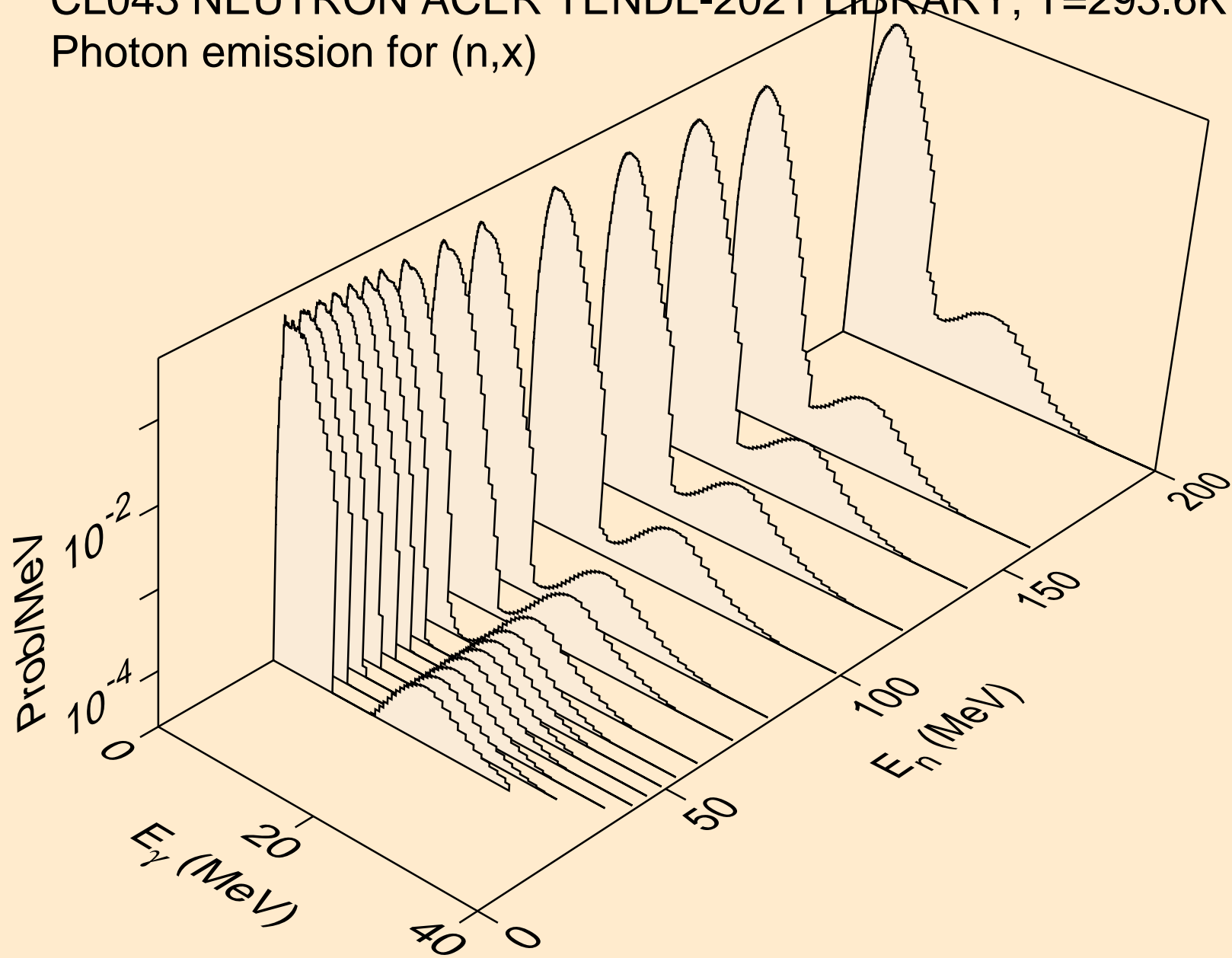

CL043 NEUTRON ACER TENDL-2021 LIBRARY; T=293.6K  
Photon emission for (n,2nd)

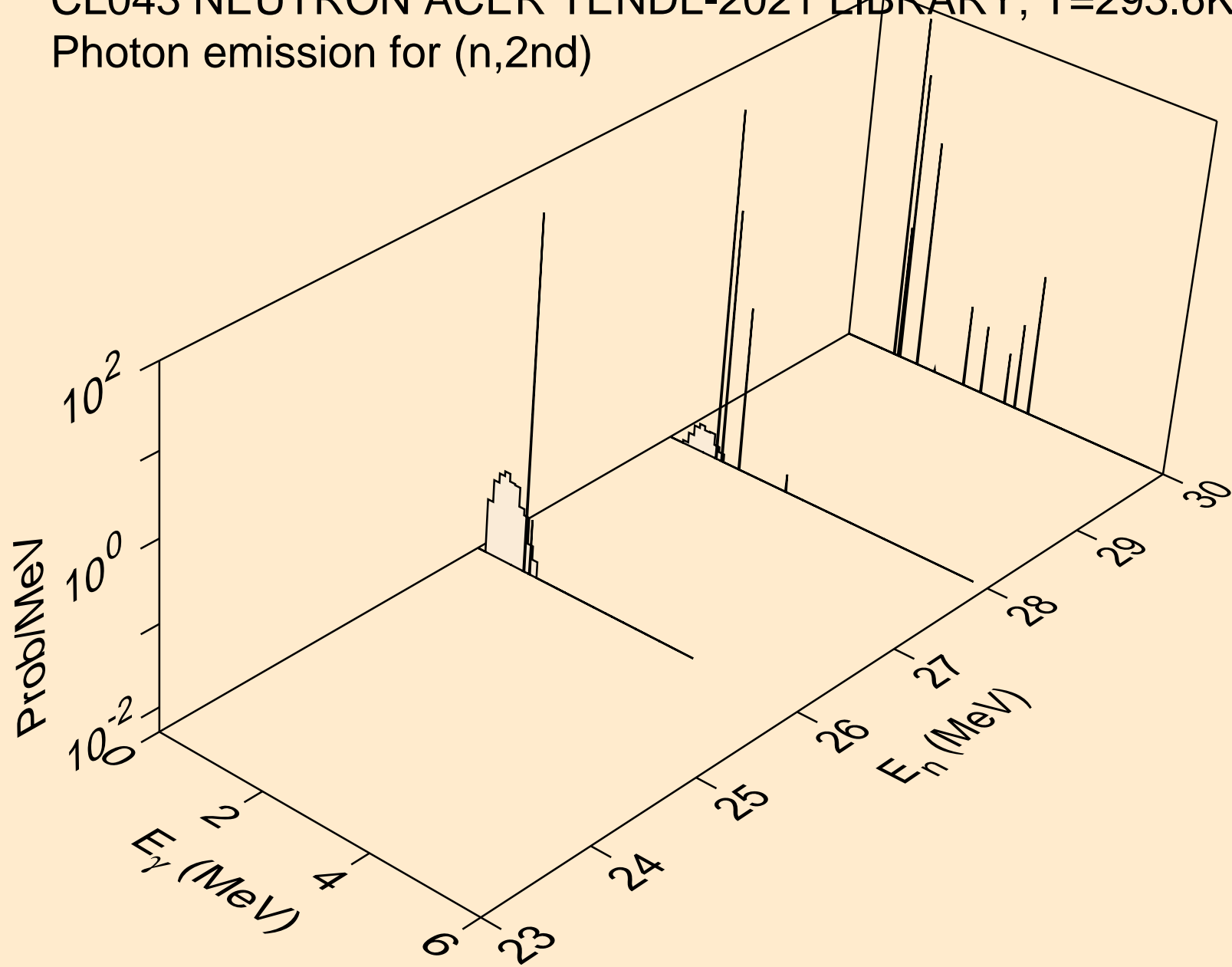

CL043 NEUTRON ACER TENDL-2021 LIBRARY; T=293.6K  
Photon emission for (n,2n)

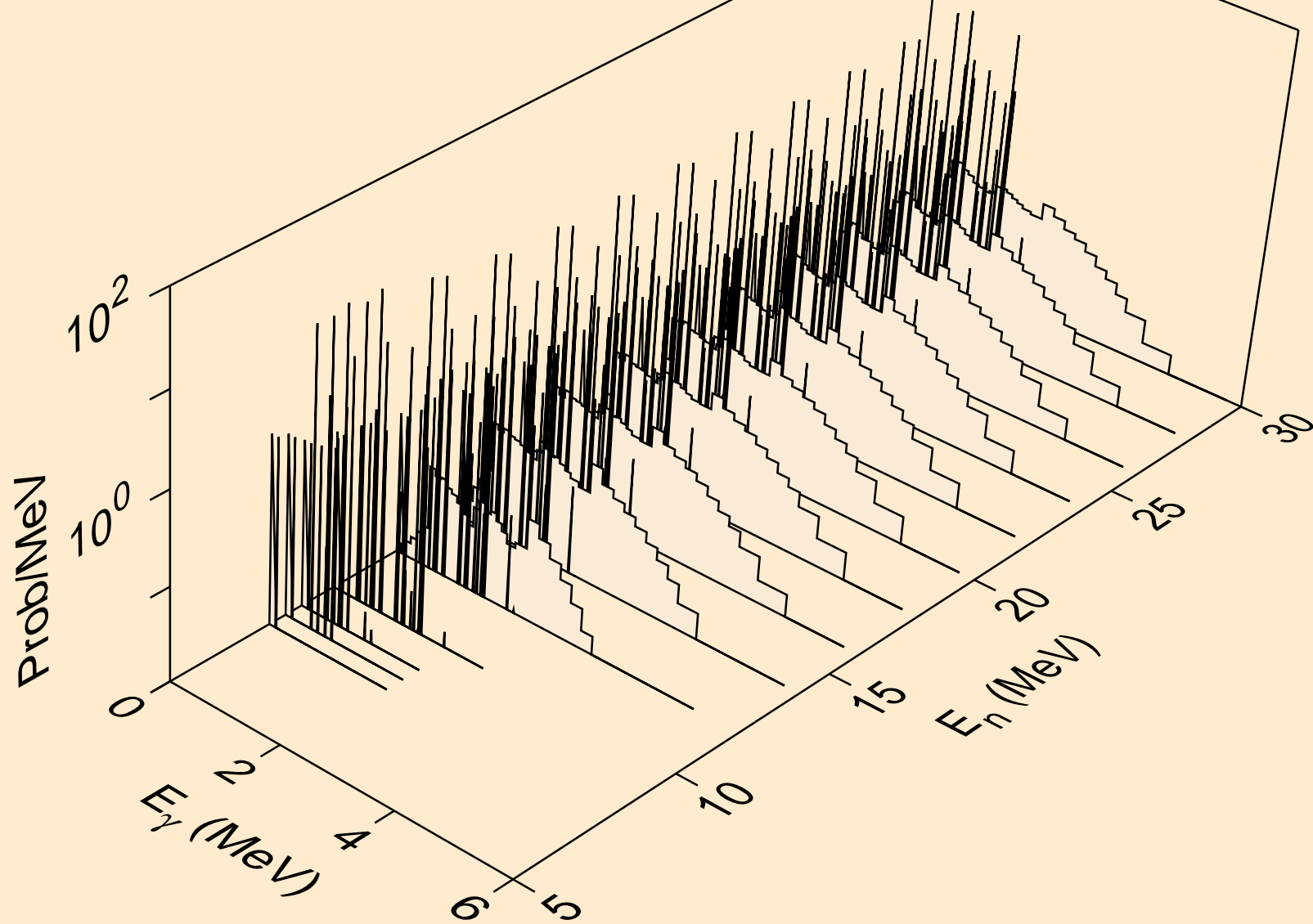

CL043 NEUTRON ACER TENDL-2021 LIBRARY; T=293.6K  
Photon emission for (n,3n)

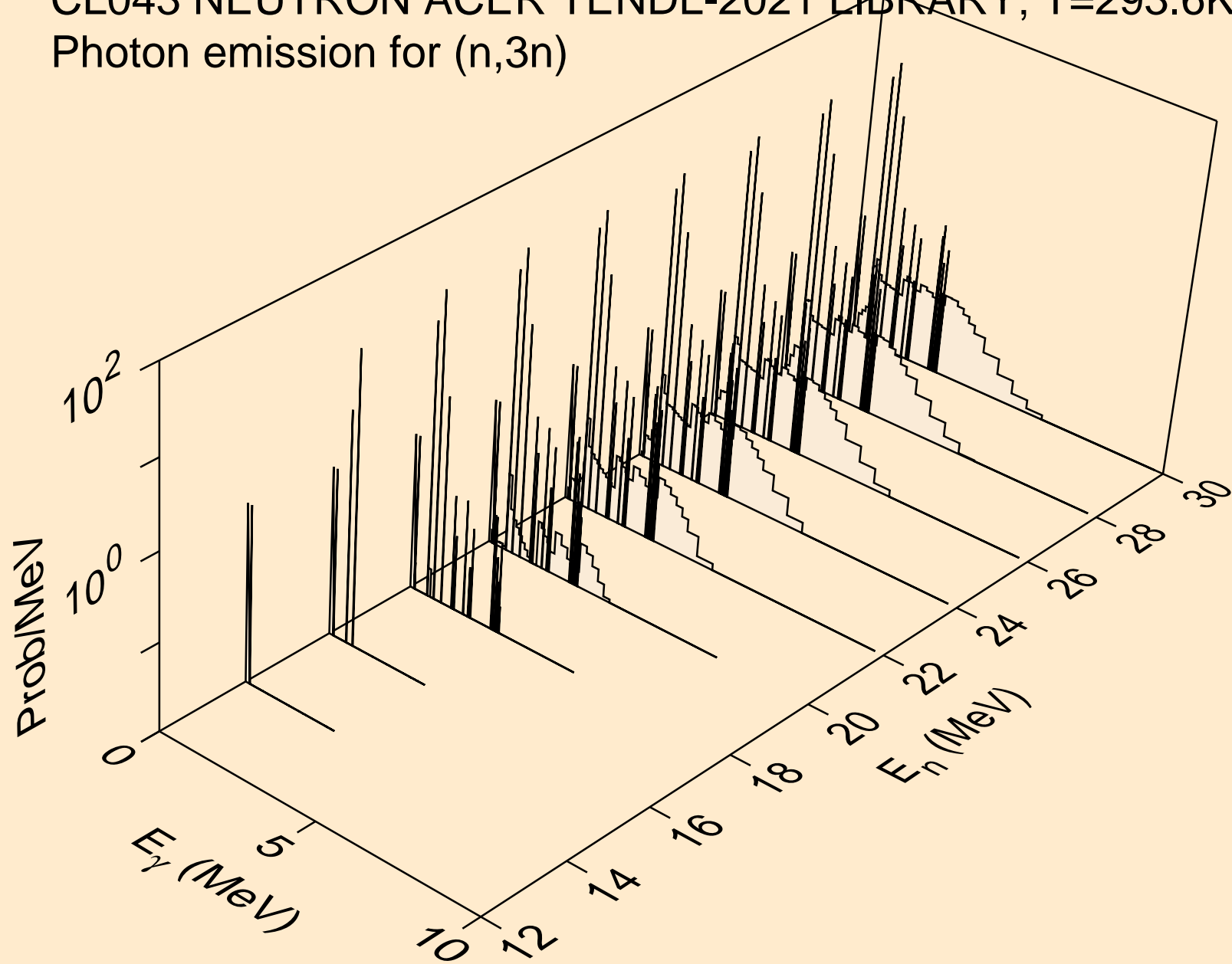

CL043 NEUTRON ACER TENDL-2021 LIBRARY; T=293.6K  
Photon emission for (n,n\*)a

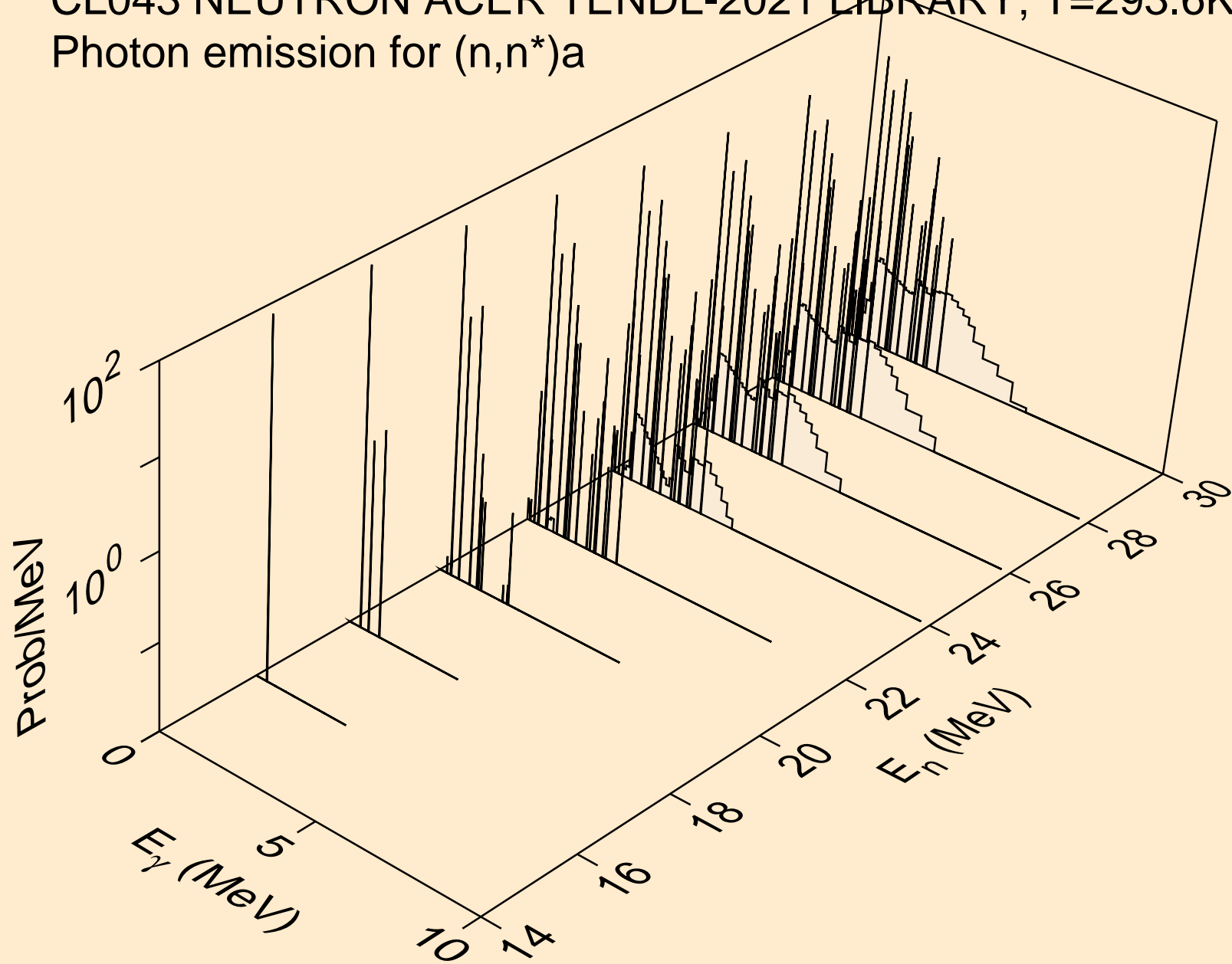

CL043 NEUTRON ACER TENDL-2021 LIBRARY; T=293.6K  
Photon emission for (n,2n)a

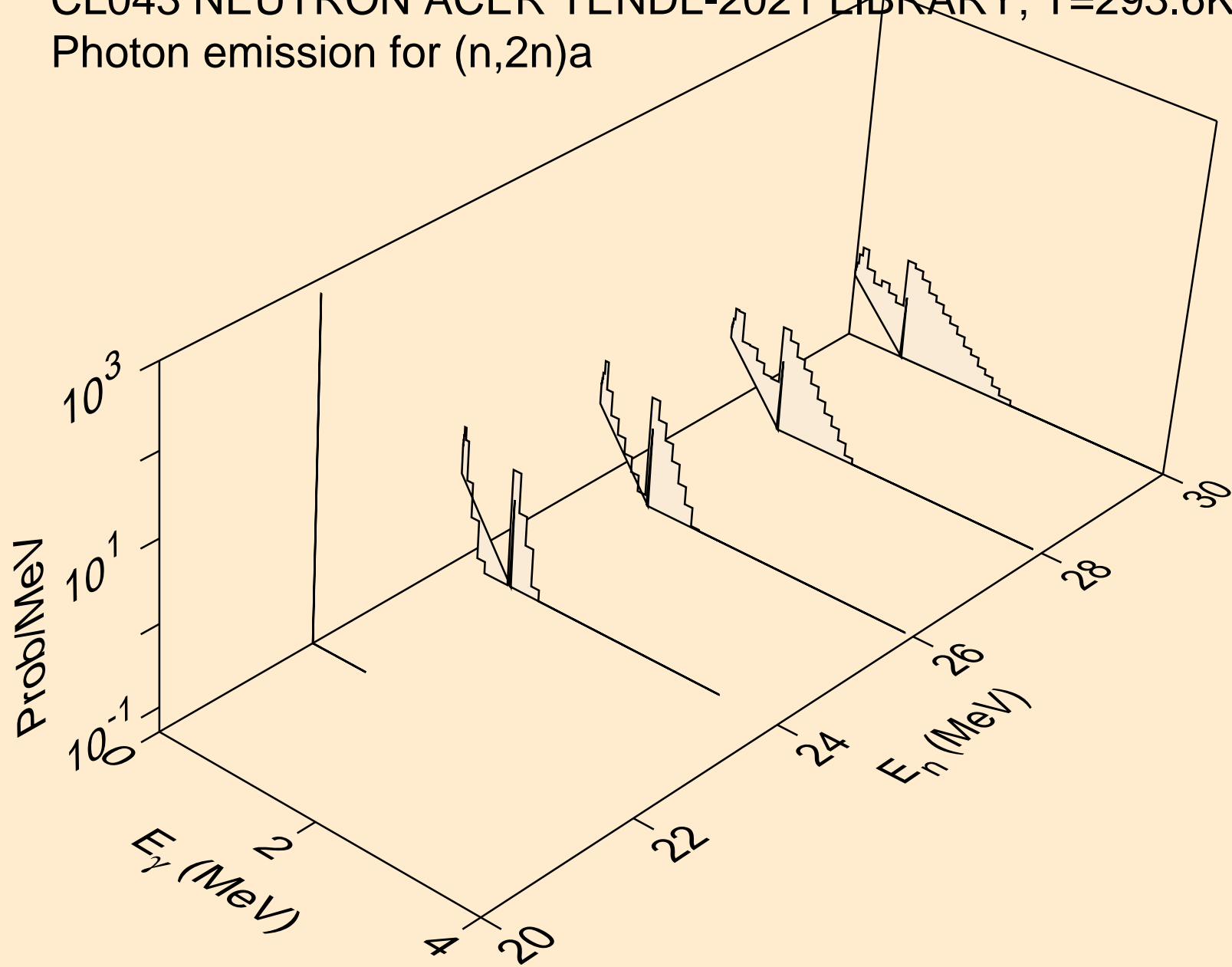

CL043 NEUTRON ACER TENDL-2021 LIBRARY; T=293.6K  
Photon emission for (n,3n)a

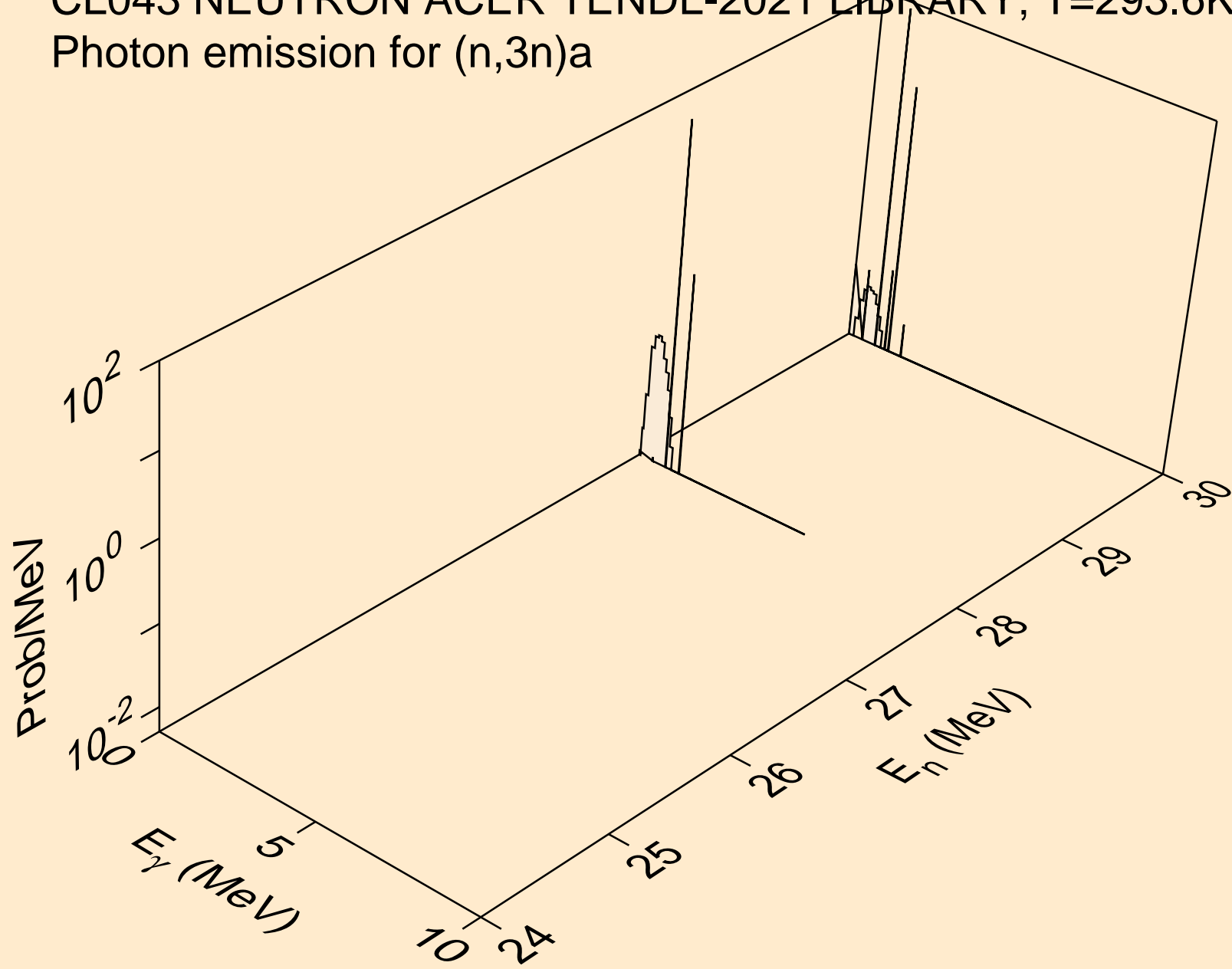



CL043 NEUTRON ACER TENDL-2021 LIBRARY; T=293.6K  
Photon emission for (n,n\*)p

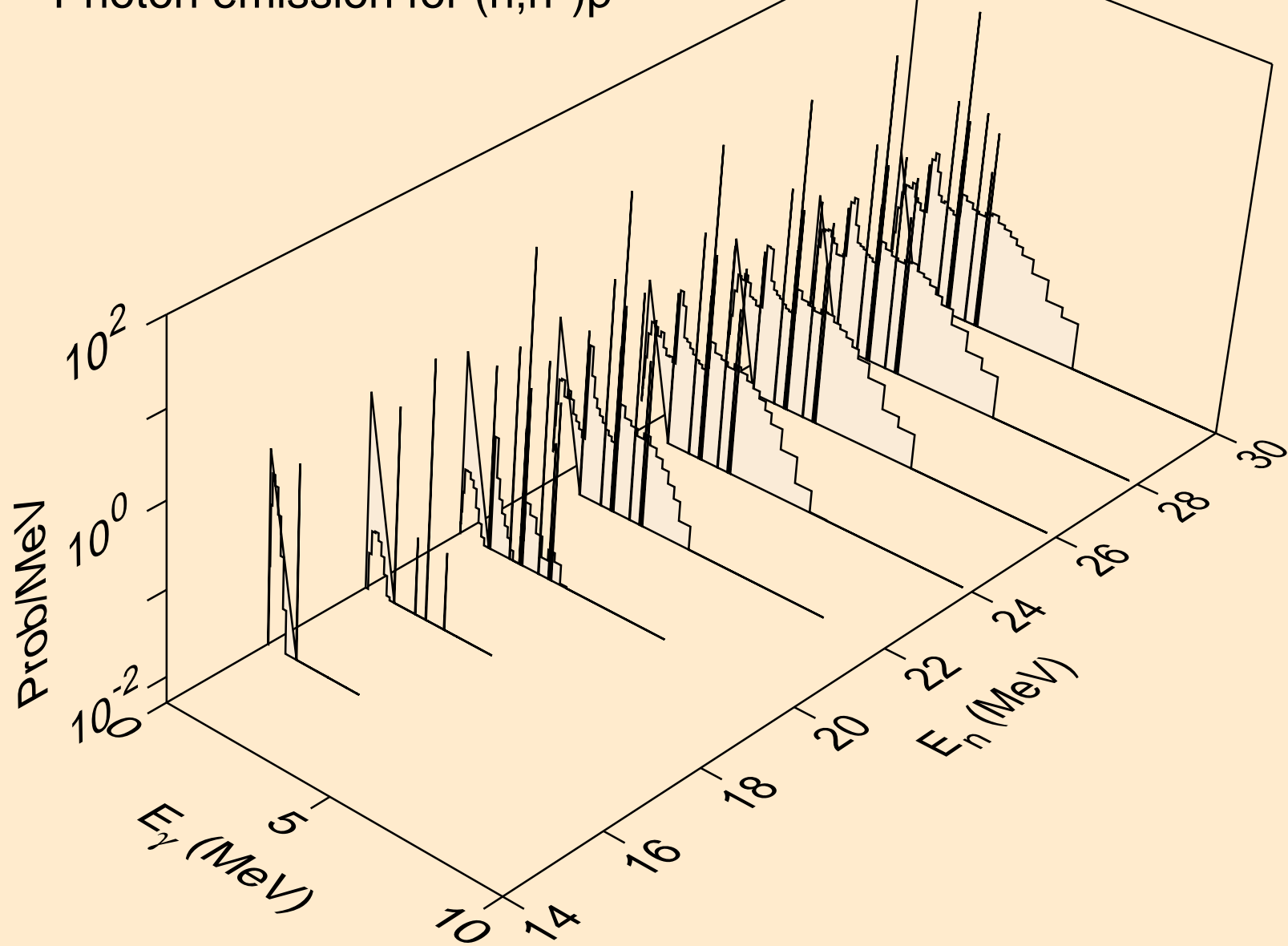

CL043 NEUTRON ACER TENDL-2021 LIBRARY; T=293.6K  
Photon emission for (n,n\*)d

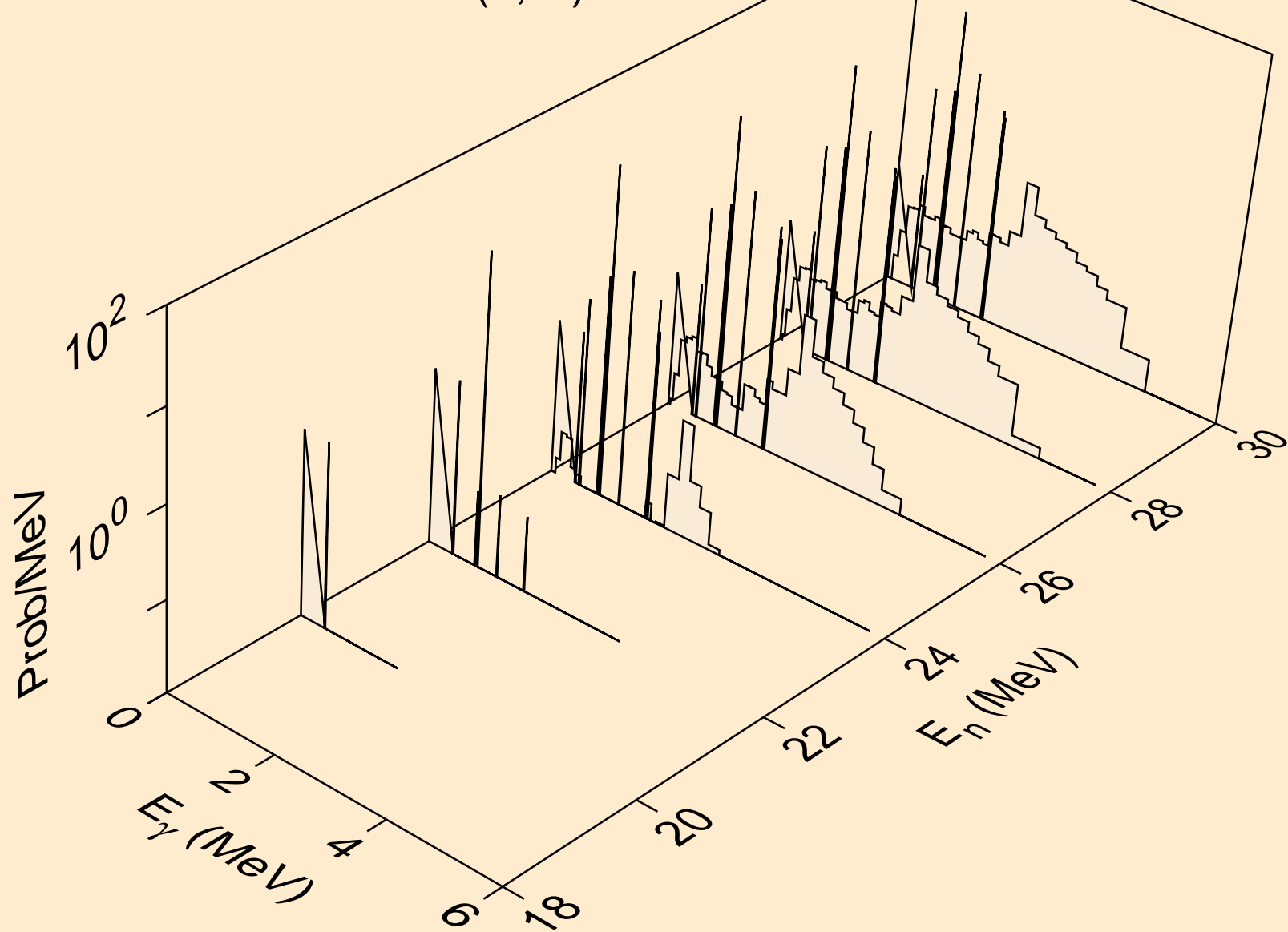

CL043 NEUTRON ACER TENDL-2021 LIBRARY; T=293.6K  
Photon emission for (n,n\*)t

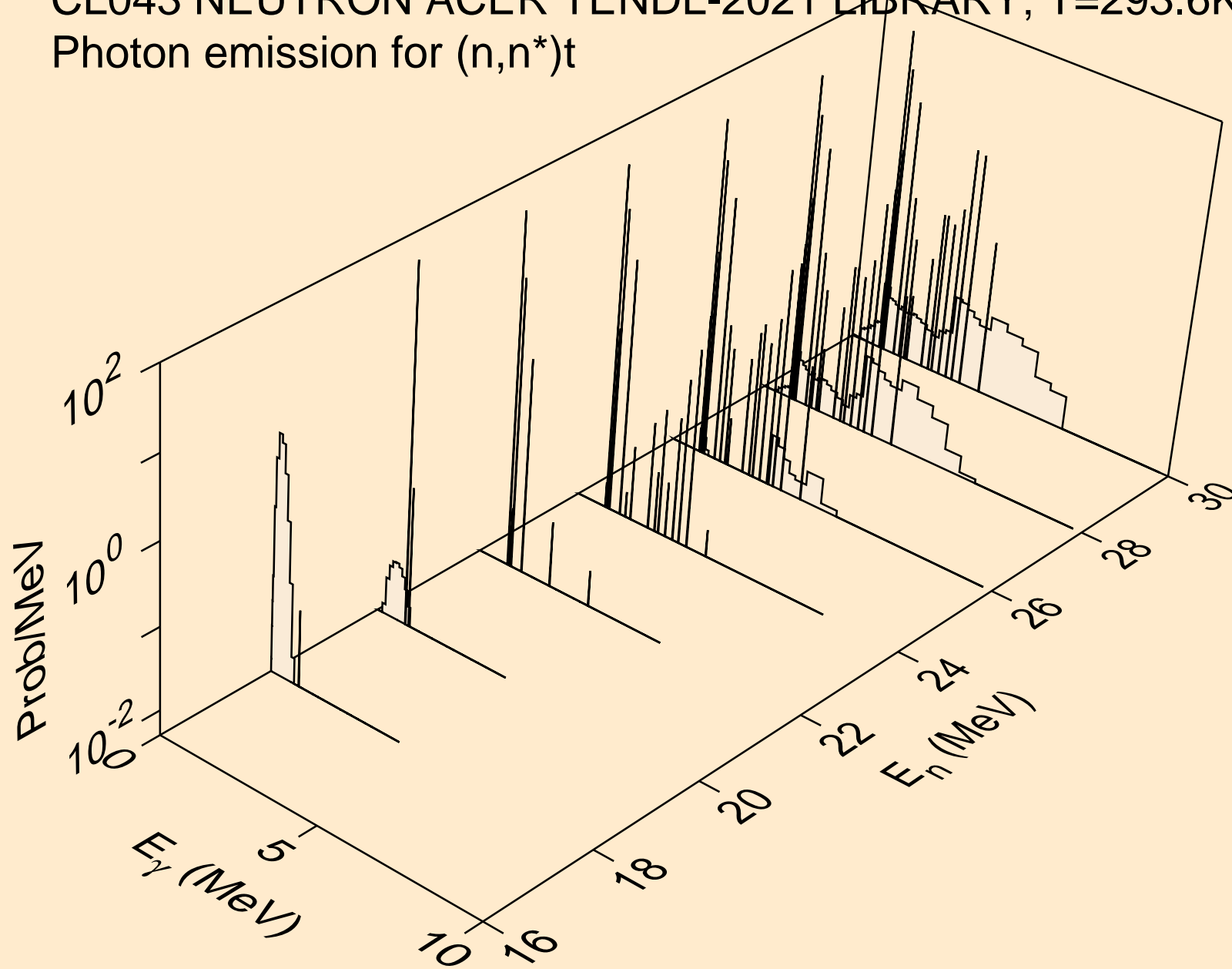

CL043 NEUTRON ACER TENDL-2021 LIBRARY; T=293.6K  
Photon emission for (n,4n)

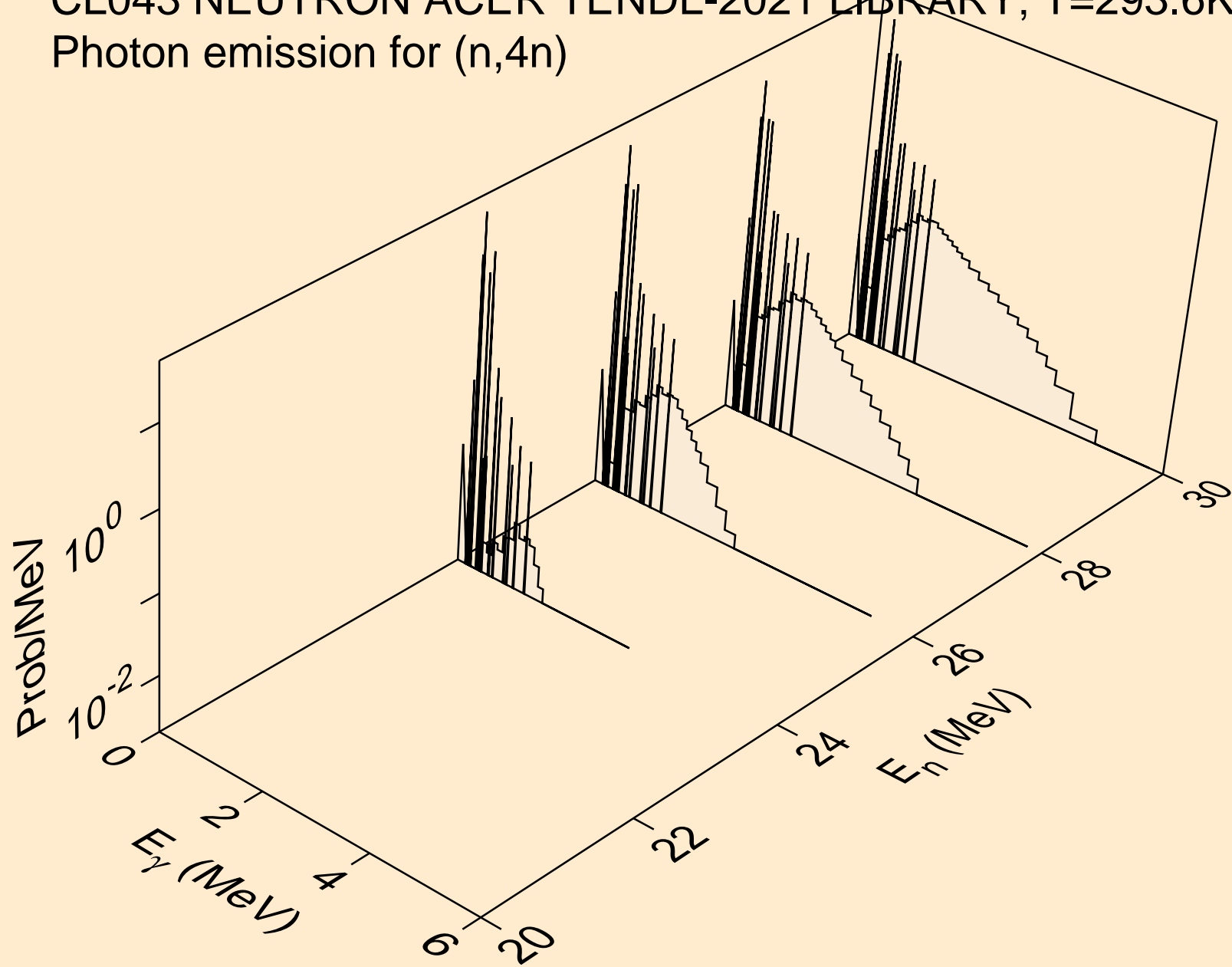

CL043 NEUTRON ACER TENDL-2021 LIBRARY; T=293.6K  
Photon emission for (n,2np)

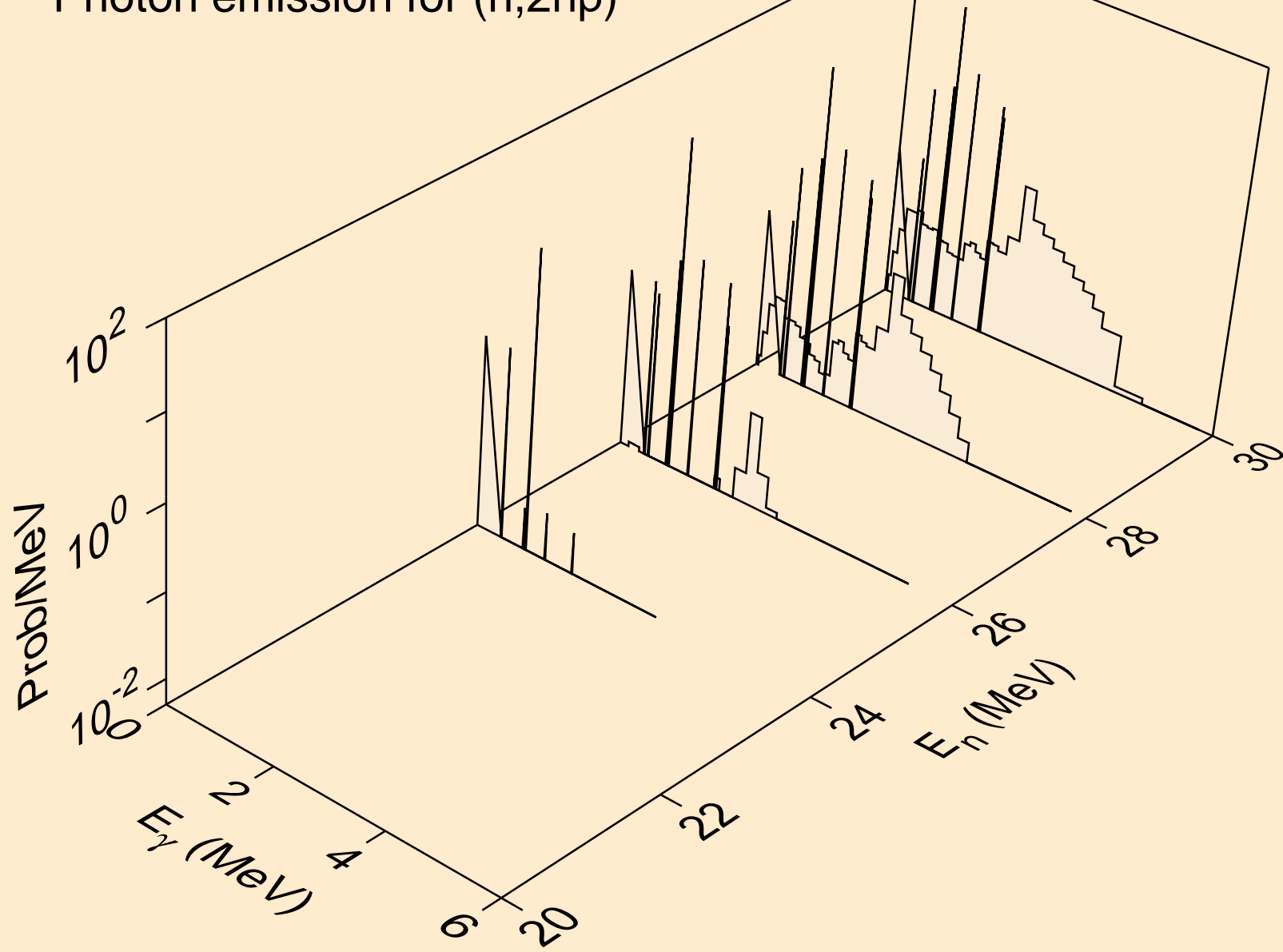

CL043 NEUTRON ACER TENDL-2021 LIBRARY; T=293.6K  
Photon emission for (n,3np)

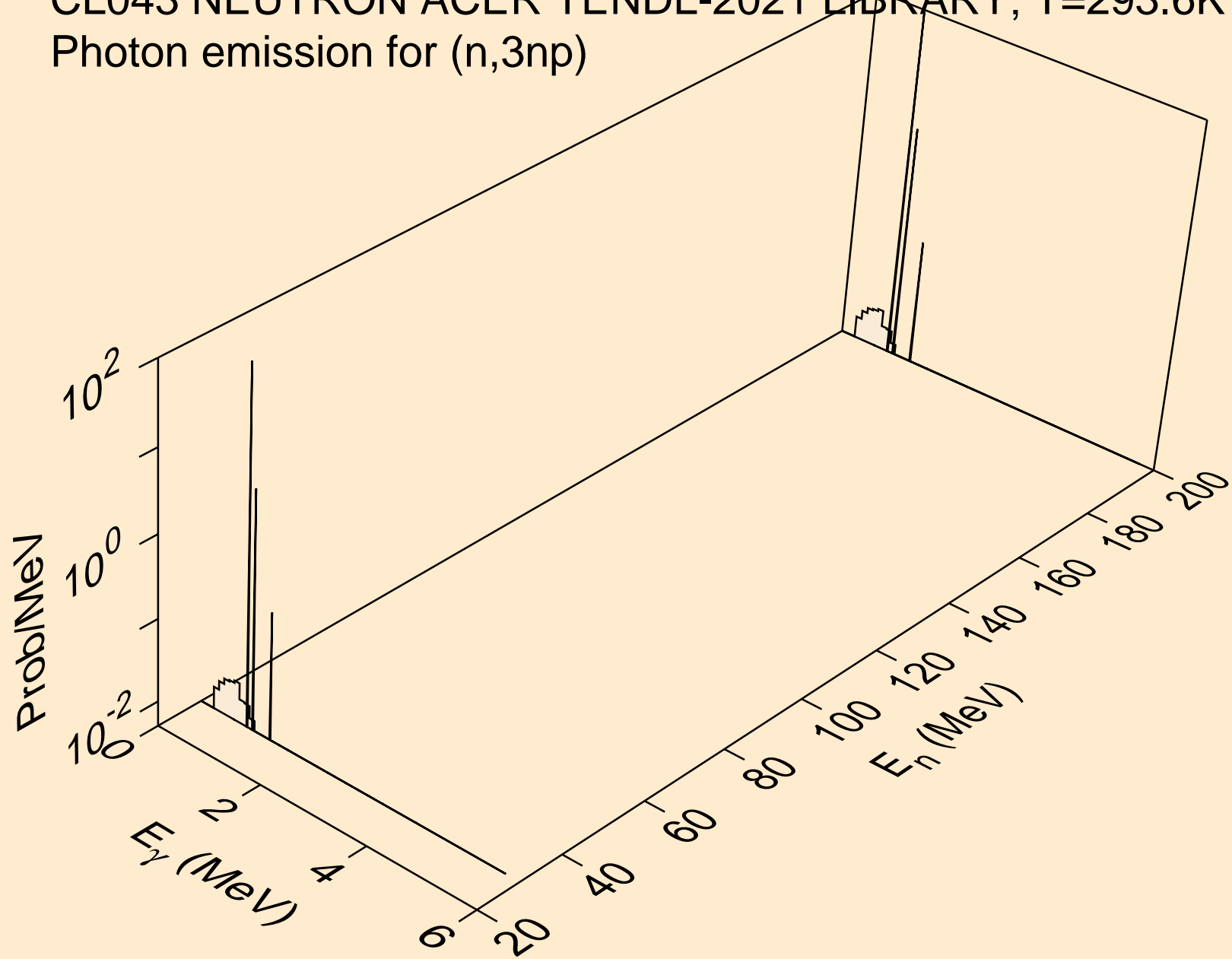

CL043 NEUTRON ACER TENDL-2021 LIBRARY; T=293.6K  
Photon emission for (n,n\*c)

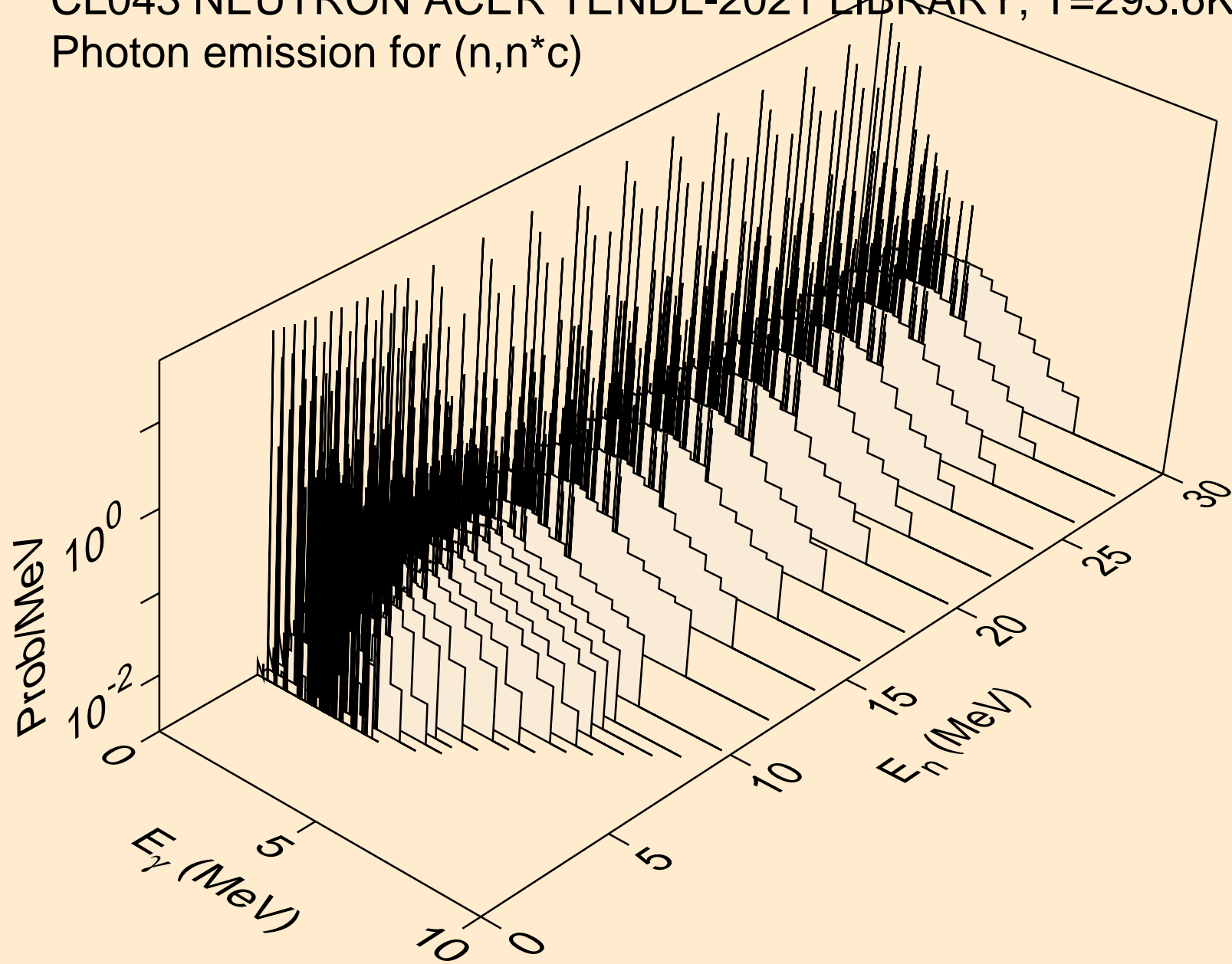

CL043 NEUTRON ACER TENDL-2021 LIBRARY; T=293.6K  
Photon emission for (n,gma)

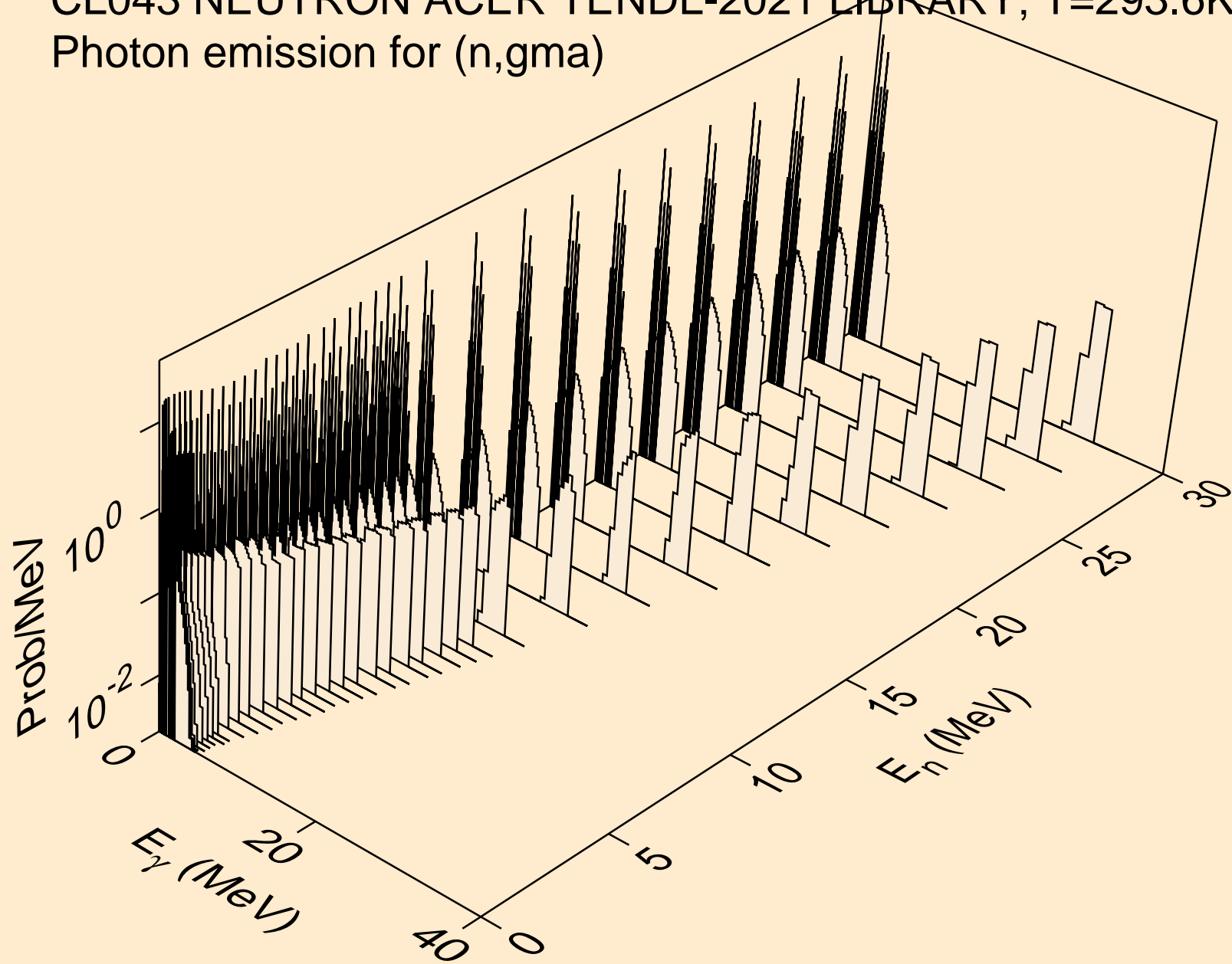



CL043 NEUTRON ACER TENDL-2021 LIBRARY; T=293.6K  
Photon emission for (n,p)

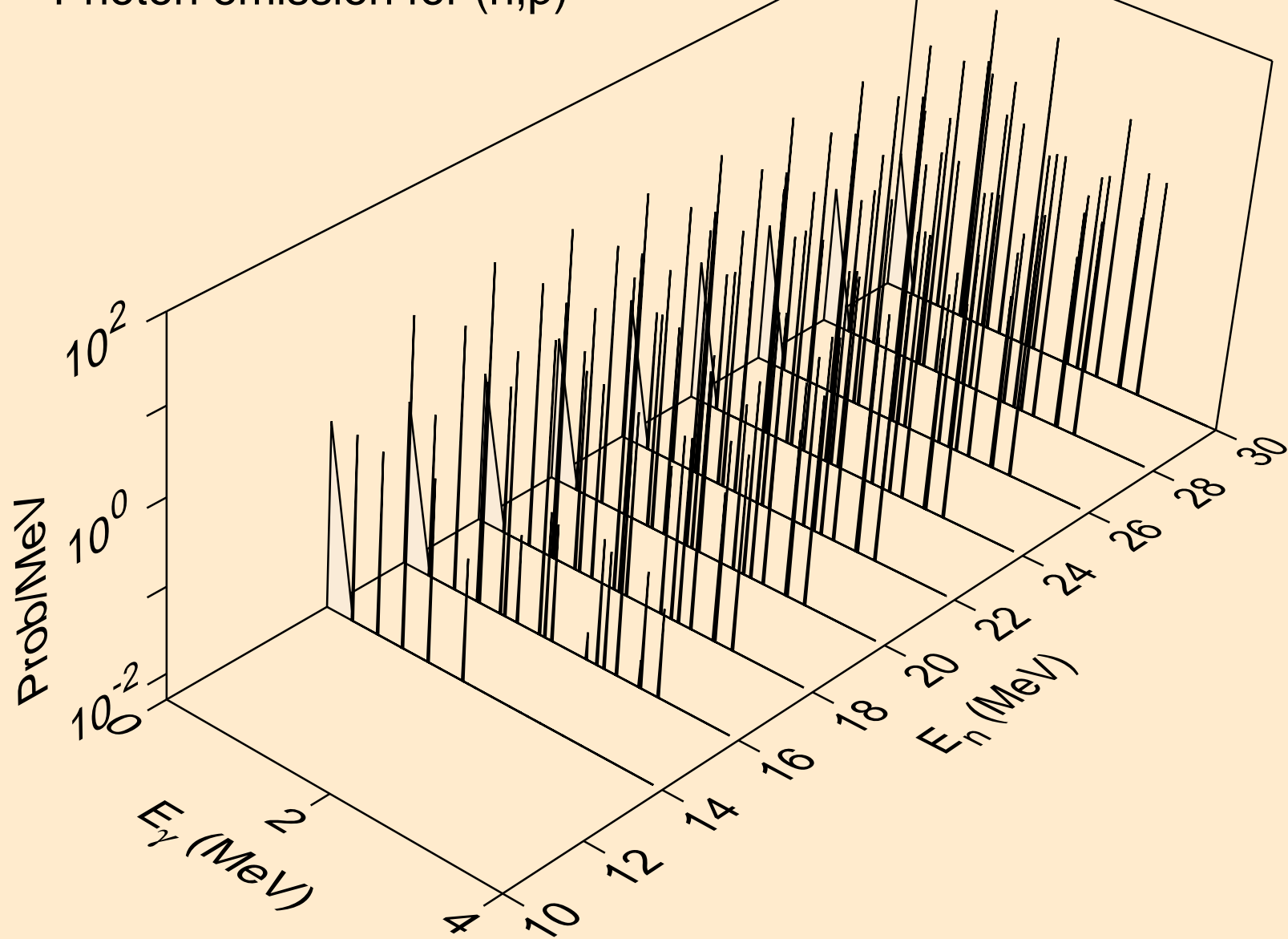

CL043 NEUTRON ACER TENDL-2021 LIBRARY; T=293.6K  
Photon emission for (n,d)

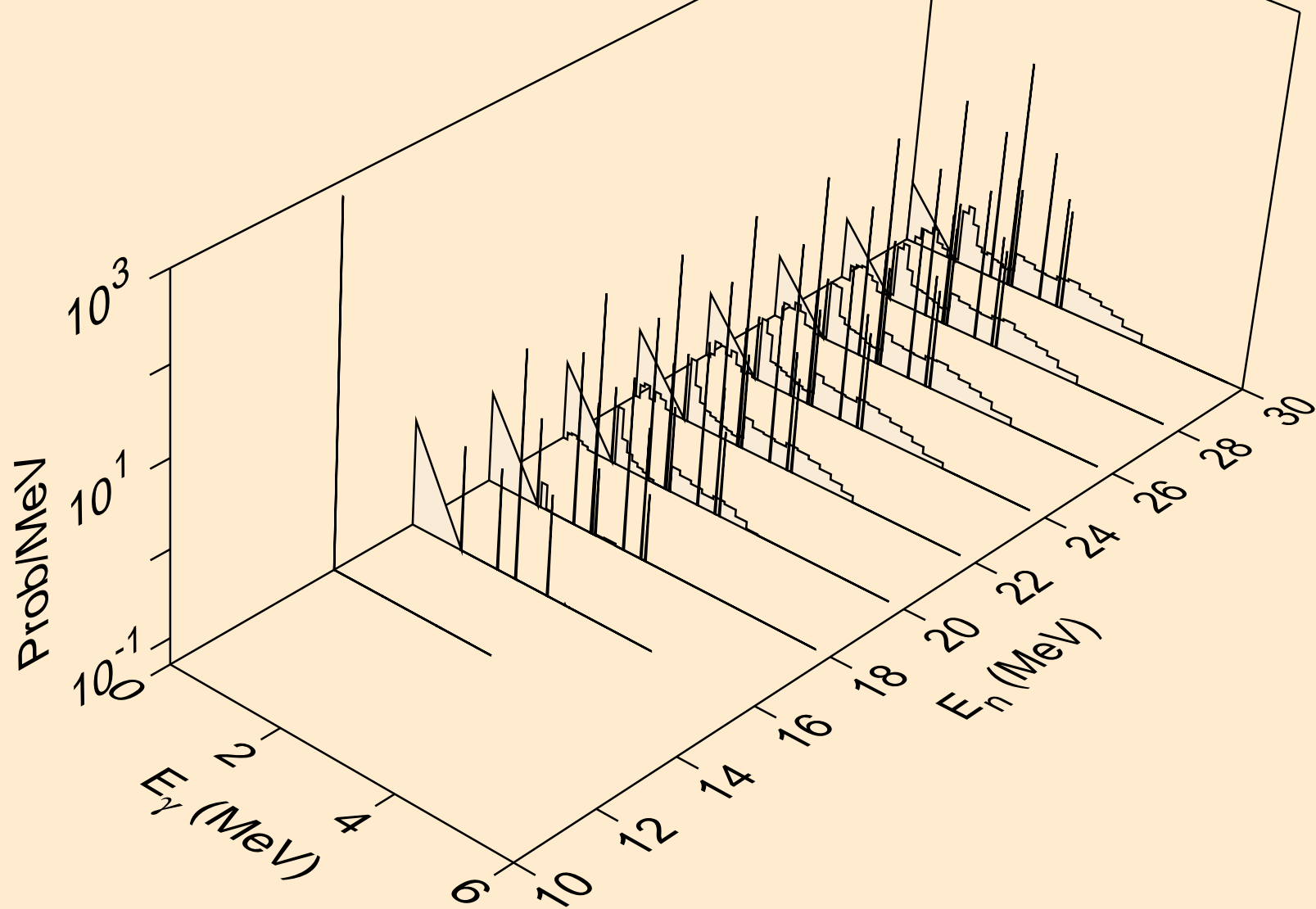

CL043 NEUTRON ACER TENDL-2021 LIBRARY; T=293.6K  
Photon emission for (n,t)

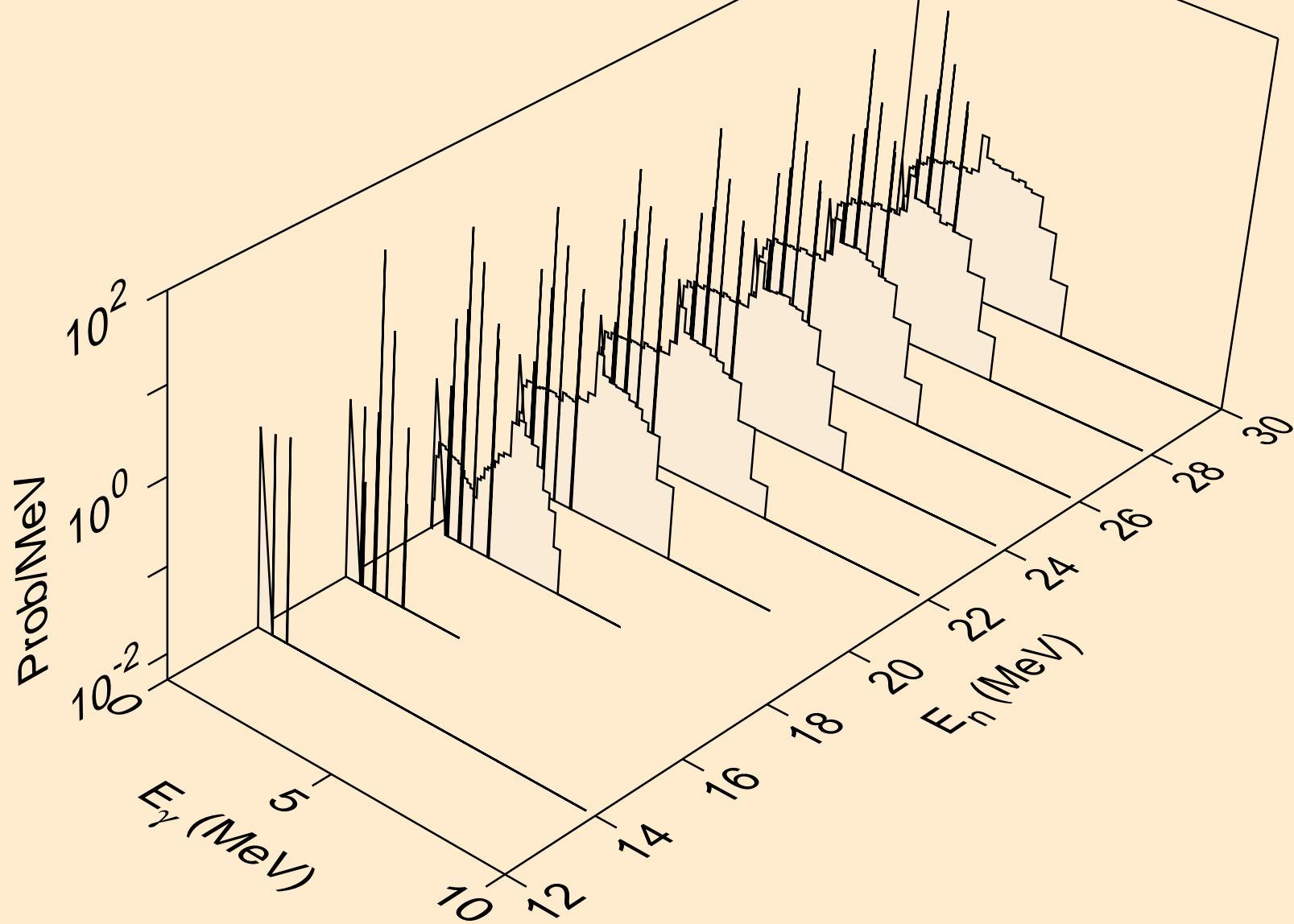

CL043 NEUTRON ACER TENDL-2021 LIBRARY; T=293.6K  
Photon emission for (n,a)

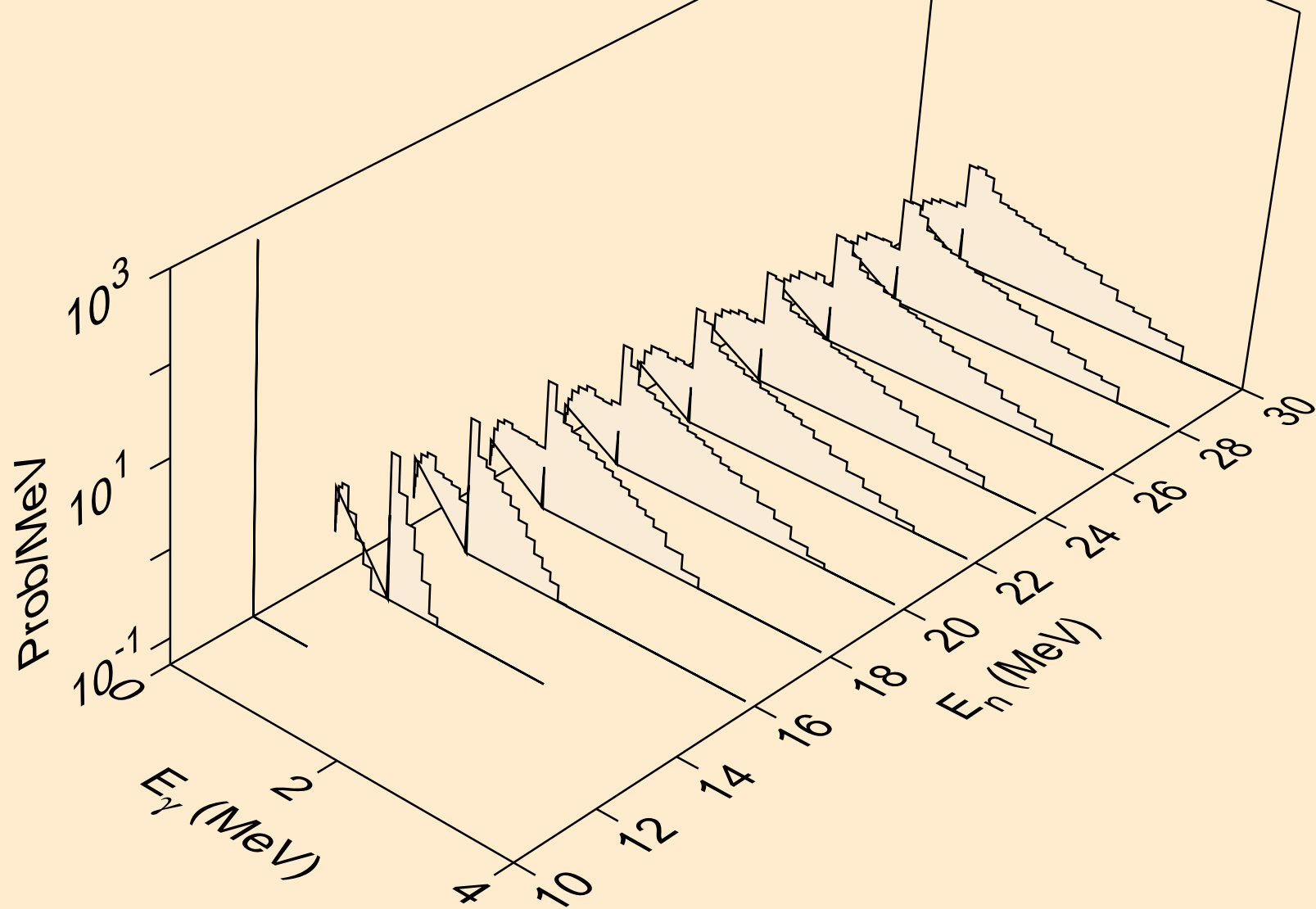

CL043 NEUTRON ACER TENDL-2021 LIBRARY; T=293.6K  
thermal capture photon spectrum

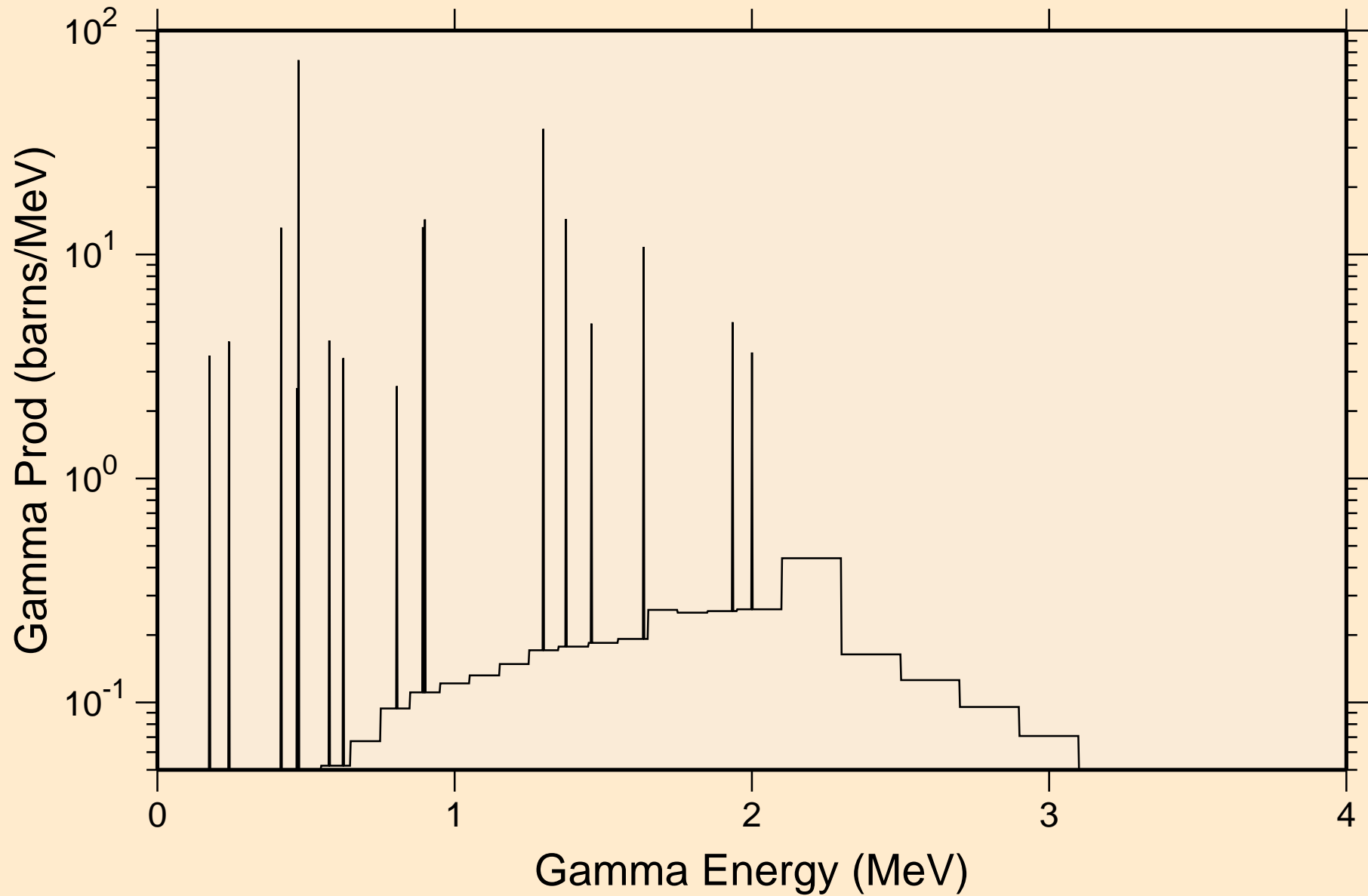

CL043 NEUTRON ACER TENDL-2021 LIBRARY; T=293.6K  
14 MeV photon spectrum

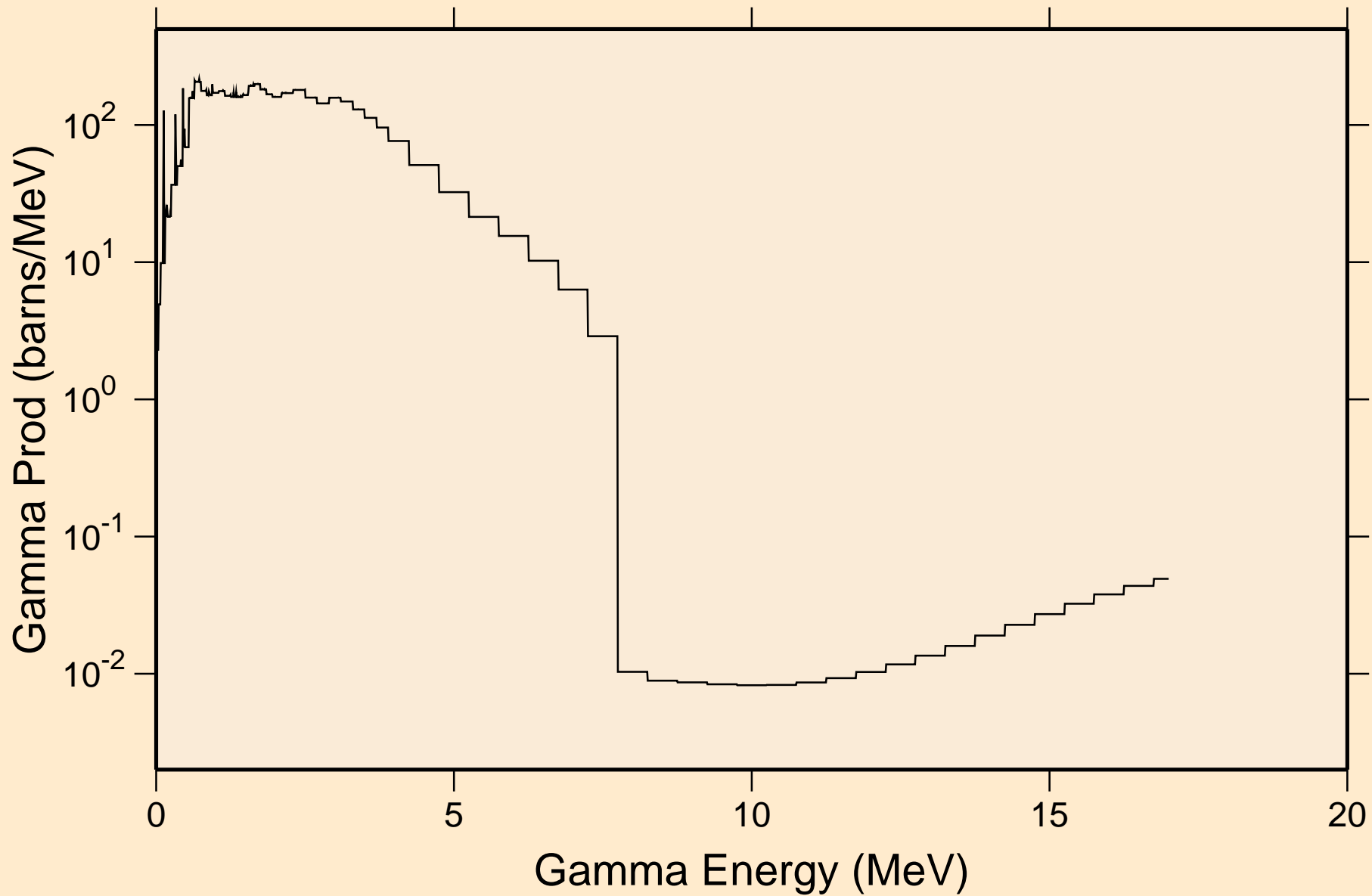

CL043 NEUTRON ACER TENDL-2021 LIBRARY; T=293.6K  
Particle heating contributions

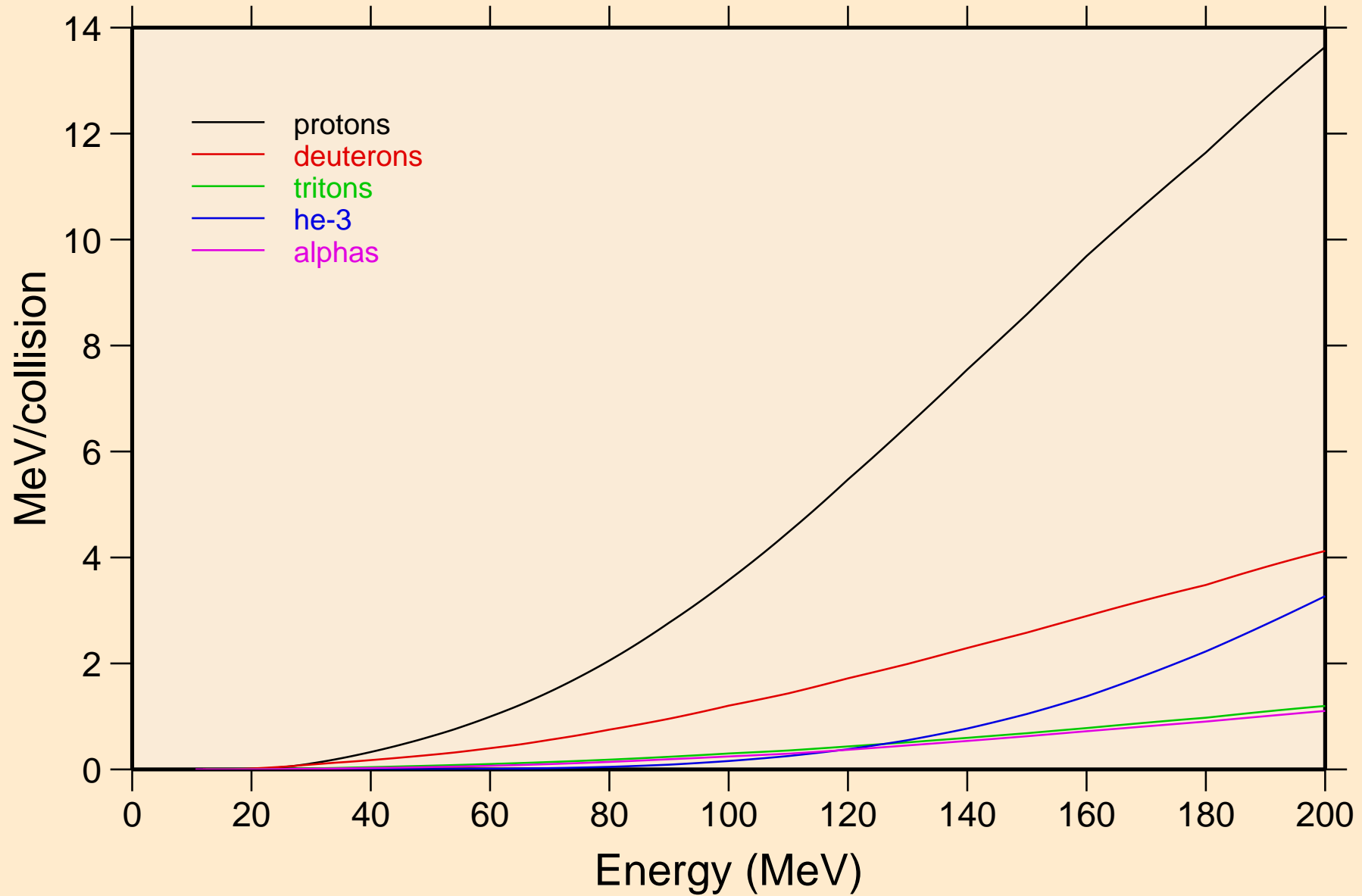

CL043 NEUTRON ACER TENDL-2021 LIBRARY; T=293.6K  
Recoil Heating

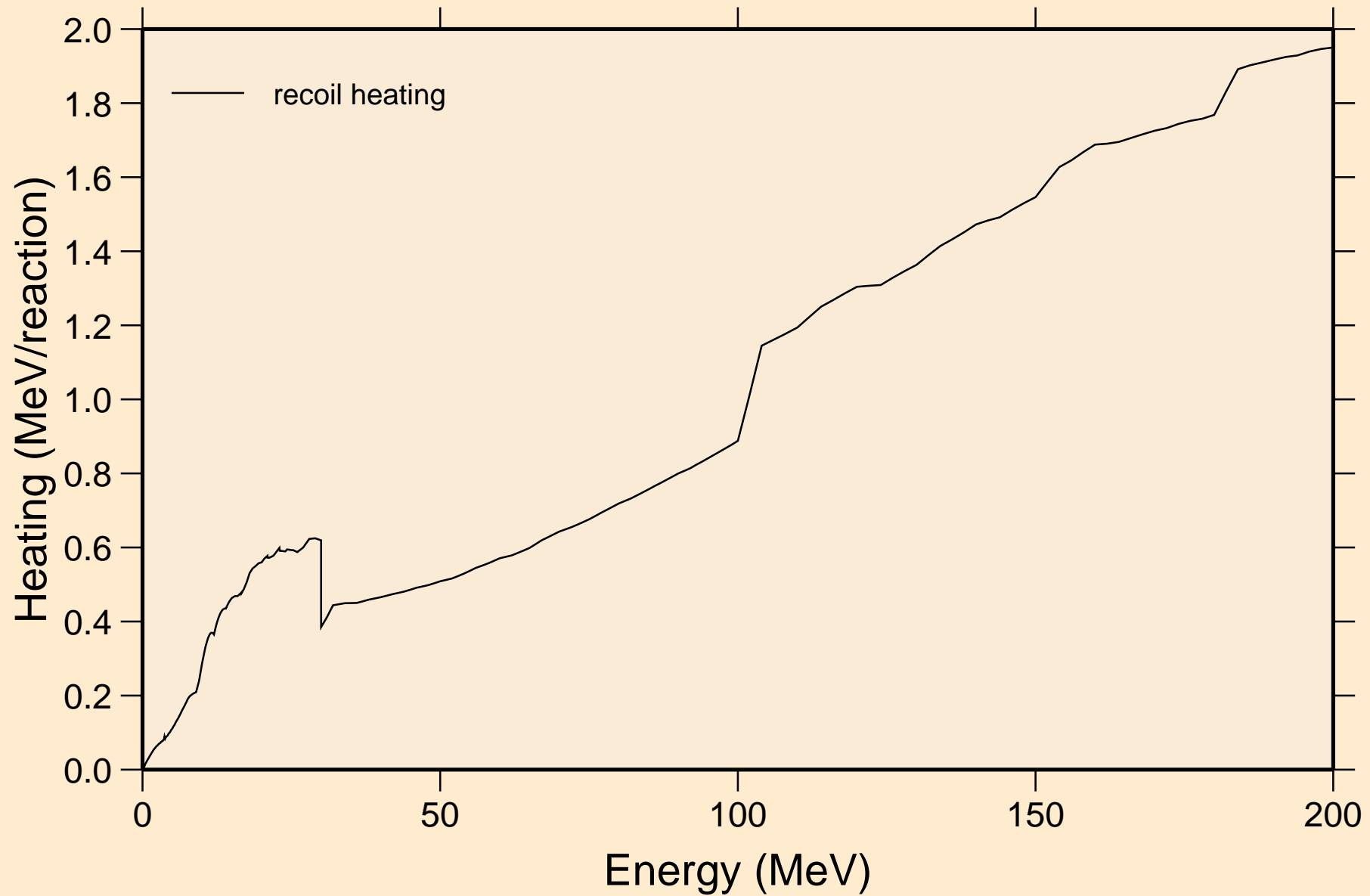



# CL043 NEUTRON ACER TENDL-2021 LIBRARY; T=293.6K

## Particle production cross sections

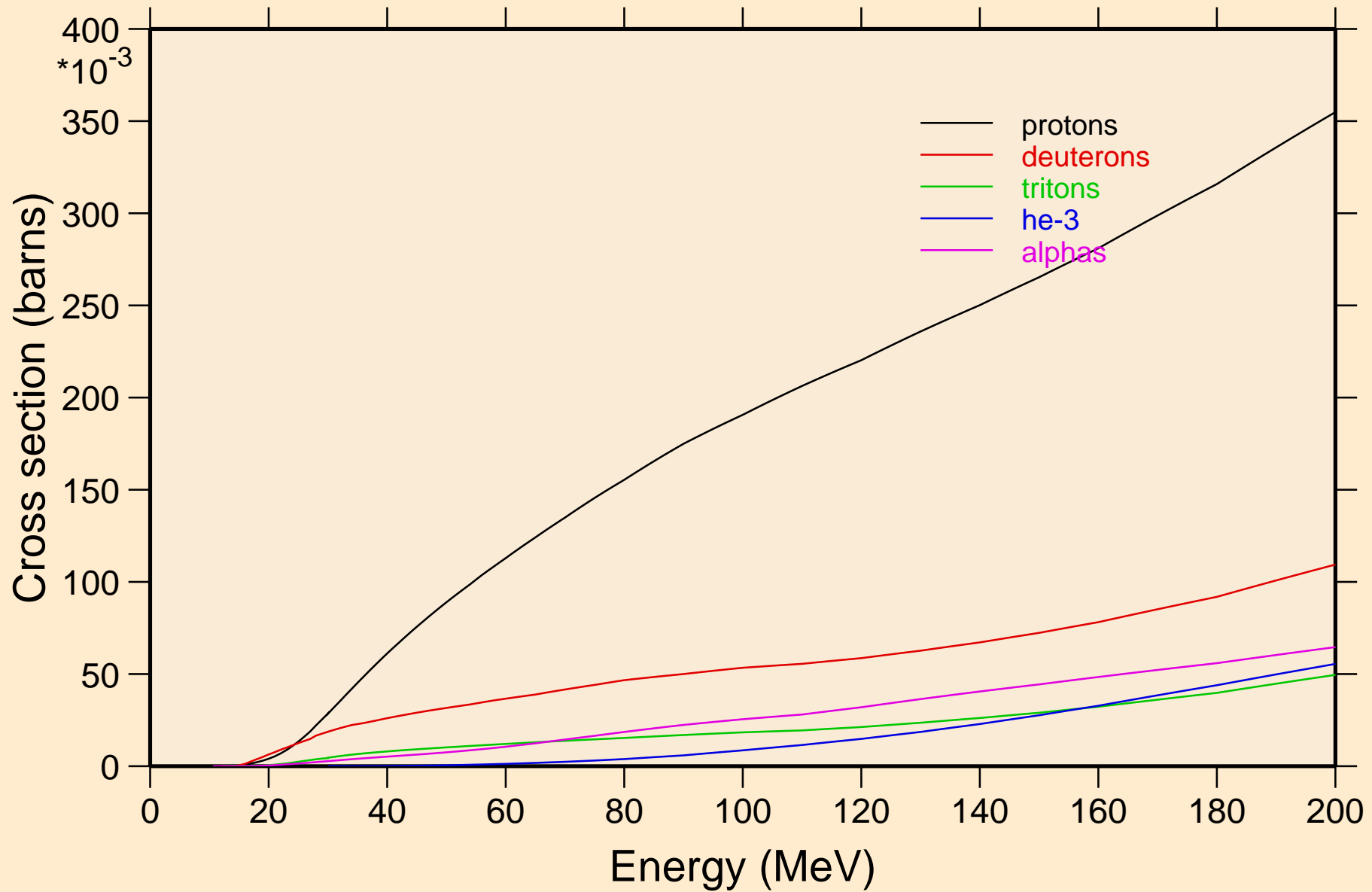

CL043 NEUTRON ACER TENDL-2021 LIBRARY; T=293.6K  
protons from (n,x)

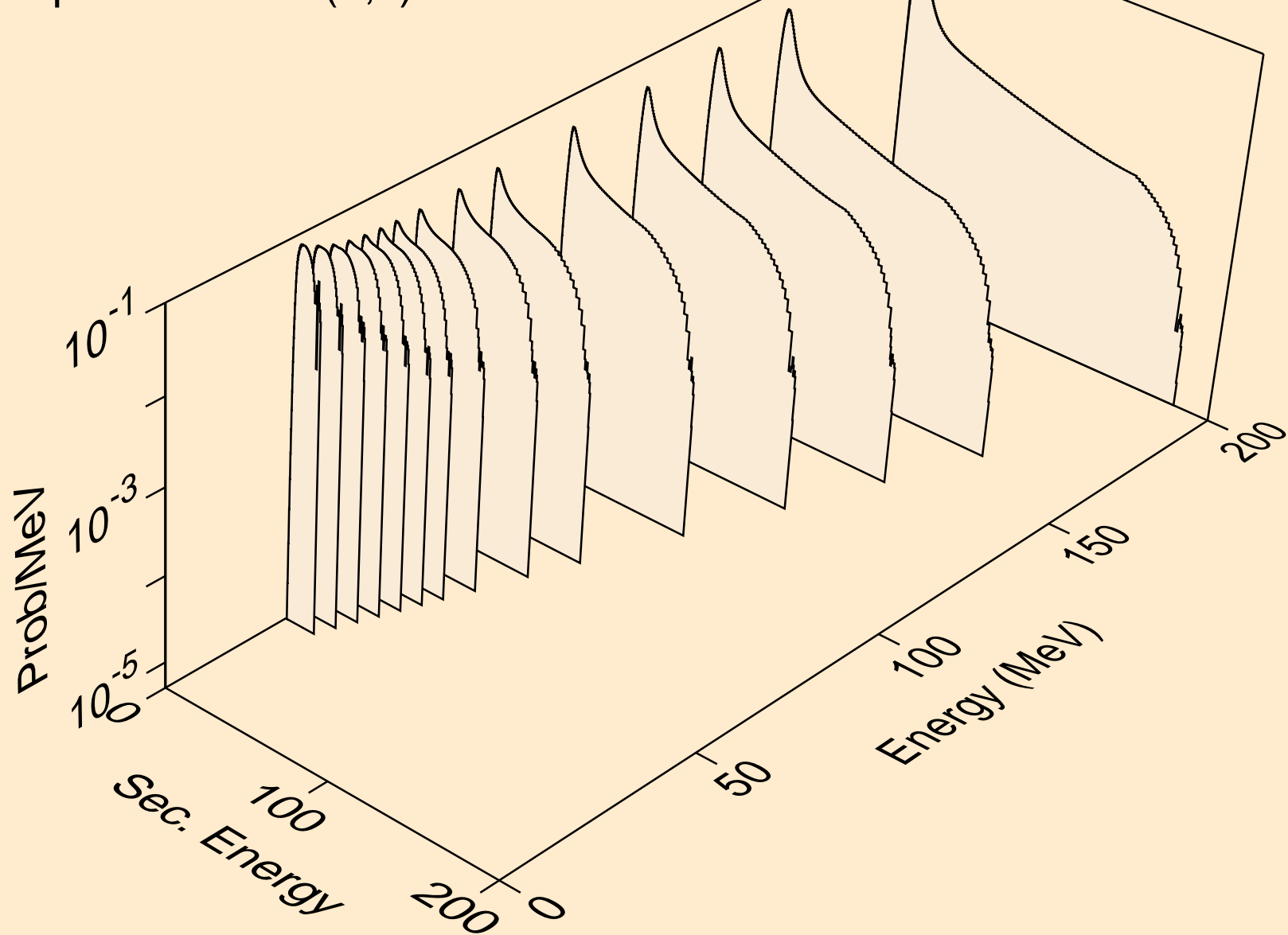

CL043 NEUTRON ACER TENDL-2021 LIBRARY; T=293.6K  
protons from (n,n\*)p

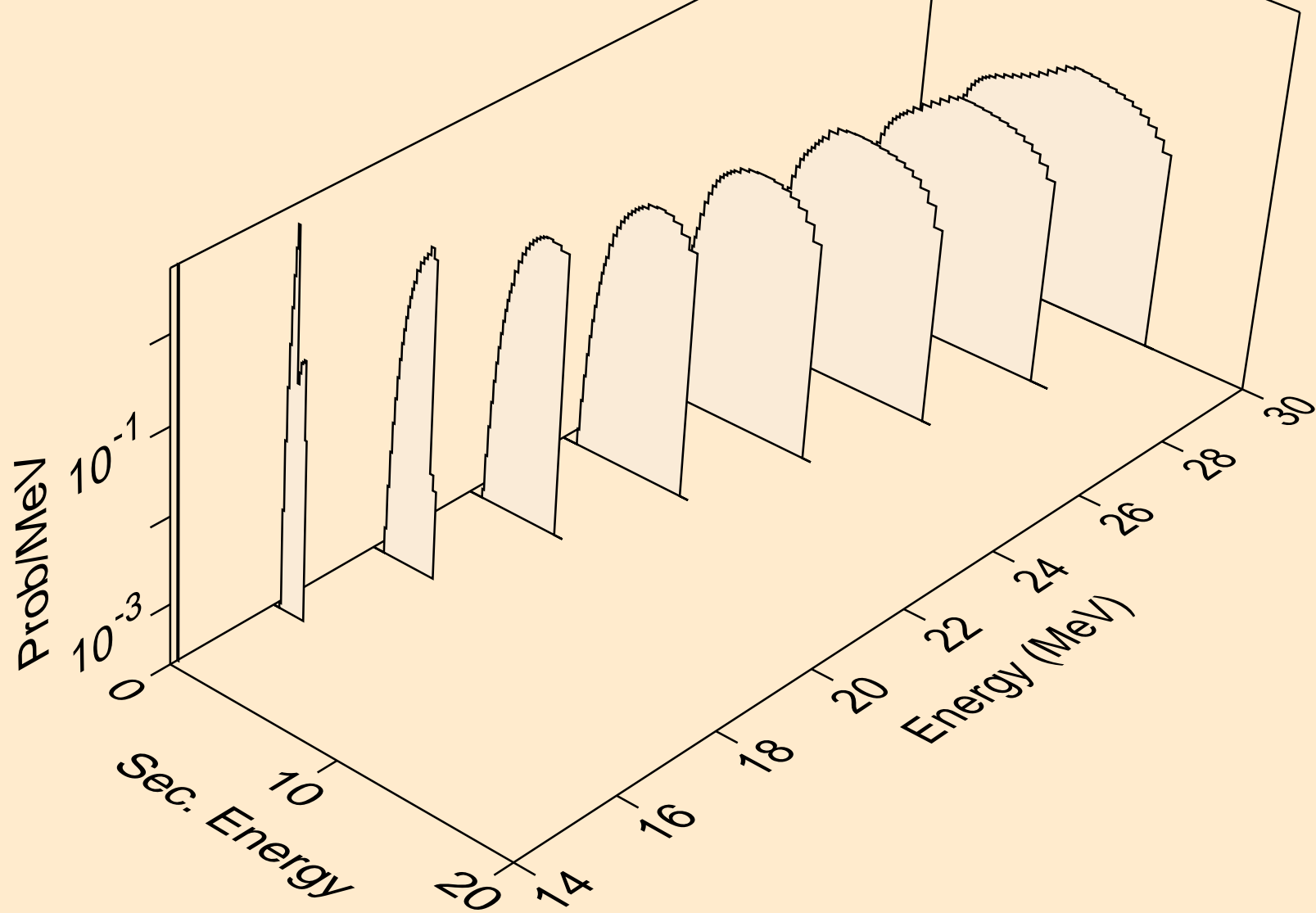

CL043 NEUTRON ACER TENDL-2021 LIBRARY; T=293.6K  
protons from (n,2np)

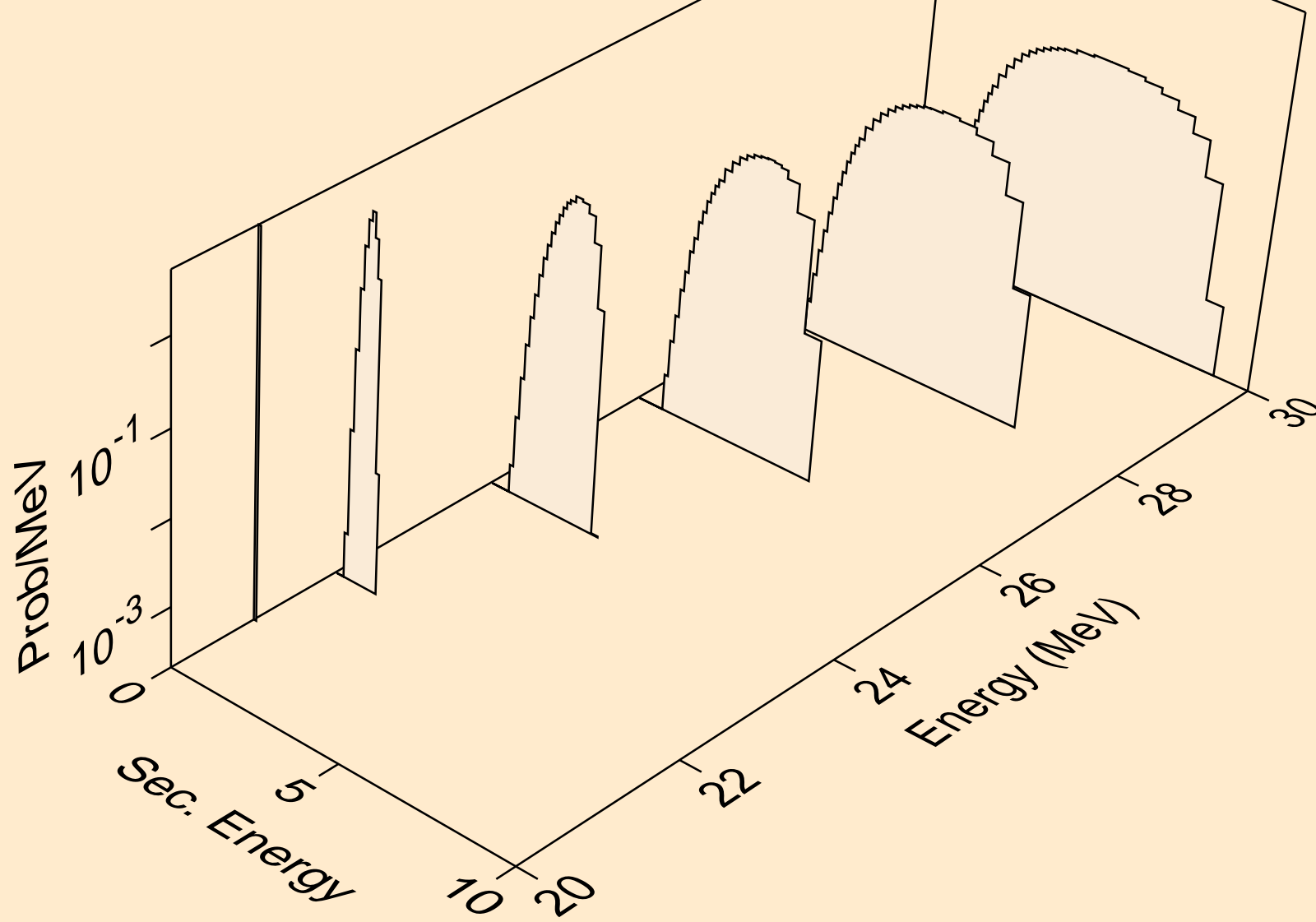

CL043 NEUTRON ACER TENDL-2021 LIBRARY; T=293.6K  
protons from (n,3np)

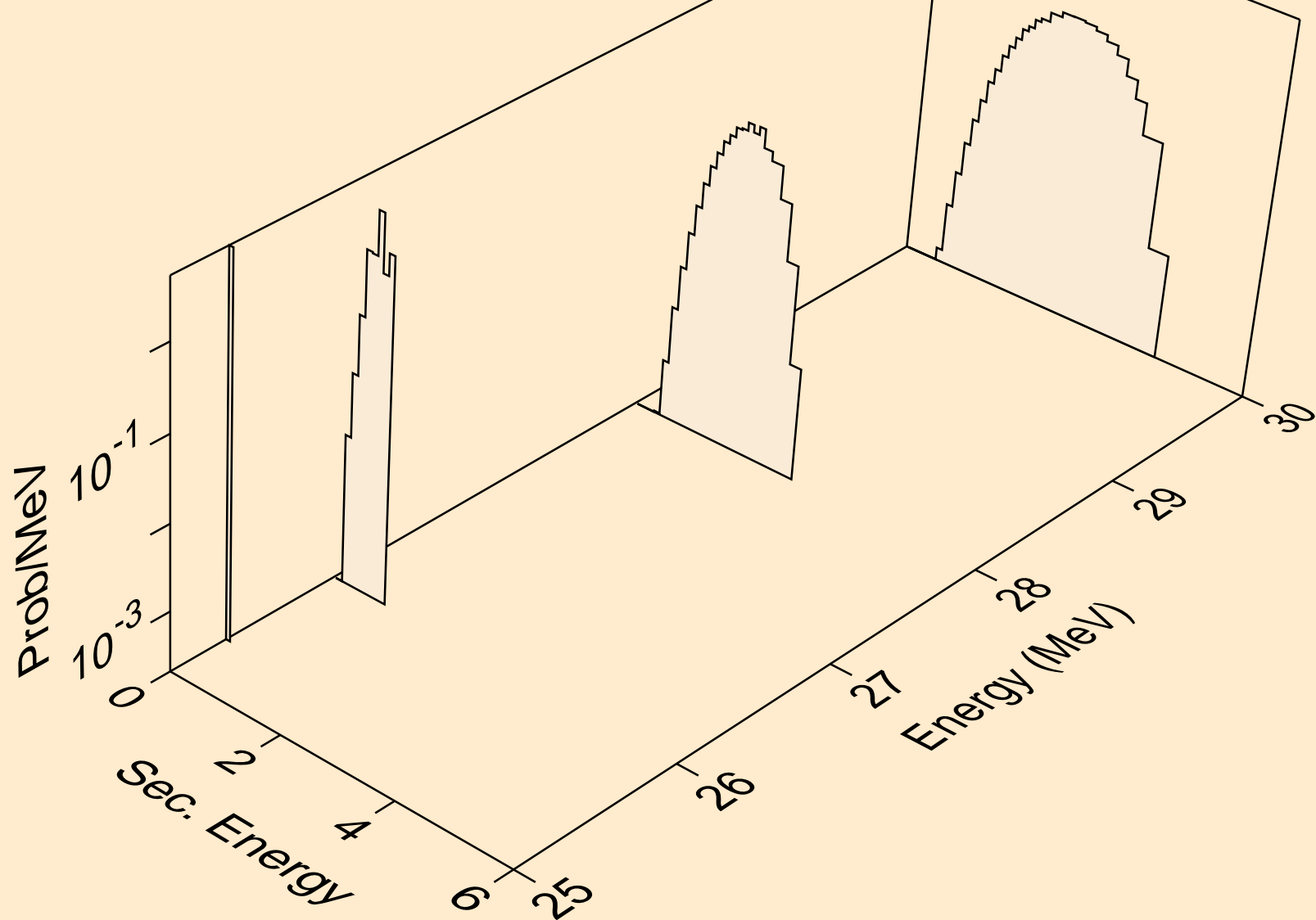

CL043 NEUTRON ACER TENDL-2021 LIBRARY; T=293.6K  
protons from (n,p)

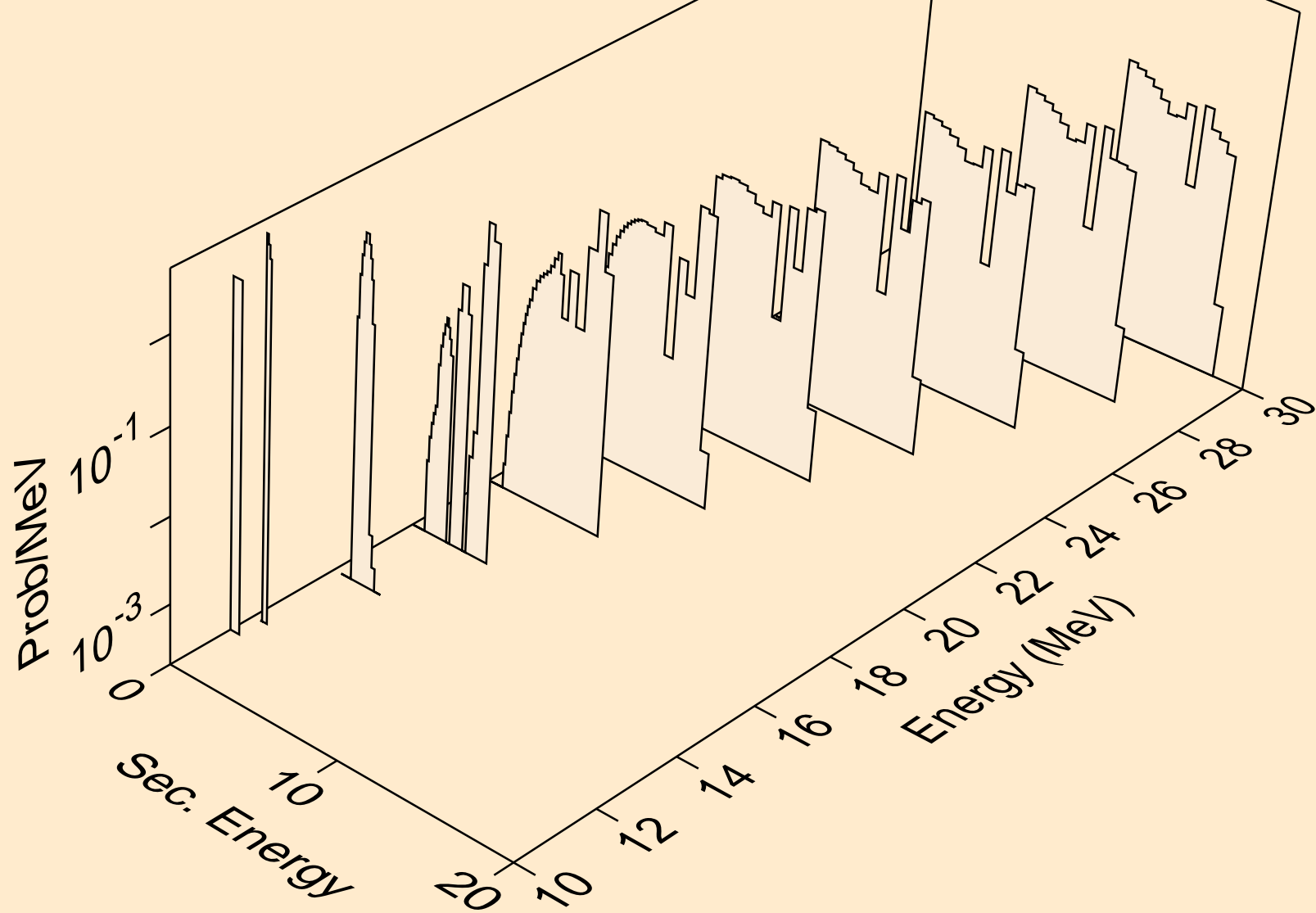

CL043 NEUTRON ACER TENDL-2021 LIBRARY; T=293.6K  
deuterons from (n,x)

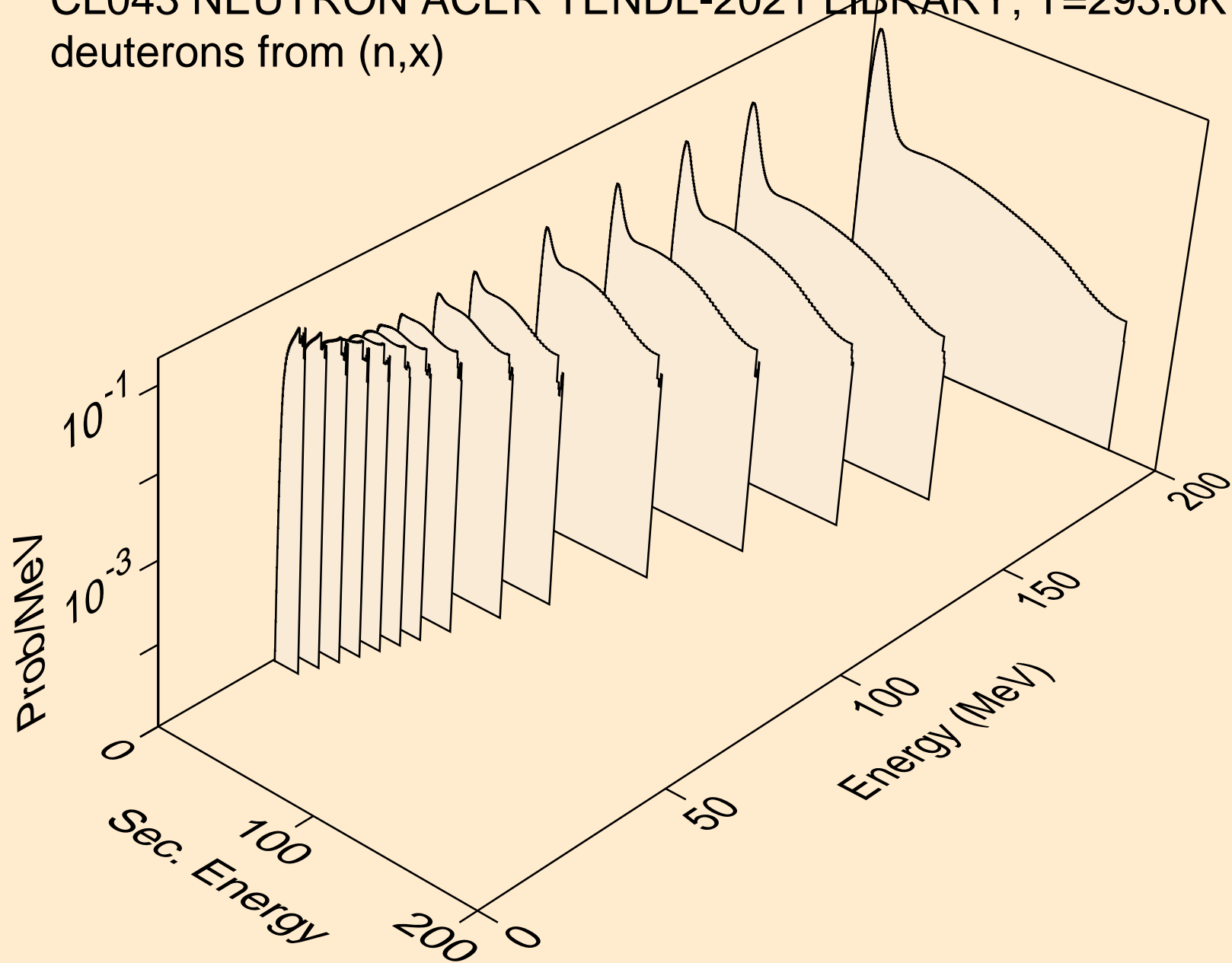

CL043 NEUTRON ACER TENDL-2021 LIBRARY; T=293.6K  
deuterons from (n,2nd)

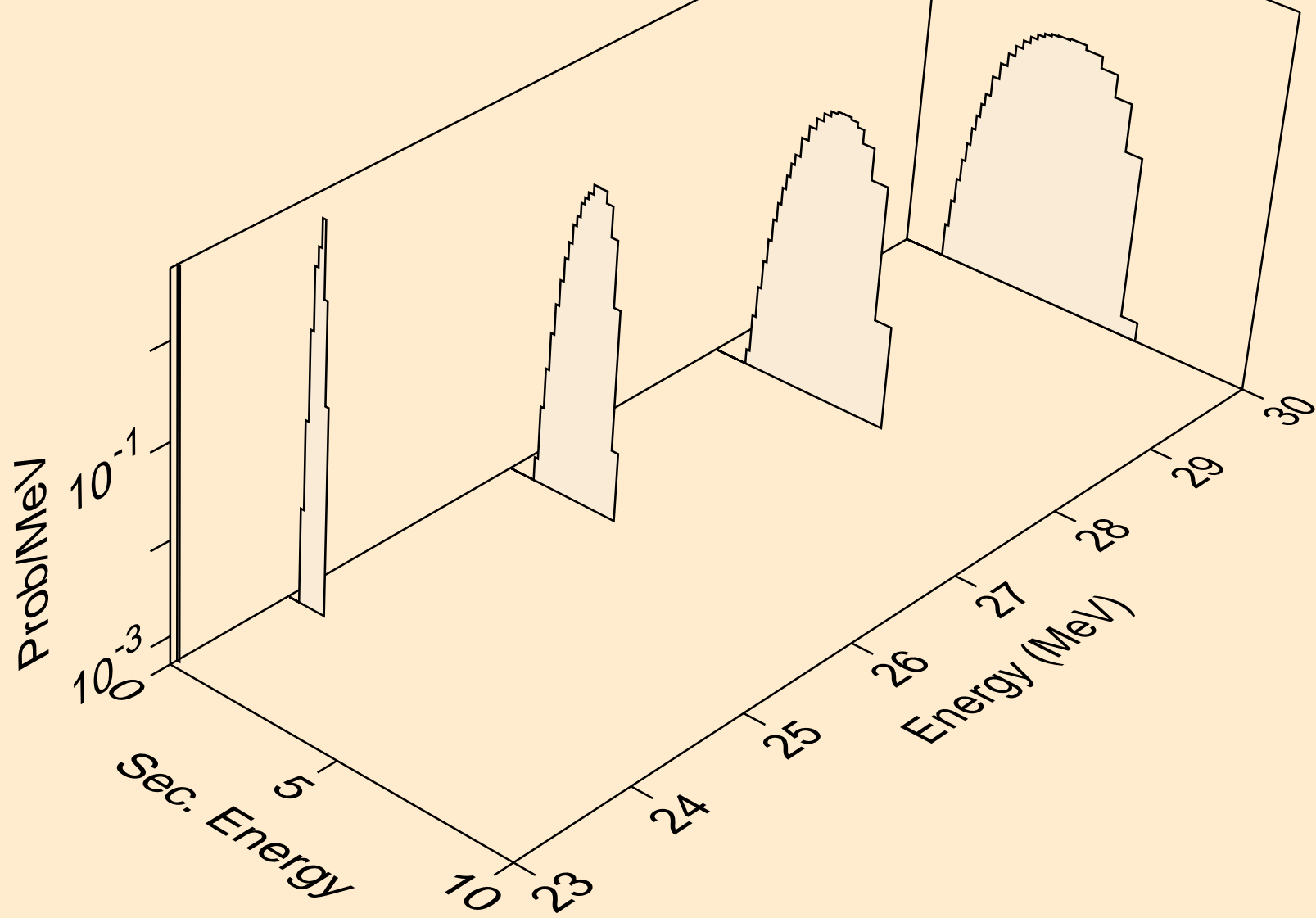



CL043 NEUTRON ACER TENDL-2021 LIBRARY; T=293.6K  
deuterons from (n,n\*)d

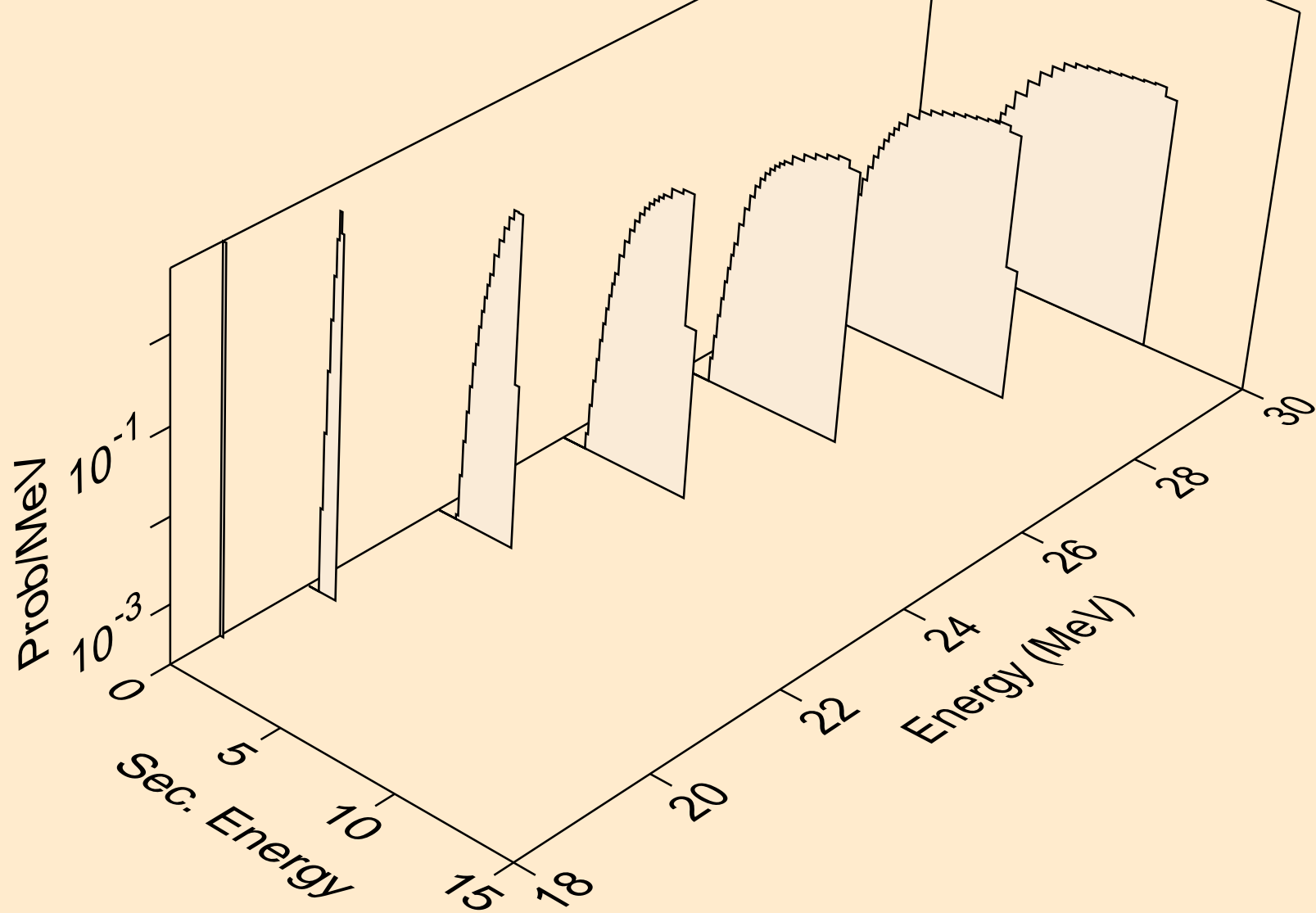

CL043 NEUTRON ACER TENDL-2021 LIBRARY; T=293.6K  
deuterons from (n,d)

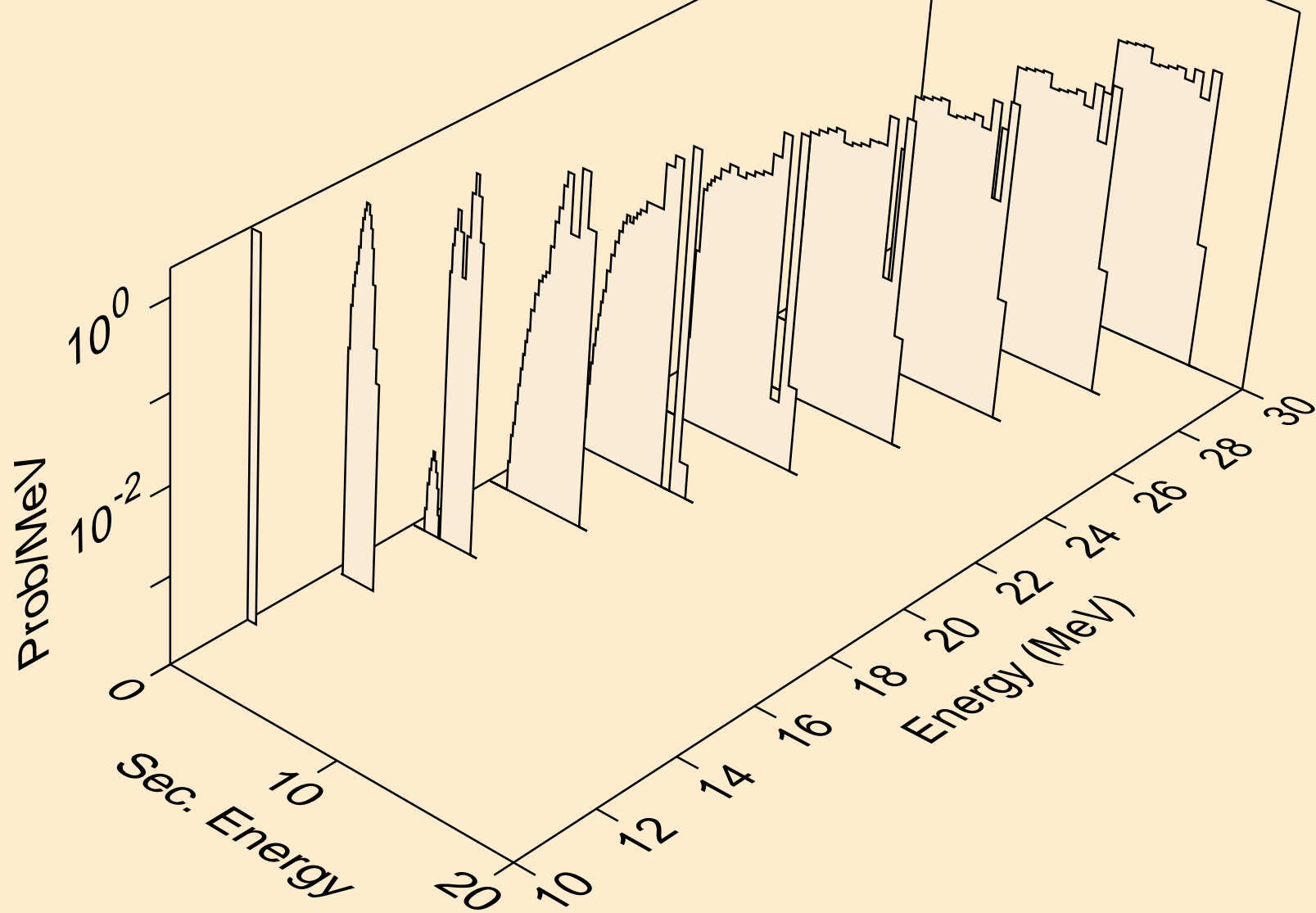

CL043 NEUTRON ACER TENDL-2021 LIBRARY; T=293.6K  
tritons from (n,x)

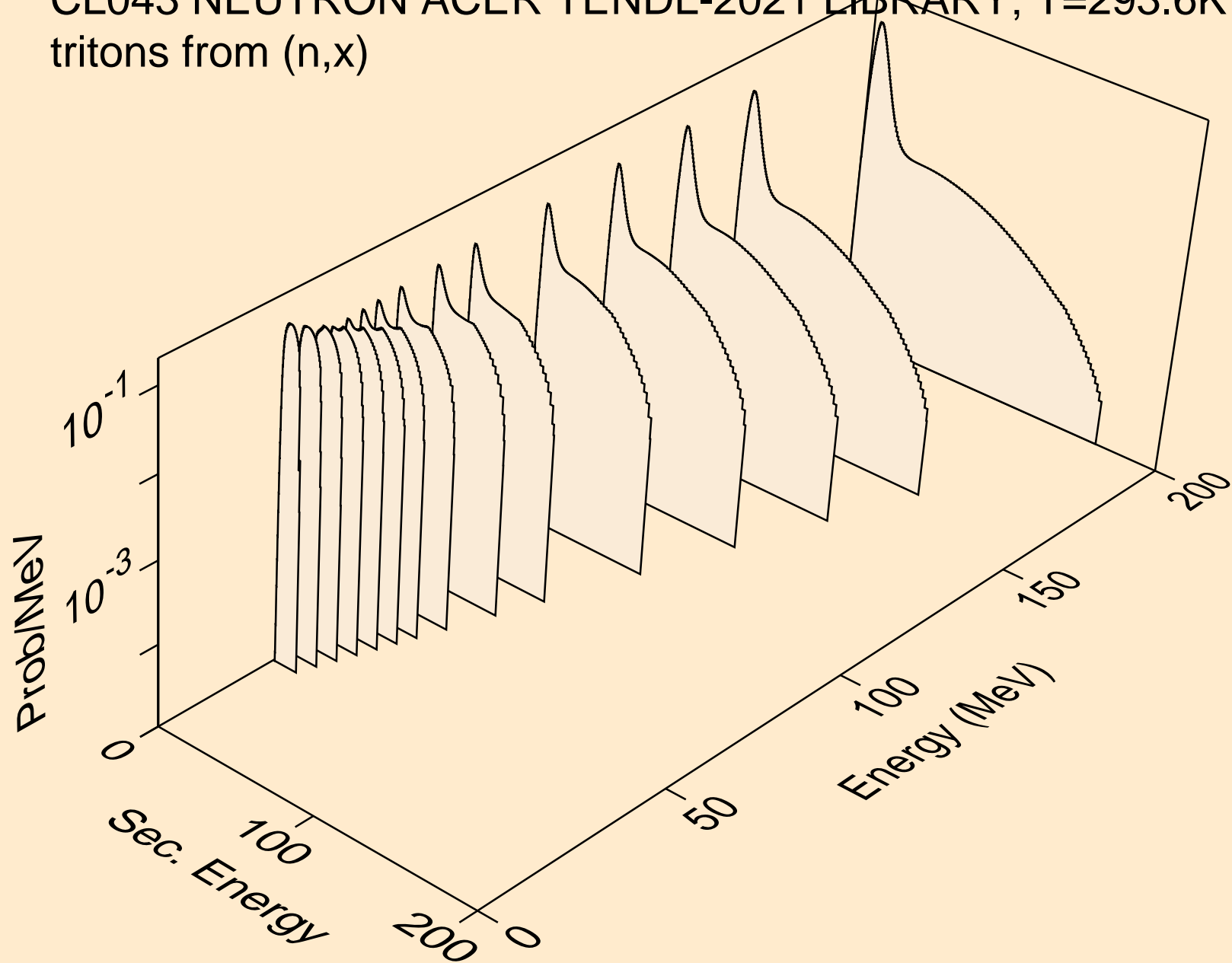

CL043 NEUTRON ACER TENDL-2021 LIBRARY; T=293.6K  
tritons from (n,n\*)t

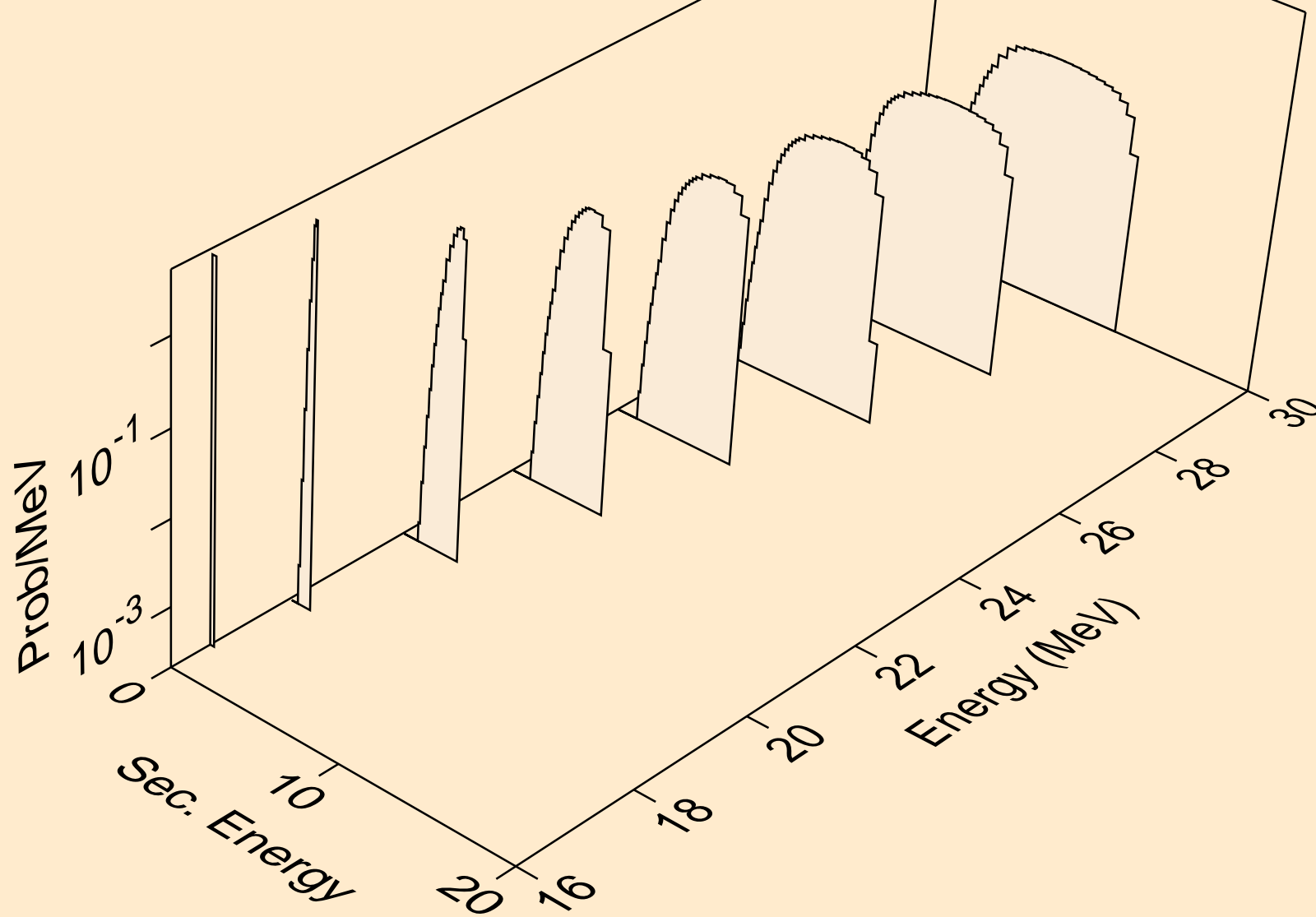

CL043 NEUTRON ACER TENDL-2021 LIBRARY; T=293.6K  
tritons from (n,t)

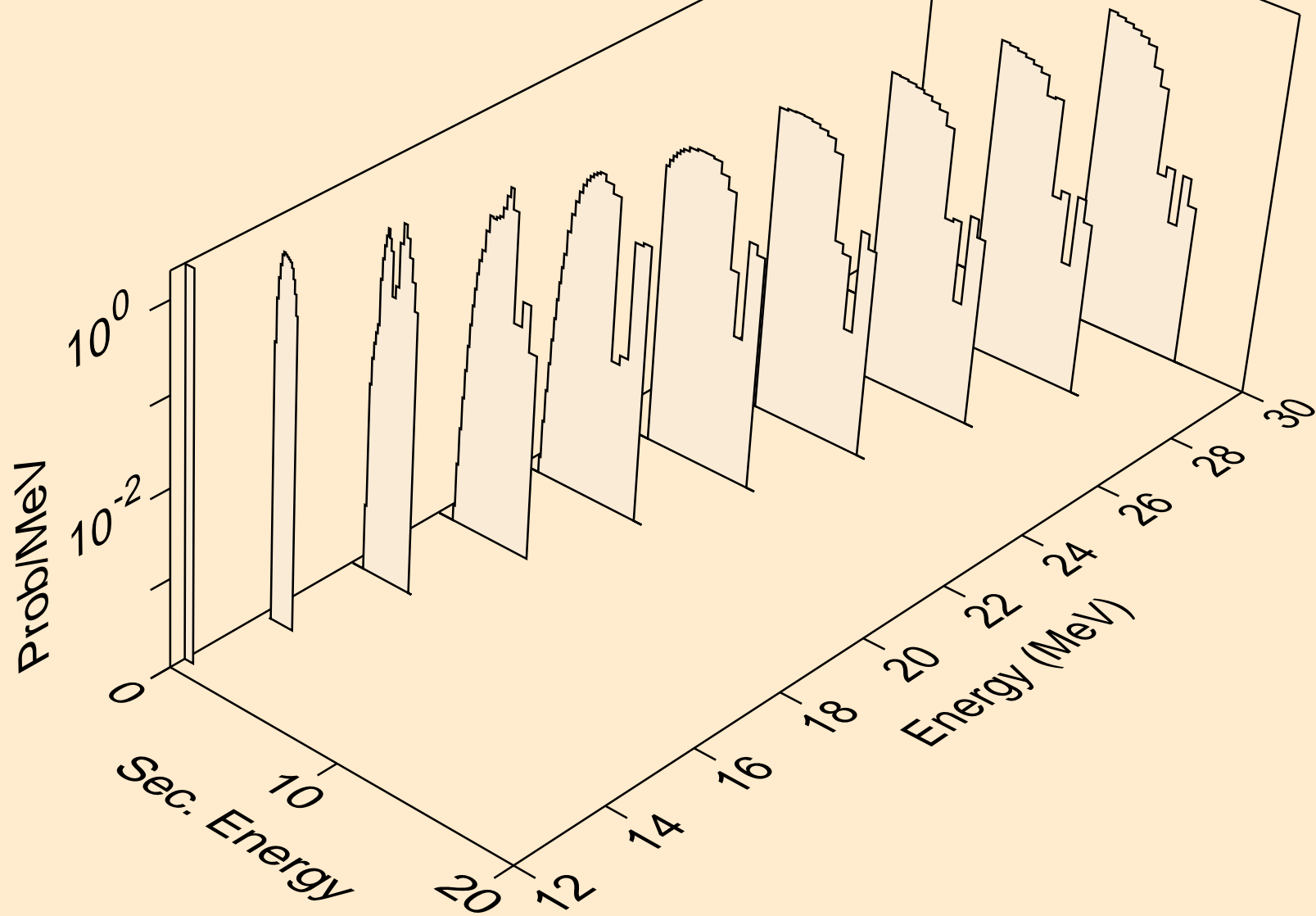

CL043 NEUTRON ACER TENDL-2021 LIBRARY; T=293.6K  
he3s from (n,x)

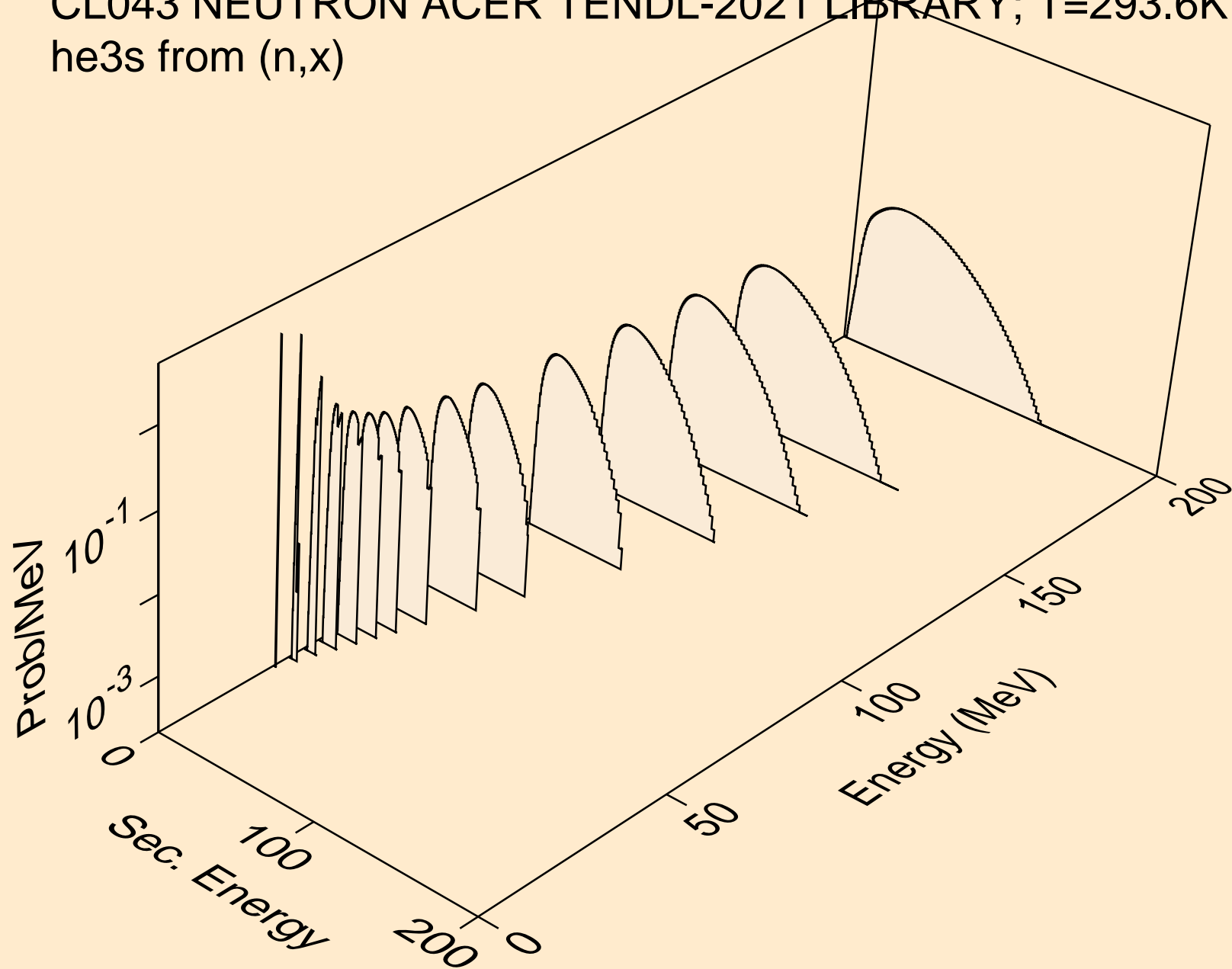

CL043 NEUTRON ACER TENDL-2021 LIBRARY; T=293.6K  
alphas from (n,x)

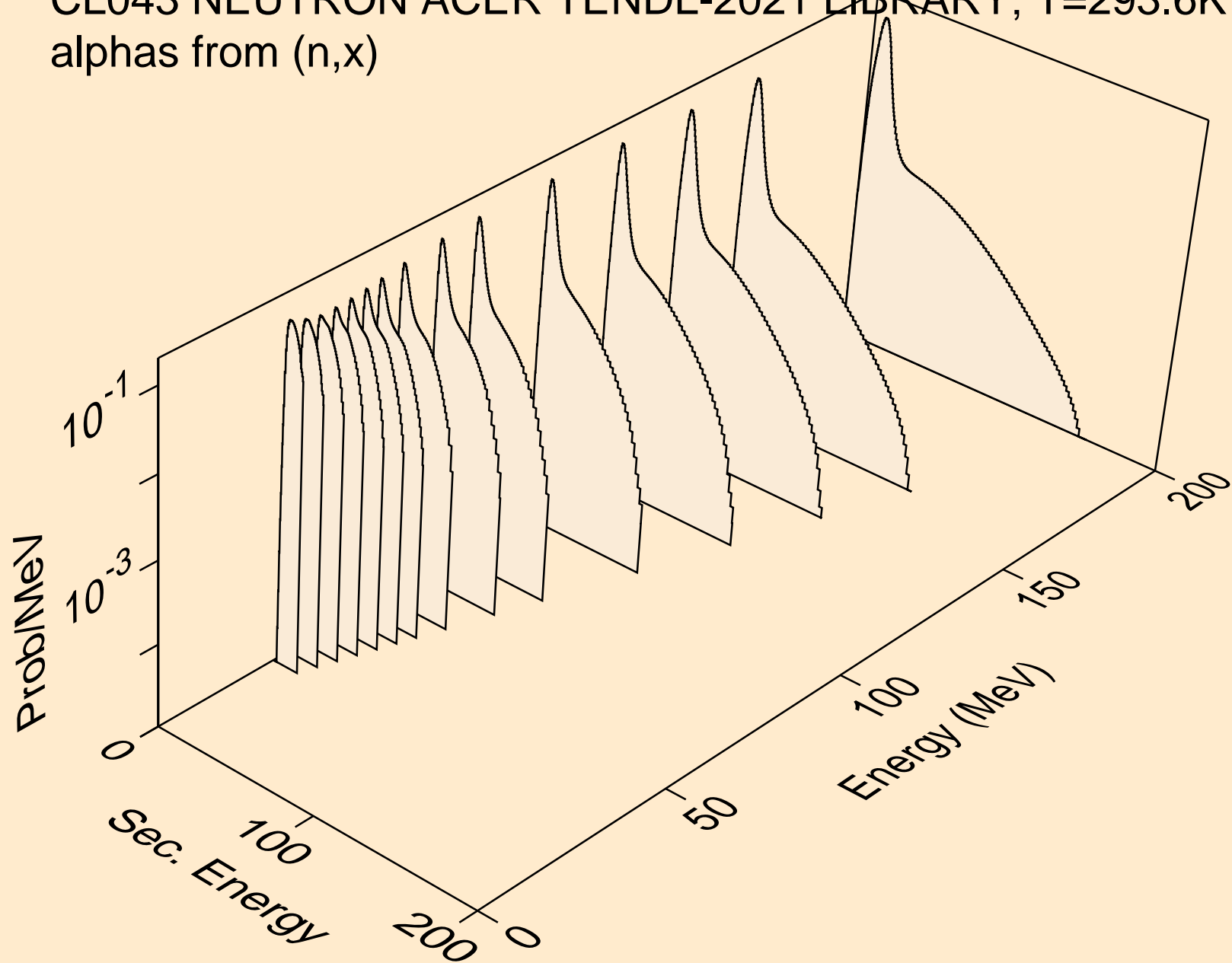

CL043 NEUTRON ACER TENDL-2021 LIBRARY; T=293.6K  
alphas from (n,n\*)a

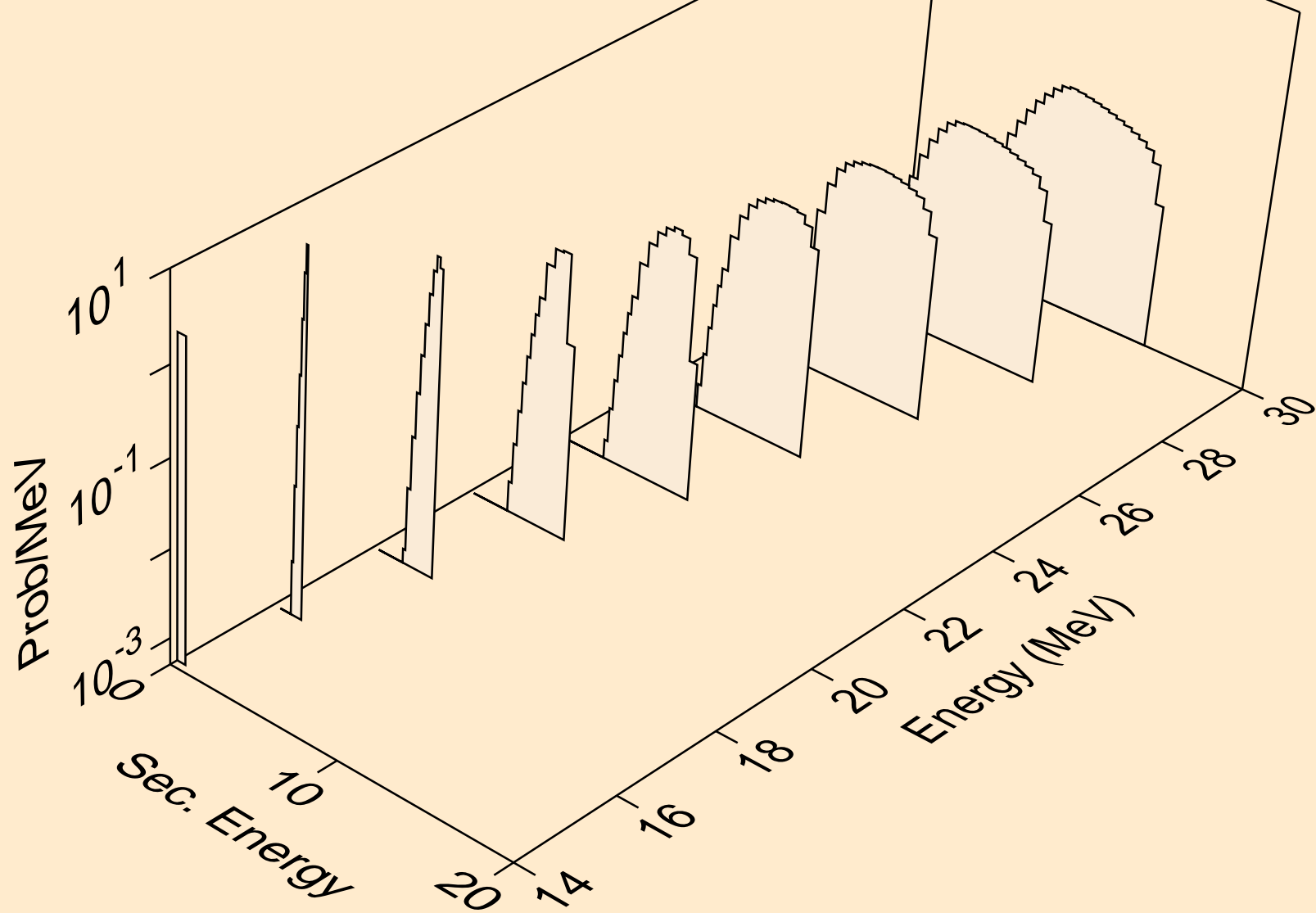



CL043 NEUTRON ACER TENDL-2021 LIBRARY; T=293.6K  
alphas from (n,2n)a

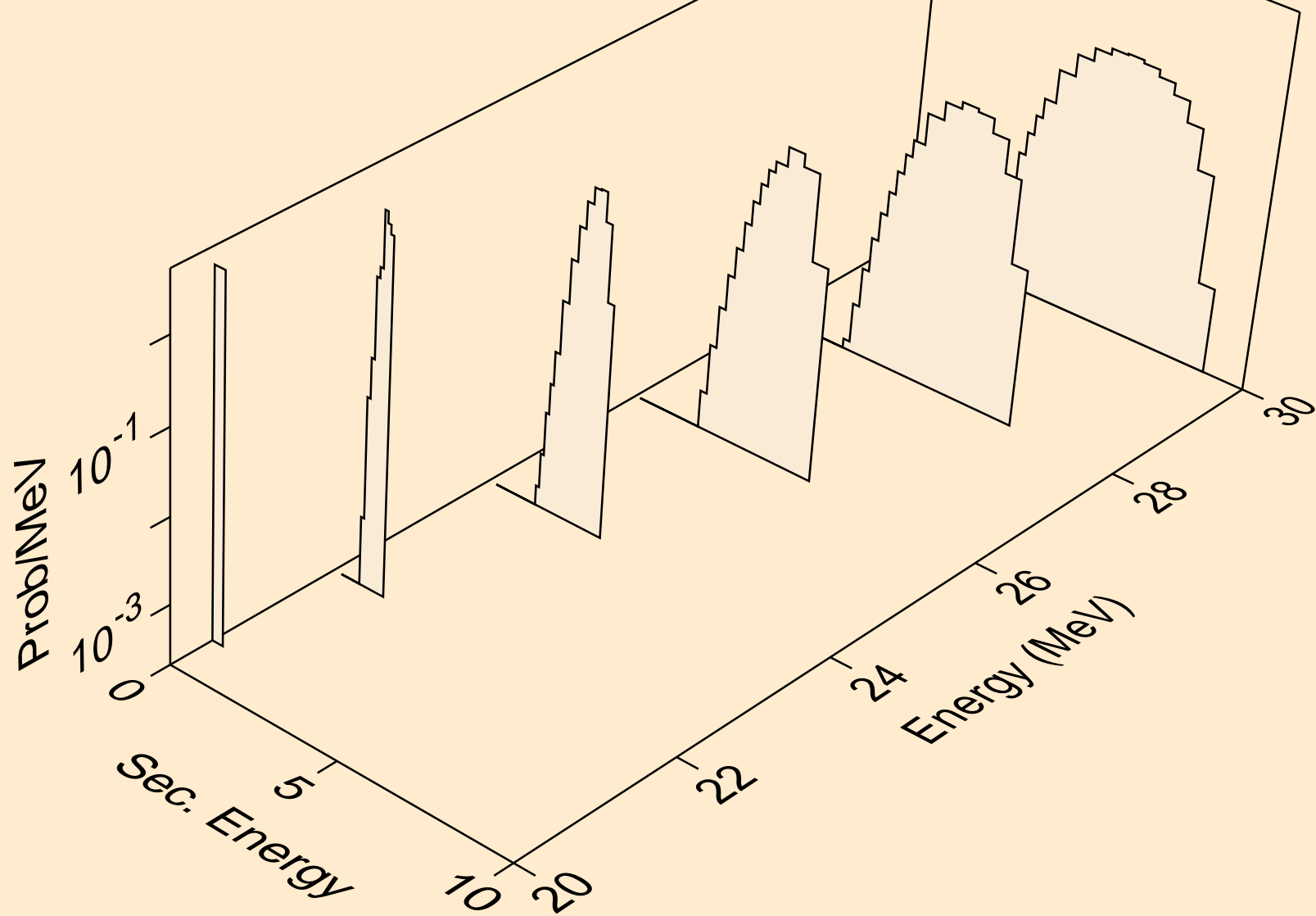

CL043 NEUTRON ACER TENDL-2021 LIBRARY; T=293.6K  
alphas from (n,3n)a

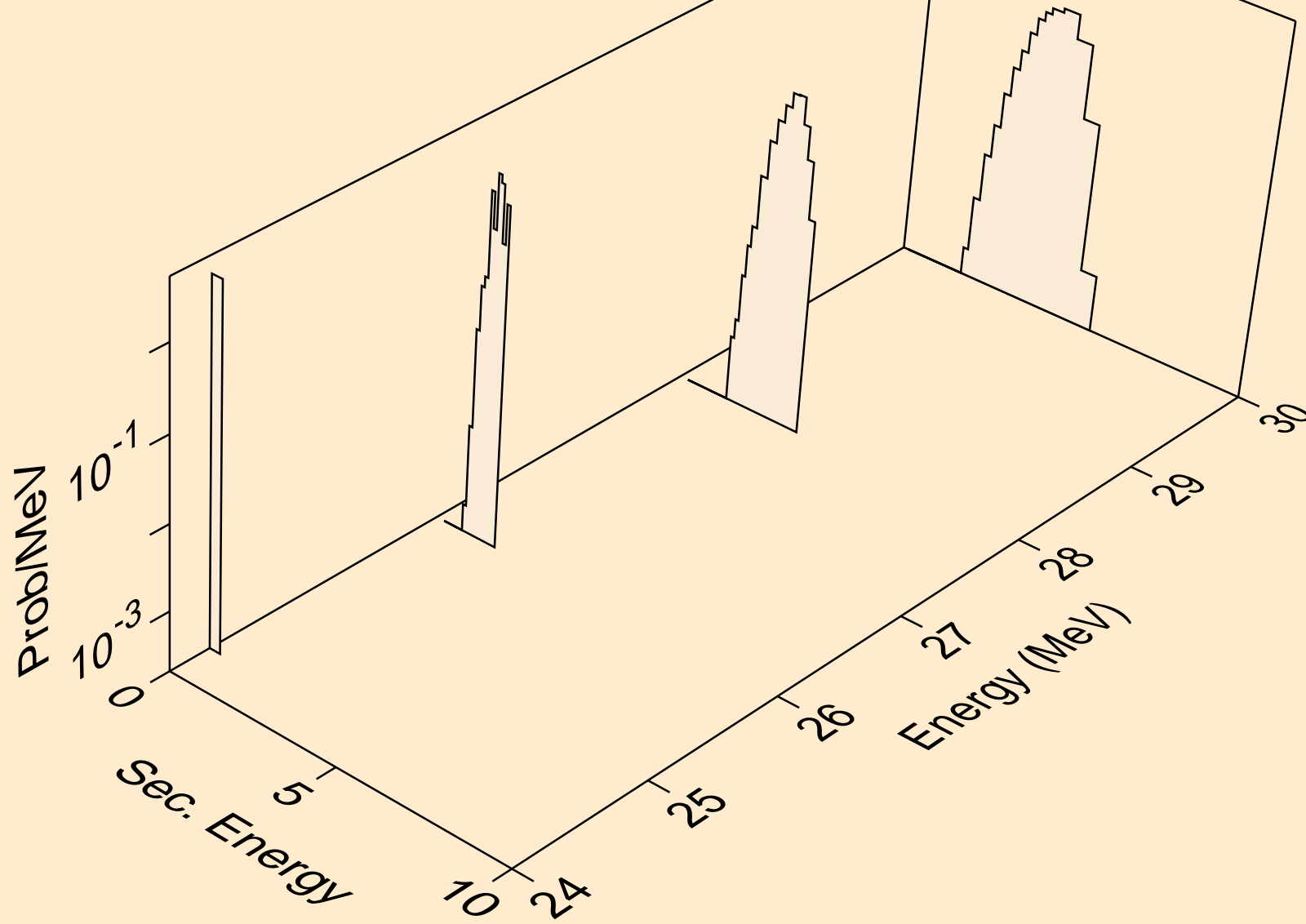

CL043 NEUTRON ACER TENDL-2021 LIBRARY; T=293.6K  
alphas from (n,a)

