

CM240 NEUTRON ACER TENDL-2021 LIBRARY; T=293.6K
Principal cross sections

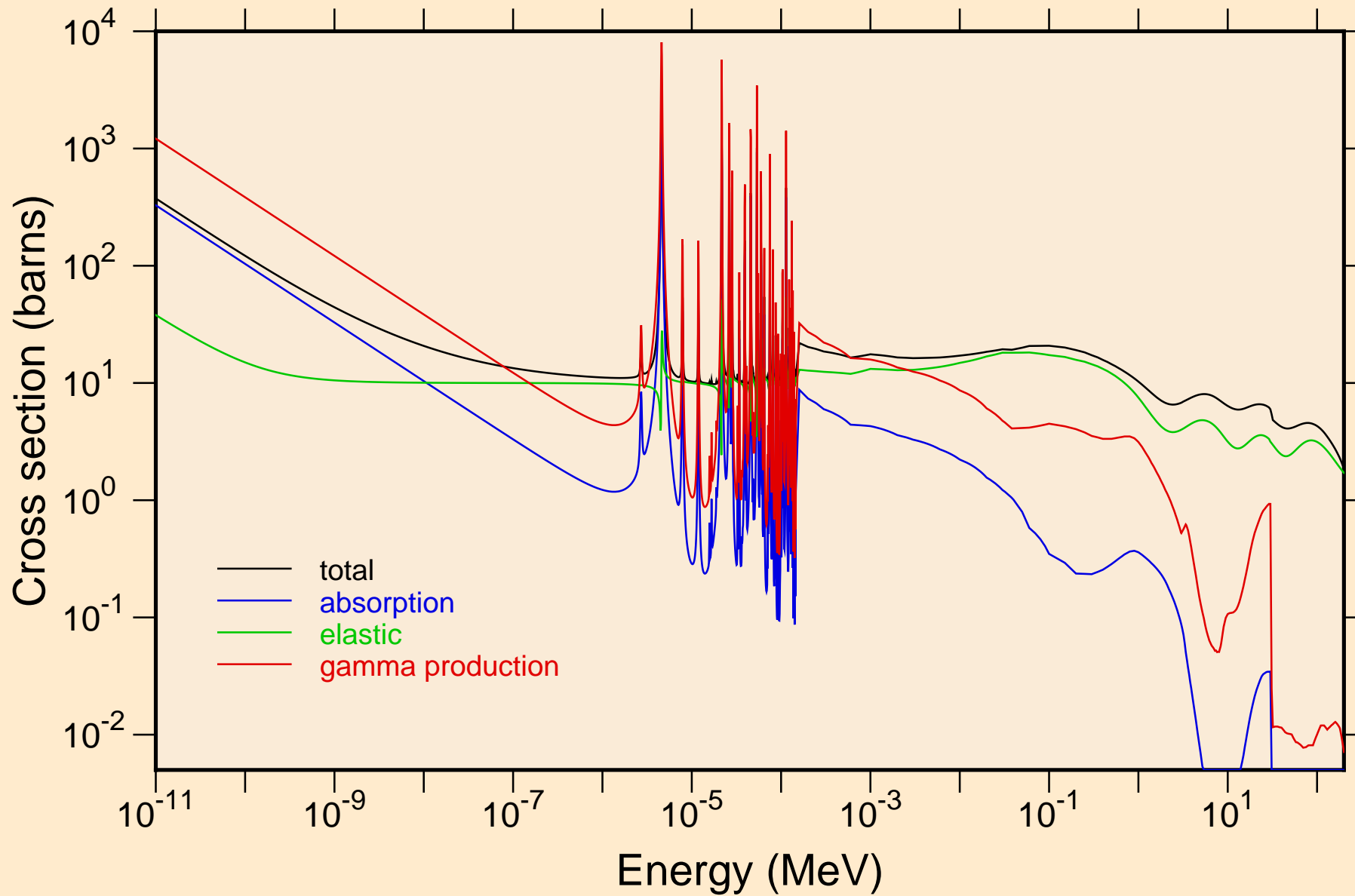

CM240 NEUTRON ACER TENDL-2021 LIBRARY; T=293.6K
resonance total cross section

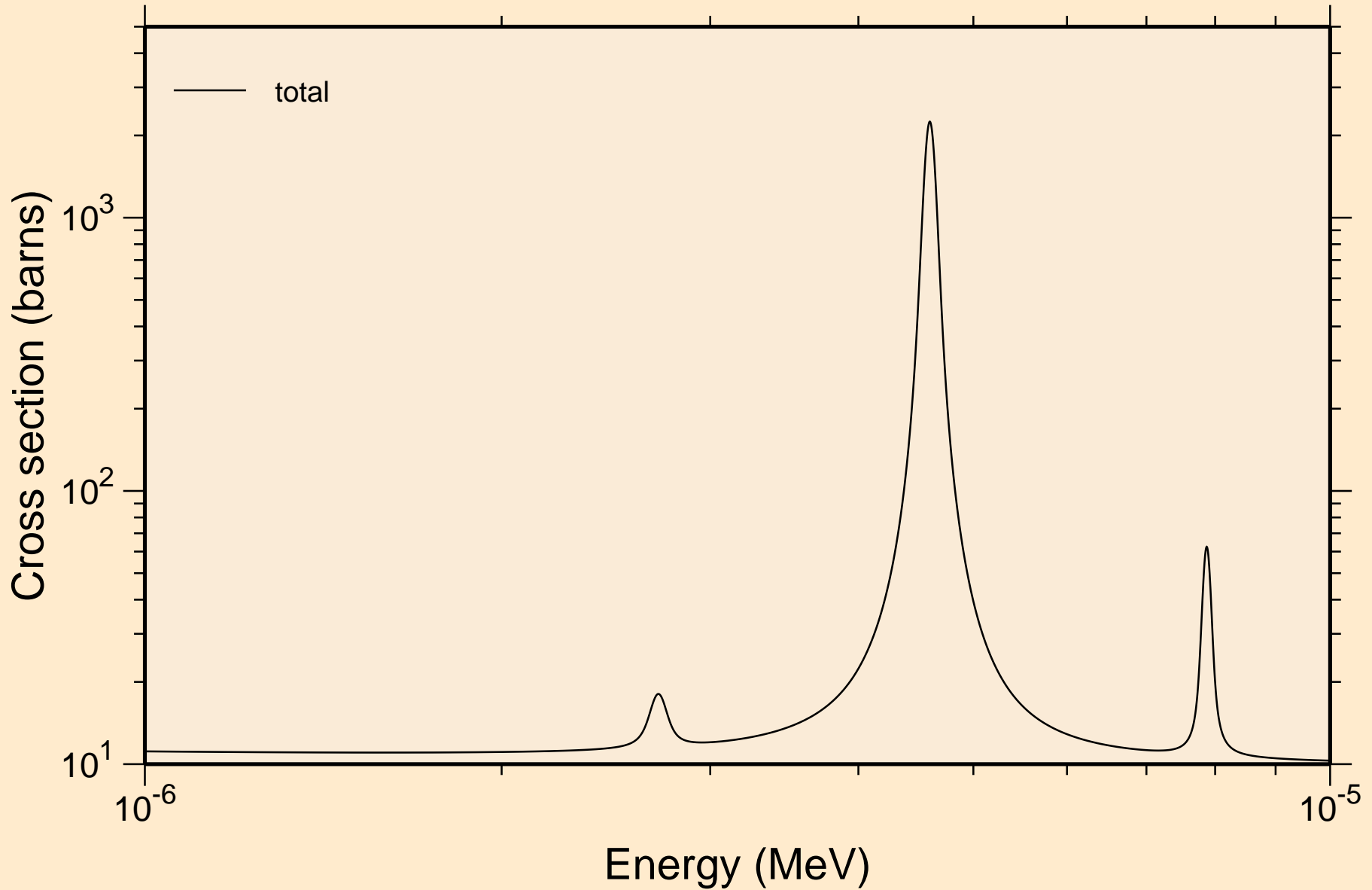

CM240 NEUTRON ACER TENDL-2021 LIBRARY; T=293.6K
resonance total cross section

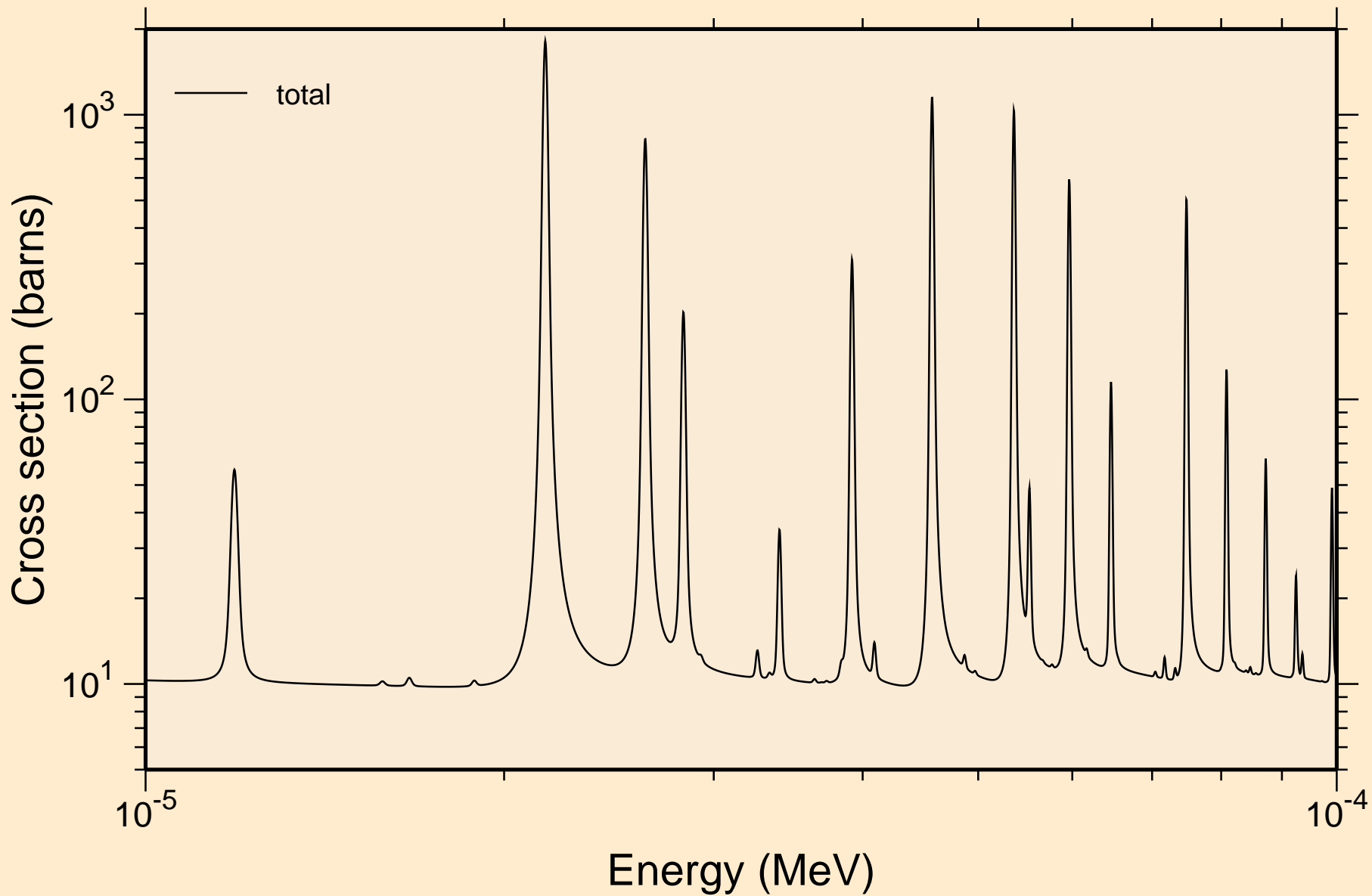

CM240 NEUTRON ACER TENDL-2021 LIBRARY; T=293.6K
resonance total cross section

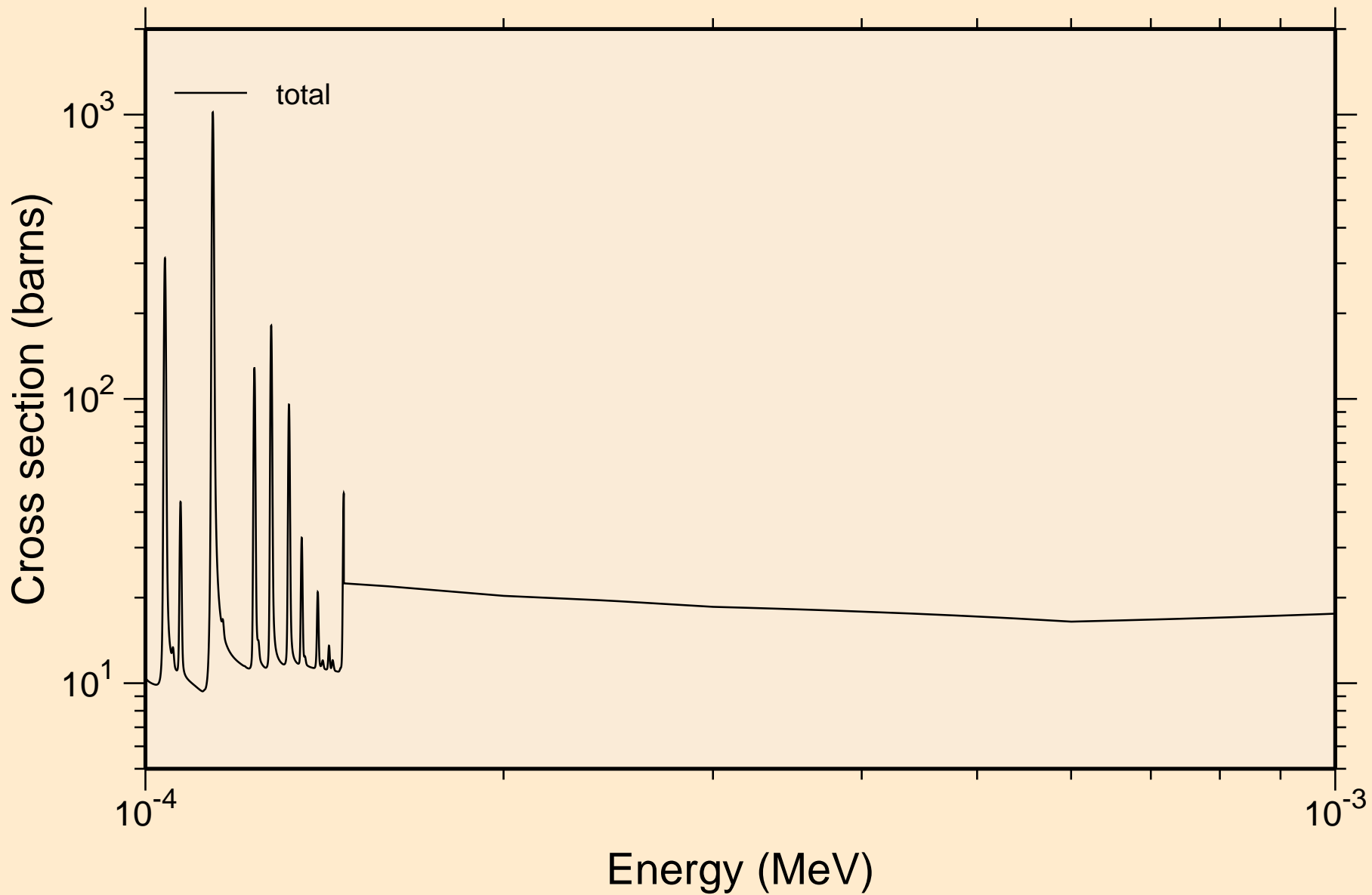

CM240 NEUTRON ACER TENDL-2021 LIBRARY; T=293.6K
resonance total cross section

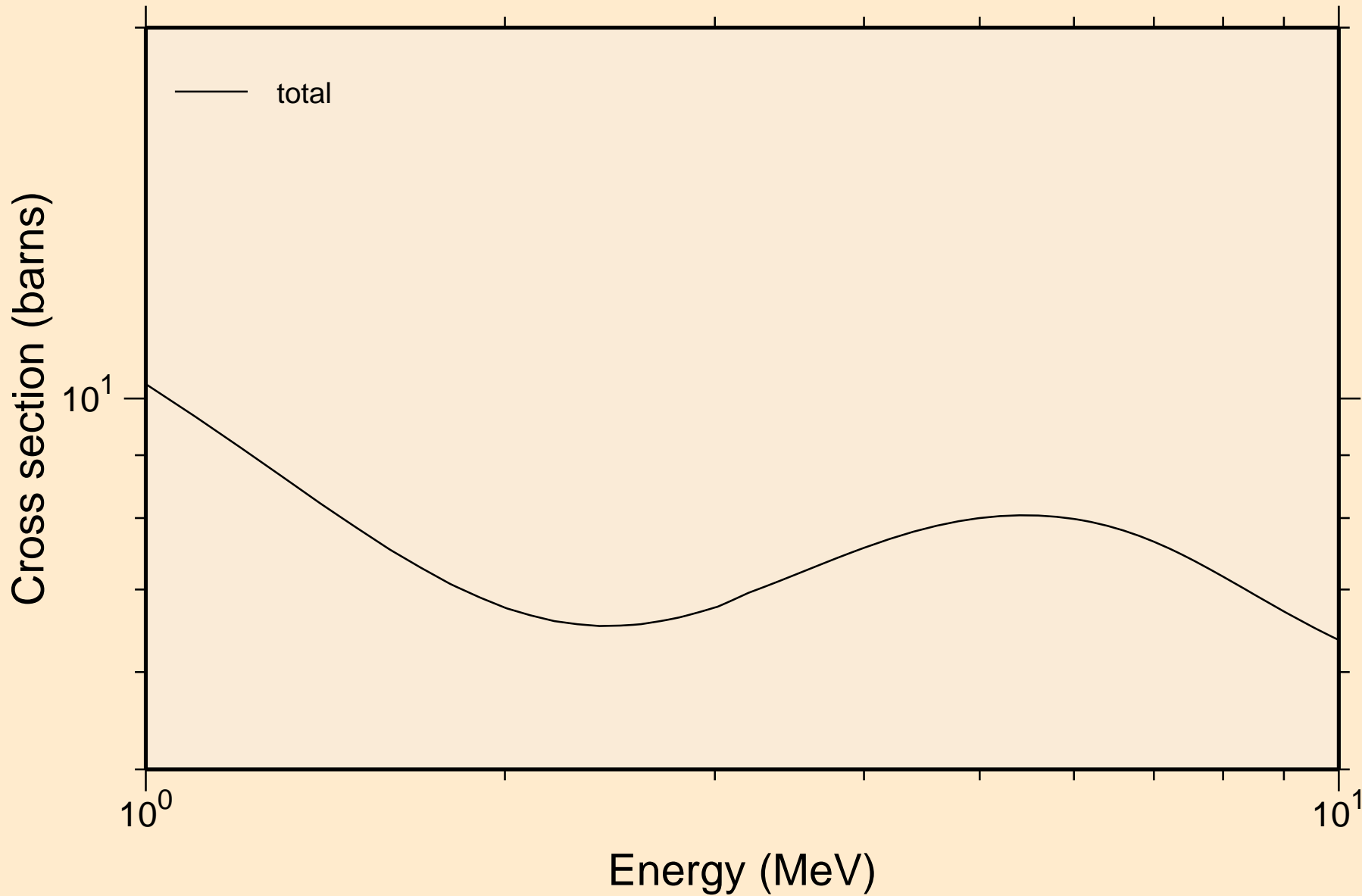

CM240 NEUTRON ACER TENDL-2021 LIBRARY; T=293.6K
resonance absorption cross sections

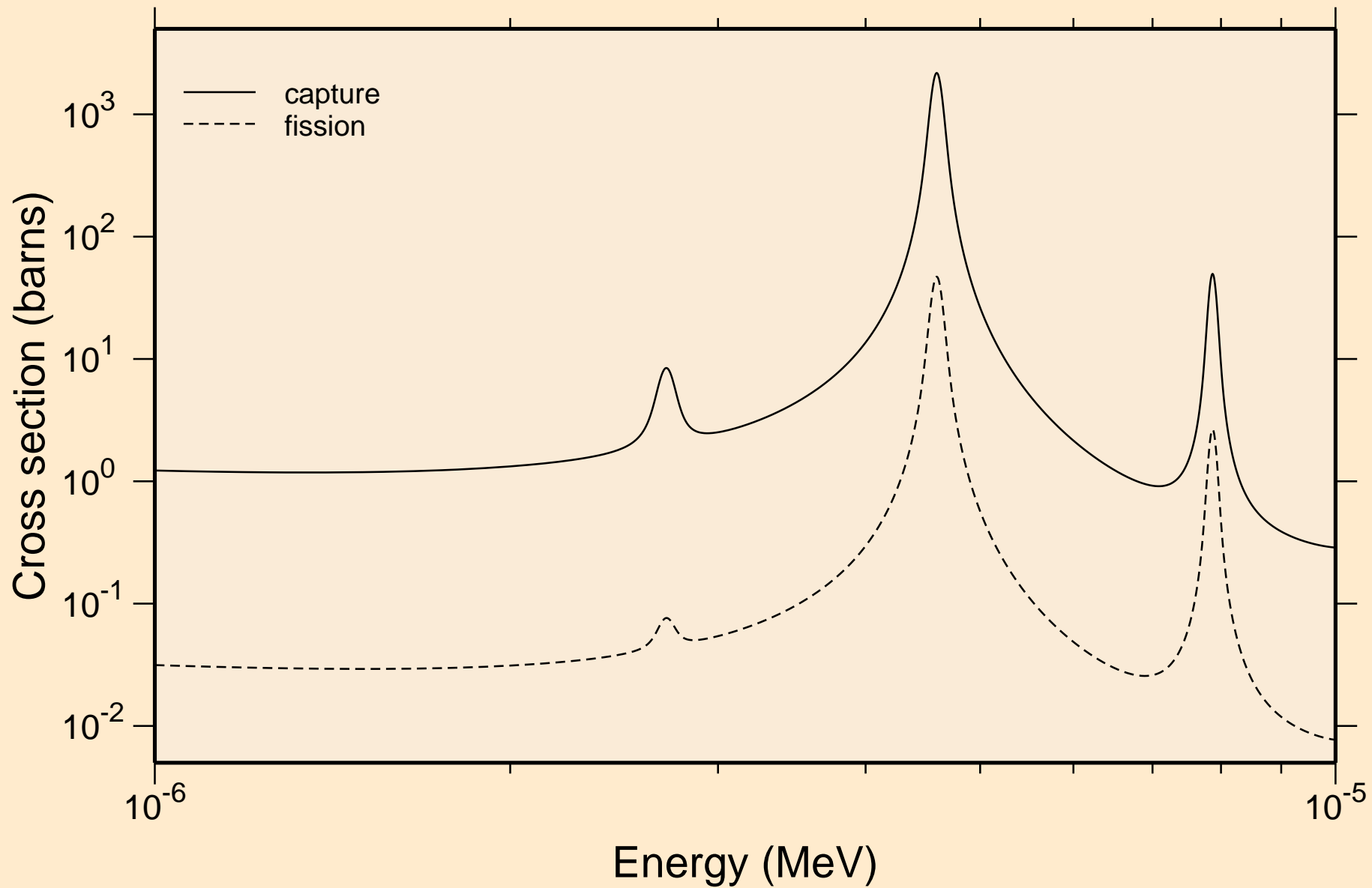

CM240 NEUTRON ACER TENDL-2021 LIBRARY; T=293.6K
resonance absorption cross sections

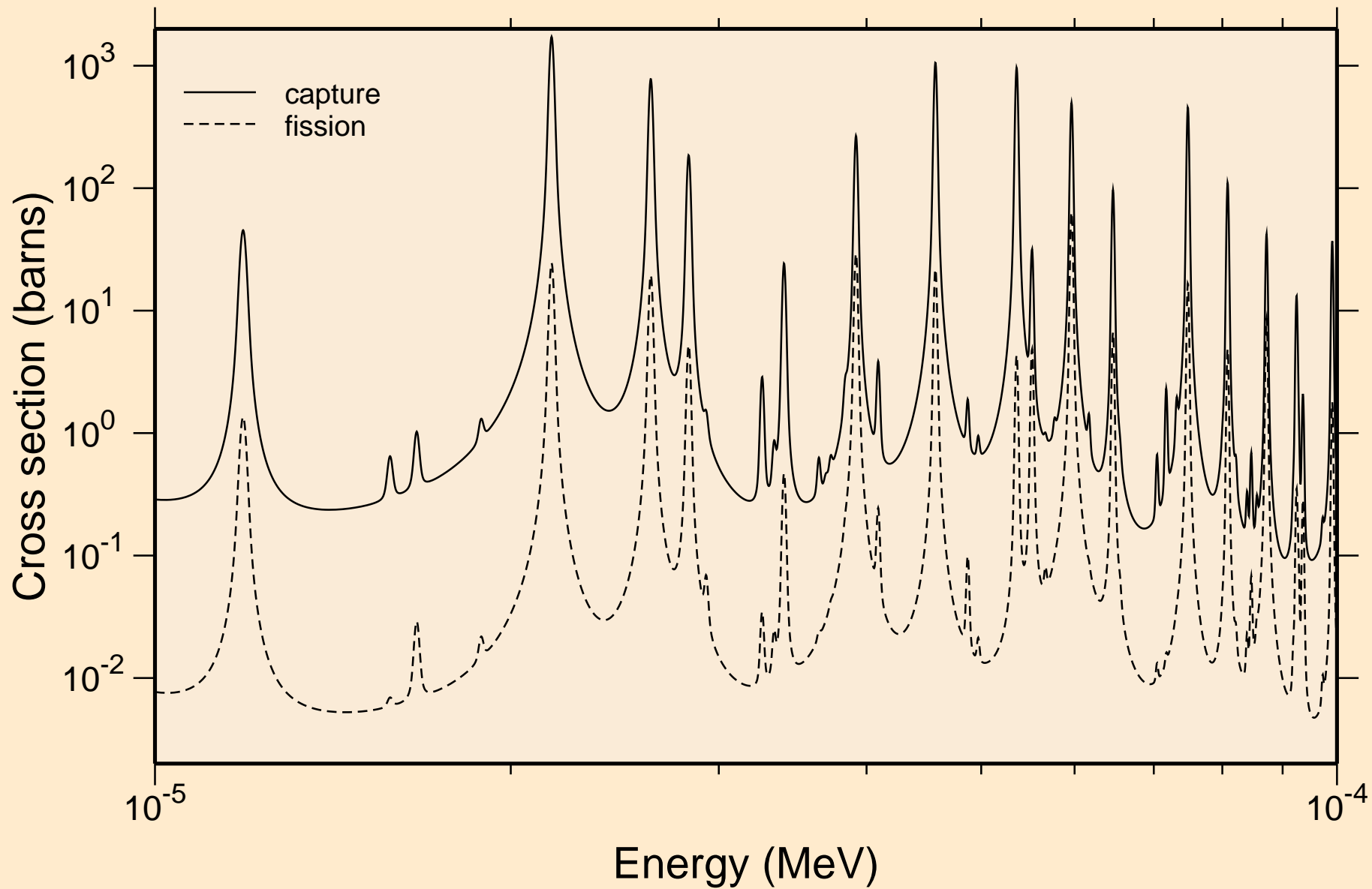

CM240 NEUTRON ACER TENDL-2021 LIBRARY; T=293.6K
resonance absorption cross sections

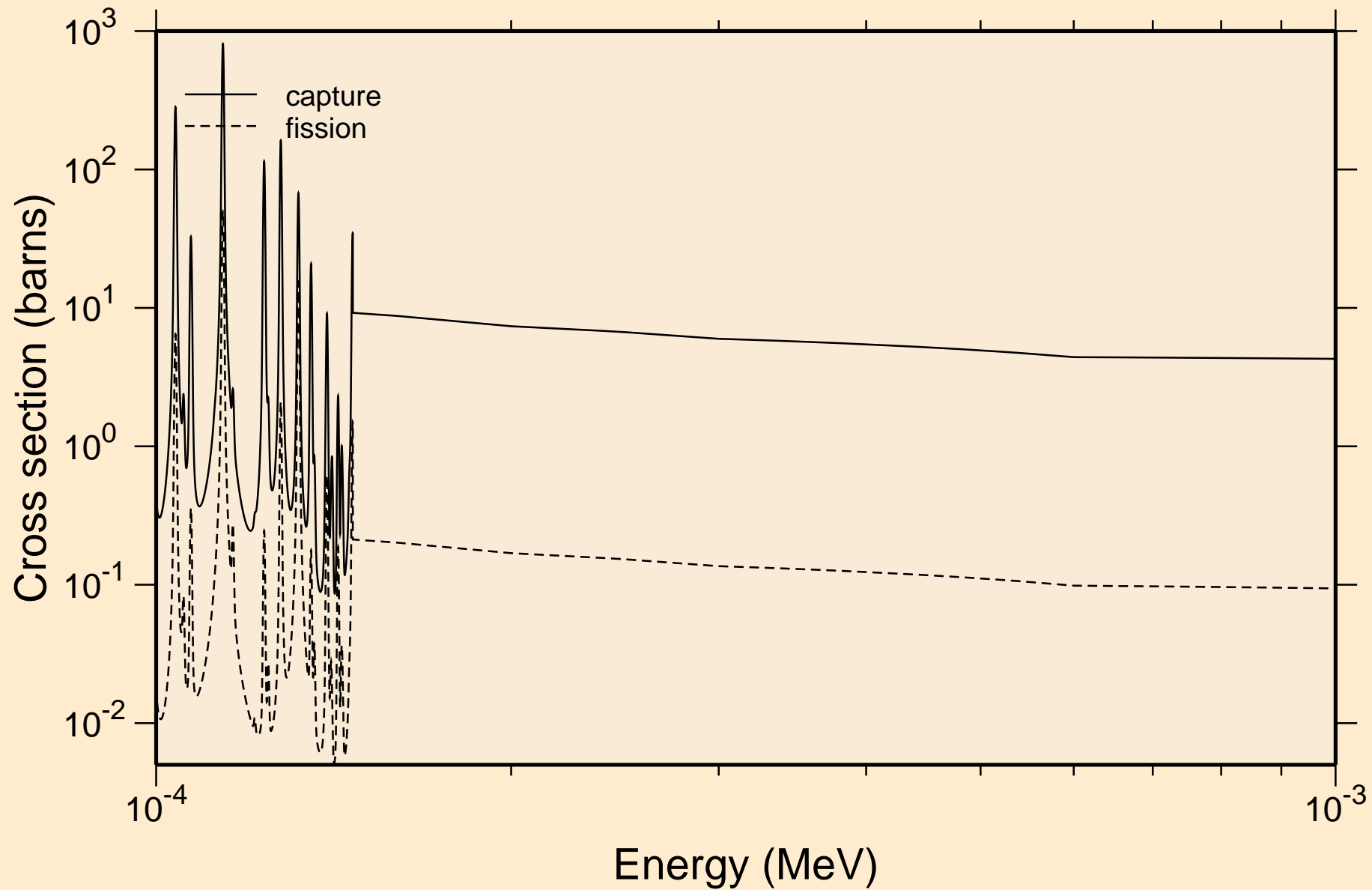

CM240 NEUTRON ACER TENDL-2021 LIBRARY; T=293.6K
resonance absorption cross sections

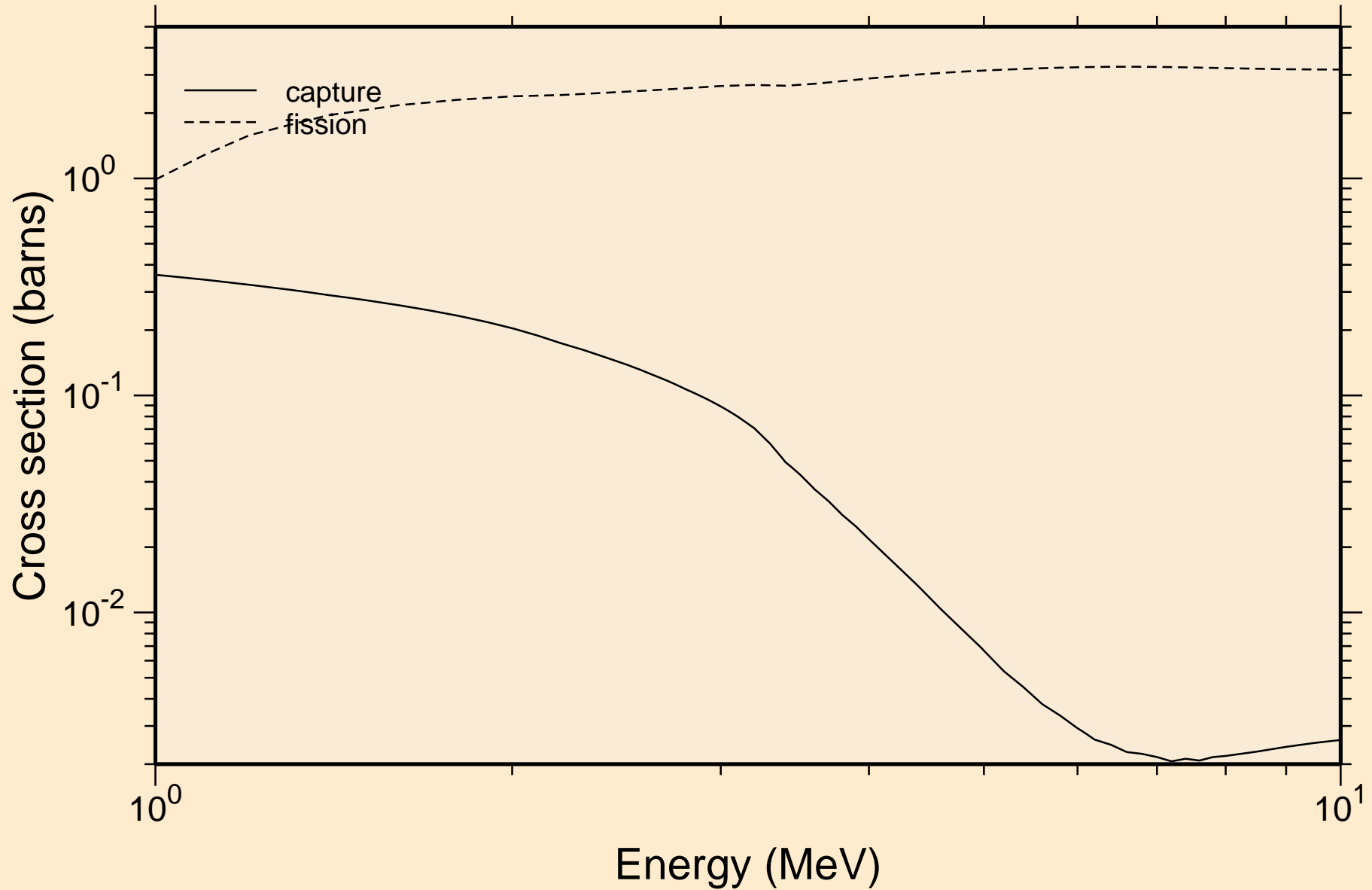

CM240 NEUTRON ACER TENDL-2021 LIBRARY; T=293.6K
Heating

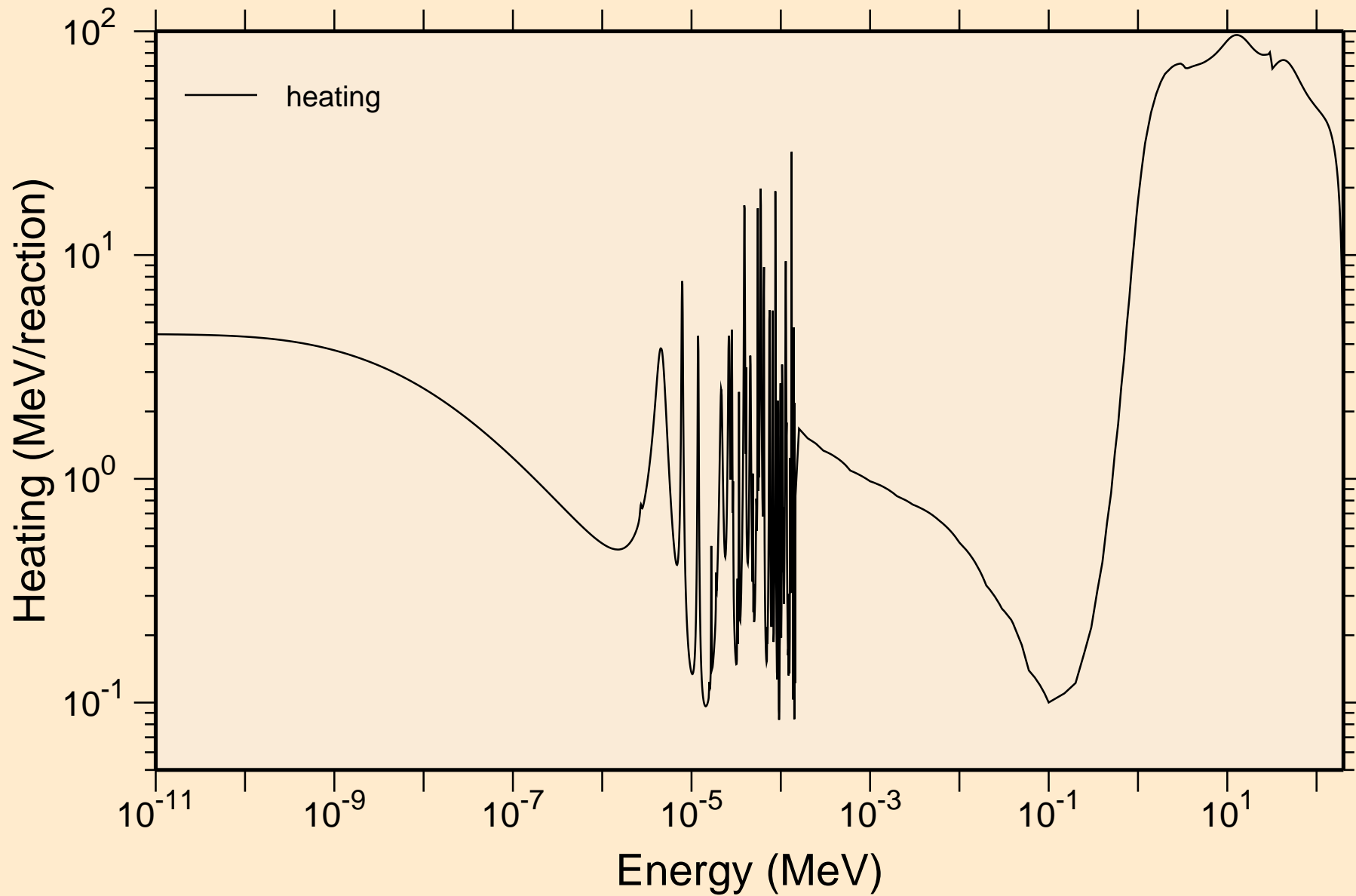

CM240 NEUTRON ACER TENDL-2021 LIBRARY; T=293.6K

Damage

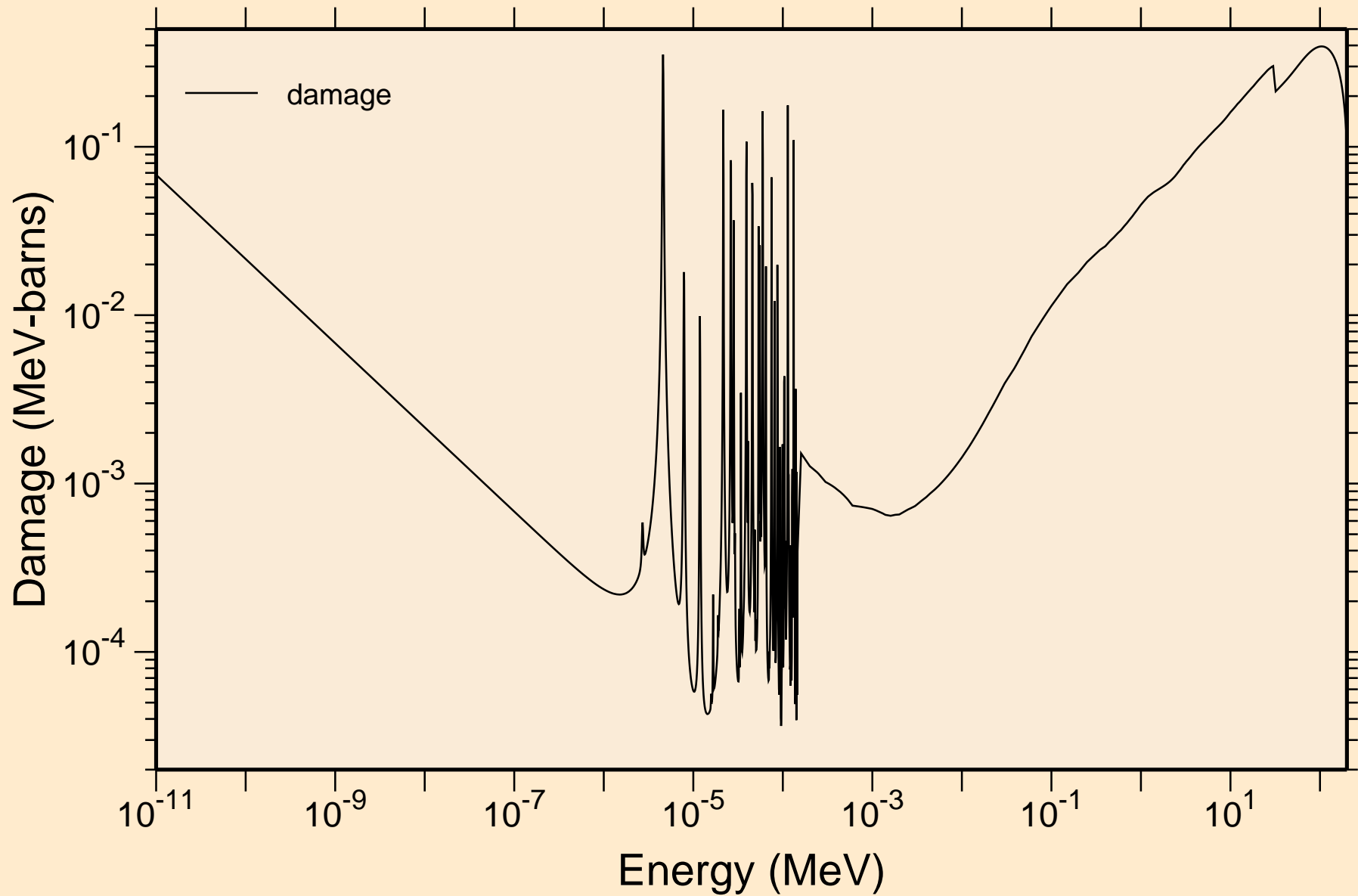

CM240 NEUTRON ACER TENDL-2021 LIBRARY; T=293.6K
Non-threshold reactions

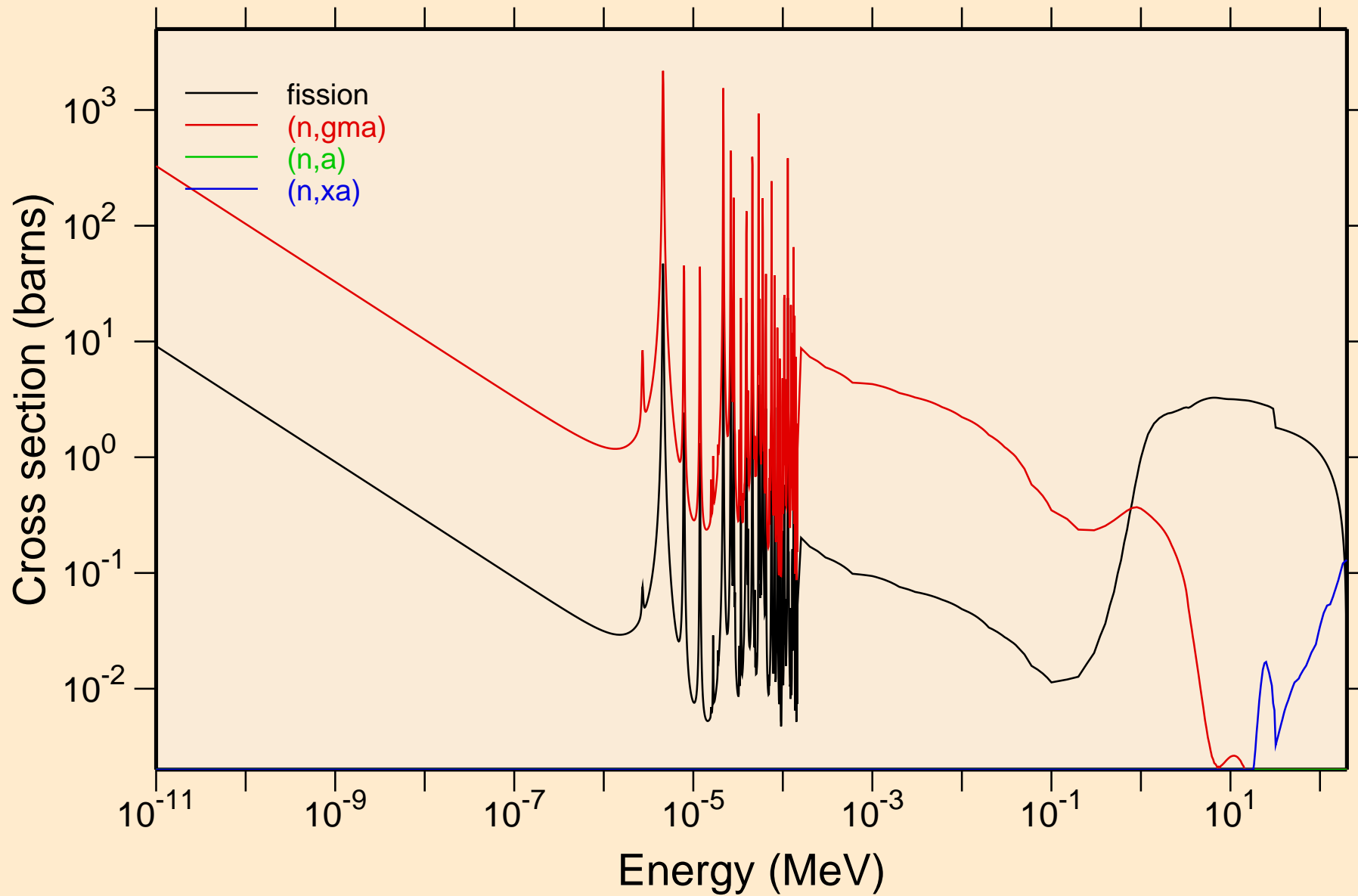

CM240 NEUTRON ACER TENDL-2021 LIBRARY; T=293.6K
Principal cross sections

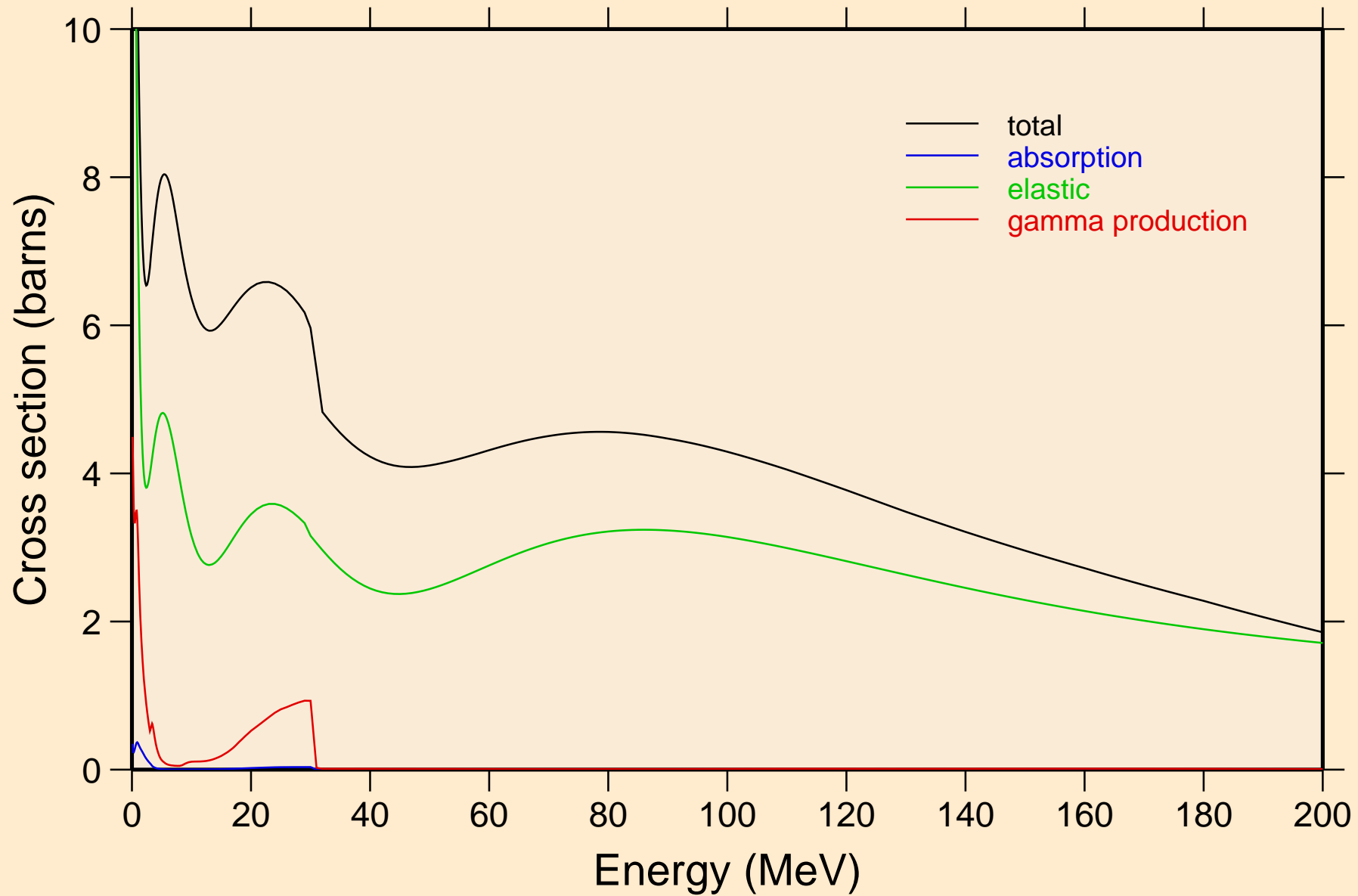

CM240 NEUTRON ACER TENDL-2021 LIBRARY; T=293.6K
Heating

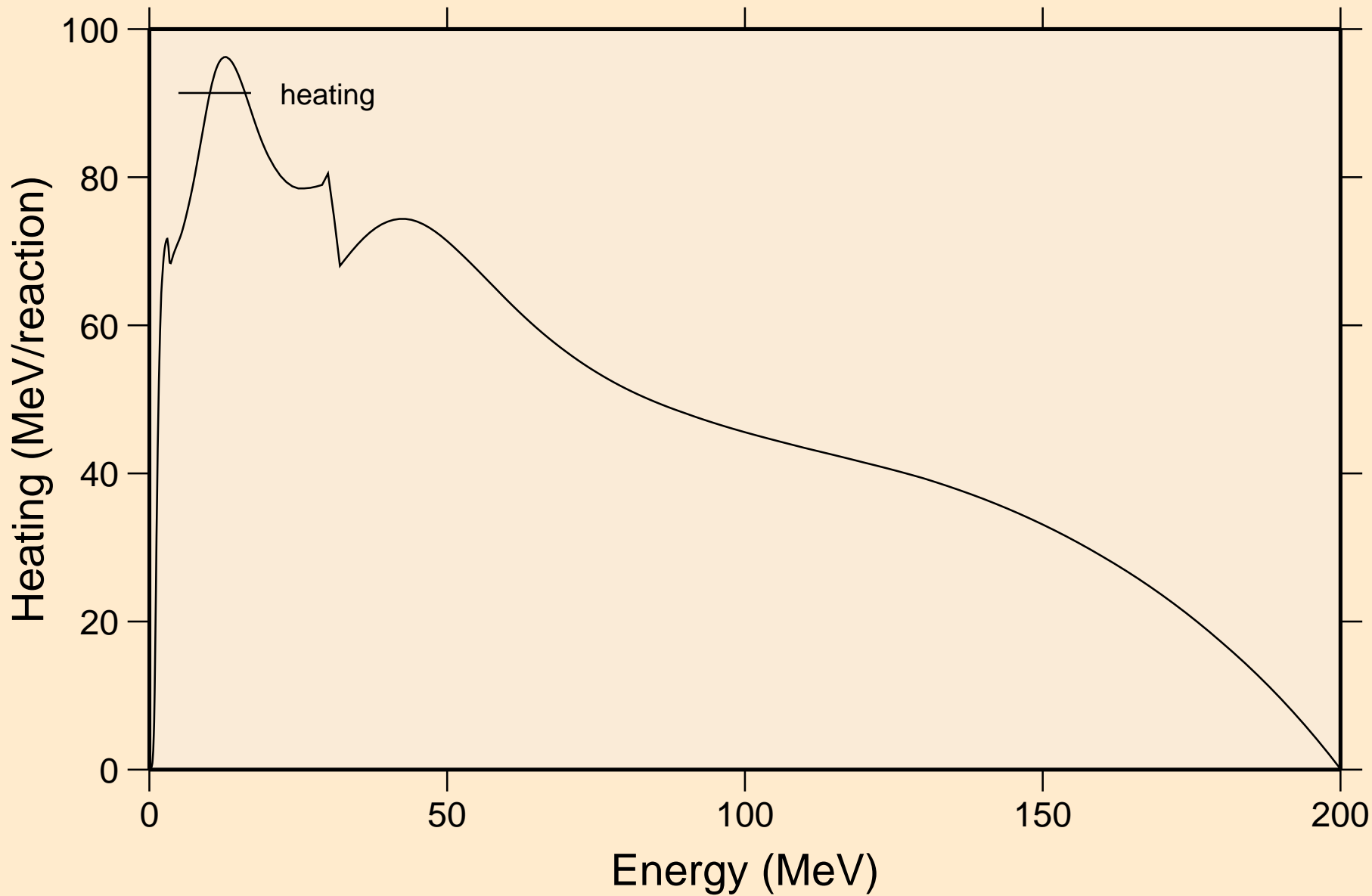

CM240 NEUTRON ACER TENDL-2021 LIBRARY; T=293.6K
Damage

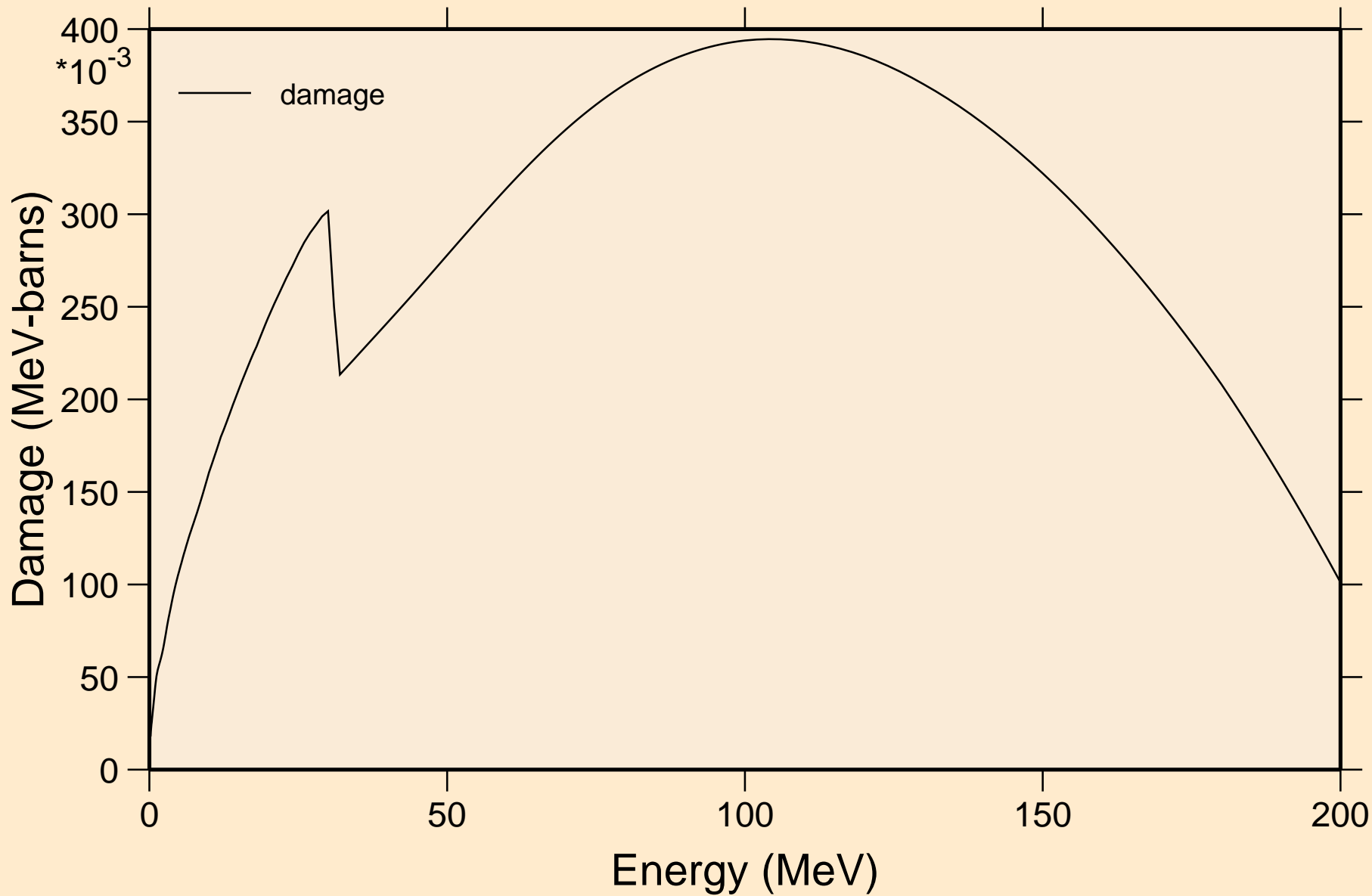

CM240 NEUTRON ACER TENDL-2021 LIBRARY; T=293.6K
Non-threshold reactions

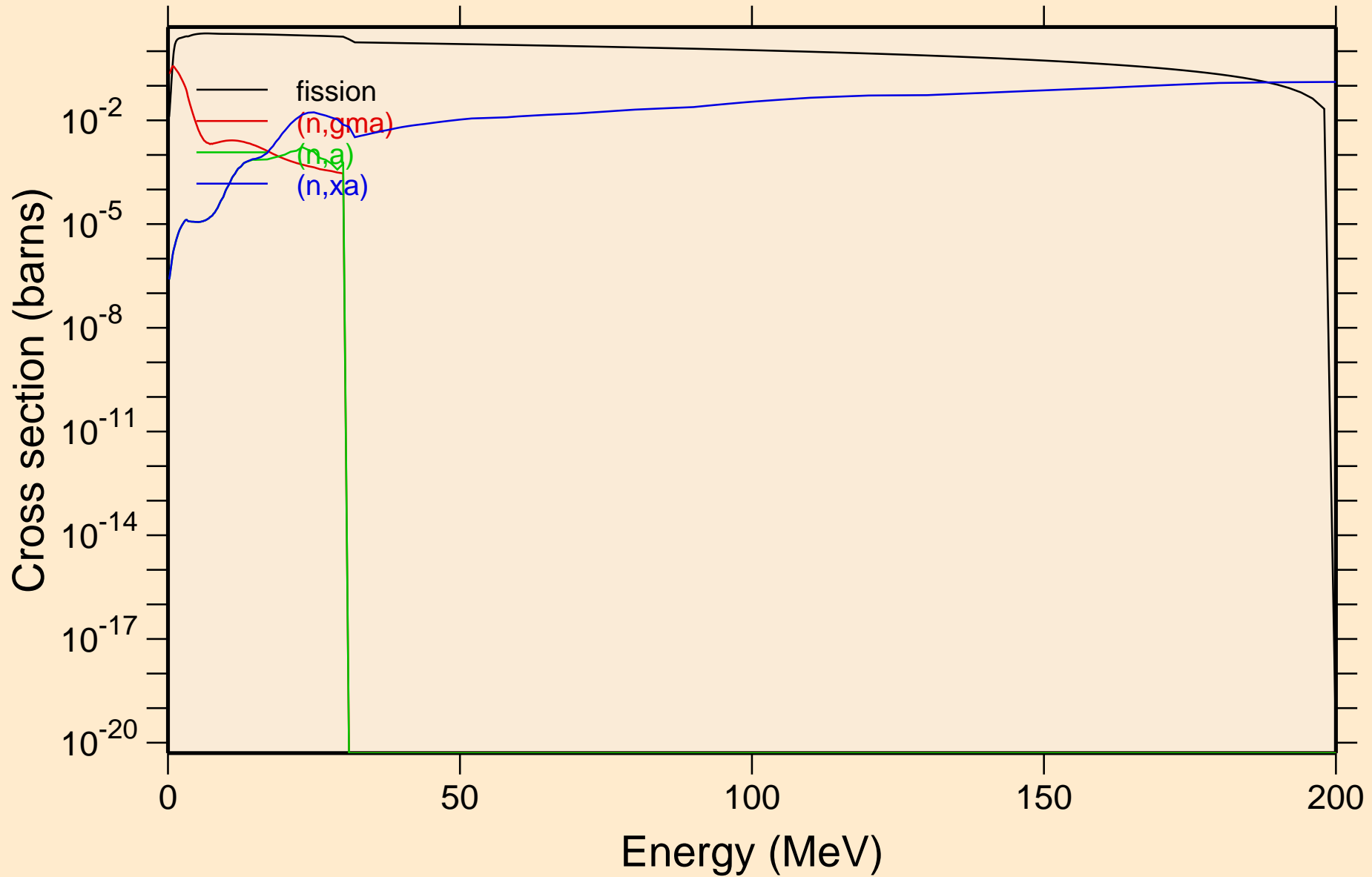

CM240 NEUTRON ACER TENDL-2021 LIBRARY; T=293.6K
Inelastic levels

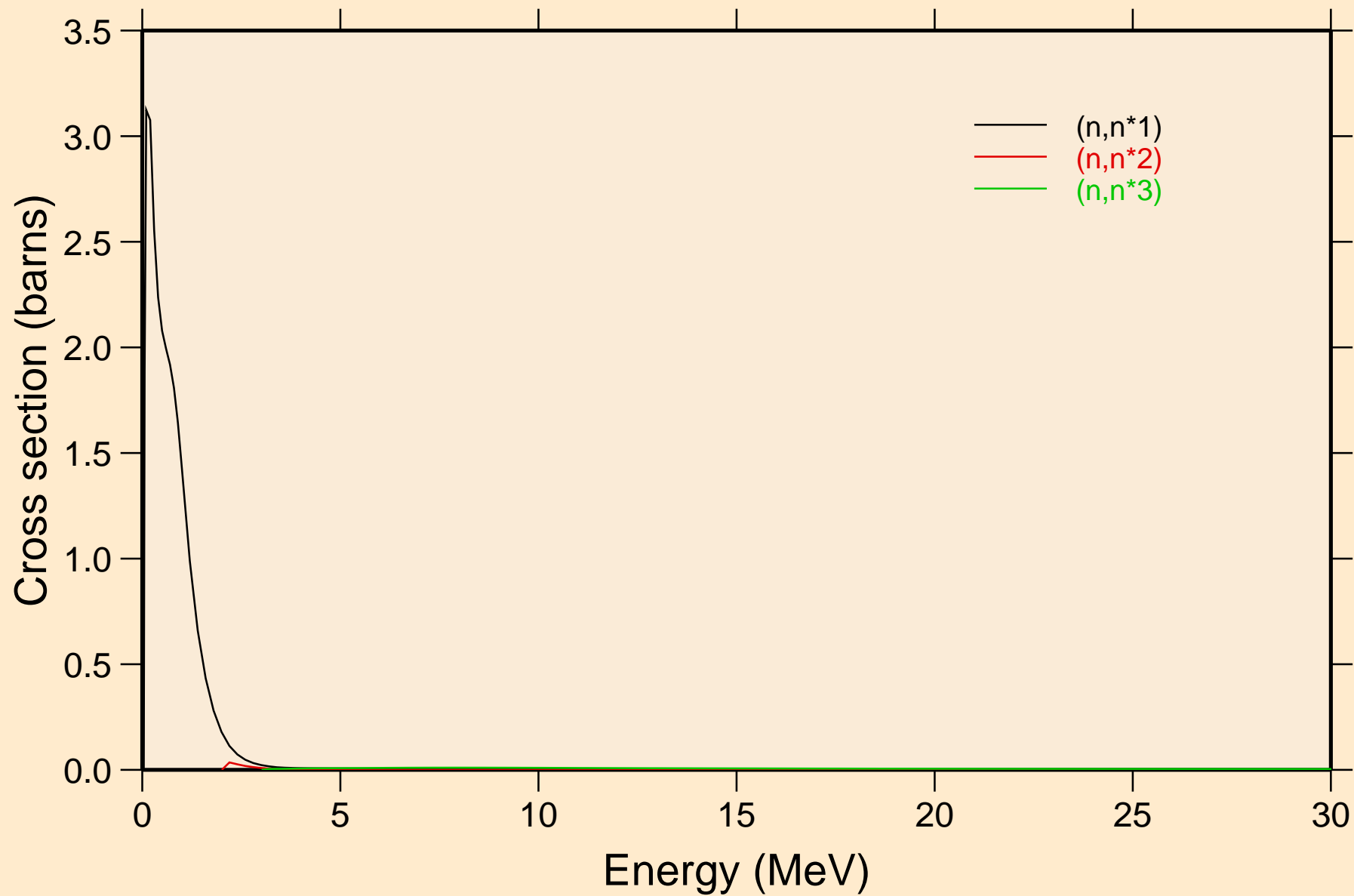

CM240 NEUTRON ACER TENDL-2021 LIBRARY; T=293.6K

Threshold reactions

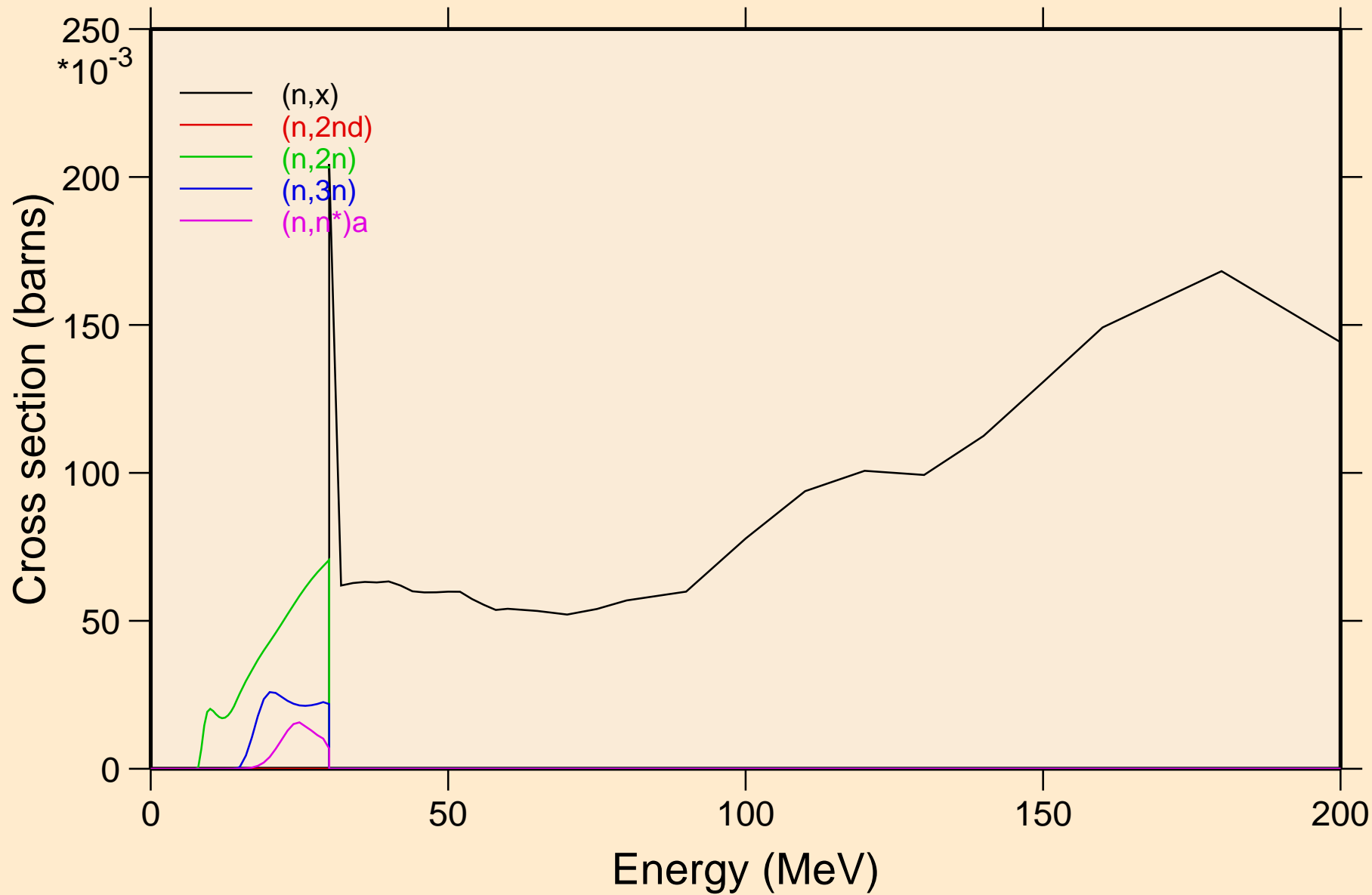

CM240 NEUTRON ACER TENDL-2021 LIBRARY; T=293.6K
Threshold reactions

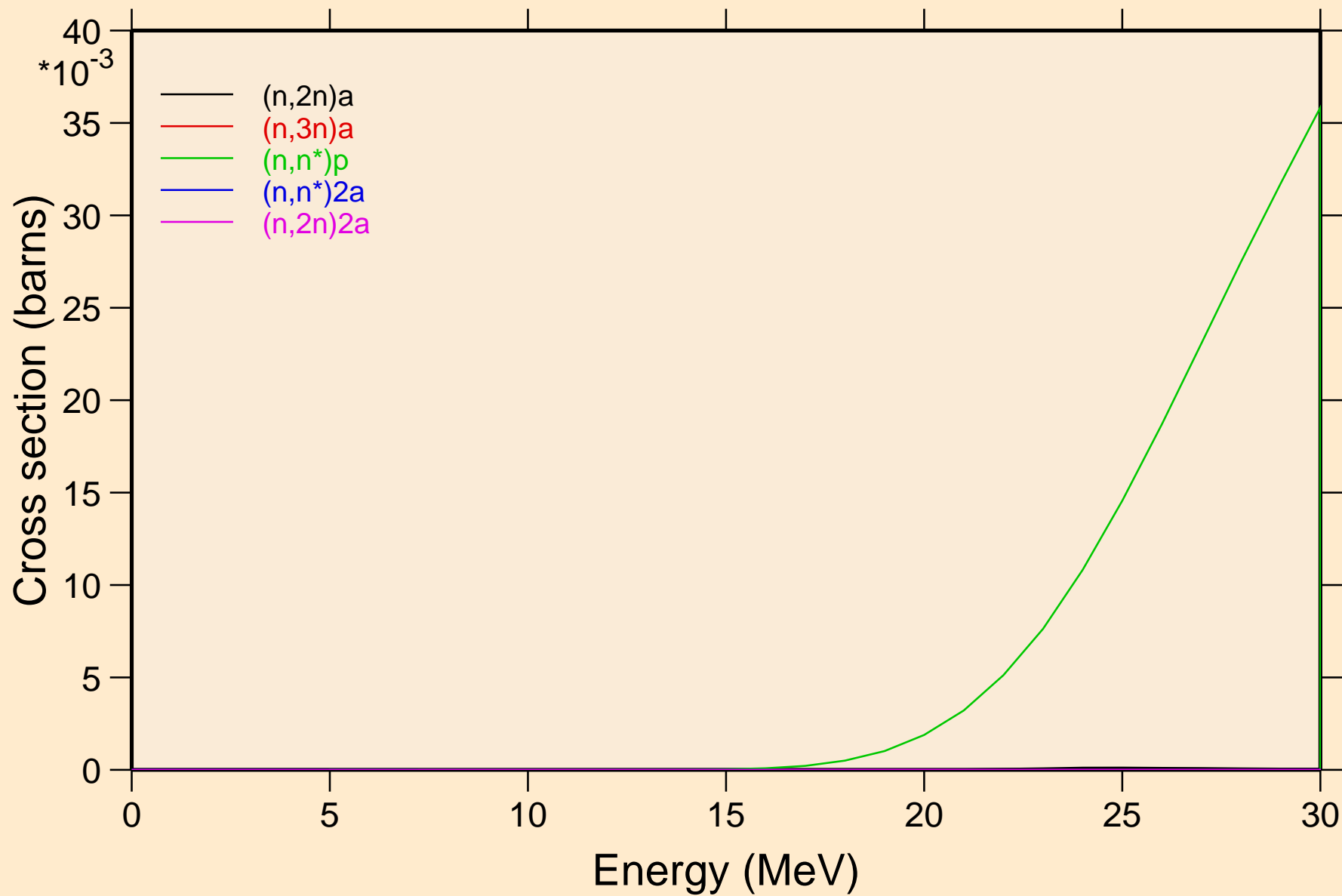

CM240 NEUTRON ACER TENDL-2021 LIBRARY; T=293.6K

Threshold reactions

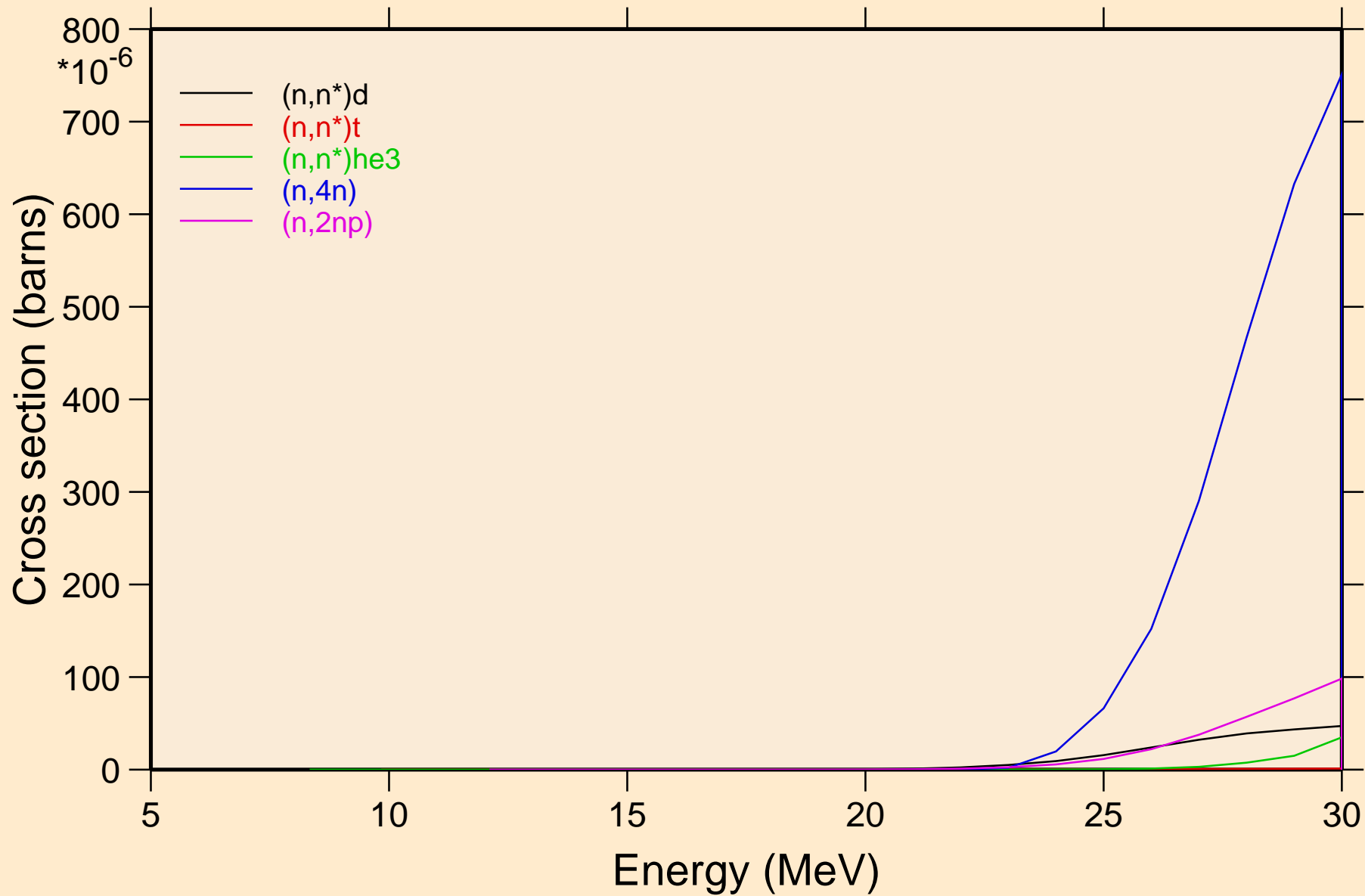

CM240 NEUTRON ACER TENDL-2021 LIBRARY; T=293.6K
Threshold reactions

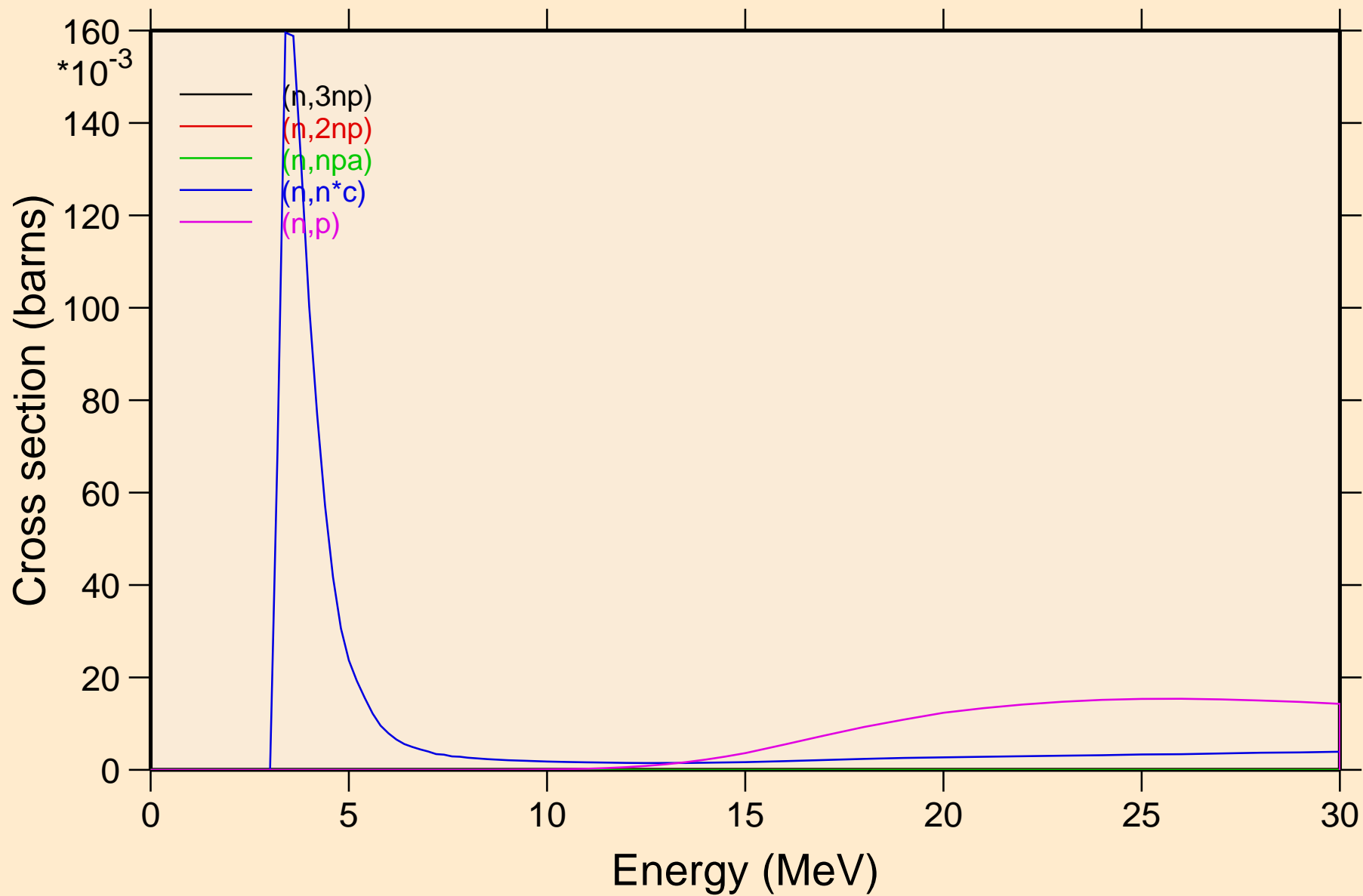

CM240 NEUTRON ACER TENDL-2021 LIBRARY; T=293.6K
Threshold reactions

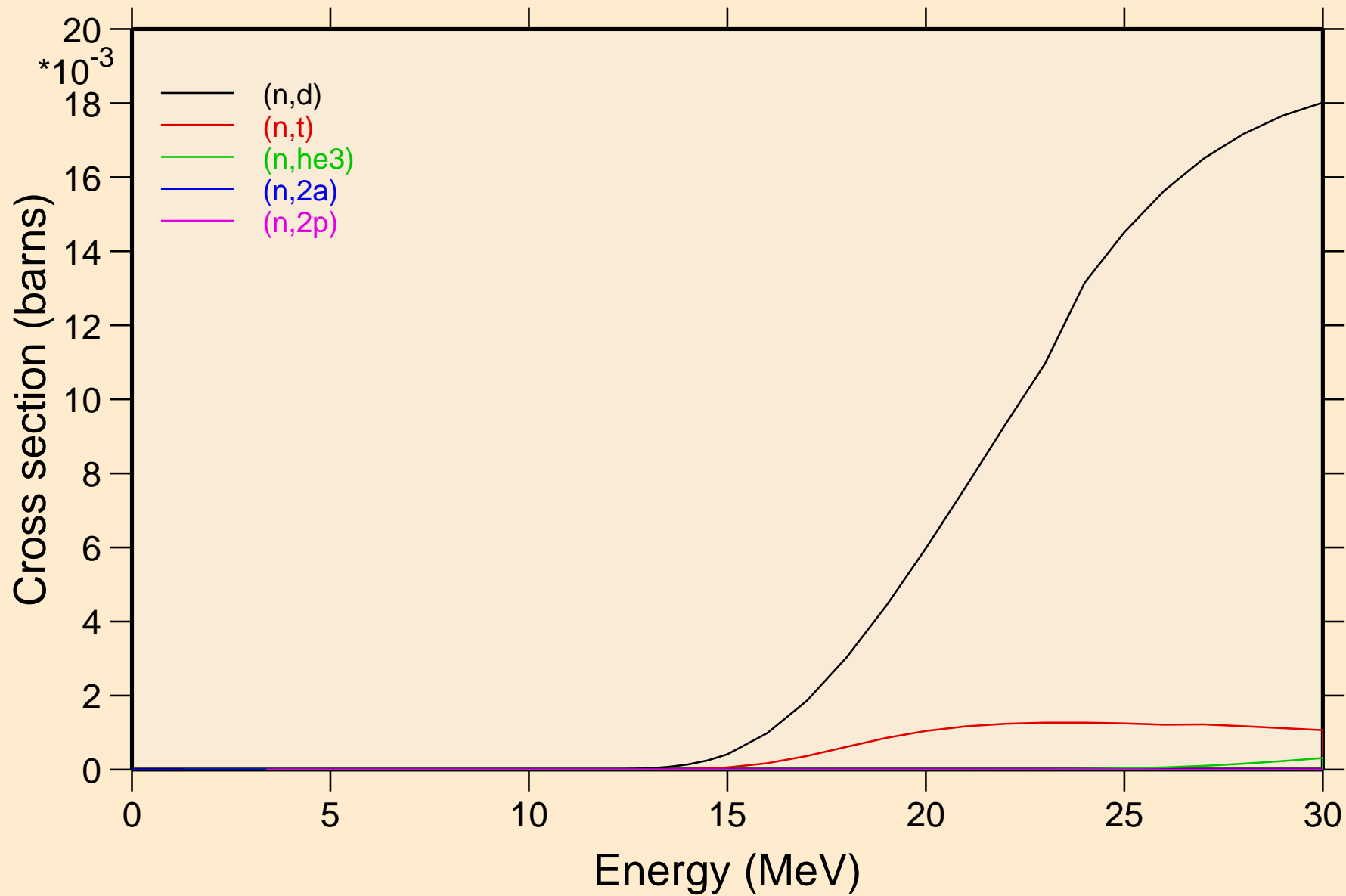

CM240 NEUTRON ACER TENDL-2021 LIBRARY; T=293.6K
Threshold reactions

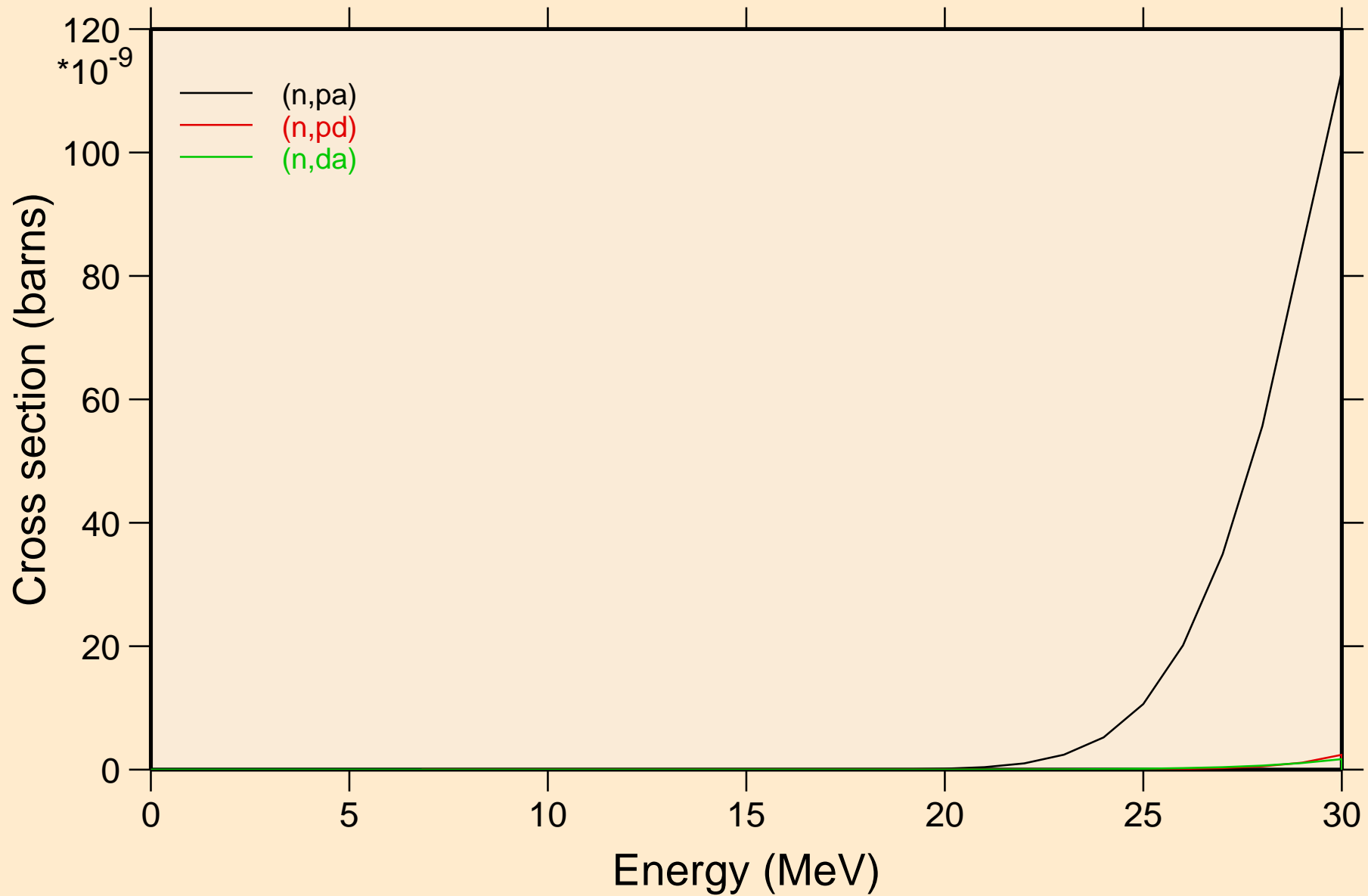

CM240 NEUTRON ACER TENDL-2021 LIBRARY; T=293.6K

Threshold reactions

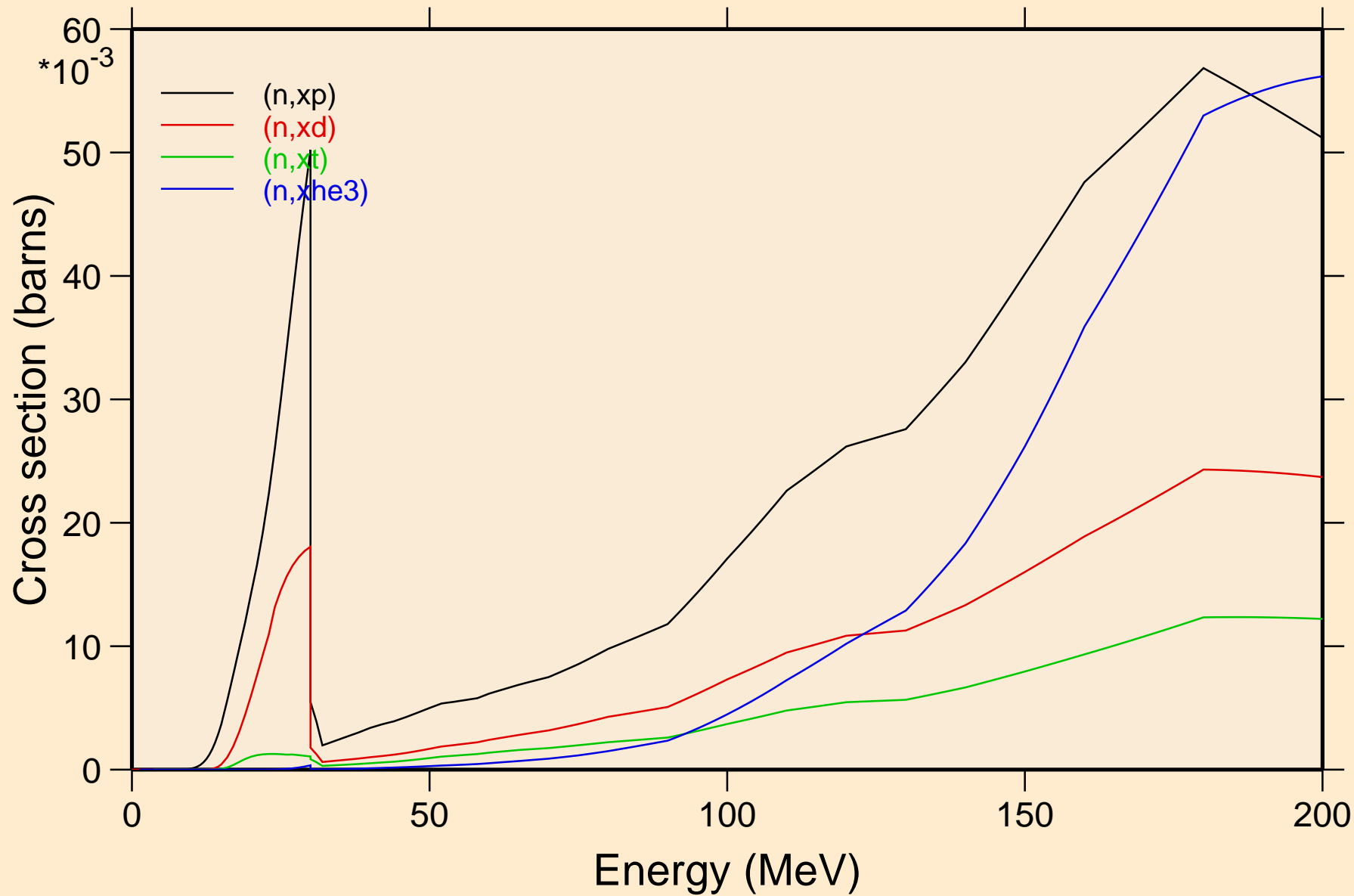

CM240 NEUTRON ACER TENDL-2021 LIBRARY; T=293.6K
angular distribution for elastic

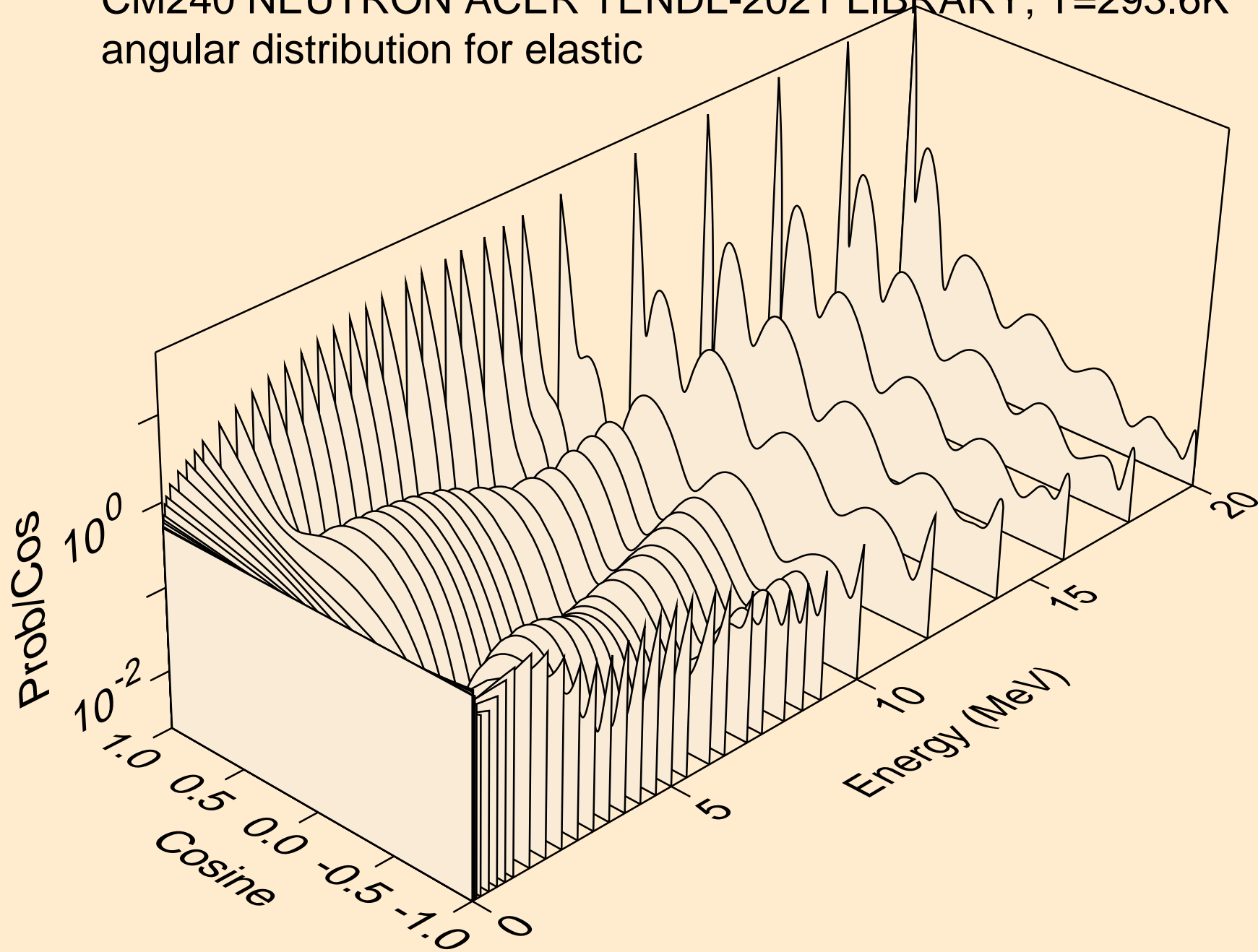

CM240 NEUTRON ACER TENDL-2021 LIBRARY; T=293.6K
angular distribution for elastic

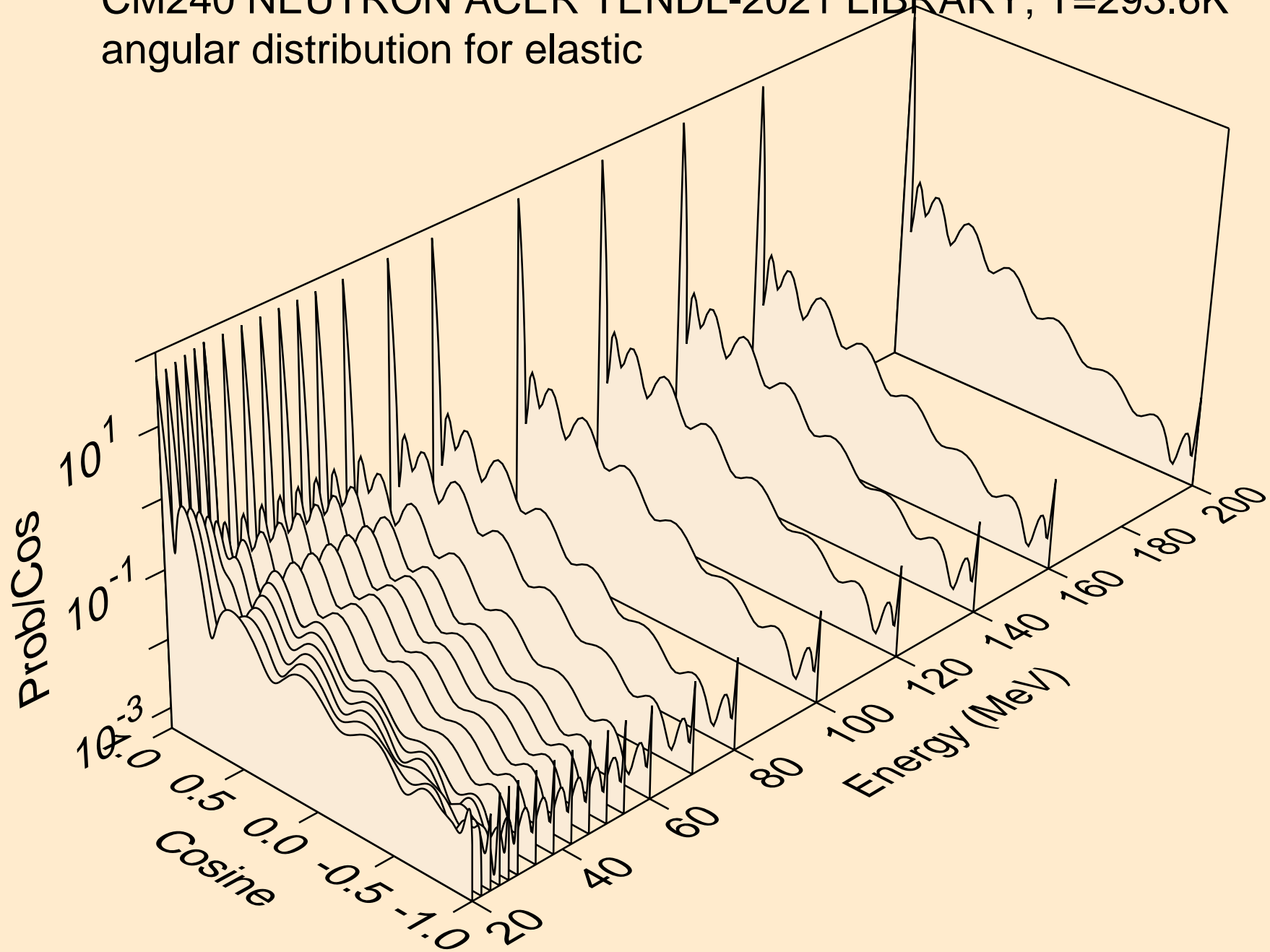

CM240 NEUTRON ACER TENDL-2021 LIBRARY; T=293.6K
angular distribution for (n,n*1)

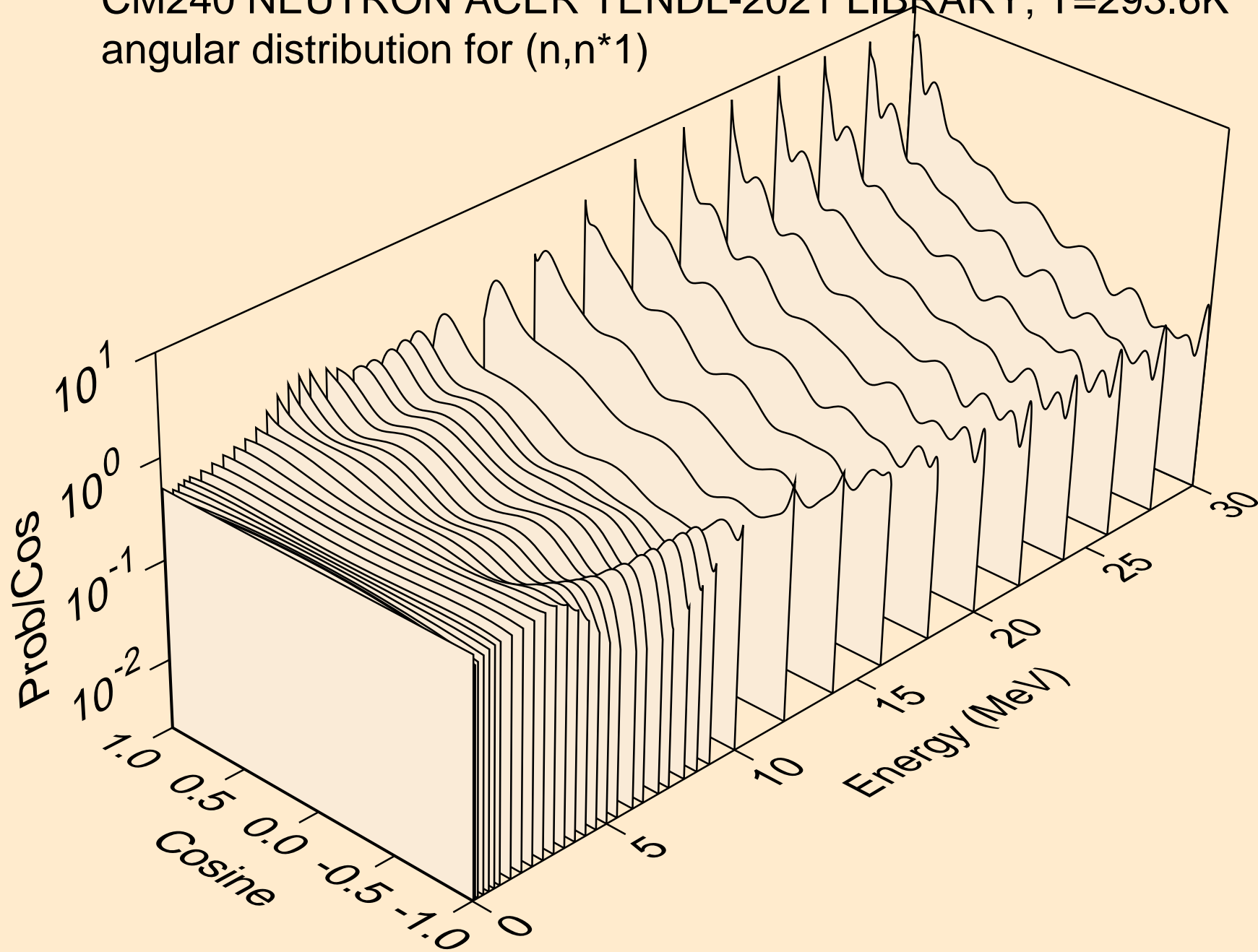

CM240 NEUTRON ACER TENDL-2021 LIBRARY; T=293.6K
angular distribution for (n,n*2)

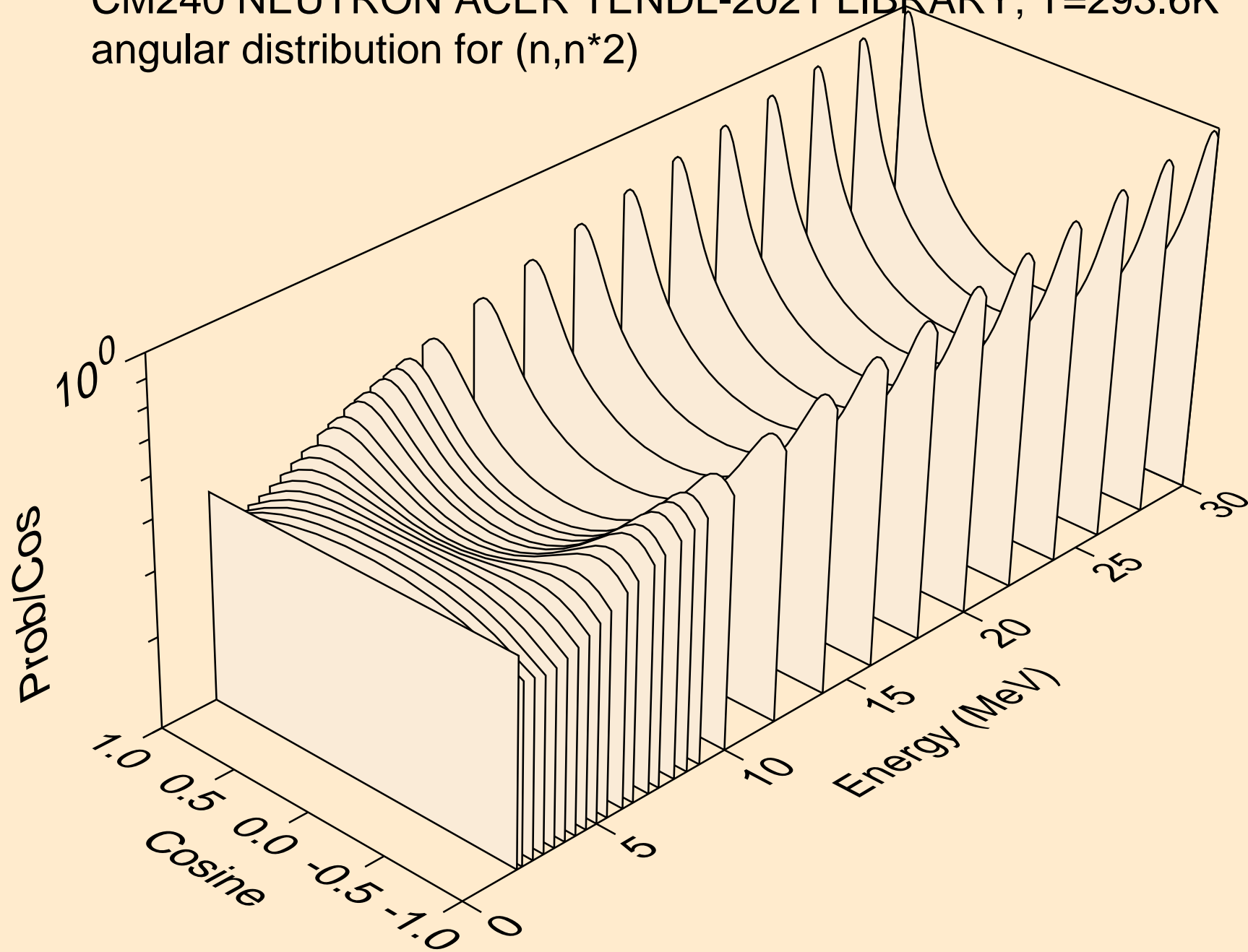

CM240 NEUTRON ACER TENDL-2021 LIBRARY; T=293.6K
angular distribution for (n,n*3)

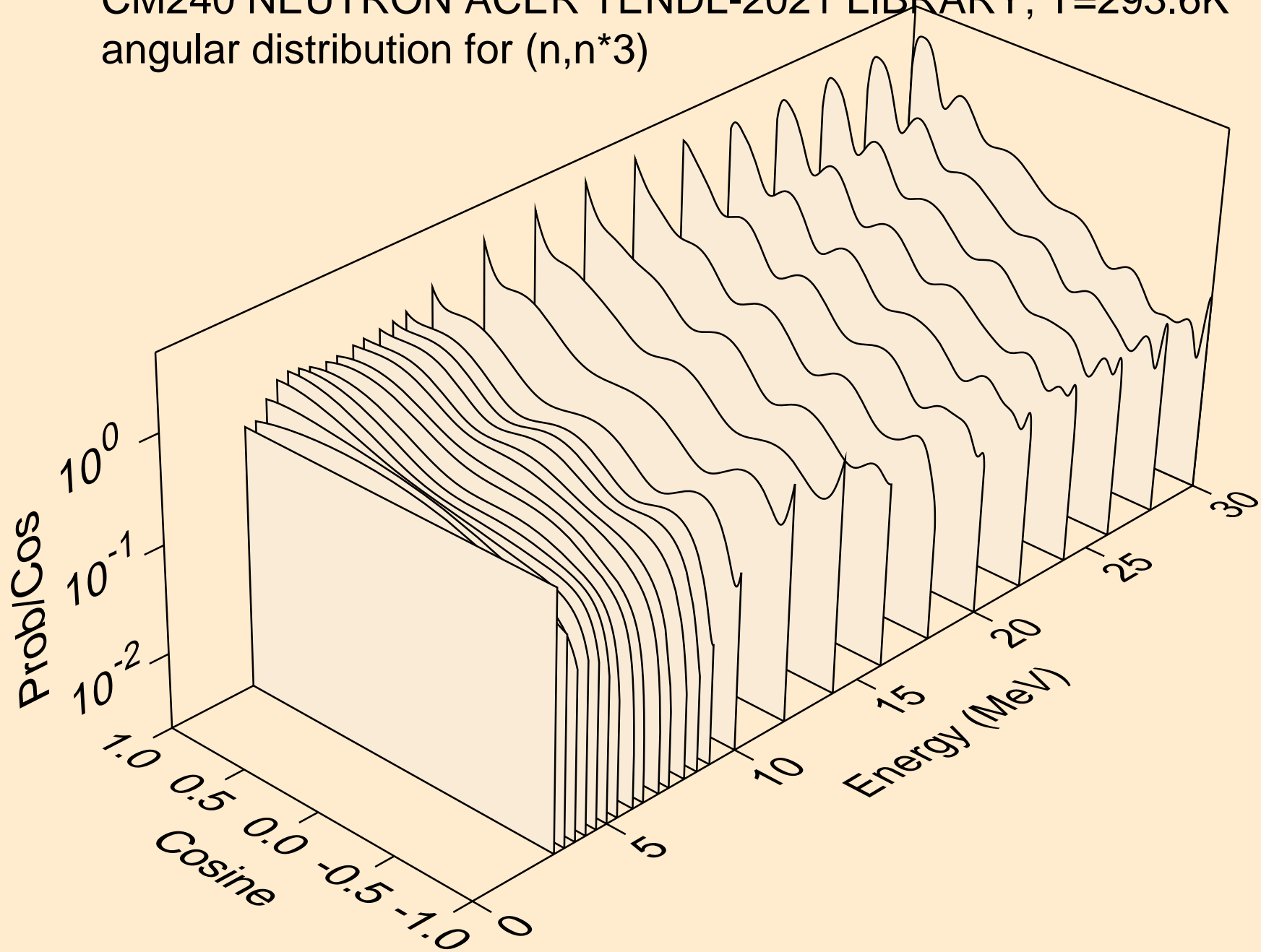

CM240 NEUTRON ACER TENDL-2021 LIBRARY; T=293.6K
Total fission nubar

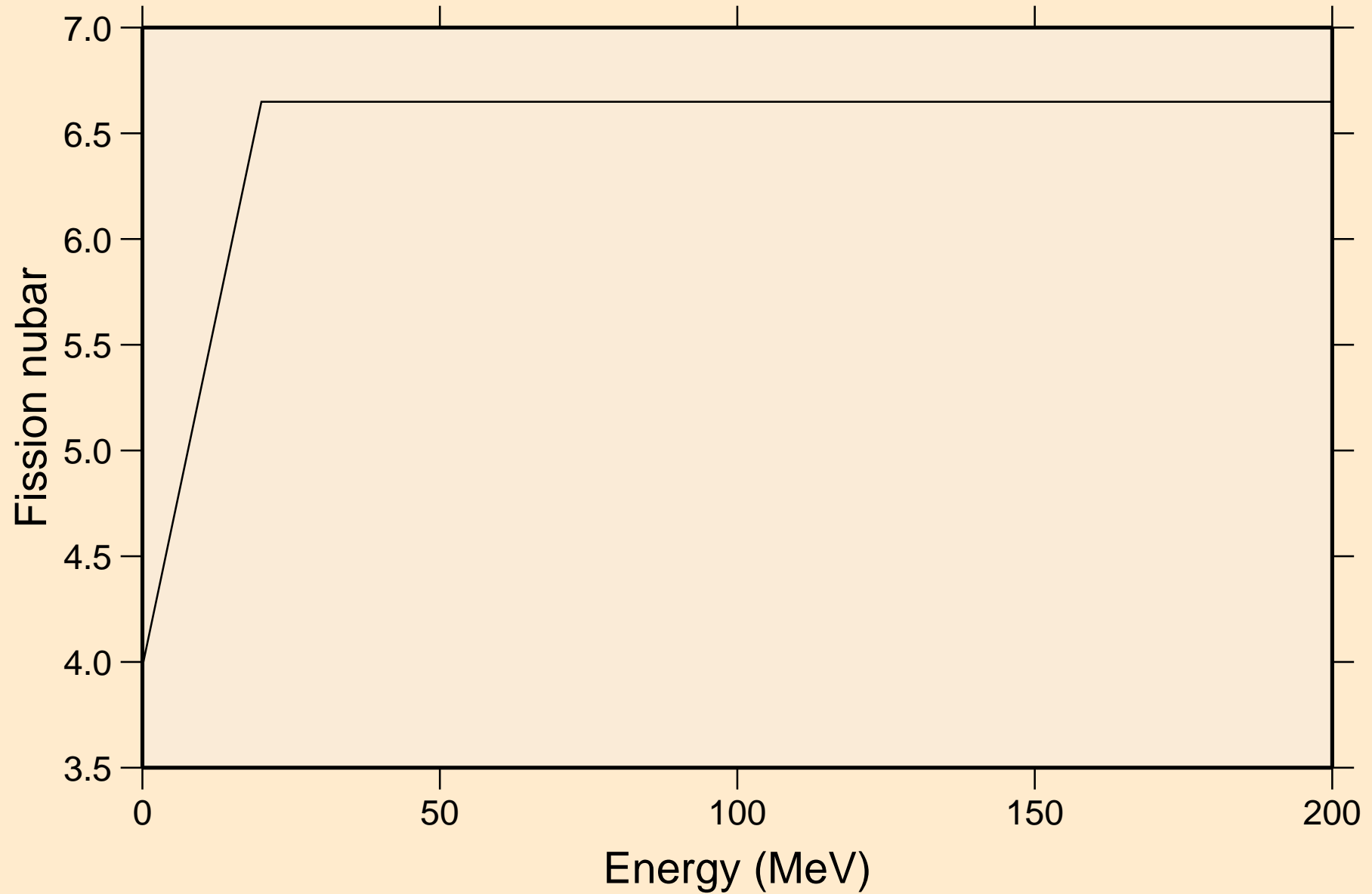

CM240 NEUTRON ACER TENDL-2021 LIBRARY; T=293.6K
Neutron emission for (n,x)

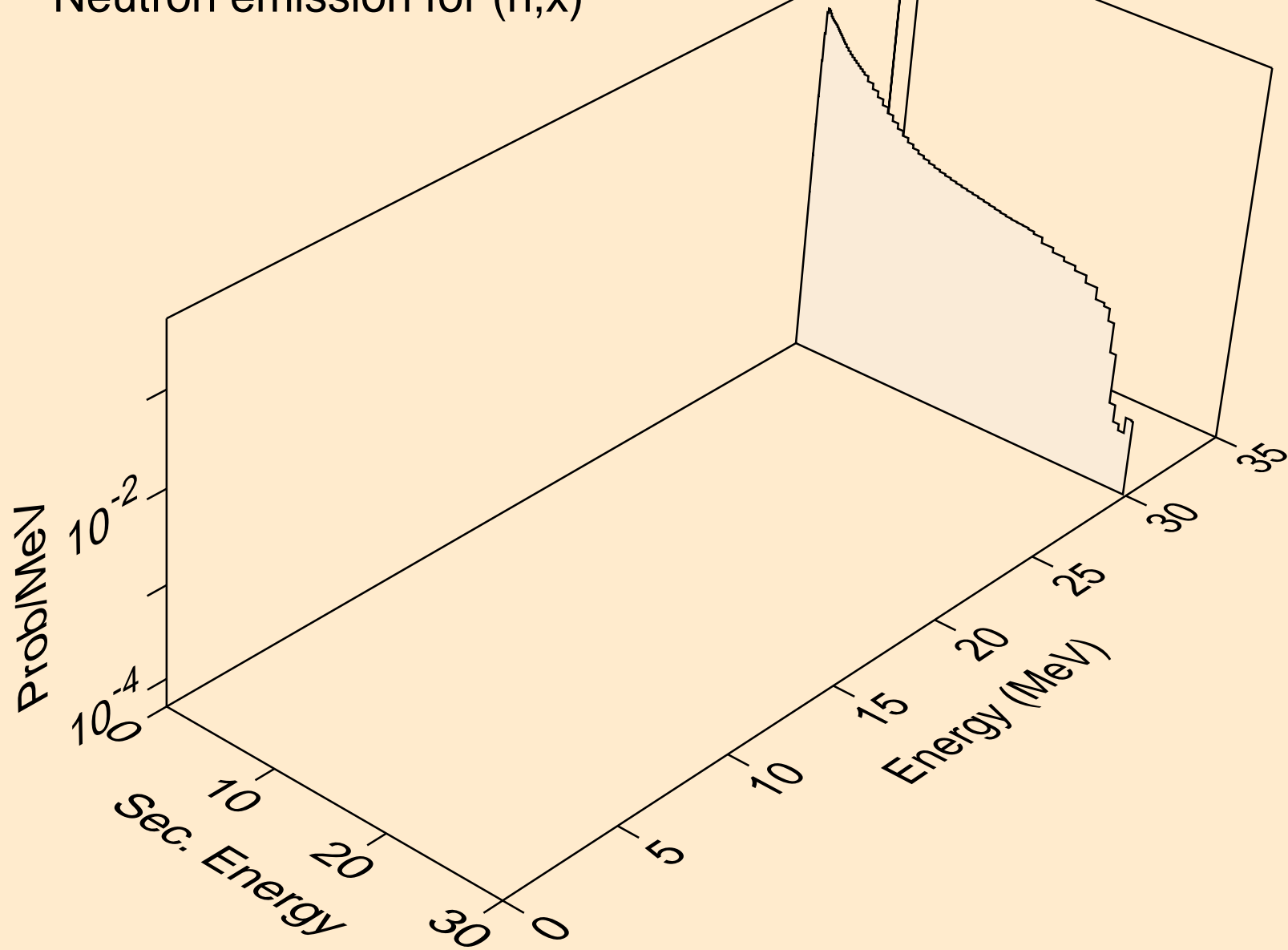

CM240 NEUTRON ACER TENDL-2021 LIBRARY; T=293.6K
Neutron emission for (n,2nd)

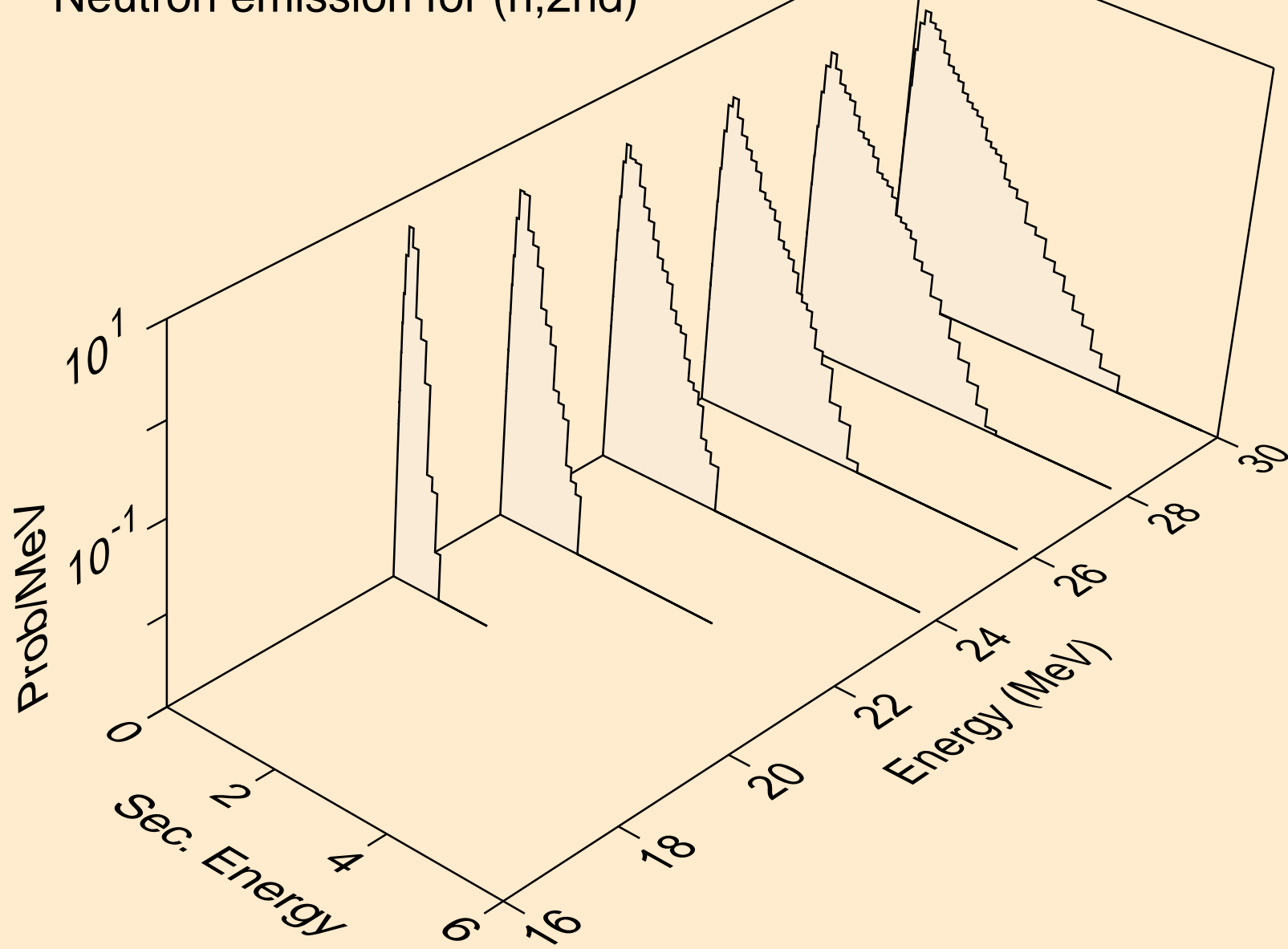

CM240 NEUTRON ACER TENDL-2021 LIBRARY; T=293.6K
Neutron emission for (n,2n)

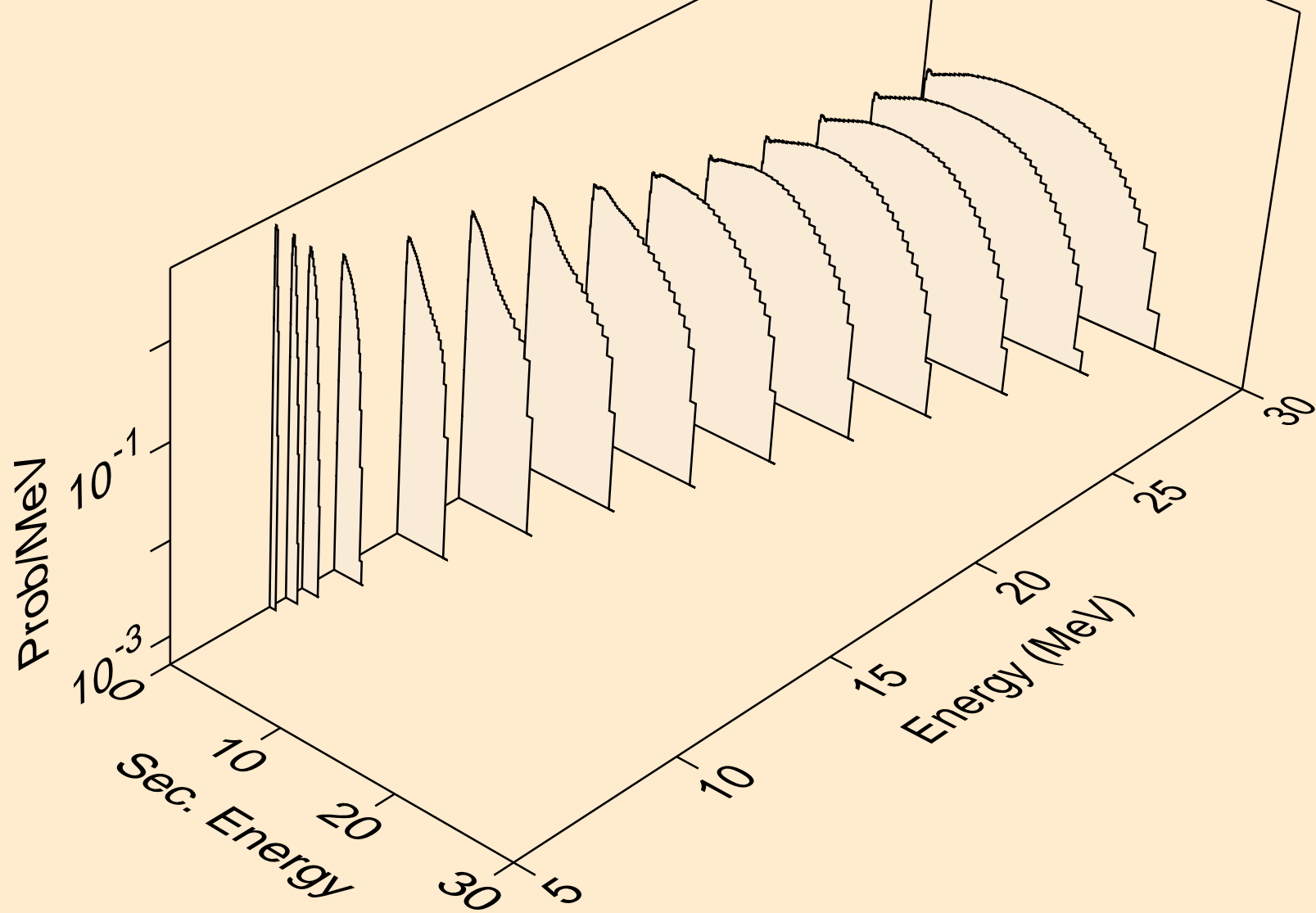

CM240 NEUTRON ACER TENDL-2021 LIBRARY; T=293.6K
Neutron emission for (n,3n)

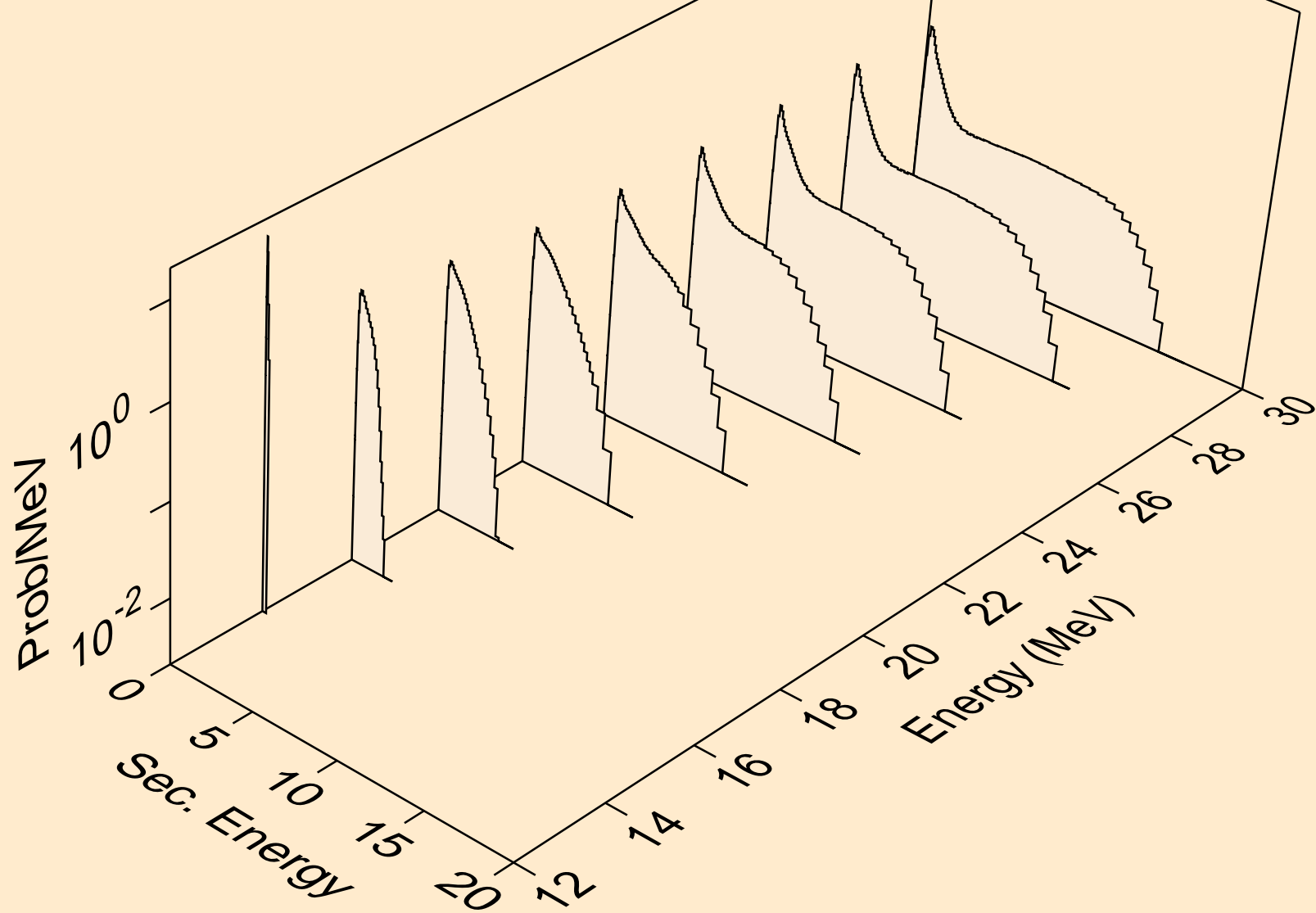

CM240 NEUTRON ACER TENDL-2021 LIBRARY; T=293.6K
Neutron emission for fission

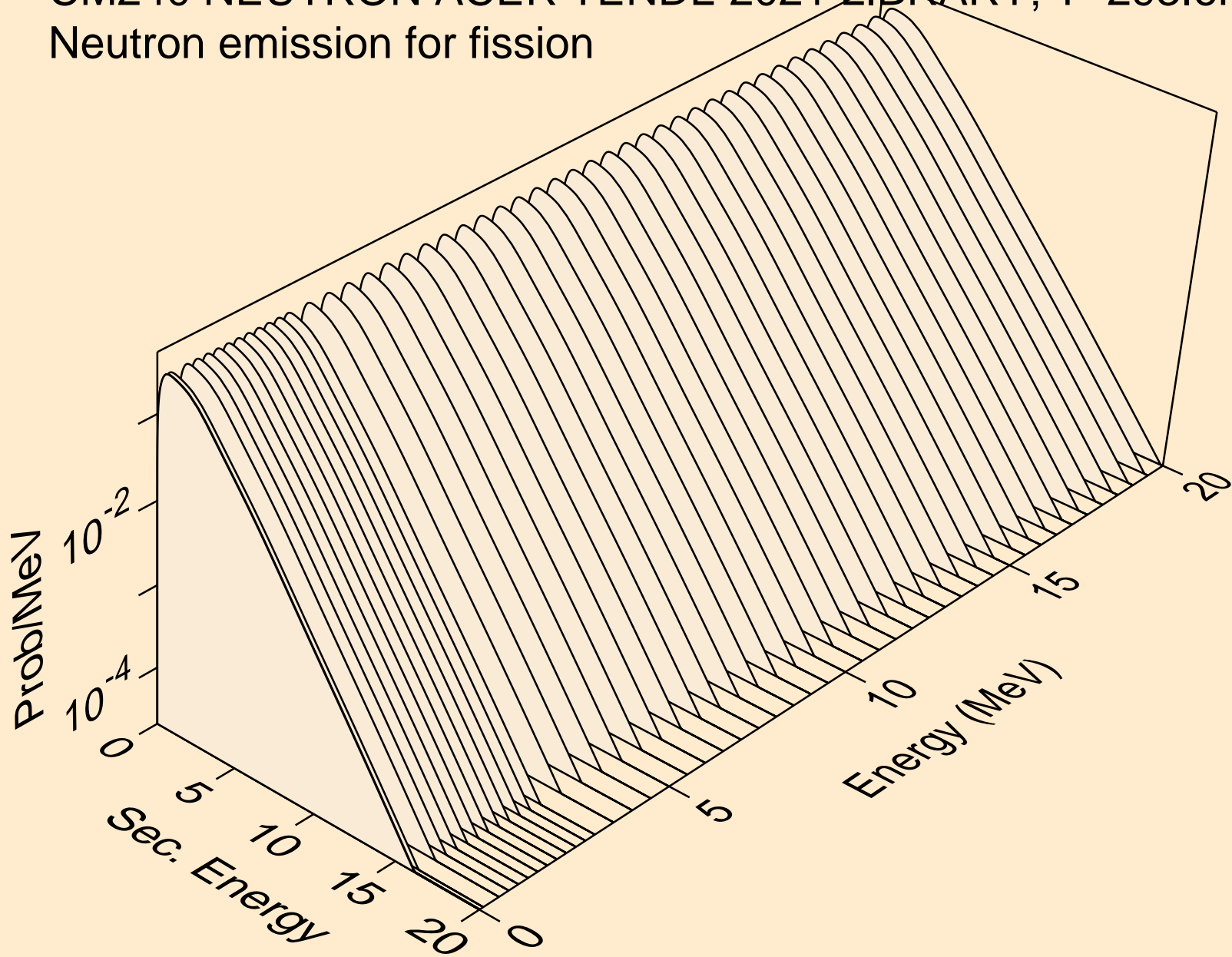

CM240 NEUTRON ACER TENDL-2021 LIBRARY; T=293.6K
Neutron emission for (n,n*)a

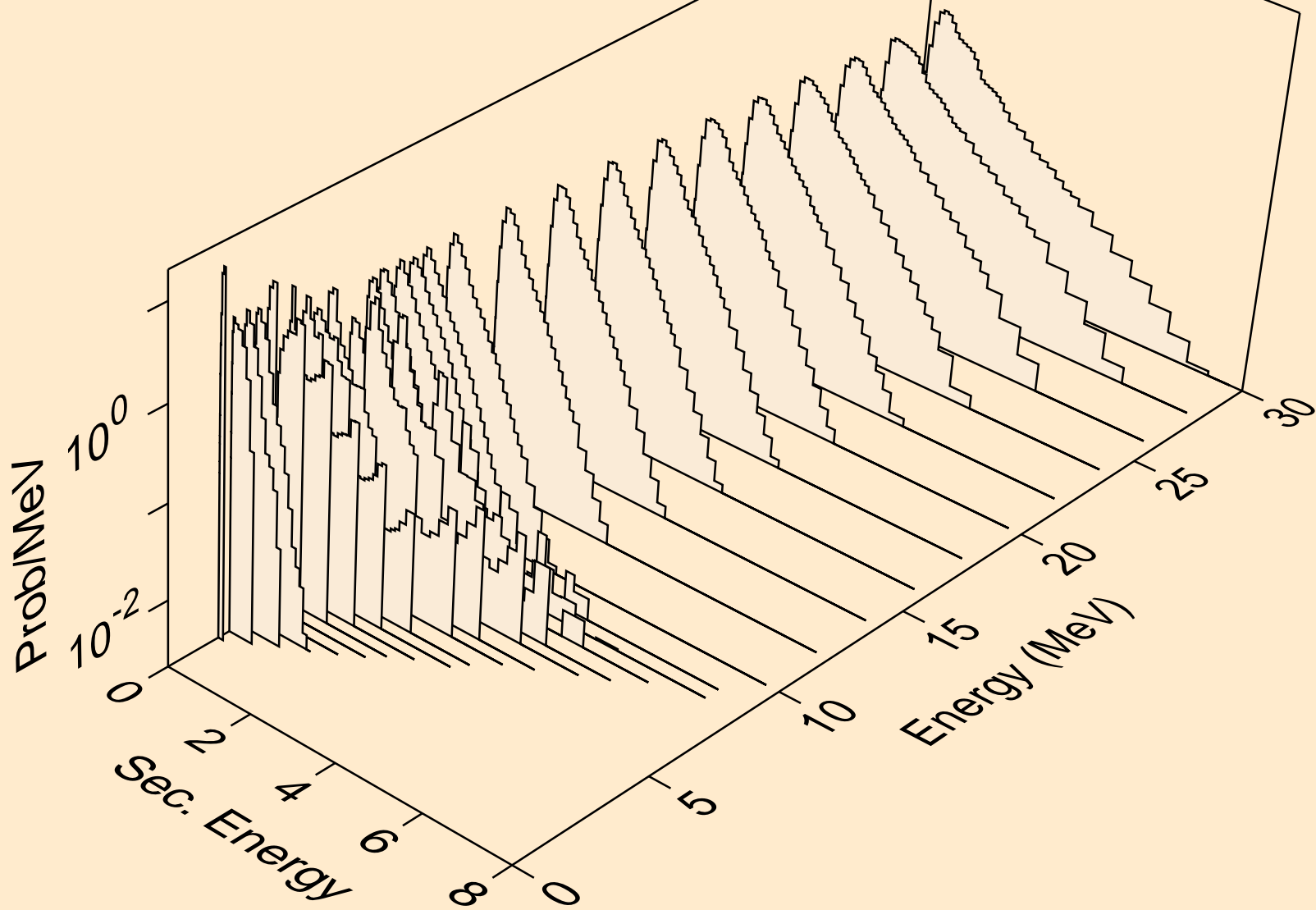

CM240 NEUTRON ACER TENDL-2021 LIBRARY; T=293.6K
Neutron emission for (n,2n)_a

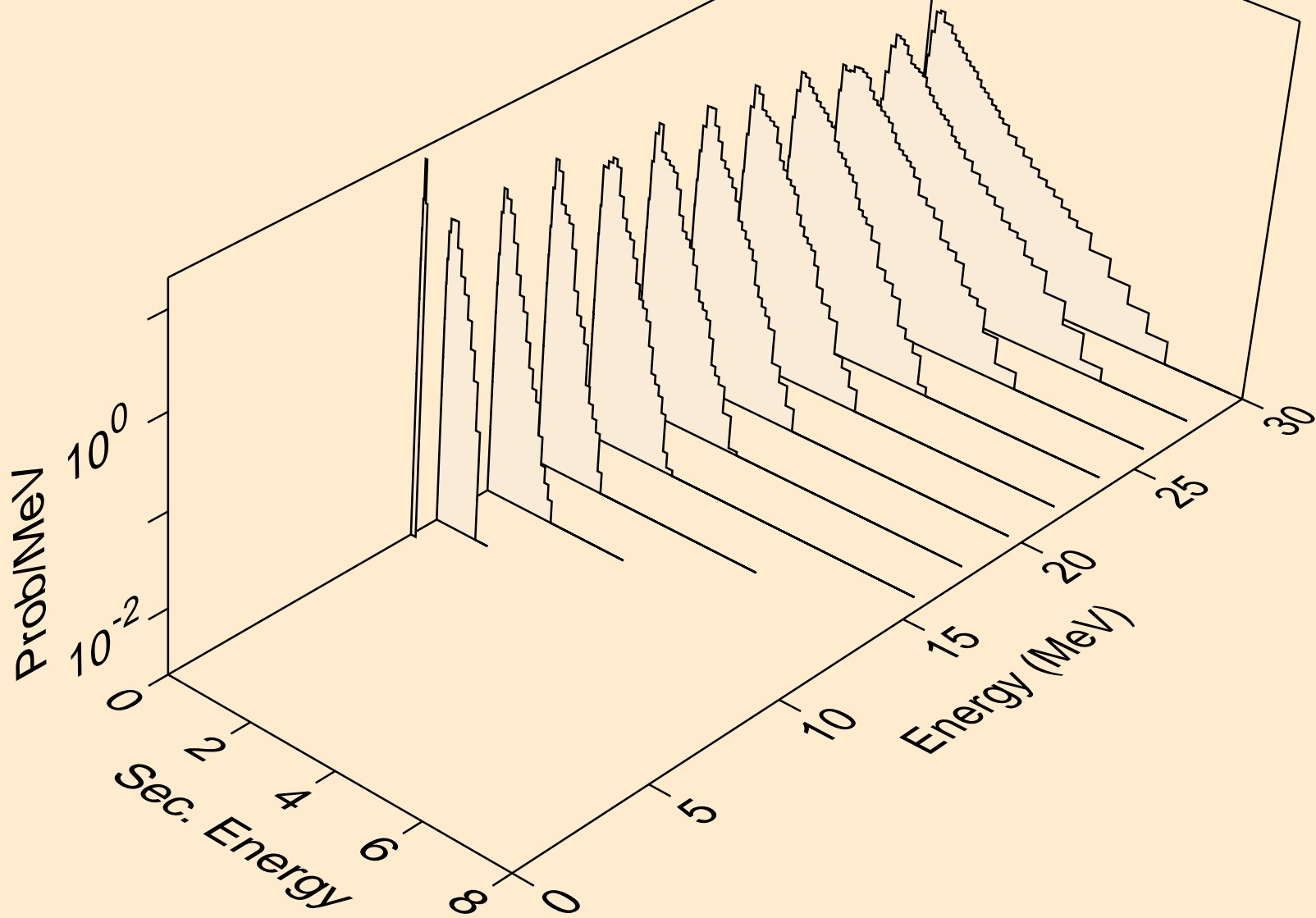

CM240 NEUTRON ACER TENDL-2021 LIBRARY; T=293.6K
Neutron emission for (n,3n)a

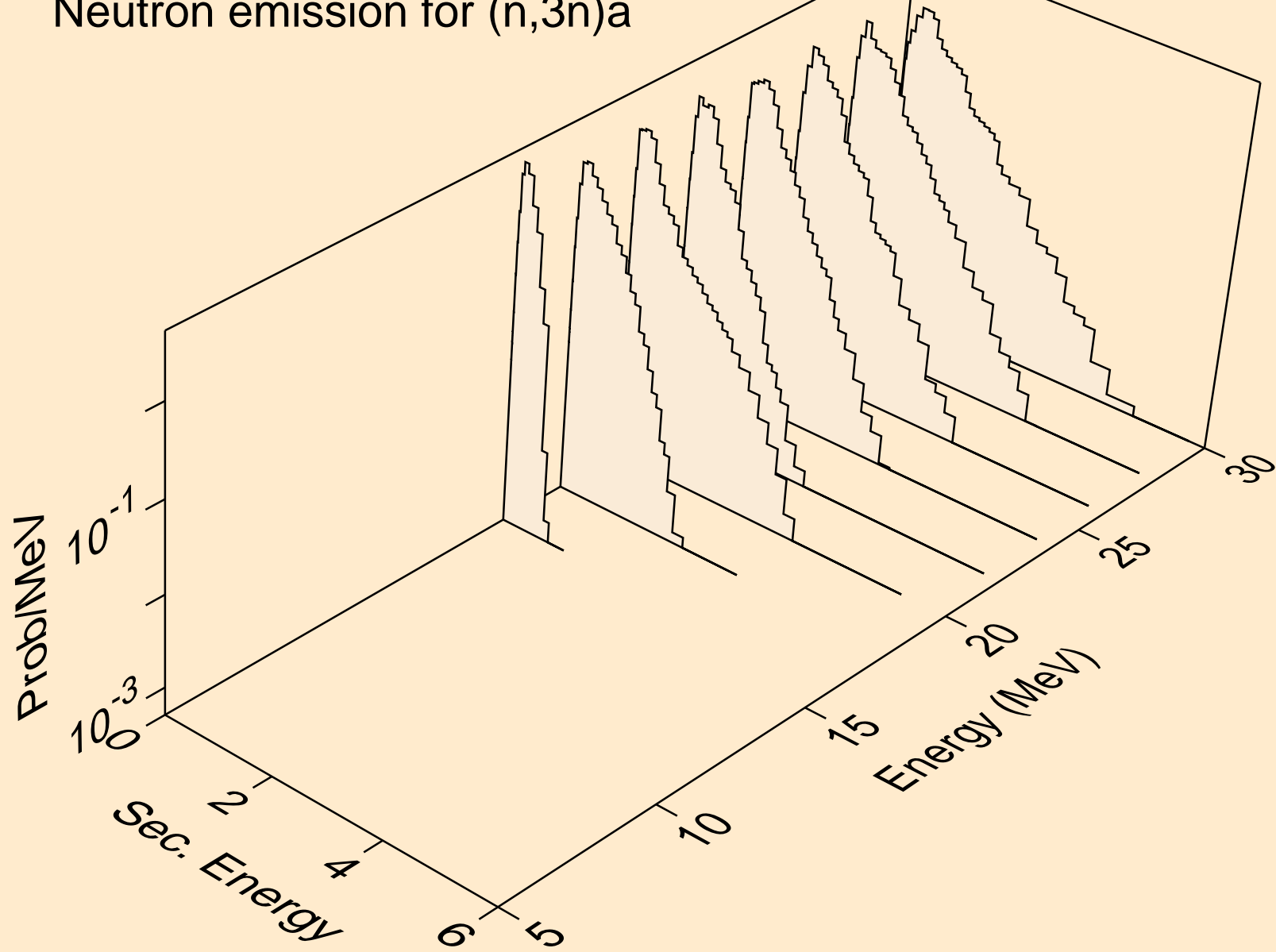

CM240 NEUTRON ACER TENDL-2021 LIBRARY; T=293.6K
Neutron emission for (n,n*)p

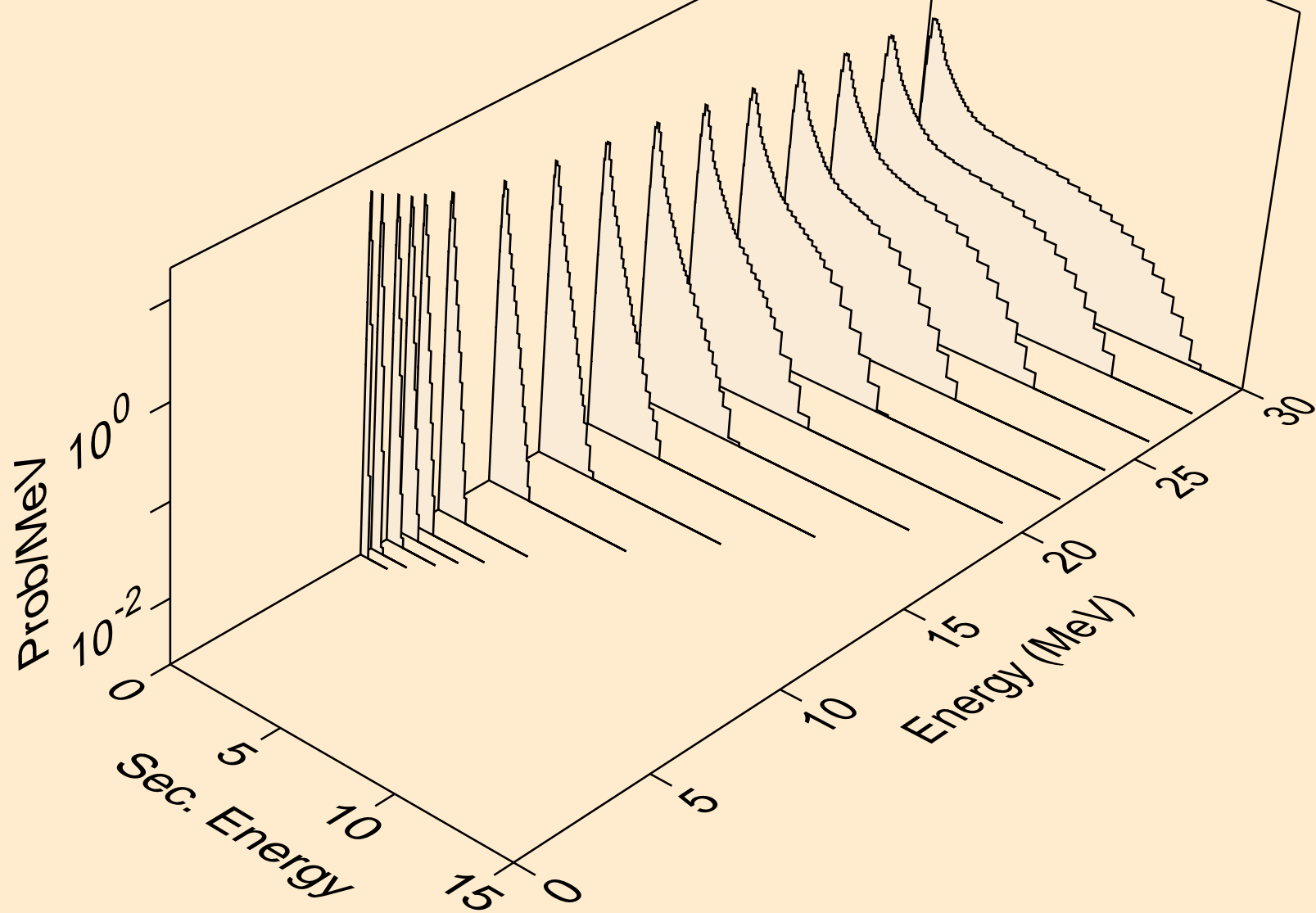

CM240 NEUTRON ACER TENDL-2021 LIBRARY; T=293.6K
Neutron emission for (n,n*)2a

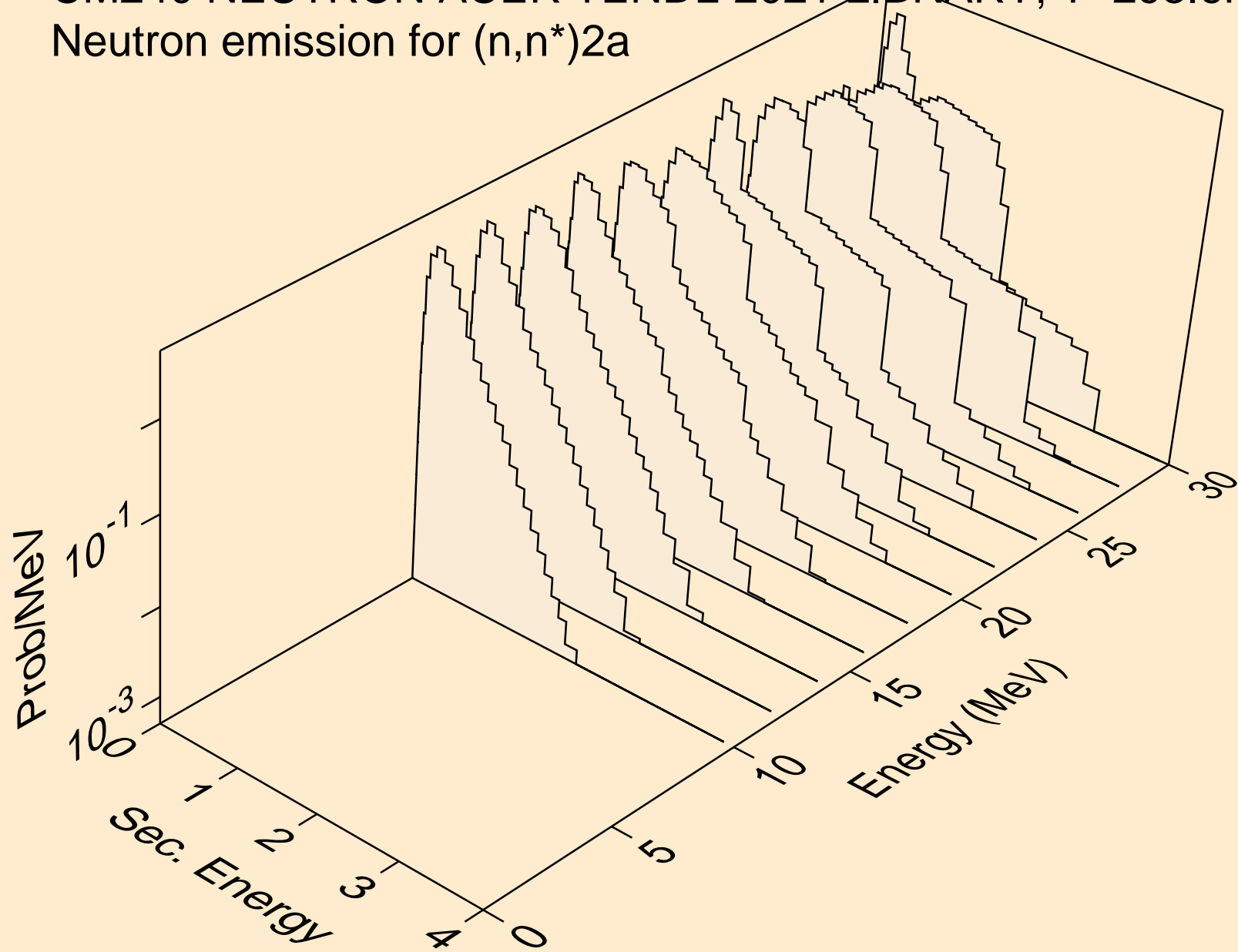

CM240 NEUTRON ACER TENDL-2021 LIBRARY; T=293.6K
Neutron emission for (n,2n)2a

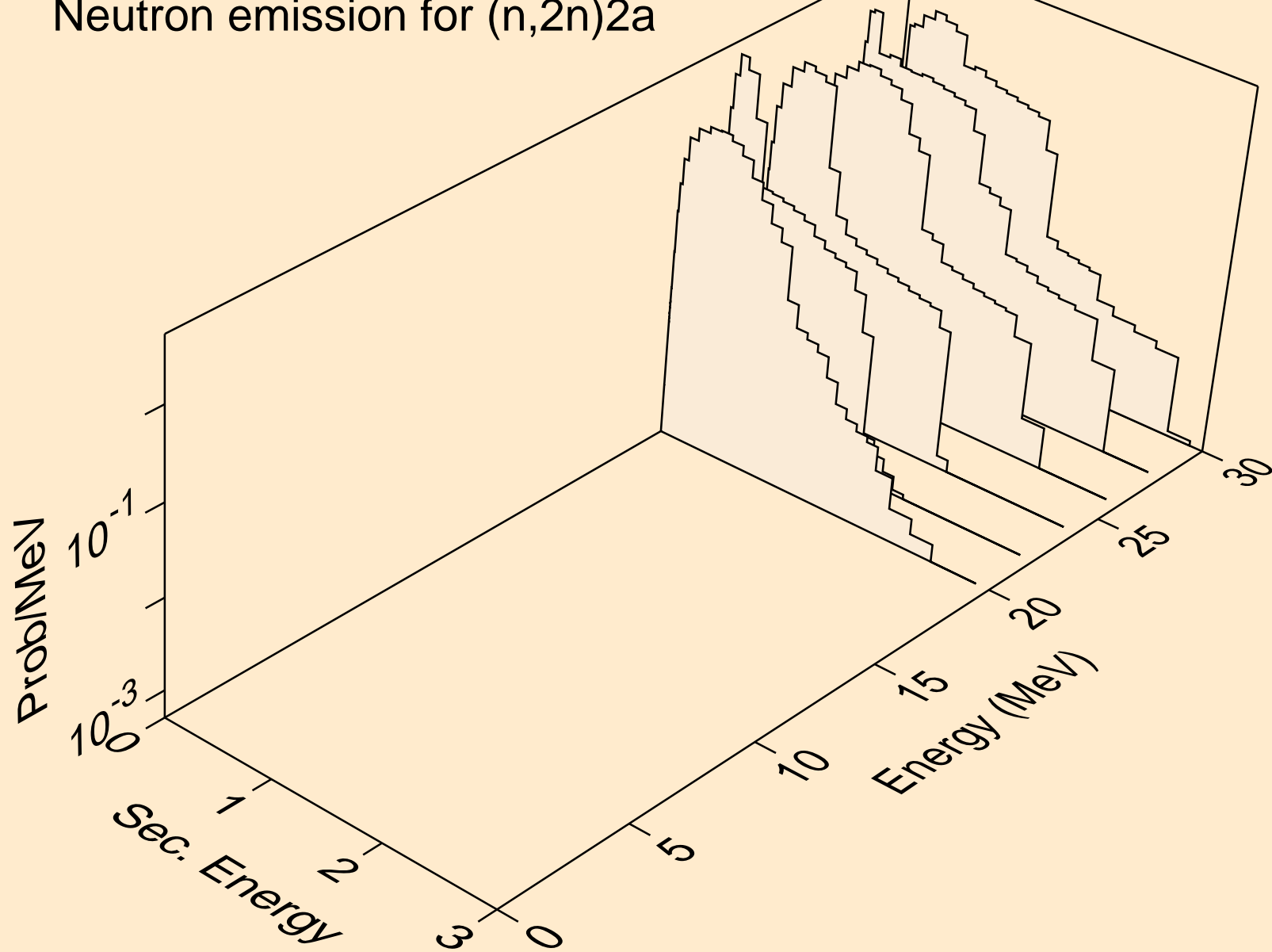

CM240 NEUTRON ACER TENDL-2021 LIBRARY; T=293.6K
Neutron emission for (n,n*)d

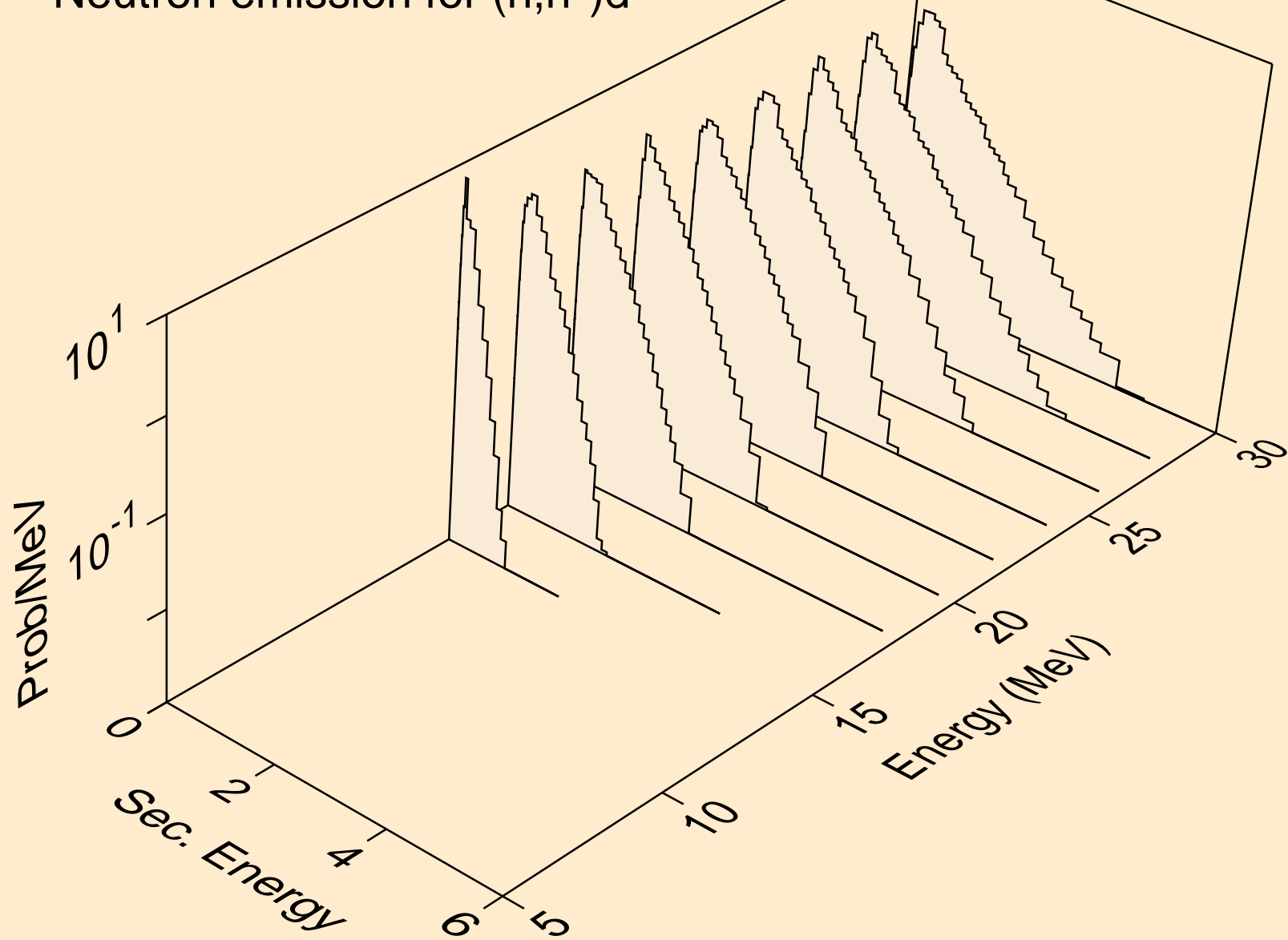

CM240 NEUTRON ACER TENDL-2021 LIBRARY; T=293.6K
Neutron emission for (n,n*)t

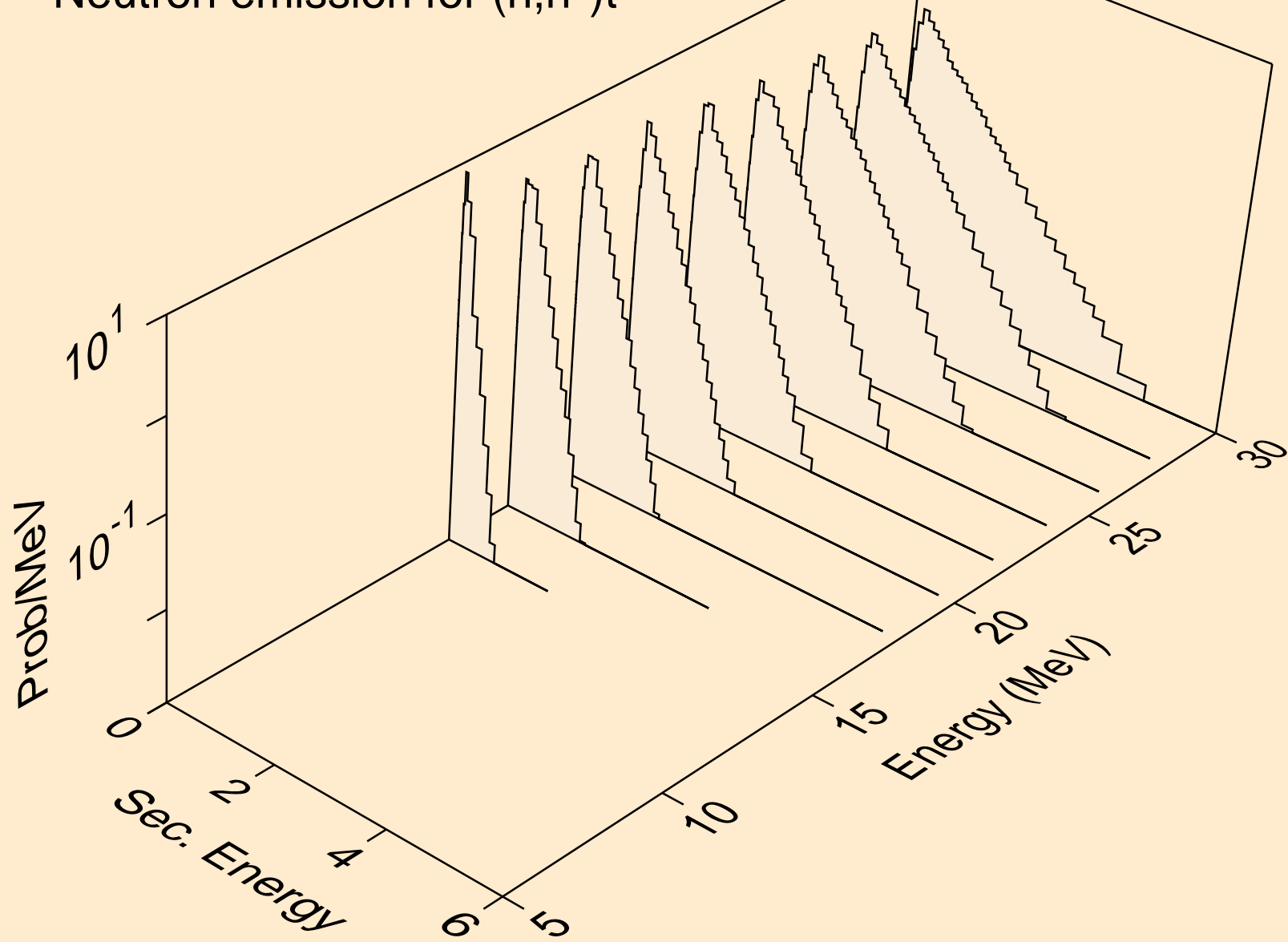

CM240 NEUTRON ACER TENDL-2021 LIBRARY; T=293.6K
Neutron emission for (n,n*)he3

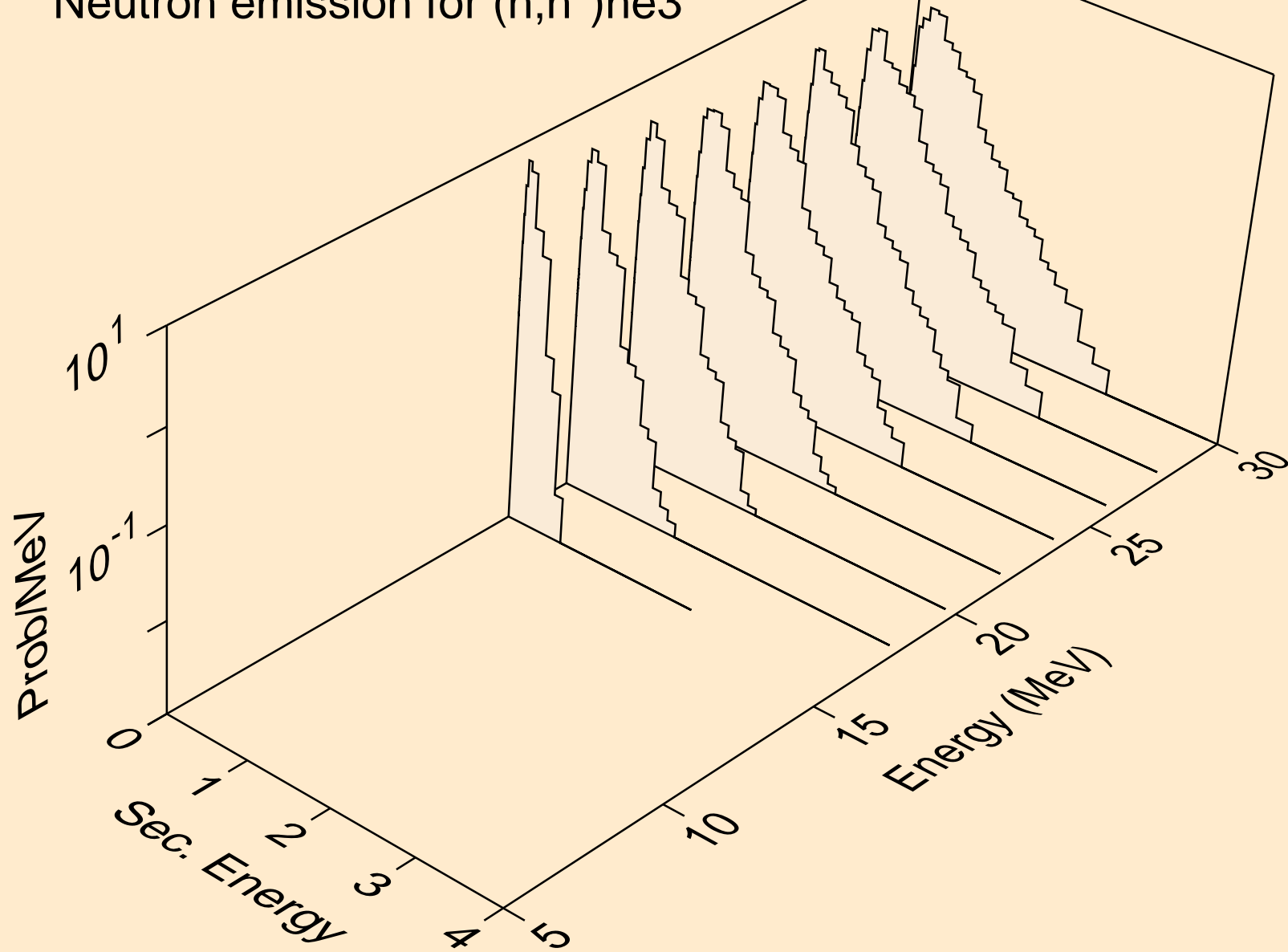

CM240 NEUTRON ACER TENDL-2021 LIBRARY; T=293.6K
Neutron emission for (n,4n)

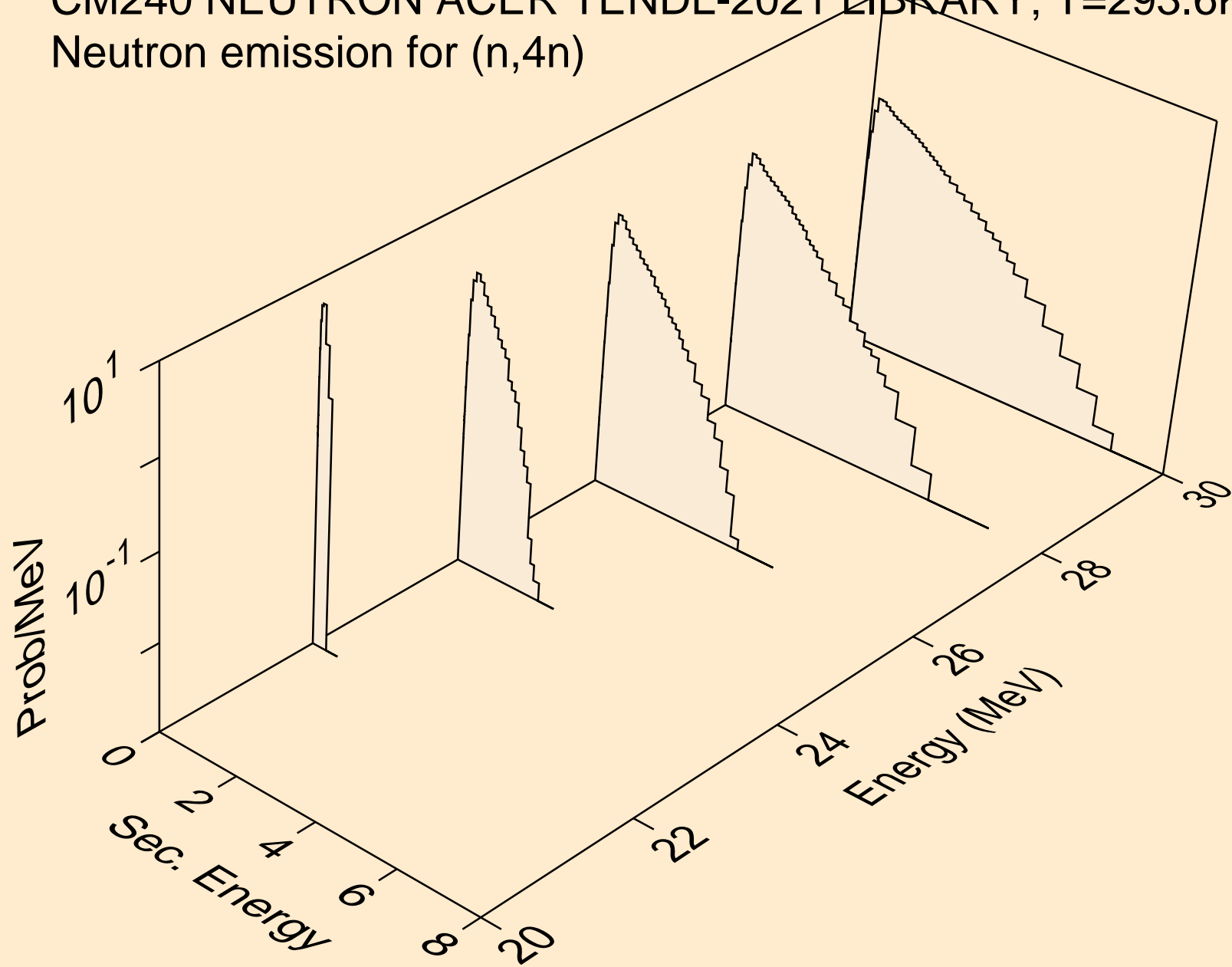

CM240 NEUTRON ACER TENDL-2021 LIBRARY; T=293.6K
Neutron emission for (n,2np)

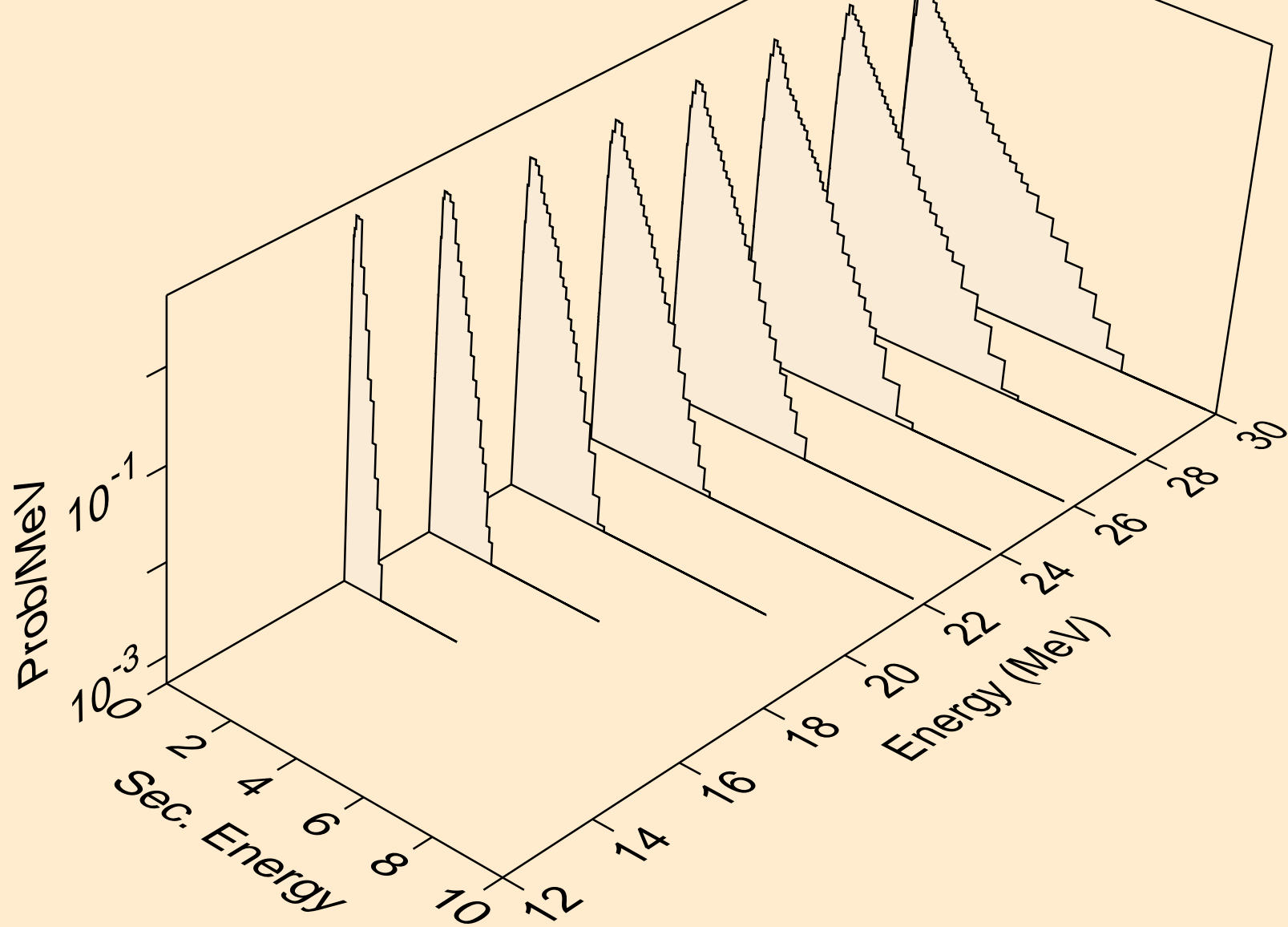

CM240 NEUTRON ACER TENDL-2021 LIBRARY; T=293.6K
Neutron emission for (n,3np)

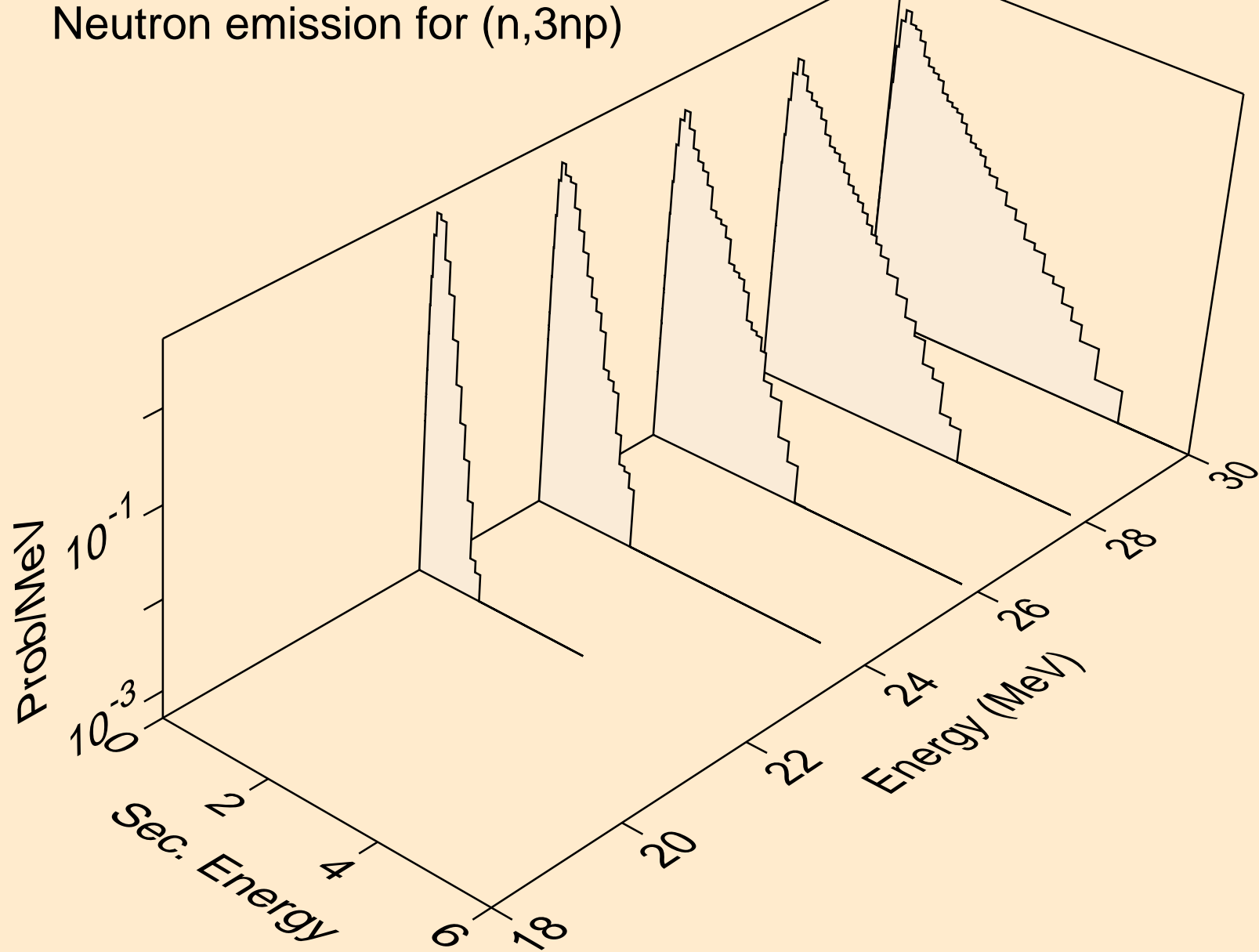

CM240 NEUTRON ACER TENDL-2021 LIBRARY; T=293.6K
Neutron emission for (n,2np)

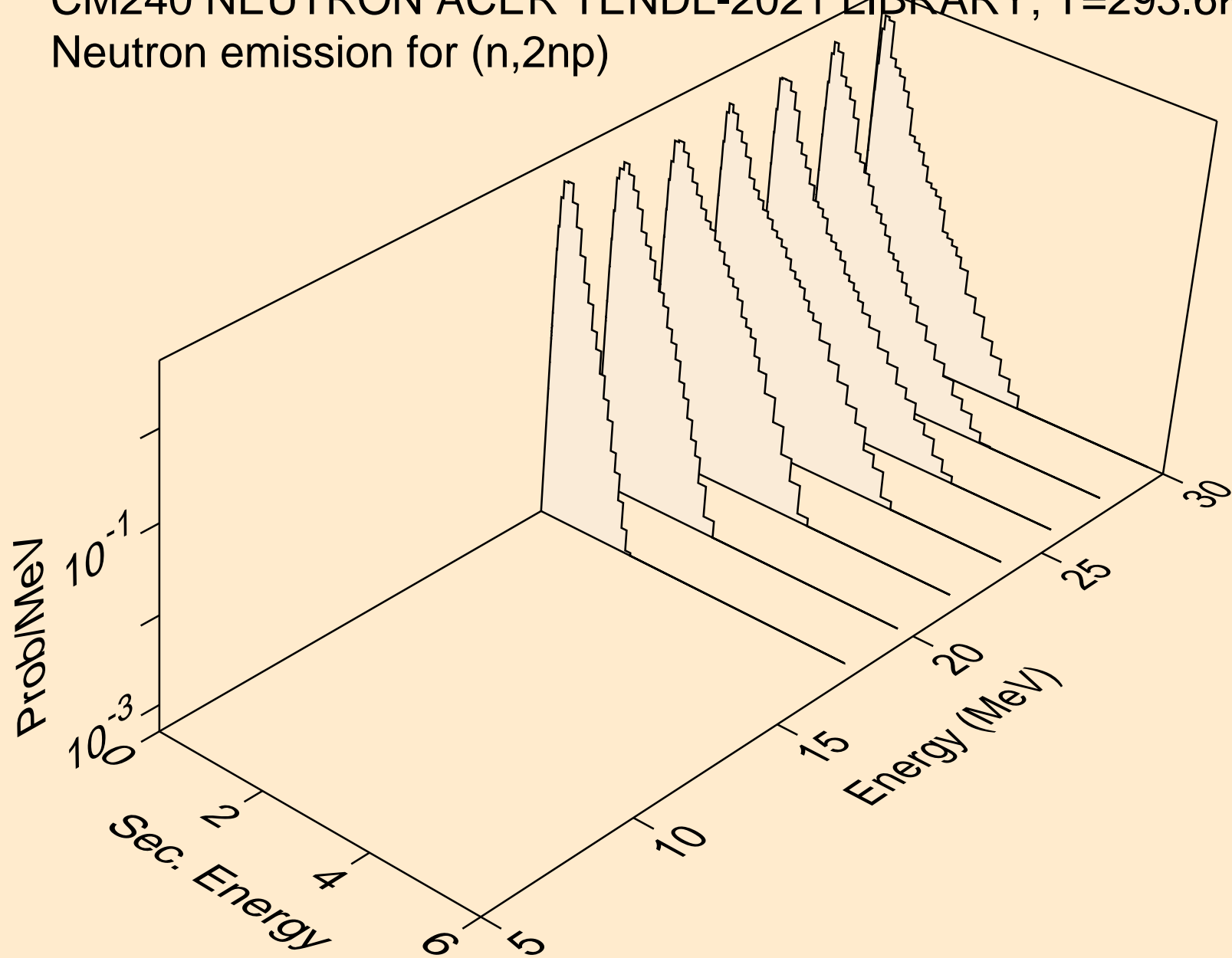

CM240 NEUTRON ACER TENDL-2021 LIBRARY; T=293.6K
Neutron emission for (n,npa)

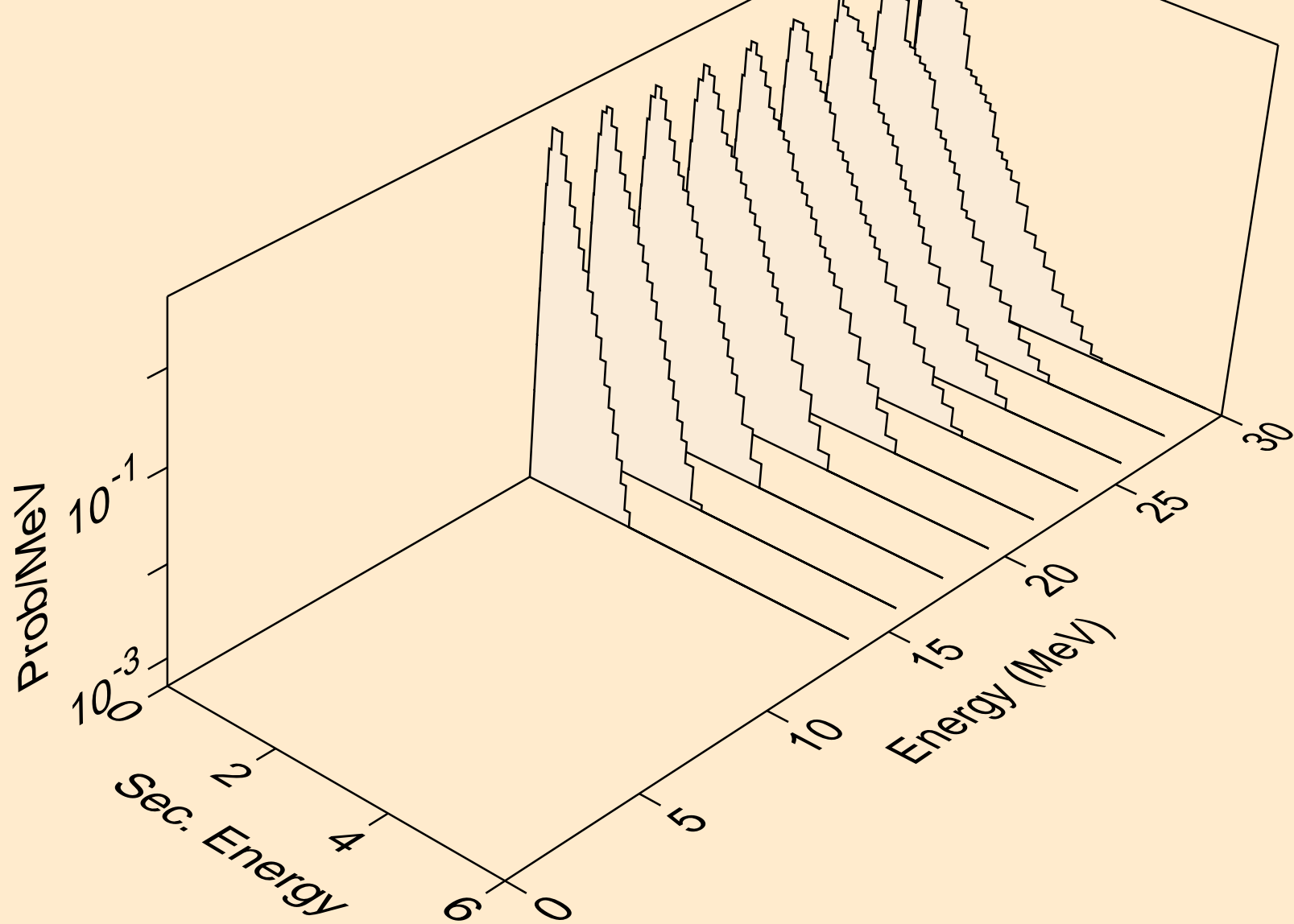

CM240 NEUTRON ACER TENDL-2021 LIBRARY; T=293.6K
Neutron emission for (n,n*c)

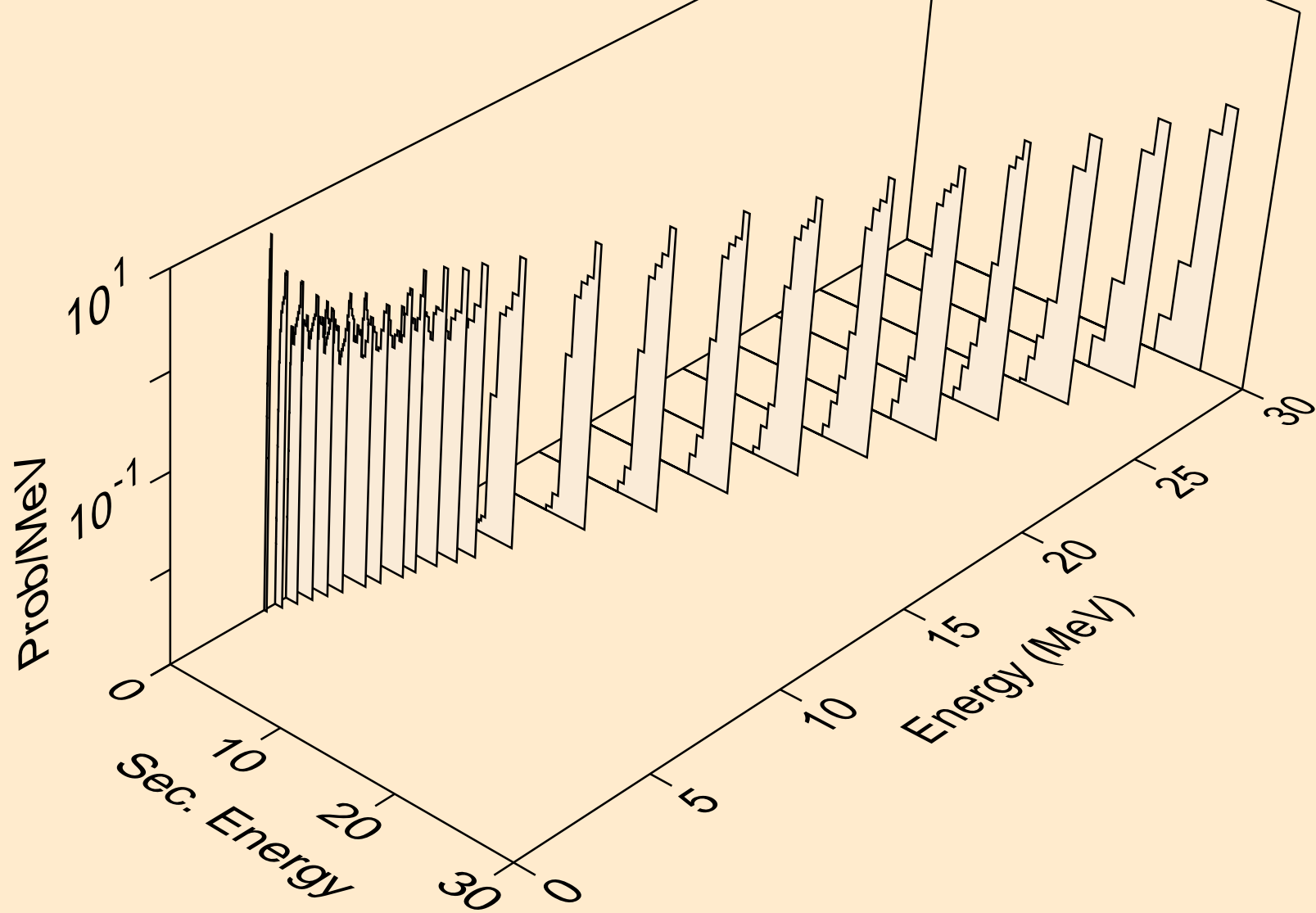

CM240 NEUTRON ACER TENDL-2021 LIBRARY; T=293.6K
Delayed nubar

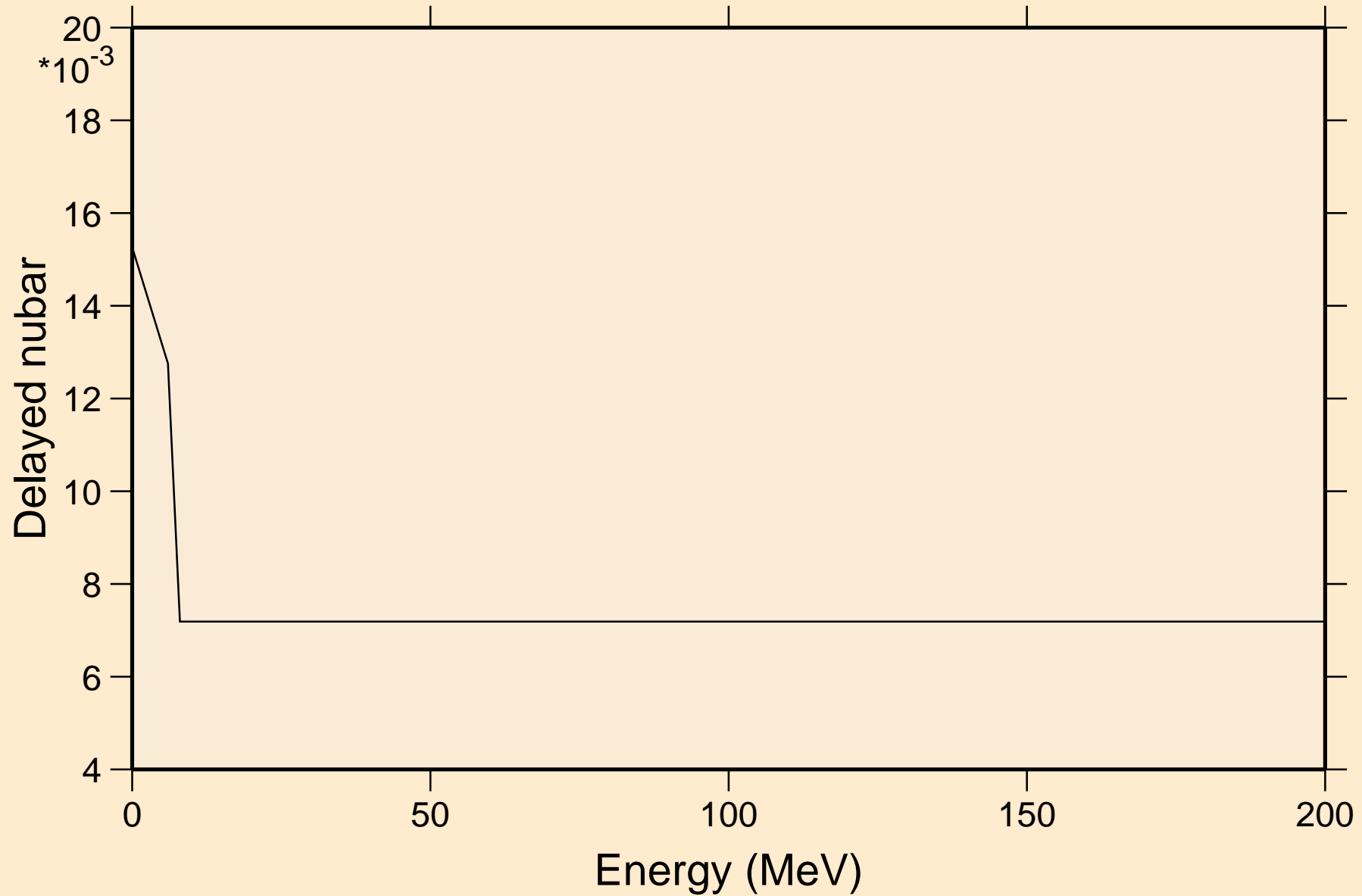

CM240 NEUTRON ACER TENDL-2021 LIBRARY; T=293.6K

Delayed neutron spectra

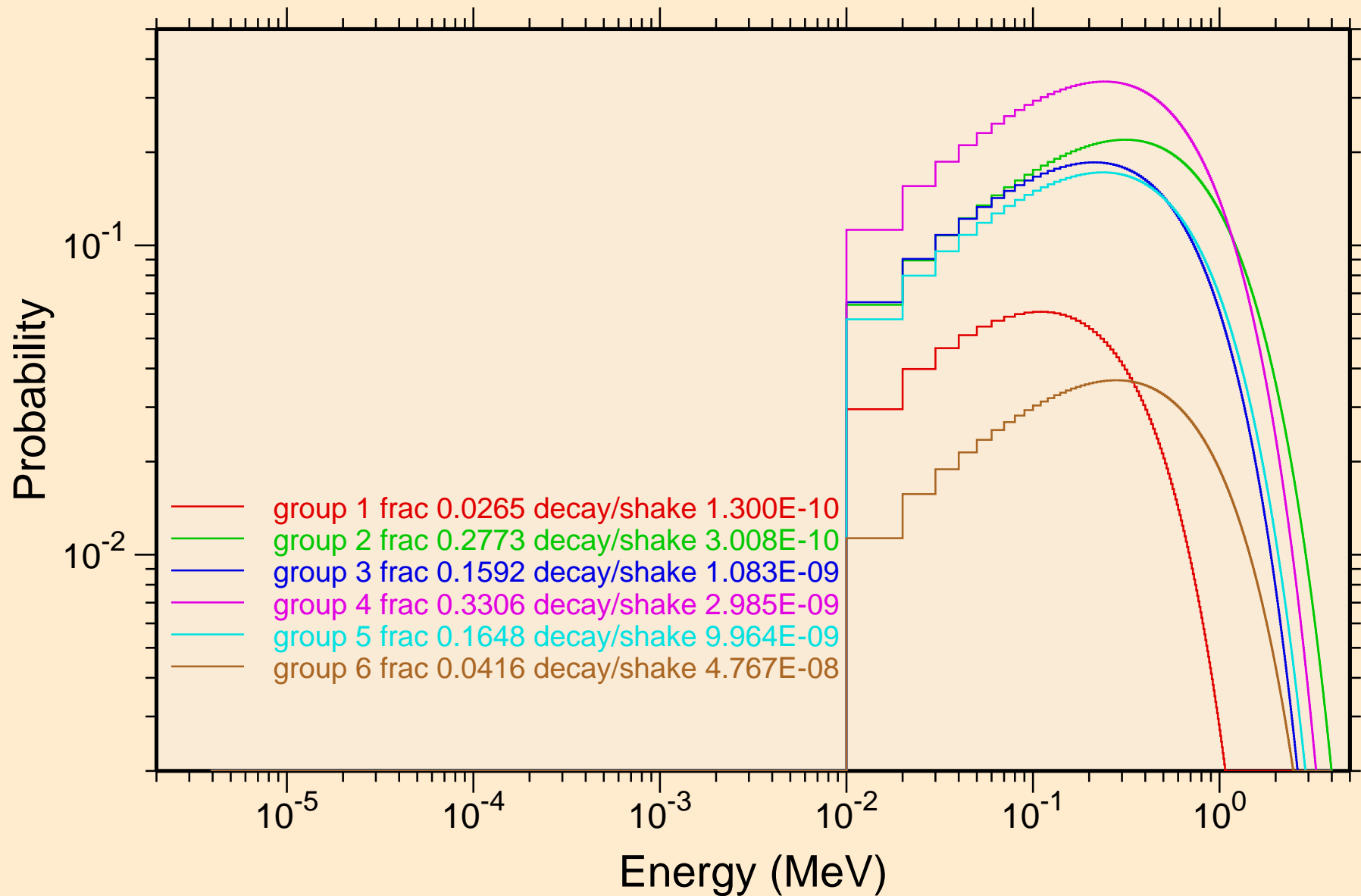

CM240 NEUTRON ACER TENDL-2021 LIBRARY; T=293.6K
Photon emission for (n,x)

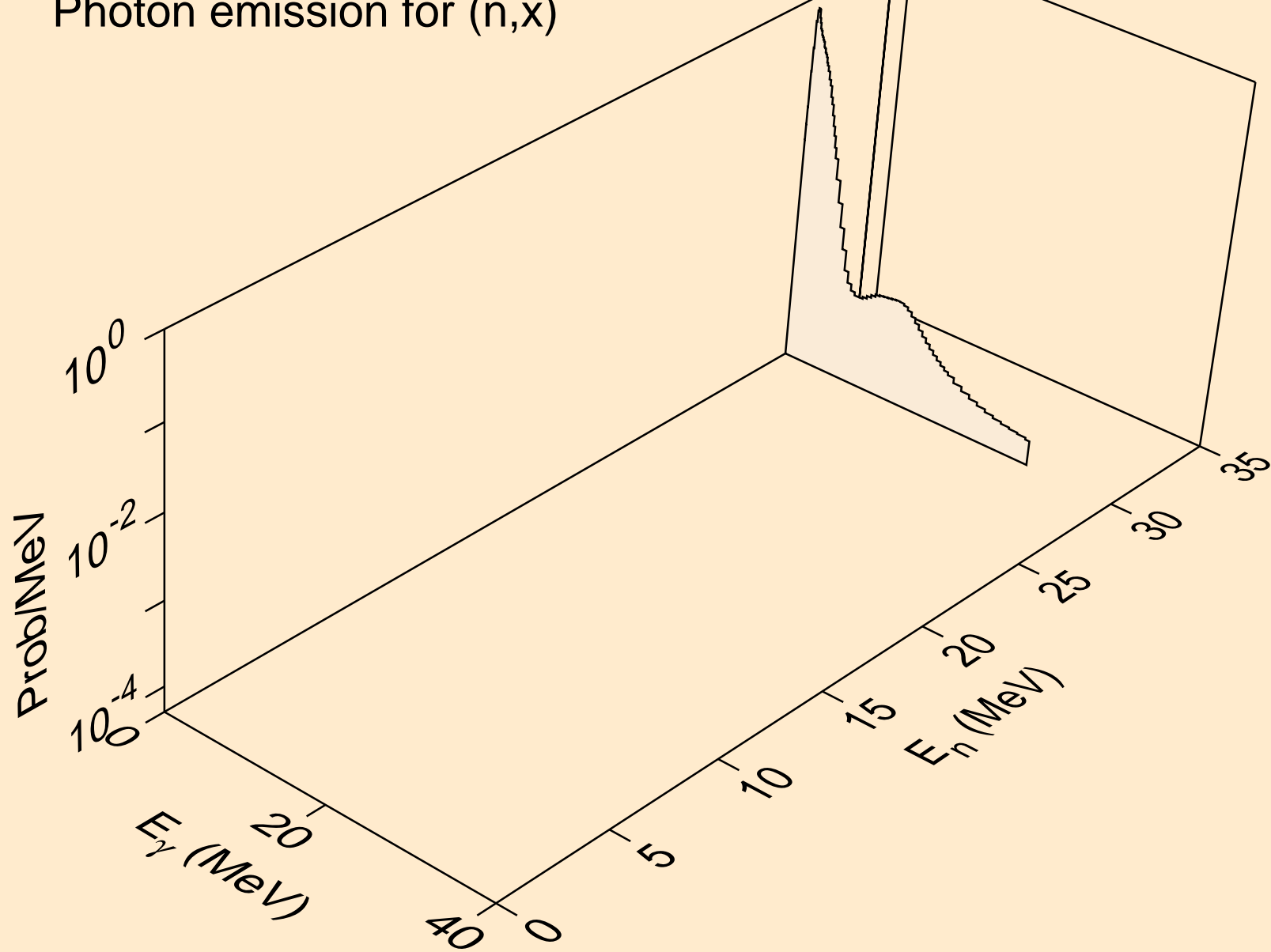

CM240 NEUTRON ACER TENDL-2021 LIBRARY; T=293.6K
Photon emission for (n,2nd)

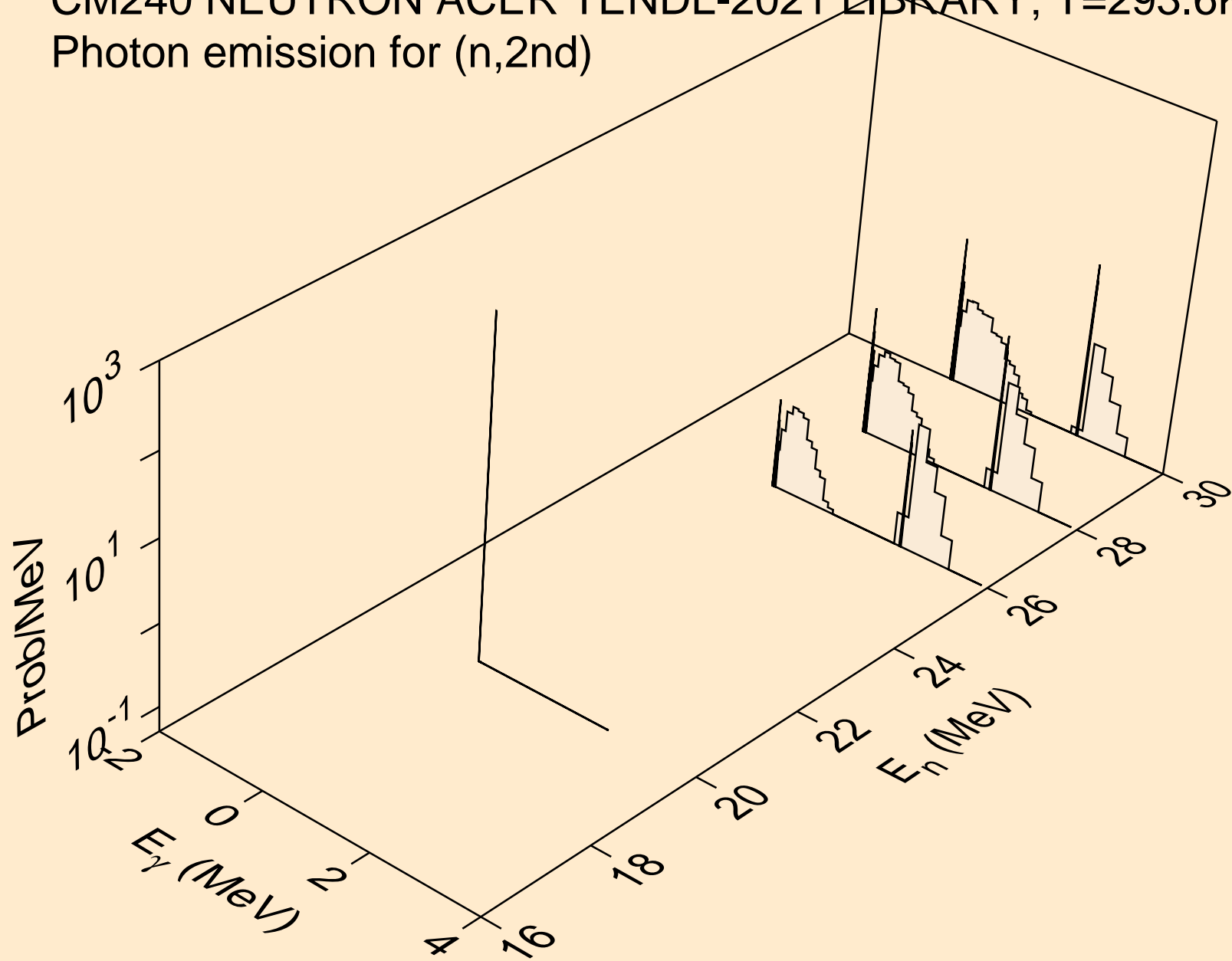

CM240 NEUTRON ACER TENDL-2021 LIBRARY; T=293.6K
Photon emission for (n,2n)

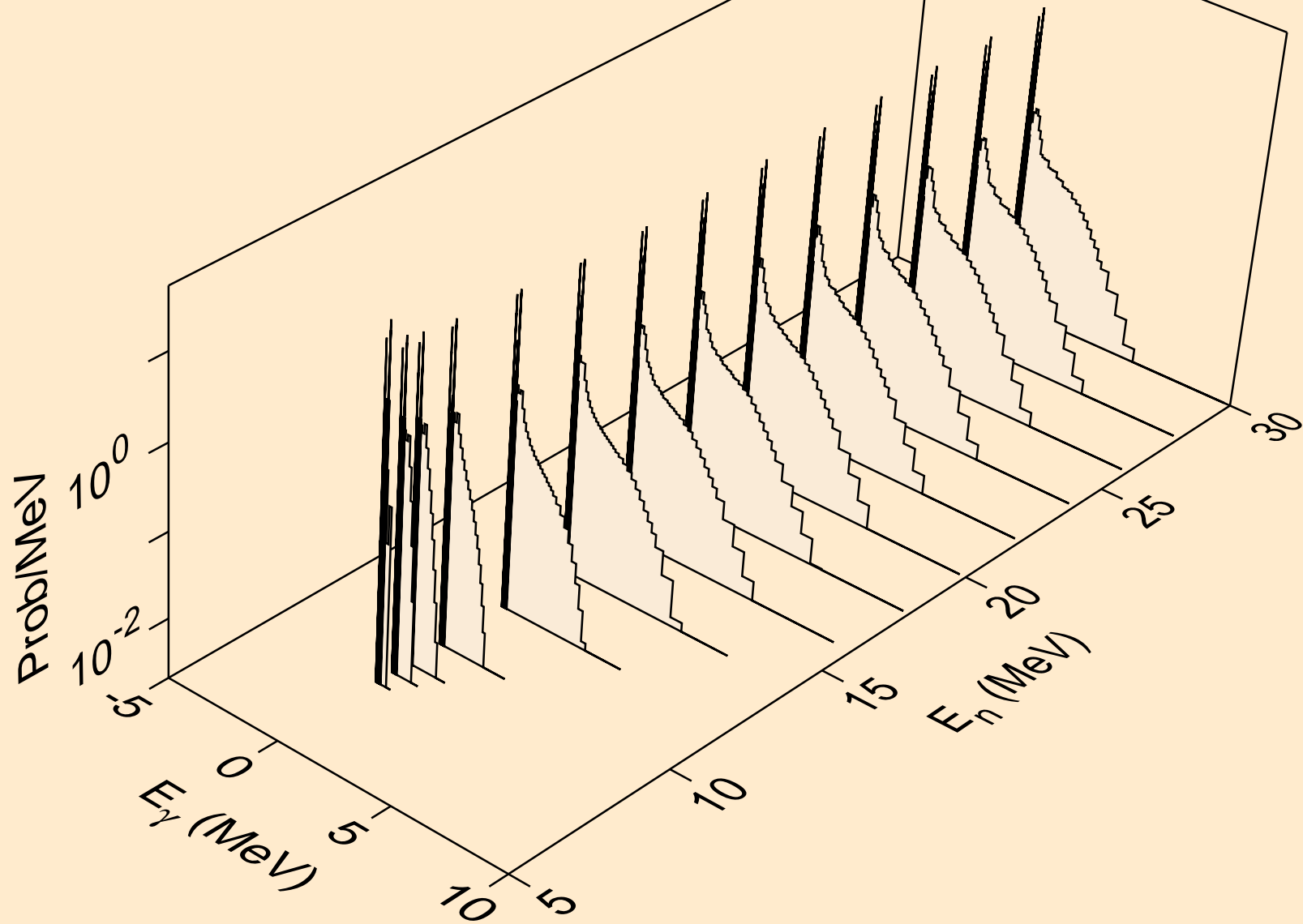

CM240 NEUTRON ACER TENDL-2021 LIBRARY; T=293.6K
Photon emission for (n,3n)

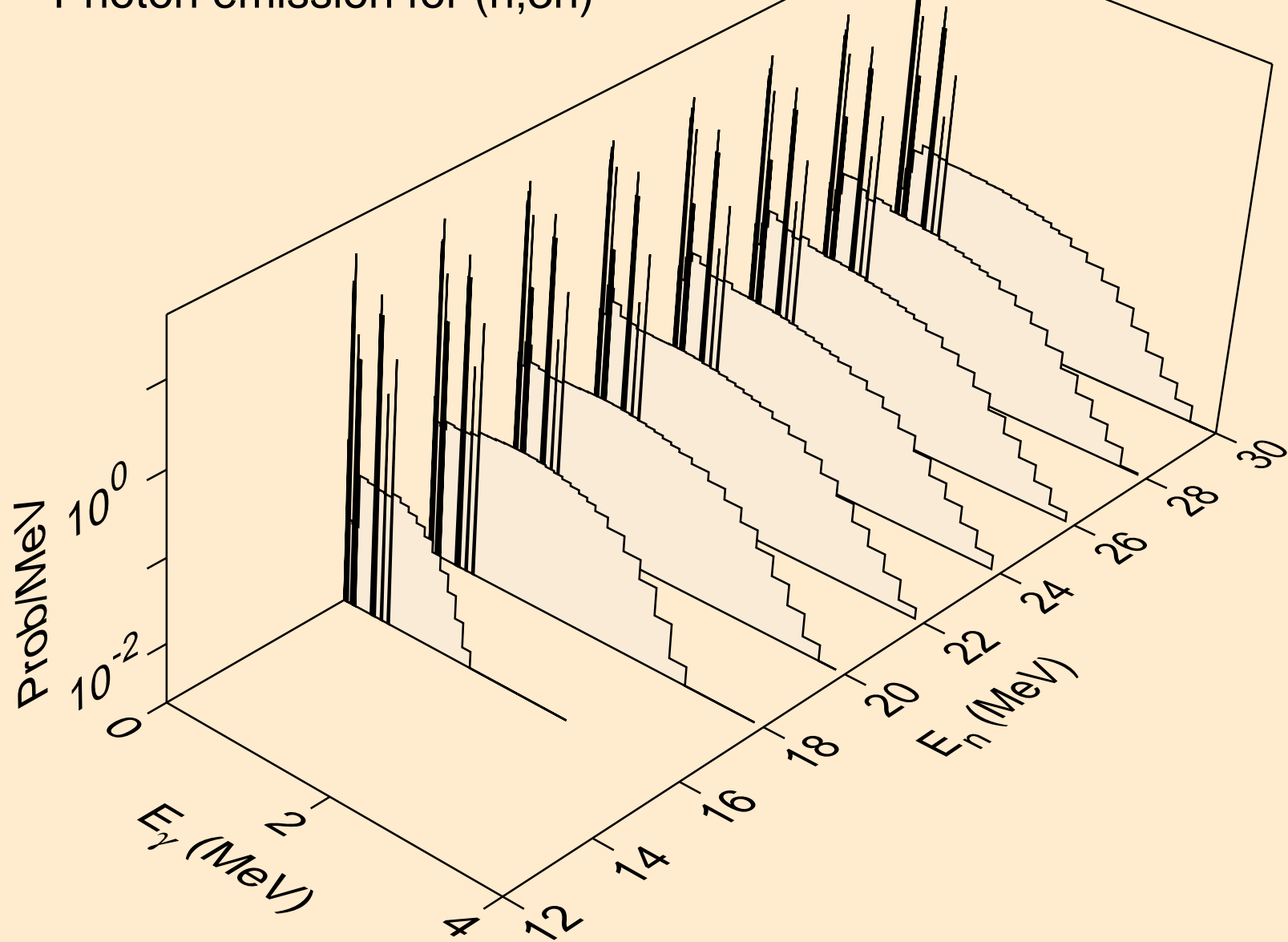

CM240 NEUTRON ACER TENDL-2021 LIBRARY; T=293.6K
Photon emission for (n,n*)a

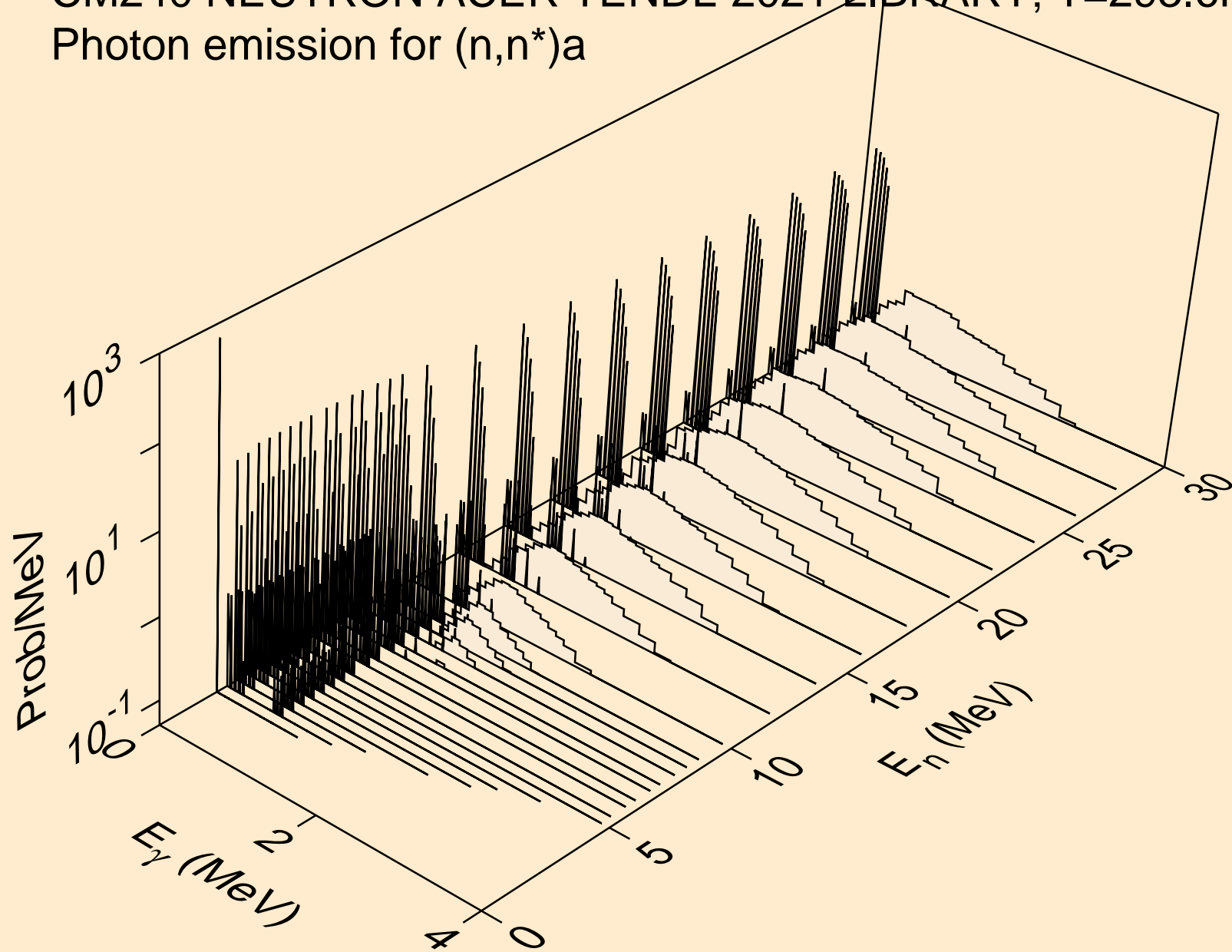

CM240 NEUTRON ACER TENDL-2021 LIBRARY; T=293.6K
Photon emission for (n,2n)a

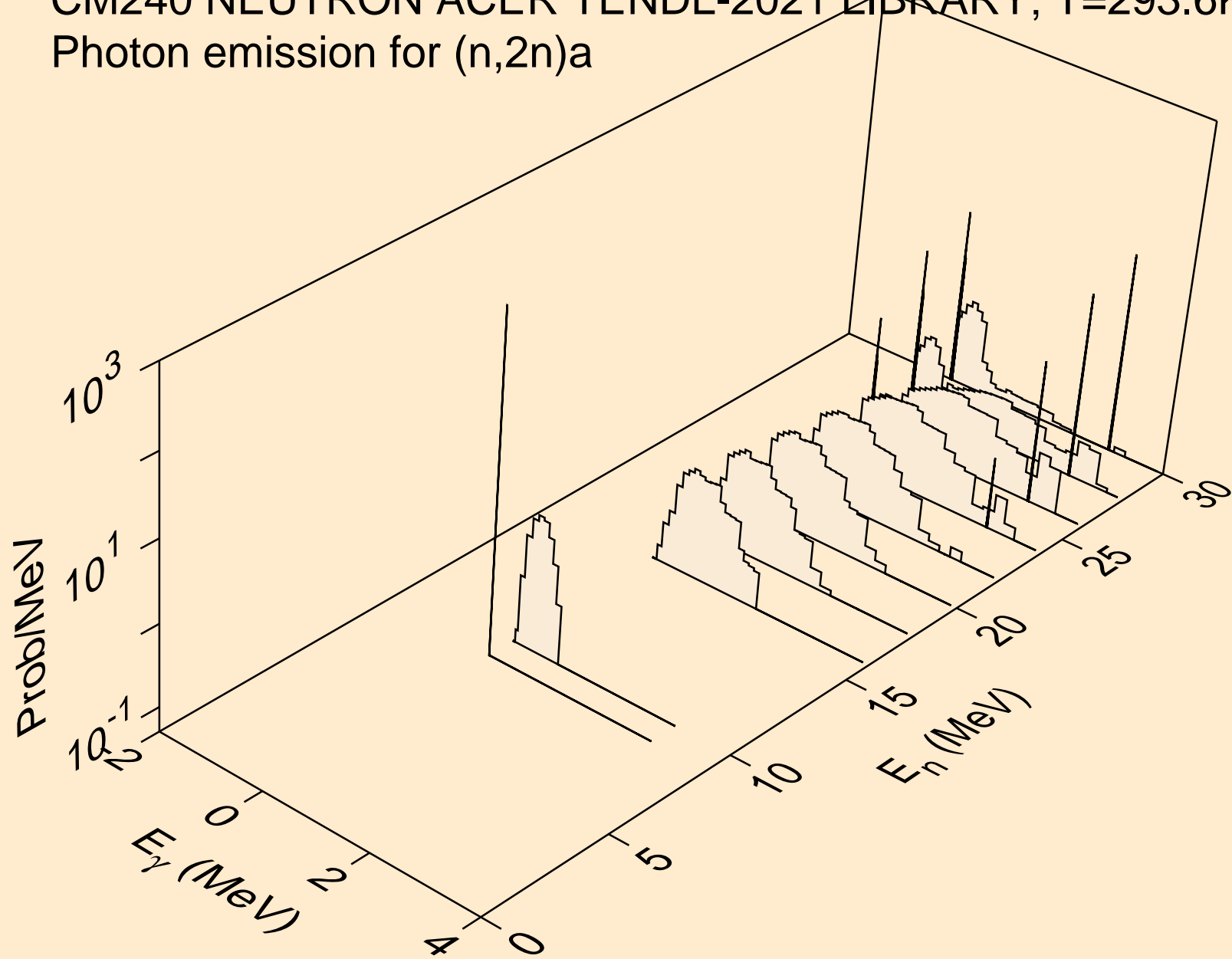

CM240 NEUTRON ACER TENDL-2021 LIBRARY; T=293.6K
Photon emission for (n,3n)a

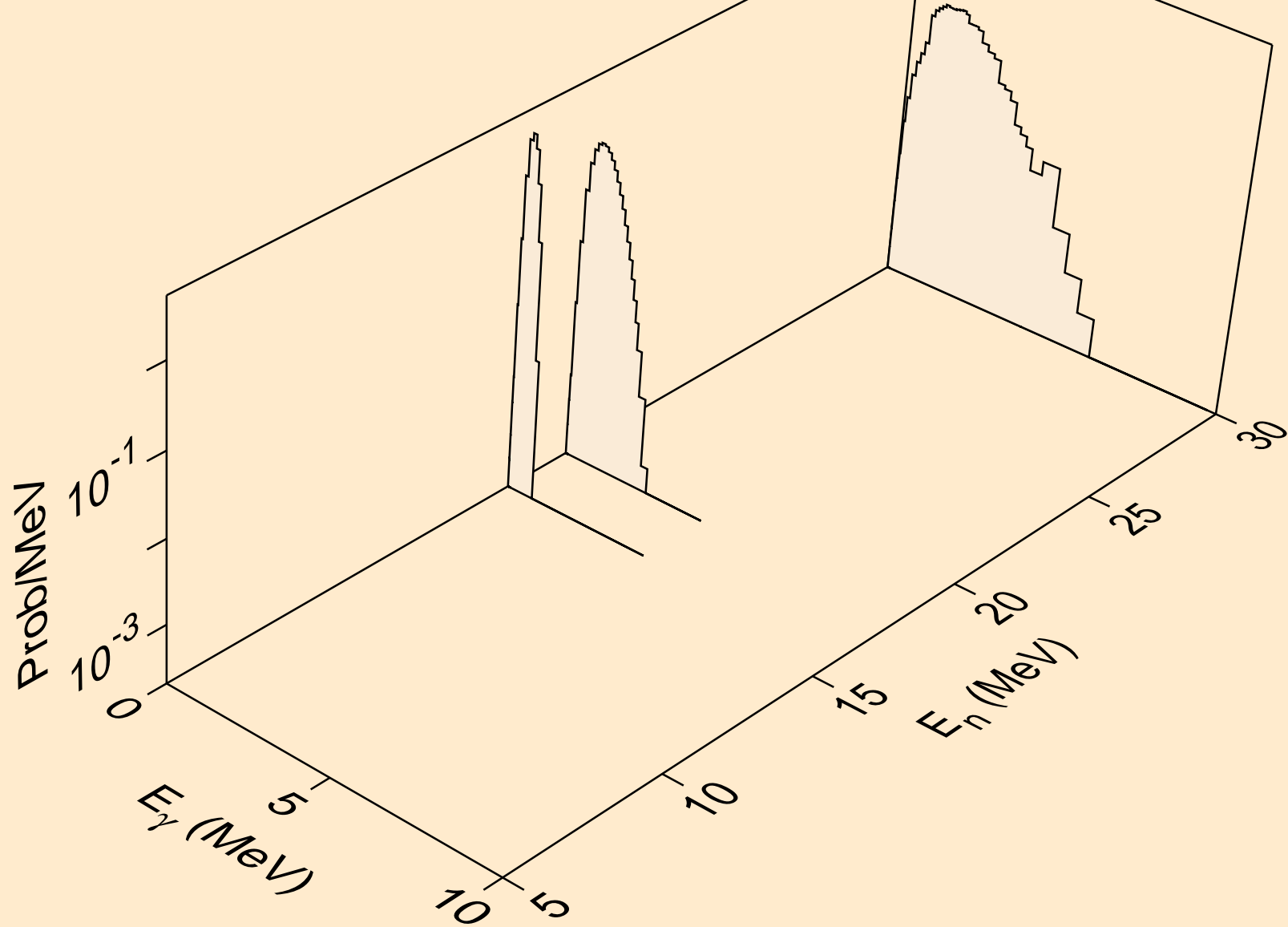

CM240 NEUTRON ACER TENDL-2021 LIBRARY; T=293.6K
Photon emission for (n,n*)p

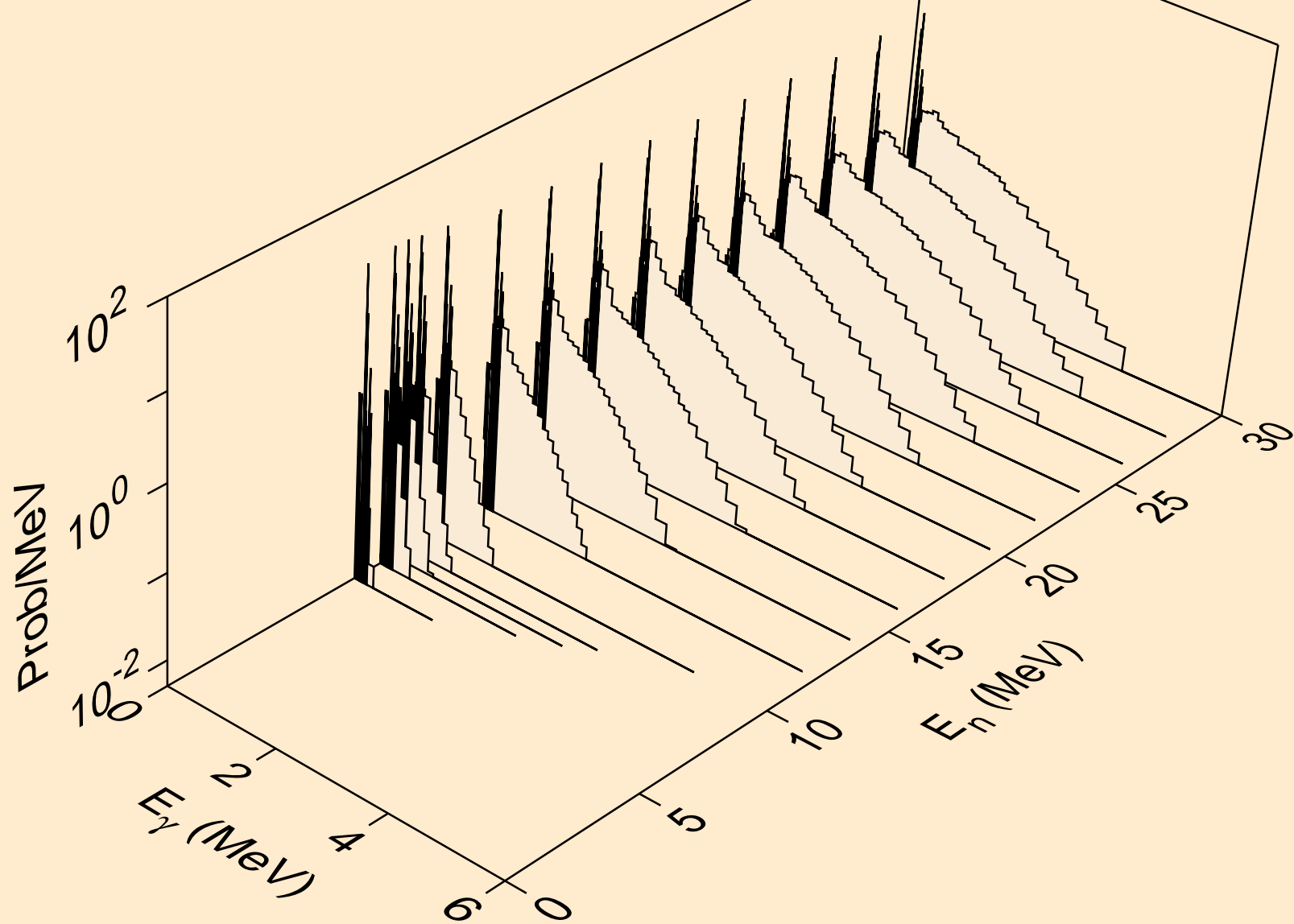

CM240 NEUTRON ACER TENDL-2021 LIBRARY; T=293.6K
Photon emission for (n,n*)2a

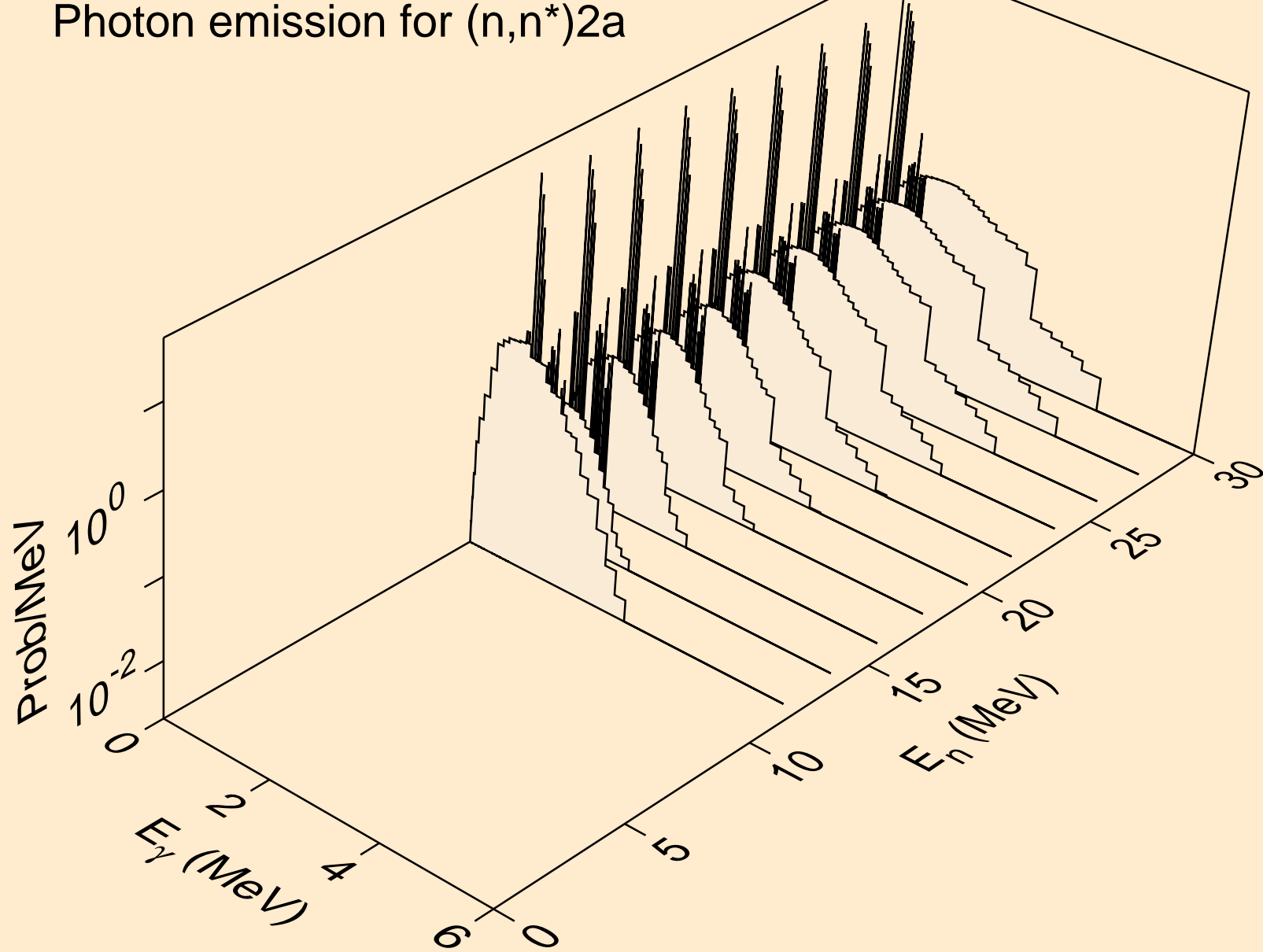

CM240 NEUTRON ACER TENDL-2021 LIBRARY; T=293.6K
Photon emission for (n,2n)2a

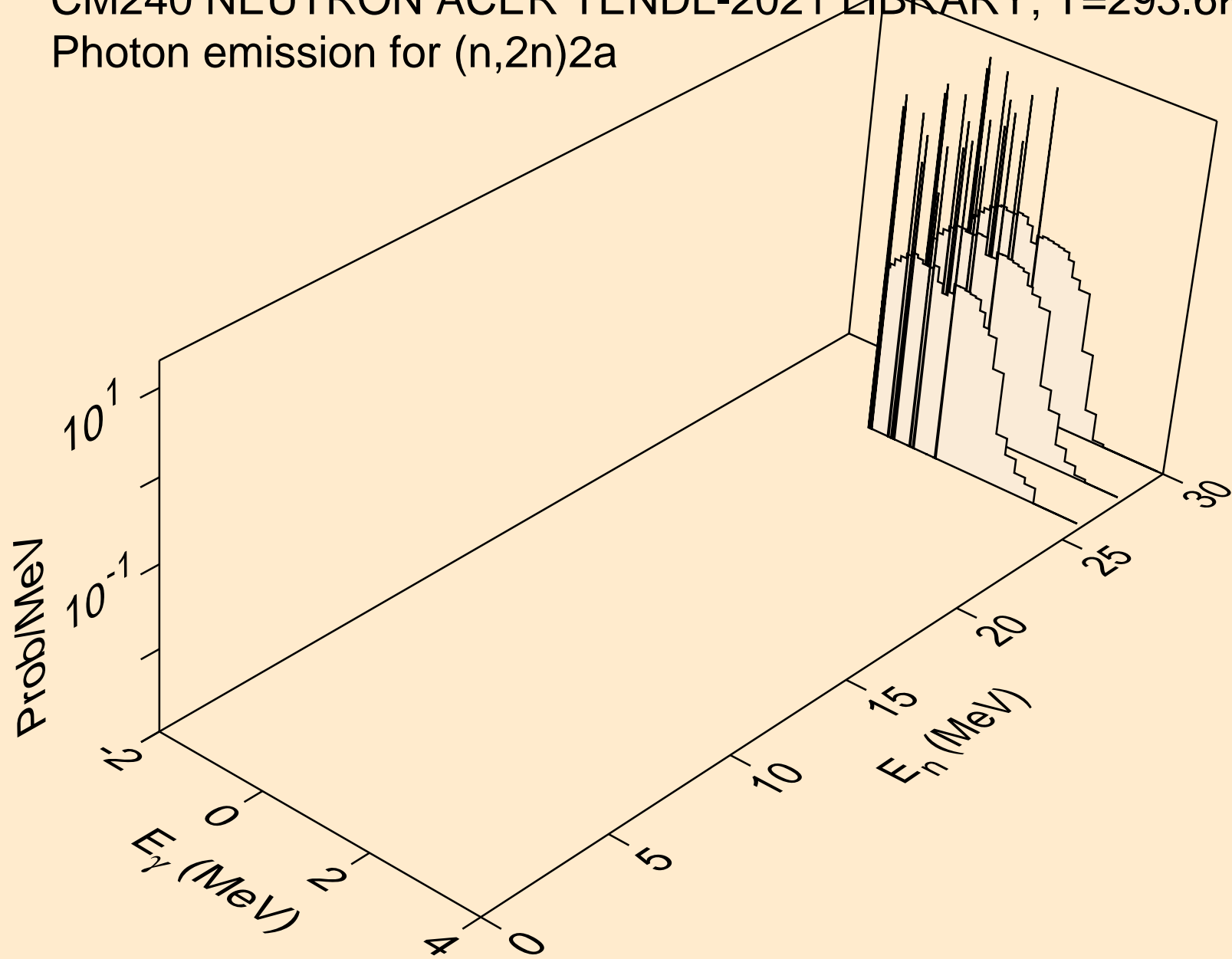

CM240 NEUTRON ACER TENDL-2021 LIBRARY; T=293.6K
Photon emission for (n,n*)d

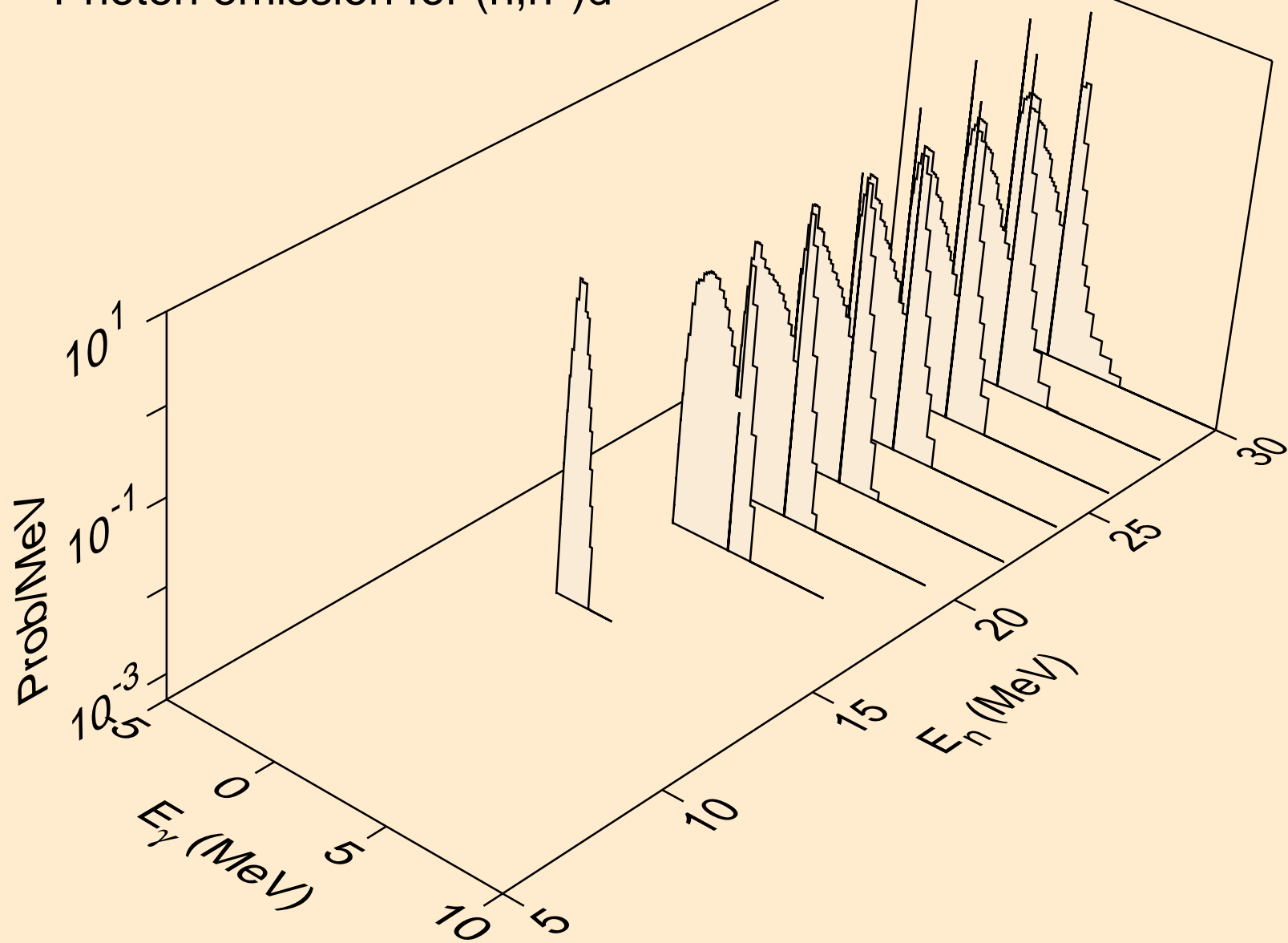

CM240 NEUTRON ACER TENDL-2021 LIBRARY; T=293.6K
Photon emission for (n,n*)t

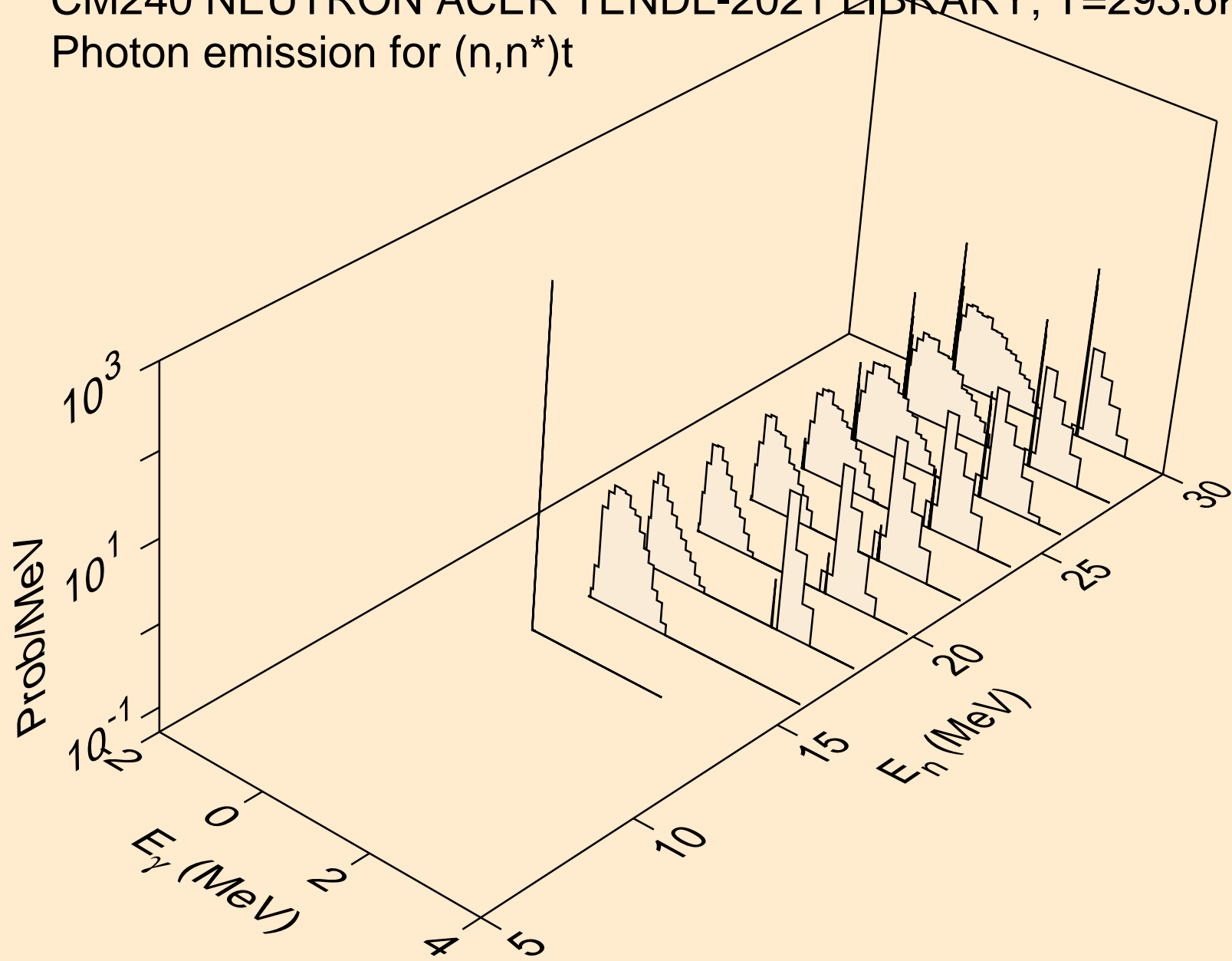

CM240 NEUTRON ACER TENDL-2021 LIBRARY; T=293.6K
Photon emission for (n,n*)he3

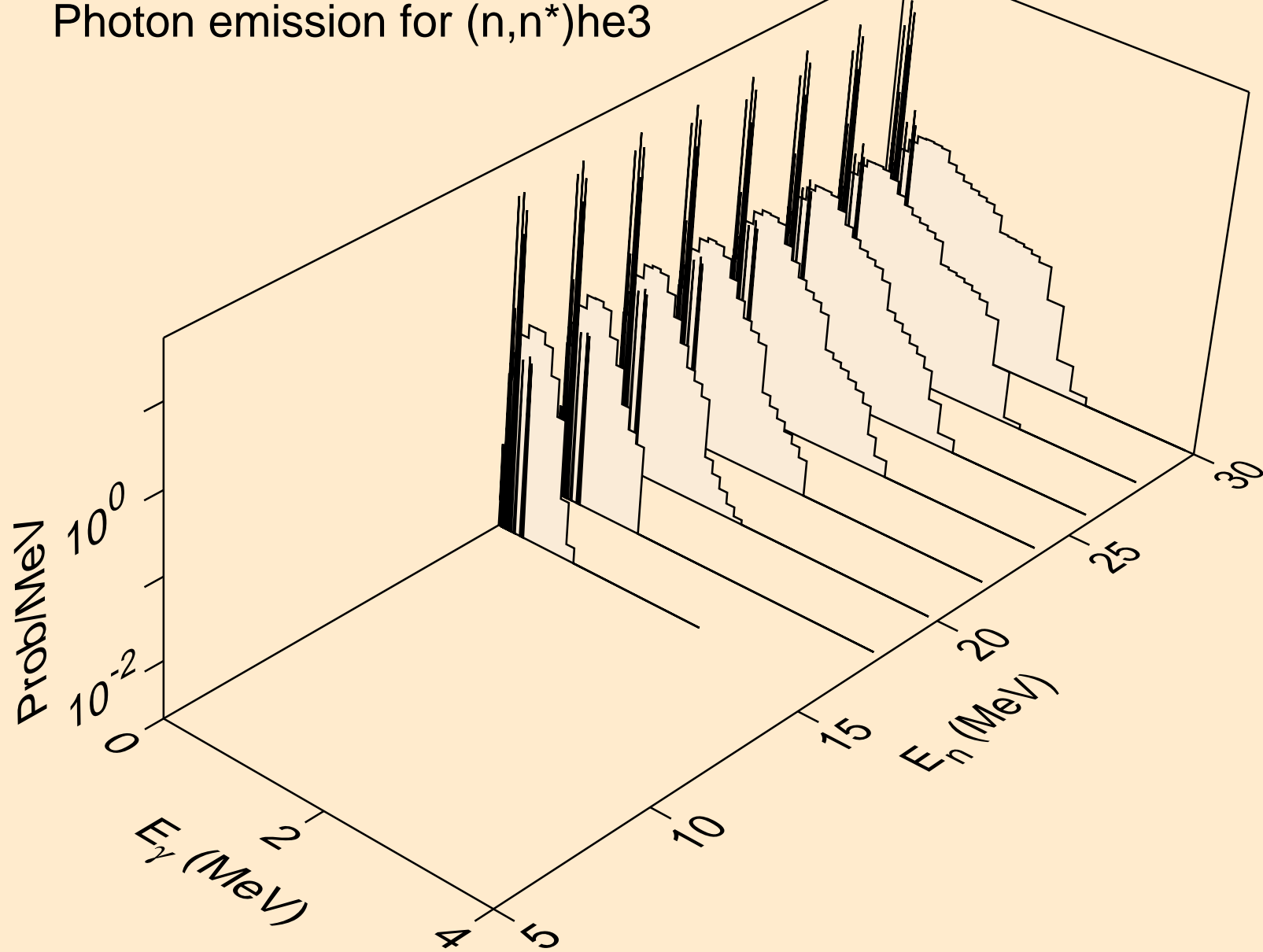

CM240 NEUTRON ACER TENDL-2021 LIBRARY; T=293.6K
Photon emission for (n,4n)

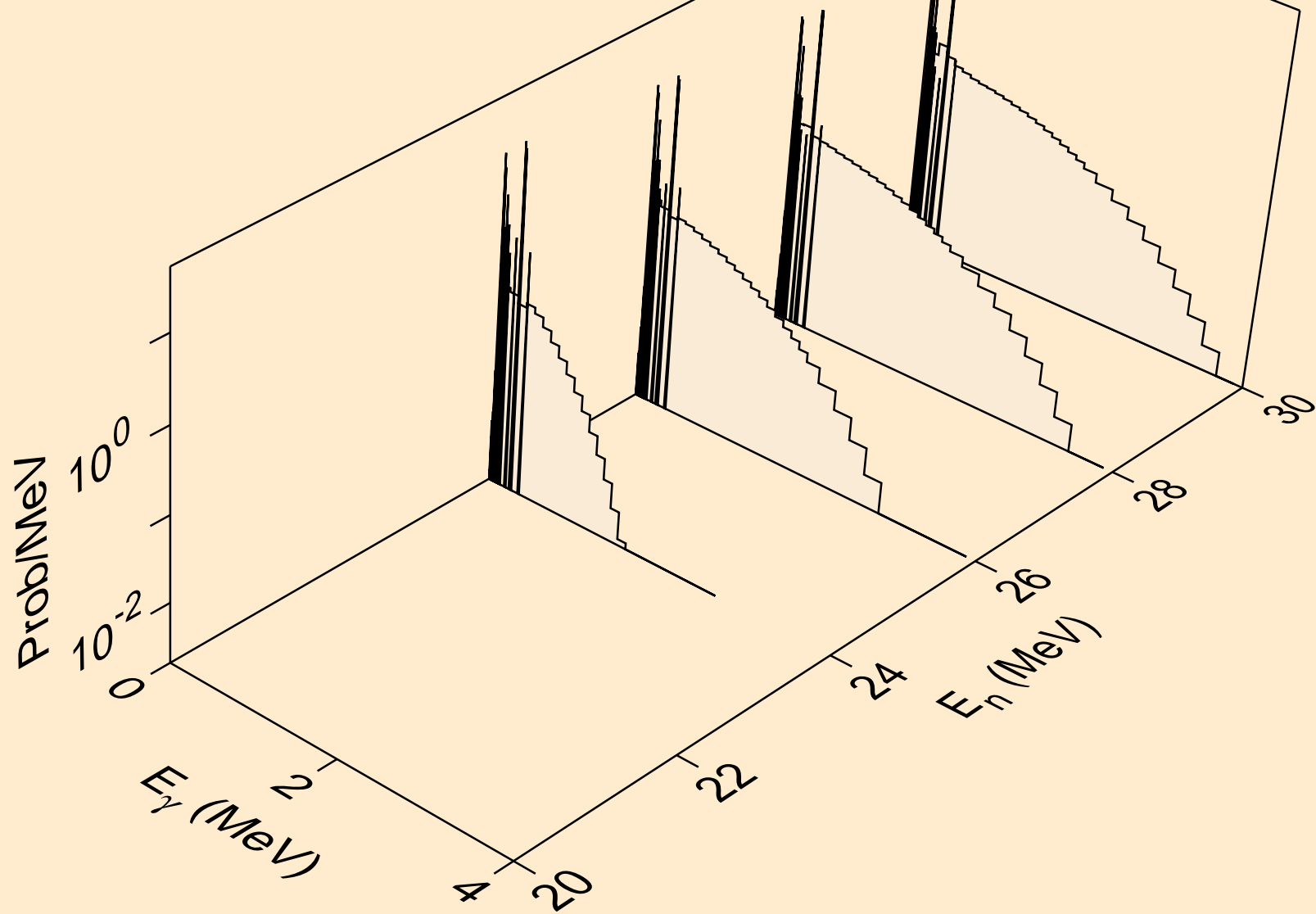

CM240 NEUTRON ACER TENDL-2021 LIBRARY; T=293.6K
Photon emission for (n,2np)

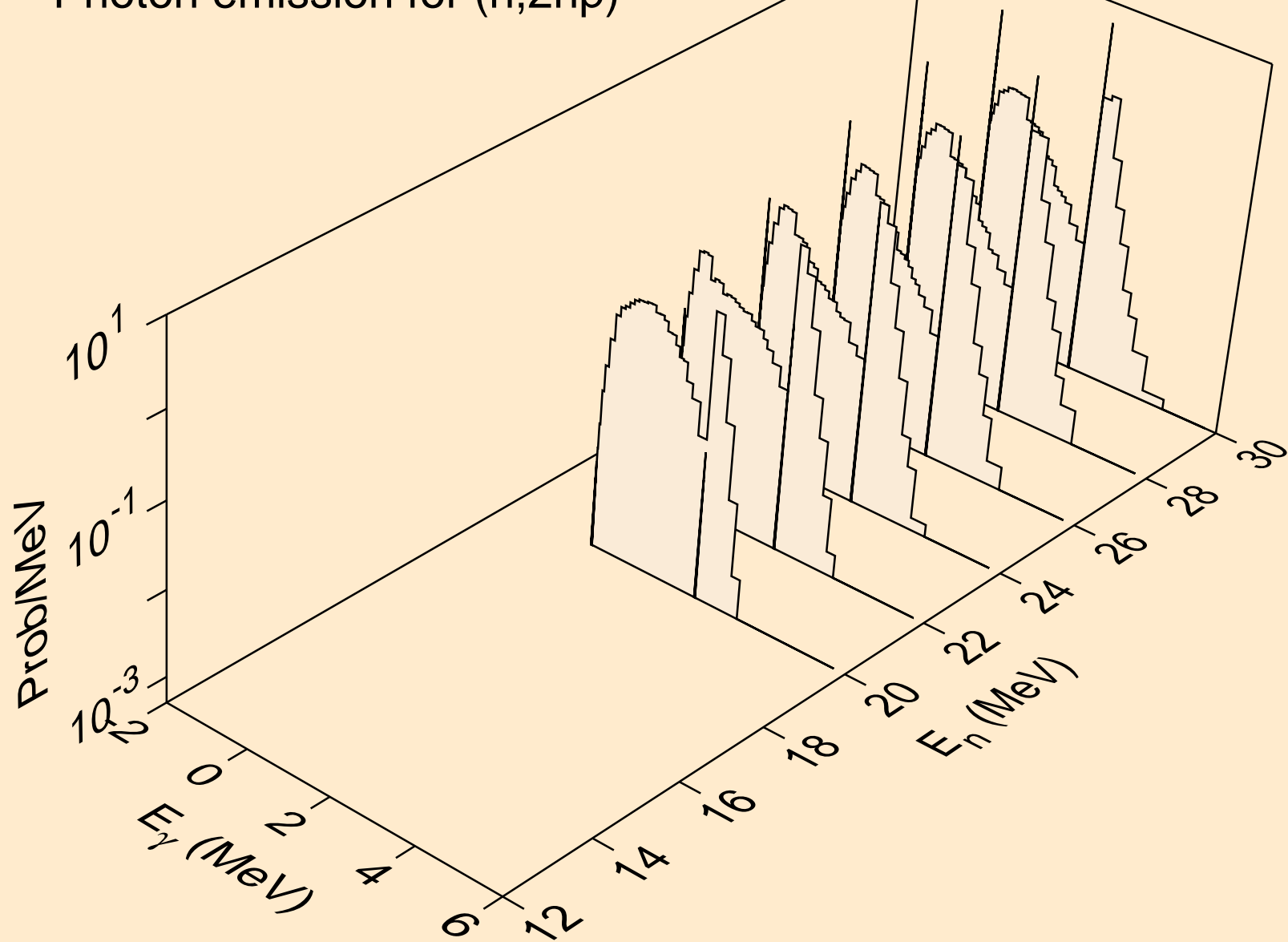

CM240 NEUTRON ACER TENDL-2021 LIBRARY; T=293.6K
Photon emission for (n,3np)

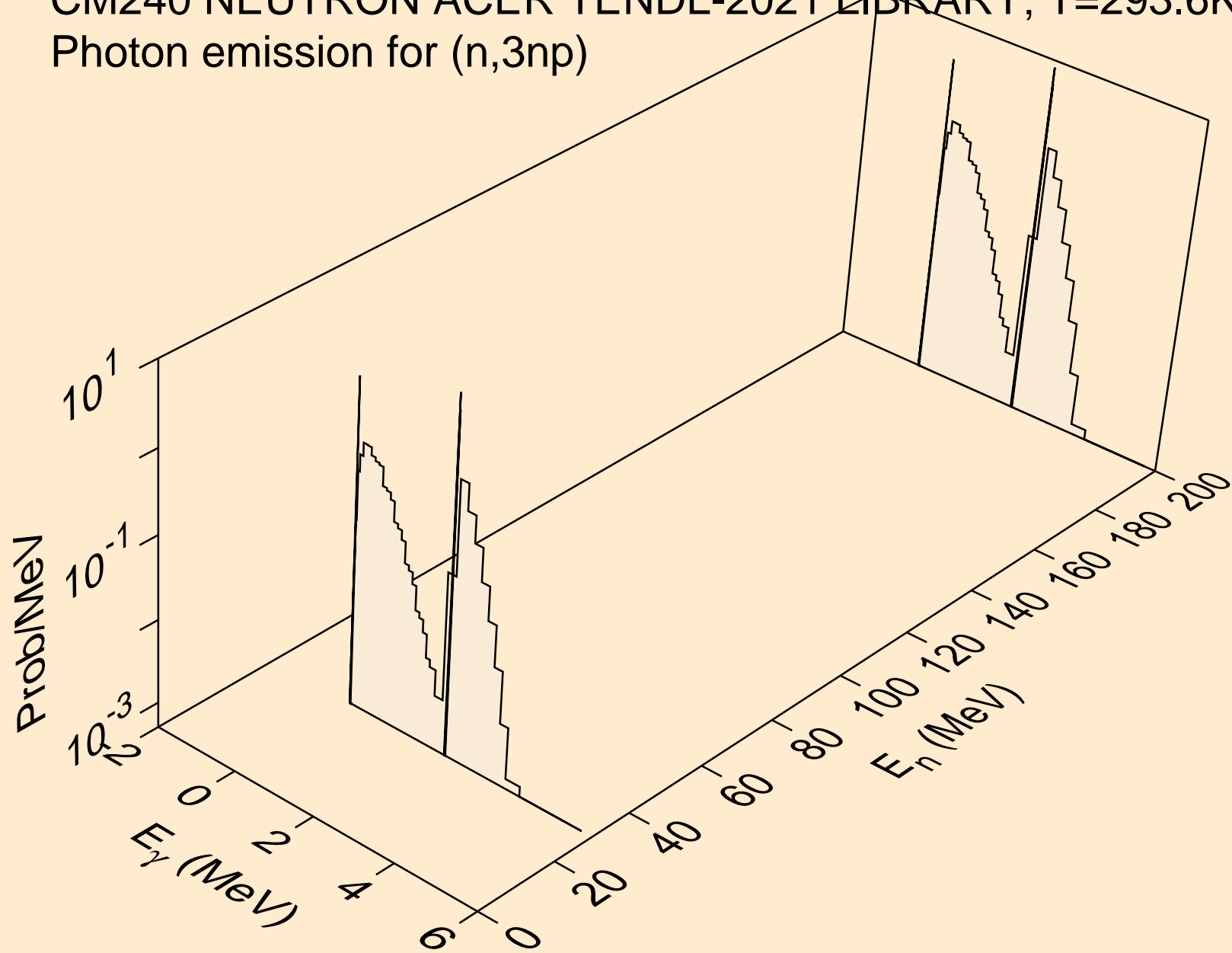

CM240 NEUTRON ACER TENDL-2021 LIBRARY; T=293.6K
Photon emission for (n,2np)

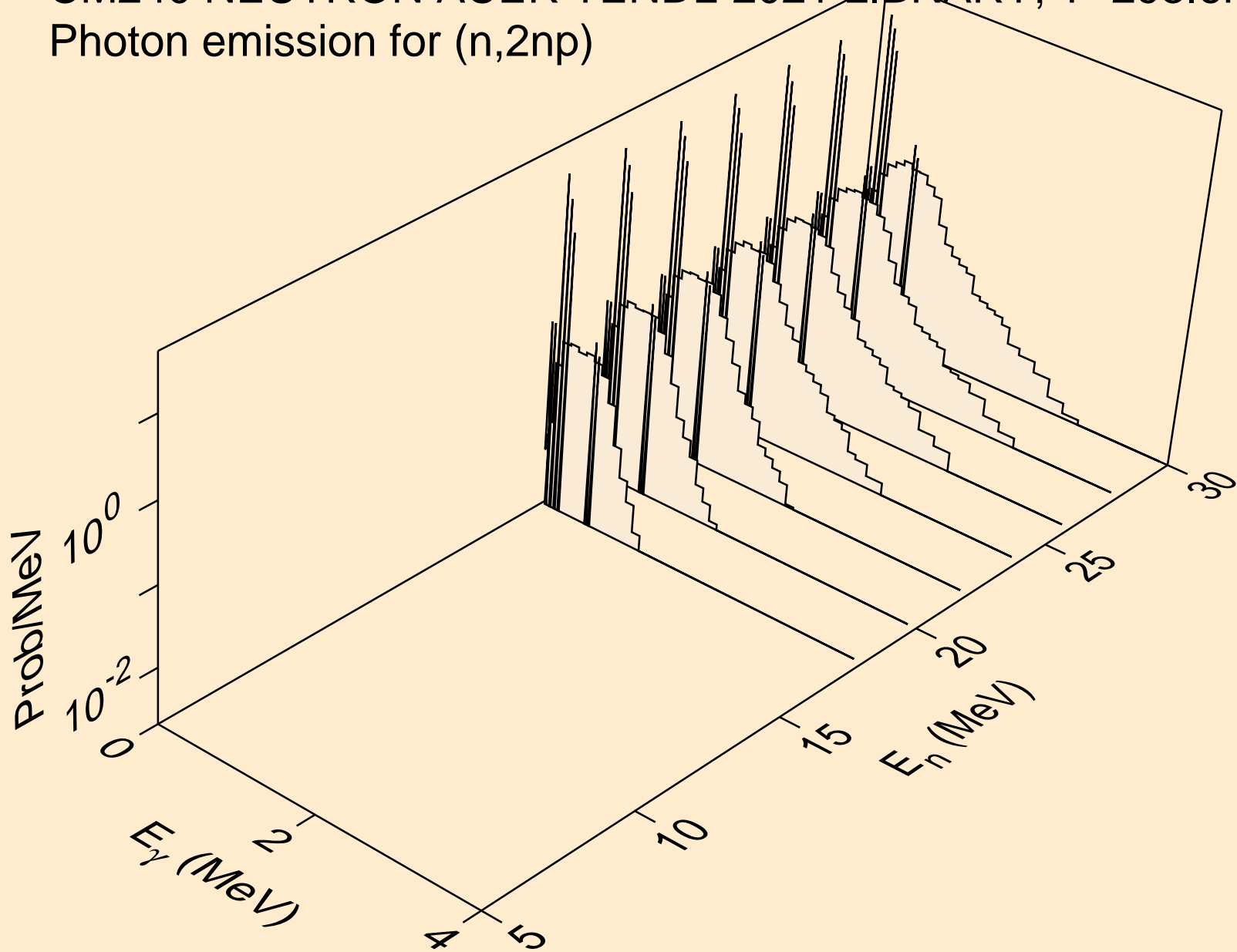

CM240 NEUTRON ACER TENDL-2021 LIBRARY; T=293.6K
Photon emission for (n,npa)

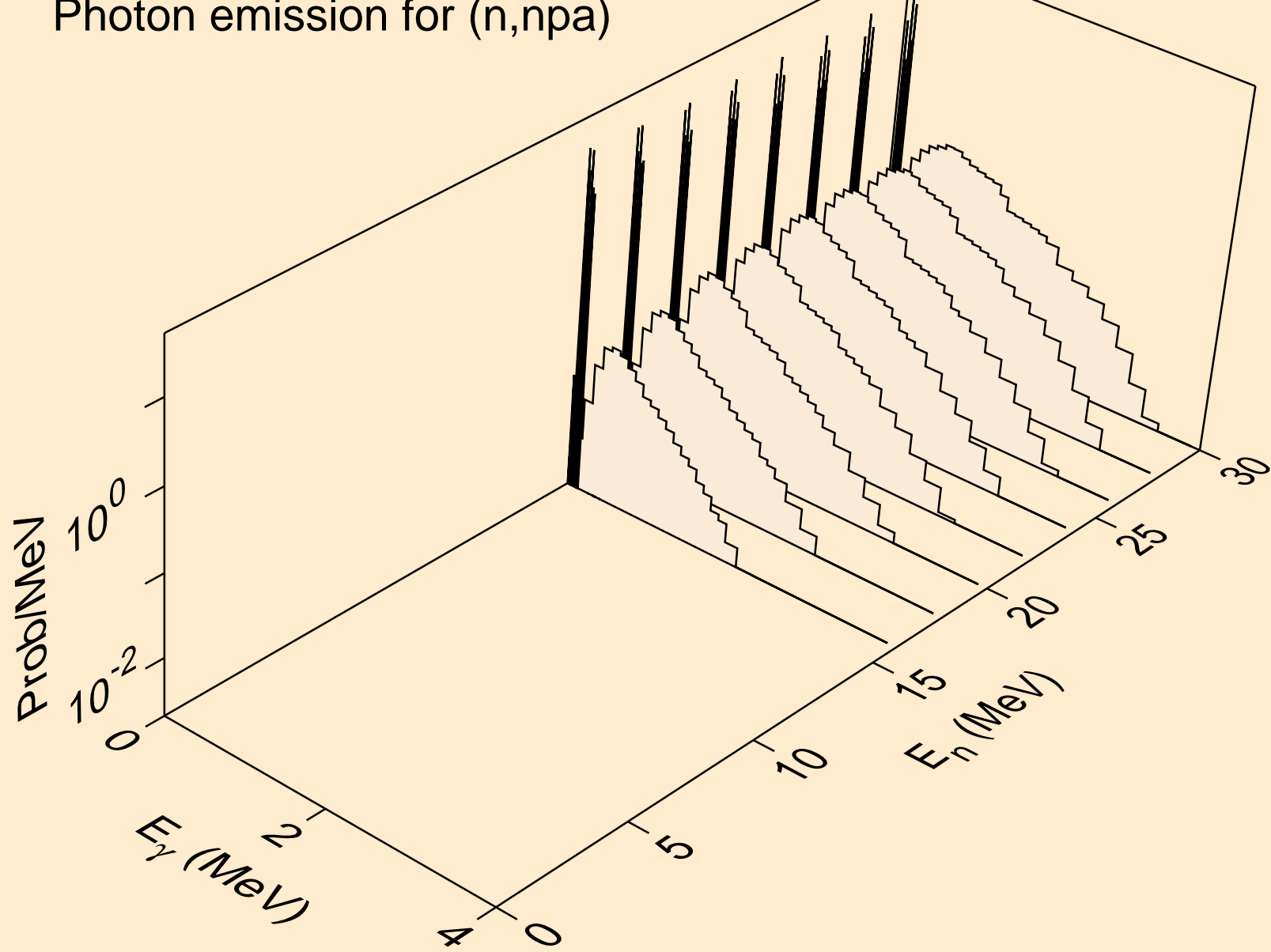

CM240 NEUTRON ACER TENDL-2021 LIBRARY; T=293.6K
Photon emission for (n,n*c)

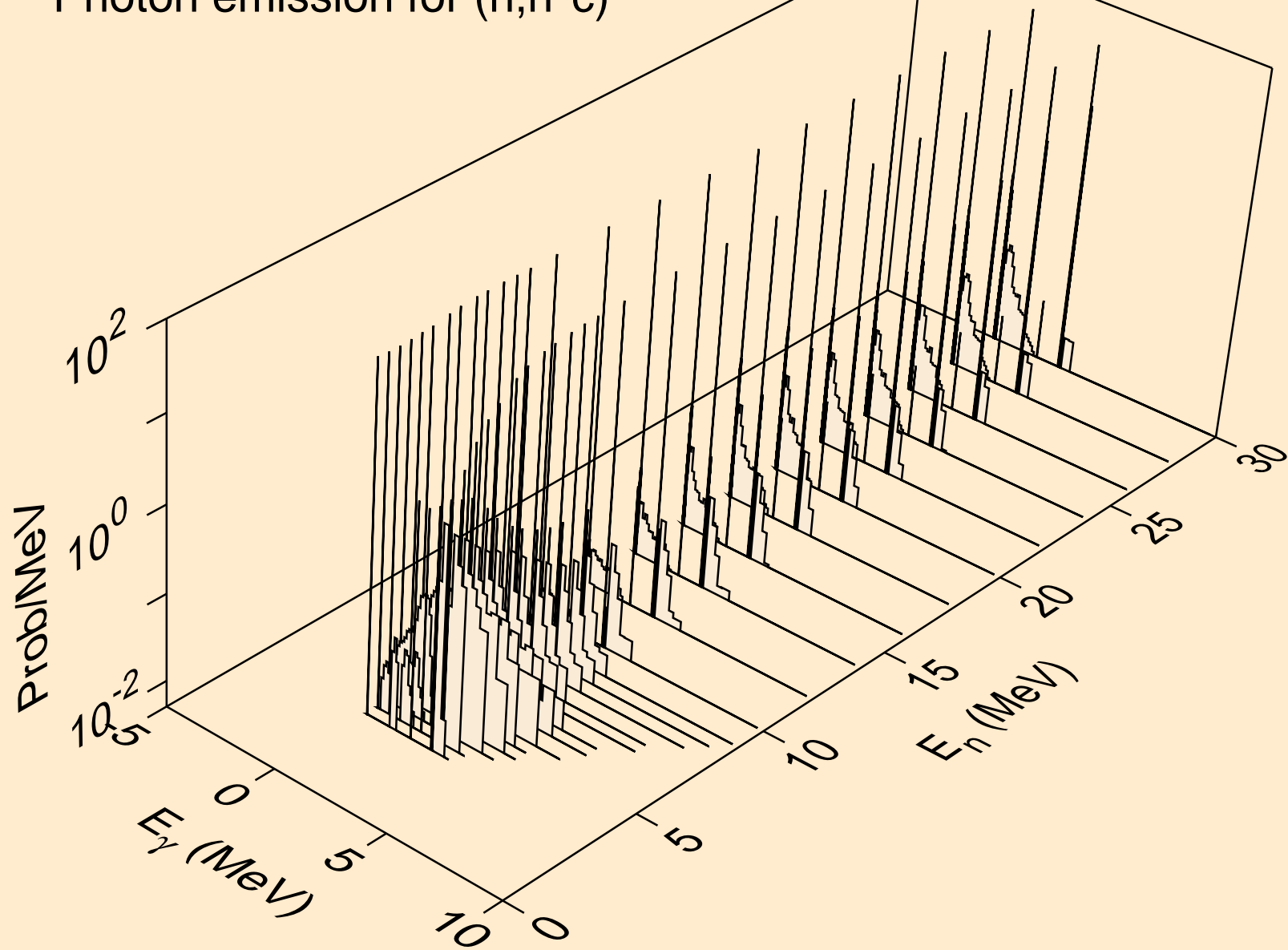

CM240 NEUTRON ACER TENDL-2021 LIBRARY; T=293.6K
Photon emission for (n,gma)

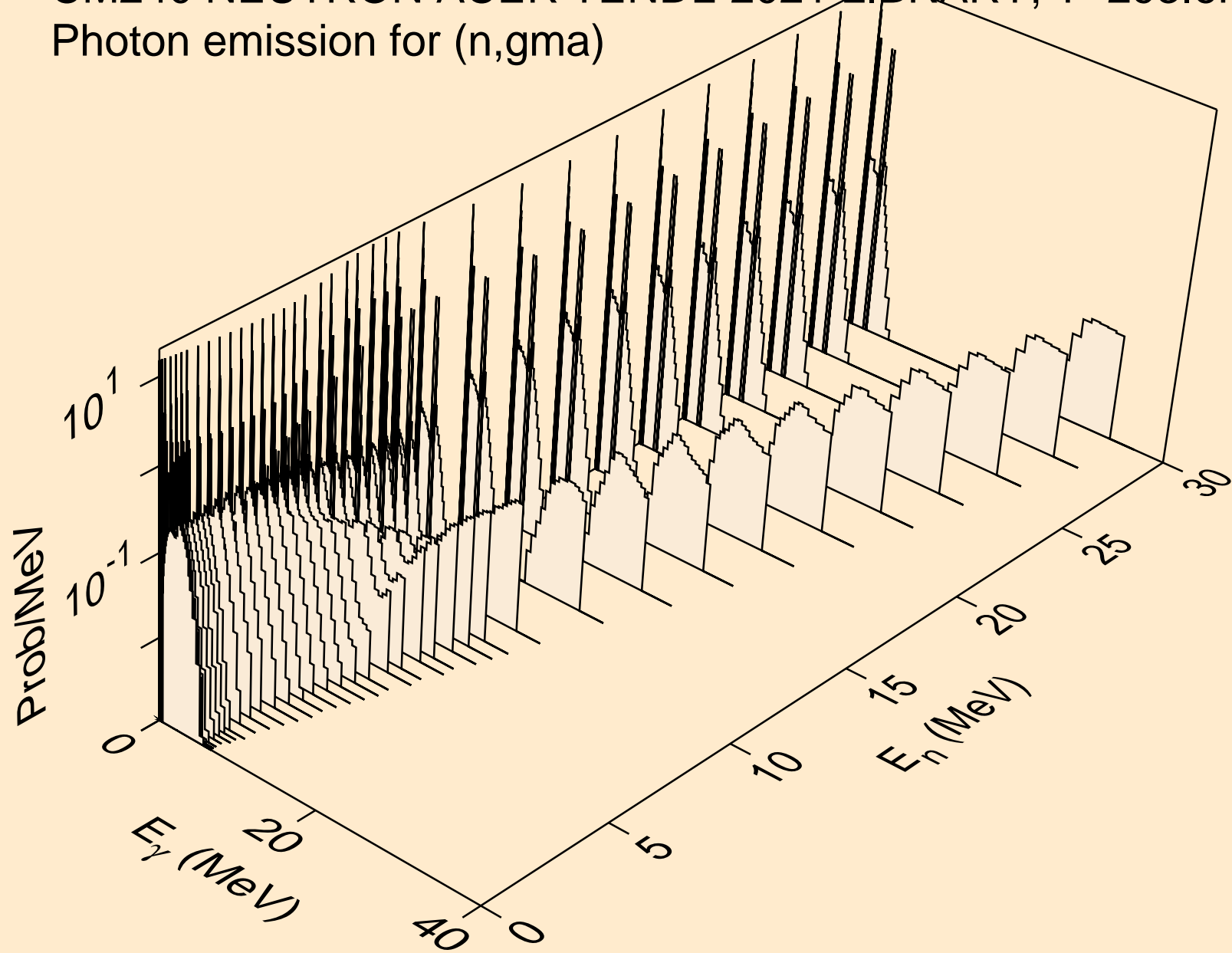

CM240 NEUTRON ACER TENDL-2021 LIBRARY; T=293.6K
Photon emission for (n,p)

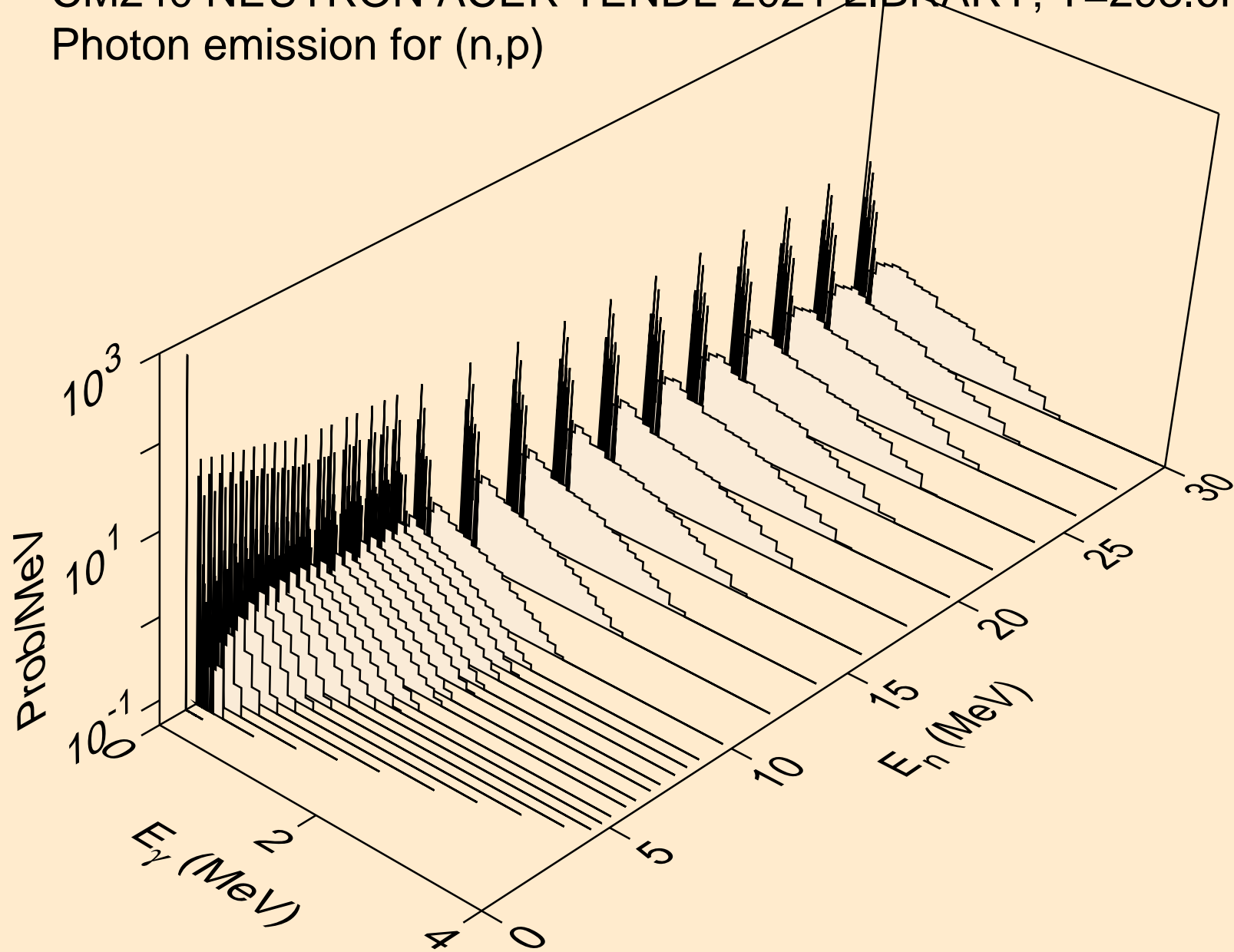

CM240 NEUTRON ACER TENDL-2021 LIBRARY; T=293.6K
Photon emission for (n,d)

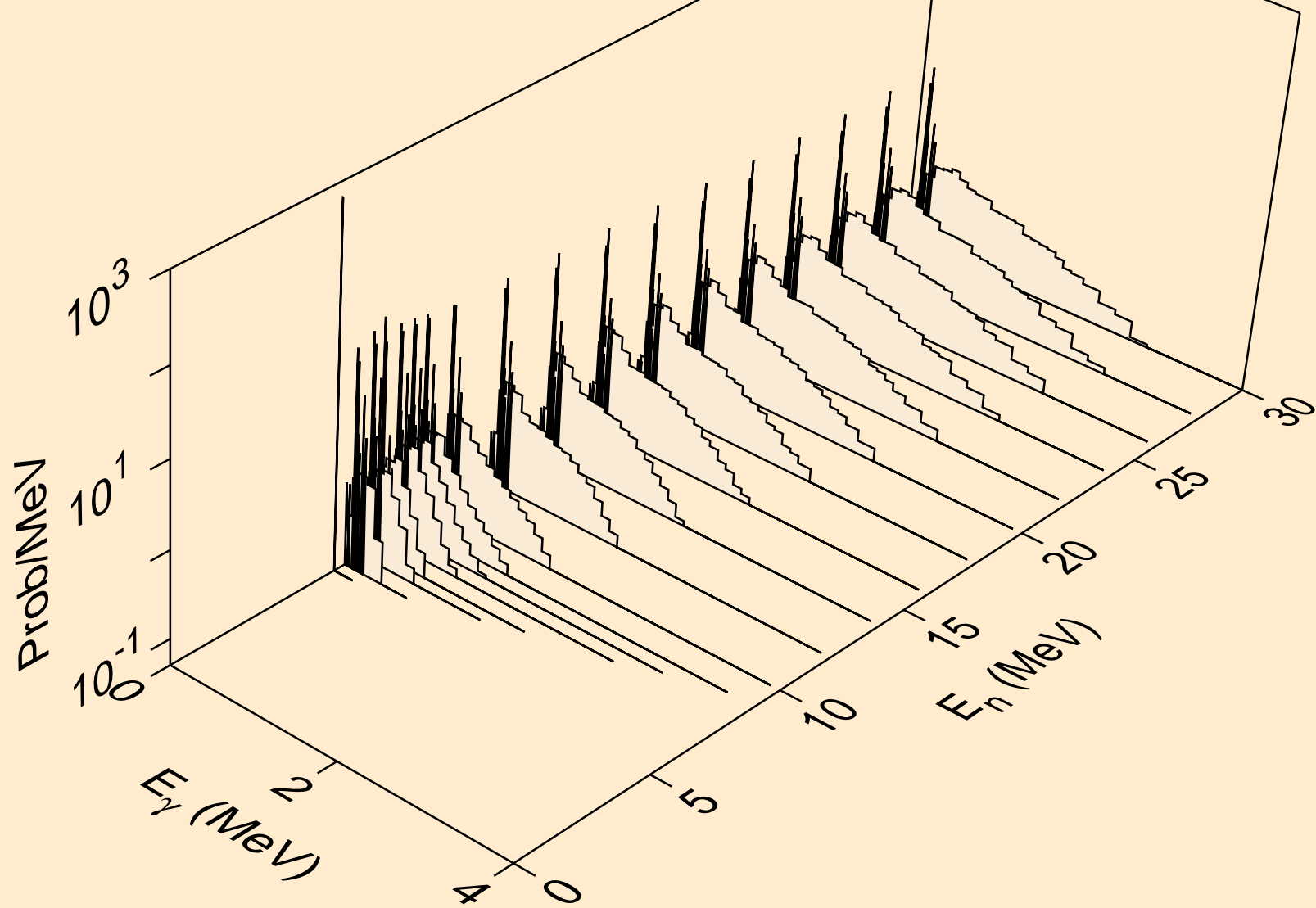

CM240 NEUTRON ACER TENDL-2021 LIBRARY; T=293.6K
Photon emission for (n,t)

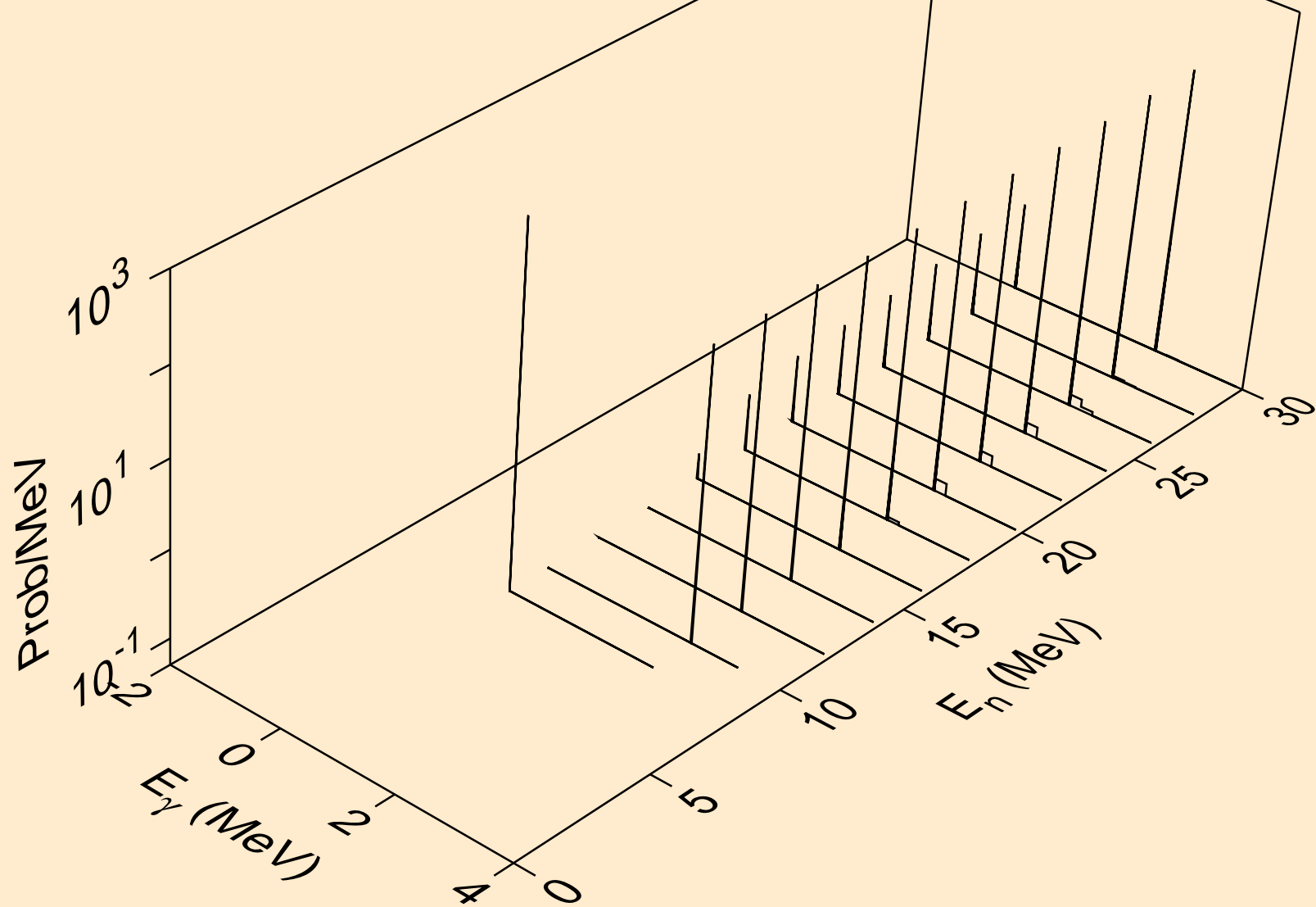

CM240 NEUTRON ACER TENDL-2021 LIBRARY; T=293.6K
Photon emission for (n,he3)

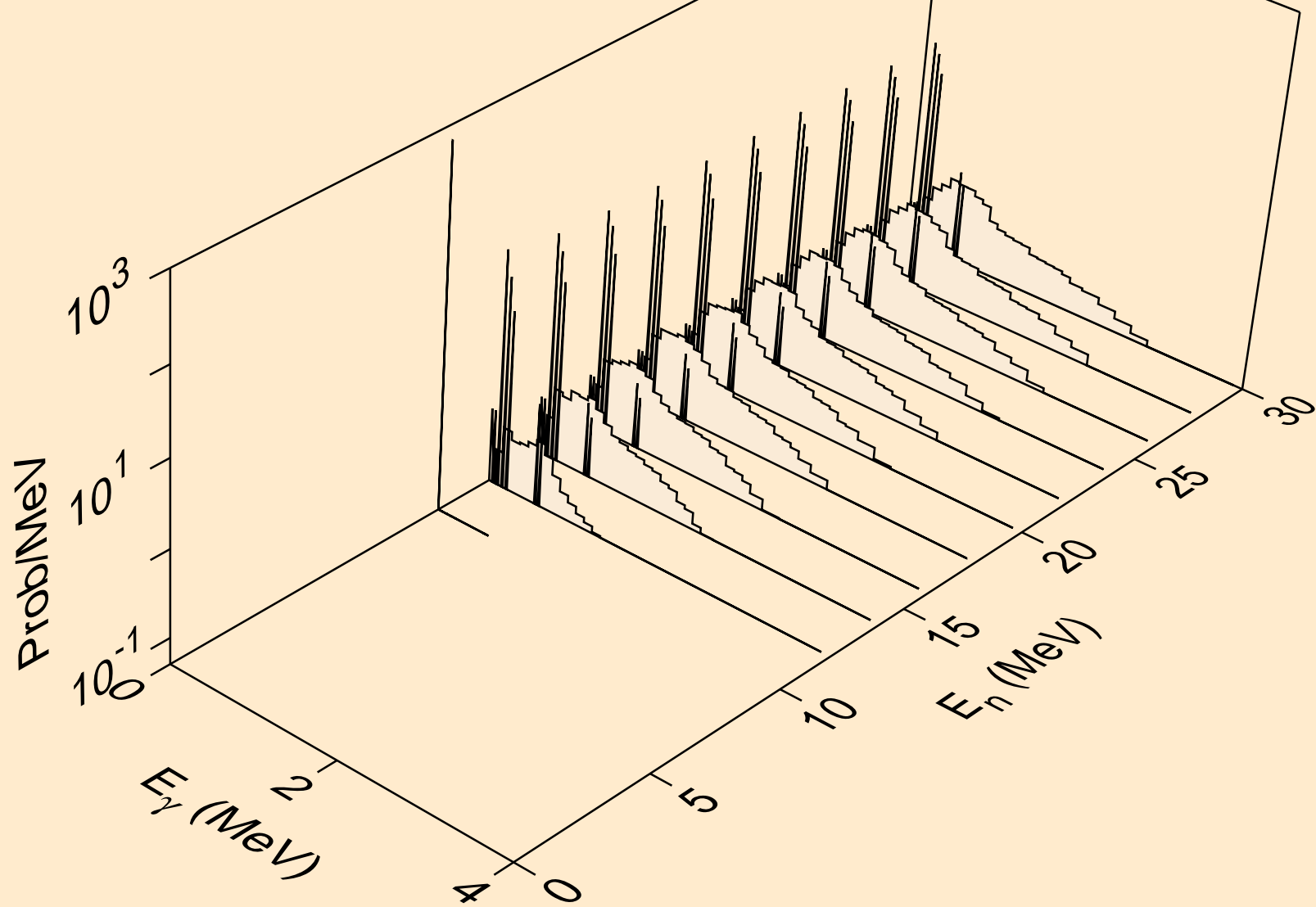

CM240 NEUTRON ACER TENDL-2021 LIBRARY; T=293.6K
Photon emission for (n,a)

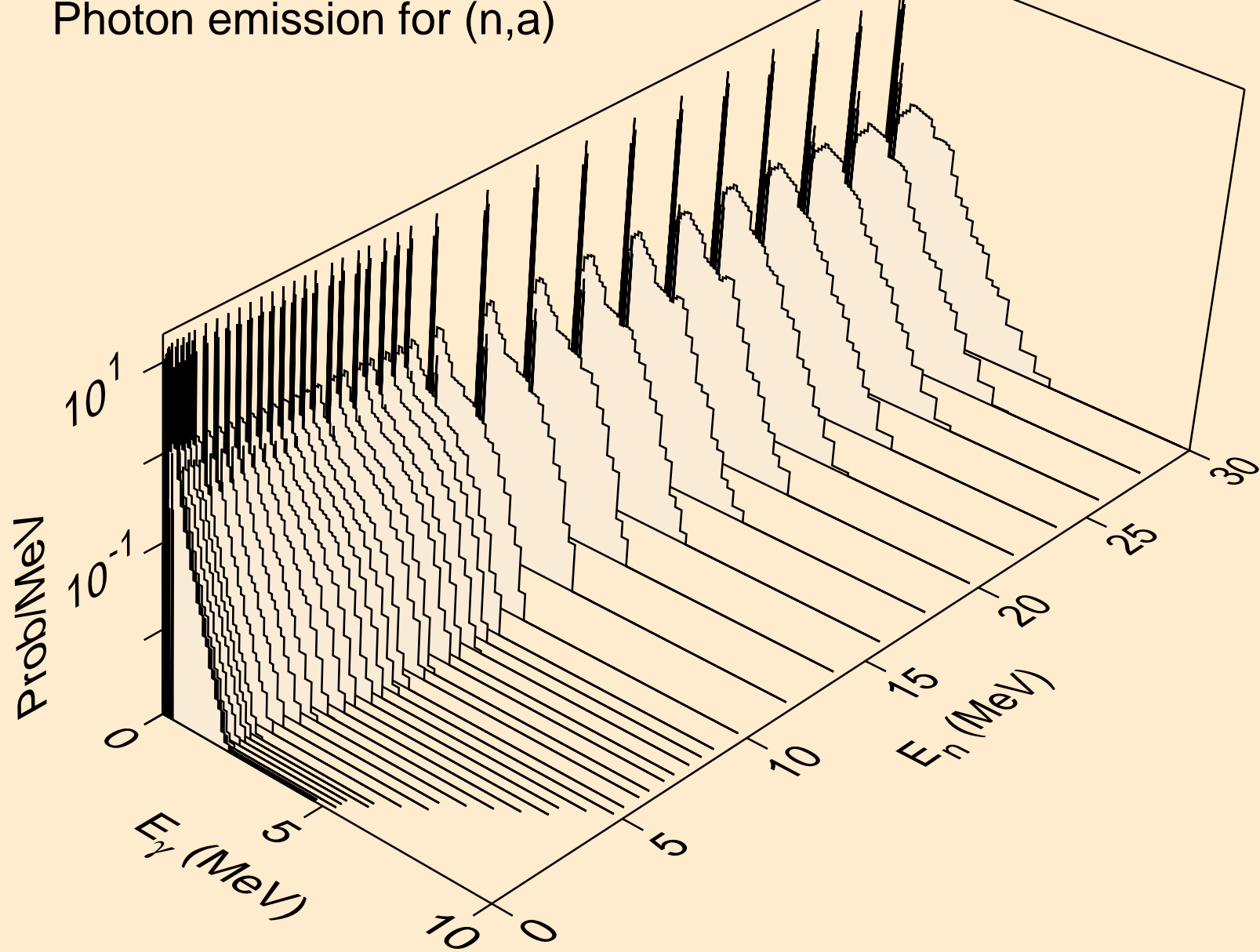

CM240 NEUTRON ACER TENDL-2021 LIBRARY; T=293.6K
Photon emission for (n,2a)

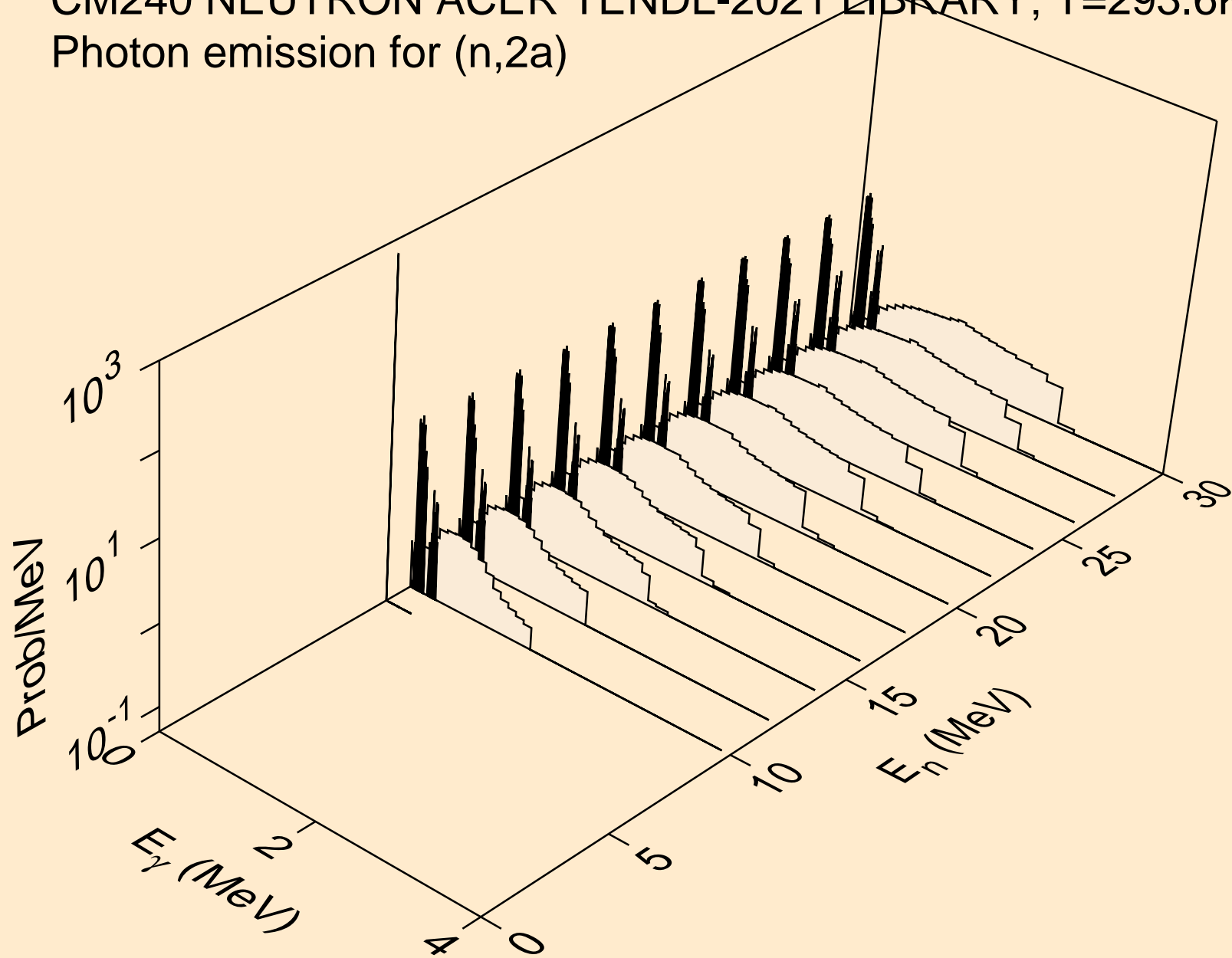

CM240 NEUTRON ACER TENDL-2021 LIBRARY; T=293.6K
Photon emission for (n,2p)

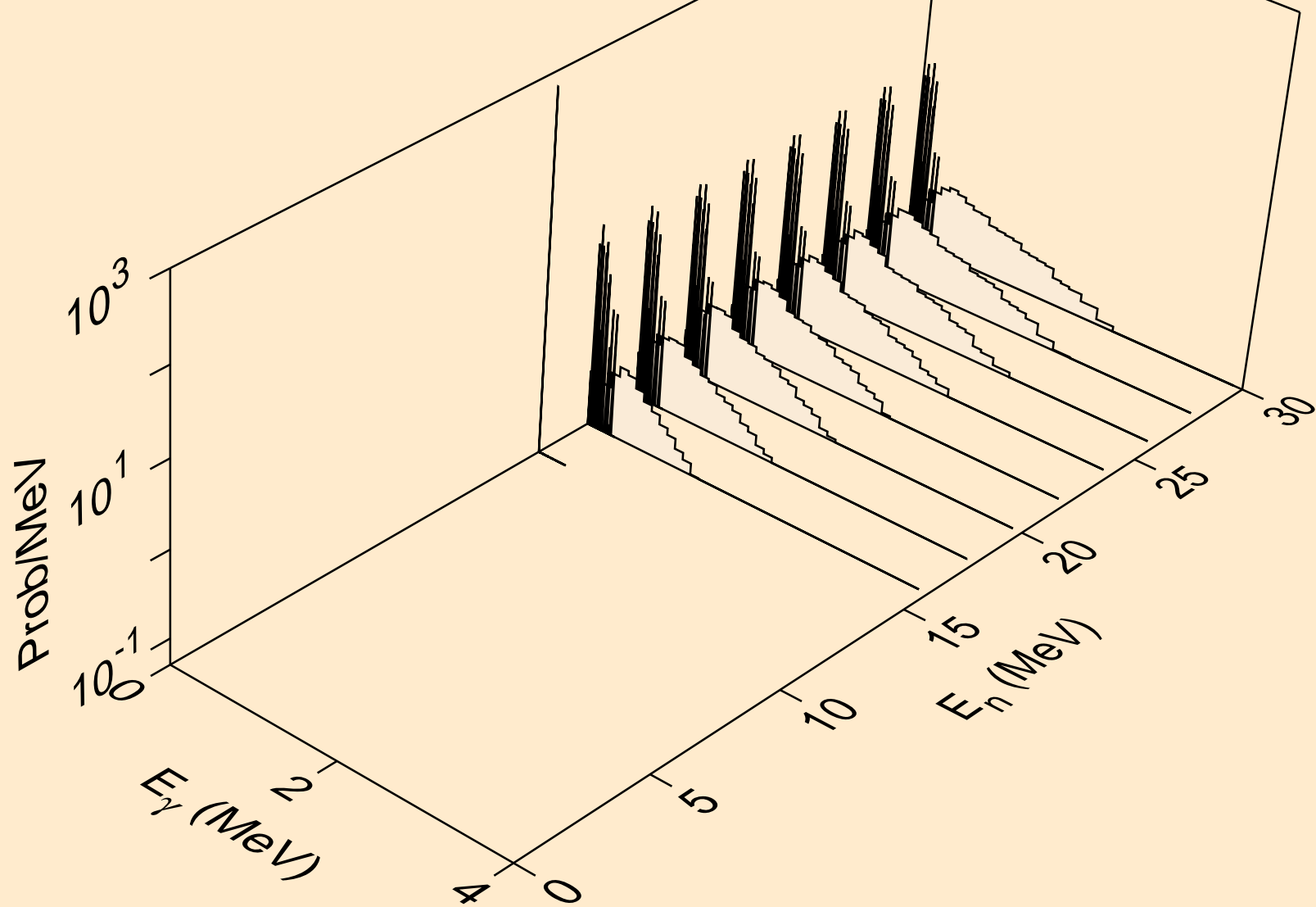

CM240 NEUTRON ACER TENDL-2021 LIBRARY; T=293.6K
Photon emission for (n,p)

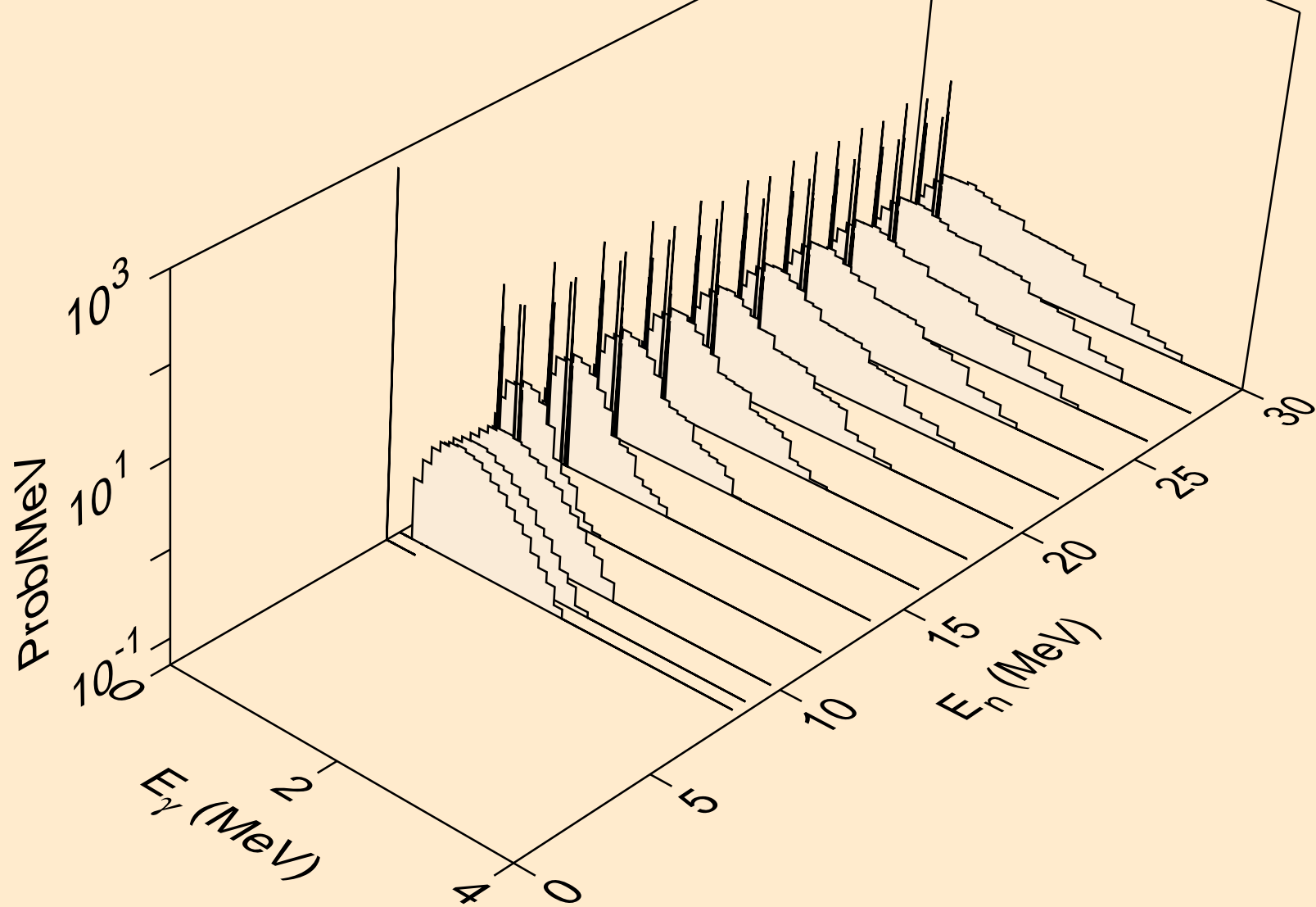

CM240 NEUTRON ACER TENDL-2021 LIBRARY; T=293.6K
Photon emission for (n,pd)

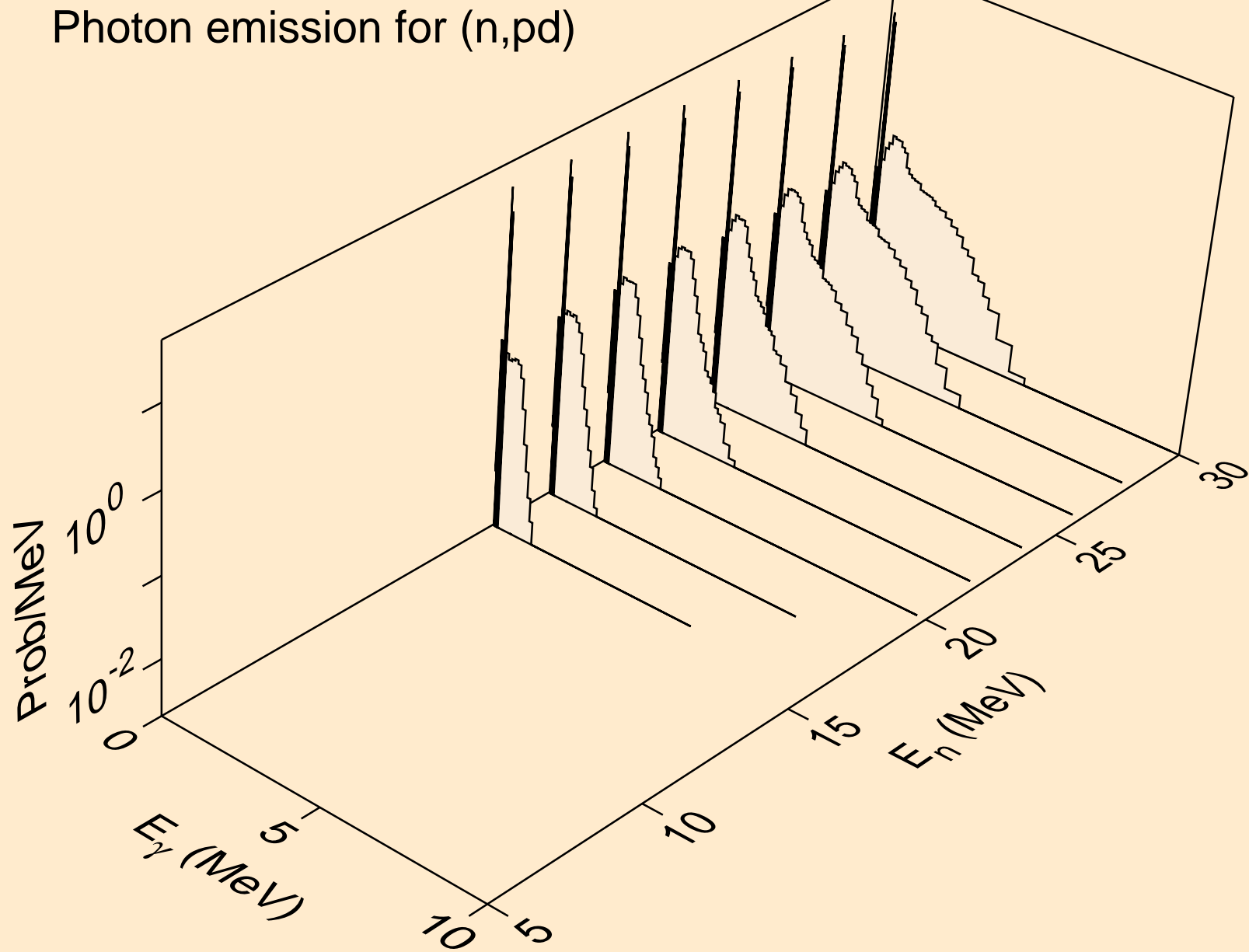

CM240 NEUTRON ACER TENDL-2021 LIBRARY; T=293.6K
Photon emission for (n,da)

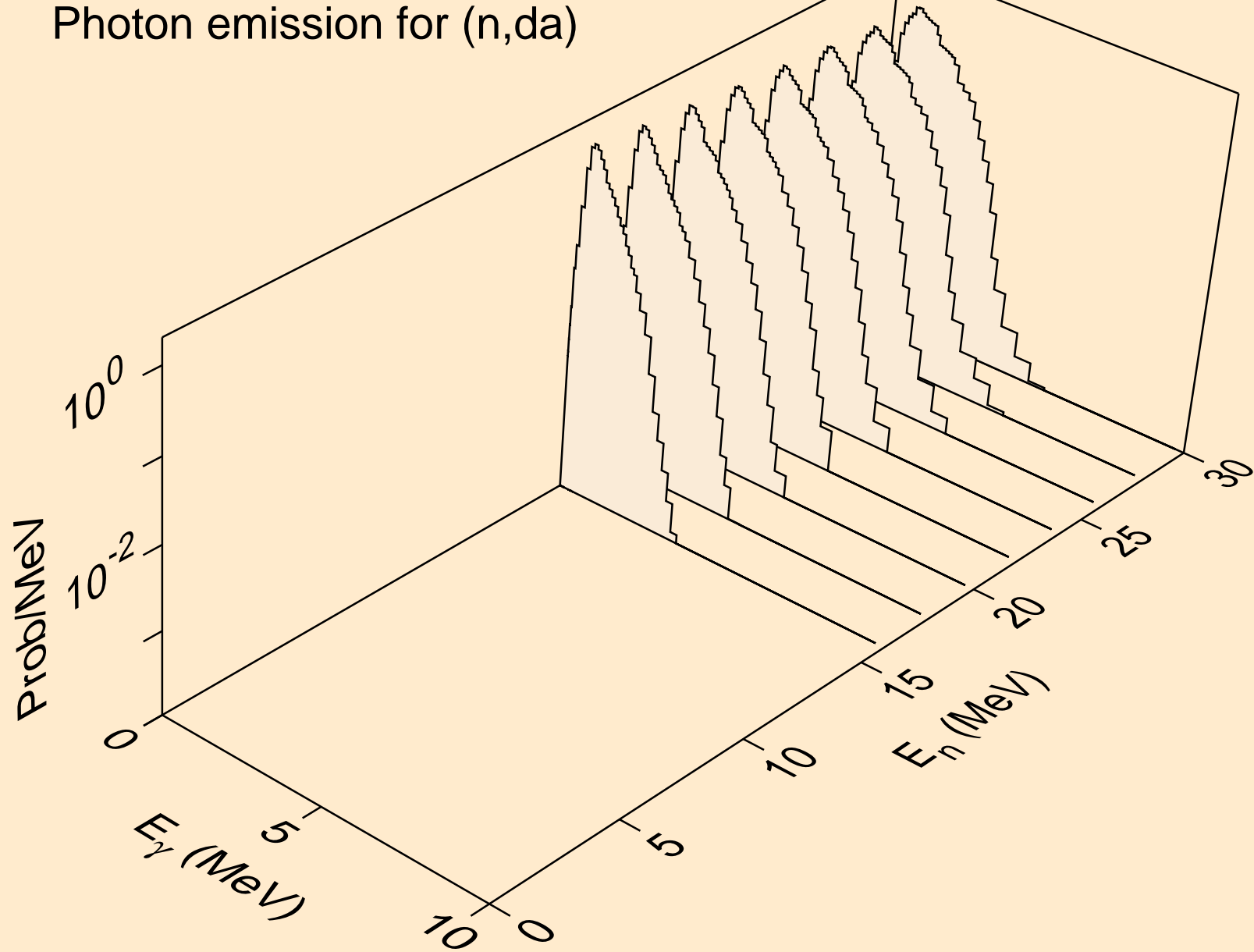

CM240 NEUTRON ACER TENDL-2021 LIBRARY; T=293.6K
thermal capture photon spectrum

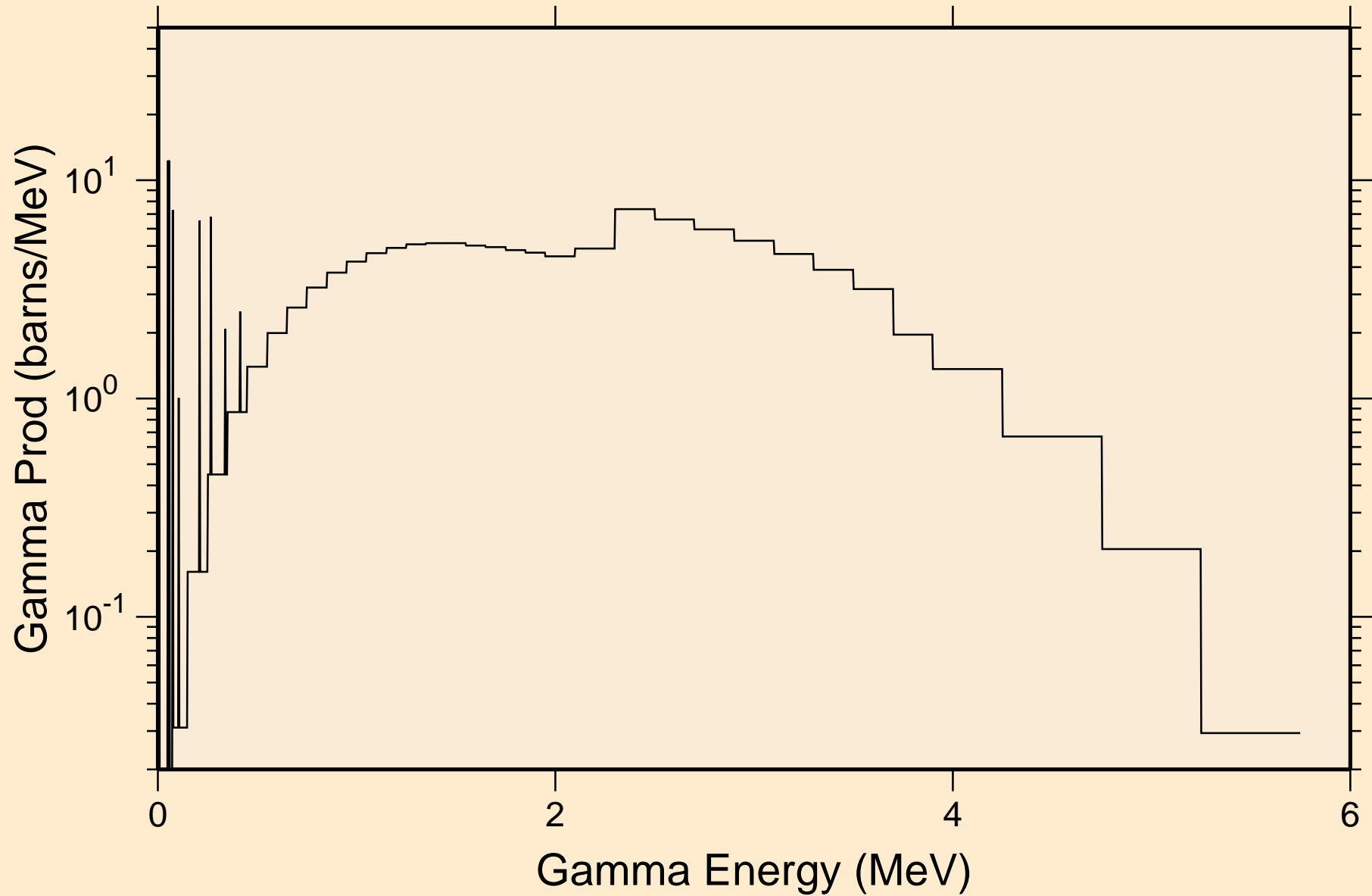

CM240 NEUTRON ACER TENDL-2021 LIBRARY; T=293.6K
14 MeV photon spectrum

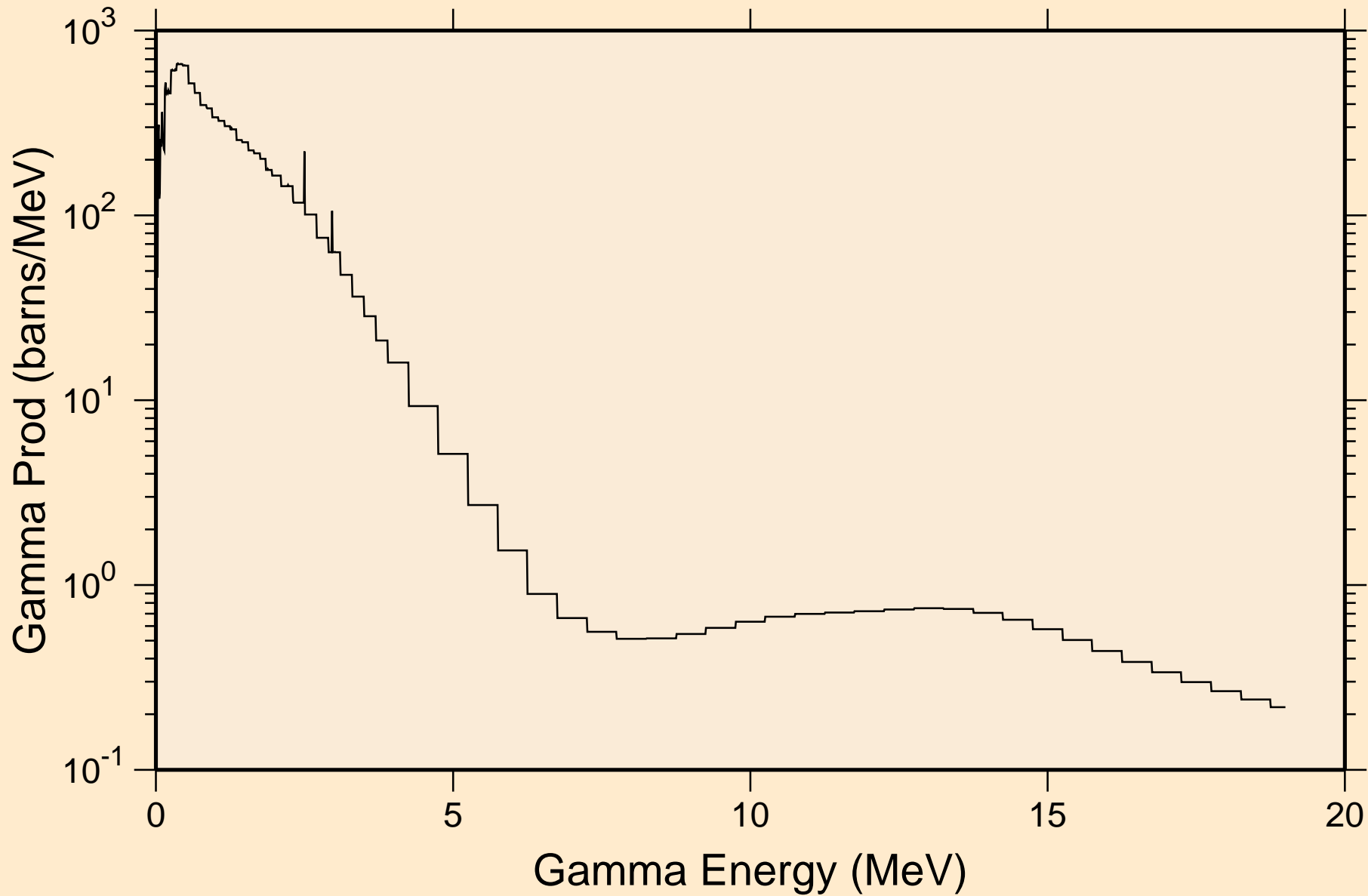

CM240 NEUTRON ACER TENDL-2021 LIBRARY; T=293.6K

Particle heating contributions

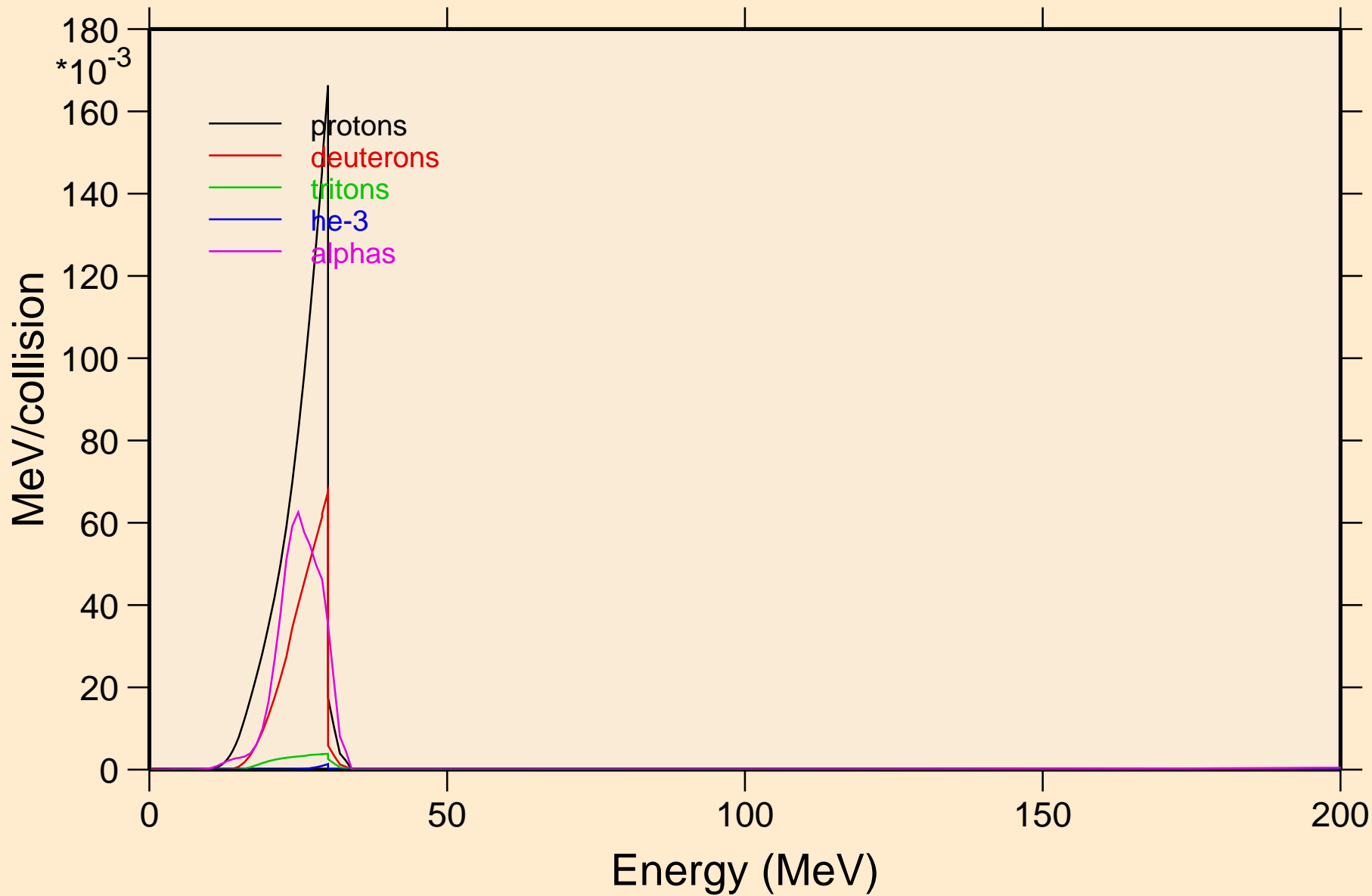

CM240 NEUTRON ACER TENDL-2021 LIBRARY; T=293.6K
Recoil Heating

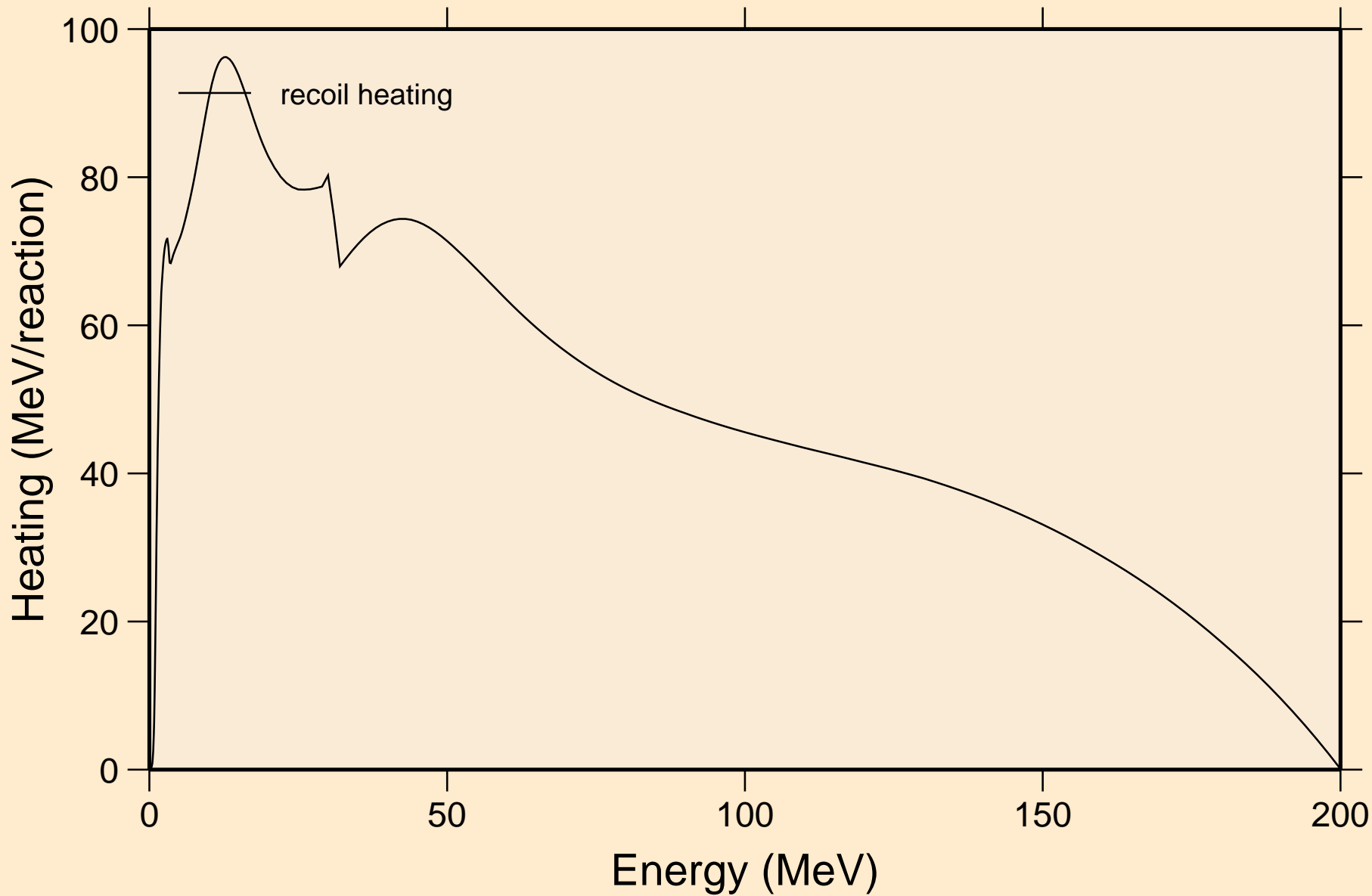

CM240 NEUTRON ACER TENDL-2021 LIBRARY; T=293.6K
Particle production cross sections

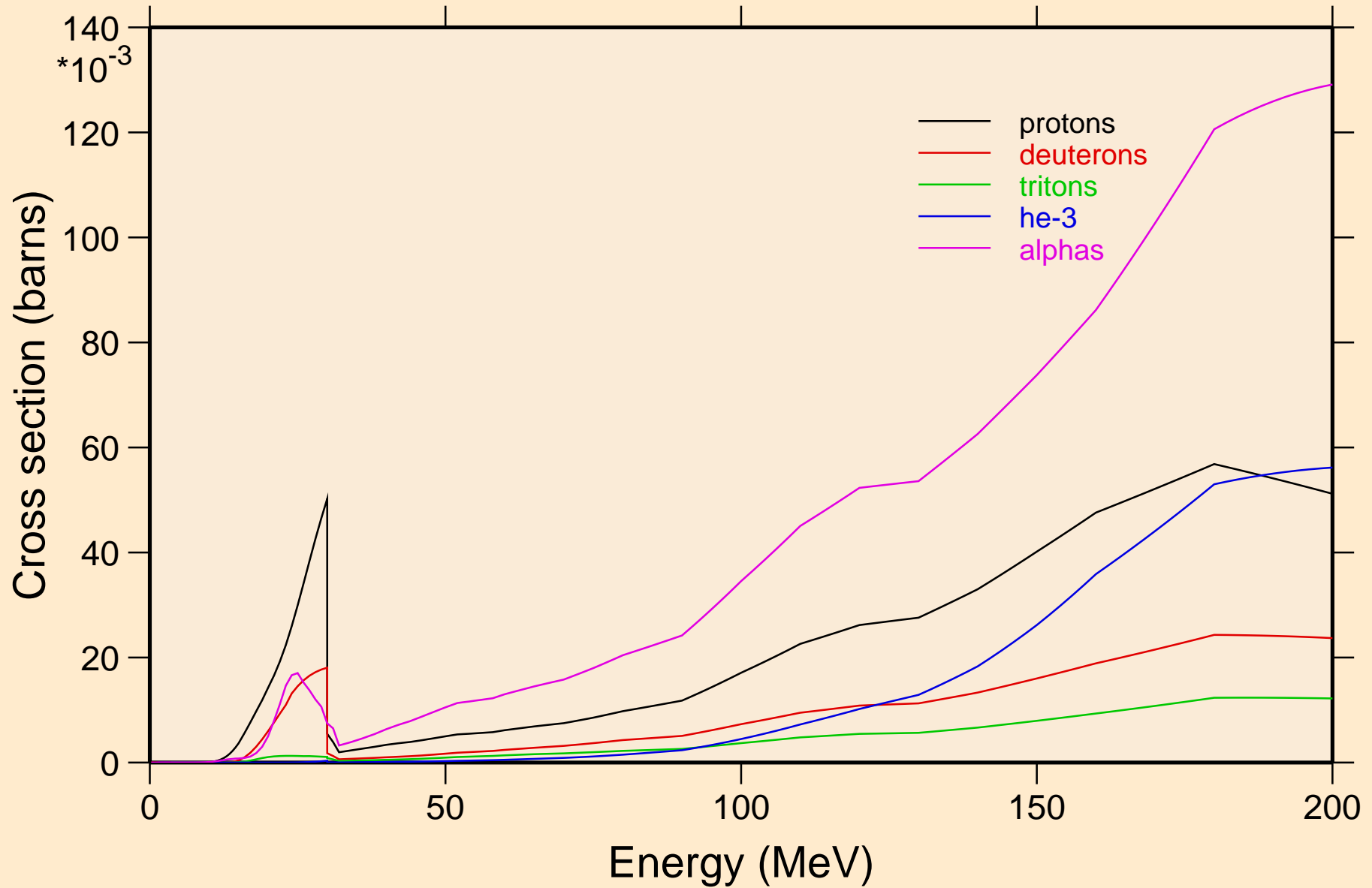

CM240 NEUTRON ACER TENDL-2021 LIBRARY; T=293.6K
protons from (n,x)

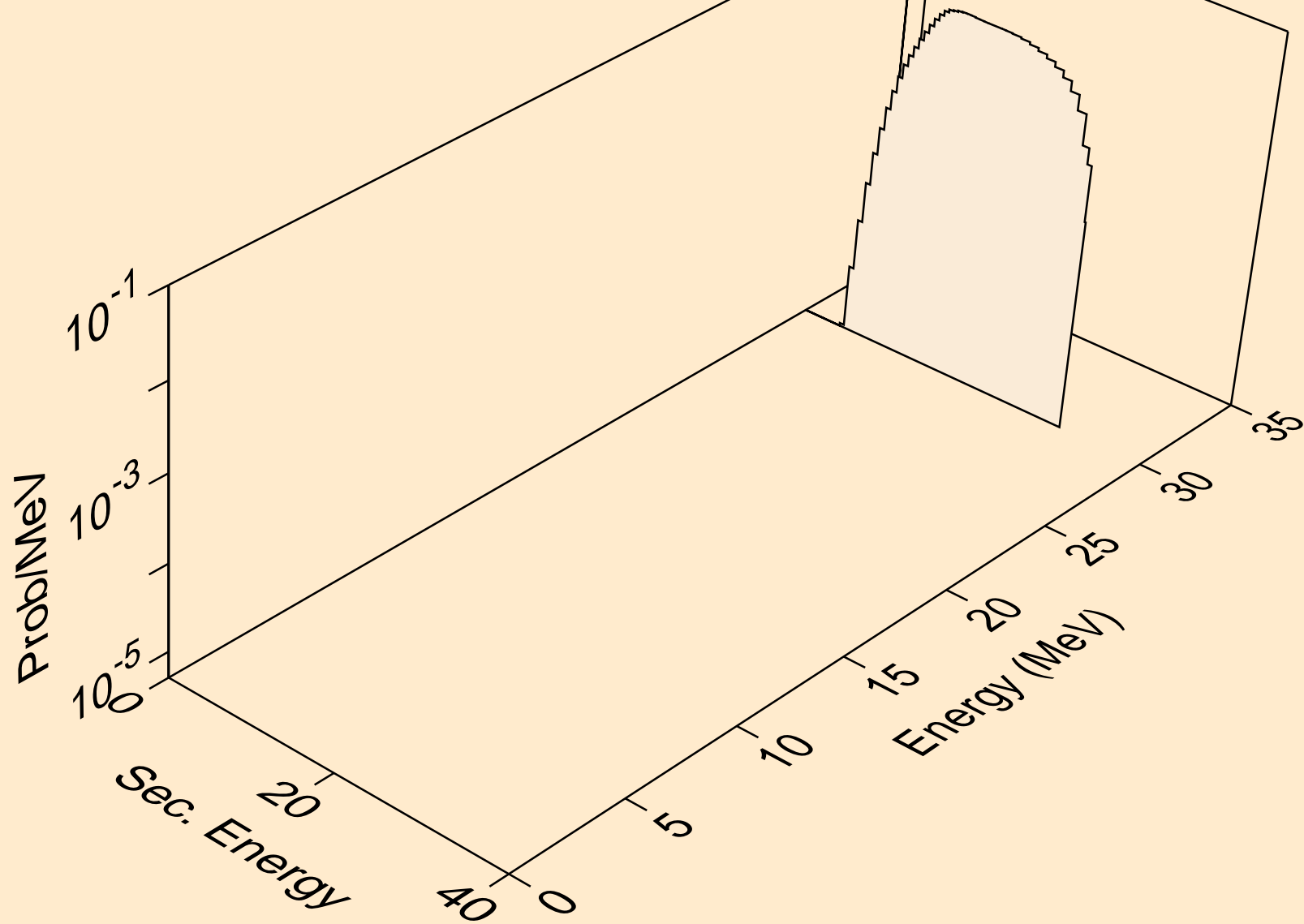

CM240 NEUTRON ACER TENDL-2021 LIBRARY; T=293.6K
protons from (n,n*)p

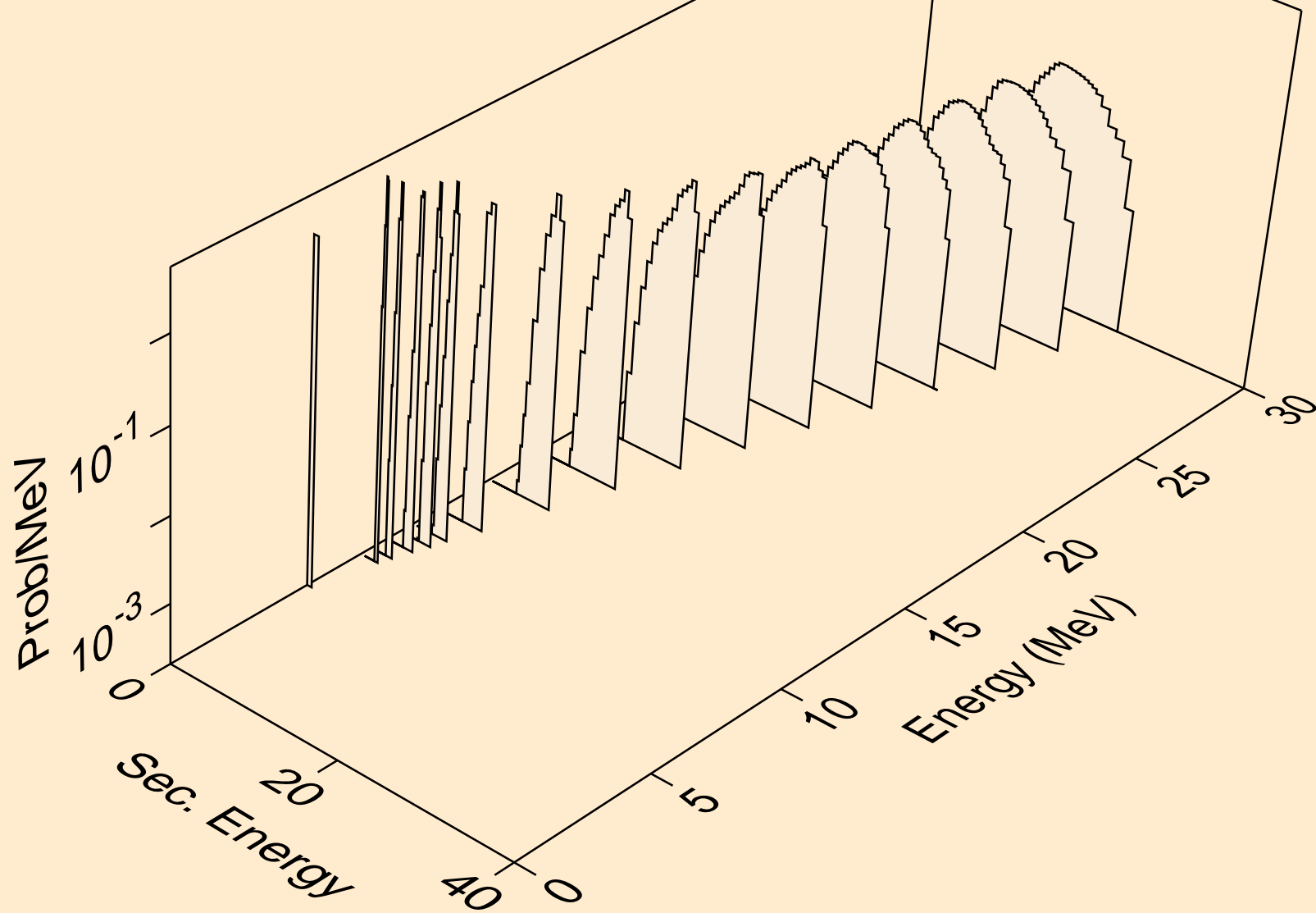

CM240 NEUTRON ACER TENDL-2021 LIBRARY; T=293.6K
protons from (n,2np)

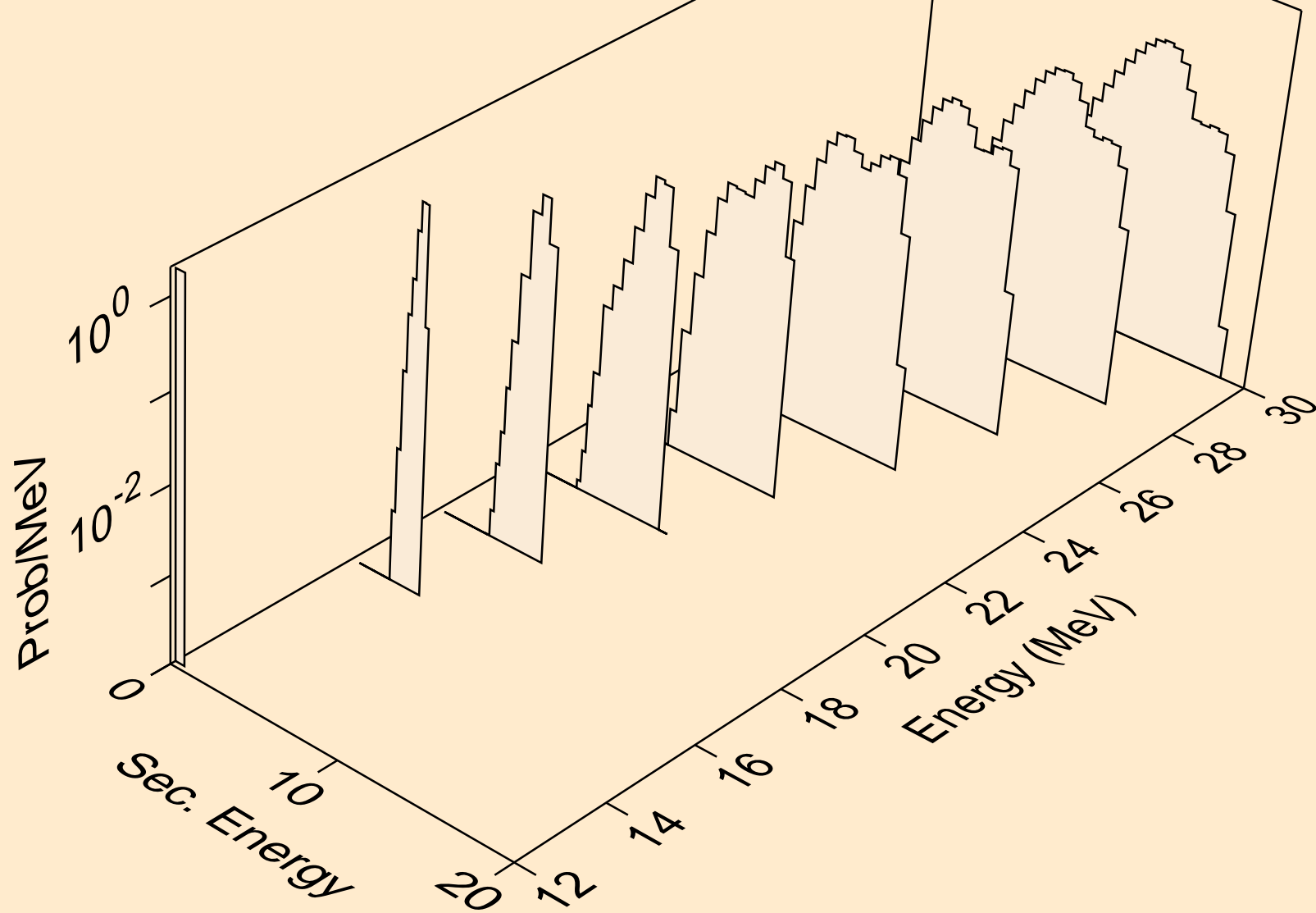

CM240 NEUTRON ACER TENDL-2021 LIBRARY; T=293.6K
protons from (n,3np)

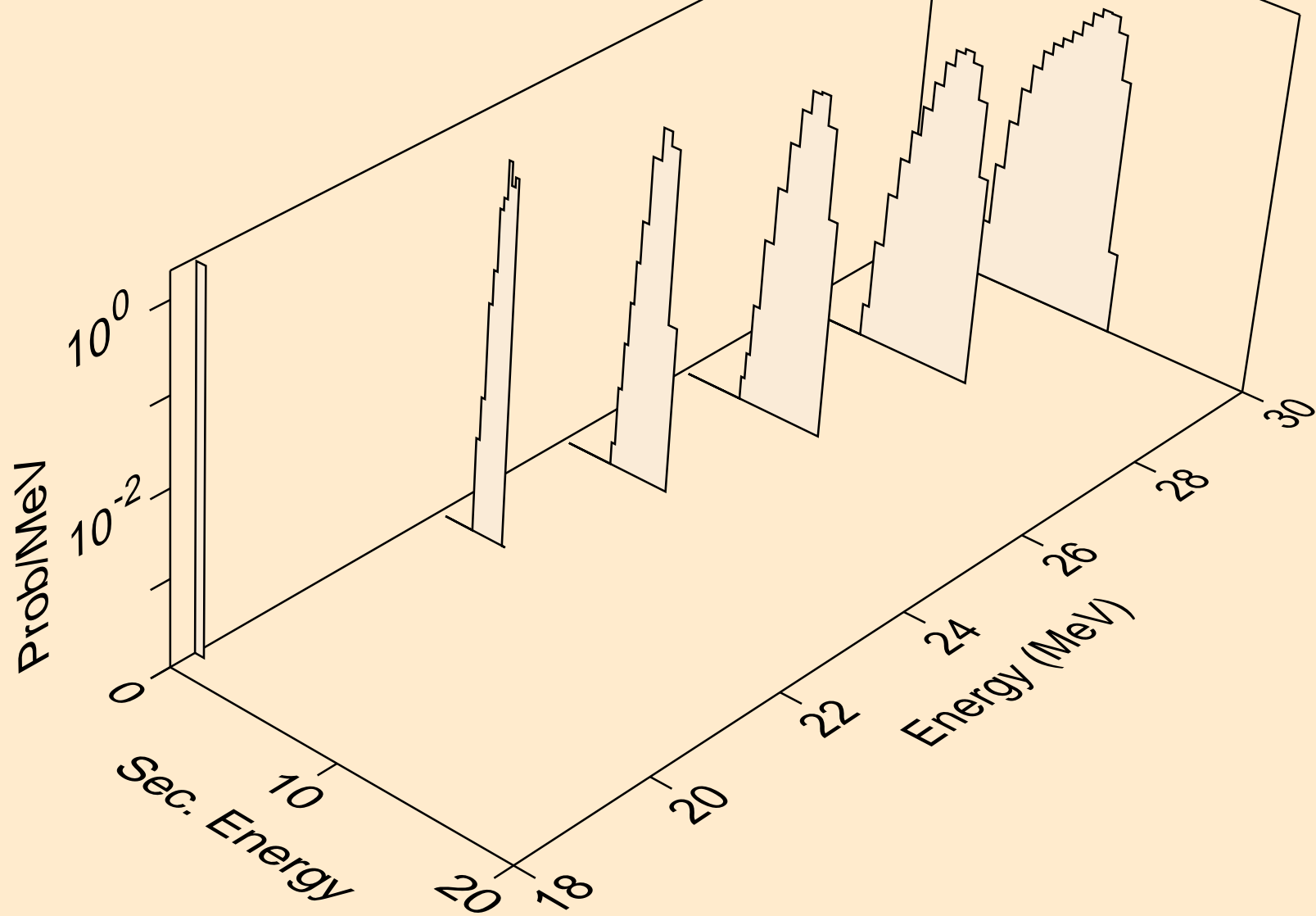

CM240 NEUTRON ACER TENDL-2021 LIBRARY; T=293.6K
protons from (n,2np)

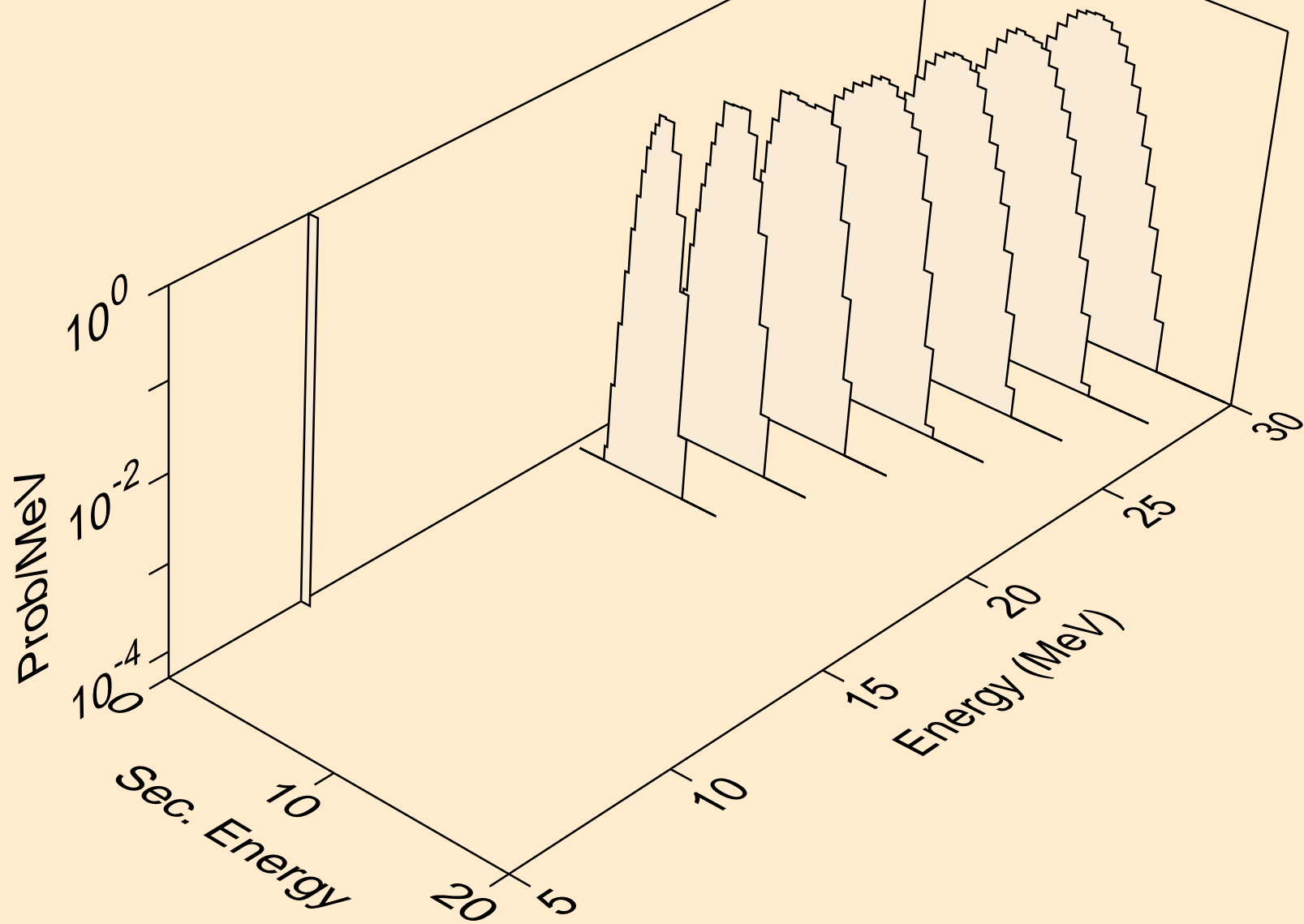

CM240 NEUTRON ACER TENDL-2021 LIBRARY; T=293.6K
protons from (n,npa)

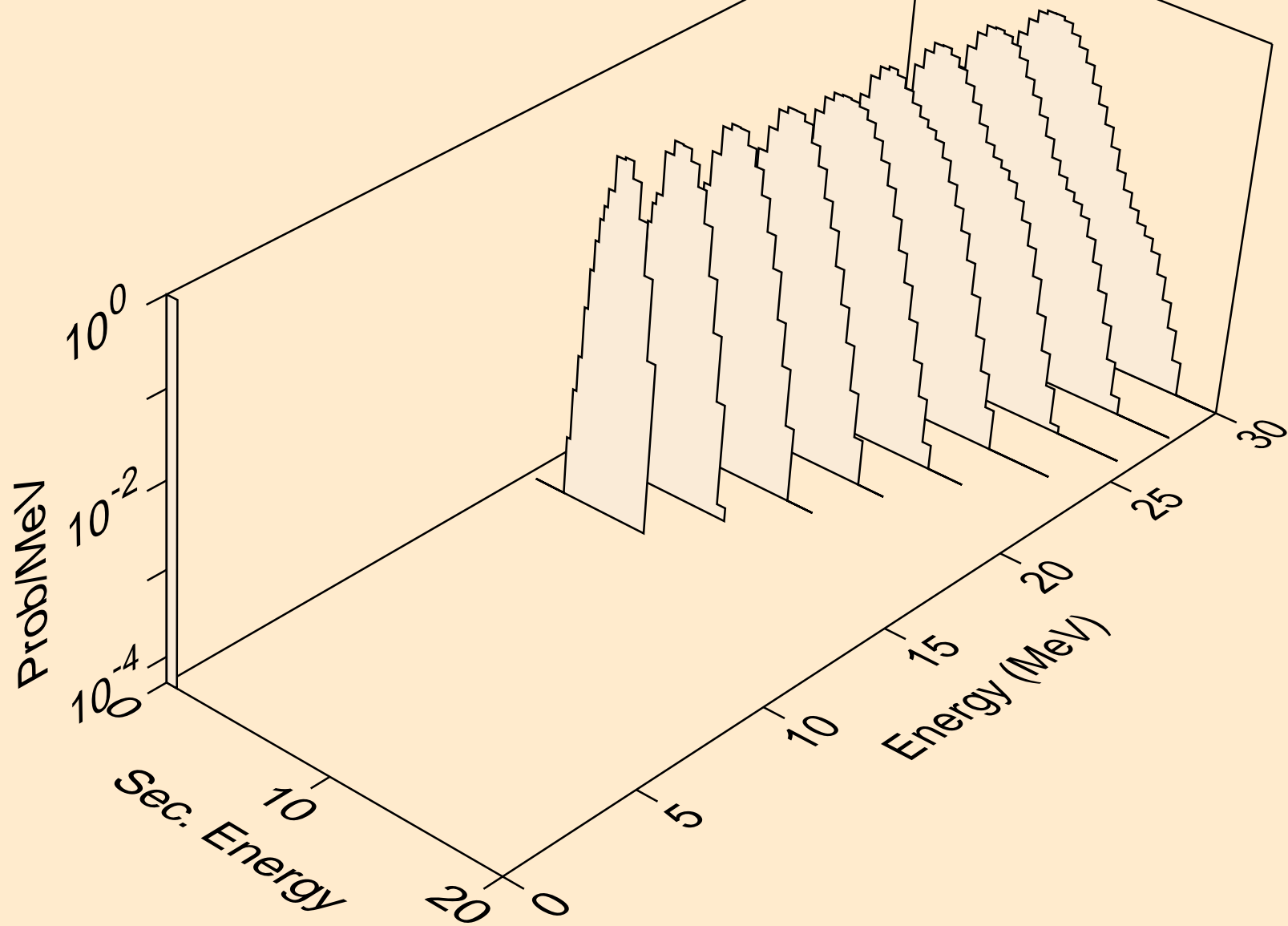

CM240 NEUTRON ACER TENDL-2021 LIBRARY; T=293.6K
protons from (n,p)

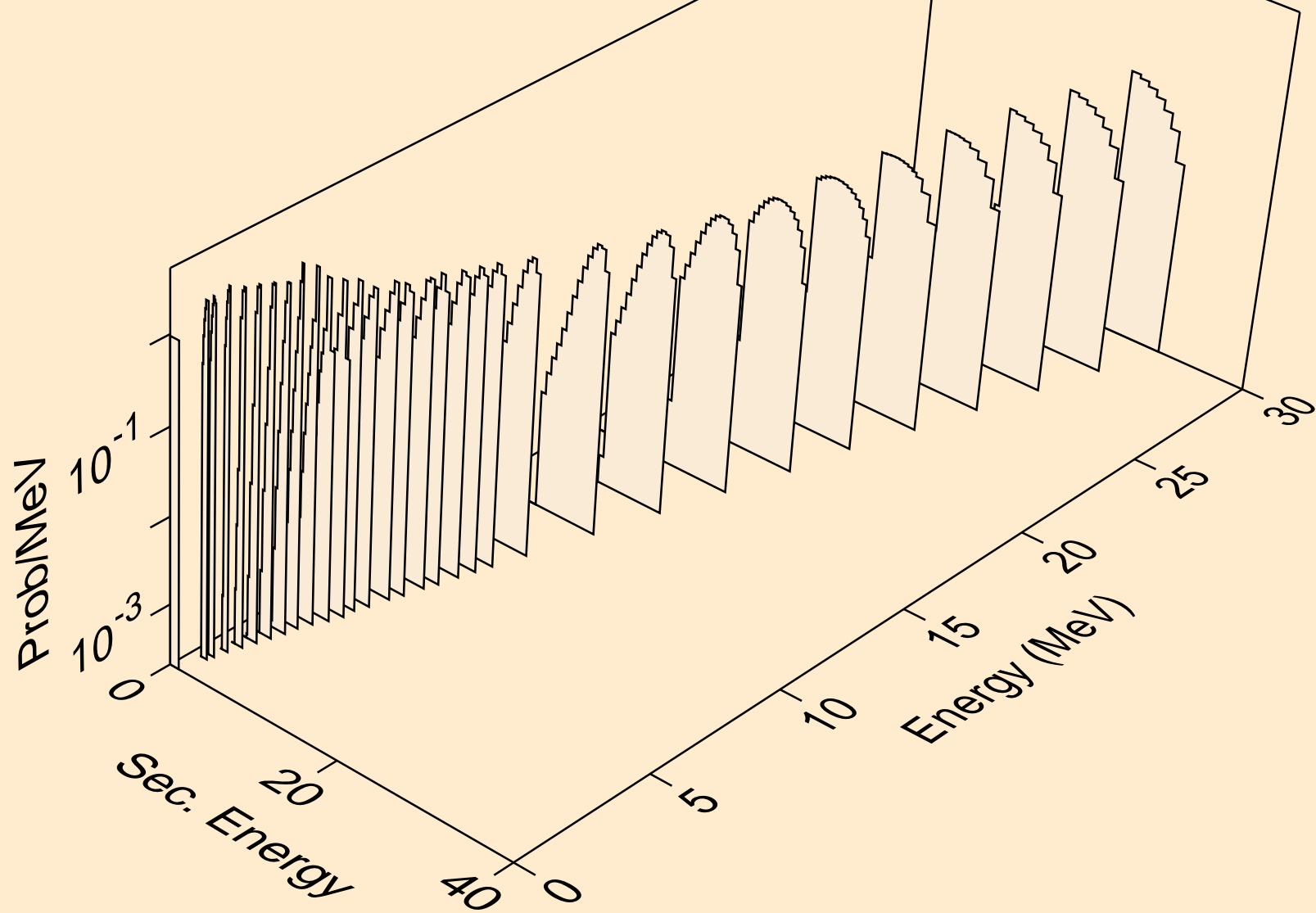

CM240 NEUTRON ACER TENDL-2021 LIBRARY; T=293.6K
protons from (n,2p)

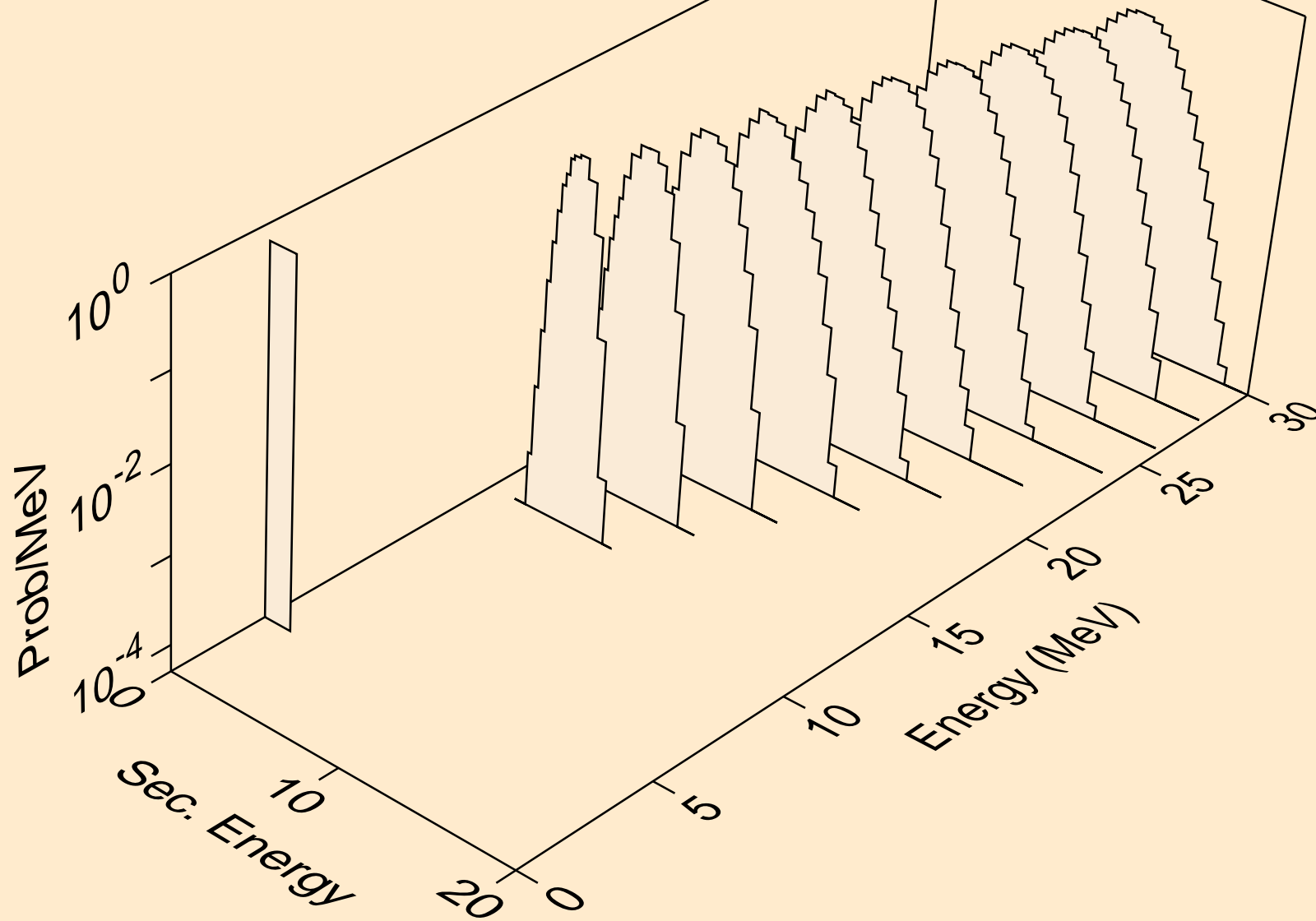

CM240 NEUTRON ACER TENDL-2021 LIBRARY; T=293.6K
protons from (n,p)

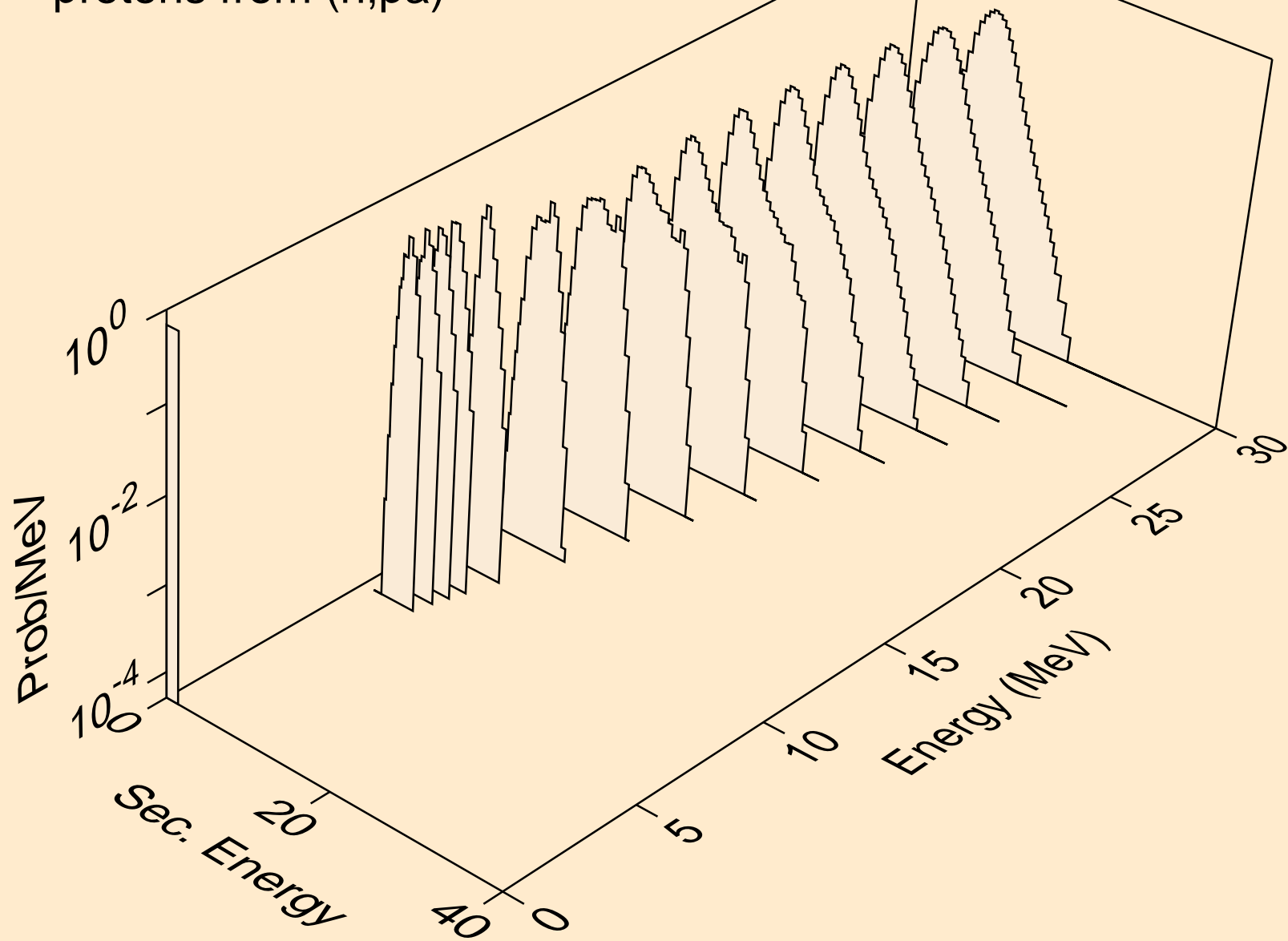

CM240 NEUTRON ACER TENDL-2021 LIBRARY; T=293.6K
protons from (n,pd)

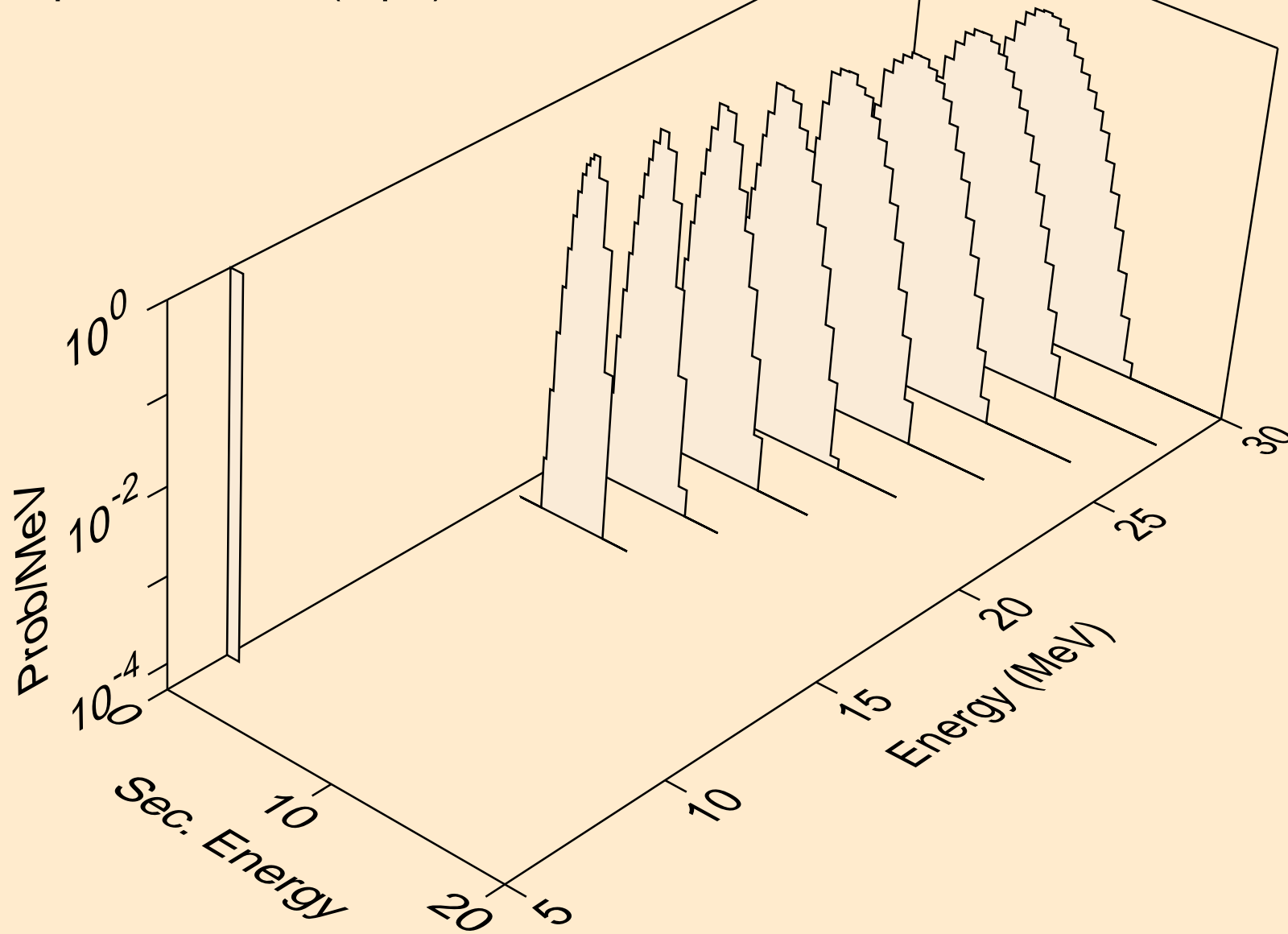

CM240 NEUTRON ACER TENDL-2021 LIBRARY; T=293.6K
deuterons from (n,x)

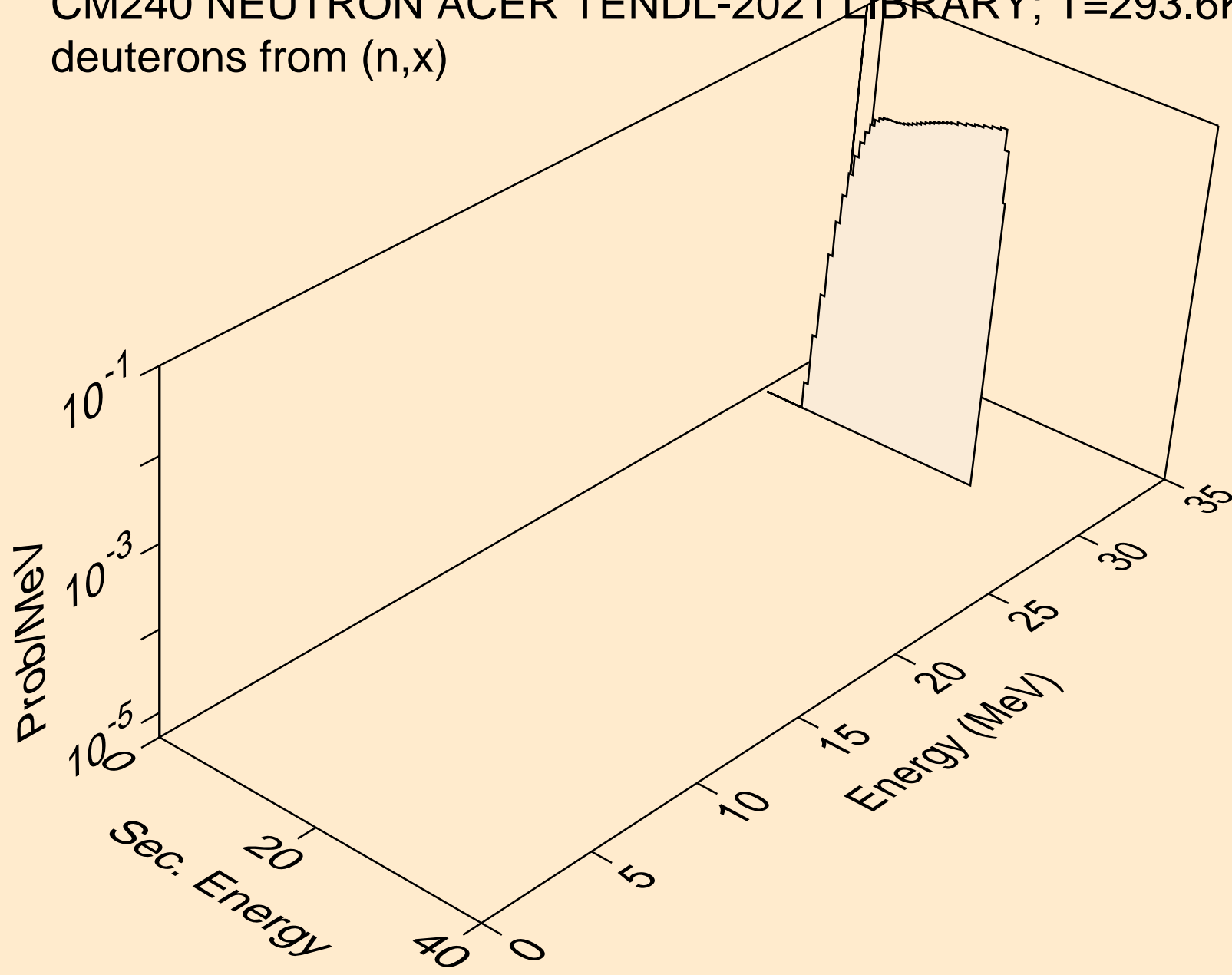

CM240 NEUTRON ACER TENDL-2021 LIBRARY; T=293.6K
deuterons from (n,2nd)

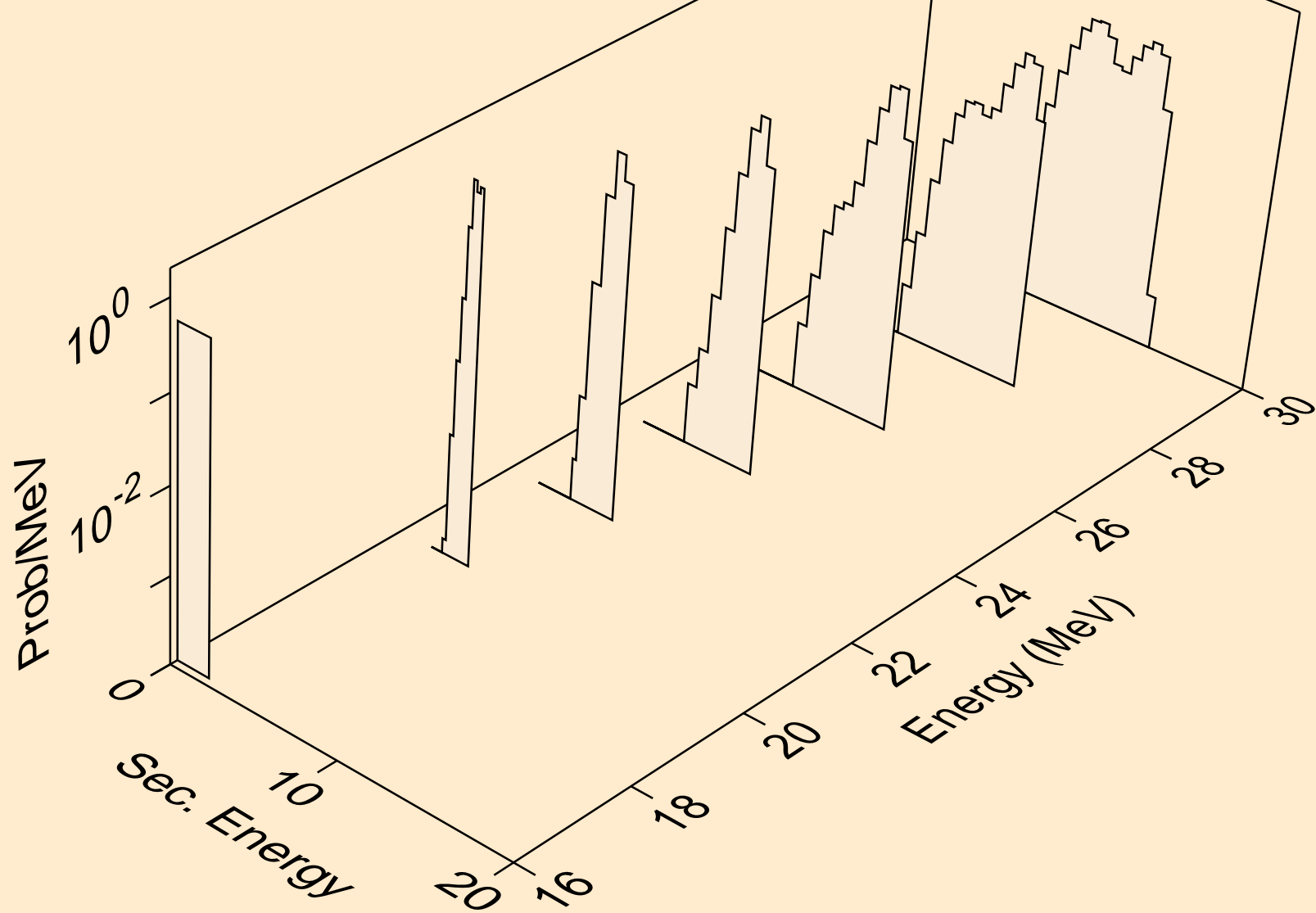

CM240 NEUTRON ACER TENDL-2021 LIBRARY; T=293.6K
deuterons from (n,n*)d

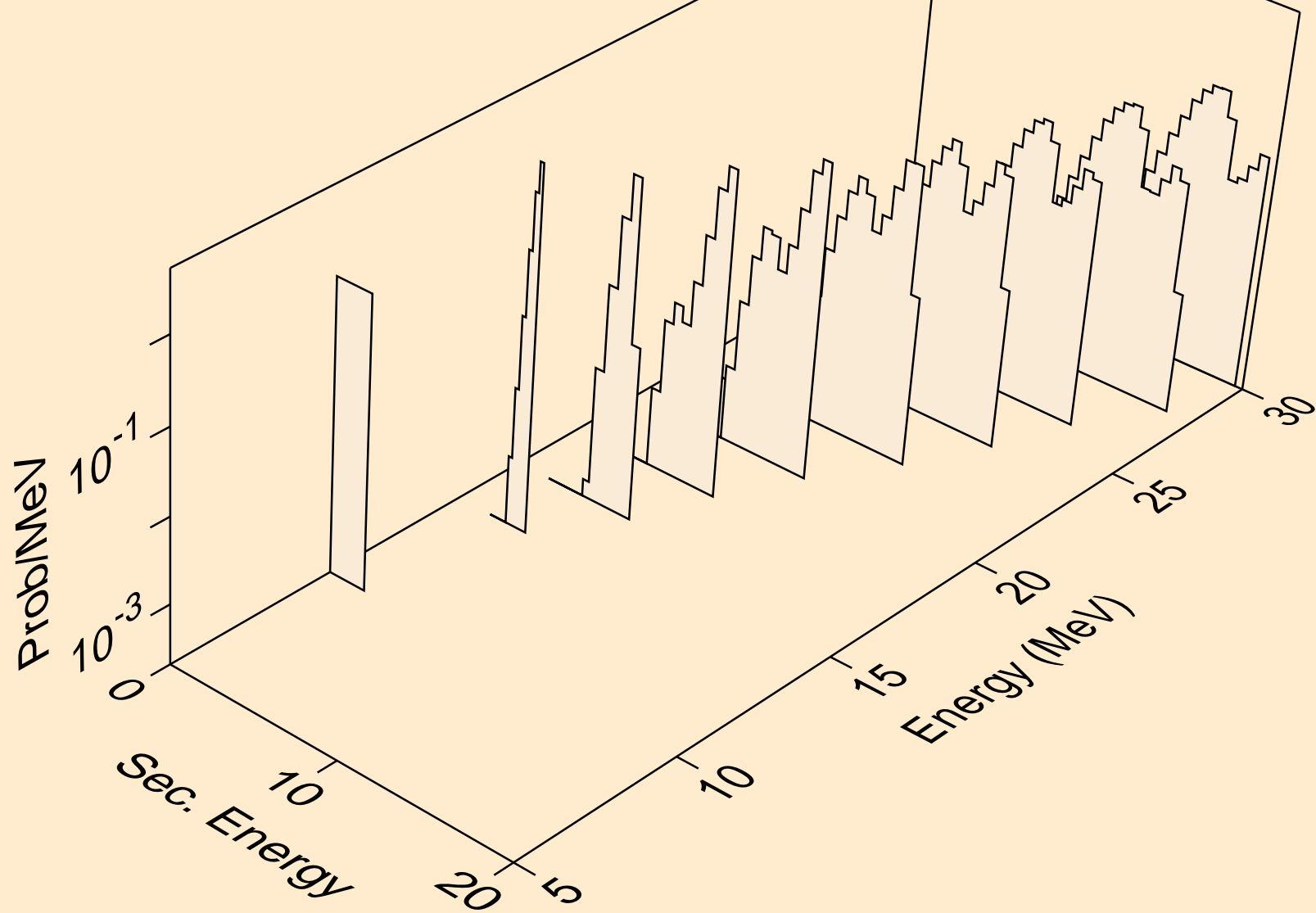

CM240 NEUTRON ACER TENDL-2021 LIBRARY; T=293.6K
deuterons from (n,d)

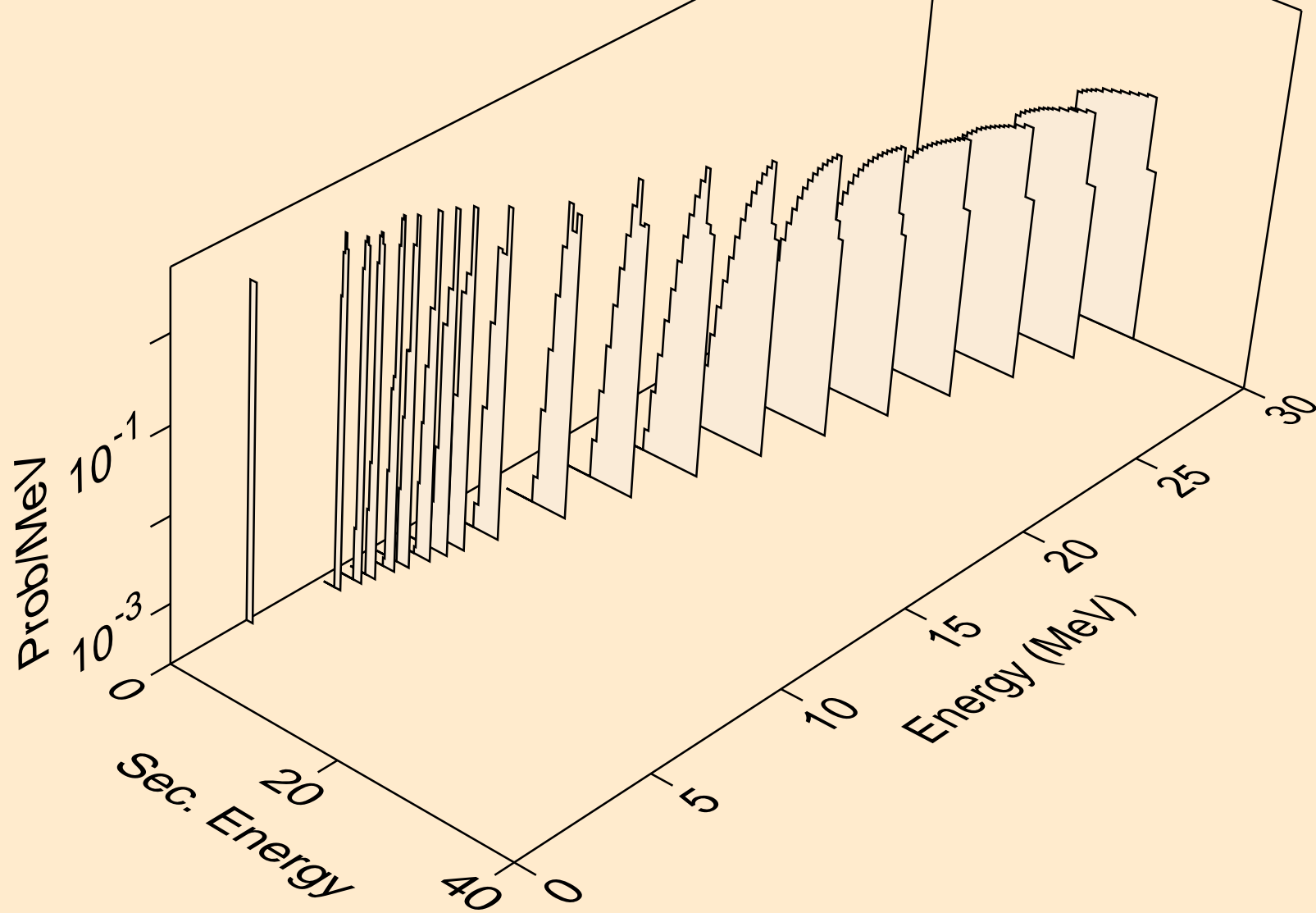

CM240 NEUTRON ACER TENDL-2021 LIBRARY; T=293.6K
deuterons from (n,pd)

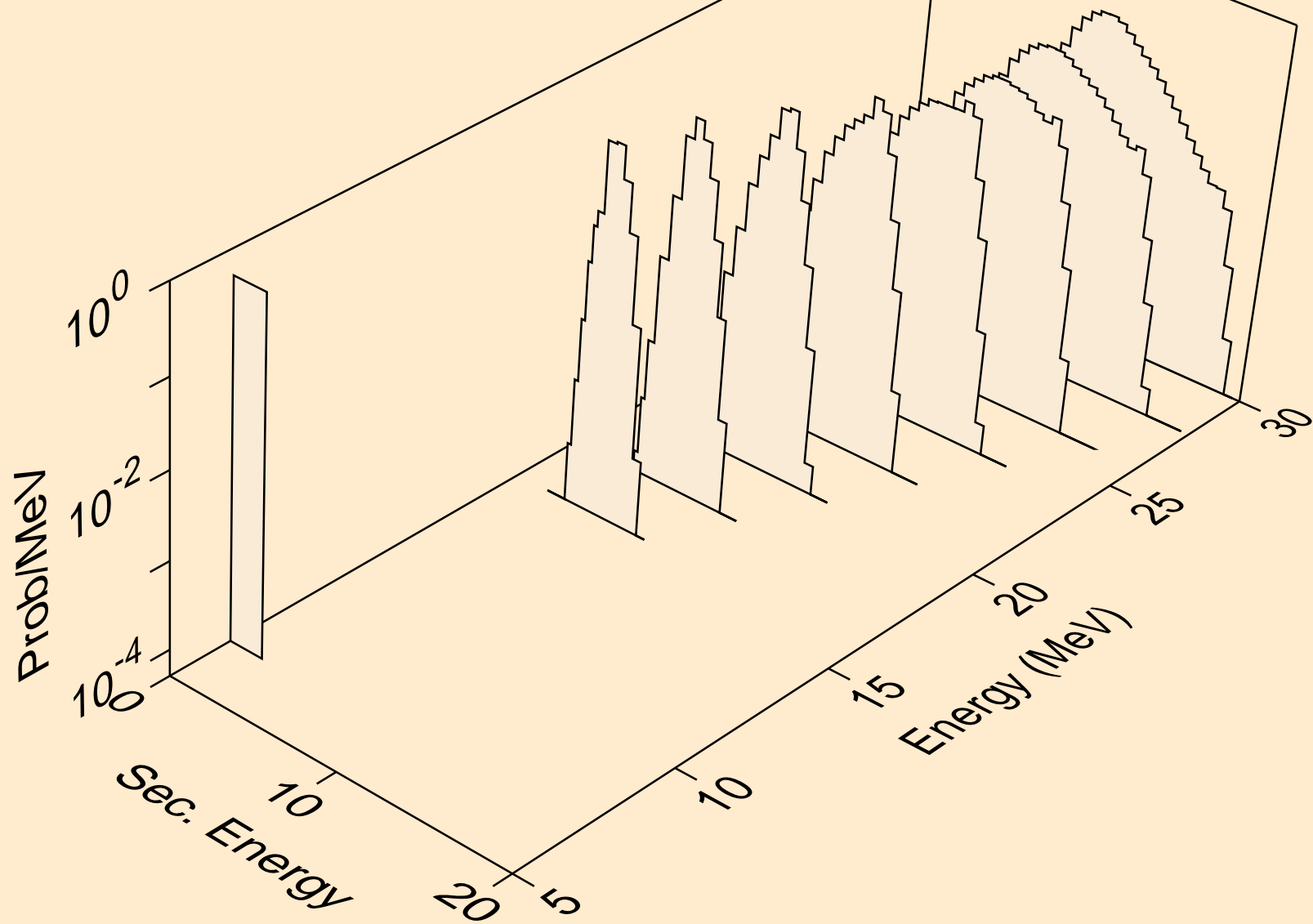

CM240 NEUTRON ACER TENDL-2021 LIBRARY; T=293.6K
deuterons from (n,da)

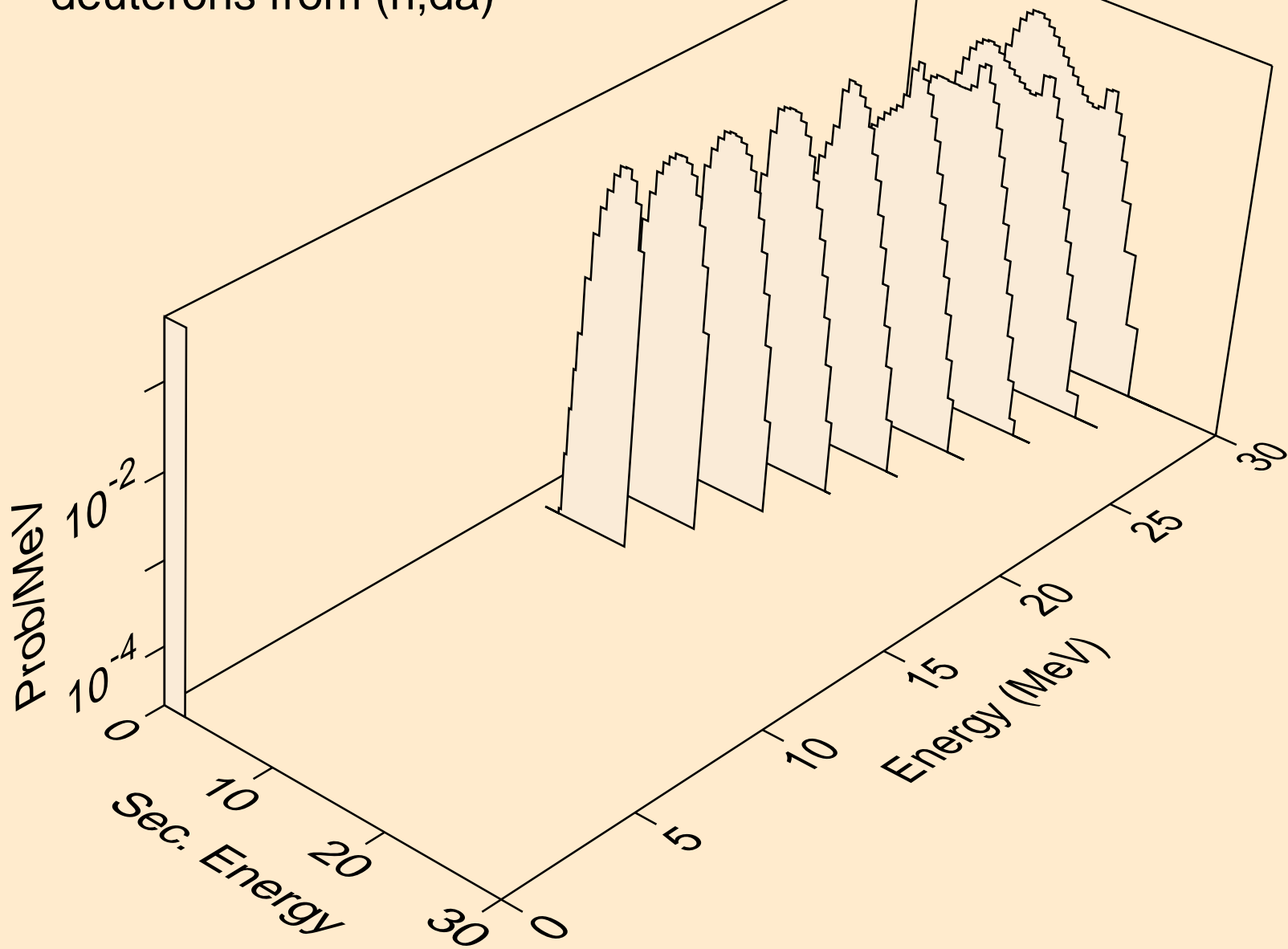

CM240 NEUTRON ACER TENDL-2021 LIBRARY; T=293.6K
tritons from (n,x)

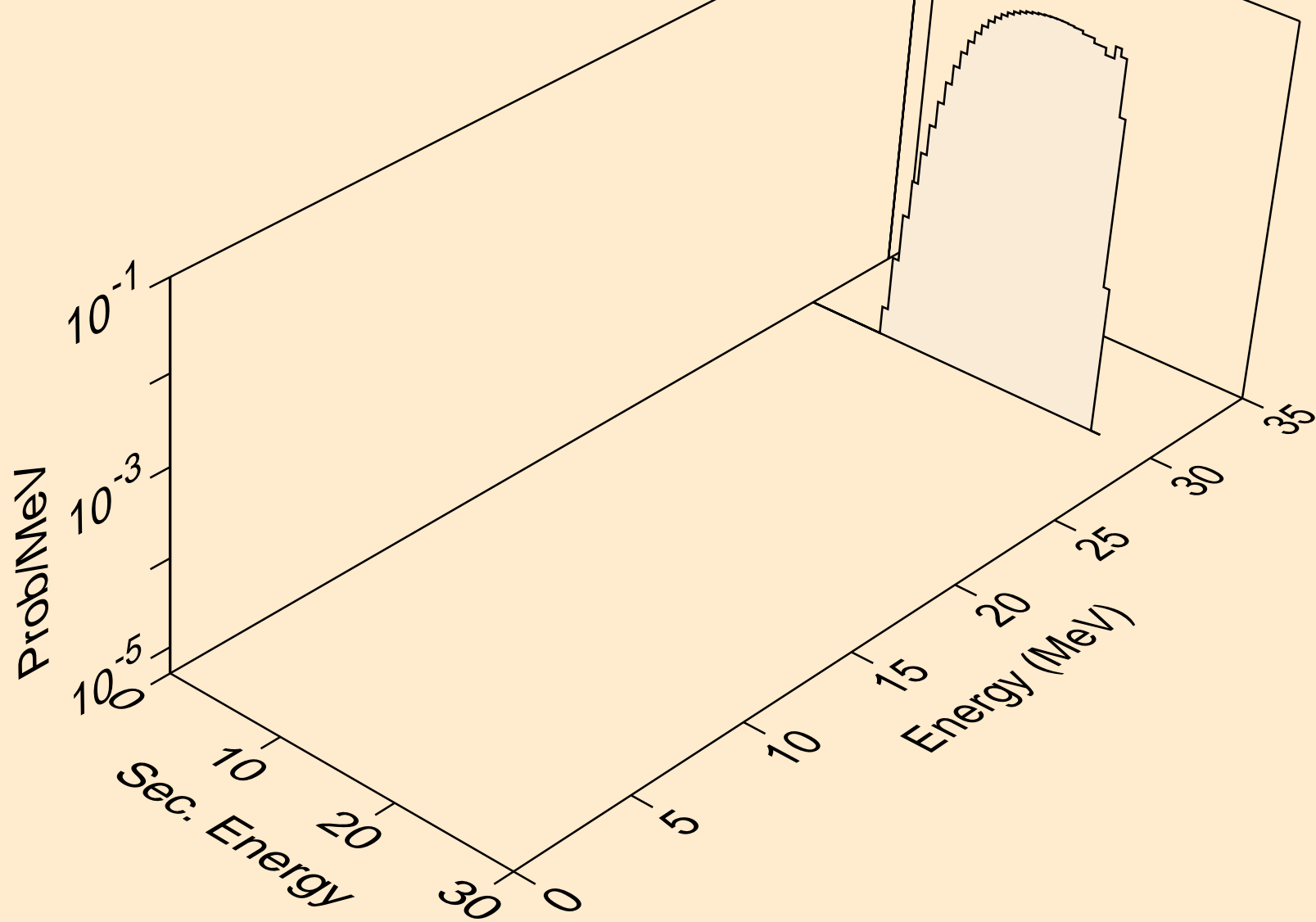

CM240 NEUTRON ACER TENDL-2021 LIBRARY; T=293.6K
tritons from (n,n*)t

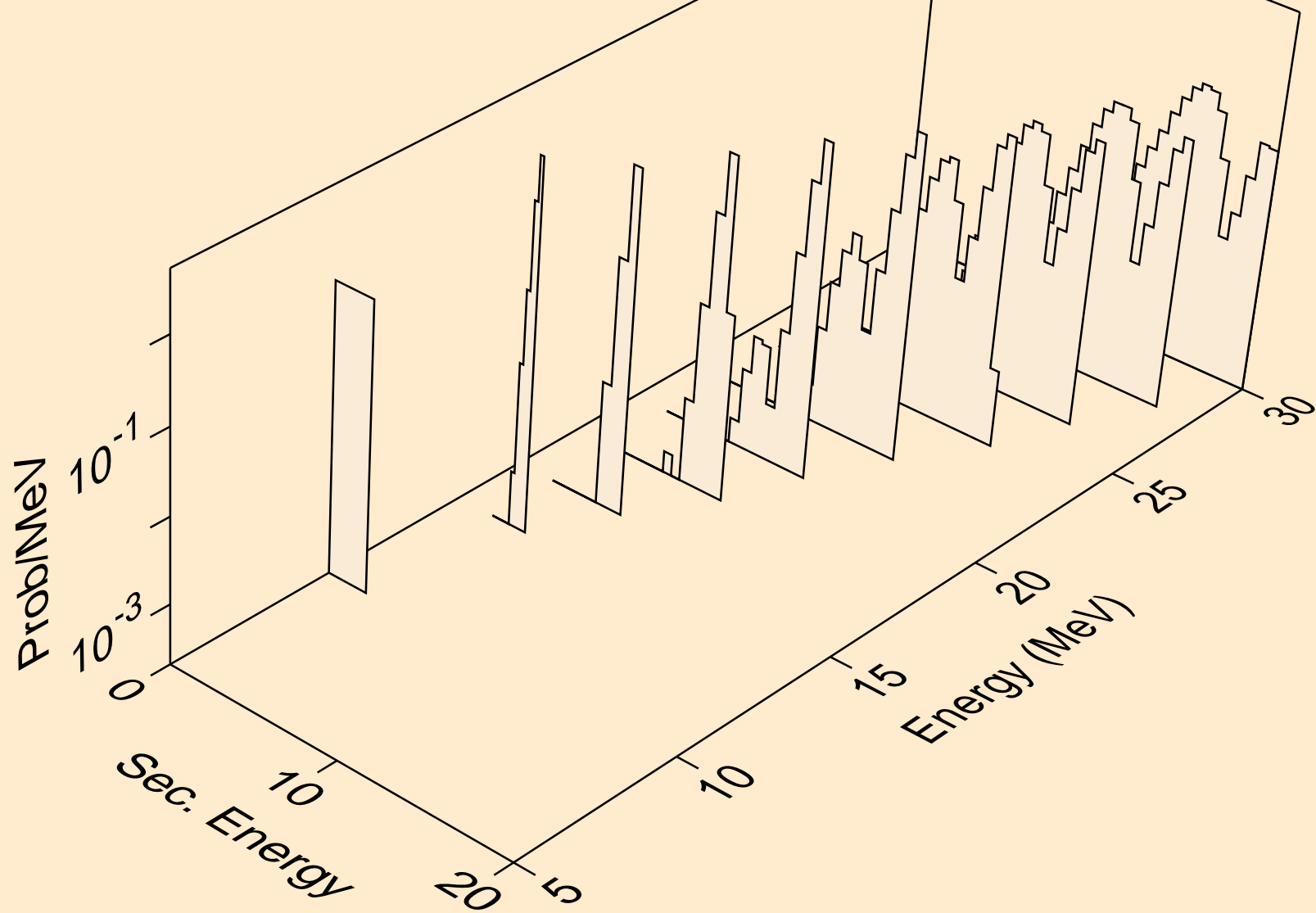

CM240 NEUTRON ACER TENDL-2021 LIBRARY; T=293.6K
tritons from (n,t)

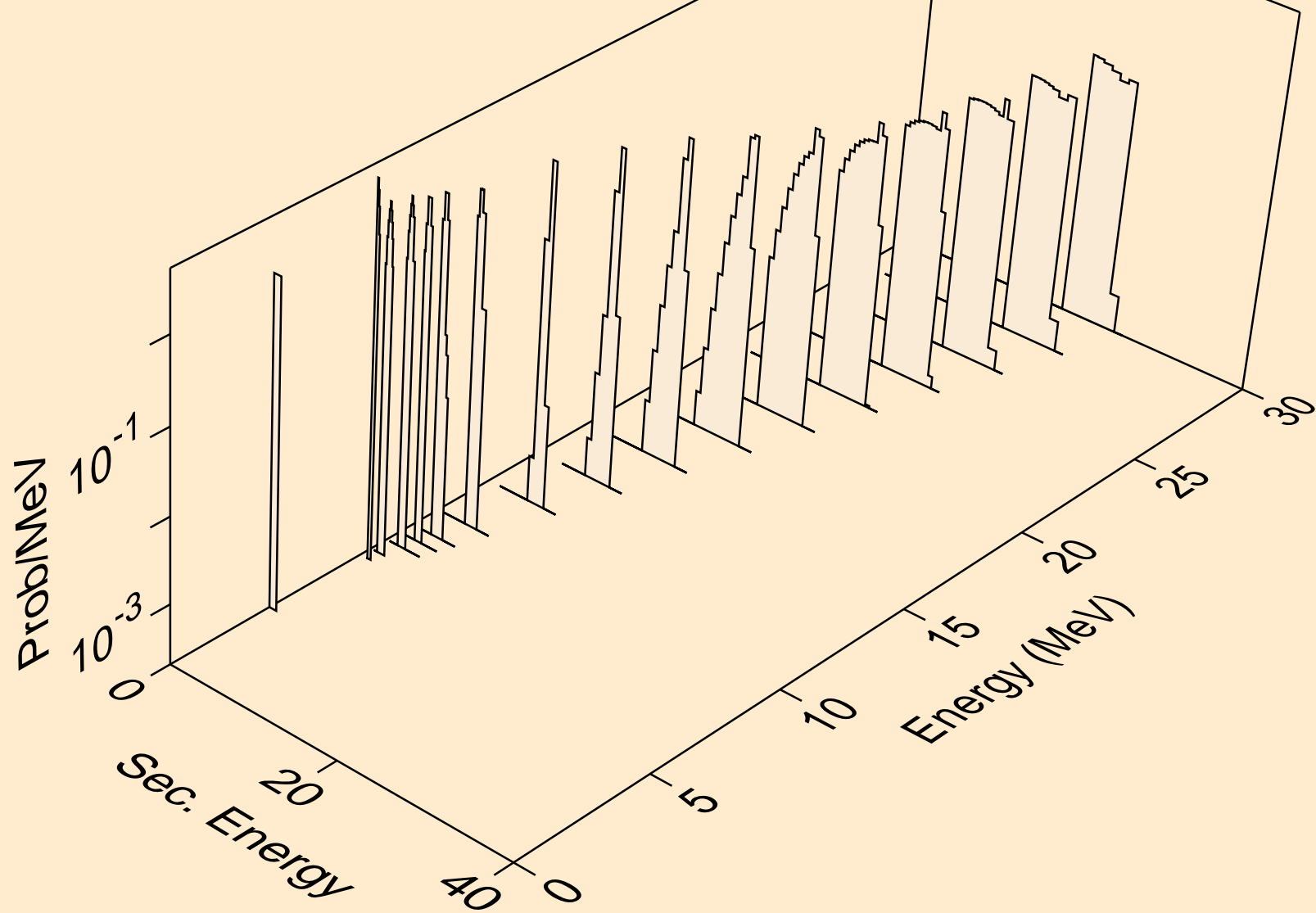

CM240 NEUTRON ACER TENDL-2021 LIBRARY; T=293.6K
he3s from (n,x)

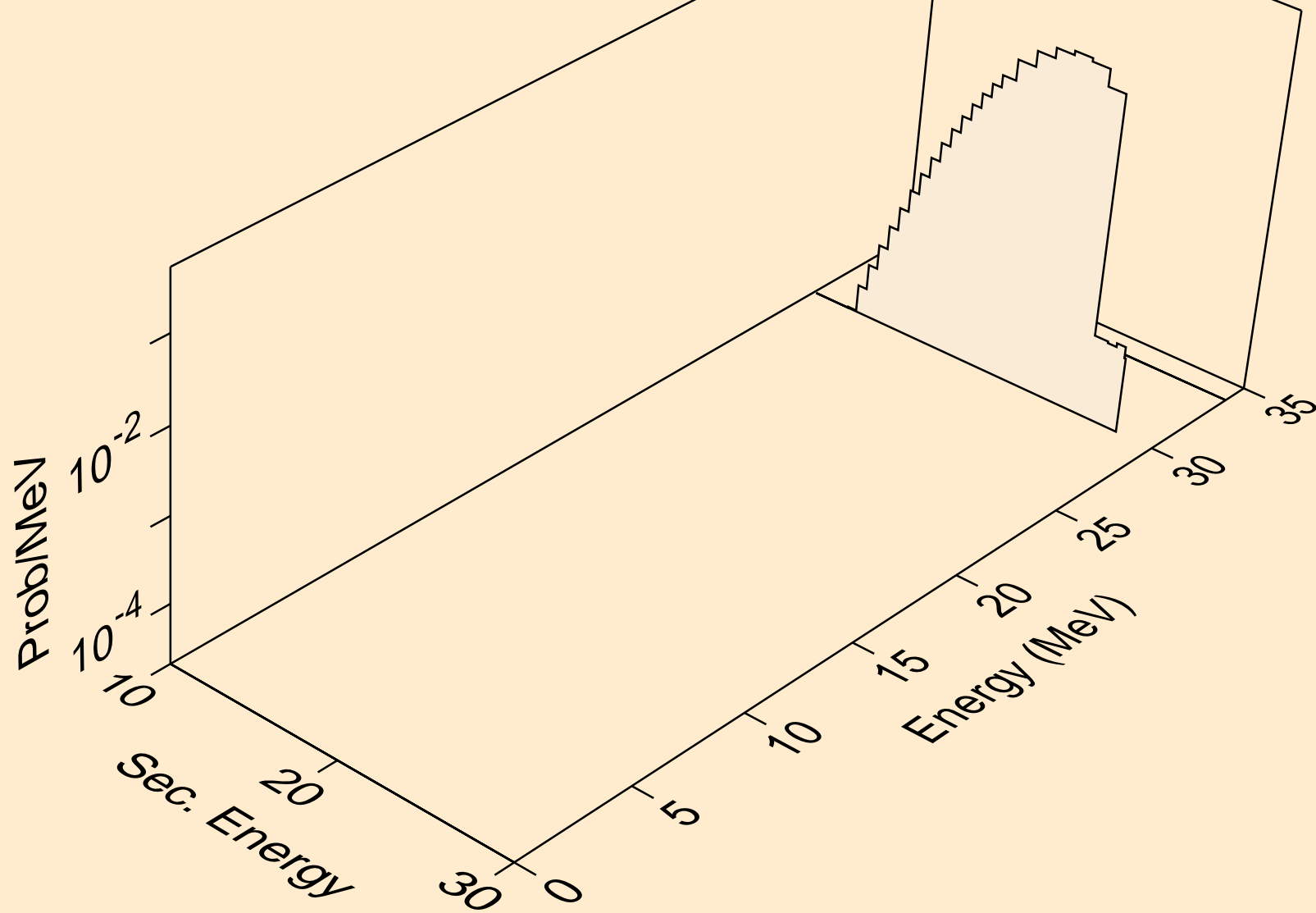

CM240 NEUTRON ACER TENDL-2021 LIBRARY; T=293.6K
he3s from (n,n*)he3

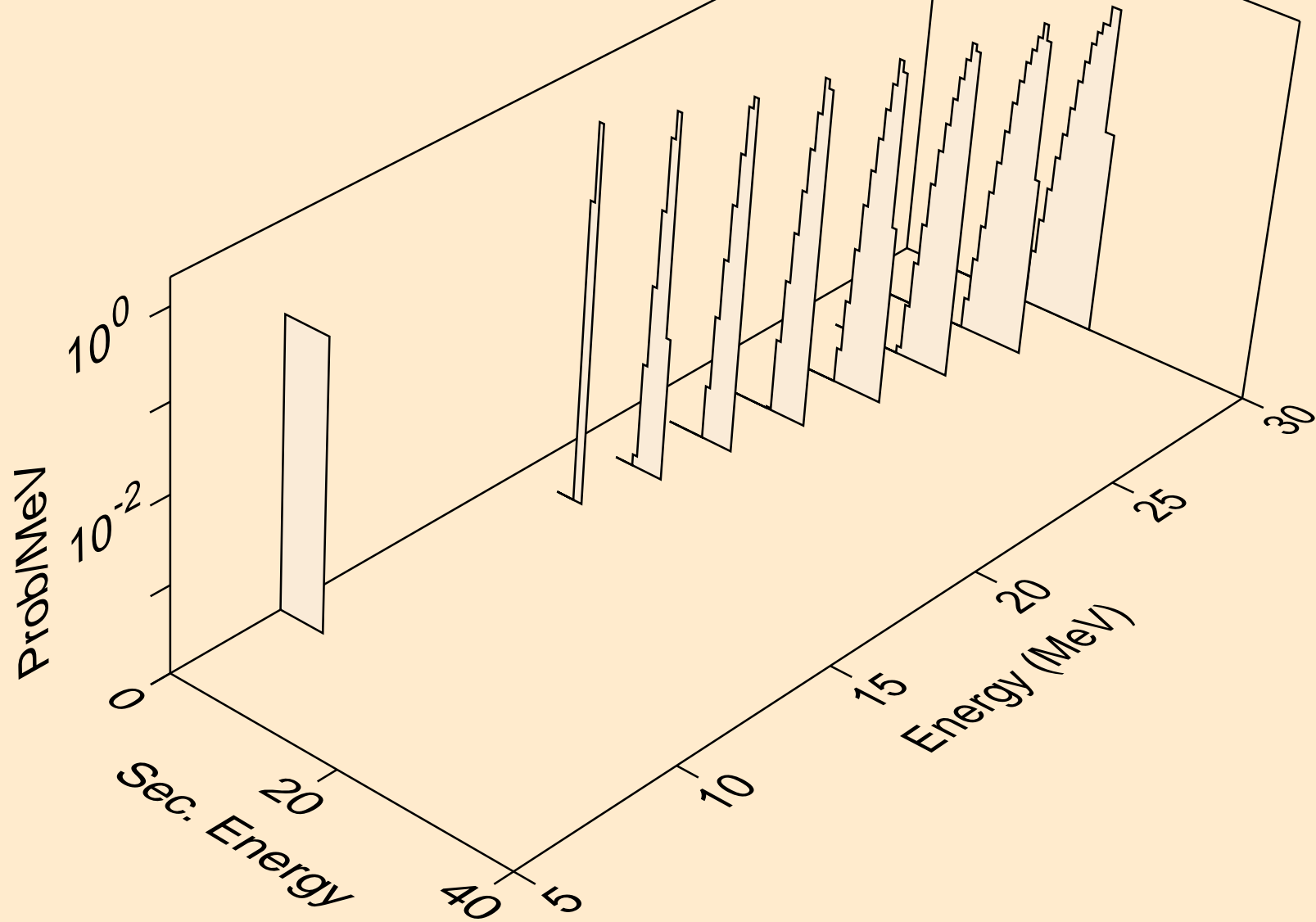

CM240 NEUTRON ACER TENDL-2021 LIBRARY; T=293.6K
he3s from (n,he3)

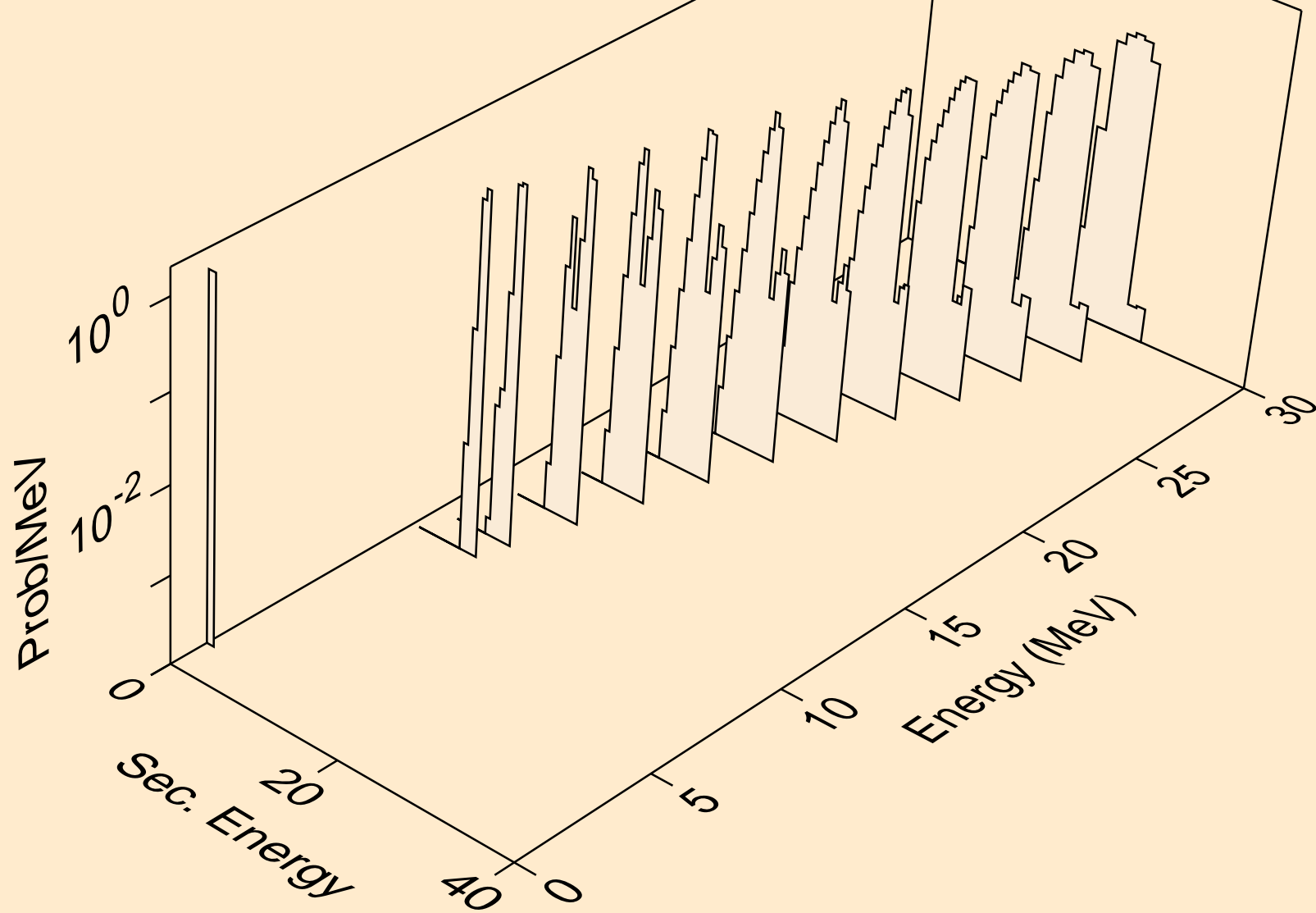

CM240 NEUTRON ACER TENDL-2021 LIBRARY; T=293.6K
alphas from (n,x)

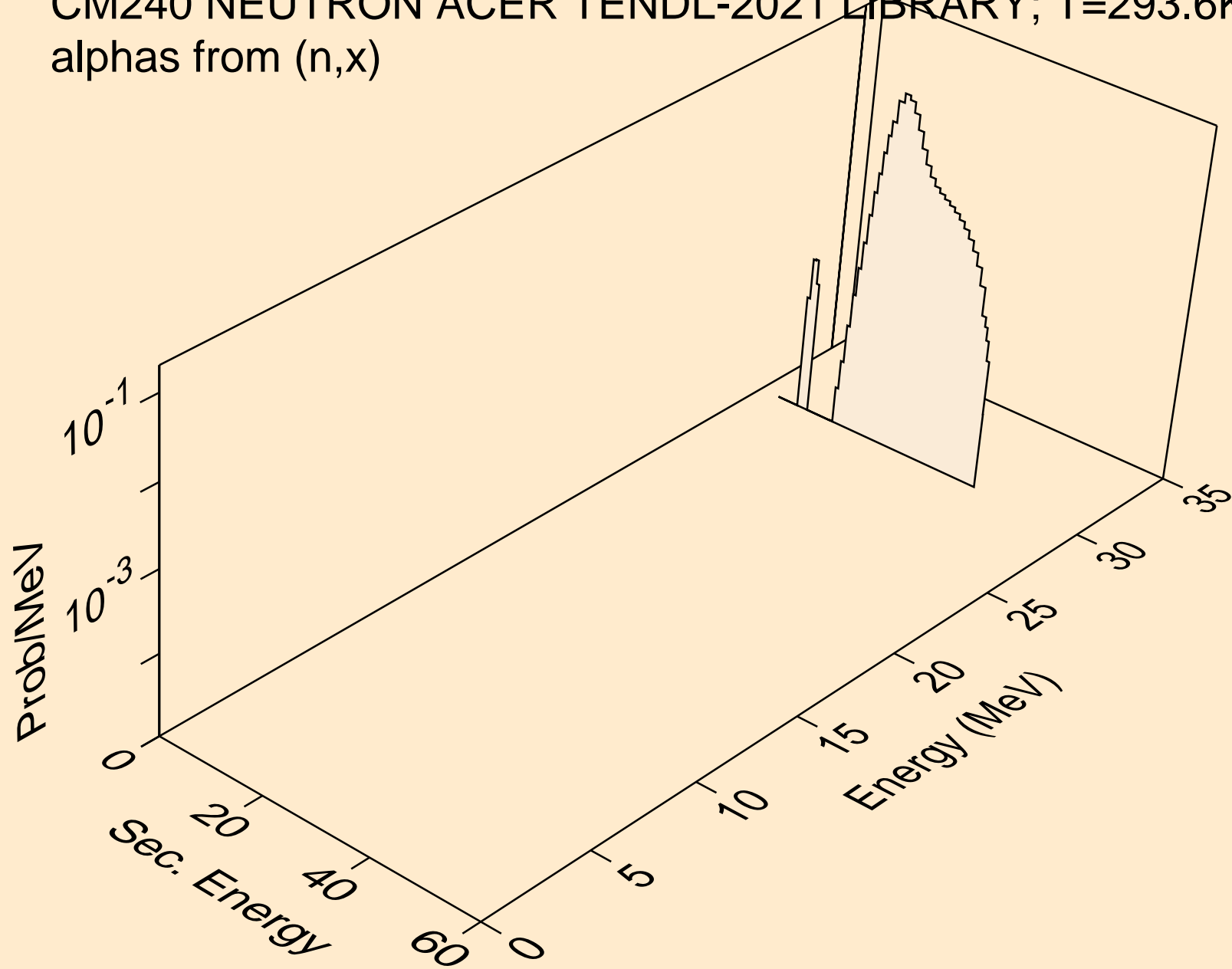

CM240 NEUTRON ACER TENDL-2021 LIBRARY; T=293.6K
alphas from (n,n*)a

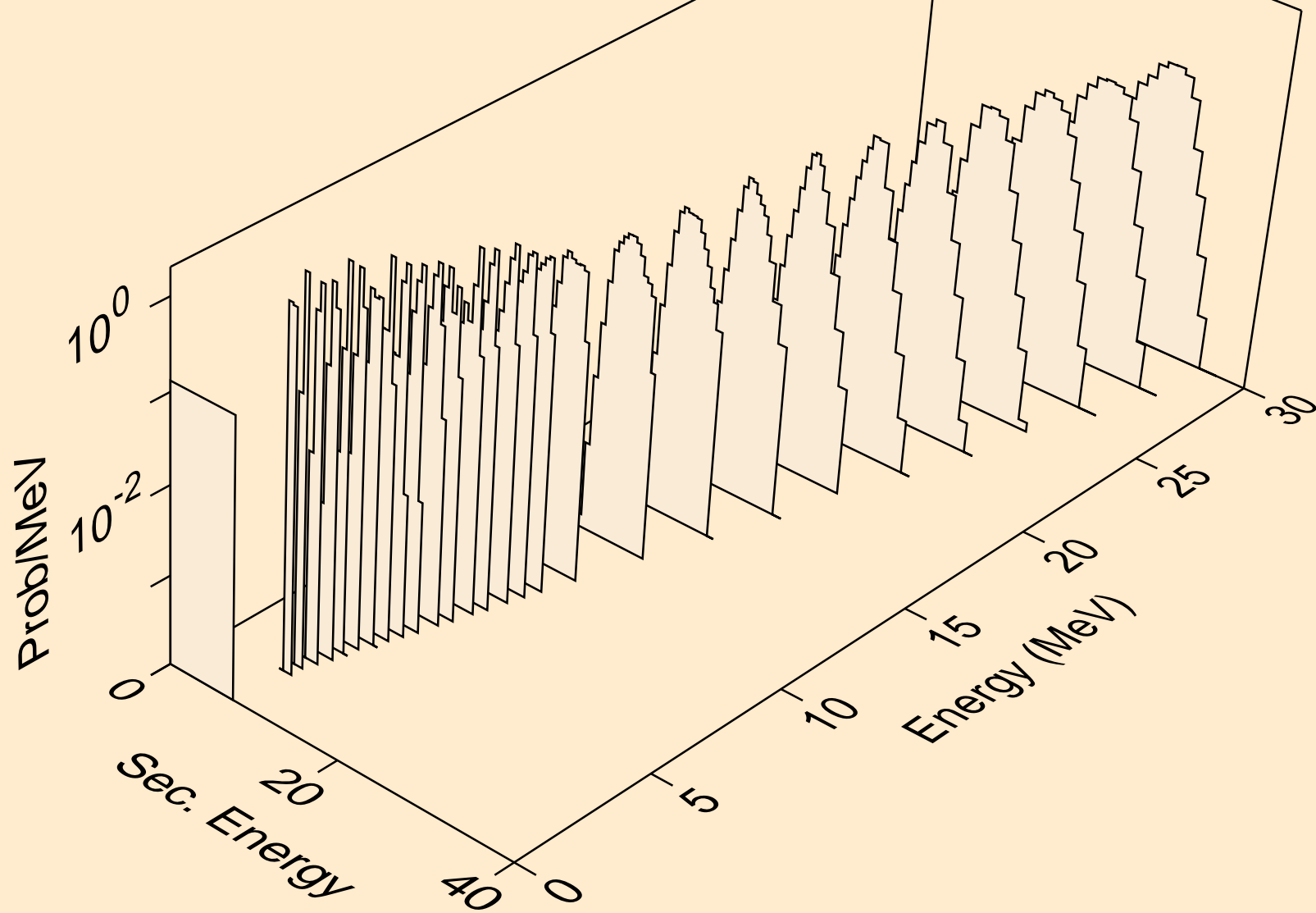

CM240 NEUTRON ACER TENDL-2021 LIBRARY; T=293.6K
alphas from (n,2n)a

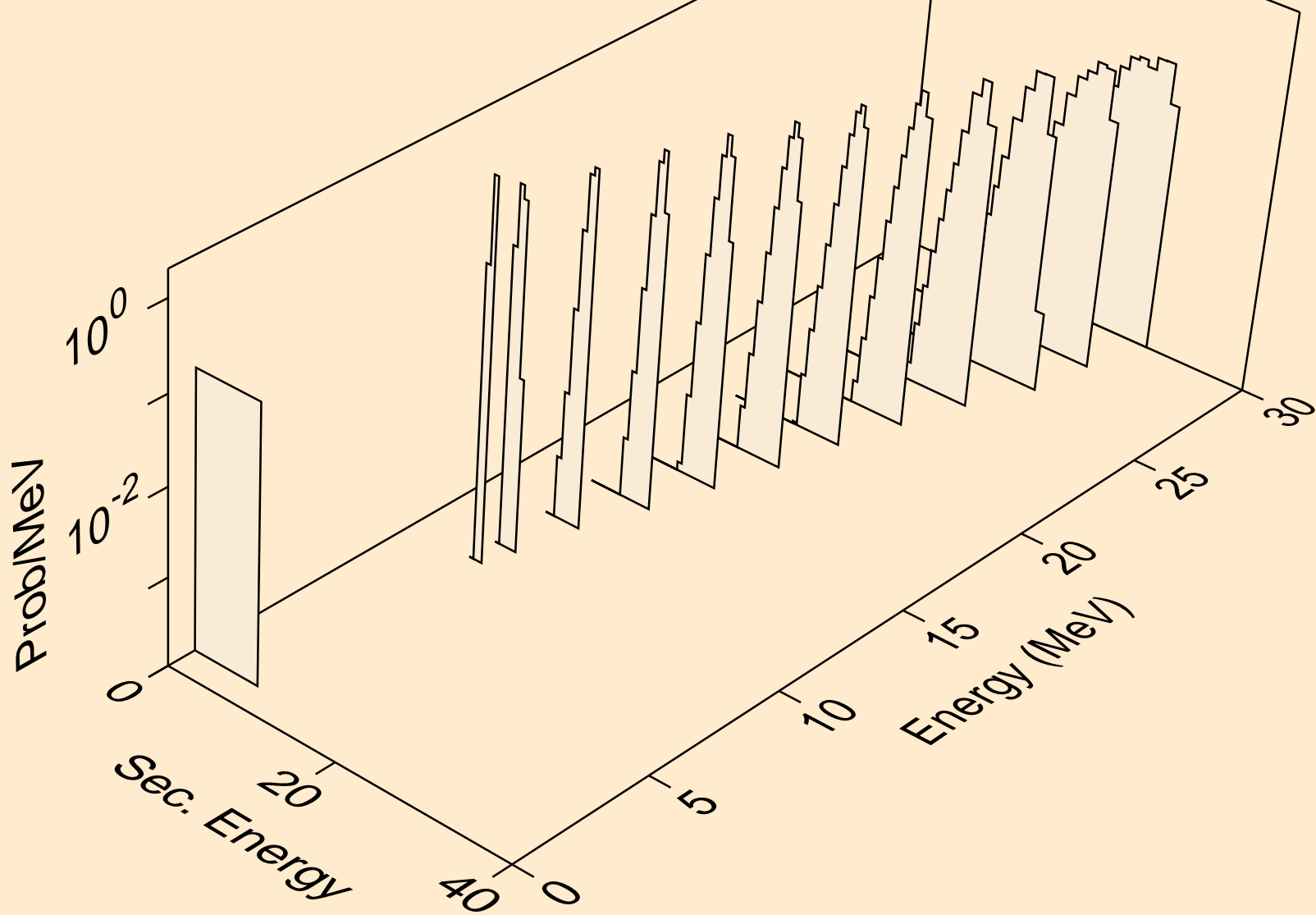

CM240 NEUTRON ACER TENDL-2021 LIBRARY; T=293.6K
alphas from (n,3n)a

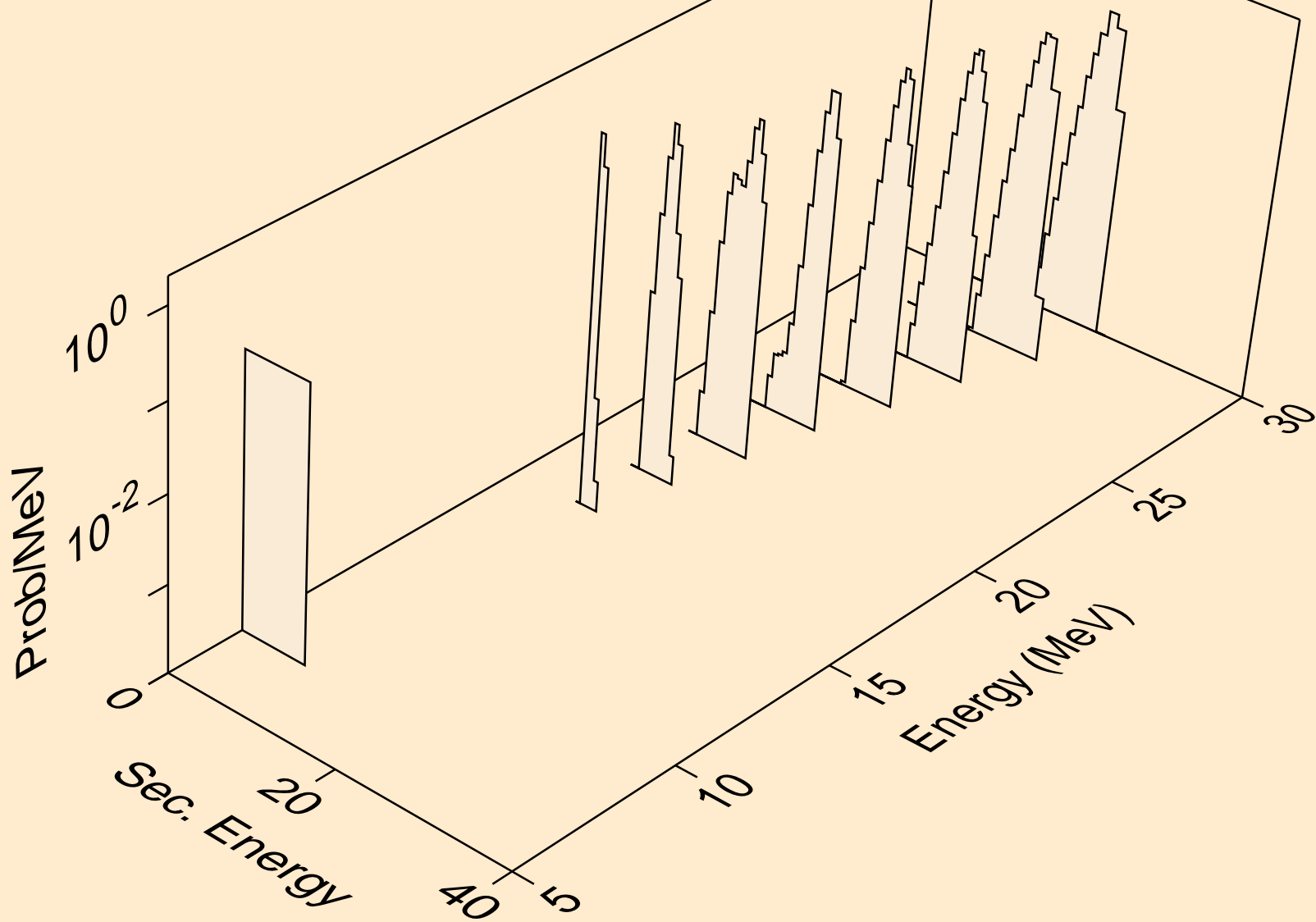

CM240 NEUTRON ACER TENDL-2021 LIBRARY; T=293.6K
alphas from (n,n*)2a

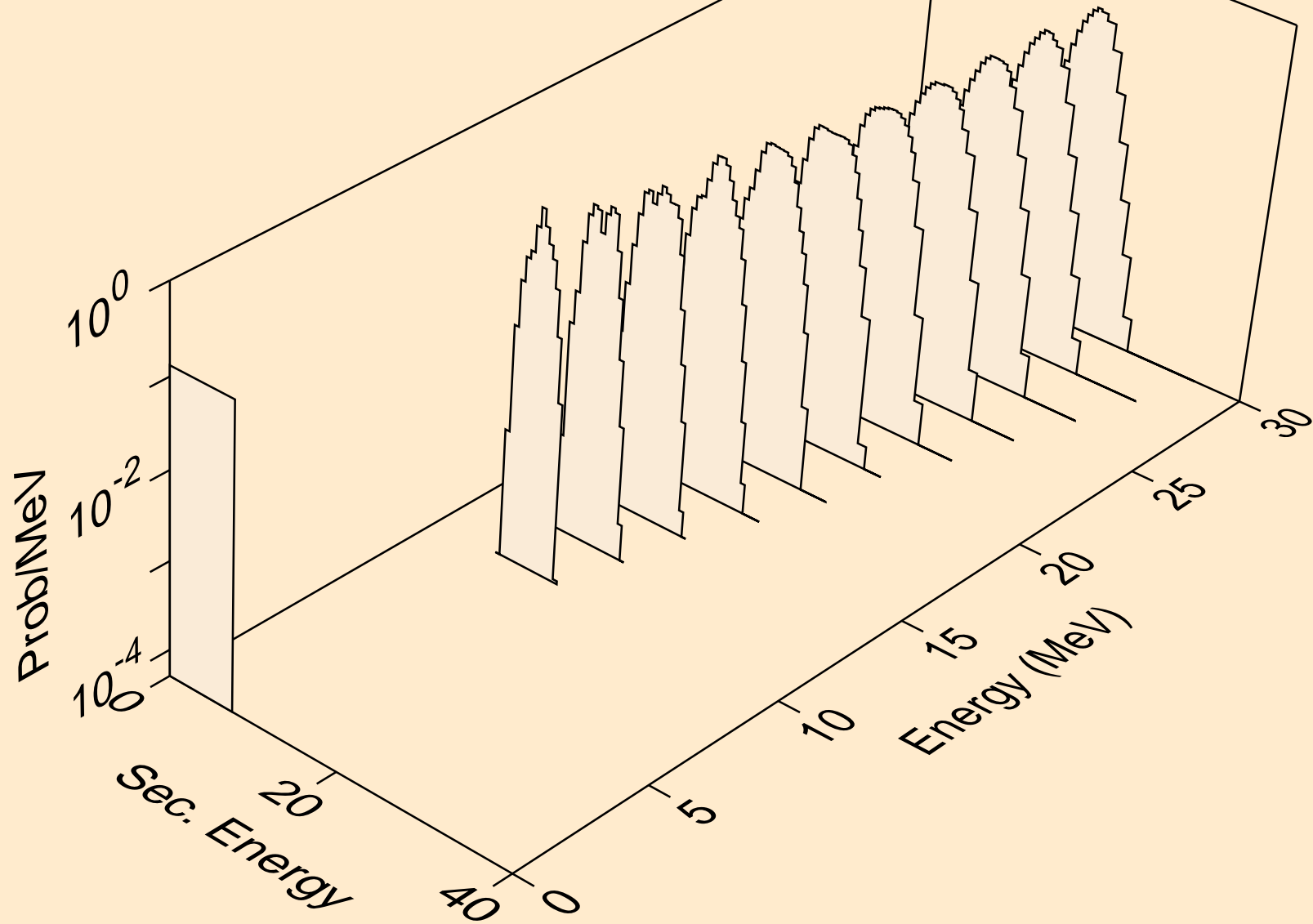

CM240 NEUTRON ACER TENDL-2021 LIBRARY; T=293.6K
alphas from (n,2n)2a

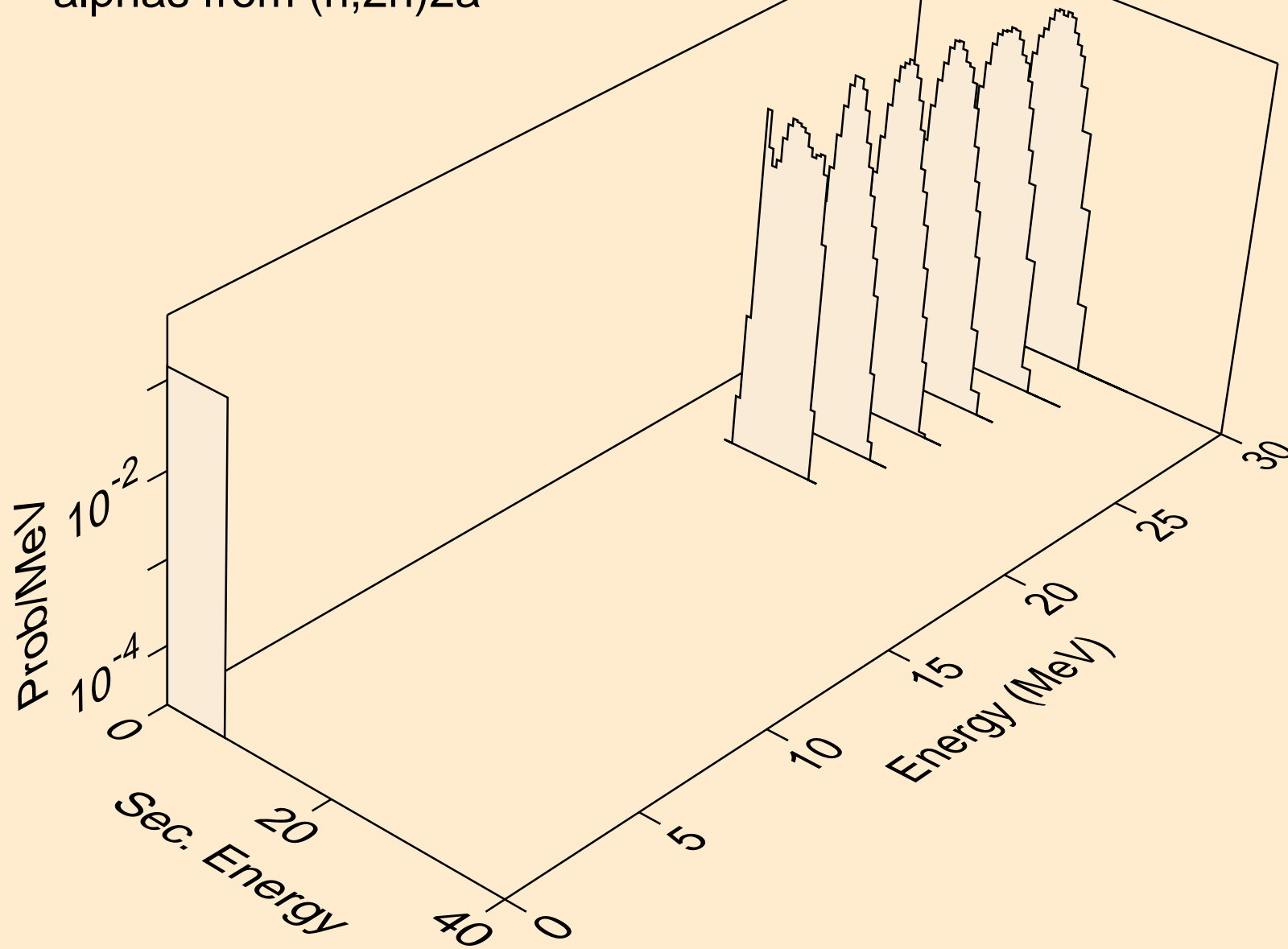

CM240 NEUTRON ACER TENDL-2021 LIBRARY; T=293.6K
alphas from (n,npa)

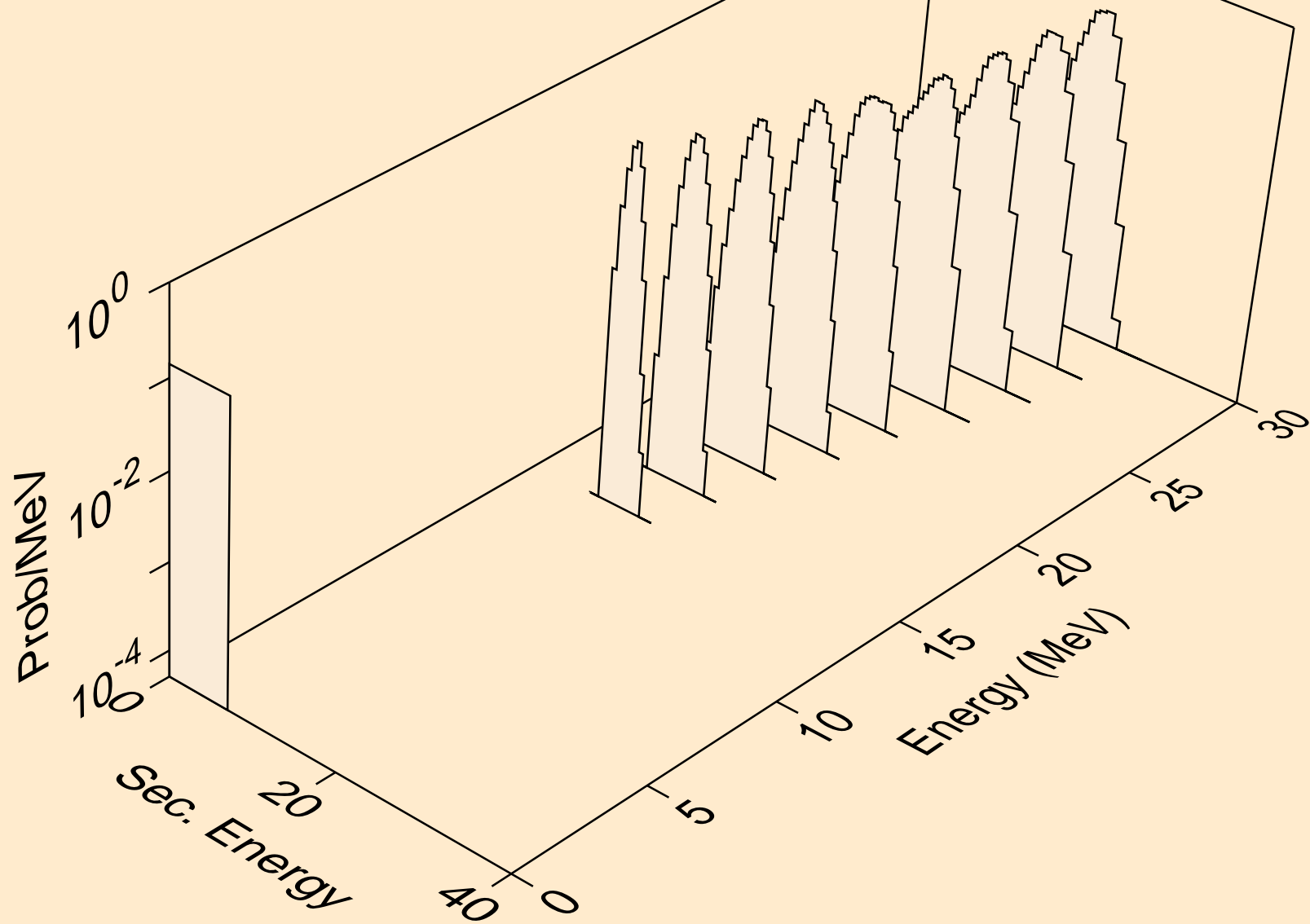

CM240 NEUTRON ACER TENDL-2021 LIBRARY; T=293.6K
alphas from (n,a)

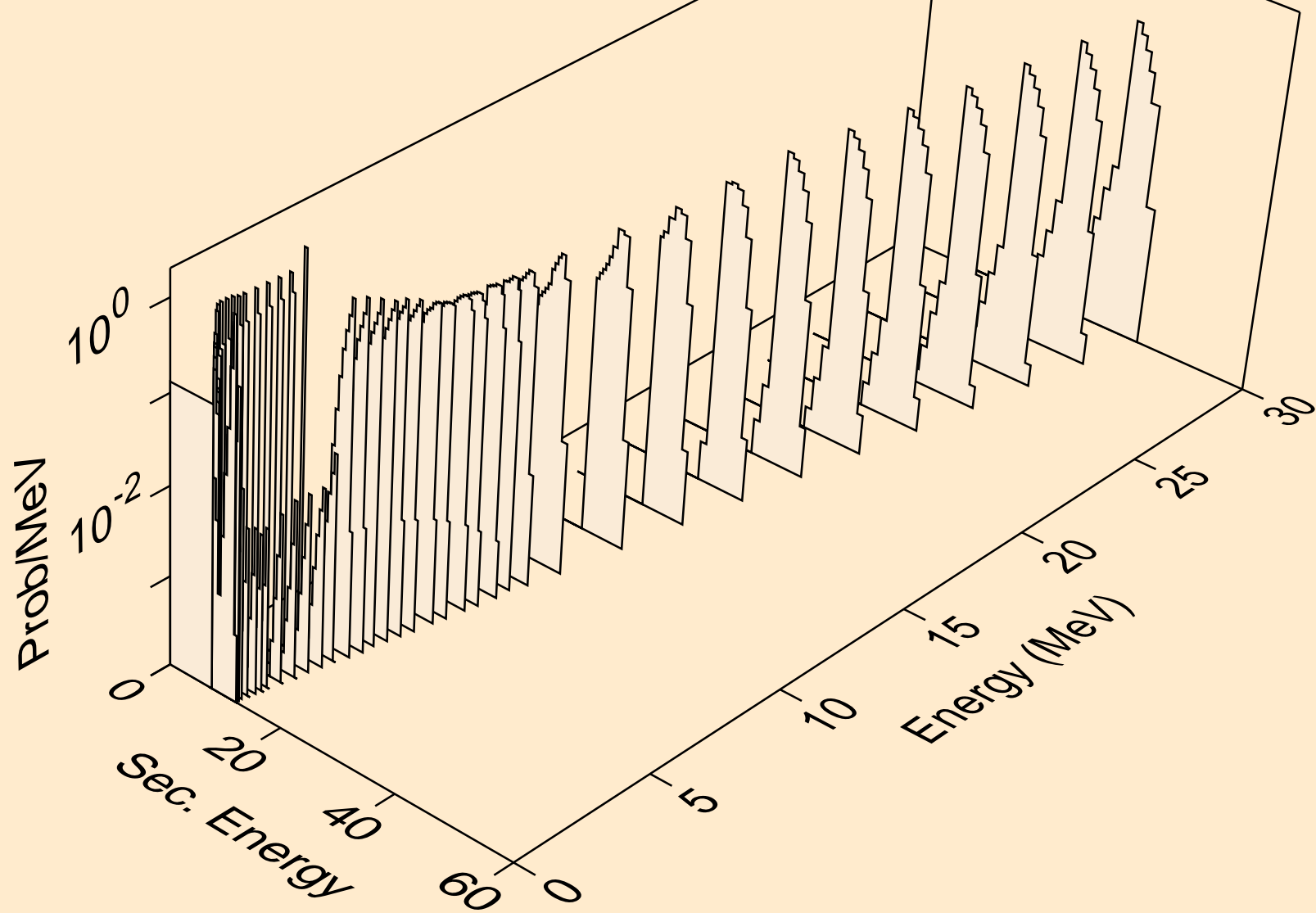

CM240 NEUTRON ACER TENDL-2021 LIBRARY; T=293.6K
alphas from (n,2a)

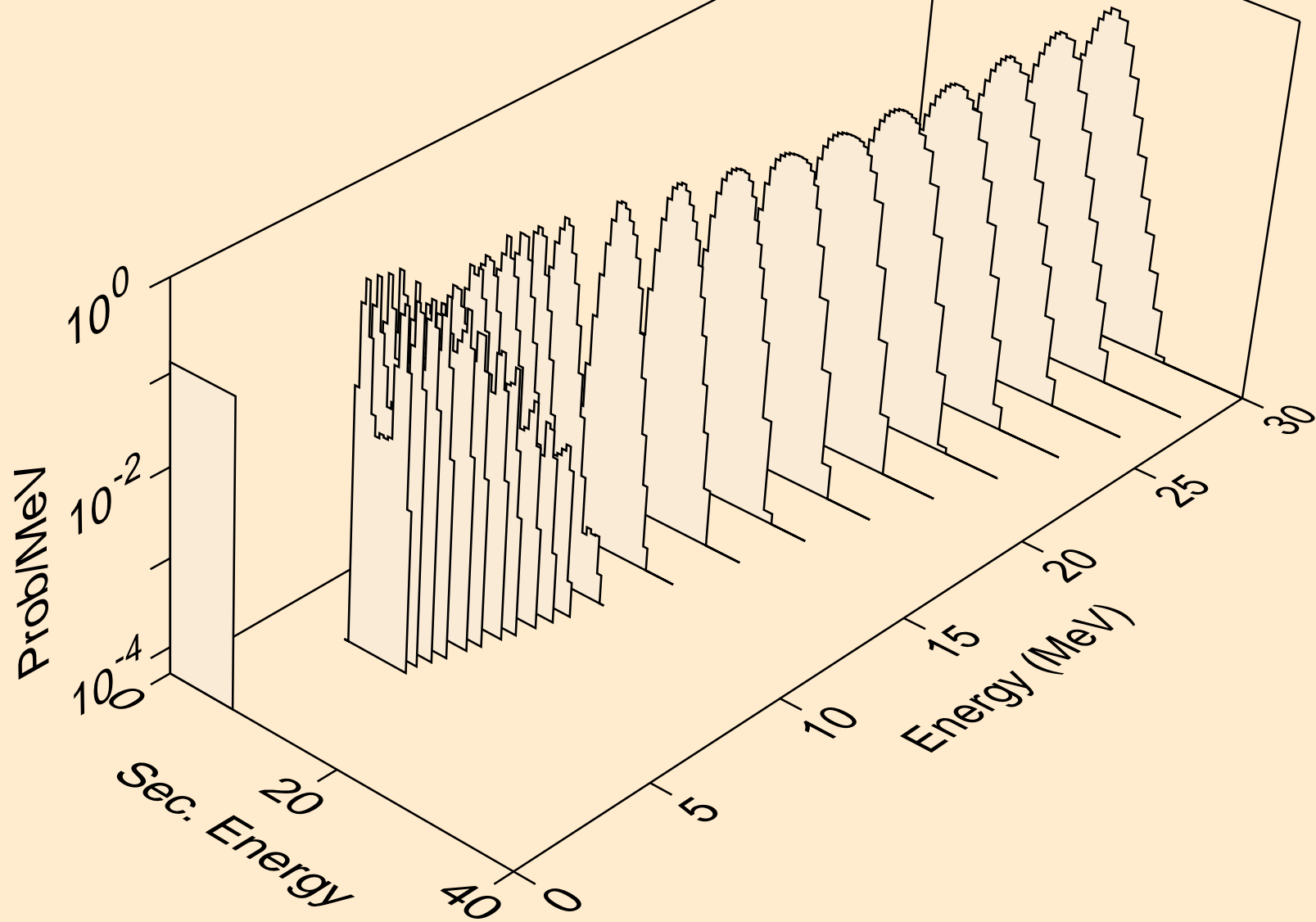

CM240 NEUTRON ACER TENDL-2021 LIBRARY; T=293.6K
alphas from (n,pa)

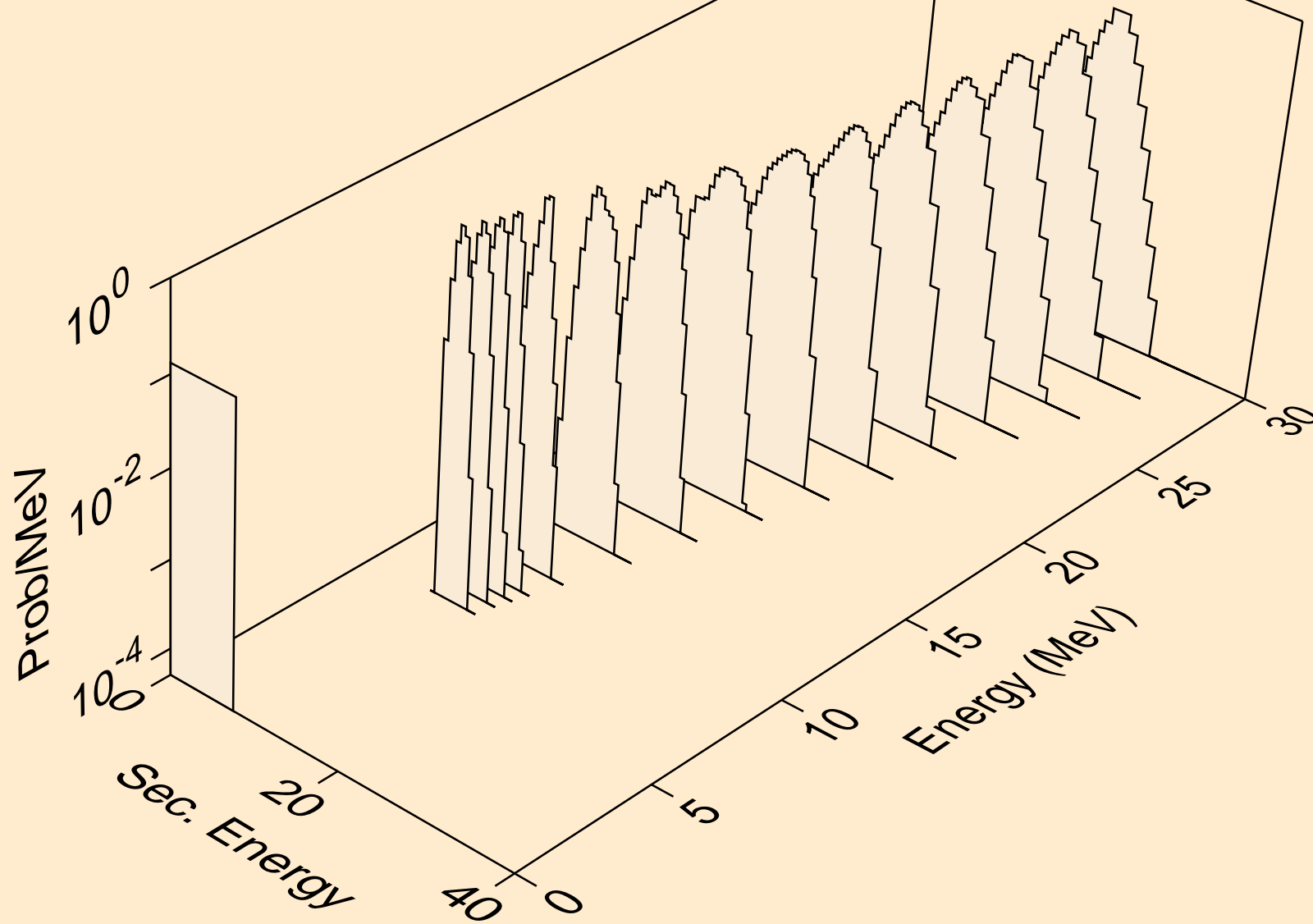

CM240 NEUTRON ACER TENDL-2021 LIBRARY; T=293.6K
alphas from (n,da)

