

CM247 NEUTRON ACER TENDL-2021 LIBRARY; T=293.6K

Principal cross sections

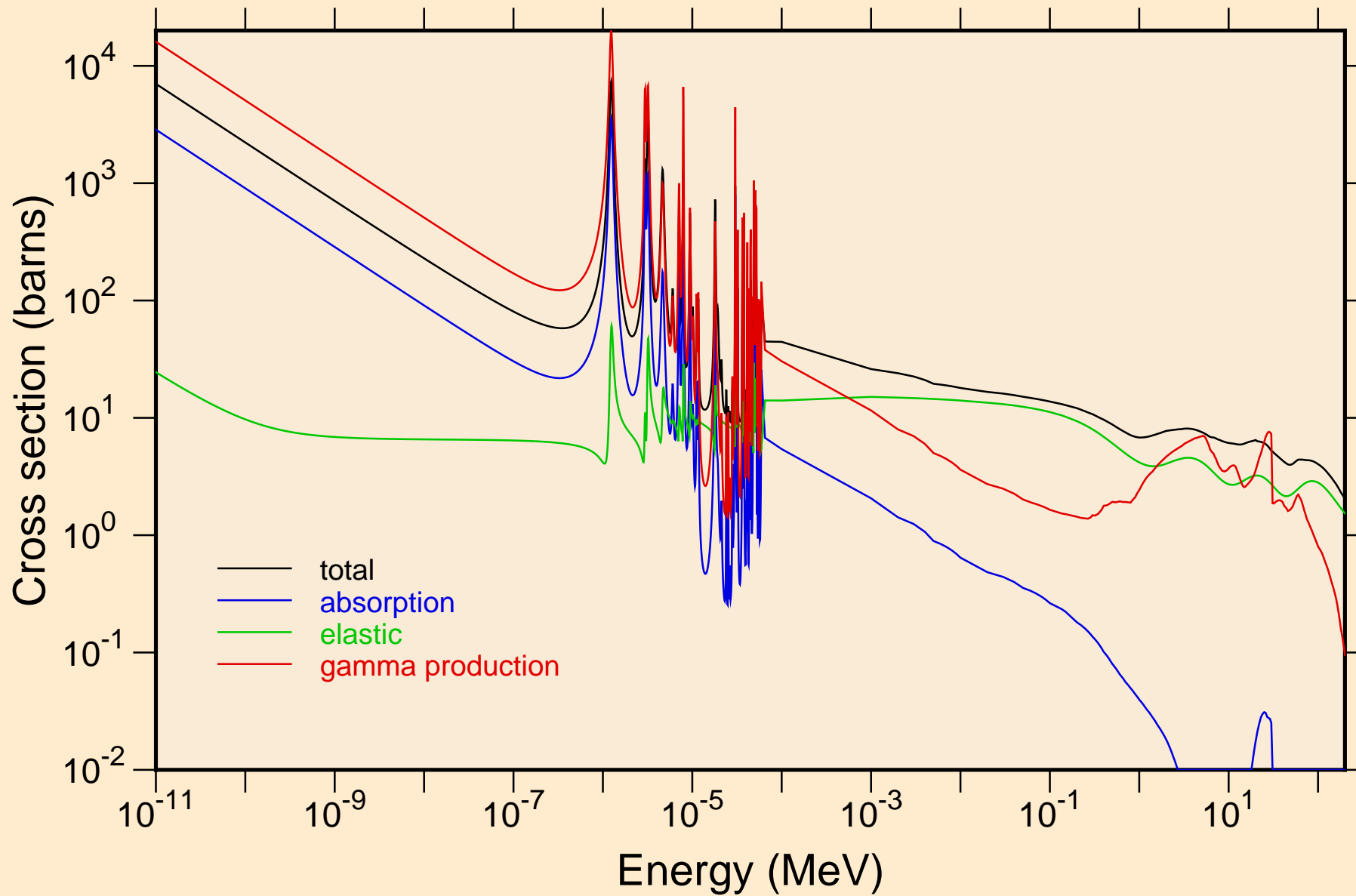

CM247 NEUTRON ACER TENDL-2021 LIBRARY; T=293.6K
resonance total cross section

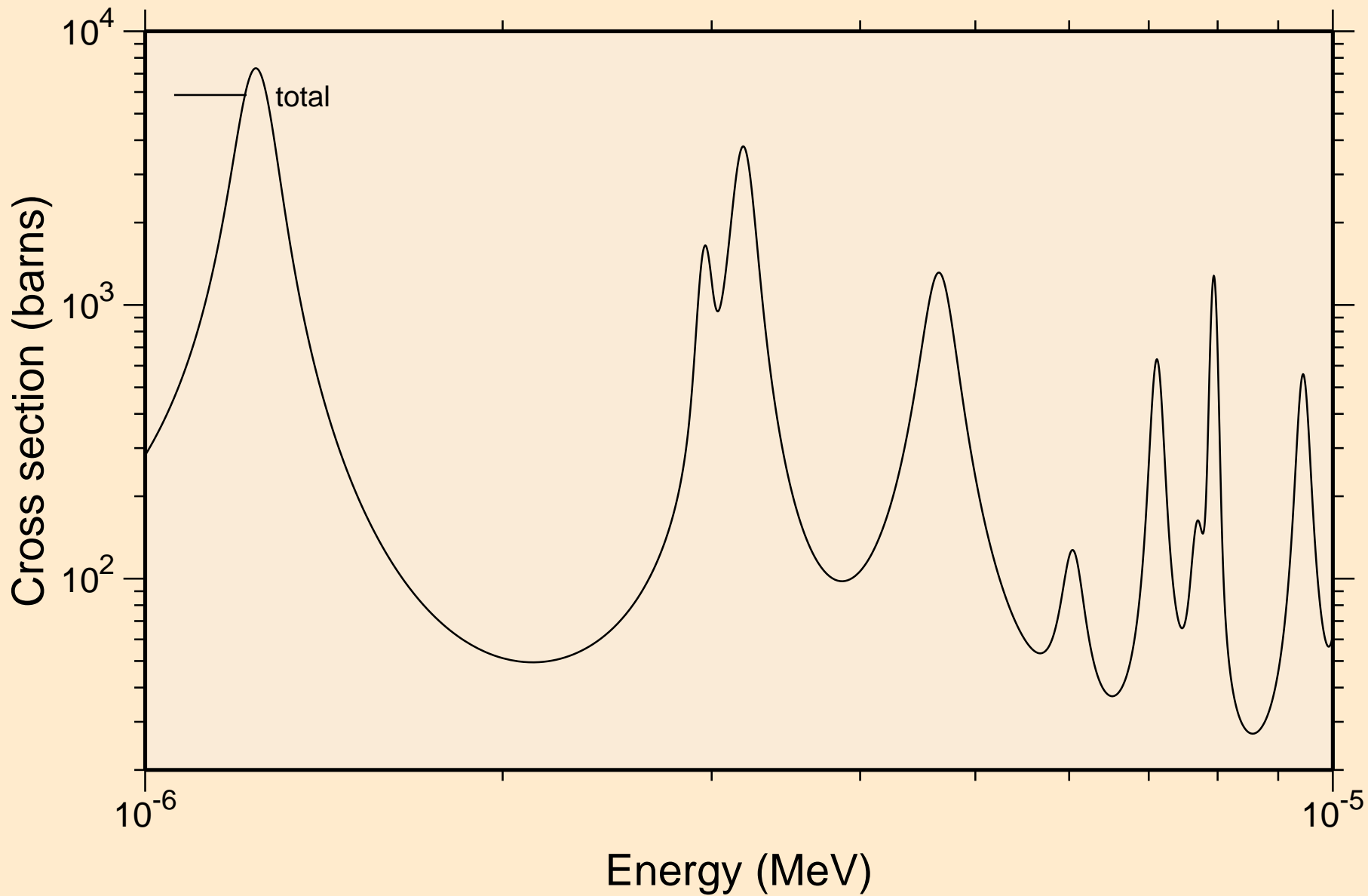

CM247 NEUTRON ACER TENDL-2021 LIBRARY; T=293.6K
resonance total cross section

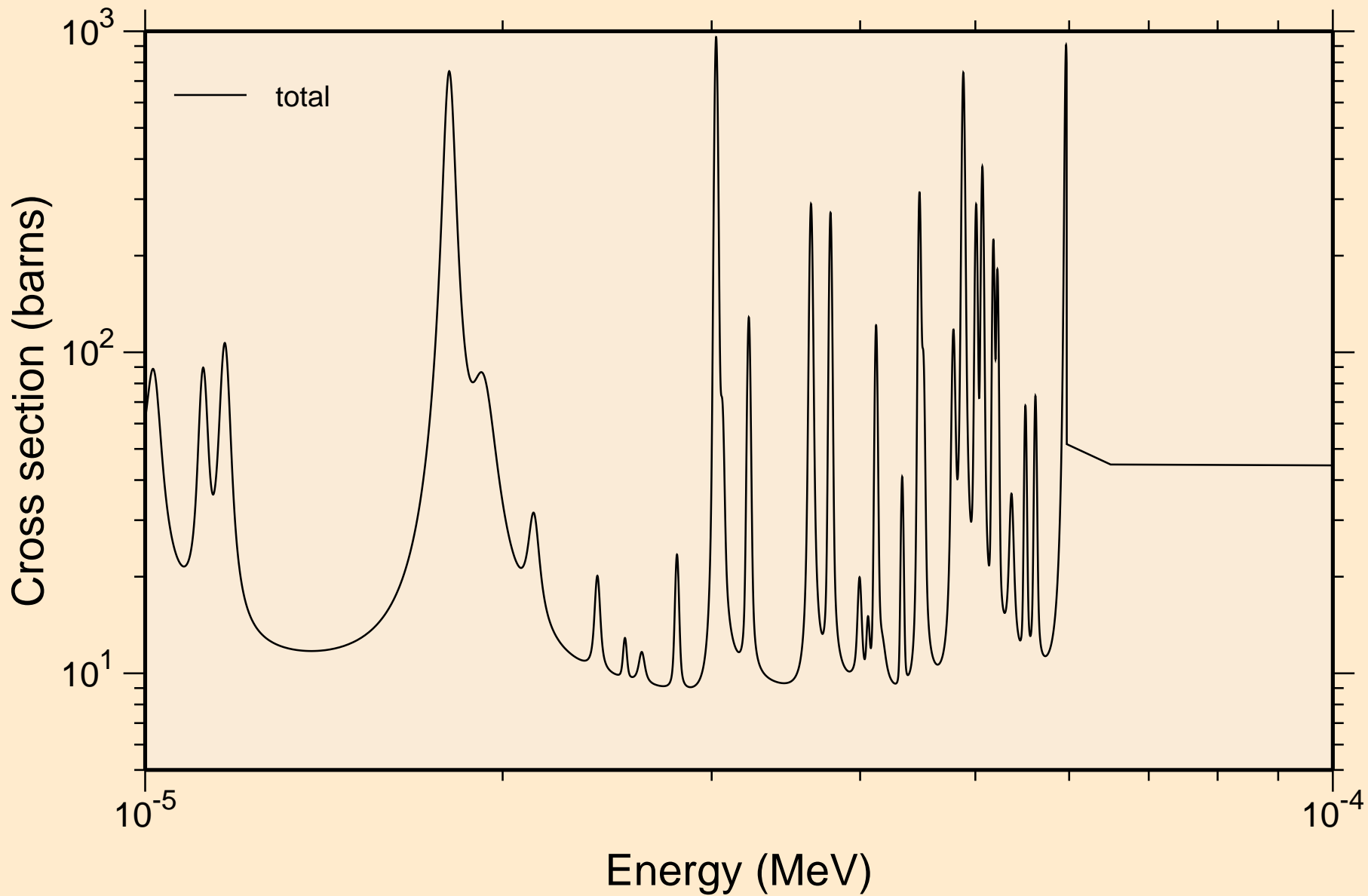

CM247 NEUTRON ACER TENDL-2021 LIBRARY; T=293.6K
resonance total cross section

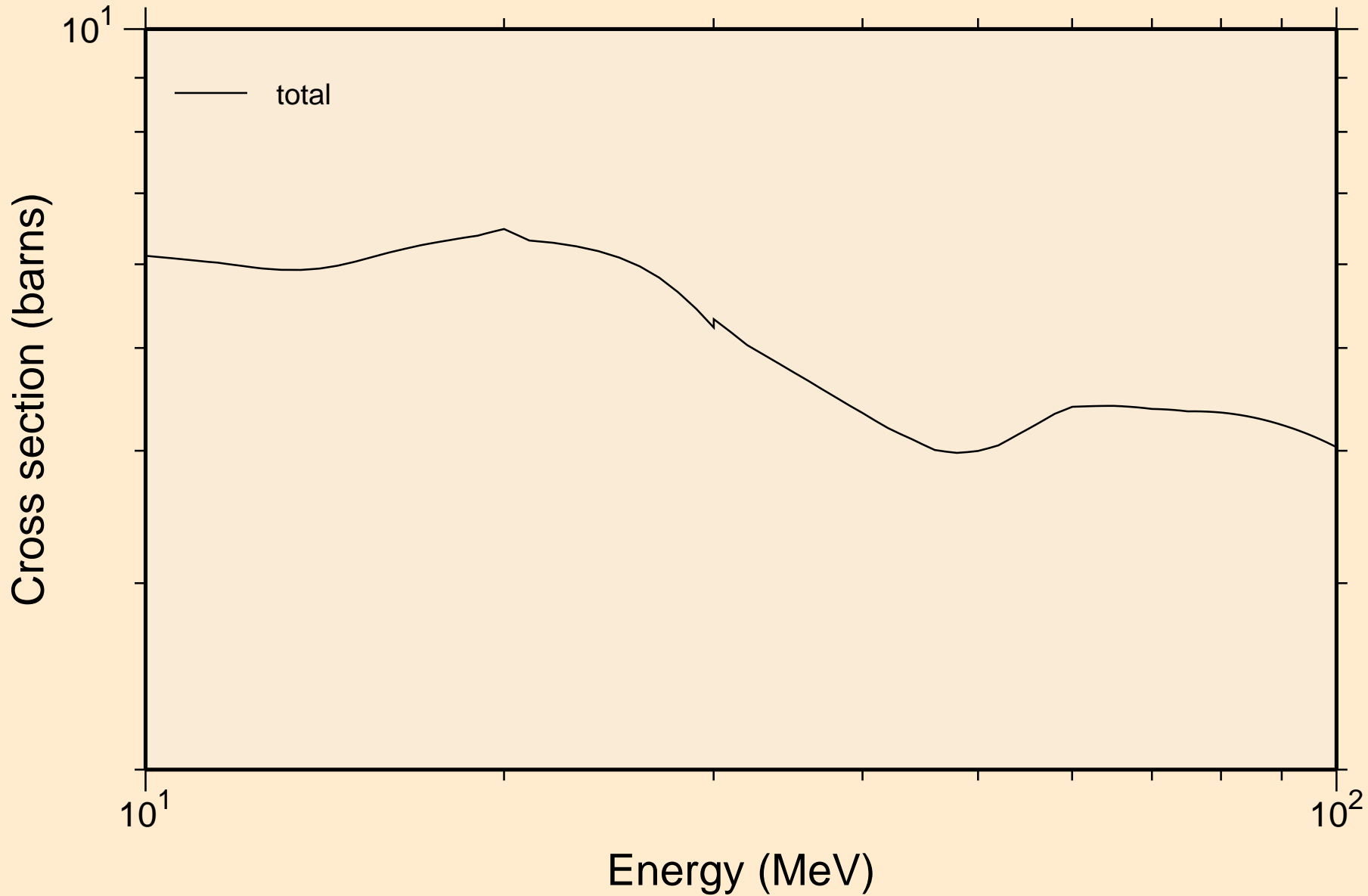

CM247 NEUTRON ACER TENDL-2021 LIBRARY; T=293.6K
resonance absorption cross sections

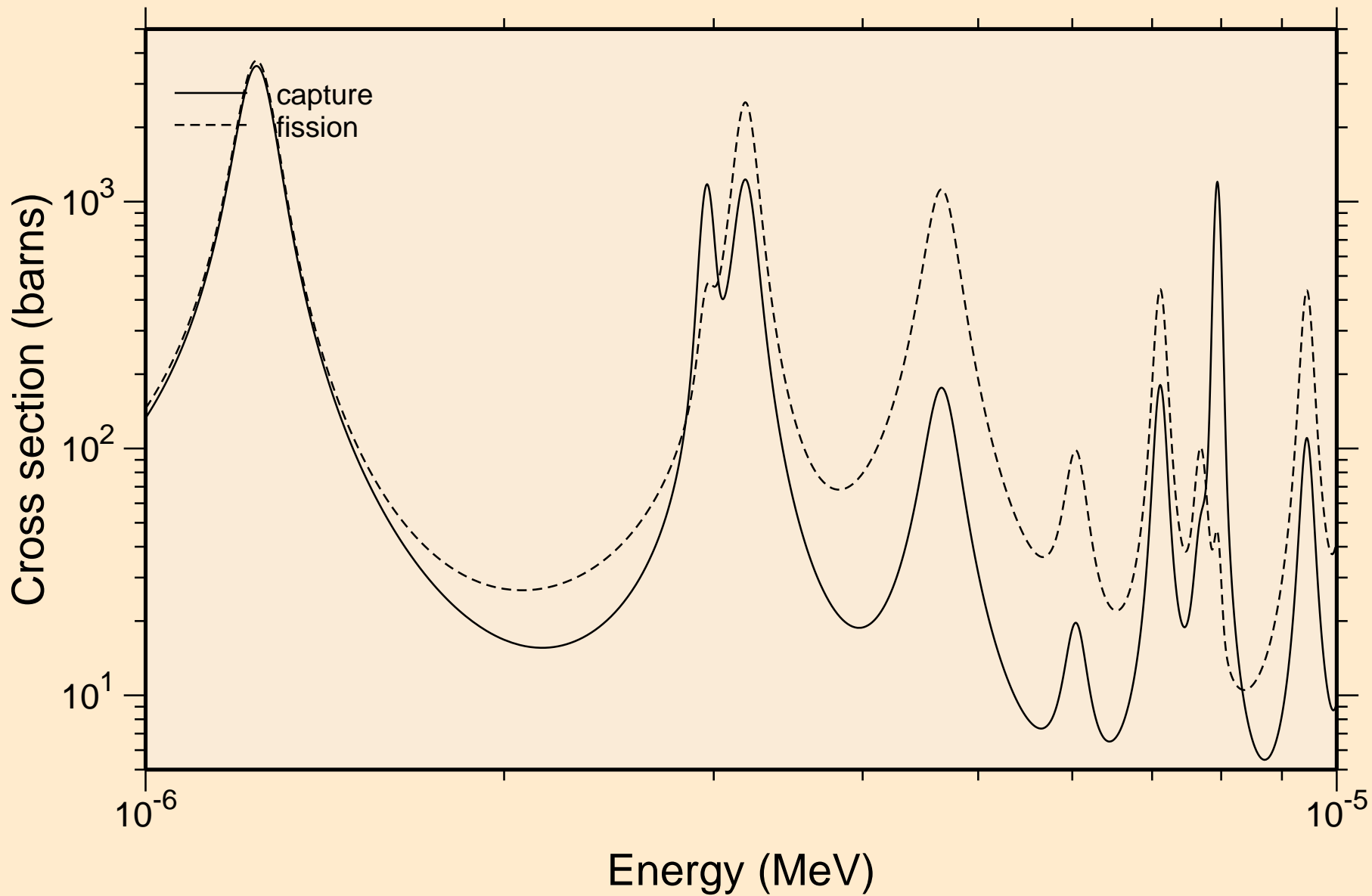

CM247 NEUTRON ACER TENDL-2021 LIBRARY; T=293.6K
resonance absorption cross sections

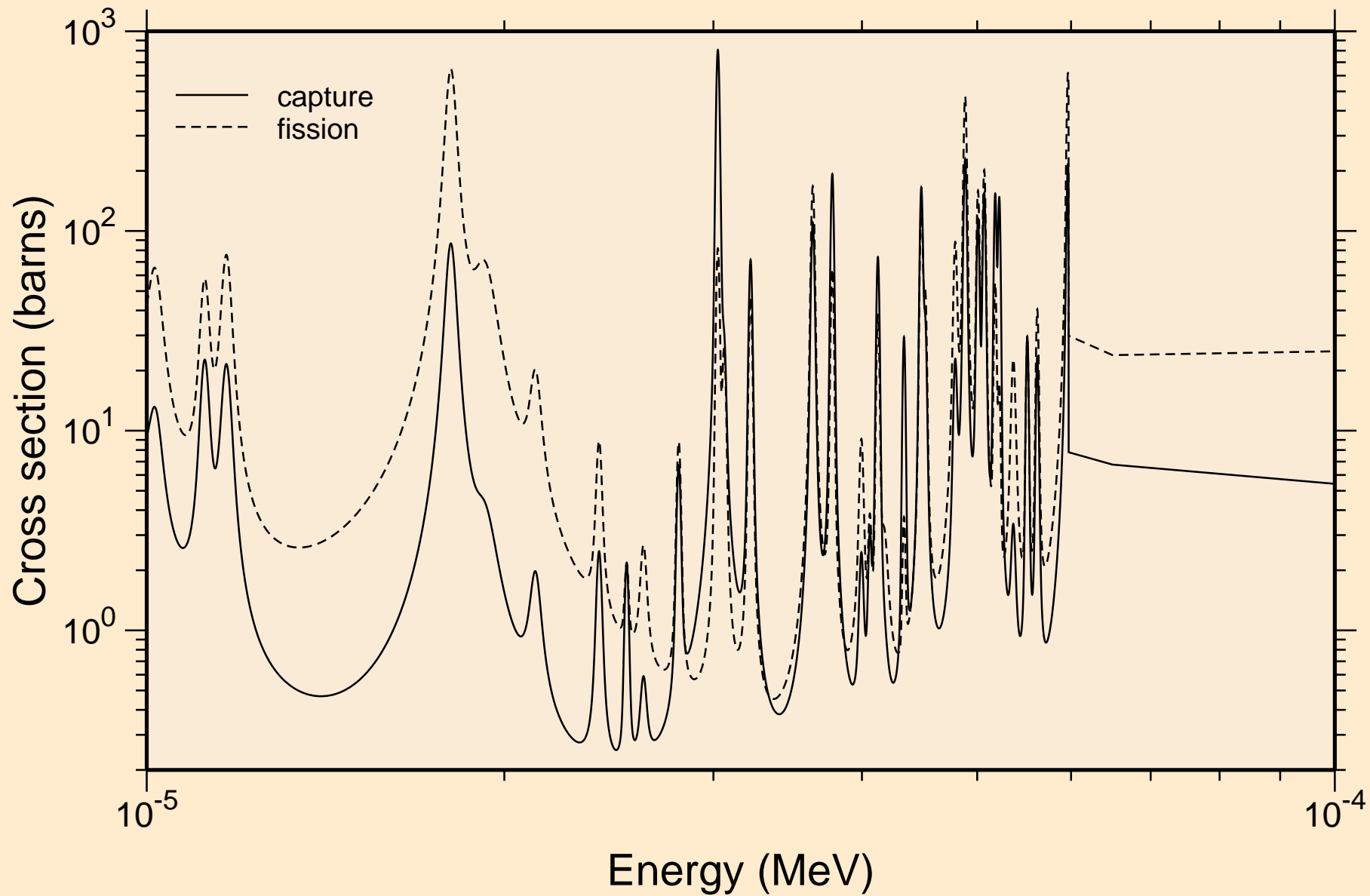

CM247 NEUTRON ACER TENDL-2021 LIBRARY; T=293.6K
resonance absorption cross sections

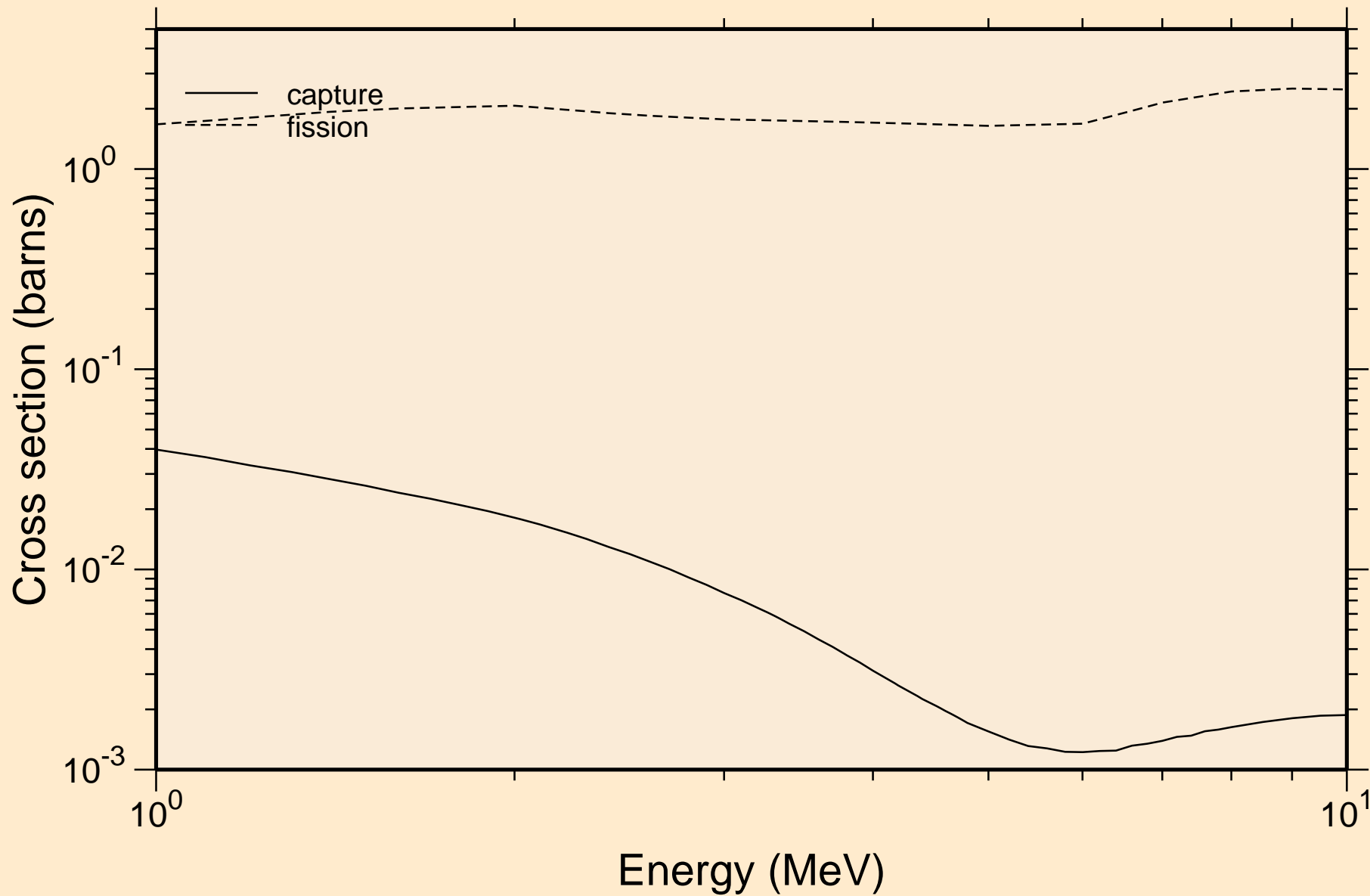

CM247 NEUTRON ACER TENDL-2021 LIBRARY; T=293.6K
Heating

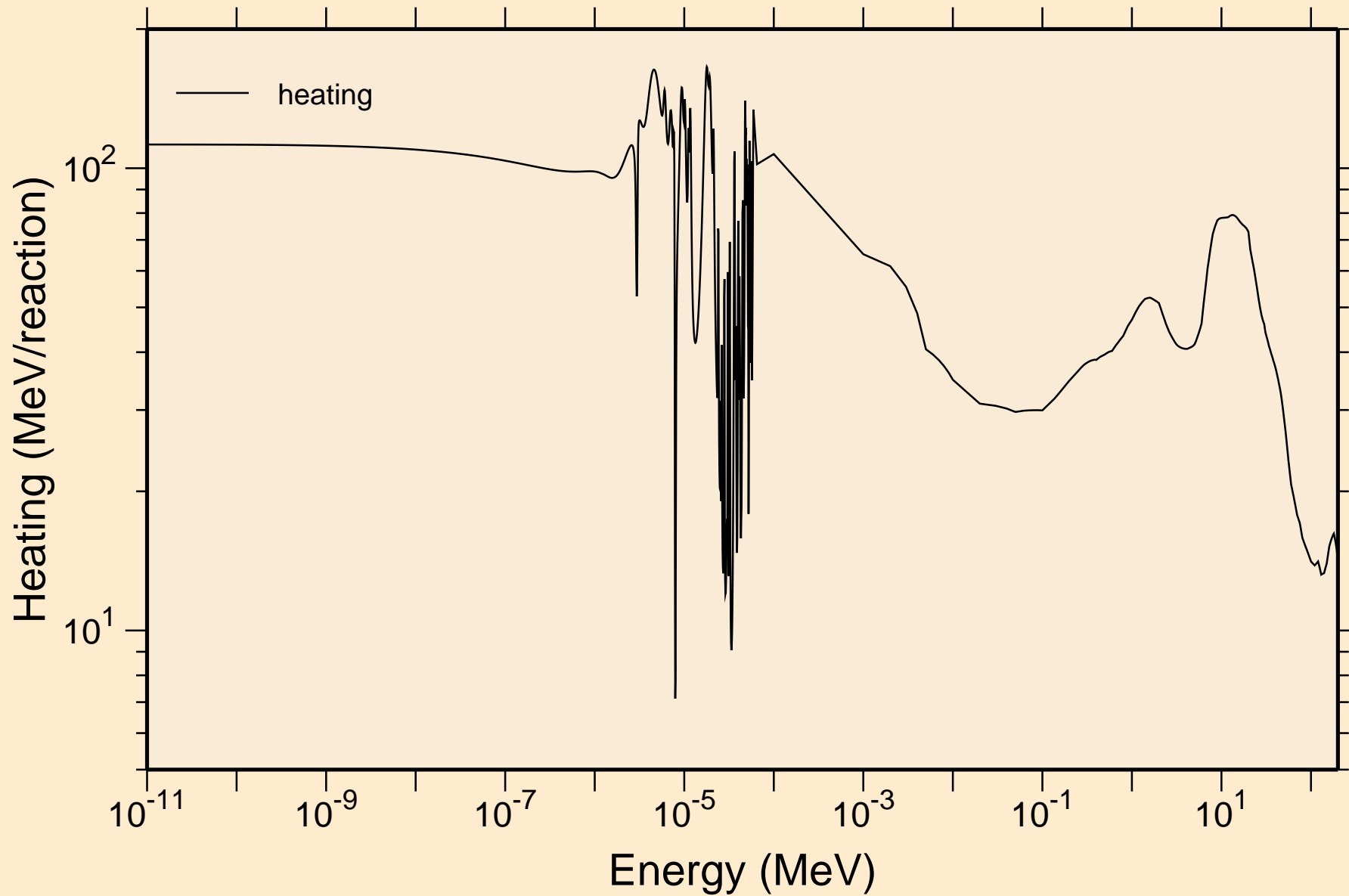

CM247 NEUTRON ACER TENDL-2021 LIBRARY; T=293.6K

Damage

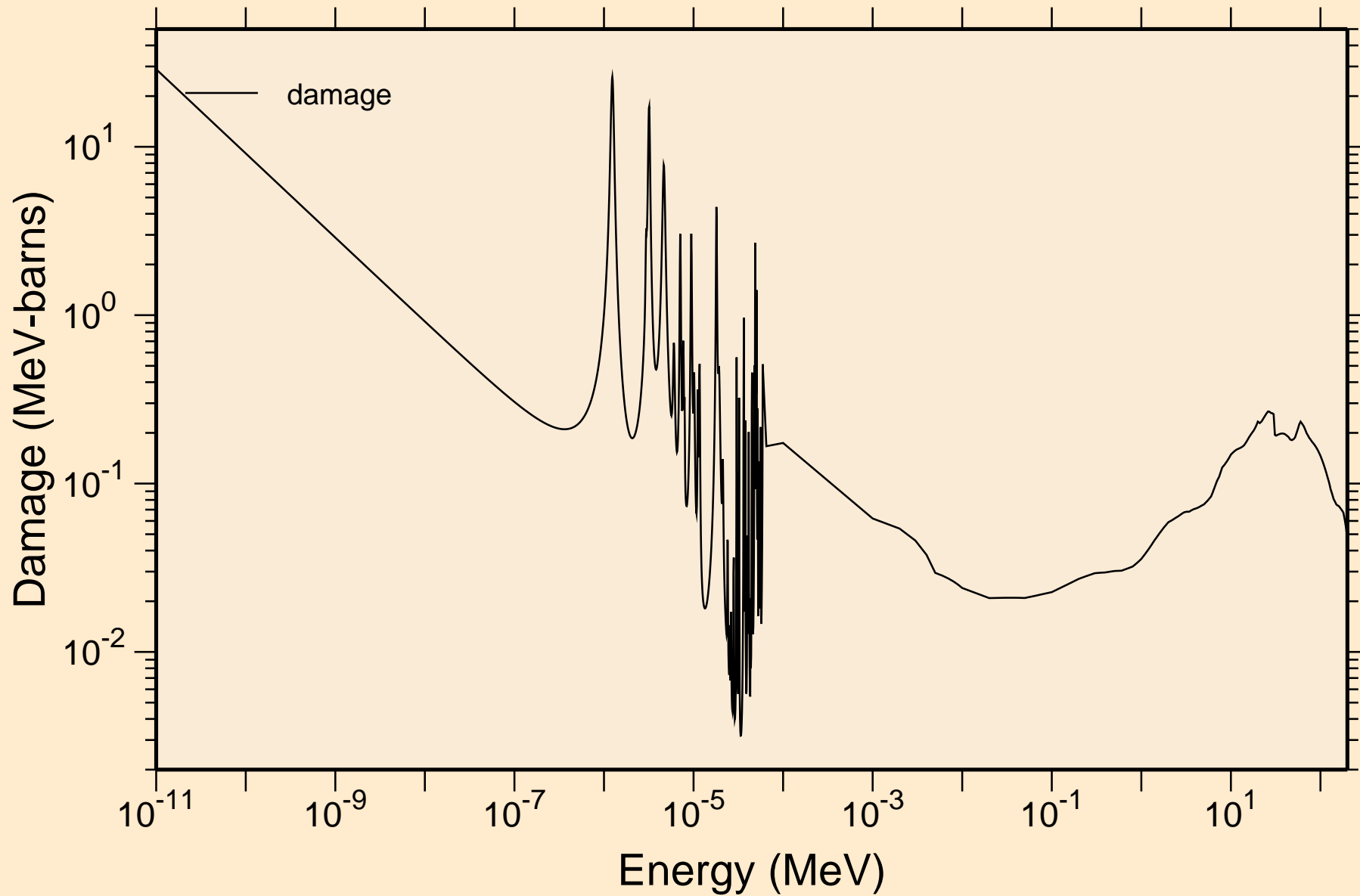

CM247 NEUTRON ACER TENDL-2021 LIBRARY; T=293.6K

Non-threshold reactions

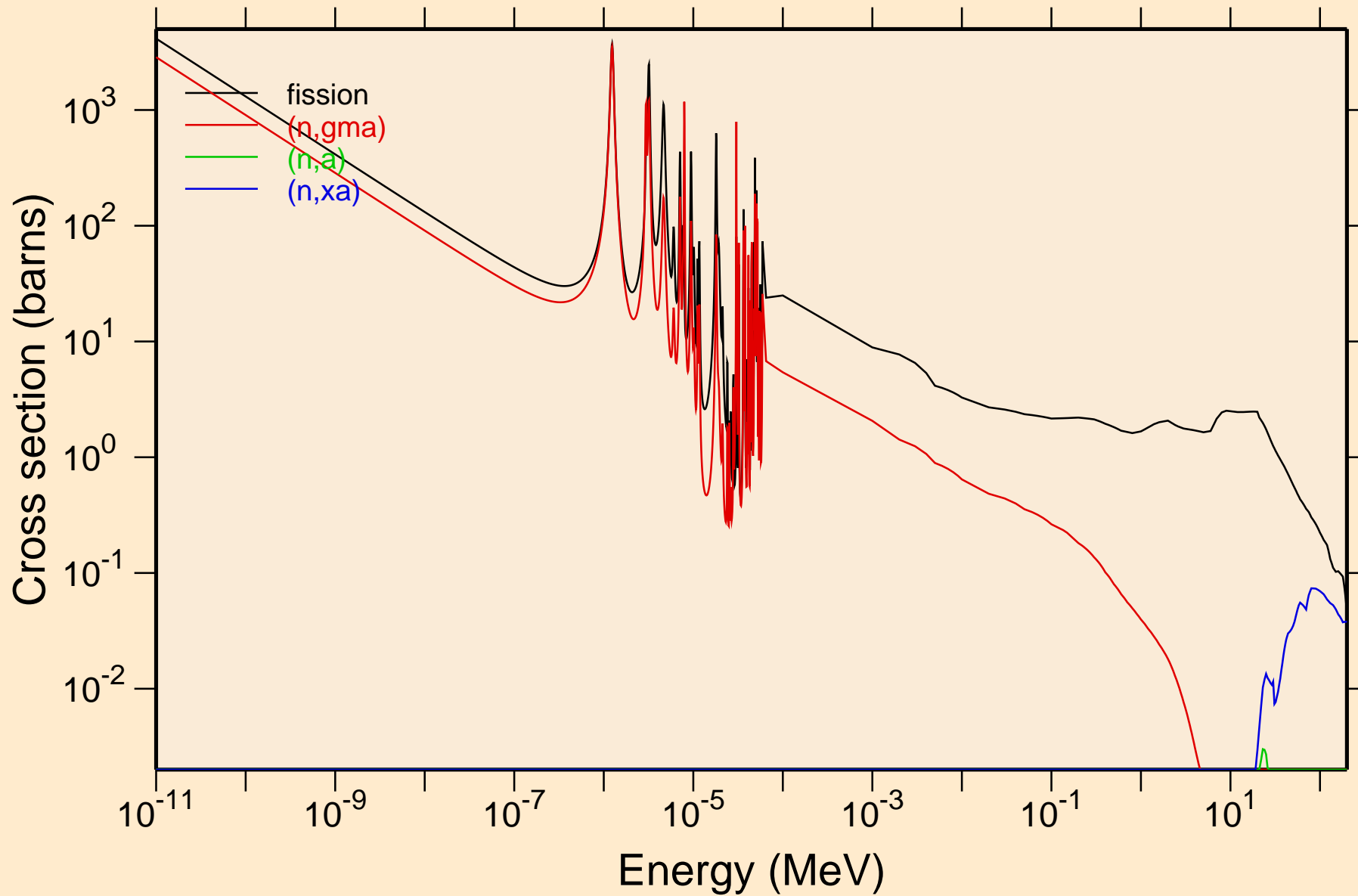

CM247 NEUTRON ACER TENDL-2021 LIBRARY; T=293.6K
Principal cross sections

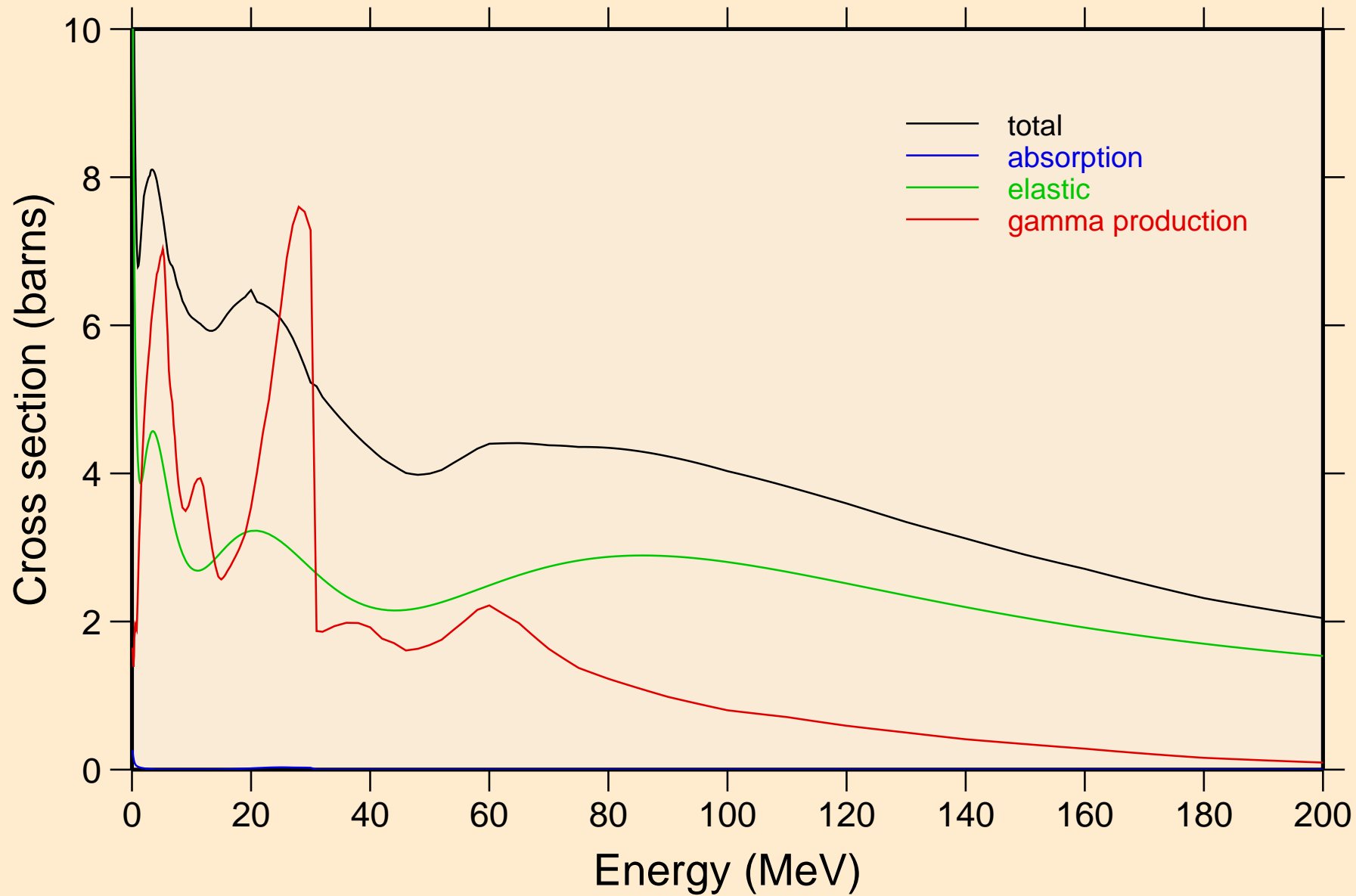

CM247 NEUTRON ACER TENDL-2021 LIBRARY; T=293.6K
Heating

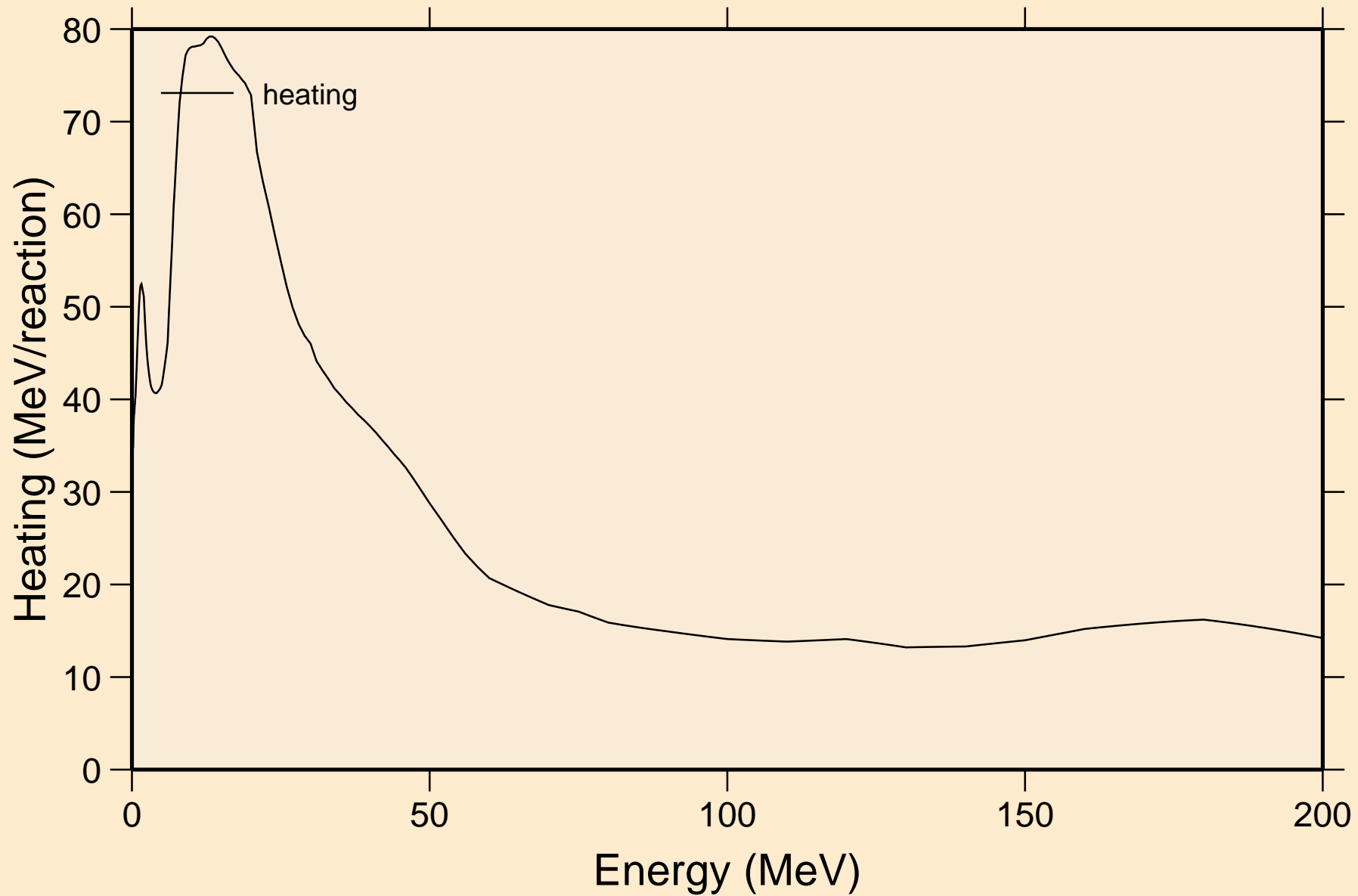

CM247 NEUTRON ACER TENDL-2021 LIBRARY; T=293.6K Damage

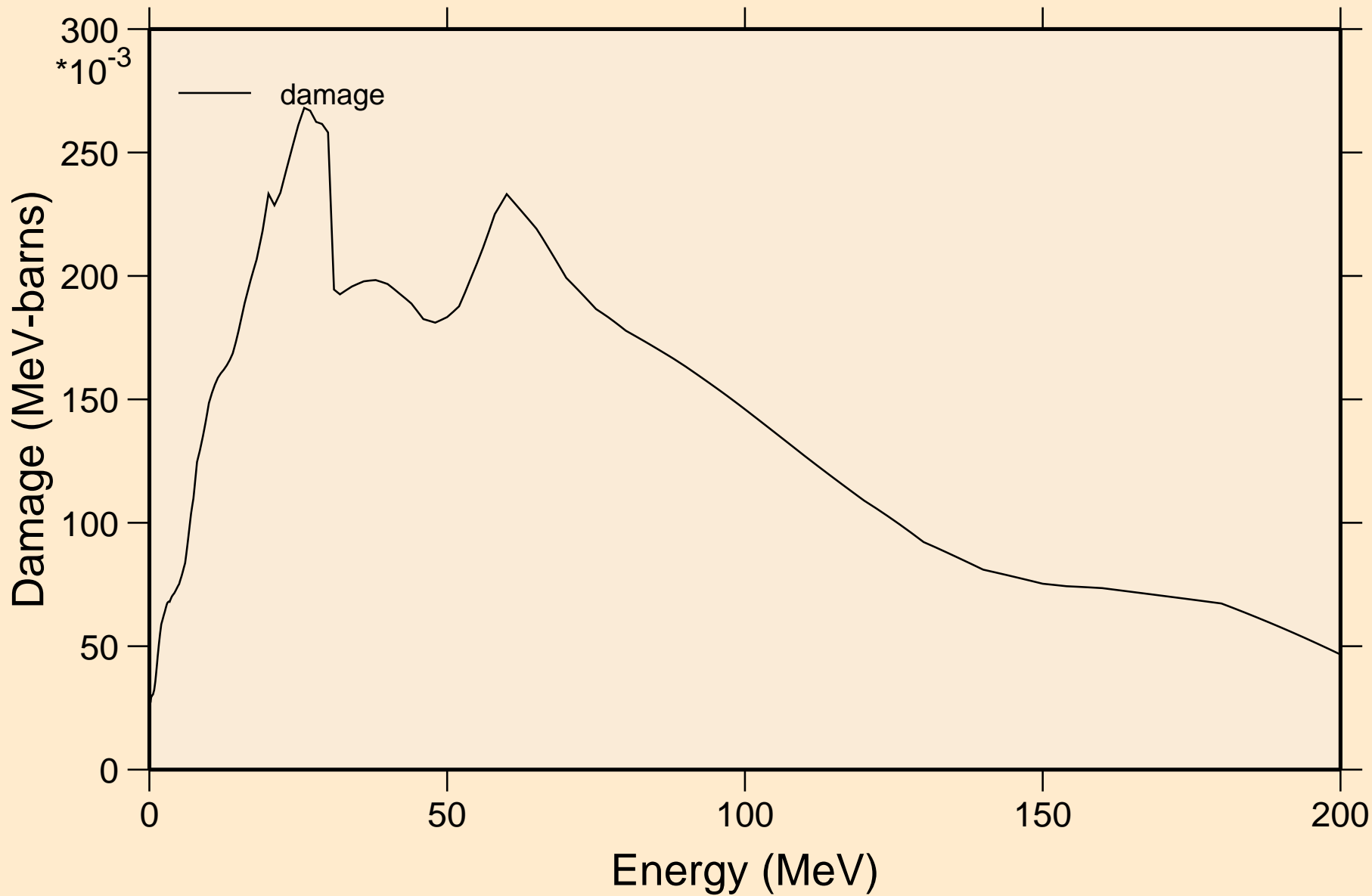

CM247 NEUTRON ACER TENDL-2021 LIBRARY; T=293.6K

Non-threshold reactions

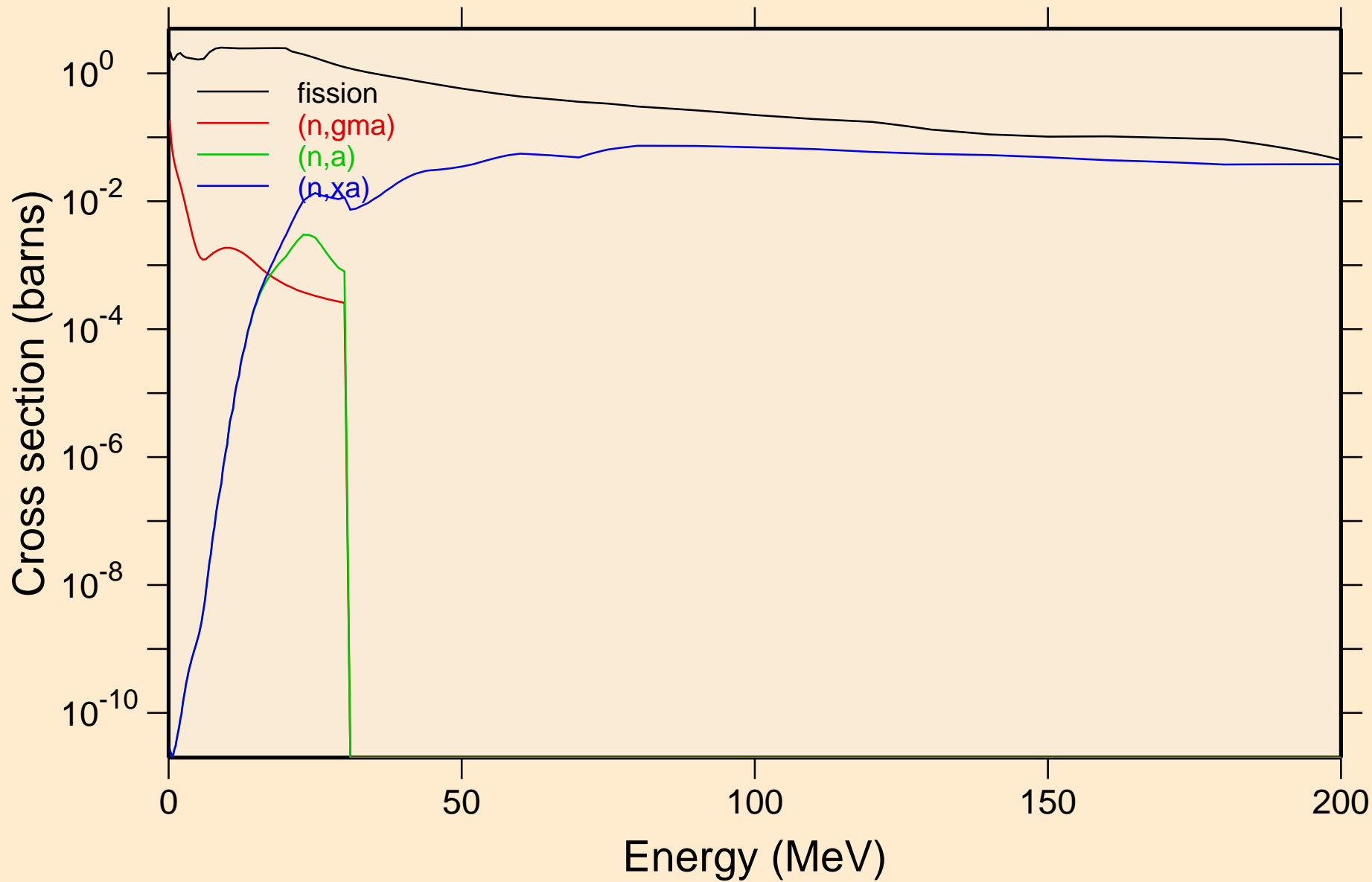

CM247 NEUTRON ACER TENDL-2021 LIBRARY; T=293.6K
Inelastic levels

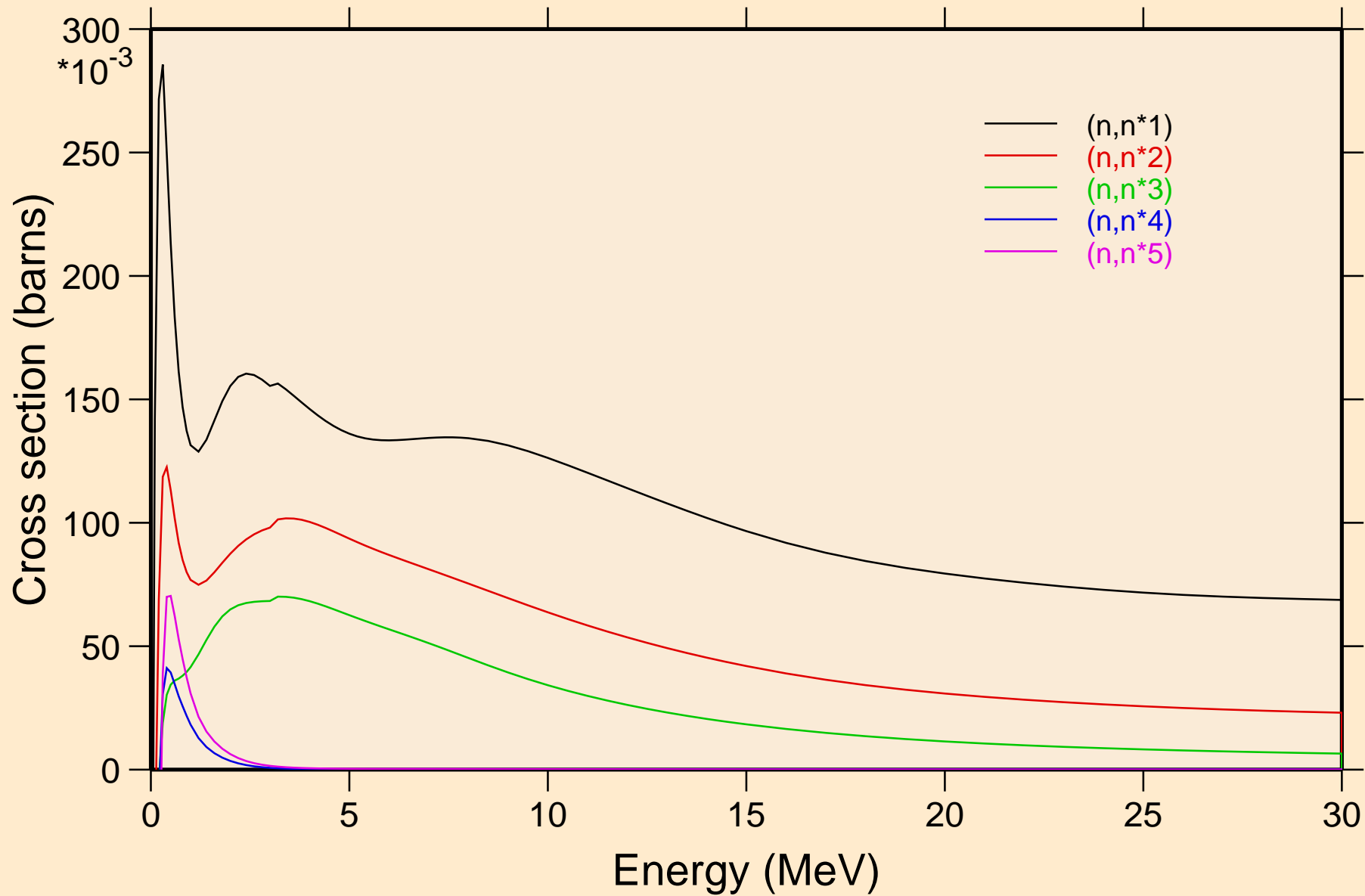

CM247 NEUTRON ACER TENDL-2021 LIBRARY; T=293.6K
Inelastic levels

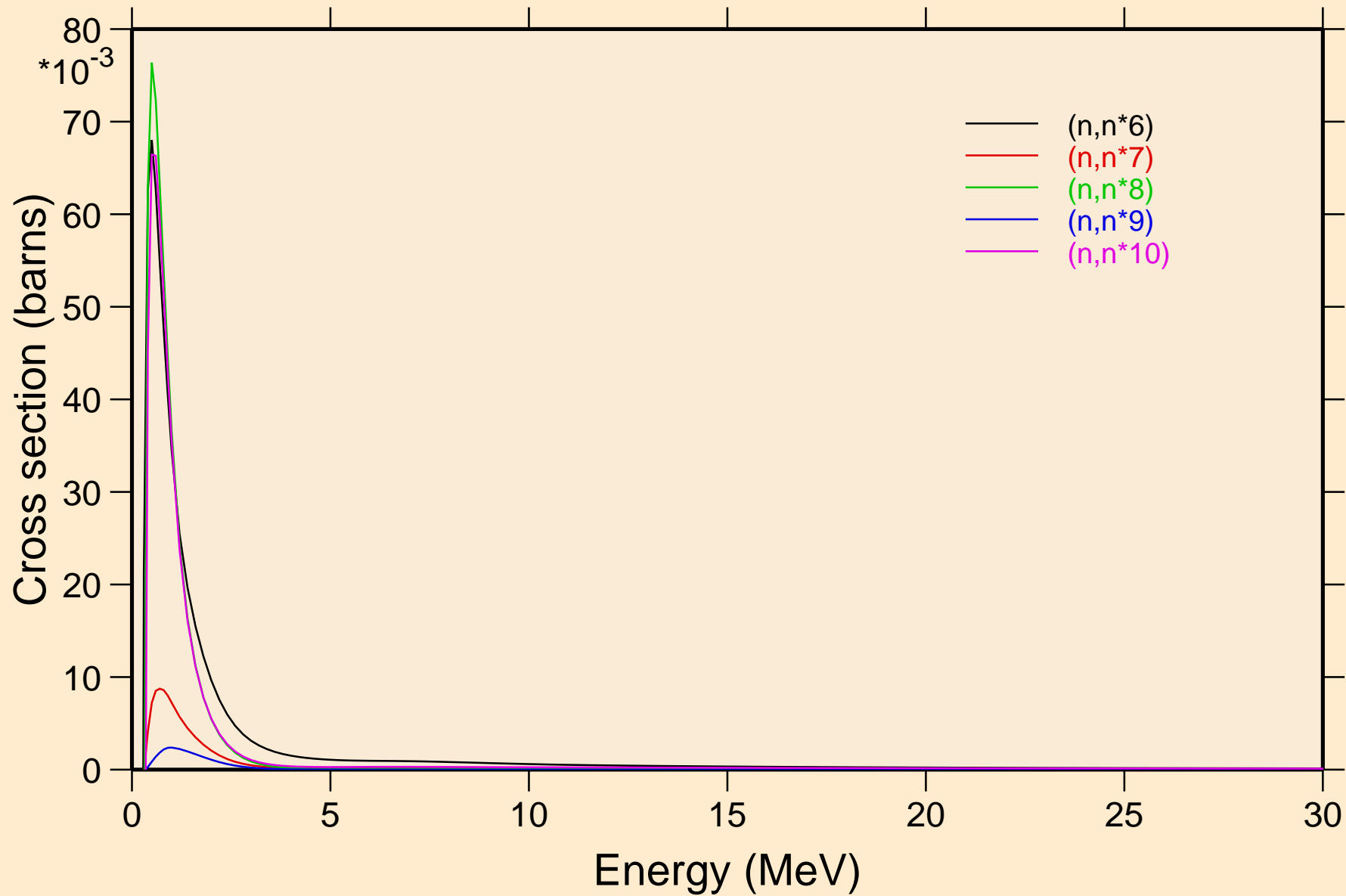

CM247 NEUTRON ACER TENDL-2021 LIBRARY; T=293.6K
Inelastic levels

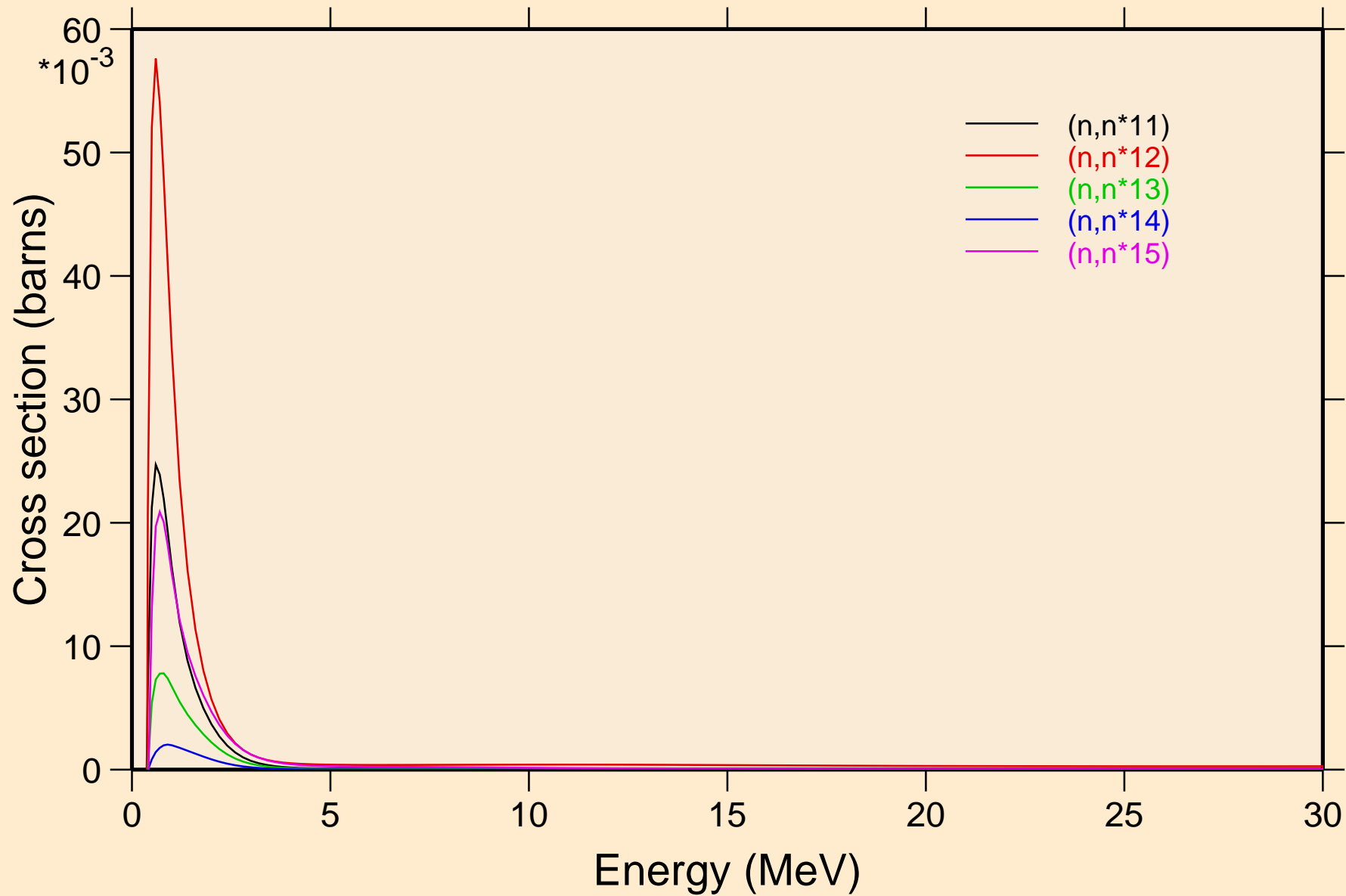

CM247 NEUTRON ACER TENDL-2021 LIBRARY; T=293.6K
Inelastic levels

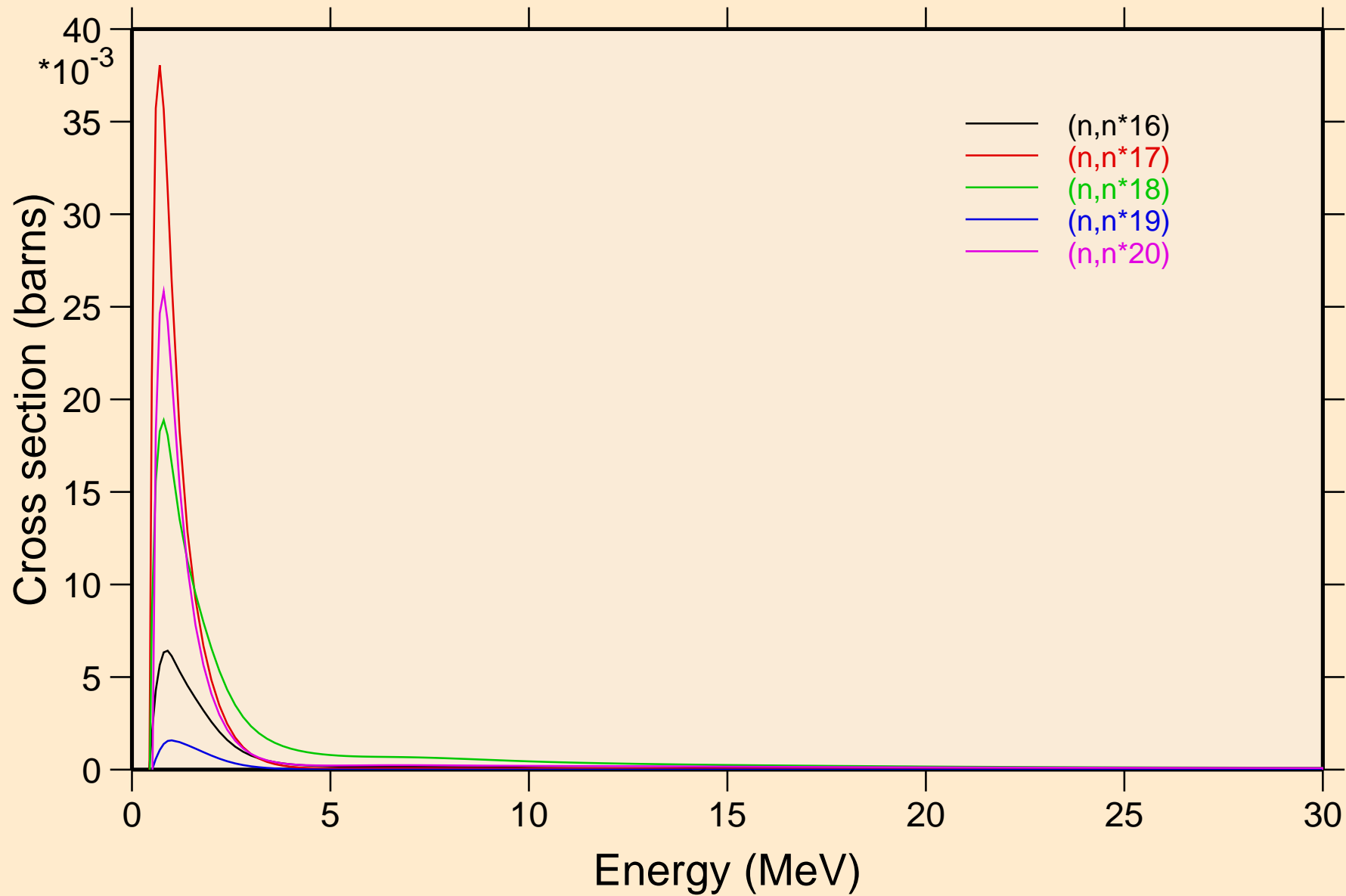

CM247 NEUTRON ACER TENDL-2021 LIBRARY; T=293.6K
Inelastic levels

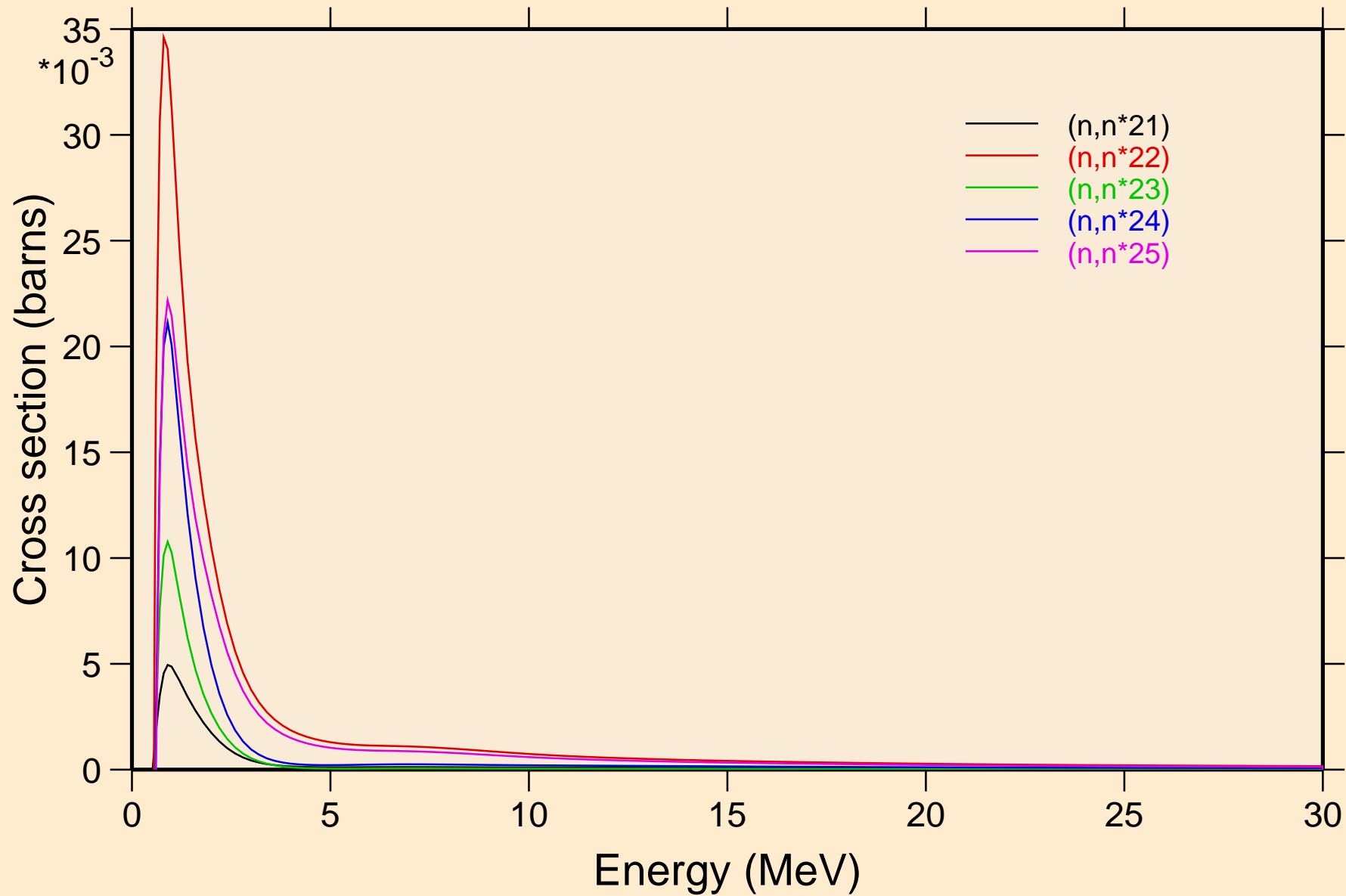

CM247 NEUTRON ACER TENDL-2021 LIBRARY; T=293.6K
Inelastic levels

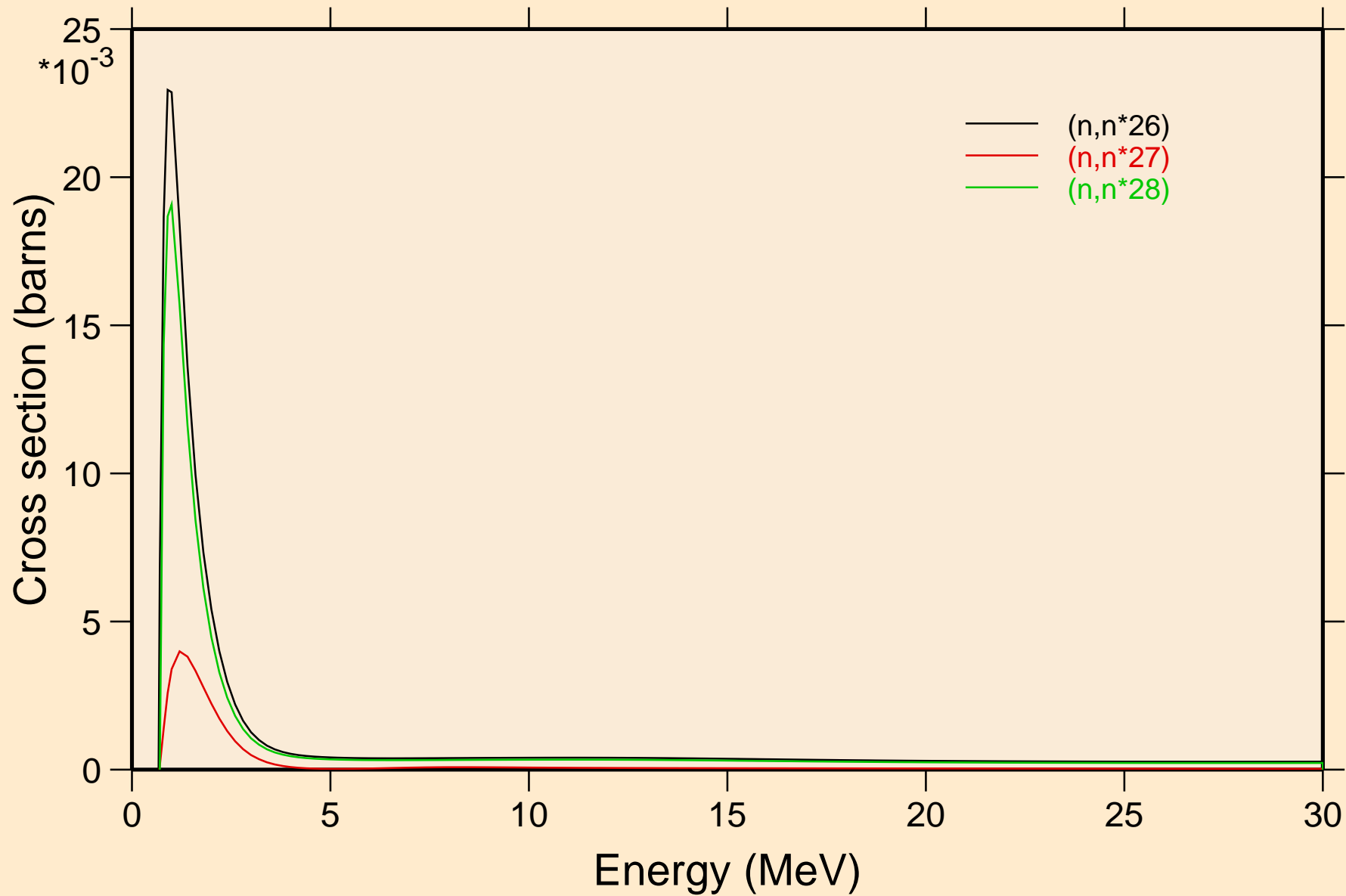

CM247 NEUTRON ACER TENDL-2021 LIBRARY; T=293.6K
Threshold reactions

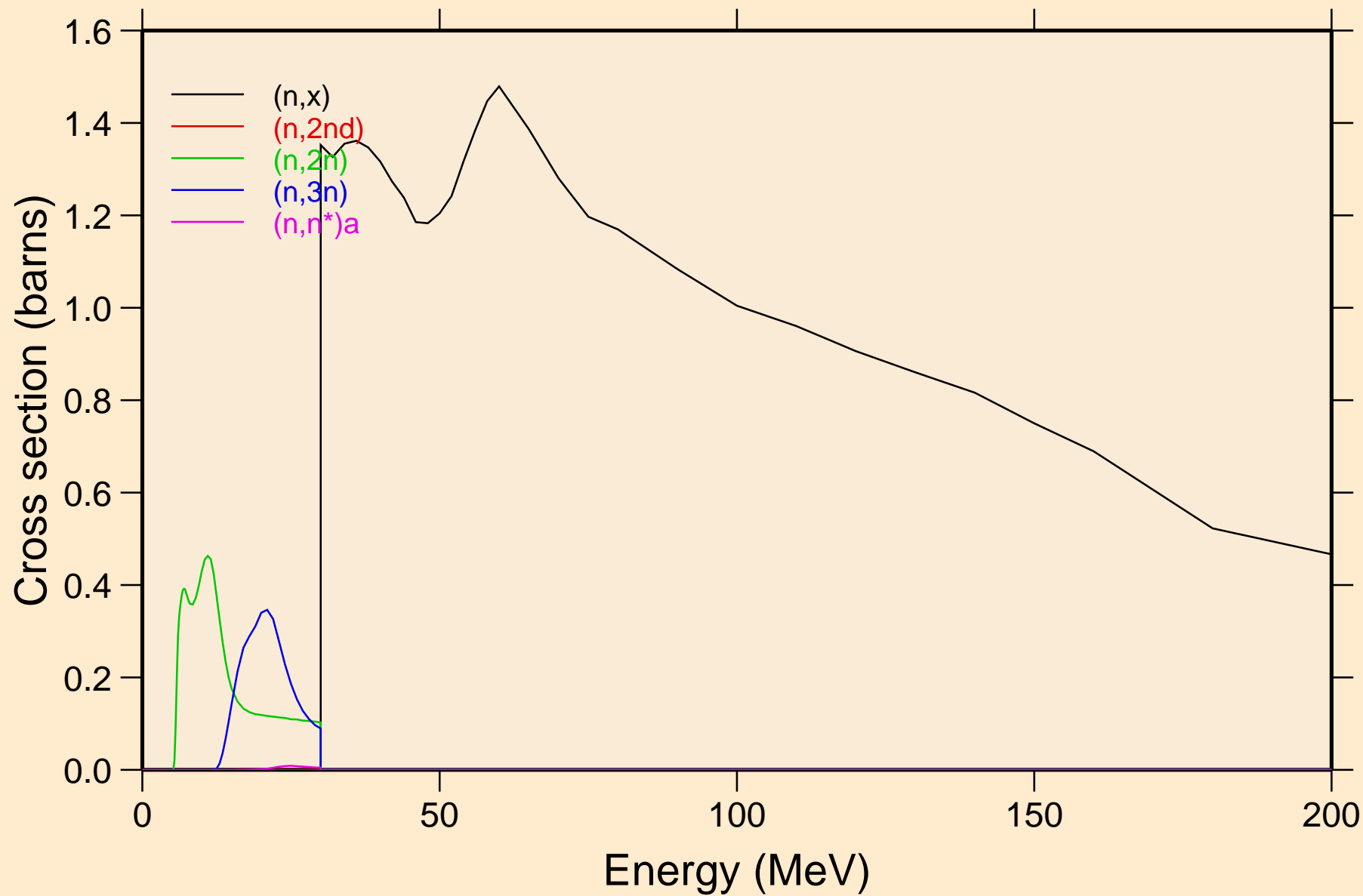

CM247 NEUTRON ACER TENDL-2021 LIBRARY; T=293.6K
Threshold reactions

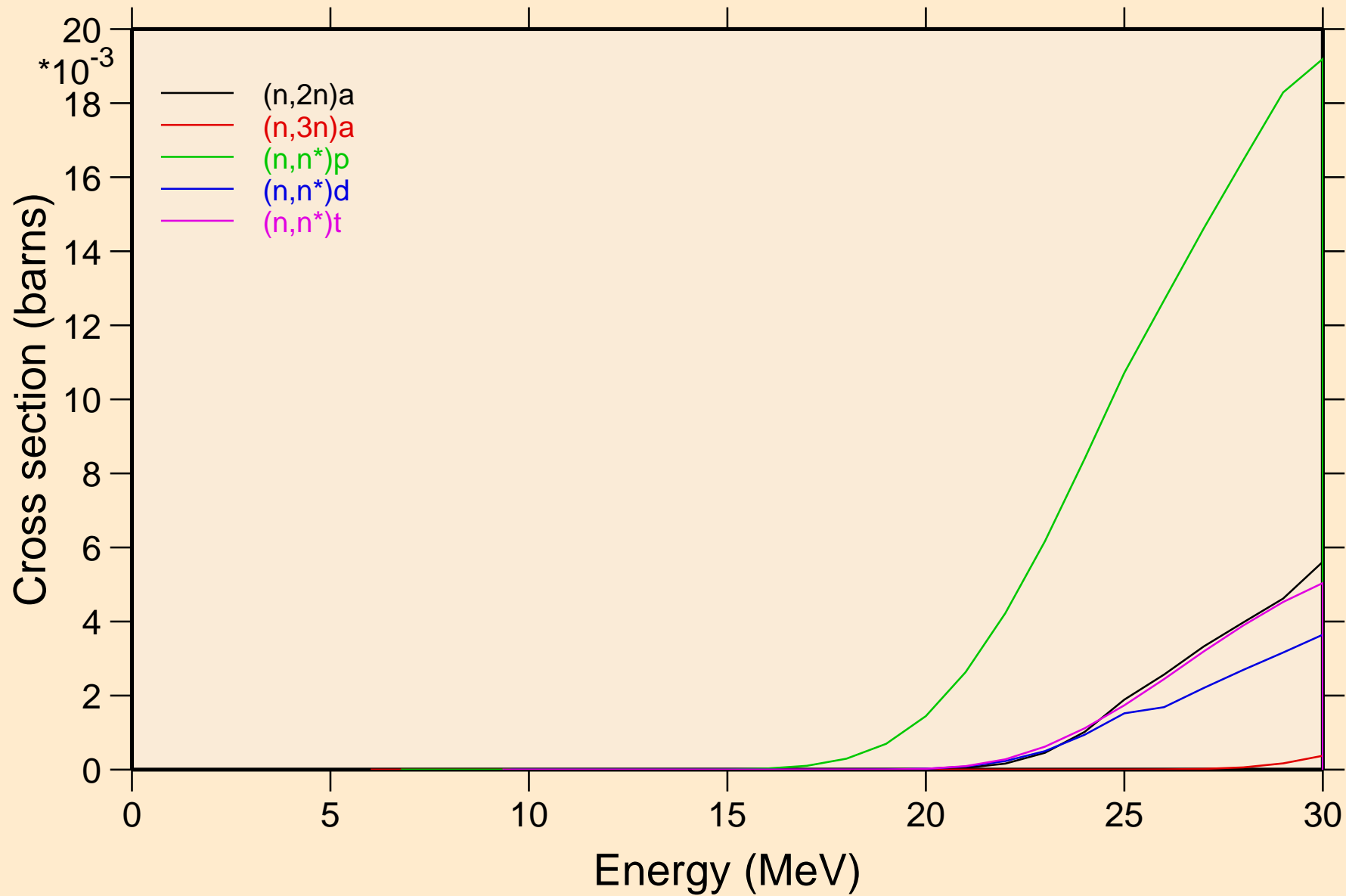

CM247 NEUTRON ACER TENDL-2021 LIBRARY; T=293.6K
Threshold reactions

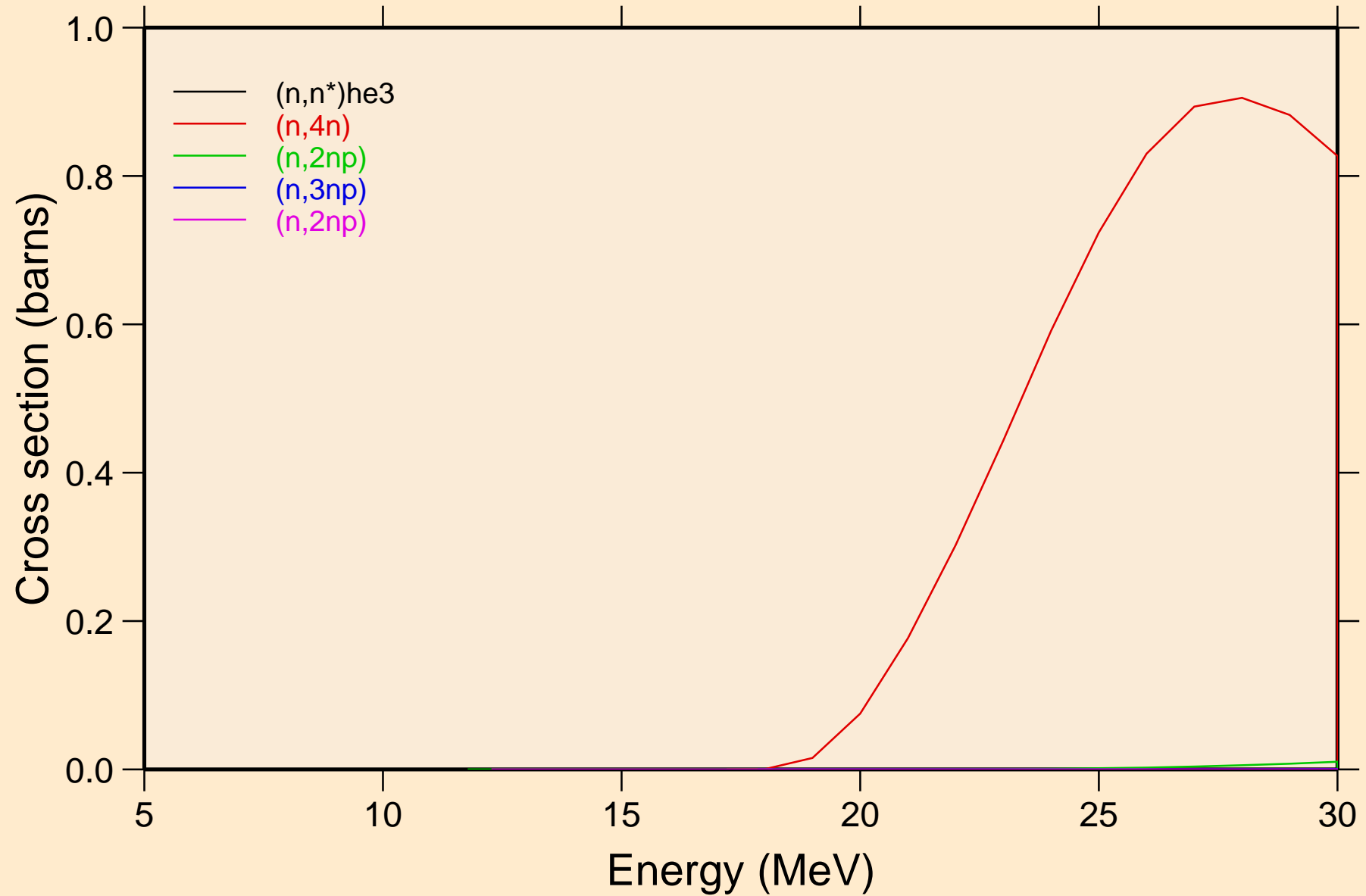

CM247 NEUTRON ACER TENDL-2021 LIBRARY; T=293.6K
Threshold reactions

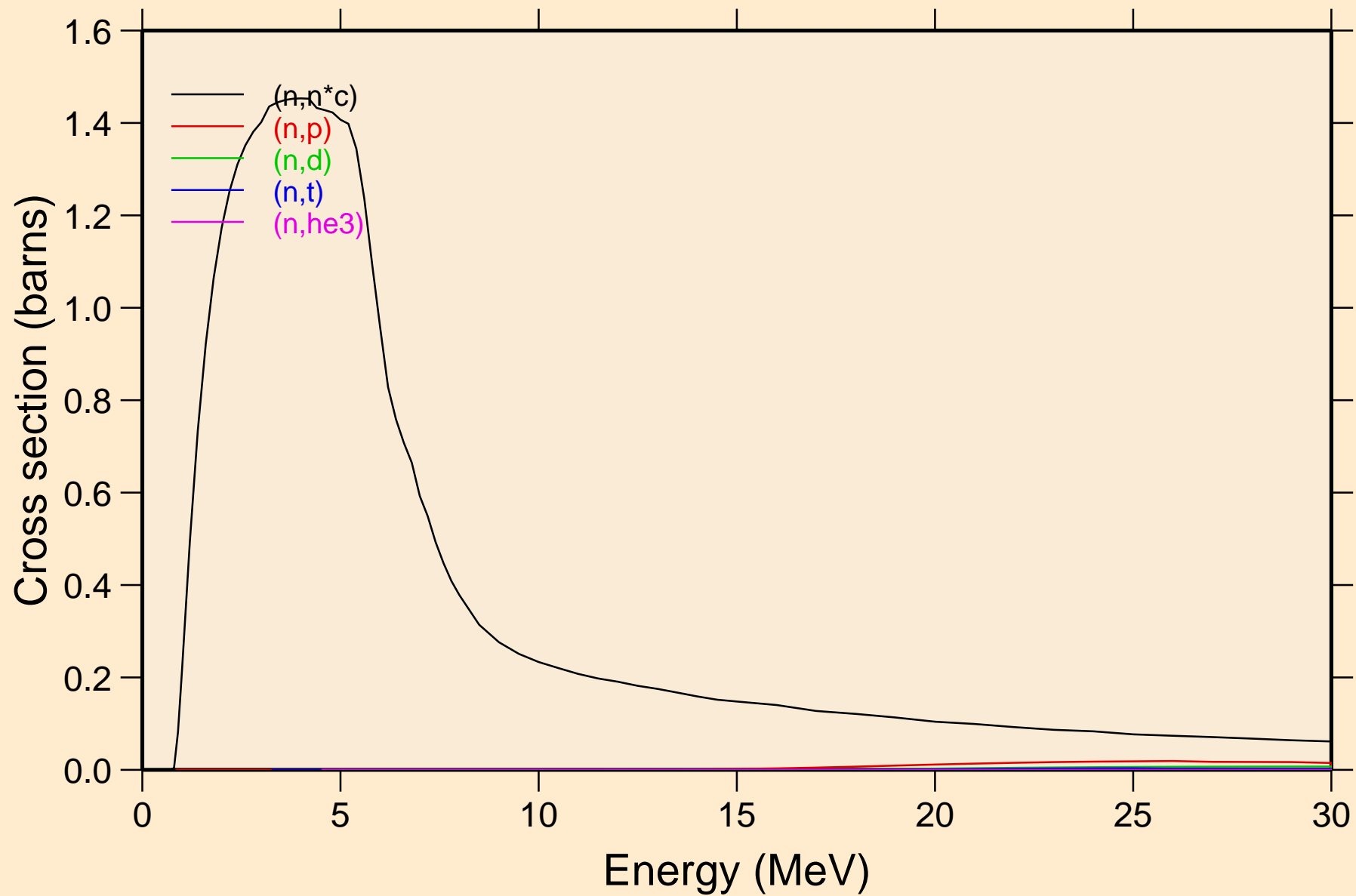

CM247 NEUTRON ACER TENDL-2021 LIBRARY; T=293.6K
Threshold reactions

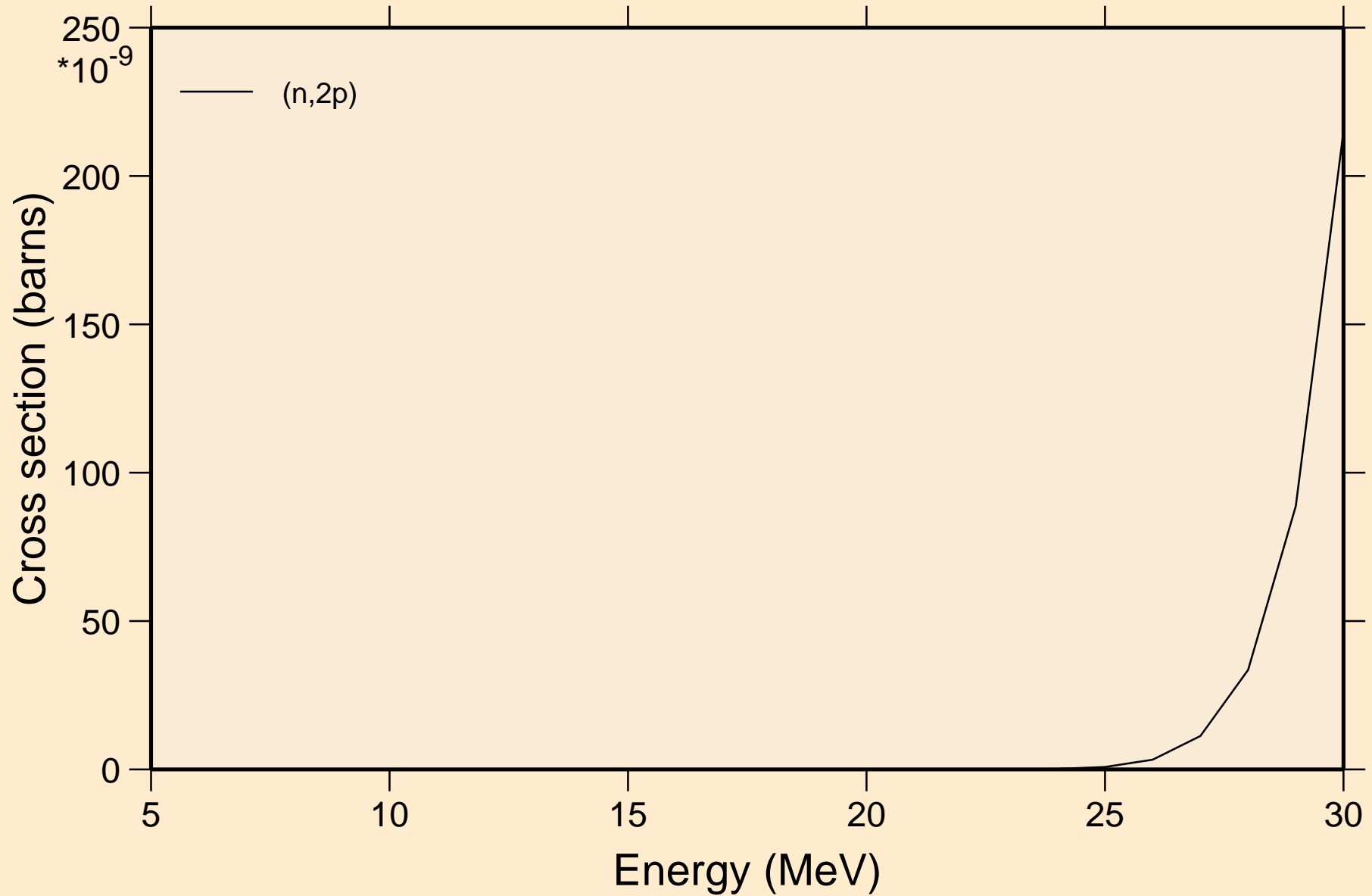

CM247 NEUTRON ACER TENDL-2021 LIBRARY; T=293.6K

Threshold reactions

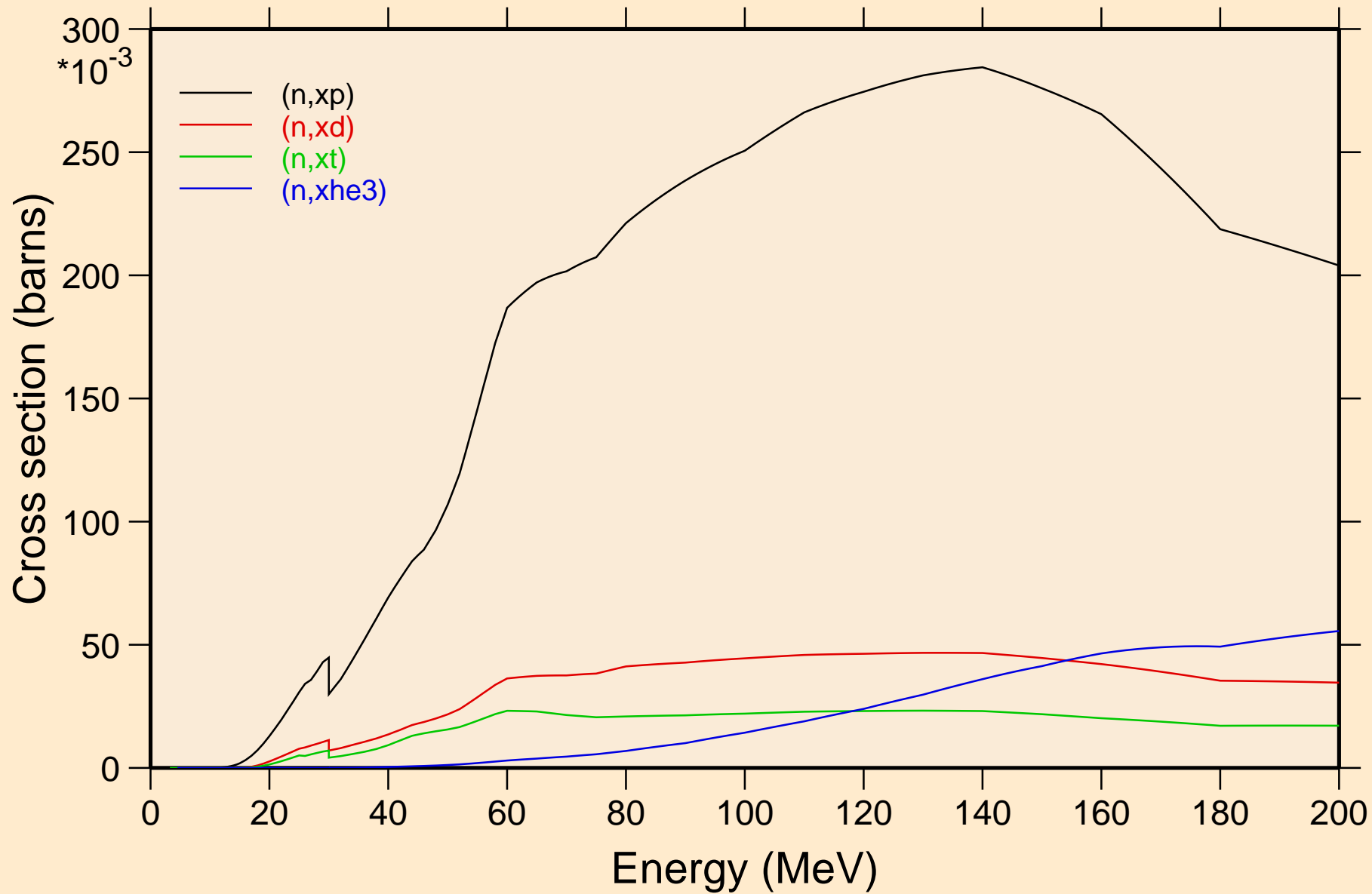

CM247 NEUTRON ACER TENDL-2021 LIBRARY; T=293.6K
angular distribution for elastic

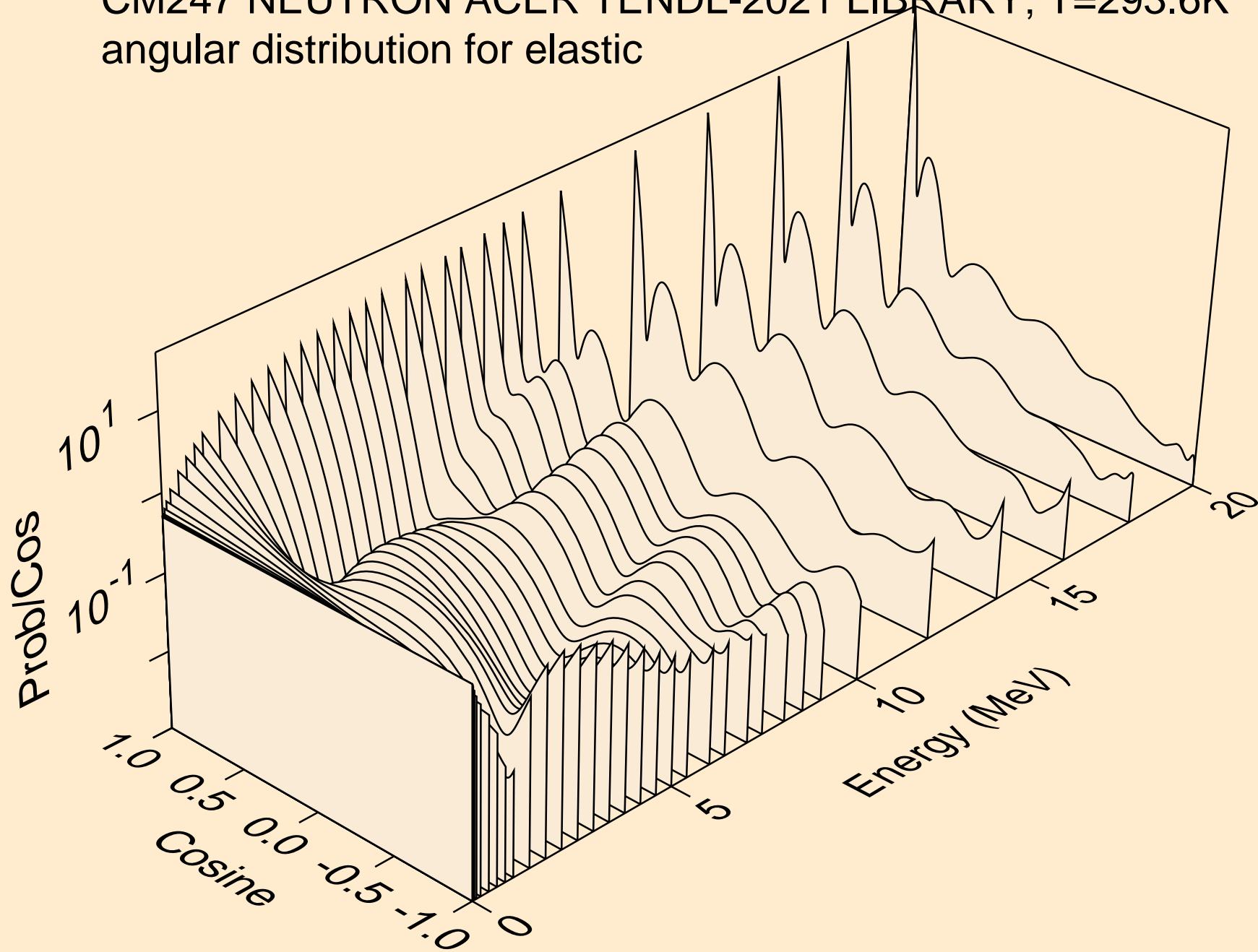

CM247 NEUTRON ACER TENDL-2021 LIBRARY; T=293.6K
angular distribution for elastic

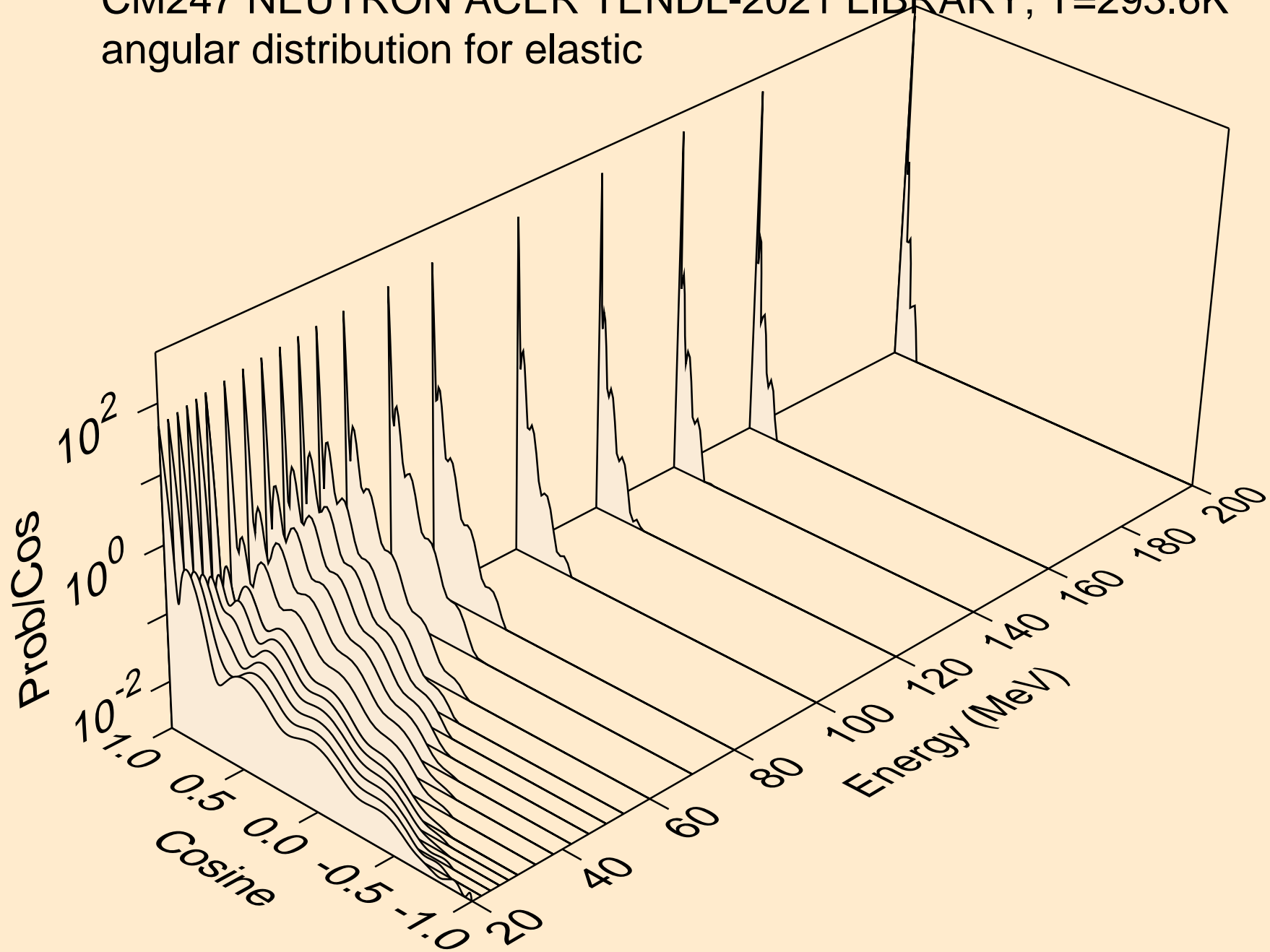

CM247 NEUTRON ACER TENDL-2021 LIBRARY; T=293.6K
angular distribution for (n,n*1)

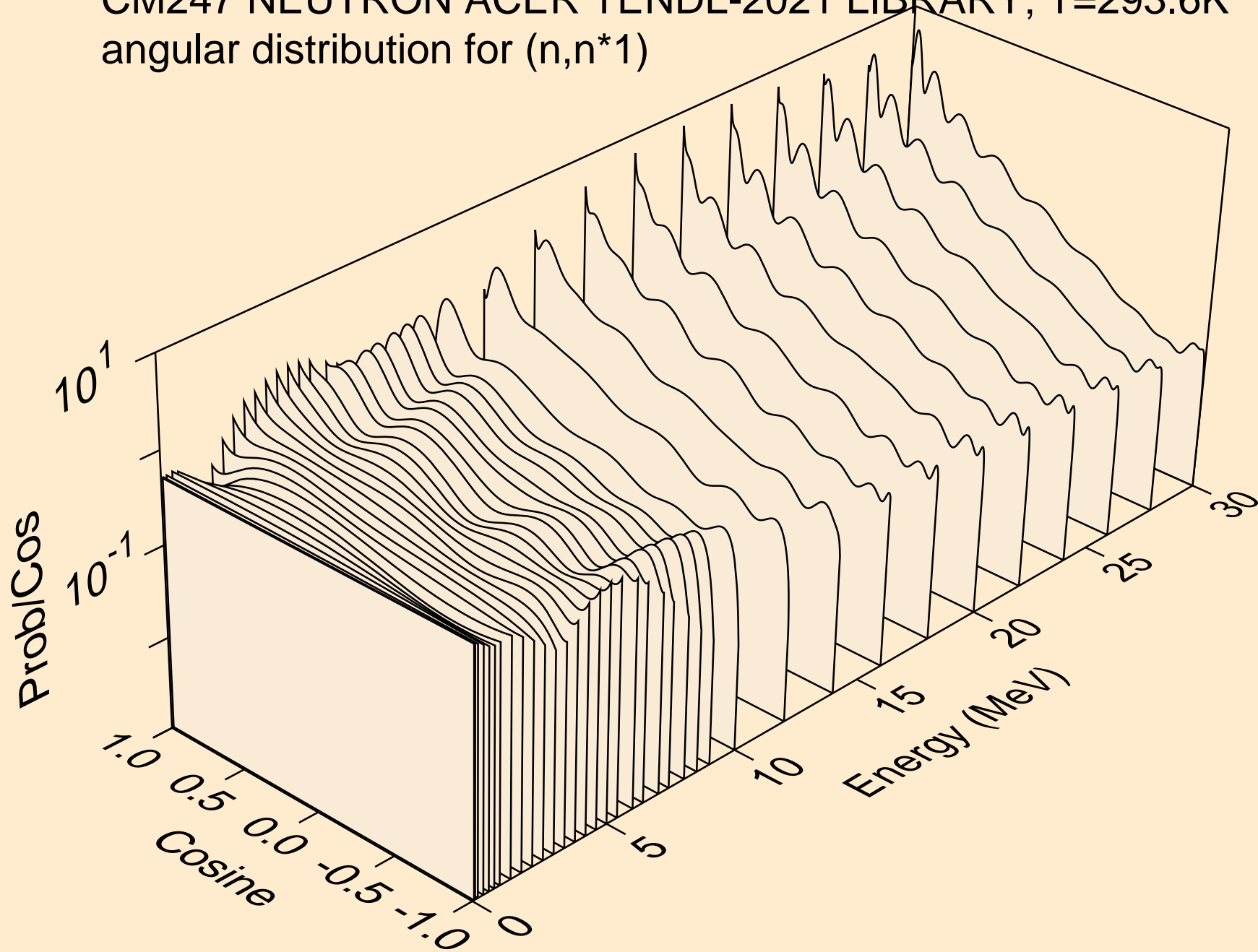

CM247 NEUTRON ACER TENDL-2021 LIBRARY; T=293.6K
angular distribution for (n,n*2)

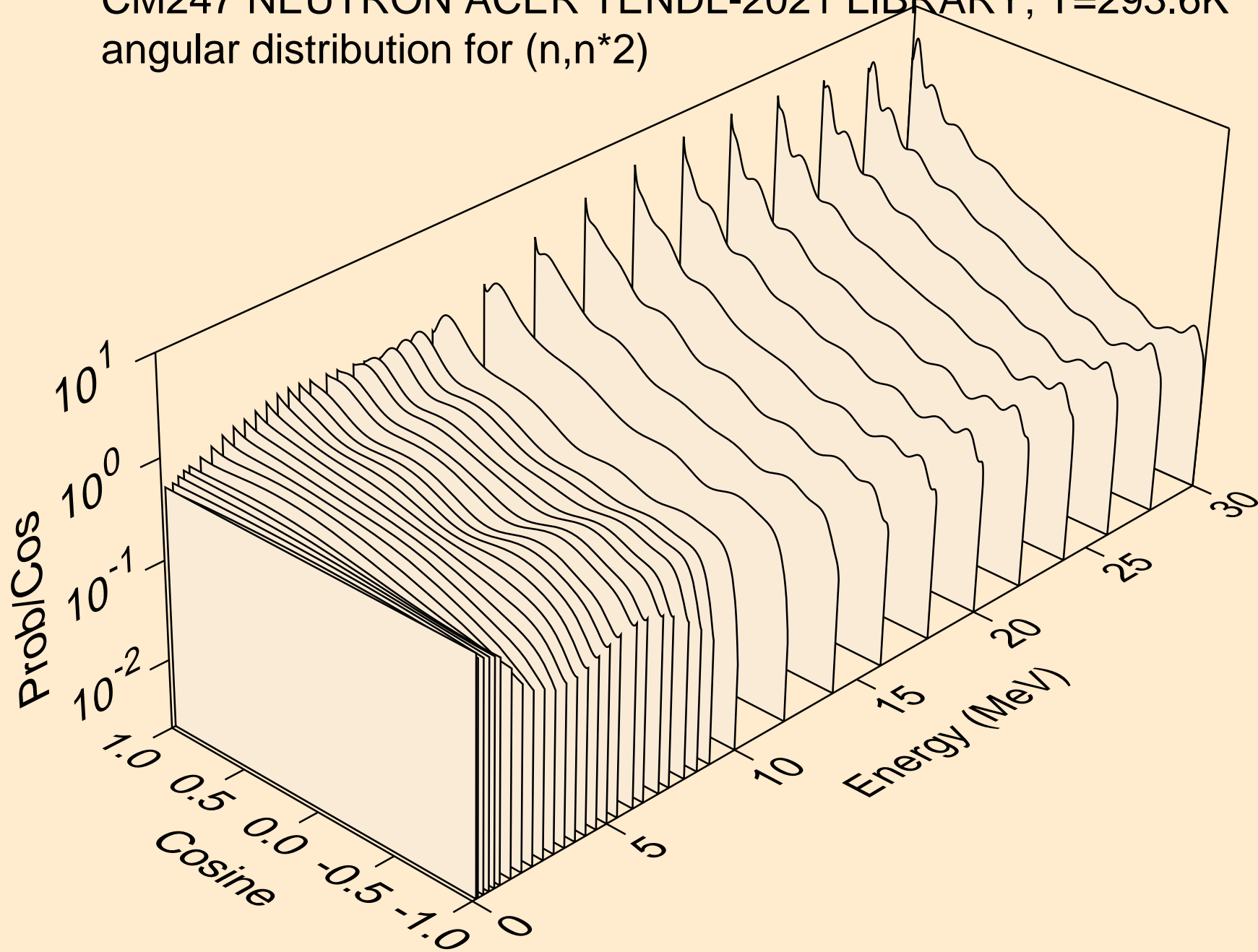

CM247 NEUTRON ACER TENDL-2021 LIBRARY; T=293.6K
angular distribution for (n,n*3)

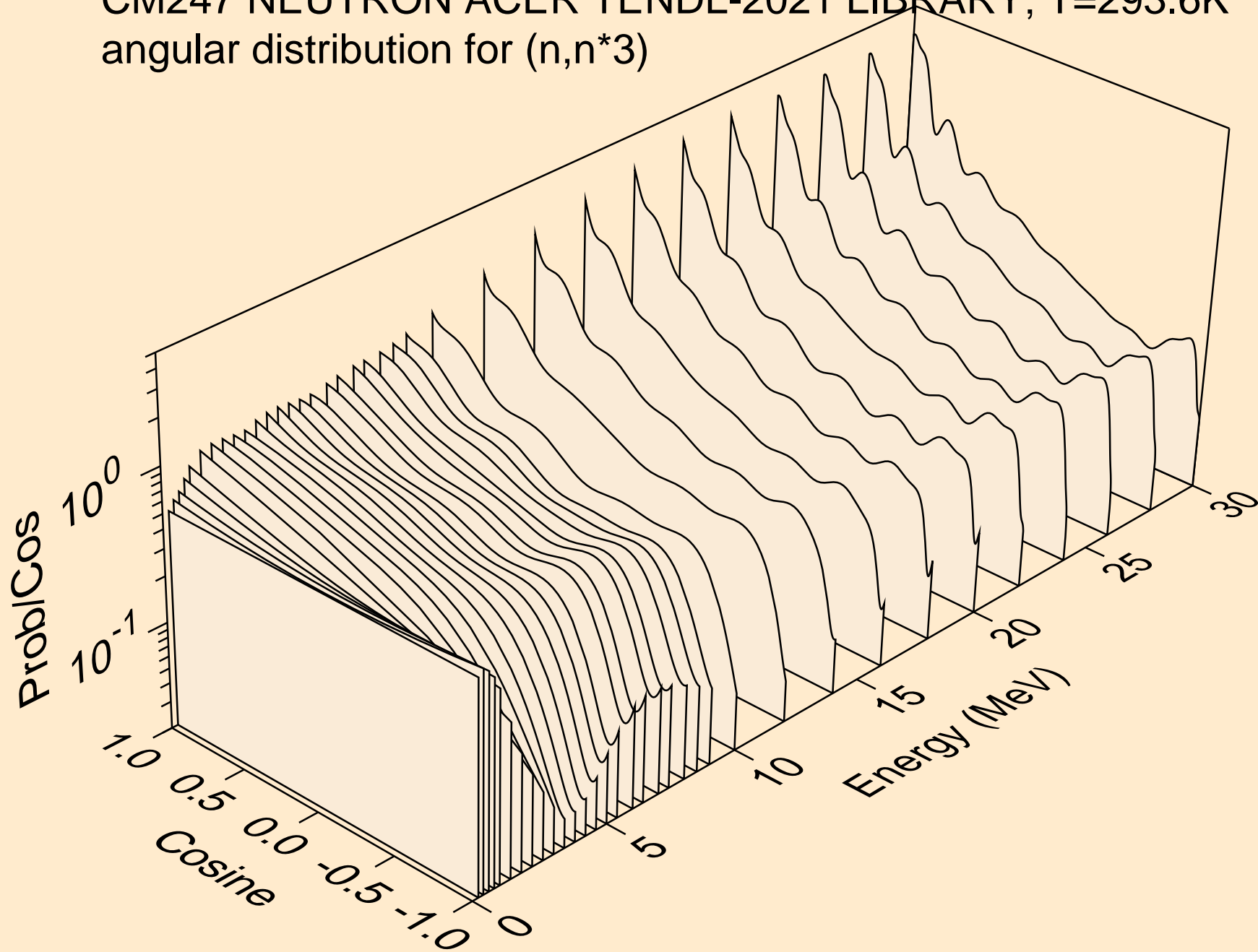

CM247 NEUTRON ACER TENDL-2021 LIBRARY; T=293.6K
angular distribution for (n,n*4)

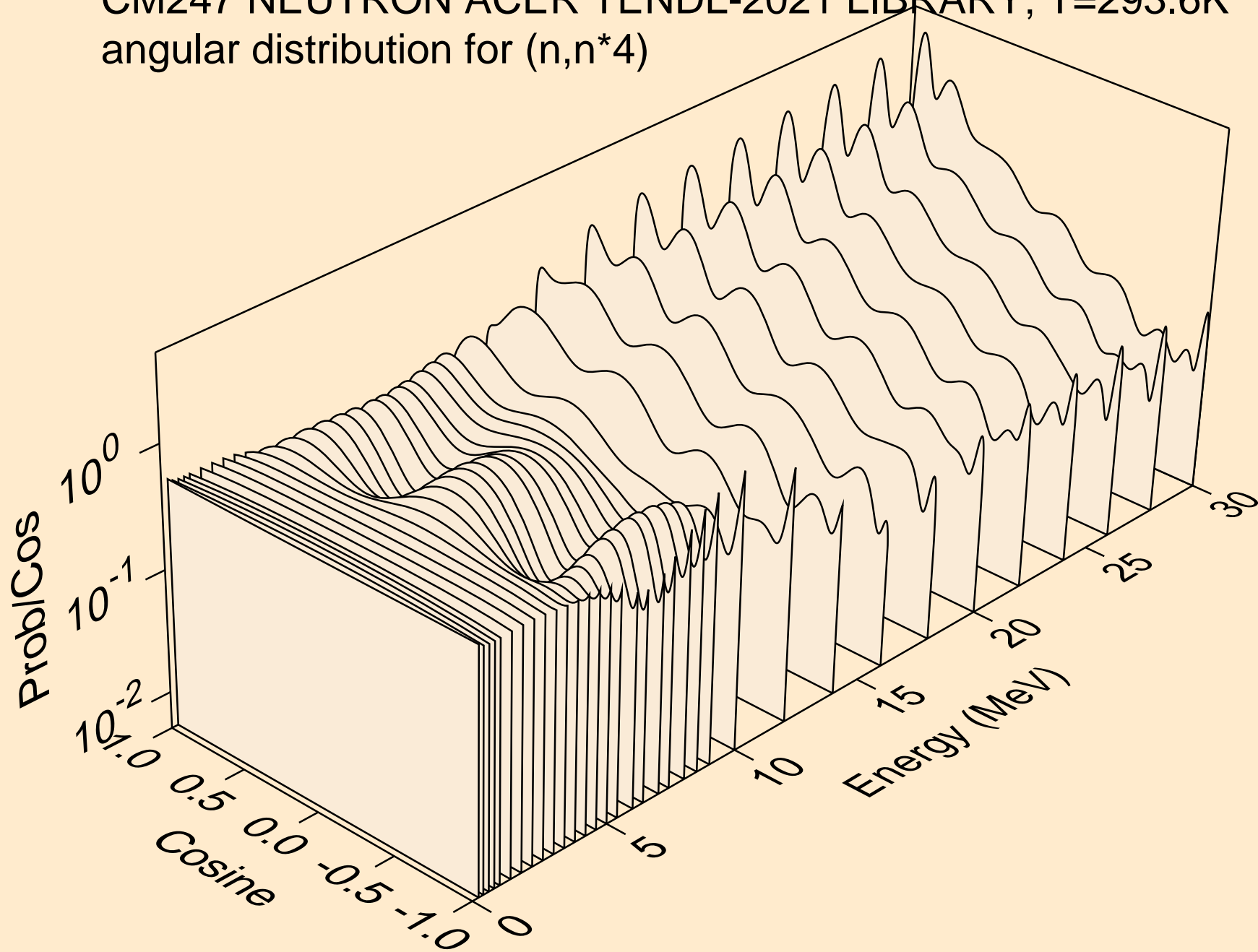

CM247 NEUTRON ACER TENDL-2021 LIBRARY; T=293.6K
angular distribution for (n,n*5)

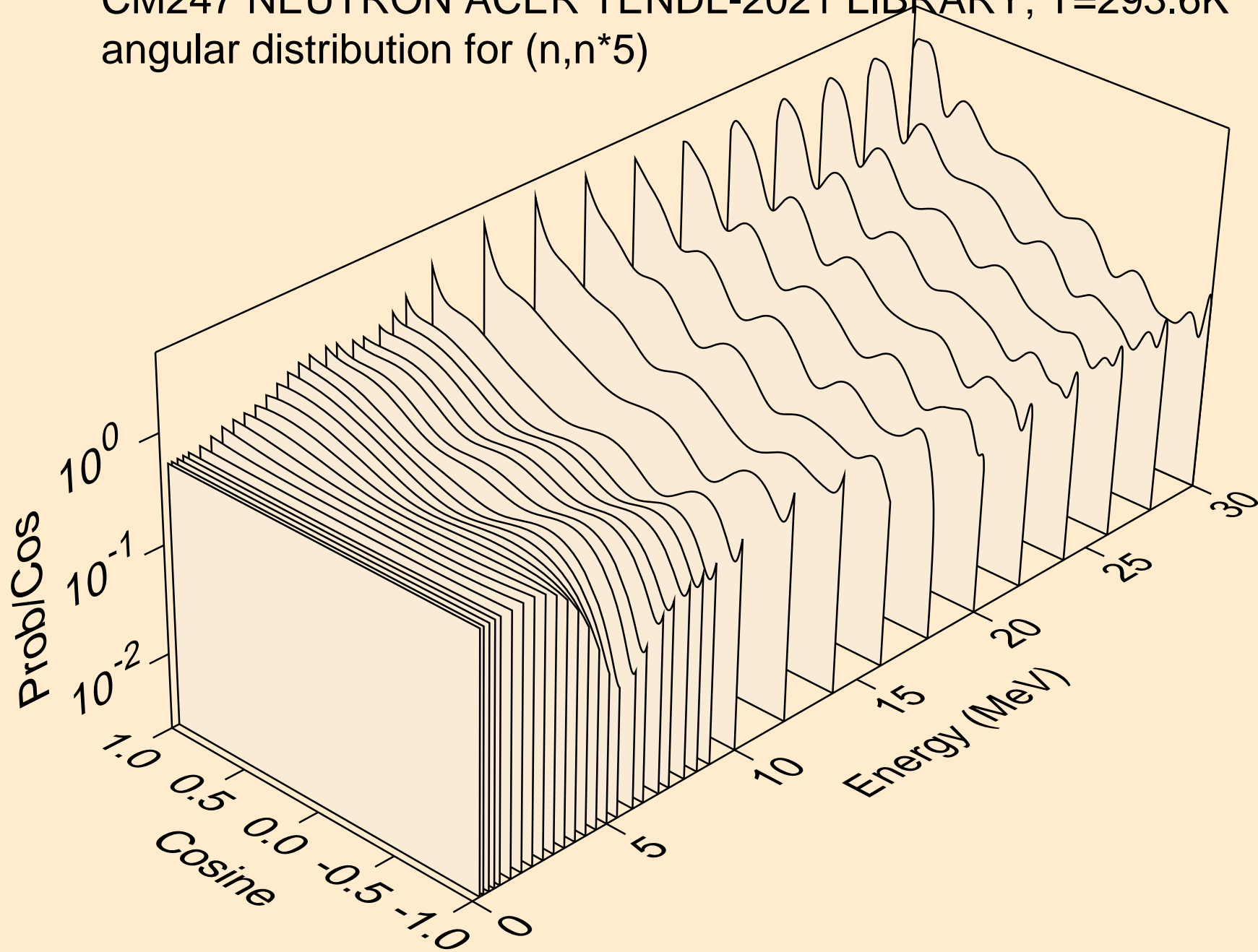

CM247 NEUTRON ACER TENDL-2021 LIBRARY; T=293.6K
angular distribution for (n,n*6)

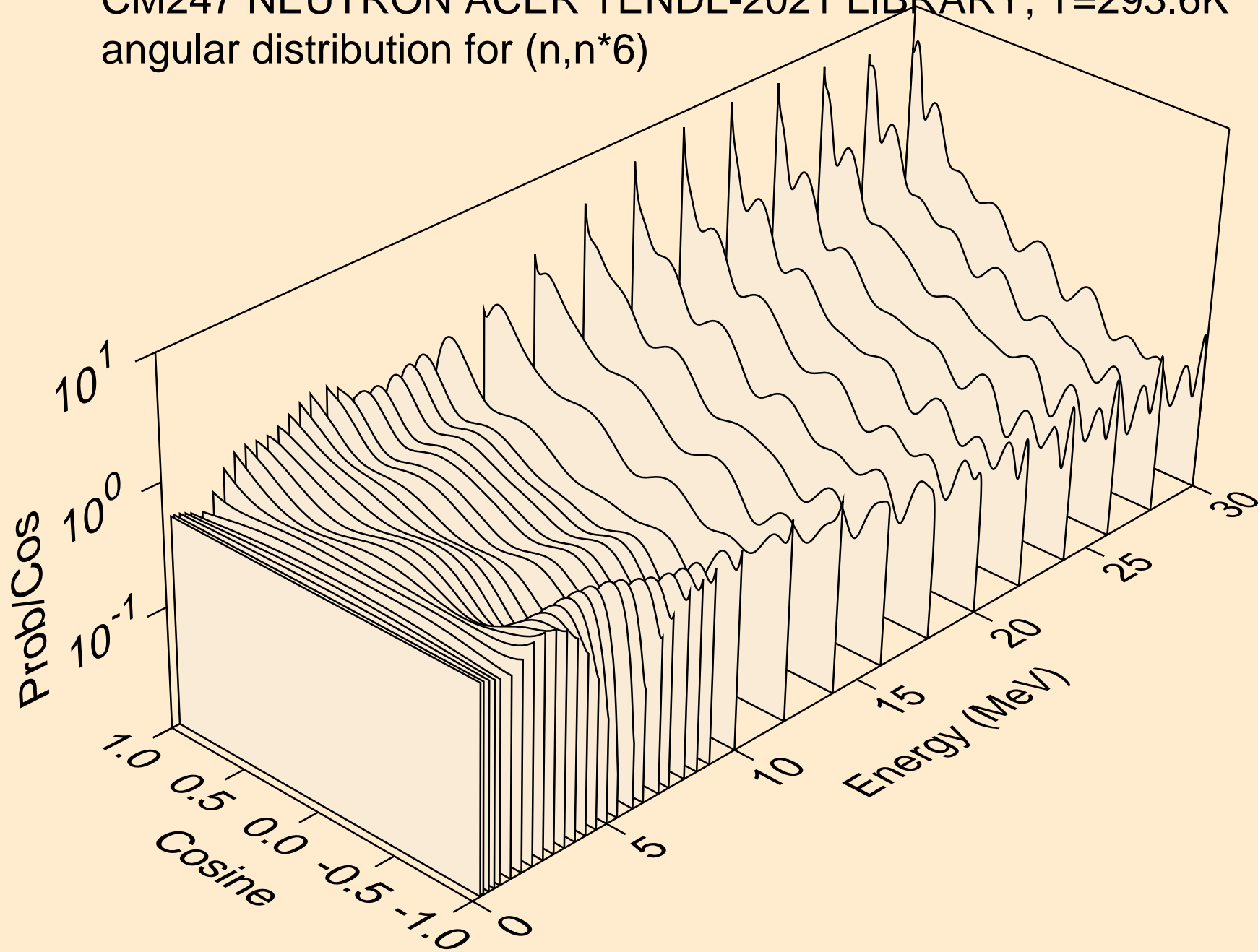

CM247 NEUTRON ACER TENDL-2021 LIBRARY; T=293.6K
angular distribution for (n,n*7)

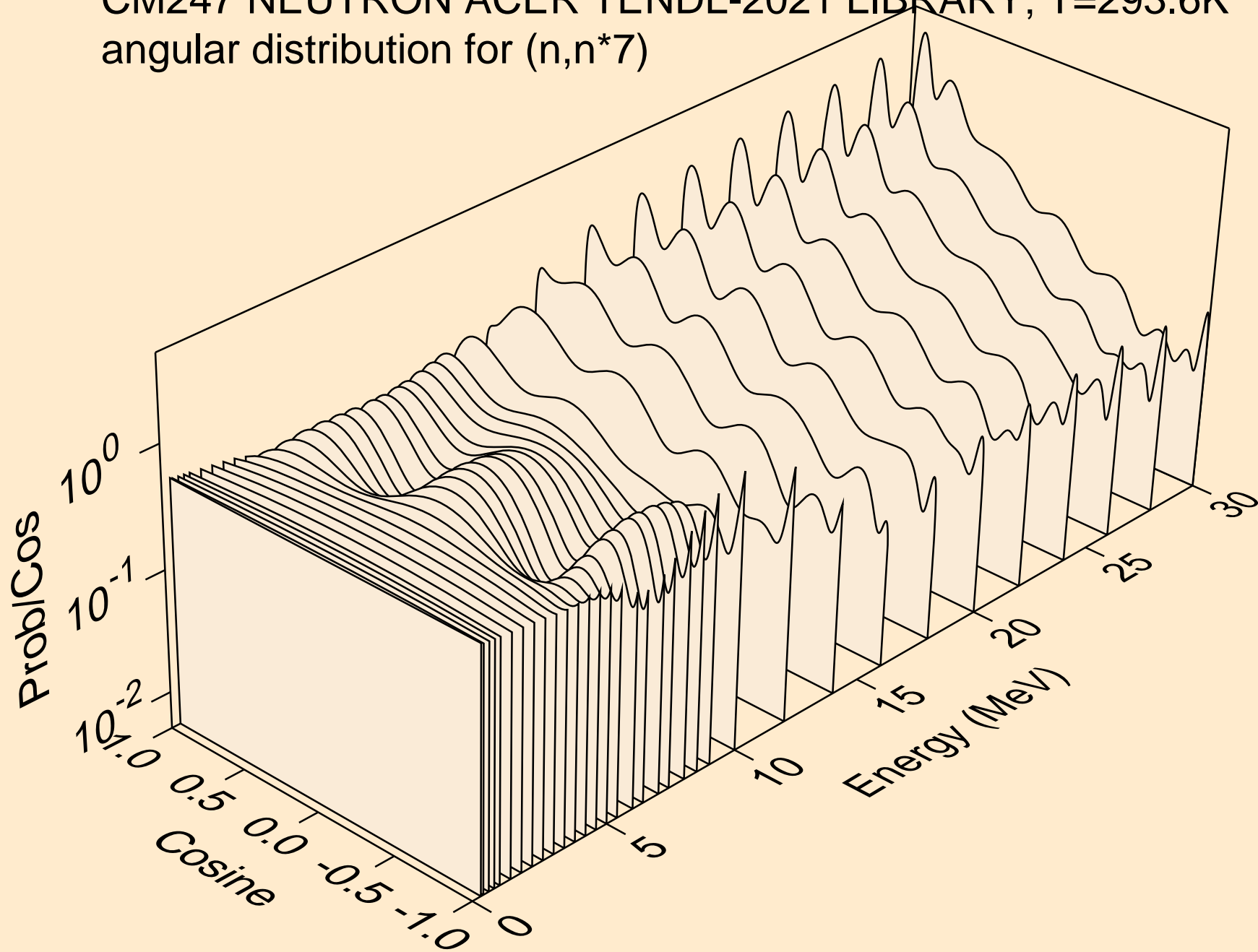

CM247 NEUTRON ACER TENDL-2021 LIBRARY; T=293.6K
angular distribution for (n,n*8)

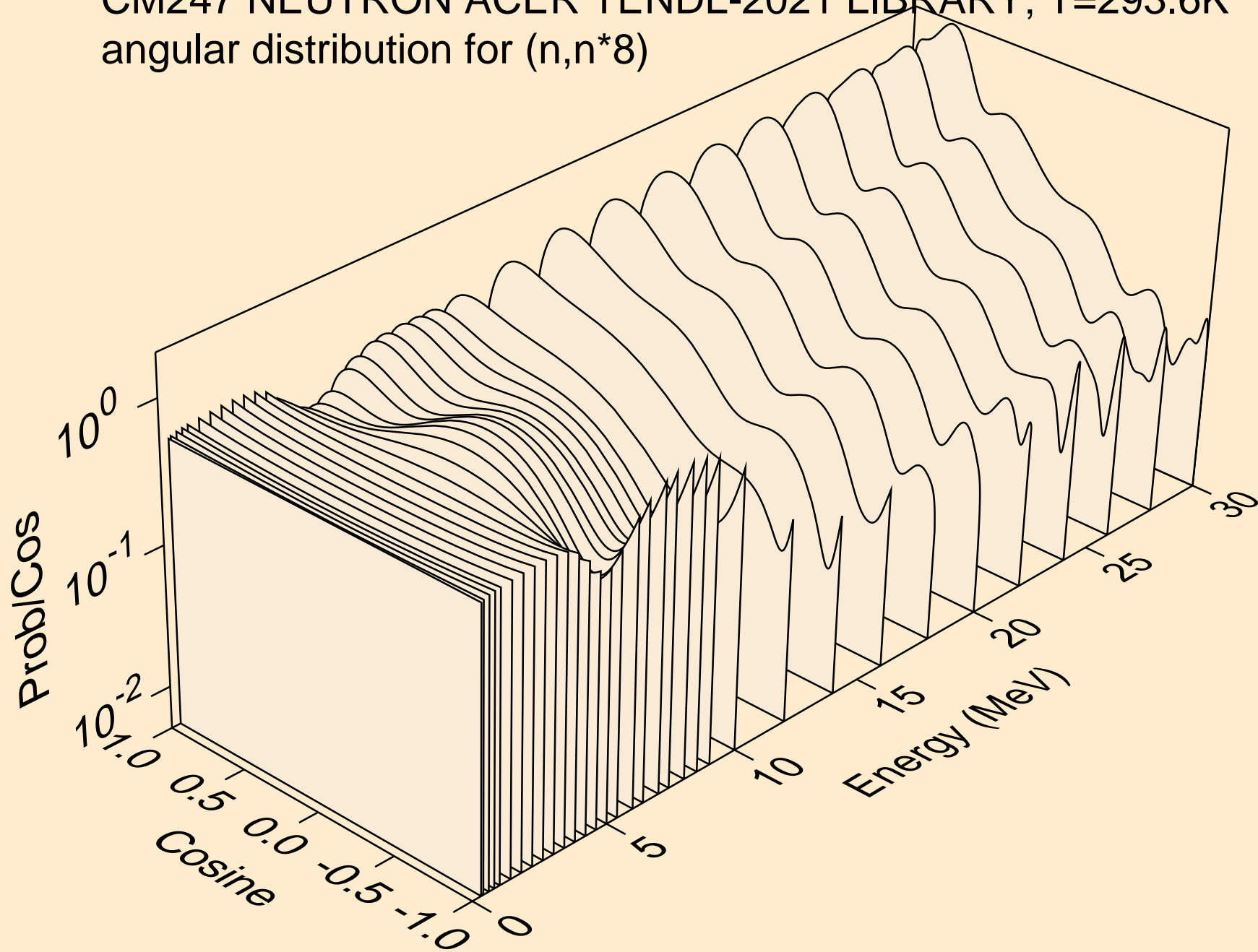

CM247 NEUTRON ACER TENDL-2021 LIBRARY; T=293.6K
angular distribution for (n,n*9)

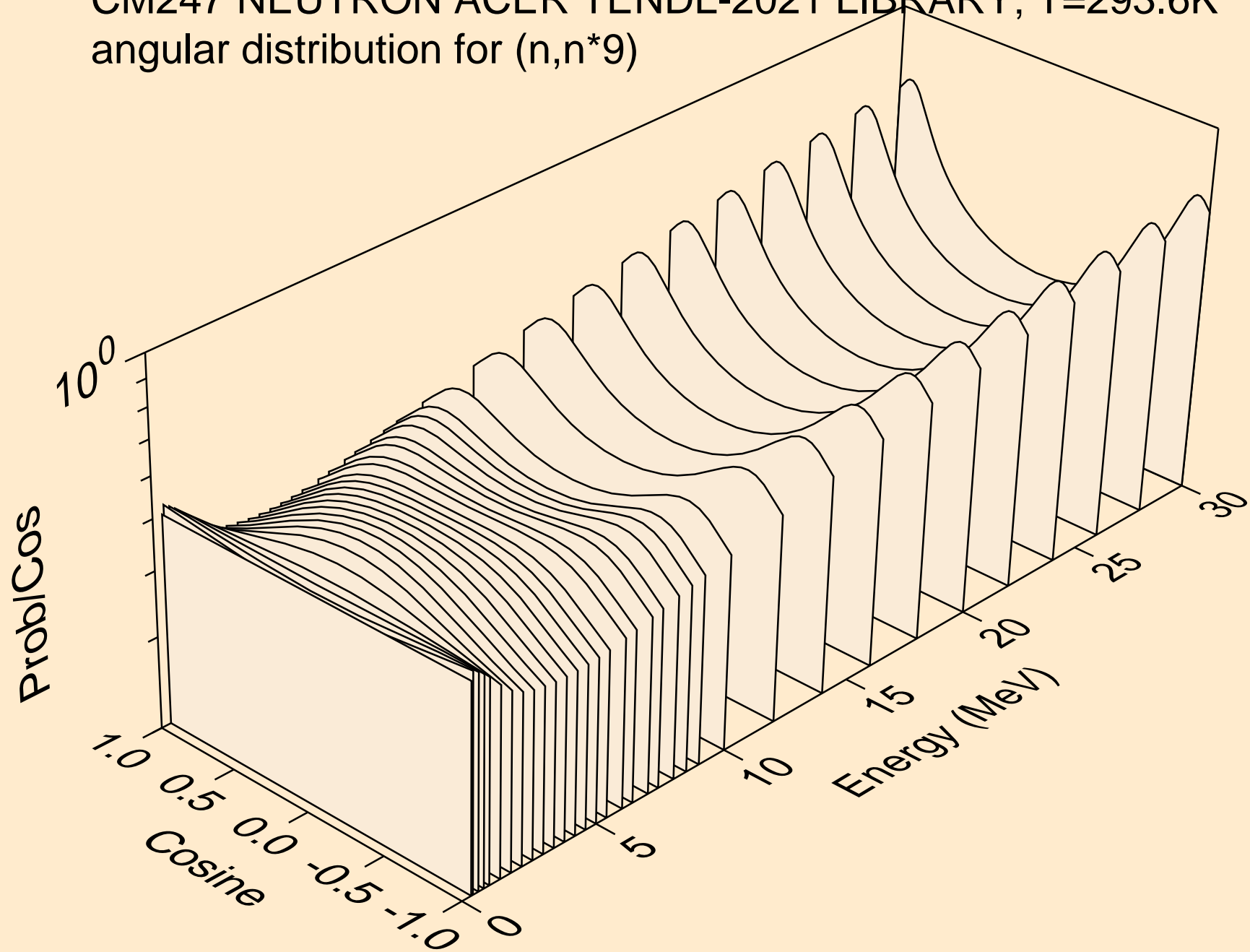

CM247 NEUTRON ACER TENDL-2021 LIBRARY; T=293.6K
angular distribution for (n,n*10)

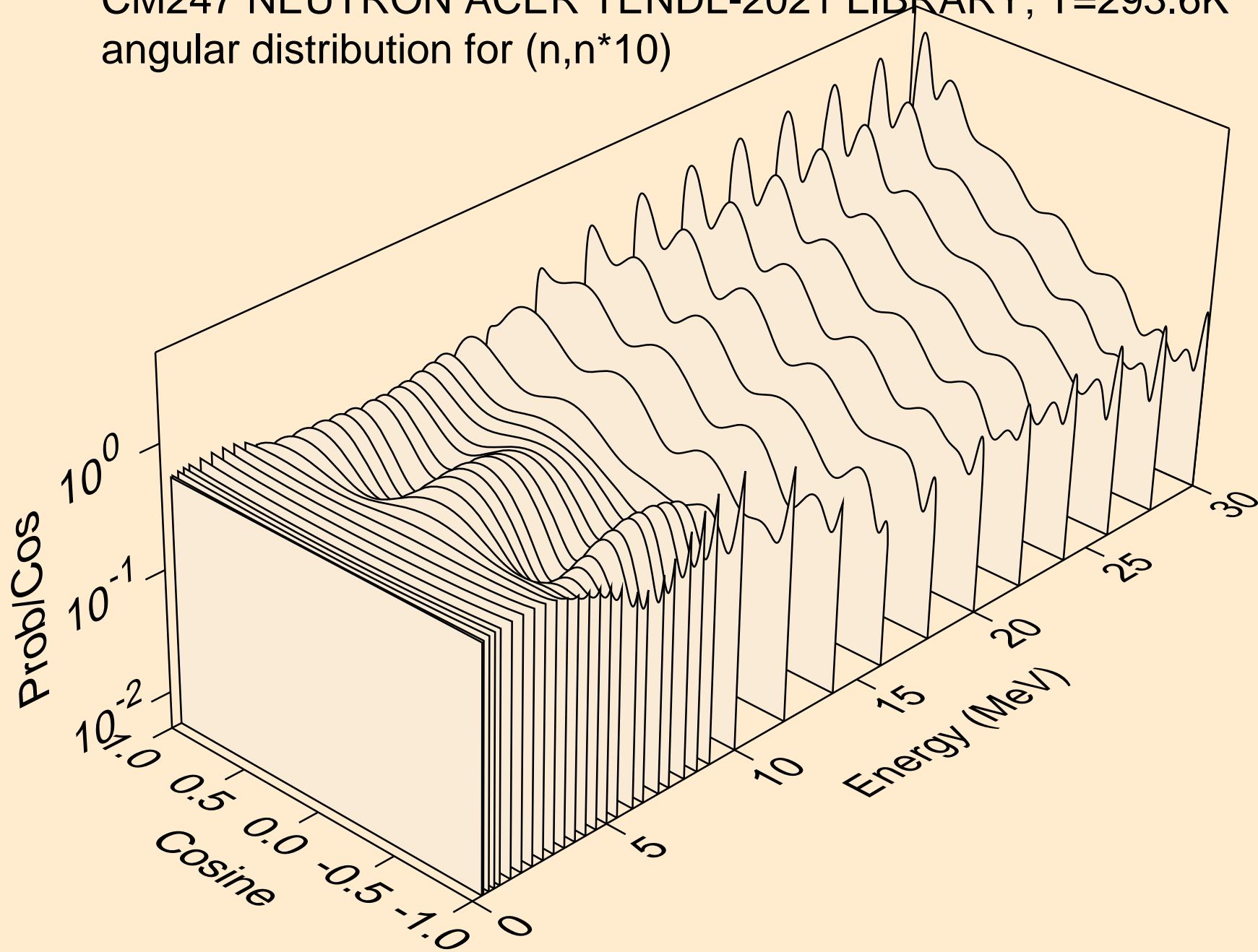

CM247 NEUTRON ACER TENDL-2021 LIBRARY; T=293.6K
angular distribution for (n,n*11)

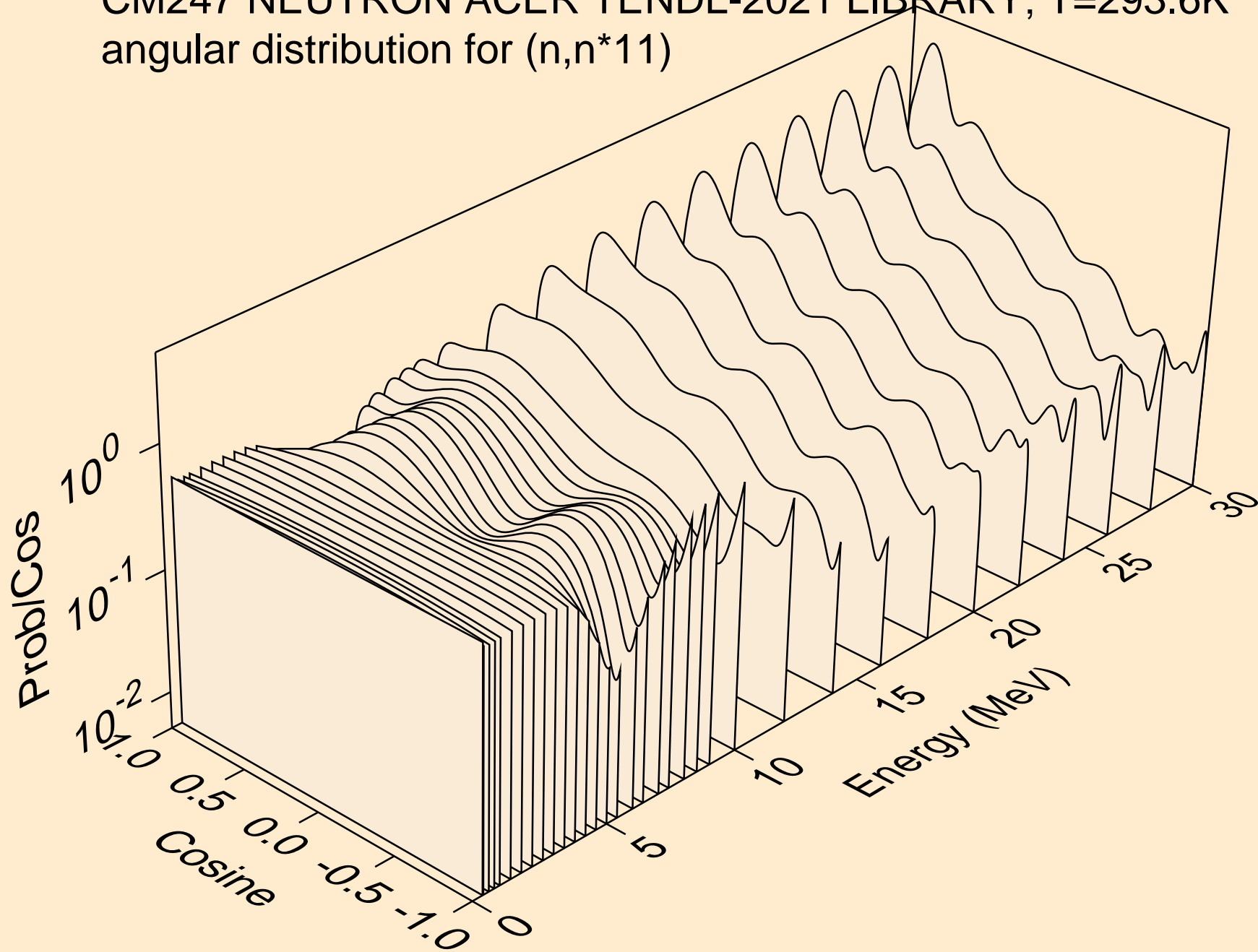

CM247 NEUTRON ACER TENDL-2021 LIBRARY; T=293.6K
angular distribution for (n,n*12)

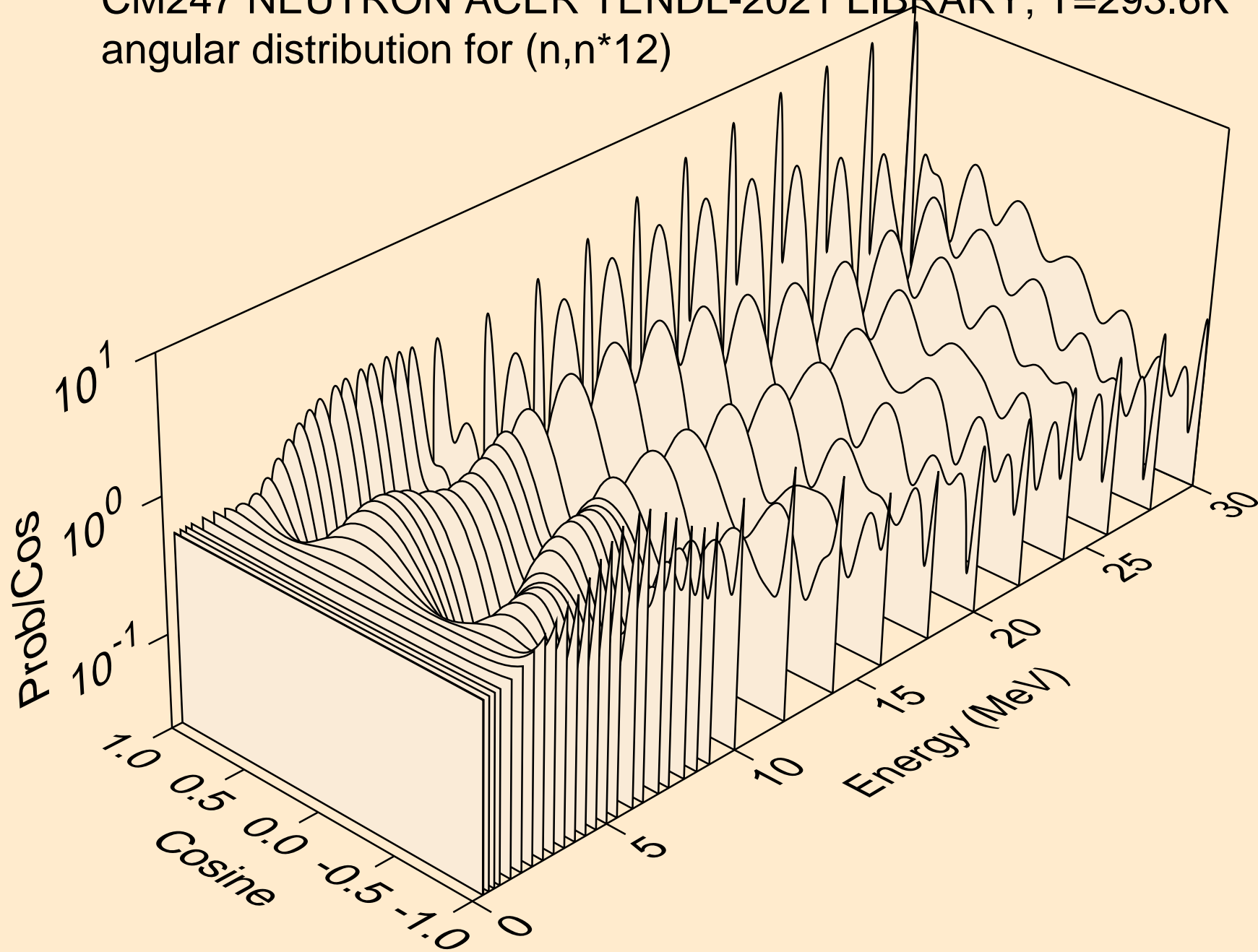

CM247 NEUTRON ACER TENDL-2021 LIBRARY; T=293.6K
angular distribution for (n,n*13)

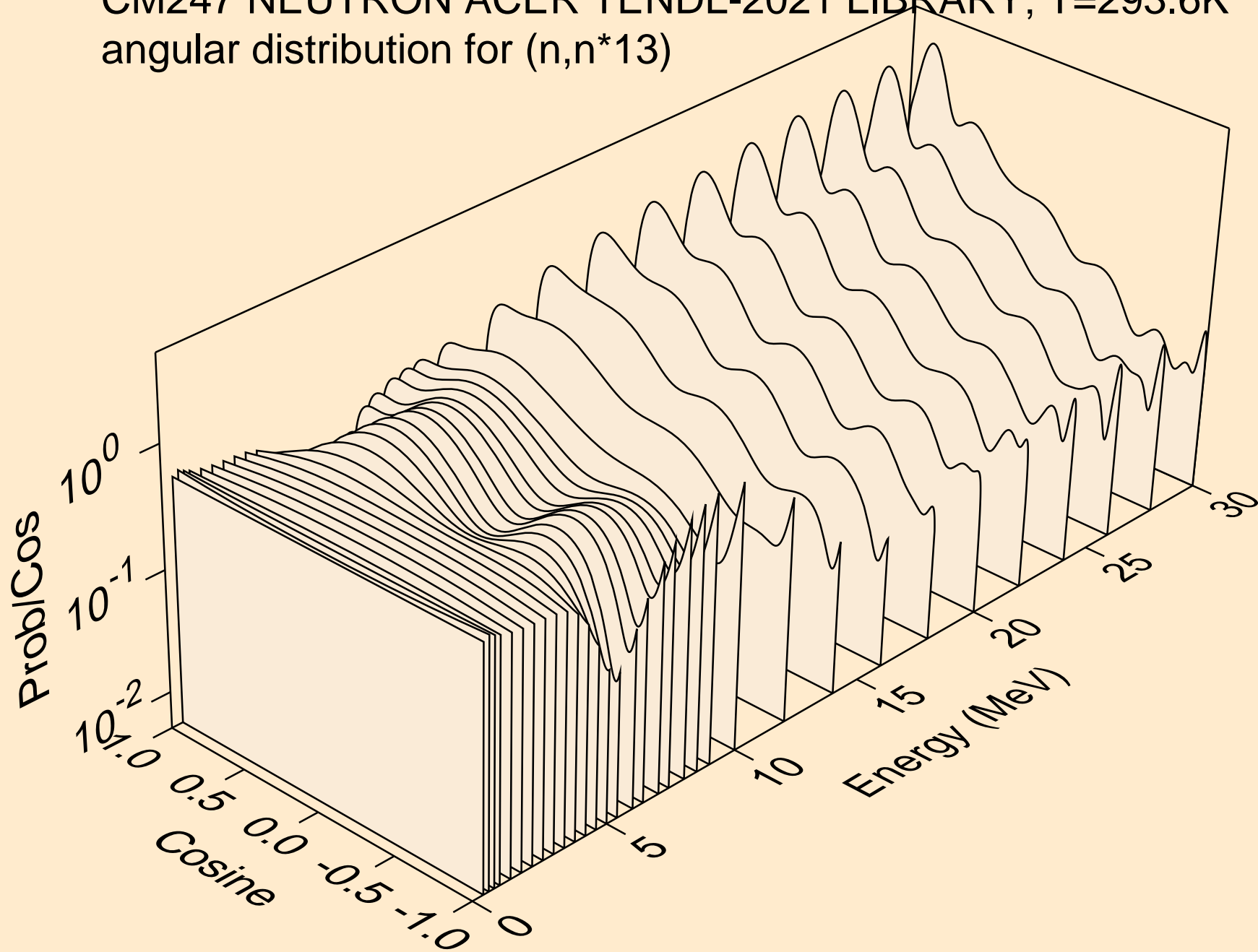

CM247 NEUTRON ACER TENDL-2021 LIBRARY; T=293.6K
angular distribution for (n,n*14)

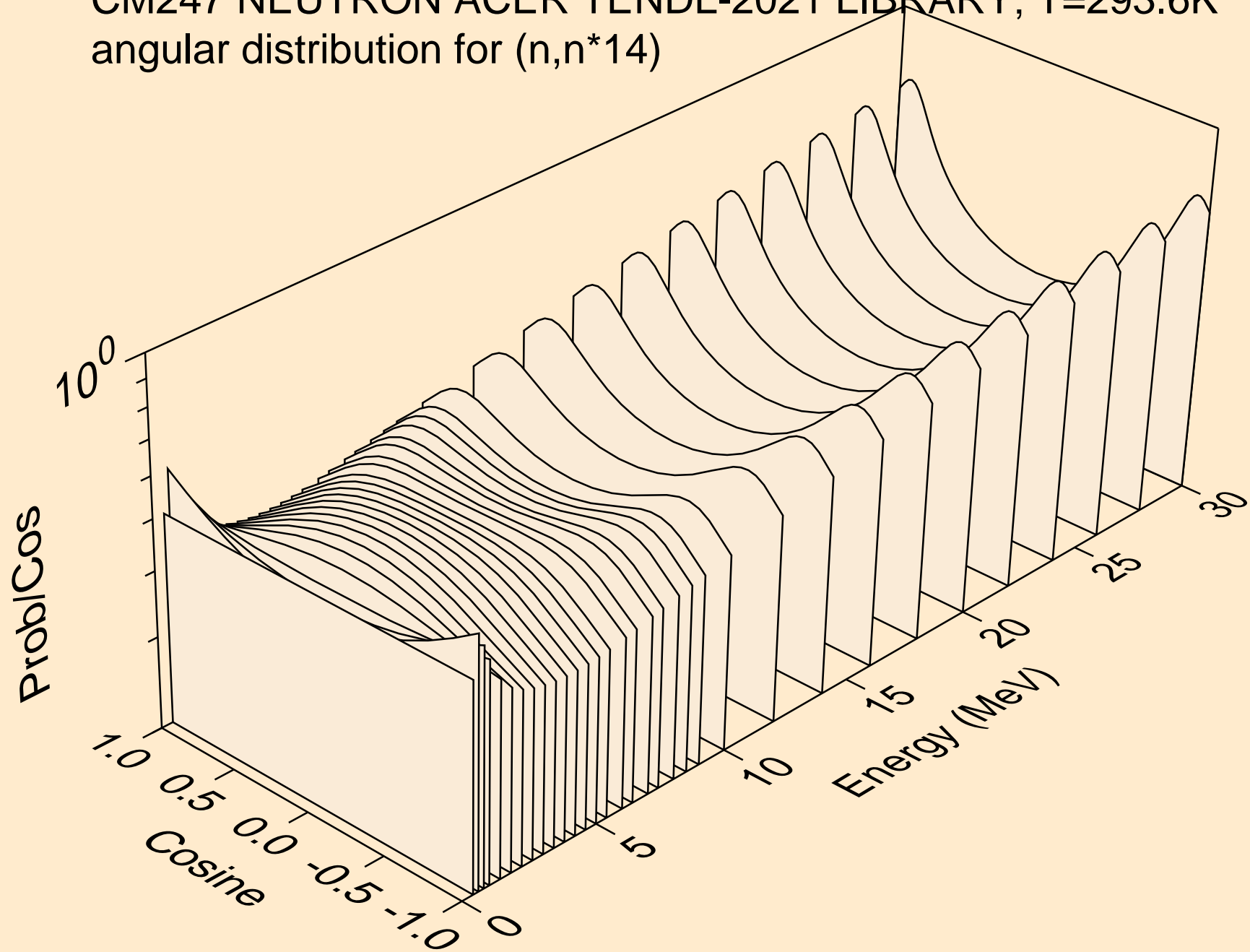

CM247 NEUTRON ACER TENDL-2021 LIBRARY; T=293.6K
angular distribution for (n,n*15)

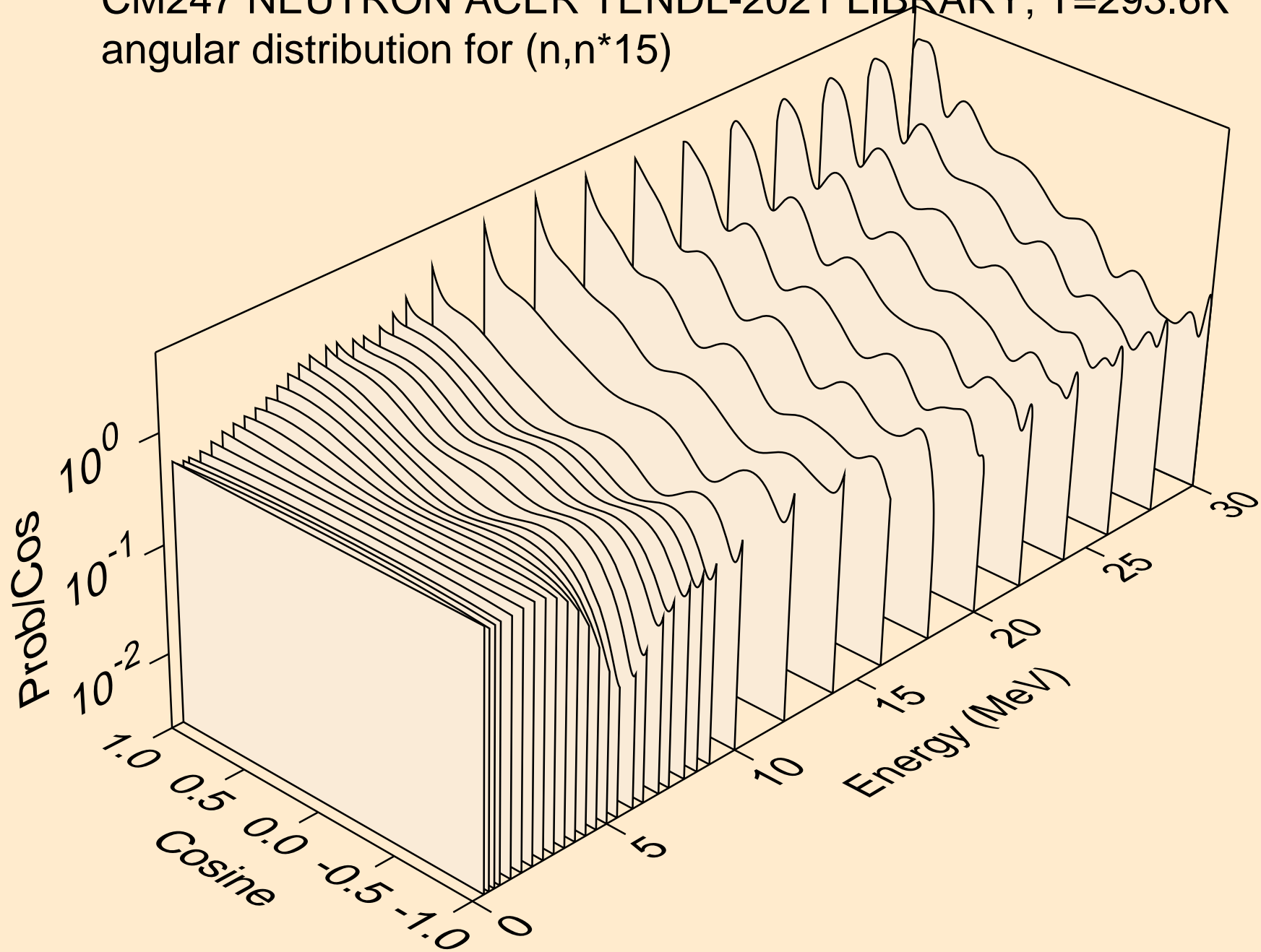

CM247 NEUTRON ACER TENDL-2021 LIBRARY; T=293.6K
angular distribution for (n,n*16)

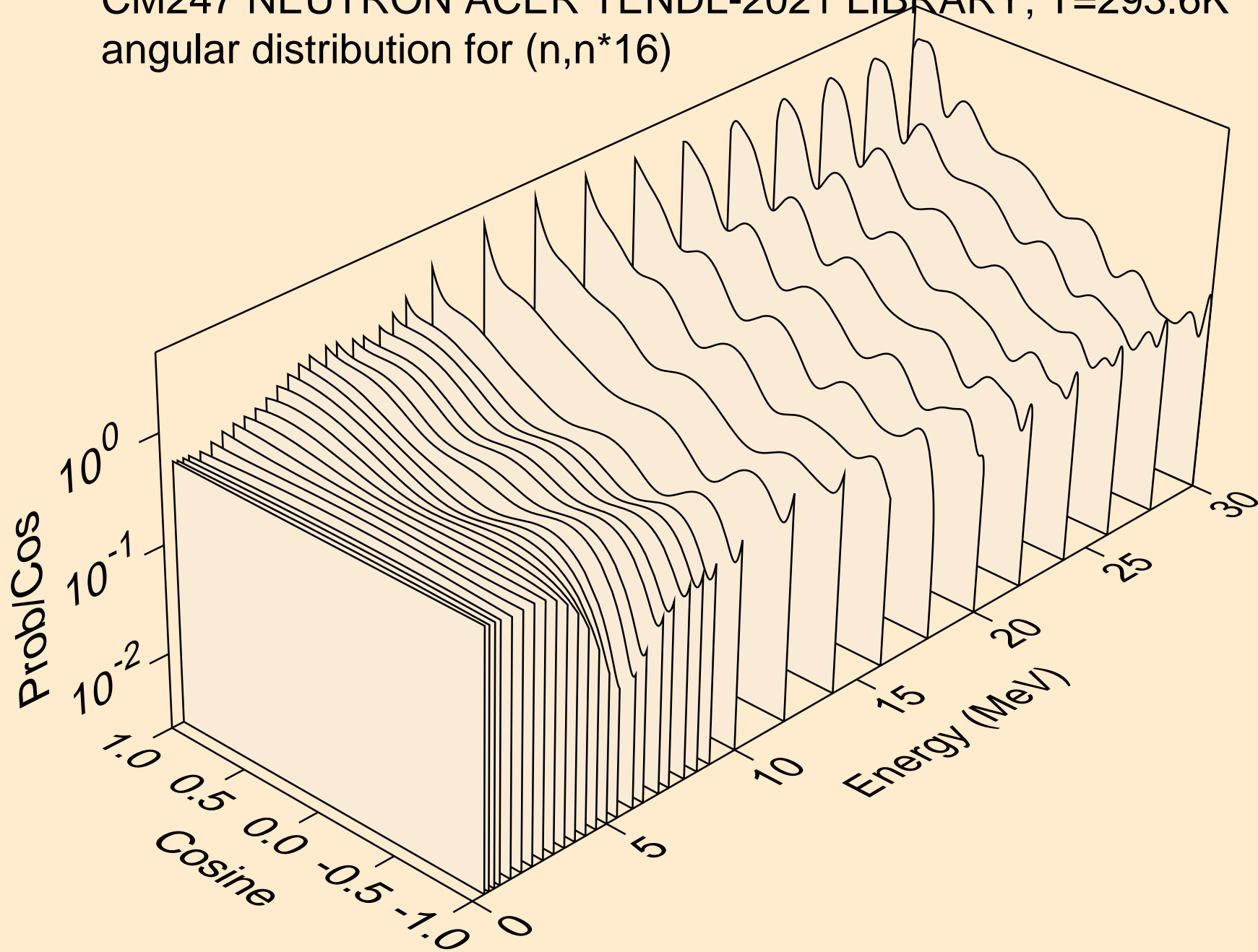

CM247 NEUTRON ACER TENDL-2021 LIBRARY; T=293.6K
angular distribution for (n,n*17)

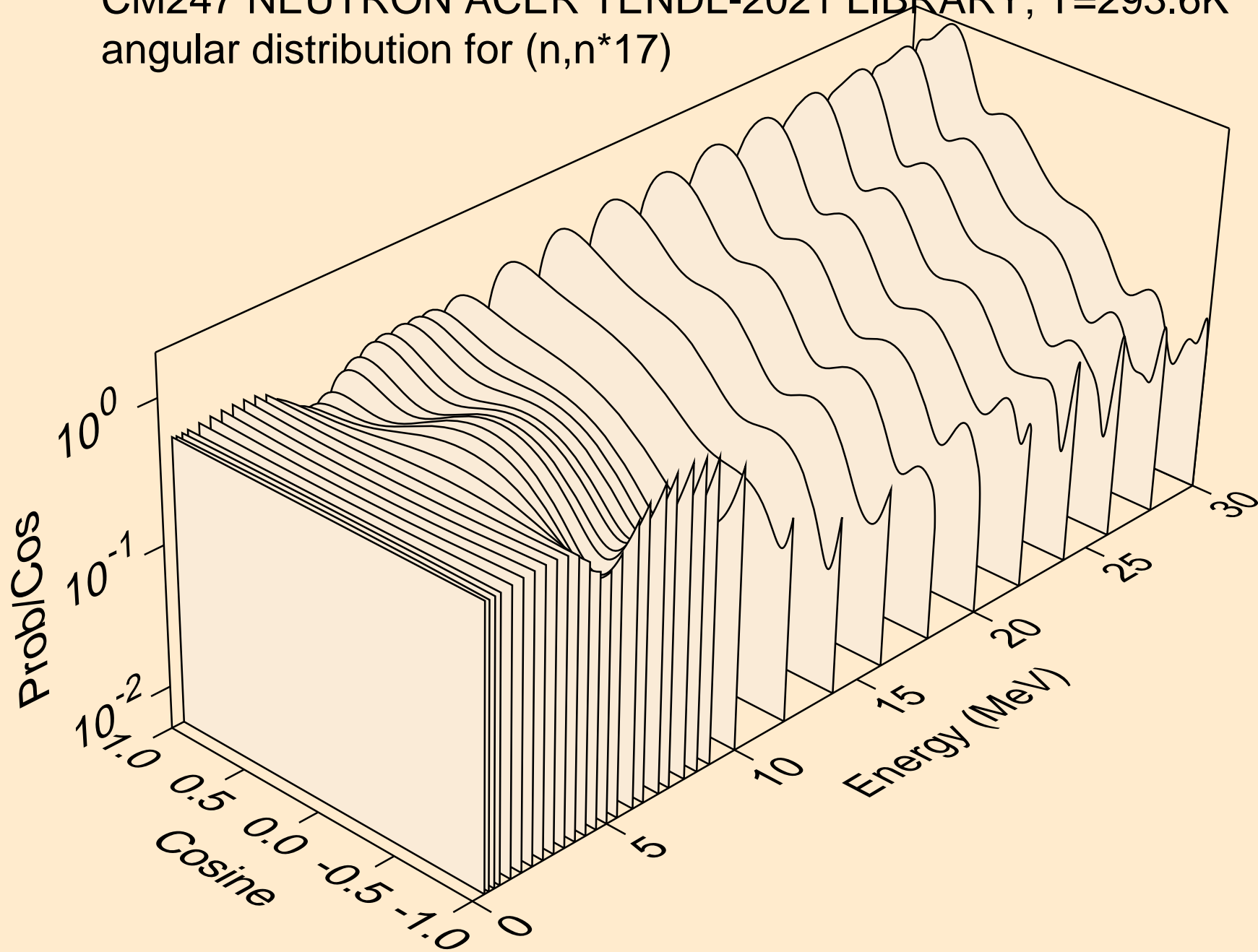

CM247 NEUTRON ACER TENDL-2021 LIBRARY; T=293.6K
angular distribution for (n,n*18)

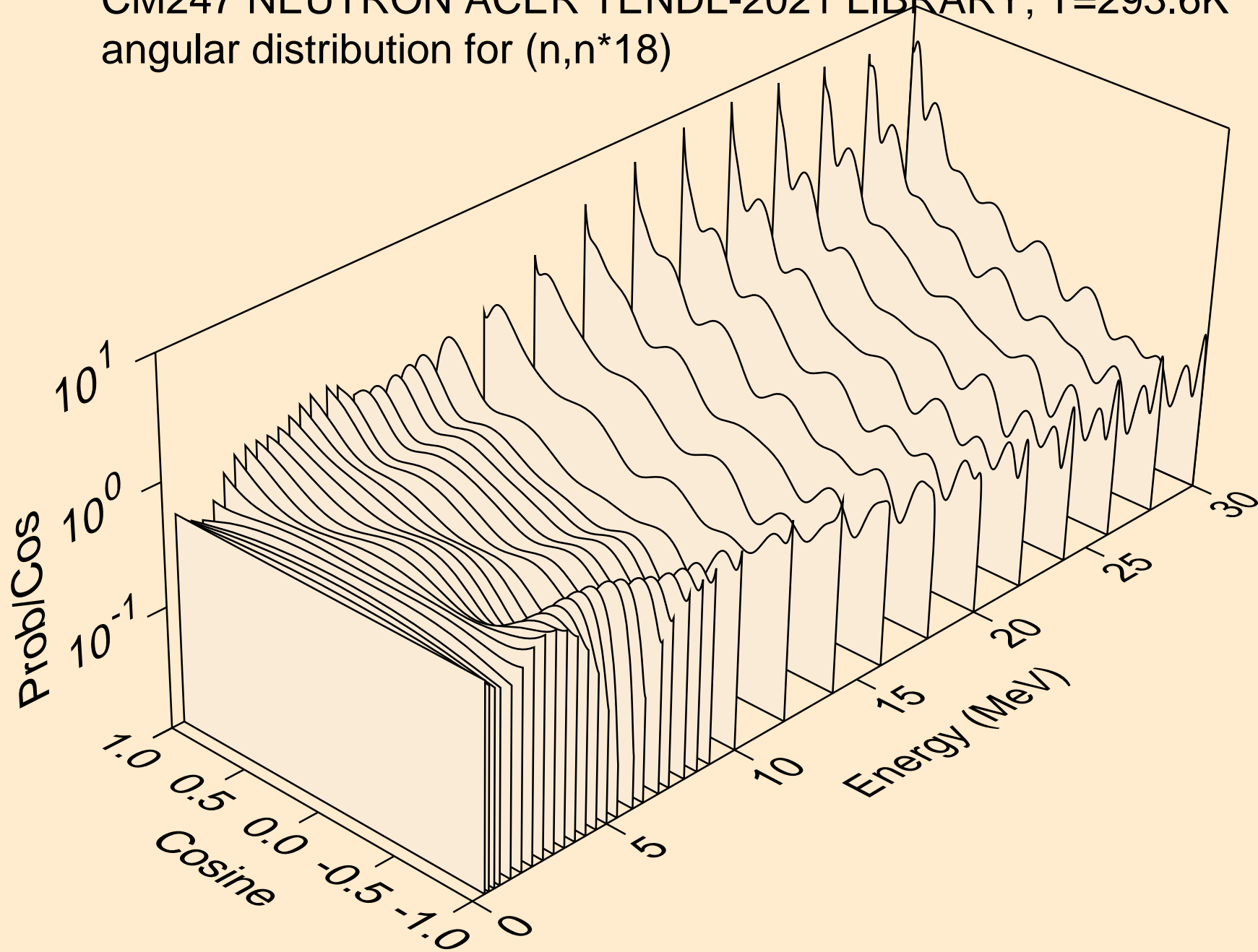

CM247 NEUTRON ACER TENDL-2021 LIBRARY; T=293.6K
angular distribution for (n,n*19)

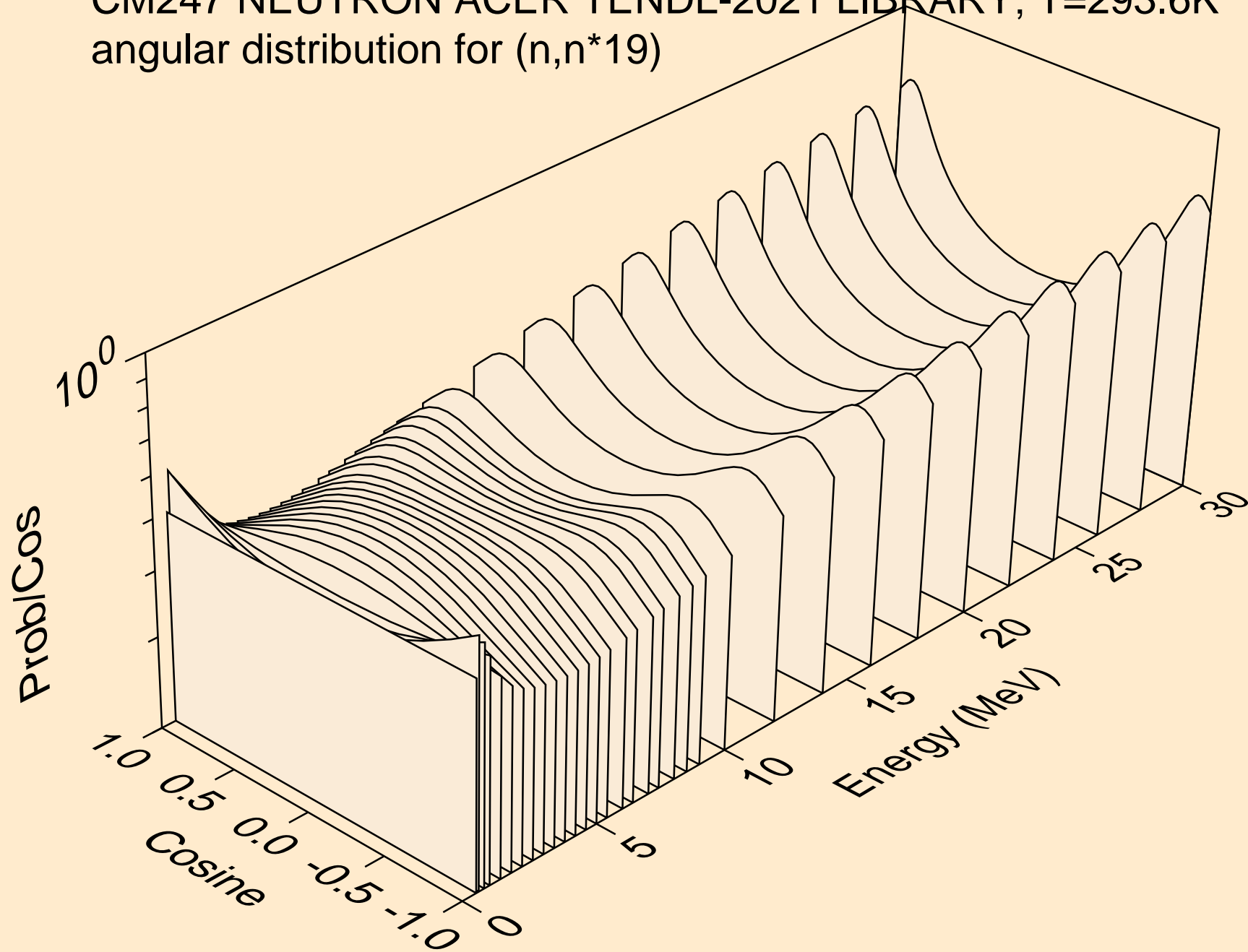

CM247 NEUTRON ACER TENDL-2021 LIBRARY; T=293.6K
angular distribution for (n,n*20)

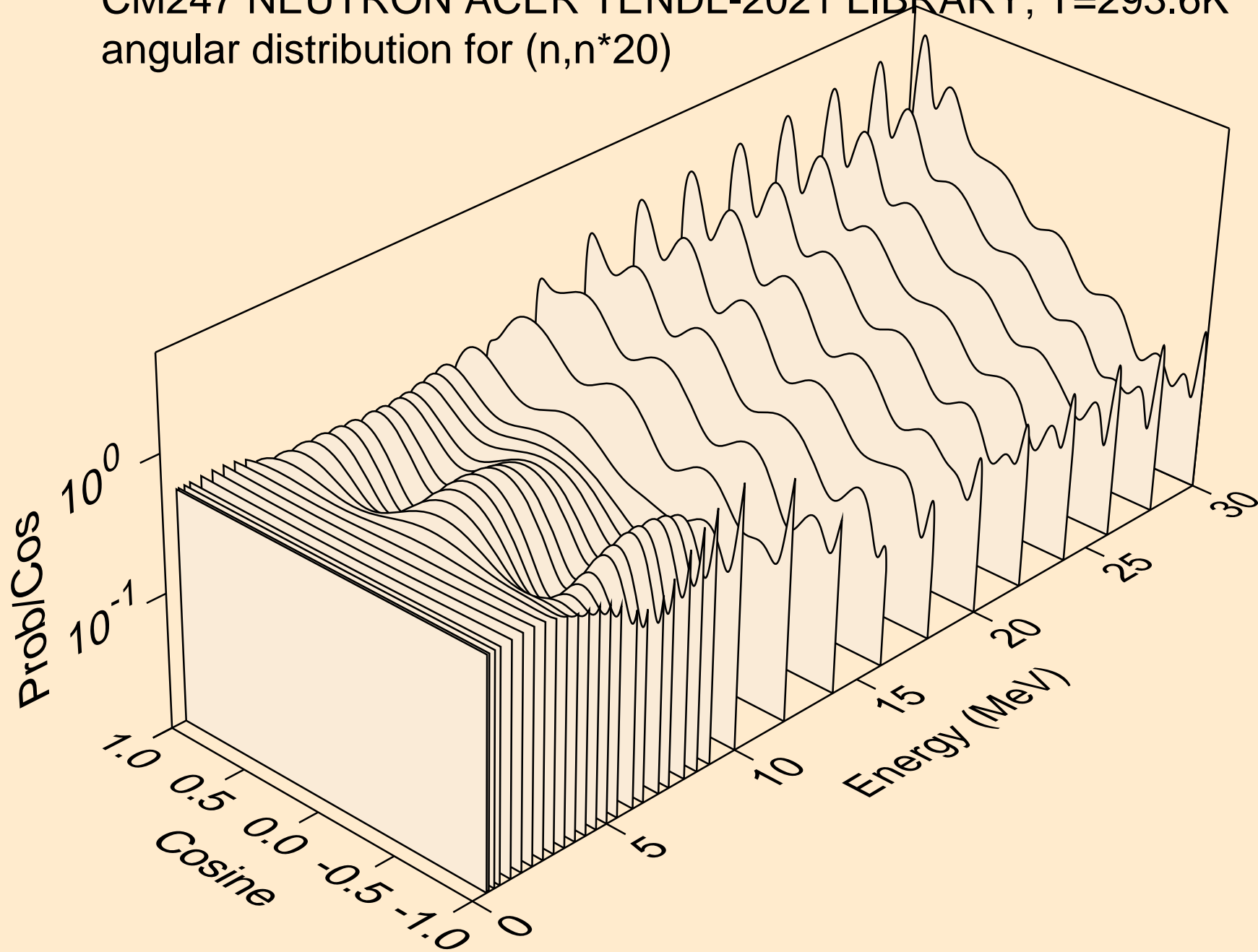

CM247 NEUTRON ACER TENDL-2021 LIBRARY; T=293.6K
angular distribution for (n,n*21)

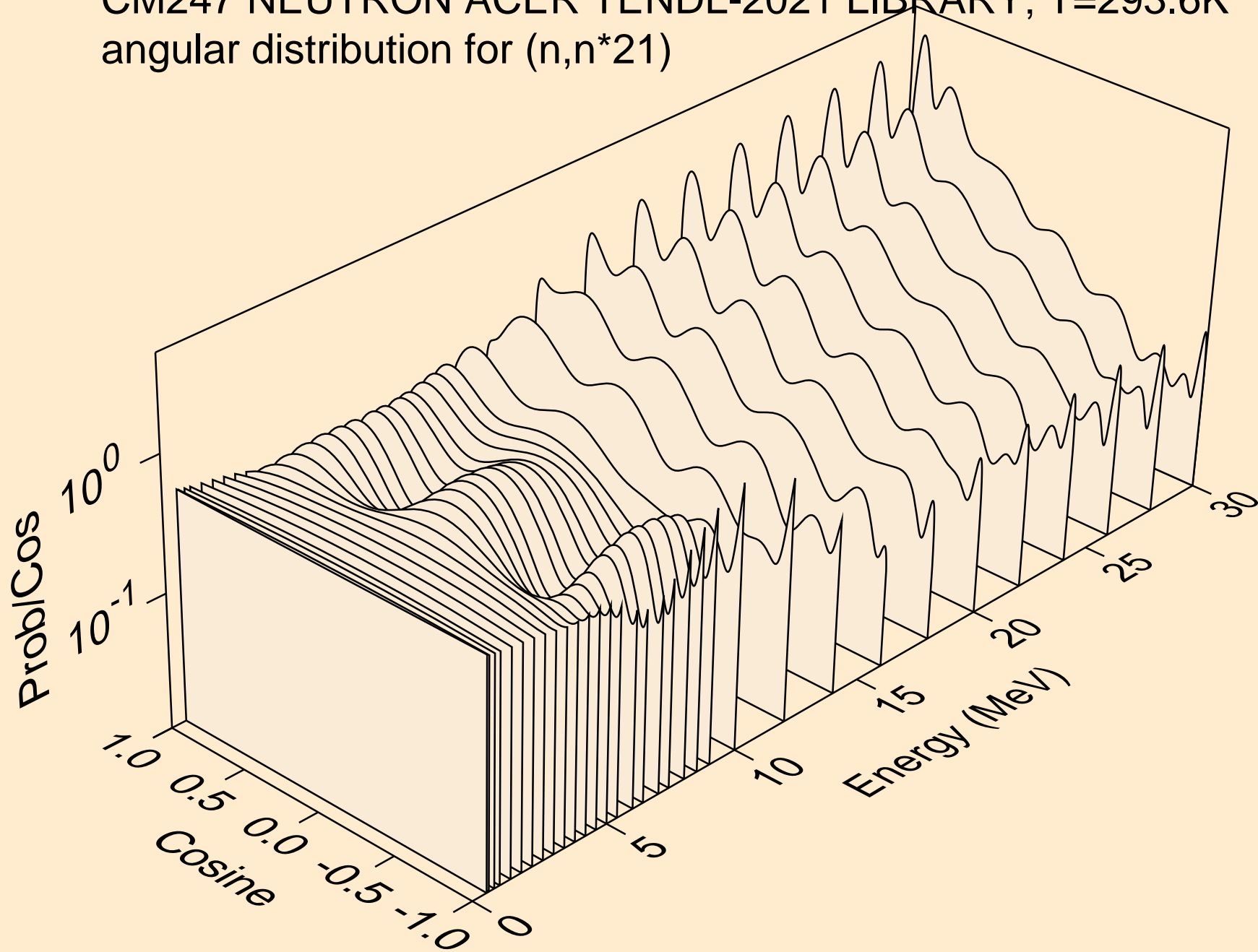

CM247 NEUTRON ACER TENDL-2021 LIBRARY; T=293.6K
angular distribution for (n,n*22)

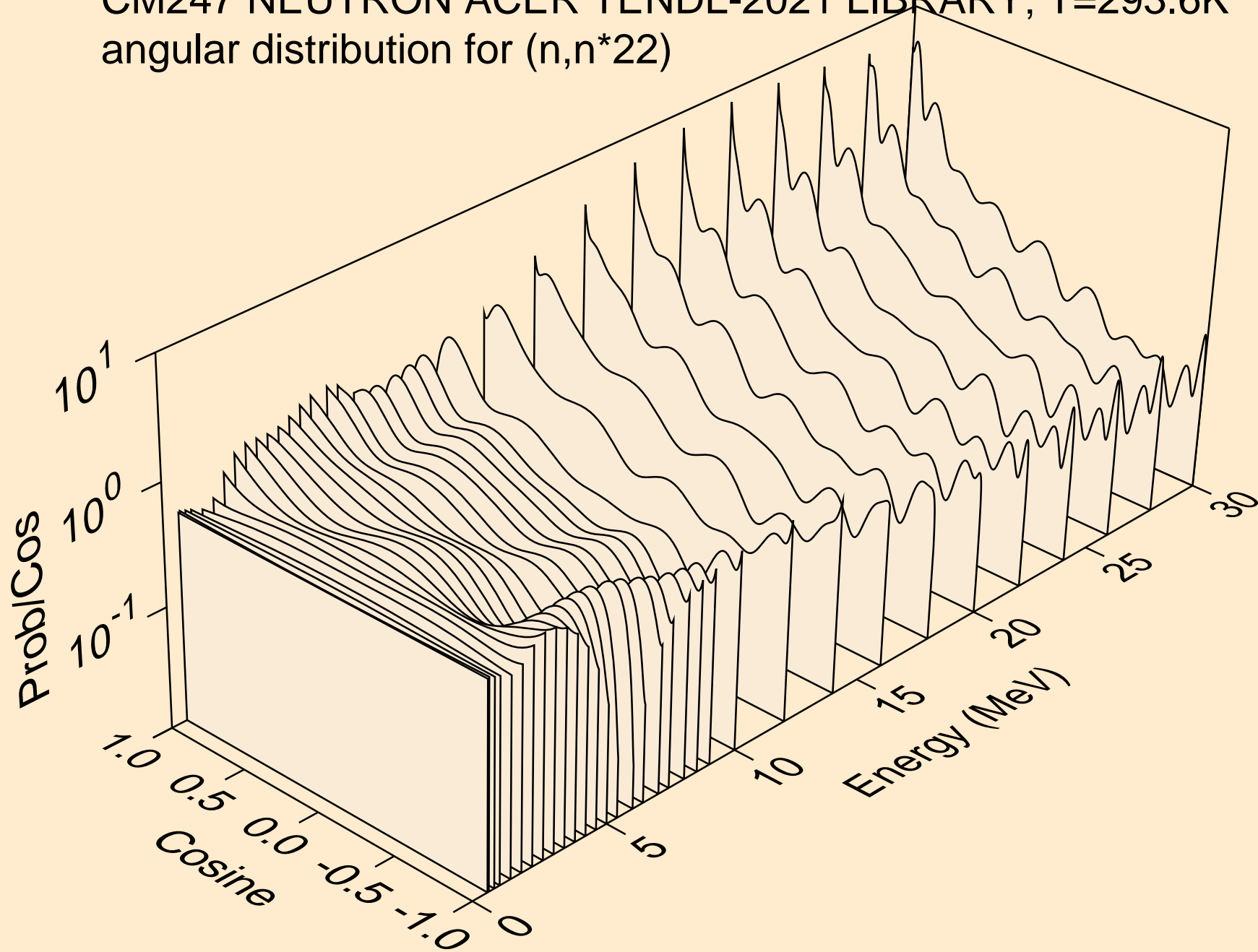

CM247 NEUTRON ACER TENDL-2021 LIBRARY; T=293.6K
angular distribution for (n,n*23)

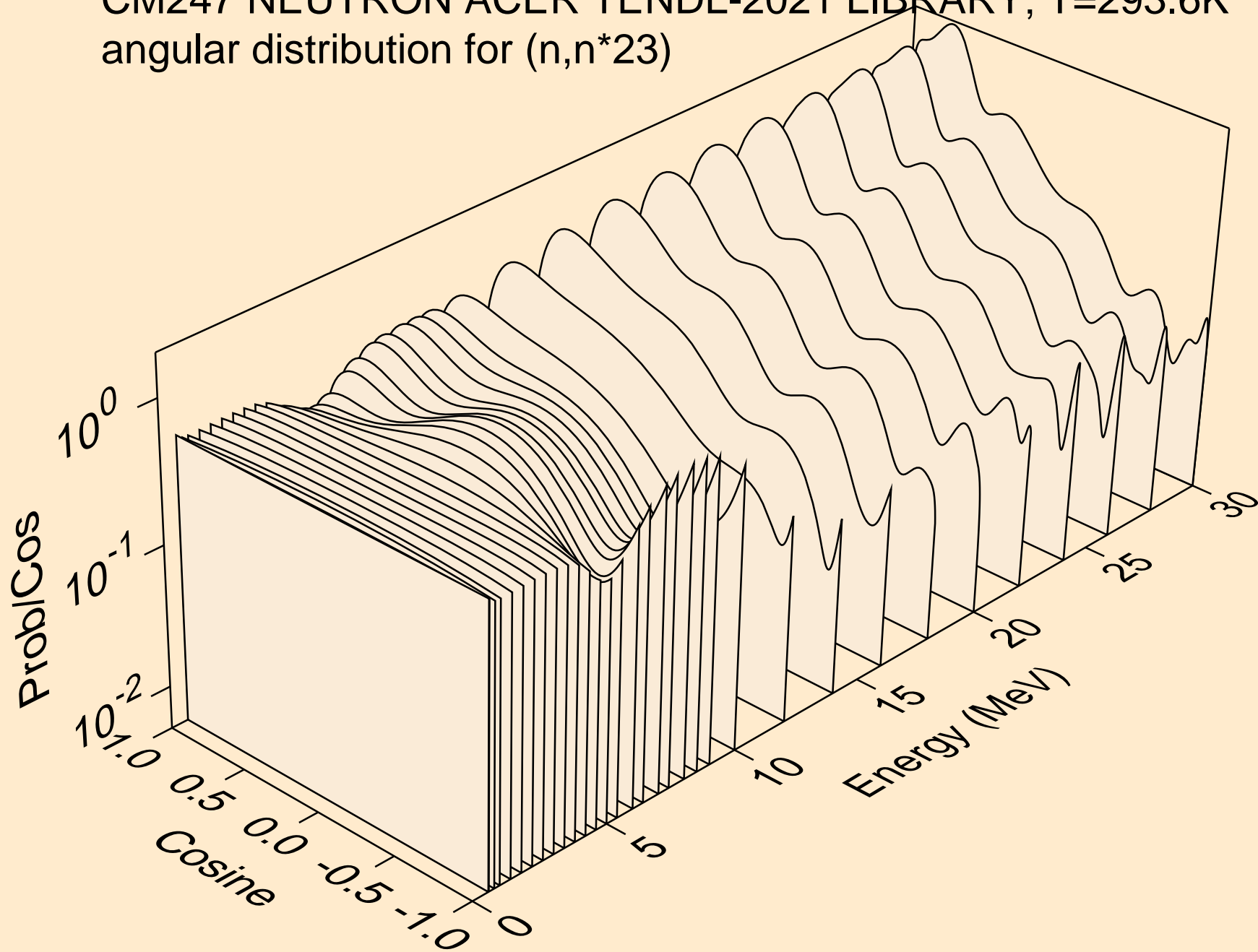

CM247 NEUTRON ACER TENDL-2021 LIBRARY; T=293.6K
angular distribution for (n,n*24)

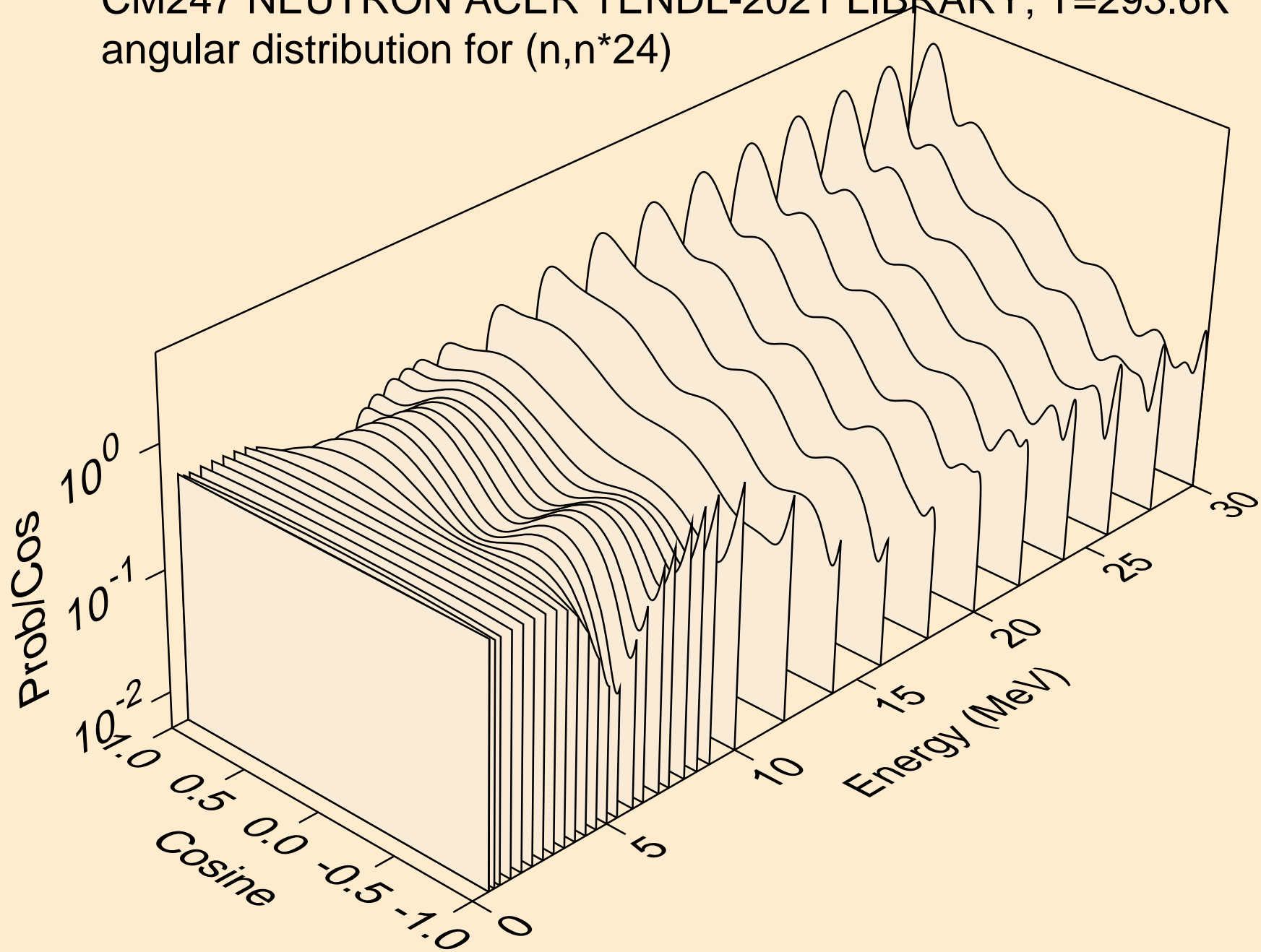

CM247 NEUTRON ACER TENDL-2021 LIBRARY; T=293.6K
angular distribution for (n,n*25)

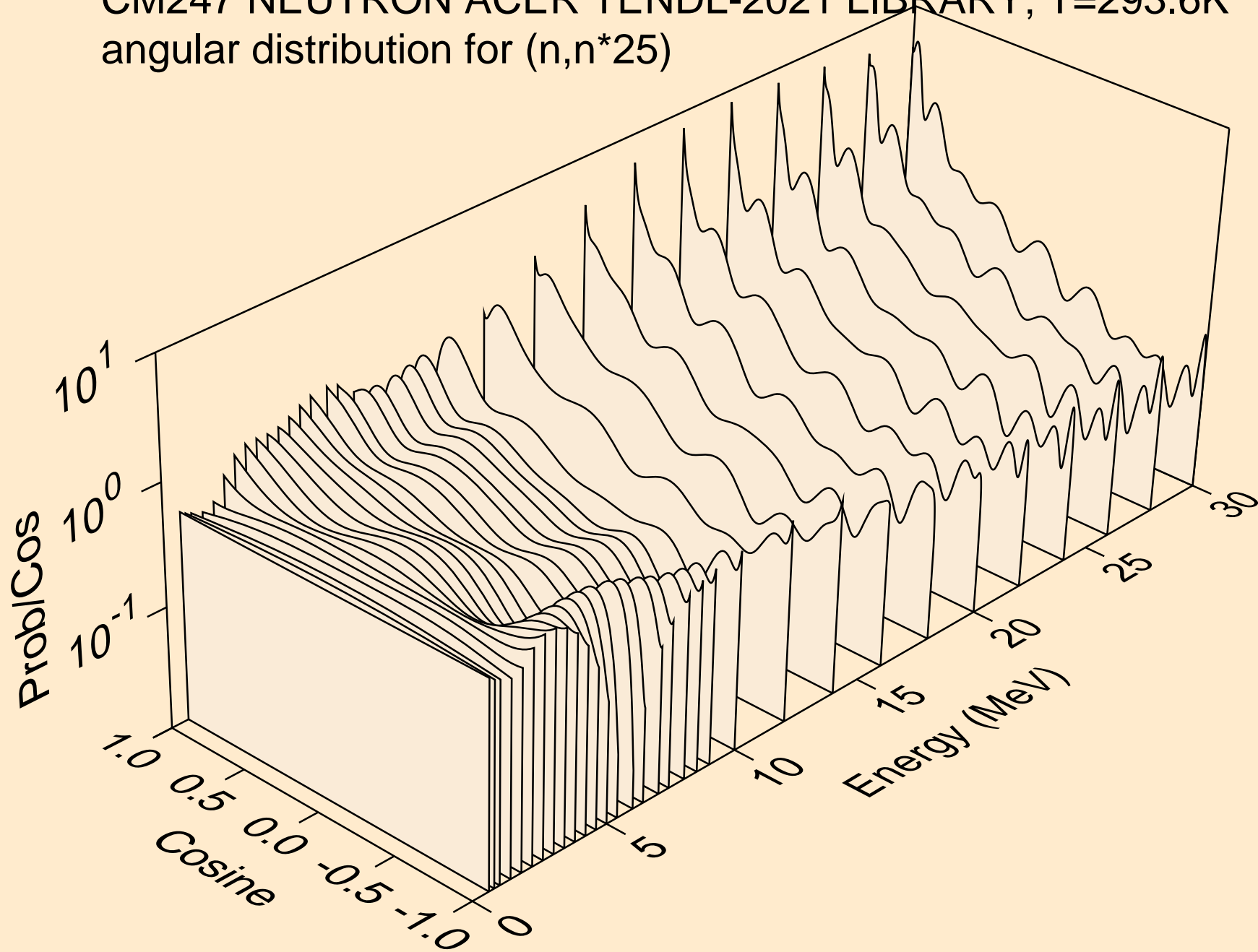

CM247 NEUTRON ACER TENDL-2021 LIBRARY; T=293.6K
angular distribution for (n,n*26)

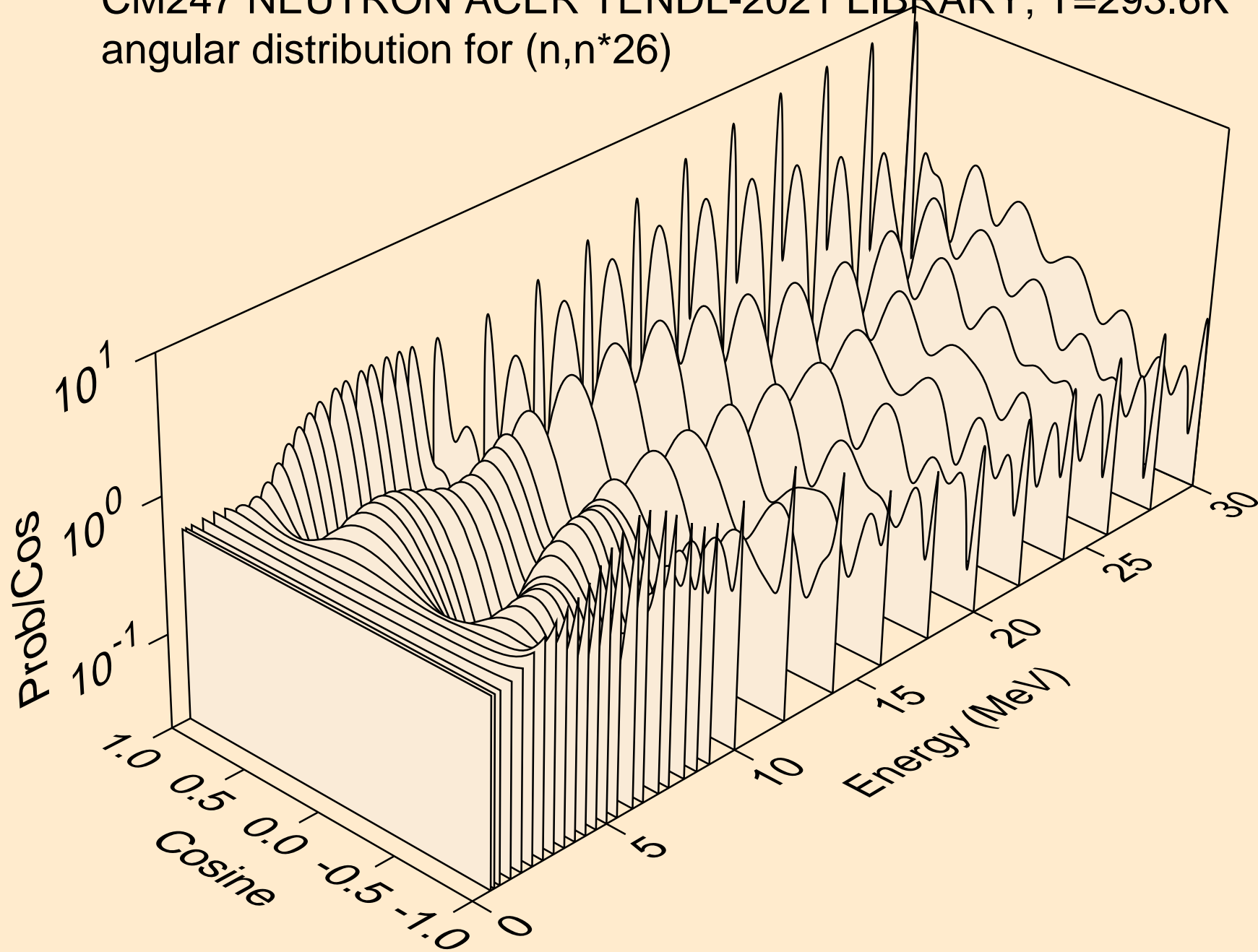

CM247 NEUTRON ACER TENDL-2021 LIBRARY; T=293.6K
angular distribution for (n,n*27)

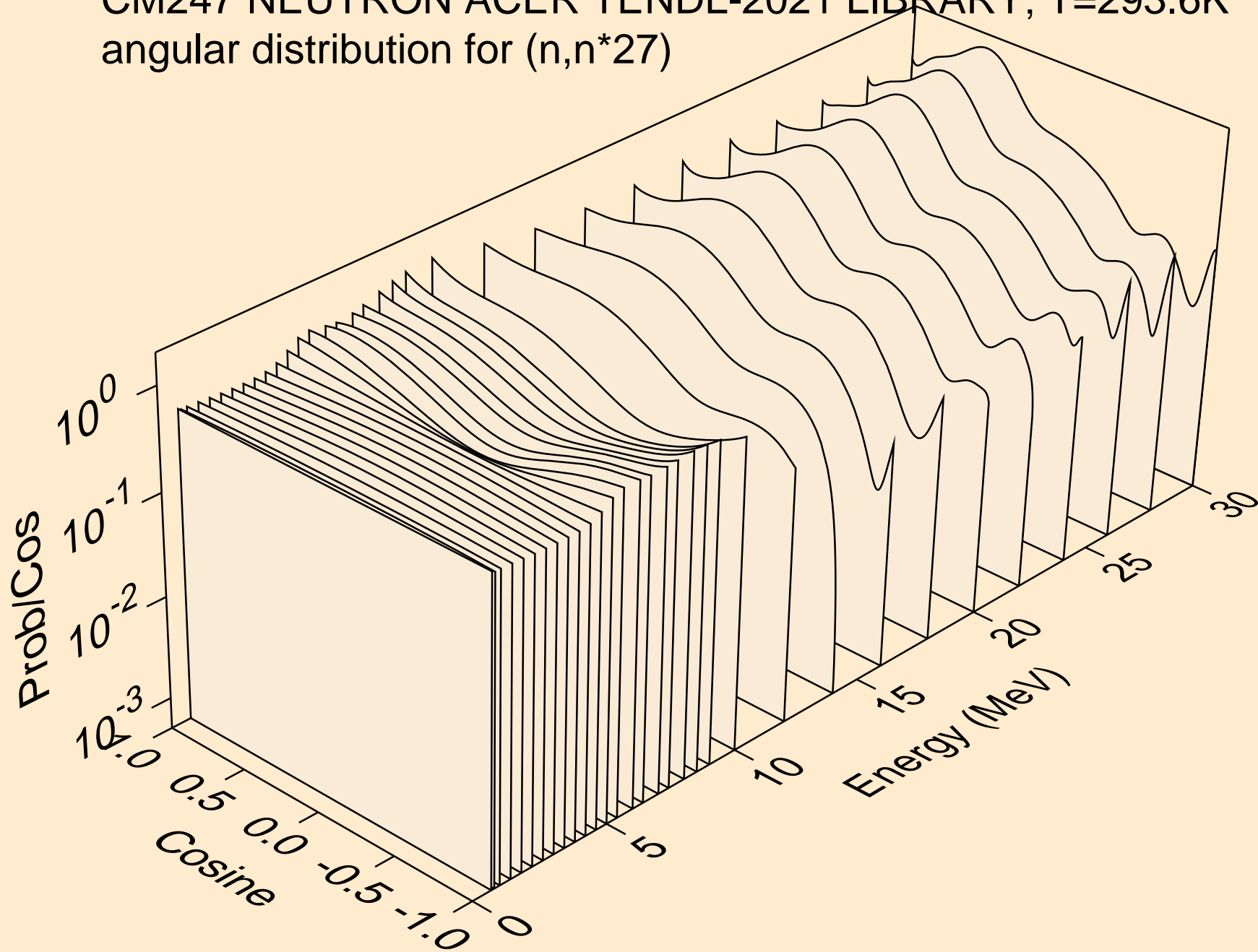

CM247 NEUTRON ACER TENDL-2021 LIBRARY; T=293.6K
angular distribution for (n,n*28)

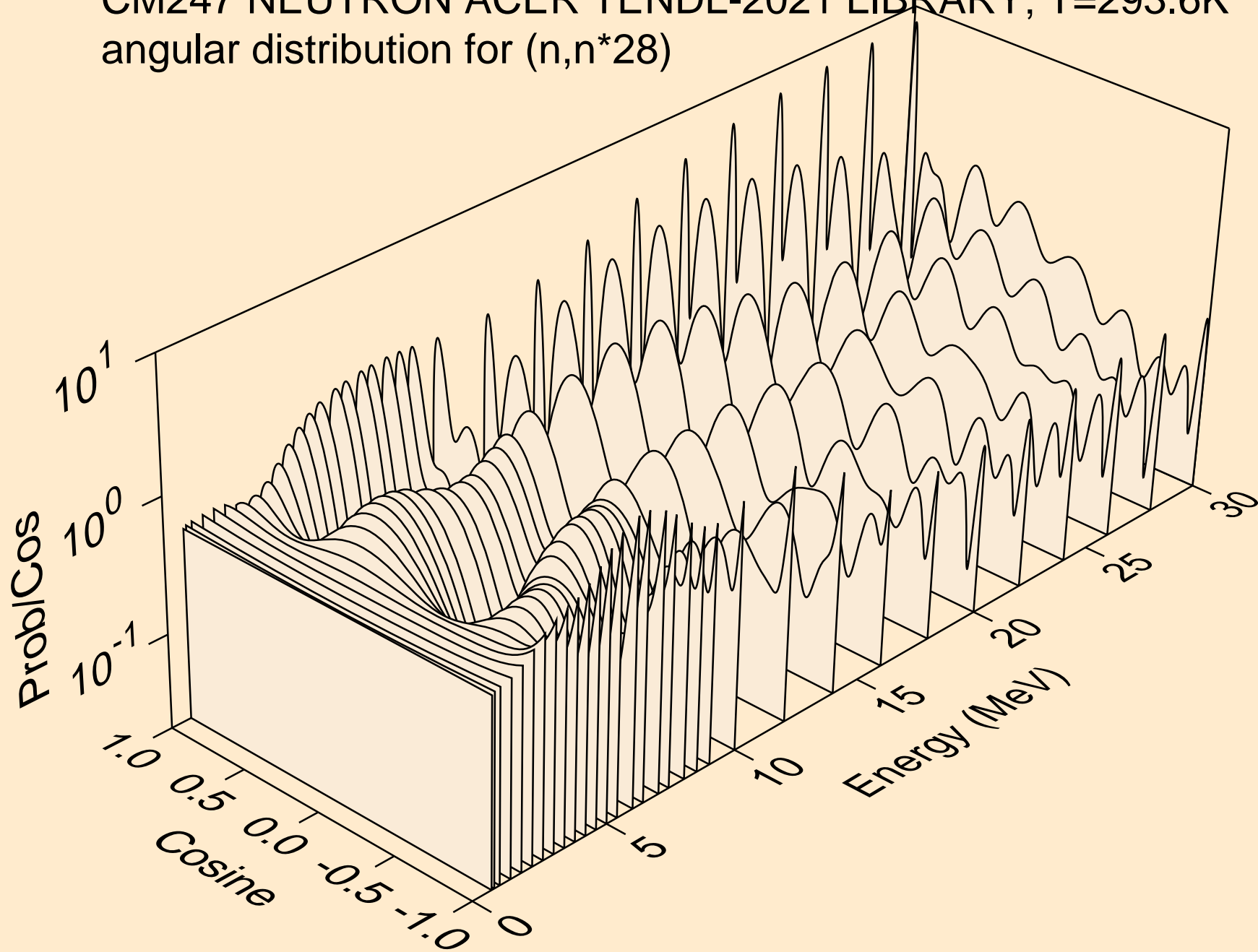

CM247 NEUTRON ACER TENDL-2021 LIBRARY; T=293.6K
Total fission nubar

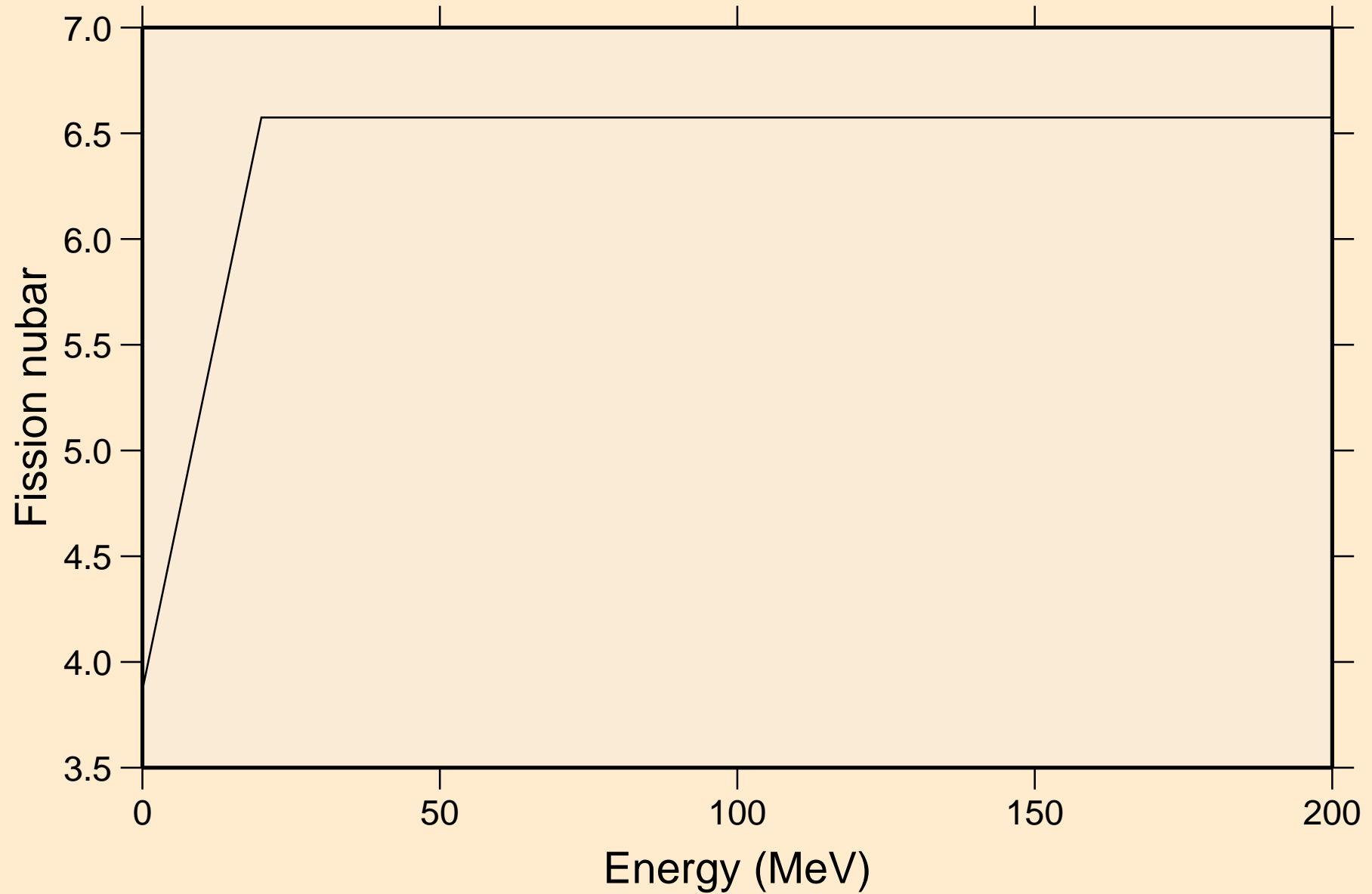

CM247 NEUTRON ACER TENDL-2021 LIBRARY; T=293.6K
Neutron emission for (n,x)

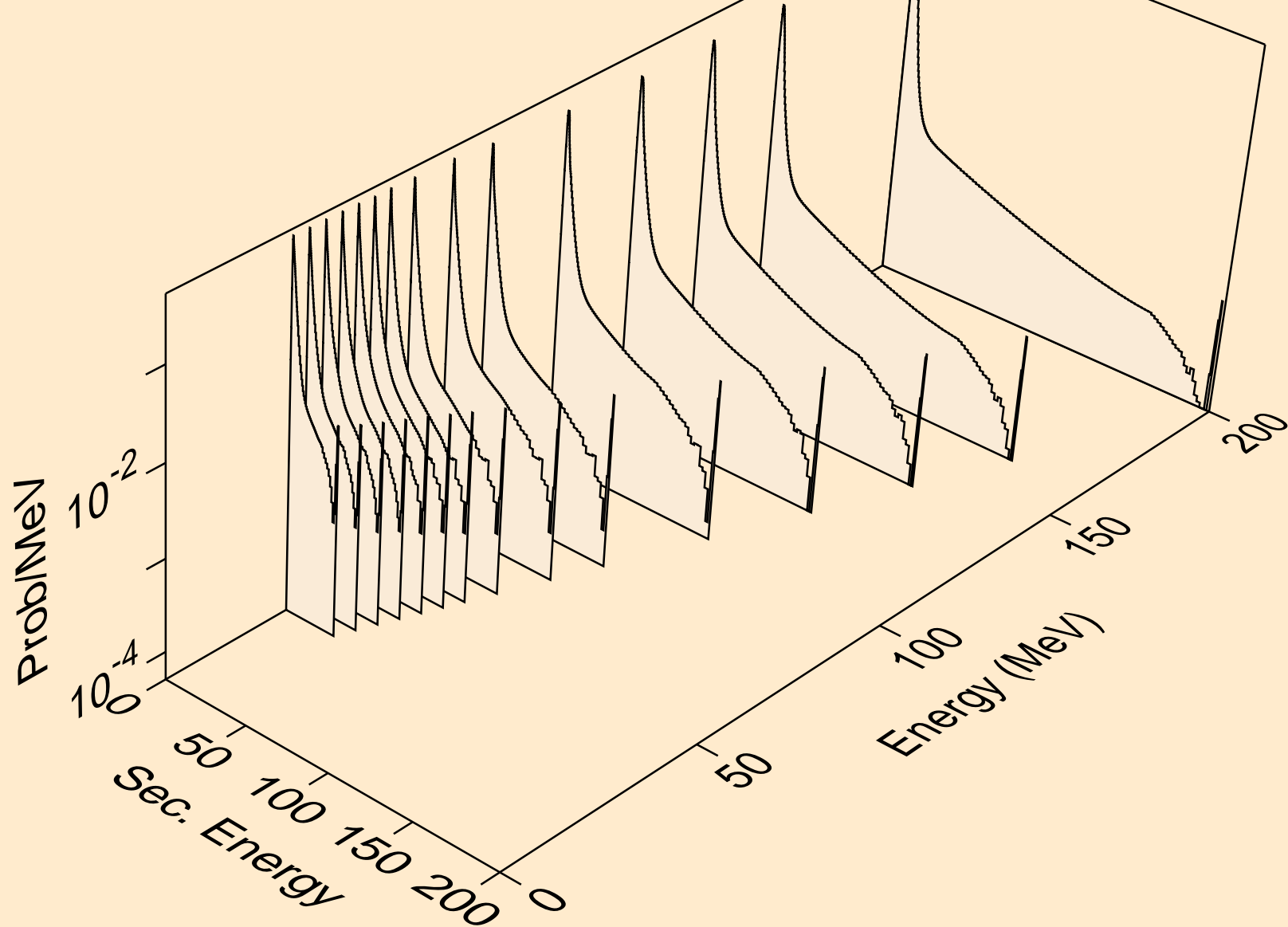

CM247 NEUTRON ACER TENDL-2021 LIBRARY; T=293.6K
Neutron emission for (n,2nd)

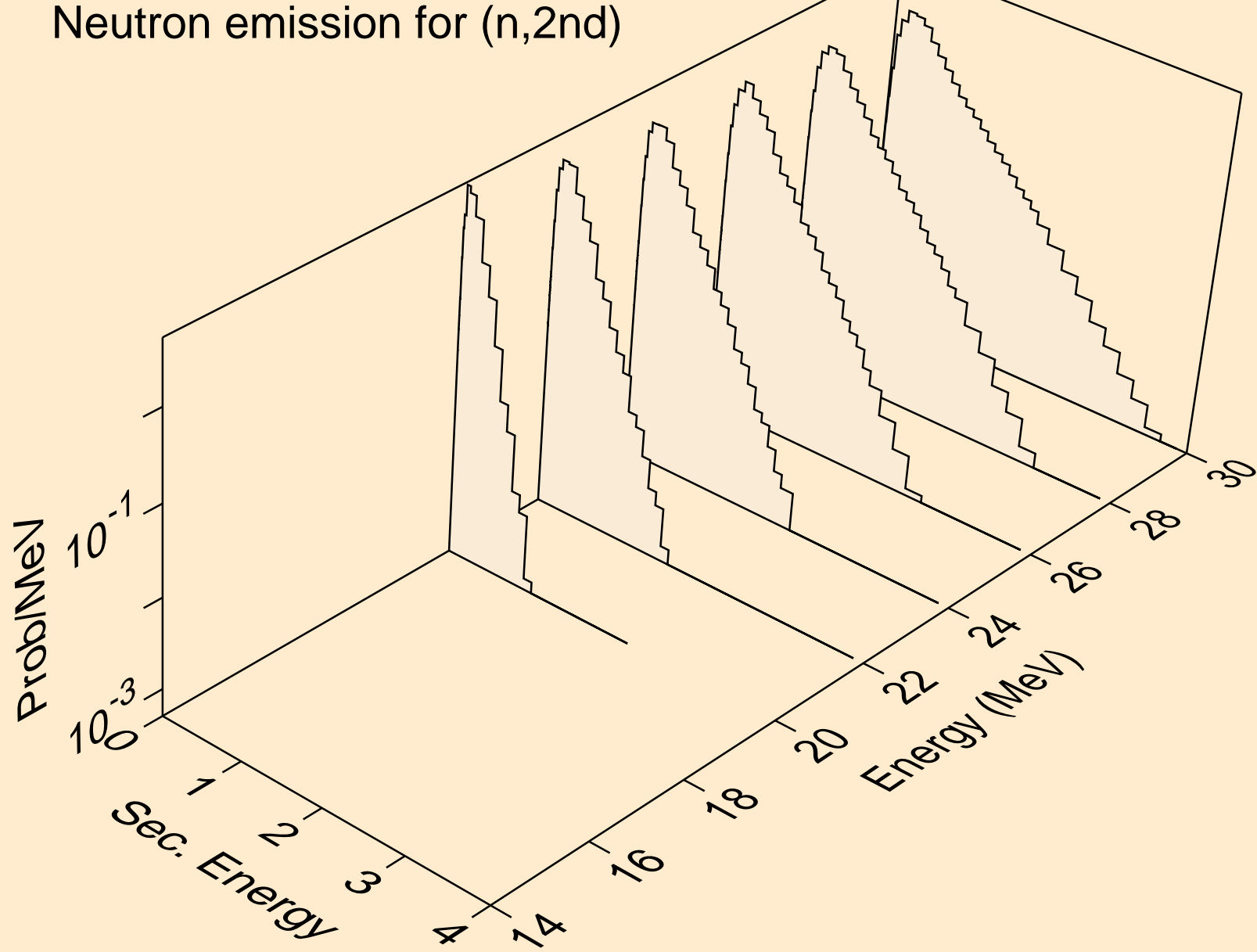

CM247 NEUTRON ACER TENDL-2021 LIBRARY; T=293.6K
Neutron emission for (n,2n)

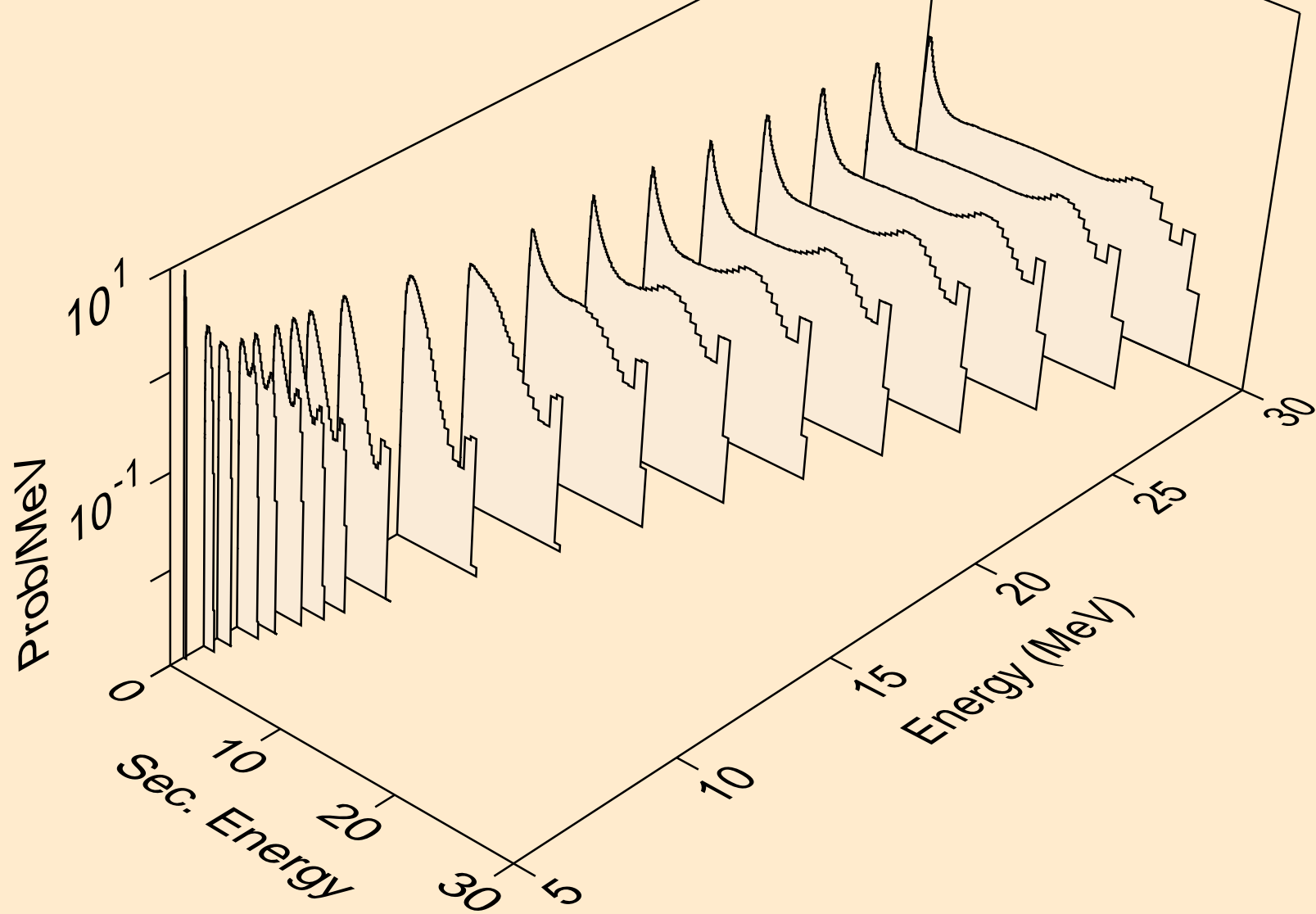

CM247 NEUTRON ACER TENDL-2021 LIBRARY; T=293.6K
Neutron emission for (n,3n)

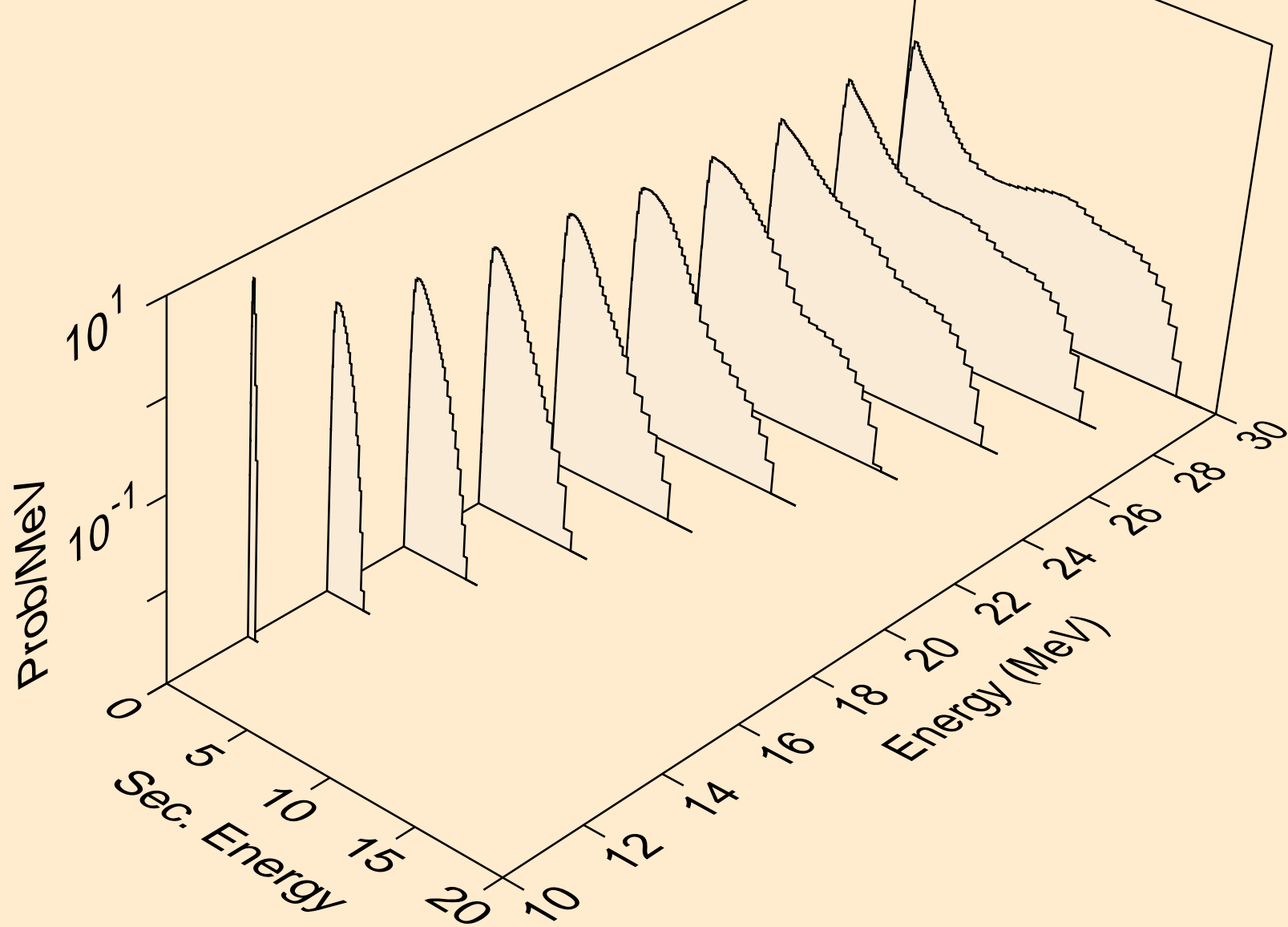

CM247 NEUTRON ACER TENDL-2021 LIBRARY; T=293.6K
Neutron emission for fission

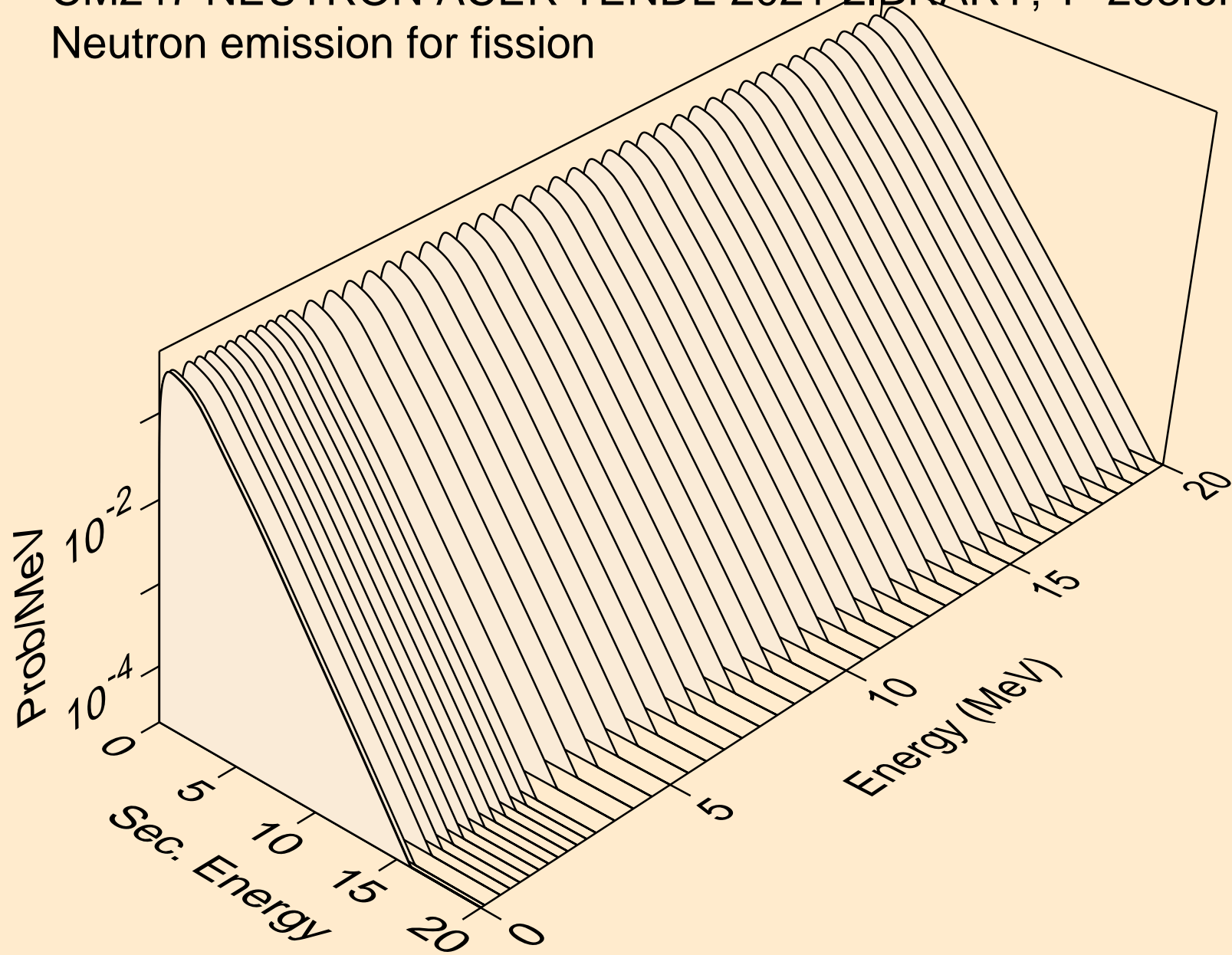

CM247 NEUTRON ACER TENDL-2021 LIBRARY; T=293.6K
Neutron emission for (n,n*)a

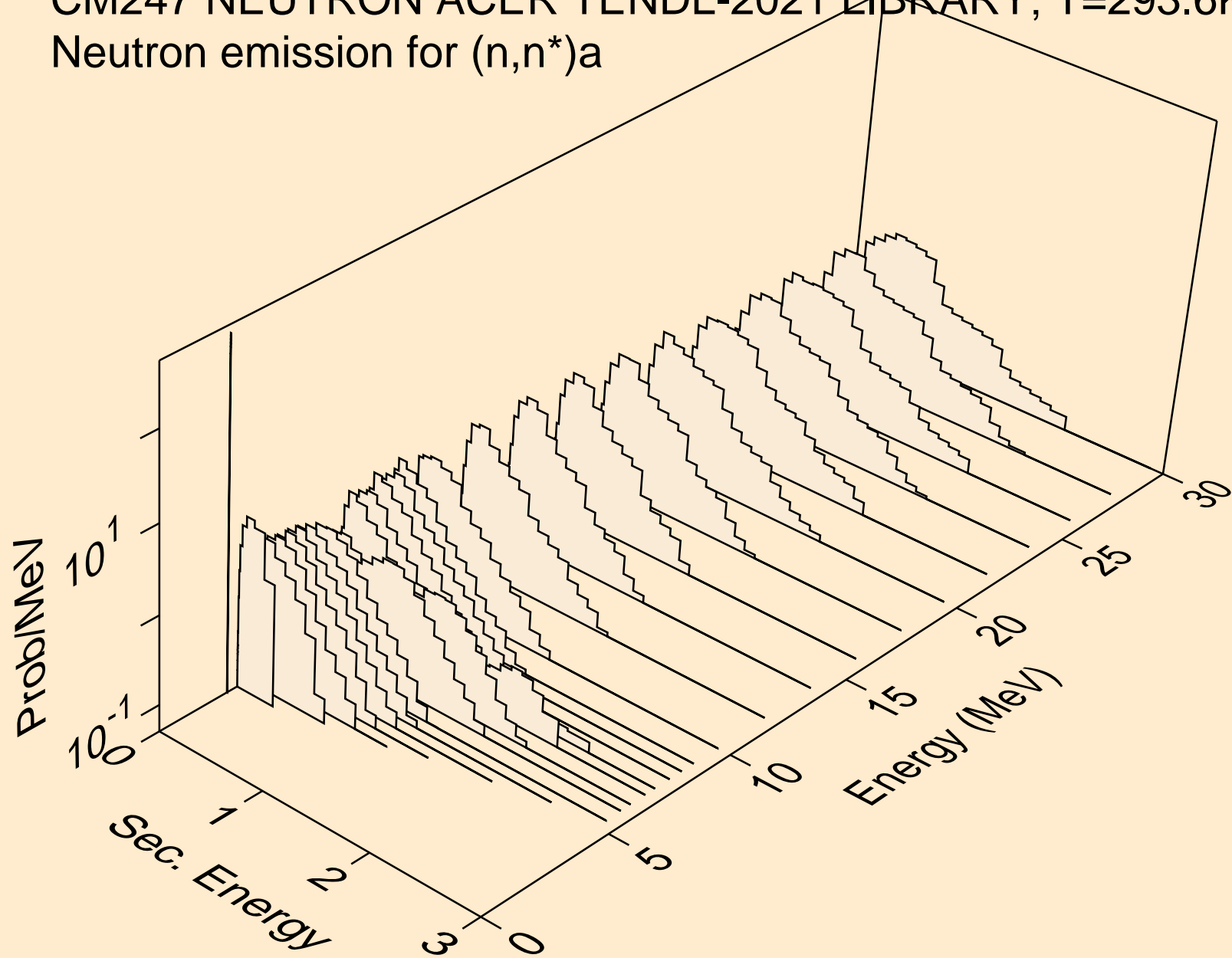

CM247 NEUTRON ACER TENDL-2021 LIBRARY; T=293.6K
Neutron emission for (n,2n)a

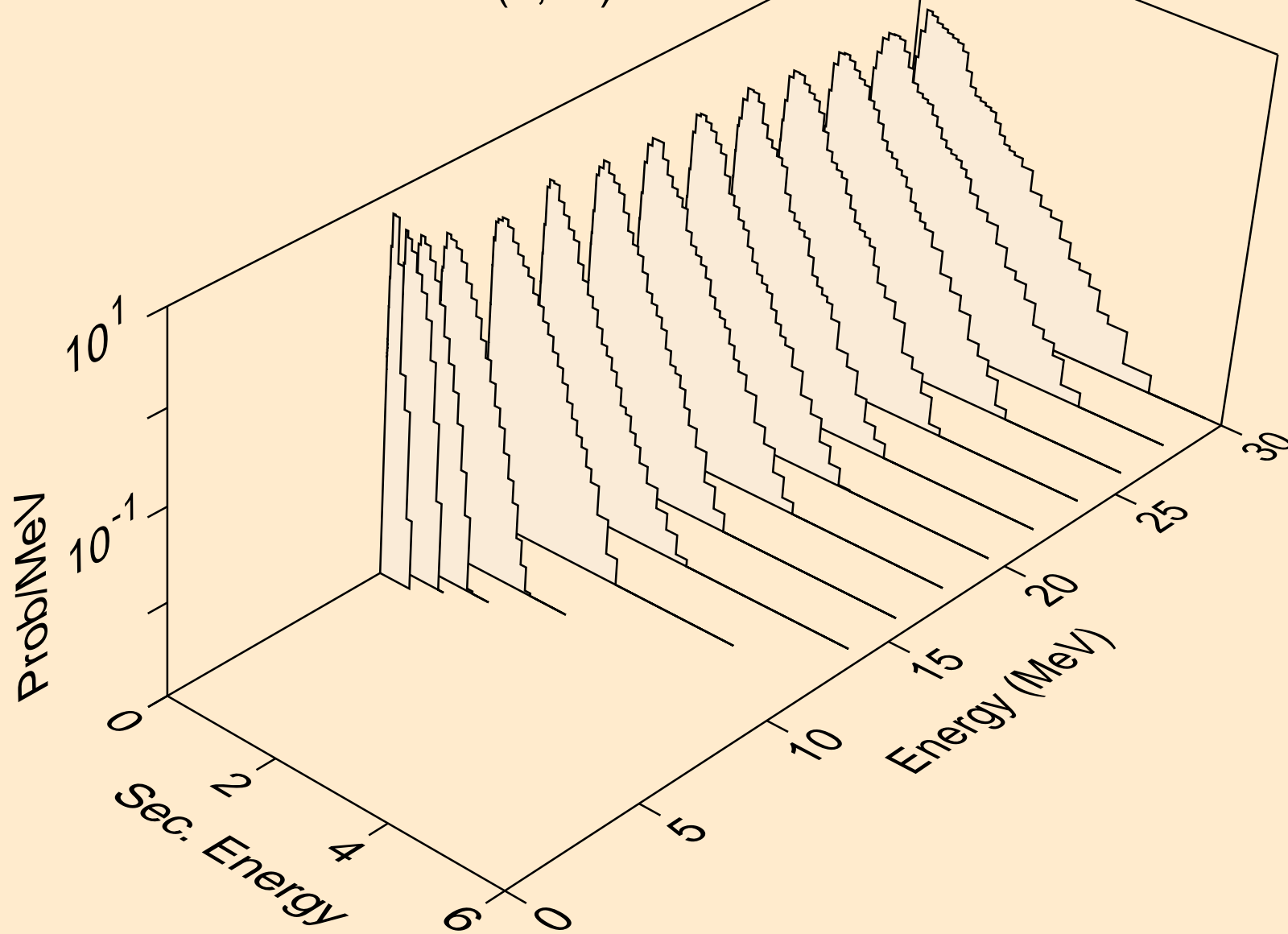

CM247 NEUTRON ACER TENDL-2021 LIBRARY; T=293.6K
Neutron emission for (n,3n)a

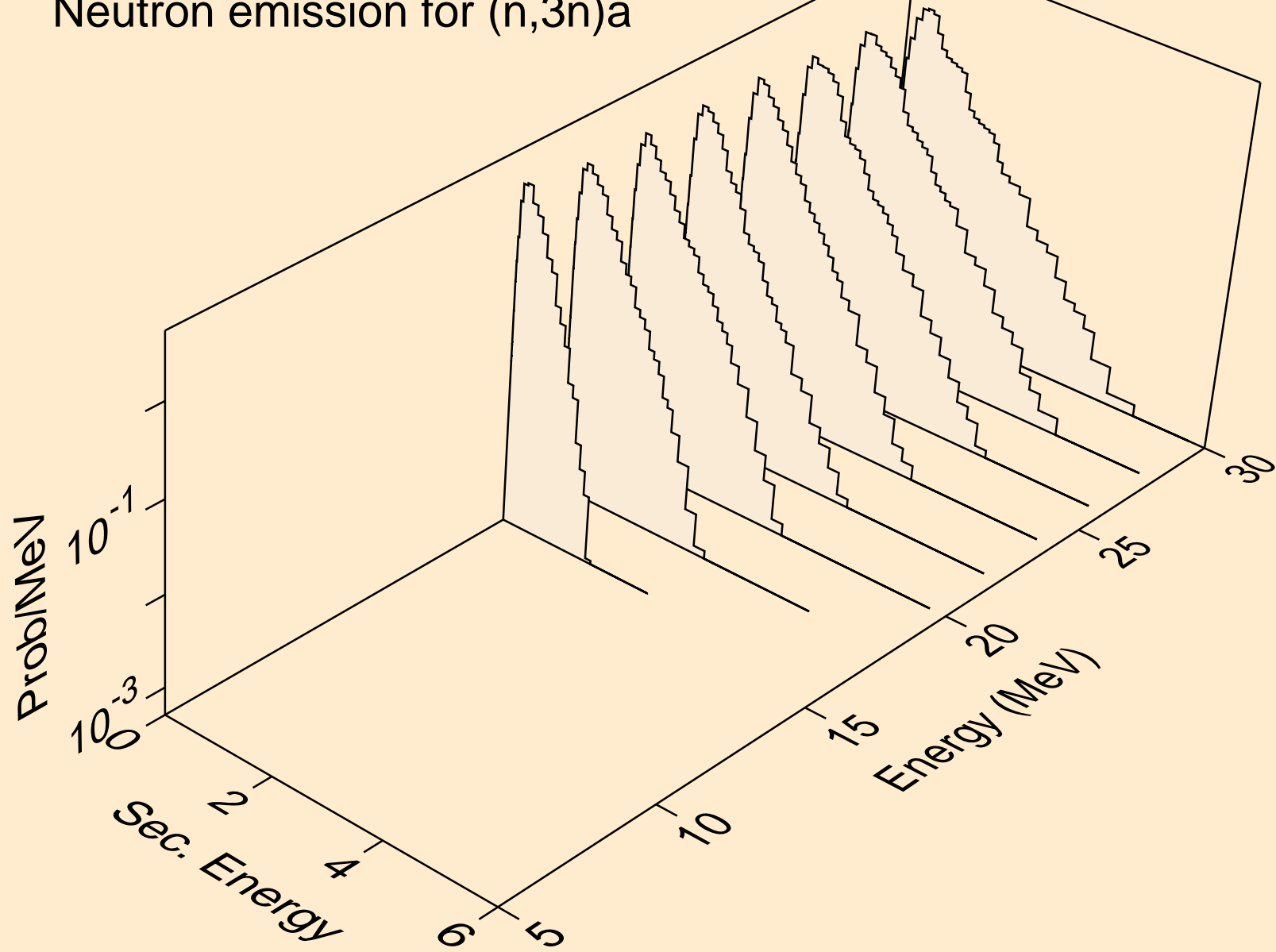

CM247 NEUTRON ACER TENDL-2021 LIBRARY; T=293.6K
Neutron emission for (n,n*)p

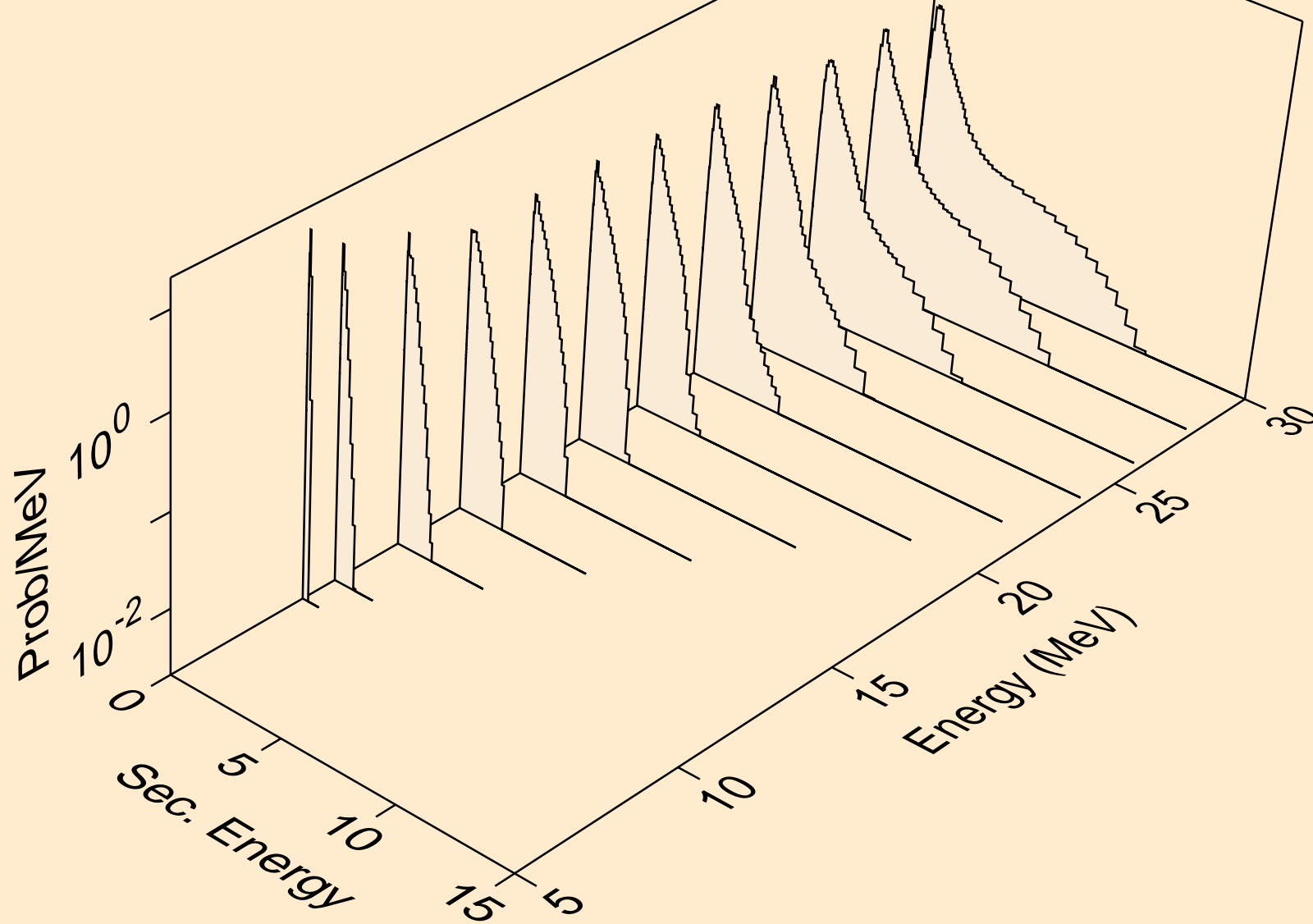

CM247 NEUTRON ACER TENDL-2021 LIBRARY; T=293.6K
Neutron emission for (n,n*)d

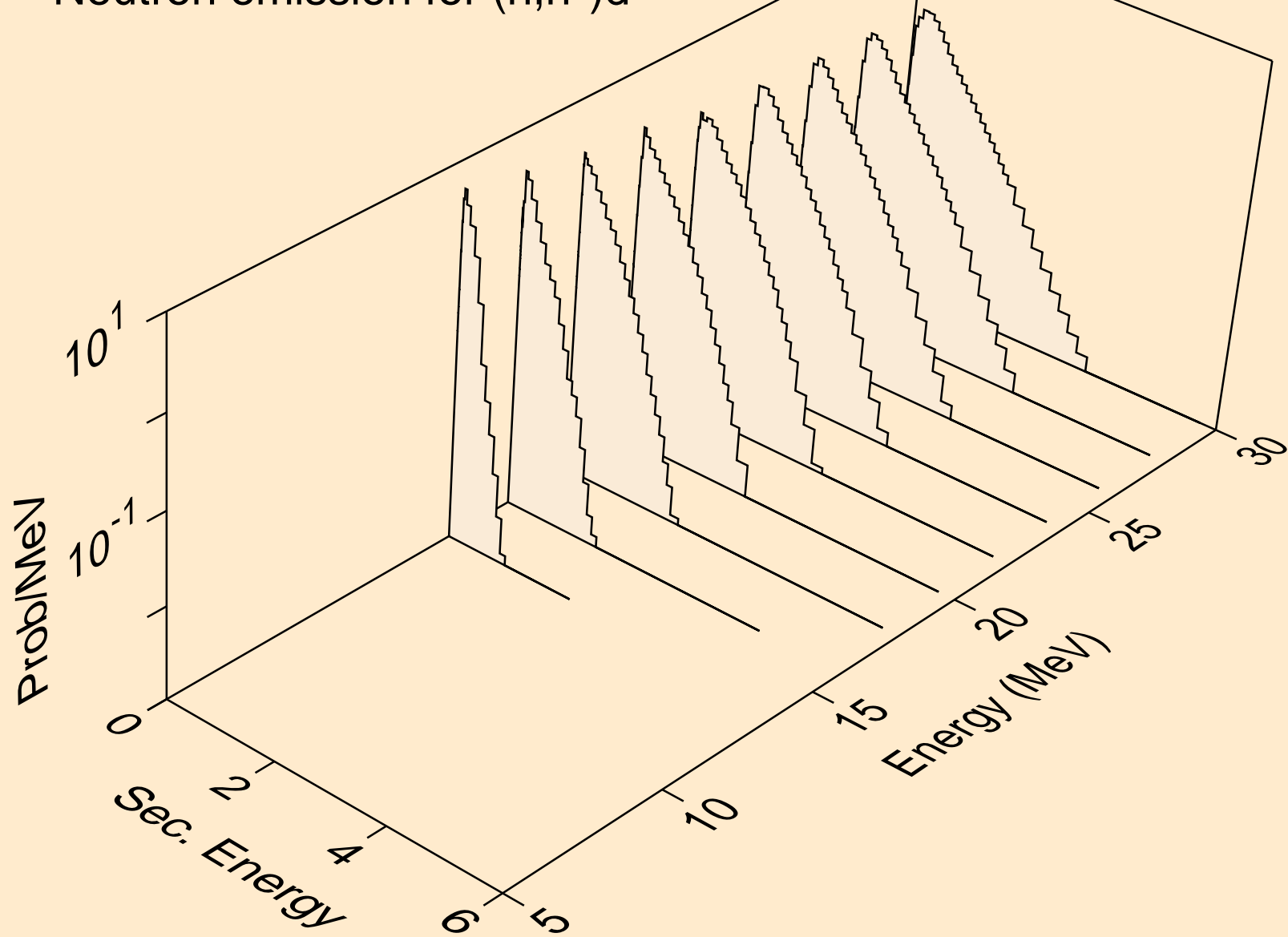

CM247 NEUTRON ACER TENDL-2021 LIBRARY; T=293.6K
Neutron emission for (n,n*)t

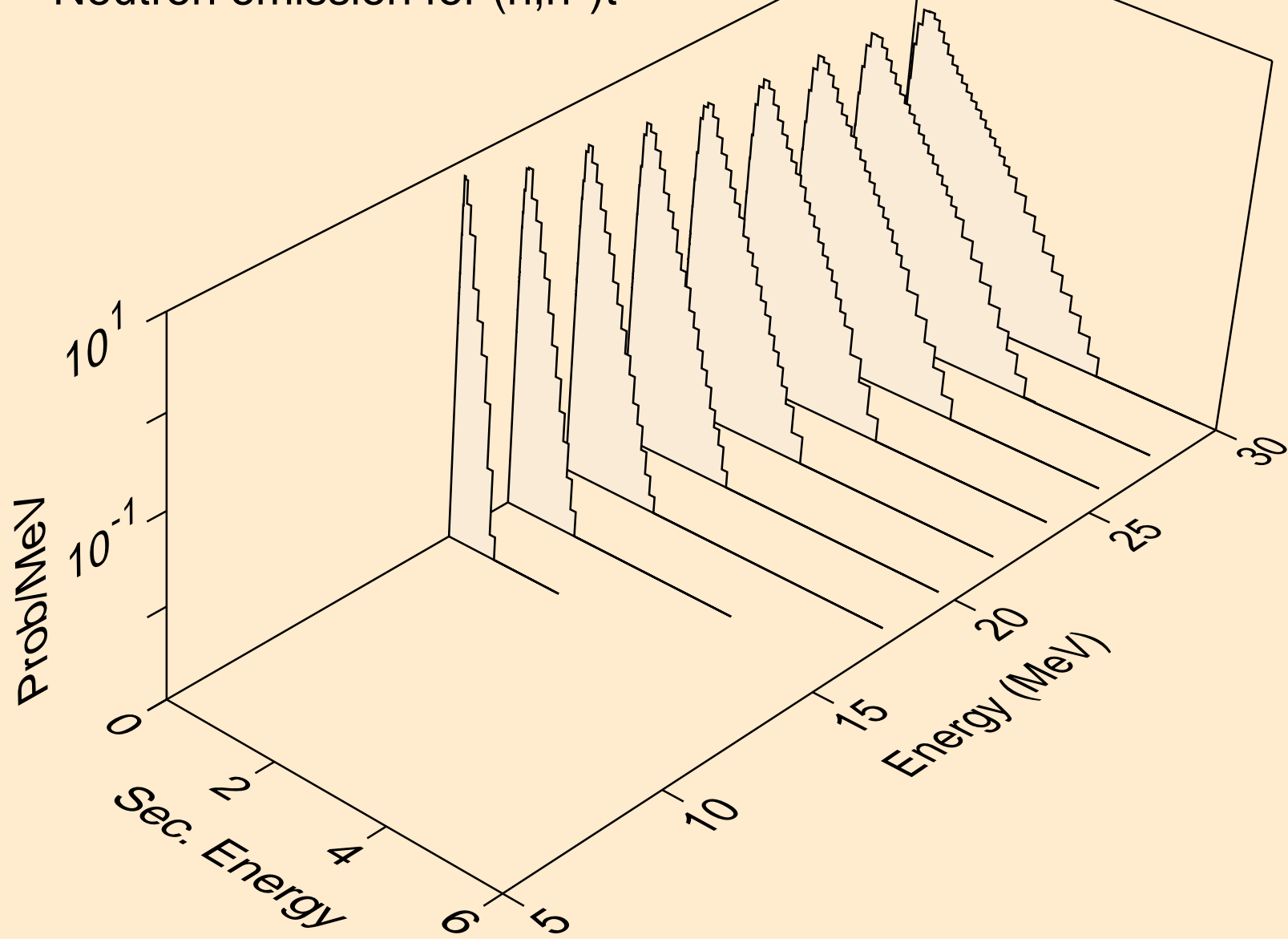

CM247 NEUTRON ACER TENDL-2021 LIBRARY; T=293.6K
Neutron emission for (n,n*)he3

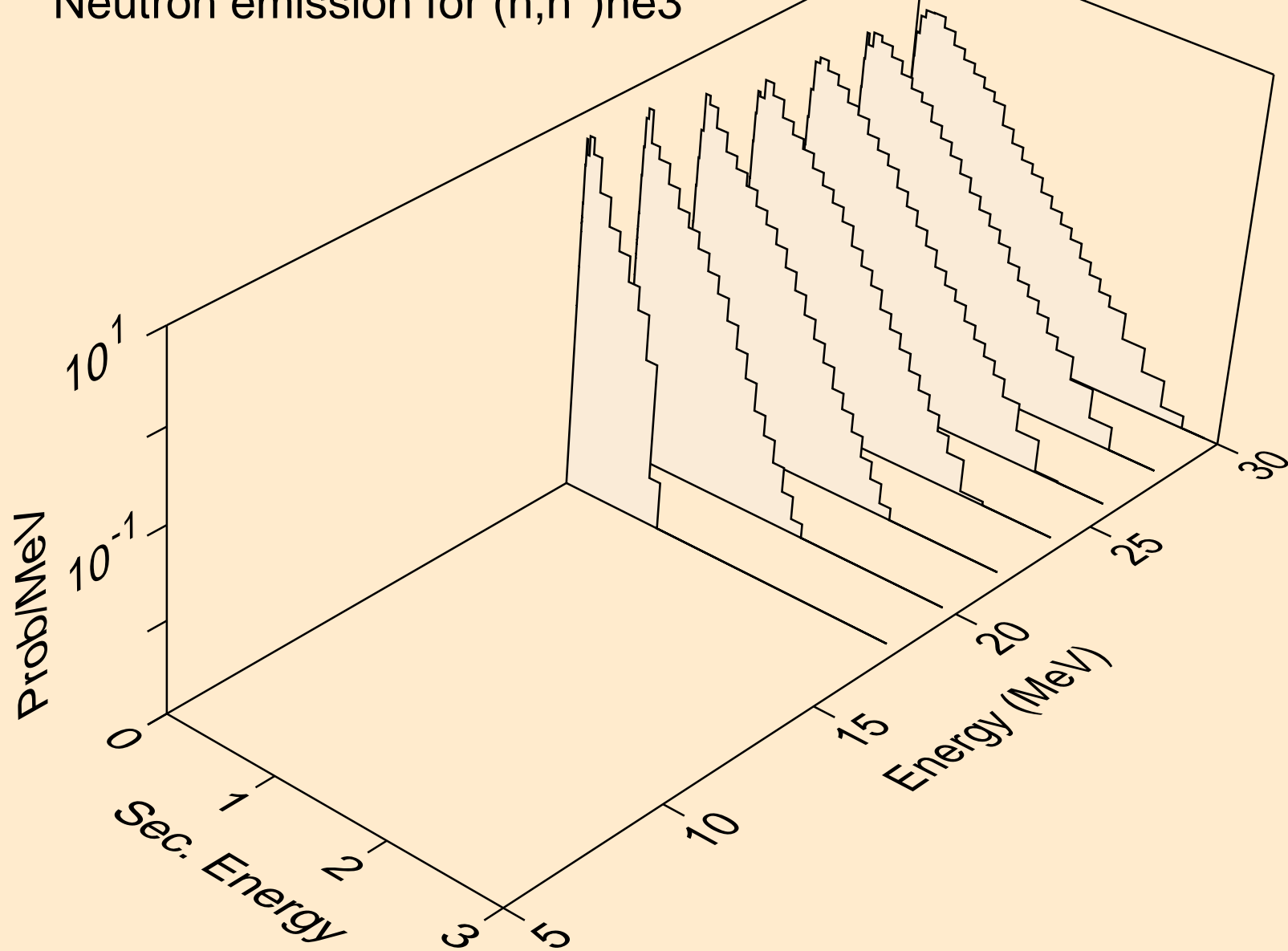

CM247 NEUTRON ACER TENDL-2021 LIBRARY; T=293.6K
Neutron emission for (n,4n)

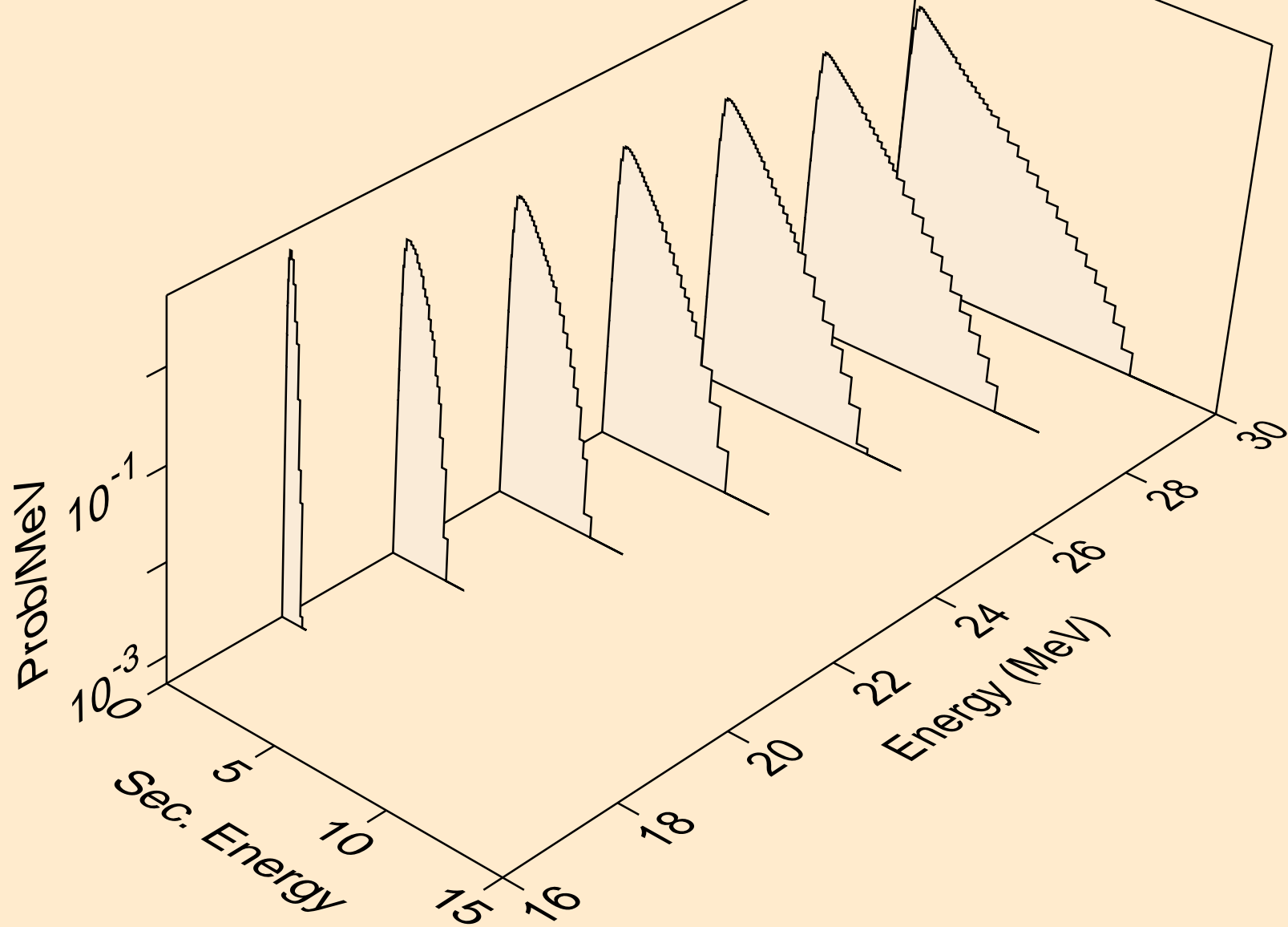

CM247 NEUTRON ACER TENDL-2021 LIBRARY; T=293.6K
Neutron emission for (n,2np)

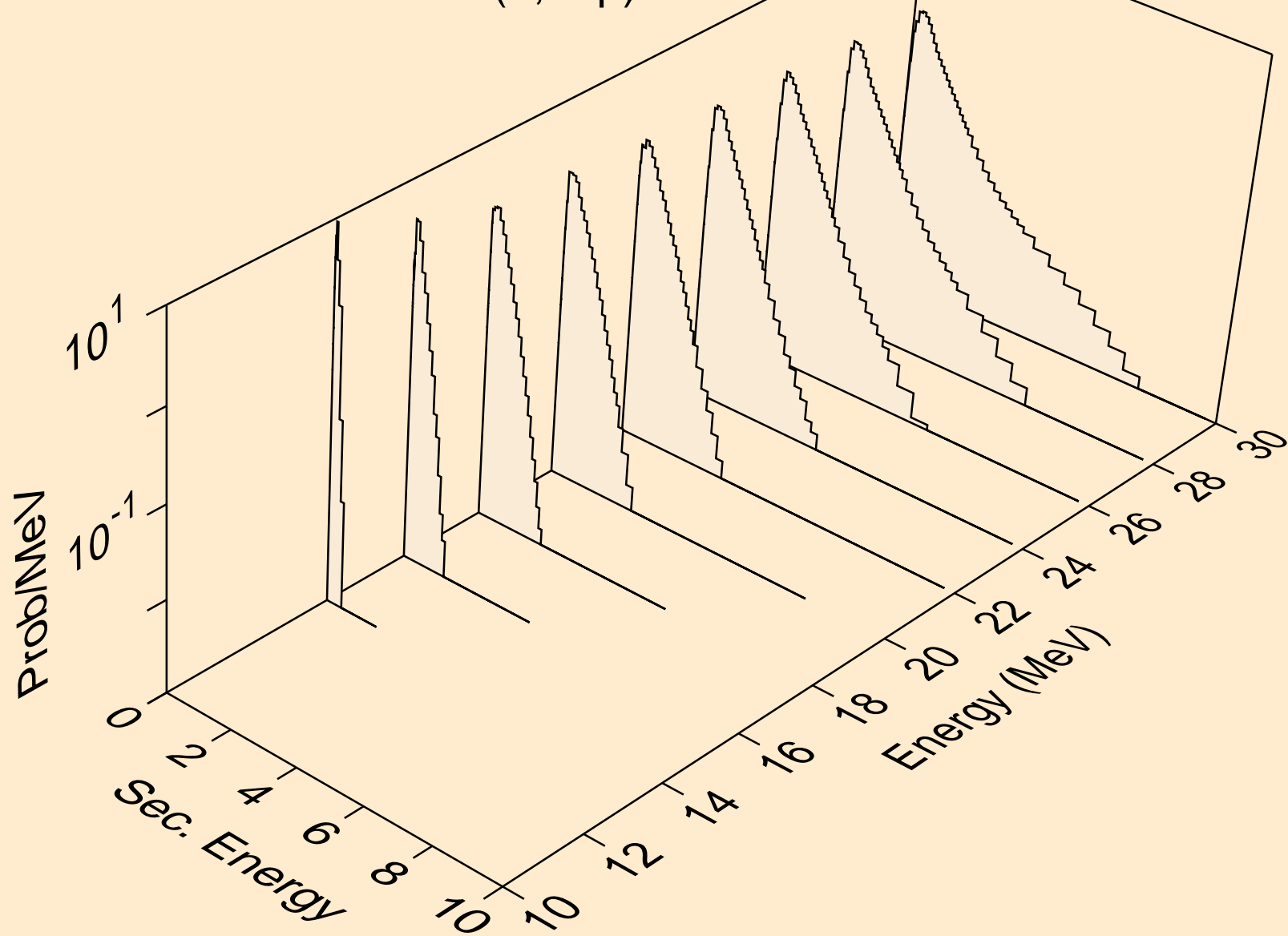

CM247 NEUTRON ACER TENDL-2021 LIBRARY; T=293.6K
Neutron emission for (n,3np)

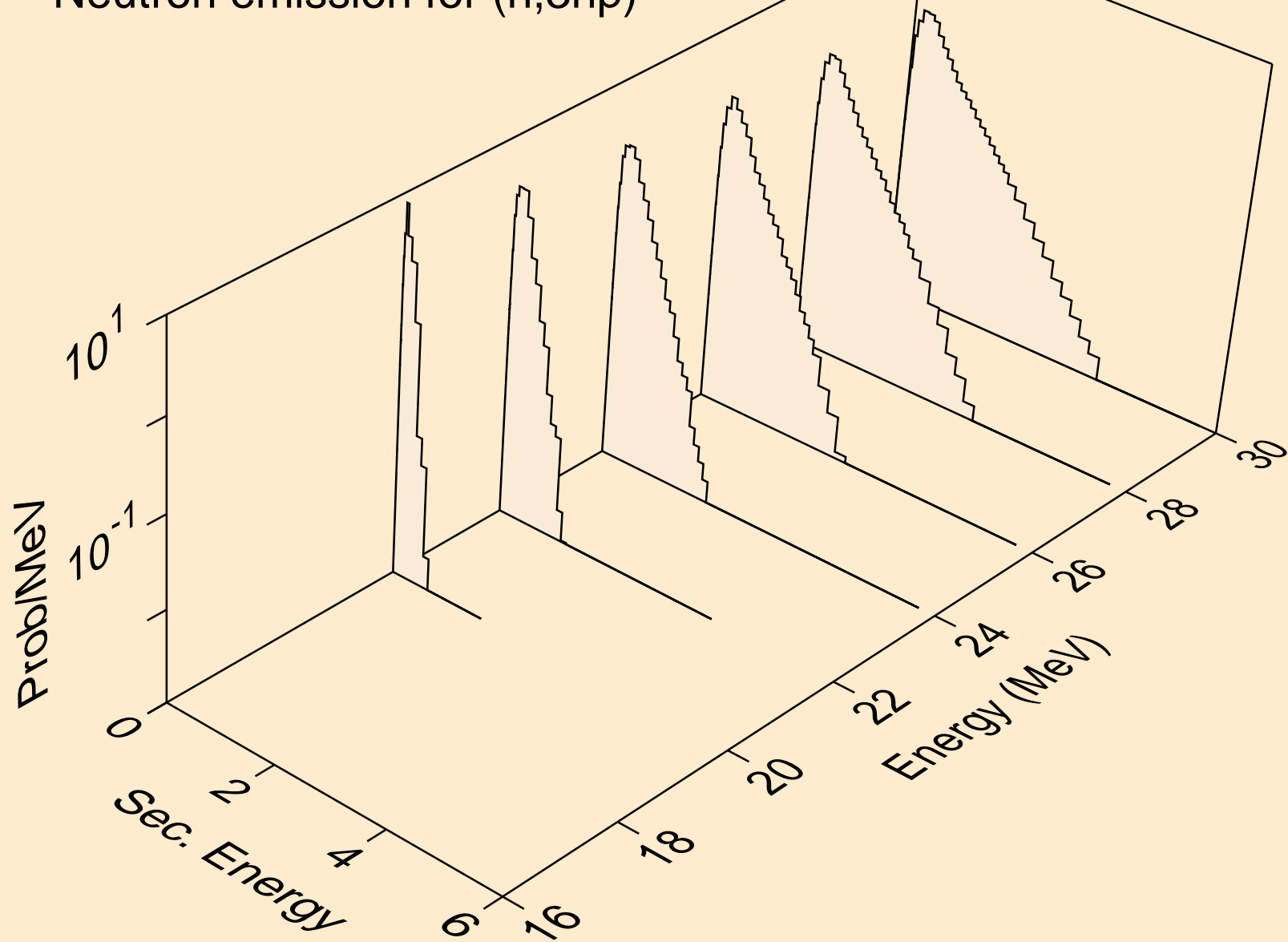

CM247 NEUTRON ACER TENDL-2021 LIBRARY; T=293.6K
Neutron emission for (n,2np)

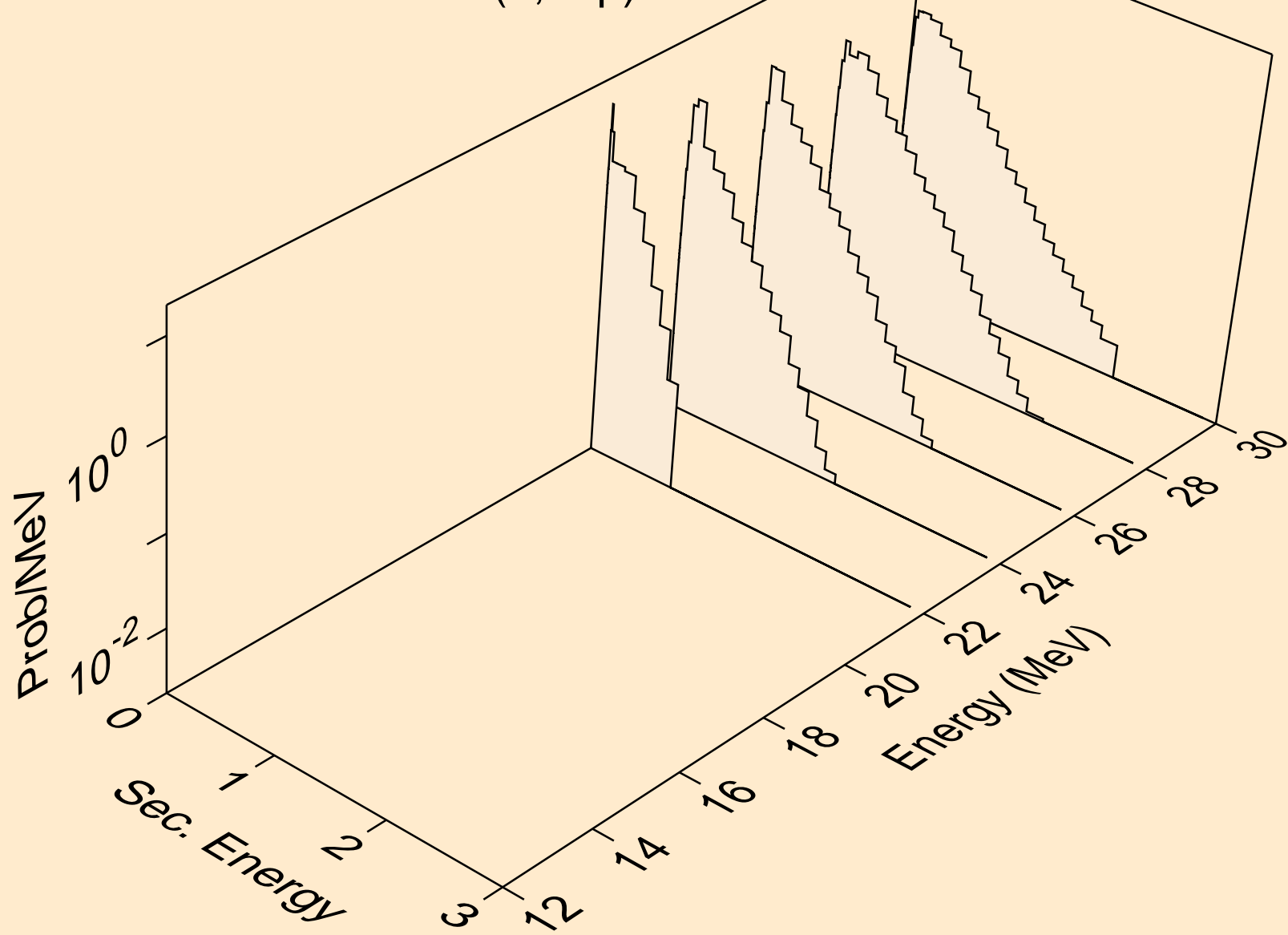

CM247 NEUTRON ACER TENDL-2021 LIBRARY; T=293.6K
Neutron emission for (n,n*c)

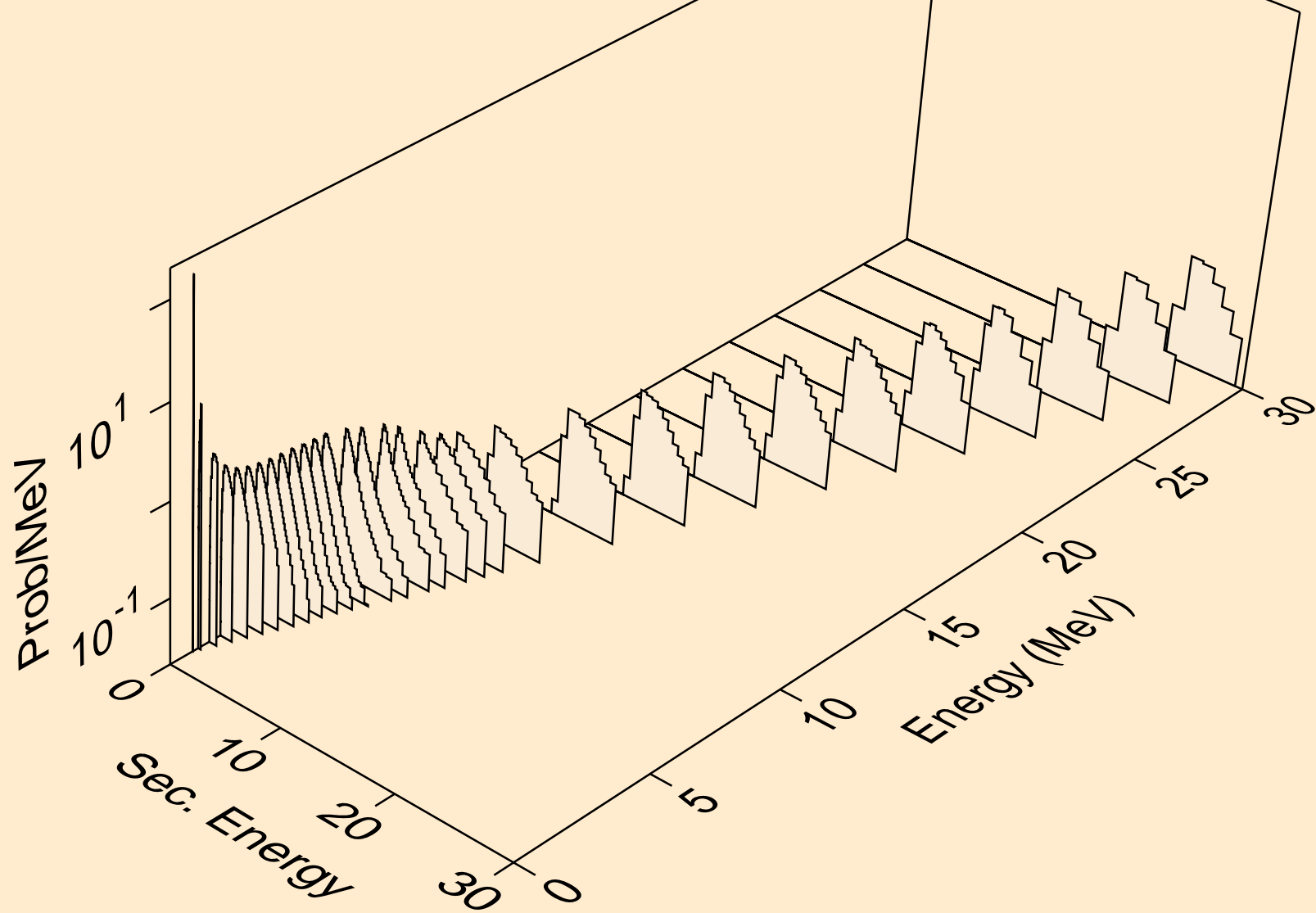

CM247 NEUTRON ACER TENDL-2021 LIBRARY; T=293.6K
Delayed nubar

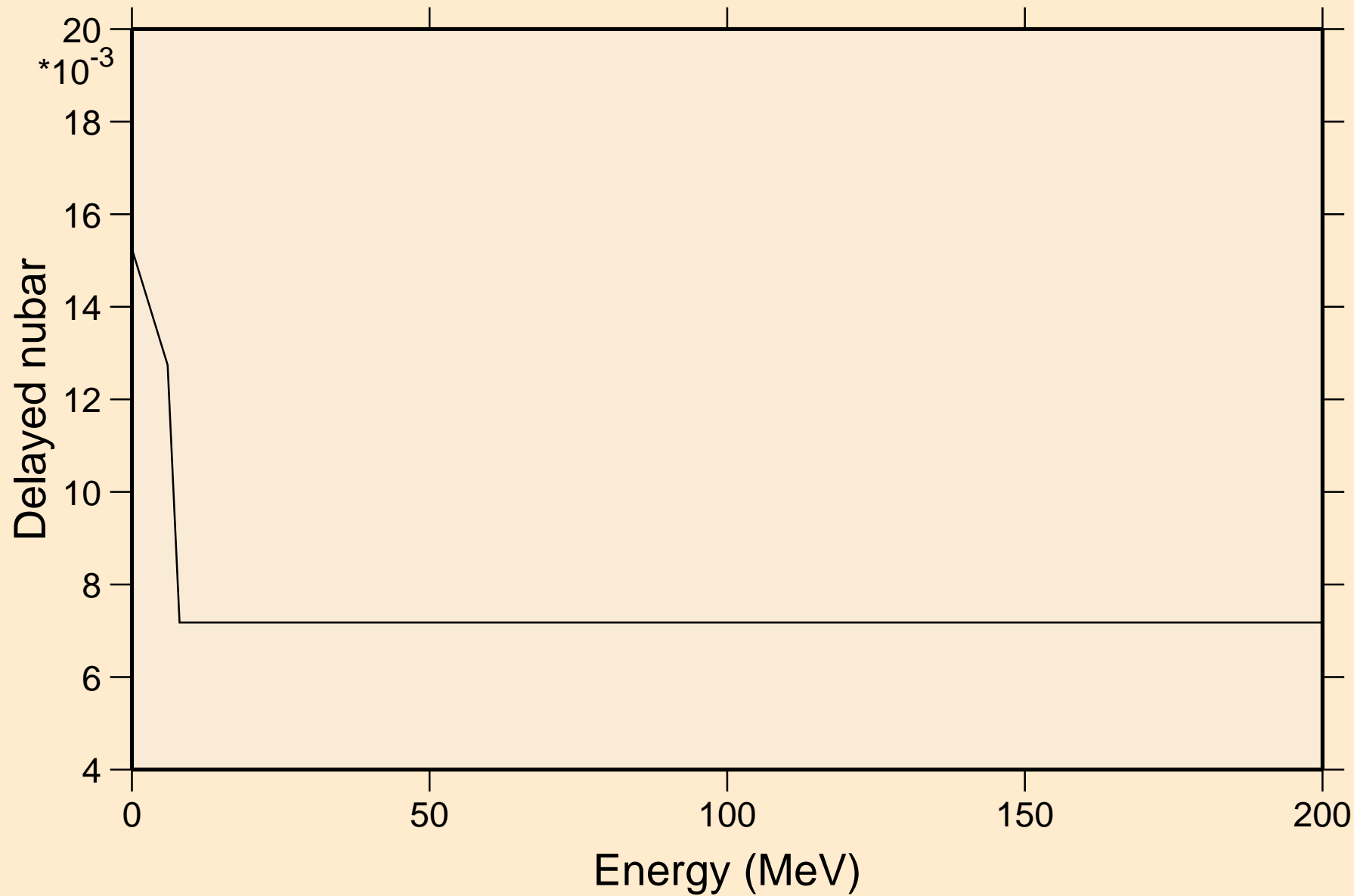

CM247 NEUTRON ACER TENDL-2021 LIBRARY; T=293.6K

Delayed neutron spectra

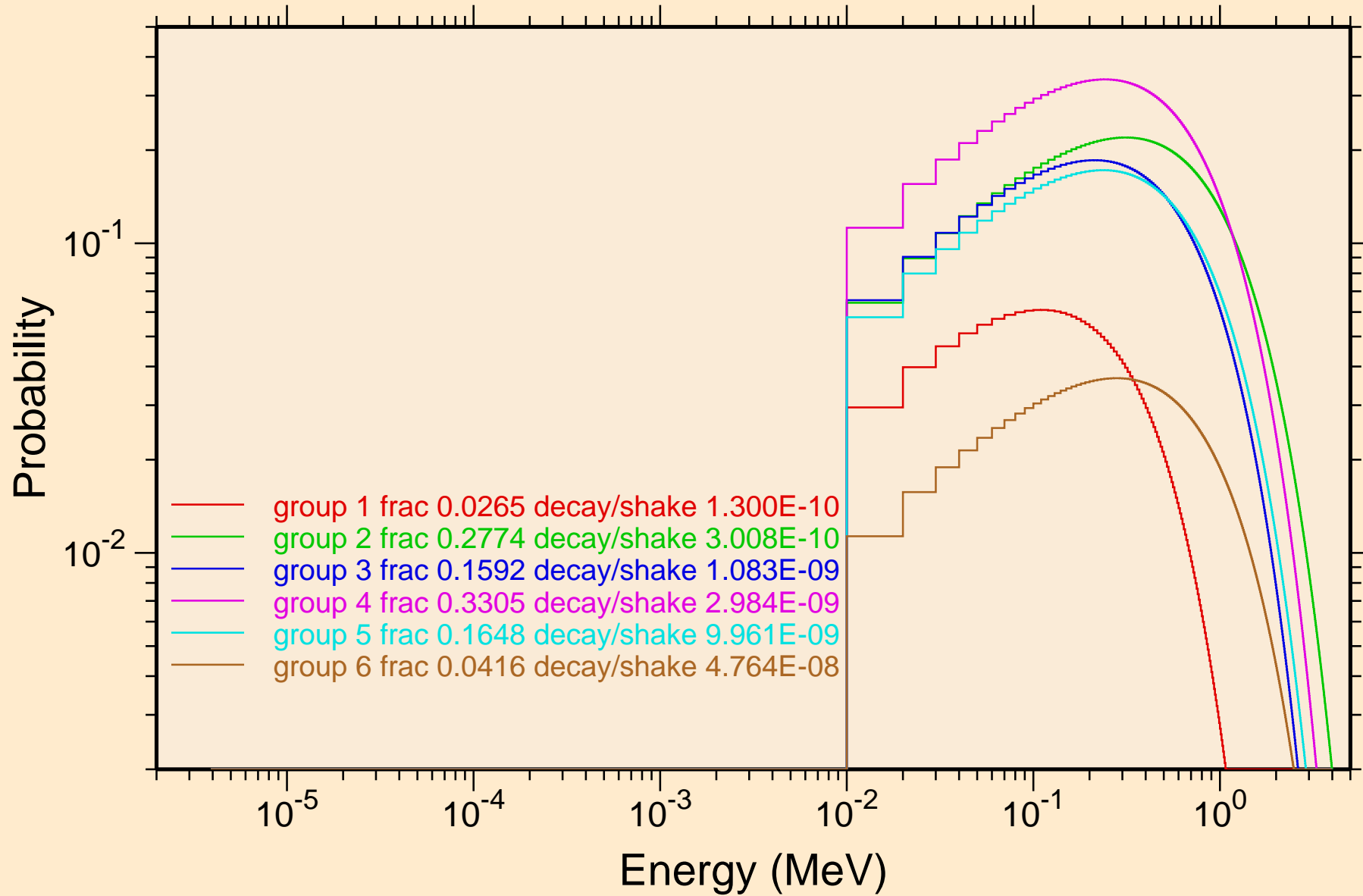

CM247 NEUTRON ACER TENDL-2021 LIBRARY; T=293.6K
Photon emission for (n,x)

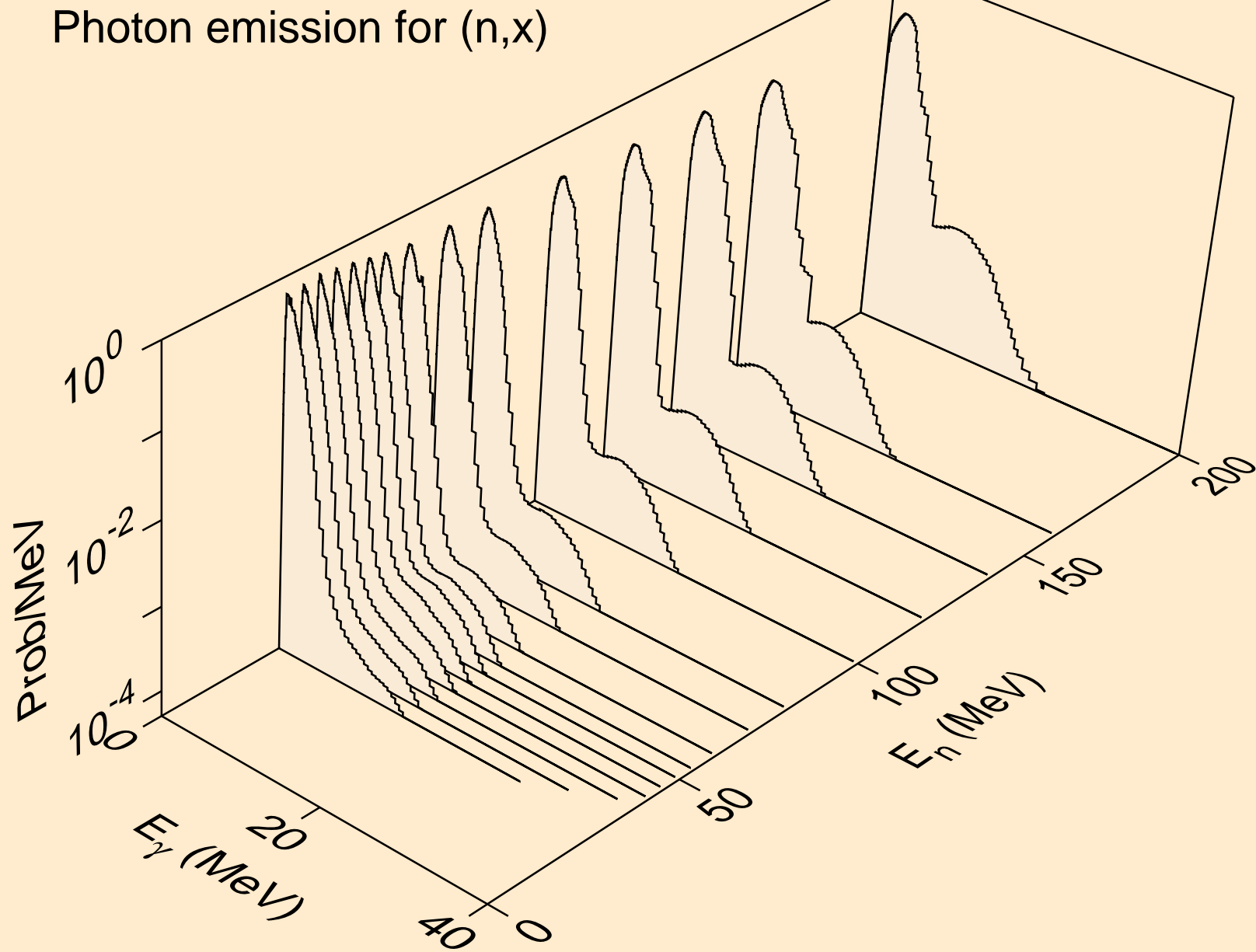

CM247 NEUTRON ACER TENDL-2021 LIBRARY; T=293.6K
Photon emission for (n,2nd)

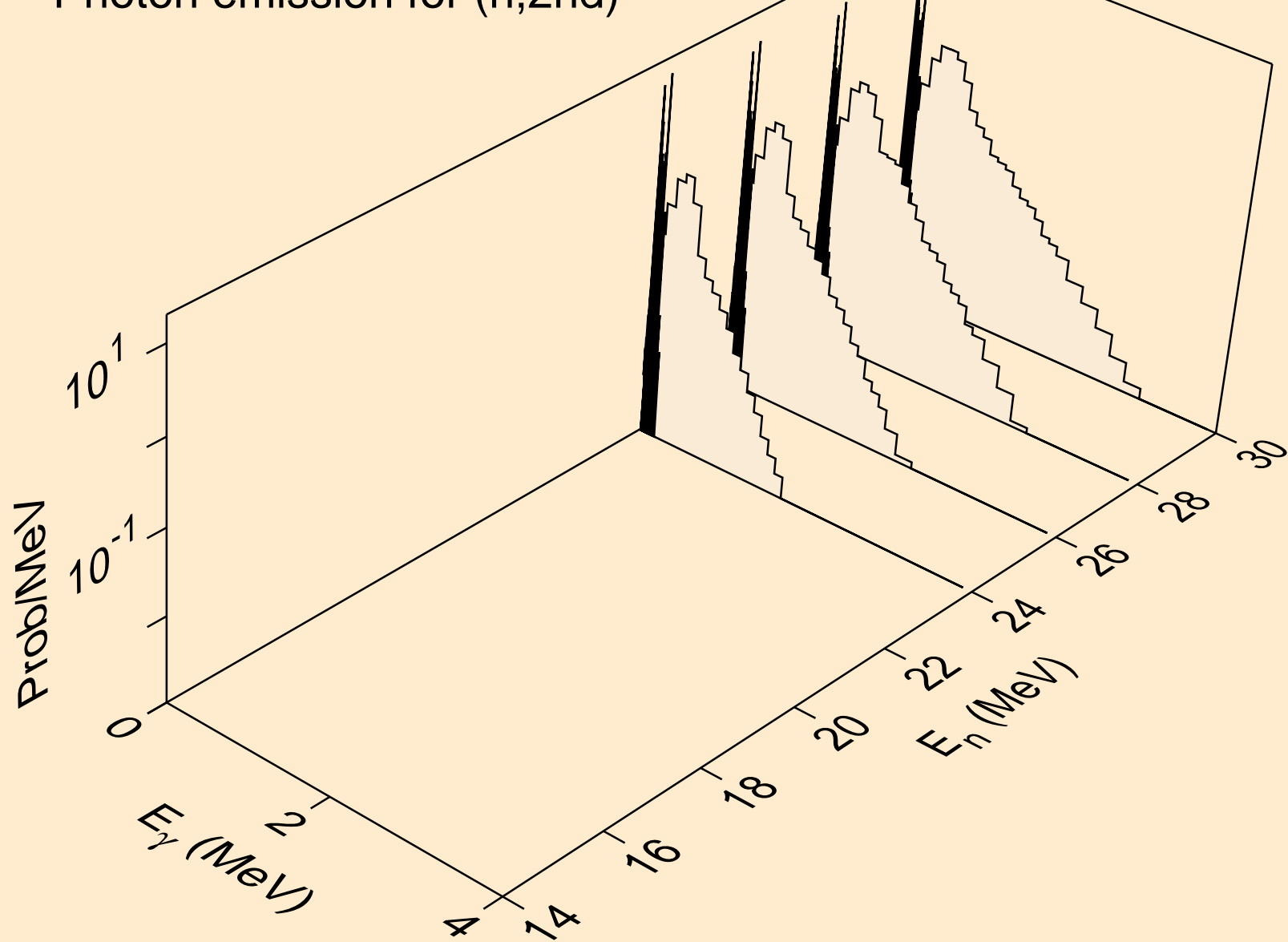

CM247 NEUTRON ACER TENDL-2021 LIBRARY; T=293.6K
Photon emission for (n,2n)

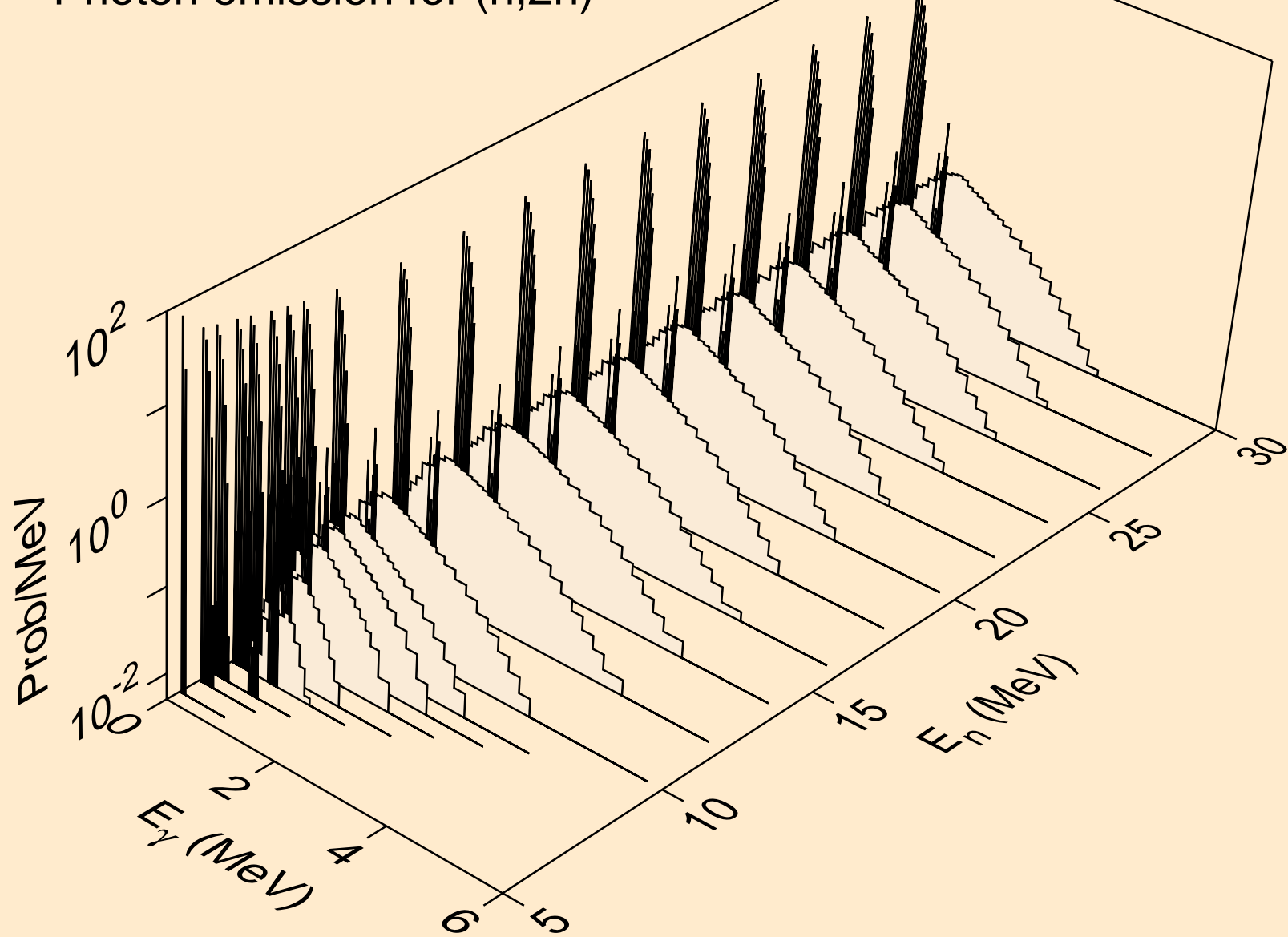

CM247 NEUTRON ACER TENDL-2021 LIBRARY; T=293.6K
Photon emission for (n,3n)

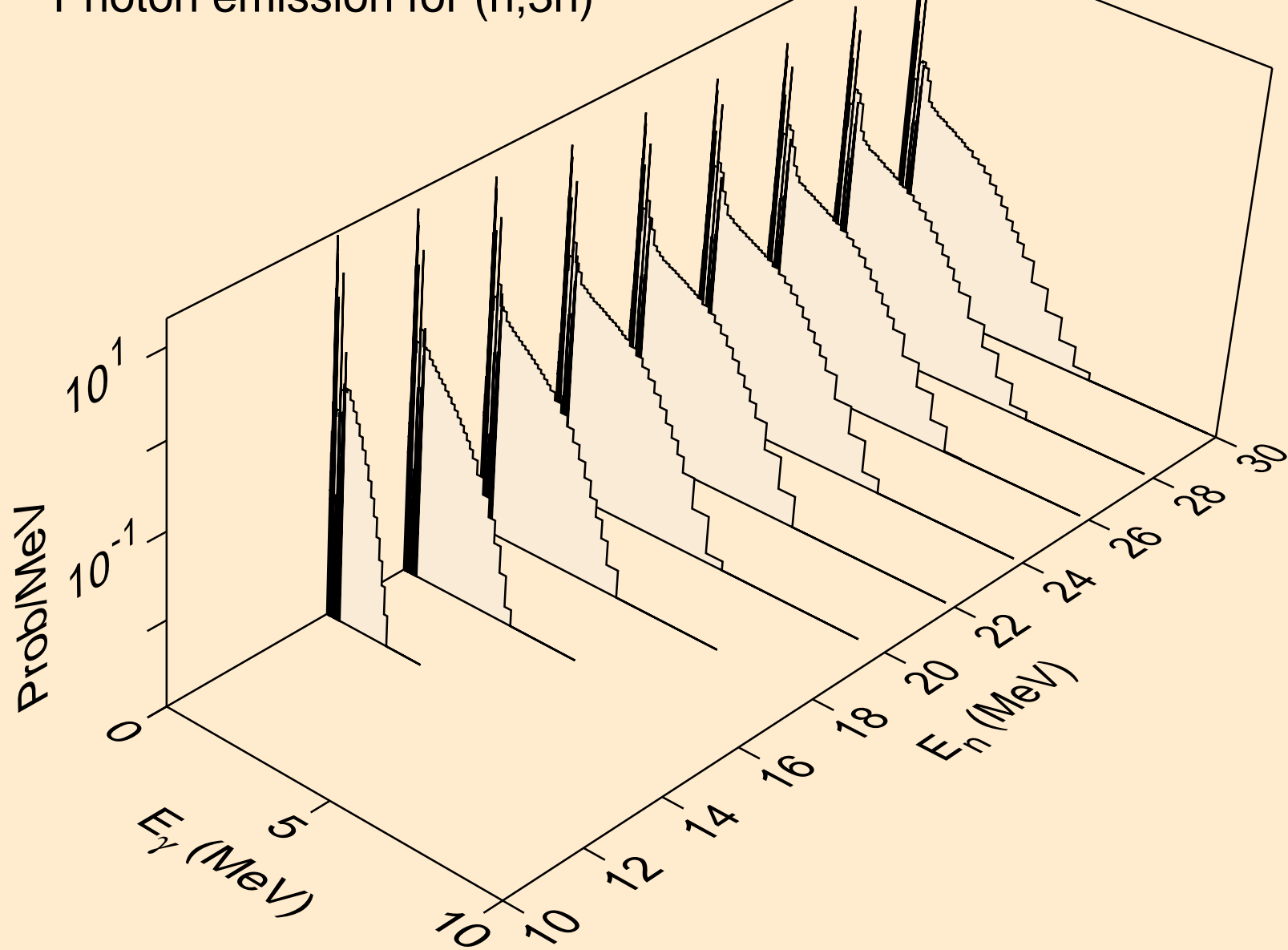

CM247 NEUTRON ACER TENDL-2021 LIBRARY; T=293.6K
Photon emission for (n,n*)a

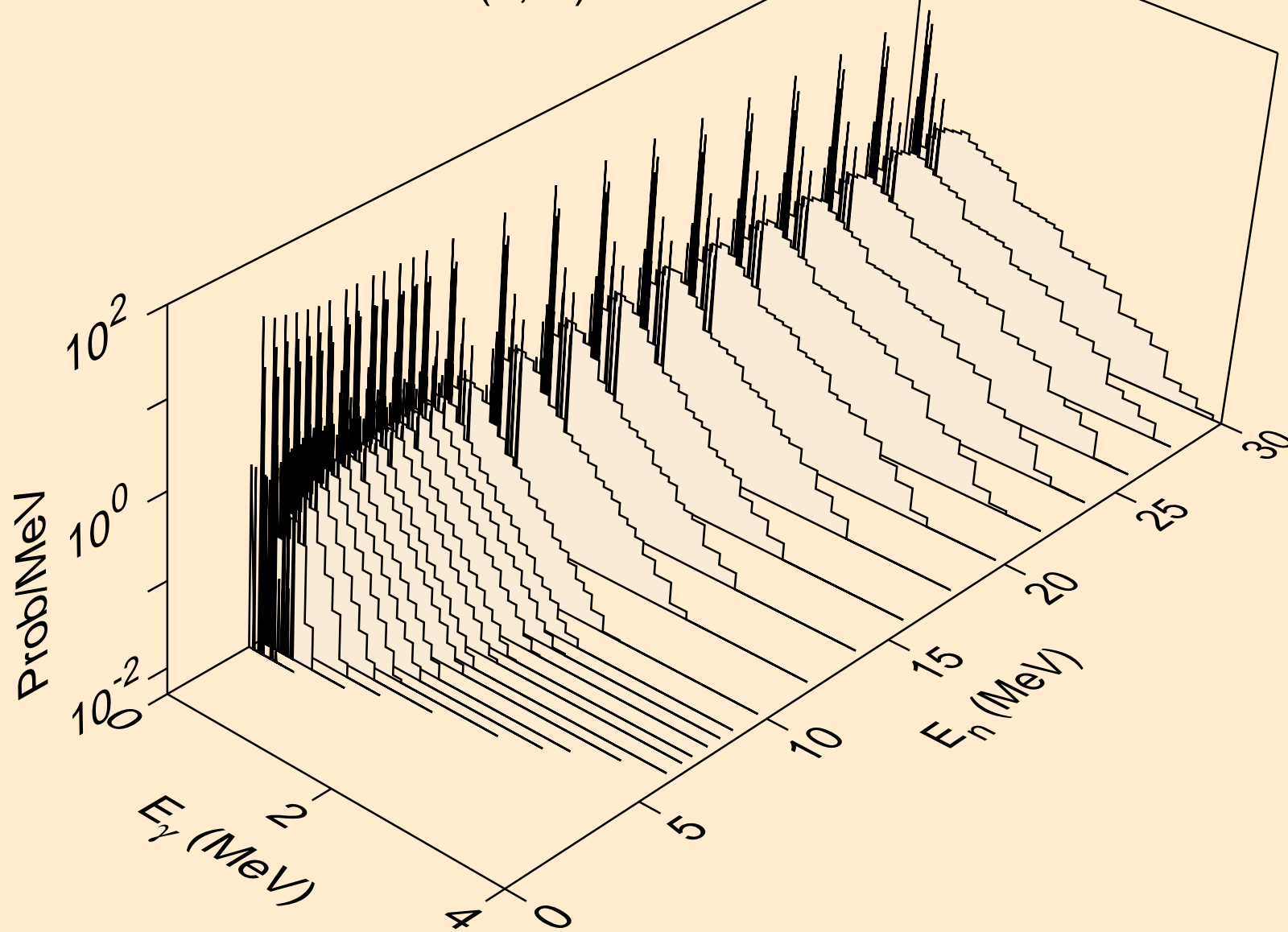

CM247 NEUTRON ACER TENDL-2021 LIBRARY; T=293.6K
Photon emission for (n,2n)a

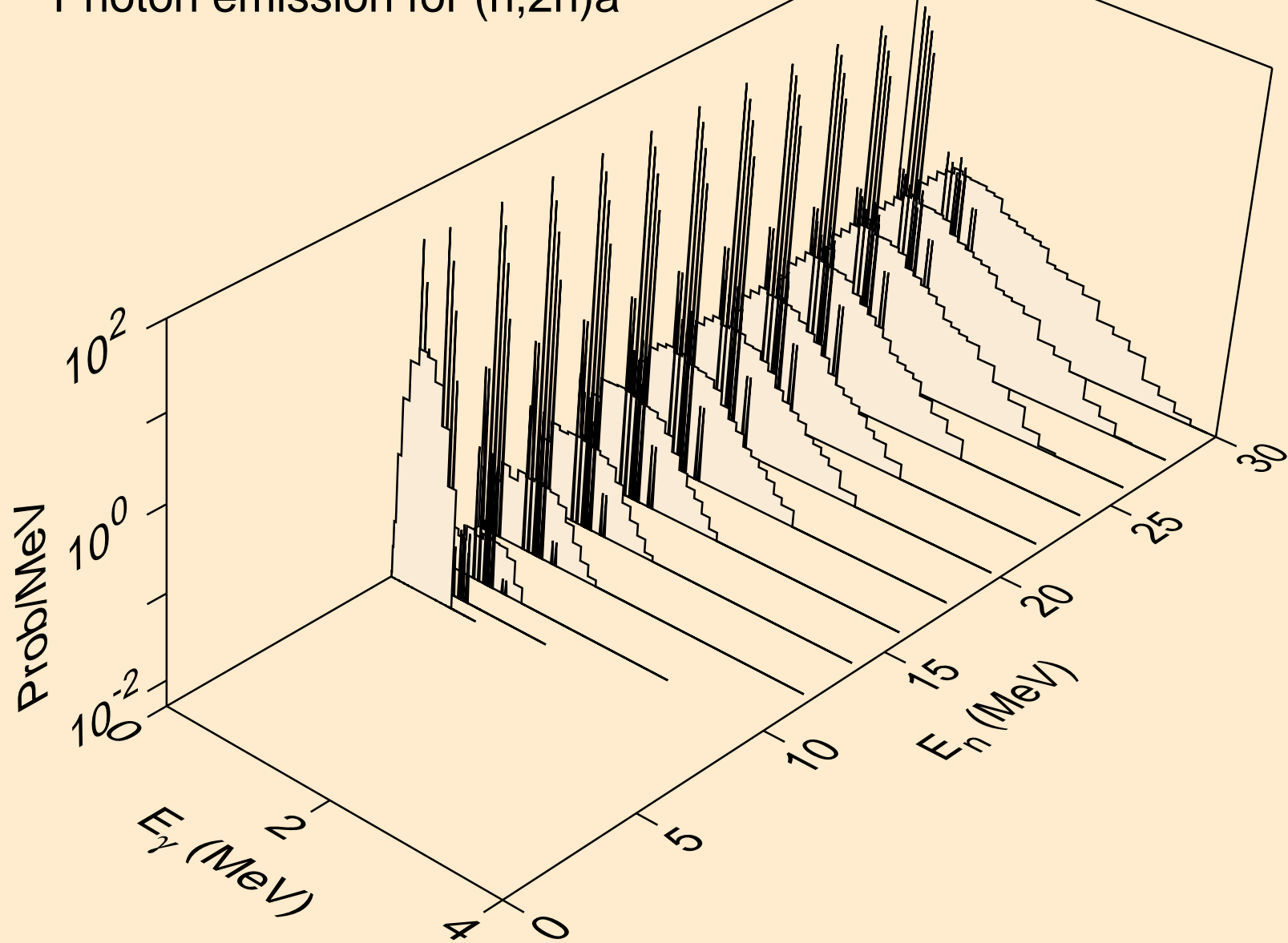

CM247 NEUTRON ACER TENDL-2021 LIBRARY; T=293.6K
Photon emission for (n,3n)a

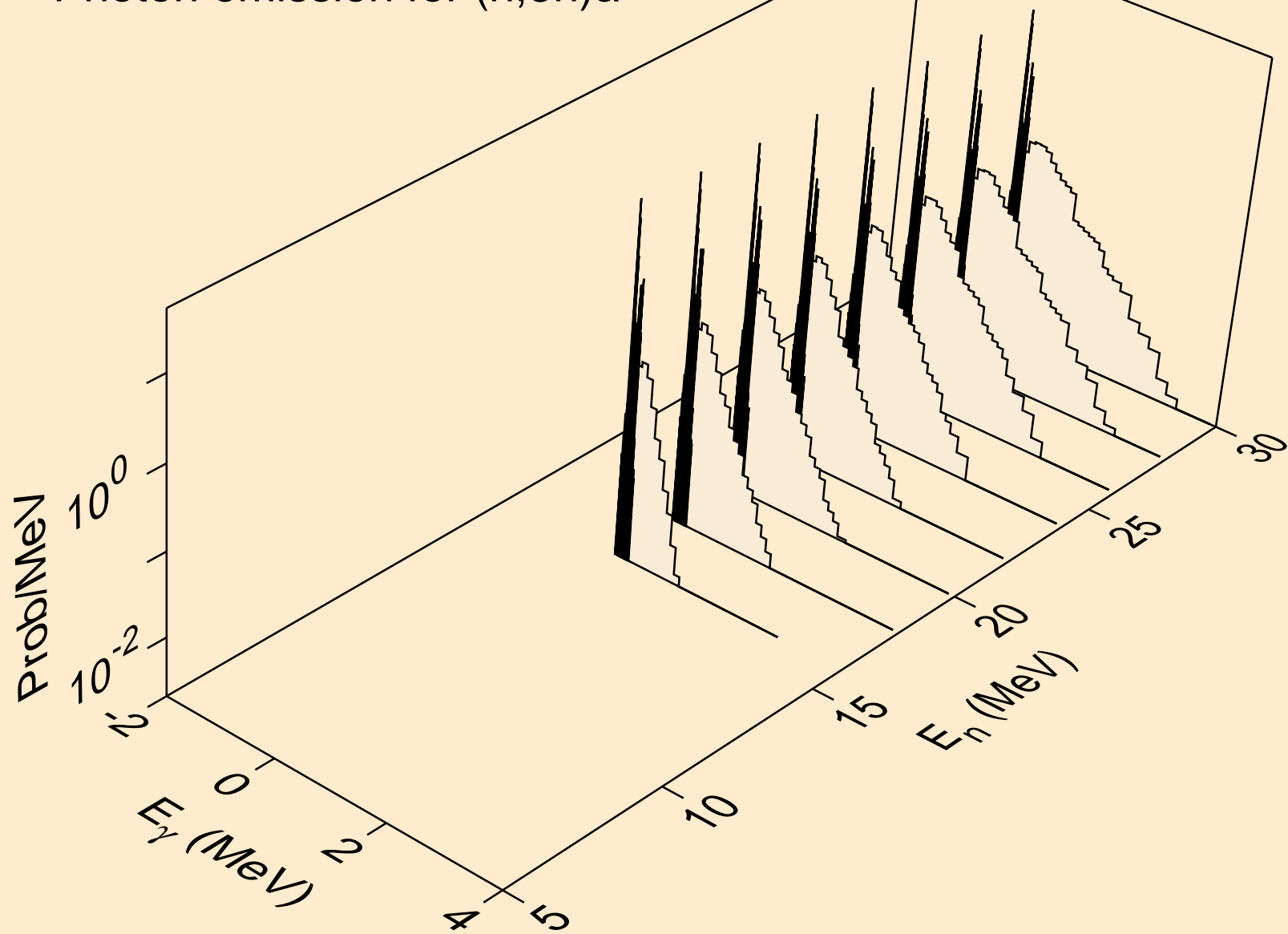

CM247 NEUTRON ACER TENDL-2021 LIBRARY; T=293.6K
Photon emission for (n,n*)p

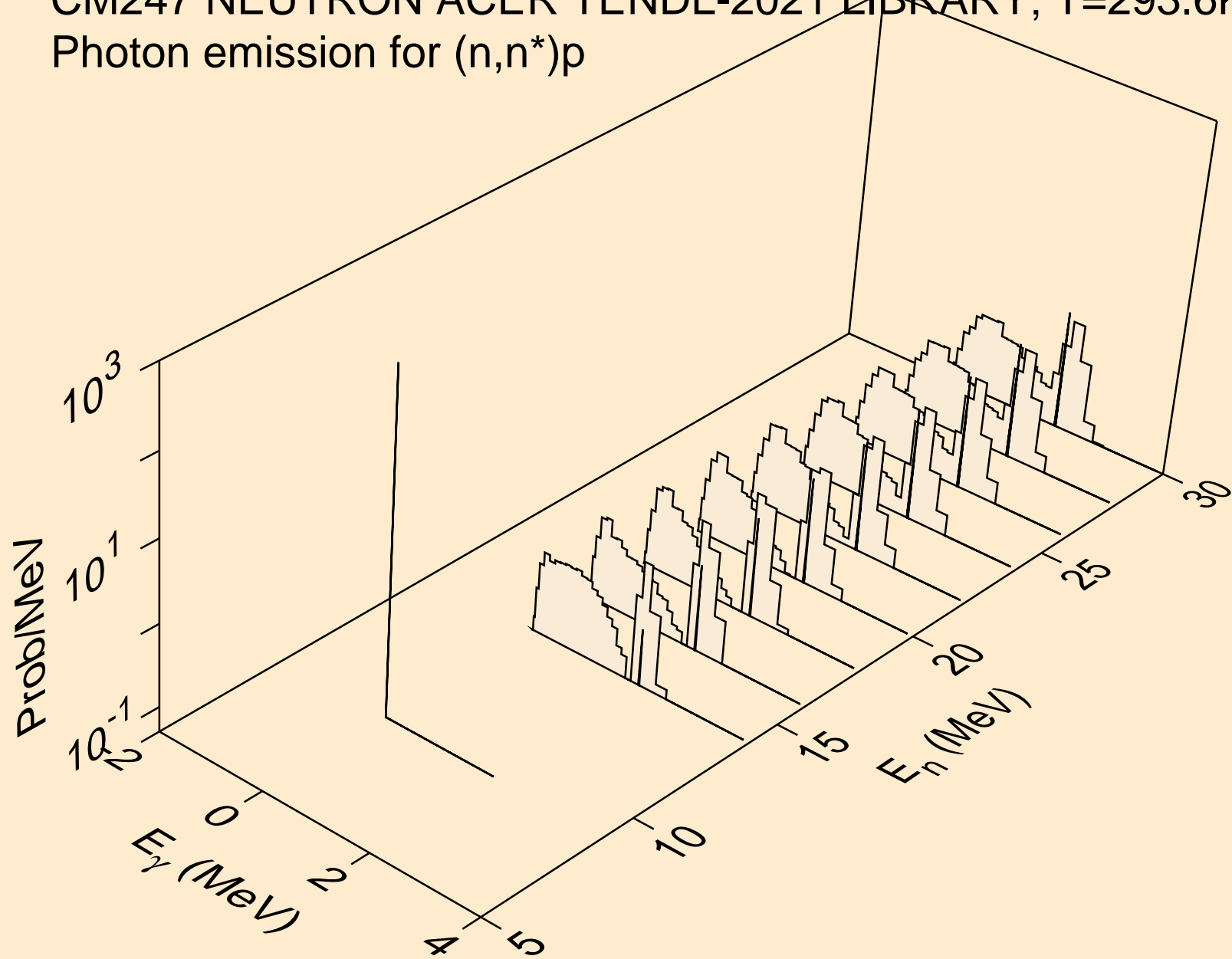

CM247 NEUTRON ACER TENDL-2021 LIBRARY; T=293.6K
Photon emission for (n,n*)d

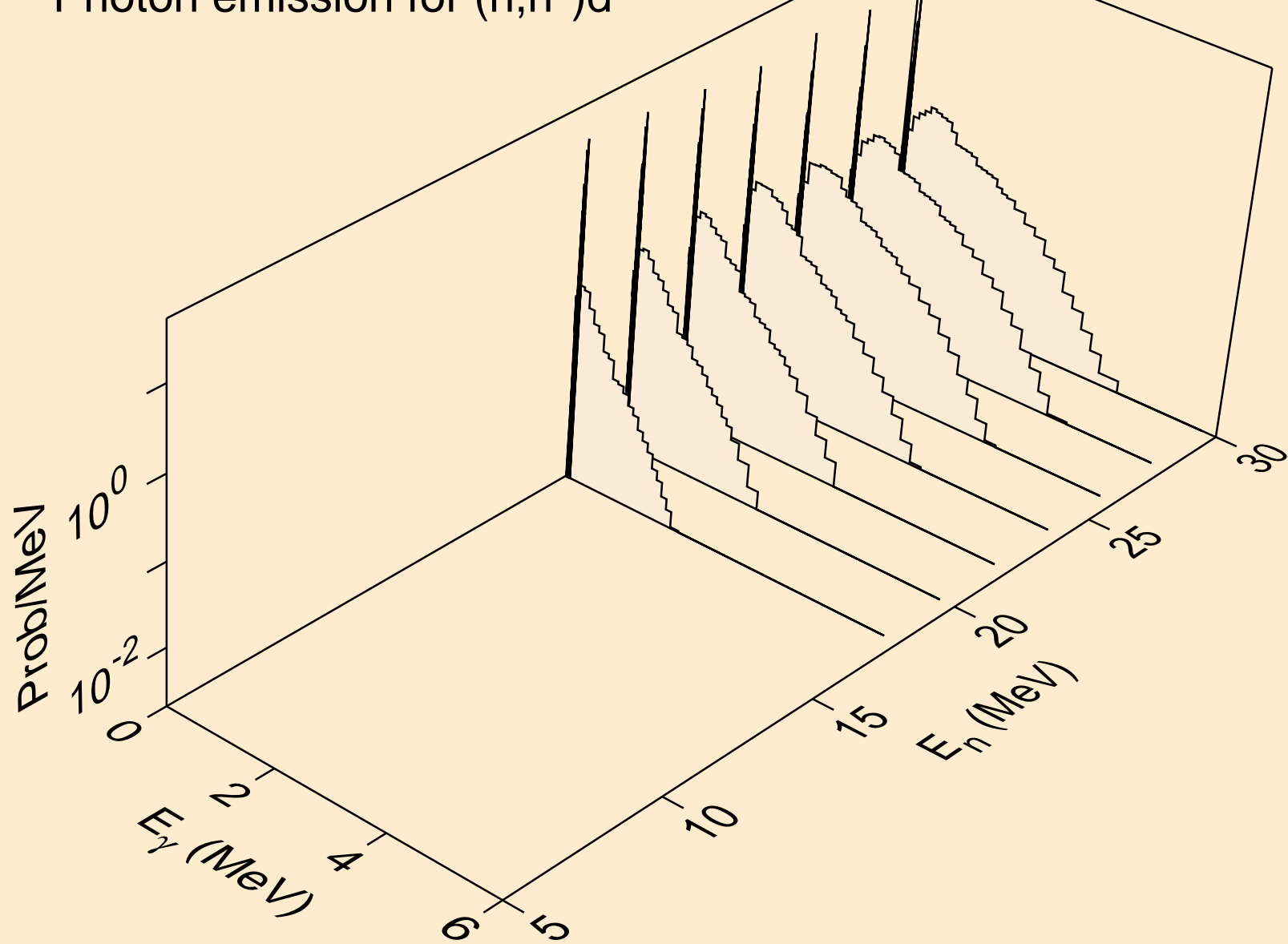

CM247 NEUTRON ACER TENDL-2021 LIBRARY; T=293.6K
Photon emission for (n,n*)t

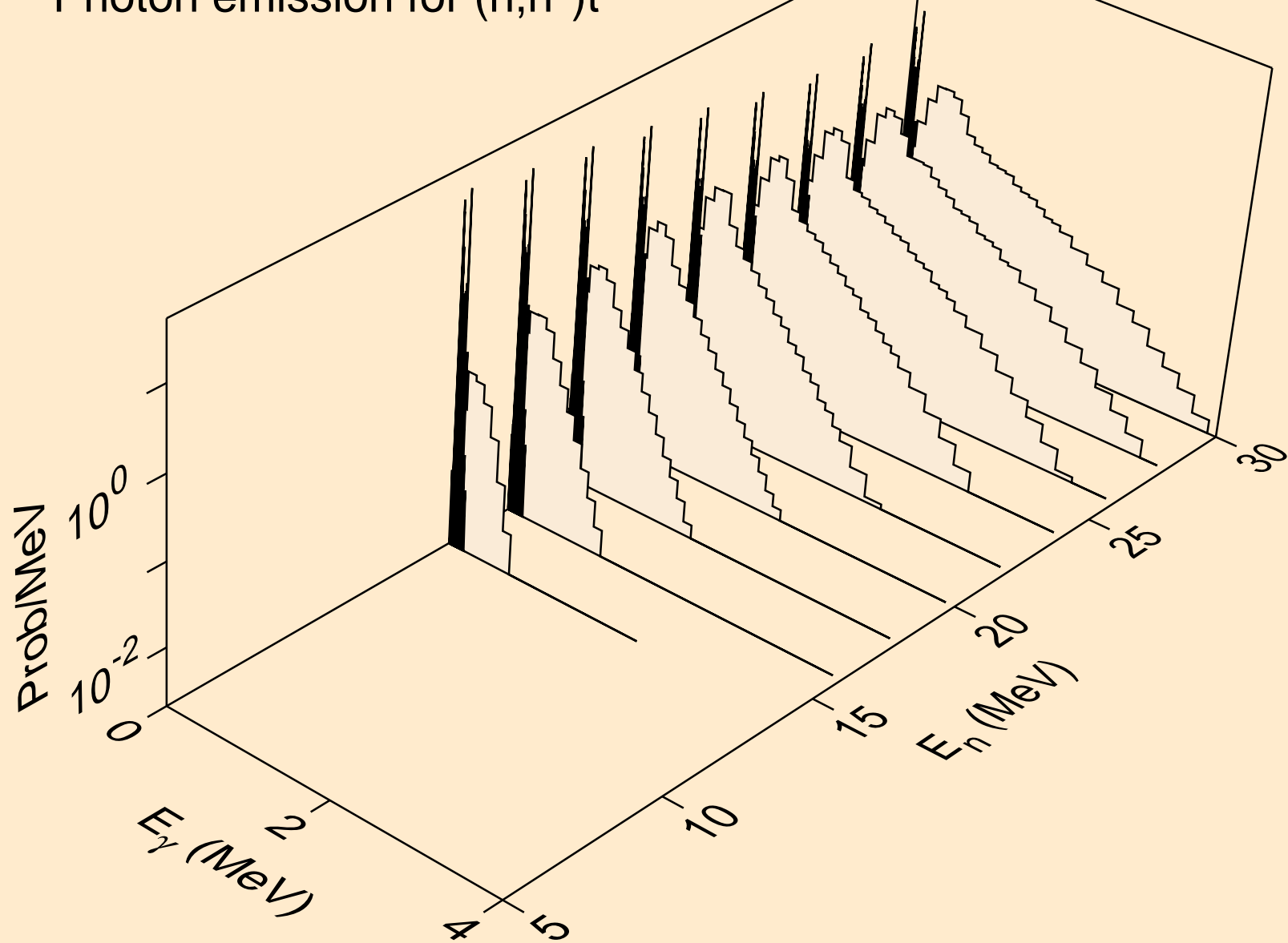

CM247 NEUTRON ACER TENDL-2021 LIBRARY; T=293.6K
Photon emission for (n,n*)he3

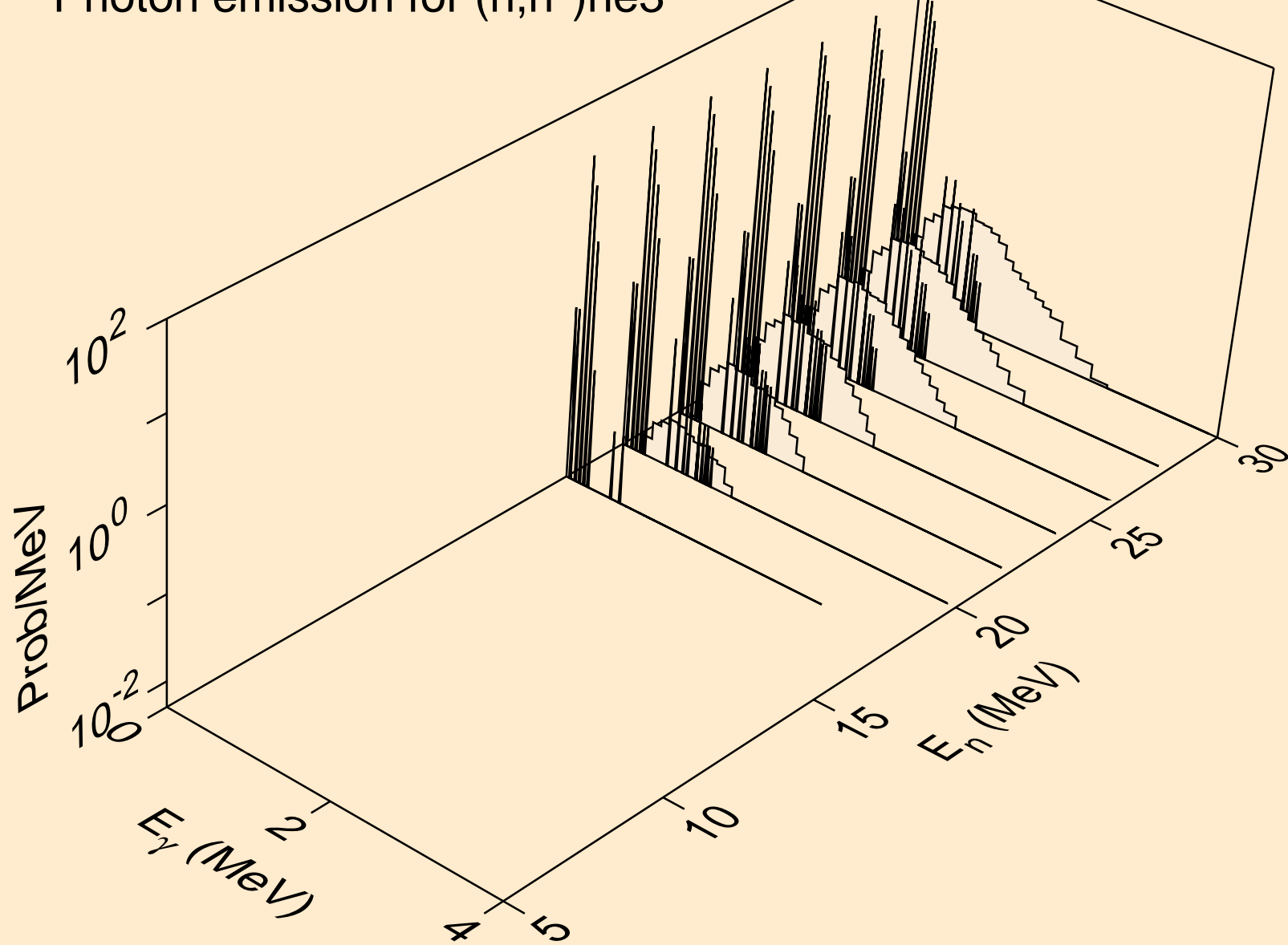

CM247 NEUTRON ACER TENDL-2021 LIBRARY; T=293.6K
Photon emission for (n,4n)

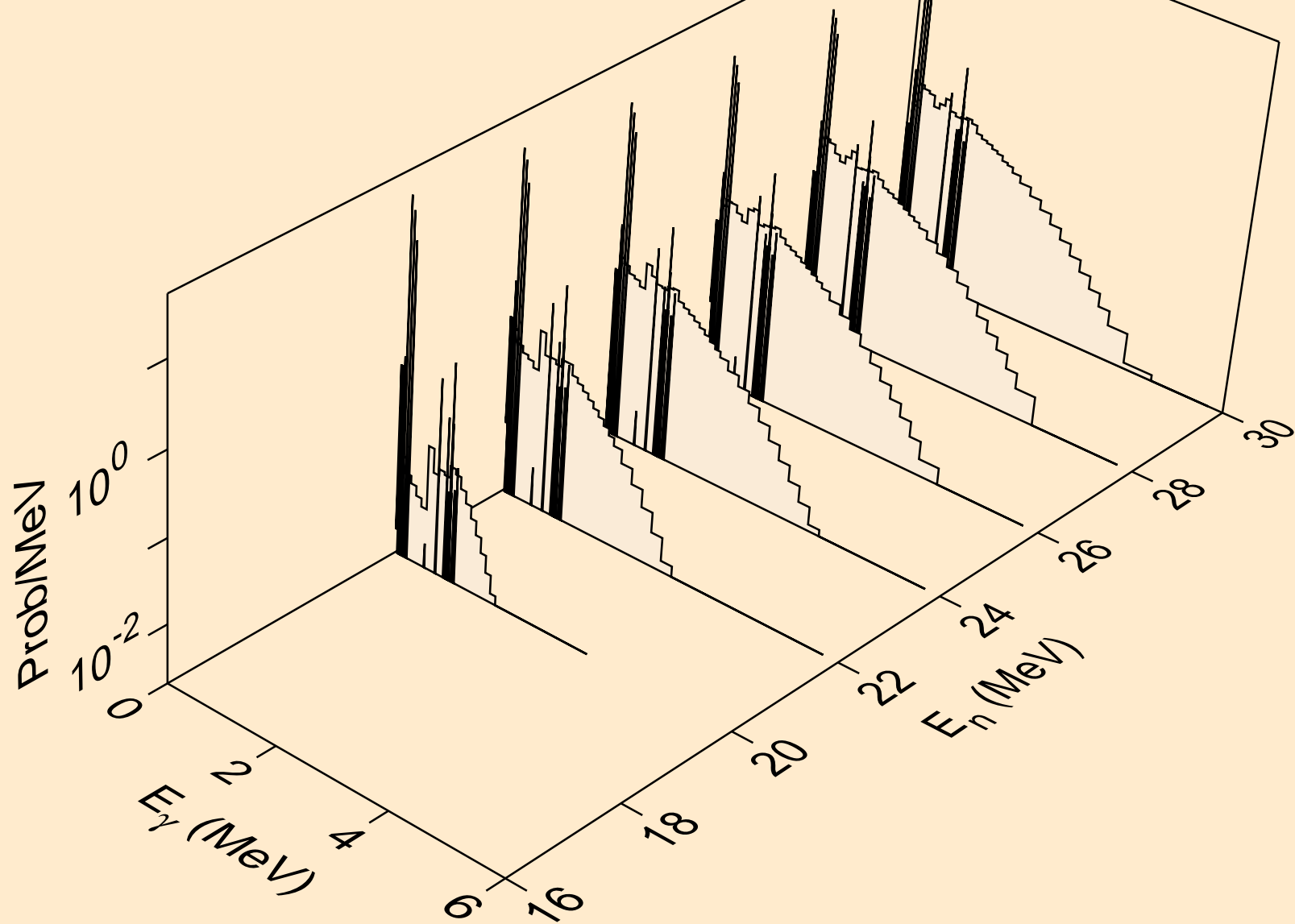

CM247 NEUTRON ACER TENDL-2021 LIBRARY; T=293.6K
Photon emission for (n,2np)

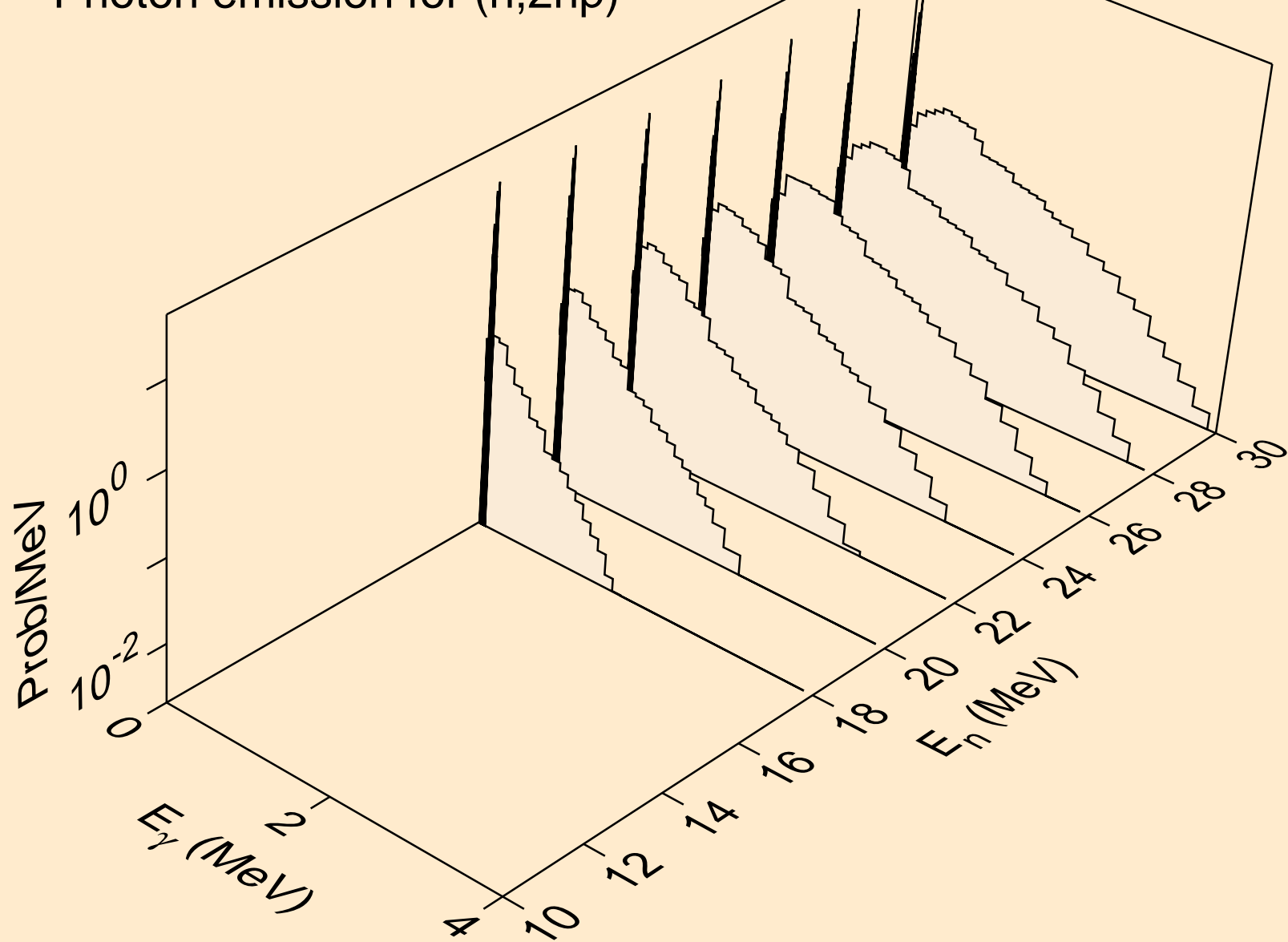

CM247 NEUTRON ACER TENDL-2021 LIBRARY; T=293.6K
Photon emission for (n,3np)

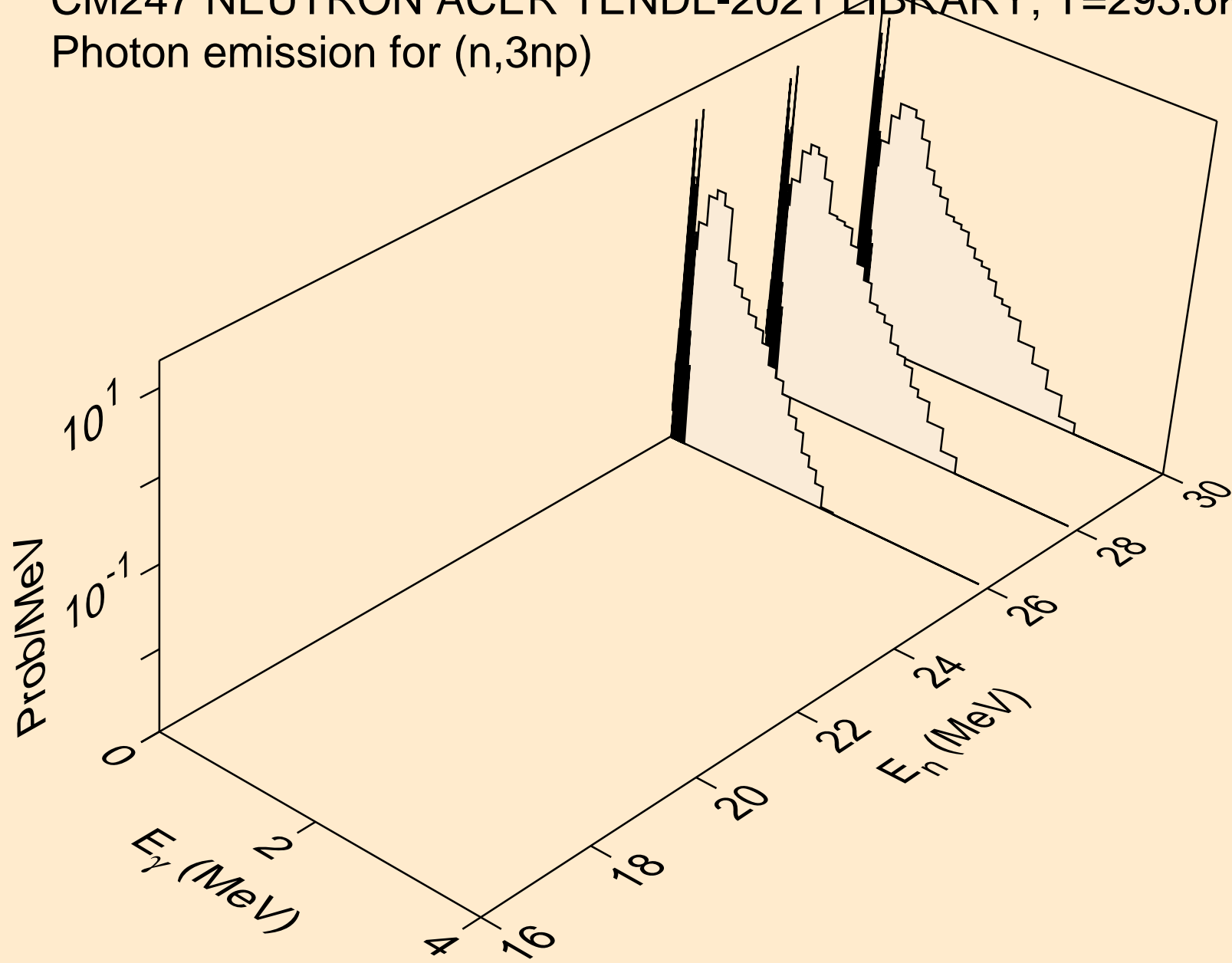

CM247 NEUTRON ACER TENDL-2021 LIBRARY; T=293.6K
Photon emission for (n,2np)

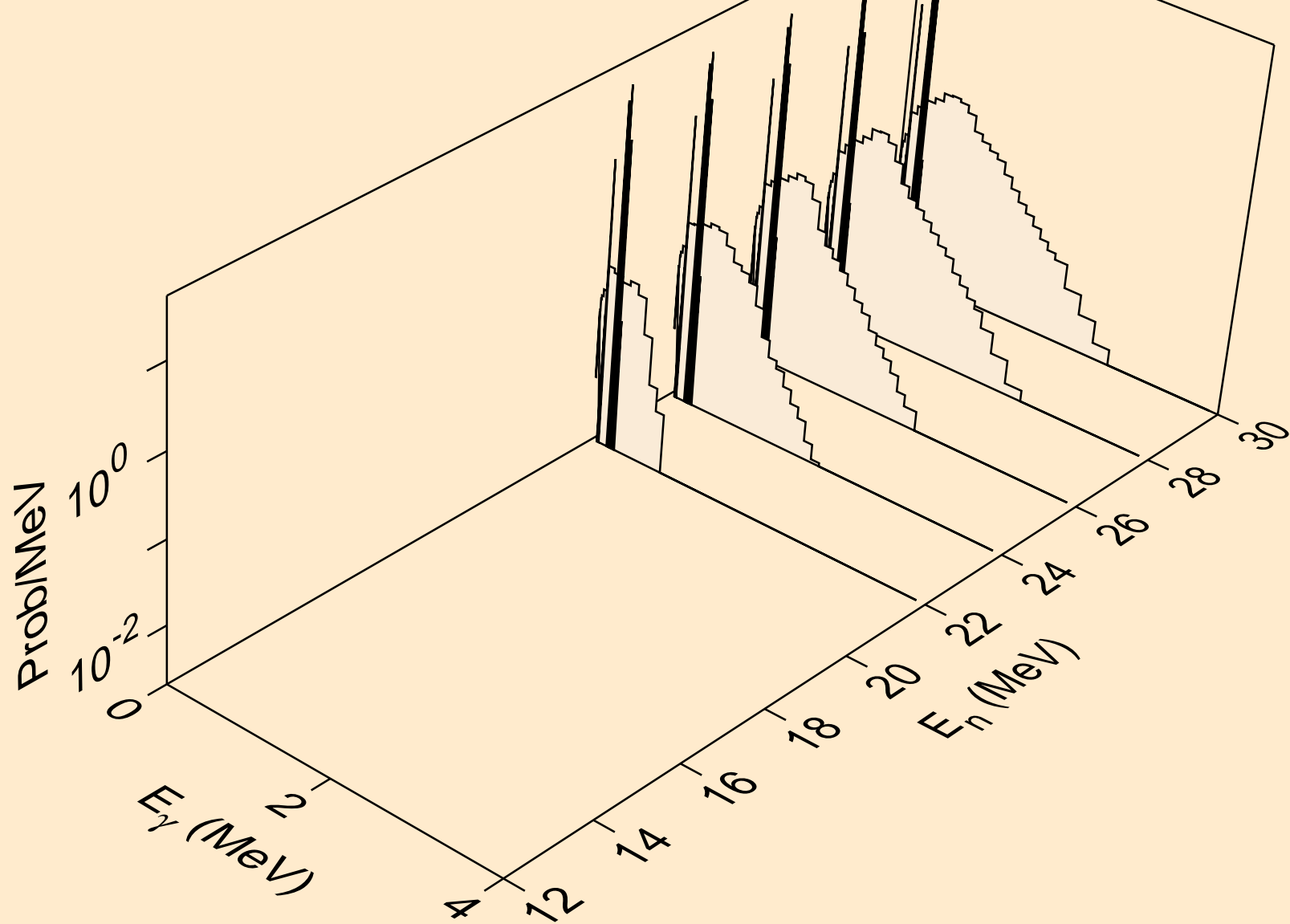

CM247 NEUTRON ACER TENDL-2021 LIBRARY; T=293.6K
Photon emission for (n,n*c)

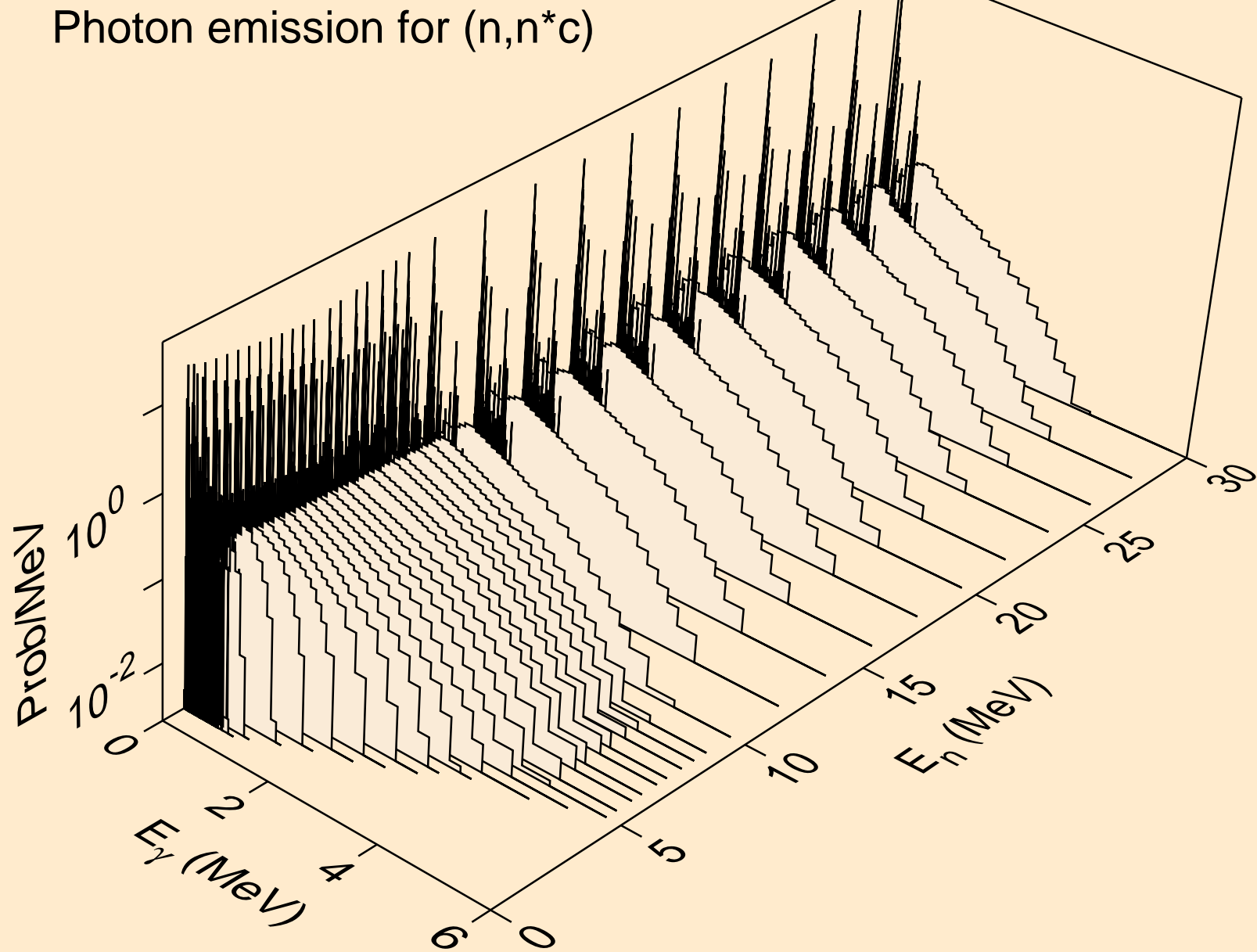

CM247 NEUTRON ACER TENDL-2021 LIBRARY; T=293.6K
Photon emission for (n,gma)

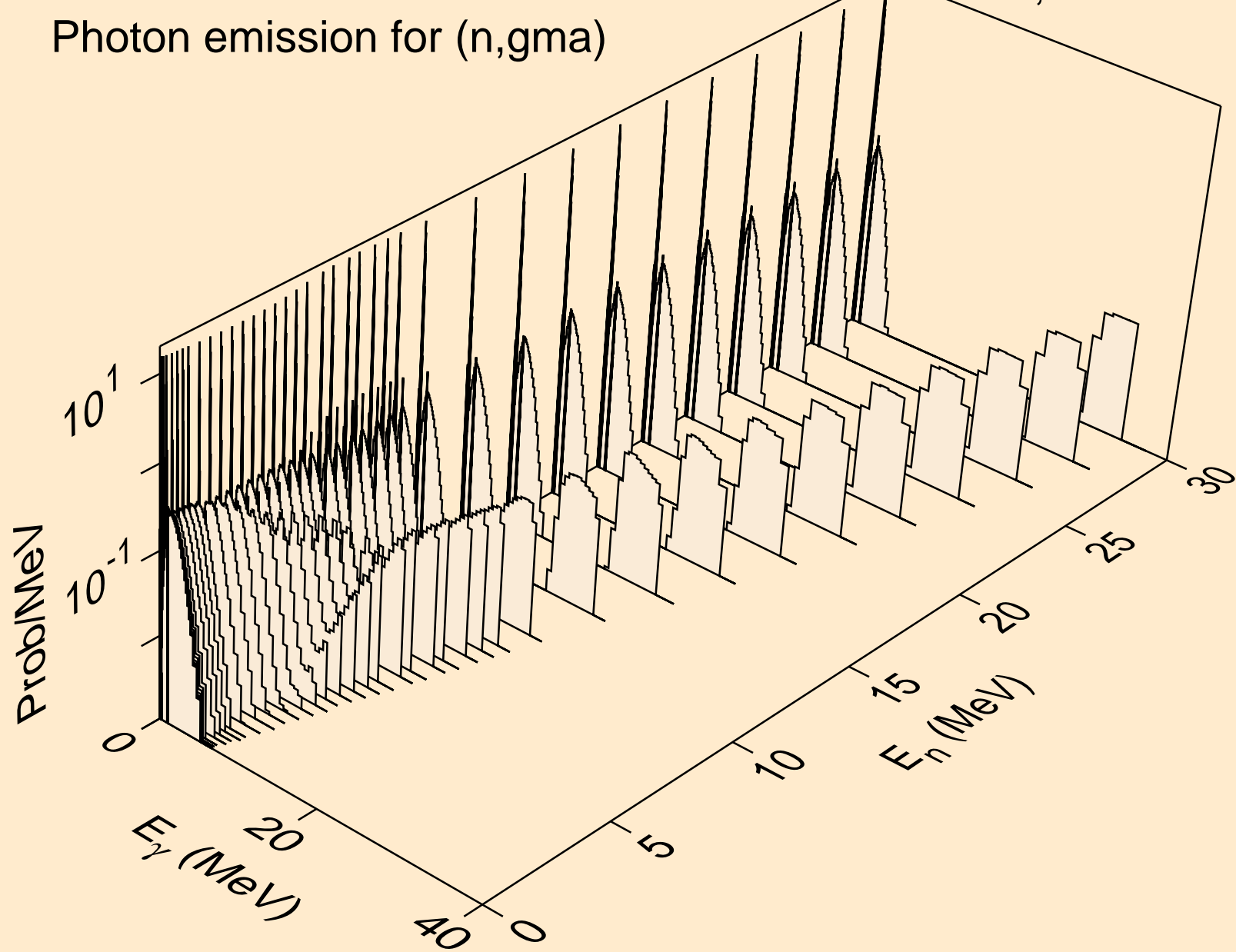

CM247 NEUTRON ACER TENDL-2021 LIBRARY; T=293.6K
Photon emission for (n,p)

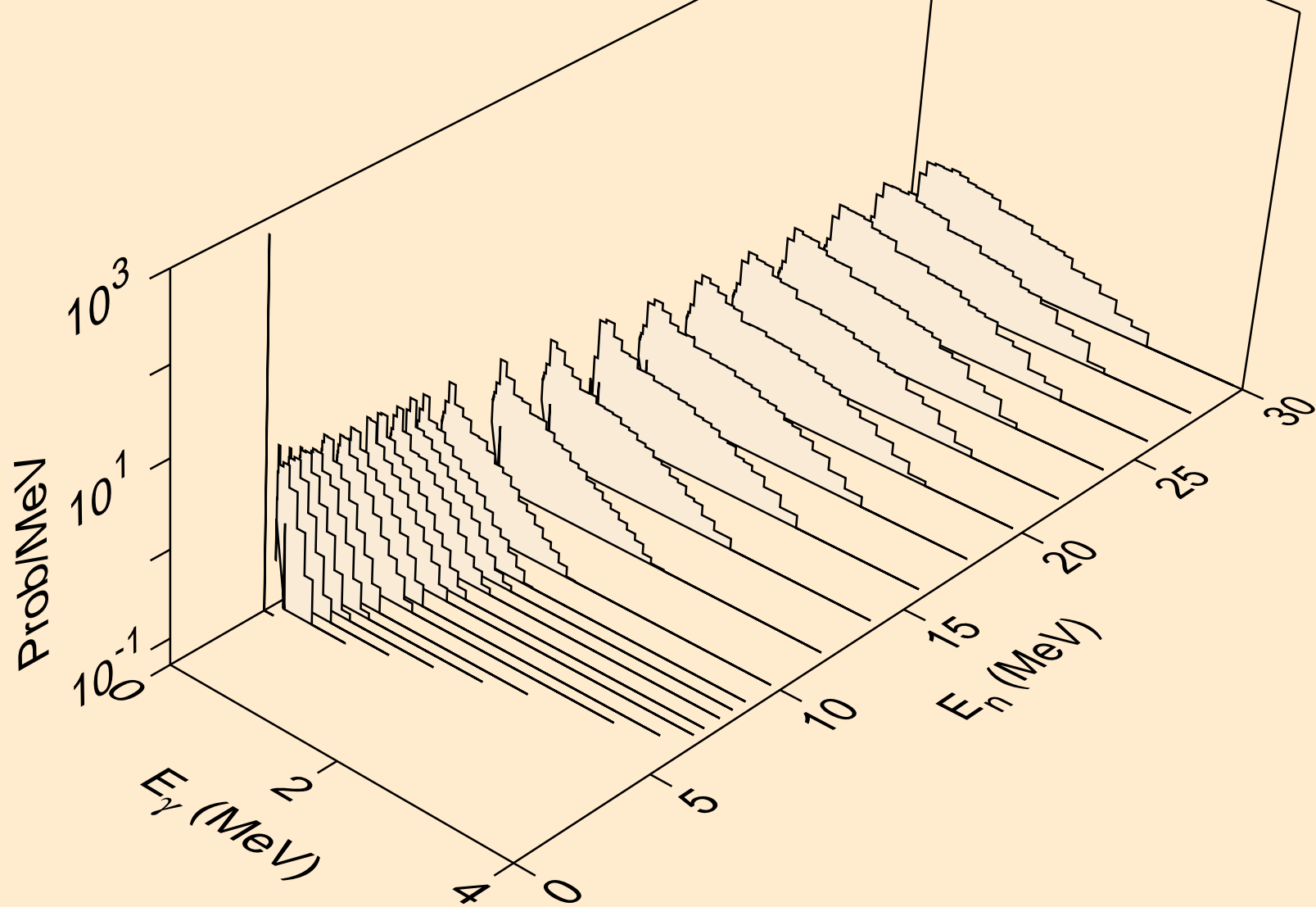

CM247 NEUTRON ACER TENDL-2021 LIBRARY; T=293.6K
Photon emission for (n,d)

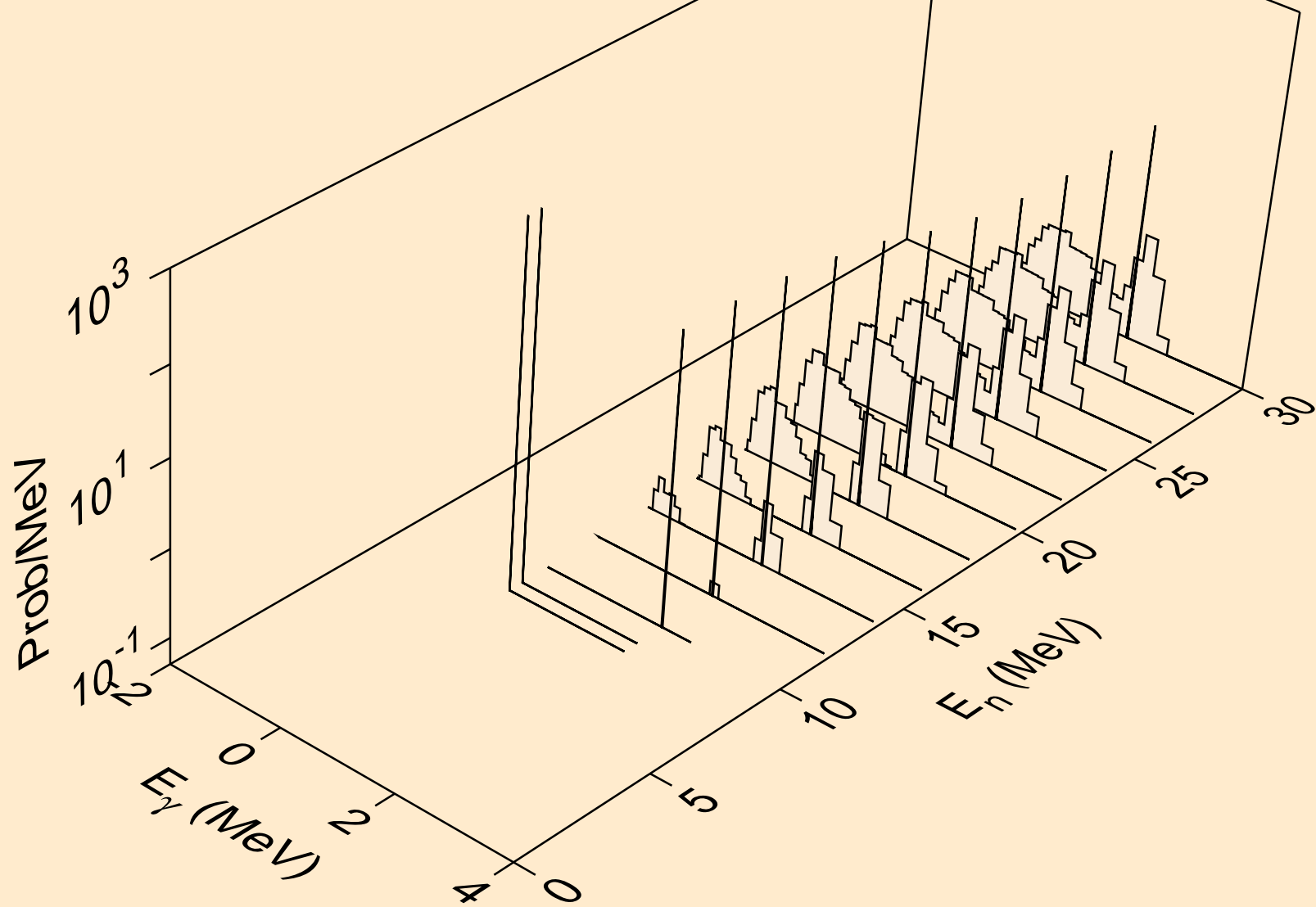

CM247 NEUTRON ACER TENDL-2021 LIBRARY; T=293.6K
Photon emission for (n,t)

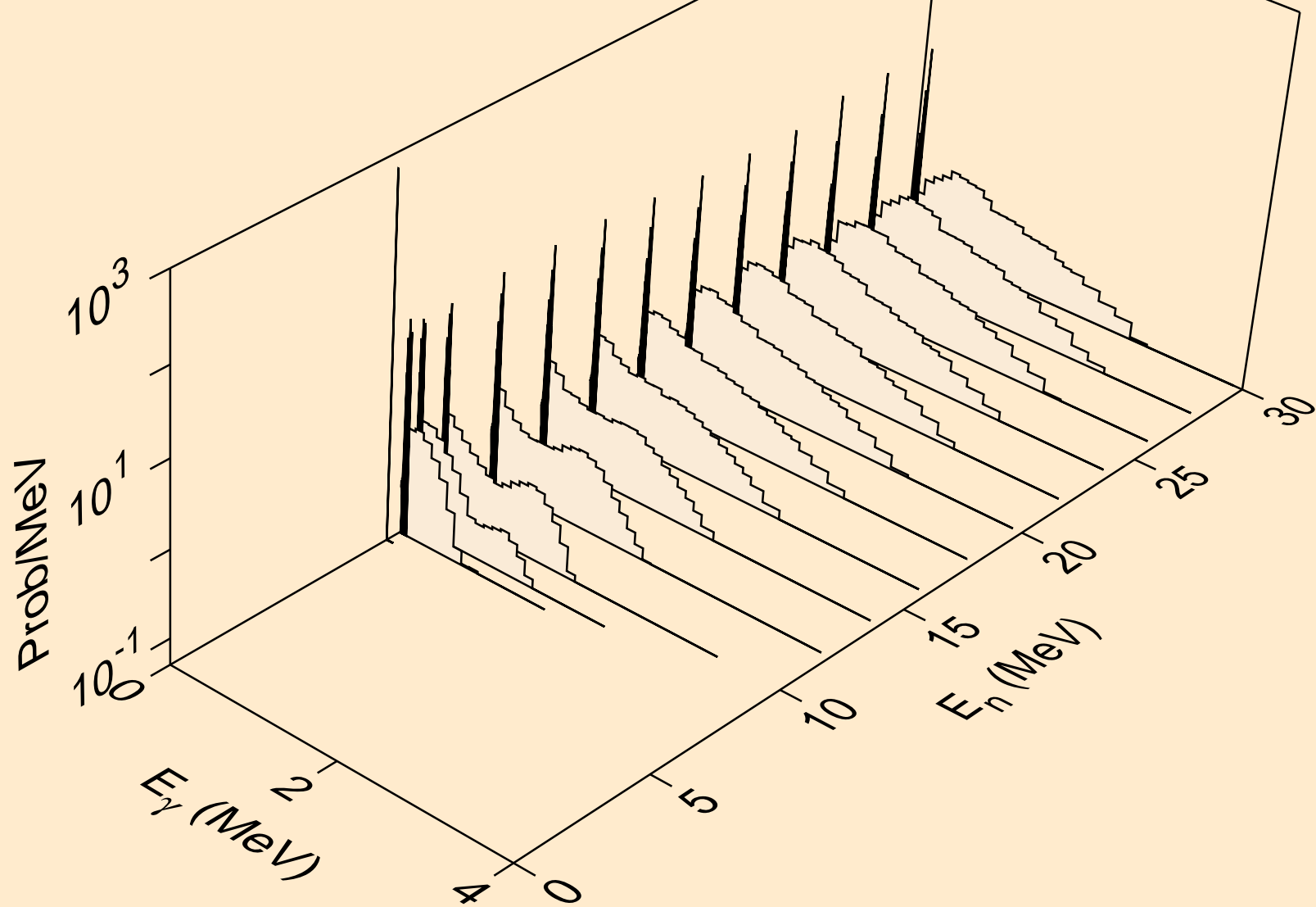

CM247 NEUTRON ACER TENDL-2021 LIBRARY; T=293.6K
Photon emission for (n,he3)

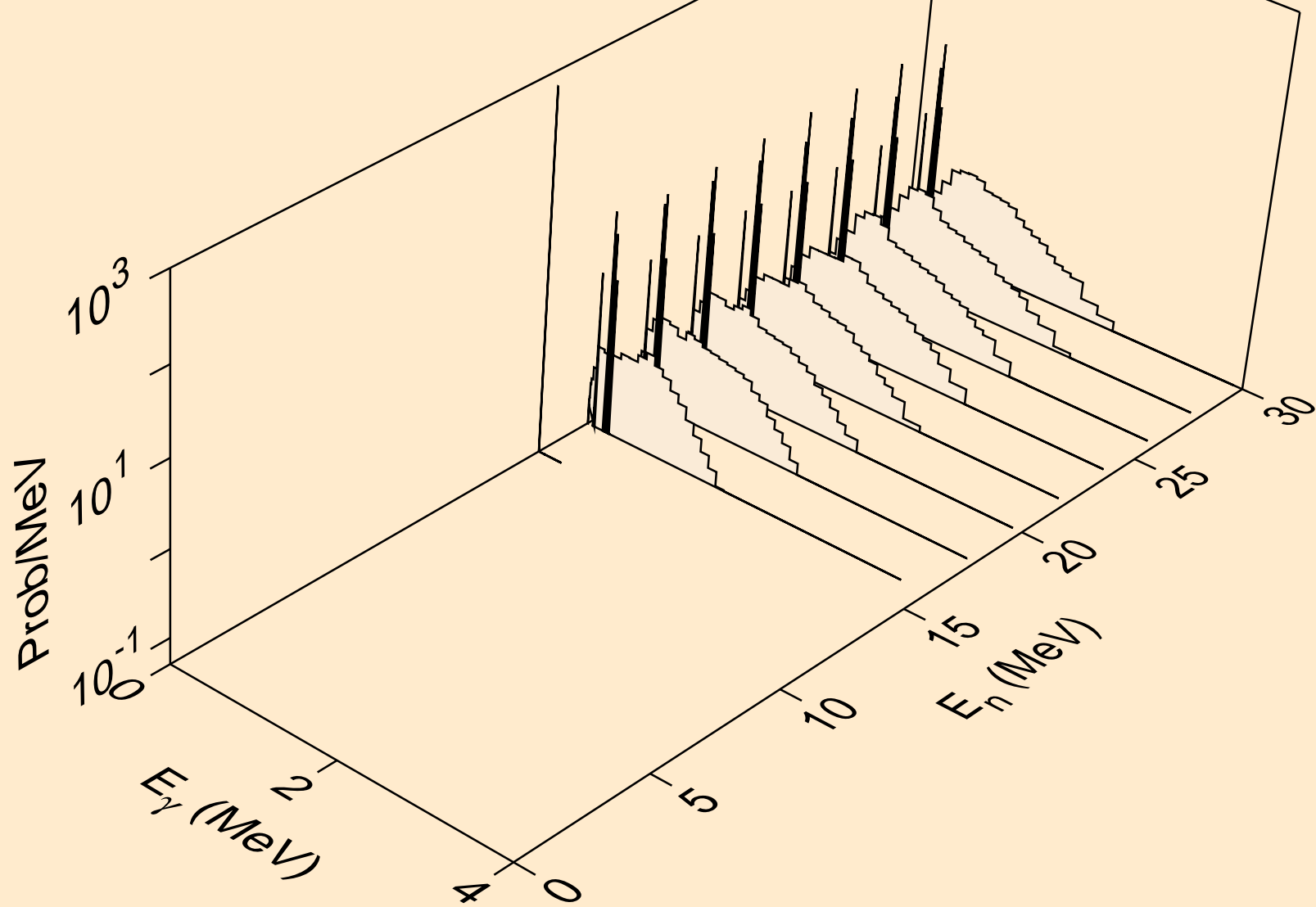

CM247 NEUTRON ACER TENDL-2021 LIBRARY; T=293.6K
Photon emission for (n,a)

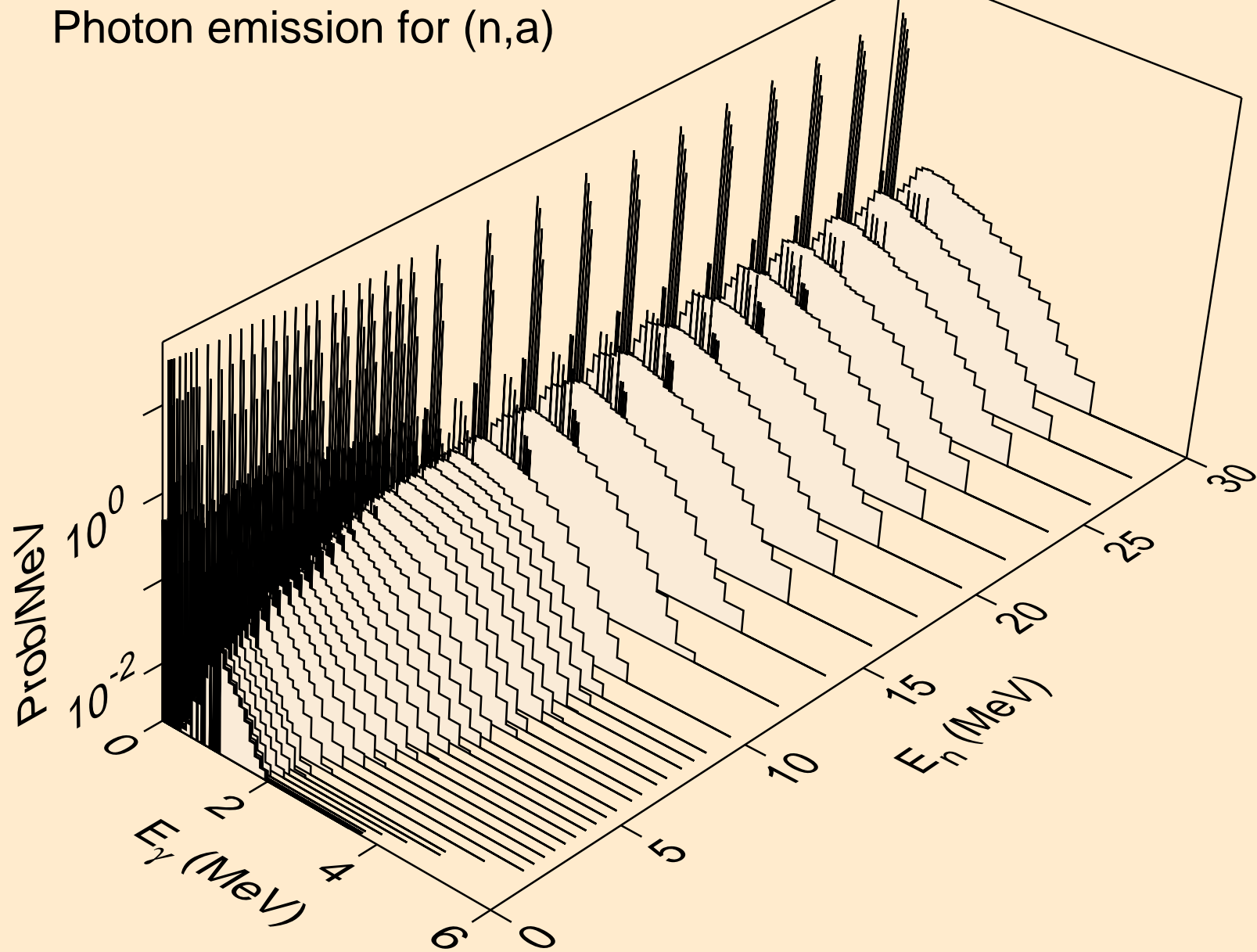

CM247 NEUTRON ACER TENDL-2021 LIBRARY; T=293.6K
Photon emission for (n,2p)

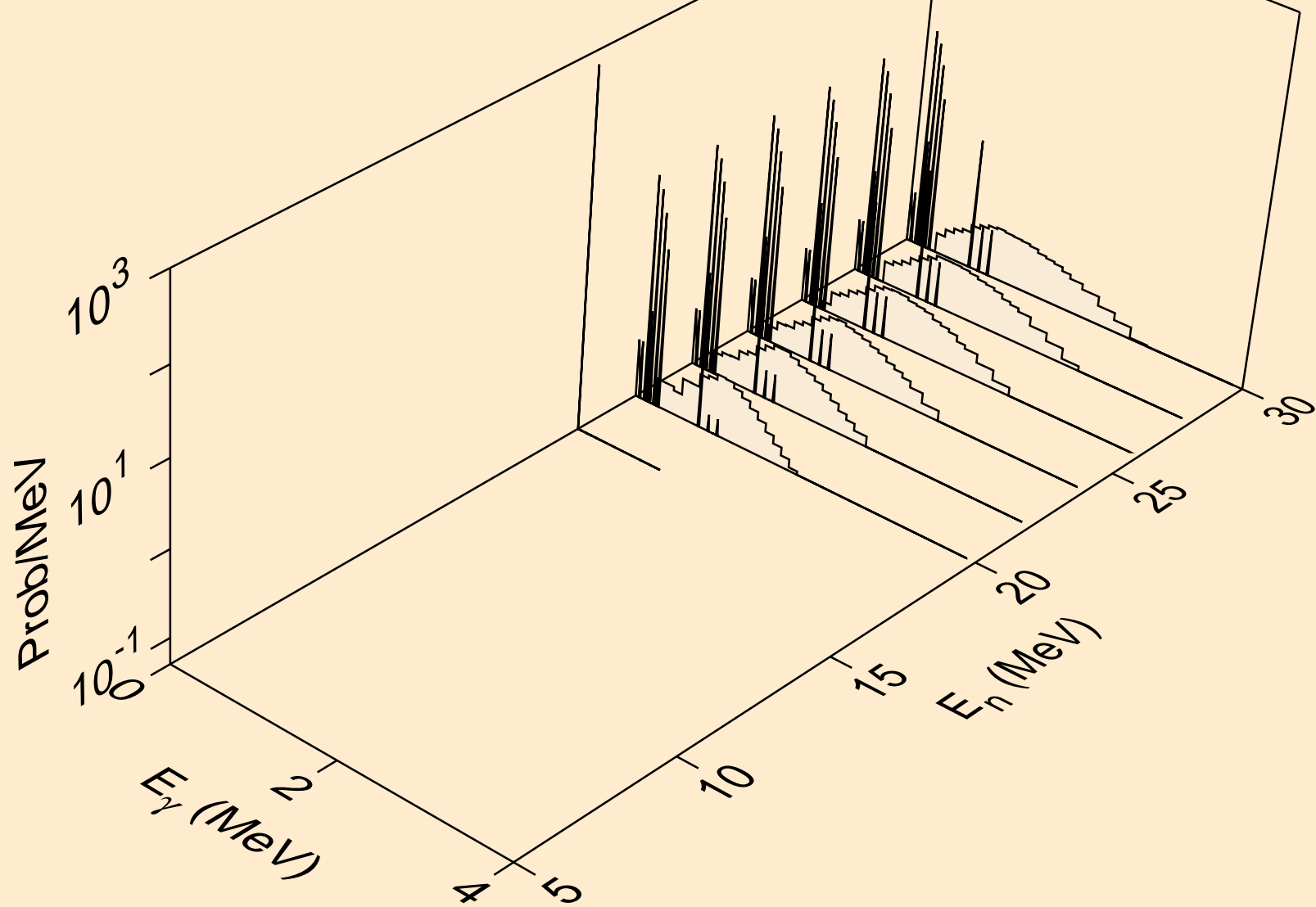

CM247 NEUTRON ACER TENDL-2021 LIBRARY; T=293.6K
thermal capture photon spectrum

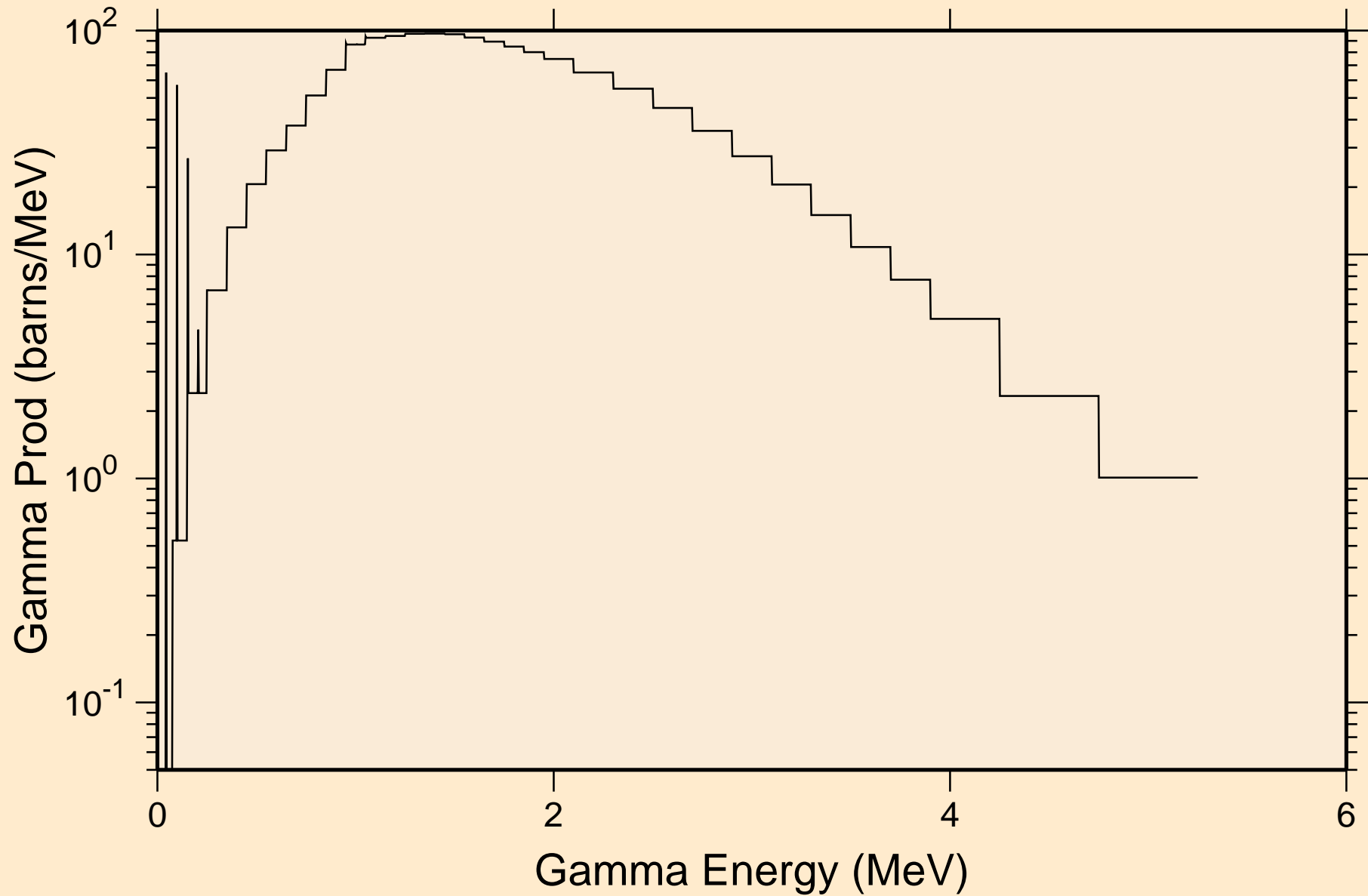

CM247 NEUTRON ACER TENDL-2021 LIBRARY; T=293.6K
14 MeV photon spectrum

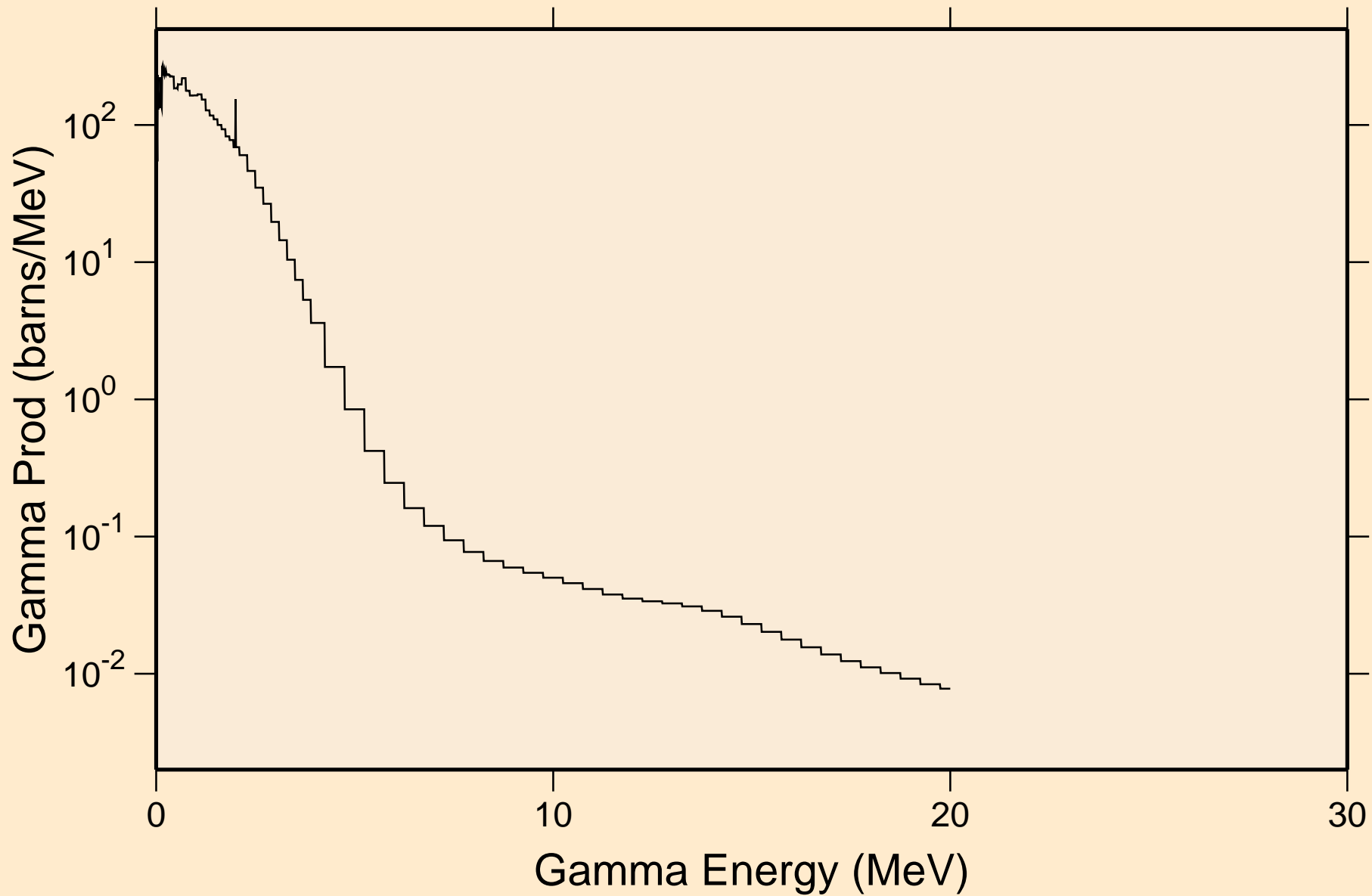

CM247 NEUTRON ACER TENDL-2021 LIBRARY; T=293.6K
Particle heating contributions

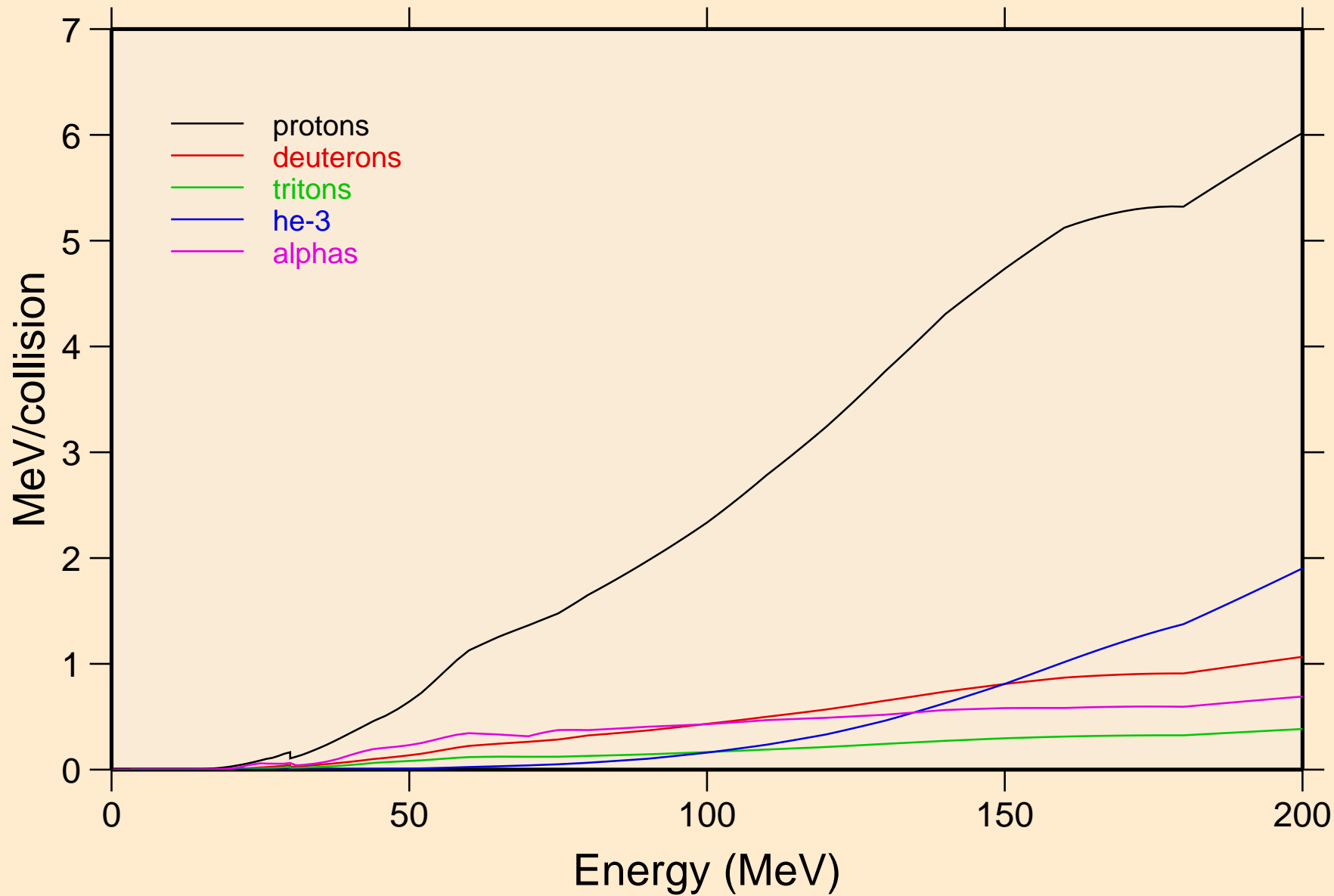

CM247 NEUTRON ACER TENDL-2021 LIBRARY; T=293.6K
Recoil Heating

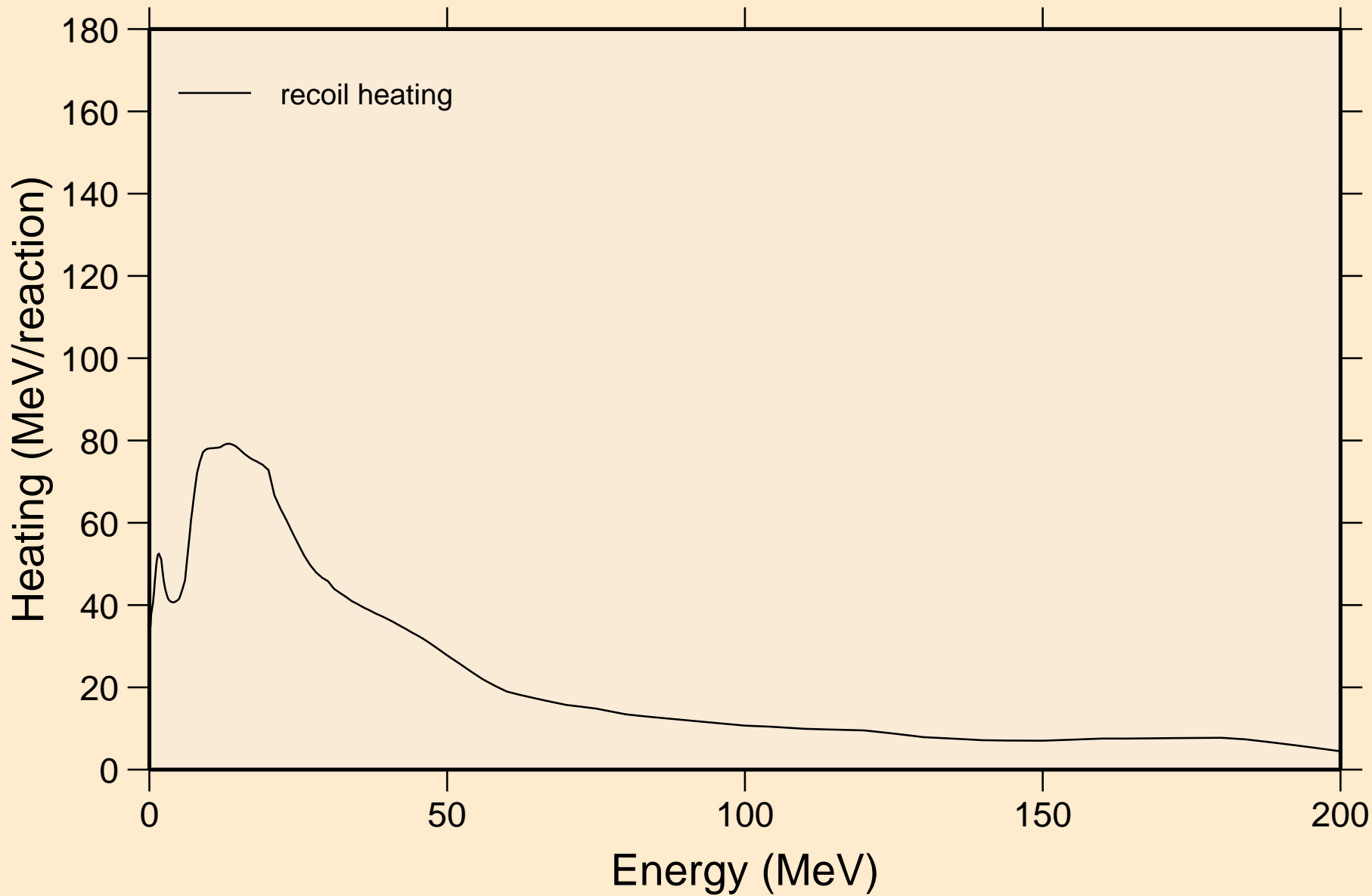

CM247 NEUTRON ACER TENDL-2021 LIBRARY; T=293.6K

Particle production cross sections

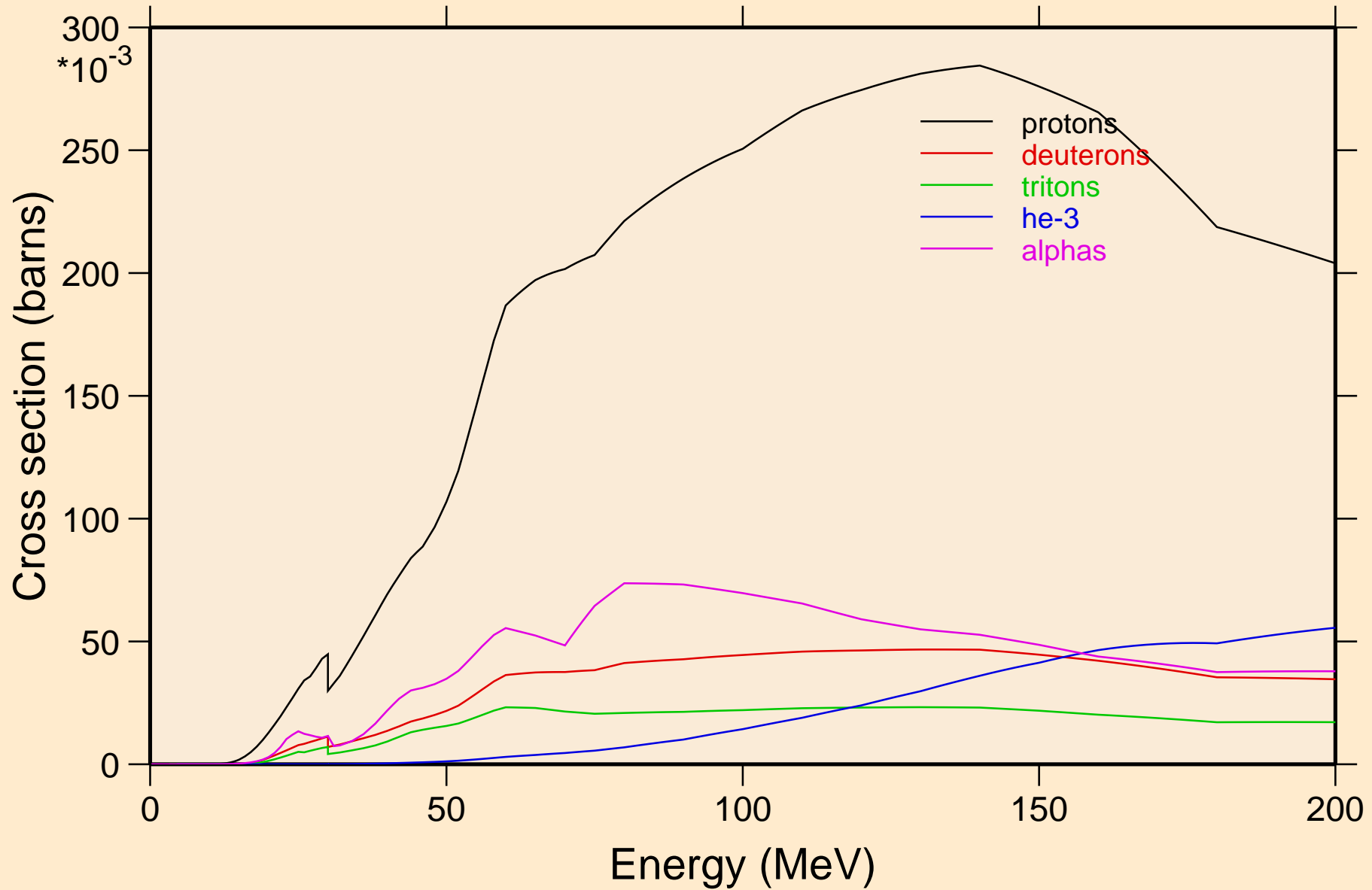

CM247 NEUTRON ACER TENDL-2021 LIBRARY; T=293.6K
protons from (n,x)

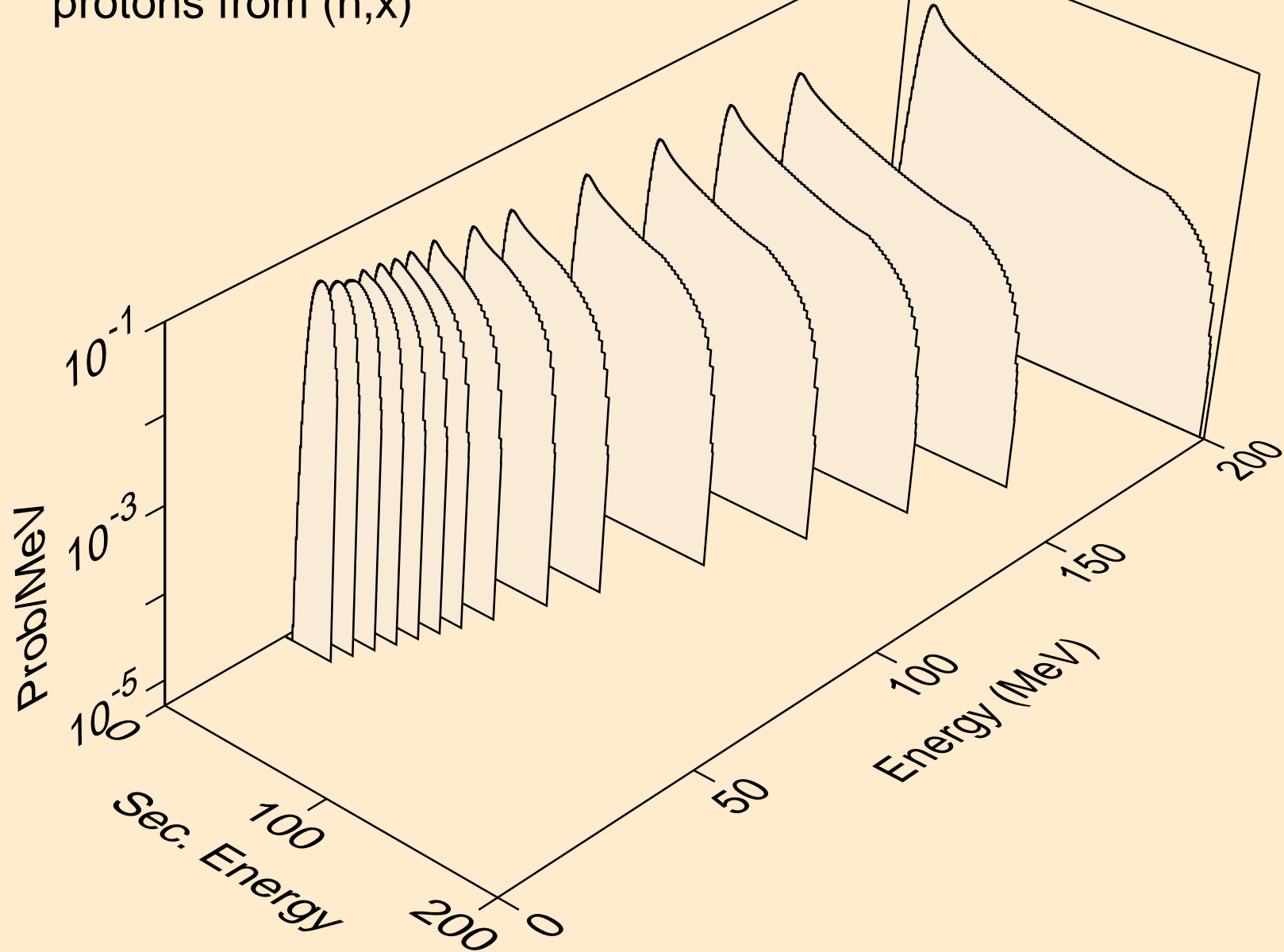

CM247 NEUTRON ACER TENDL-2021 LIBRARY; T=293.6K
protons from (n,n*)p

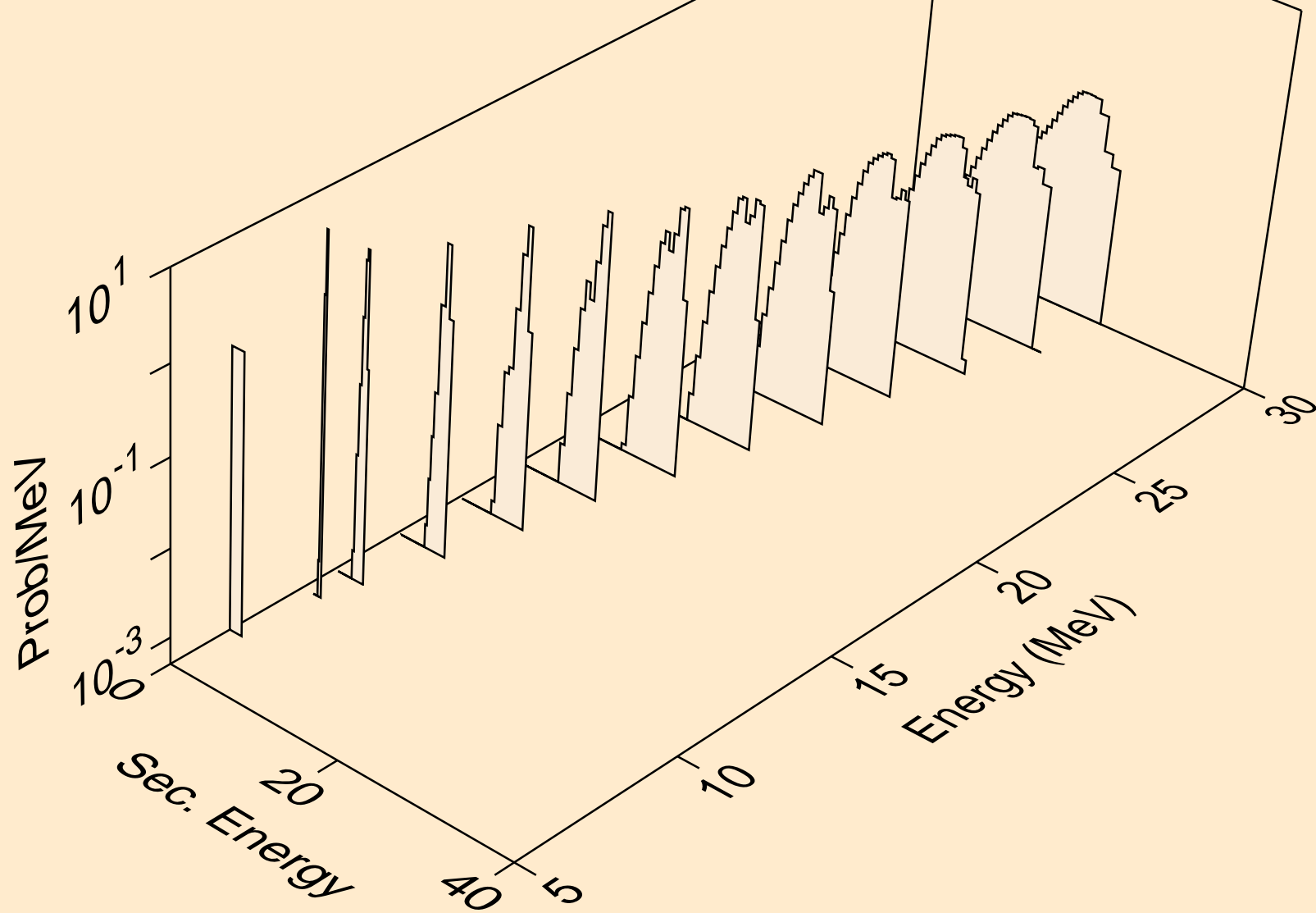

CM247 NEUTRON ACER TENDL-2021 LIBRARY; T=293.6K
protons from (n,2np)

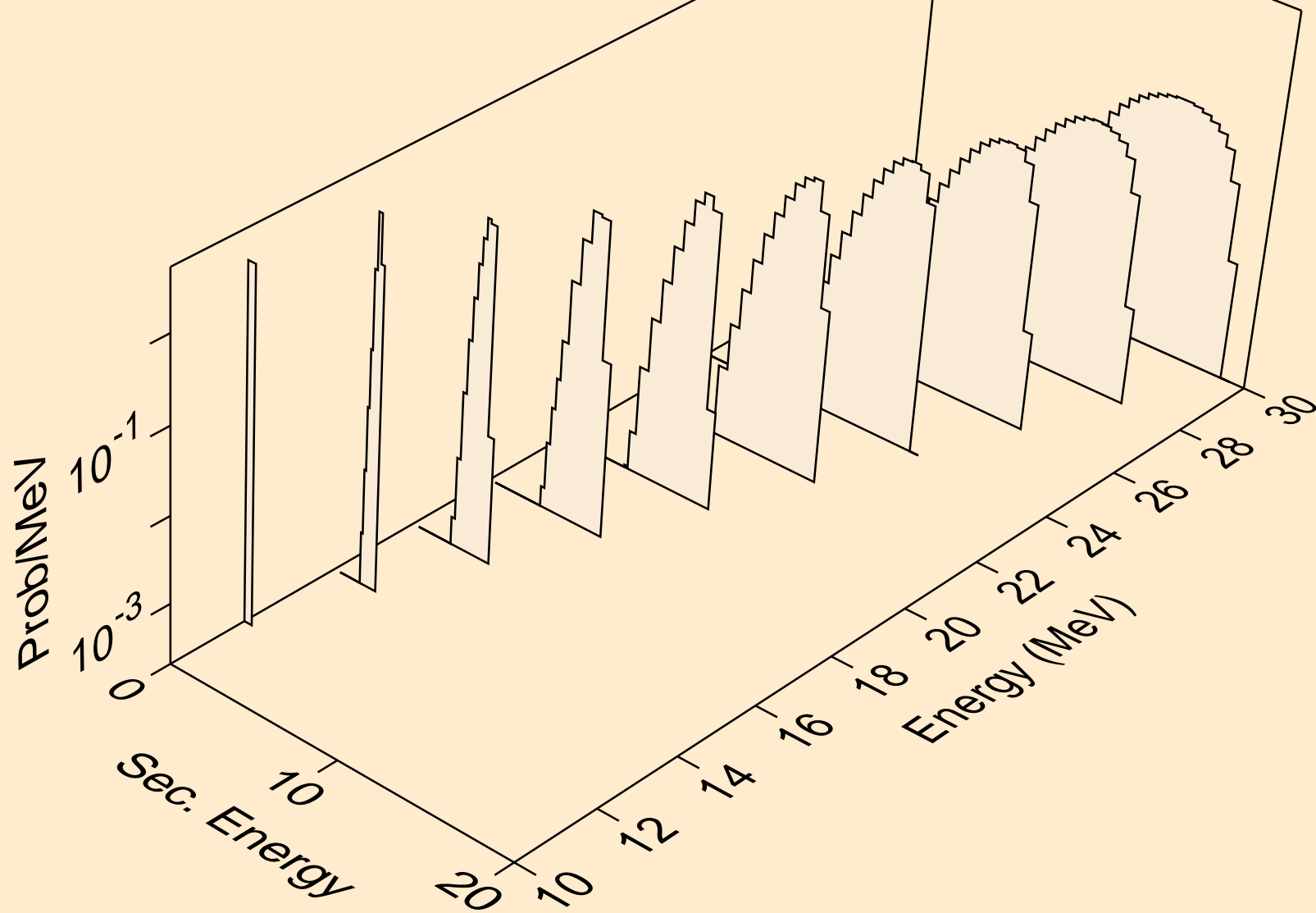

CM247 NEUTRON ACER TENDL-2021 LIBRARY; T=293.6K
protons from (n,3np)

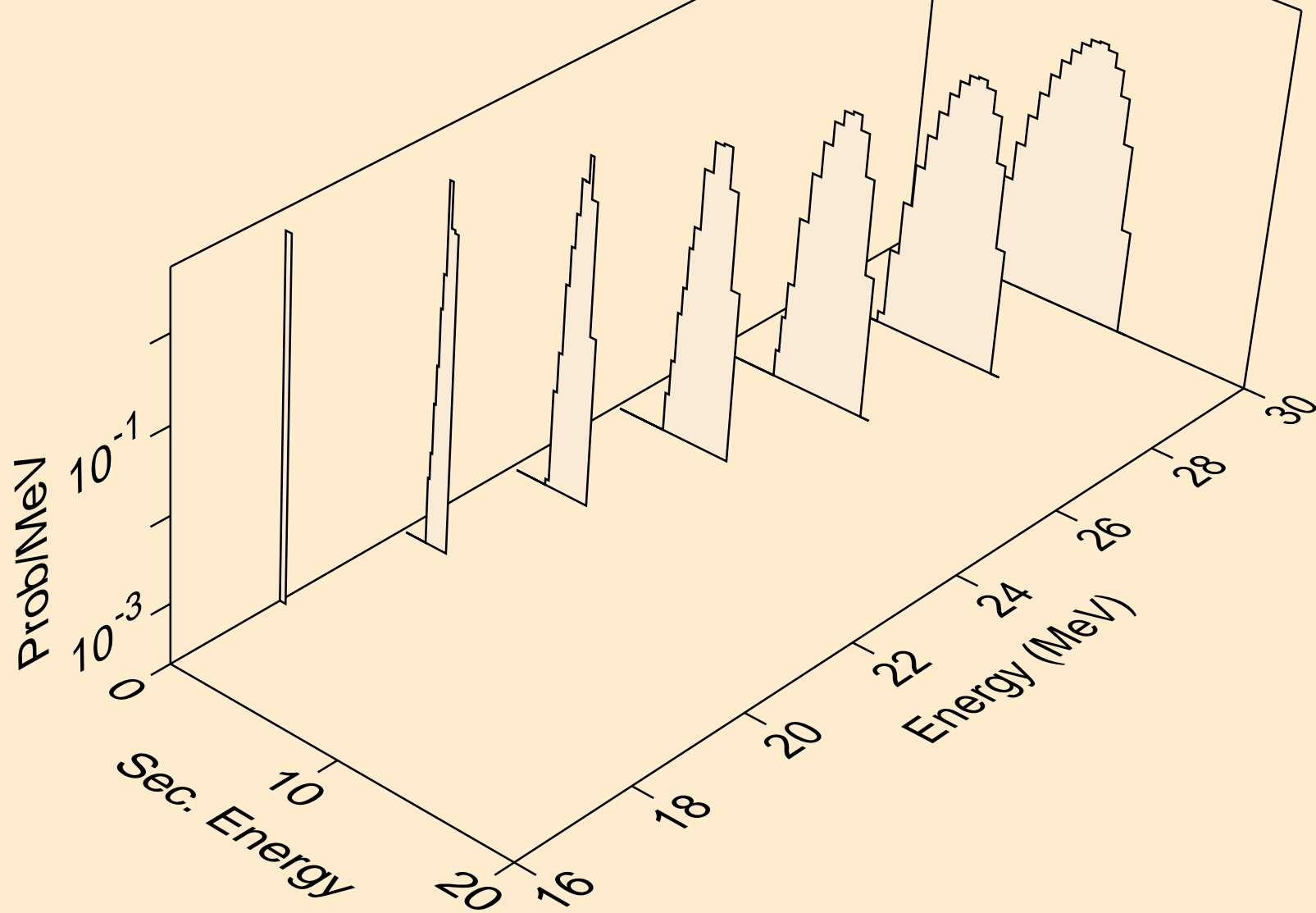

CM247 NEUTRON ACER TENDL-2021 LIBRARY; T=293.6K
protons from (n,2np)

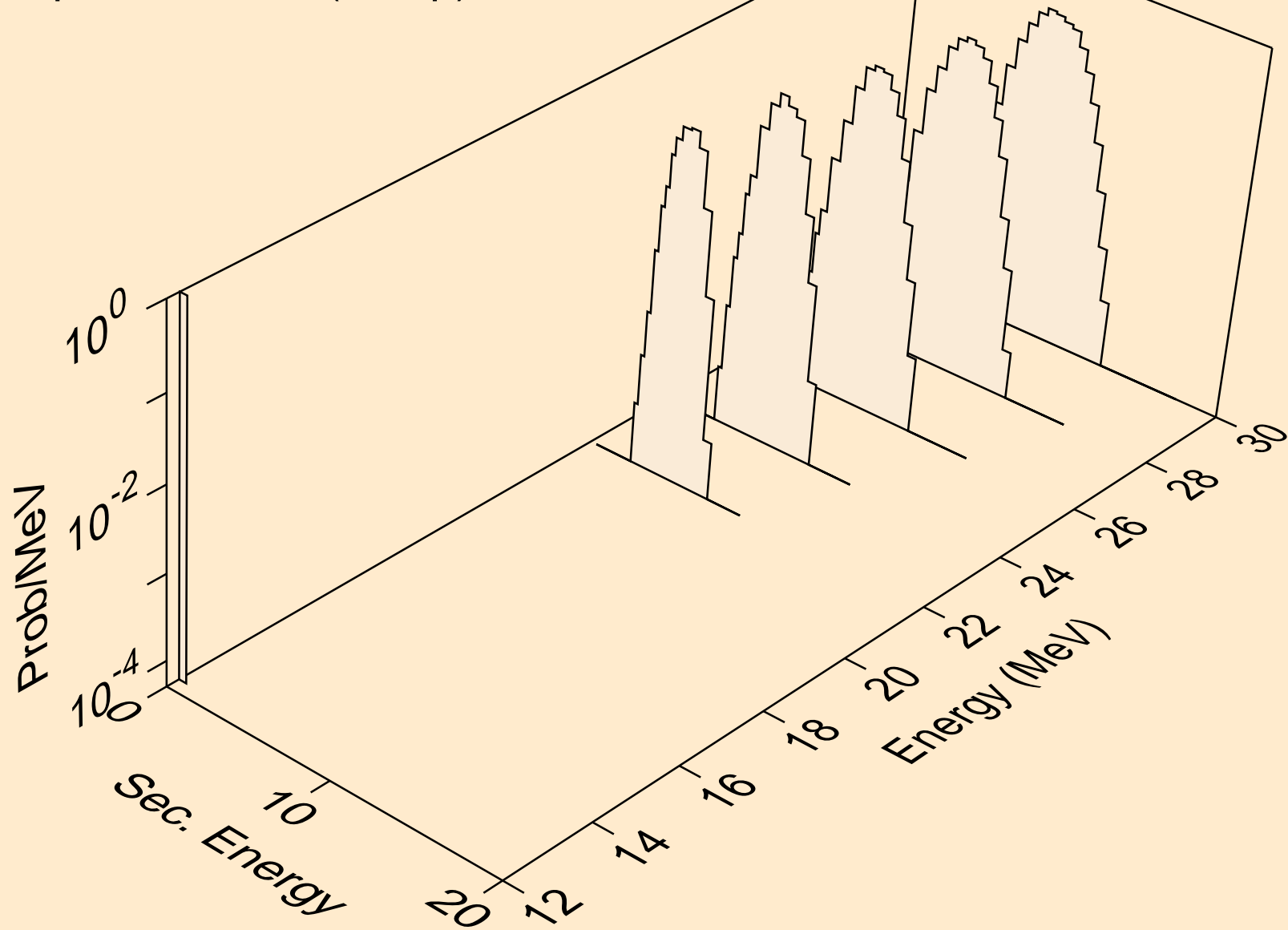

CM247 NEUTRON ACER TENDL-2021 LIBRARY; T=293.6K
protons from (n,p)

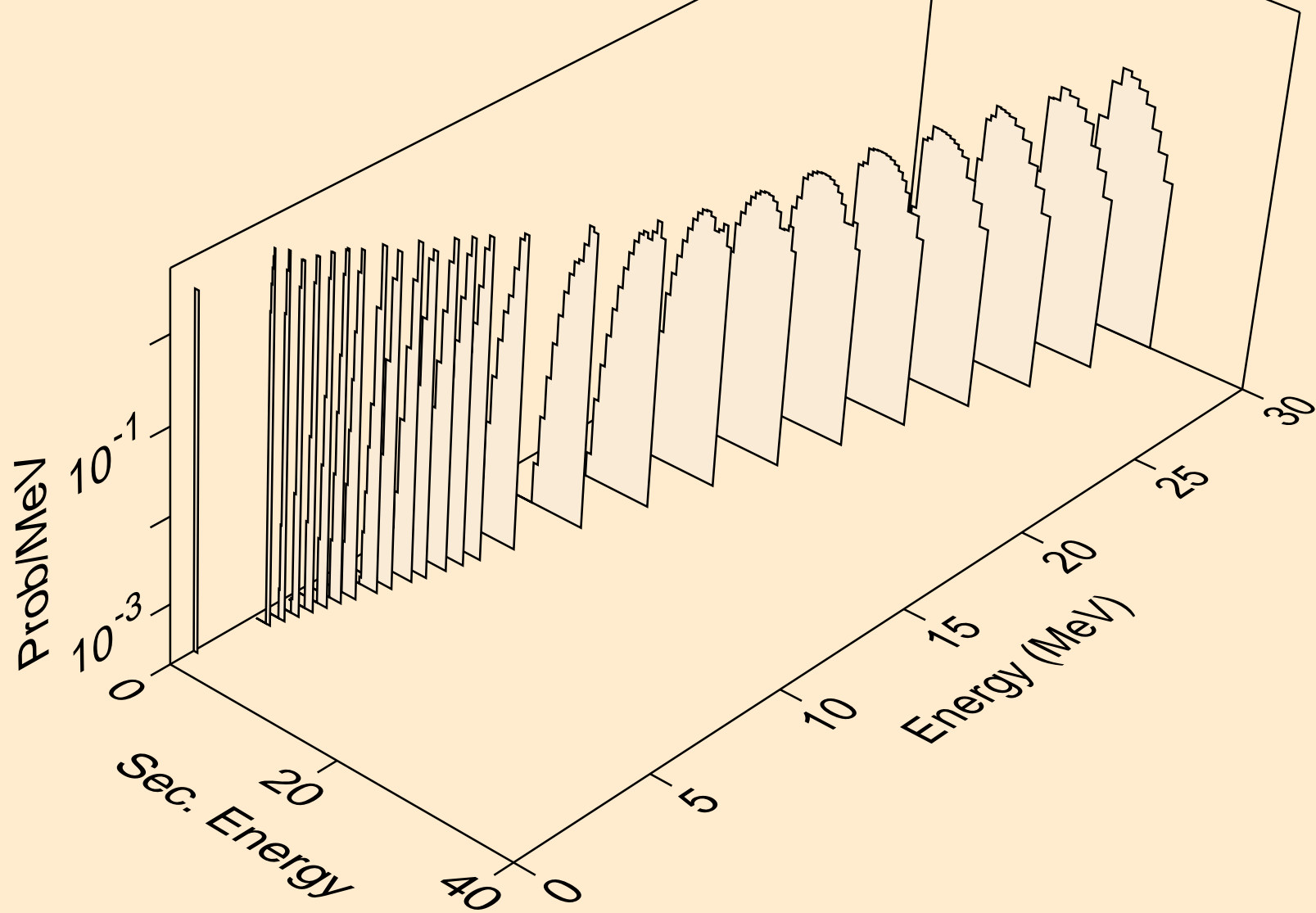

CM247 NEUTRON ACER TENDL-2021 LIBRARY; T=293.6K
protons from (n,2p)

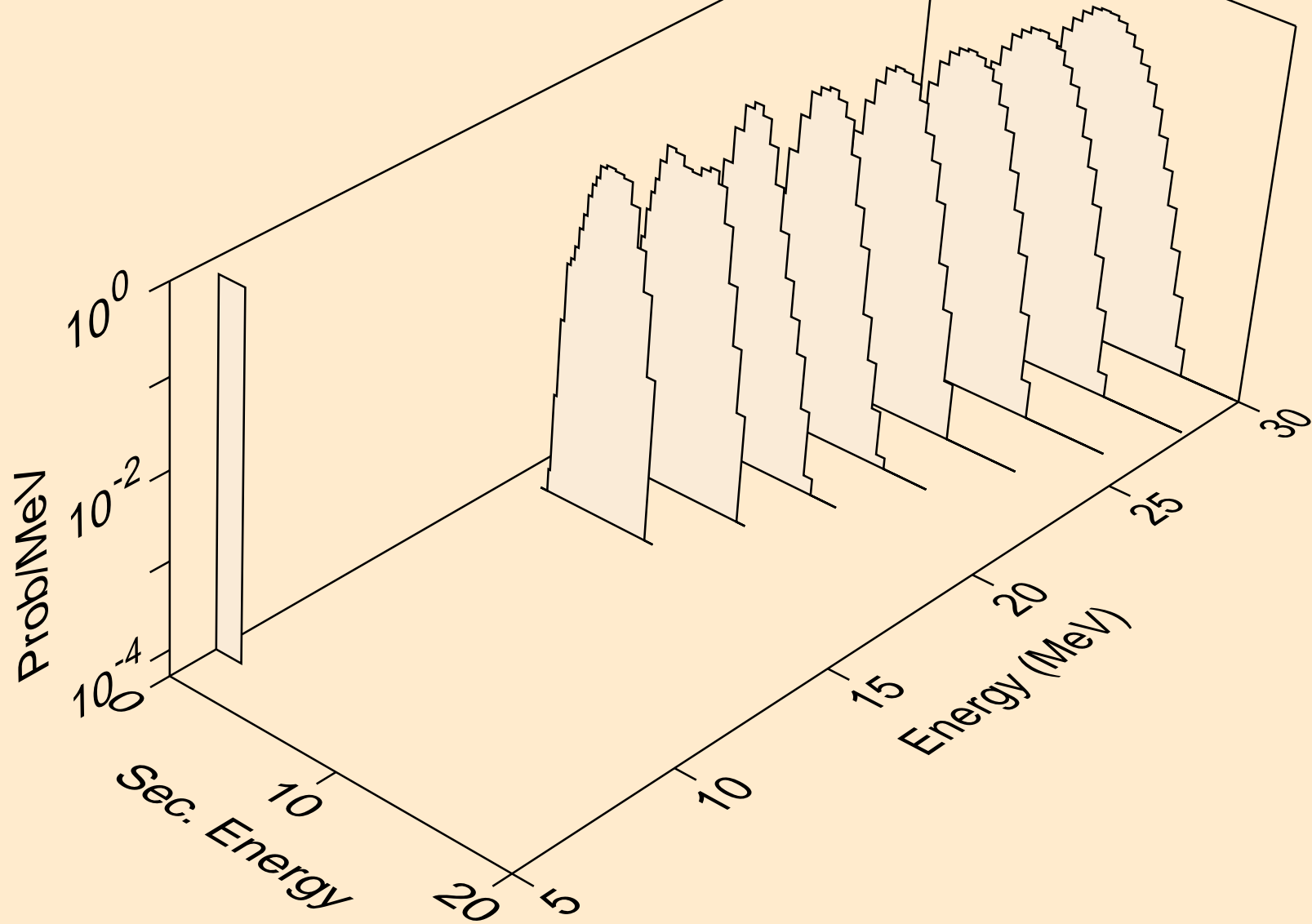

CM247 NEUTRON ACER TENDL-2021 LIBRARY; T=293.6K
deuterons from (n,x)

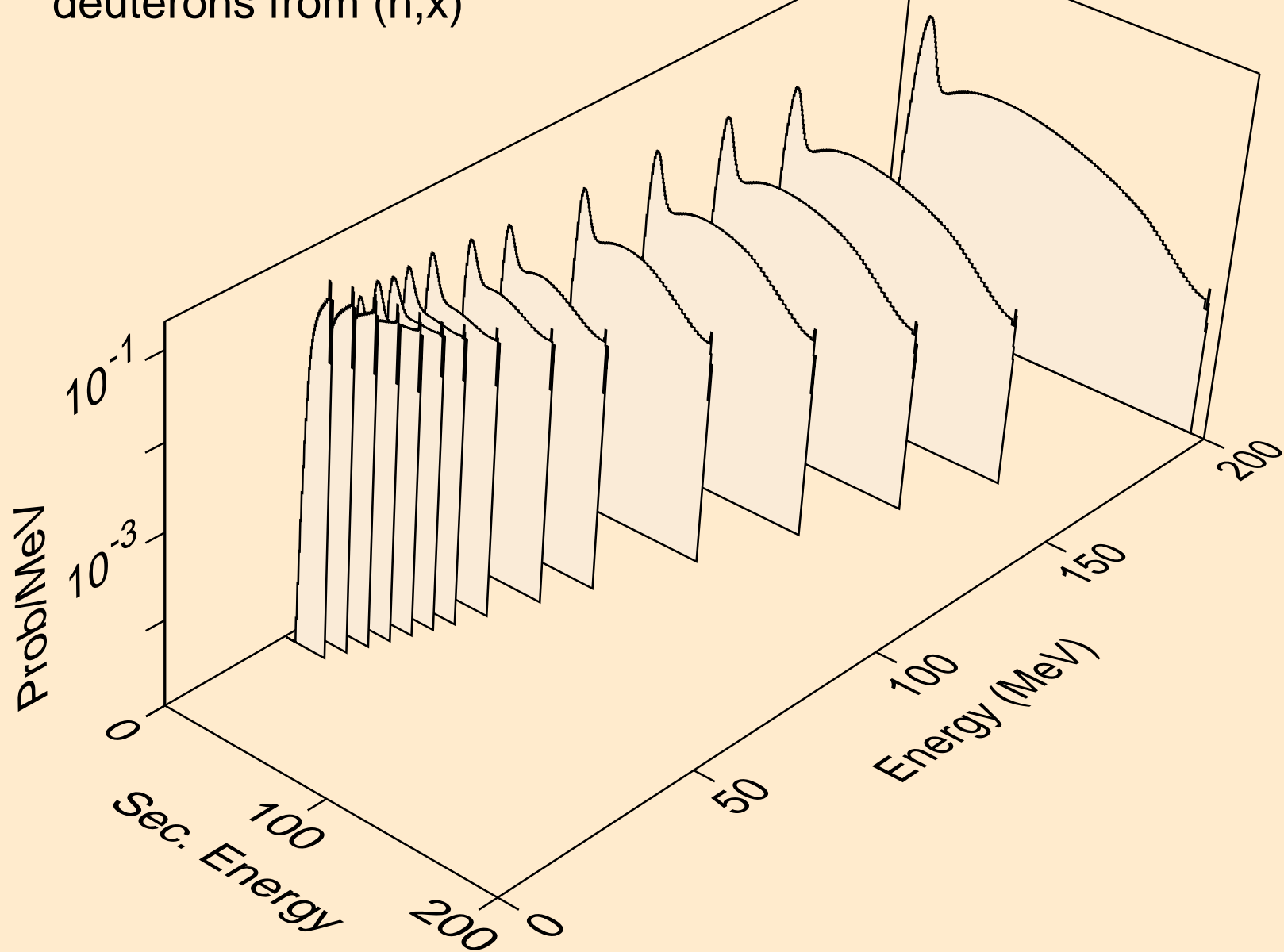

CM247 NEUTRON ACER TENDL-2021 LIBRARY; T=293.6K
deuterons from (n,2nd)

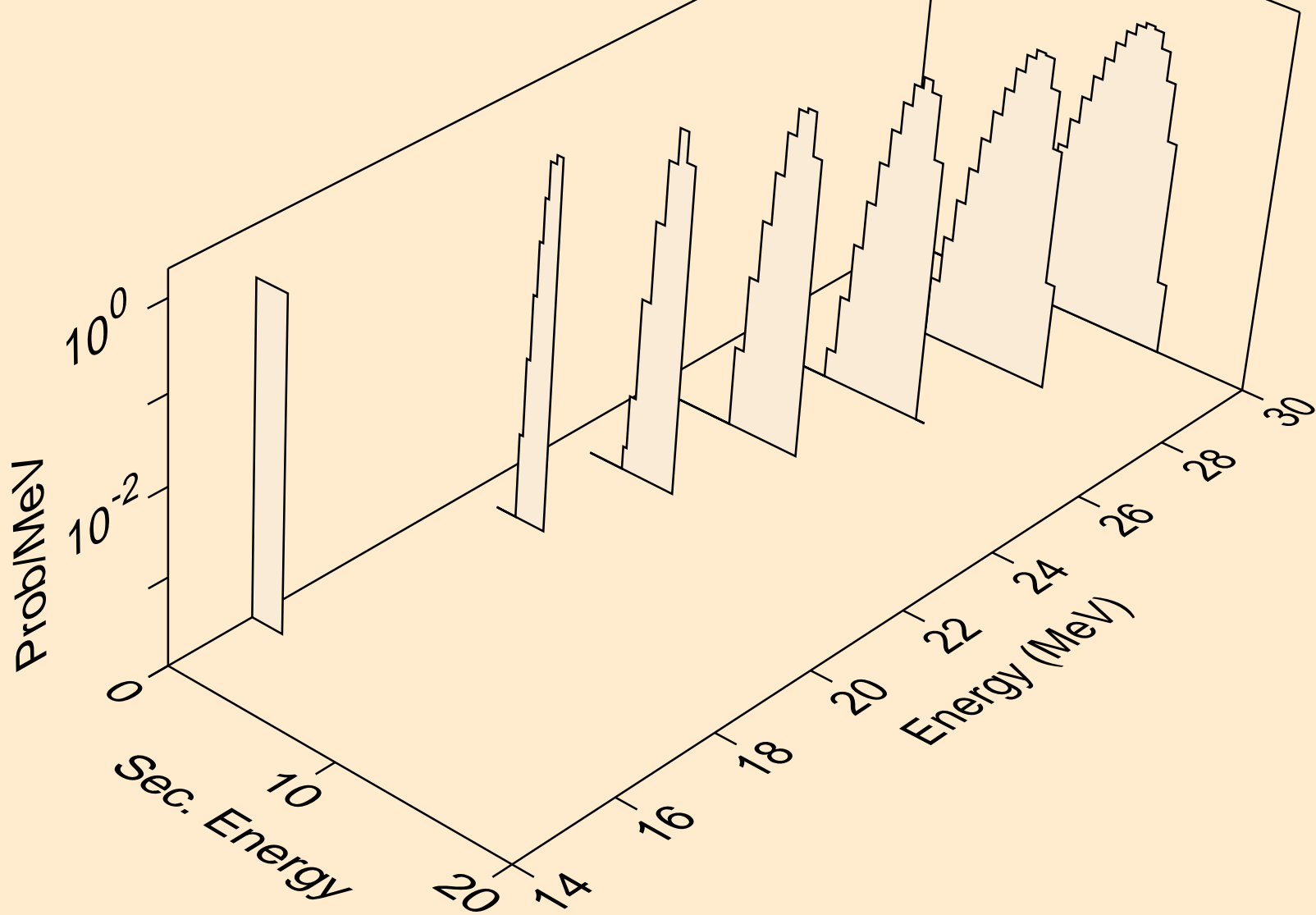

CM247 NEUTRON ACER TENDL-2021 LIBRARY; T=293.6K
deuterons from (n,n*)d

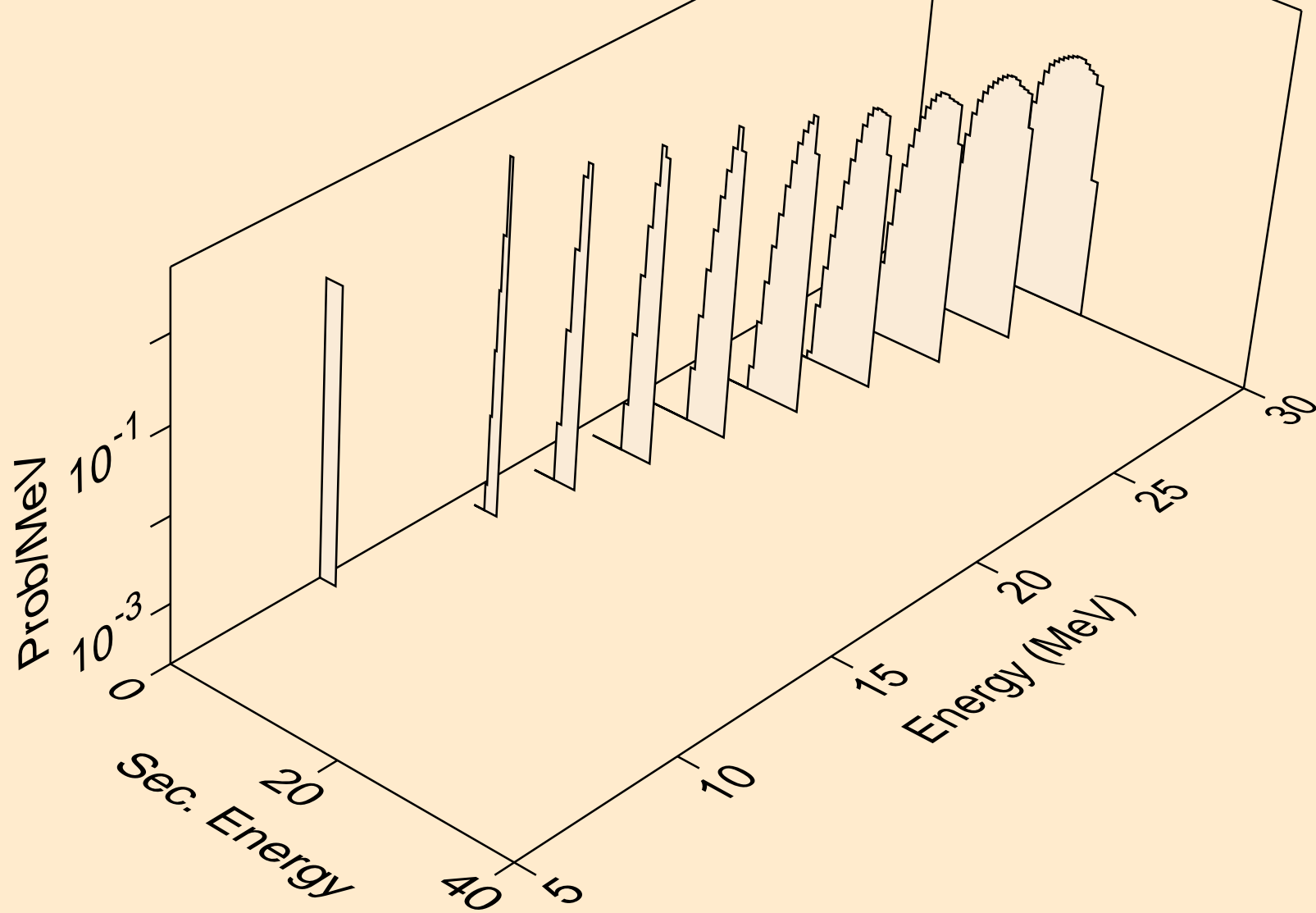

CM247 NEUTRON ACER TENDL-2021 LIBRARY; T=293.6K
deuterons from (n,d)

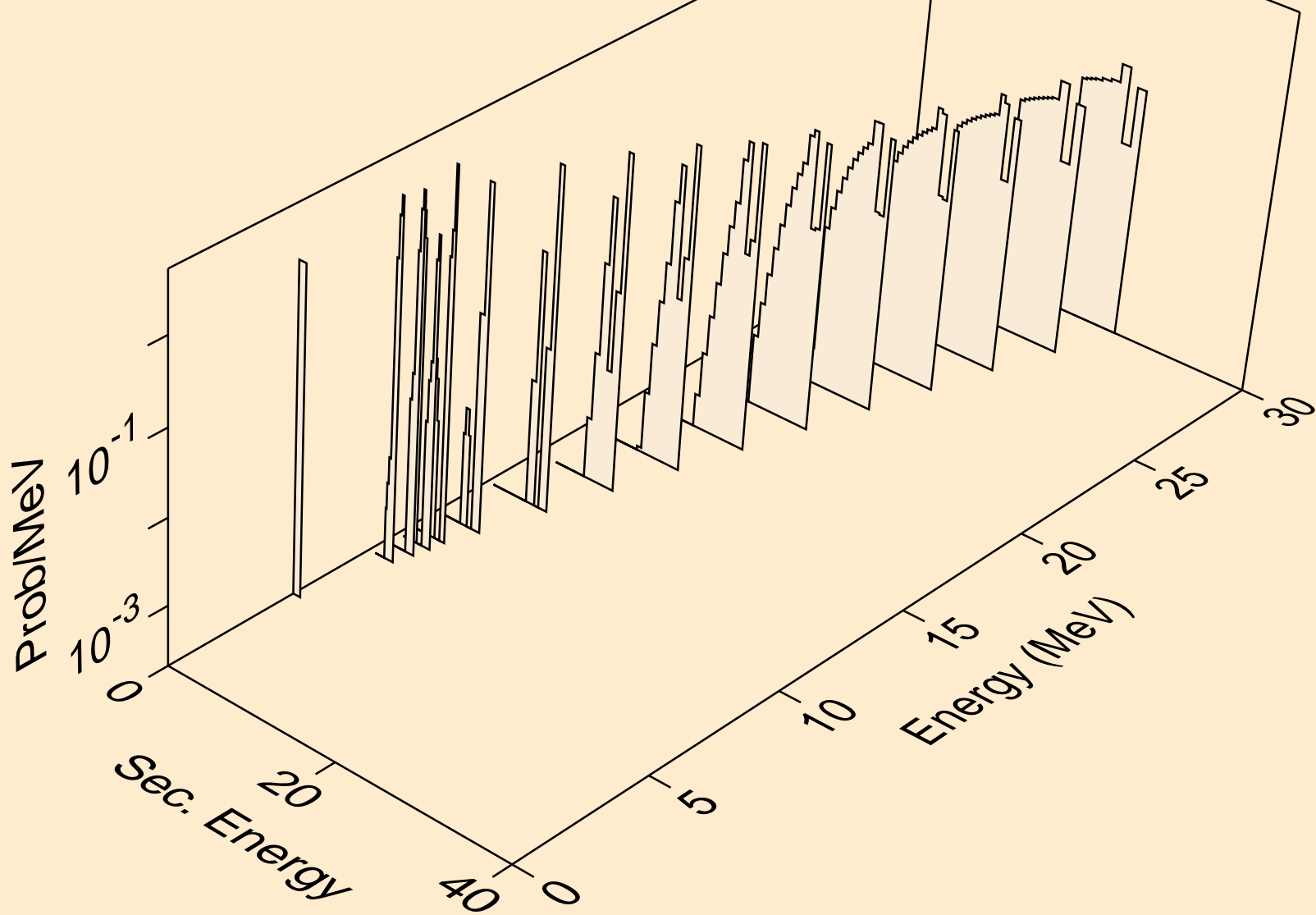

CM247 NEUTRON ACER TENDL-2021 LIBRARY; T=293.6K
tritons from (n,x)

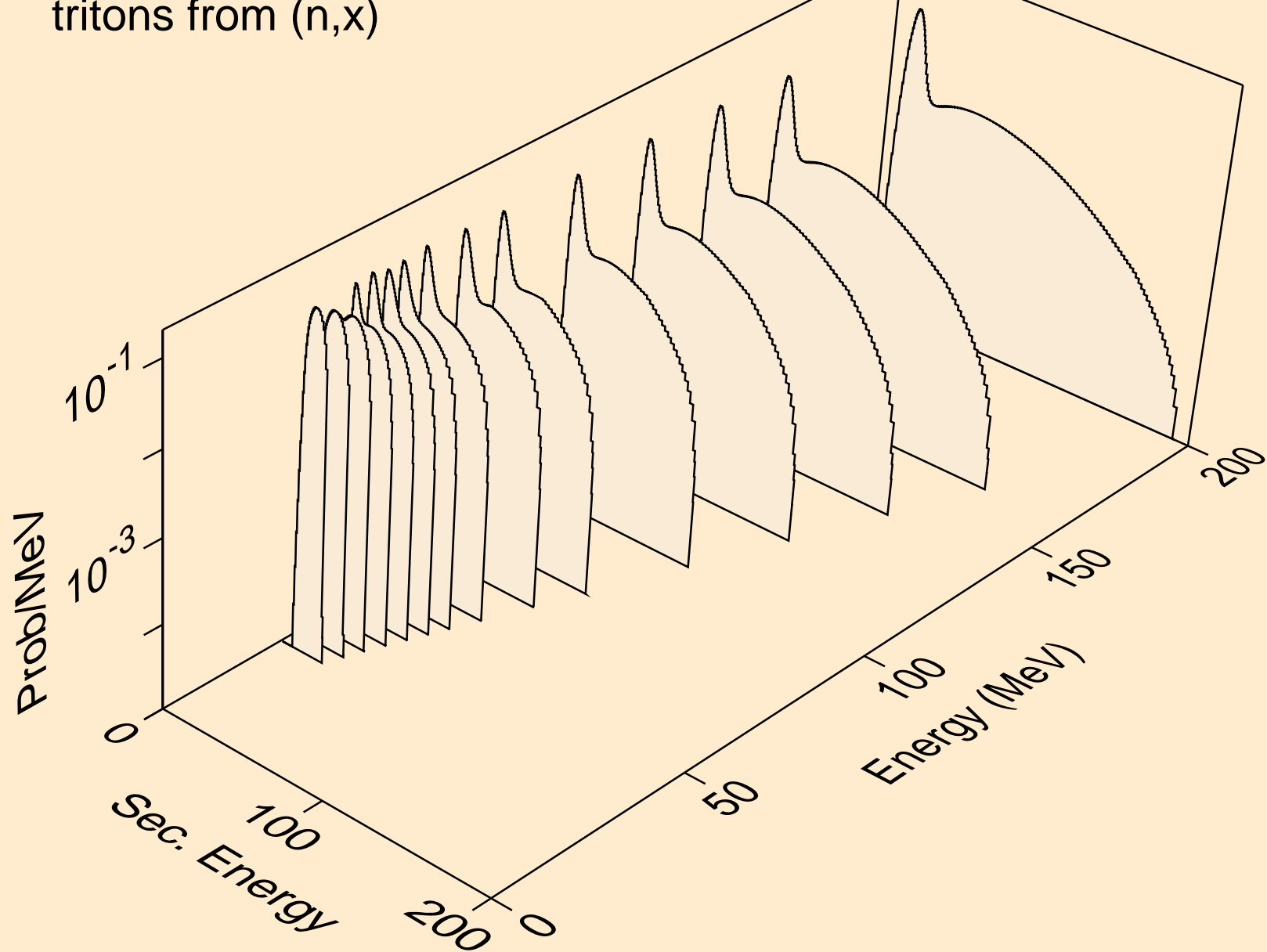

CM247 NEUTRON ACER TENDL-2021 LIBRARY; T=293.6K
tritons from (n,n*)t

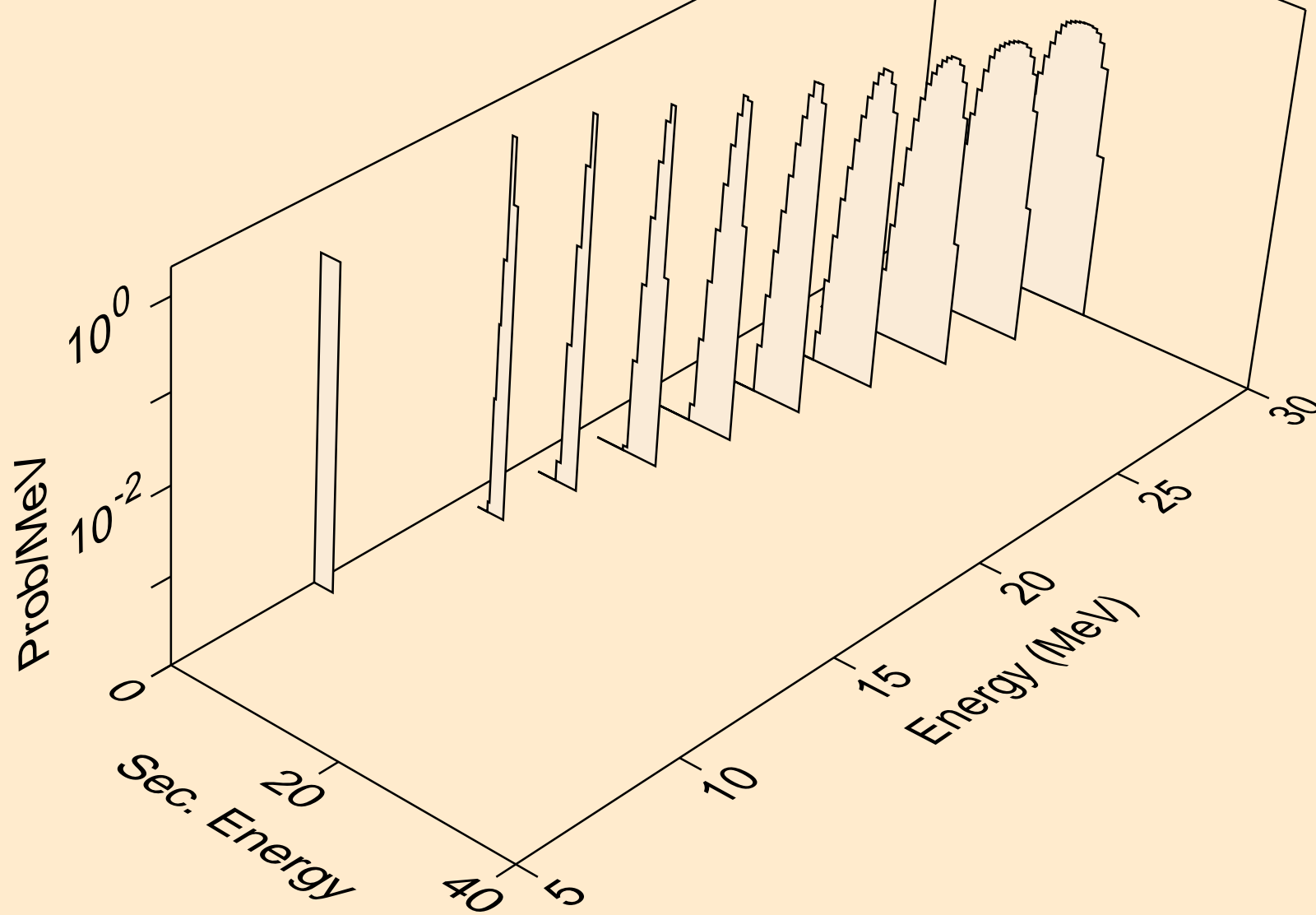

CM247 NEUTRON ACER TENDL-2021 LIBRARY; T=293.6K
tritons from (n,t)

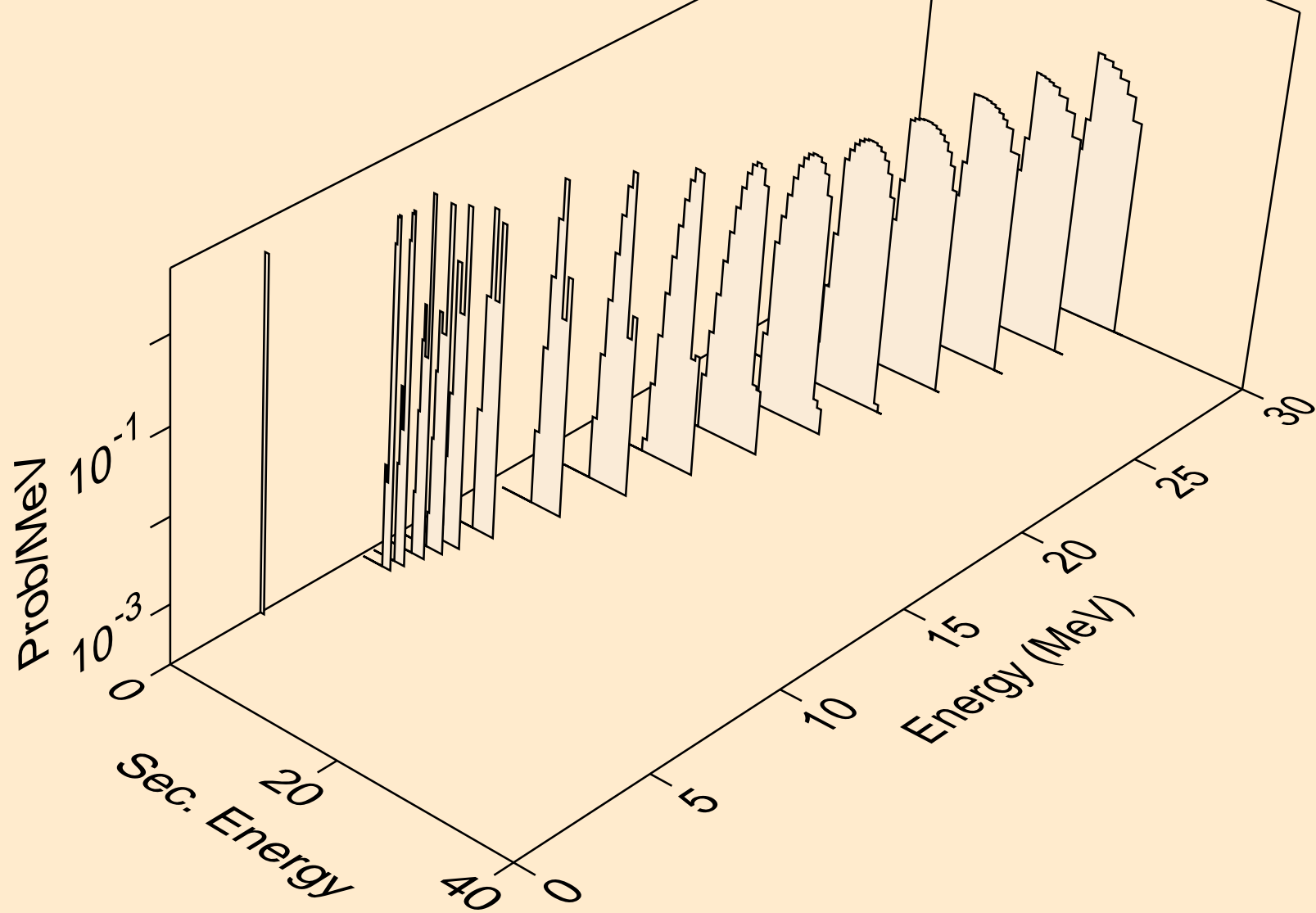

CM247 NEUTRON ACER TENDL-2021 LIBRARY; T=293.6K
he3s from (n,x)

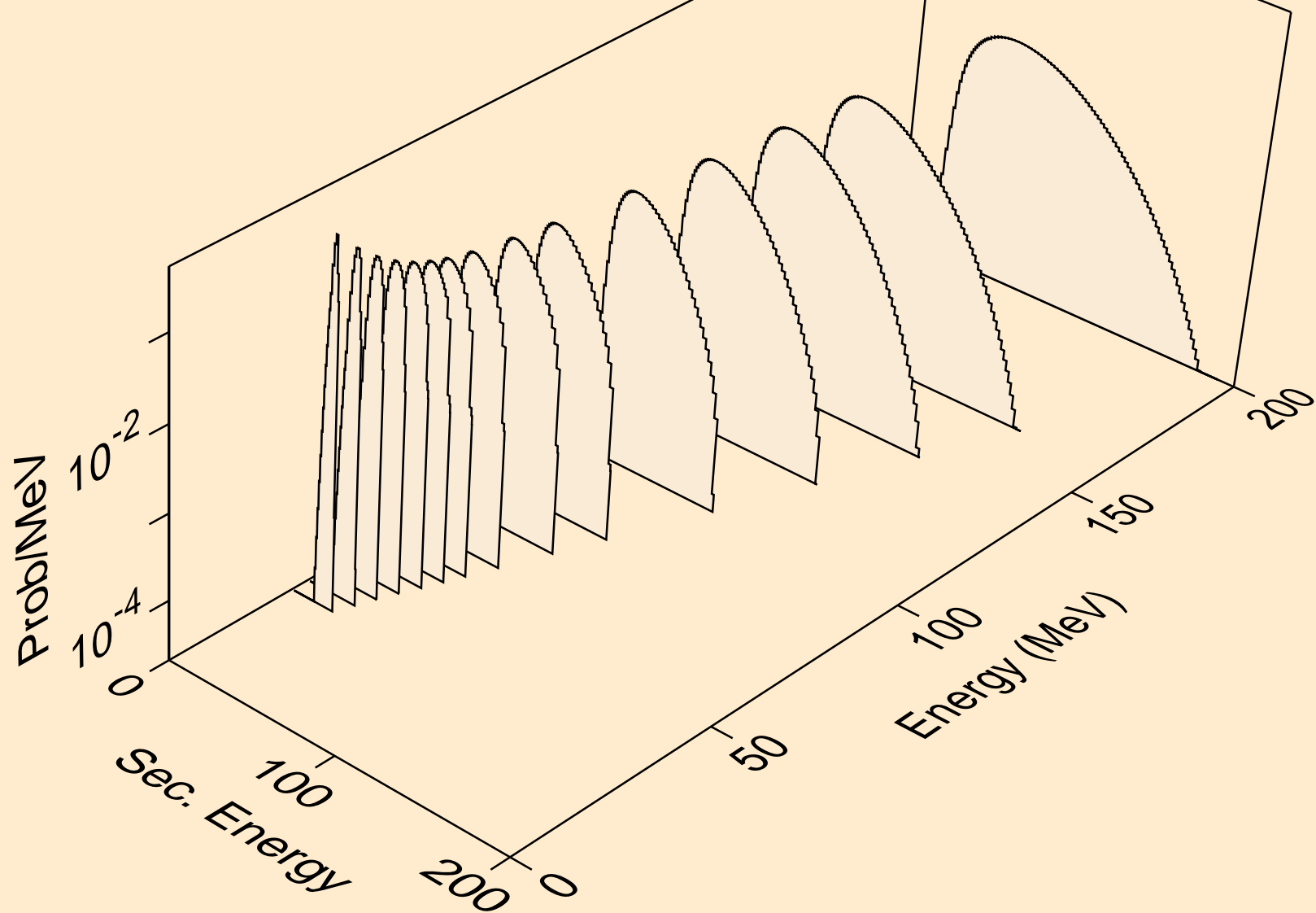

CM247 NEUTRON ACER TENDL-2021 LIBRARY; T=293.6K
he3s from (n,n*)he3

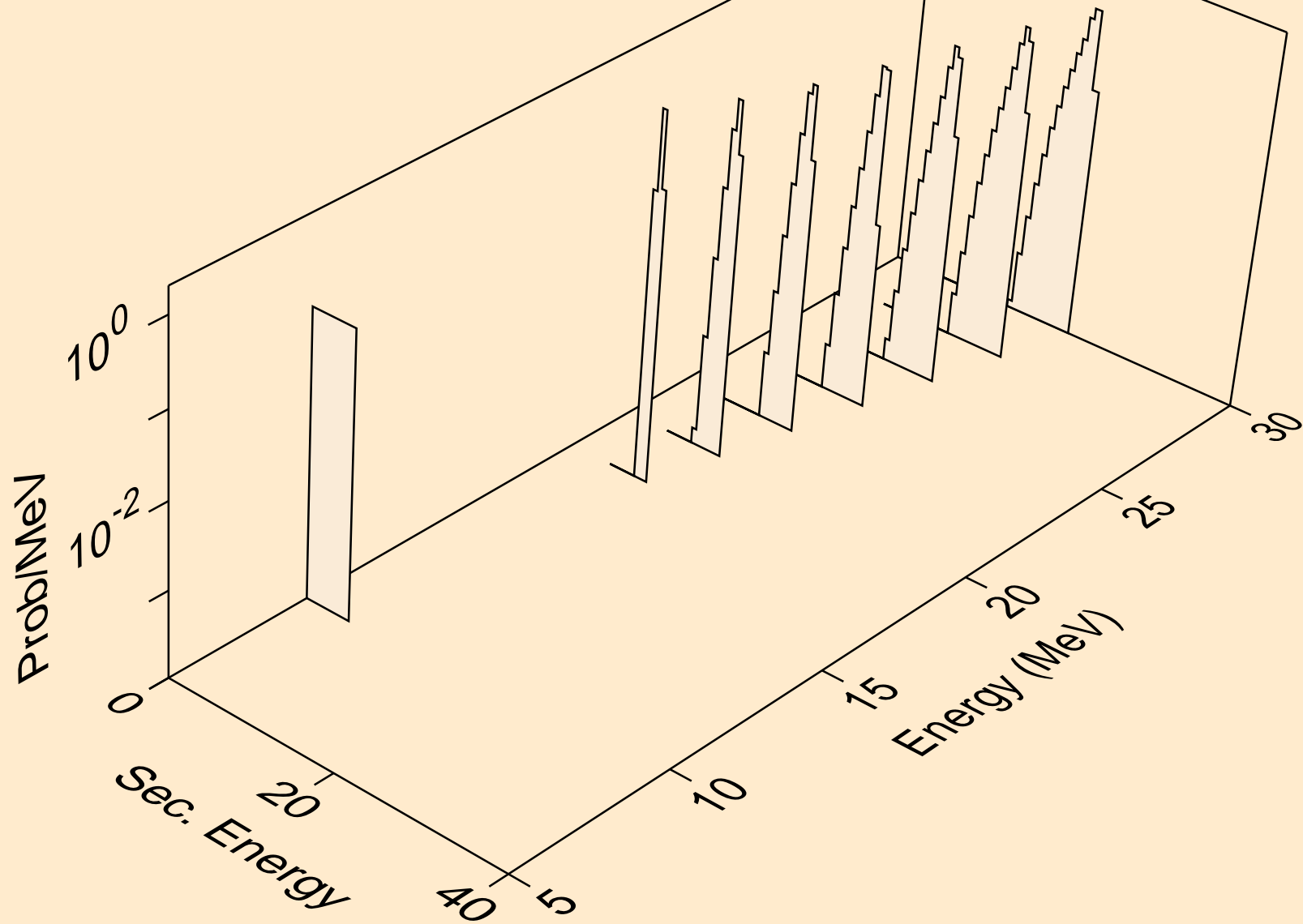

CM247 NEUTRON ACER TENDL-2021 LIBRARY; T=293.6K
he3s from (n,he3)

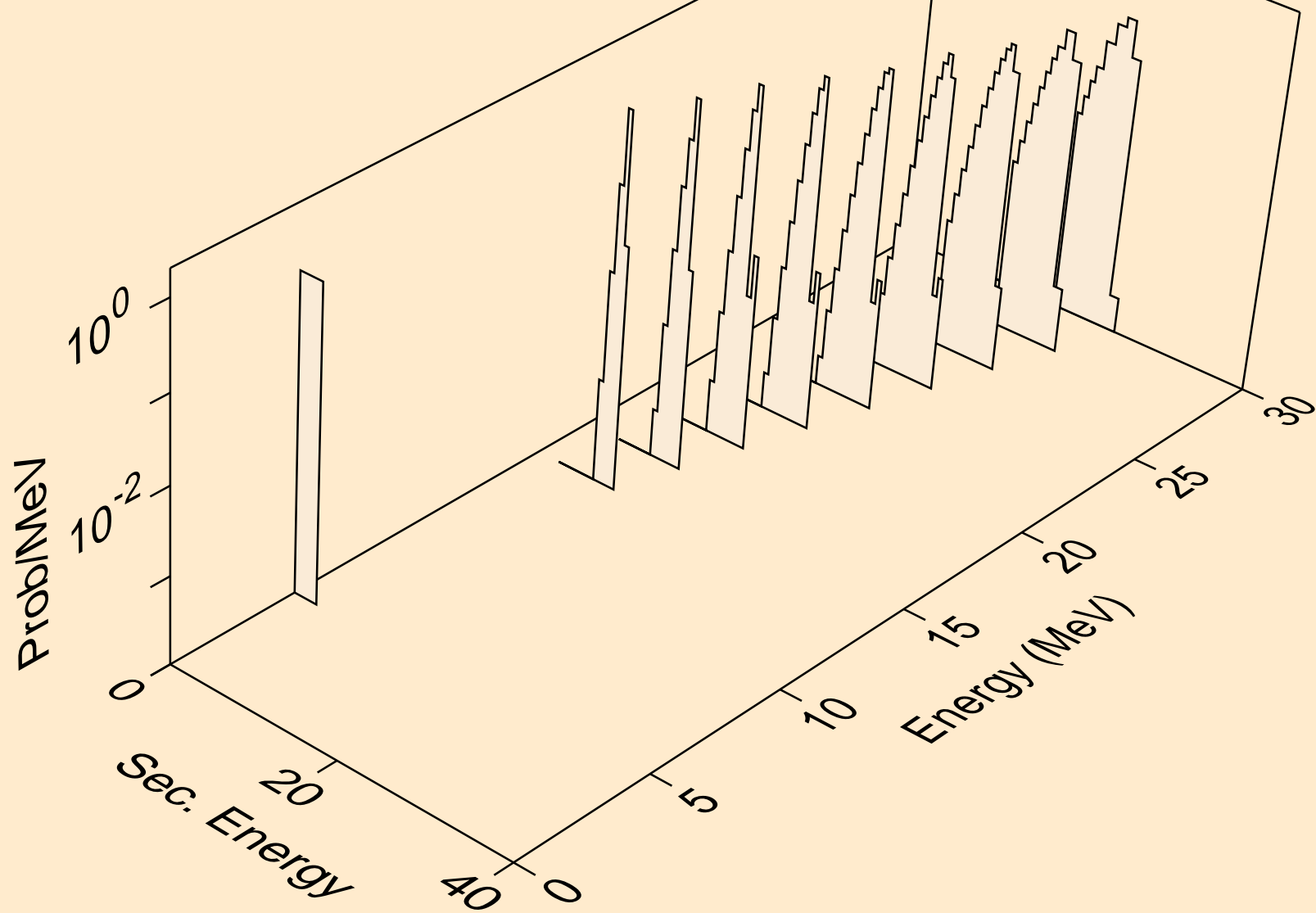

CM247 NEUTRON ACER TENDL-2021 LIBRARY; T=293.6K
alphas from (n,x)

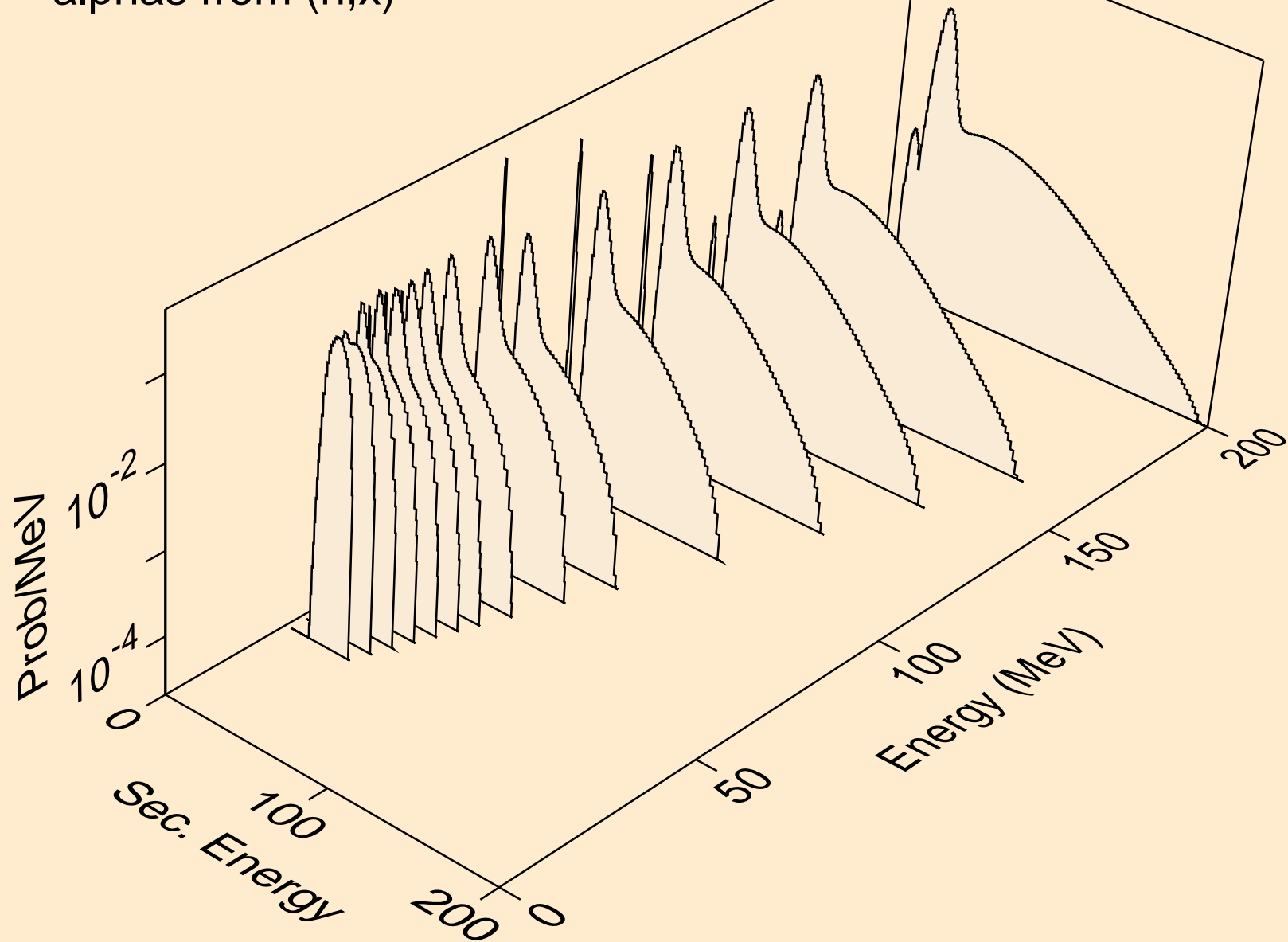

CM247 NEUTRON ACER TENDL-2021 LIBRARY; T=293.6K
alphas from (n,n*)a

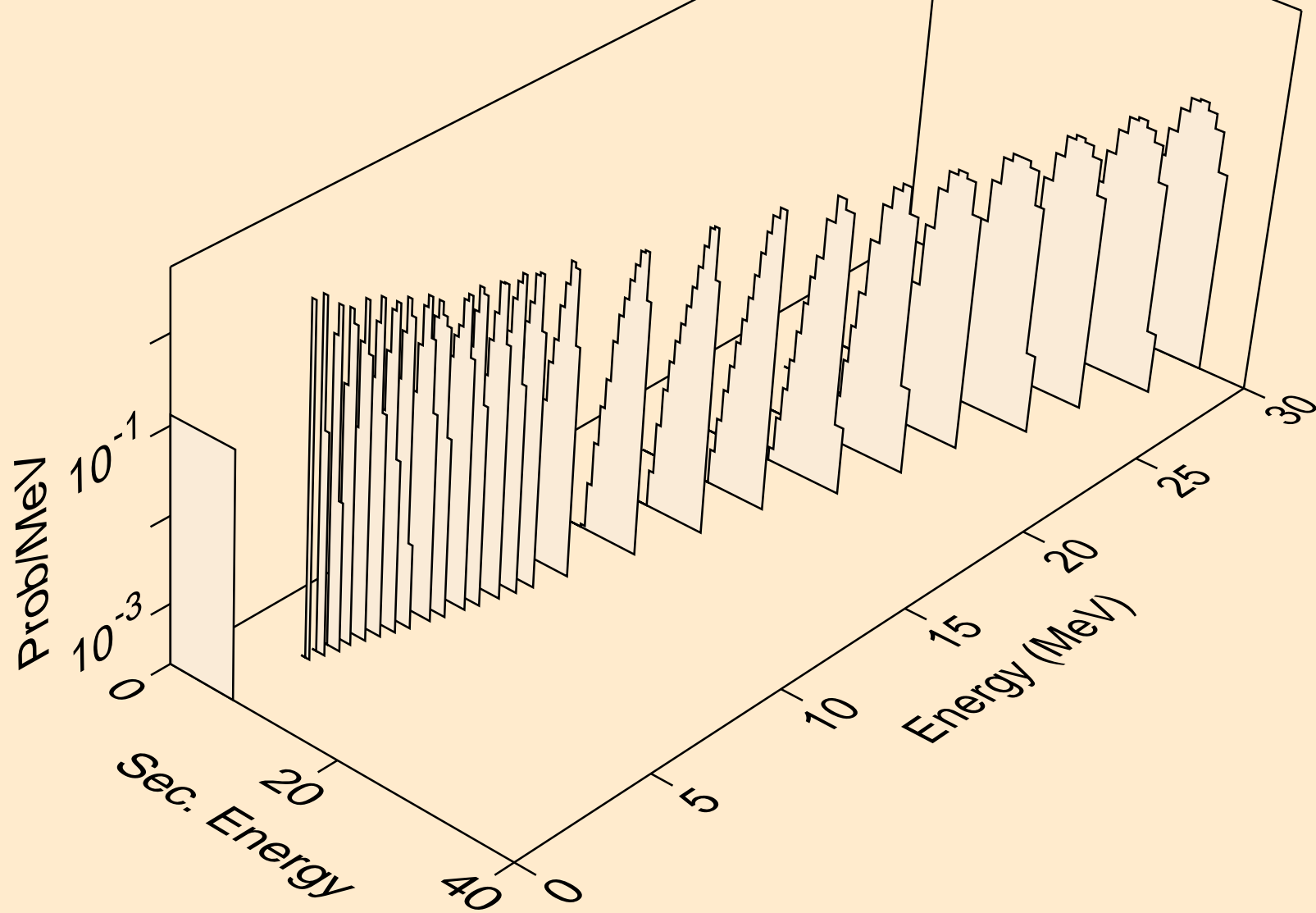

CM247 NEUTRON ACER TENDL-2021 LIBRARY; T=293.6K
alphas from (n,2n)a

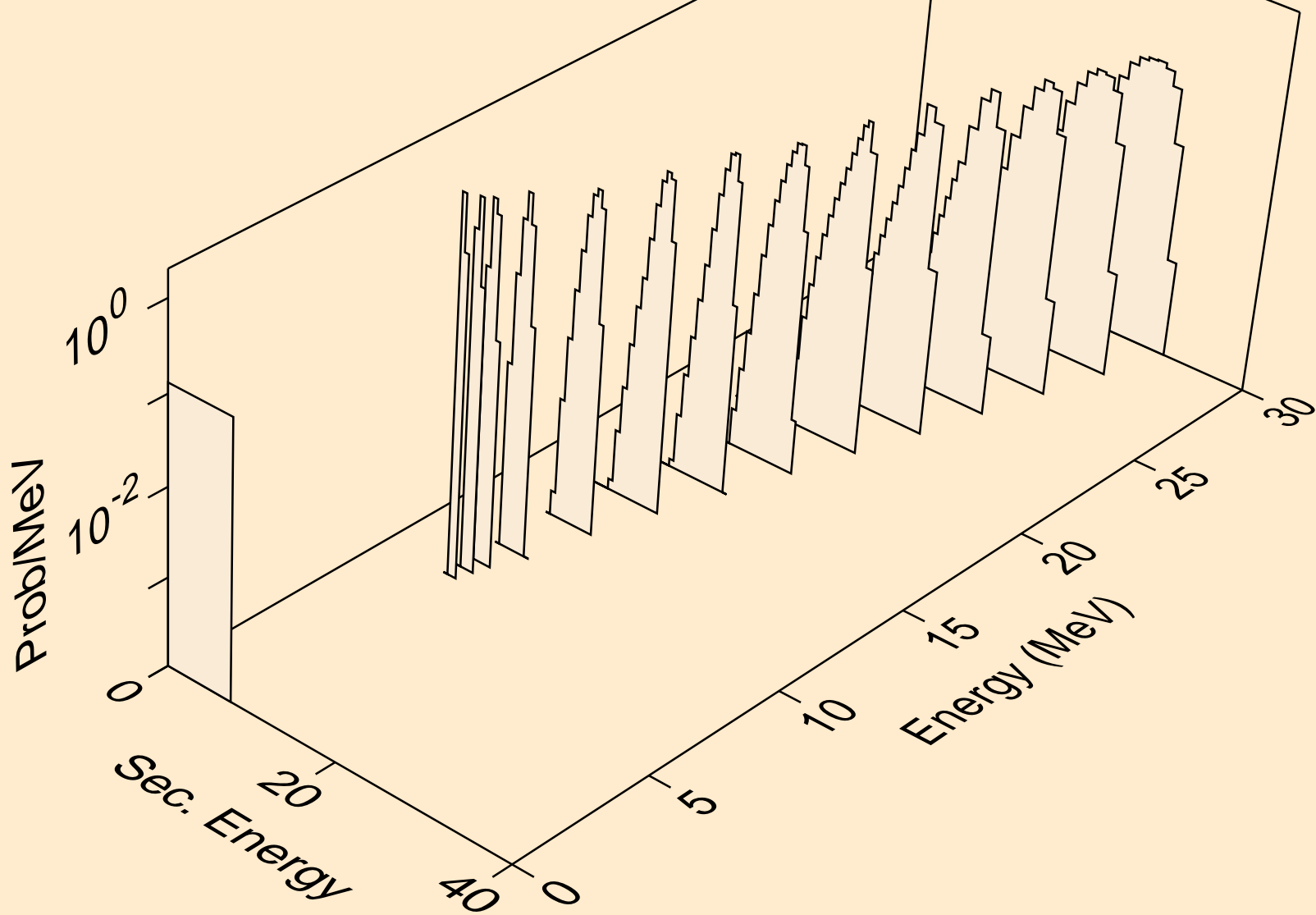

CM247 NEUTRON ACER TENDL-2021 LIBRARY; T=293.6K
alphas from (n,3n)a

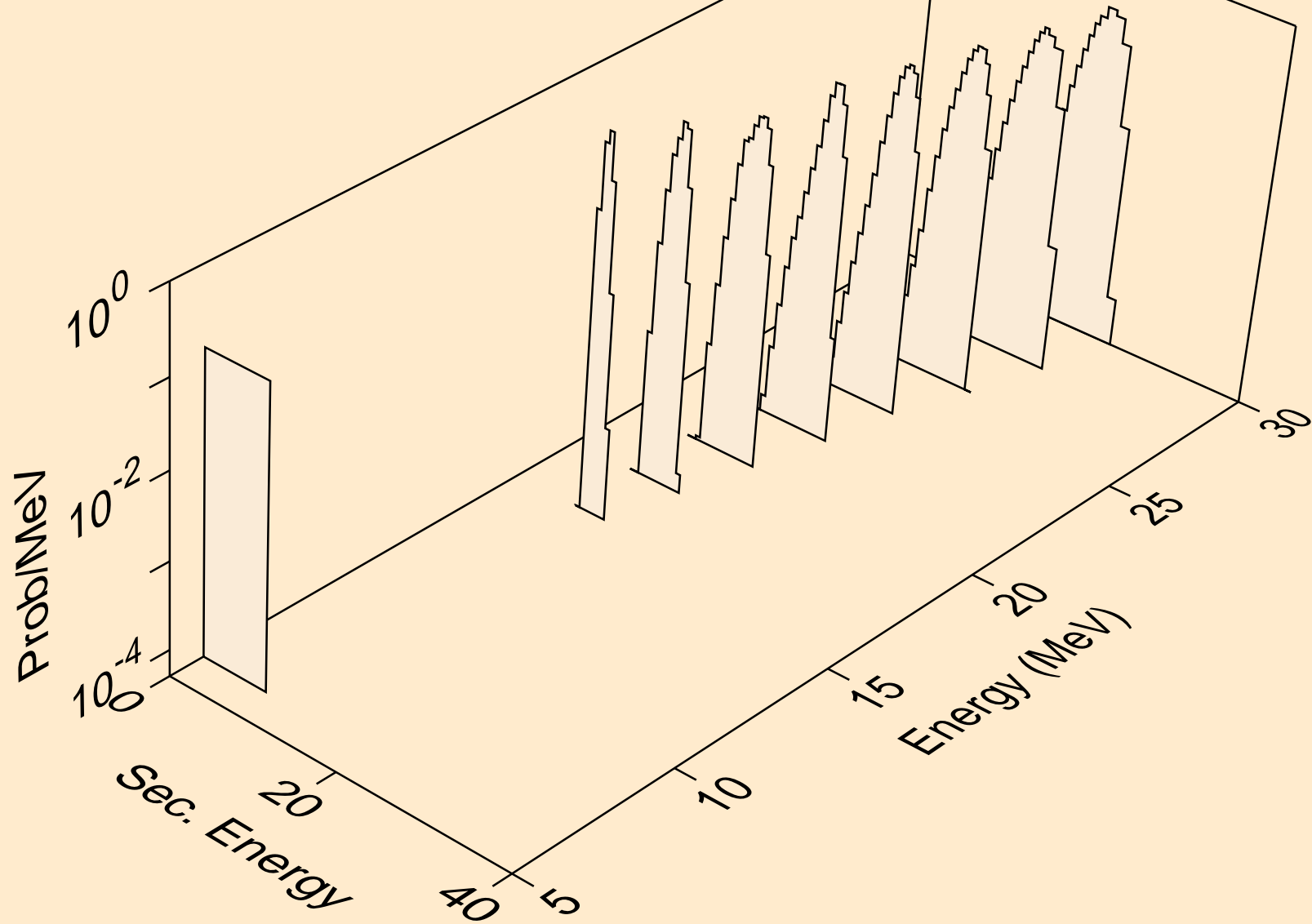

CM247 NEUTRON ACER TENDL-2021 LIBRARY; T=293.6K
alphas from (n,a)

