

CM249 NEUTRON ACER TENDL-2021 LIBRARY; T=293.6K

Principal cross sections

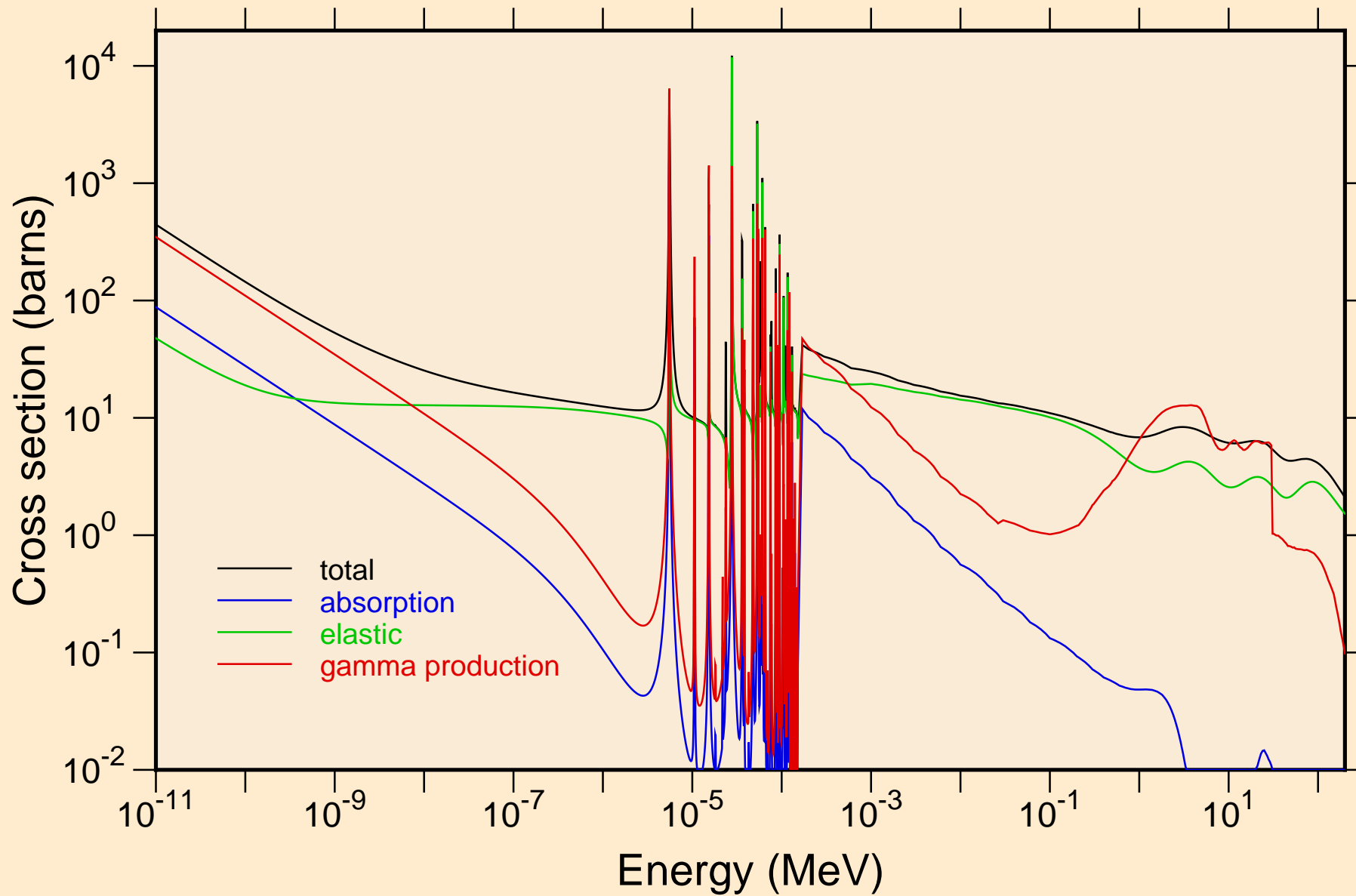

CM249 NEUTRON ACER TENDL-2021 LIBRARY; T=293.6K
resonance total cross section

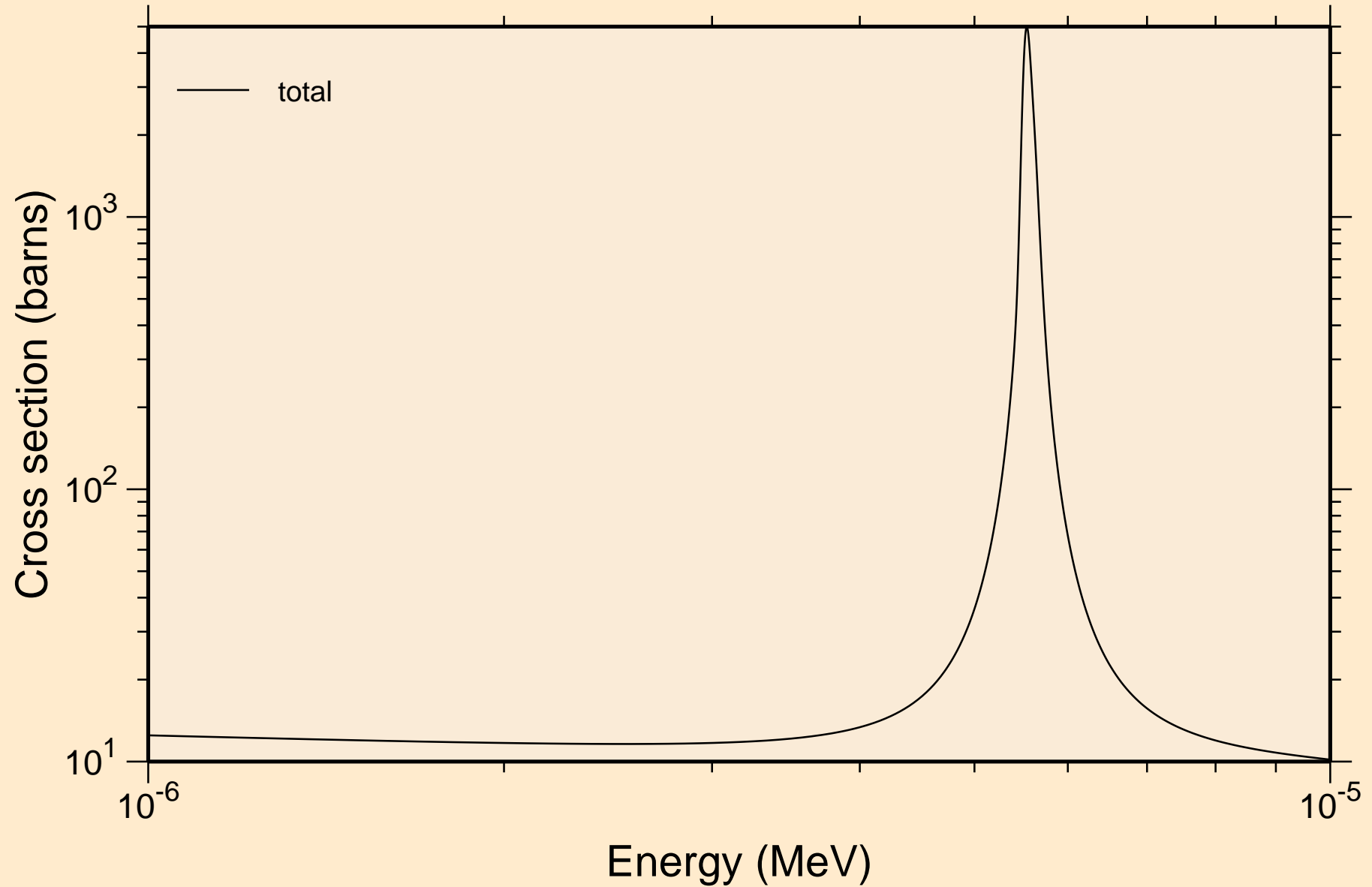

CM249 NEUTRON ACER TENDL-2021 LIBRARY; T=293.6K
resonance total cross section

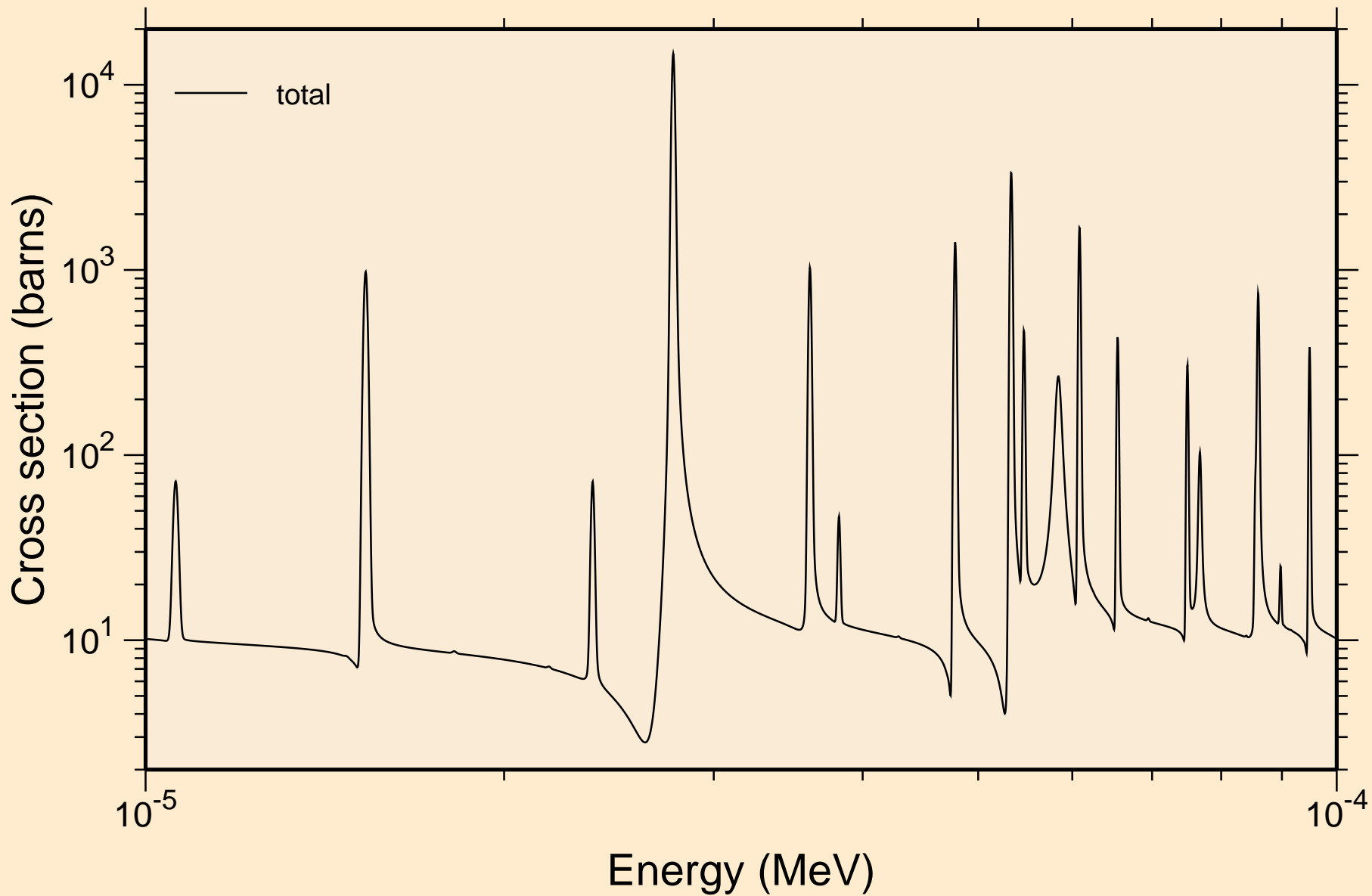

CM249 NEUTRON ACER TENDL-2021 LIBRARY; T=293.6K
resonance total cross section

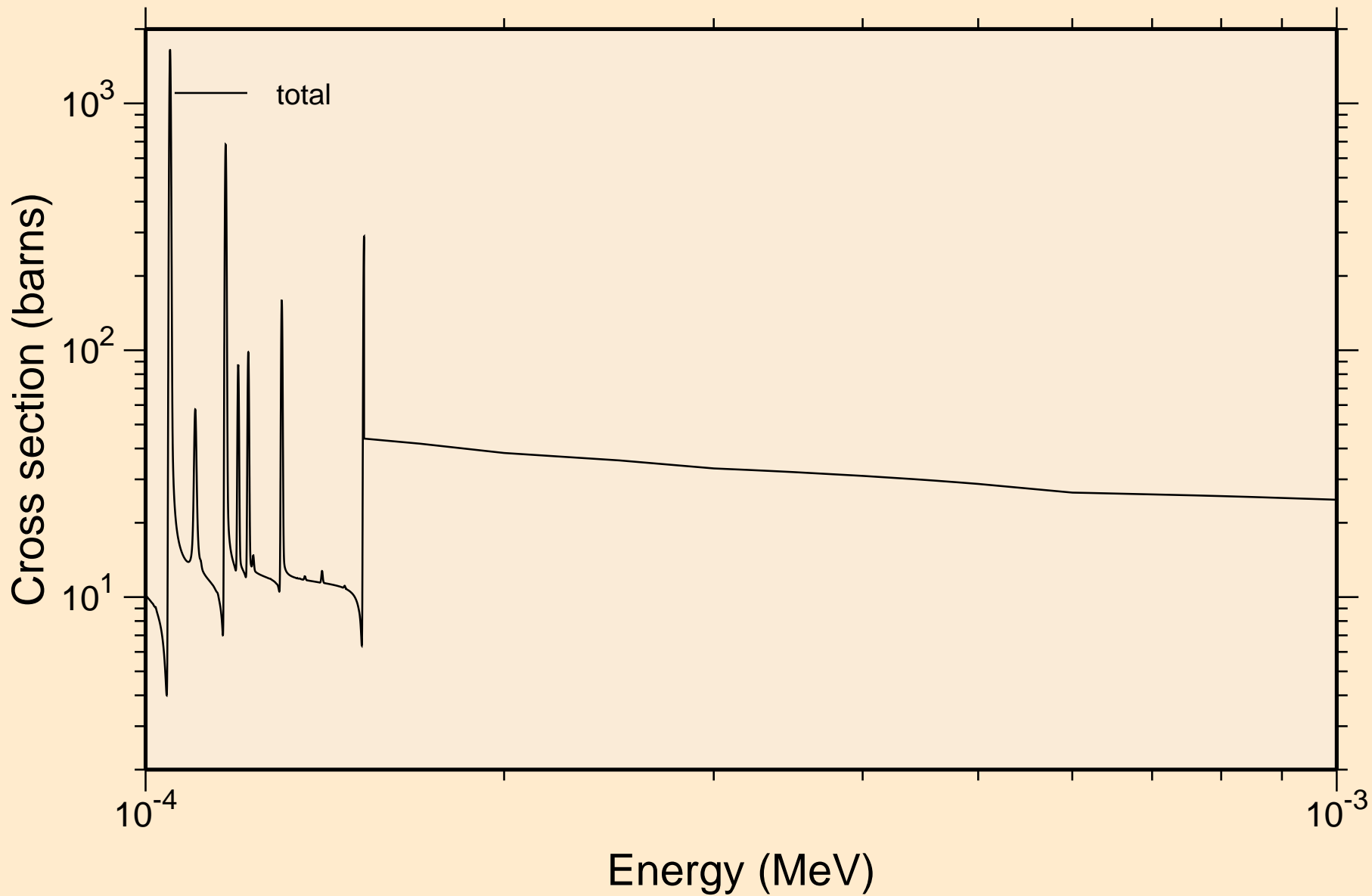

CM249 NEUTRON ACER TENDL-2021 LIBRARY; T=293.6K
resonance total cross section

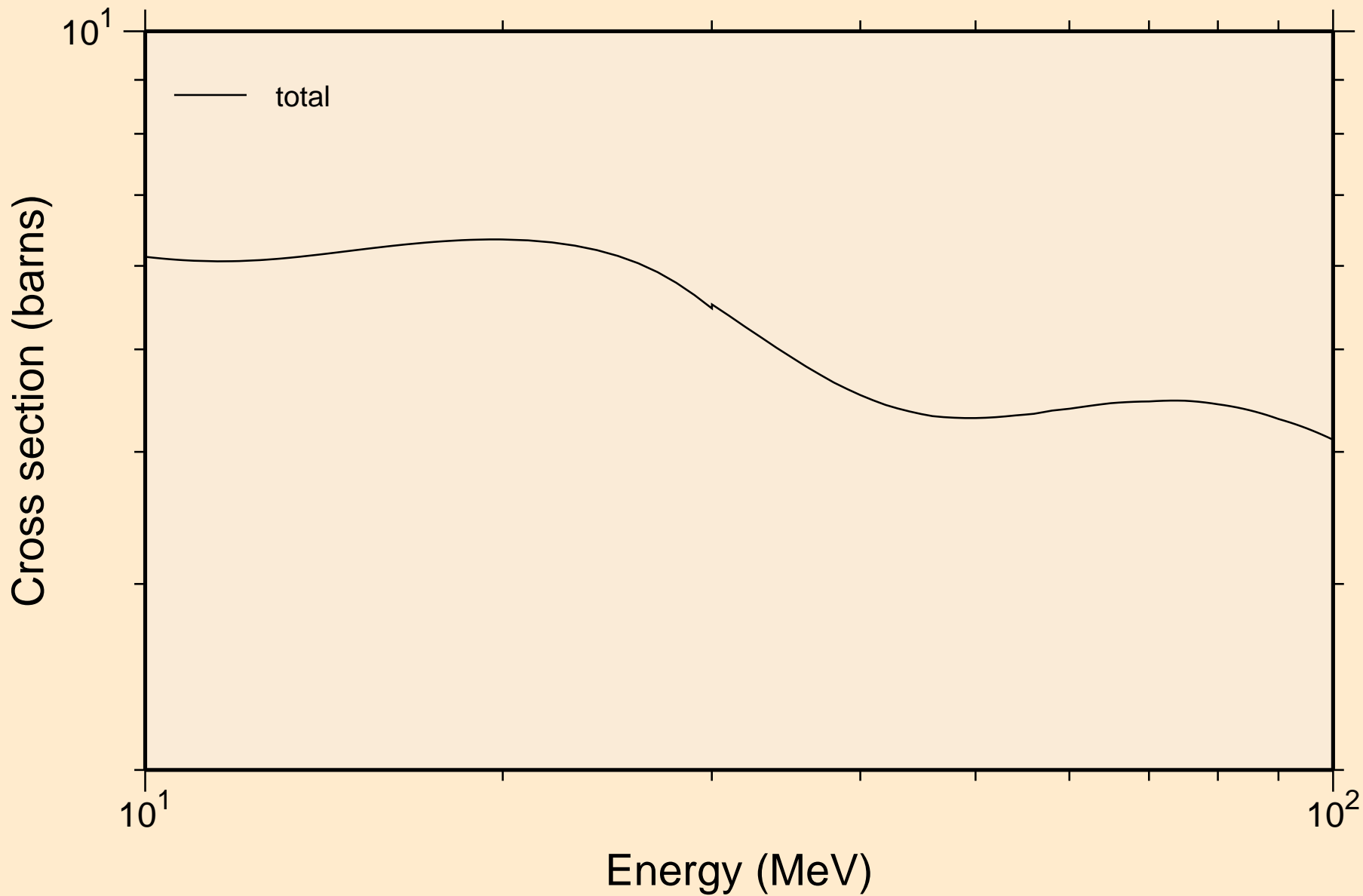

CM249 NEUTRON ACER TENDL-2021 LIBRARY; T=293.6K
resonance absorption cross sections

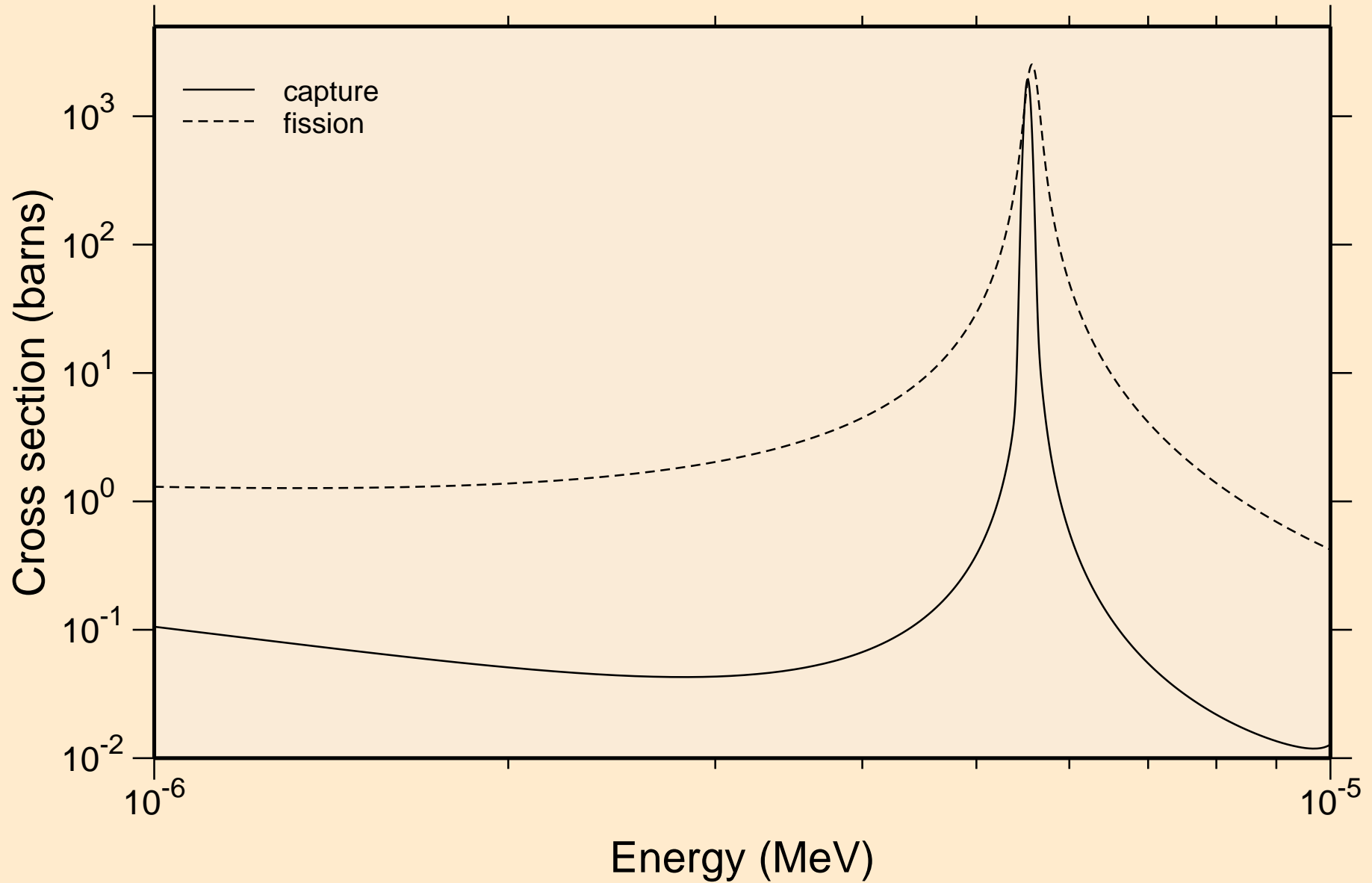

CM249 NEUTRON ACER TENDL-2021 LIBRARY; T=293.6K resonance absorption cross sections

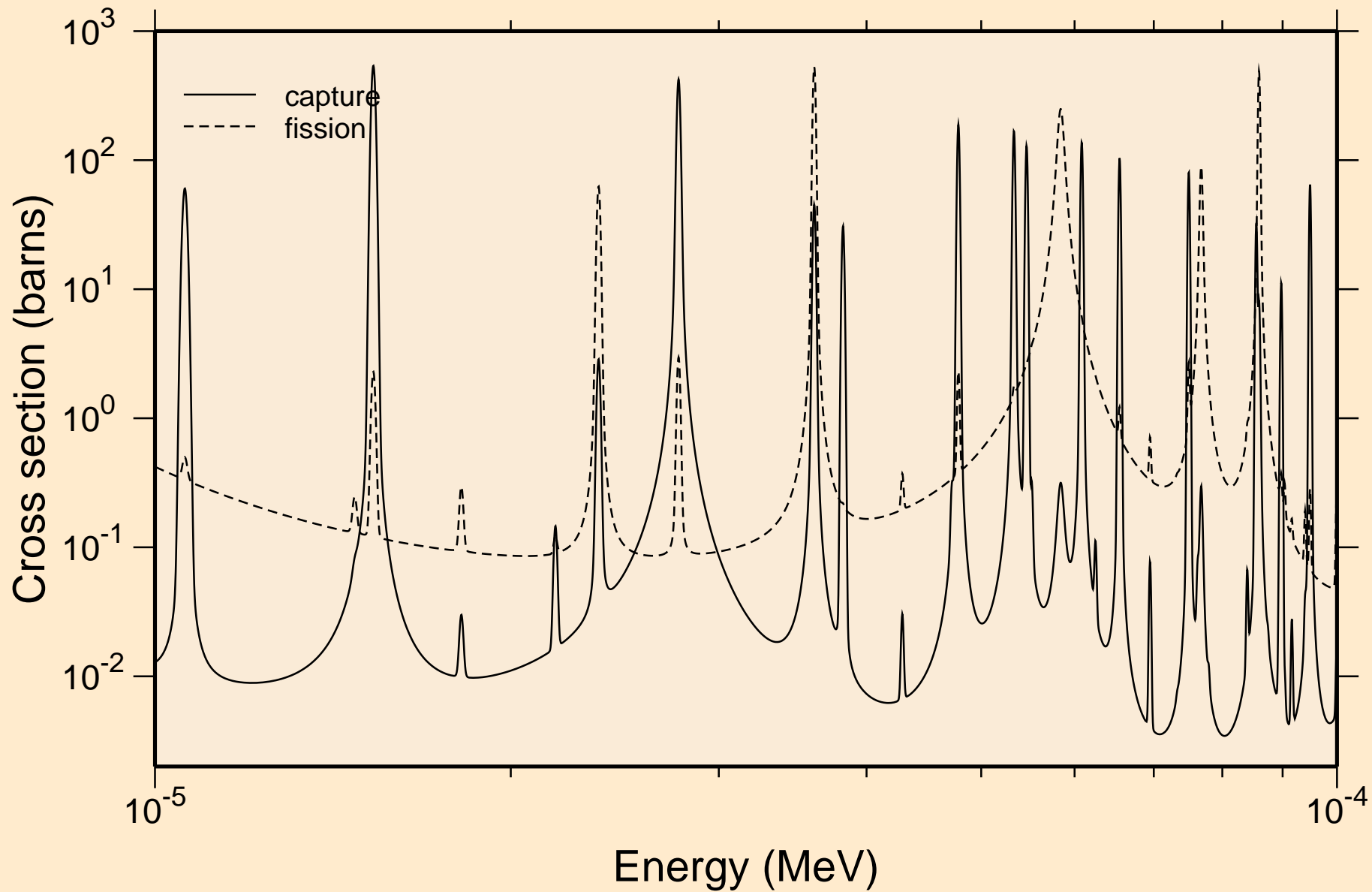

CM249 NEUTRON ACER TENDL-2021 LIBRARY; T=293.6K
resonance absorption cross sections

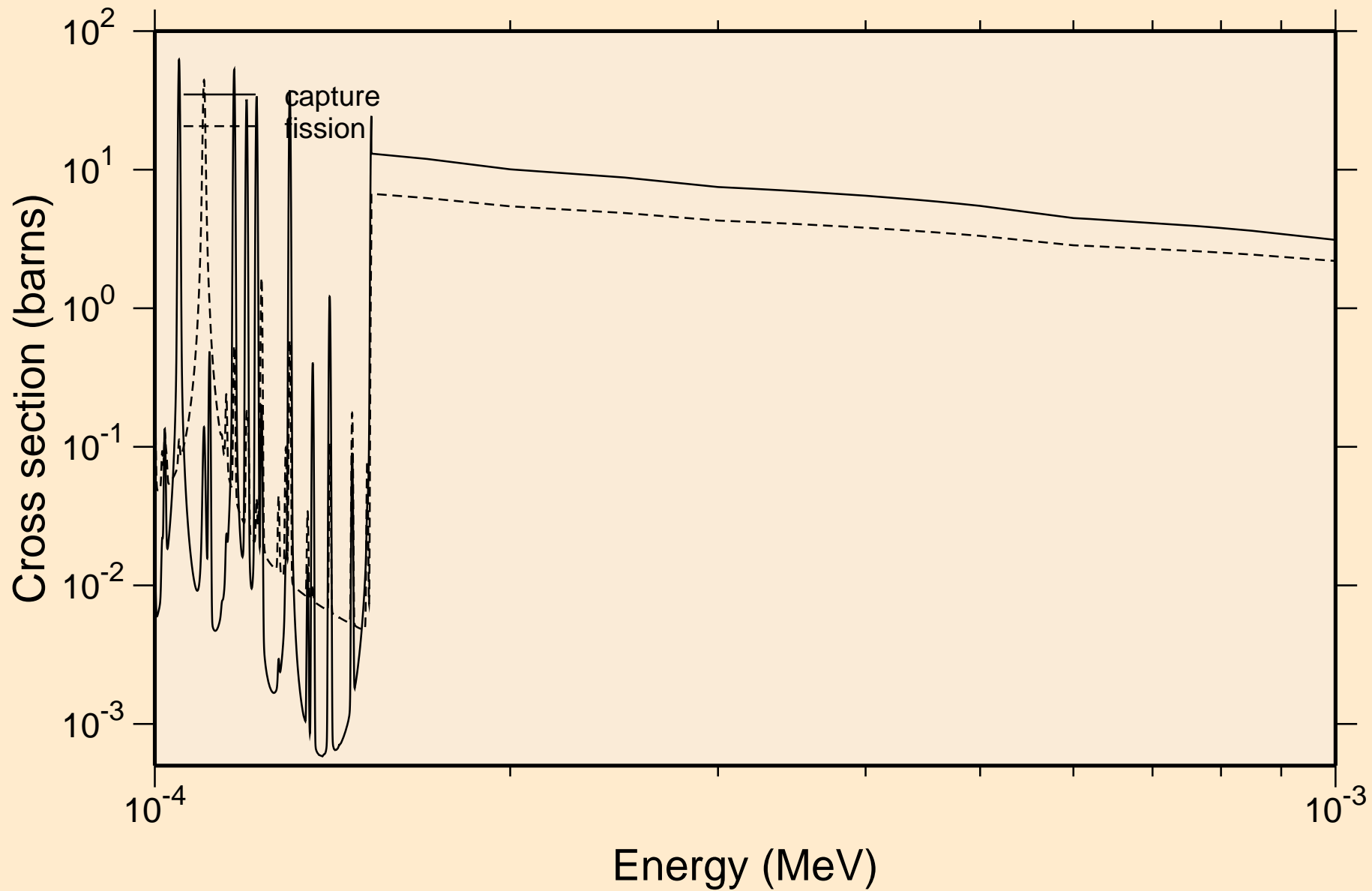

CM249 NEUTRON ACER TENDL-2021 LIBRARY; T=293.6K
resonance absorption cross sections

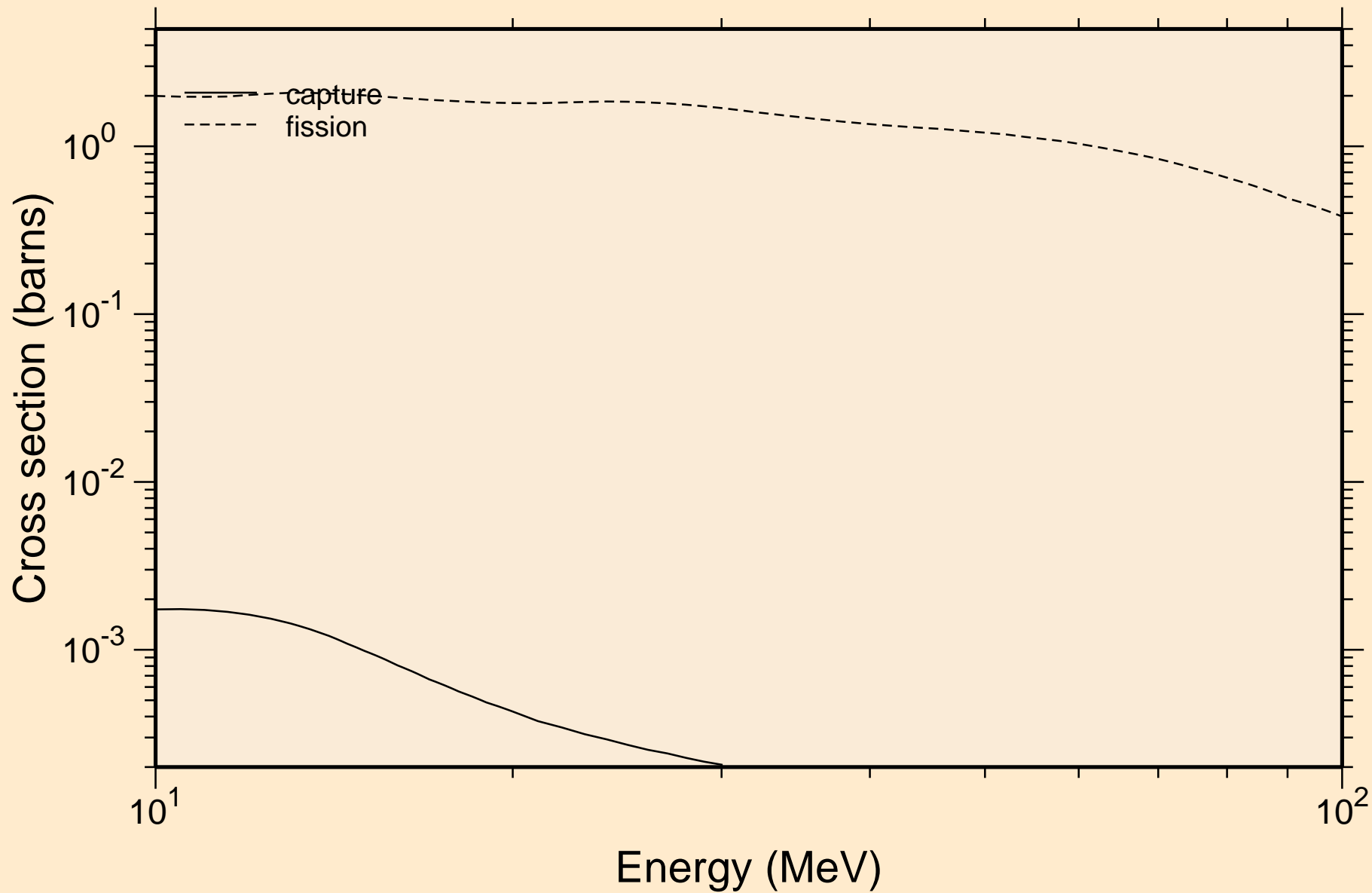

CM249 NEUTRON ACER TENDL-2021 LIBRARY; T=293.6K
Heating

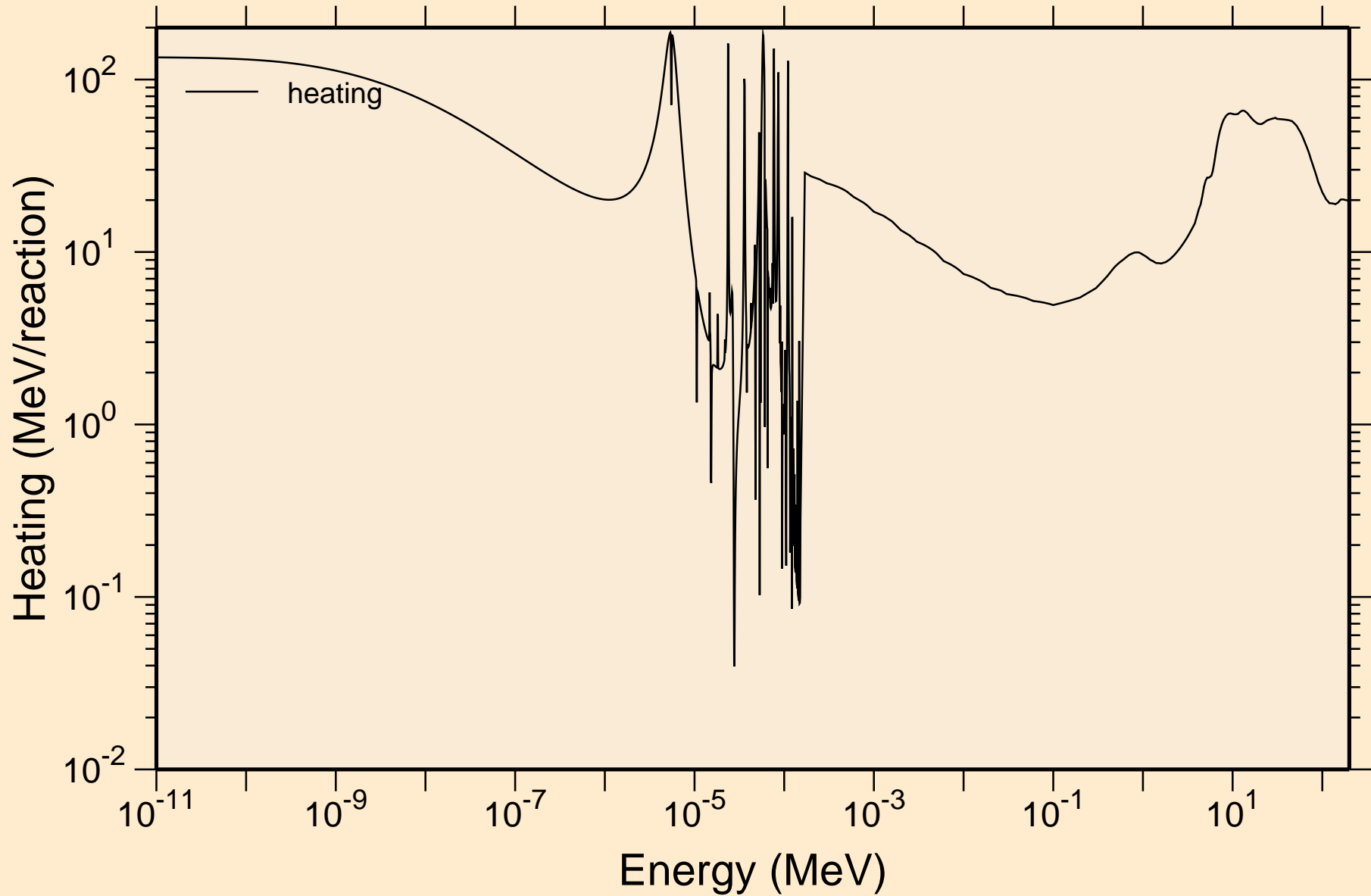

CM249 NEUTRON ACER TENDL-2021 LIBRARY; T=293.6K Damage

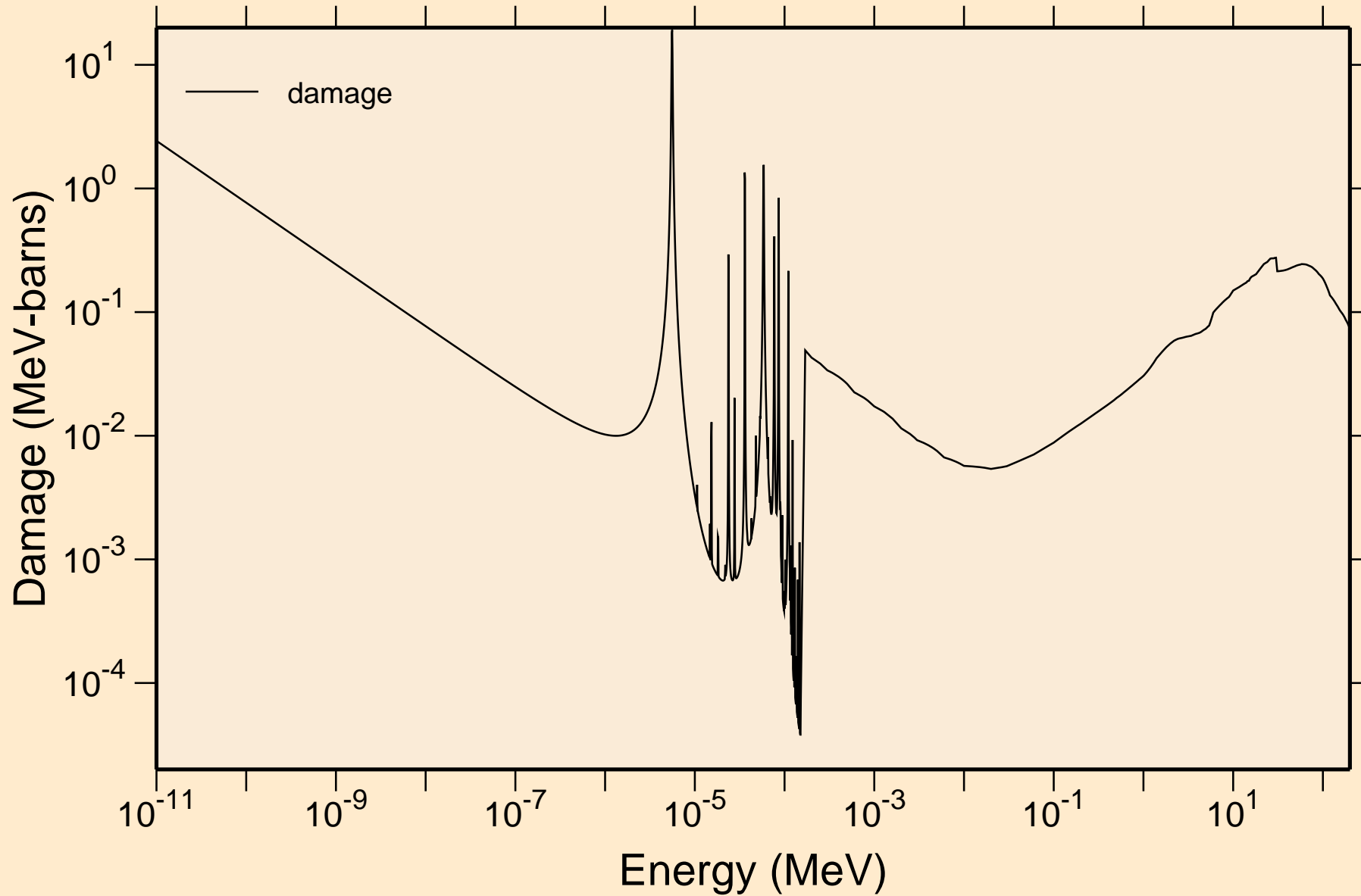

CM249 NEUTRON ACER TENDL-2021 LIBRARY; T=293.6K
Non-threshold reactions

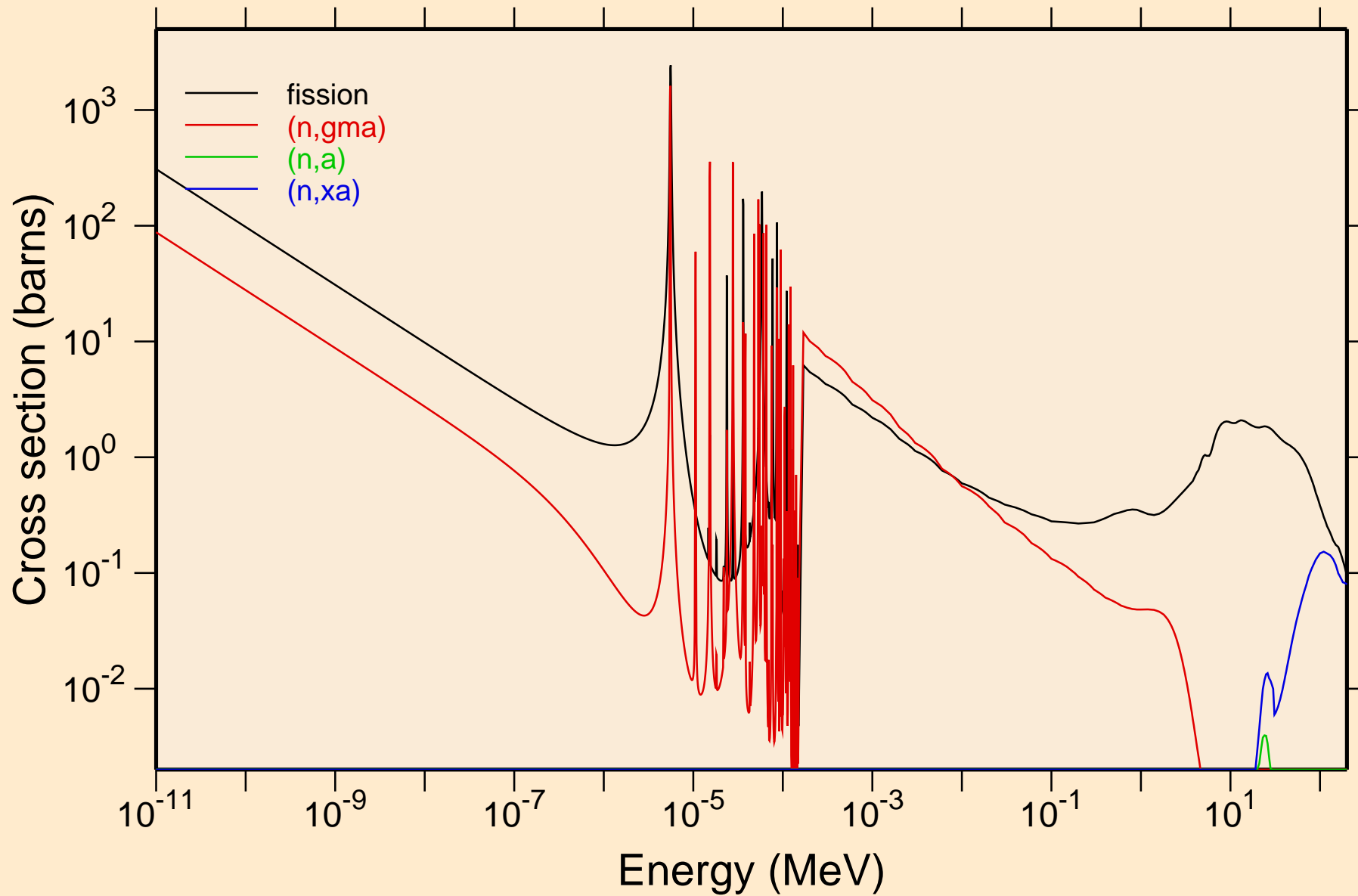

CM249 NEUTRON ACER TENDL-2021 LIBRARY; T=293.6K
Principal cross sections

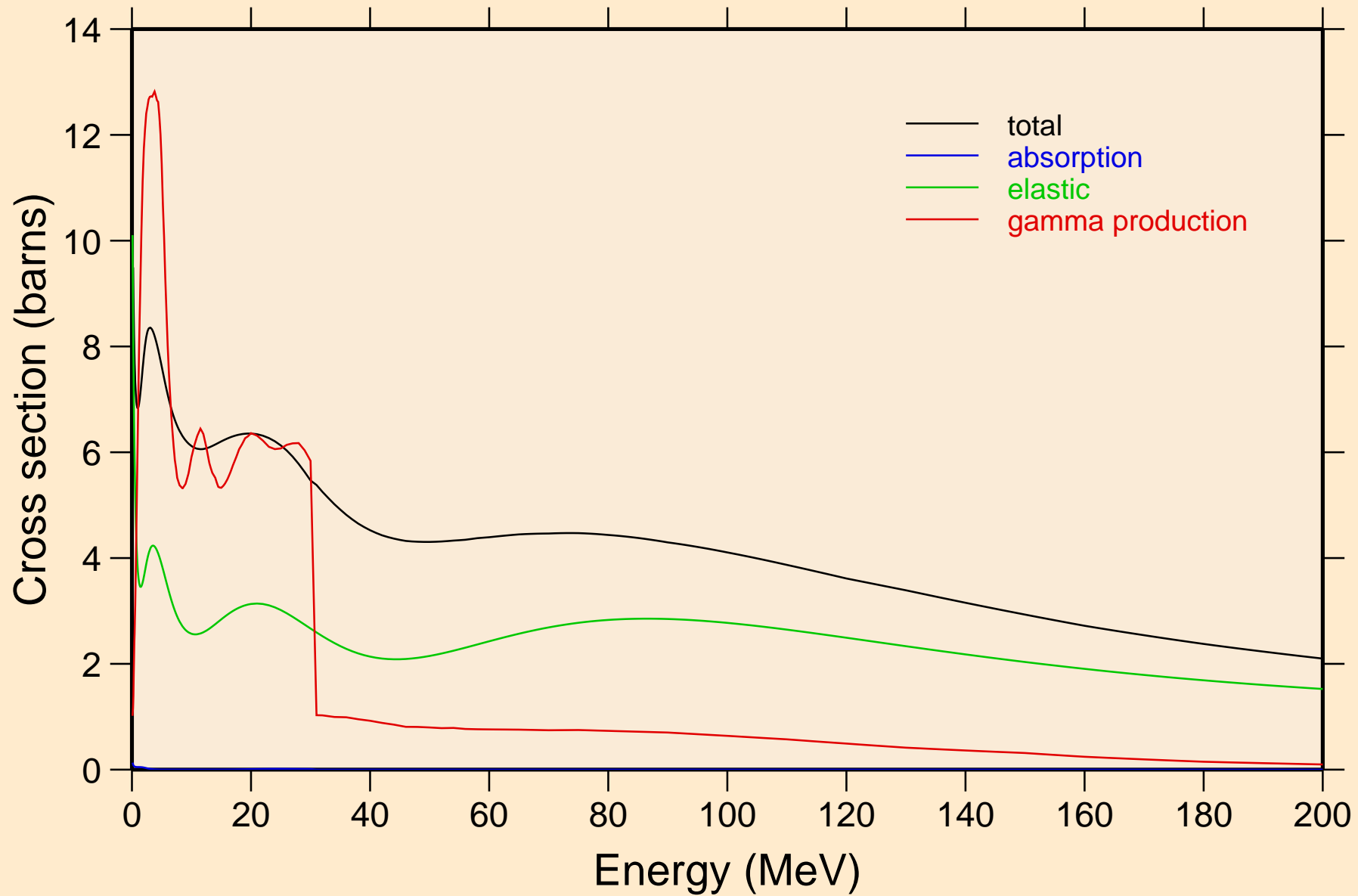

CM249 NEUTRON ACER TENDL-2021 LIBRARY; T=293.6K
Heating

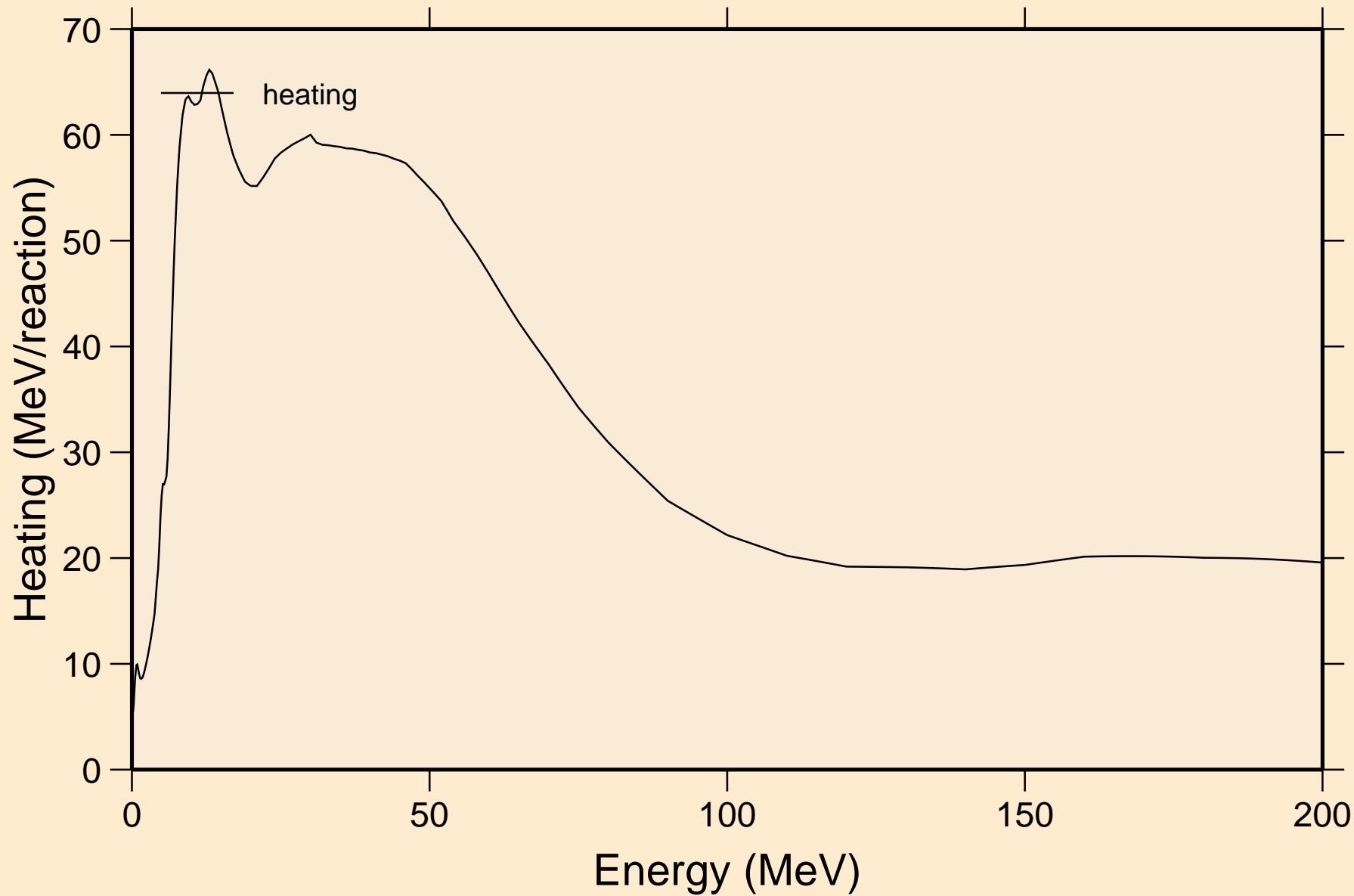

CM249 NEUTRON ACER TENDL-2021 LIBRARY; T=293.6K
Damage

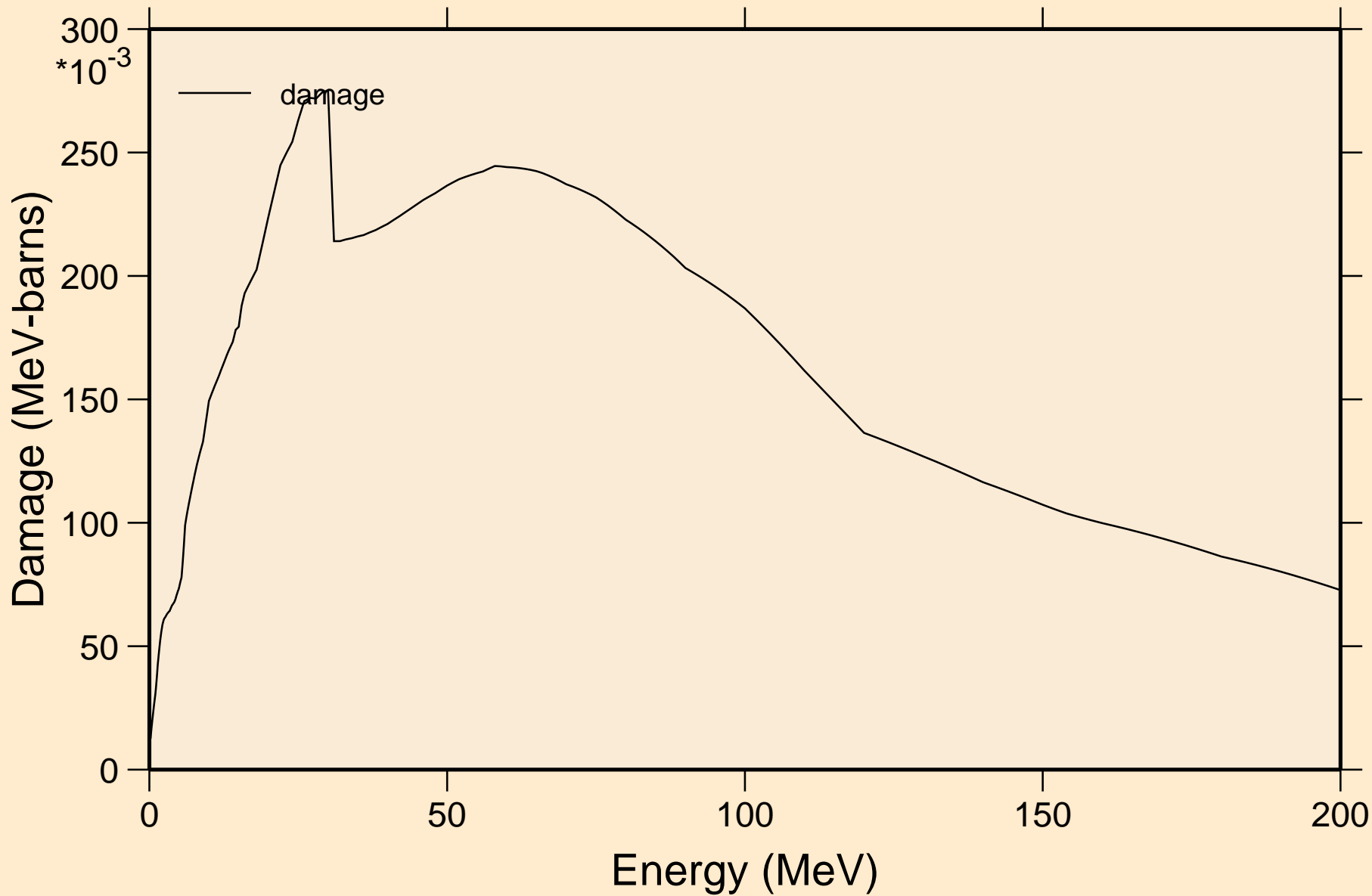

CM249 NEUTRON ACER TENDL-2021 LIBRARY; T=293.6K
Non-threshold reactions

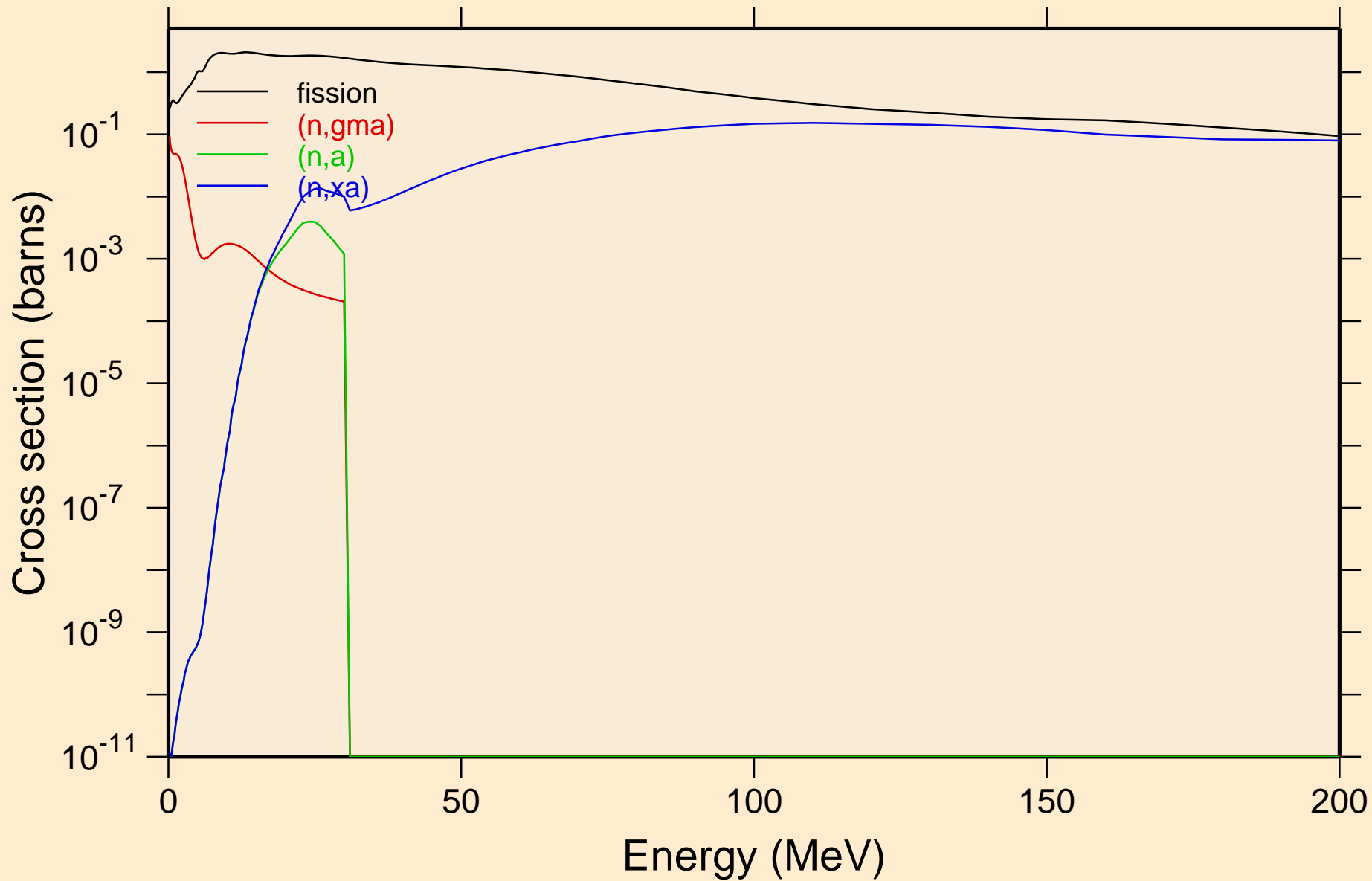

CM249 NEUTRON ACER TENDL-2021 LIBRARY; T=293.6K
Inelastic levels

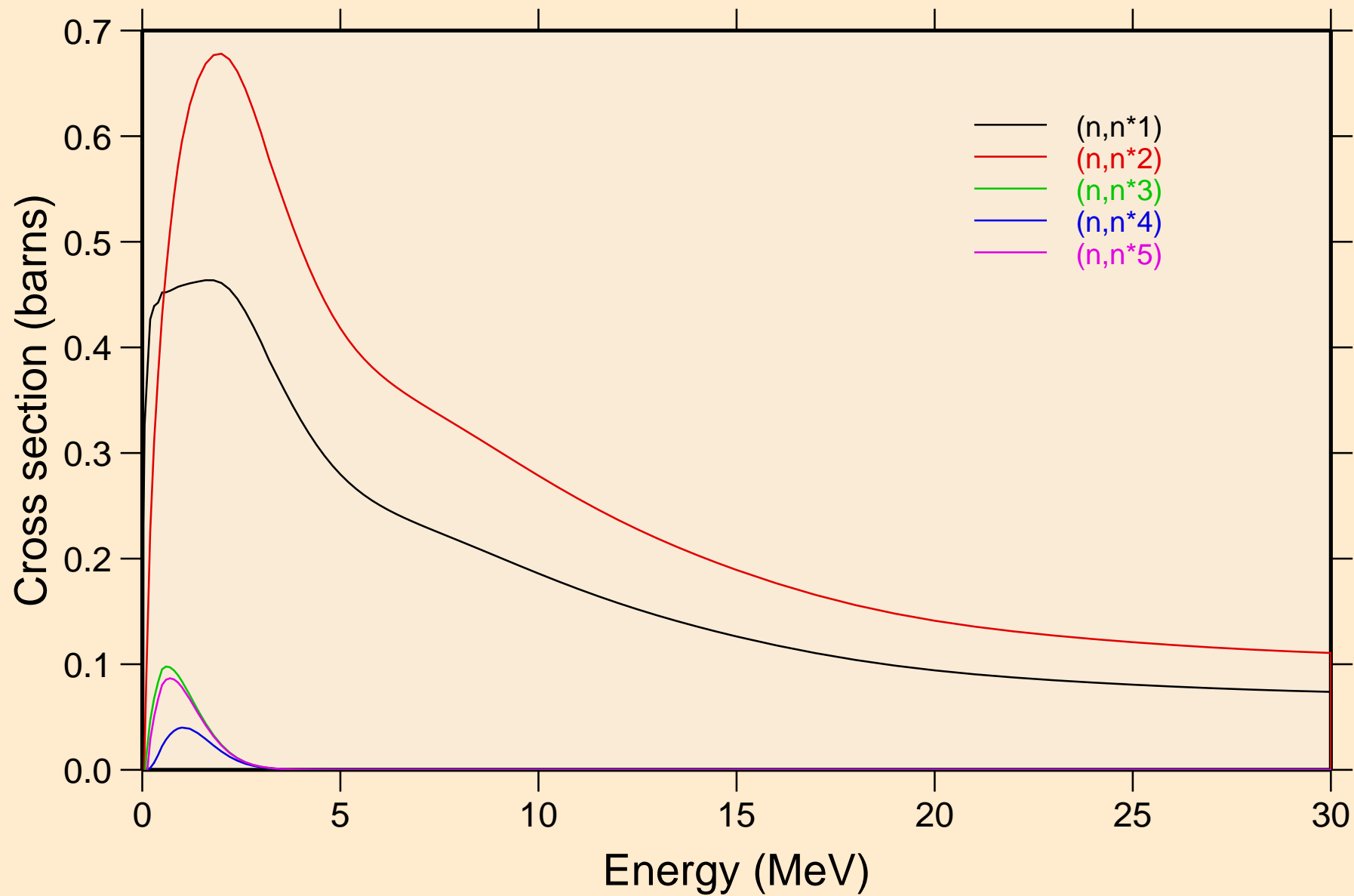

CM249 NEUTRON ACER TENDL-2021 LIBRARY; T=293.6K
Inelastic levels

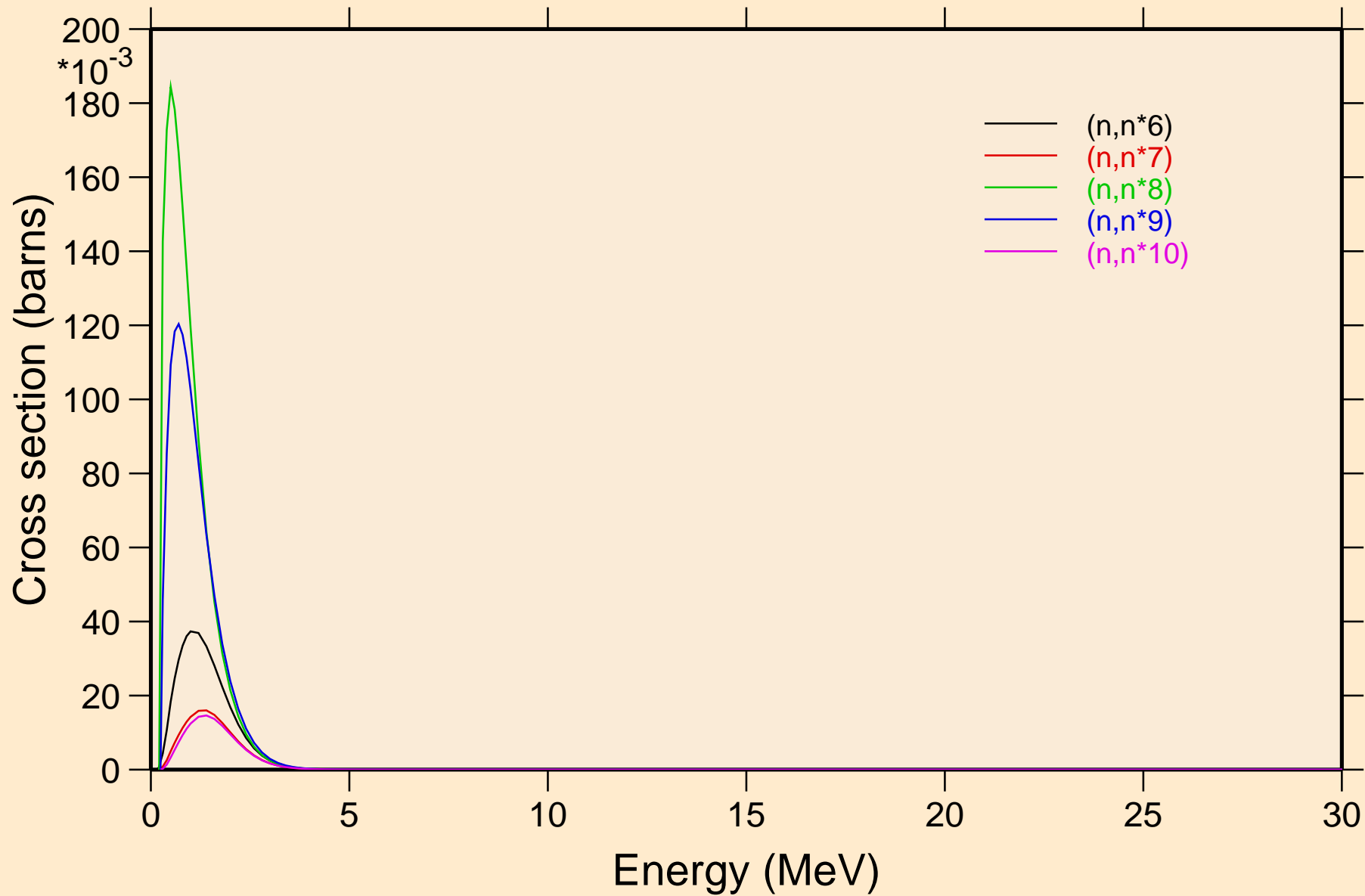

CM249 NEUTRON ACER TENDL-2021 LIBRARY; T=293.6K
Inelastic levels

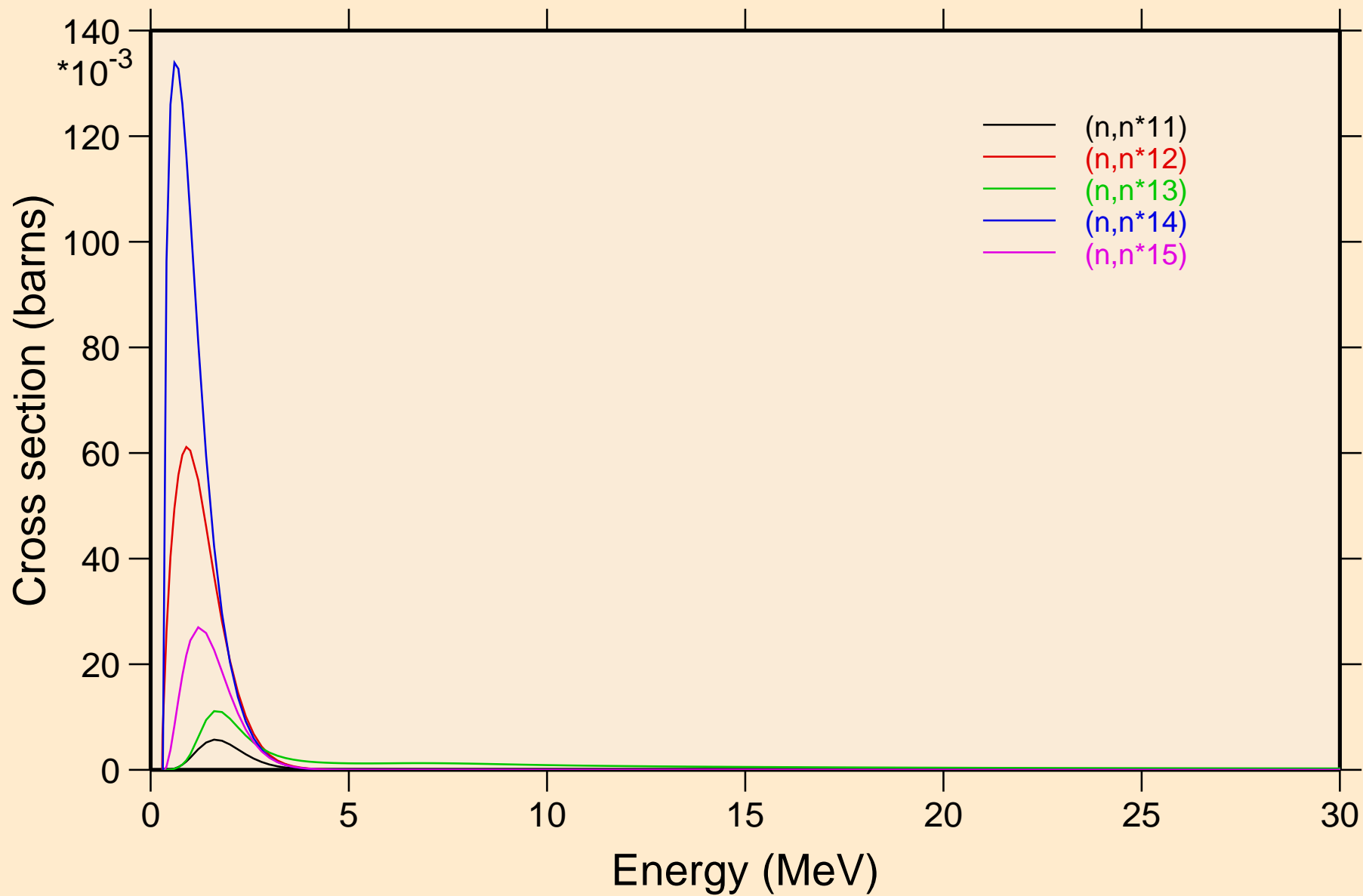

CM249 NEUTRON ACER TENDL-2021 LIBRARY; T=293.6K
Inelastic levels

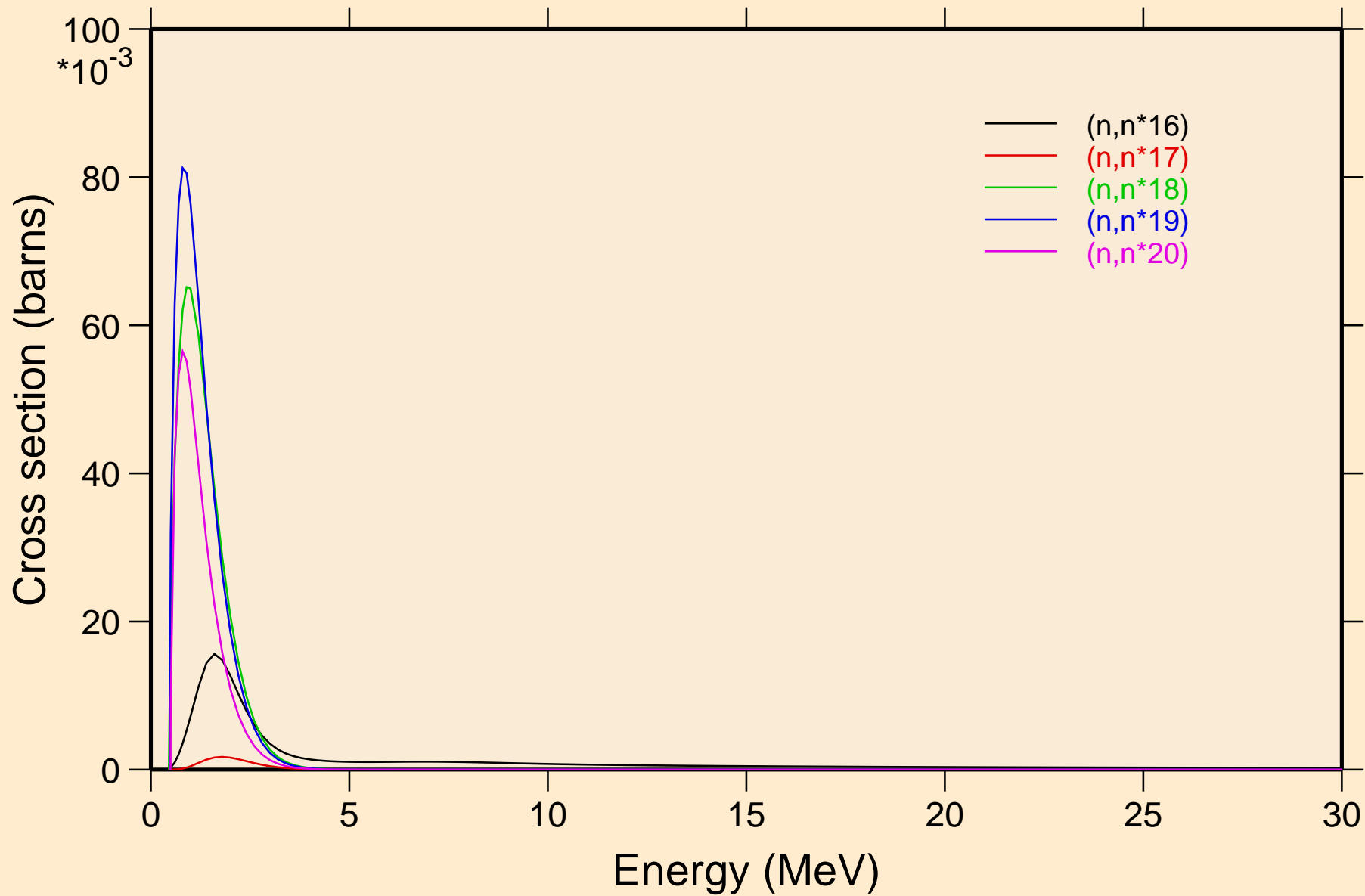

CM249 NEUTRON ACER TENDL-2021 LIBRARY; T=293.6K
Inelastic levels

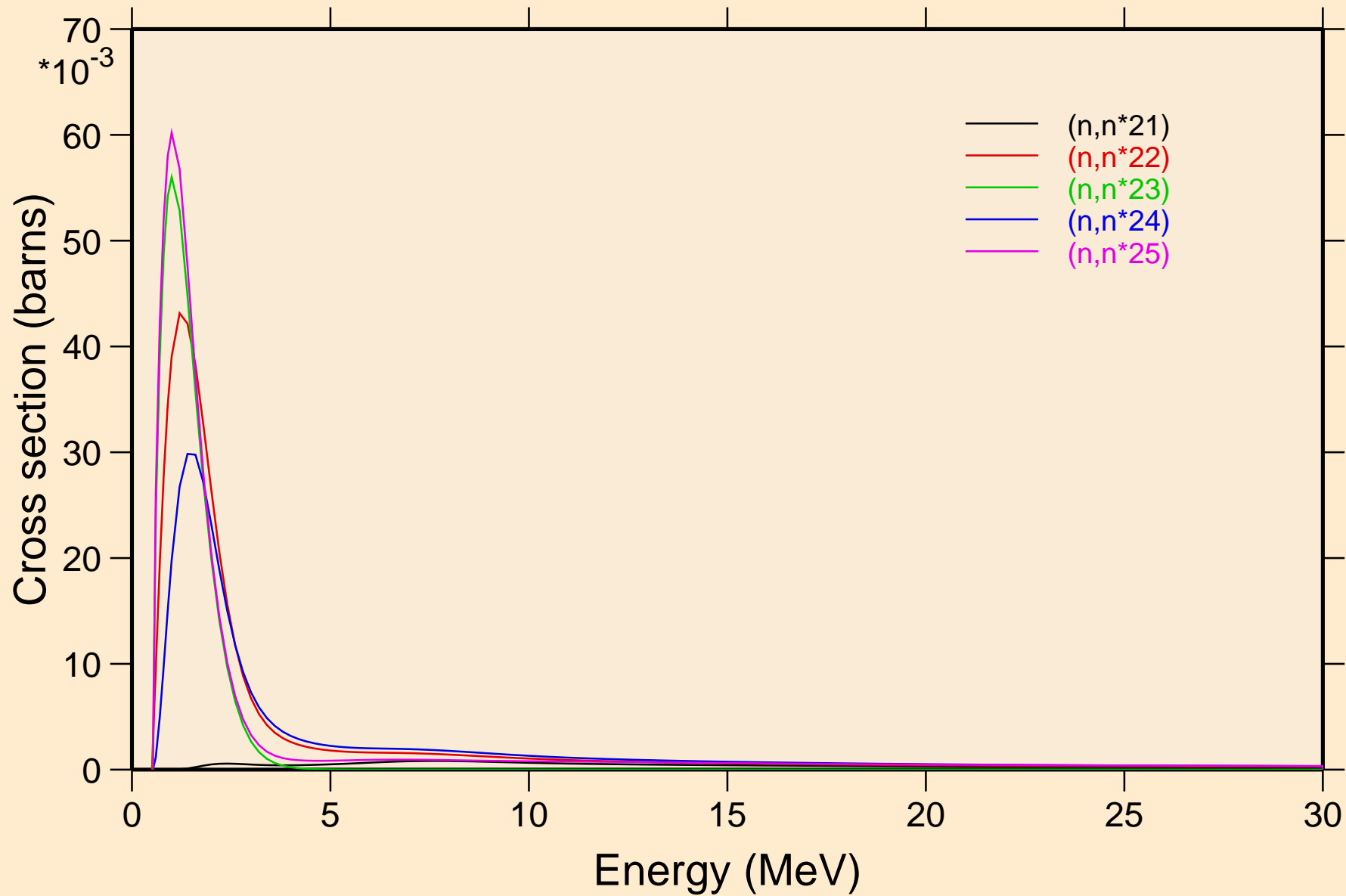

CM249 NEUTRON ACER TENDL-2021 LIBRARY; T=293.6K
Inelastic levels

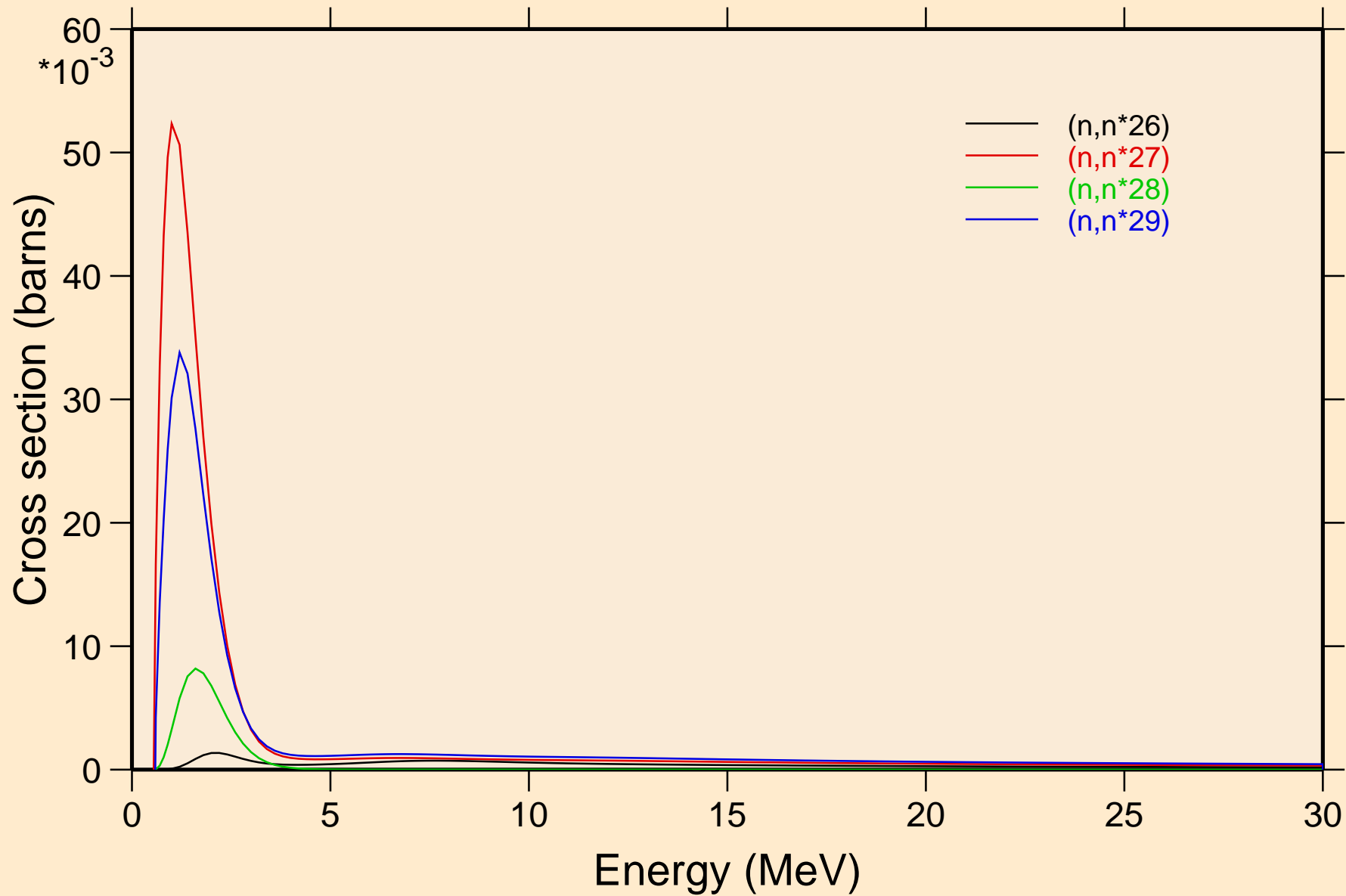

CM249 NEUTRON ACER TENDL-2021 LIBRARY; T=293.6K

Threshold reactions

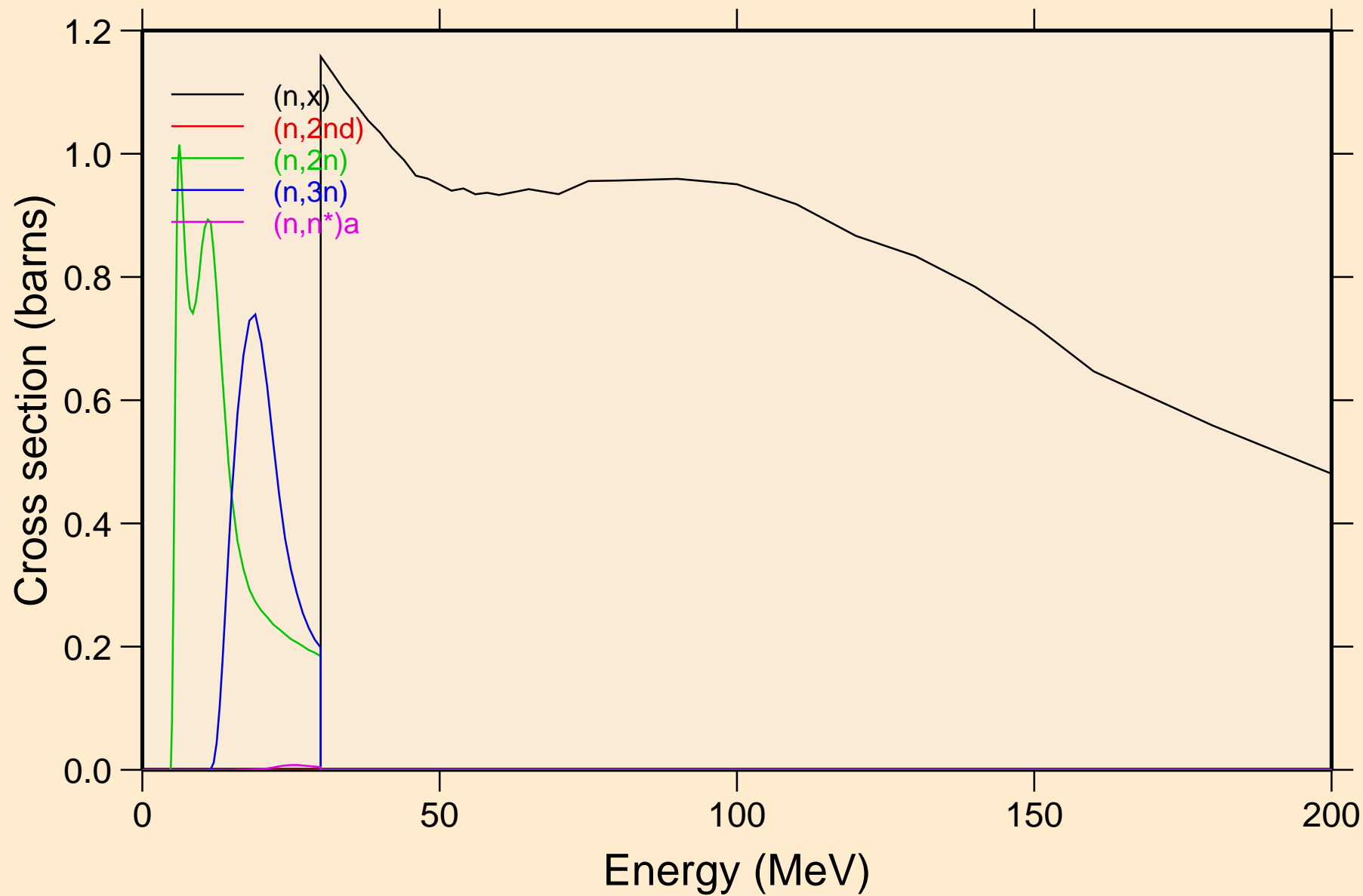

CM249 NEUTRON ACER TENDL-2021 LIBRARY; T=293.6K

Threshold reactions

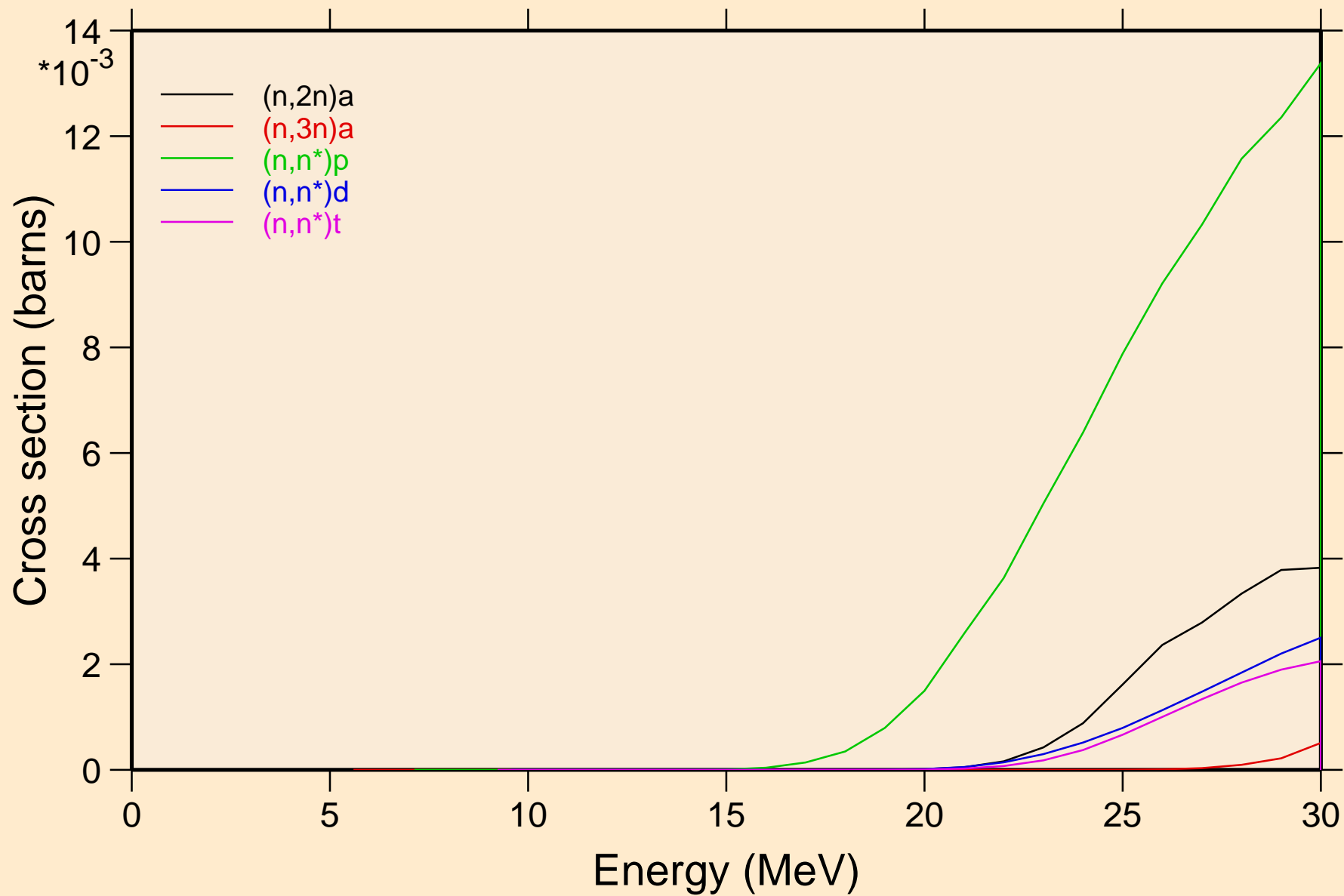

CM249 NEUTRON ACER TENDL-2021 LIBRARY; T=293.6K
Threshold reactions

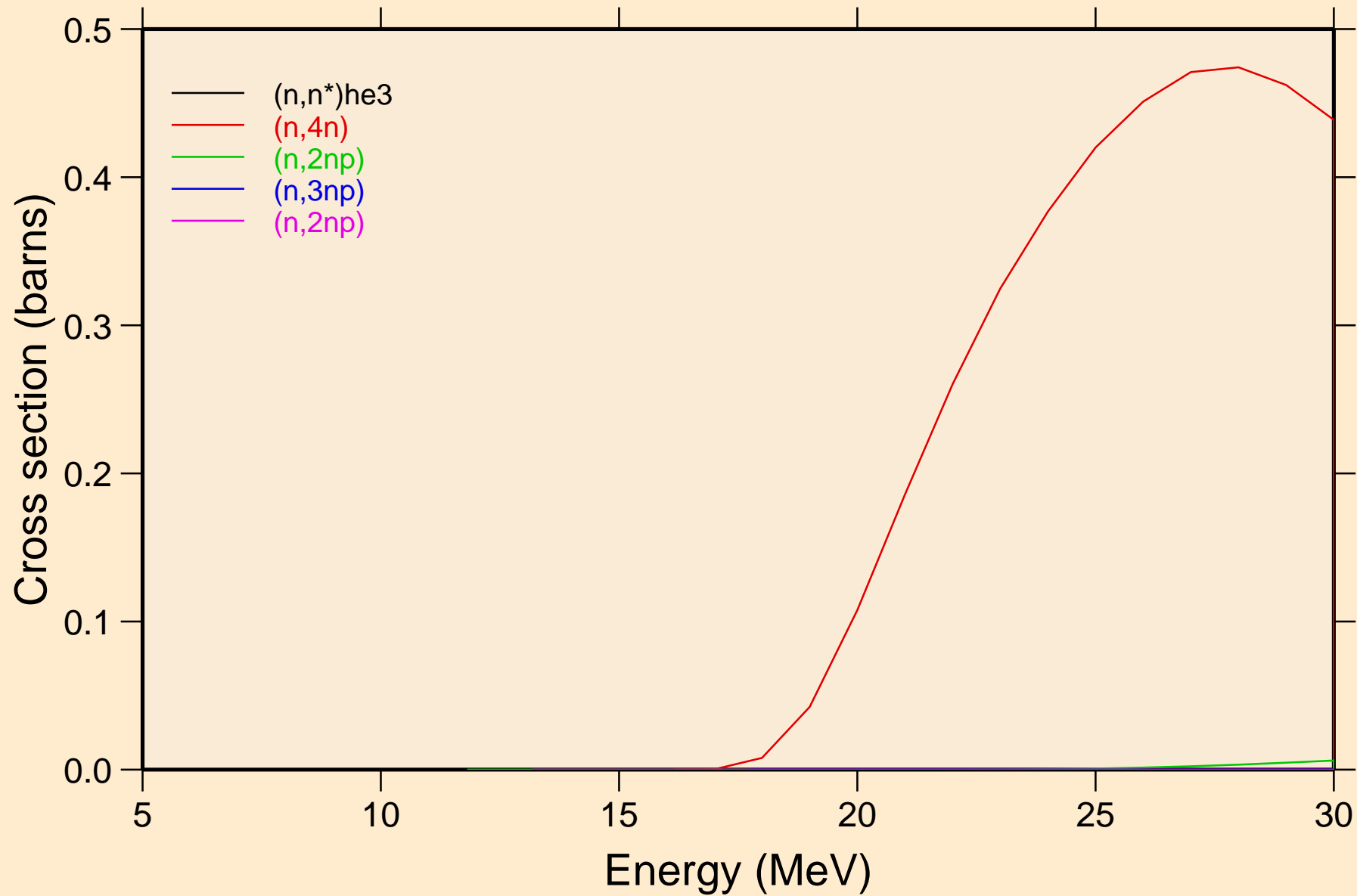

CM249 NEUTRON ACER TENDL-2021 LIBRARY; T=293.6K
Threshold reactions

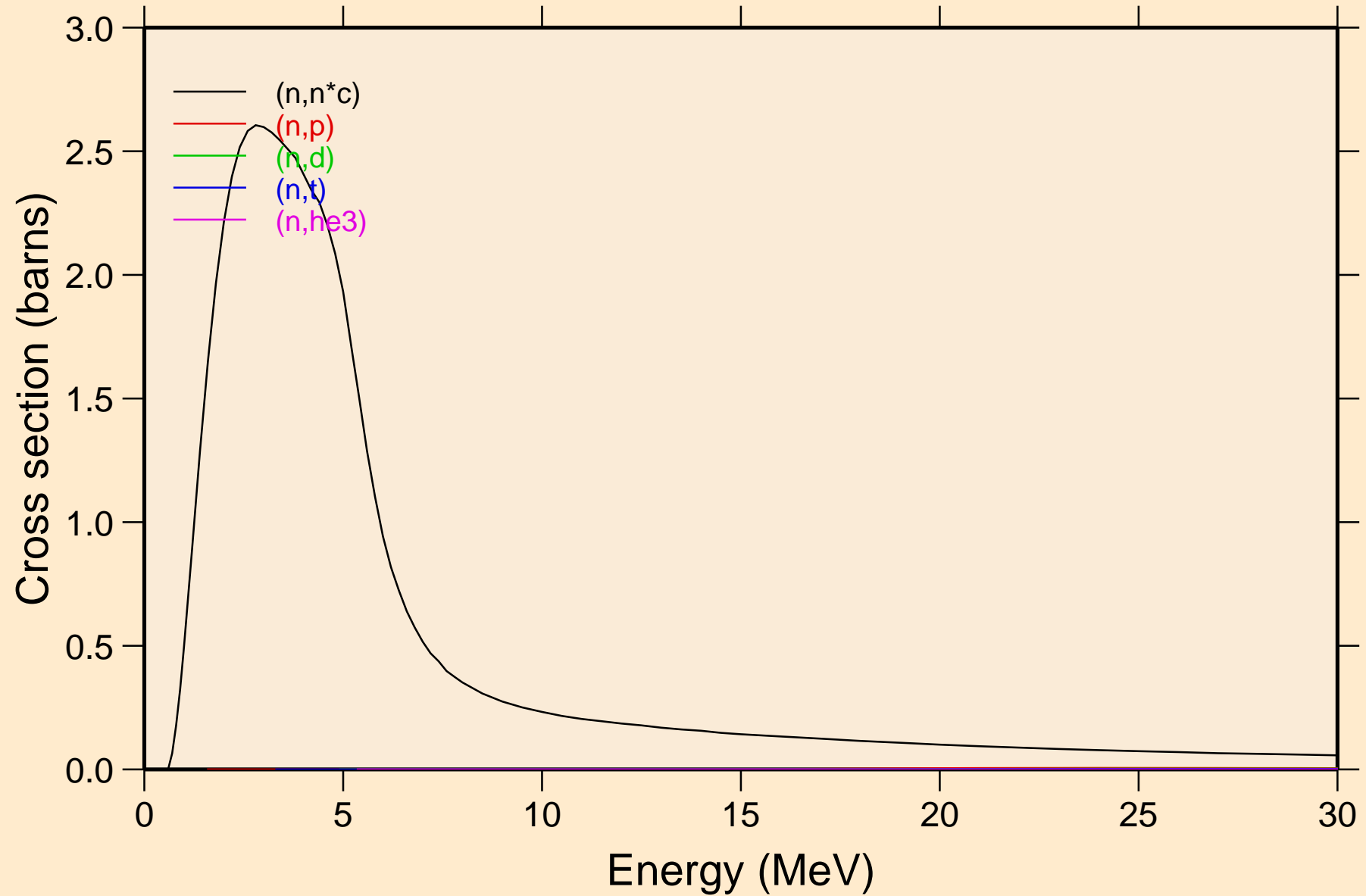

CM249 NEUTRON ACER TENDL-2021 LIBRARY; T=293.6K
Threshold reactions

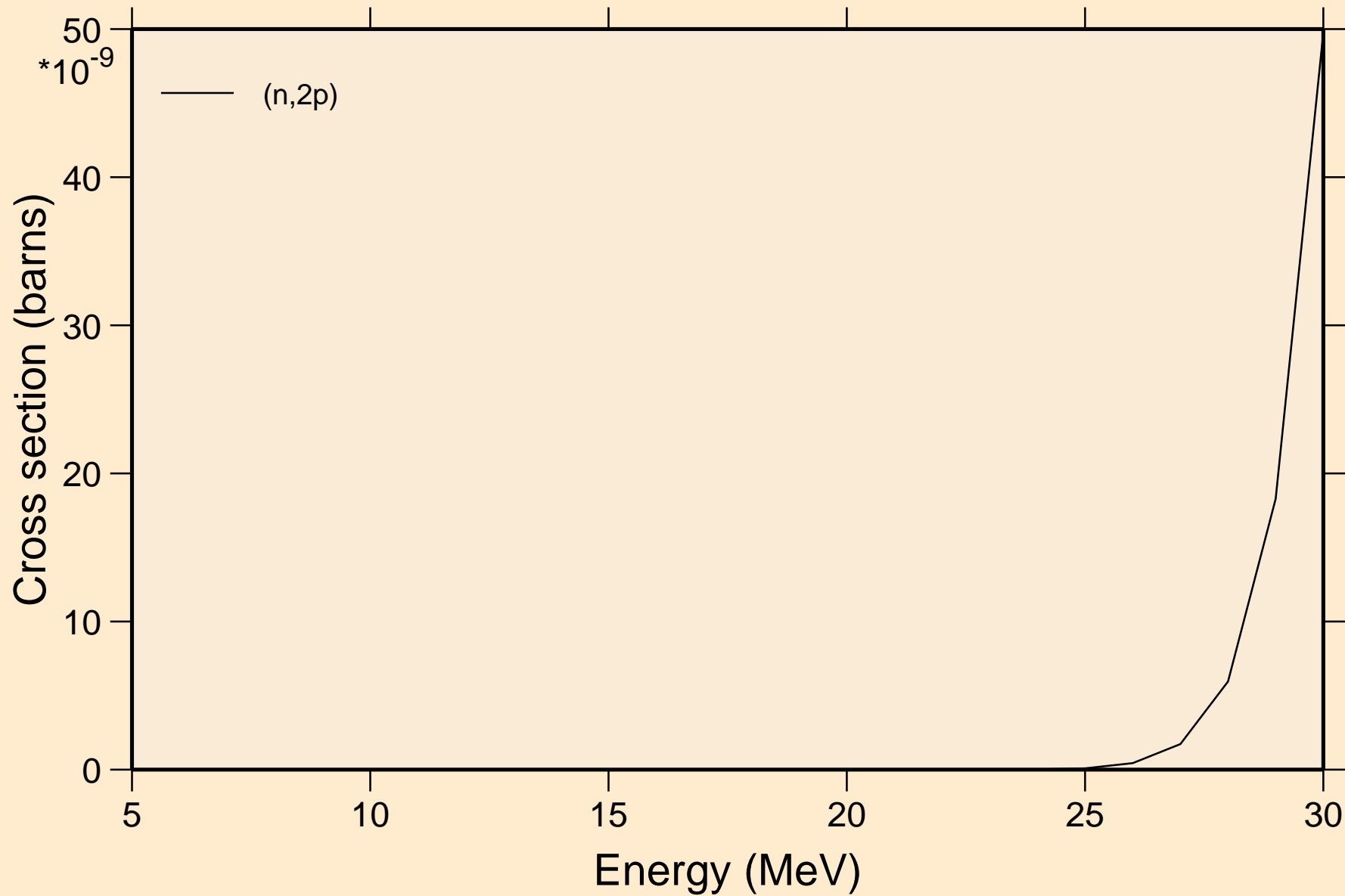

CM249 NEUTRON ACER TENDL-2021 LIBRARY; T=293.6K
Threshold reactions

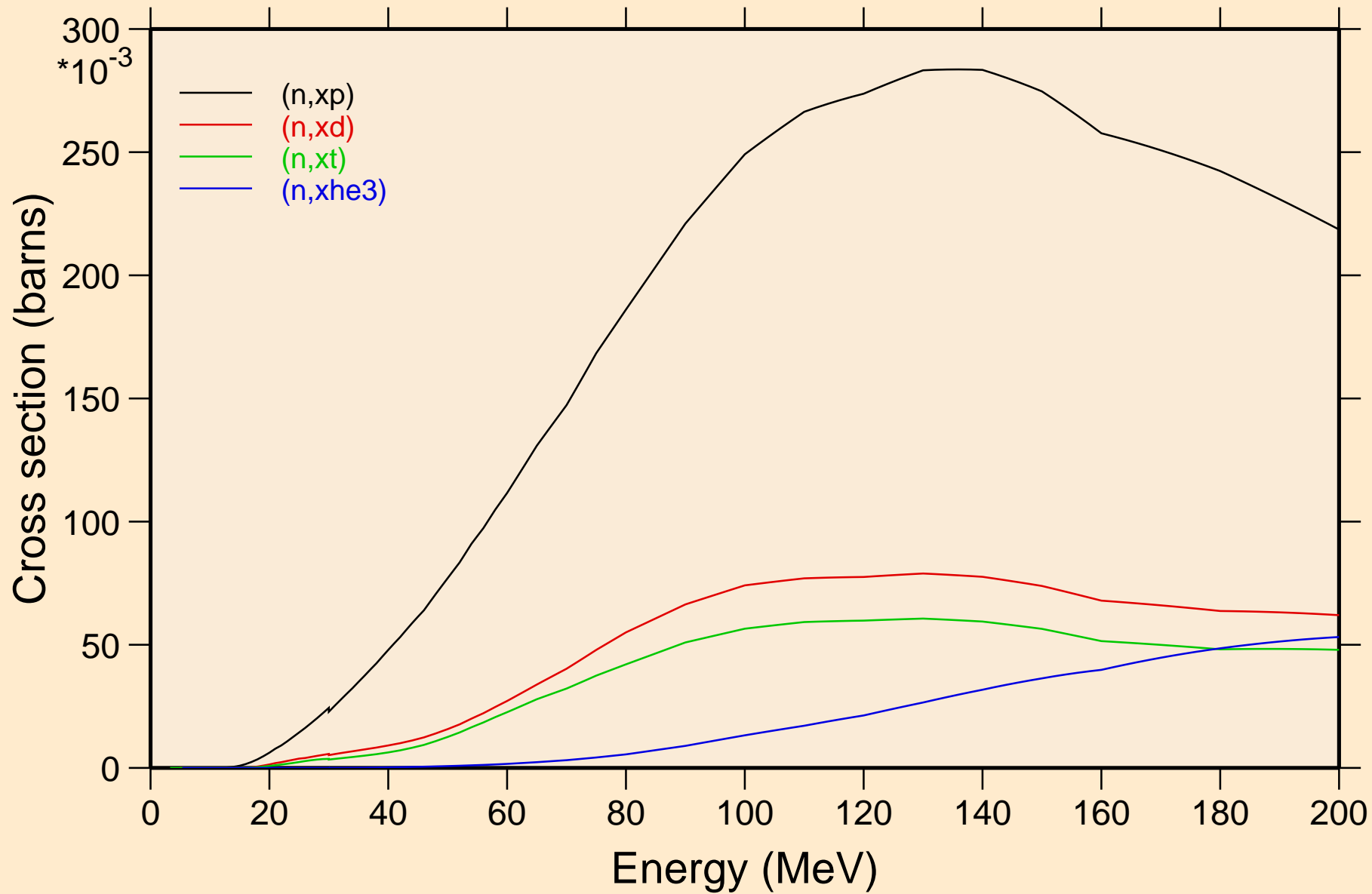

CM249 NEUTRON ACER TENDL-2021 LIBRARY; T=293.6K
angular distribution for elastic

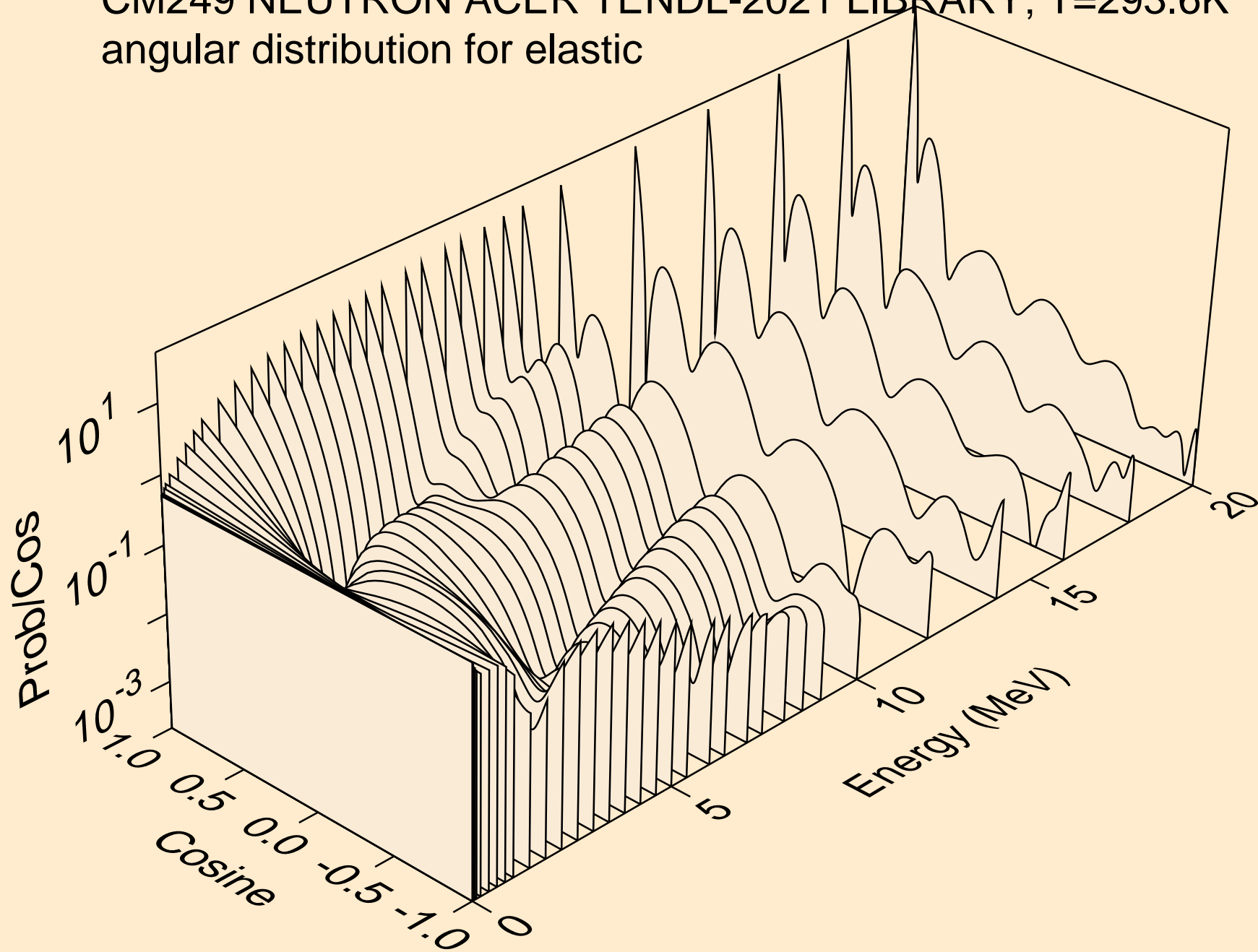

CM249 NEUTRON ACER TENDL-2021 LIBRARY; T=293.6K
angular distribution for elastic

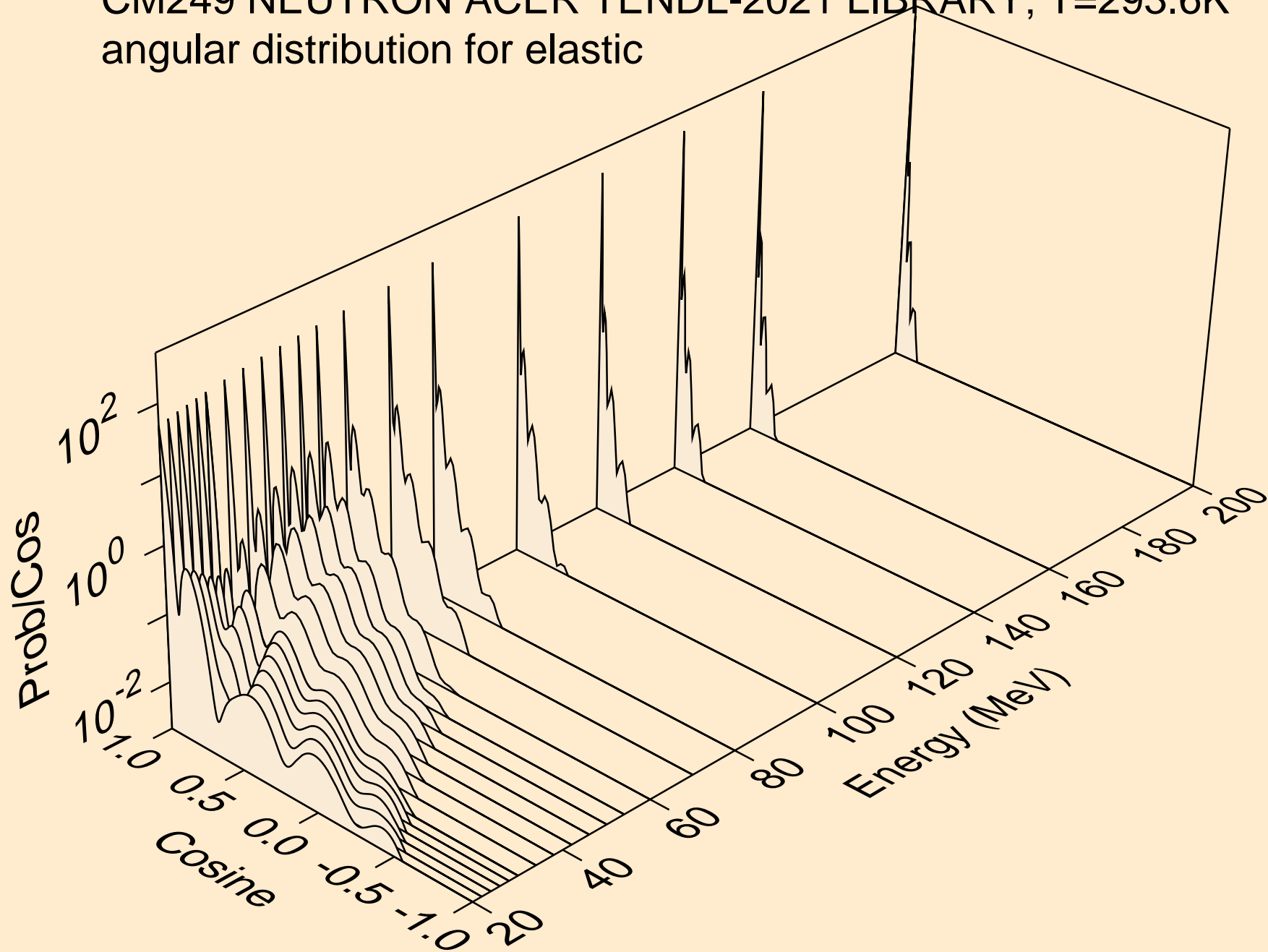

CM249 NEUTRON ACER TENDL-2021 LIBRARY; T=293.6K
angular distribution for (n,n*1)

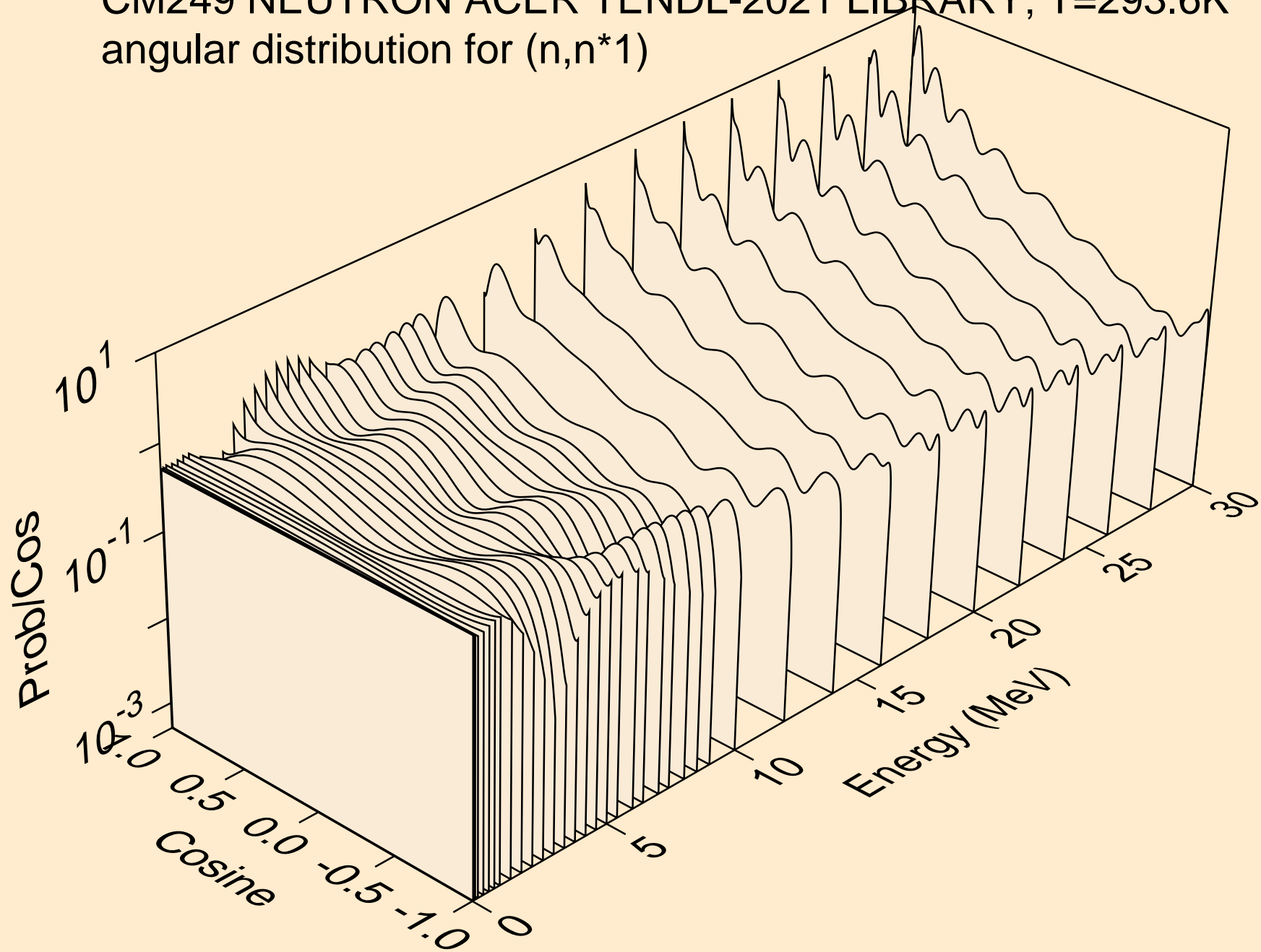

CM249 NEUTRON ACER TENDL-2021 LIBRARY; T=293.6K
angular distribution for (n,n*2)

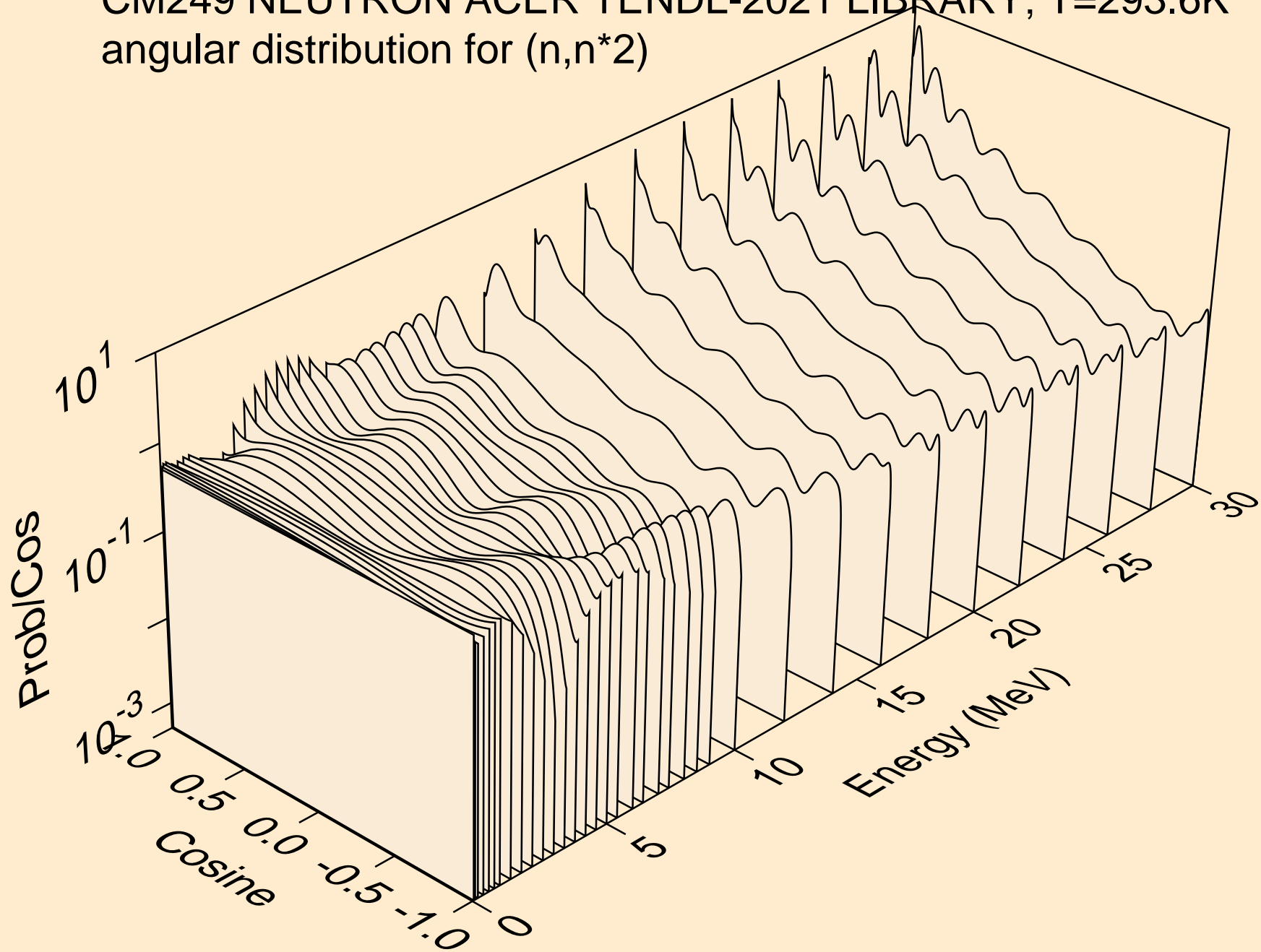

CM249 NEUTRON ACER TENDL-2021 LIBRARY; T=293.6K
angular distribution for (n,n*3)

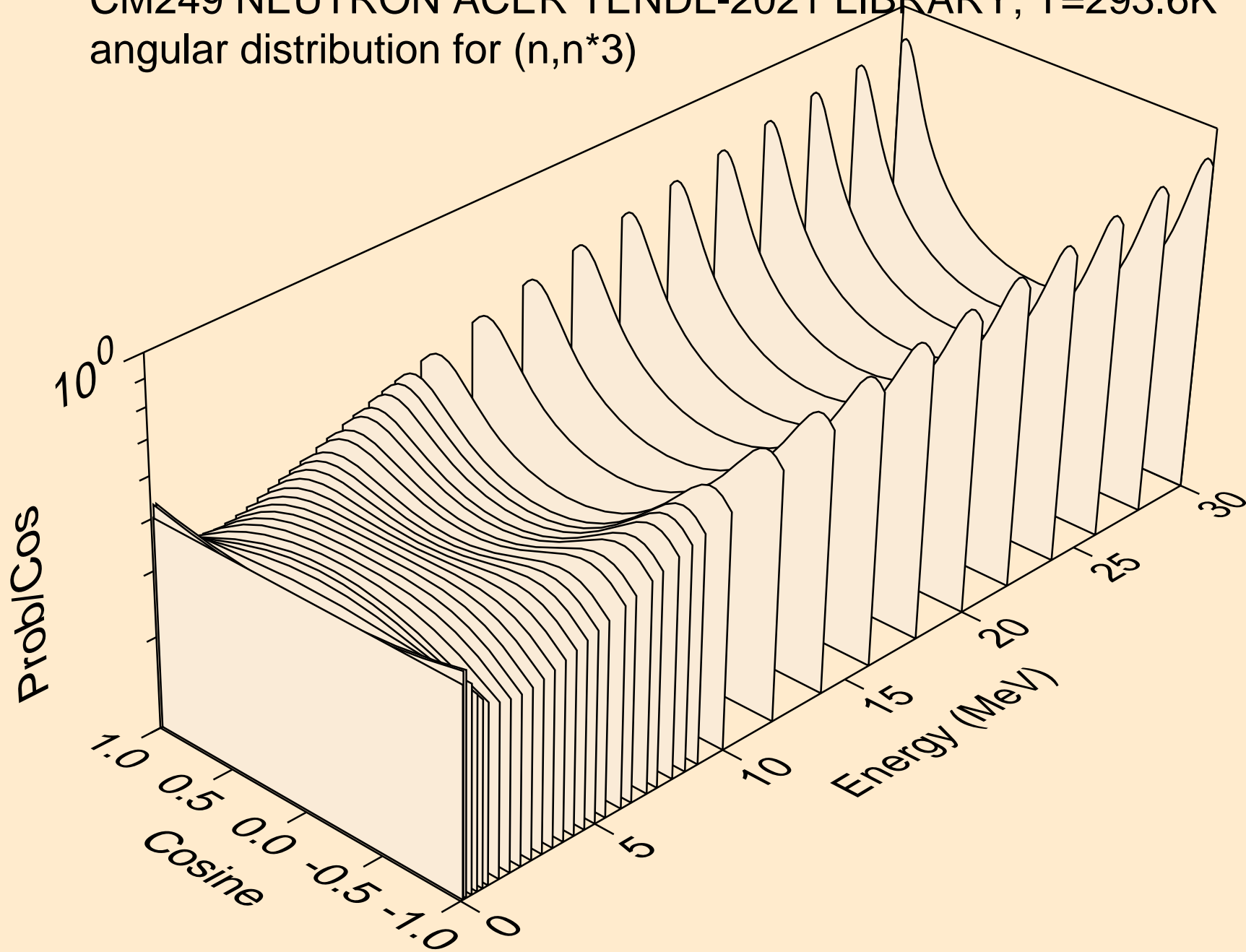

CM249 NEUTRON ACER TENDL-2021 LIBRARY; T=293.6K
angular distribution for (n,n*4)

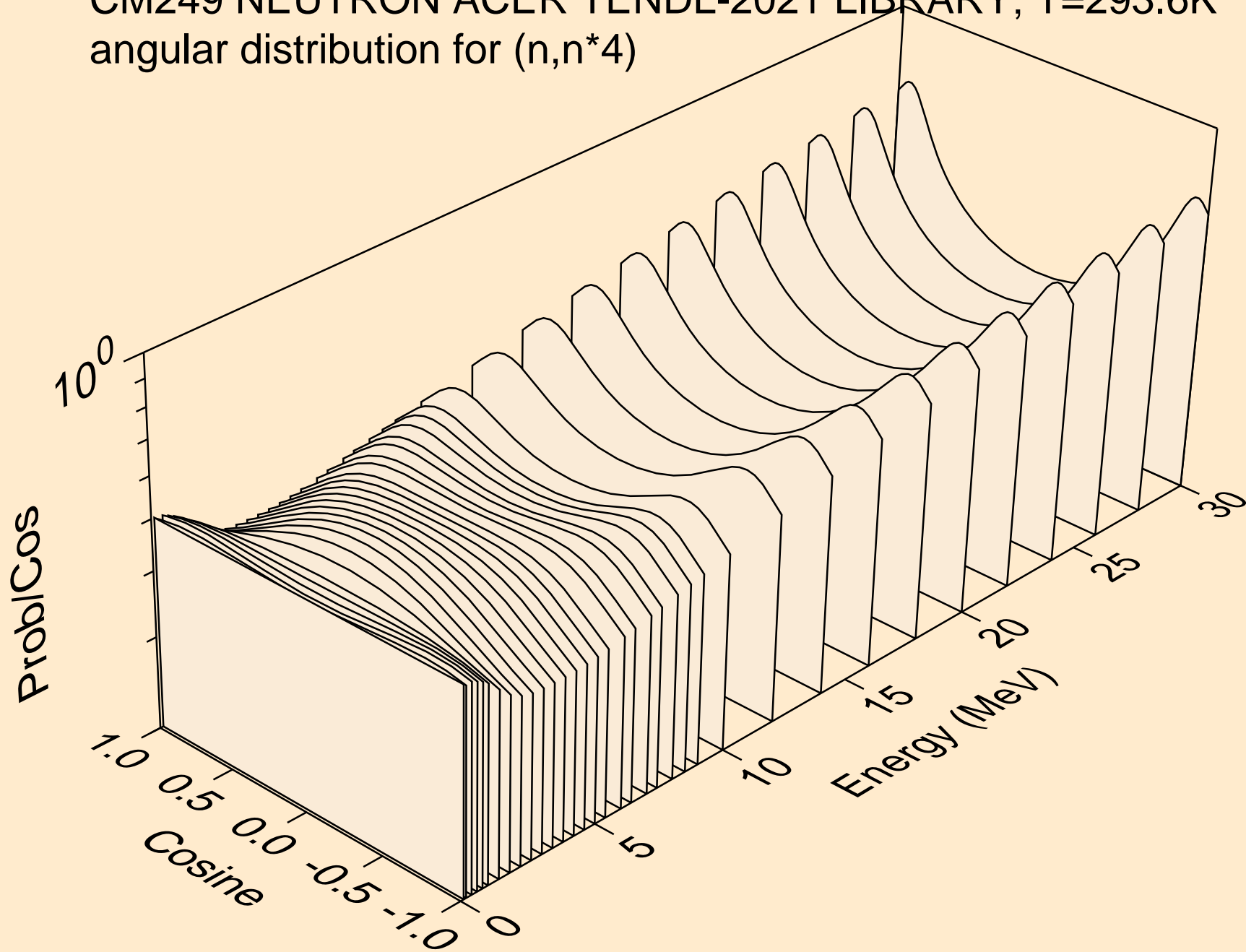

CM249 NEUTRON ACER TENDL-2021 LIBRARY; T=293.6K
angular distribution for (n,n*5)

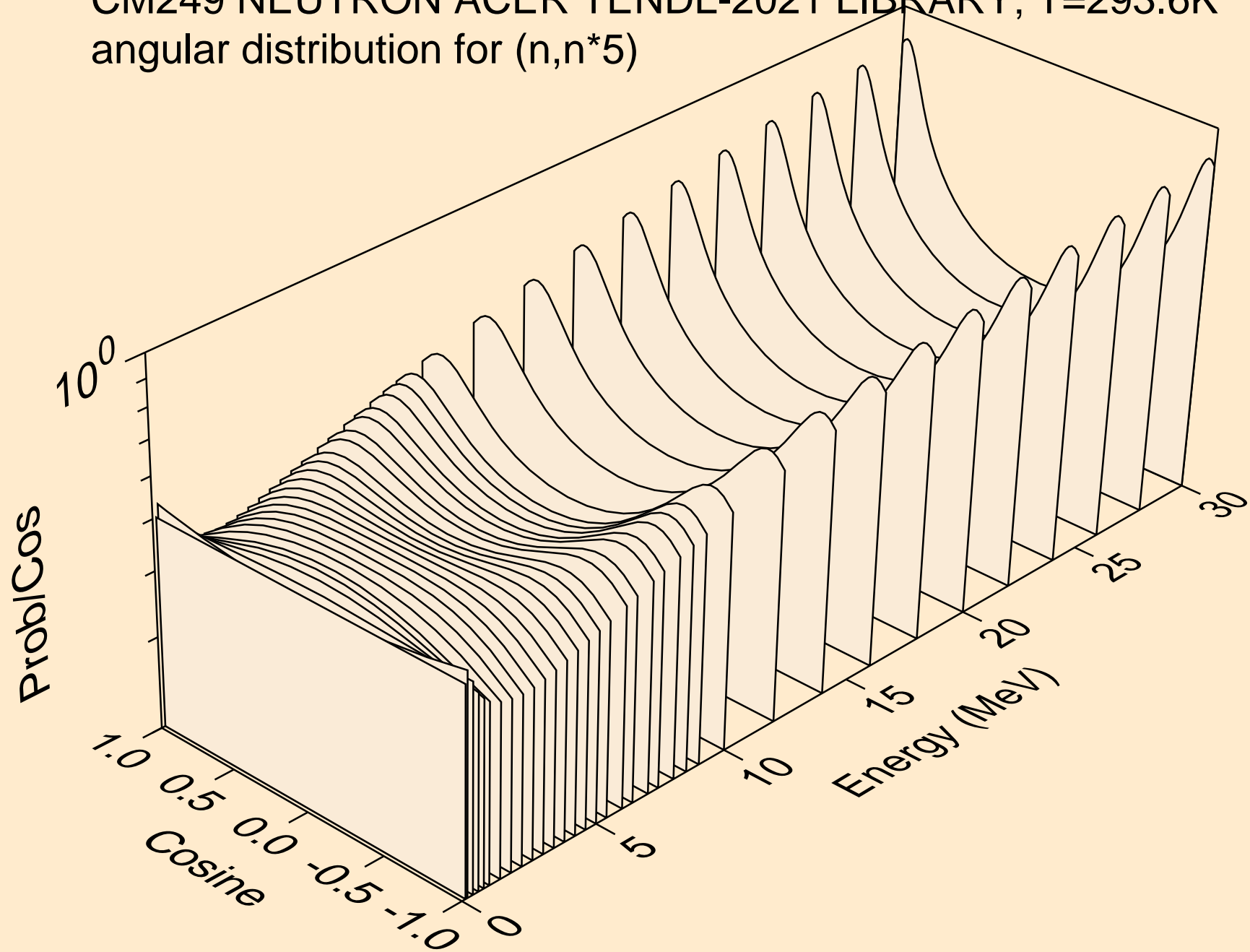

CM249 NEUTRON ACER TENDL-2021 LIBRARY; T=293.6K
angular distribution for (n,n*6)

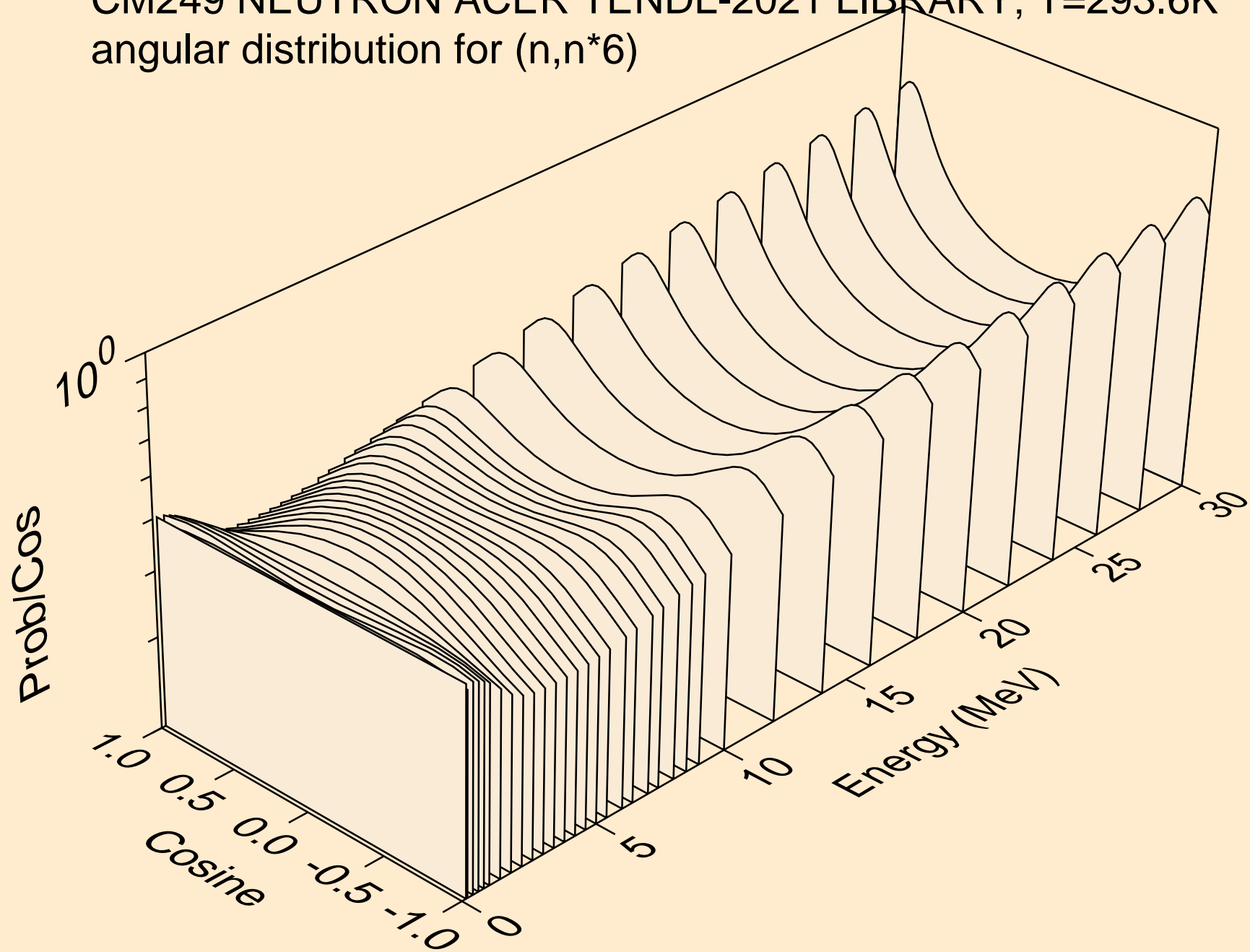

CM249 NEUTRON ACER TENDL-2021 LIBRARY; T=293.6K
angular distribution for (n,n*7)

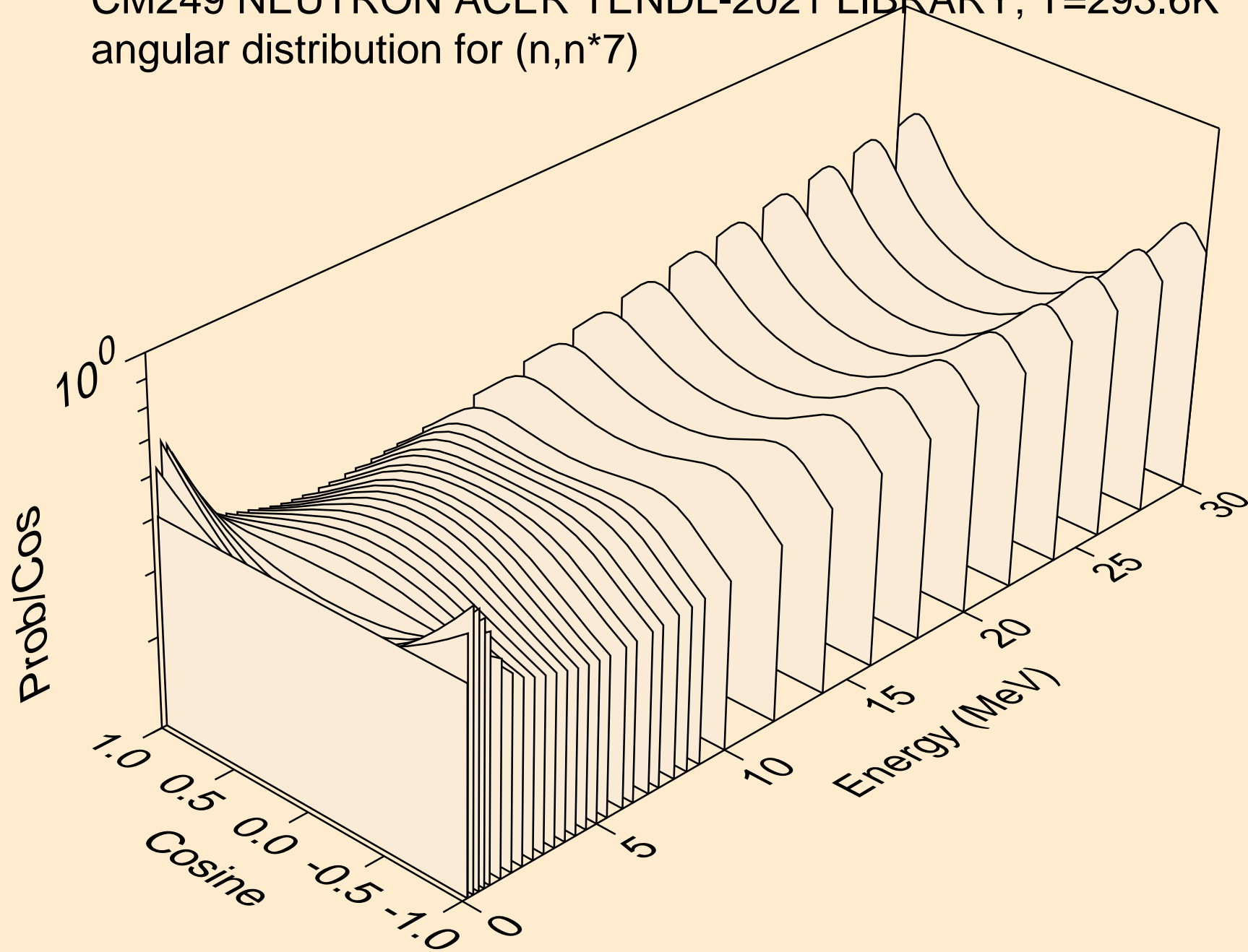

CM249 NEUTRON ACER TENDL-2021 LIBRARY; T=293.6K
angular distribution for (n,n*8)

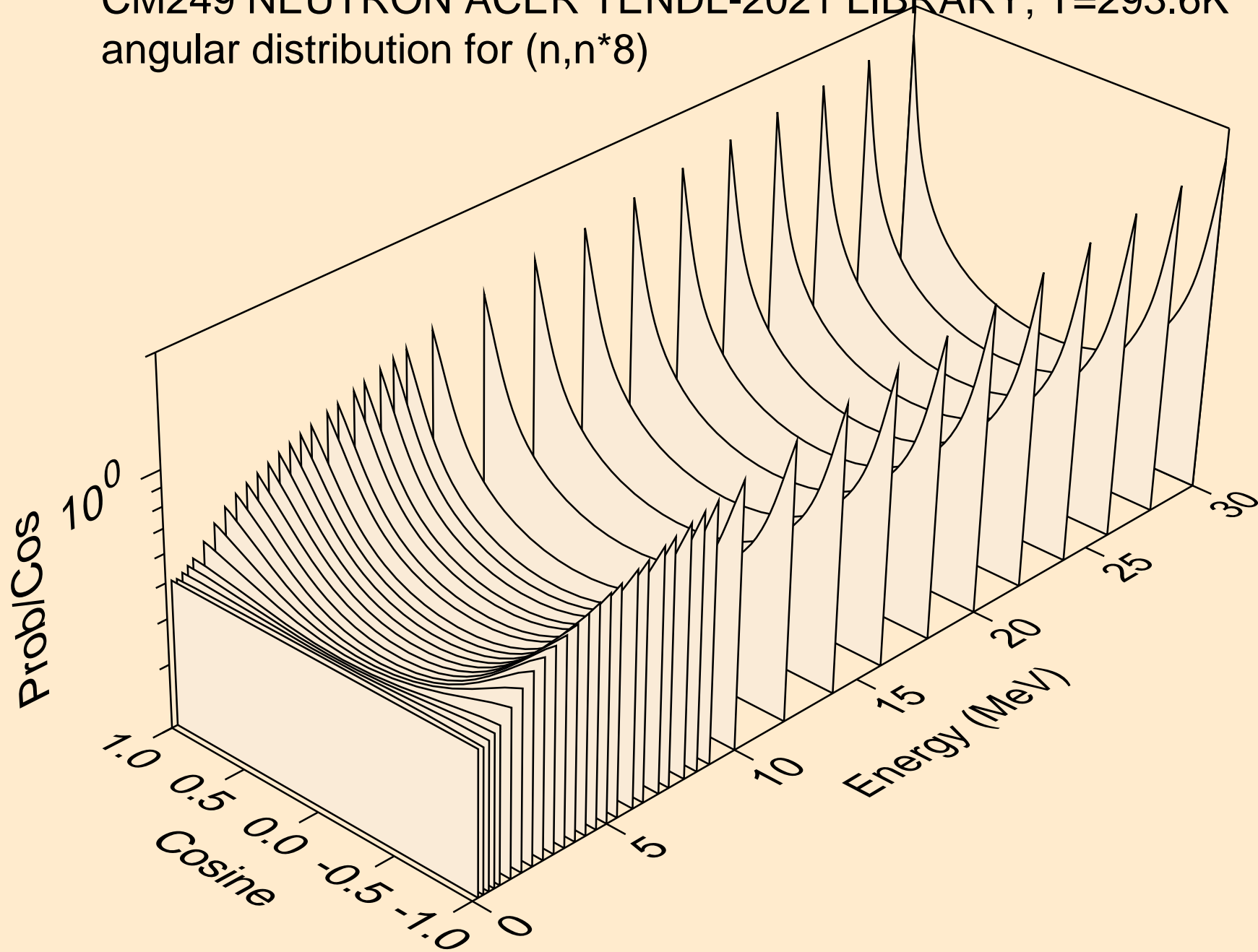

CM249 NEUTRON ACER TENDL-2021 LIBRARY; T=293.6K
angular distribution for (n,n*9)

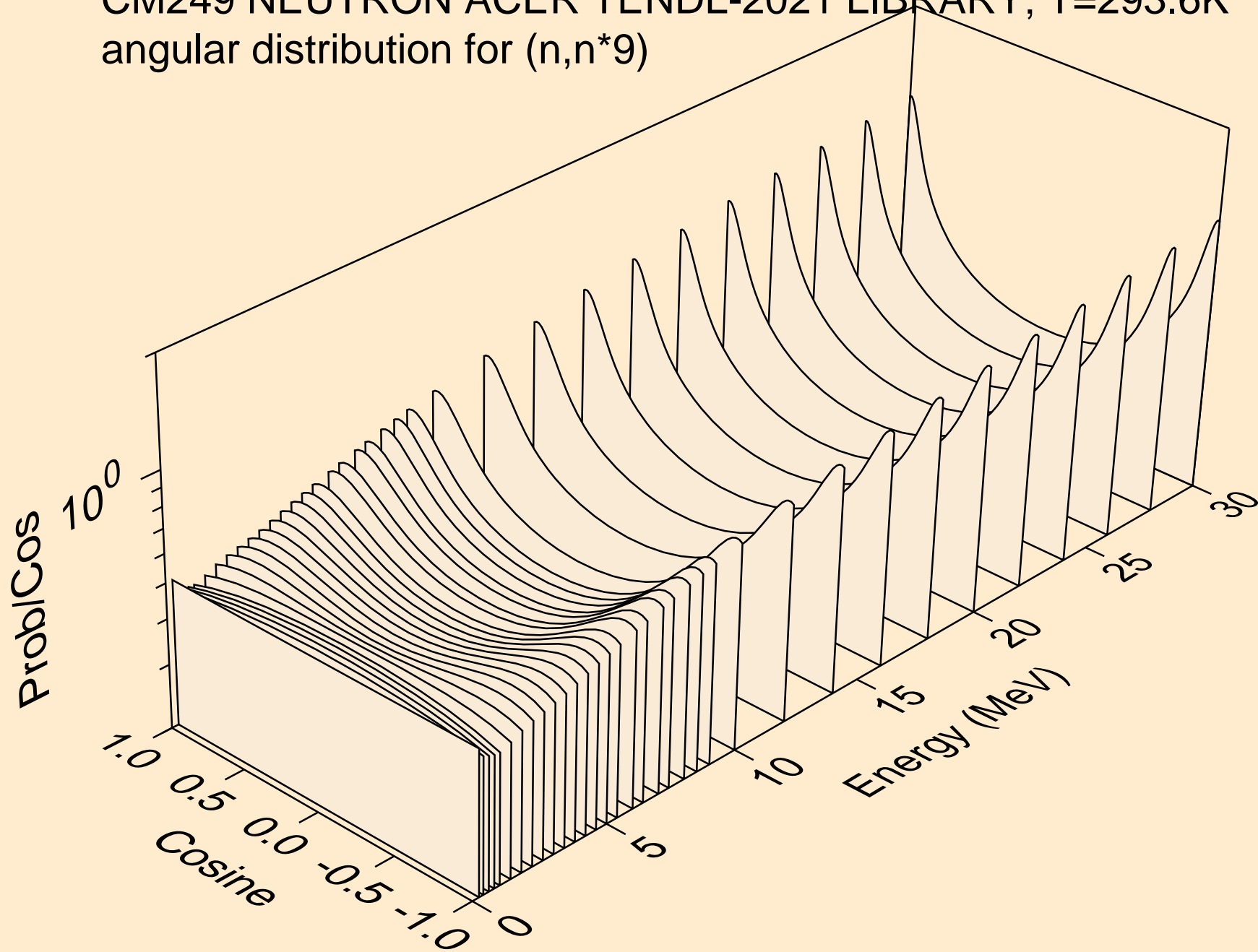

CM249 NEUTRON ACER TENDL-2021 LIBRARY; T=293.6K
angular distribution for (n,n*10)

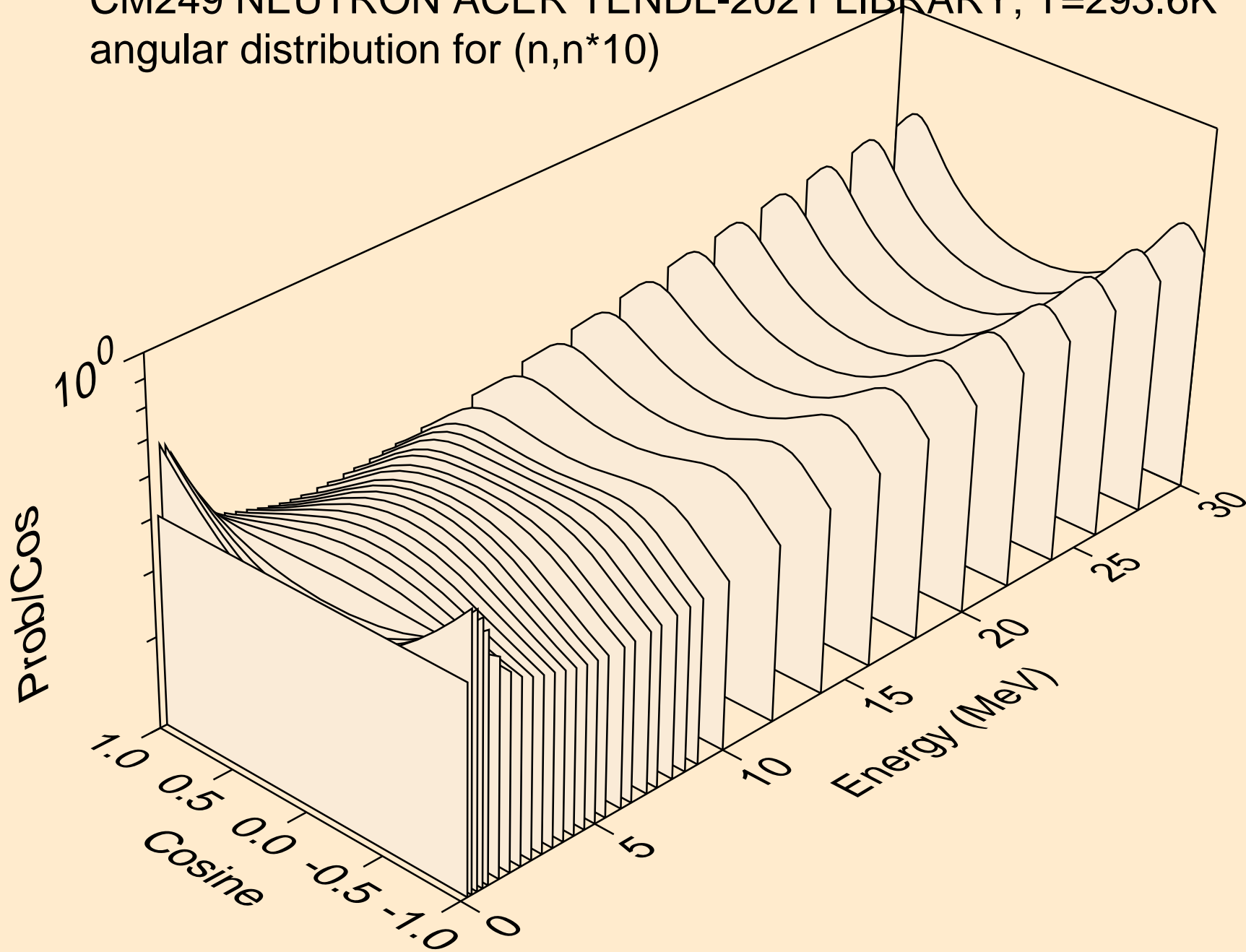

CM249 NEUTRON ACER TENDL-2021 LIBRARY; T=293.6K
angular distribution for (n,n*11)

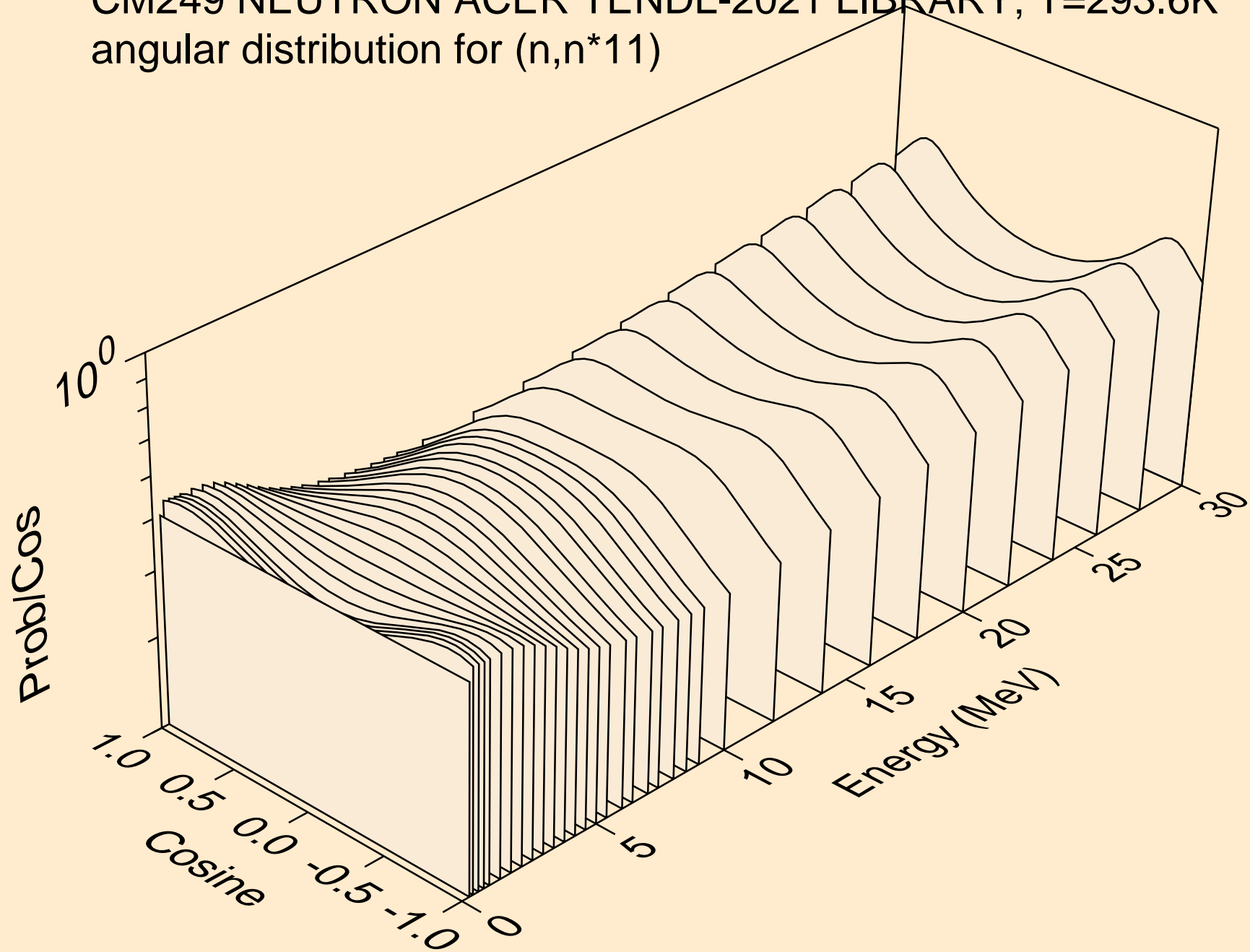

CM249 NEUTRON ACER TENDL-2021 LIBRARY; T=293.6K
angular distribution for (n,n*12)

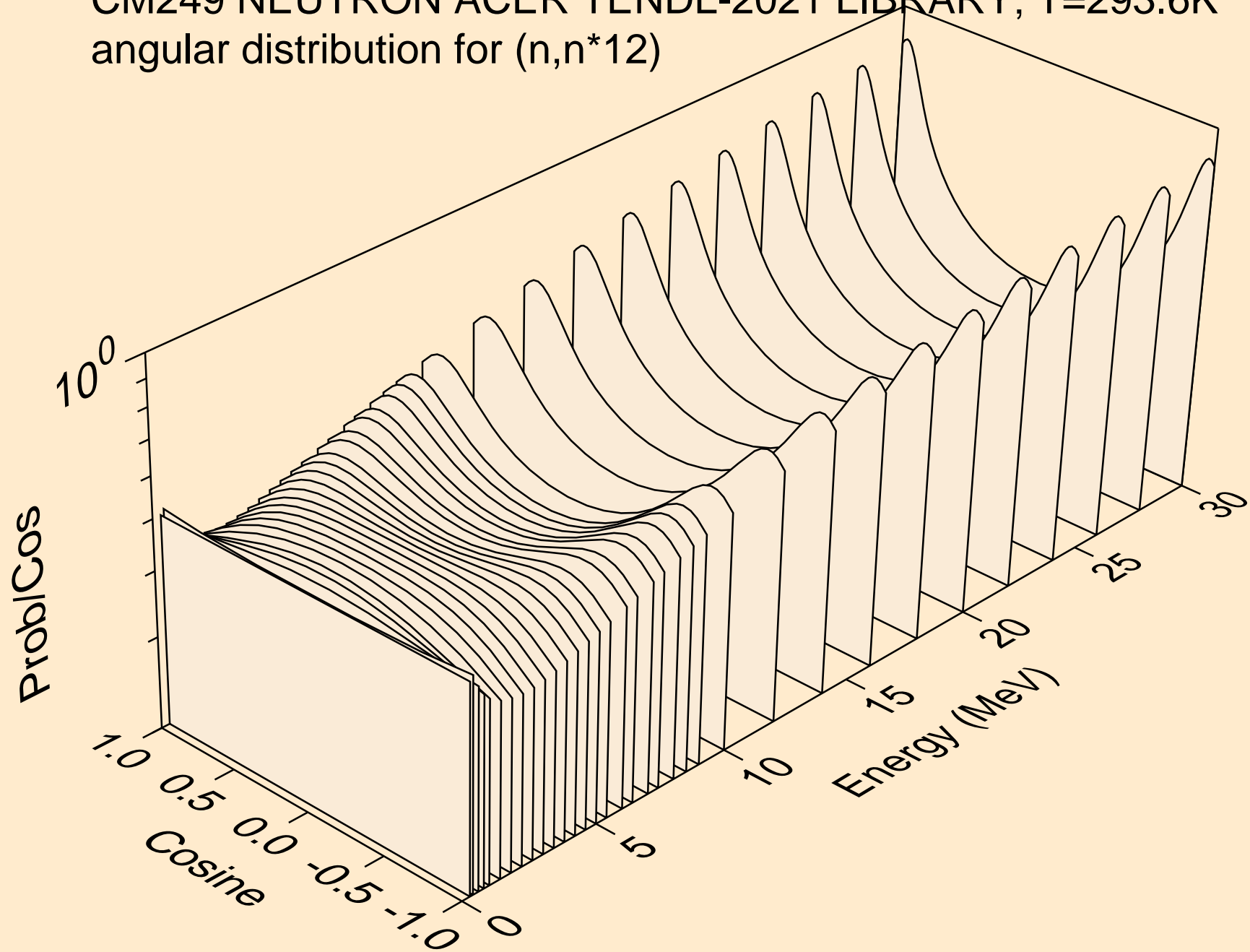

CM249 NEUTRON ACER TENDL-2021 LIBRARY; T=293.6K
angular distribution for (n,n*13)

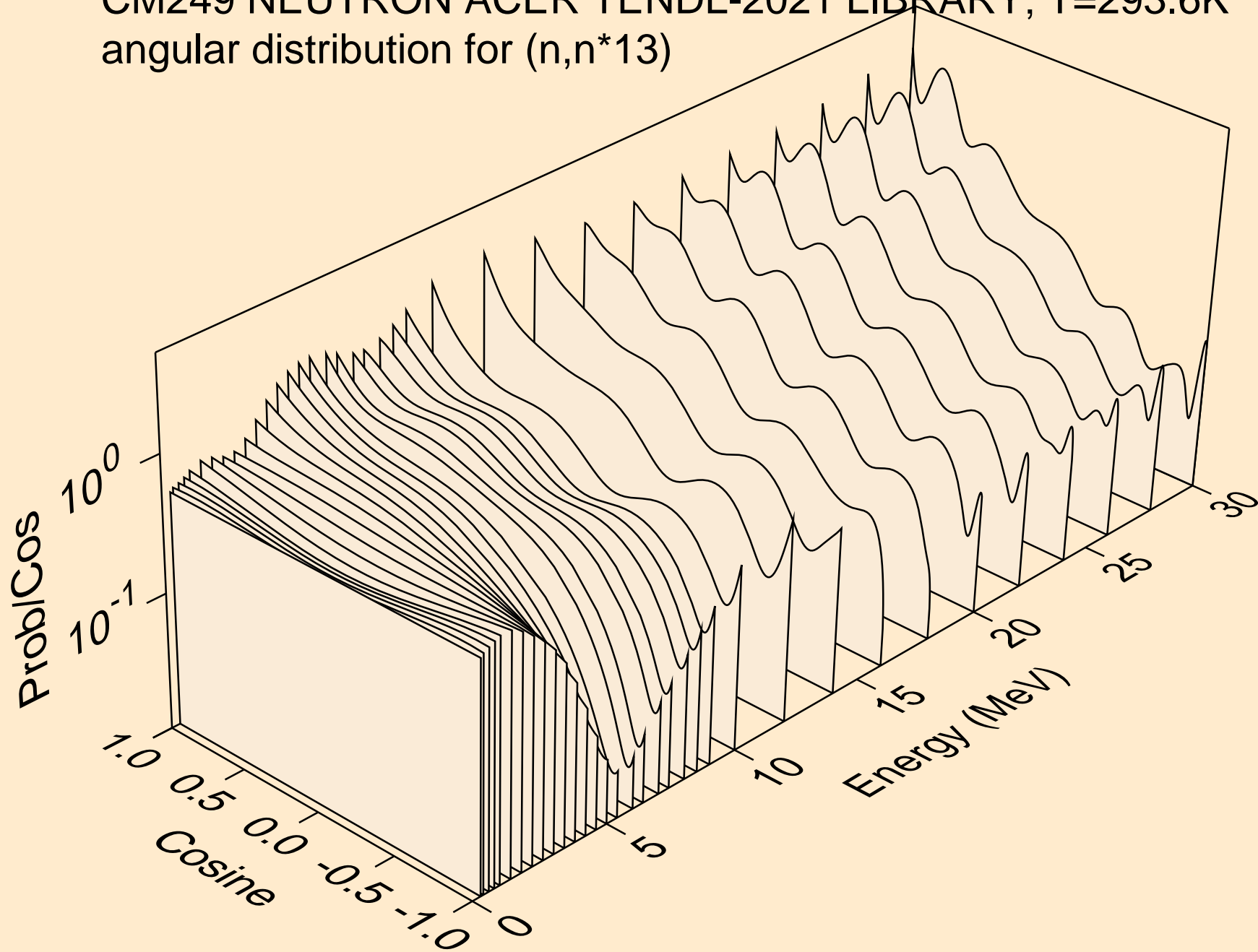

CM249 NEUTRON ACER TENDL-2021 LIBRARY; T=293.6K
angular distribution for (n,n*14)

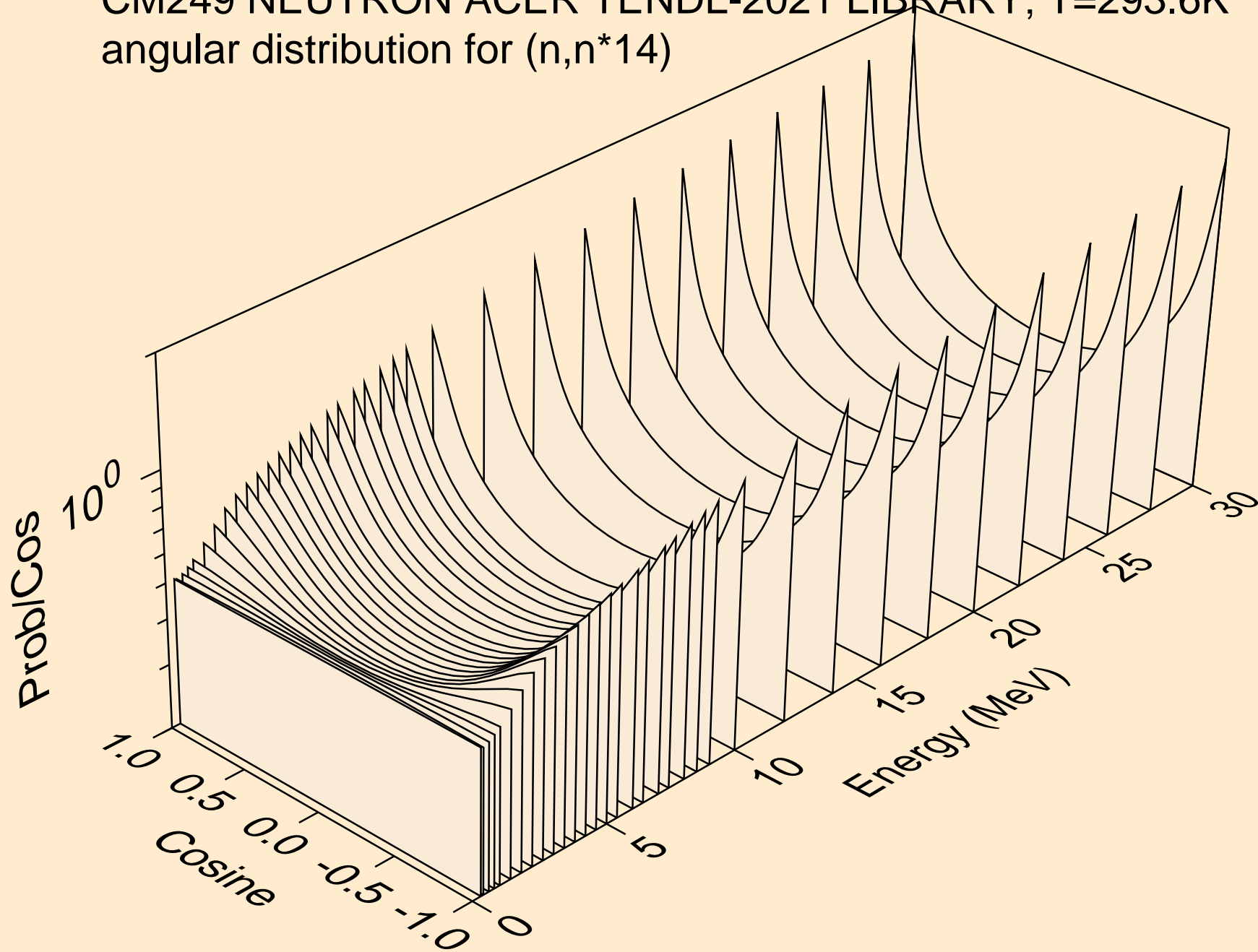

CM249 NEUTRON ACER TENDL-2021 LIBRARY; T=293.6K
angular distribution for (n,n*15)

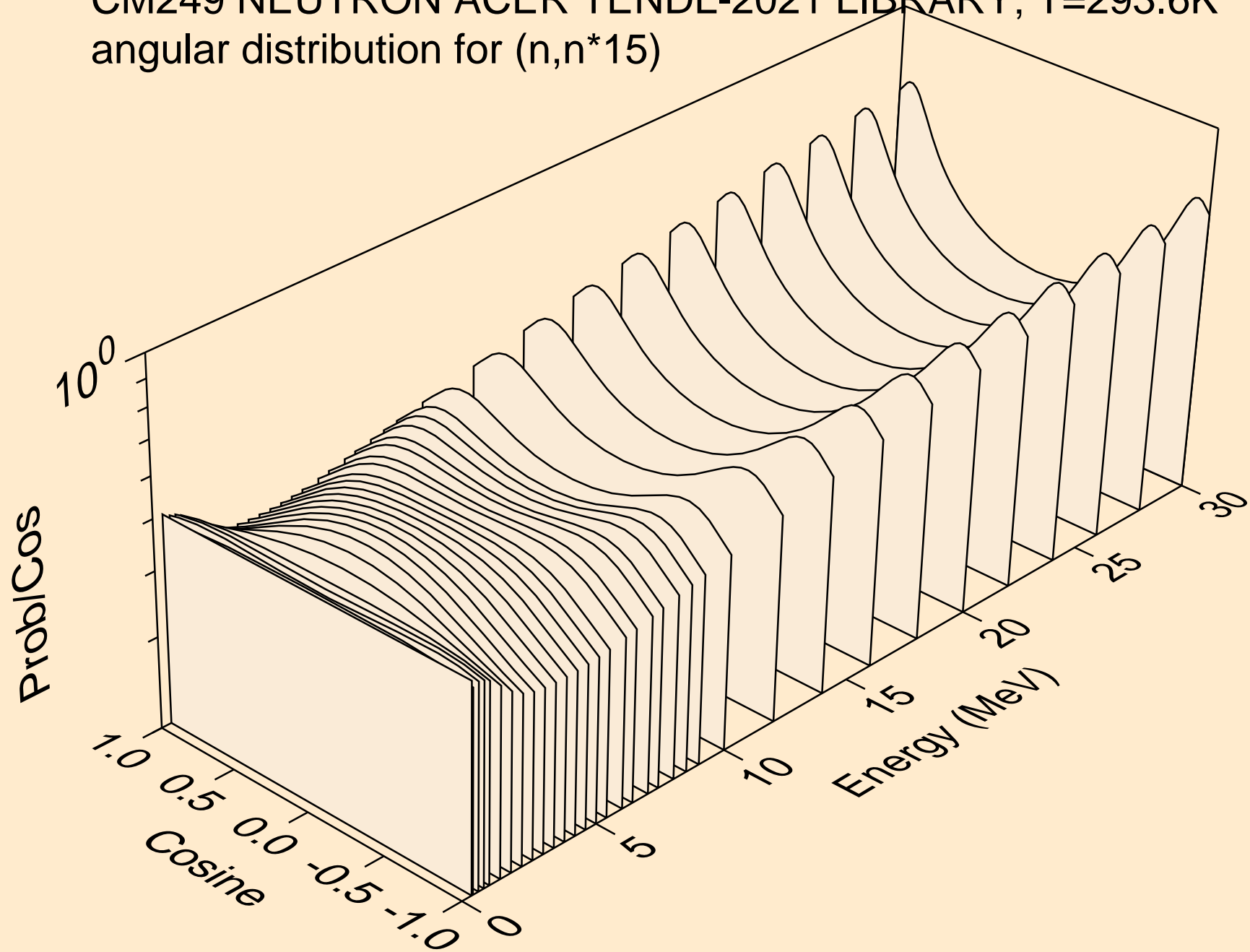

CM249 NEUTRON ACER TENDL-2021 LIBRARY; T=293.6K
angular distribution for (n,n*16)

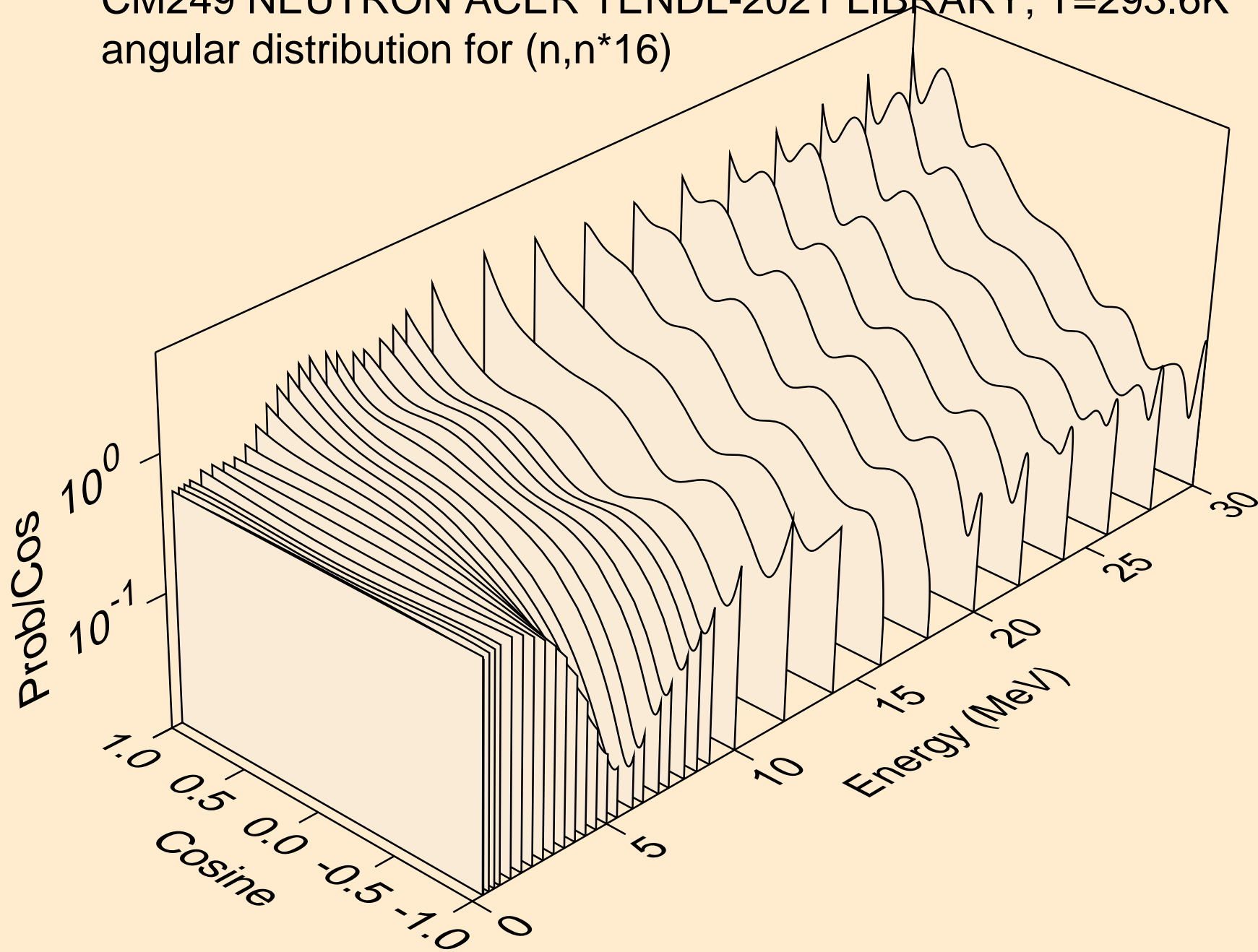

CM249 NEUTRON ACER TENDL-2021 LIBRARY; T=293.6K
angular distribution for (n,n*17)

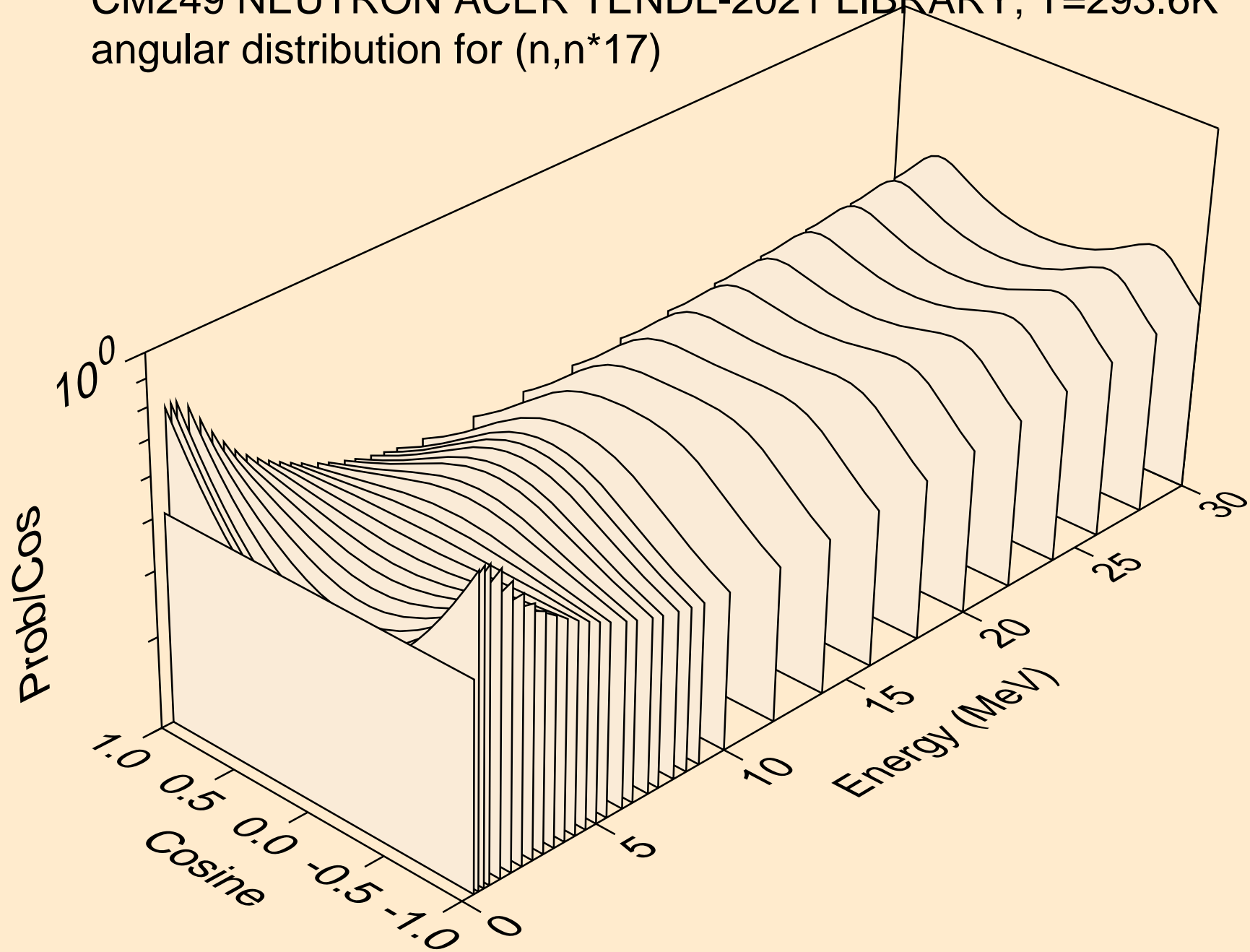

CM249 NEUTRON ACER TENDL-2021 LIBRARY; T=293.6K
angular distribution for (n,n*18)

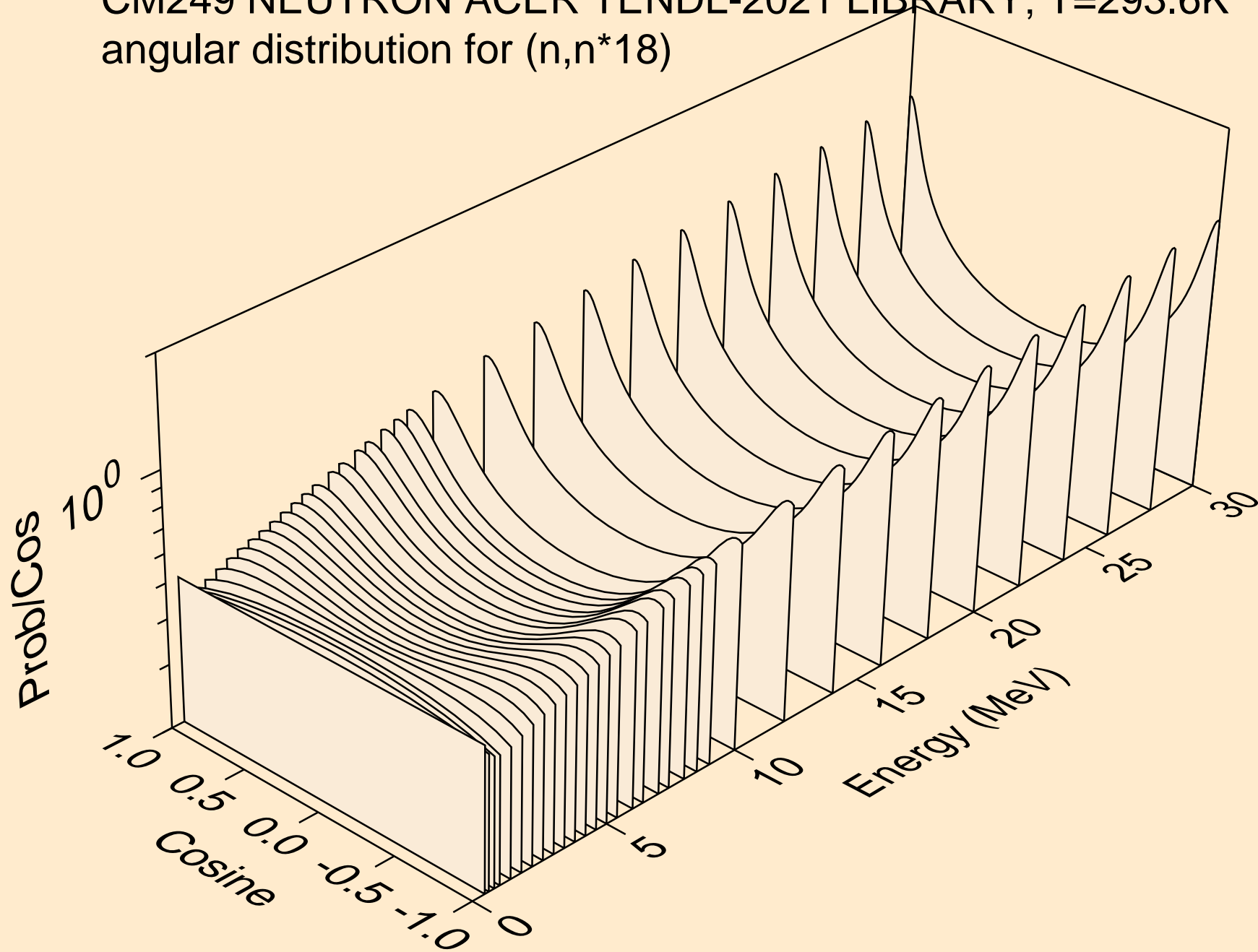

CM249 NEUTRON ACER TENDL-2021 LIBRARY; T=293.6K
angular distribution for (n,n*19)

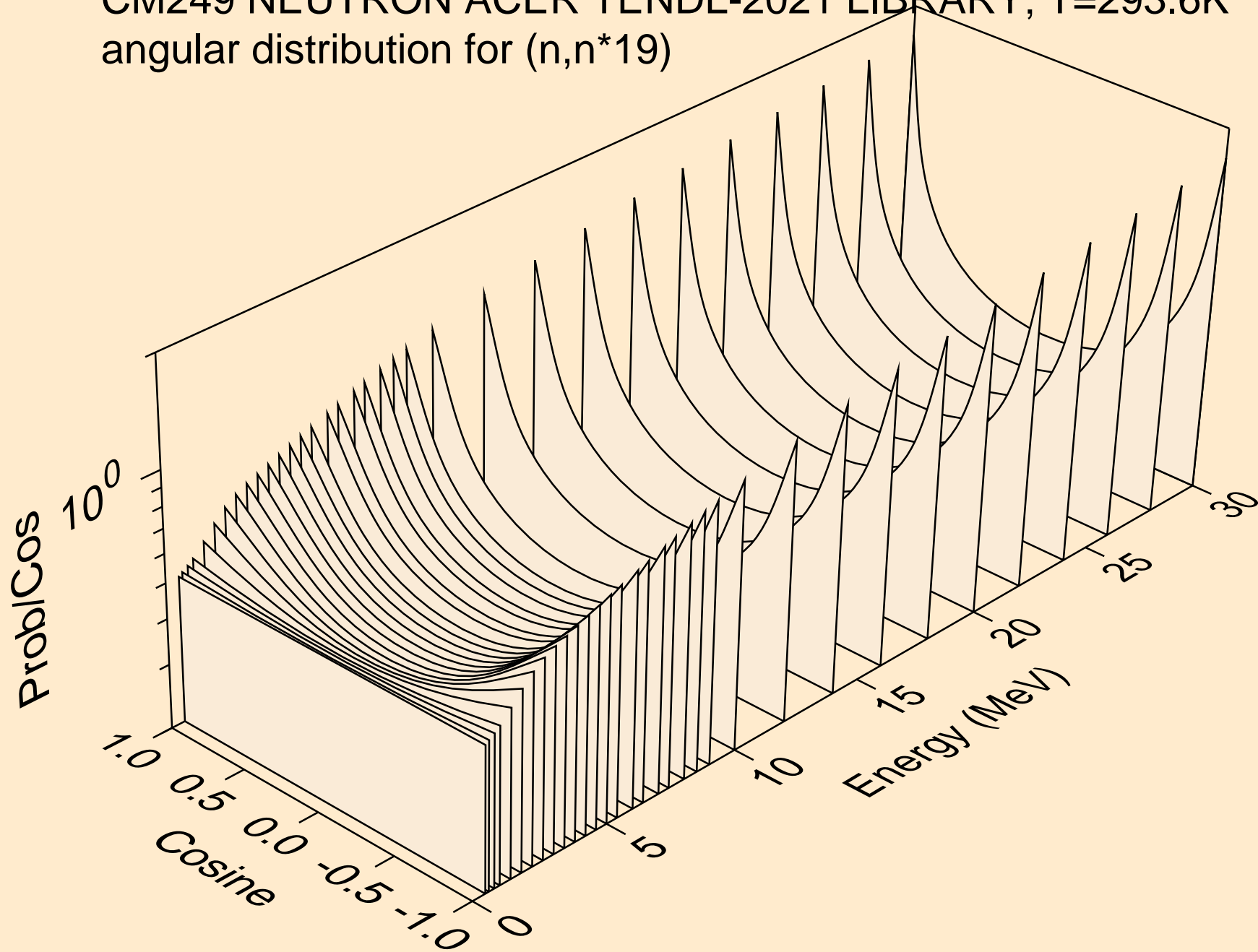

CM249 NEUTRON ACER TENDL-2021 LIBRARY; T=293.6K
angular distribution for (n,n*20)

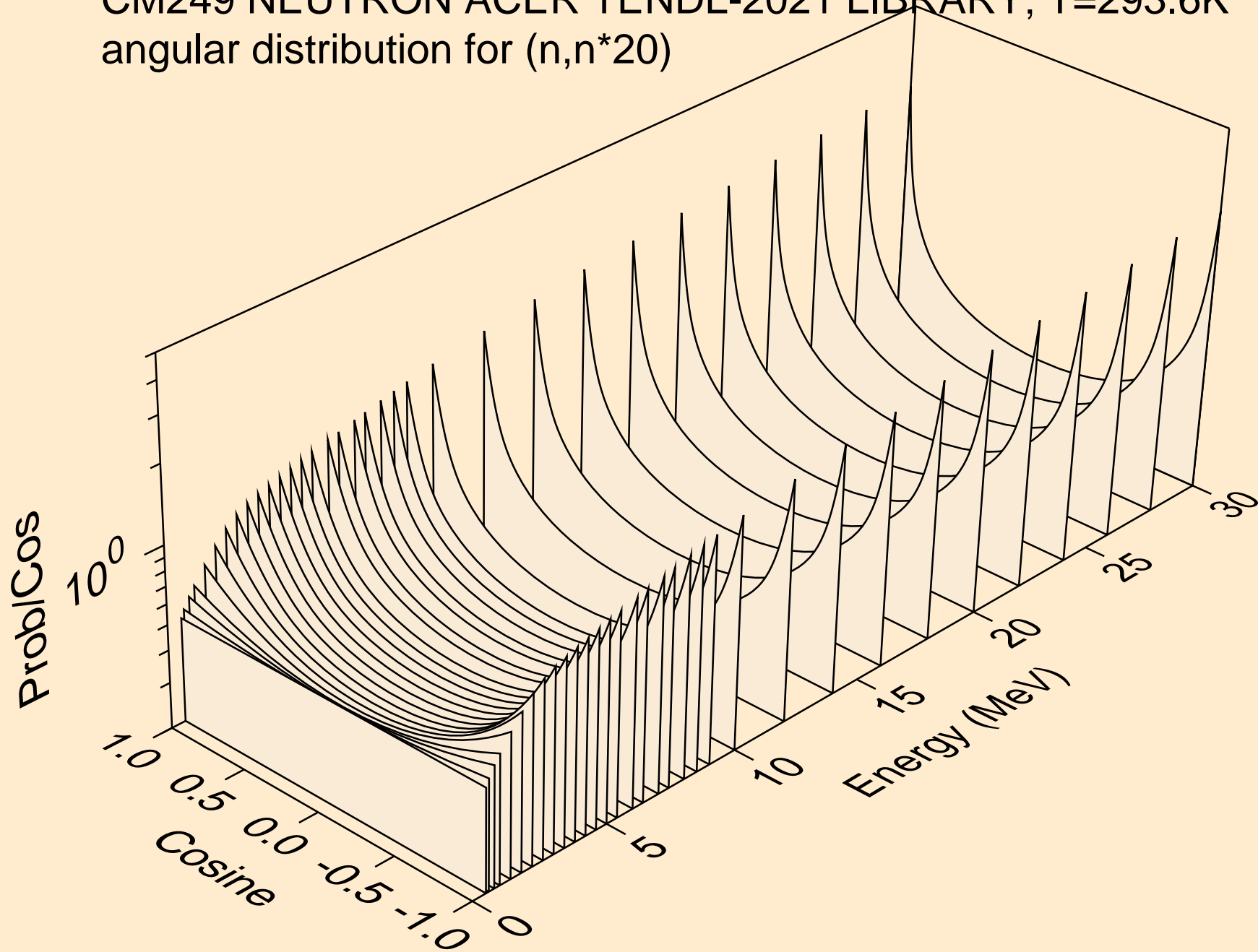

CM249 NEUTRON ACER TENDL-2021 LIBRARY; T=293.6K
angular distribution for (n,n*21)

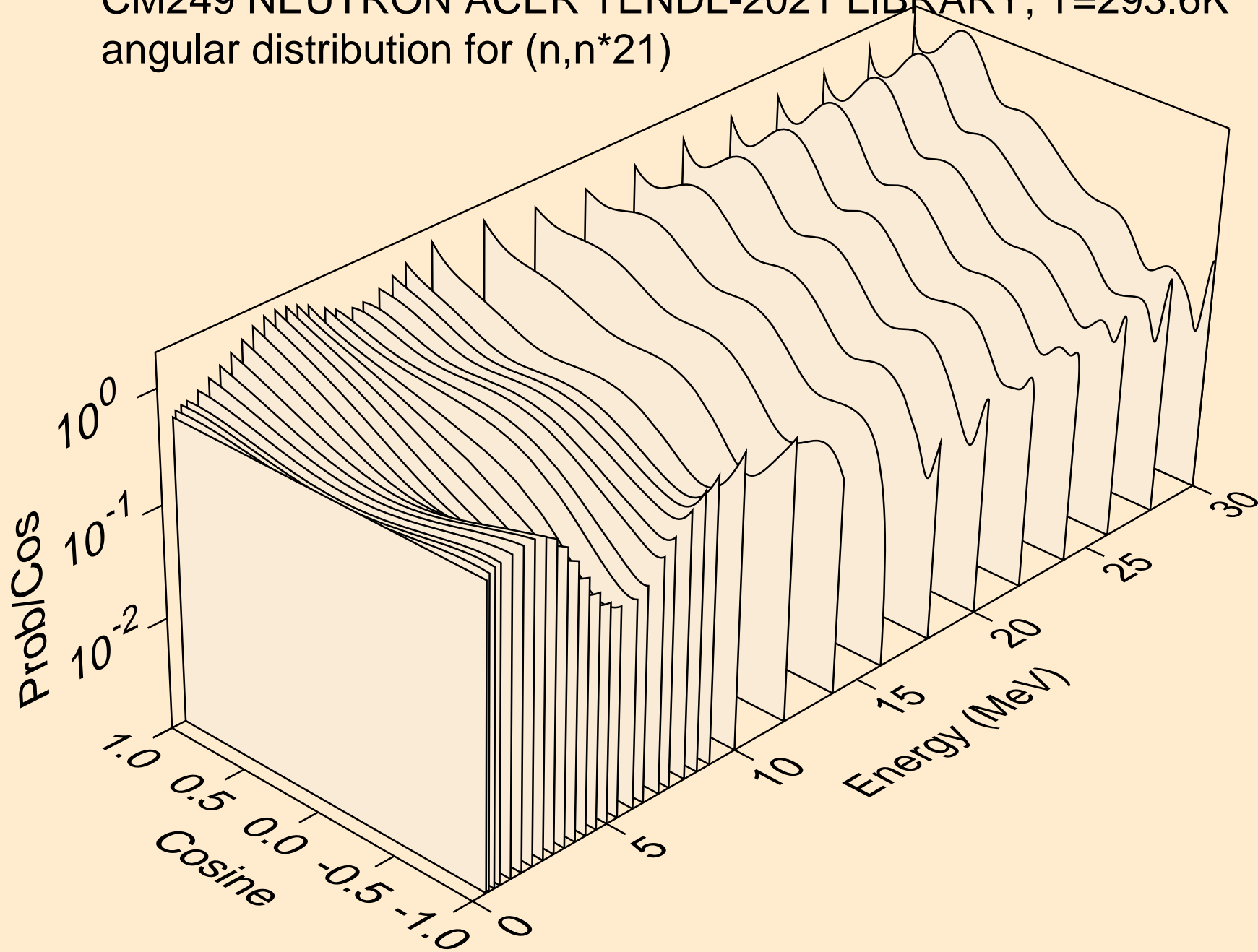

CM249 NEUTRON ACER TENDL-2021 LIBRARY; T=293.6K
angular distribution for (n,n*22)

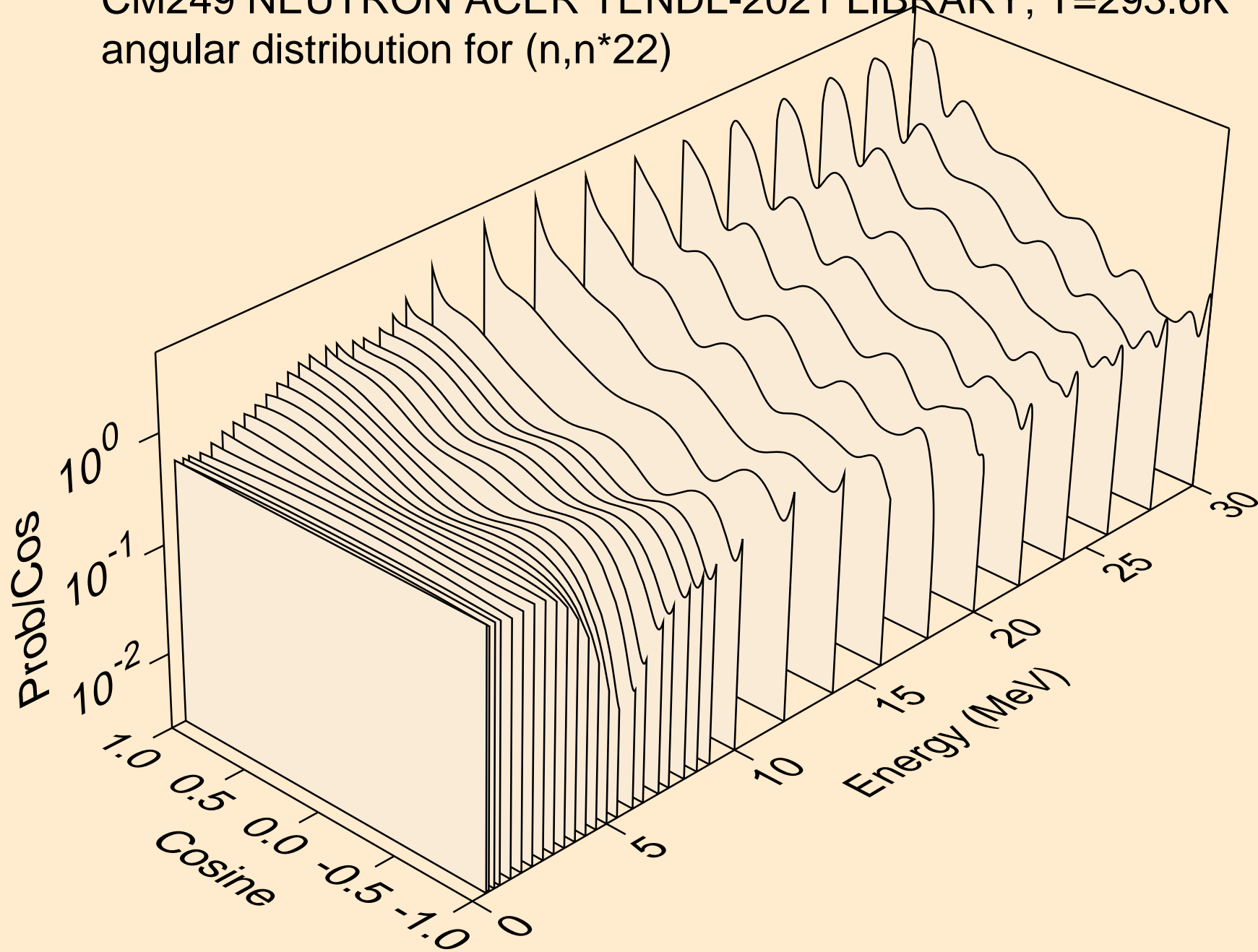

CM249 NEUTRON ACER TENDL-2021 LIBRARY; T=293.6K
angular distribution for (n,n*23)

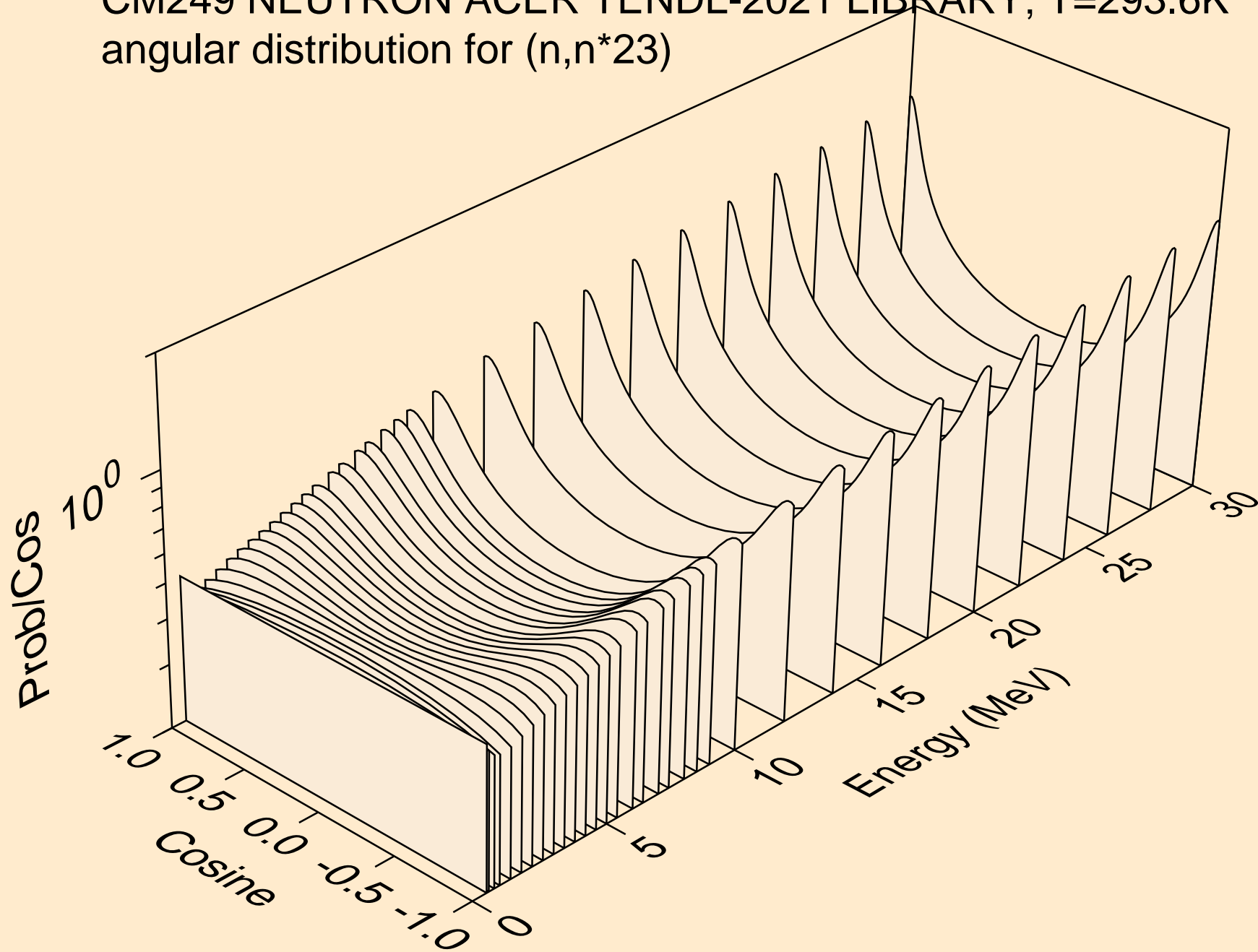

CM249 NEUTRON ACER TENDL-2021 LIBRARY; T=293.6K
angular distribution for (n,n*24)

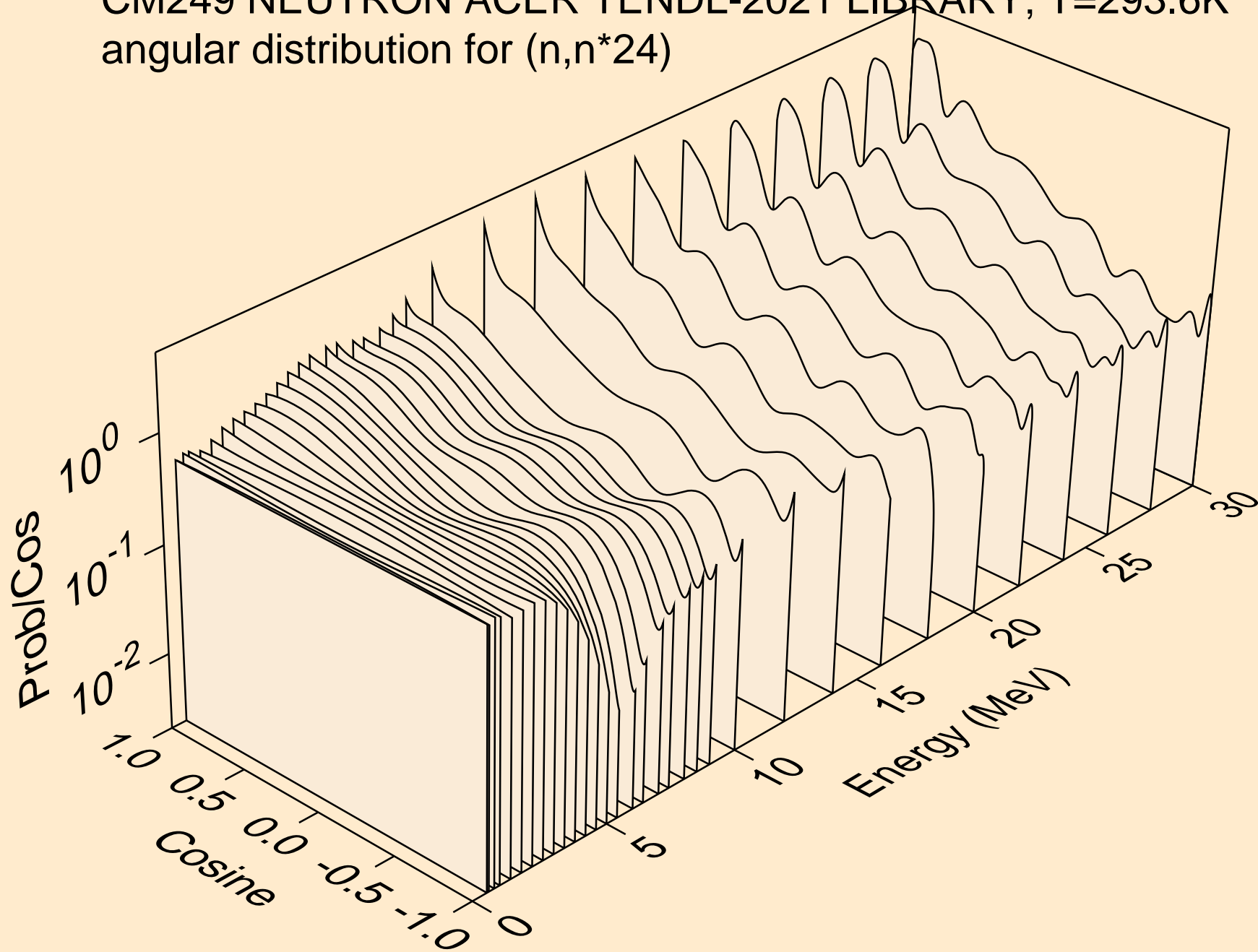

CM249 NEUTRON ACER TENDL-2021 LIBRARY; T=293.6K
angular distribution for (n,n*25)

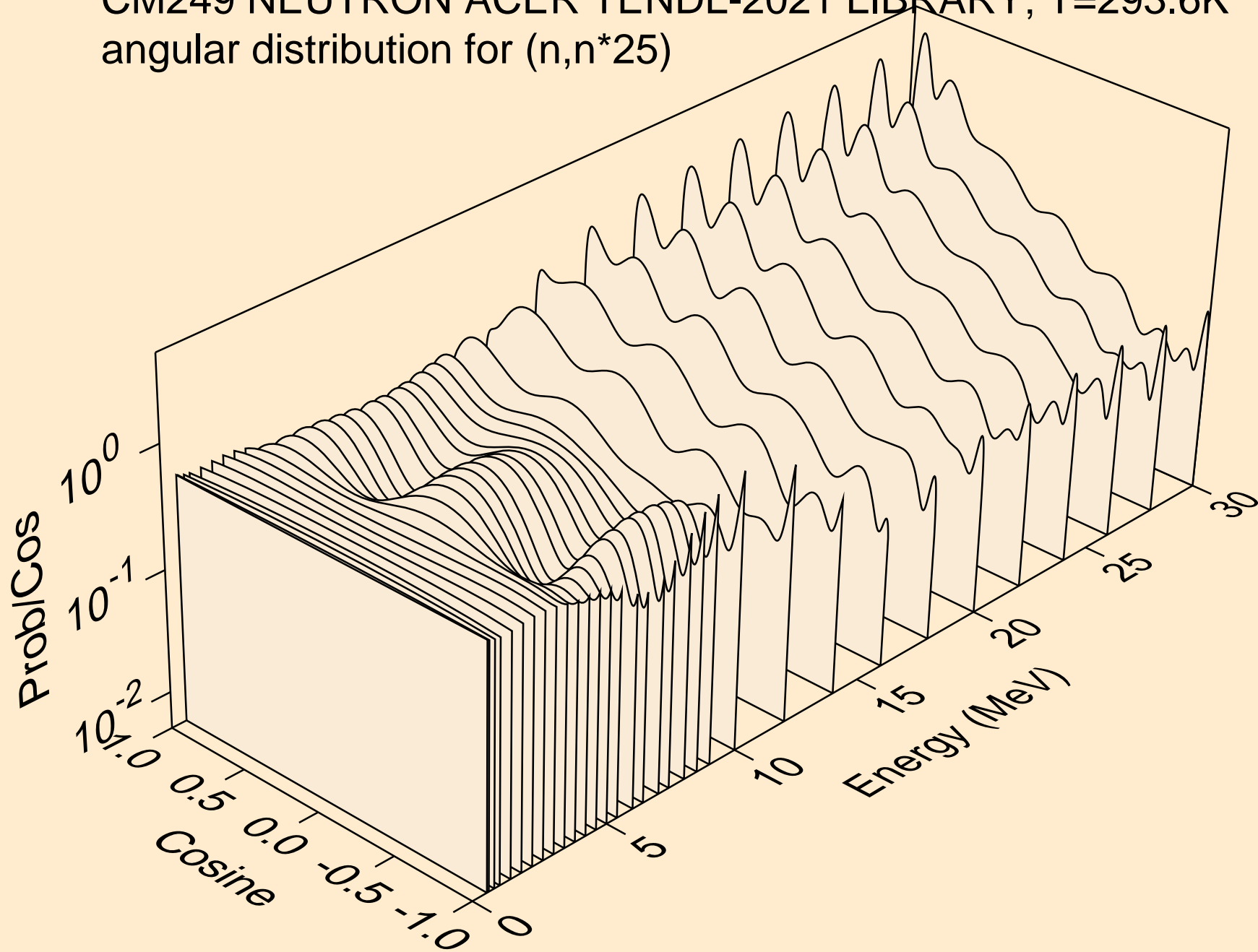

CM249 NEUTRON ACER TENDL-2021 LIBRARY; T=293.6K
angular distribution for (n,n*26)

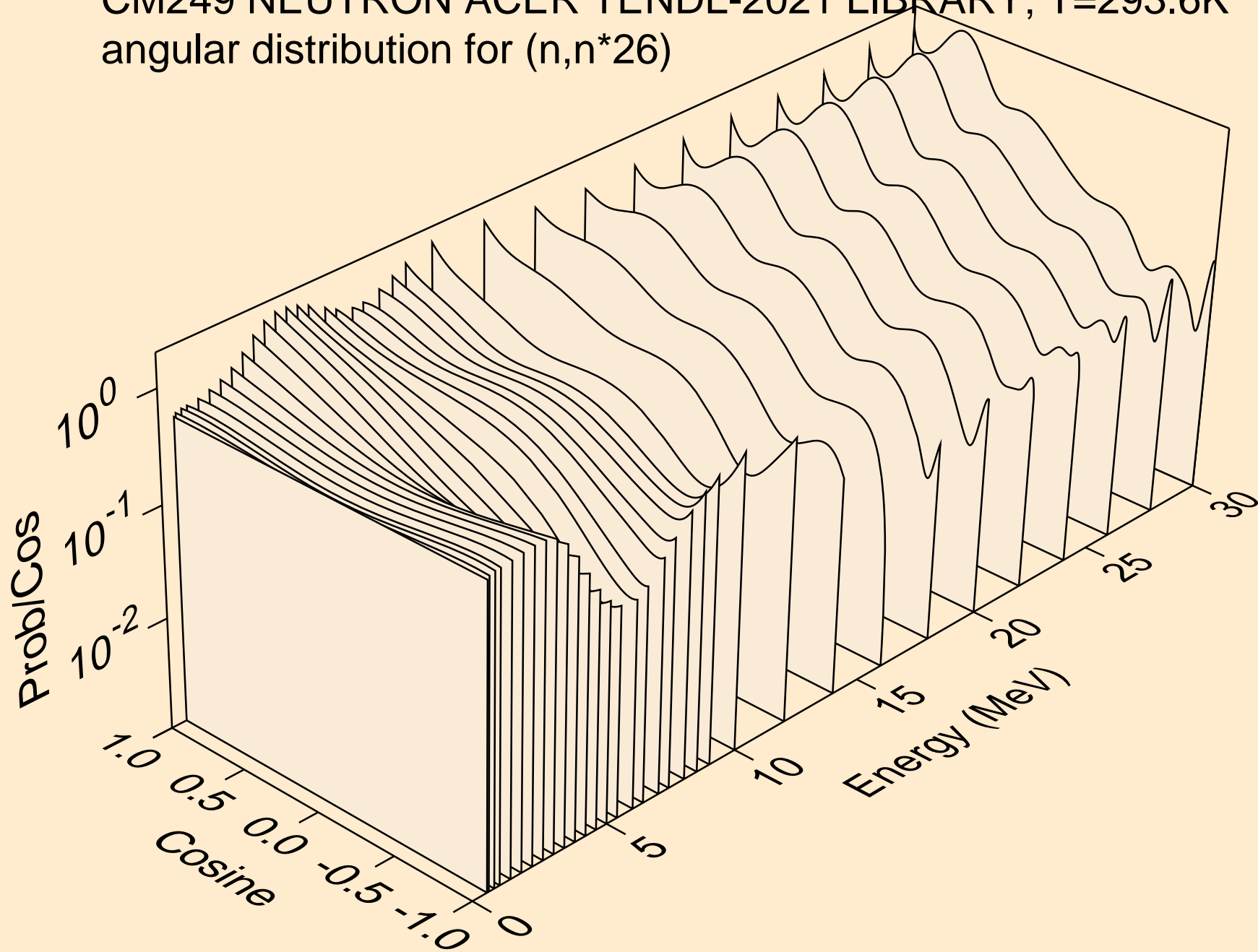

CM249 NEUTRON ACER TENDL-2021 LIBRARY; T=293.6K
angular distribution for (n,n*27)

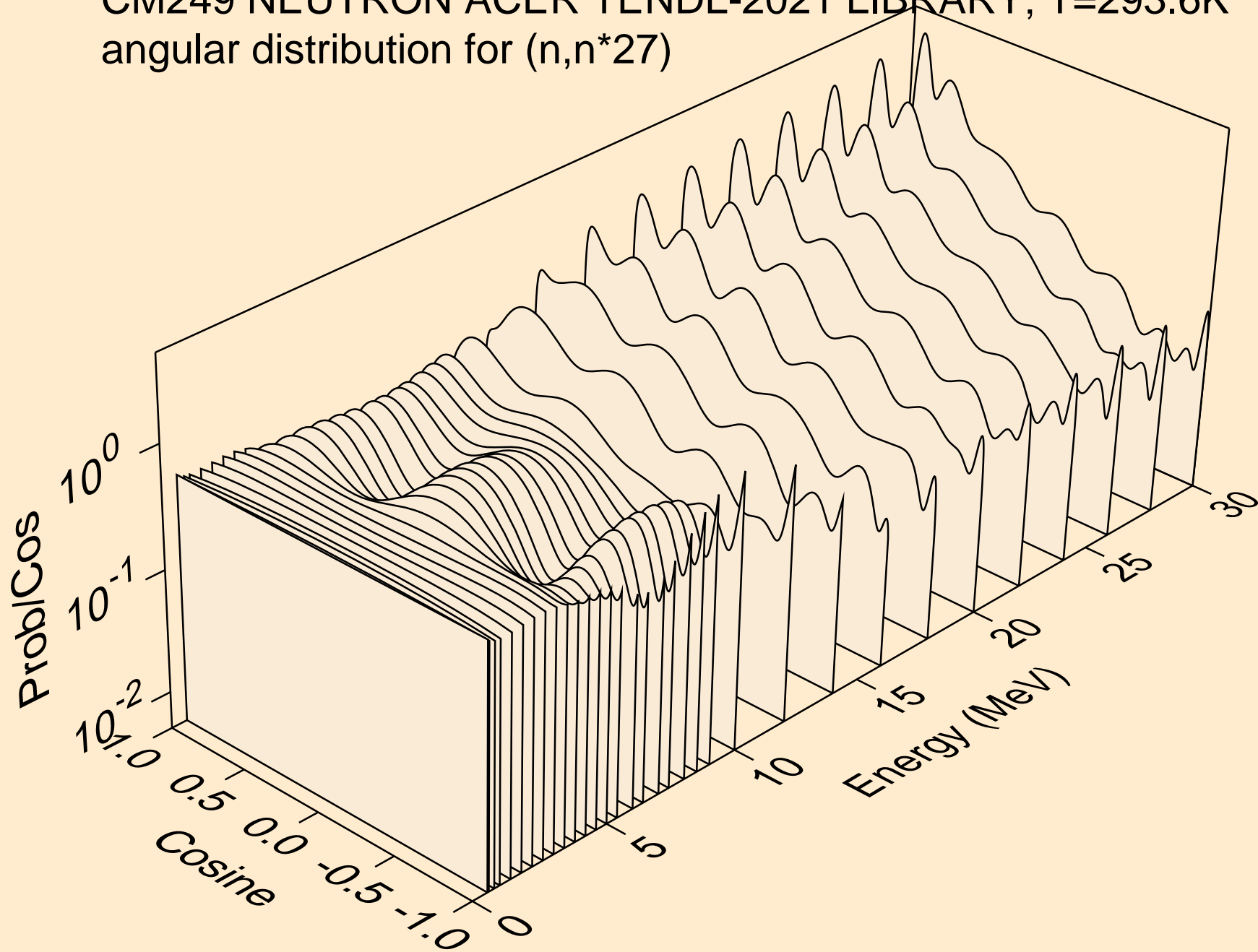

CM249 NEUTRON ACER TENDL-2021 LIBRARY; T=293.6K
angular distribution for (n,n*28)

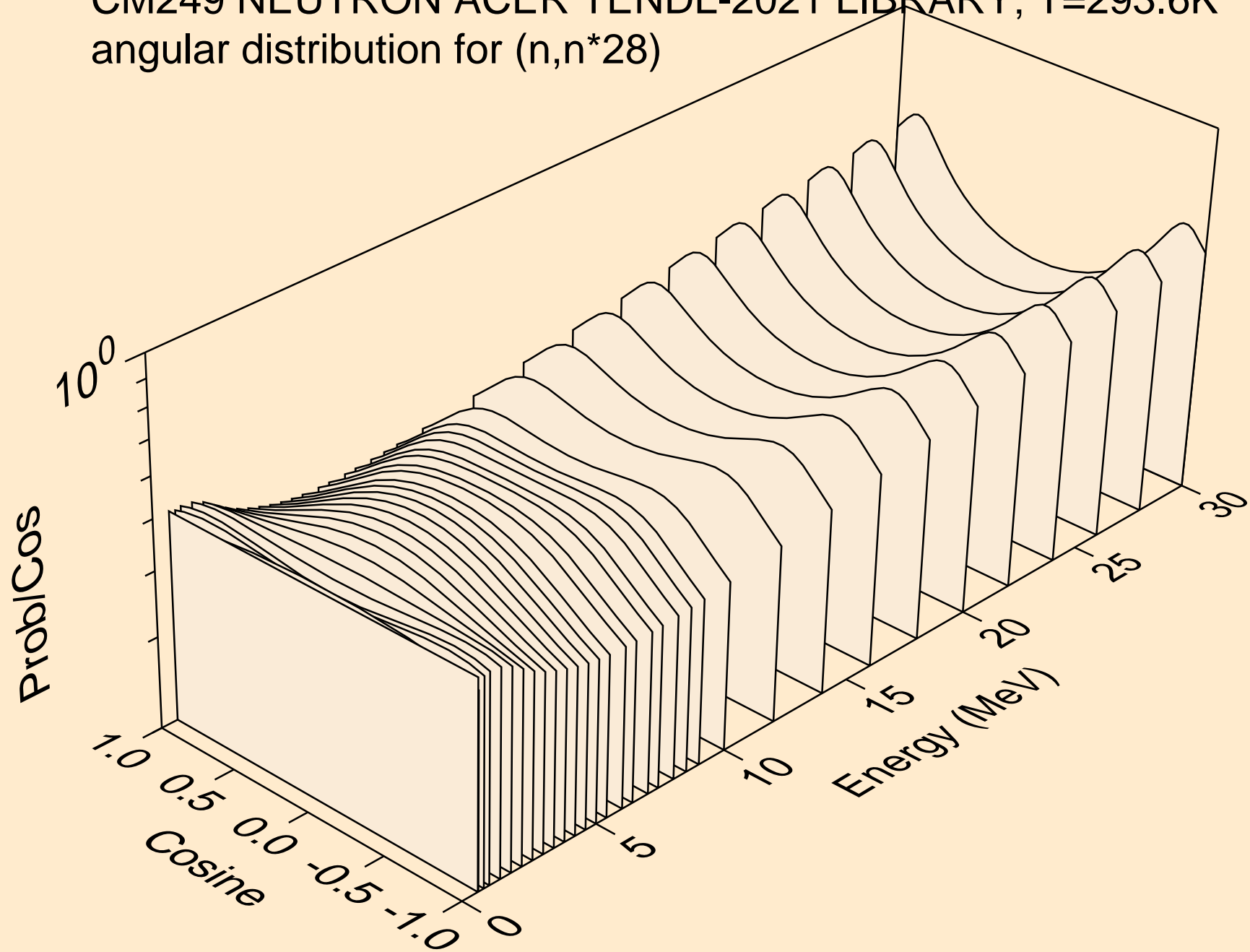

CM249 NEUTRON ACER TENDL-2021 LIBRARY; T=293.6K
angular distribution for (n,n*29)

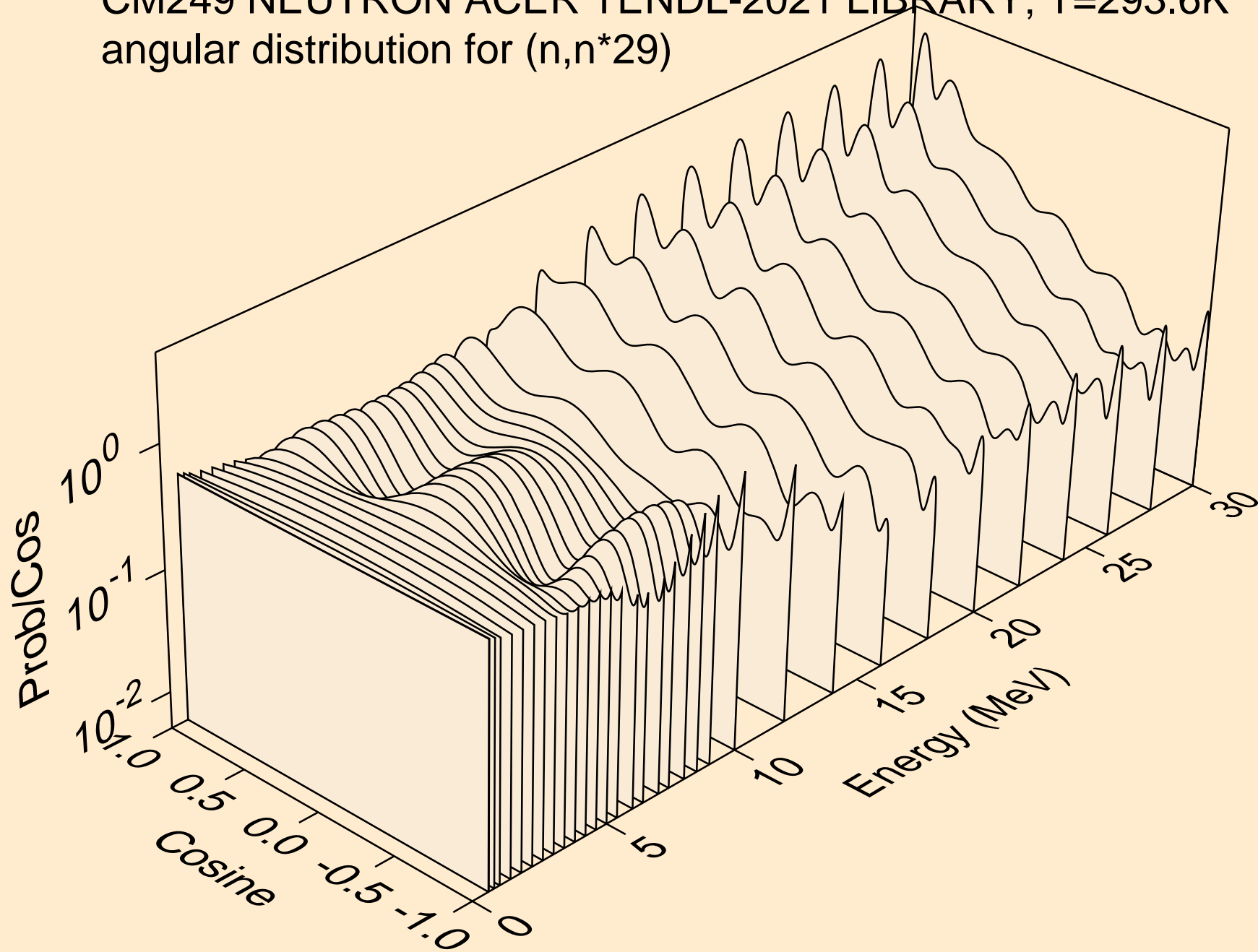

CM249 NEUTRON ACER TENDL-2021 LIBRARY; T=293.6K
Total fission nubar

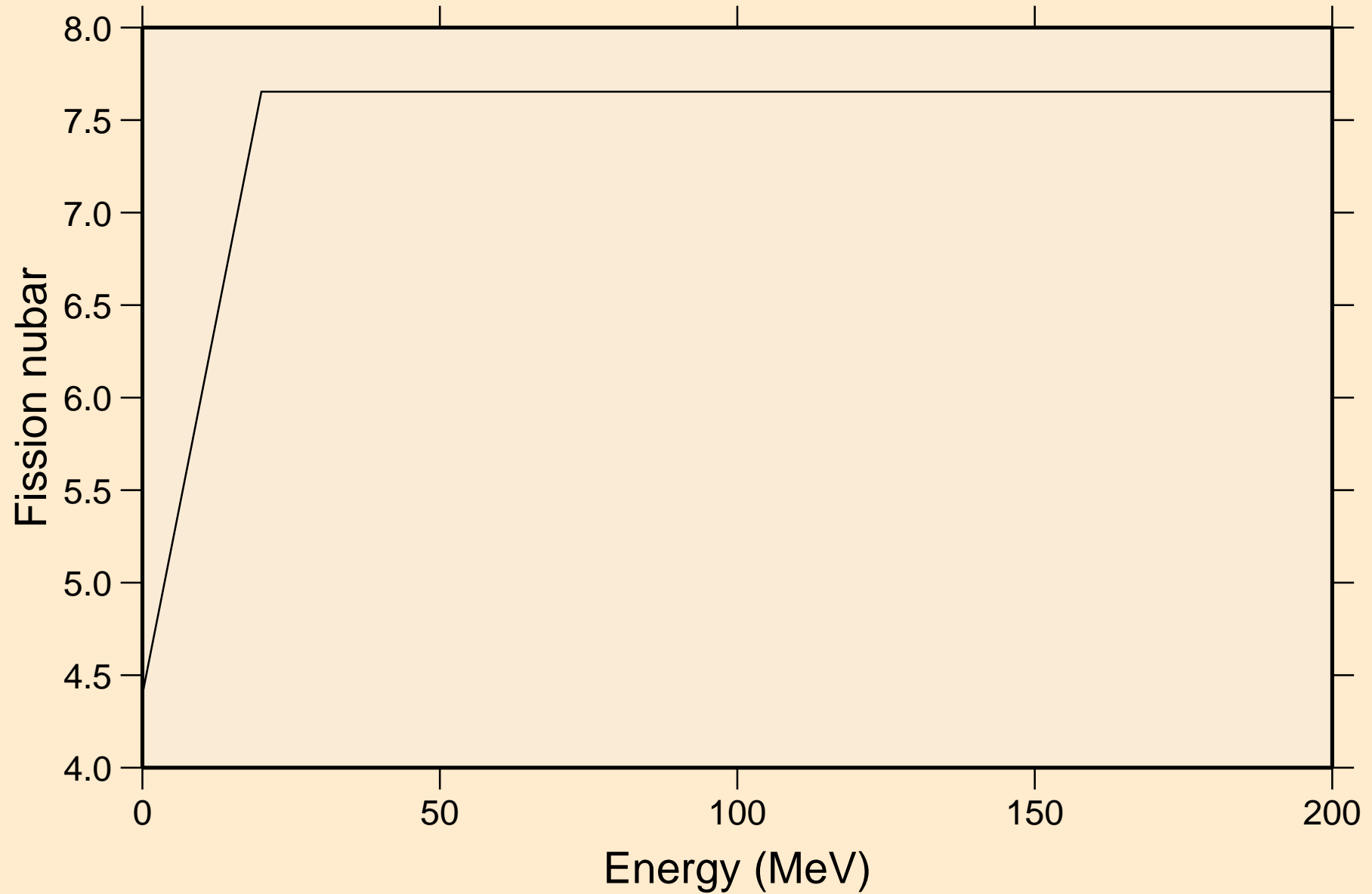

CM249 NEUTRON ACER TENDL-2021 LIBRARY; T=293.6K
Neutron emission for (n,x)

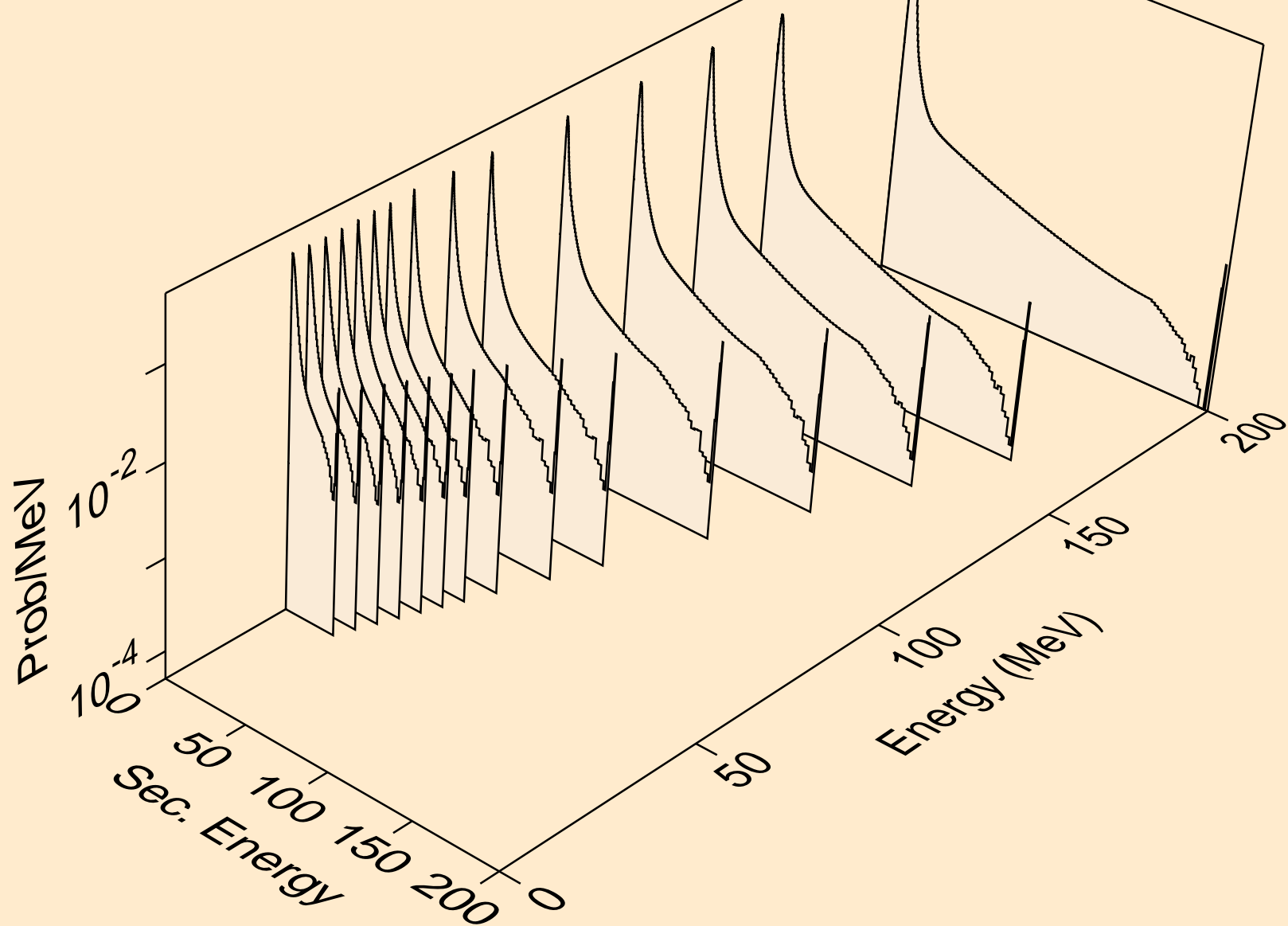

CM249 NEUTRON ACER TENDL-2021 LIBRARY; T=293.6K
Neutron emission for (n,2nd)

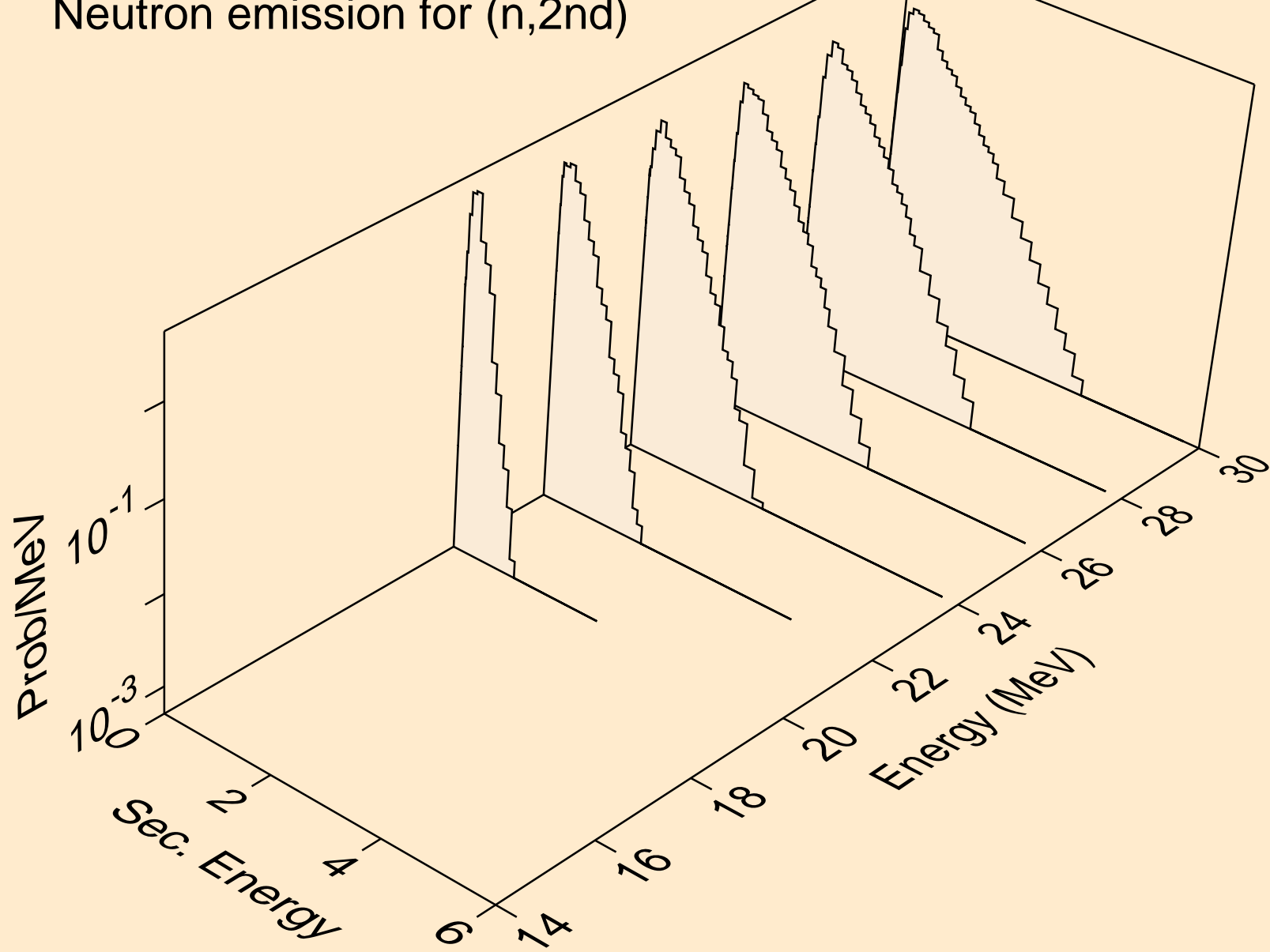

CM249 NEUTRON ACER TENDL-2021 LIBRARY; T=293.6K
Neutron emission for (n,2n)

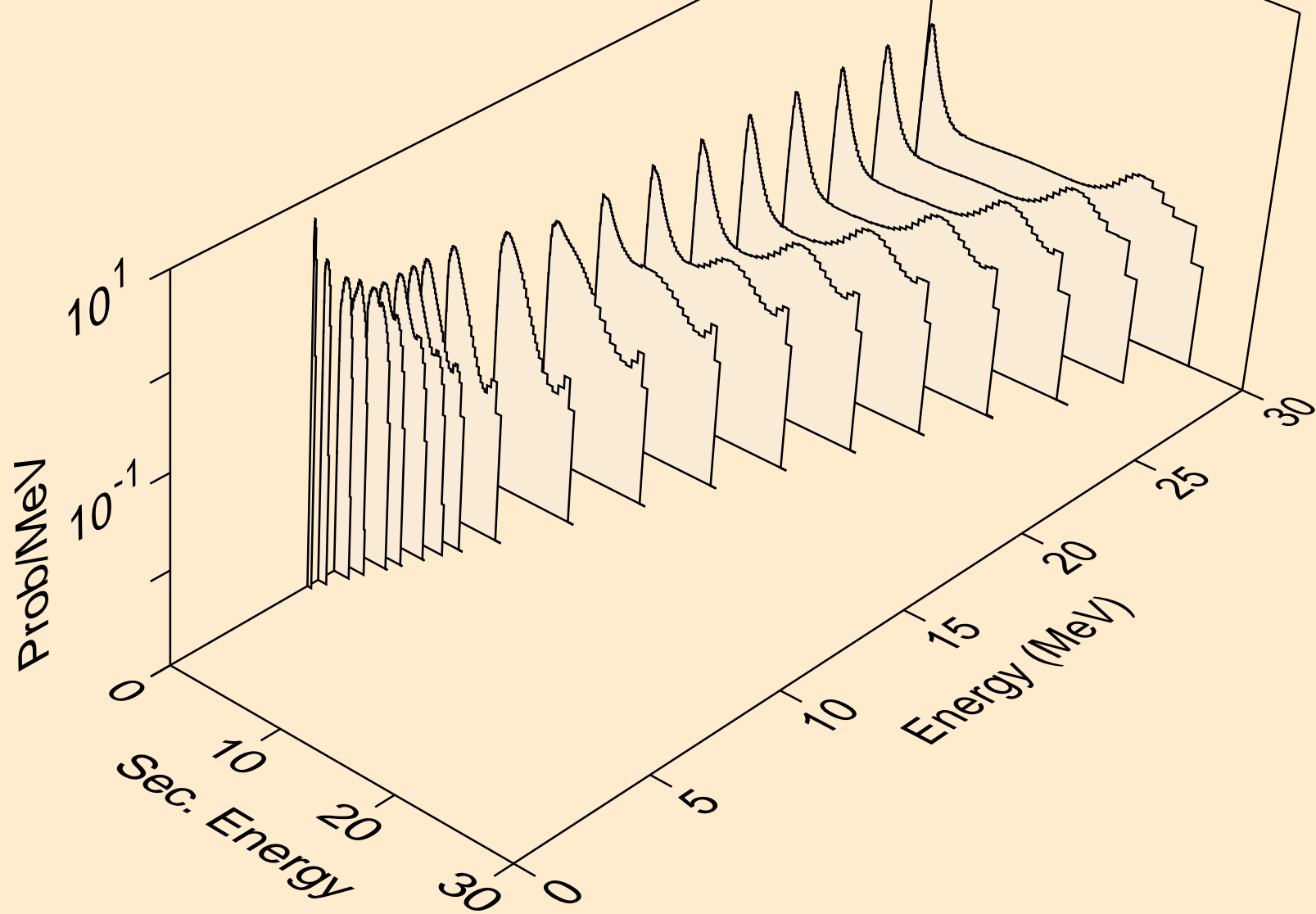

CM249 NEUTRON ACER TENDL-2021 LIBRARY; T=293.6K
Neutron emission for (n,3n)

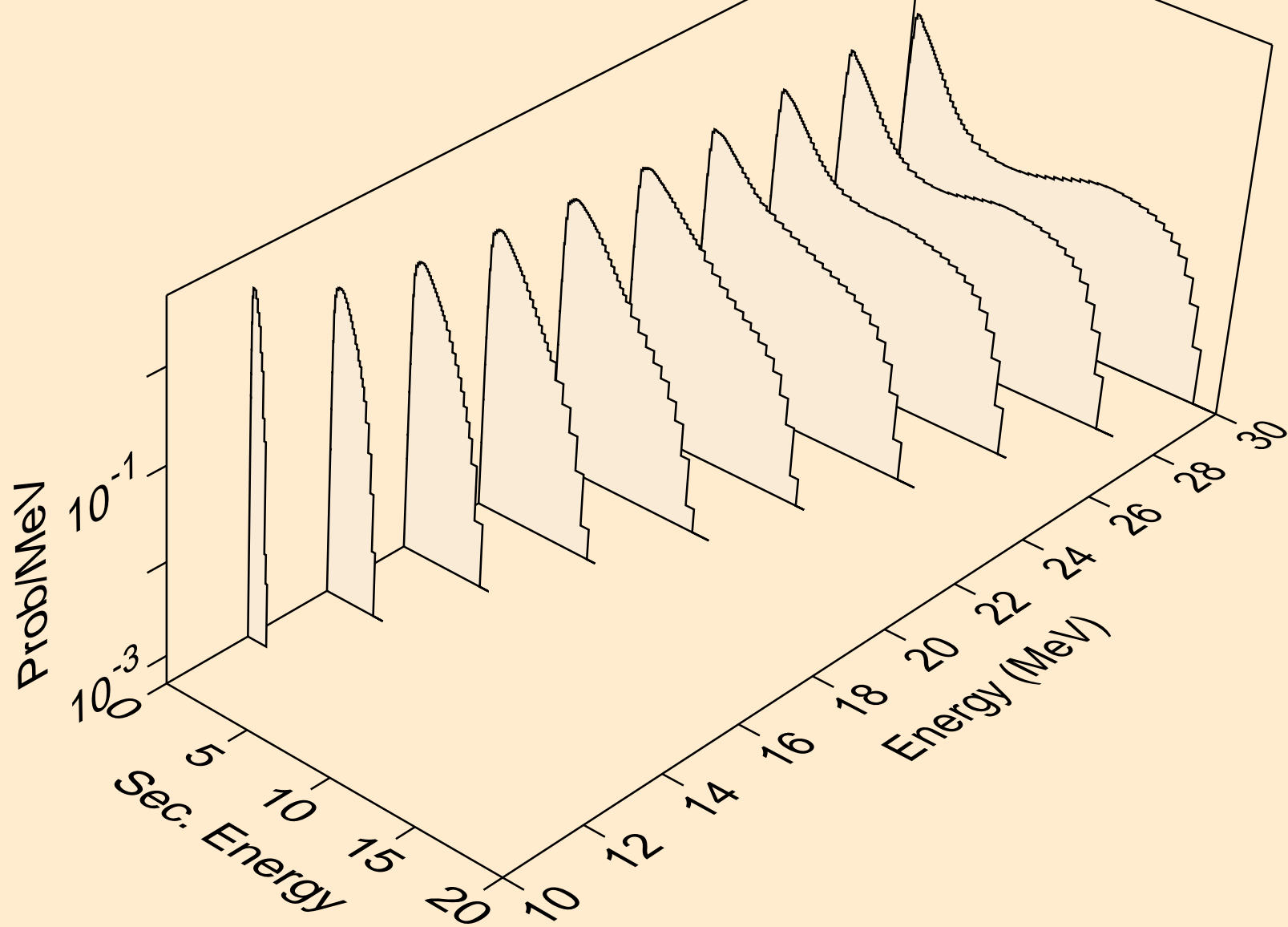

CM249 NEUTRON ACER TENDL-2021 LIBRARY; T=293.6K
Neutron emission for fission

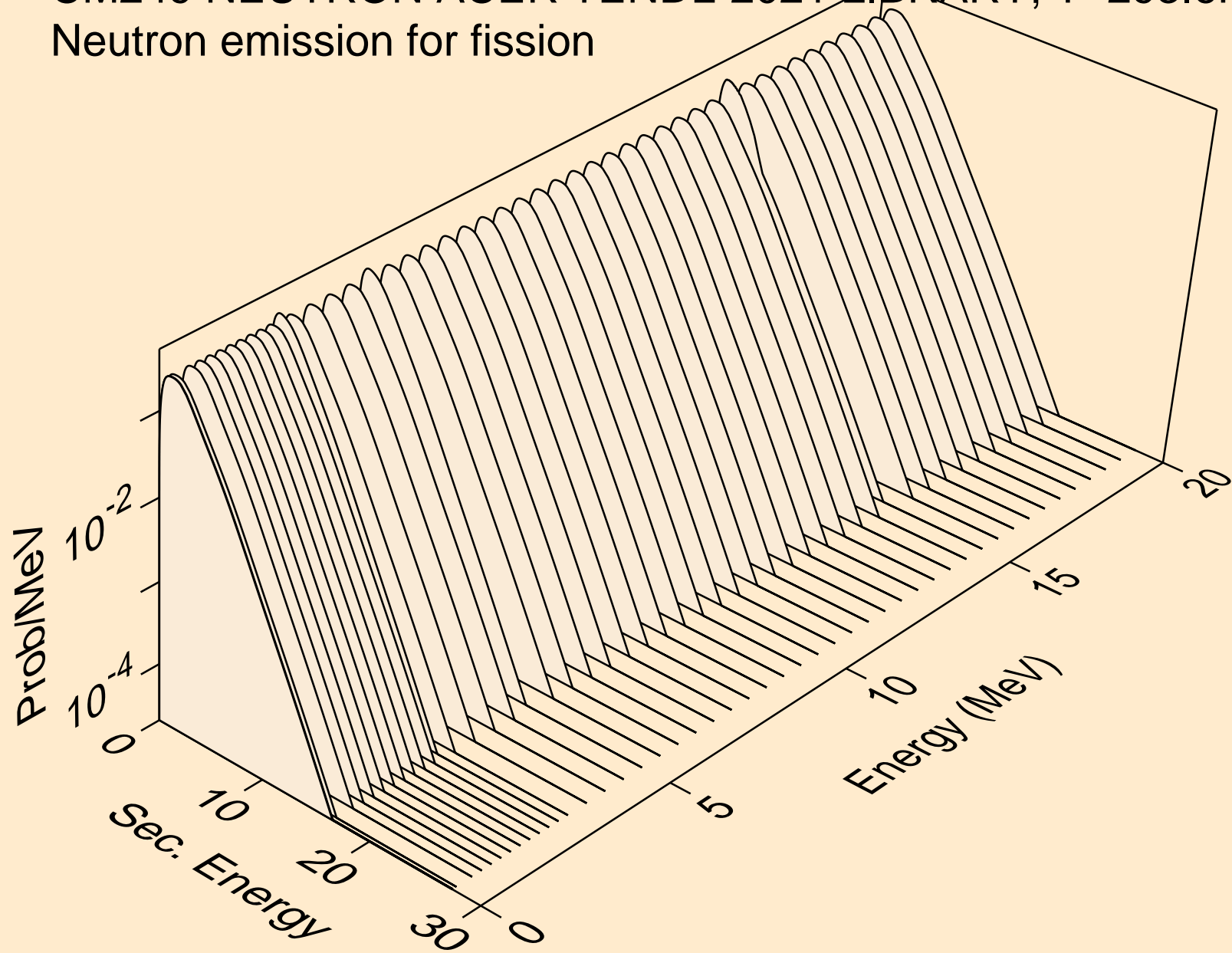

CM249 NEUTRON ACER TENDL-2021 LIBRARY; T=293.6K
Neutron emission for (n,n*)a

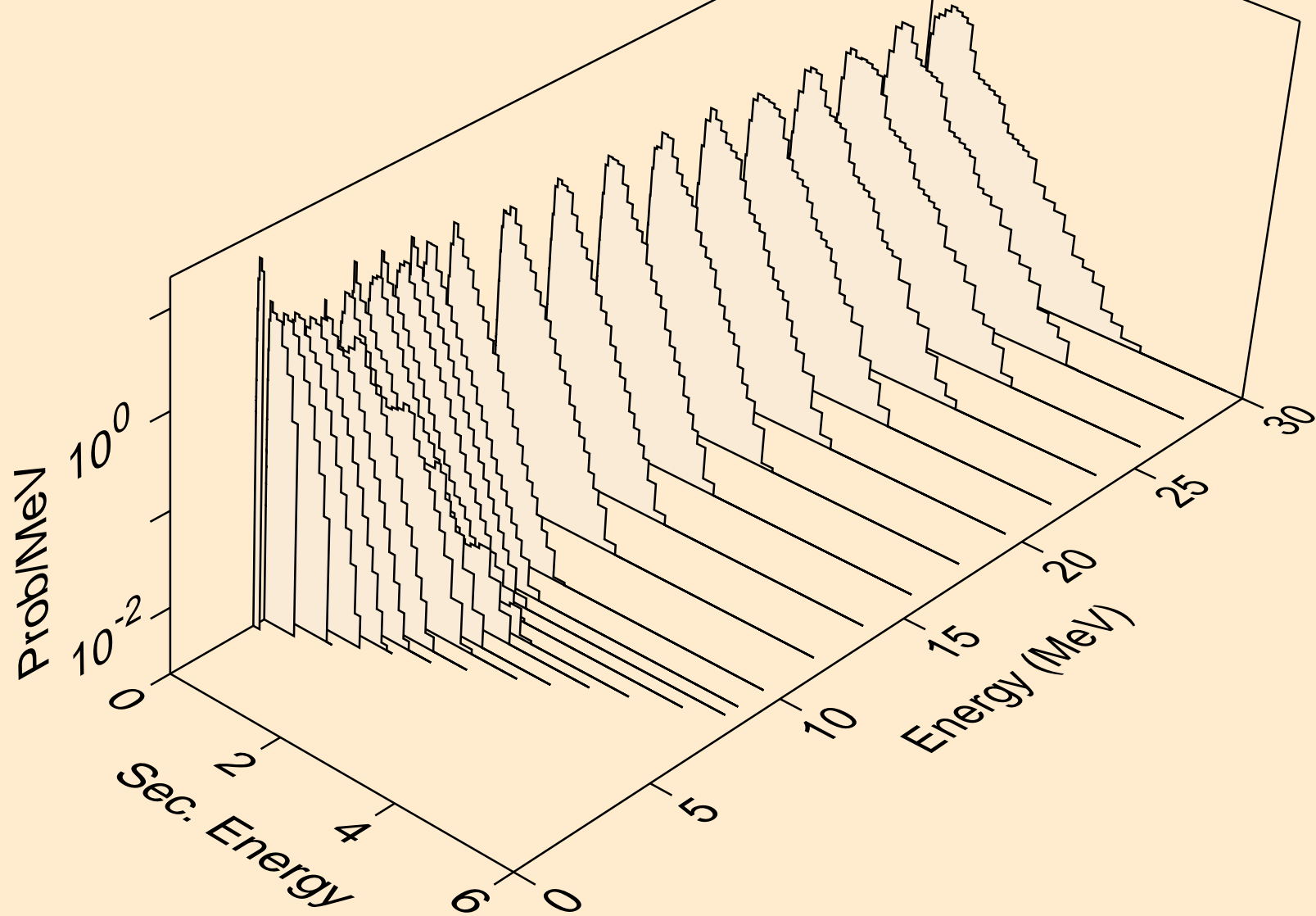

CM249 NEUTRON ACER TENDL-2021 LIBRARY; T=293.6K
Neutron emission for (n,2n)a

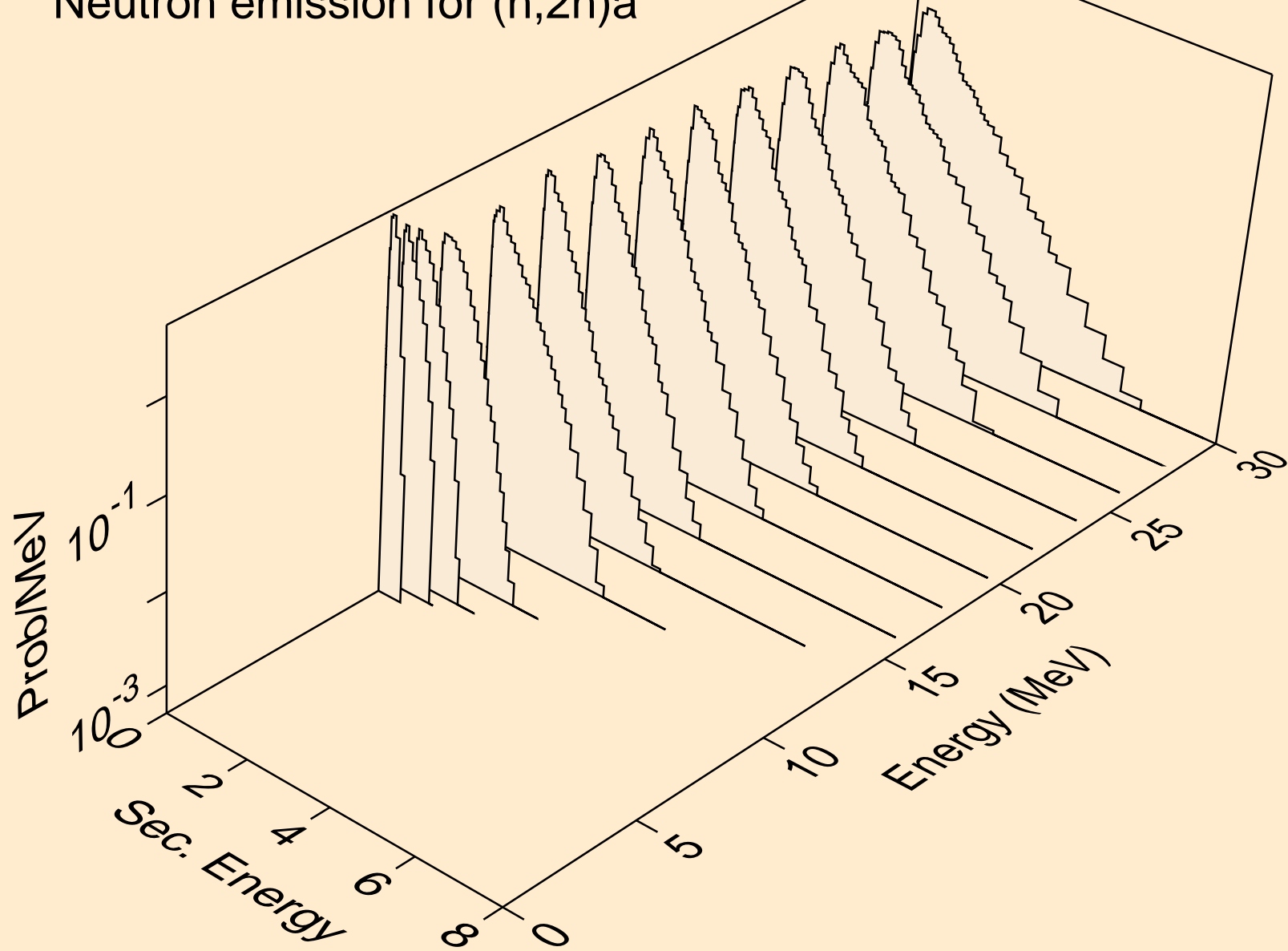

CM249 NEUTRON ACER TENDL-2021 LIBRARY; T=293.6K
Neutron emission for (n,3n)a

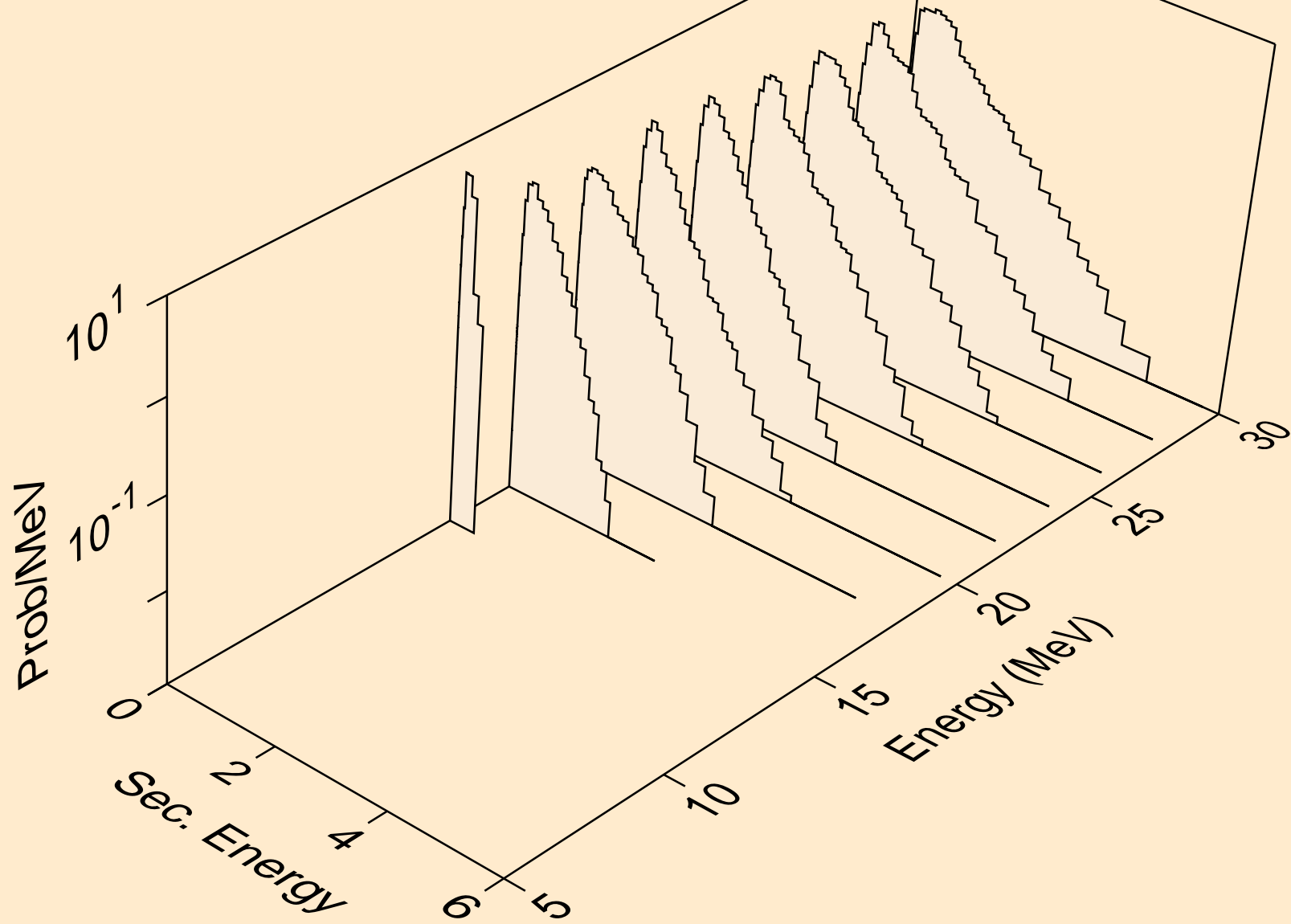

CM249 NEUTRON ACER TENDL-2021 LIBRARY; T=293.6K
Neutron emission for (n,n*)p

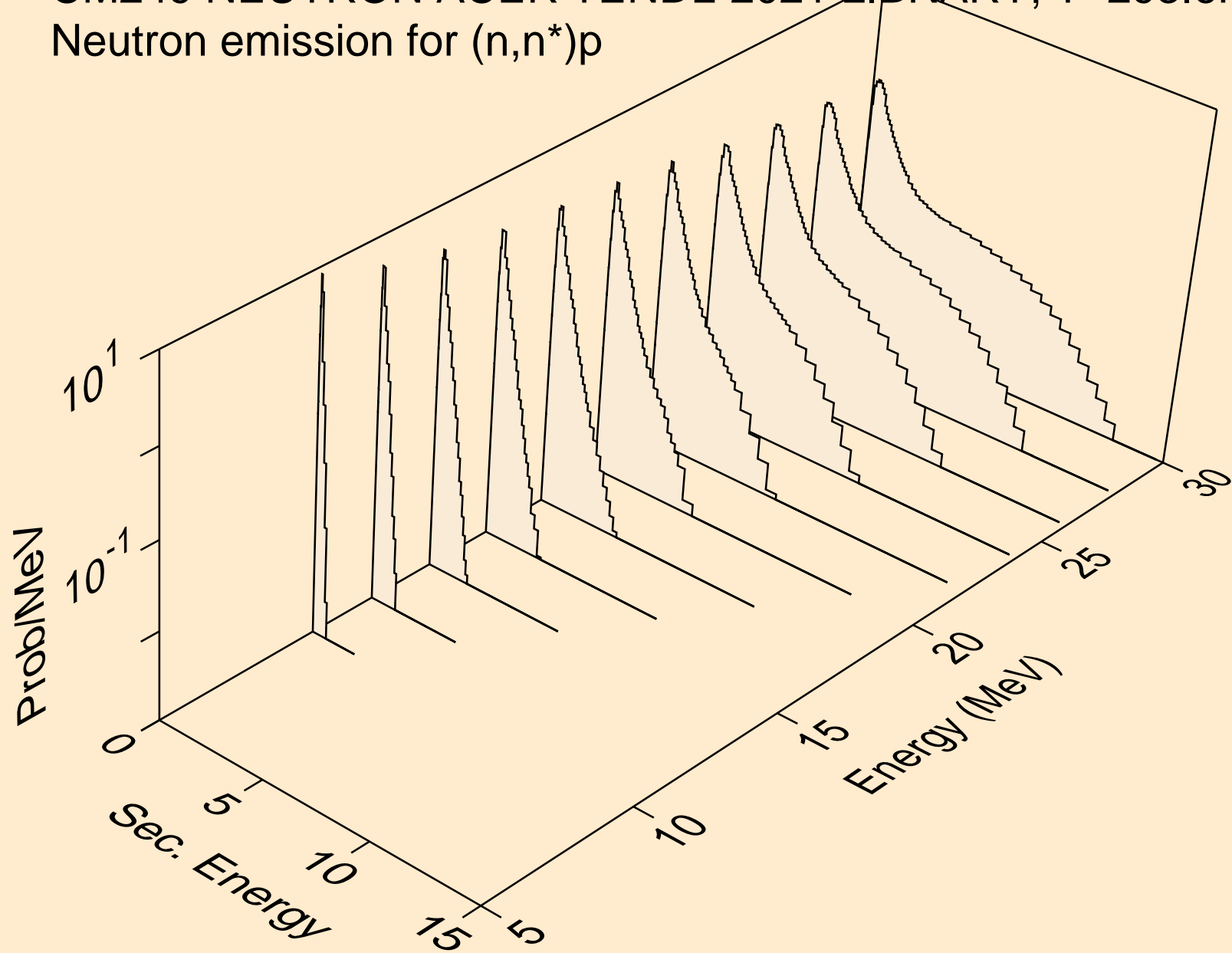

CM249 NEUTRON ACER TENDL-2021 LIBRARY; T=293.6K
Neutron emission for (n,n*)d

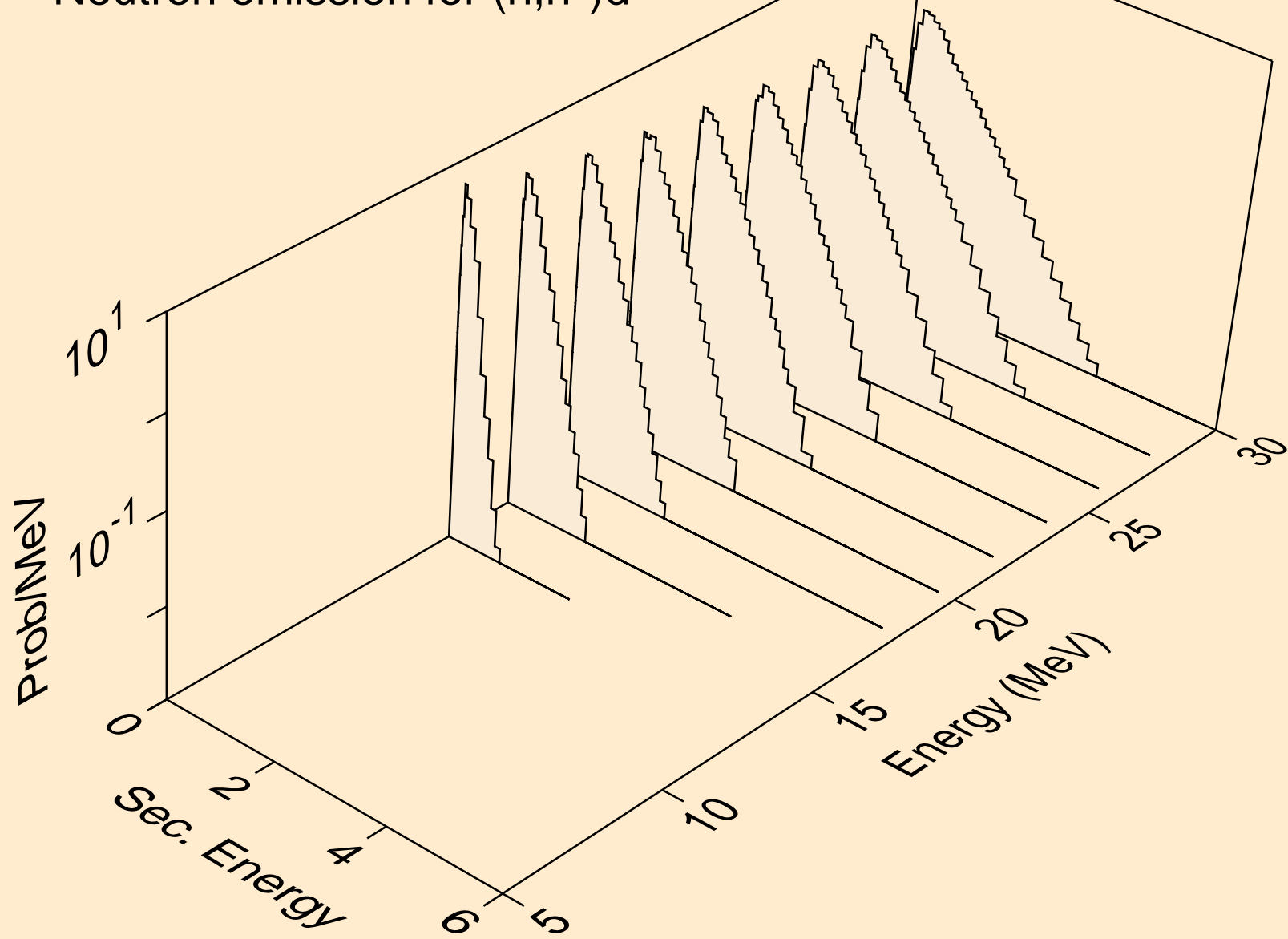

CM249 NEUTRON ACER TENDL-2021 LIBRARY; T=293.6K
Neutron emission for (n,n*)t

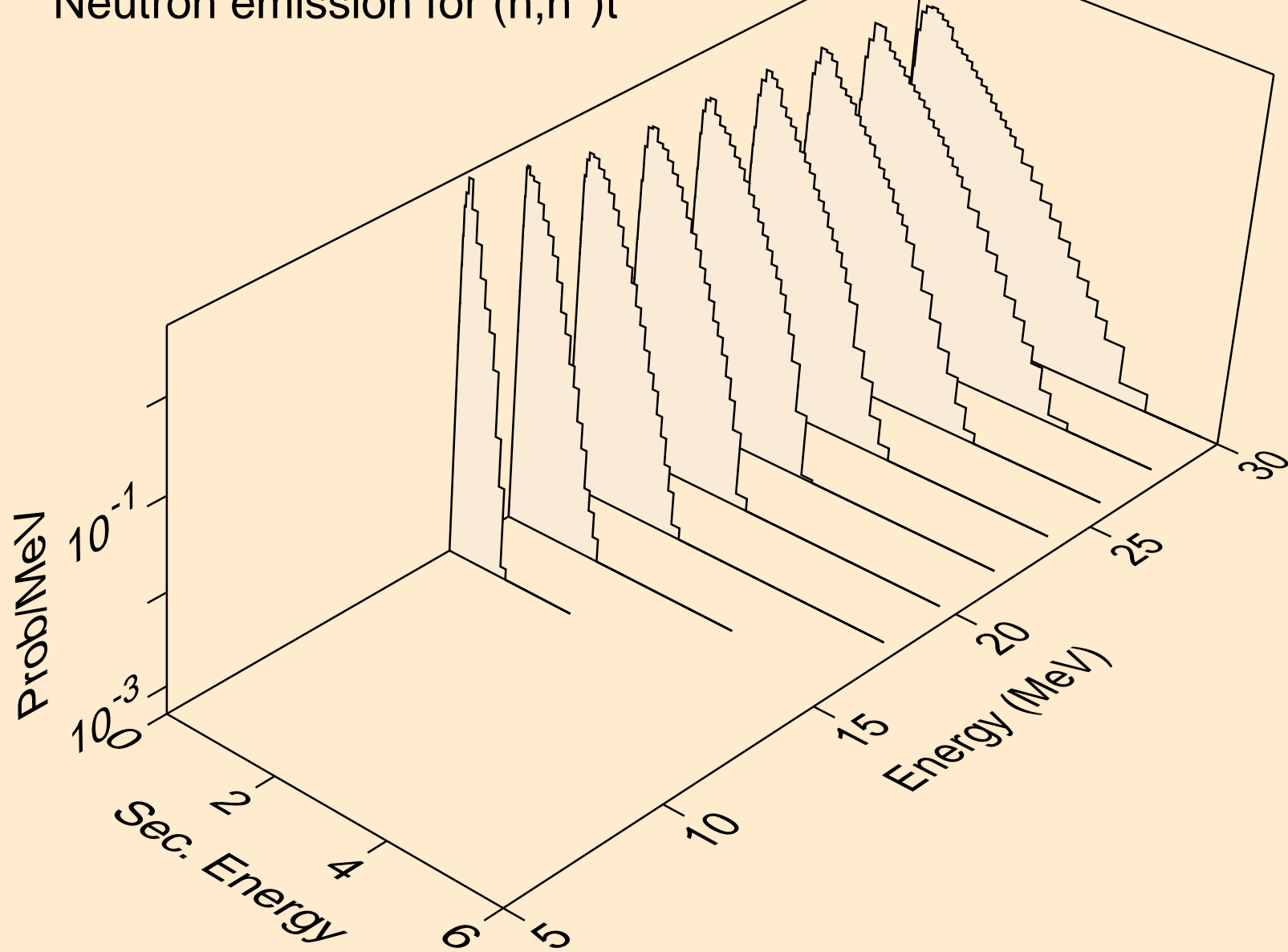

CM249 NEUTRON ACER TENDL-2021 LIBRARY; T=293.6K
Neutron emission for (n,n*)he3

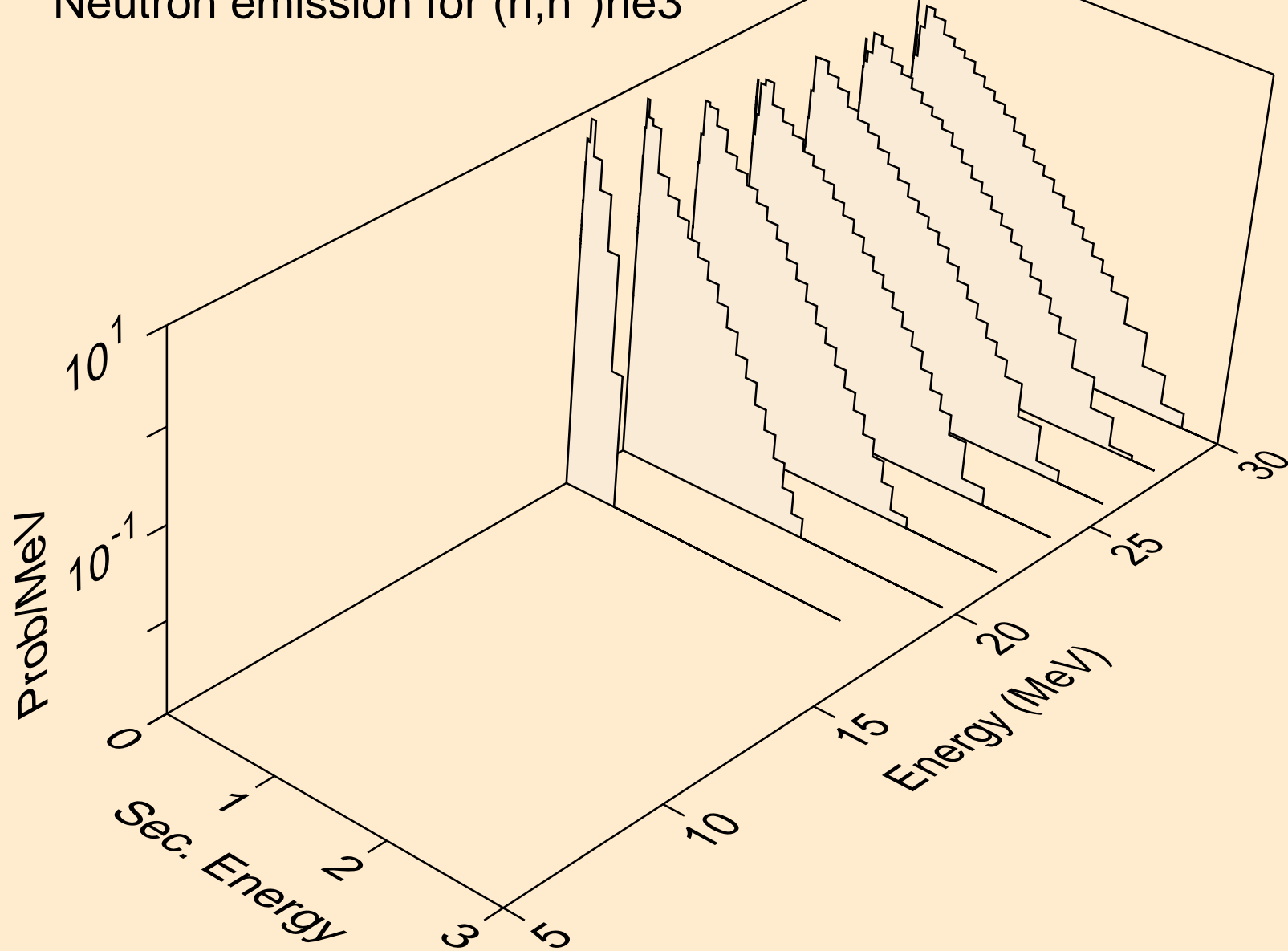

CM249 NEUTRON ACER TENDL-2021 LIBRARY; T=293.6K
Neutron emission for (n,4n)

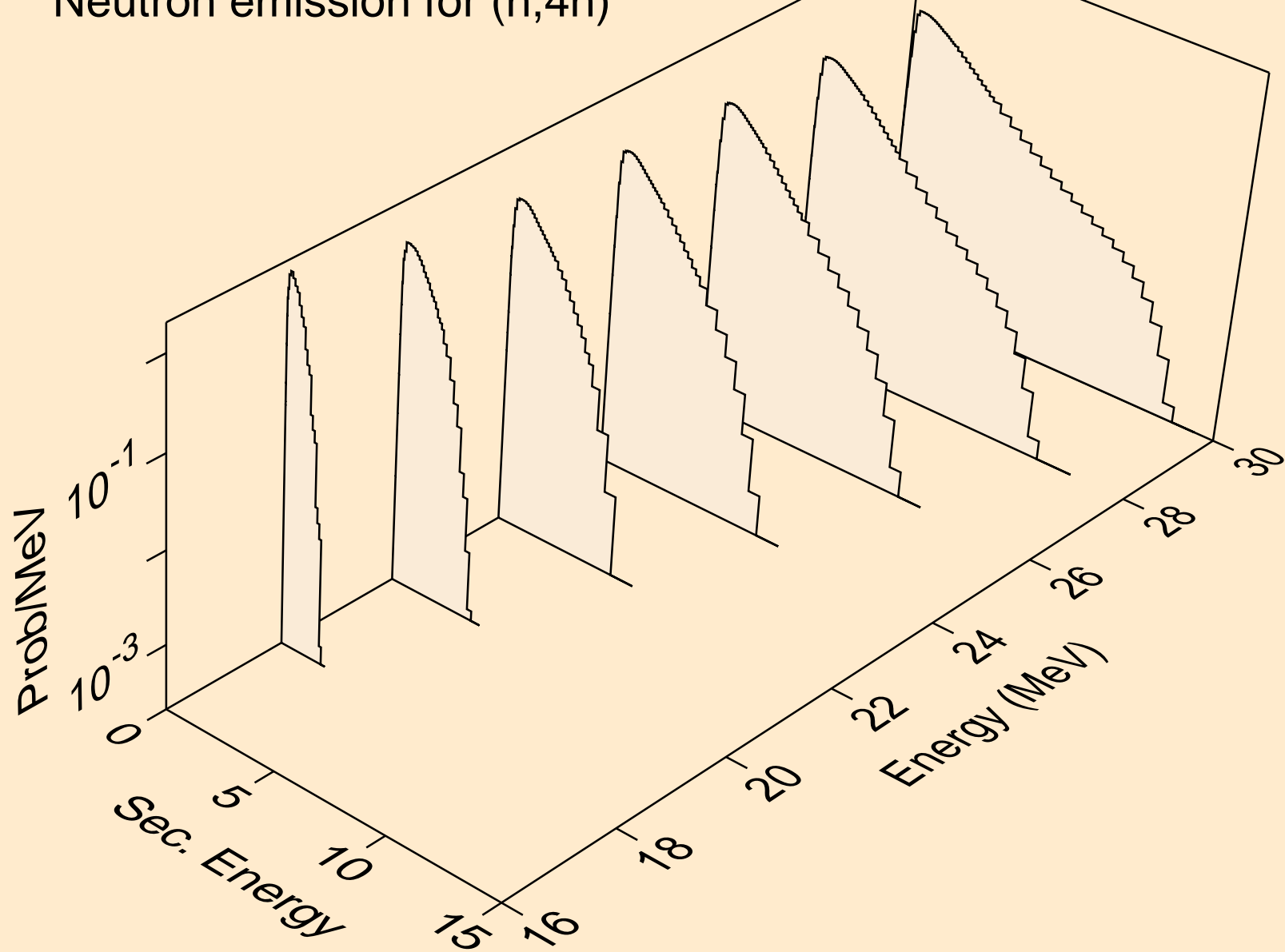

CM249 NEUTRON ACER TENDL-2021 LIBRARY; T=293.6K
Neutron emission for (n,2np)

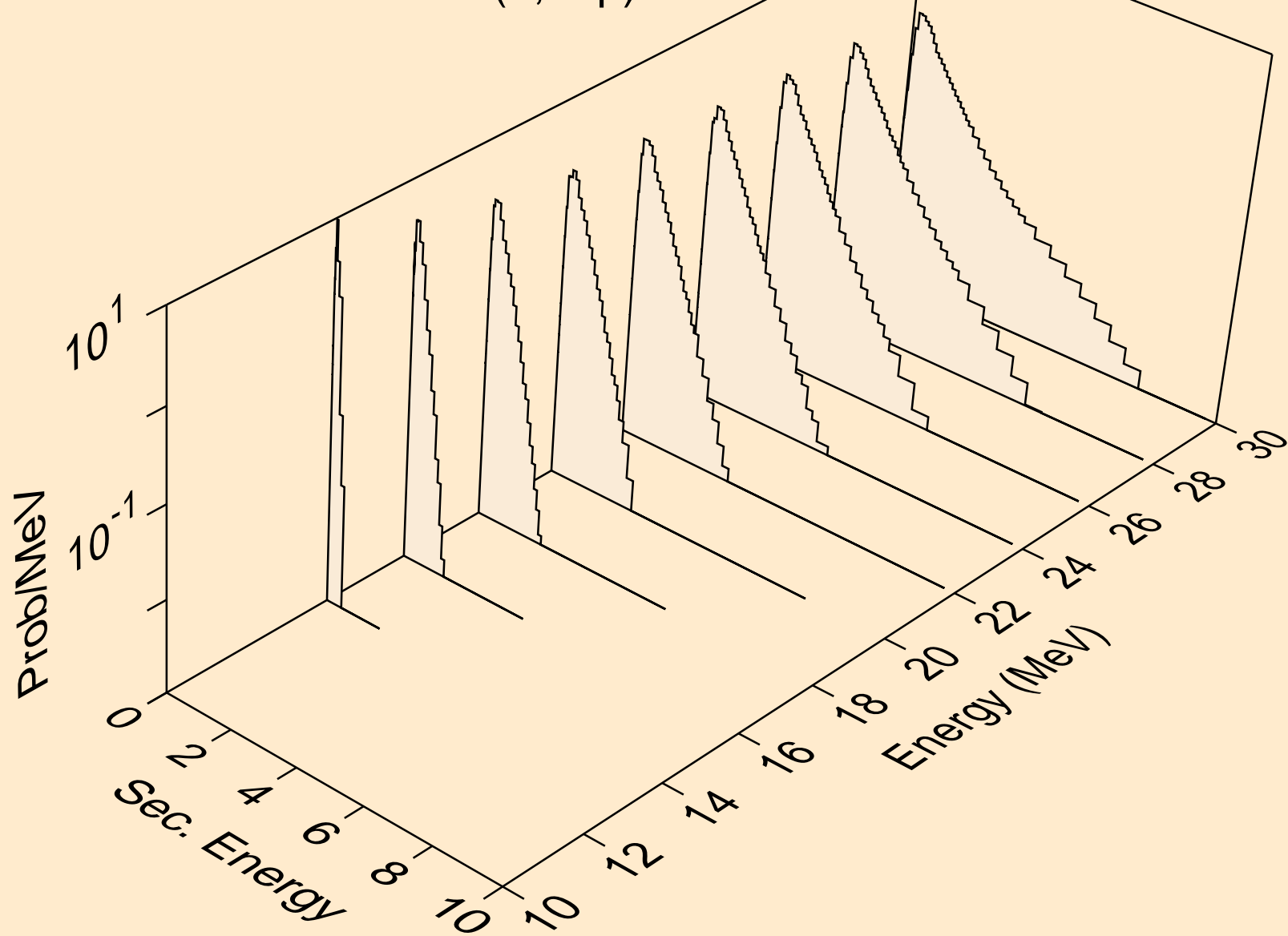

CM249 NEUTRON ACER TENDL-2021 LIBRARY; T=293.6K
Neutron emission for (n,3np)

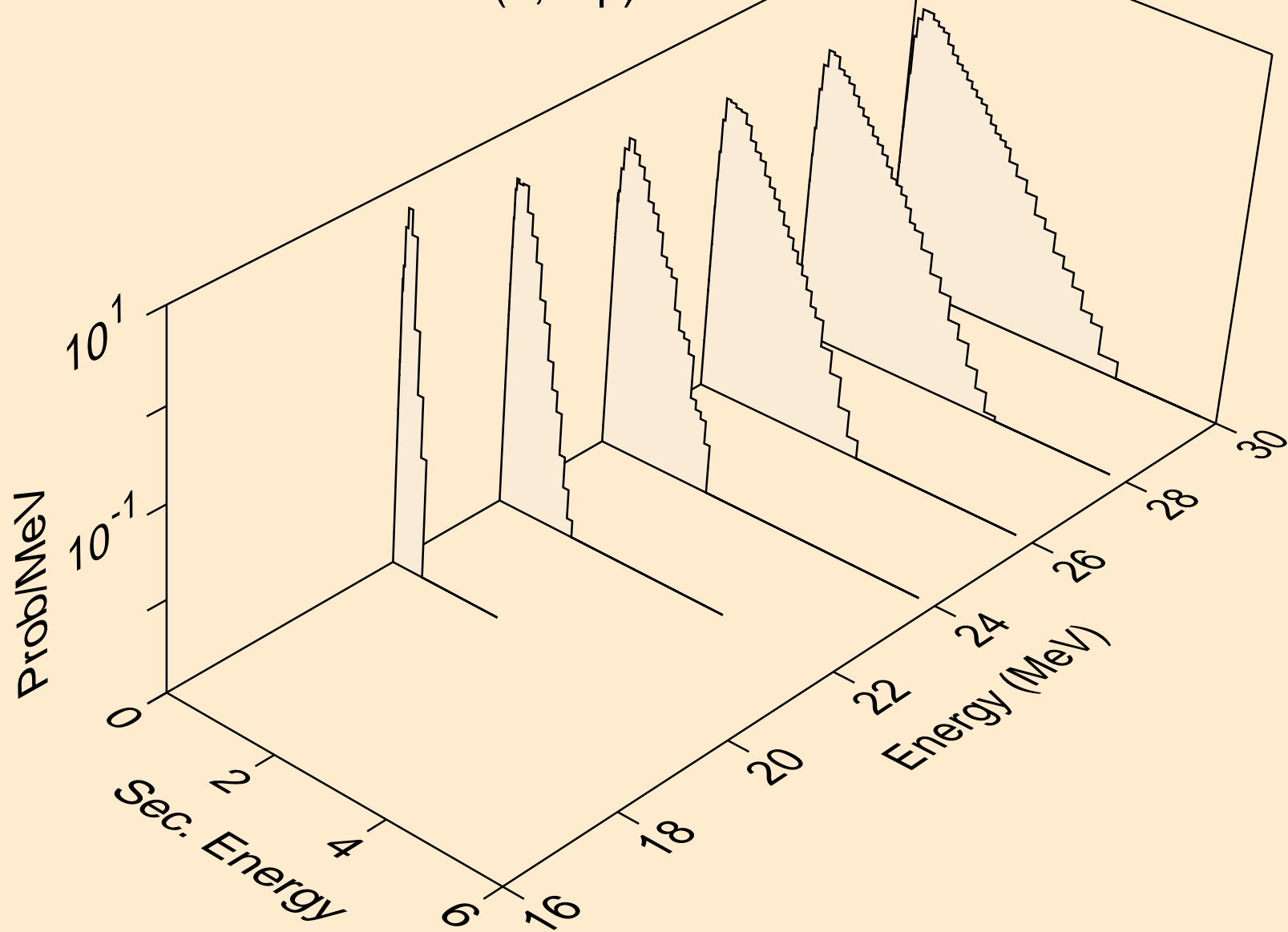

CM249 NEUTRON ACER TENDL-2021 LIBRARY; T=293.6K
Neutron emission for (n,2np)

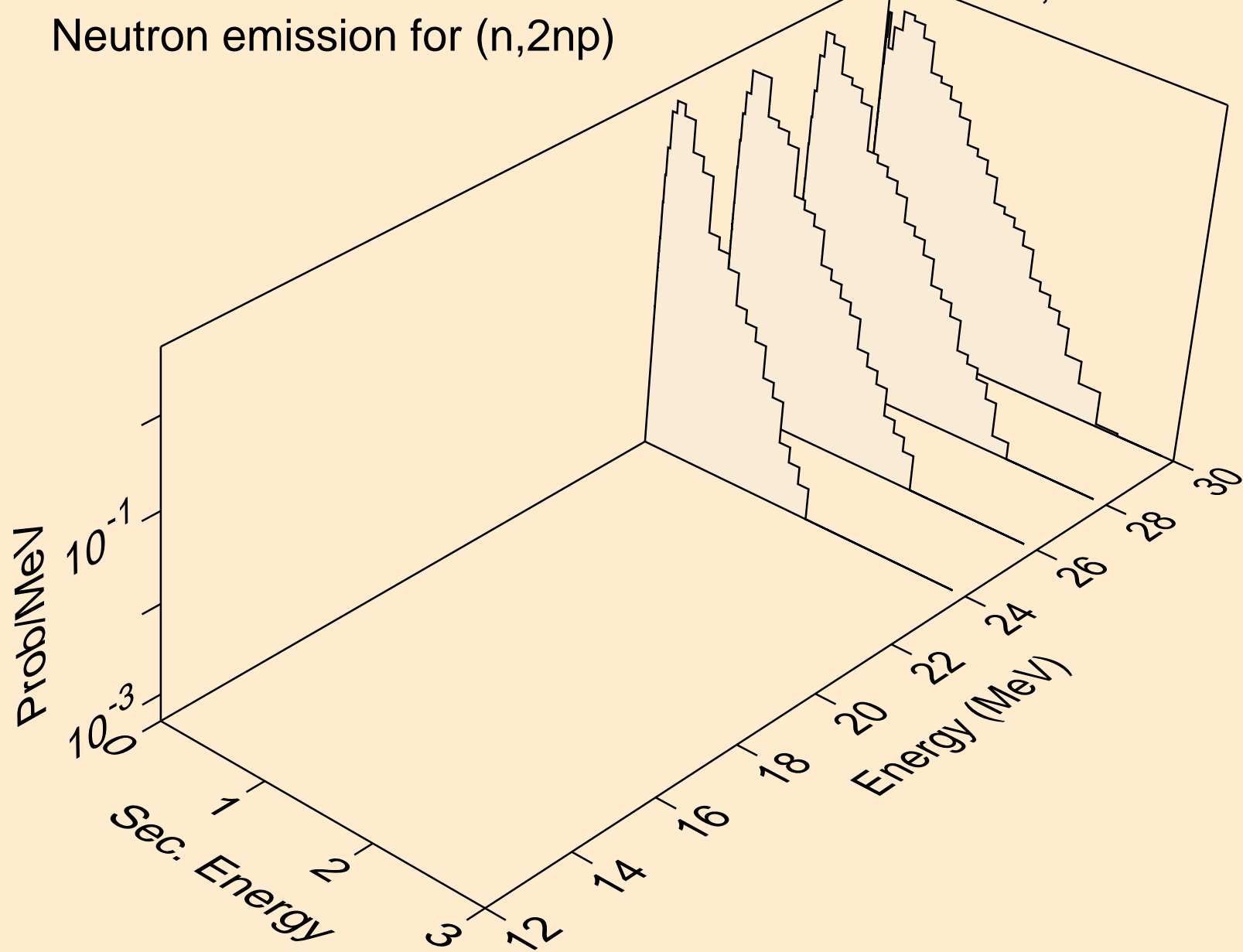

CM249 NEUTRON ACER TENDL-2021 LIBRARY; T=293.6K
Neutron emission for (n,n*c)

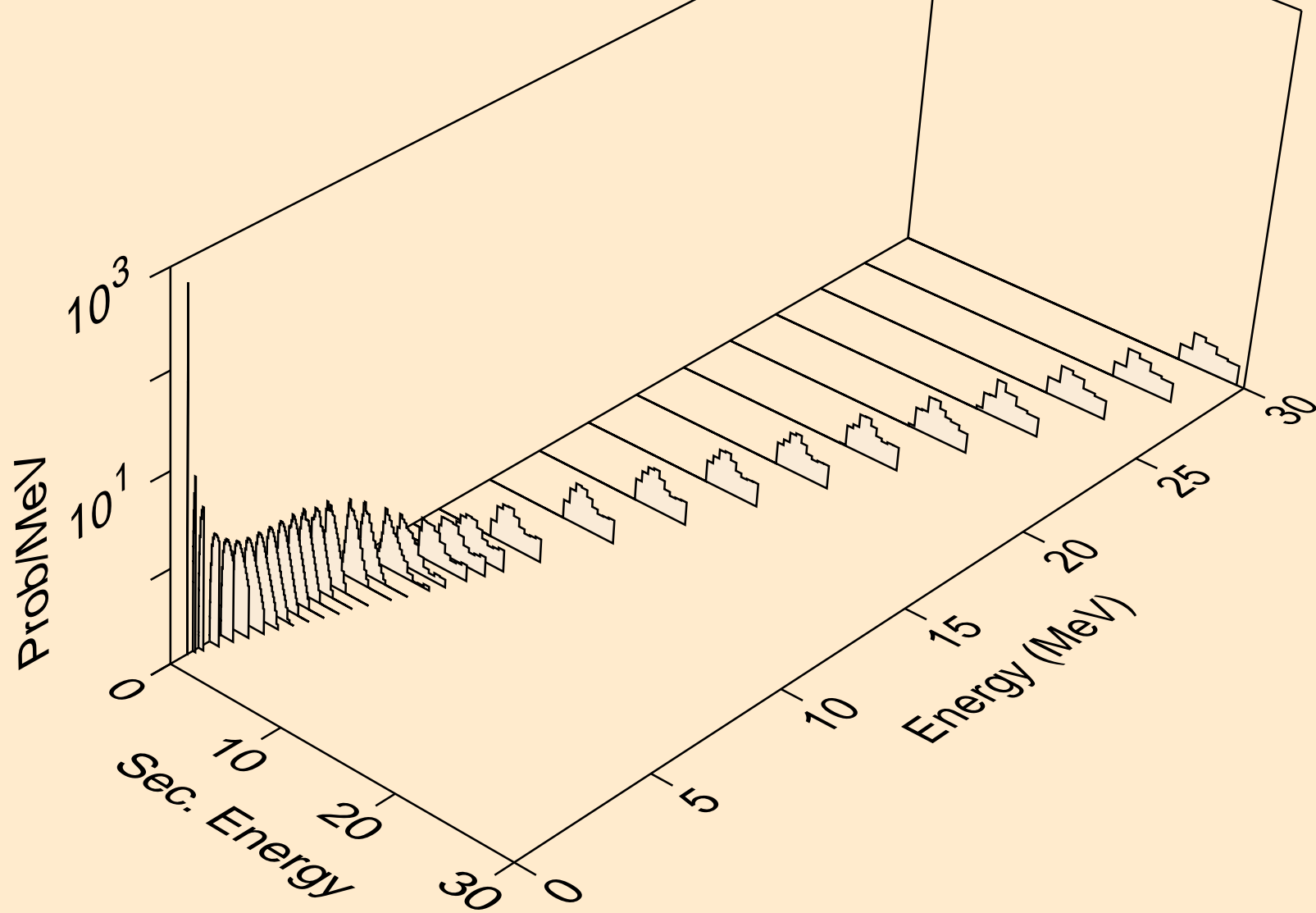

CM249 NEUTRON ACER TENDL-2021 LIBRARY; T=293.6K

Delayed nubar

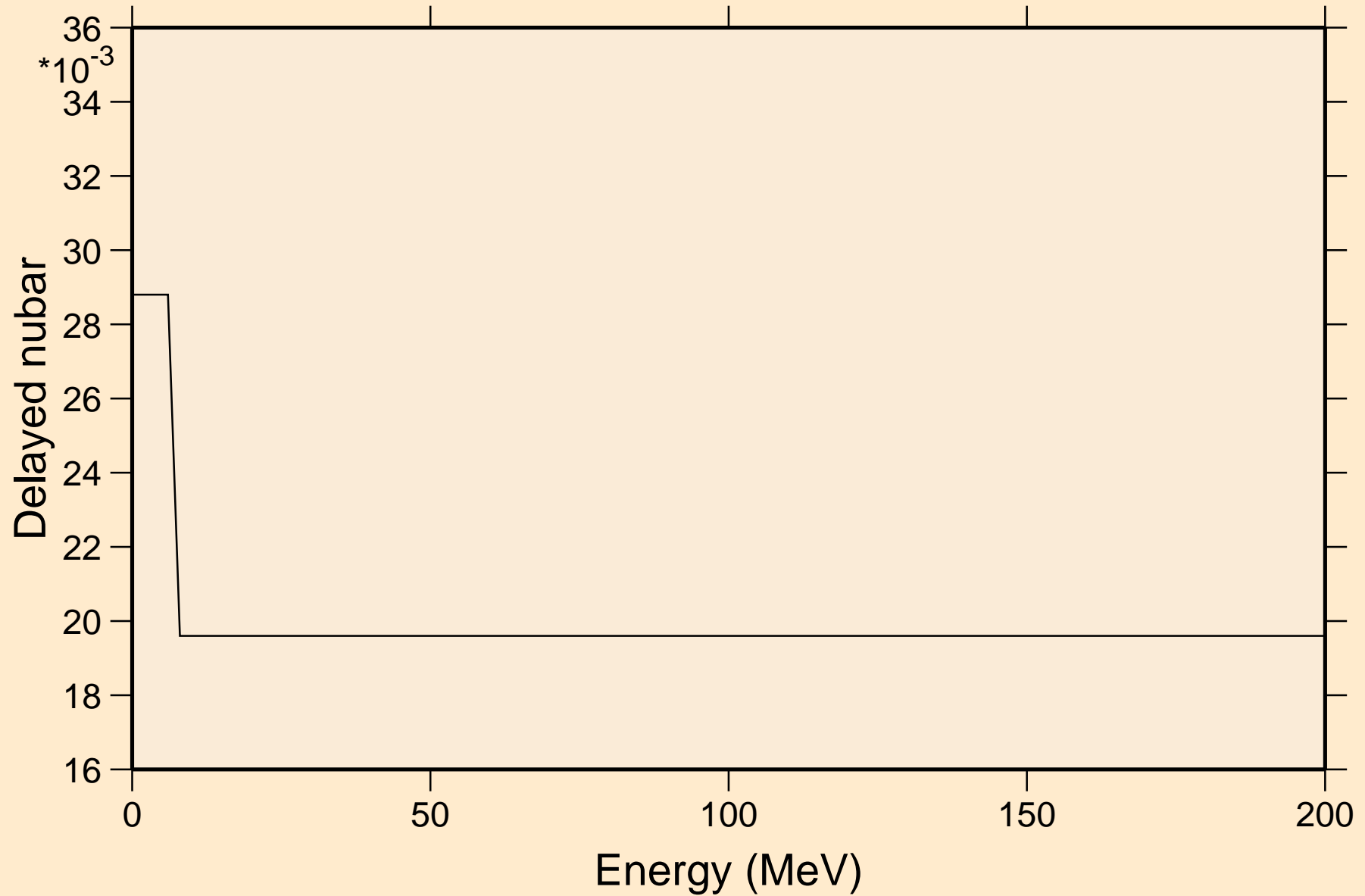

CM249 NEUTRON ACER TENDL-2021 LIBRARY; T=293.6K

Delayed neutron spectra

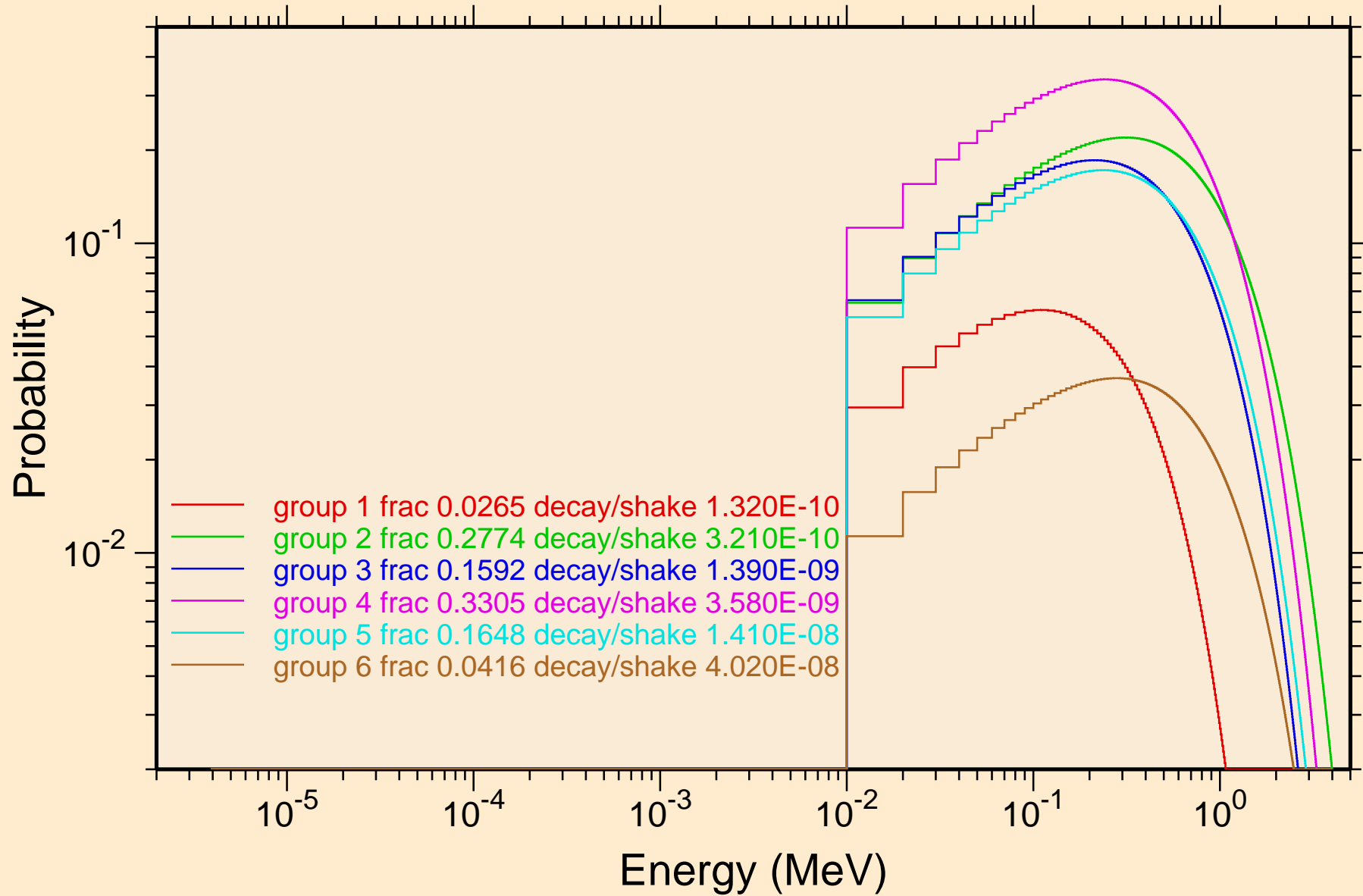

CM249 NEUTRON ACER TENDL-2021 LIBRARY; T=293.6K
Photon emission for (n,x)

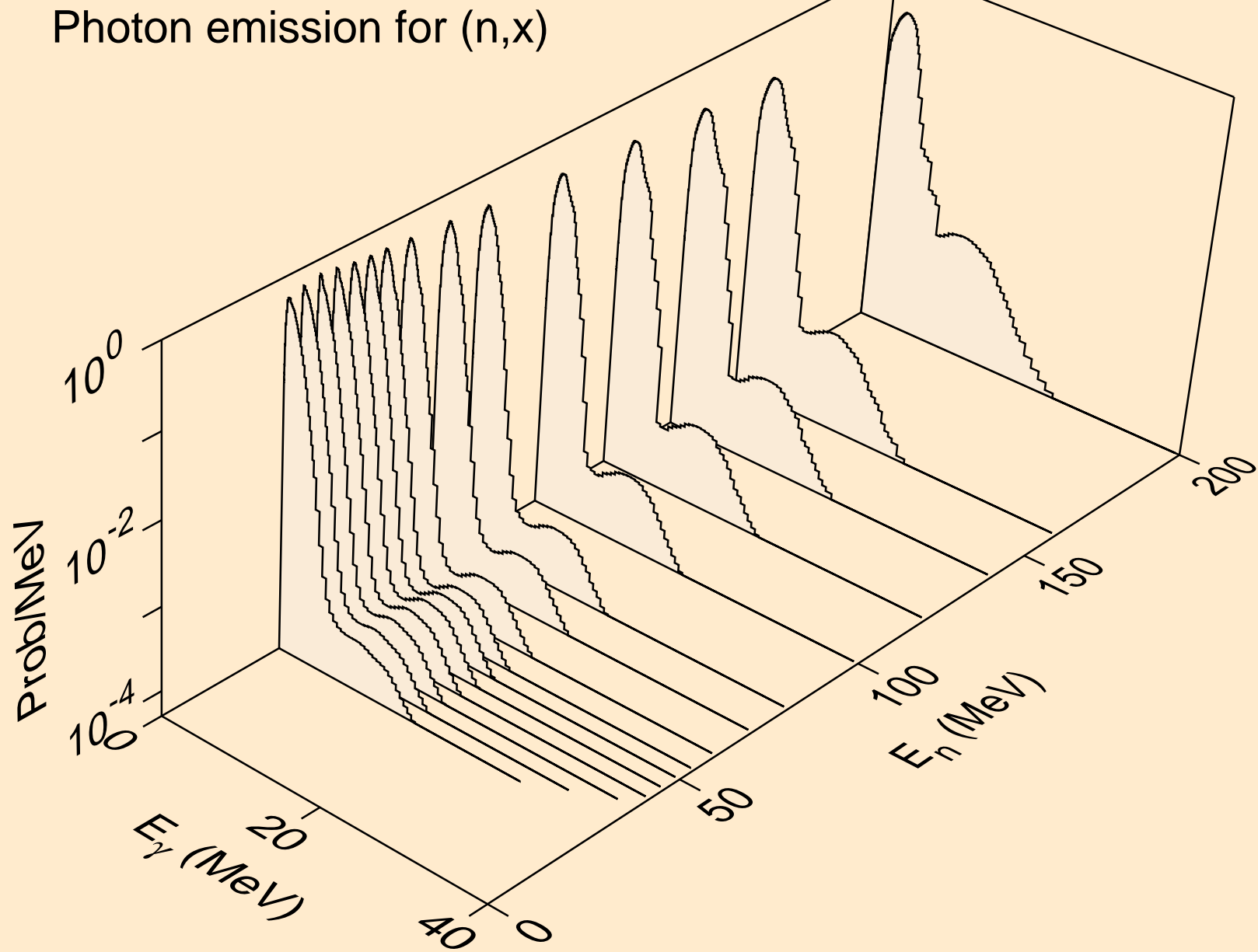

CM249 NEUTRON ACER TENDL-2021 LIBRARY; T=293.6K
Photon emission for (n,2nd)

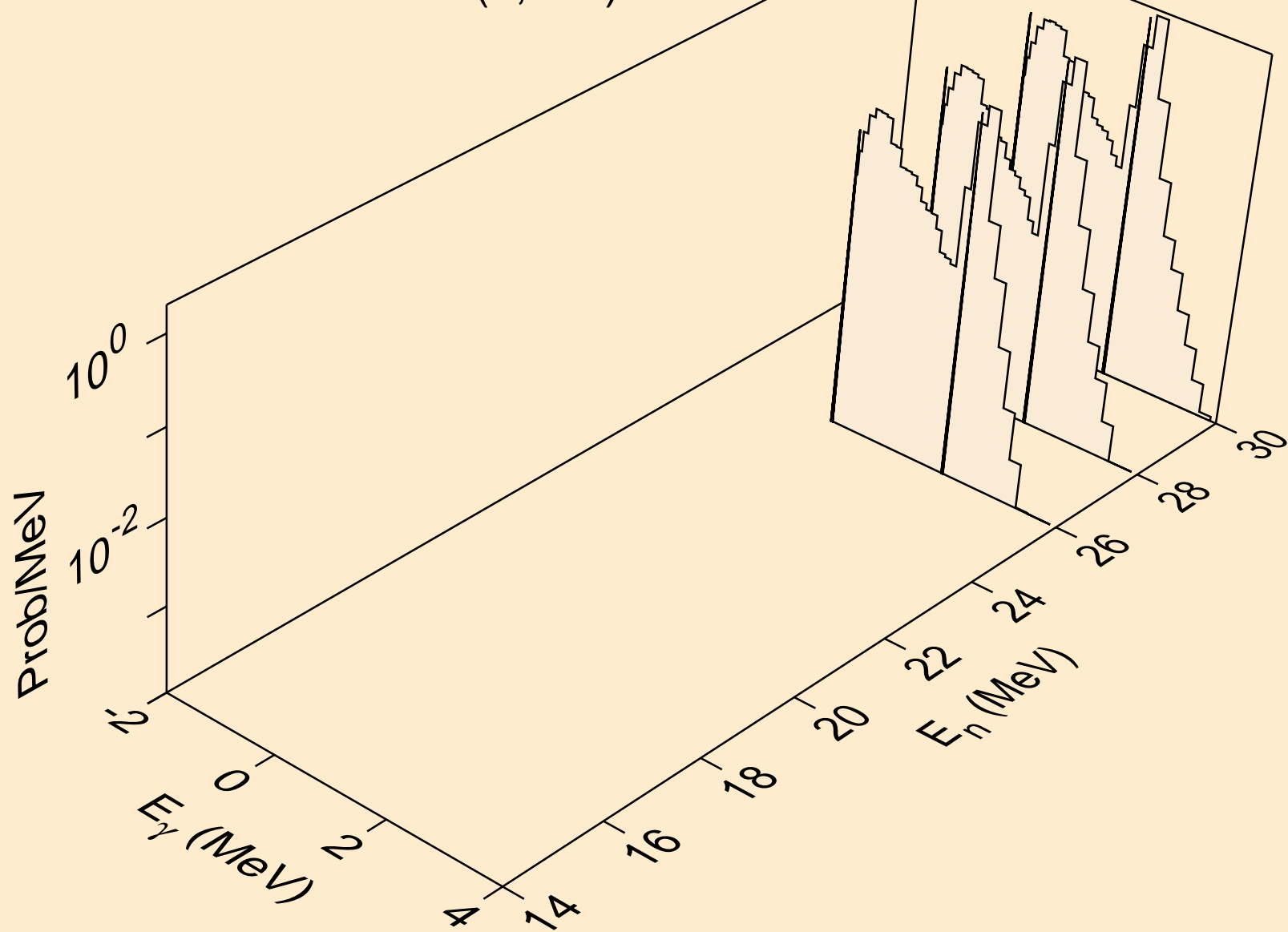

CM249 NEUTRON ACER TENDL-2021 LIBRARY; T=293.6K
Photon emission for (n,2n)

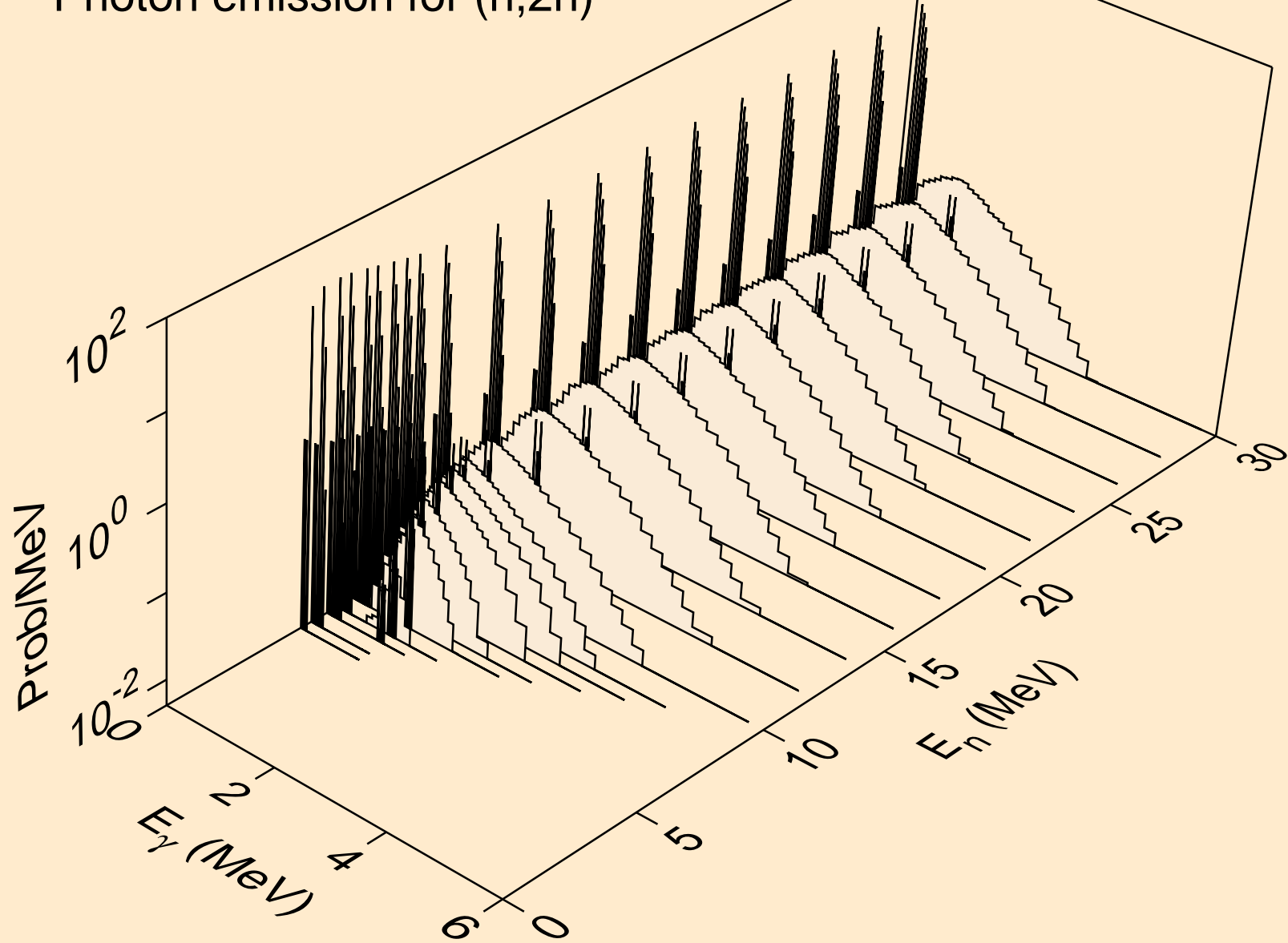

CM249 NEUTRON ACER TENDL-2021 LIBRARY; T=293.6K
Photon emission for (n,3n)

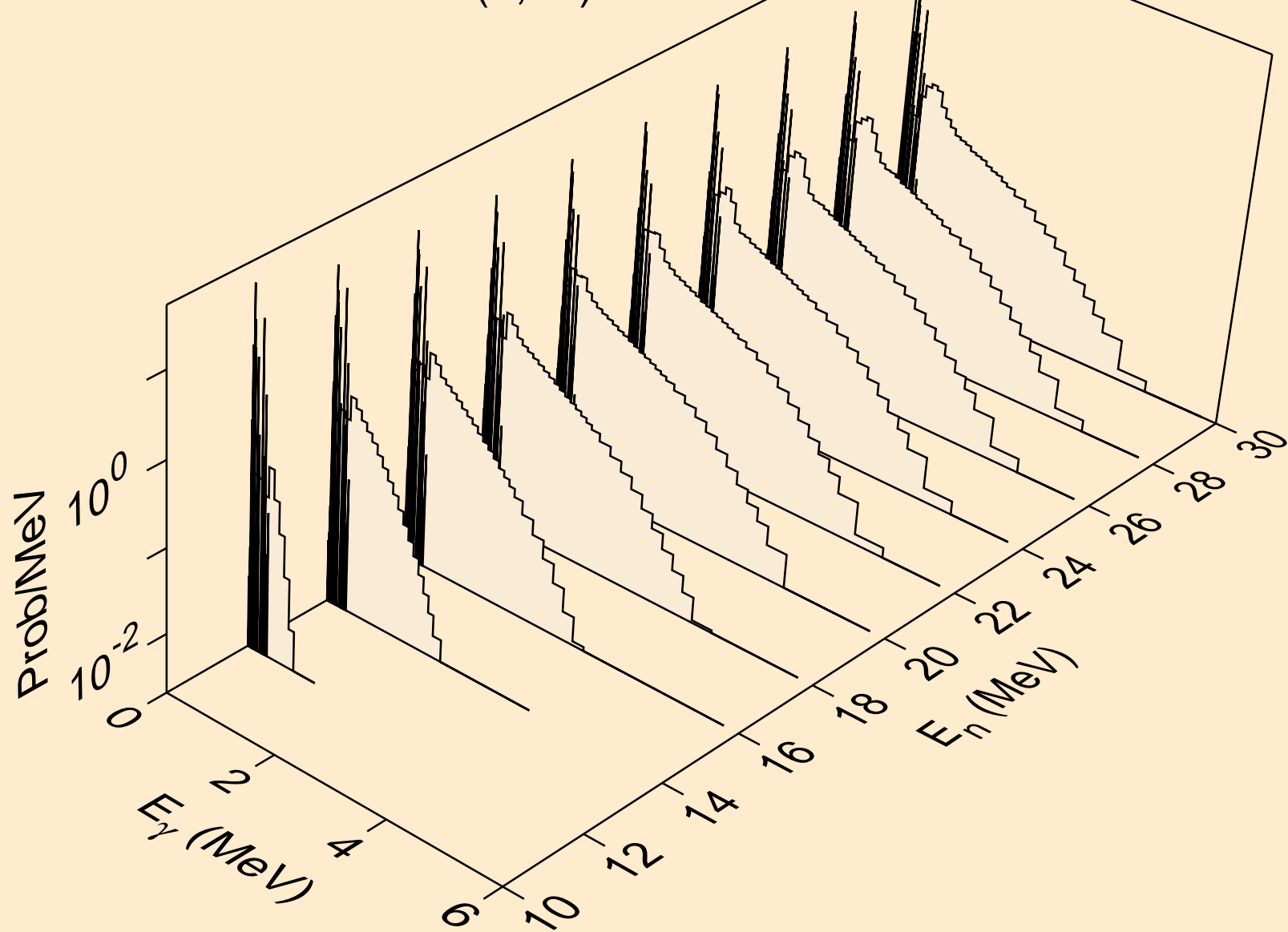

CM249 NEUTRON ACER TENDL-2021 LIBRARY; T=293.6K
Photon emission for (n,n*)a

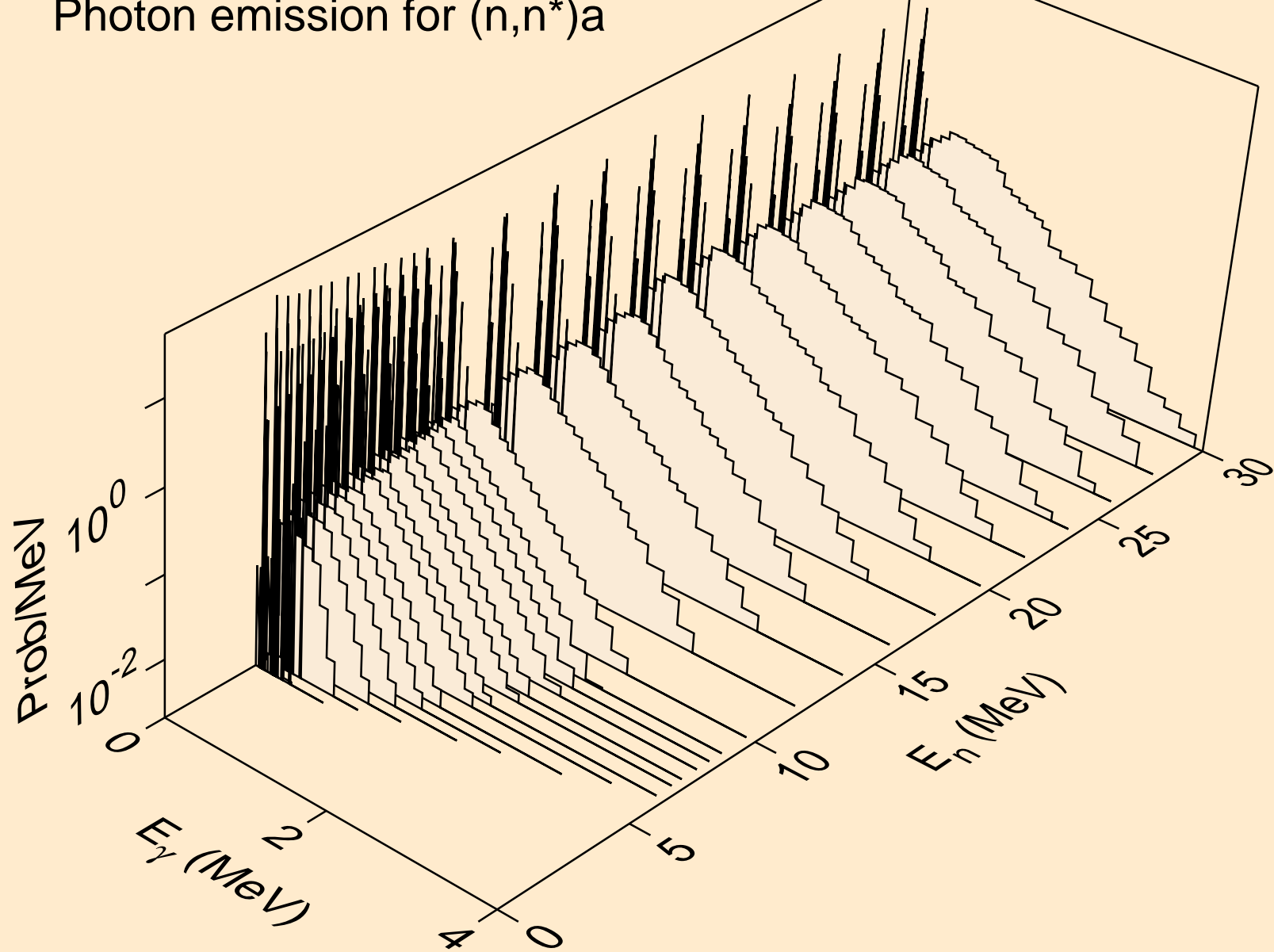

CM249 NEUTRON ACER TENDL-2021 LIBRARY; T=293.6K
Photon emission for (n,2n)a

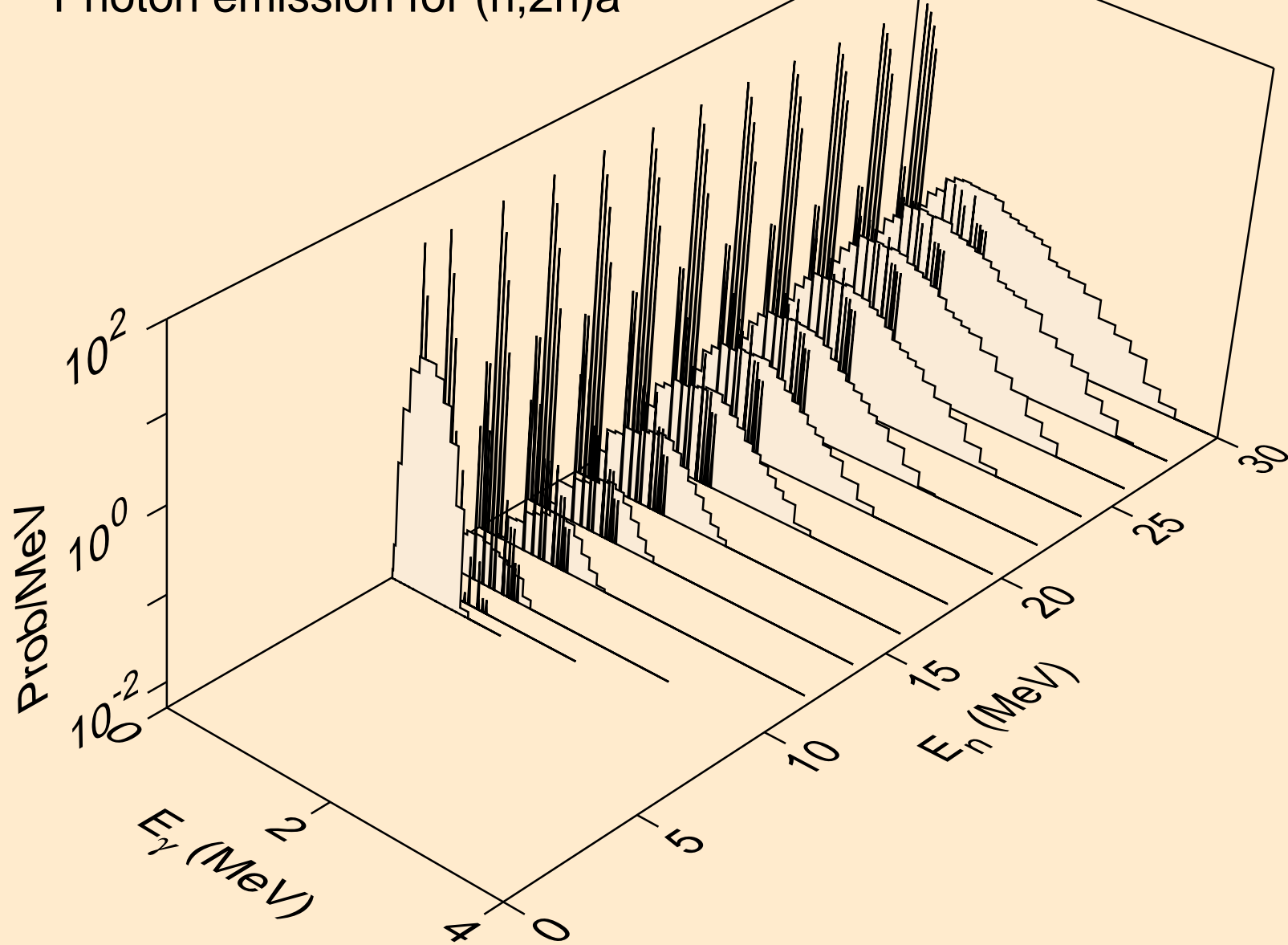

CM249 NEUTRON ACER TENDL-2021 LIBRARY; T=293.6K
Photon emission for (n,3n)a

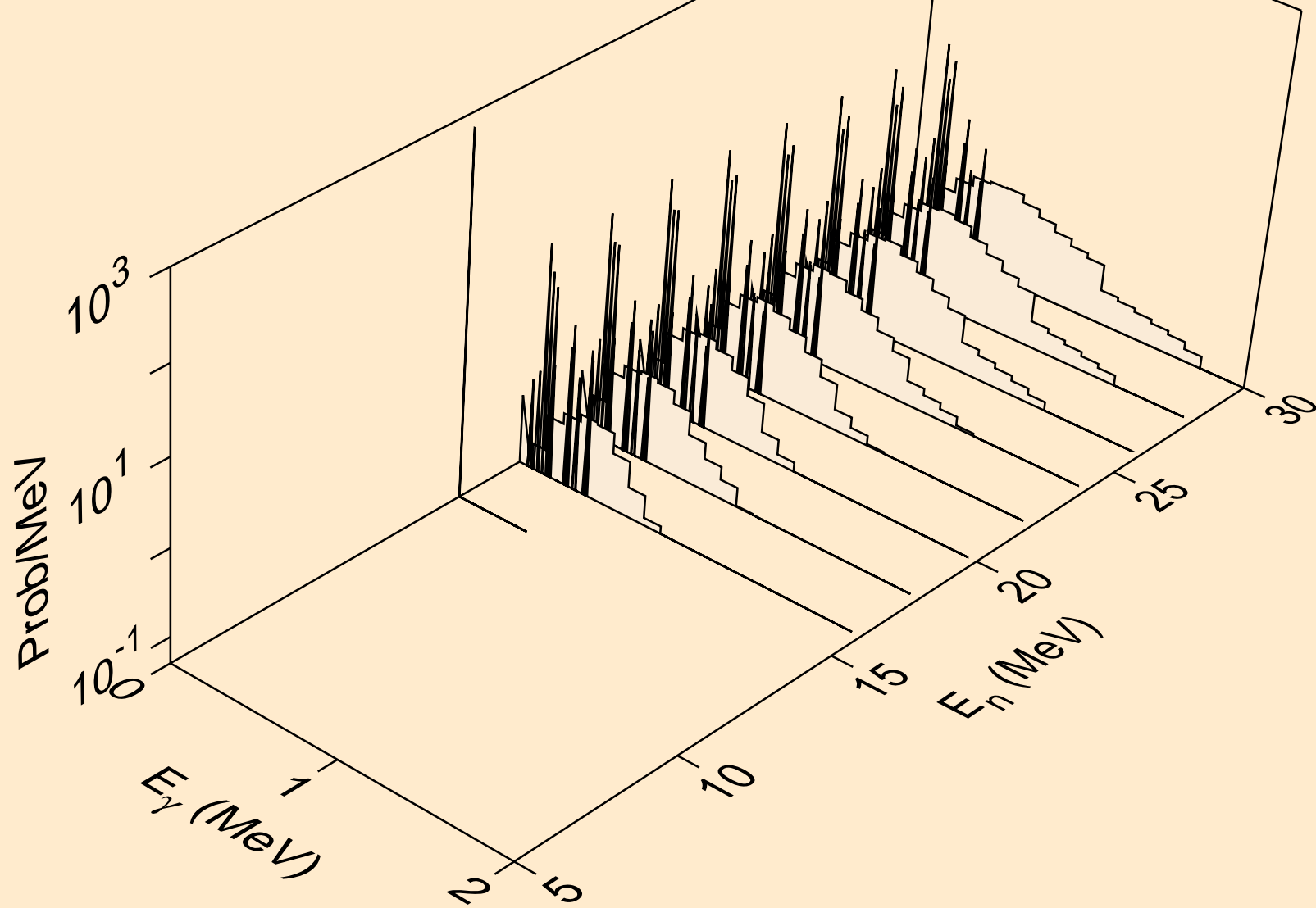

CM249 NEUTRON ACER TENDL-2021 LIBRARY; T=293.6K
Photon emission for (n,n*)p

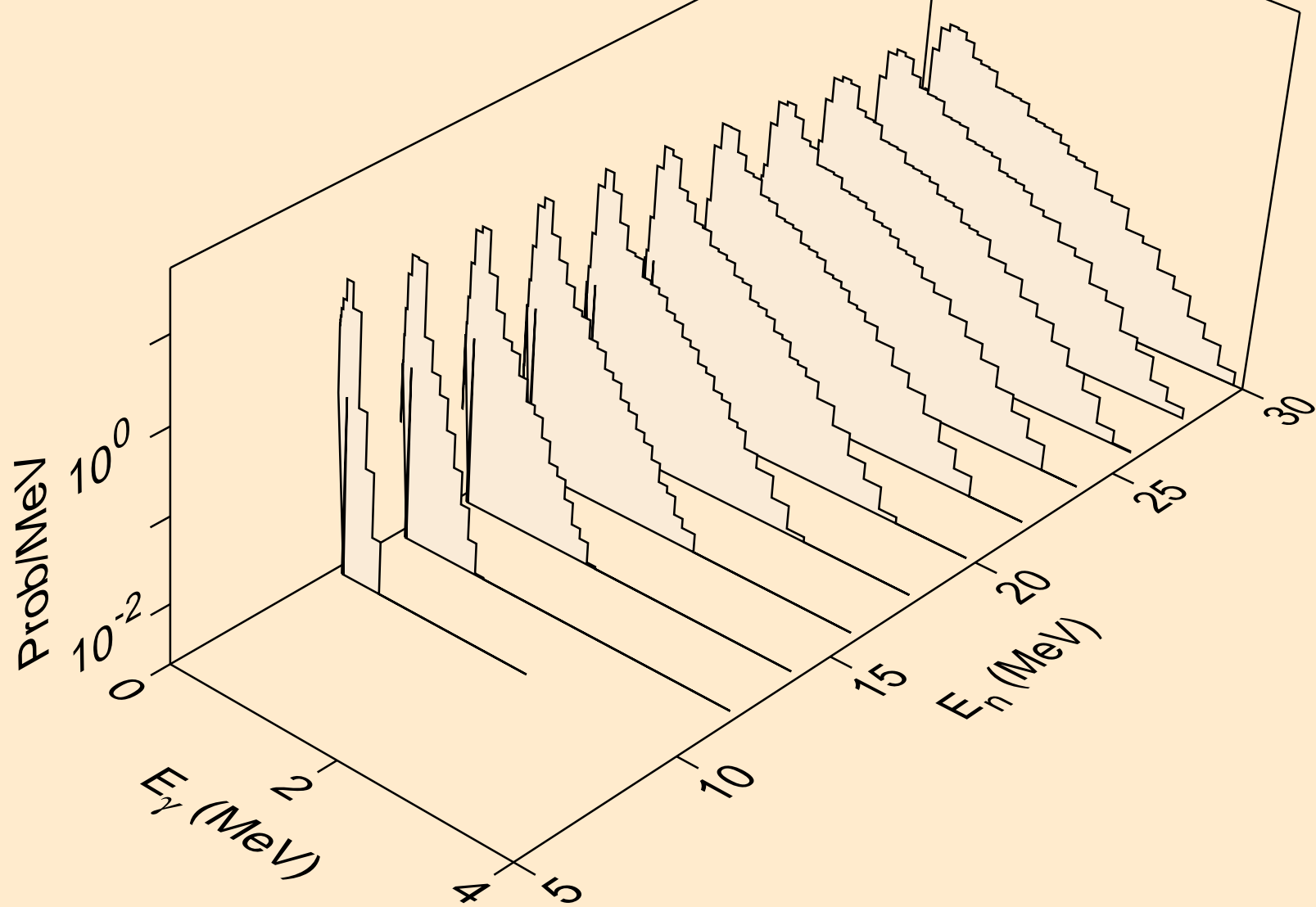

CM249 NEUTRON ACER TENDL-2021 LIBRARY; T=293.6K
Photon emission for (n,n*)d

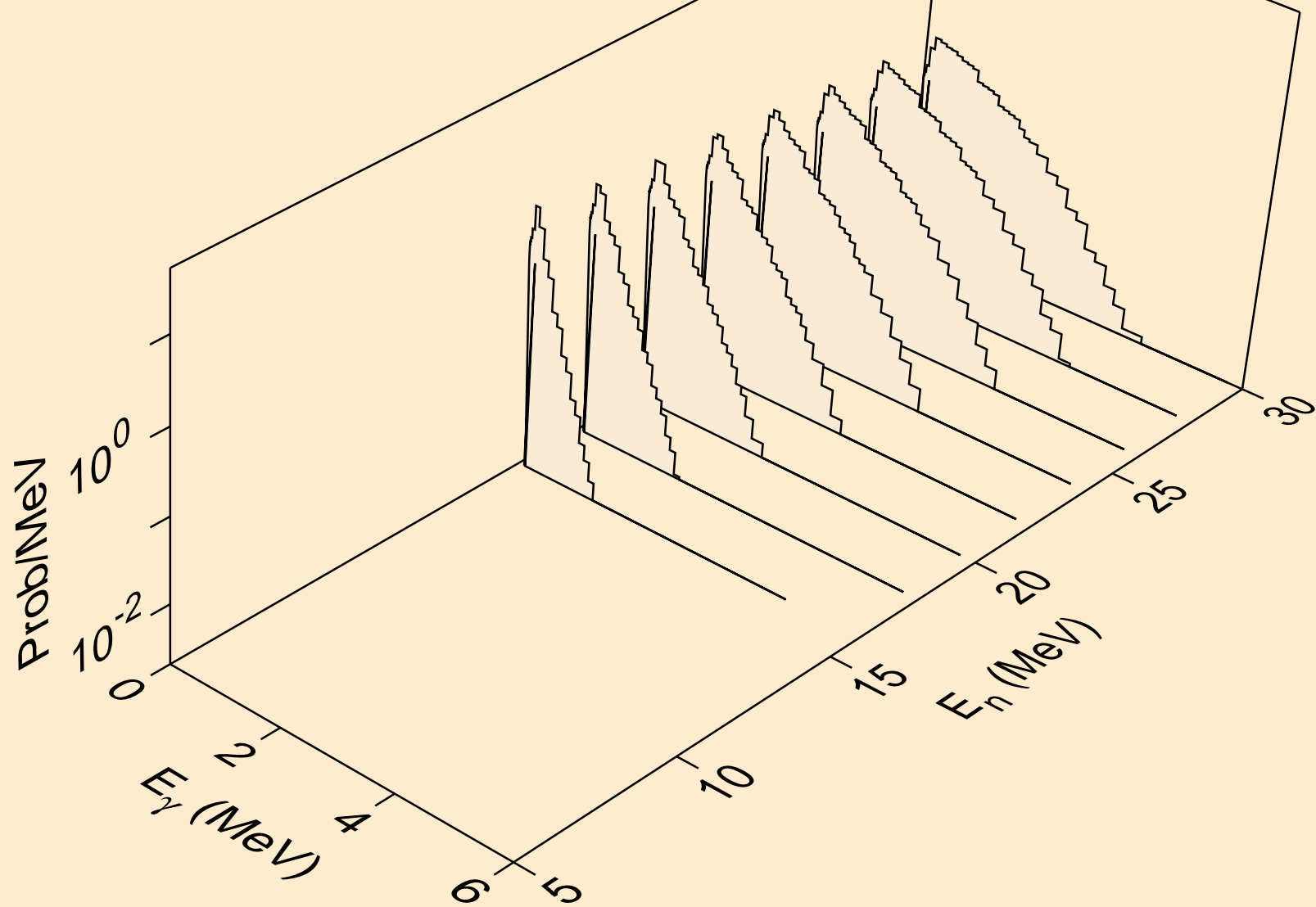

CM249 NEUTRON ACER TENDL-2021 LIBRARY; T=293.6K
Photon emission for (n,n*)t

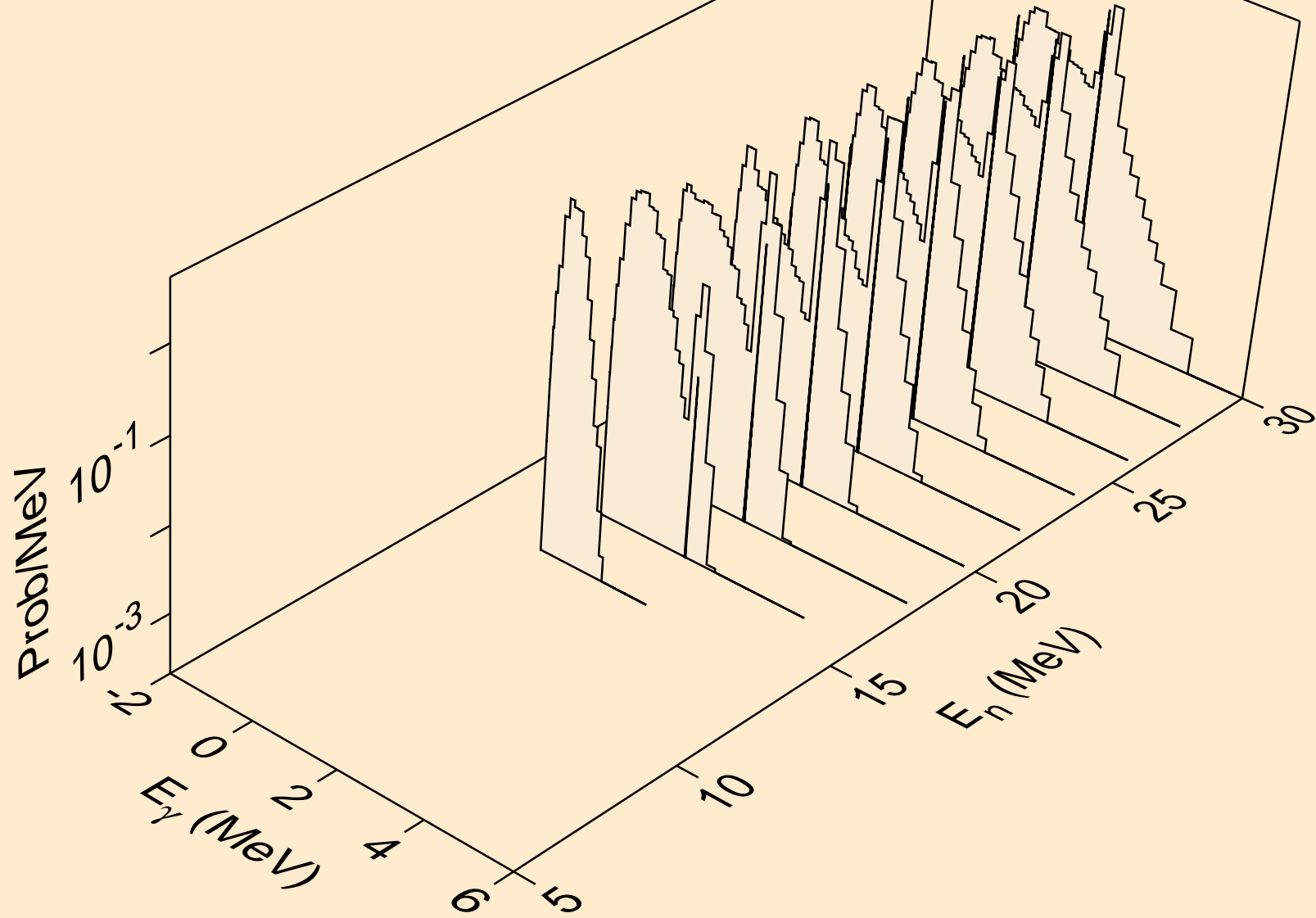

CM249 NEUTRON ACER TENDL-2021 LIBRARY; T=293.6K
Photon emission for (n,n*)he3

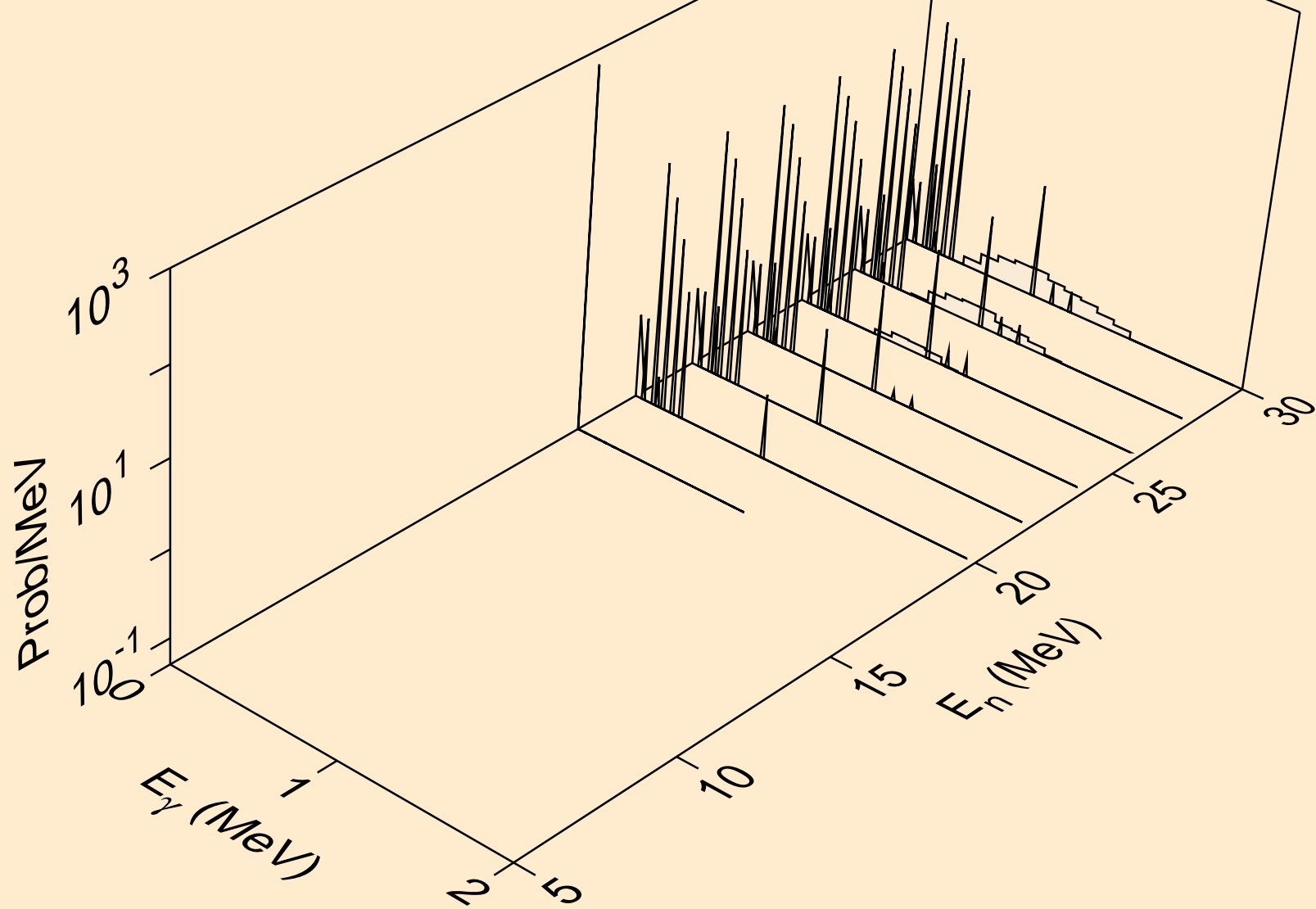

CM249 NEUTRON ACER TENDL-2021 LIBRARY; T=293.6K
Photon emission for (n,4n)

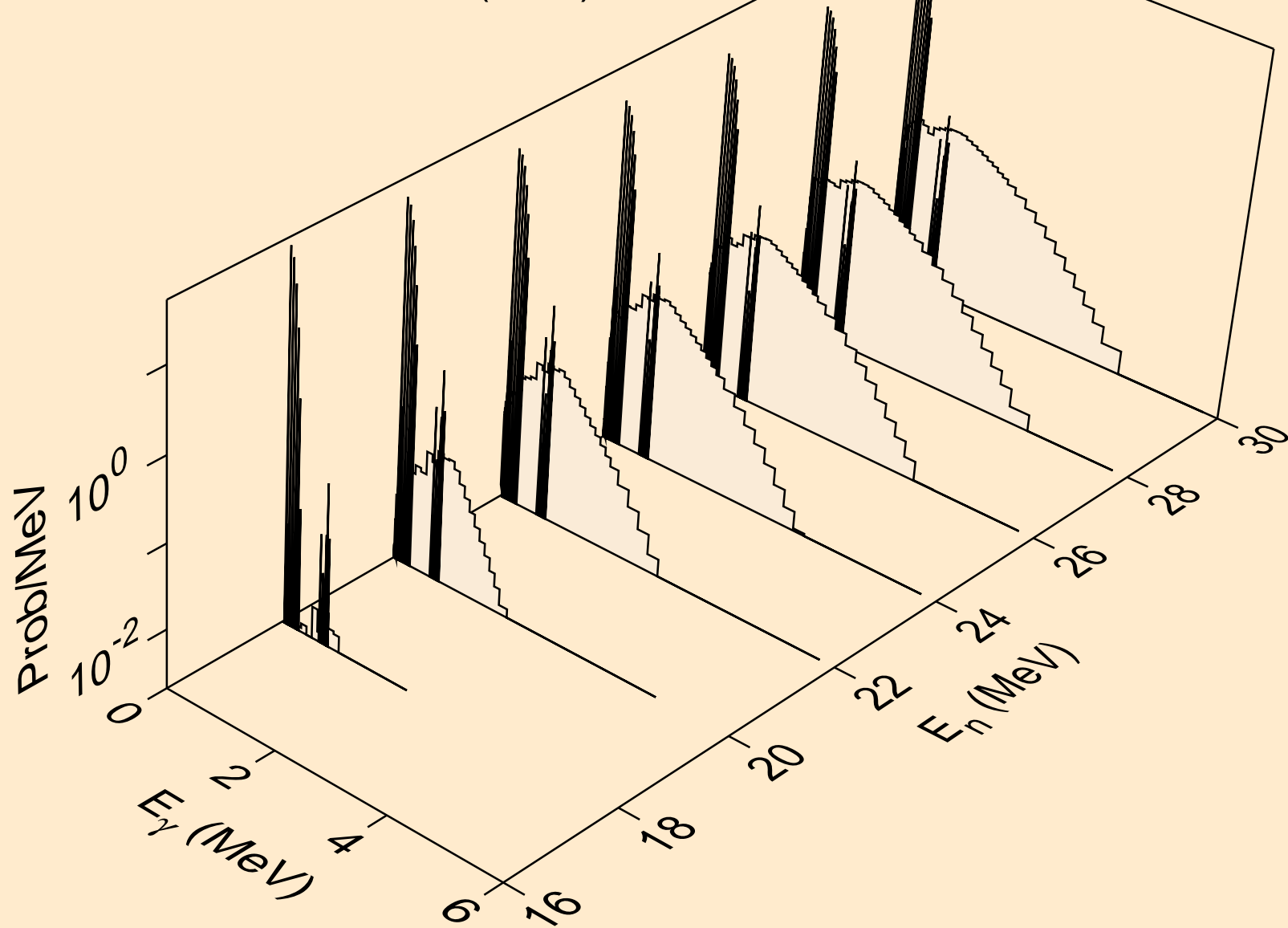

CM249 NEUTRON ACER TENDL-2021 LIBRARY; T=293.6K
Photon emission for (n,2np)

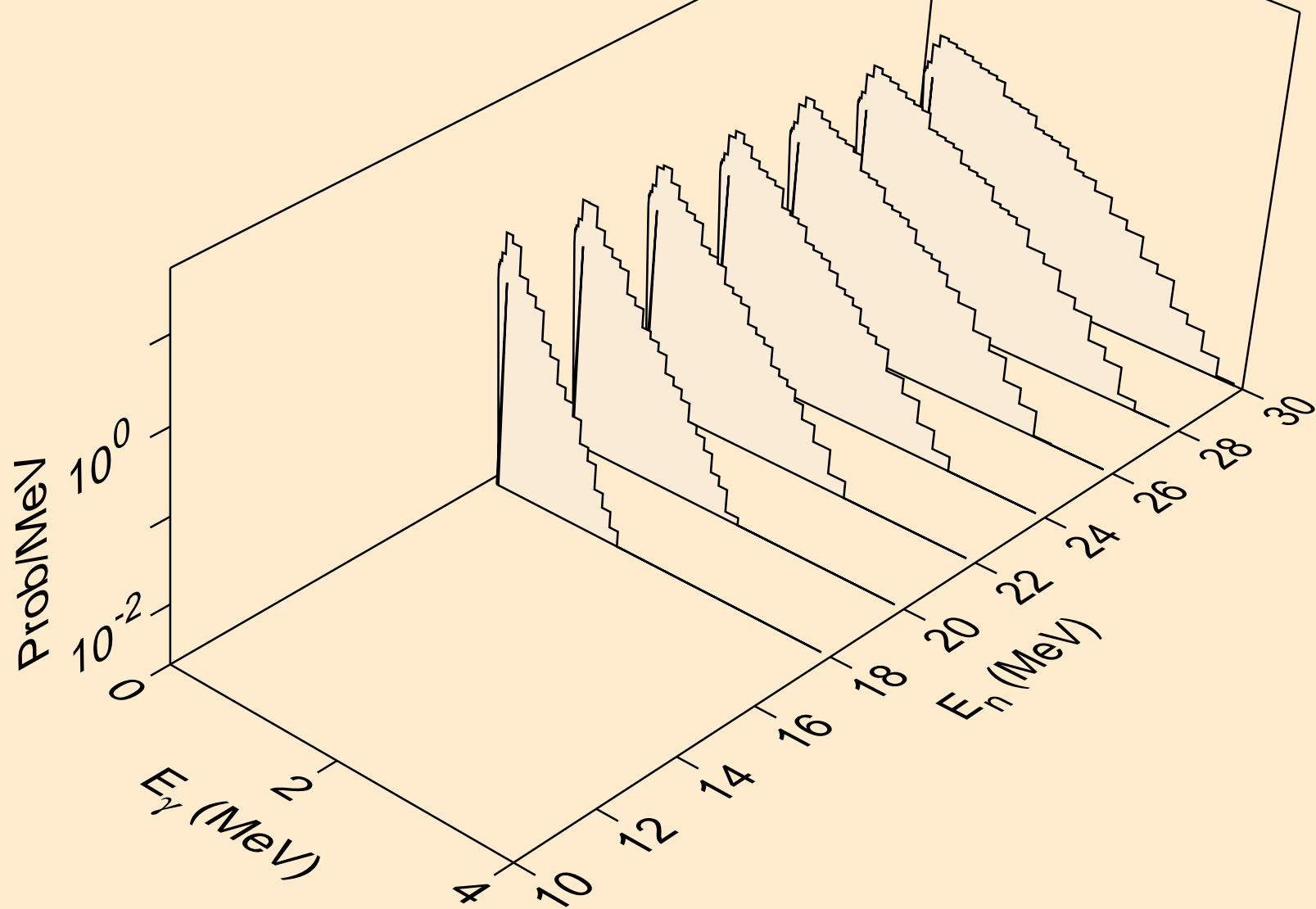

CM249 NEUTRON ACER TENDL-2021 LIBRARY; T=293.6K
Photon emission for (n,3np)

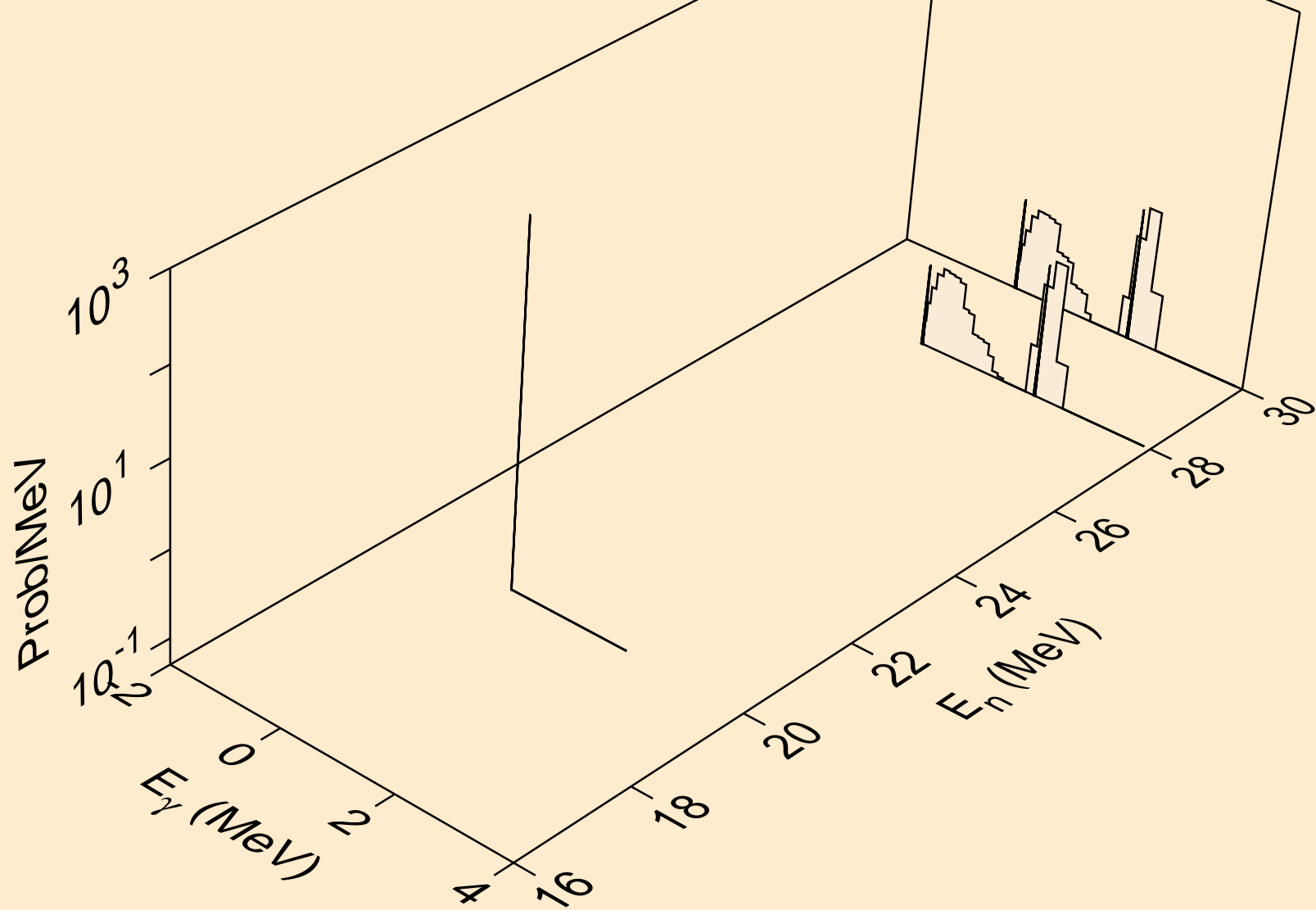

CM249 NEUTRON ACER TENDL-2021 LIBRARY; T=293.6K
Photon emission for (n,2np)

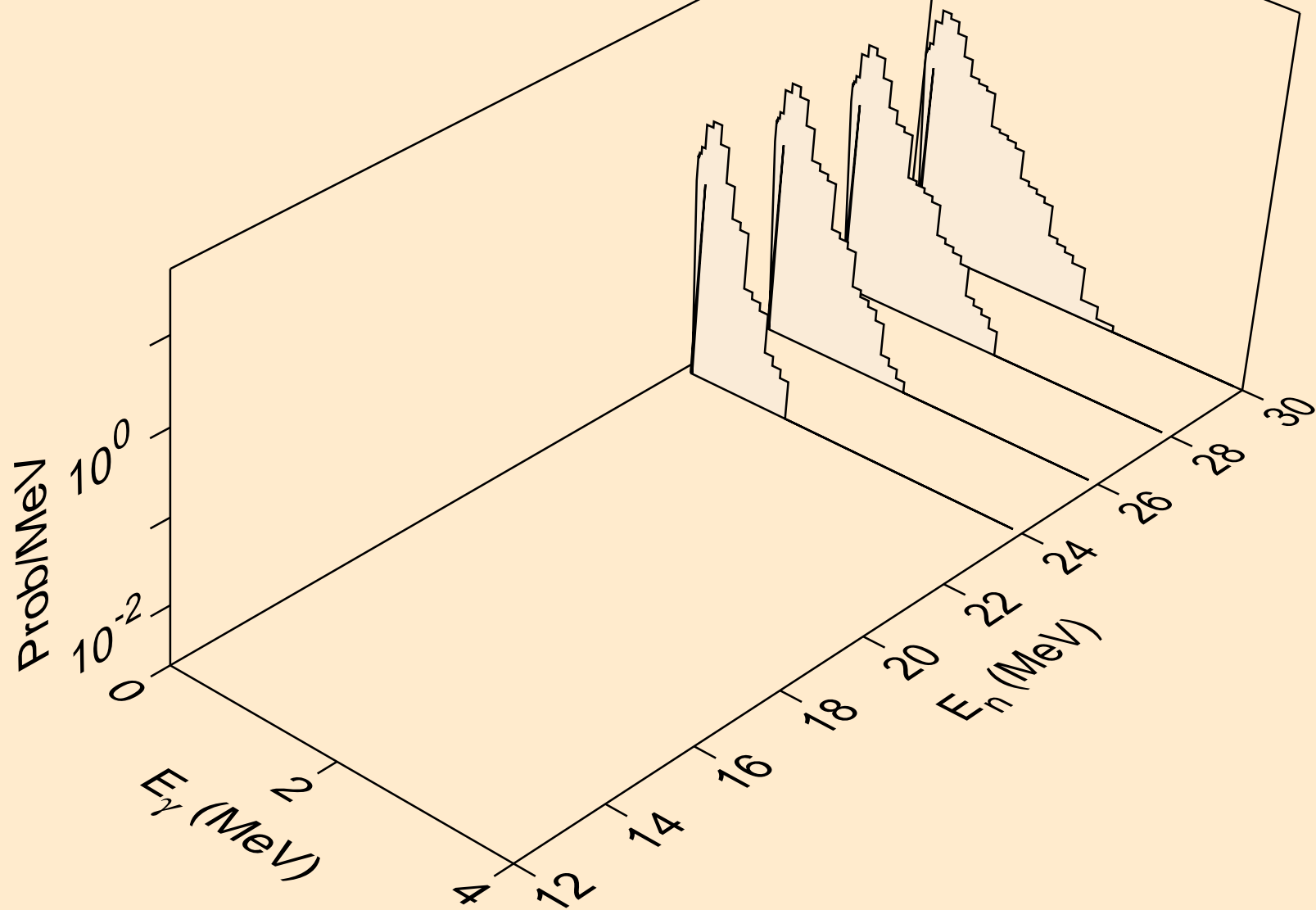

CM249 NEUTRON ACER TENDL-2021 LIBRARY; T=293.6K
Photon emission for (n,n*c)

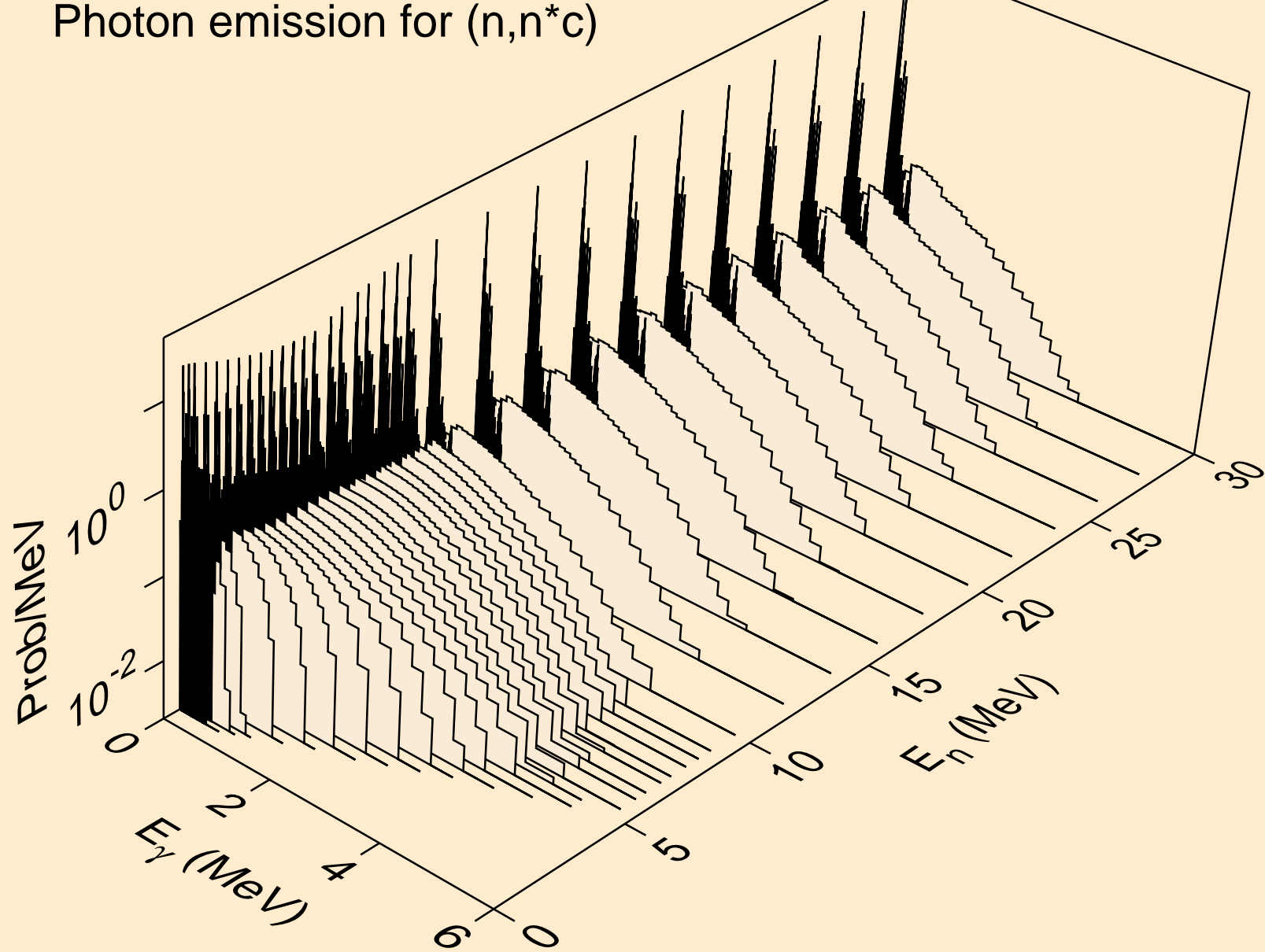

CM249 NEUTRON ACER TENDL-2021 LIBRARY; T=293.6K
Photon emission for (n,gma)

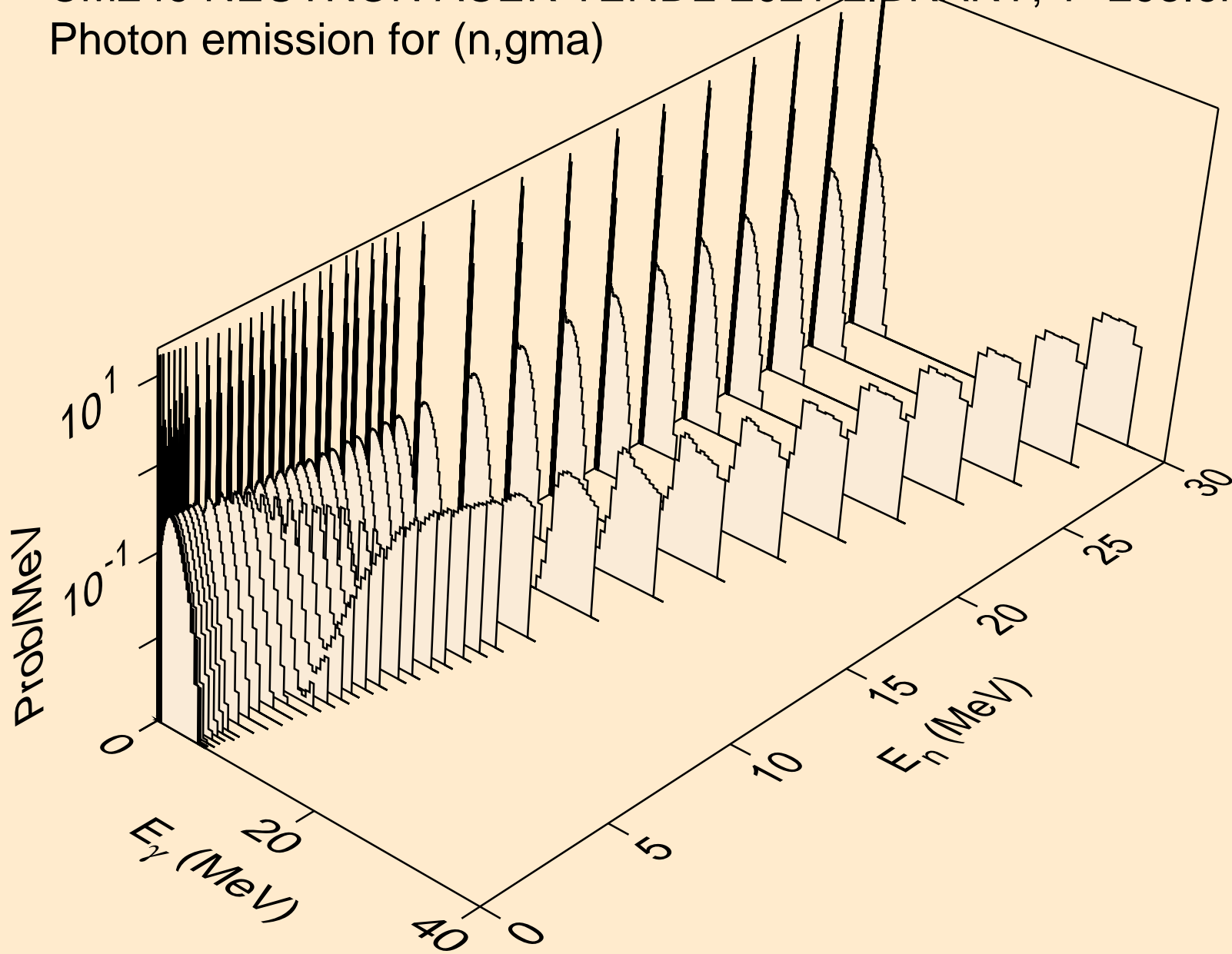

CM249 NEUTRON ACER TENDL-2021 LIBRARY; T=293.6K
Photon emission for (n,p)

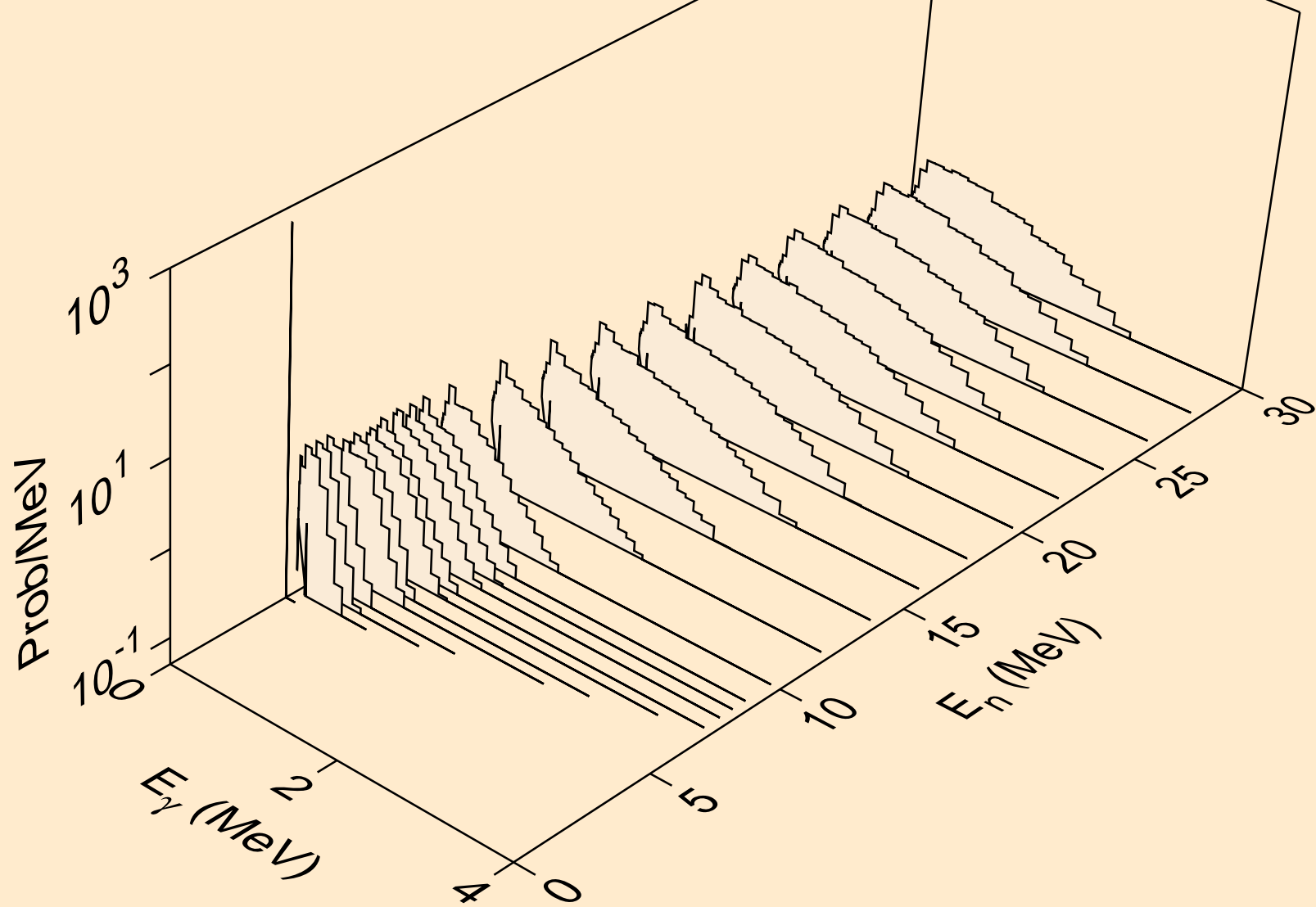

CM249 NEUTRON ACER TENDL-2021 LIBRARY; T=293.6K
Photon emission for (n,d)

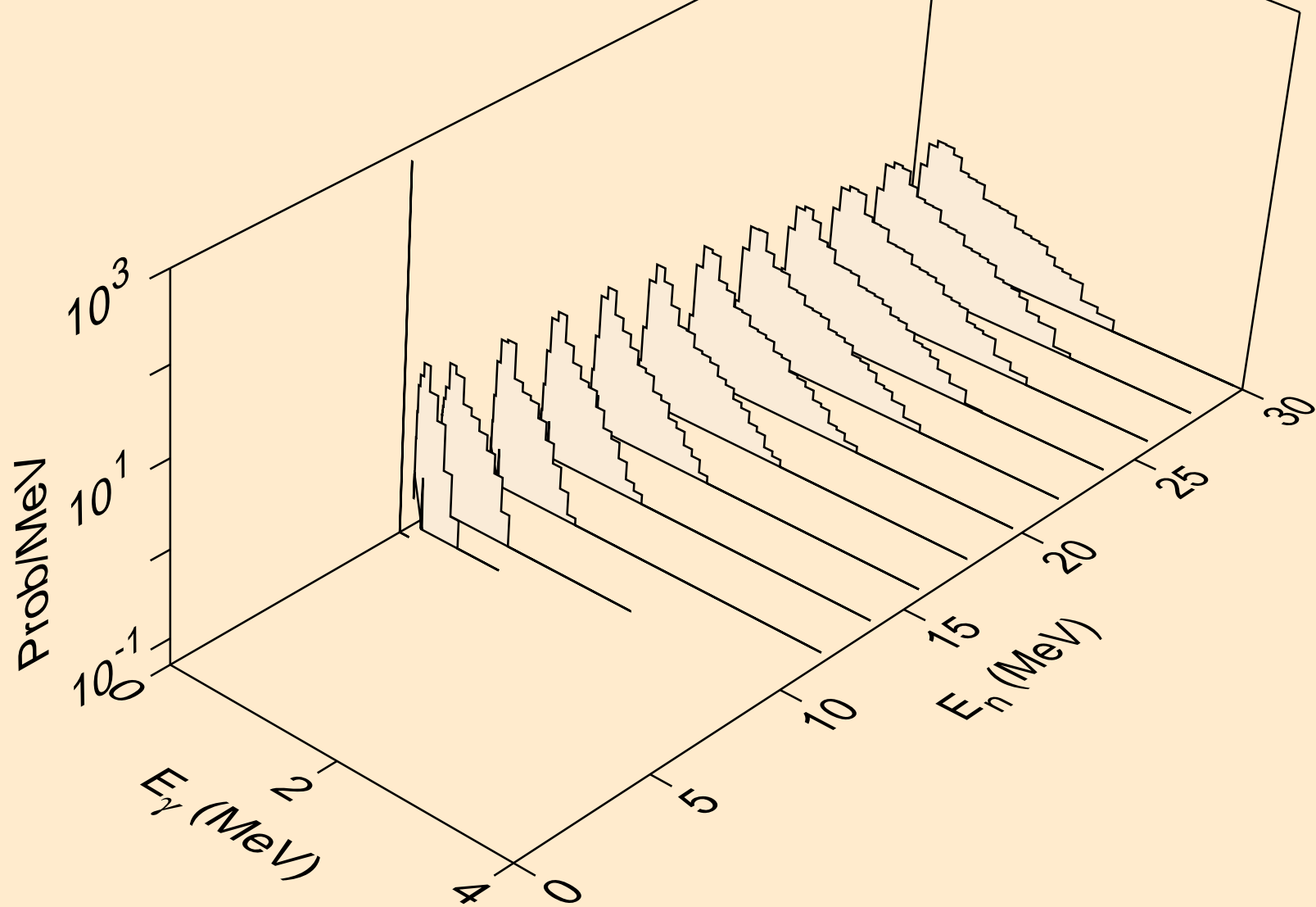

CM249 NEUTRON ACER TENDL-2021 LIBRARY; T=293.6K
Photon emission for (n,t)

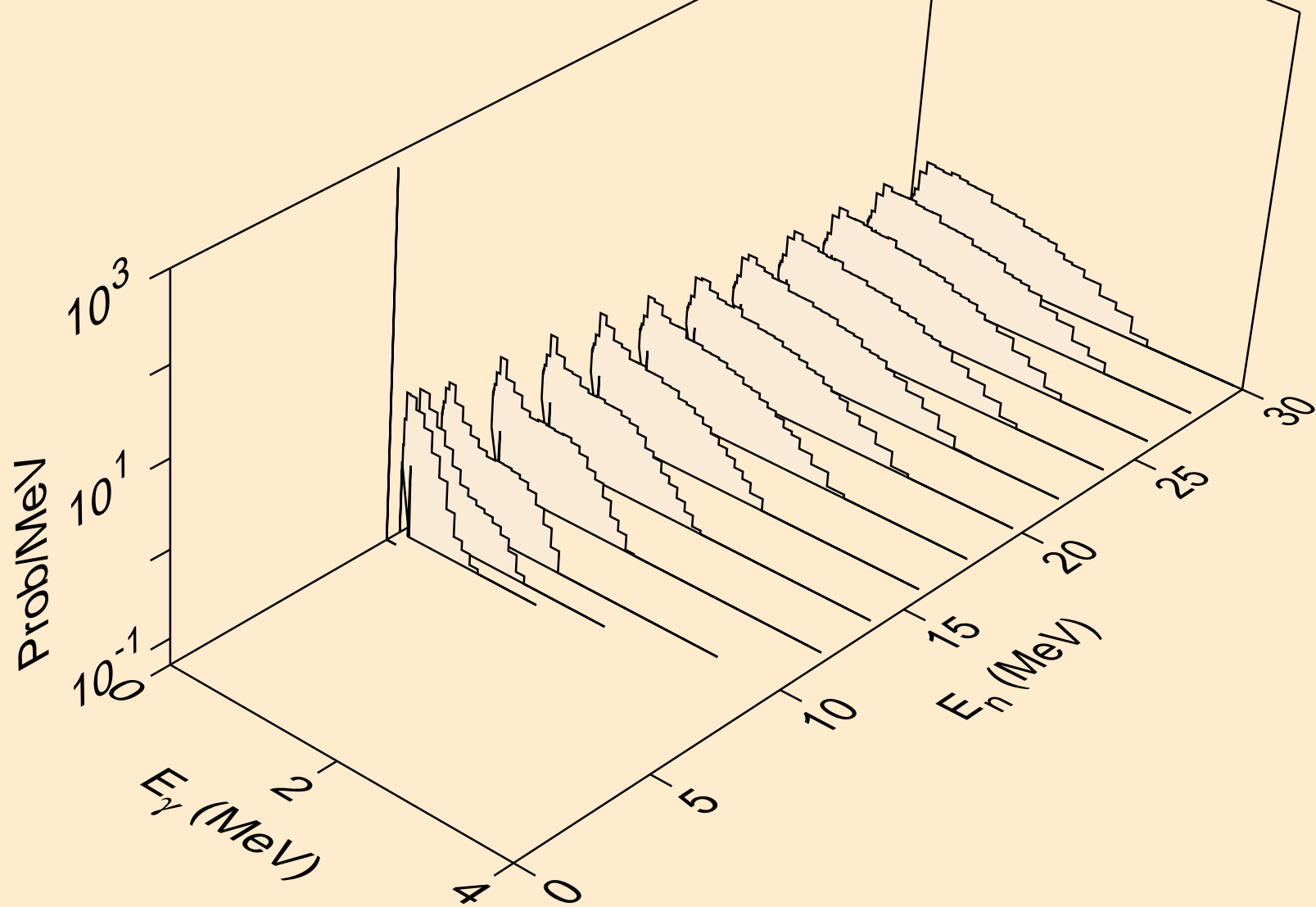

CM249 NEUTRON ACER TENDL-2021 LIBRARY; T=293.6K
Photon emission for (n,he3)

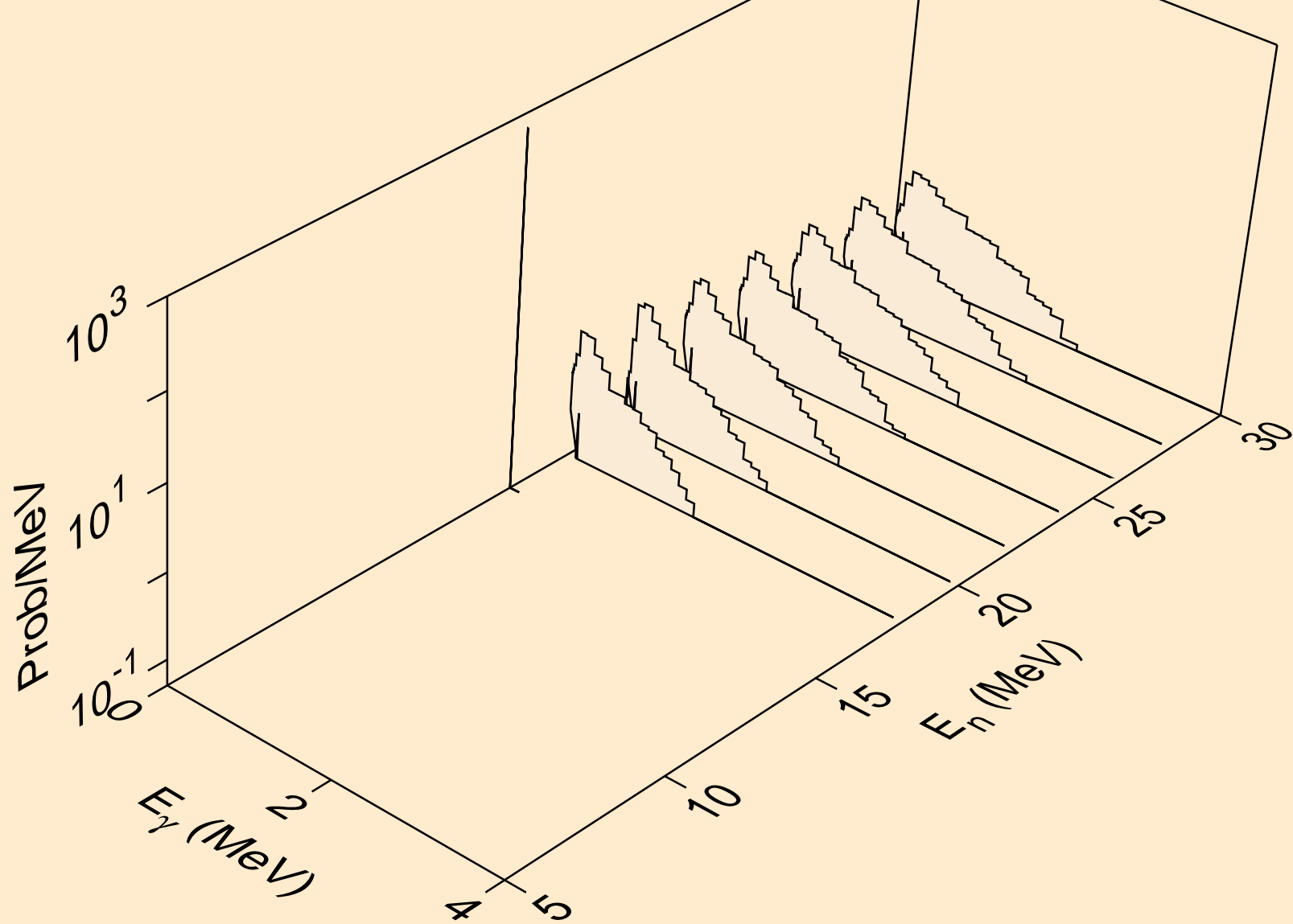

CM249 NEUTRON ACER TENDL-2021 LIBRARY; T=293.6K
Photon emission for (n,a)

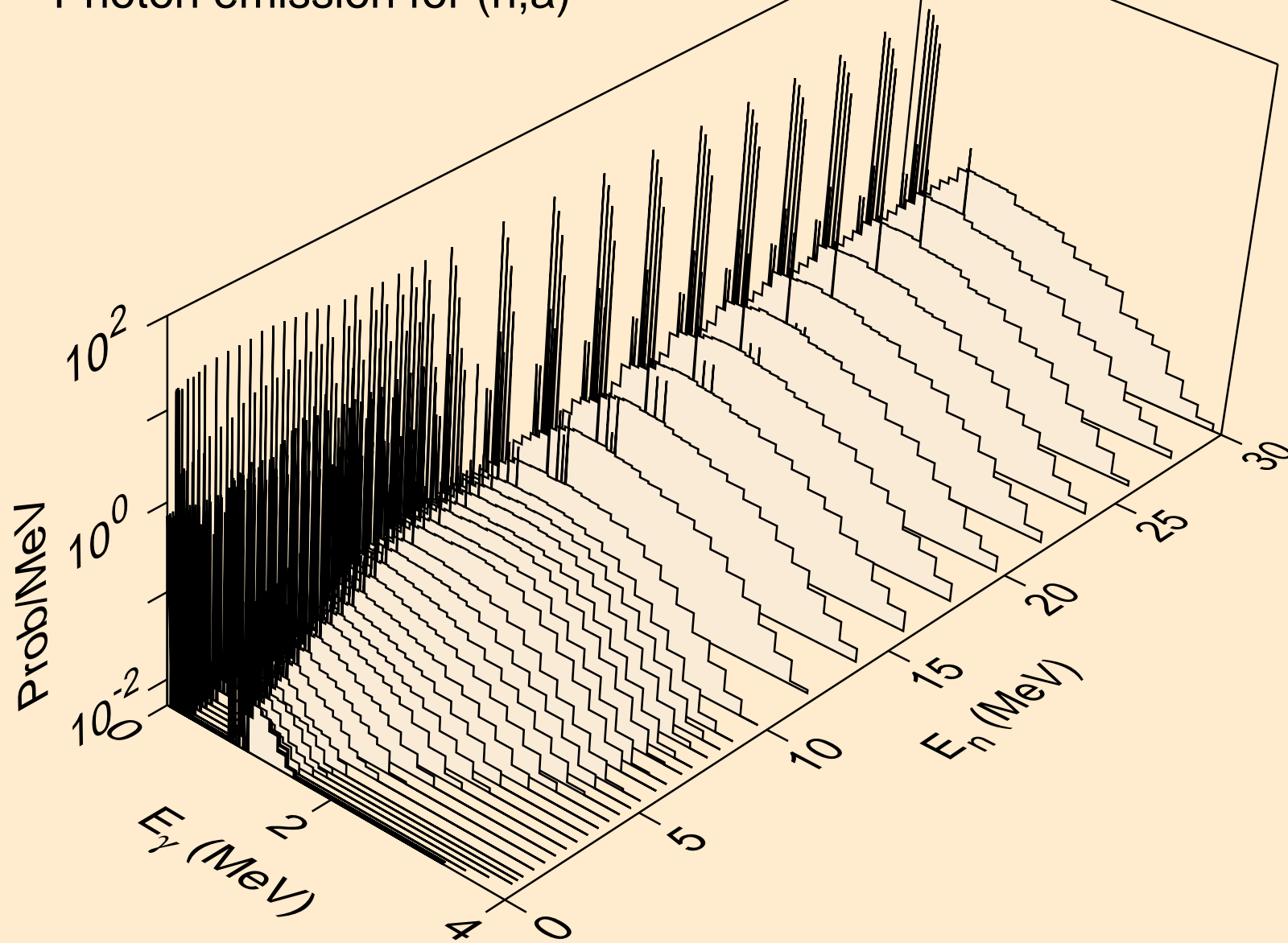

CM249 NEUTRON ACER TENDL-2021 LIBRARY; T=293.6K
Photon emission for (n,2p)

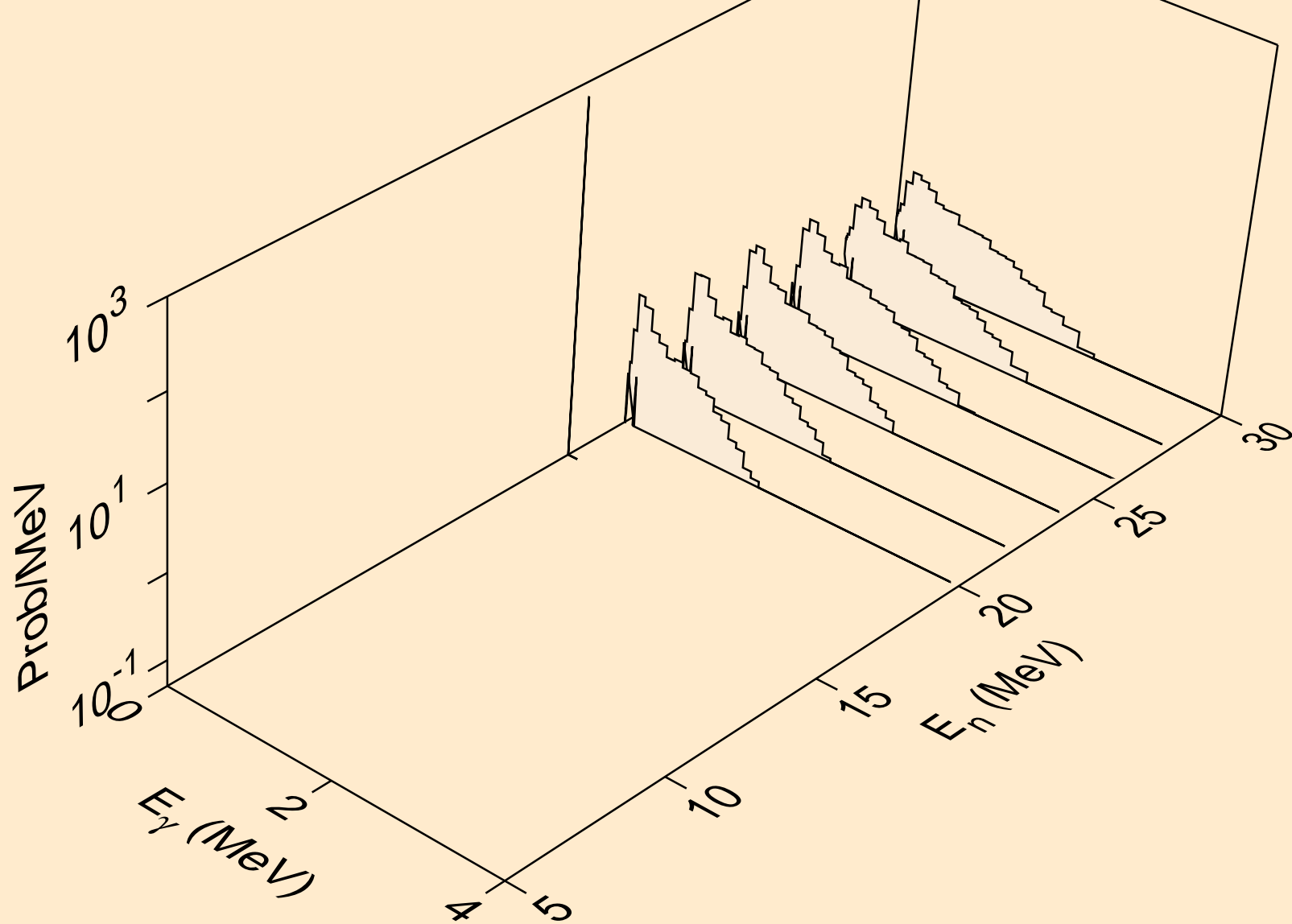

CM249 NEUTRON ACER TENDL-2021 LIBRARY; T=293.6K
thermal capture photon spectrum

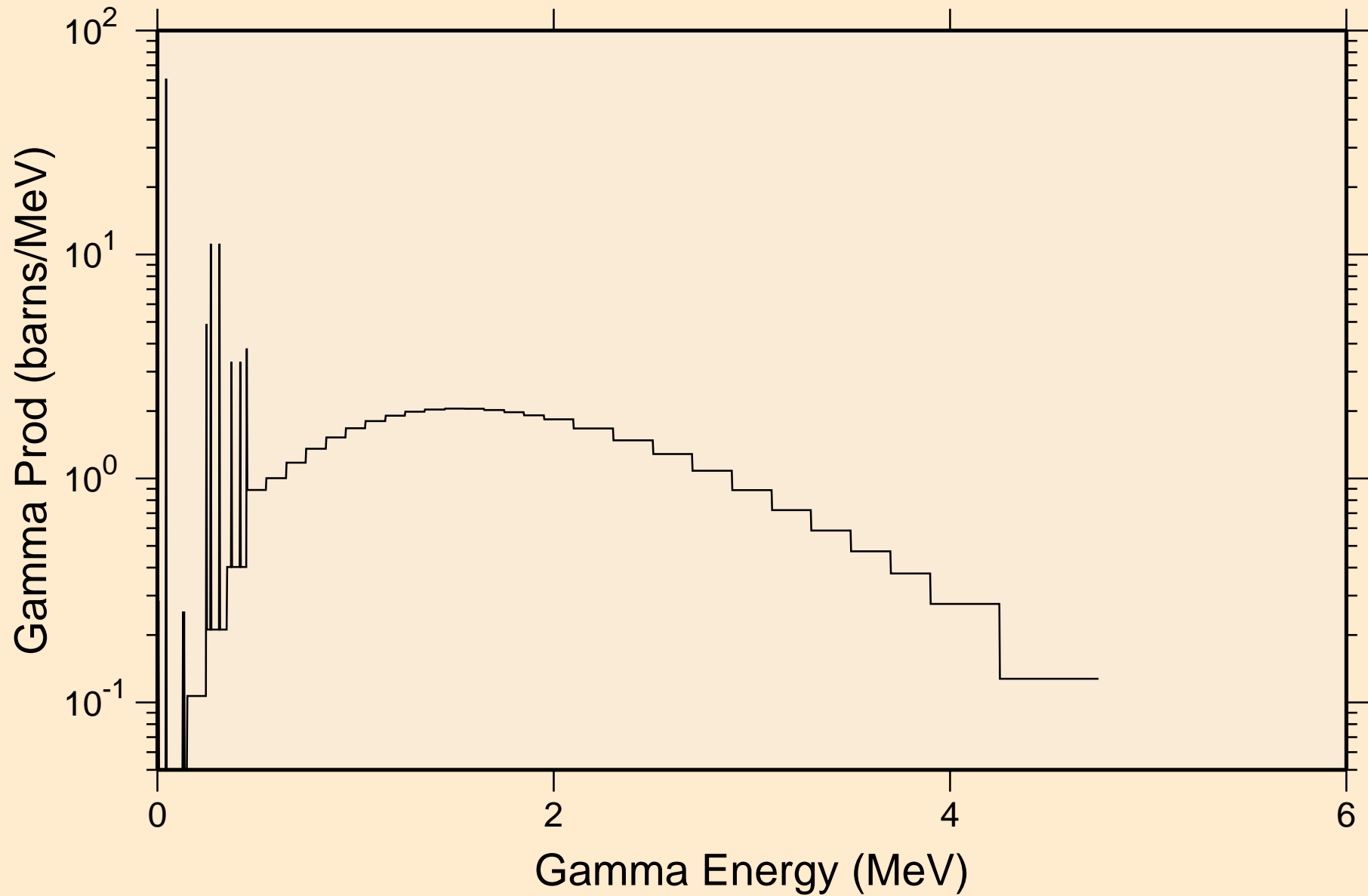

CM249 NEUTRON ACER TENDL-2021 LIBRARY; T=293.6K
14 MeV photon spectrum

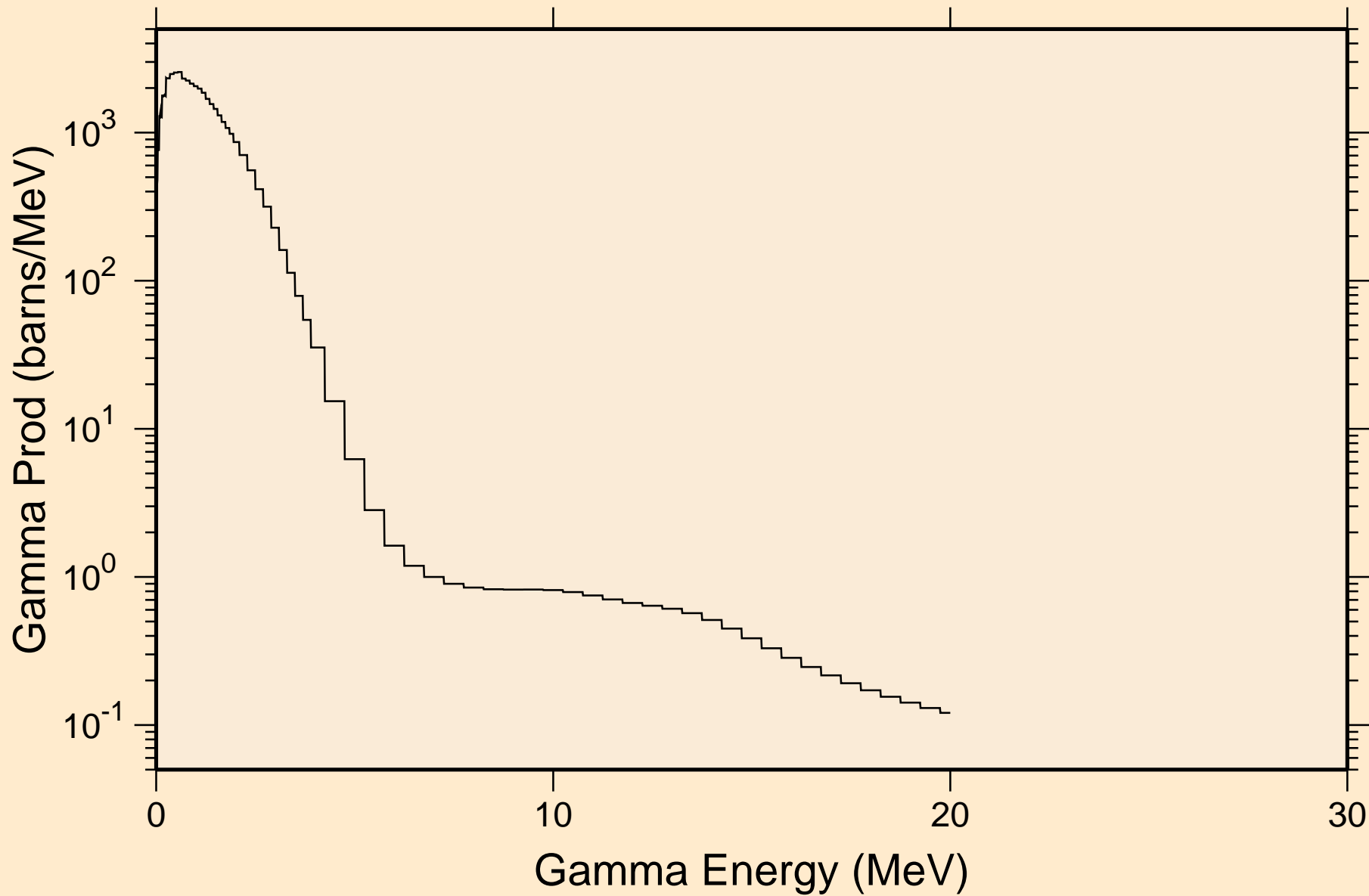

CM249 NEUTRON ACER TENDL-2021 LIBRARY; T=293.6K
Particle heating contributions

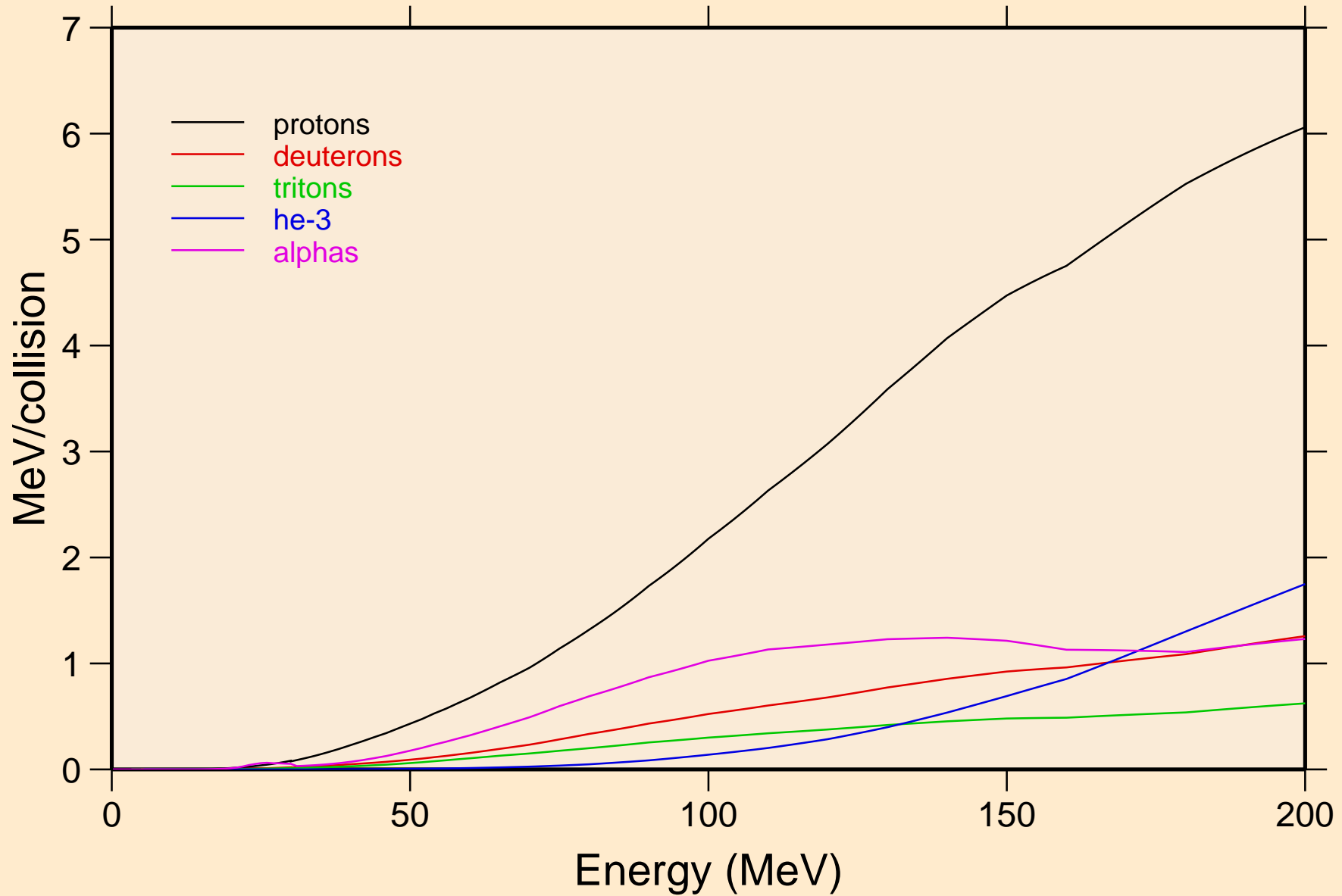

CM249 NEUTRON ACER TENDL-2021 LIBRARY; T=293.6K
Recoil Heating

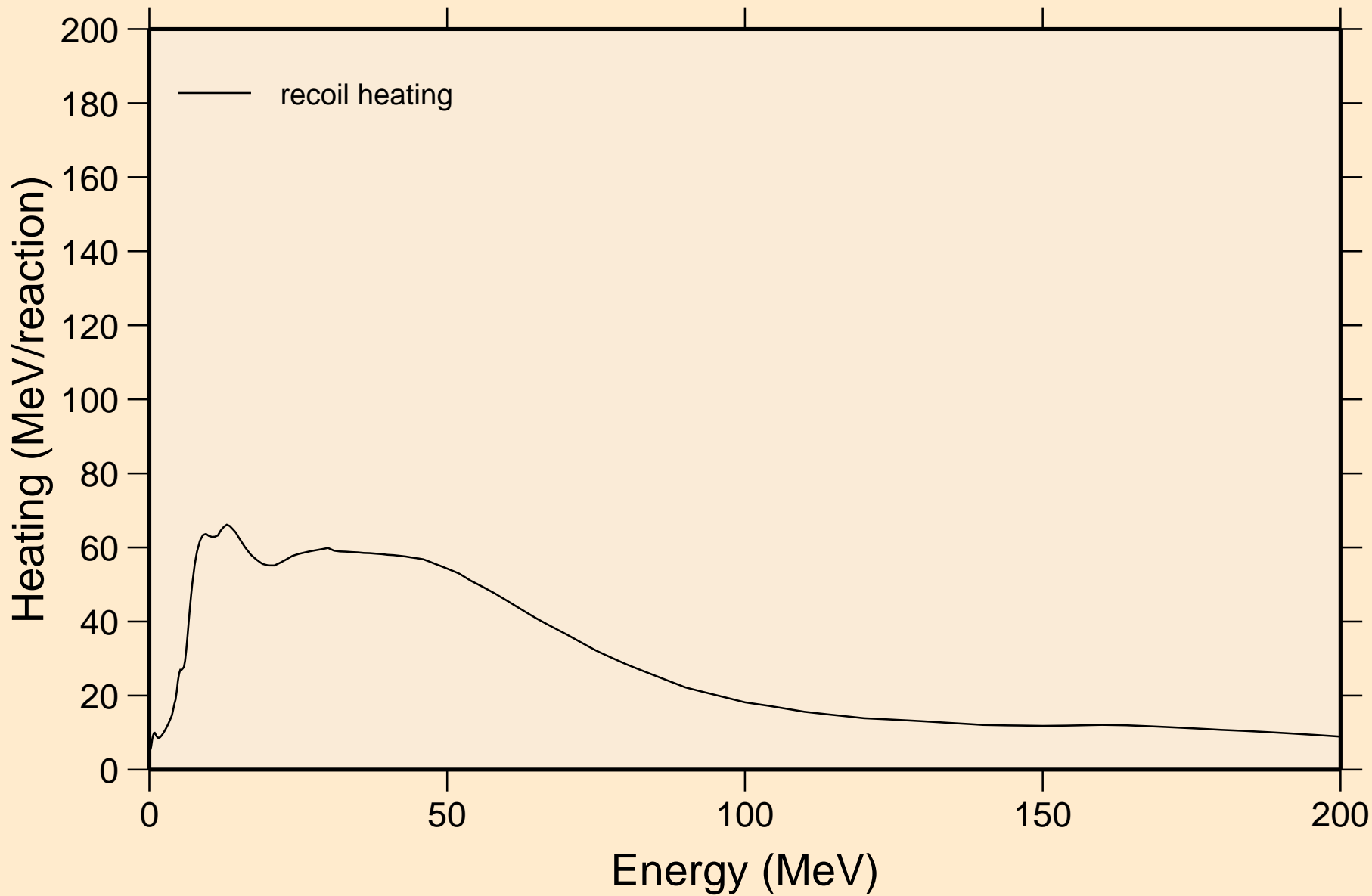

CM249 NEUTRON ACER TENDL-2021 LIBRARY; T=293.6K
Particle production cross sections

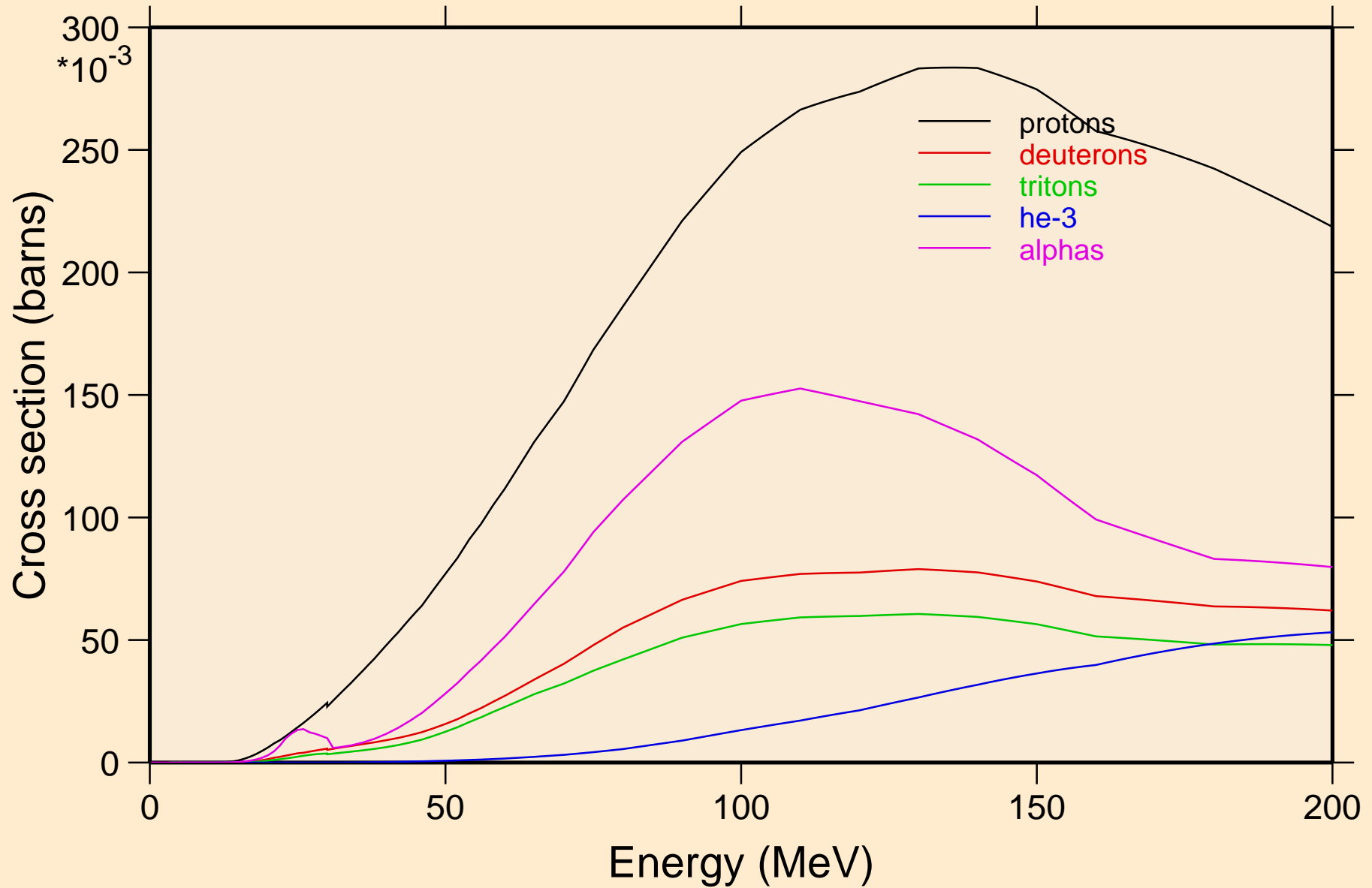

CM249 NEUTRON ACER TENDL-2021 LIBRARY; T=293.6K
protons from (n,x)

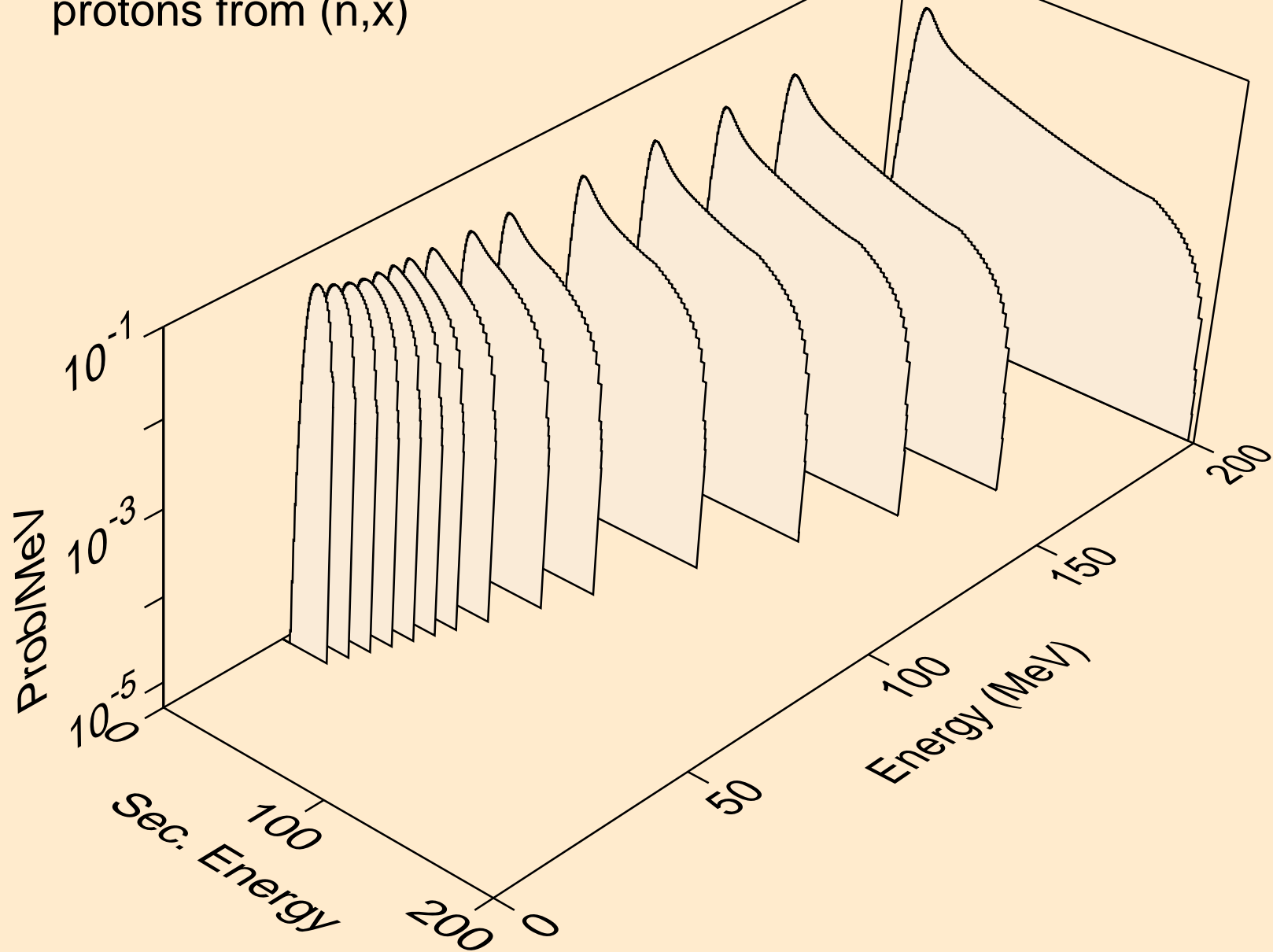

CM249 NEUTRON ACER TENDL-2021 LIBRARY; T=293.6K
protons from (n,n*)p

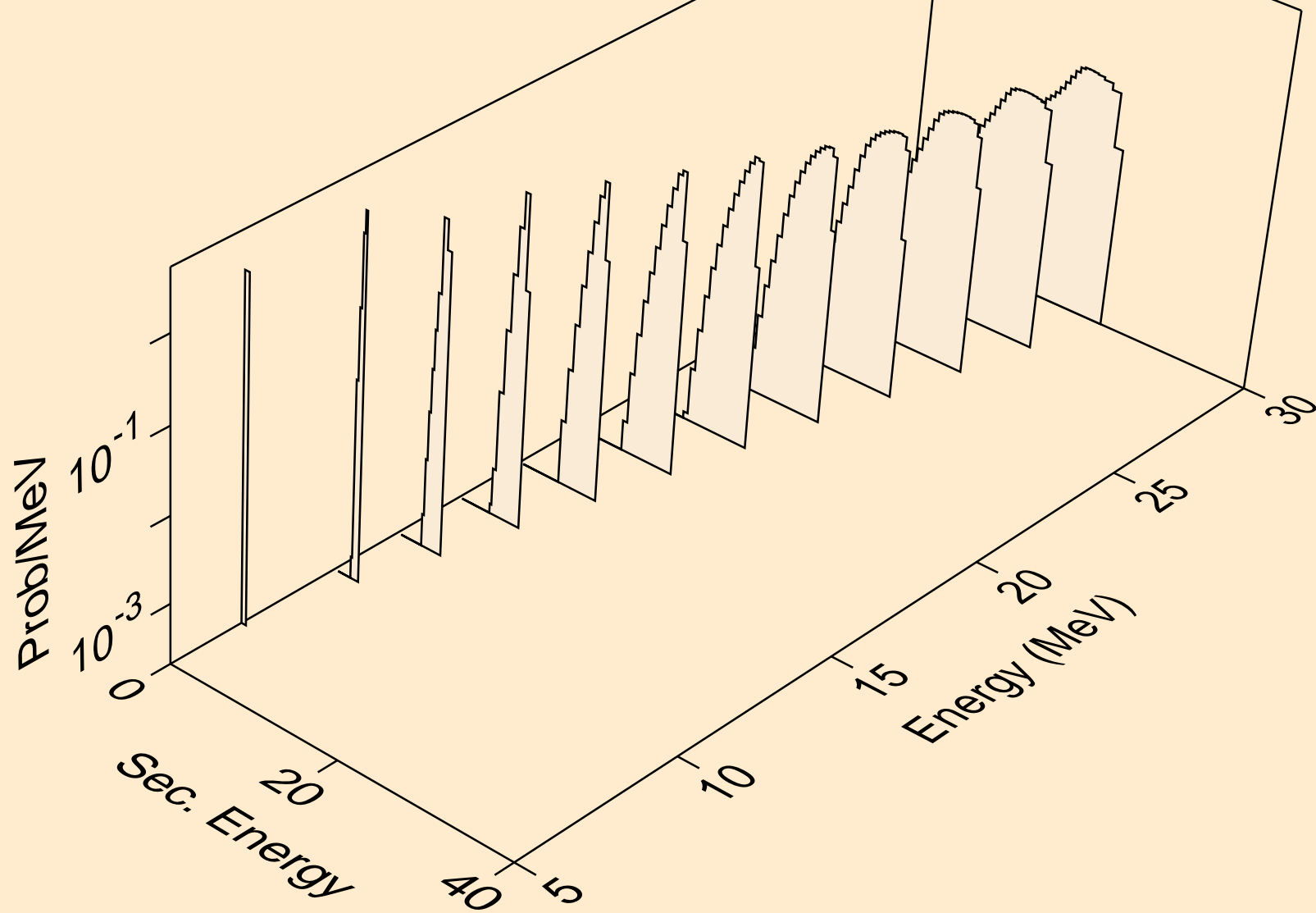

CM249 NEUTRON ACER TENDL-2021 LIBRARY; T=293.6K
protons from (n,2np)

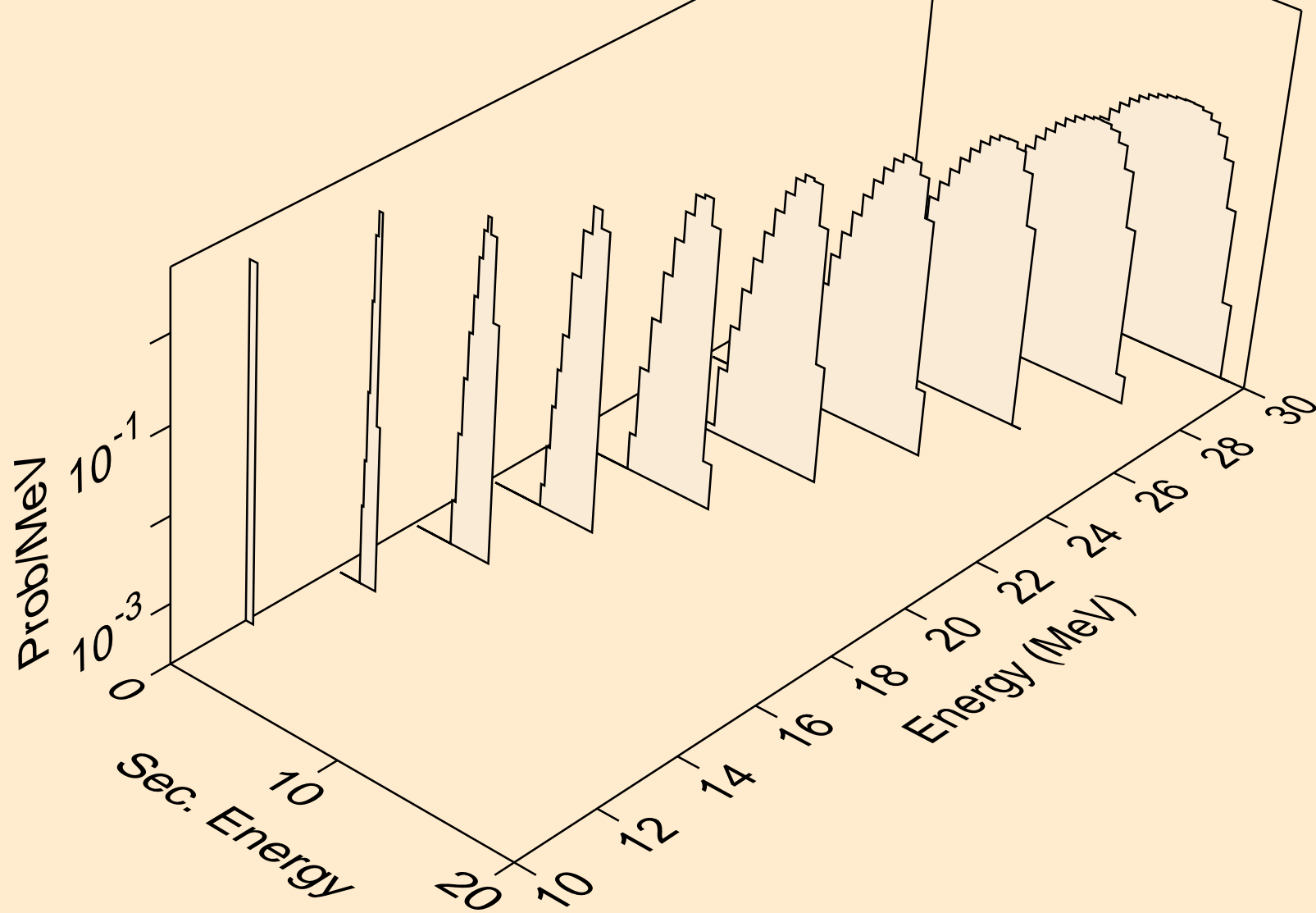

CM249 NEUTRON ACER TENDL-2021 LIBRARY; T=293.6K
protons from (n,3np)

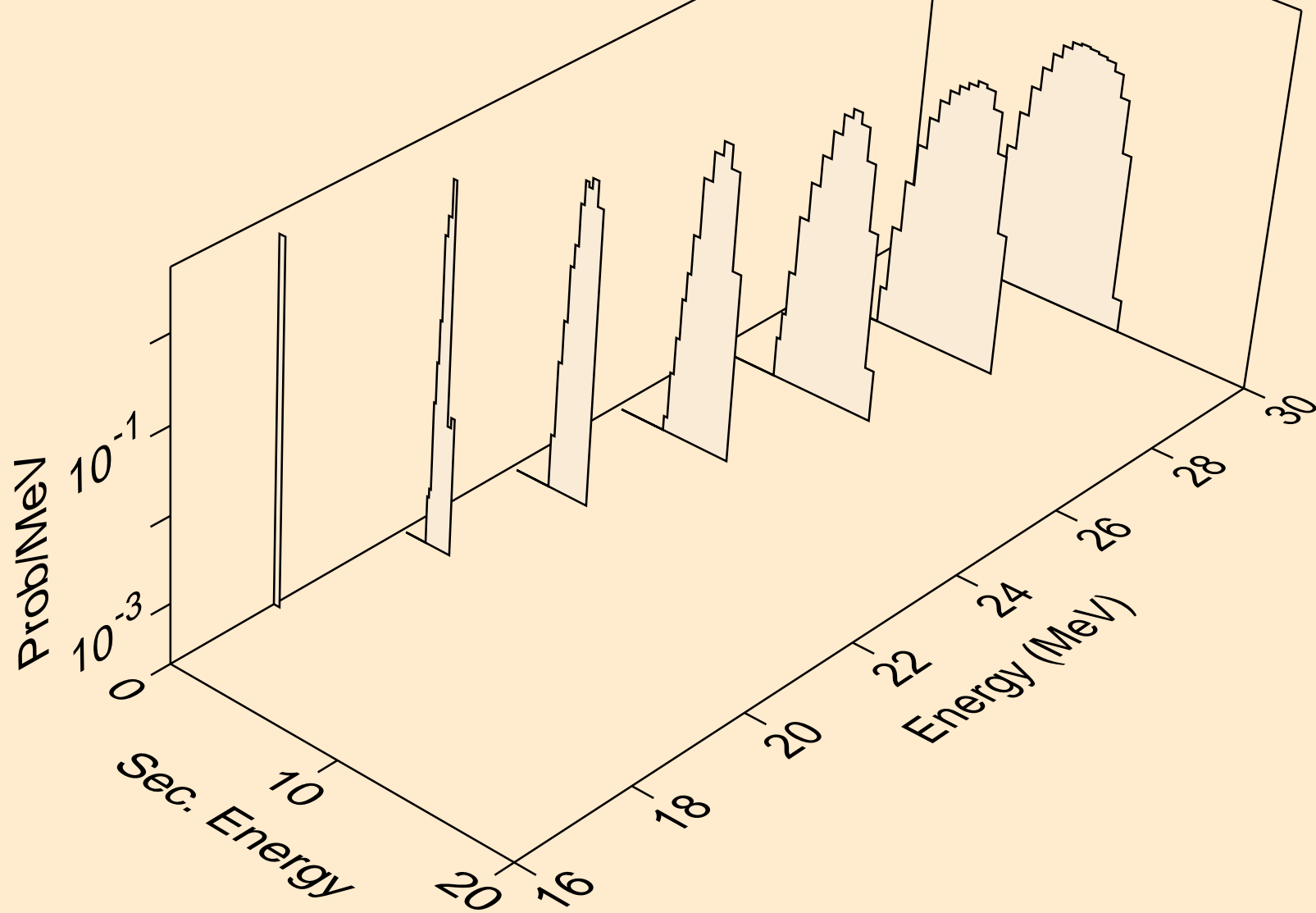

CM249 NEUTRON ACER TENDL-2021 LIBRARY; T=293.6K
protons from (n,2np)

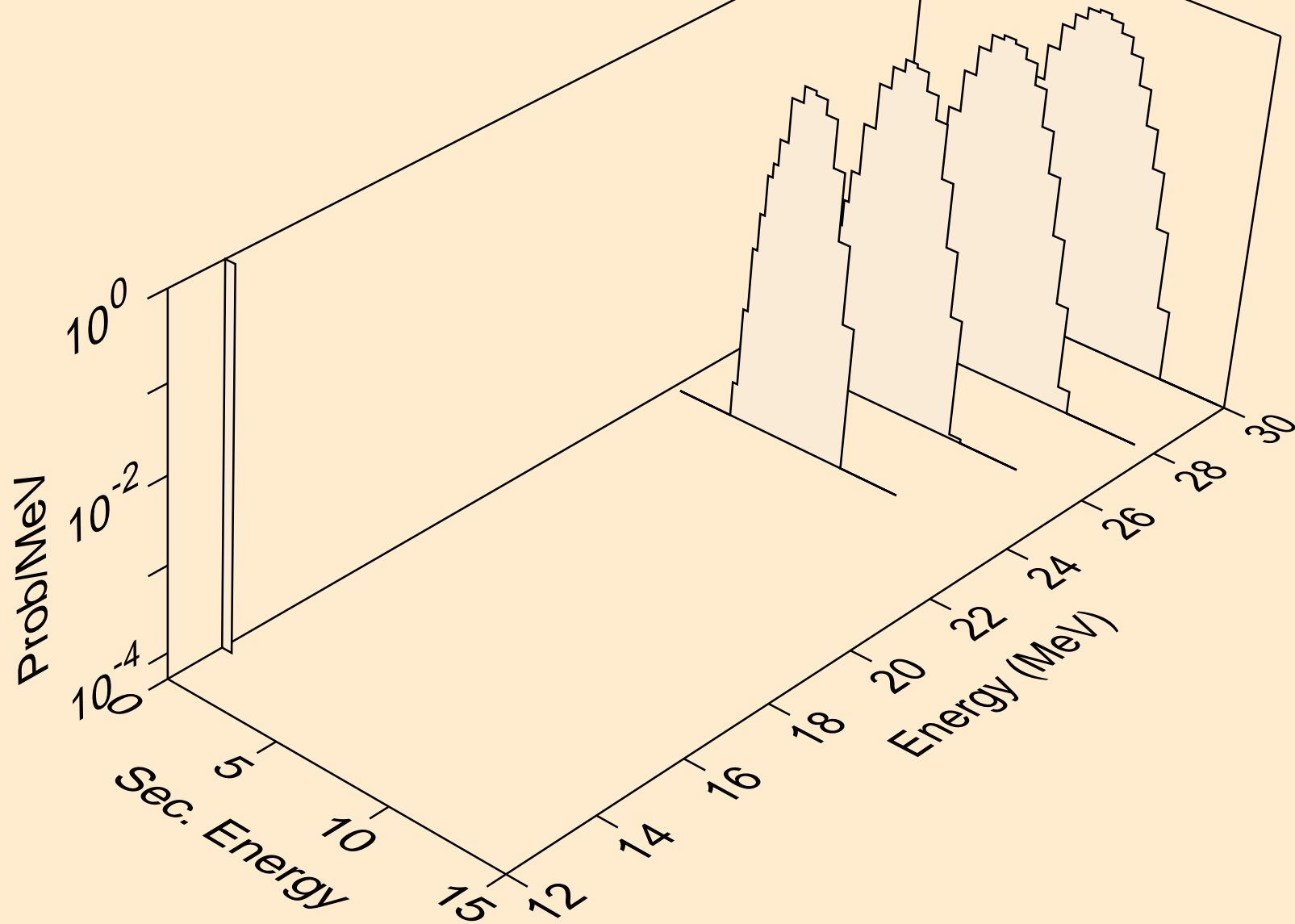

CM249 NEUTRON ACER TENDL-2021 LIBRARY; T=293.6K
protons from (n,p)

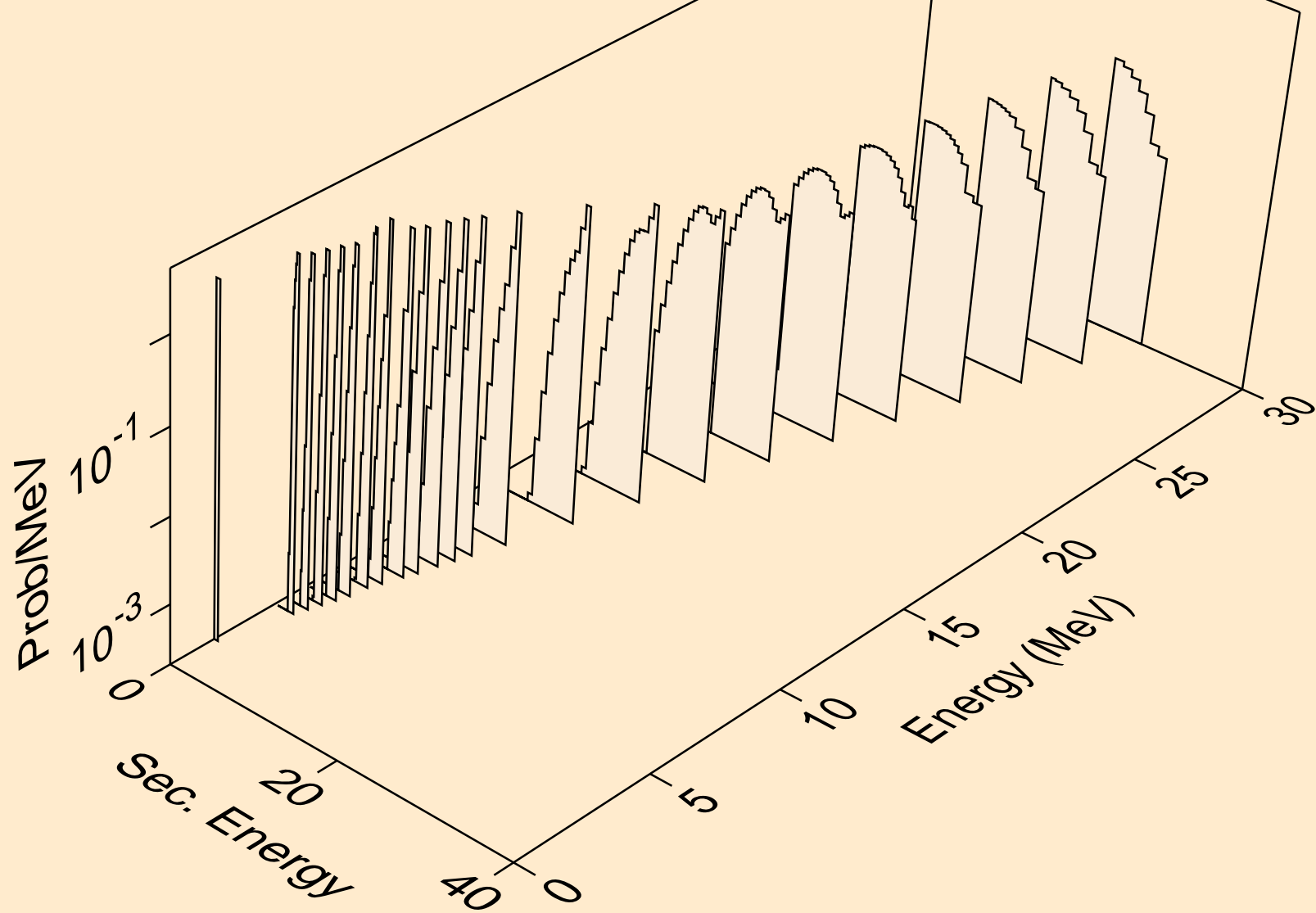

CM249 NEUTRON ACER TENDL-2021 LIBRARY; T=293.6K
protons from (n,2p)

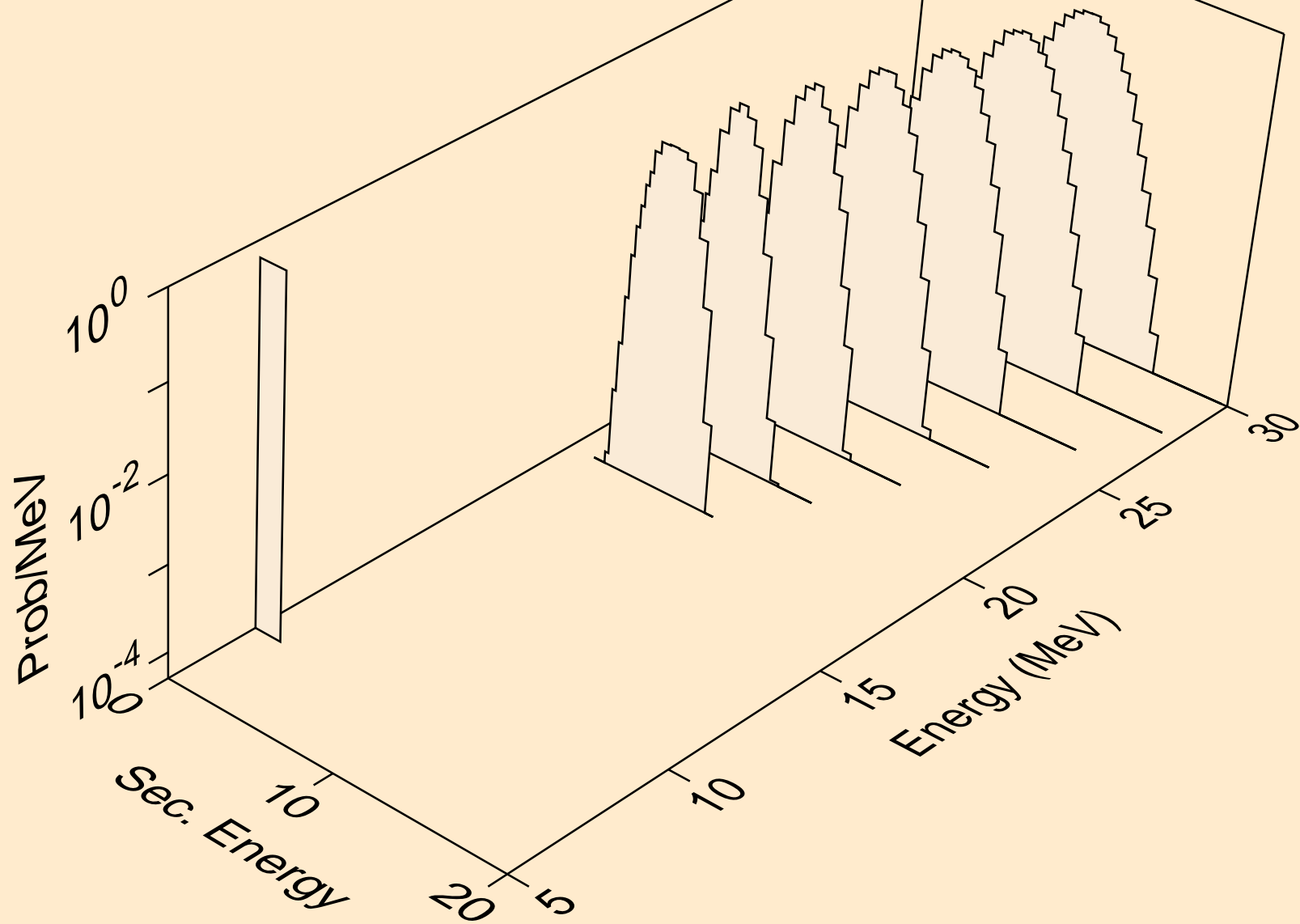

CM249 NEUTRON ACER TENDL-2021 LIBRARY; T=293.6K
deuterons from (n,x)

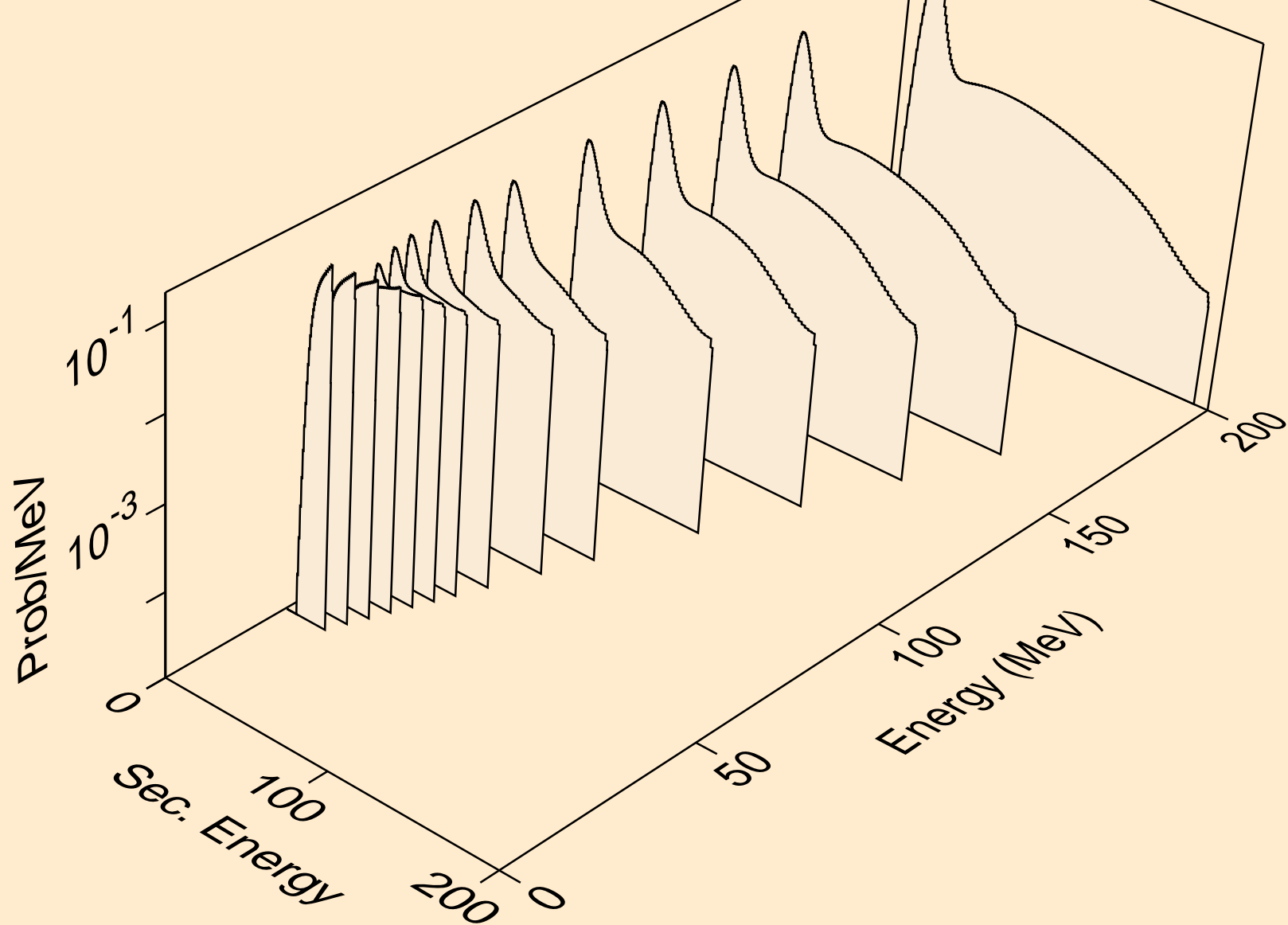

CM249 NEUTRON ACER TENDL-2021 LIBRARY; T=293.6K
deuterons from (n,2nd)

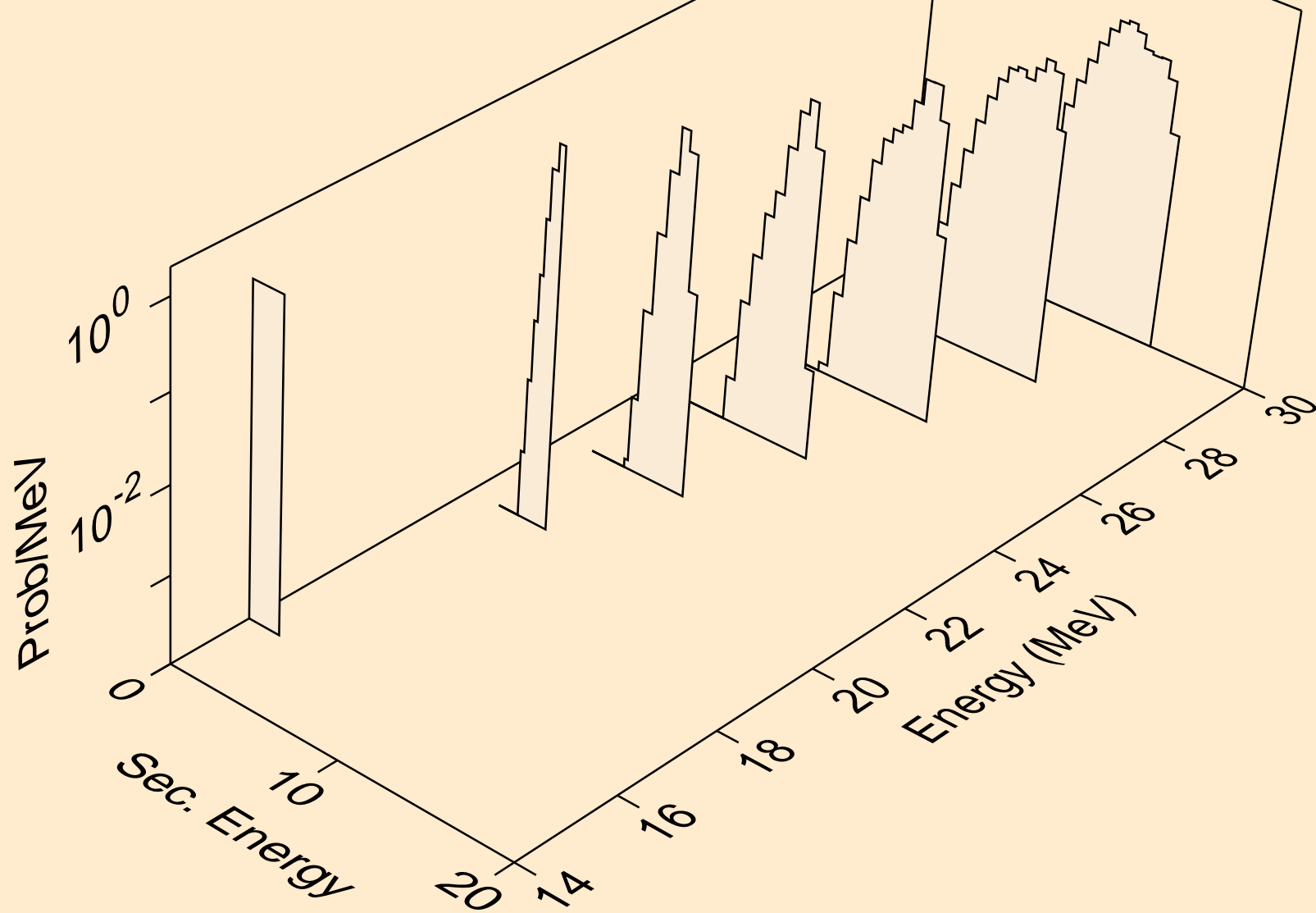

CM249 NEUTRON ACER TENDL-2021 LIBRARY; T=293.6K
deuterons from (n,n*)d

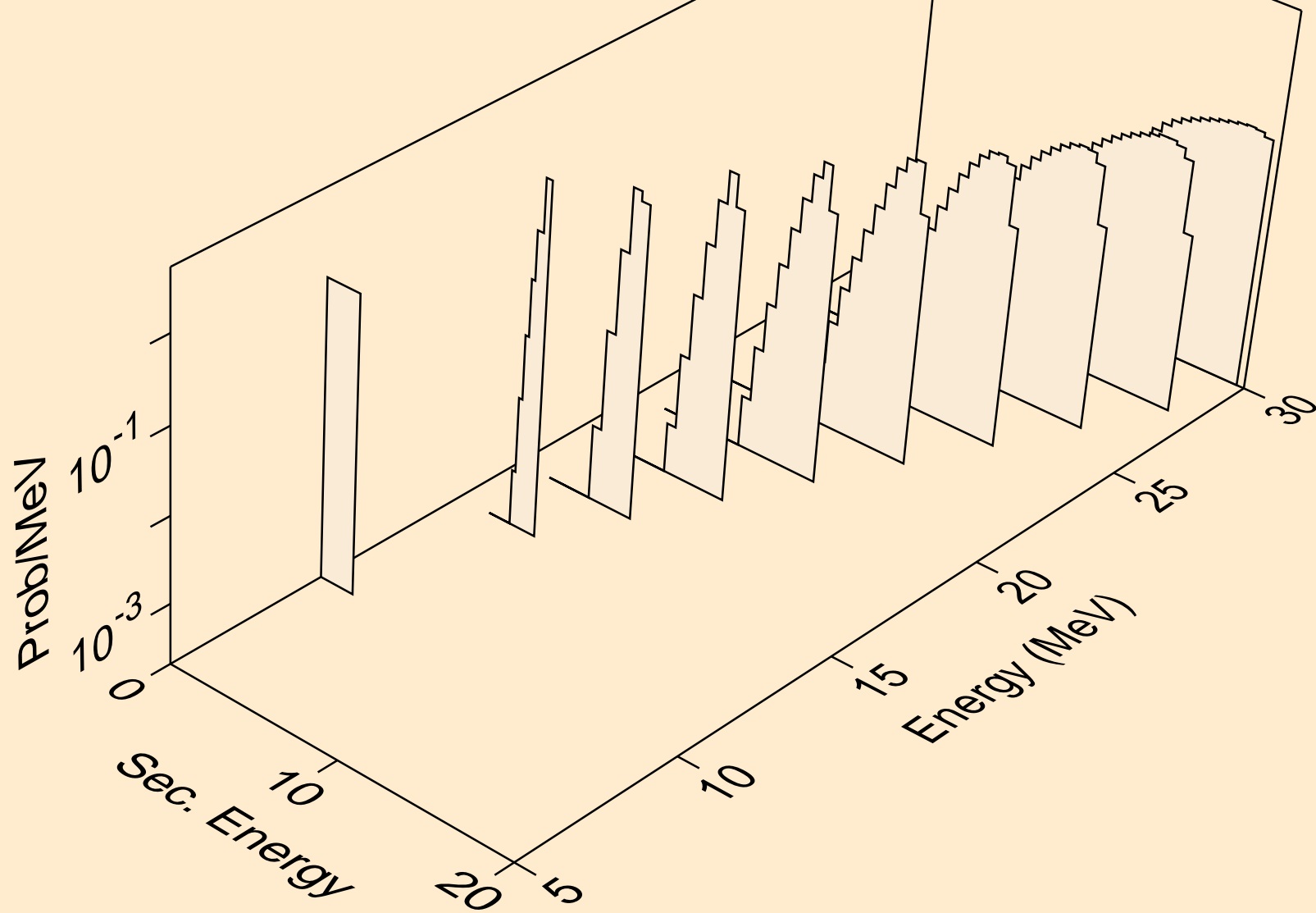

CM249 NEUTRON ACER TENDL-2021 LIBRARY; T=293.6K
deuterons from (n,d)

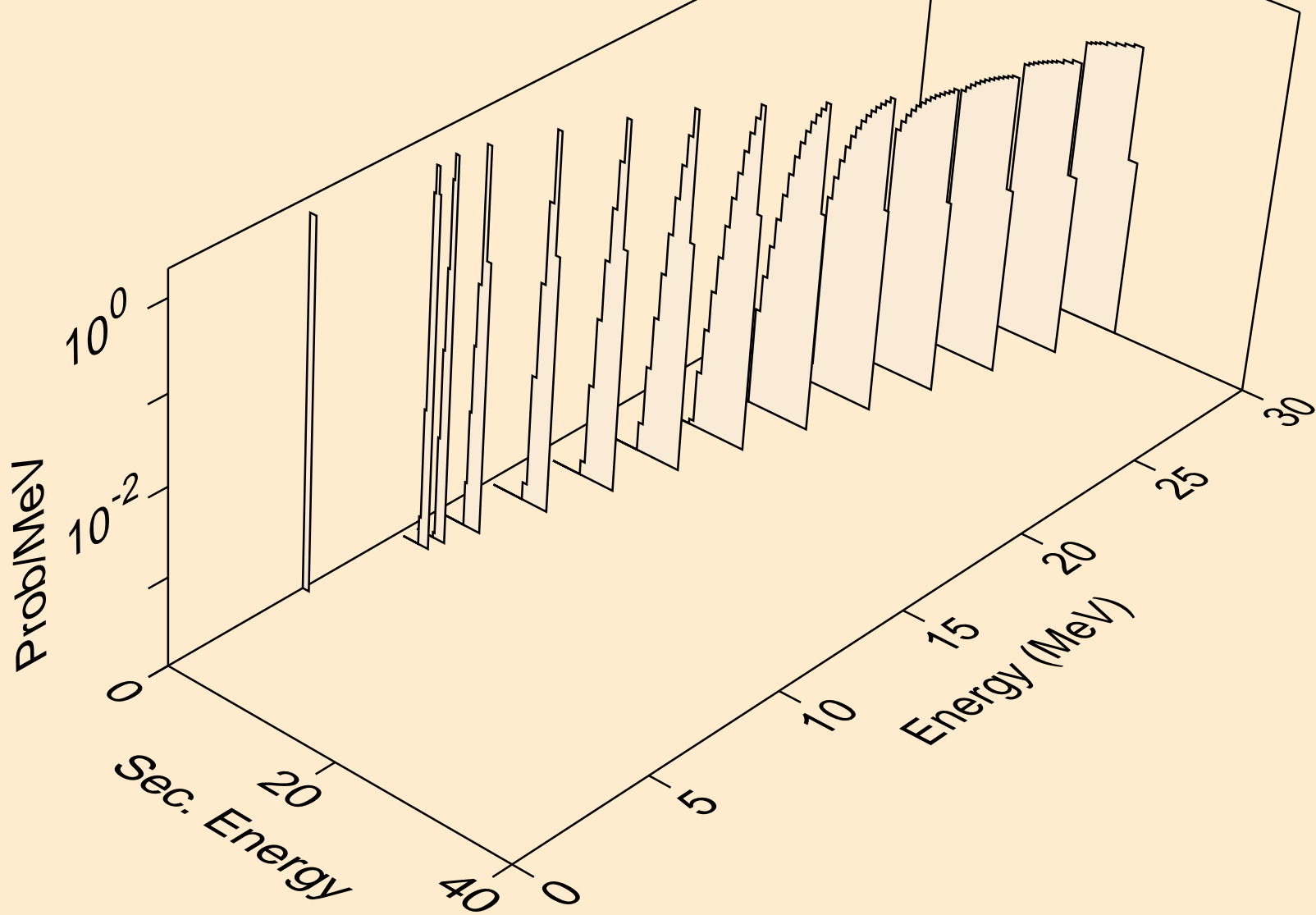

CM249 NEUTRON ACER TENDL-2021 LIBRARY; T=293.6K
tritons from (n,x)

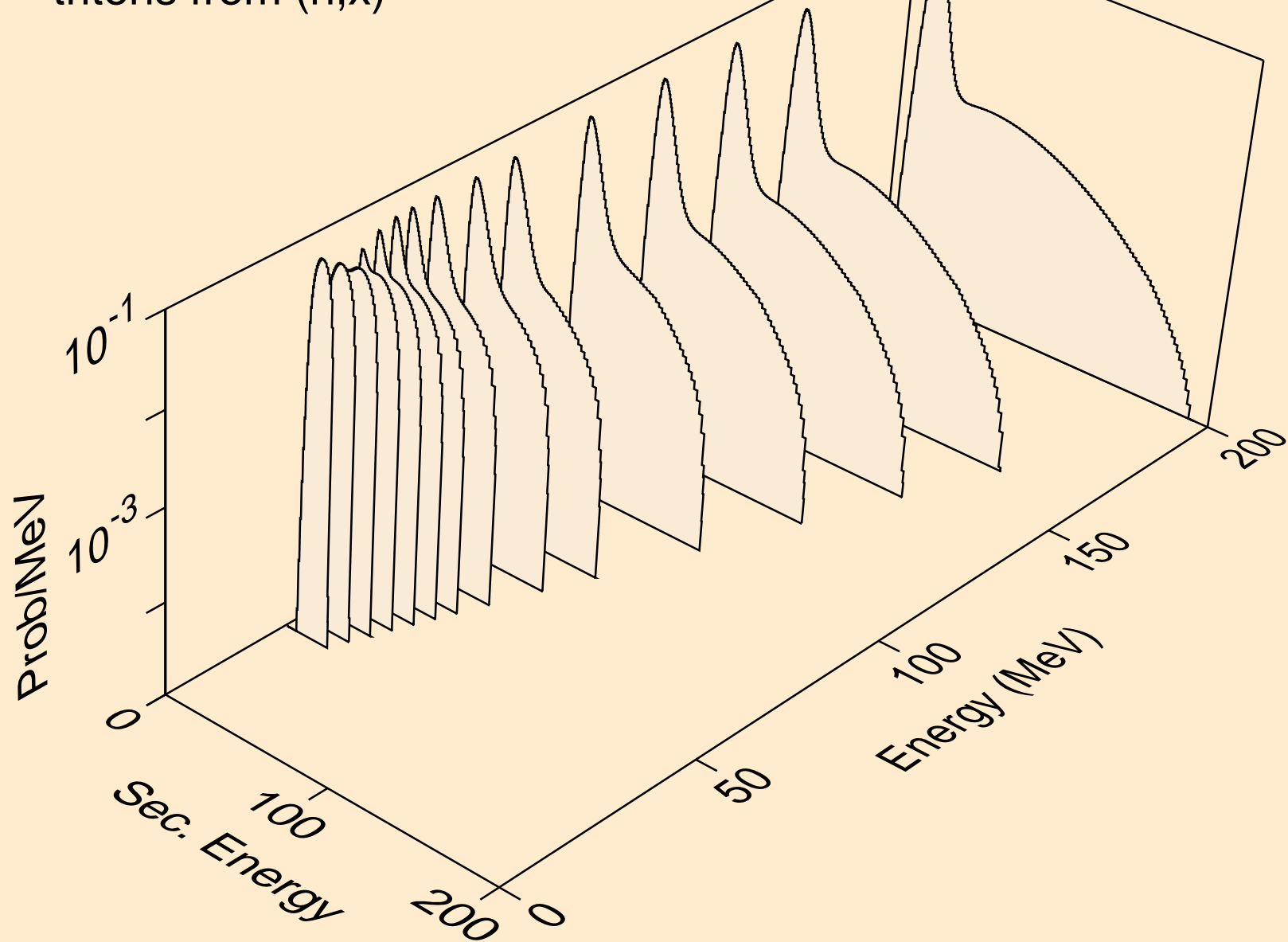

CM249 NEUTRON ACER TENDL-2021 LIBRARY; T=293.6K
tritons from (n,n*)t

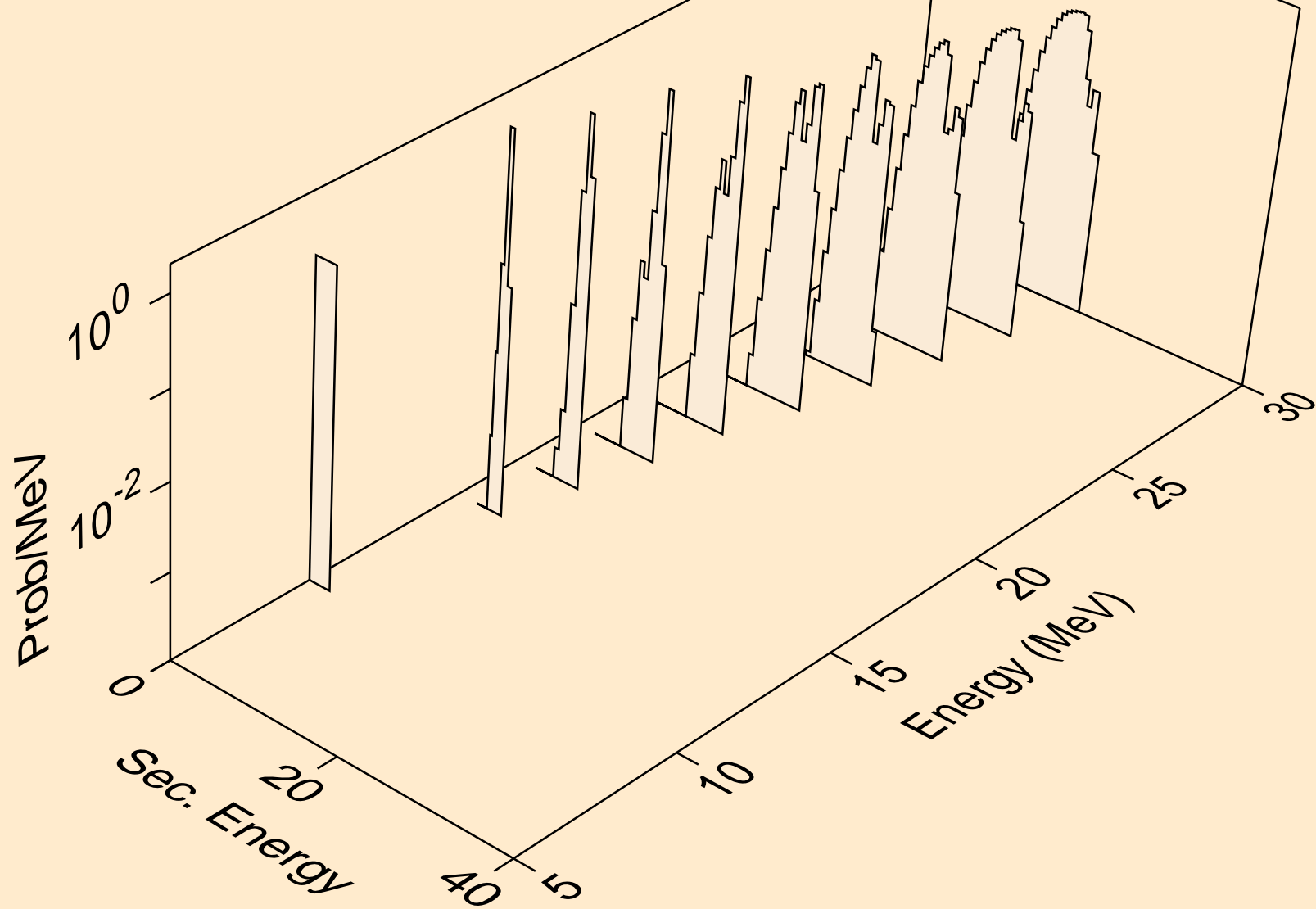

CM249 NEUTRON ACER TENDL-2021 LIBRARY; T=293.6K
tritons from (n,t)

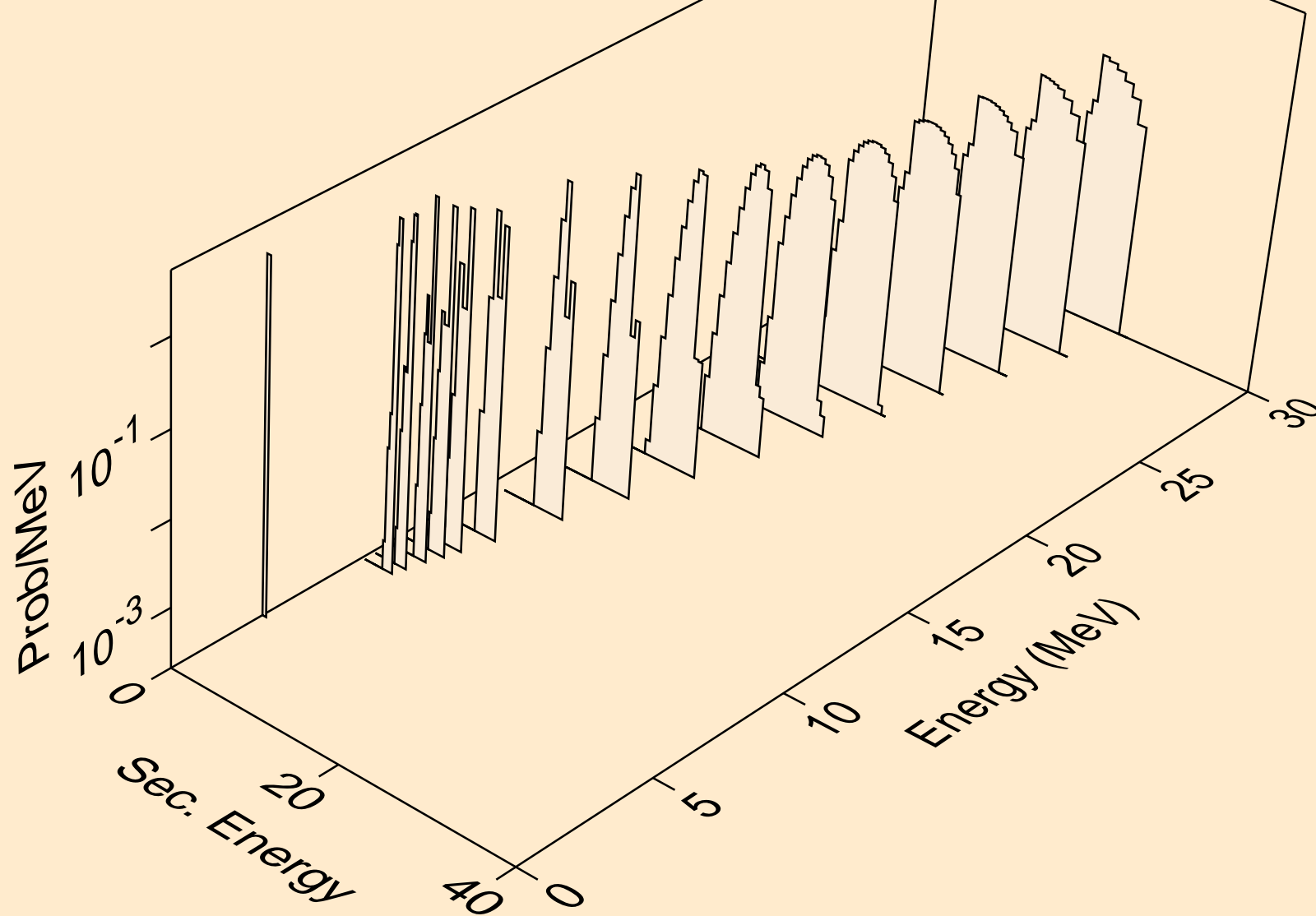

CM249 NEUTRON ACER TENDL-2021 LIBRARY; T=293.6K
he3s from (n,x)

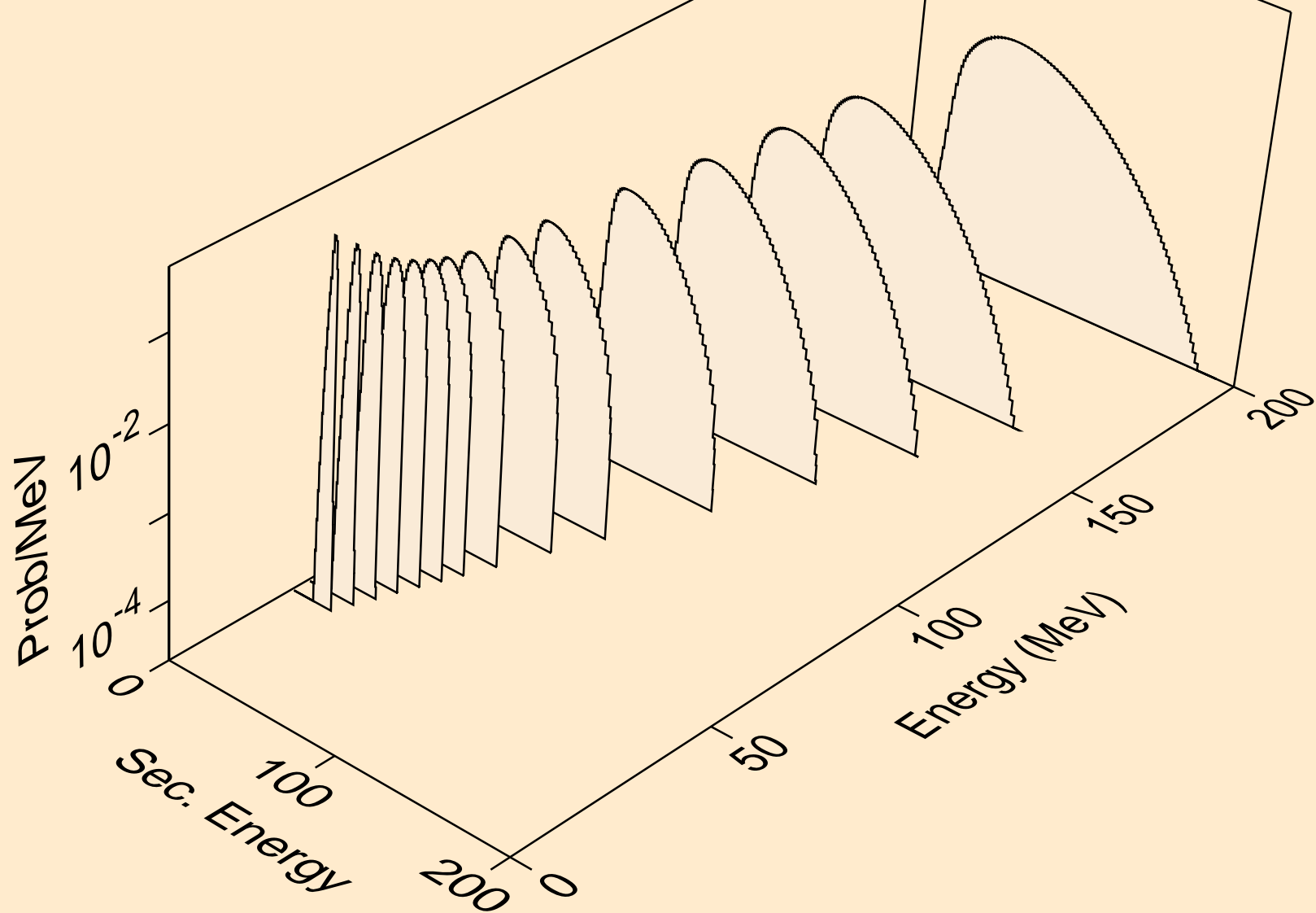

CM249 NEUTRON ACER TENDL-2021 LIBRARY; T=293.6K
he3s from (n,n*)he3

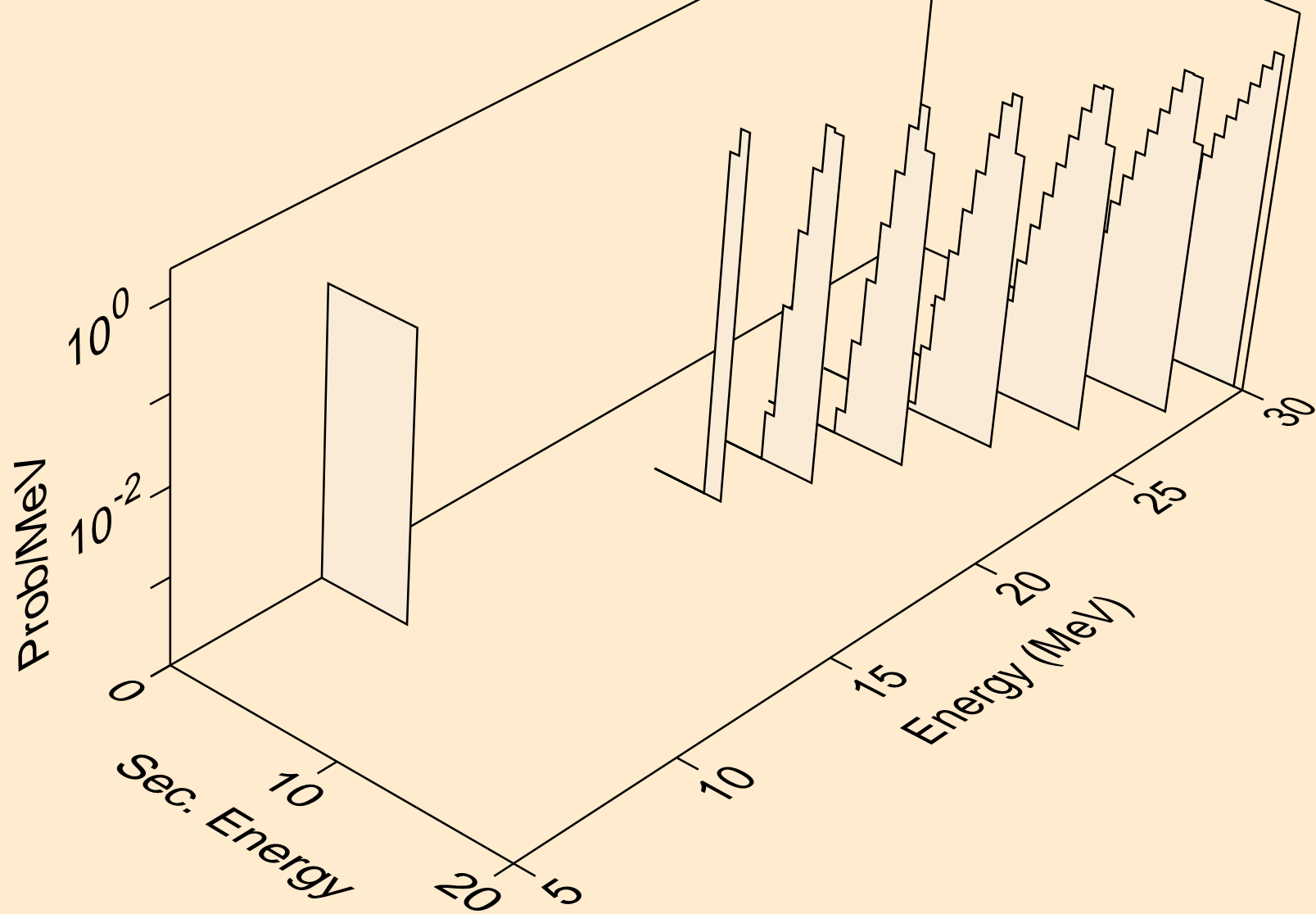

CM249 NEUTRON ACER TENDL-2021 LIBRARY; T=293.6K
he3s from (n,he3)

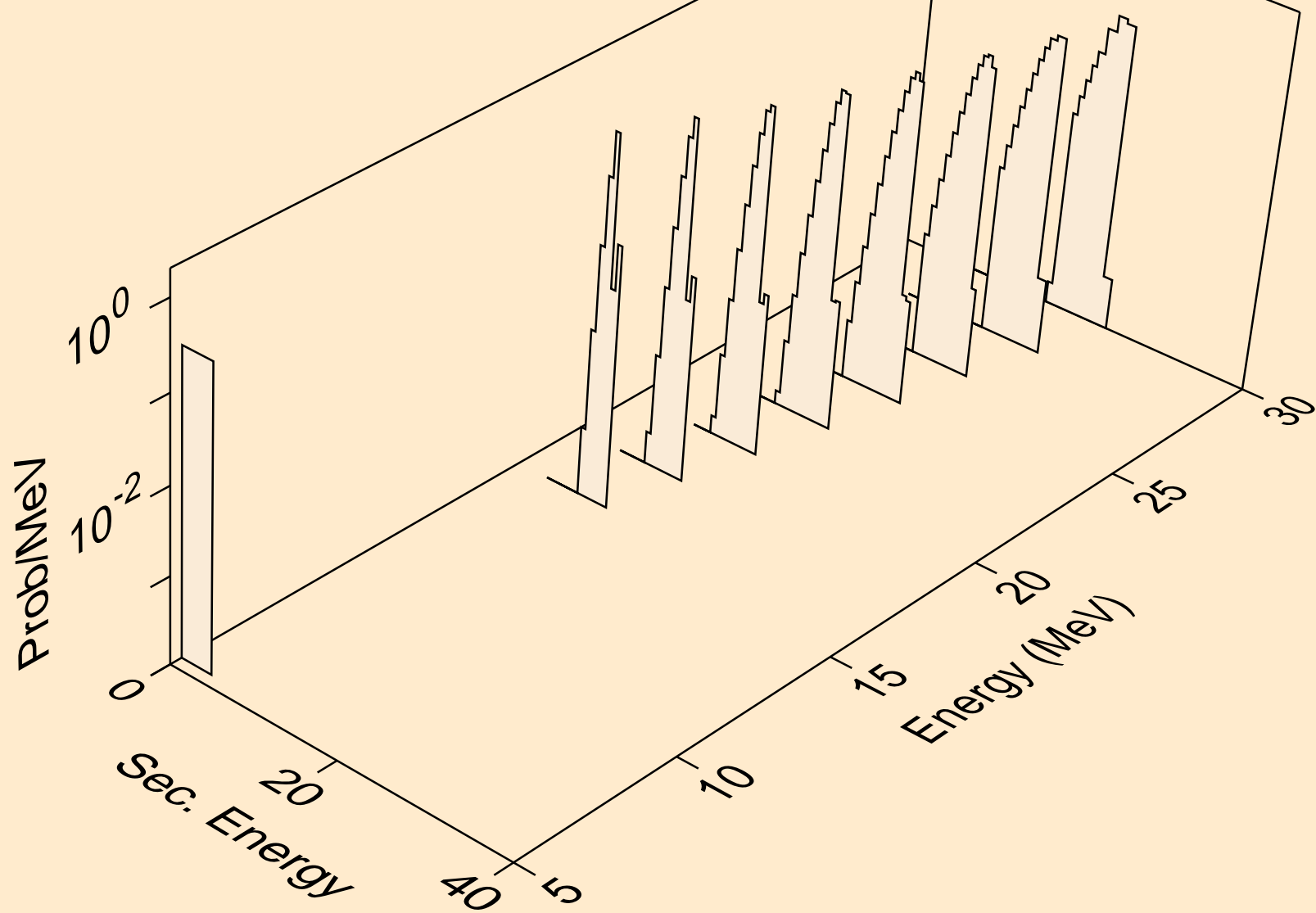

CM249 NEUTRON ACER TENDL-2021 LIBRARY; T=293.6K
alphas from (n,x)

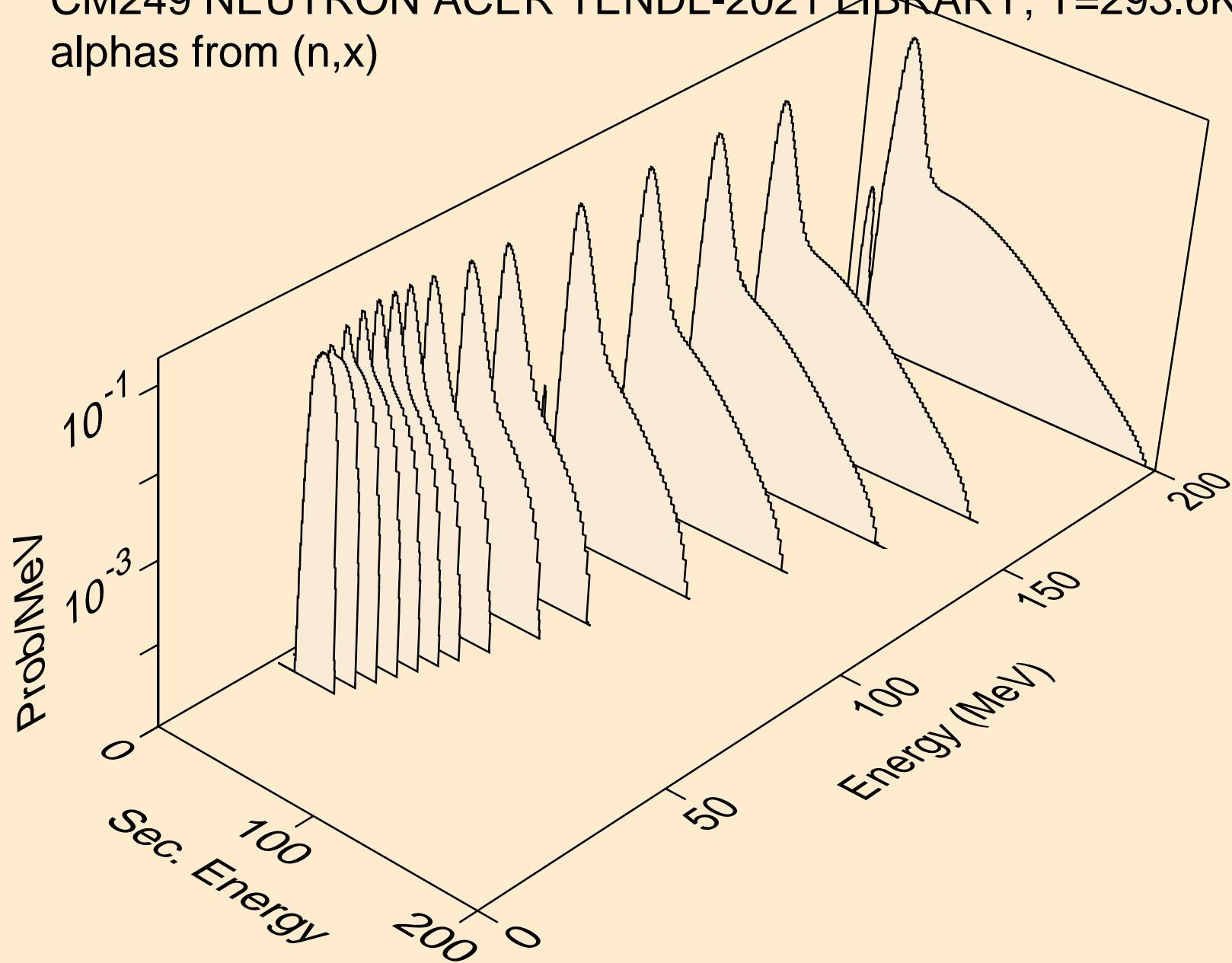

CM249 NEUTRON ACER TENDL-2021 LIBRARY; T=293.6K
alphas from (n,n*)a

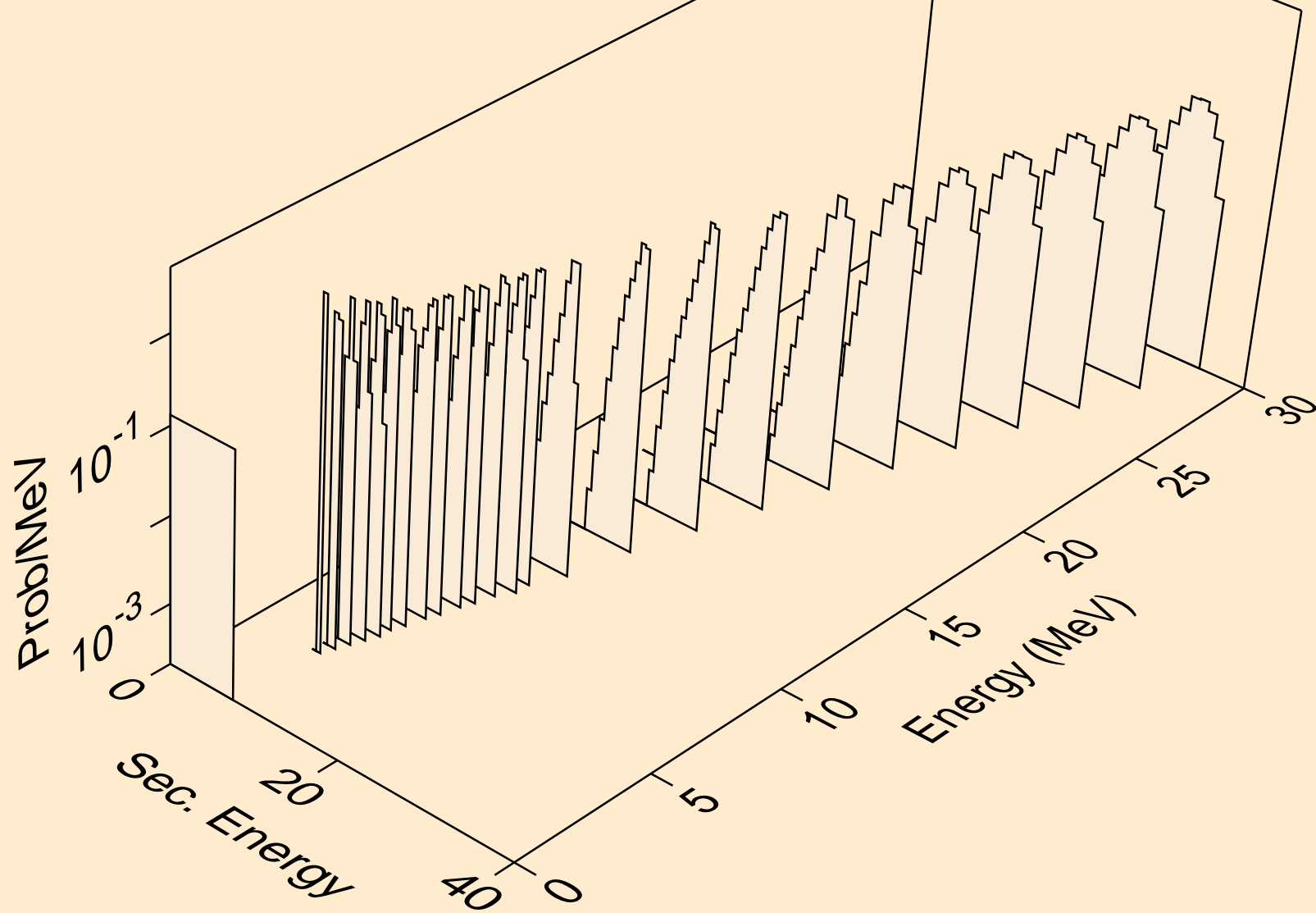

CM249 NEUTRON ACER TENDL-2021 LIBRARY; T=293.6K
alphas from (n,2n)a

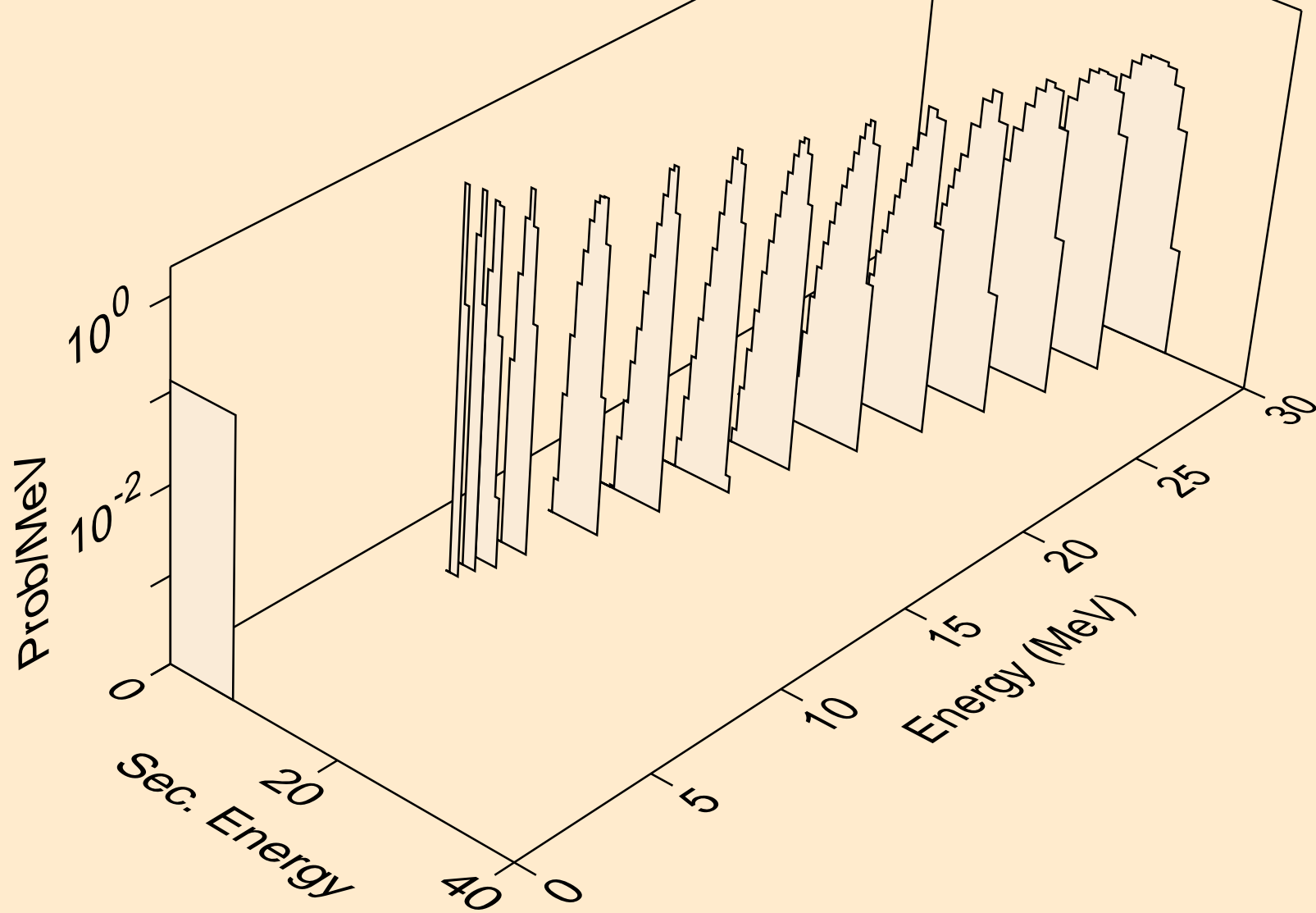

CM249 NEUTRON ACER TENDL-2021 LIBRARY; T=293.6K
alphas from (n,3n)a

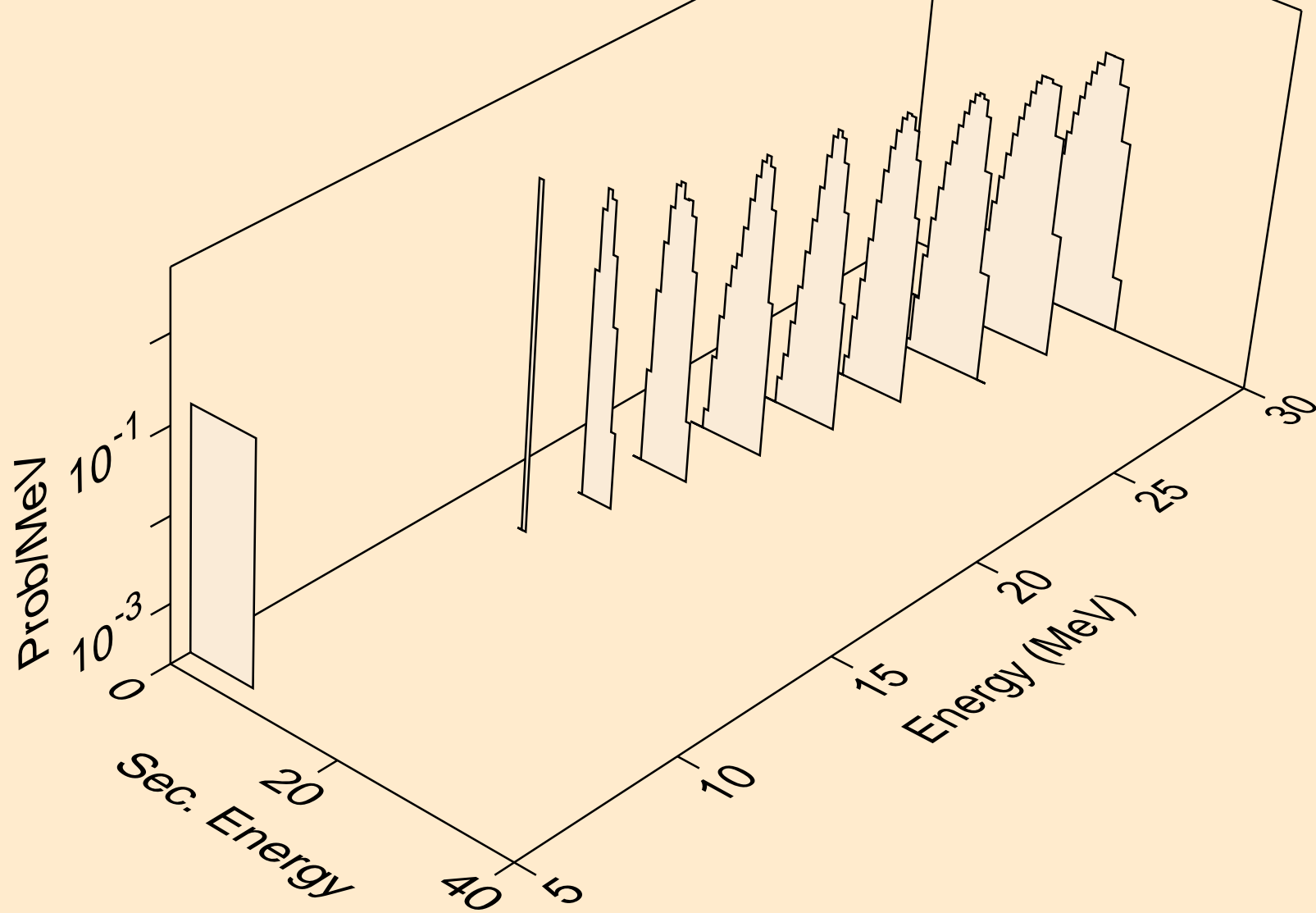

CM249 NEUTRON ACER TENDL-2021 LIBRARY; T=293.6K
alphas from (n,a)

