

CM251 NEUTRON ACER TENDL-2021 LIBRARY; T=293.6K

Principal cross sections

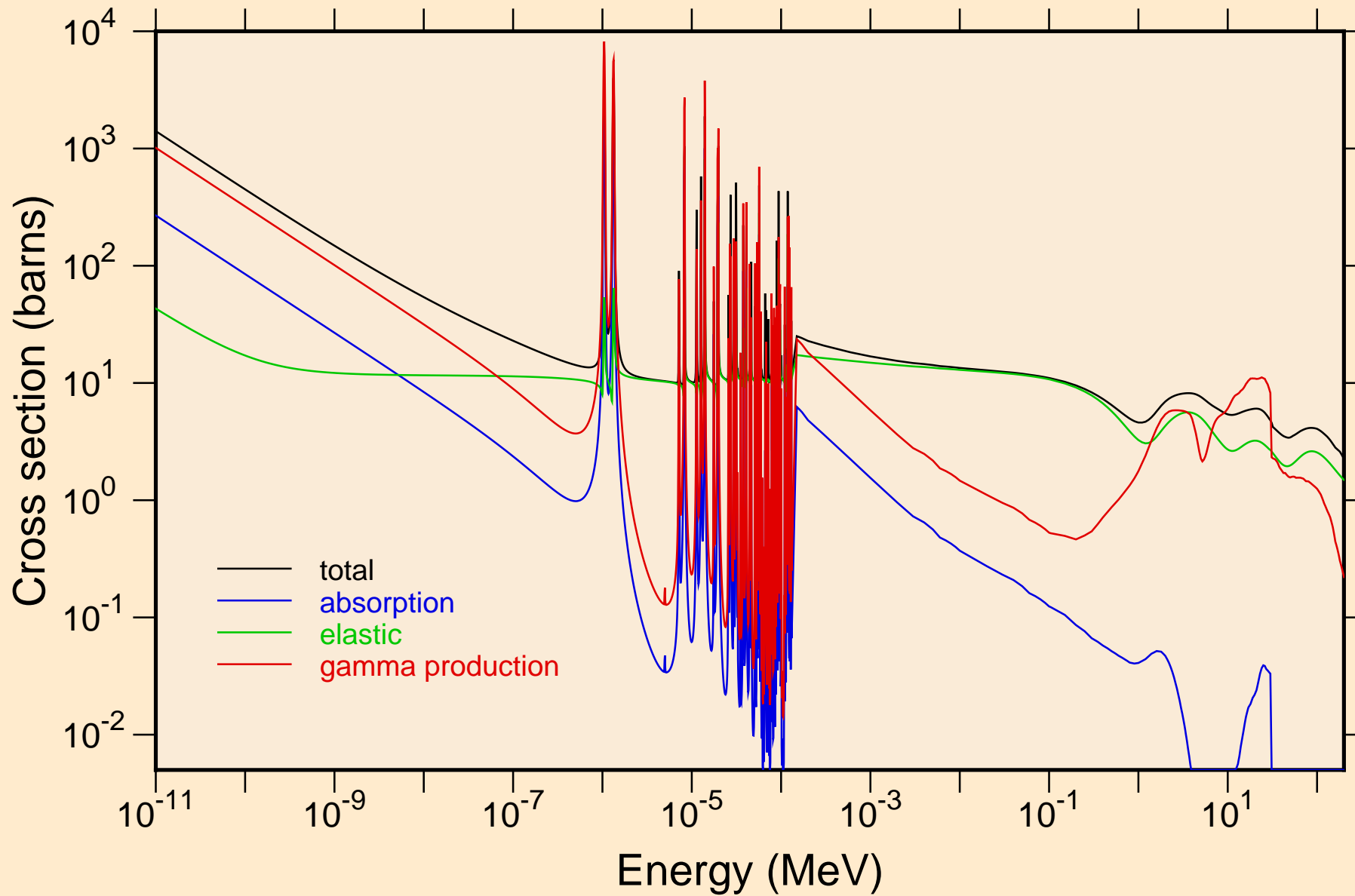

CM251 NEUTRON ACER TENDL-2021 LIBRARY; T=293.6K
resonance total cross section

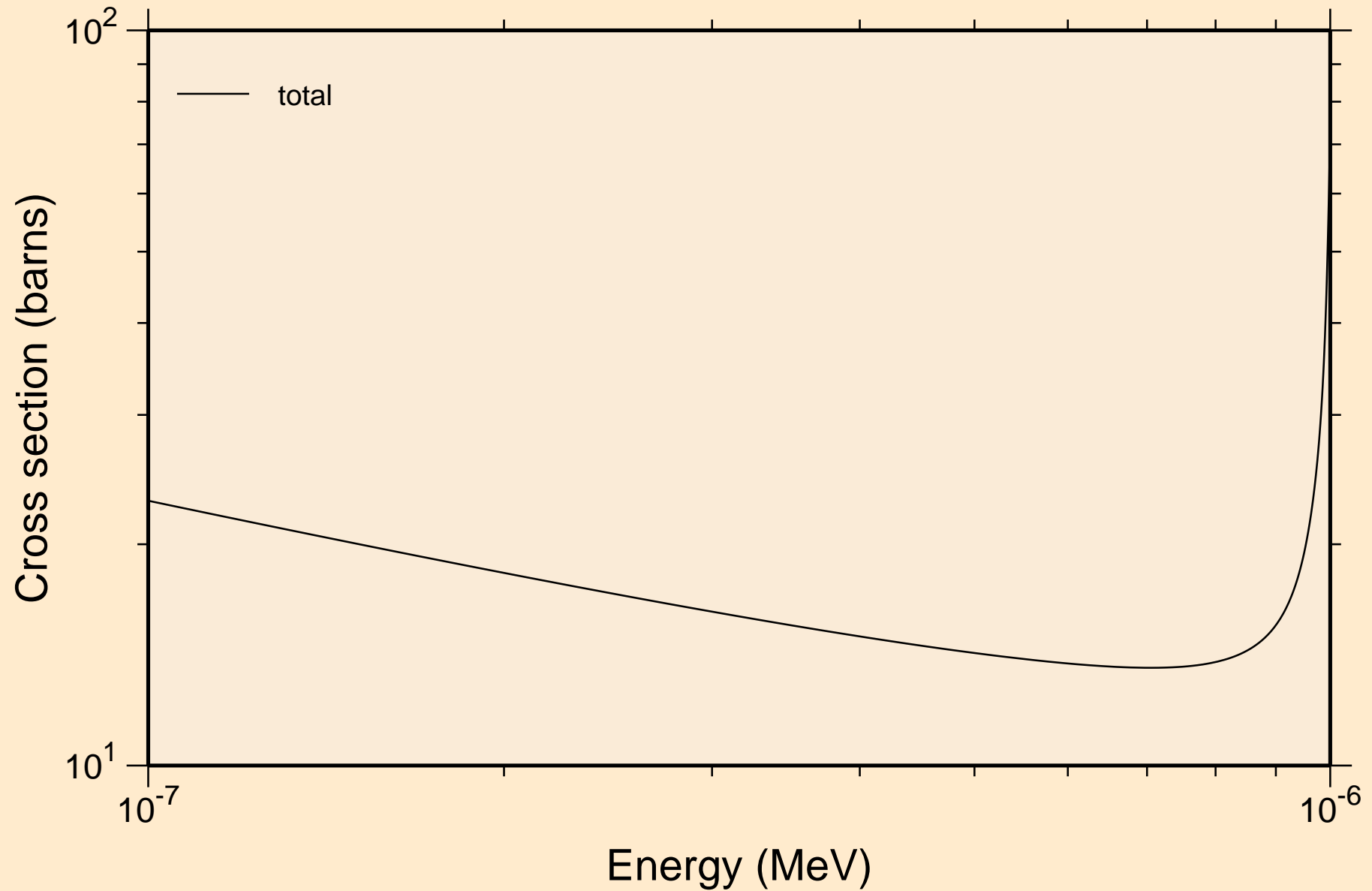

CM251 NEUTRON ACER TENDL-2021 LIBRARY; T=293.6K
resonance total cross section

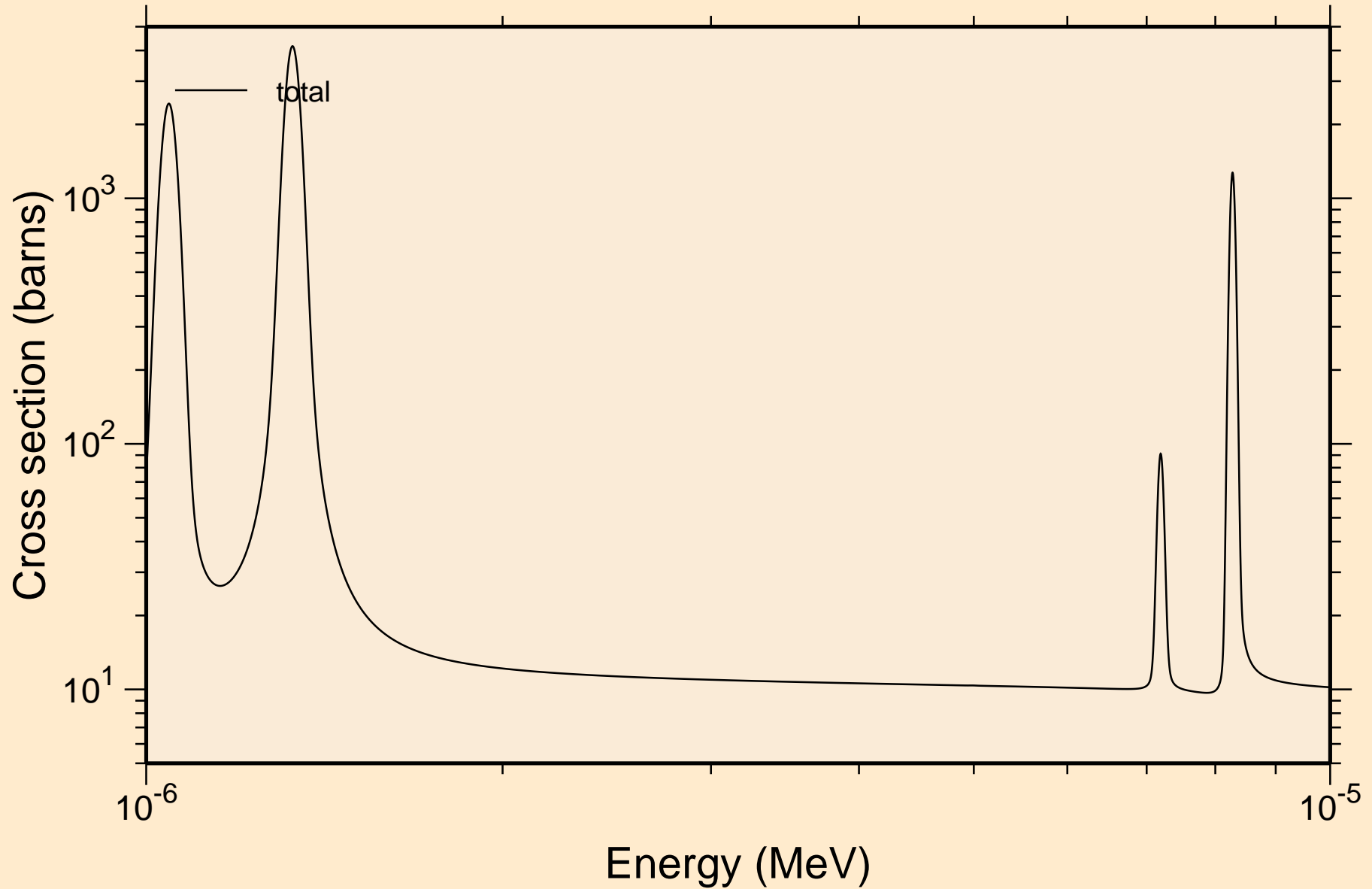

CM251 NEUTRON ACER TENDL-2021 LIBRARY; T=293.6K
resonance total cross section

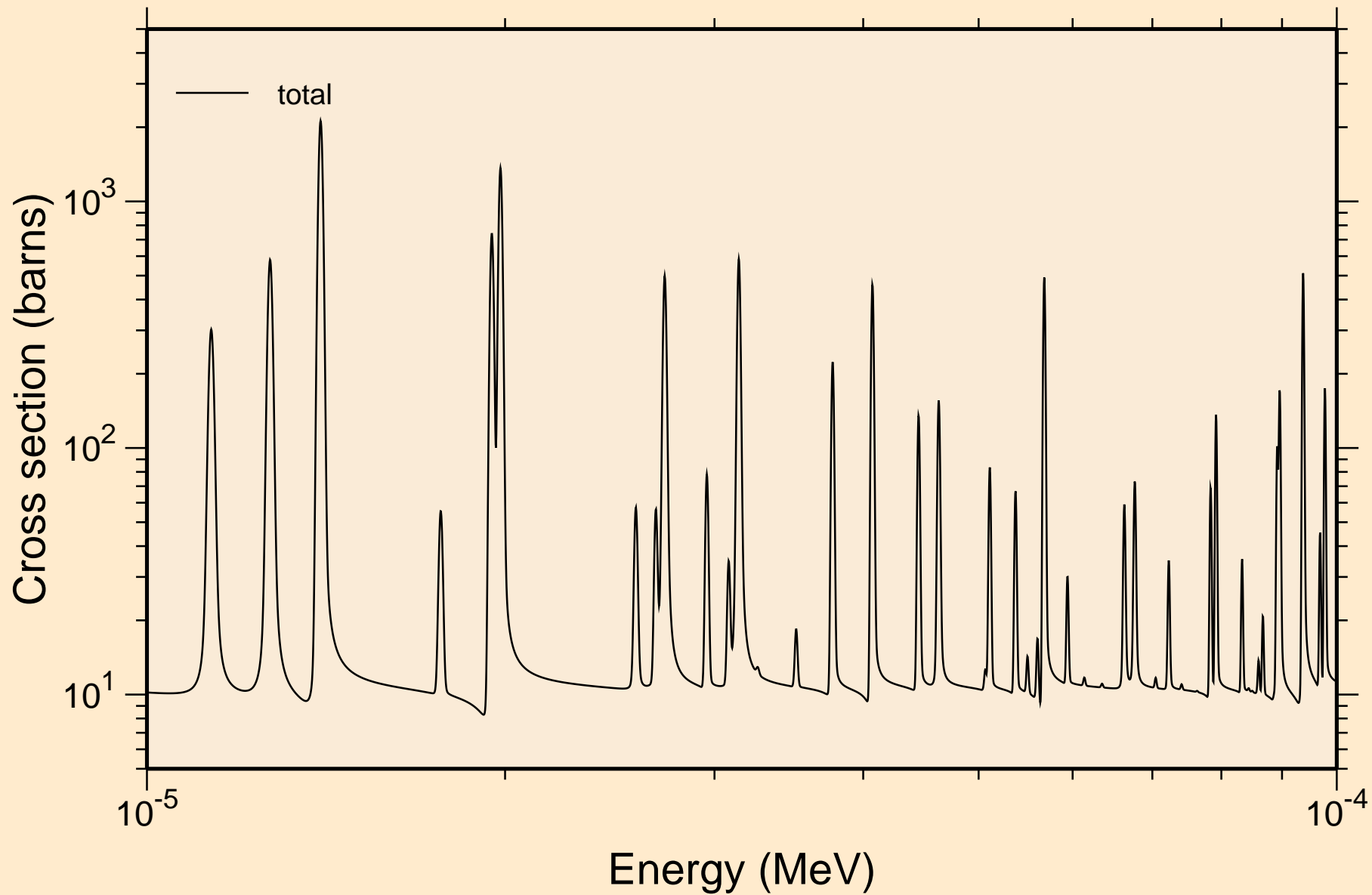

CM251 NEUTRON ACER TENDL-2021 LIBRARY; T=293.6K
resonance total cross section

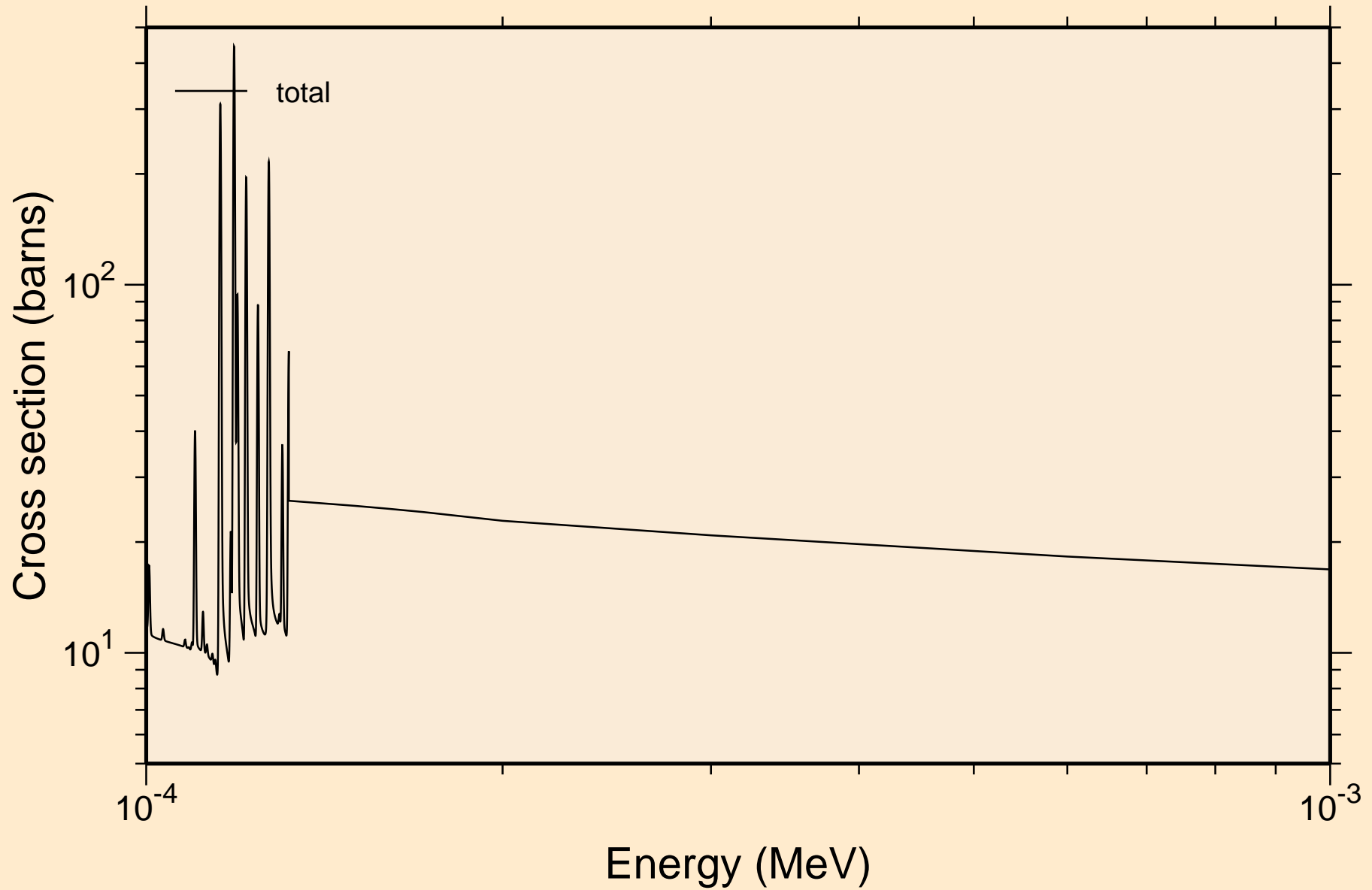

CM251 NEUTRON ACER TENDL-2021 LIBRARY; T=293.6K
resonance total cross section

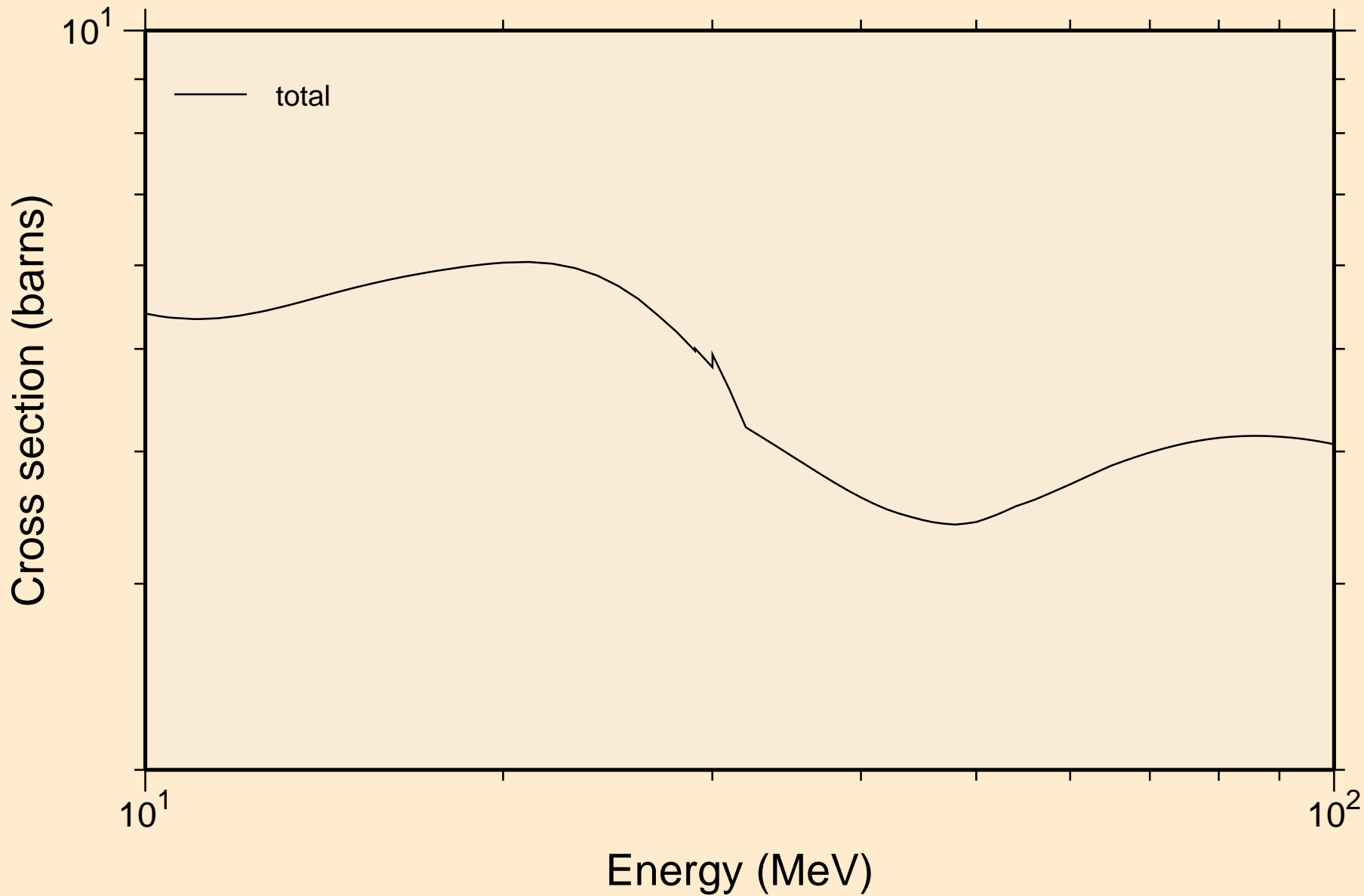

CM251 NEUTRON ACER TENDL-2021 LIBRARY; T=293.6K
resonance absorption cross sections

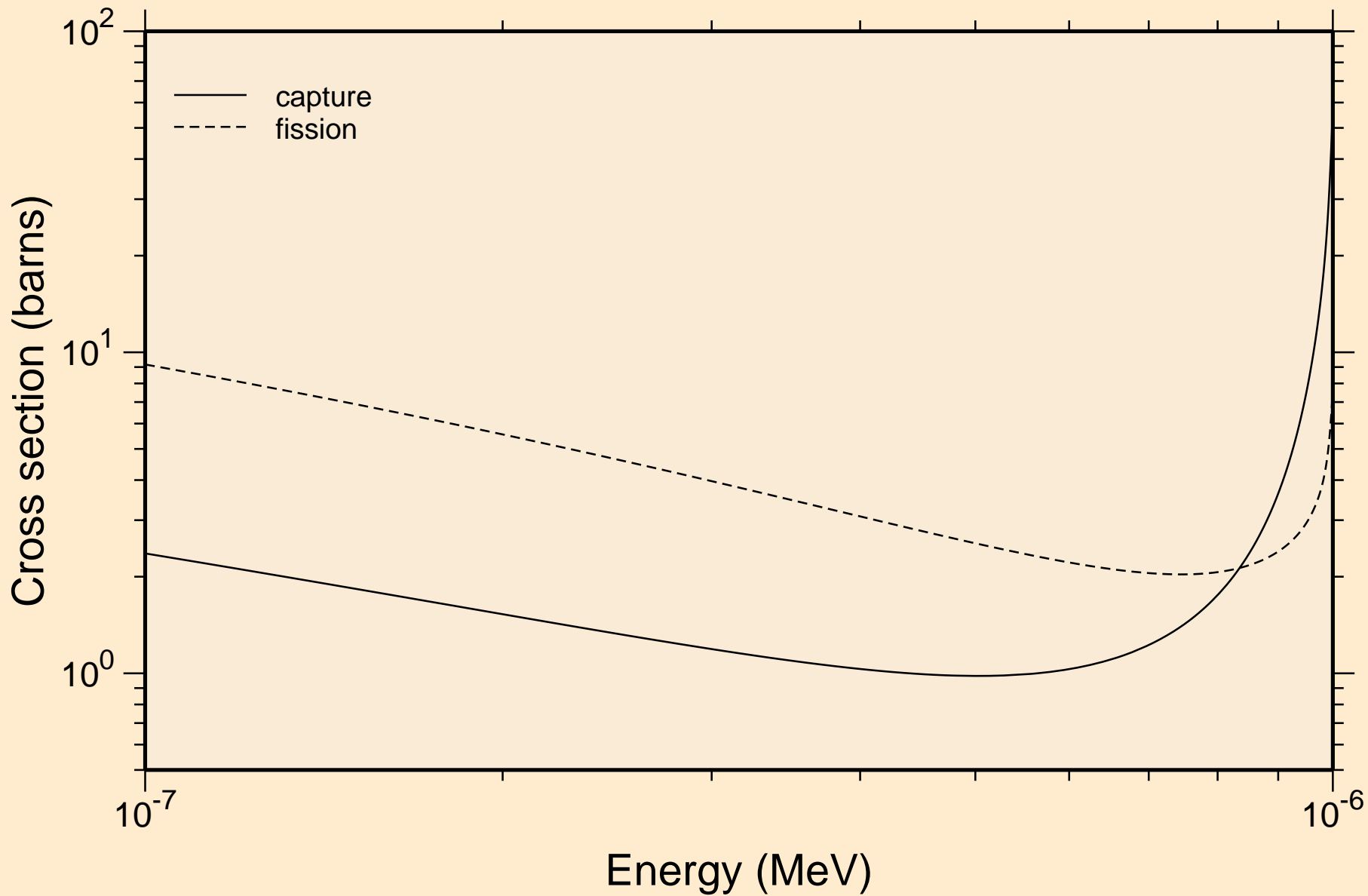

CM251 NEUTRON ACER TENDL-2021 LIBRARY; T=293.6K
resonance absorption cross sections

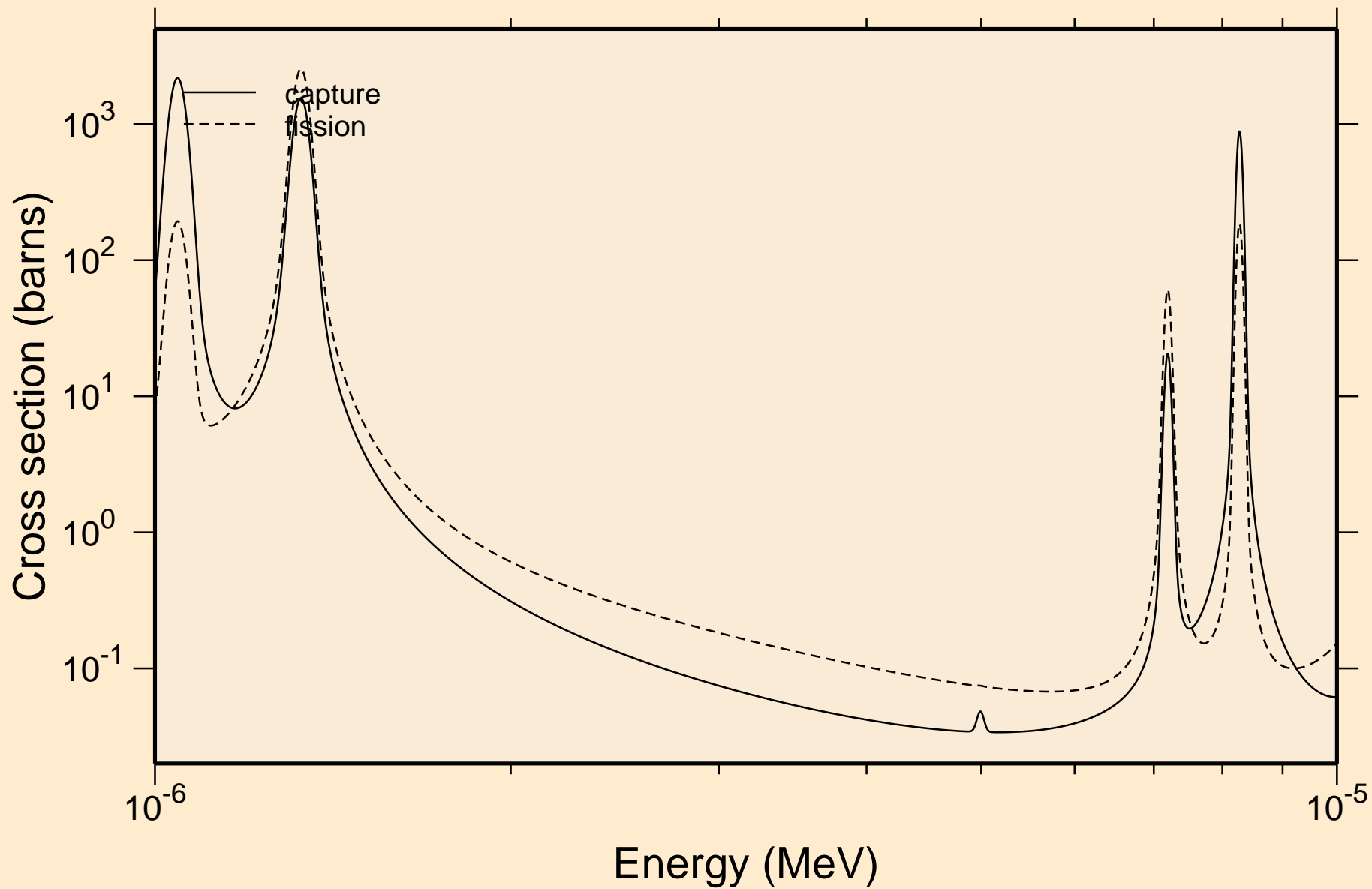

CM251 NEUTRON ACER TENDL-2021 LIBRARY; T=293.6K
resonance absorption cross sections

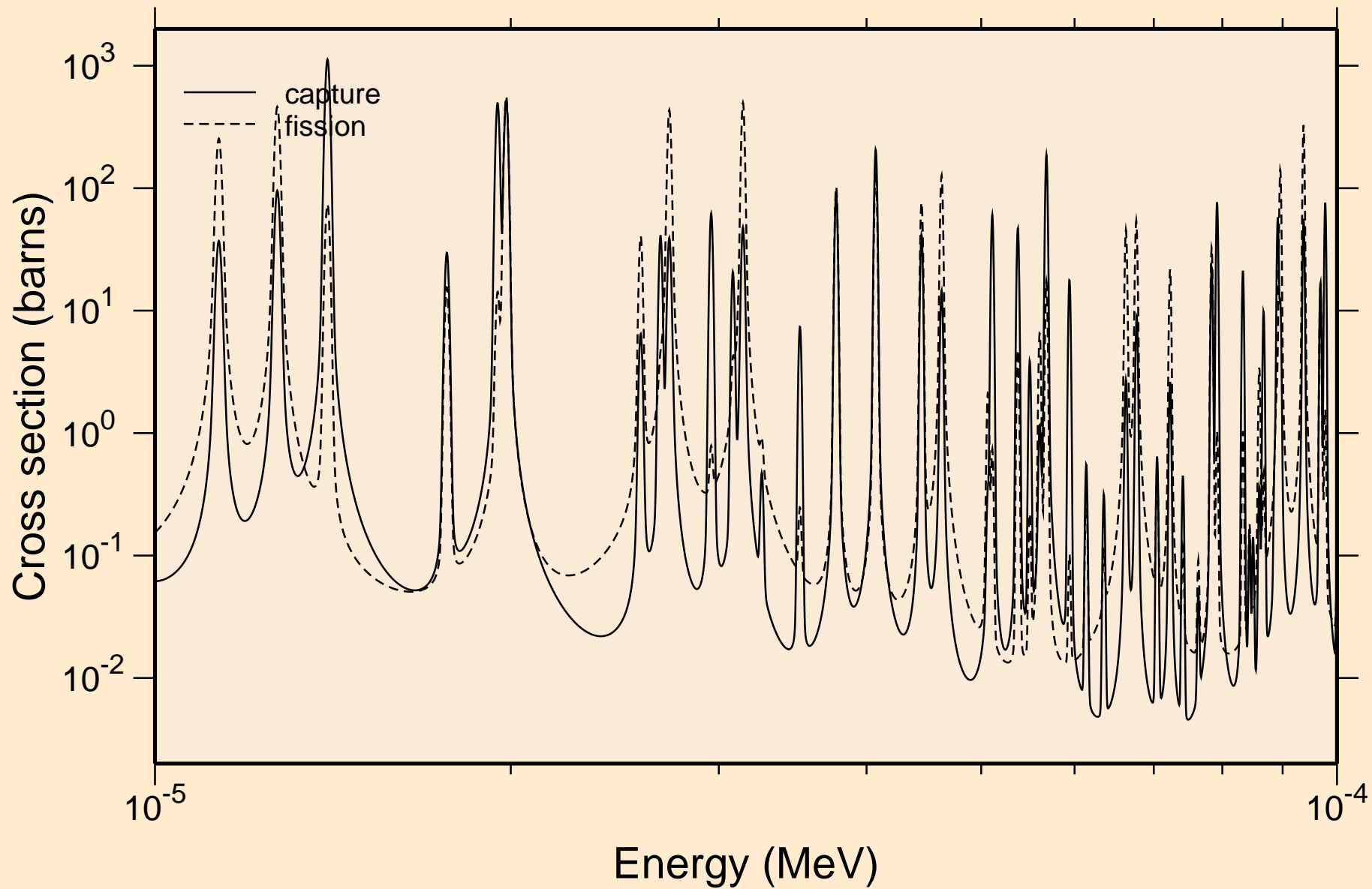

CM251 NEUTRON ACER TENDL-2021 LIBRARY; T=293.6K
resonance absorption cross sections

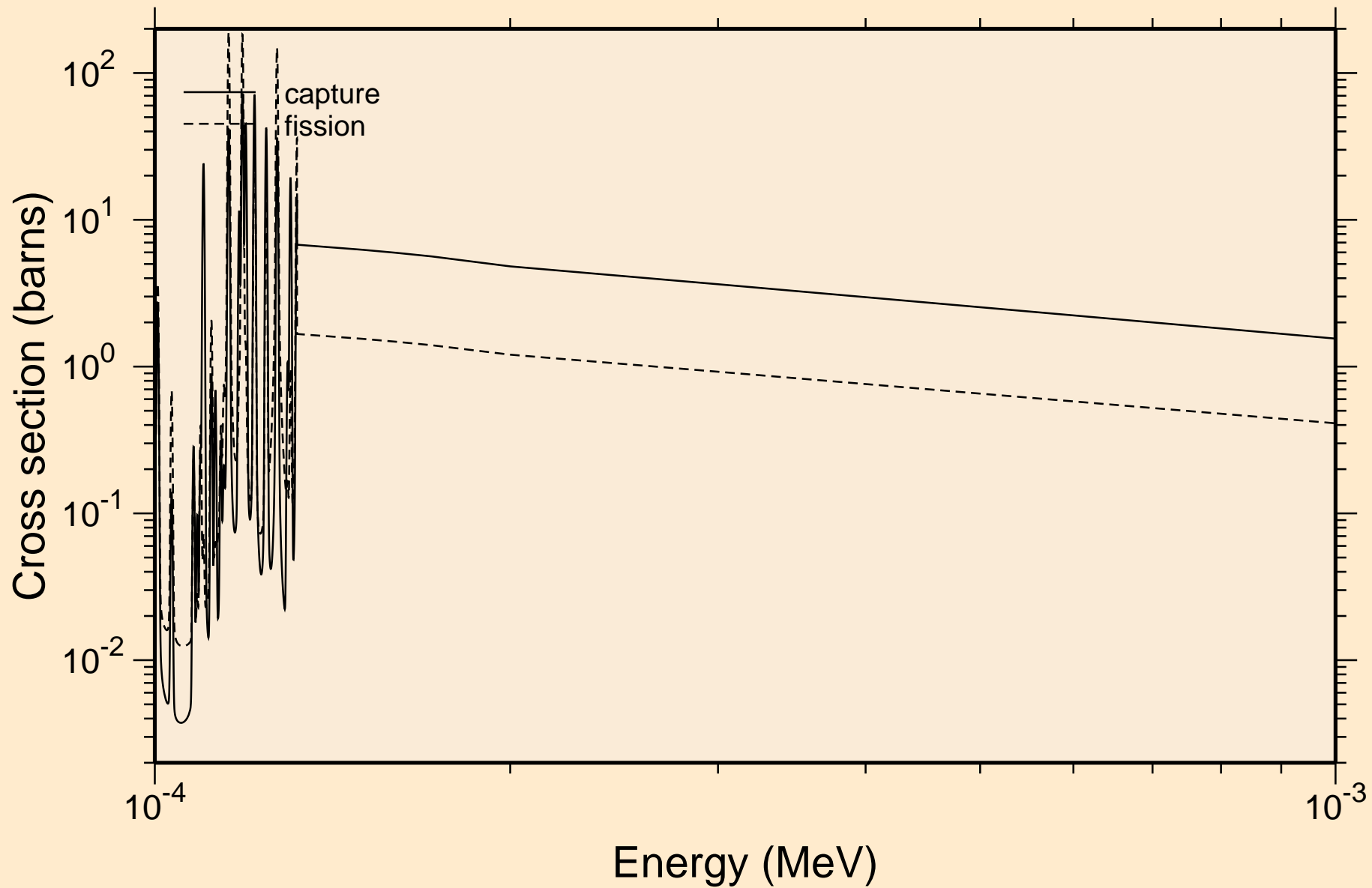

CM251 NEUTRON ACER TENDL-2021 LIBRARY; T=293.6K
resonance absorption cross sections

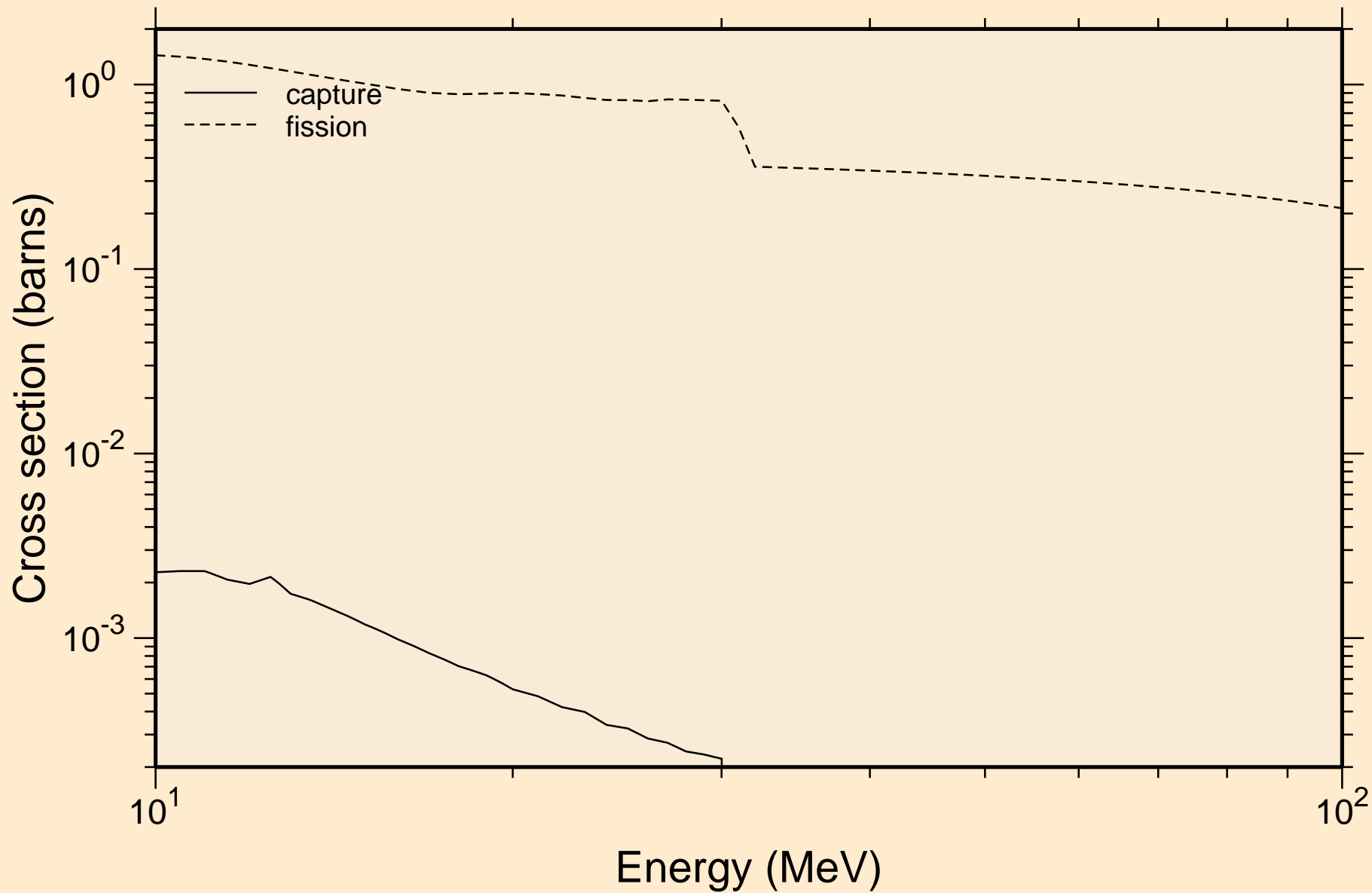

CM251 NEUTRON ACER TENDL-2021 LIBRARY; T=293.6K
Heating

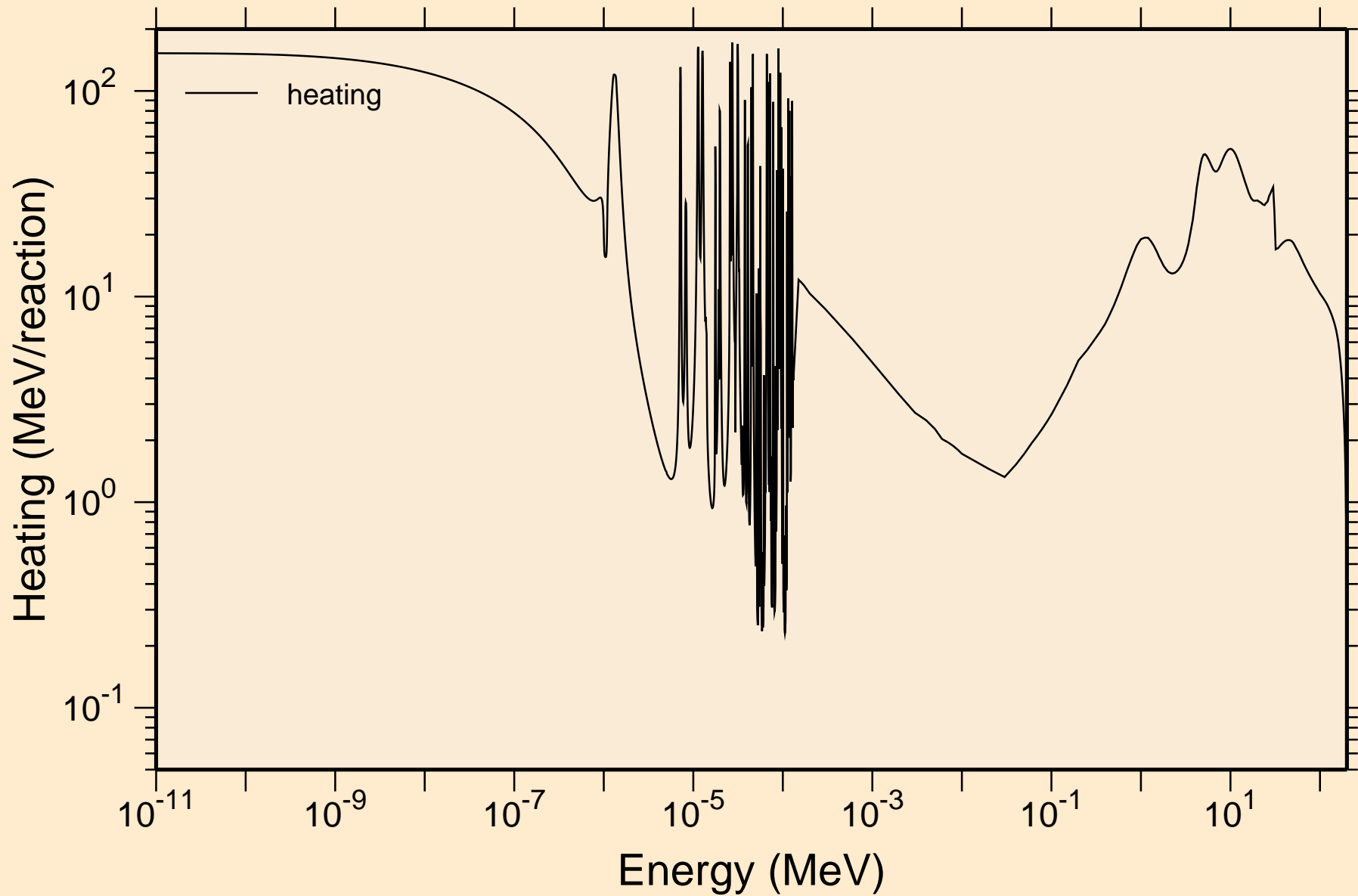

CM251 NEUTRON ACER TENDL-2021 LIBRARY; T=293.6K
Damage

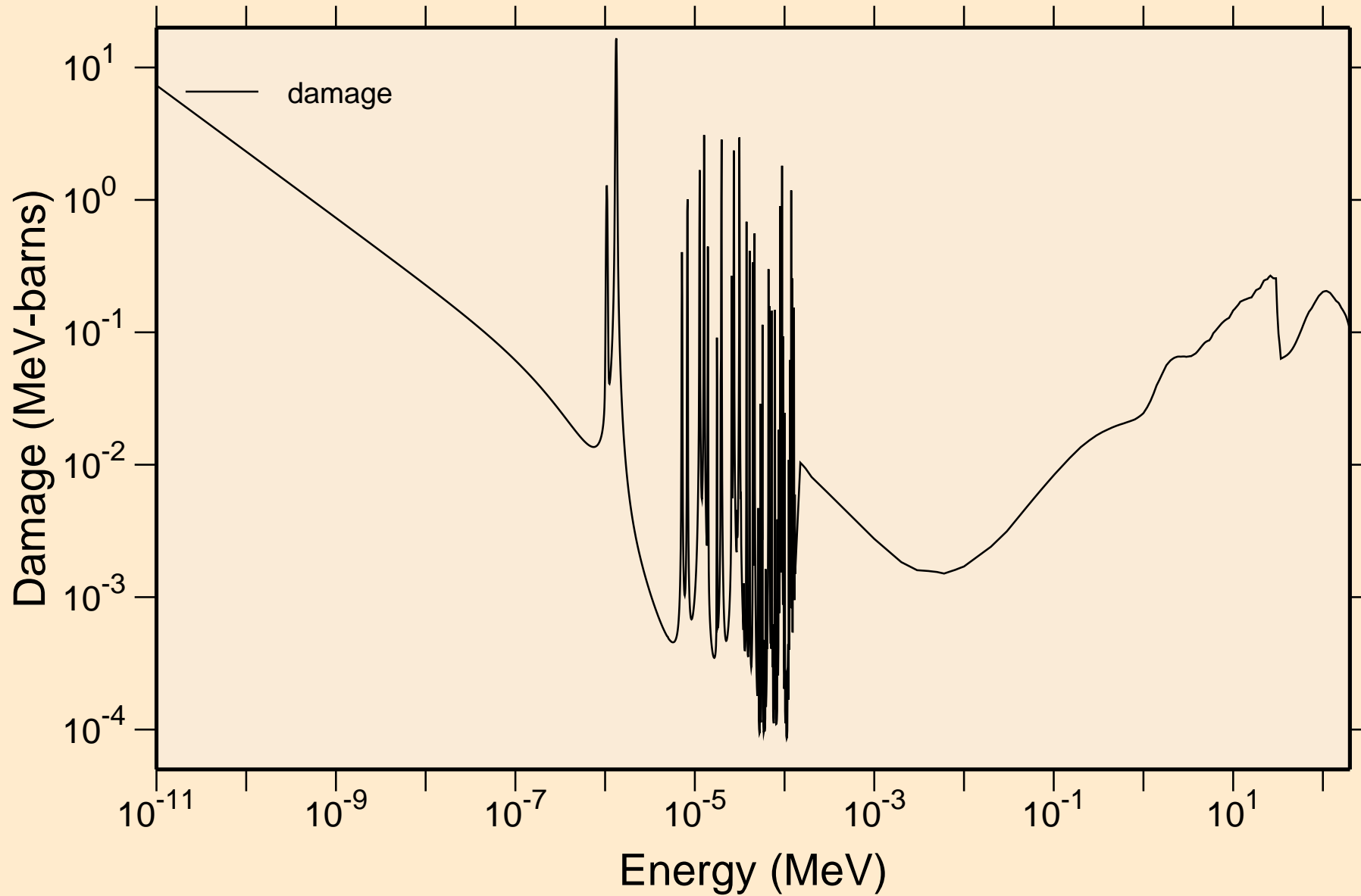

CM251 NEUTRON ACER TENDL-2021 LIBRARY; T=293.6K
Non-threshold reactions

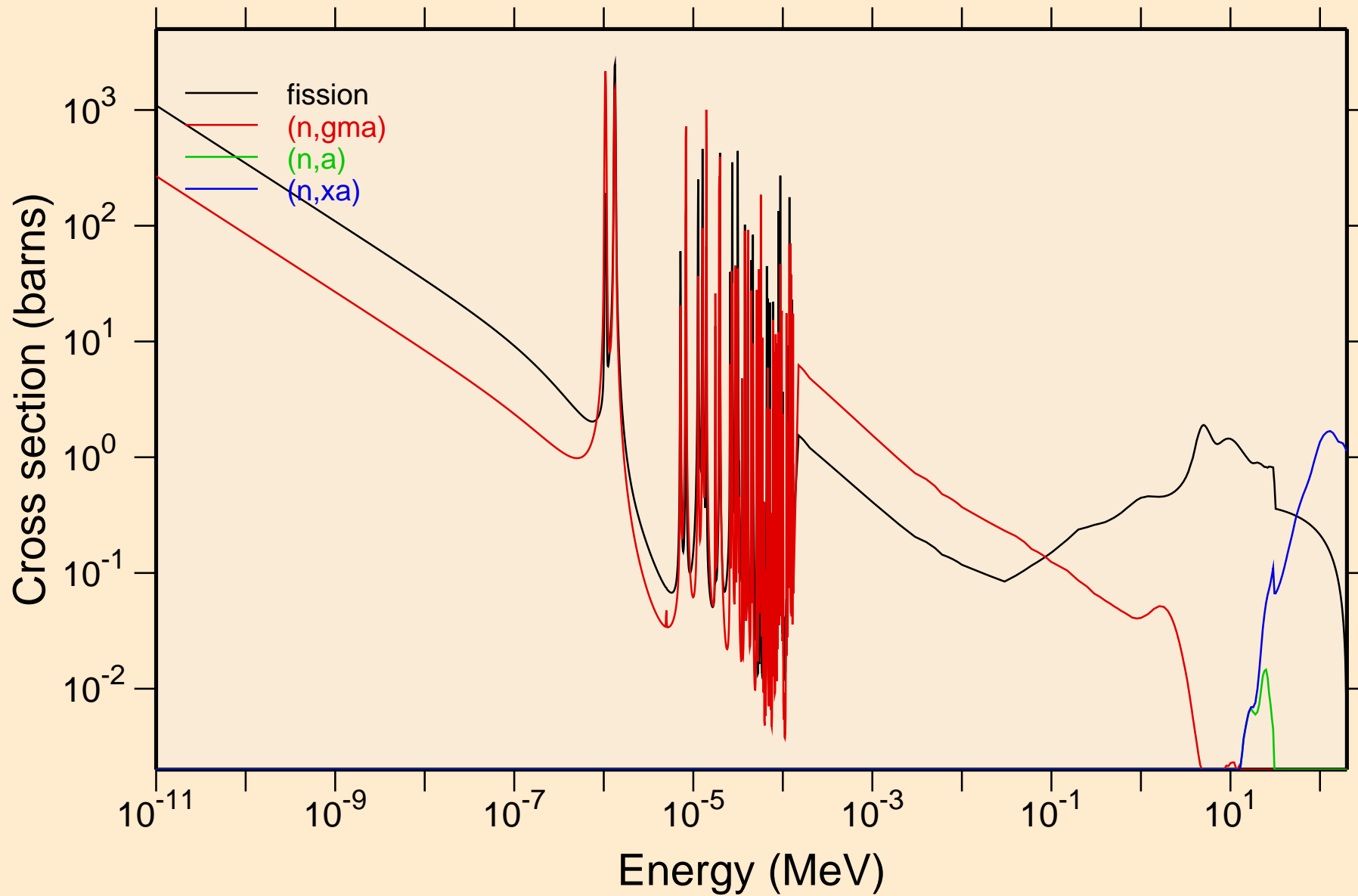

CM251 NEUTRON ACER TENDL-2021 LIBRARY; T=293.6K
Principal cross sections

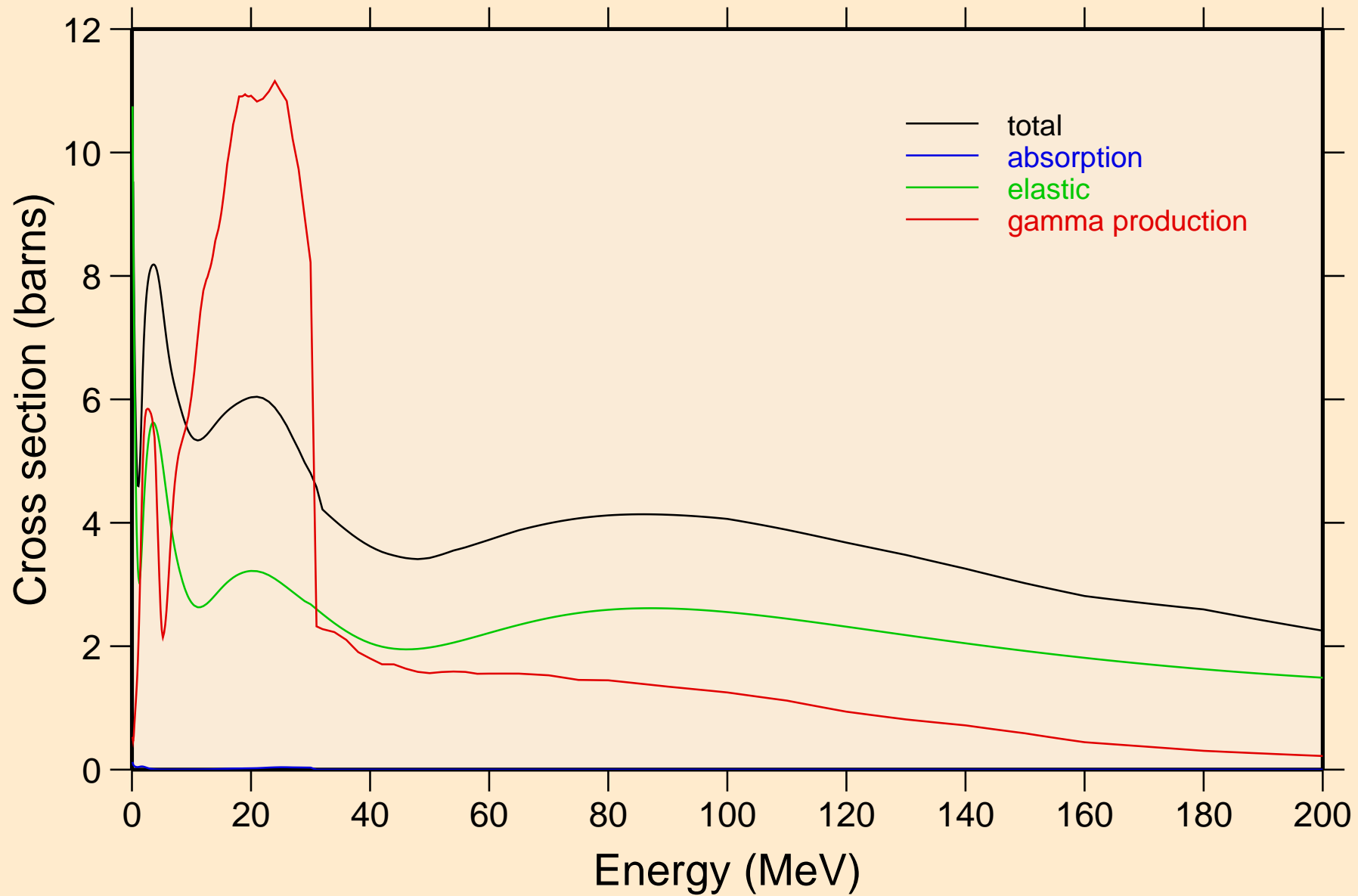

CM251 NEUTRON ACER TENDL-2021 LIBRARY; T=293.6K
Heating

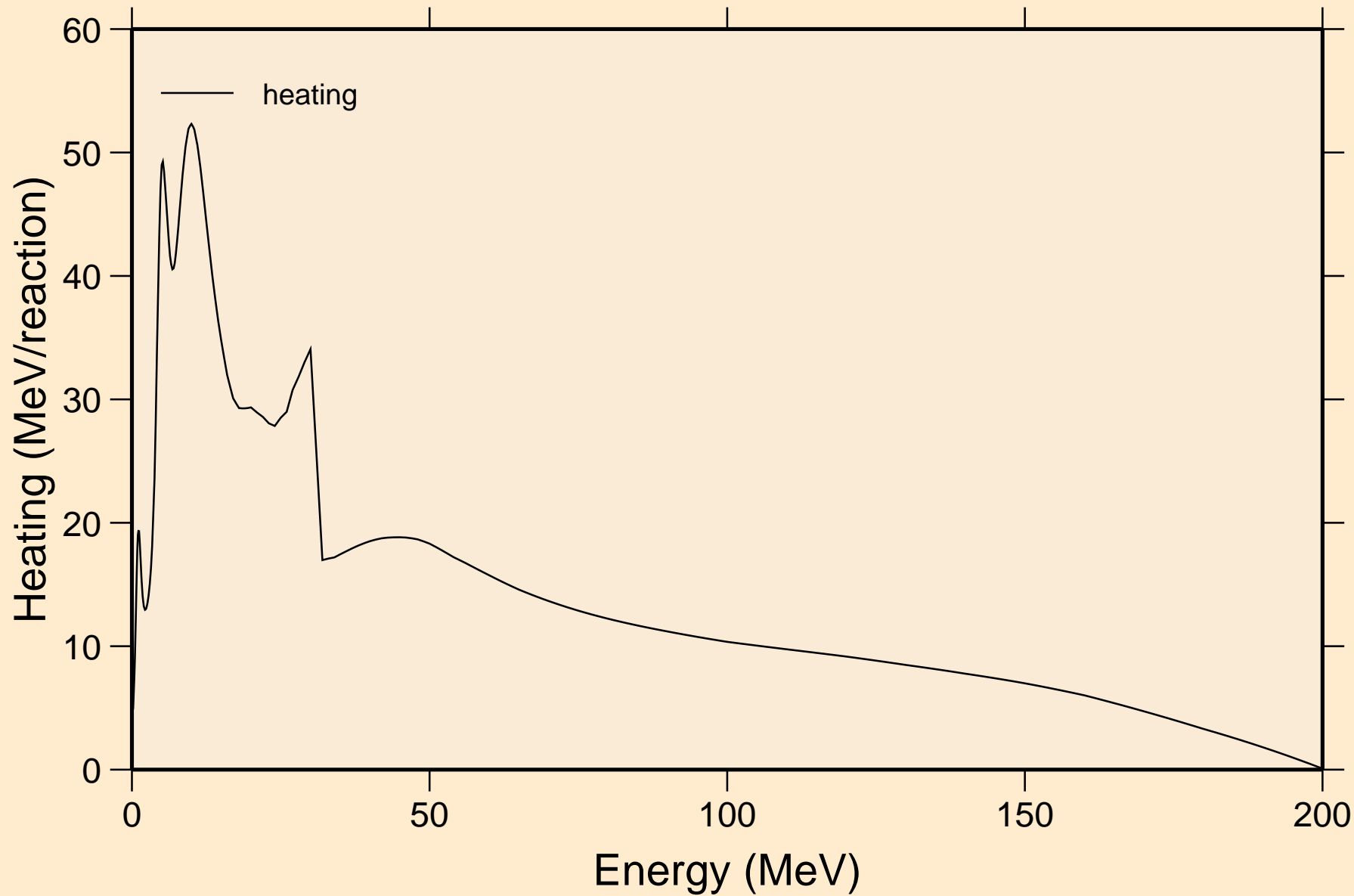

CM251 NEUTRON ACER TENDL-2021 LIBRARY; T=293.6K
Damage

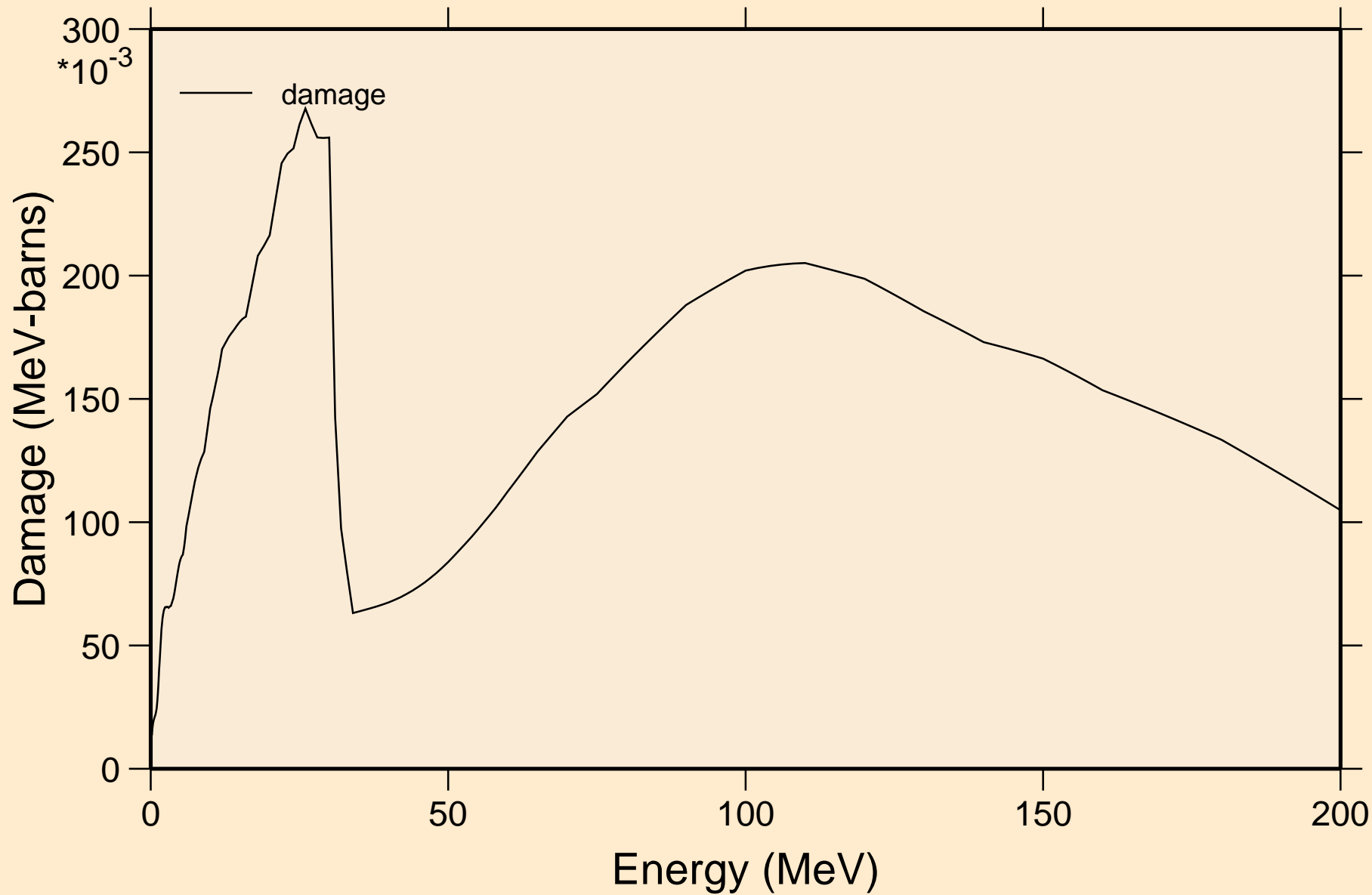

CM251 NEUTRON ACER TENDL-2021 LIBRARY; T=293.6K

Non-threshold reactions

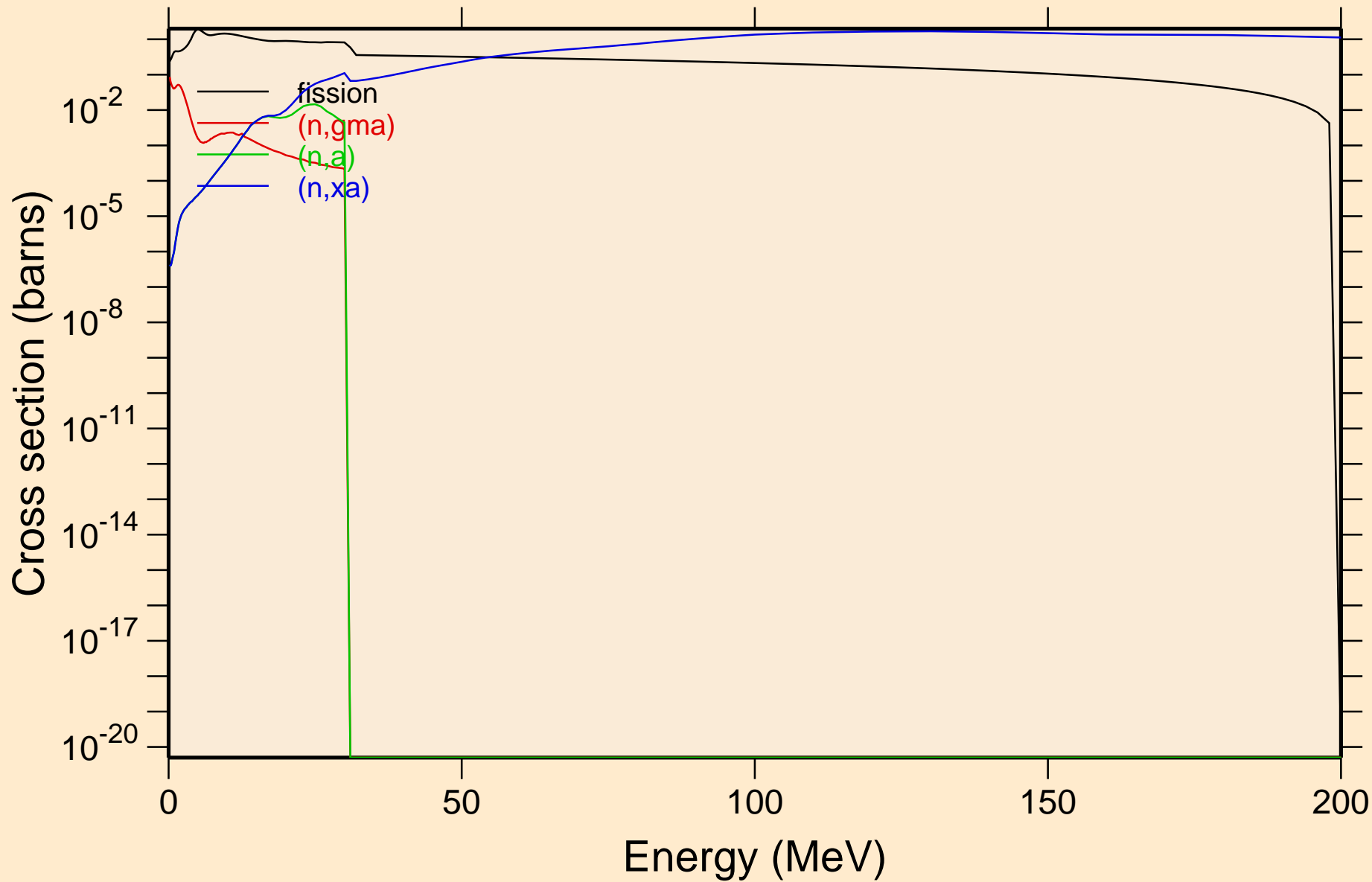

CM251 NEUTRON ACER TENDL-2021 LIBRARY; T=293.6K
Inelastic levels

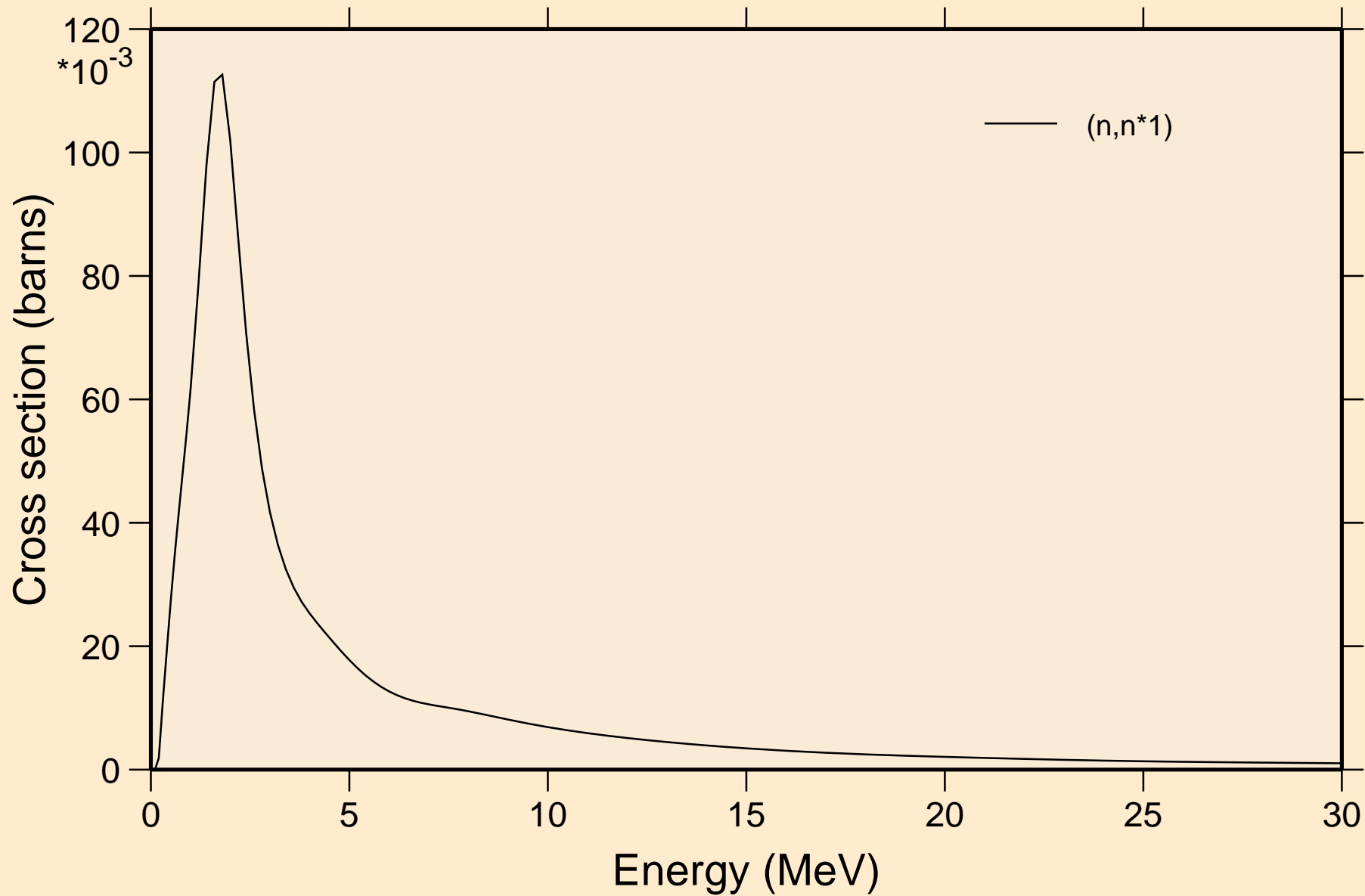

CM251 NEUTRON ACER TENDL-2021 LIBRARY; T=293.6K
Threshold reactions

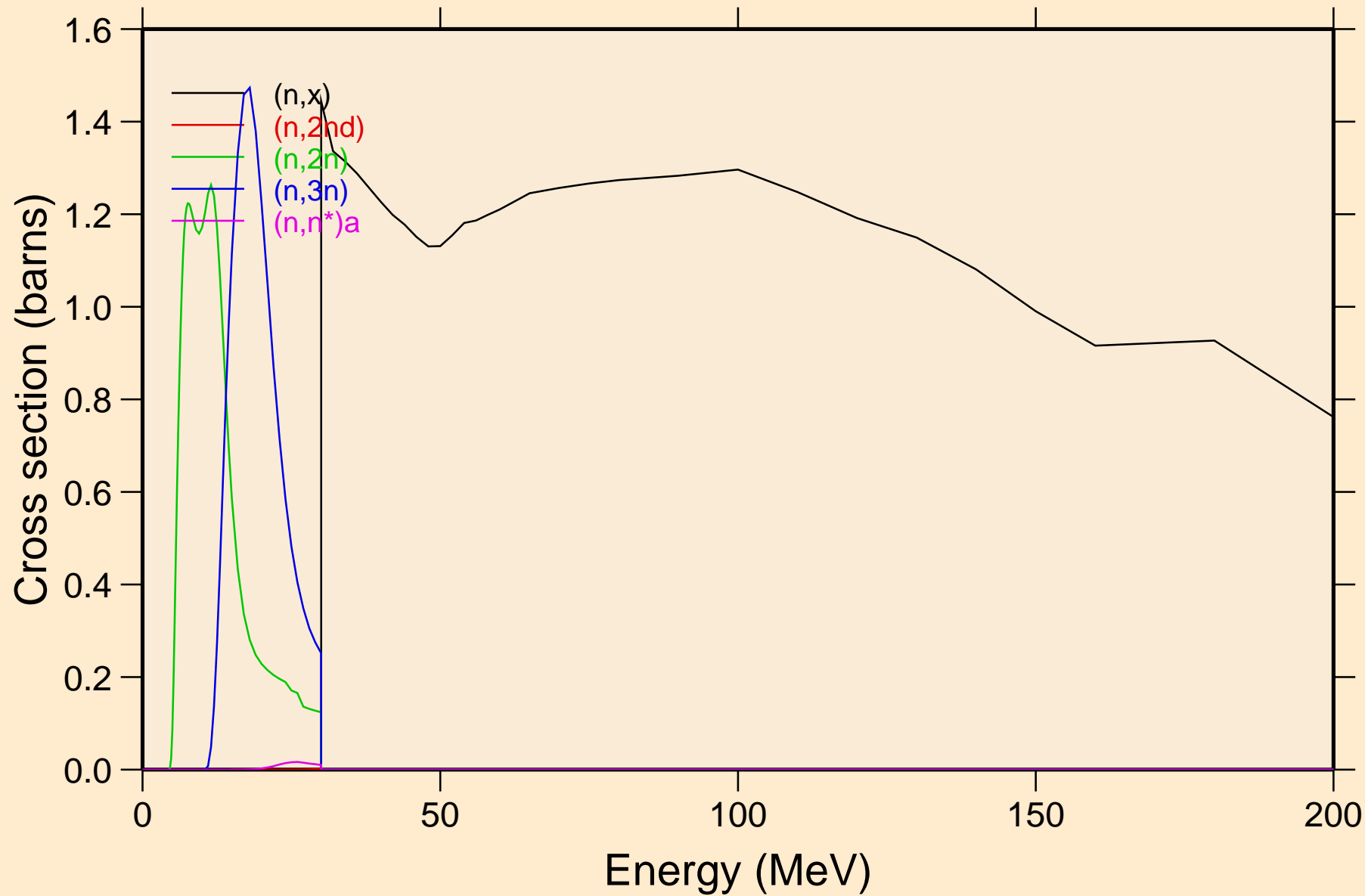

CM251 NEUTRON ACER TENDL-2021 LIBRARY; T=293.6K
Threshold reactions

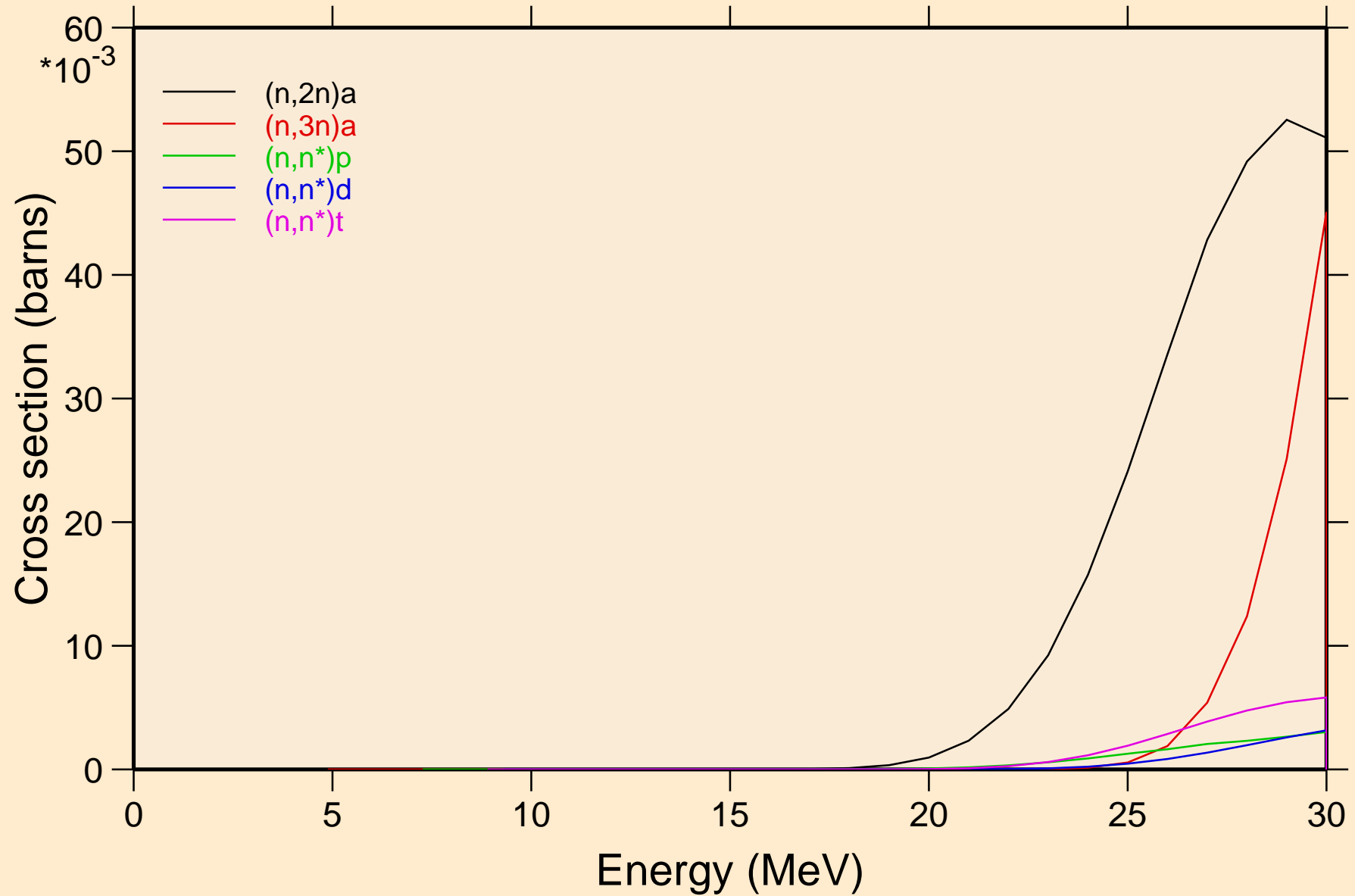

CM251 NEUTRON ACER TENDL-2021 LIBRARY; T=293.6K
Threshold reactions

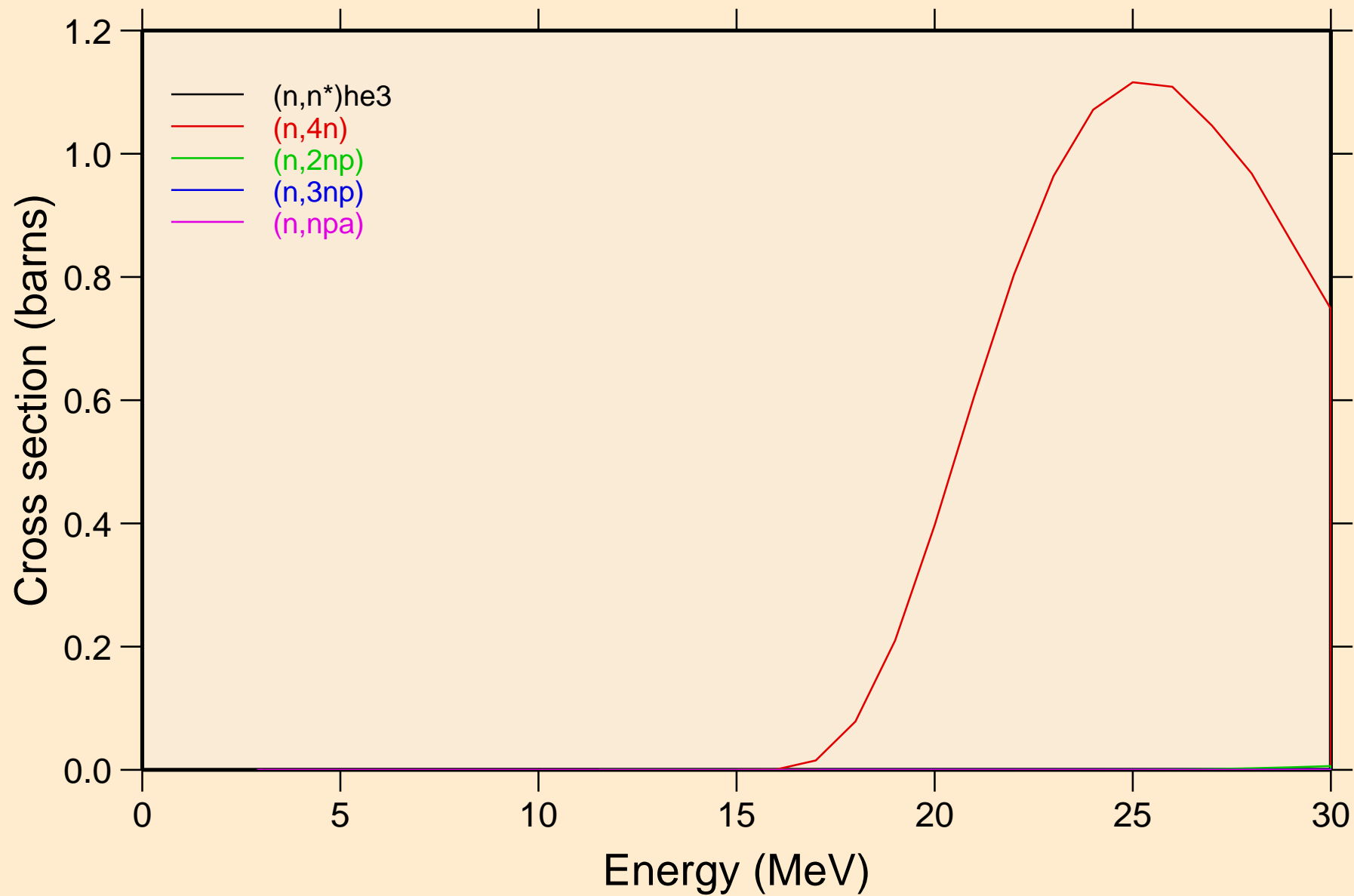

CM251 NEUTRON ACER TENDL-2021 LIBRARY; T=293.6K
Threshold reactions

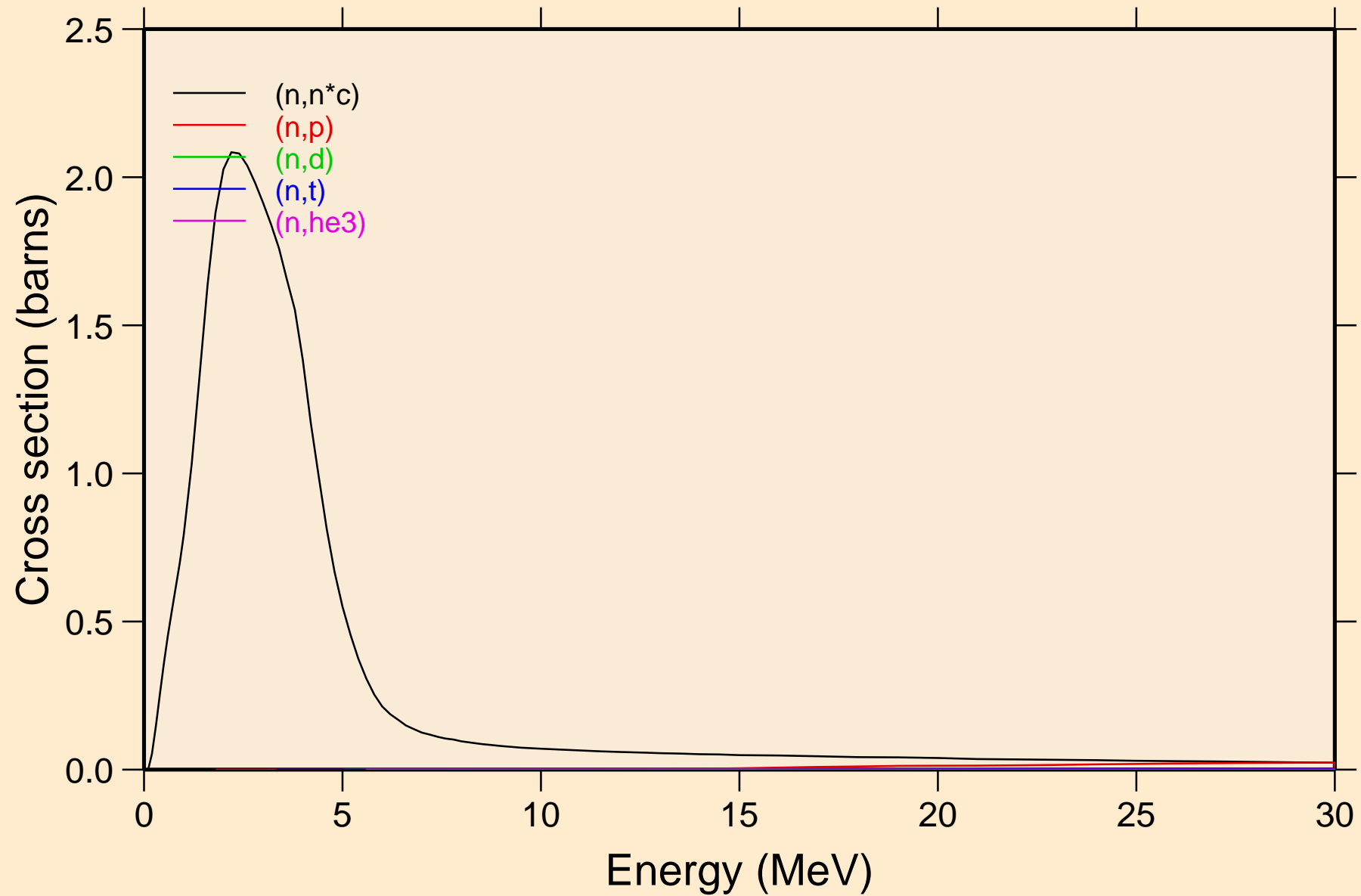

CM251 NEUTRON ACER TENDL-2021 LIBRARY; T=293.6K
Threshold reactions

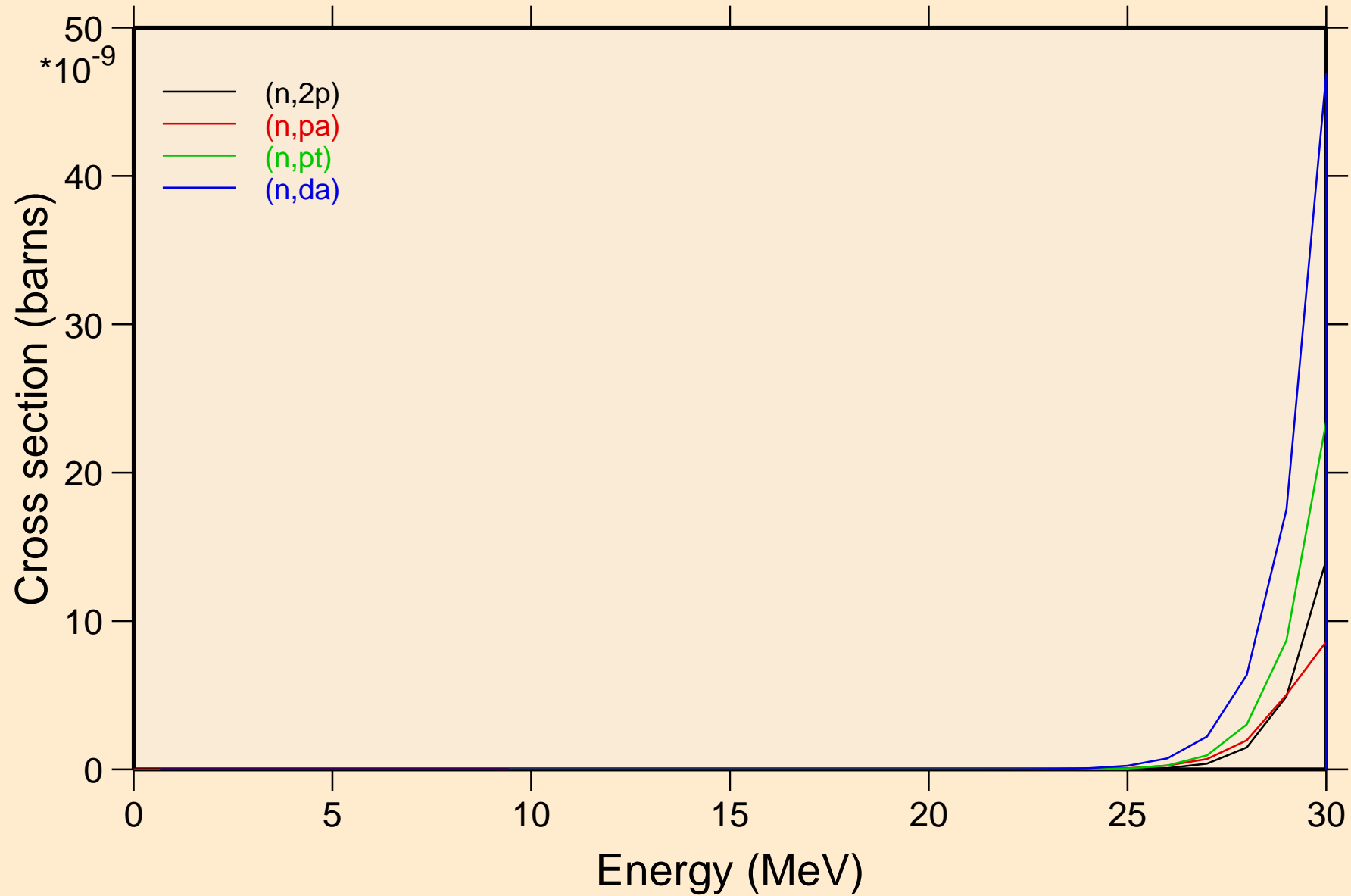

CM251 NEUTRON ACER TENDL-2021 LIBRARY; T=293.6K

Threshold reactions

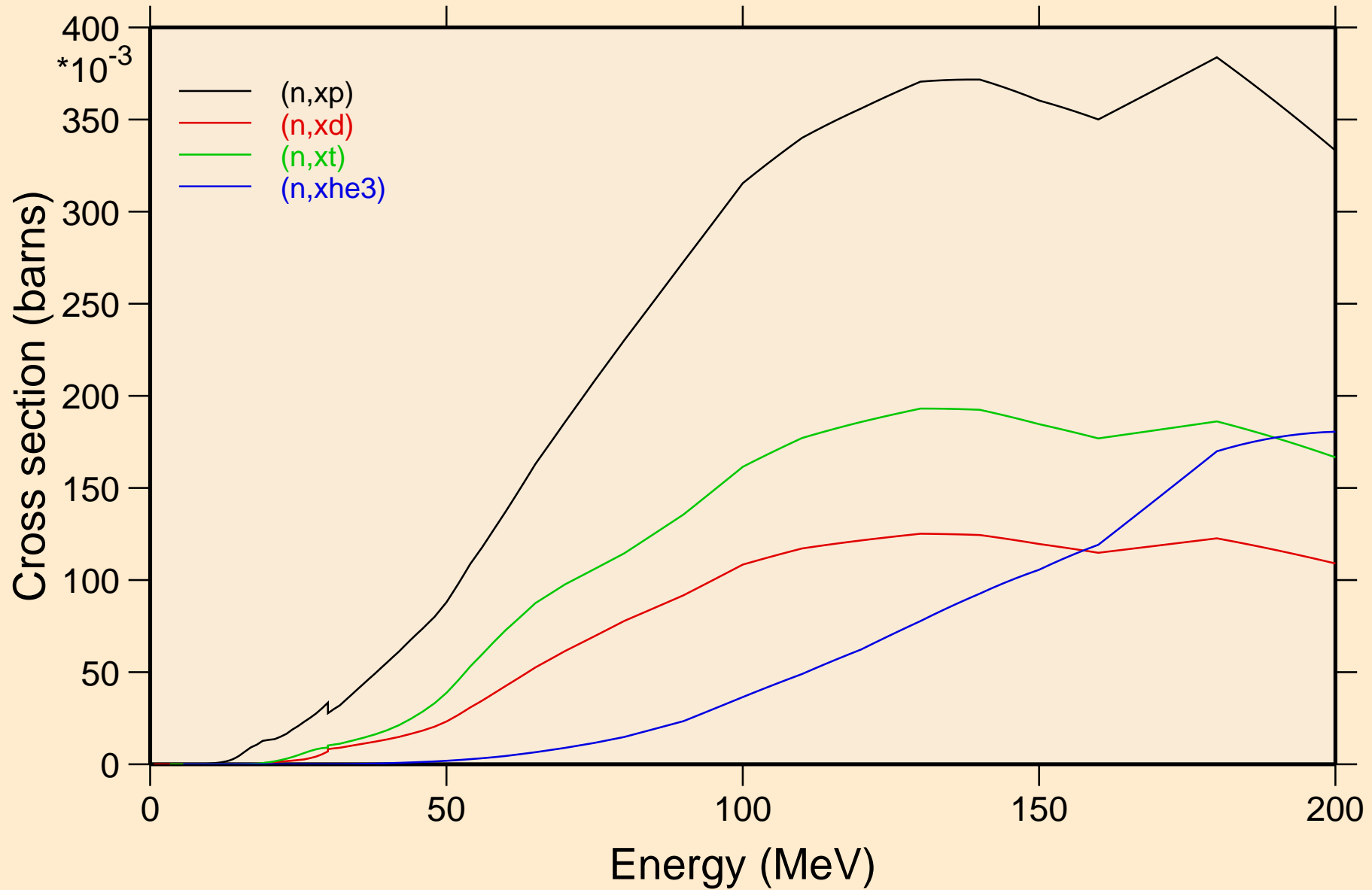

CM251 NEUTRON ACER TENDL-2021 LIBRARY; T=293.6K
angular distribution for elastic

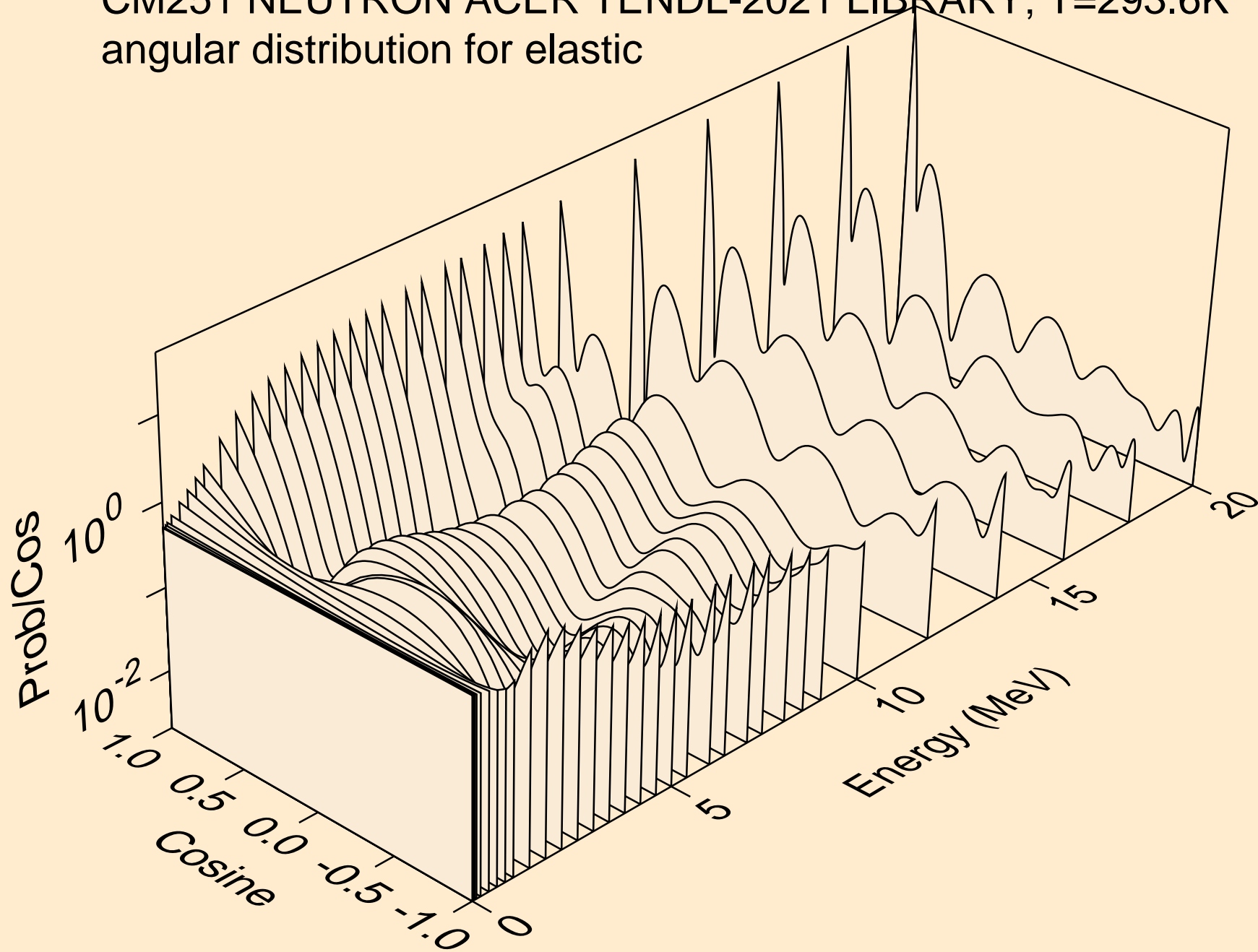

CM251 NEUTRON ACER TENDL-2021 LIBRARY; T=293.6K
angular distribution for elastic

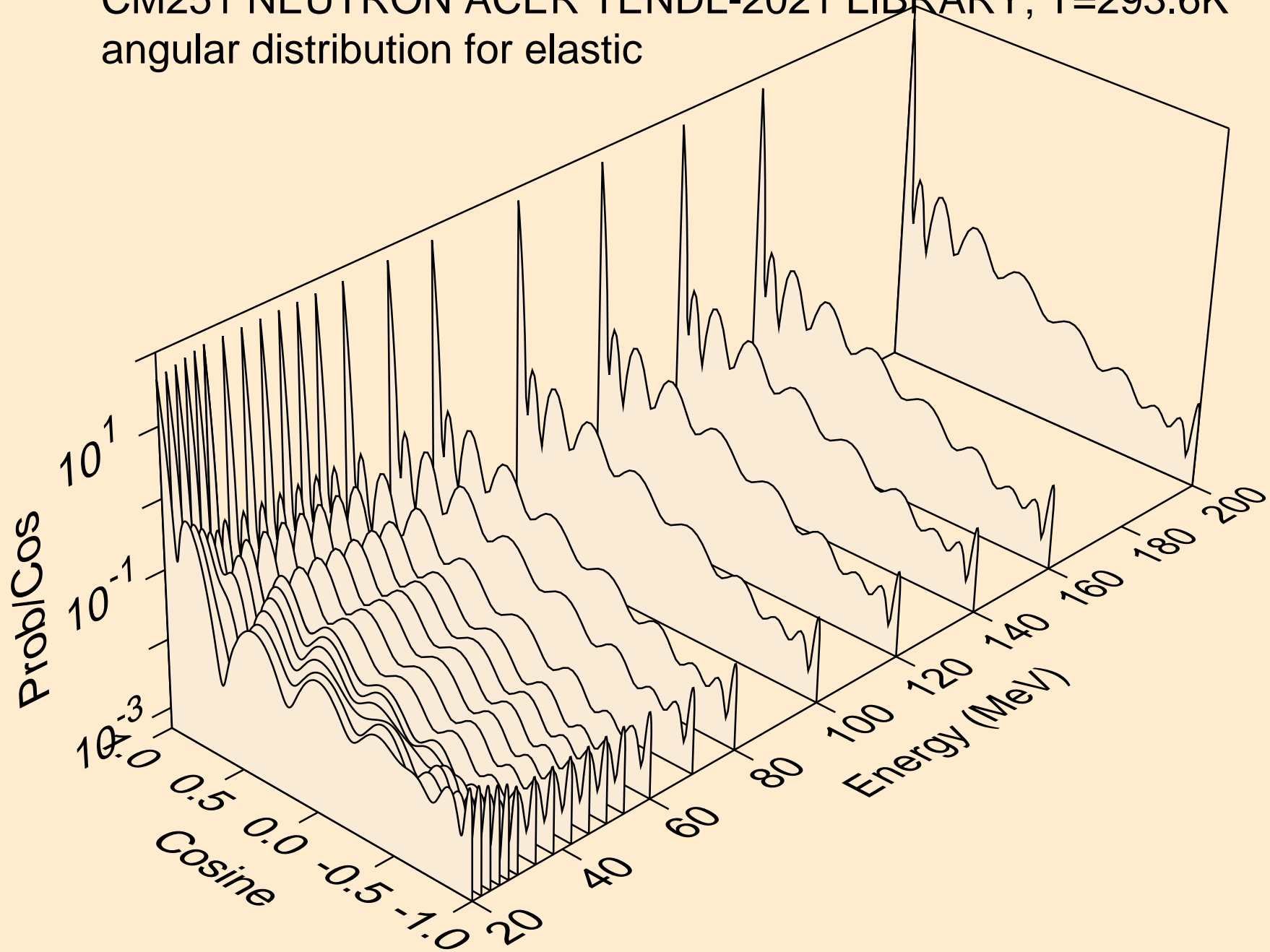

CM251 NEUTRON ACER TENDL-2021 LIBRARY; T=293.6K
angular distribution for (n,n*1)

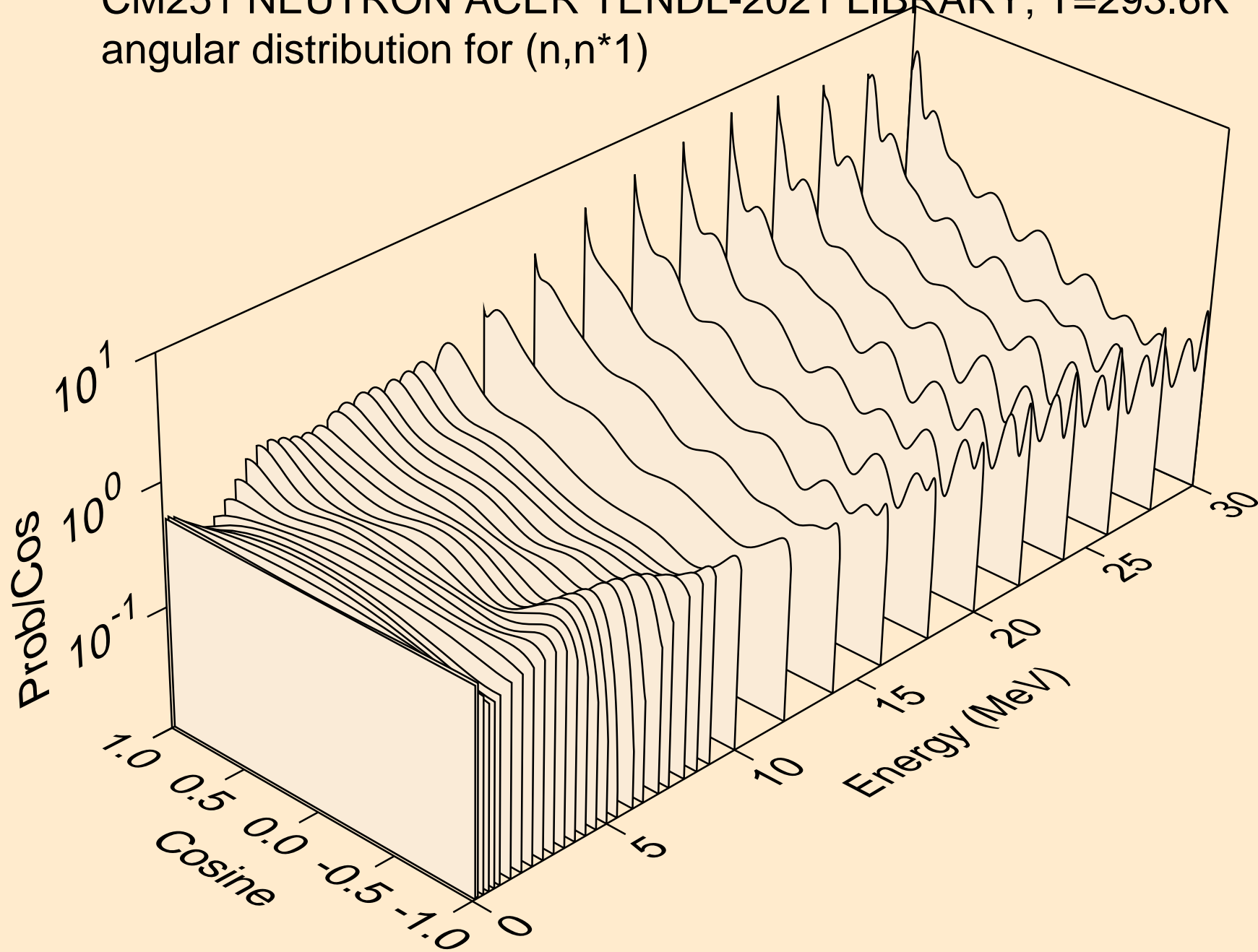

CM251 NEUTRON ACER TENDL-2021 LIBRARY; T=293.6K
Total fission nubar

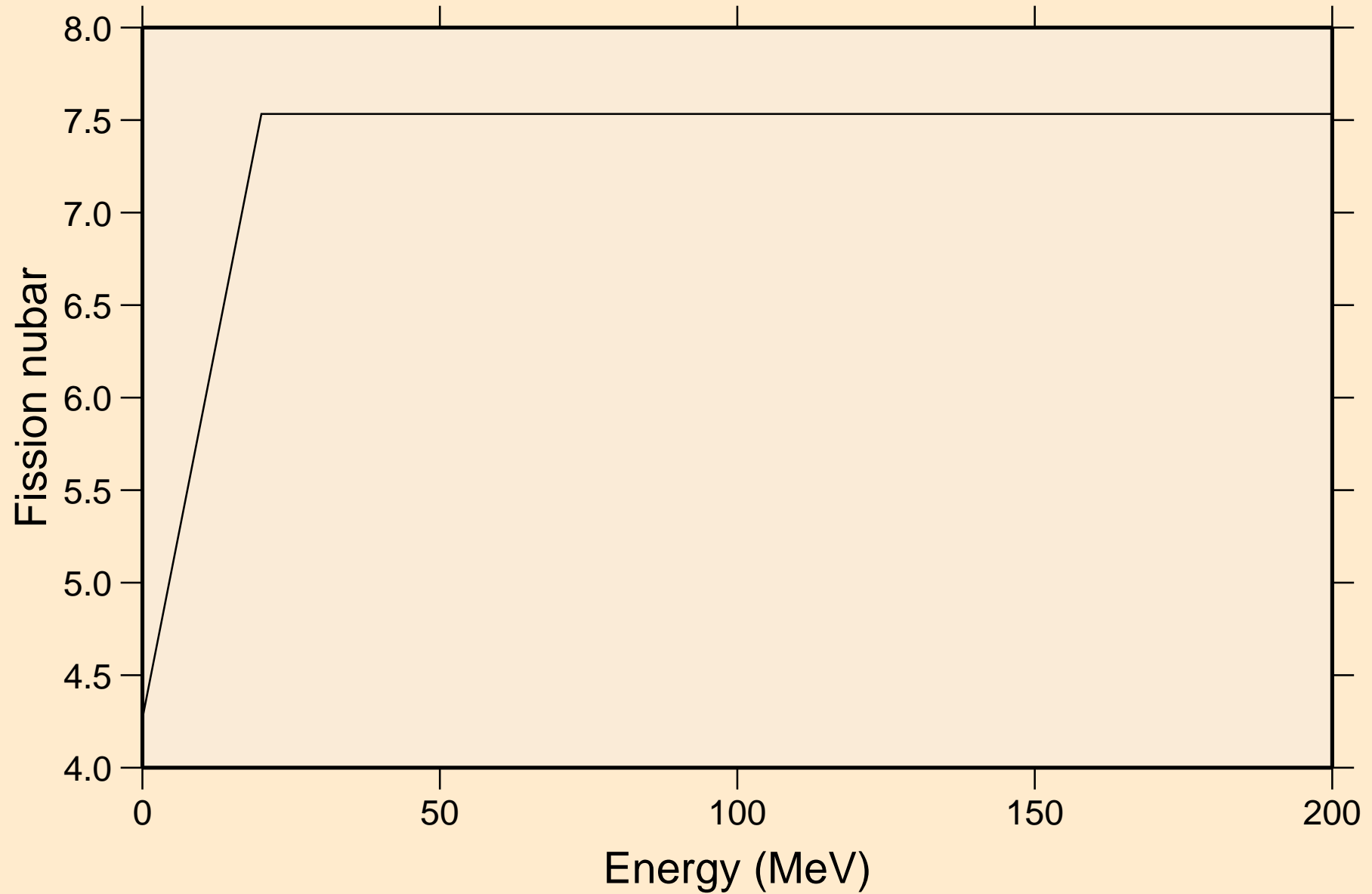

CM251 NEUTRON ACER TENDL-2021 LIBRARY; T=293.6K
Neutron emission for (n,x)

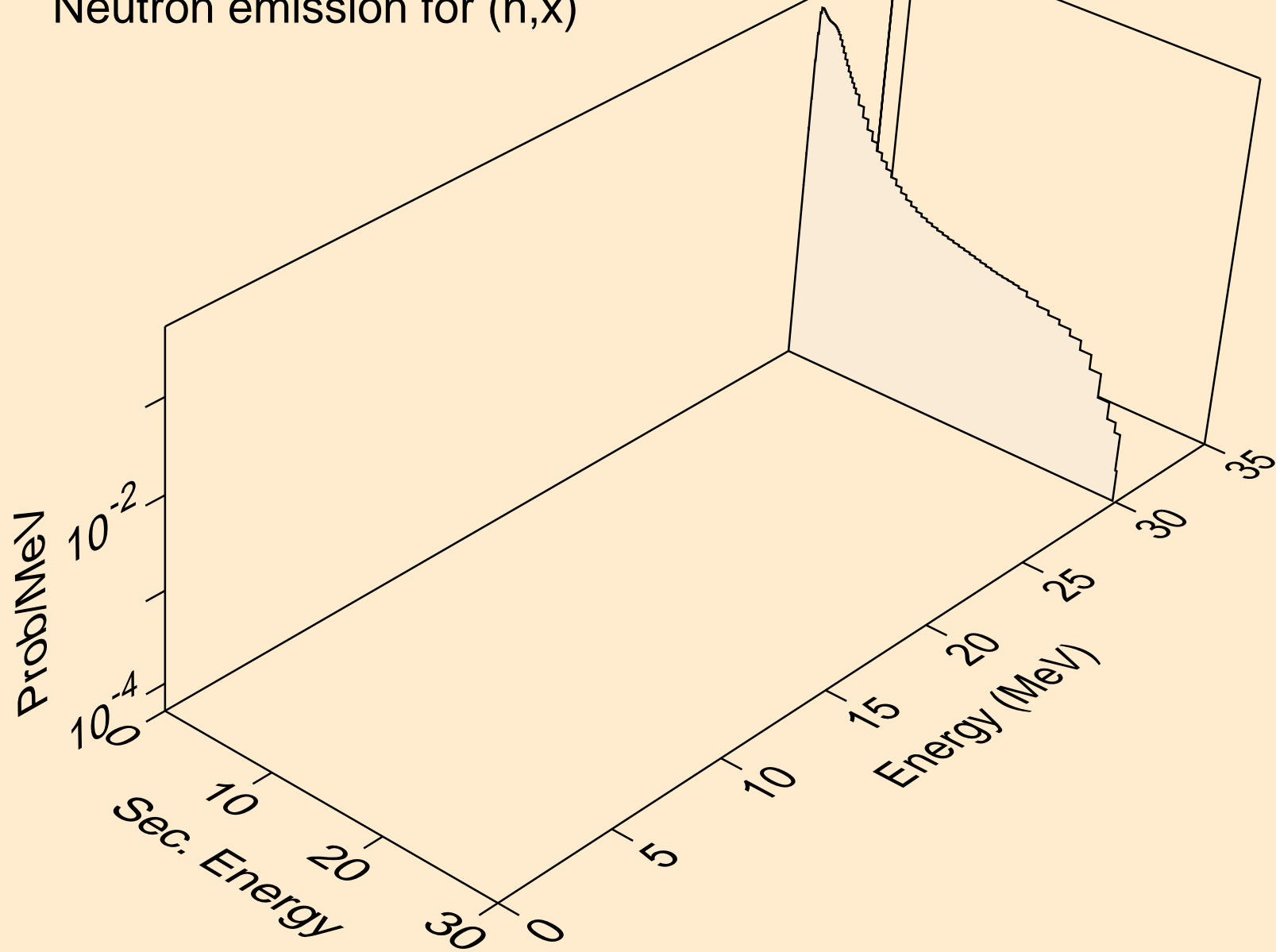

CM251 NEUTRON ACER TENDL-2021 LIBRARY; T=293.6K
Neutron emission for (n,2nd)

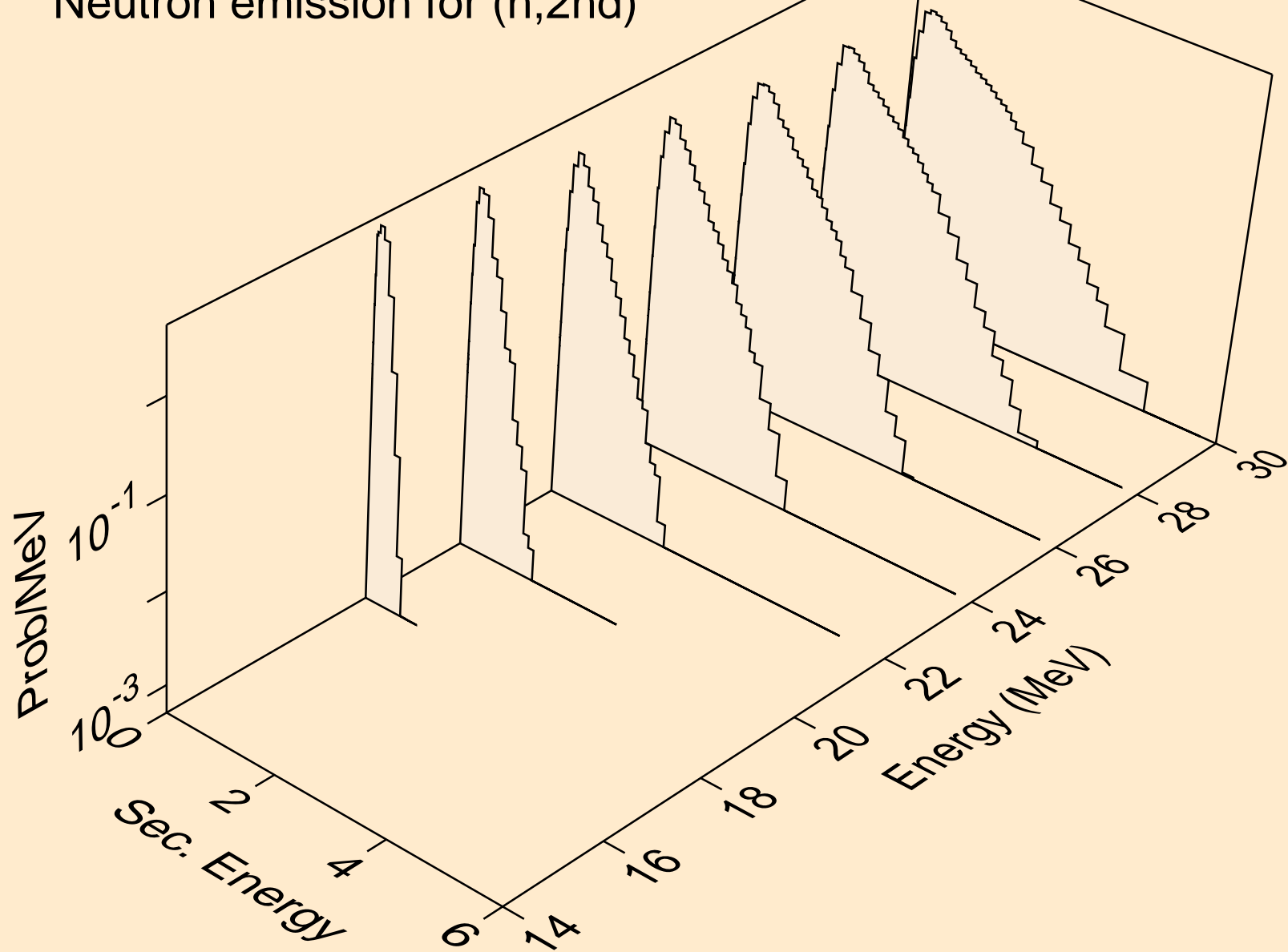

CM251 NEUTRON ACER TENDL-2021 LIBRARY; T=293.6K
Neutron emission for (n,2n)

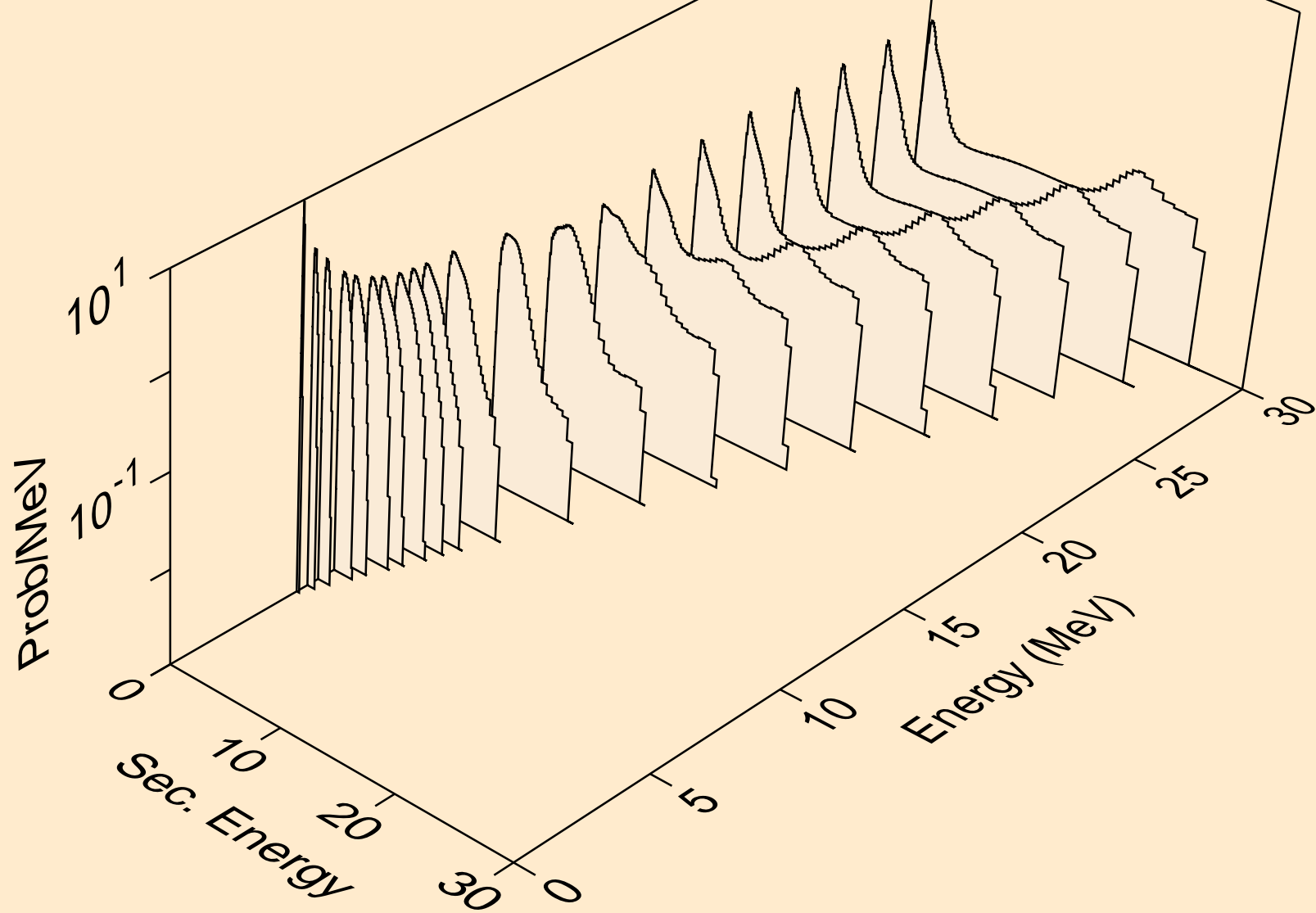

CM251 NEUTRON ACER TENDL-2021 LIBRARY; T=293.6K
Neutron emission for (n,3n)

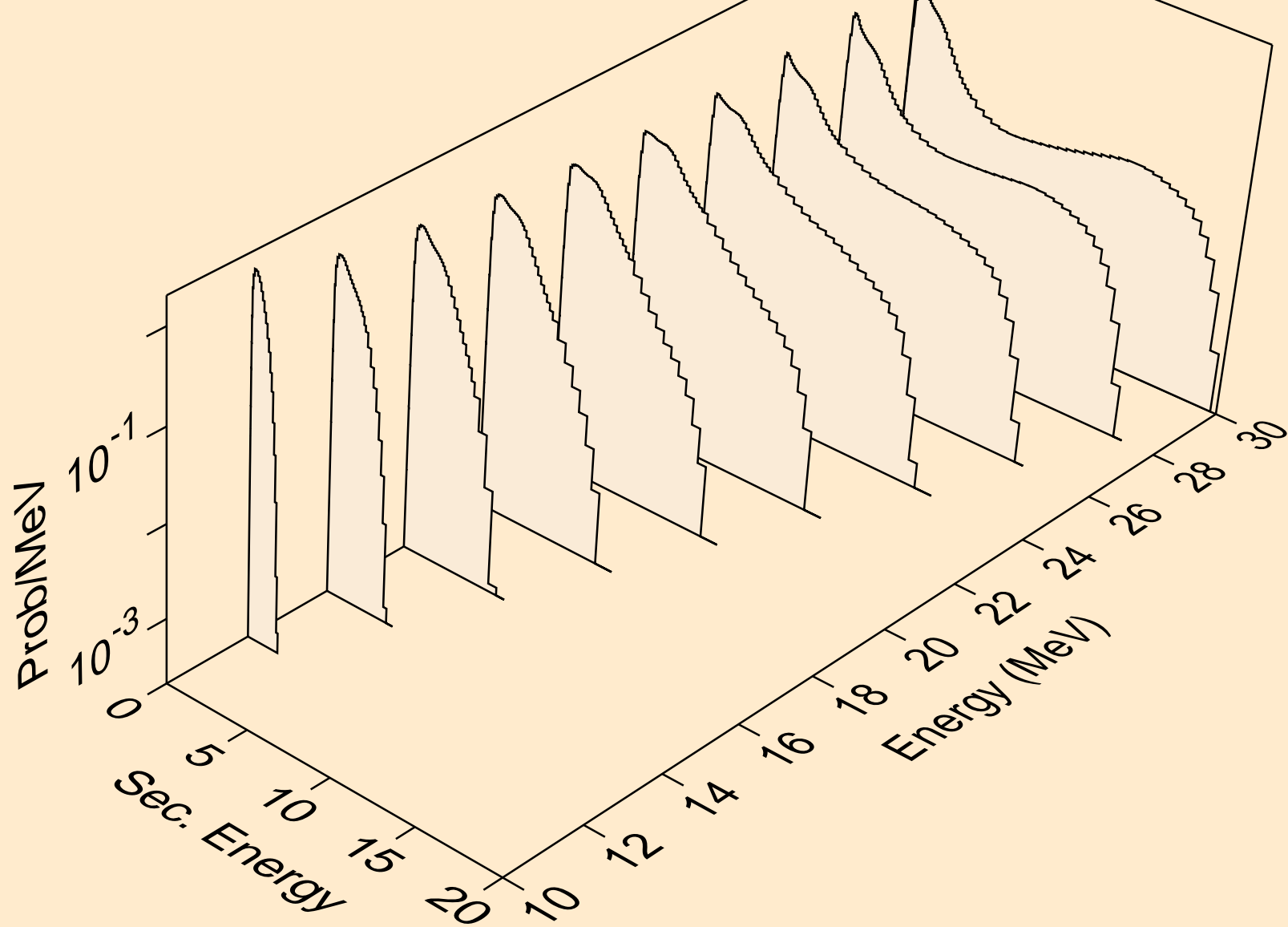

CM251 NEUTRON ACER TENDL-2021 LIBRARY; T=293.6K
Neutron emission for fission

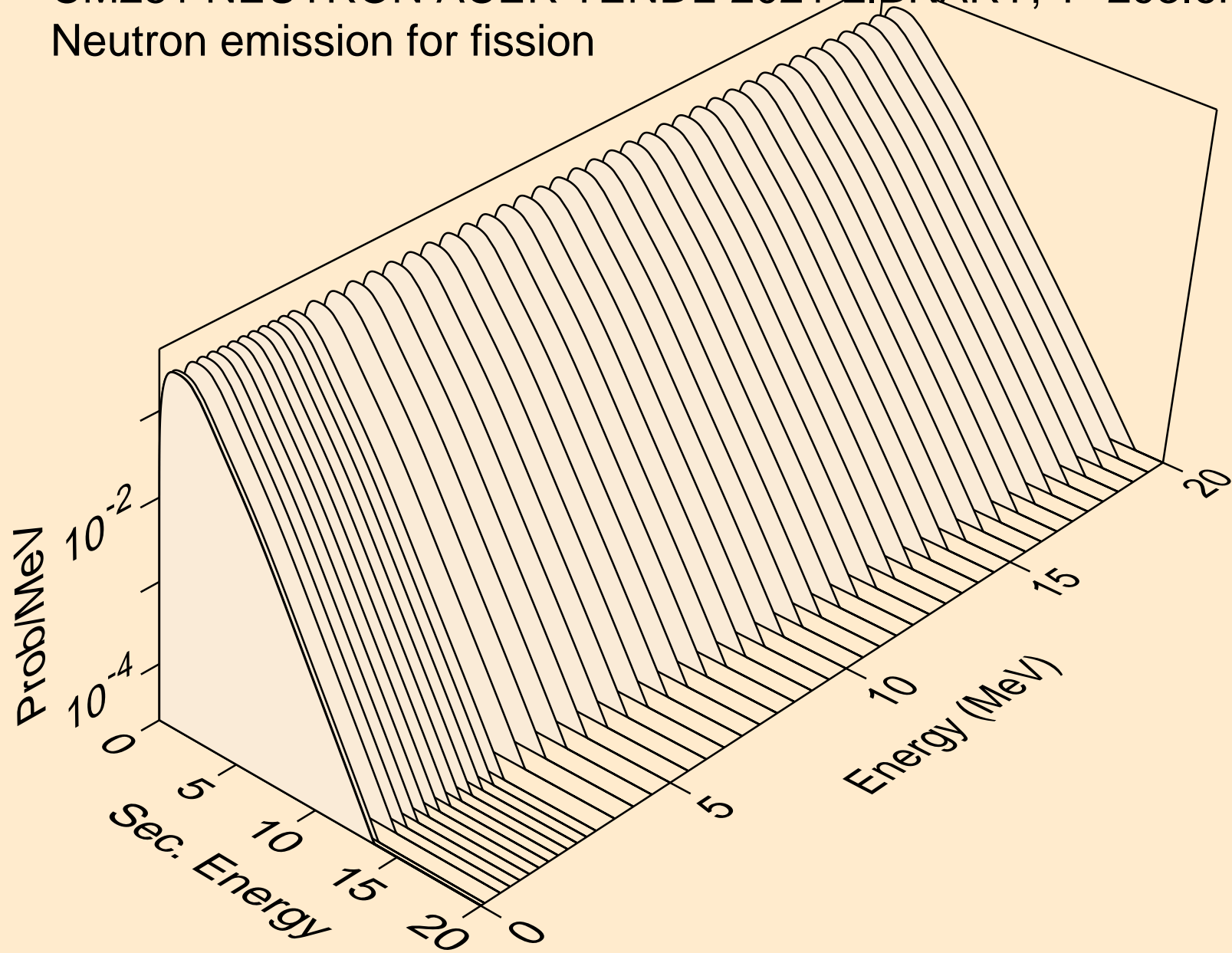

CM251 NEUTRON ACER TENDL-2021 LIBRARY; T=293.6K
Neutron emission for (n,n*)a

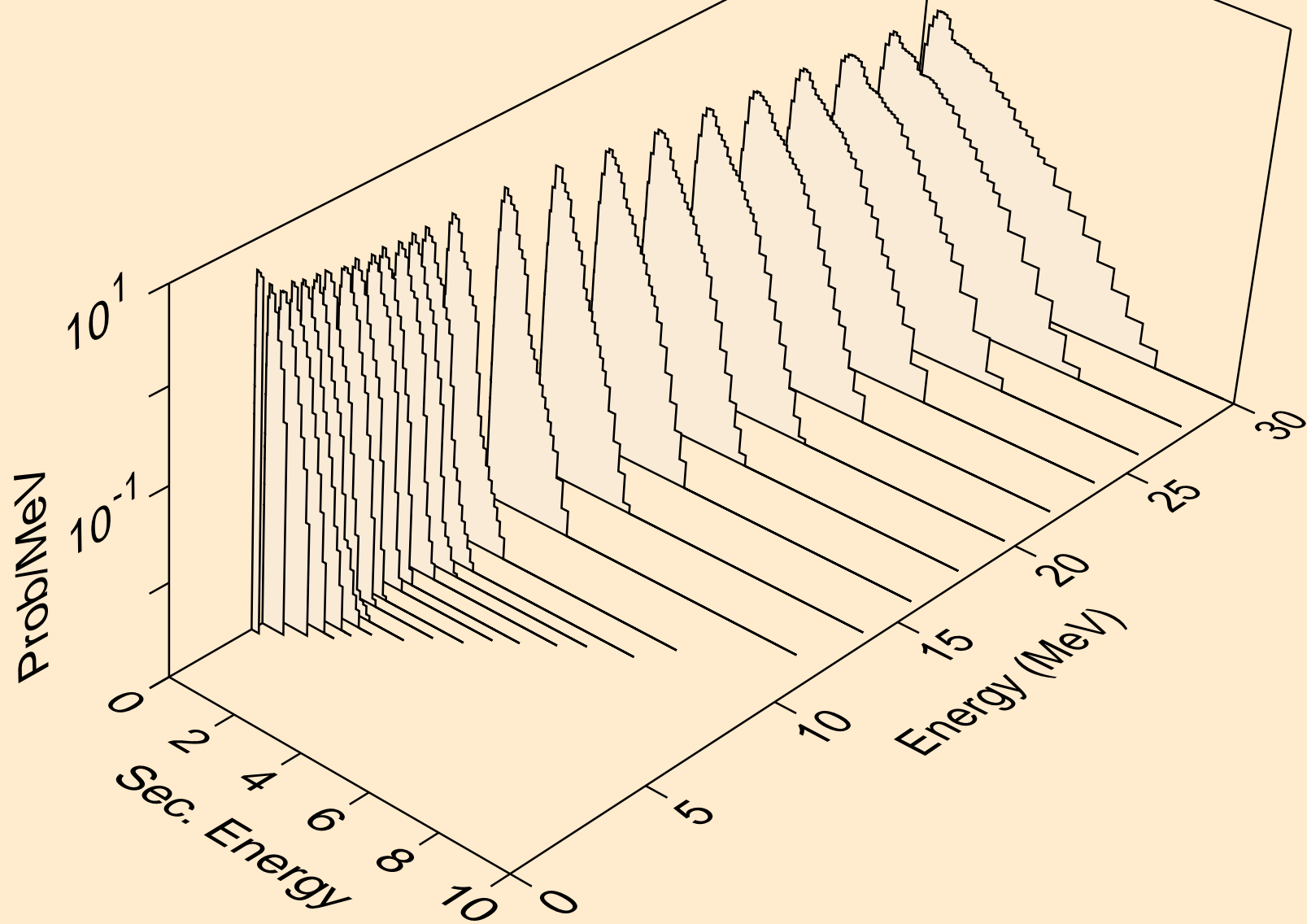

CM251 NEUTRON ACER TENDL-2021 LIBRARY; T=293.6K
Neutron emission for (n,2n)a

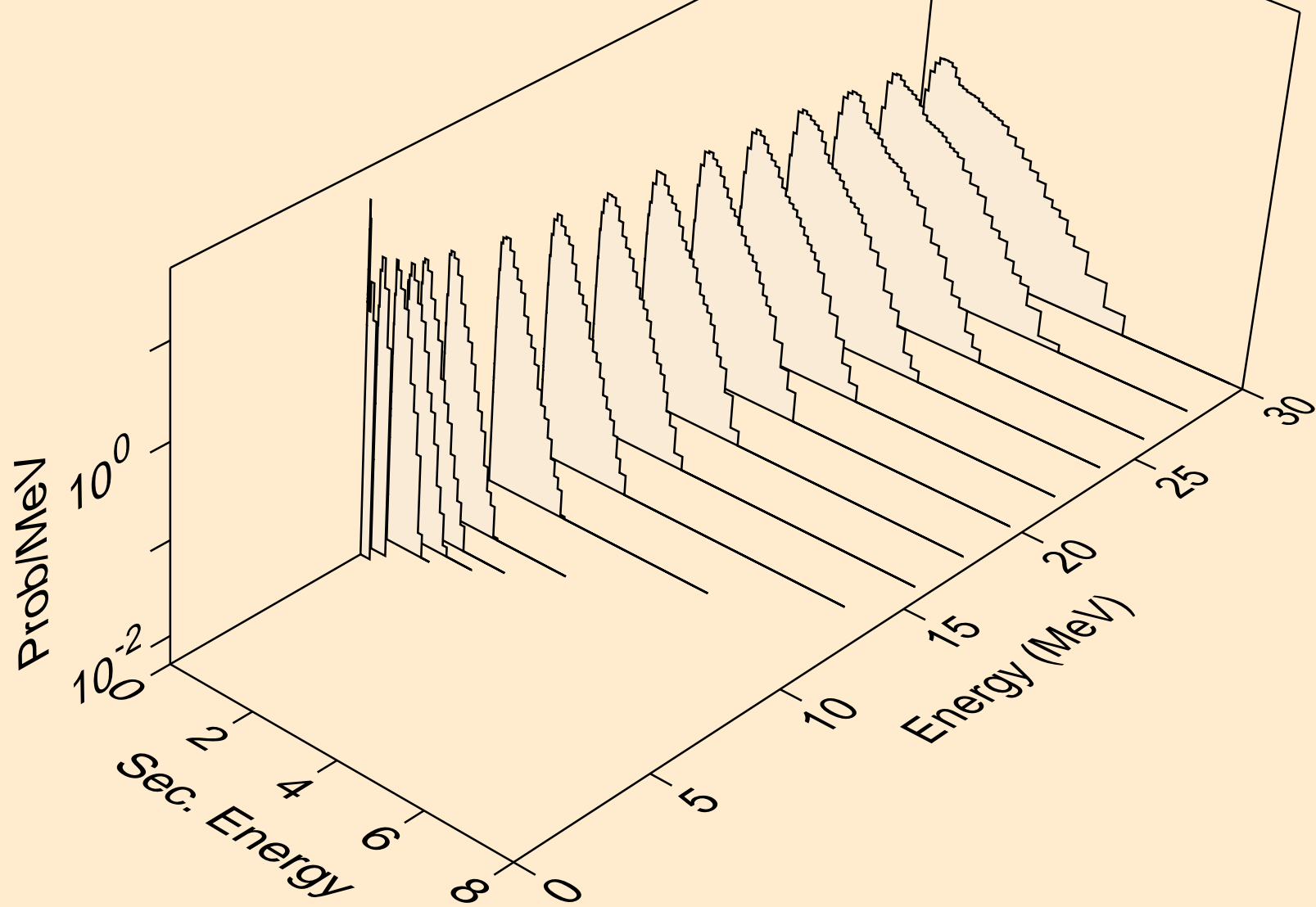

CM251 NEUTRON ACER TENDL-2021 LIBRARY; T=293.6K
Neutron emission for (n,3n)a

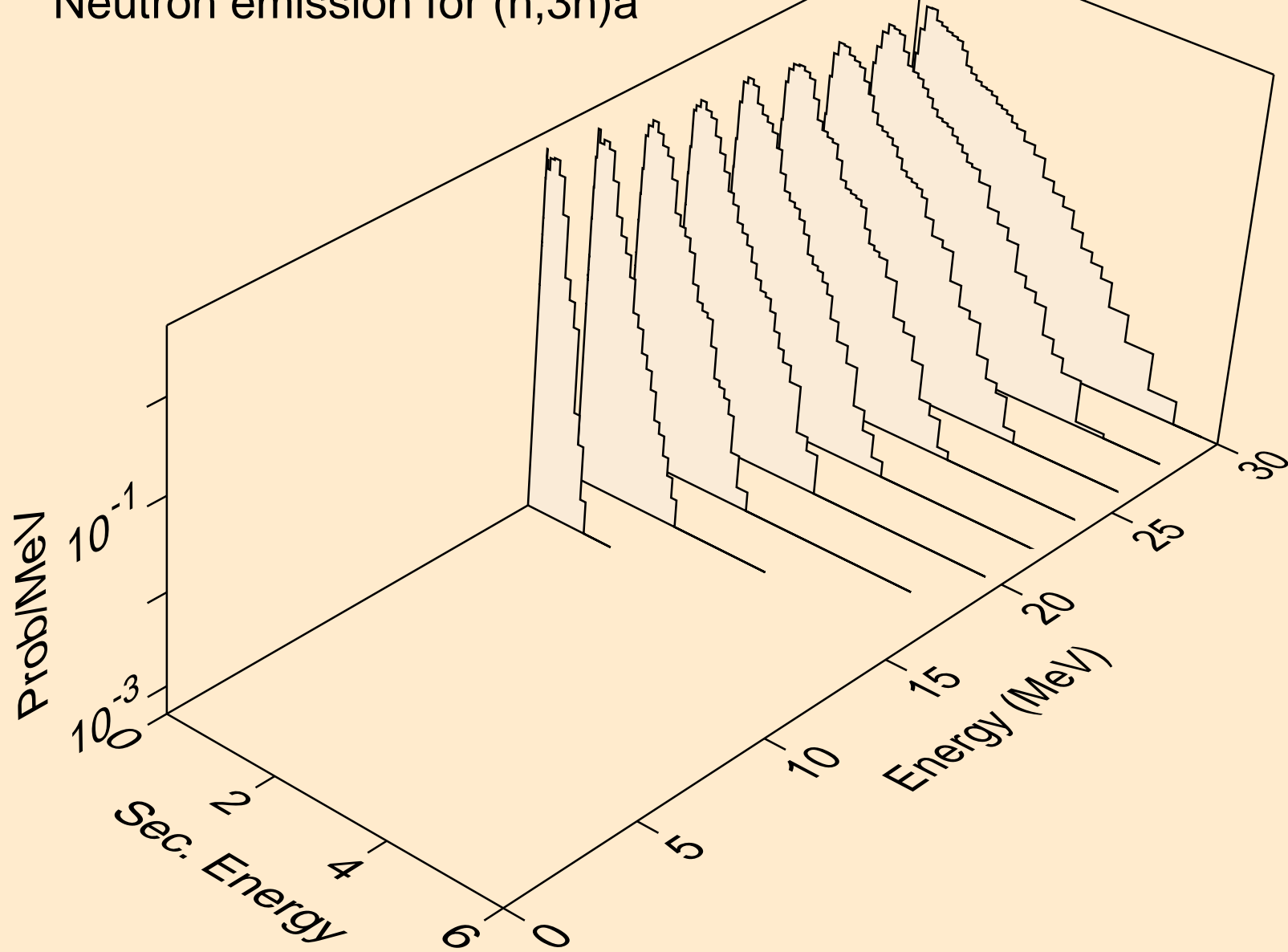

CM251 NEUTRON ACER TENDL-2021 LIBRARY; T=293.6K
Neutron emission for (n,n*)p

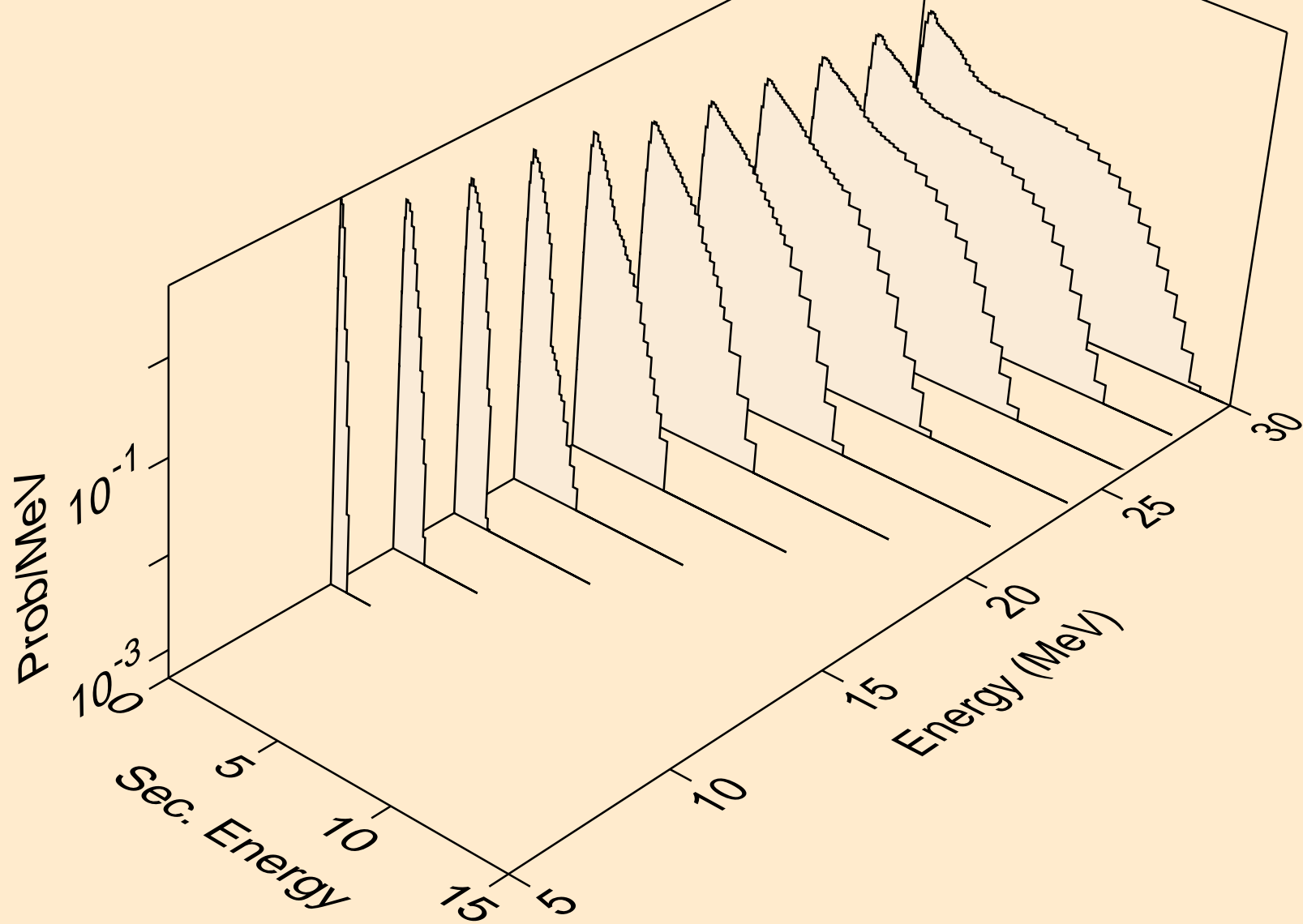

CM251 NEUTRON ACER TENDL-2021 LIBRARY; T=293.6K
Neutron emission for (n,n*)d

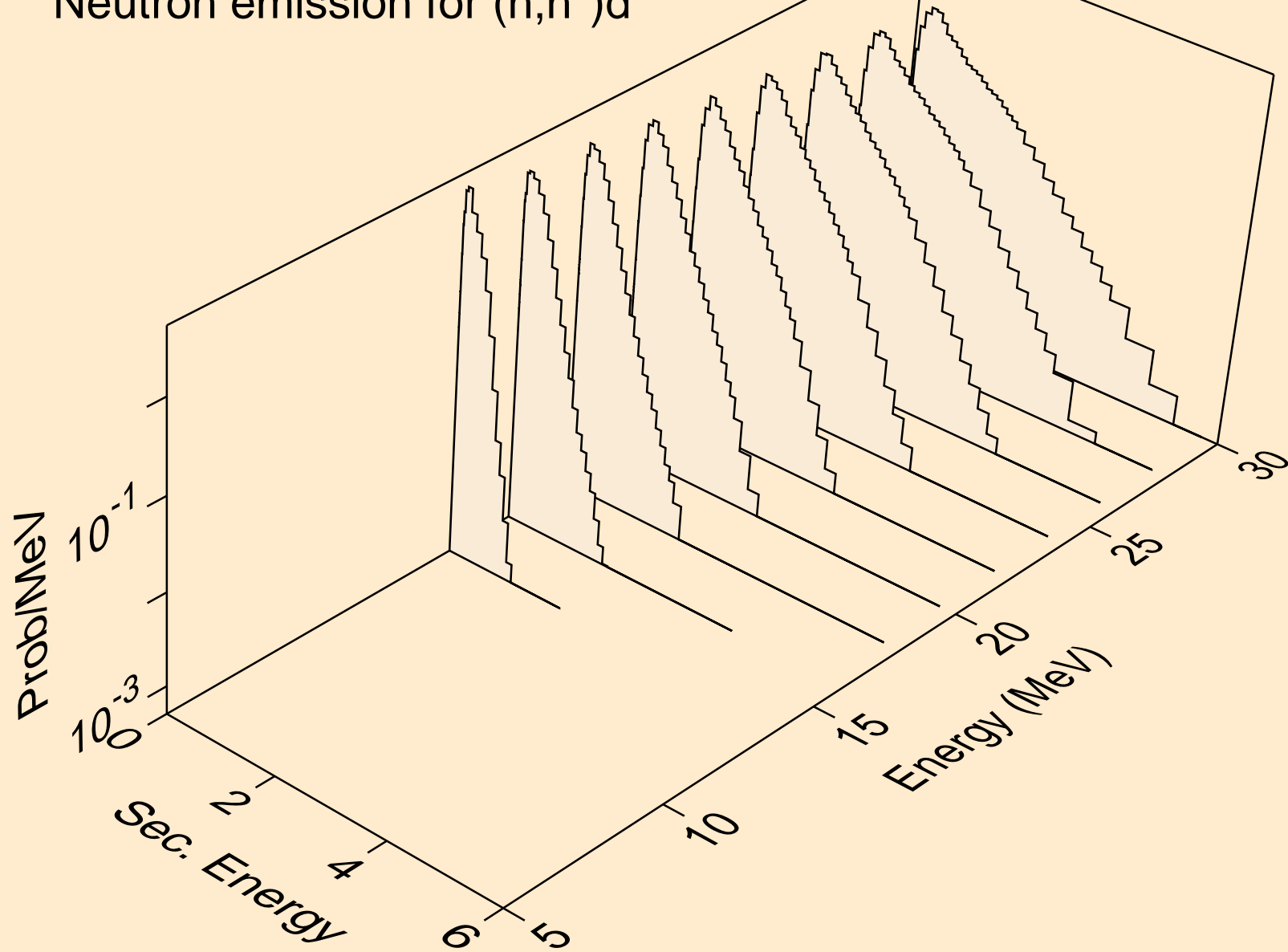

CM251 NEUTRON ACER TENDL-2021 LIBRARY; T=293.6K
Neutron emission for (n,n*)t

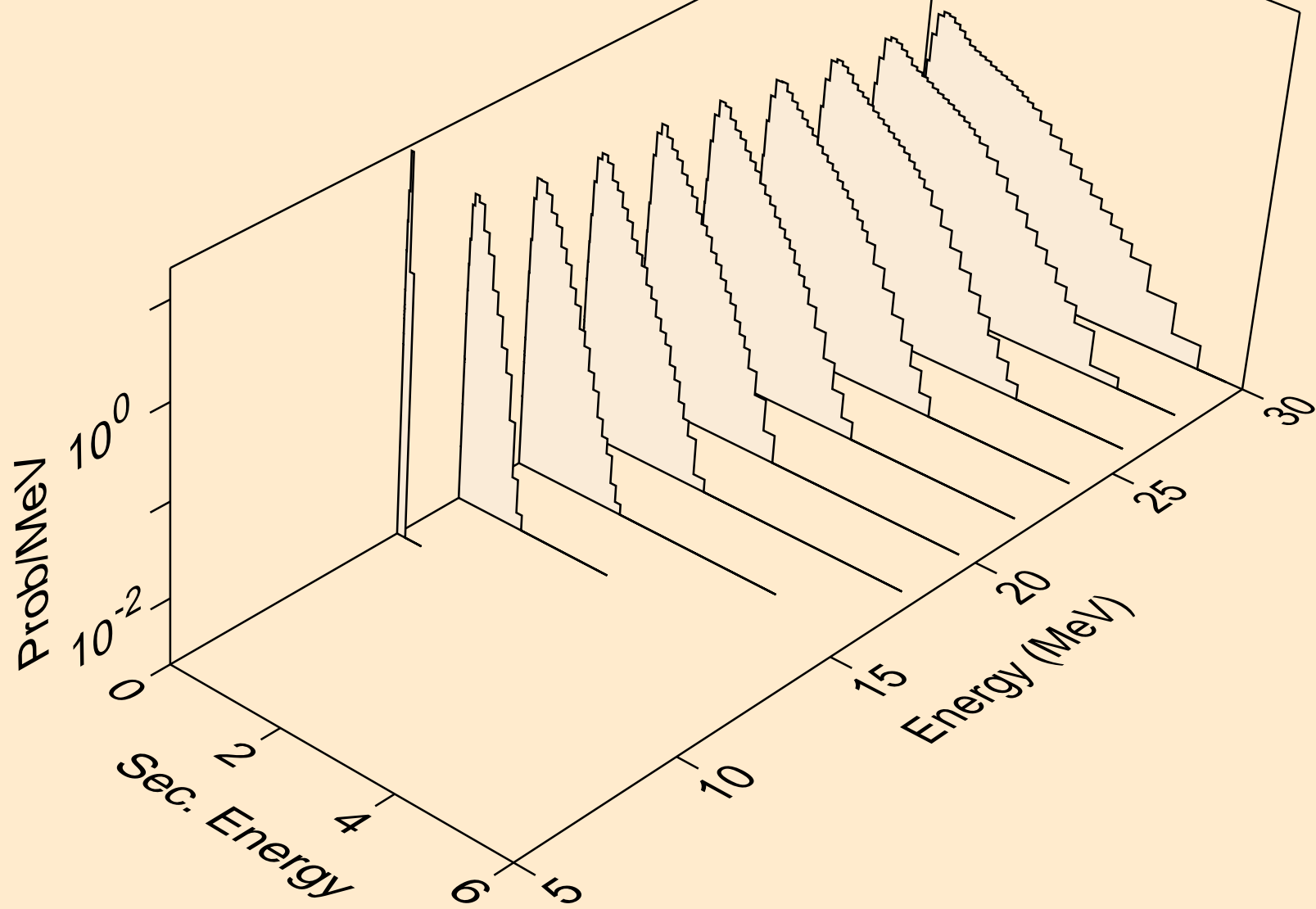

CM251 NEUTRON ACER TENDL-2021 LIBRARY; T=293.6K
Neutron emission for (n,n*)he3

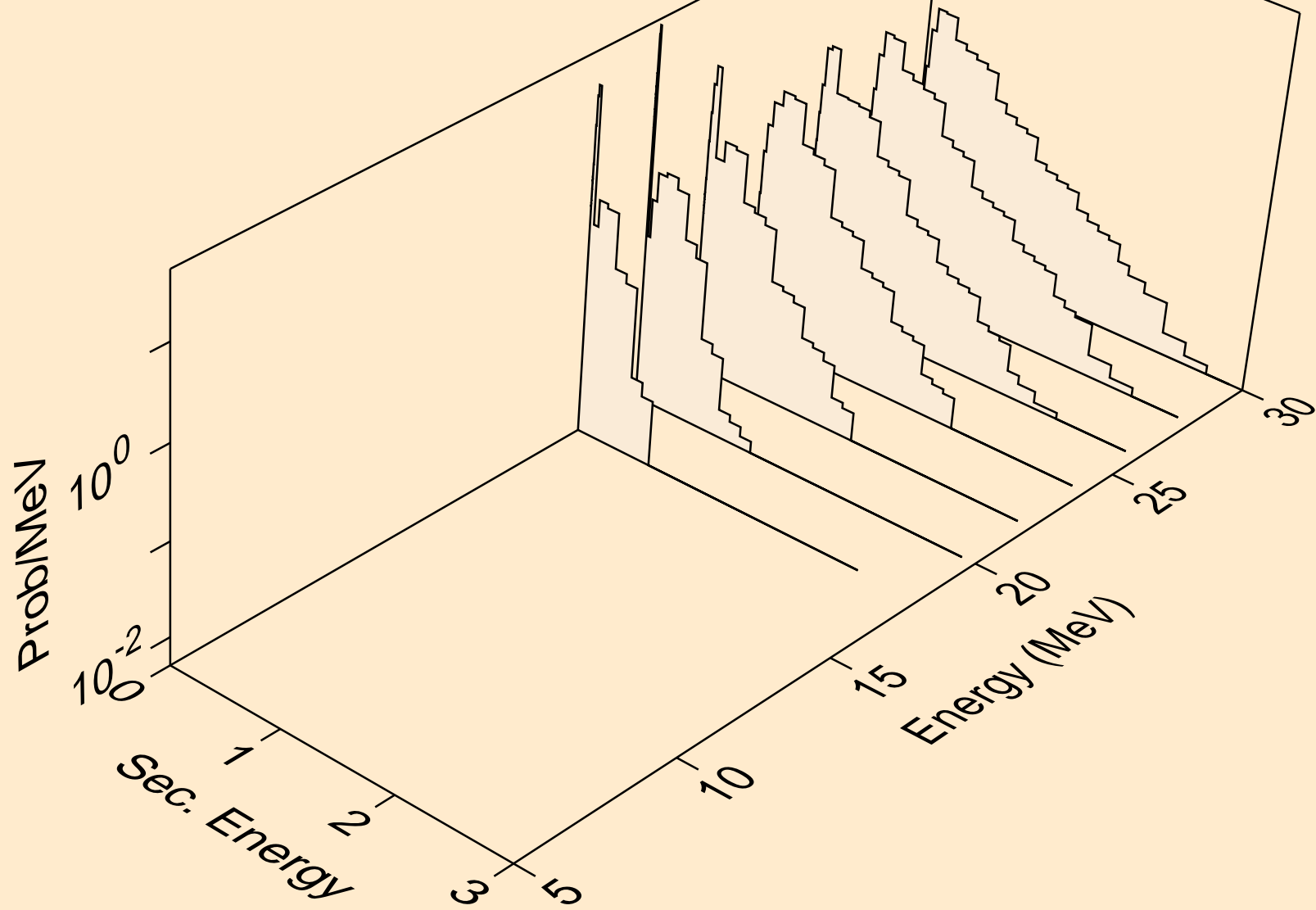

CM251 NEUTRON ACER TENDL-2021 LIBRARY; T=293.6K
Neutron emission for (n,4n)

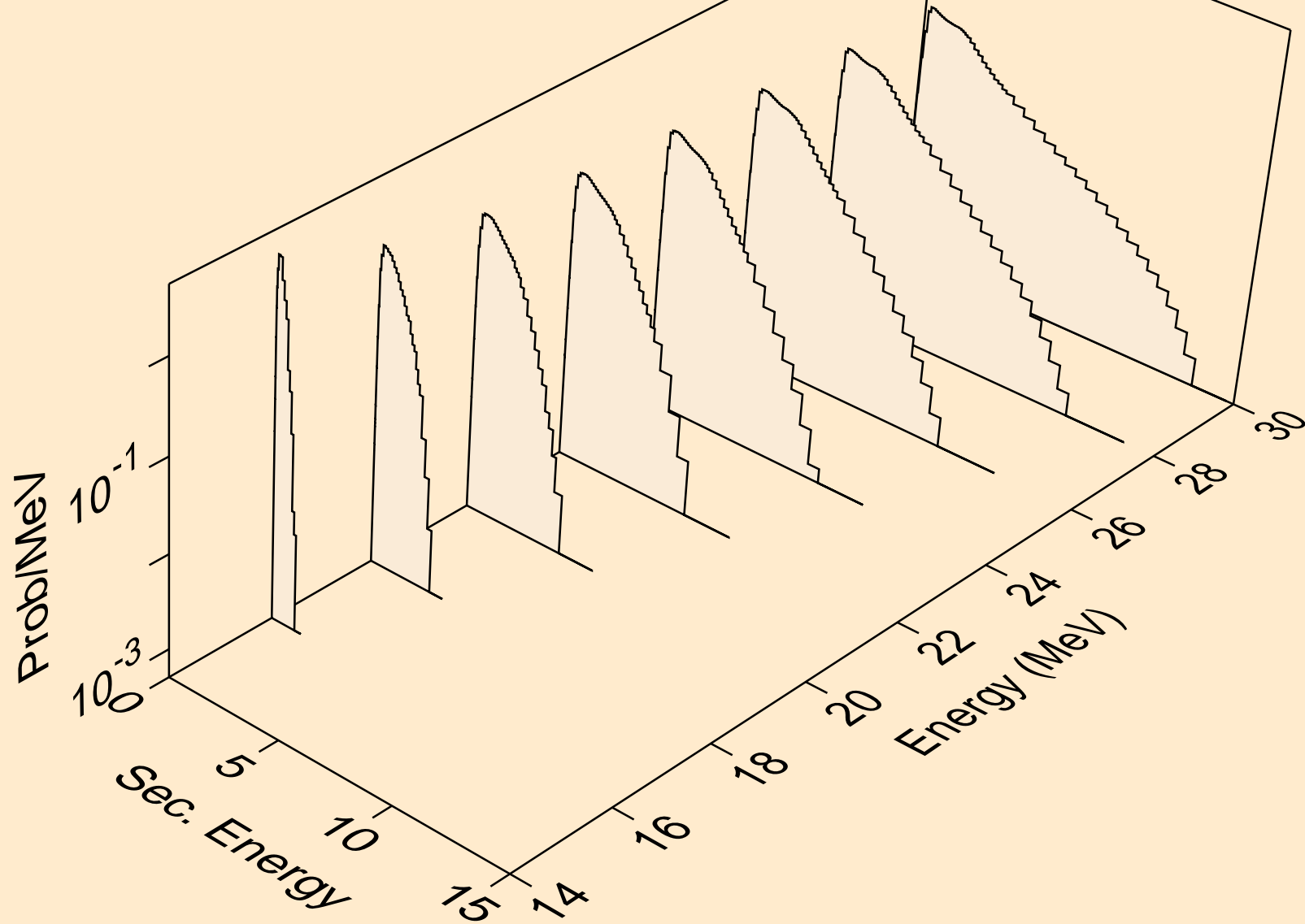

CM251 NEUTRON ACER TENDL-2021 LIBRARY; T=293.6K
Neutron emission for (n,2np)

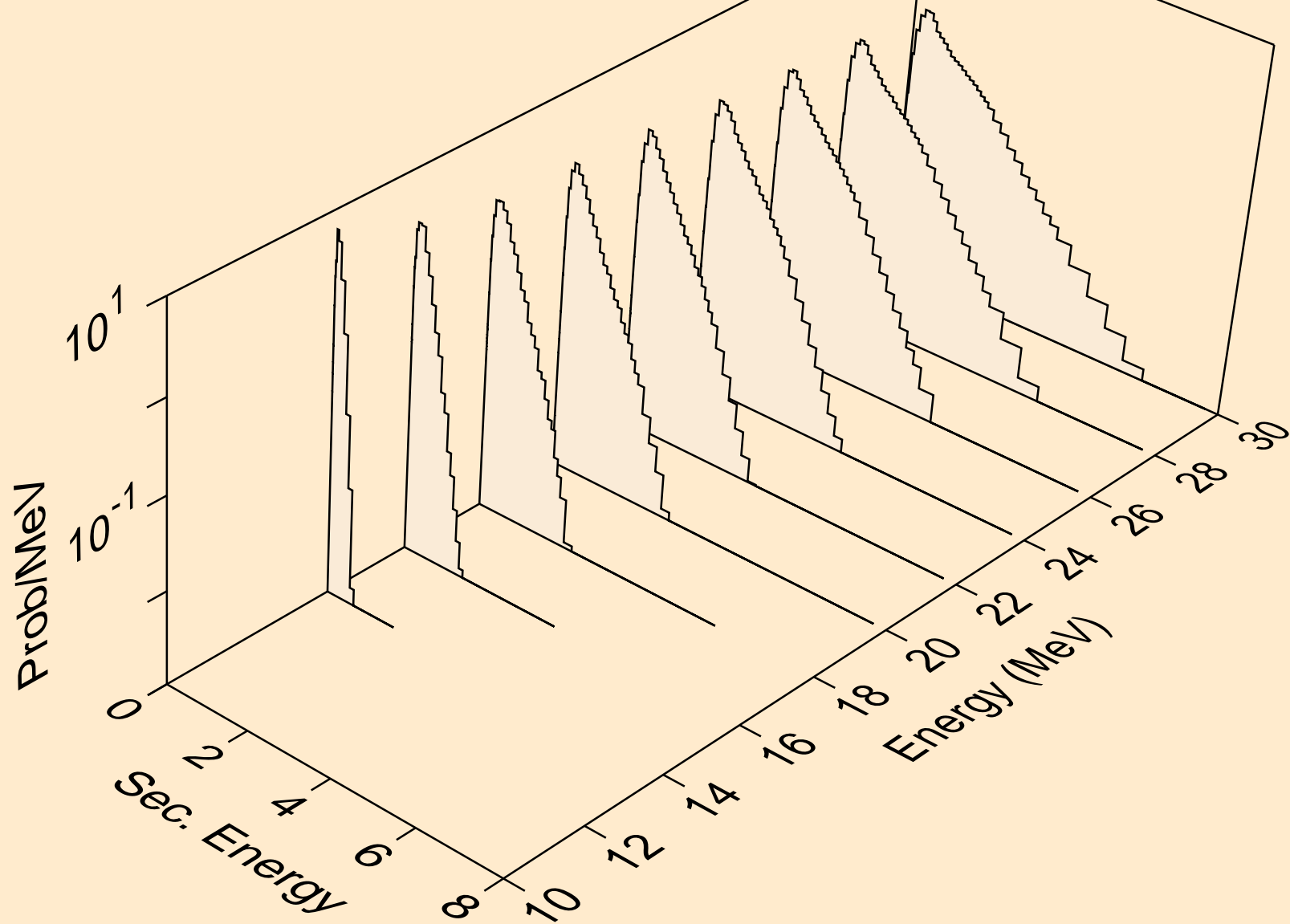

CM251 NEUTRON ACER TENDL-2021 LIBRARY; T=293.6K
Neutron emission for (n,3np)

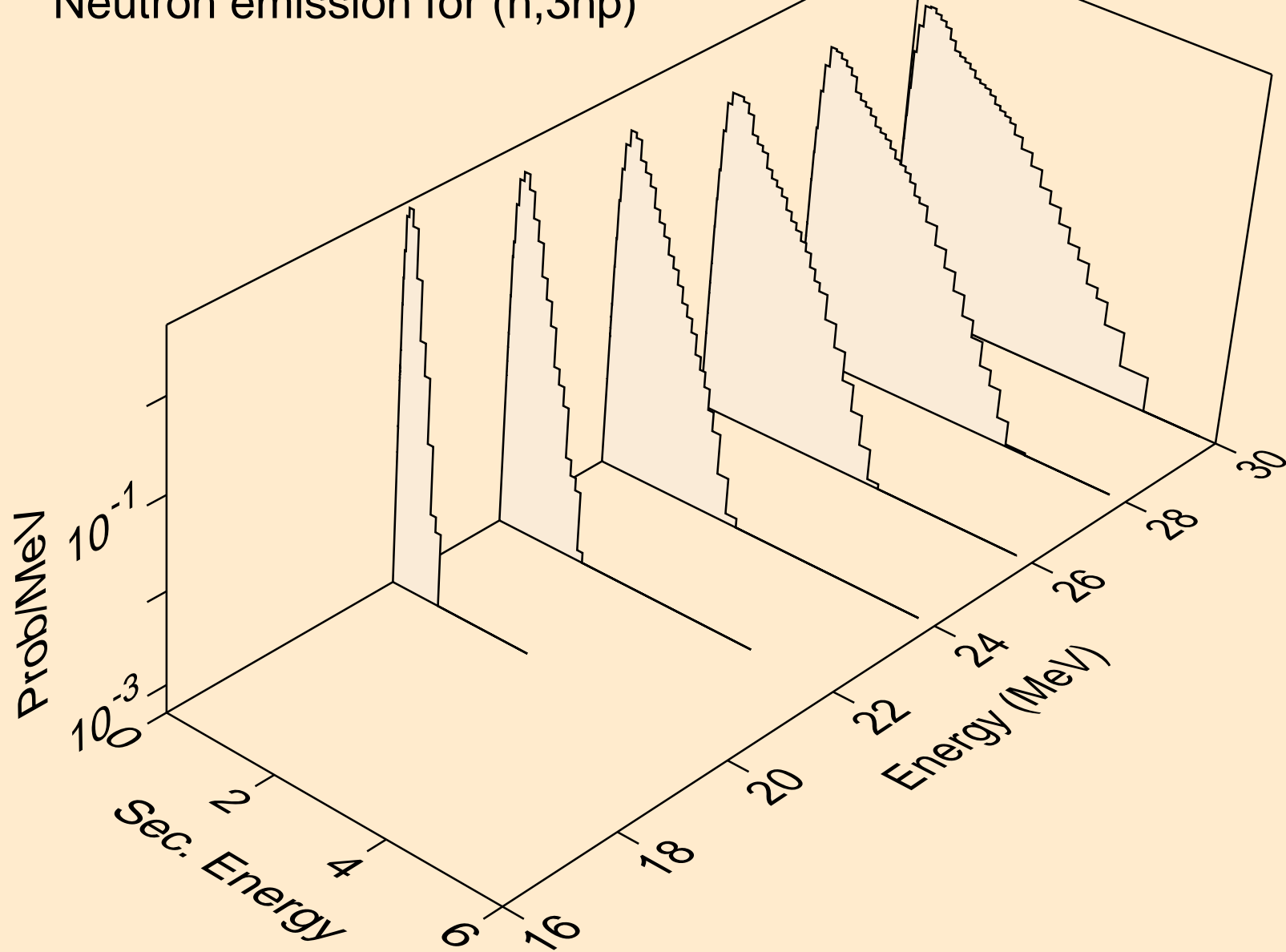

CM251 NEUTRON ACER TENDL-2021 LIBRARY; T=293.6K
Neutron emission for (n,npa)

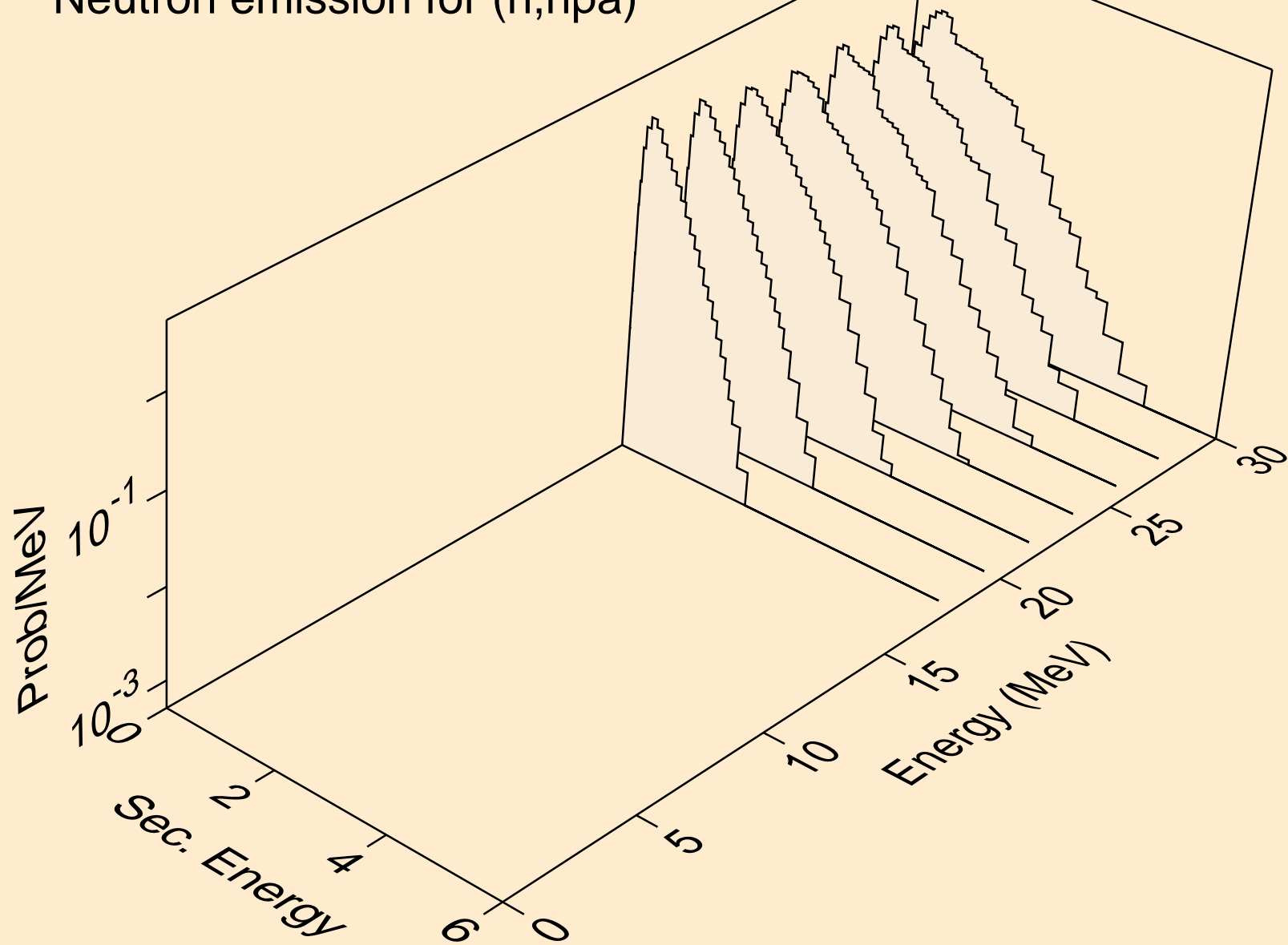

CM251 NEUTRON ACER TENDL-2021 LIBRARY; T=293.6K
Neutron emission for (n,n*c)

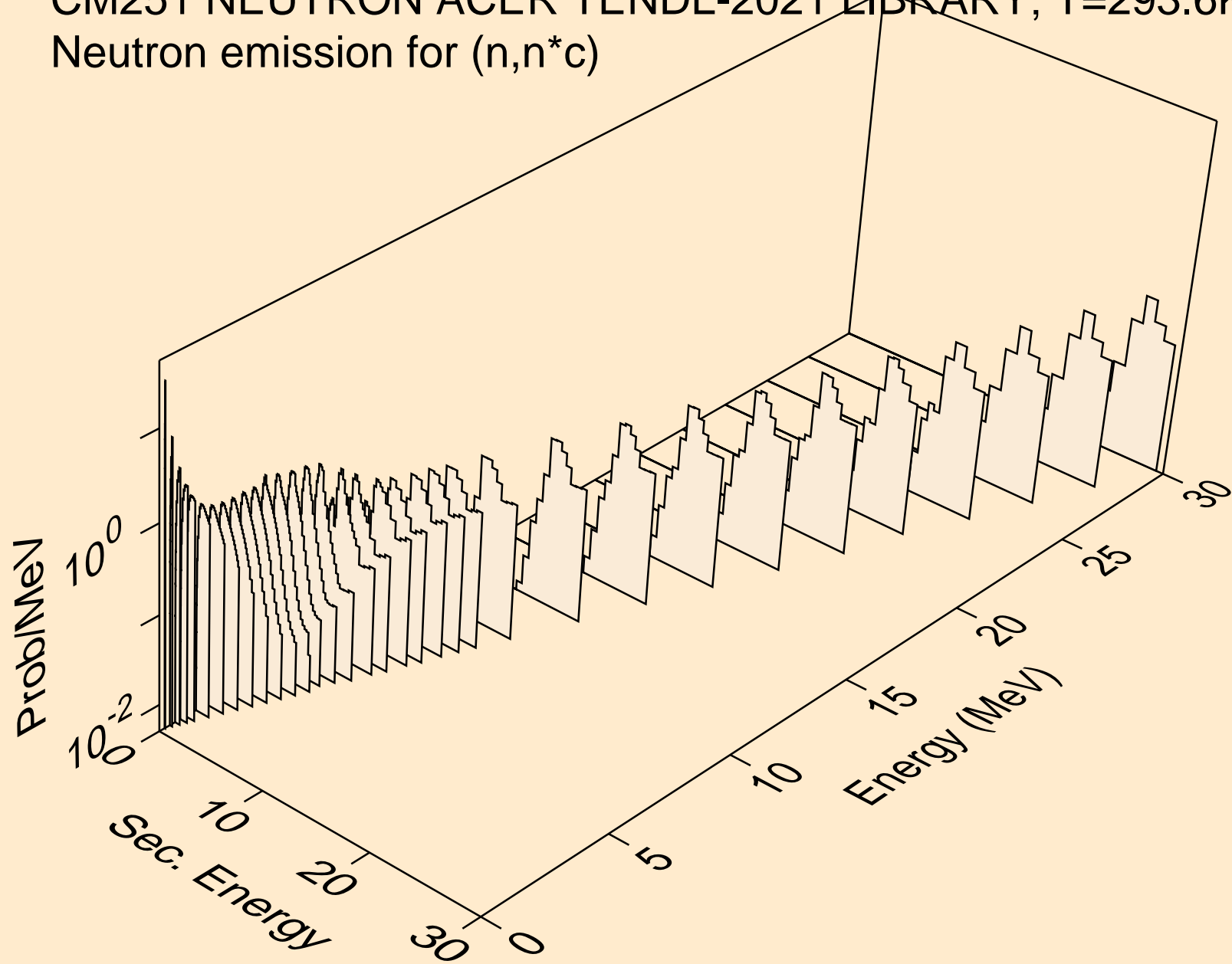

CM251 NEUTRON ACER TENDL-2021 LIBRARY; T=293.6K

Delayed nubar

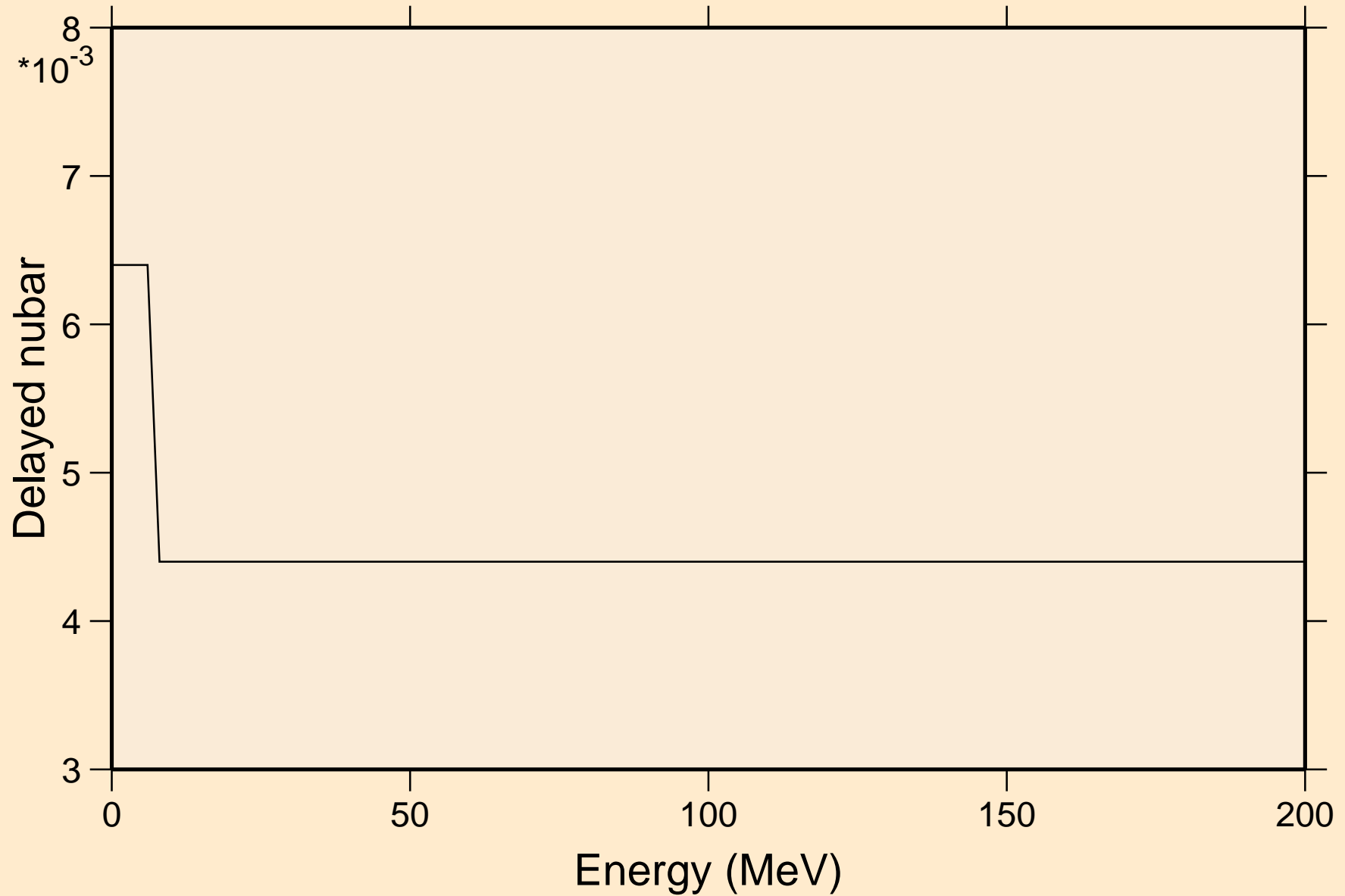

CM251 NEUTRON ACER TENDL-2021 LIBRARY; T=293.6K

Delayed neutron spectra

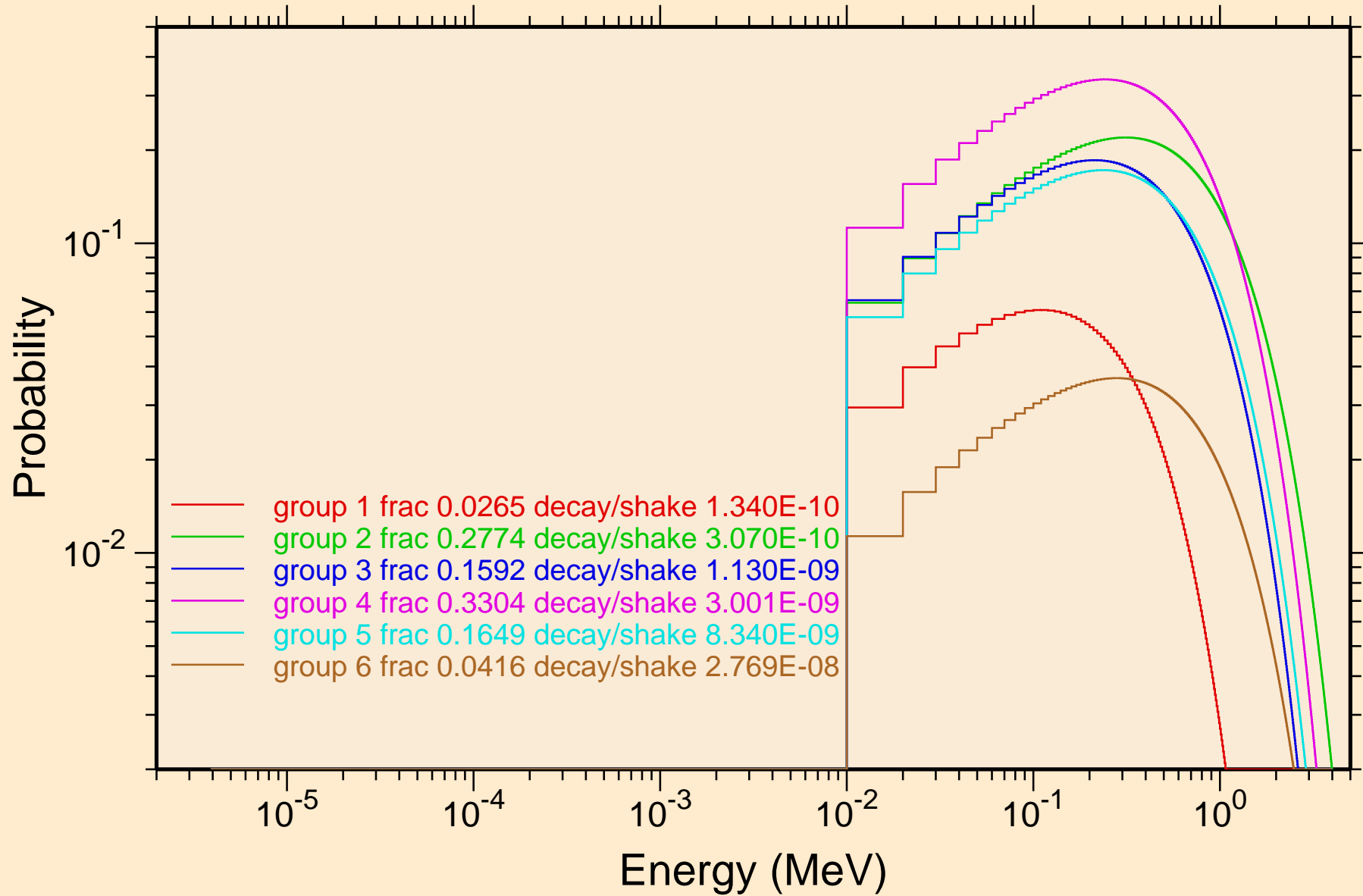

CM251 NEUTRON ACER TENDL-2021 LIBRARY; T=293.6K
Photon emission for (n,x)

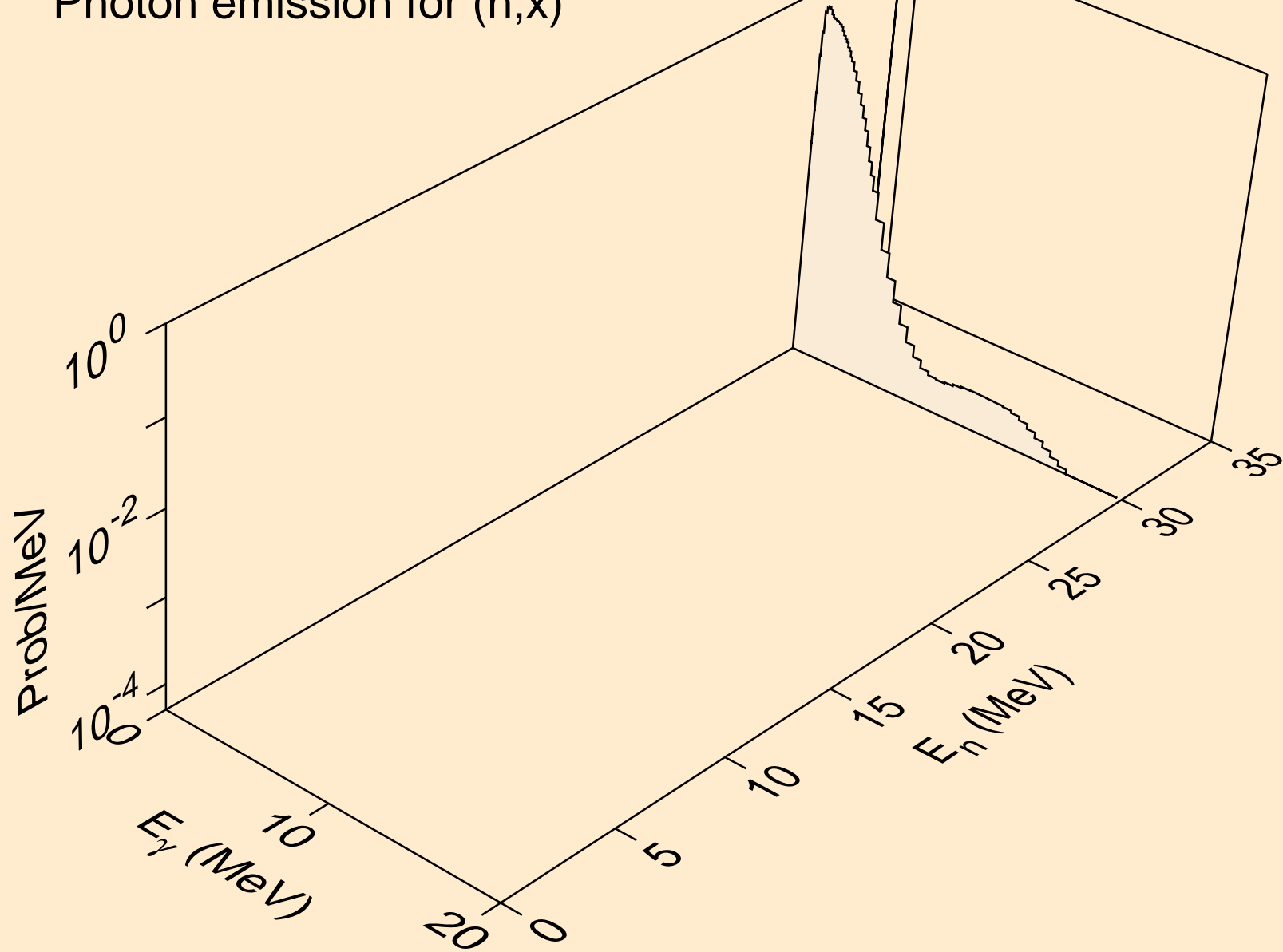

CM251 NEUTRON ACER TENDL-2021 LIBRARY; T=293.6K
Photon emission for (n,2nd)

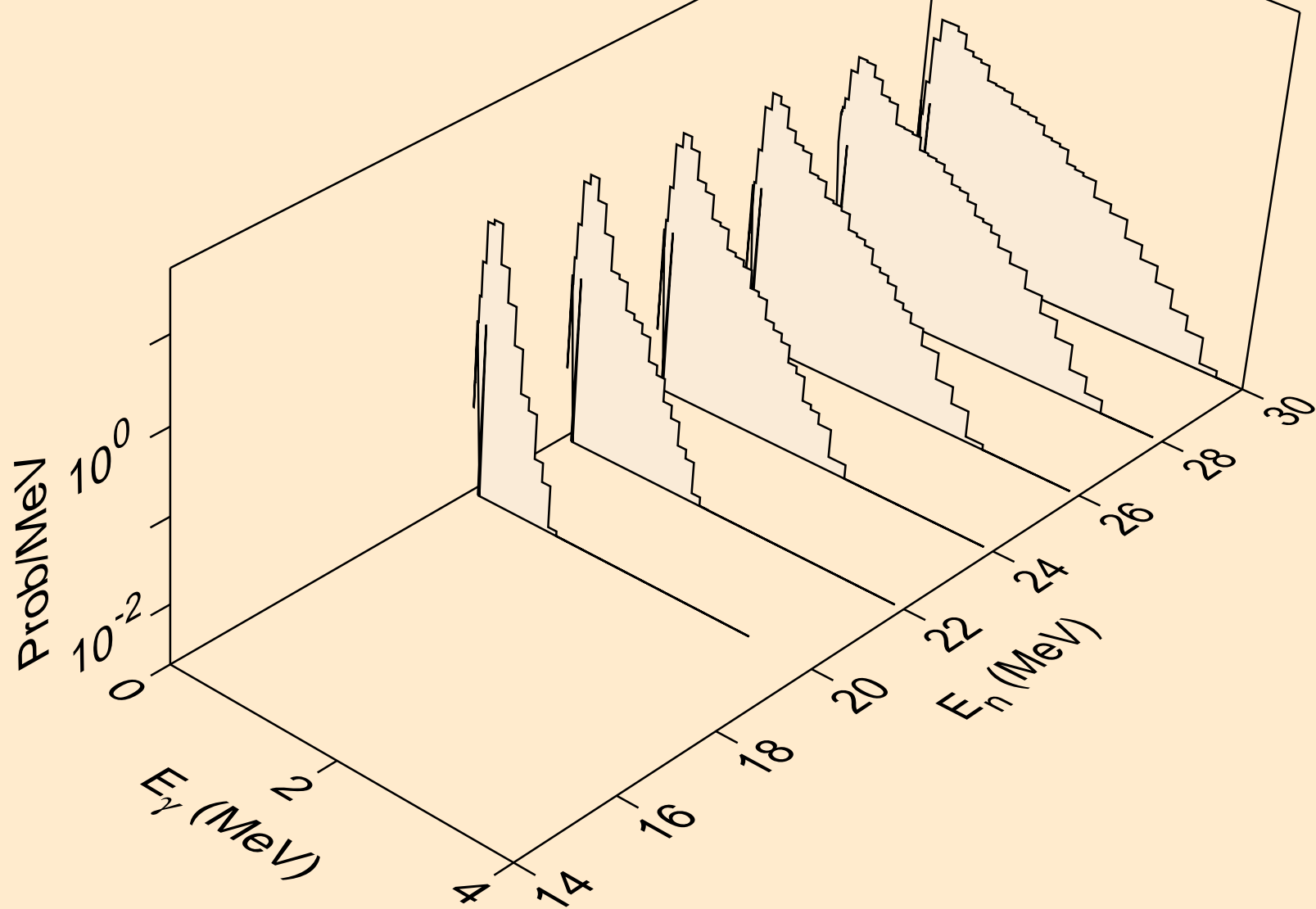

CM251 NEUTRON ACER TENDL-2021 LIBRARY; T=293.6K
Photon emission for (n,2n)

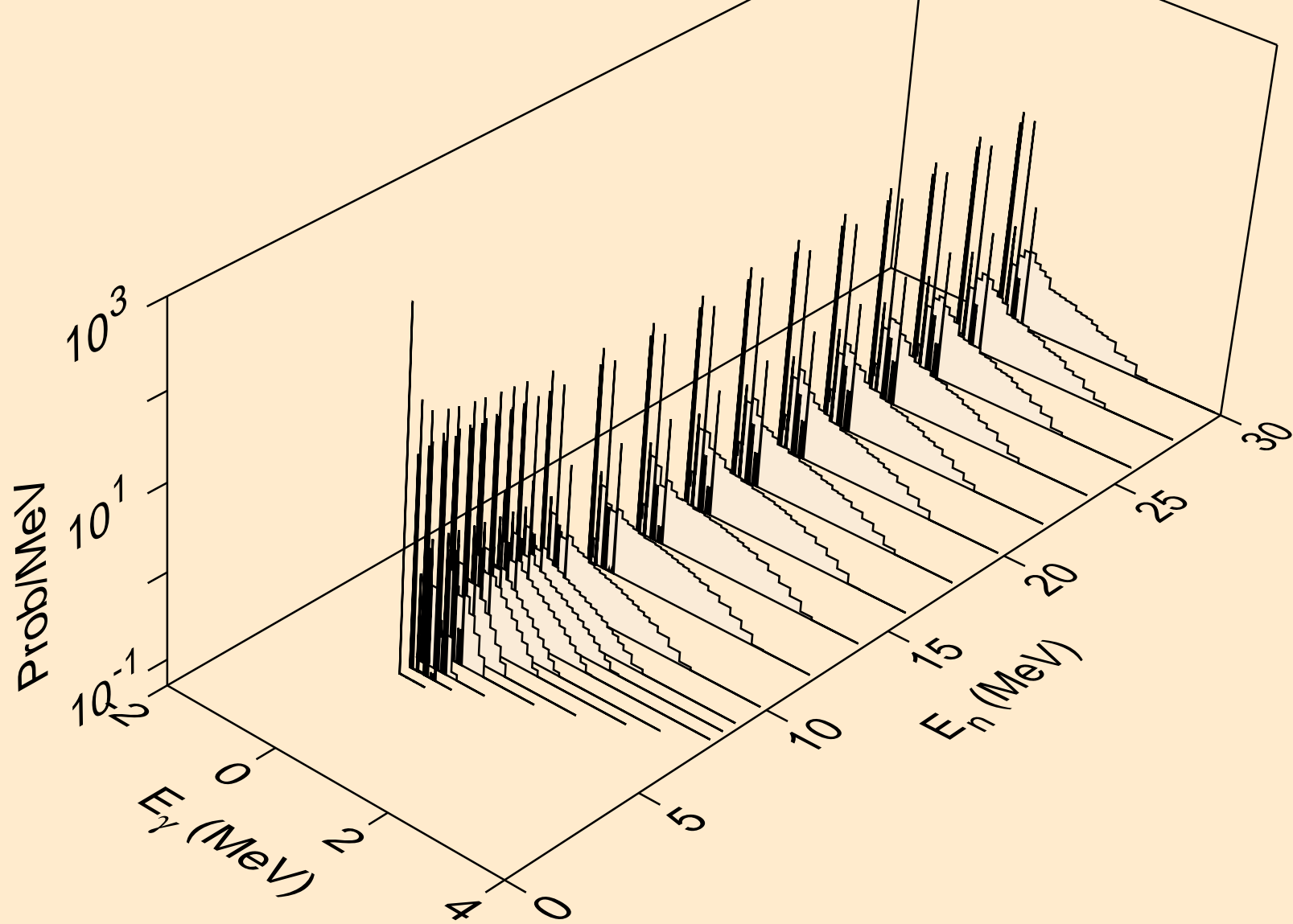

CM251 NEUTRON ACER TENDL-2021 LIBRARY; T=293.6K
Photon emission for (n,3n)

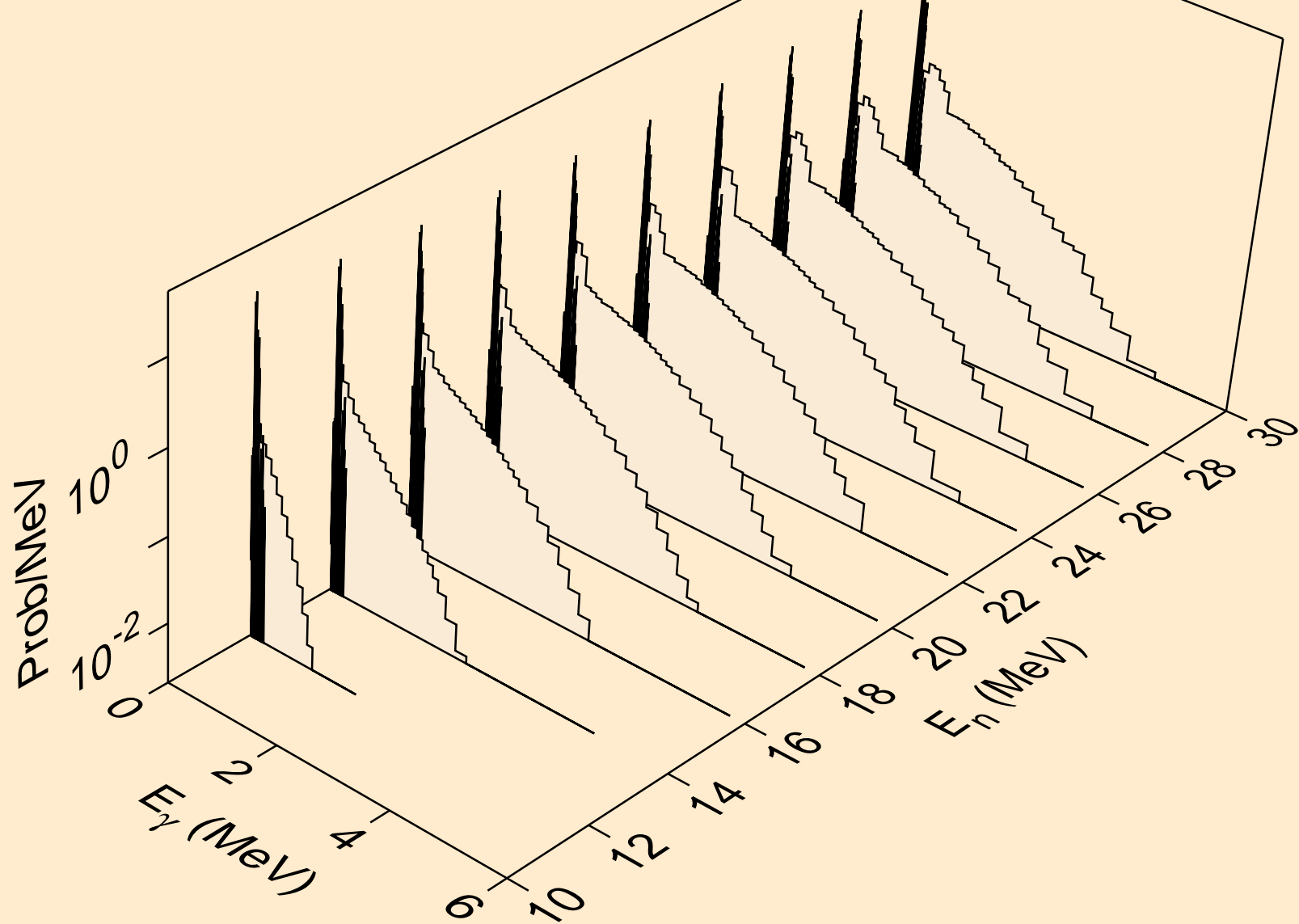

CM251 NEUTRON ACER TENDL-2021 LIBRARY; T=293.6K
Photon emission for (n,n*)a

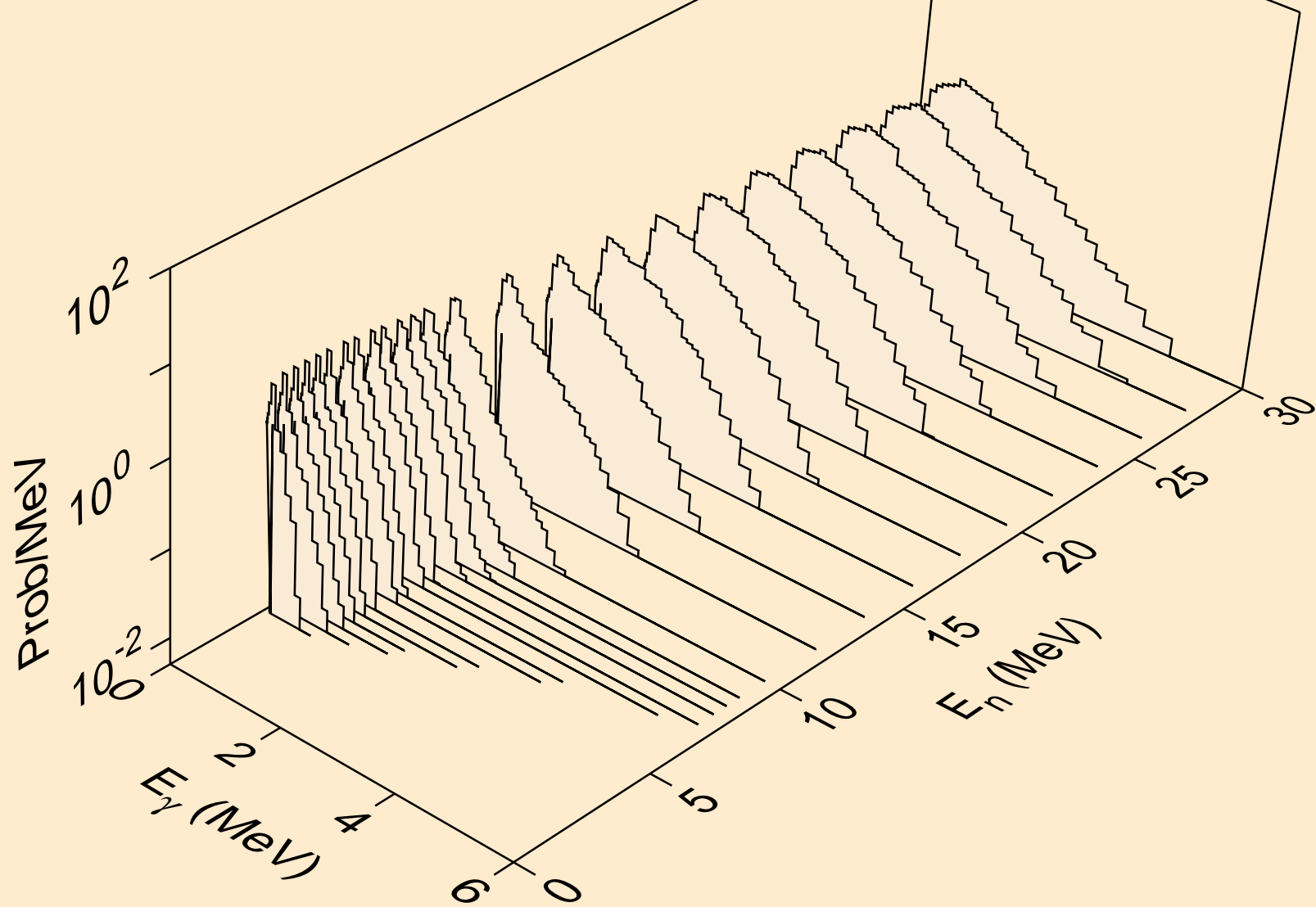

CM251 NEUTRON ACER TENDL-2021 LIBRARY; T=293.6K
Photon emission for (n,2n)a

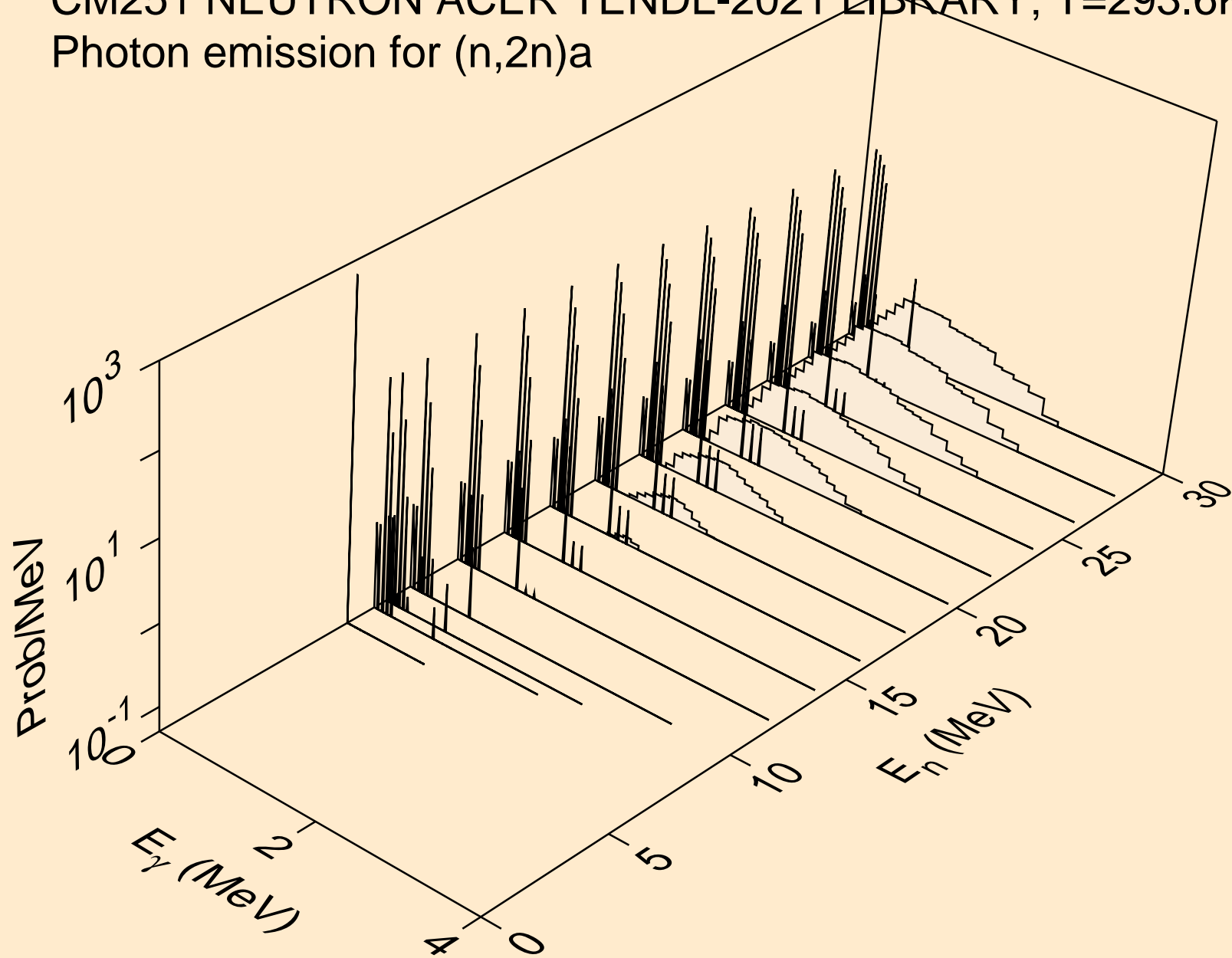

CM251 NEUTRON ACER TENDL-2021 LIBRARY; T=293.6K
Photon emission for (n,3n)a

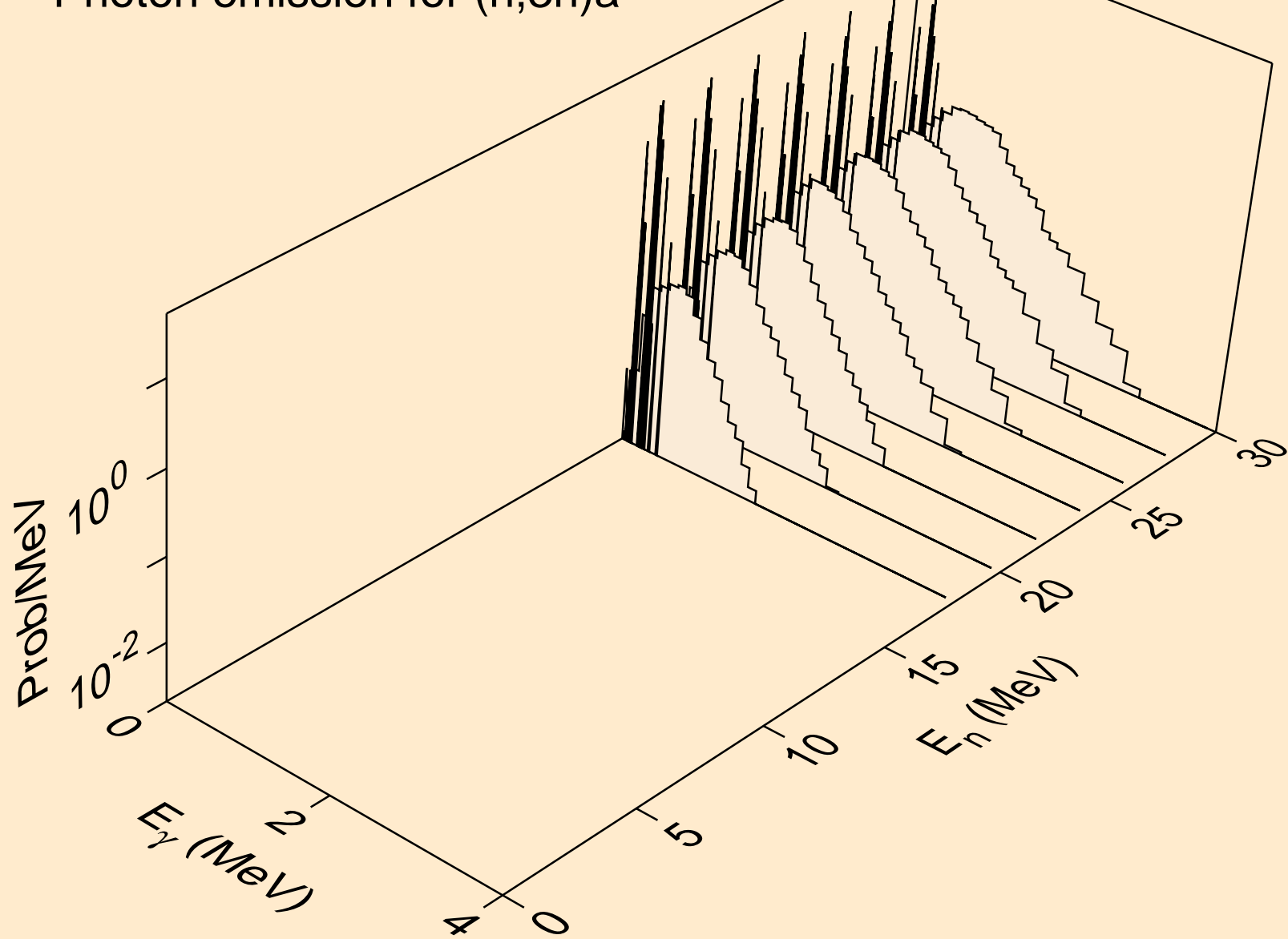

CM251 NEUTRON ACER TENDL-2021 LIBRARY; T=293.6K
Photon emission for (n,n*)p

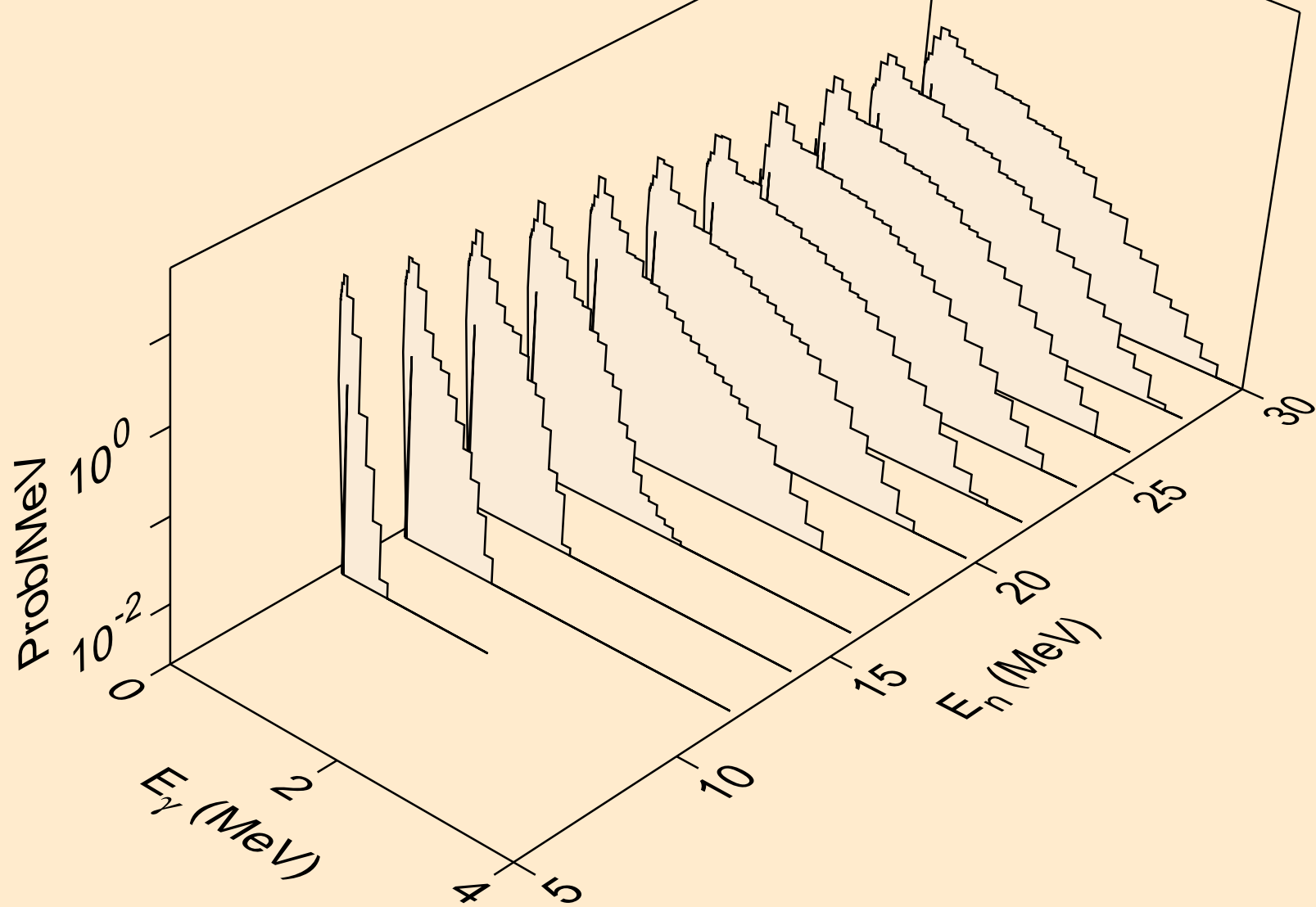

CM251 NEUTRON ACER TENDL-2021 LIBRARY; T=293.6K
Photon emission for (n,n*)d

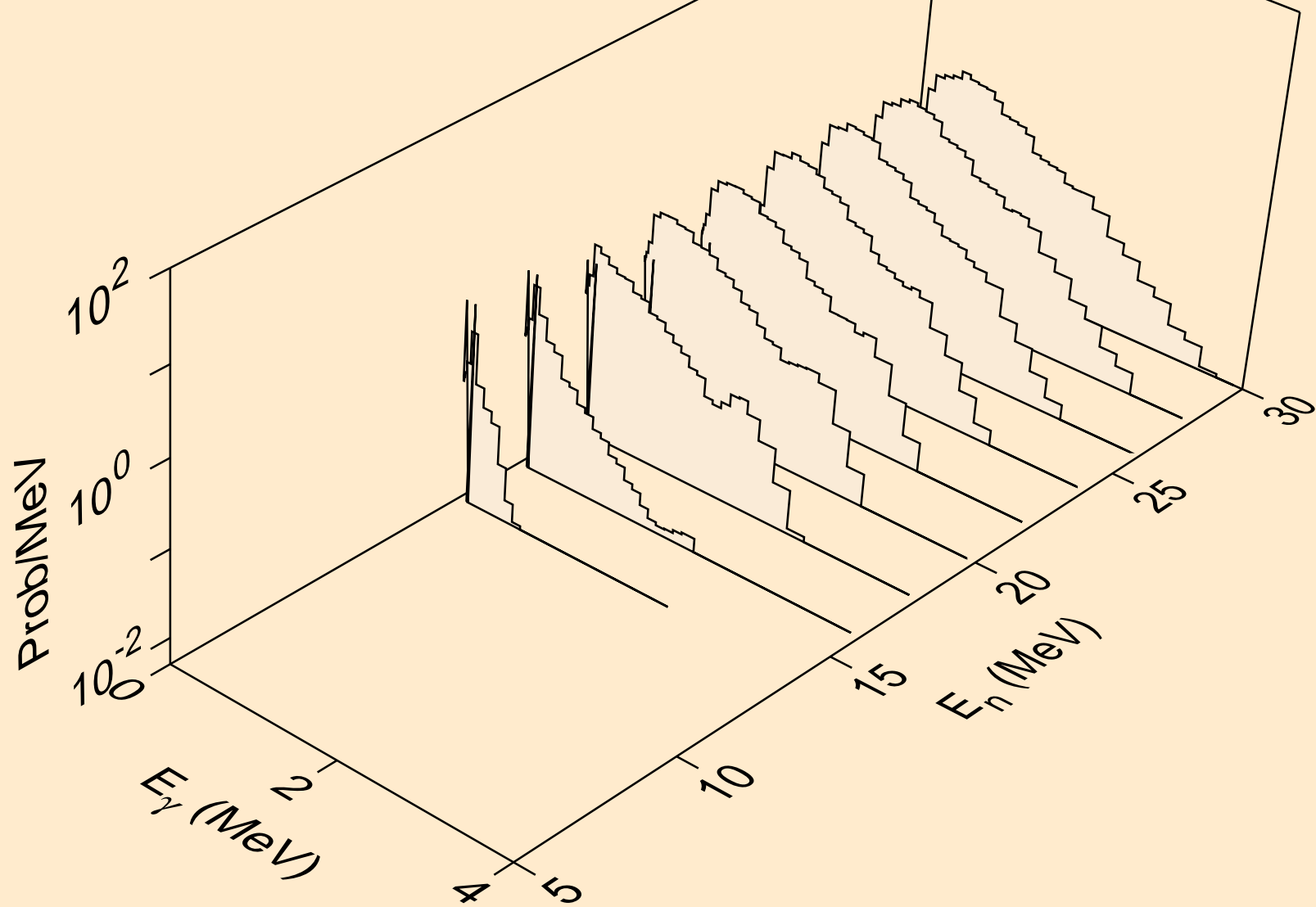

CM251 NEUTRON ACER TENDL-2021 LIBRARY; T=293.6K
Photon emission for (n,n*)t

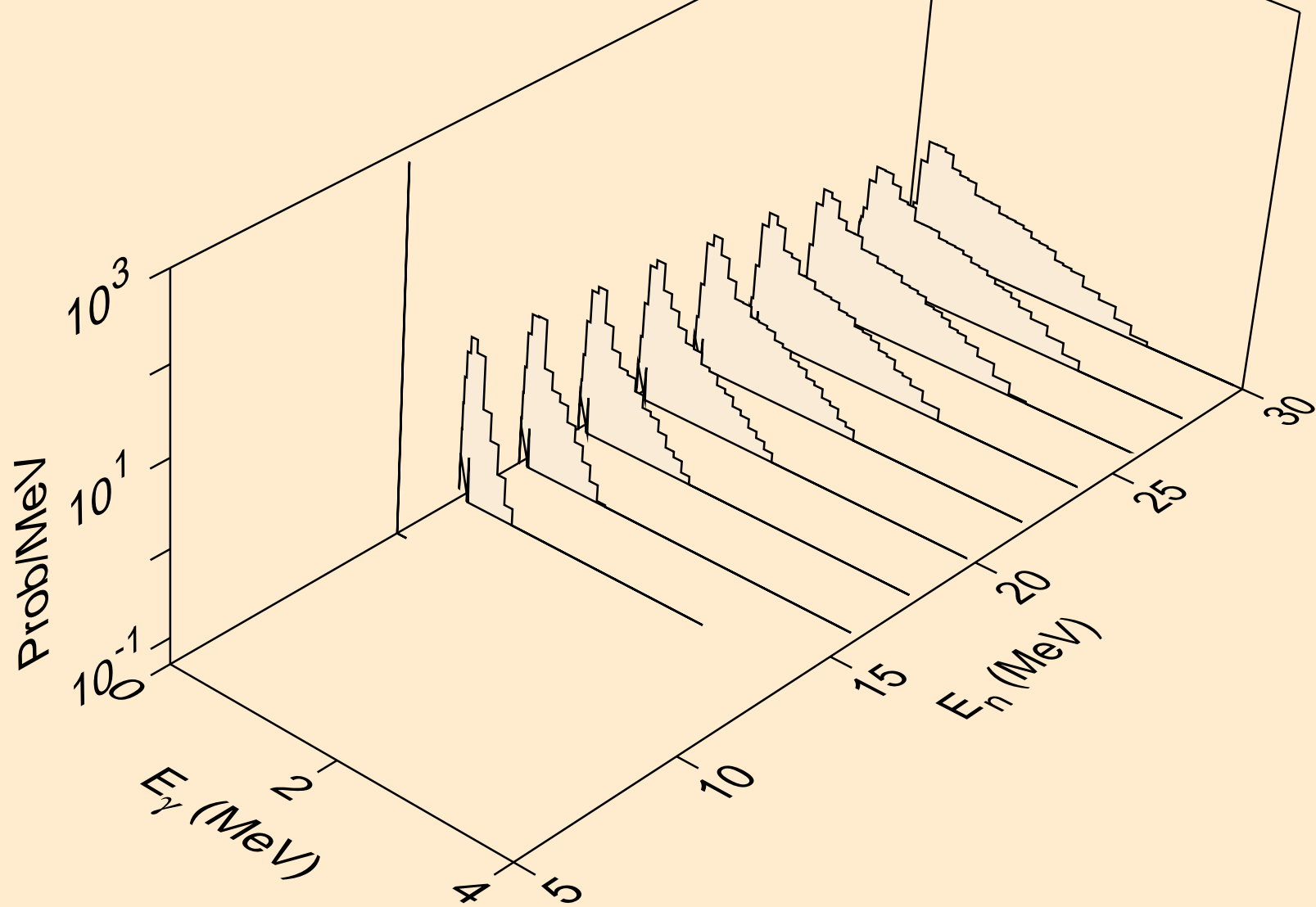

CM251 NEUTRON ACER TENDL-2021 LIBRARY; T=293.6K
Photon emission for (n,n*)he3

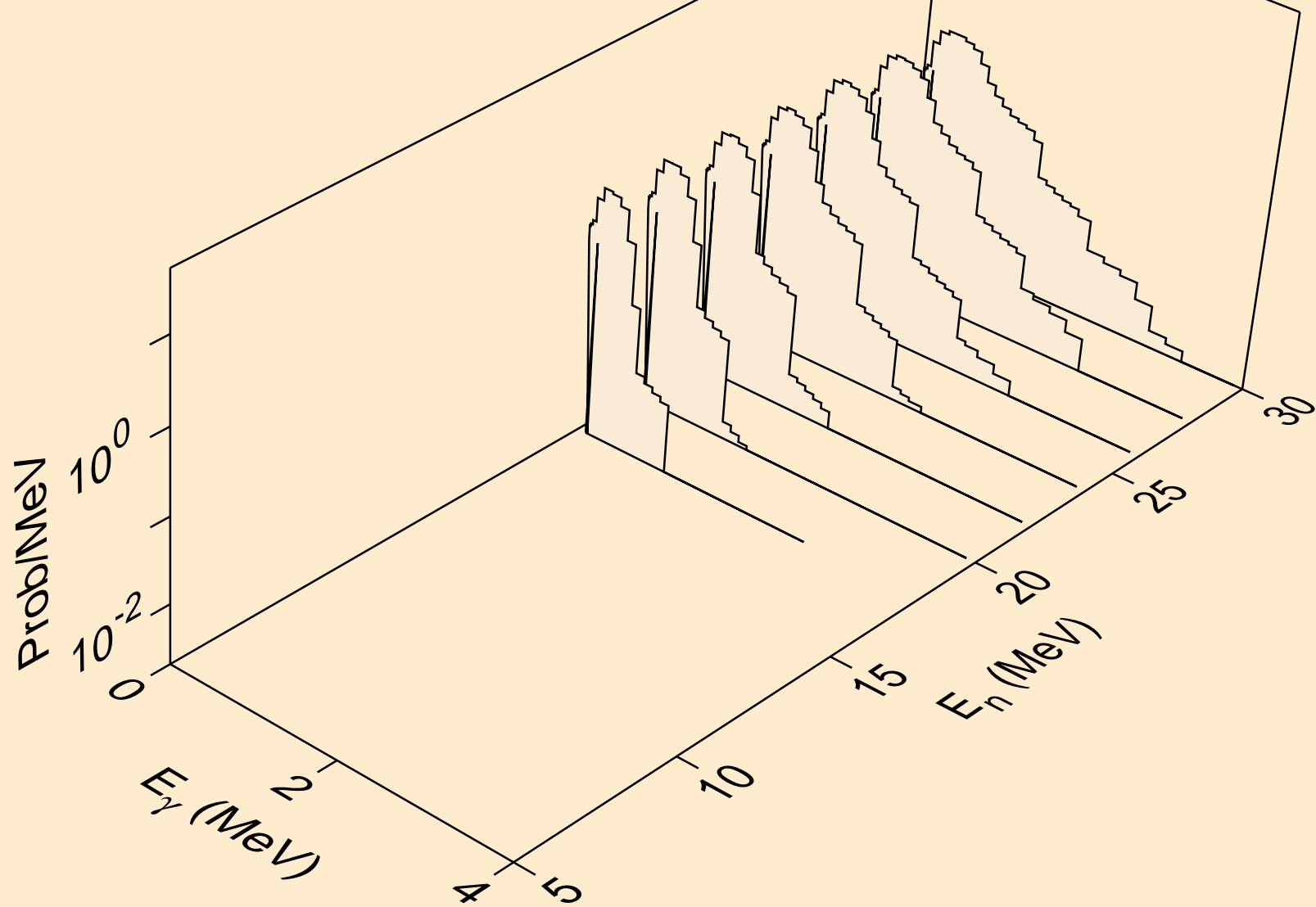

CM251 NEUTRON ACER TENDL-2021 LIBRARY; T=293.6K
Photon emission for (n,4n)

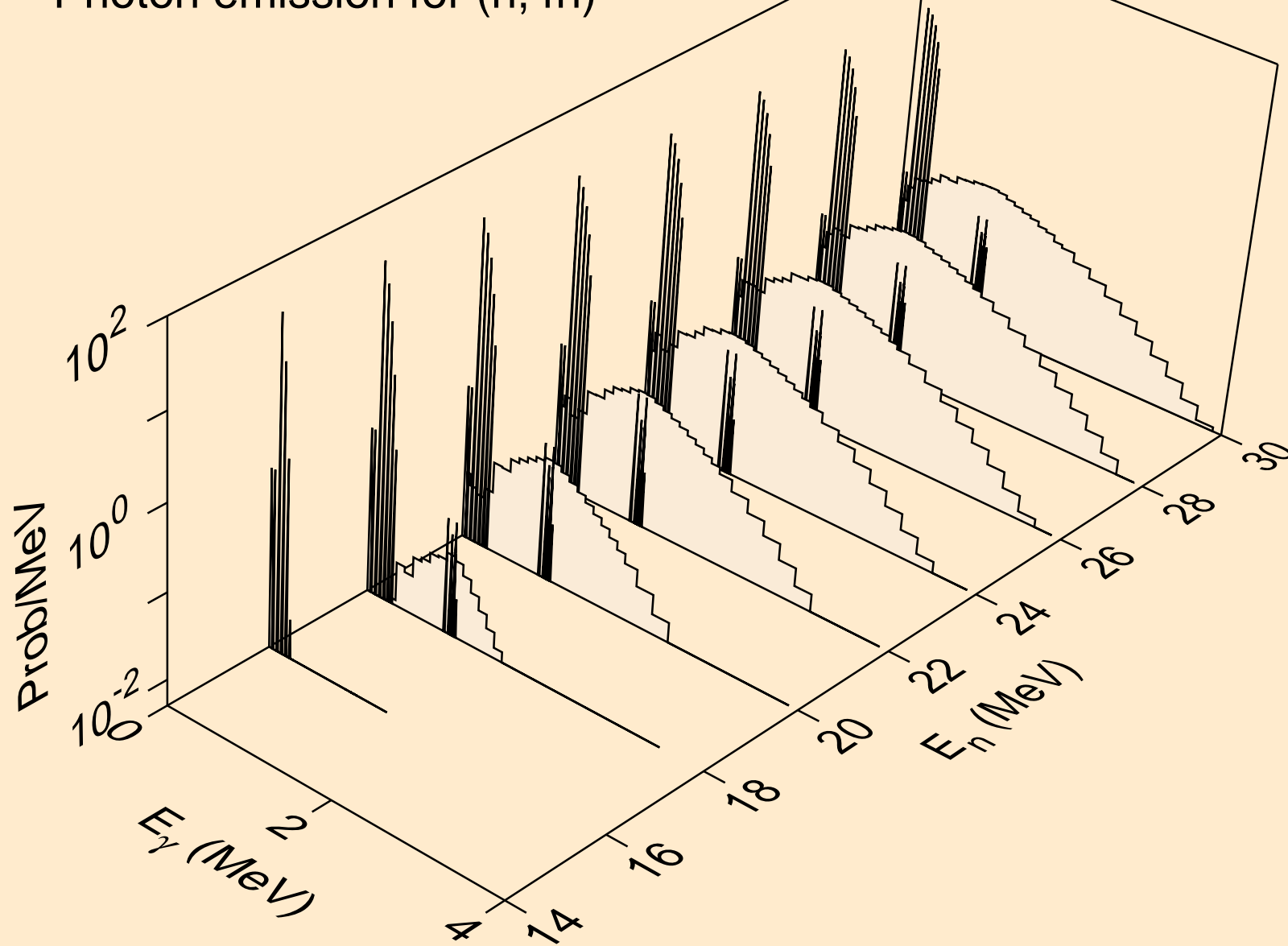

CM251 NEUTRON ACER TENDL-2021 LIBRARY; T=293.6K
Photon emission for (n,2np)

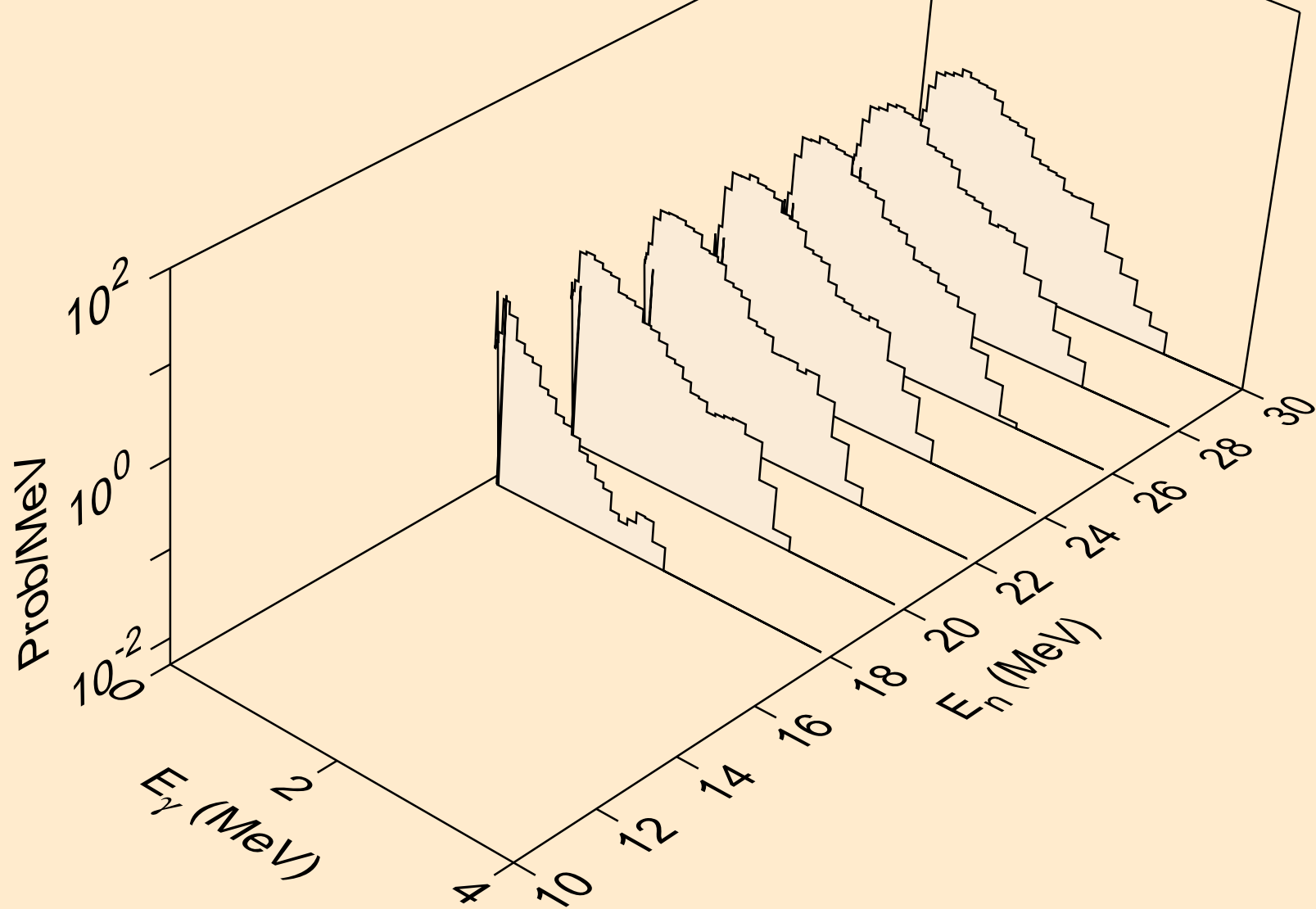

CM251 NEUTRON ACER TENDL-2021 LIBRARY; T=293.6K
Photon emission for (n,3np)

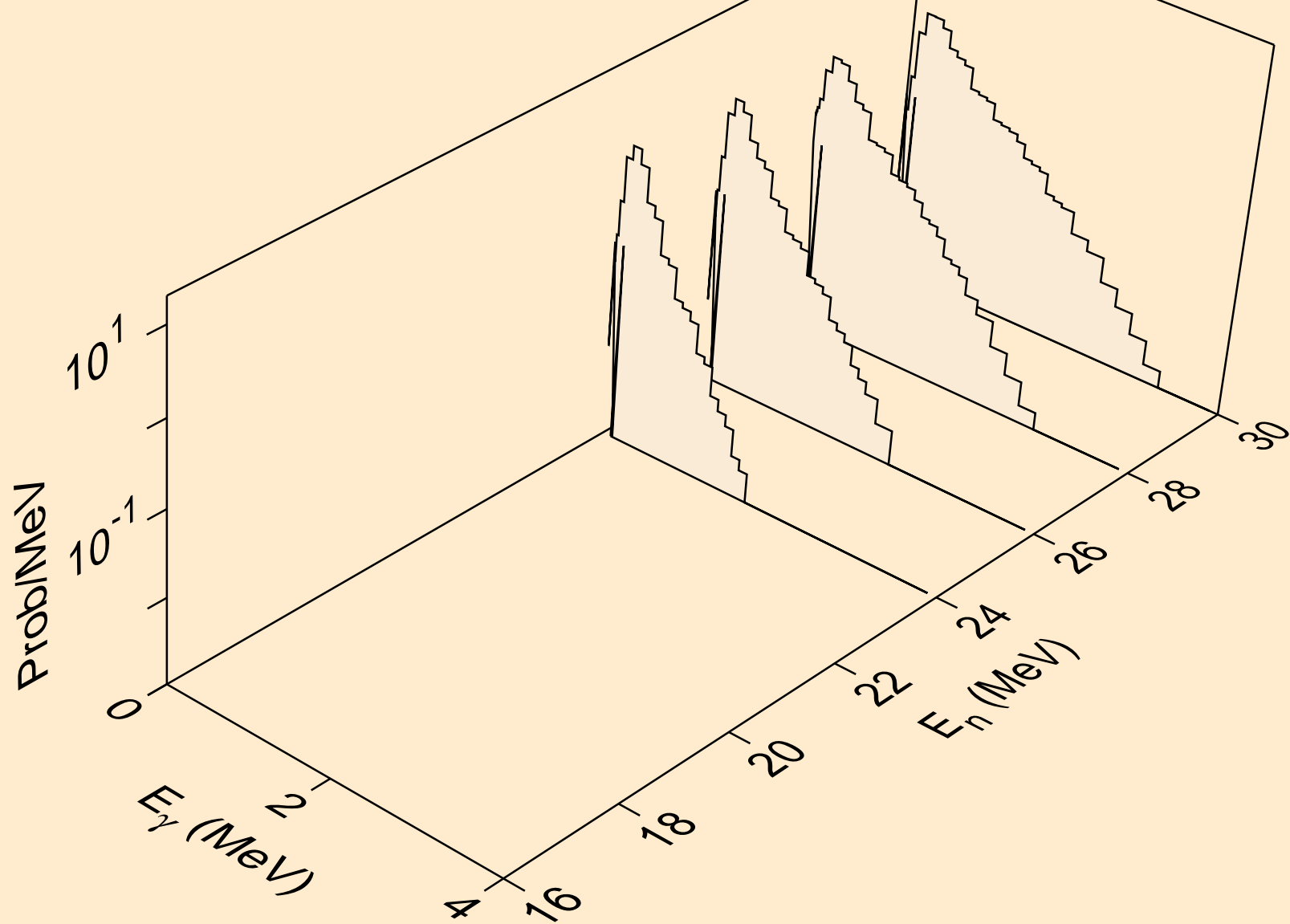

CM251 NEUTRON ACER TENDL-2021 LIBRARY; T=293.6K
Photon emission for (n,npa)

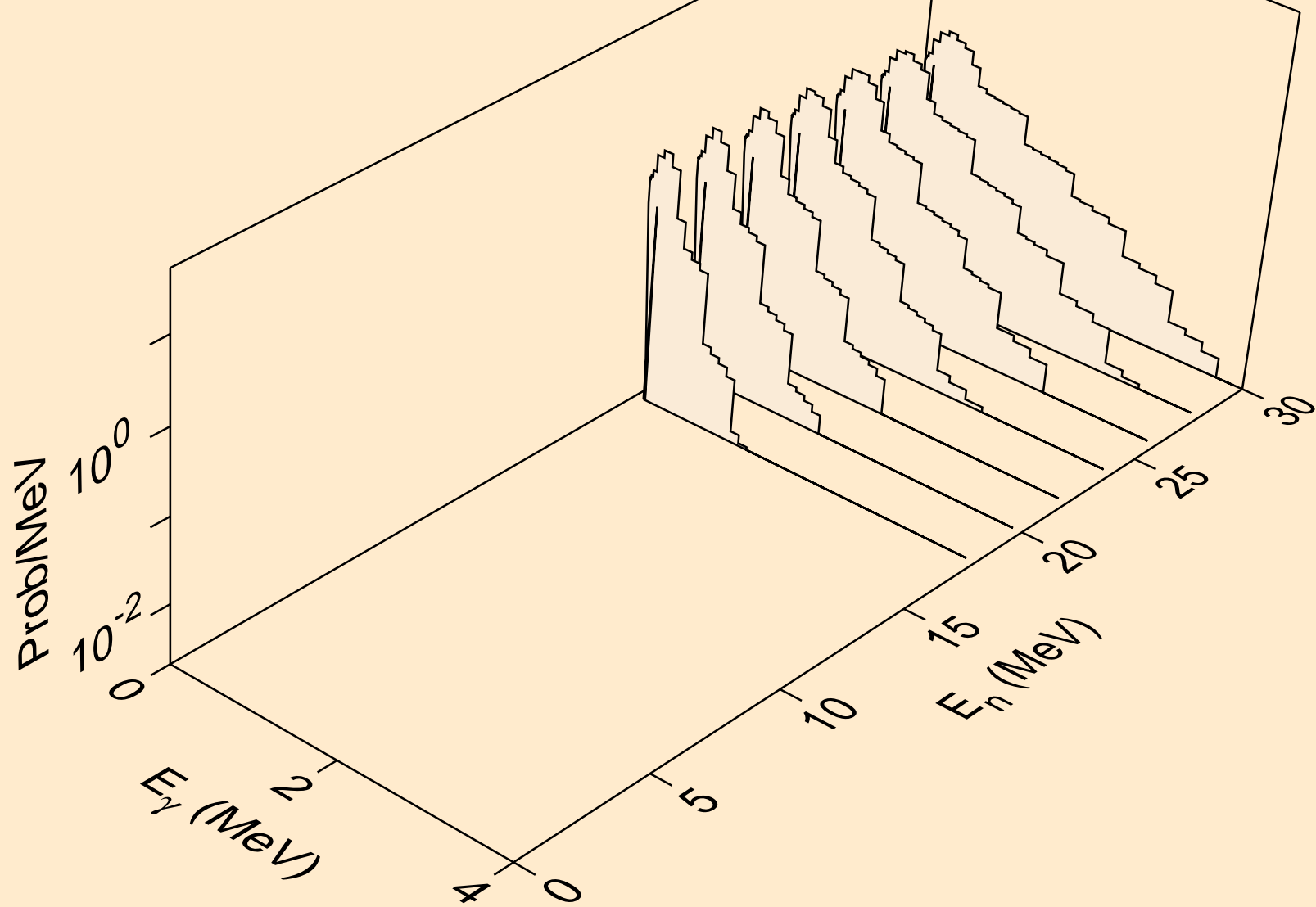

CM251 NEUTRON ACER TENDL-2021 LIBRARY; T=293.6K
Photon emission for (n,n*c)

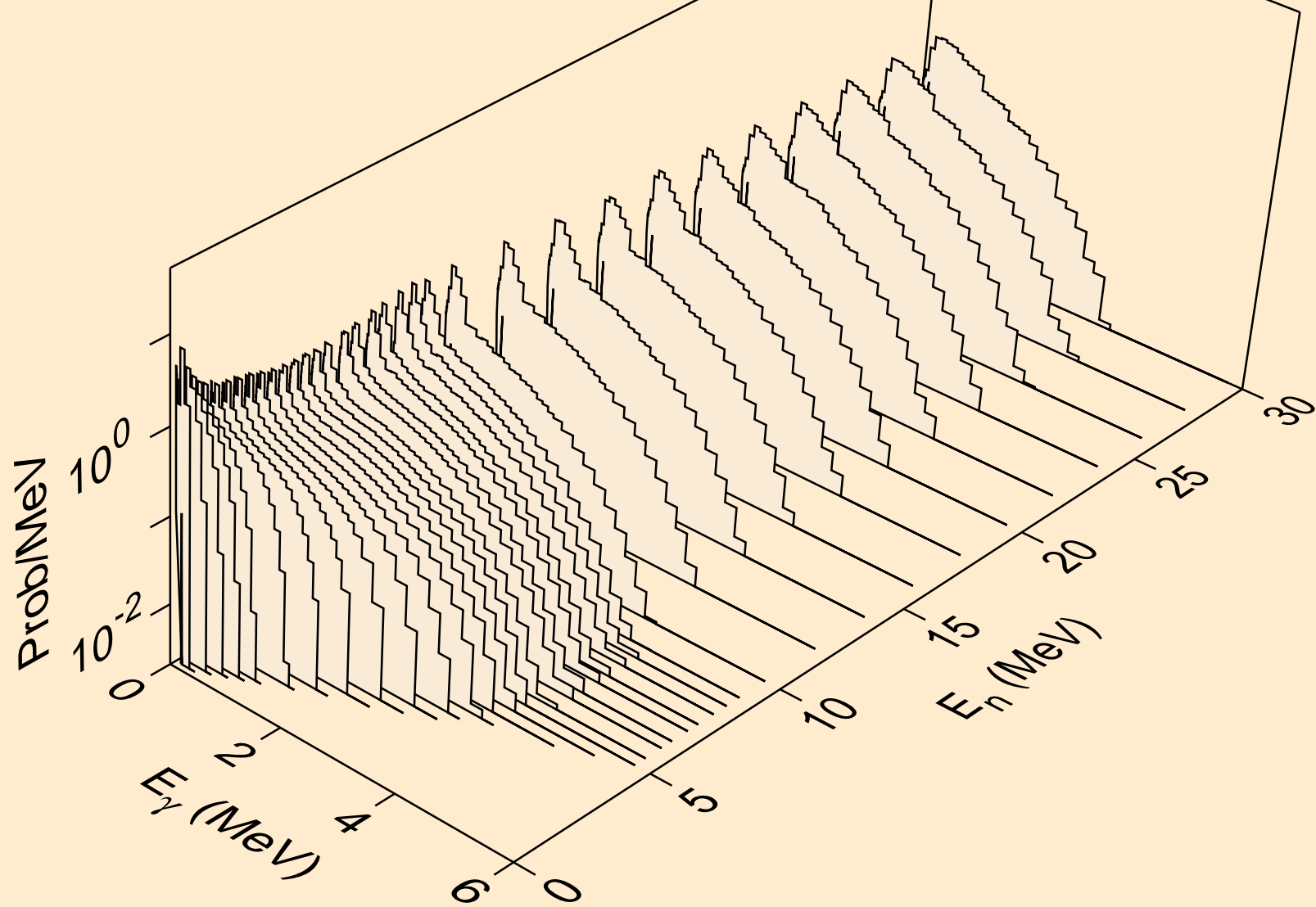

CM251 NEUTRON ACER TENDL-2021 LIBRARY; T=293.6K
Photon emission for (n,gma)

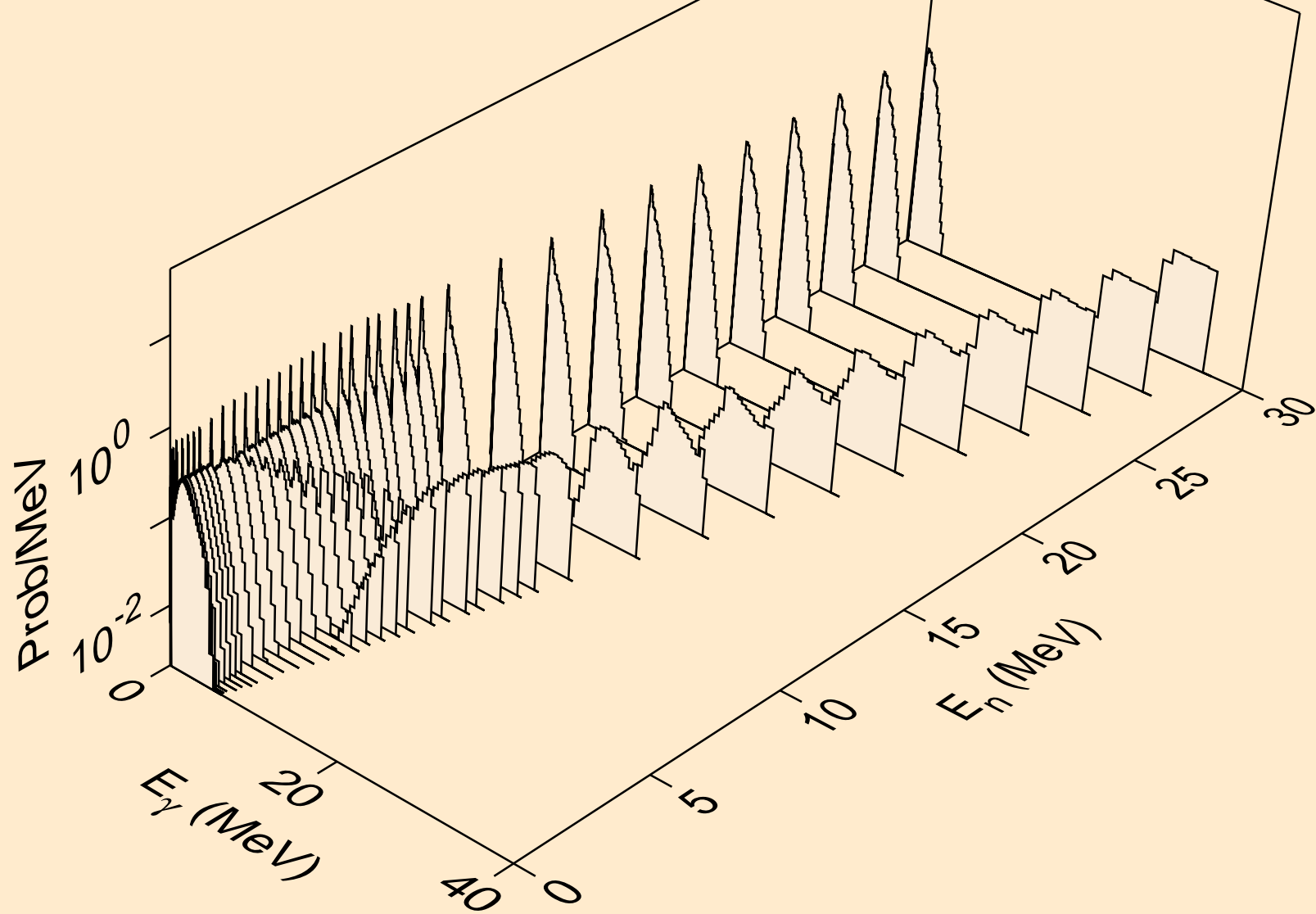

CM251 NEUTRON ACER TENDL-2021 LIBRARY; T=293.6K
Photon emission for (n,p)

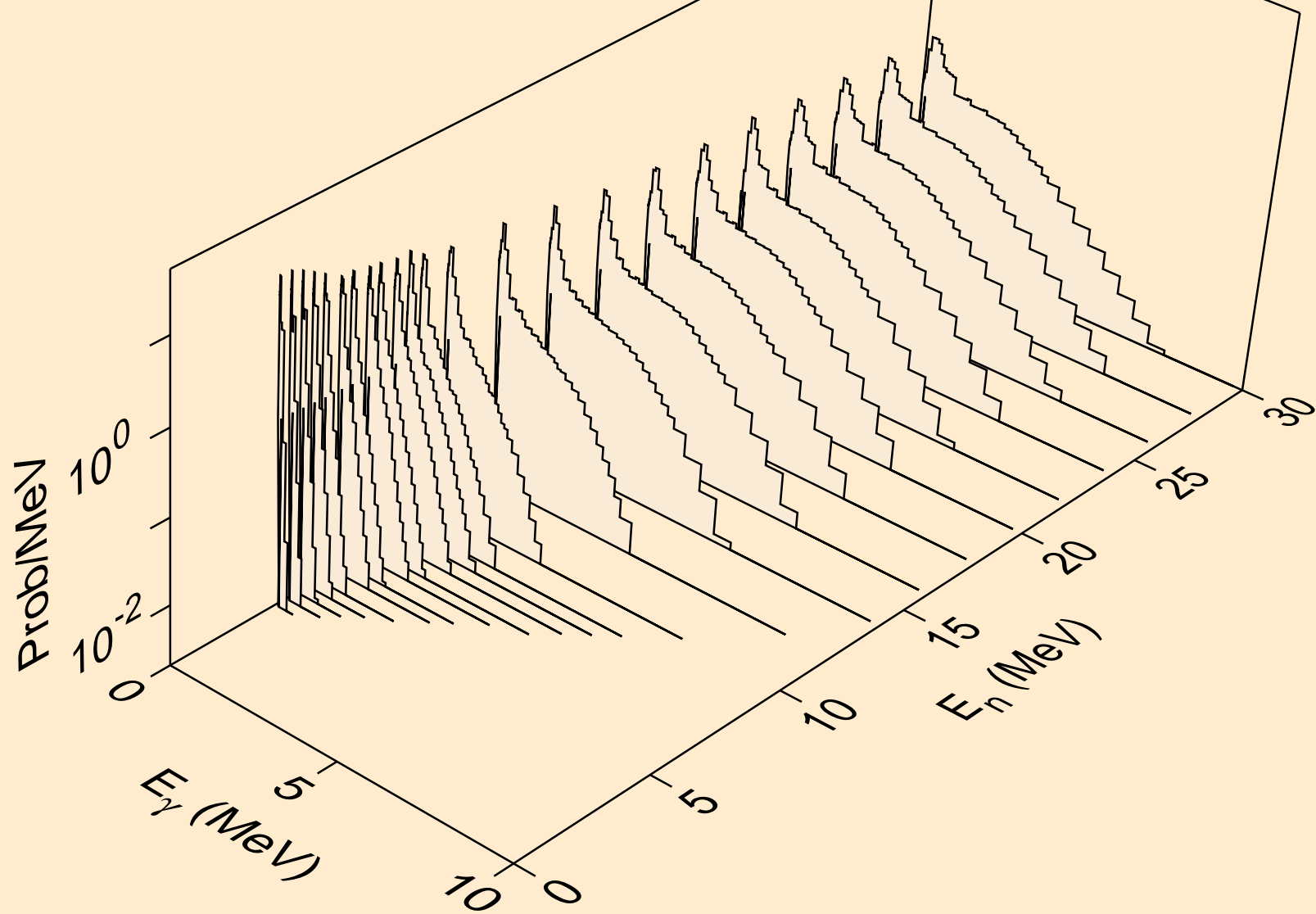

CM251 NEUTRON ACER TENDL-2021 LIBRARY; T=293.6K
Photon emission for (n,d)

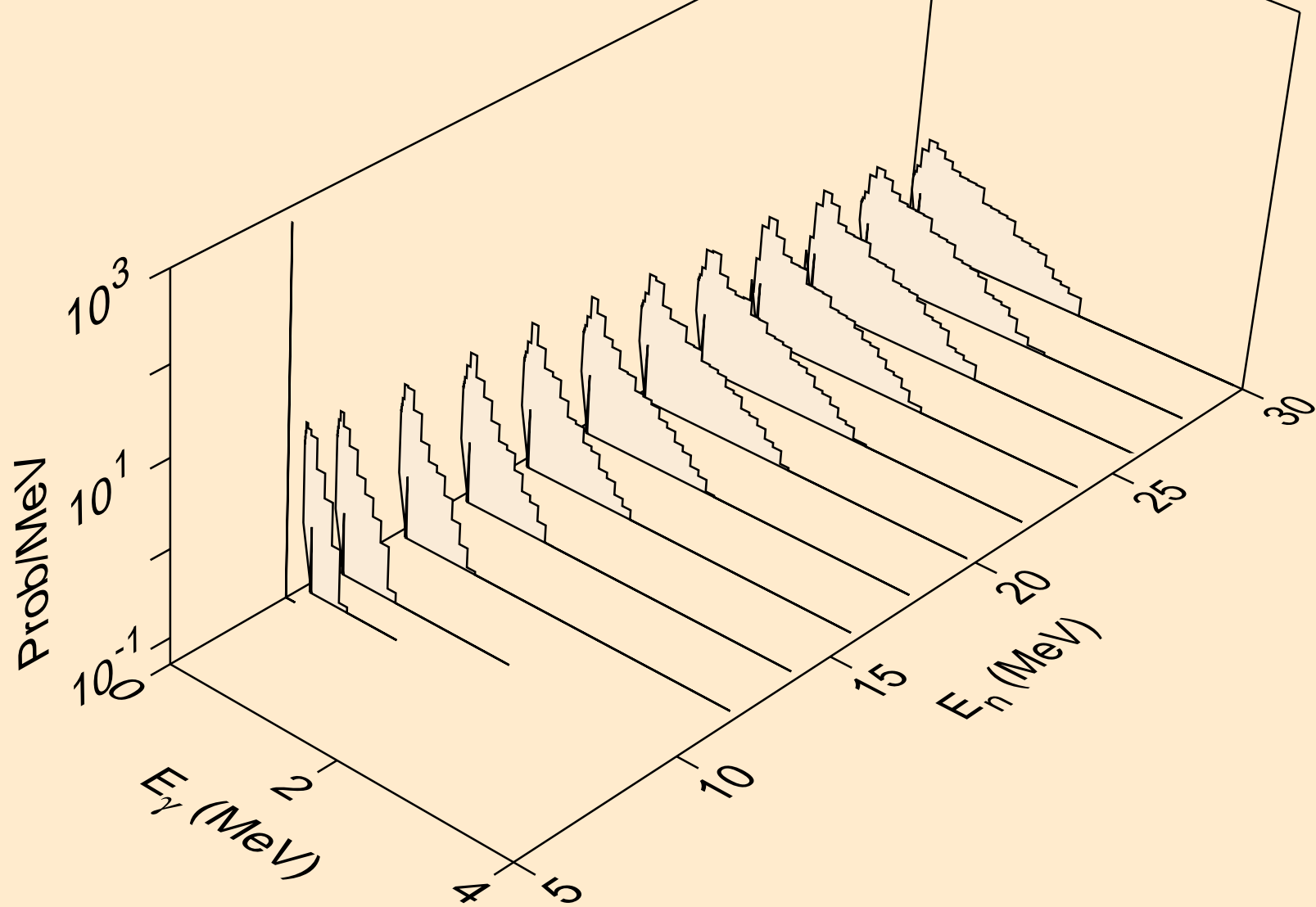

CM251 NEUTRON ACER TENDL-2021 LIBRARY; T=293.6K
Photon emission for (n,t)

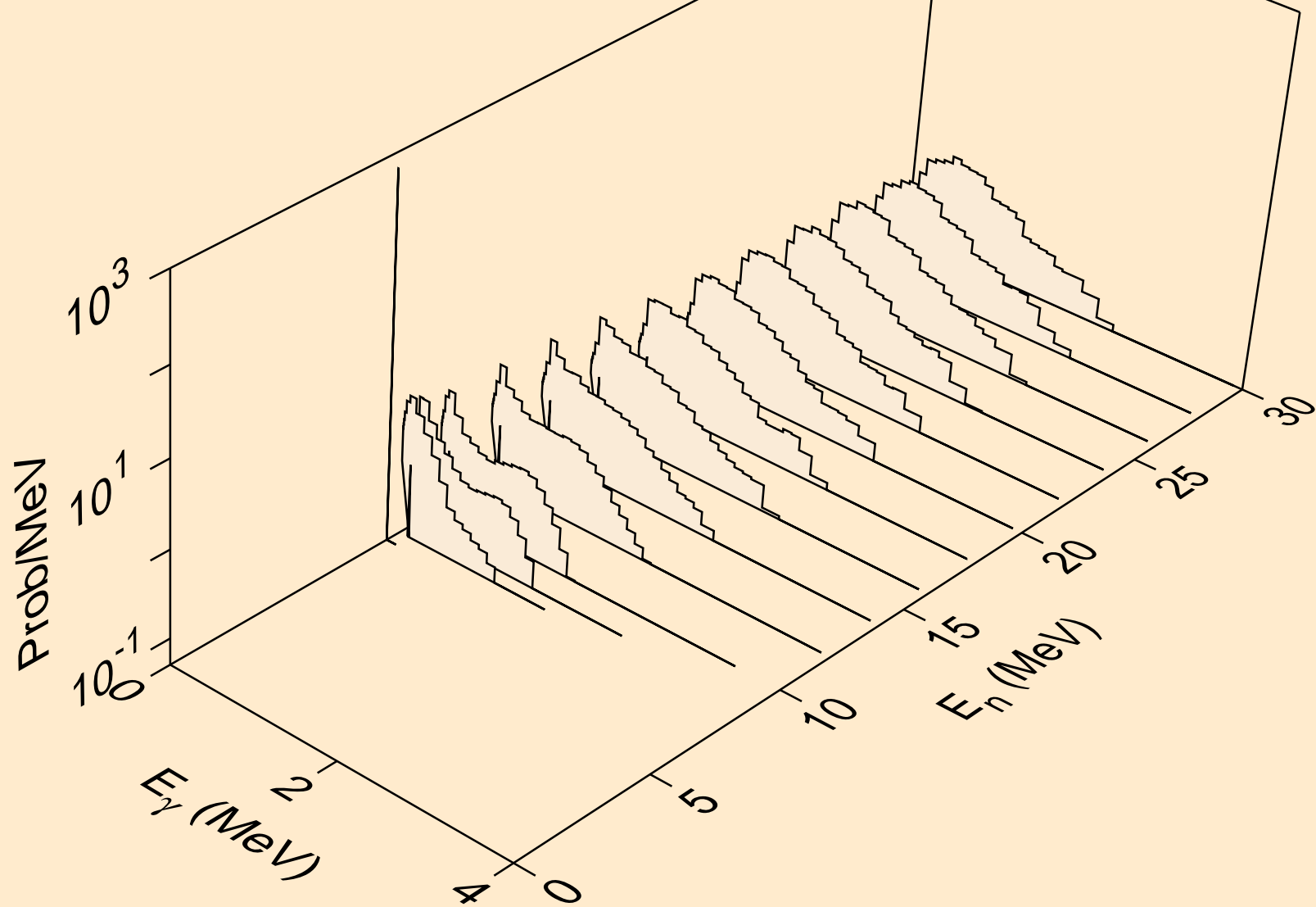

CM251 NEUTRON ACER TENDL-2021 LIBRARY; T=293.6K
Photon emission for (n,he3)

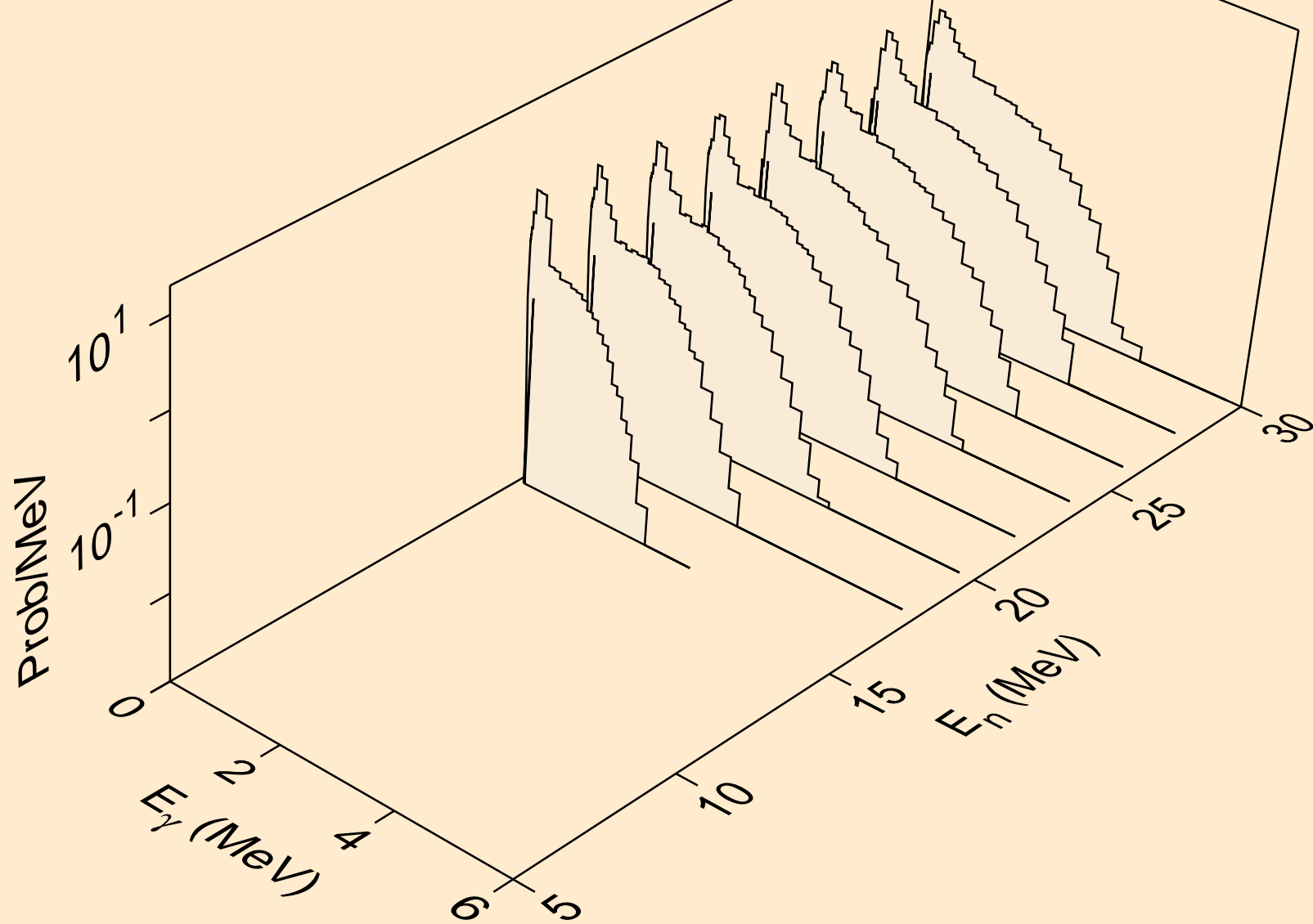

CM251 NEUTRON ACER TENDL-2021 LIBRARY; T=293.6K
Photon emission for (n,a)

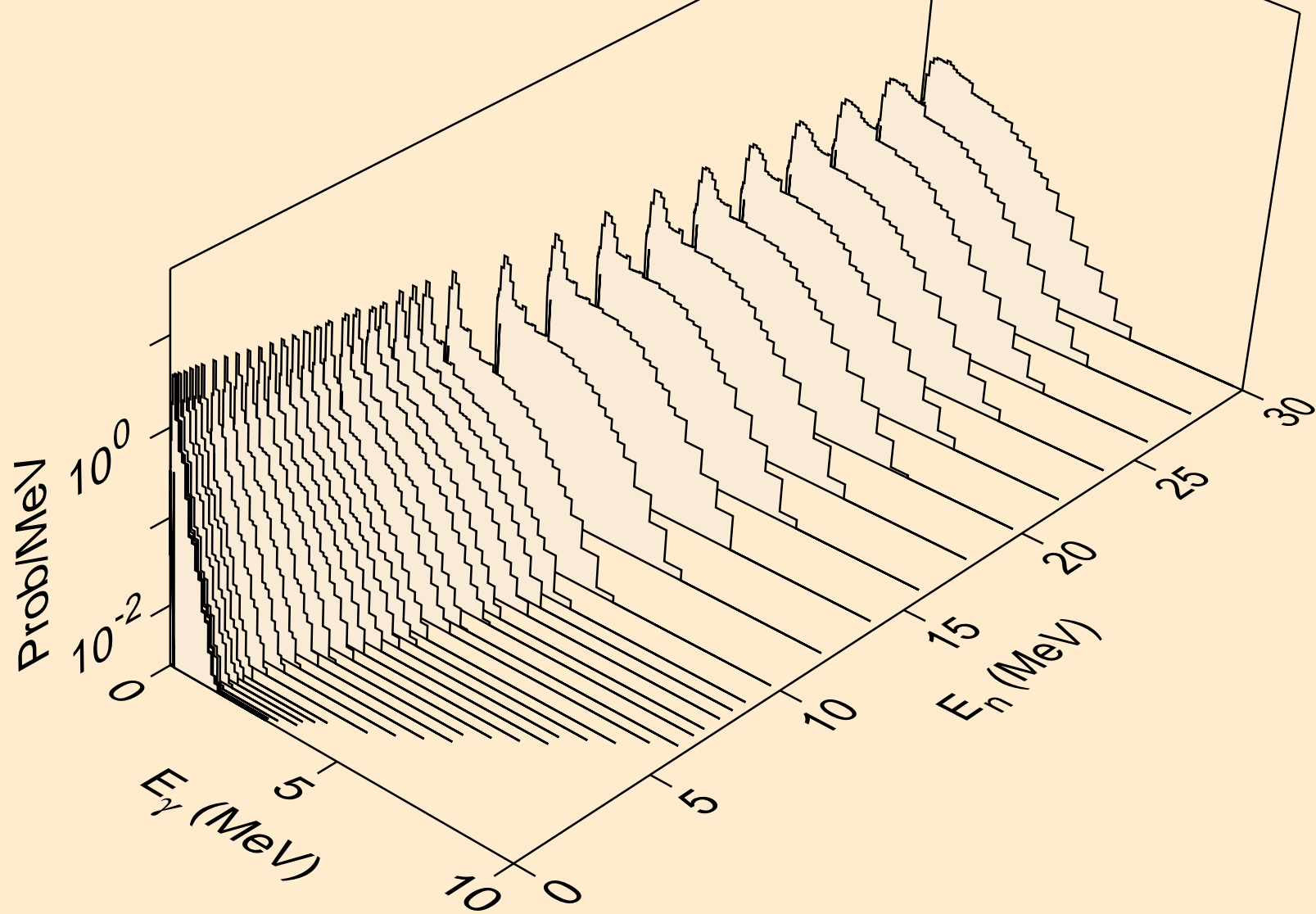

CM251 NEUTRON ACER TENDL-2021 LIBRARY; T=293.6K
Photon emission for (n,2p)

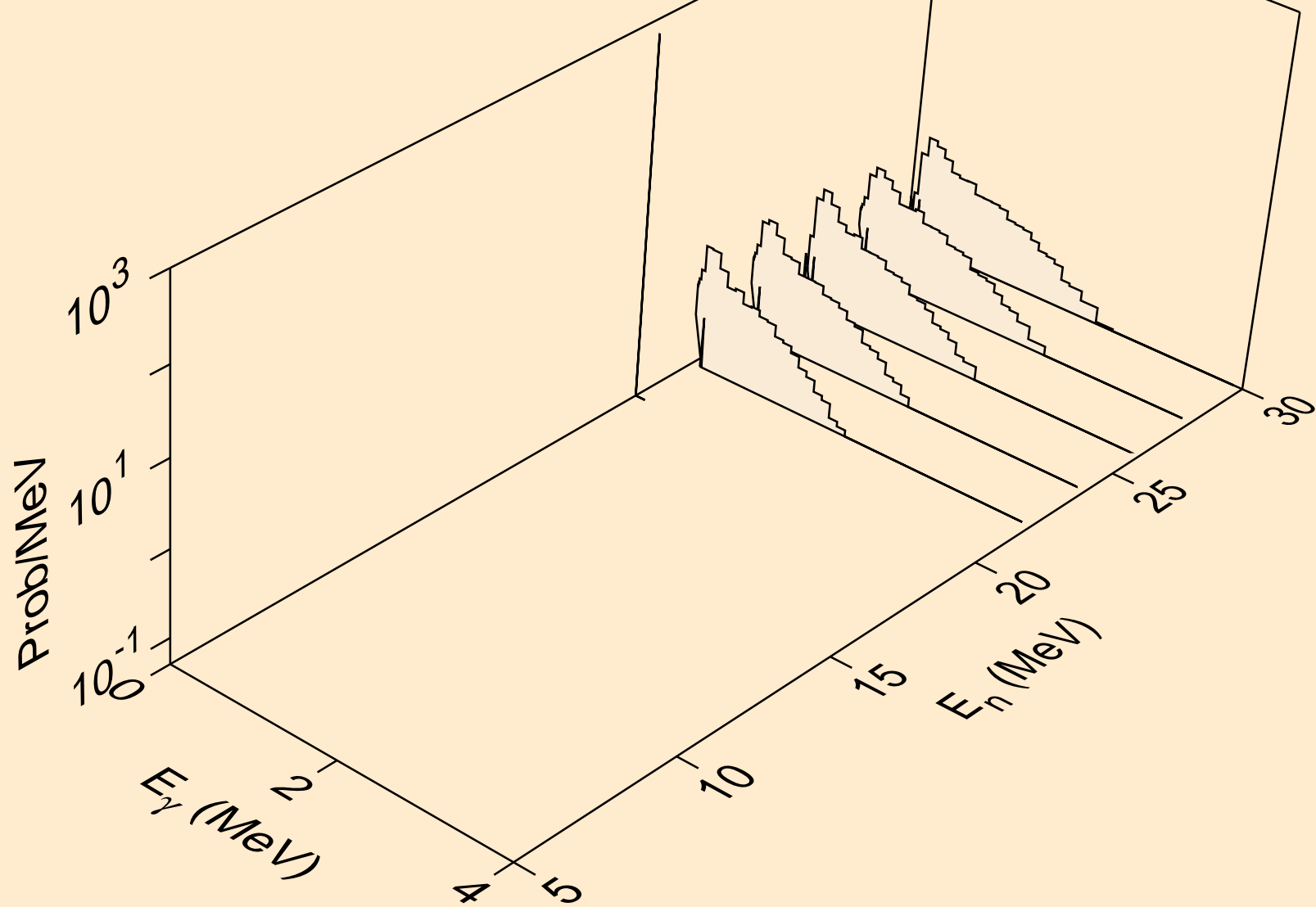

CM251 NEUTRON ACER TENDL-2021 LIBRARY; T=293.6K
Photon emission for (n,p α)

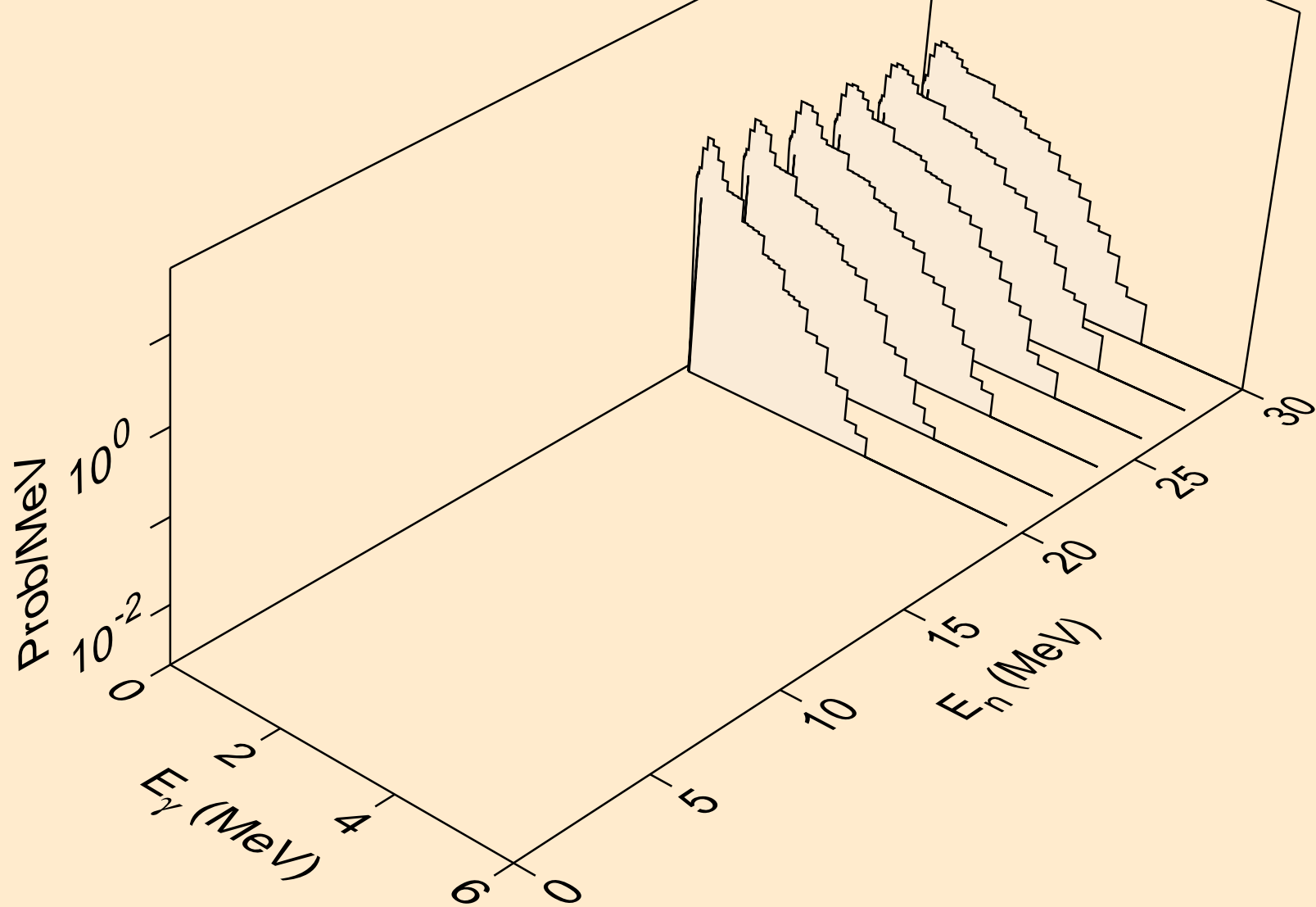

CM251 NEUTRON ACER TENDL-2021 LIBRARY; T=293.6K
Photon emission for (n,pt)

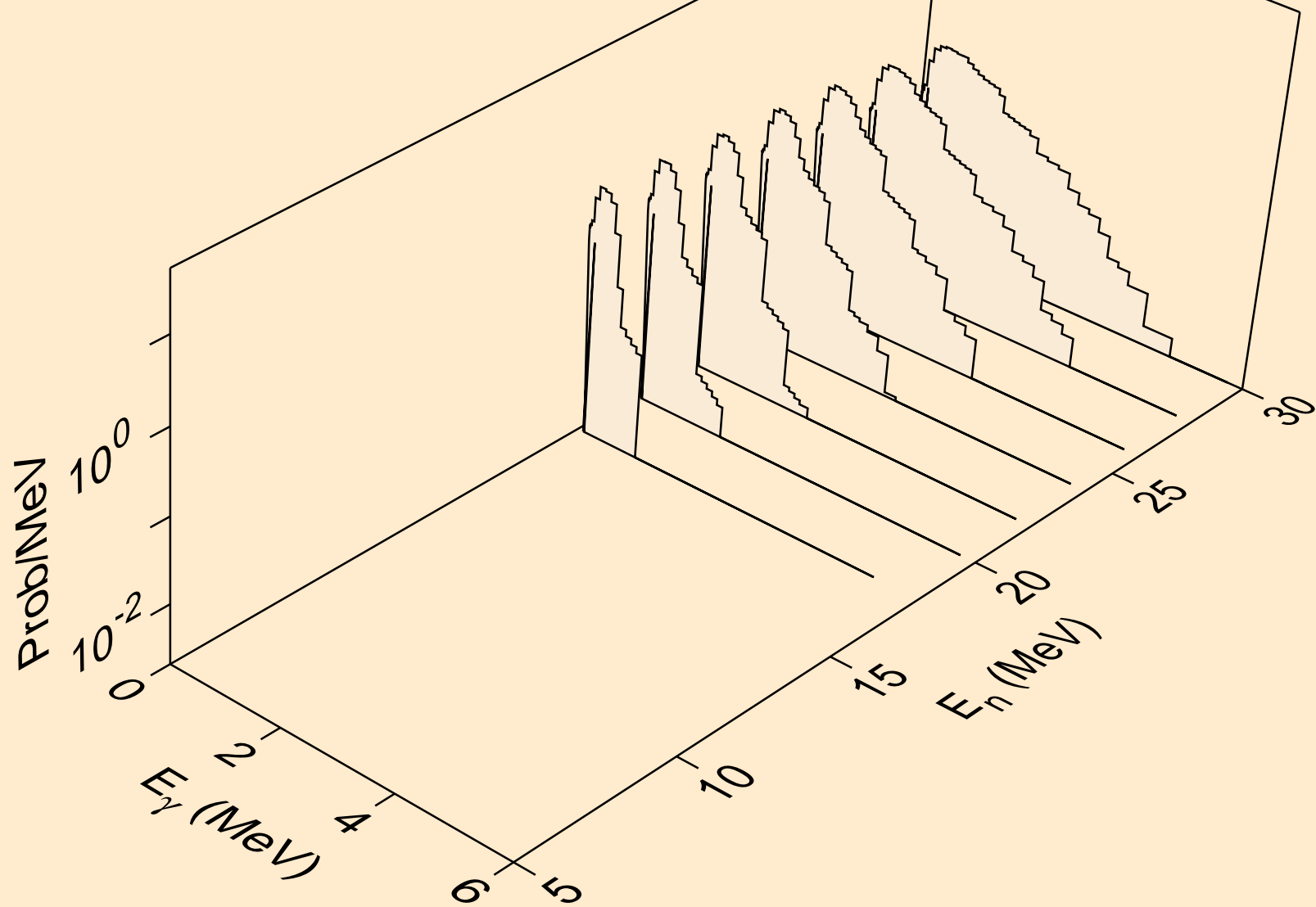

CM251 NEUTRON ACER TENDL-2021 LIBRARY; T=293.6K
Photon emission for (n,da)

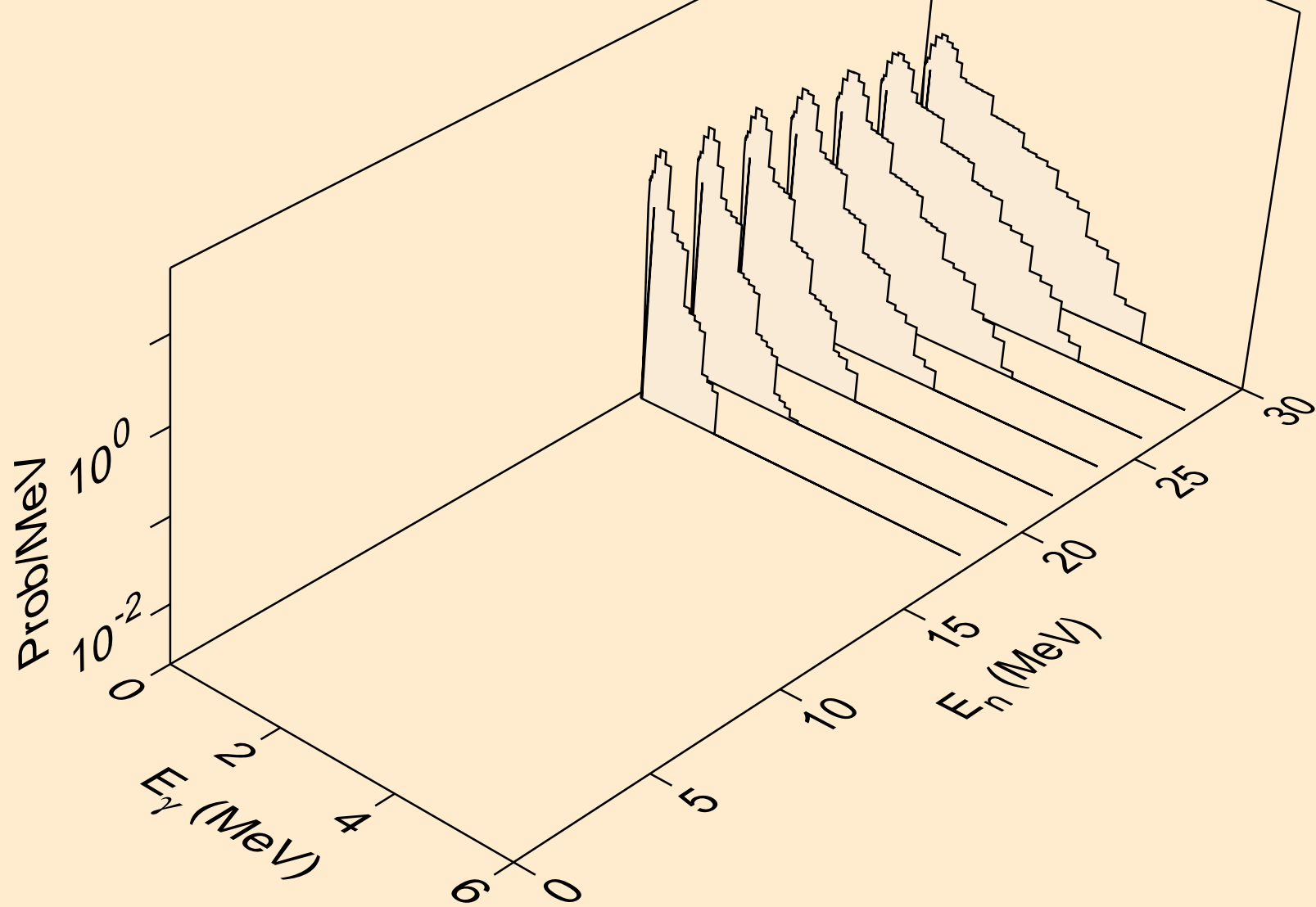

CM251 NEUTRON ACER TENDL-2021 LIBRARY; T=293.6K
thermal capture photon spectrum

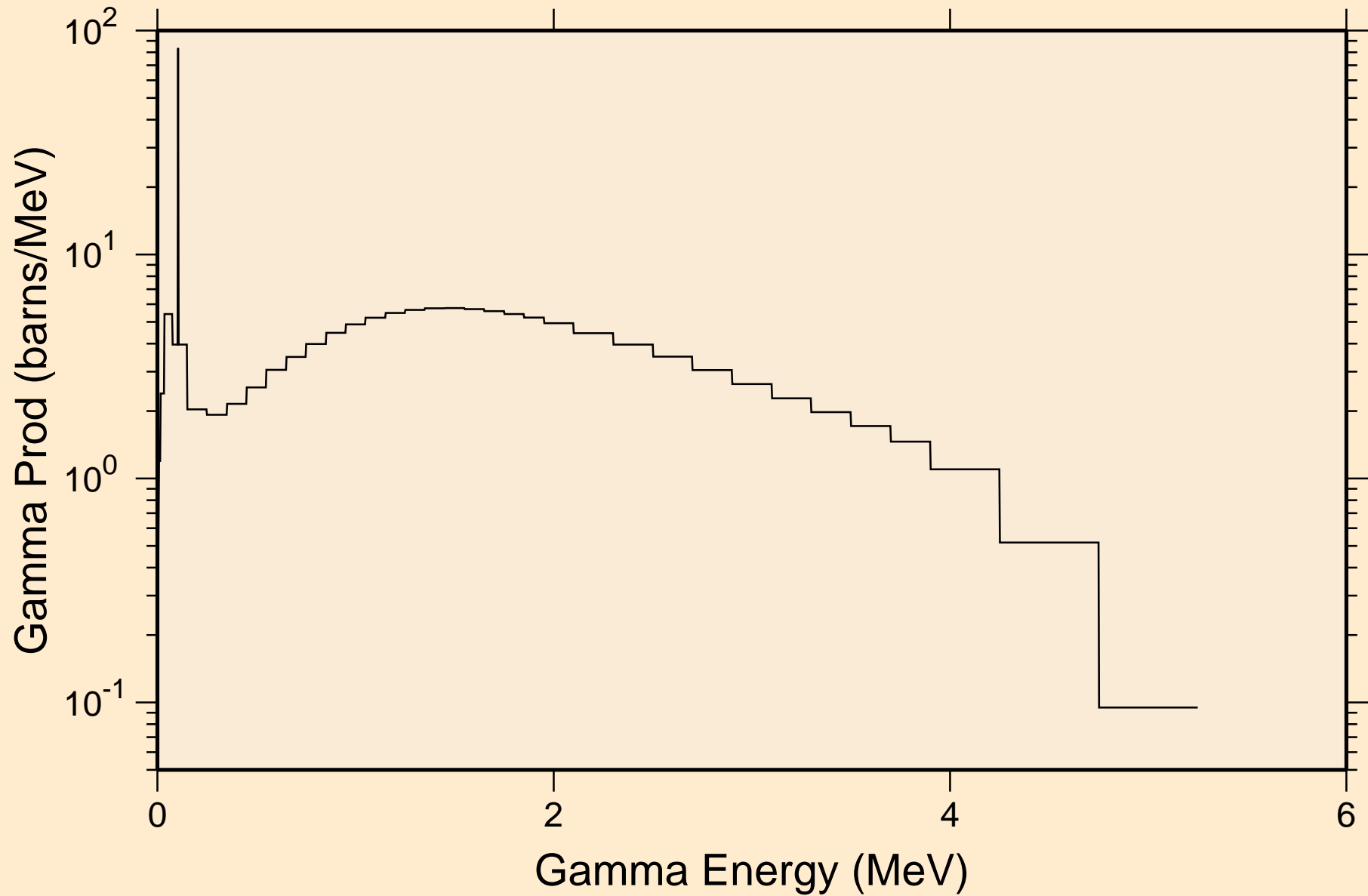

CM251 NEUTRON ACER TENDL-2021 LIBRARY; T=293.6K
14 MeV photon spectrum

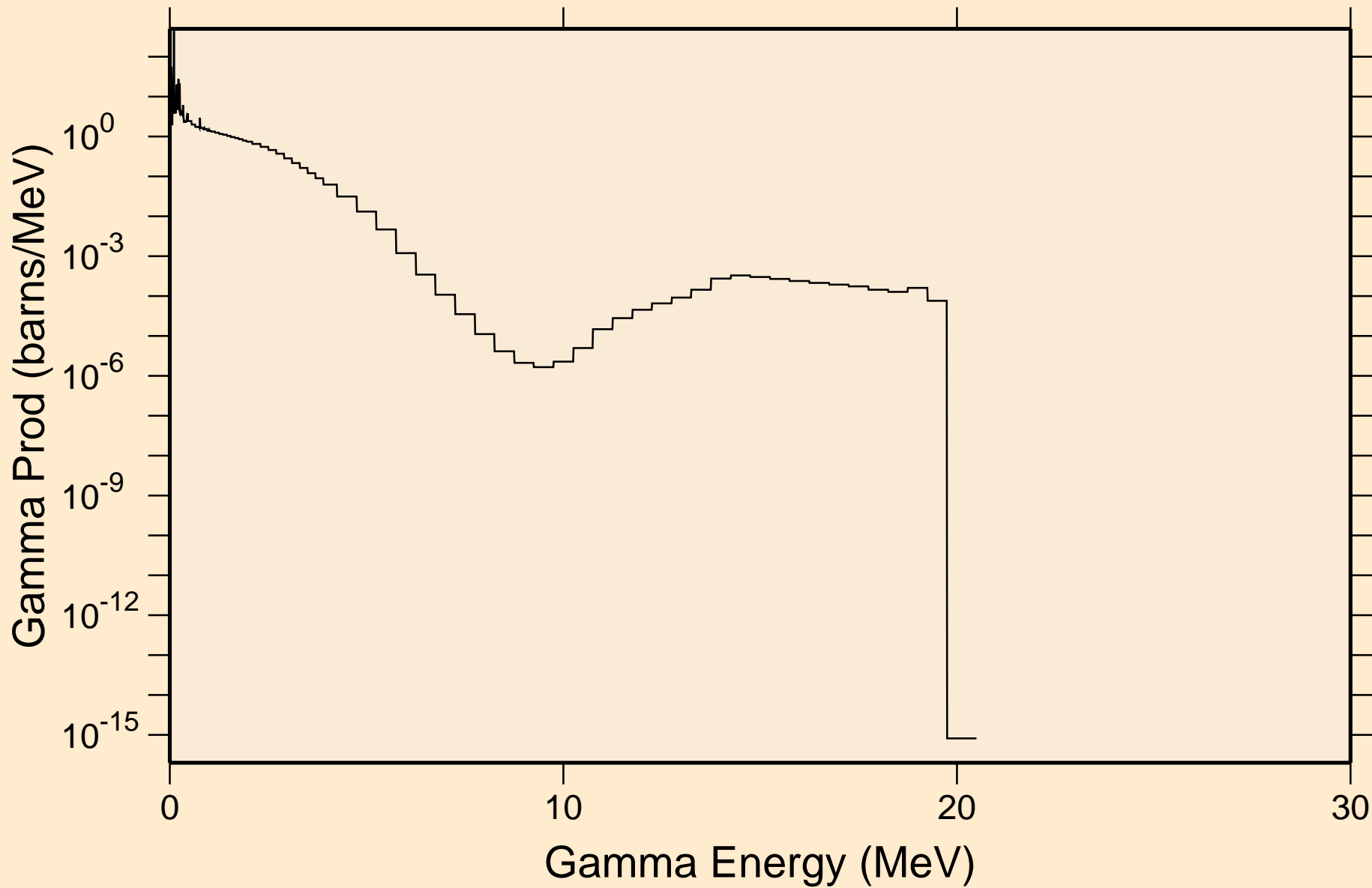

CM251 NEUTRON ACER TENDL-2021 LIBRARY; T=293.6K
Particle heating contributions

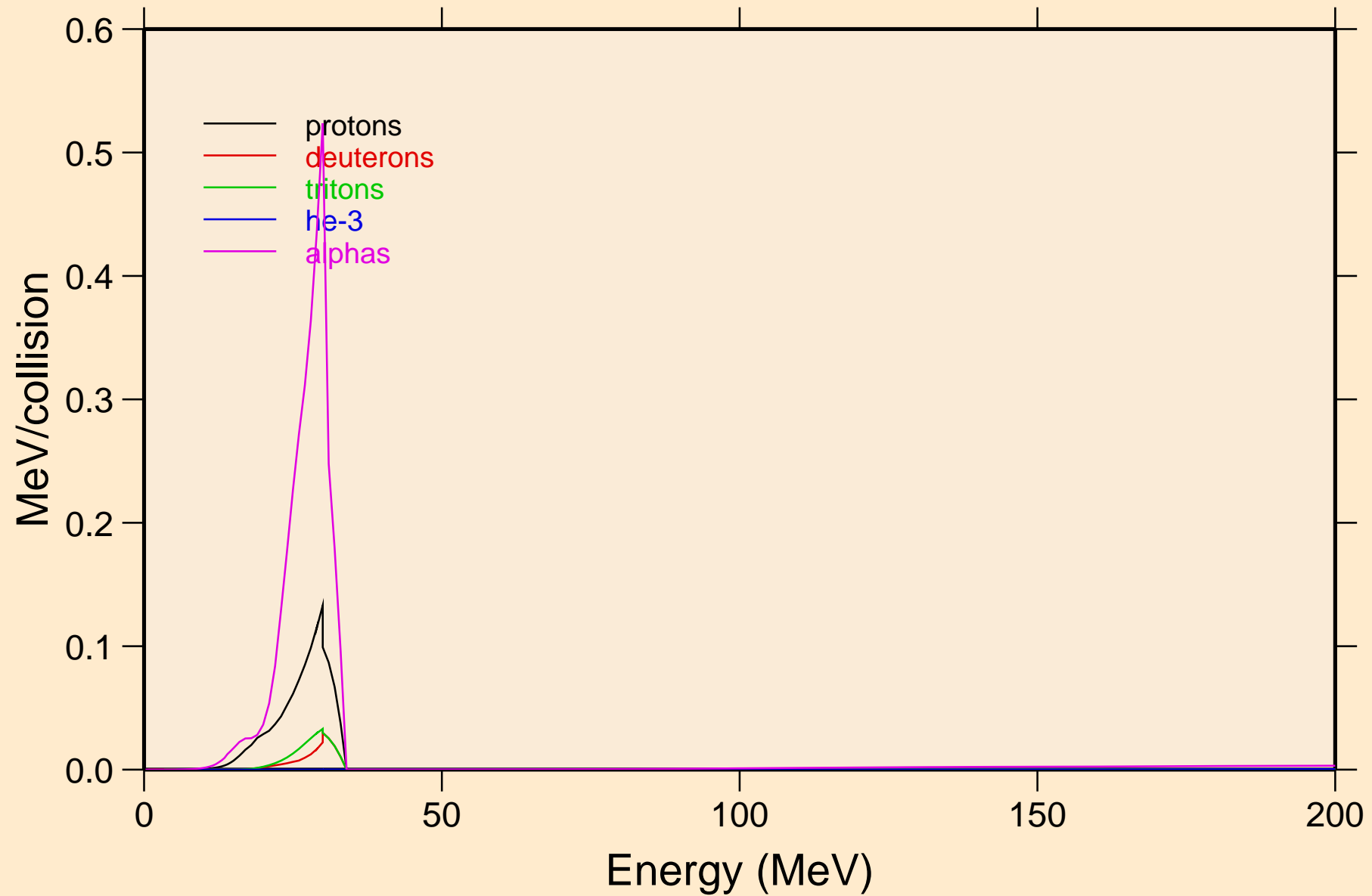

CM251 NEUTRON ACER TENDL-2021 LIBRARY; T=293.6K
Recoil Heating

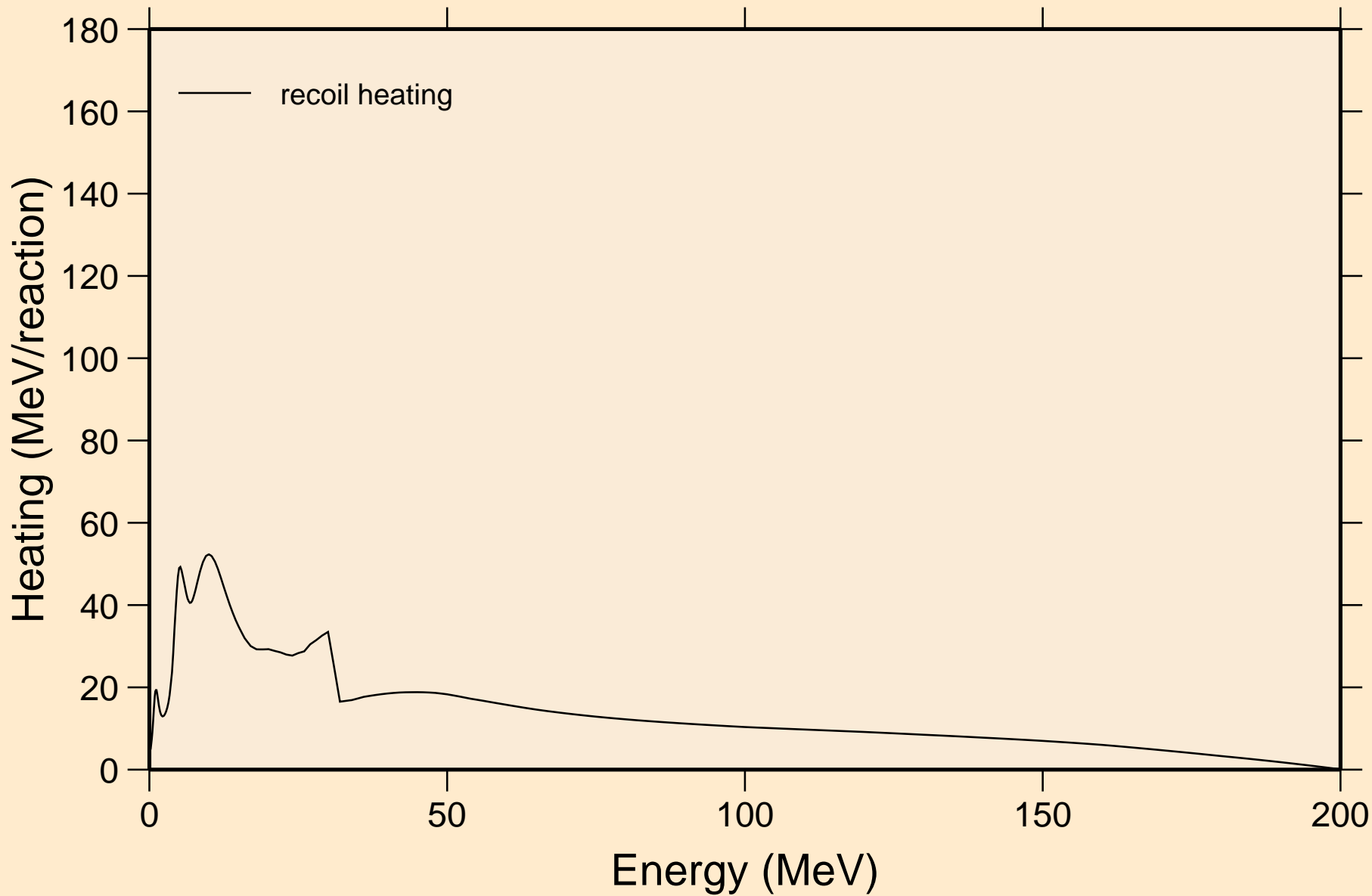

CM251 NEUTRON ACER TENDL-2021 LIBRARY; T=293.6K
Particle production cross sections

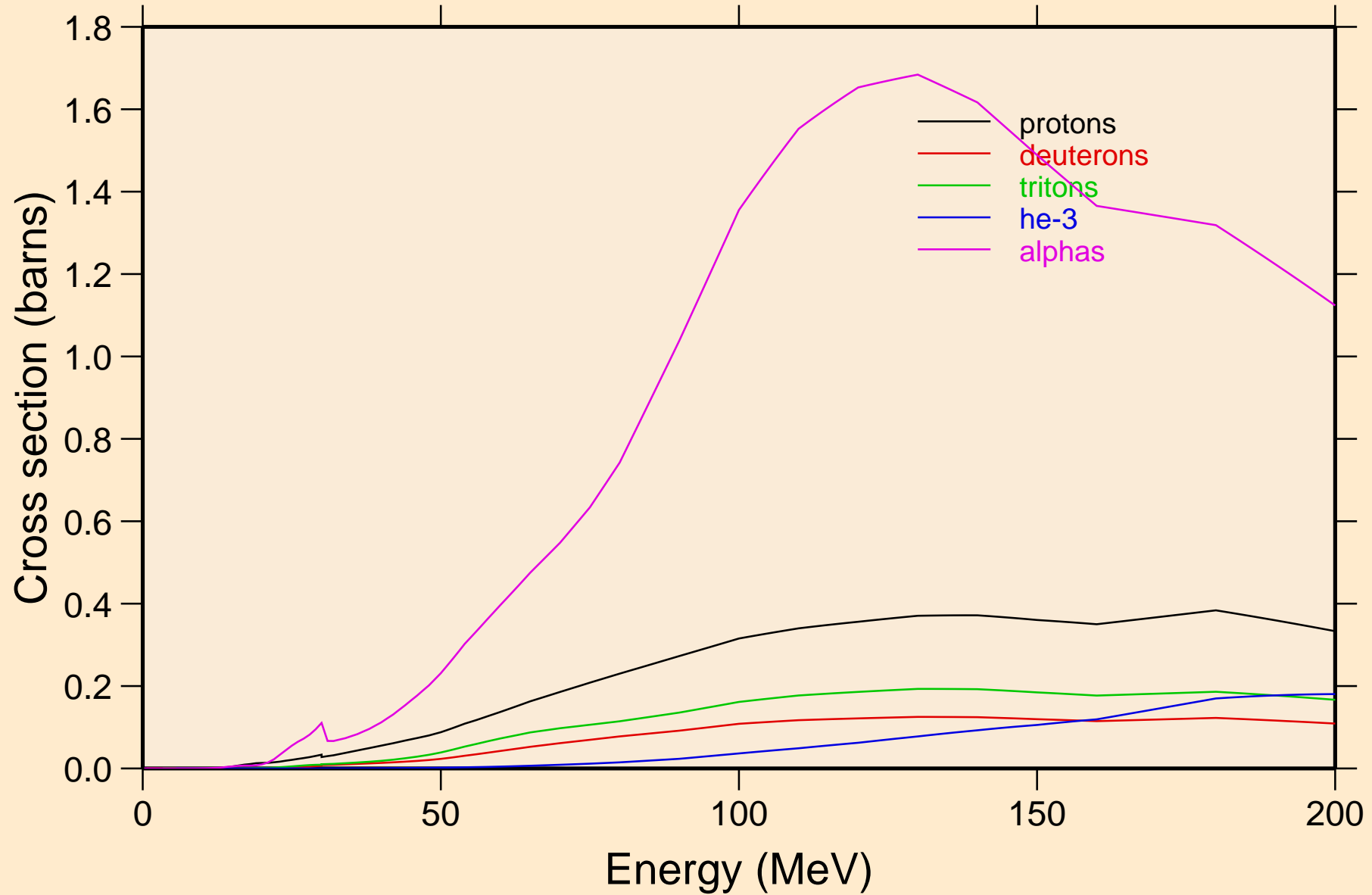

CM251 NEUTRON ACER TENDL-2021 LIBRARY; T=293.6K
protons from (n,x)

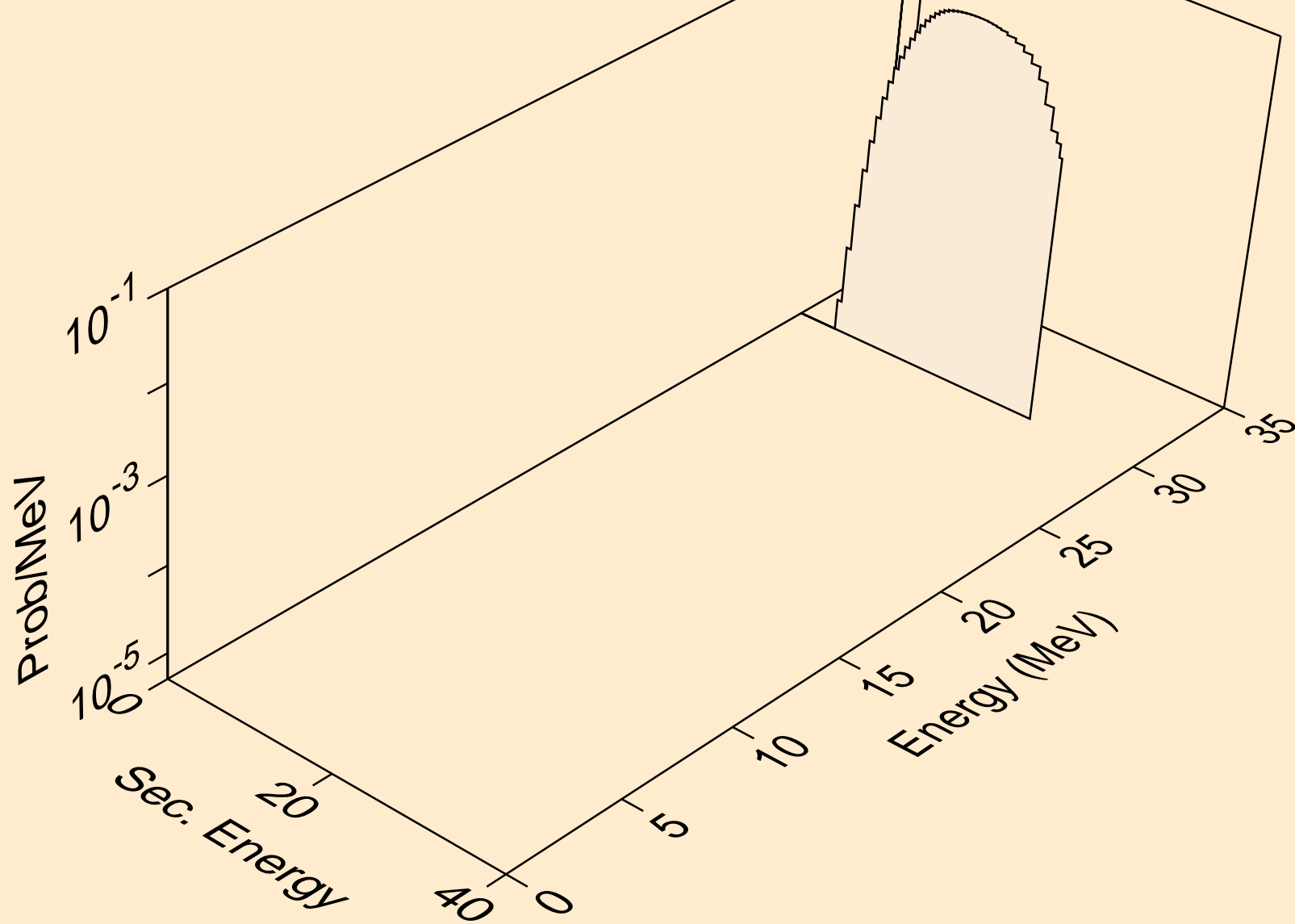

CM251 NEUTRON ACER TENDL-2021 LIBRARY; T=293.6K
protons from (n,n*)p

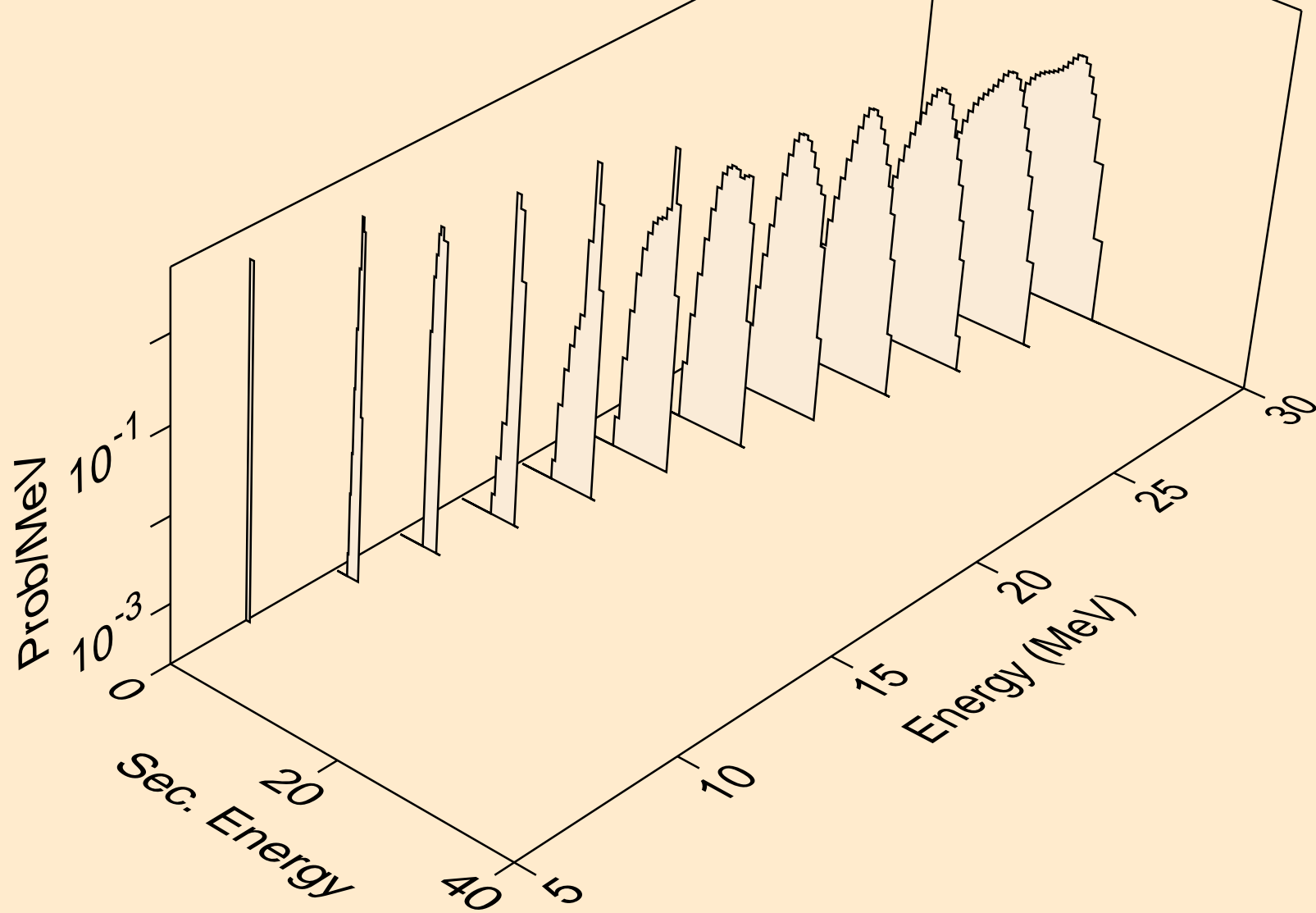

CM251 NEUTRON ACER TENDL-2021 LIBRARY; T=293.6K
protons from (n,2np)

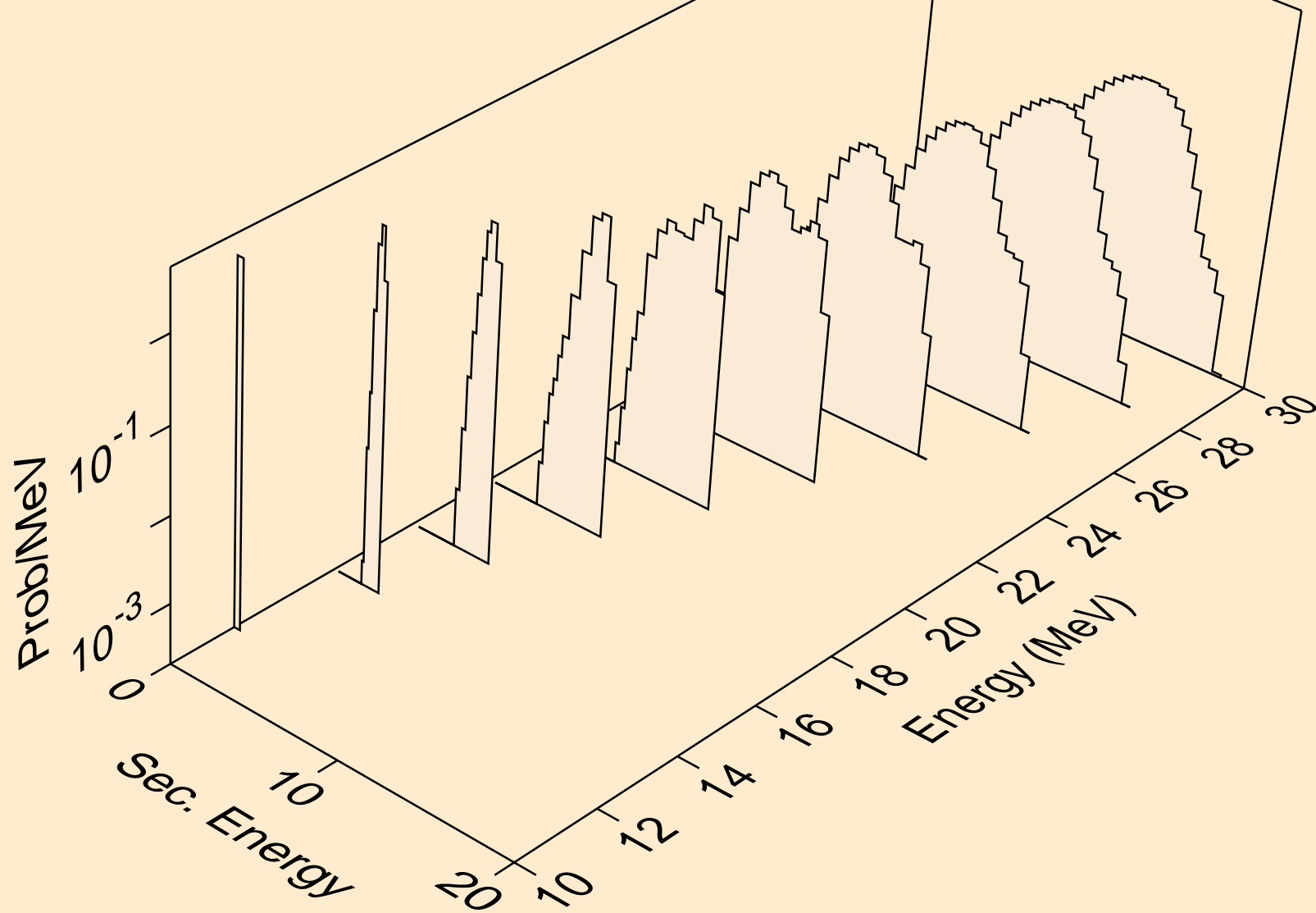

CM251 NEUTRON ACER TENDL-2021 LIBRARY; T=293.6K
protons from (n,3np)

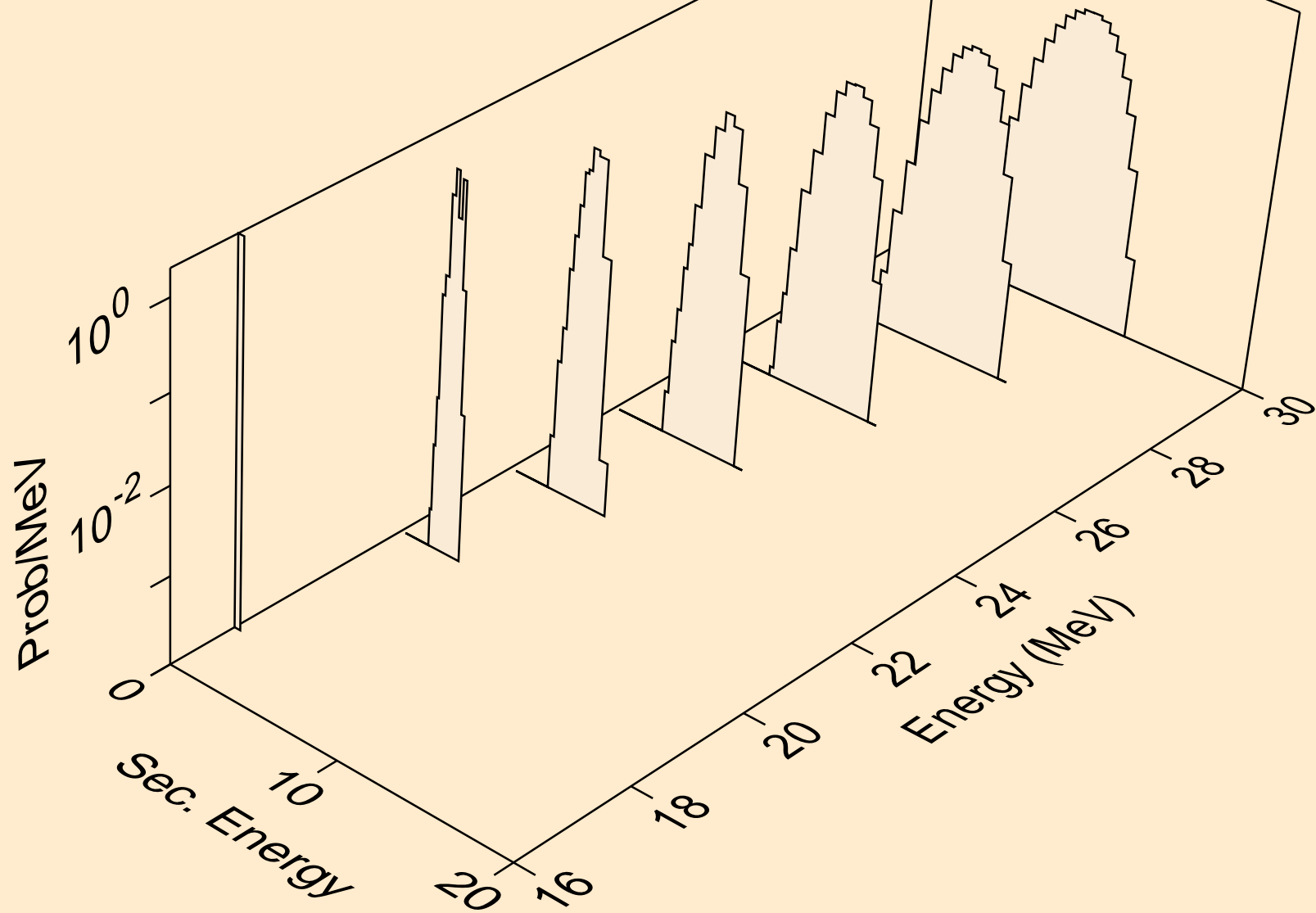

CM251 NEUTRON ACER TENDL-2021 LIBRARY; T=293.6K
protons from (n,npa)

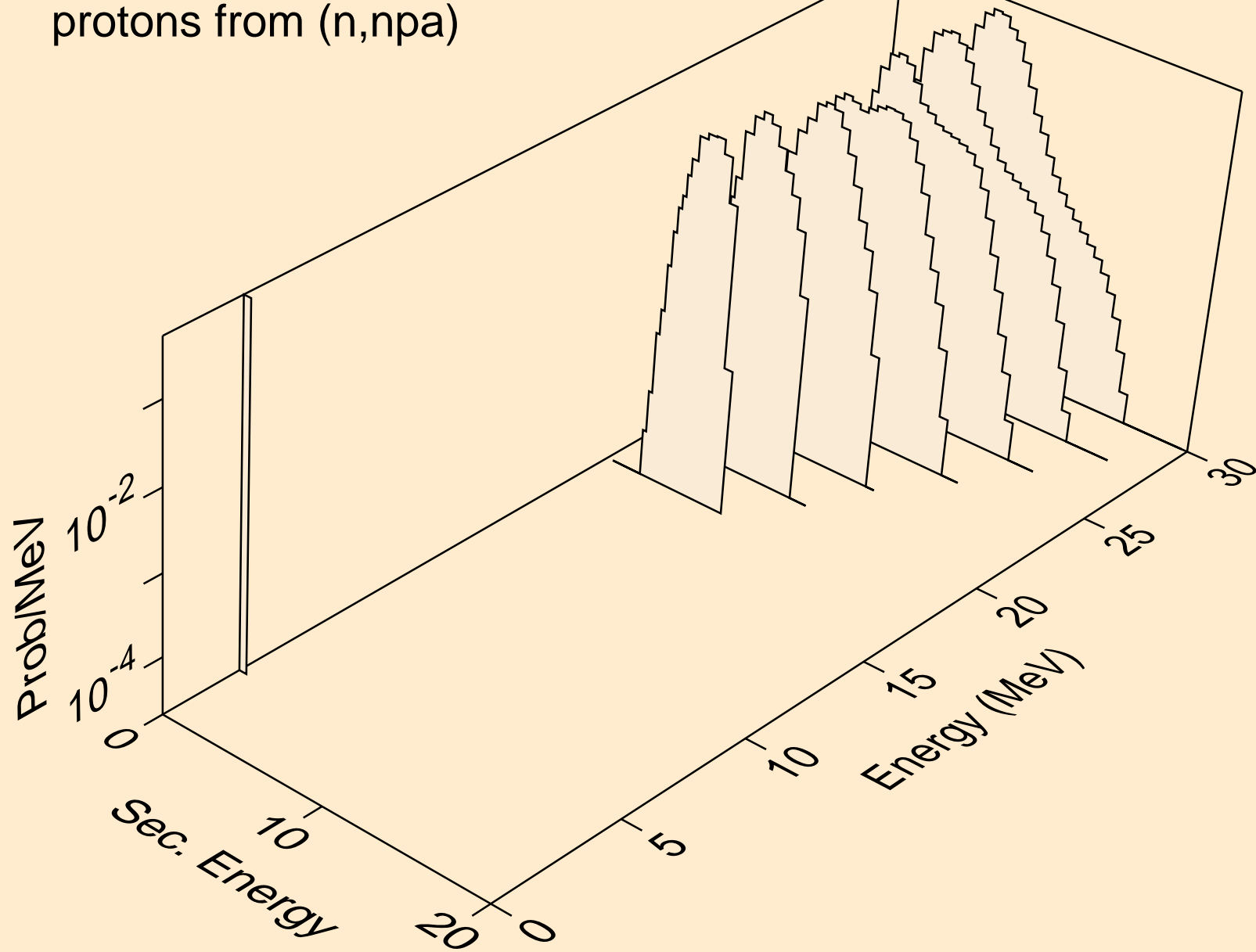

CM251 NEUTRON ACER TENDL-2021 LIBRARY; T=293.6K
protons from (n,p)

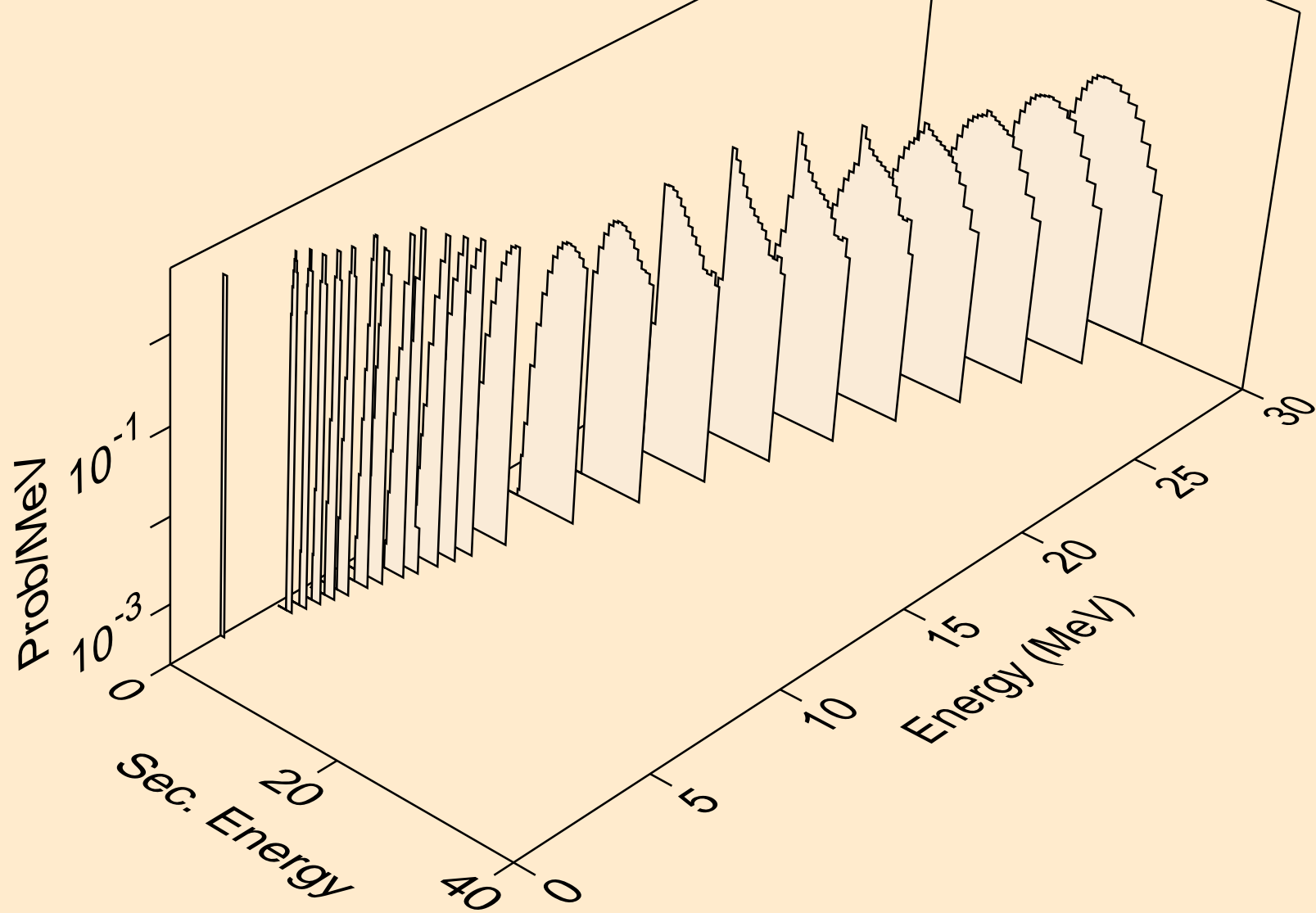

CM251 NEUTRON ACER TENDL-2021 LIBRARY; T=293.6K
protons from (n,2p)

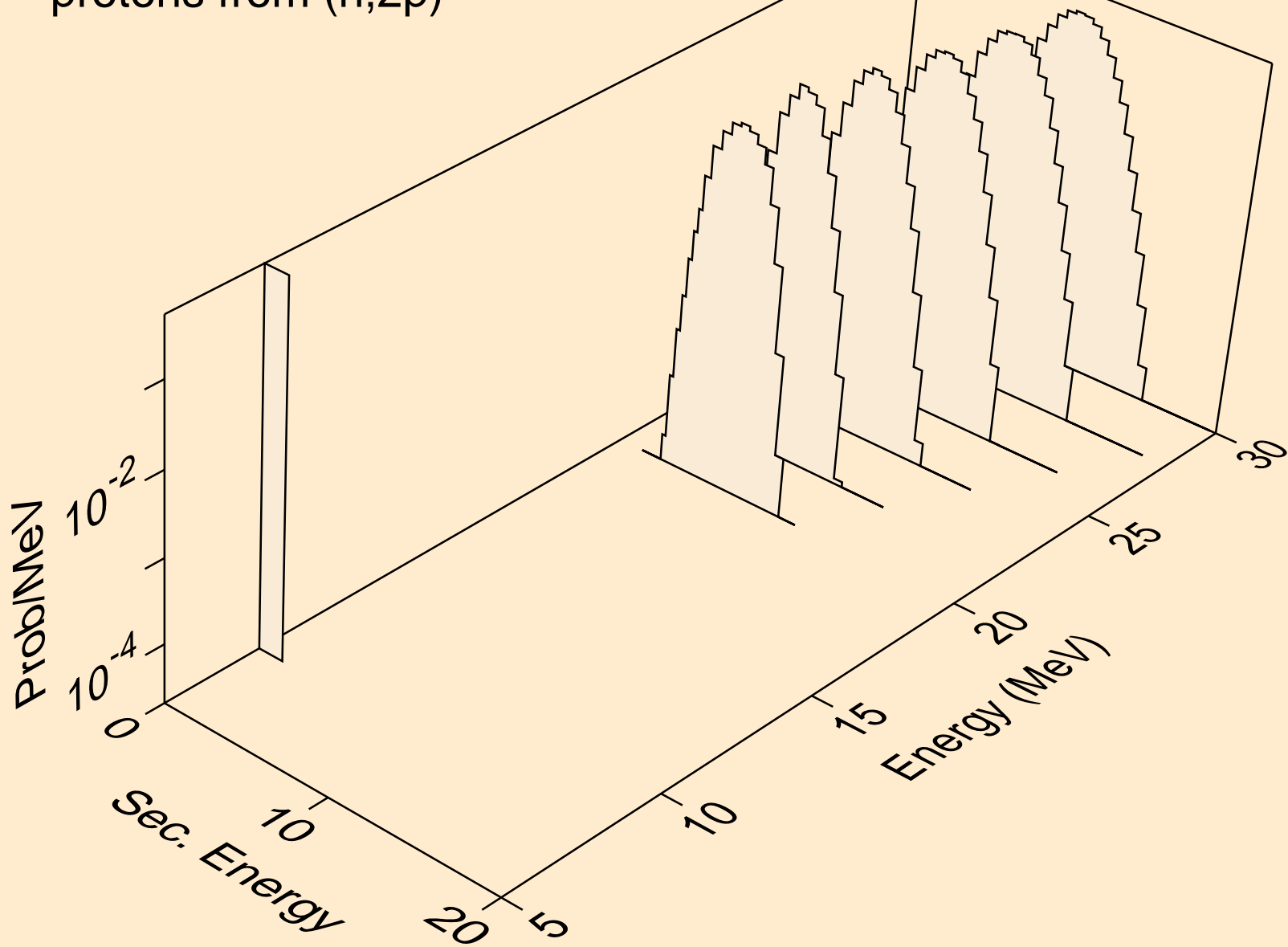

CM251 NEUTRON ACER TENDL-2021 LIBRARY; T=293.6K
protons from (n,p)

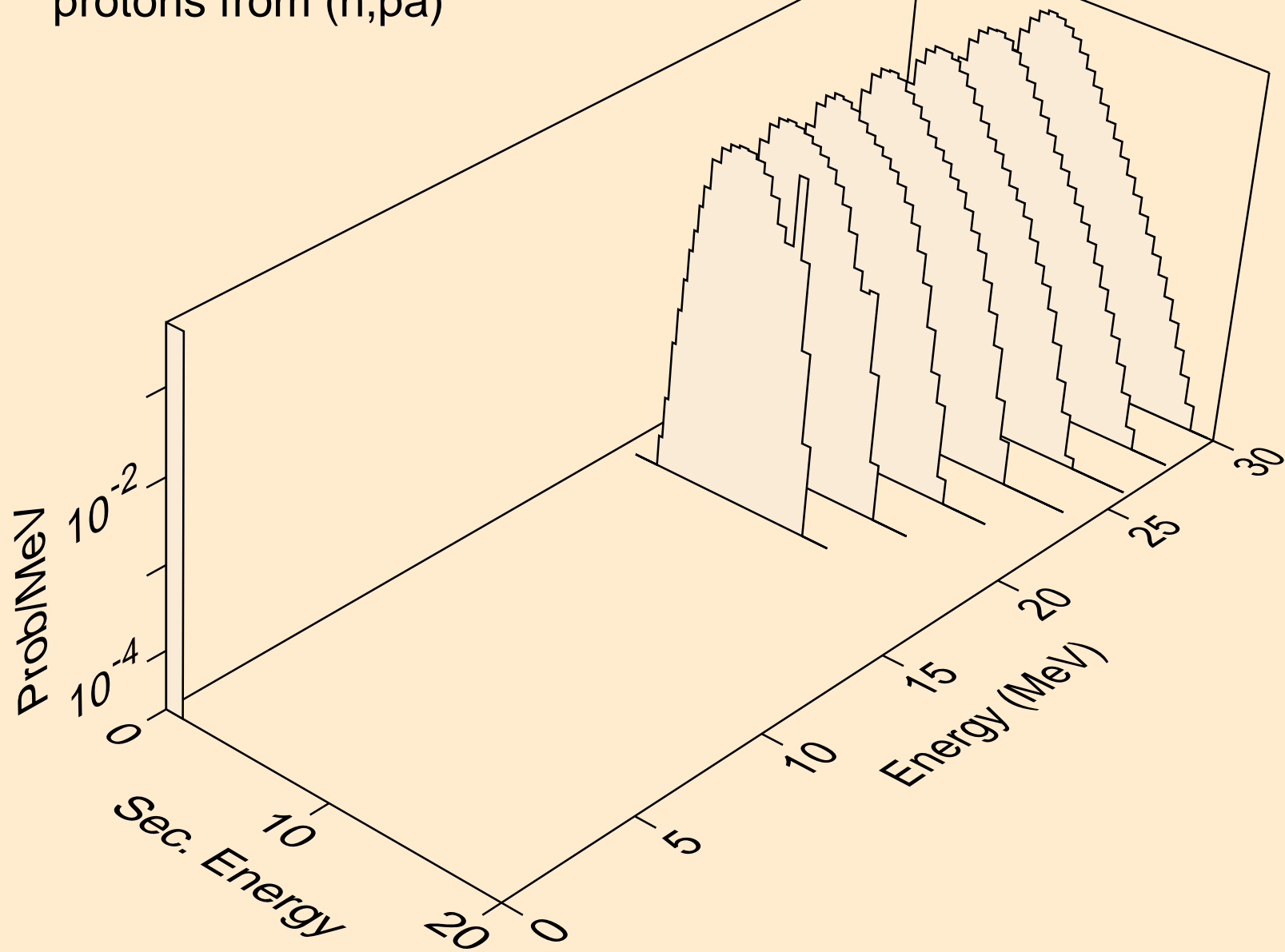

CM251 NEUTRON ACER TENDL-2021 LIBRARY; T=293.6K
protons from (n,pt)

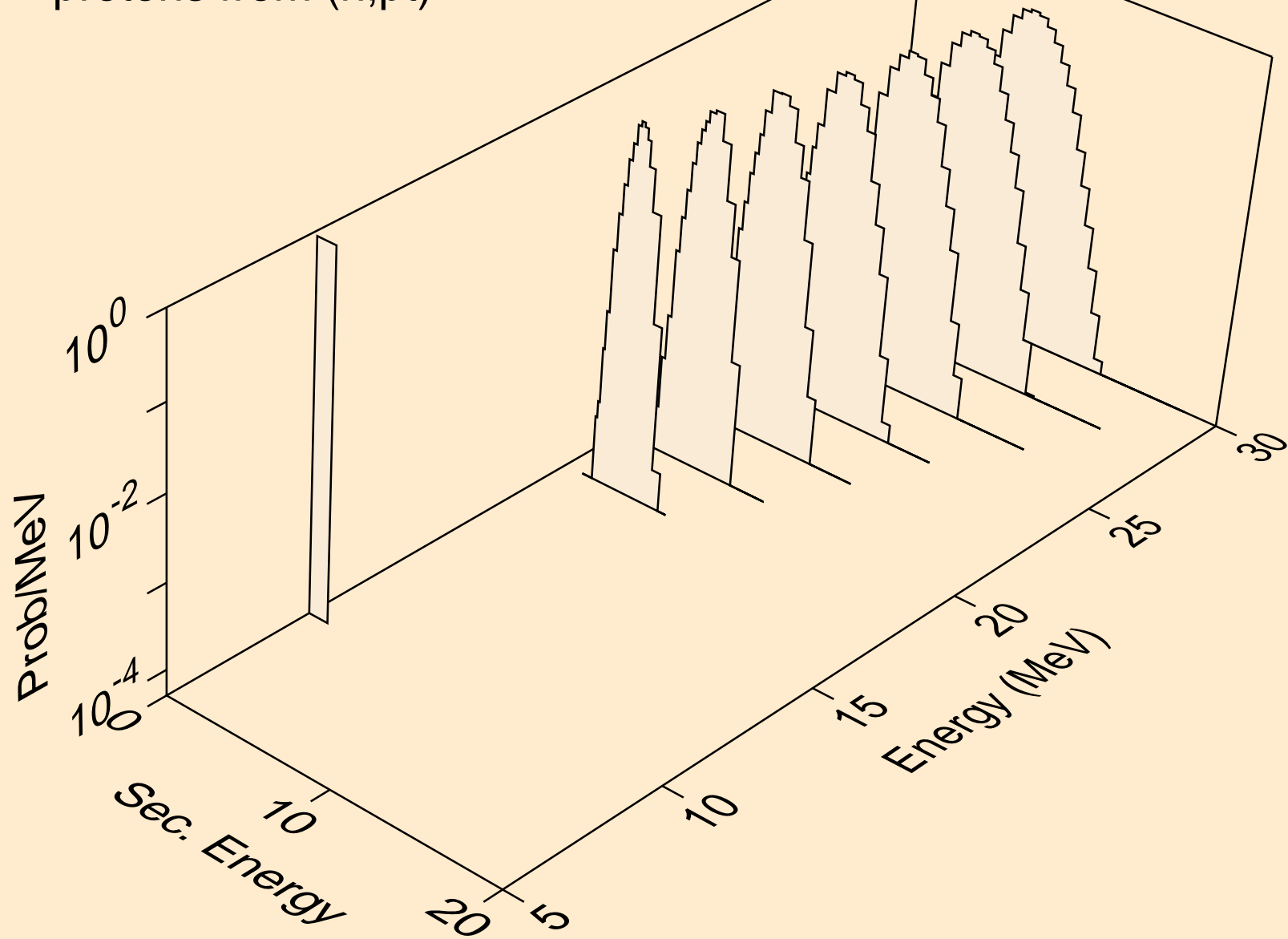

CM251 NEUTRON ACER TENDL-2021 LIBRARY; T=293.6K
deuterons from (n,x)

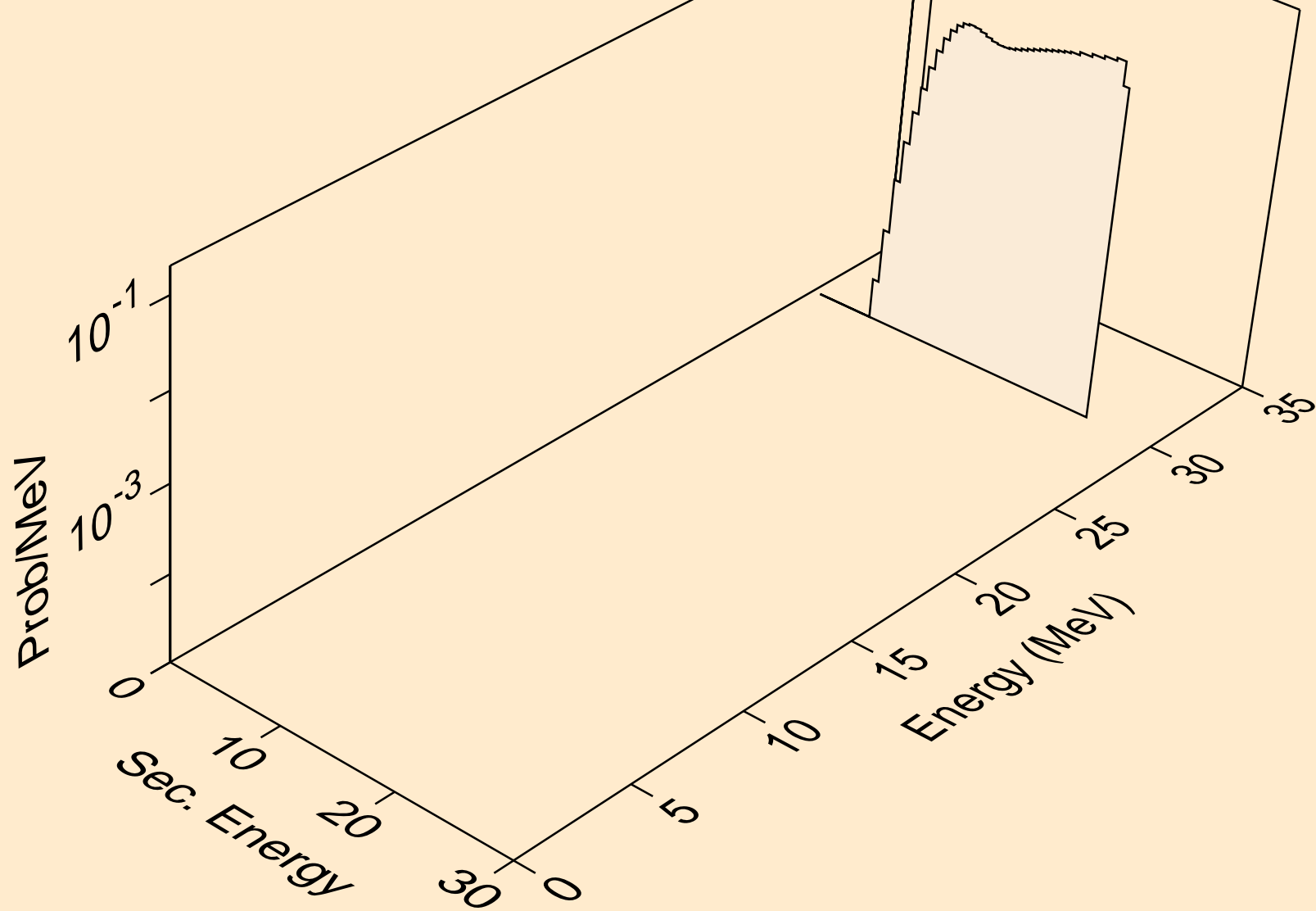

CM251 NEUTRON ACER TENDL-2021 LIBRARY; T=293.6K
deuterons from (n,2nd)

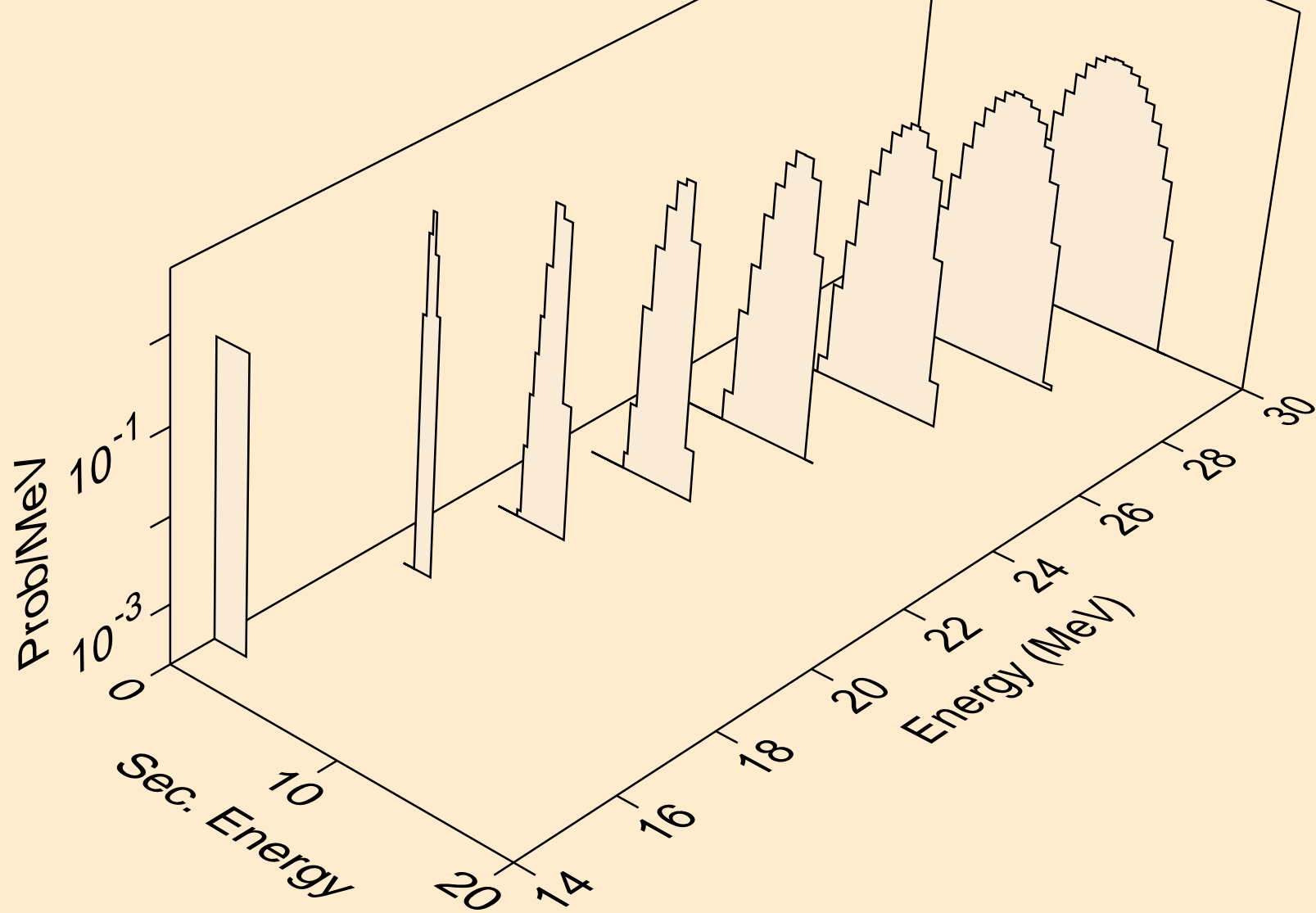

CM251 NEUTRON ACER TENDL-2021 LIBRARY; T=293.6K
deuterons from (n,n*)d

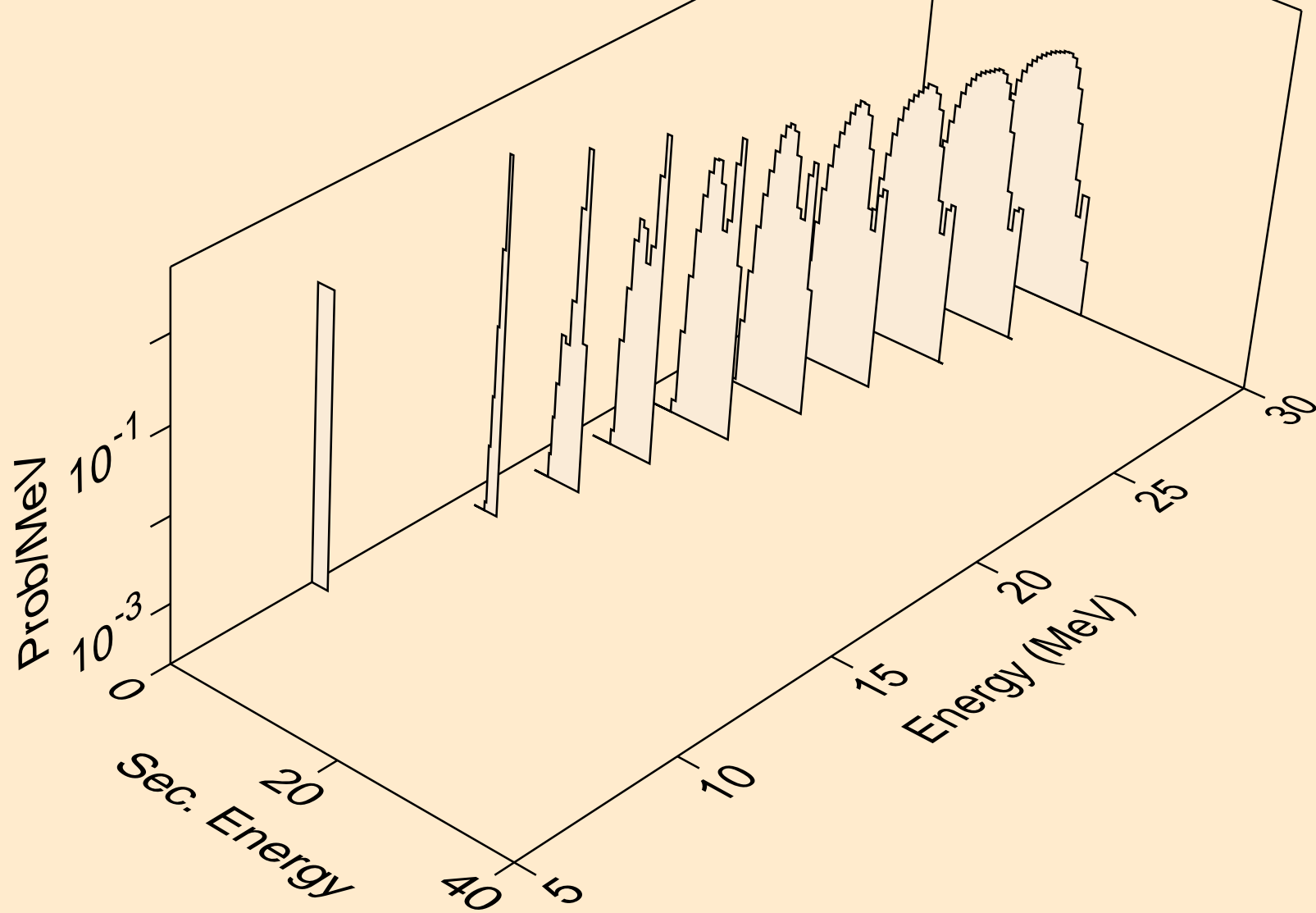

CM251 NEUTRON ACER TENDL-2021 LIBRARY; T=293.6K
deuterons from (n,d)

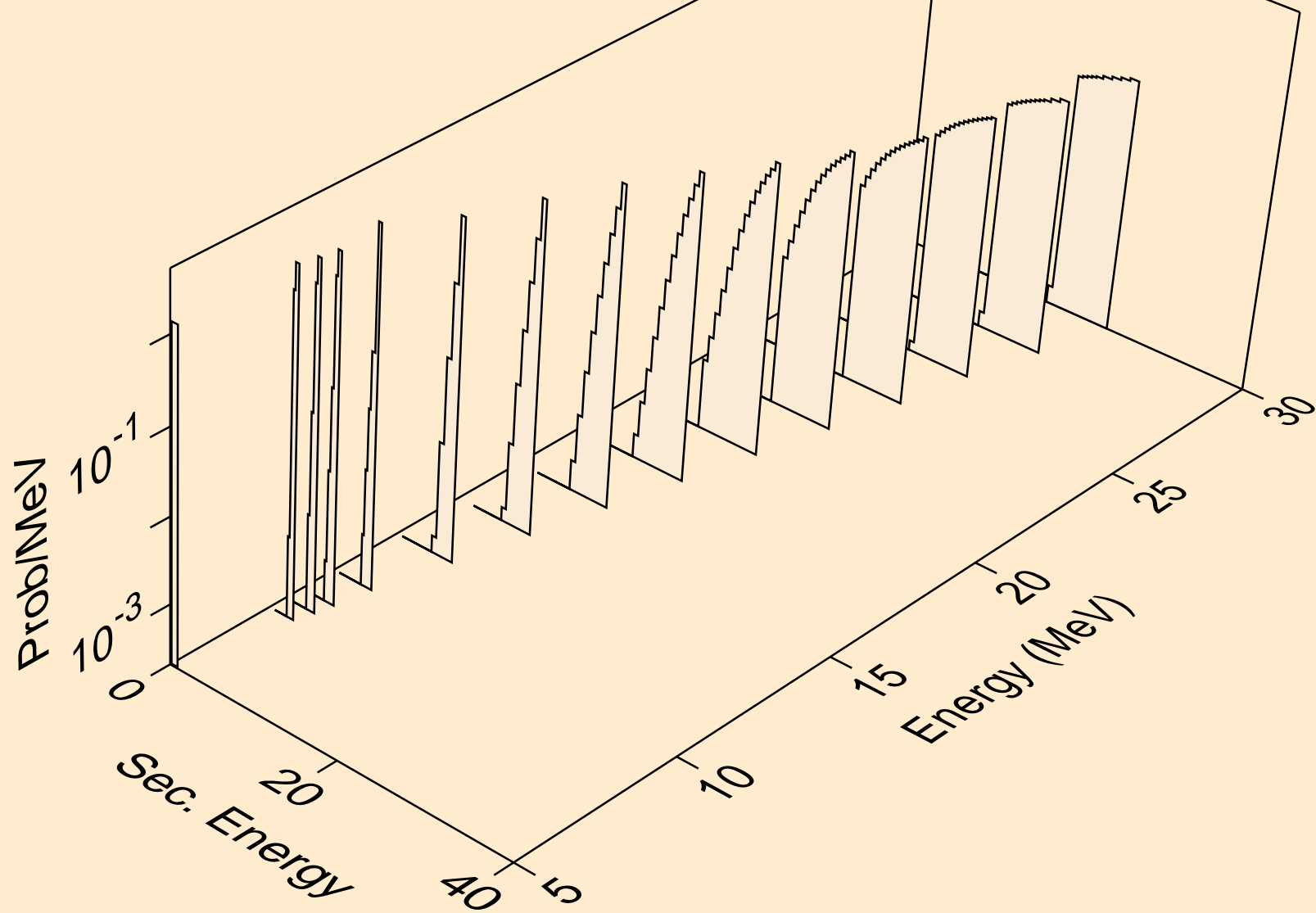

CM251 NEUTRON ACER TENDL-2021 LIBRARY; T=293.6K
deuterons from (n,da)

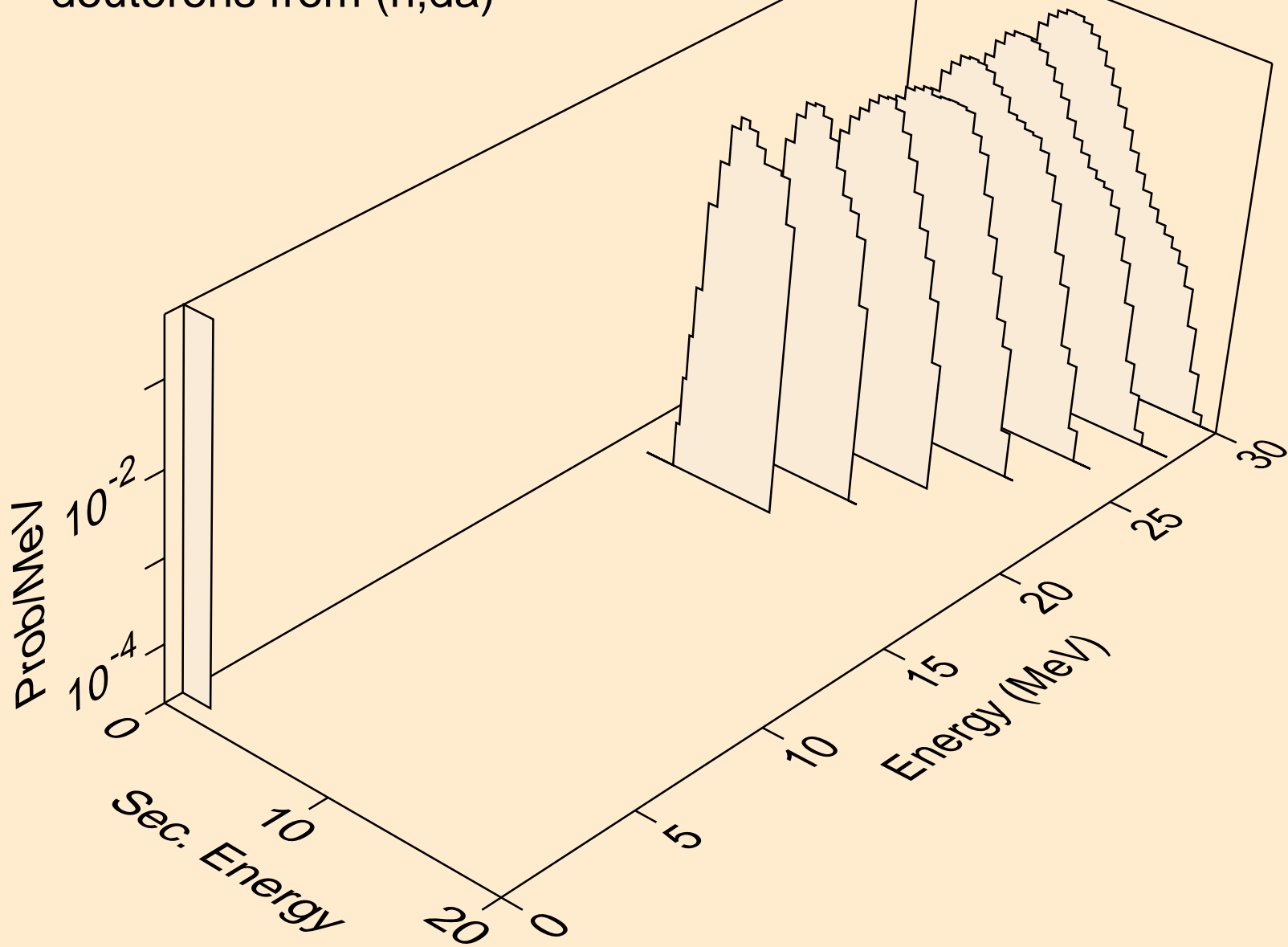

CM251 NEUTRON ACER TENDL-2021 LIBRARY; T=293.6K
tritons from (n,x)

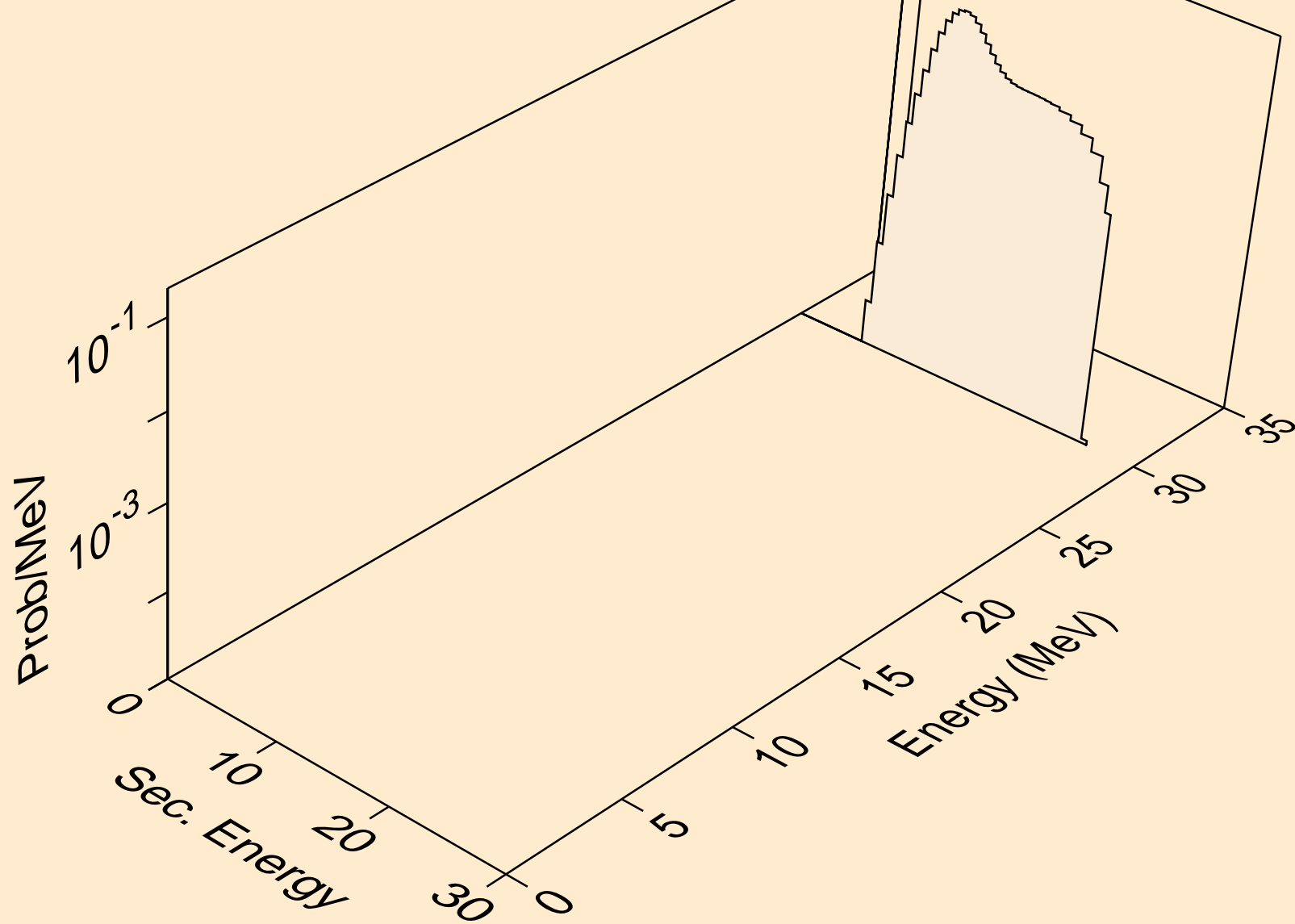

CM251 NEUTRON ACER TENDL-2021 LIBRARY; T=293.6K
tritons from (n,n*)t

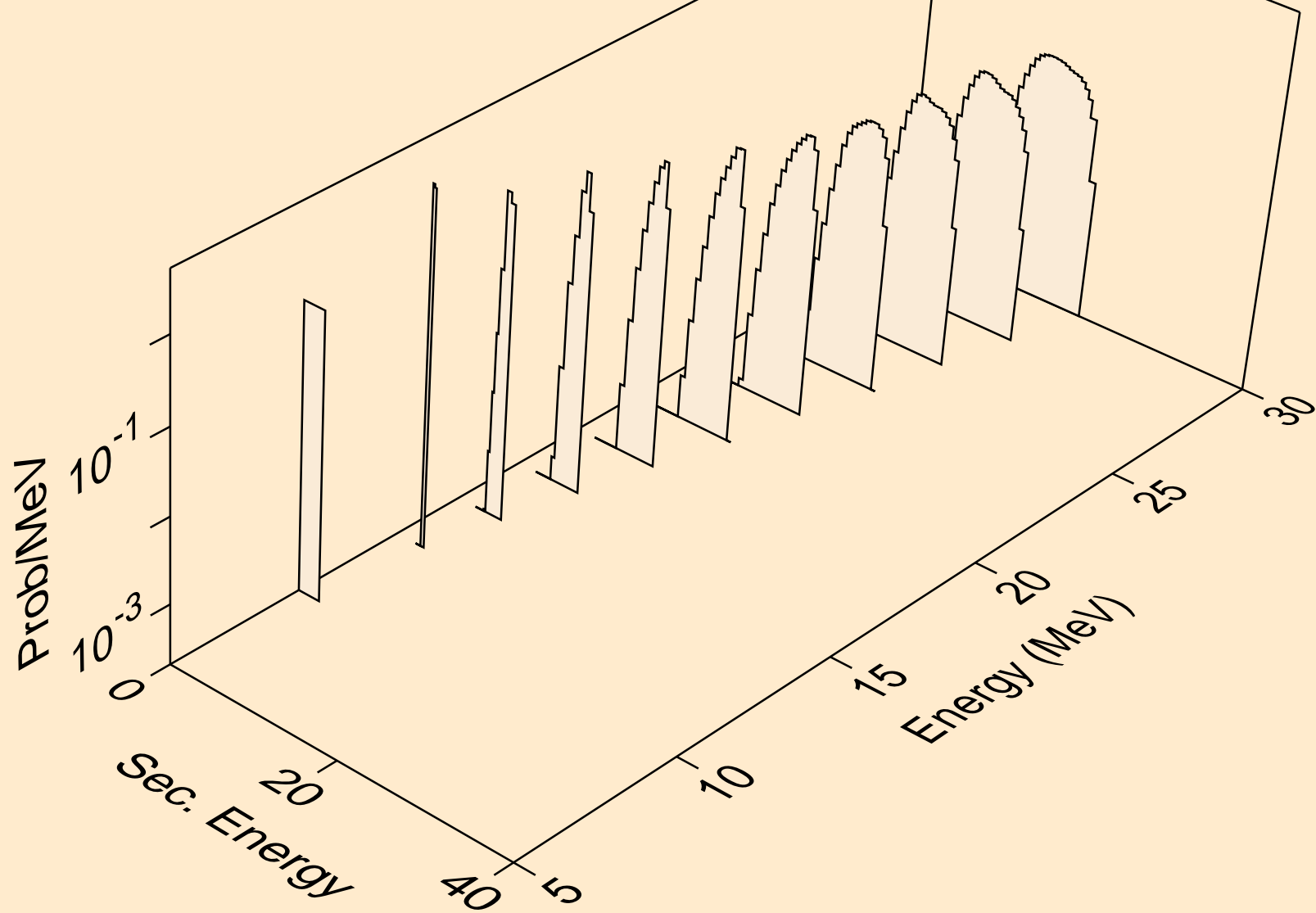

CM251 NEUTRON ACER TENDL-2021 LIBRARY; T=293.6K
tritons from (n,t)

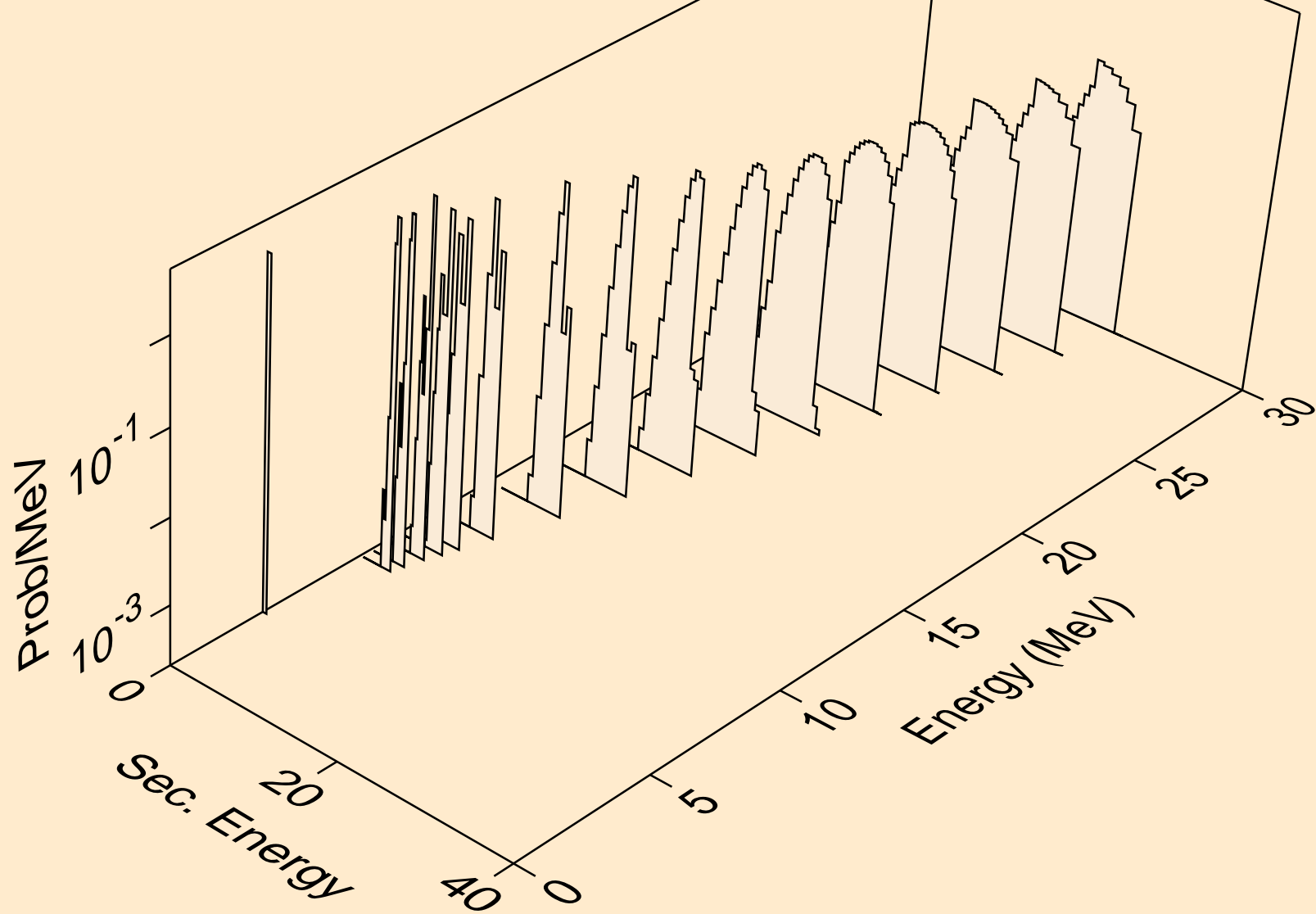

CM251 NEUTRON ACER TENDL-2021 LIBRARY; T=293.6K
tritons from (n,pt)

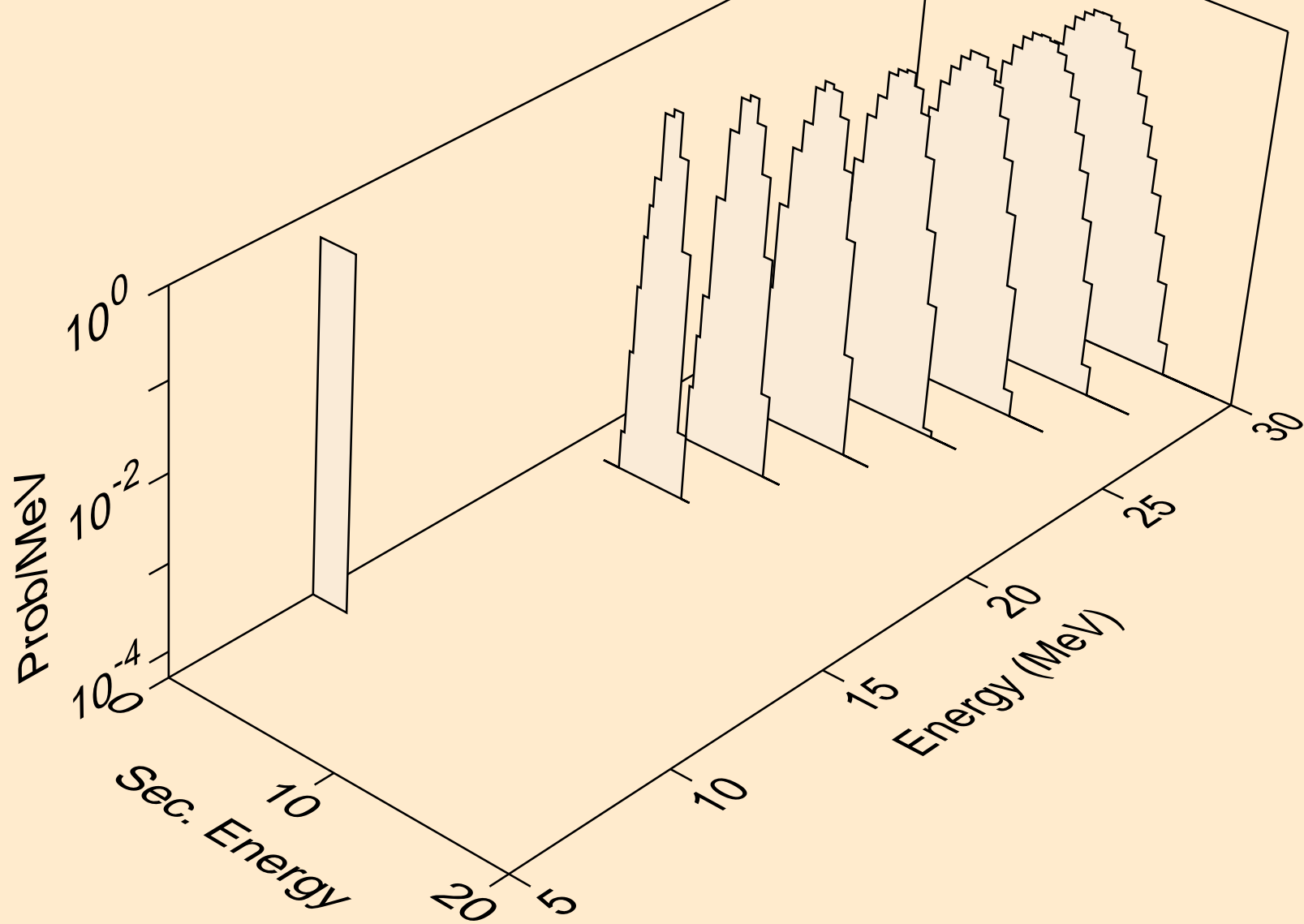

CM251 NEUTRON ACER TENDL-2021 LIBRARY; T=293.6K
he3s from (n,x)

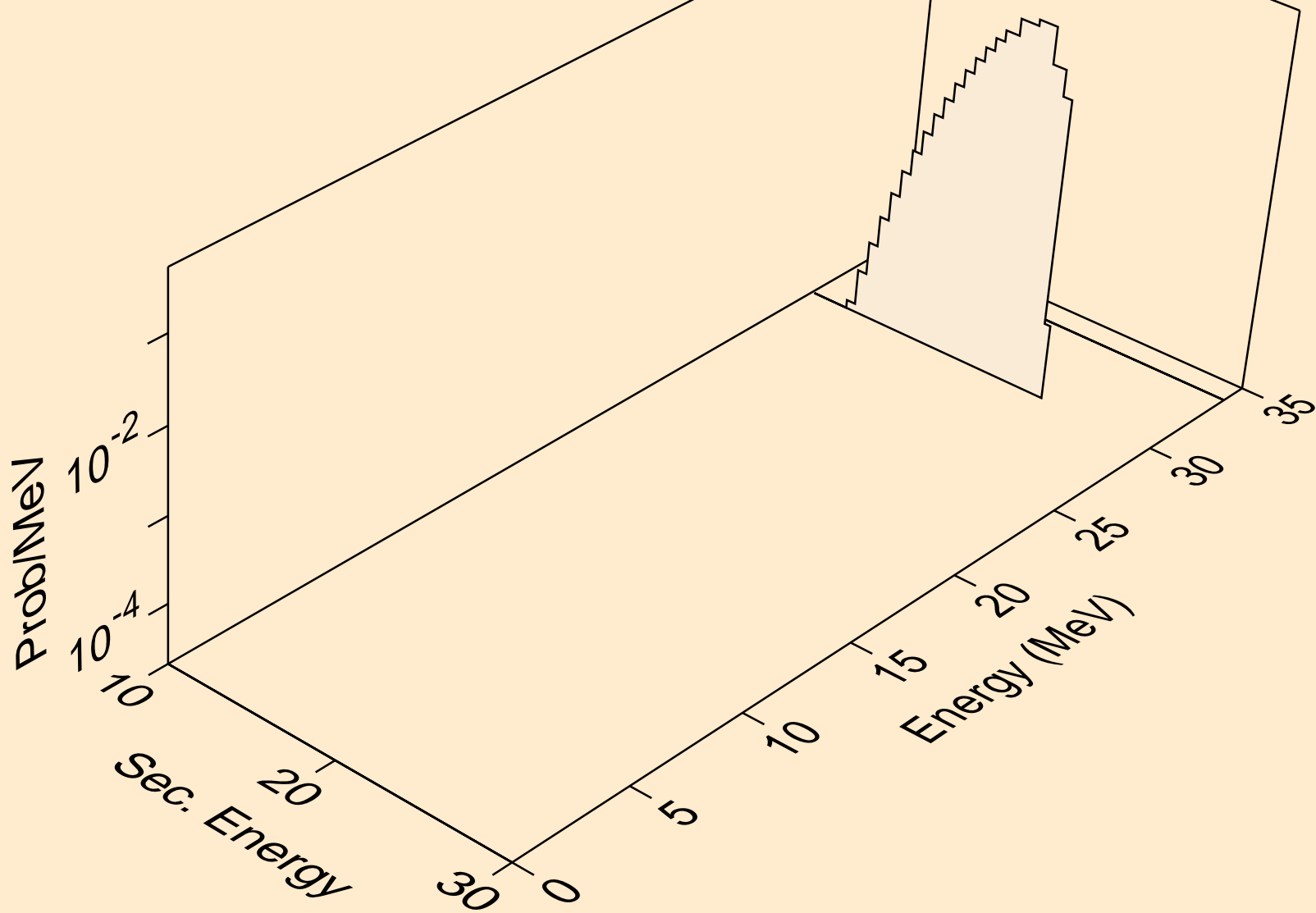

CM251 NEUTRON ACER TENDL-2021 LIBRARY; T=293.6K
he3s from (n,n*)he3

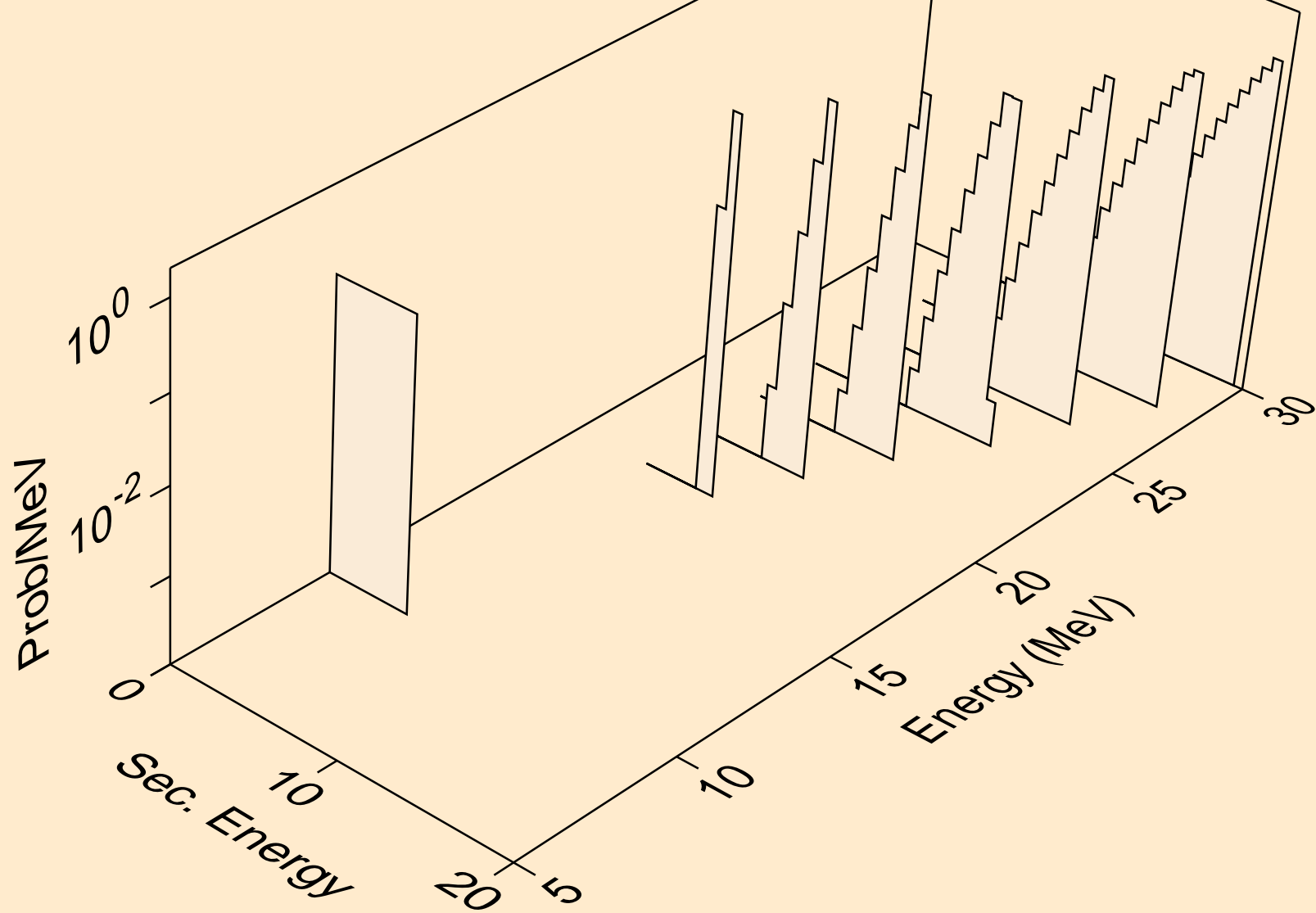

CM251 NEUTRON ACER TENDL-2021 LIBRARY; T=293.6K
he3s from (n,he3)

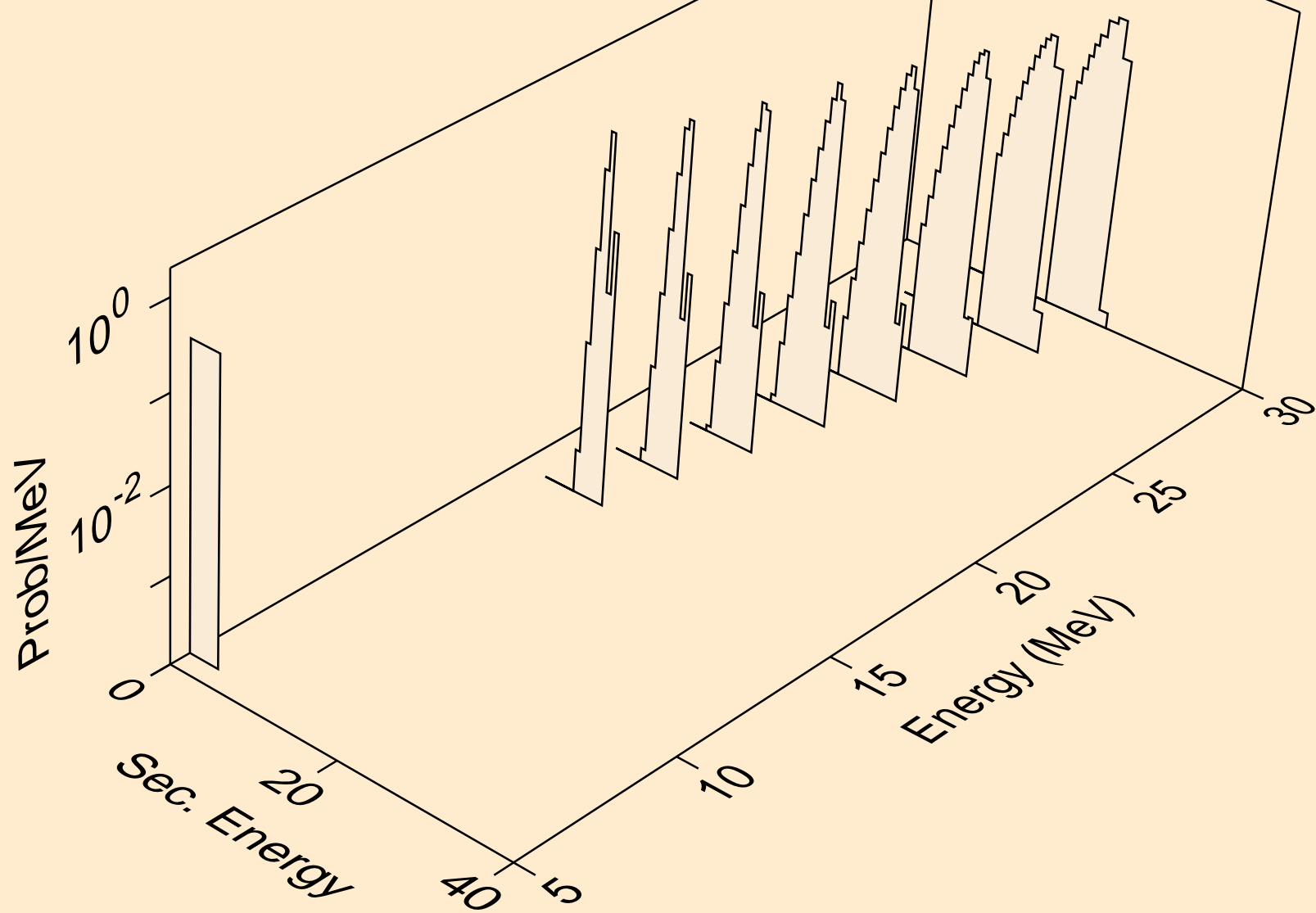

CM251 NEUTRON ACER TENDL-2021 LIBRARY; T=293.6K
alphas from (n,x)

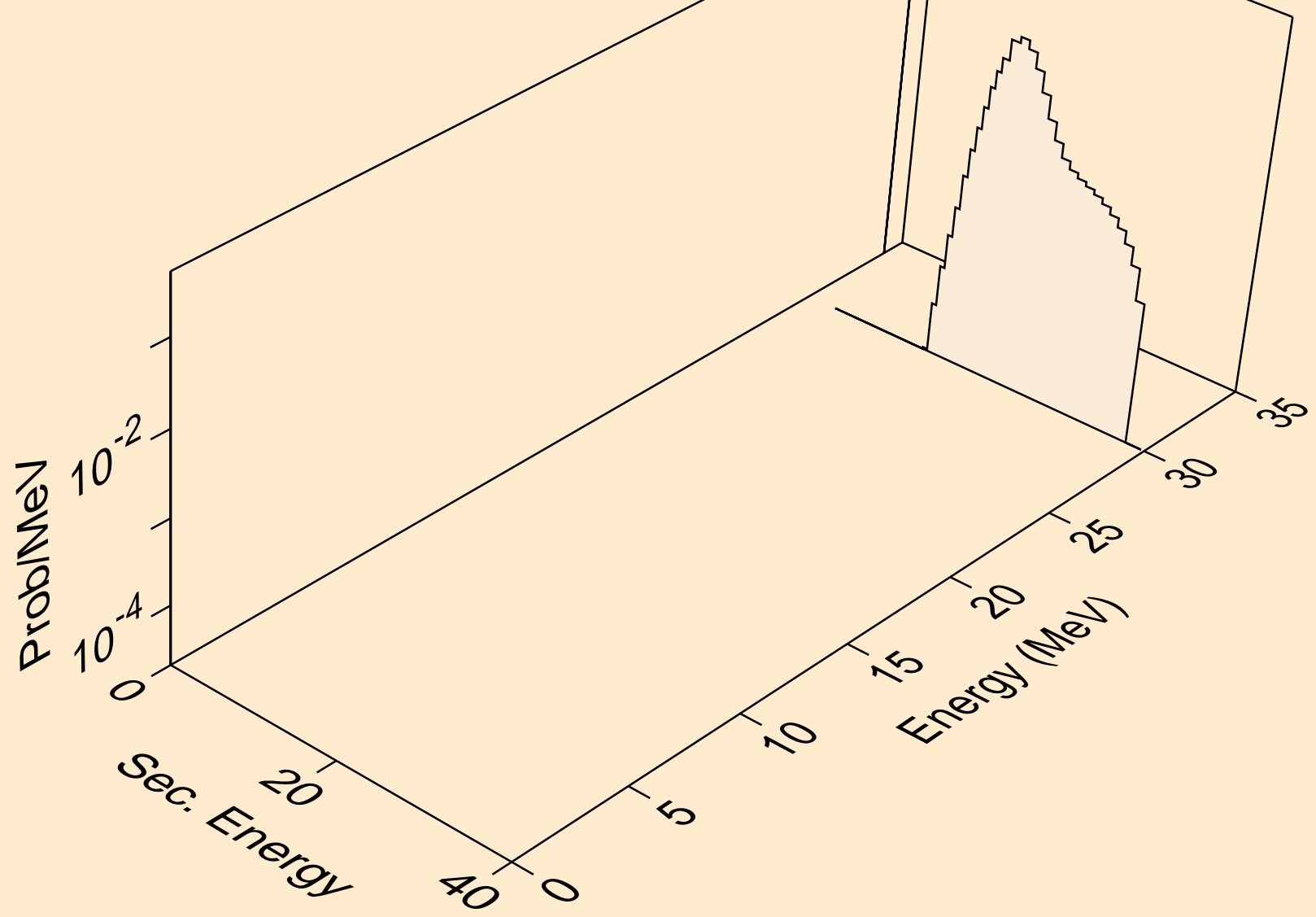

CM251 NEUTRON ACER TENDL-2021 LIBRARY; T=293.6K
alphas from (n,n*)a

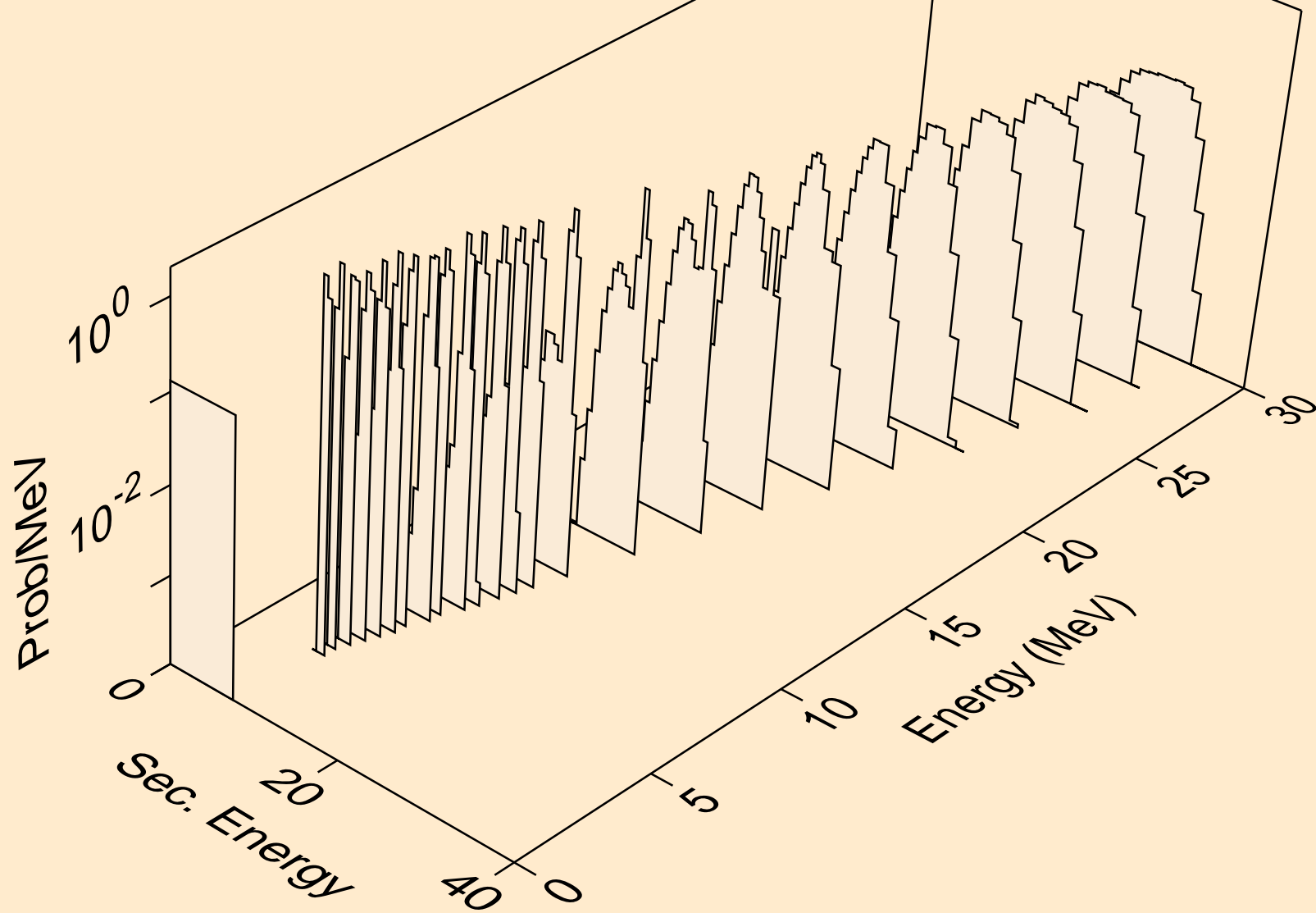

CM251 NEUTRON ACER TENDL-2021 LIBRARY; T=293.6K
alphas from (n,2n)a

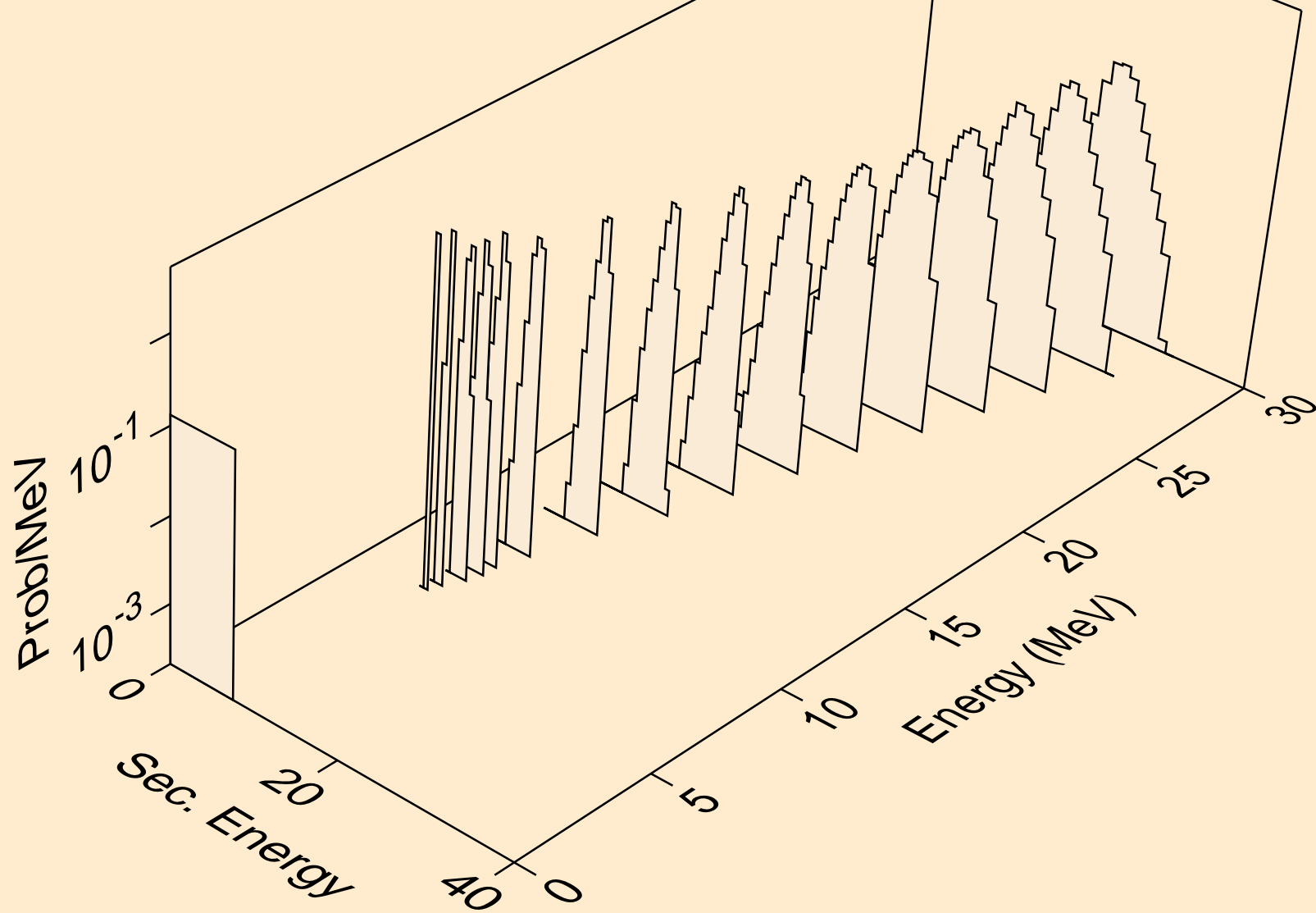

CM251 NEUTRON ACER TENDL-2021 LIBRARY; T=293.6K
alphas from (n,3n)a

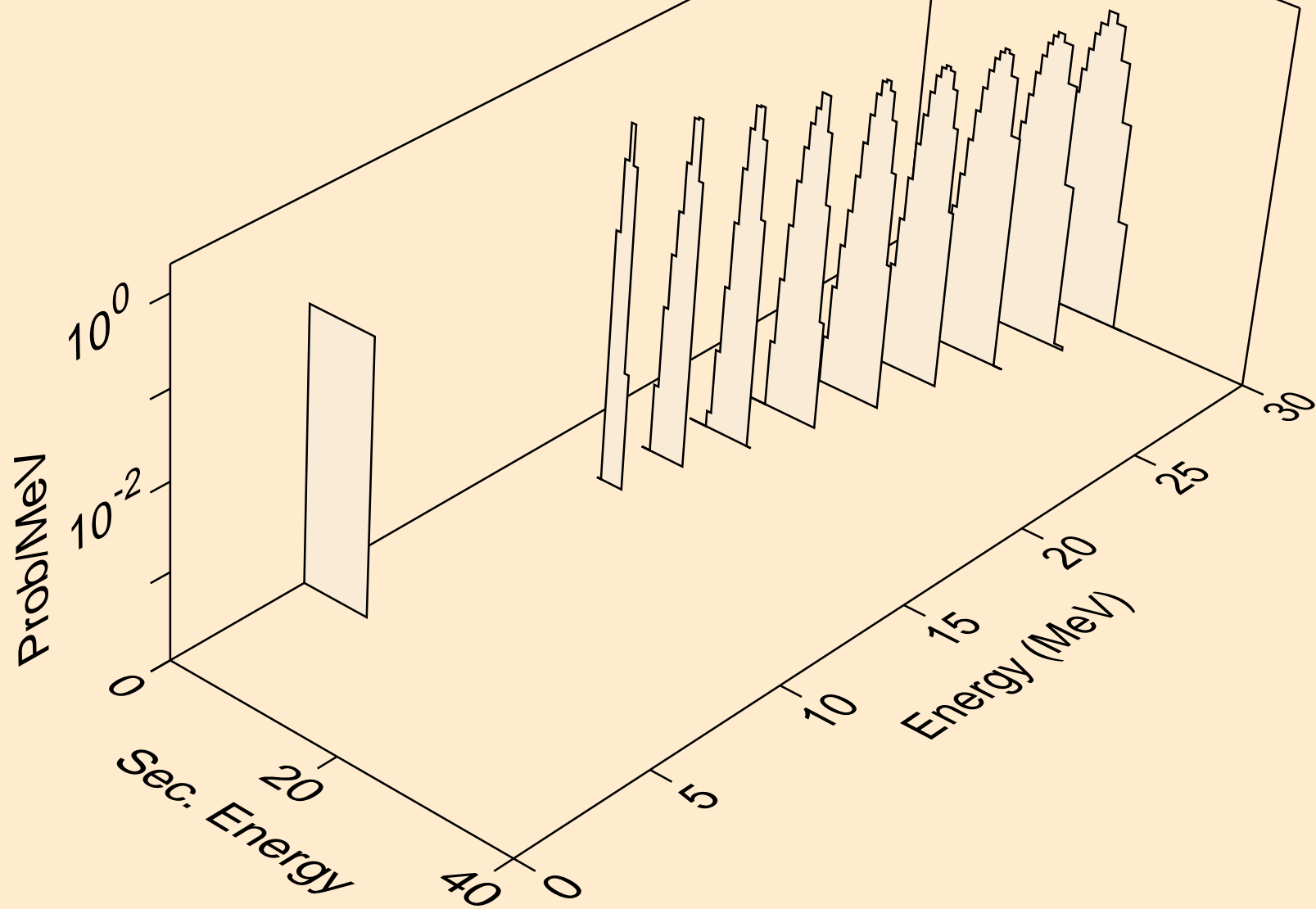

CM251 NEUTRON ACER TENDL-2021 LIBRARY; T=293.6K
alphas from (n,npa)

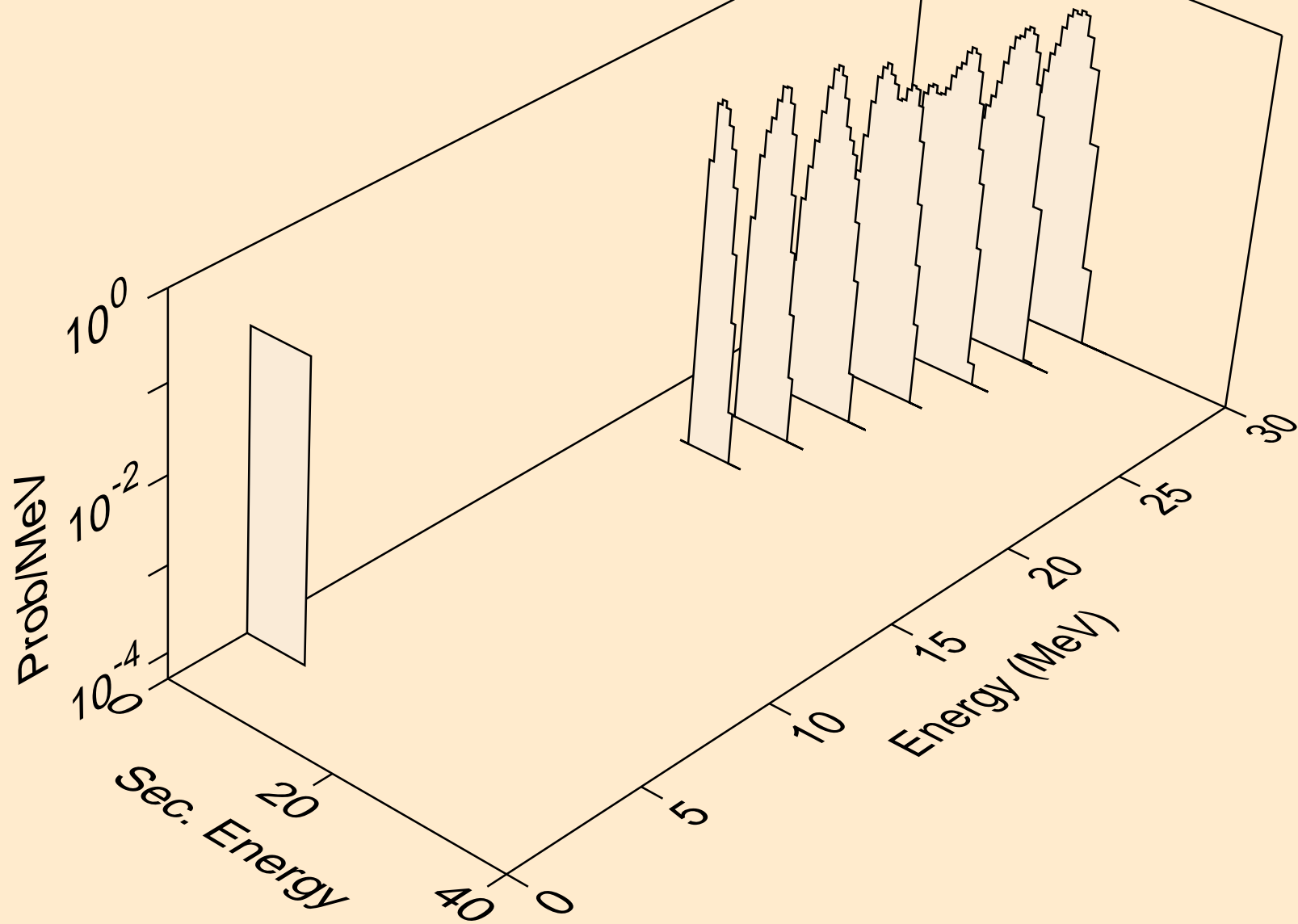

CM251 NEUTRON ACER TENDL-2021 LIBRARY; T=293.6K
alphas from (n,a)

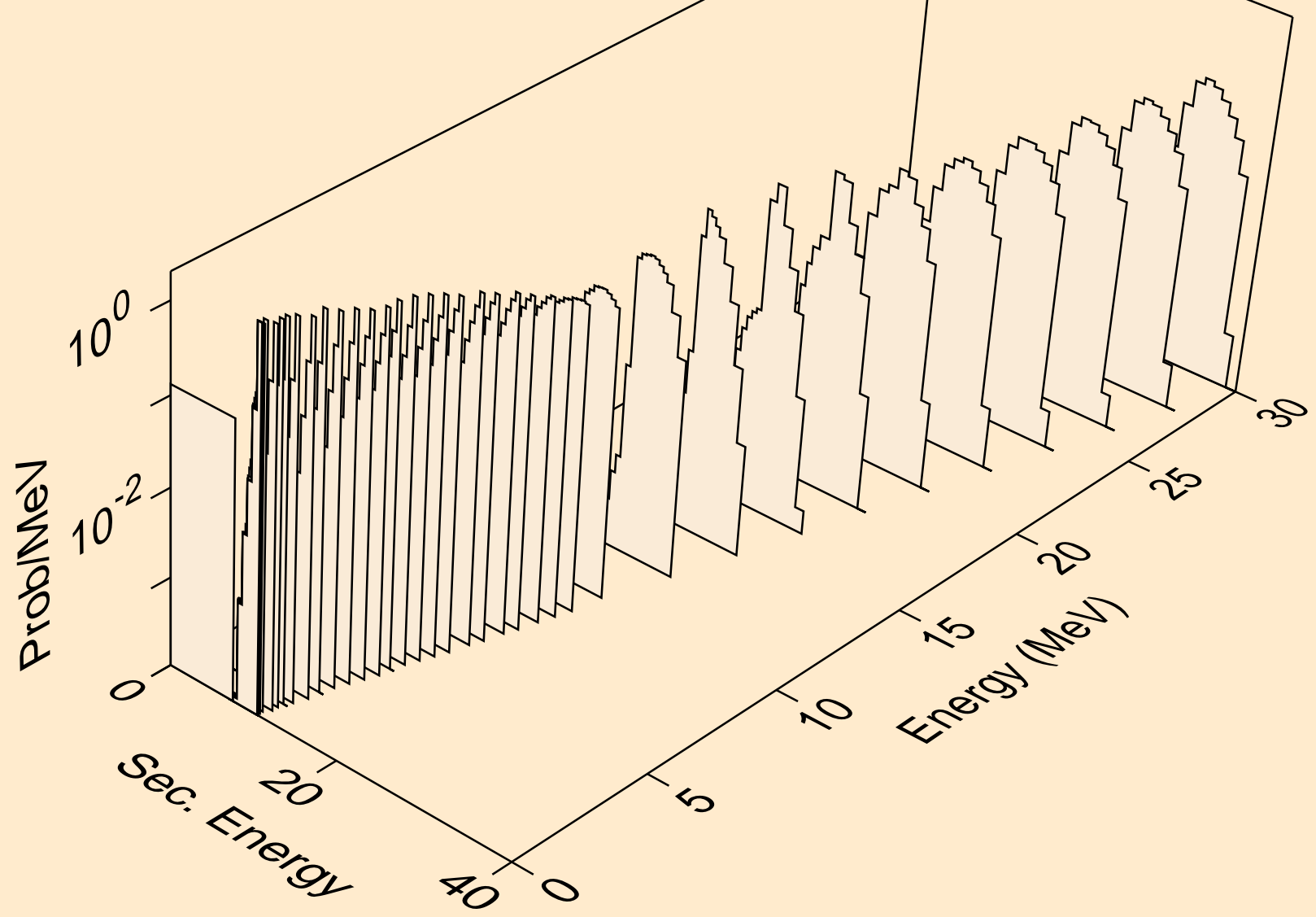

CM251 NEUTRON ACER TENDL-2021 LIBRARY; T=293.6K
alphas from (n,pa)

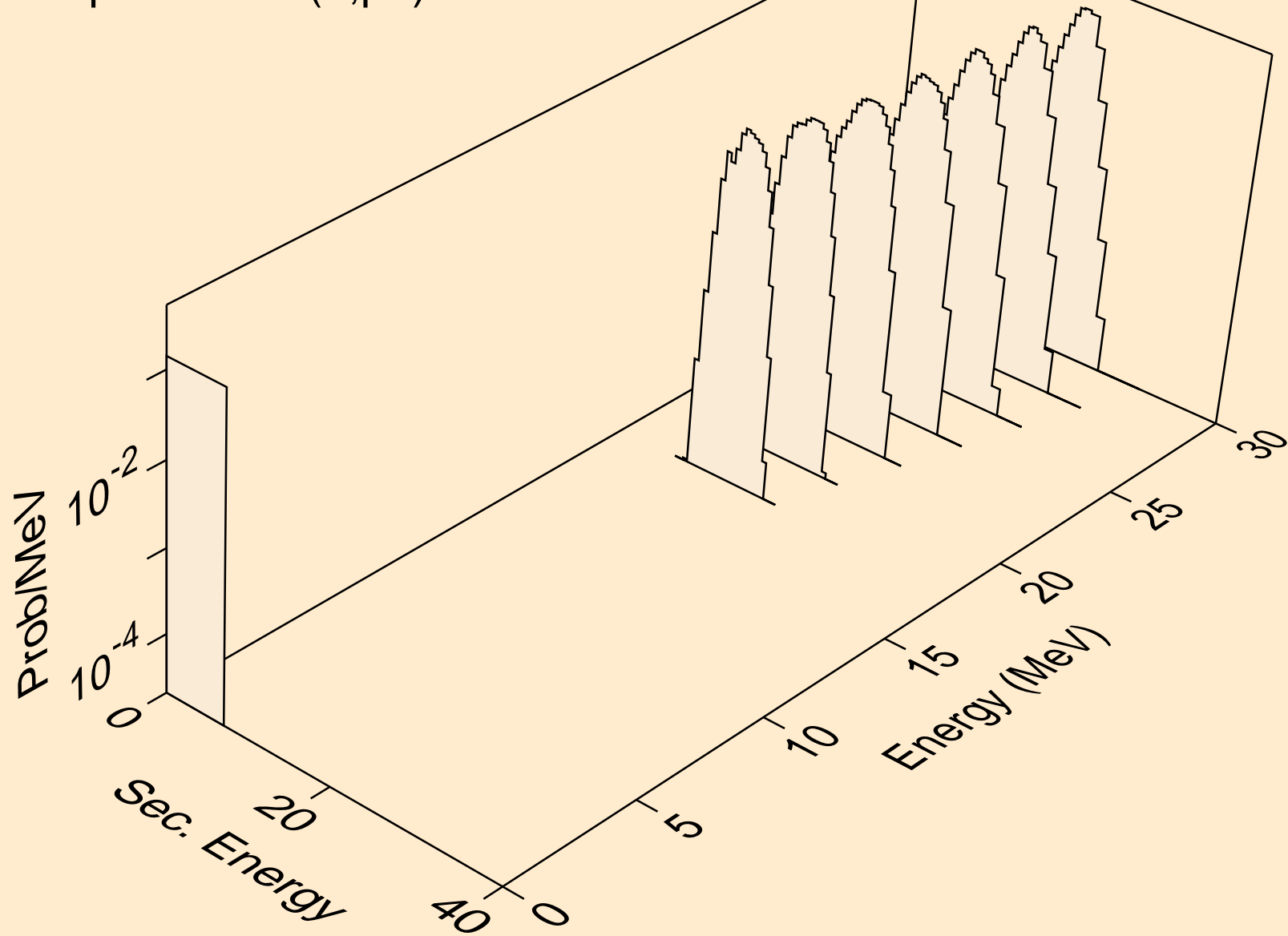

CM251 NEUTRON ACER TENDL-2021 LIBRARY; T=293.6K
alphas from (n,da)

