

CN285 NEUTRON ACER TENDL-2021 LIBRARY; T=293.6K

Principal cross sections

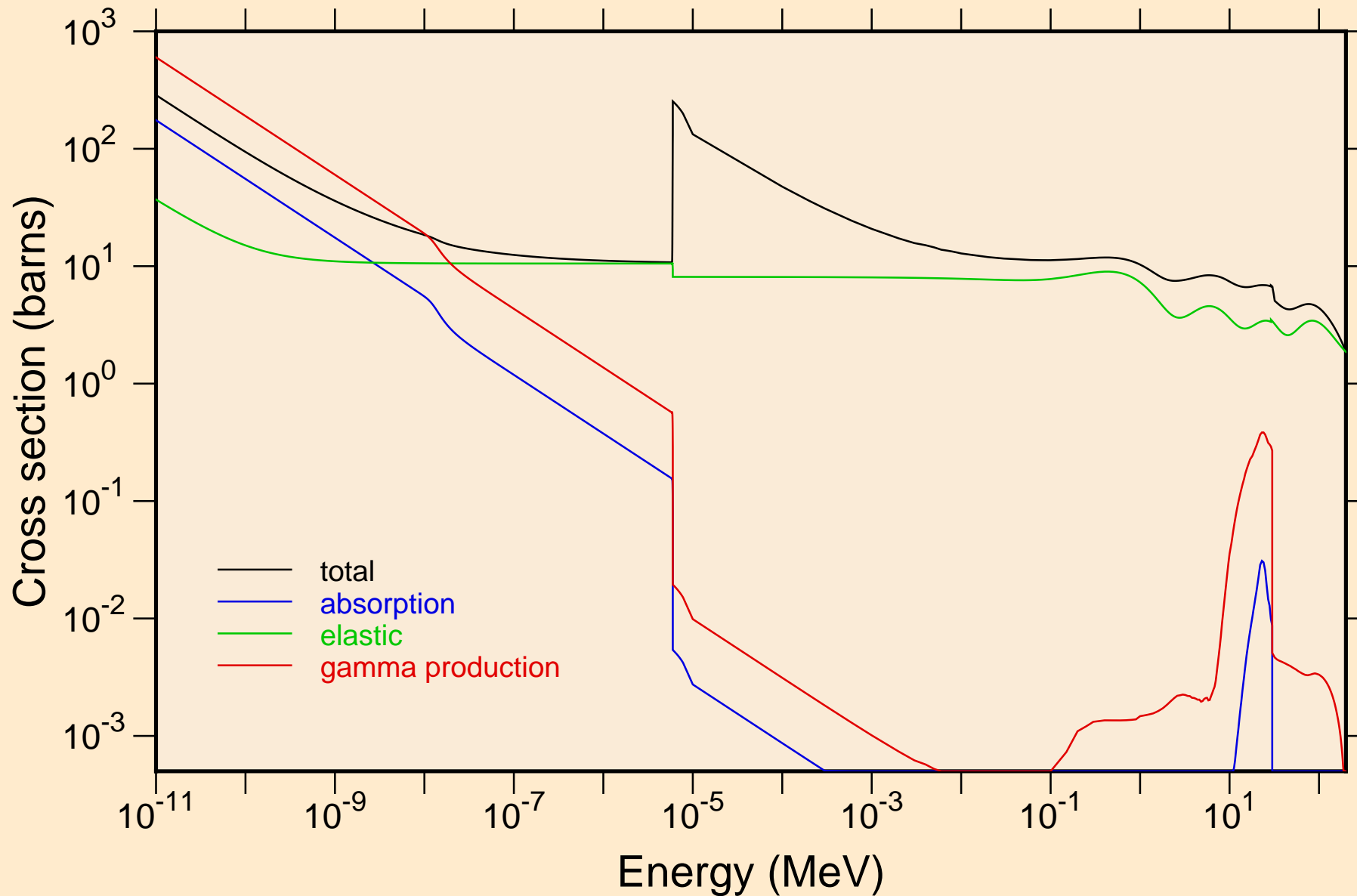

CN285 NEUTRON ACER TENDL-2021 LIBRARY; T=293.6K
Heating

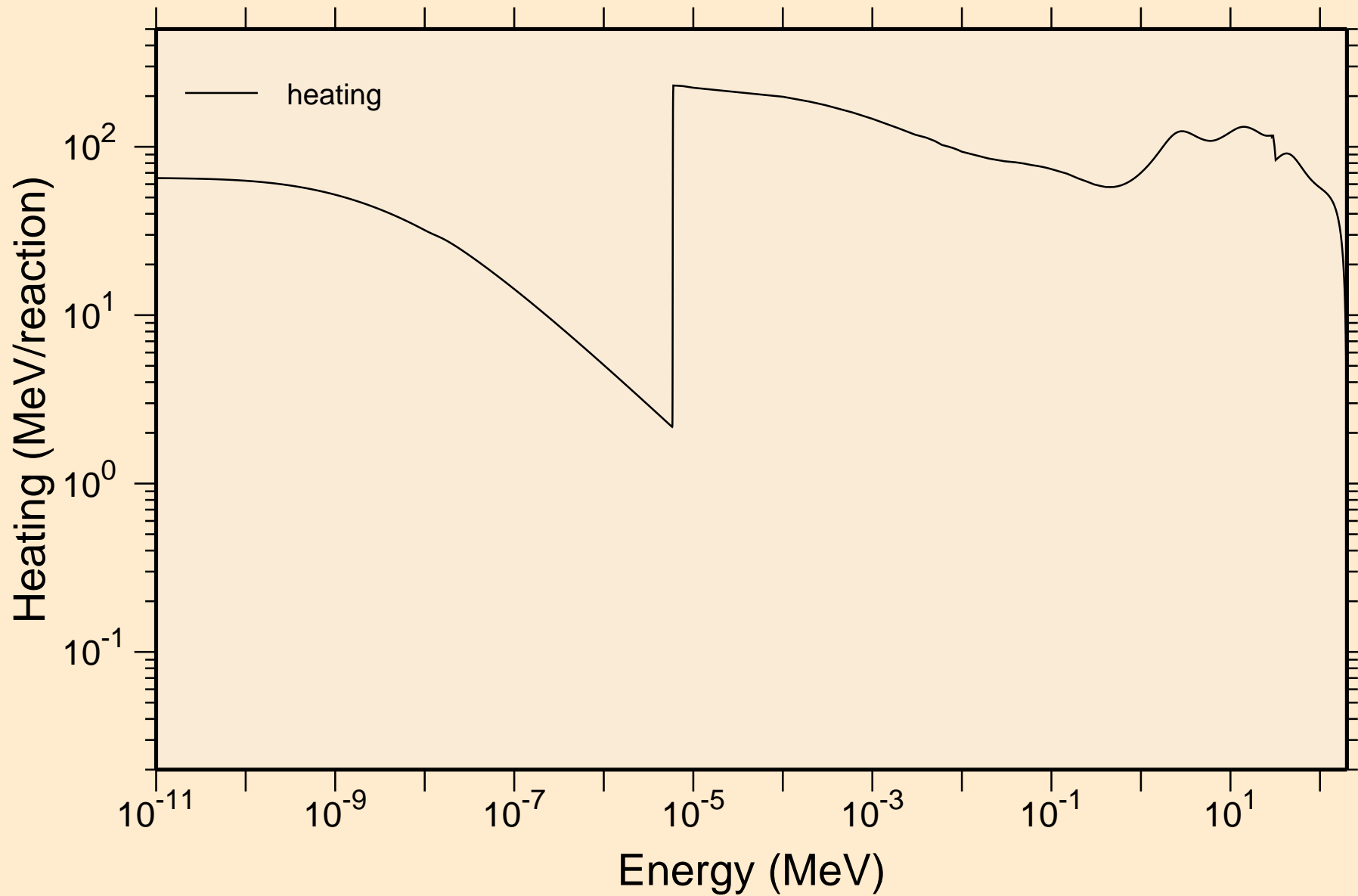

CN285 NEUTRON ACER TENDL-2021 LIBRARY; T=293.6K
Damage

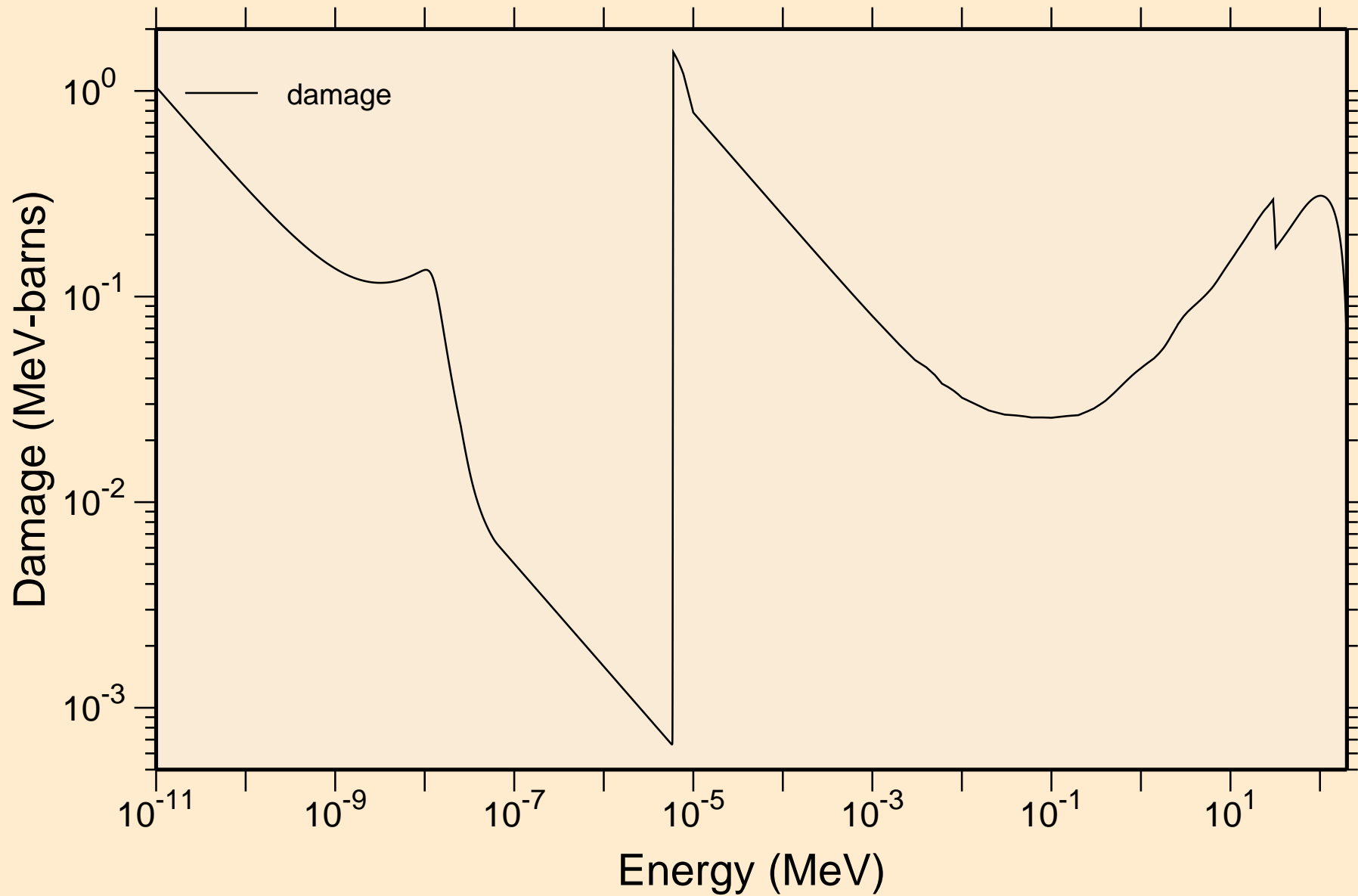

CN285 NEUTRON ACER TENDL-2021 LIBRARY; T=293.6K
Non-threshold reactions

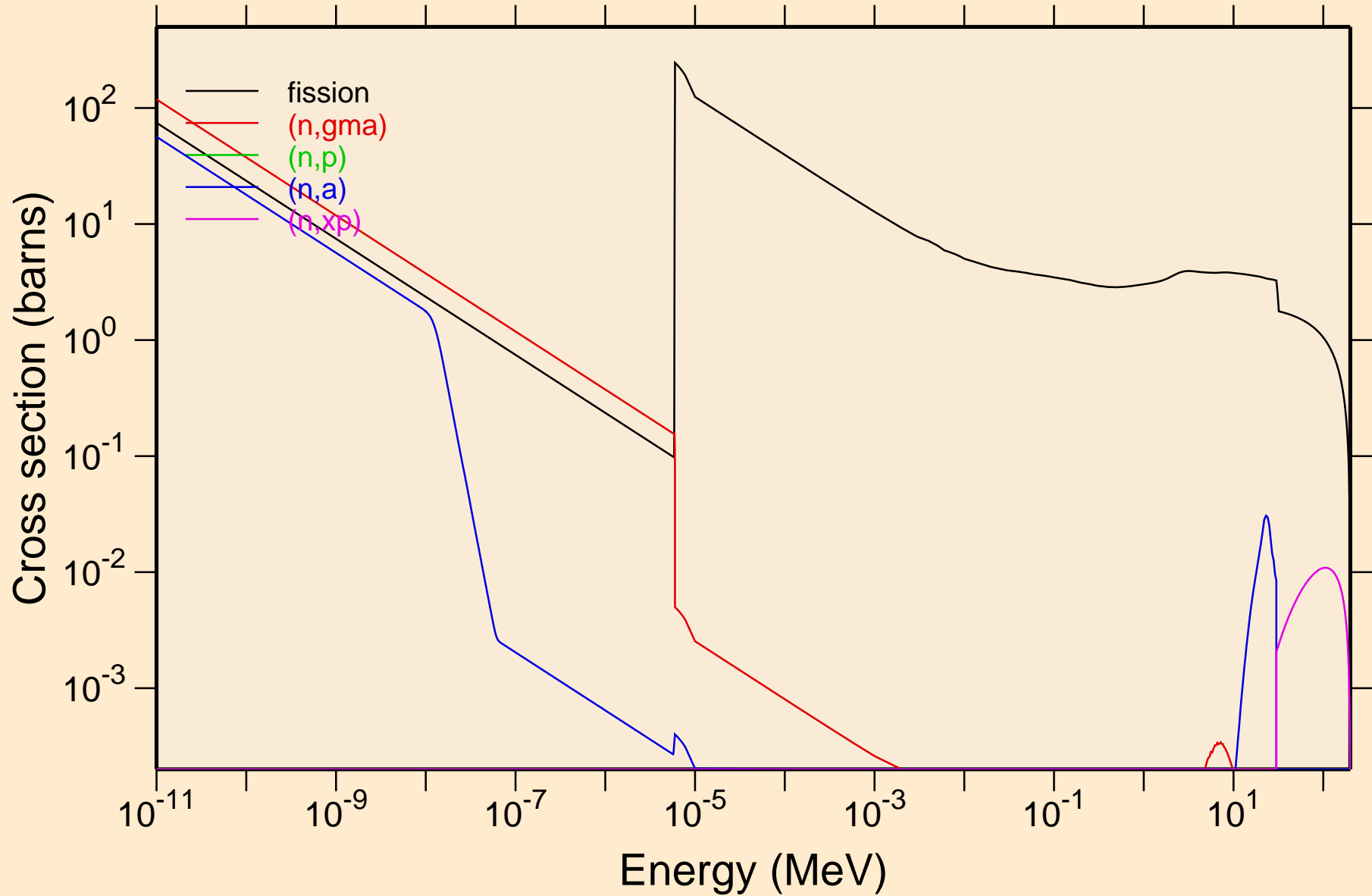

CN285 NEUTRON ACER TENDL-2021 LIBRARY; T=293.6K
Non-threshold reactions

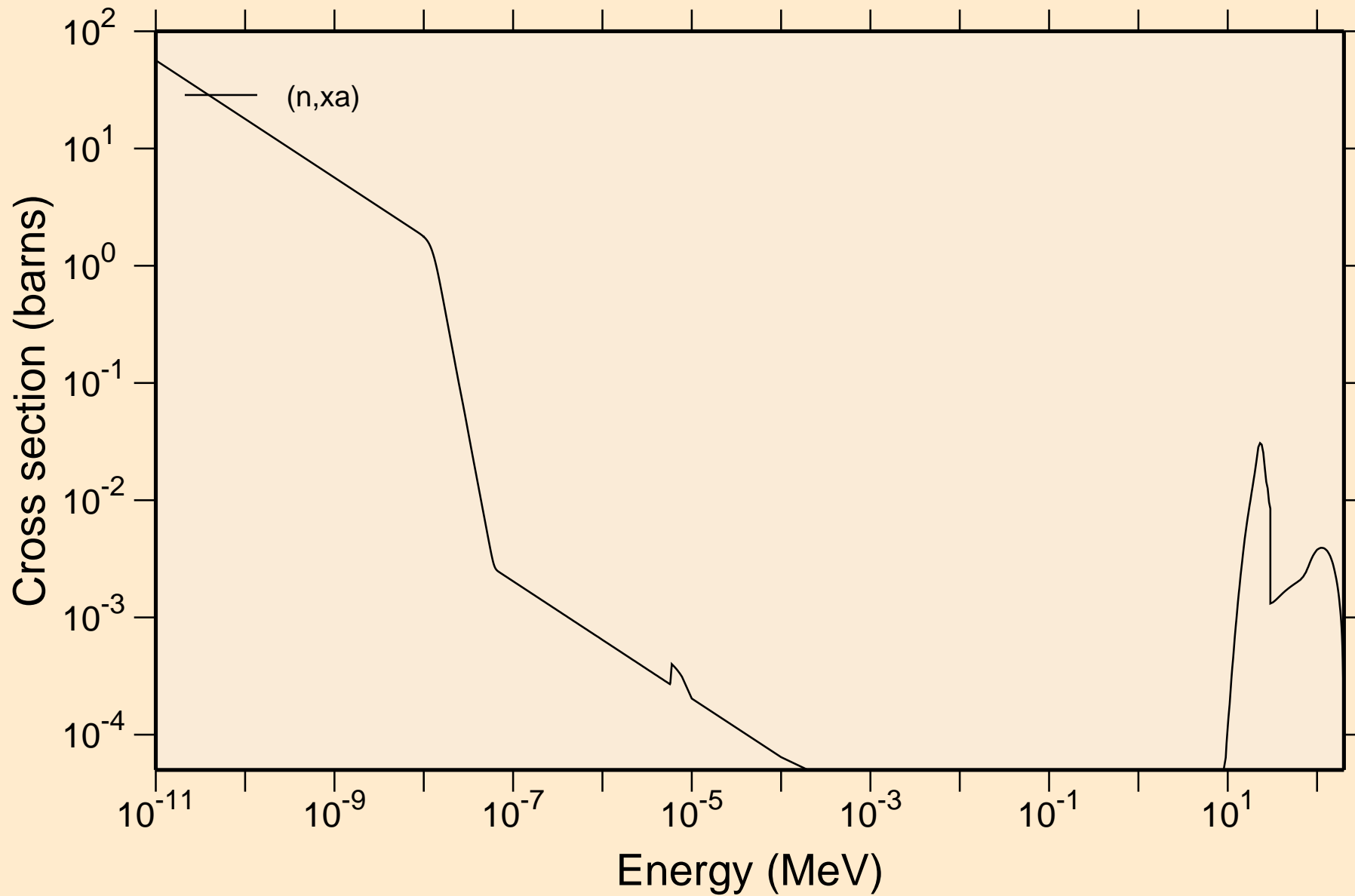

CN285 NEUTRON ACER TENDL-2021 LIBRARY; T=293.6K

Principal cross sections

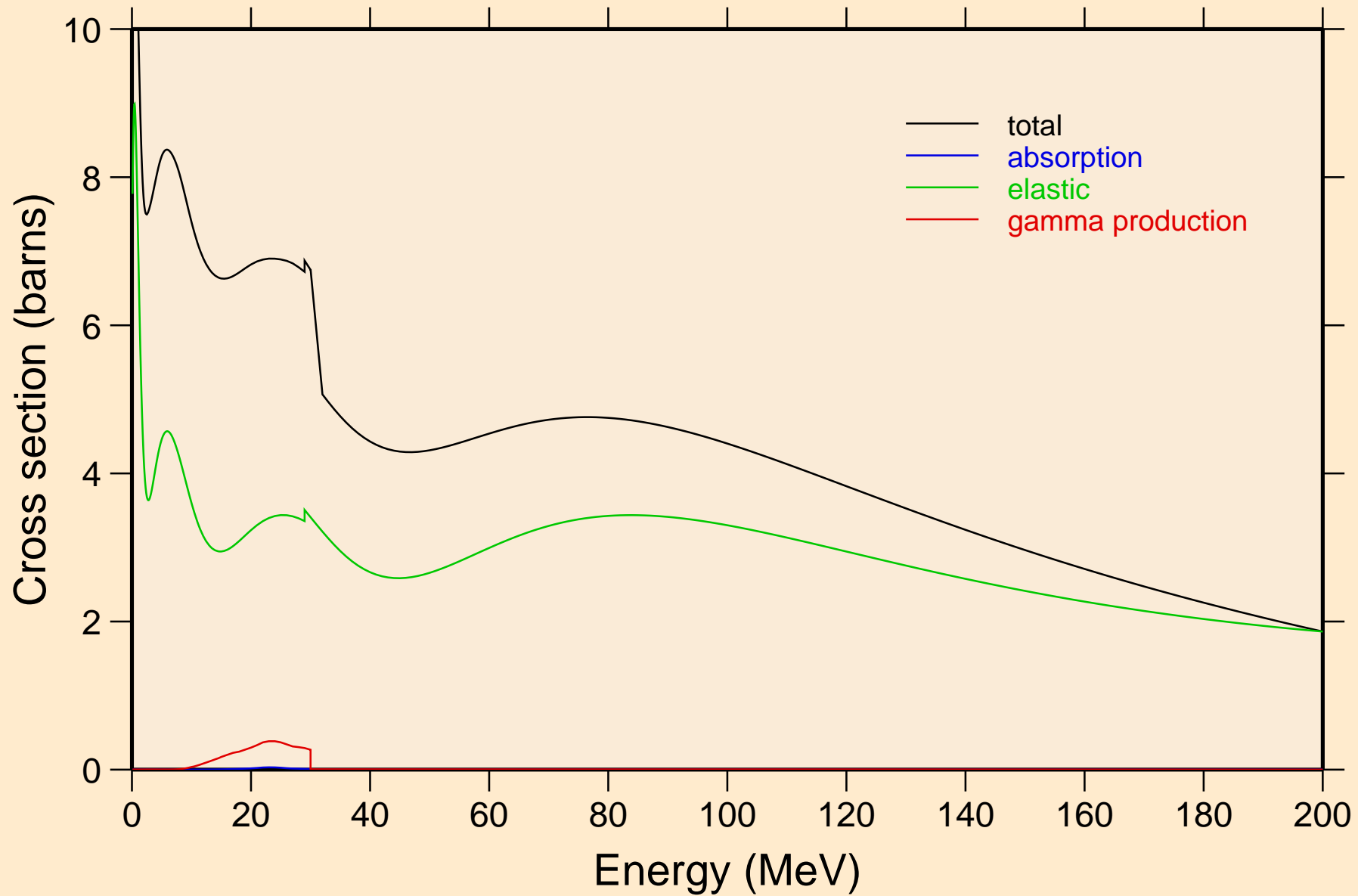

CN285 NEUTRON ACER TENDL-2021 LIBRARY; T=293.6K
Heating

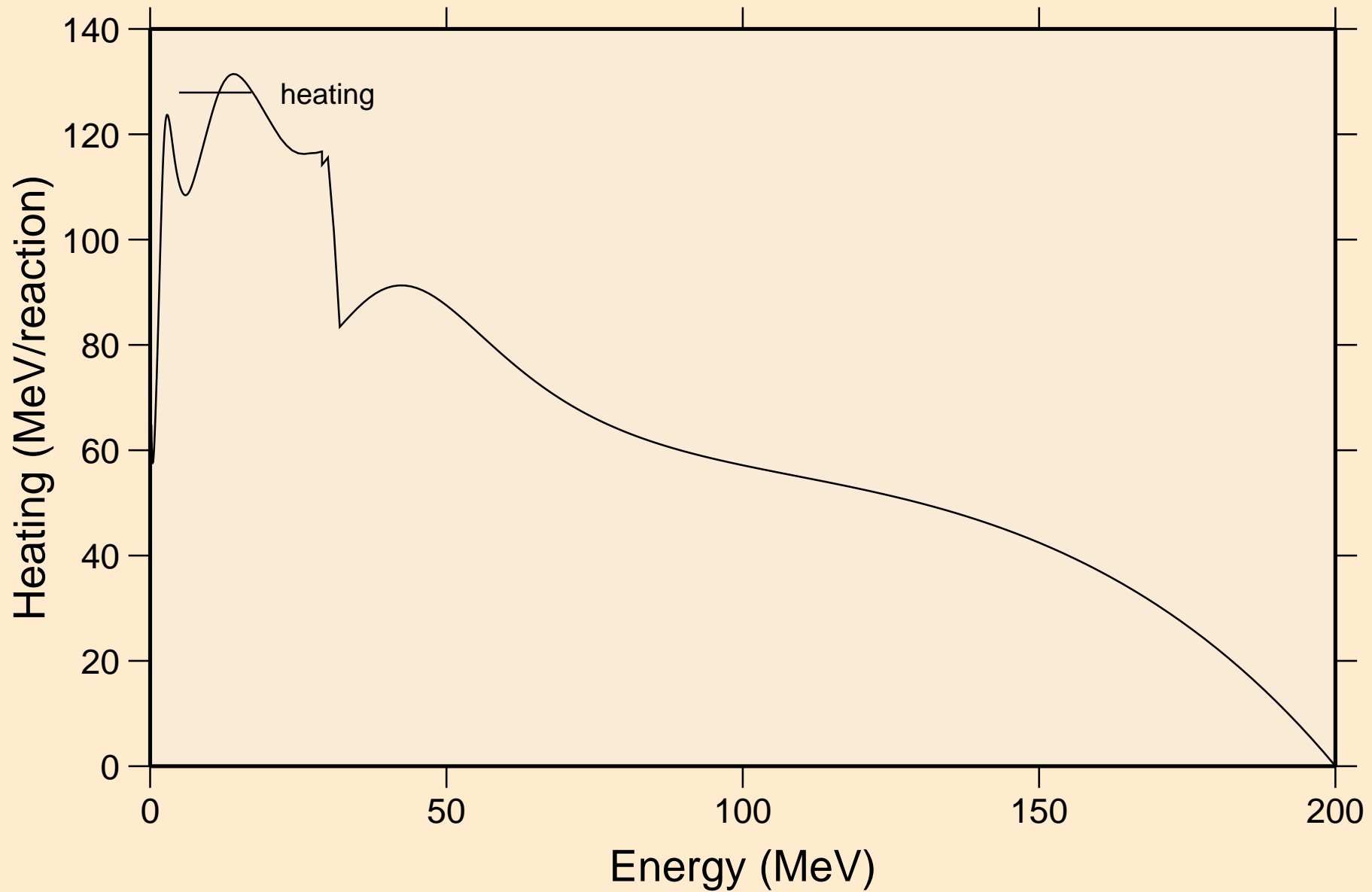

CN285 NEUTRON ACER TENDL-2021 LIBRARY; T=293.6K
Damage

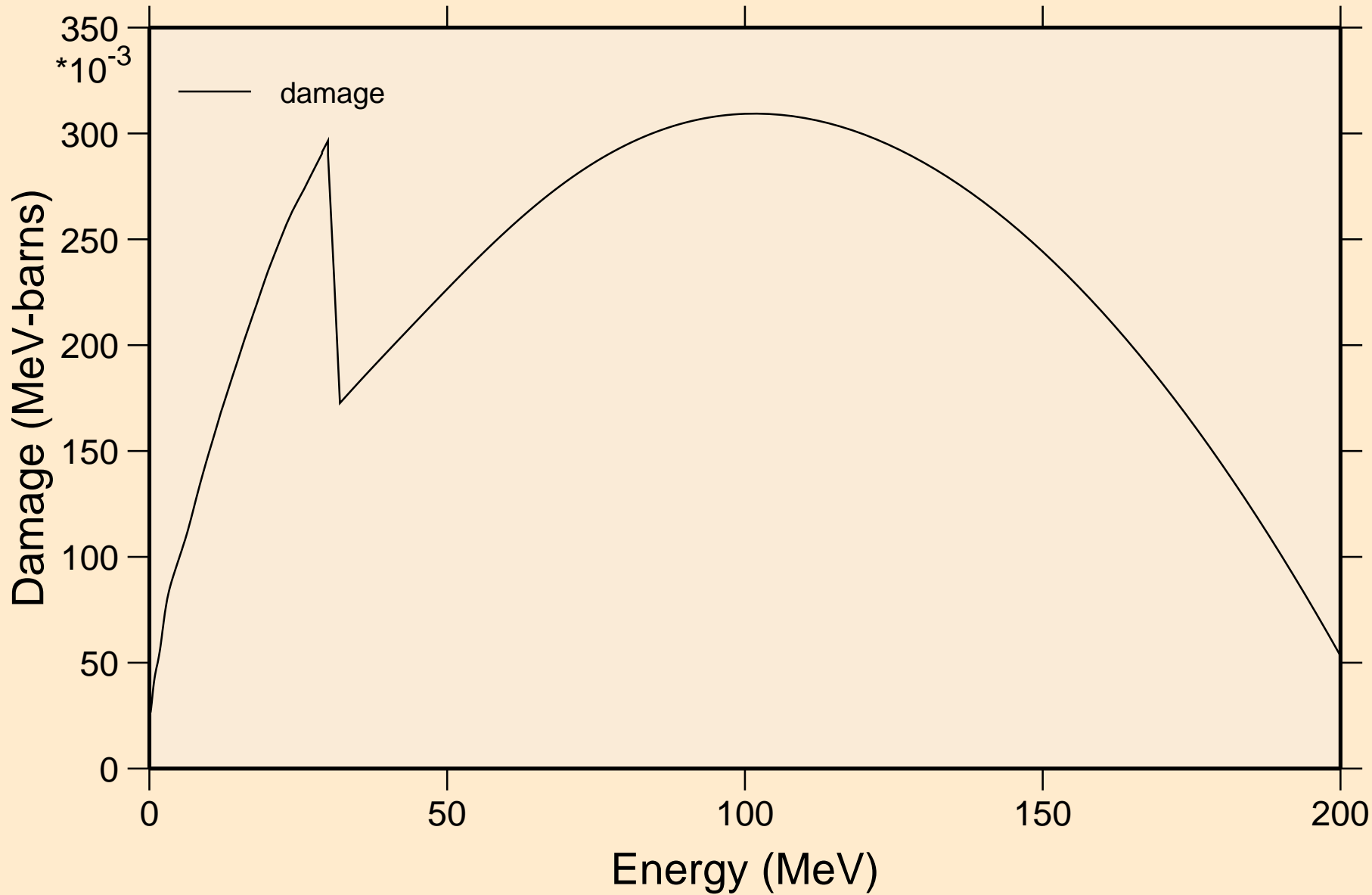

CN285 NEUTRON ACER TENDL-2021 LIBRARY; T=293.6K

Non-threshold reactions

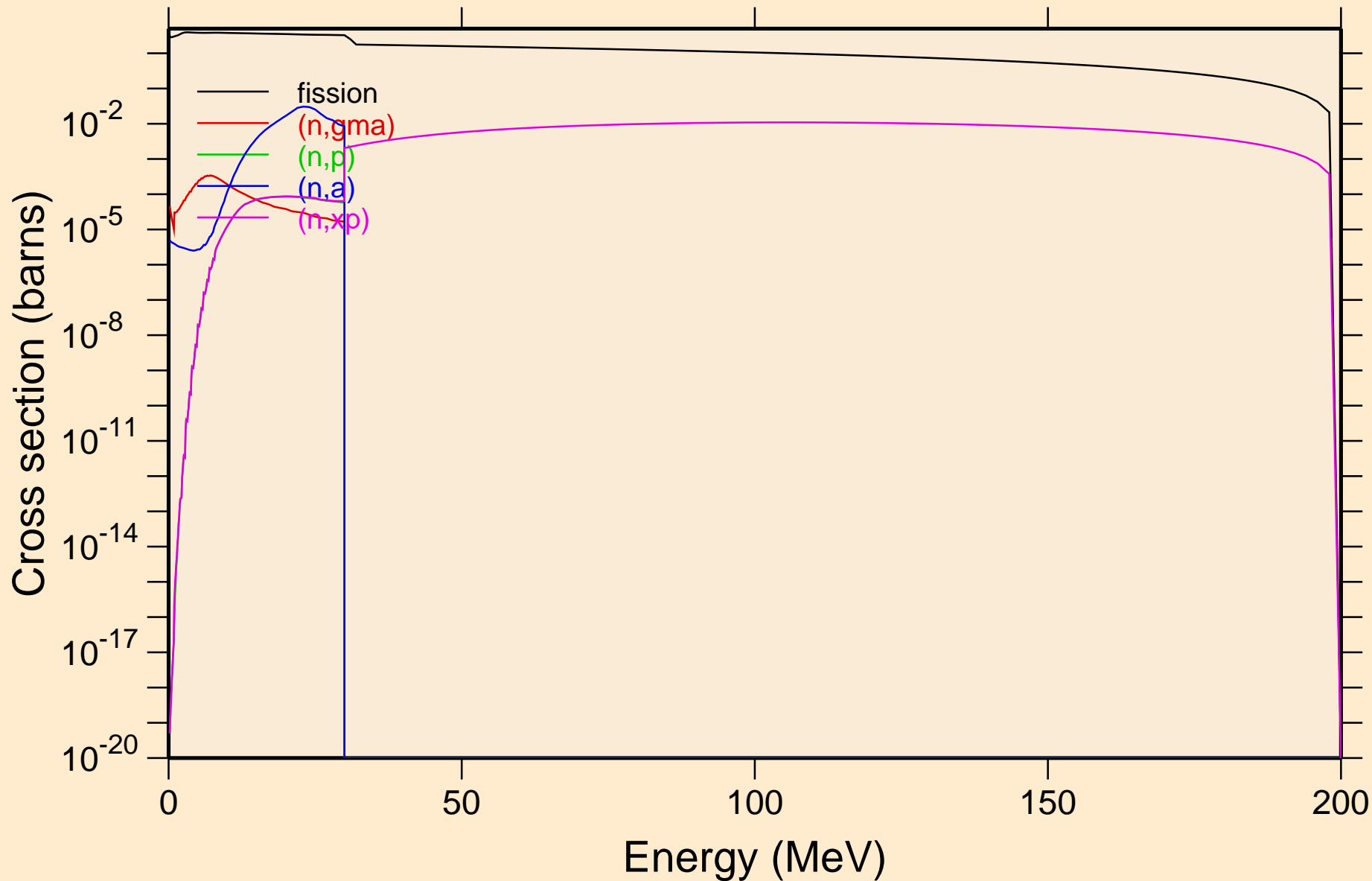

CN285 NEUTRON ACER TENDL-2021 LIBRARY; T=293.6K
Non-threshold reactions

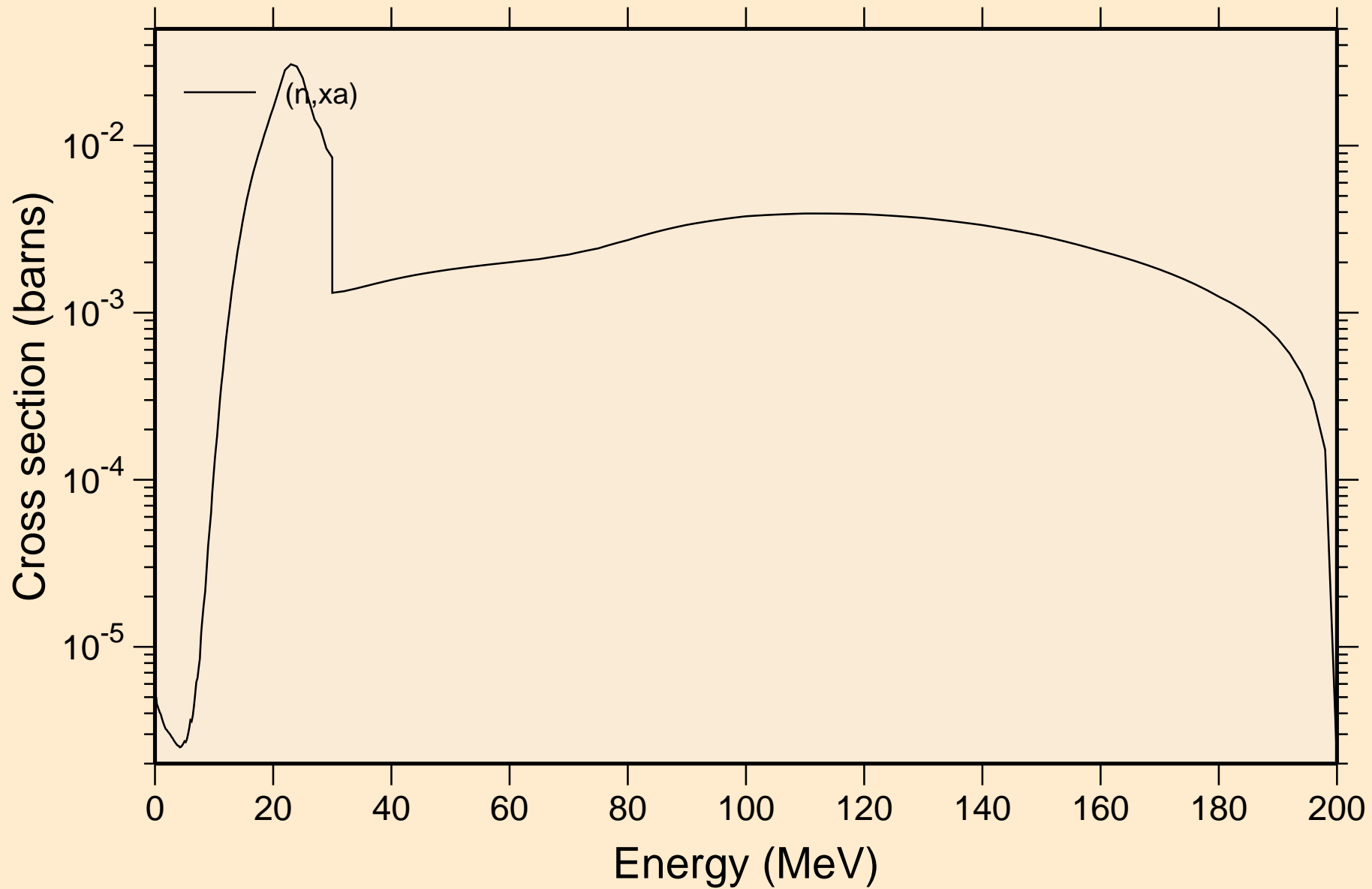

CN285 NEUTRON ACER TENDL-2021 LIBRARY; T=293.6K
Inelastic levels

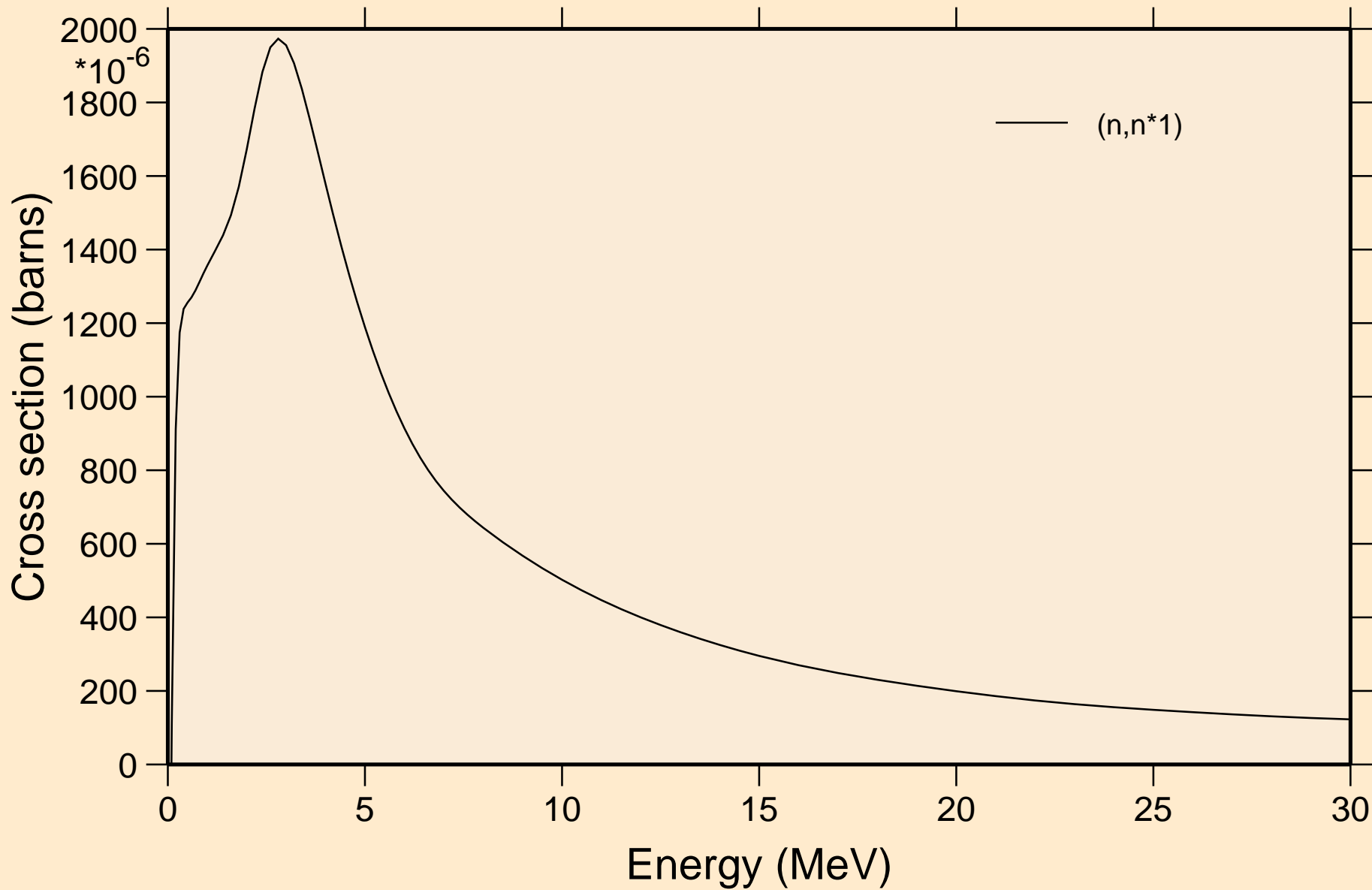

CN285 NEUTRON ACER TENDL-2021 LIBRARY; T=293.6K
Threshold reactions

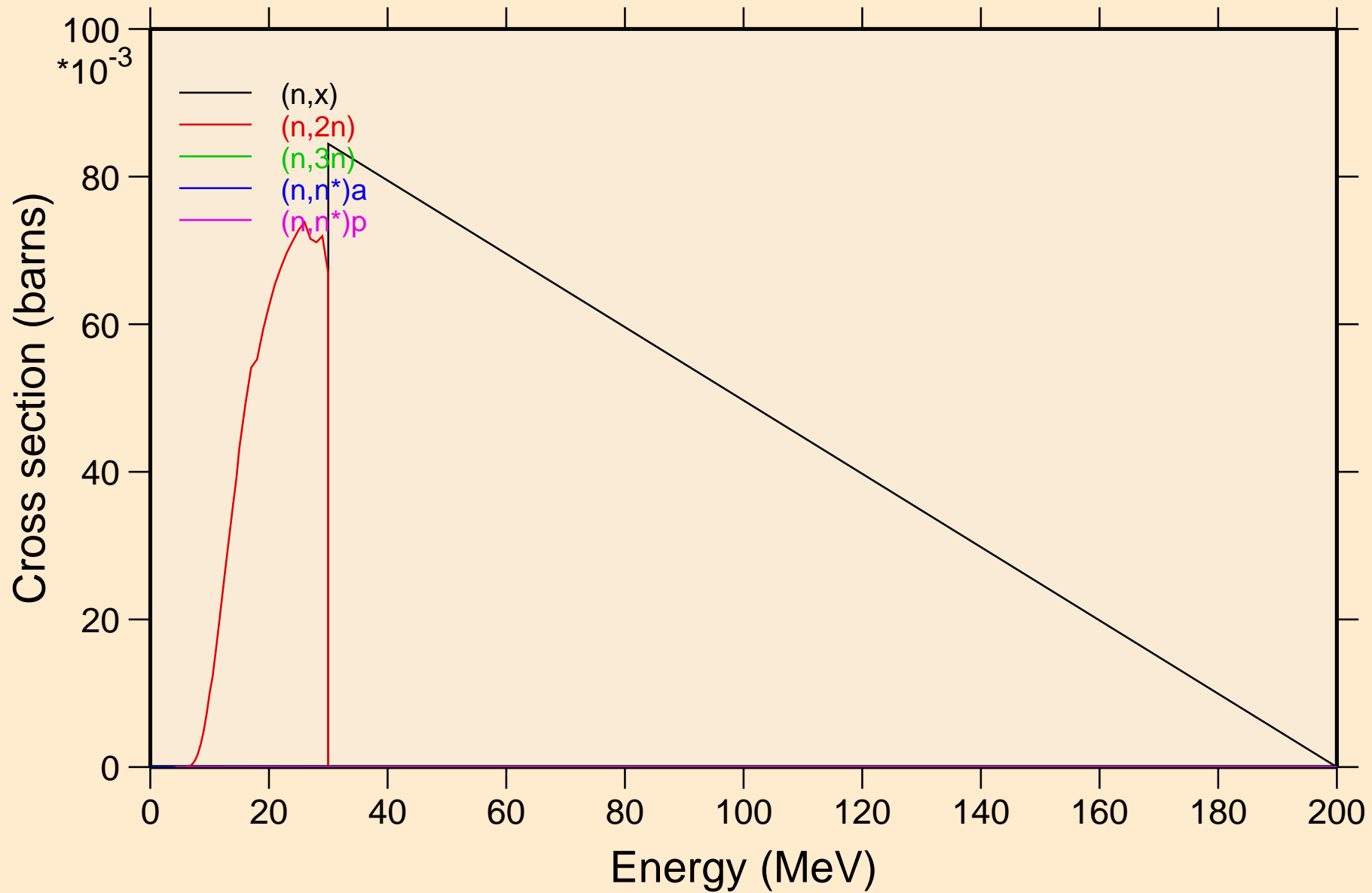

CN285 NEUTRON ACER TENDL-2021 LIBRARY; T=293.6K

Threshold reactions

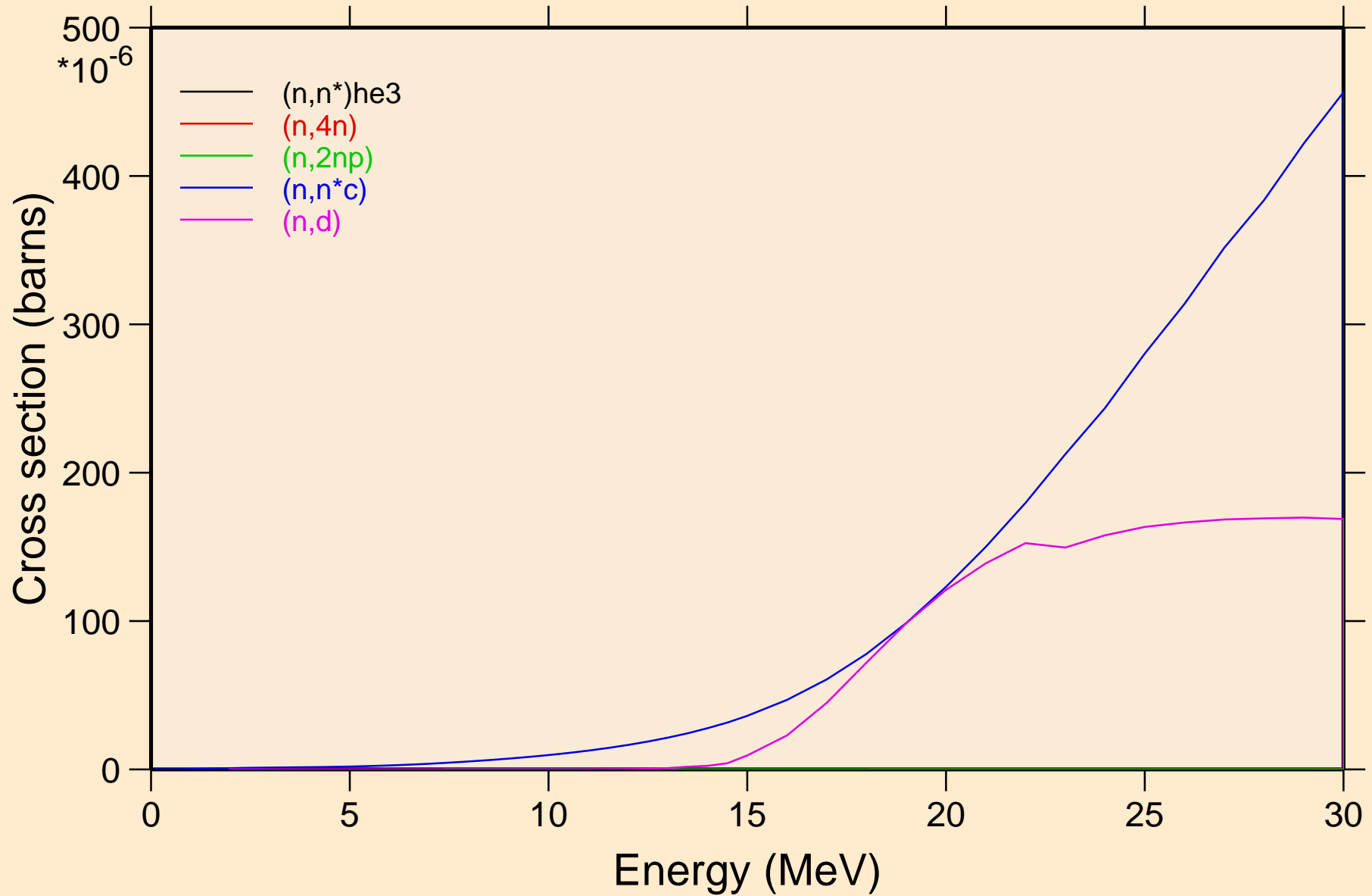

CN285 NEUTRON ACER TENDL-2021 LIBRARY; T=293.6K
Threshold reactions

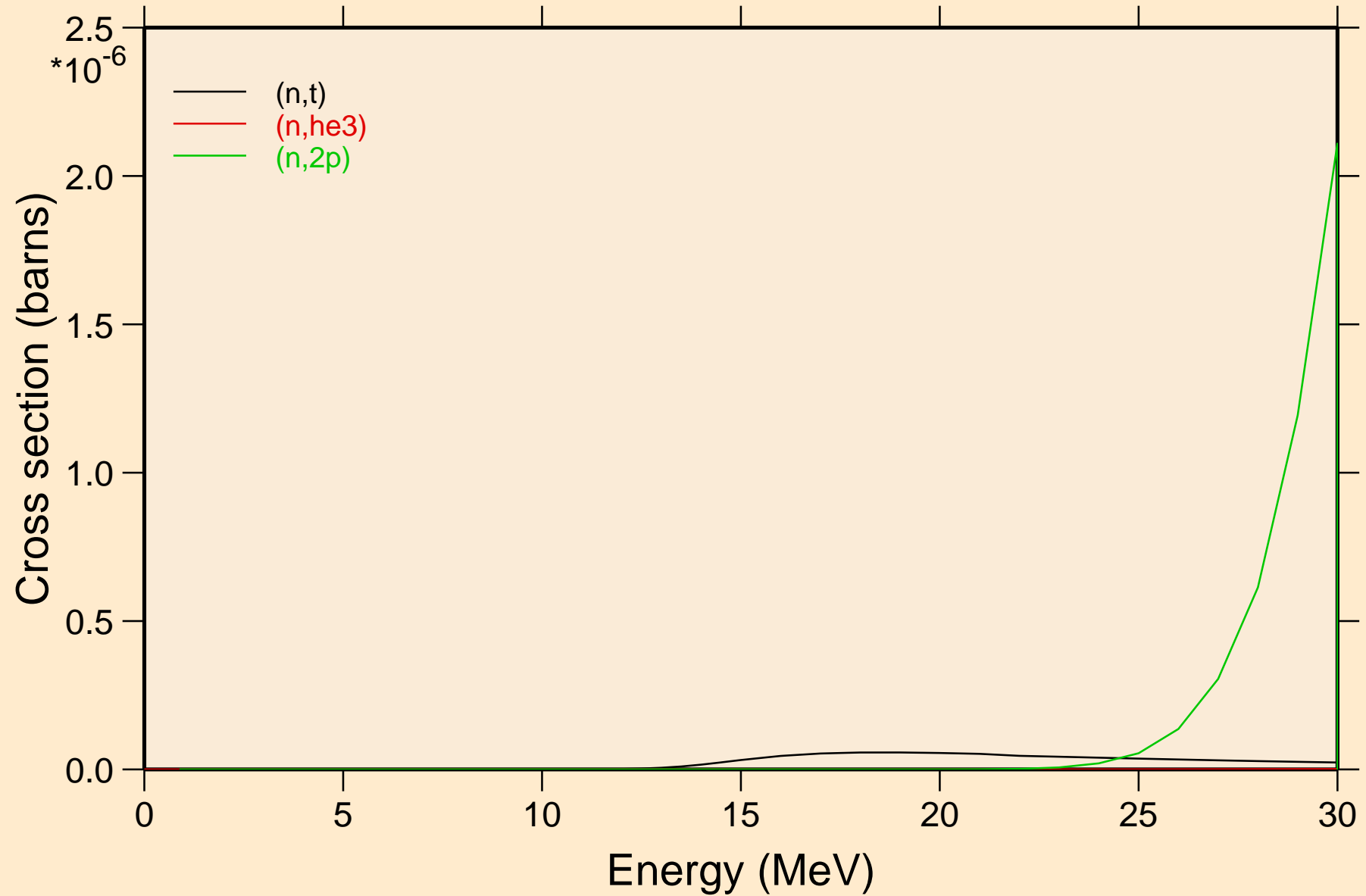

CN285 NEUTRON ACER TENDL-2021 LIBRARY; T=293.6K

Threshold reactions

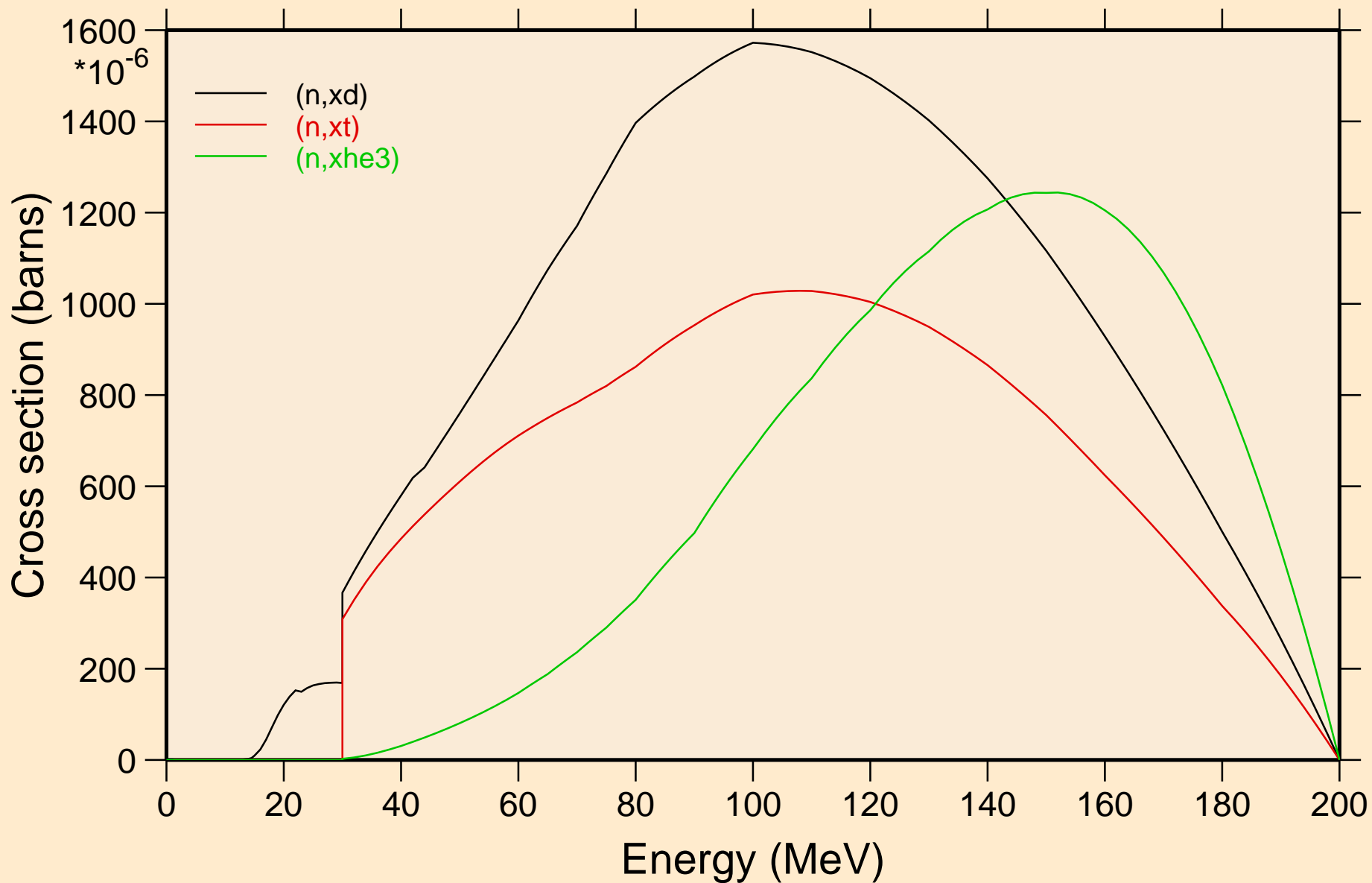

CN285 NEUTRON ACER TENDL-2021 LIBRARY; T=293.6K
angular distribution for elastic

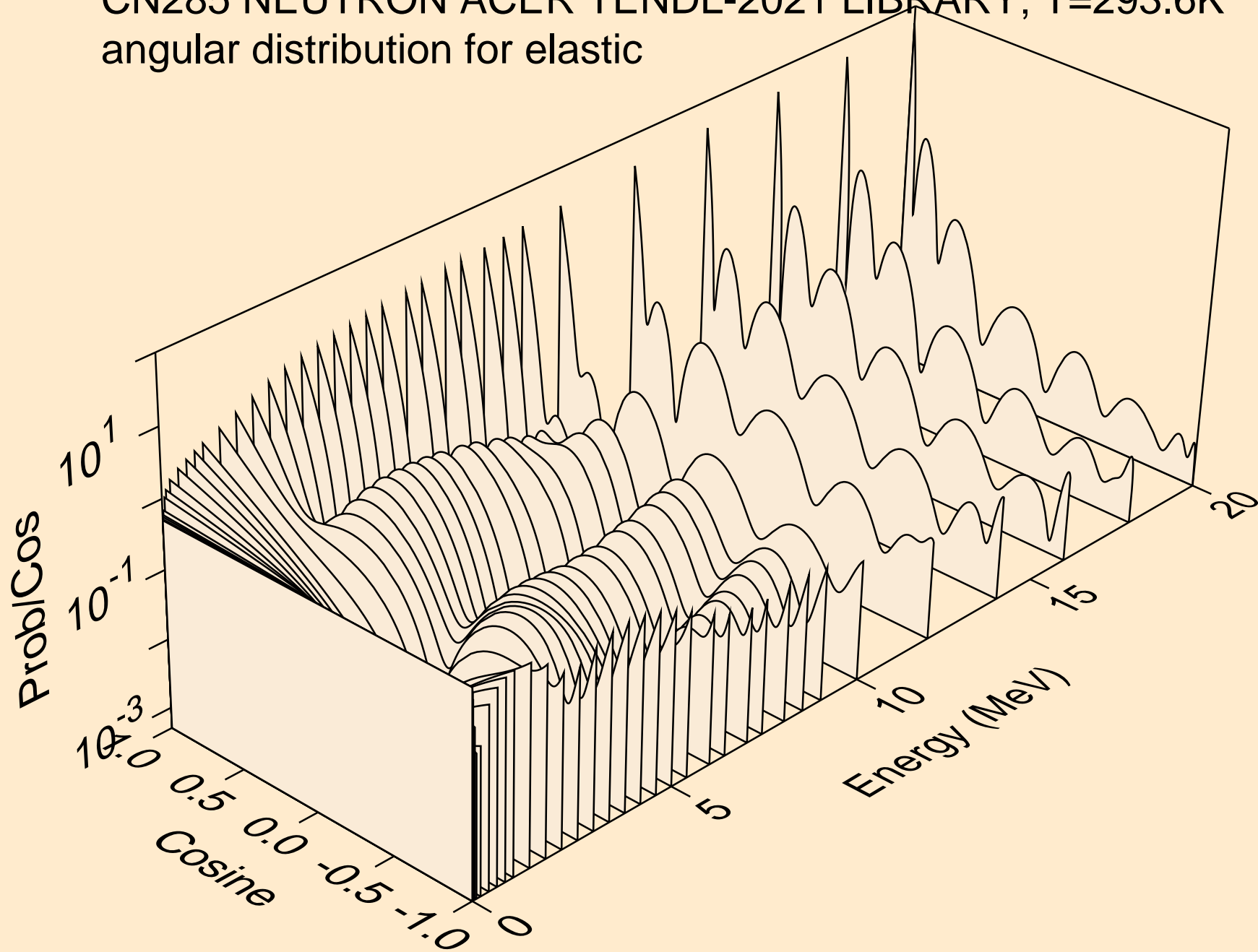

CN285 NEUTRON ACER TENDL-2021 LIBRARY; T=293.6K
angular distribution for elastic

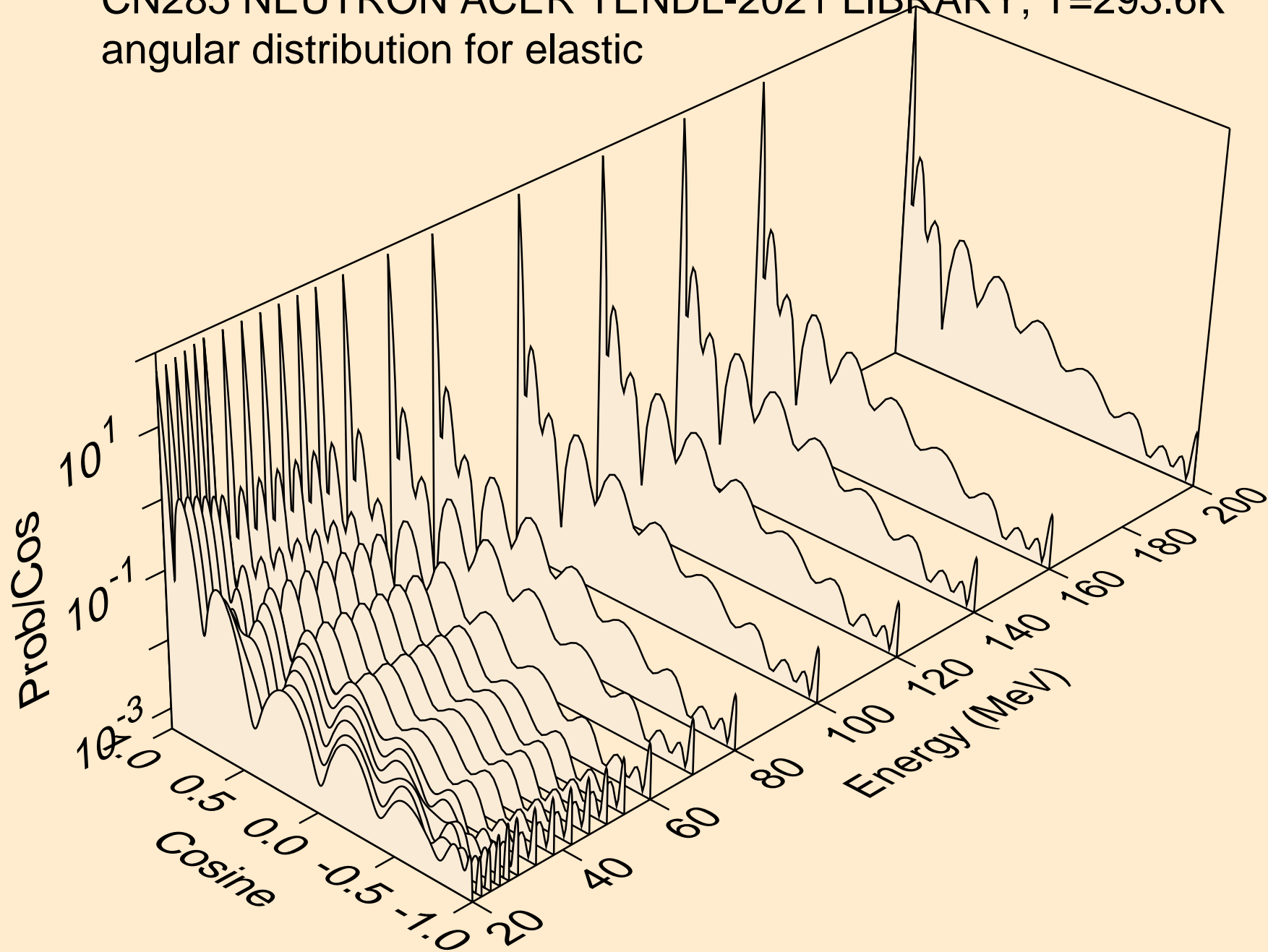

CN285 NEUTRON ACER TENDL-2021 LIBRARY; T=293.6K
angular distribution for (n,n*1)

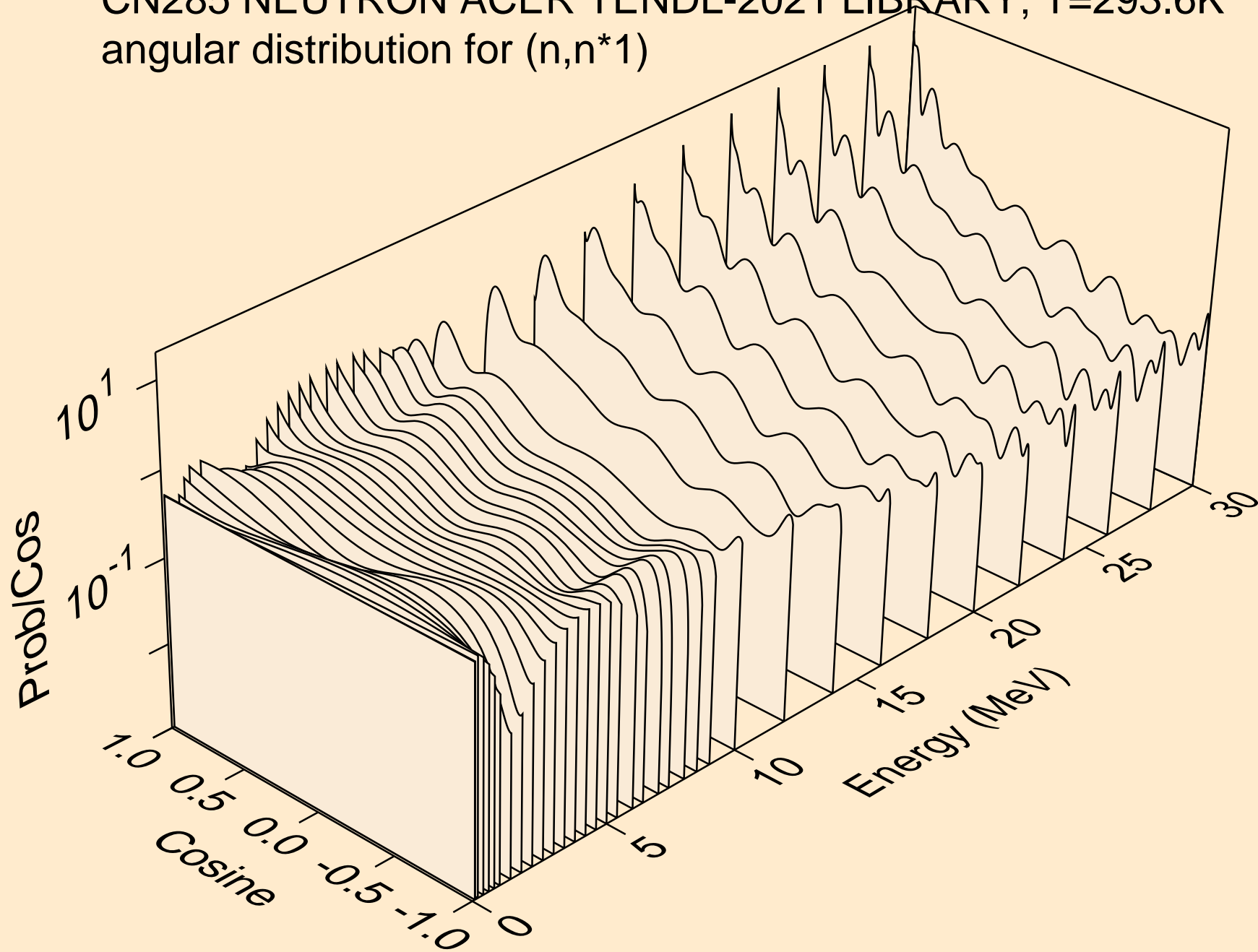

CN285 NEUTRON ACER TENDL-2021 LIBRARY; T=293.6K
Total fission nubar

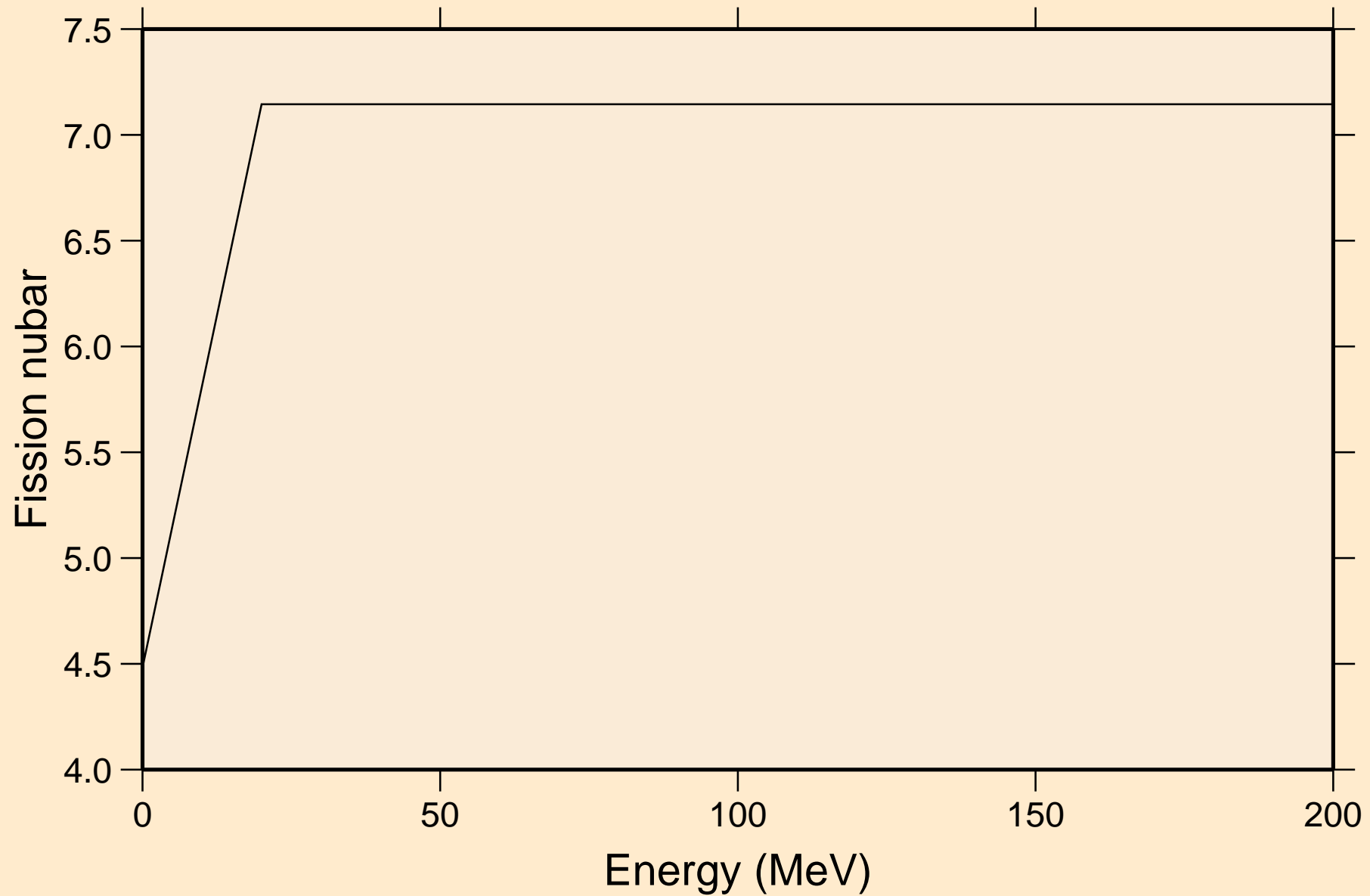

CN285 NEUTRON ACER TENDL-2021 LIBRARY; T=293.6K
Neutron emission for (n,x)

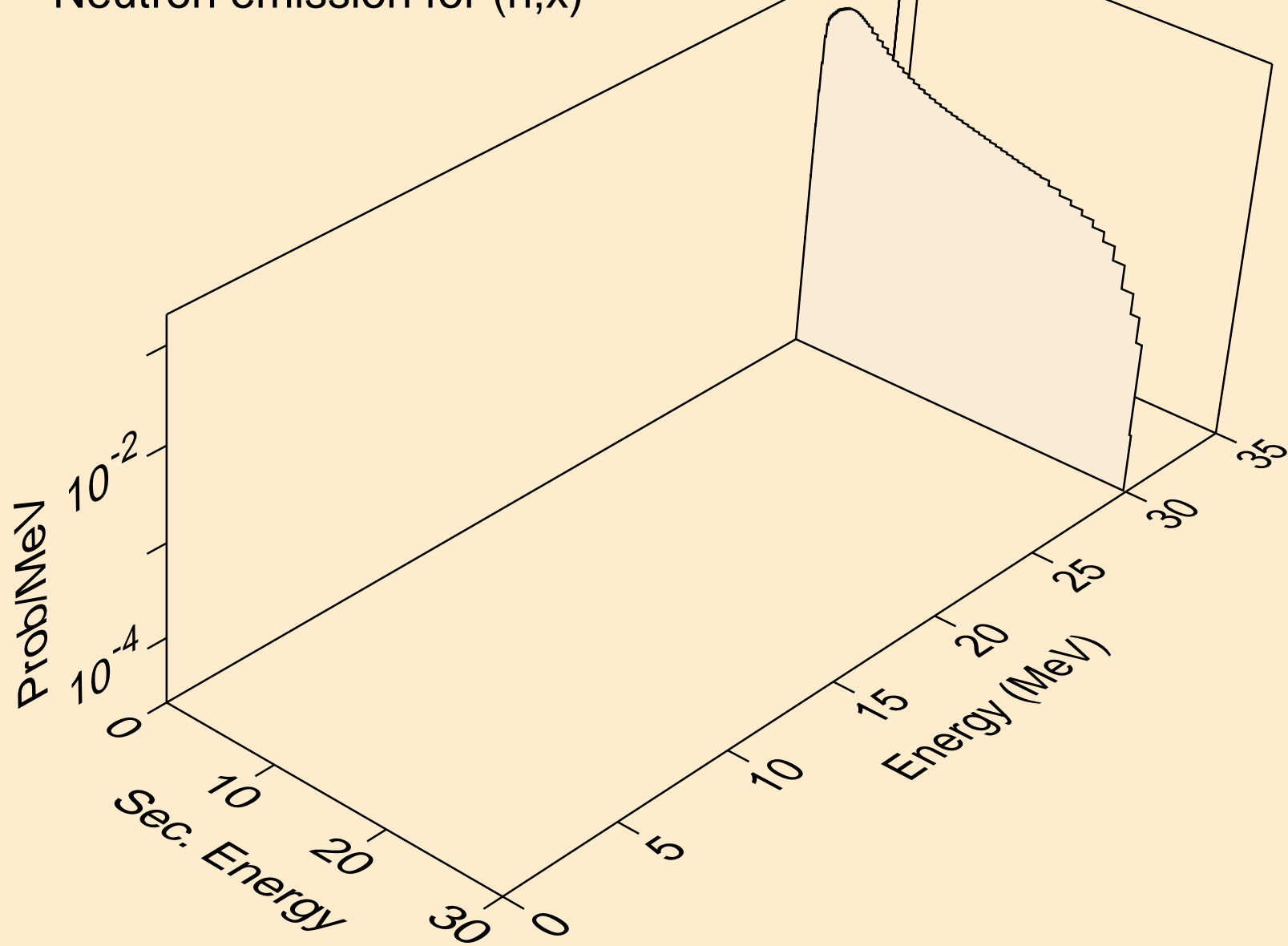

CN285 NEUTRON ACER TENDL-2021 LIBRARY; T=293.6K
Neutron emission for (n,2n)

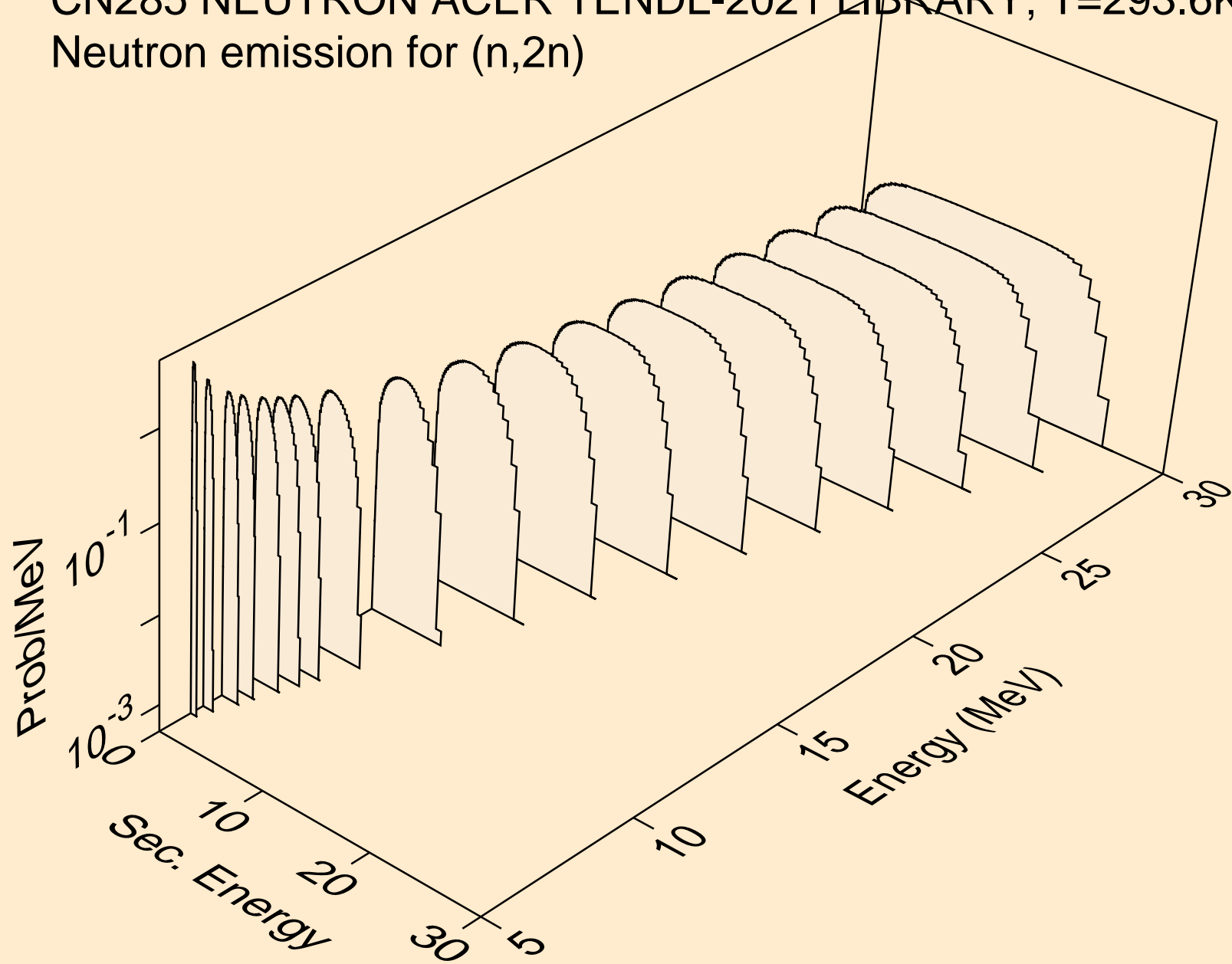

CN285 NEUTRON ACER TENDL-2021 LIBRARY; T=293.6K
Neutron emission for (n,3n)

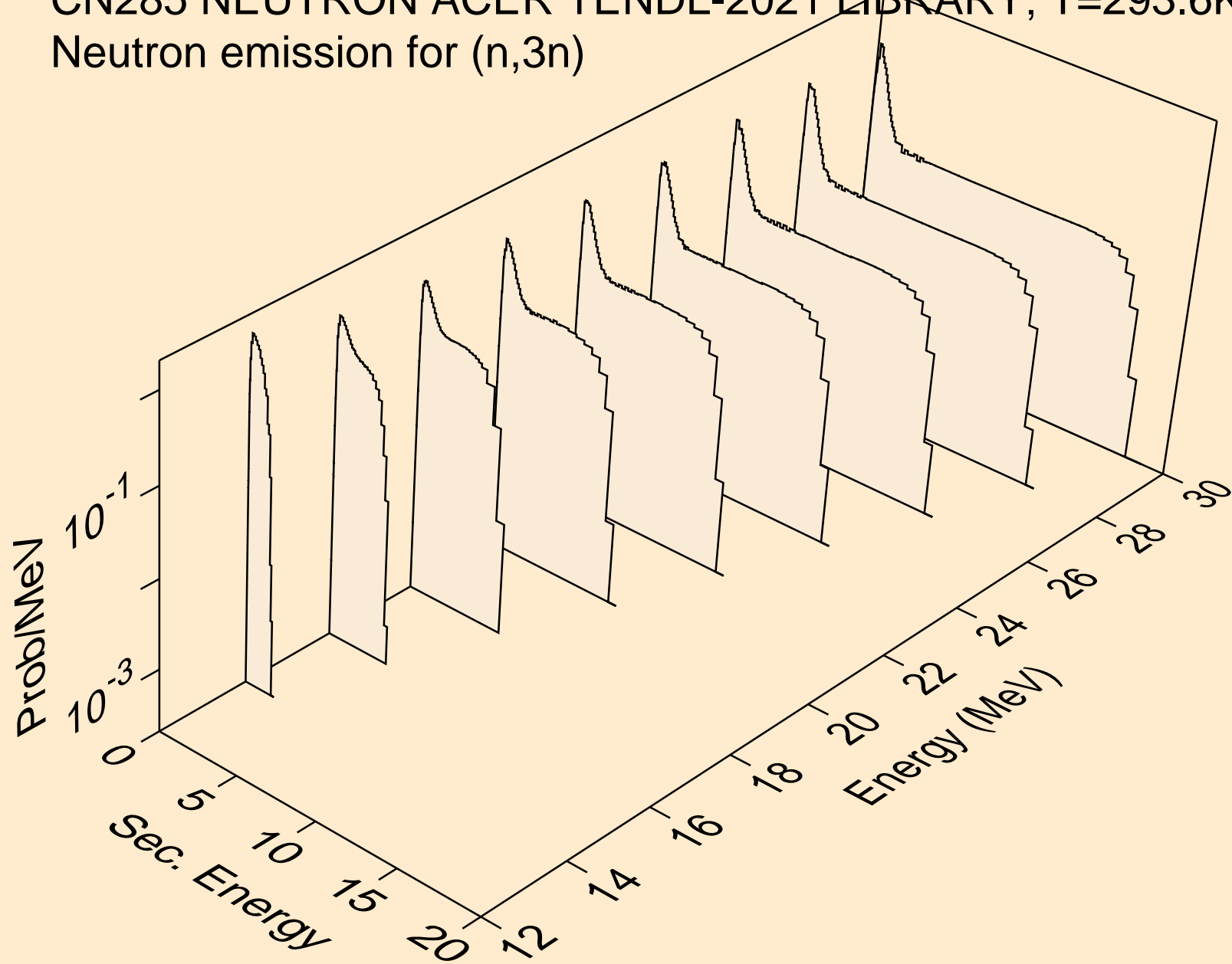

CN285 NEUTRON ACER TENDL-2021 LIBRARY; T=293.6K
Neutron emission for fission

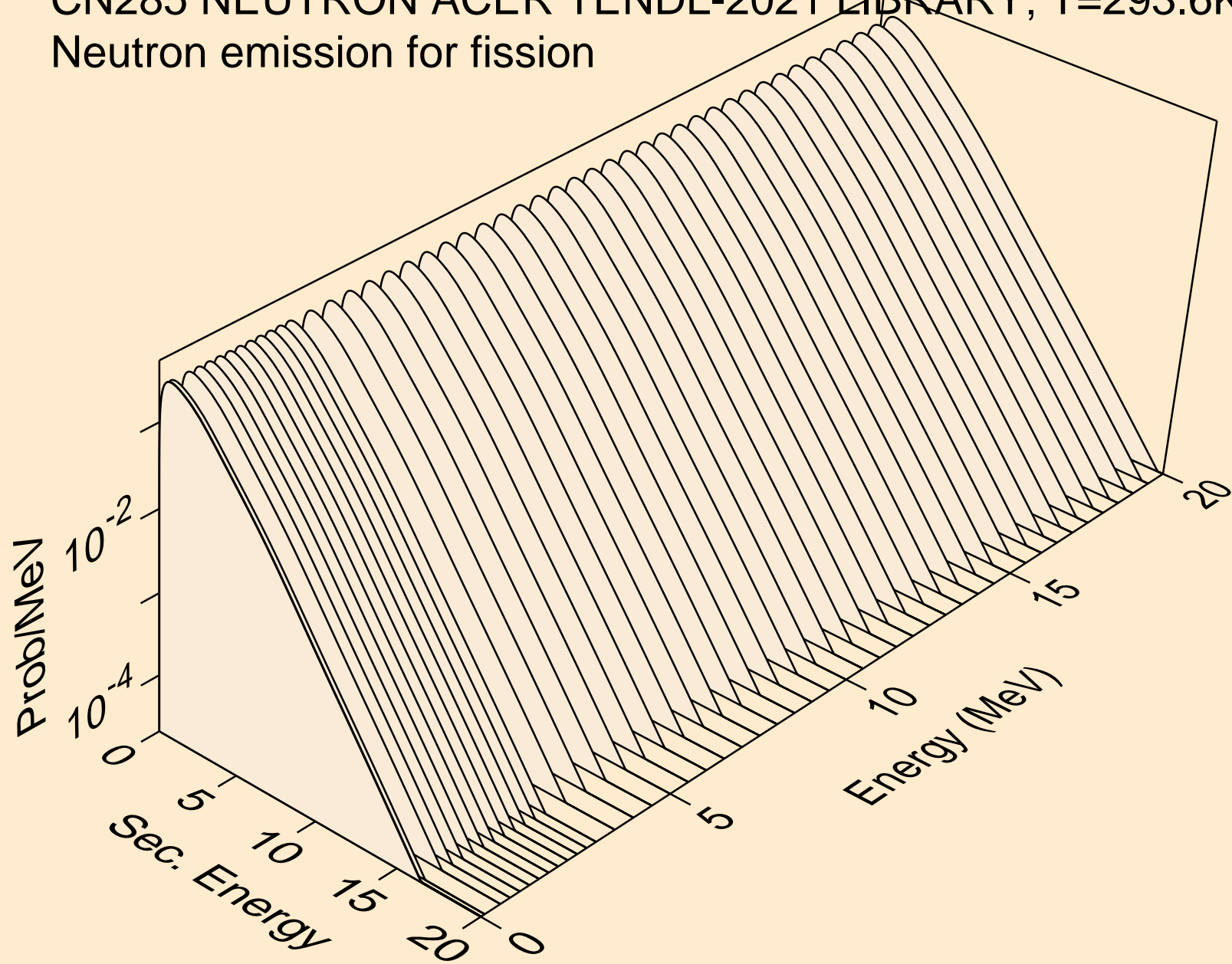

CN285 NEUTRON ACER TENDL-2021 LIBRARY; T=293.6K
Neutron emission for (n,n*)a

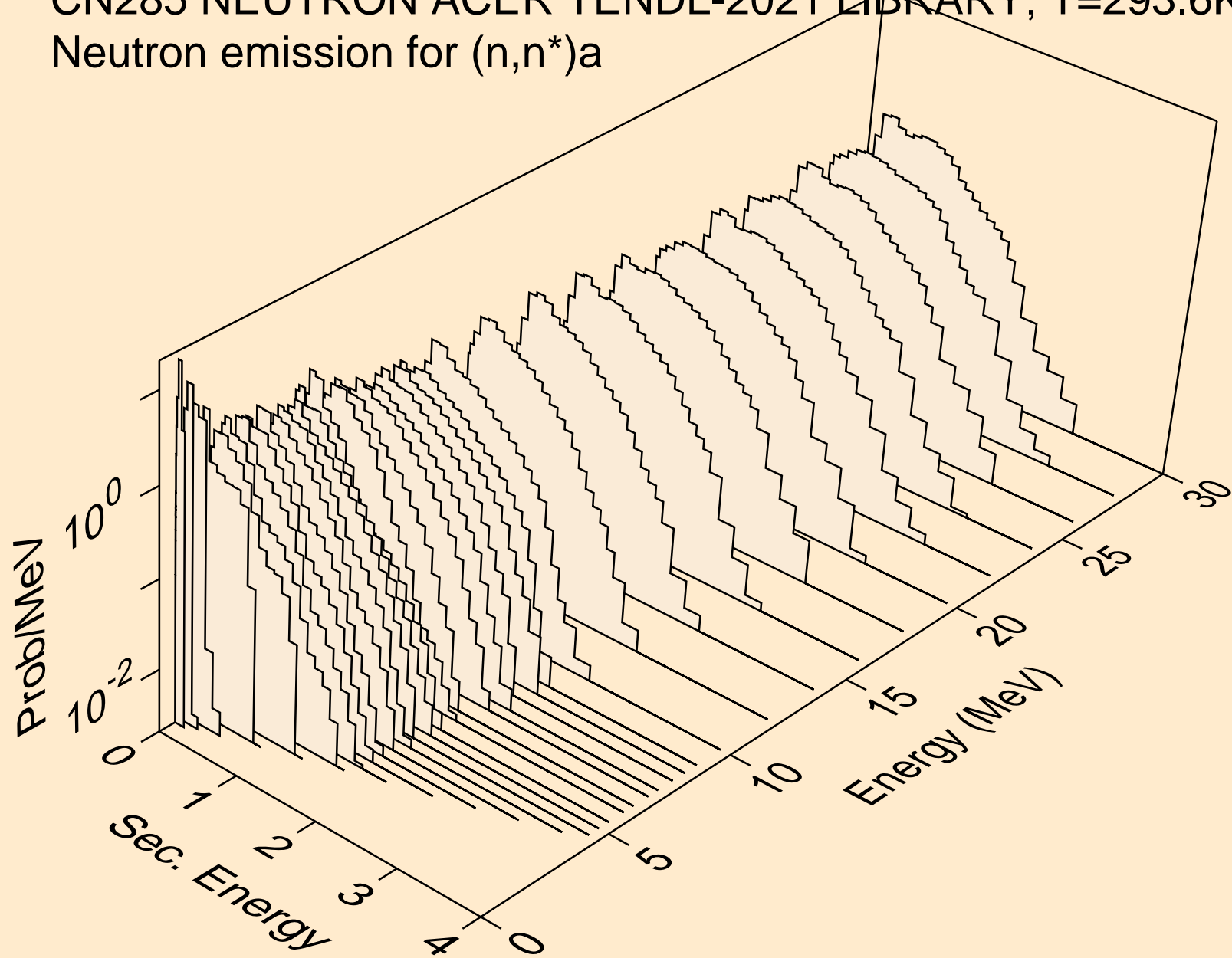

CN285 NEUTRON ACER TENDL-2021 LIBRARY; T=293.6K
Neutron emission for (n,n*)p

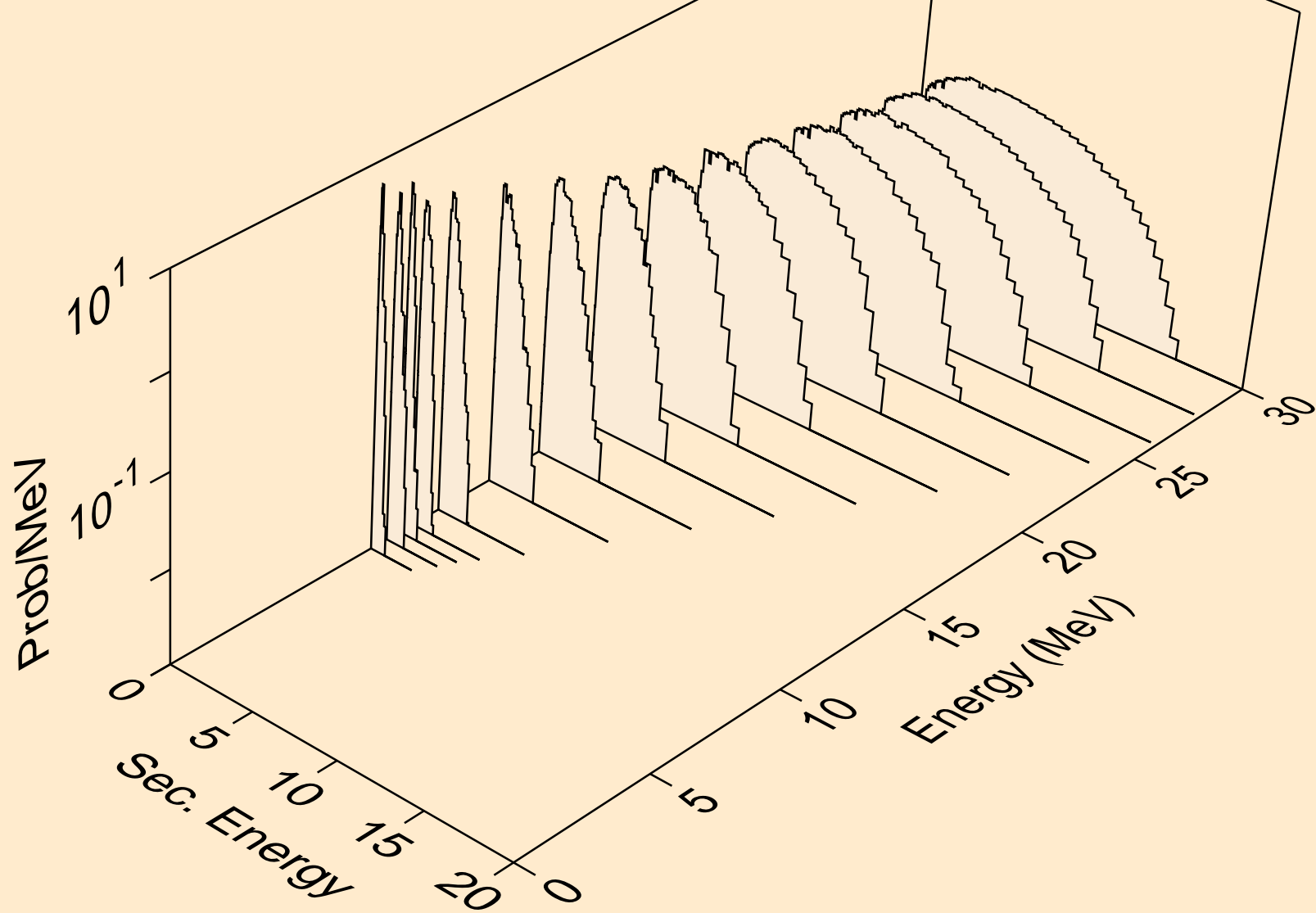

CN285 NEUTRON ACER TENDL-2021 LIBRARY; T=293.6K
Neutron emission for (n,n*)he3

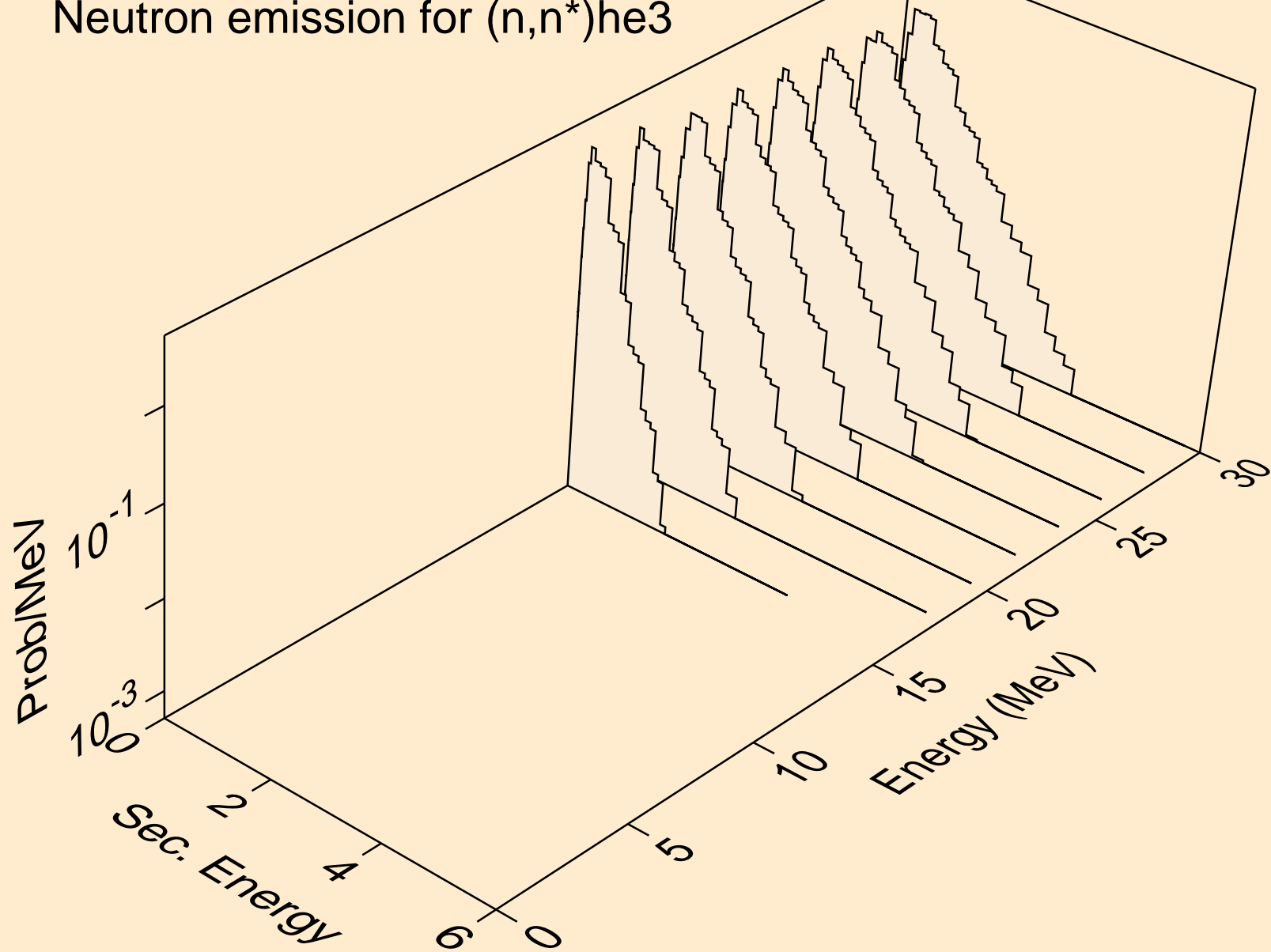

CN285 NEUTRON ACER TENDL-2021 LIBRARY; T=293.6K
Neutron emission for (n,4n)

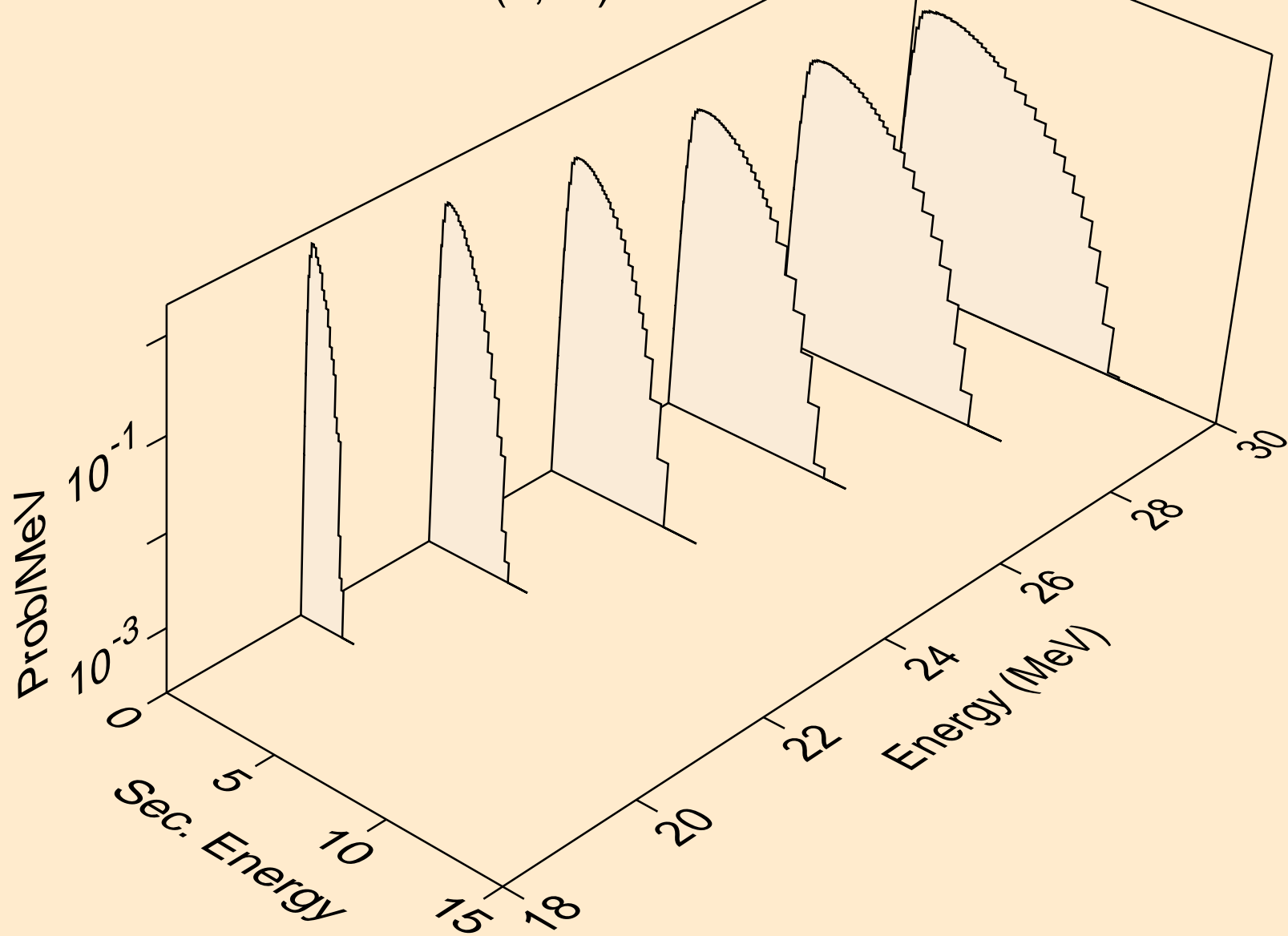

CN285 NEUTRON ACER TENDL-2021 LIBRARY; T=293.6K
Neutron emission for (n,2np)

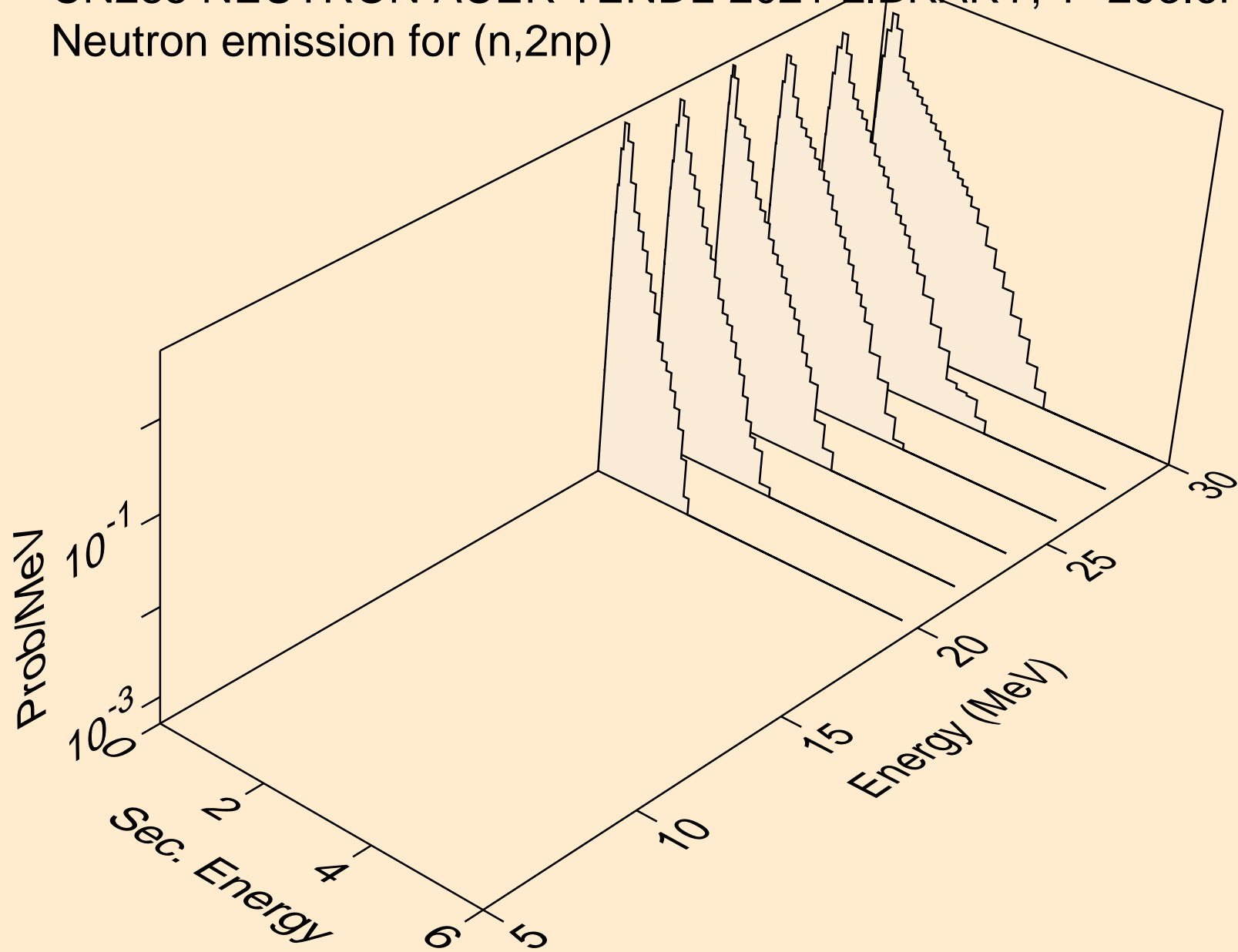

CN285 NEUTRON ACER TENDL-2021 LIBRARY; T=293.6K
Neutron emission for (n,n*c)

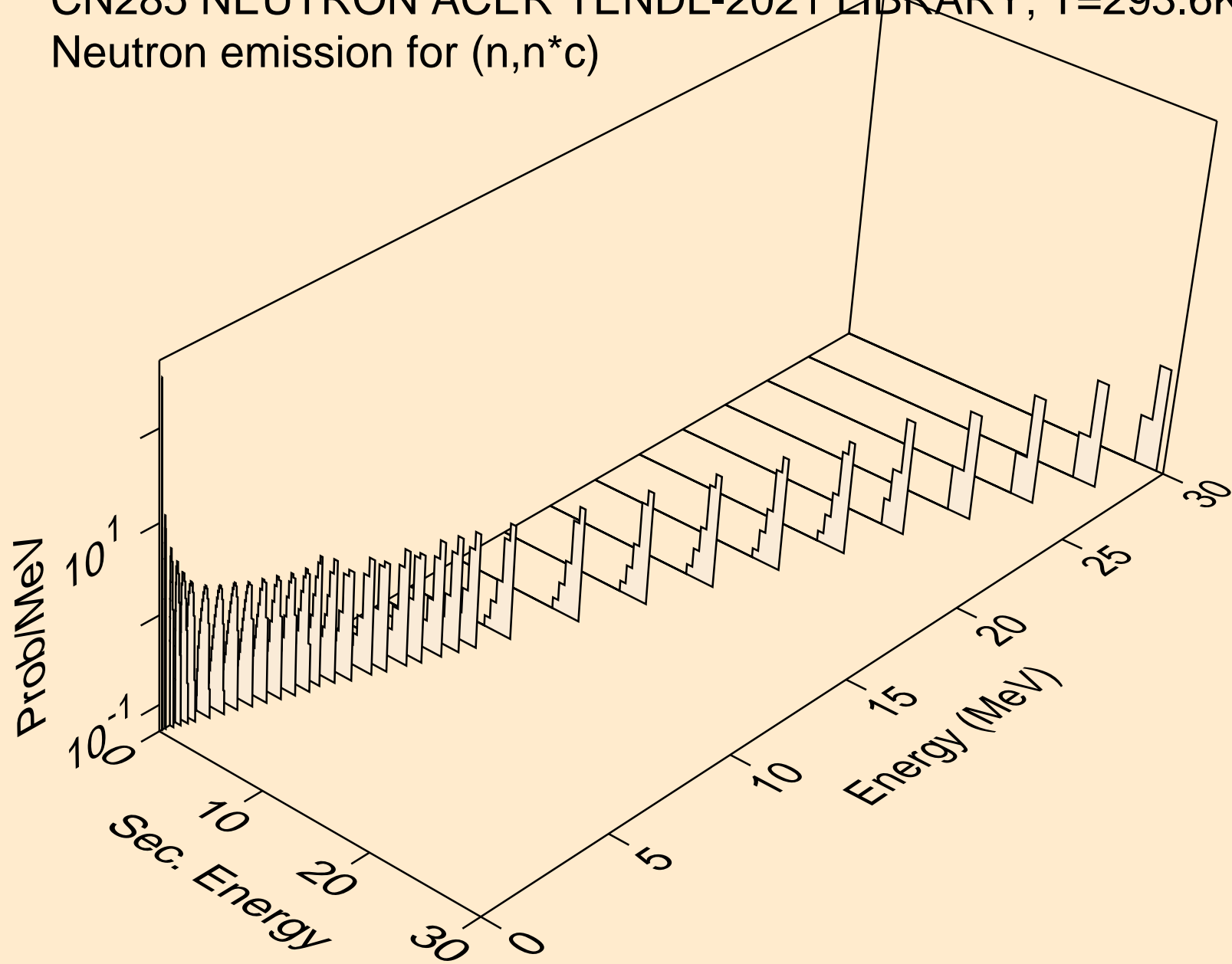

CN285 NEUTRON ACER TENDL-2021 LIBRARY; T=293.6K
Delayed nubar

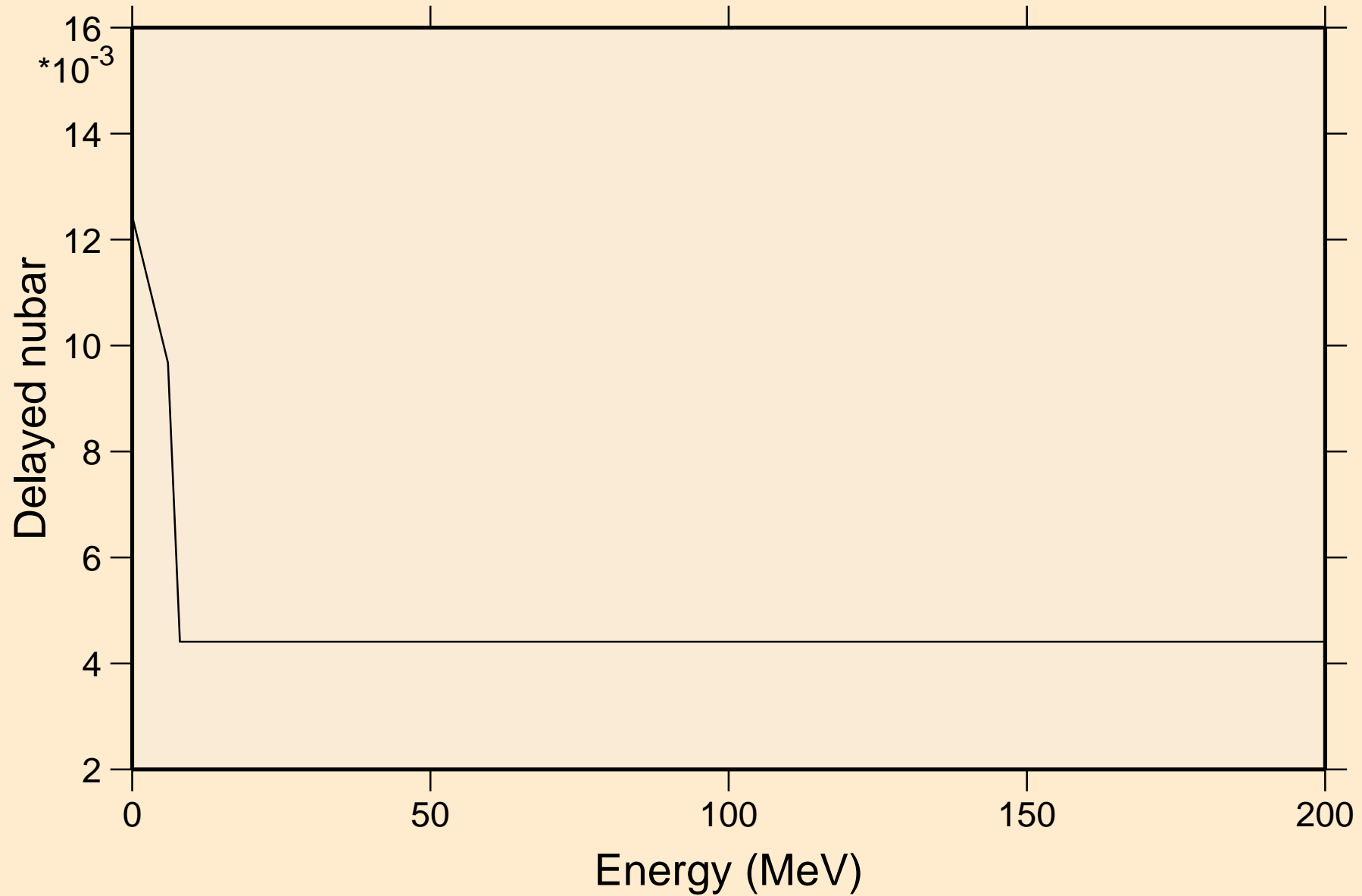

CN285 NEUTRON ACER TENDL-2021 LIBRARY; T=293.6K

Delayed neutron spectra

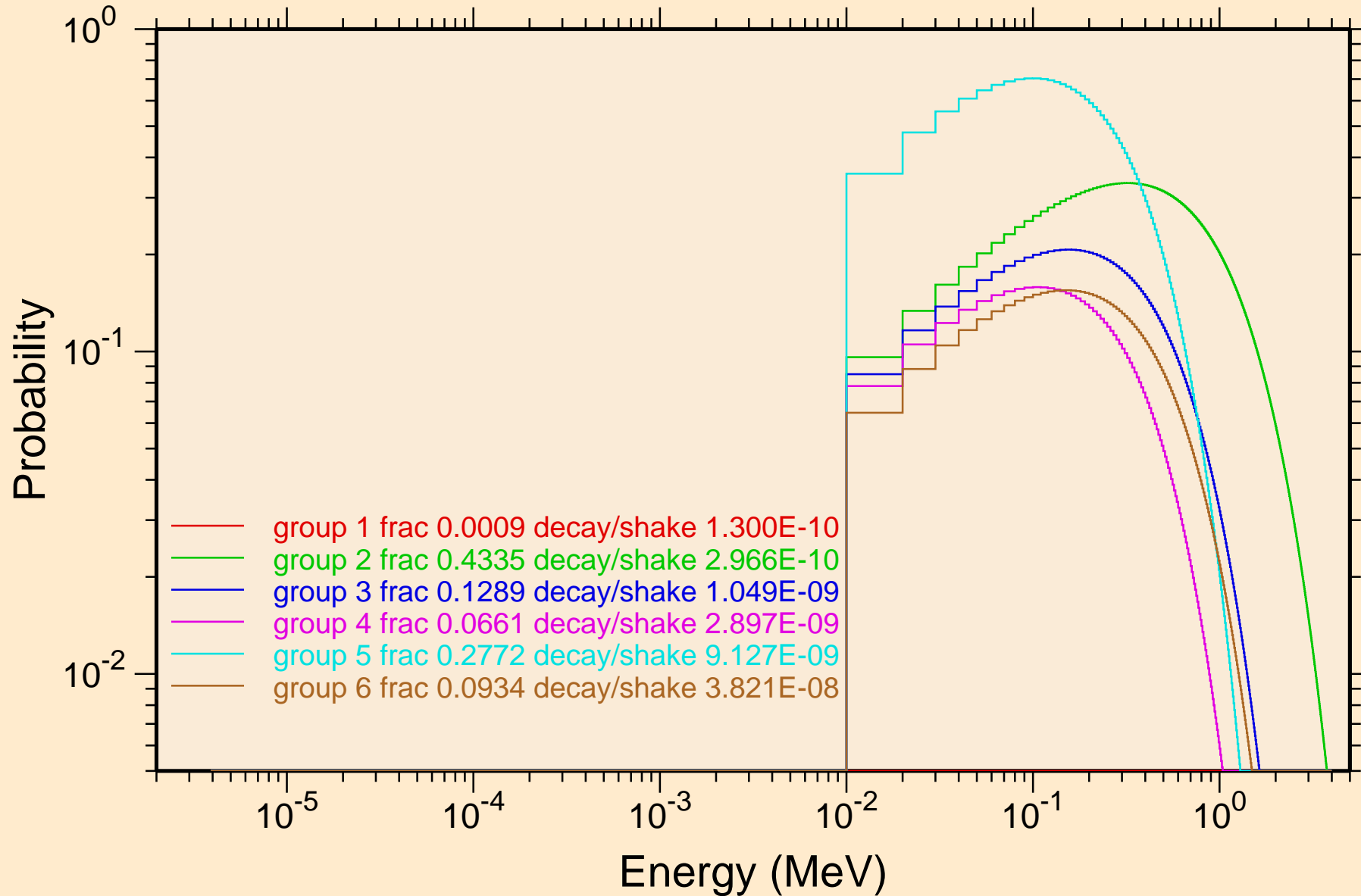

CN285 NEUTRON ACER TENDL-2021 LIBRARY; T=293.6K
Photon emission for (n,x)

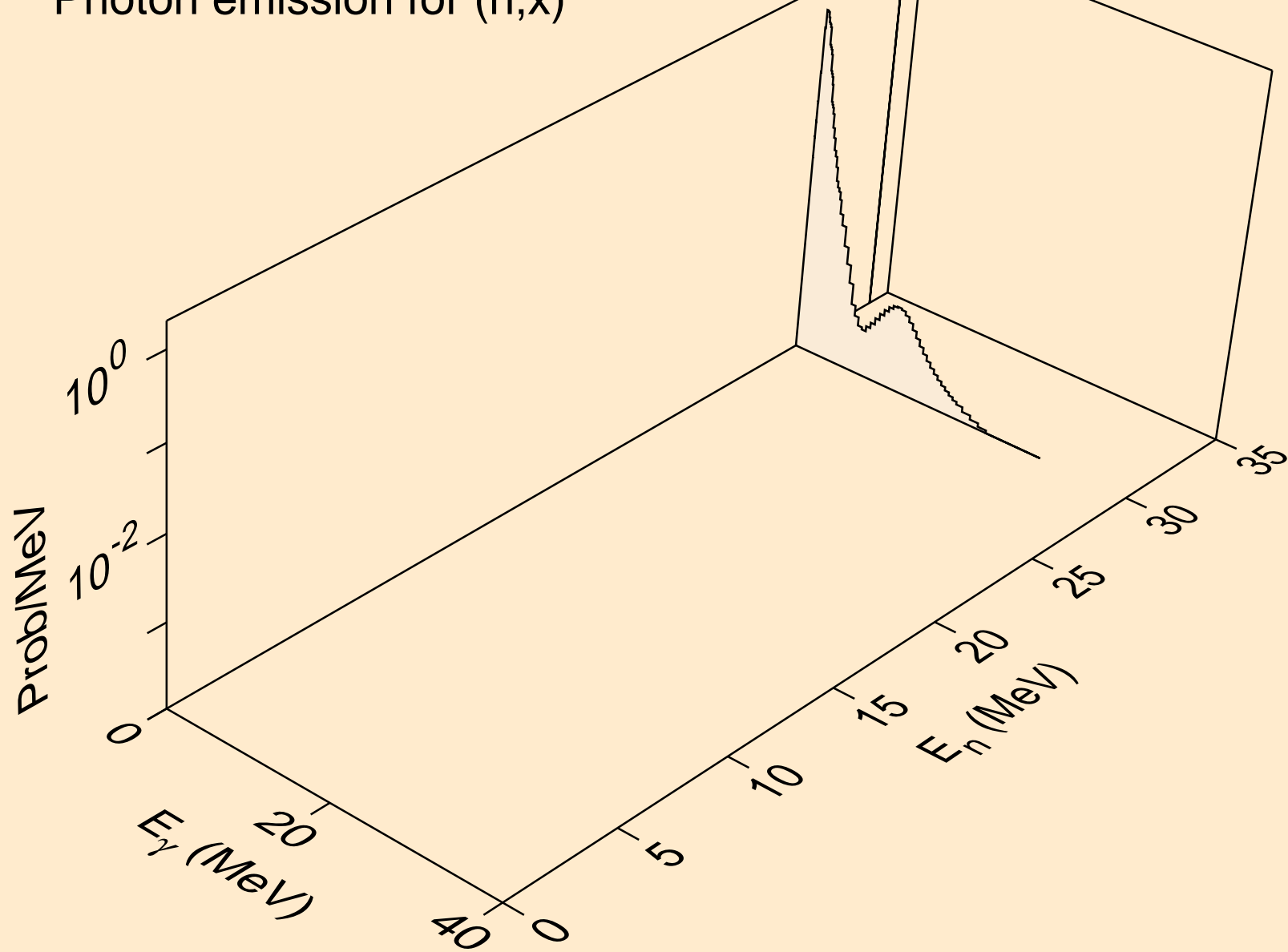

CN285 NEUTRON ACER TENDL-2021 LIBRARY; T=293.6K
Photon emission for (n,2n)

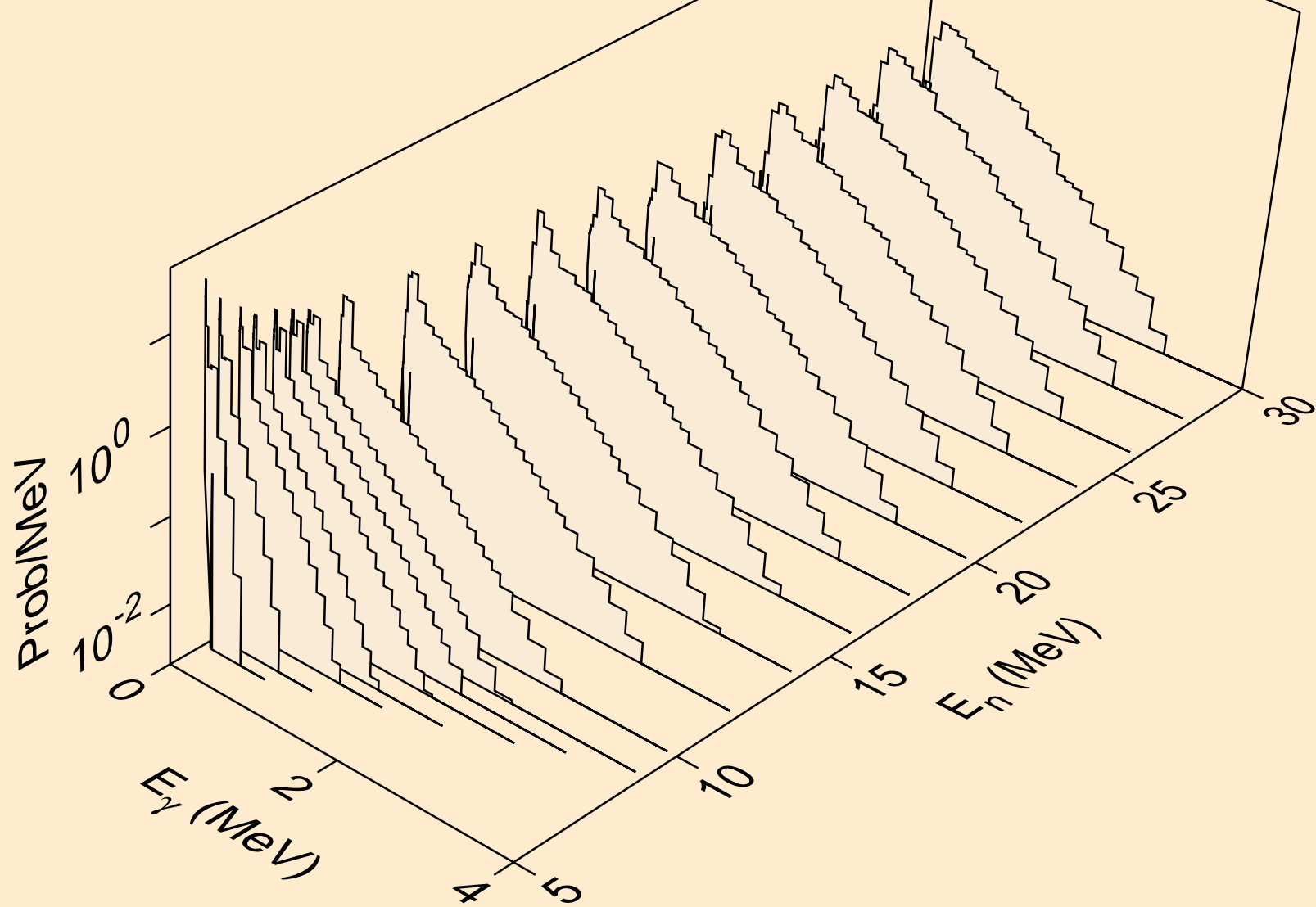

CN285 NEUTRON ACER TENDL-2021 LIBRARY; T=293.6K
Photon emission for (n,3n)

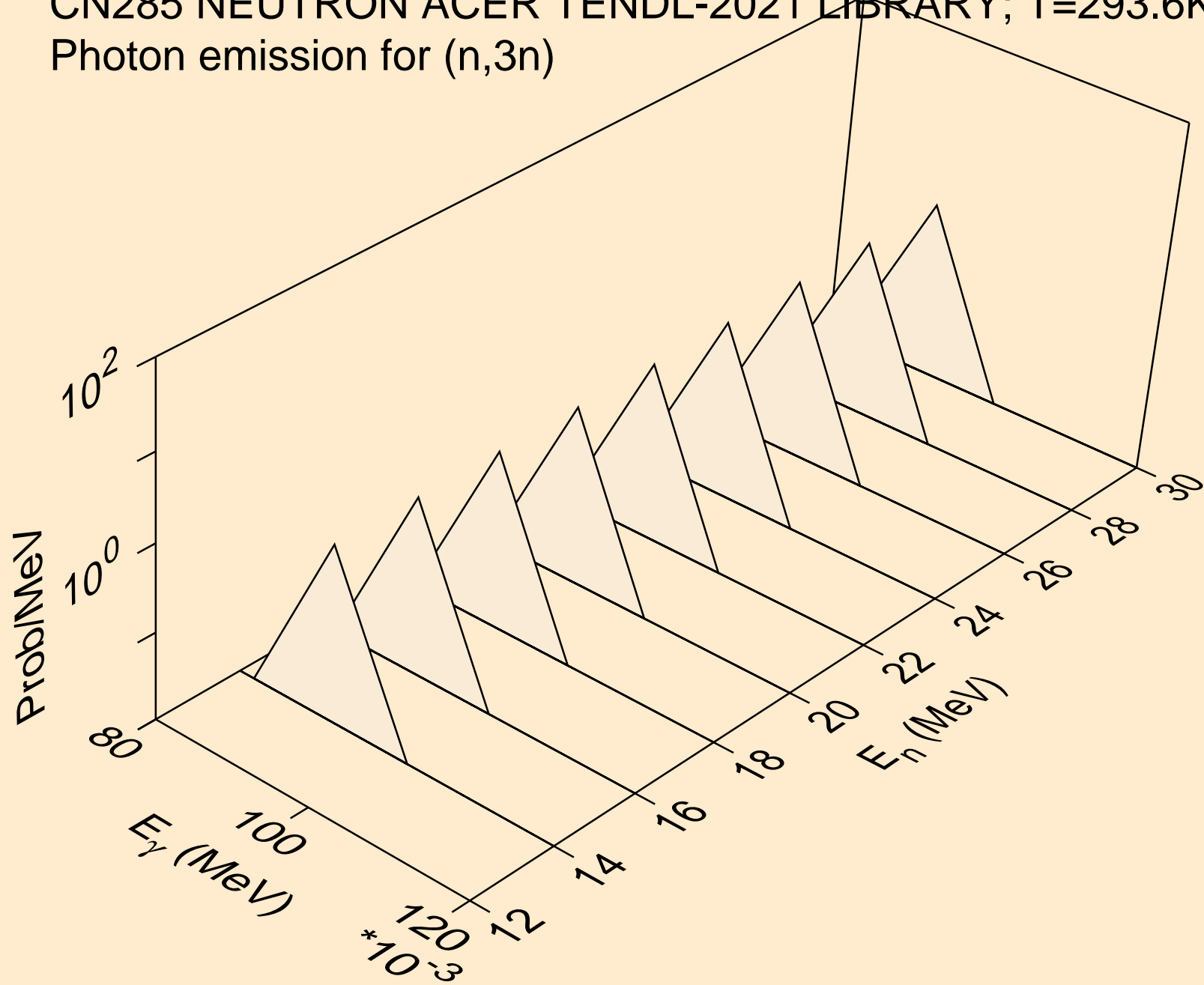

CN285 NEUTRON ACER TENDL-2021 LIBRARY; T=293.6K
Photon emission for (n,n*)a

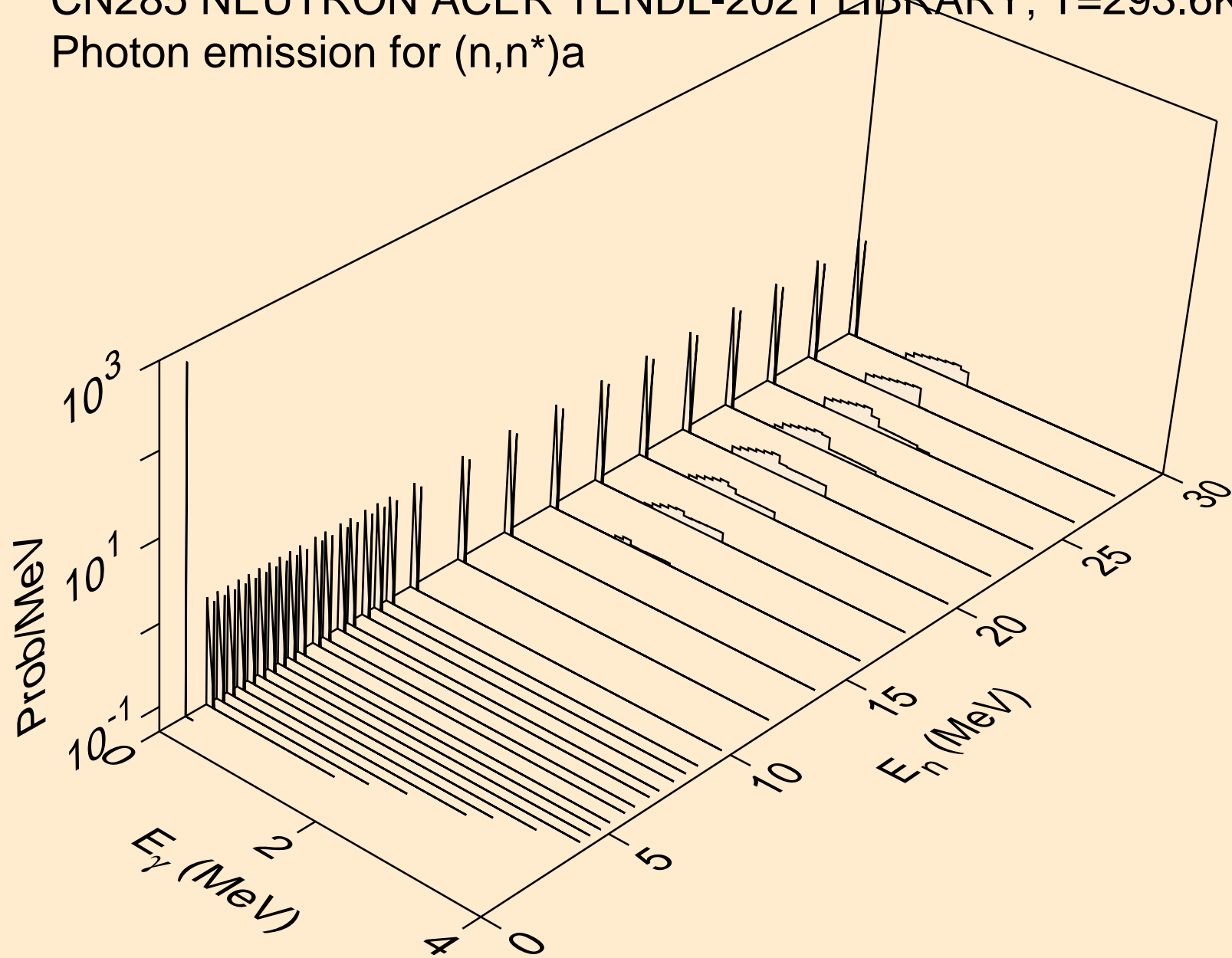

CN285 NEUTRON ACER TENDL-2021 LIBRARY; T=293.6K
Photon emission for (n,n*)p

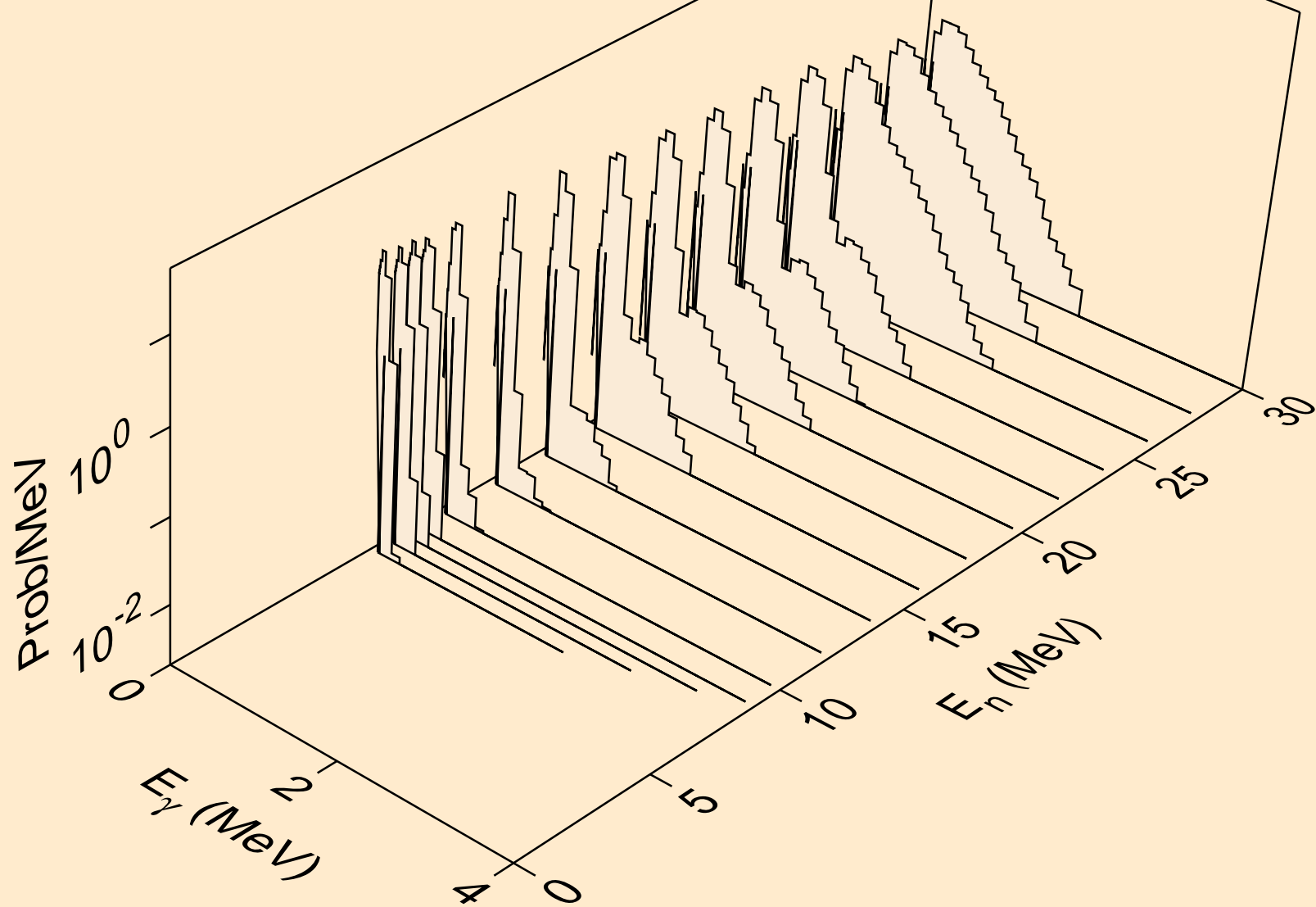

CN285 NEUTRON ACER TENDL-2021 LIBRARY; T=293.6K
Photon emission for (n,n*)he3

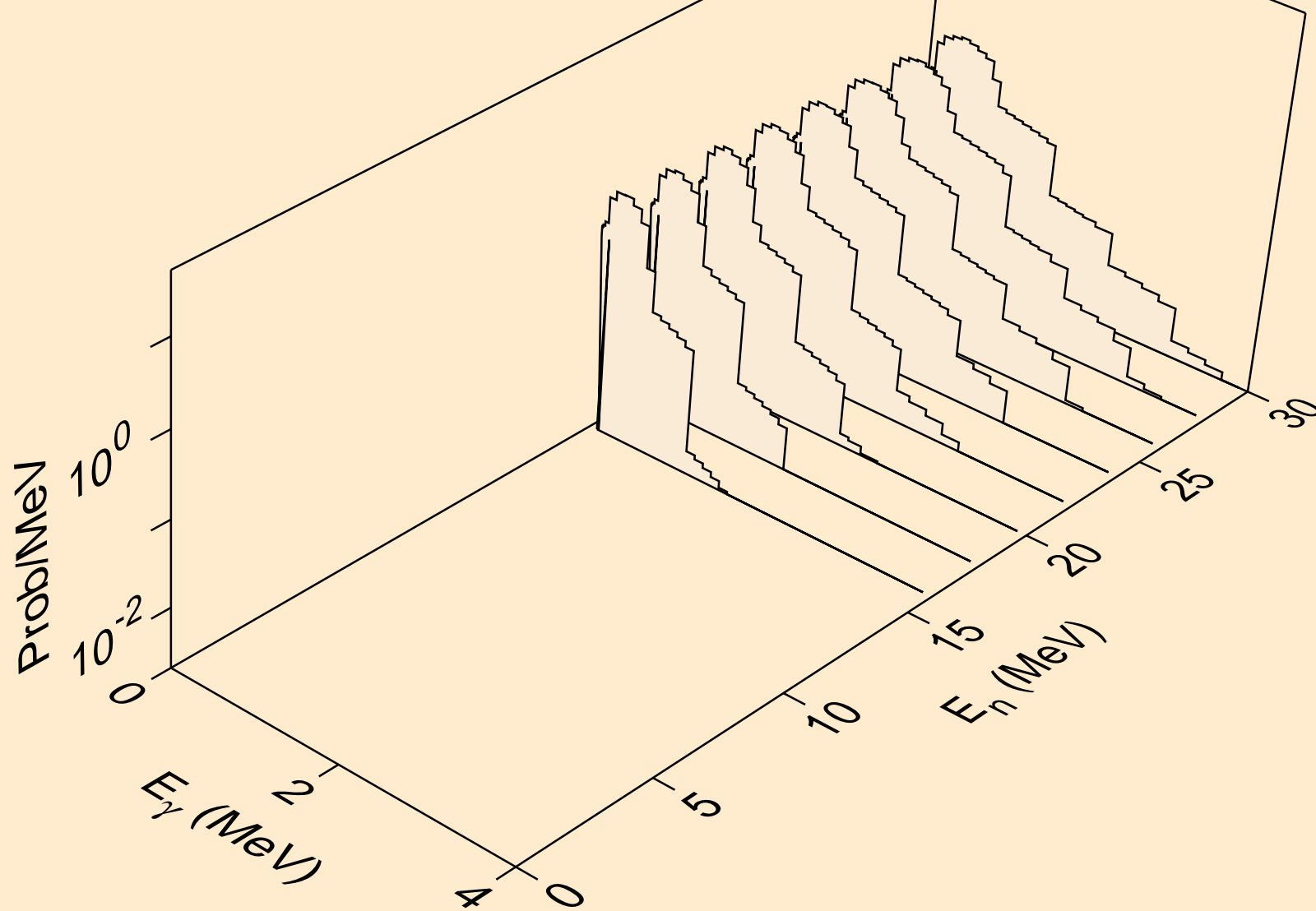

CN285 NEUTRON ACER TENDL-2021 LIBRARY; T=293.6K
Photon emission for (n,4n)

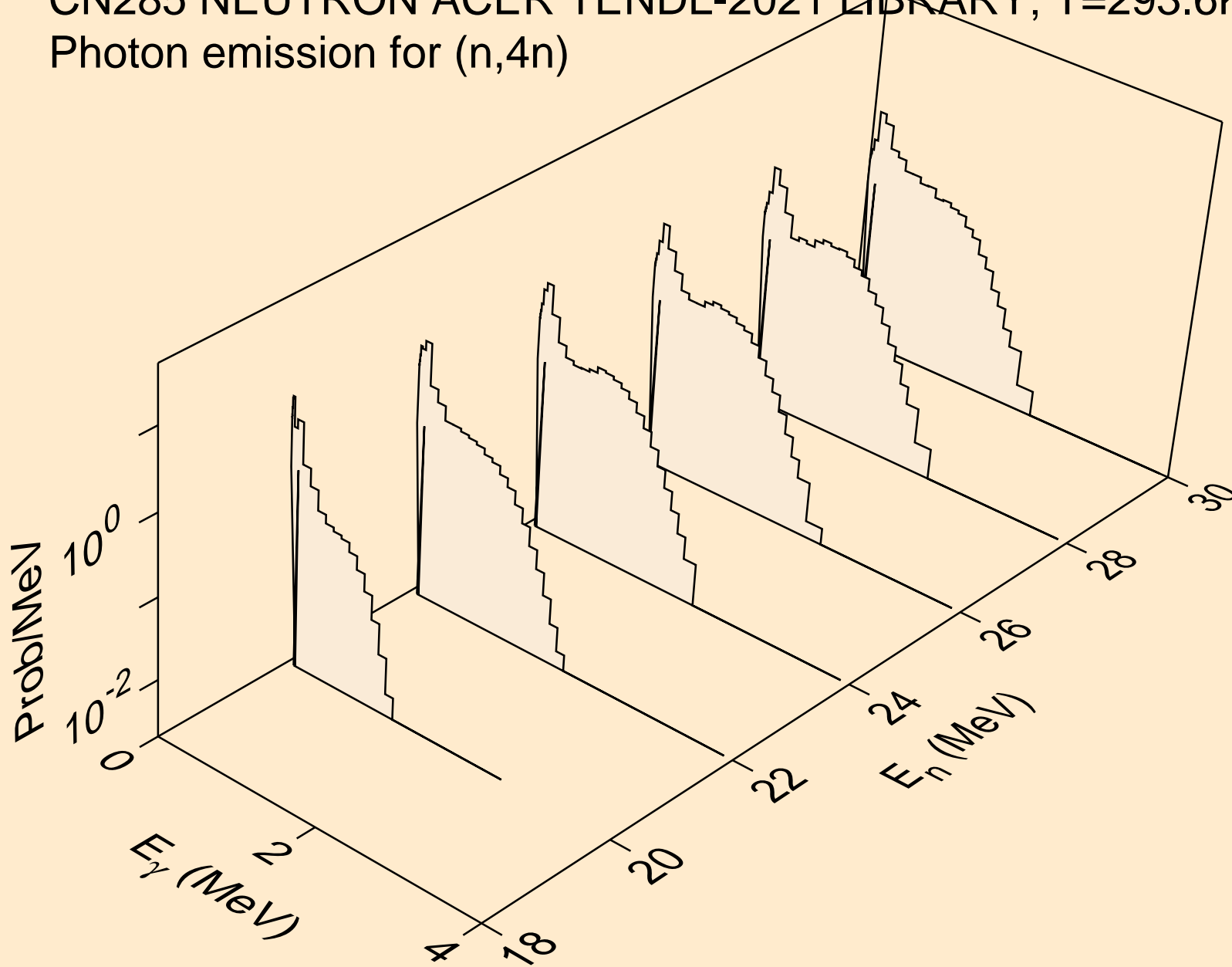

CN285 NEUTRON ACER TENDL-2021 LIBRARY; T=293.6K
Photon emission for (n,2np)

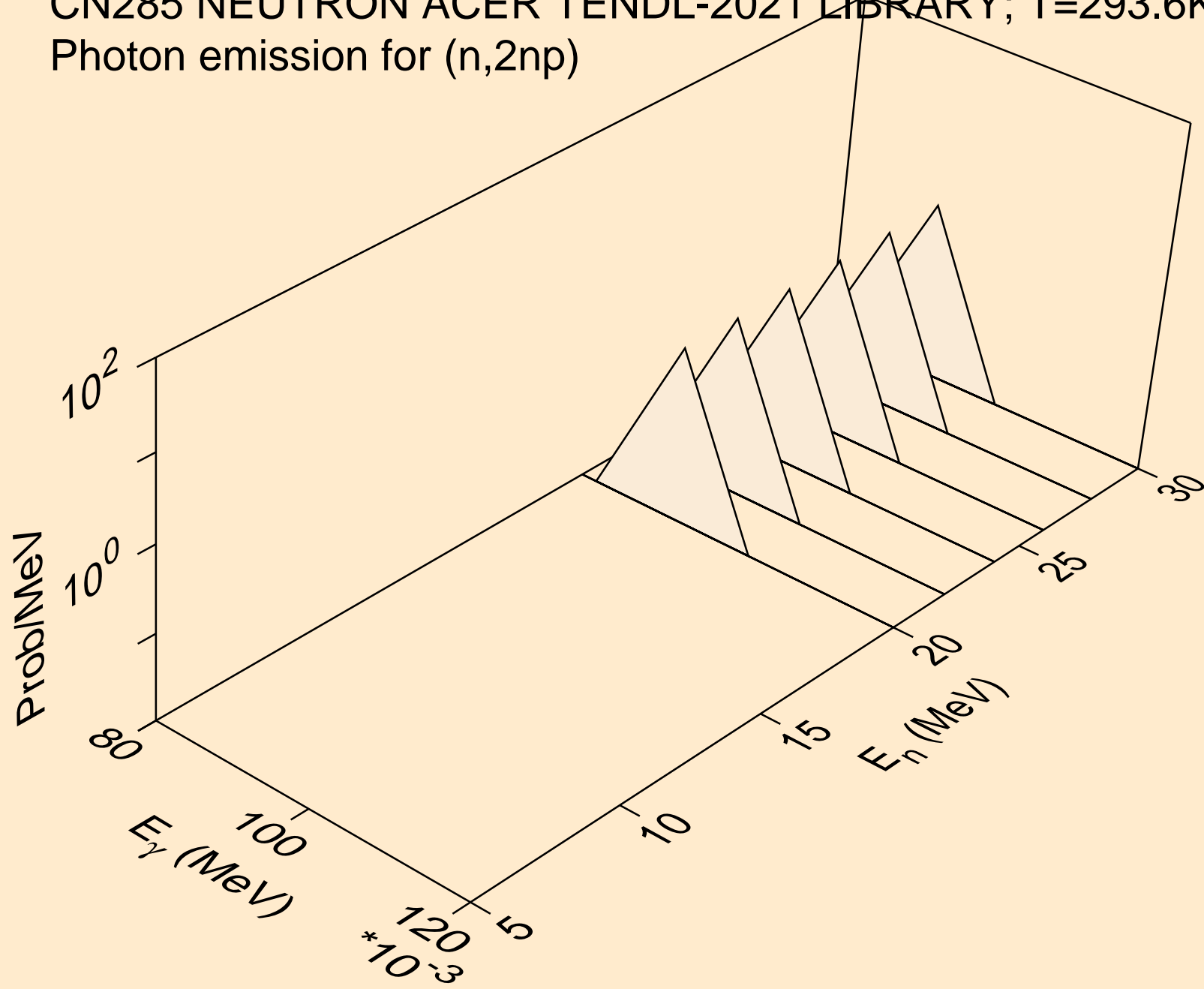

CN285 NEUTRON ACER TENDL-2021 LIBRARY; T=293.6K
Photon emission for (n,n*c)

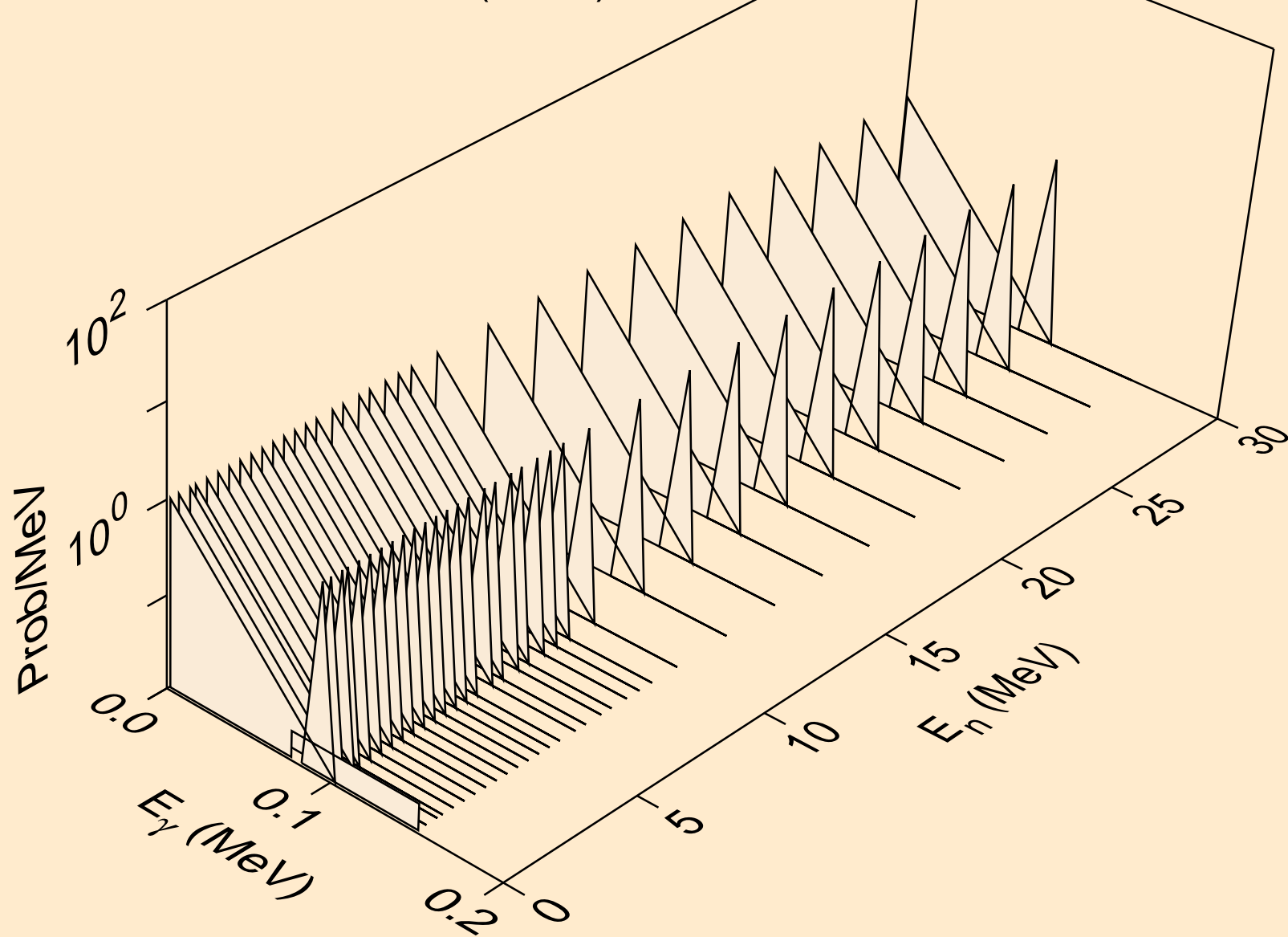

CN285 NEUTRON ACER TENDL-2021 LIBRARY; T=293.6K
Photon emission for (n,gma)

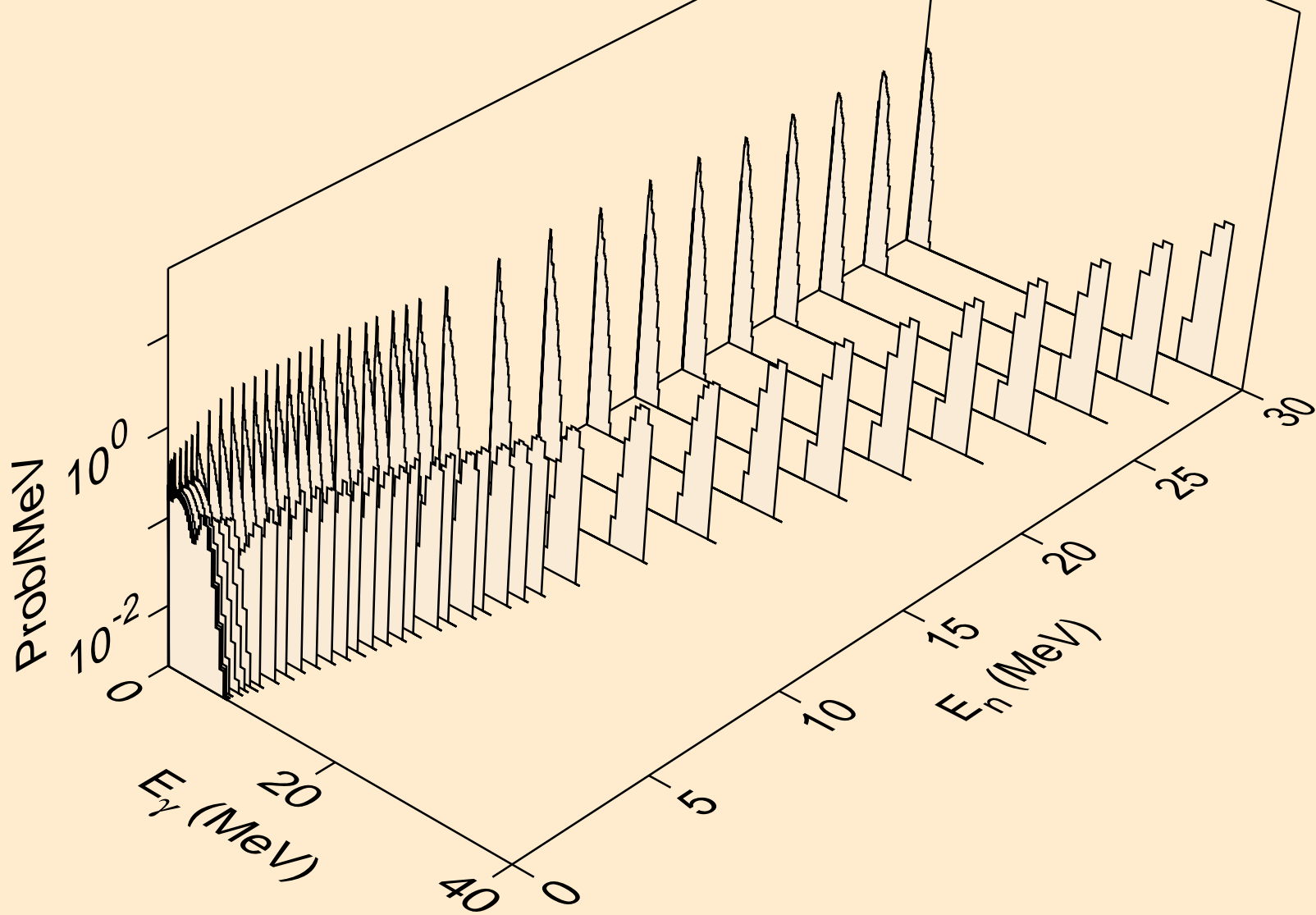

CN285 NEUTRON ACER TENDL-2021 LIBRARY; T=293.6K
Photon emission for (n,p)

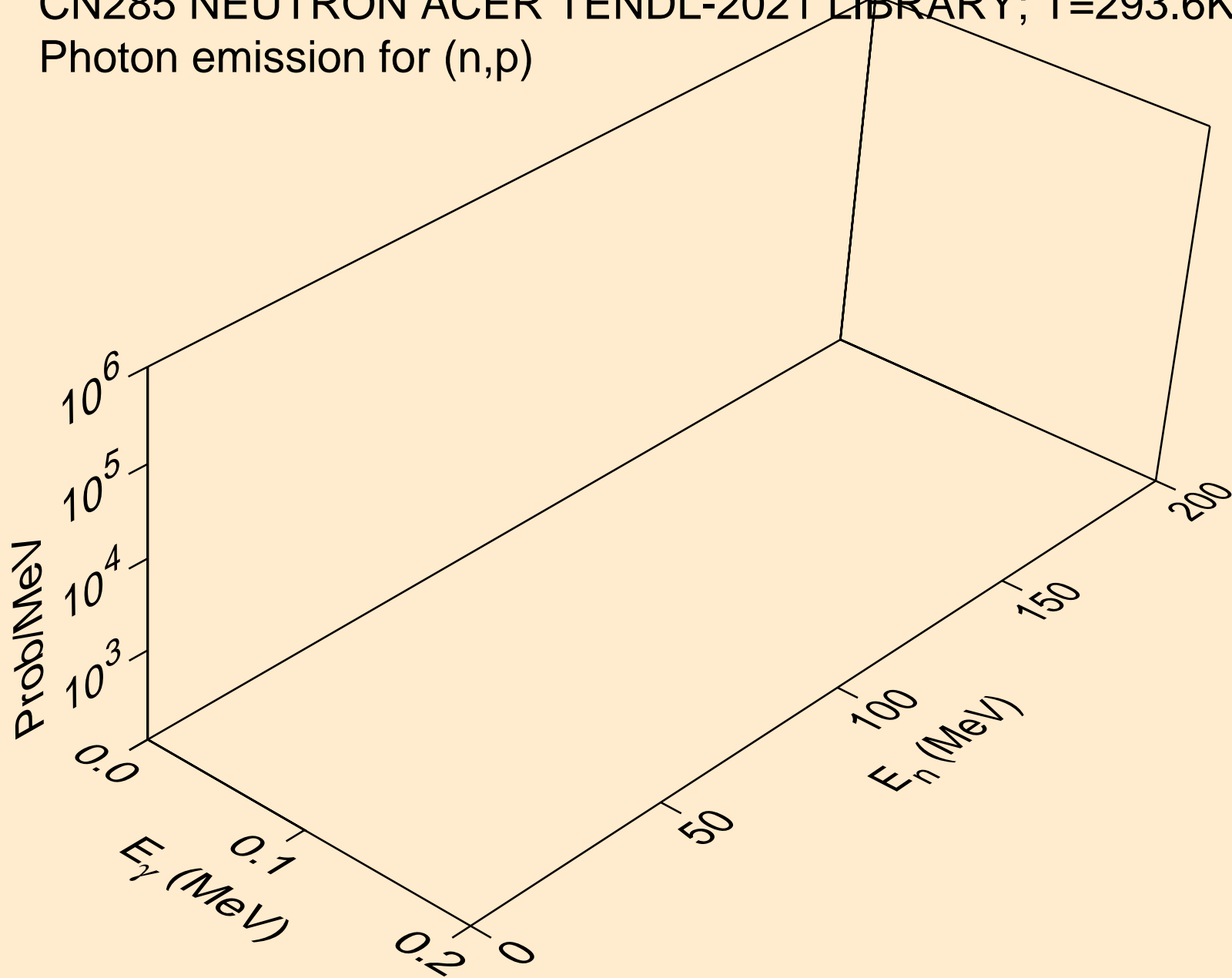

CN285 NEUTRON ACER TENDL-2021 LIBRARY; T=293.6K
Photon emission for (n,d)

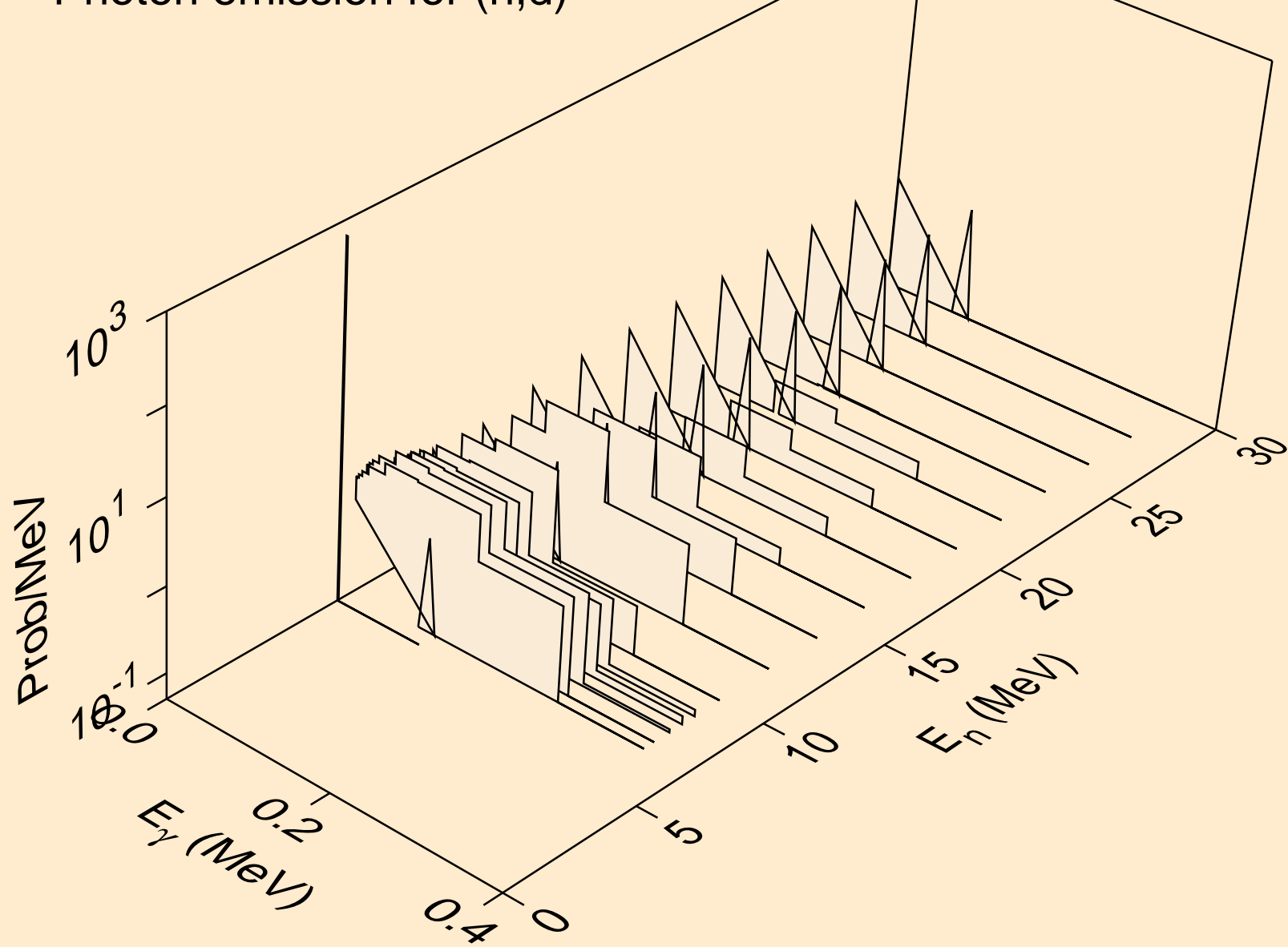

CN285 NEUTRON ACER TENDL-2021 LIBRARY; T=293.6K
Photon emission for (n,t)

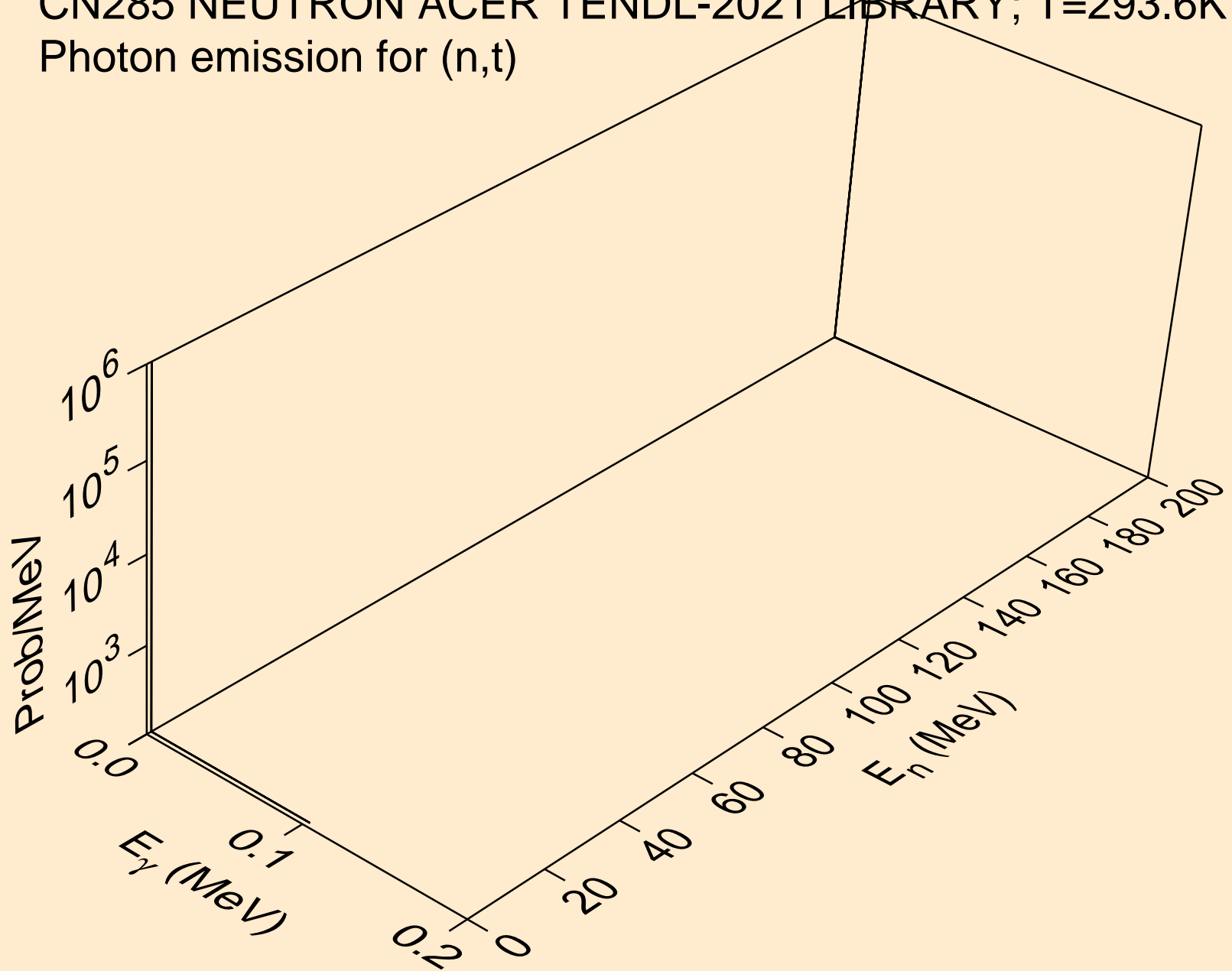

CN285 NEUTRON ACER TENDL-2021 LIBRARY; T=293.6K
Photon emission for (n,he3)

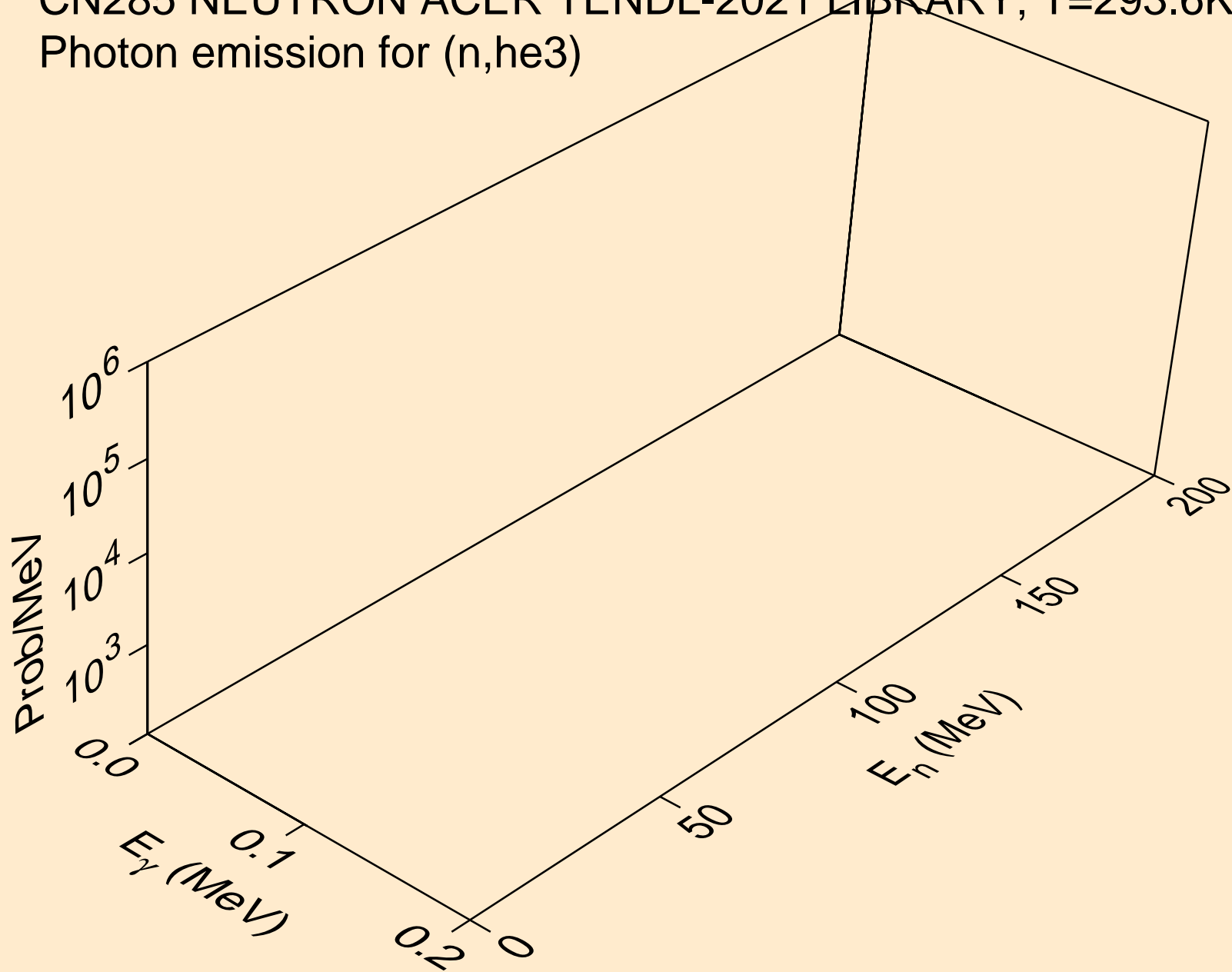

CN285 NEUTRON ACER TENDL-2021 LIBRARY; T=293.6K
Photon emission for (n,a)

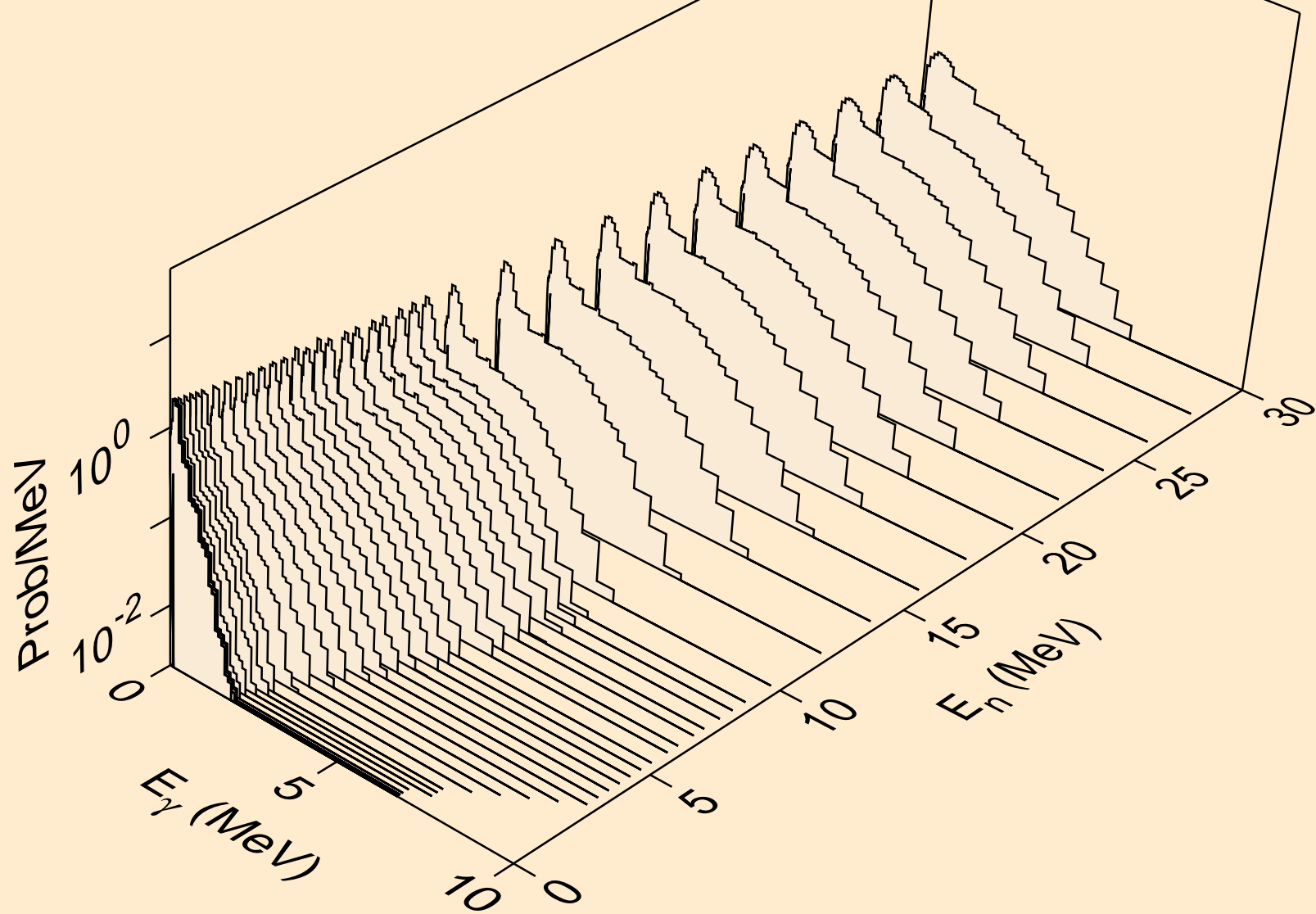

CN285 NEUTRON ACER TENDL-2021 LIBRARY; T=293.6K
Photon emission for (n,2p)

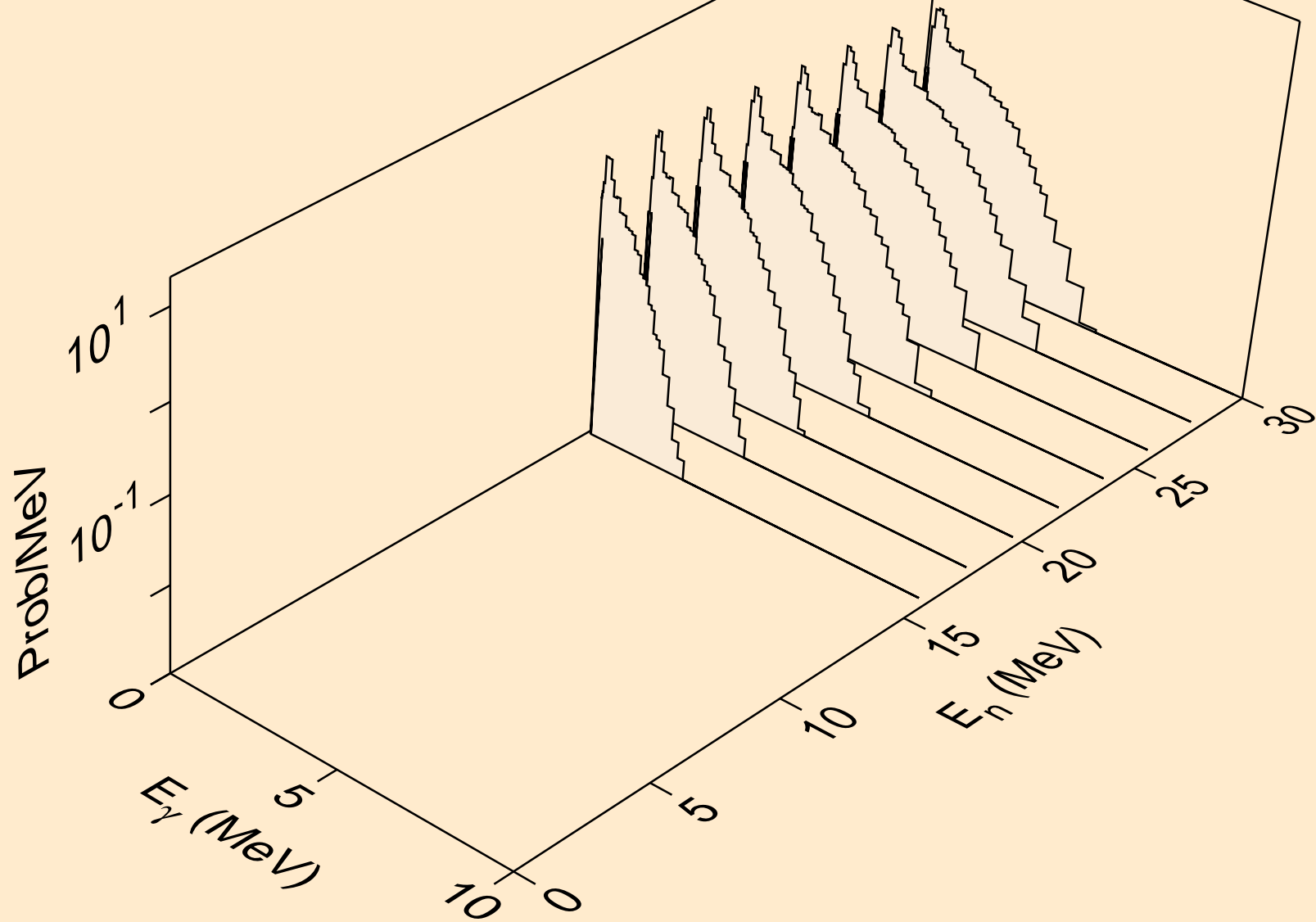

CN285 NEUTRON ACER TENDL-2021 LIBRARY; T=293.6K
thermal capture photon spectrum

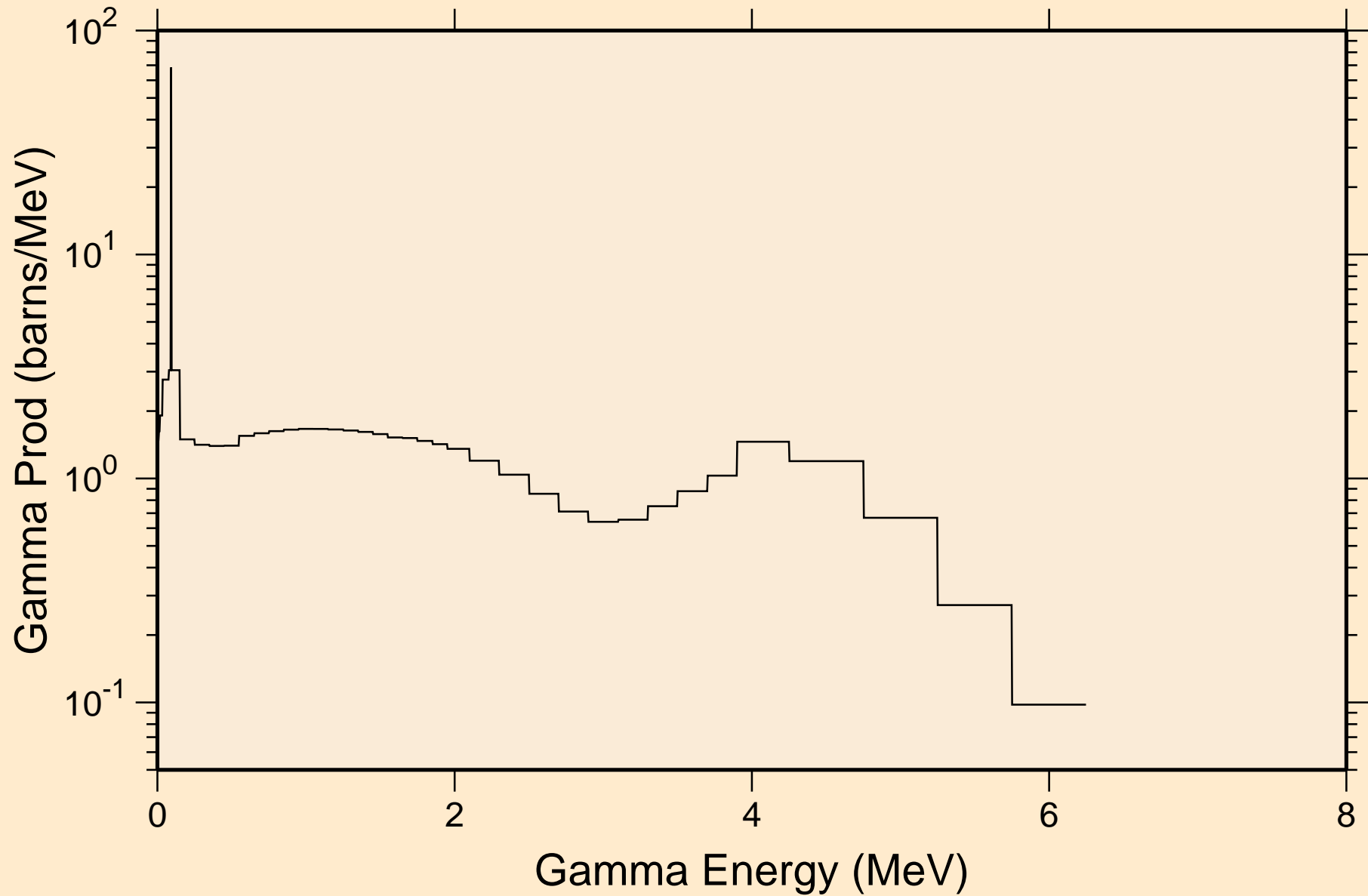

CN285 NEUTRON ACER TENDL-2021 LIBRARY; T=293.6K
14 MeV photon spectrum

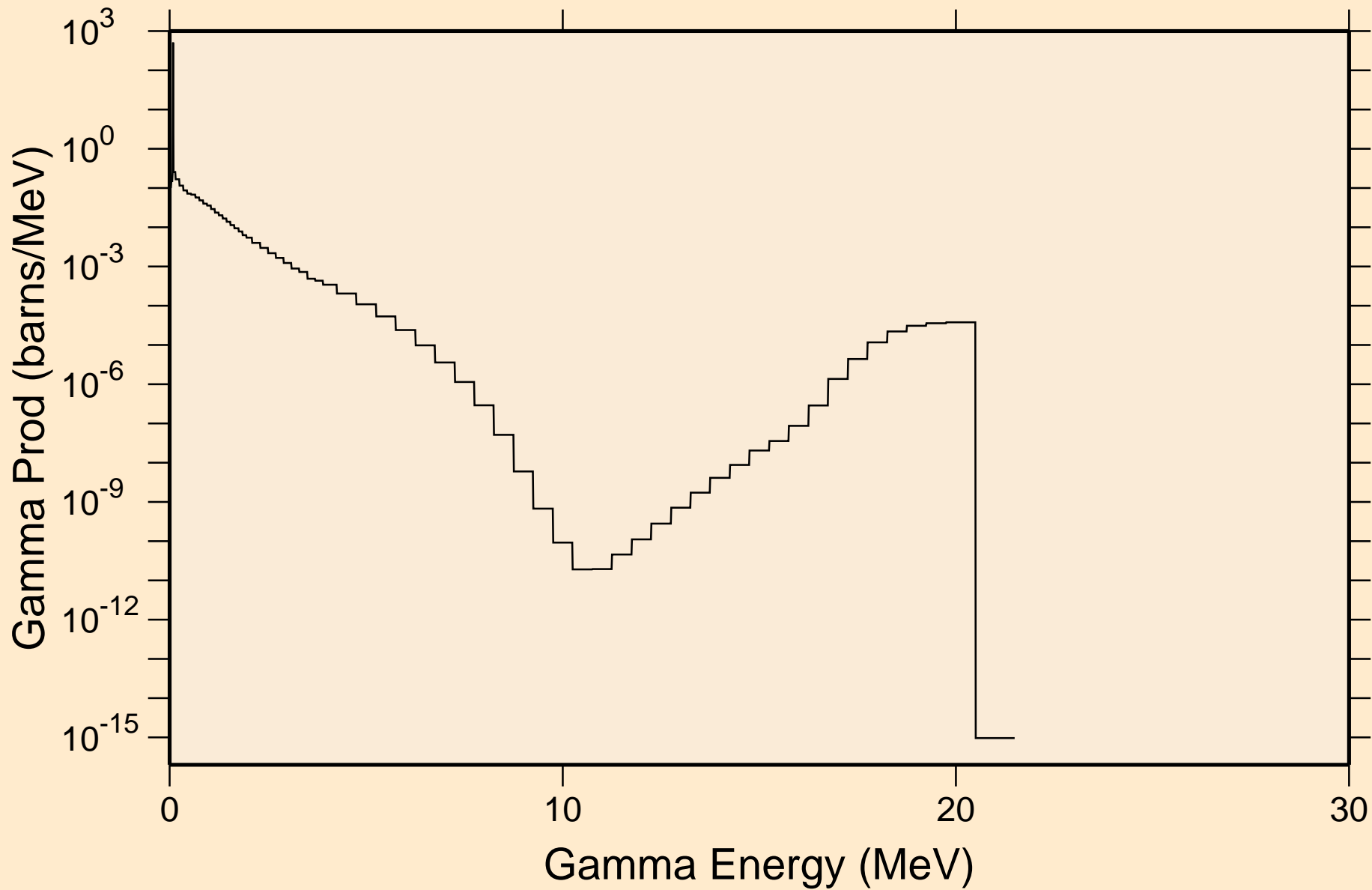

CN285 NEUTRON ACER TENDL-2021 LIBRARY; T=293.6K

Particle heating contributions

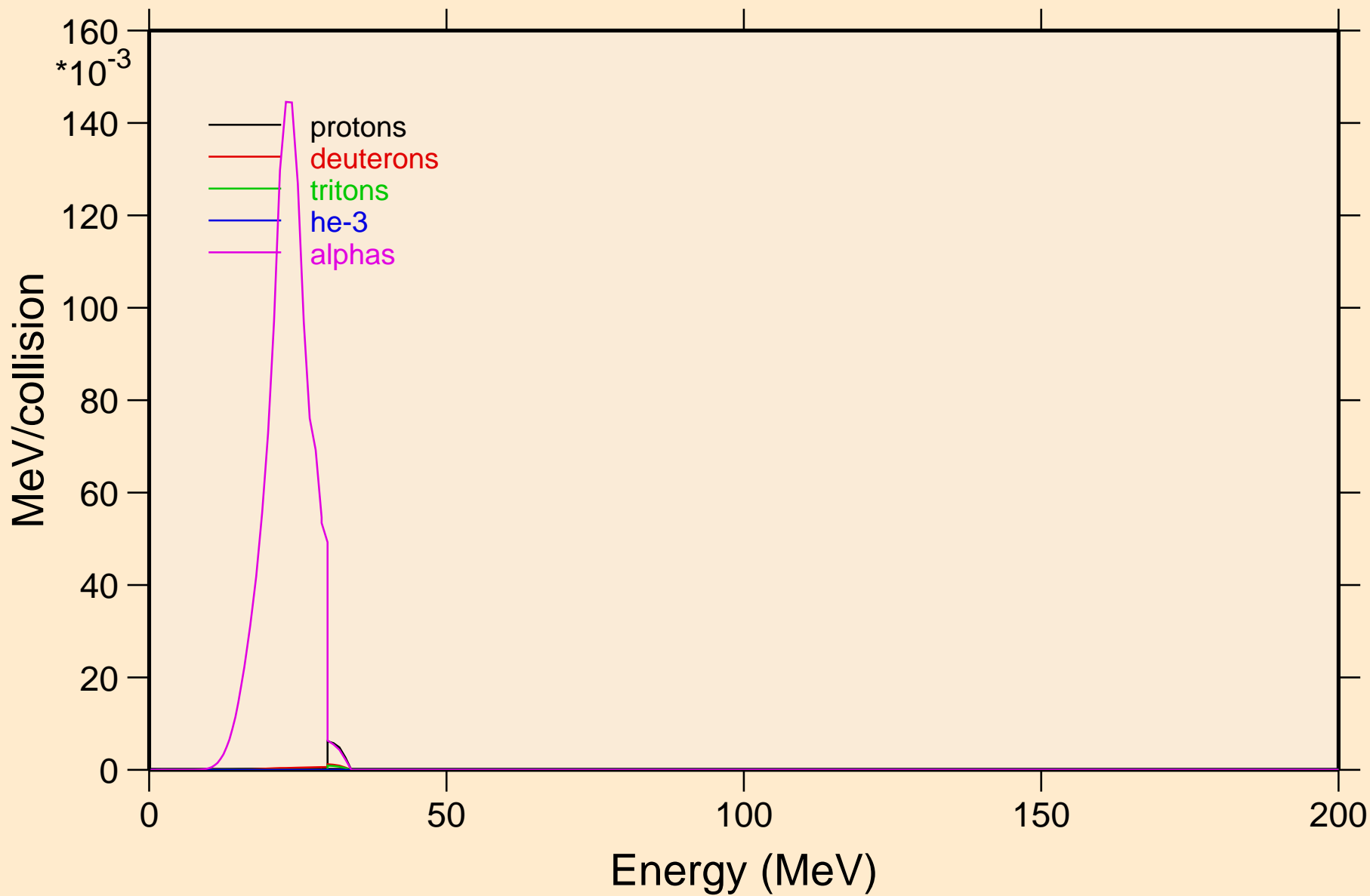

CN285 NEUTRON ACER TENDL-2021 LIBRARY; T=293.6K
Recoil Heating

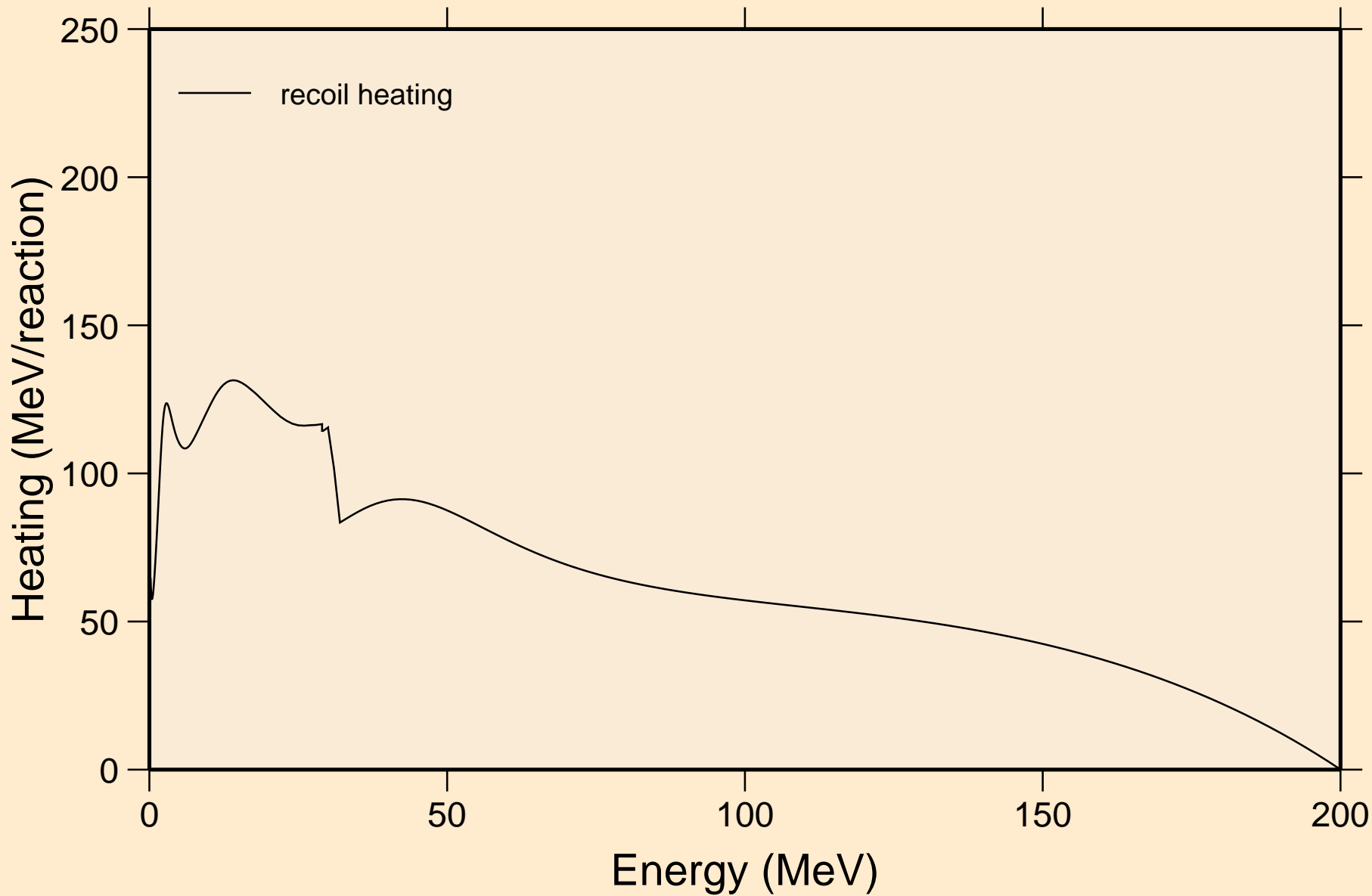

CN285 NEUTRON ACER TENDL-2021 LIBRARY; T=293.6K
Particle production cross sections

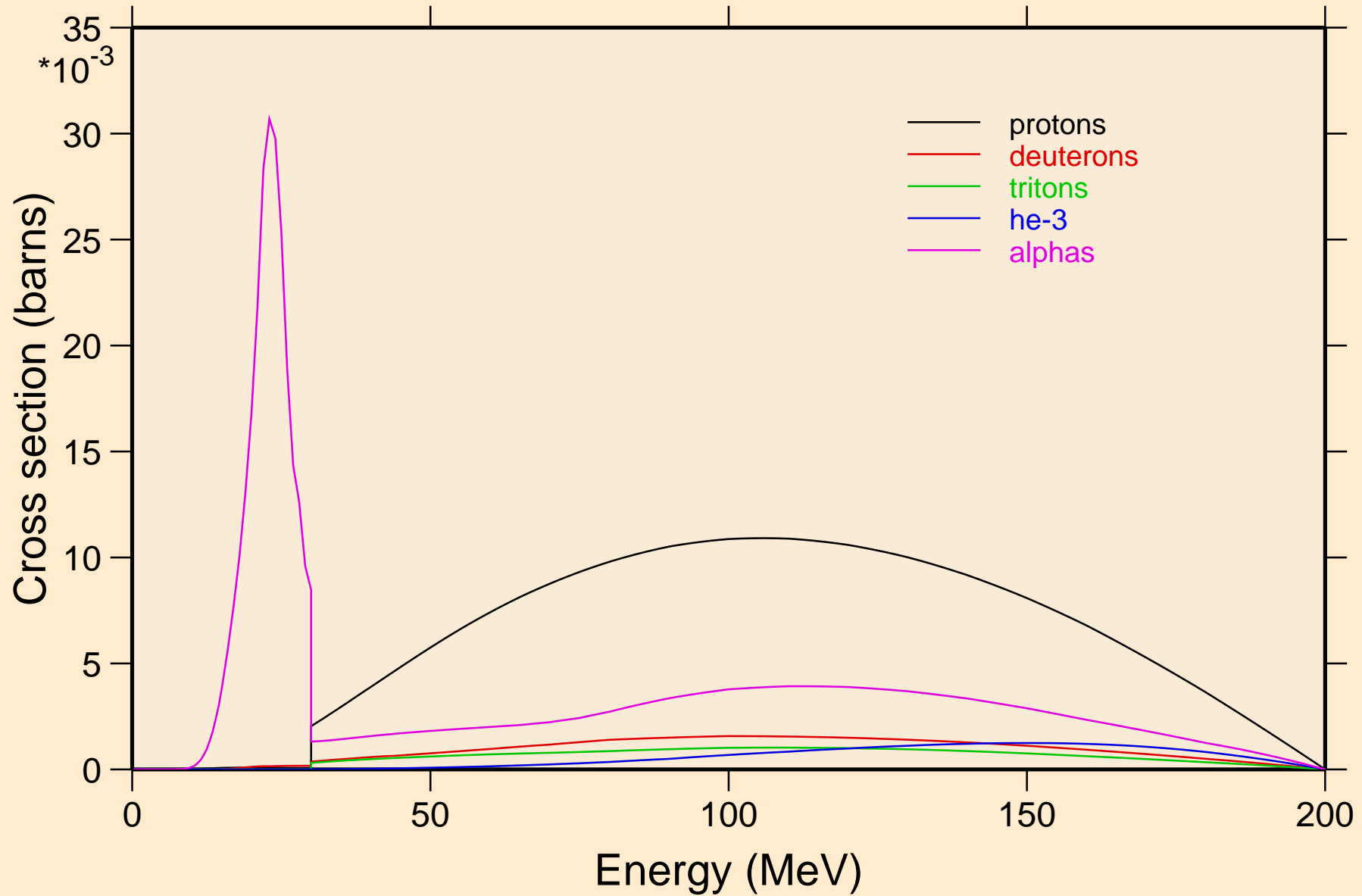

CN285 NEUTRON ACER TENDL-2021 LIBRARY; T=293.6K
protons from (n,x)

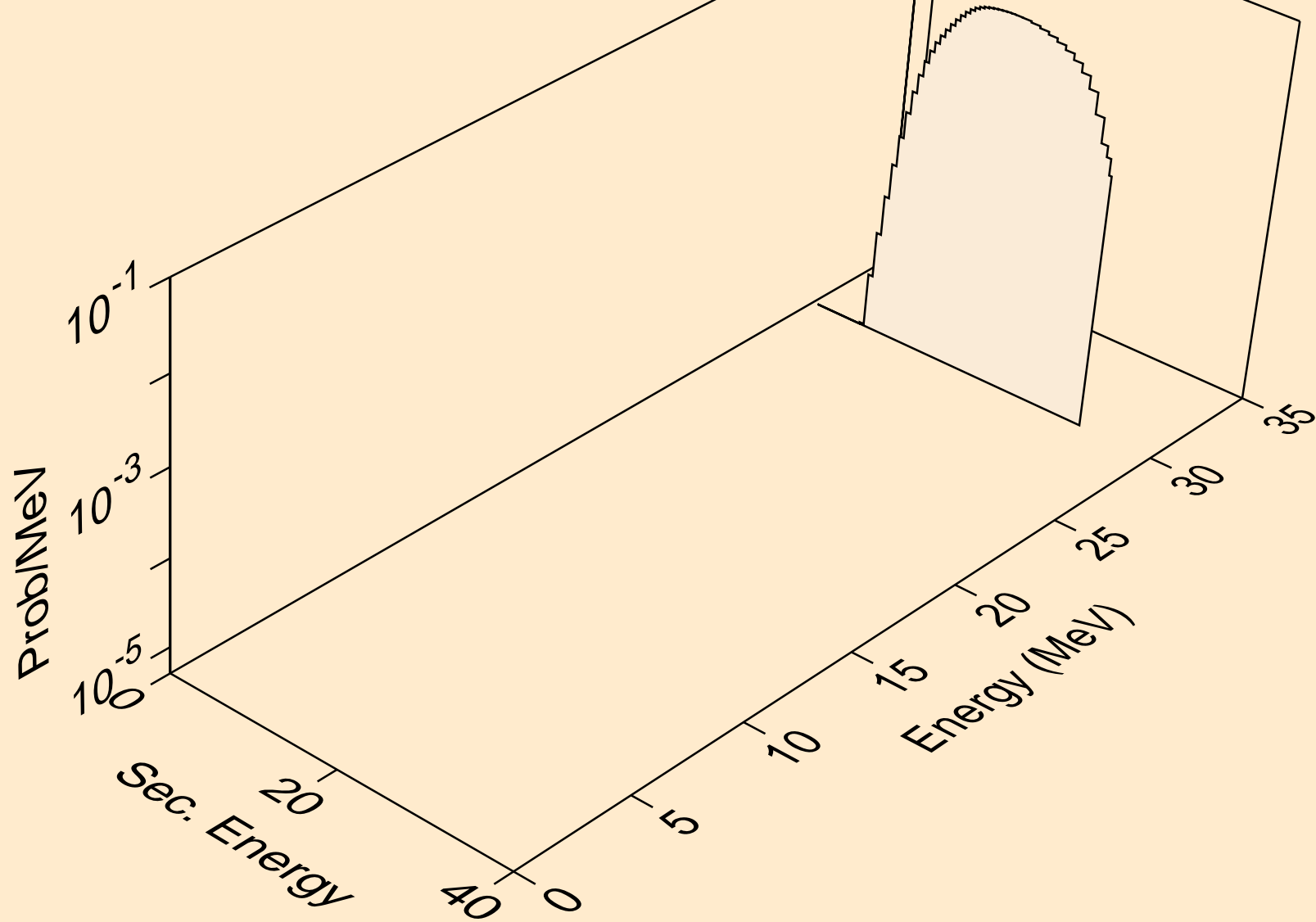

CN285 NEUTRON ACER TENDL-2021 LIBRARY; T=293.6K
protons from (n,n*)p

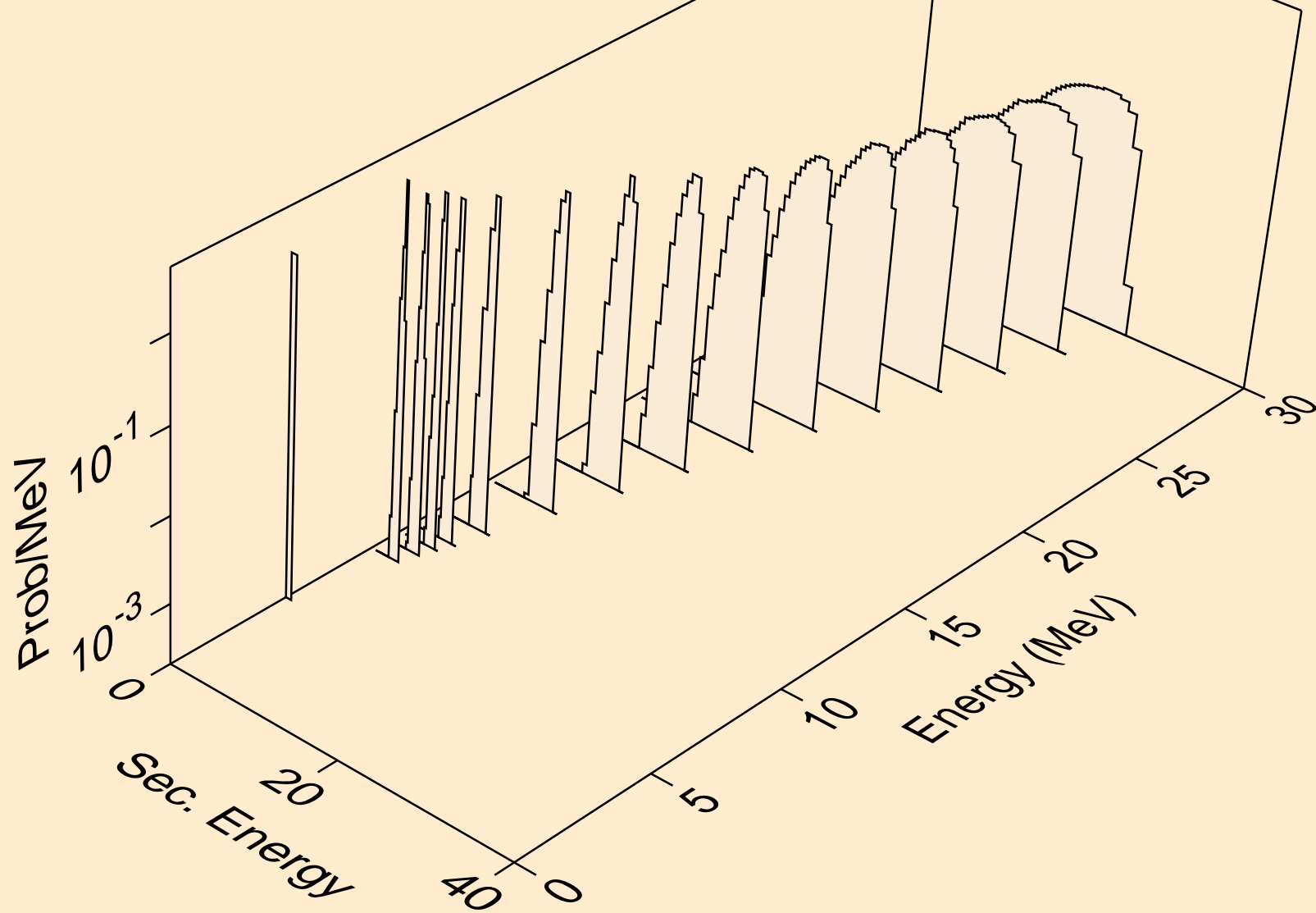

CN285 NEUTRON ACER TENDL-2021 LIBRARY; T=293.6K
protons from (n,2np)

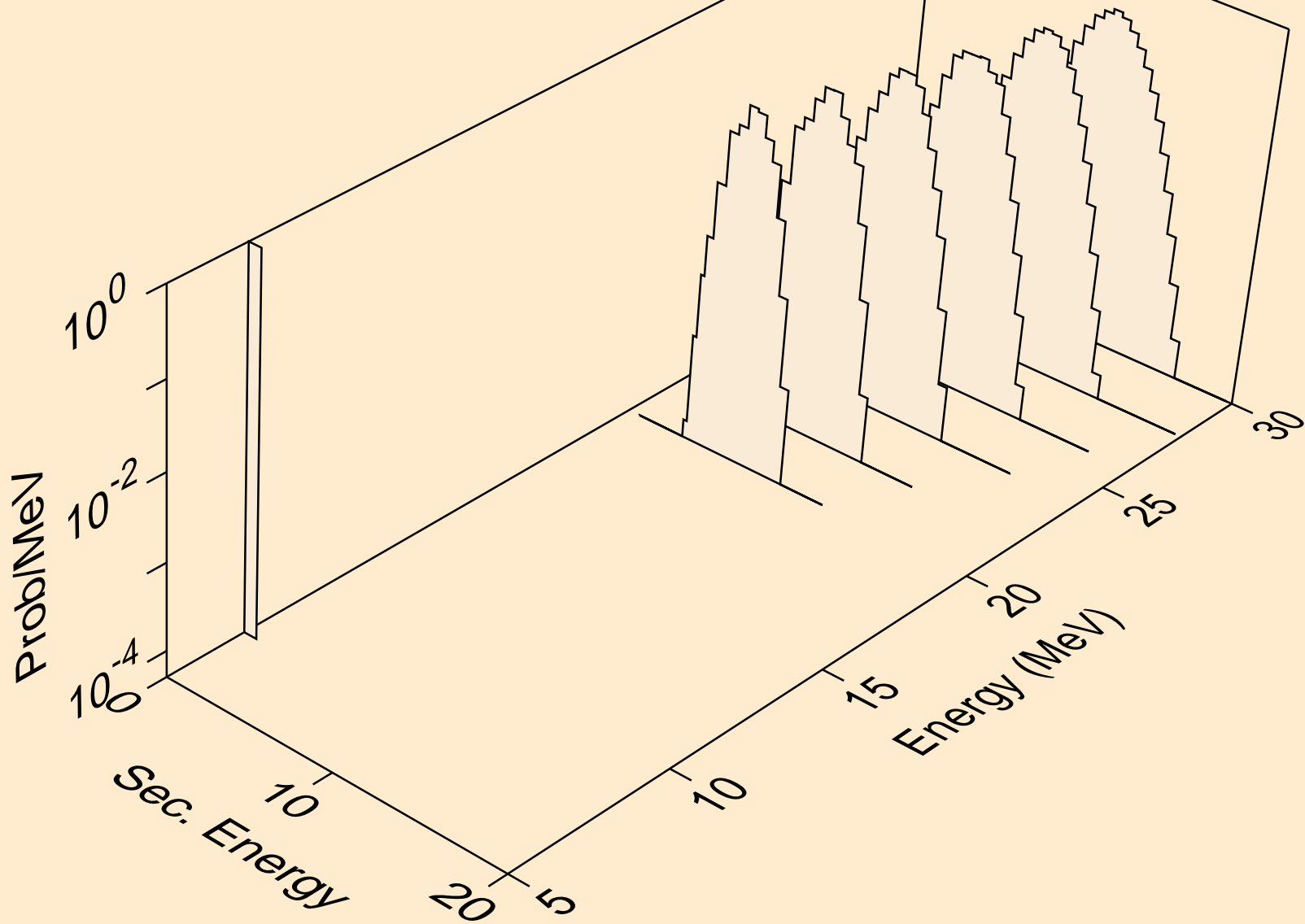

CN285 NEUTRON ACER TENDL-2021 LIBRARY; T=293.6K
protons from (n,p)

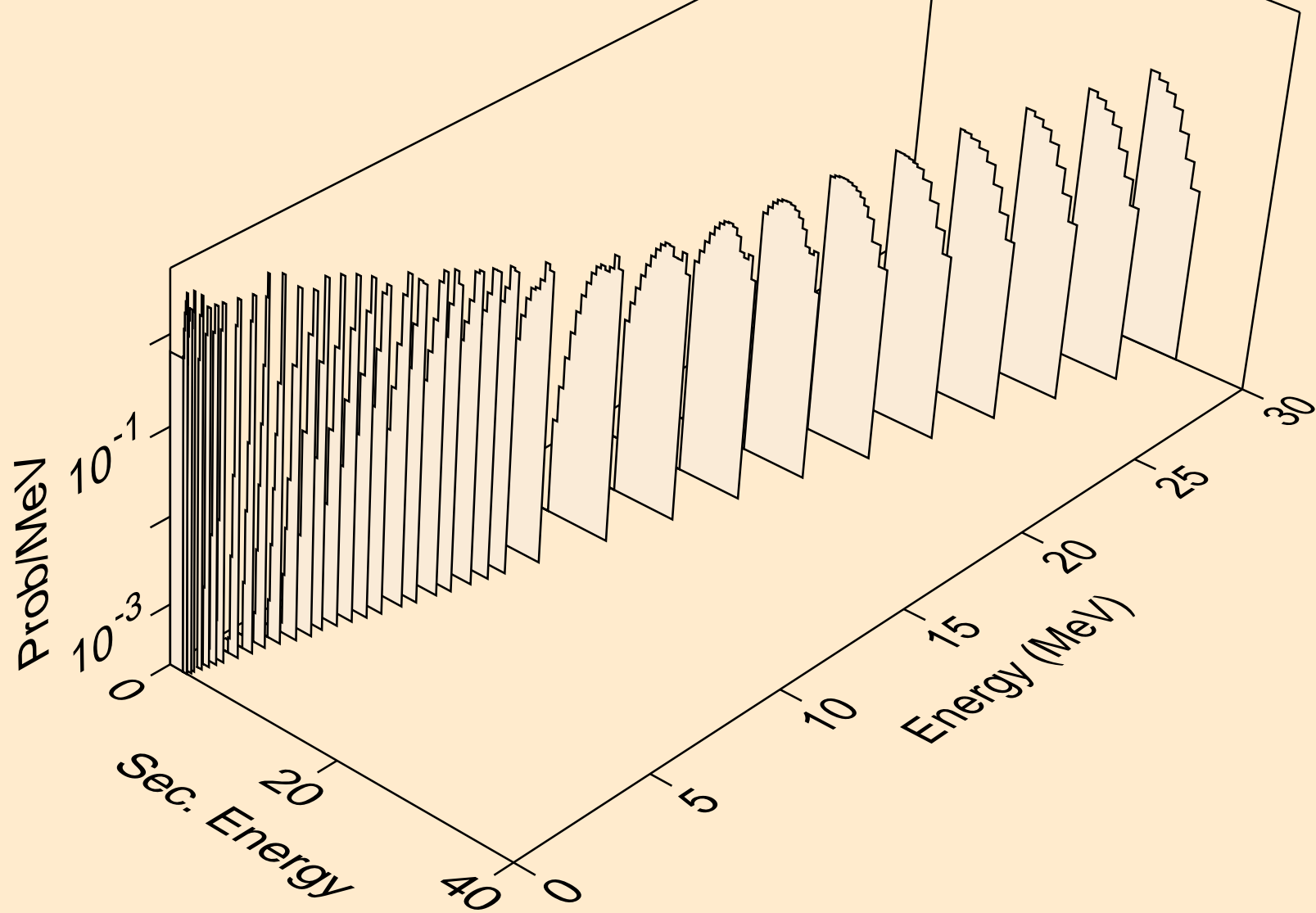

CN285 NEUTRON ACER TENDL-2021 LIBRARY; T=293.6K
protons from (n,2p)

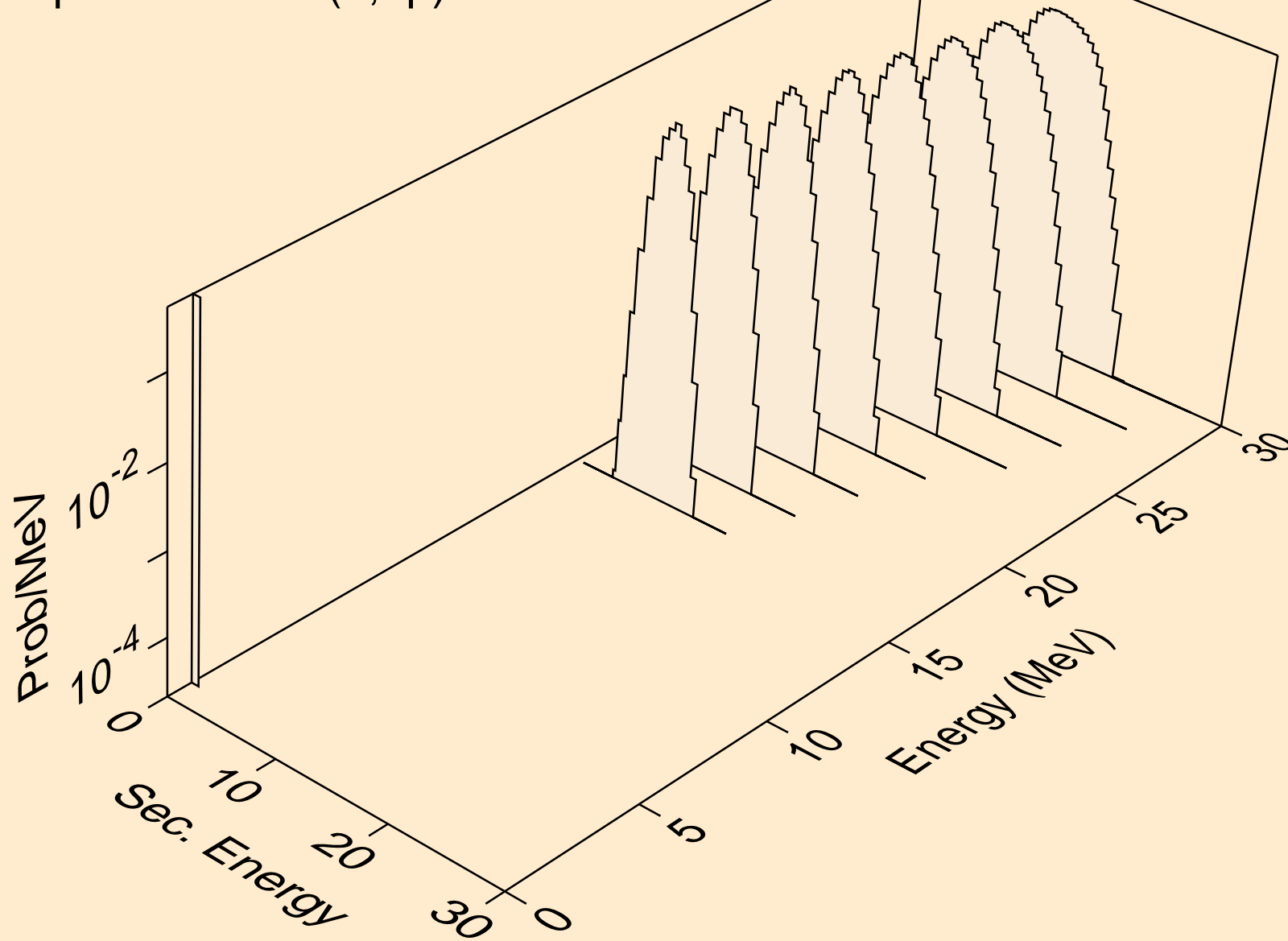

CN285 NEUTRON ACER TENDL-2021 LIBRARY; T=293.6K
deuterons from (n,x)

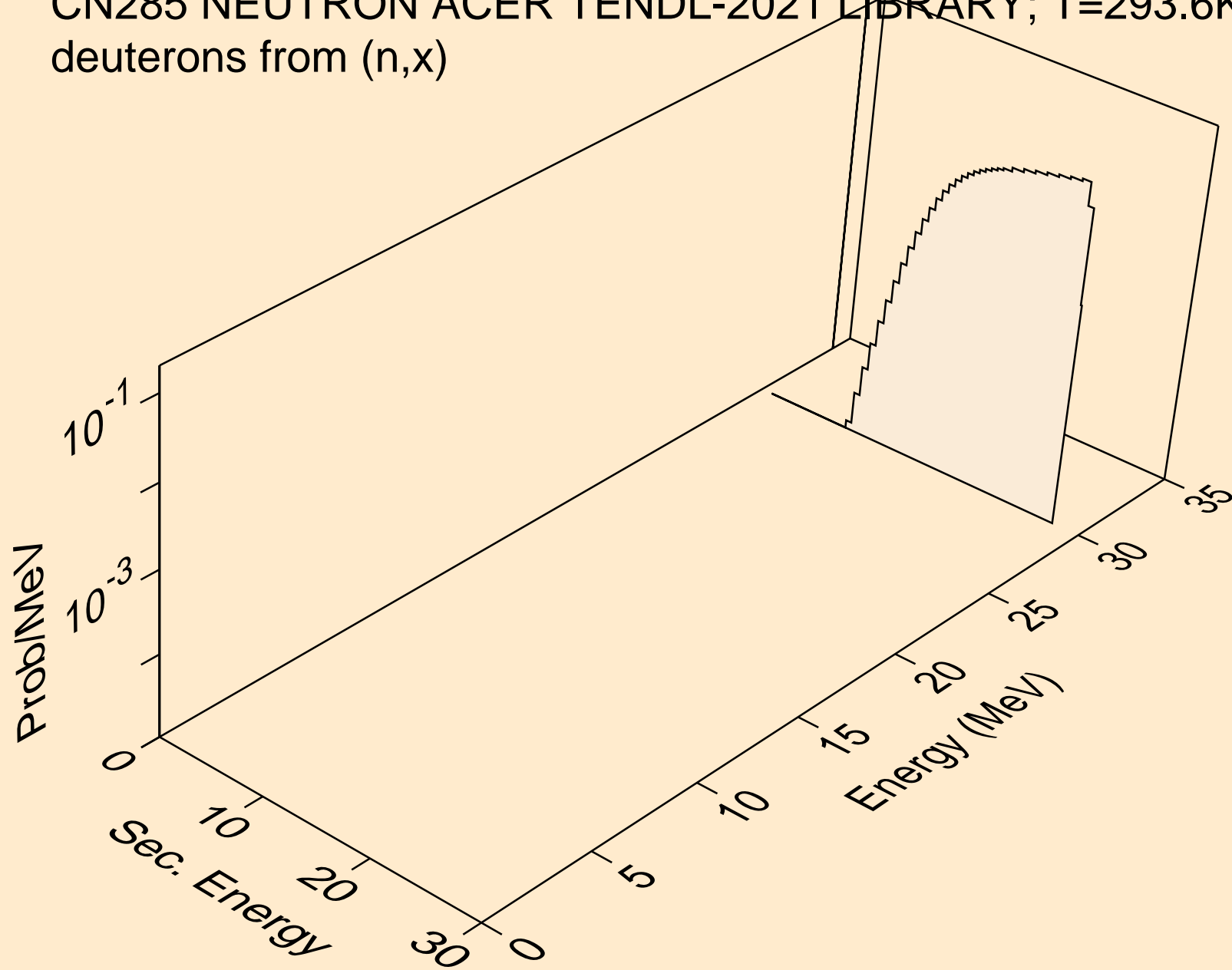

CN285 NEUTRON ACER TENDL-2021 LIBRARY; T=293.6K
deuterons from (n,d)

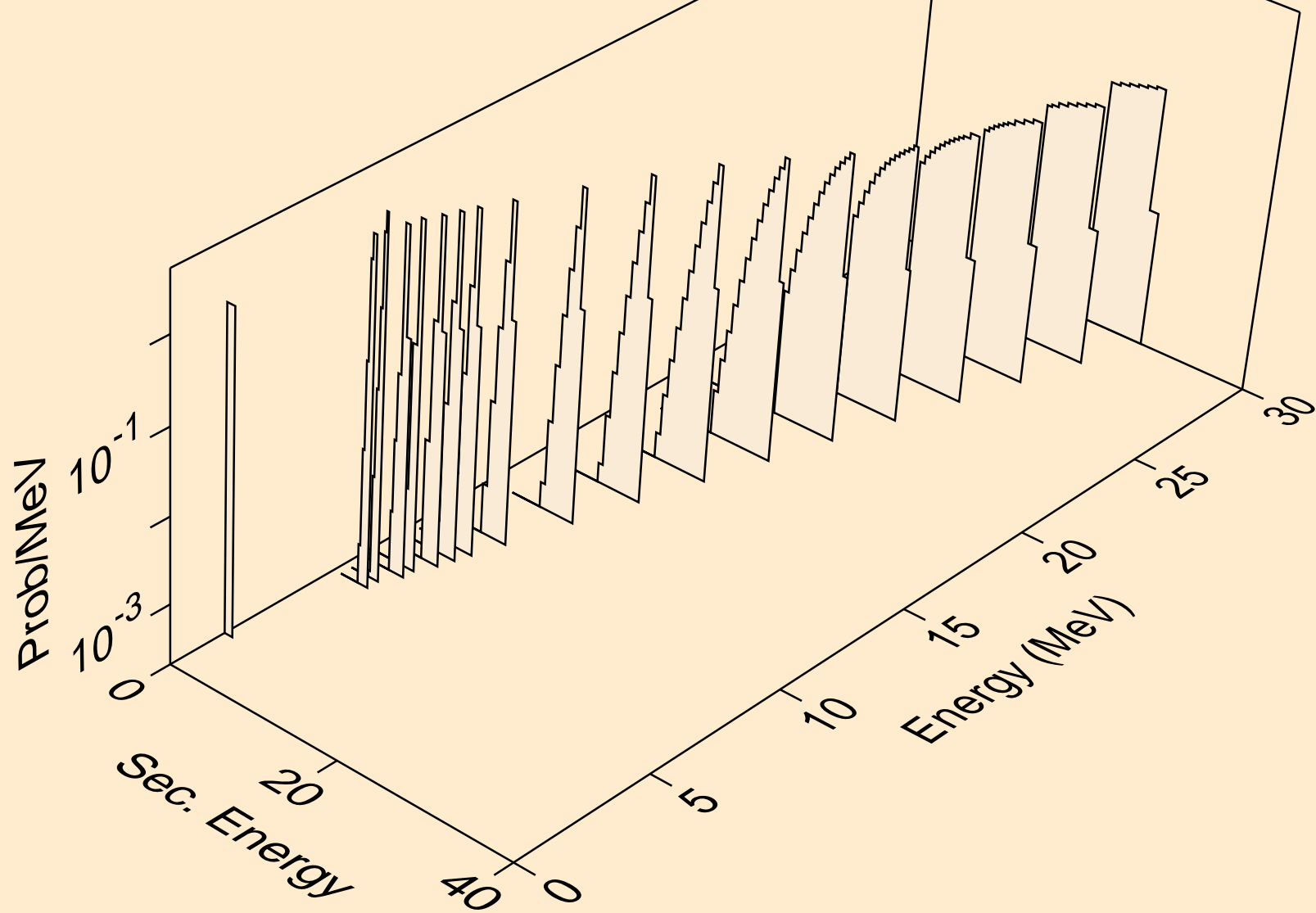

CN285 NEUTRON ACER TENDL-2021 LIBRARY; T=293.6K
tritons from (n,x)

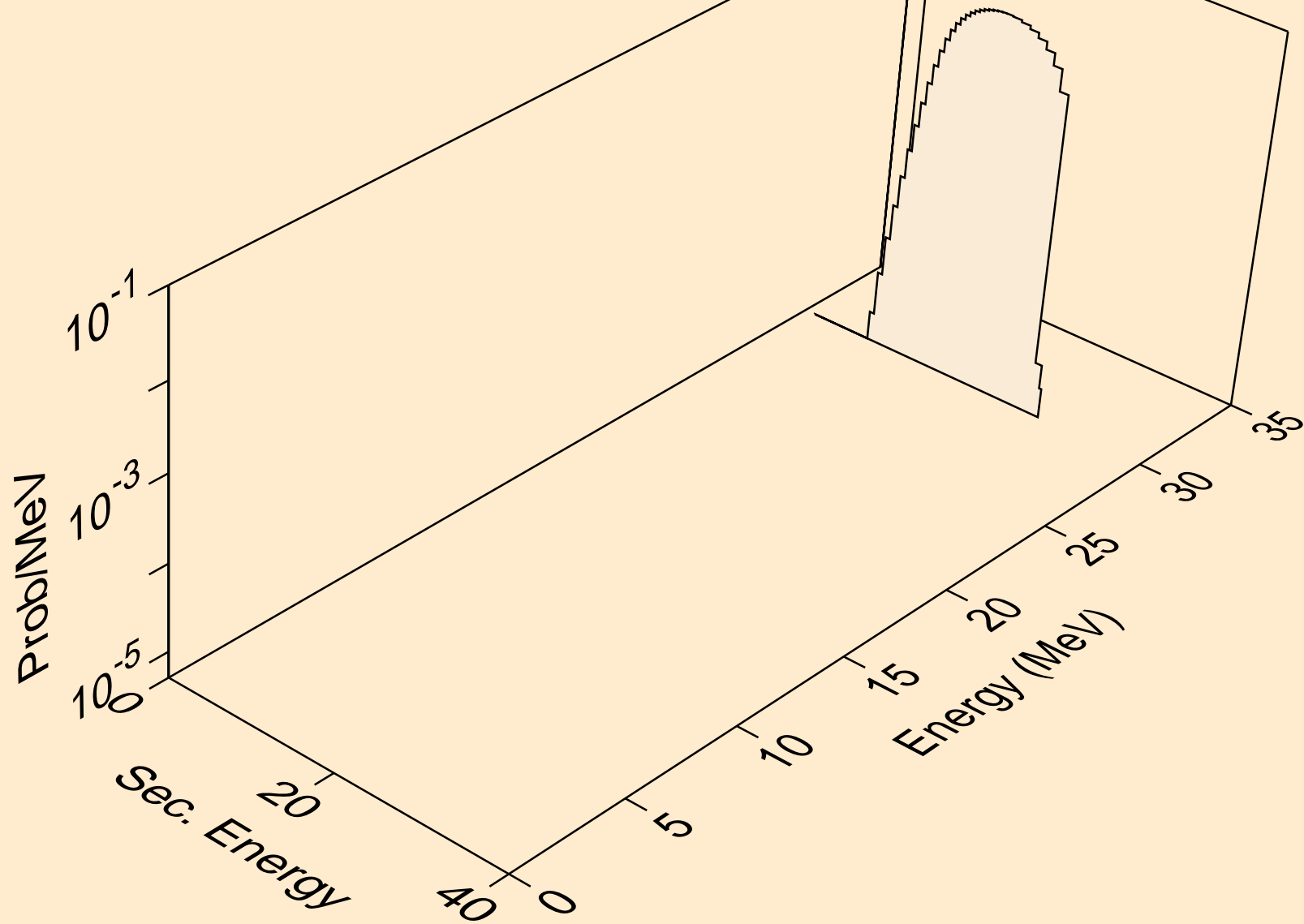

CN285 NEUTRON ACER TENDL-2021 LIBRARY; T=293.6K
tritons from (n,t)

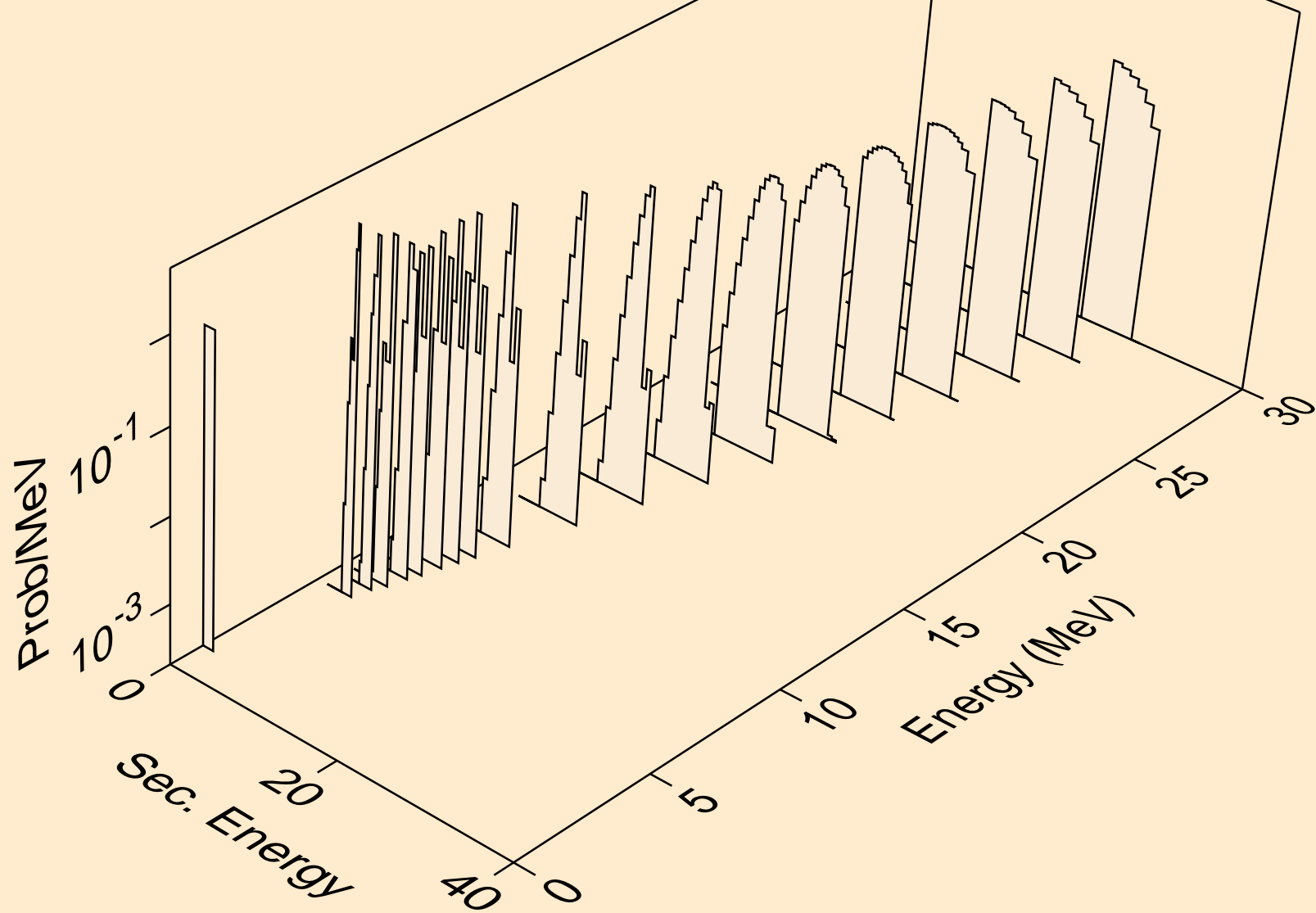

CN285 NEUTRON ACER TENDL-2021 LIBRARY; T=293.6K
he3s from (n,x)

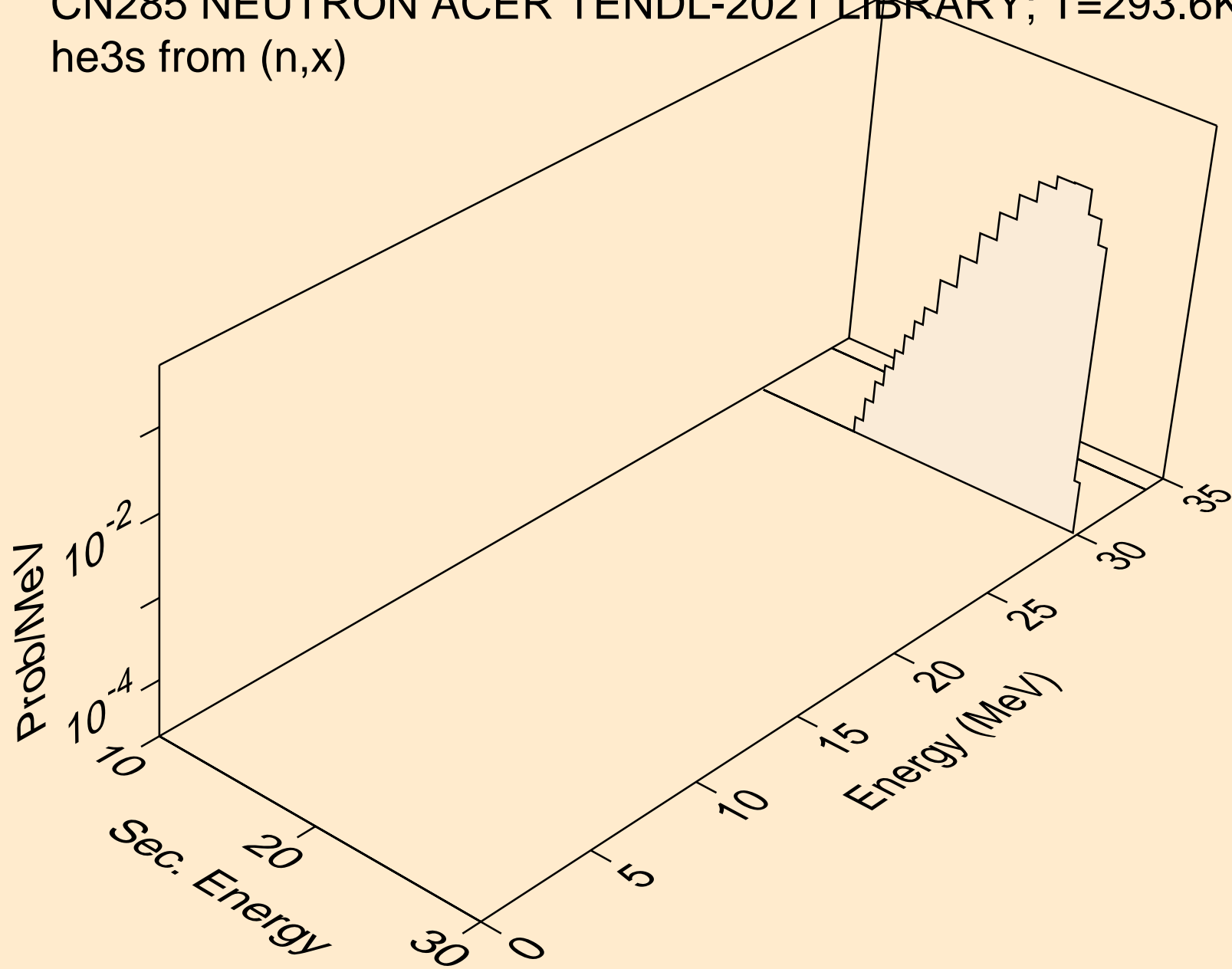

CN285 NEUTRON ACER TENDL-2021 LIBRARY; T=293.6K
he3s from (n,n*)he3

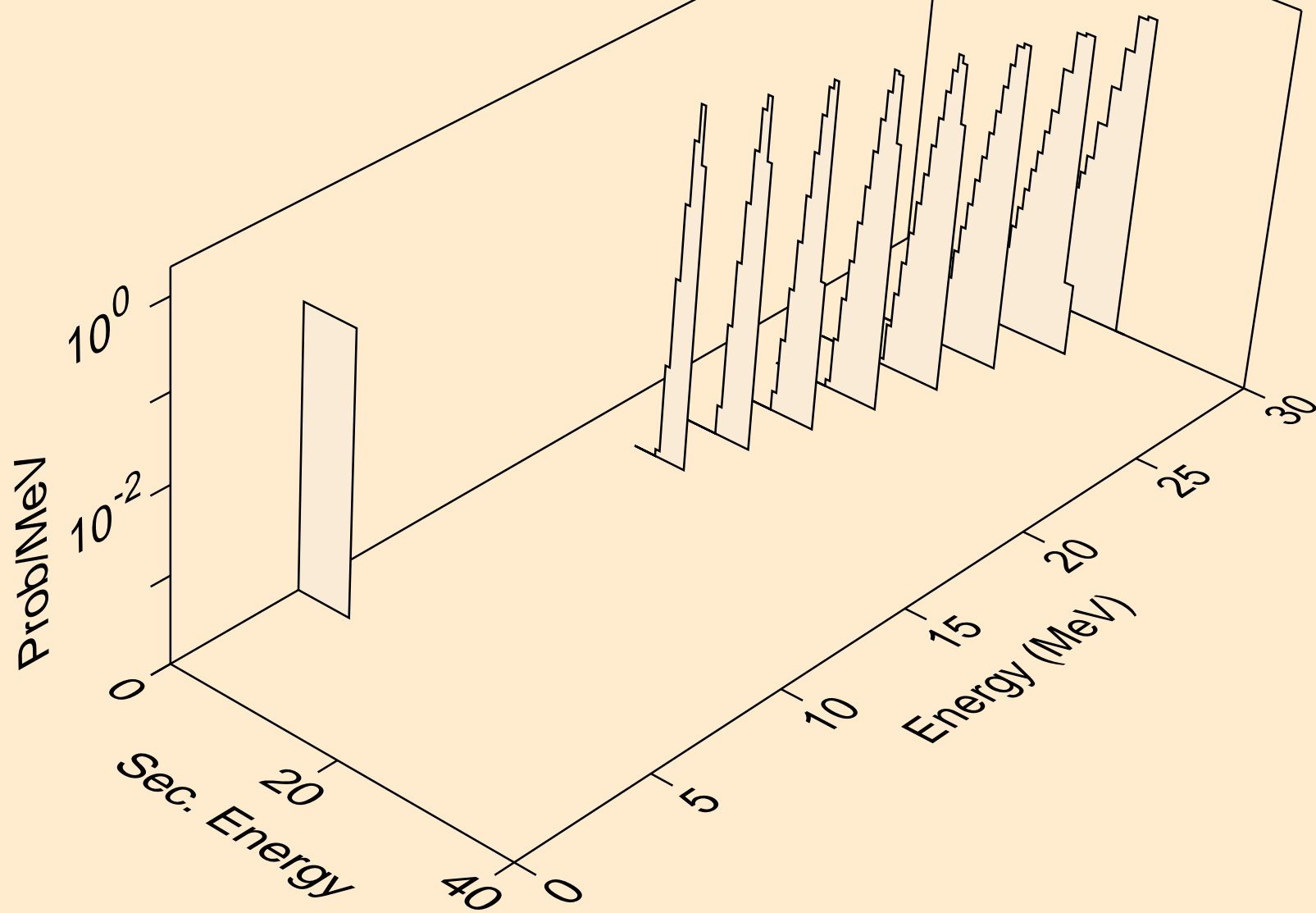

CN285 NEUTRON ACER TENDL-2021 LIBRARY; T=293.6K
he3s from (n,he3)

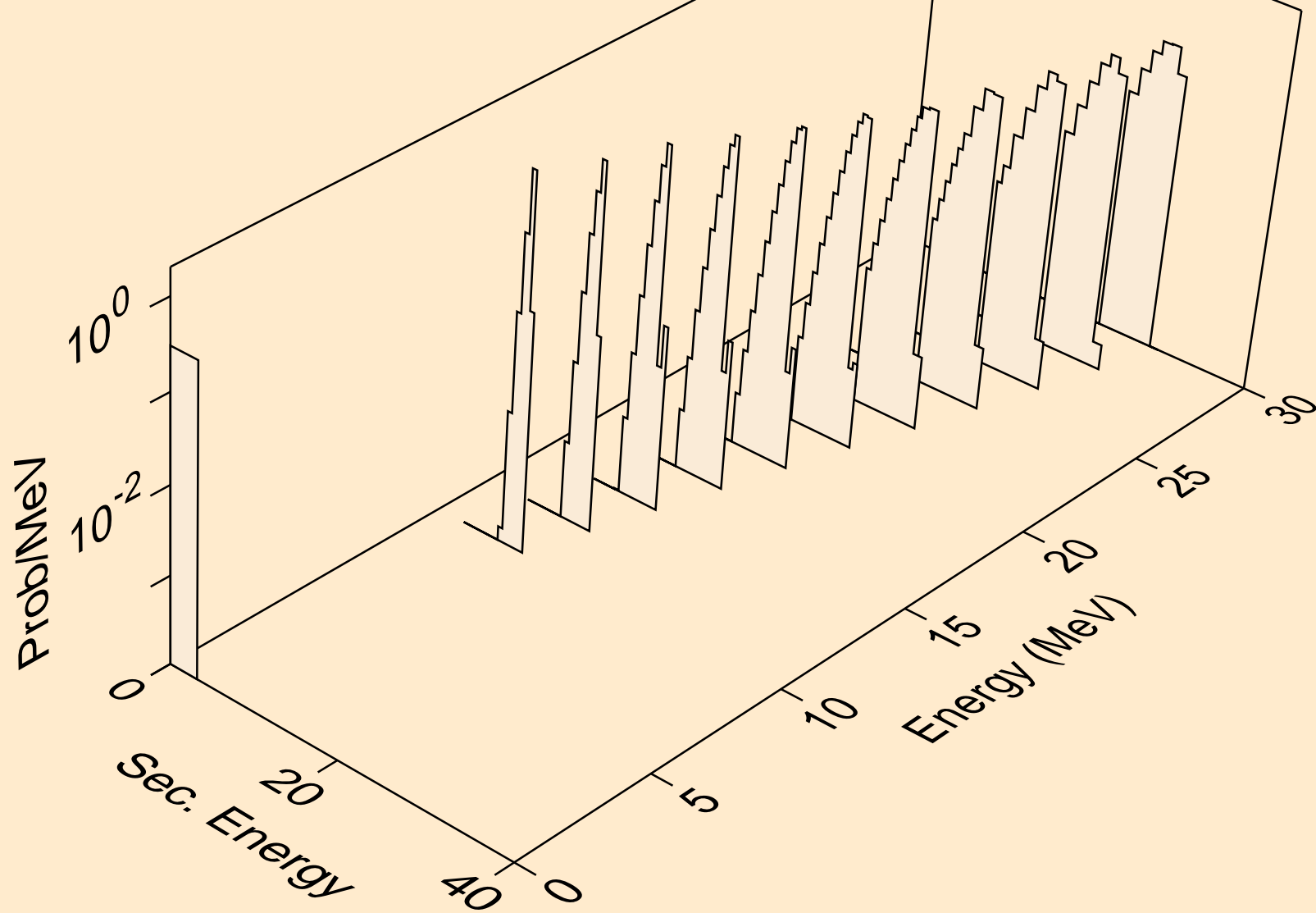

CN285 NEUTRON ACER TENDL-2021 LIBRARY; T=293.6K
alphas from (n,x)

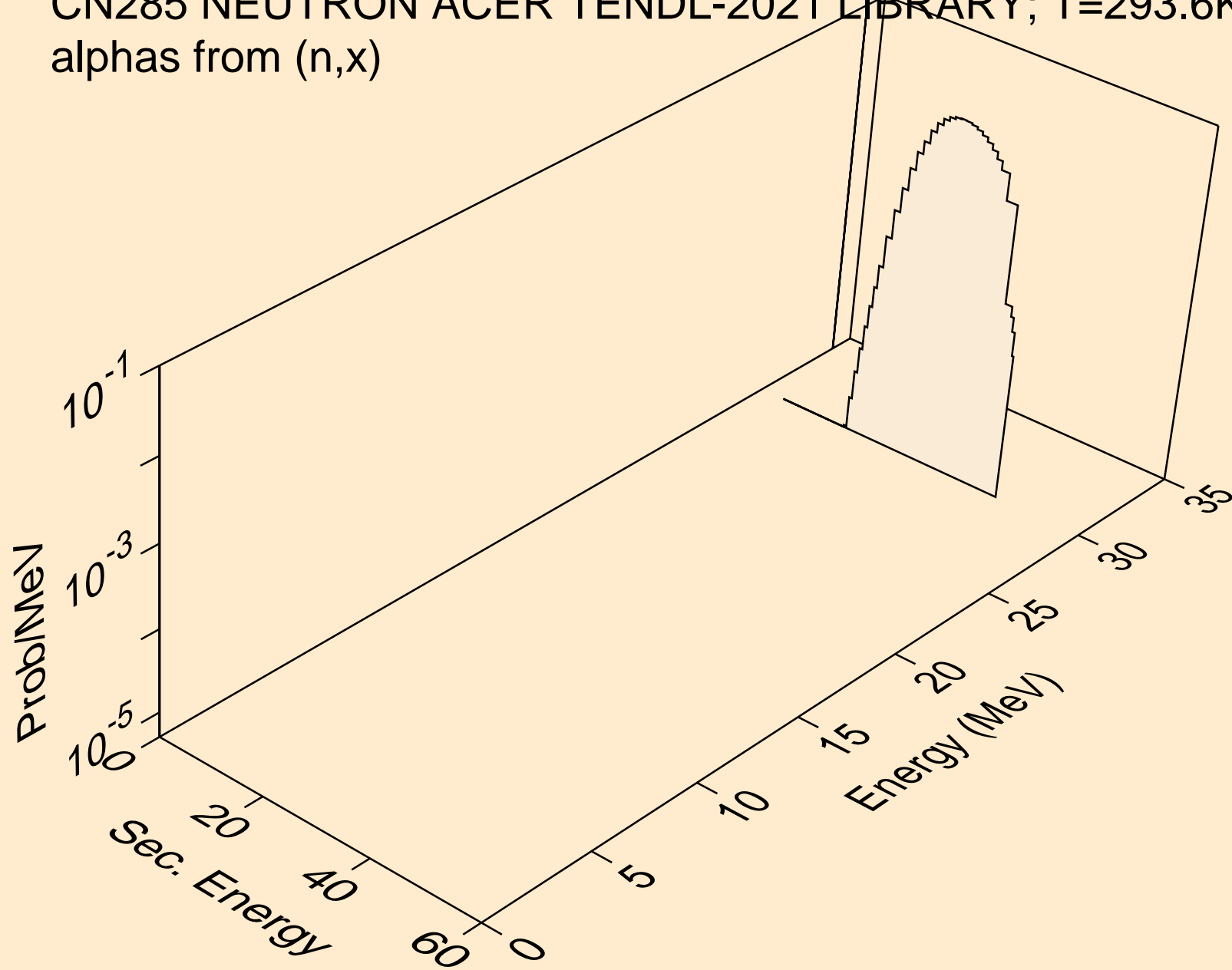

CN285 NEUTRON ACER TENDL-2021 LIBRARY; T=293.6K
alphas from (n,n*)a

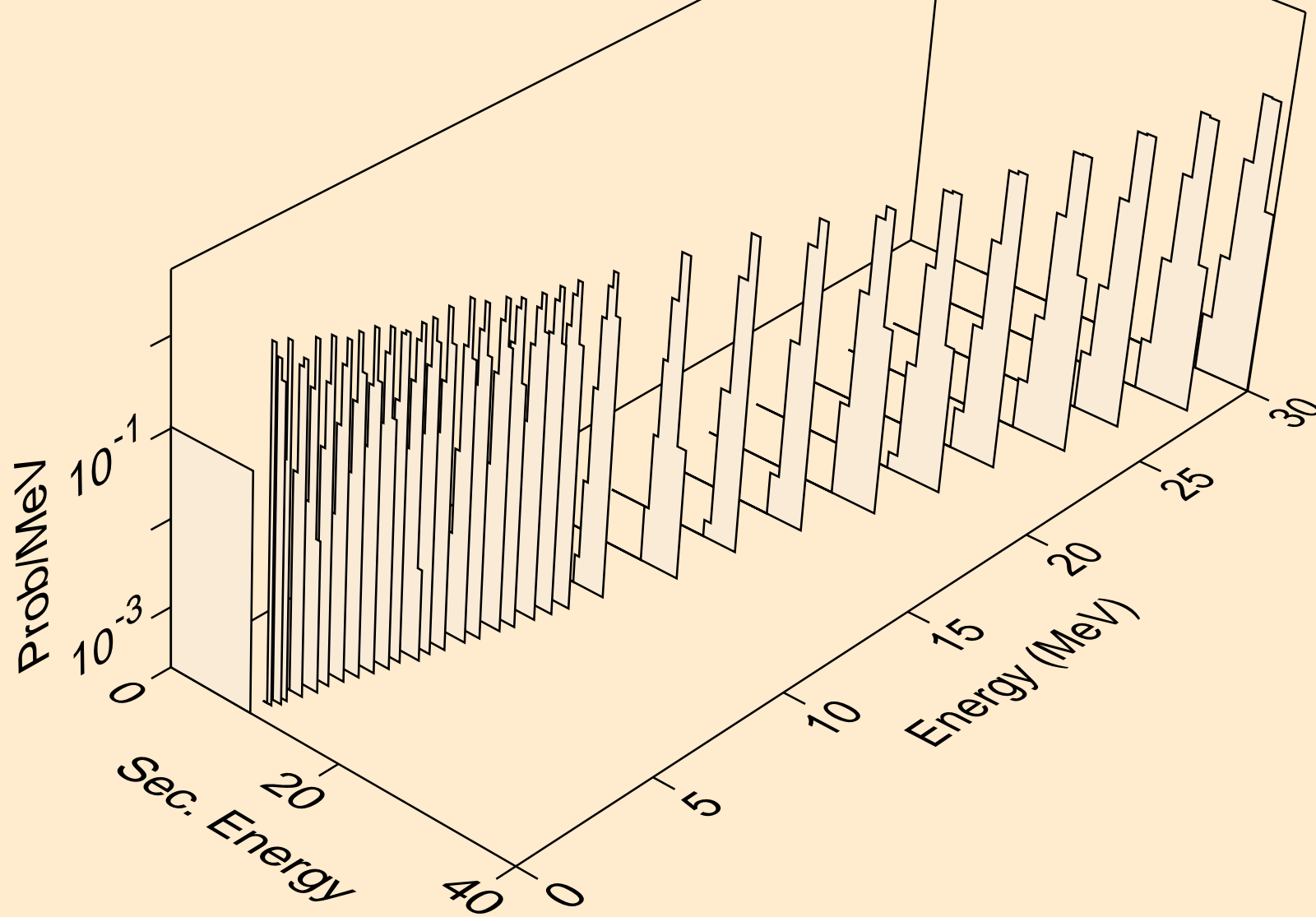

CN285 NEUTRON ACER TENDL-2021 LIBRARY; T=293.6K
alphas from (n,a)

