

CO059 NEUTRON ACER TENDL-2021 LIBRARY; T=293.6K  
Principal cross sections

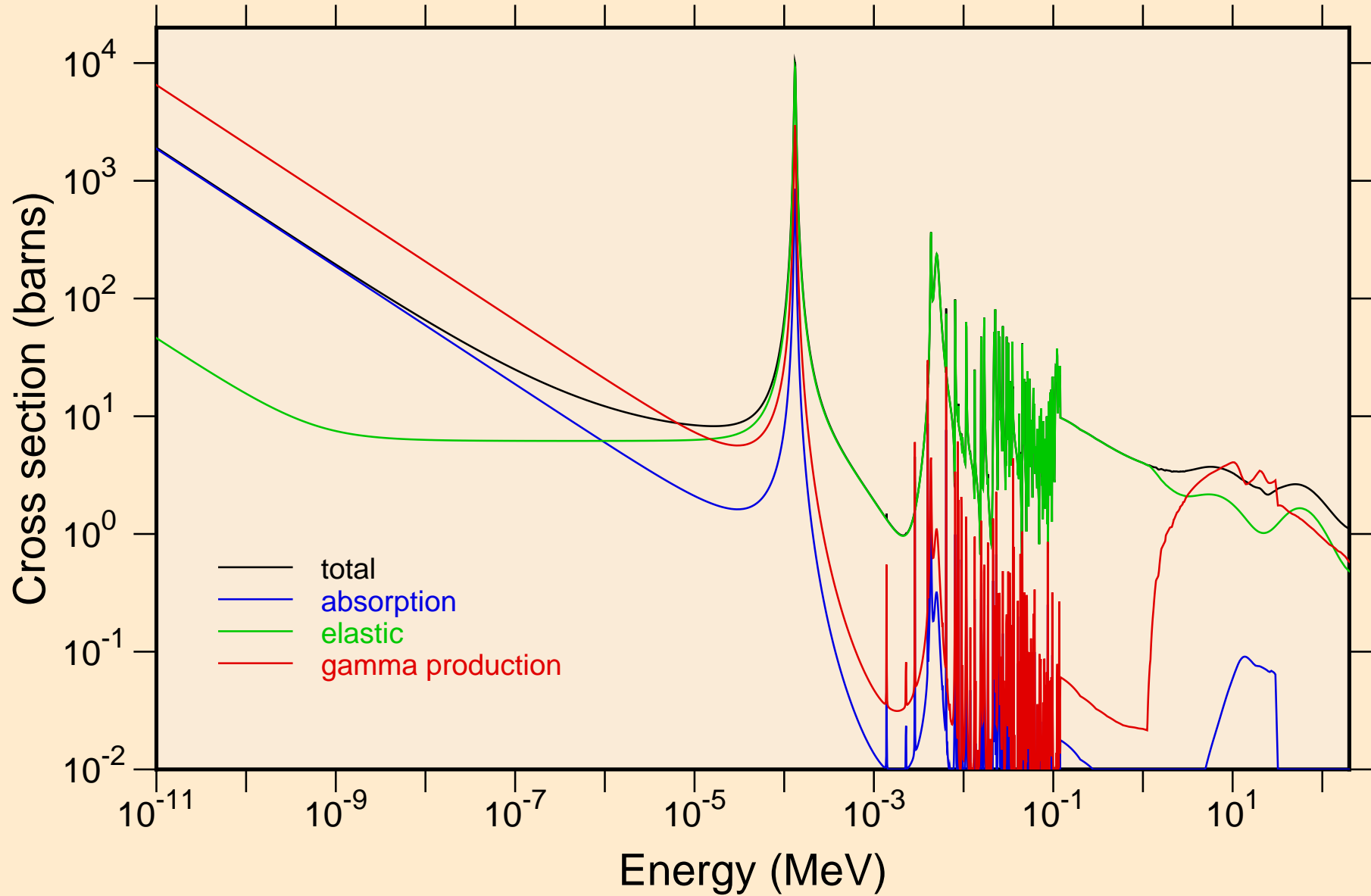

CO059 NEUTRON ACER TENDL-2021 LIBRARY; T=293.6K  
resonance total cross section

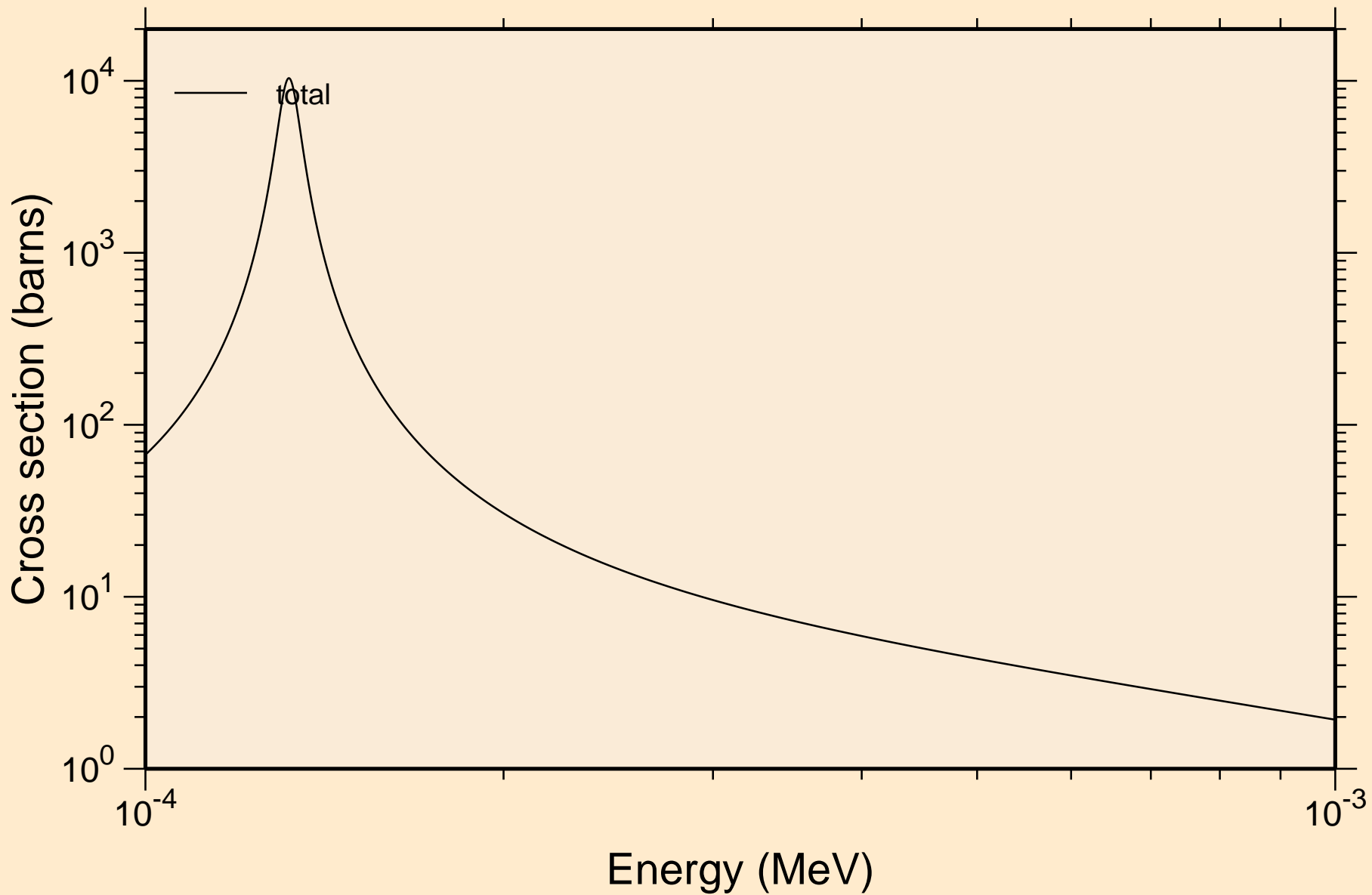

CO059 NEUTRON ACER TENDL-2021 LIBRARY; T=293.6K  
resonance total cross section

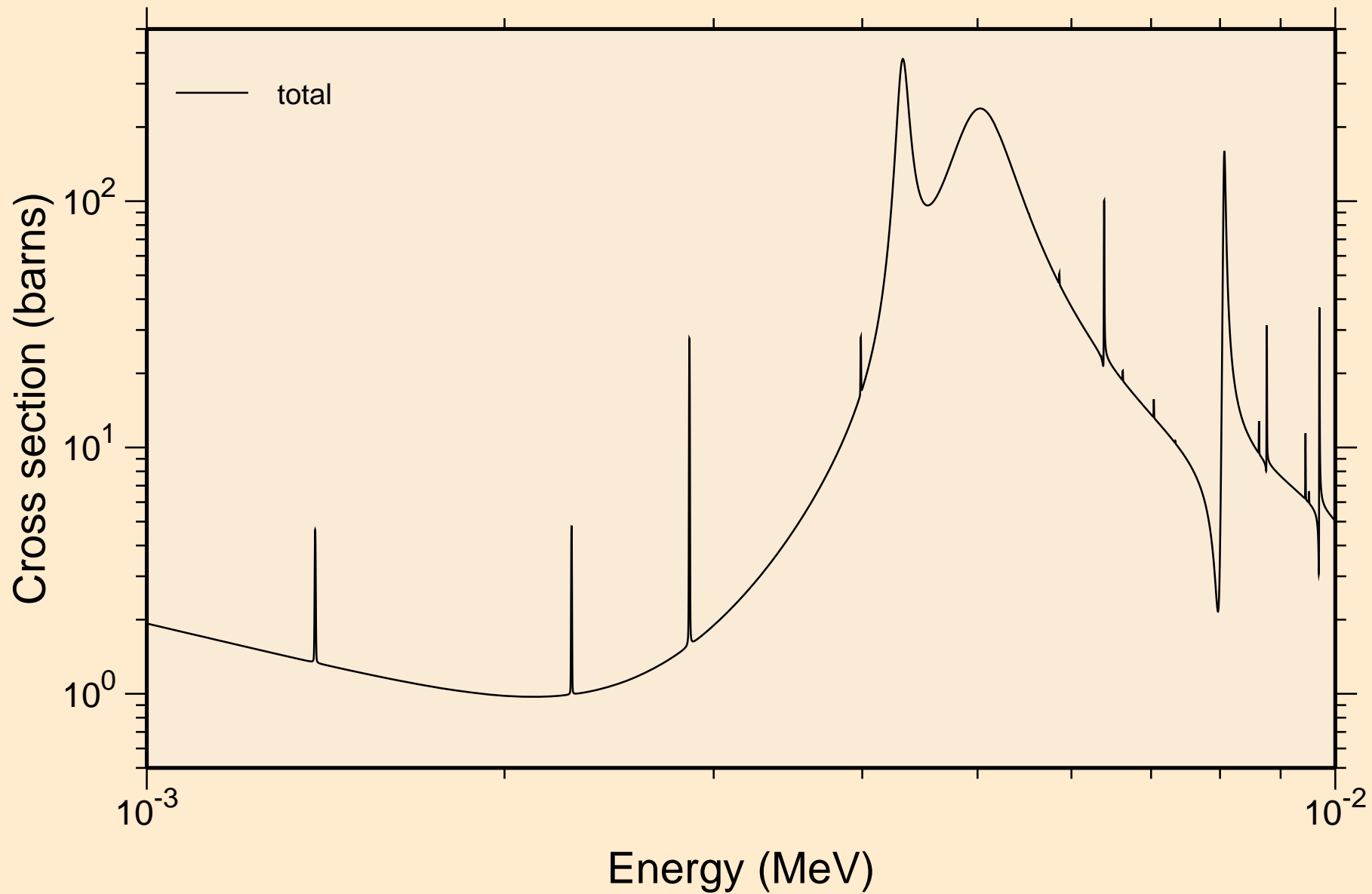

CO059 NEUTRON ACER TENDL-2021 LIBRARY; T=293.6K  
resonance total cross section

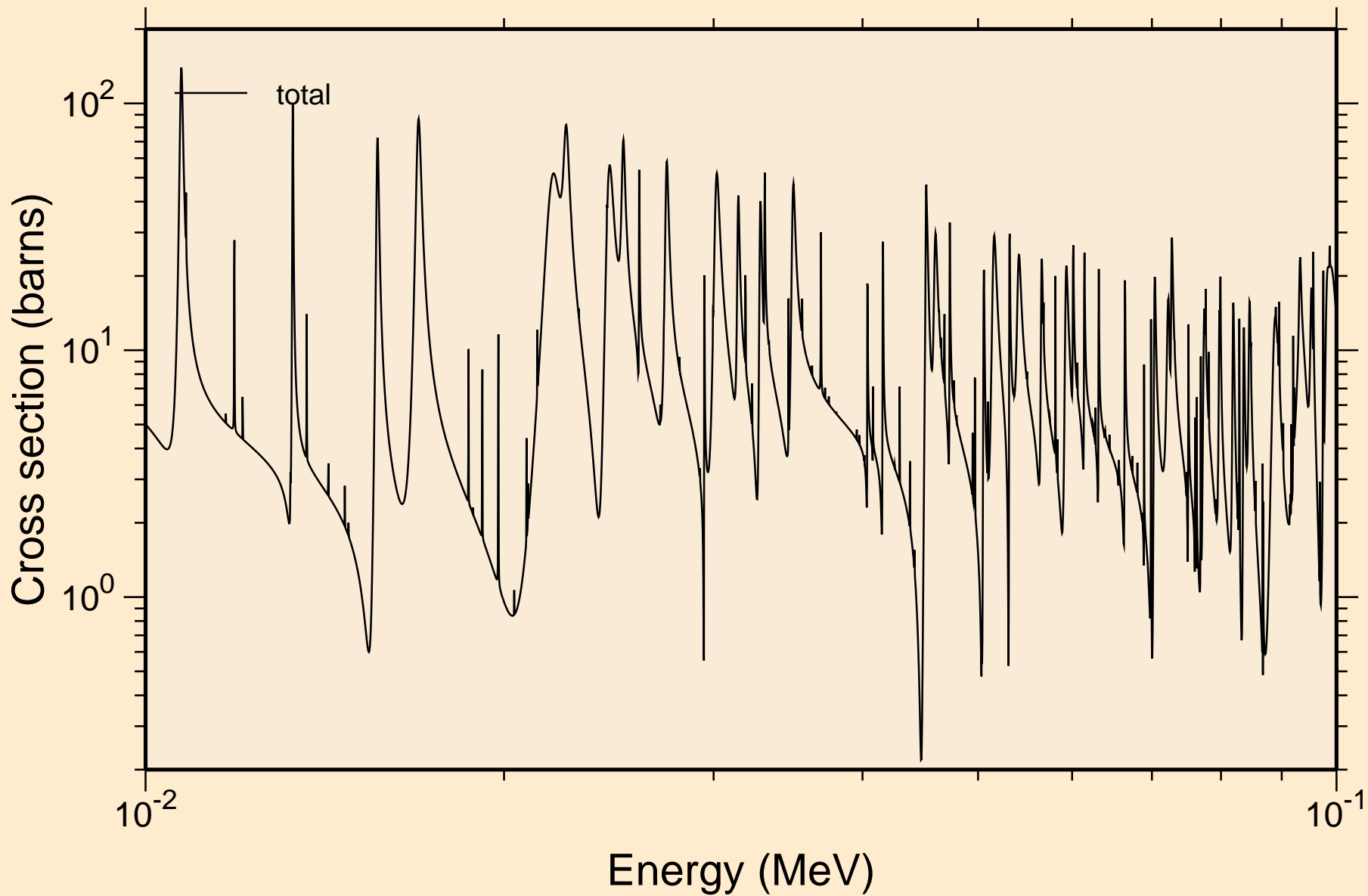

CO059 NEUTRON ACER TENDL-2021 LIBRARY; T=293.6K  
resonance total cross section

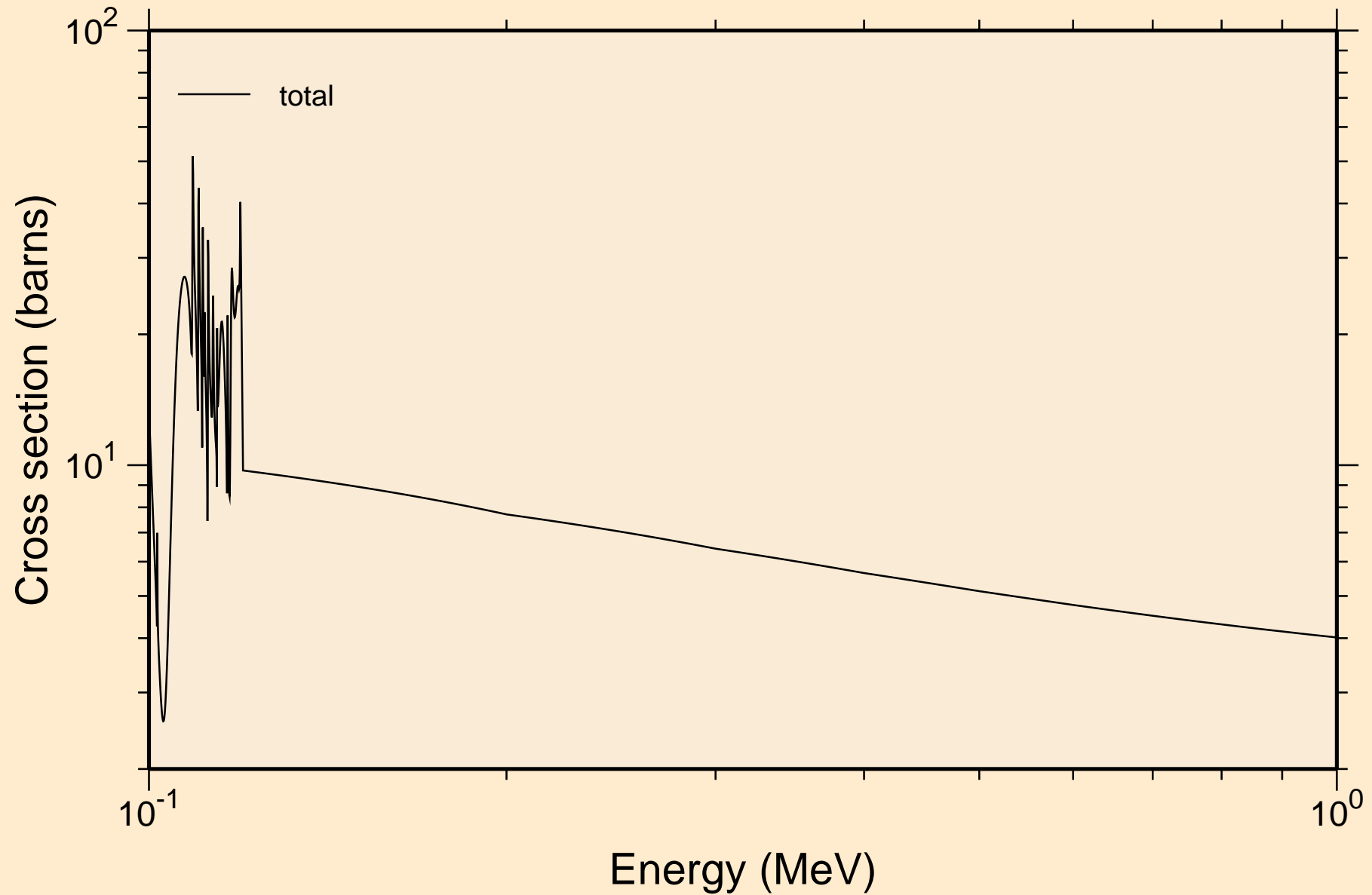

C059 NEUTRON ACER TENDL-2021 LIBRARY; T=293.6K  
resonance total cross section

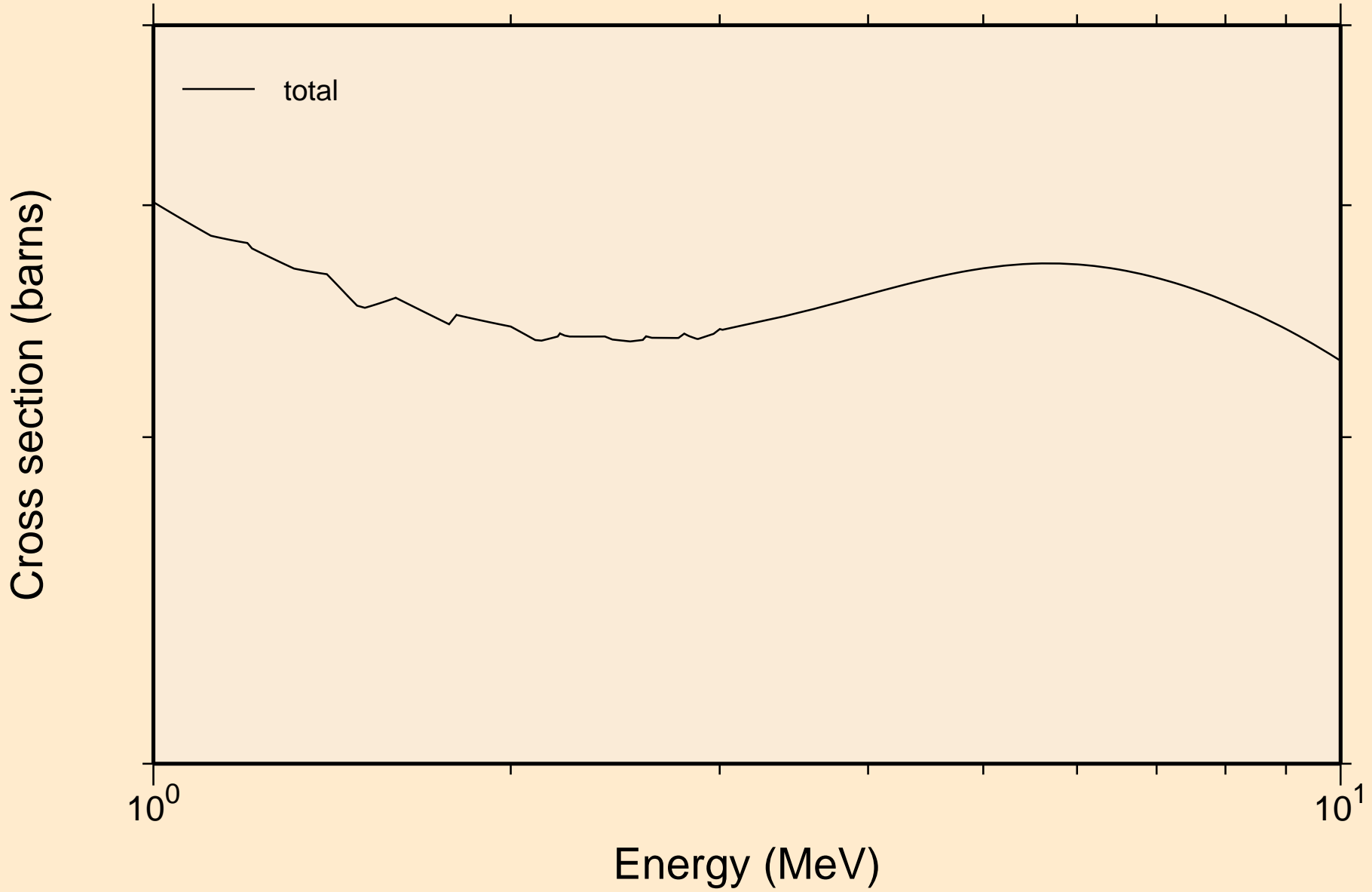

CO059 NEUTRON ACER TENDL-2021 LIBRARY; T=293.6K  
resonance absorption cross sections

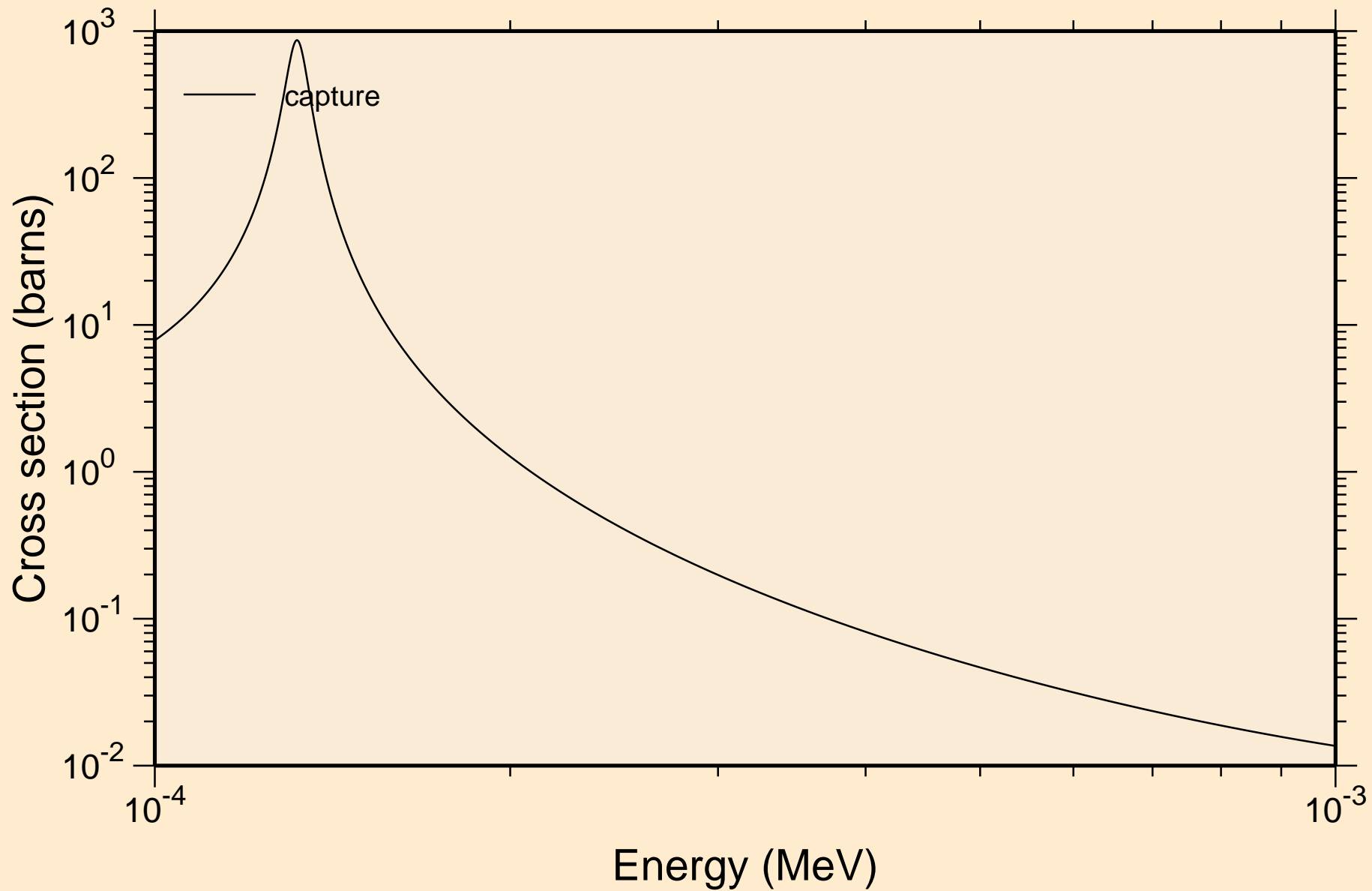

CO059 NEUTRON ACER TENDL-2021 LIBRARY; T=293.6K  
resonance absorption cross sections

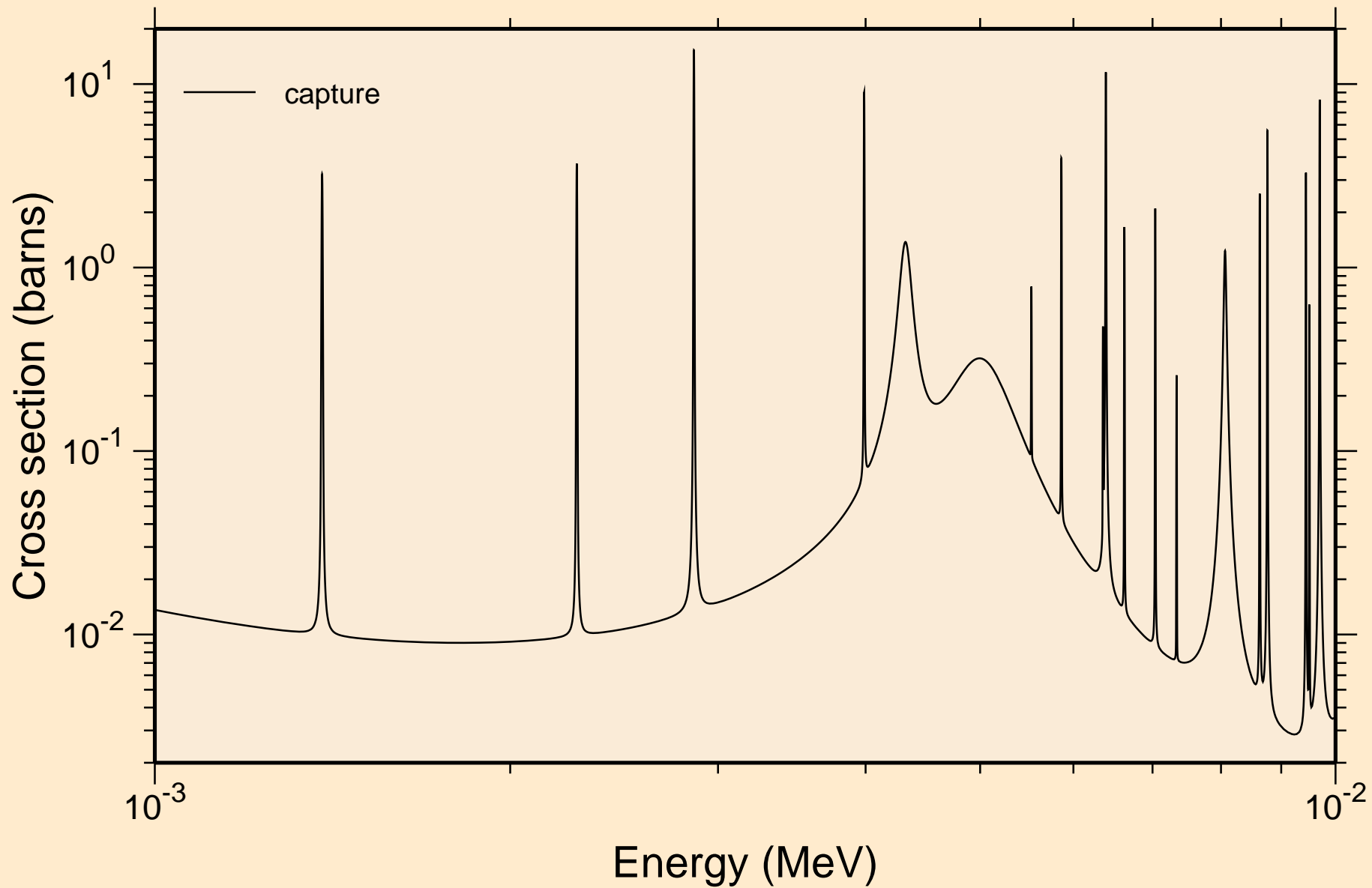



CO059 NEUTRON ACER TENDL-2021 LIBRARY; T=293.6K  
resonance absorption cross sections

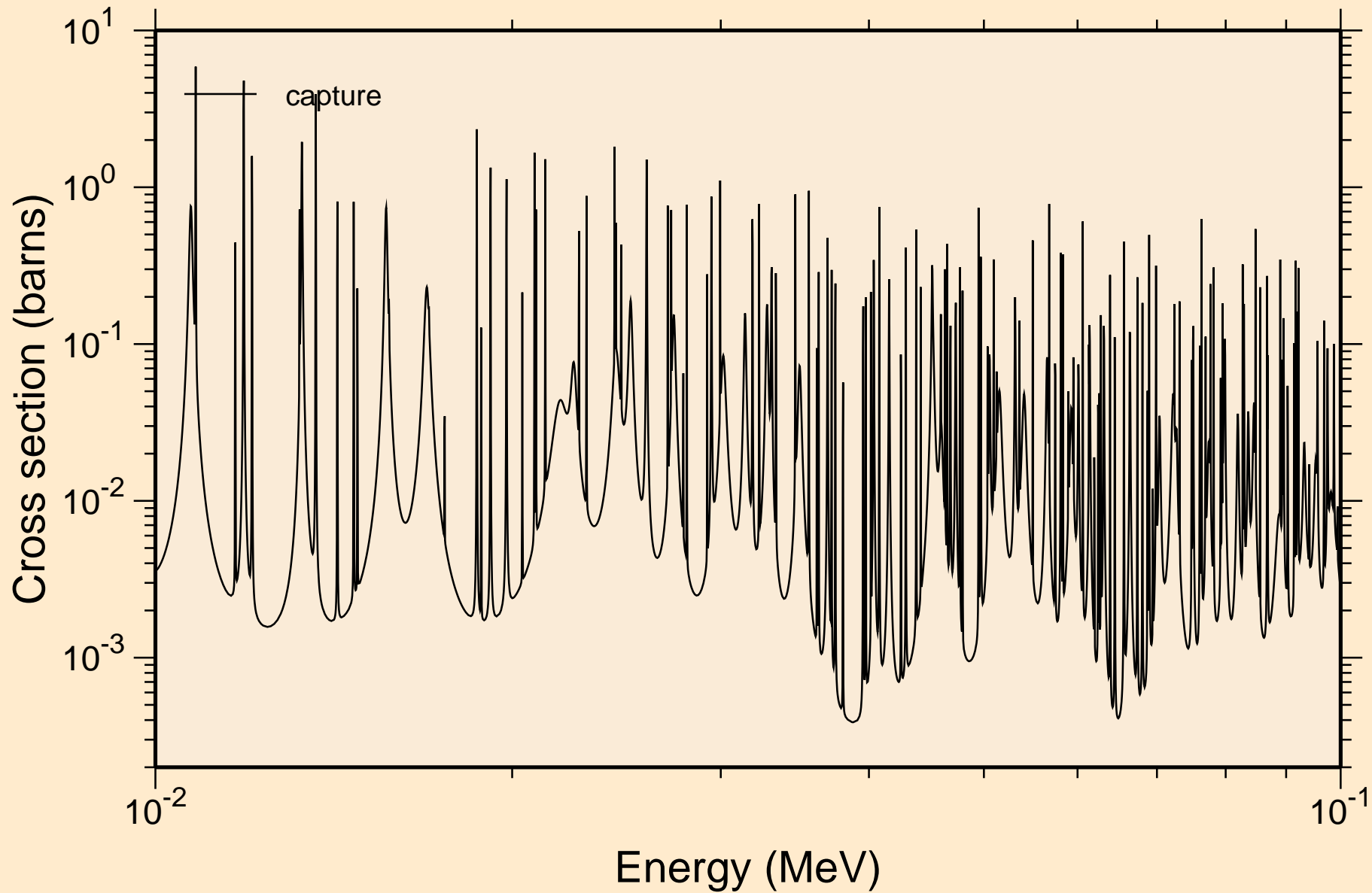

CO059 NEUTRON ACER TENDL-2021 LIBRARY; T=293.6K  
resonance absorption cross sections

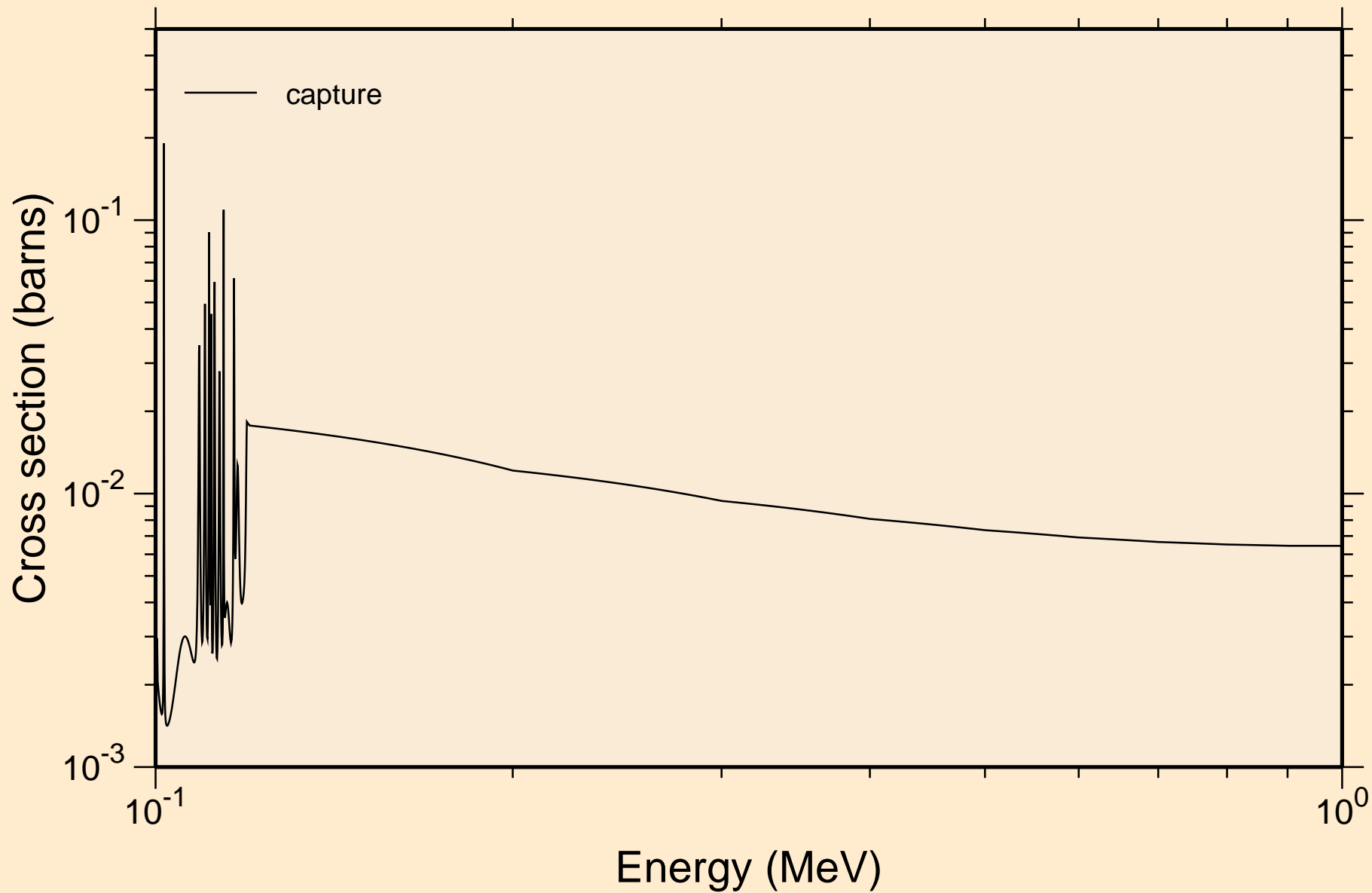

CO059 NEUTRON ACER TENDL-2021 LIBRARY; T=293.6K  
resonance absorption cross sections

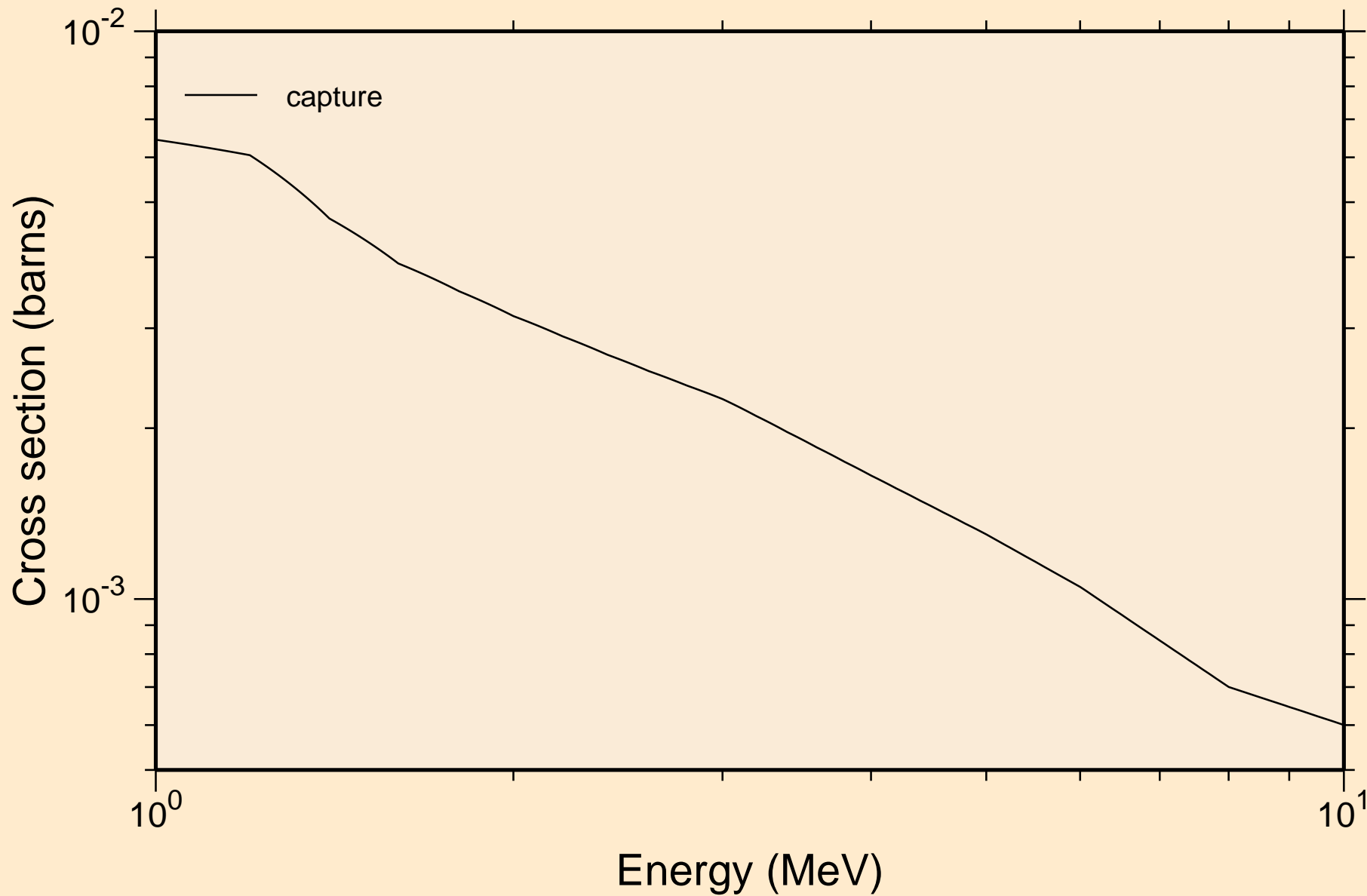

CO059 NEUTRON ACER TENDL-2021 LIBRARY; T=293.6K  
Heating

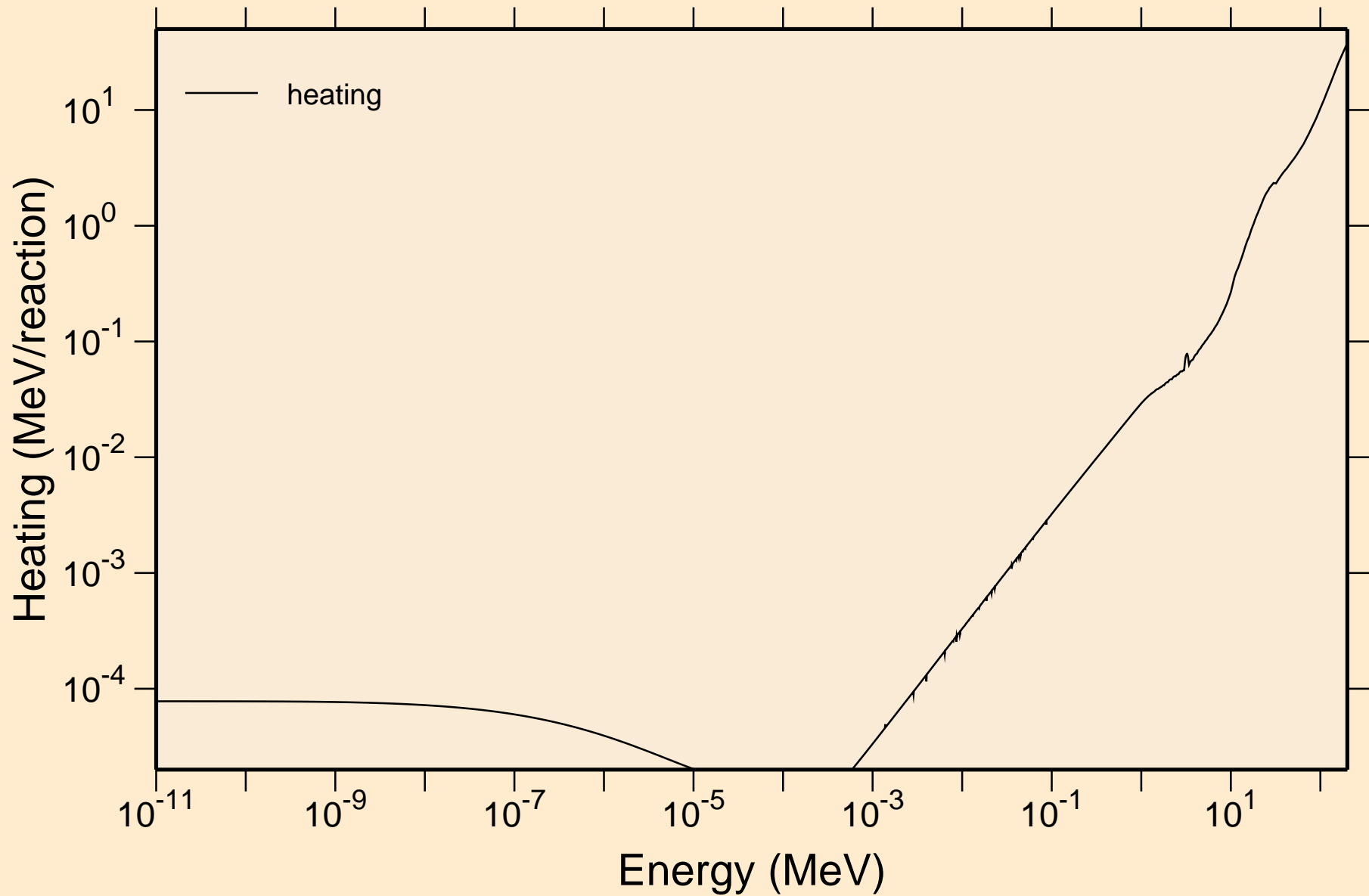

CO059 NEUTRON ACER TENDL-2021 LIBRARY; T=293.6K  
Damage

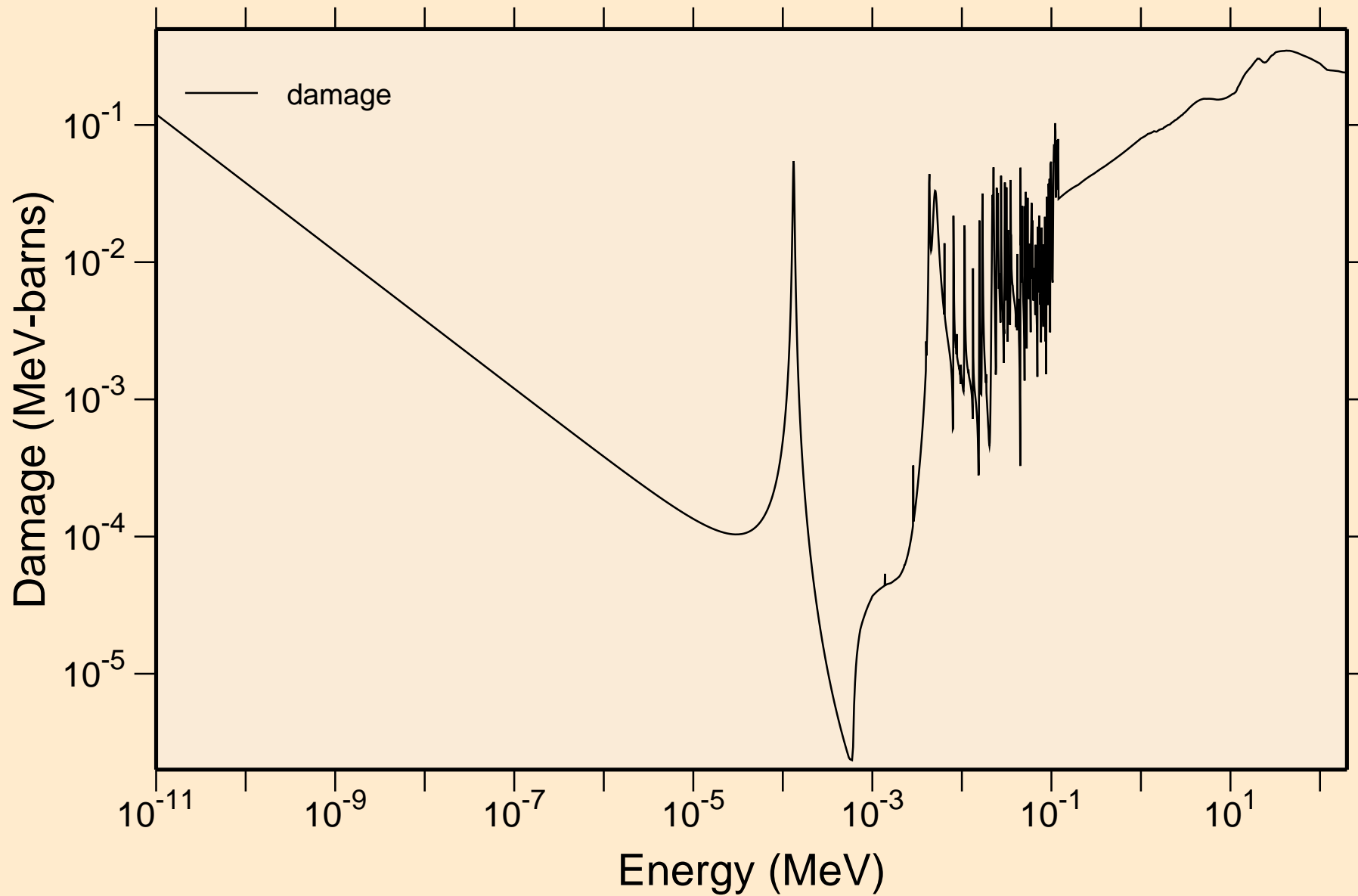

CO059 NEUTRON ACER TENDL-2021 LIBRARY; T=293.6K  
Non-threshold reactions

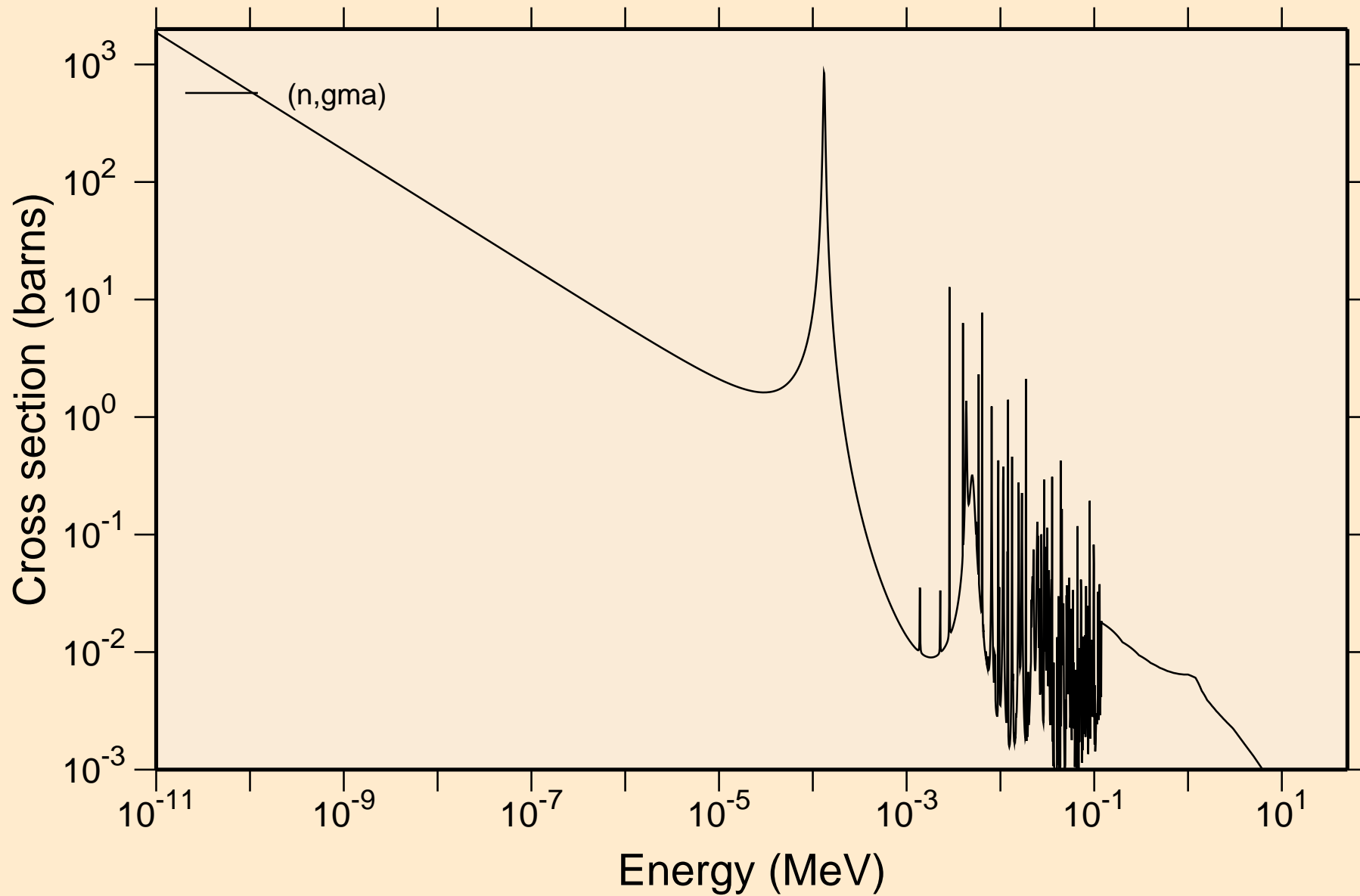

CO059 NEUTRON ACER TENDL-2021 LIBRARY; T=293.6K  
Principal cross sections

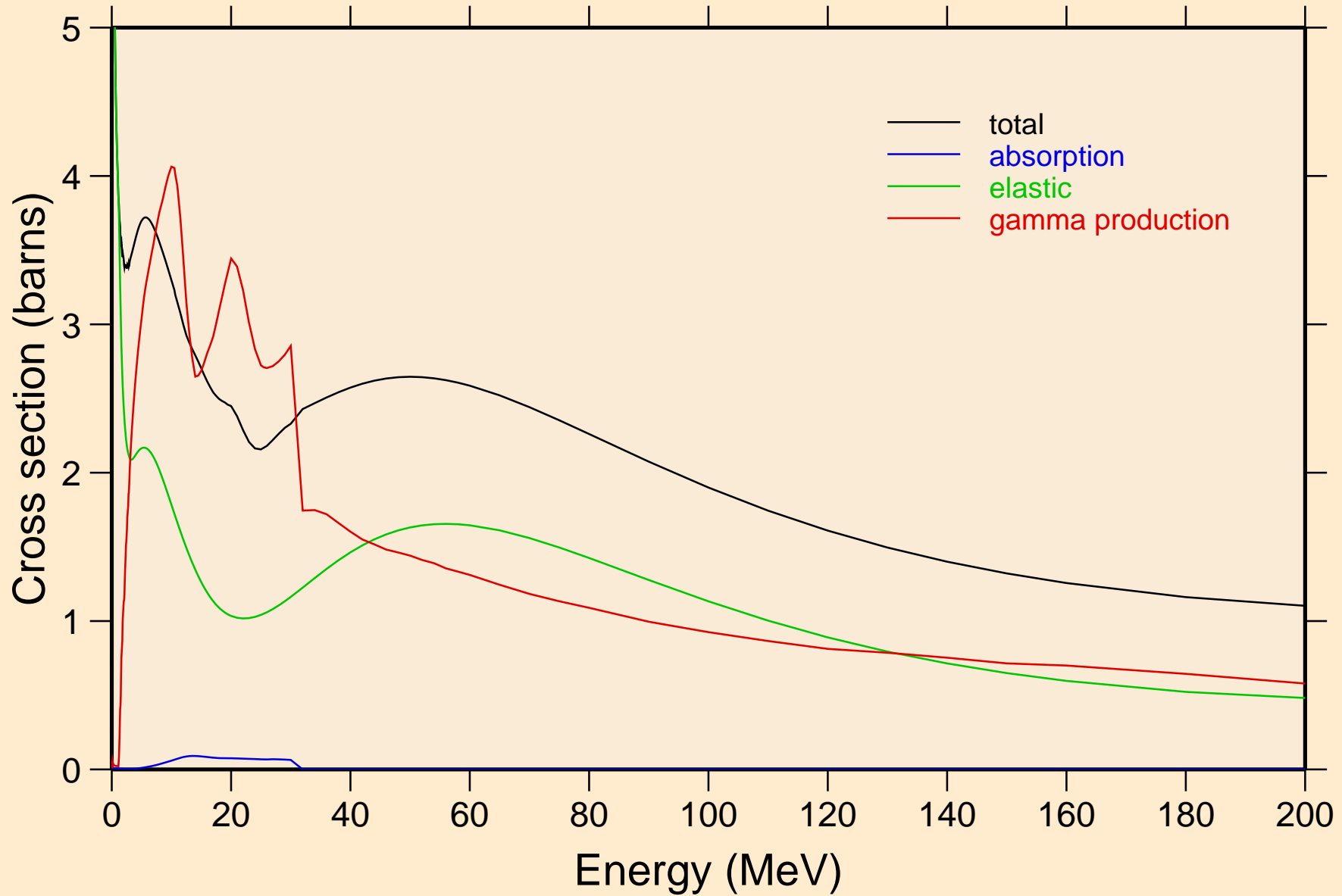

CO059 NEUTRON ACER TENDL-2021 LIBRARY; T=293.6K

Heating

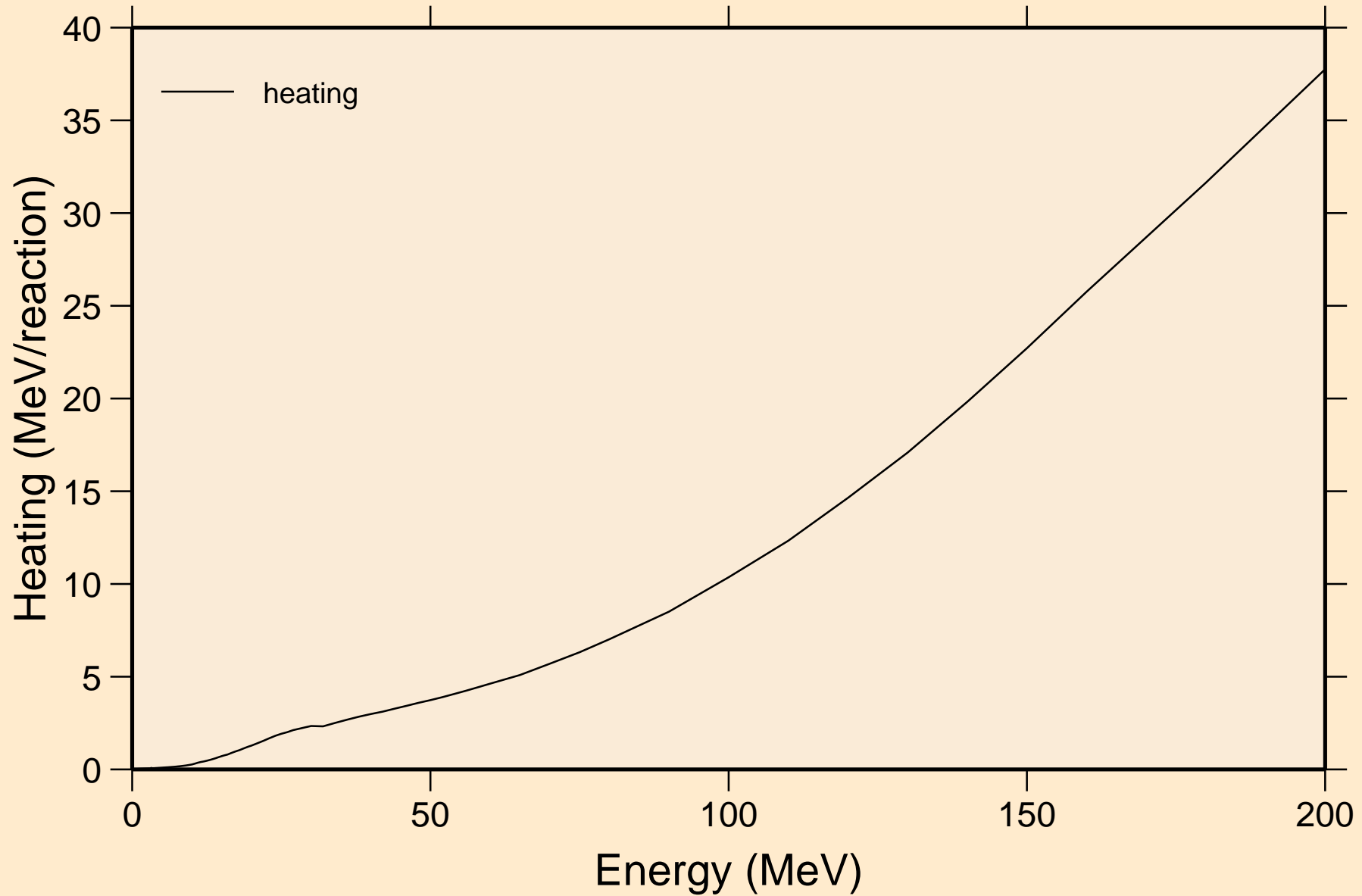



CO059 NEUTRON ACER TENDL-2021 LIBRARY; T=293.6K  
Damage

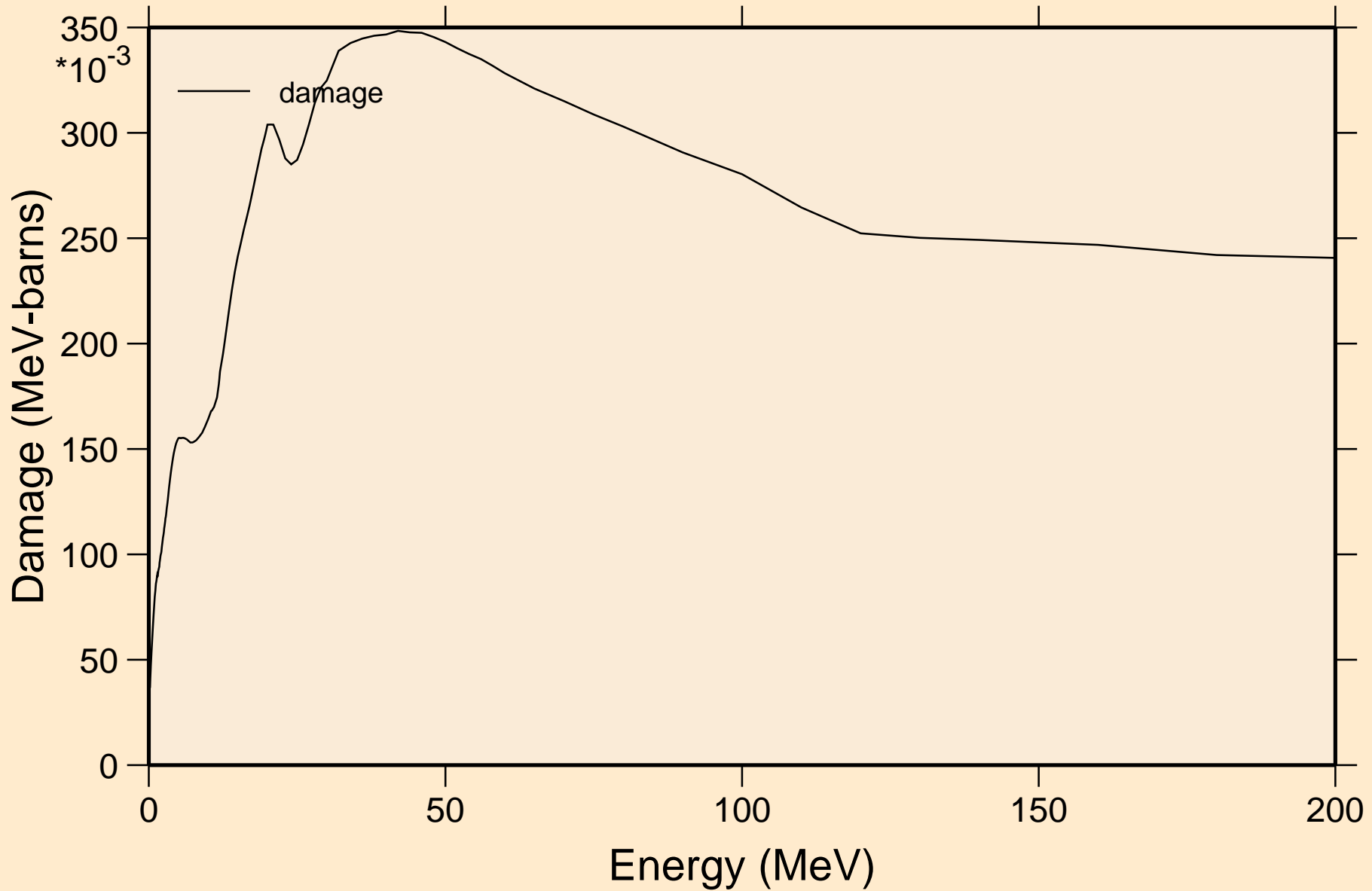

CO059 NEUTRON ACER TENDL-2021 LIBRARY; T=293.6K  
Non-threshold reactions

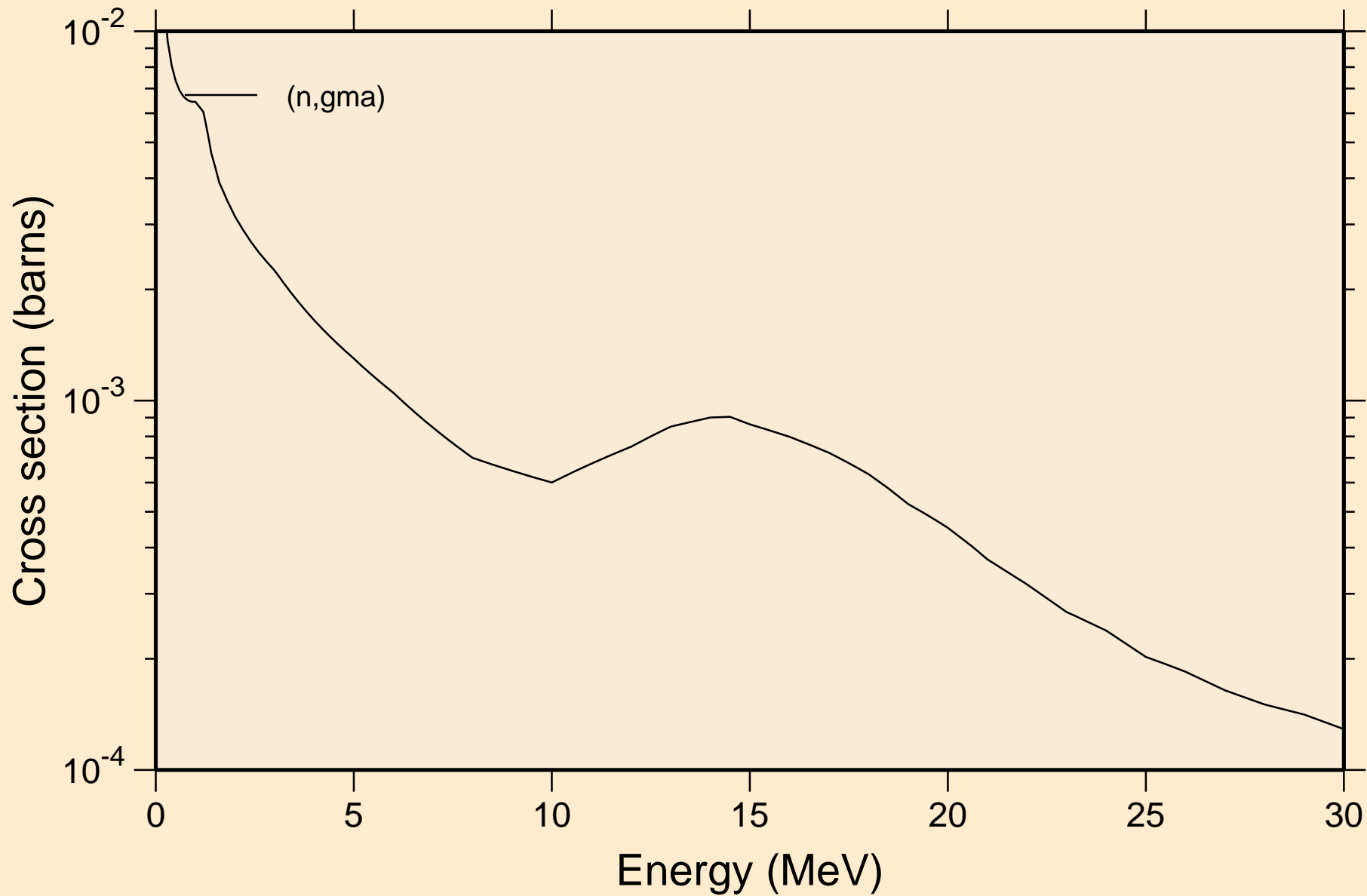

CO059 NEUTRON ACER TENDL-2021 LIBRARY; T=293.6K  
Inelastic levels

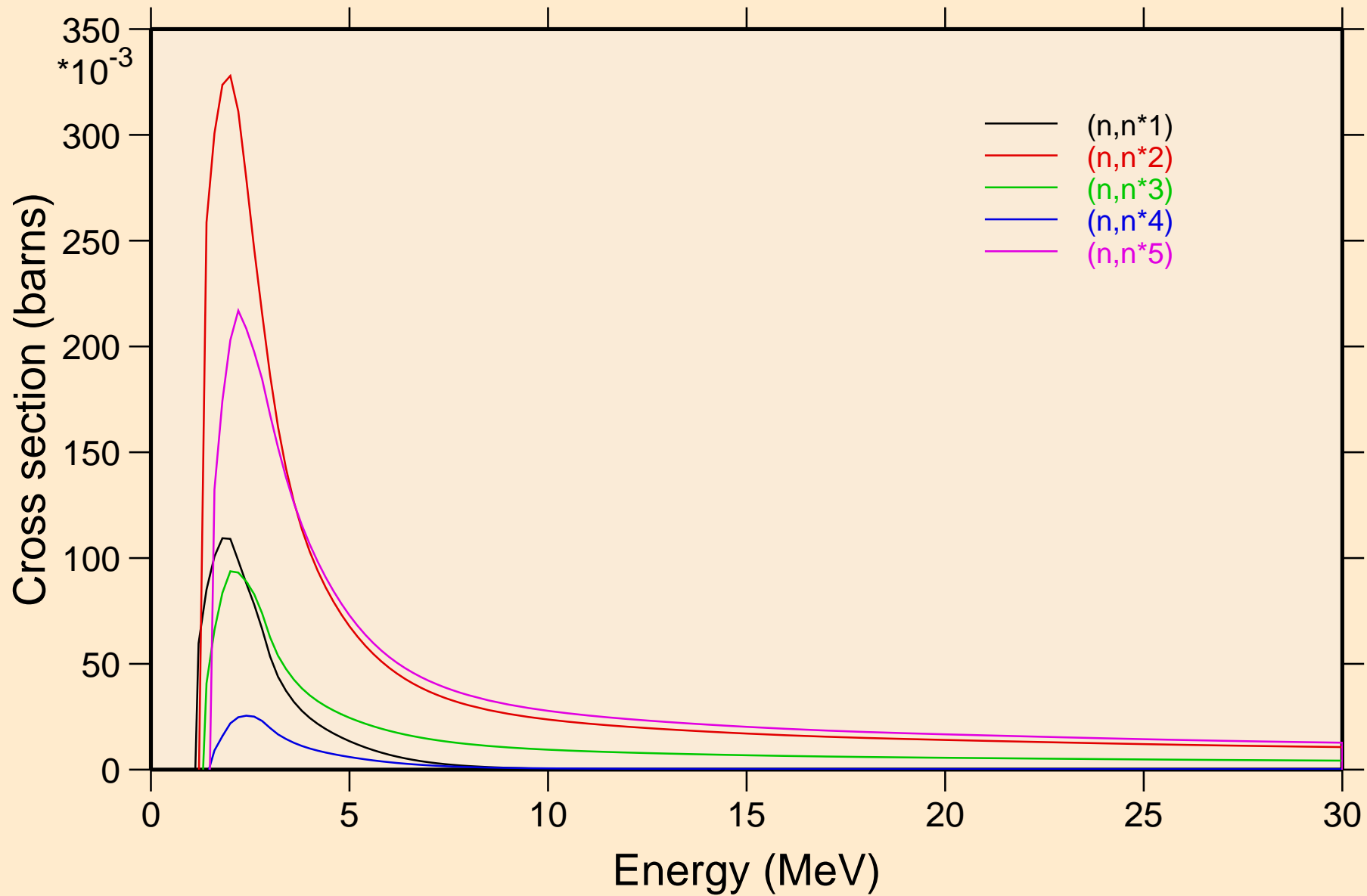

CO059 NEUTRON ACER TENDL-2021 LIBRARY; T=293.6K  
Inelastic levels

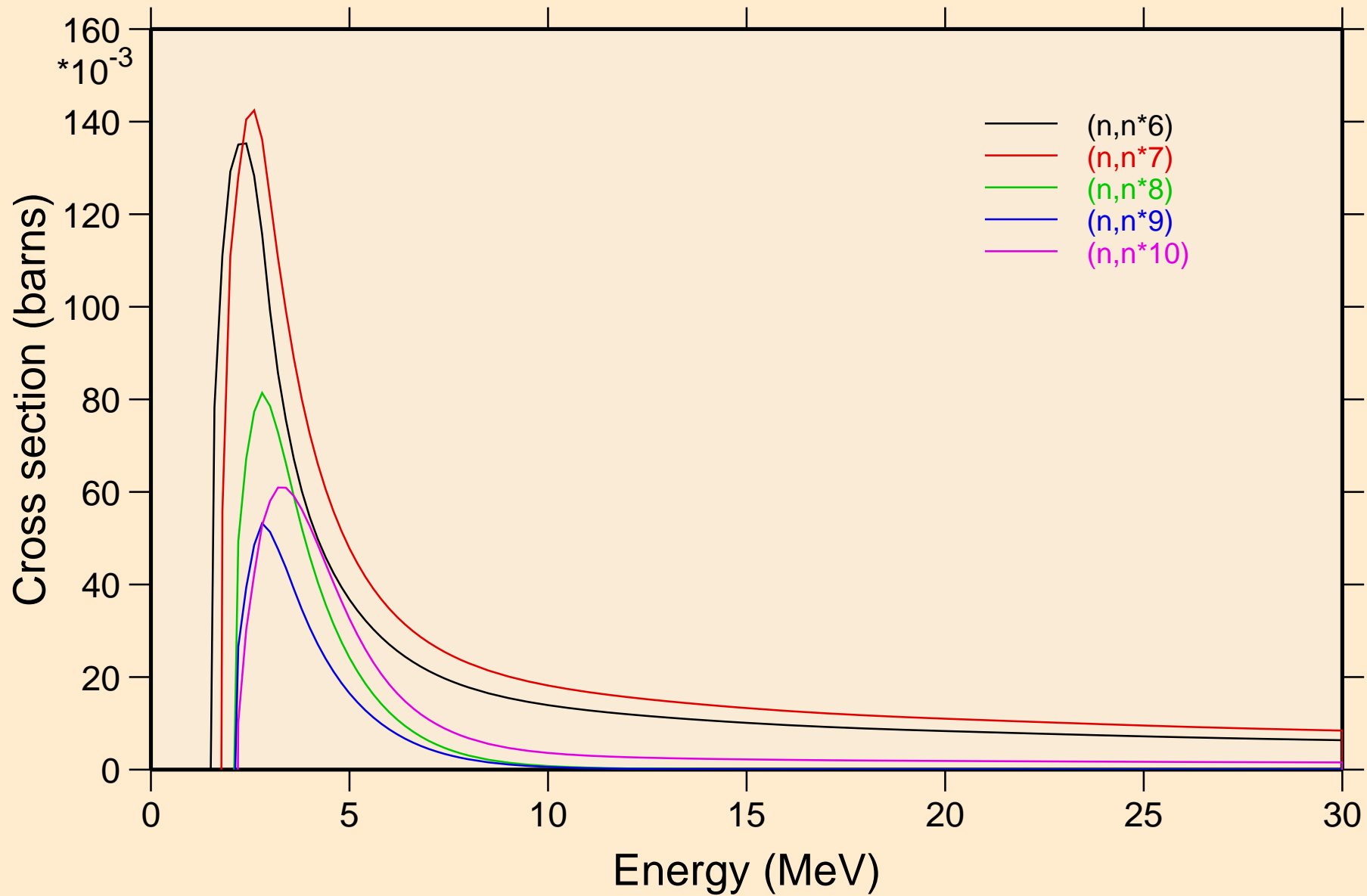

CO059 NEUTRON ACER TENDL-2021 LIBRARY; T=293.6K  
Inelastic levels

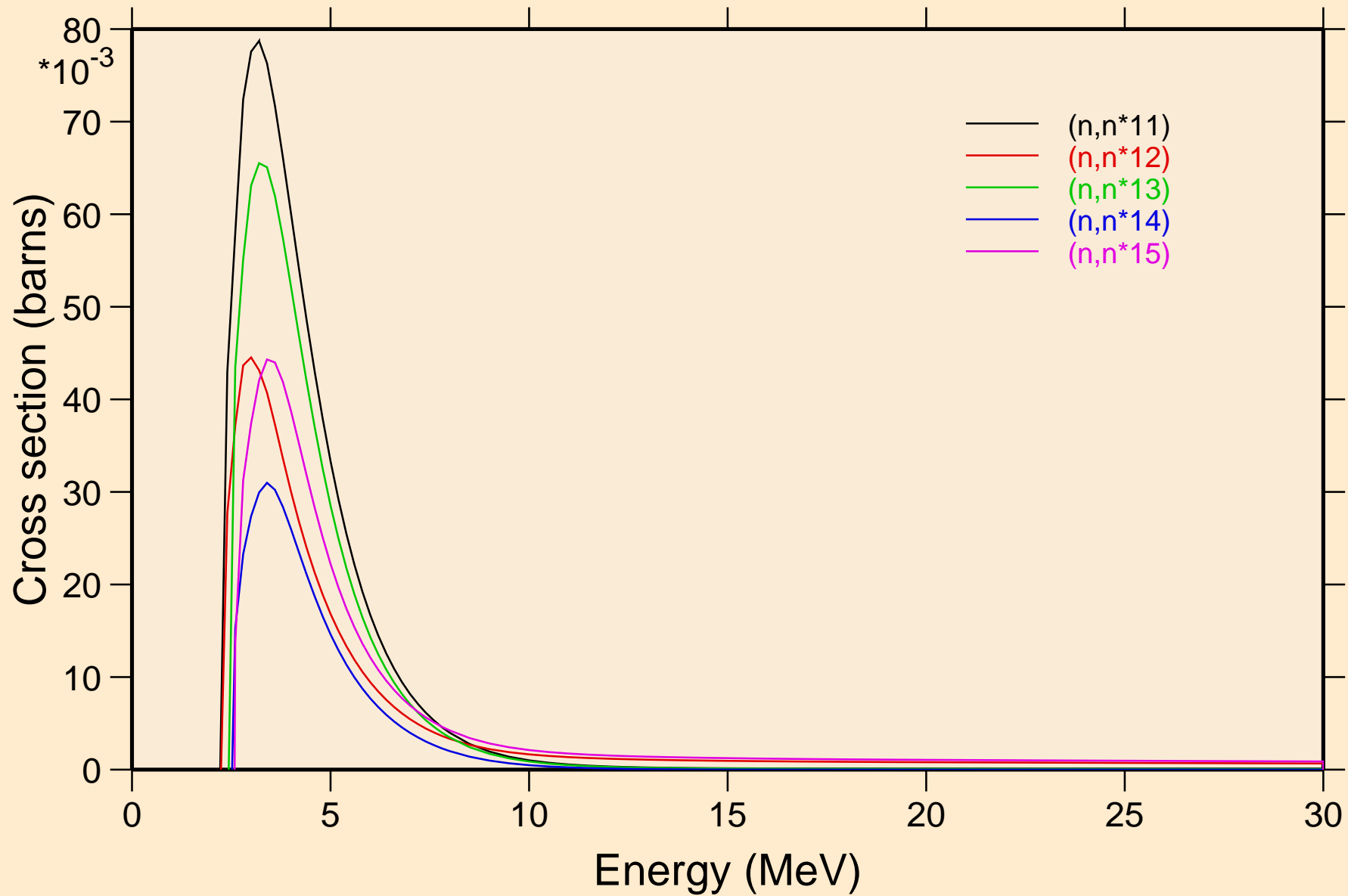

CO059 NEUTRON ACER TENDL-2021 LIBRARY; T=293.6K  
Inelastic levels

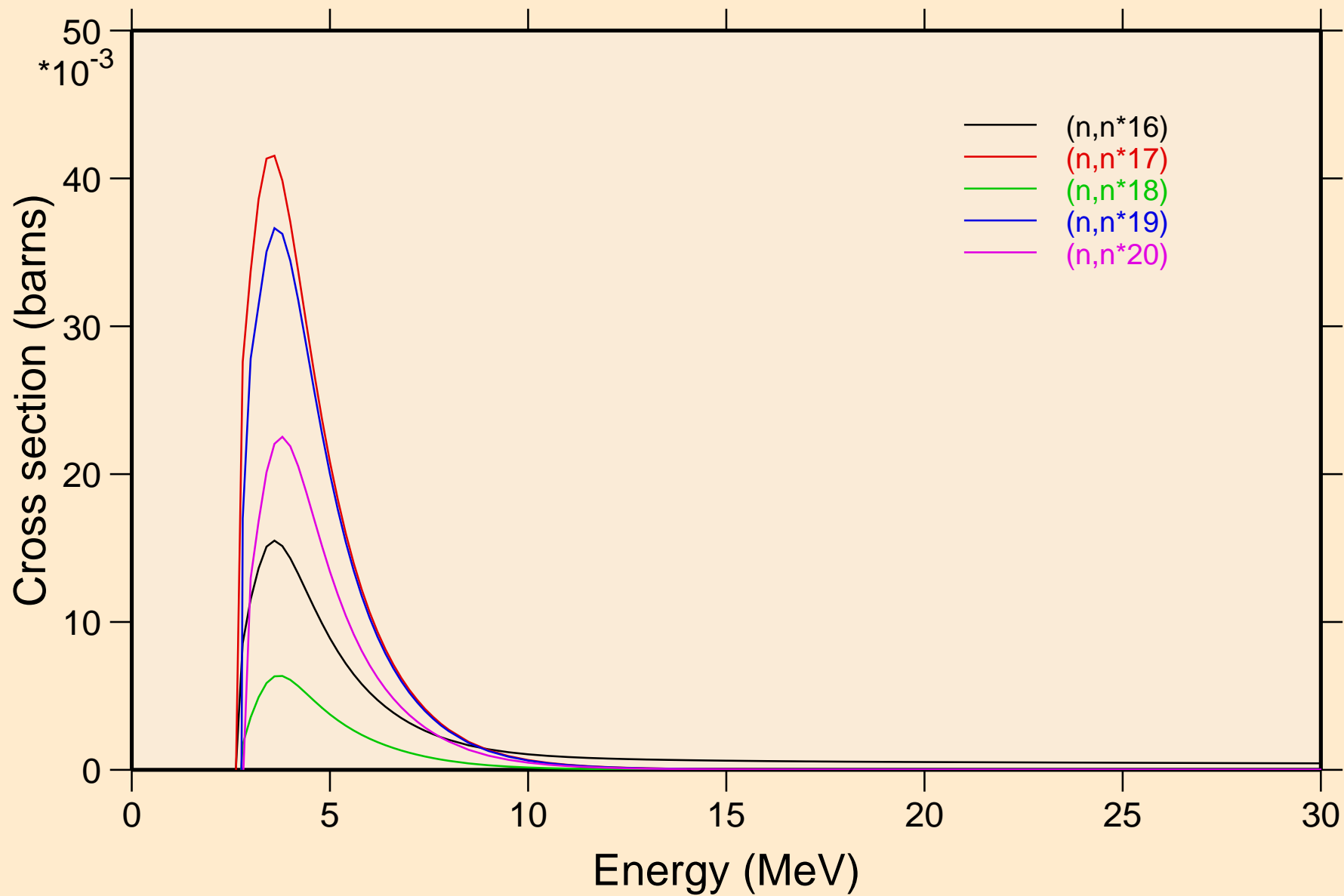

CO059 NEUTRON ACER TENDL-2021 LIBRARY; T=293.6K  
Inelastic levels

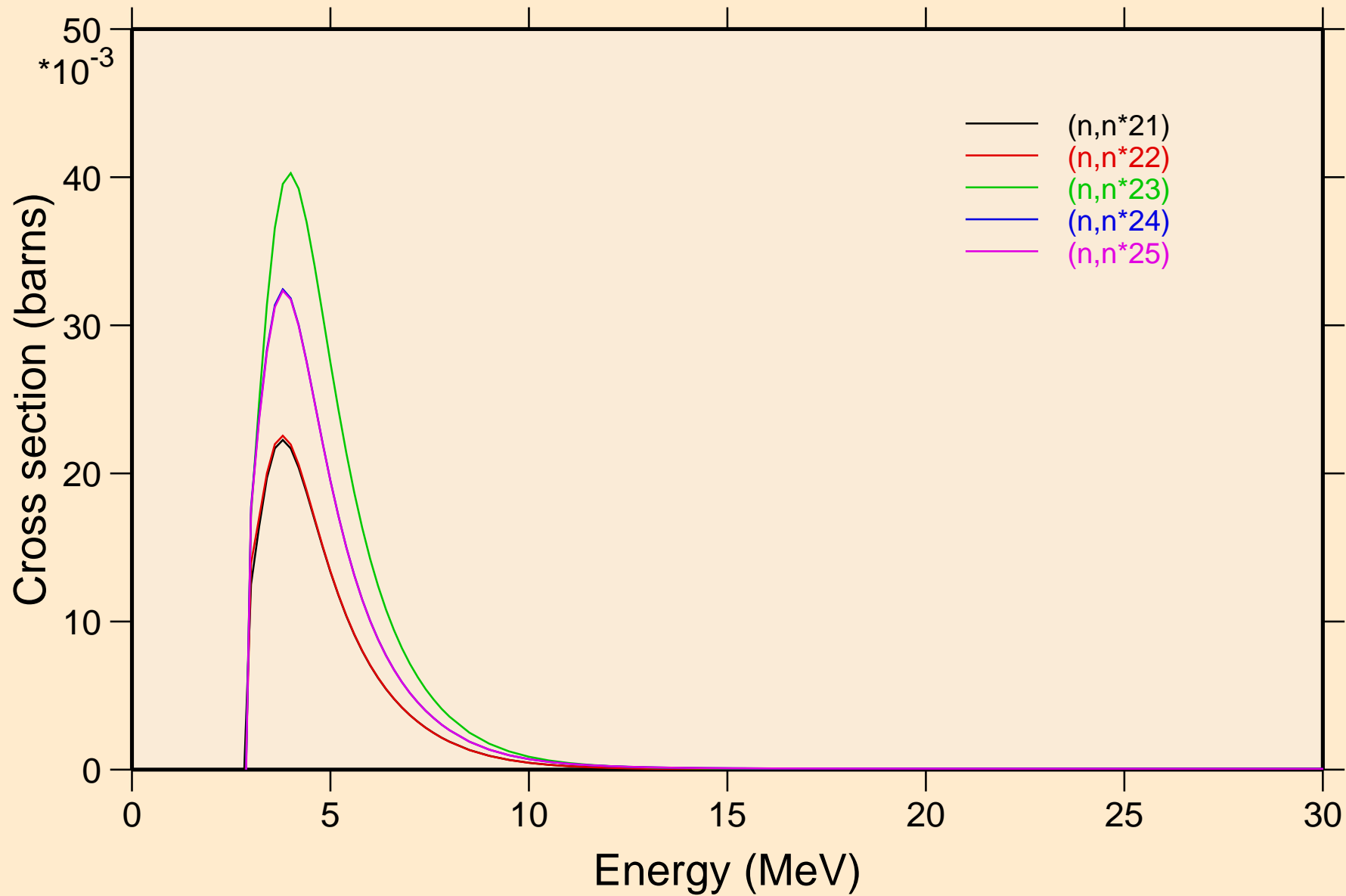

CO059 NEUTRON ACER TENDL-2021 LIBRARY; T=293.6K  
Inelastic levels

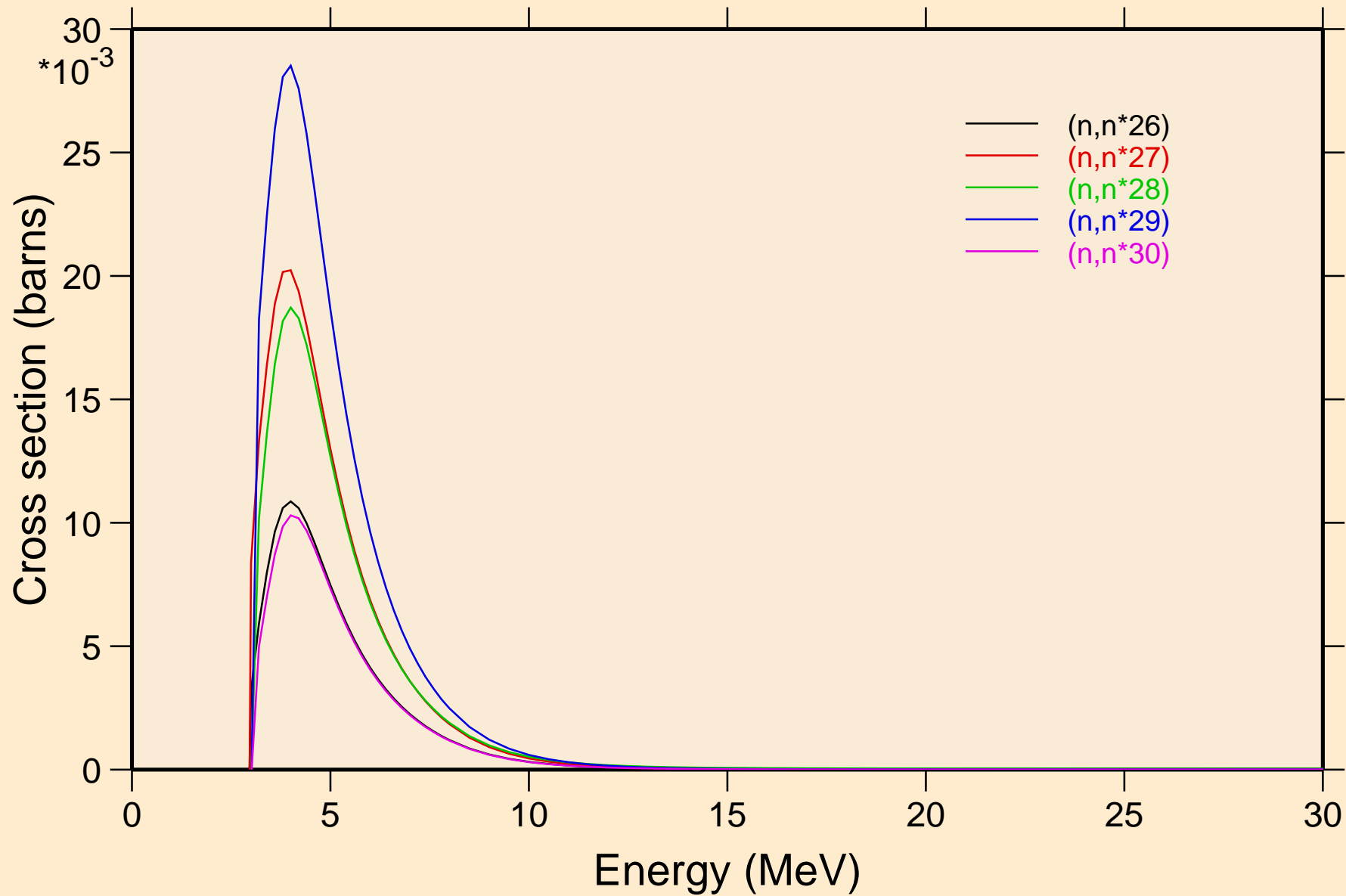



CO059 NEUTRON ACER TENDL-2021 LIBRARY; T=293.6K  
Threshold reactions

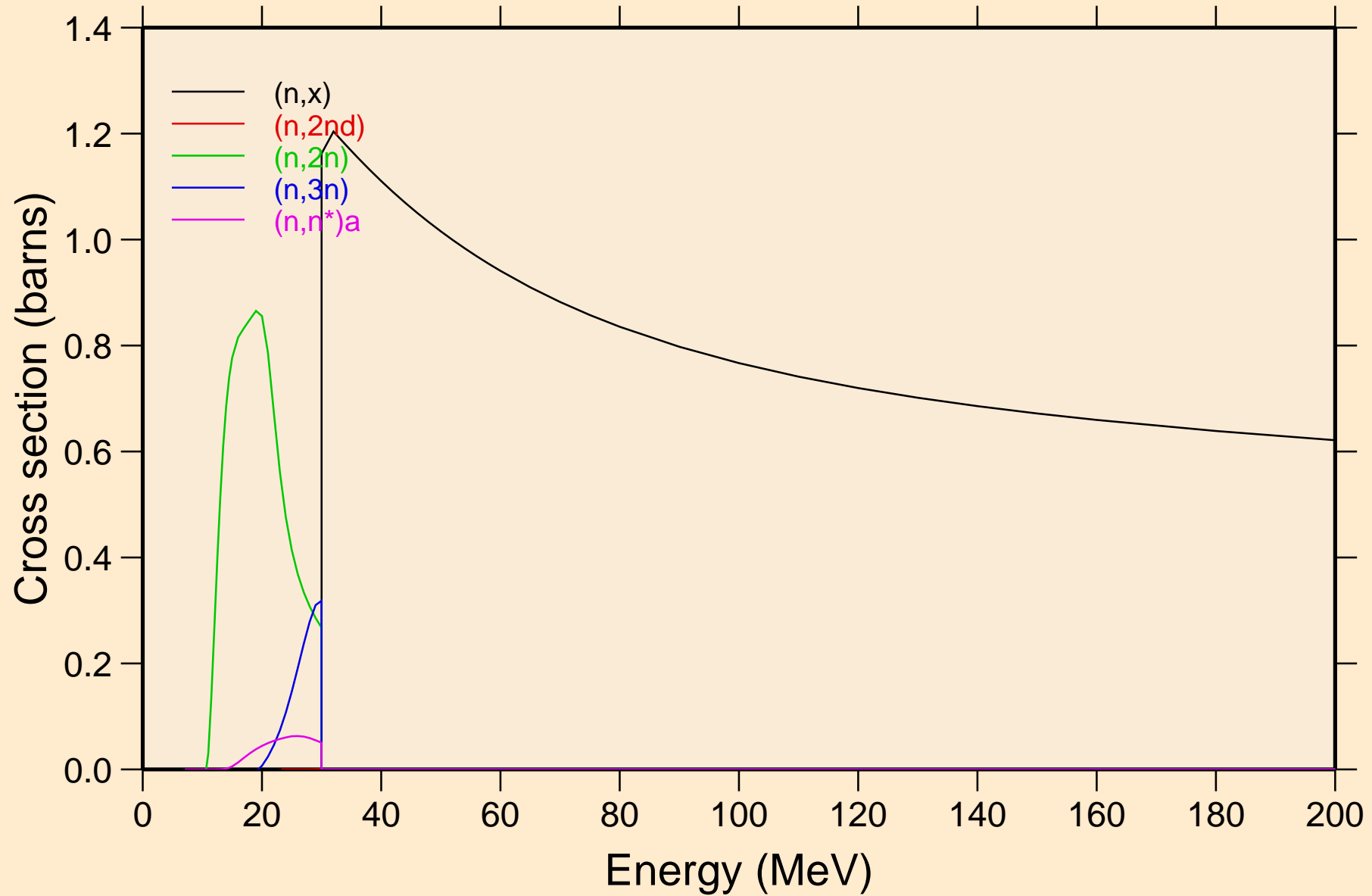

CO059 NEUTRON ACER TENDL-2021 LIBRARY; T=293.6K  
Threshold reactions

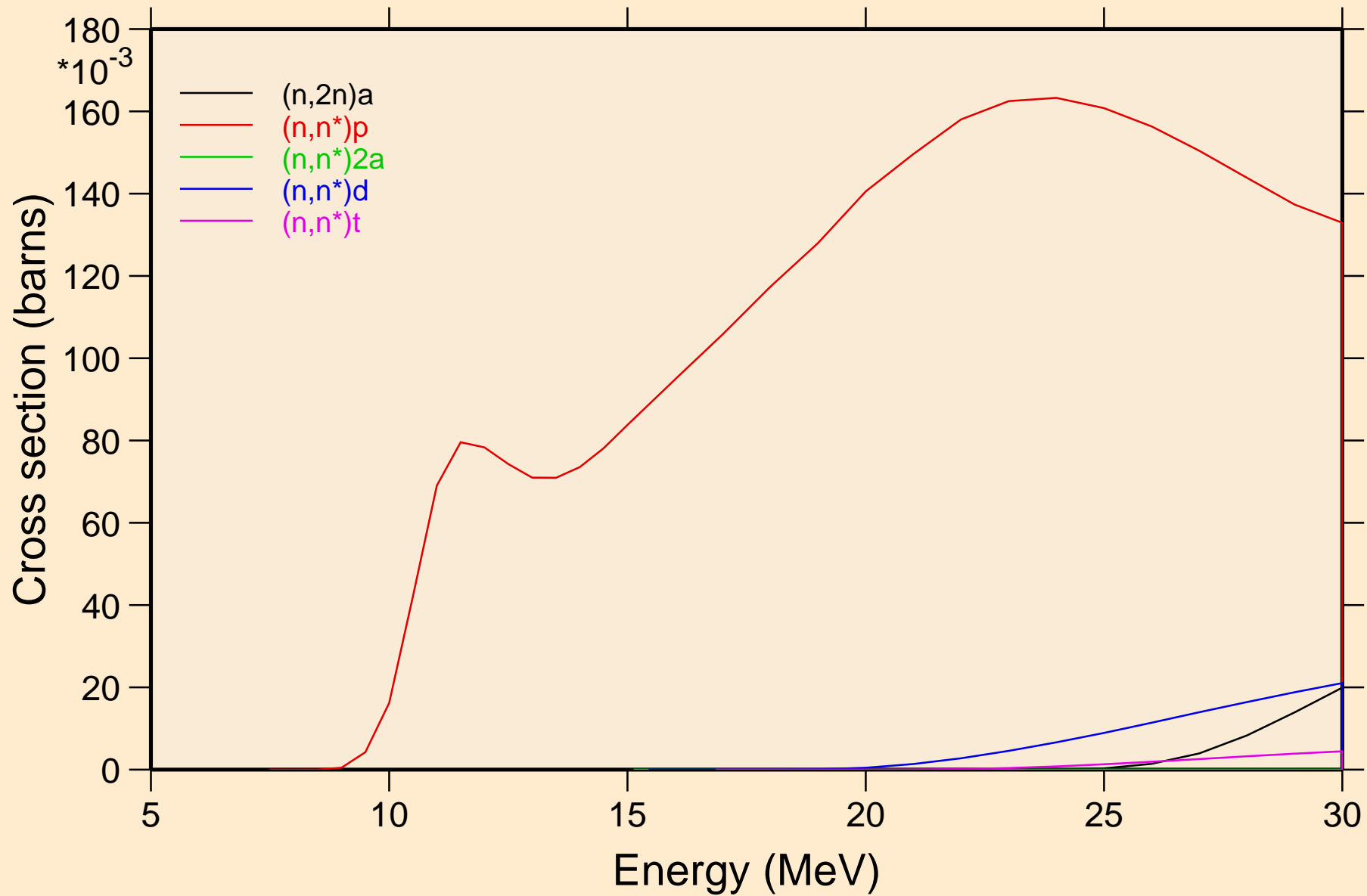

CO059 NEUTRON ACER TENDL-2021 LIBRARY; T=293.6K  
Threshold reactions

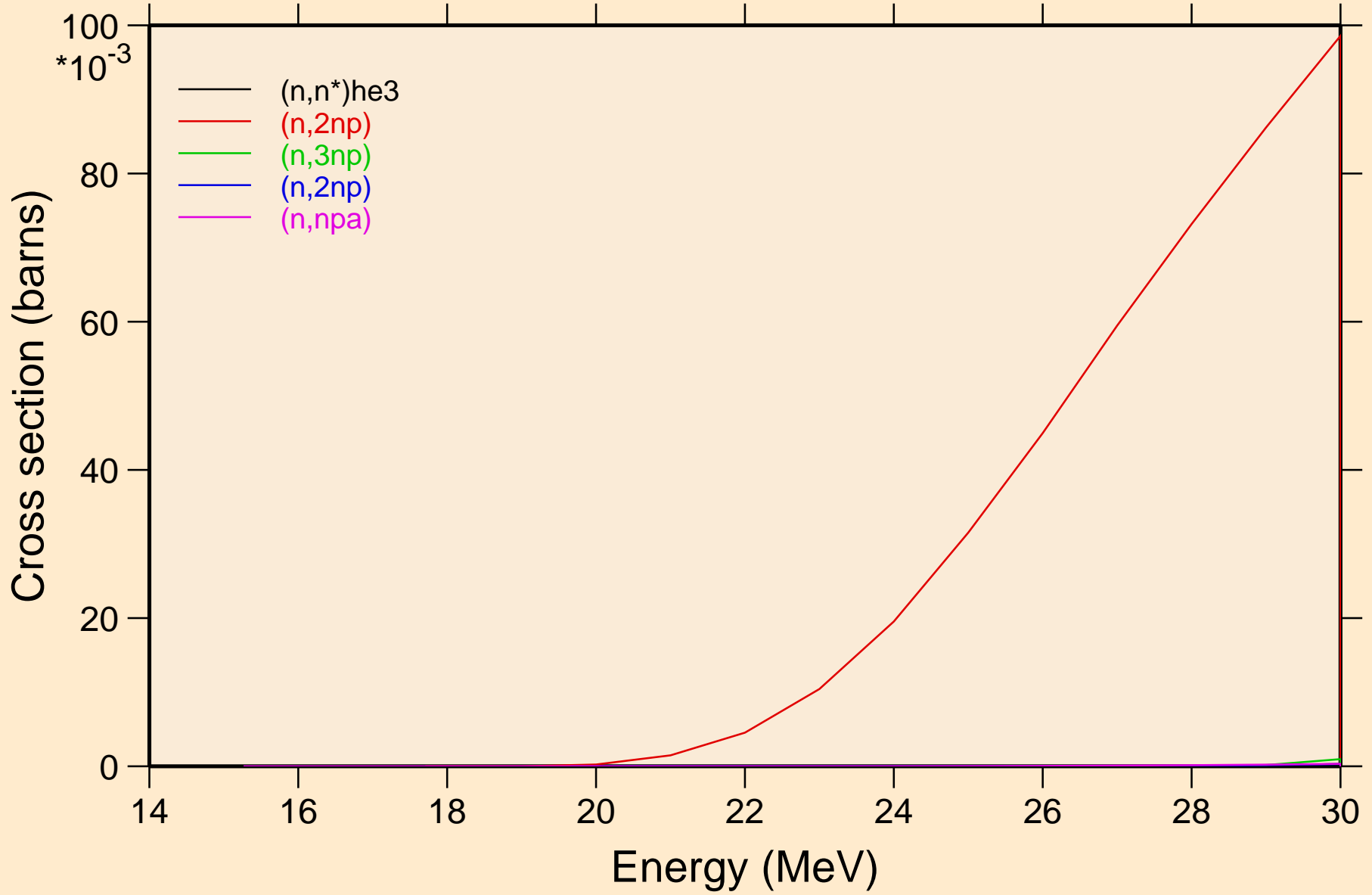

CO059 NEUTRON ACER TENDL-2021 LIBRARY; T=293.6K  
Threshold reactions

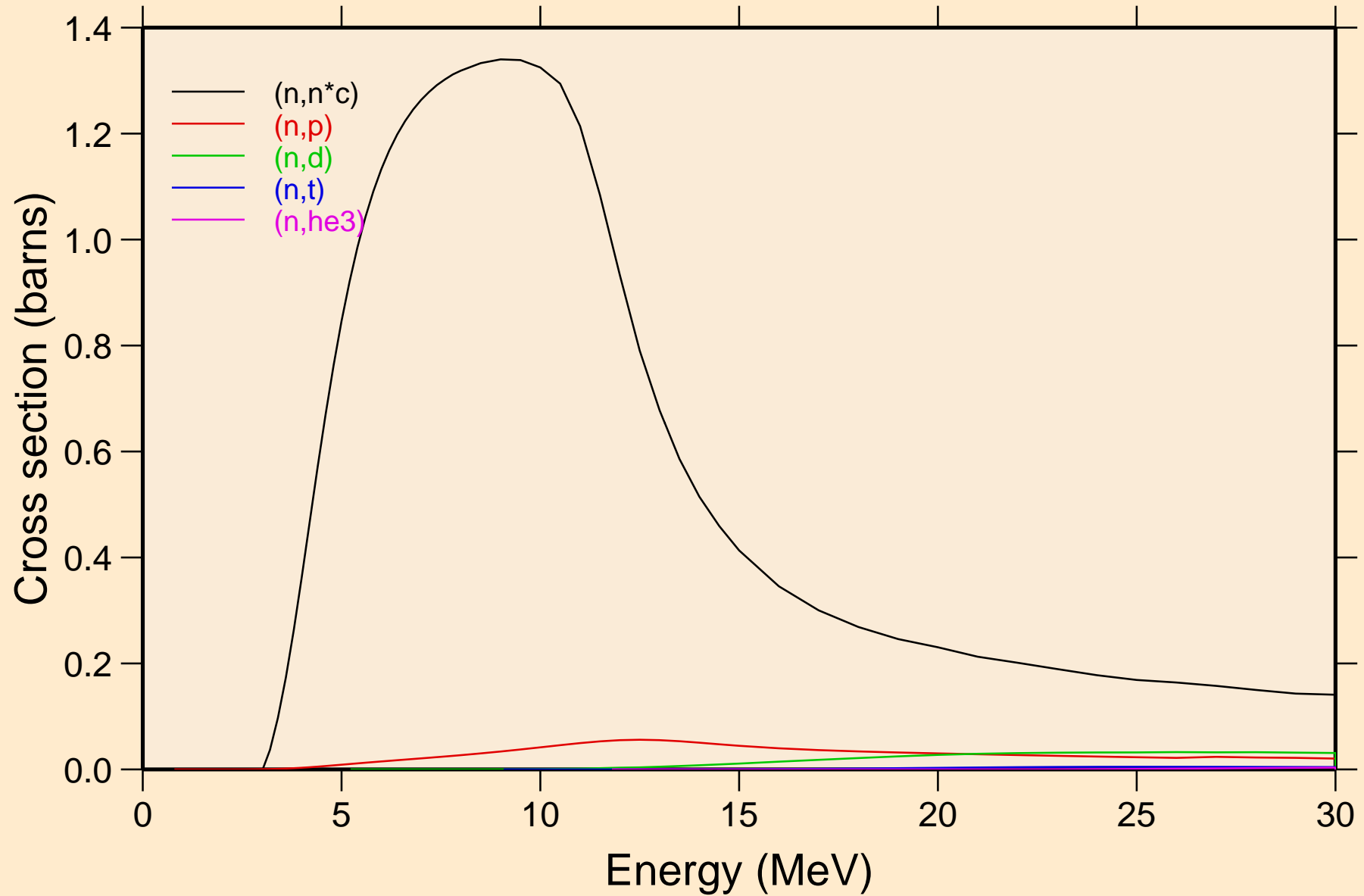

CO059 NEUTRON ACER TENDL-2021 LIBRARY; T=293.6K  
Threshold reactions

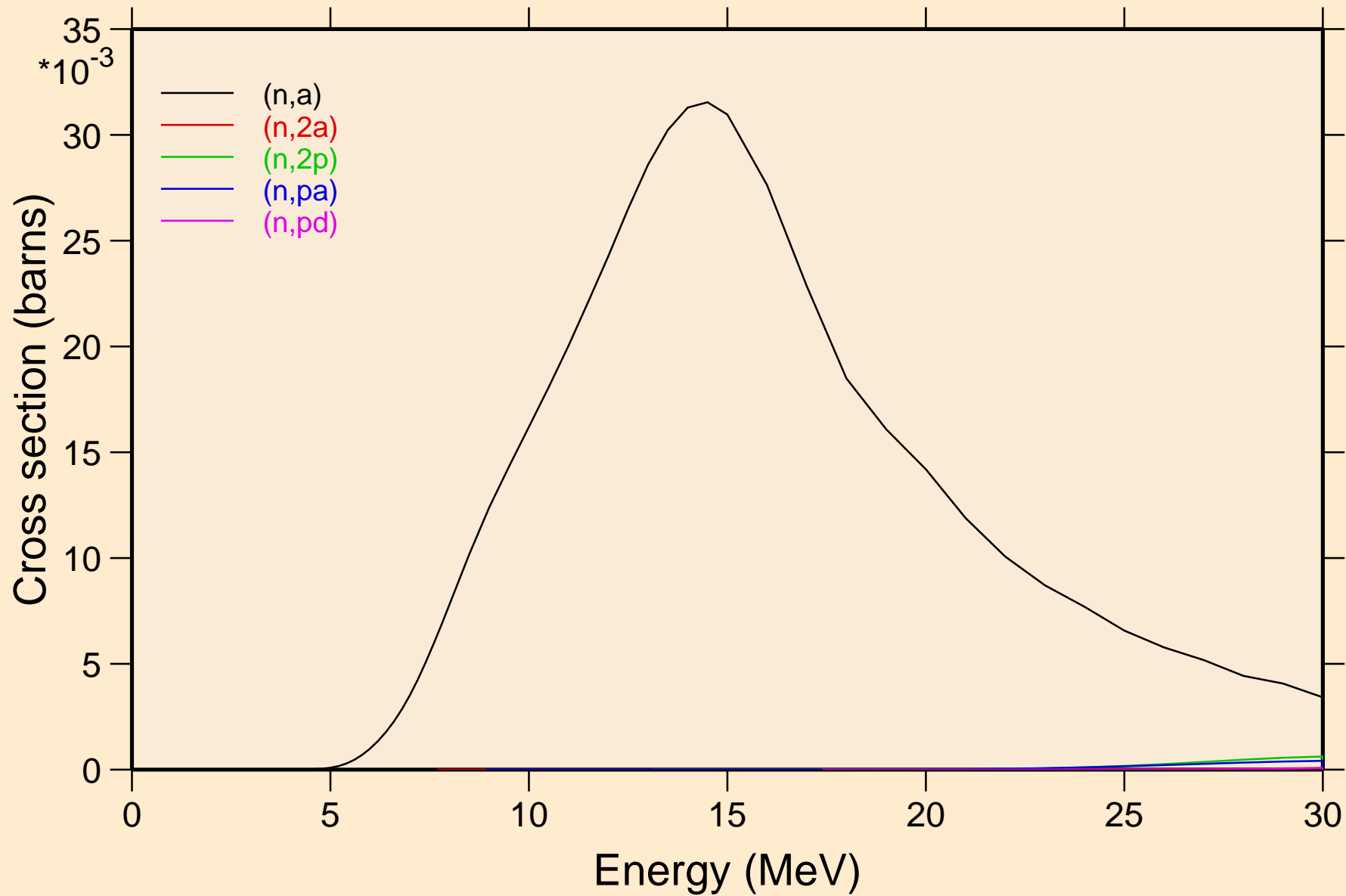

CO059 NEUTRON ACER TENDL-2021 LIBRARY; T=293.6K  
Threshold reactions

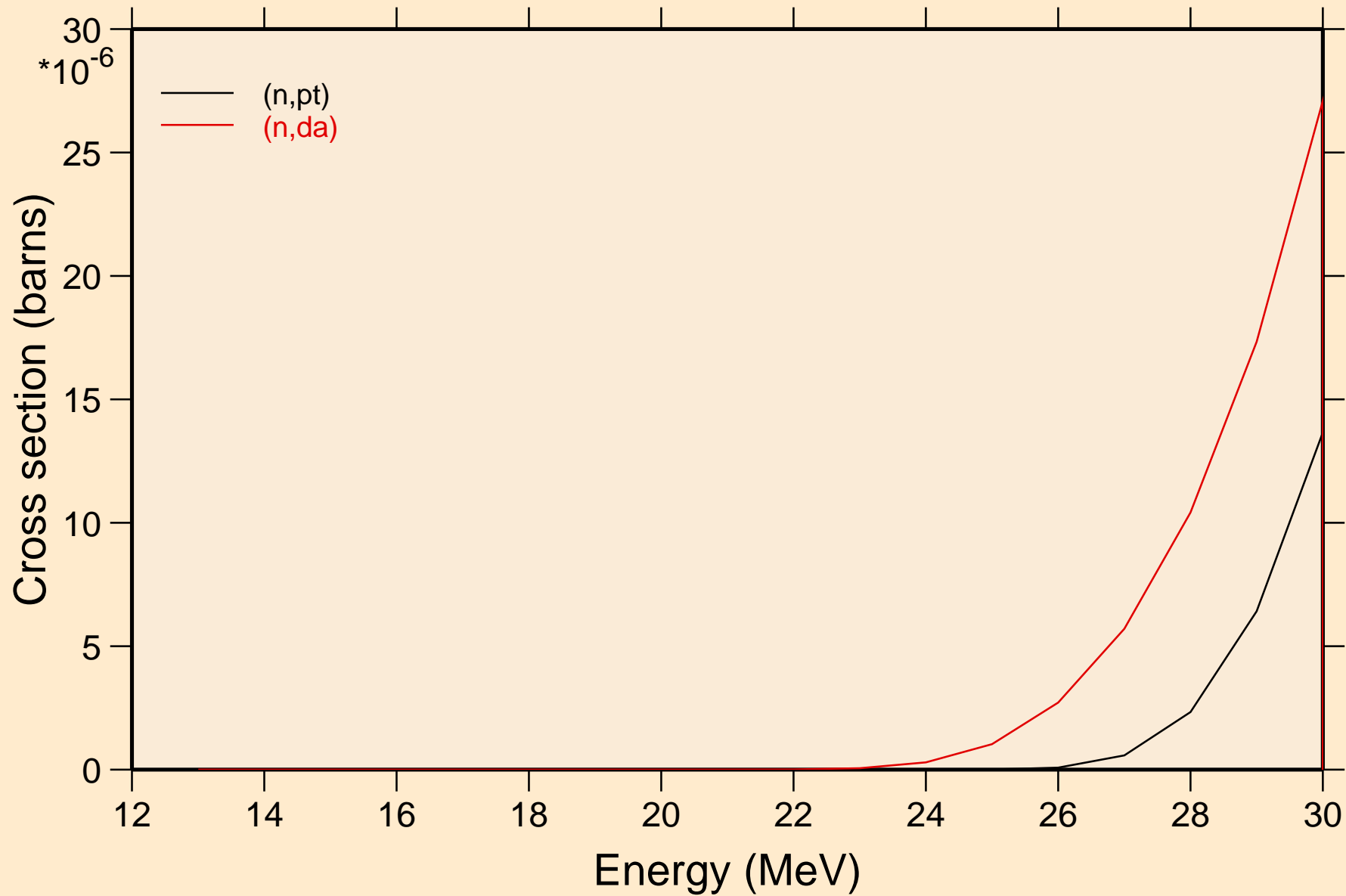

CO059 NEUTRON ACER TENDL-2021 LIBRARY; T=293.6K  
Threshold reactions

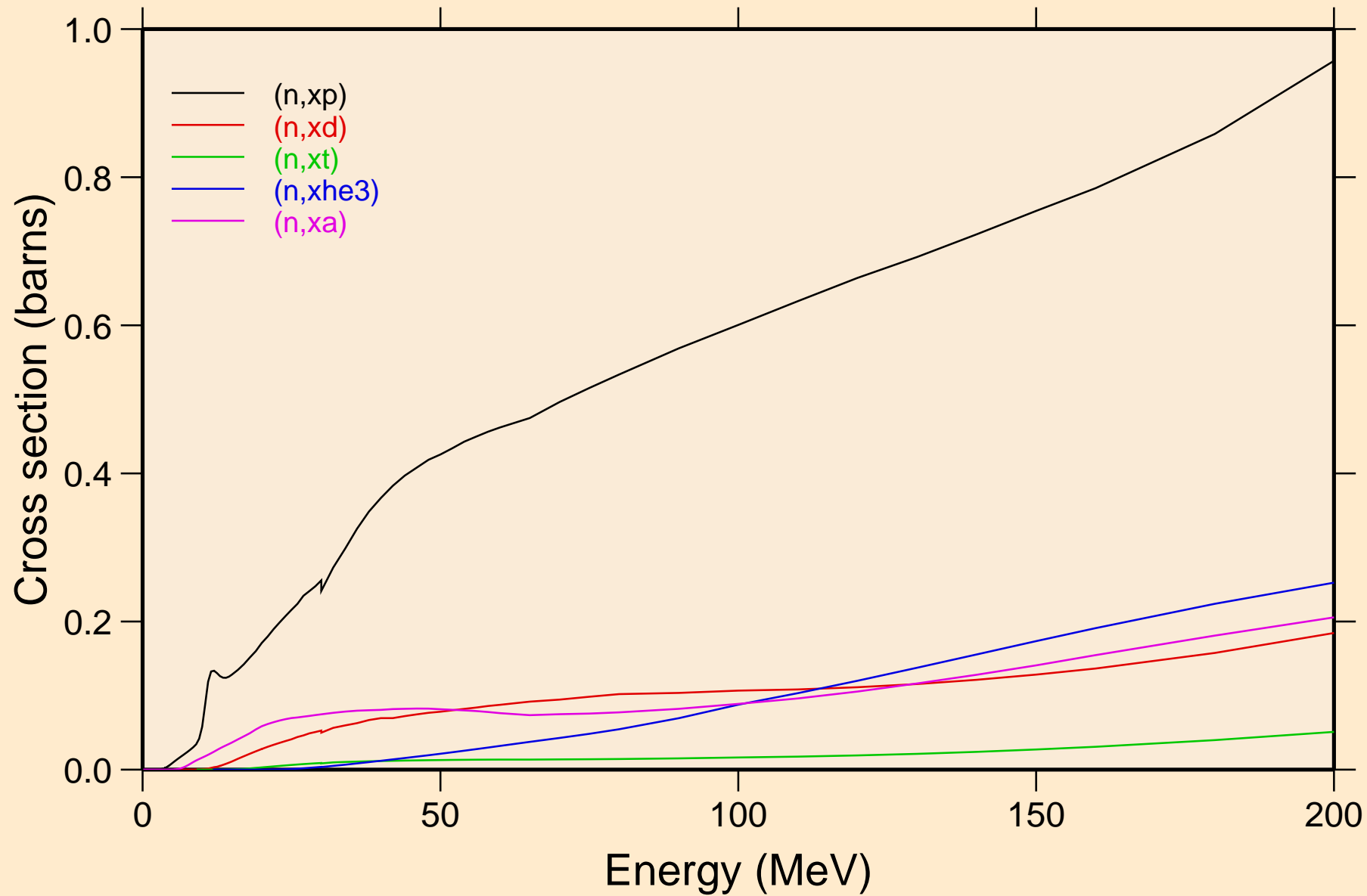

CO059 NEUTRON ACER TENDL-2021 LIBRARY; T=293.6K  
angular distribution for elastic

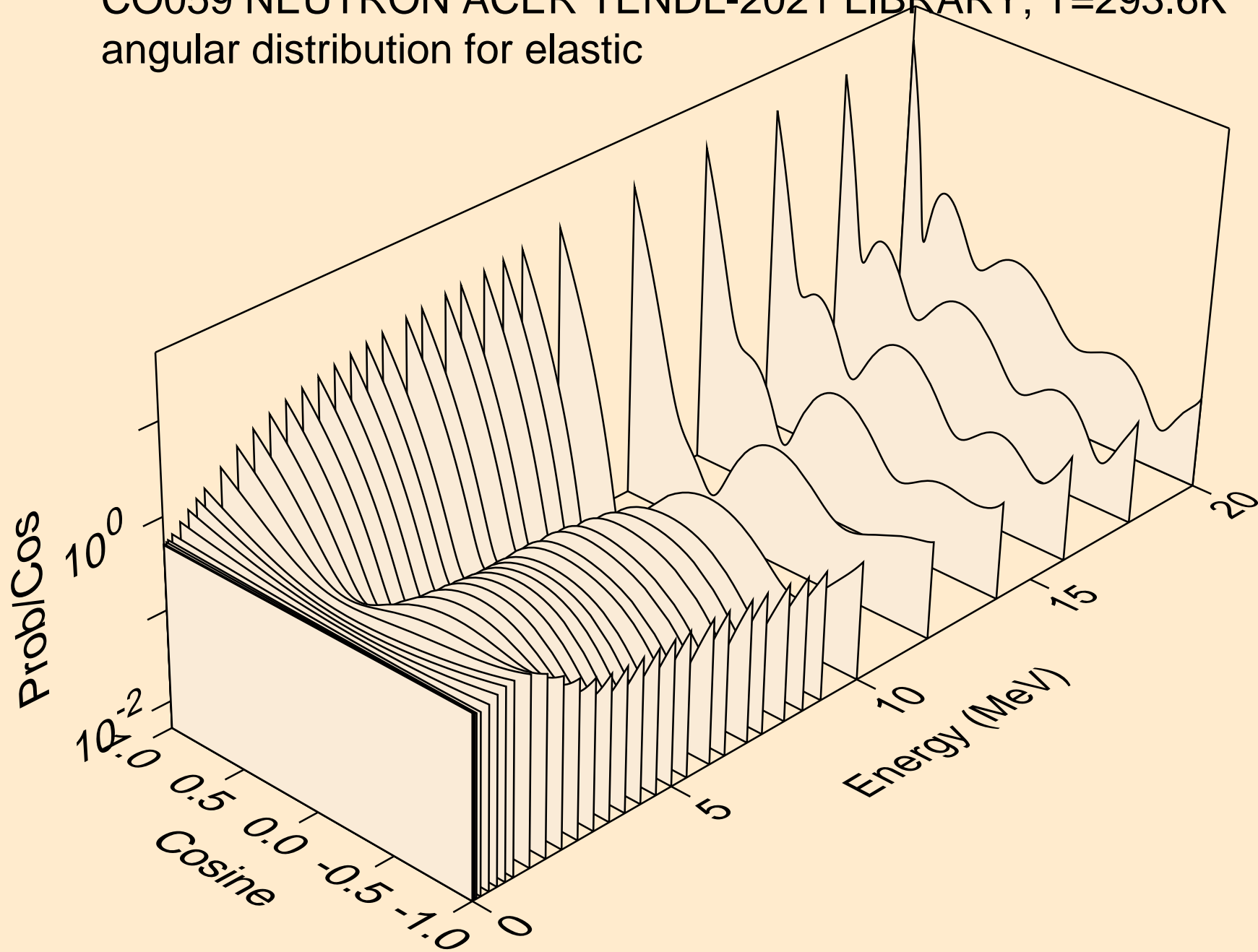



CO059 NEUTRON ACER TENDL-2021 LIBRARY; T=293.6K  
angular distribution for elastic

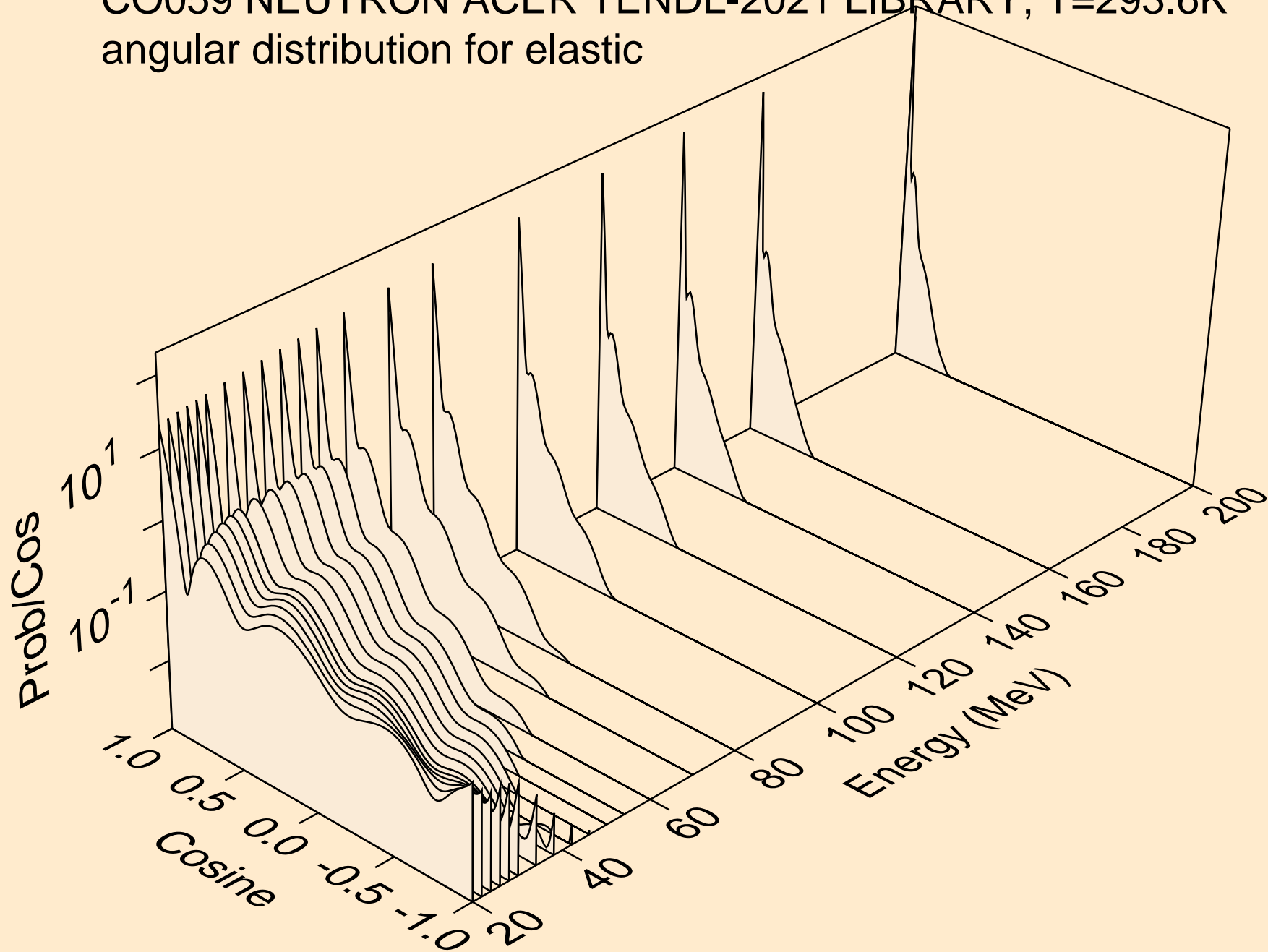

CO059 NEUTRON ACER TENDL-2021 LIBRARY; T=293.6K  
angular distribution for (n,n\*1)

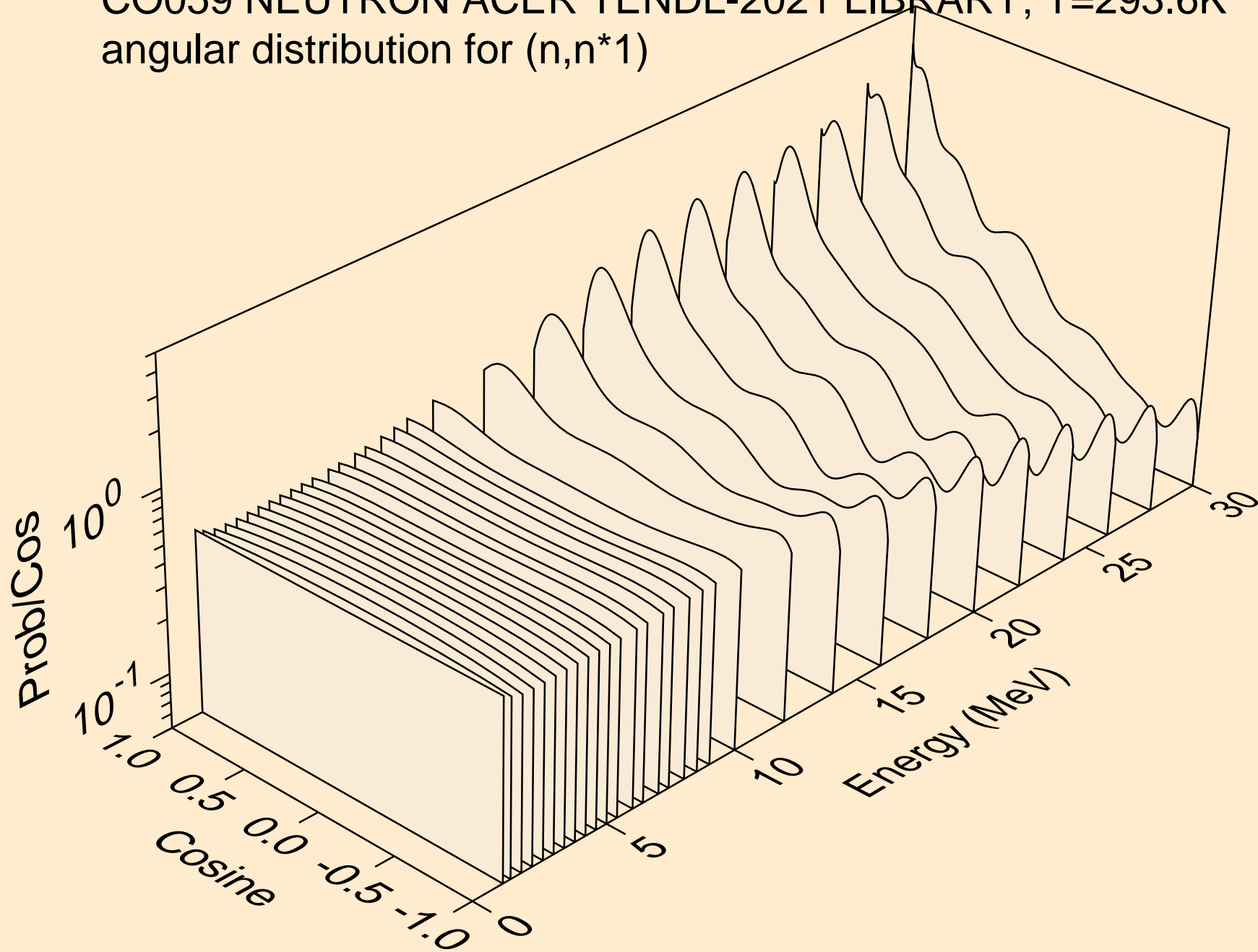

CO059 NEUTRON ACER TENDL-2021 LIBRARY; T=293.6K  
angular distribution for (n,n\*2)

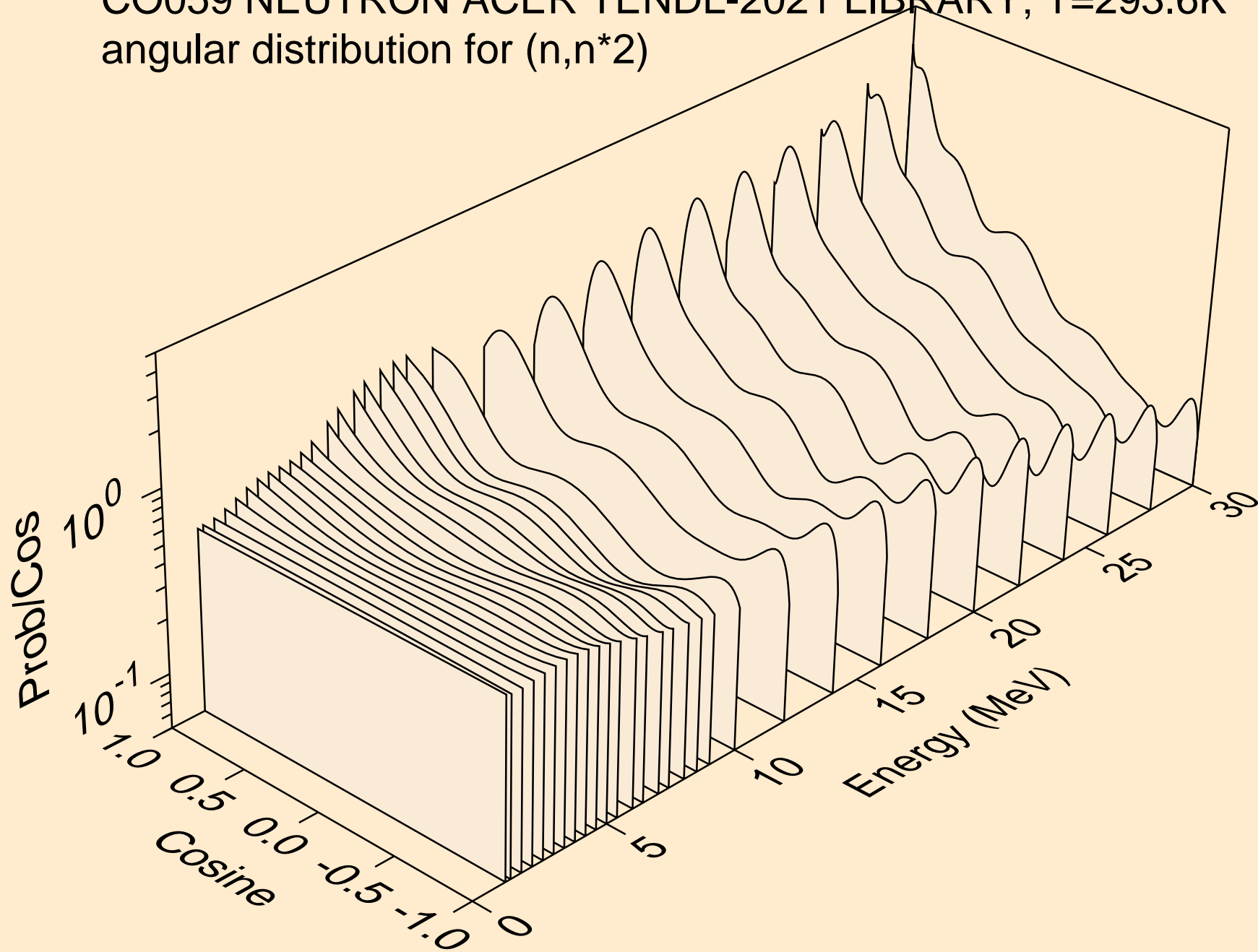

CO059 NEUTRON ACER TENDL-2021 LIBRARY; T=293.6K  
angular distribution for (n,n\*3)

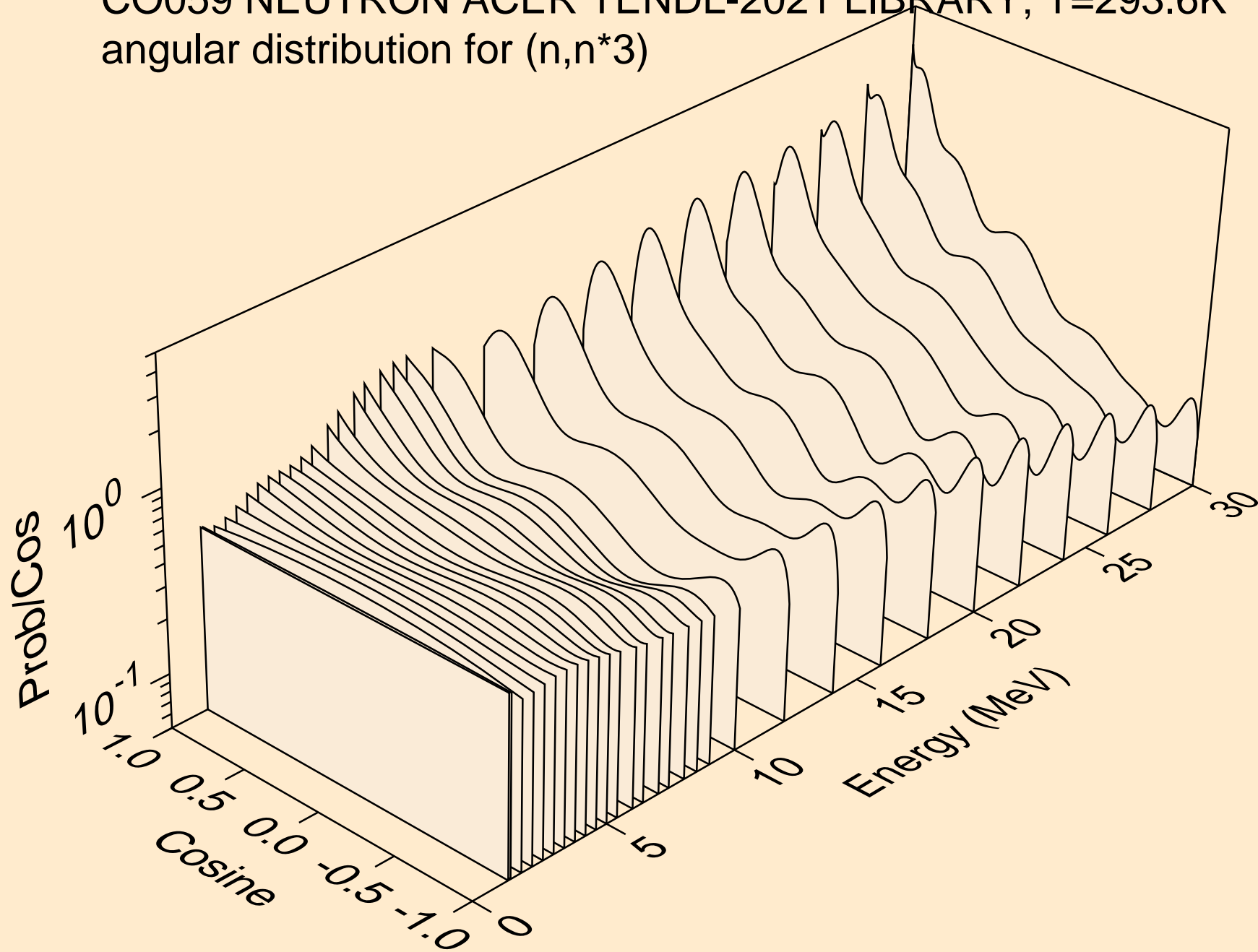

CO059 NEUTRON ACER TENDL-2021 LIBRARY; T=293.6K  
angular distribution for (n,n\*4)

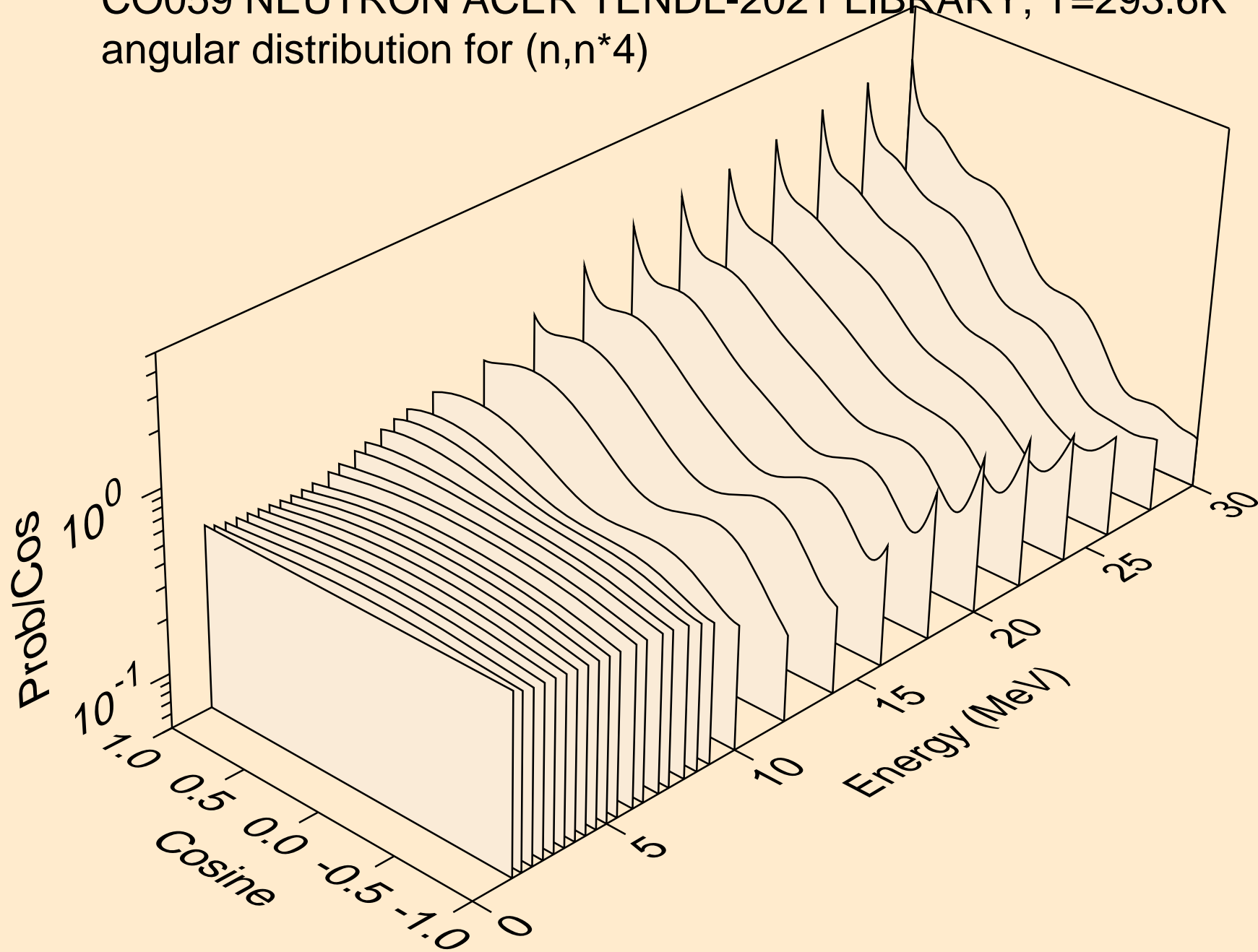

CO059 NEUTRON ACER TENDL-2021 LIBRARY; T=293.6K  
angular distribution for (n,n\*5)

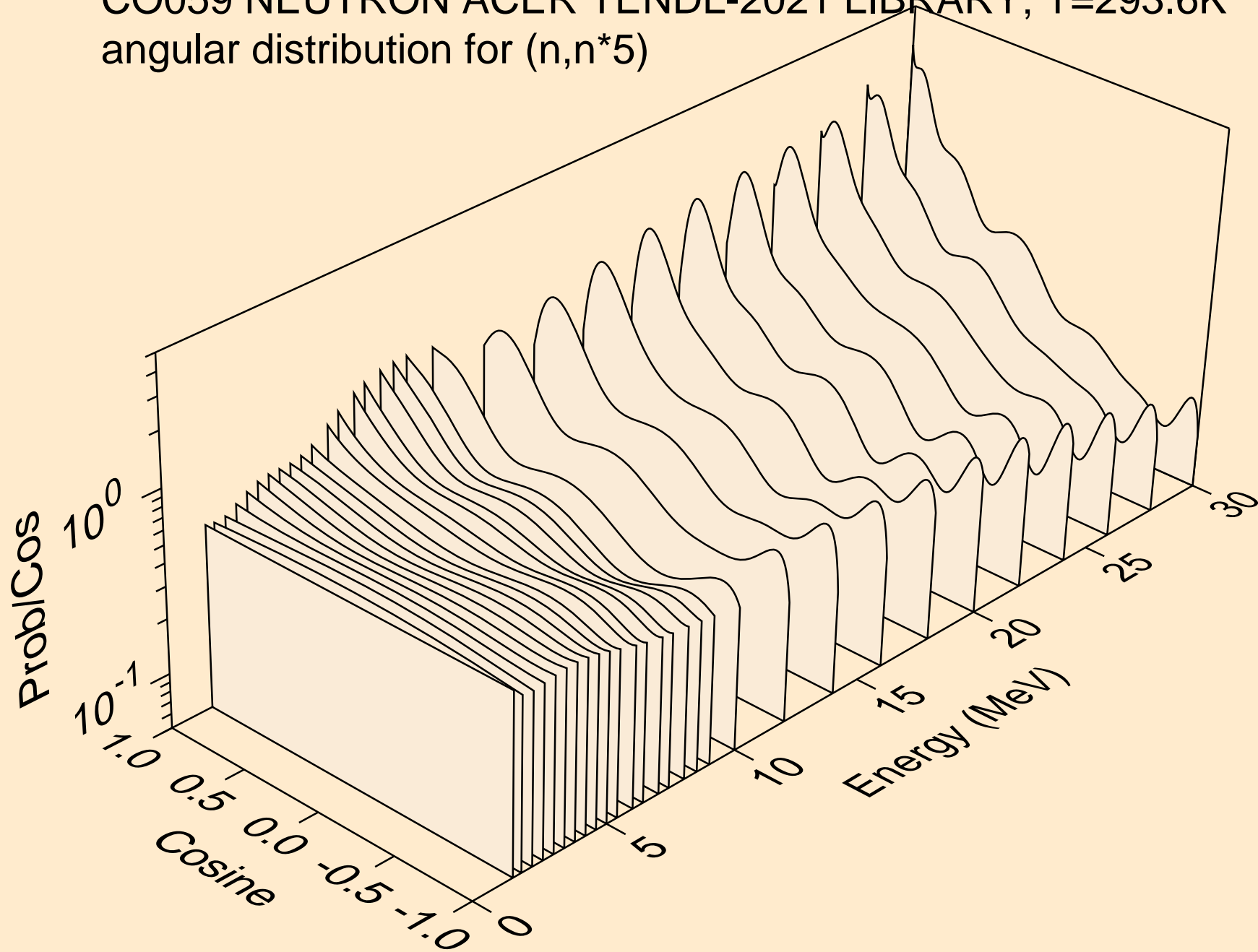

CO059 NEUTRON ACER TENDL-2021 LIBRARY; T=293.6K  
angular distribution for (n,n\*6)

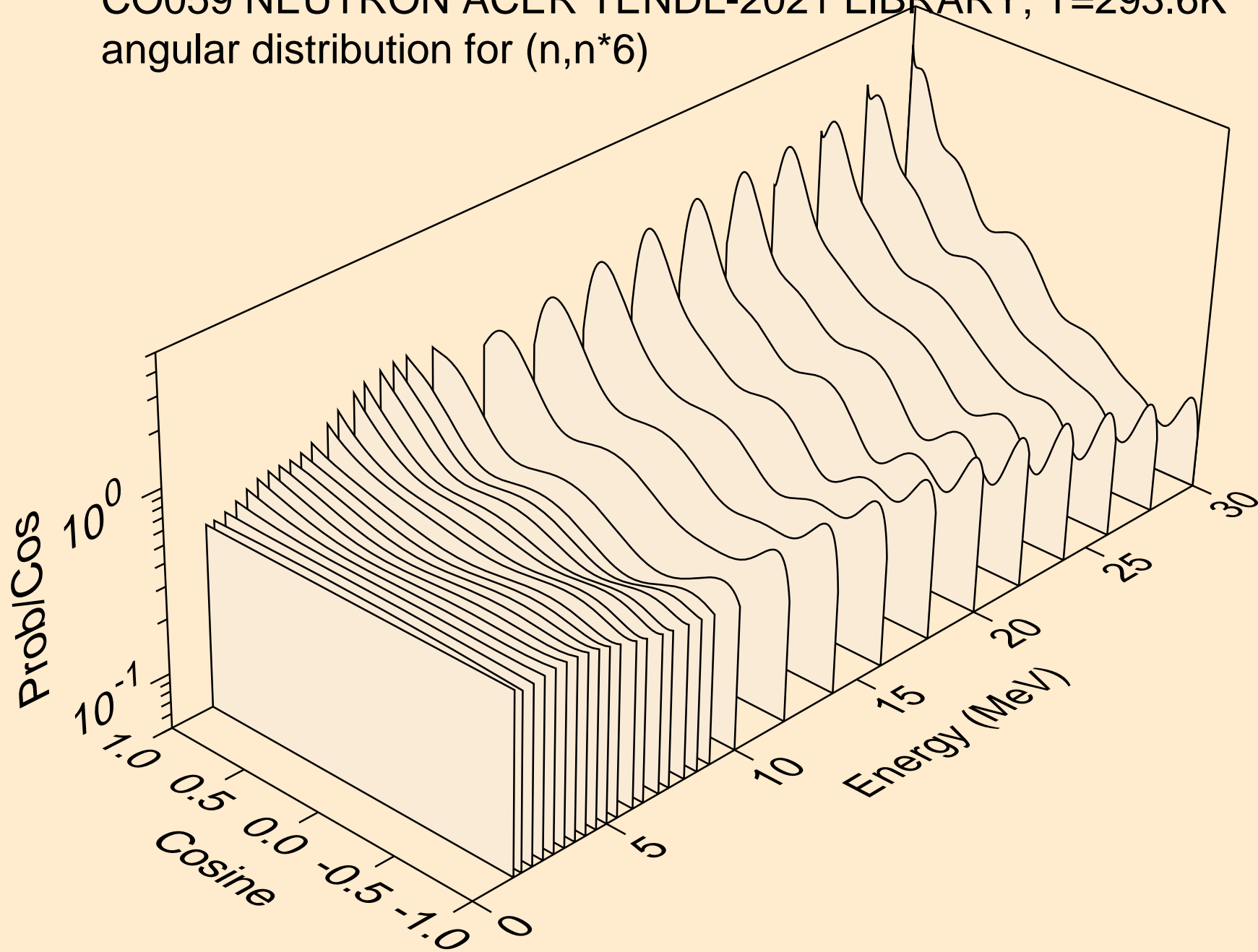

CO059 NEUTRON ACER TENDL-2021 LIBRARY; T=293.6K  
angular distribution for (n,n\*7)

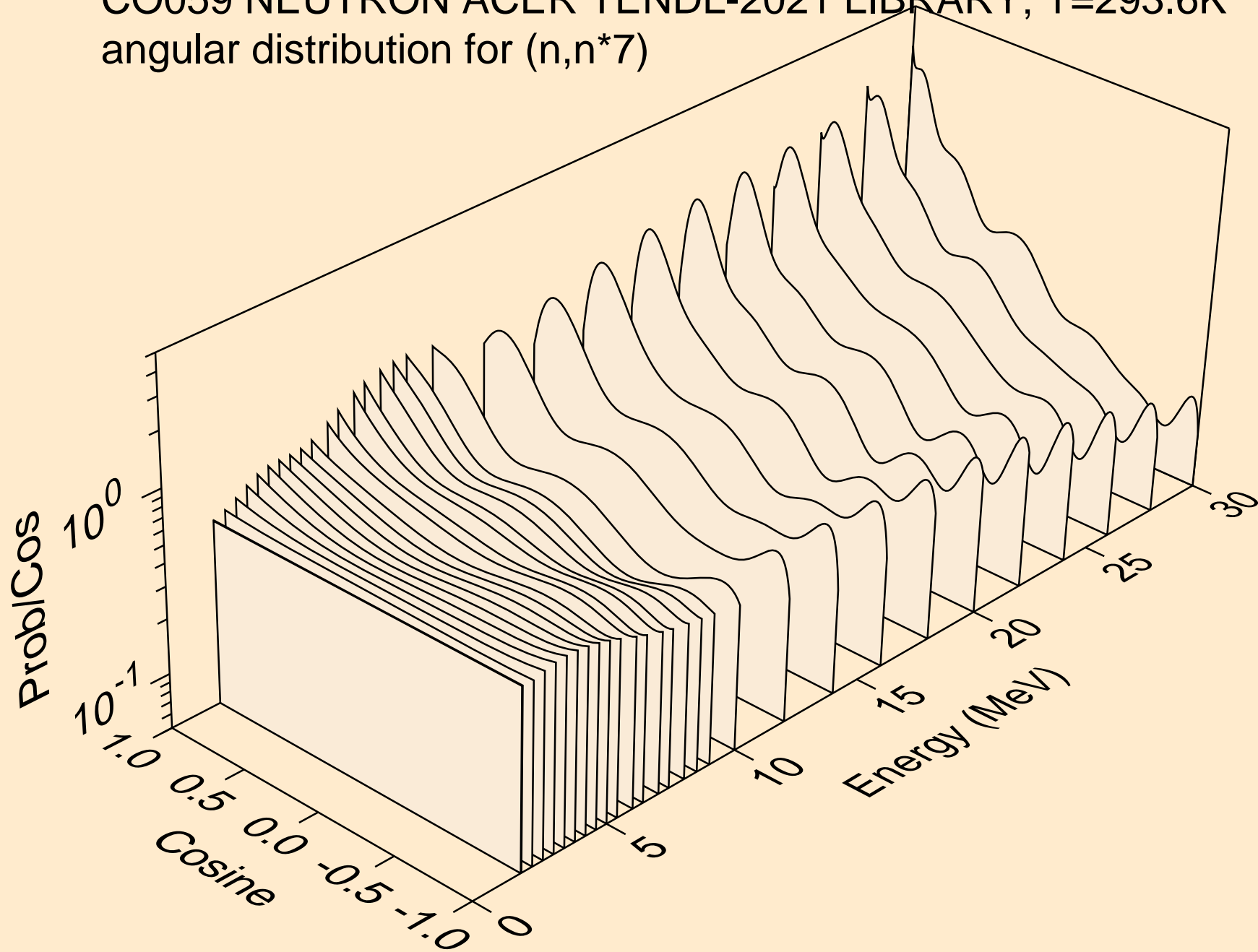



CO059 NEUTRON ACER TENDL-2021 LIBRARY; T=293.6K  
angular distribution for (n,n\*8)

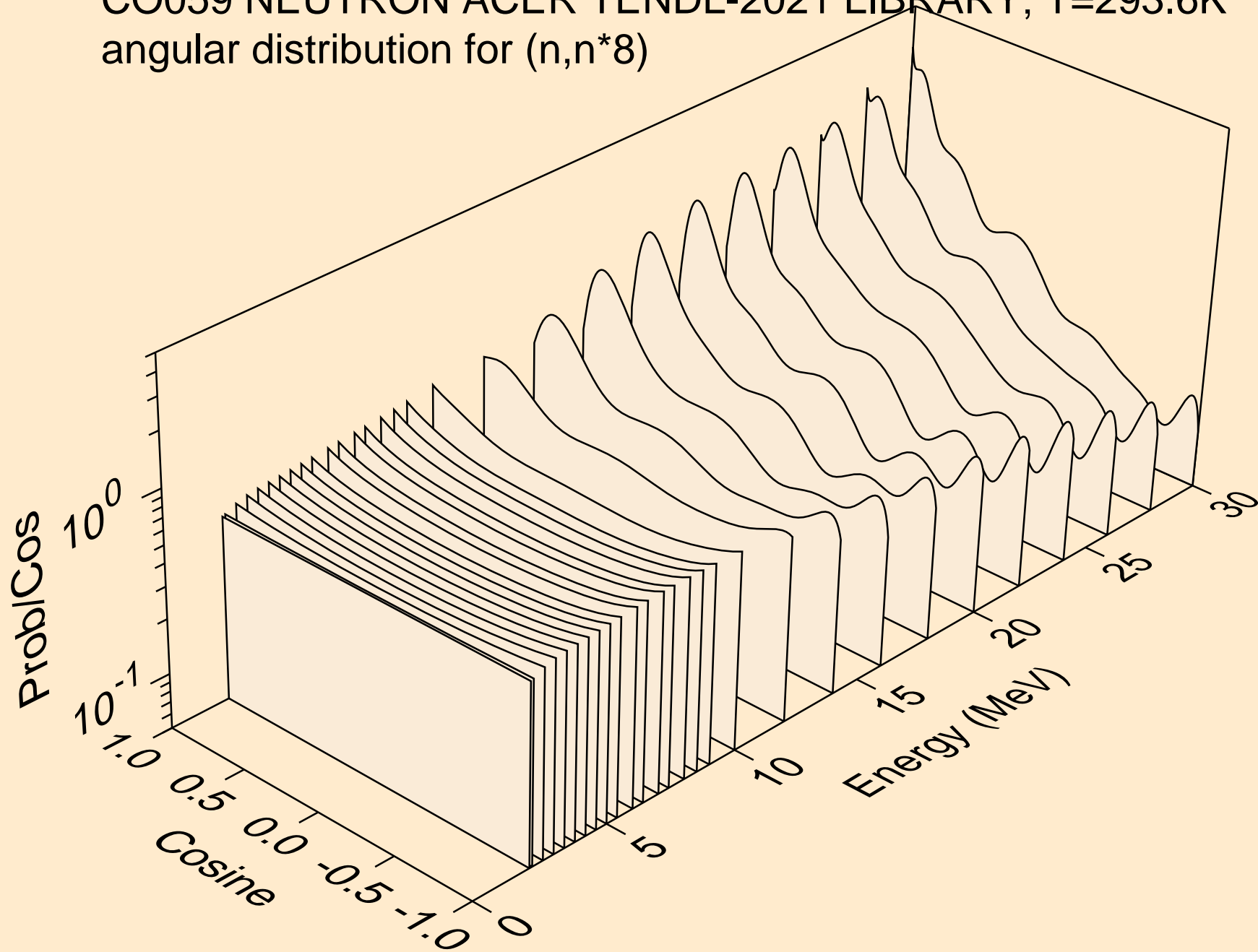

CO059 NEUTRON ACER TENDL-2021 LIBRARY; T=293.6K  
angular distribution for (n,n\*9)

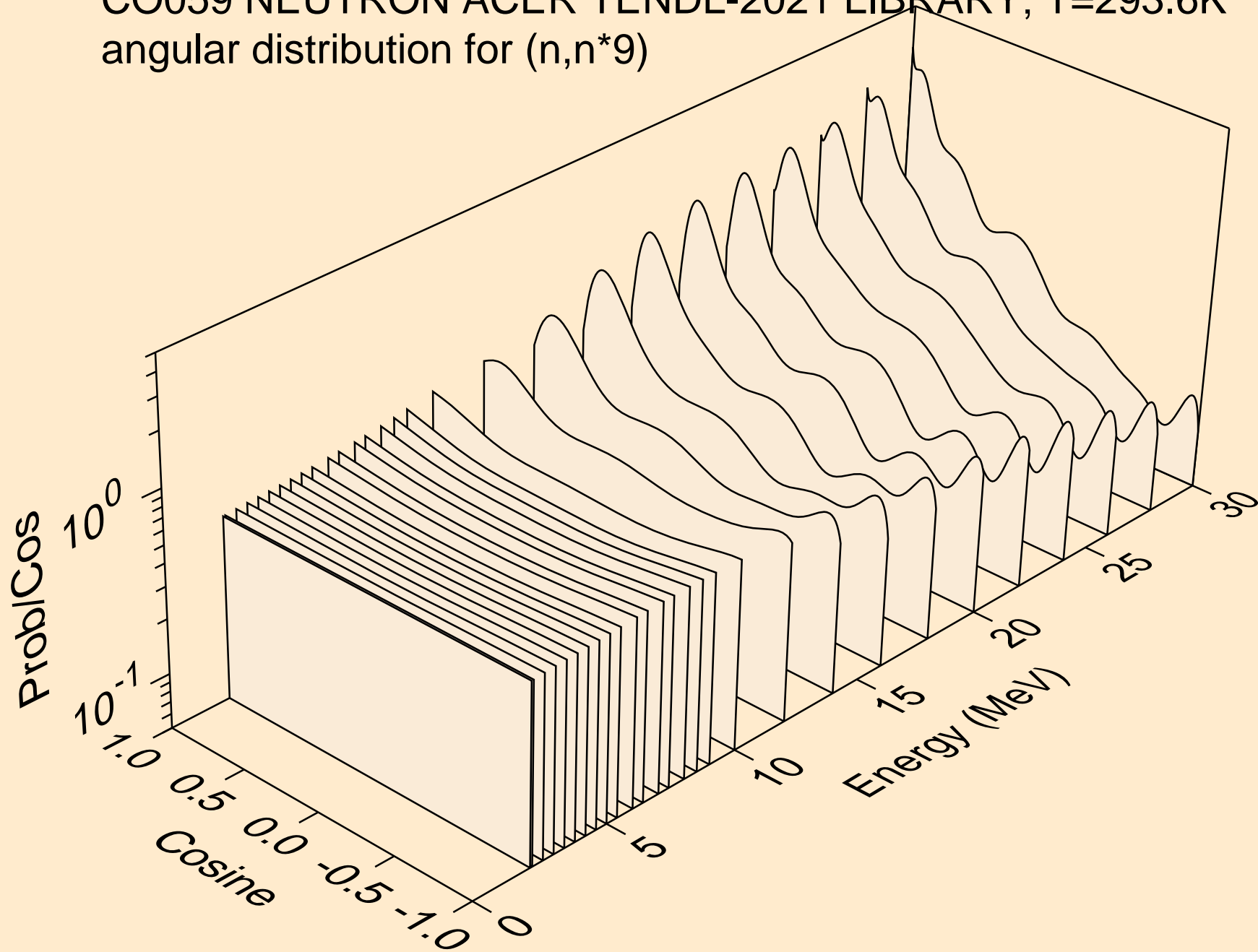

CO059 NEUTRON ACER TENDL-2021 LIBRARY; T=293.6K  
angular distribution for (n,n\*10)

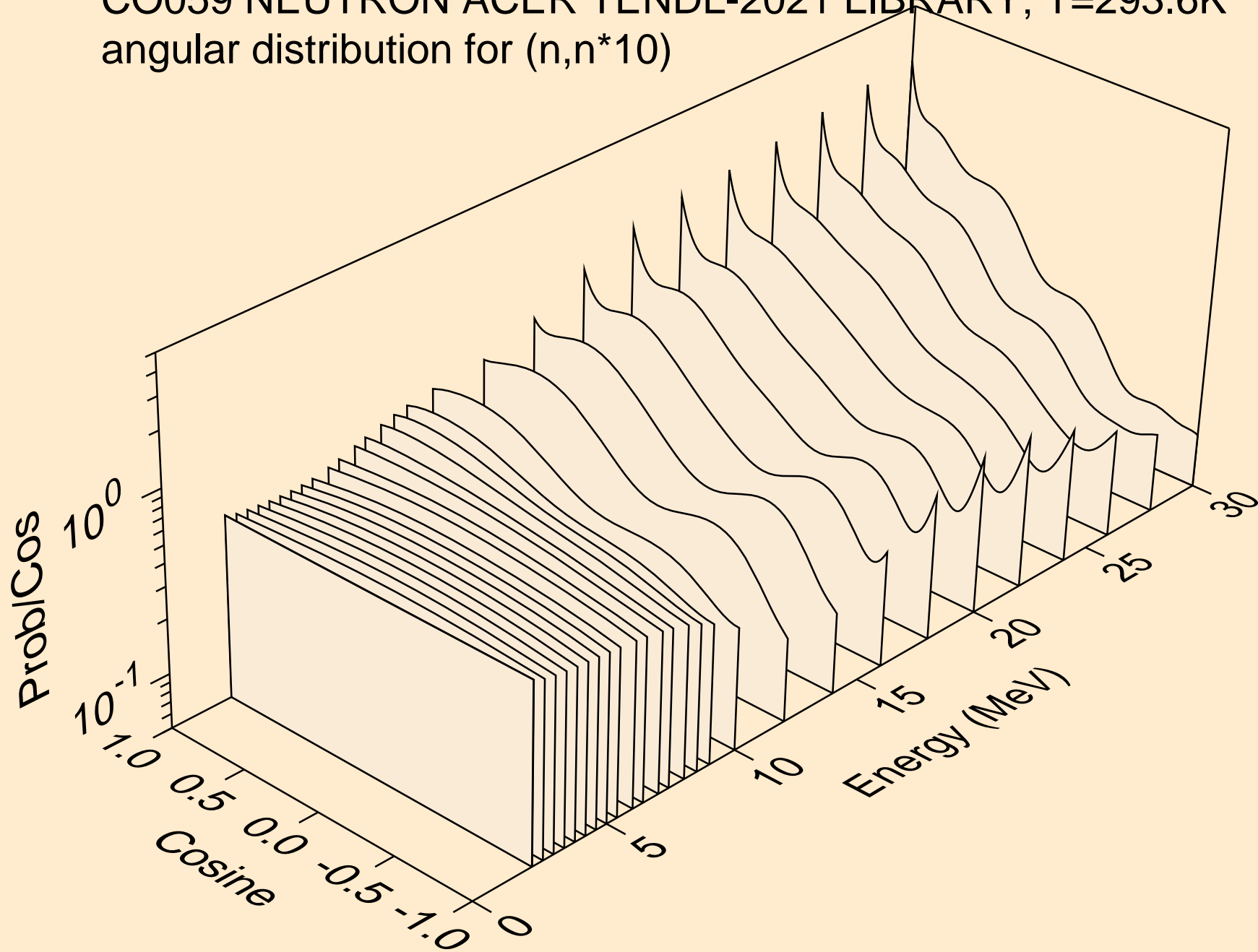

CO059 NEUTRON ACER TENDL-2021 LIBRARY; T=293.6K  
angular distribution for (n,n\*11)

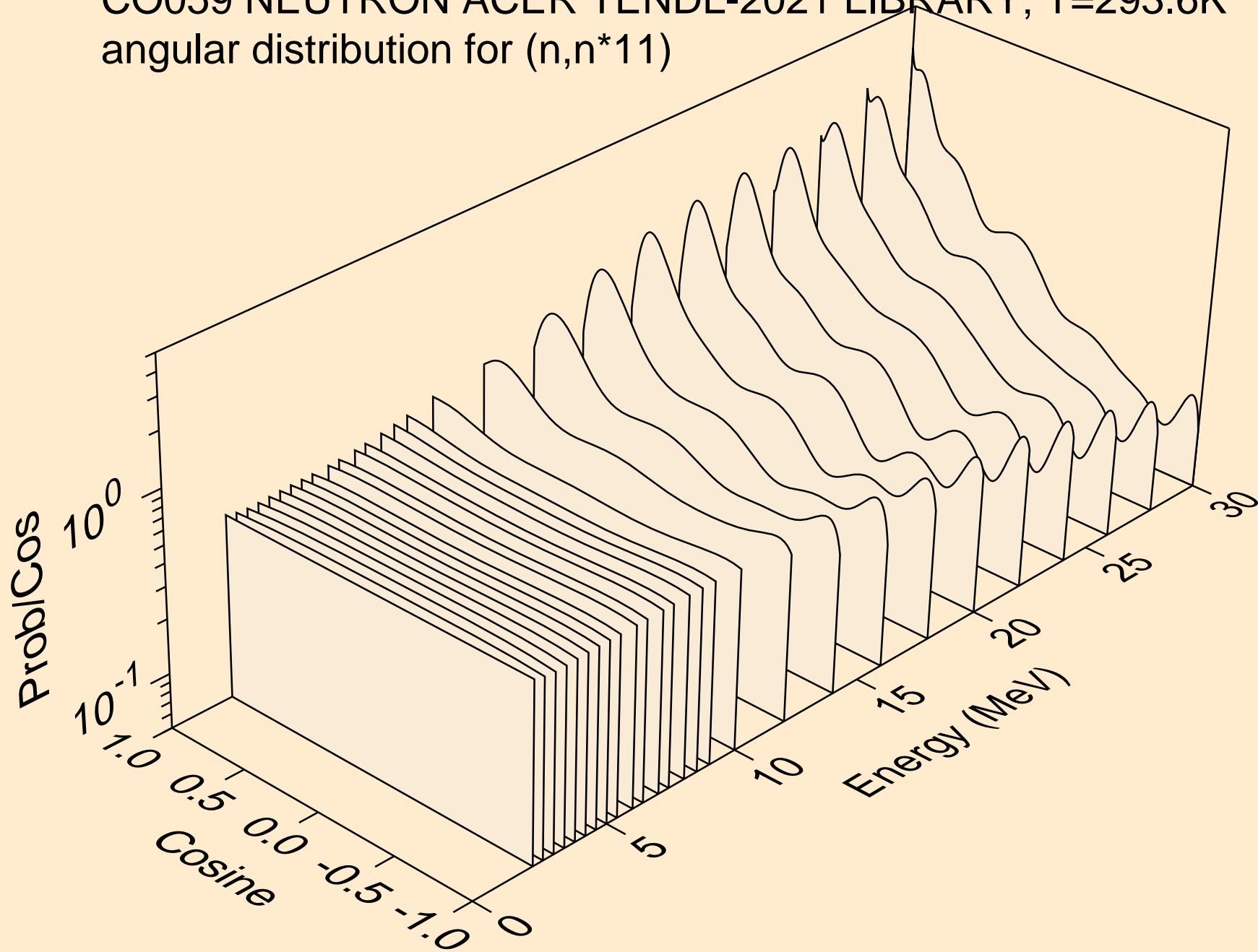

CO059 NEUTRON ACER TENDL-2021 LIBRARY; T=293.6K  
angular distribution for (n,n\*12)

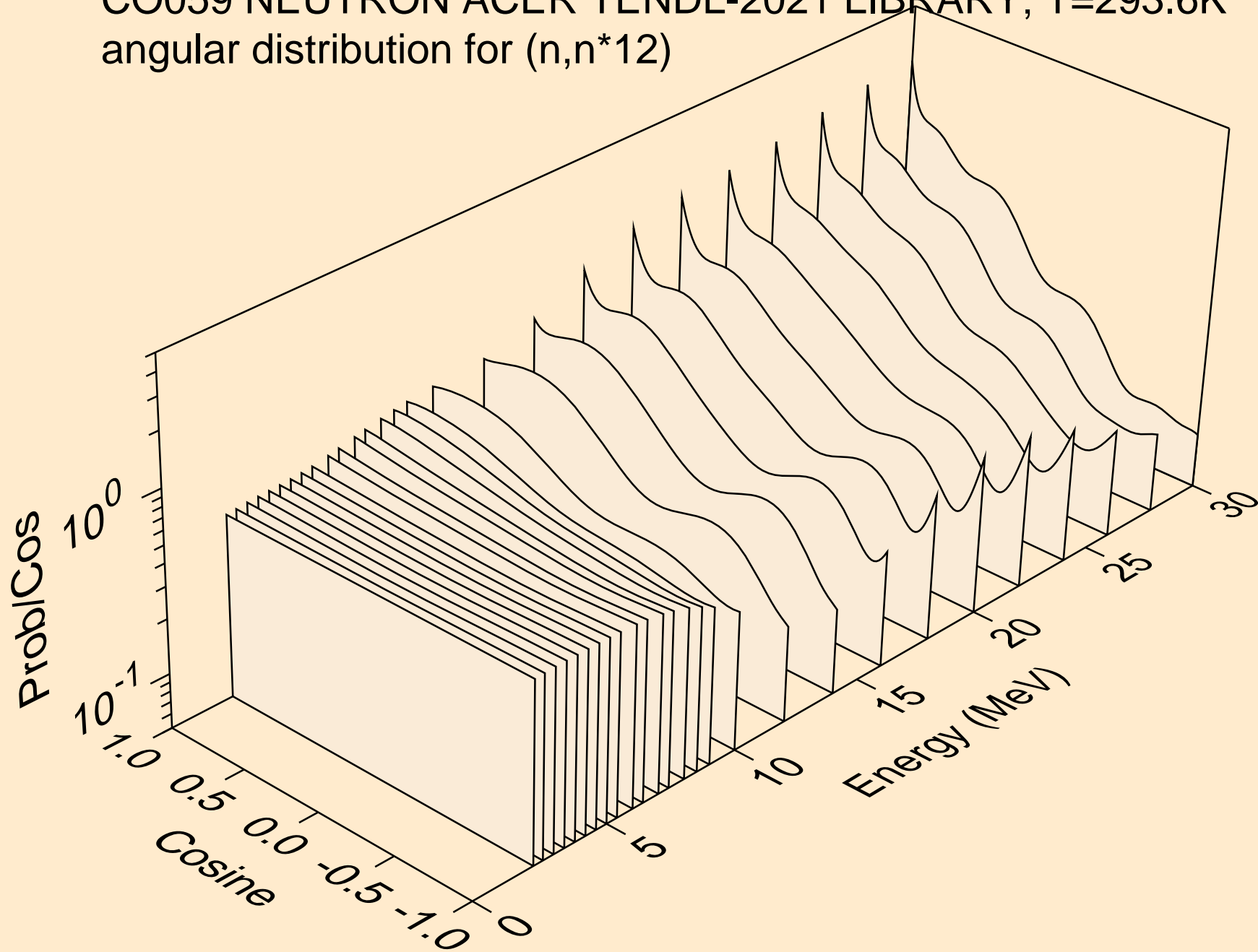

CO059 NEUTRON ACER TENDL-2021 LIBRARY; T=293.6K  
angular distribution for (n,n\*13)

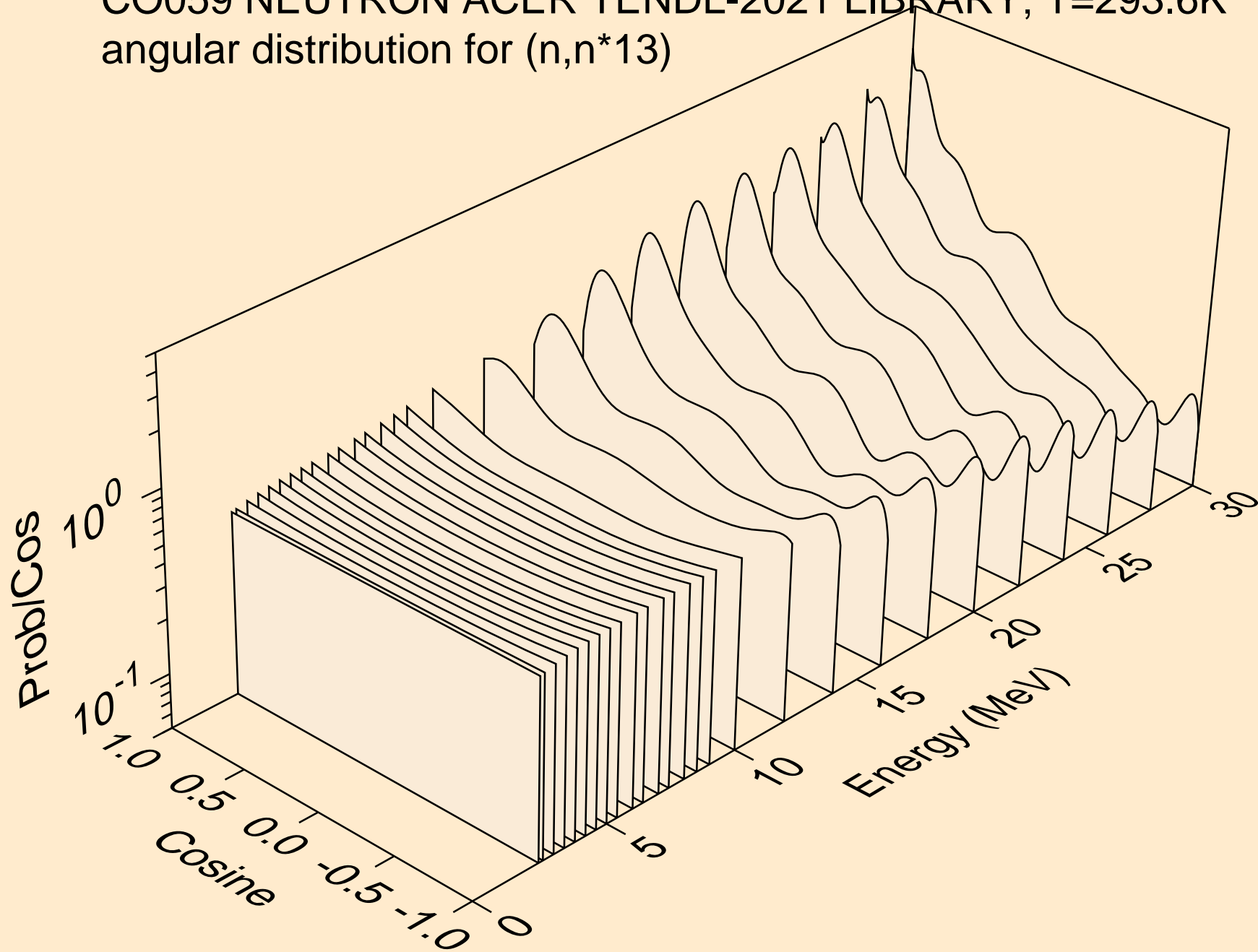

CO059 NEUTRON ACER TENDL-2021 LIBRARY; T=293.6K  
angular distribution for (n,n\*14)

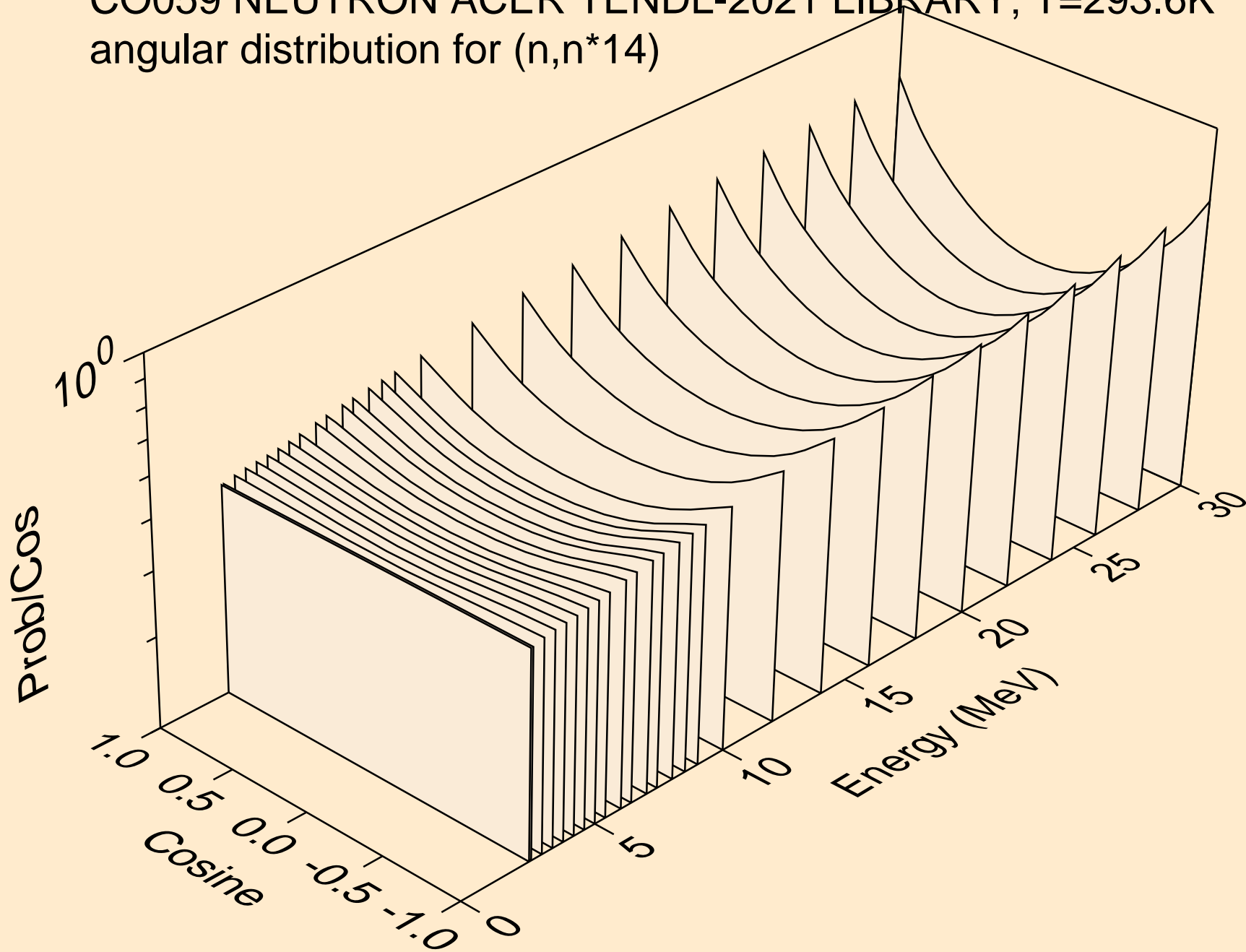

CO059 NEUTRON ACER TENDL-2021 LIBRARY; T=293.6K  
angular distribution for (n,n\*15)

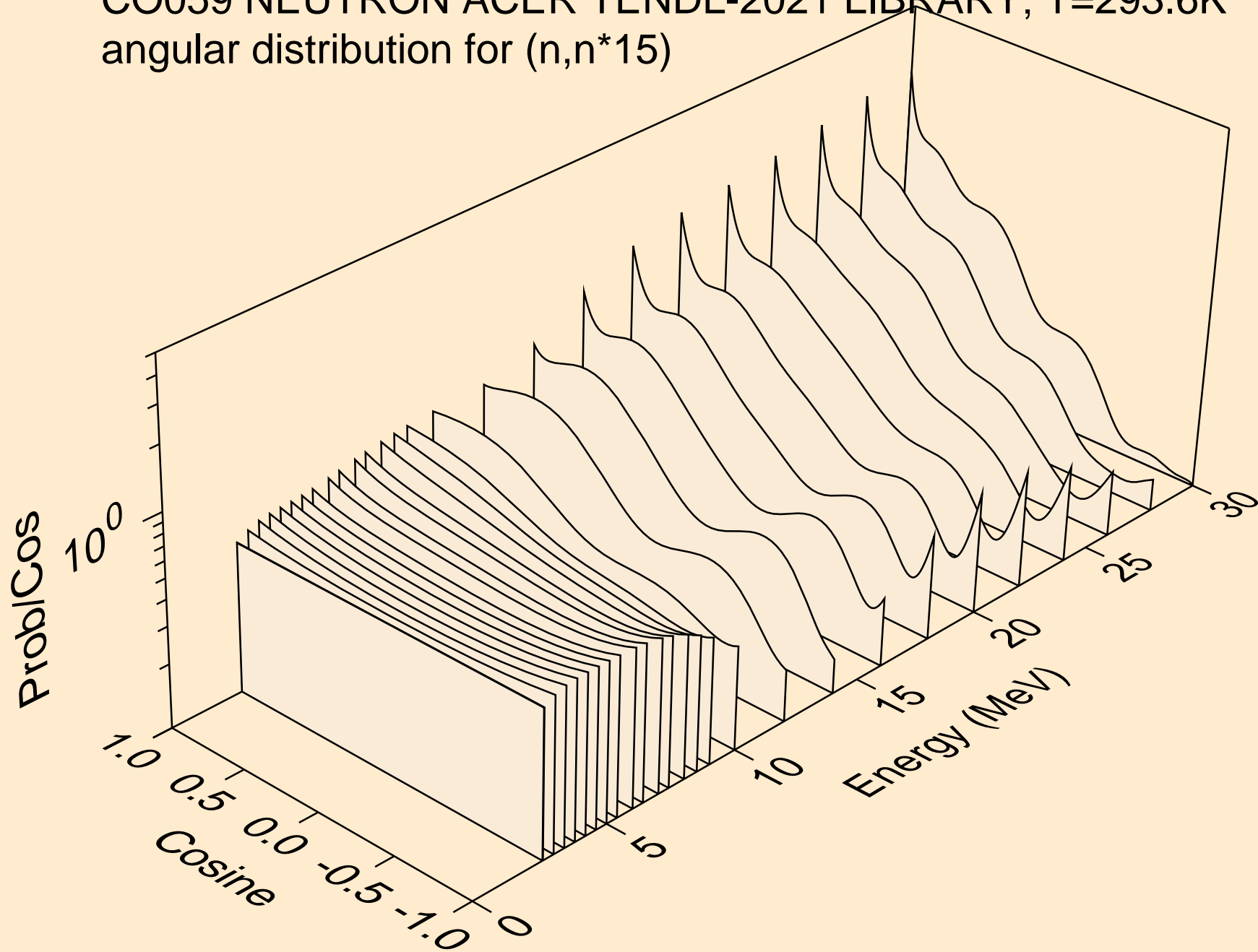



CO059 NEUTRON ACER TENDL-2021 LIBRARY; T=293.6K  
angular distribution for (n,n\*16)

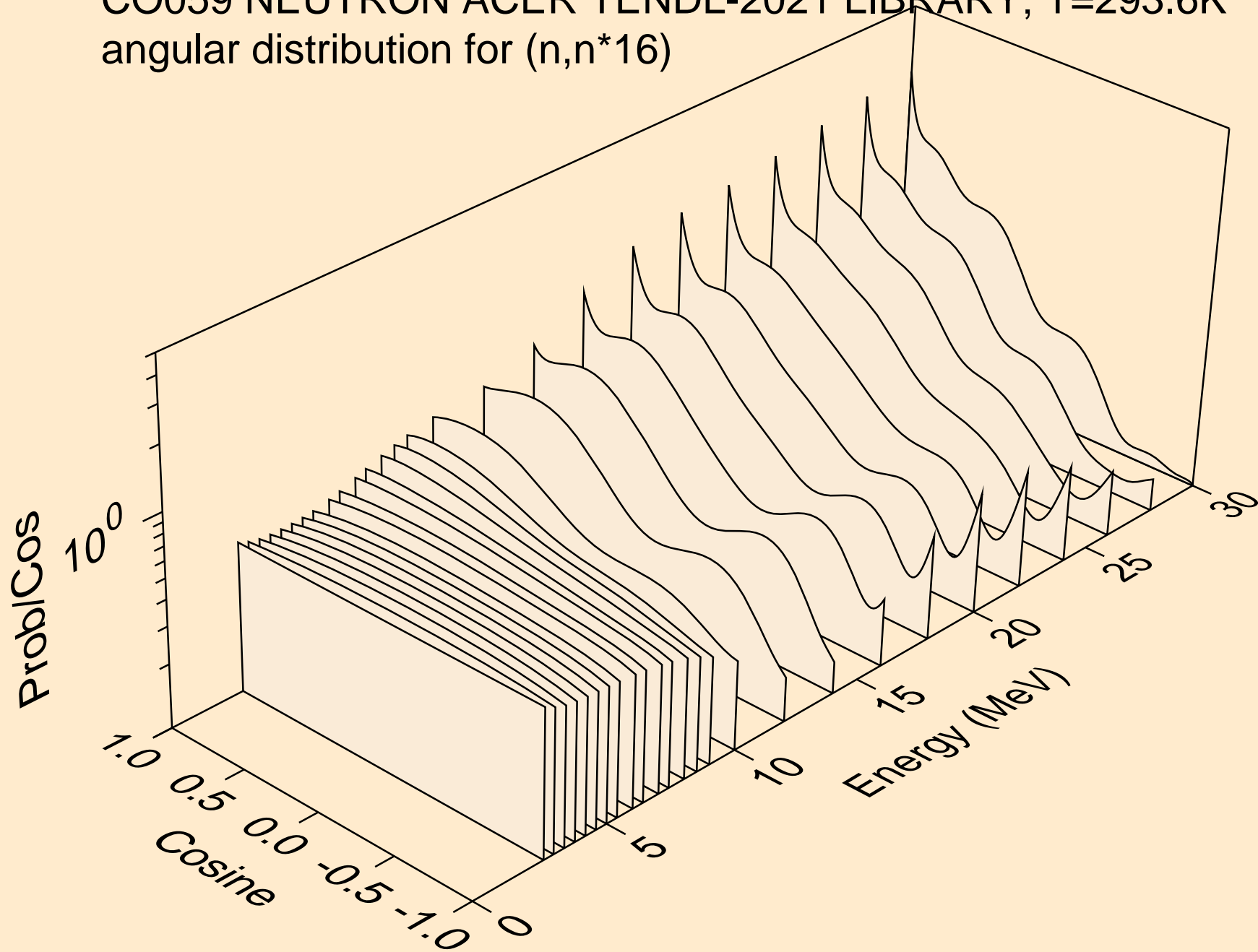

CO059 NEUTRON ACER TENDL-2021 LIBRARY; T=293.6K  
angular distribution for (n,n\*17)

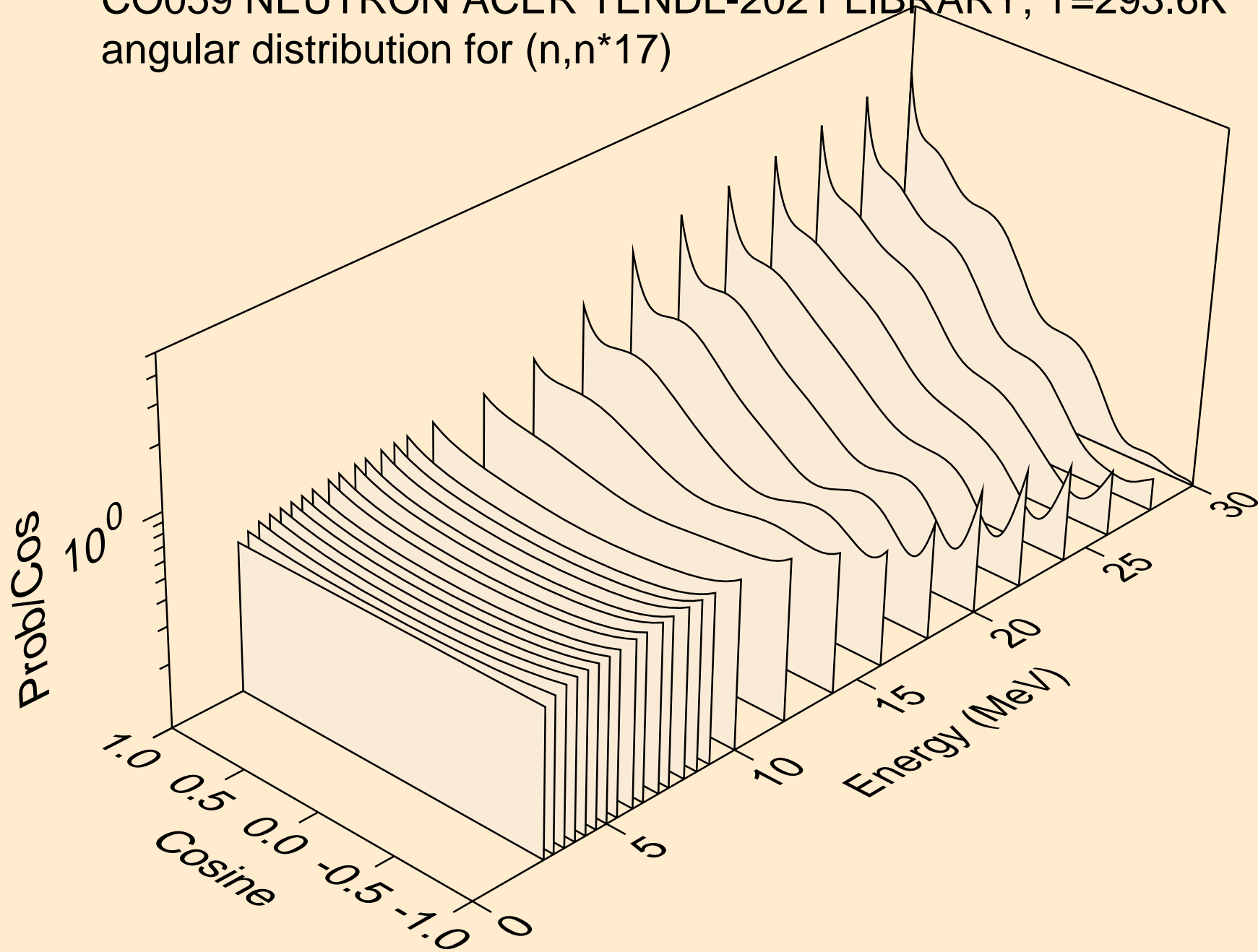

CO059 NEUTRON ACER TENDL-2021 LIBRARY; T=293.6K  
angular distribution for (n,n\*18)

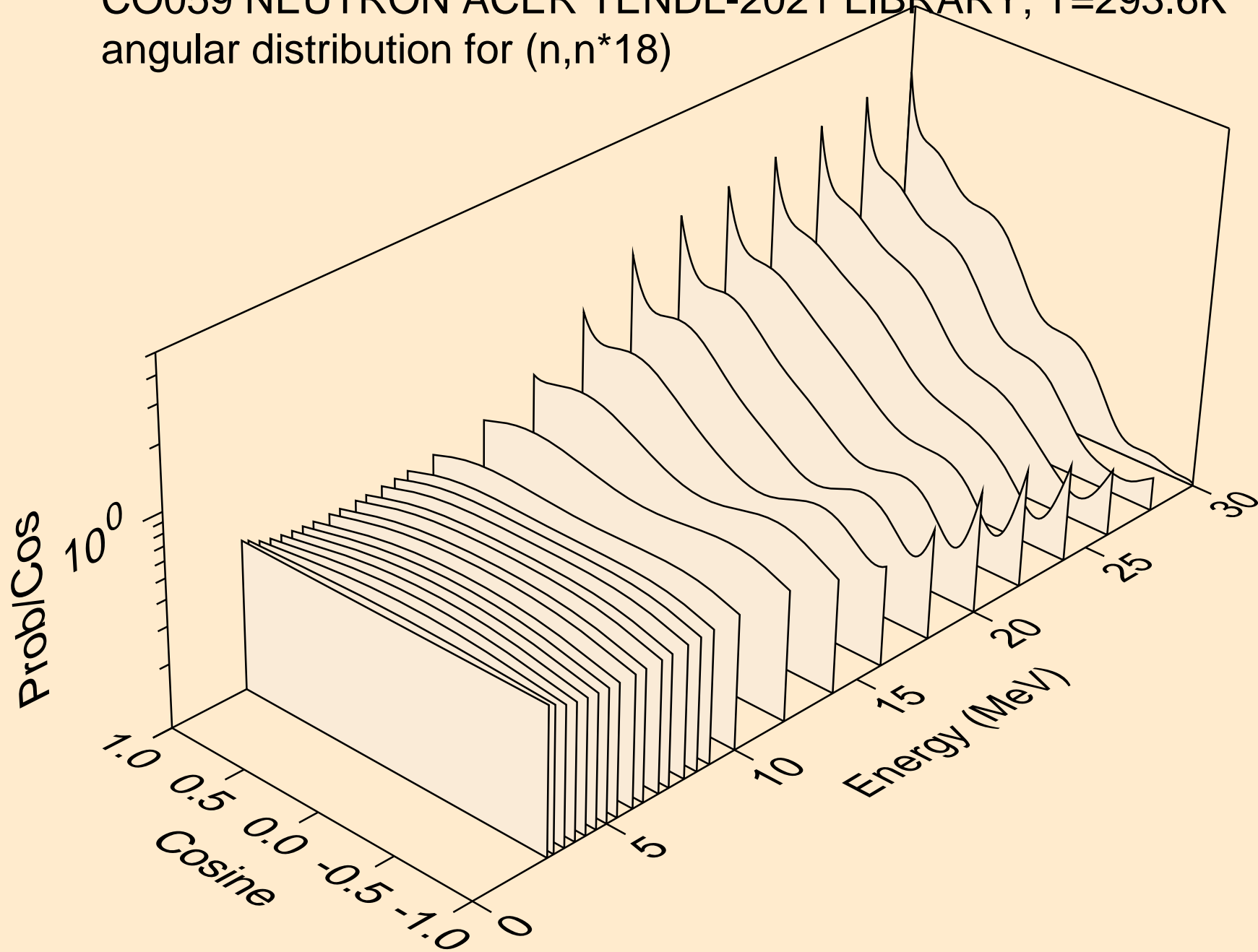

CO059 NEUTRON ACER TENDL-2021 LIBRARY; T=293.6K  
angular distribution for (n,n\*19)

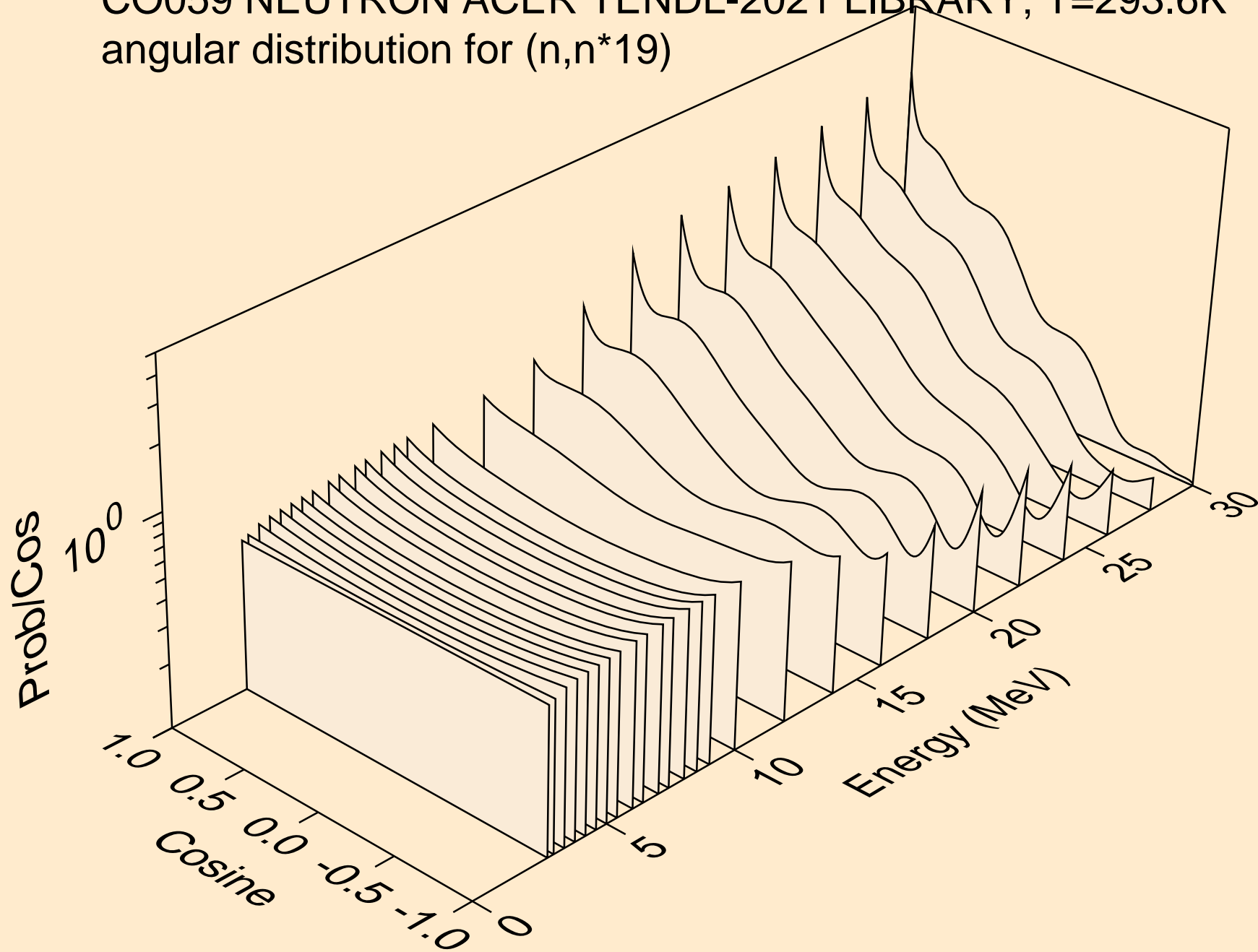

CO059 NEUTRON ACER TENDL-2021 LIBRARY; T=293.6K  
angular distribution for (n,n\*20)

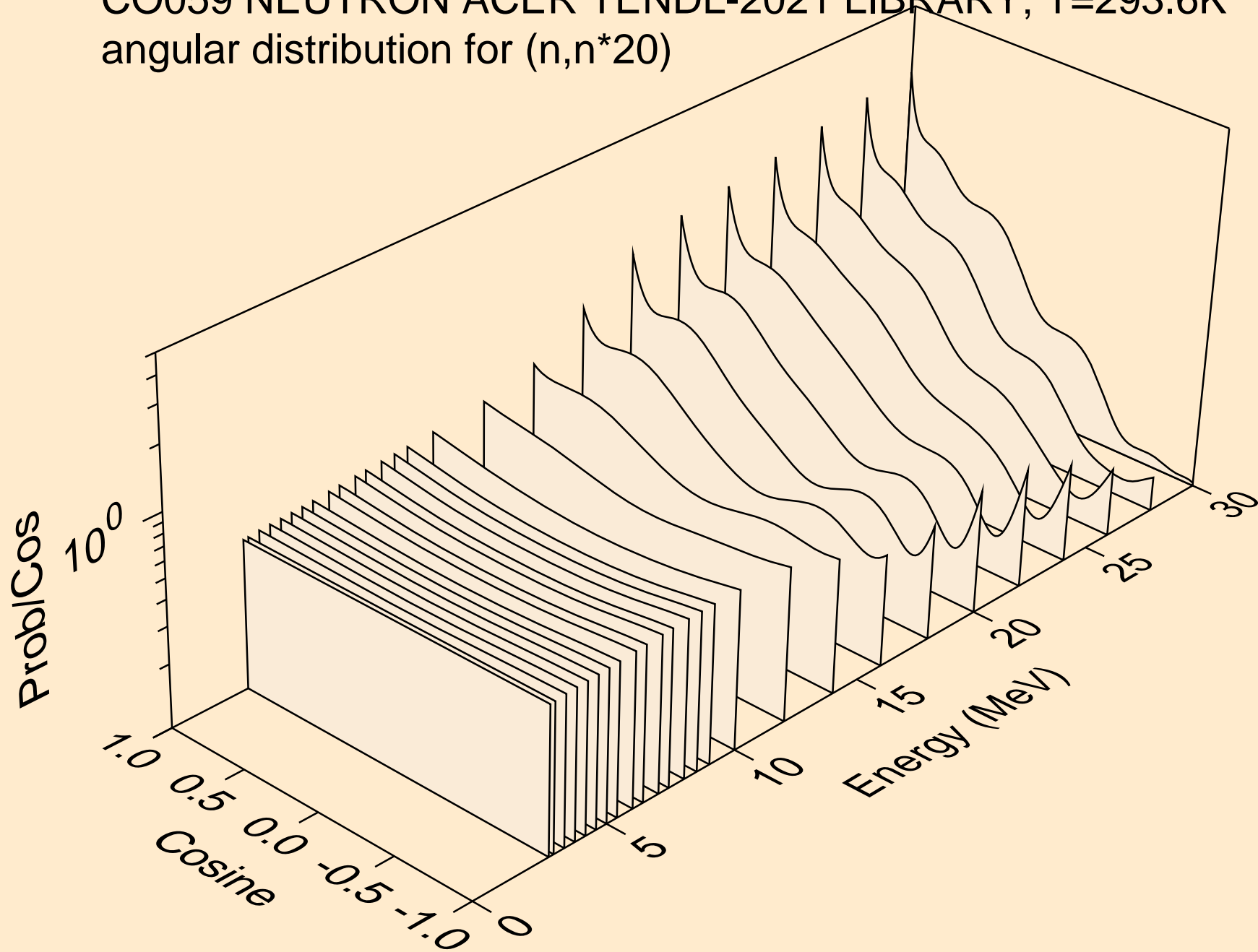

CO059 NEUTRON ACER TENDL-2021 LIBRARY; T=293.6K  
angular distribution for (n,n\*21)

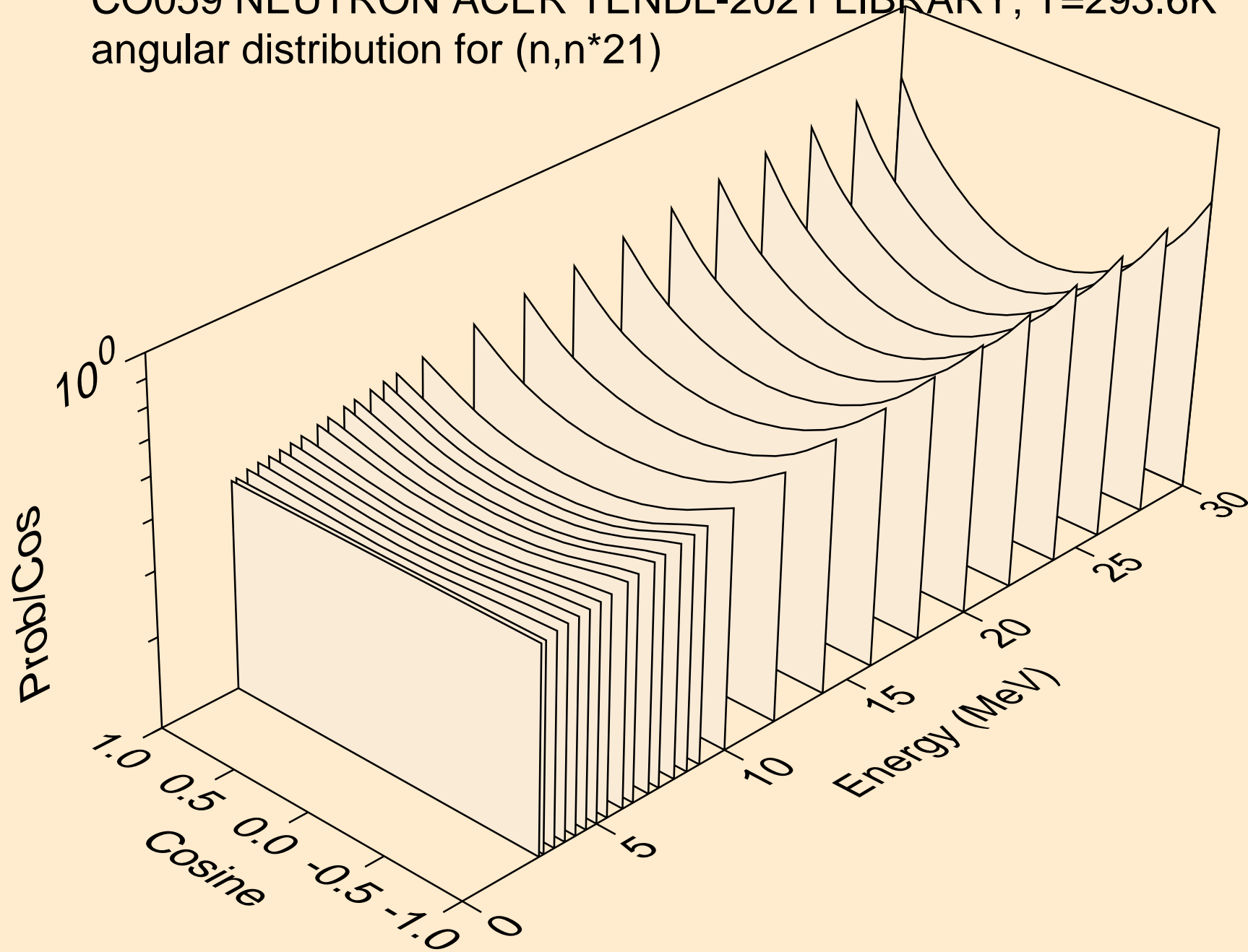

CO059 NEUTRON ACER TENDL-2021 LIBRARY; T=293.6K  
angular distribution for (n,n\*22)

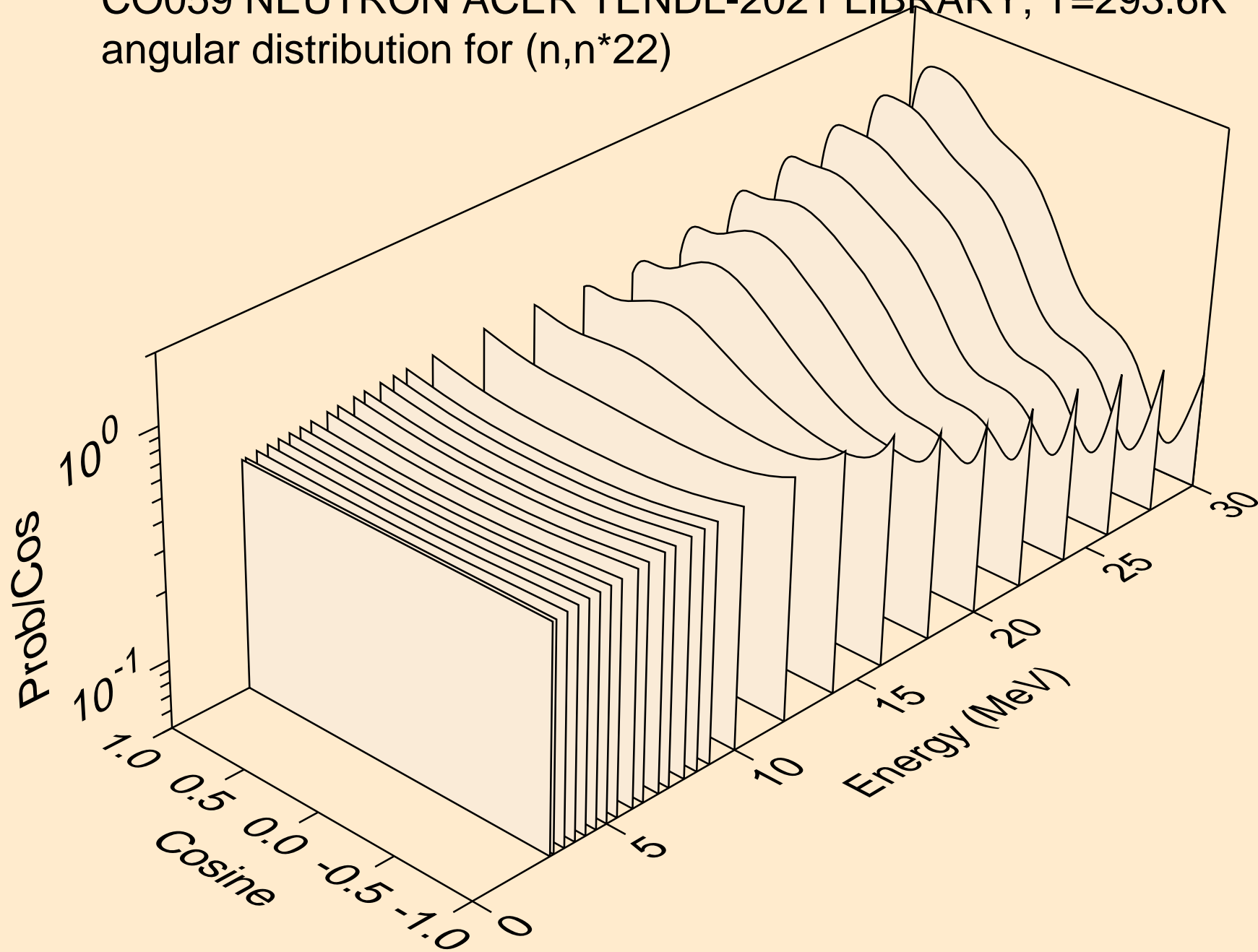

CO059 NEUTRON ACER TENDL-2021 LIBRARY; T=293.6K  
angular distribution for (n,n\*23)

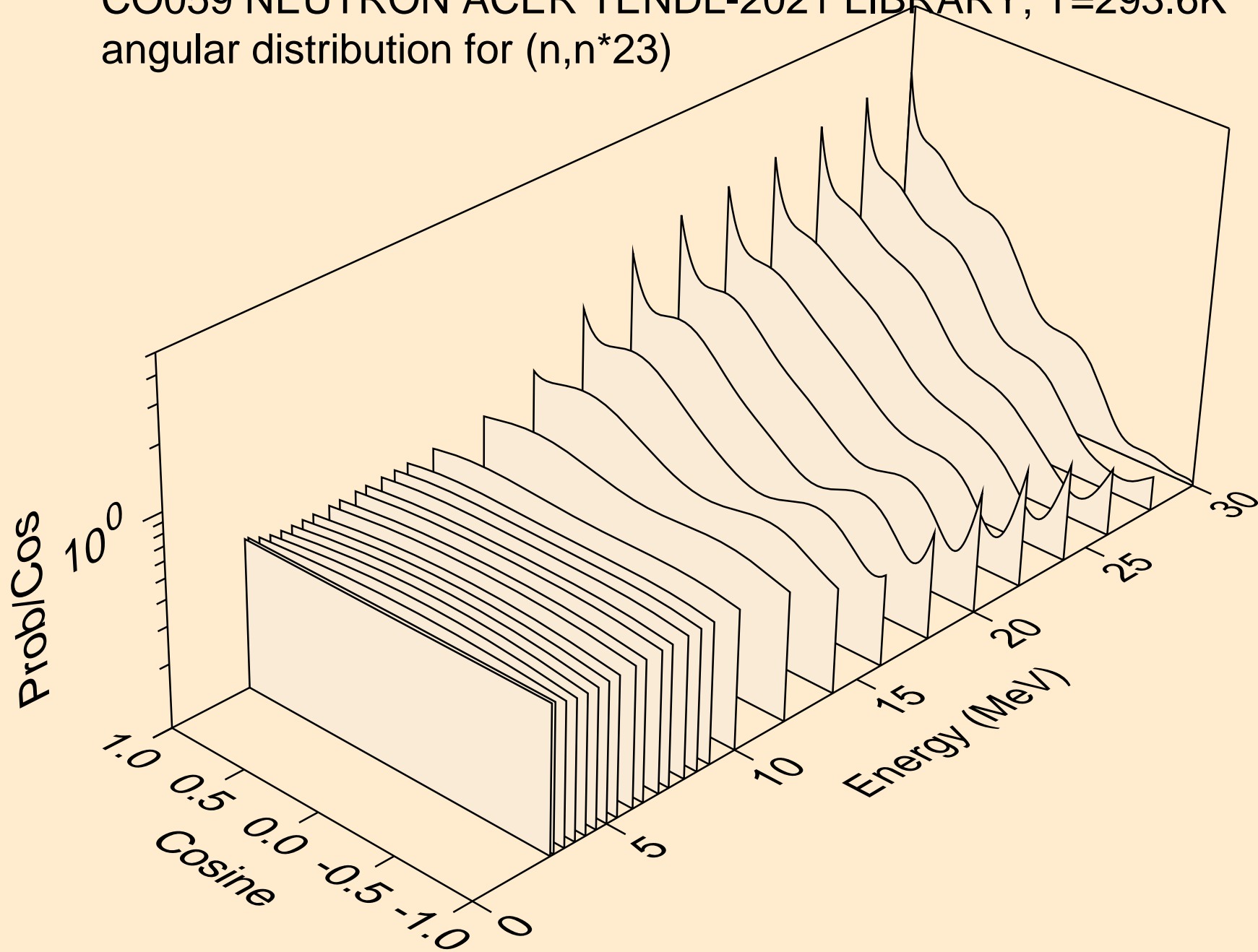



CO059 NEUTRON ACER TENDL-2021 LIBRARY; T=293.6K  
angular distribution for (n,n\*24)

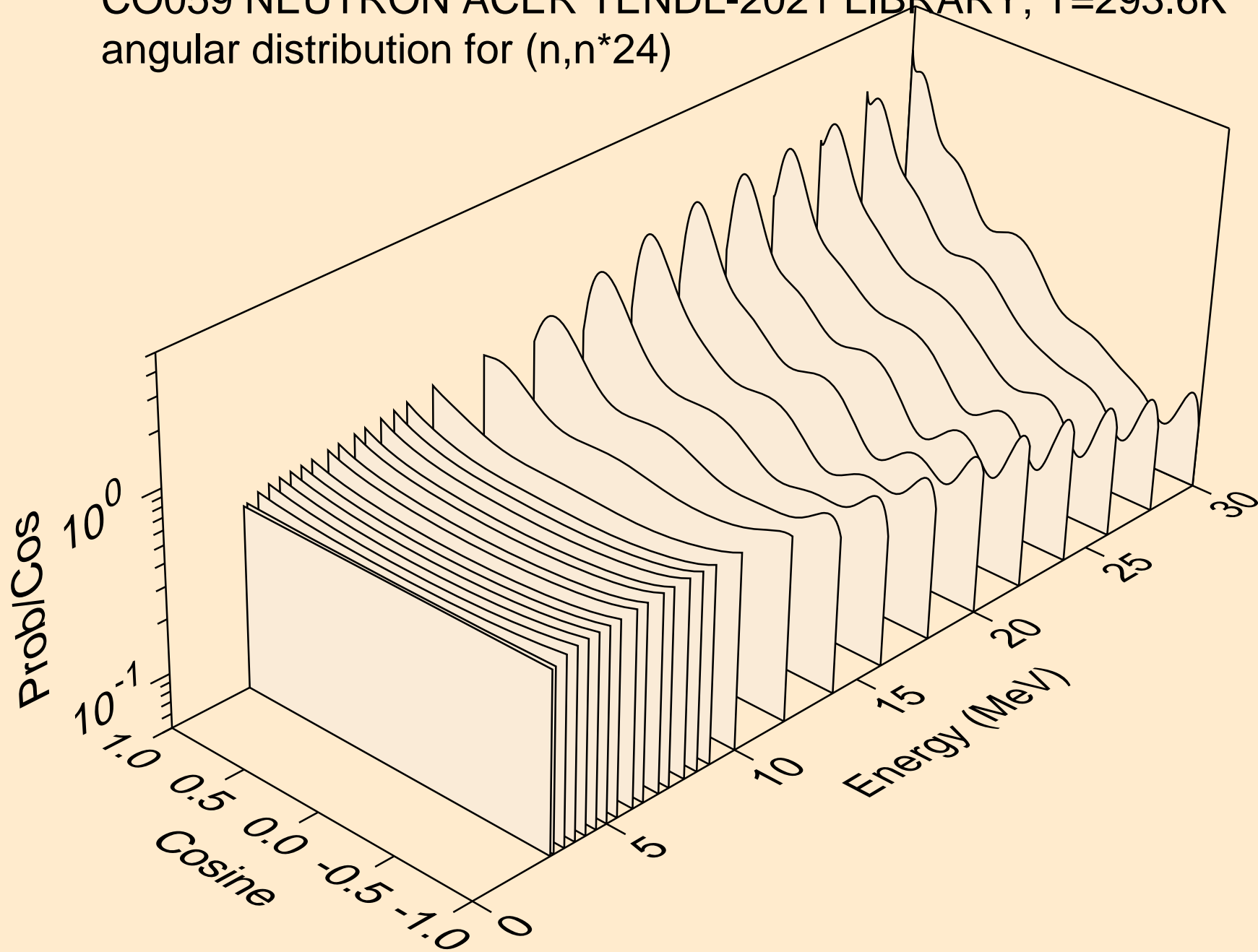

CO059 NEUTRON ACER TENDL-2021 LIBRARY; T=293.6K  
angular distribution for (n,n\*25)

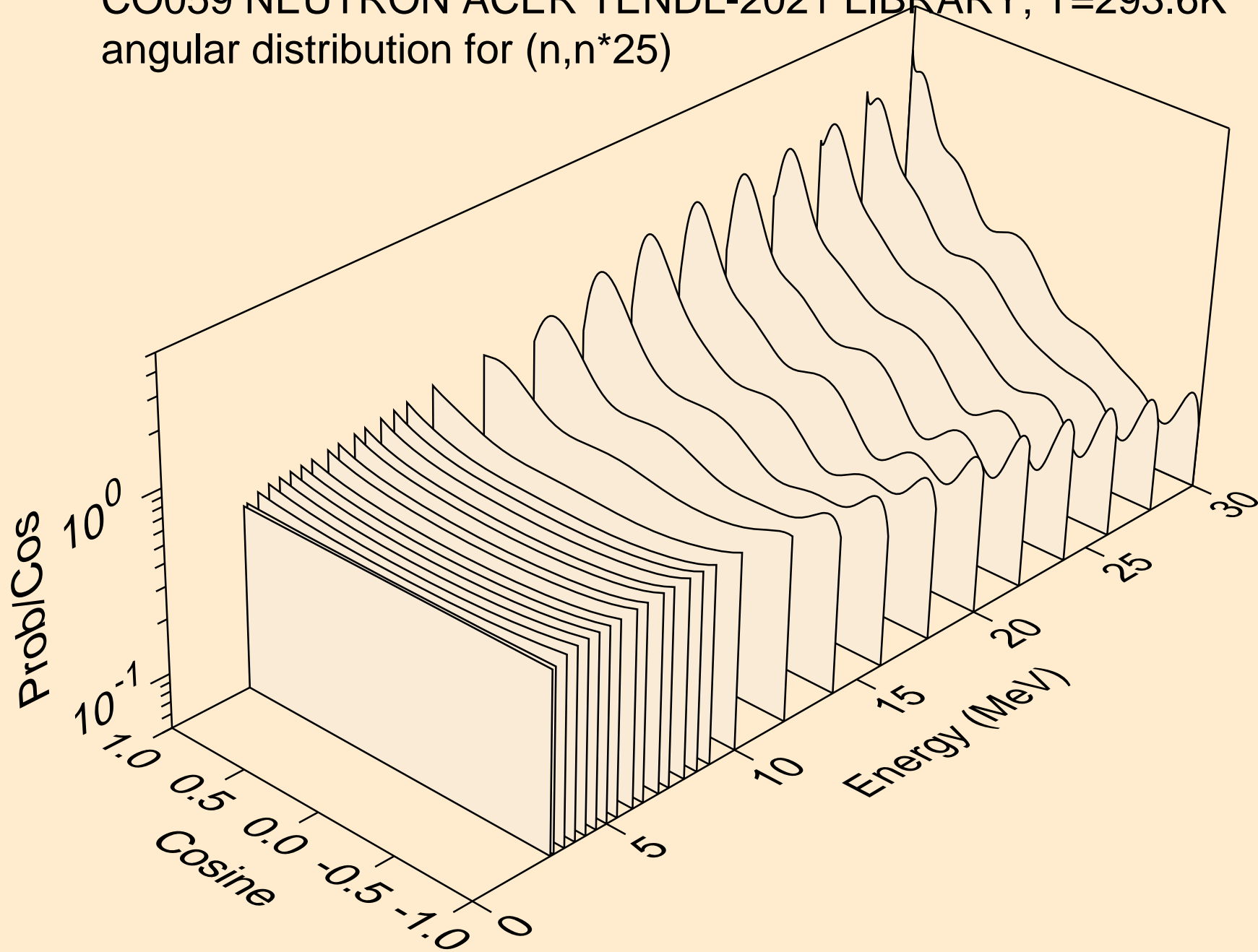

CO059 NEUTRON ACER TENDL-2021 LIBRARY; T=293.6K  
angular distribution for (n,n\*26)

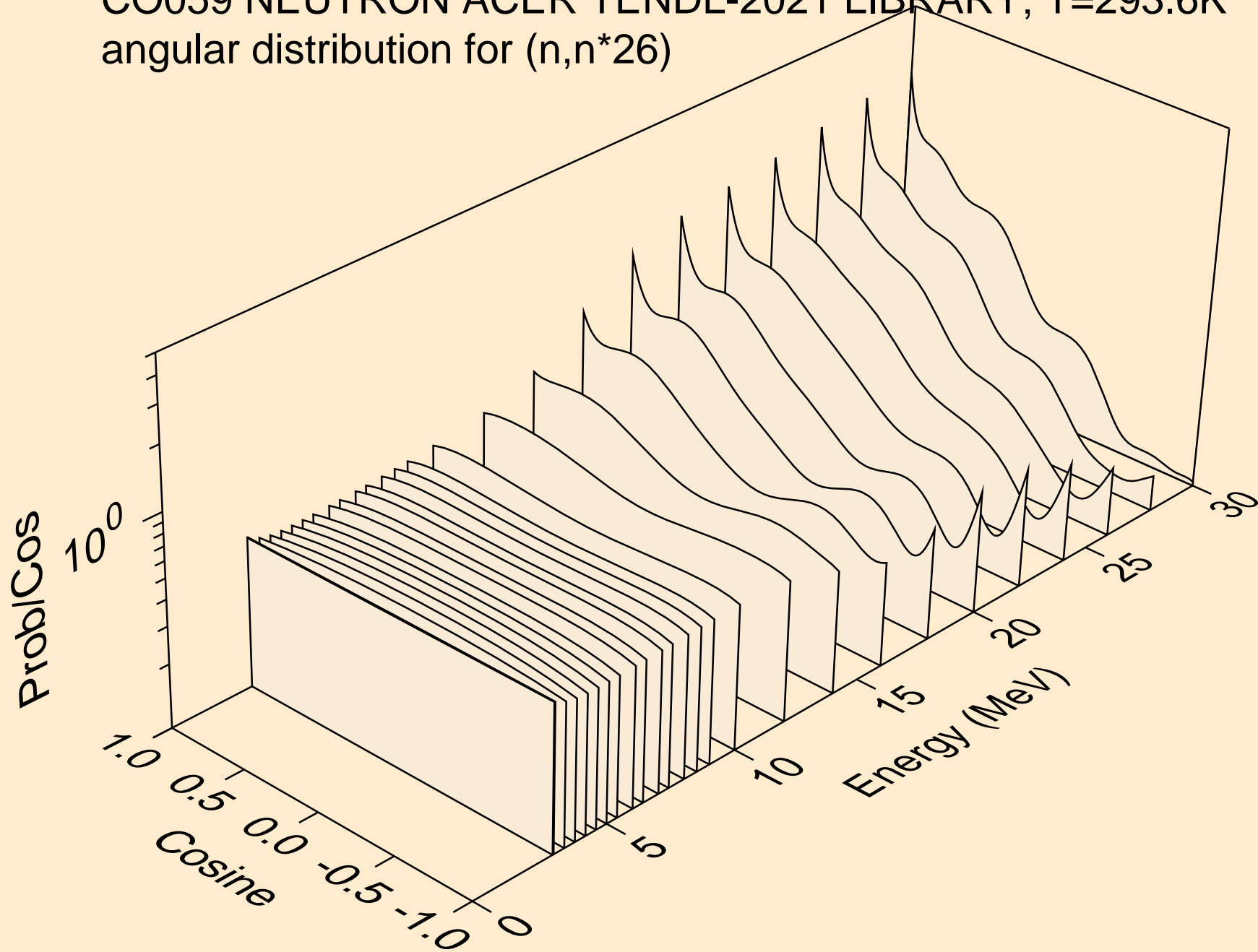

CO059 NEUTRON ACER TENDL-2021 LIBRARY; T=293.6K  
angular distribution for (n,n\*27)

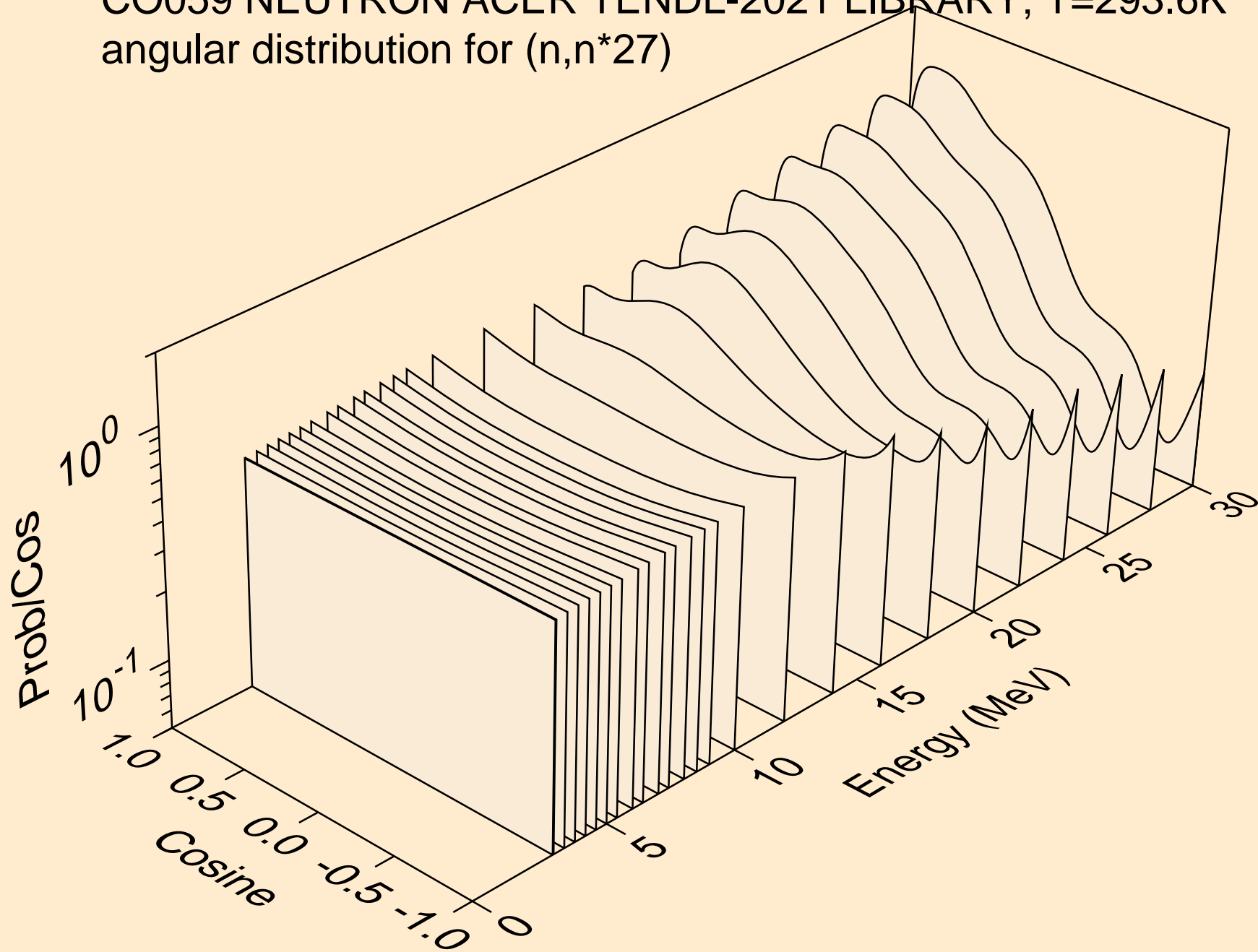

CO059 NEUTRON ACER TENDL-2021 LIBRARY; T=293.6K  
angular distribution for (n,n\*28)

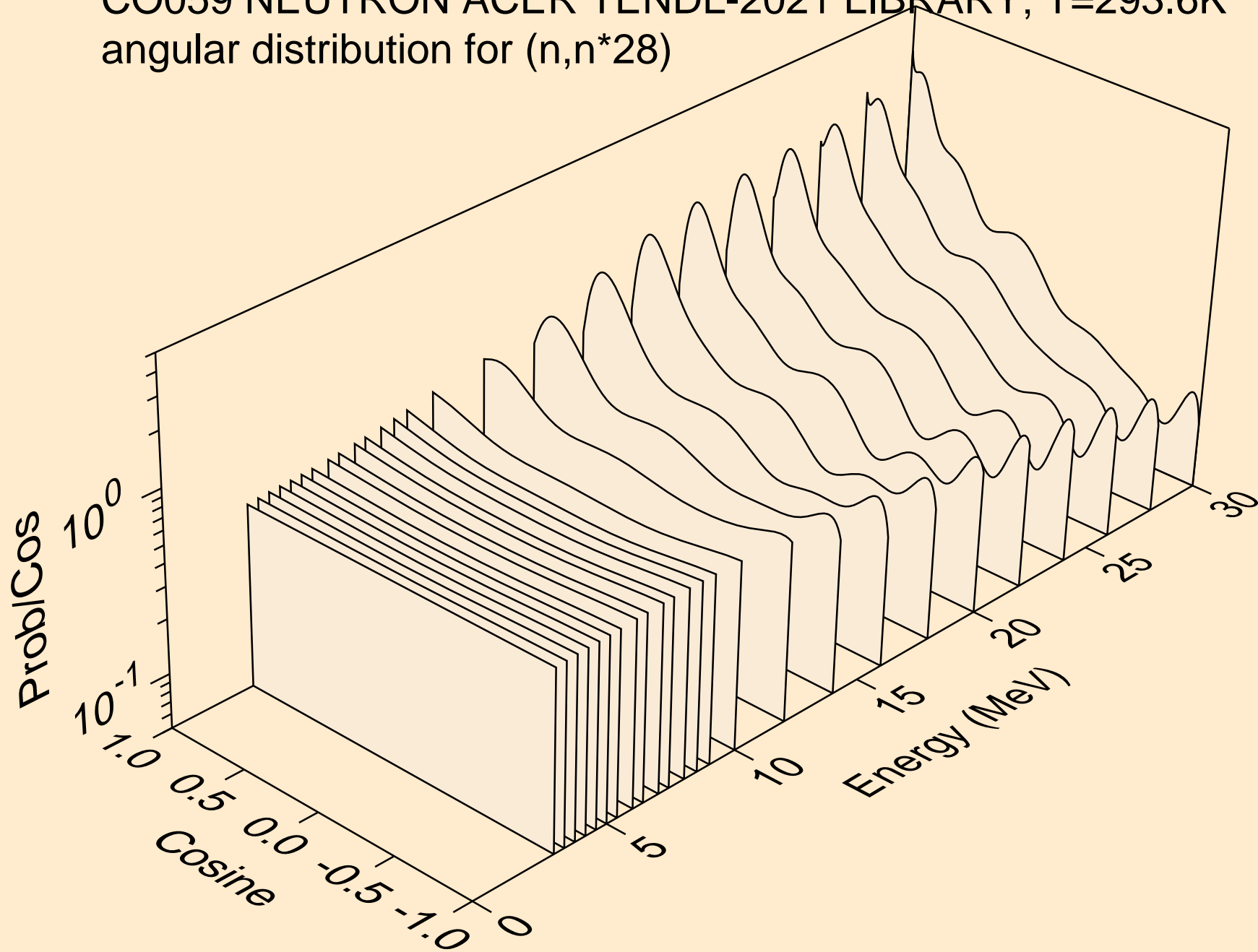

CO059 NEUTRON ACER TENDL-2021 LIBRARY; T=293.6K  
angular distribution for (n,n\*29)

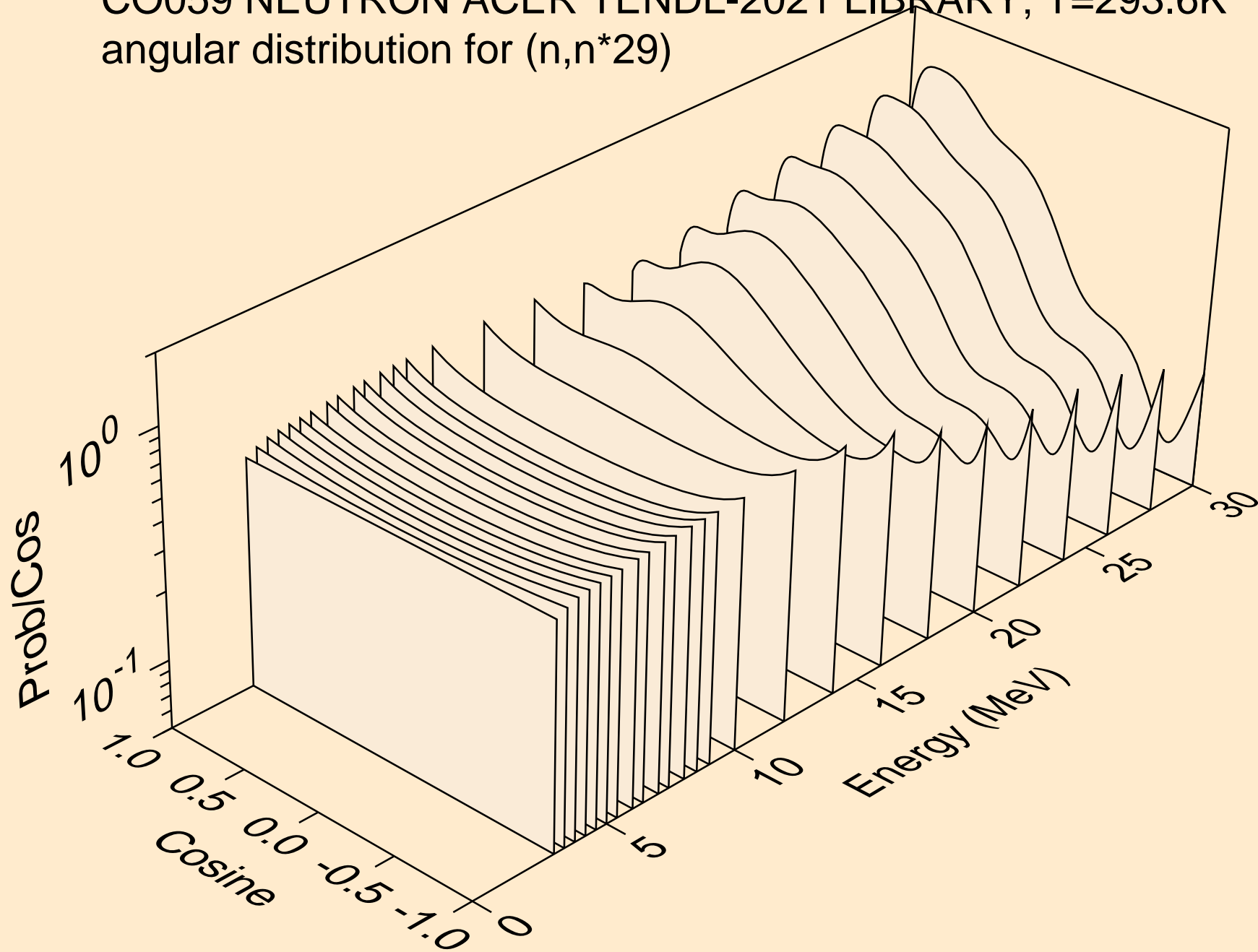

CO059 NEUTRON ACER TENDL-2021 LIBRARY; T=293.6K  
angular distribution for (n,n\*30)

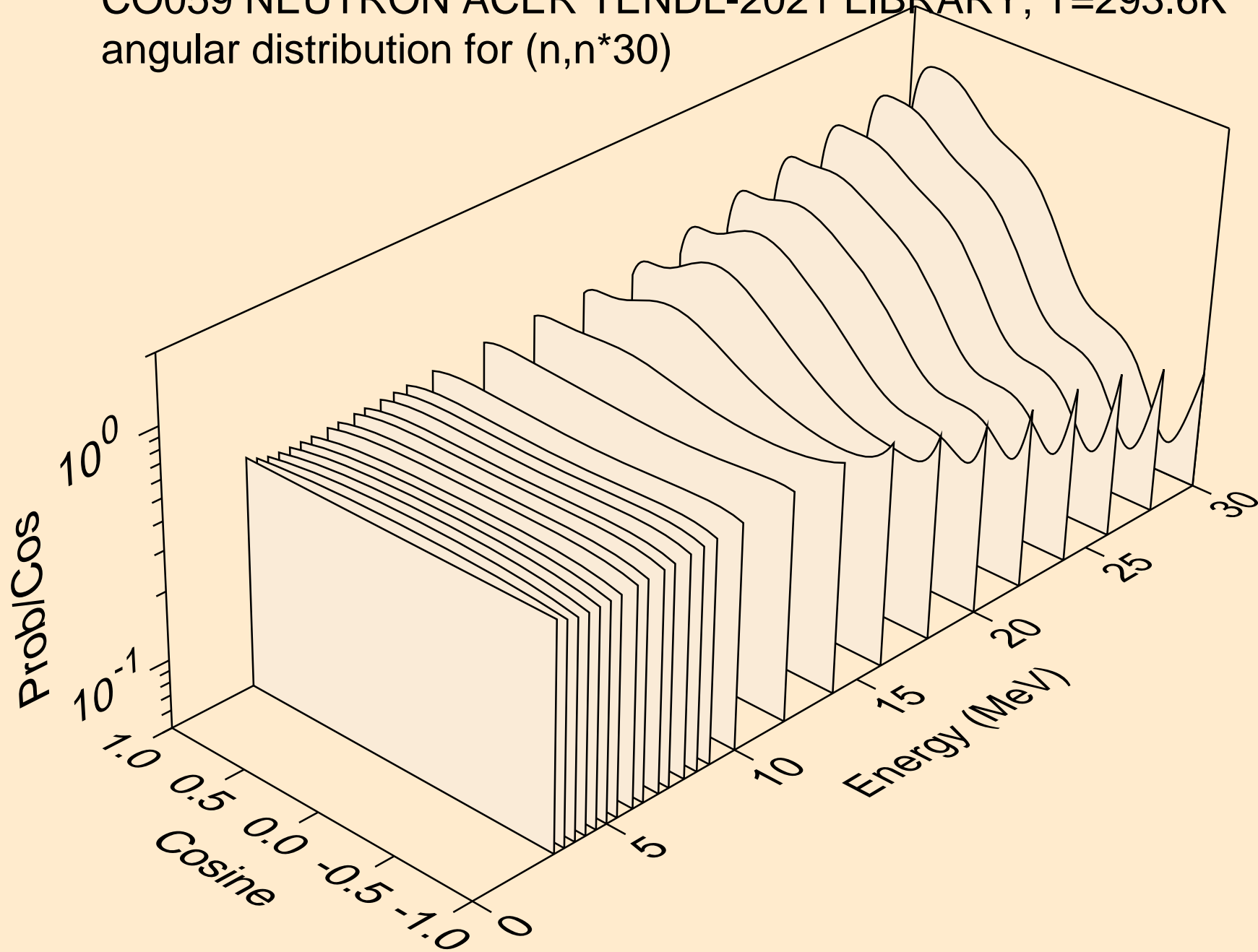

CO059 NEUTRON ACER TENDL-2021 LIBRARY; T=293.6K  
Neutron emission for (n,x)

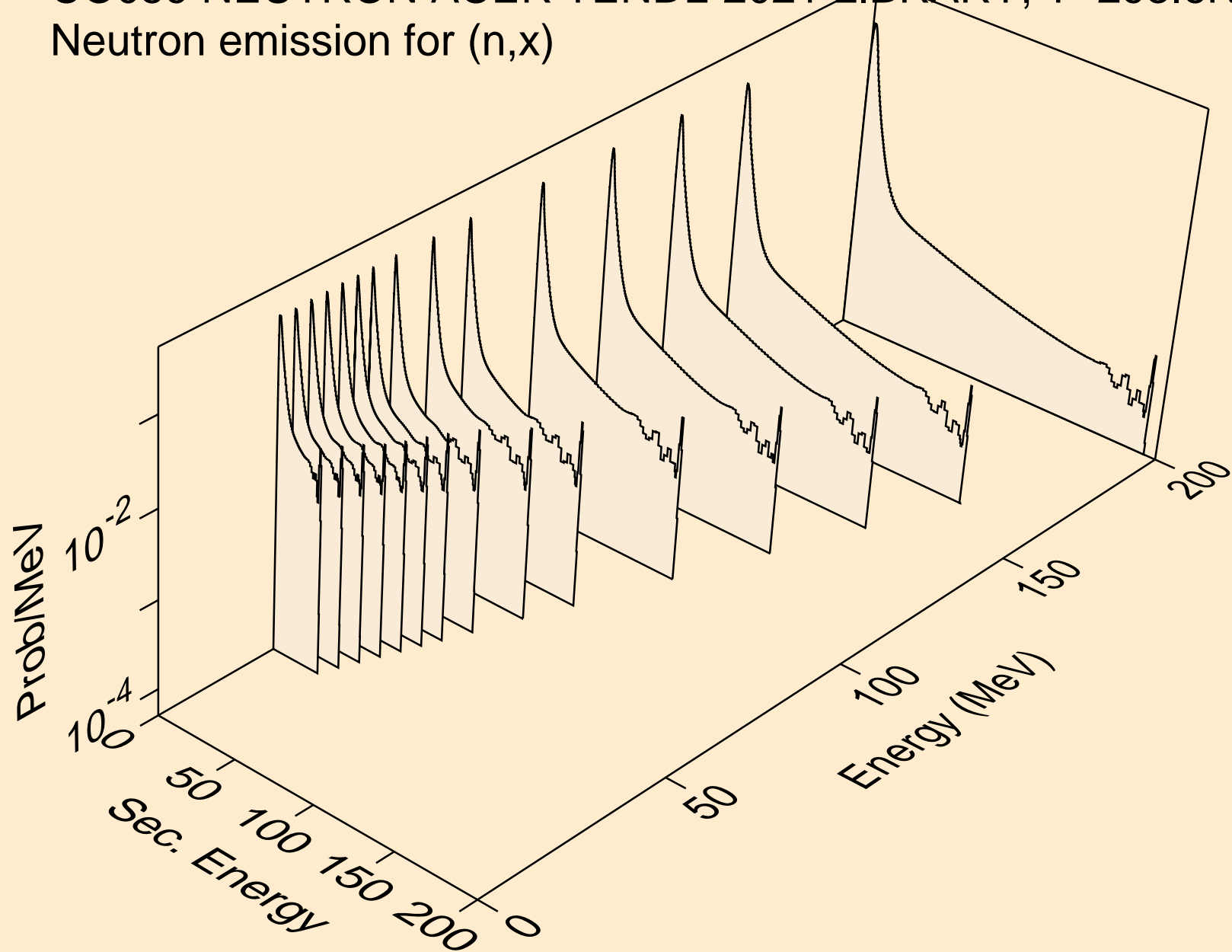



CO059 NEUTRON ACER TENDL-2021 LIBRARY; T=293.6K  
Neutron emission for (n,2nd)

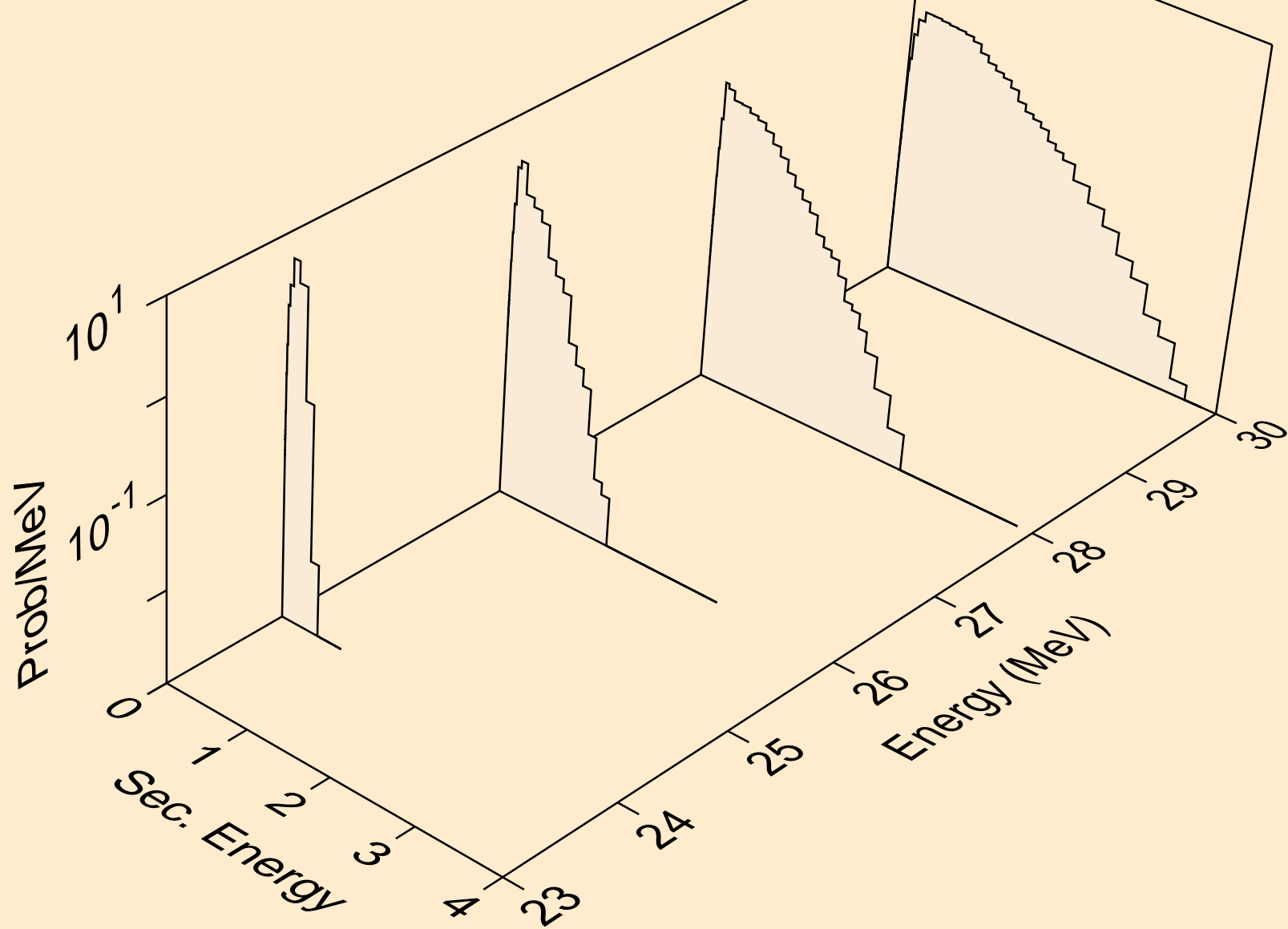

CO059 NEUTRON ACER TENDL-2021 LIBRARY; T=293.6K  
Neutron emission for (n,2n)

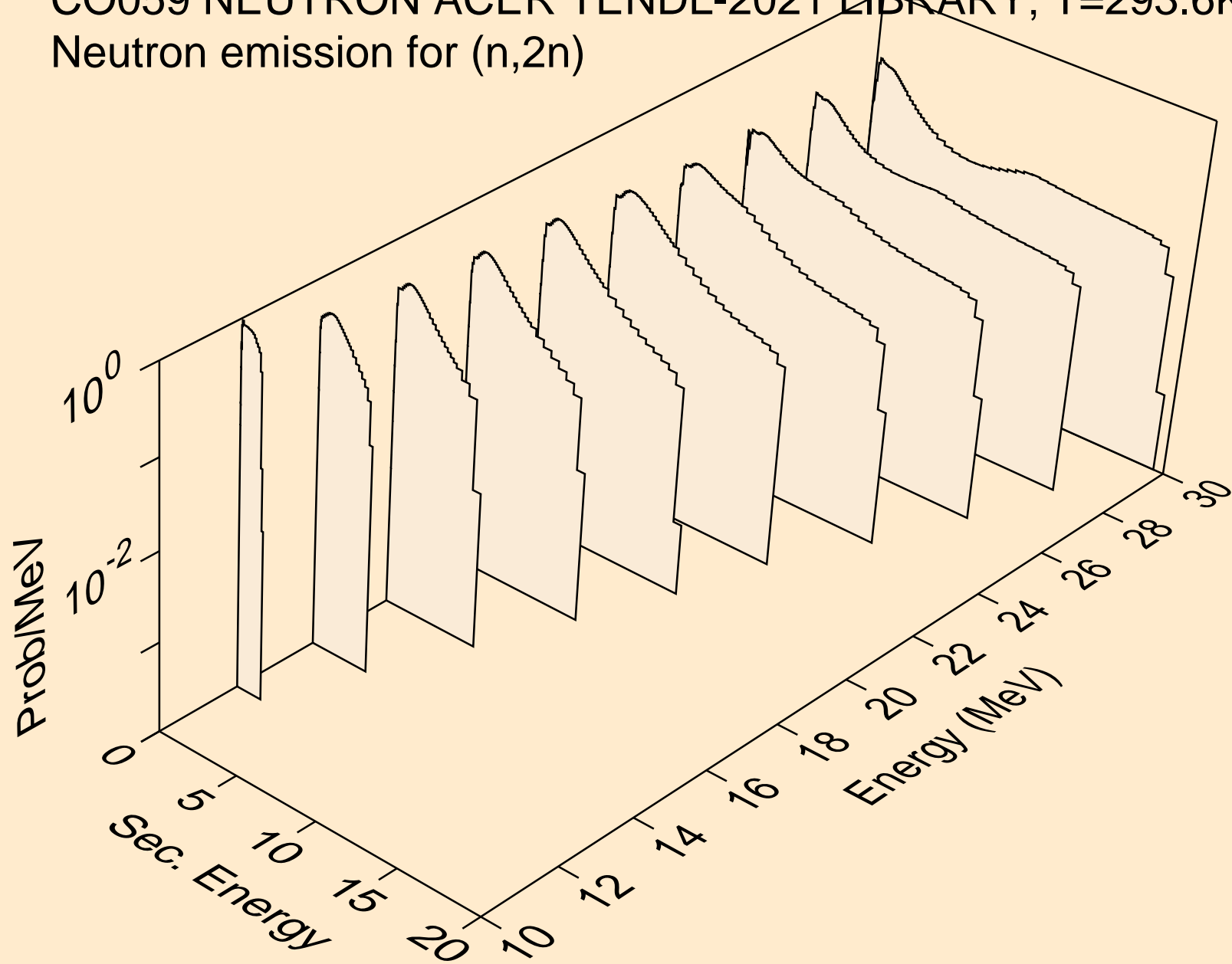

CO059 NEUTRON ACER TENDL-2021 LIBRARY; T=293.6K  
Neutron emission for (n,3n)

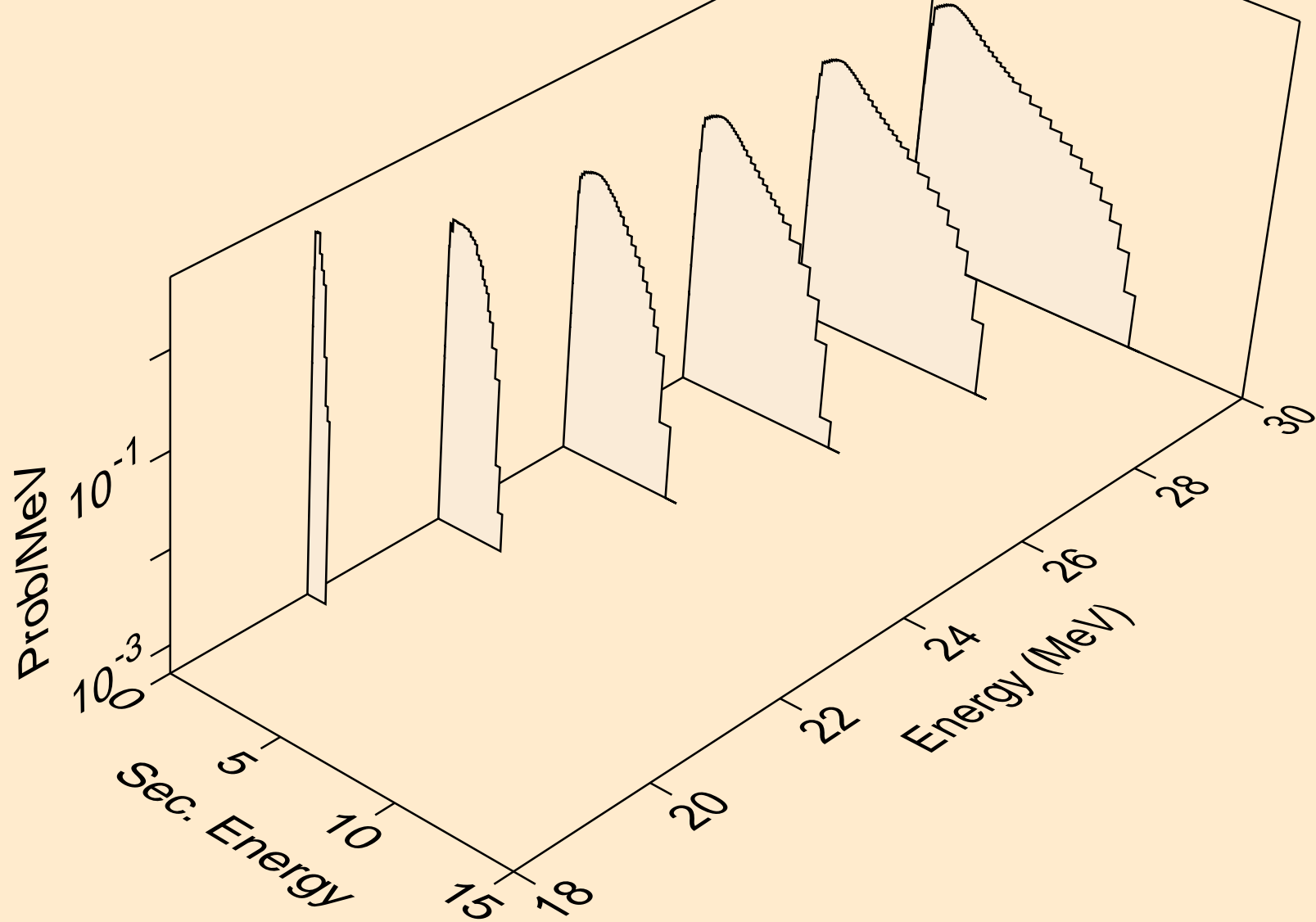

CO059 NEUTRON ACER TENDL-2021 LIBRARY; T=293.6K  
Neutron emission for (n,n\*)a

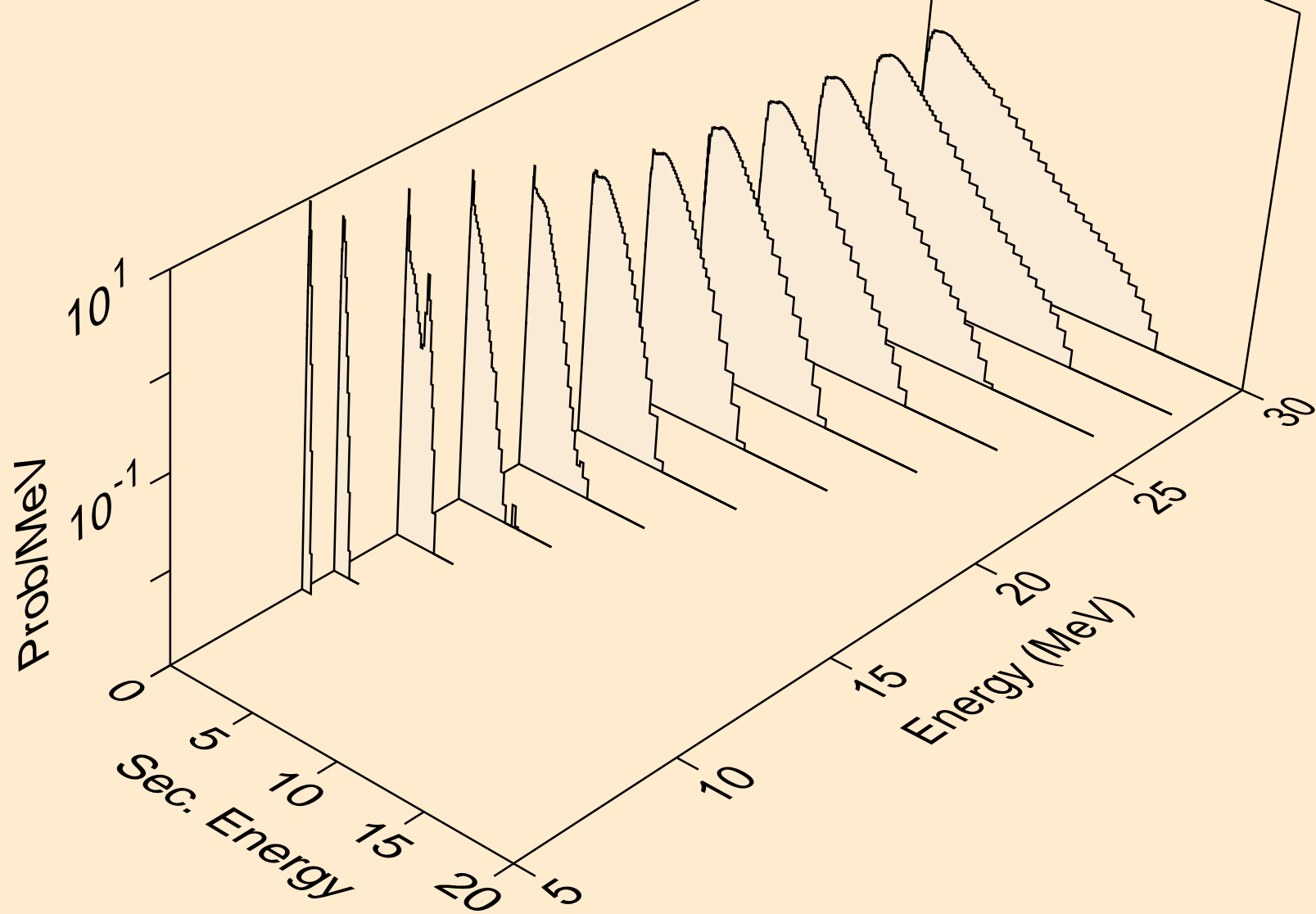

CO059 NEUTRON ACER TENDL-2021 LIBRARY; T=293.6K  
Neutron emission for (n,2n)a

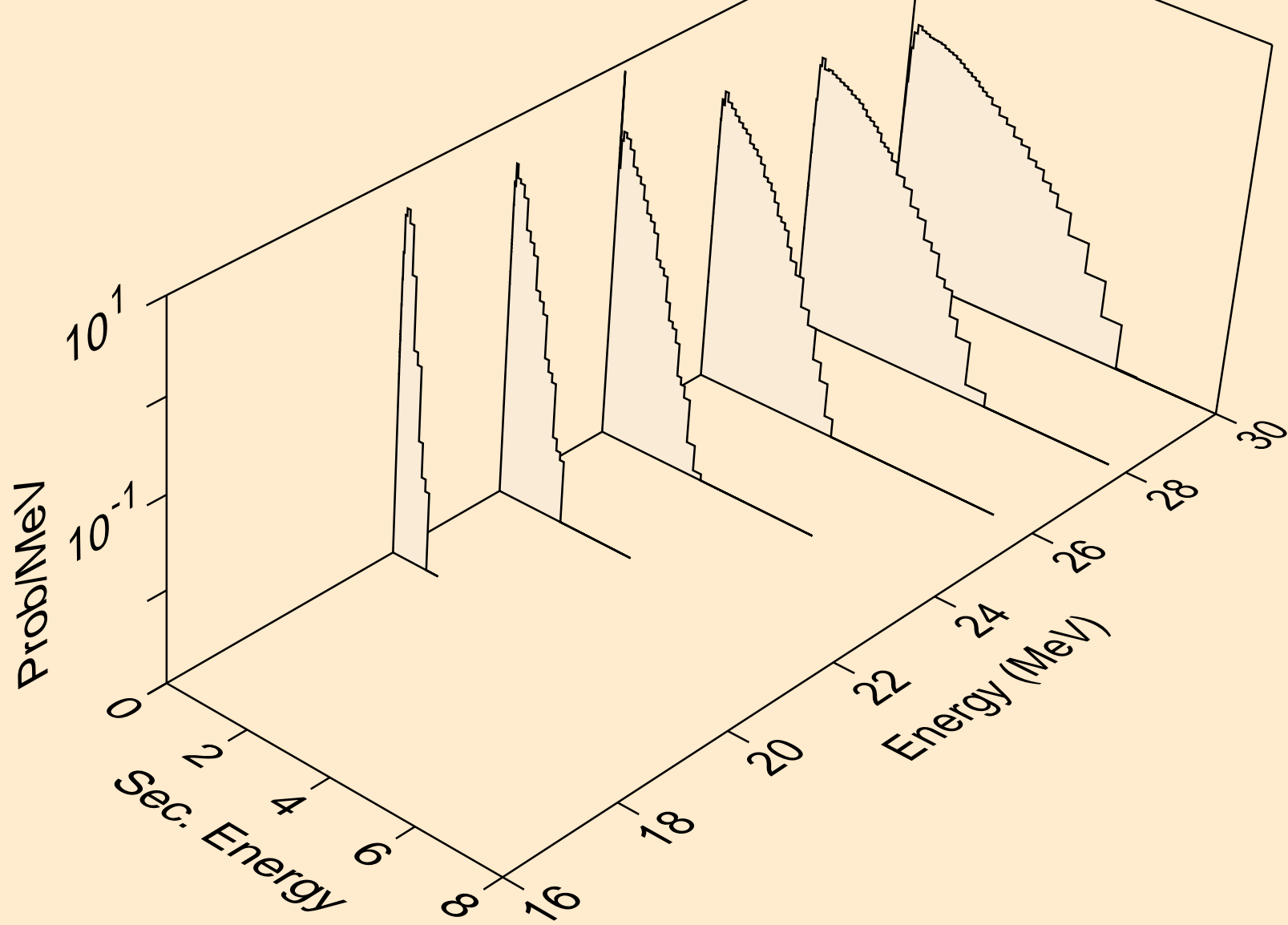

CO059 NEUTRON ACER TENDL-2021 LIBRARY; T=293.6K  
Neutron emission for (n,n\*)p

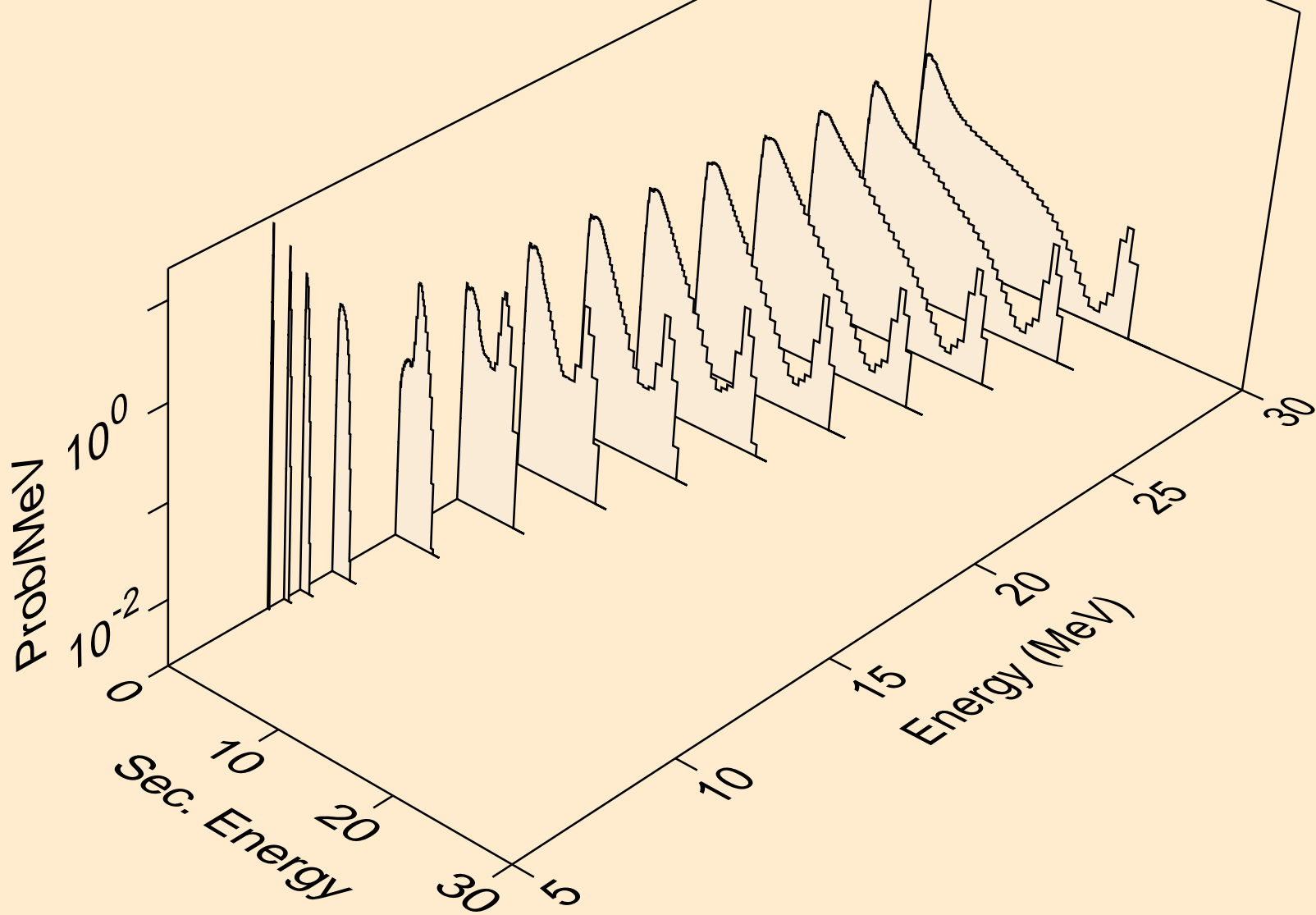

CO059 NEUTRON ACER TENDL-2021 LIBRARY; T=293.6K  
Neutron emission for (n,n\*)2a

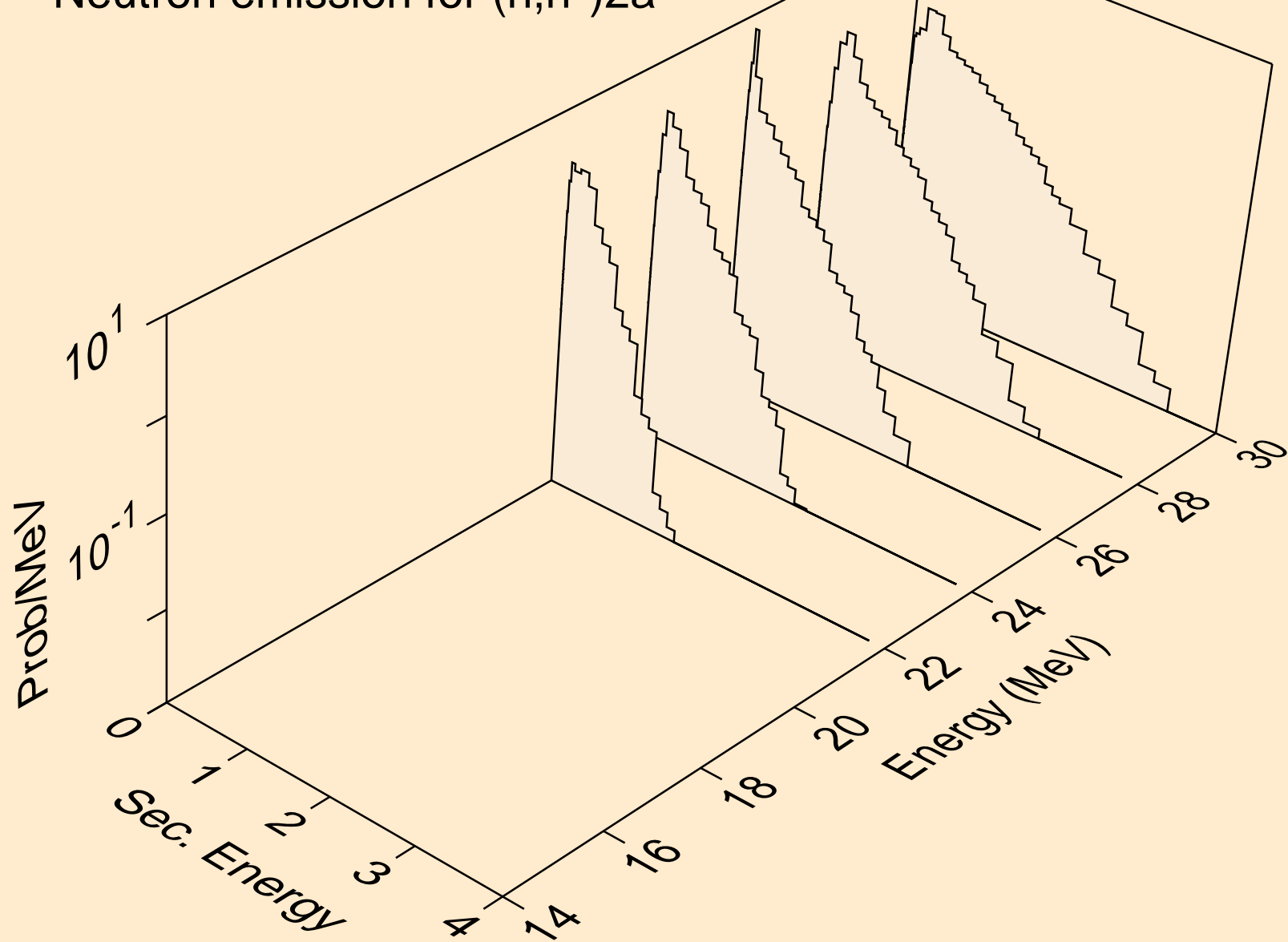

CO059 NEUTRON ACER TENDL-2021 LIBRARY; T=293.6K  
Neutron emission for (n,n\*)d

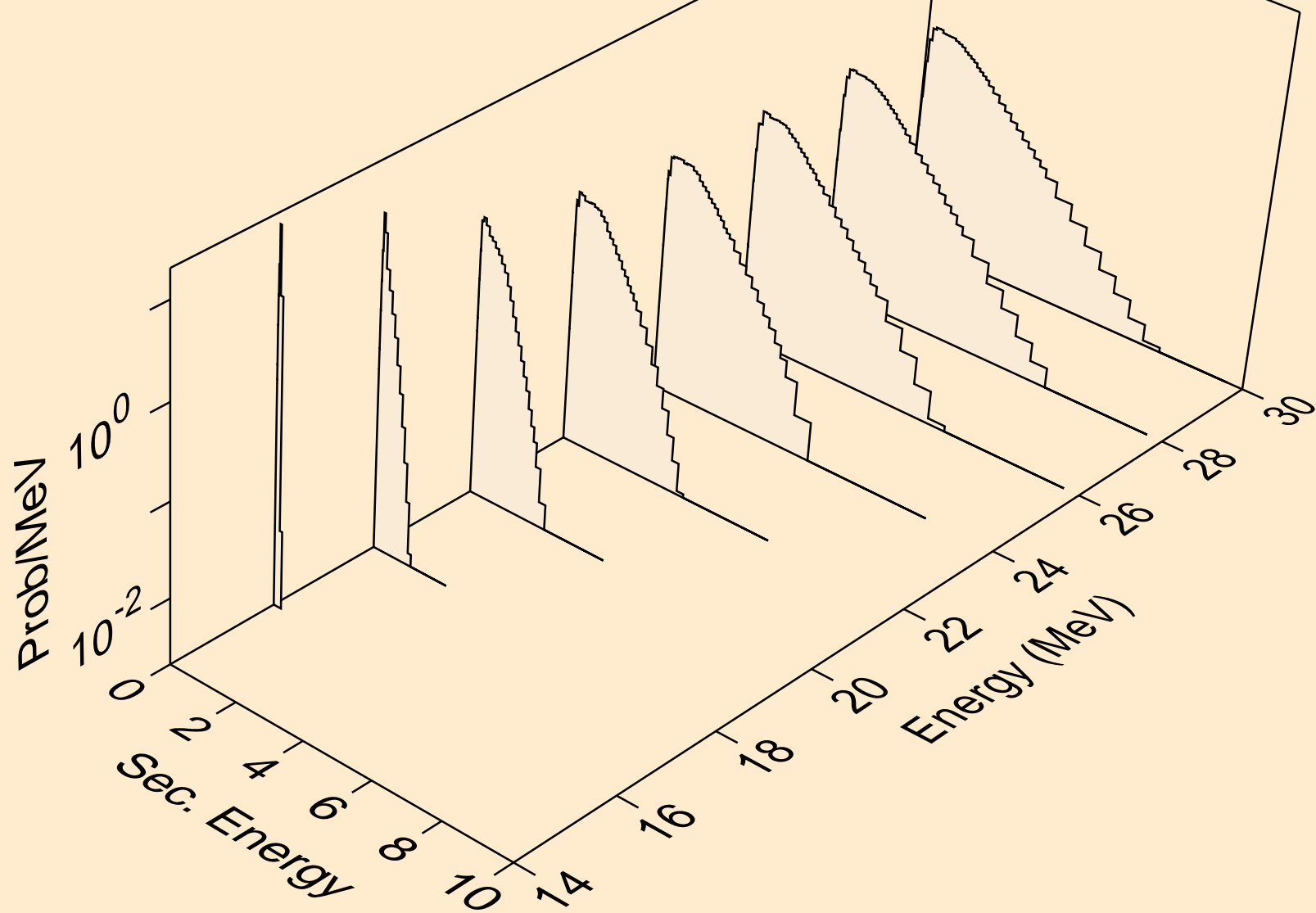



CO059 NEUTRON ACER TENDL-2021 LIBRARY; T=293.6K  
Neutron emission for (n,n\*)t

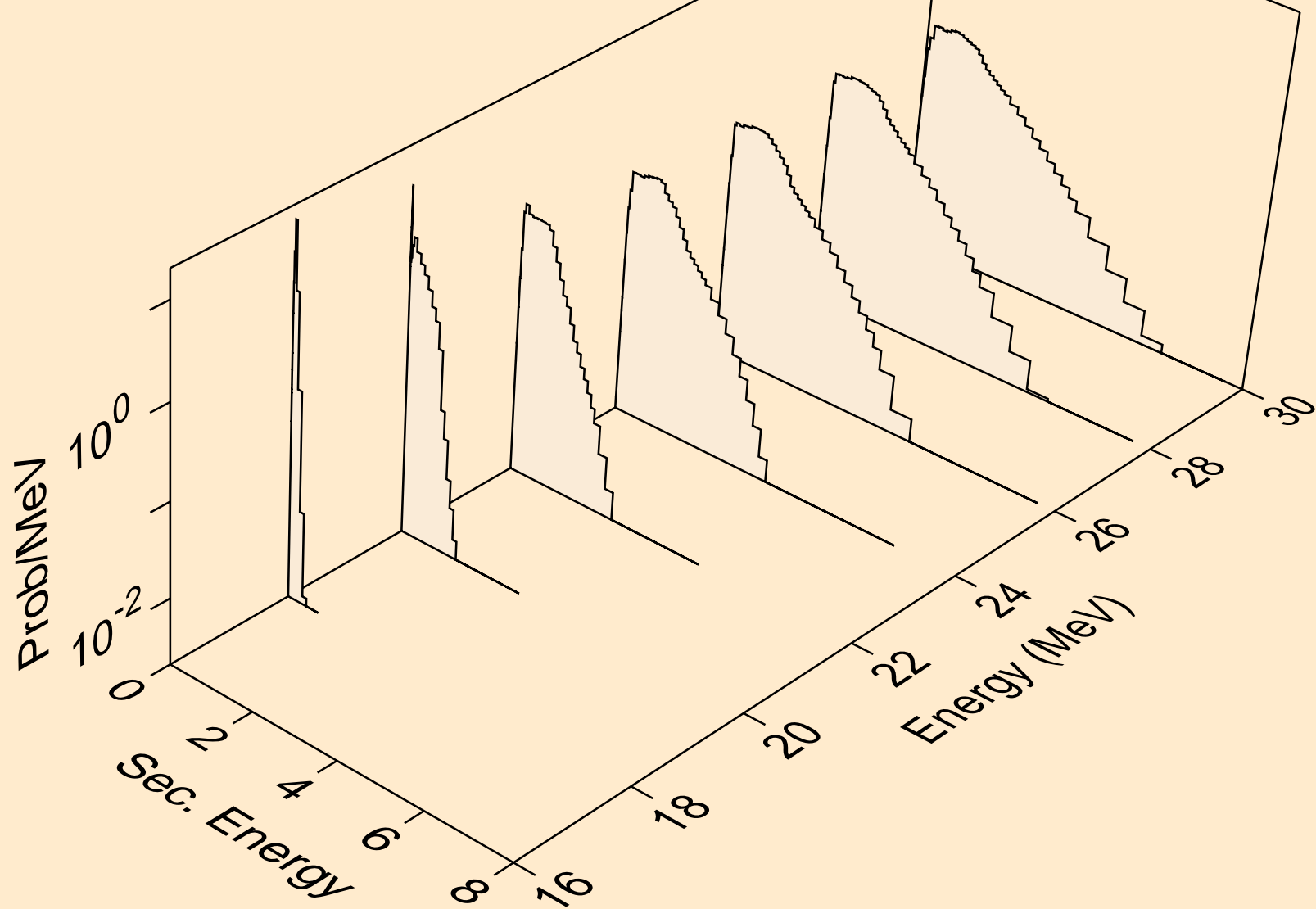

CO059 NEUTRON ACER TENDL-2021 LIBRARY; T=293.6K  
Neutron emission for (n,n\*)he3

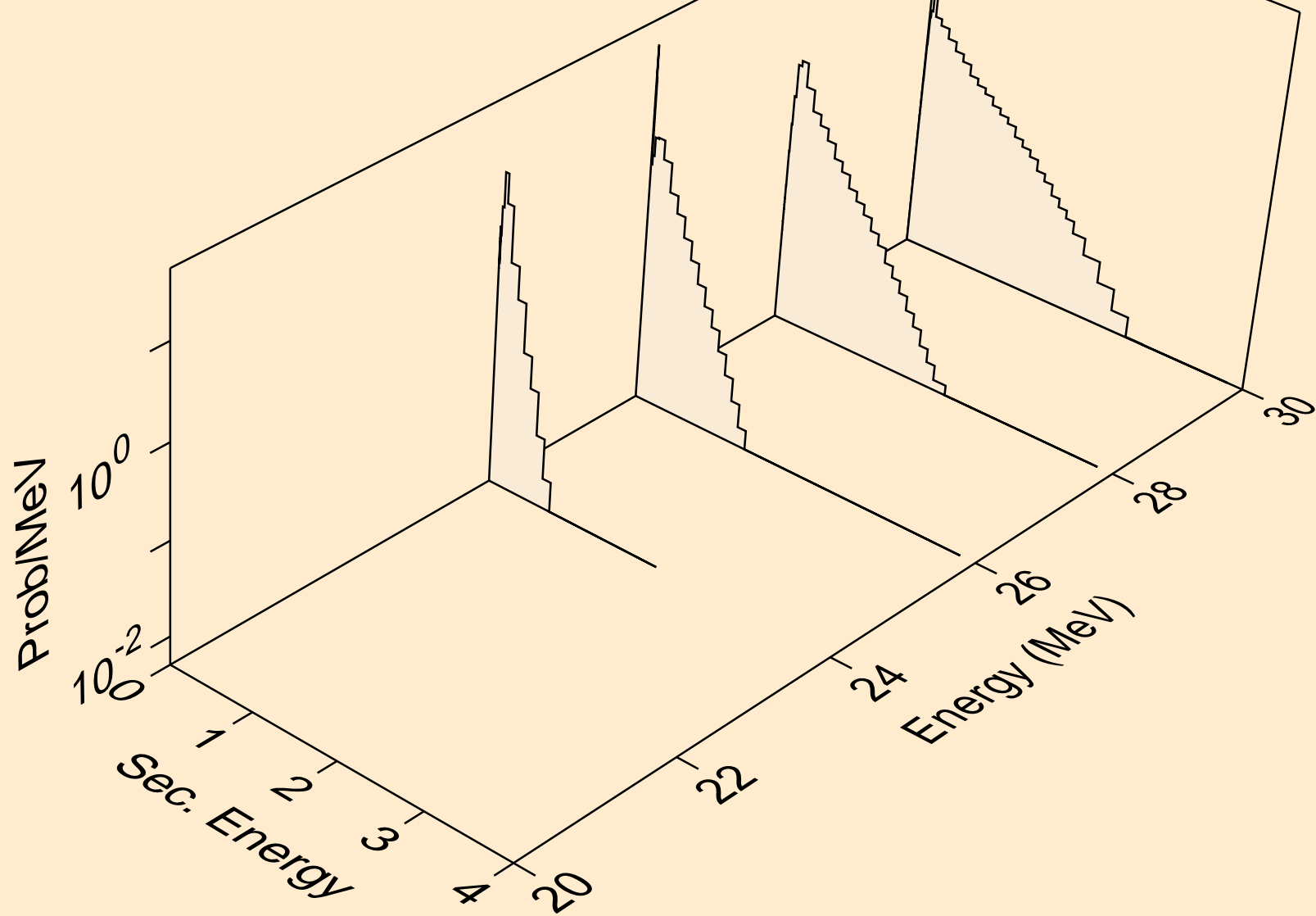

CO059 NEUTRON ACER TENDL-2021 LIBRARY; T=293.6K  
Neutron emission for (n,2np)

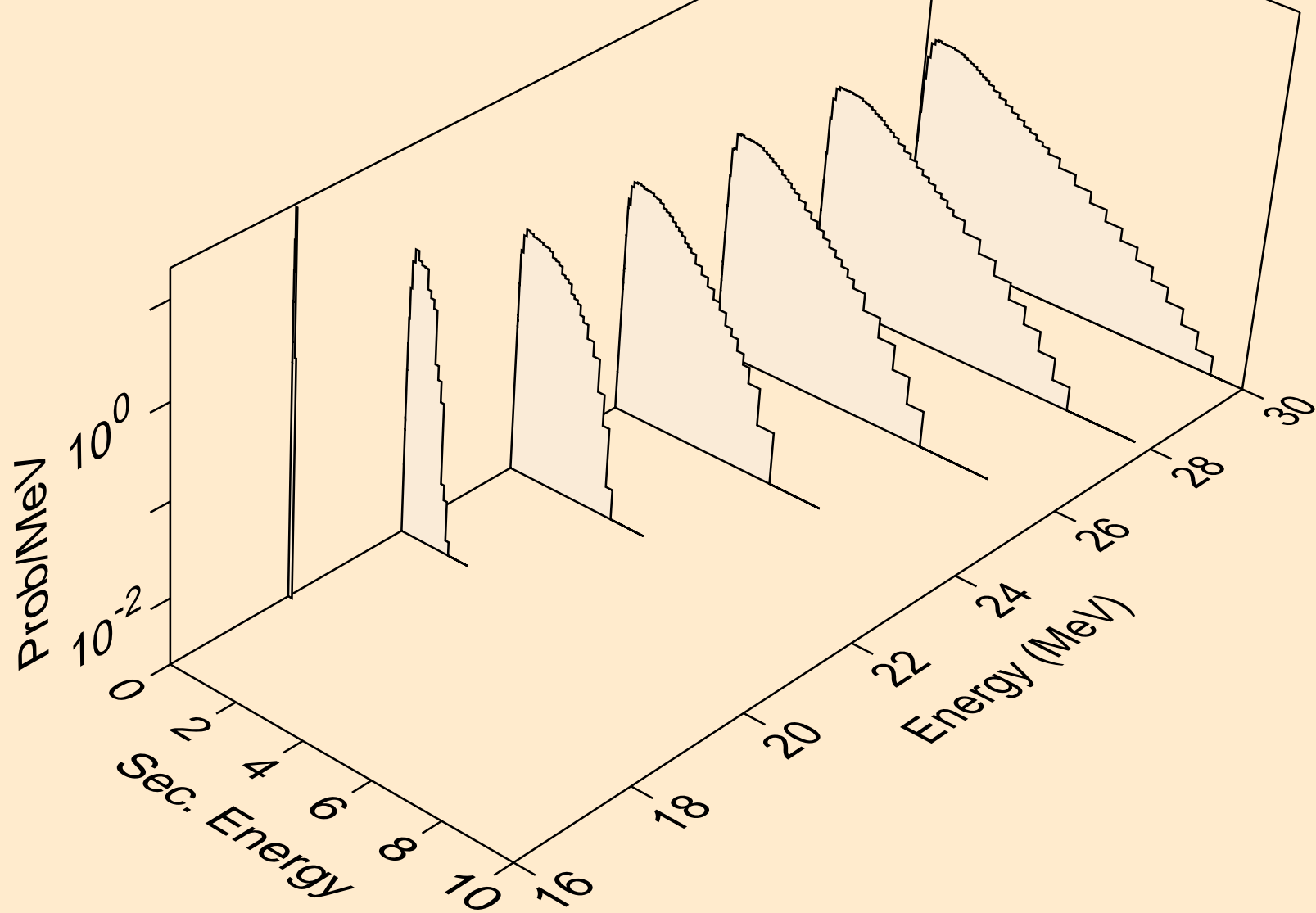

CO059 NEUTRON ACER TENDL-2021 LIBRARY; T=293.6K  
Neutron emission for (n,3np)

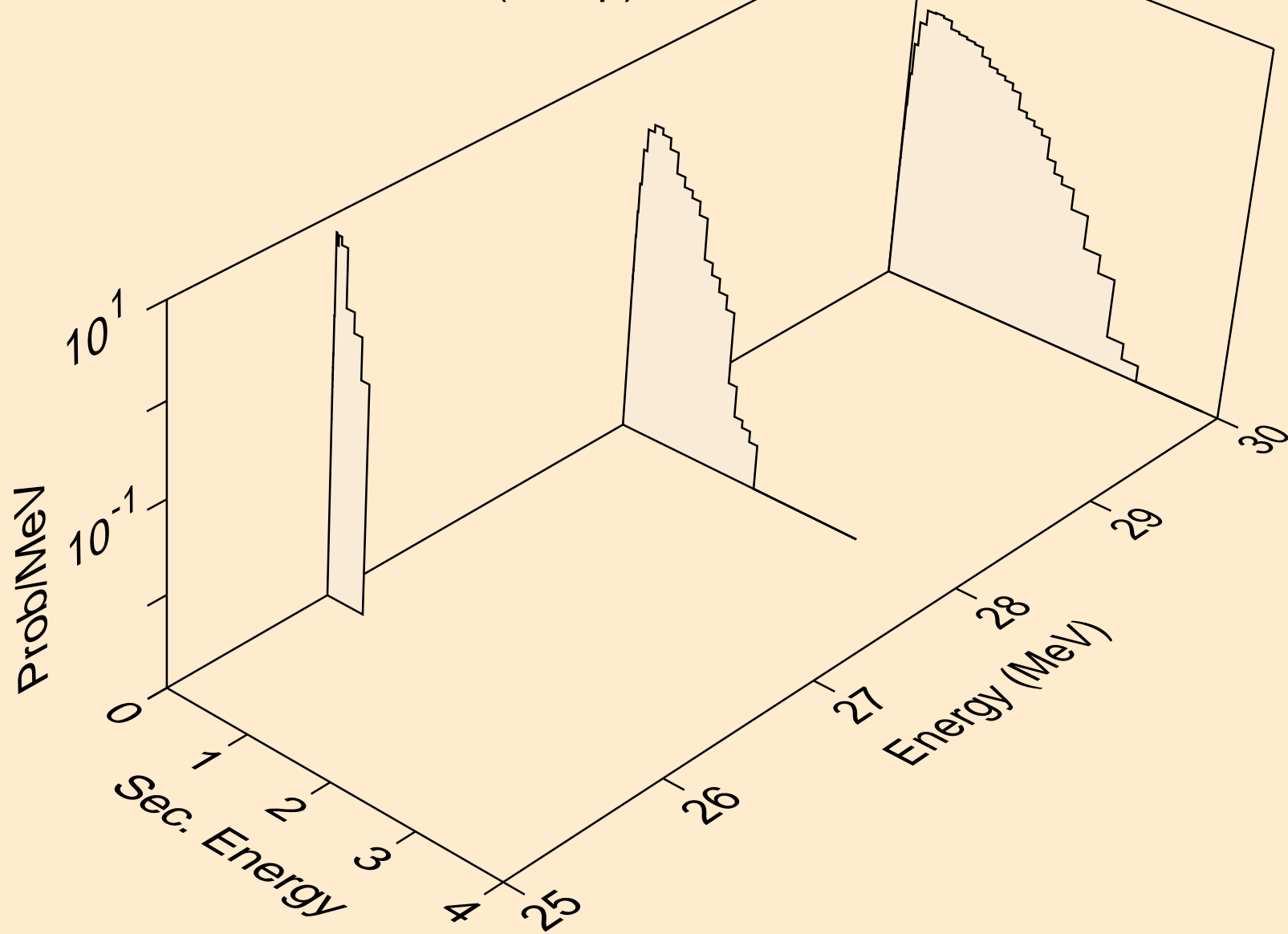

CO059 NEUTRON ACER TENDL-2021 LIBRARY; T=293.6K  
Neutron emission for (n,2np)

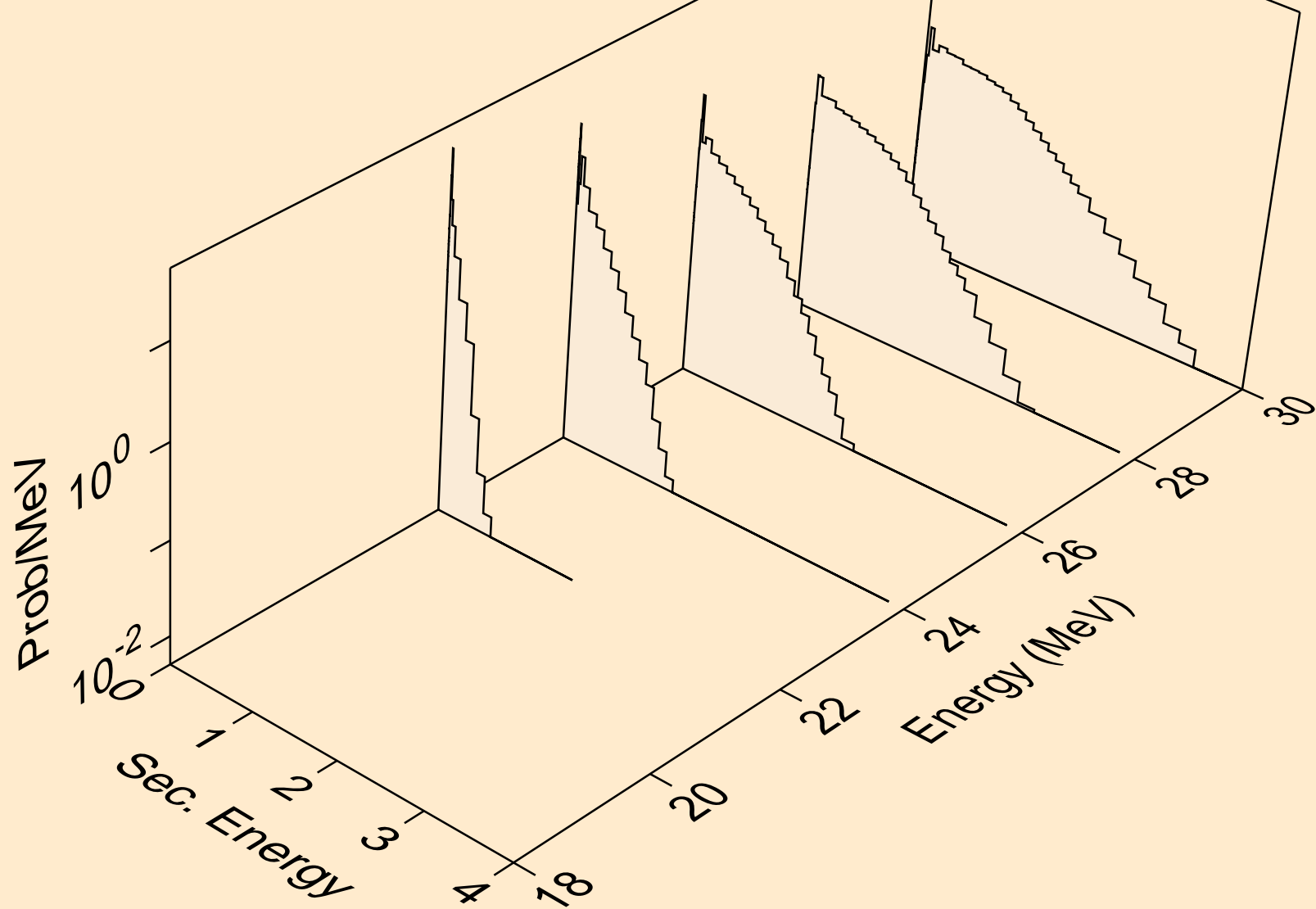

CO059 NEUTRON ACER TENDL-2021 LIBRARY; T=293.6K  
Neutron emission for (n,npa)

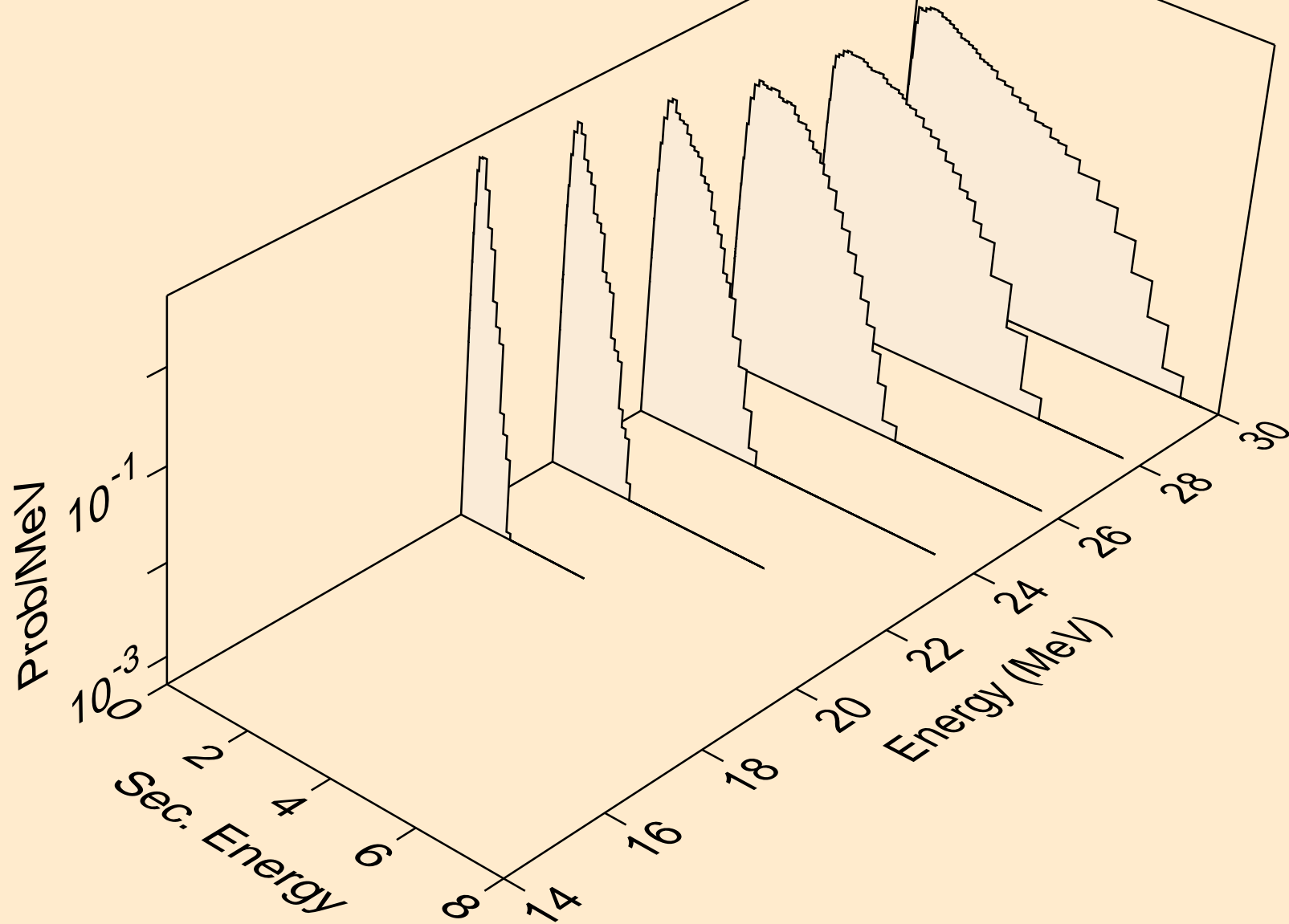

CO059 NEUTRON ACER TENDL-2021 LIBRARY; T=293.6K  
Neutron emission for (n,n\*c)

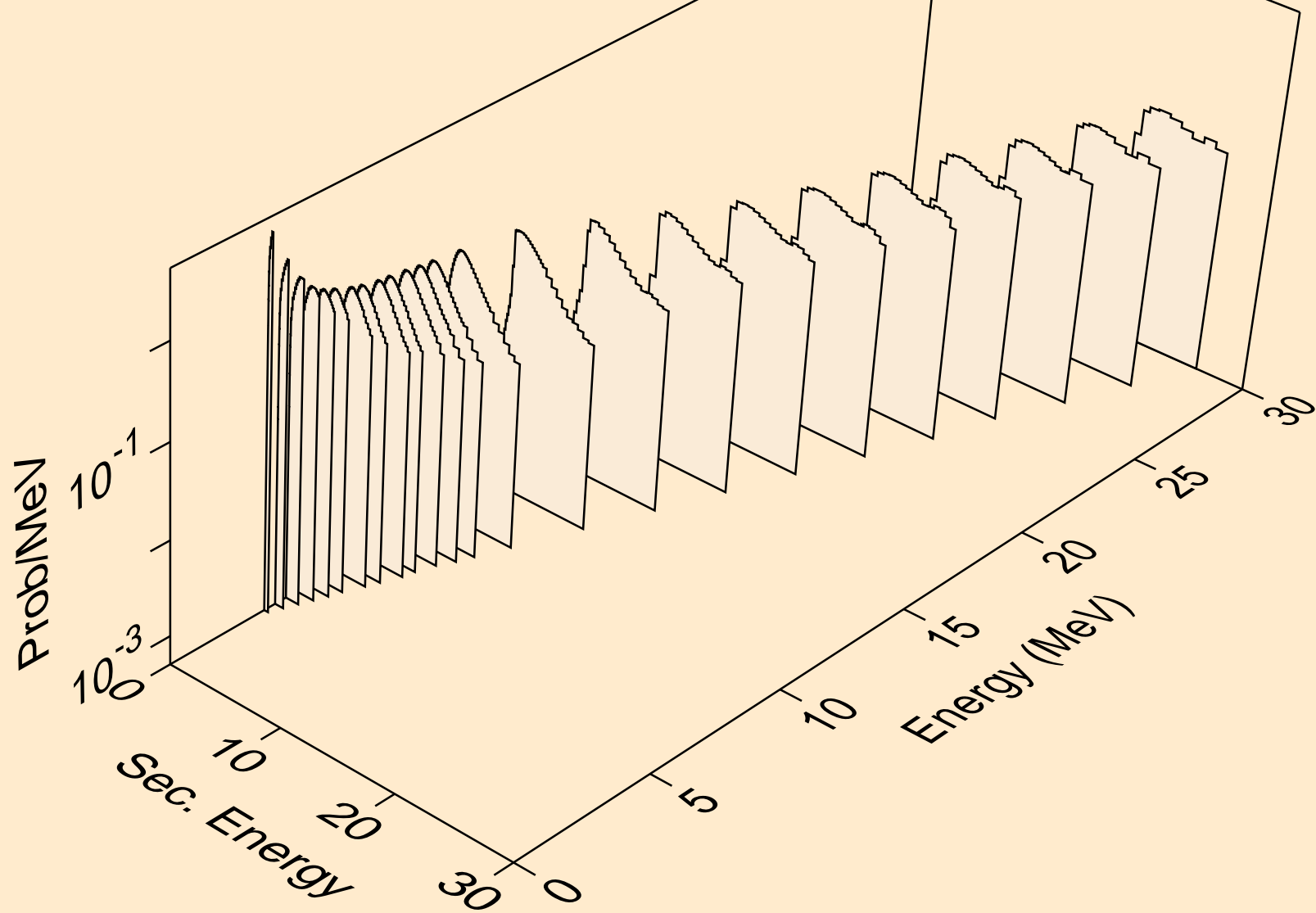

CO059 NEUTRON ACER TENDL-2021 LIBRARY; T=293.6K  
Photon emission for (n,x)

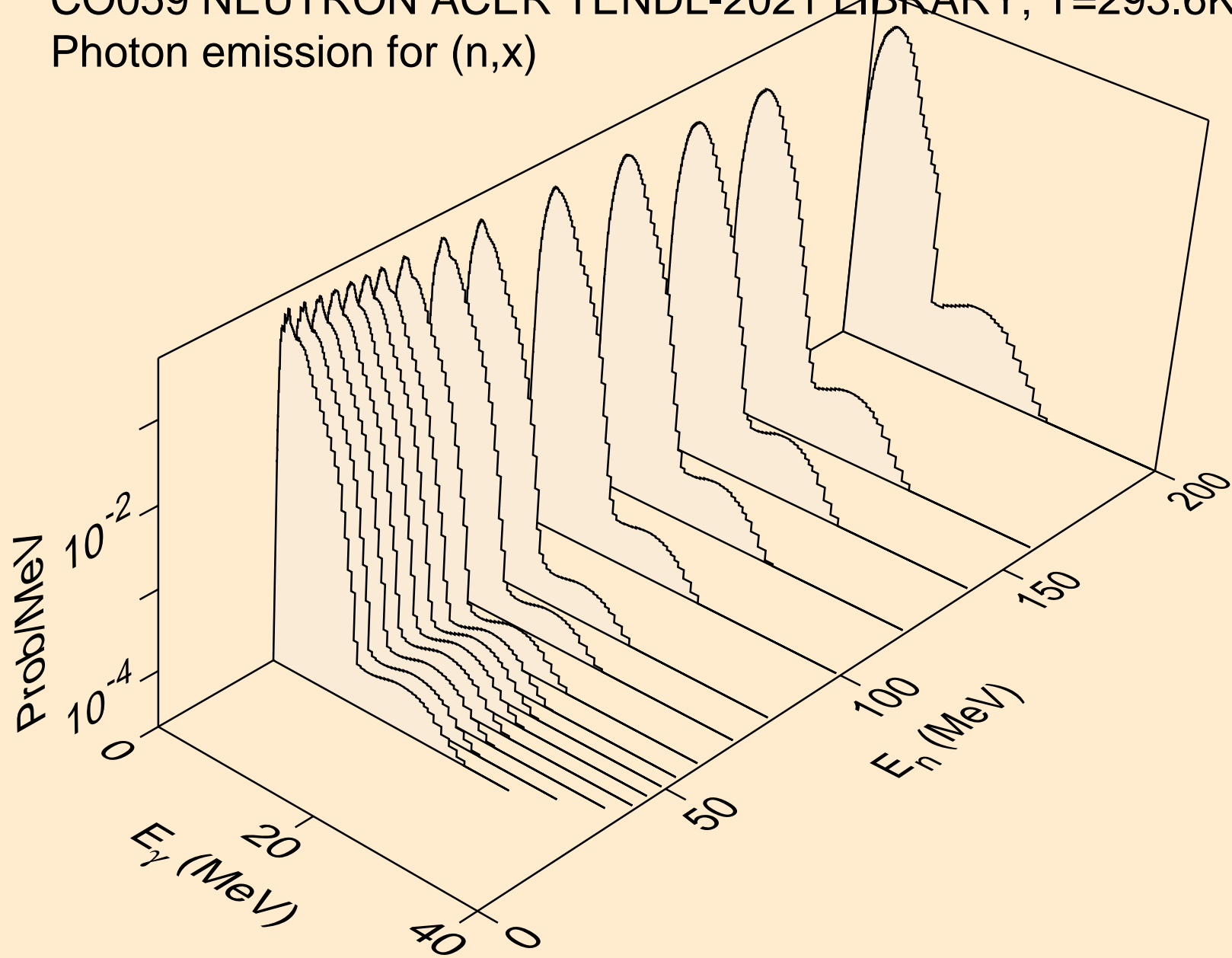



CO059 NEUTRON ACER TENDL-2021 LIBRARY; T=293.6K  
Photon emission for (n,2nd)

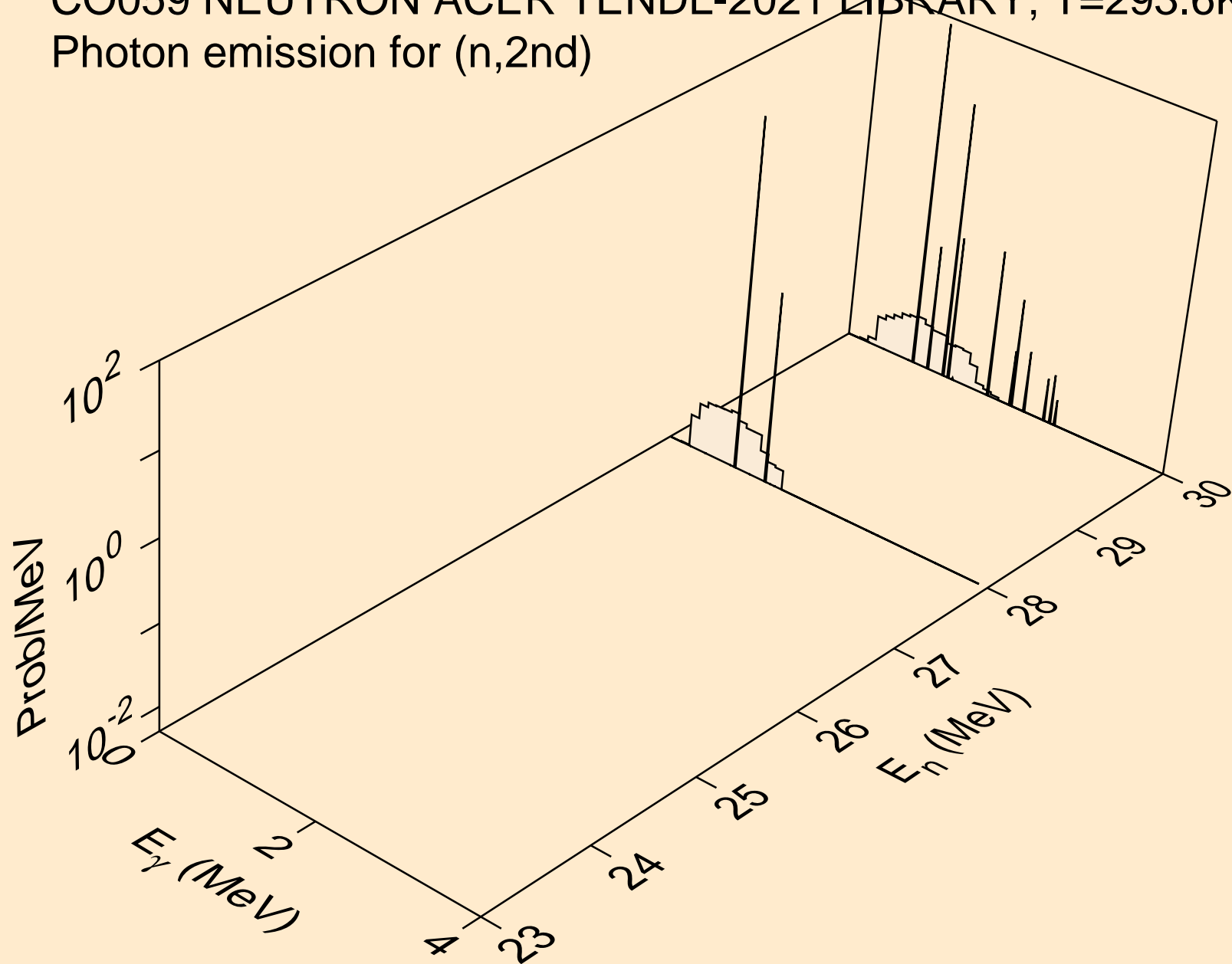

CO059 NEUTRON ACER TENDL-2021 LIBRARY; T=293.6K  
Photon emission for (n,2n)

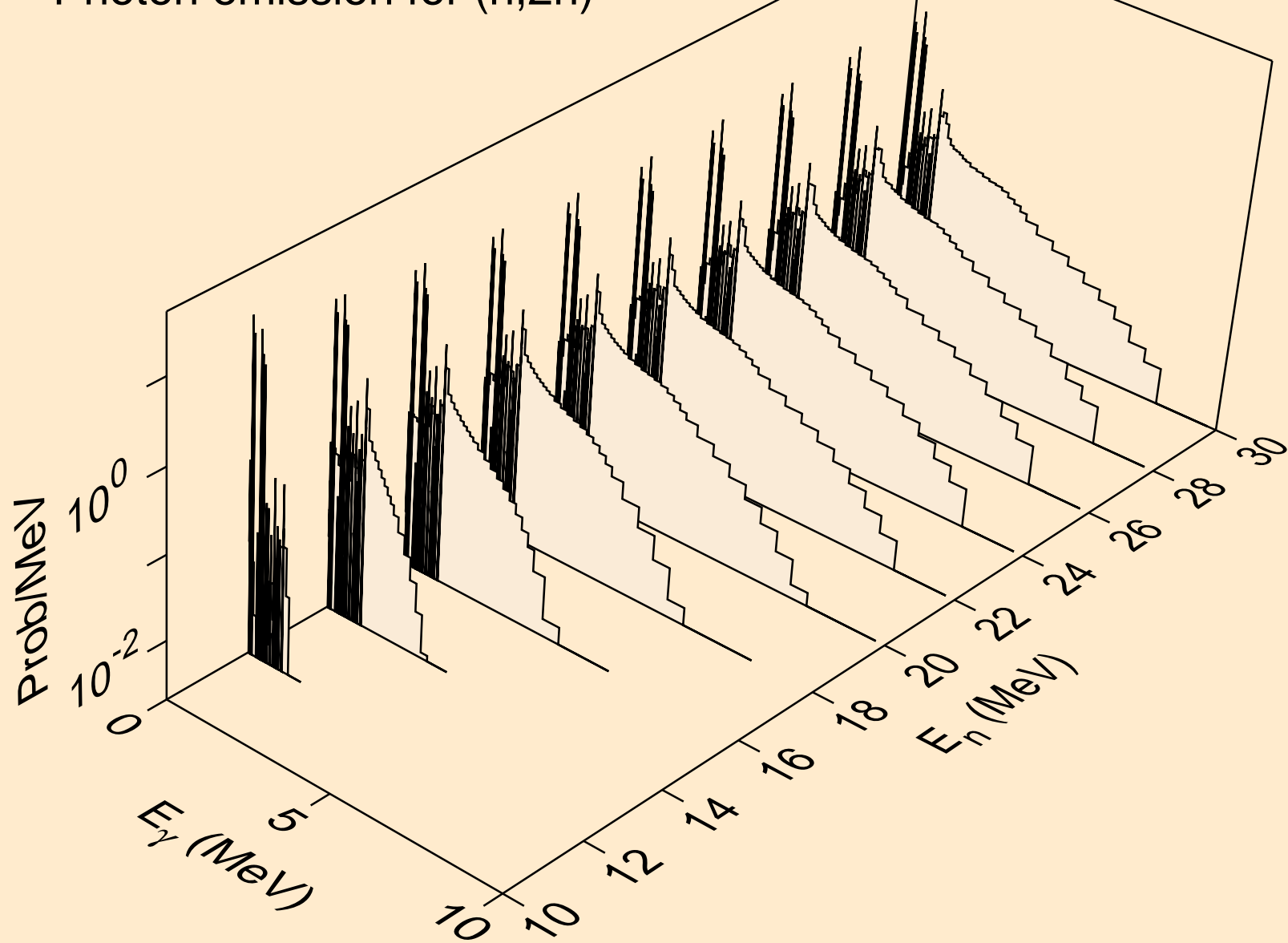

CO059 NEUTRON ACER TENDL-2021 LIBRARY; T=293.6K  
Photon emission for (n,3n)

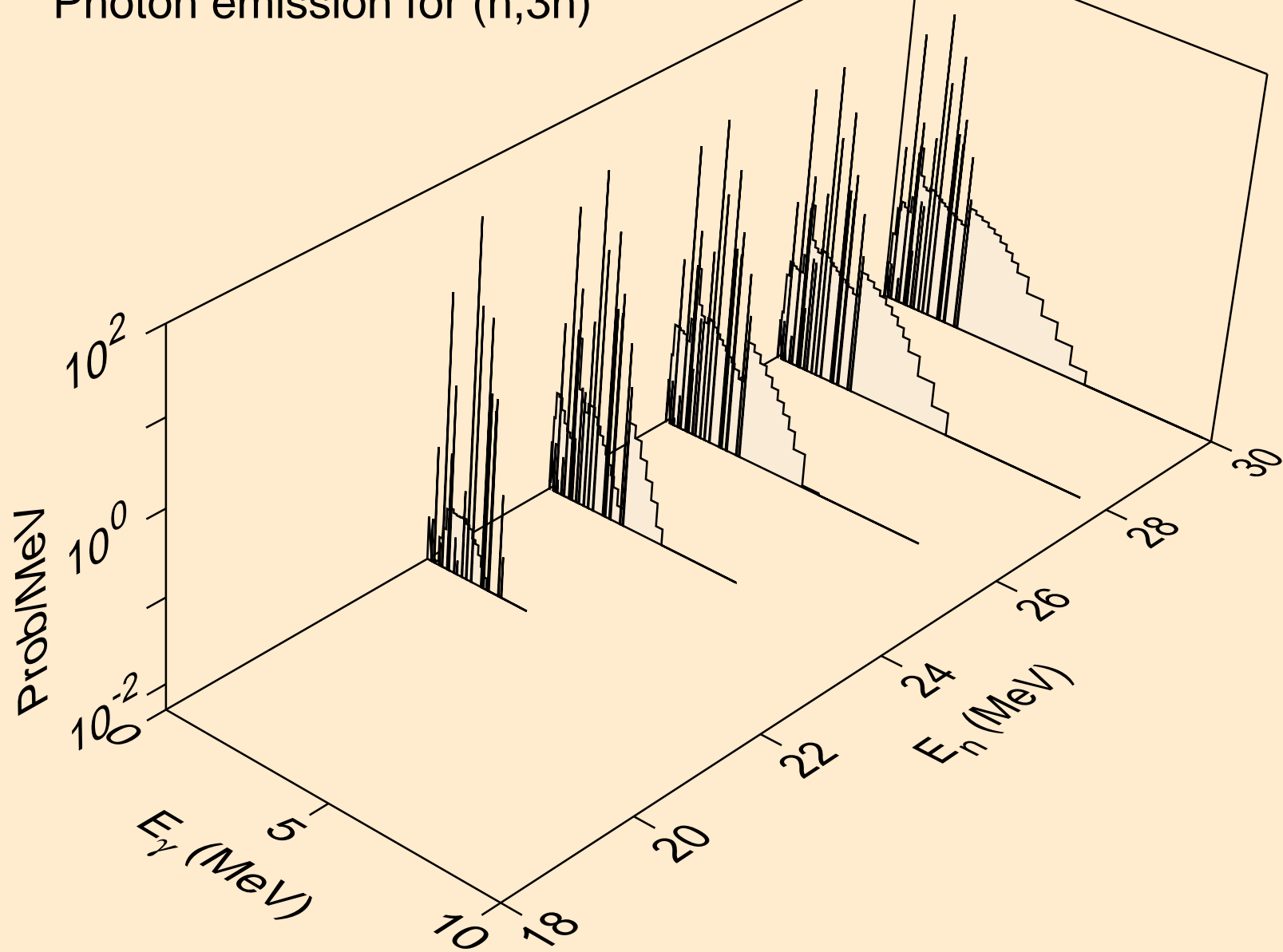

CO059 NEUTRON ACER TENDL-2021 LIBRARY; T=293.6K  
Photon emission for (n,n\*)a

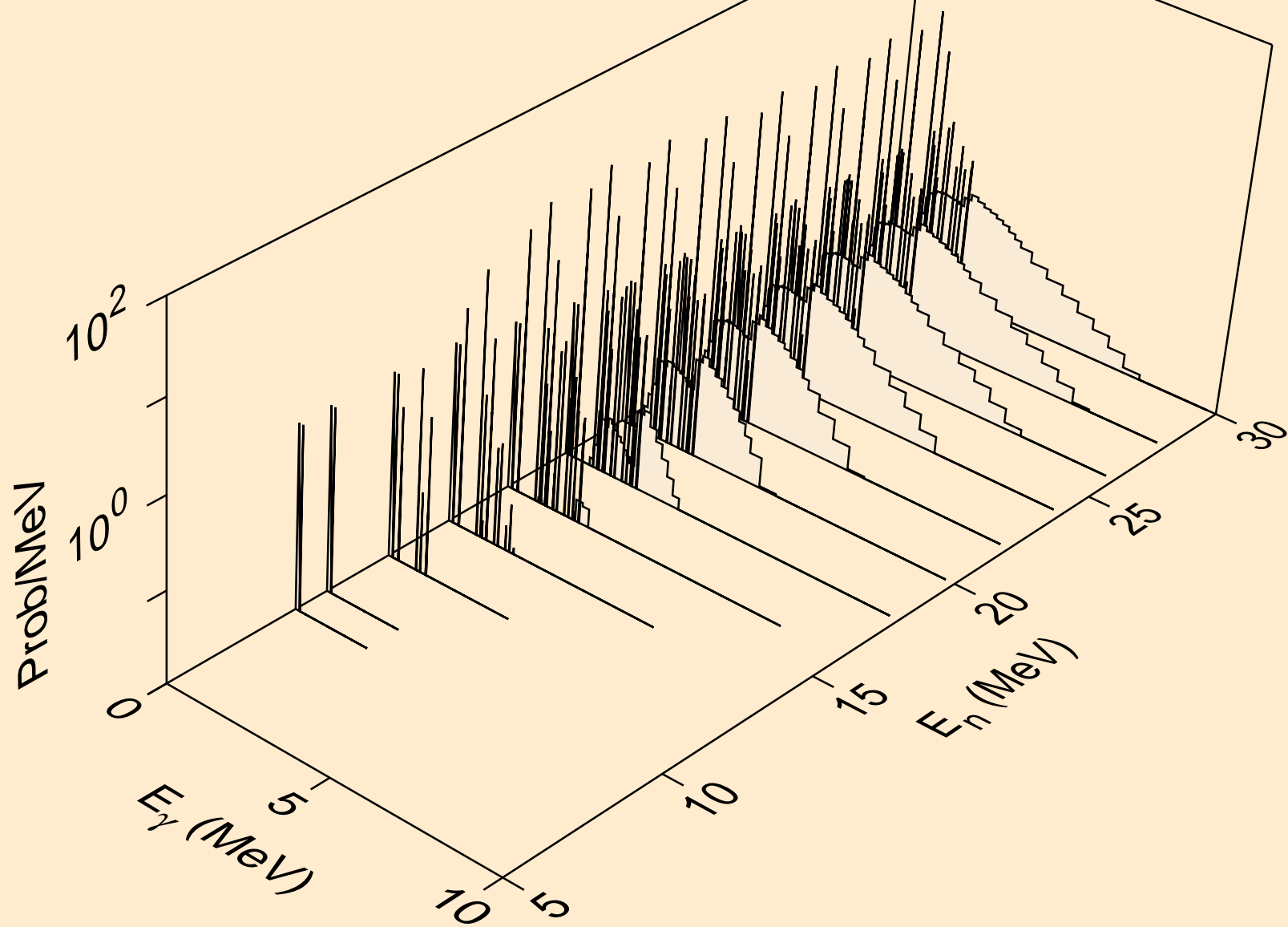

CO059 NEUTRON ACER TENDL-2021 LIBRARY; T=293.6K  
Photon emission for (n,2n)a

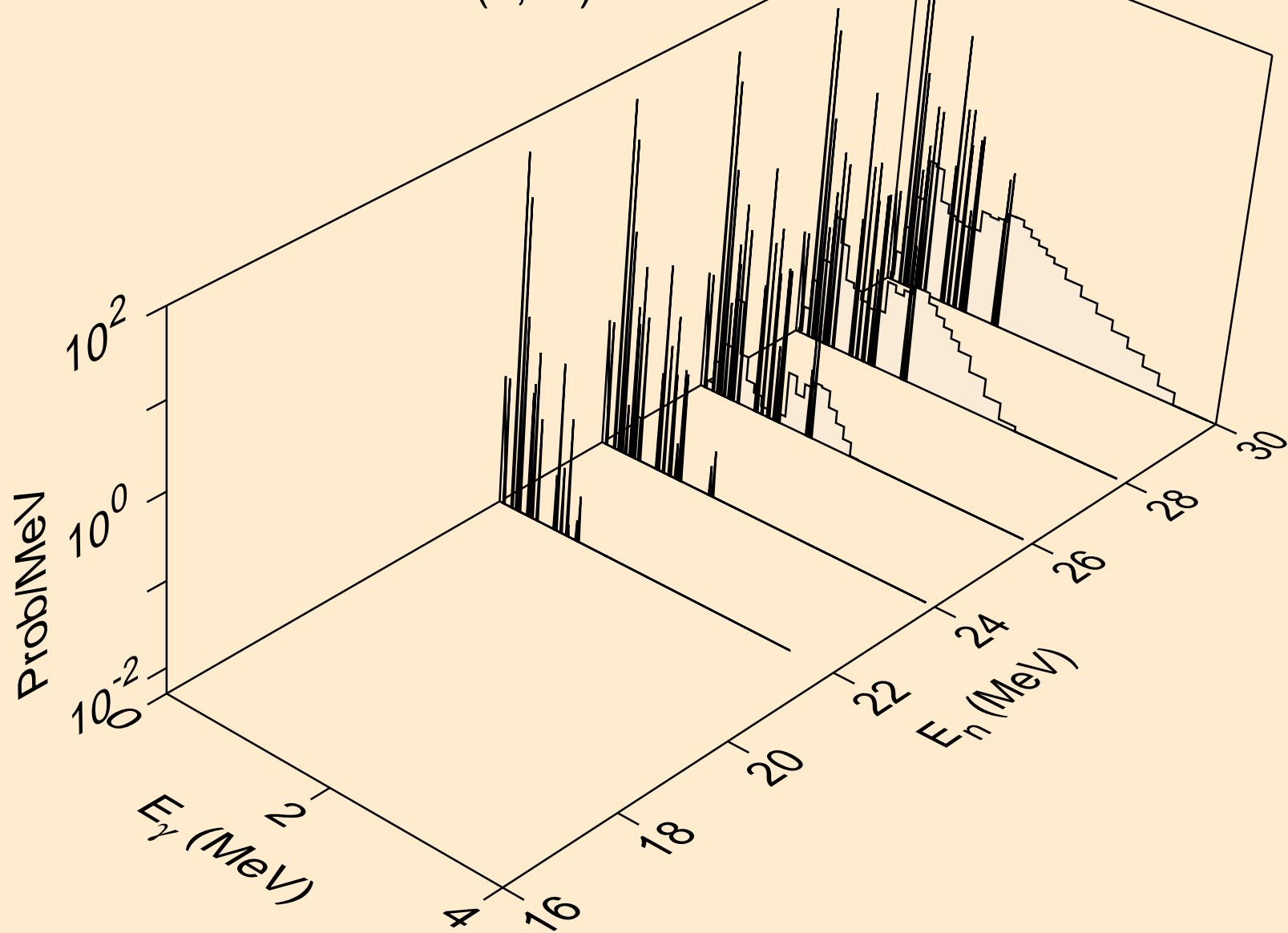

CO059 NEUTRON ACER TENDL-2021 LIBRARY; T=293.6K  
Photon emission for (n,n\*)p

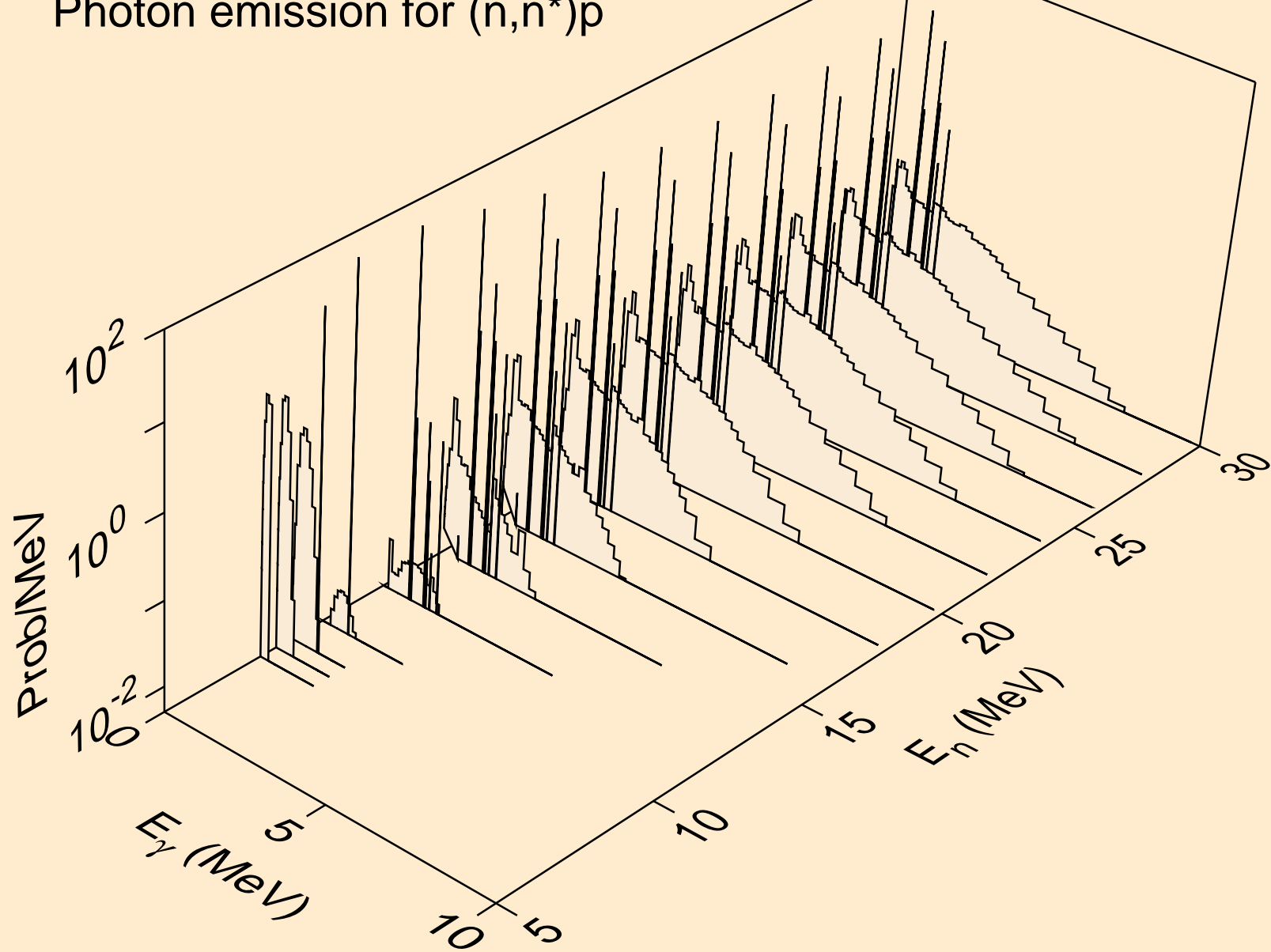

CO059 NEUTRON ACER TENDL-2021 LIBRARY; T=293.6K  
Photon emission for (n,n\*)2a

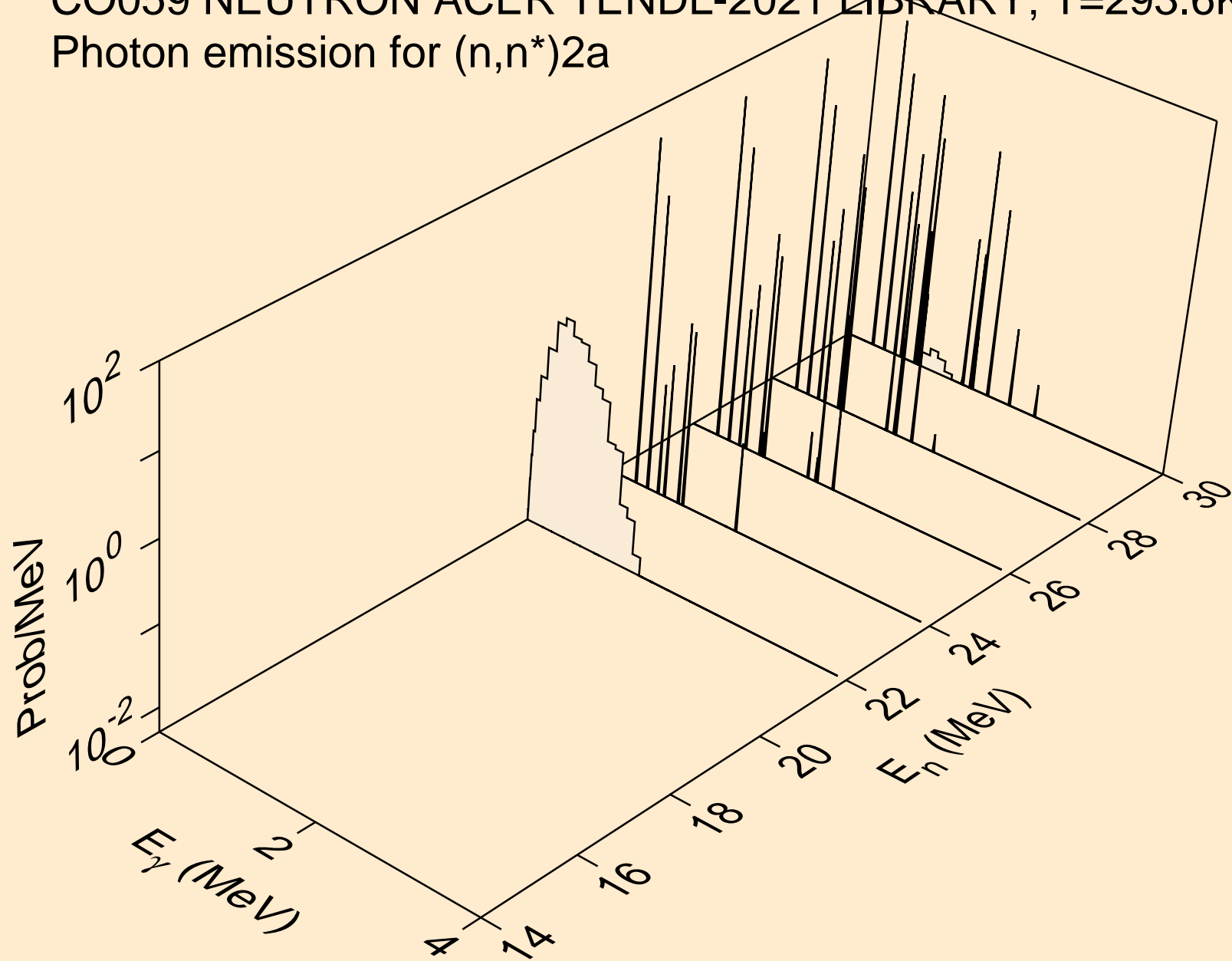

CO059 NEUTRON ACER TENDL-2021 LIBRARY; T=293.6K  
Photon emission for (n,n\*)d

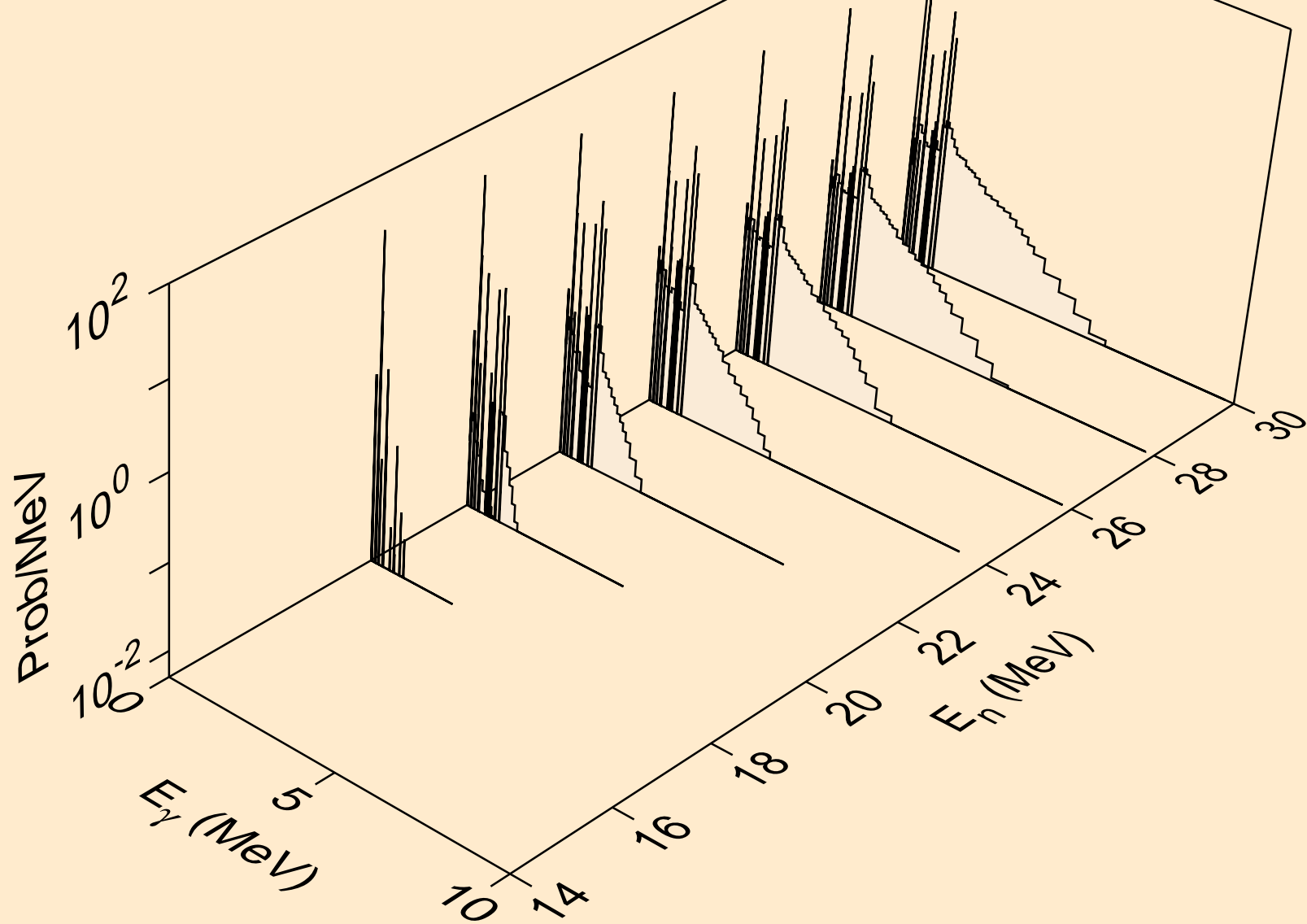



CO059 NEUTRON ACER TENDL-2021 LIBRARY; T=293.6K  
Photon emission for (n,n\*)t

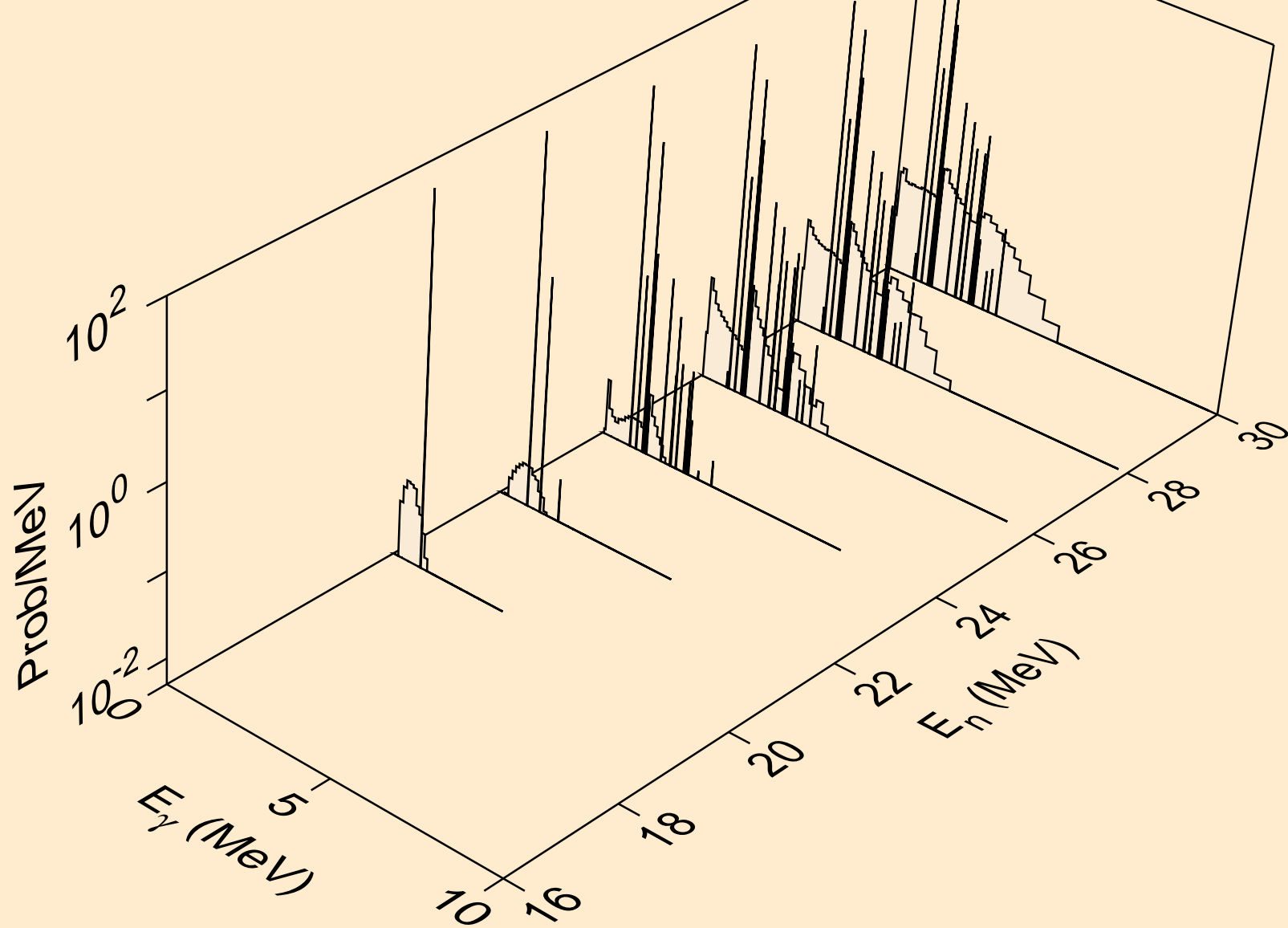

CO059 NEUTRON ACER TENDL-2021 LIBRARY; T=293.6K  
Photon emission for (n,n\*)he3

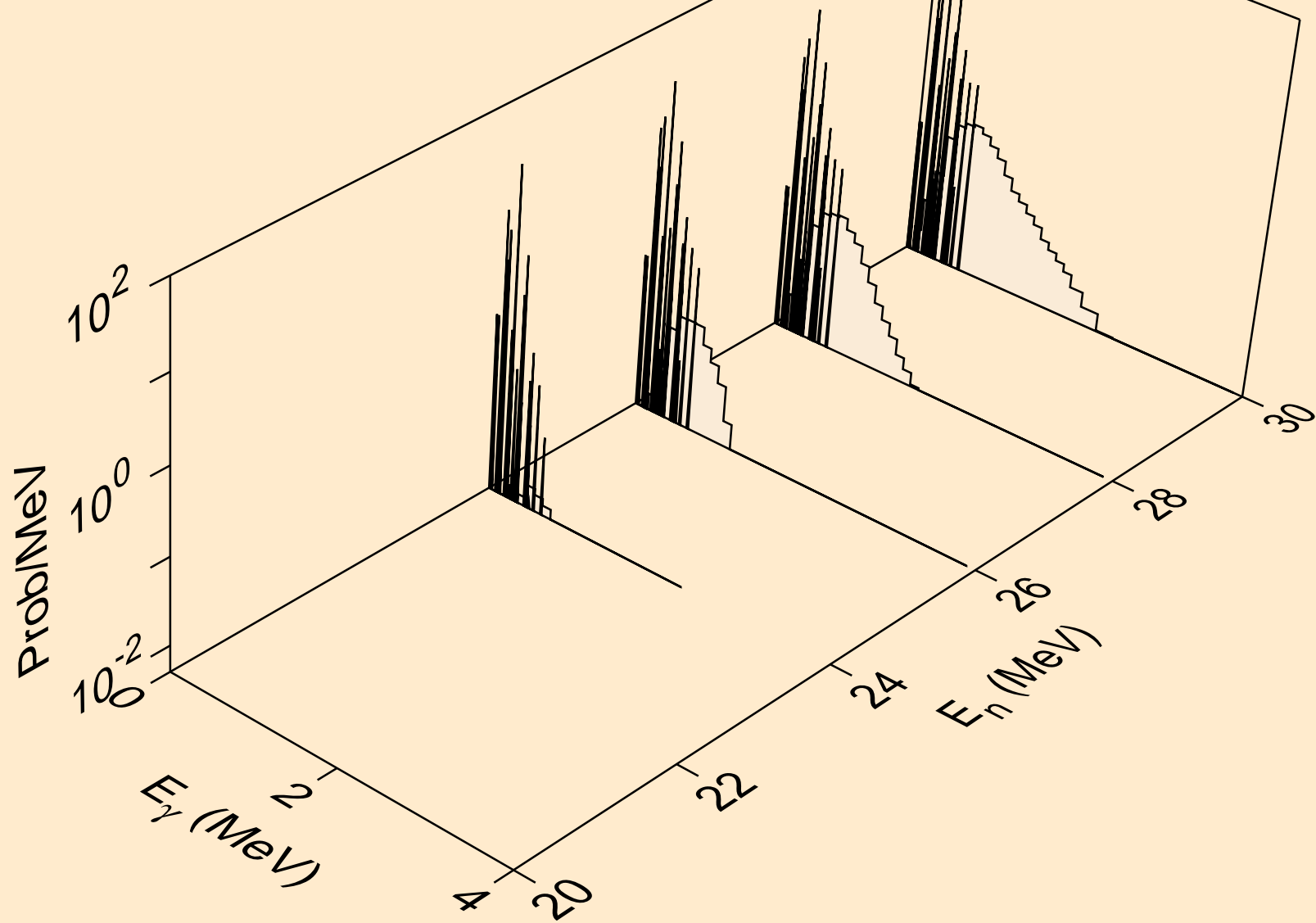

CO059 NEUTRON ACER TENDL-2021 LIBRARY; T=293.6K  
Photon emission for (n,2np)

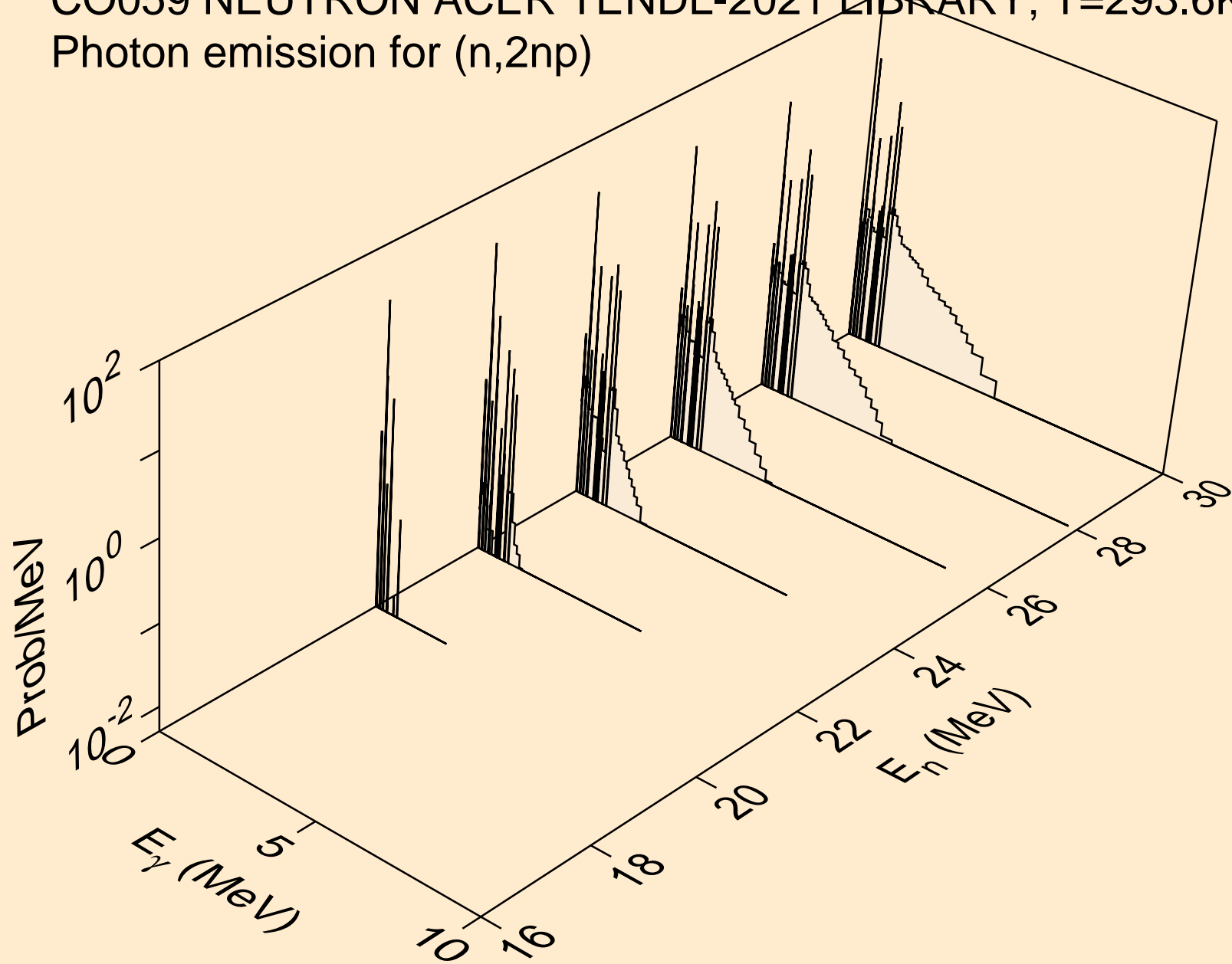

CO059 NEUTRON ACER TENDL-2021 LIBRARY; T=293.6K  
Photon emission for (n,3np)

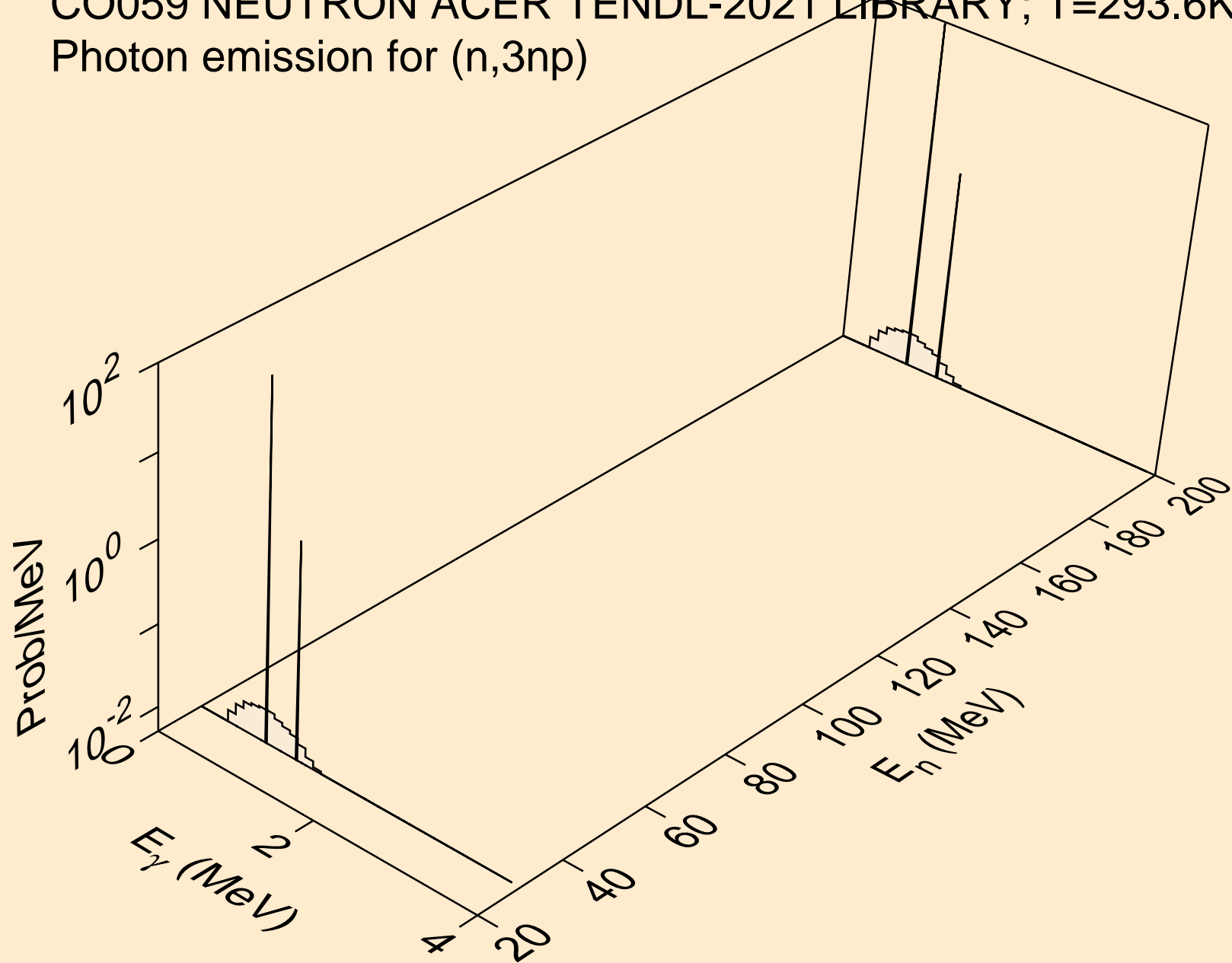

CO059 NEUTRON ACER TENDL-2021 LIBRARY; T=293.6K  
Photon emission for (n,2np)

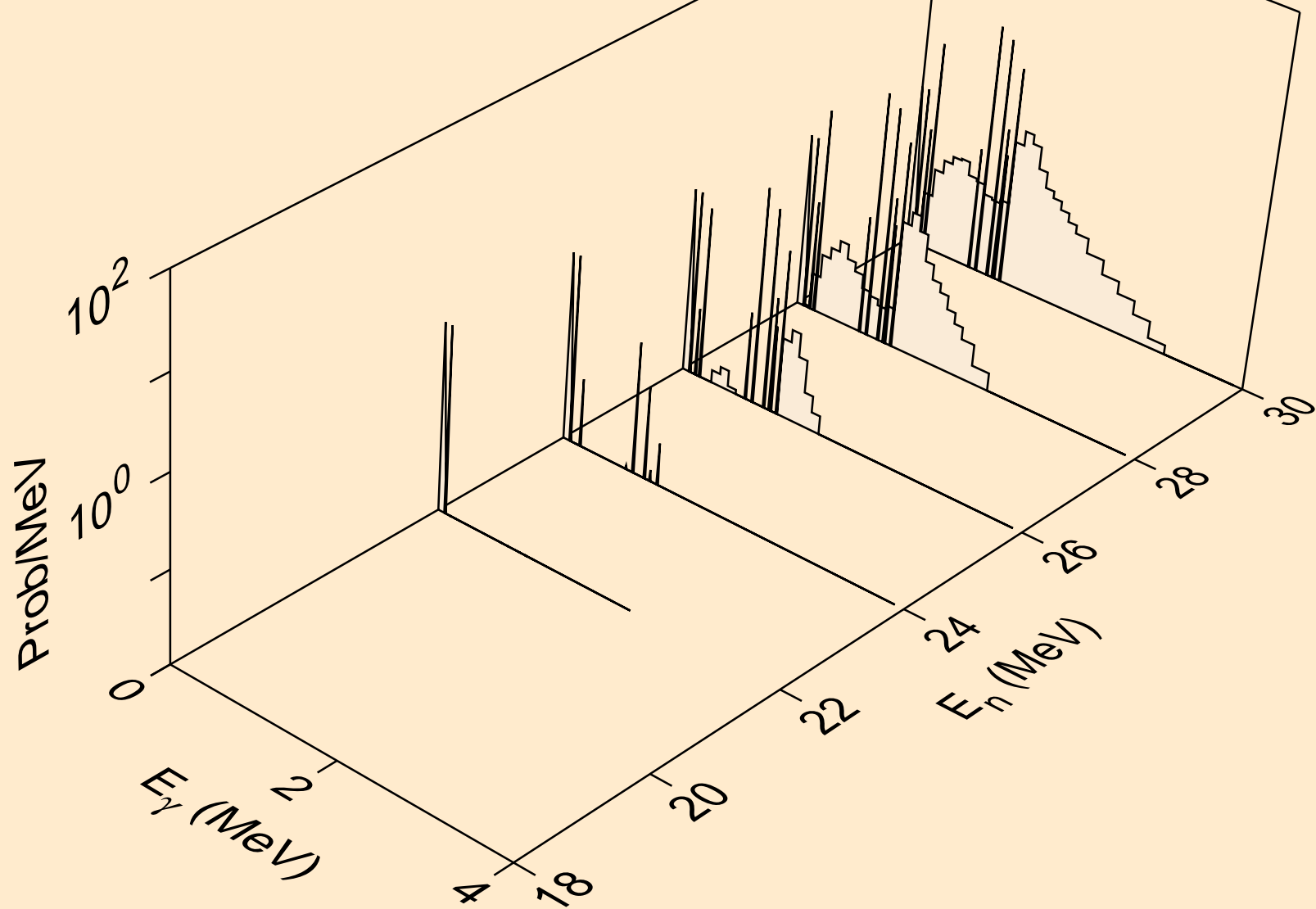

CO059 NEUTRON ACER TENDL-2021 LIBRARY; T=293.6K  
Photon emission for (n,npa)

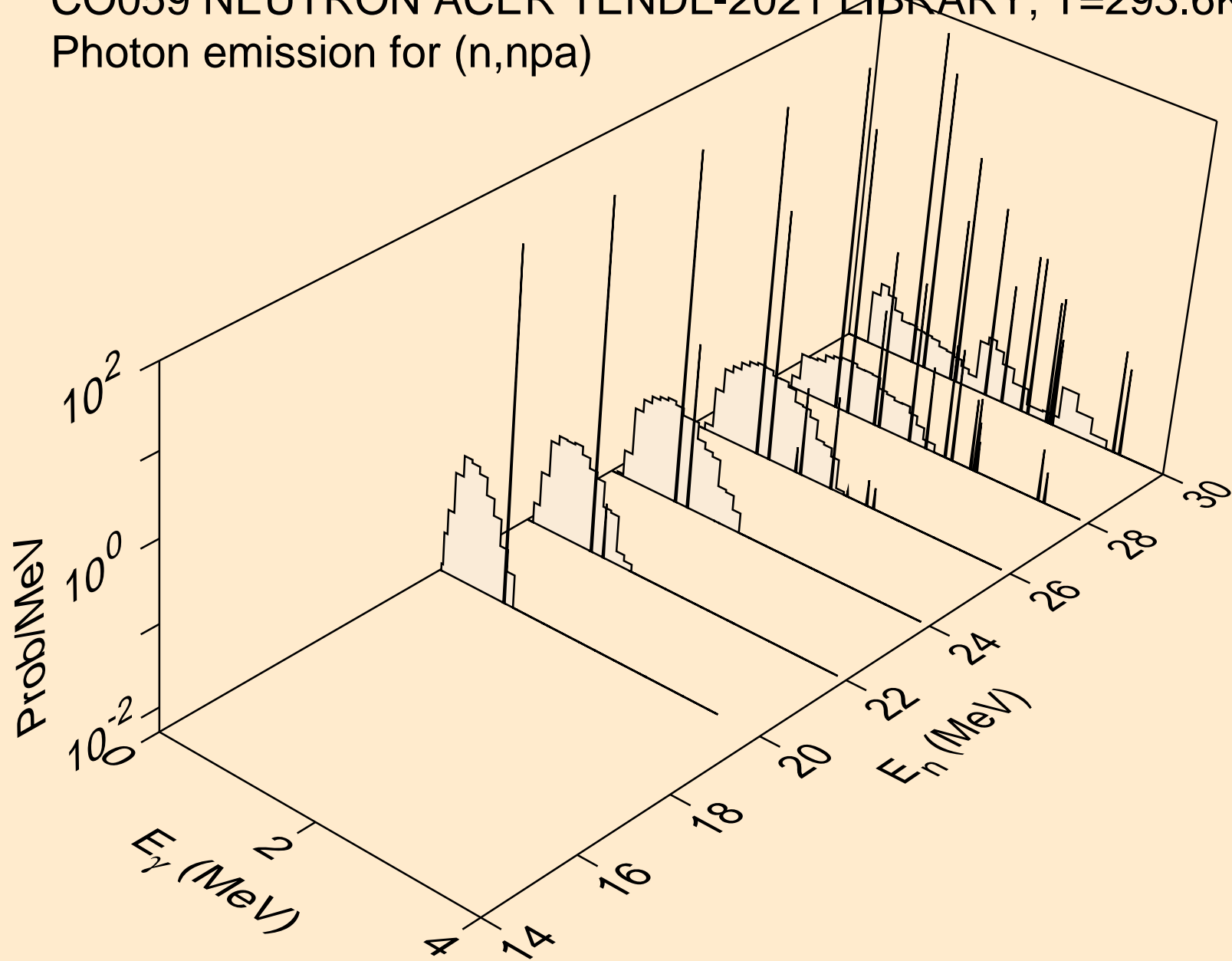

CO059 NEUTRON ACER TENDL-2021 LIBRARY; T=293.6K  
Photon emission for (n,n\*c)

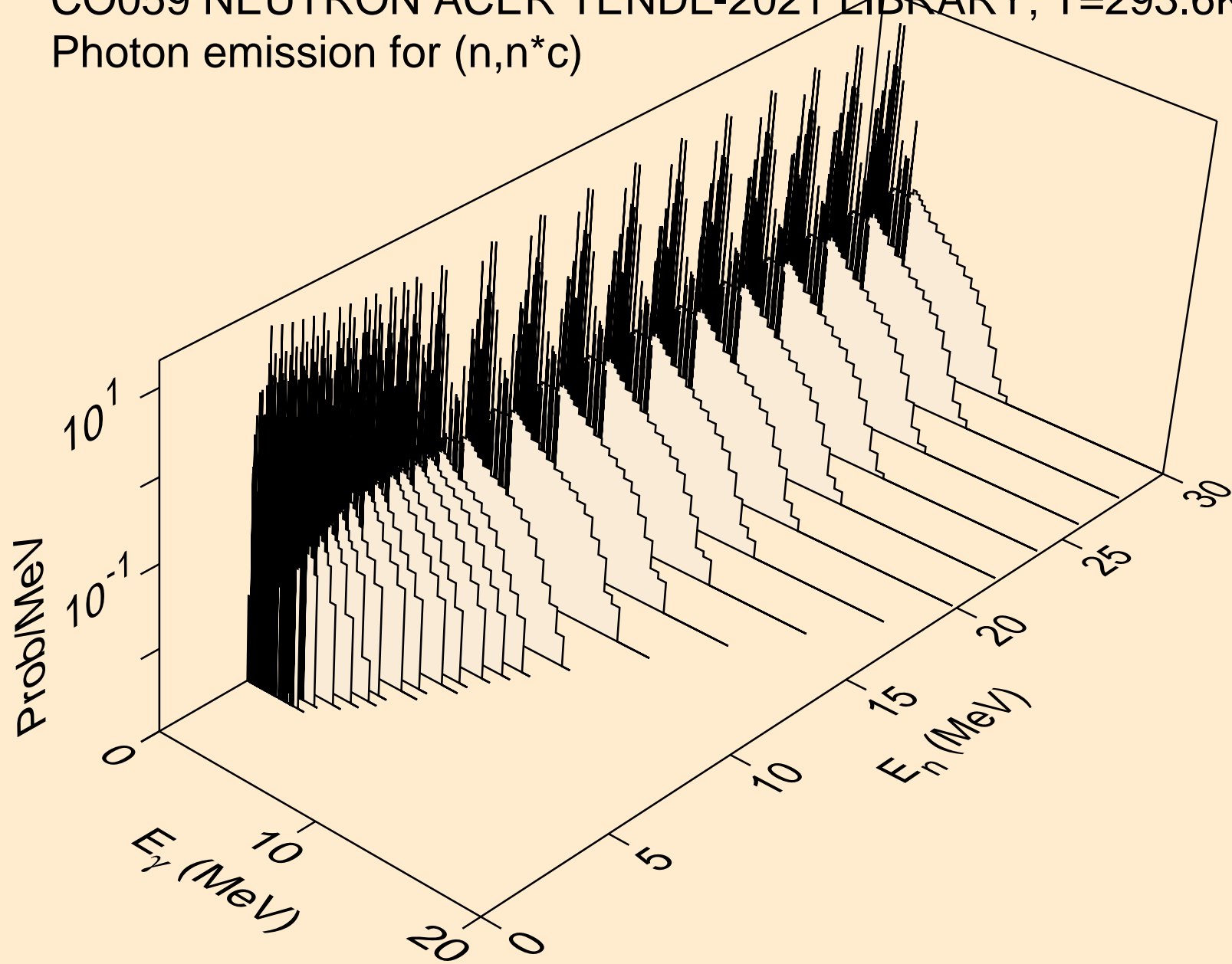

CO059 NEUTRON ACER TENDL-2021 LIBRARY; T=293.6K  
Photon emission for (n,gma)

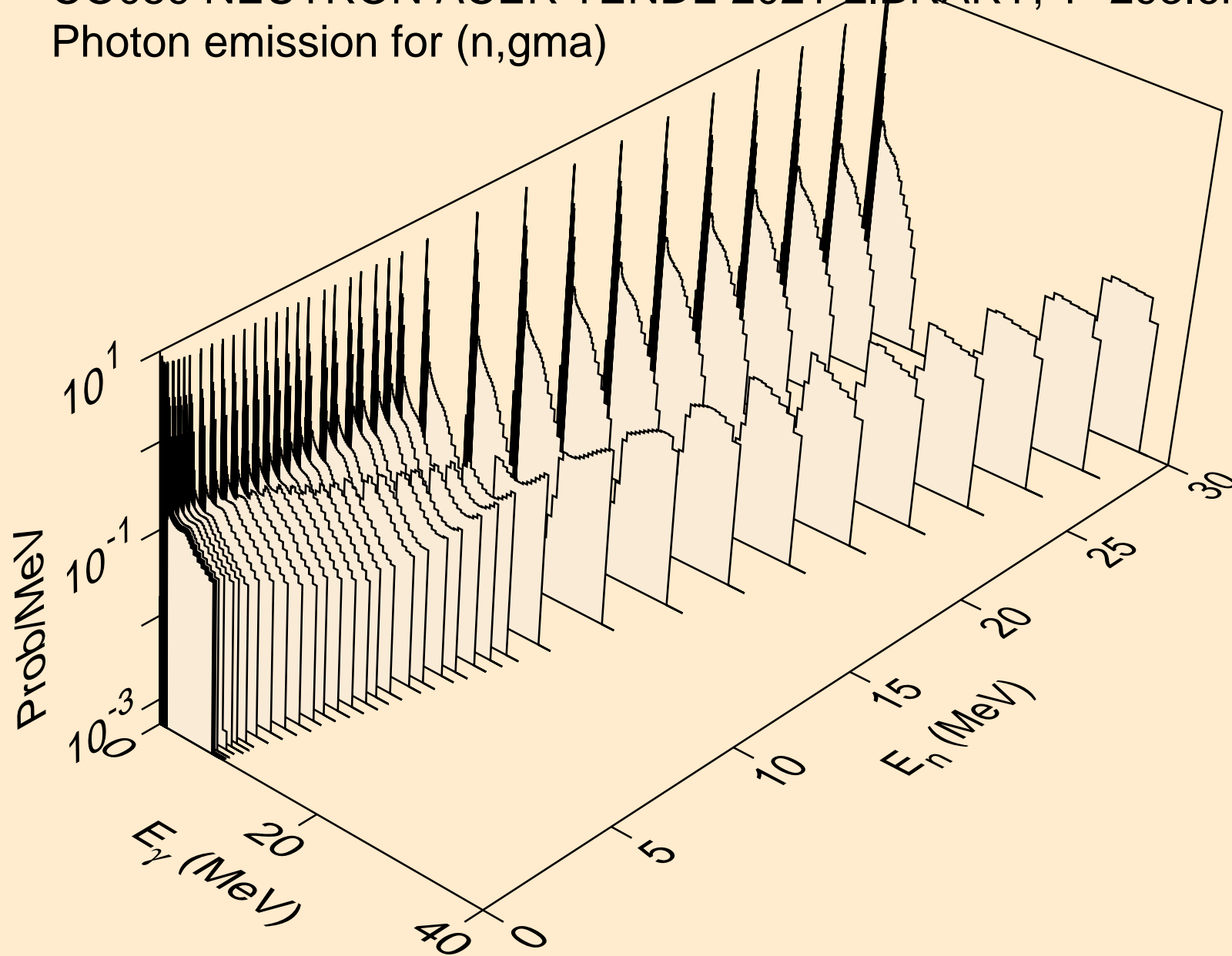



CO059 NEUTRON ACER TENDL-2021 LIBRARY; T=293.6K  
Photon emission for (n,p)

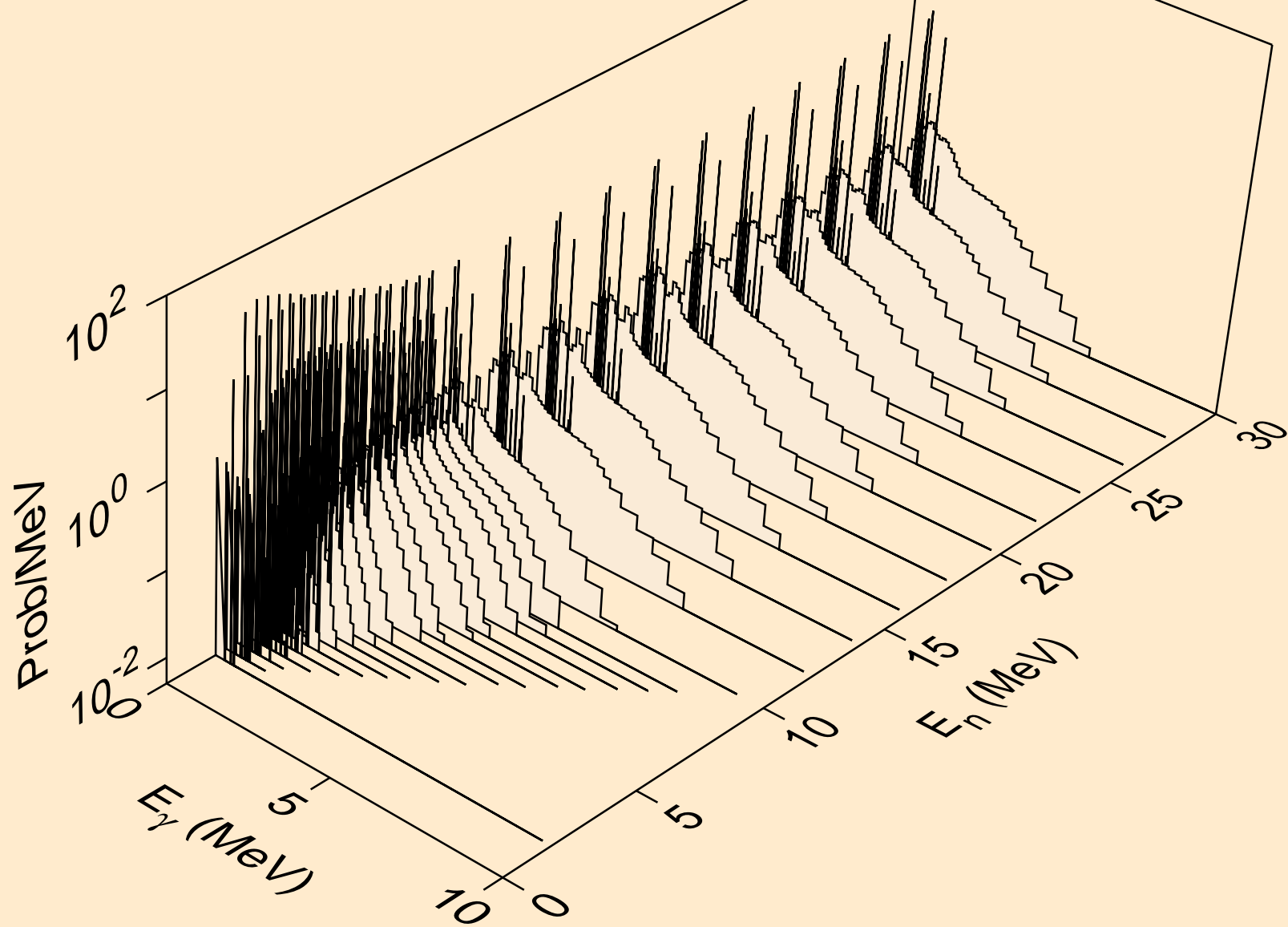

CO059 NEUTRON ACER TENDL-2021 LIBRARY; T=293.6K  
Photon emission for (n,d)

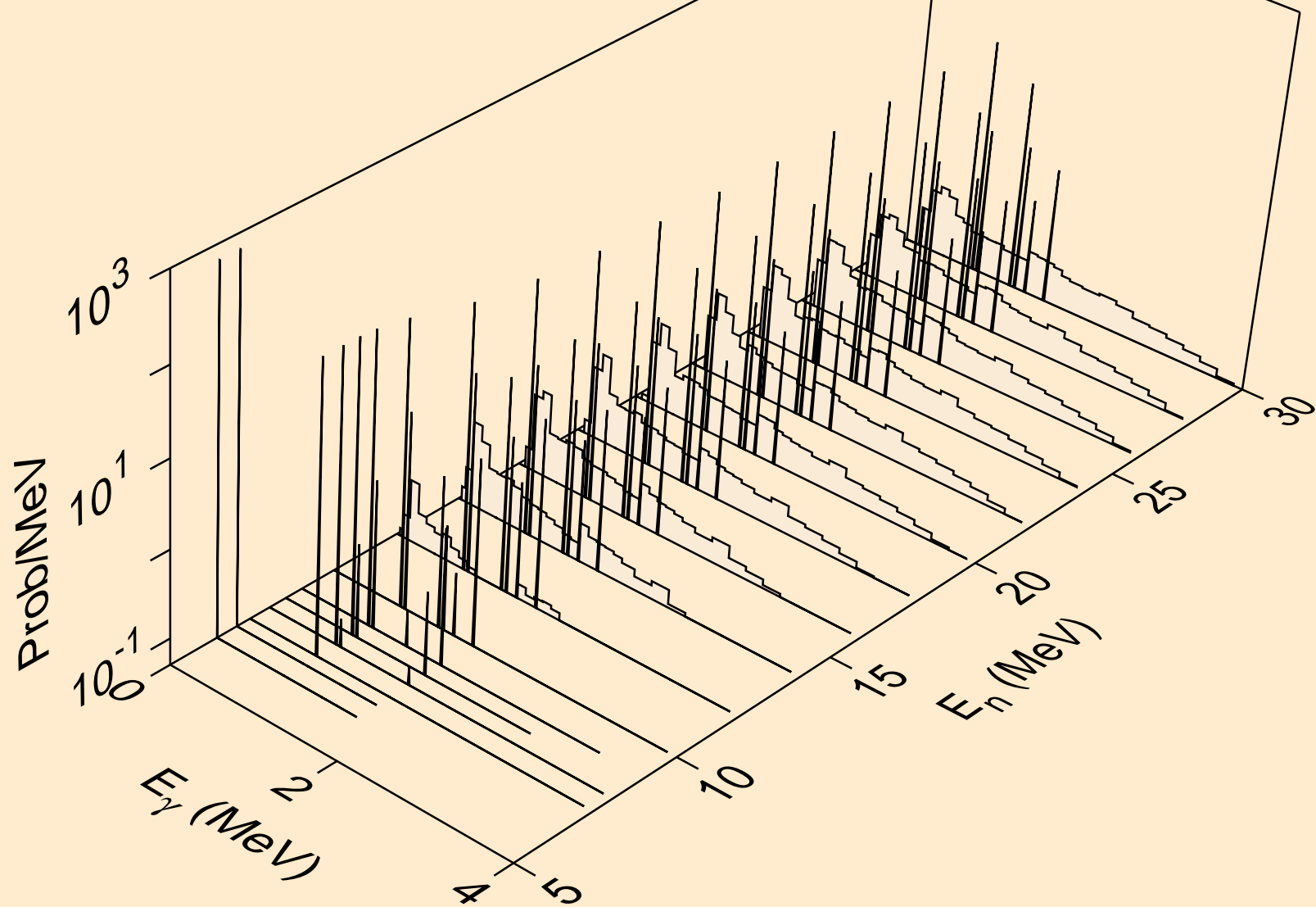

CO059 NEUTRON ACER TENDL-2021 LIBRARY; T=293.6K  
Photon emission for (n,t)

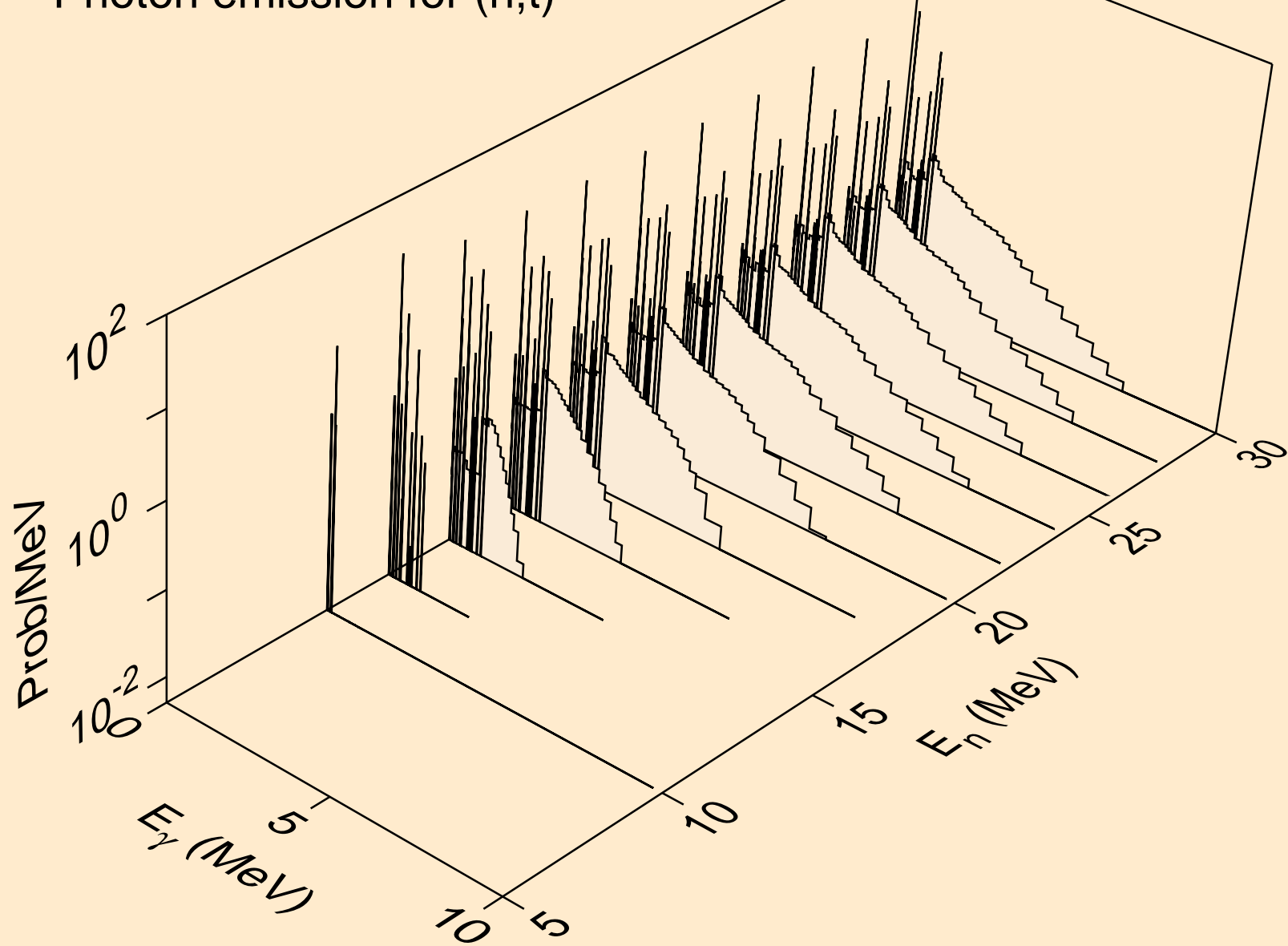

CO059 NEUTRON ACER TENDL-2021 LIBRARY; T=293.6K  
Photon emission for (n,he3)

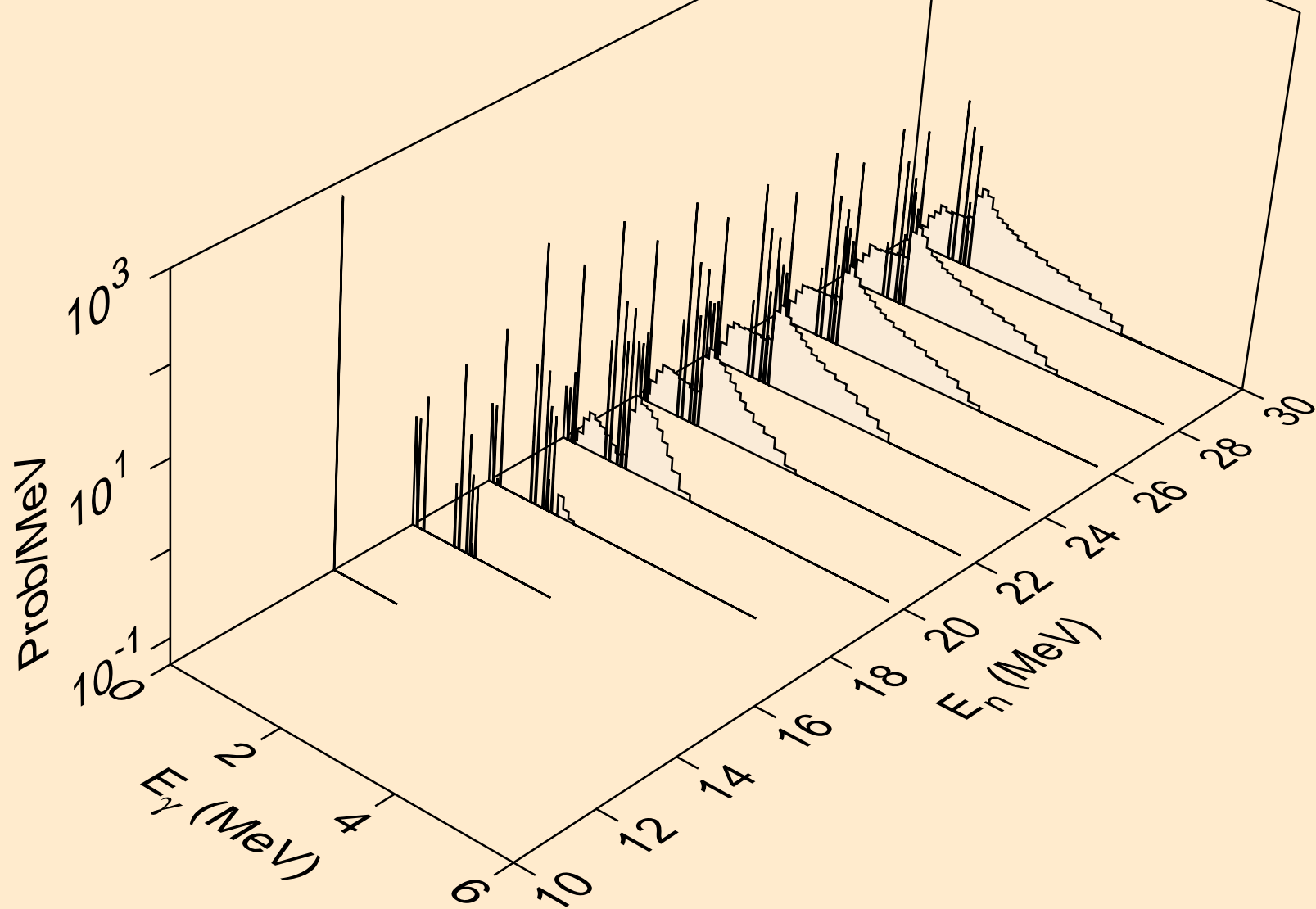

CO059 NEUTRON ACER TENDL-2021 LIBRARY; T=293.6K  
Photon emission for (n,a)

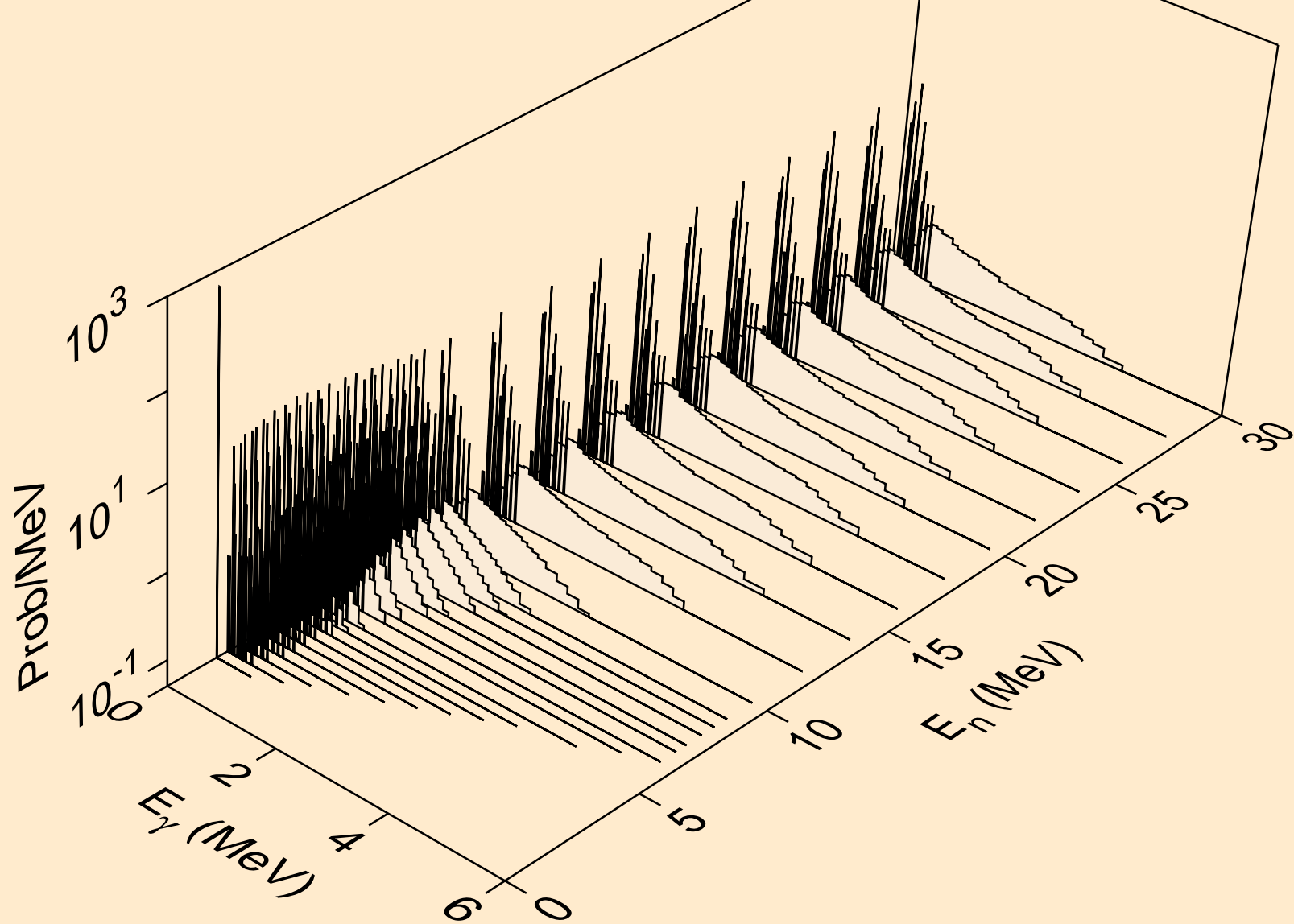

CO059 NEUTRON ACER TENDL-2021 LIBRARY; T=293.6K  
Photon emission for (n,2a)

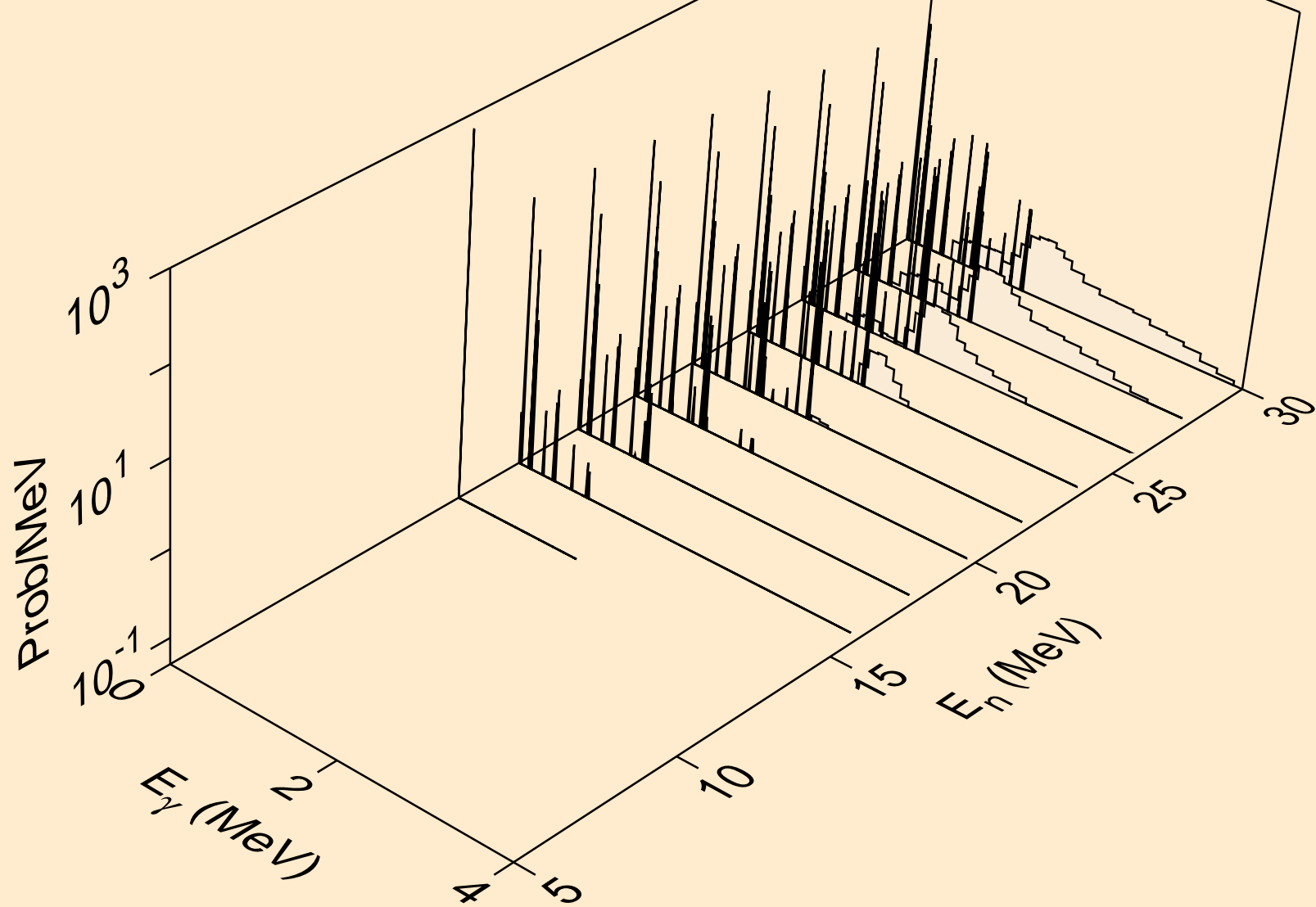

CO059 NEUTRON ACER TENDL-2021 LIBRARY; T=293.6K  
Photon emission for (n,2p)

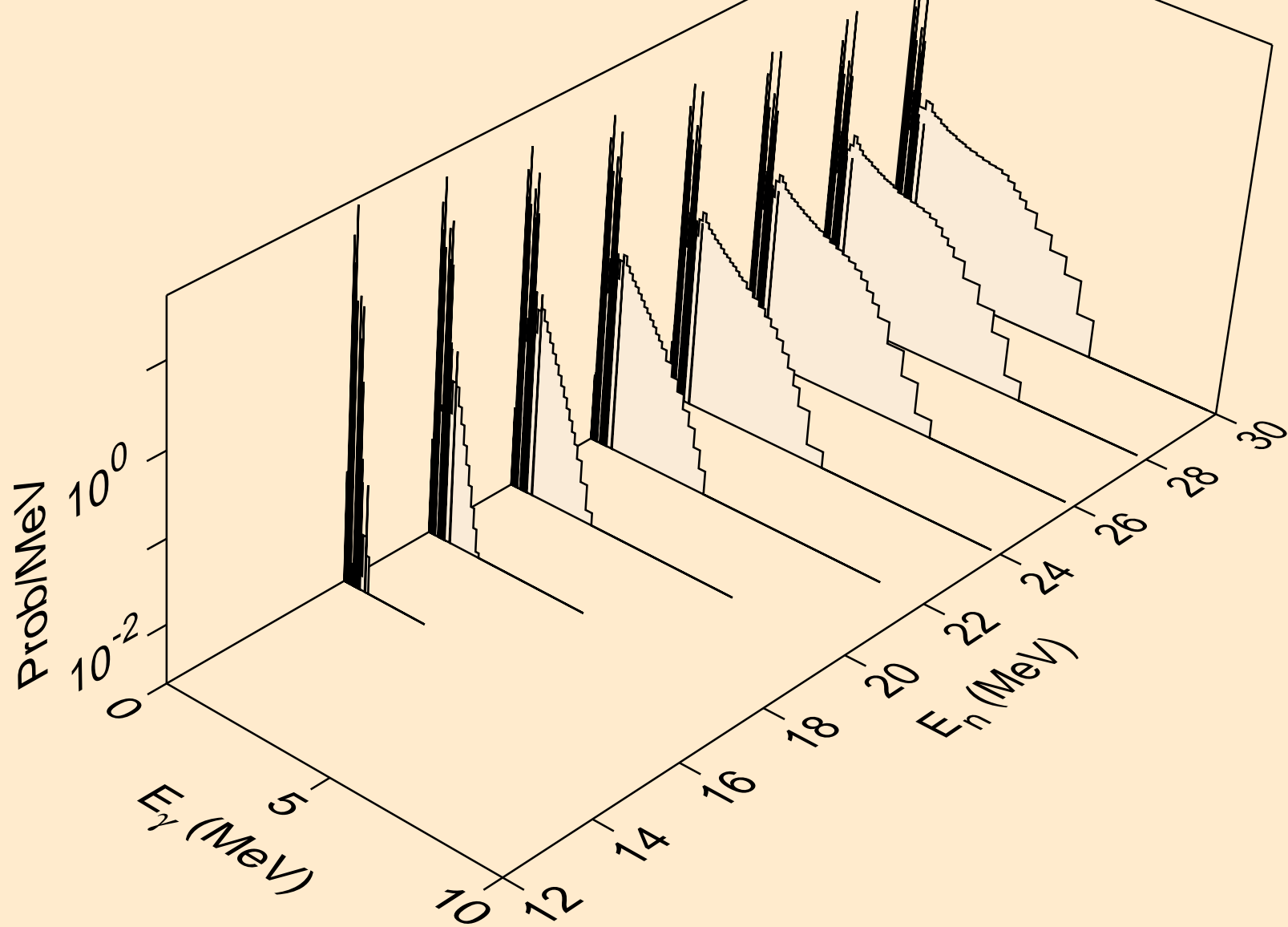

CO059 NEUTRON ACER TENDL-2021 LIBRARY; T=293.6K  
Photon emission for (n,p $\alpha$ )

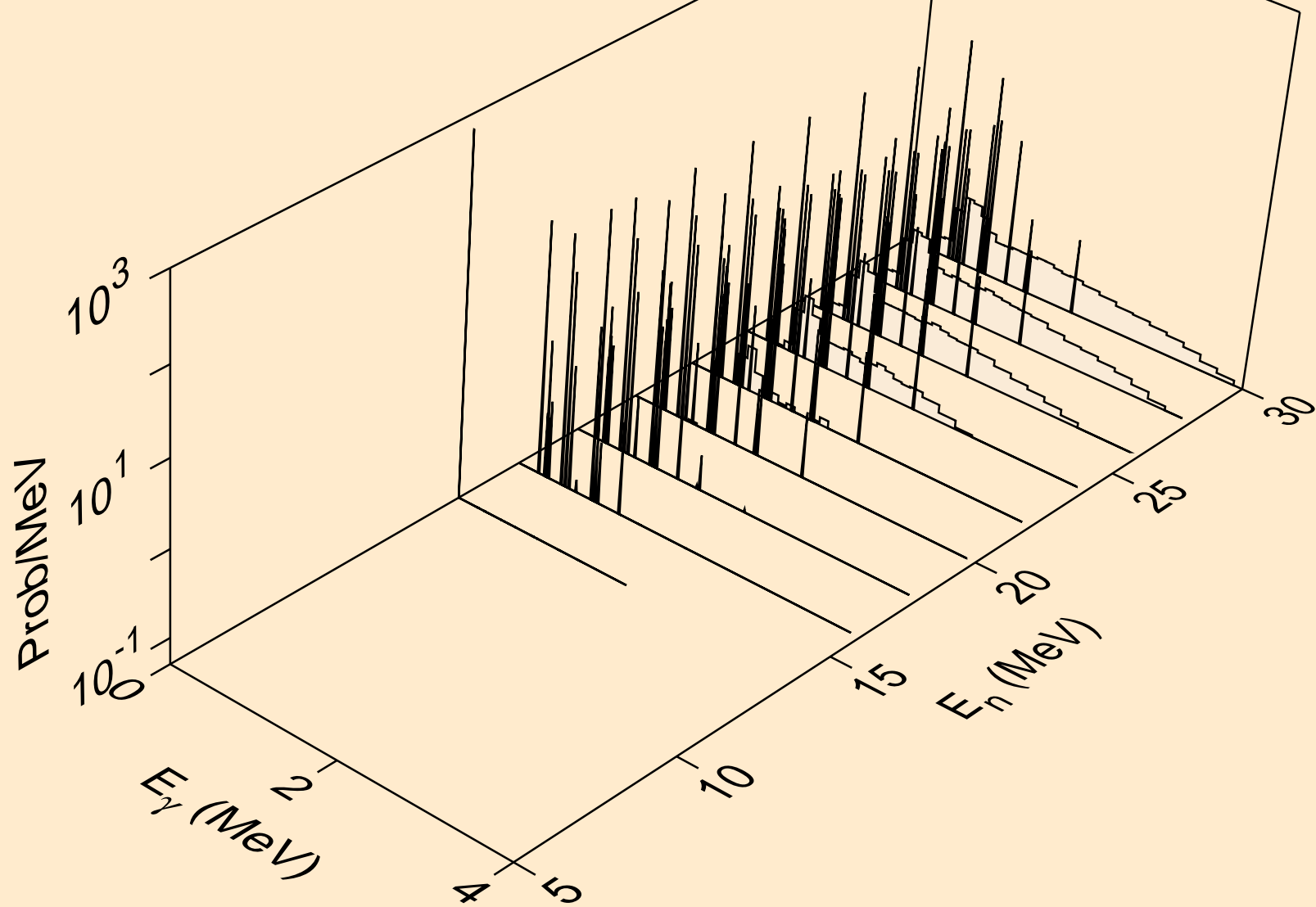



CO059 NEUTRON ACER TENDL-2021 LIBRARY; T=293.6K  
Photon emission for (n,pd)

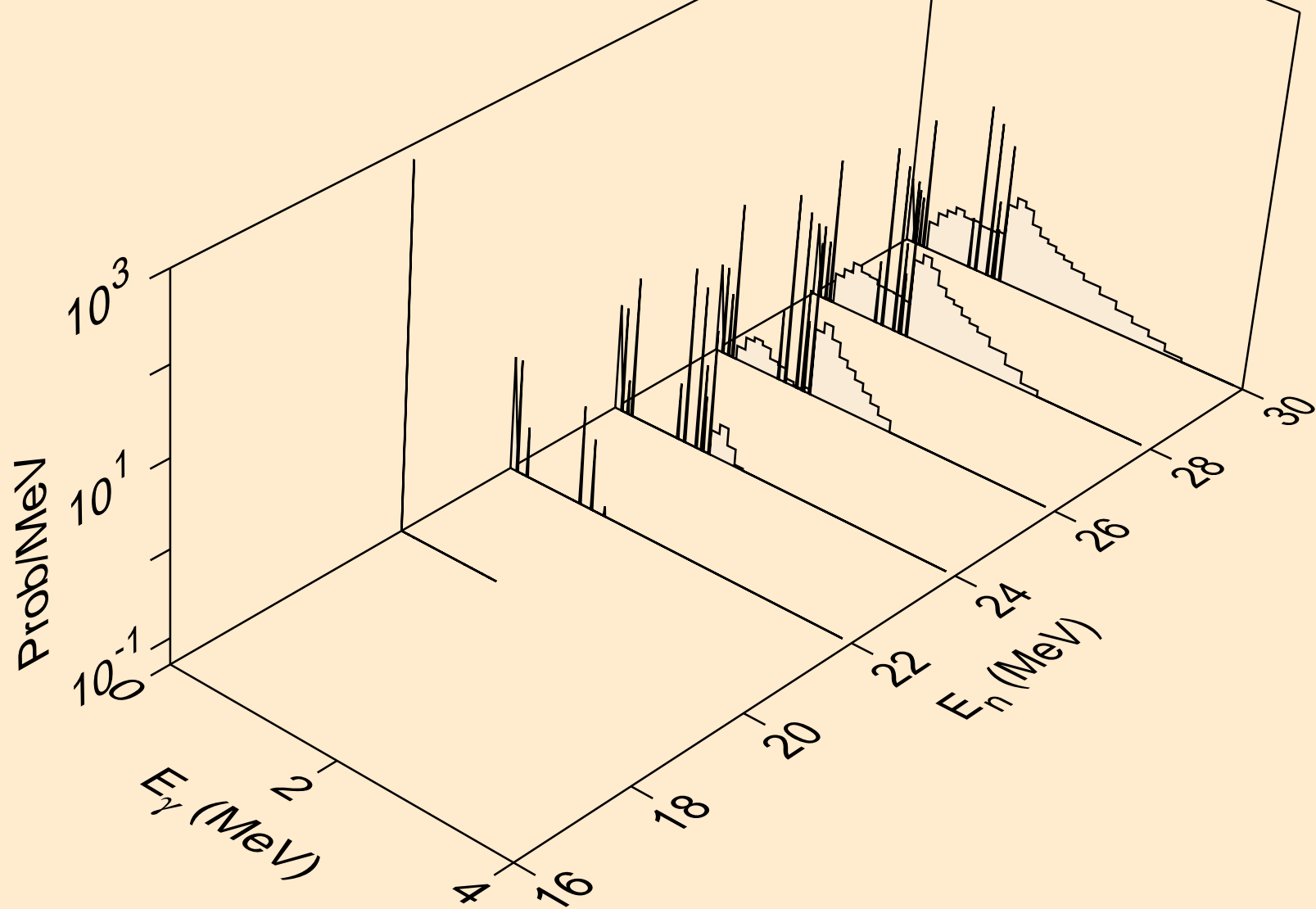

CO059 NEUTRON ACER TENDL-2021 LIBRARY; T=293.6K  
Photon emission for (n,pt)

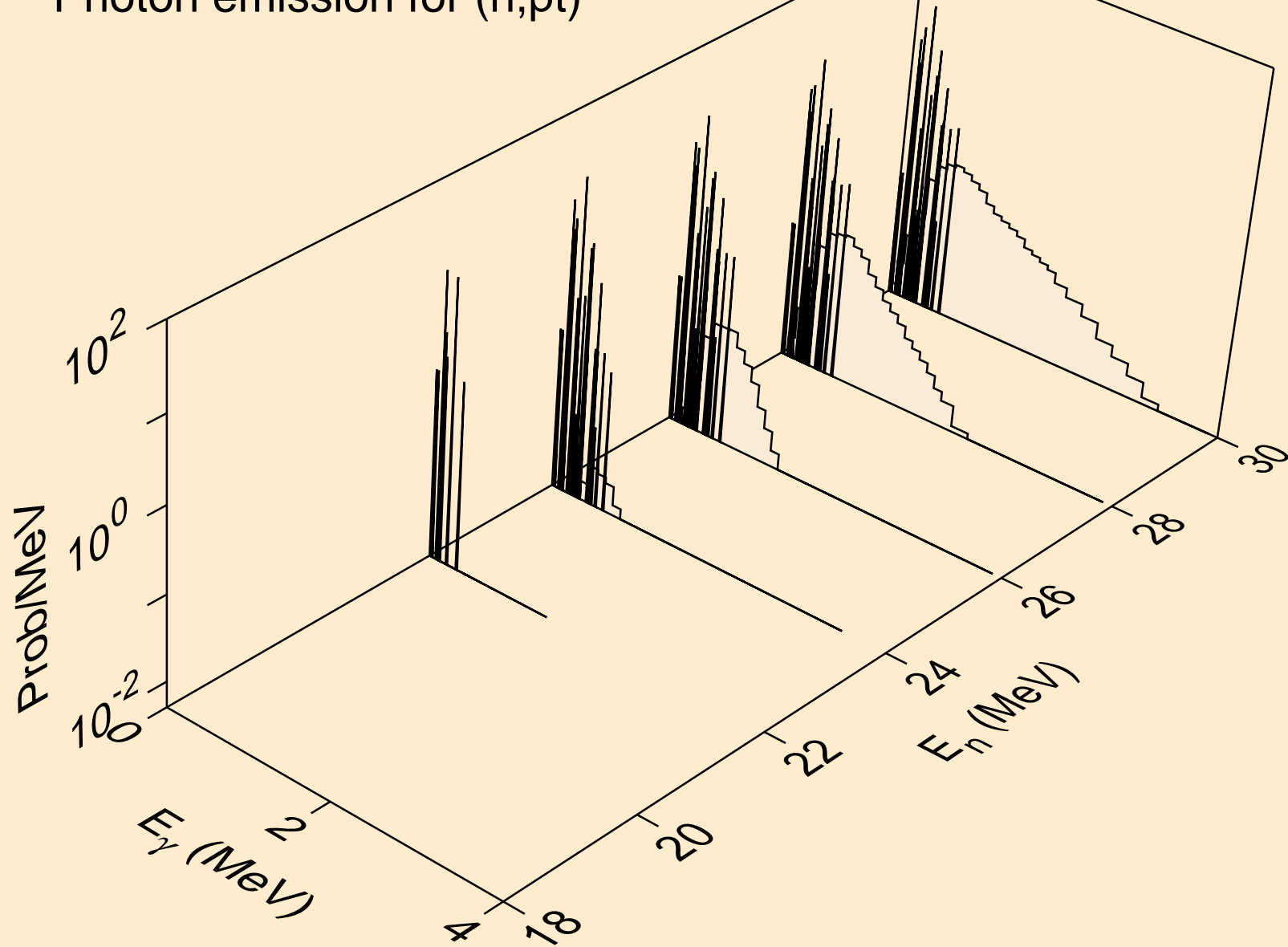

CO059 NEUTRON ACER TENDL-2021 LIBRARY; T=293.6K  
Photon emission for (n,da)

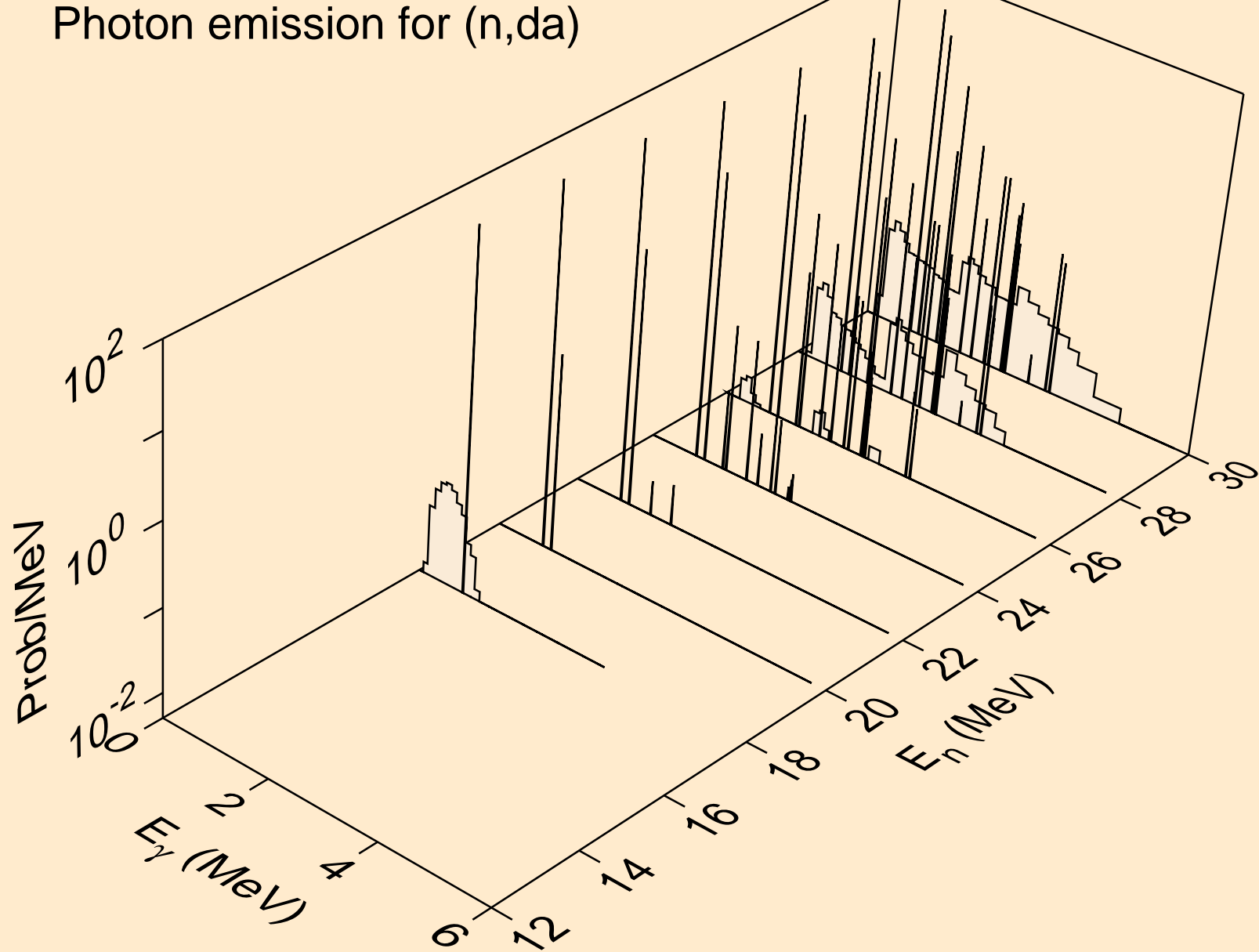

CO059 NEUTRON ACER TENDL-2021 LIBRARY; T=293.6K  
thermal capture photon spectrum

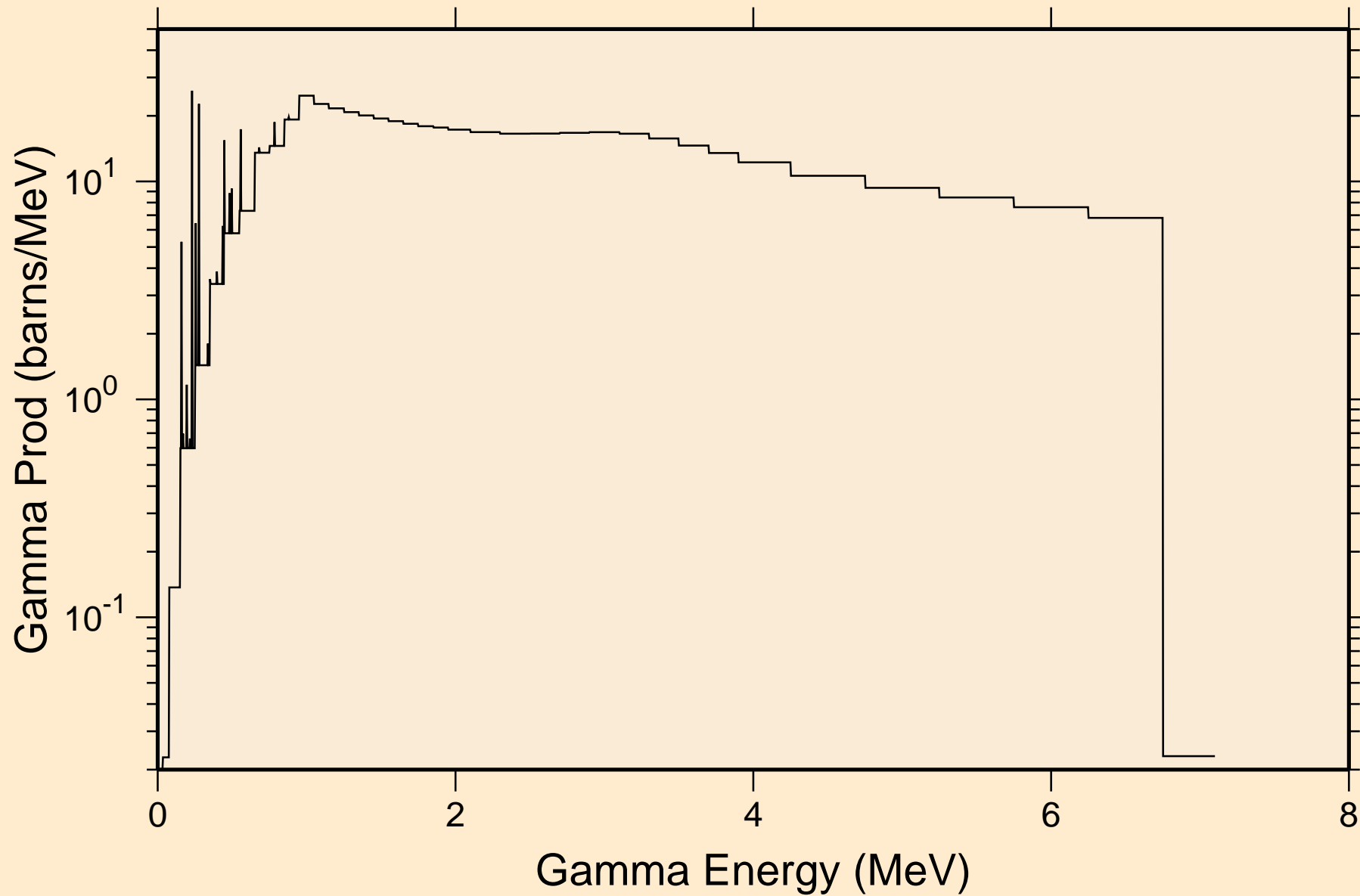

CO059 NEUTRON ACER TENDL-2021 LIBRARY; T=293.6K  
14 MeV photon spectrum

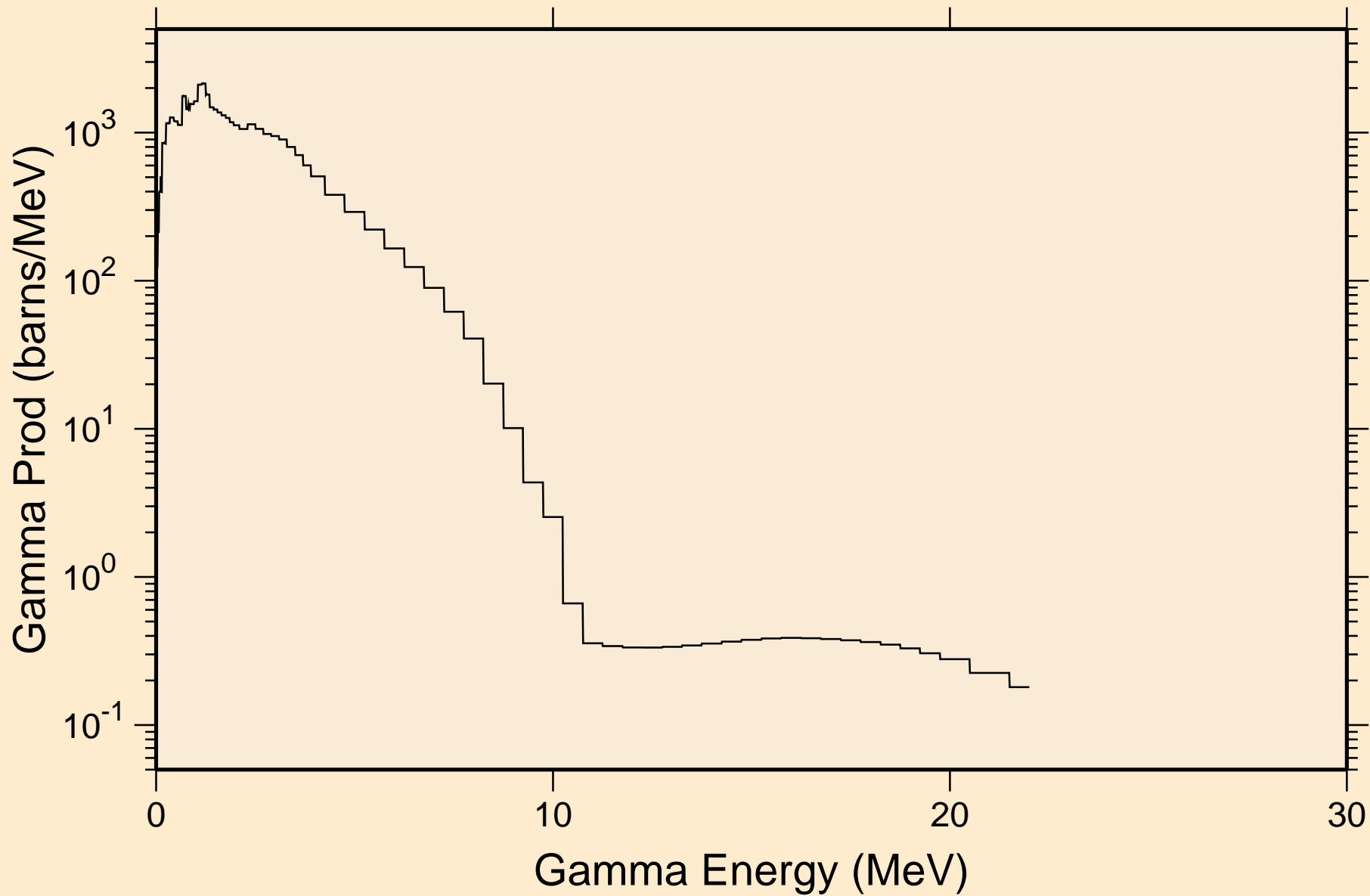

CO059 NEUTRON ACER TENDL-2021 LIBRARY; T=293.6K  
Particle heating contributions

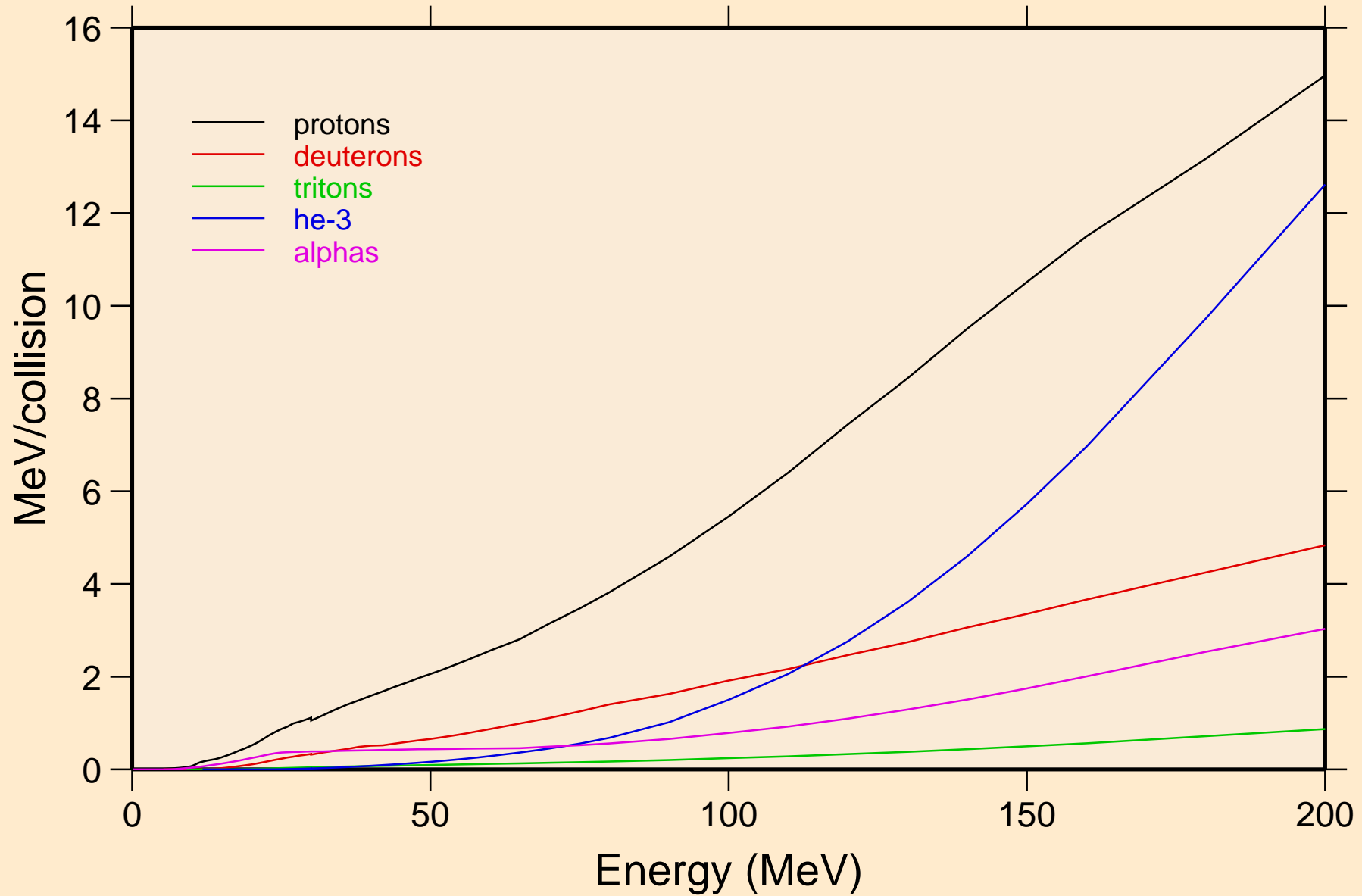

CO059 NEUTRON ACER TENDL-2021 LIBRARY; T=293.6K  
Recoil Heating

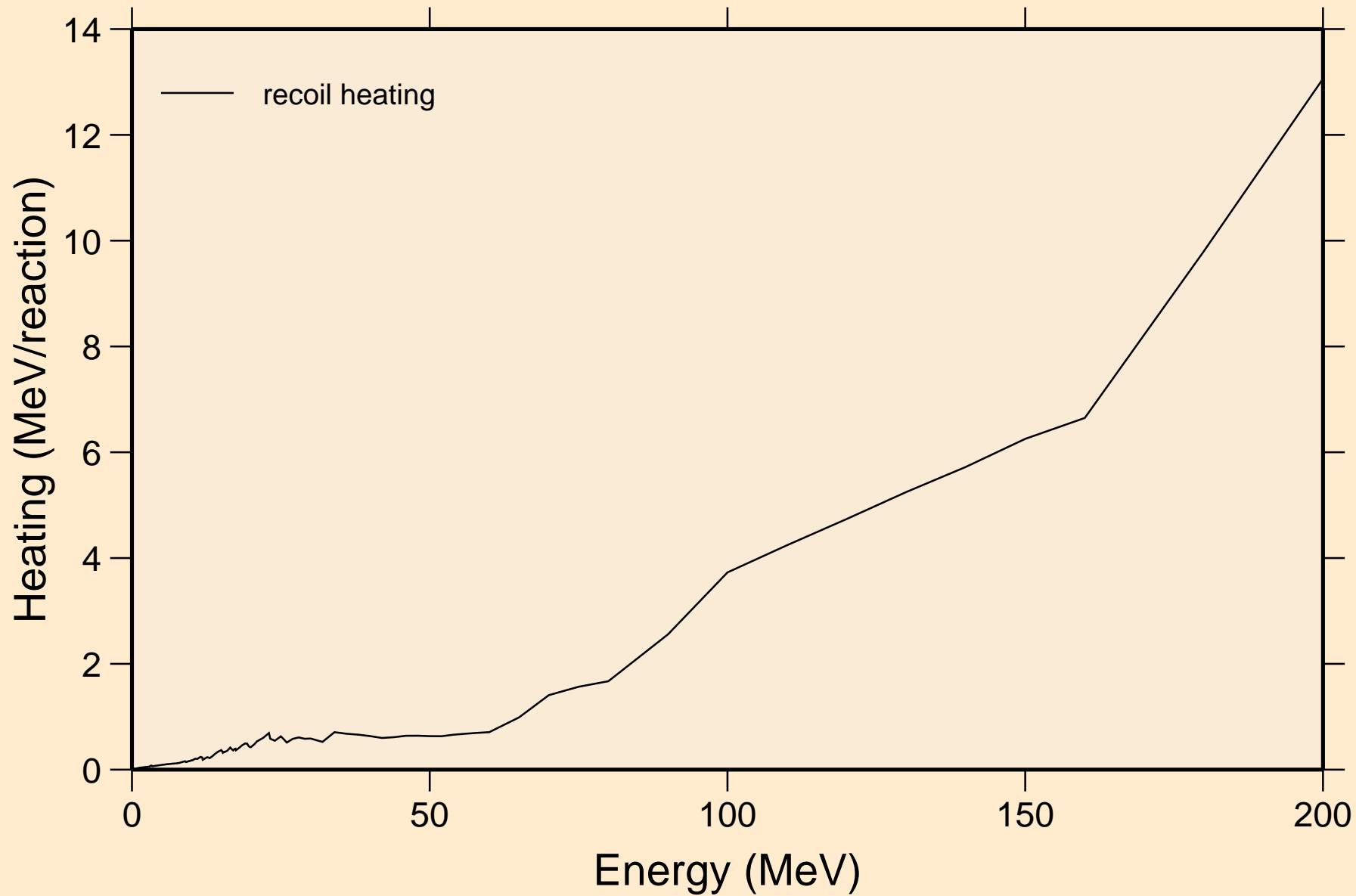

CO059 NEUTRON ACER TENDL-2021 LIBRARY; T=293.6K  
Particle production cross sections

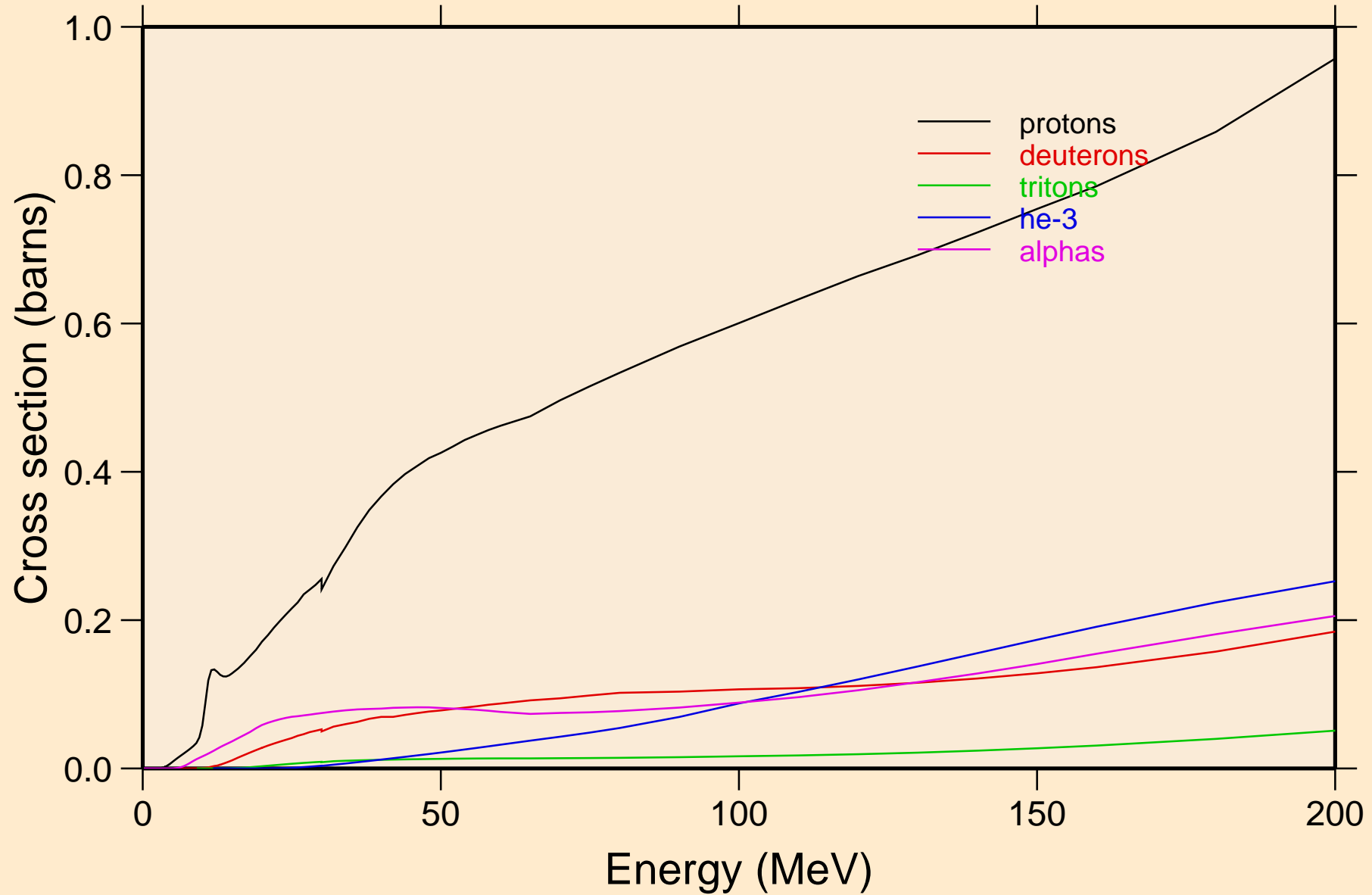



CO059 NEUTRON ACER TENDL-2021 LIBRARY; T=293.6K  
protons from (n,x)

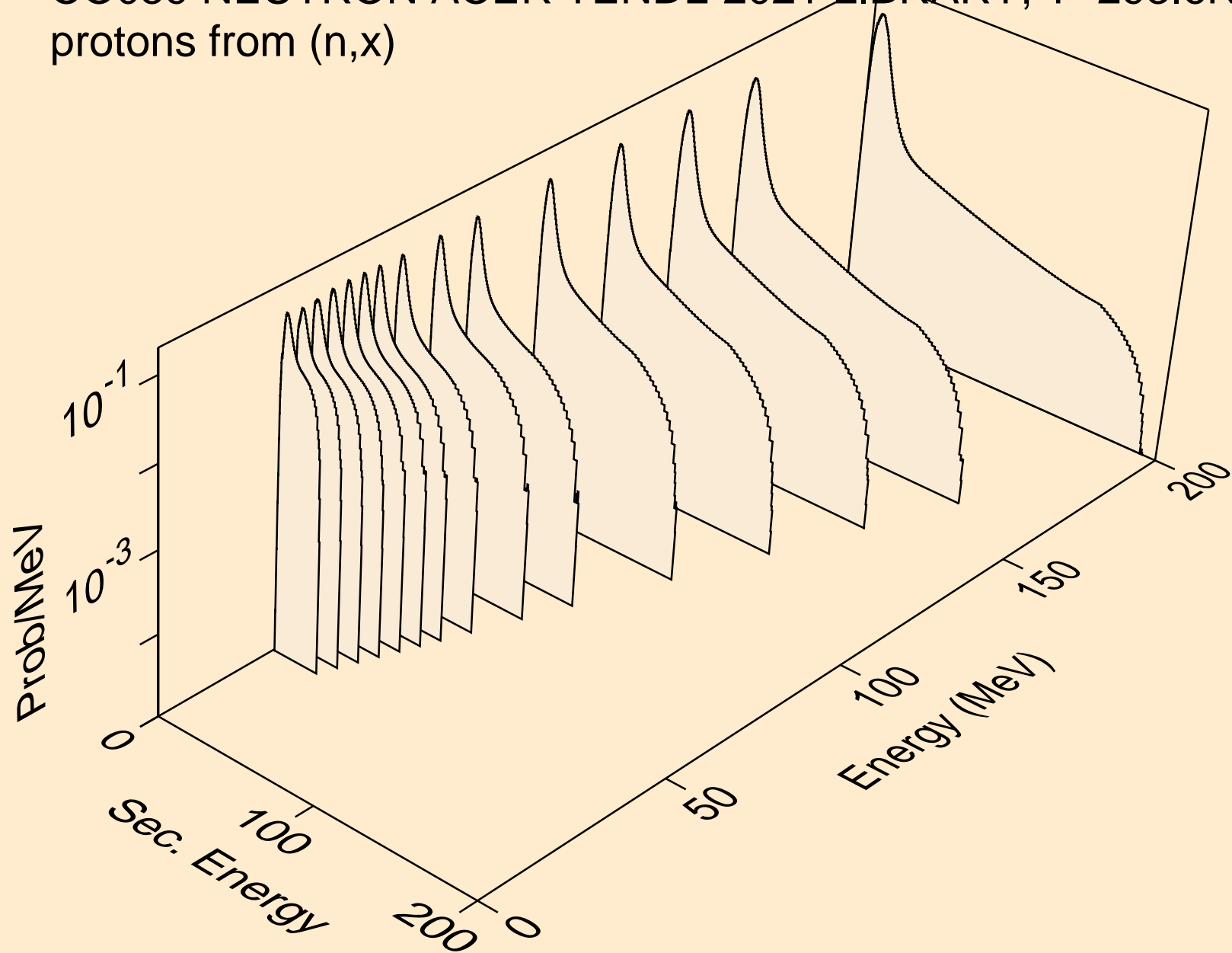

CO059 NEUTRON ACER TENDL-2021 LIBRARY; T=293.6K  
protons from (n,n\*)p

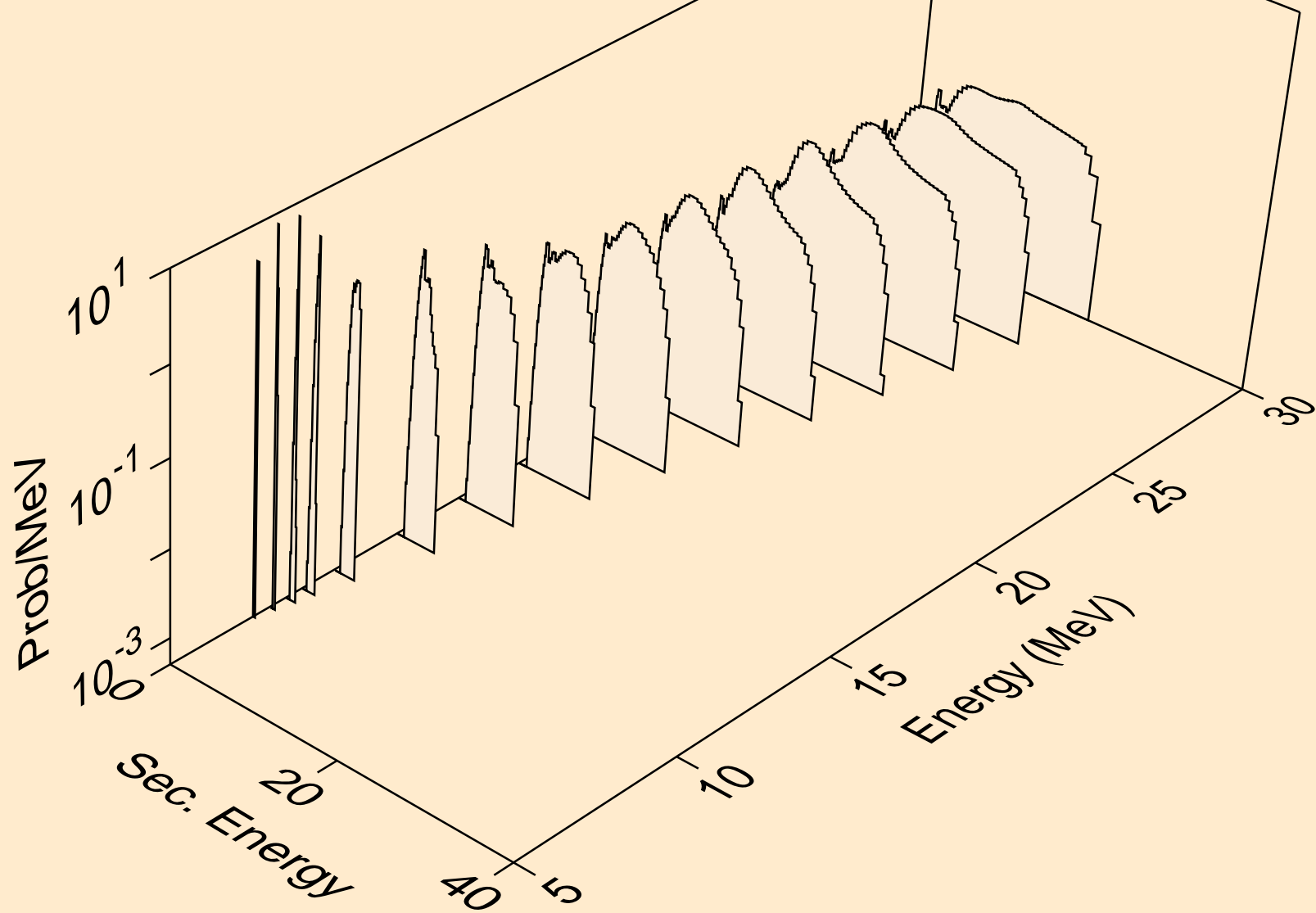

CO059 NEUTRON ACER TENDL-2021 LIBRARY; T=293.6K  
protons from (n,2np)

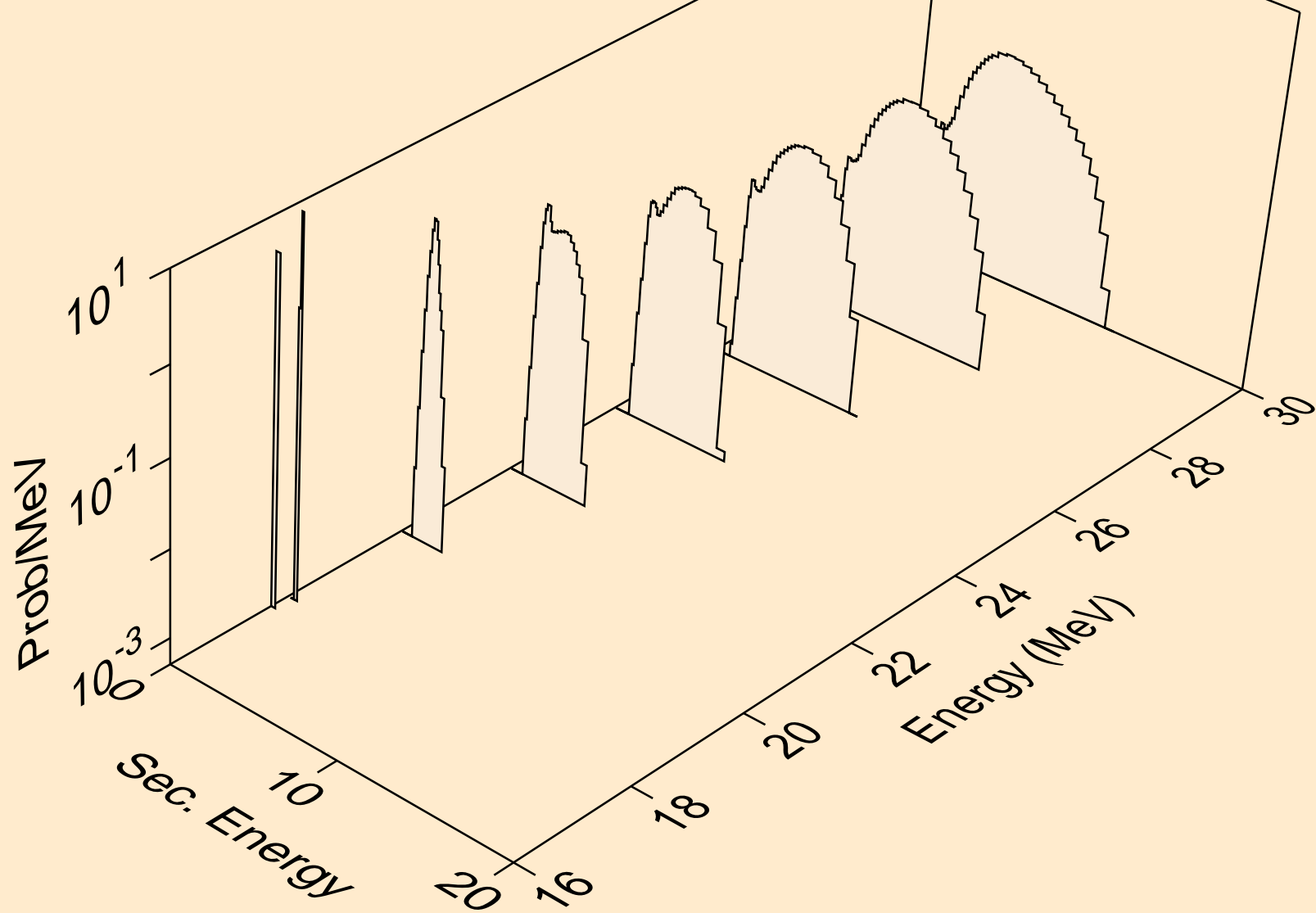

CO059 NEUTRON ACER TENDL-2021 LIBRARY; T=293.6K  
protons from (n,3np)

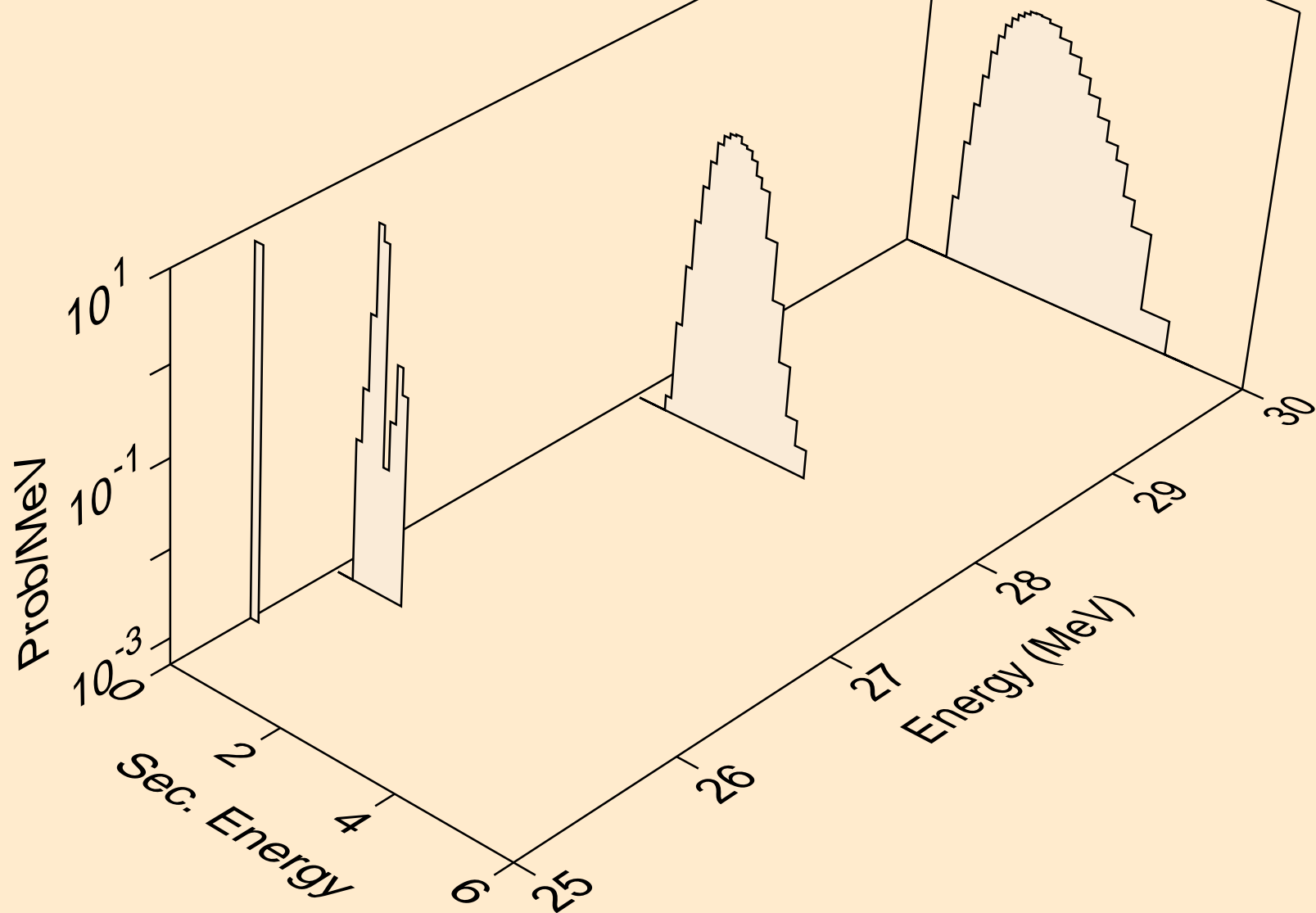

CO059 NEUTRON ACER TENDL-2021 LIBRARY; T=293.6K  
protons from (n,2np)

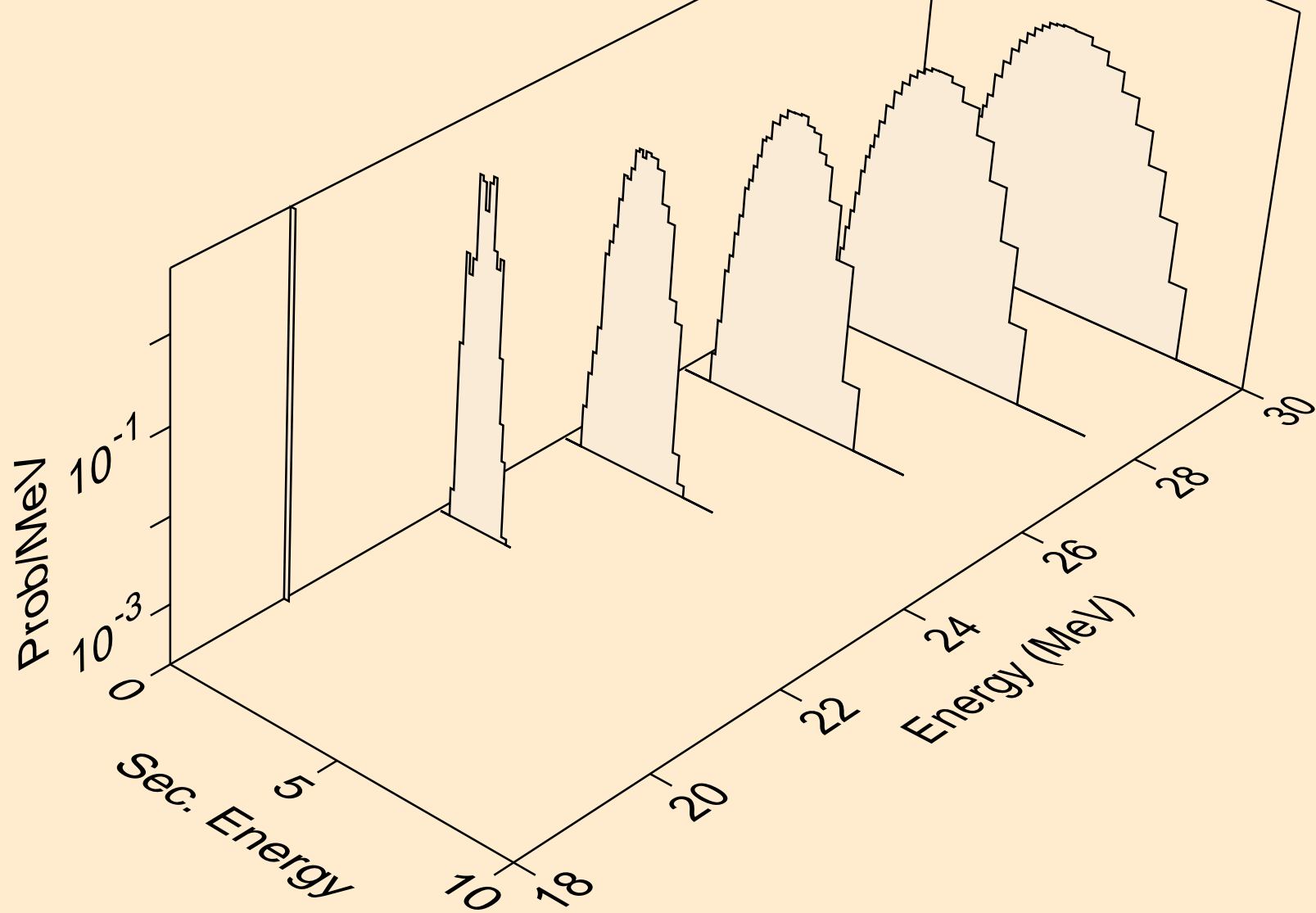

CO059 NEUTRON ACER TENDL-2021 LIBRARY; T=293.6K  
protons from (n,npa)

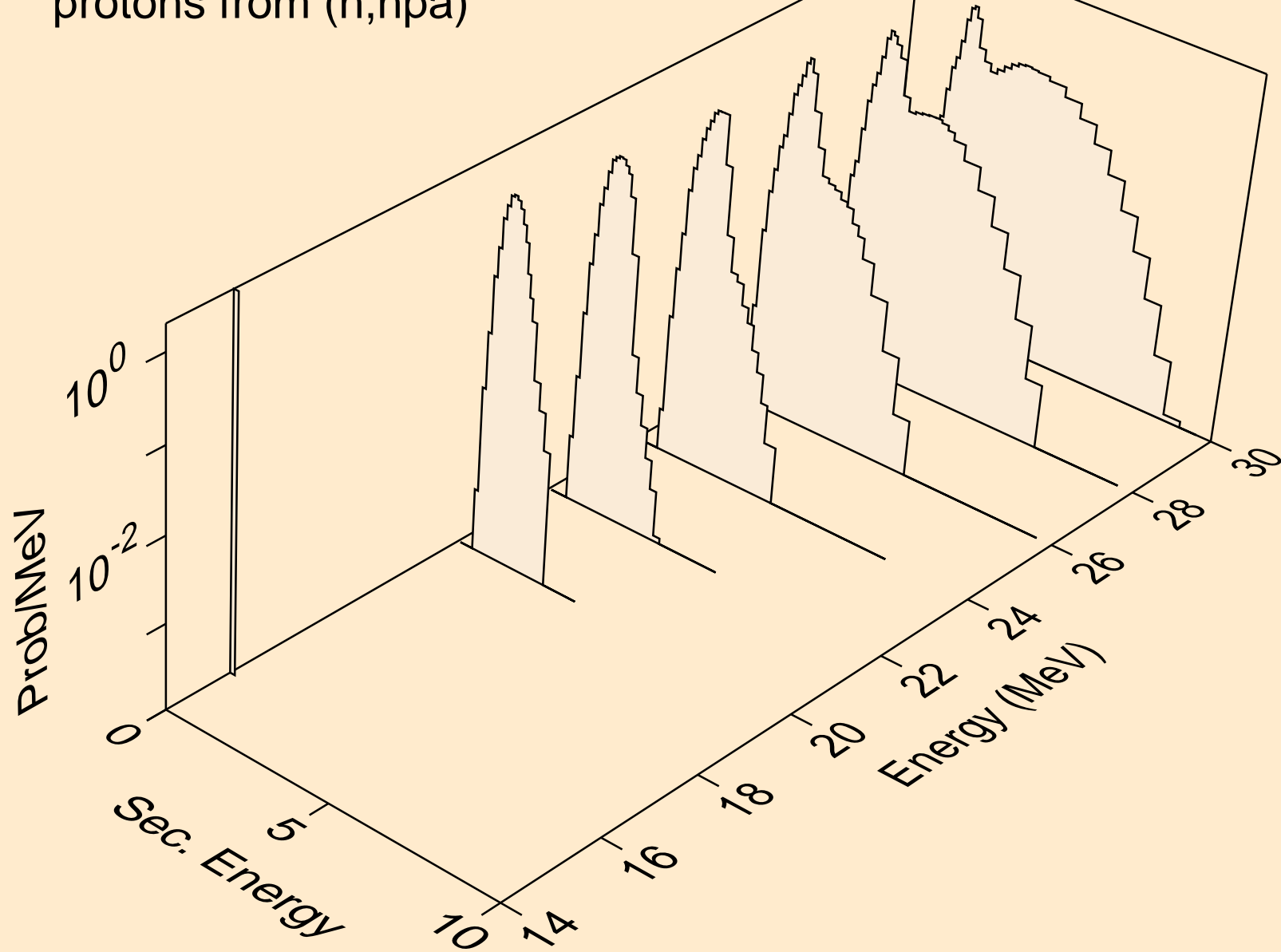

CO059 NEUTRON ACER TENDL-2021 LIBRARY; T=293.6K  
protons from (n,p)

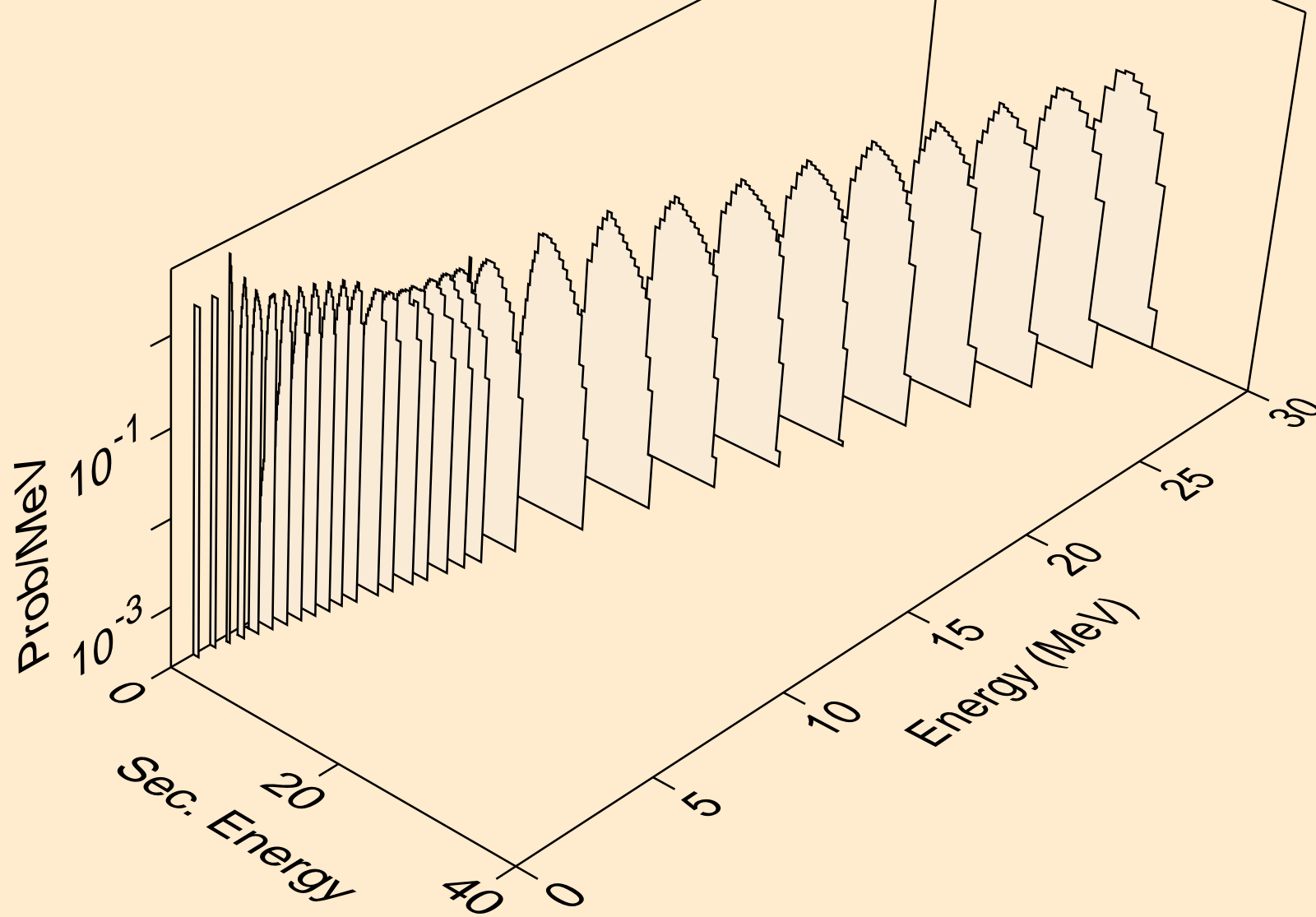

CO059 NEUTRON ACER TENDL-2021 LIBRARY; T=293.6K  
protons from (n,2p)

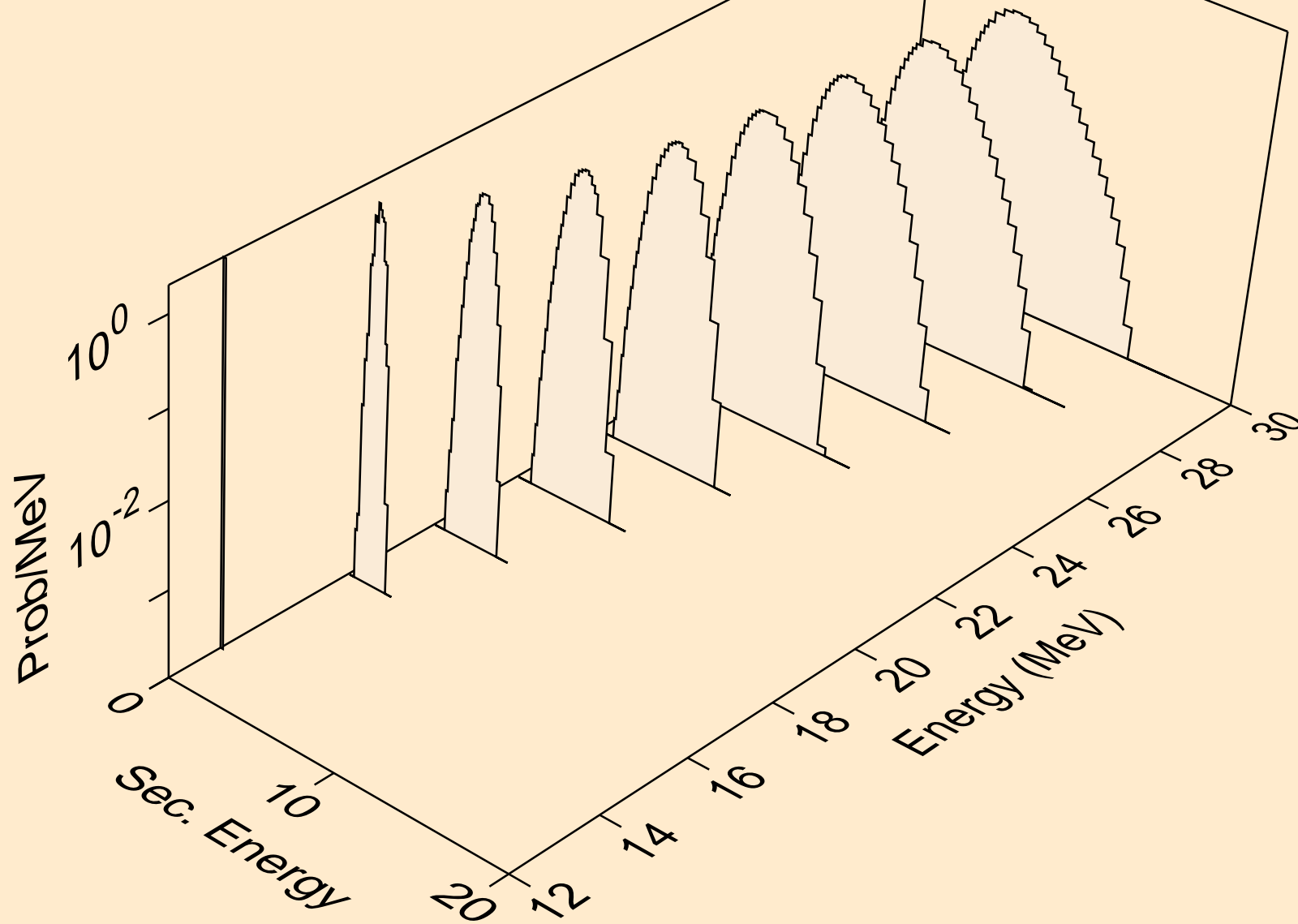



CO059 NEUTRON ACER TENDL-2021 LIBRARY; T=293.6K  
protons from (n,p)

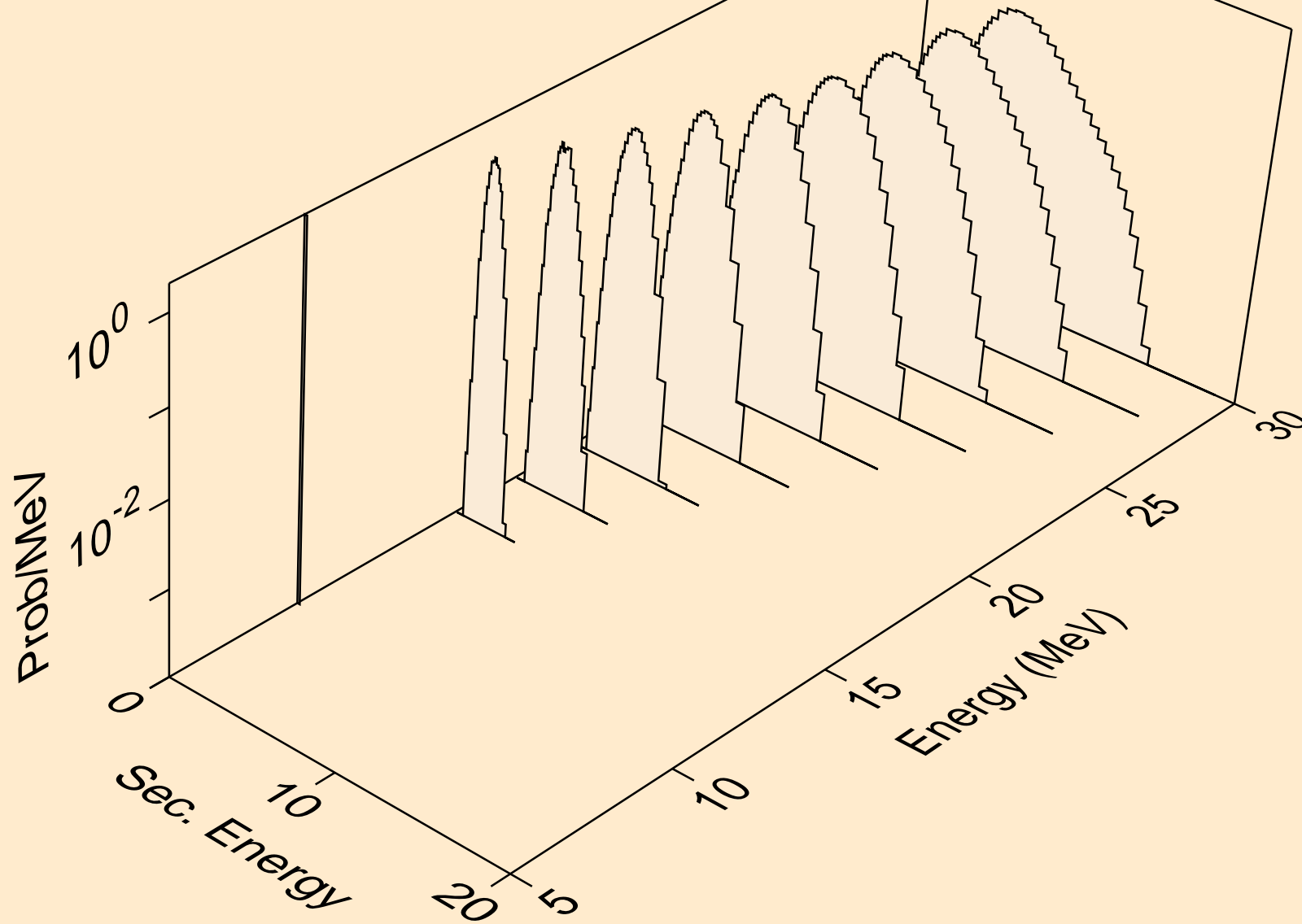

CO059 NEUTRON ACER TENDL-2021 LIBRARY; T=293.6K  
protons from (n,pd)

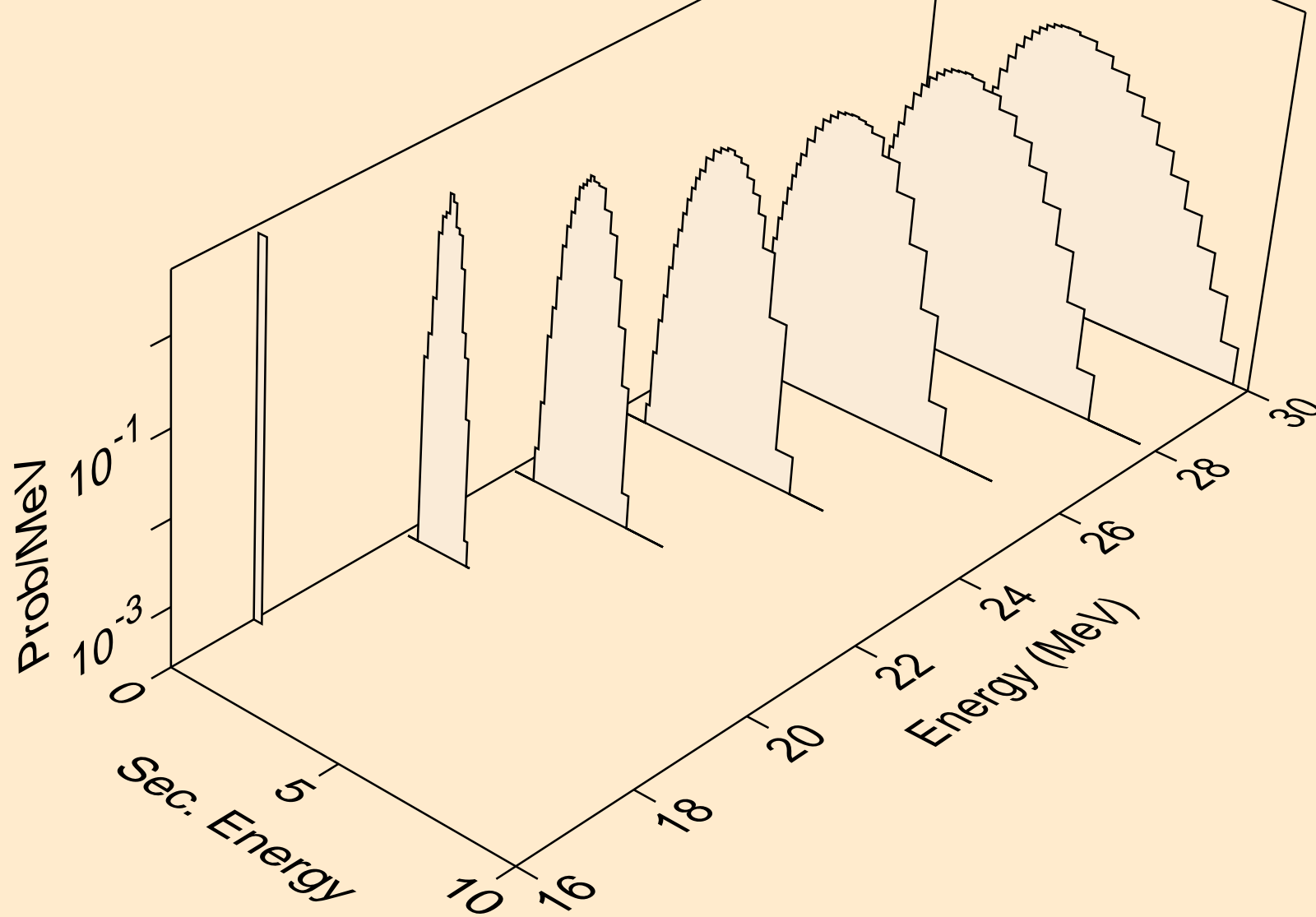

CO059 NEUTRON ACER TENDL-2021 LIBRARY; T=293.6K  
protons from (n,pt)

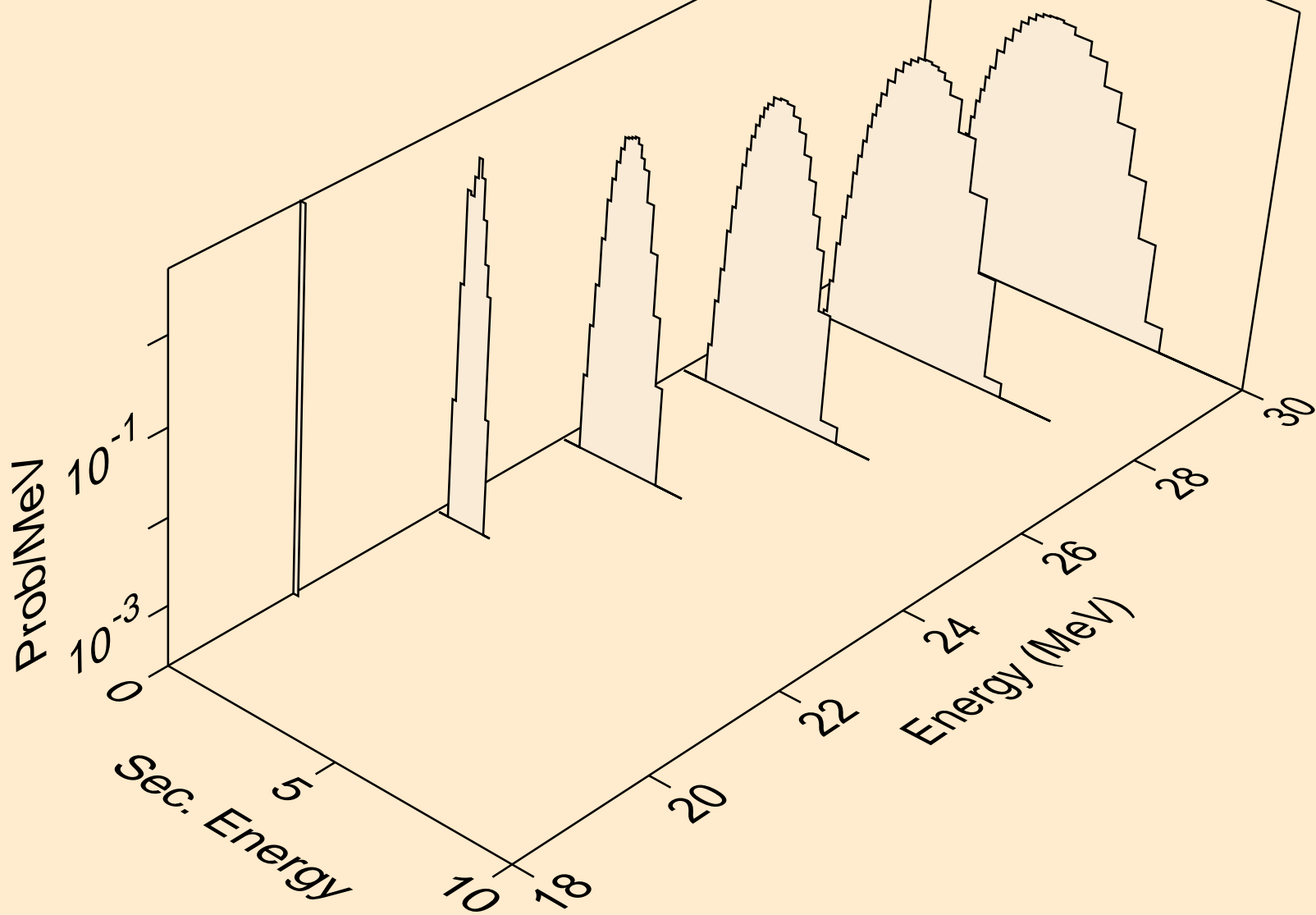

CO059 NEUTRON ACER TENDL-2021 LIBRARY; T=293.6K  
deuterons from (n,x)

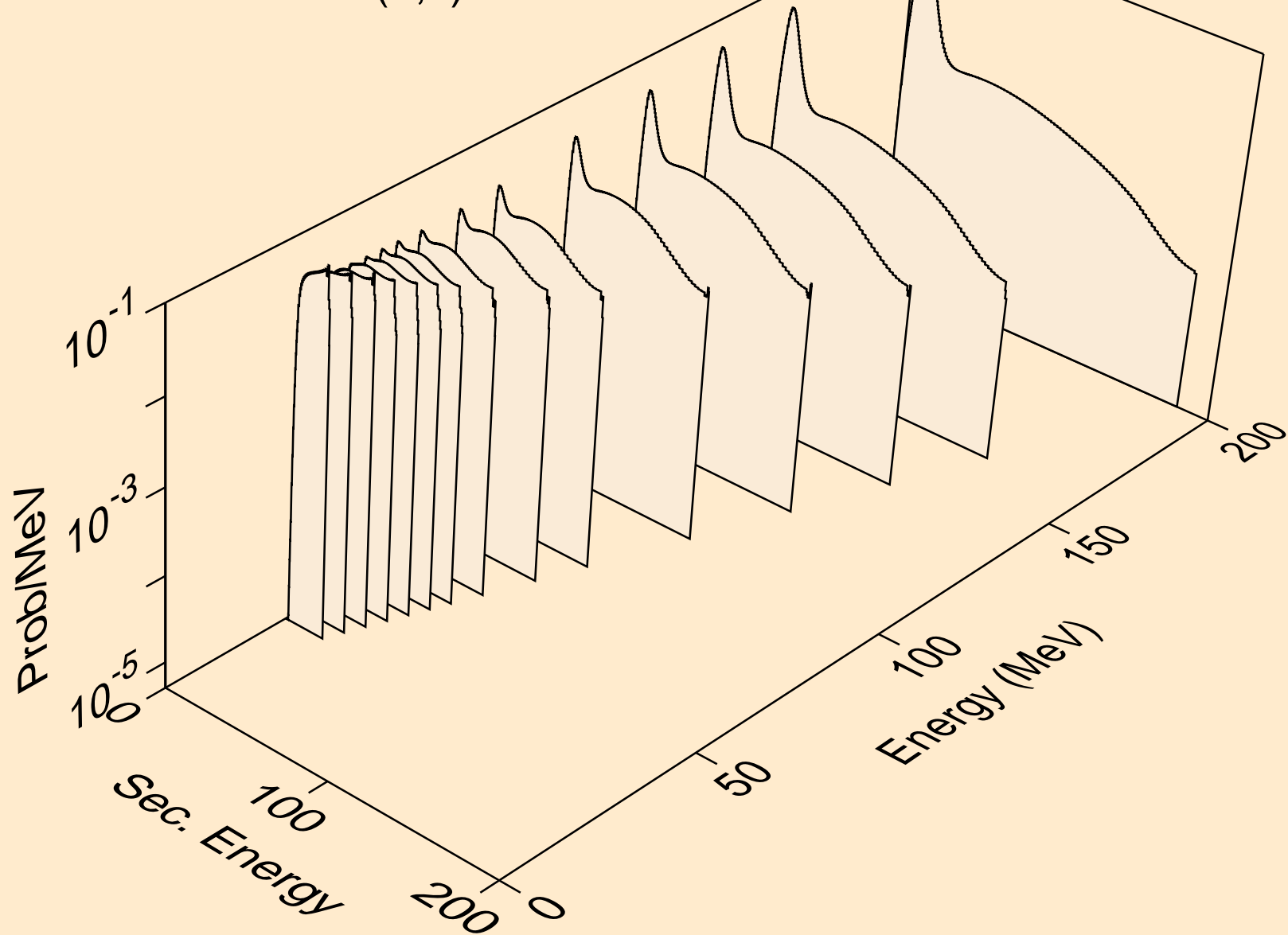

CO059 NEUTRON ACER TENDL-2021 LIBRARY; T=293.6K  
deuterons from (n,2nd)

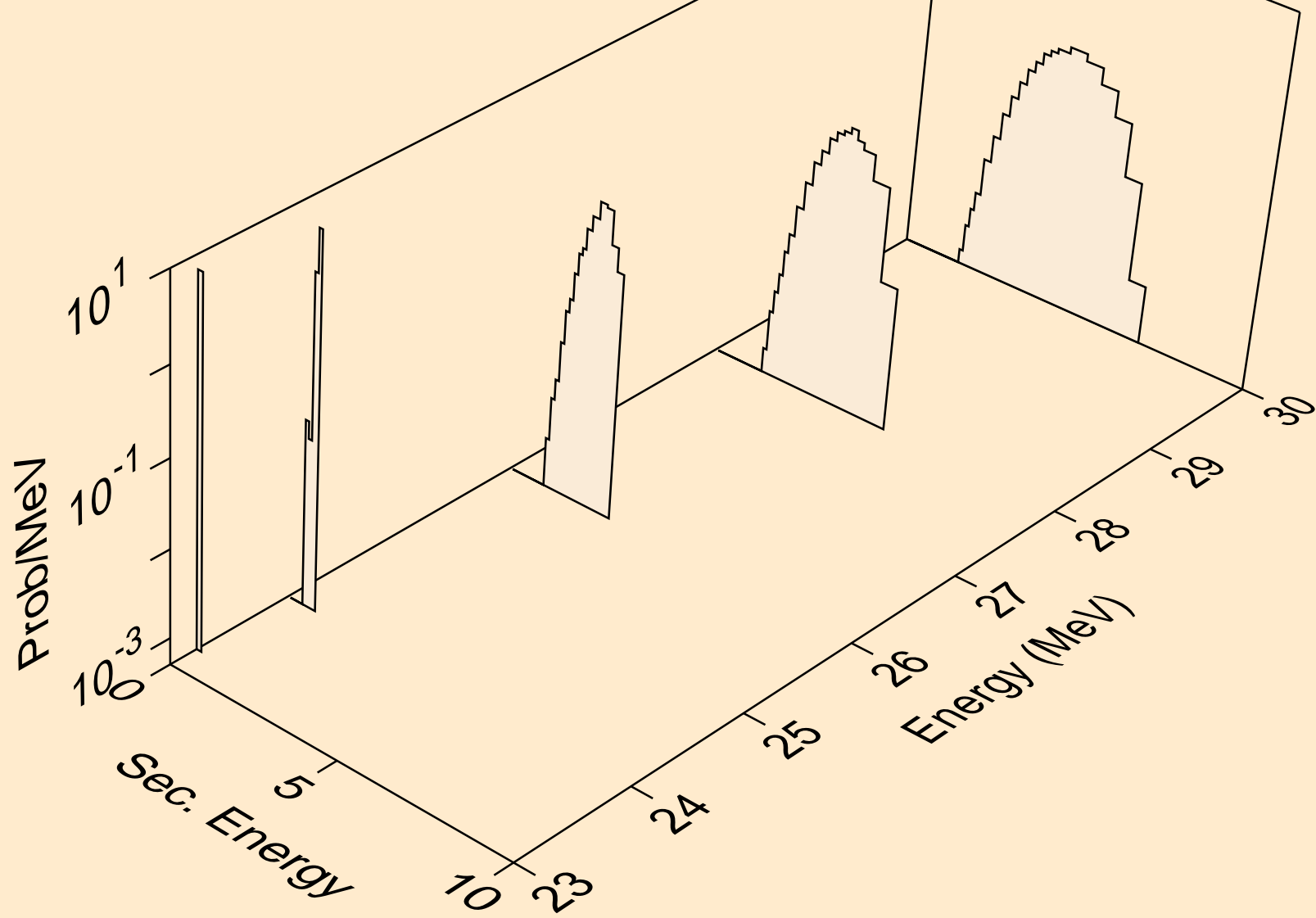

CO059 NEUTRON ACER TENDL-2021 LIBRARY; T=293.6K  
deuterons from (n,n\*)d

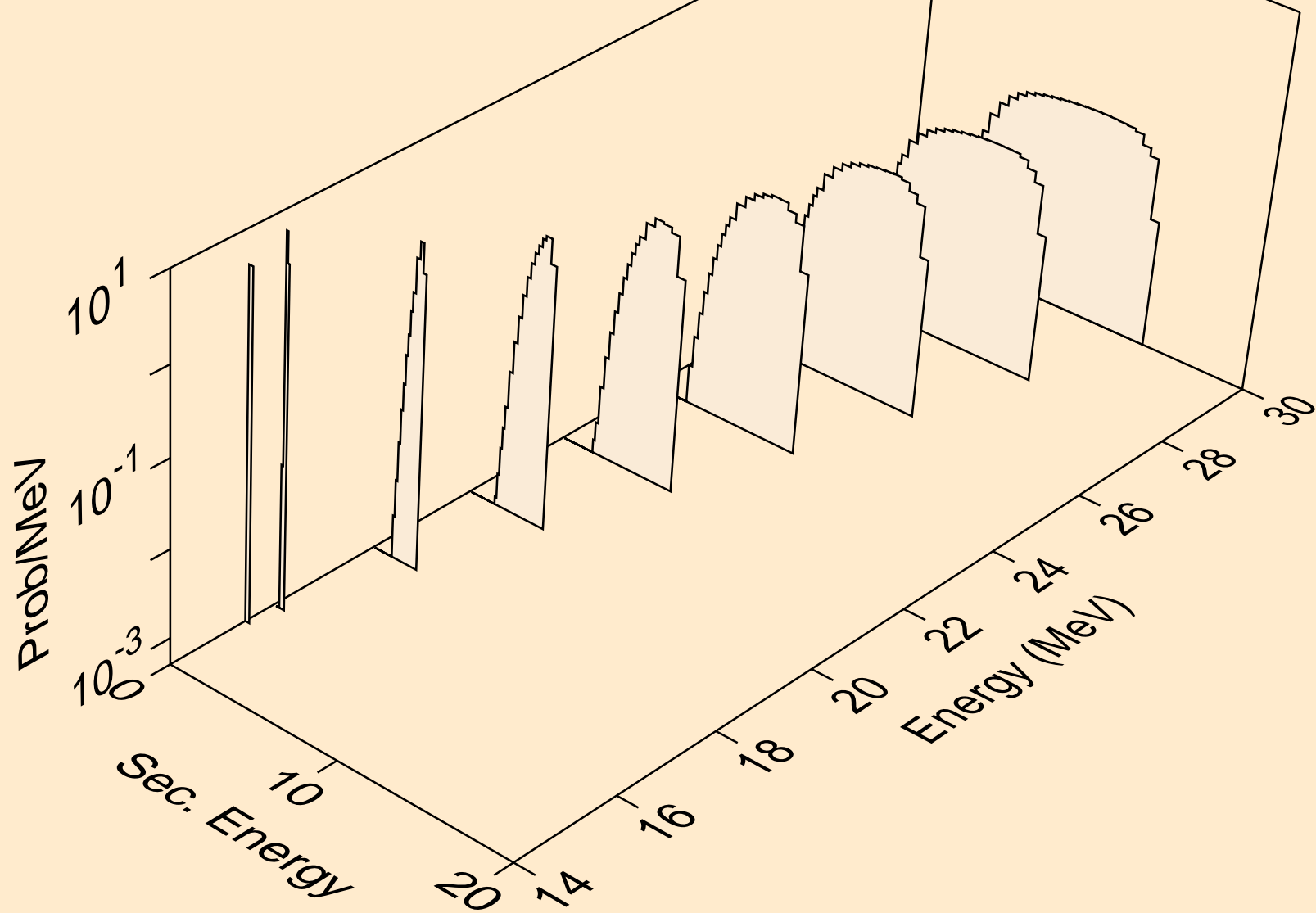

CO059 NEUTRON ACER TENDL-2021 LIBRARY; T=293.6K  
deuterons from (n,d)

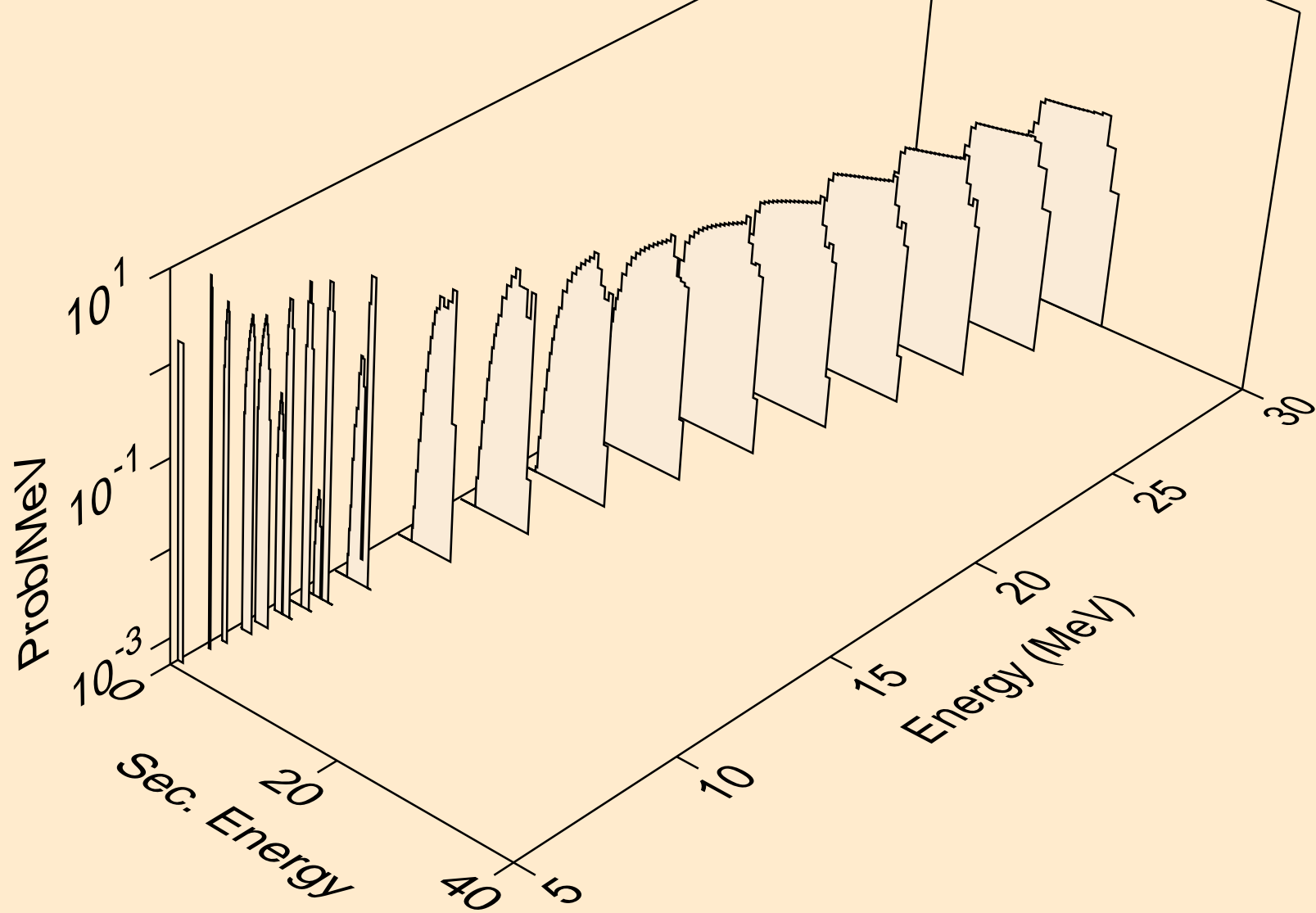

CO059 NEUTRON ACER TENDL-2021 LIBRARY; T=293.6K  
deuterons from (n,pd)

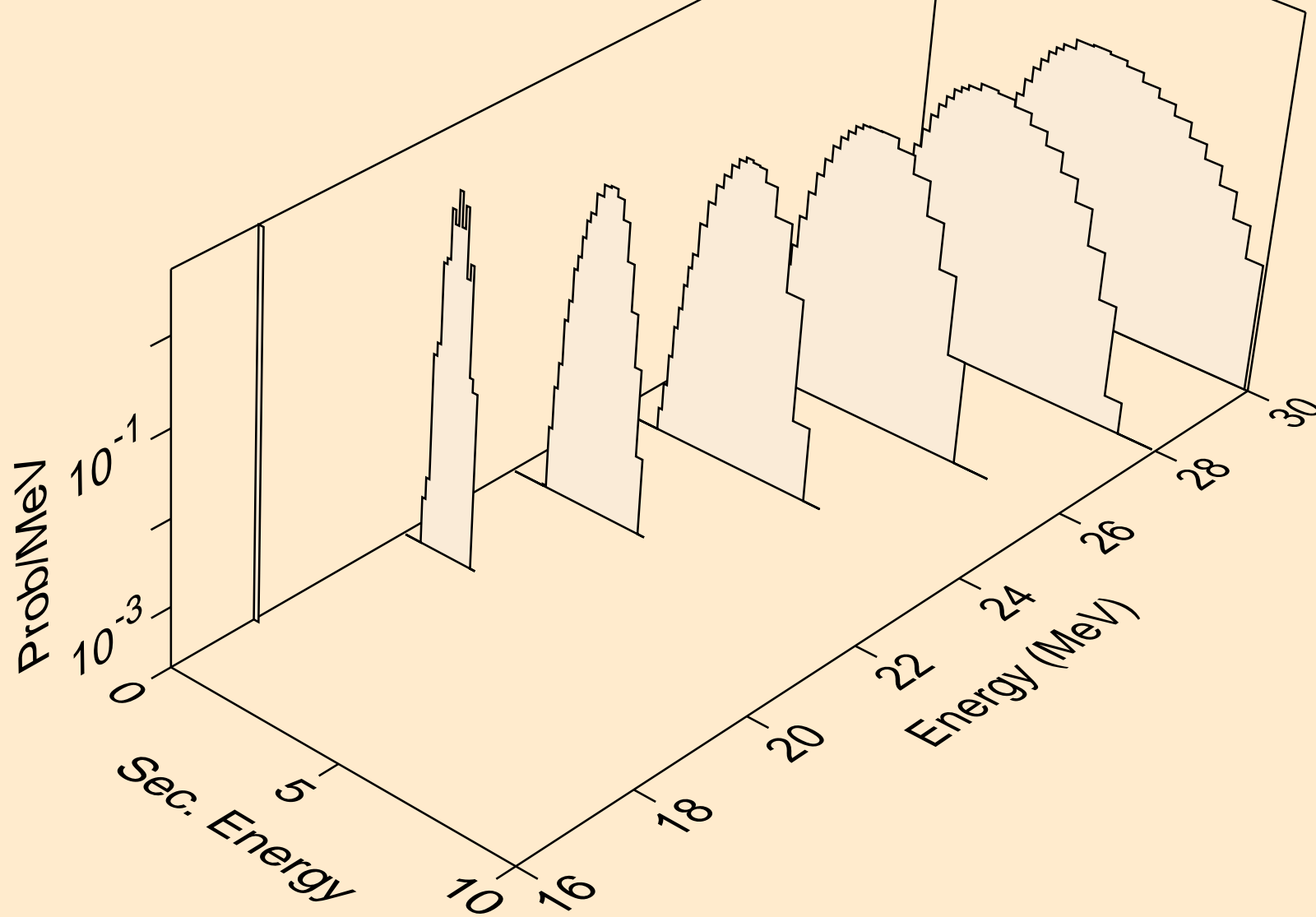



CO059 NEUTRON ACER TENDL-2021 LIBRARY; T=293.6K  
deuterons from (n,da)

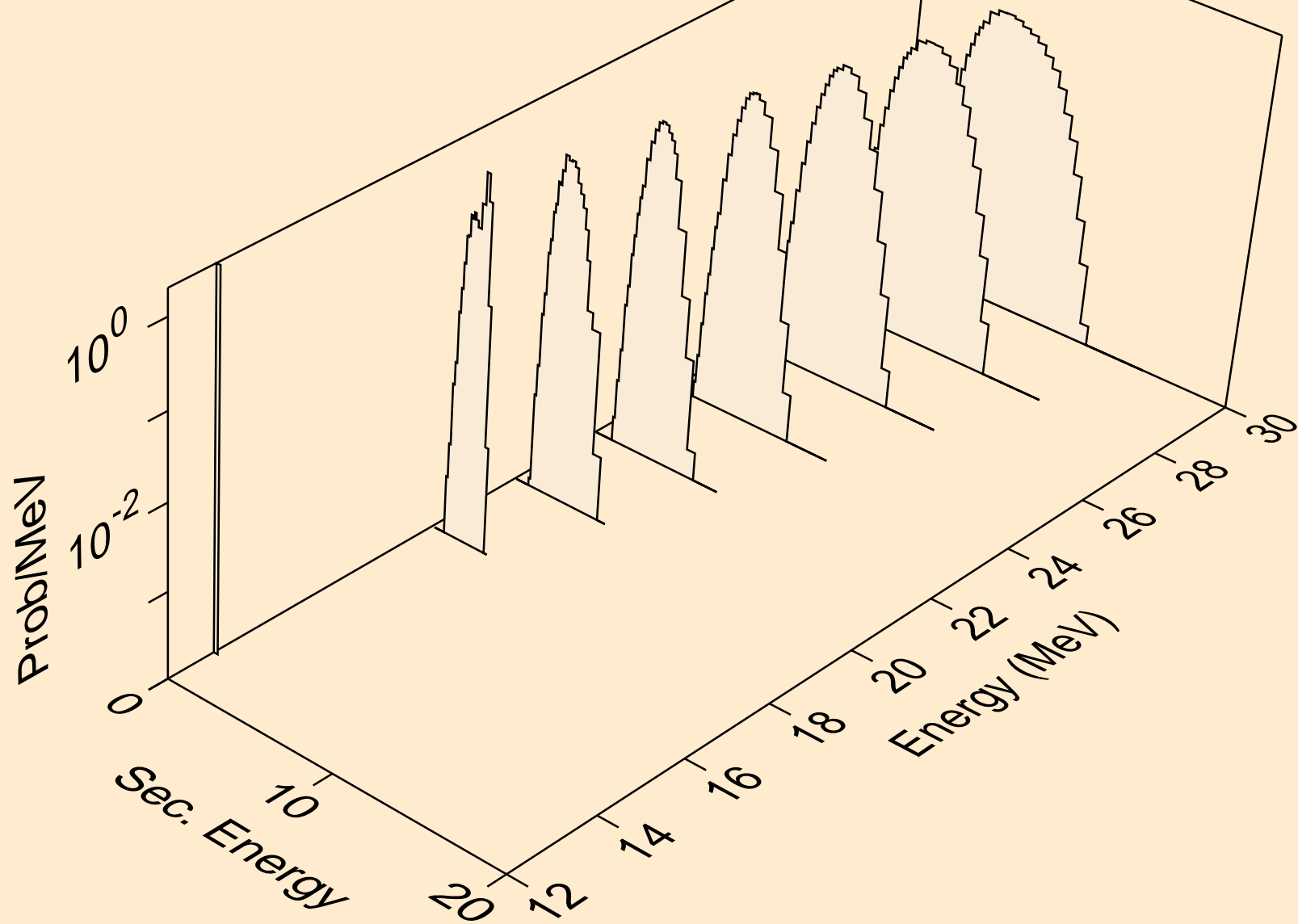

CO059 NEUTRON ACER TENDL-2021 LIBRARY; T=293.6K  
tritons from (n,x)

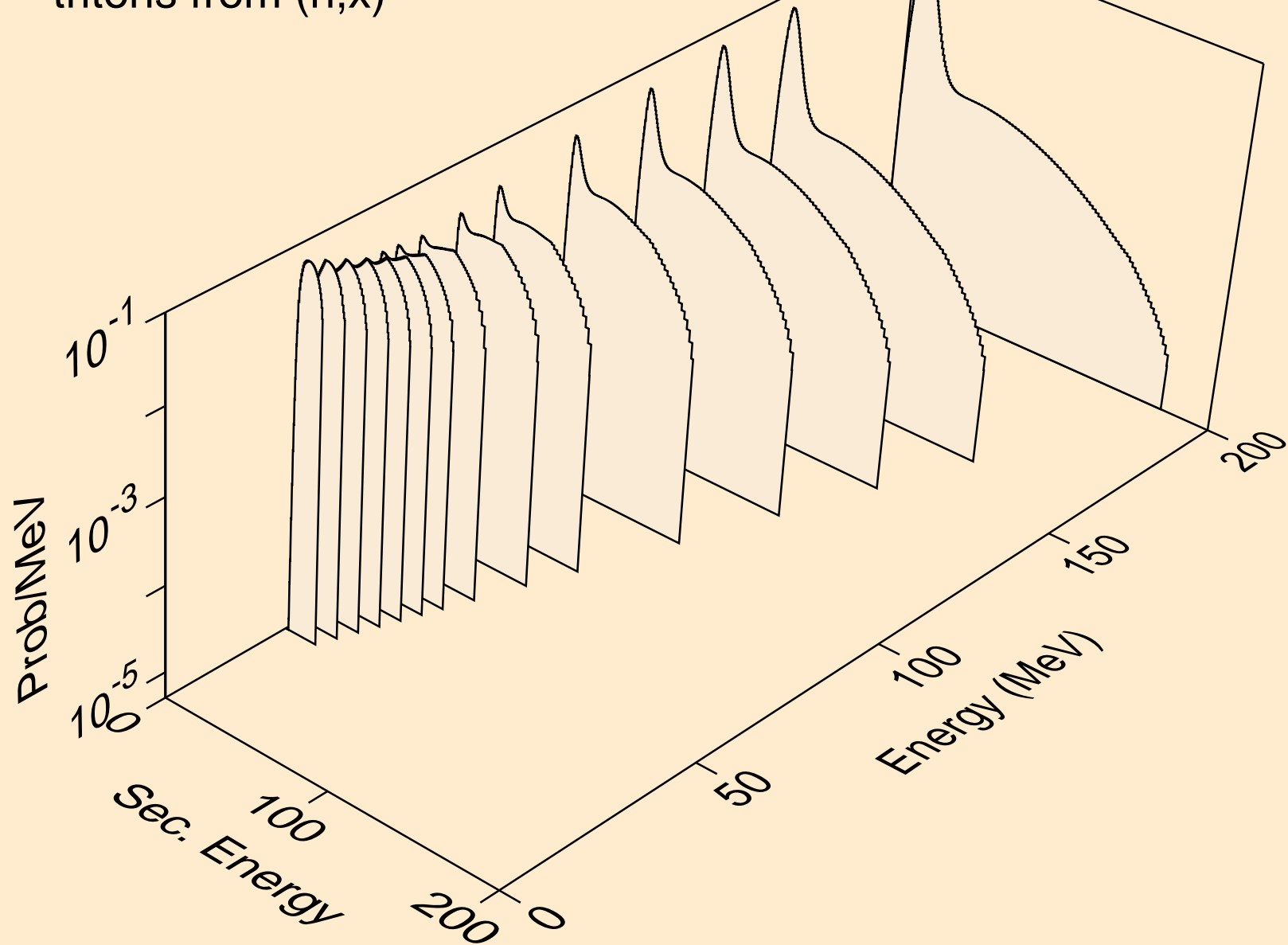

CO059 NEUTRON ACER TENDL-2021 LIBRARY; T=293.6K  
tritons from (n,n\*)t

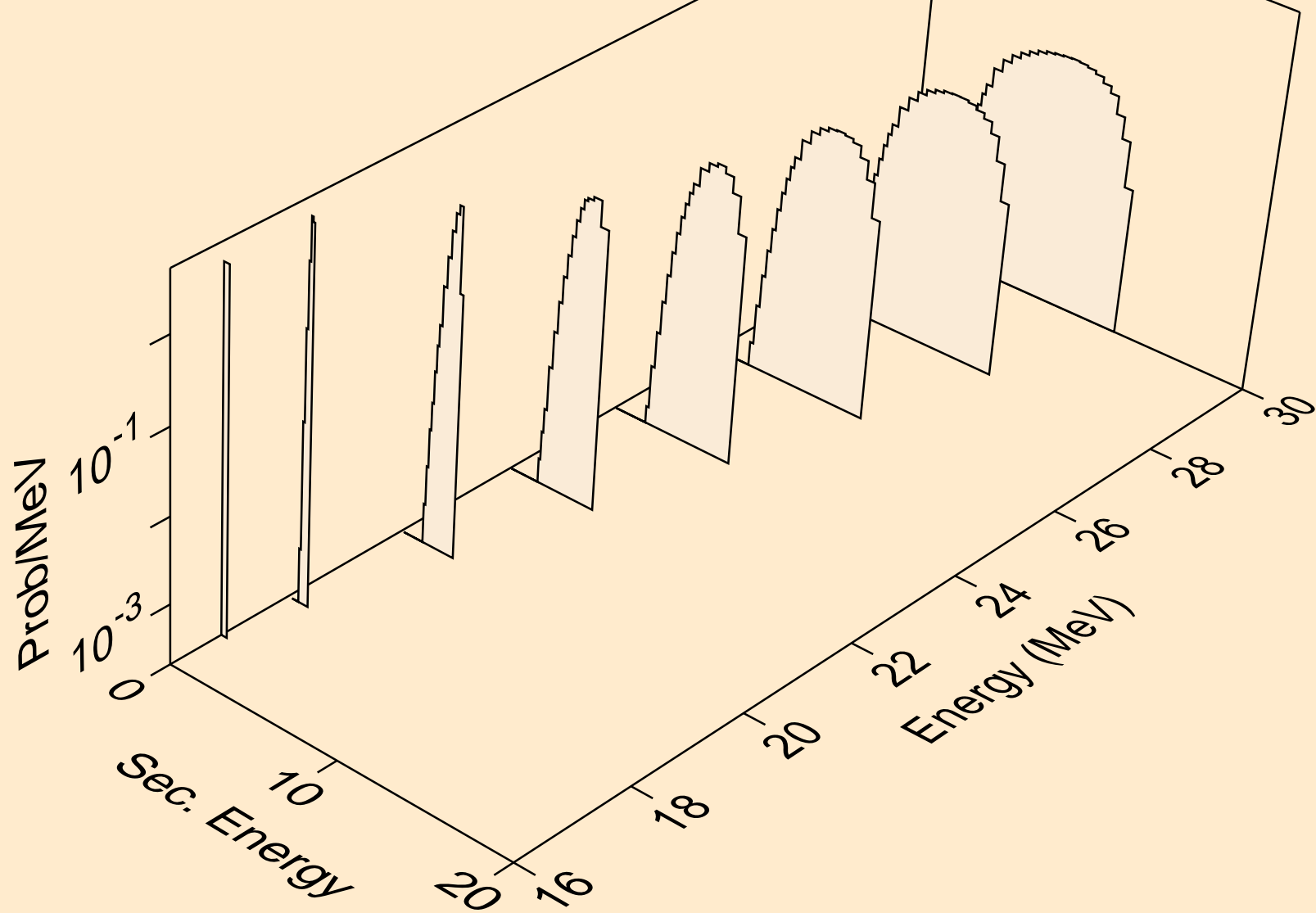

CO059 NEUTRON ACER TENDL-2021 LIBRARY; T=293.6K  
tritons from (n,t)

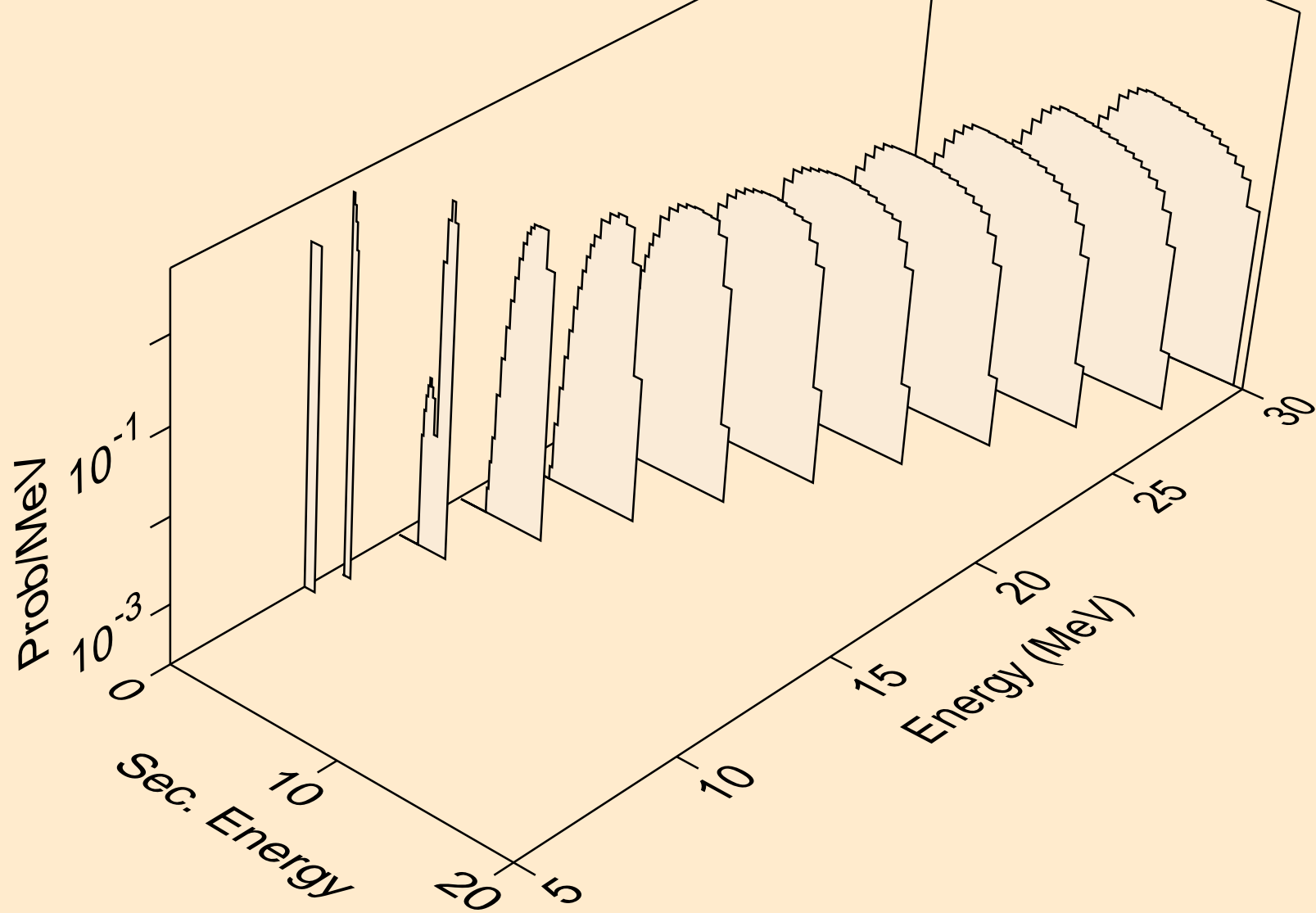

CO059 NEUTRON ACER TENDL-2021 LIBRARY; T=293.6K  
tritons from (n,pt)

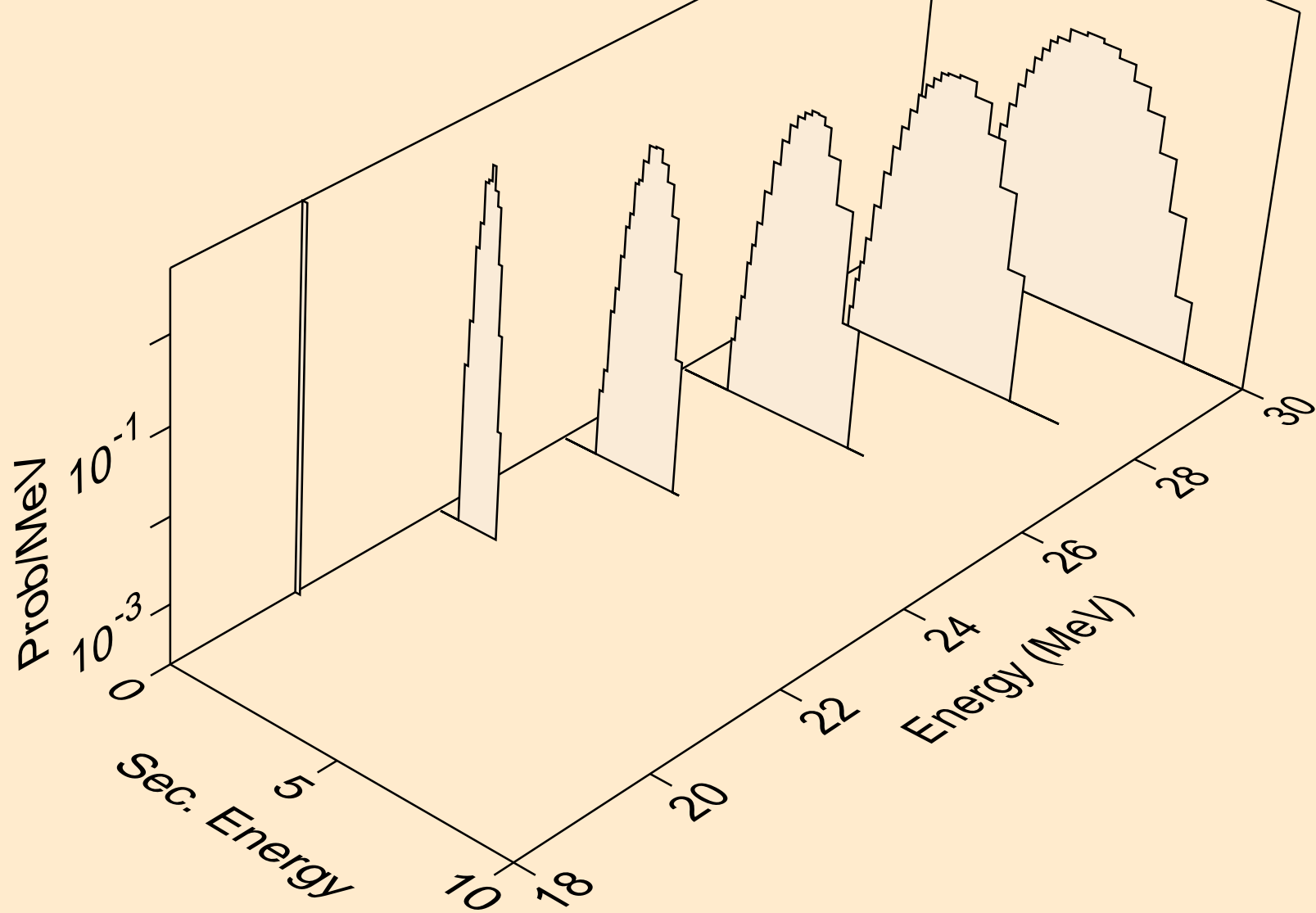

CO059 NEUTRON ACER TENDL-2021 LIBRARY; T=293.6K  
he3s from (n,x)

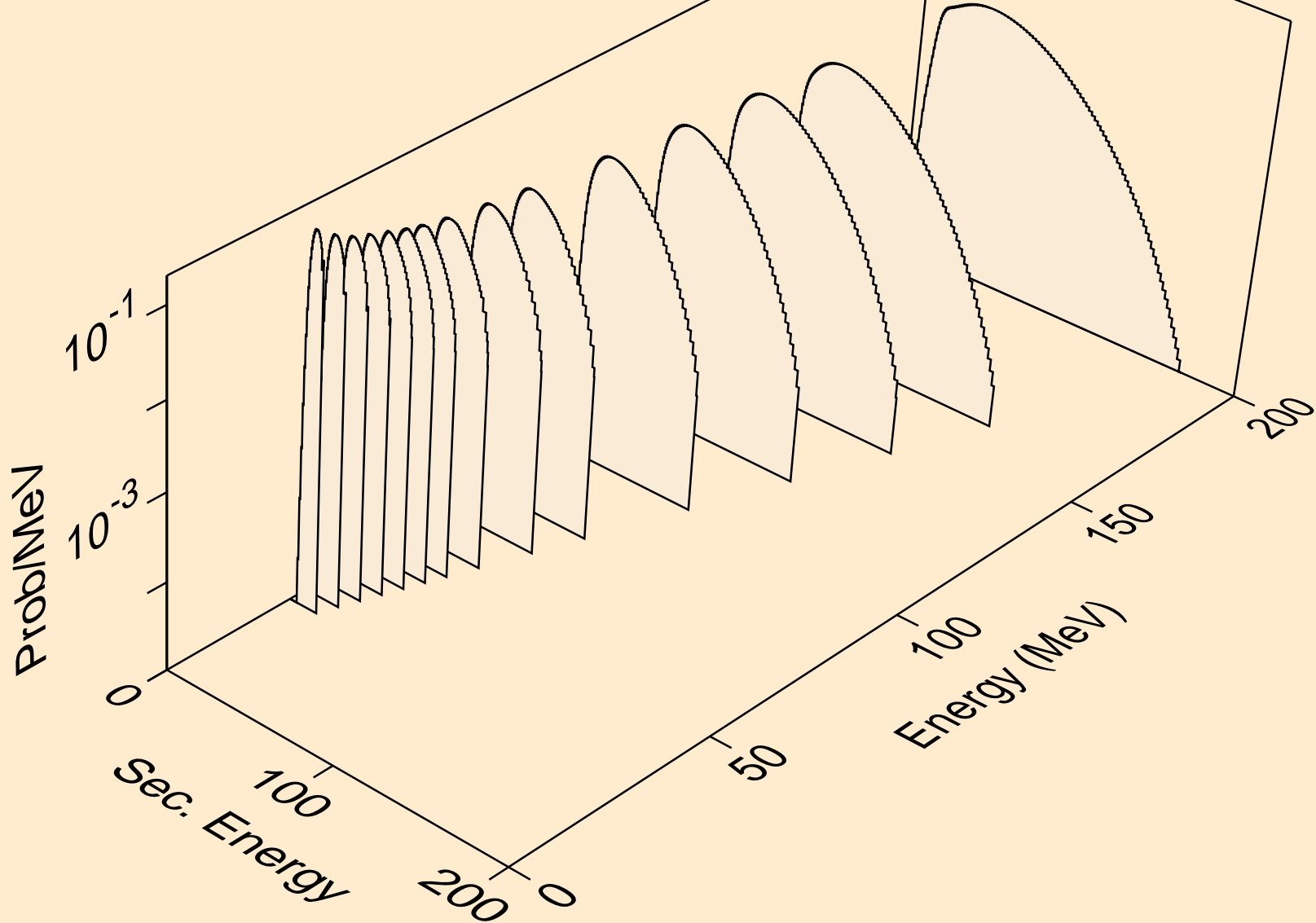

CO059 NEUTRON ACER TENDL-2021 LIBRARY; T=293.6K  
he3s from (n,n\*)he3

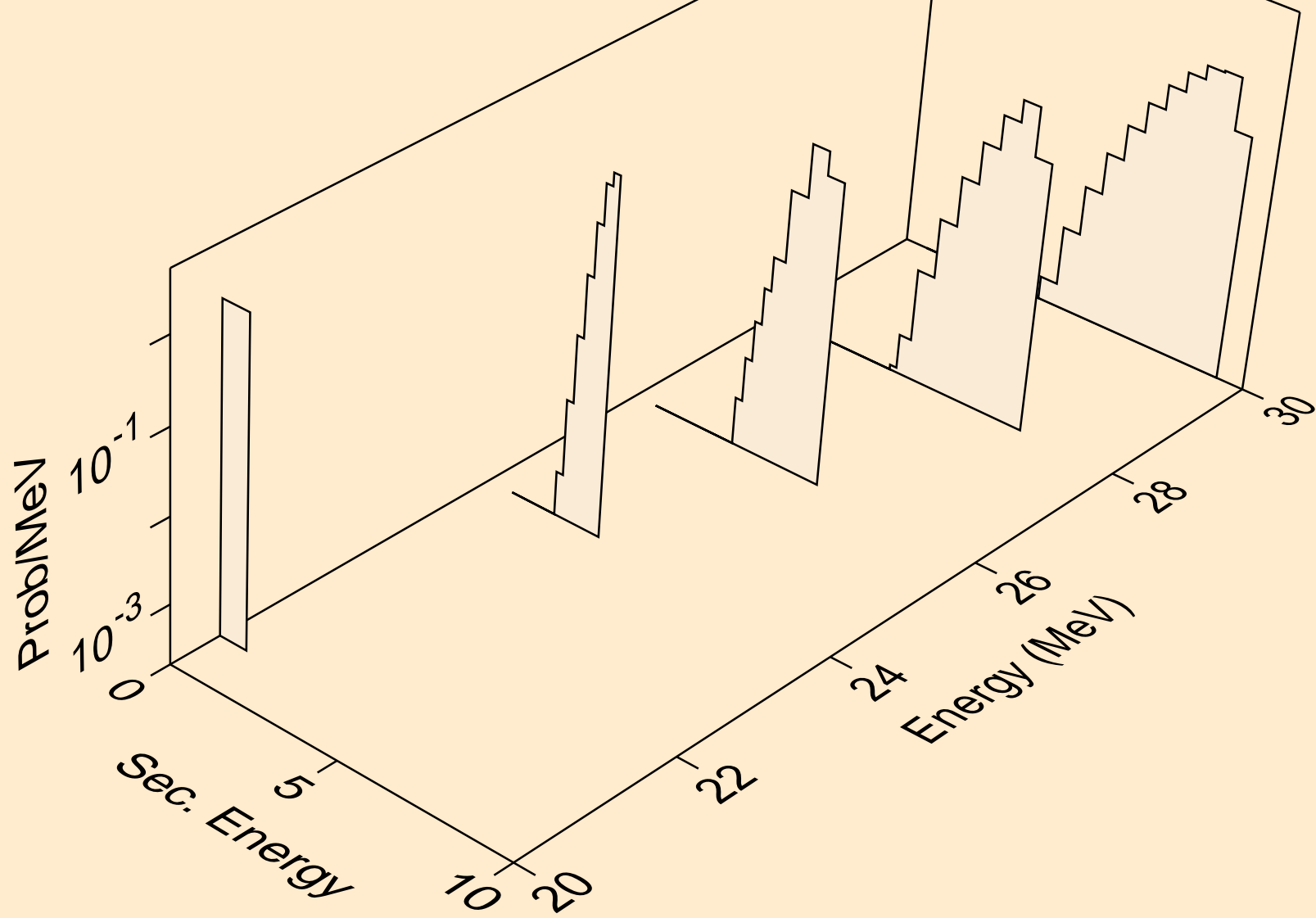

CO059 NEUTRON ACER TENDL-2021 LIBRARY; T=293.6K  
he3s from (n,he3)

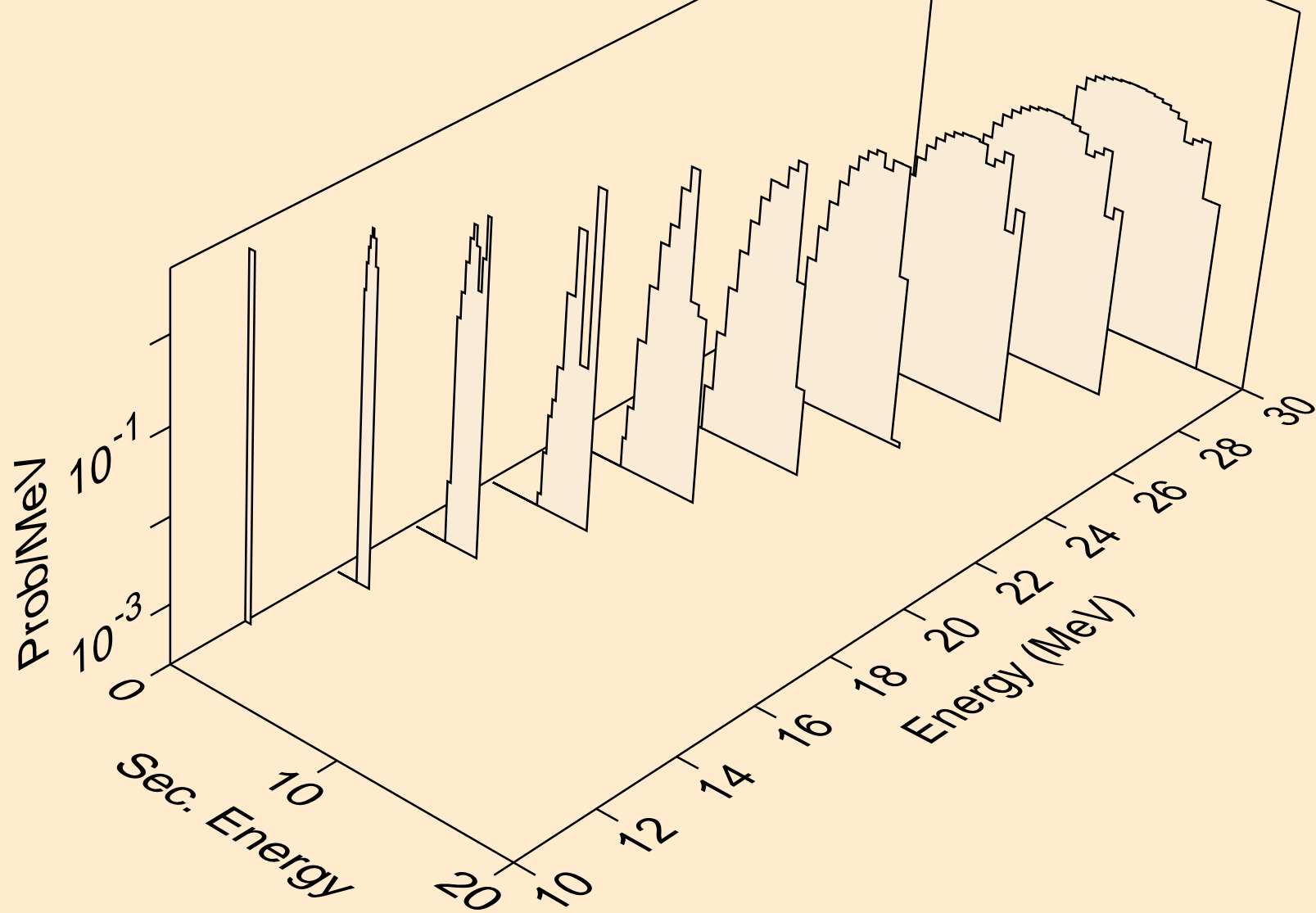



CO059 NEUTRON ACER TENDL-2021 LIBRARY; T=293.6K  
alphas from (n,x)

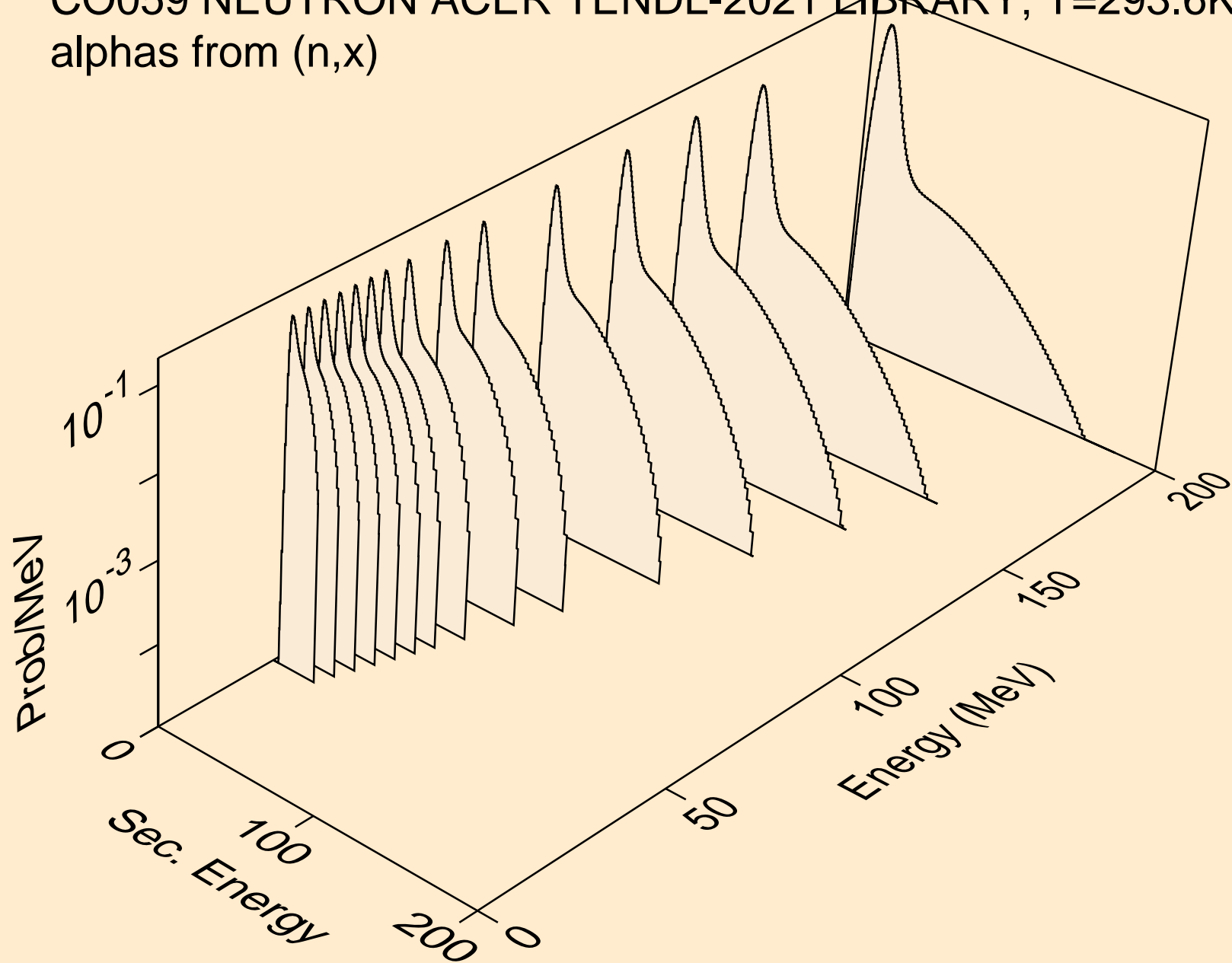

CO059 NEUTRON ACER TENDL-2021 LIBRARY; T=293.6K  
alphas from (n,n\*)a

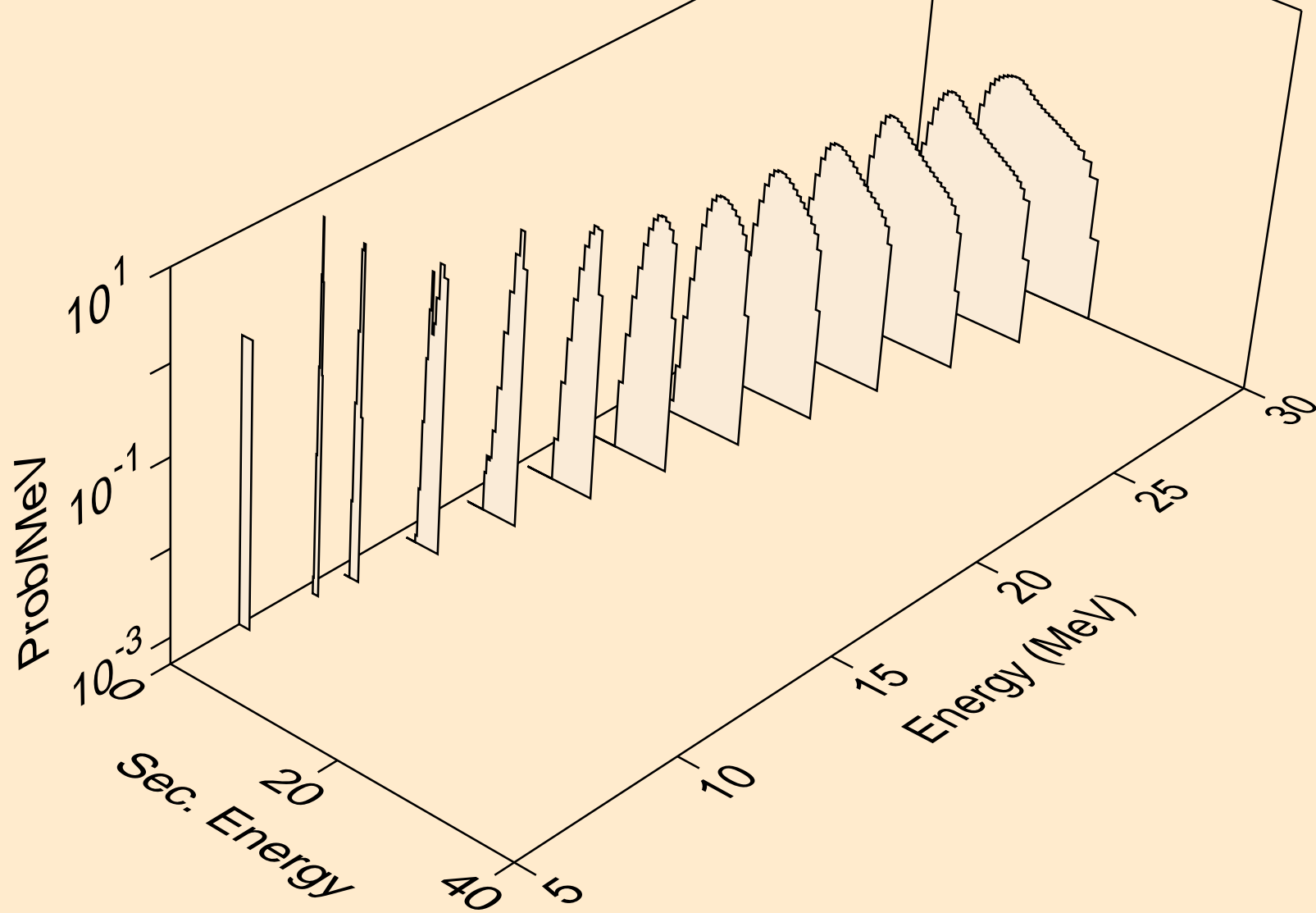

CO059 NEUTRON ACER TENDL-2021 LIBRARY; T=293.6K  
alphas from (n,2n)a

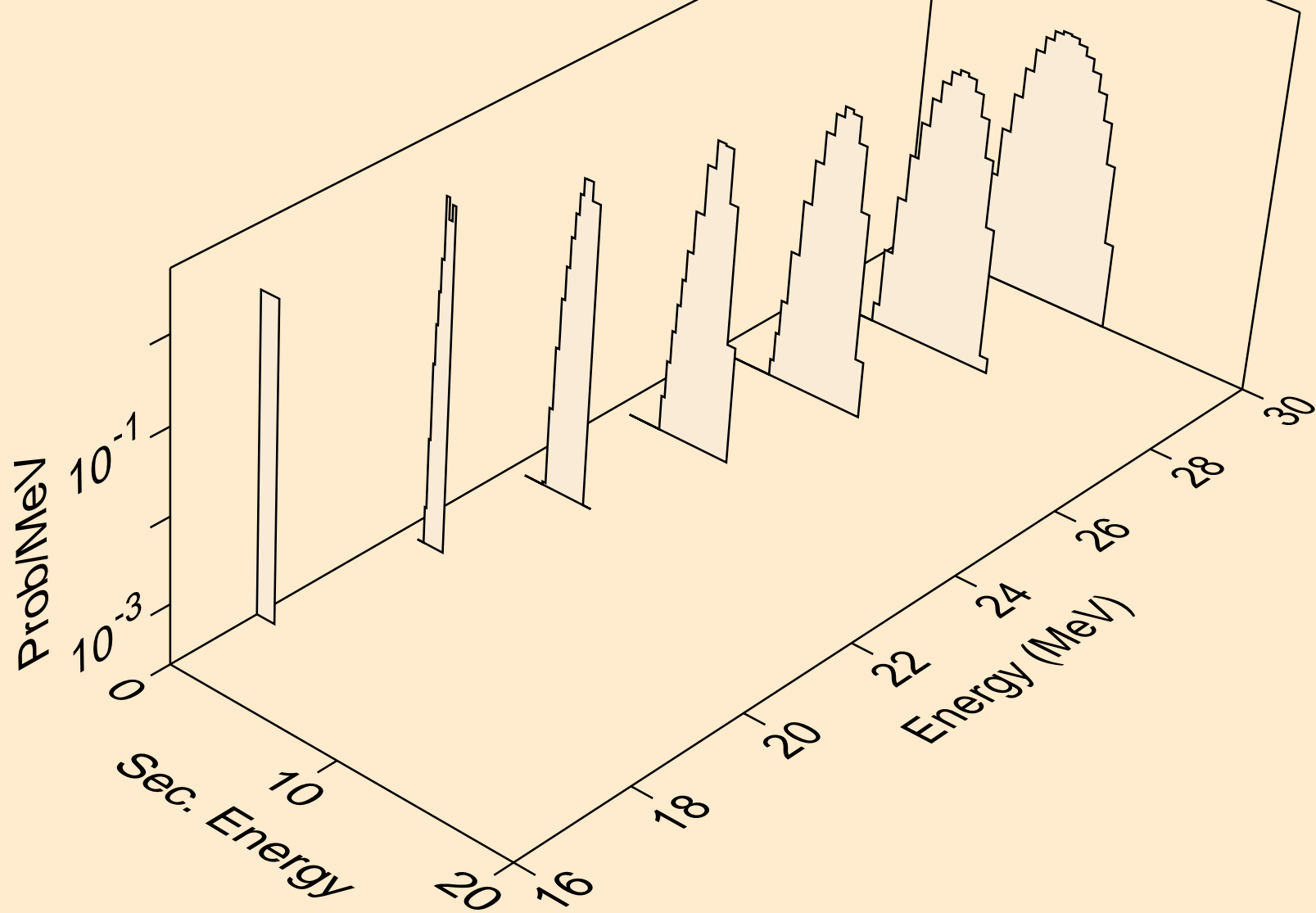

CO059 NEUTRON ACER TENDL-2021 LIBRARY; T=293.6K  
alphas from (n,n\*)2a

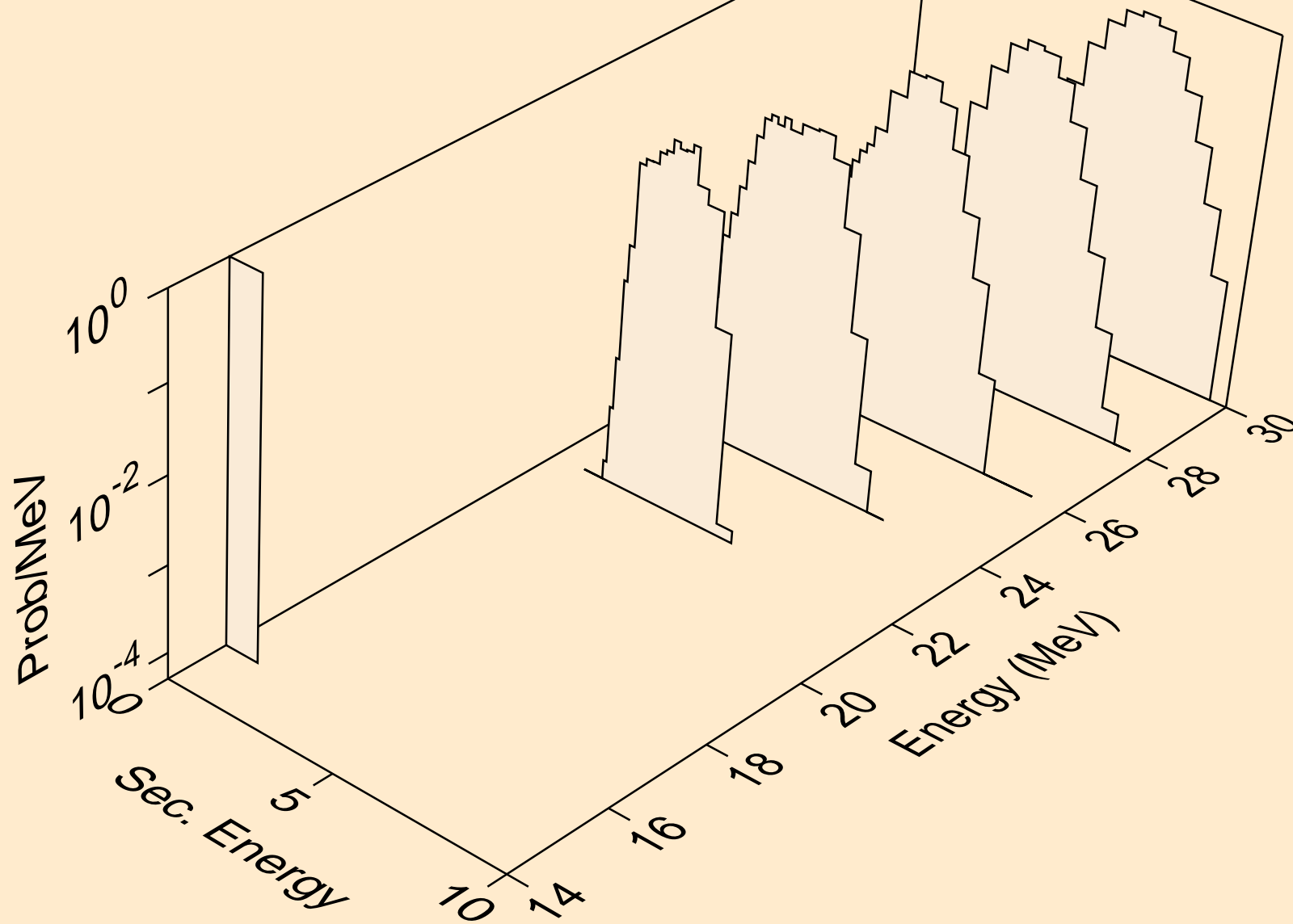

CO059 NEUTRON ACER TENDL-2021 LIBRARY; T=293.6K  
alphas from (n,npa)

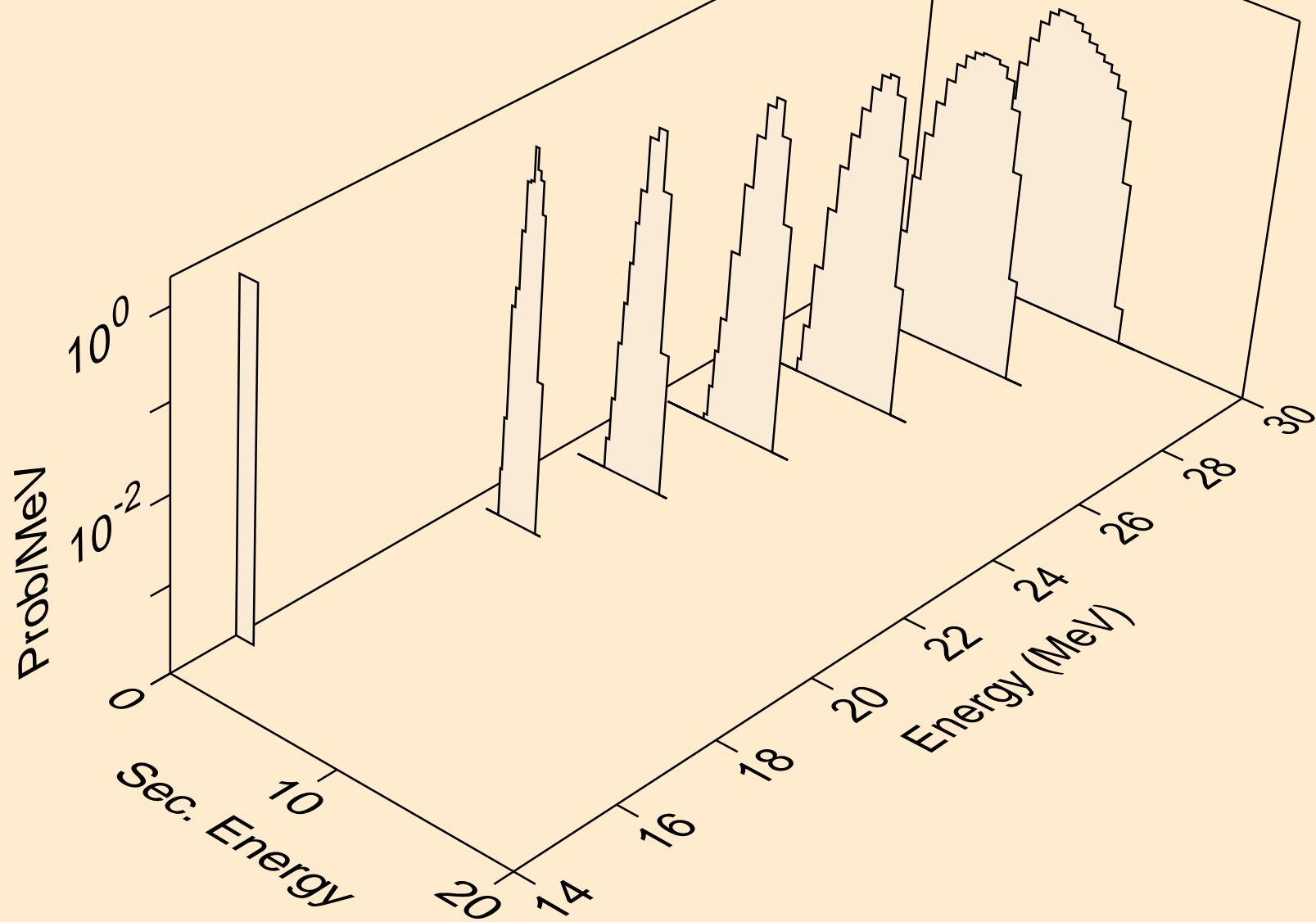

CO059 NEUTRON ACER TENDL-2021 LIBRARY; T=293.6K  
alphas from (n,a)

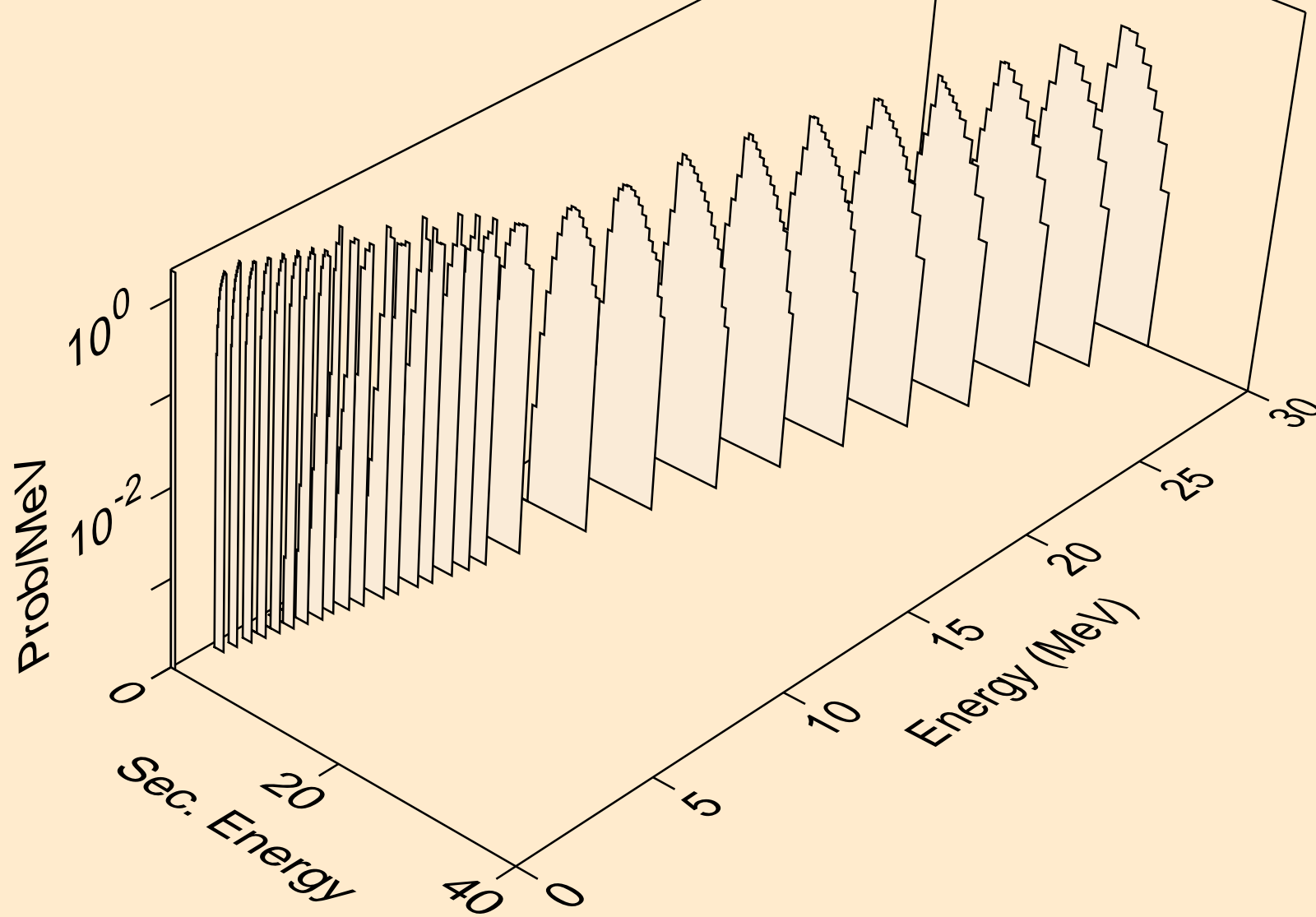

CO059 NEUTRON ACER TENDL-2021 LIBRARY; T=293.6K  
alphas from (n,2a)

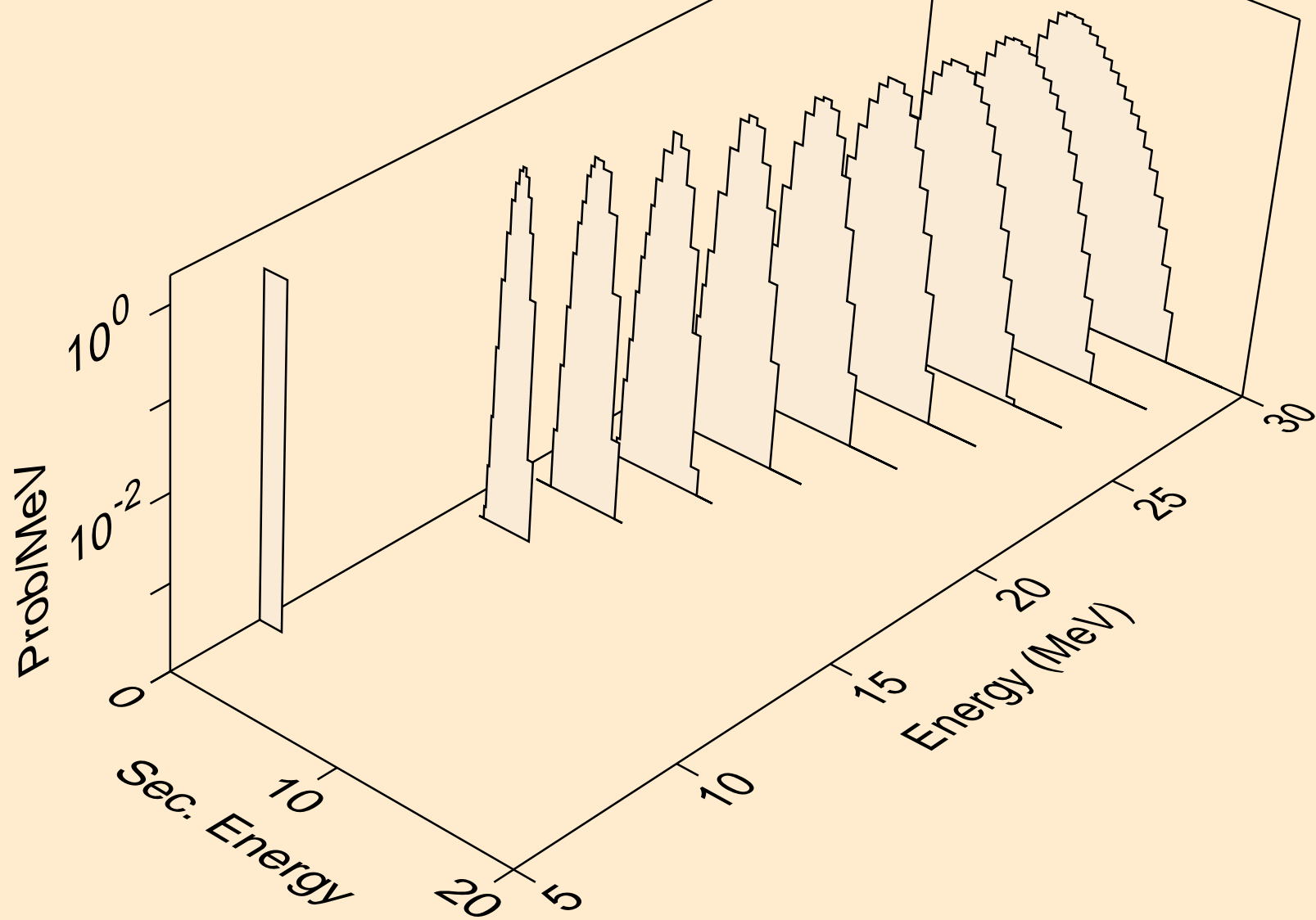

CO059 NEUTRON ACER TENDL-2021 LIBRARY; T=293.6K  
alphas from (n,pa)

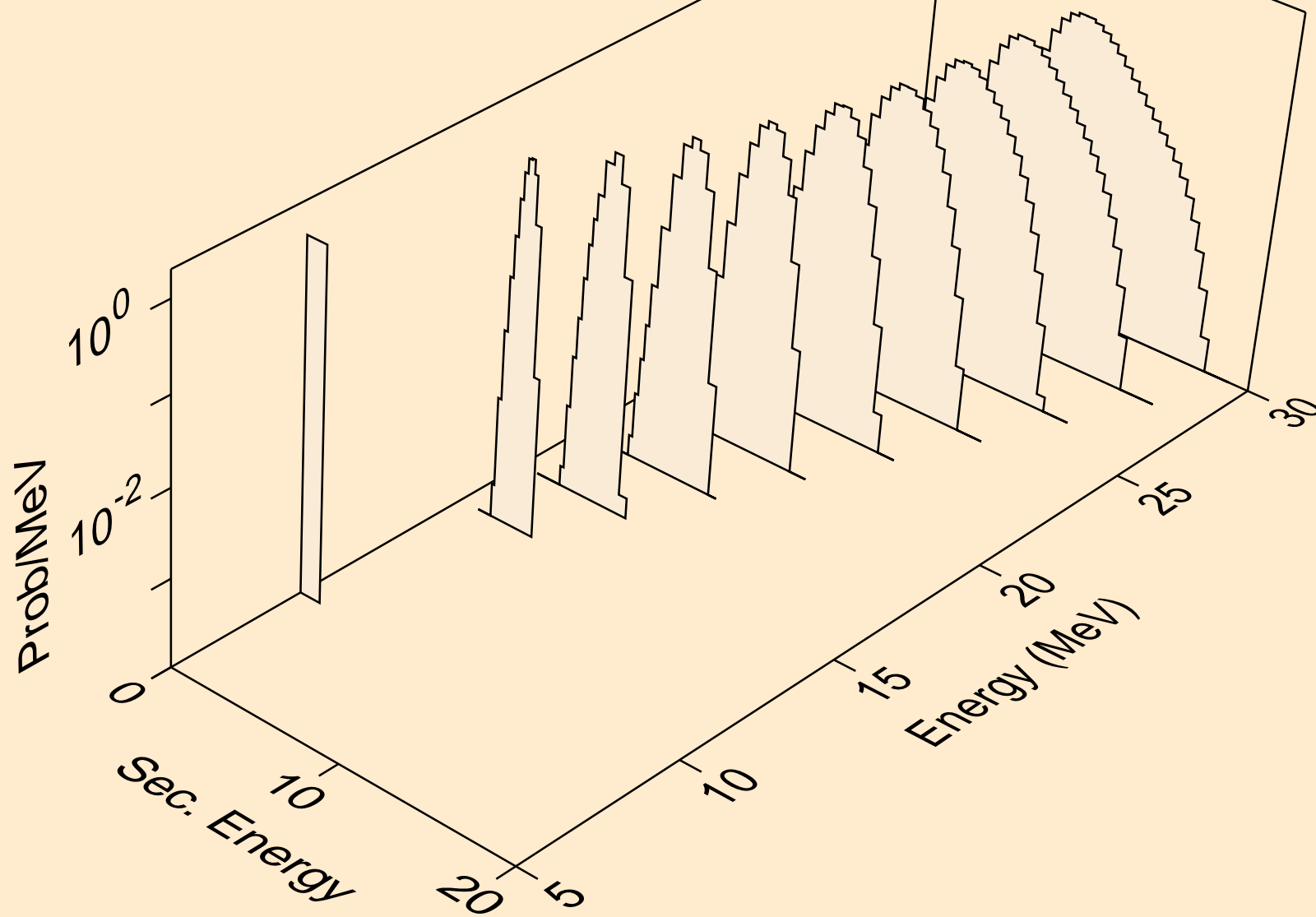



CO059 NEUTRON ACER TENDL-2021 LIBRARY; T=293.6K  
alphas from (n,da)

