

CR052 NEUTRON ACER TENDL-2021 LIBRARY; T=293.6K
Principal cross sections

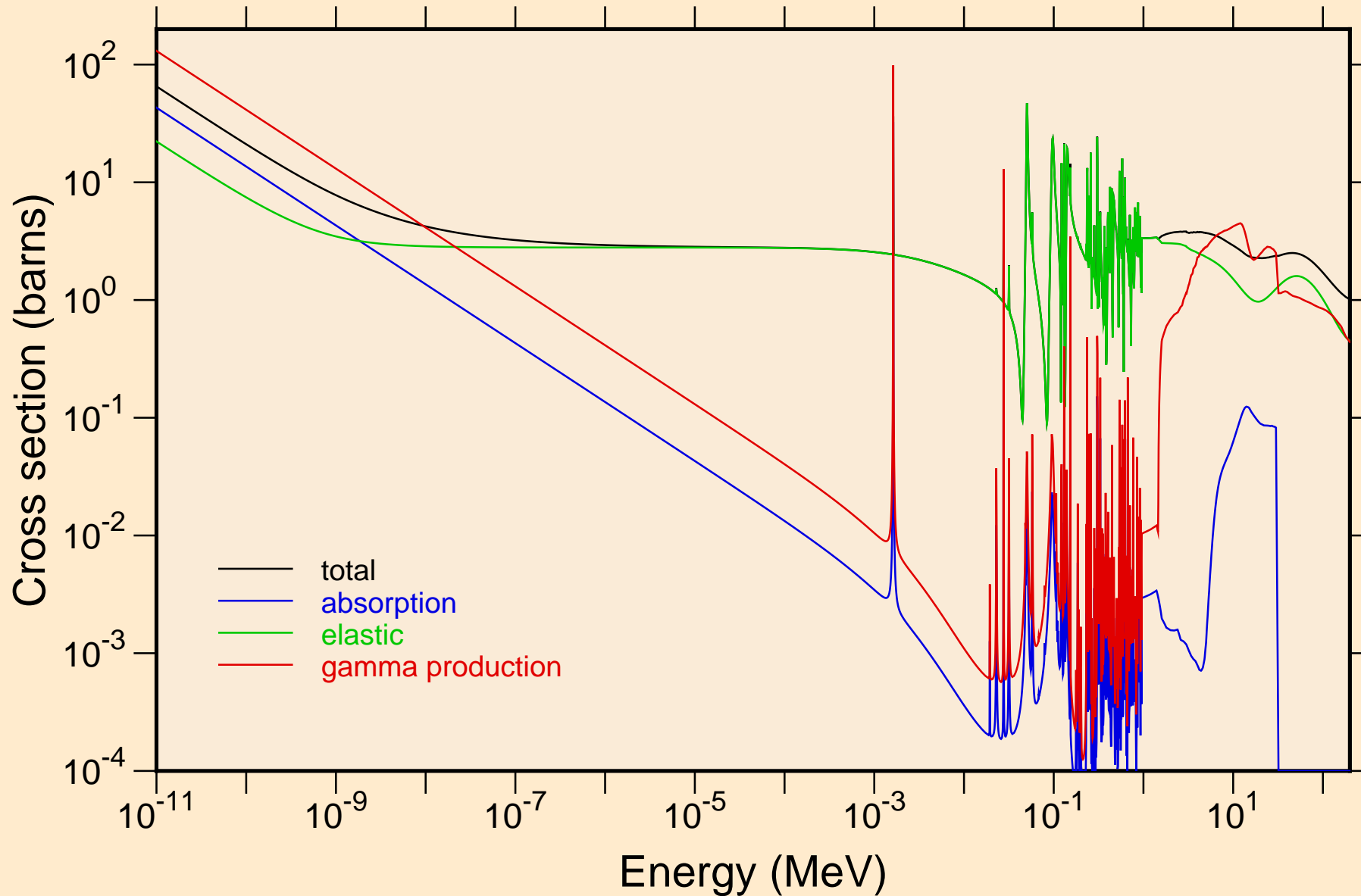

CR052 NEUTRON ACER TENDL-2021 LIBRARY; T=293.6K
resonance total cross section

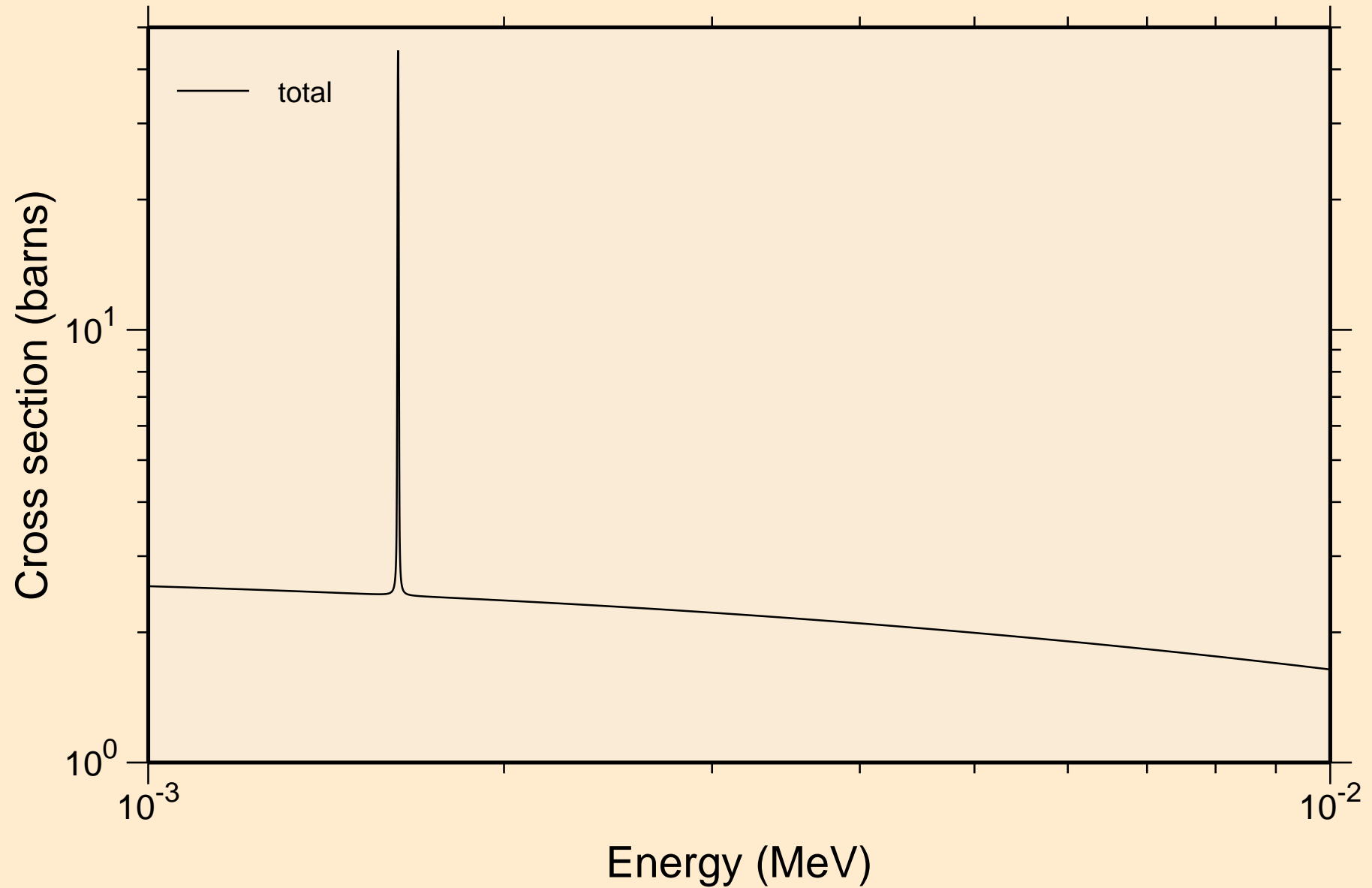

CR052 NEUTRON ACER TENDL-2021 LIBRARY; T=293.6K
resonance total cross section

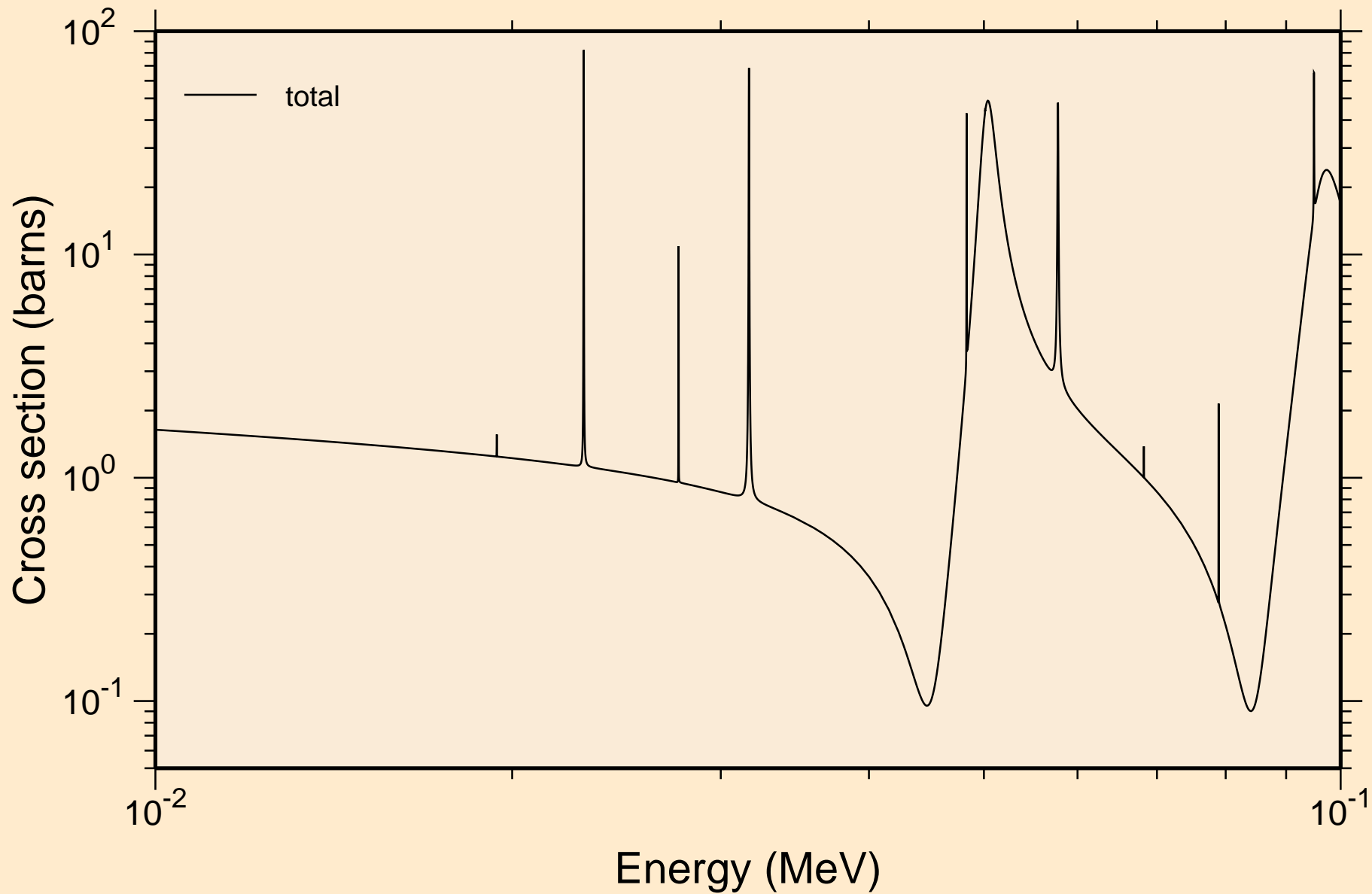

CR052 NEUTRON ACER TENDL-2021 LIBRARY; T=293.6K
resonance total cross section

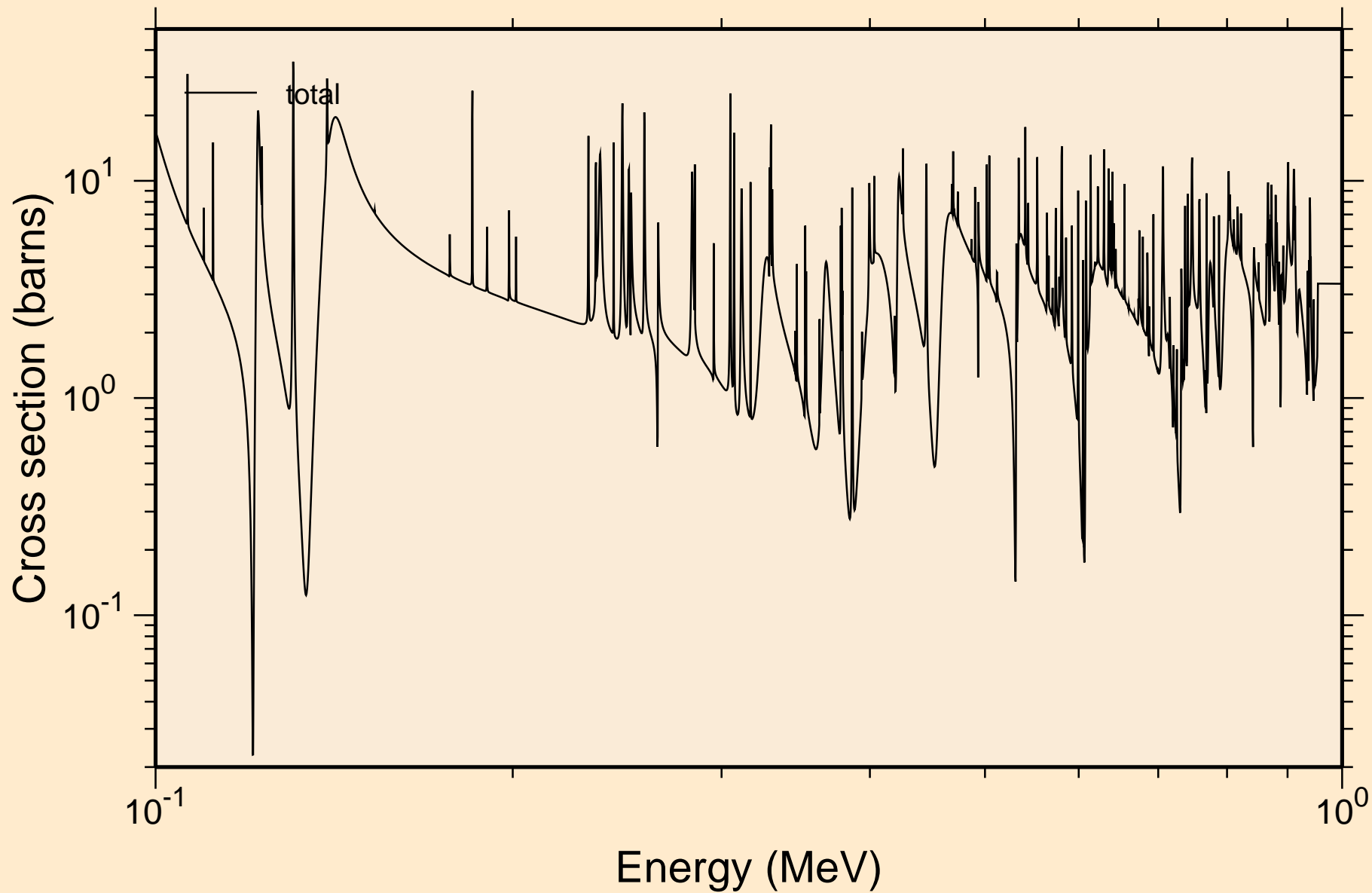

CR052 NEUTRON ACER TENDL-2021 LIBRARY; T=293.6K
resonance total cross section

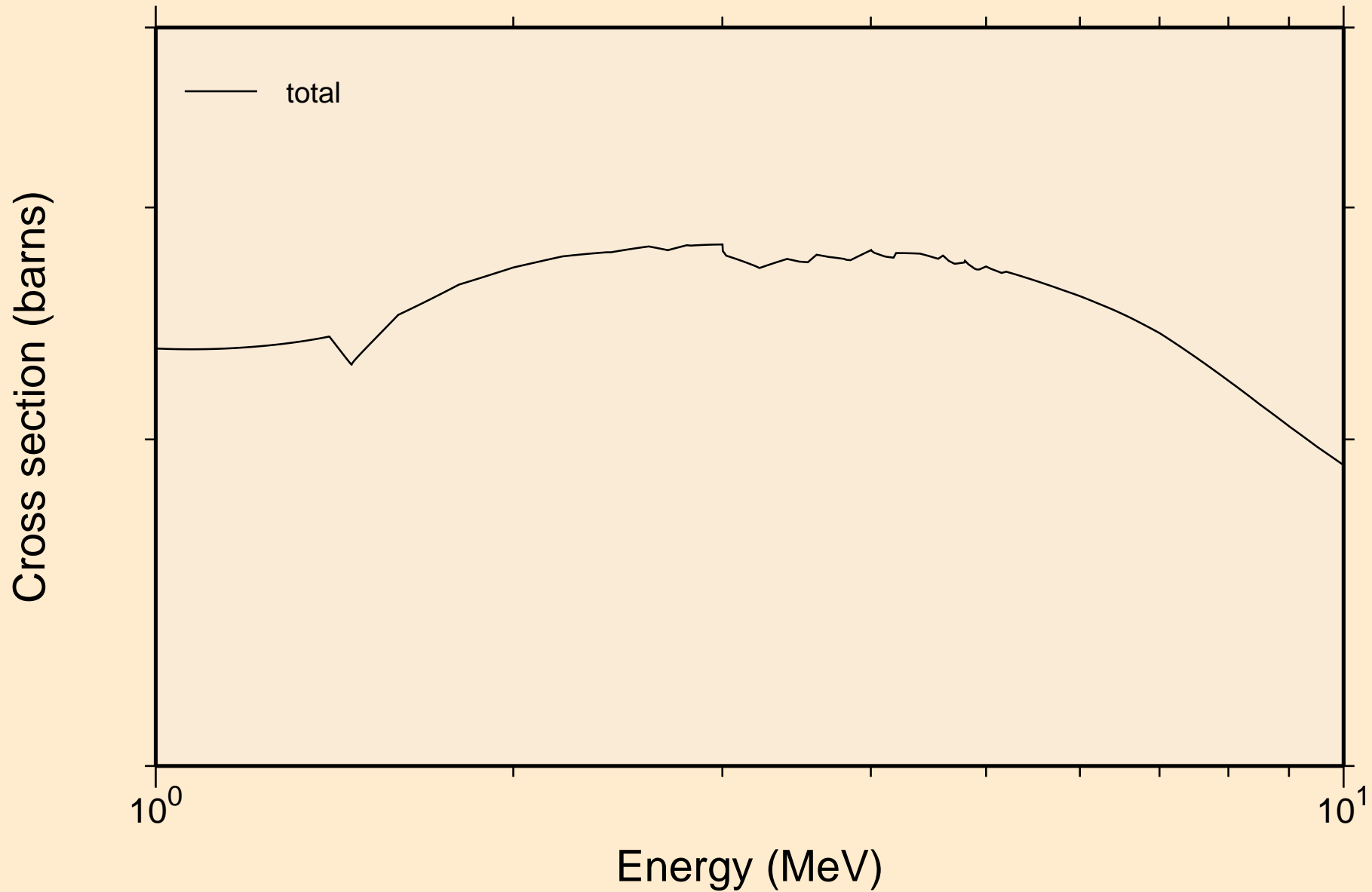

CR052 NEUTRON ACER TENDL-2021 LIBRARY; T=293.6K
resonance absorption cross sections

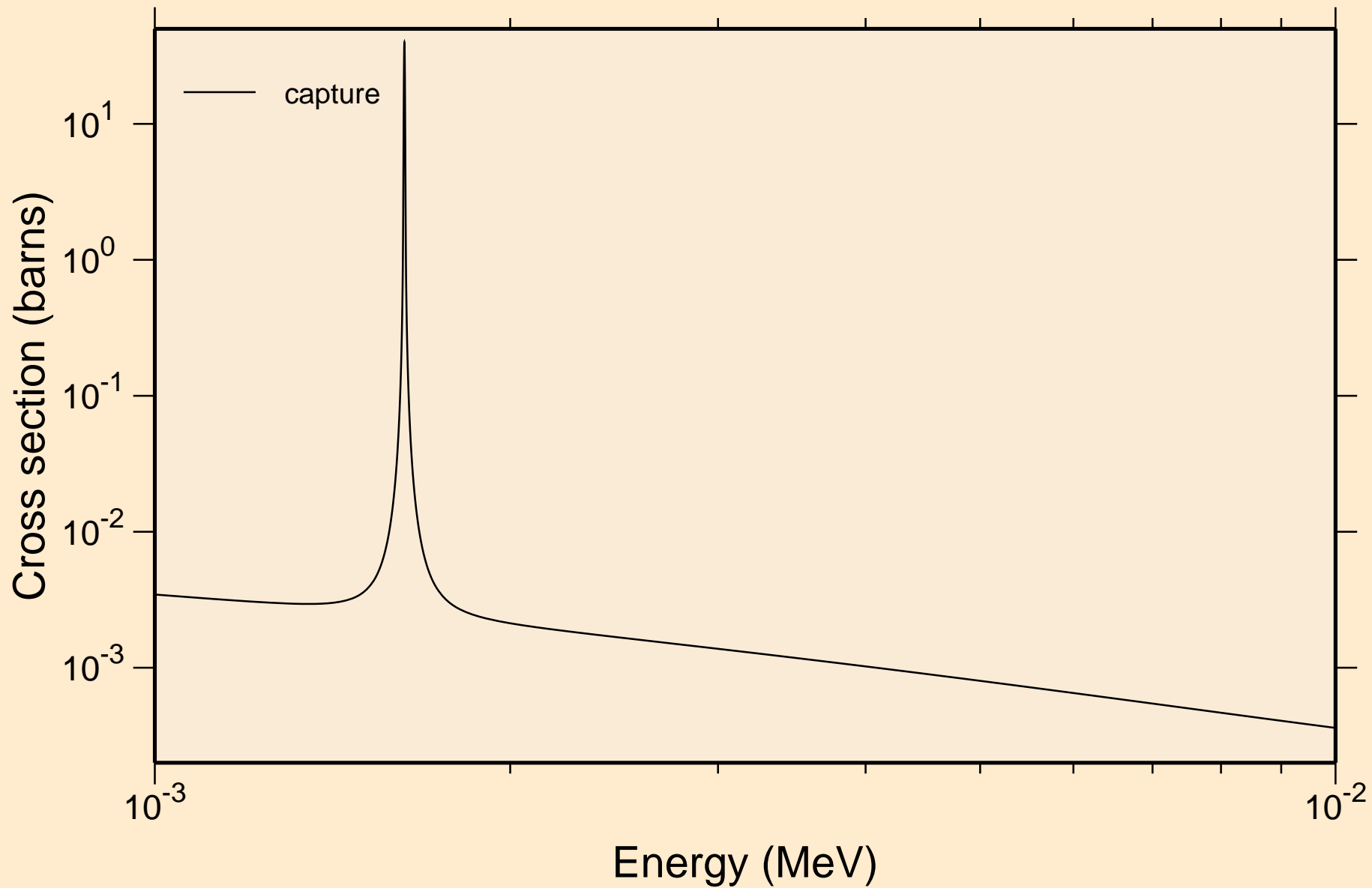

CR052 NEUTRON ACER TENDL-2021 LIBRARY; T=293.6K
resonance absorption cross sections

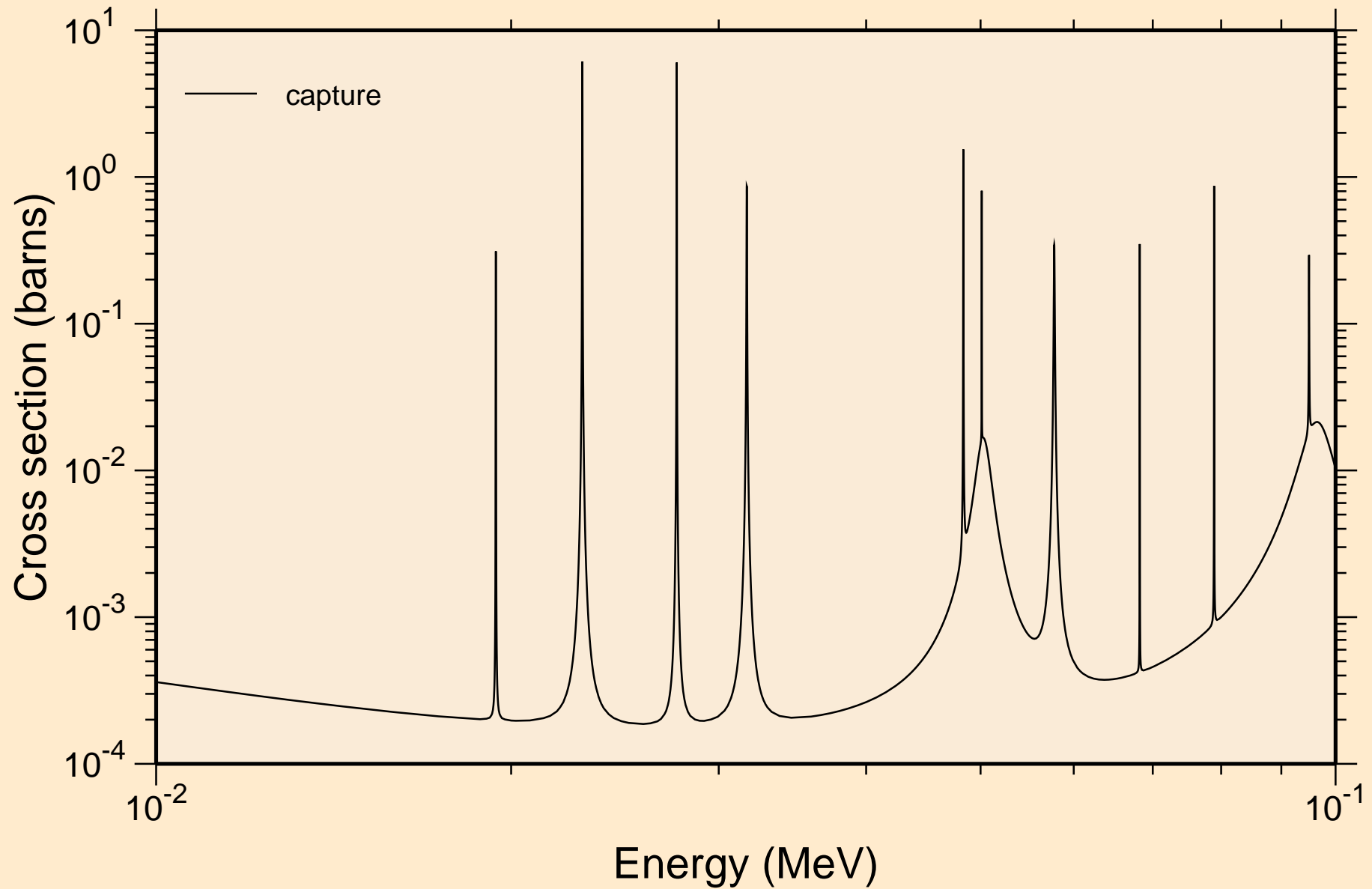

CR052 NEUTRON ACER TENDL-2021 LIBRARY; T=293.6K
resonance absorption cross sections

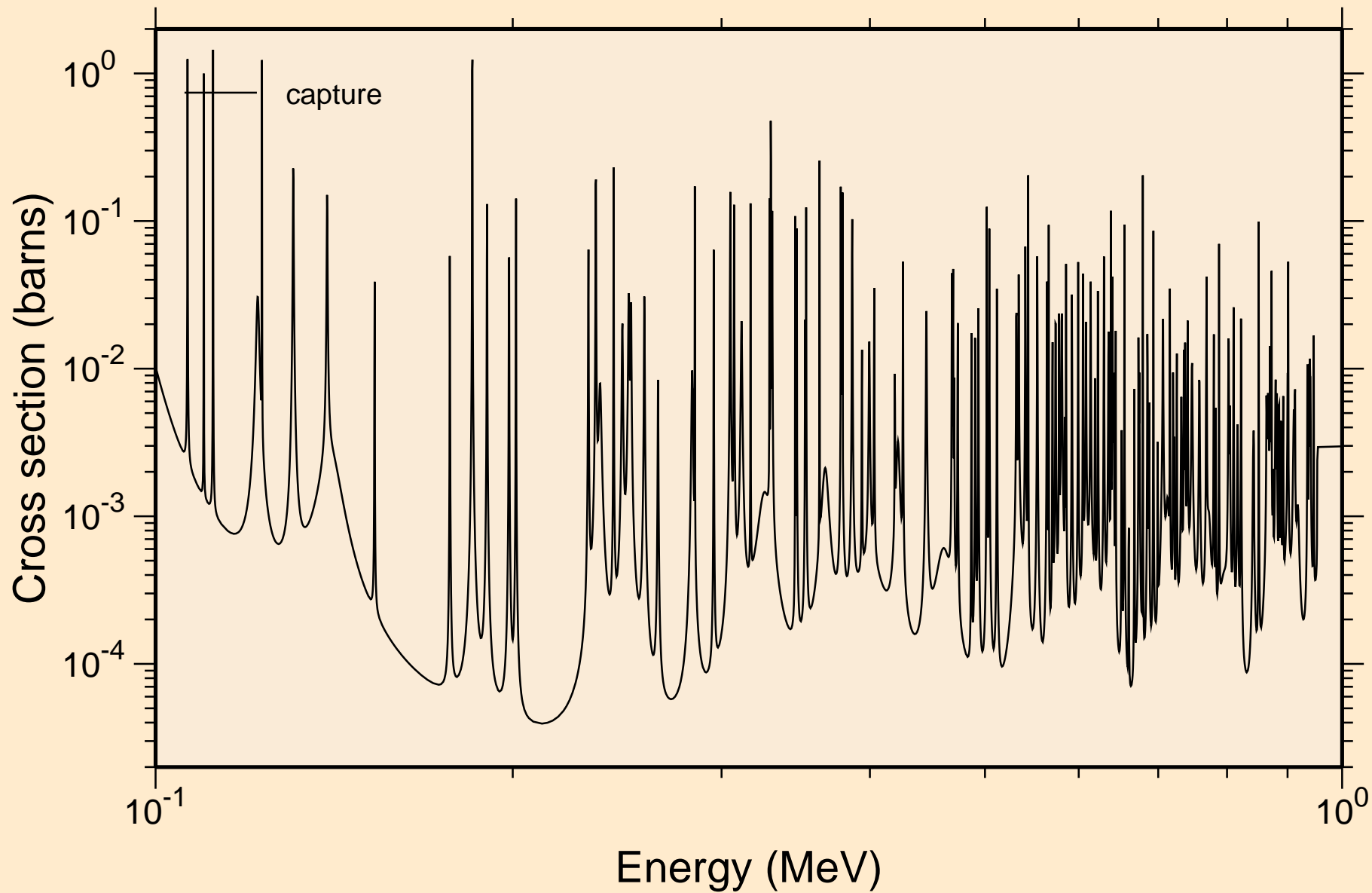

CR052 NEUTRON ACER TENDL-2021 LIBRARY; T=293.6K
resonance absorption cross sections

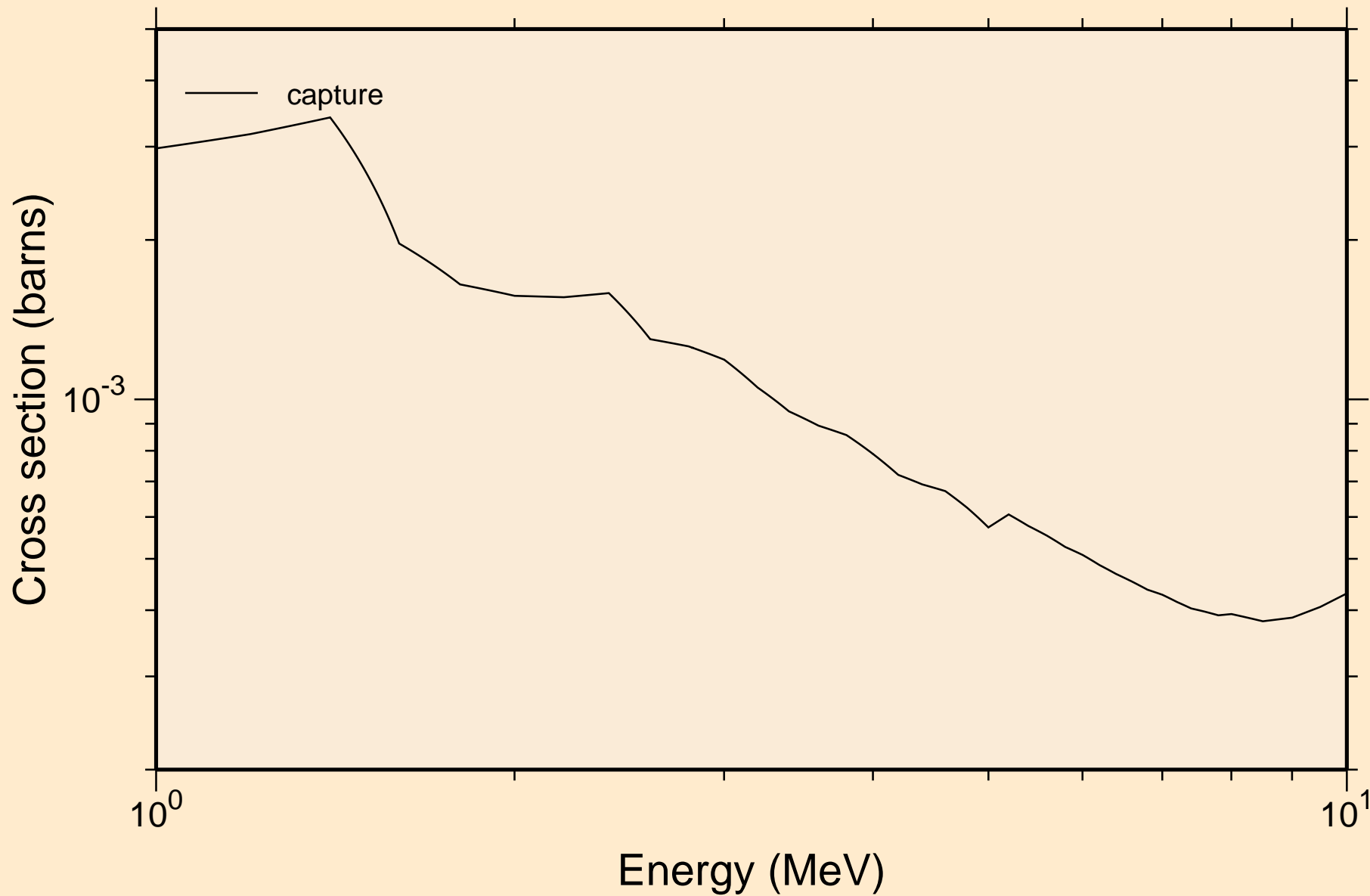

CR052 NEUTRON ACER TENDL-2021 LIBRARY; T=293.6K
Heating

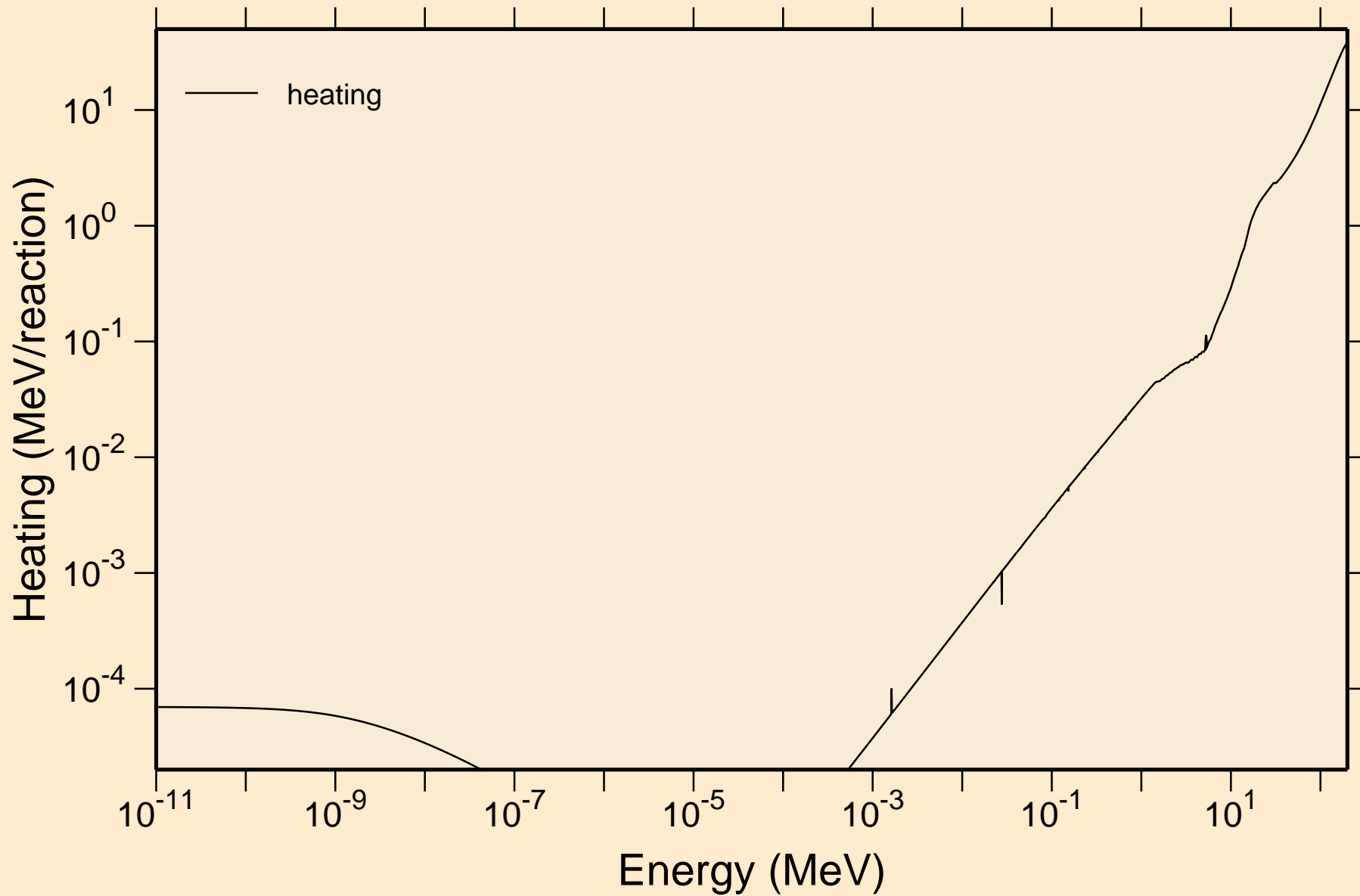

CR052 NEUTRON ACER TENDL-2021 LIBRARY; T=293.6K
Damage

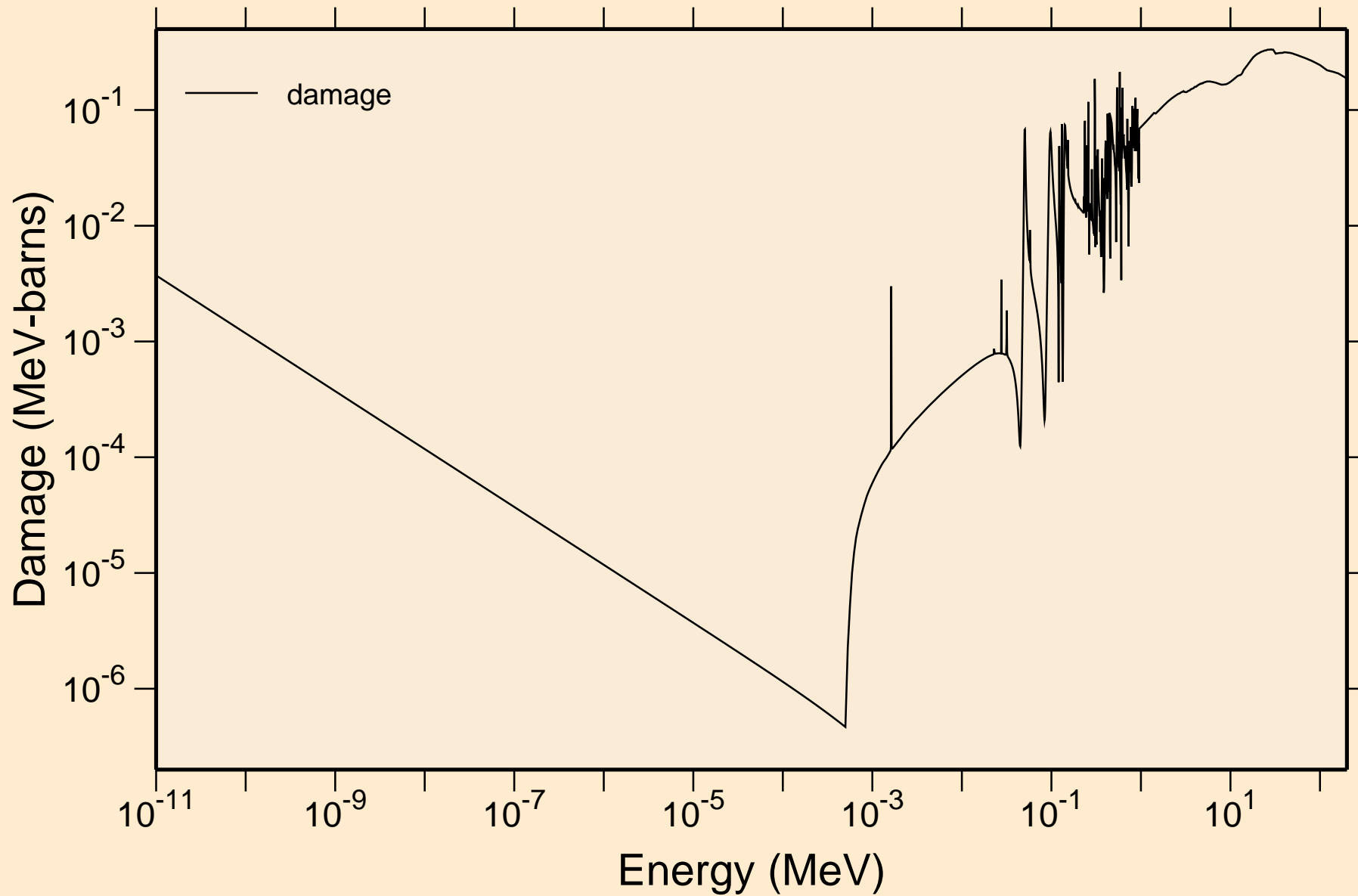

CR052 NEUTRON ACER TENDL-2021 LIBRARY; T=293.6K
Non-threshold reactions

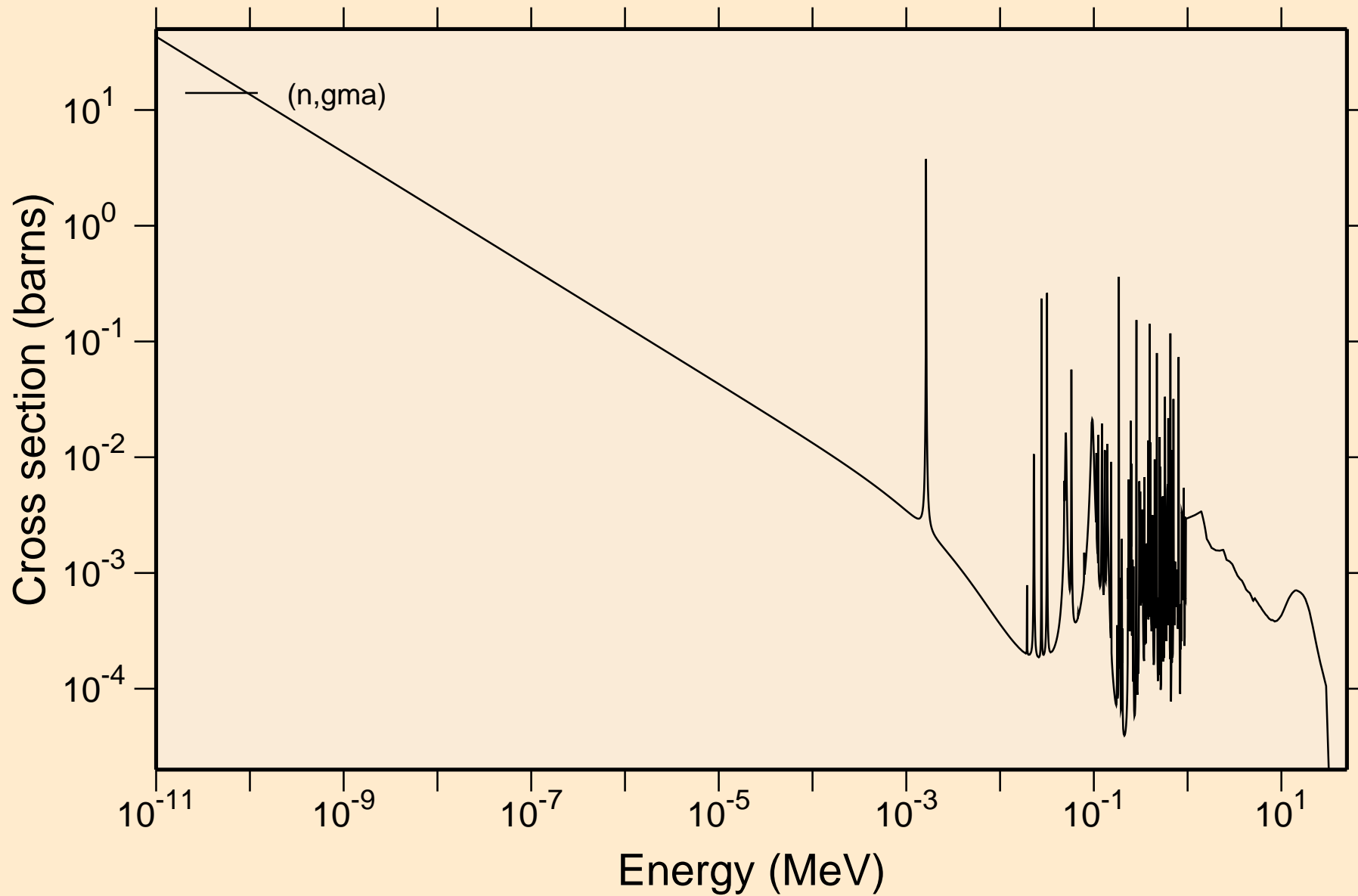

CR052 NEUTRON ACER TENDL-2021 LIBRARY; T=293.6K
Principal cross sections

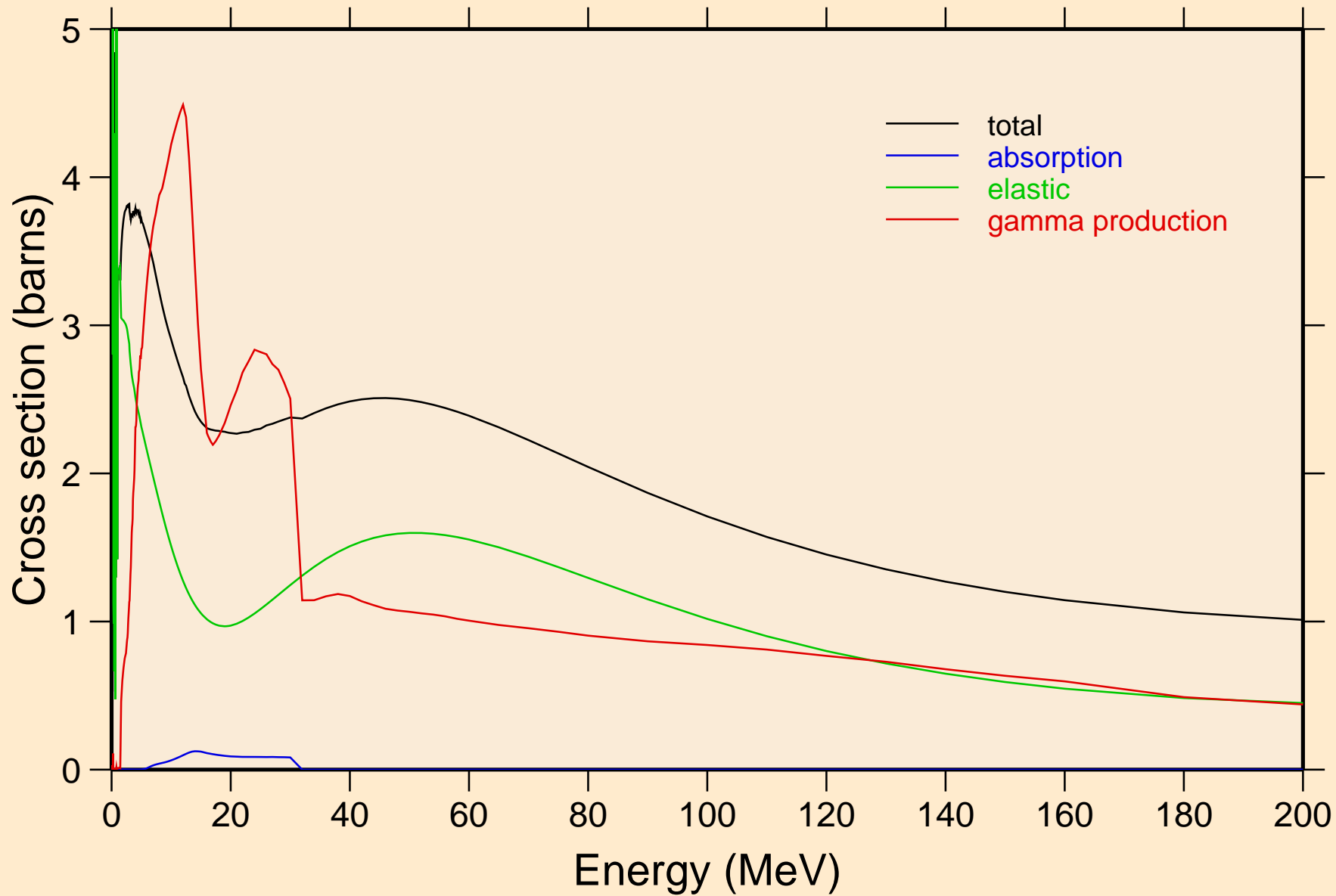

CR052 NEUTRON ACER TENDL-2021 LIBRARY; T=293.6K
Heating

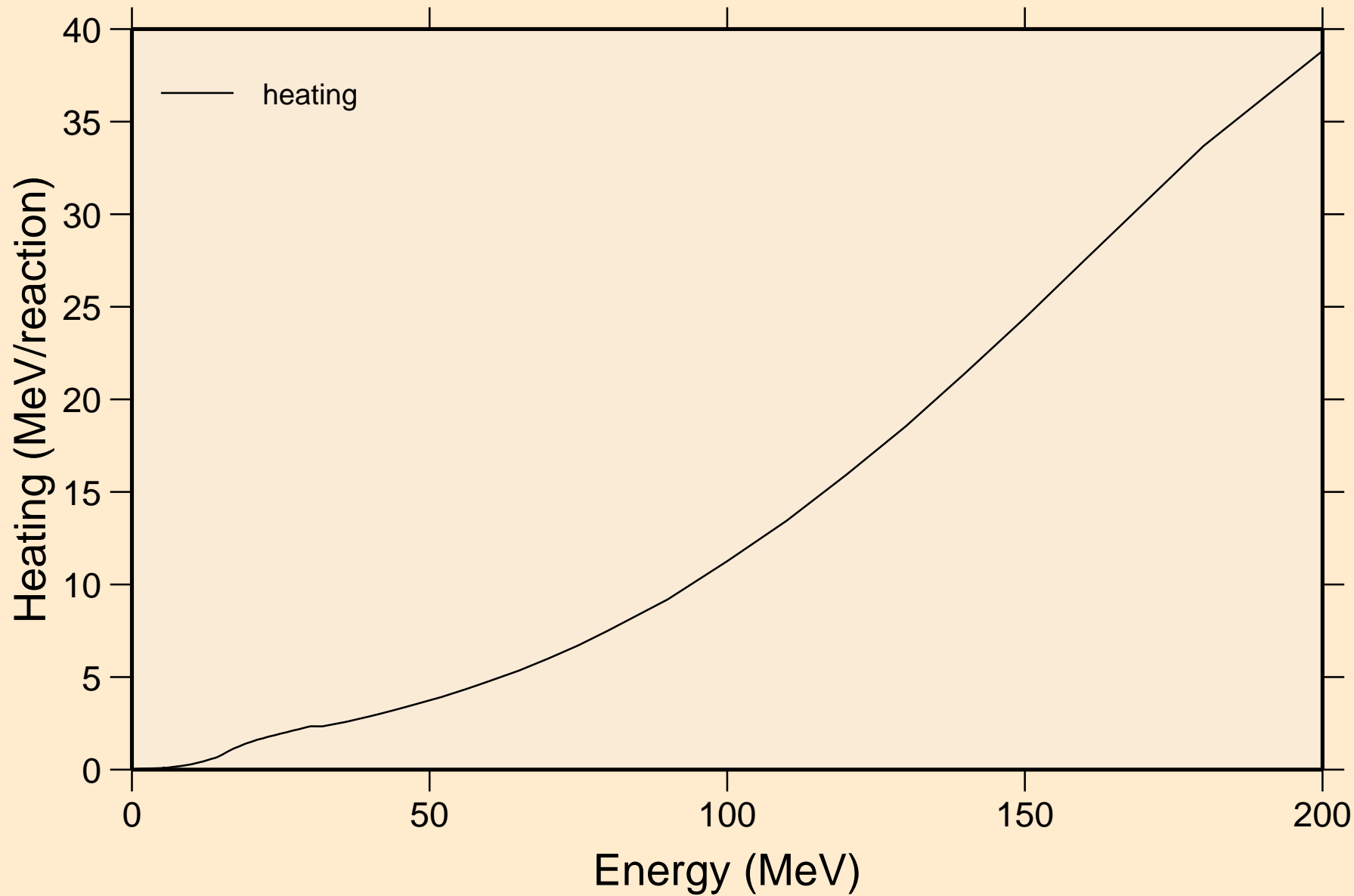

CR052 NEUTRON ACER TENDL-2021 LIBRARY; T=293.6K
Damage

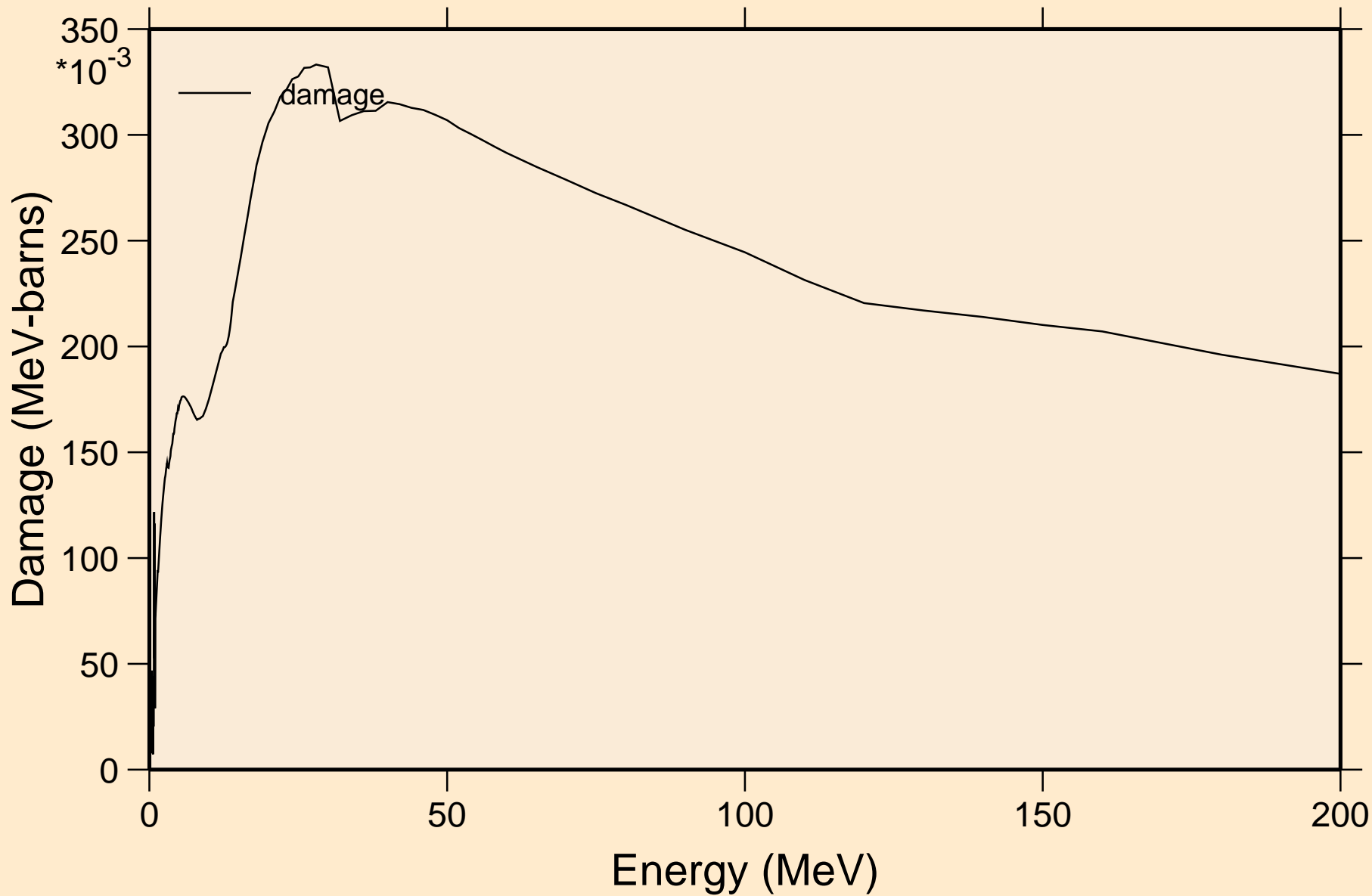

CR052 NEUTRON ACER TENDL-2021 LIBRARY; T=293.6K
Non-threshold reactions

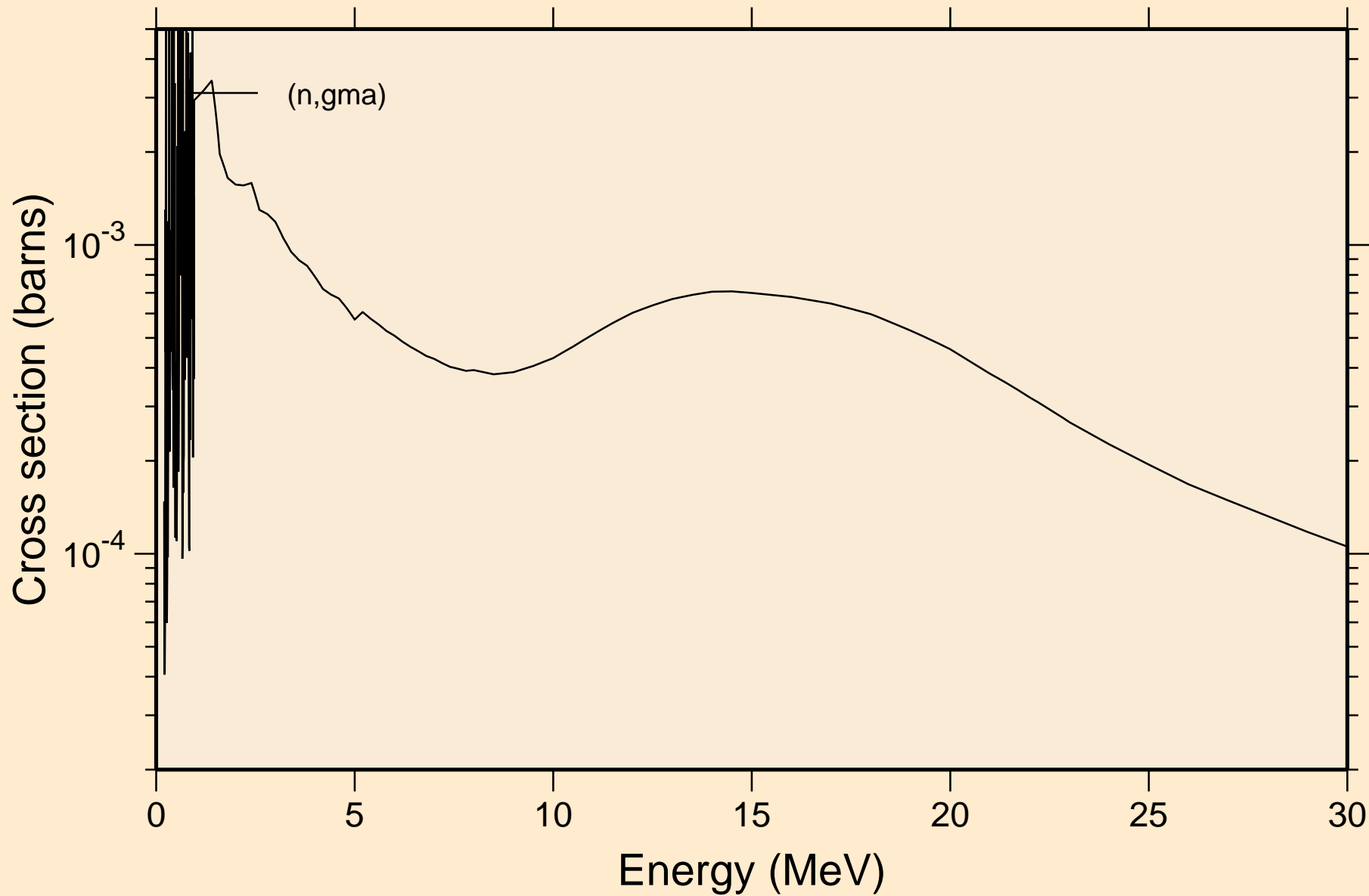

CR052 NEUTRON ACER TENDL-2021 LIBRARY; T=293.6K
Inelastic levels

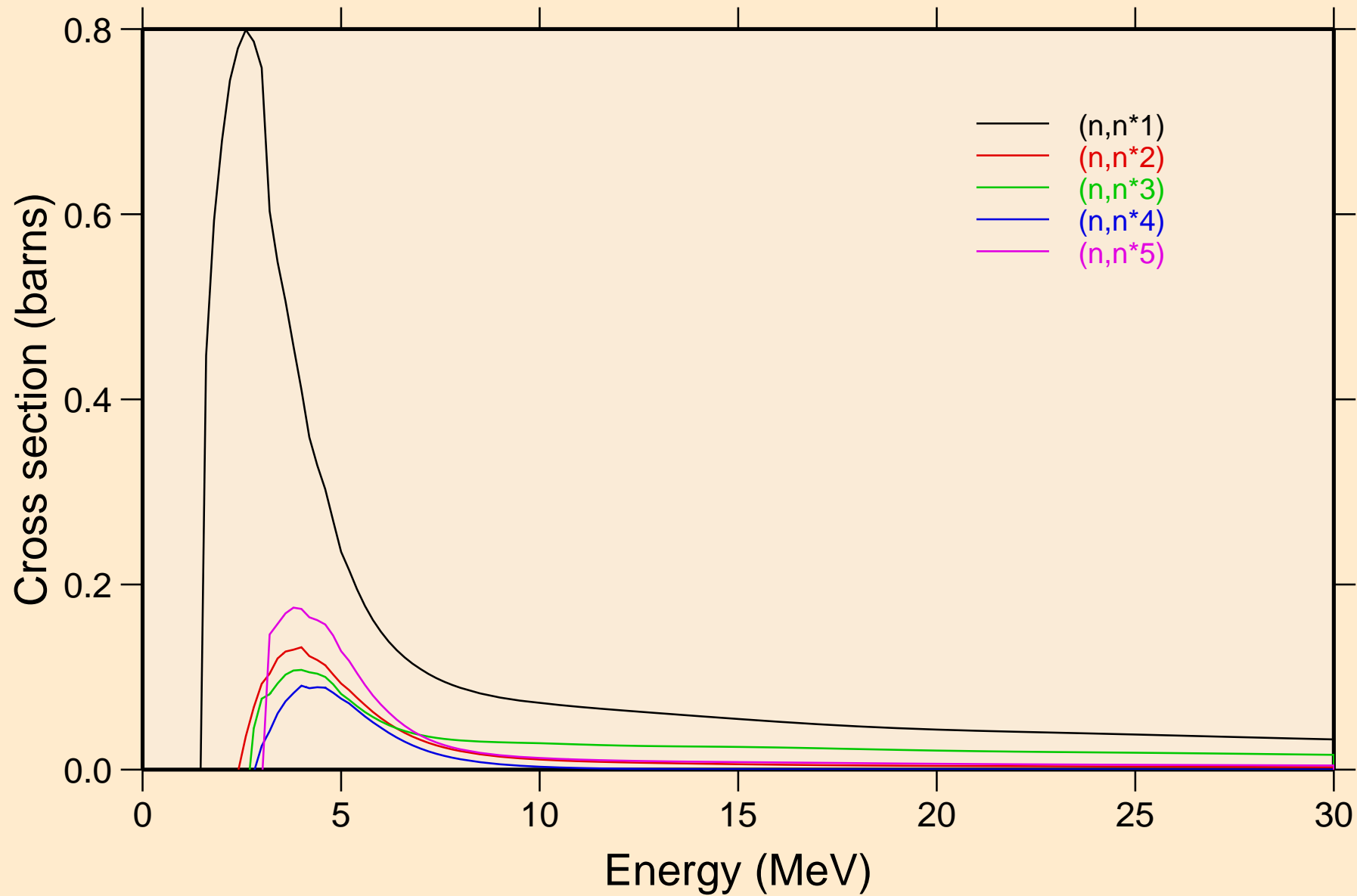

CR052 NEUTRON ACER TENDL-2021 LIBRARY; T=293.6K
Inelastic levels

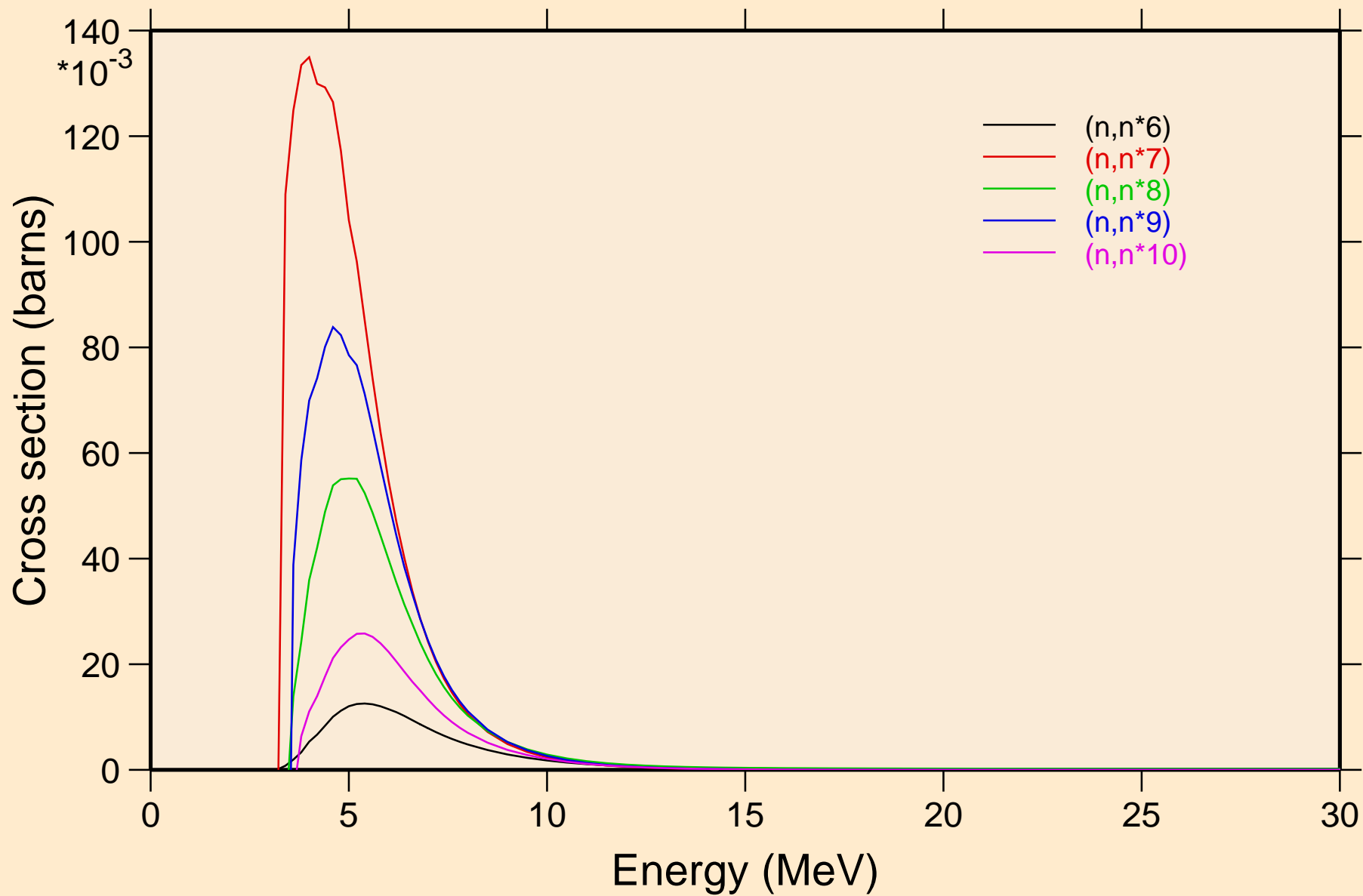

CR052 NEUTRON ACER TENDL-2021 LIBRARY; T=293.6K
Inelastic levels

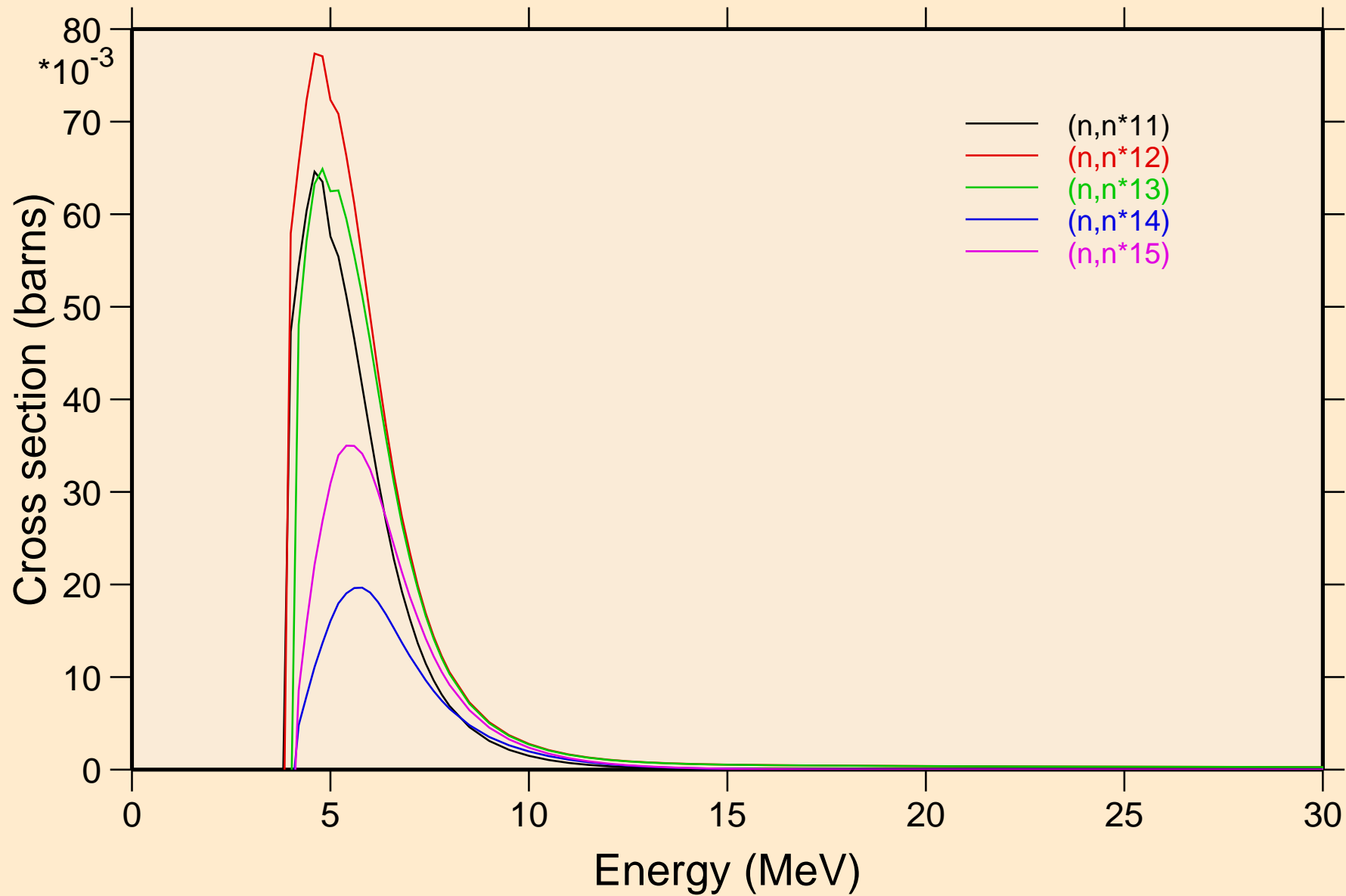

CR052 NEUTRON ACER TENDL-2021 LIBRARY; T=293.6K
Inelastic levels

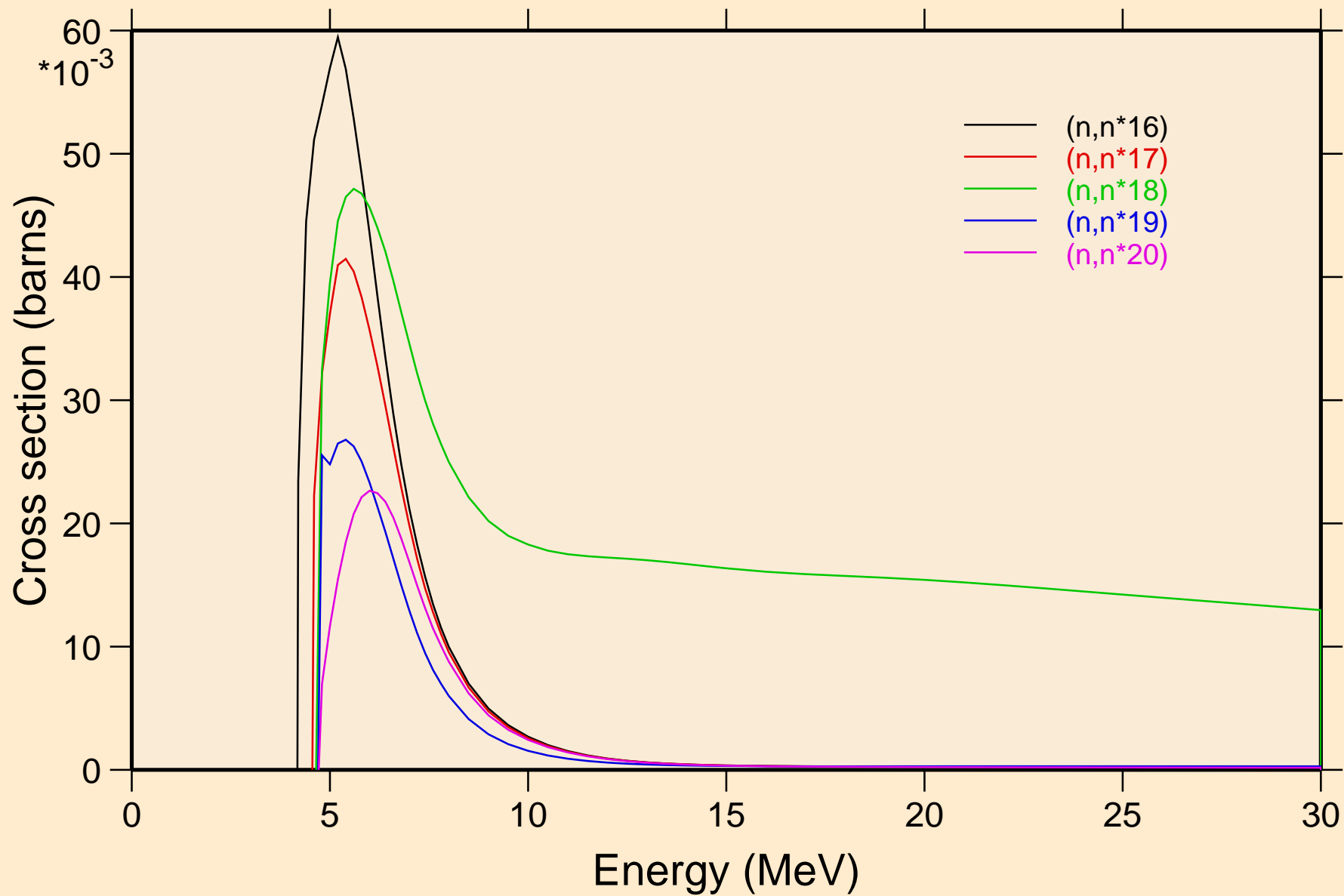

CR052 NEUTRON ACER TENDL-2021 LIBRARY; T=293.6K
Inelastic levels

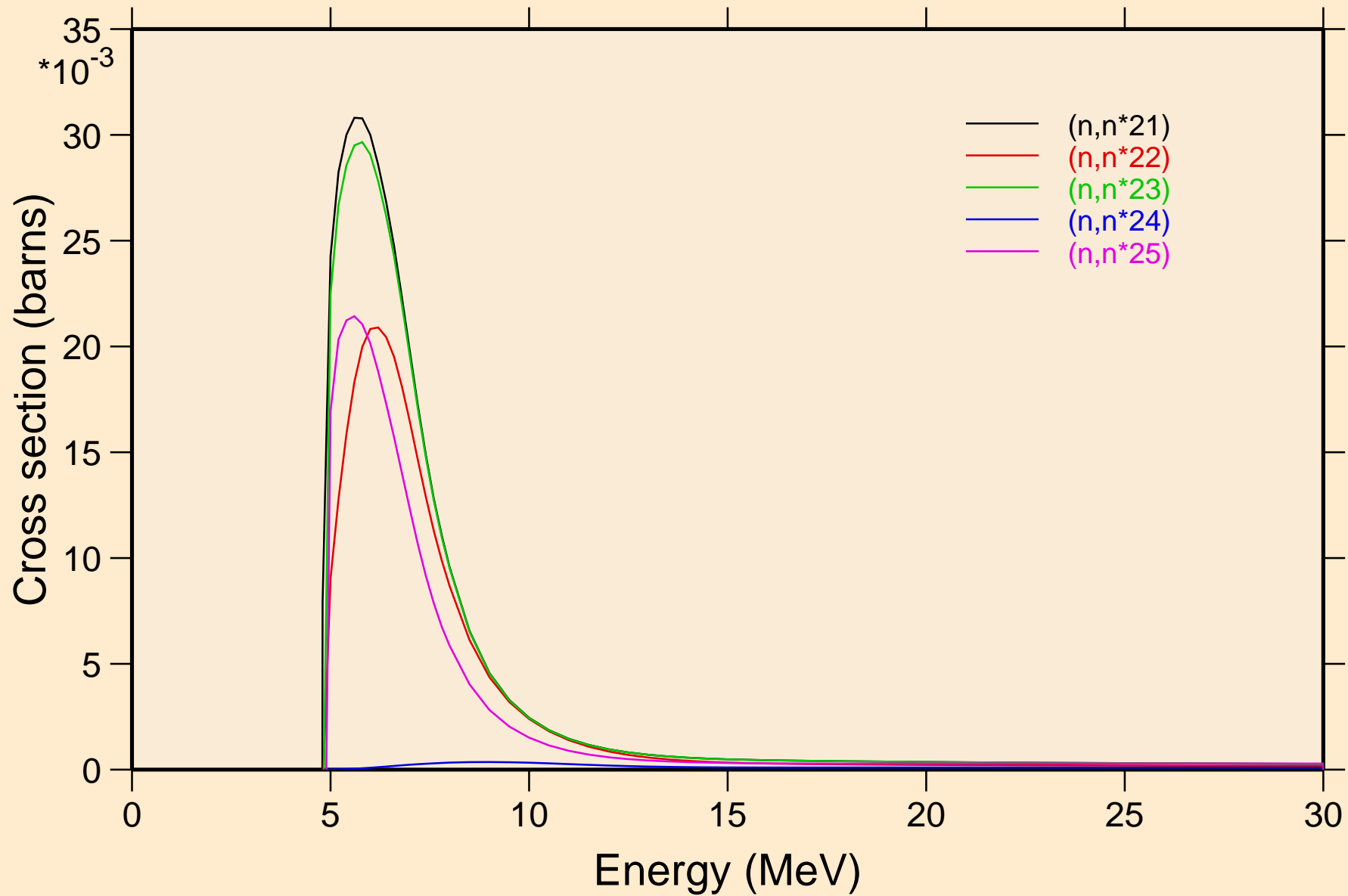

CR052 NEUTRON ACER TENDL-2021 LIBRARY; T=293.6K
Inelastic levels

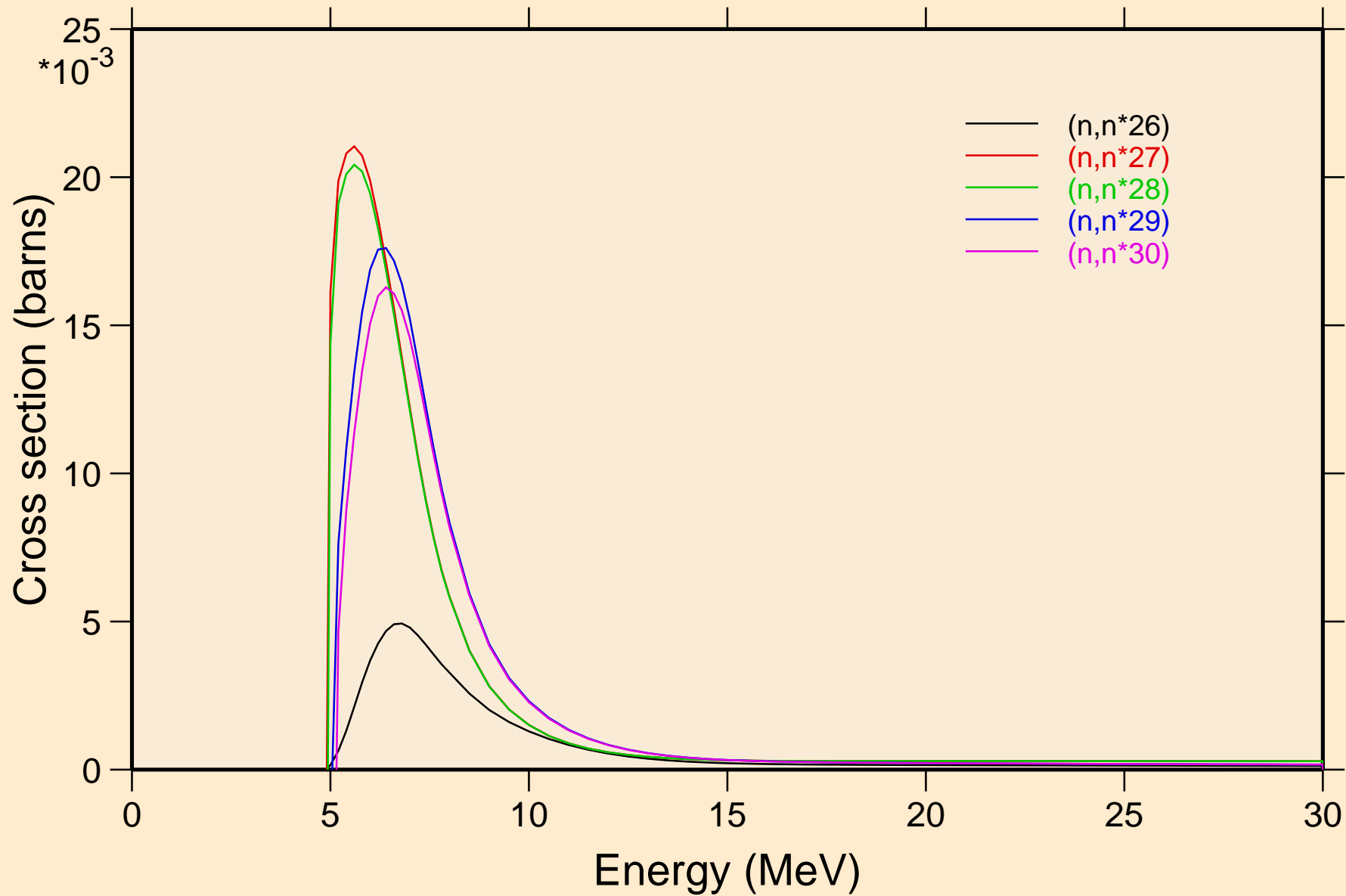

CR052 NEUTRON ACER TENDL-2021 LIBRARY; T=293.6K
Threshold reactions

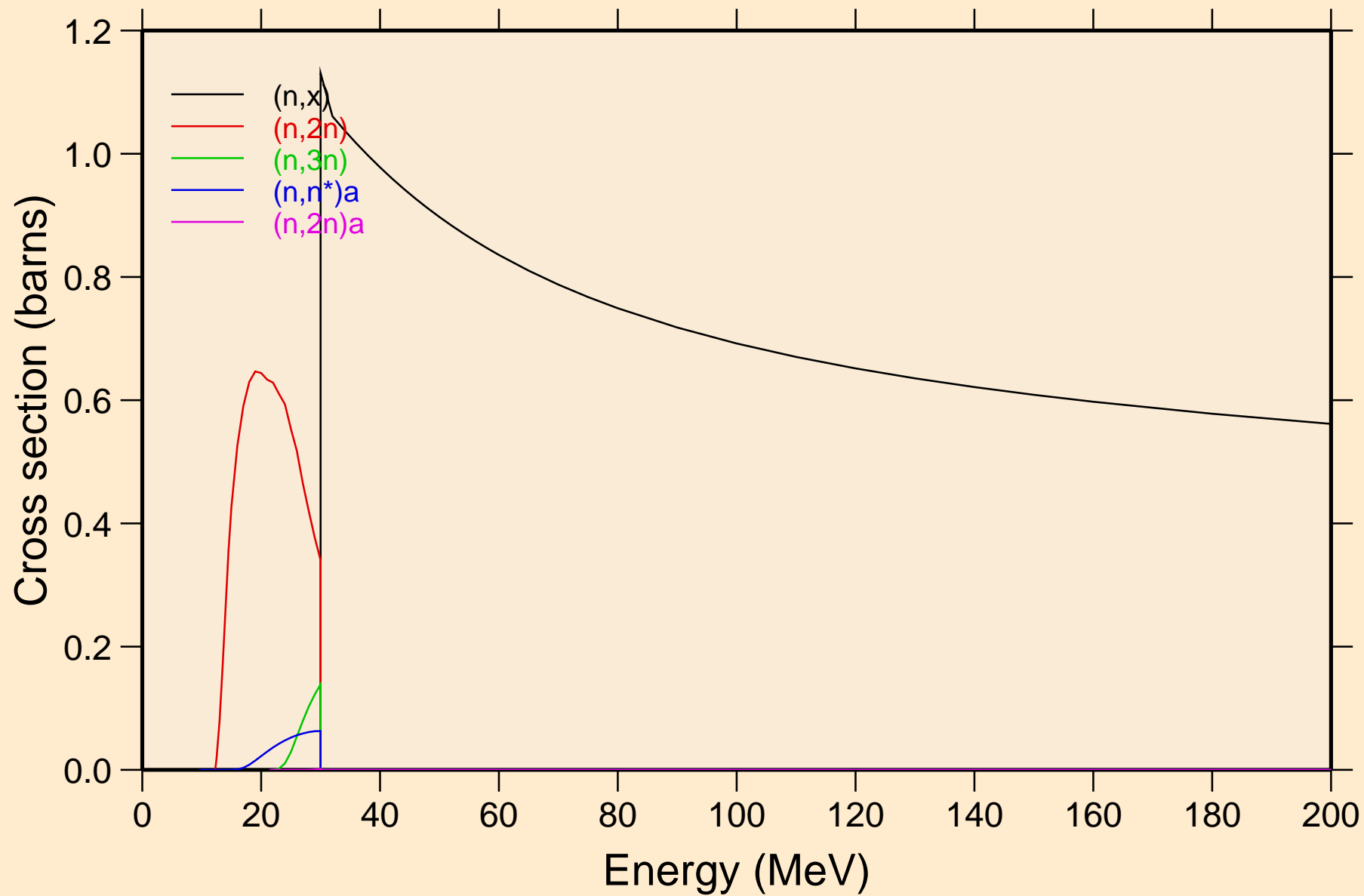

CR052 NEUTRON ACER TENDL-2021 LIBRARY; T=293.6K
Threshold reactions

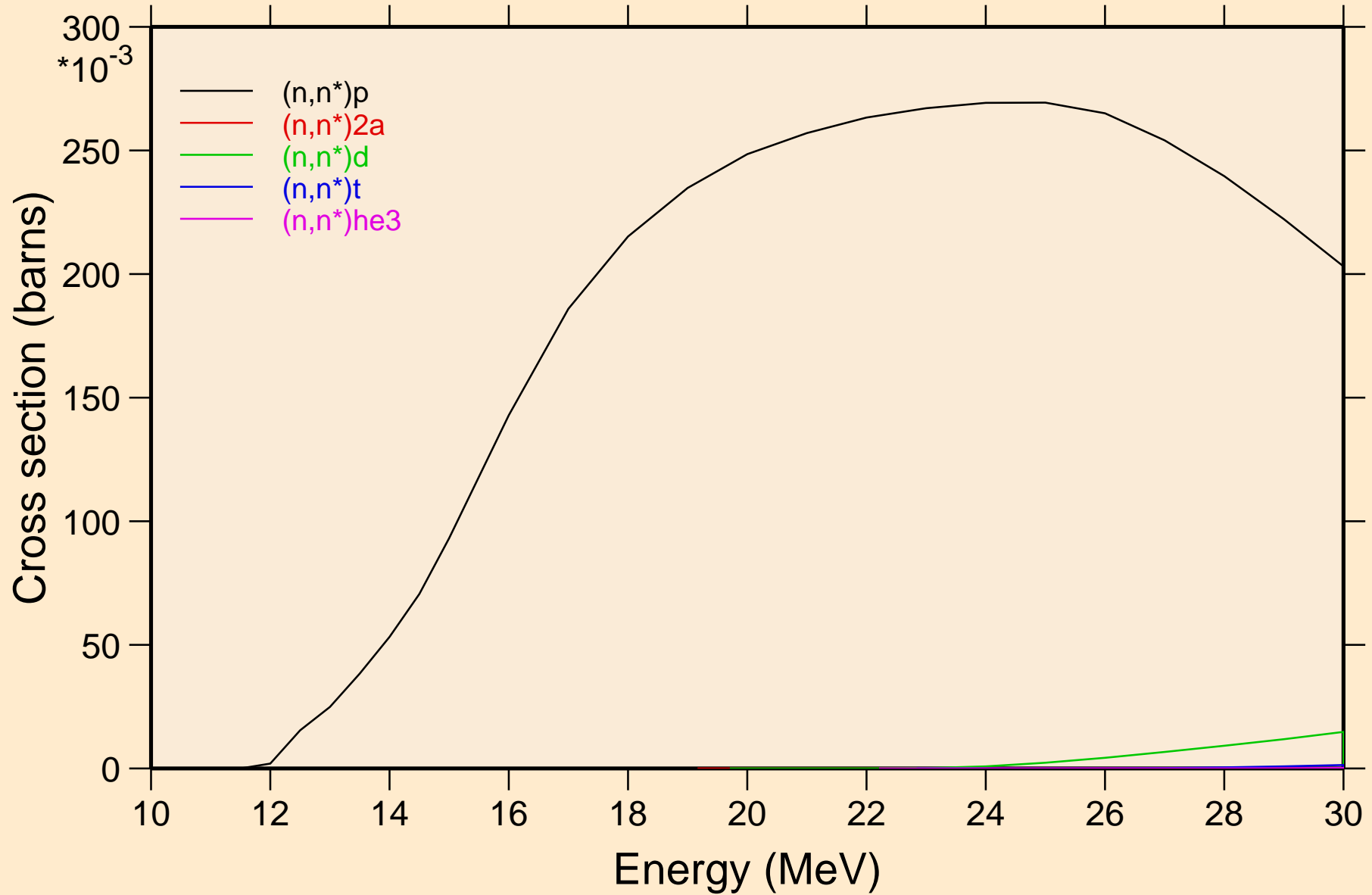

CR052 NEUTRON ACER TENDL-2021 LIBRARY; T=293.6K
Threshold reactions

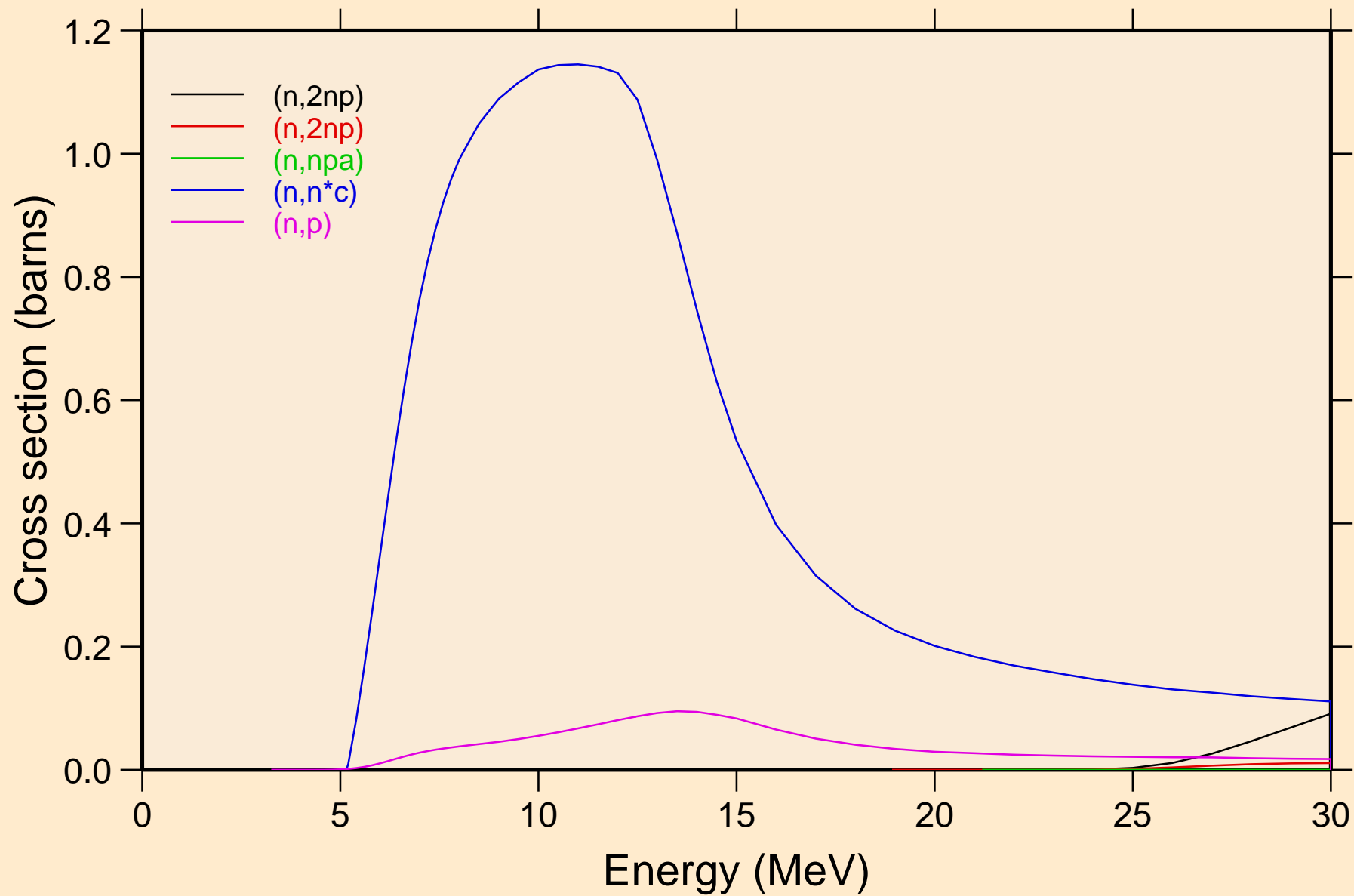

CR052 NEUTRON ACER TENDL-2021 LIBRARY; T=293.6K
Threshold reactions

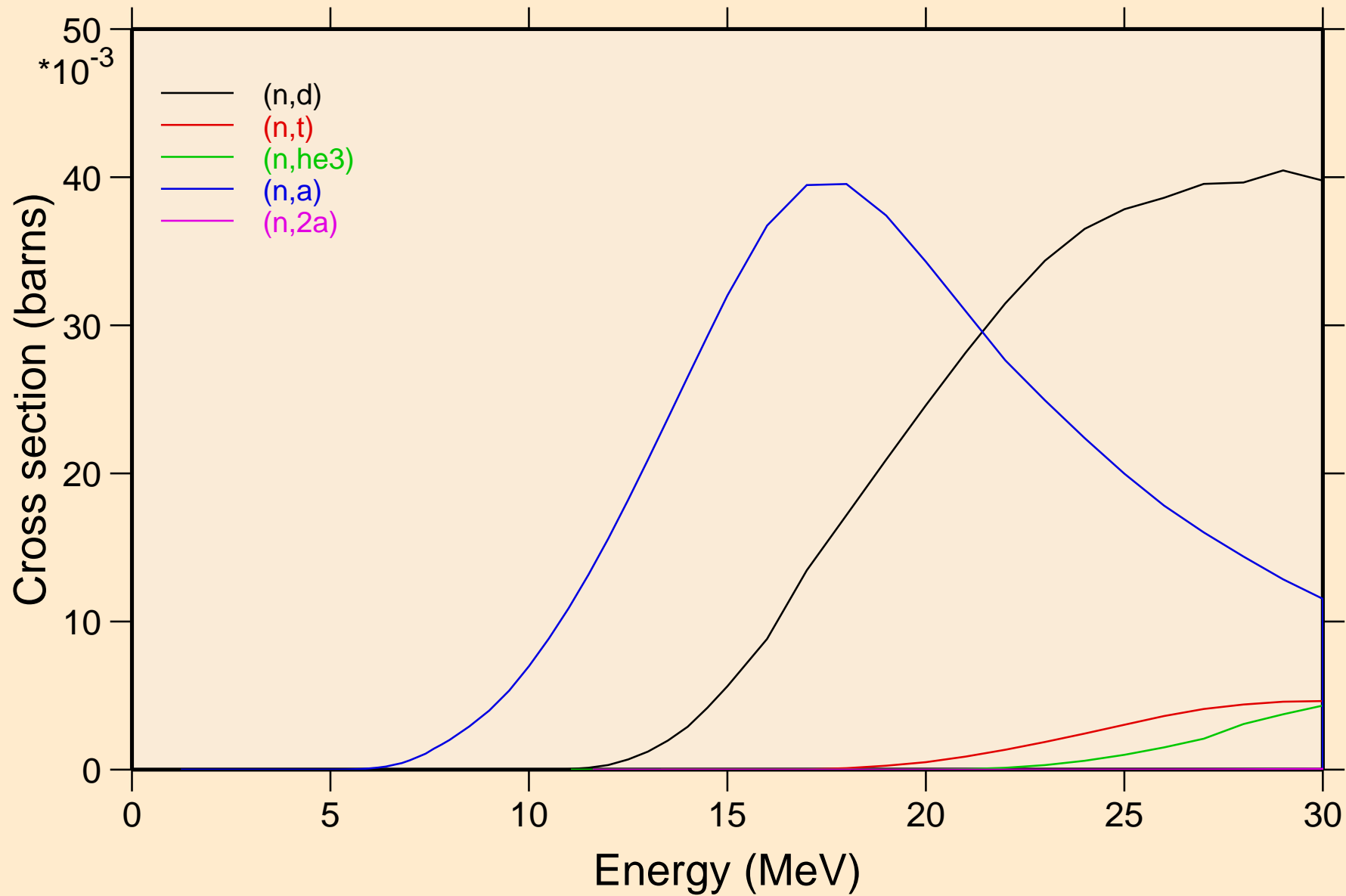

CR052 NEUTRON ACER TENDL-2021 LIBRARY; T=293.6K

Threshold reactions

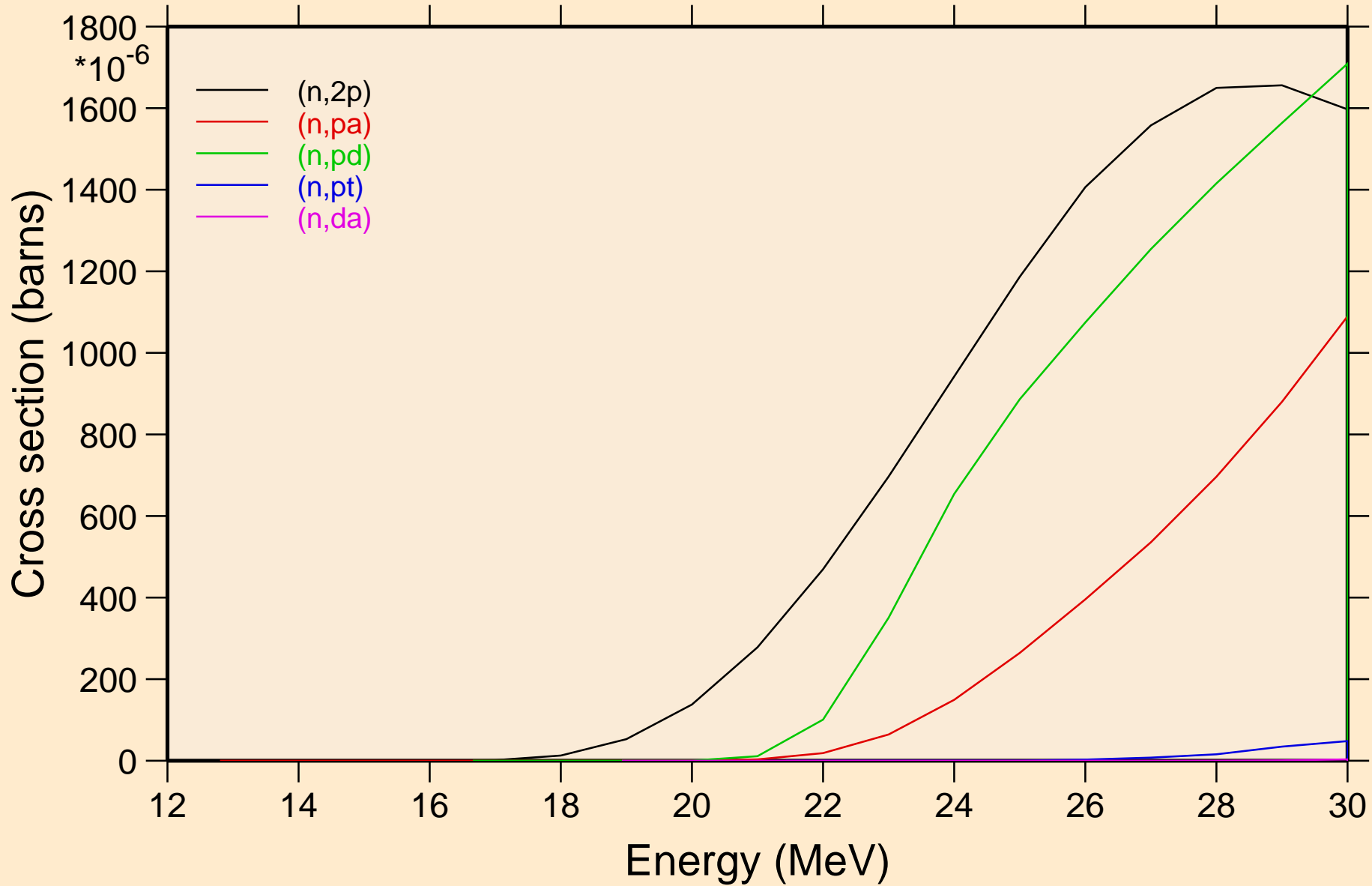

CR052 NEUTRON ACER TENDL-2021 LIBRARY; T=293.6K
Threshold reactions

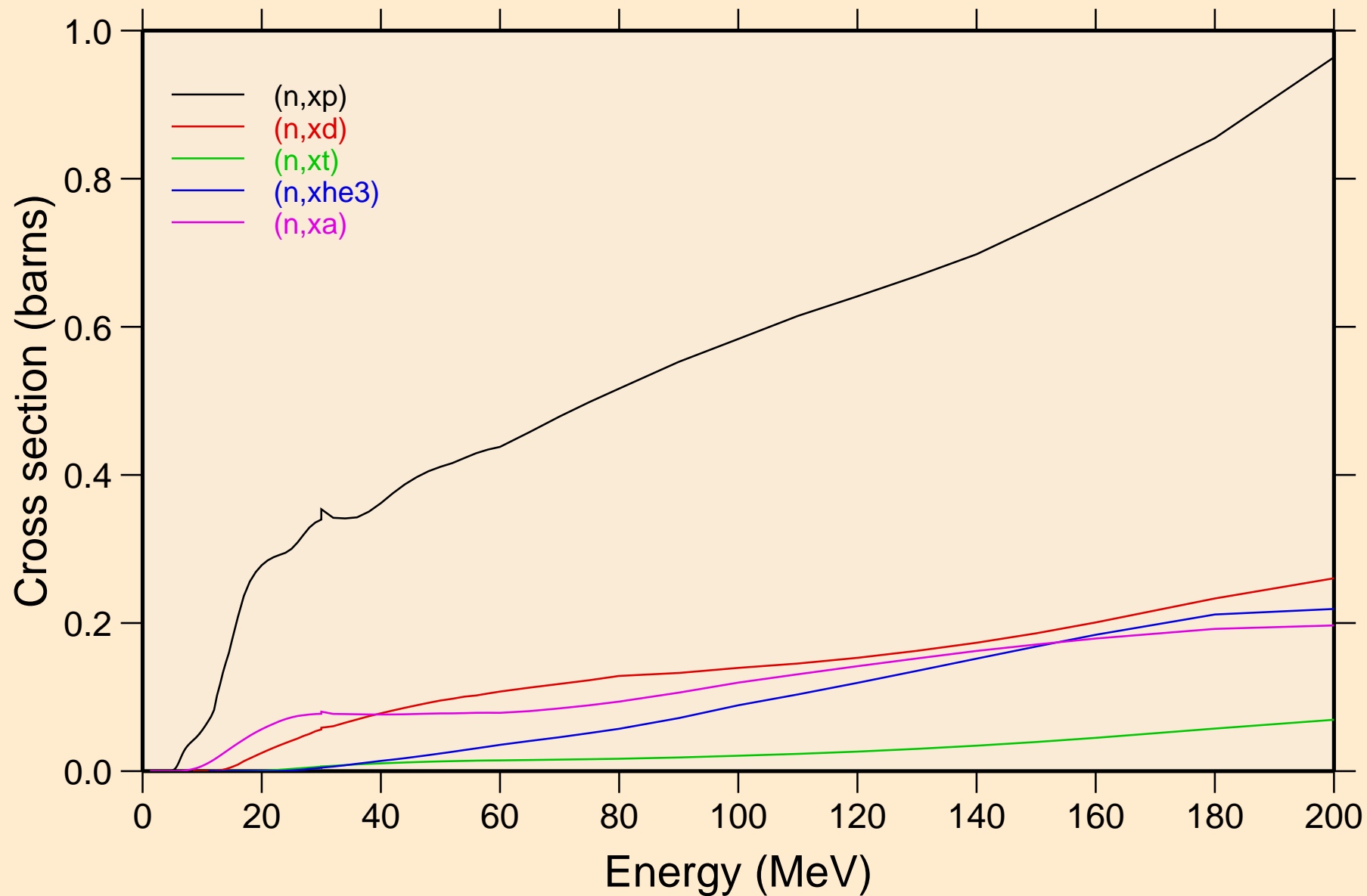

CR052 NEUTRON ACER TENDL-2021 LIBRARY; T=293.6K
angular distribution for elastic

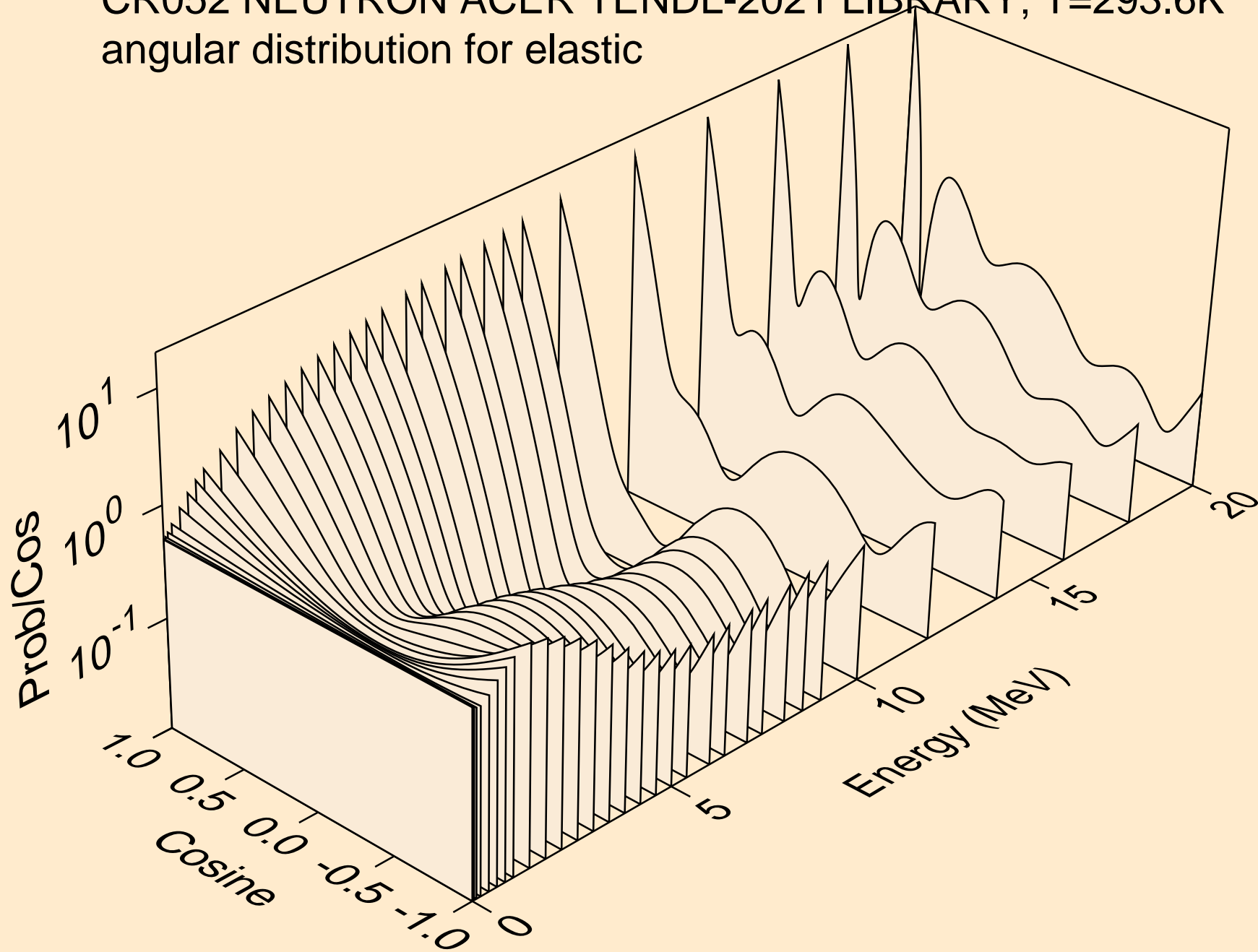

CR052 NEUTRON ACER TENDL-2021 LIBRARY; T=293.6K
angular distribution for elastic

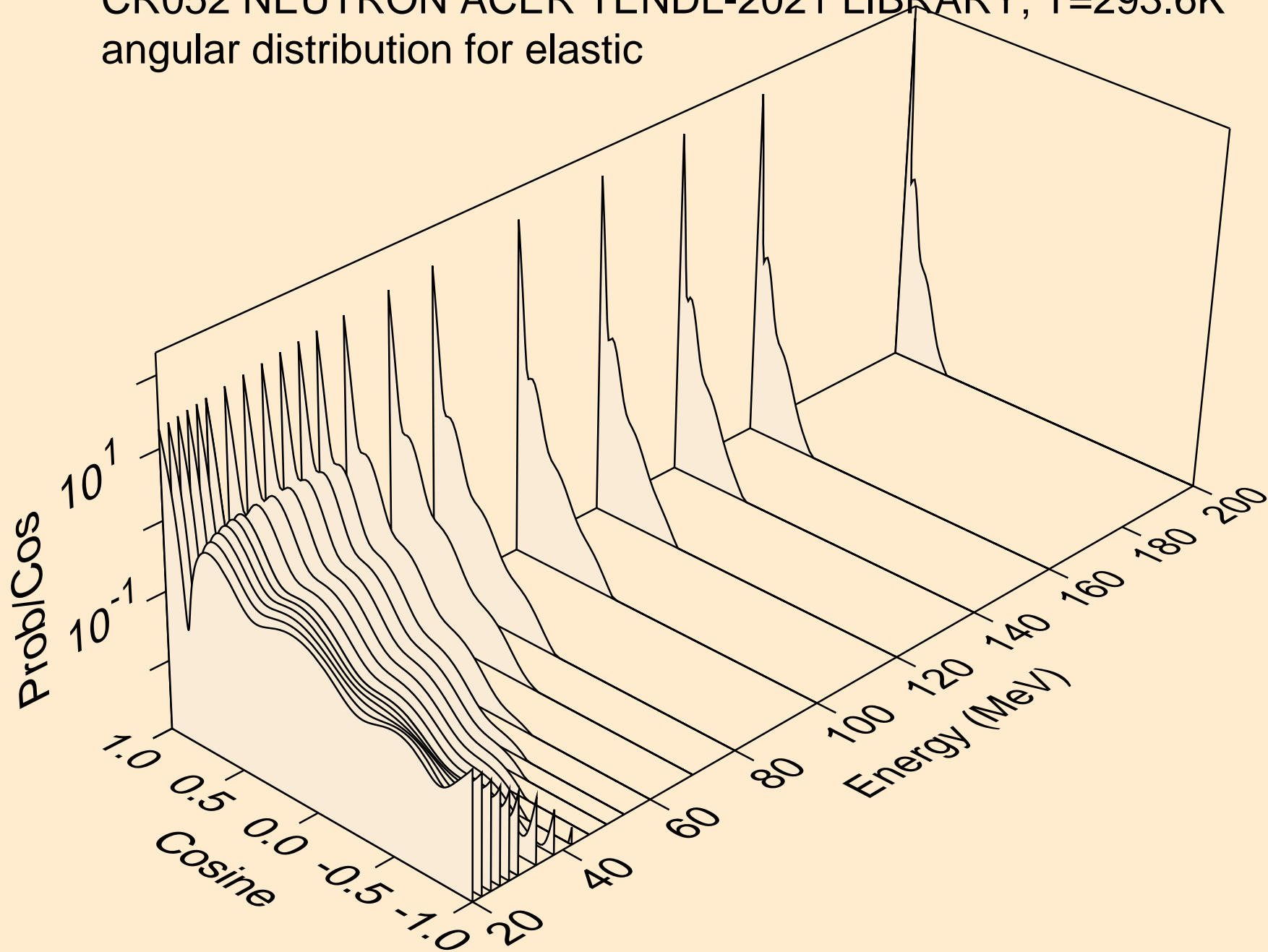

CR052 NEUTRON ACER TENDL-2021 LIBRARY; T=293.6K
angular distribution for (n,n*1)

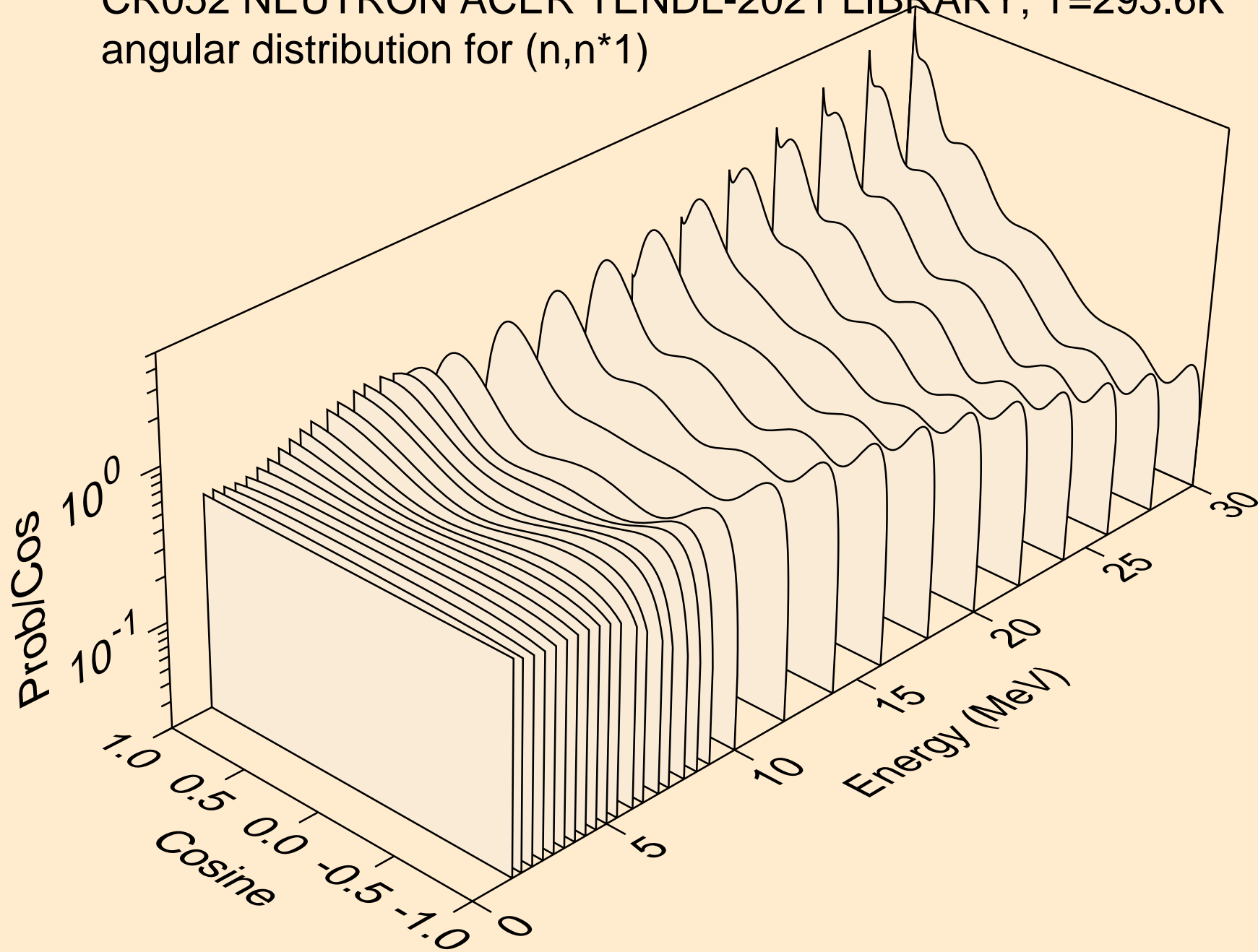

CR052 NEUTRON ACER TENDL-2021 LIBRARY; T=293.6K
angular distribution for (n,n*2)

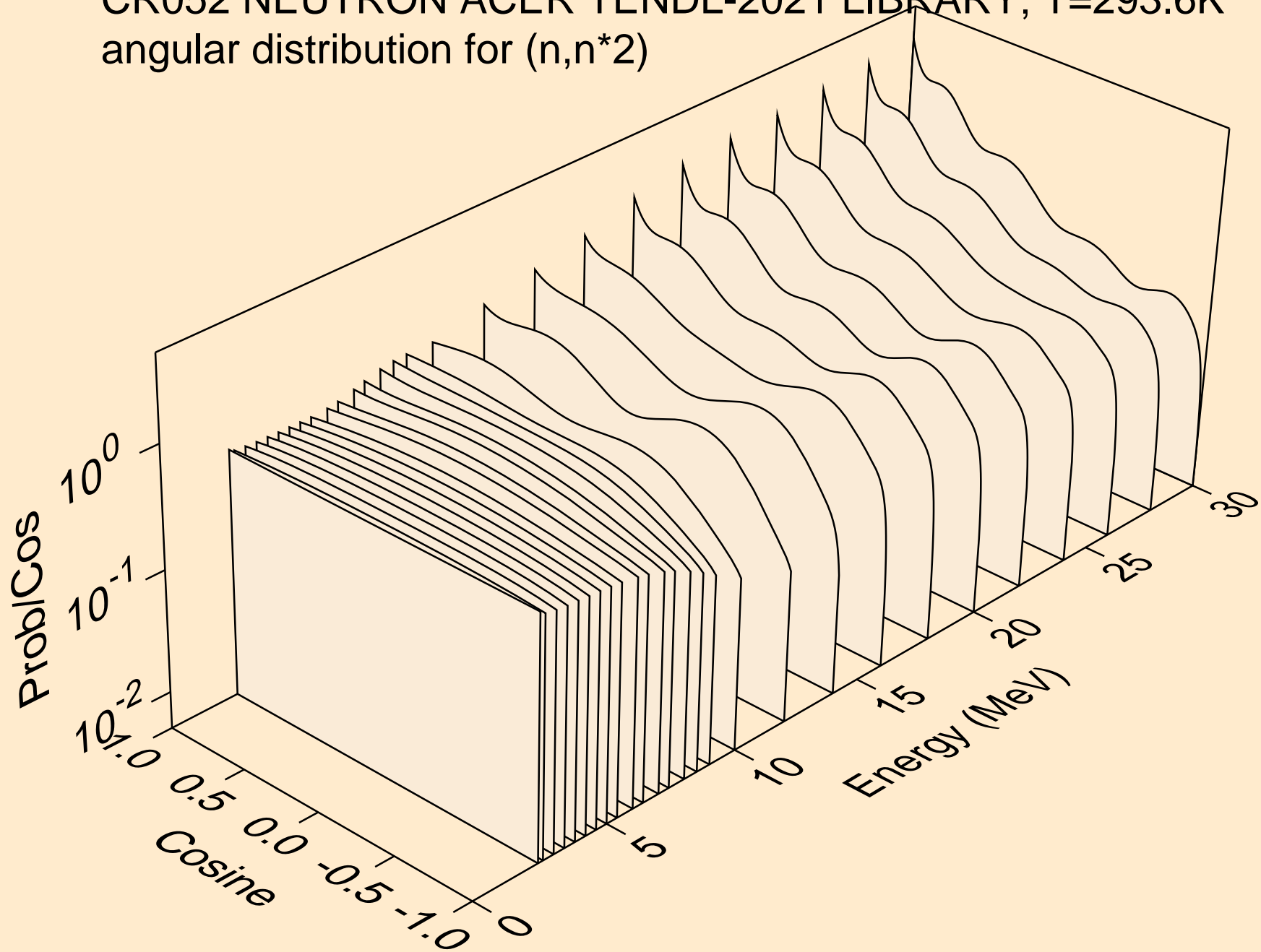

CR052 NEUTRON ACER TENDL-2021 LIBRARY; T=293.6K
angular distribution for (n,n*3)

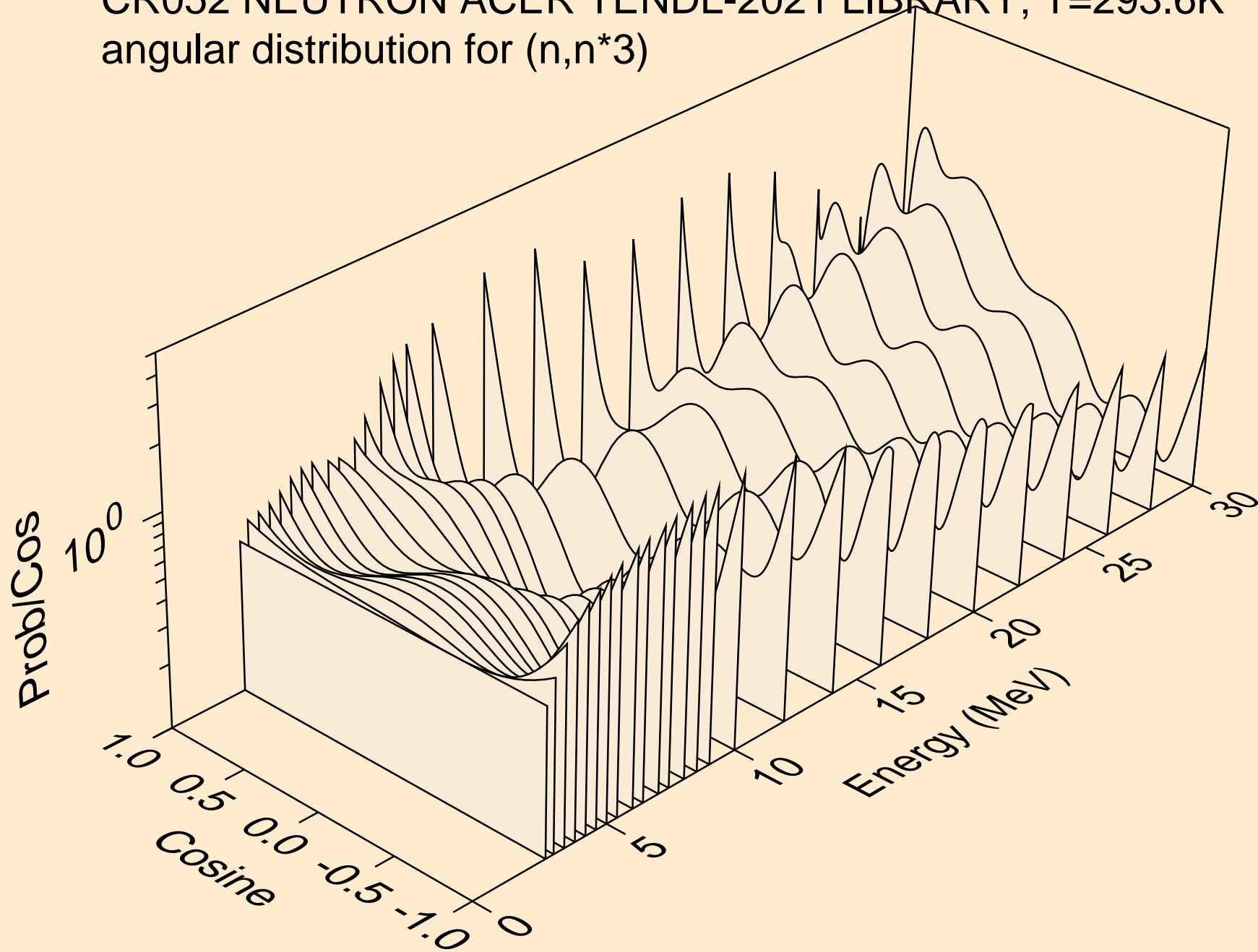

CR052 NEUTRON ACER TENDL-2021 LIBRARY; T=293.6K
angular distribution for (n,n*4)

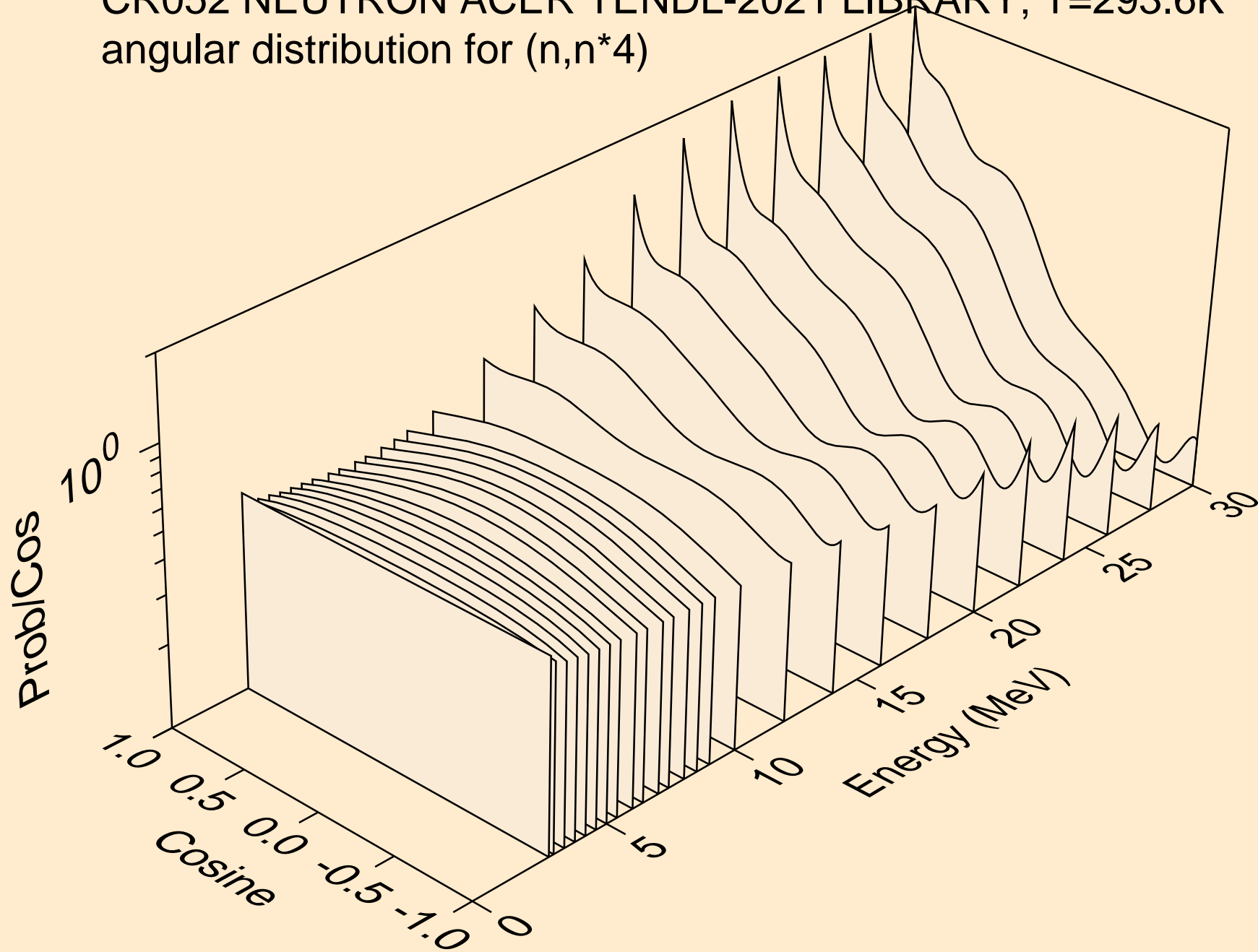

CR052 NEUTRON ACER TENDL-2021 LIBRARY; T=293.6K
angular distribution for (n,n*5)

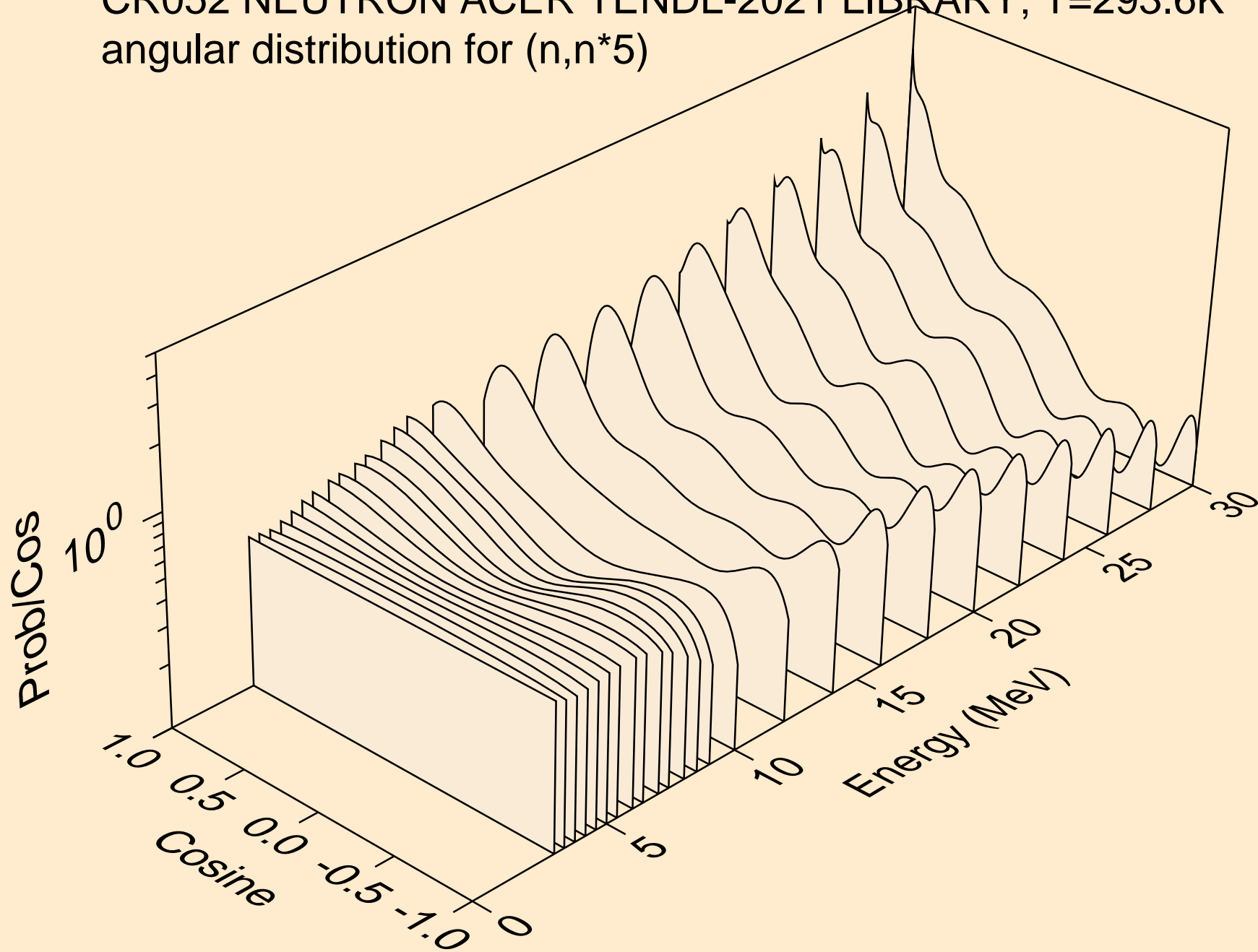

CR052 NEUTRON ACER TENDL-2021 LIBRARY; T=293.6K
angular distribution for (n,n*6)

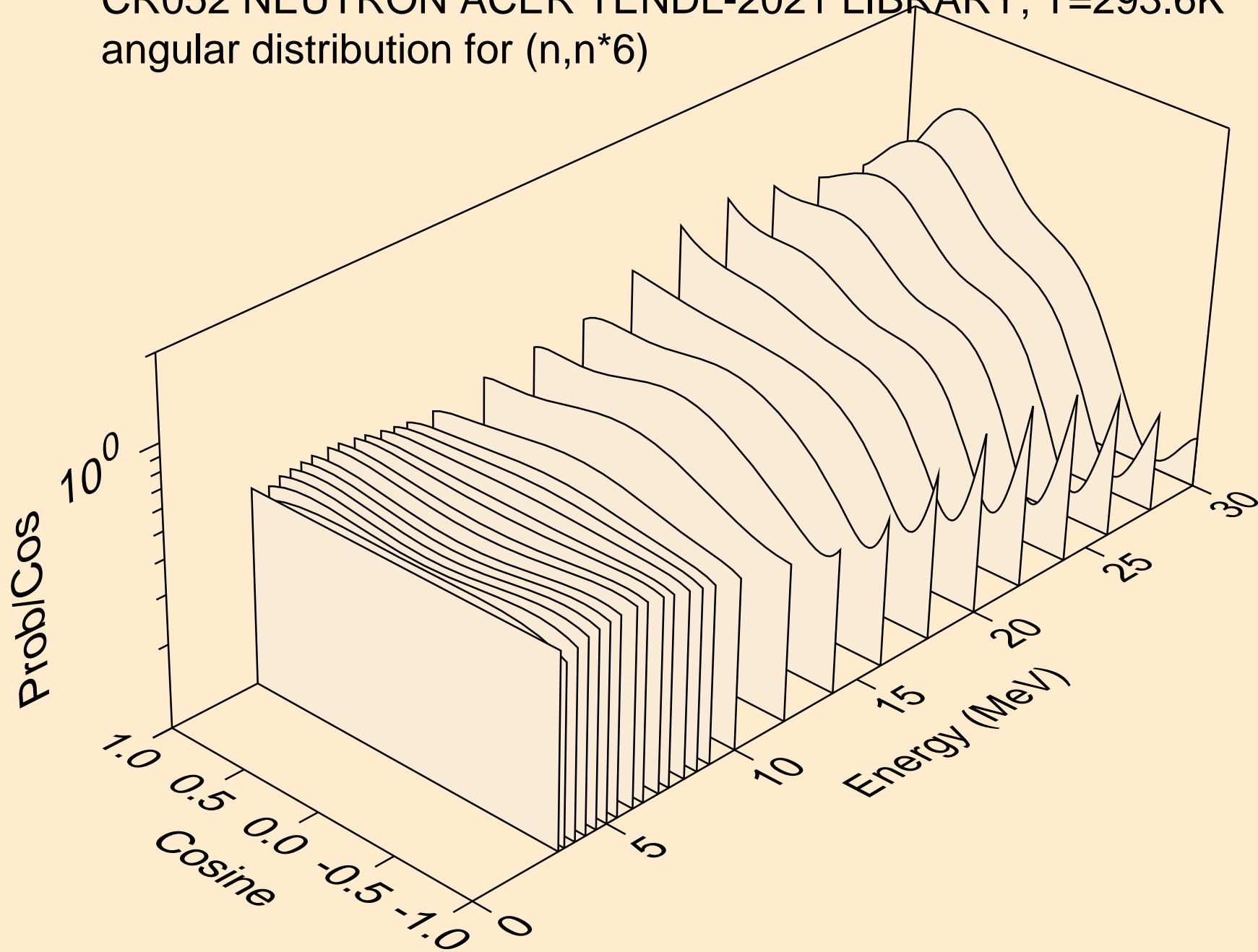

CR052 NEUTRON ACER TENDL-2021 LIBRARY; T=293.6K
angular distribution for (n,n*7)

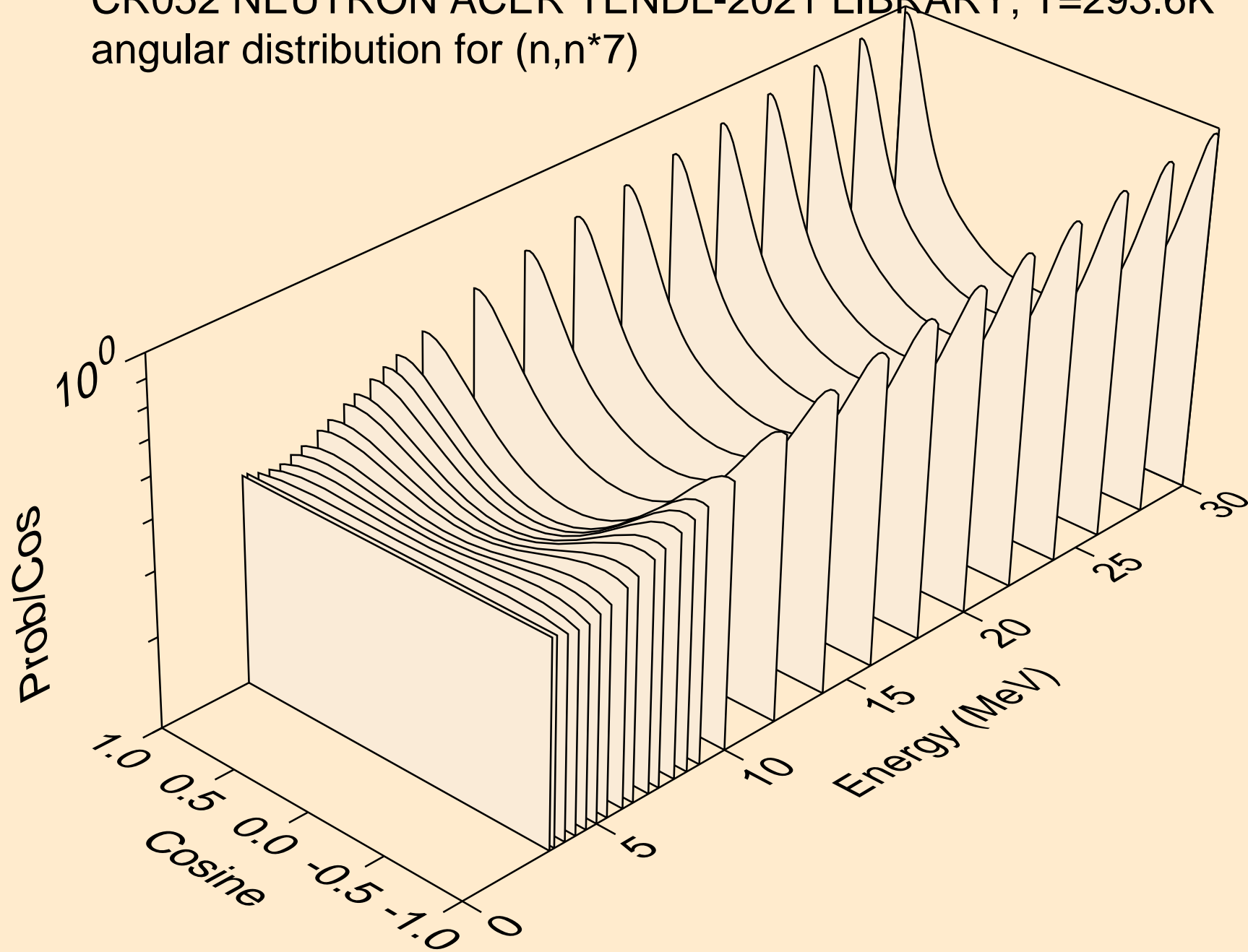

CR052 NEUTRON ACER TENDL-2021 LIBRARY; T=293.6K
angular distribution for (n,n*8)

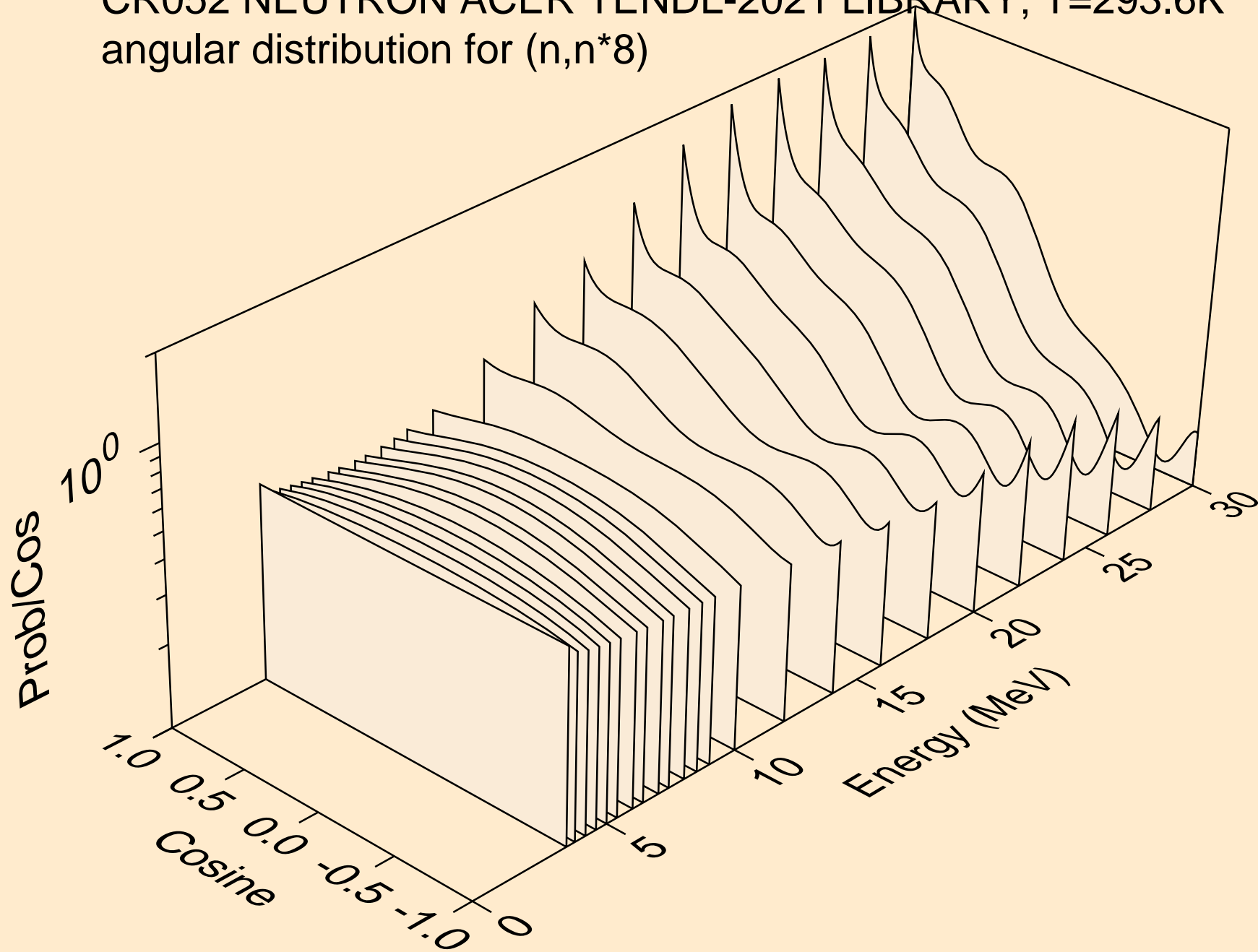

CR052 NEUTRON ACER TENDL-2021 LIBRARY; T=293.6K
angular distribution for (n,n*9)

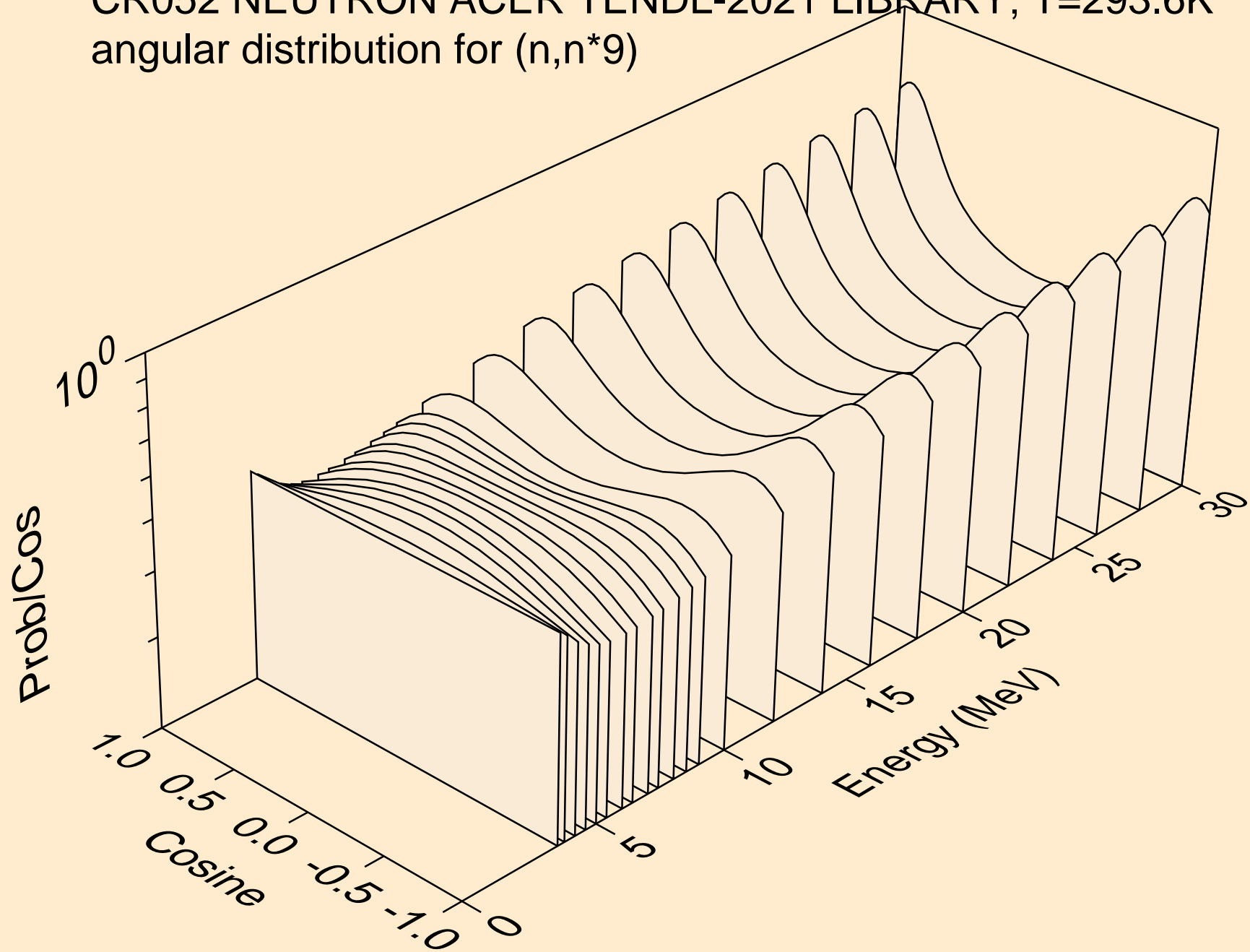

CR052 NEUTRON ACER TENDL-2021 LIBRARY; T=293.6K
angular distribution for (n,n*10)

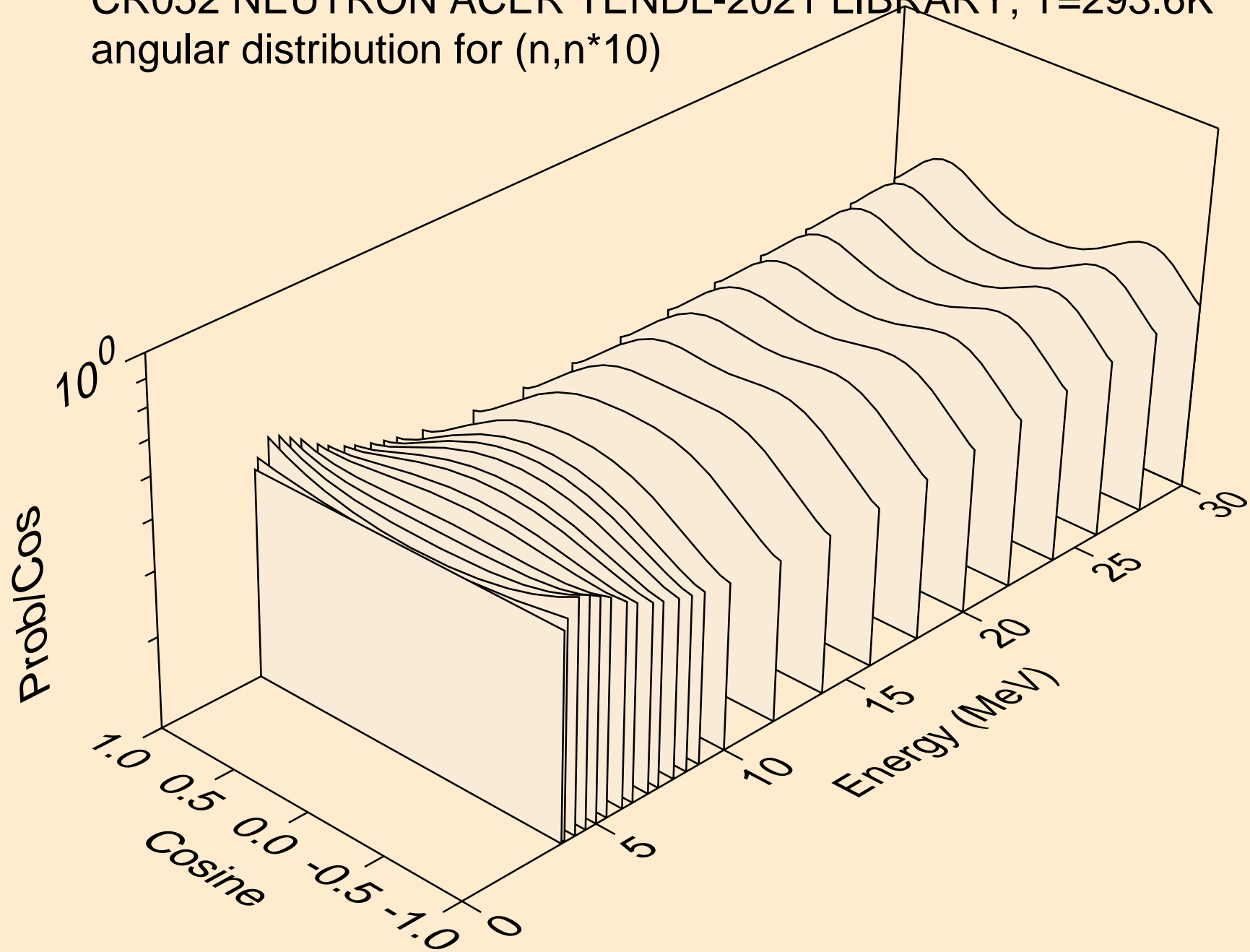

CR052 NEUTRON ACER TENDL-2021 LIBRARY; T=293.6K
angular distribution for (n,n*11)

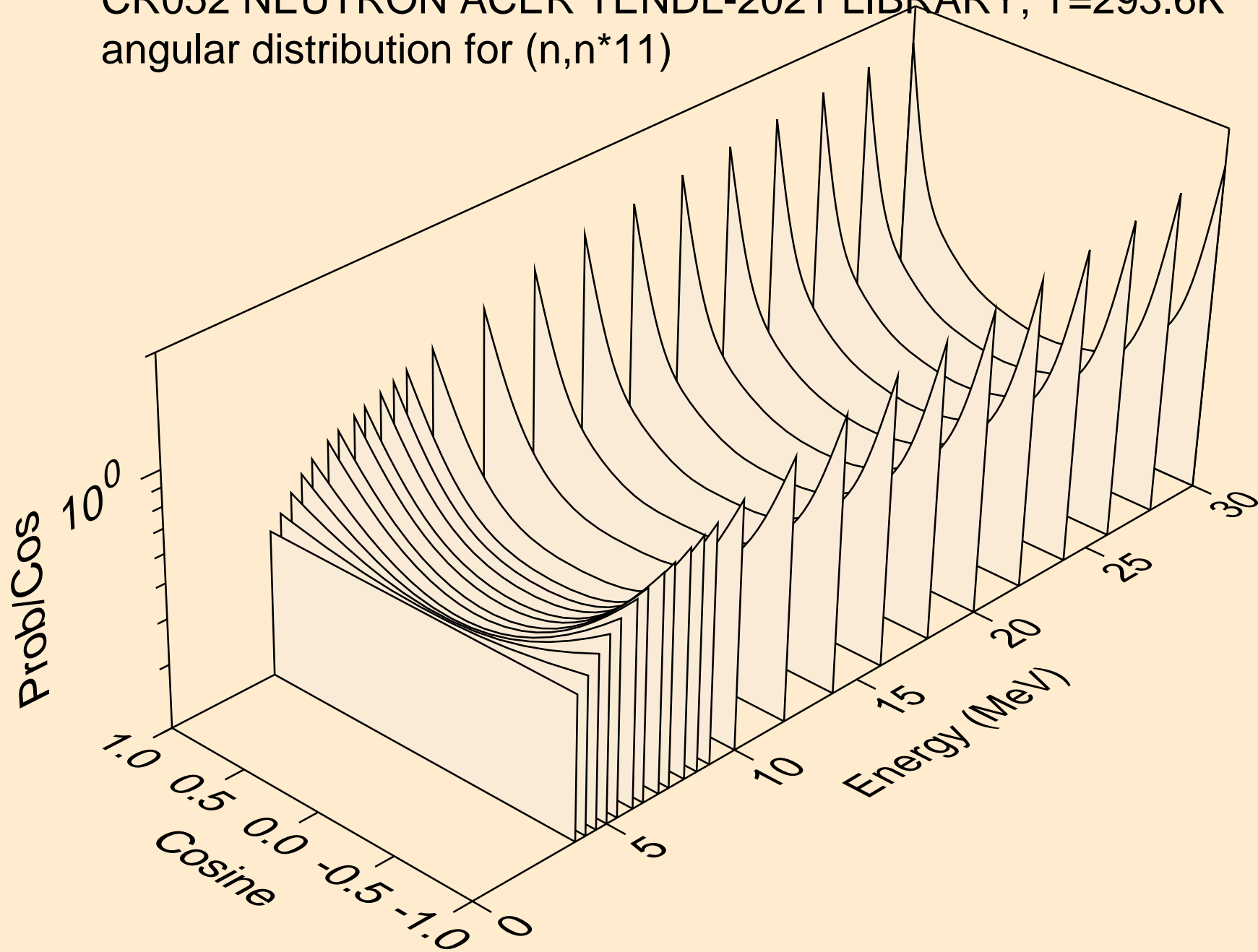

CR052 NEUTRON ACER TENDL-2021 LIBRARY; T=293.6K
angular distribution for (n,n*12)

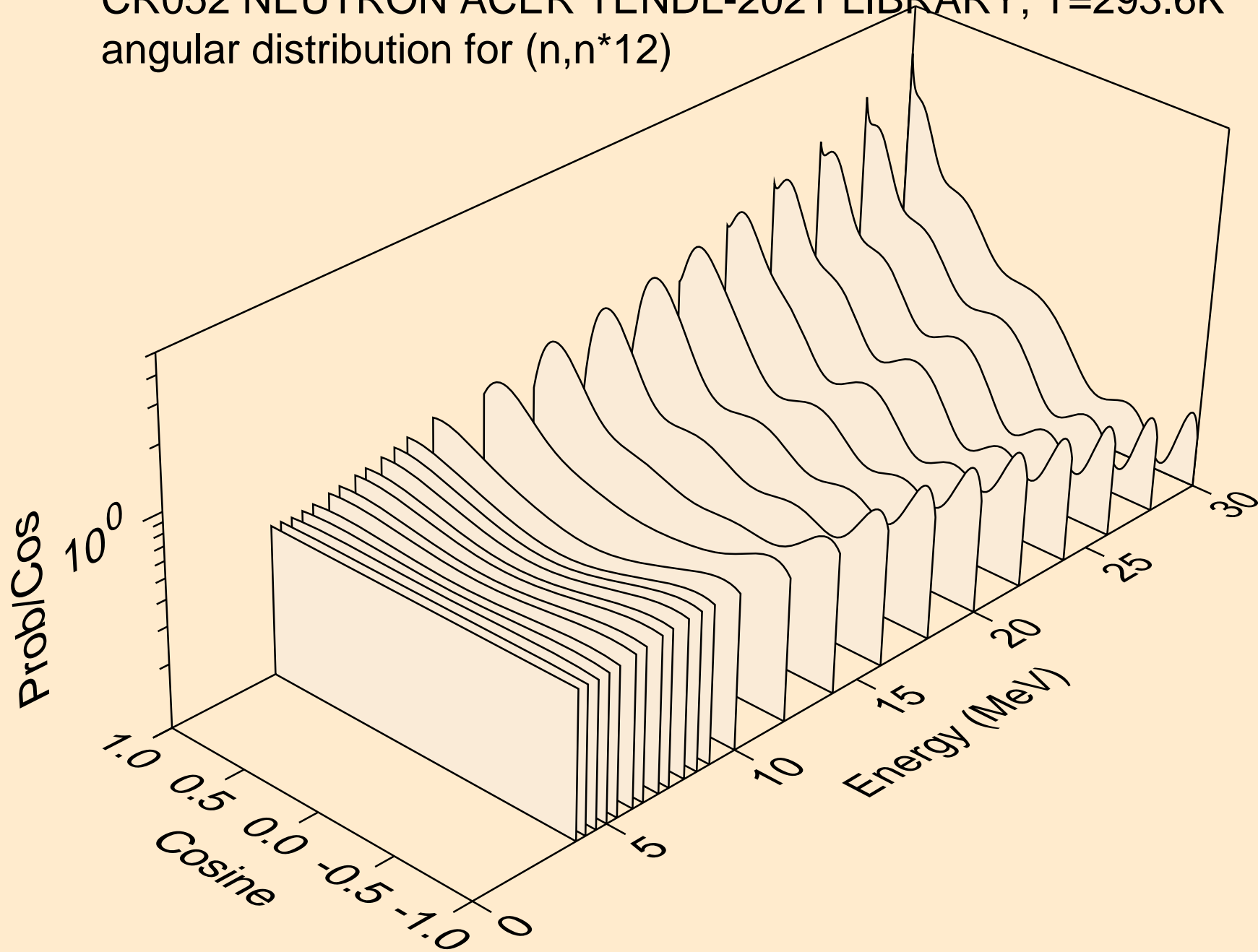

CR052 NEUTRON ACER TENDL-2021 LIBRARY; T=293.6K
angular distribution for (n,n*13)

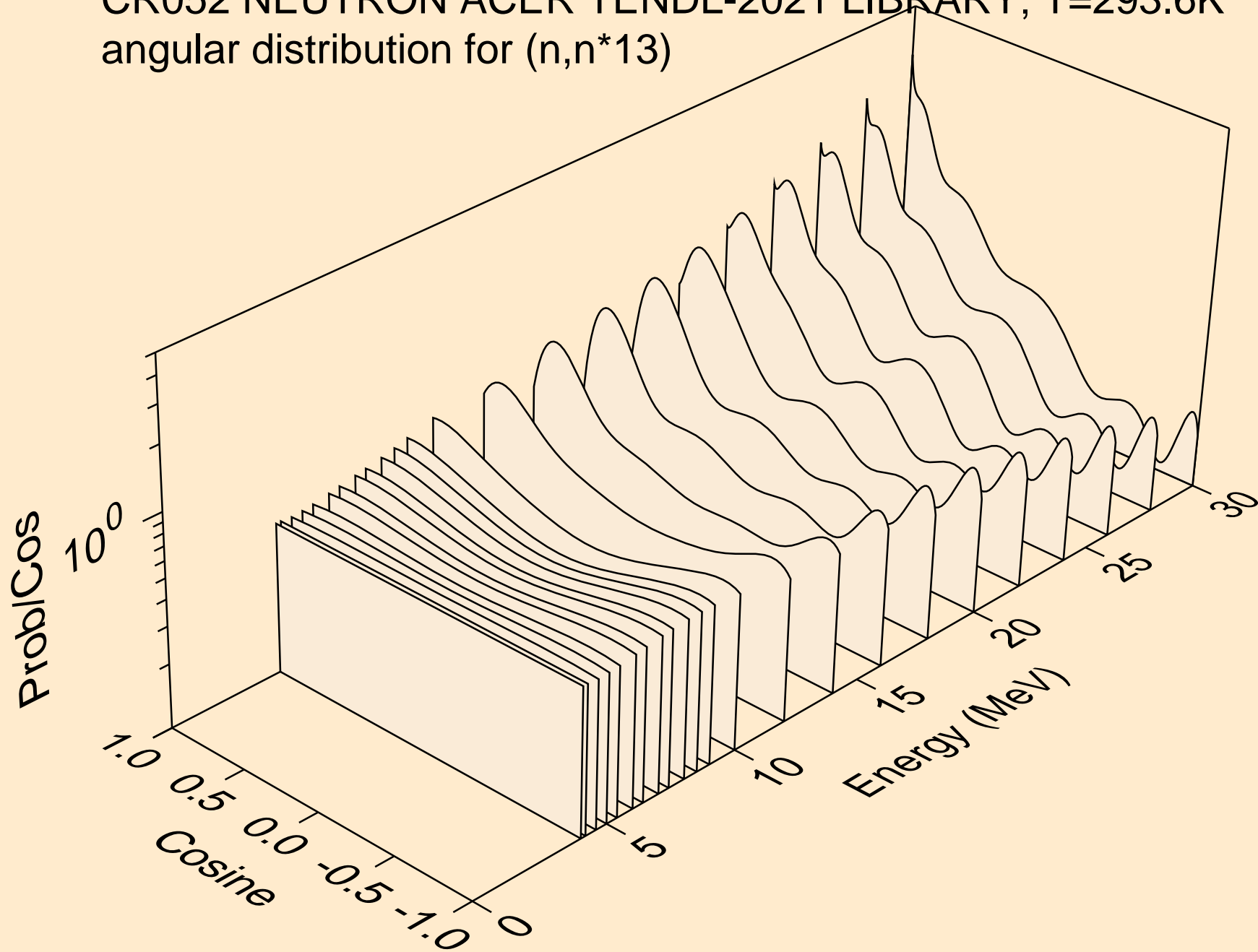

CR052 NEUTRON ACER TENDL-2021 LIBRARY; T=293.6K
angular distribution for (n,n*14)

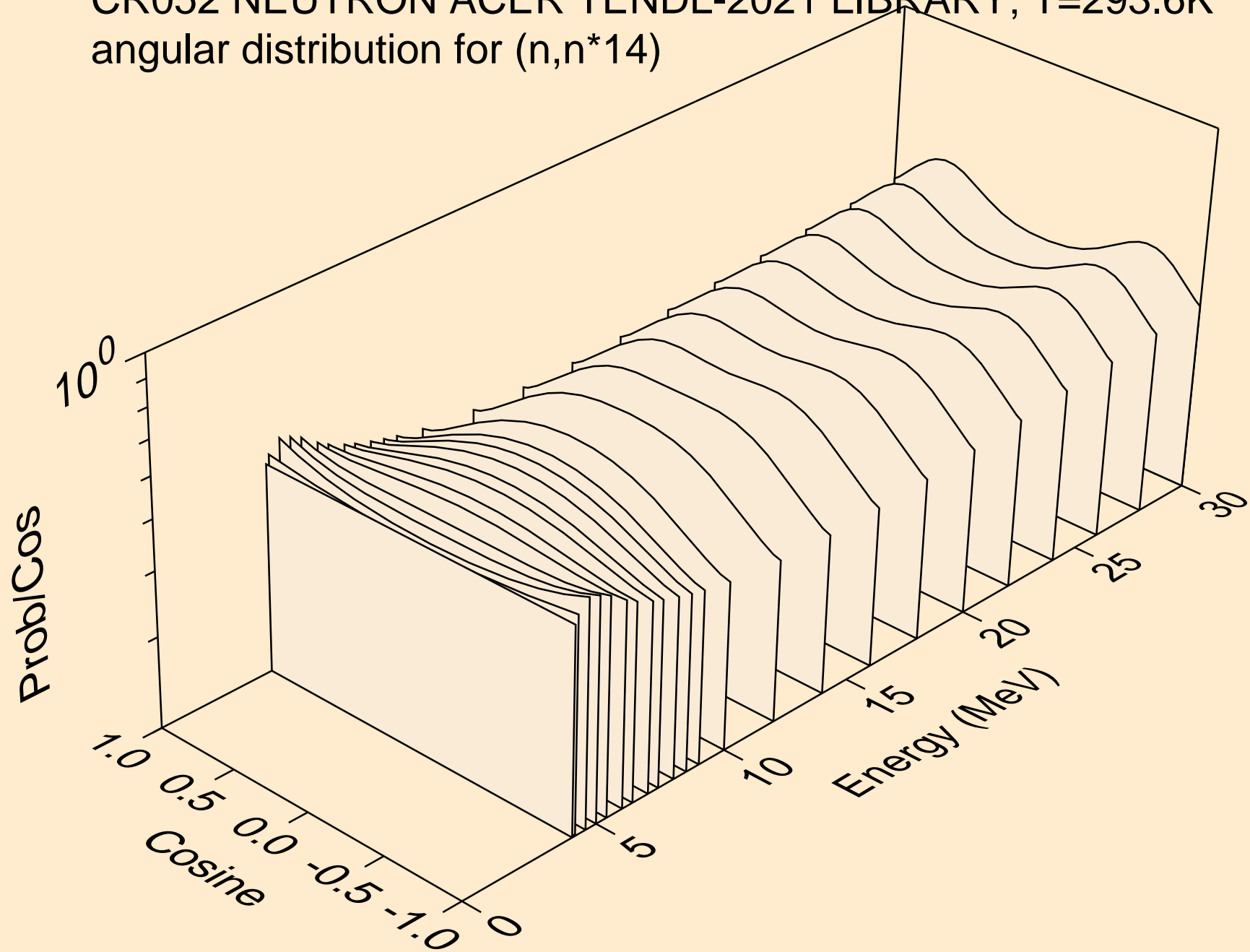

CR052 NEUTRON ACER TENDL-2021 LIBRARY; T=293.6K
angular distribution for (n,n*15)

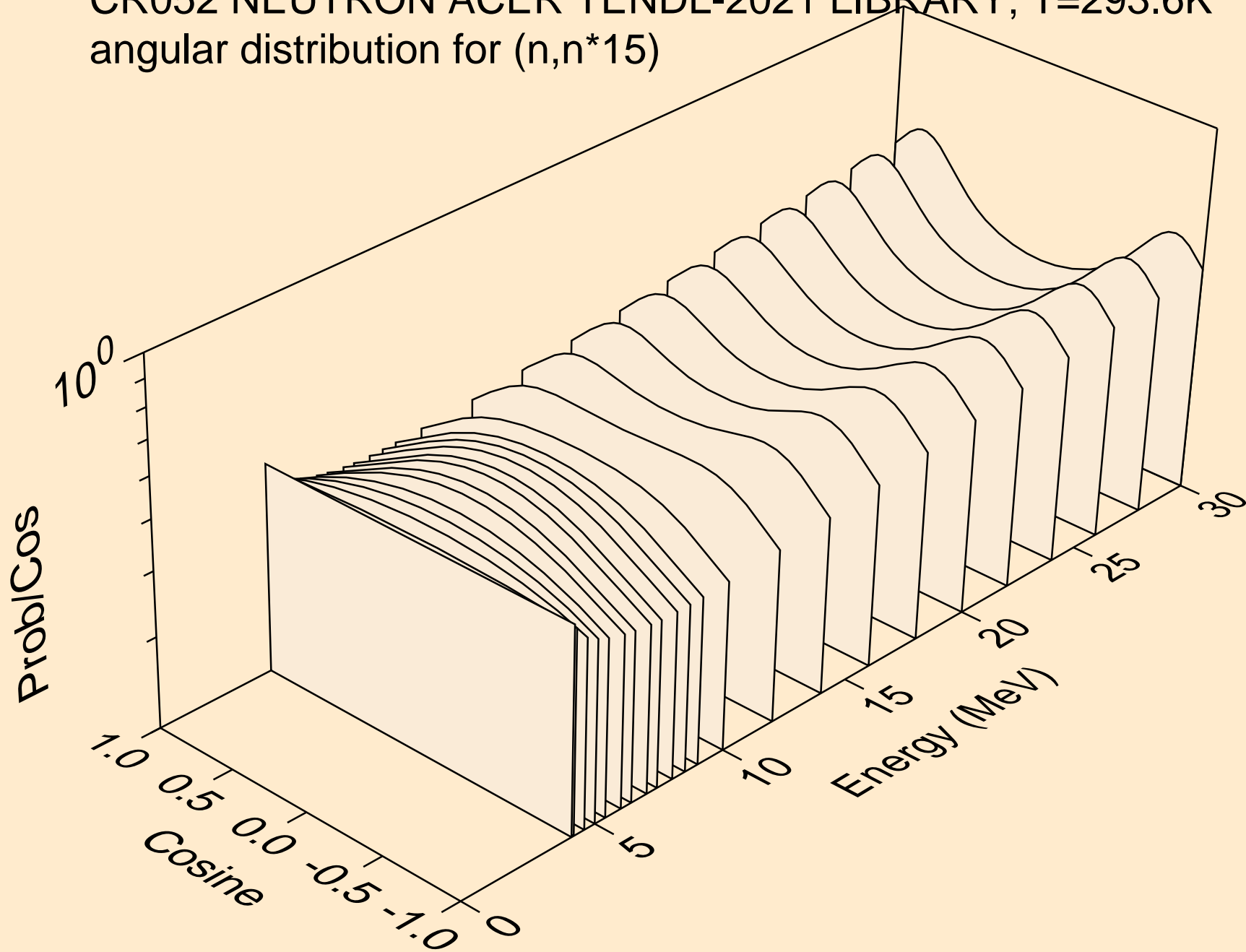

CR052 NEUTRON ACER TENDL-2021 LIBRARY; T=293.6K
angular distribution for (n,n*16)

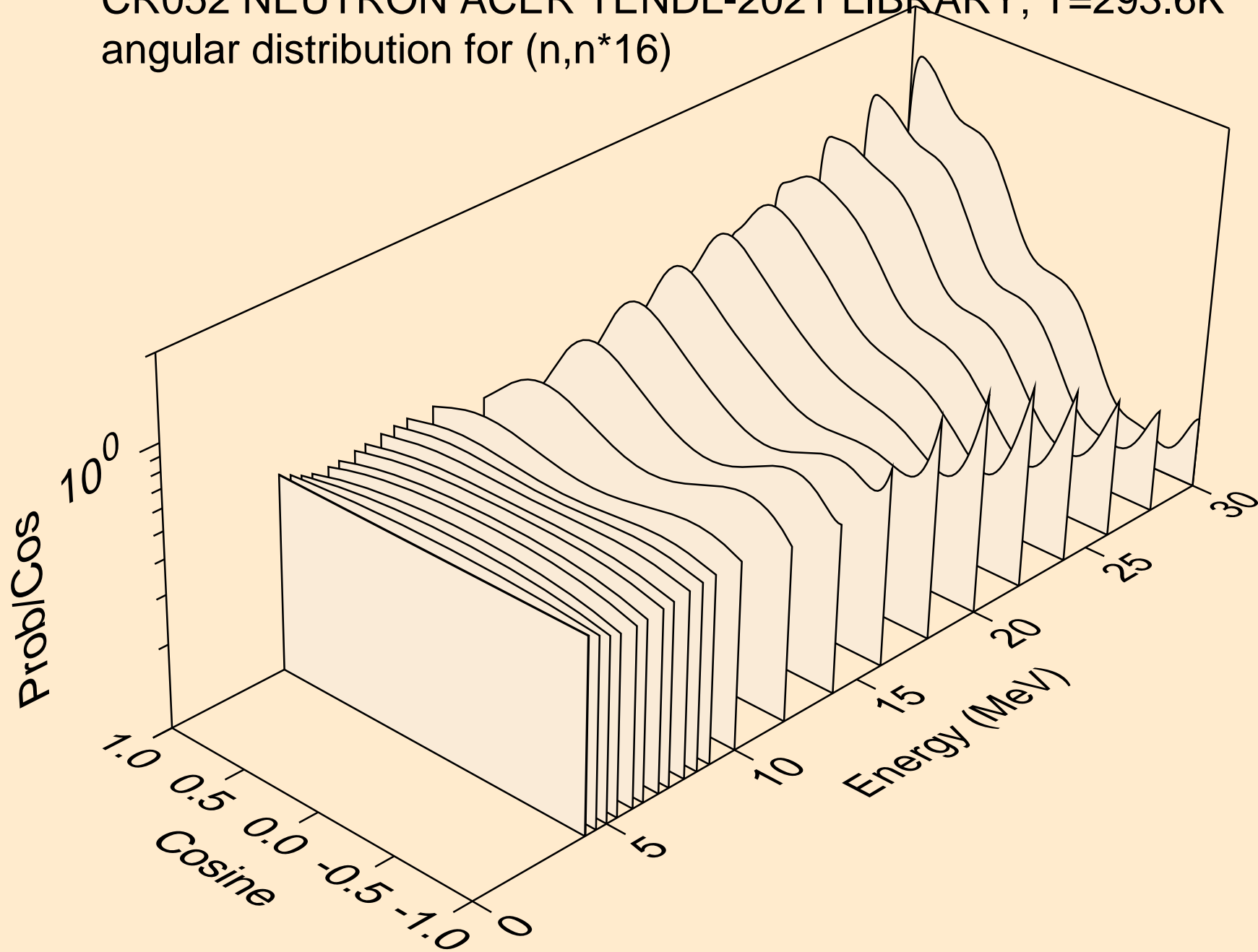

CR052 NEUTRON ACER TENDL-2021 LIBRARY; T=293.6K
angular distribution for (n,n*17)

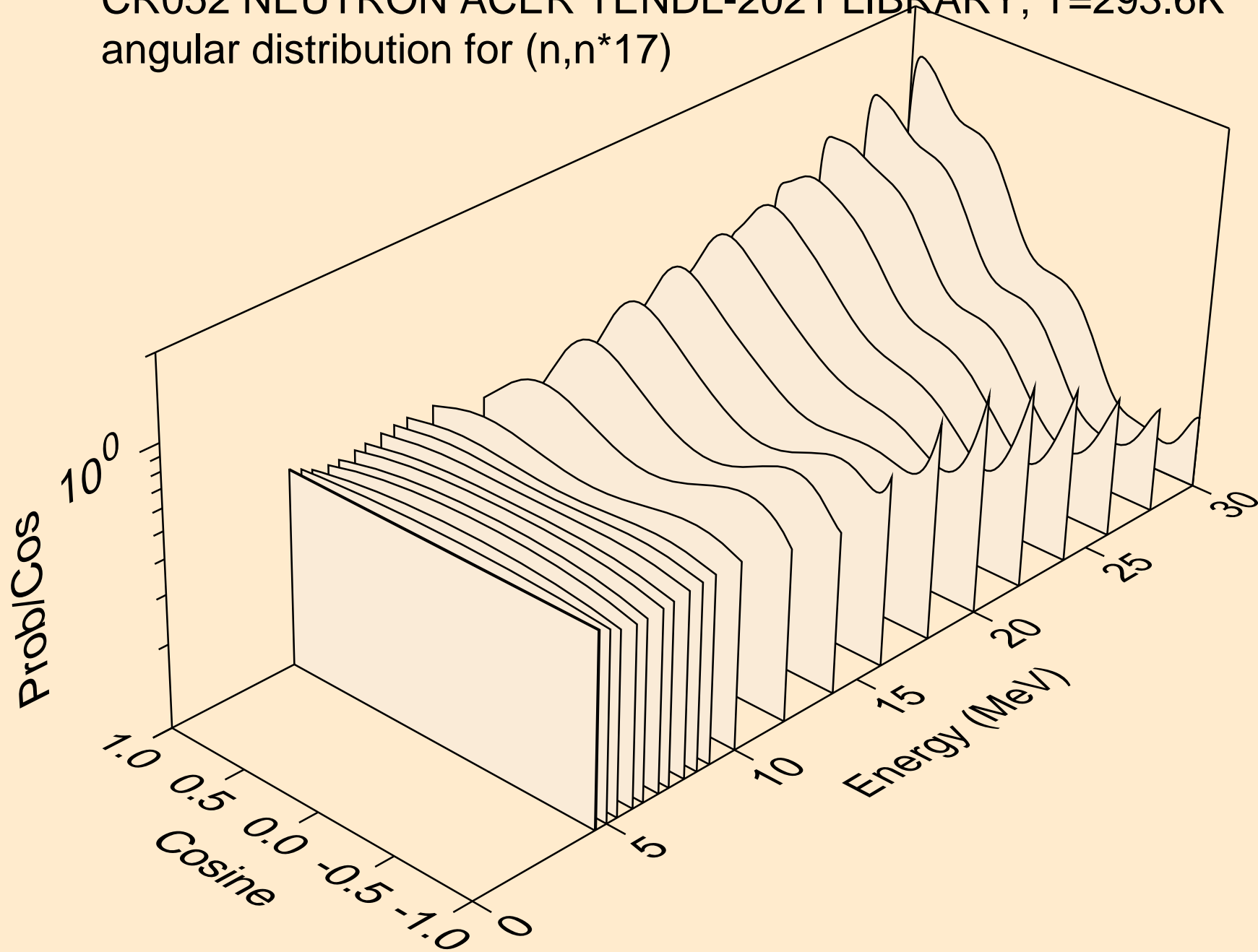

CR052 NEUTRON ACER TENDL-2021 LIBRARY; T=293.6K
angular distribution for (n,n*18)

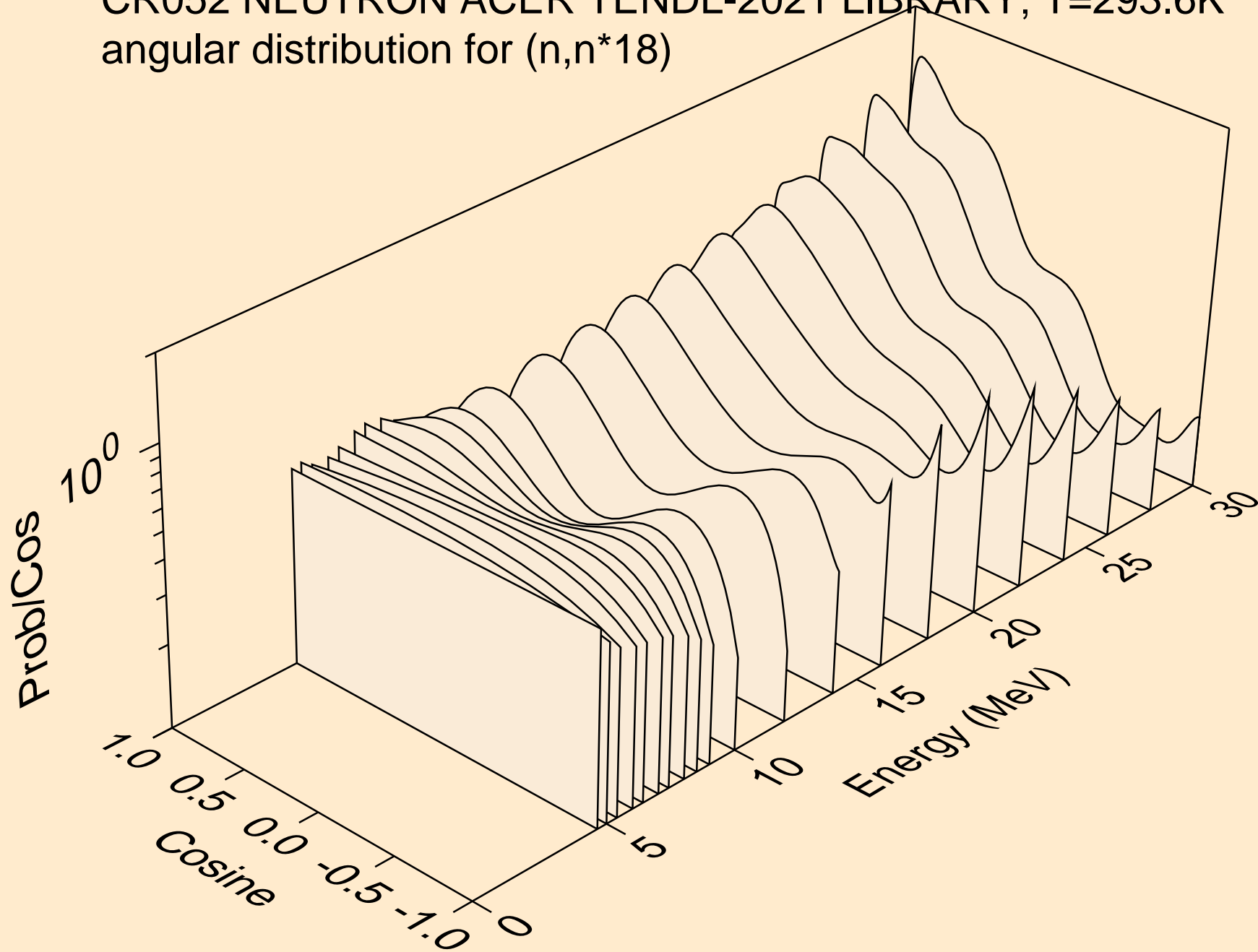

CR052 NEUTRON ACER TENDL-2021 LIBRARY; T=293.6K
angular distribution for (n,n*19)

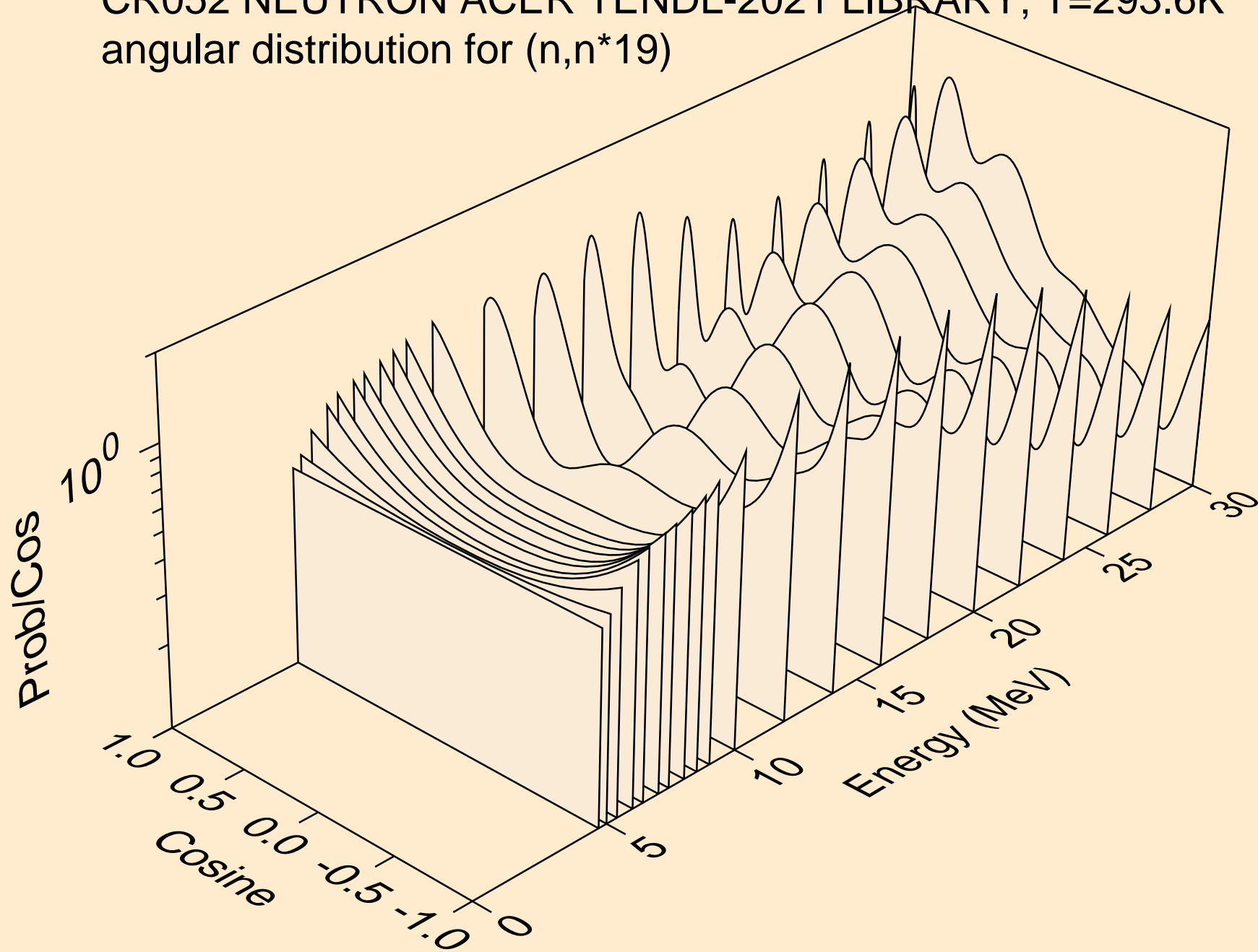

CR052 NEUTRON ACER TENDL-2021 LIBRARY; T=293.6K
angular distribution for (n,n*20)

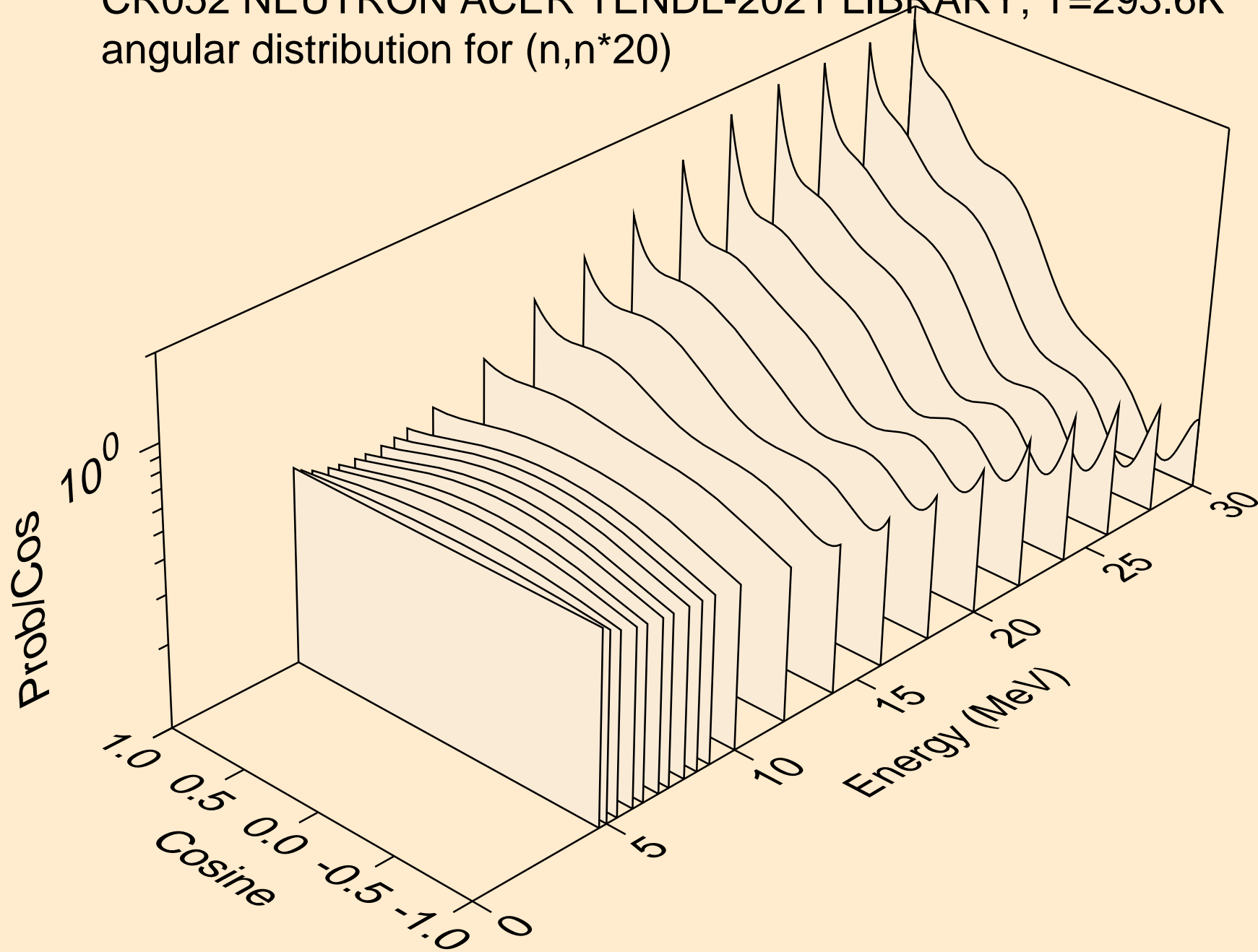

CR052 NEUTRON ACER TENDL-2021 LIBRARY; T=293.6K
angular distribution for (n,n*21)

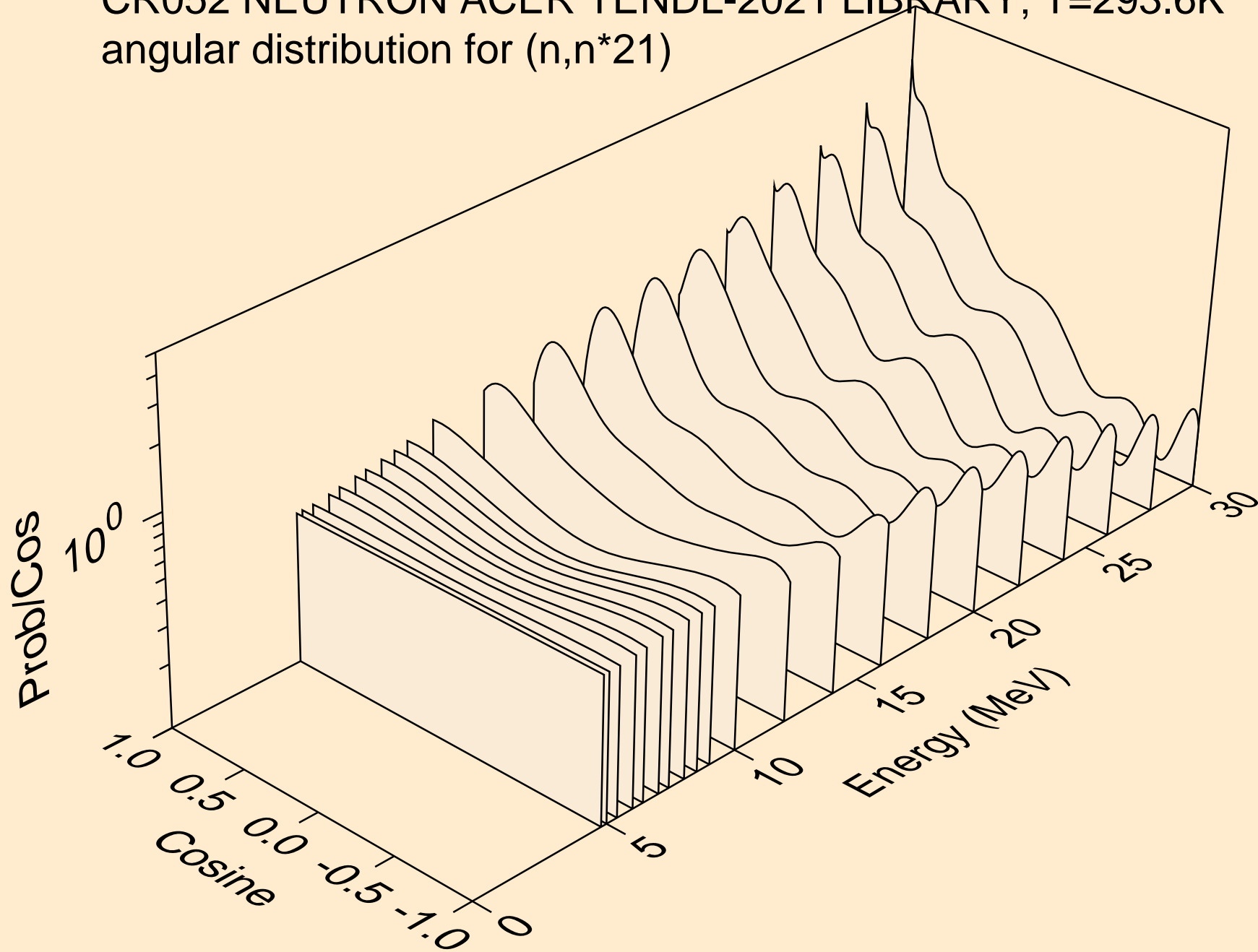

CR052 NEUTRON ACER TENDL-2021 LIBRARY; T=293.6K
angular distribution for (n,n*22)

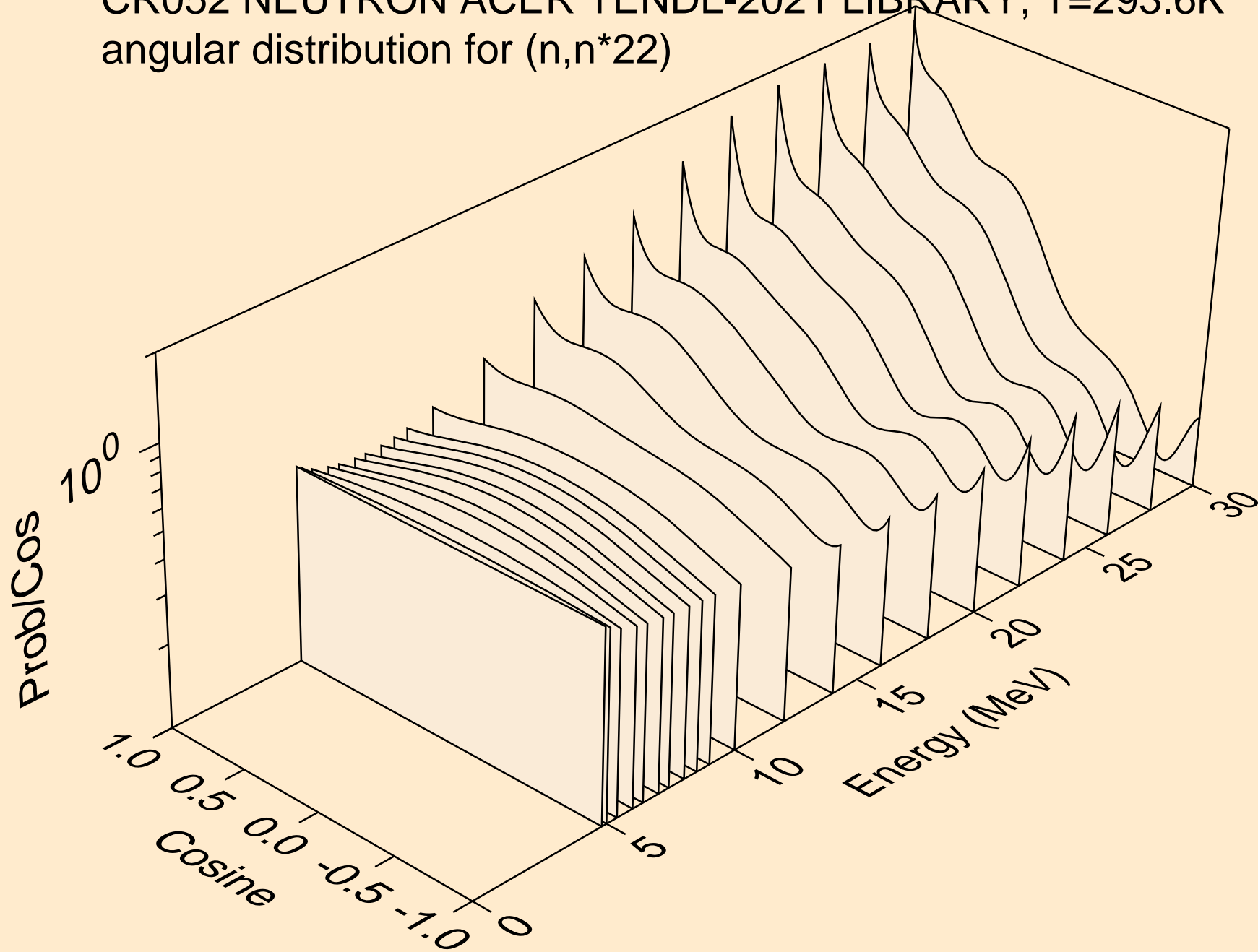

CR052 NEUTRON ACER TENDL-2021 LIBRARY; T=293.6K
angular distribution for (n,n*23)

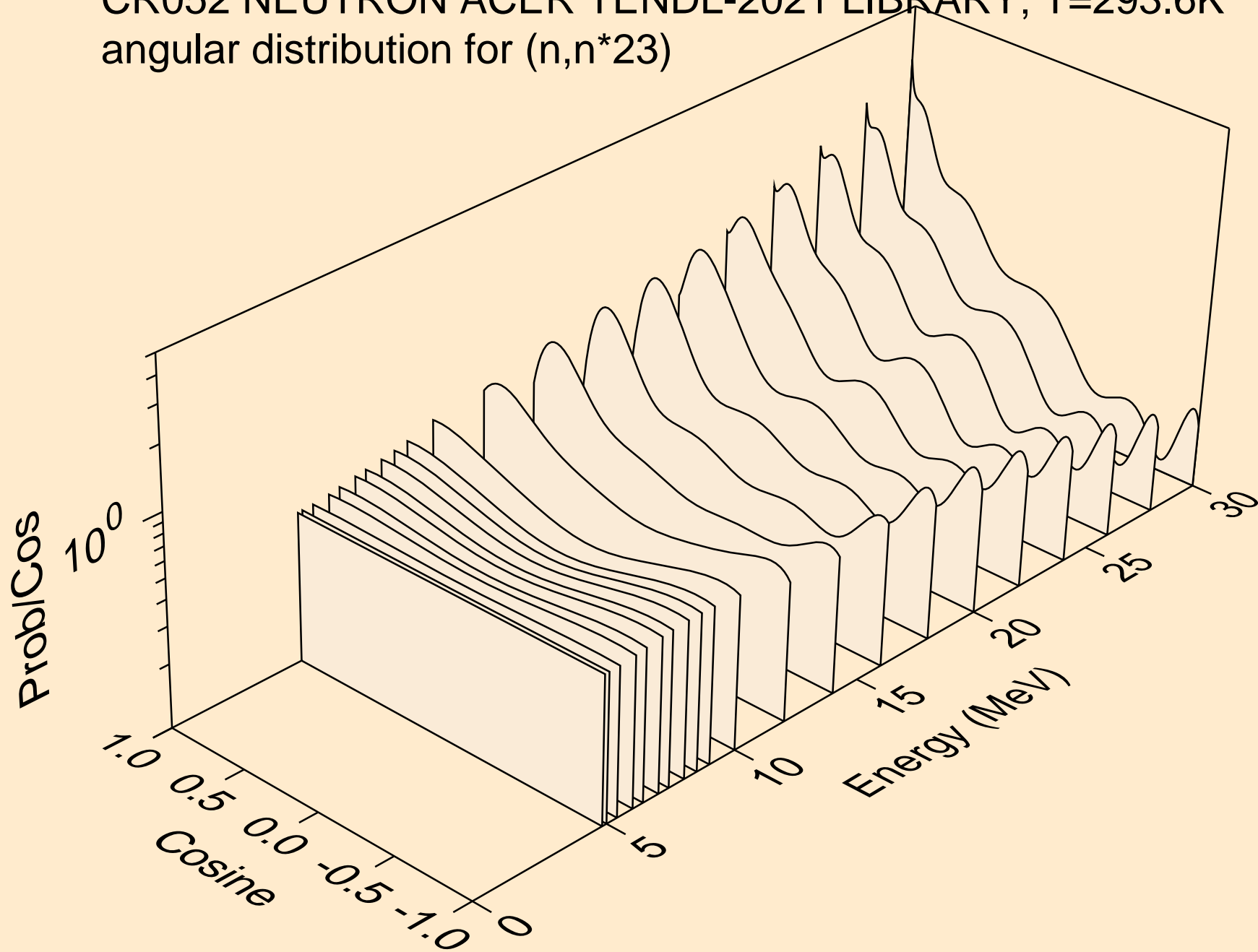

CR052 NEUTRON ACER TENDL-2021 LIBRARY; T=293.6K
angular distribution for (n,n*24)

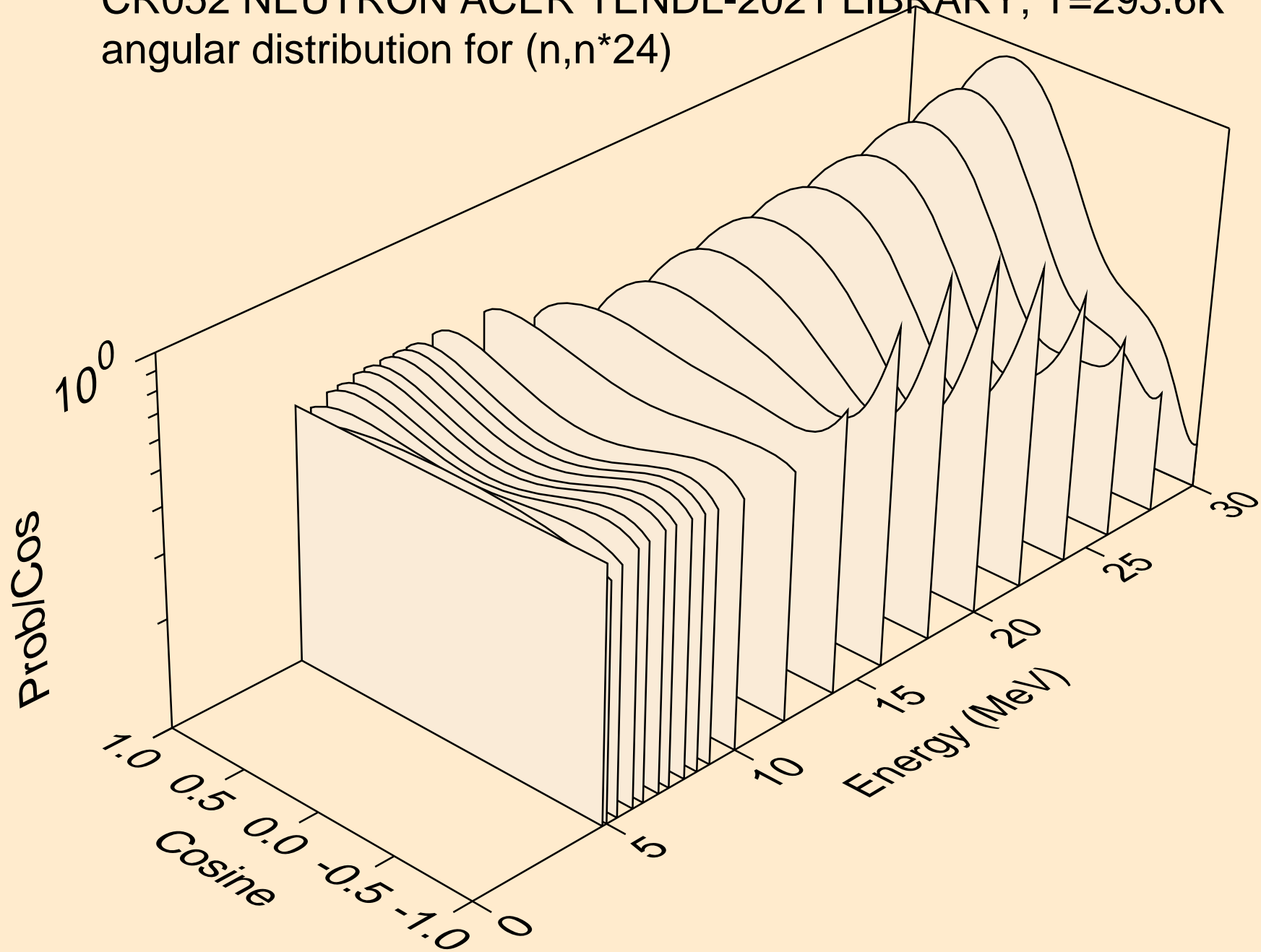

CR052 NEUTRON ACER TENDL-2021 LIBRARY; T=293.6K
angular distribution for (n,n*25)

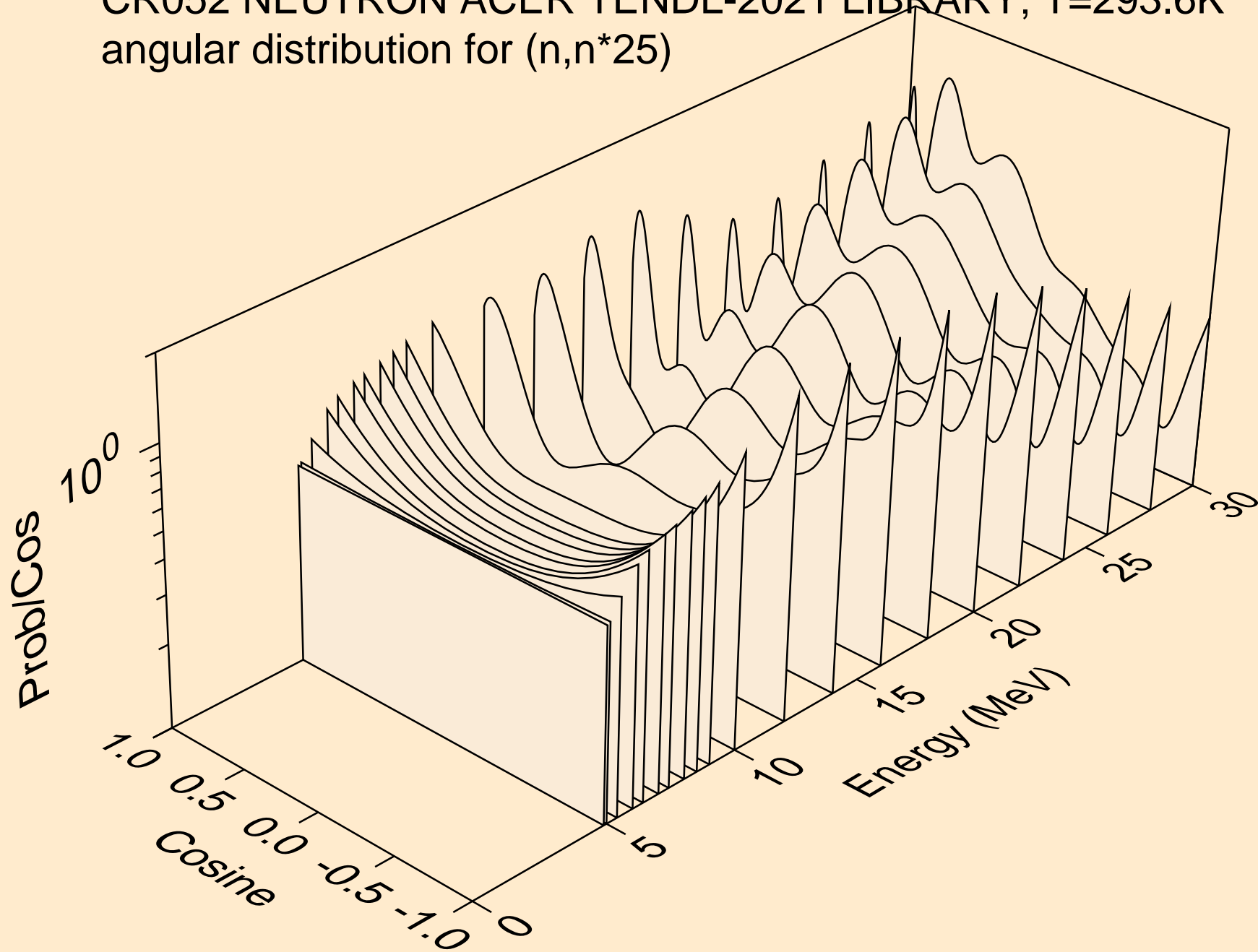

CR052 NEUTRON ACER TENDL-2021 LIBRARY; T=293.6K
angular distribution for (n,n*26)

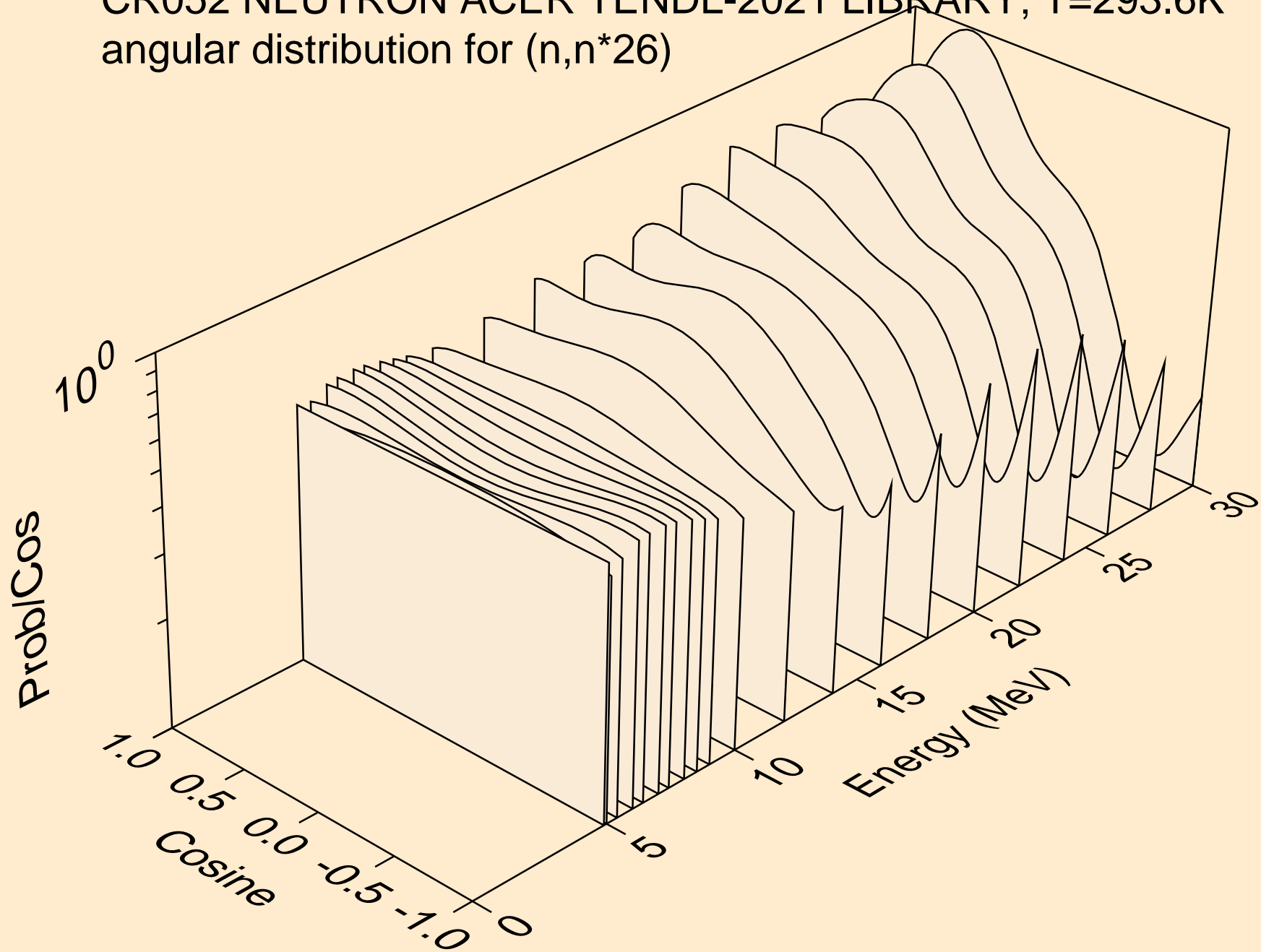

CR052 NEUTRON ACER TENDL-2021 LIBRARY; T=293.6K
angular distribution for (n,n*27)

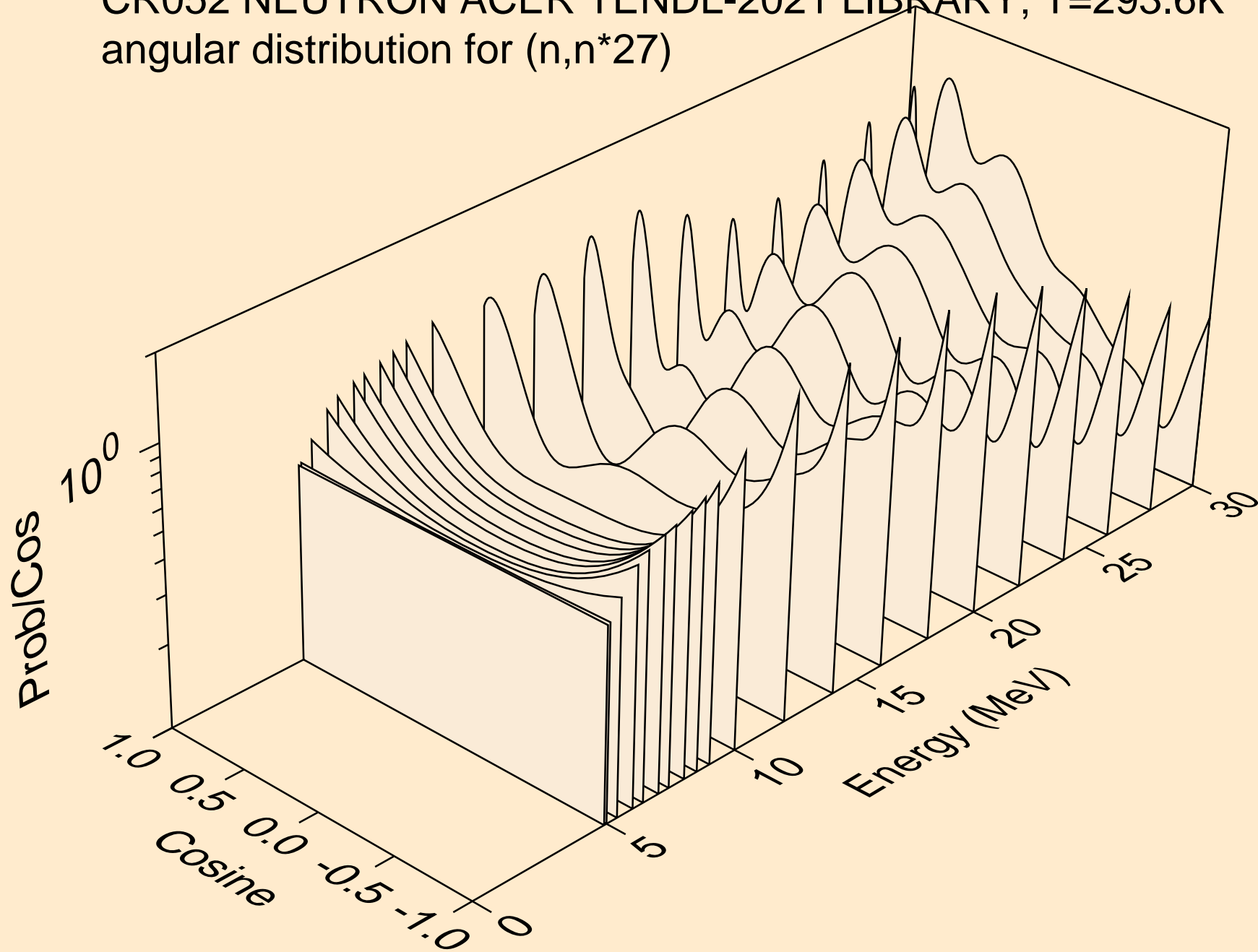

CR052 NEUTRON ACER TENDL-2021 LIBRARY; T=293.6K
angular distribution for (n,n*28)

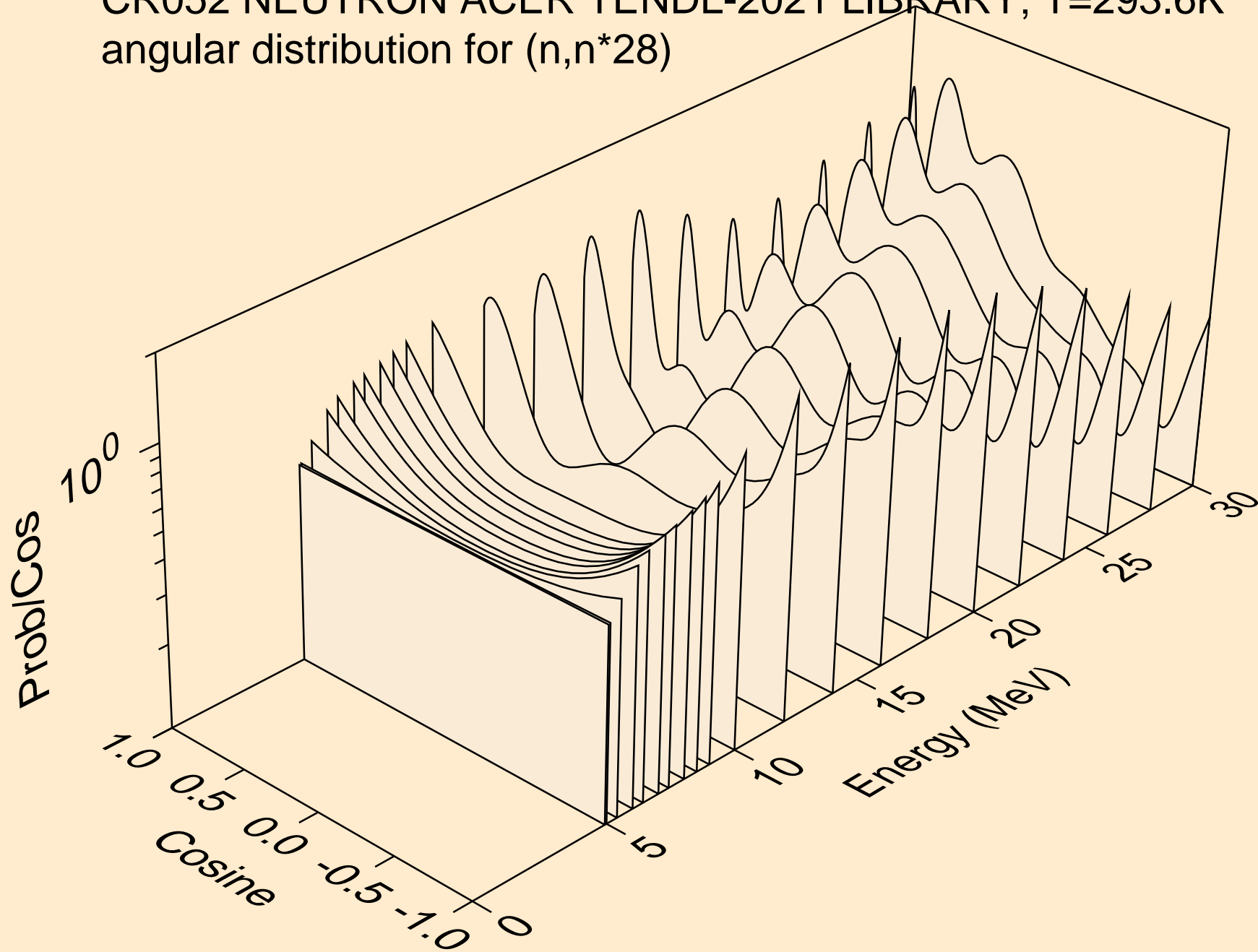

CR052 NEUTRON ACER TENDL-2021 LIBRARY; T=293.6K
angular distribution for (n,n*29)

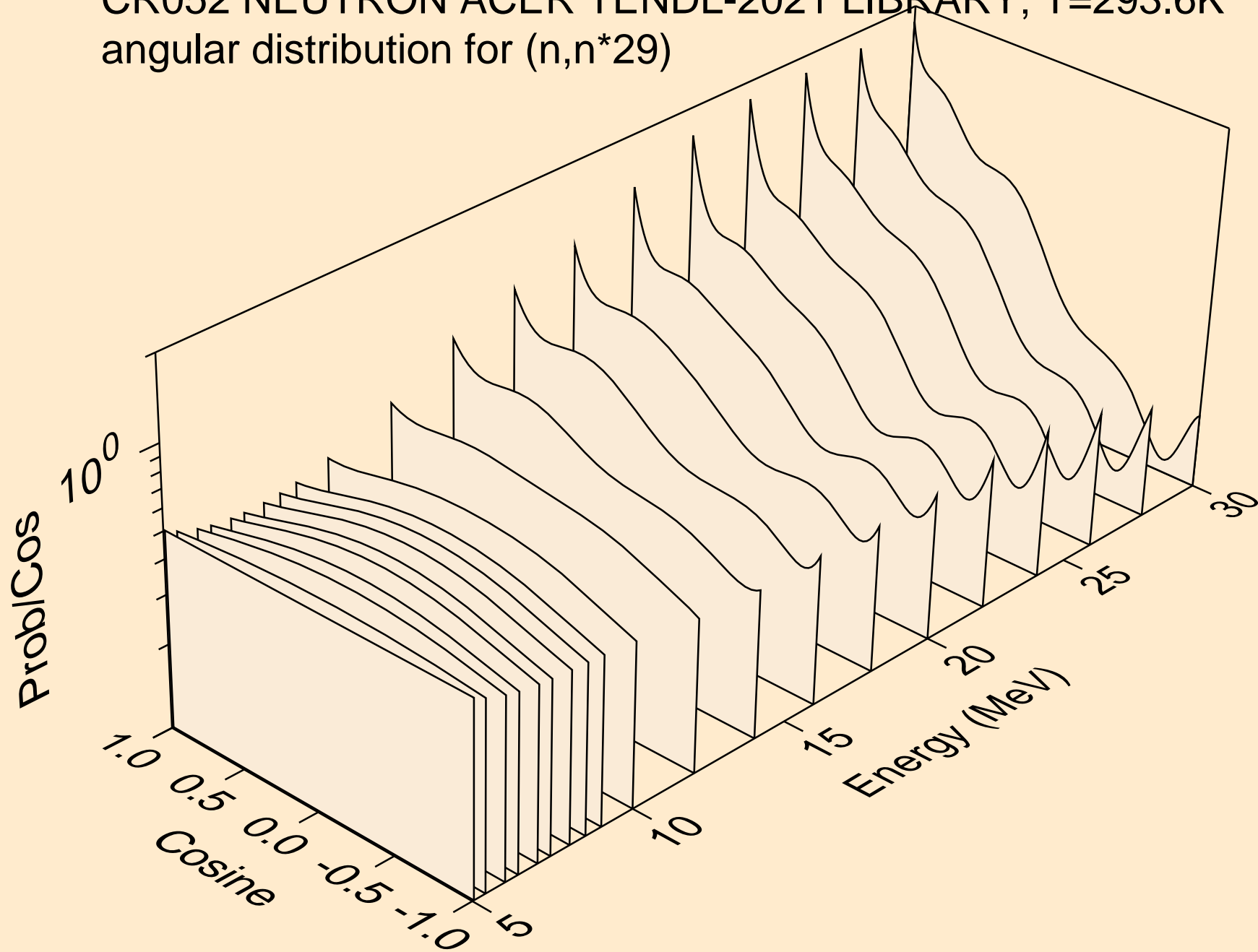

CR052 NEUTRON ACER TENDL-2021 LIBRARY; T=293.6K
angular distribution for (n,n*30)

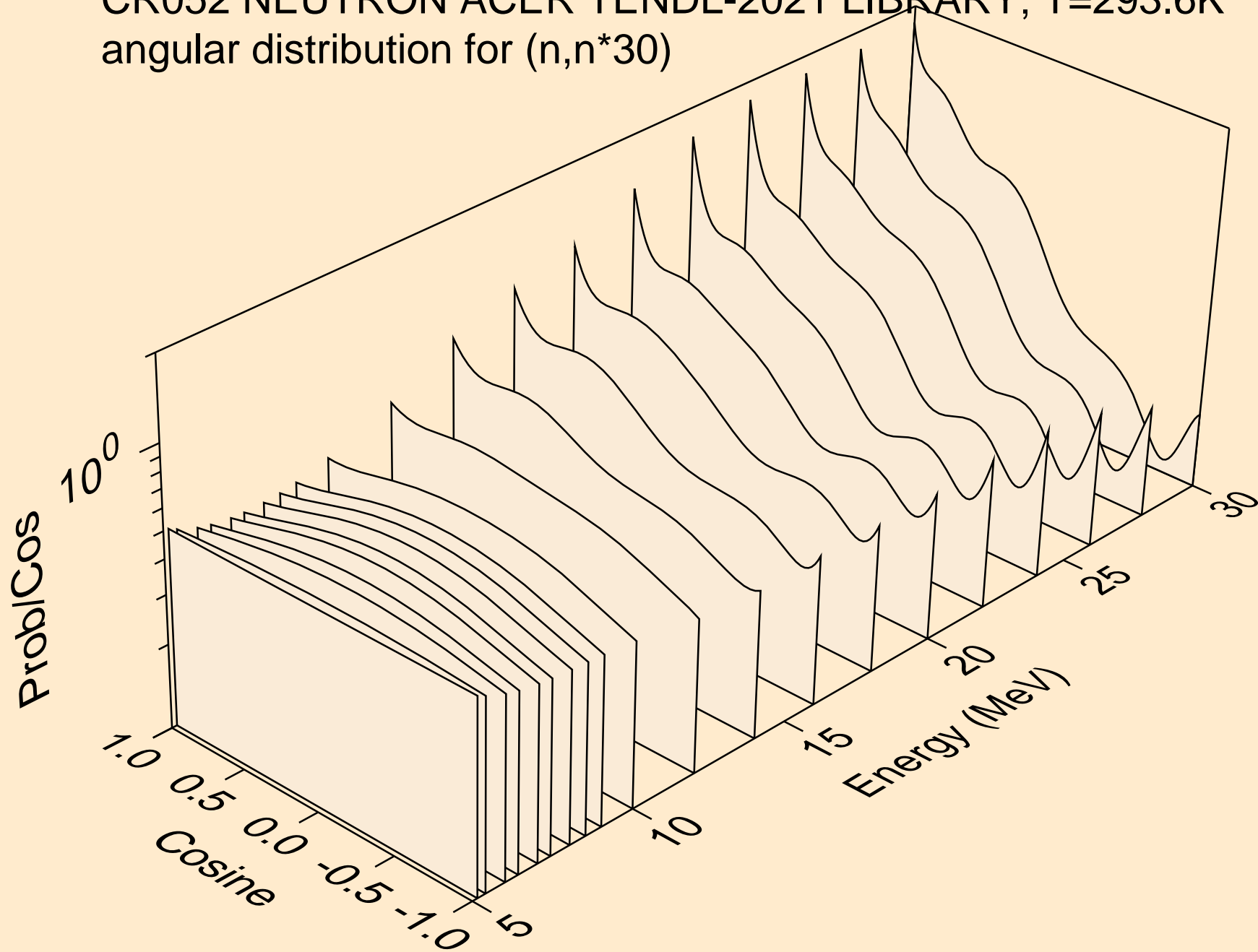

CR052 NEUTRON ACER TENDL-2021 LIBRARY; T=293.6K
Neutron emission for (n,x)

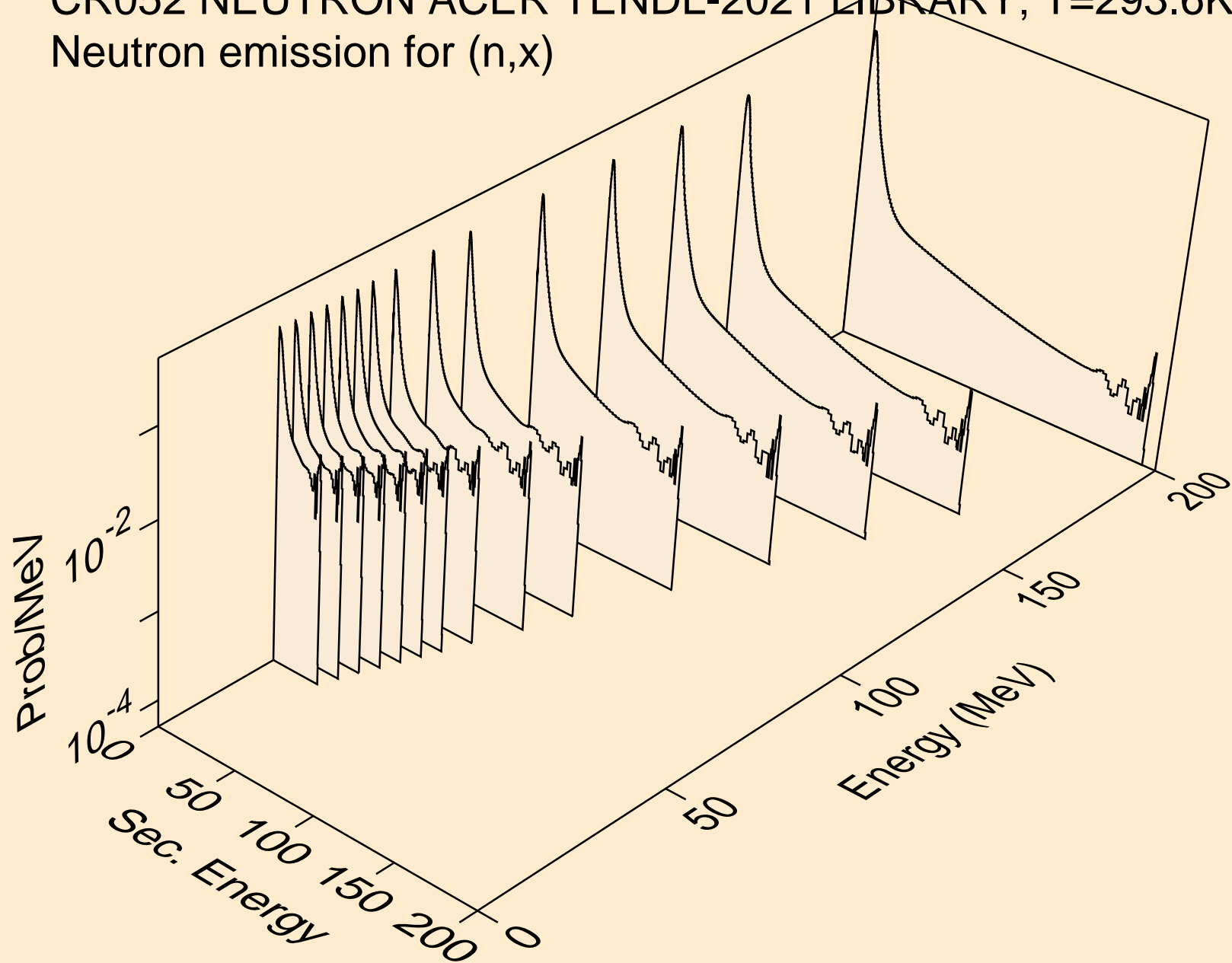

CR052 NEUTRON ACER TENDL-2021 LIBRARY; T=293.6K
Neutron emission for (n,2n)

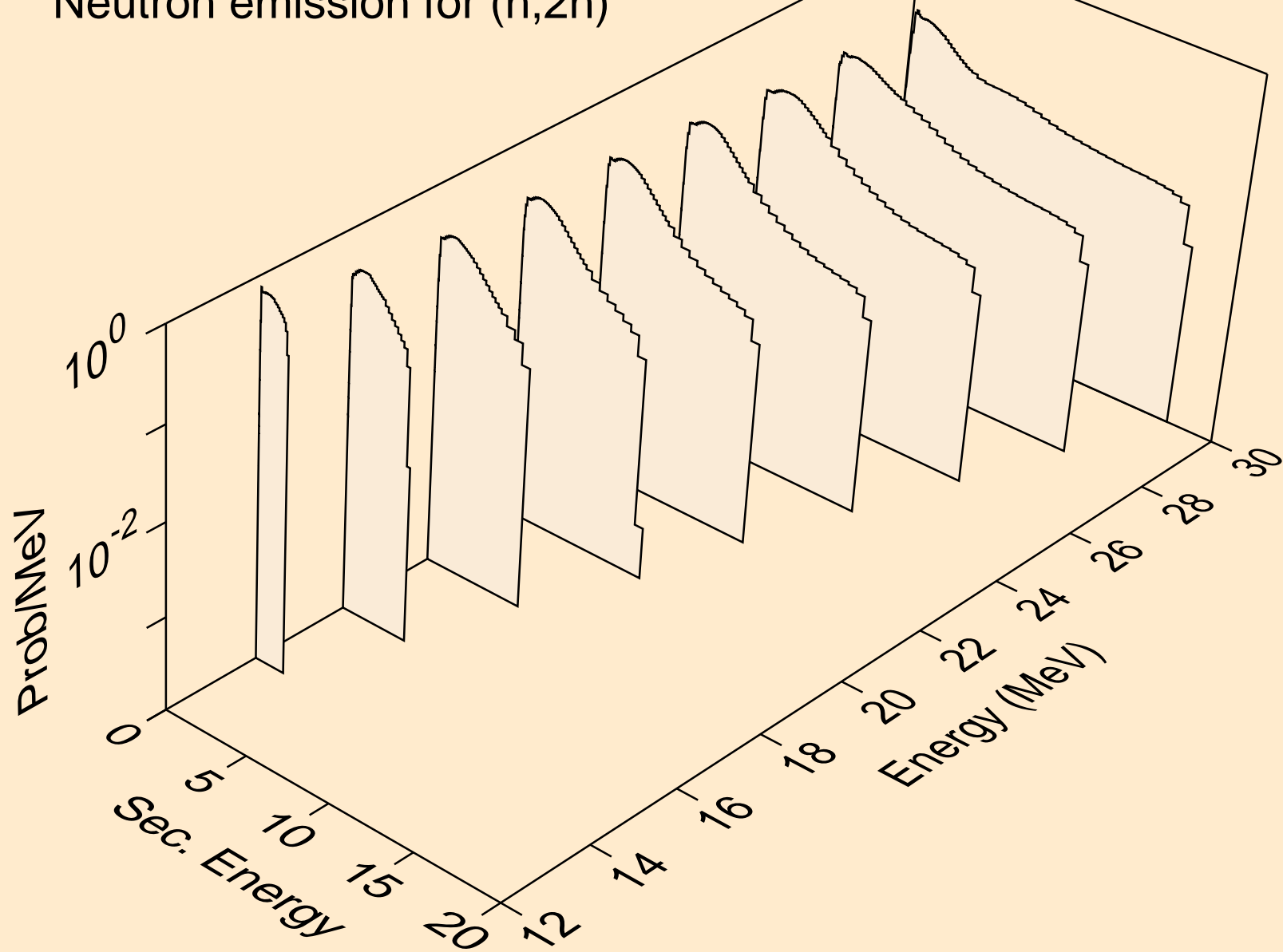

CR052 NEUTRON ACER TENDL-2021 LIBRARY; T=293.6K
Neutron emission for (n,3n)

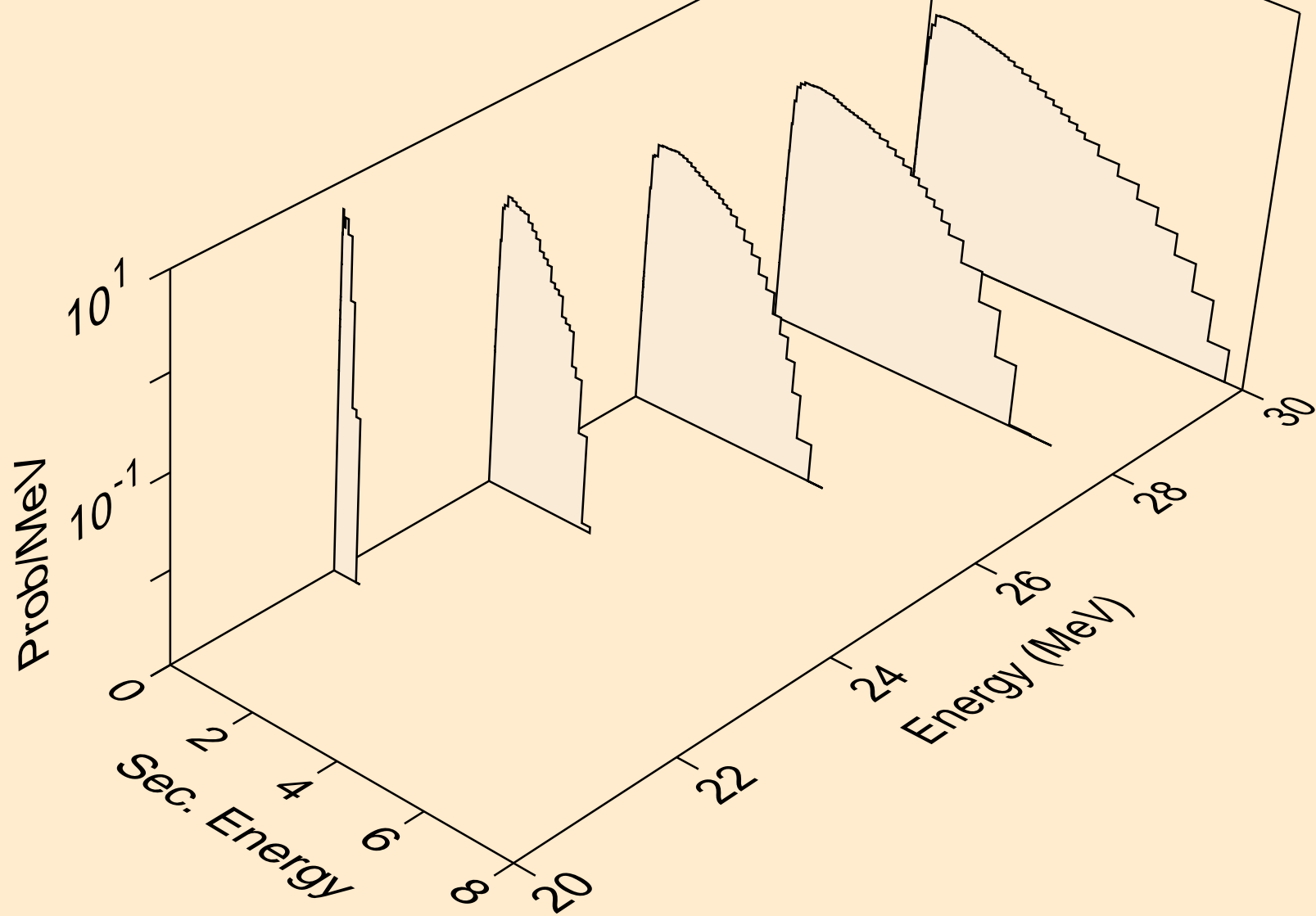

CR052 NEUTRON ACER TENDL-2021 LIBRARY; T=293.6K
Neutron emission for (n,n*)a

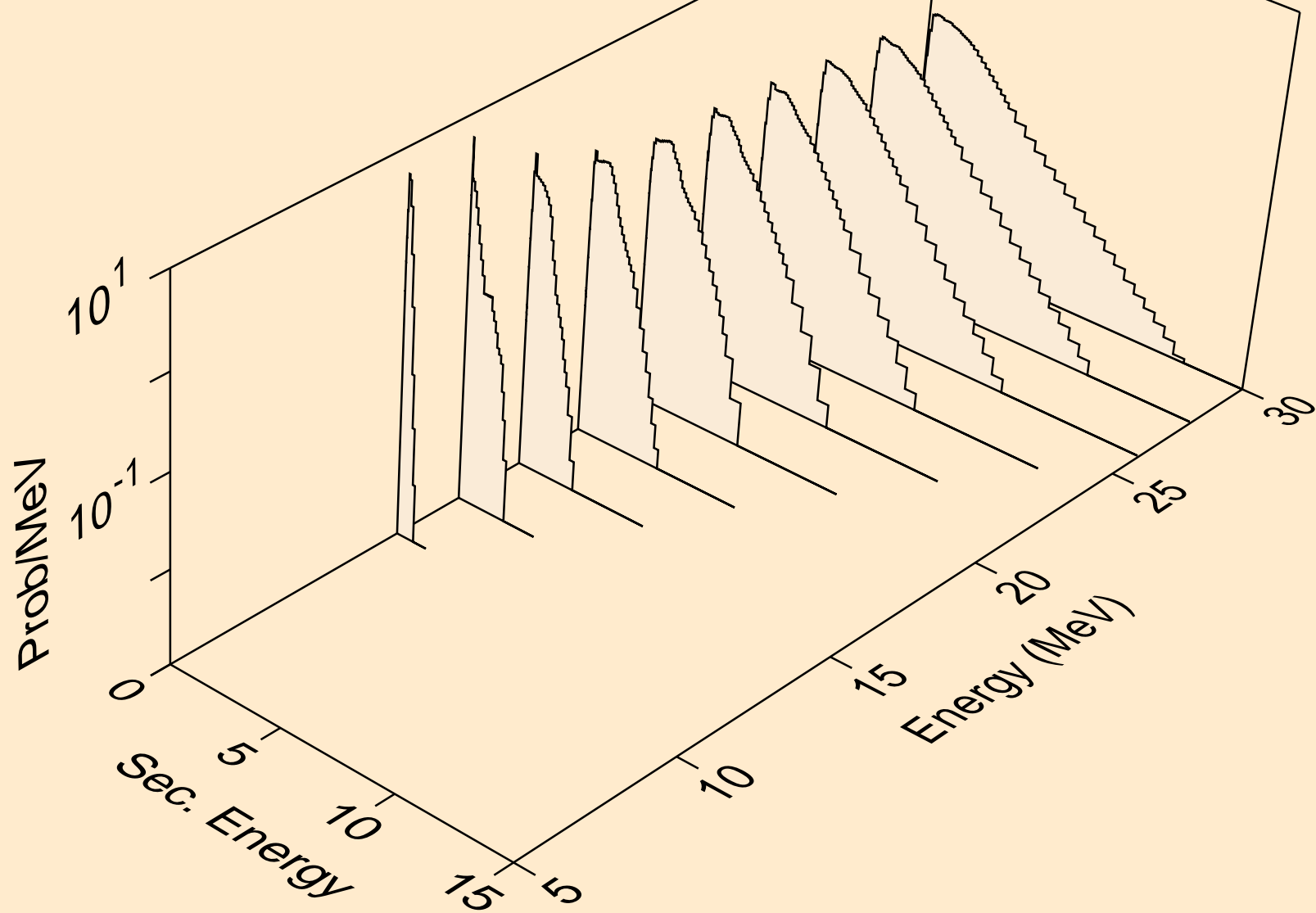

CR052 NEUTRON ACER TENDL-2021 LIBRARY; T=293.6K
Neutron emission for (n,2n)a

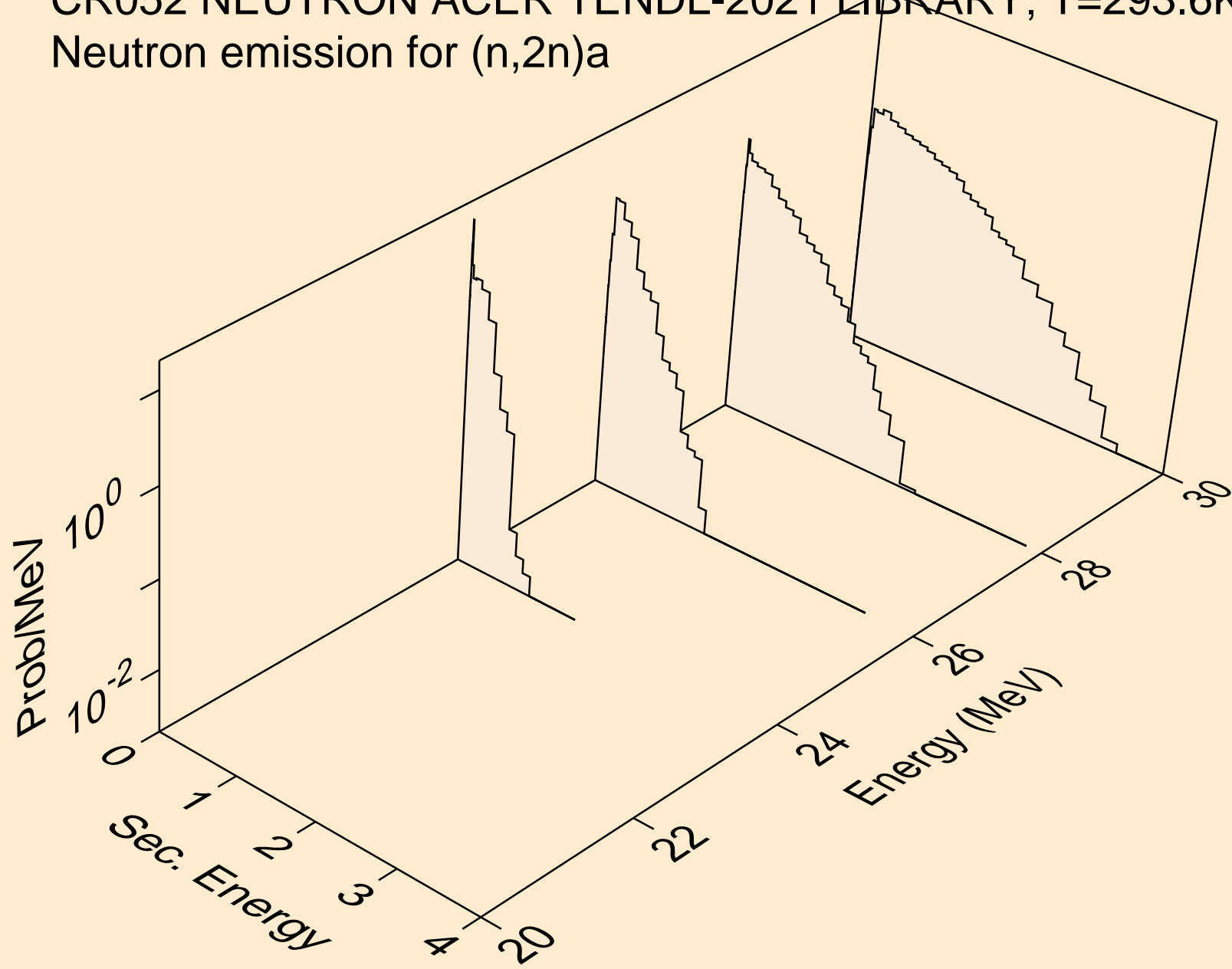

CR052 NEUTRON ACER TENDL-2021 LIBRARY; T=293.6K
Neutron emission for (n,n*)p

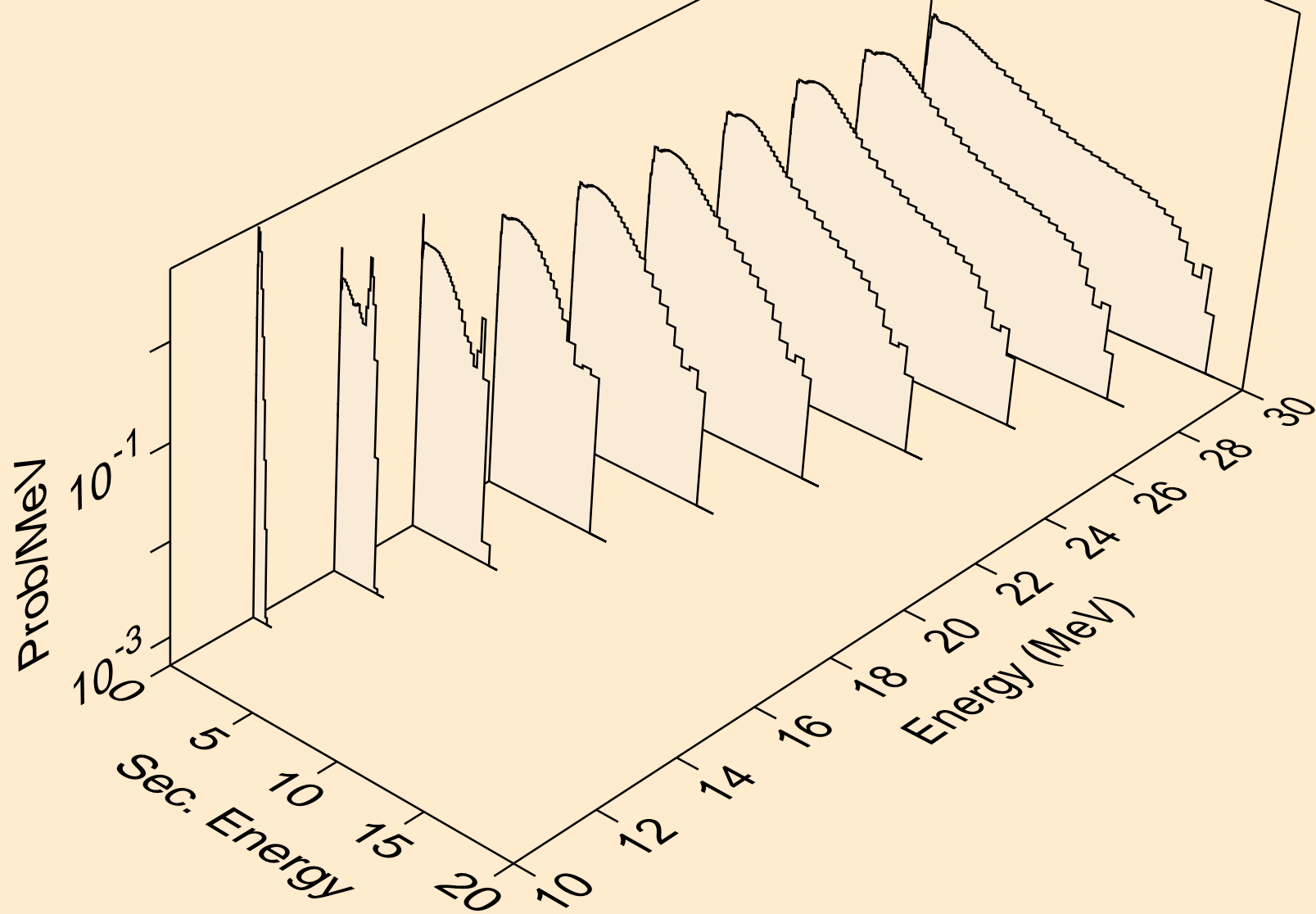

CR052 NEUTRON ACER TENDL-2021 LIBRARY; T=293.6K
Neutron emission for (n,n*)2a

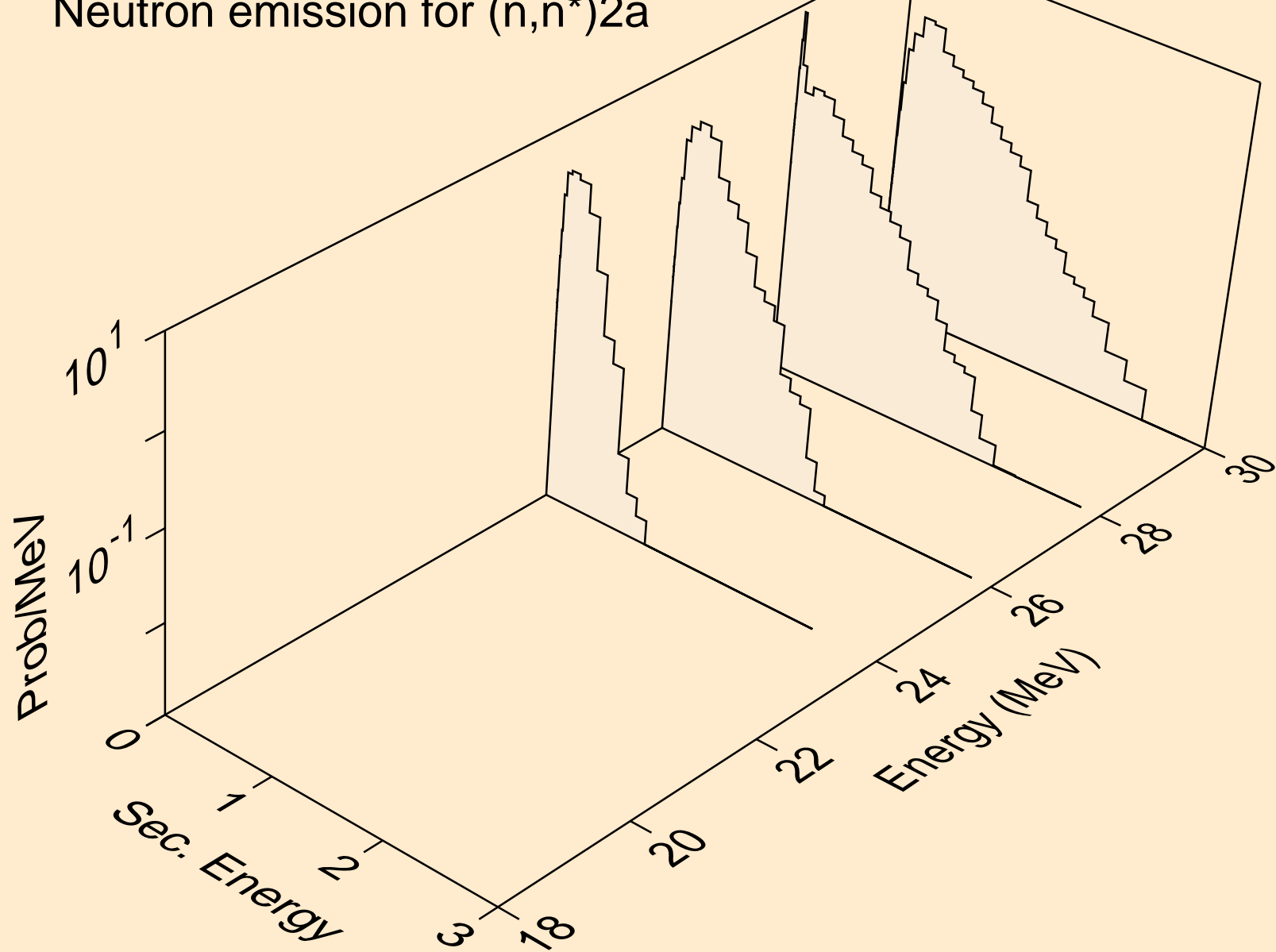

CR052 NEUTRON ACER TENDL-2021 LIBRARY; T=293.6K
Neutron emission for (n,n*)d

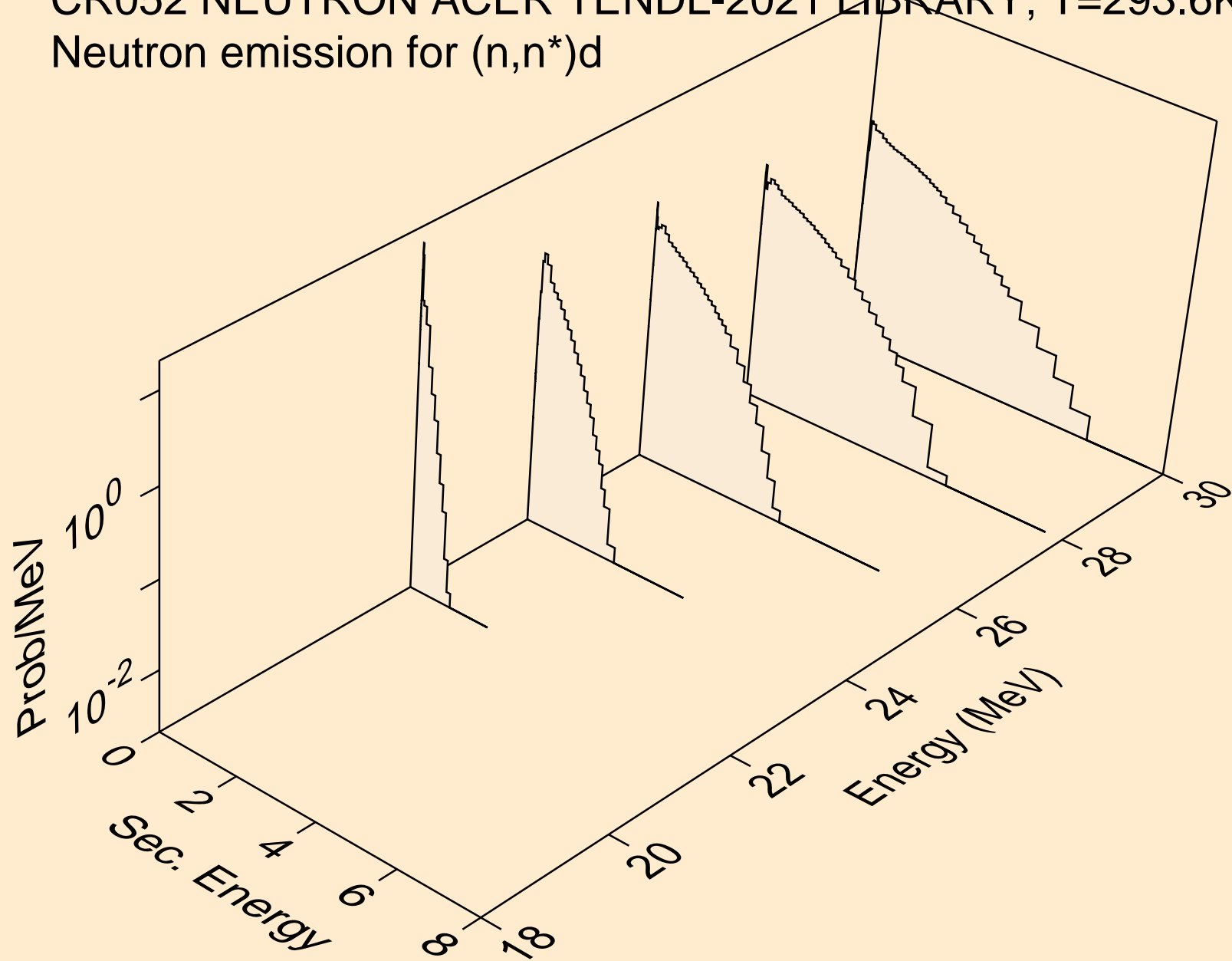

CR052 NEUTRON ACER TENDL-2021 LIBRARY; T=293.6K
Neutron emission for (n,n*)t

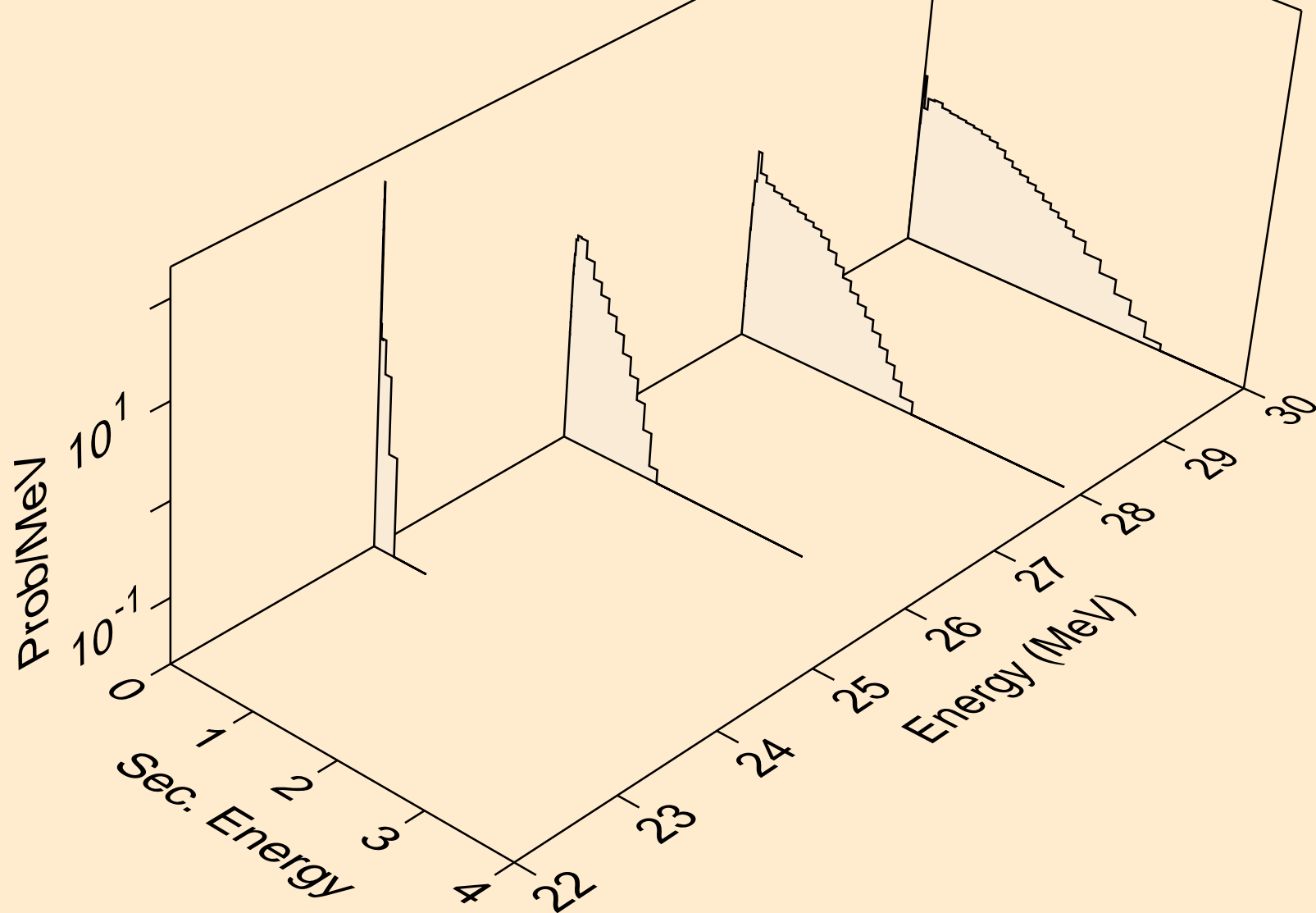

CR052 NEUTRON ACER TENDL-2021 LIBRARY; T=293.6K
Neutron emission for (n,n*)he3

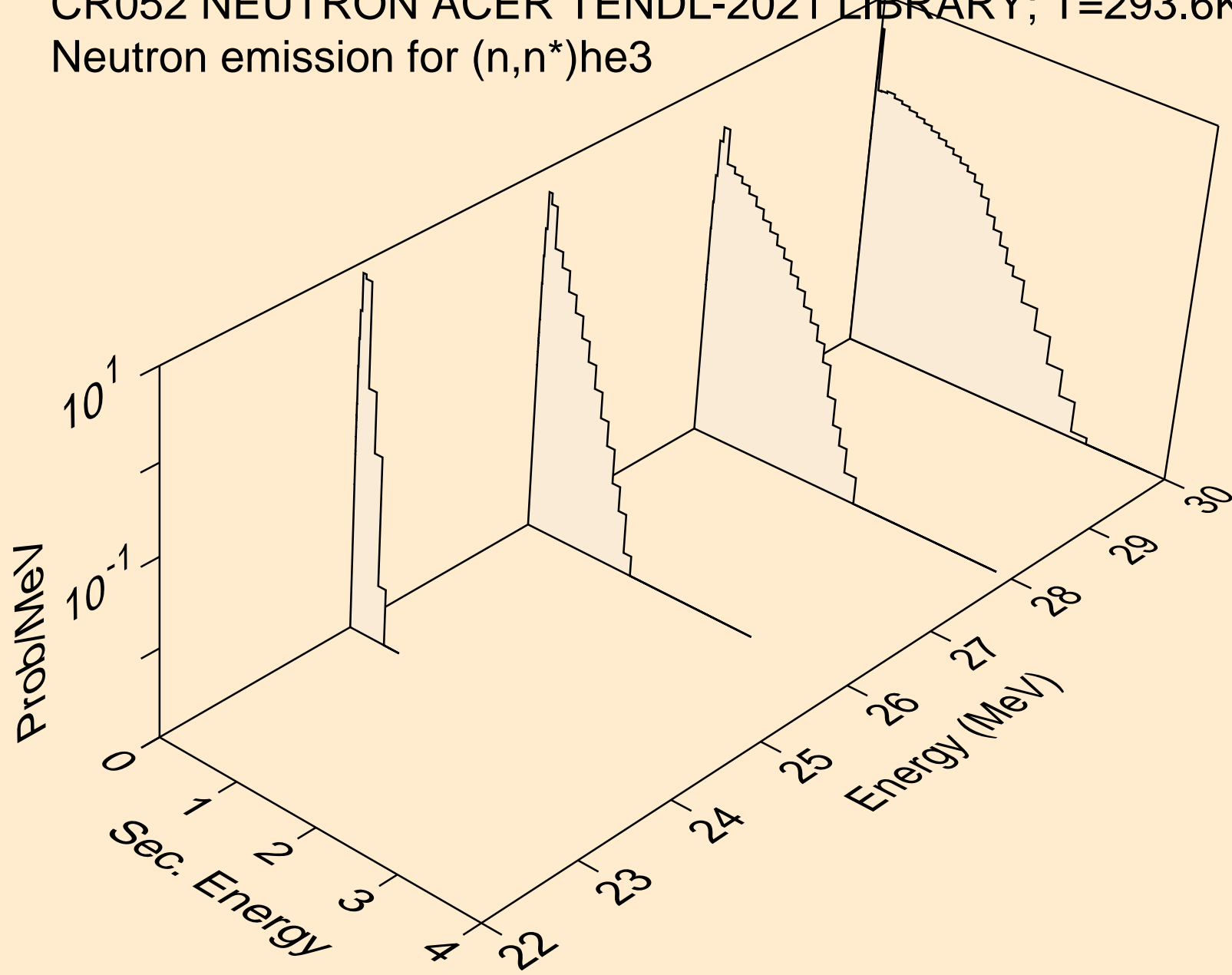

CR052 NEUTRON ACER TENDL-2021 LIBRARY; T=293.6K
Neutron emission for (n,2np)

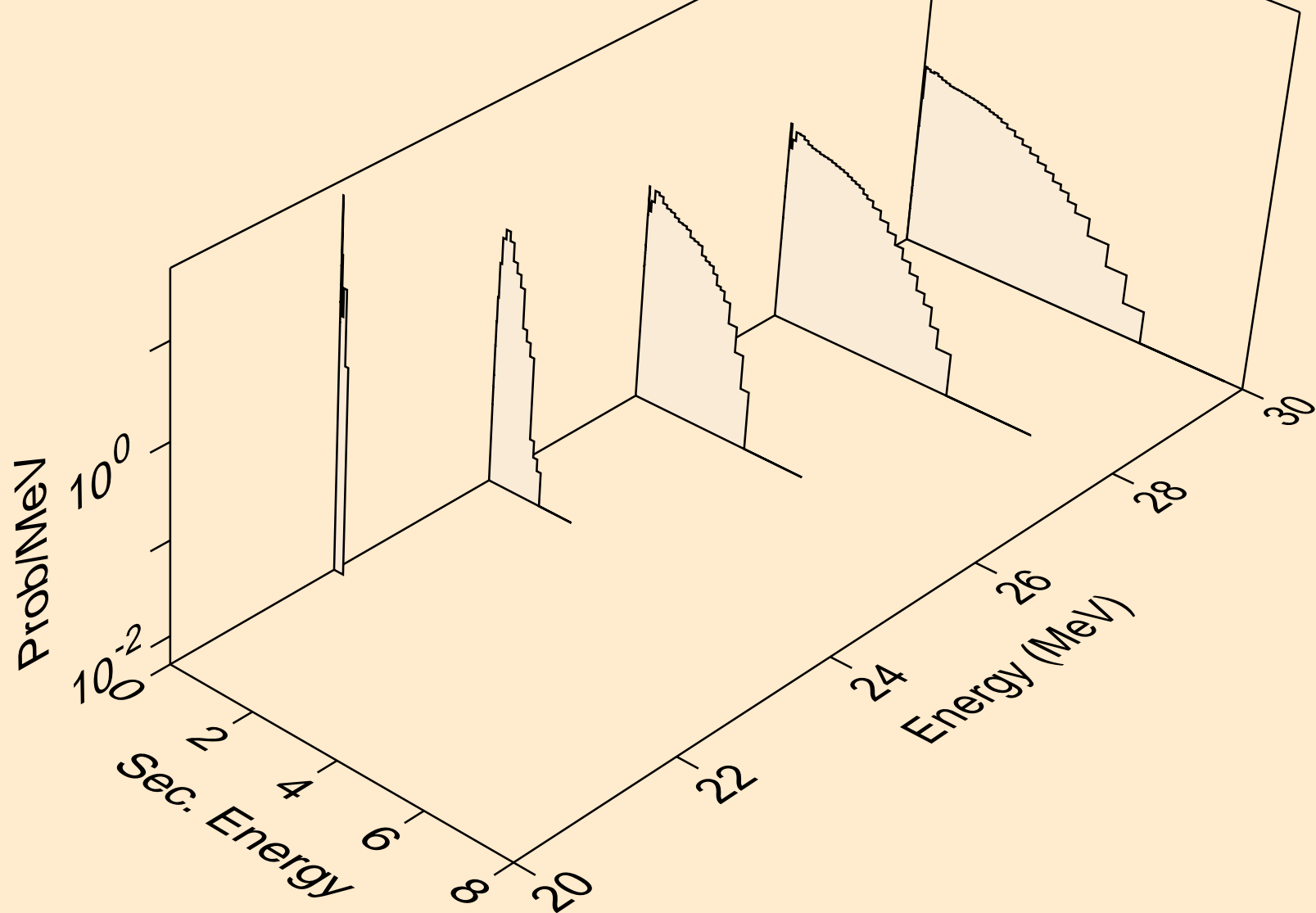

CR052 NEUTRON ACER TENDL-2021 LIBRARY; T=293.6K
Neutron emission for (n,2np)

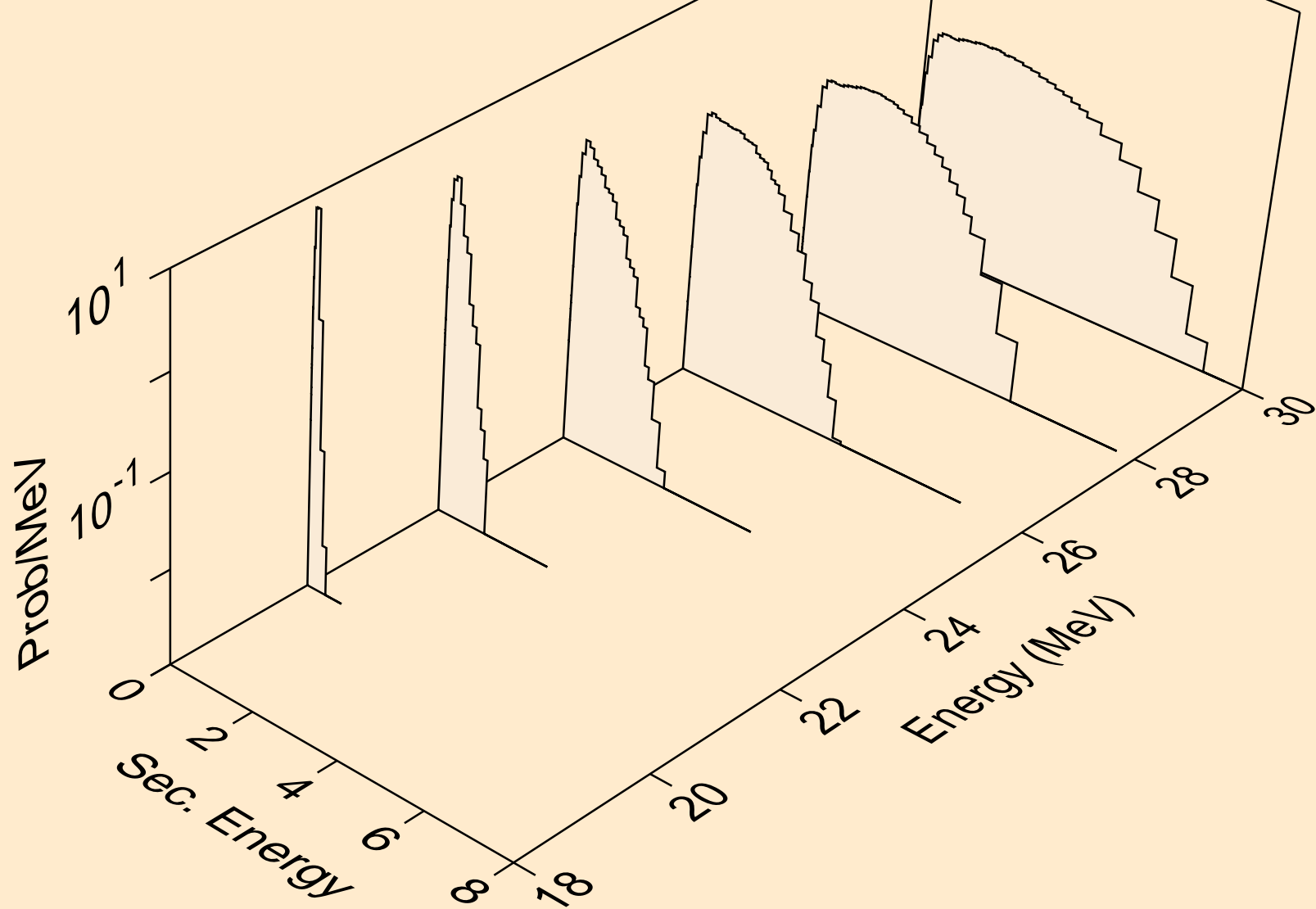

CR052 NEUTRON ACER TENDL-2021 LIBRARY; T=293.6K
Neutron emission for (n,npa)

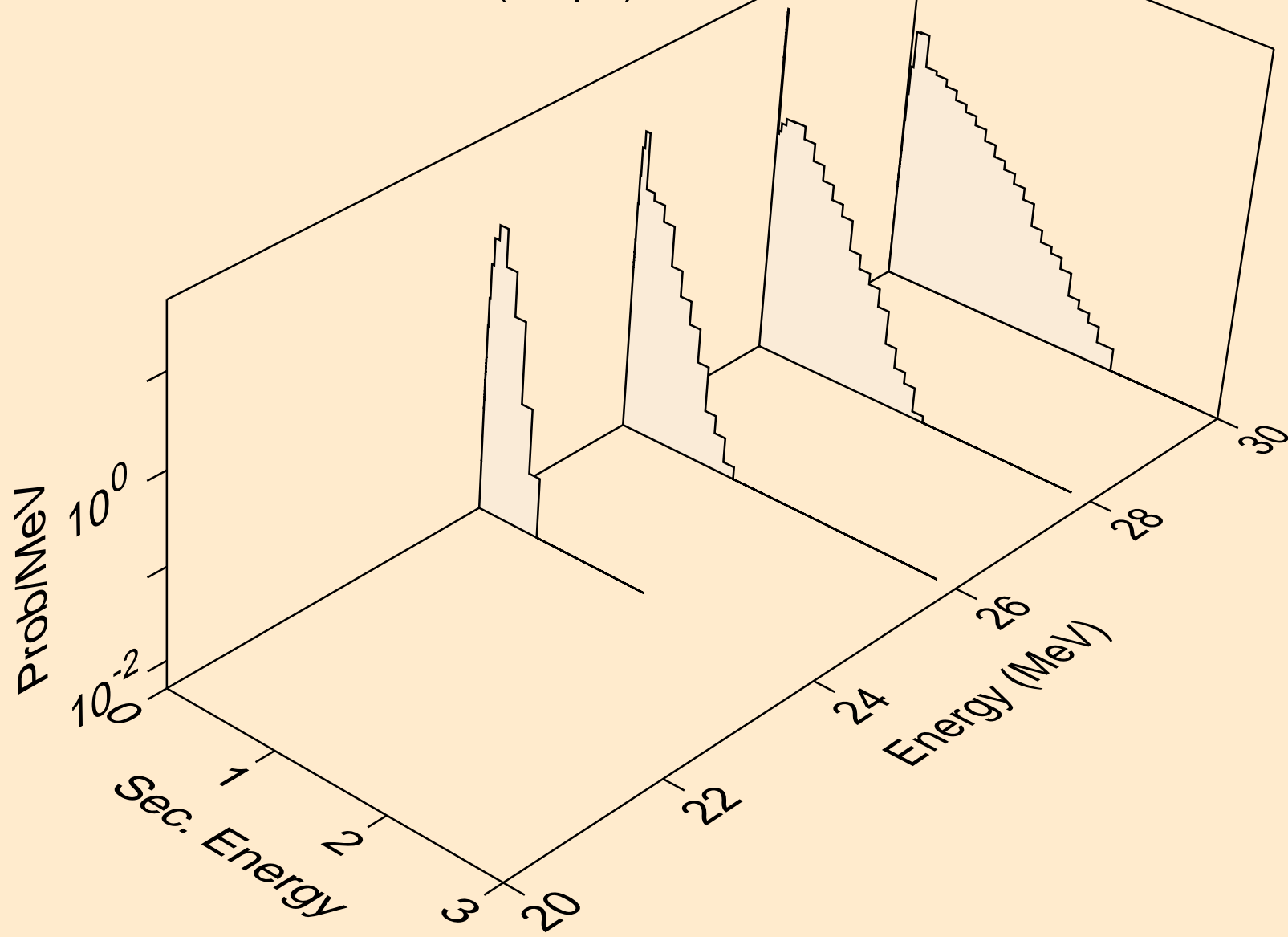

CR052 NEUTRON ACER TENDL-2021 LIBRARY; T=293.6K
Neutron emission for (n,n*c)

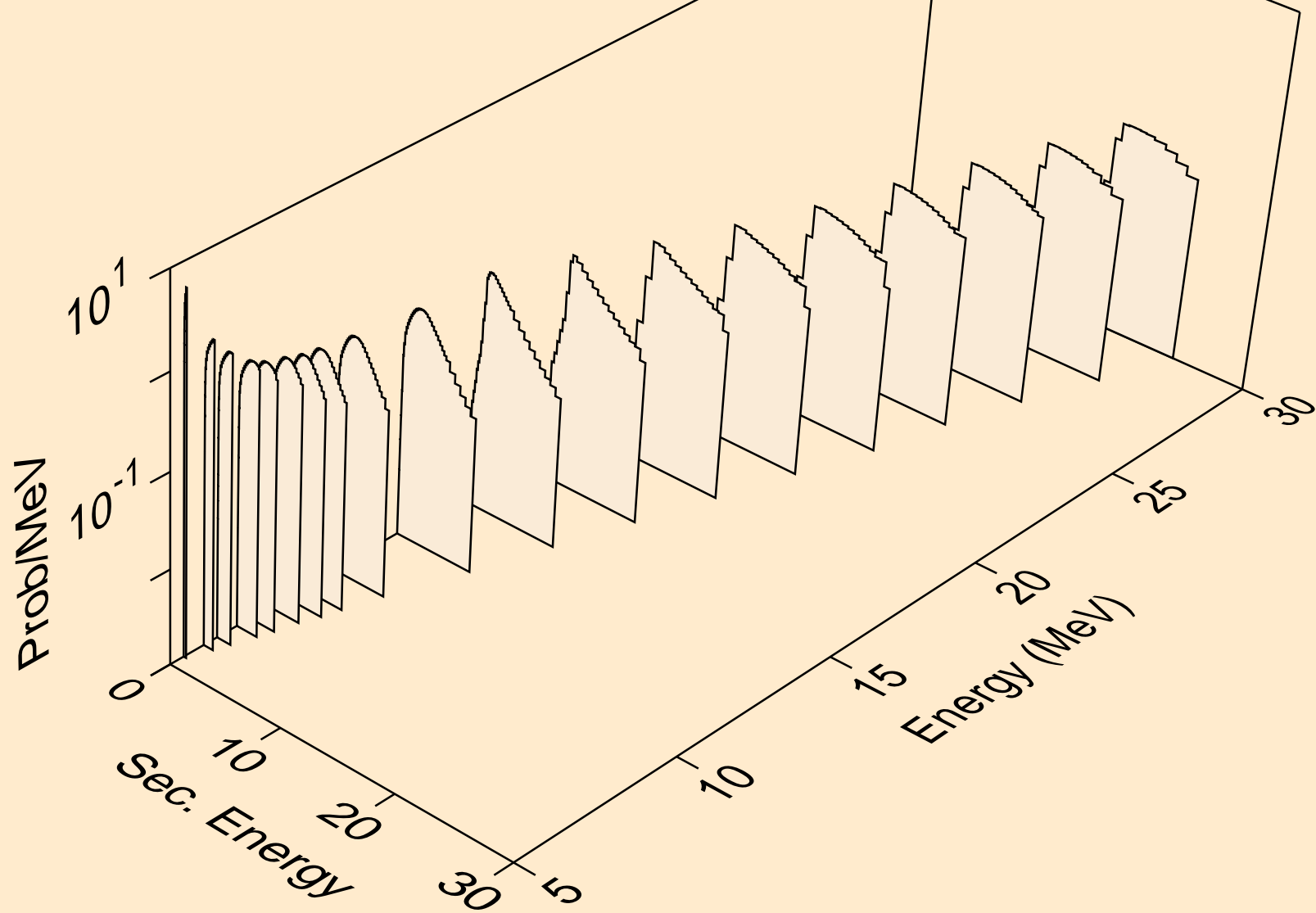

CR052 NEUTRON ACER TENDL-2021 LIBRARY; T=293.6K
Photon emission for (n,x)

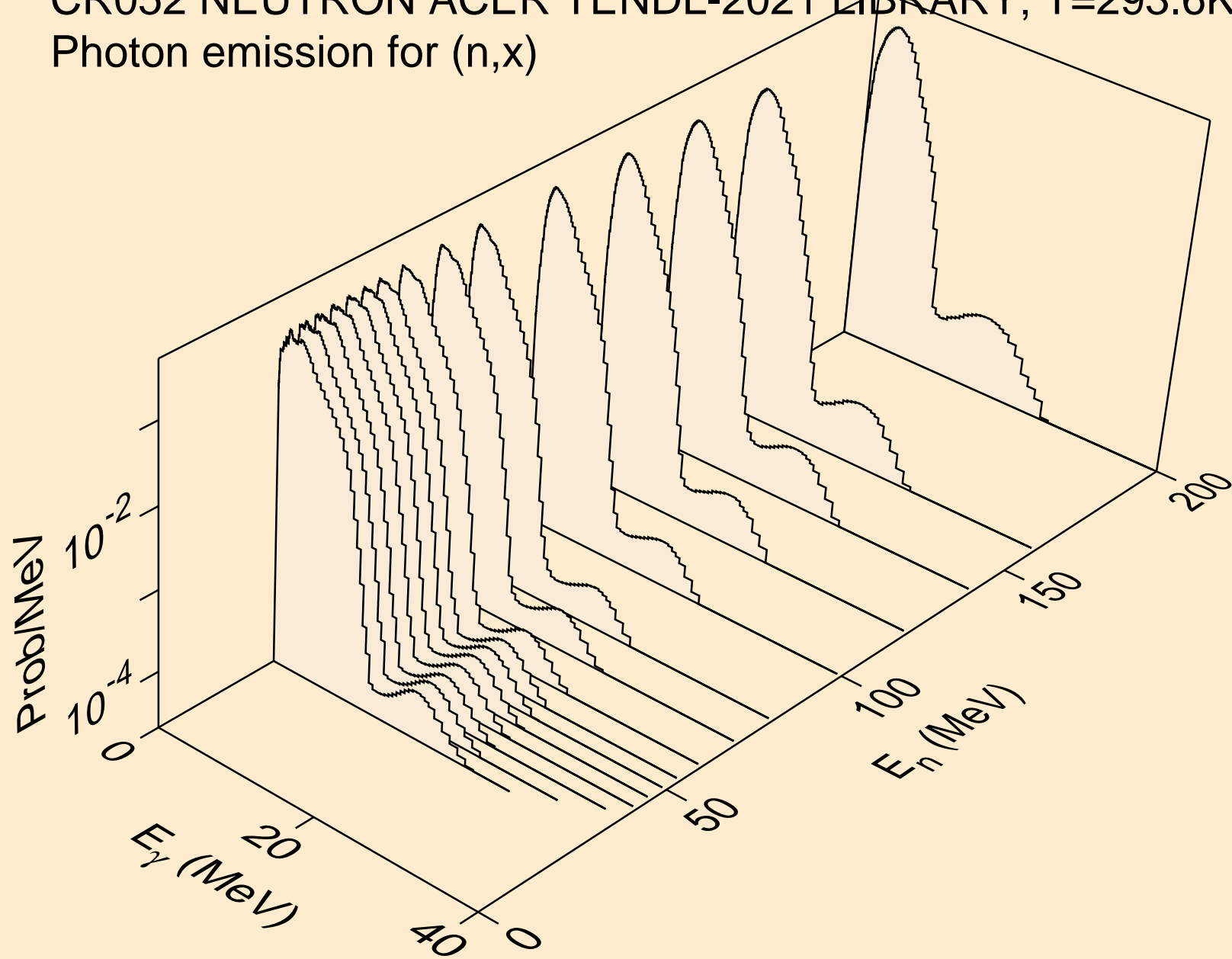

CR052 NEUTRON ACER TENDL-2021 LIBRARY; T=293.6K
Photon emission for (n,2n)

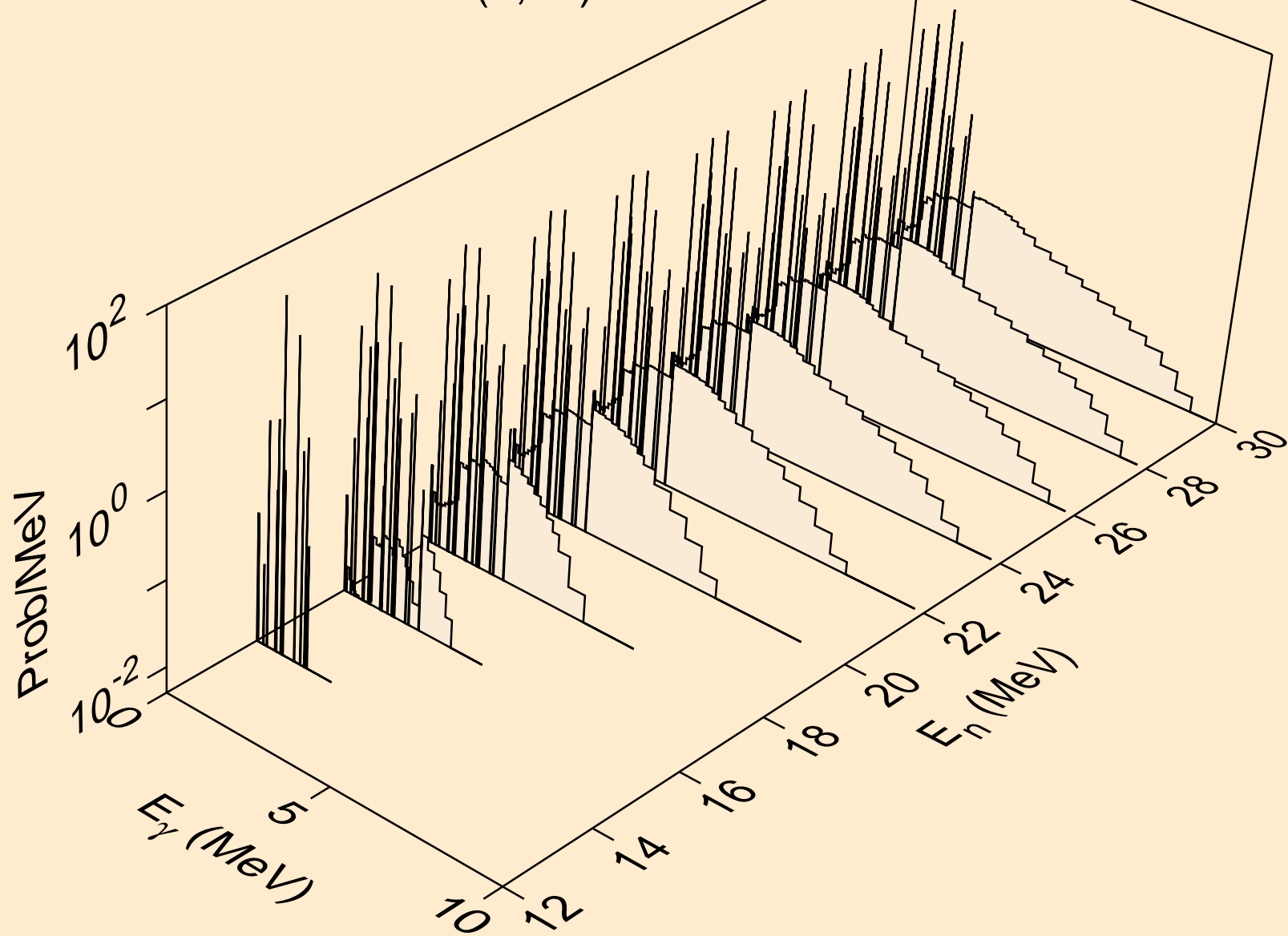

CR052 NEUTRON ACER TENDL-2021 LIBRARY; T=293.6K
Photon emission for (n,3n)

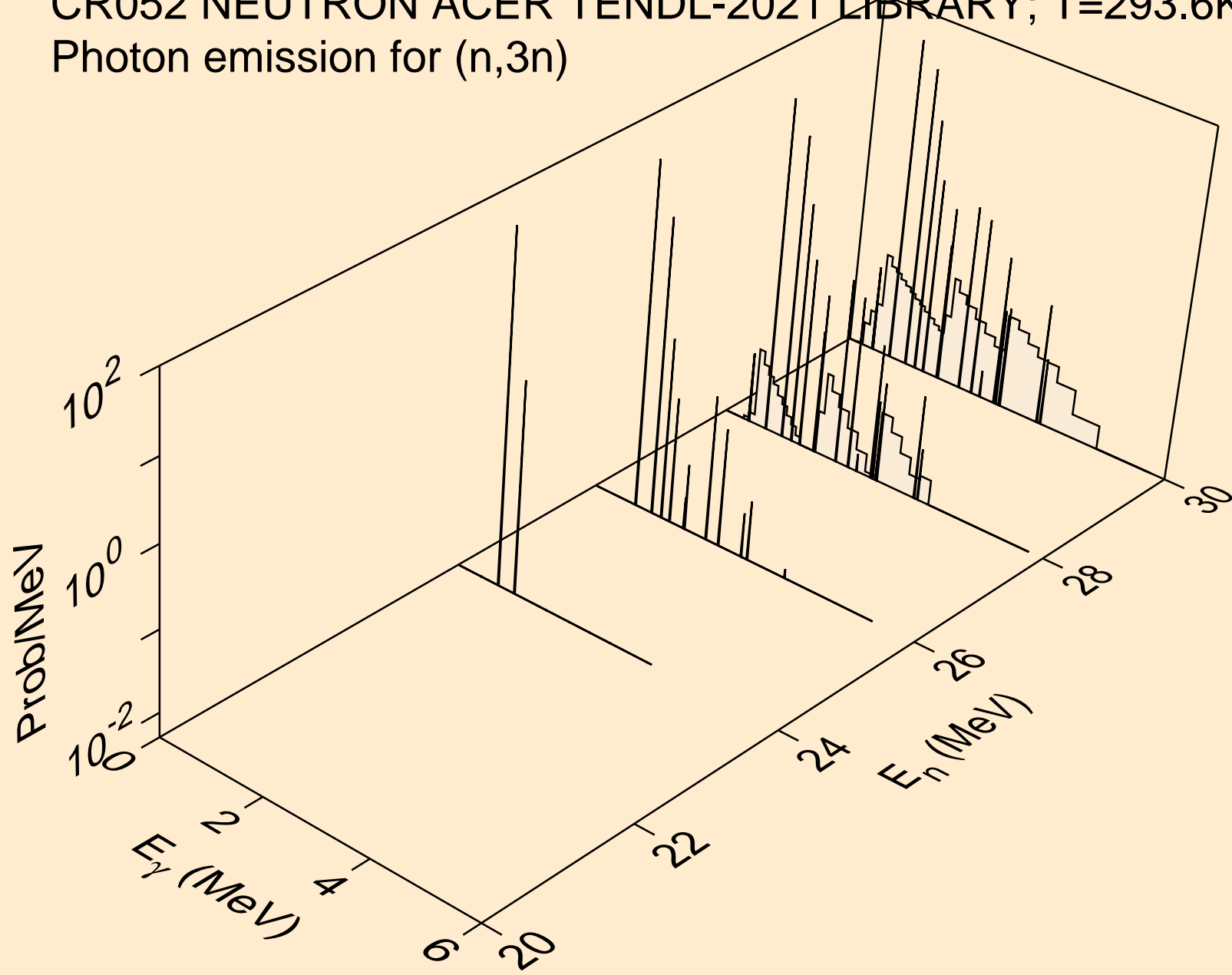

CR052 NEUTRON ACER TENDL-2021 LIBRARY; T=293.6K
Photon emission for (n,n*)a

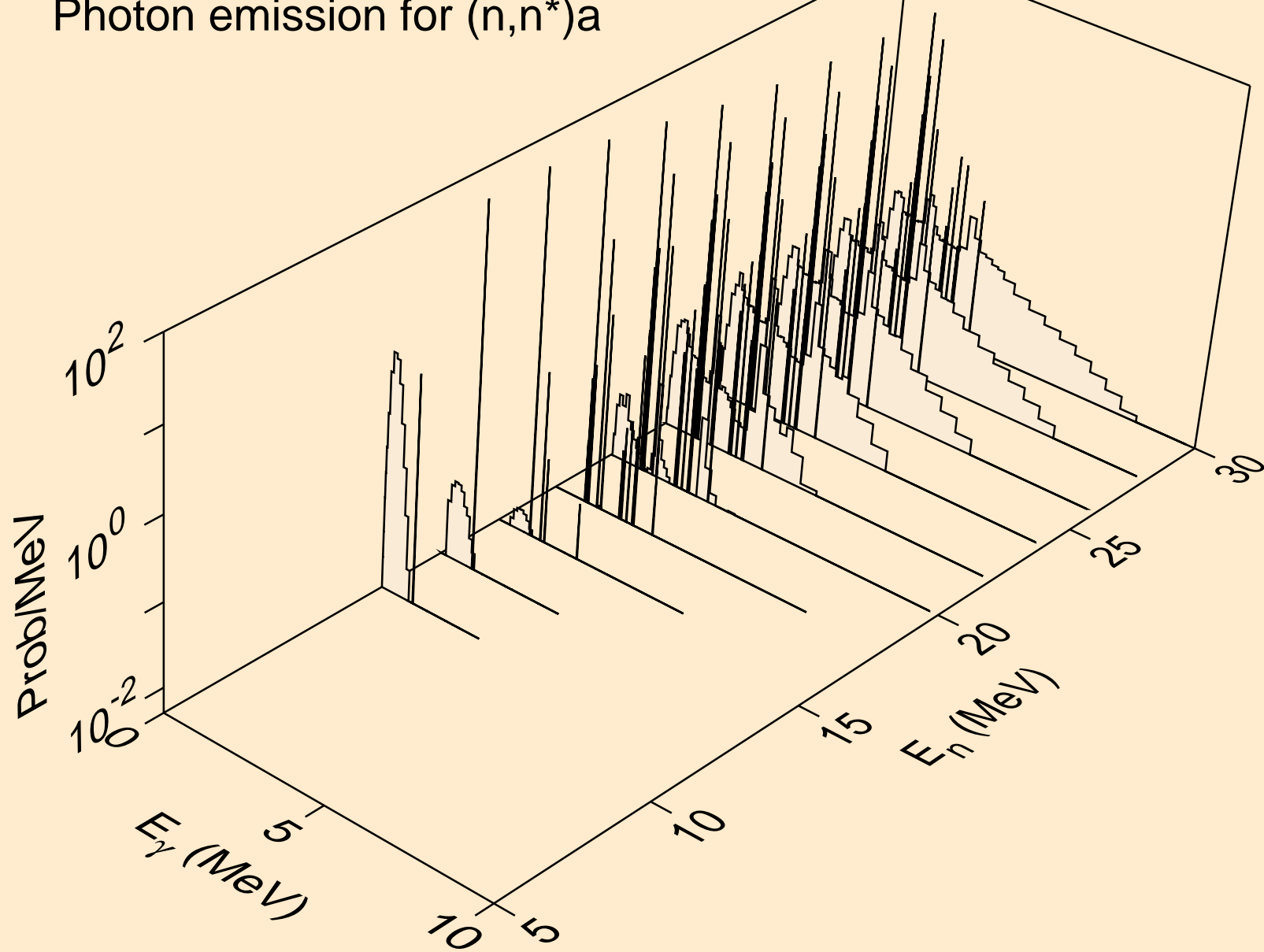

CR052 NEUTRON ACER TENDL-2021 LIBRARY; T=293.6K
Photon emission for (n,2n)a

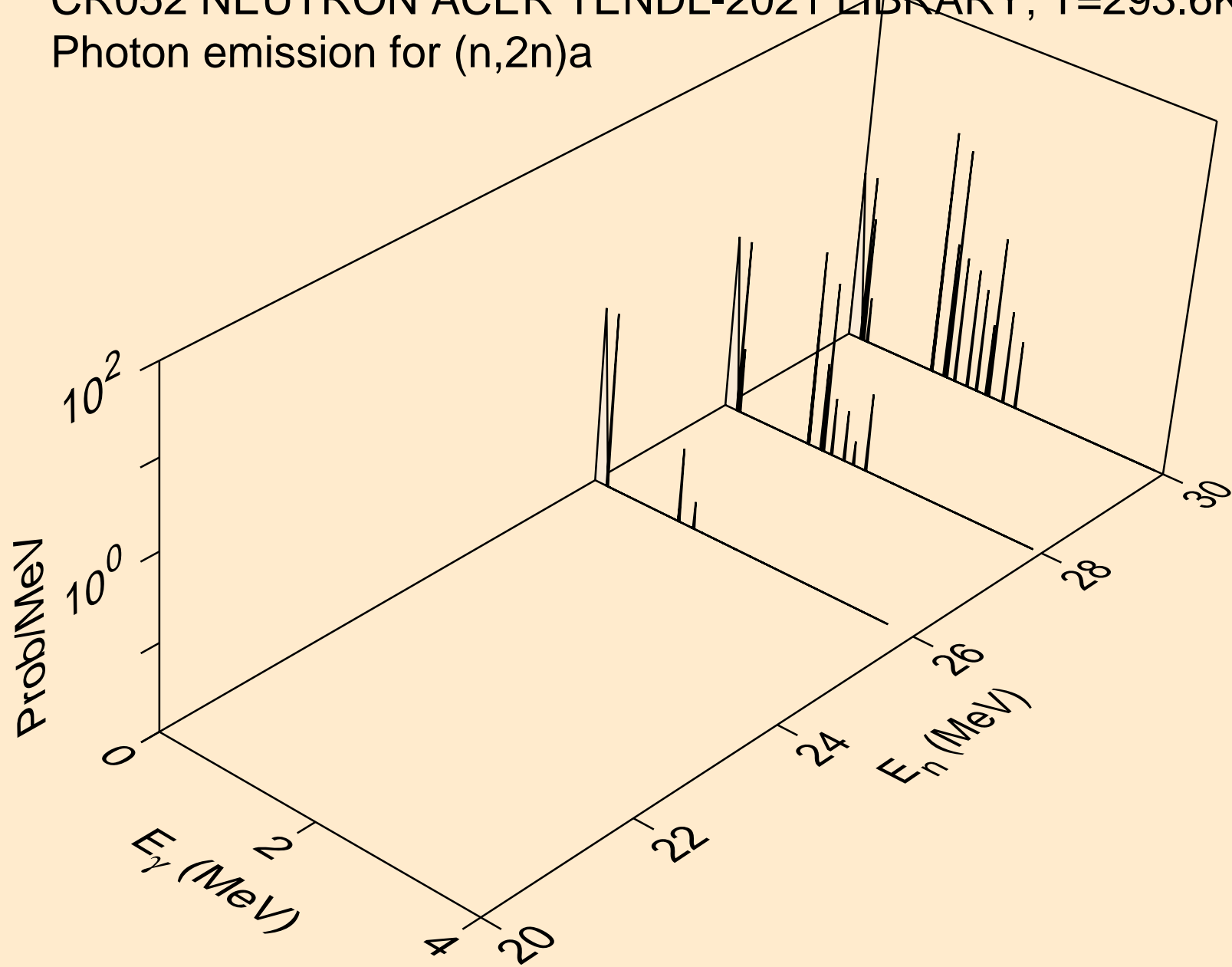

CR052 NEUTRON ACER TENDL-2021 LIBRARY; T=293.6K
Photon emission for (n,n*)p

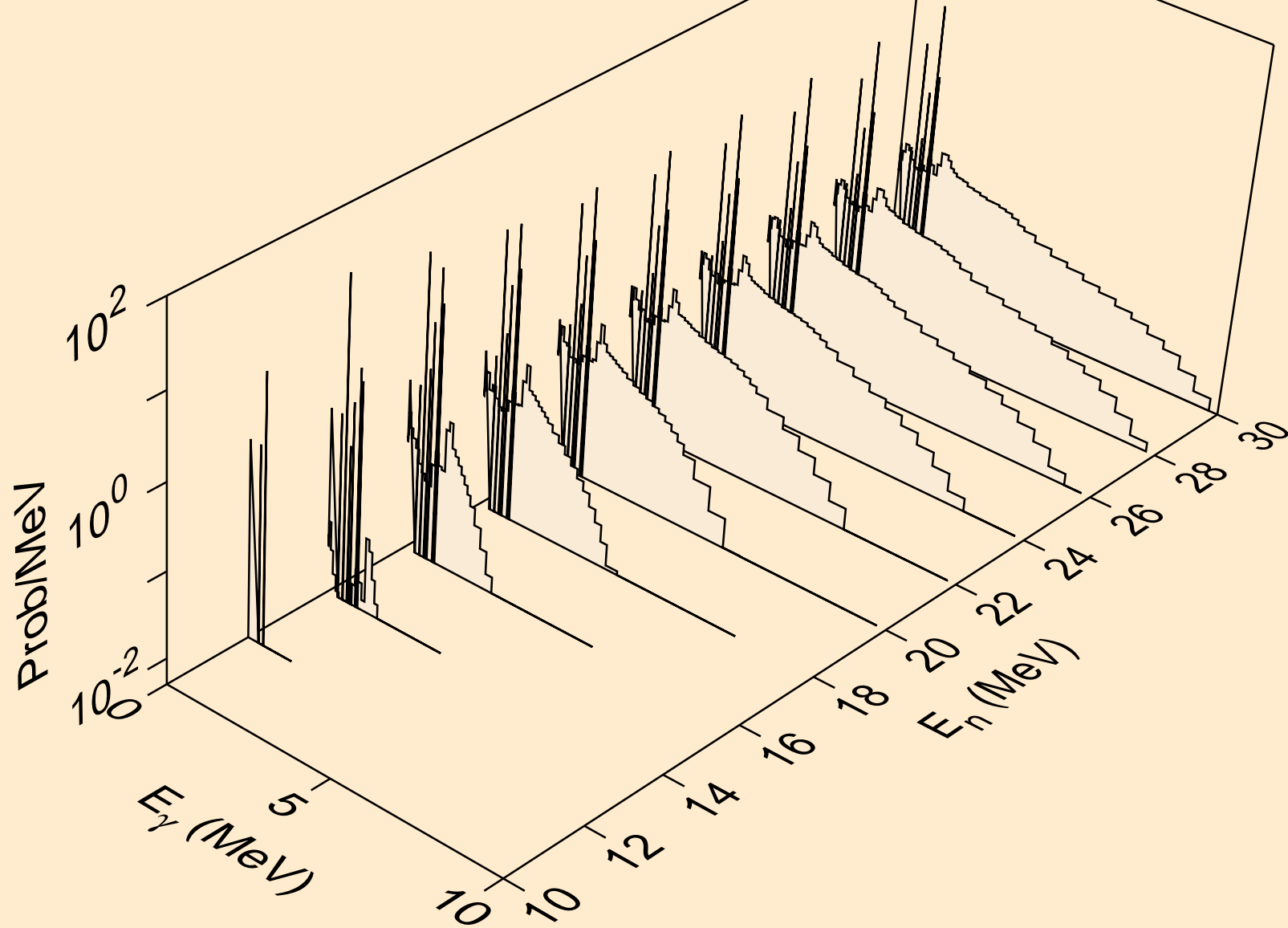

CR052 NEUTRON ACER TENDL-2021 LIBRARY; T=293.6K
Photon emission for (n,n*)2a

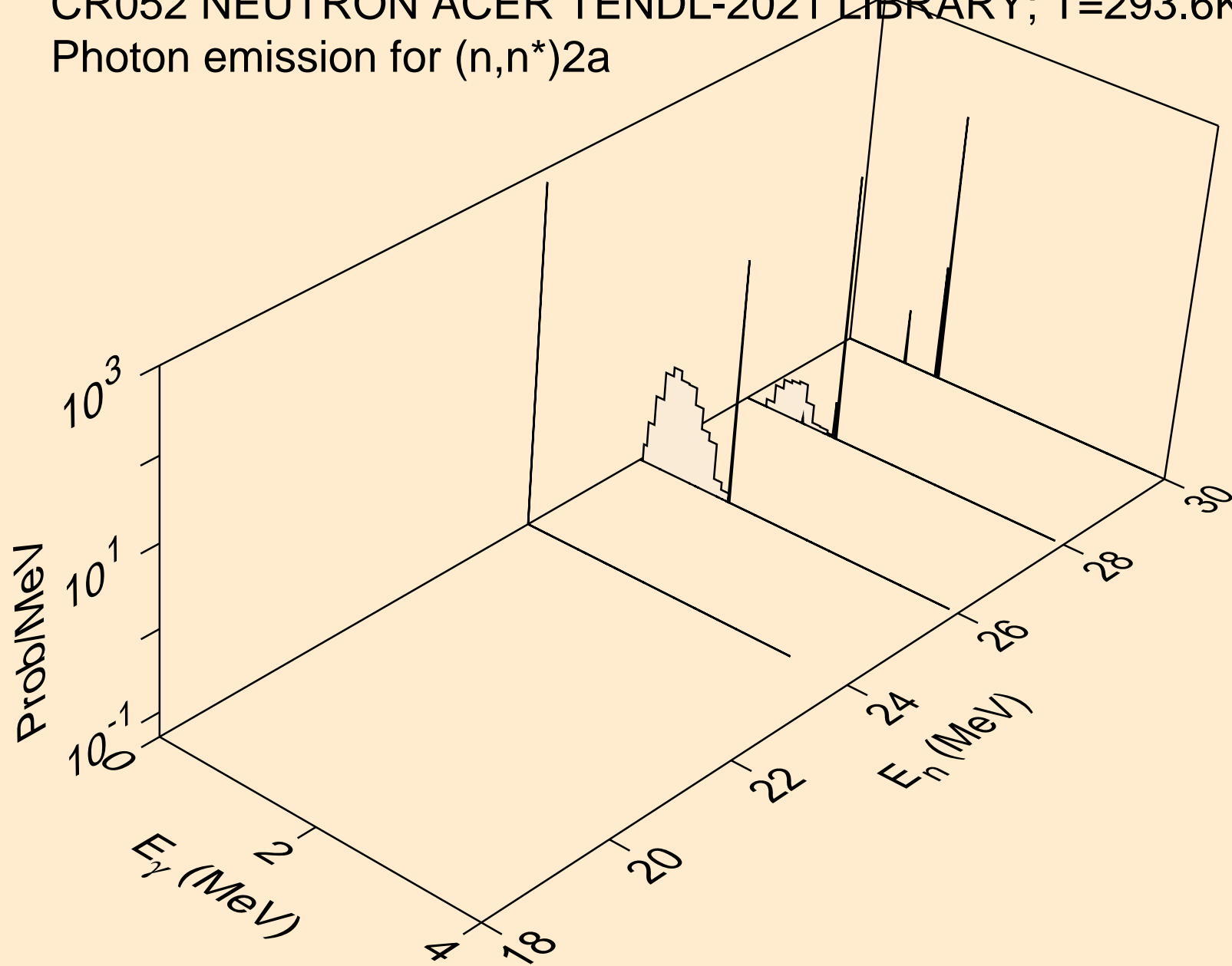

CR052 NEUTRON ACER TENDL-2021 LIBRARY; T=293.6K
Photon emission for (n,n*)d

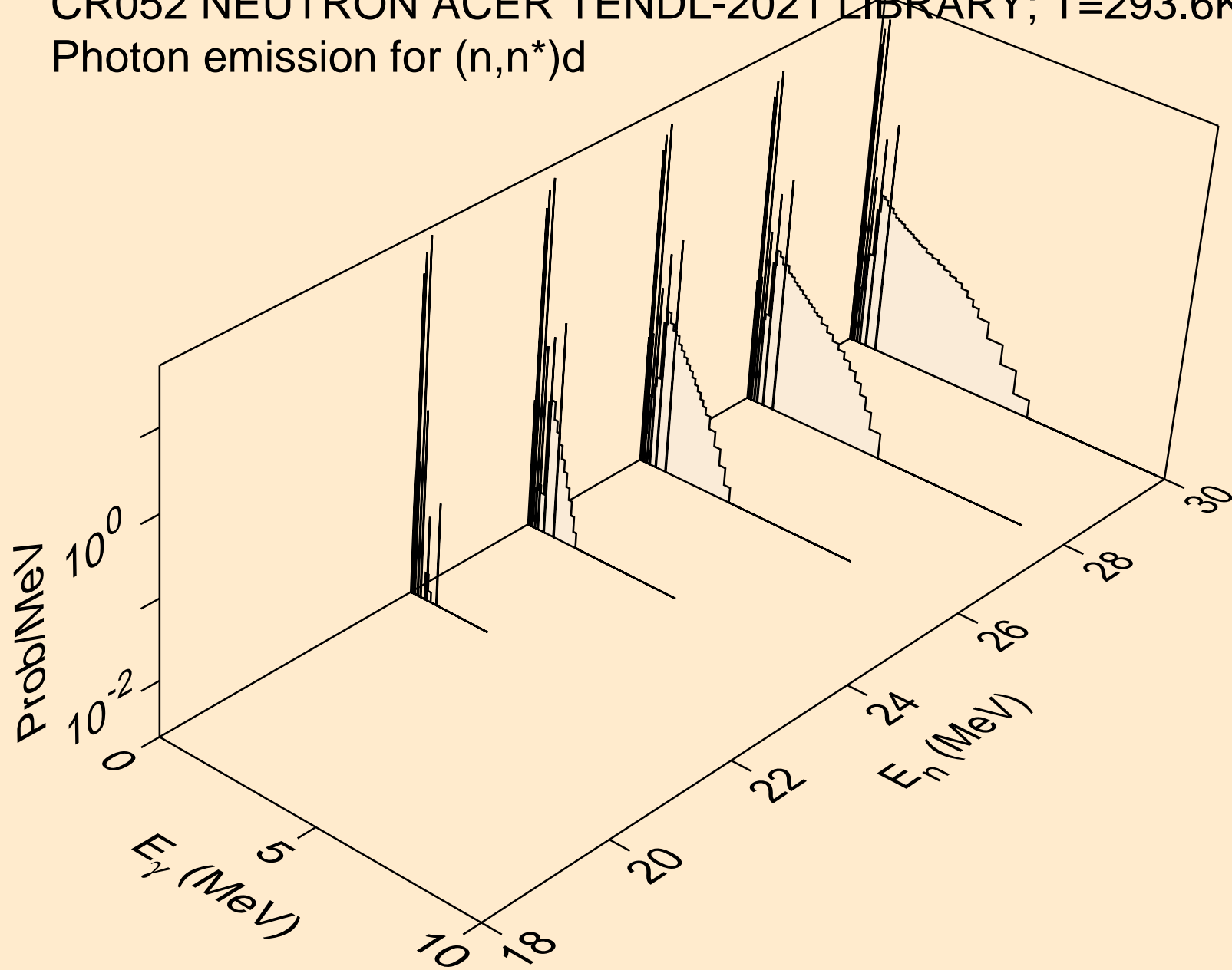

CR052 NEUTRON ACER TENDL-2021 LIBRARY; T=293.6K
Photon emission for (n,n*)t

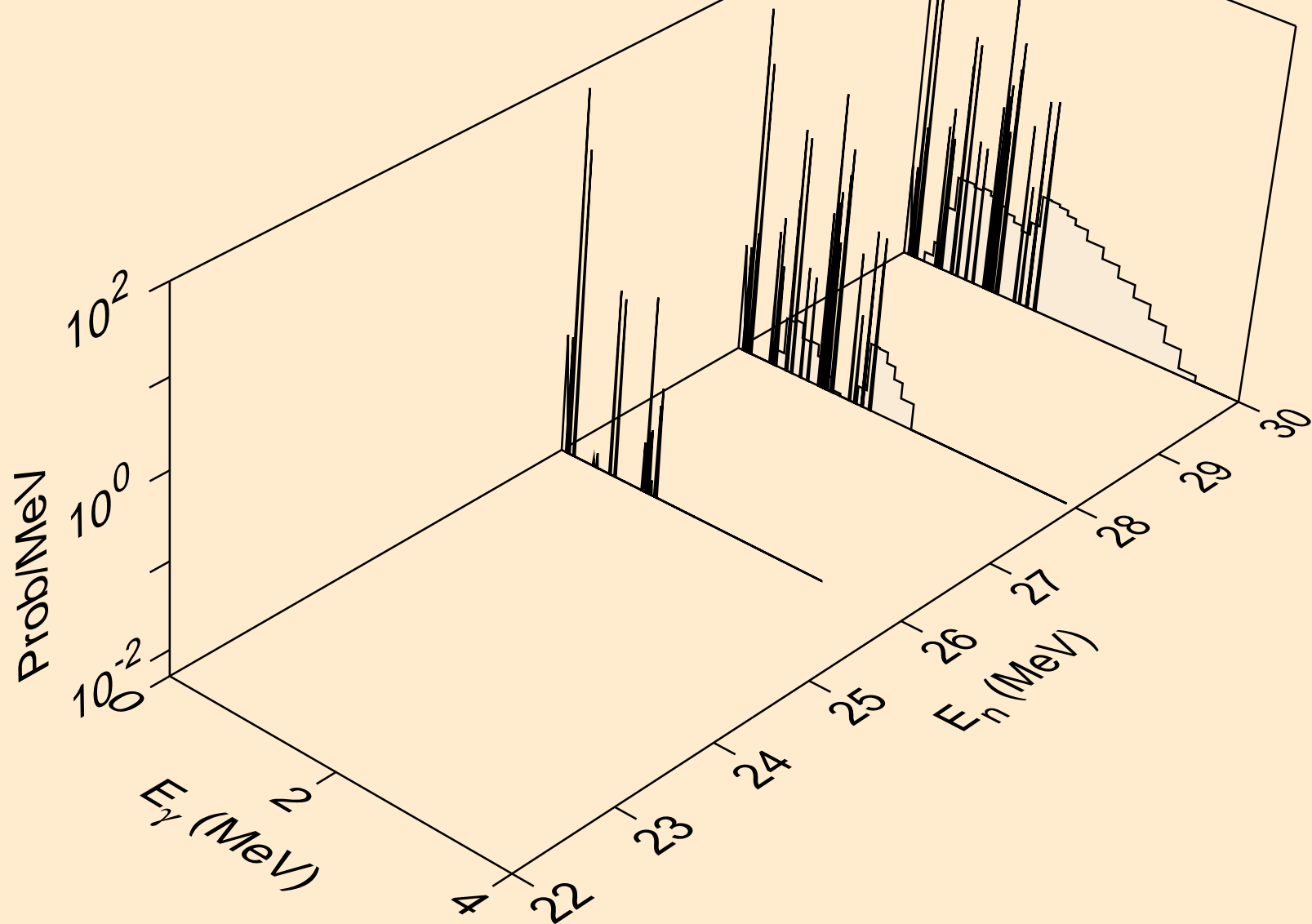

CR052 NEUTRON ACER TENDL-2021 LIBRARY; T=293.6K
Photon emission for (n,n*)he3

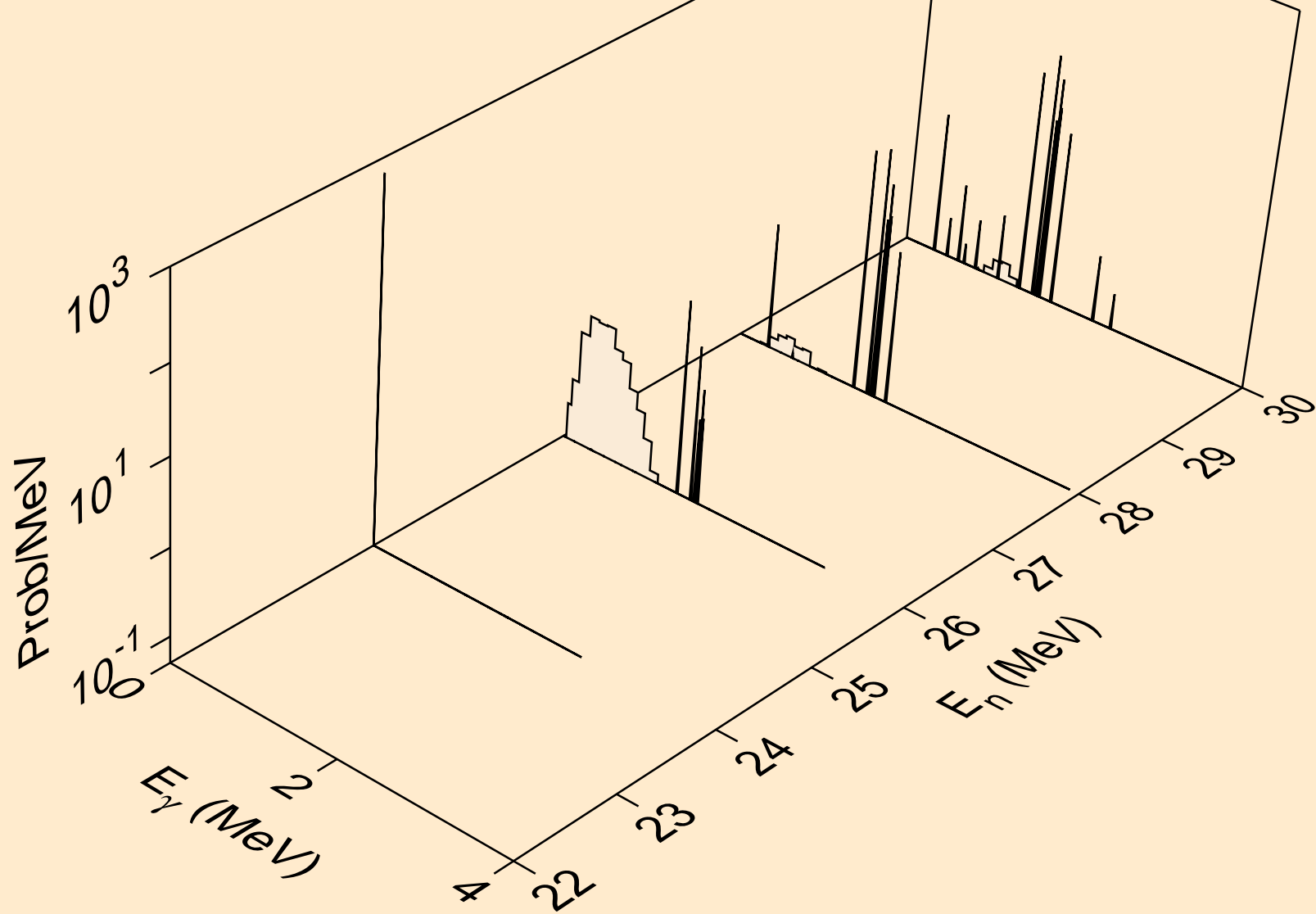

CR052 NEUTRON ACER TENDL-2021 LIBRARY; T=293.6K
Photon emission for (n,2np)

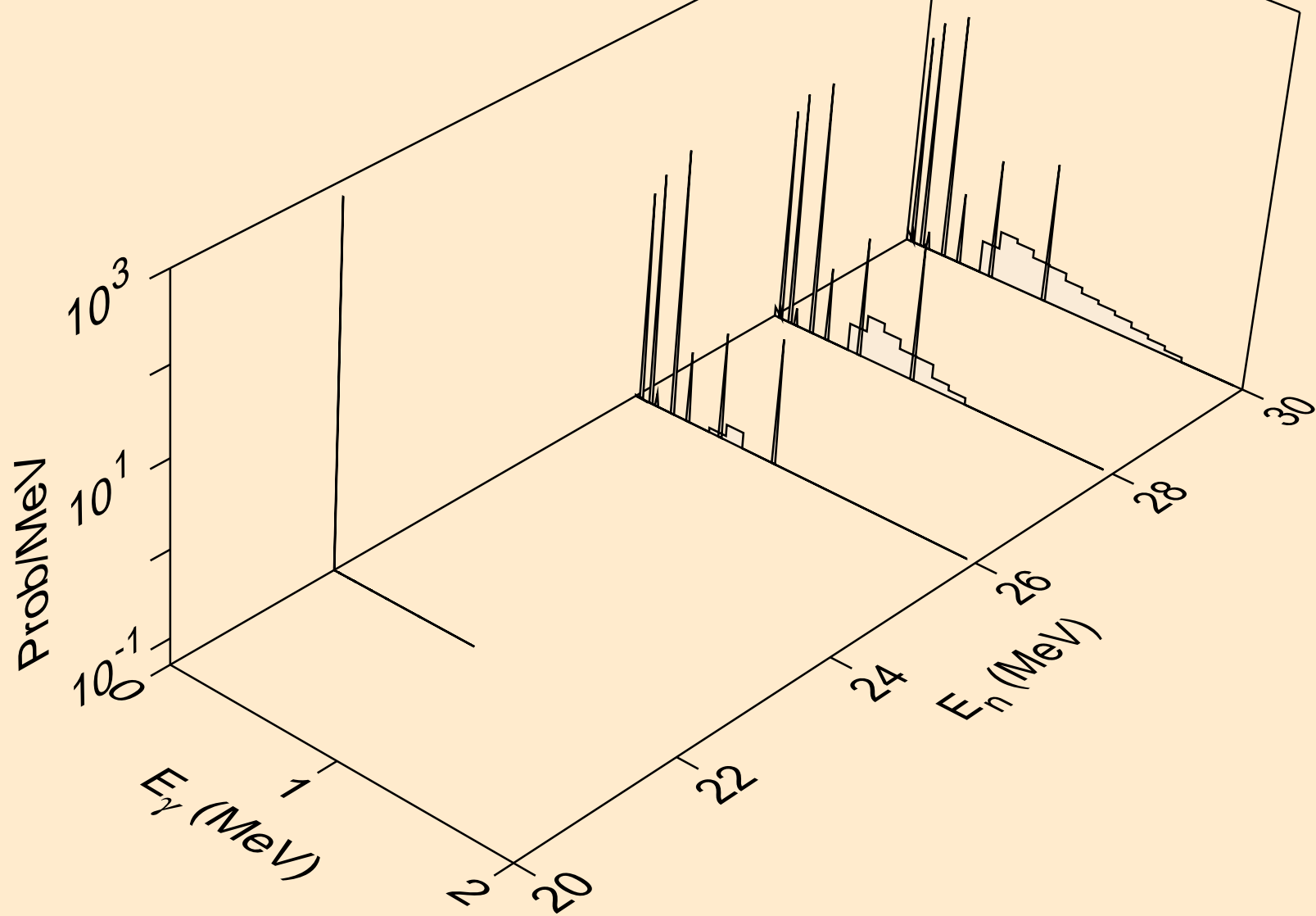

CR052 NEUTRON ACER TENDL-2021 LIBRARY; T=293.6K
Photon emission for (n,2np)

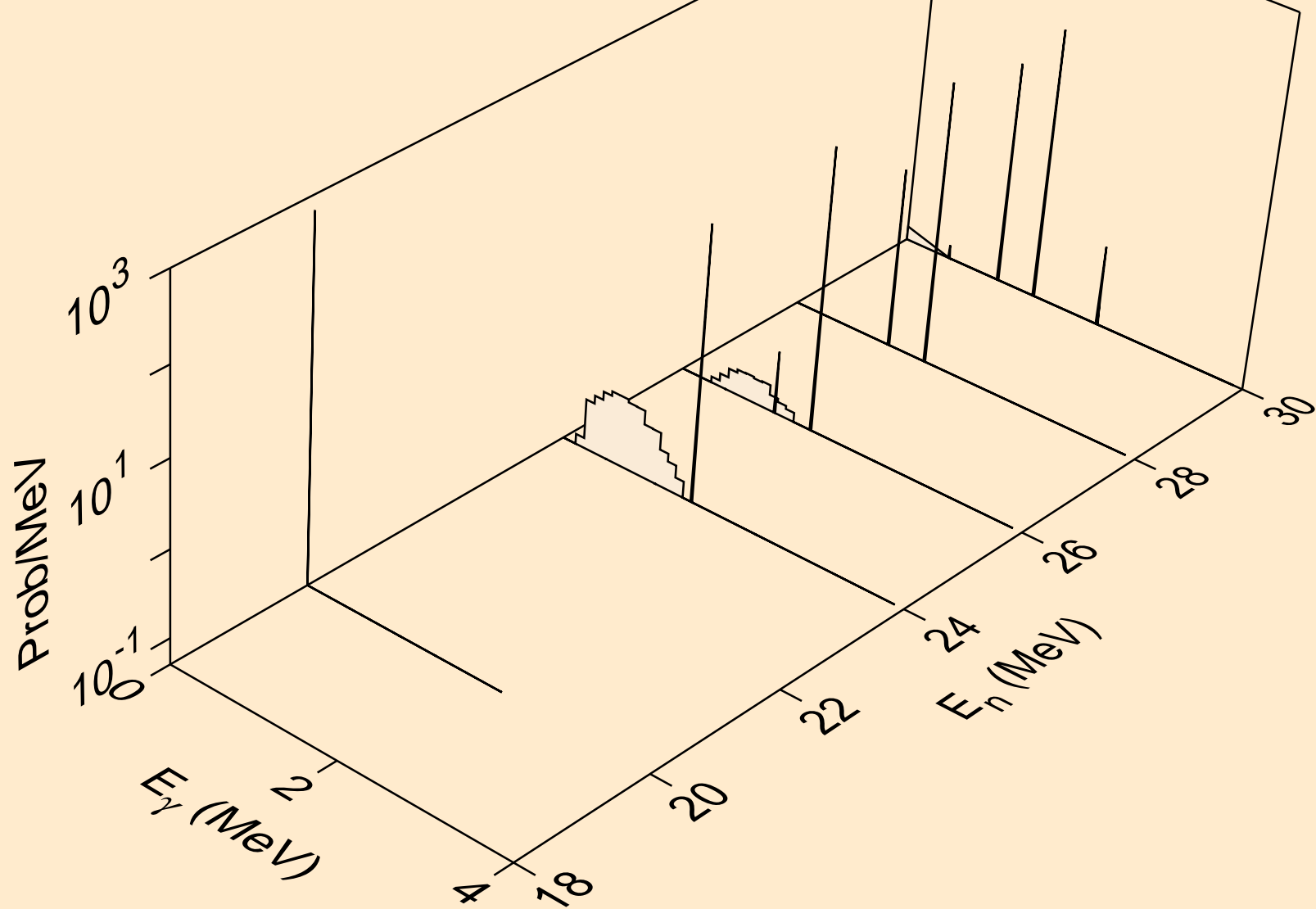

CR052 NEUTRON ACER TENDL-2021 LIBRARY; T=293.6K
Photon emission for (n,npa)

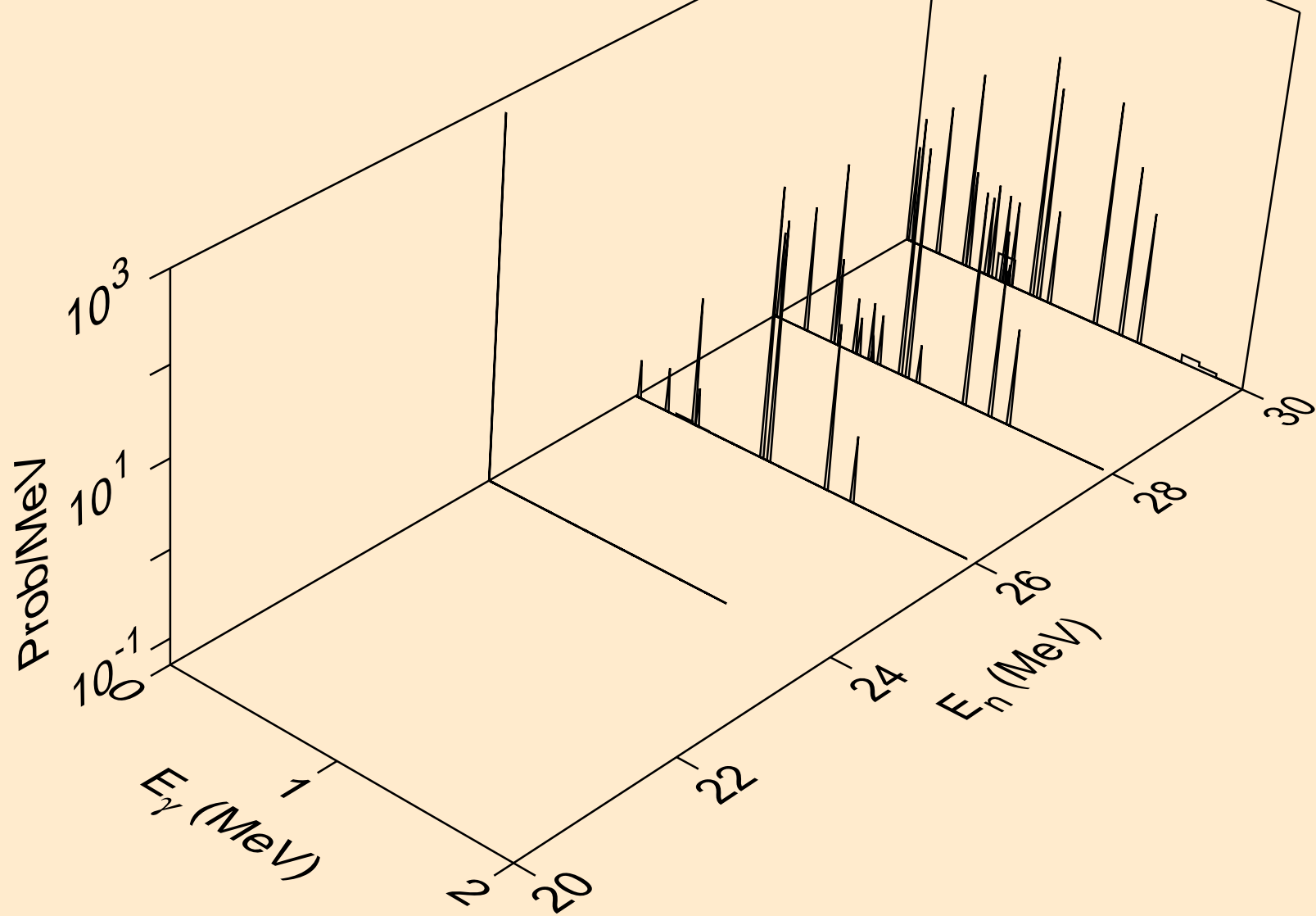

CR052 NEUTRON ACER TENDL-2021 LIBRARY; T=293.6K
Photon emission for (n,n*c)

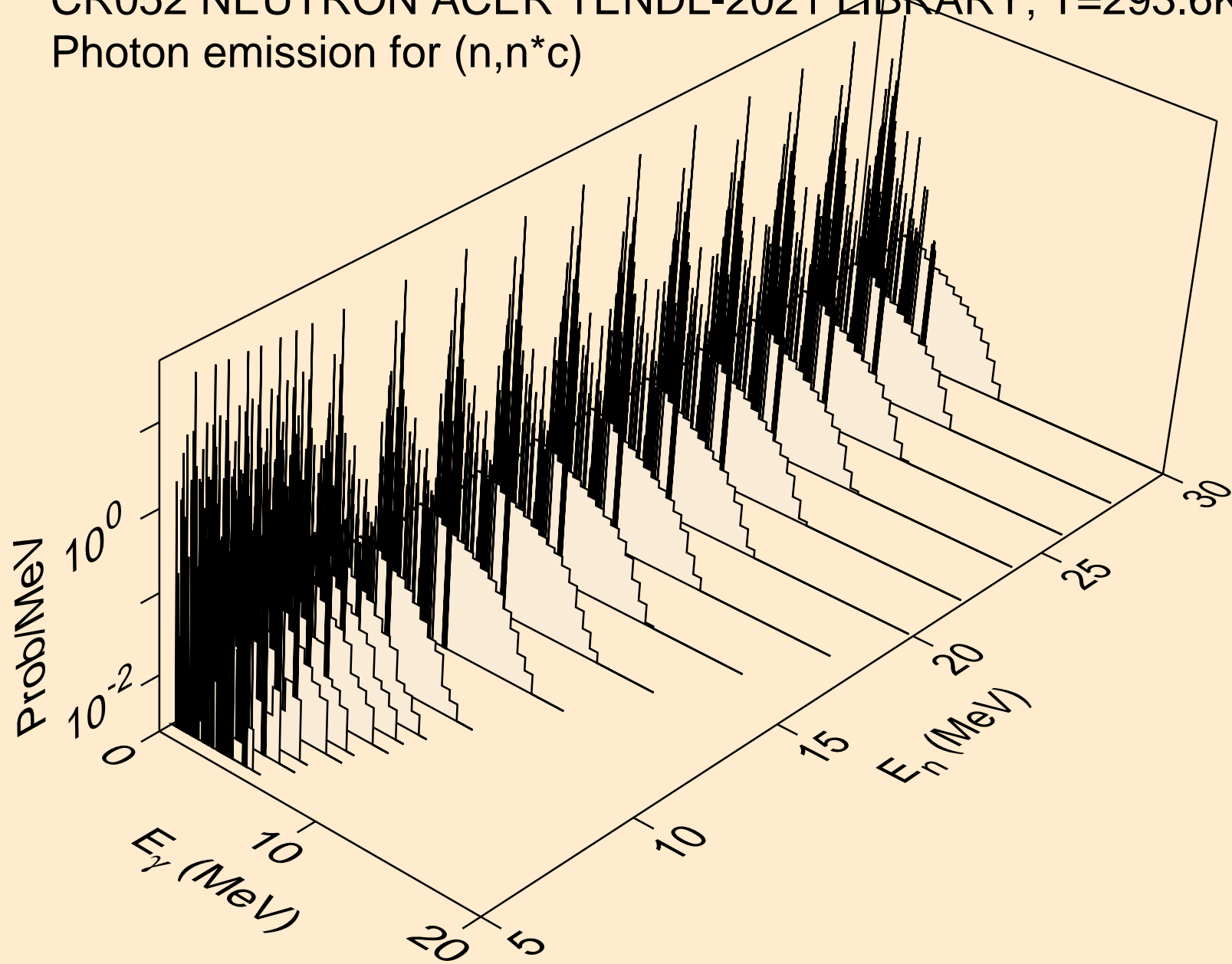

CR052 NEUTRON ACER TENDL-2021 LIBRARY; T=293.6K
Photon emission for (n,gma)

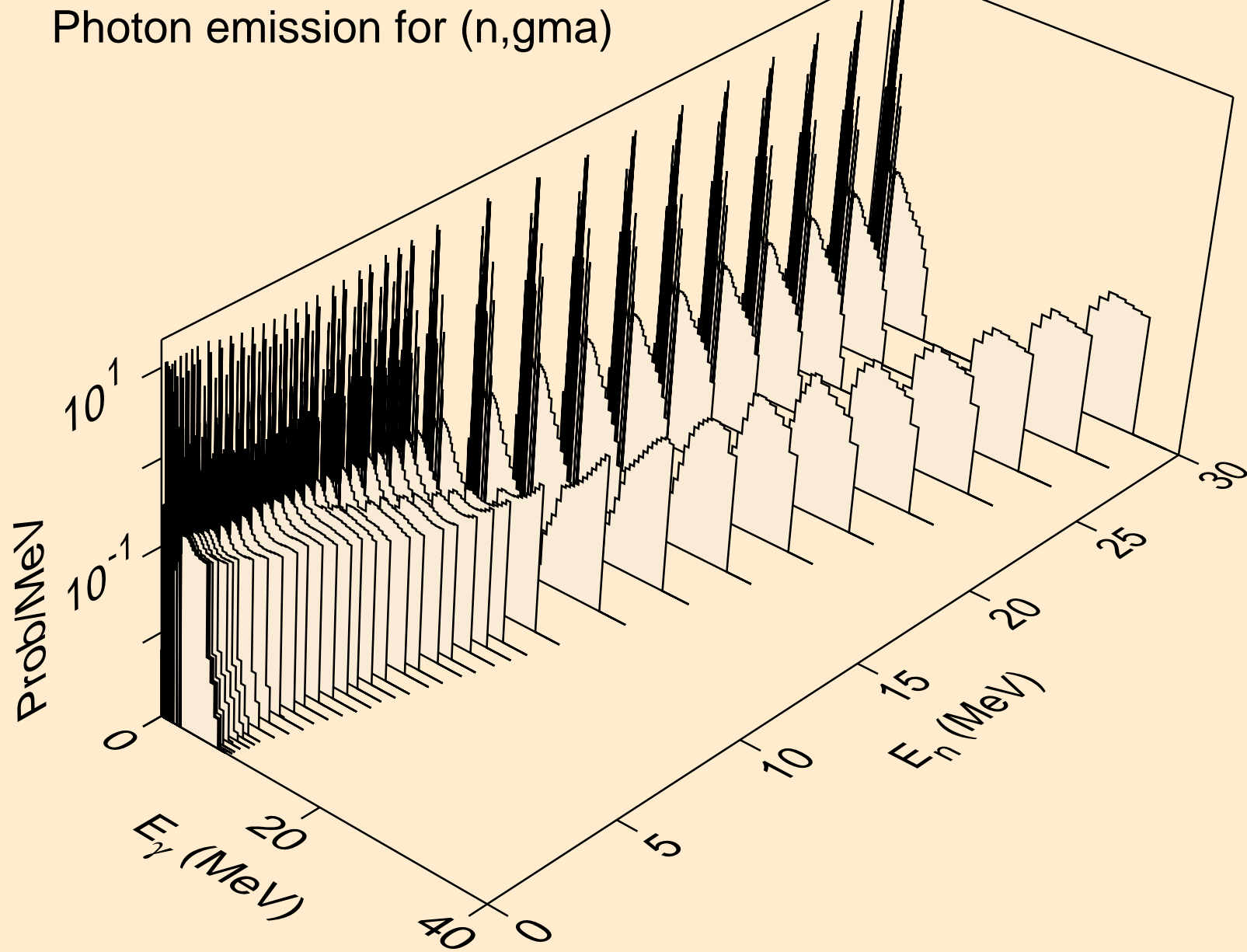

CR052 NEUTRON ACER TENDL-2021 LIBRARY; T=293.6K
Photon emission for (n,p)

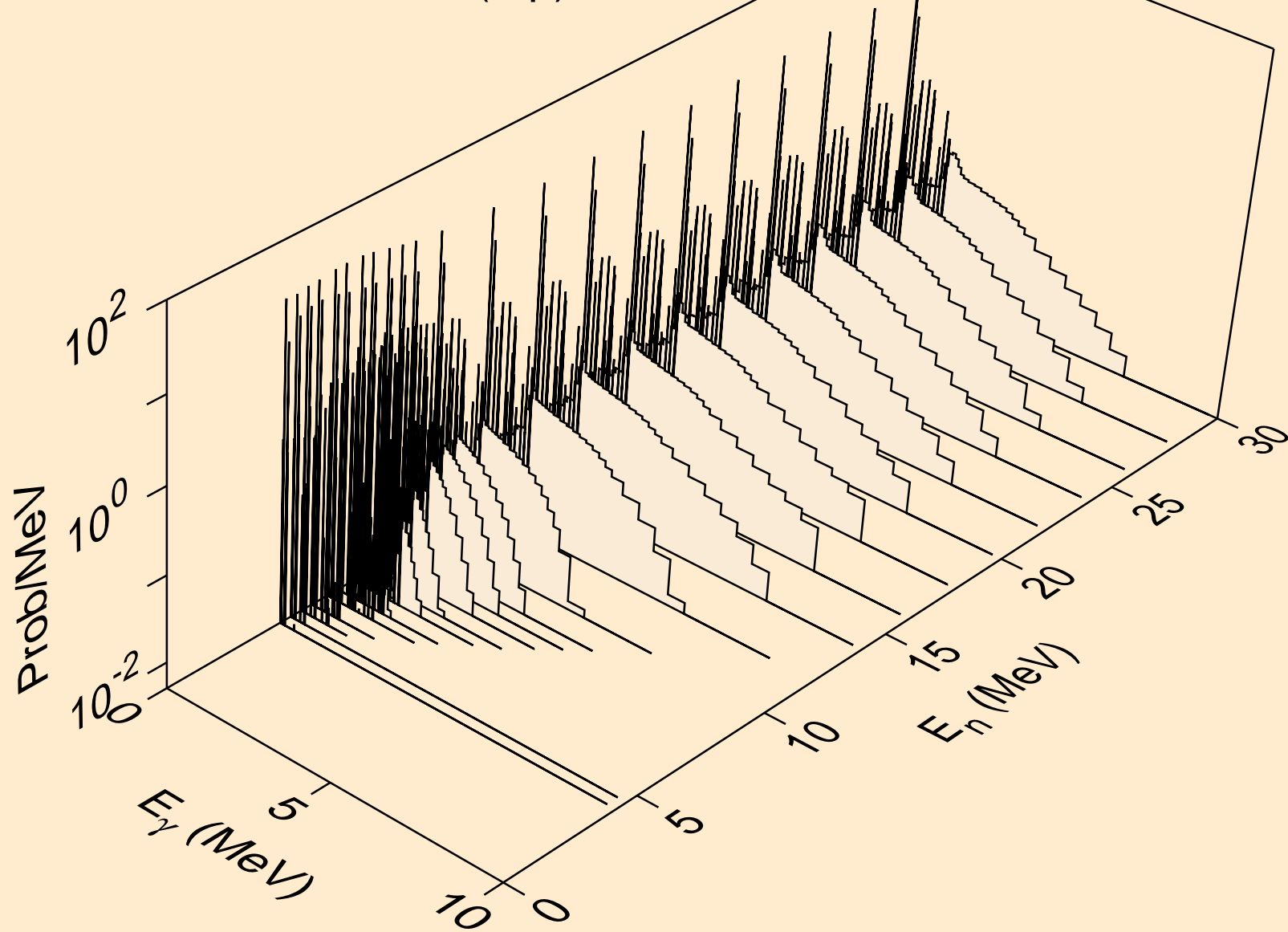

CR052 NEUTRON ACER TENDL-2021 LIBRARY; T=293.6K
Photon emission for (n,d)

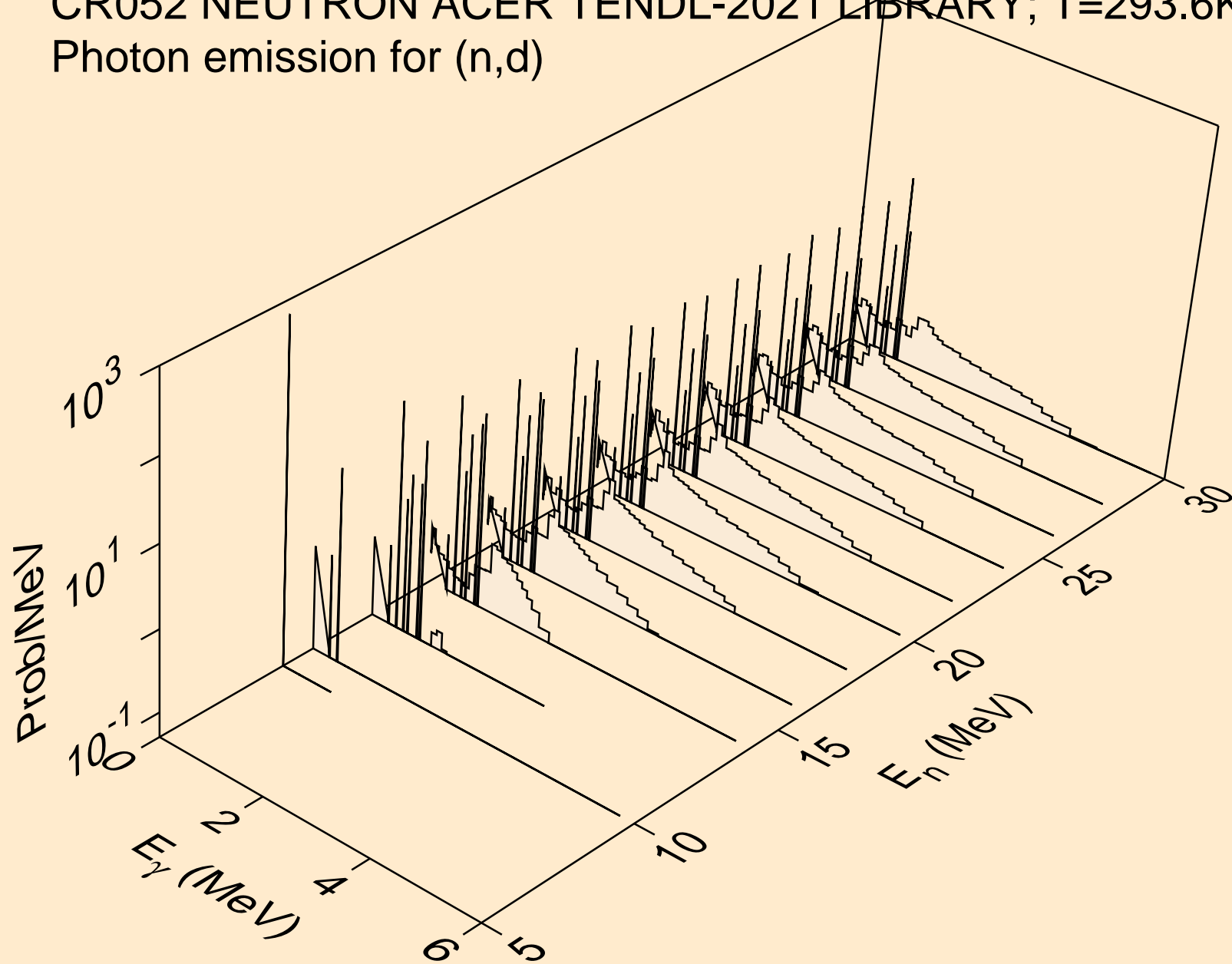

CR052 NEUTRON ACER TENDL-2021 LIBRARY; T=293.6K
Photon emission for (n,t)

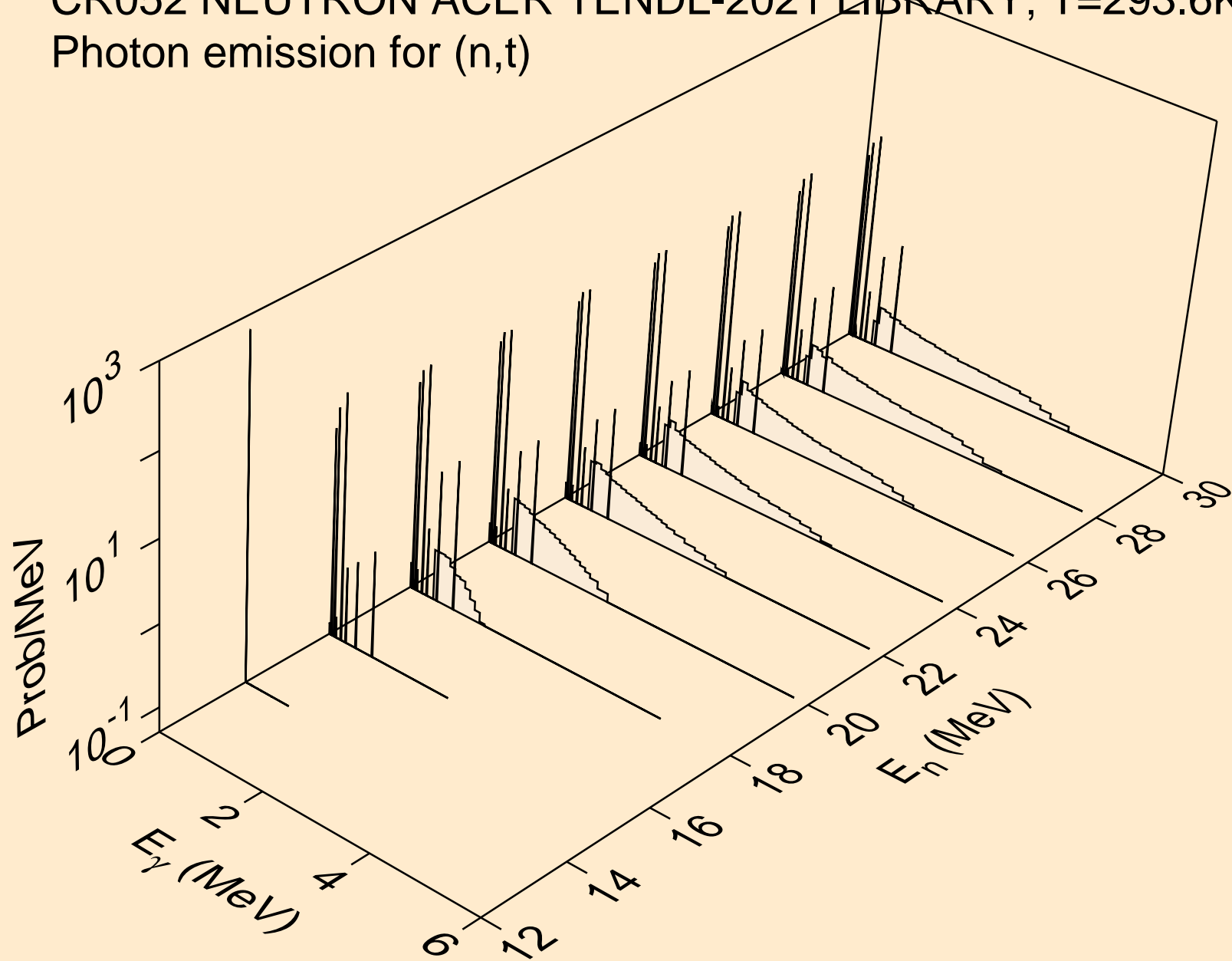

CR052 NEUTRON ACER TENDL-2021 LIBRARY; T=293.6K
Photon emission for (n,he3)

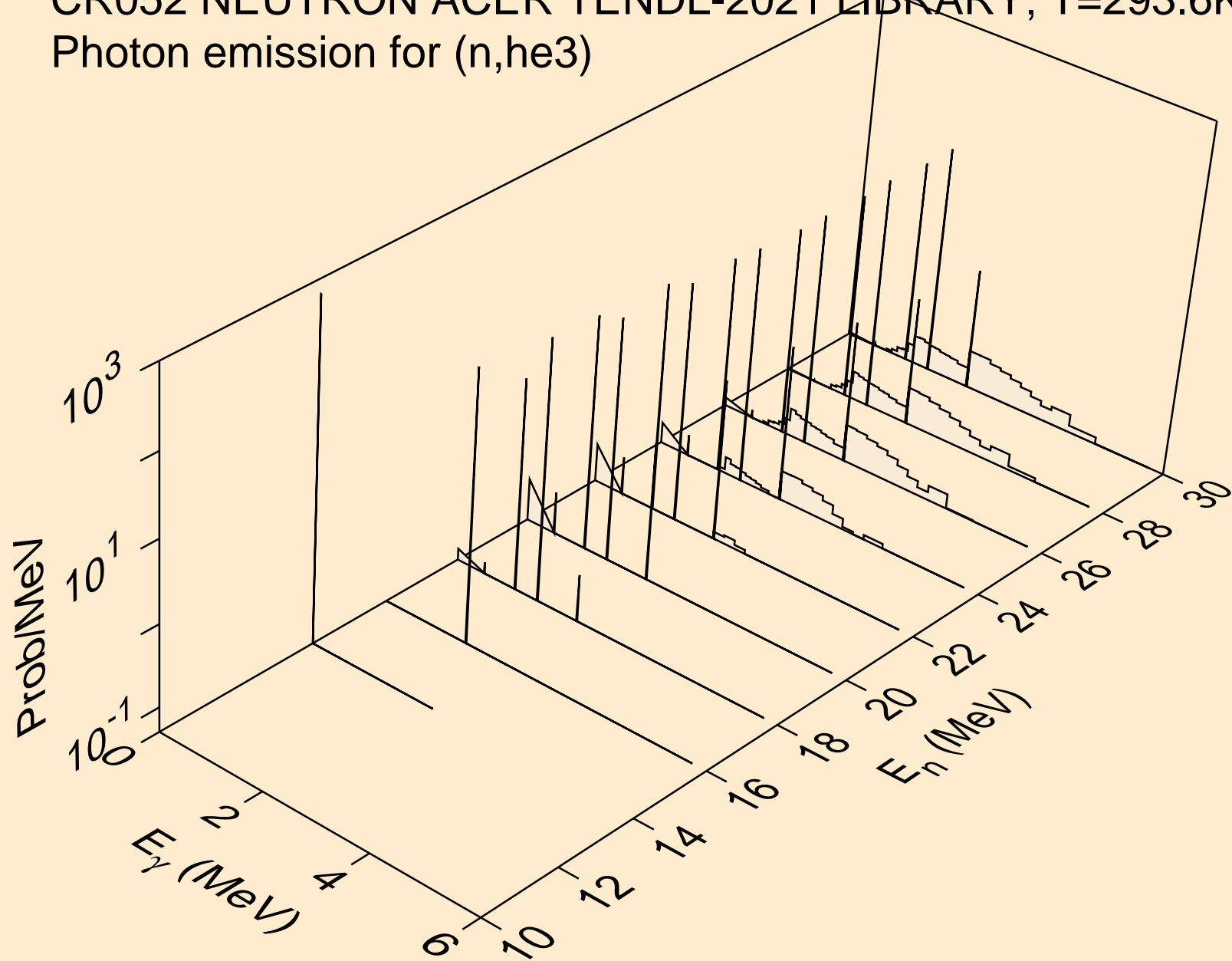

CR052 NEUTRON ACER TENDL-2021 LIBRARY; T=293.6K
Photon emission for (n,a)

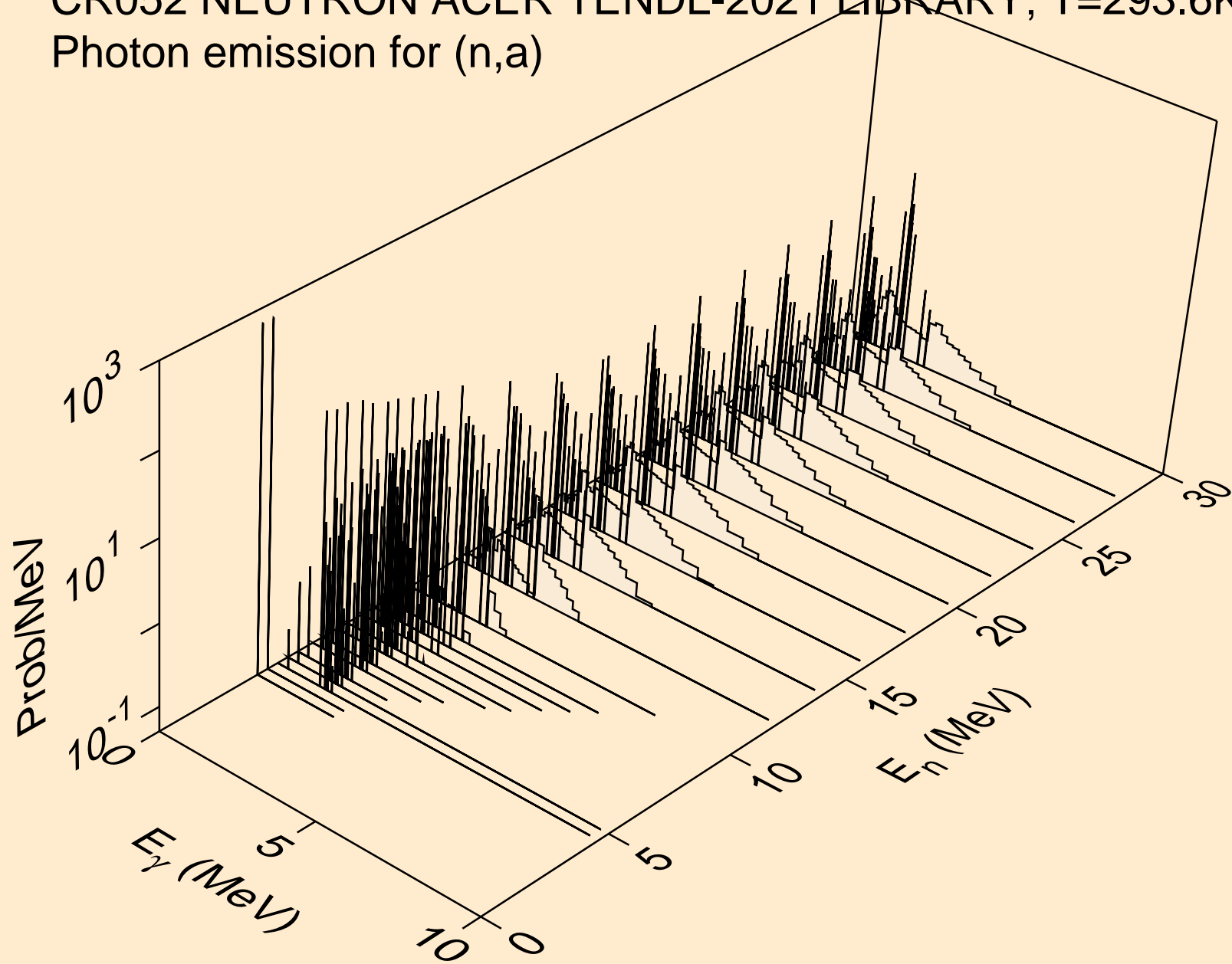

CR052 NEUTRON ACER TENDL-2021 LIBRARY; T=293.6K
Photon emission for (n,2a)

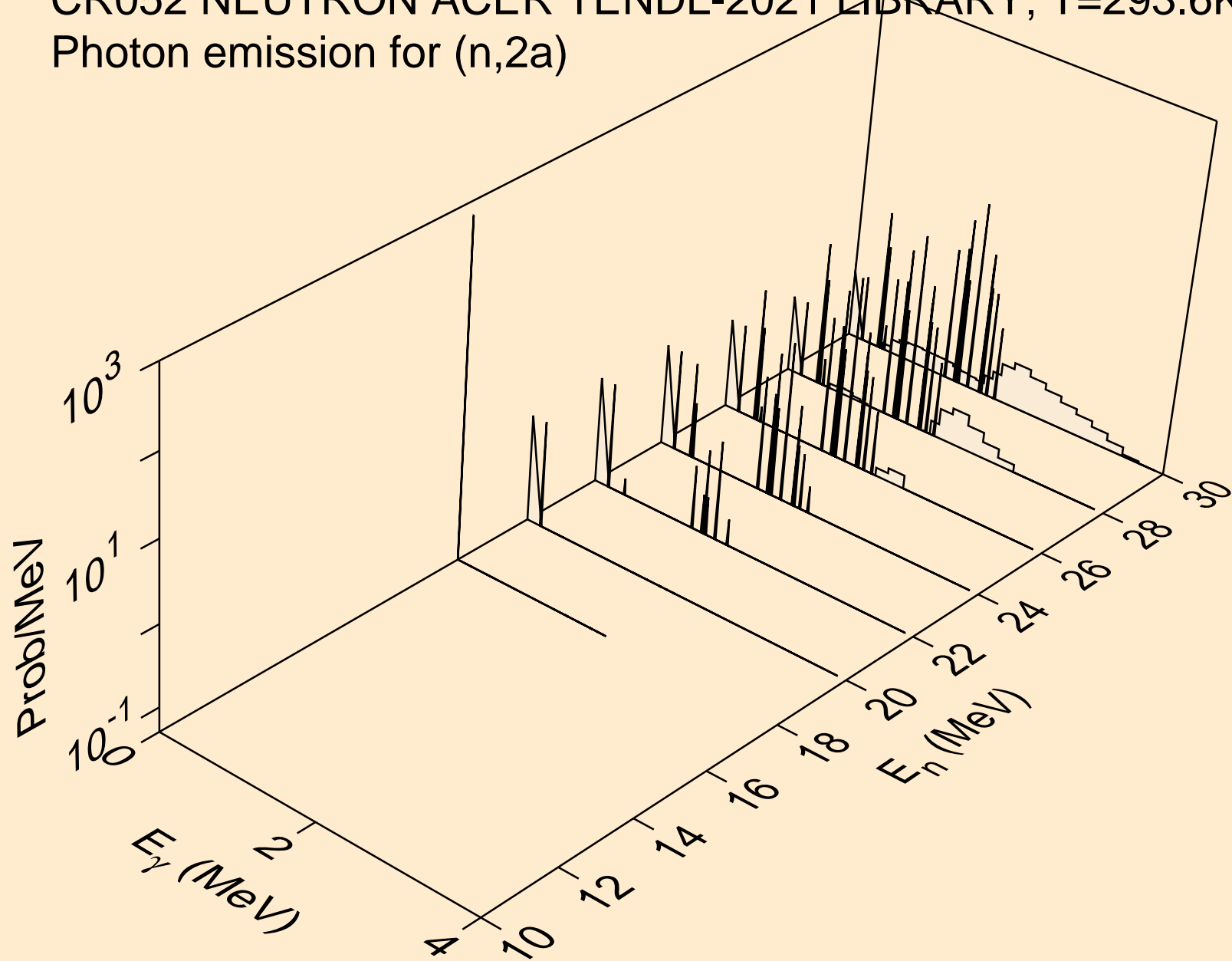

CR052 NEUTRON ACER TENDL-2021 LIBRARY; T=293.6K
Photon emission for (n,2p)

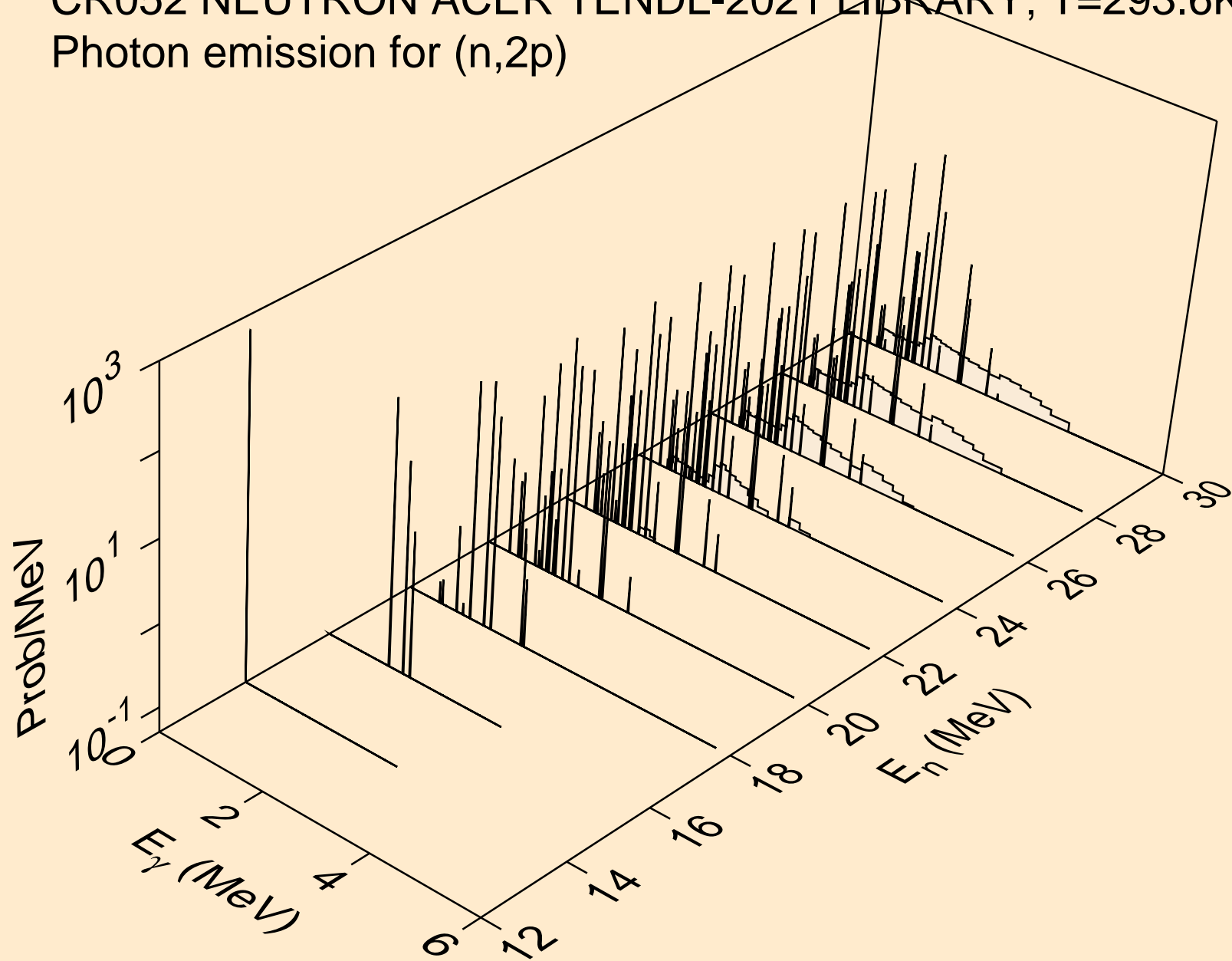

CR052 NEUTRON ACER TENDL-2021 LIBRARY; T=293.6K
Photon emission for (n,p α)

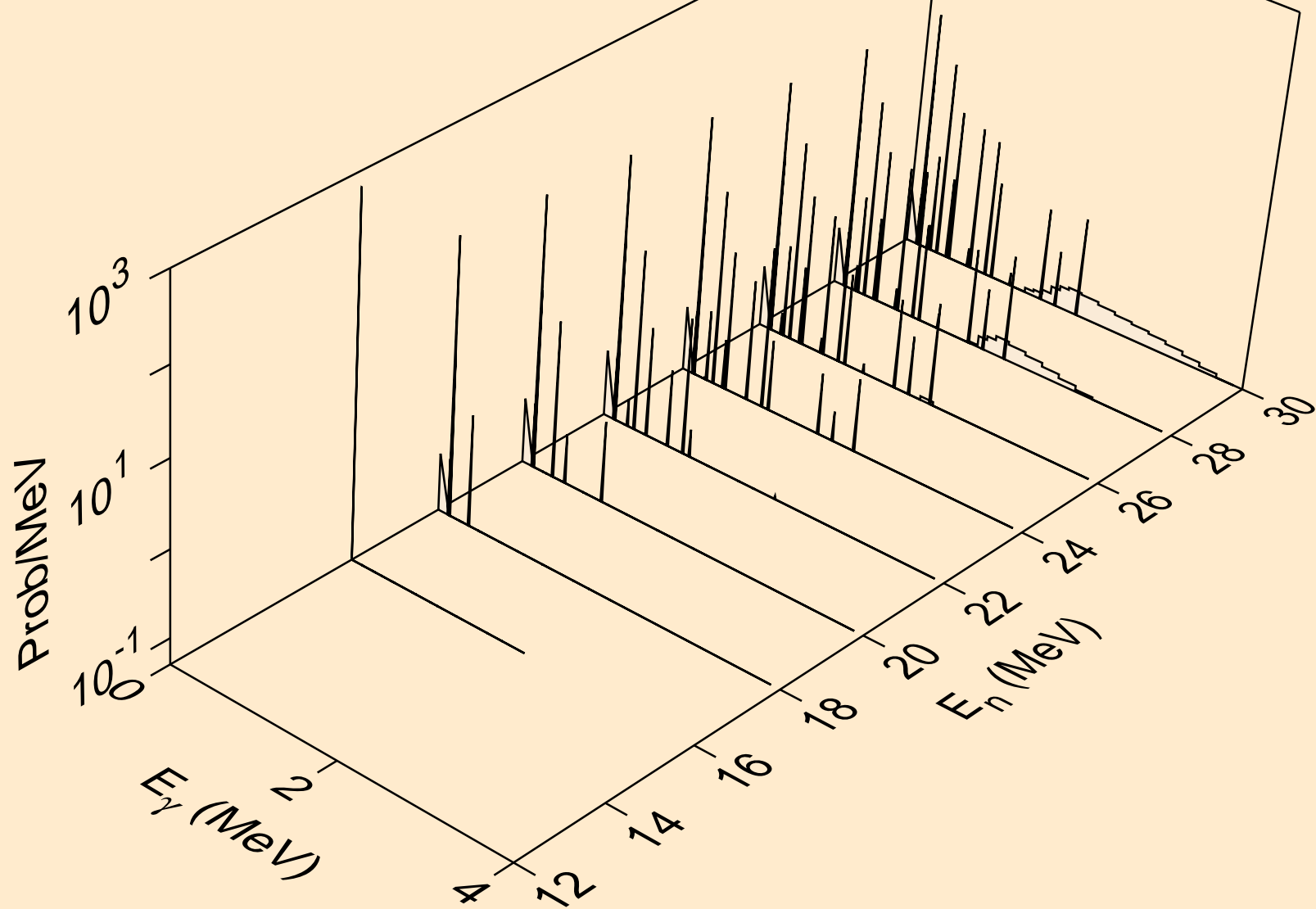

CR052 NEUTRON ACER TENDL-2021 LIBRARY; T=293.6K
Photon emission for (n,pd)

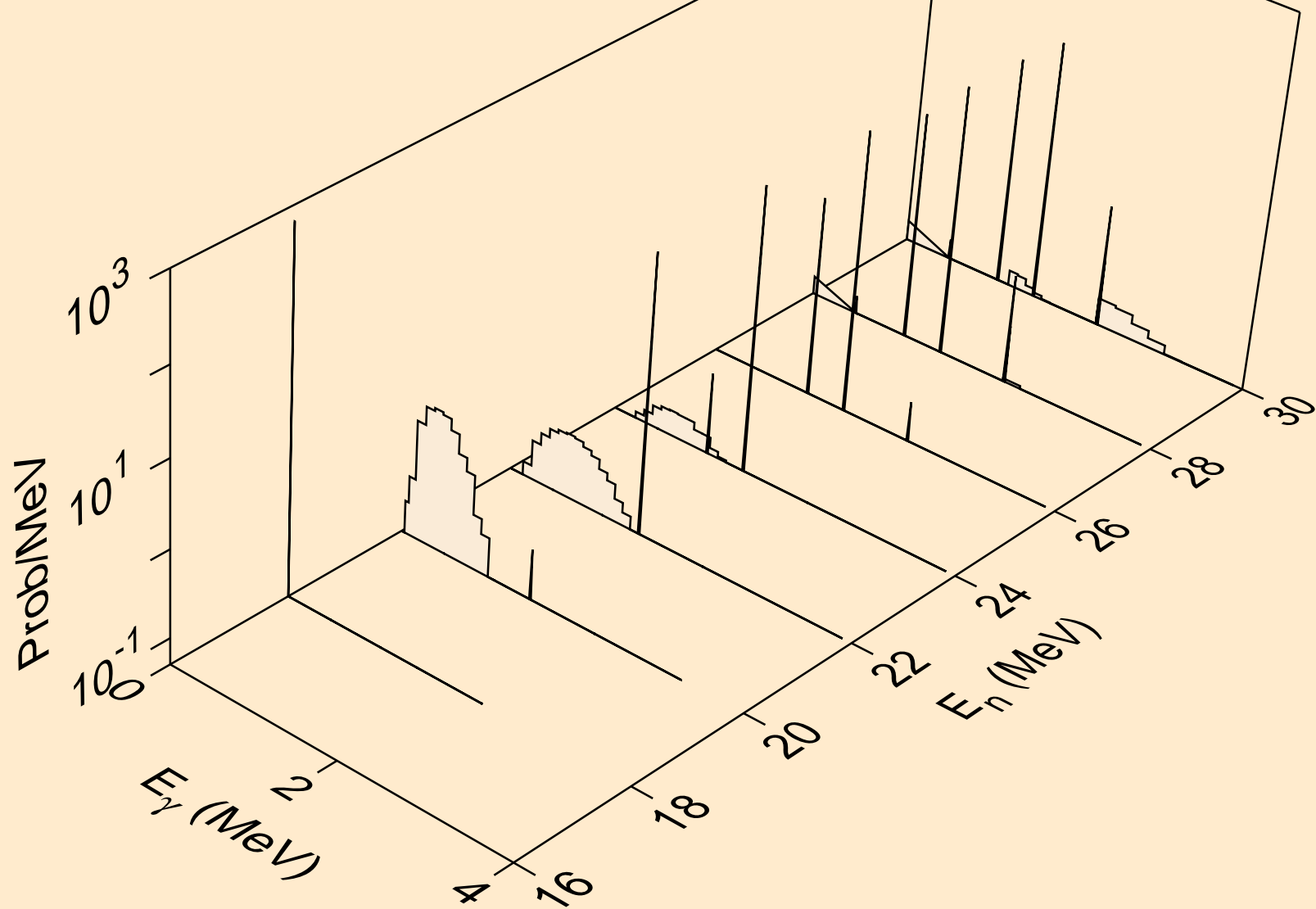

CR052 NEUTRON ACER TENDL-2021 LIBRARY; T=293.6K
Photon emission for (n,pt)

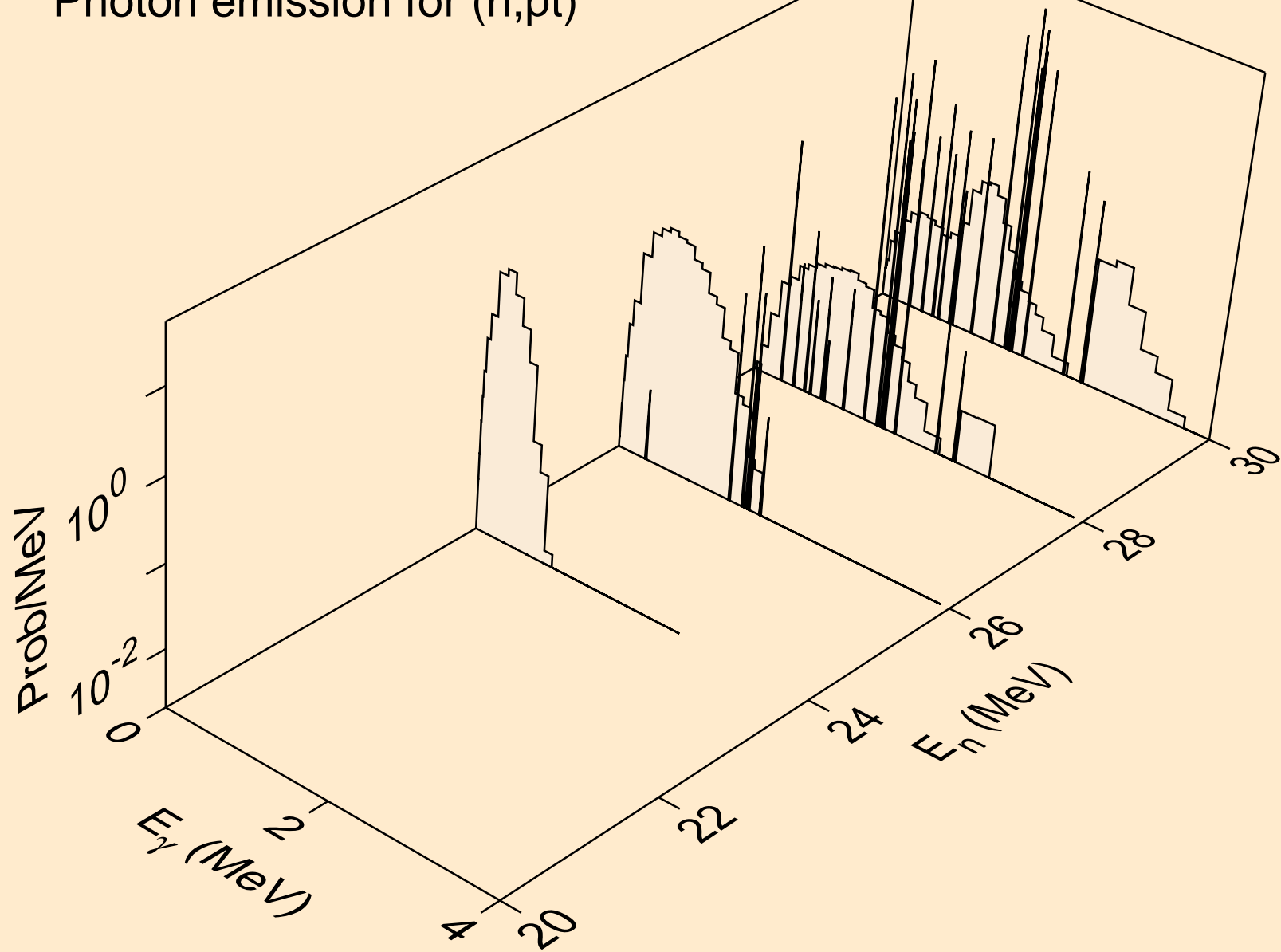

CR052 NEUTRON ACER TENDL-2021 LIBRARY; T=293.6K
Photon emission for (n,da)

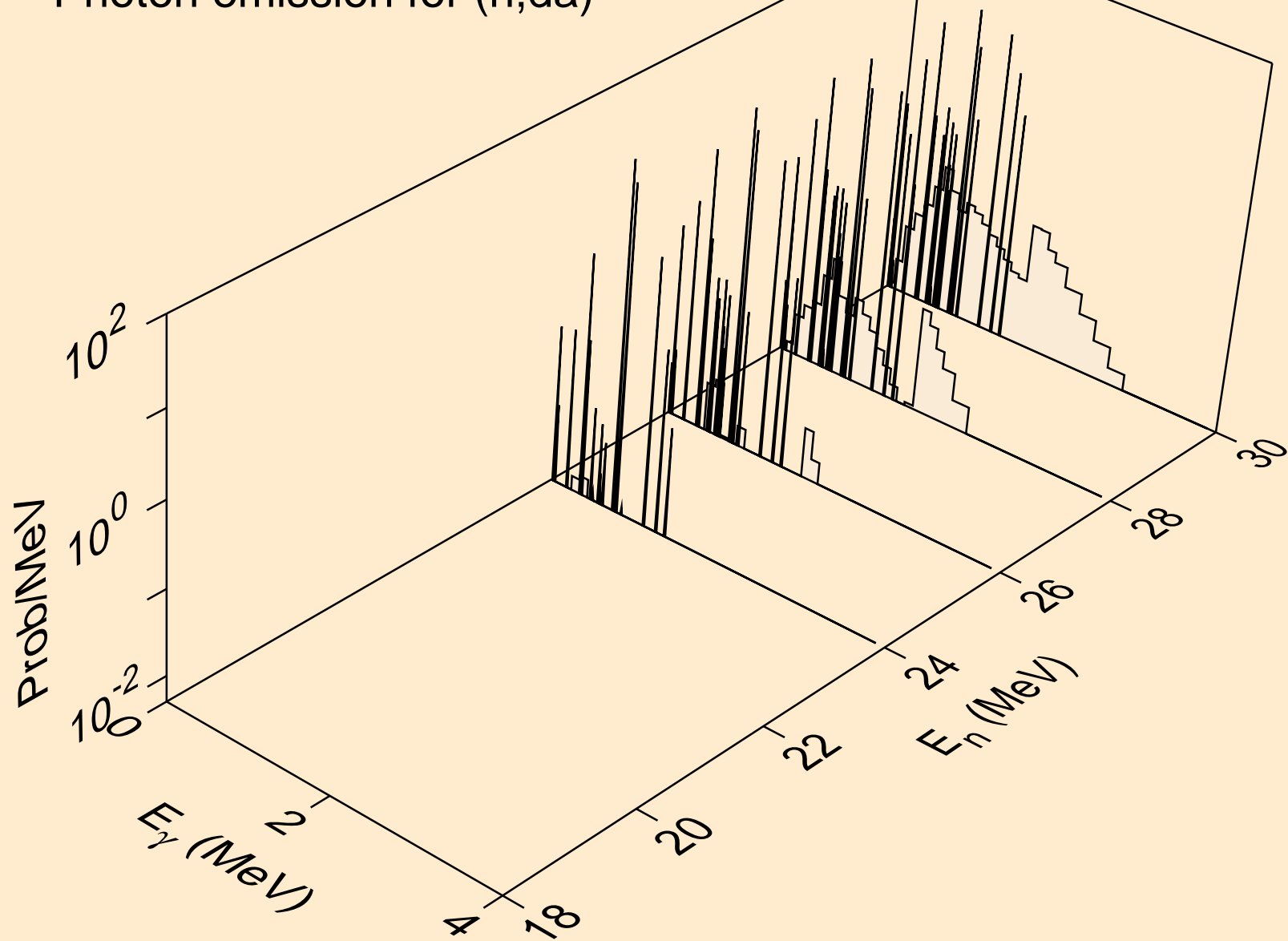

CR052 NEUTRON ACER TENDL-2021 LIBRARY; T=293.6K
thermal capture photon spectrum

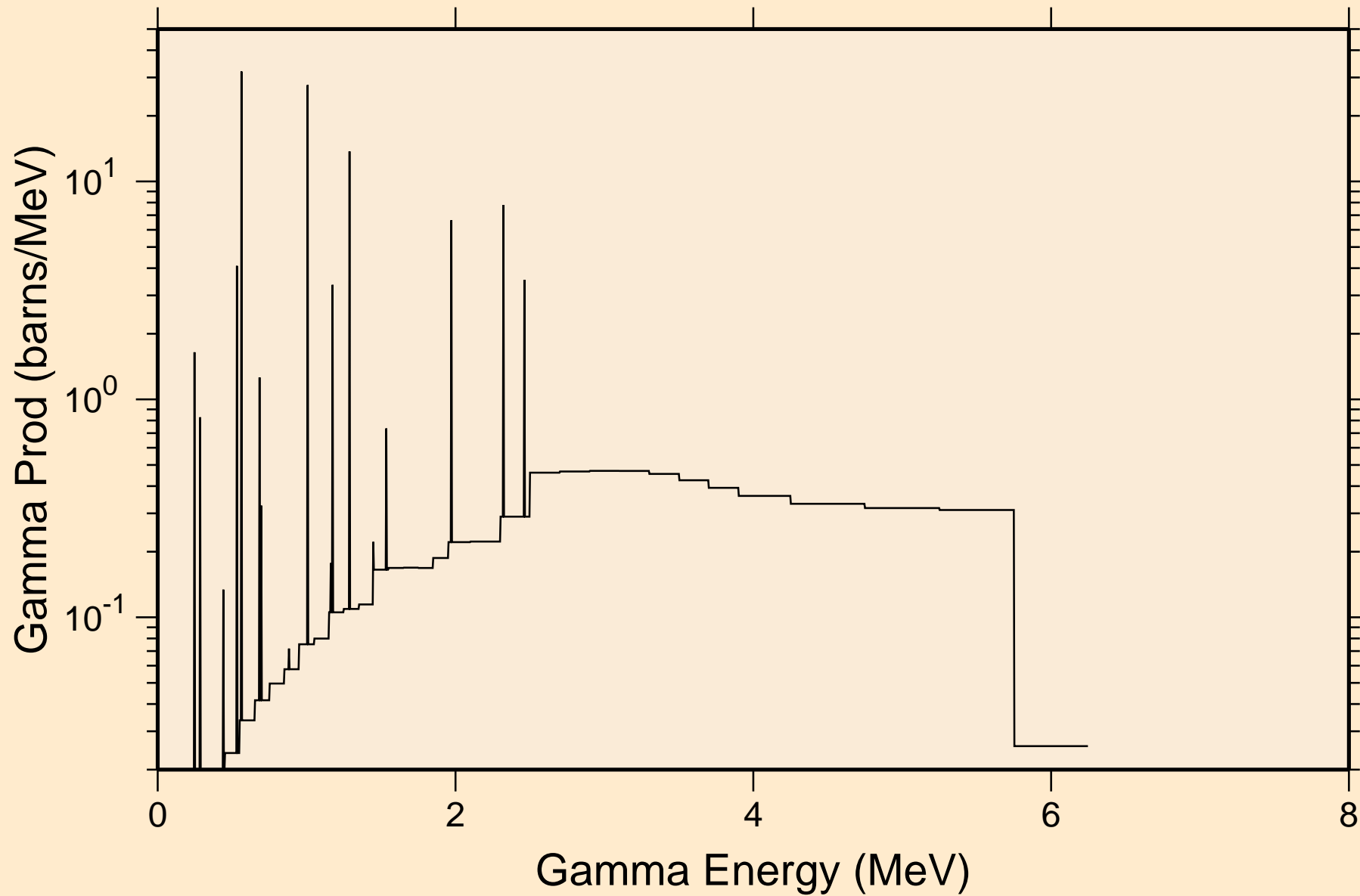

CR052 NEUTRON ACER TENDL-2021 LIBRARY; T=293.6K
14 MeV photon spectrum

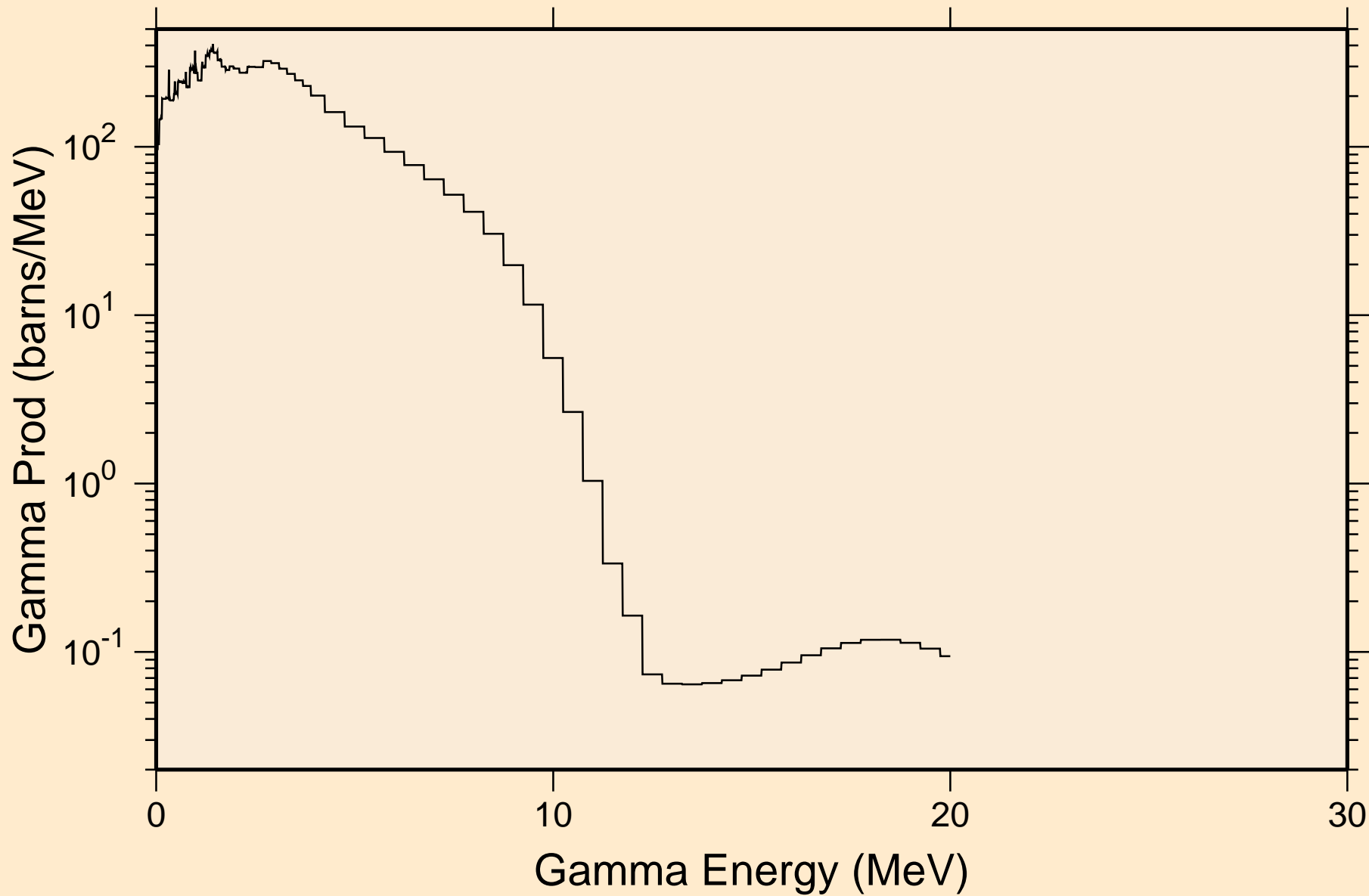

CR052 NEUTRON ACER TENDL-2021 LIBRARY; T=293.6K
Particle heating contributions

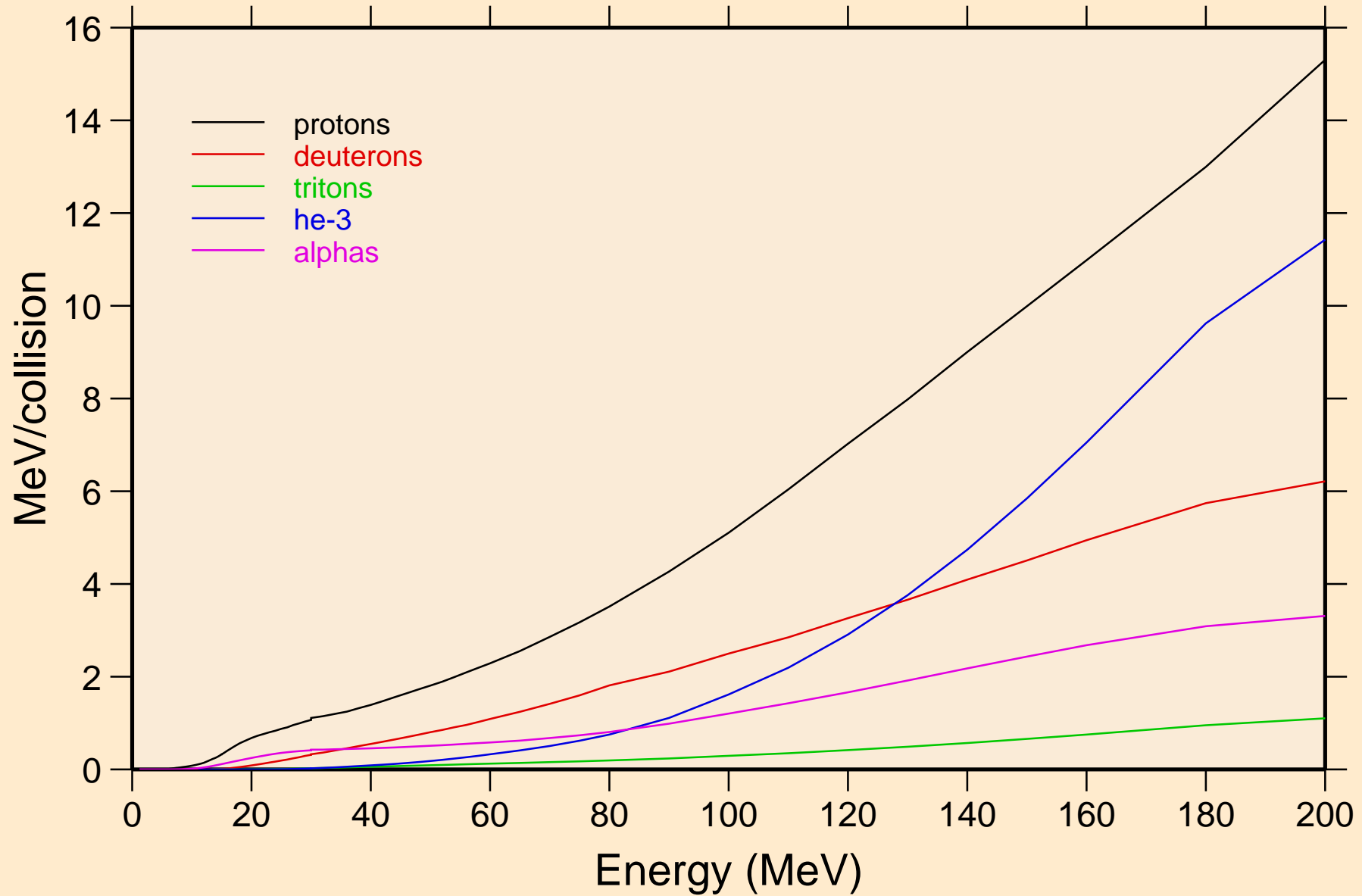

CR052 NEUTRON ACER TENDL-2021 LIBRARY; T=293.6K
Recoil Heating

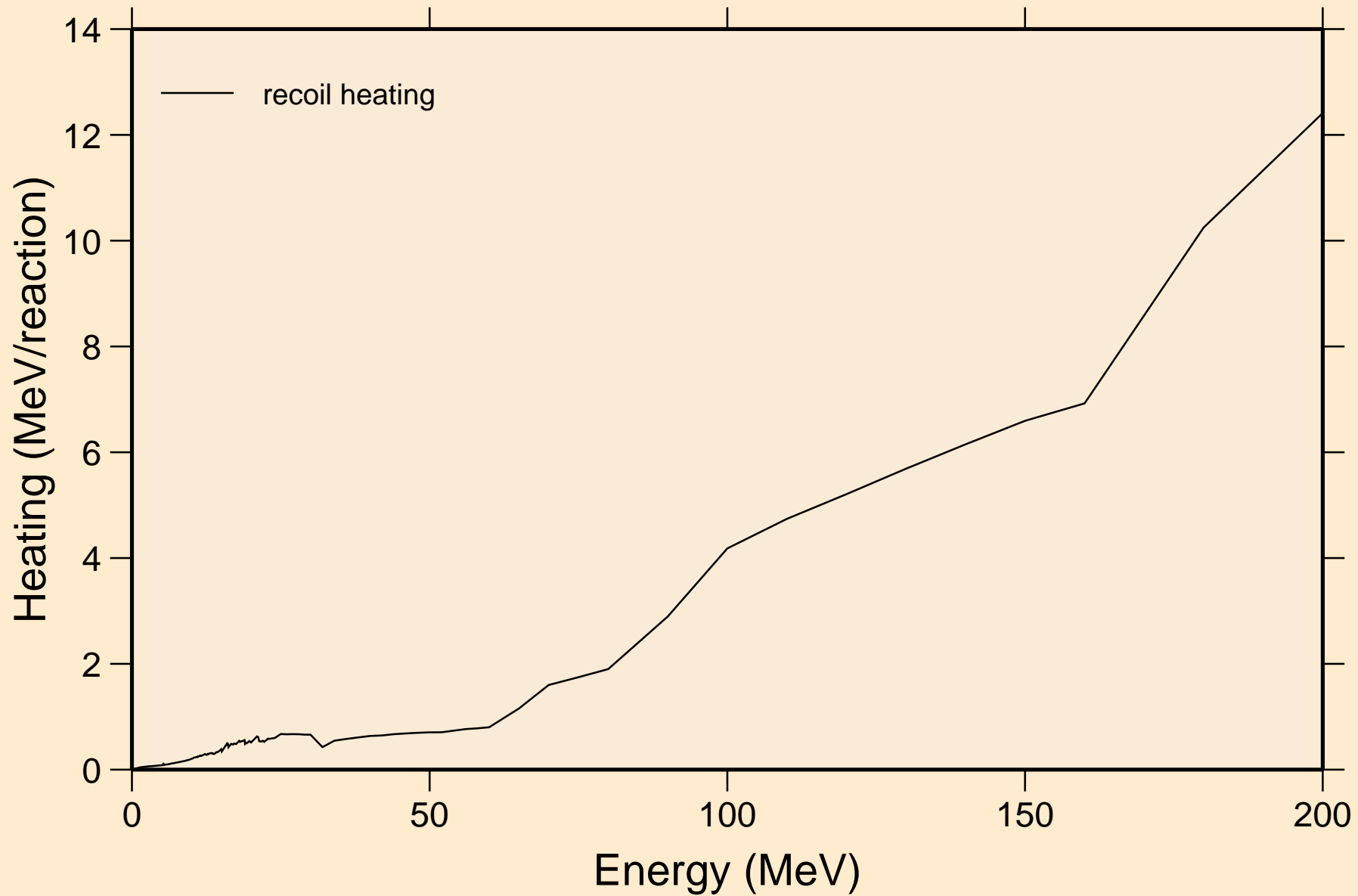

CR052 NEUTRON ACER TENDL-2021 LIBRARY; T=293.6K
Particle production cross sections

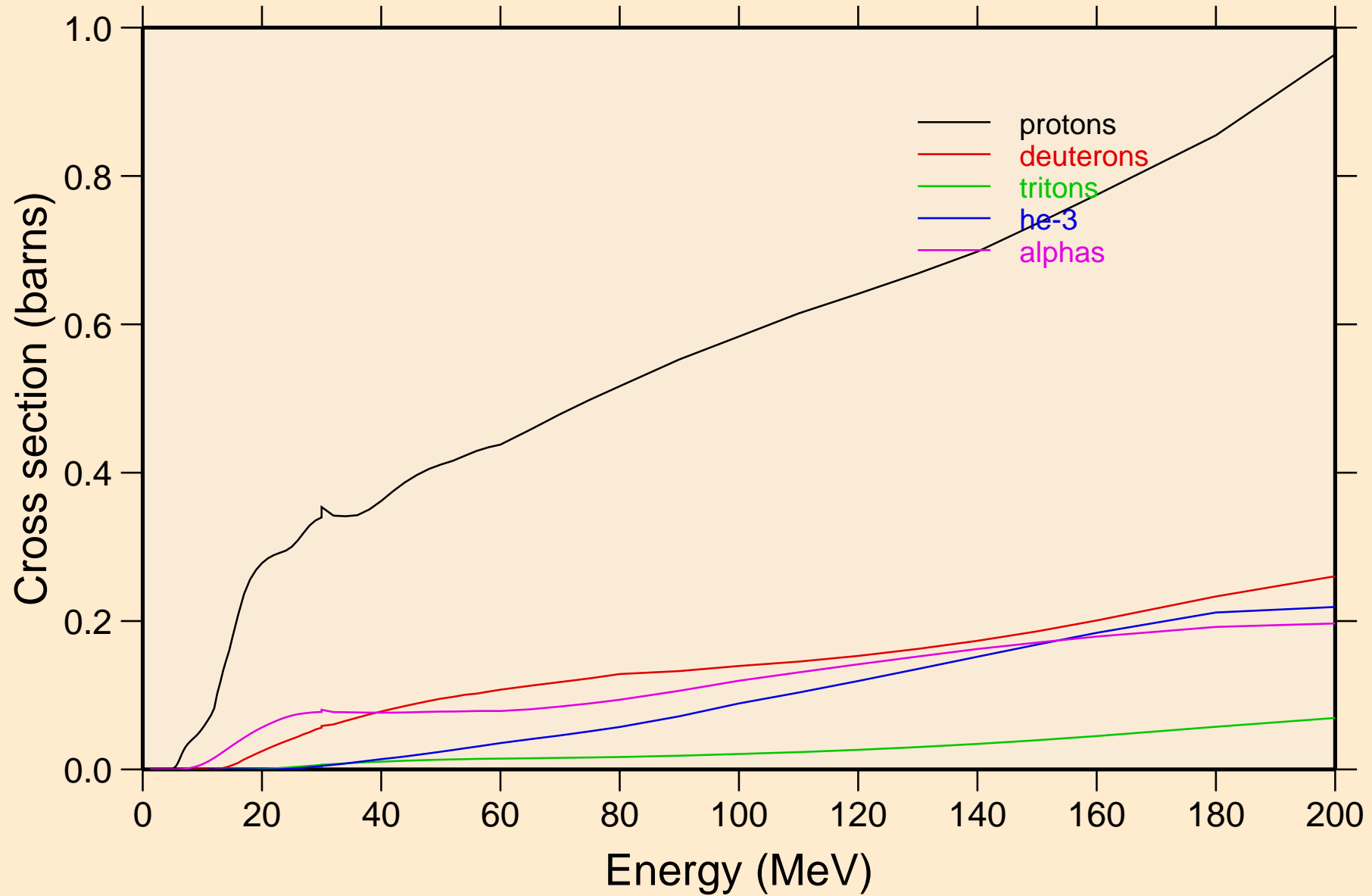

CR052 NEUTRON ACER TENDL-2021 LIBRARY; T=293.6K
protons from (n,x)

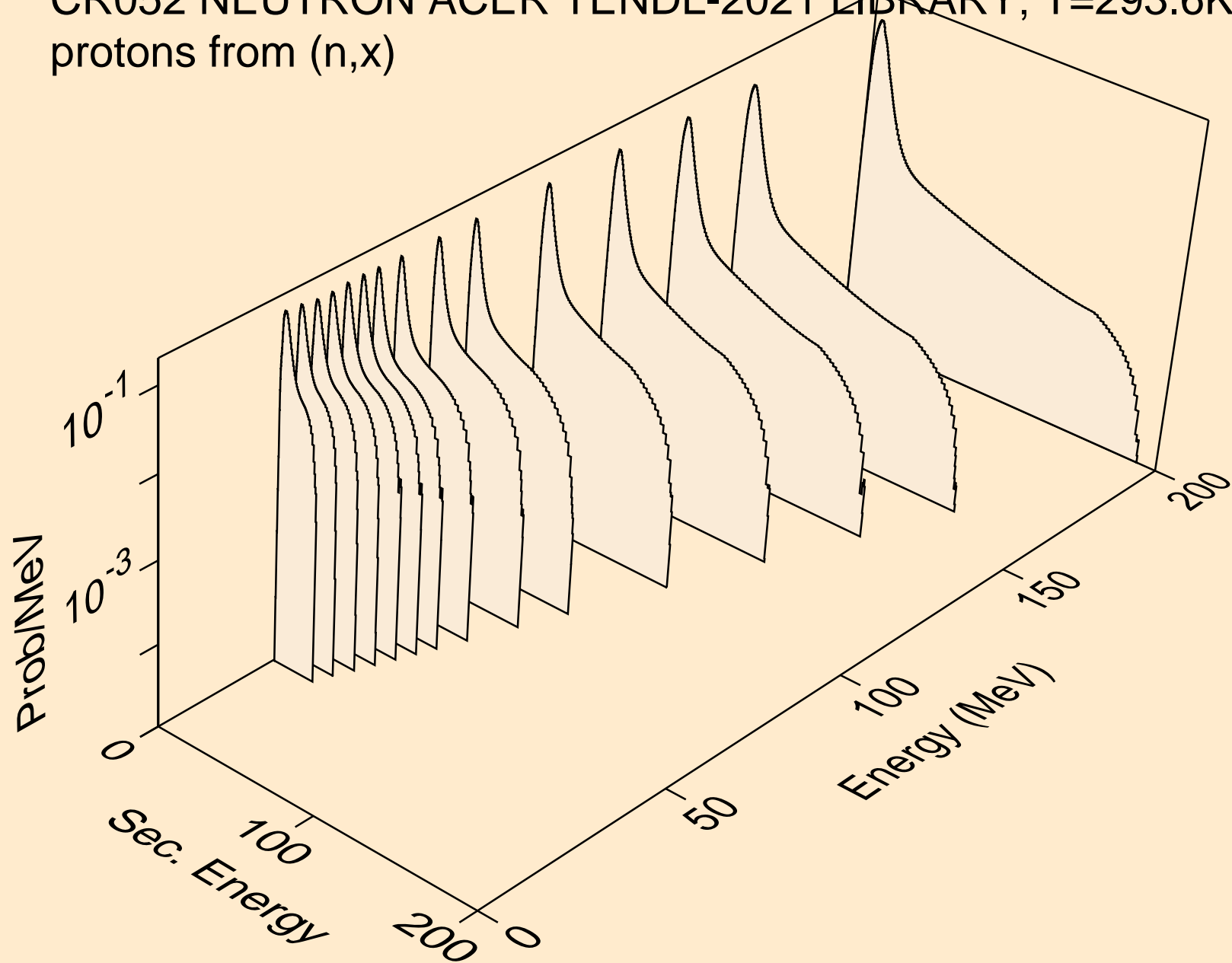

CR052 NEUTRON ACER TENDL-2021 LIBRARY; T=293.6K
protons from (n,n*)p

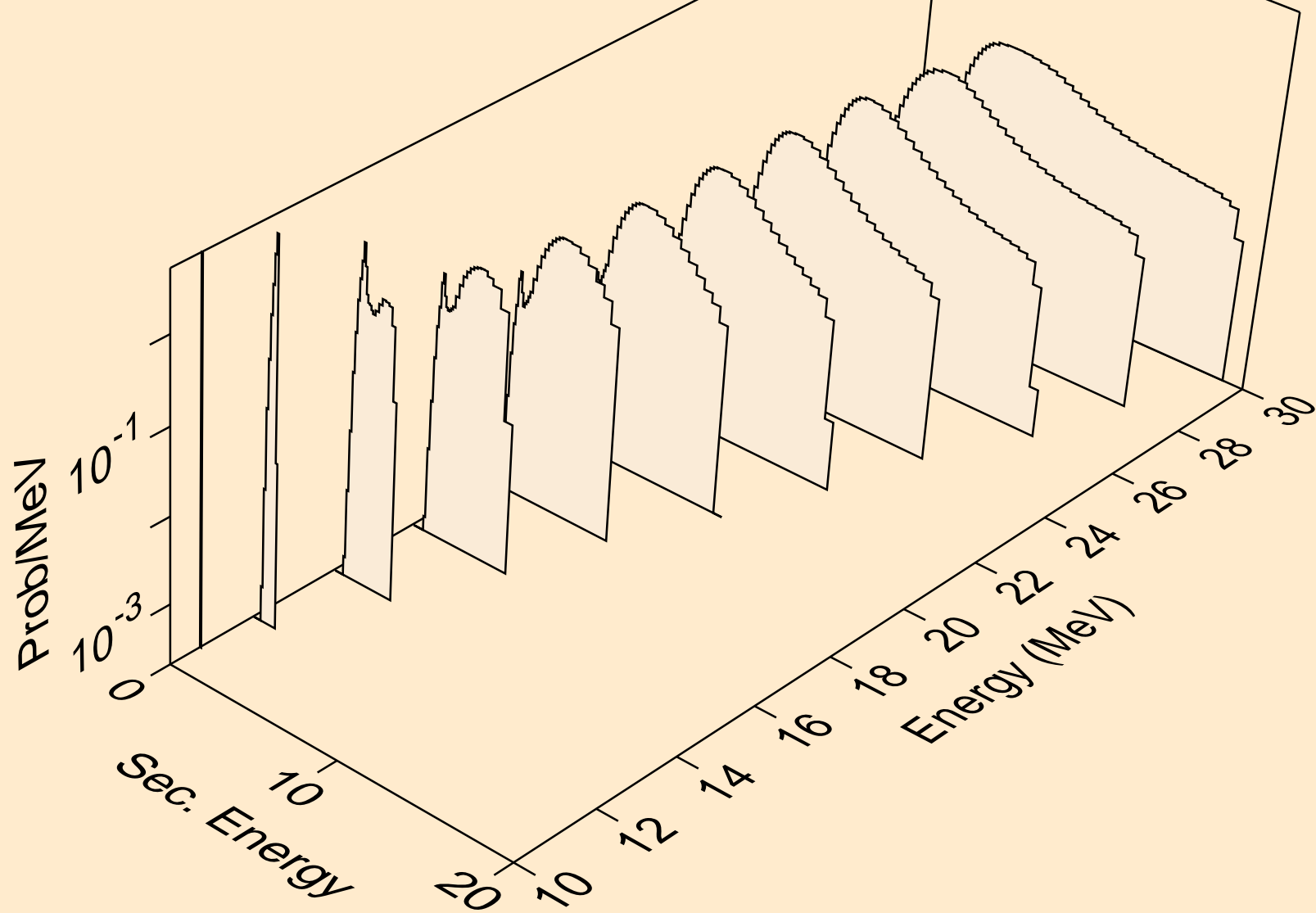

CR052 NEUTRON ACER TENDL-2021 LIBRARY; T=293.6K
protons from (n,2np)

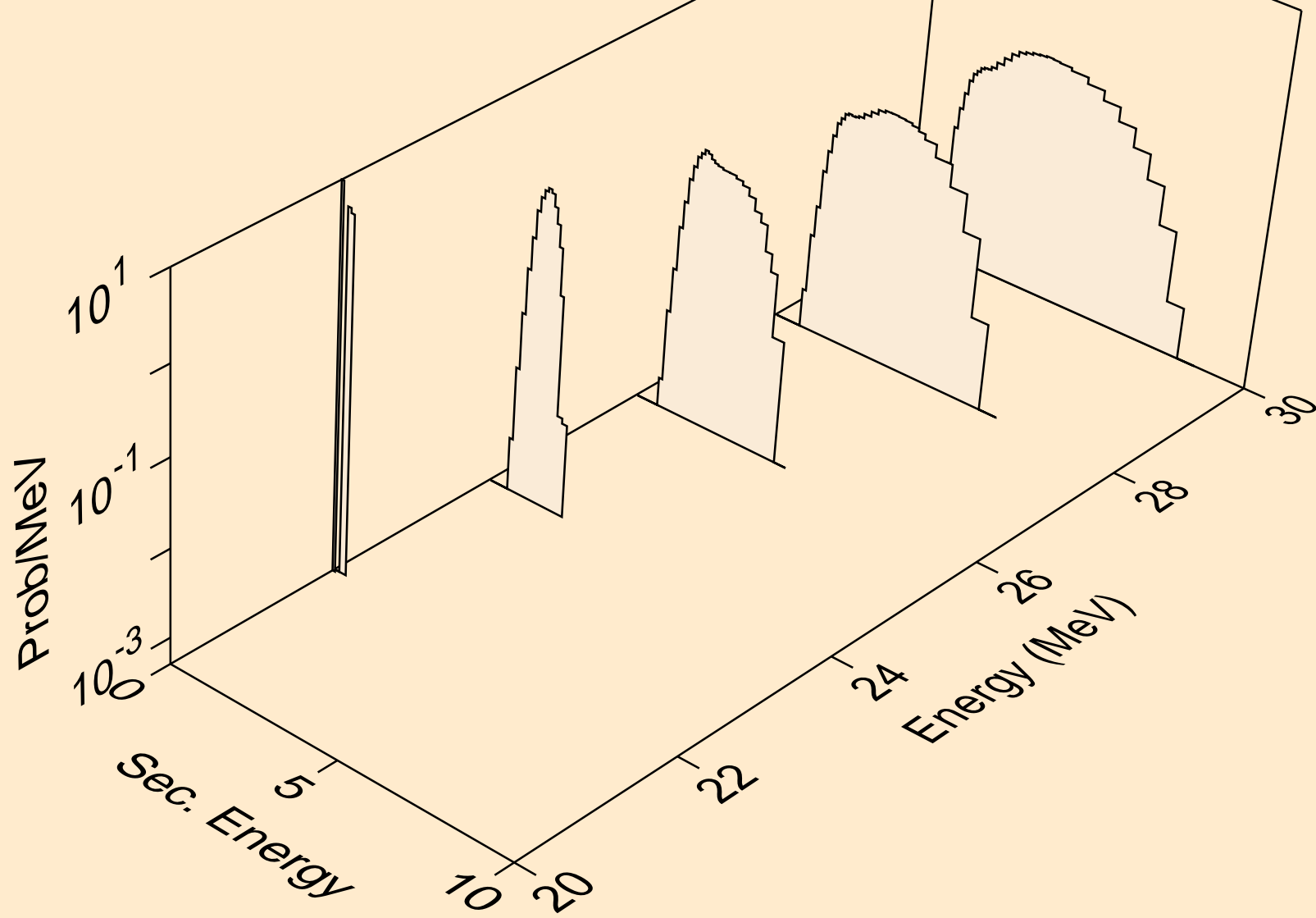

CR052 NEUTRON ACER TENDL-2021 LIBRARY; T=293.6K
protons from (n,2np)

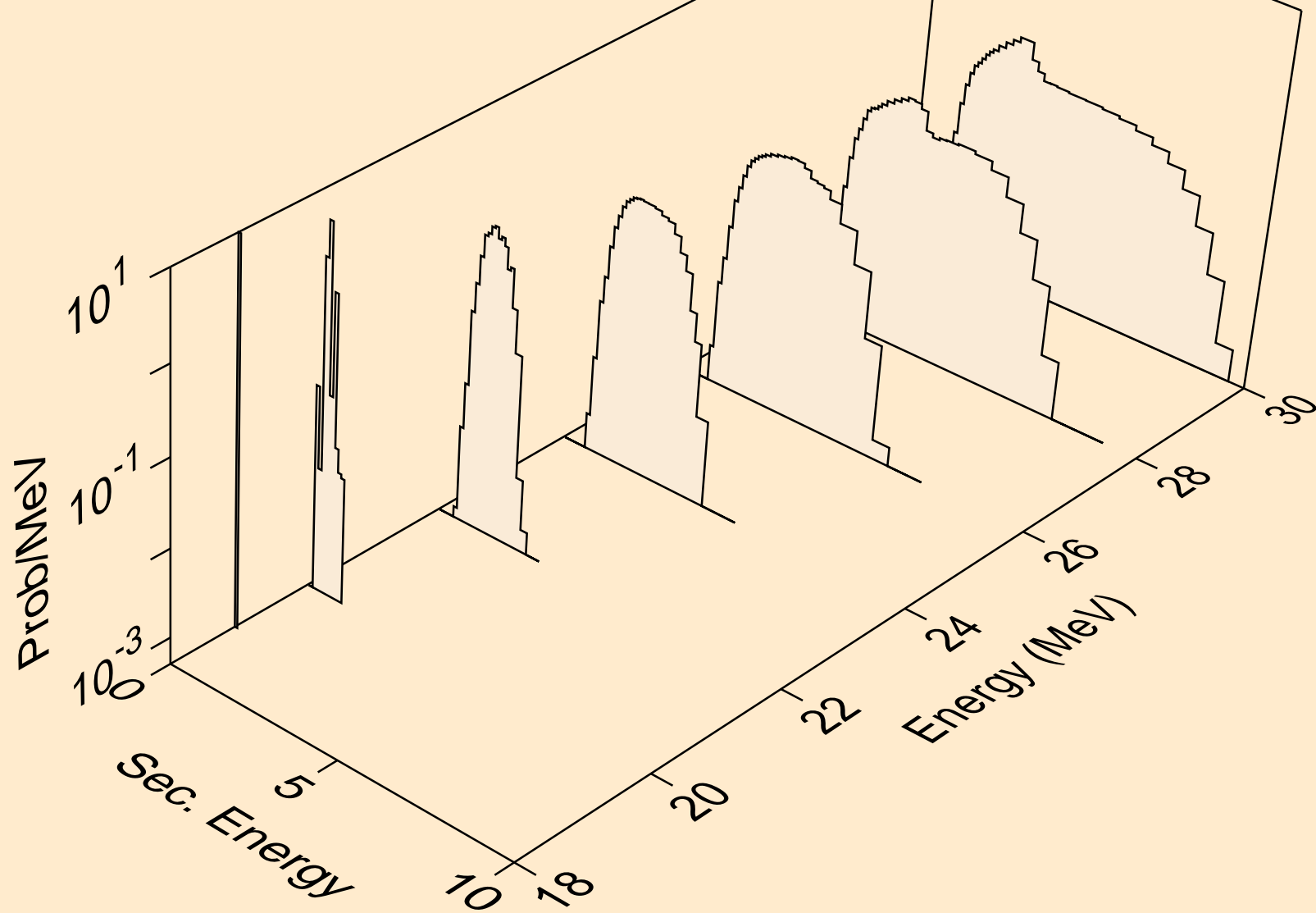

CR052 NEUTRON ACER TENDL-2021 LIBRARY; T=293.6K
protons from (n,npa)

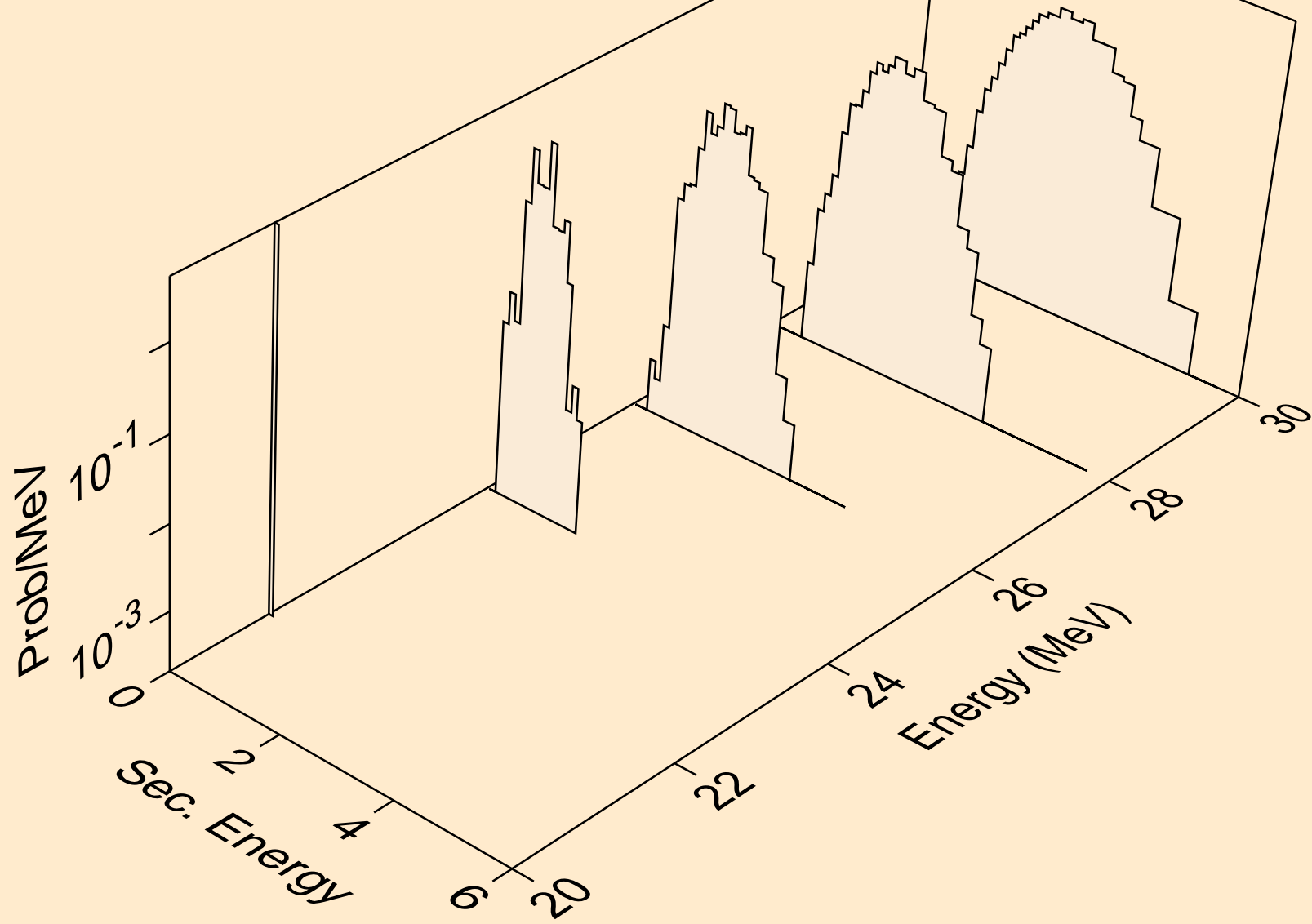

CR052 NEUTRON ACER TENDL-2021 LIBRARY; T=293.6K
protons from (n,p)

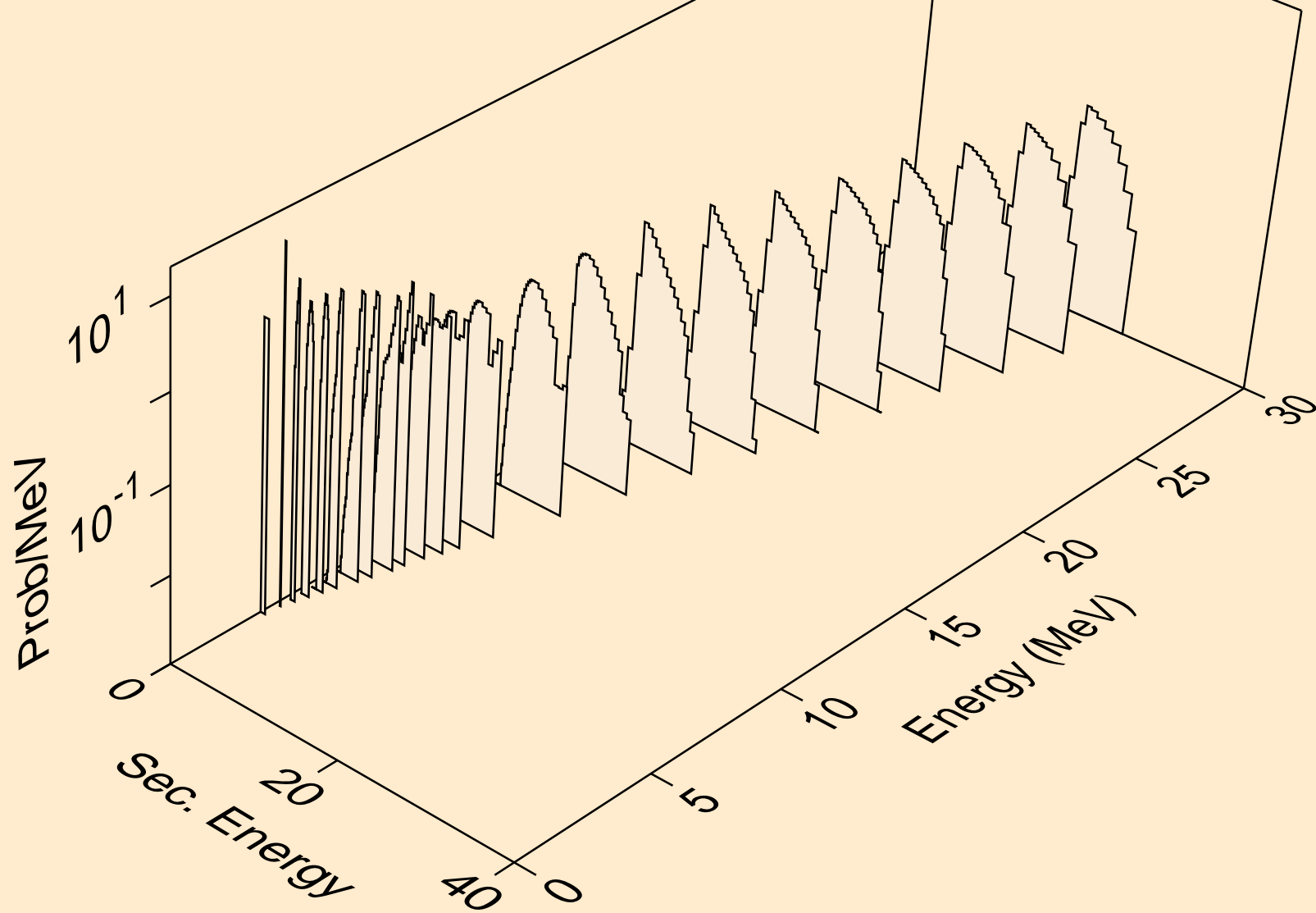

CR052 NEUTRON ACER TENDL-2021 LIBRARY; T=293.6K
protons from (n,2p)

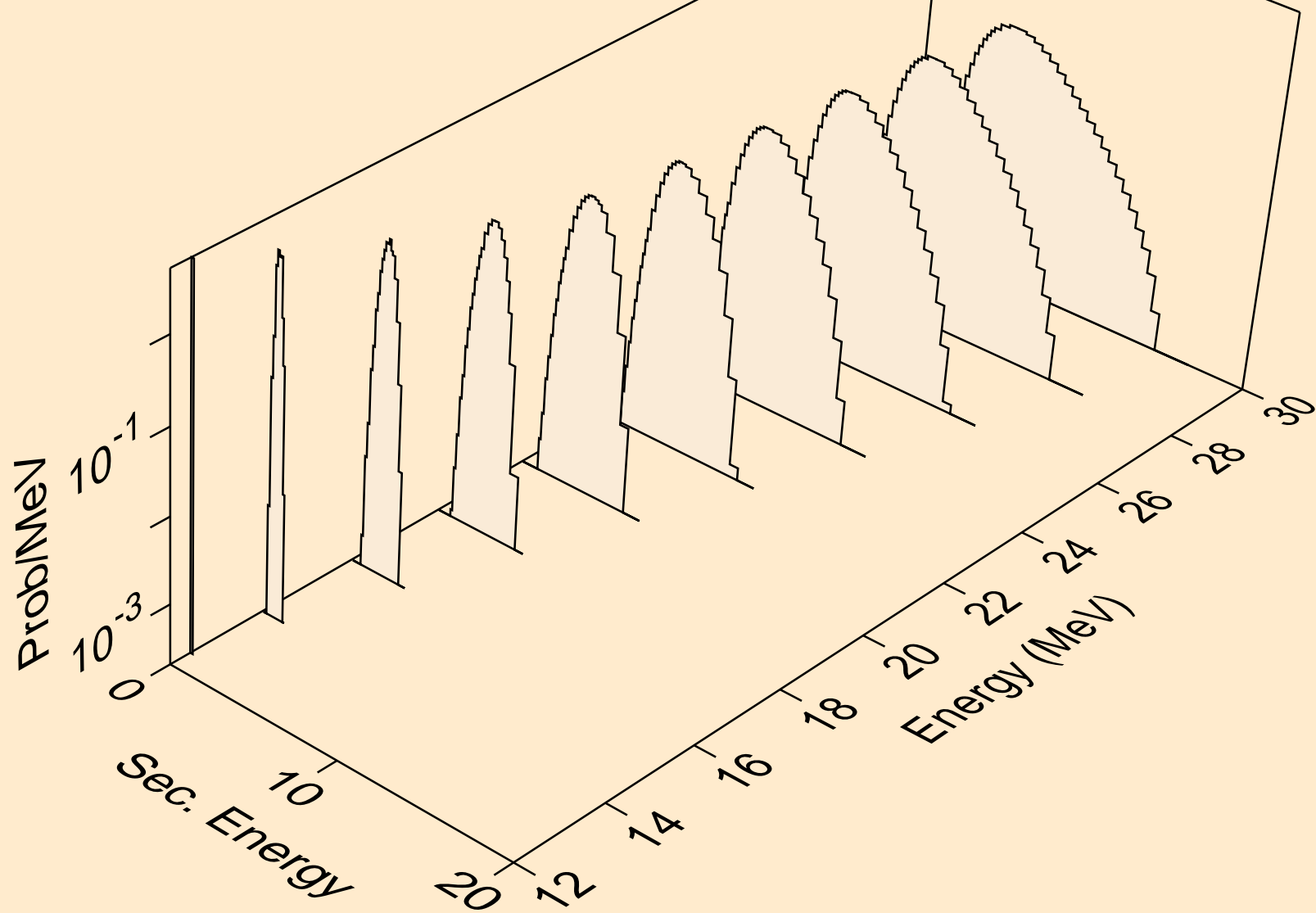

CR052 NEUTRON ACER TENDL-2021 LIBRARY; T=293.6K
protons from (n,p)

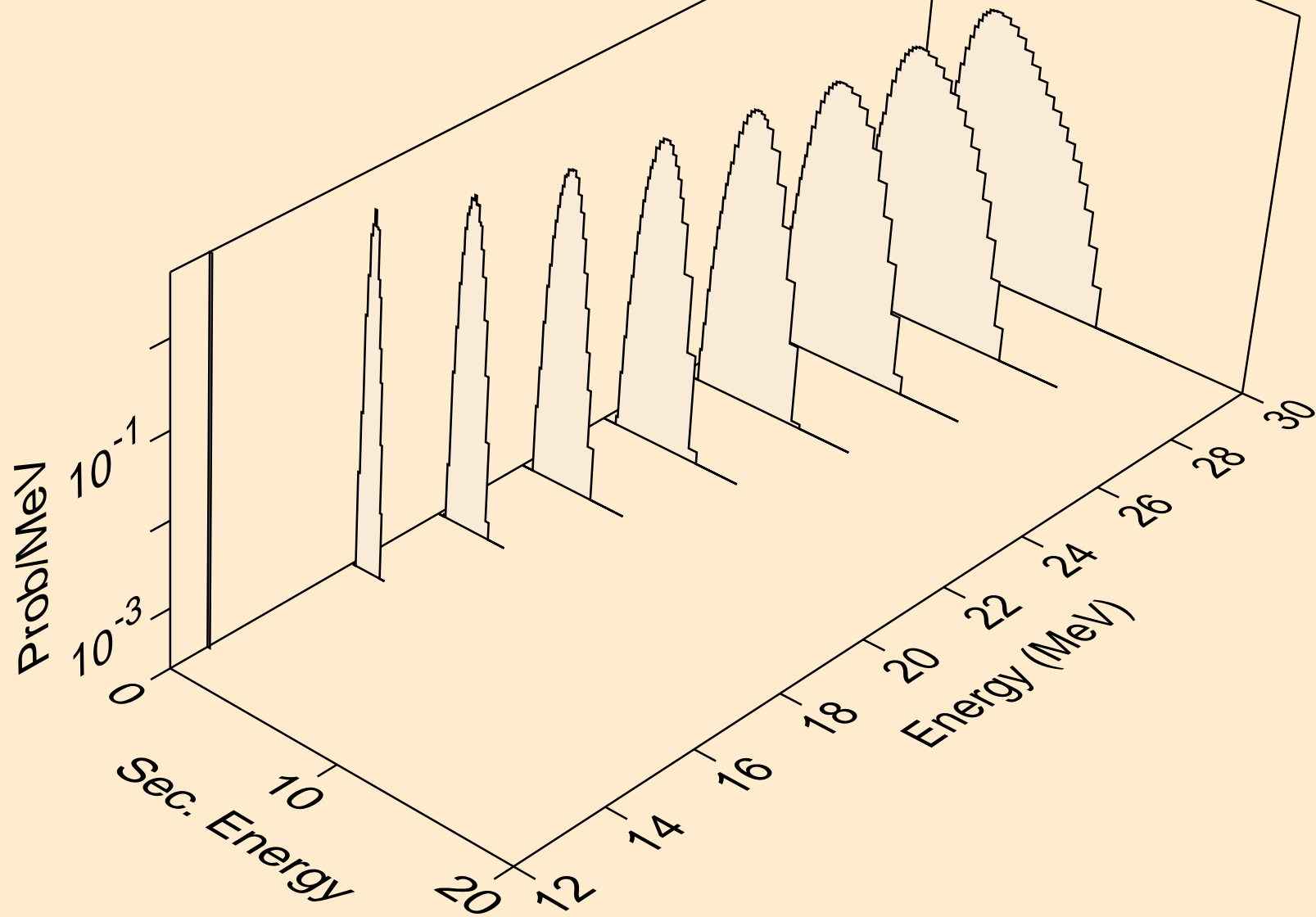

CR052 NEUTRON ACER TENDL-2021 LIBRARY; T=293.6K
protons from (n,pd)

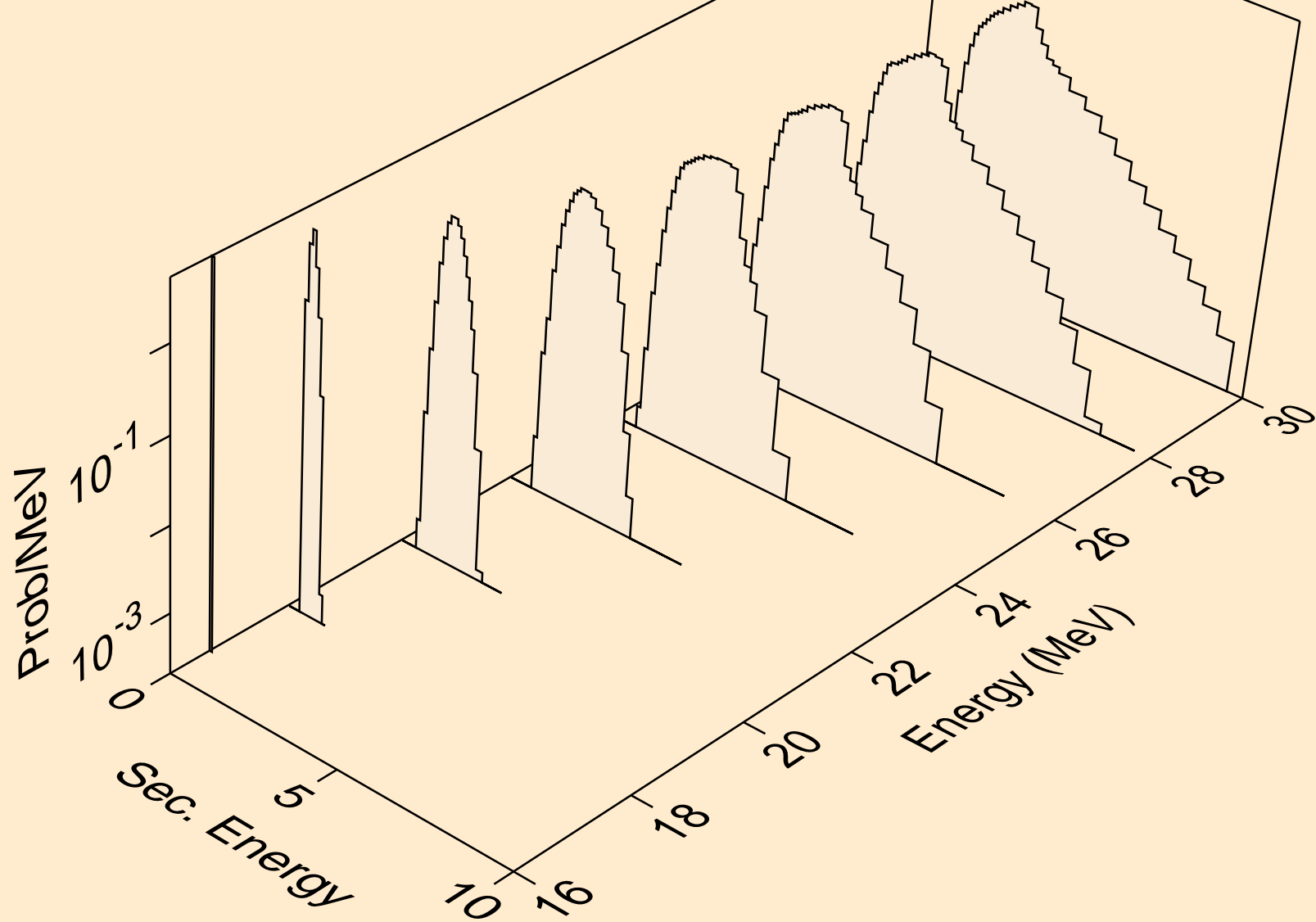

CR052 NEUTRON ACER TENDL-2021 LIBRARY; T=293.6K
protons from (n,pt)

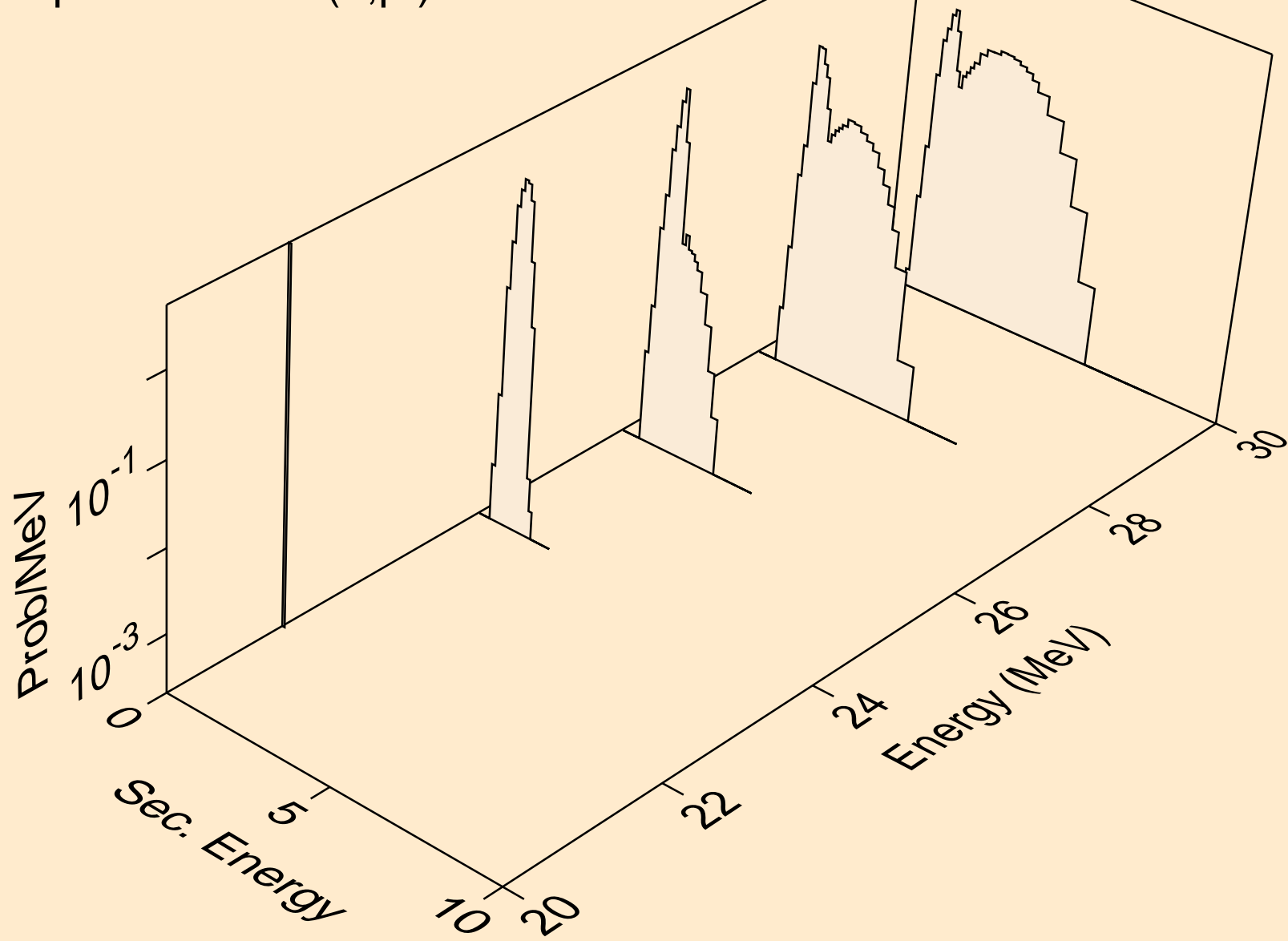

CR052 NEUTRON ACER TENDL-2021 LIBRARY; T=293.6K
deuterons from (n,x)

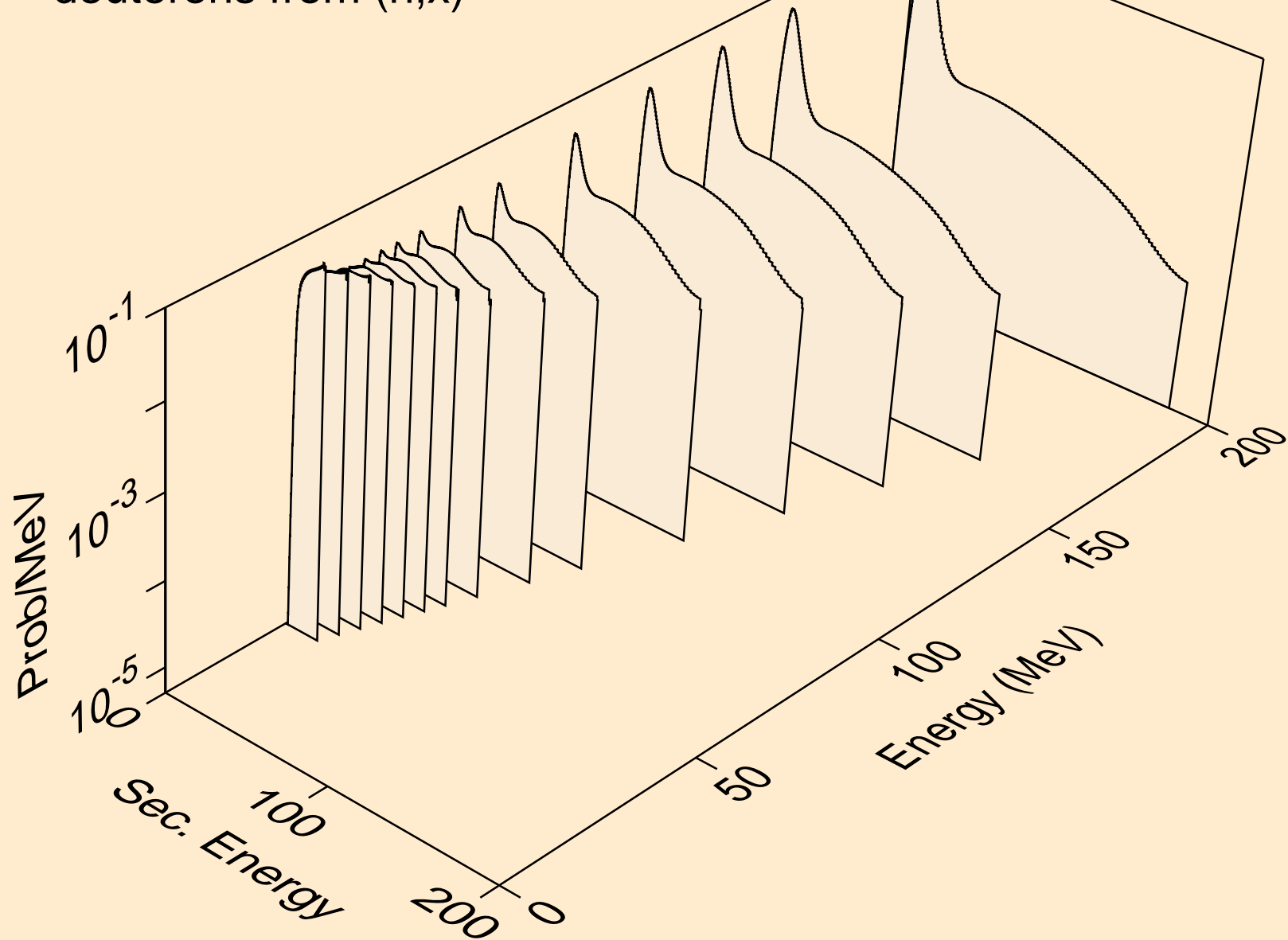

CR052 NEUTRON ACER TENDL-2021 LIBRARY; T=293.6K
deuterons from (n,n*)d

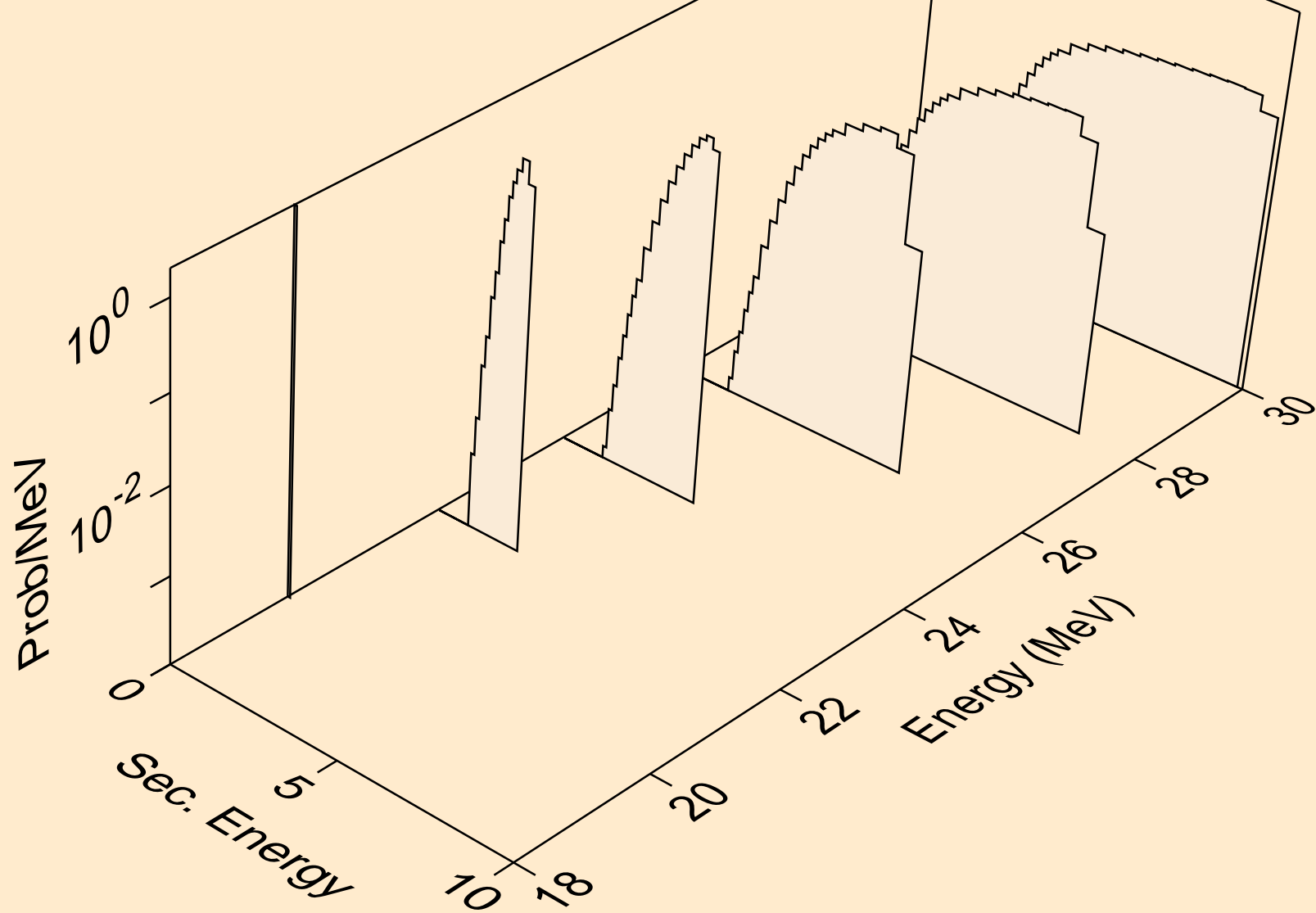

CR052 NEUTRON ACER TENDL-2021 LIBRARY; T=293.6K
deuterons from (n,d)

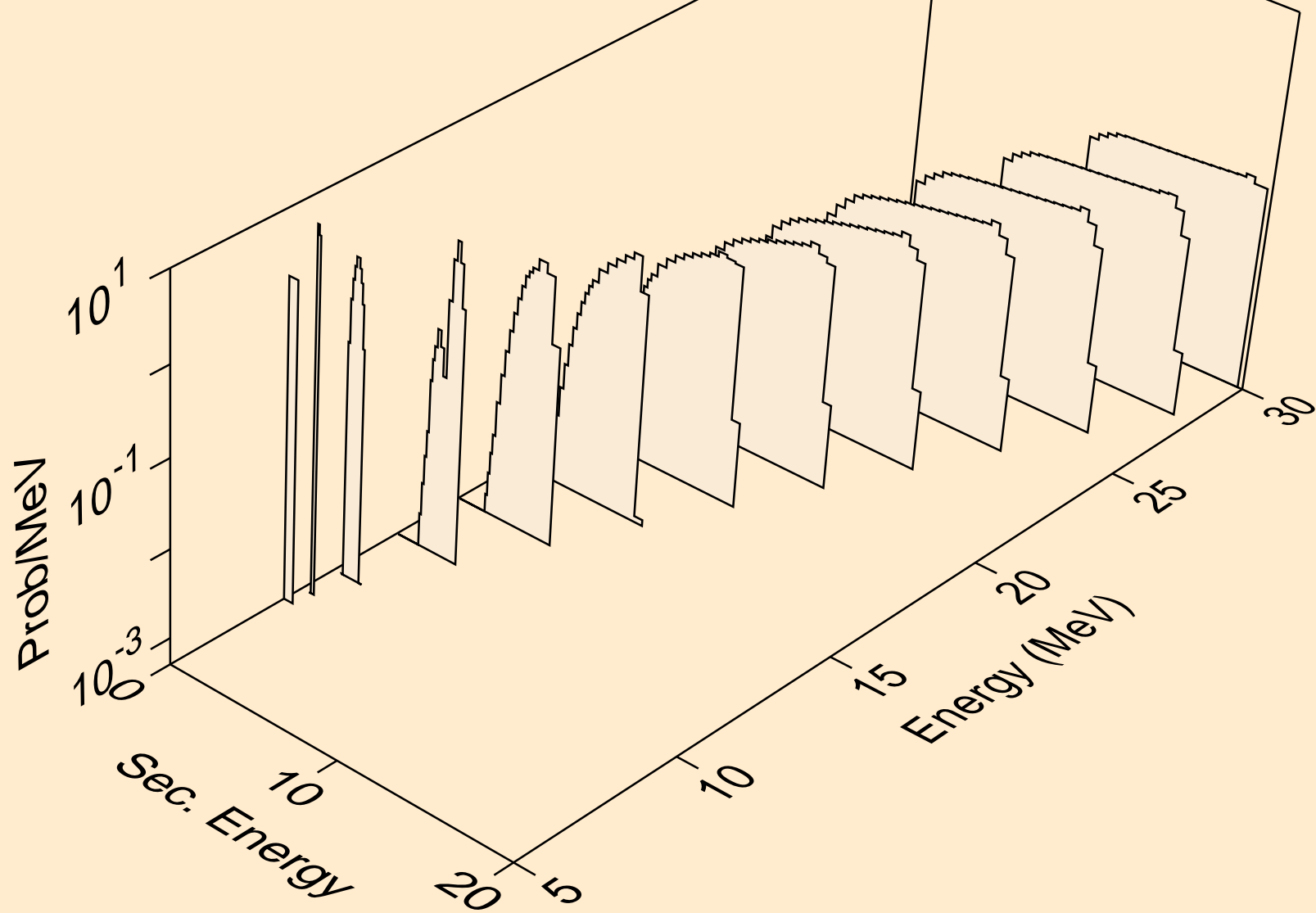

CR052 NEUTRON ACER TENDL-2021 LIBRARY; T=293.6K
deuterons from (n,pd)

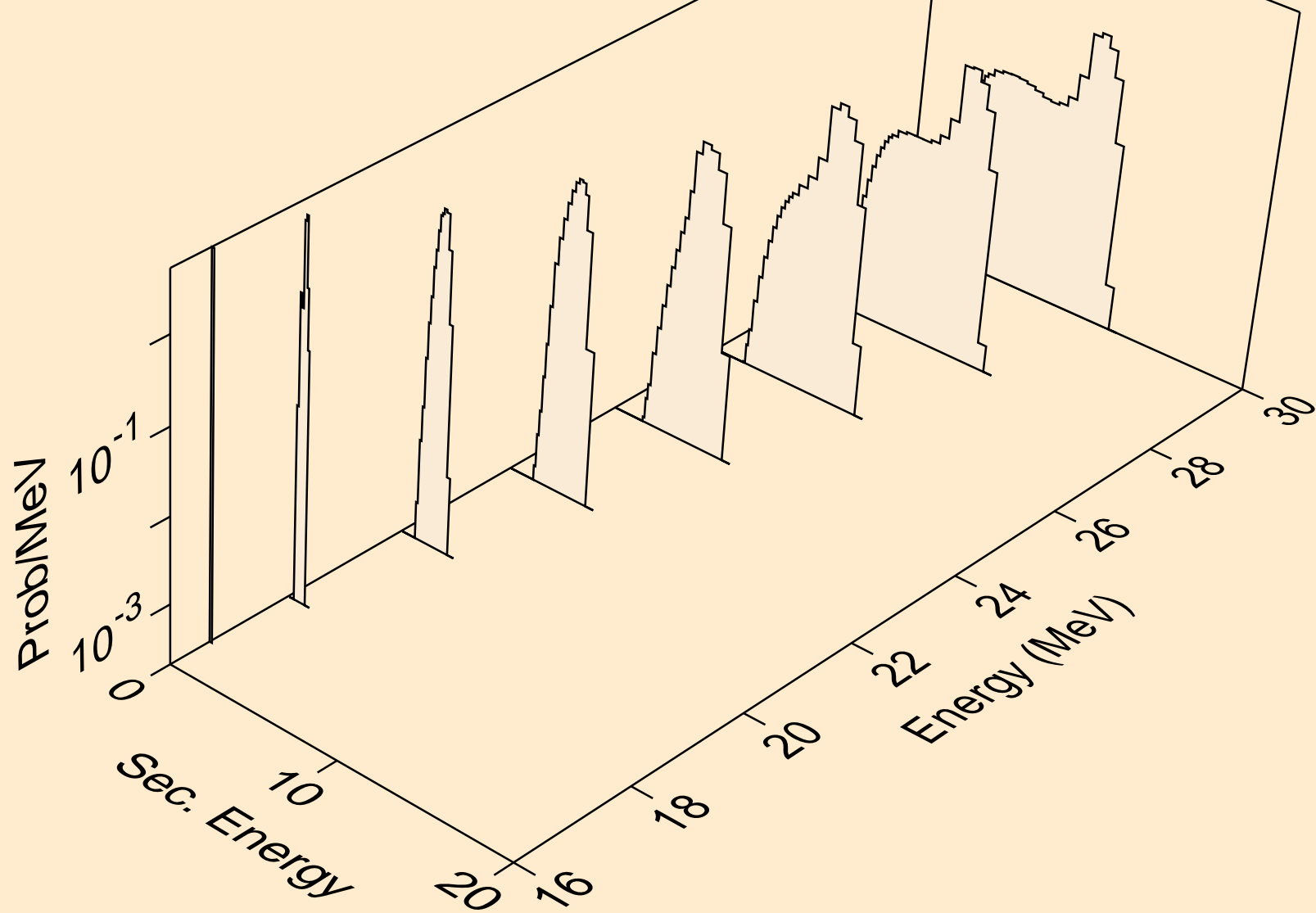

CR052 NEUTRON ACER TENDL-2021 LIBRARY; T=293.6K
deuterons from (n,da)

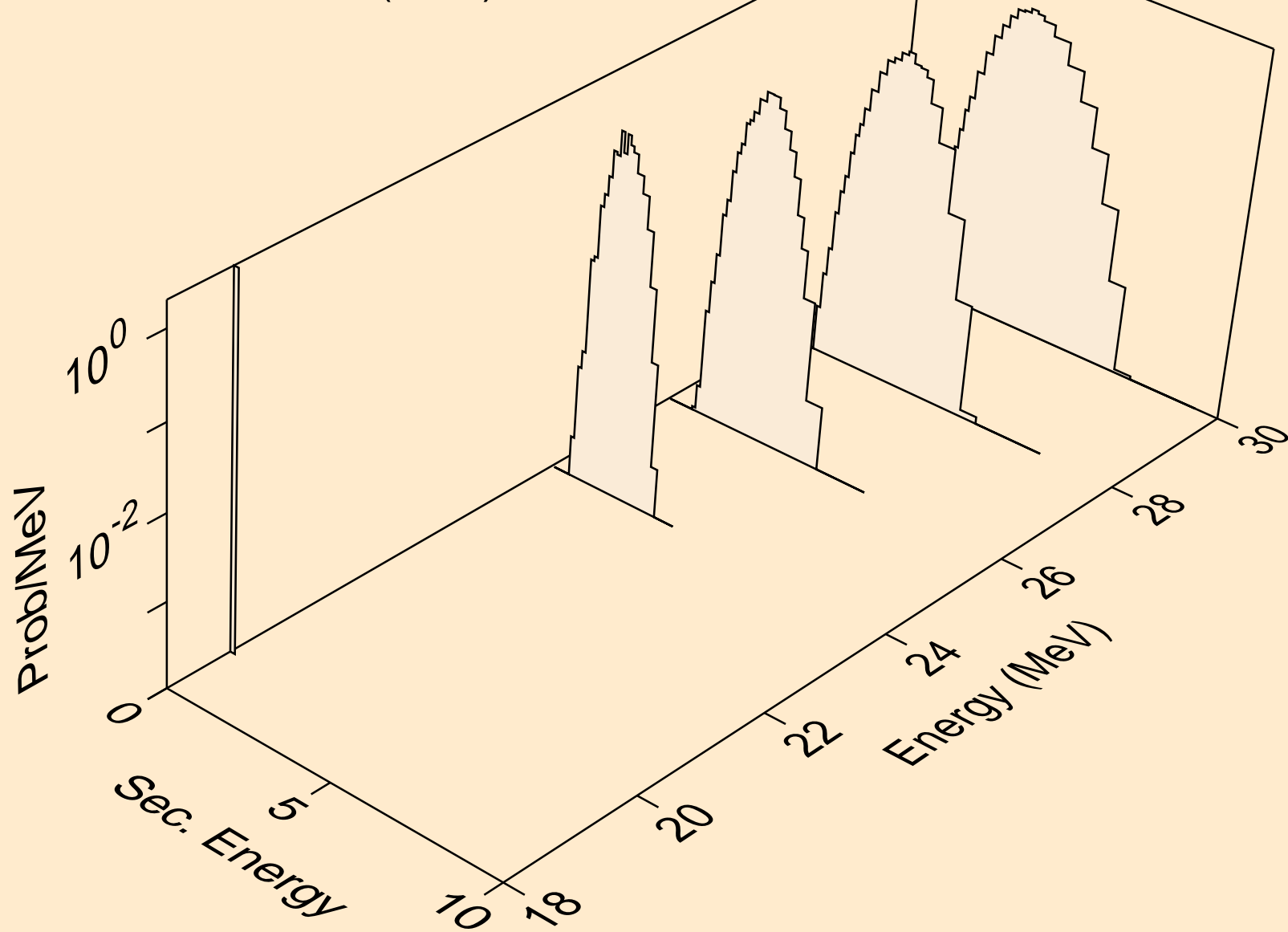

CR052 NEUTRON ACER TENDL-2021 LIBRARY; T=293.6K
tritons from (n,x)

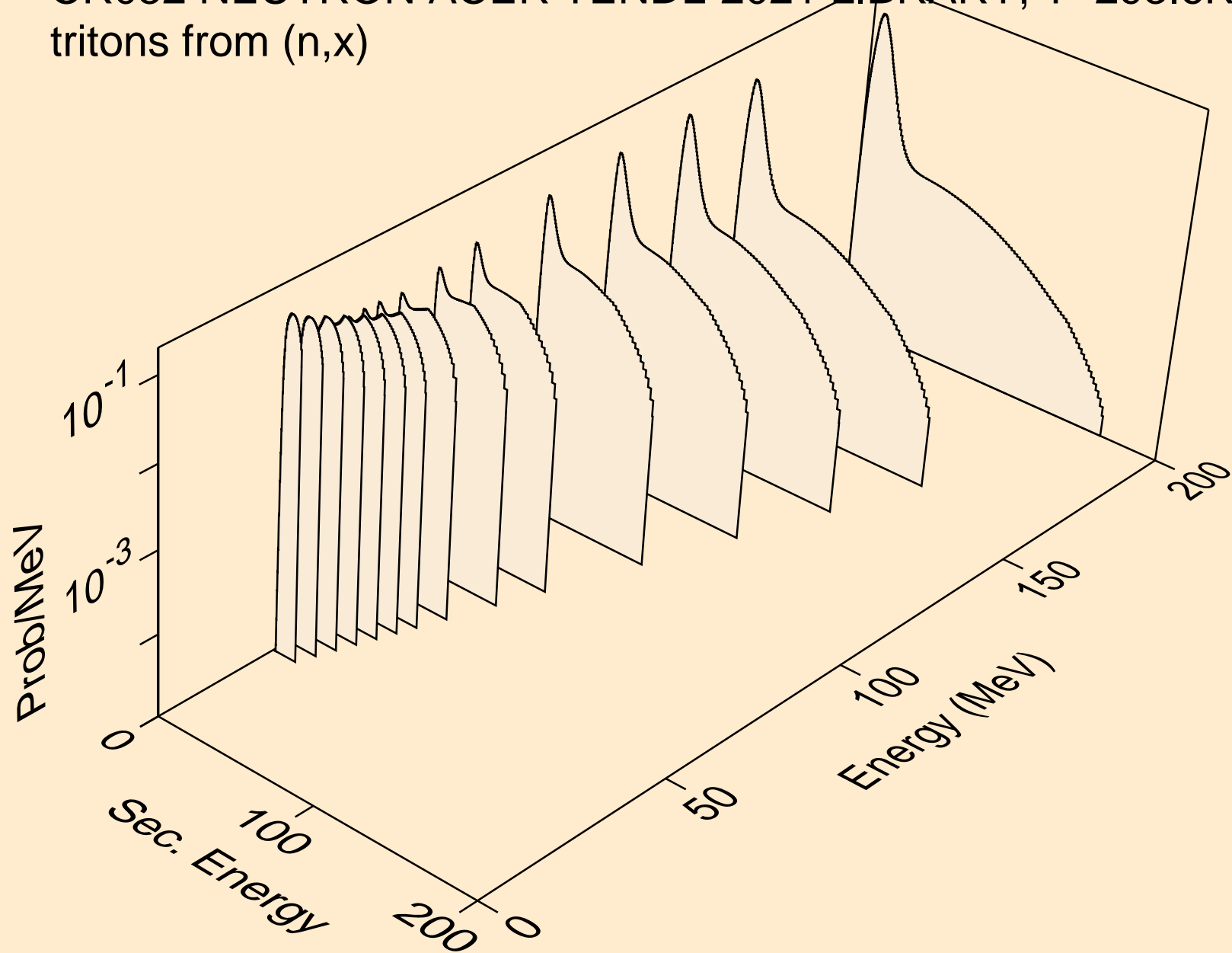

CR052 NEUTRON ACER TENDL-2021 LIBRARY; T=293.6K
tritons from (n,n*)t

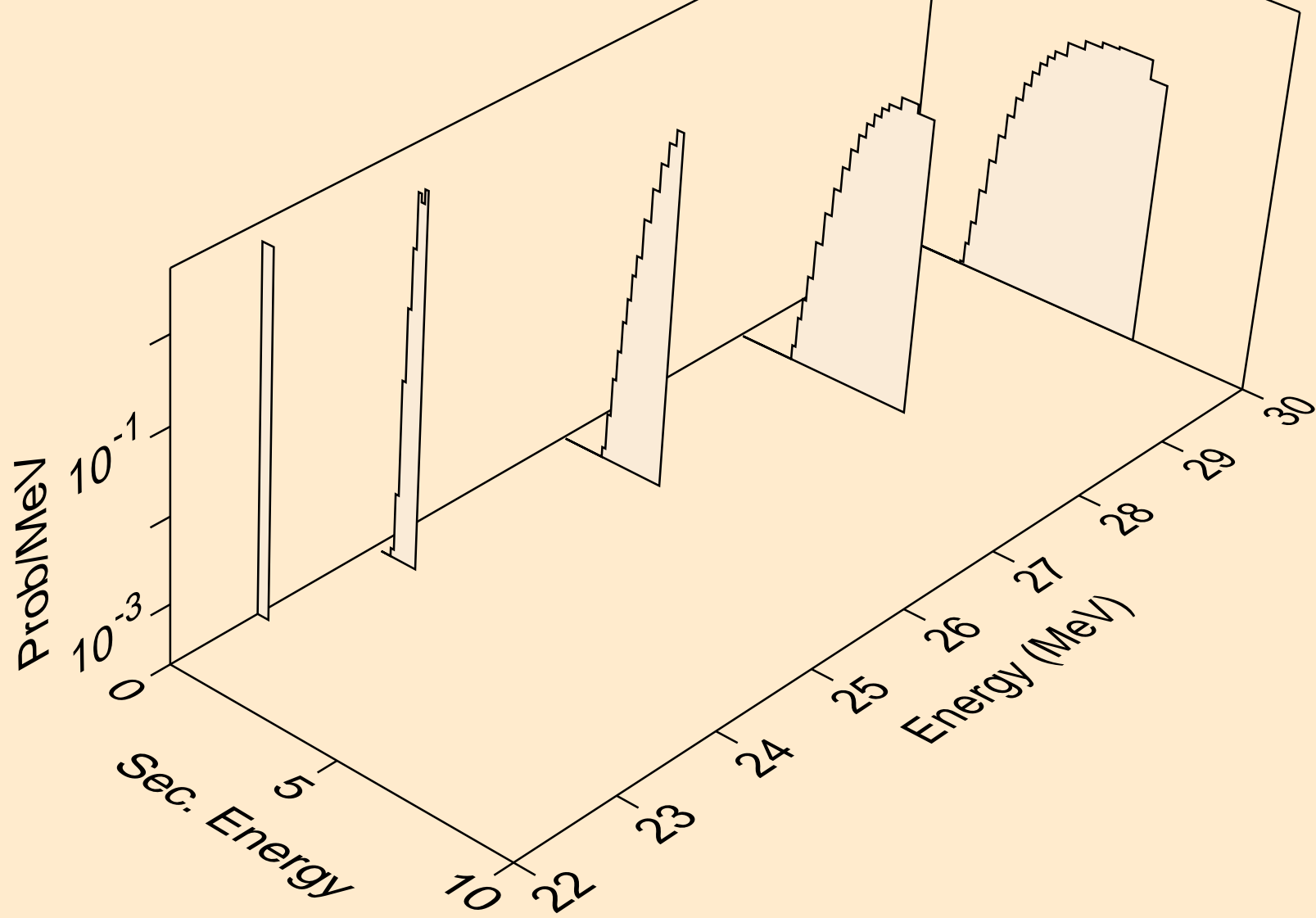

CR052 NEUTRON ACER TENDL-2021 LIBRARY; T=293.6K
tritons from (n,t)

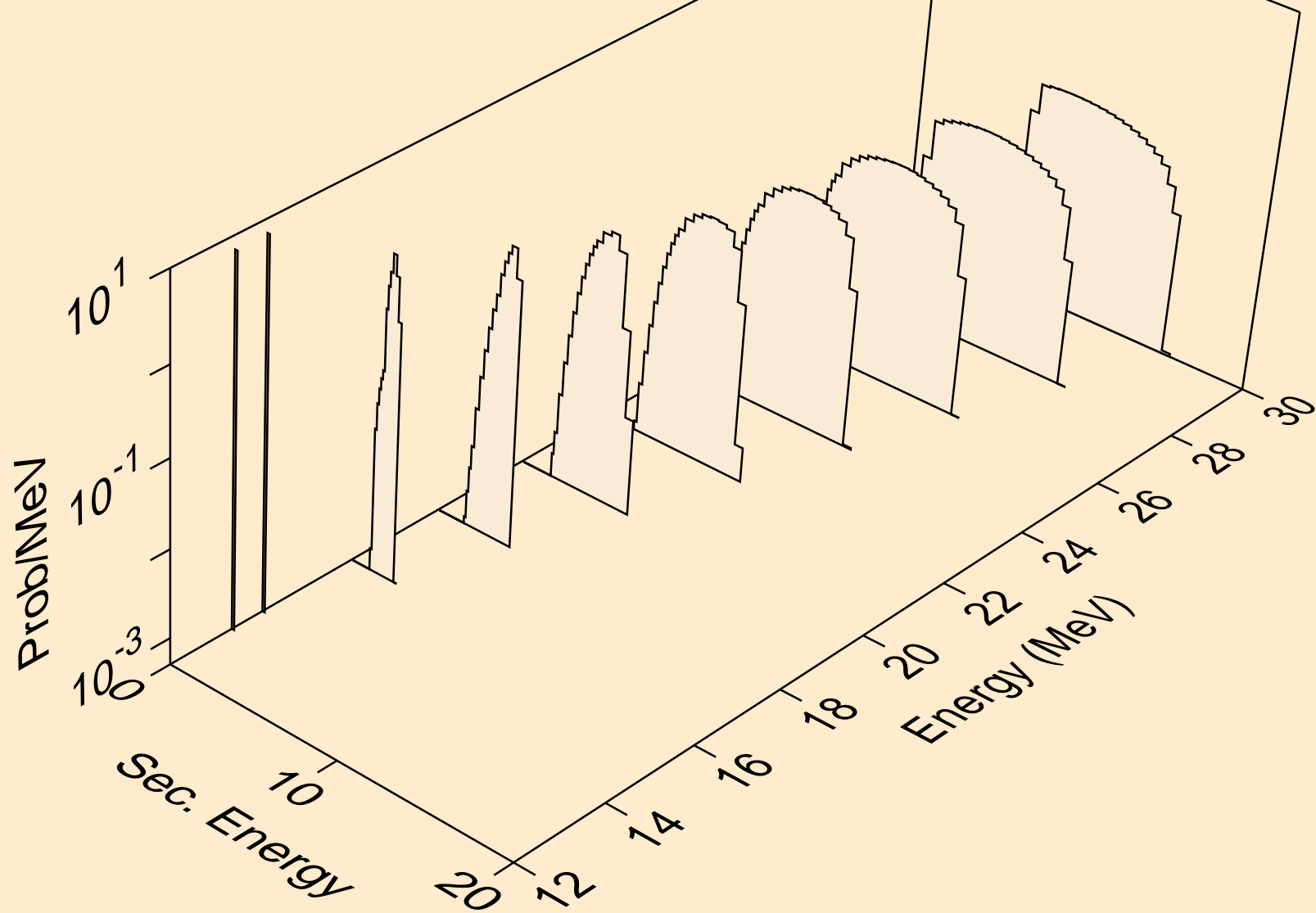

CR052 NEUTRON ACER TENDL-2021 LIBRARY; T=293.6K
tritons from (n,pt)

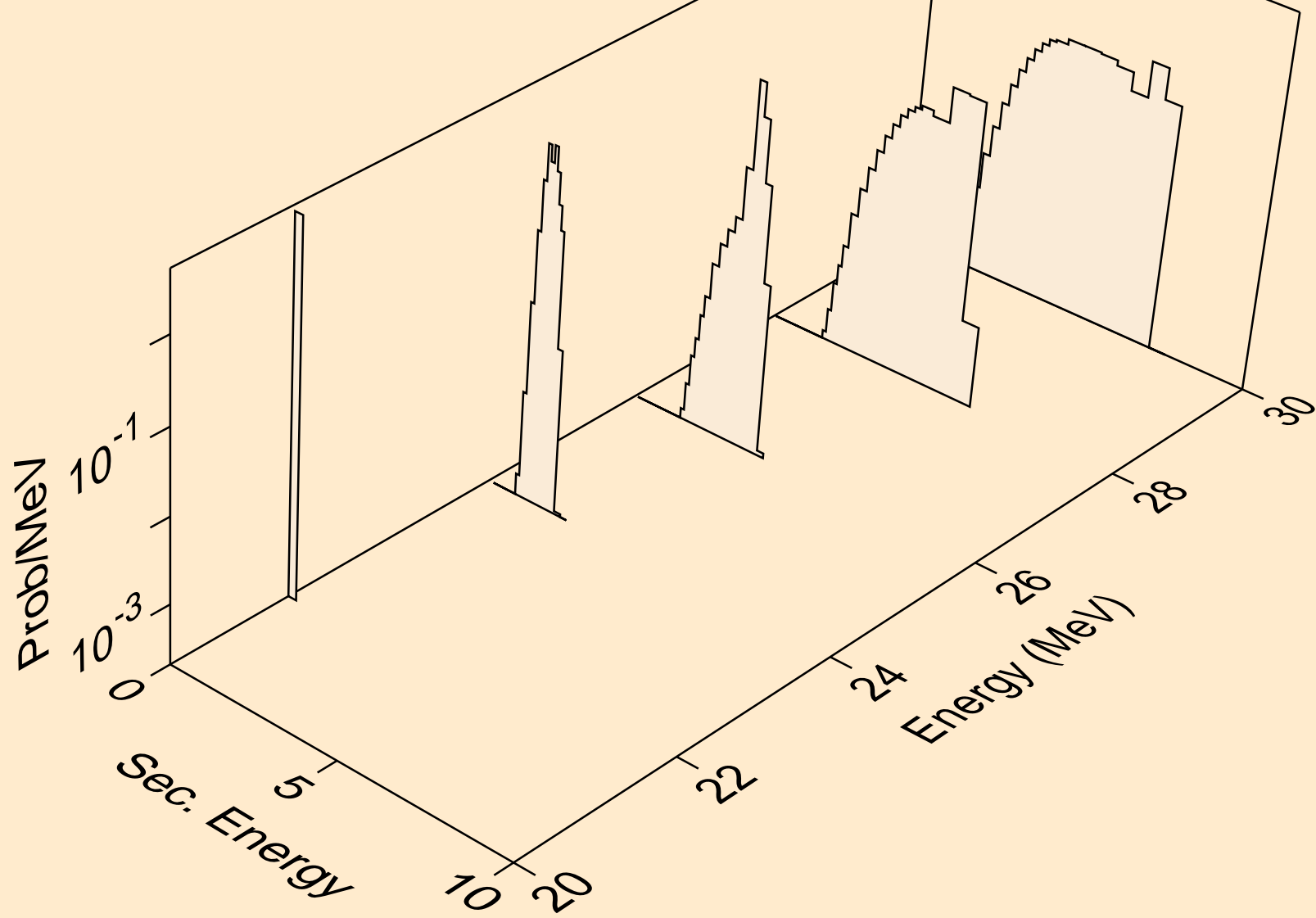

CR052 NEUTRON ACER TENDL-2021 LIBRARY; T=293.6K
he3s from (n,x)

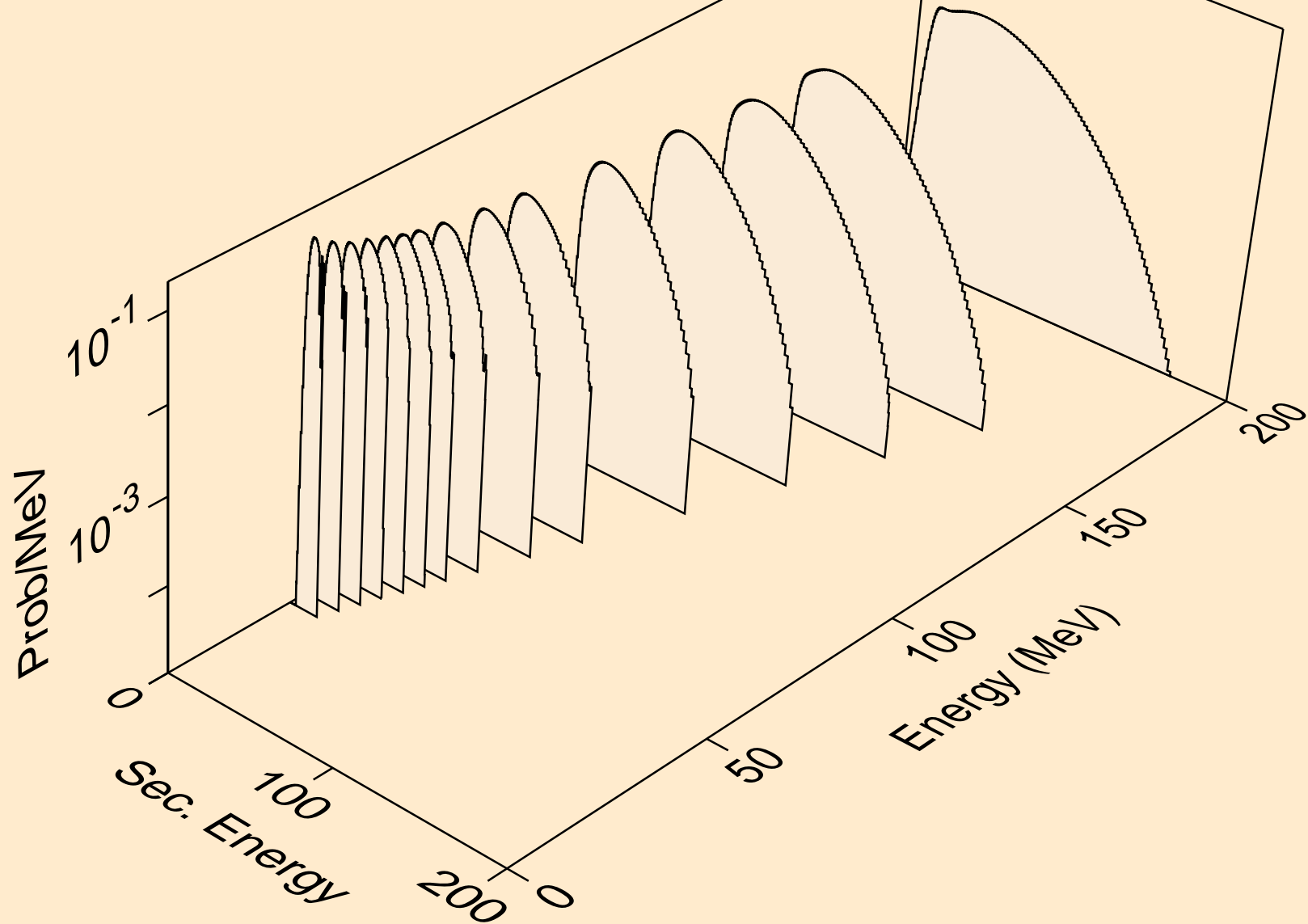

CR052 NEUTRON ACER TENDL-2021 LIBRARY; T=293.6K
he3s from (n,n*)he3

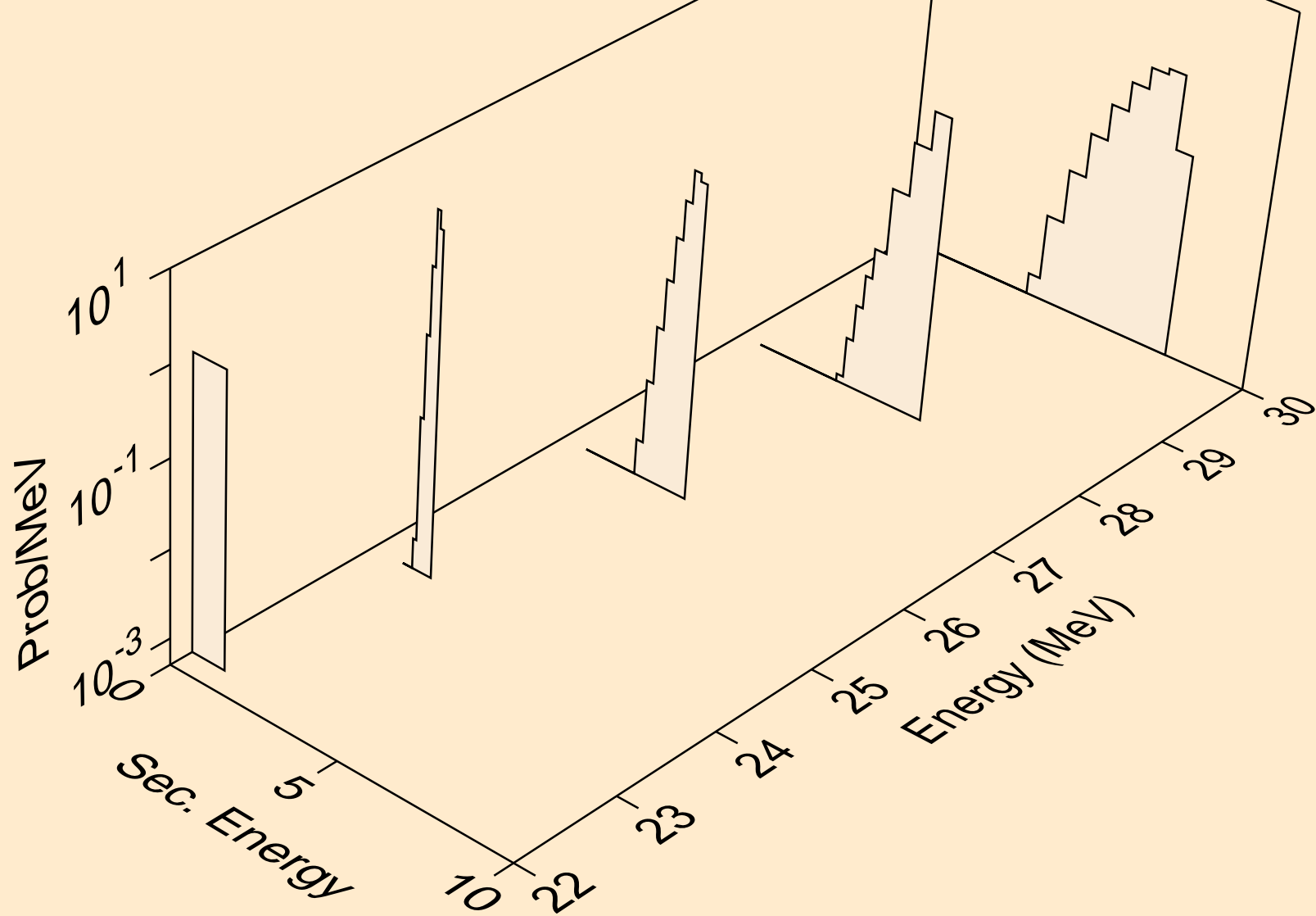

CR052 NEUTRON ACER TENDL-2021 LIBRARY; T=293.6K
he3s from (n,he3)

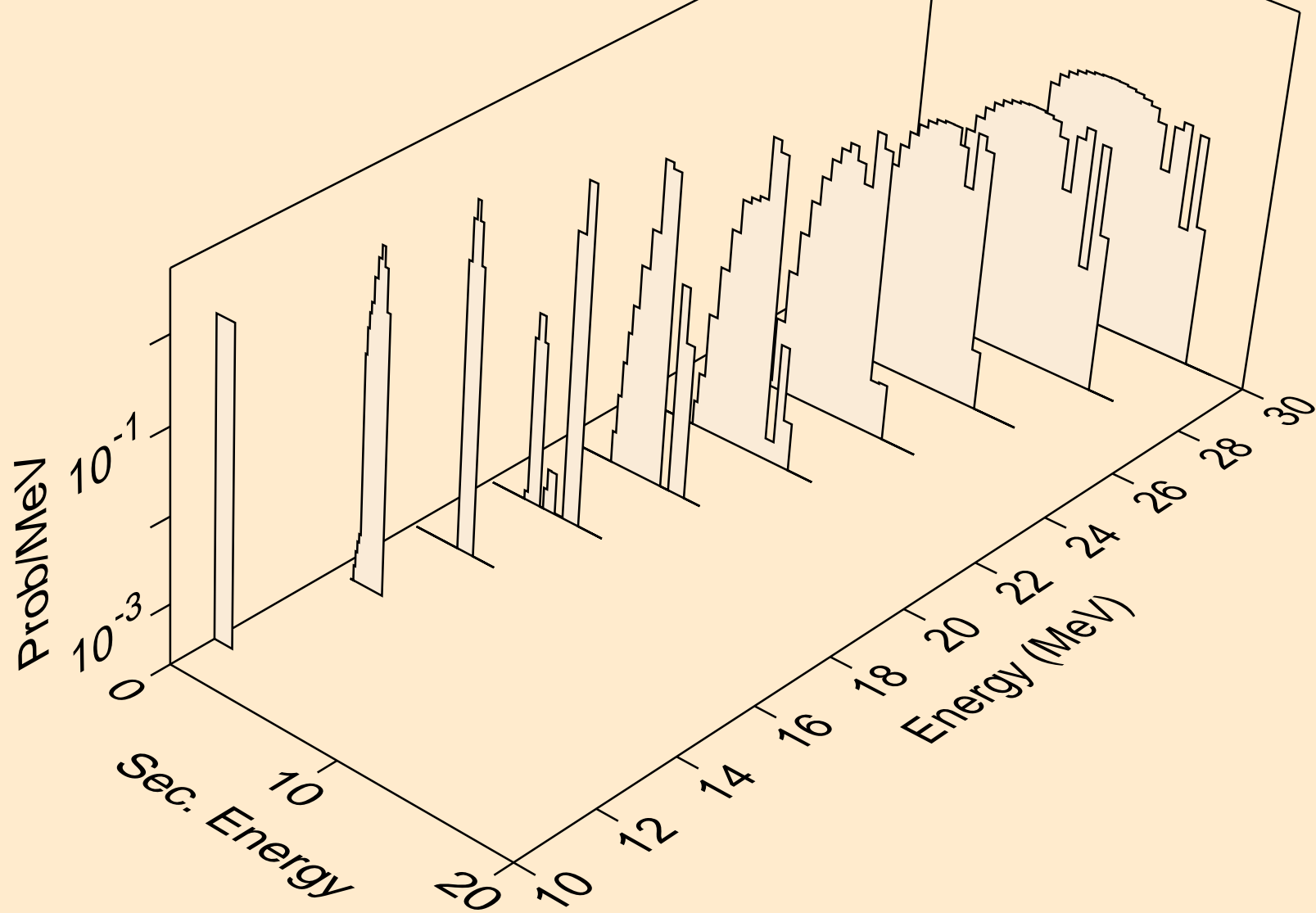

CR052 NEUTRON ACER TENDL-2021 LIBRARY; T=293.6K
alphas from (n,x)

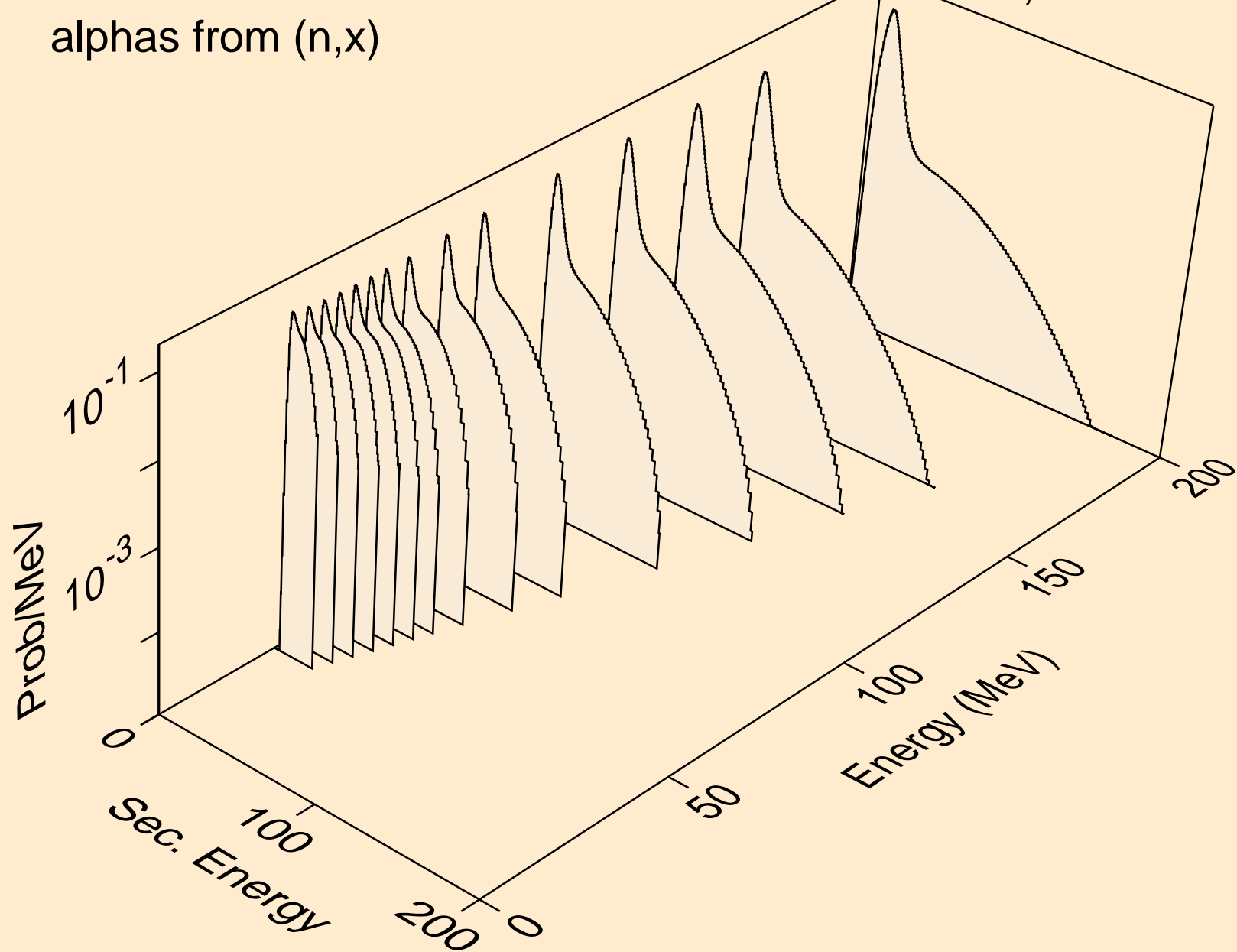

CR052 NEUTRON ACER TENDL-2021 LIBRARY; T=293.6K
alphas from (n,n*)a

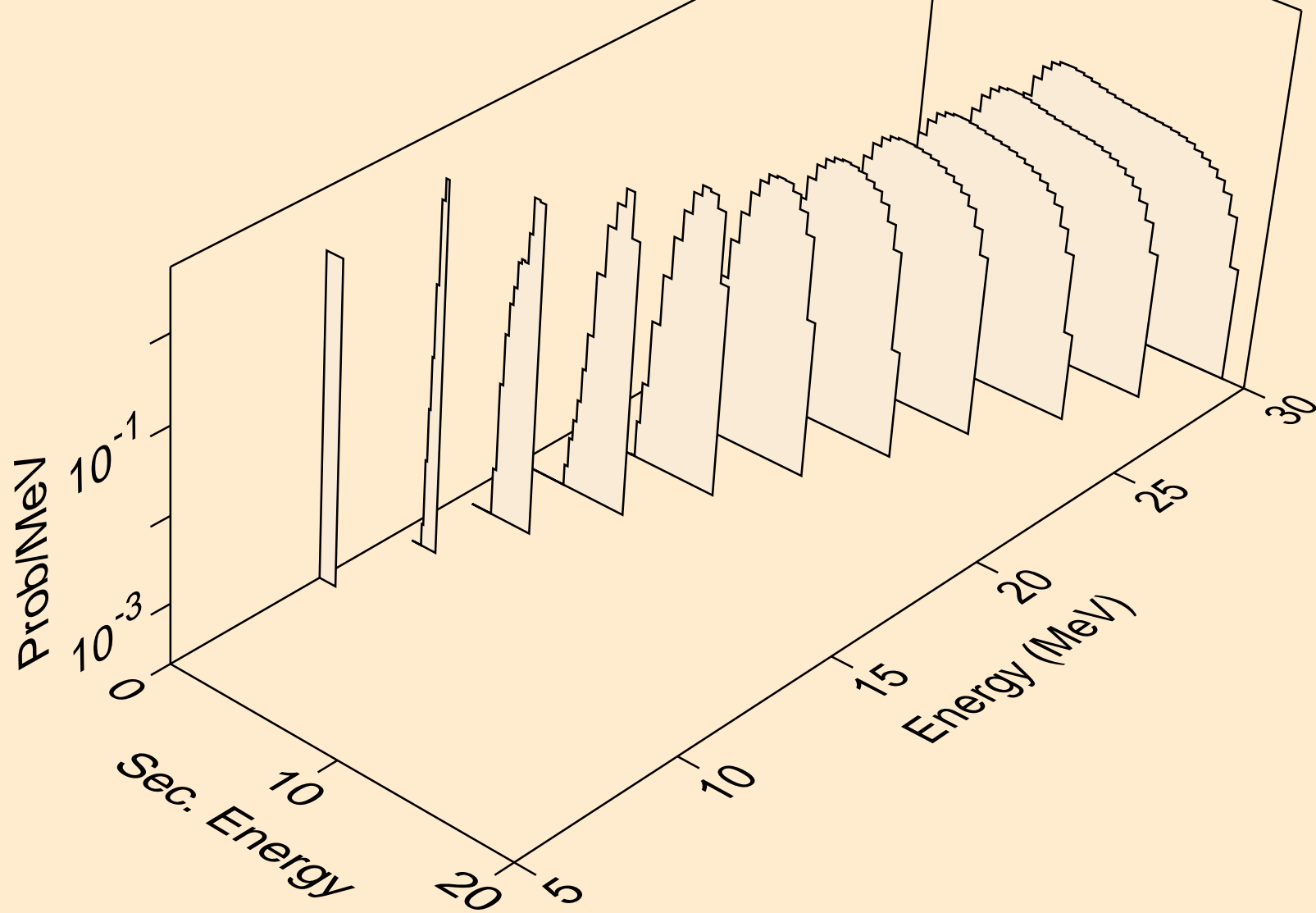

CR052 NEUTRON ACER TENDL-2021 LIBRARY; T=293.6K
alphas from (n,2n)a

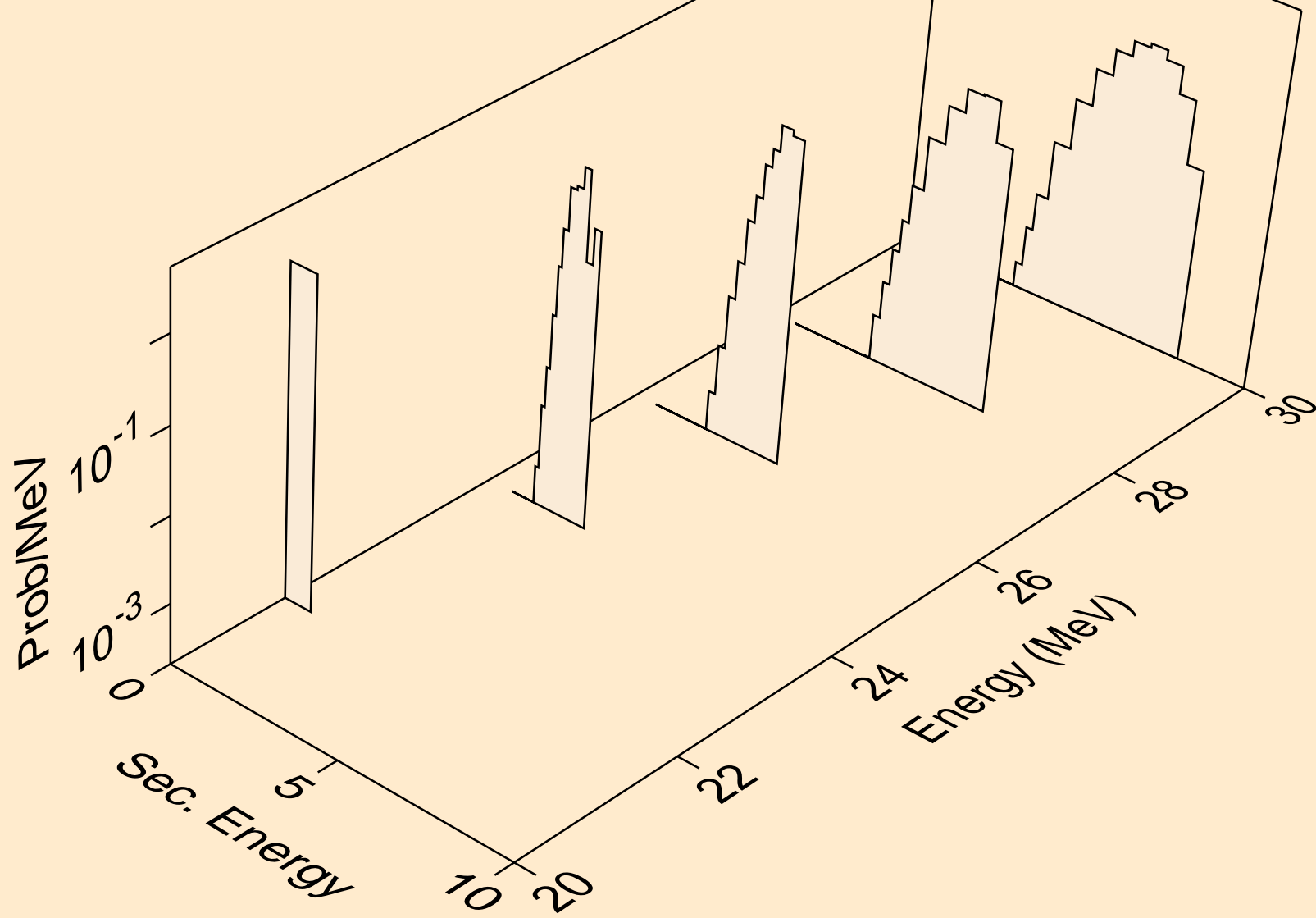

CR052 NEUTRON ACER TENDL-2021 LIBRARY; T=293.6K
alphas from (n,n*)2a

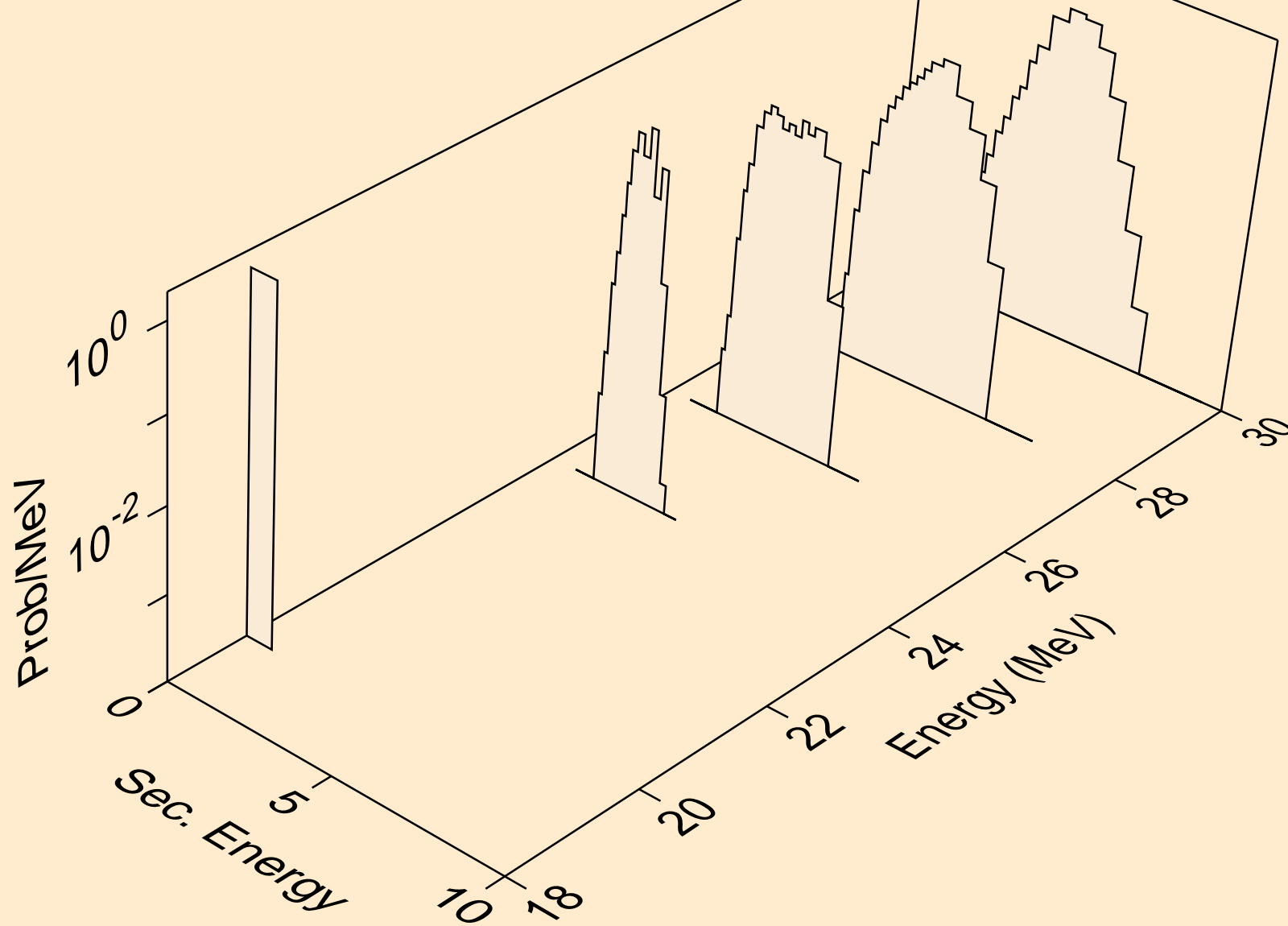

CR052 NEUTRON ACER TENDL-2021 LIBRARY; T=293.6K
alphas from (n,npa)

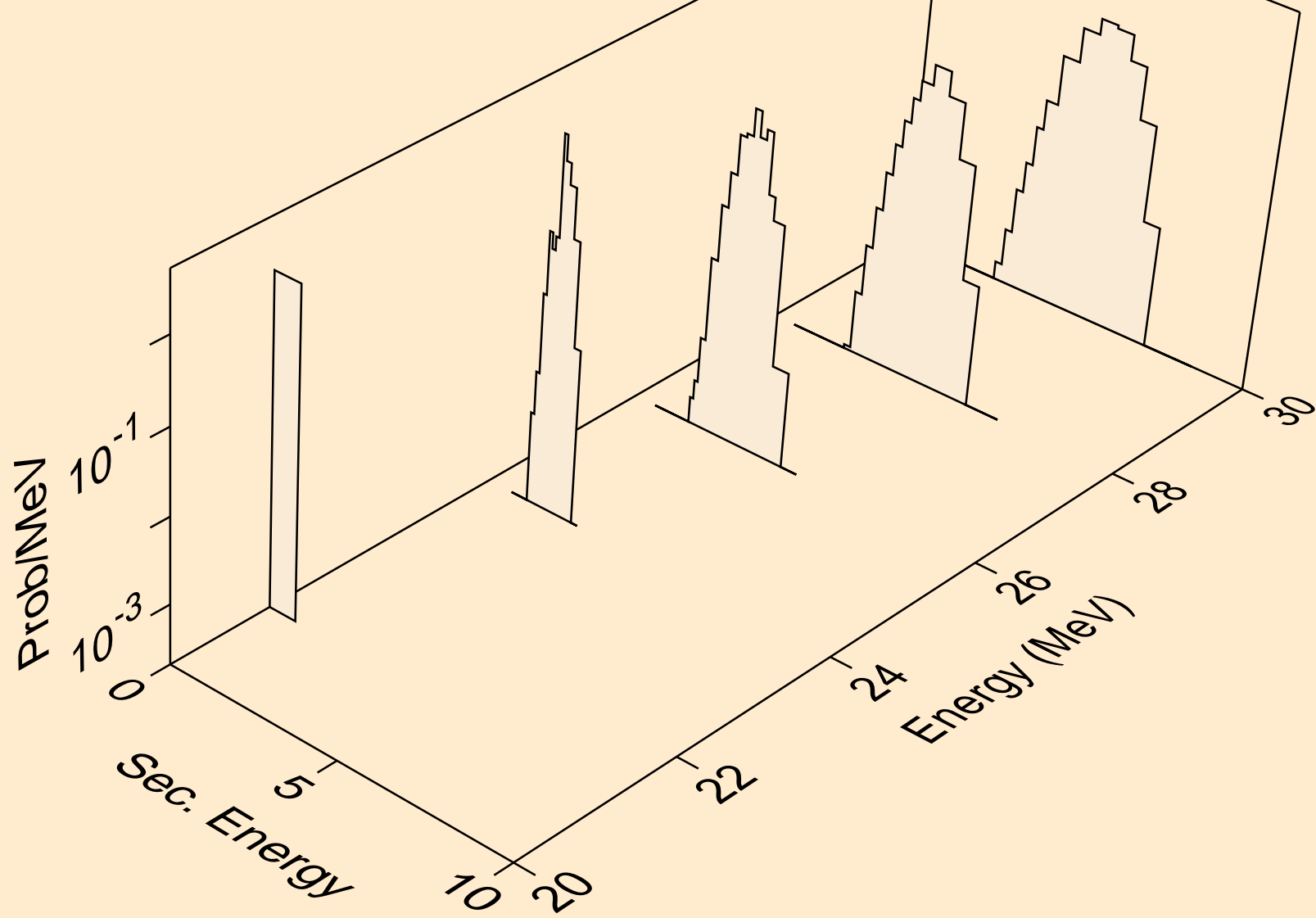

CR052 NEUTRON ACER TENDL-2021 LIBRARY; T=293.6K
alphas from (n,a)

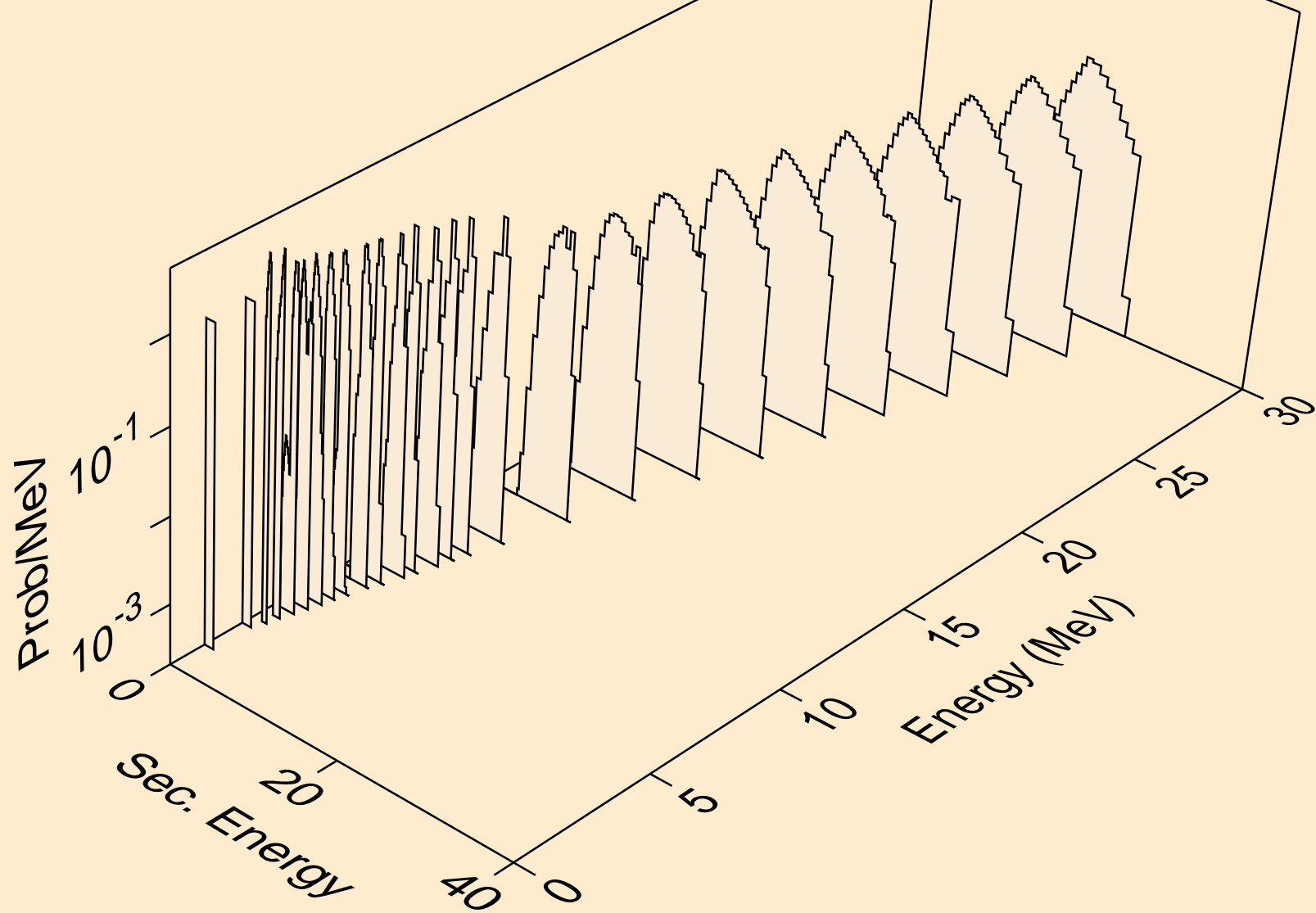

CR052 NEUTRON ACER TENDL-2021 LIBRARY; T=293.6K
alphas from (n,2a)

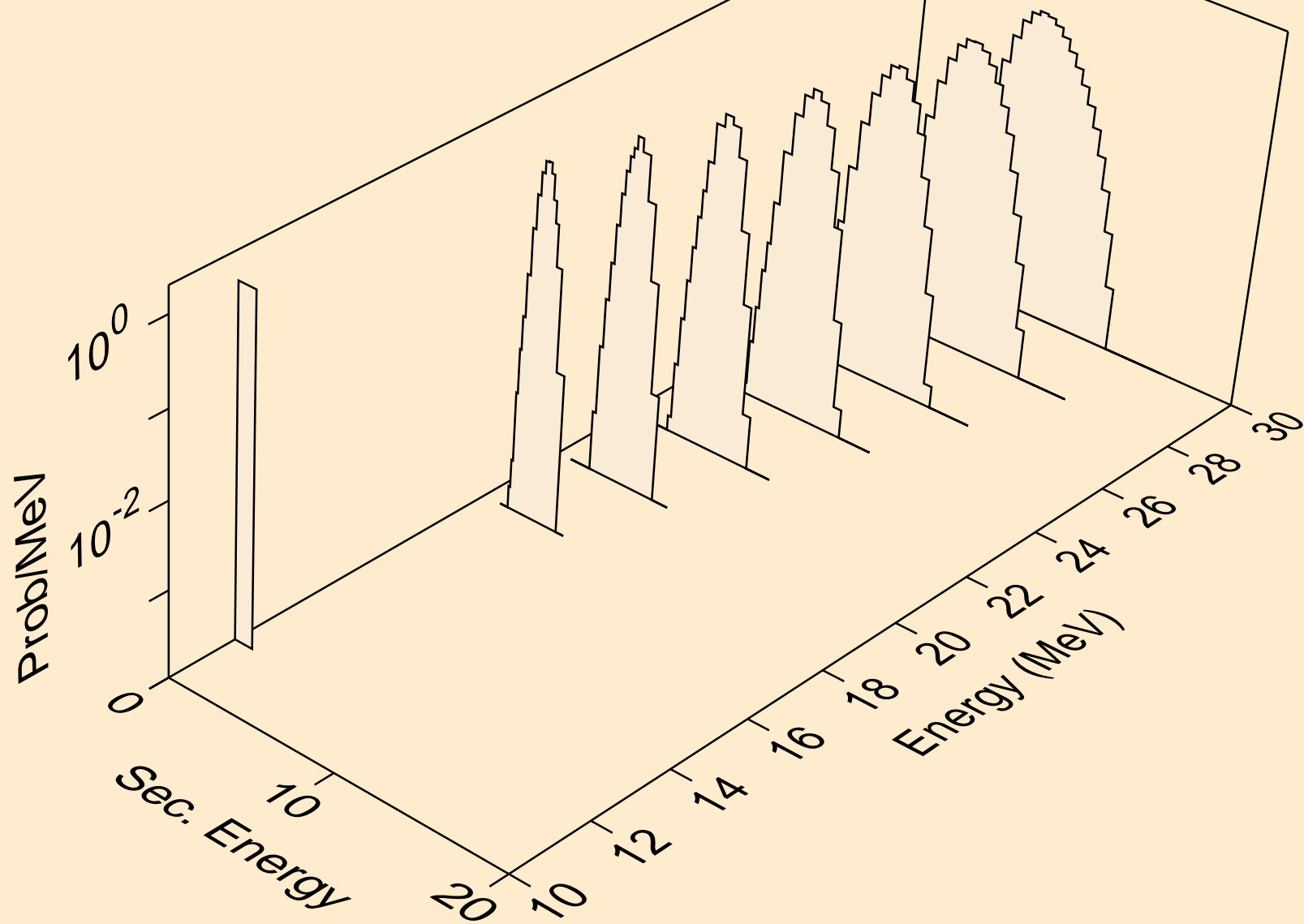

CR052 NEUTRON ACER TENDL-2021 LIBRARY; T=293.6K
alphas from (n,pa)

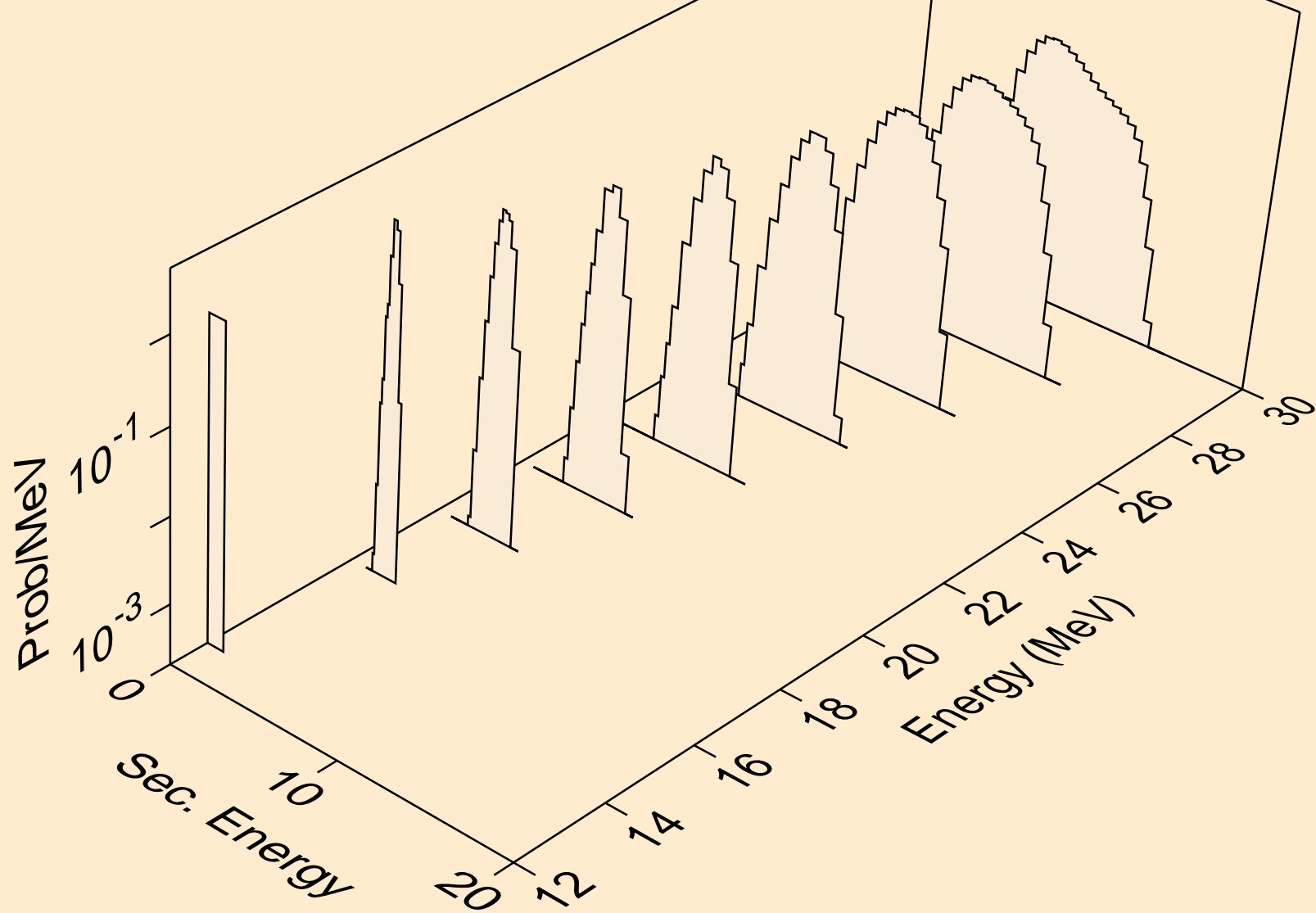

CR052 NEUTRON ACER TENDL-2021 LIBRARY; T=293.6K
alphas from (n,da)

