

# CS116M NEUTRON ACER TENDL-2021 LIBRARY; T=293.6K

## Principal cross sections

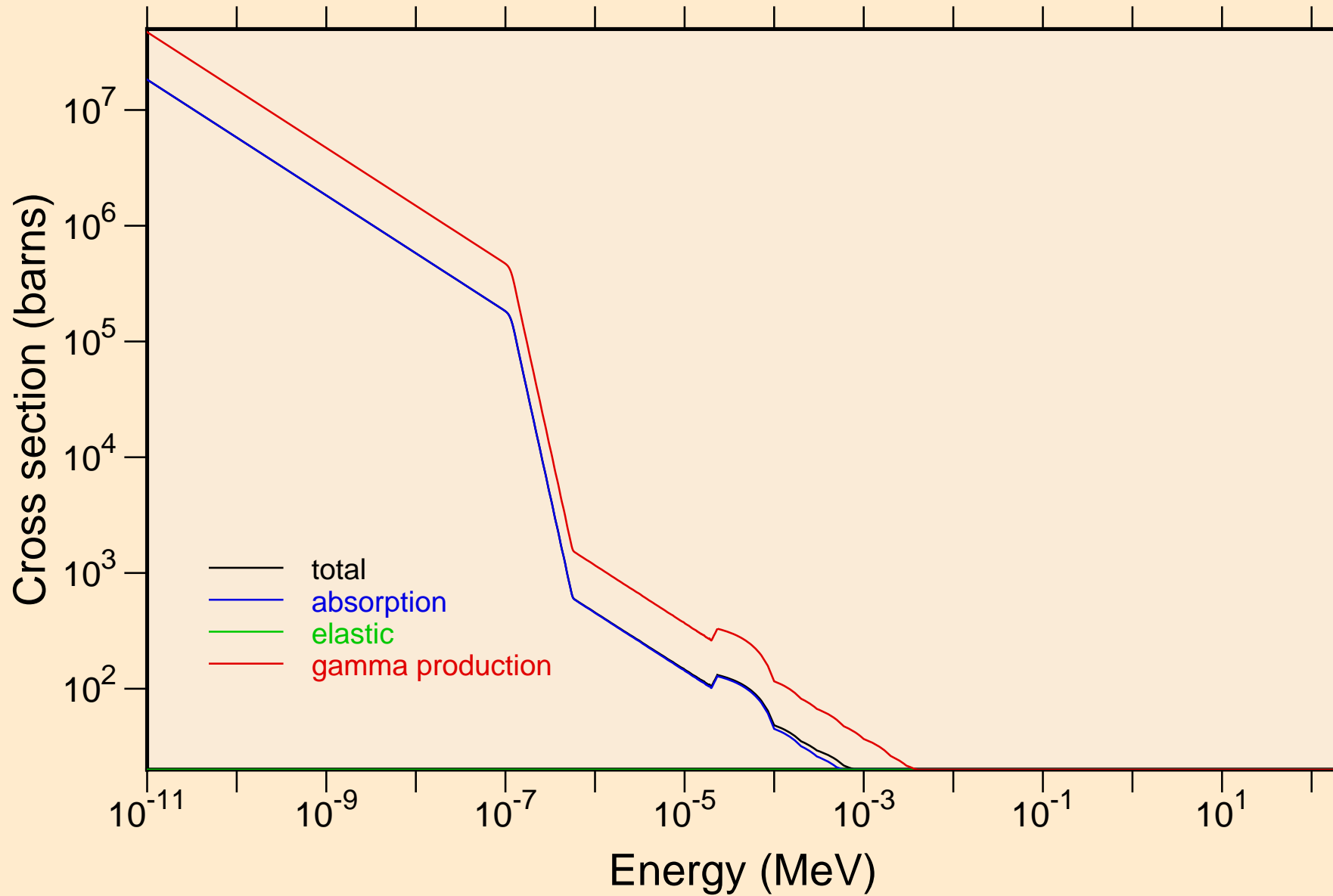

CS116M NEUTRON ACER TENDL-2021 LIBRARY; T=293.6K  
resonance total cross section

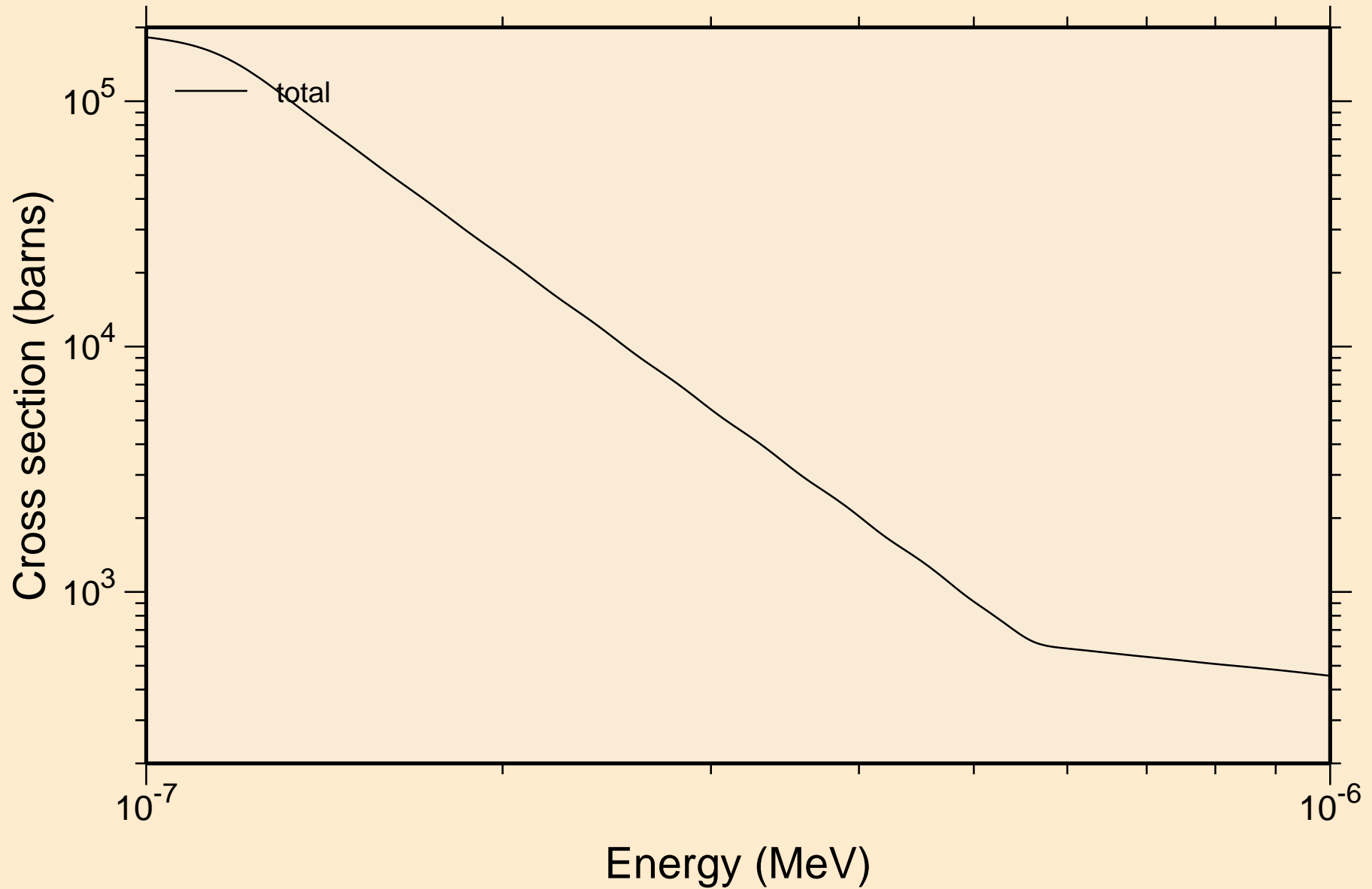

CS116M NEUTRON ACER TENDL-2021 LIBRARY; T=293.6K  
resonance total cross section

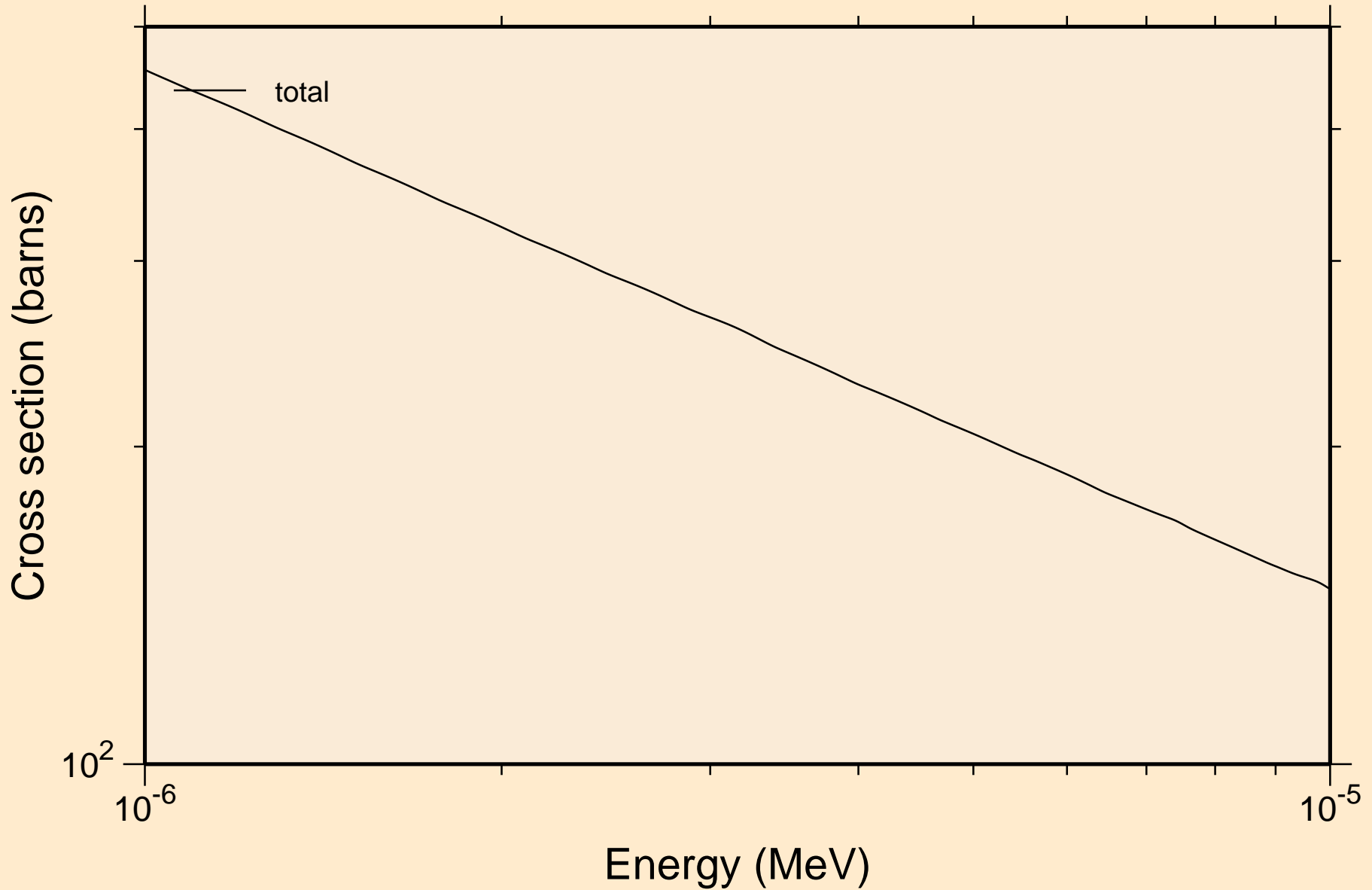

CS116M NEUTRON ACER TENDL-2021 LIBRARY; T=293.6K  
resonance total cross section

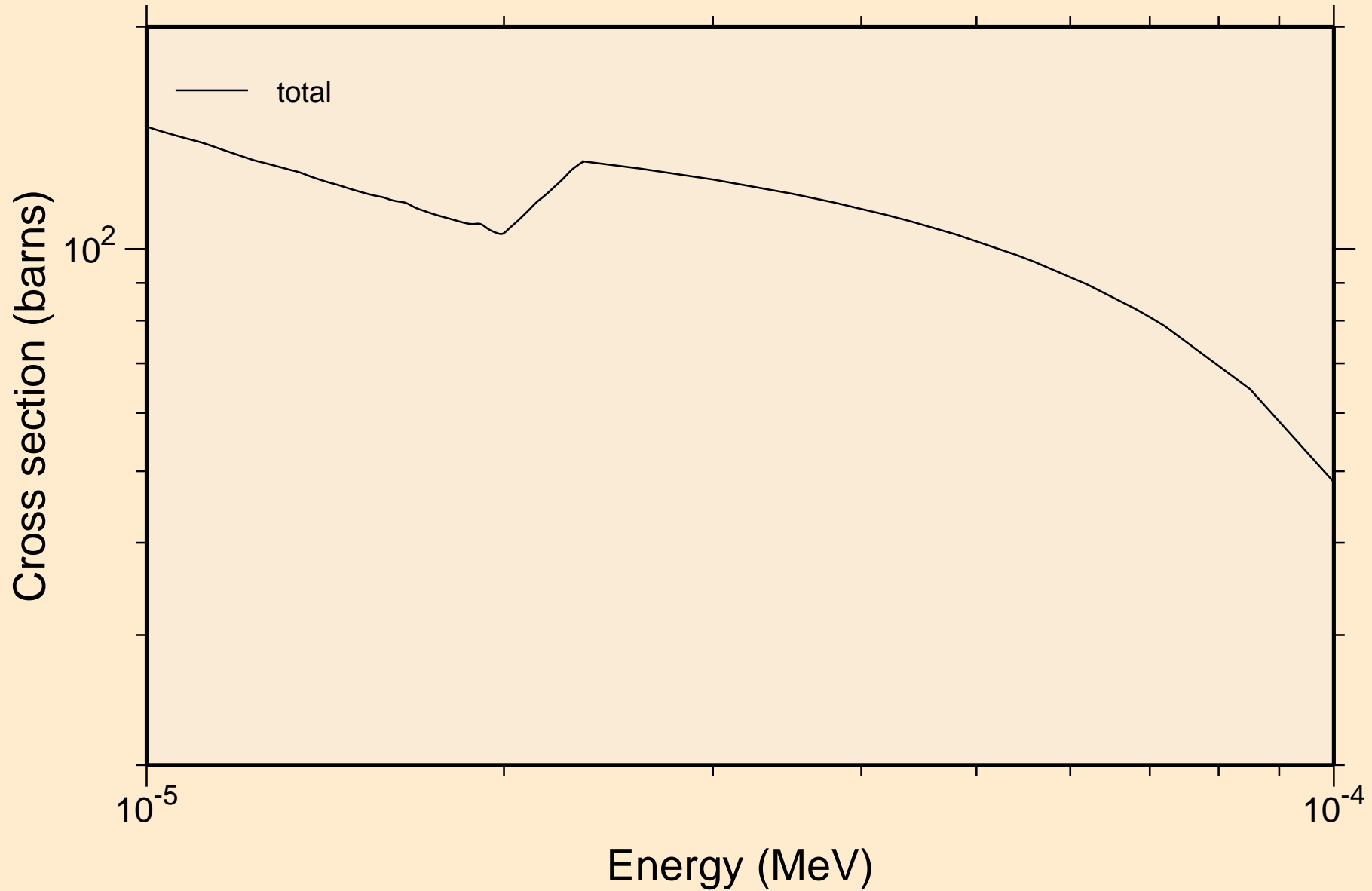

C<sup>116</sup>M NEUTRON ACER TENDL-2021 LIBRARY; T=293.6K  
resonance total cross section

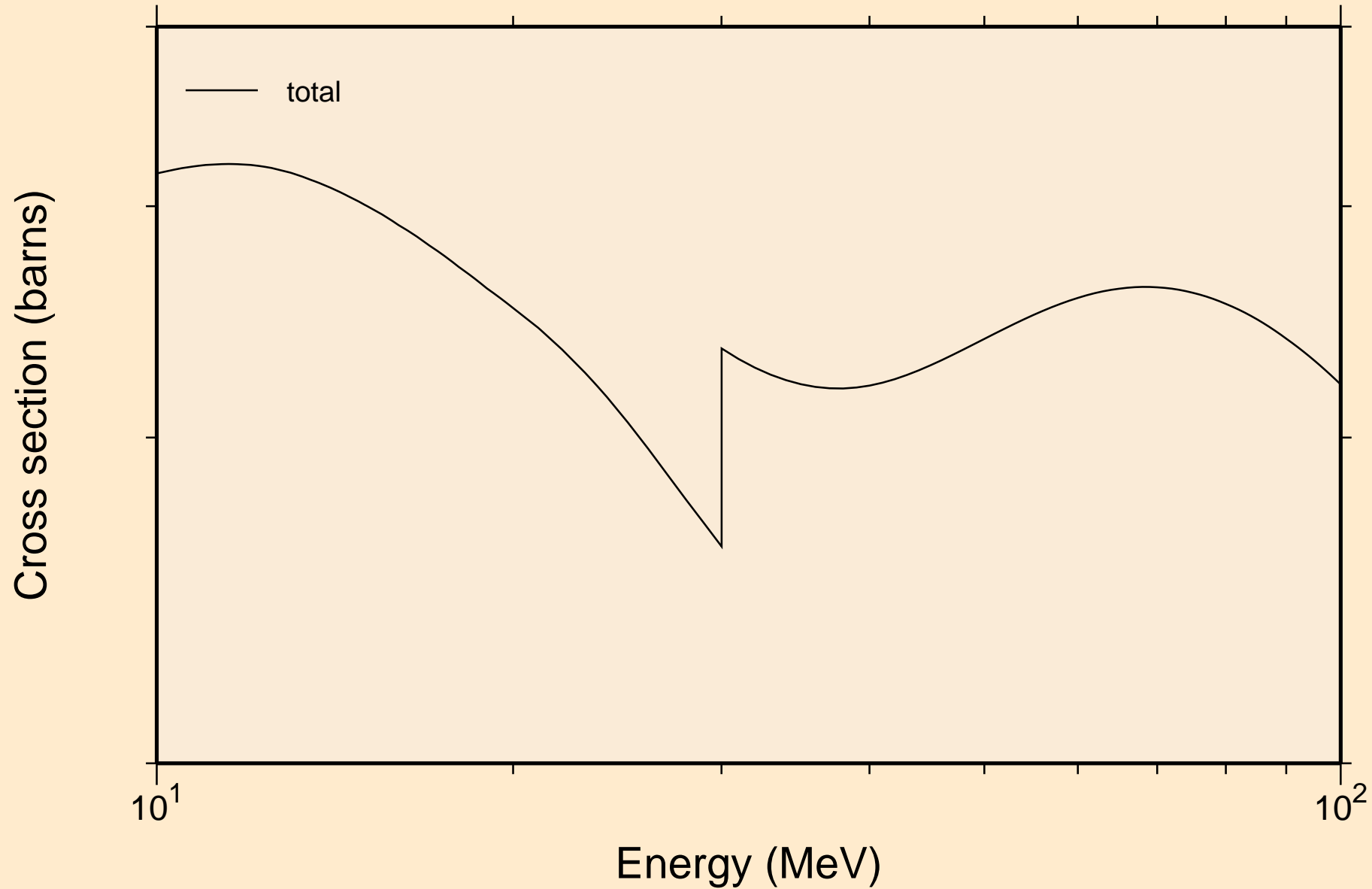

CS116M NEUTRON ACER TENDL-2021 LIBRARY; T=293.6K  
resonance absorption cross sections

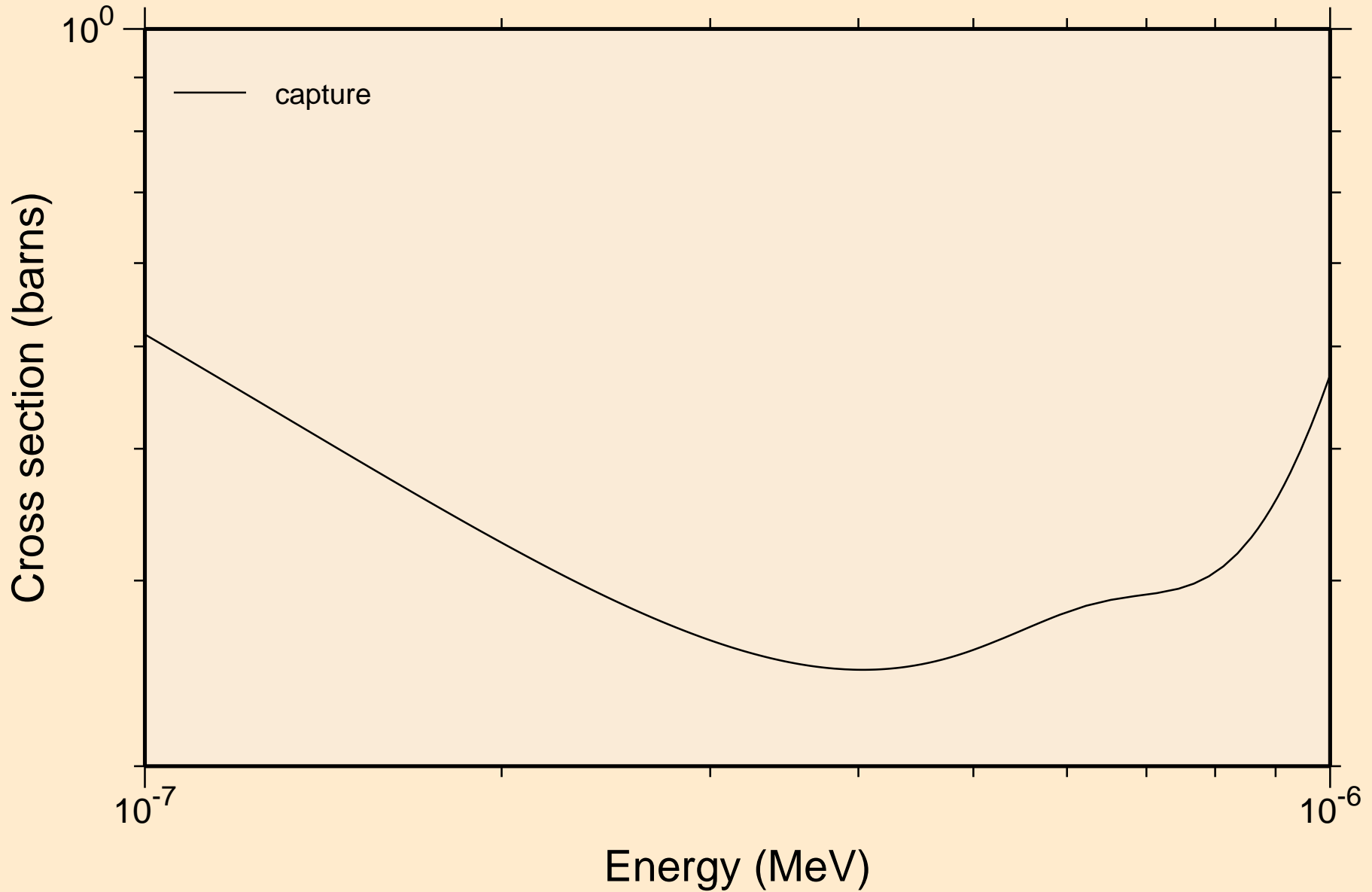

CS116M NEUTRON ACER TENDL-2021 LIBRARY; T=293.6K  
resonance absorption cross sections

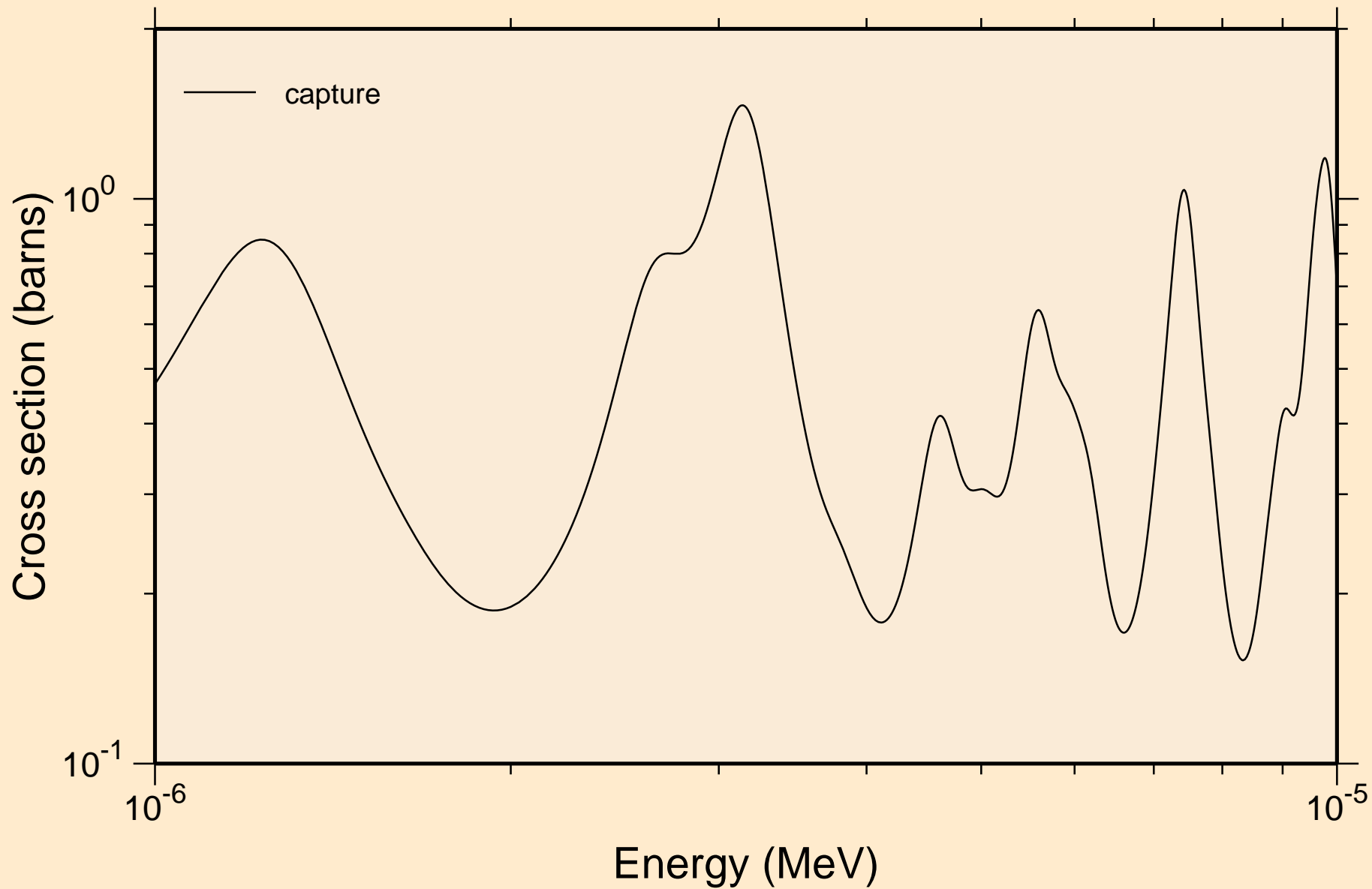

CS116M NEUTRON ACER TENDL-2021 LIBRARY; T=293.6K  
resonance absorption cross sections

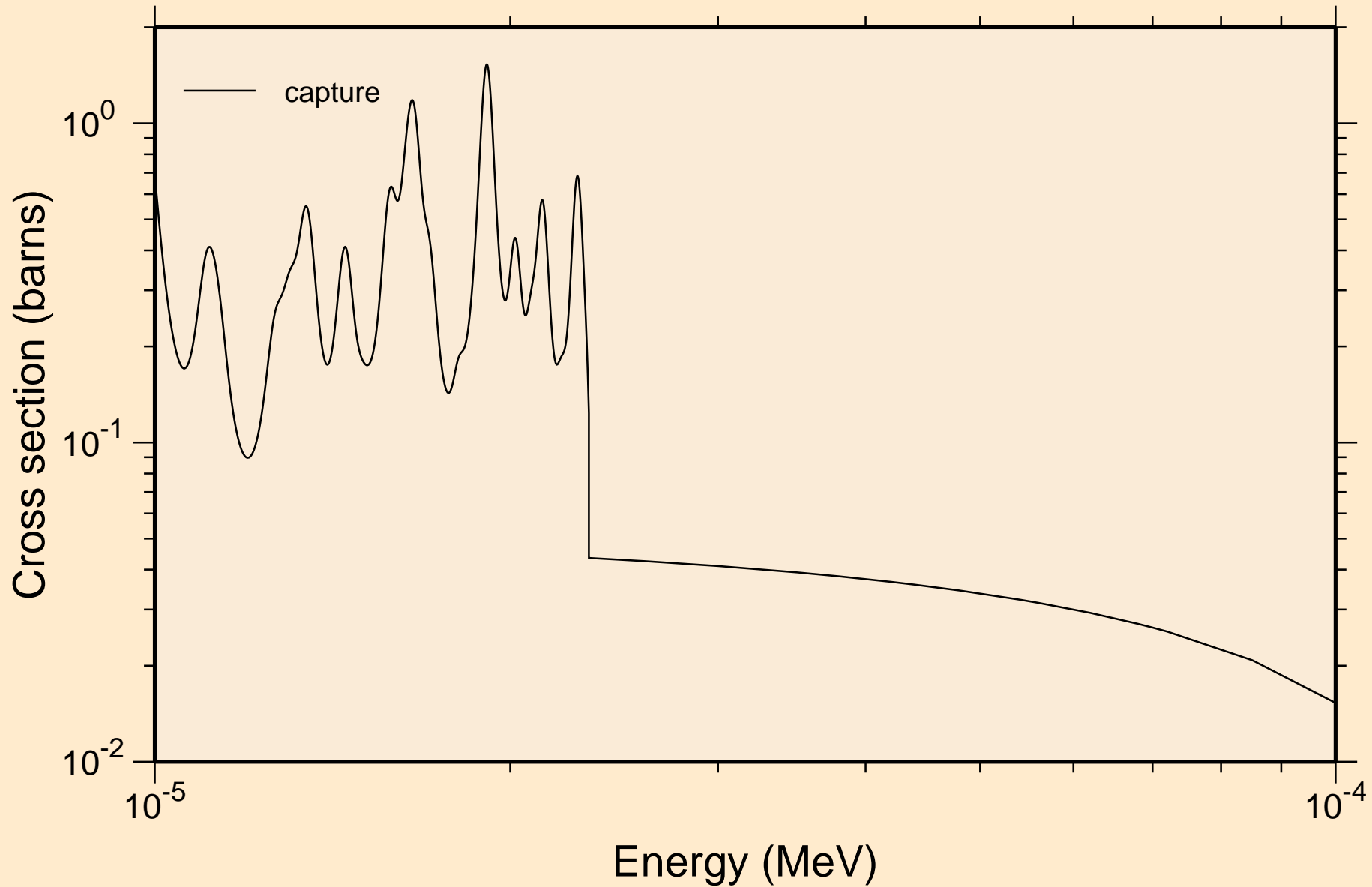



CS116M NEUTRON ACER TENDL-2021 LIBRARY; T=293.6K  
resonance absorption cross sections

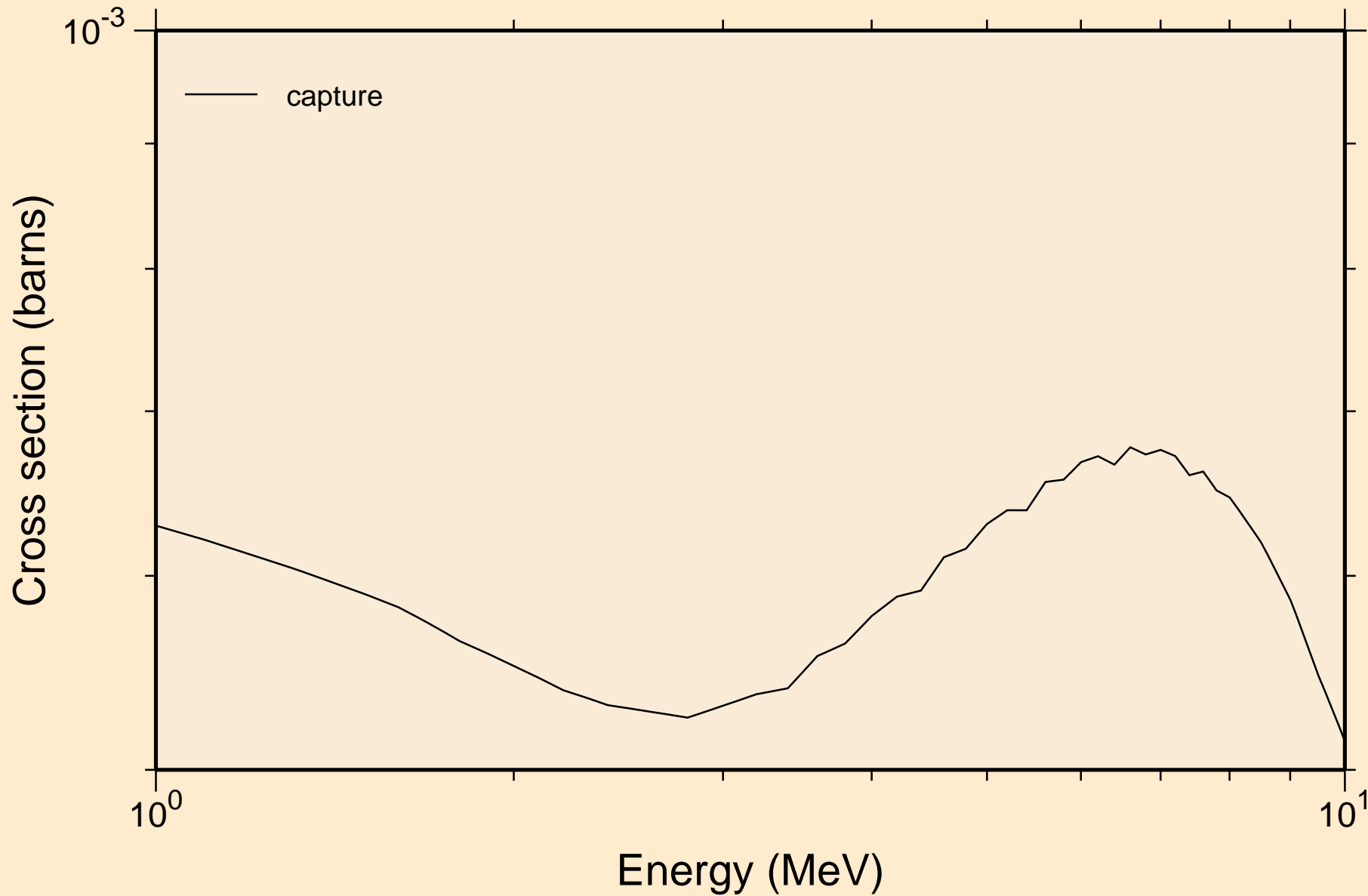

CS116M NEUTRON ACER TENDL-2021 LIBRARY; T=293.6K  
Heating

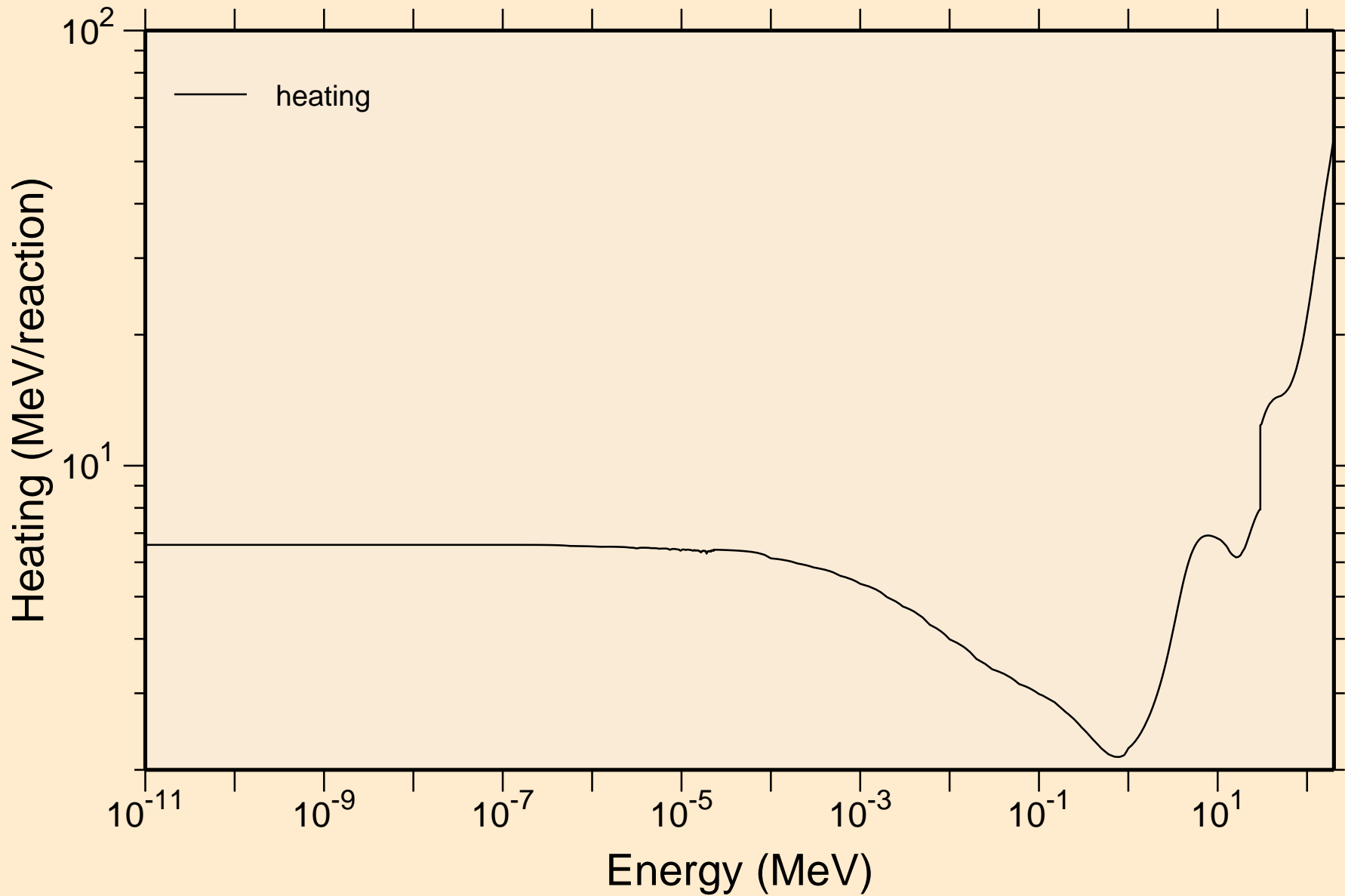

CS116M NEUTRON ACER TENDL-2021 LIBRARY; T=293.6K  
Damage

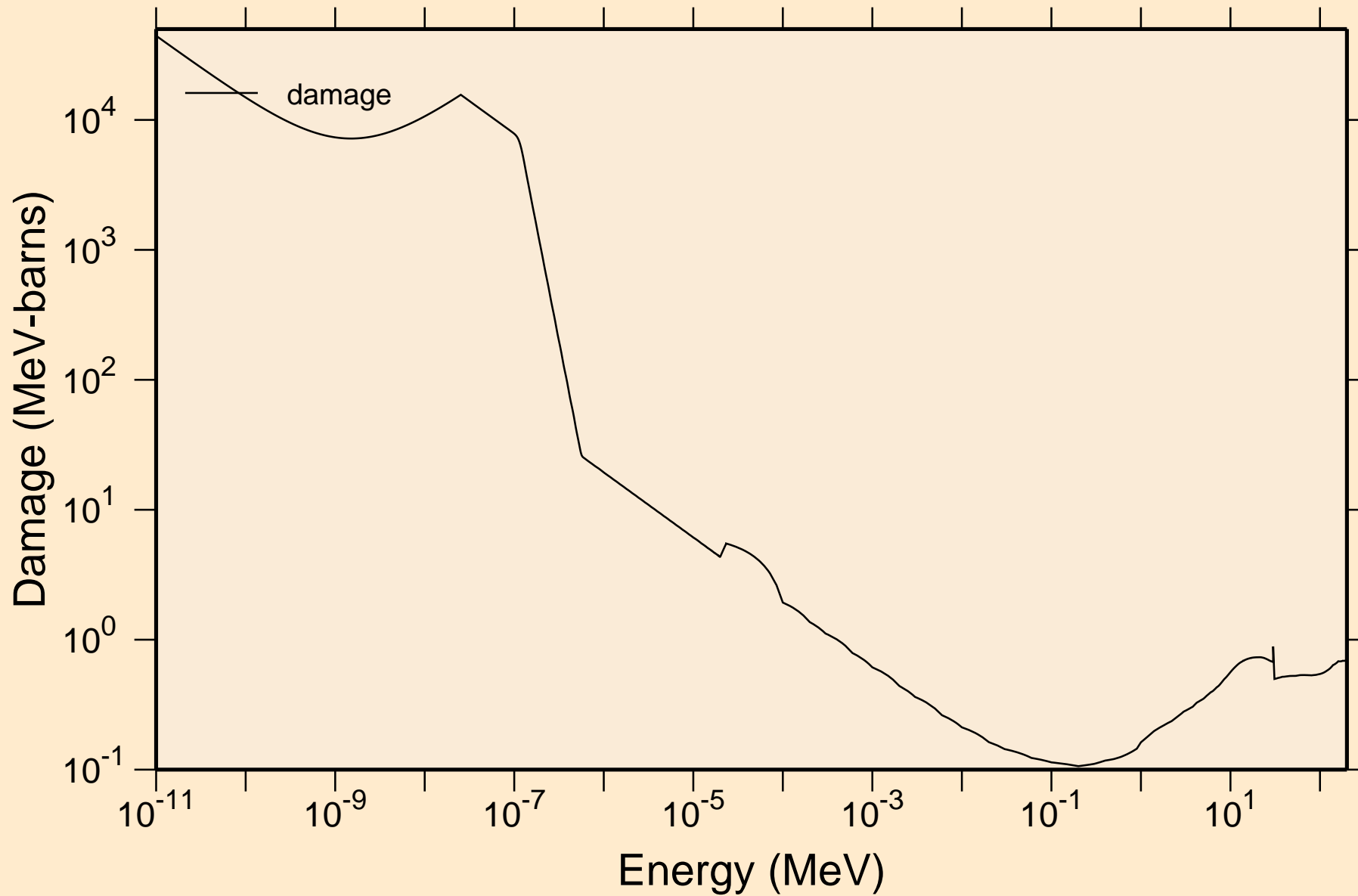



# CS116M NEUTRON ACER TENDL-2021 LIBRARY; T=293.6K

## Non-threshold reactions

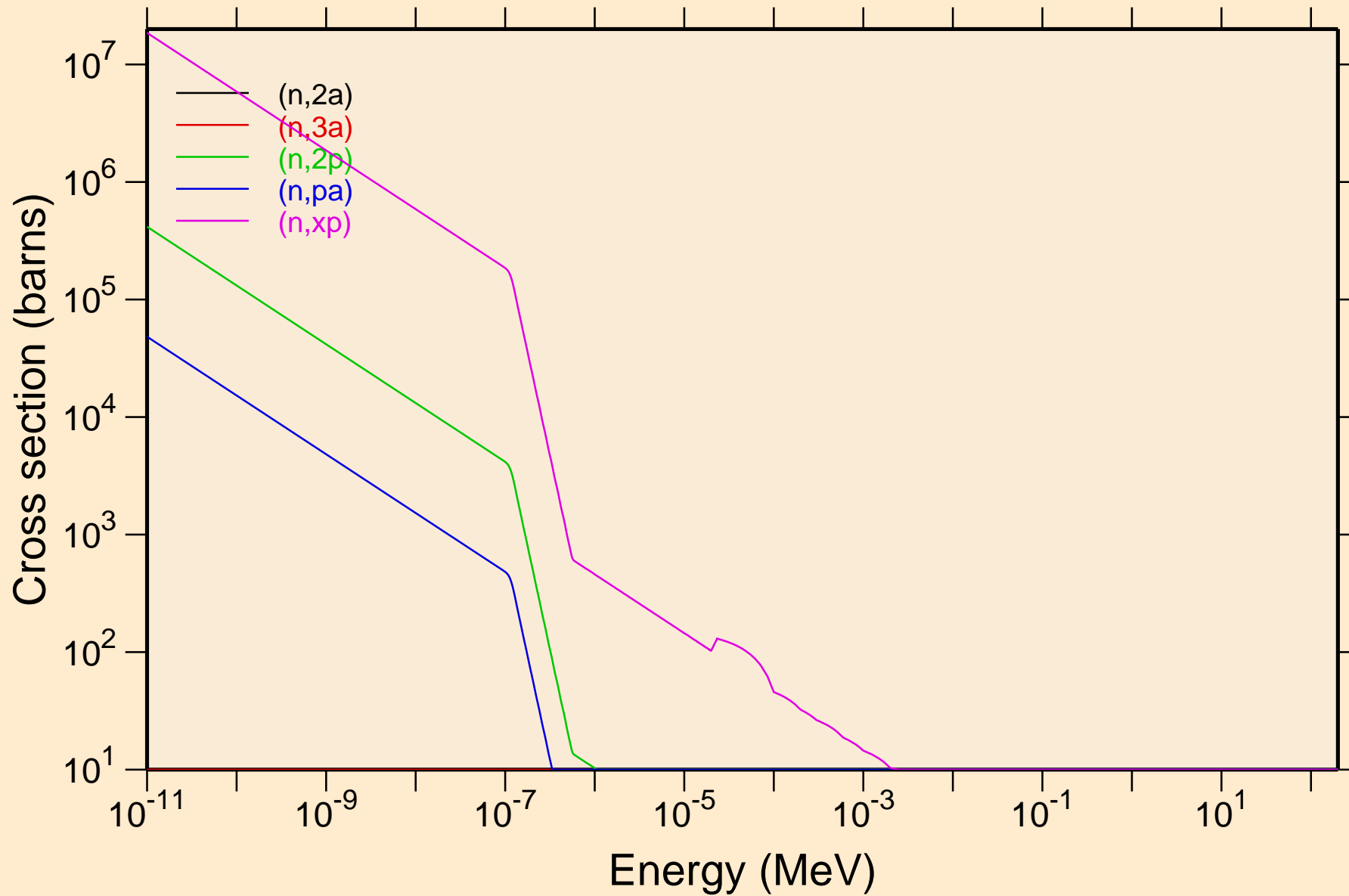

CS116M NEUTRON ACER TENDL-2021 LIBRARY; T=293.6K  
Non-threshold reactions

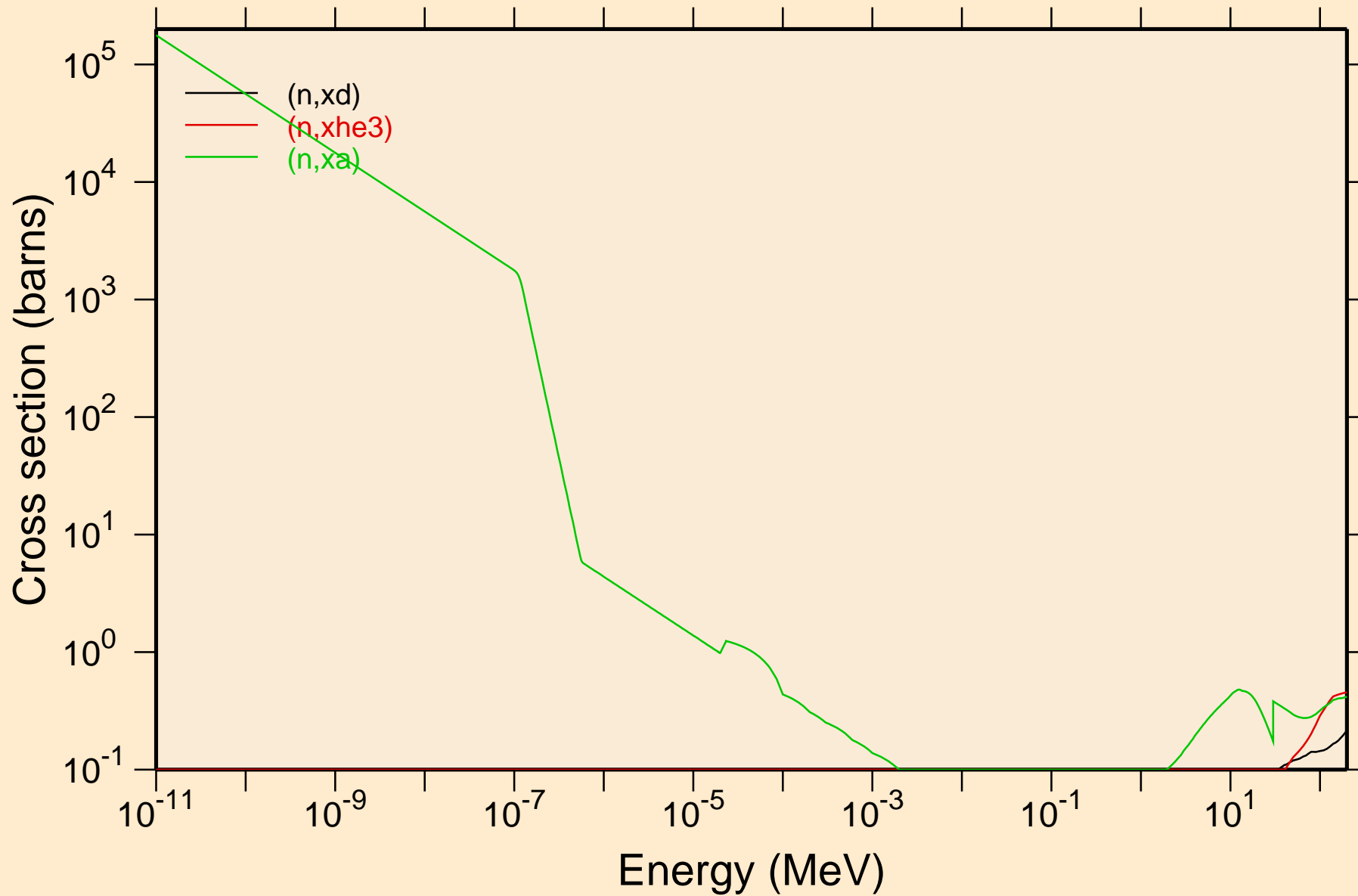

# CS116M NEUTRON ACER TENDL-2021 LIBRARY; T=293.6K

## Principal cross sections

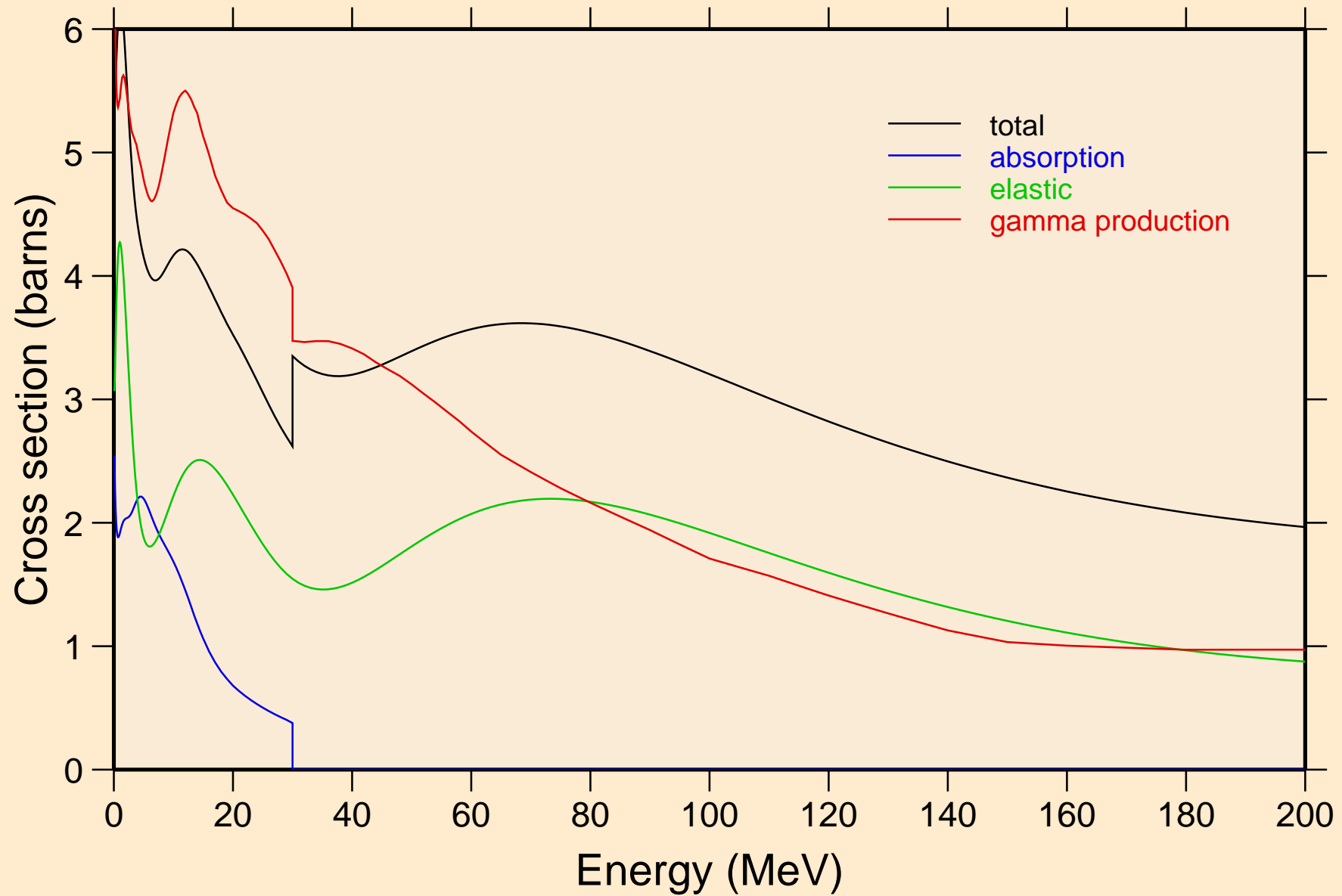

CS116M NEUTRON ACER TENDL-2021 LIBRARY; T=293.6K  
Heating

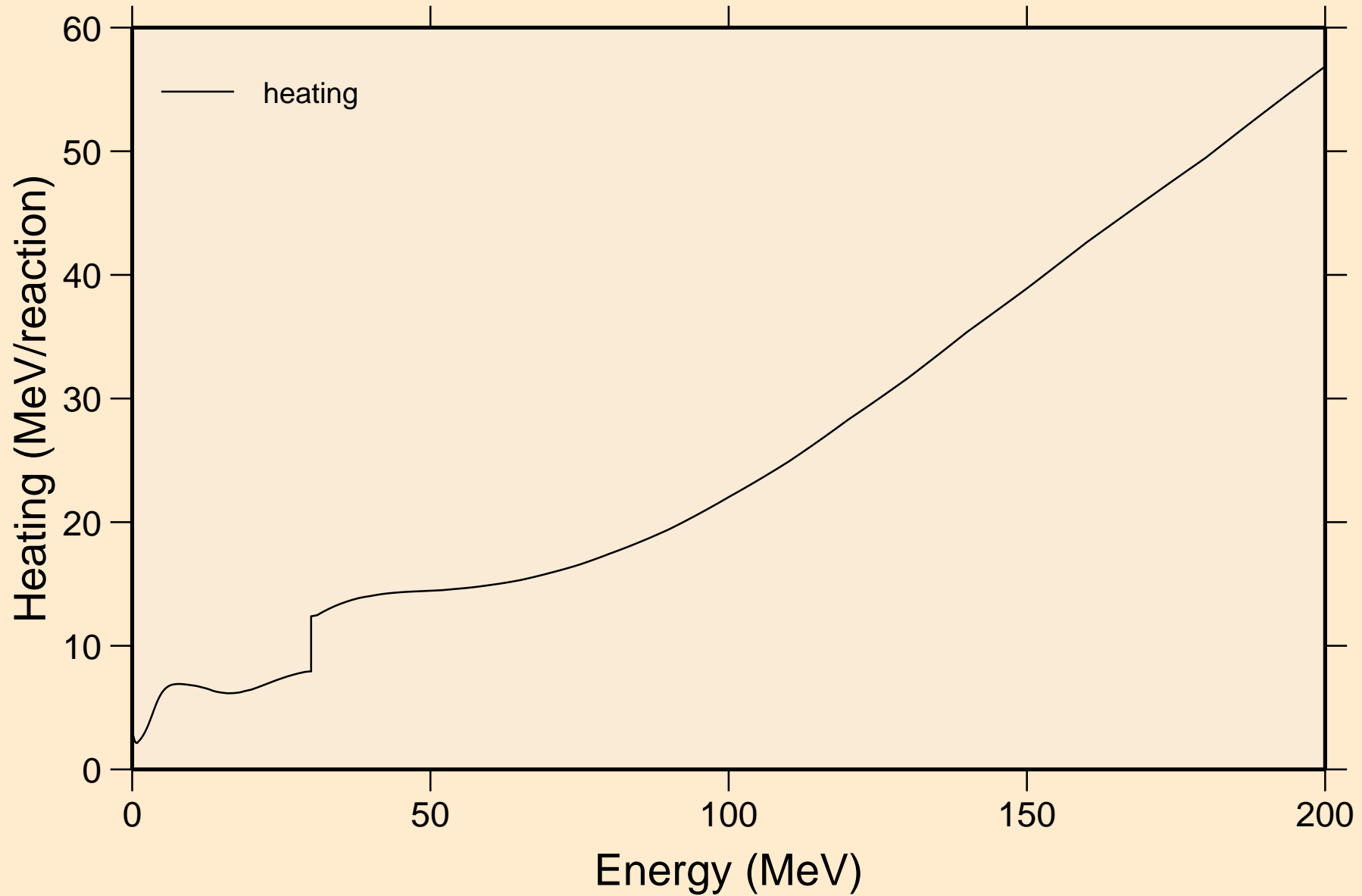



# CS116M NEUTRON ACER TENDL-2021 LIBRARY; T=293.6K Damage

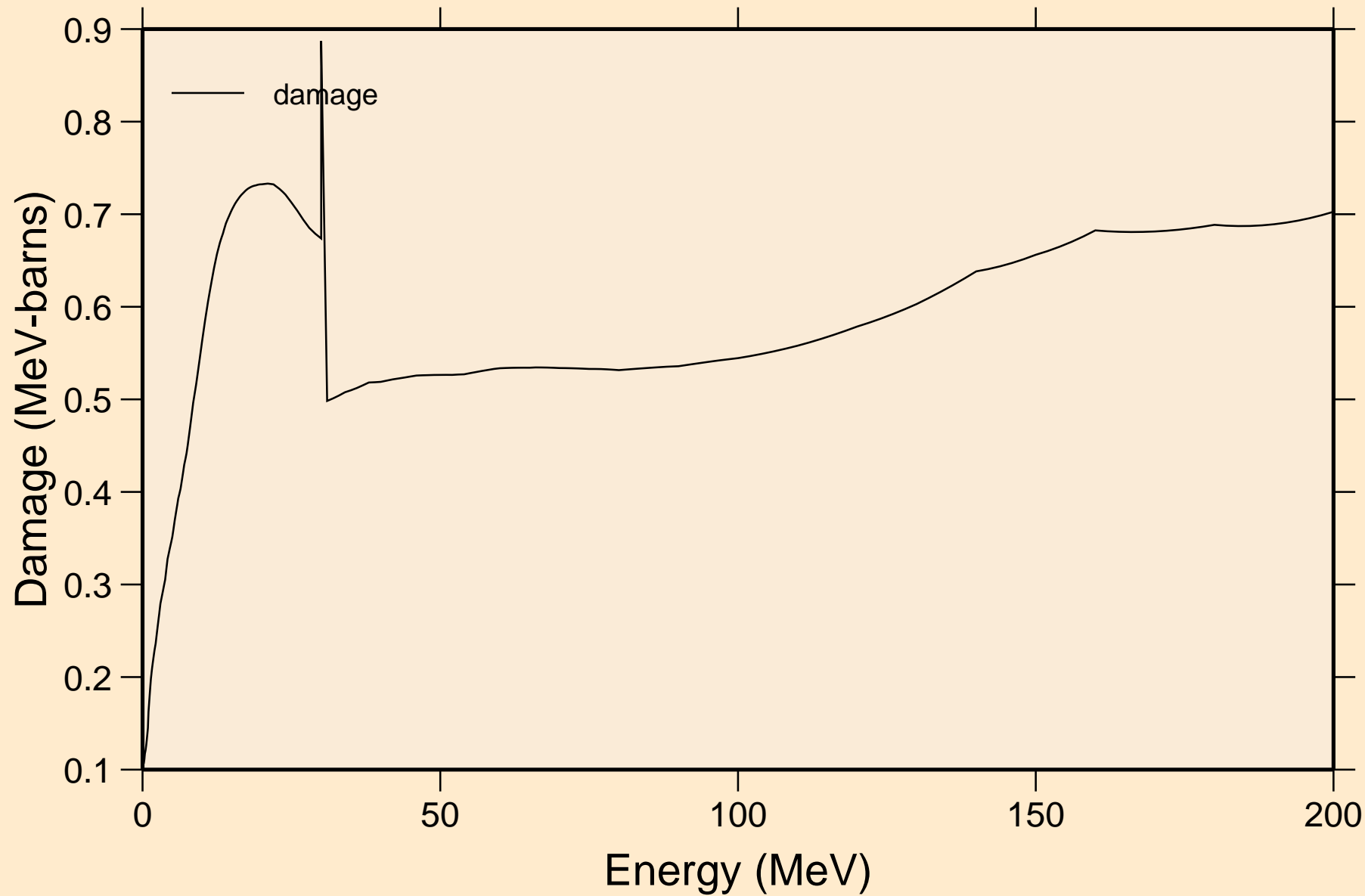

CS116M NEUTRON ACER TENDL-2021 LIBRARY; T=293.6K  
Non-threshold reactions

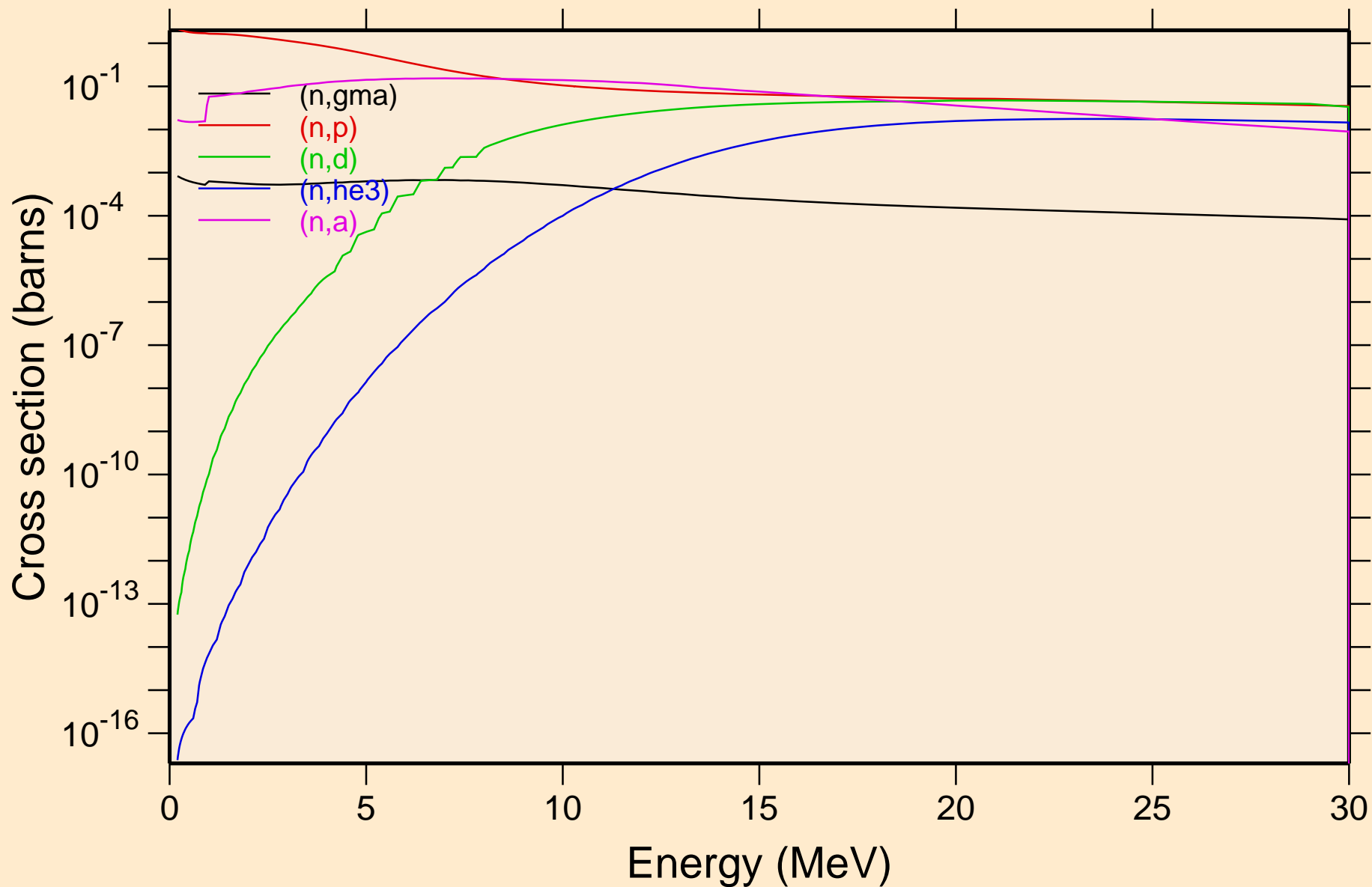

CS116M NEUTRON ACER TENDL-2021 LIBRARY; T=293.6K  
Non-threshold reactions

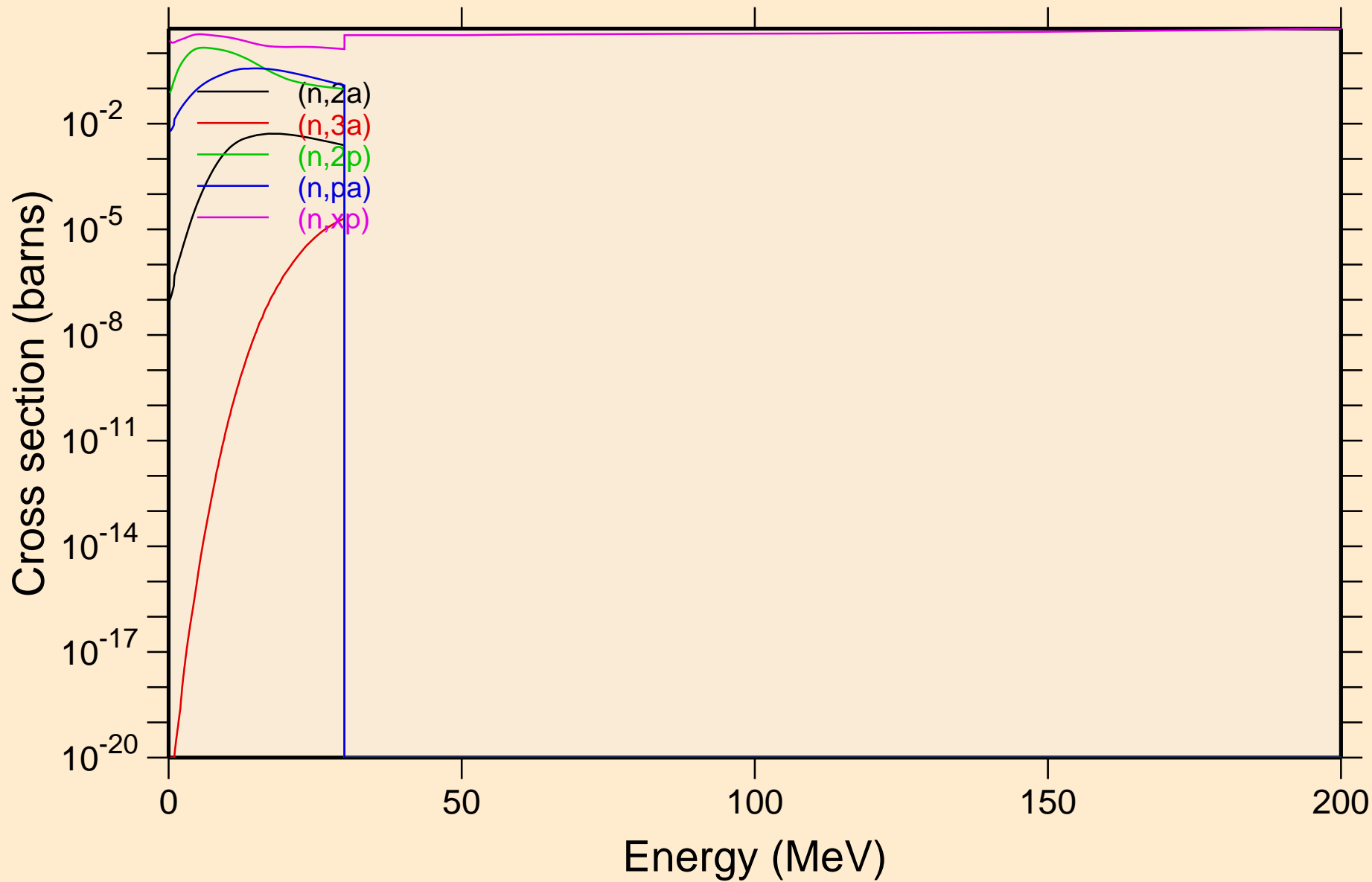

CS116M NEUTRON ACER TENDL-2021 LIBRARY; T=293.6K  
Non-threshold reactions

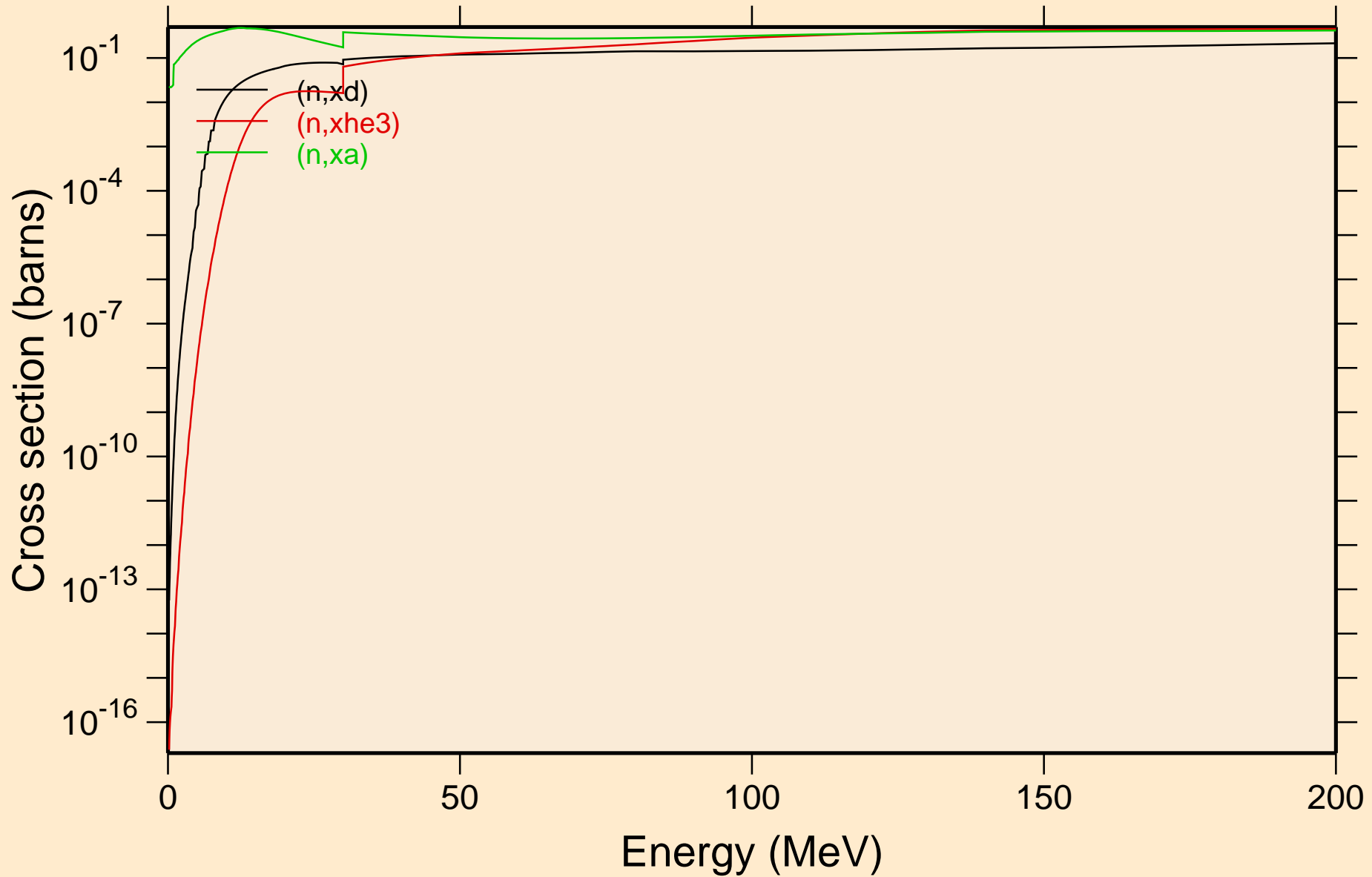

CS116M NEUTRON ACER TENDL-2021 LIBRARY; T=293.6K  
Inelastic levels

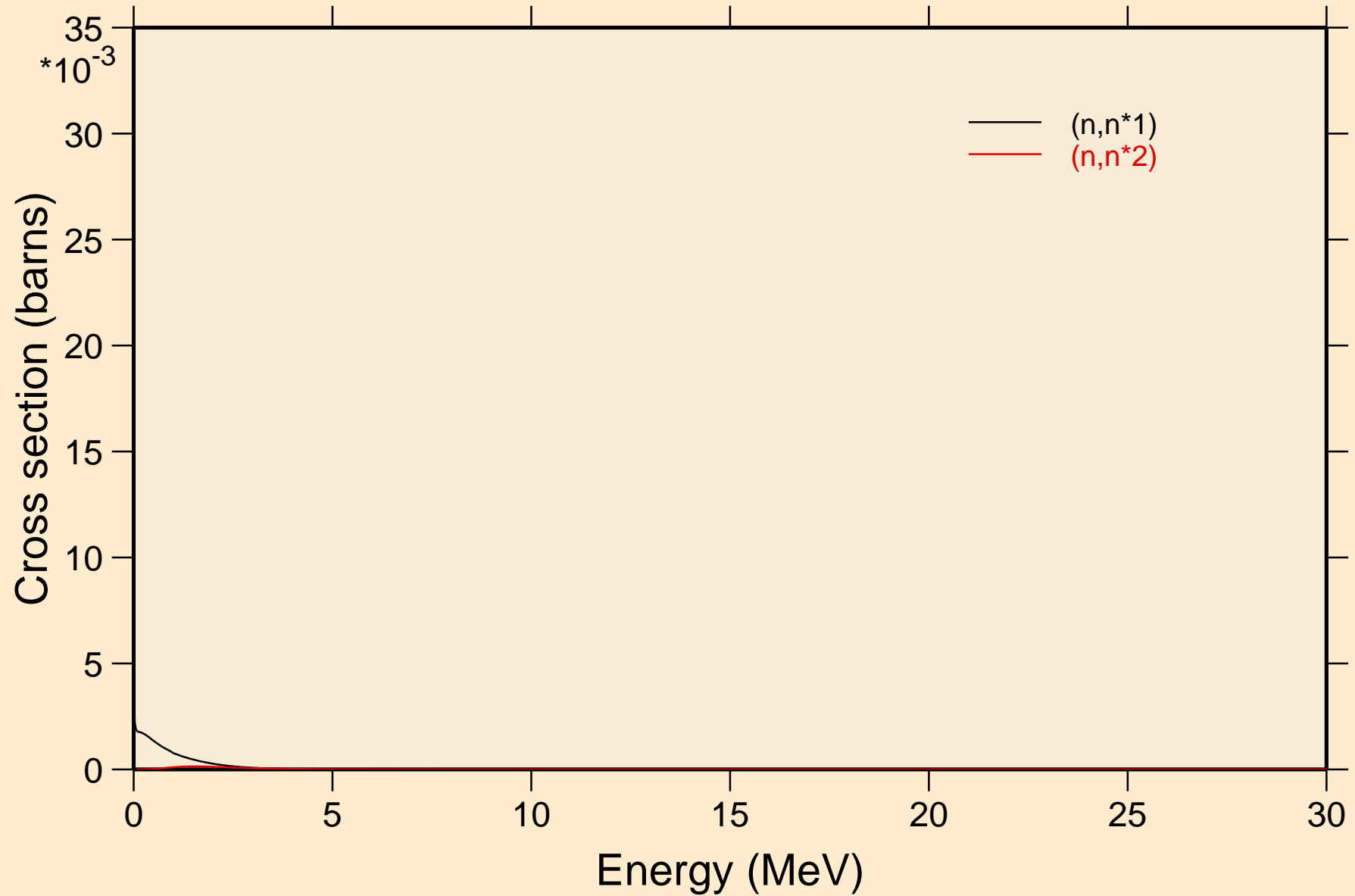

# CS116M NEUTRON ACER TENDL-2021 LIBRARY; T=293.6K

## Threshold reactions

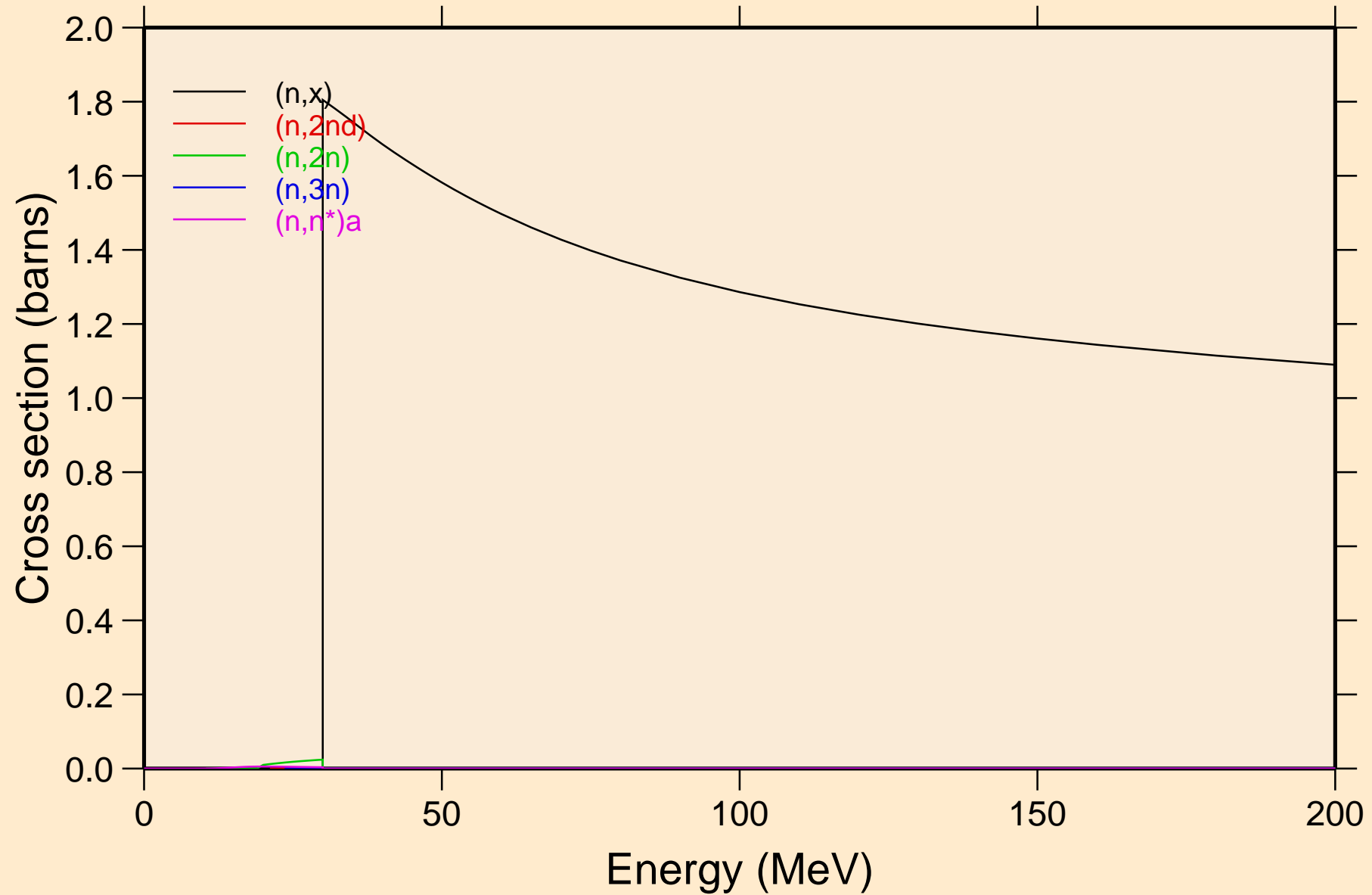

# CS116M NEUTRON ACER TENDL-2021 LIBRARY; T=293.6K

## Threshold reactions

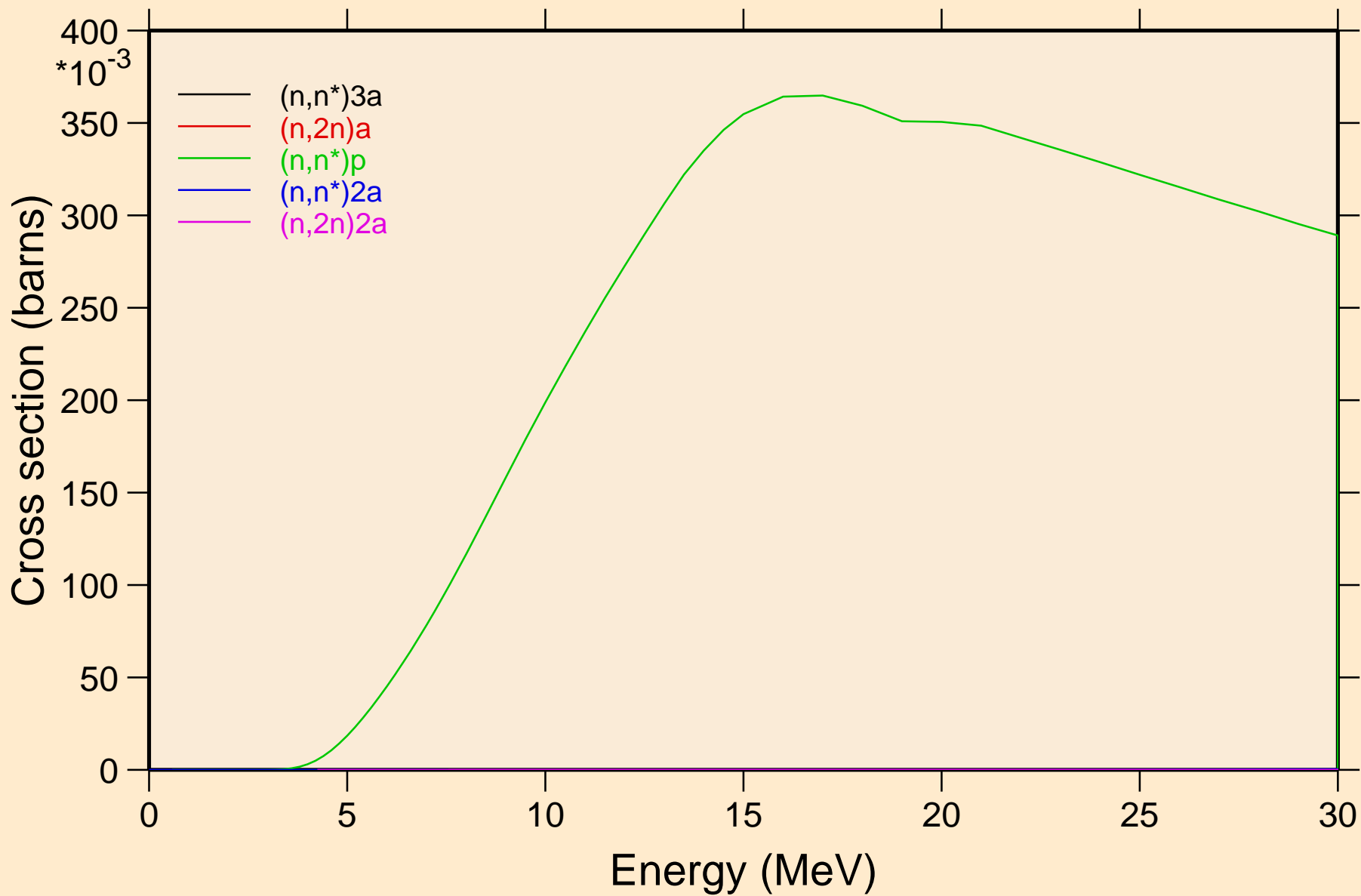

# CS116M NEUTRON ACER TENDL-2021 LIBRARY; T=293.6K

## Threshold reactions

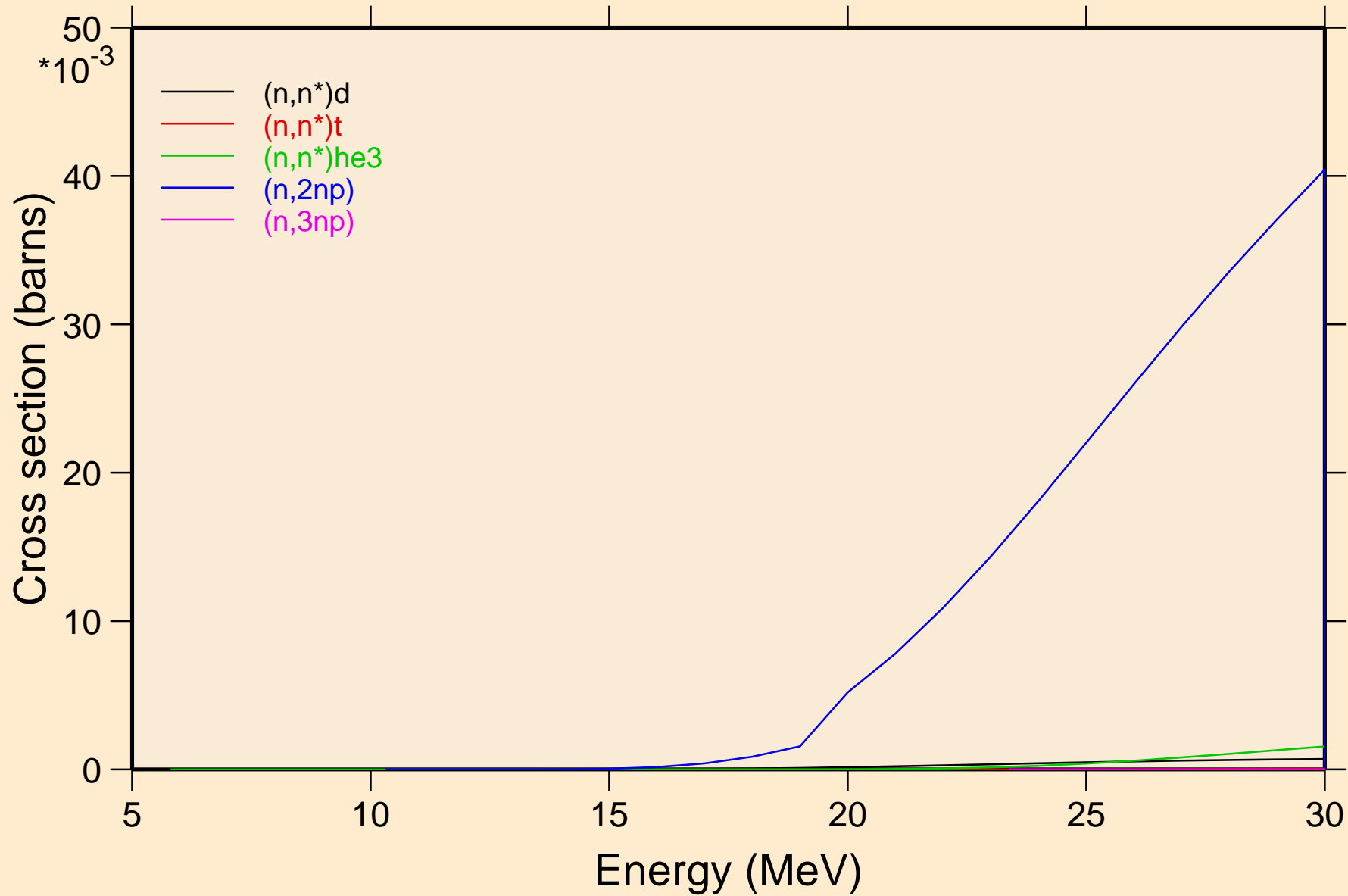



# CS116M NEUTRON ACER TENDL-2021 LIBRARY; T=293.6K

## Threshold reactions

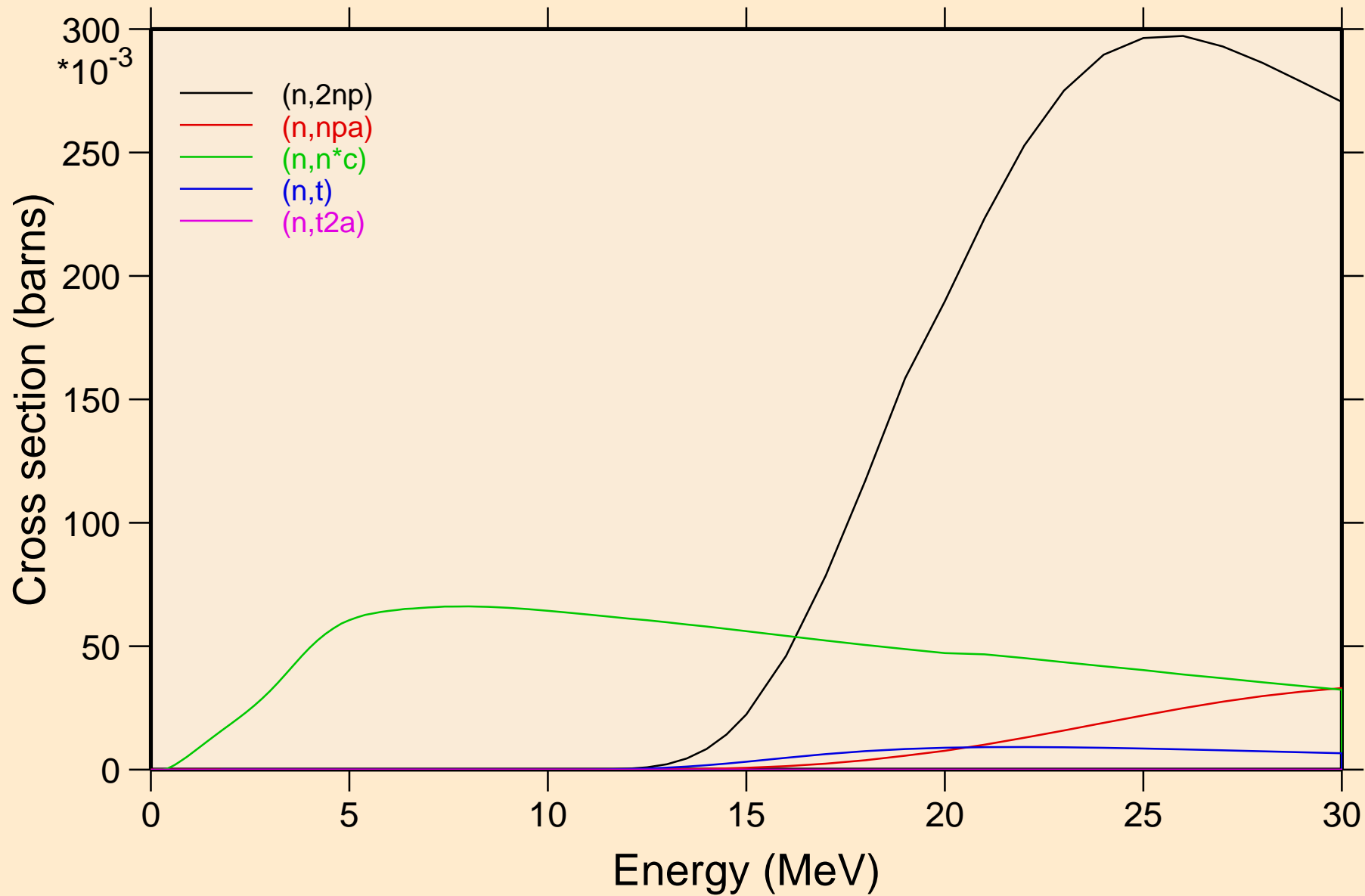

# CS116M NEUTRON ACER TENDL-2021 LIBRARY; T=293.6K

## Threshold reactions

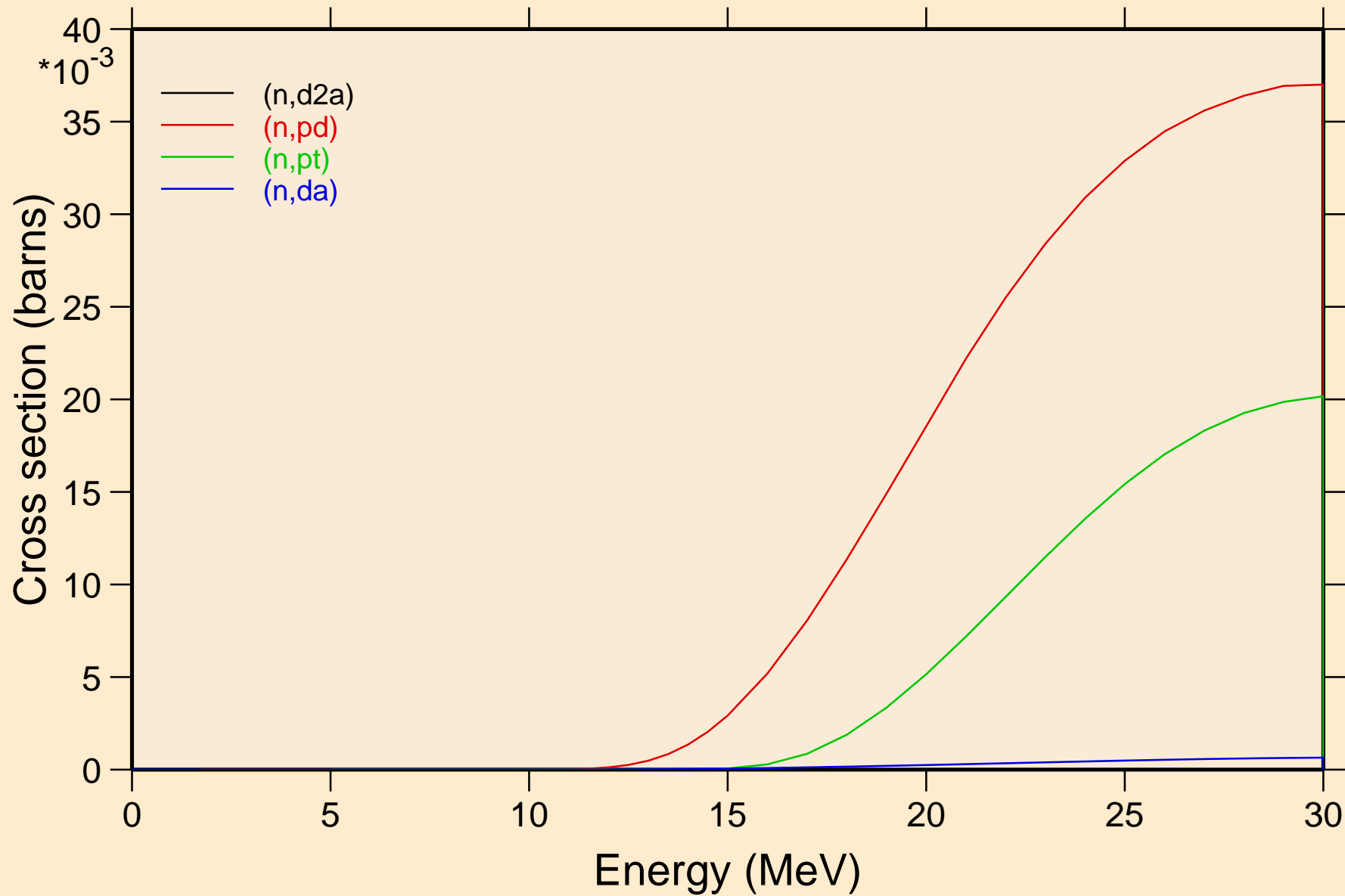

CS116M NEUTRON ACER TENDL-2021 LIBRARY; T=293.6K  
Threshold reactions

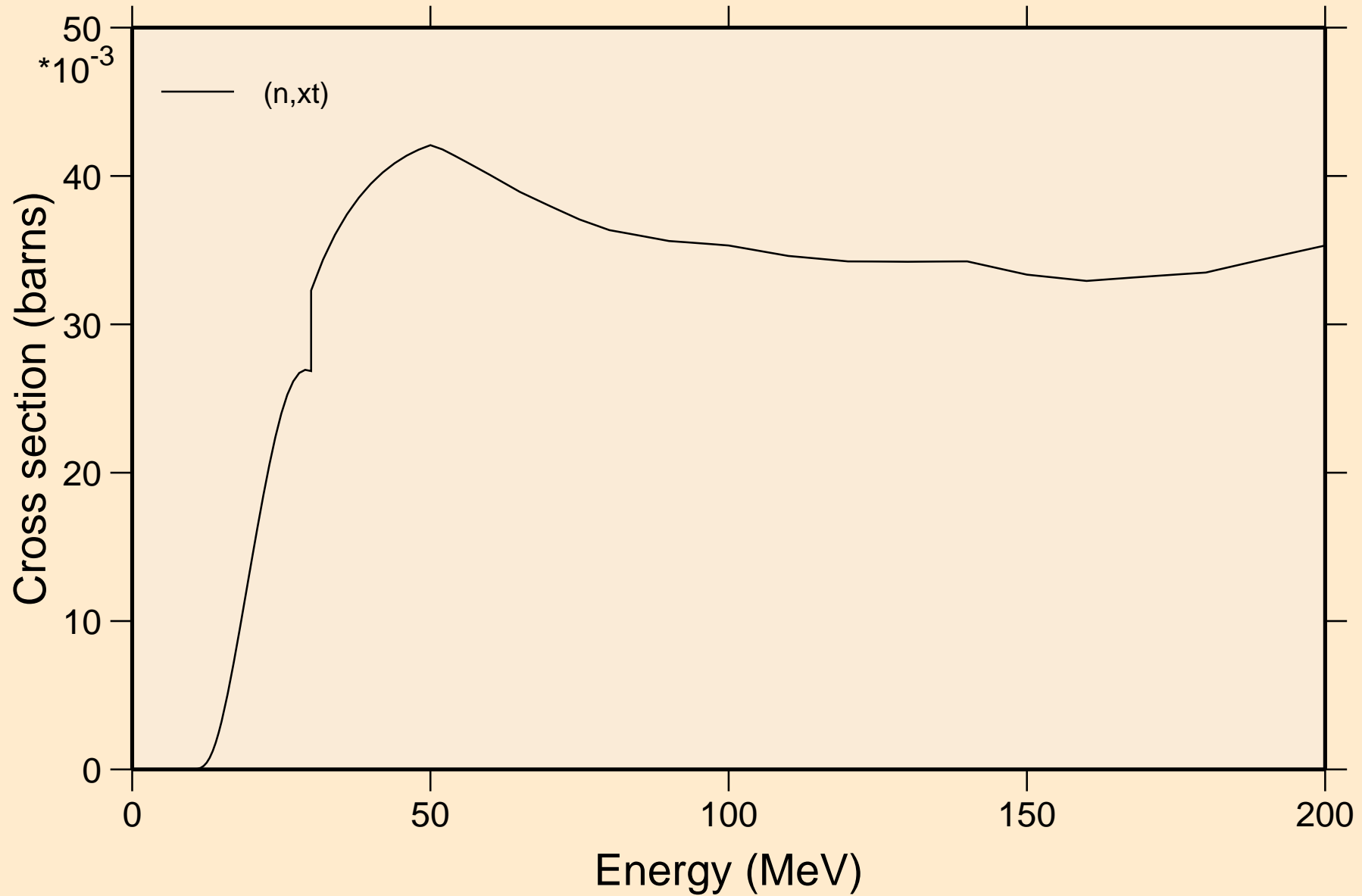

CS116M NEUTRON ACER TENDL-2021 LIBRARY; T=293.6K  
angular distribution for elastic

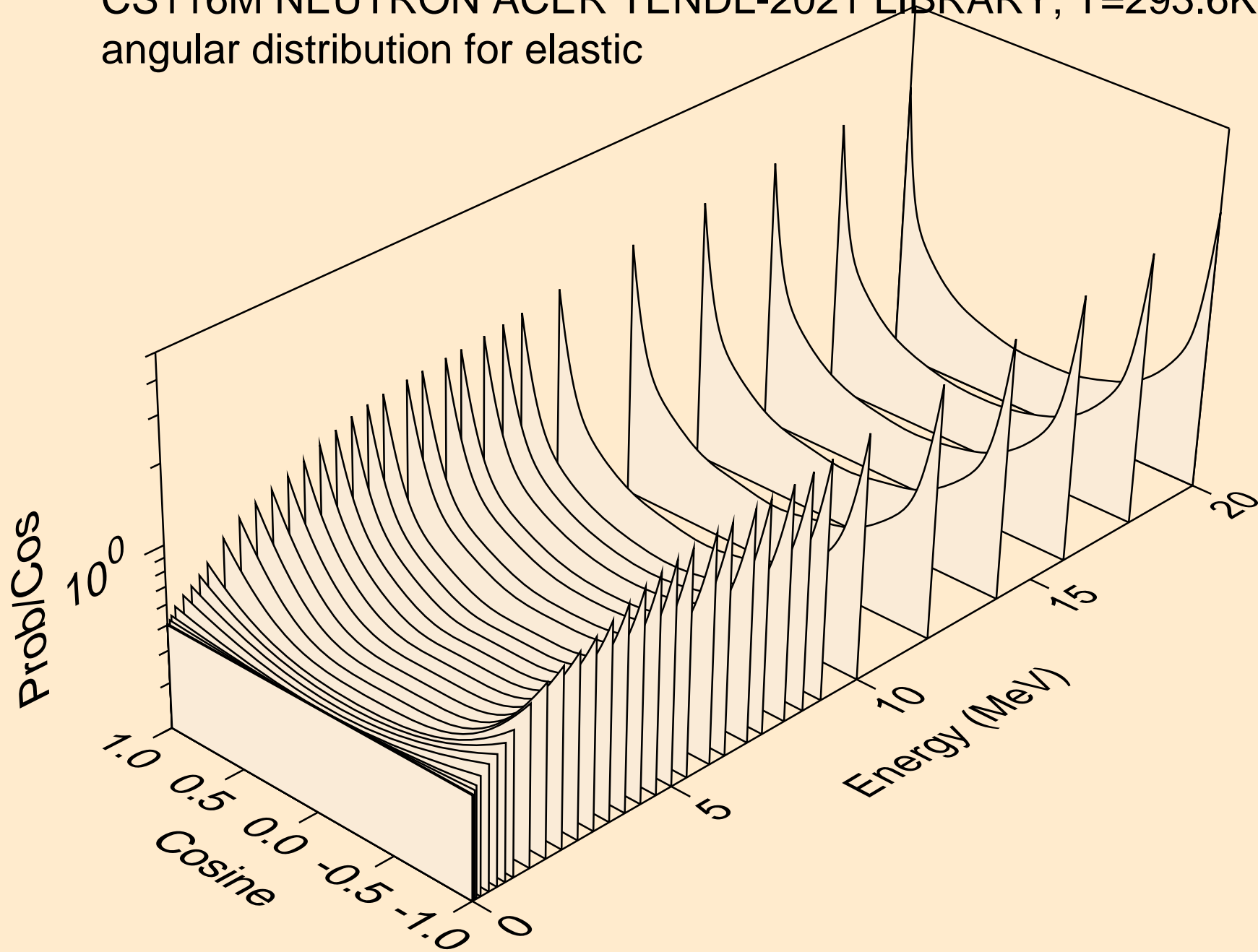

CS116M NEUTRON ACER TENDL-2021 LIBRARY; T=293.6K  
angular distribution for elastic

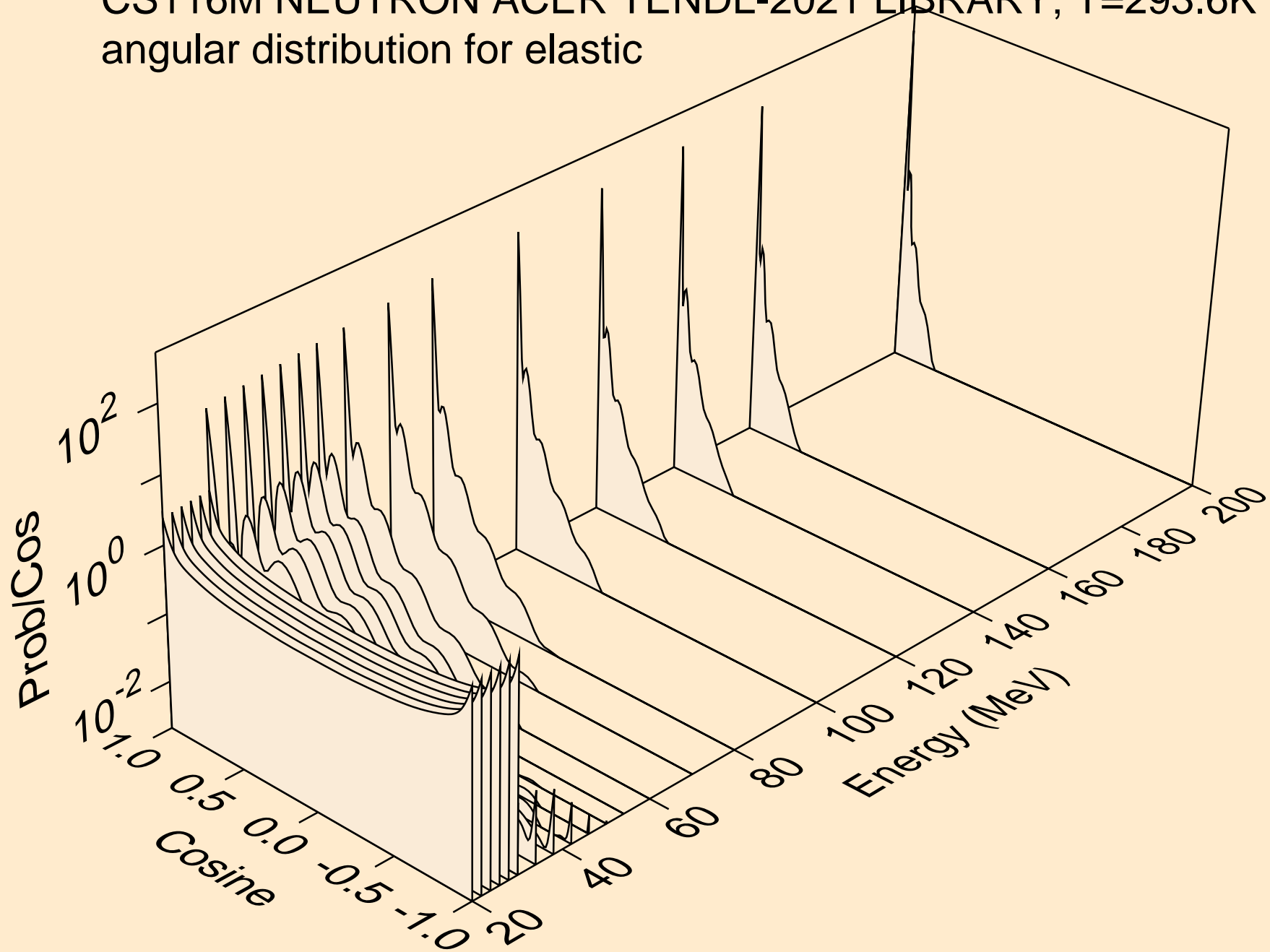

CS116M NEUTRON ACER TENDL-2021 LIBRARY; T=293.6K  
angular distribution for (n,n\*1)

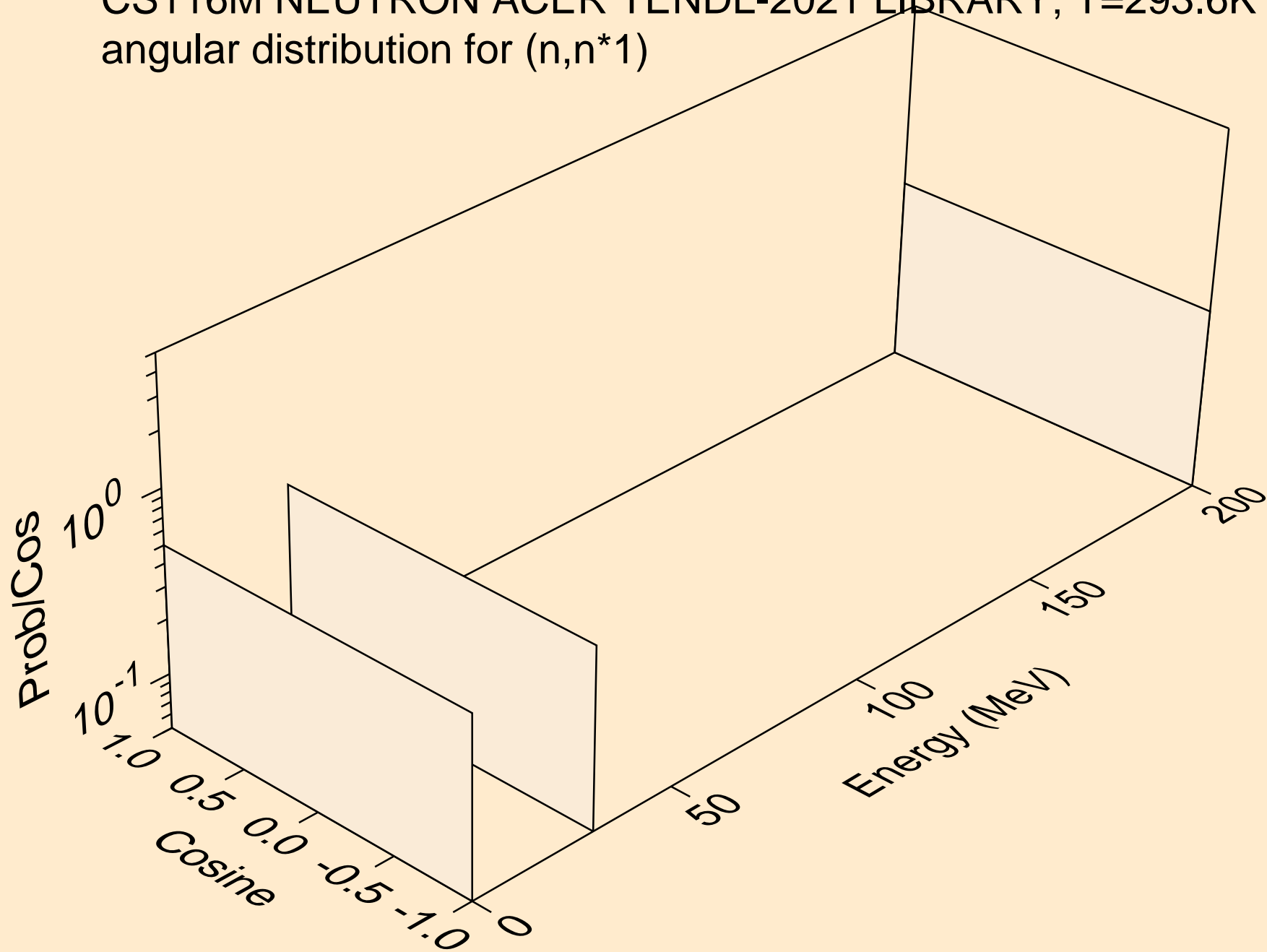

CS116M NEUTRON ACER TENDL-2021 LIBRARY; T=293.6K  
angular distribution for (n,n\*2)

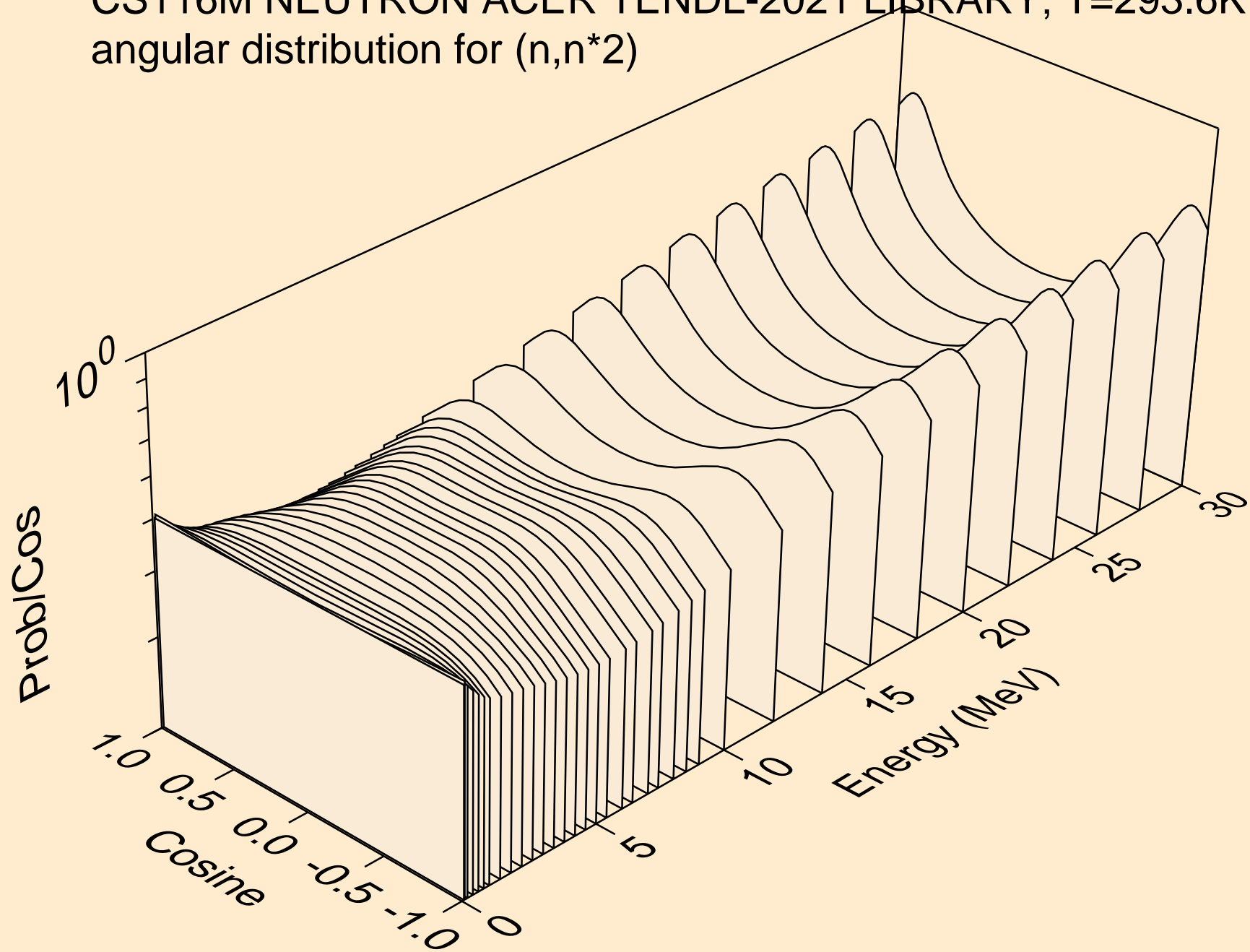

CS116M NEUTRON ACER TENDL-2021 LIBRARY; T=293.6K  
Neutron emission for (n,x)

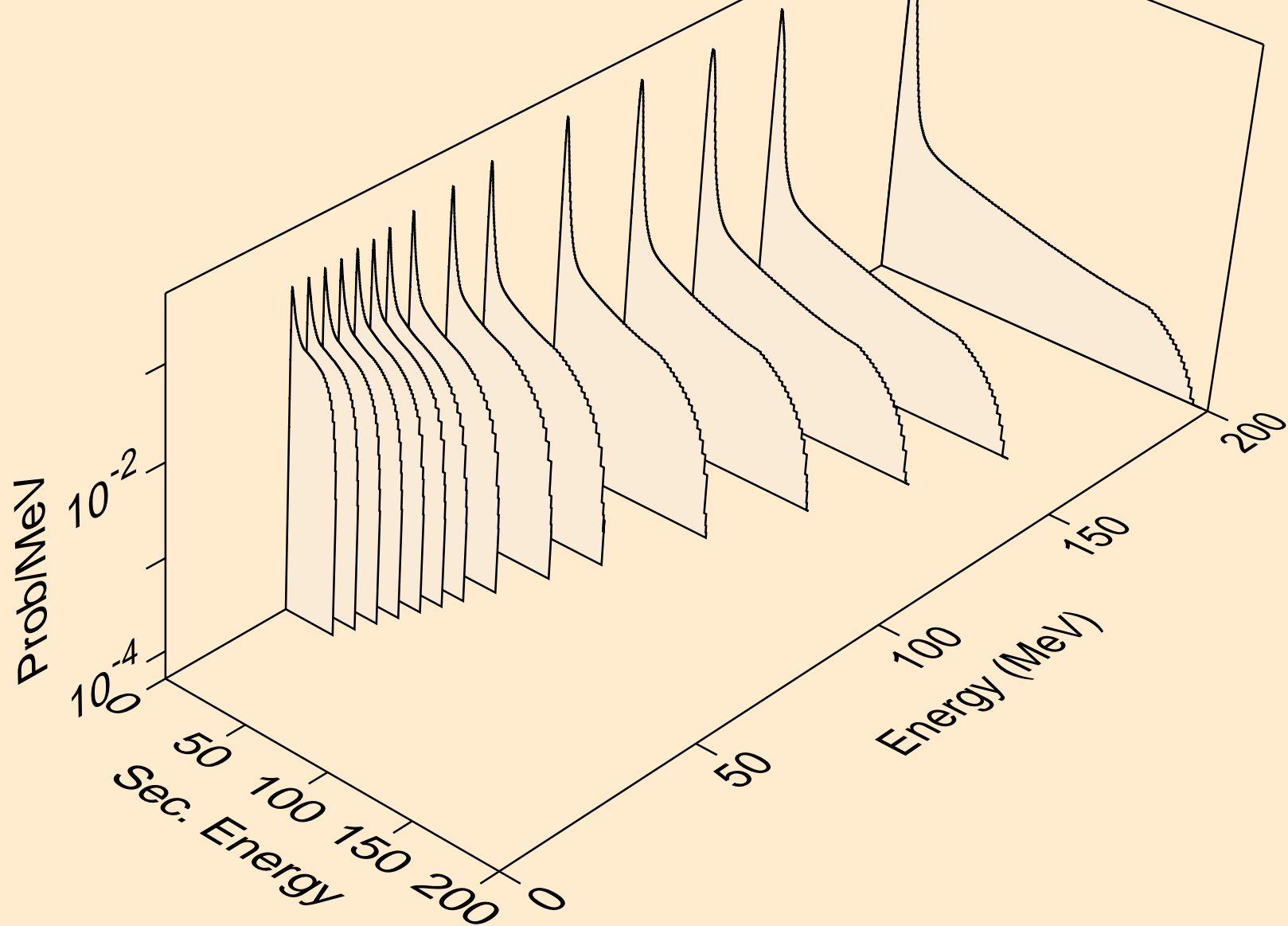



CS116M NEUTRON ACER TENDL-2021 LIBRARY; T=293.6K  
Neutron emission for (n,2nd)

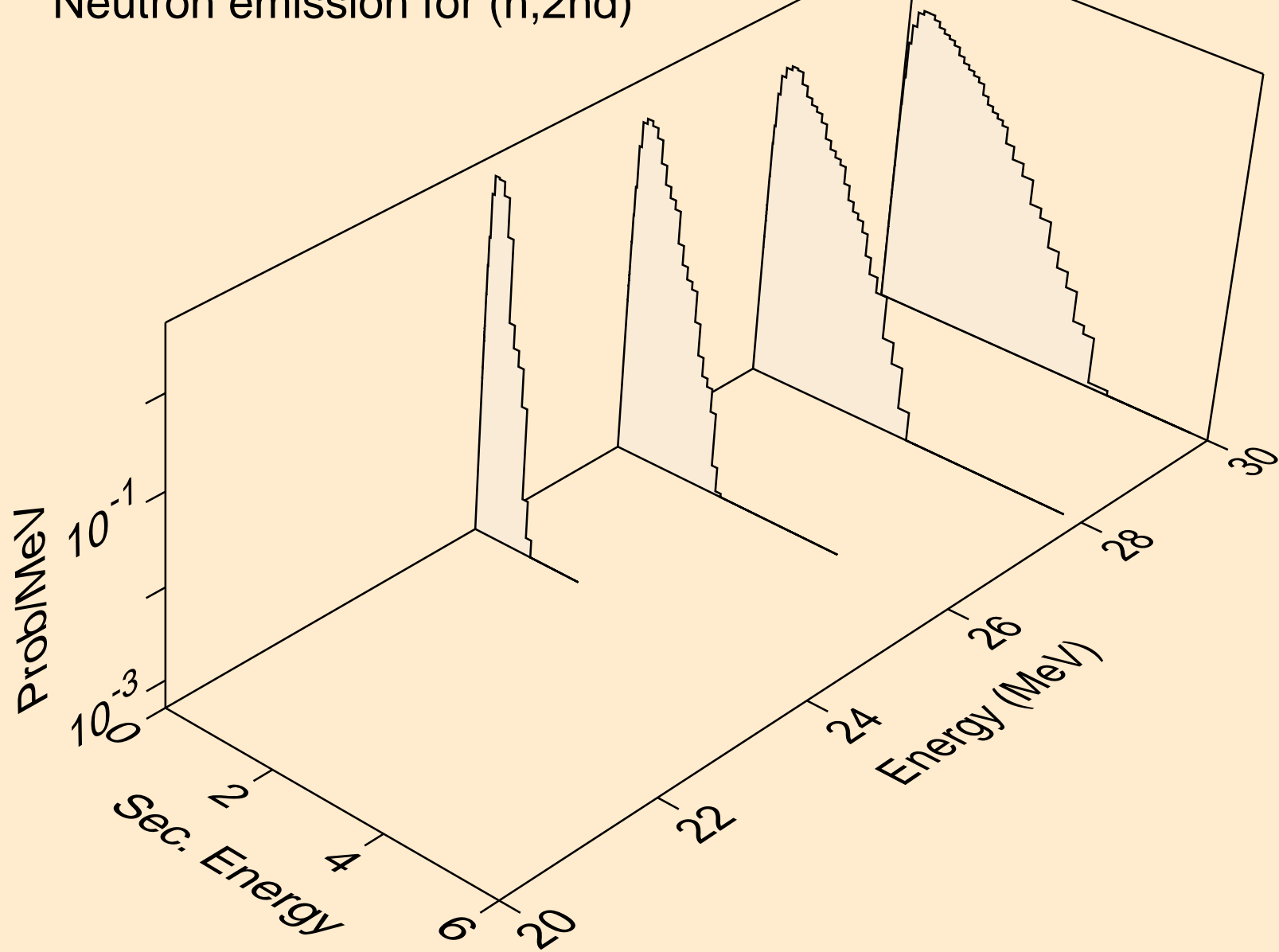

CS116M NEUTRON ACER TENDL-2021 LIBRARY; T=293.6K  
Neutron emission for (n,2n)

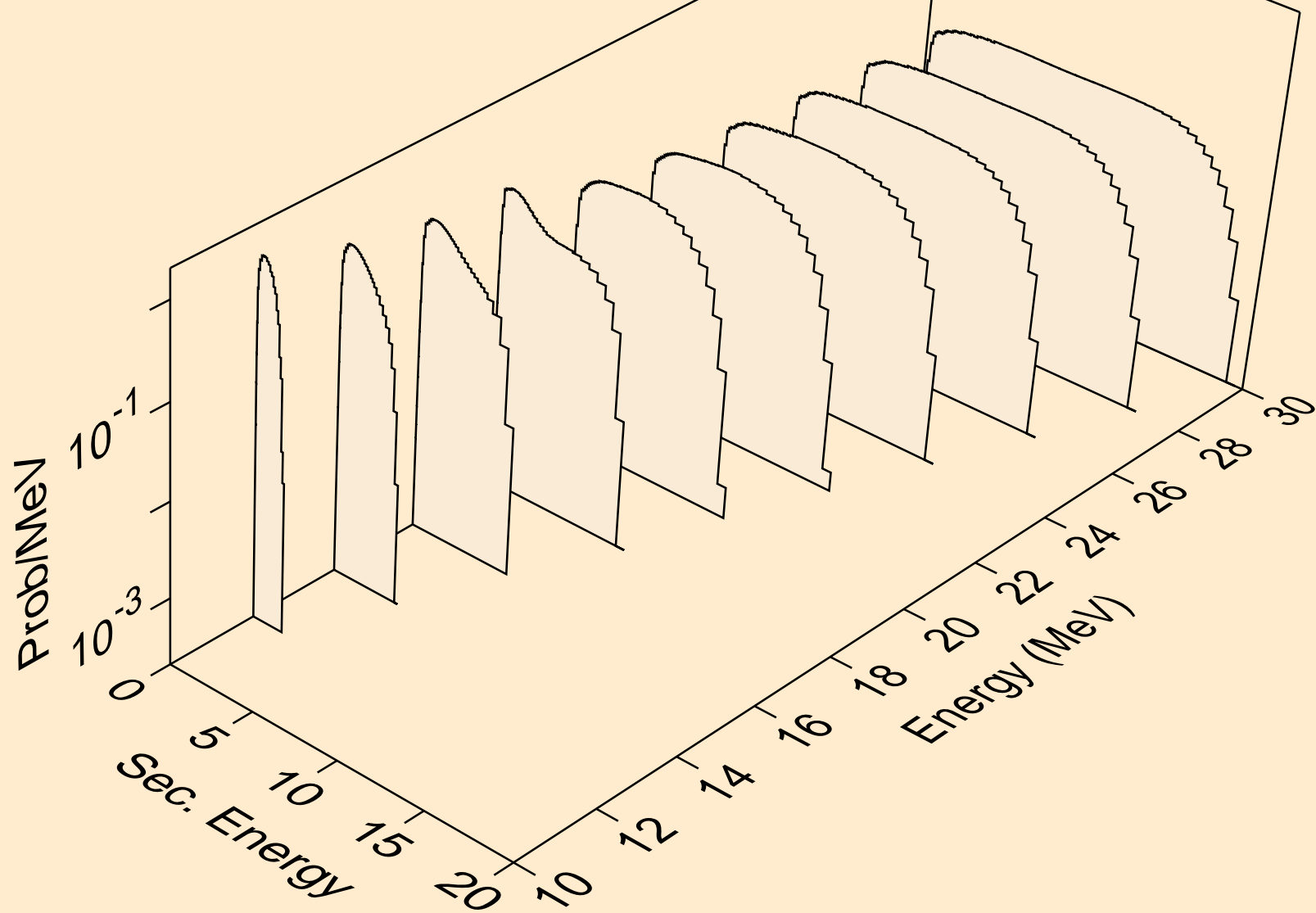

CS116M NEUTRON ACER TENDL-2021 LIBRARY; T=293.6K  
Neutron emission for (n,3n)

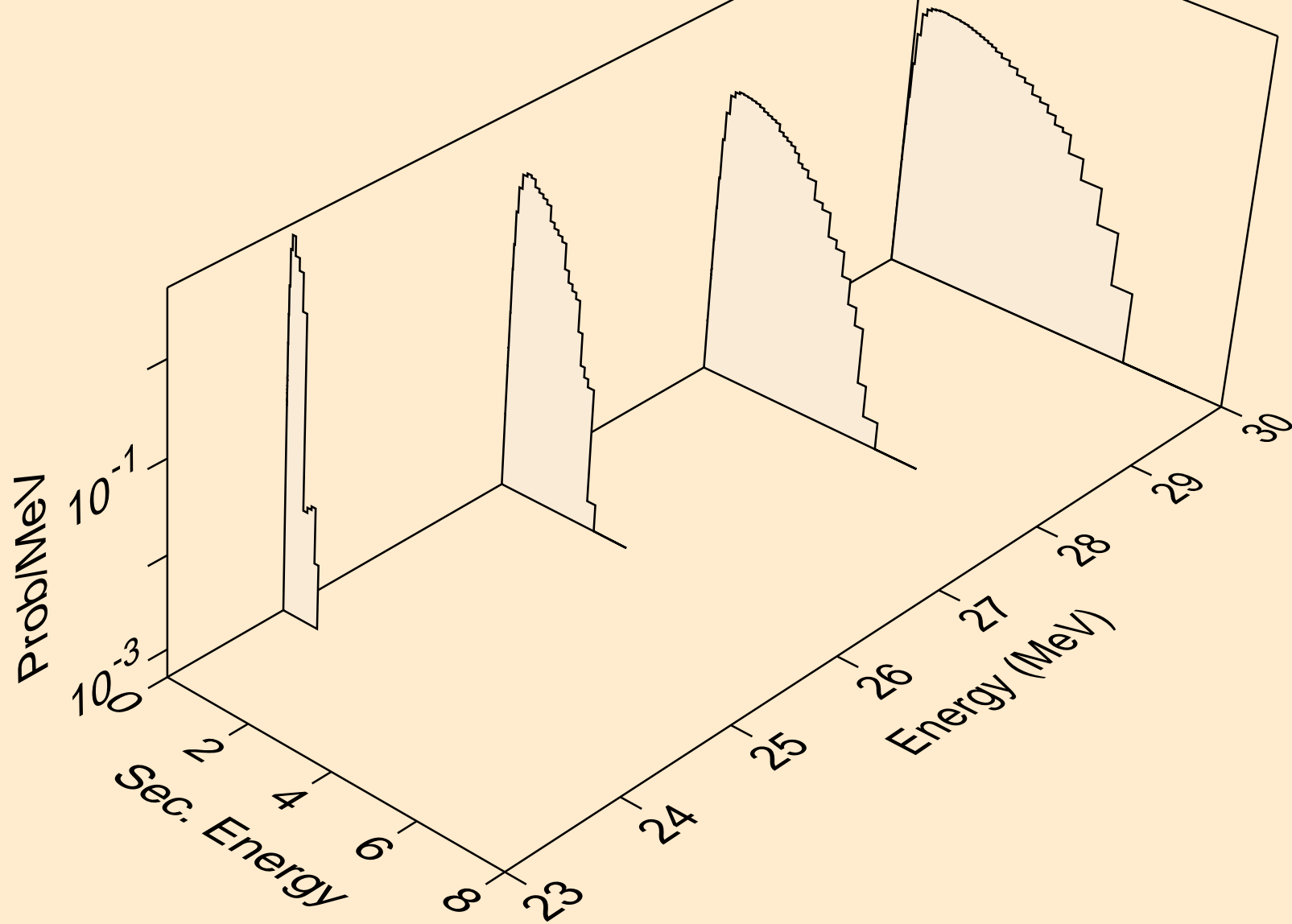

CS116M NEUTRON ACER TENDL-2021 LIBRARY; T=293.6K  
Neutron emission for (n,n\*)a

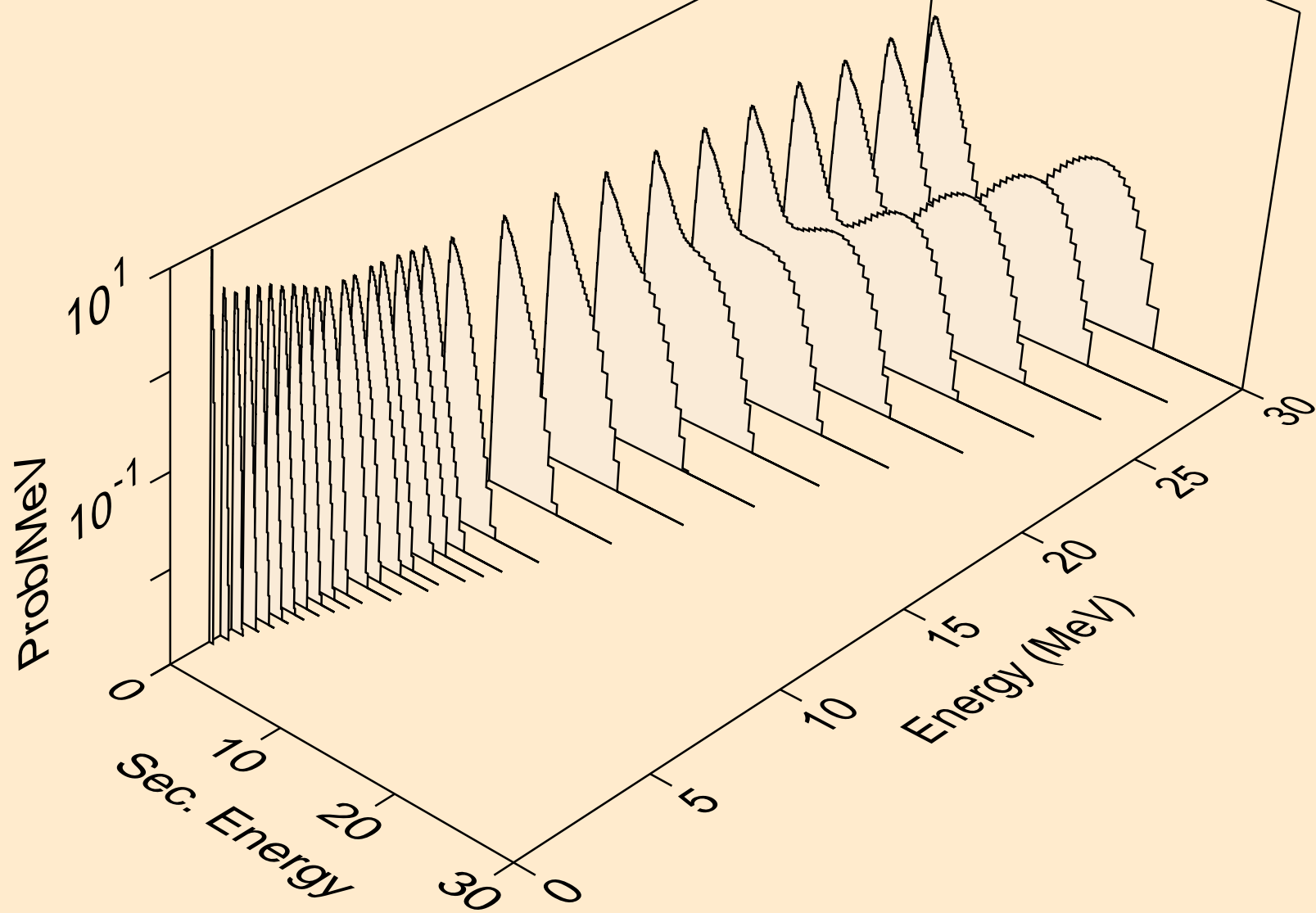

CS116M NEUTRON ACER TENDL-2021 LIBRARY; T=293.6K  
Neutron emission for (n,n\*)3a

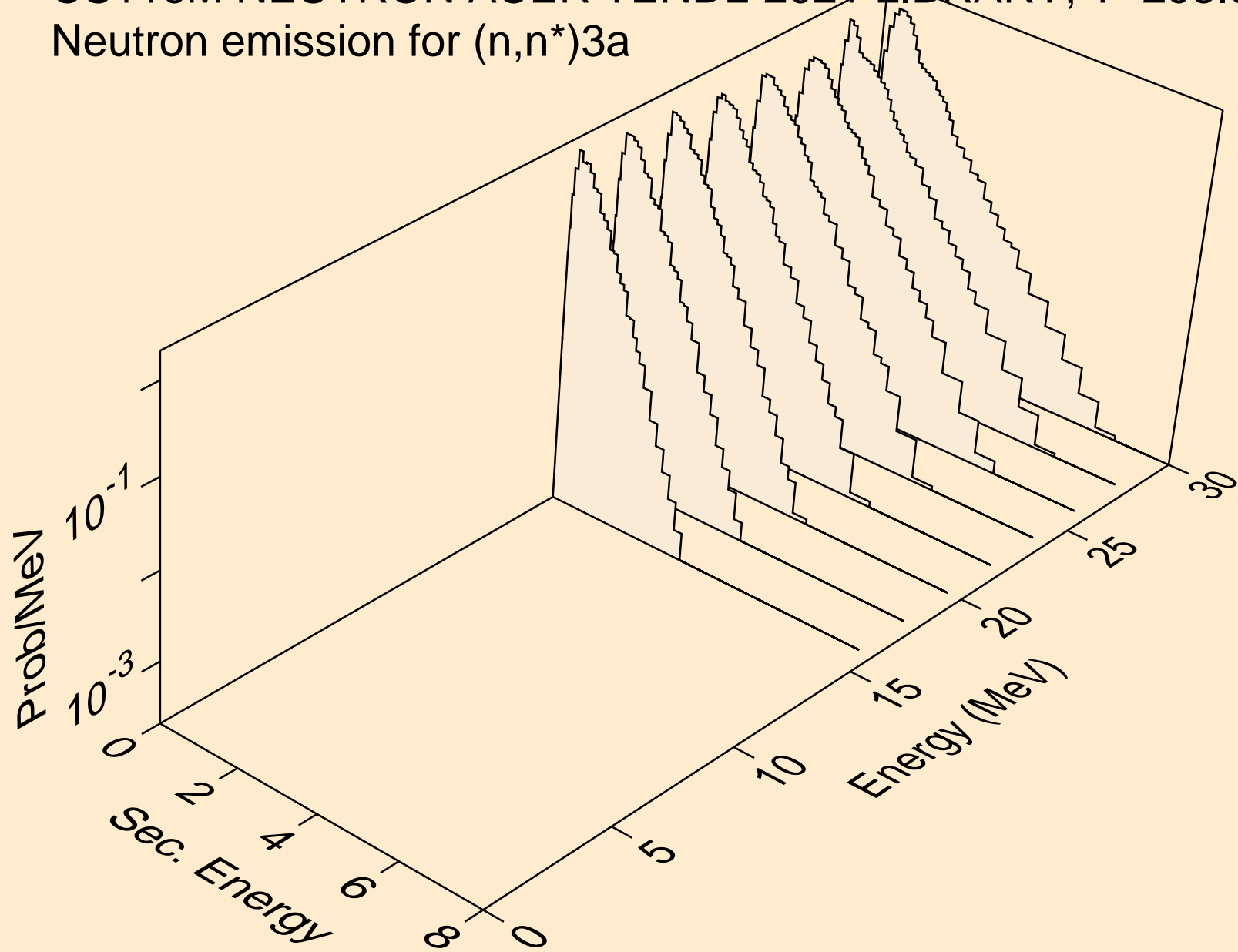

CS116M NEUTRON ACER TENDL-2021 LIBRARY; T=293.6K  
Neutron emission for (n,2n)<sub>a</sub>

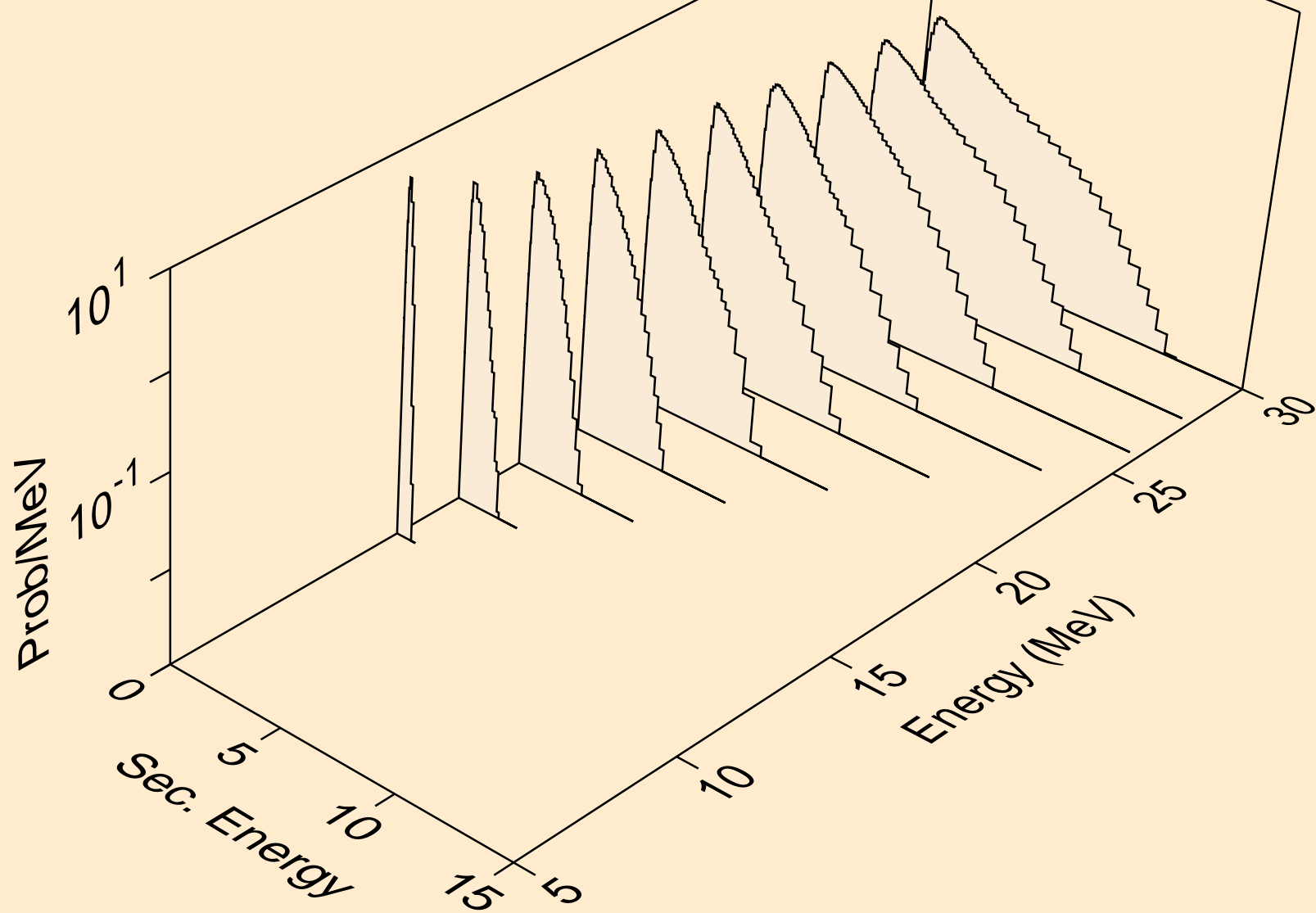

CS116M NEUTRON ACER TENDL-2021 LIBRARY; T=293.6K  
Neutron emission for (n,n\*)p

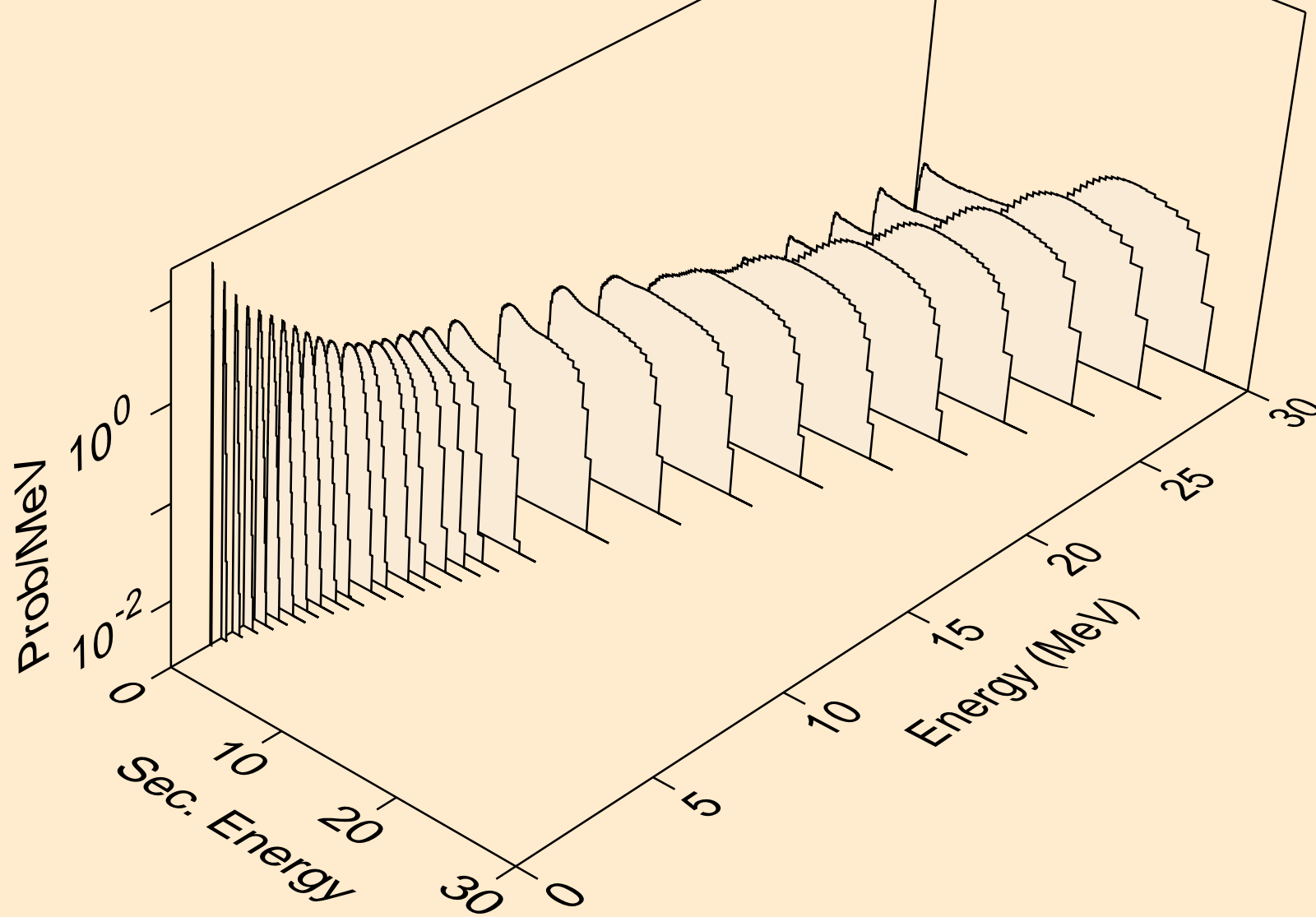

CS116M NEUTRON ACER TENDL-2021 LIBRARY; T=293.6K  
Neutron emission for (n,n\*)2a

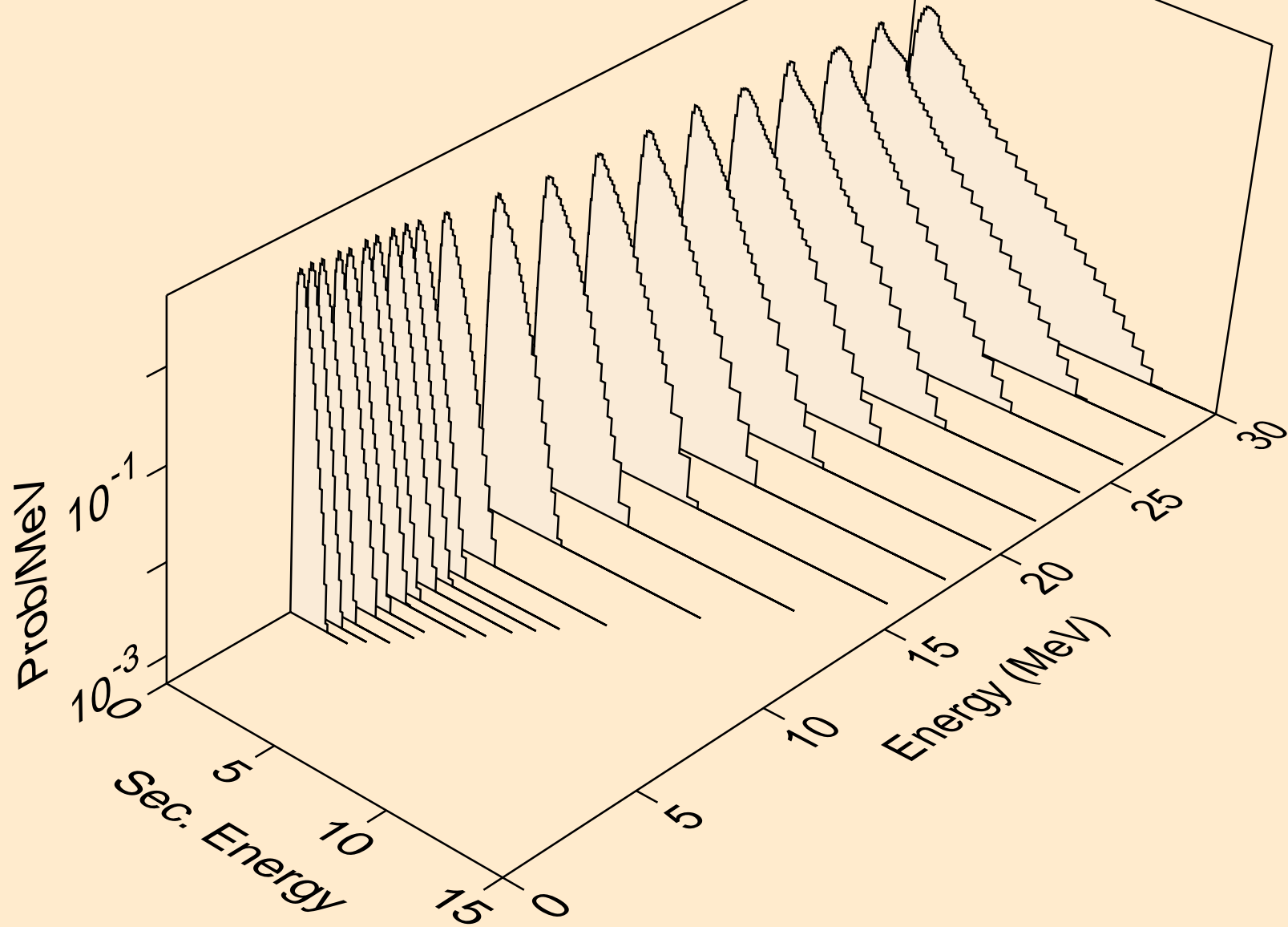



CS116M NEUTRON ACER TENDL-2021 LIBRARY; T=293.6K  
Neutron emission for (n,2n)2a

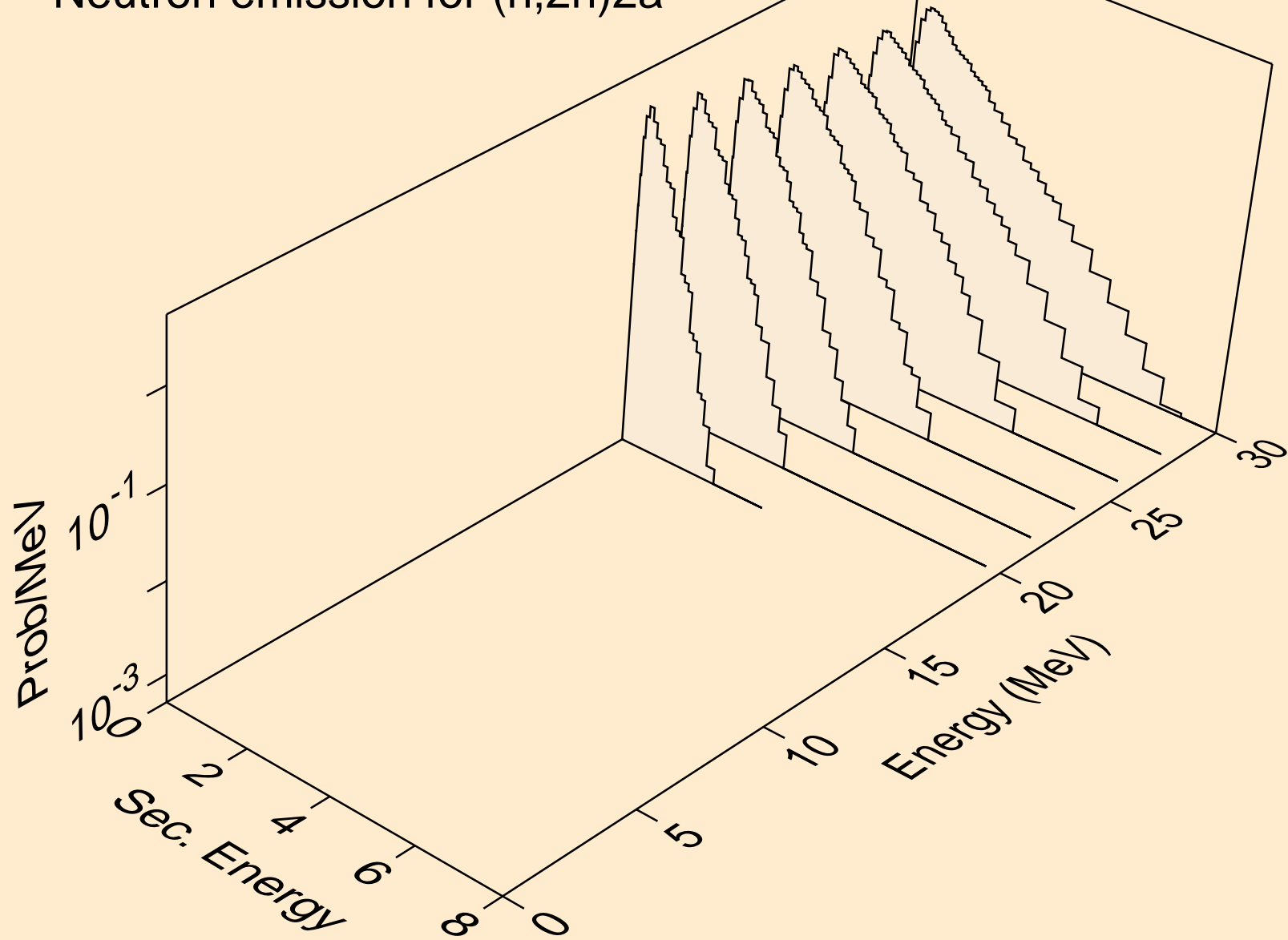

CS116M NEUTRON ACER TENDL-2021 LIBRARY; T=293.6K  
Neutron emission for (n,n\*)d

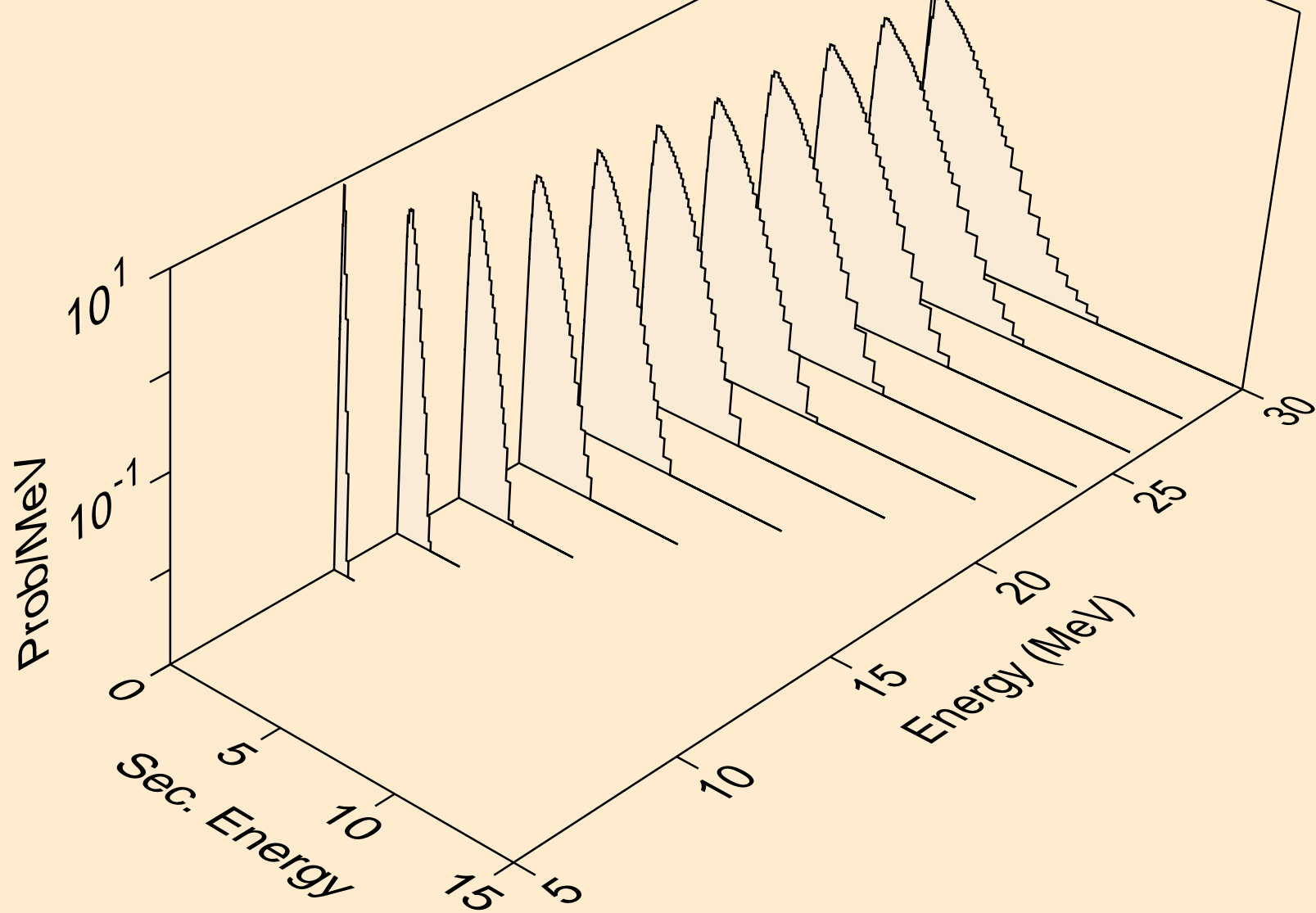

CS116M NEUTRON ACER TENDL-2021 LIBRARY; T=293.6K  
Neutron emission for (n,n\*)t

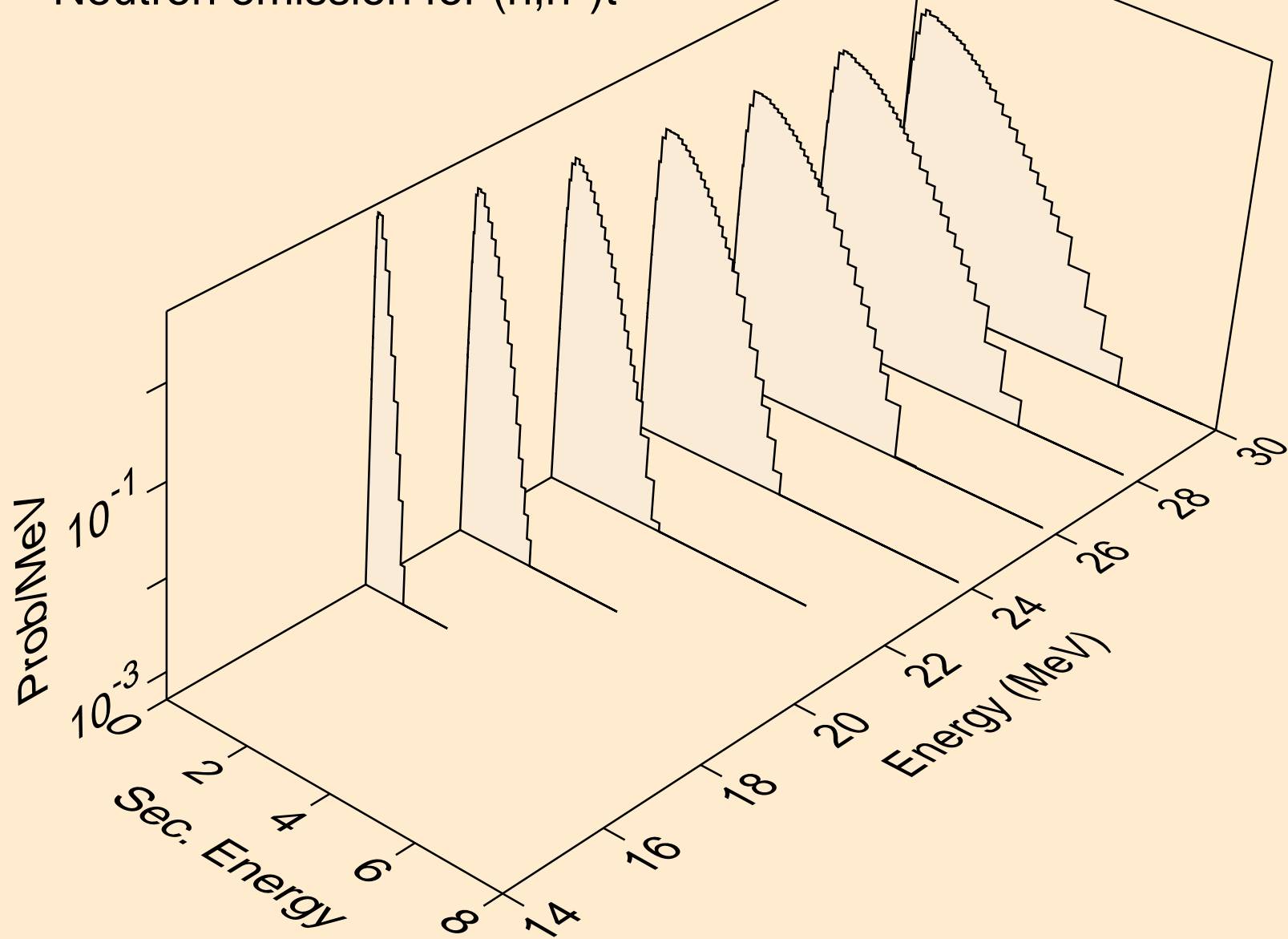

CS116M NEUTRON ACER TENDL-2021 LIBRARY; T=293.6K  
Neutron emission for (n,n\*)he3

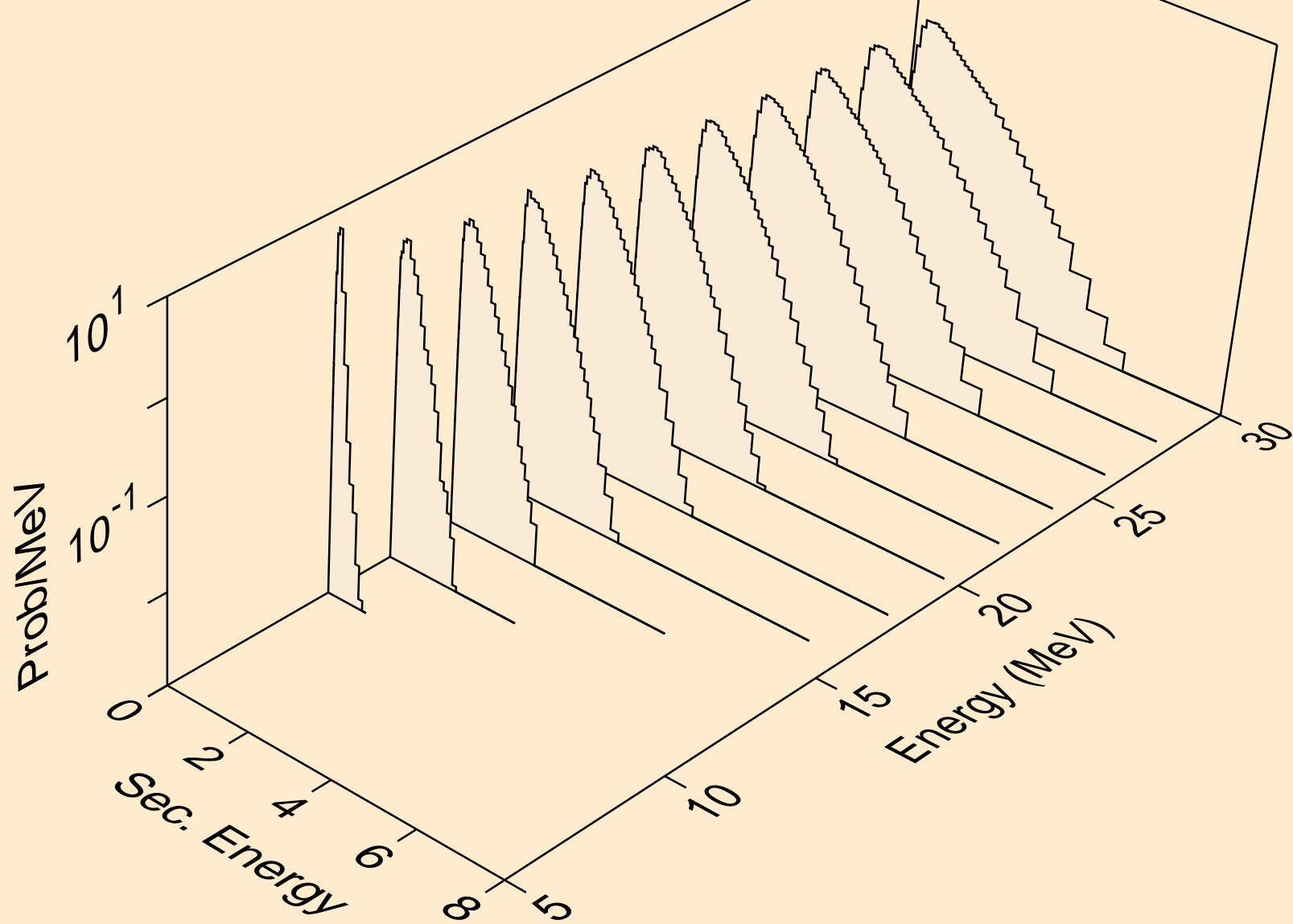

CS116M NEUTRON ACER TENDL-2021 LIBRARY; T=293.6K  
Neutron emission for (n,2np)

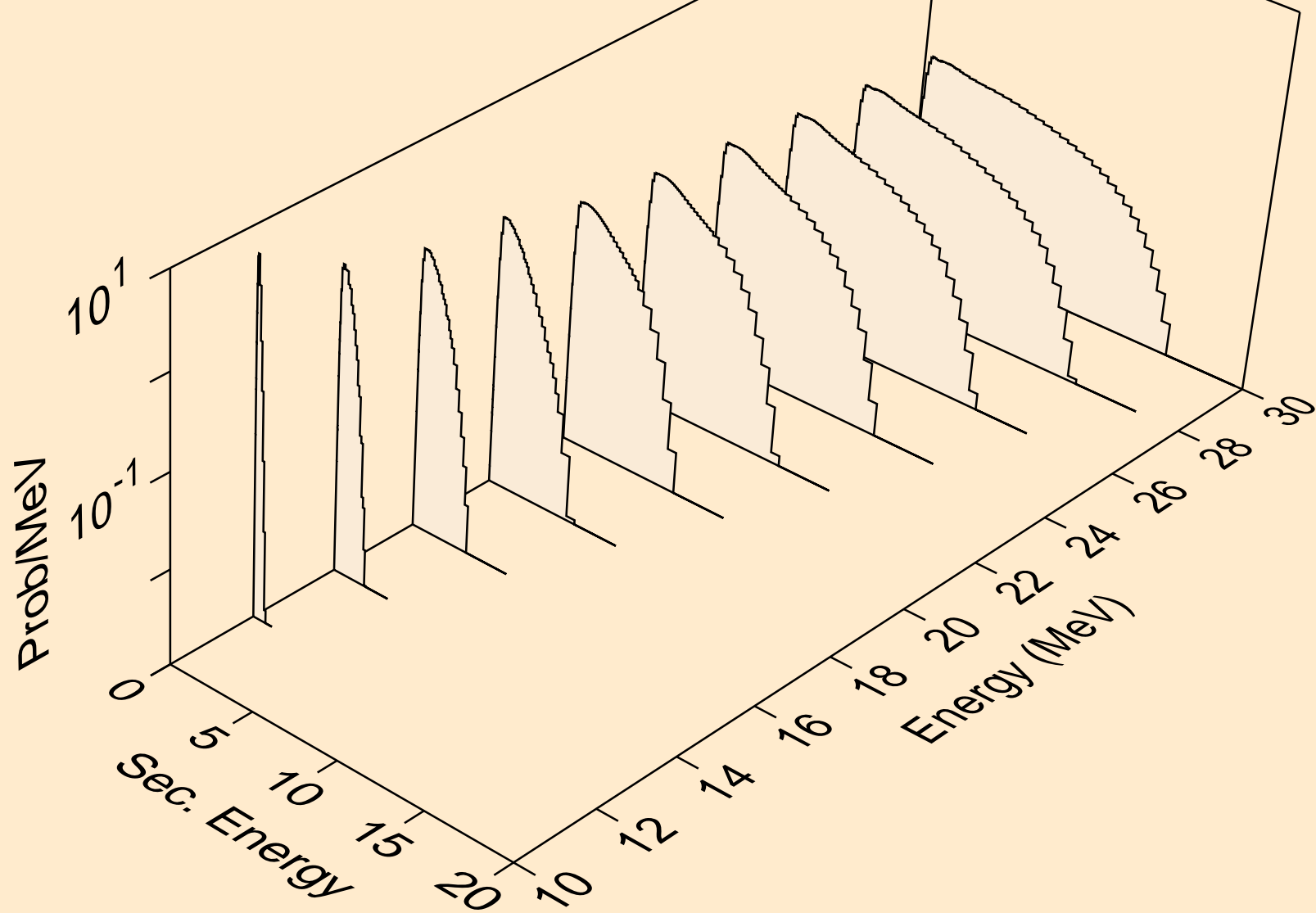

CS116M NEUTRON ACER TENDL-2021 LIBRARY; T=293.6K  
Neutron emission for (n,3np)

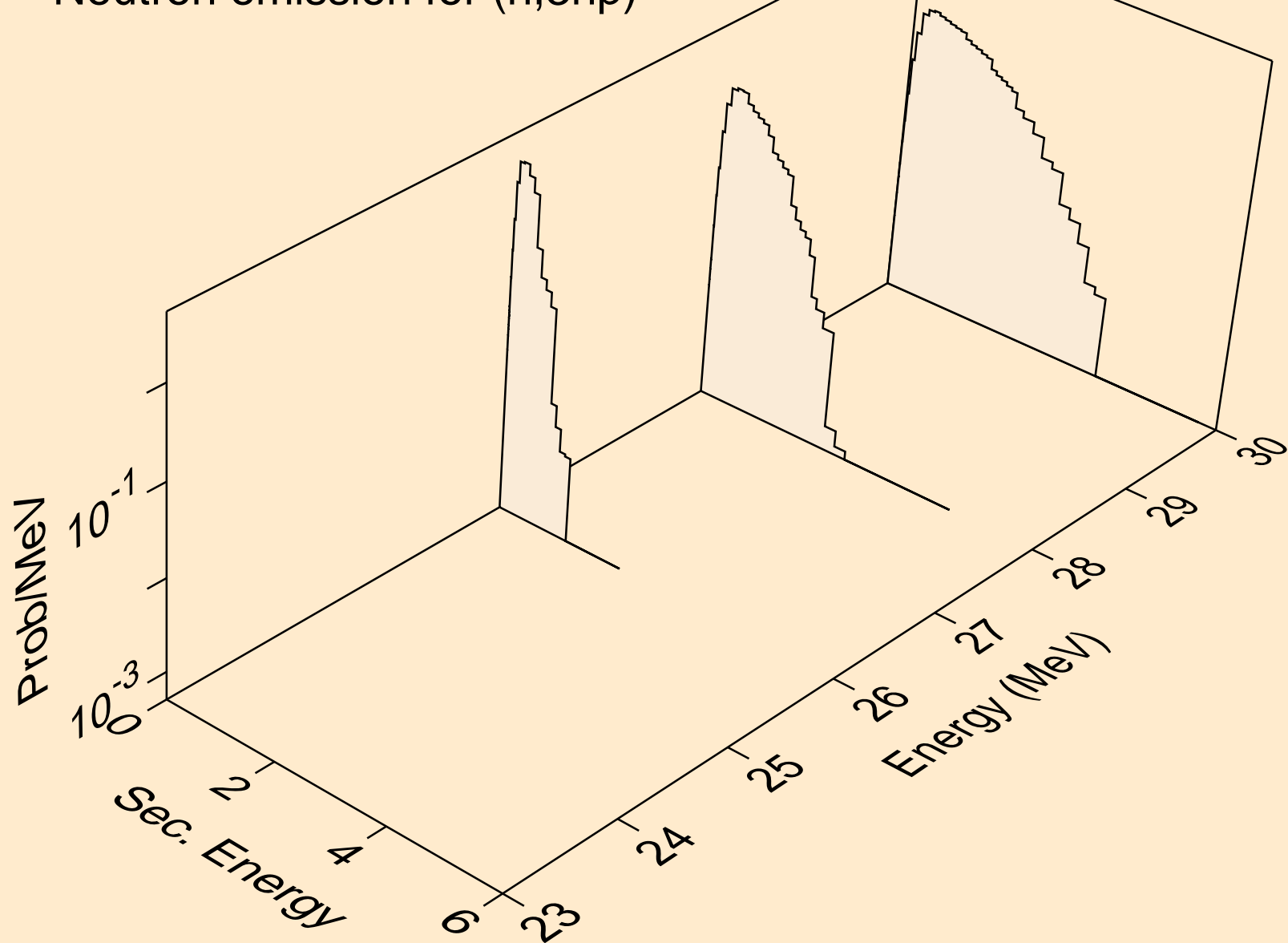

CS116M NEUTRON ACER TENDL-2021 LIBRARY; T=293.6K  
Neutron emission for (n,2np)

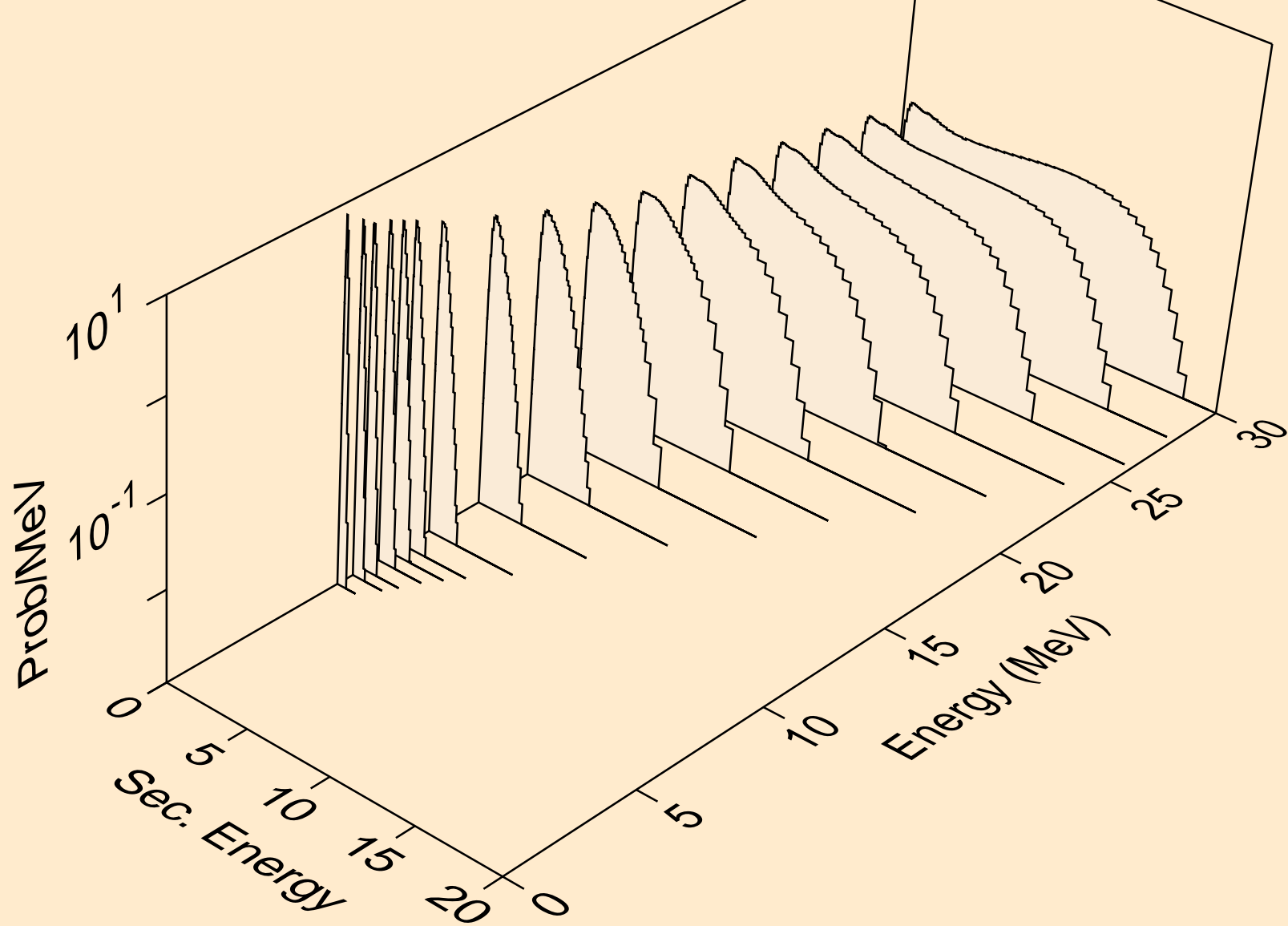

CS116M NEUTRON ACER TENDL-2021 LIBRARY; T=293.6K  
Neutron emission for (n,npa)

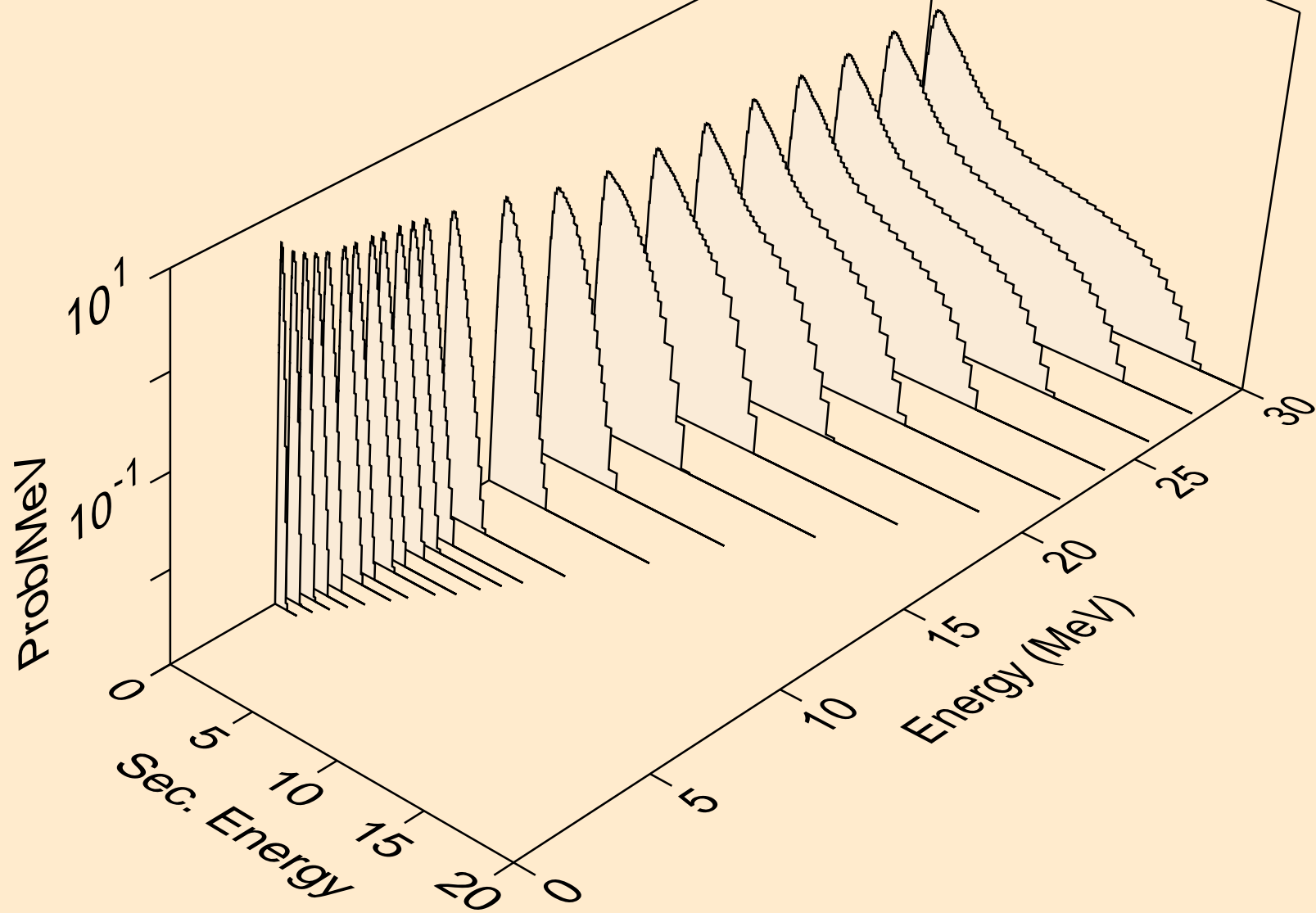



CS116M NEUTRON ACER TENDL-2021 LIBRARY; T=293.6K  
Neutron emission for (n,n\*c)

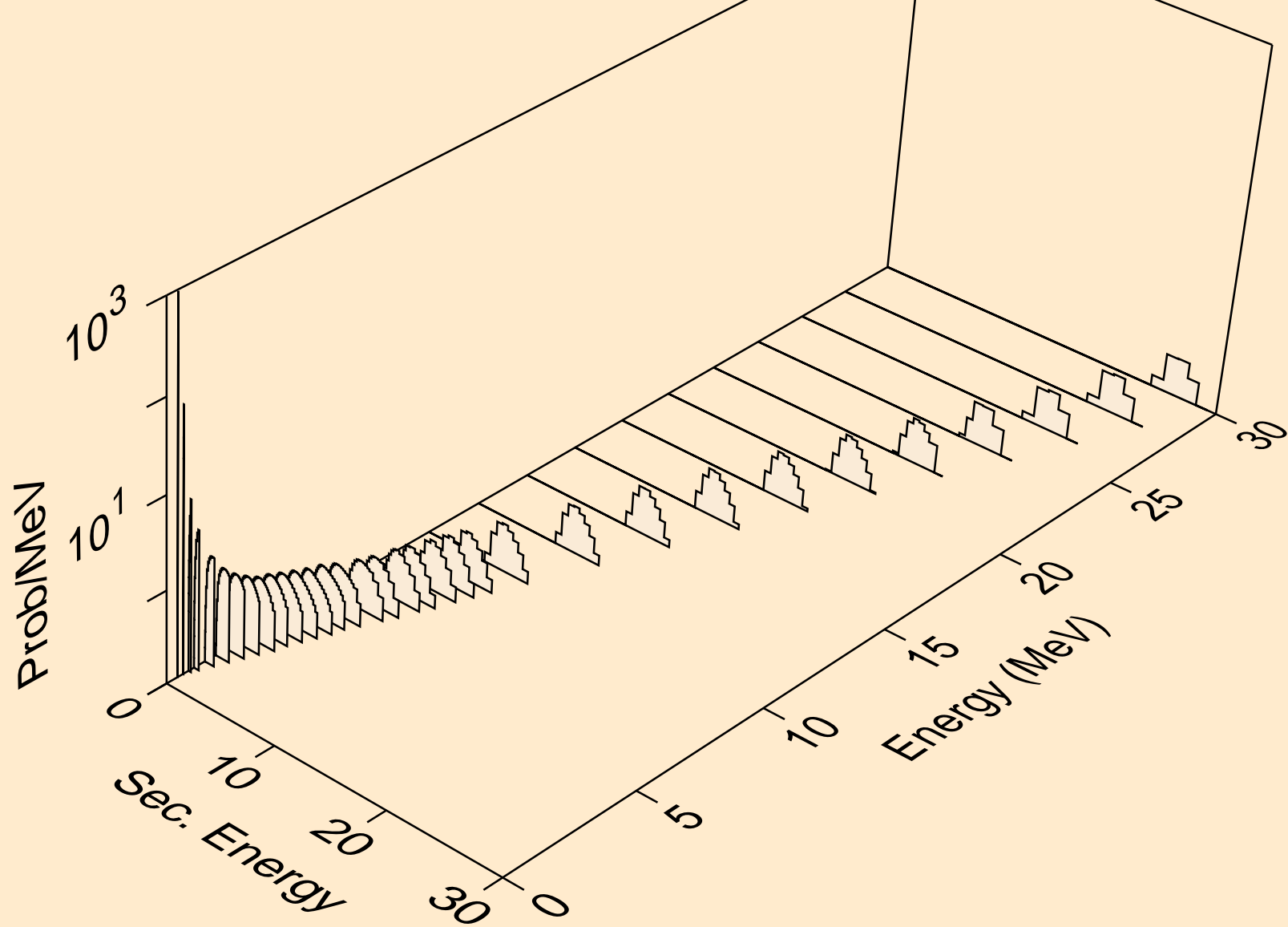

CS116M NEUTRON ACER TENDL-2021 LIBRARY; T=293.6K  
Photon emission for (n,x)

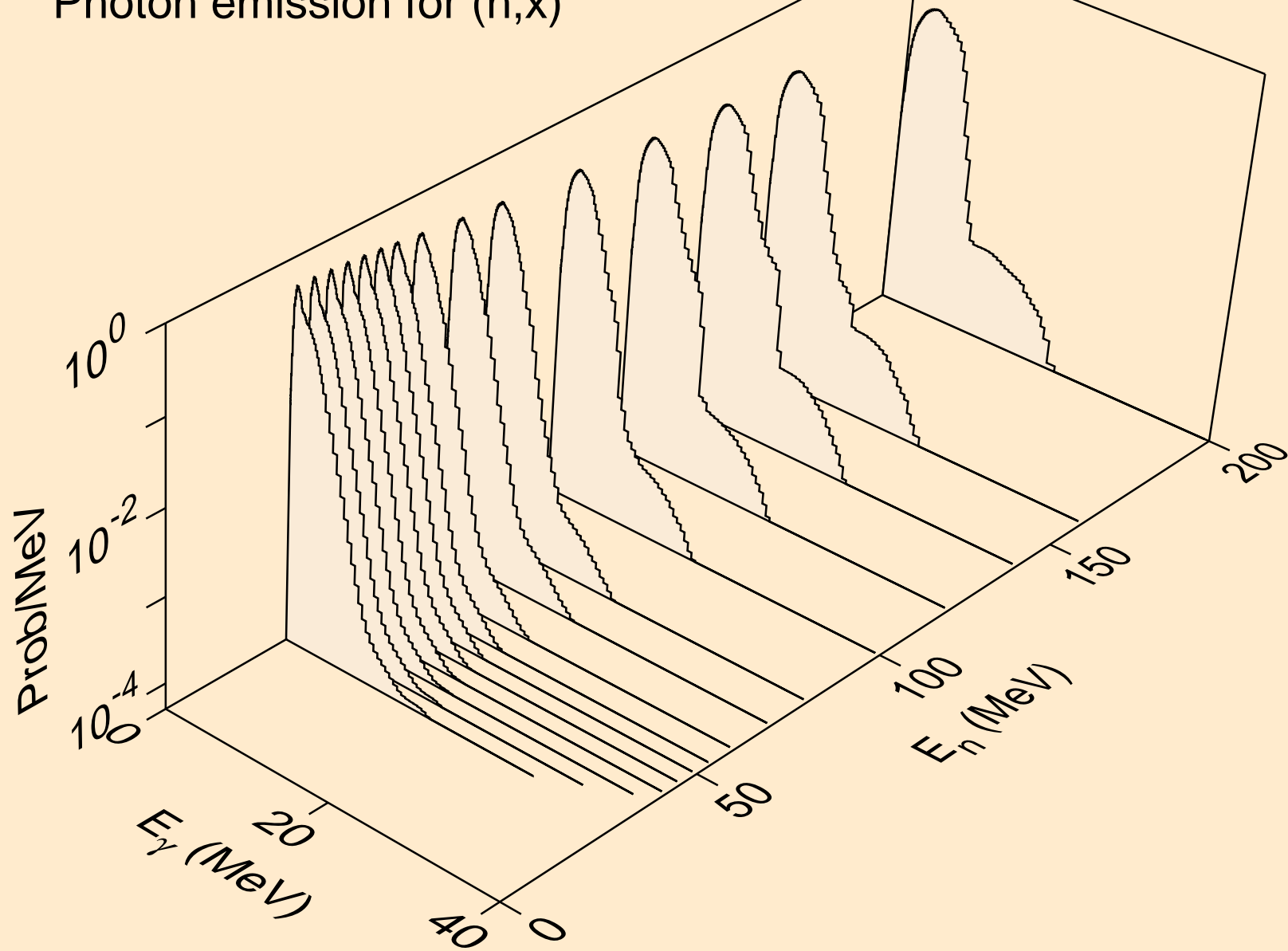

CS116M NEUTRON ACER TENDL-2021 LIBRARY; T=293.6K  
Photon emission for (n,2nd)

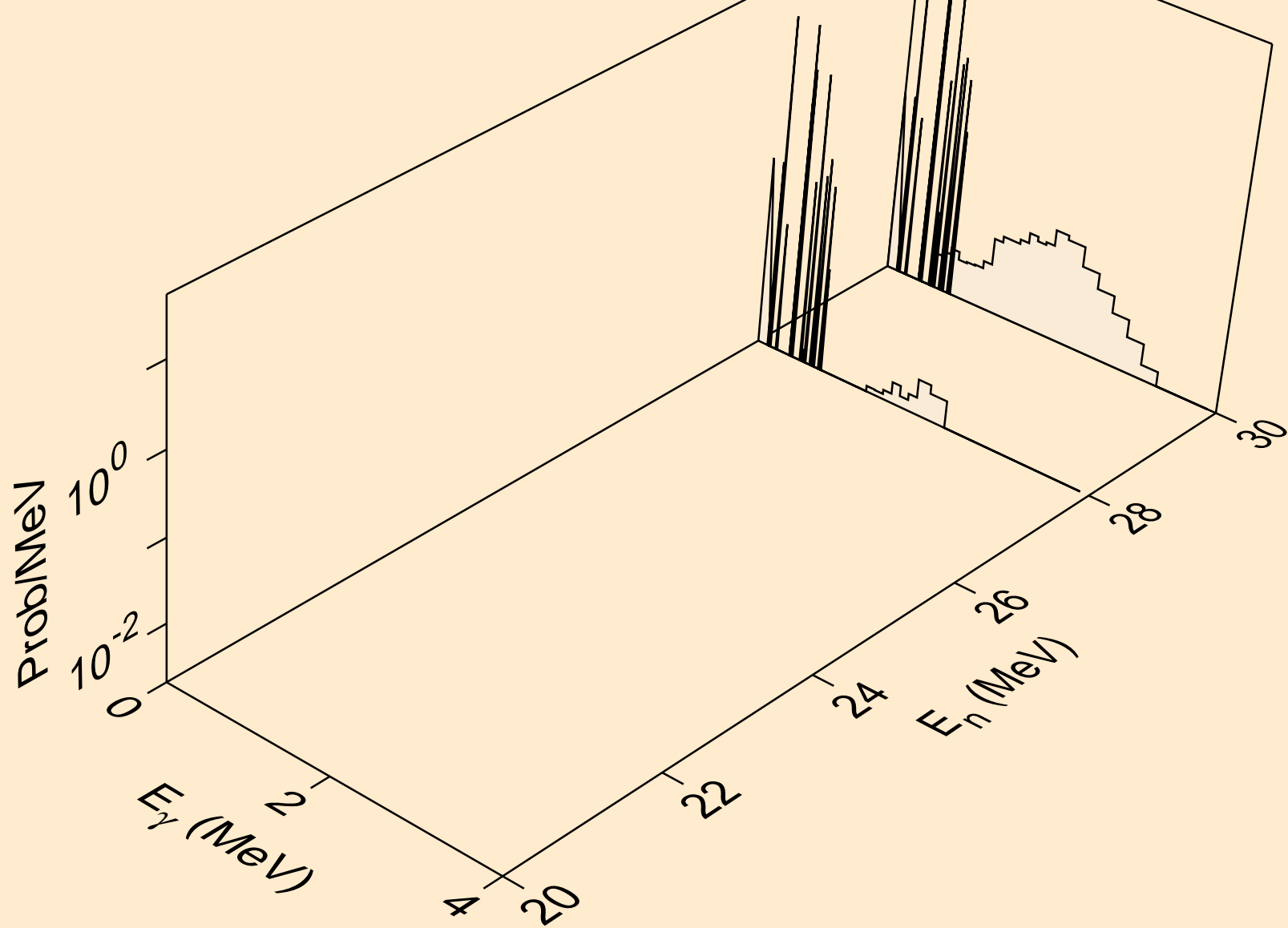

CS116M NEUTRON ACER TENDL-2021 LIBRARY; T=293.6K  
Photon emission for (n,2n)

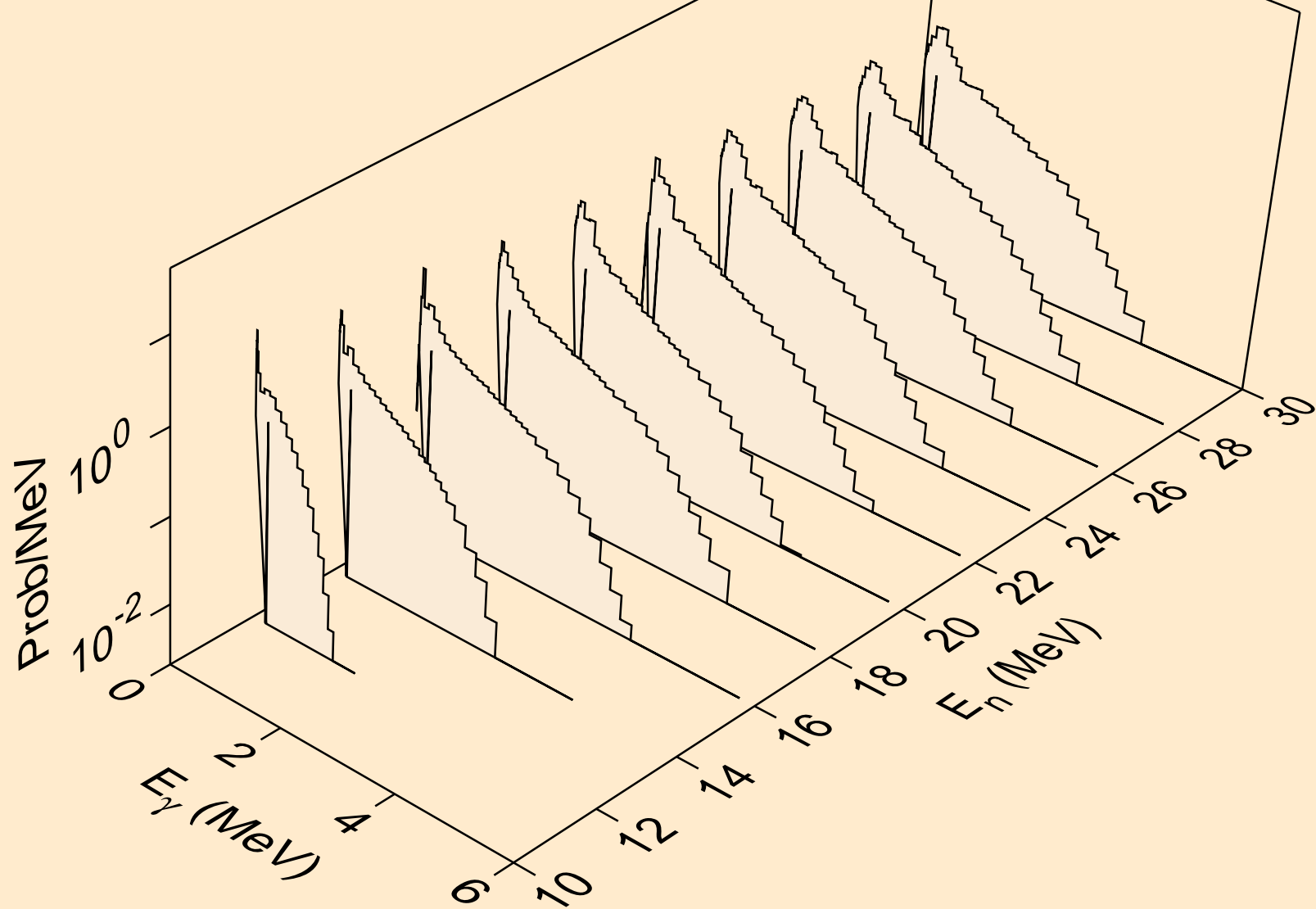

CS116M NEUTRON ACER TENDL-2021 LIBRARY; T=293.6K  
Photon emission for (n,3n)

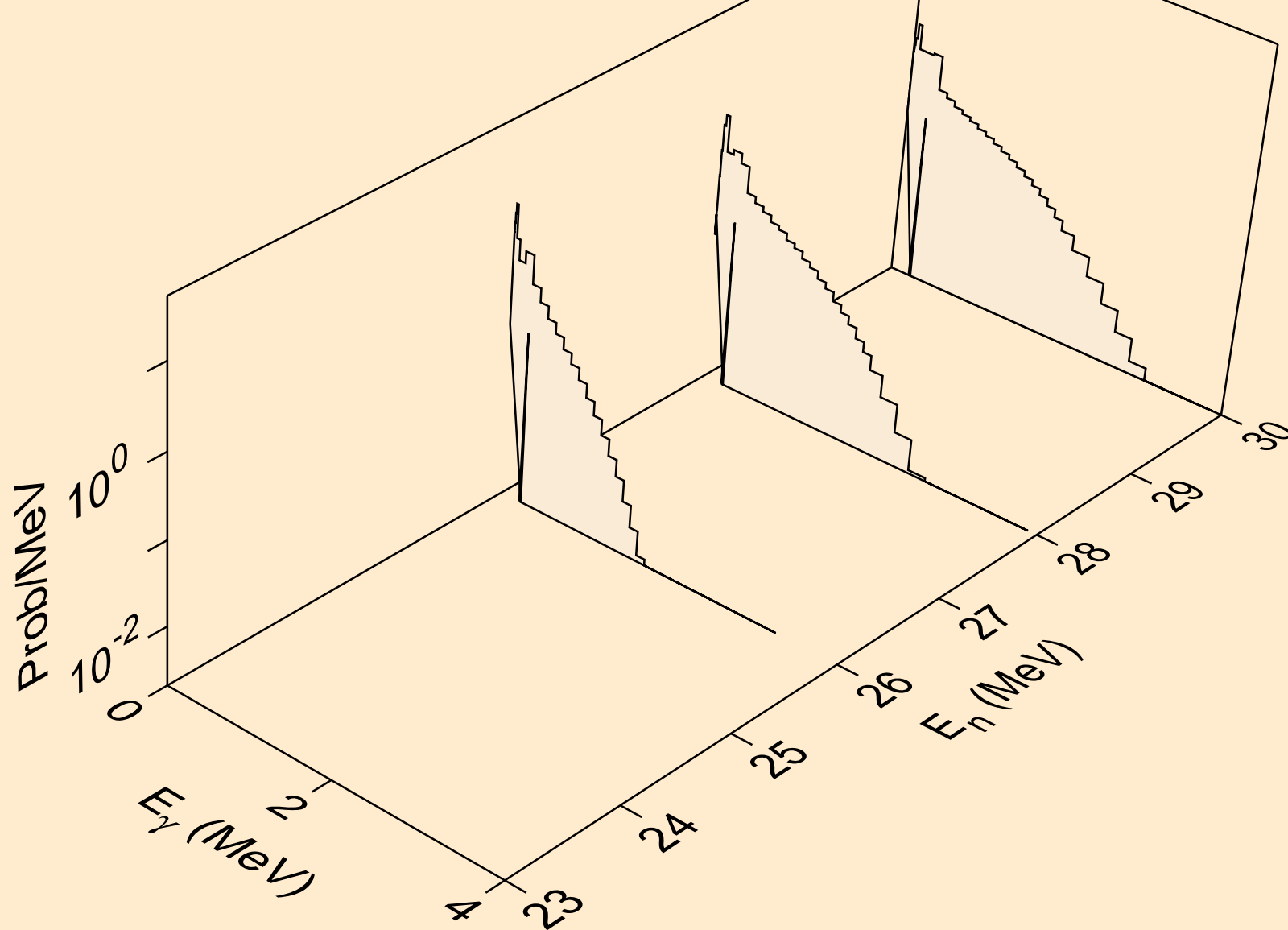

CS116M NEUTRON ACER TENDL-2021 LIBRARY; T=293.6K  
Photon emission for (n,n\*)a

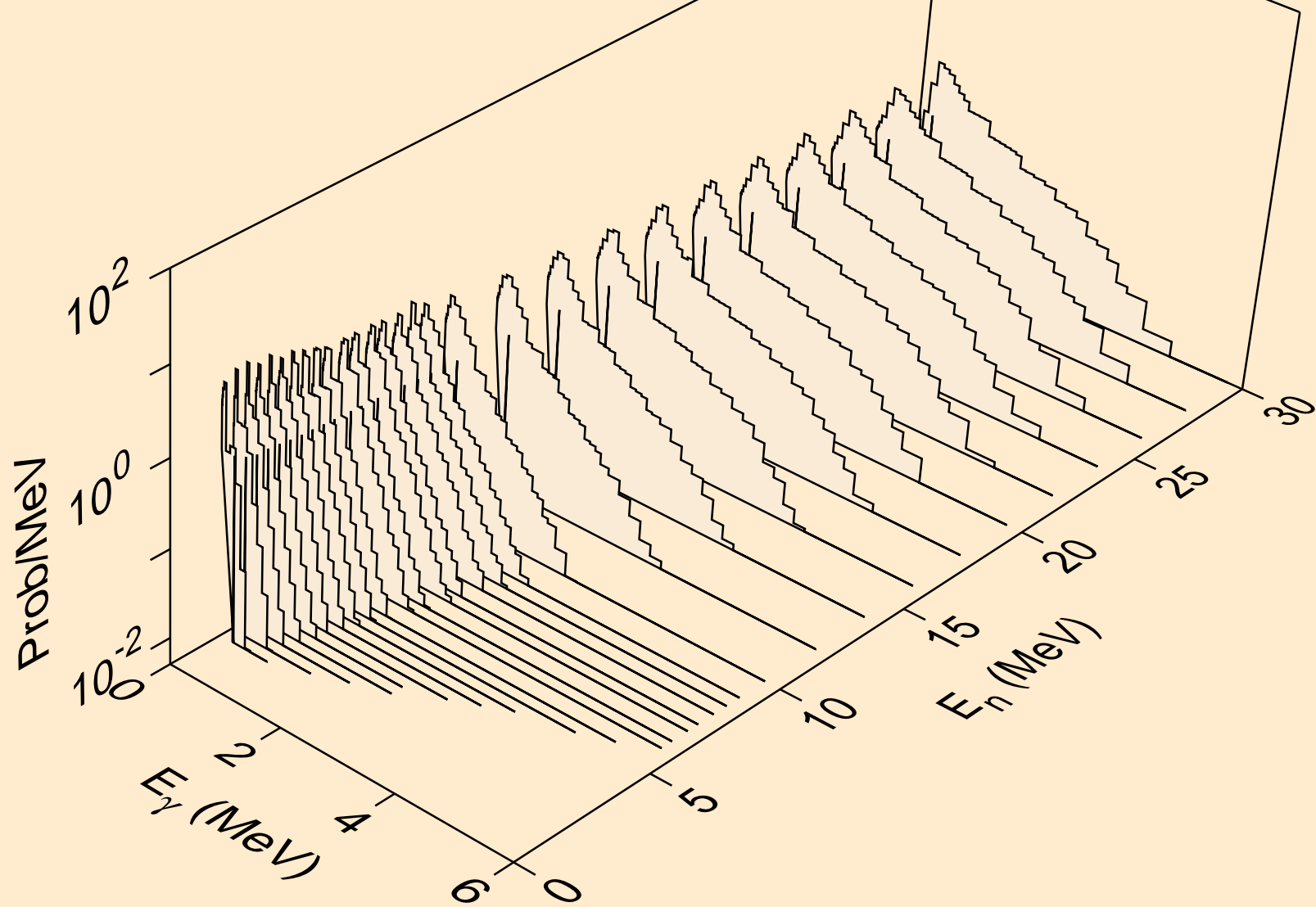

CS116M NEUTRON ACER TENDL-2021 LIBRARY; T=293.6K  
Photon emission for (n,n\*)3a

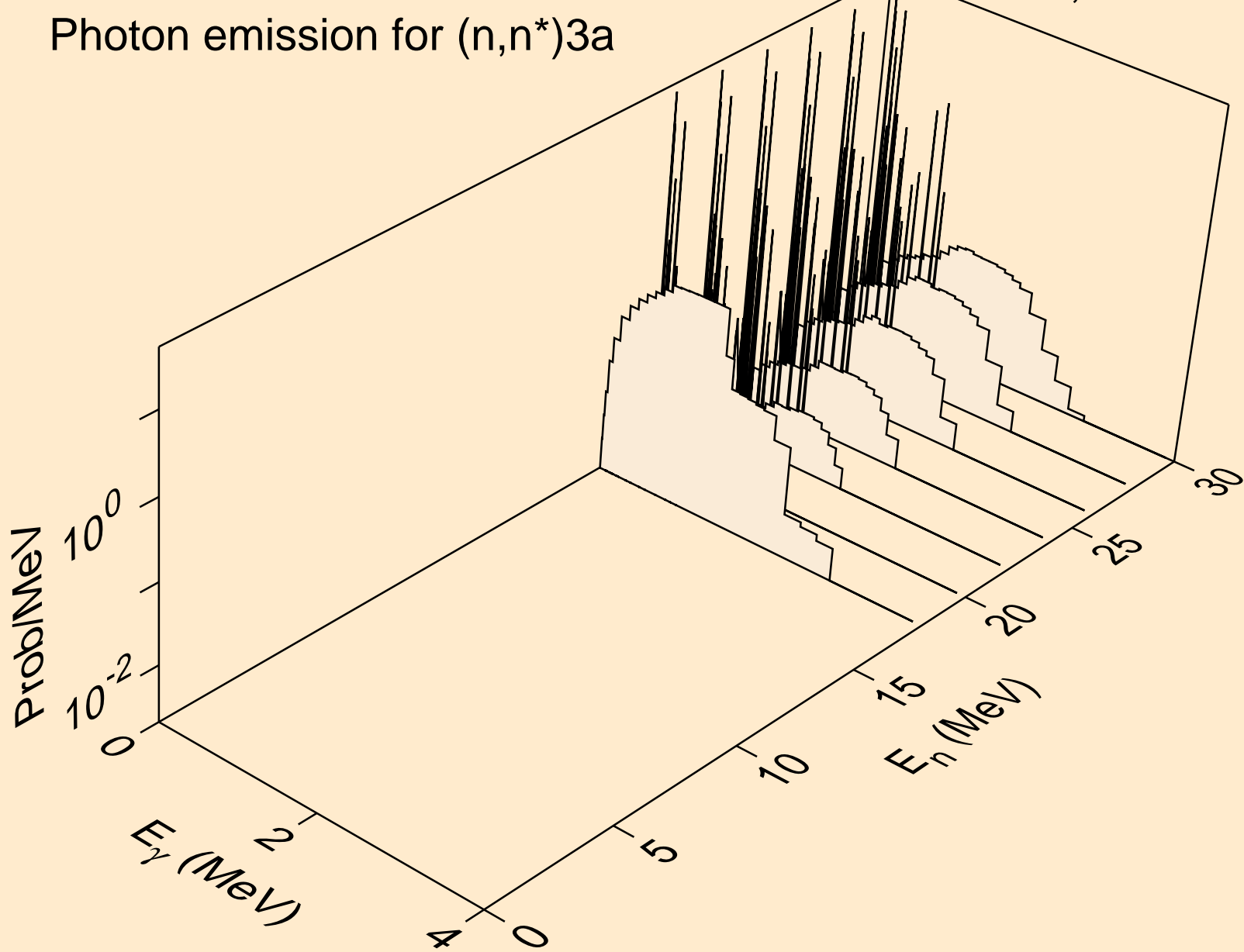

CS116M NEUTRON ACER TENDL-2021 LIBRARY; T=293.6K  
Photon emission for (n,2n)a

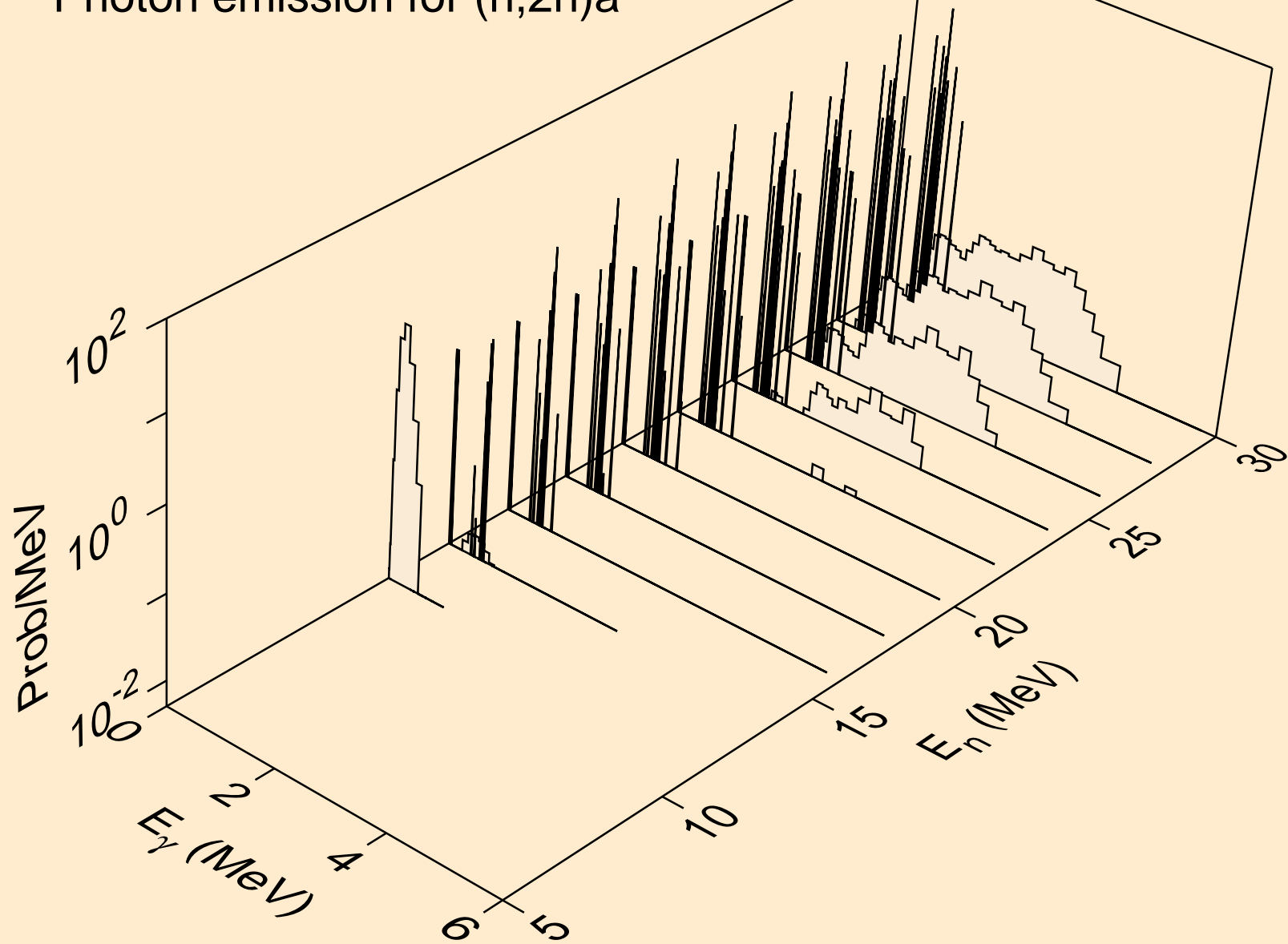



CS116M NEUTRON ACER TENDL-2021 LIBRARY; T=293.6K  
Photon emission for (n,n\*)p

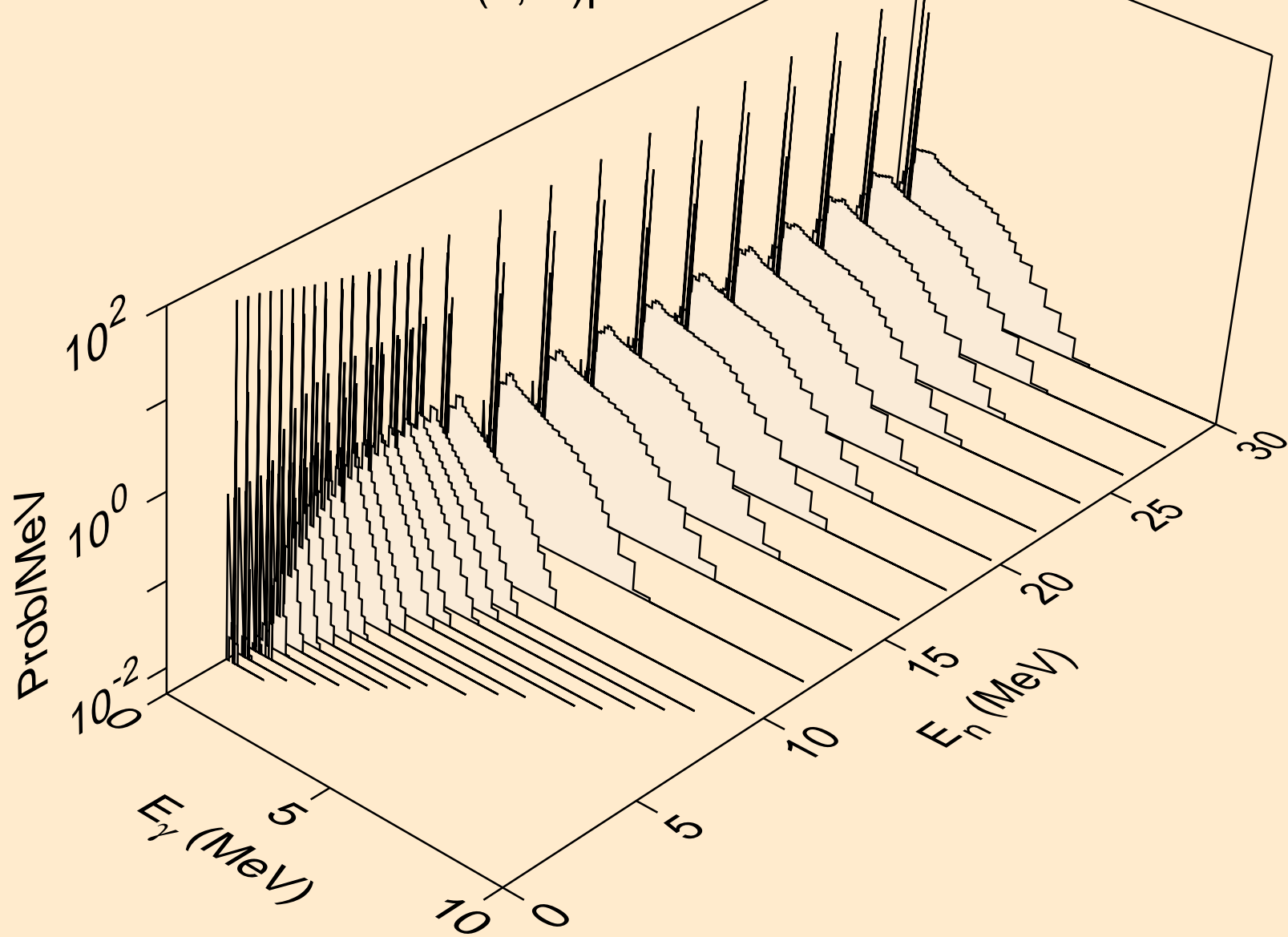

CS116M NEUTRON ACER TENDL-2021 LIBRARY; T=293.6K  
Photon emission for (n,n\*)2a

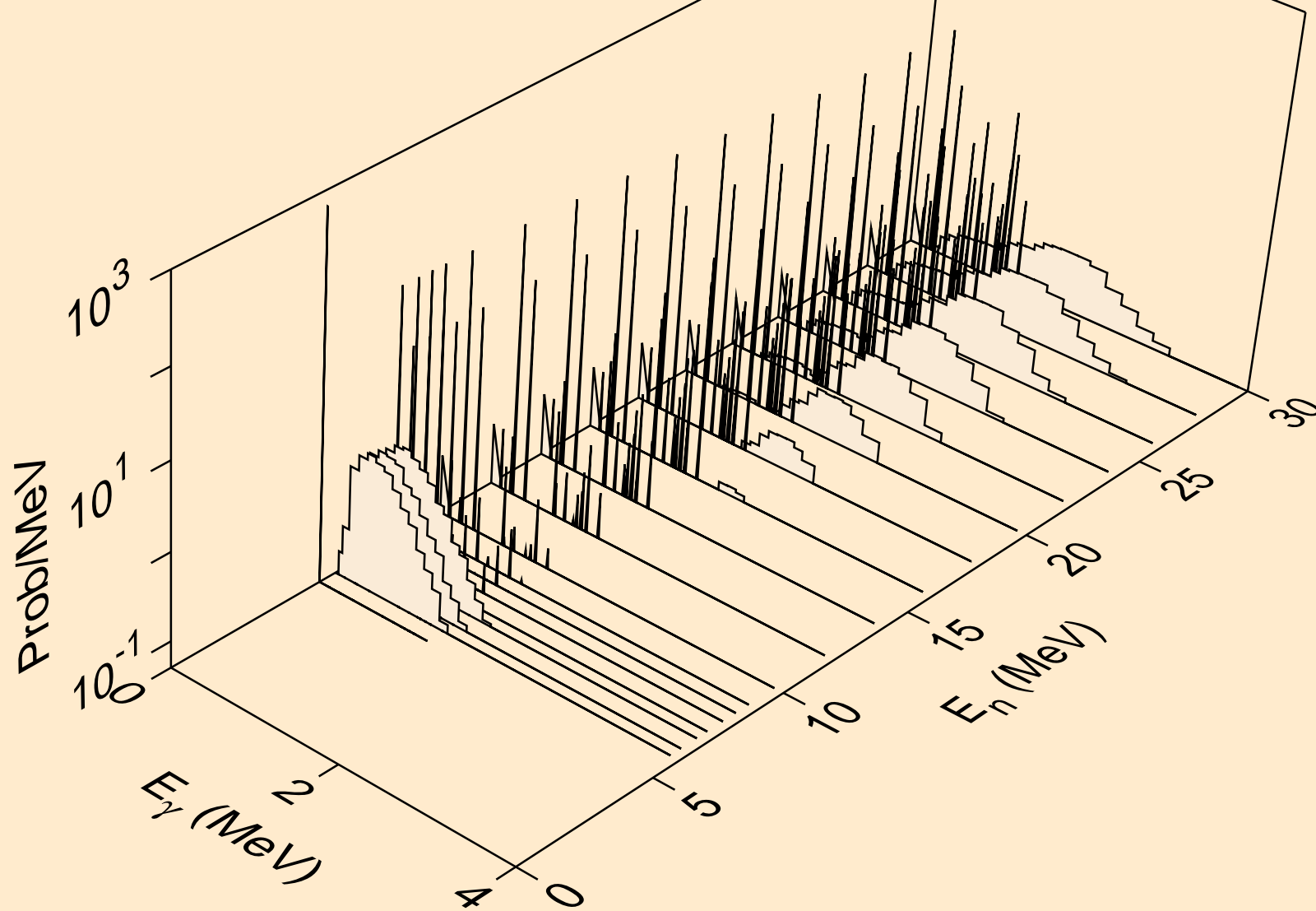

CS116M NEUTRON ACER TENDL-2021 LIBRARY; T=293.6K  
Photon emission for (n,2n)2a

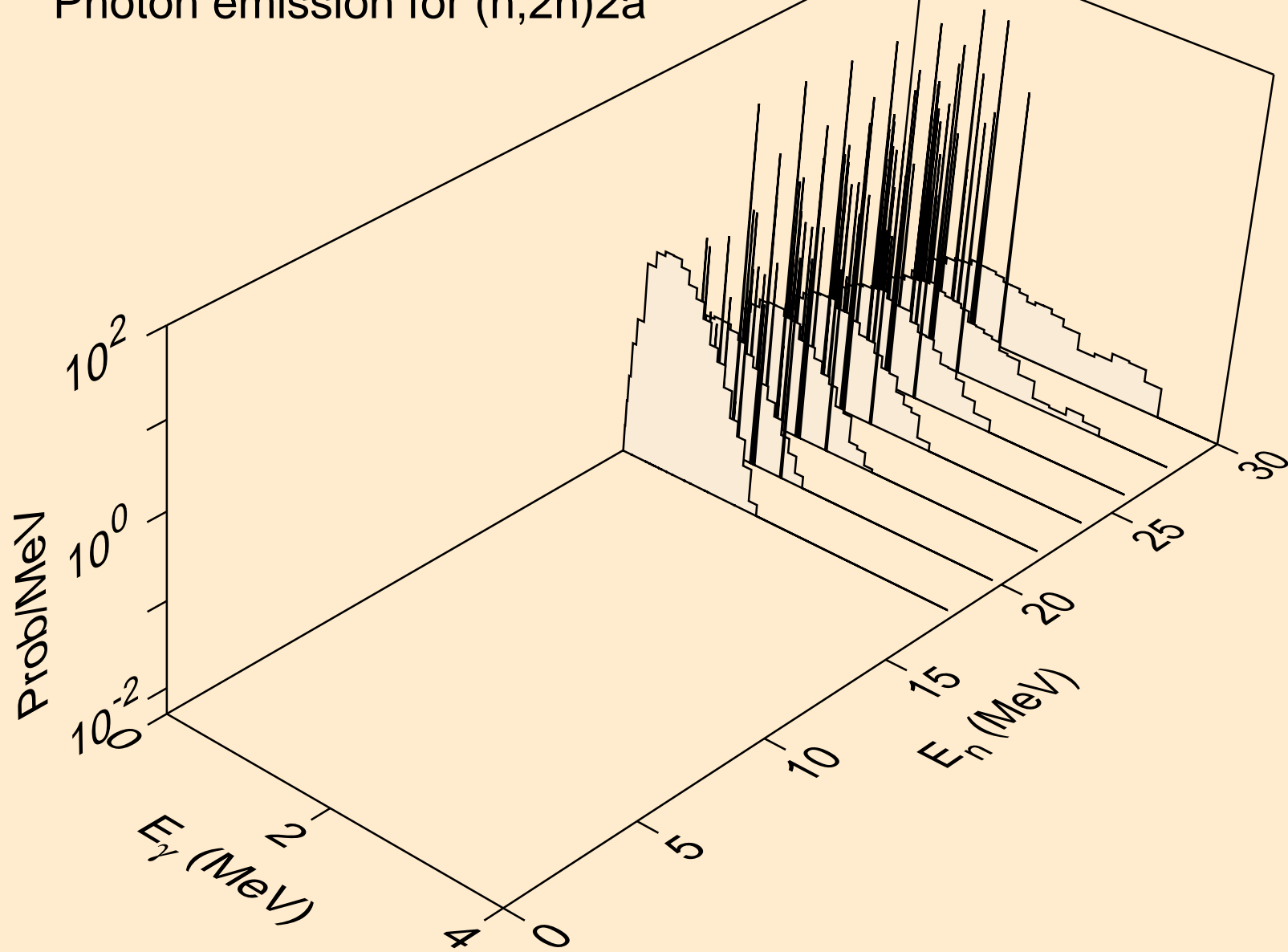

CS116M NEUTRON ACER TENDL-2021 LIBRARY; T=293.6K  
Photon emission for (n,n\*)d

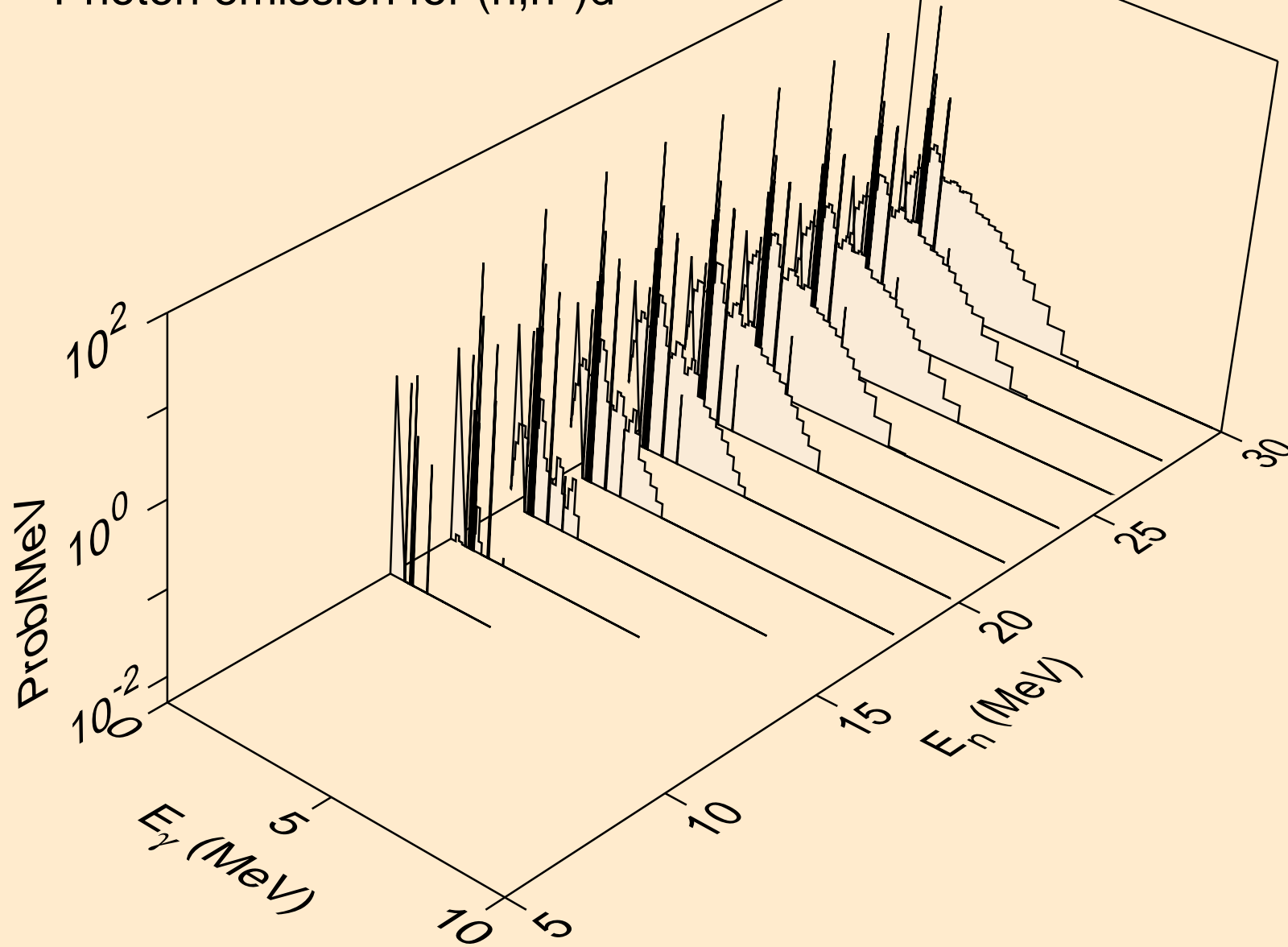

CS116M NEUTRON ACER TENDL-2021 LIBRARY; T=293.6K  
Photon emission for (n,n\*)t

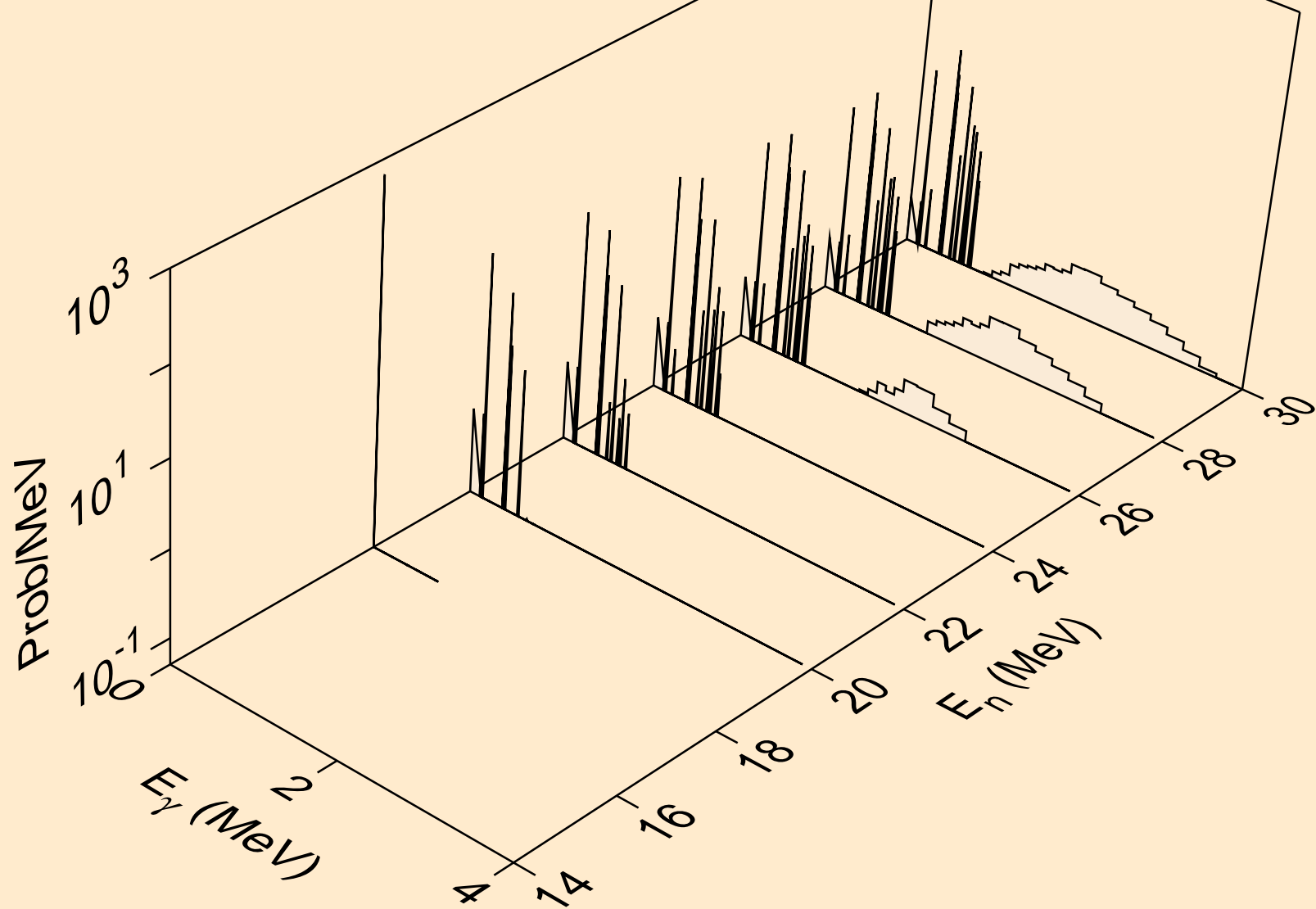

CS116M NEUTRON ACER TENDL-2021 LIBRARY; T=293.6K  
Photon emission for (n,n\*)he3

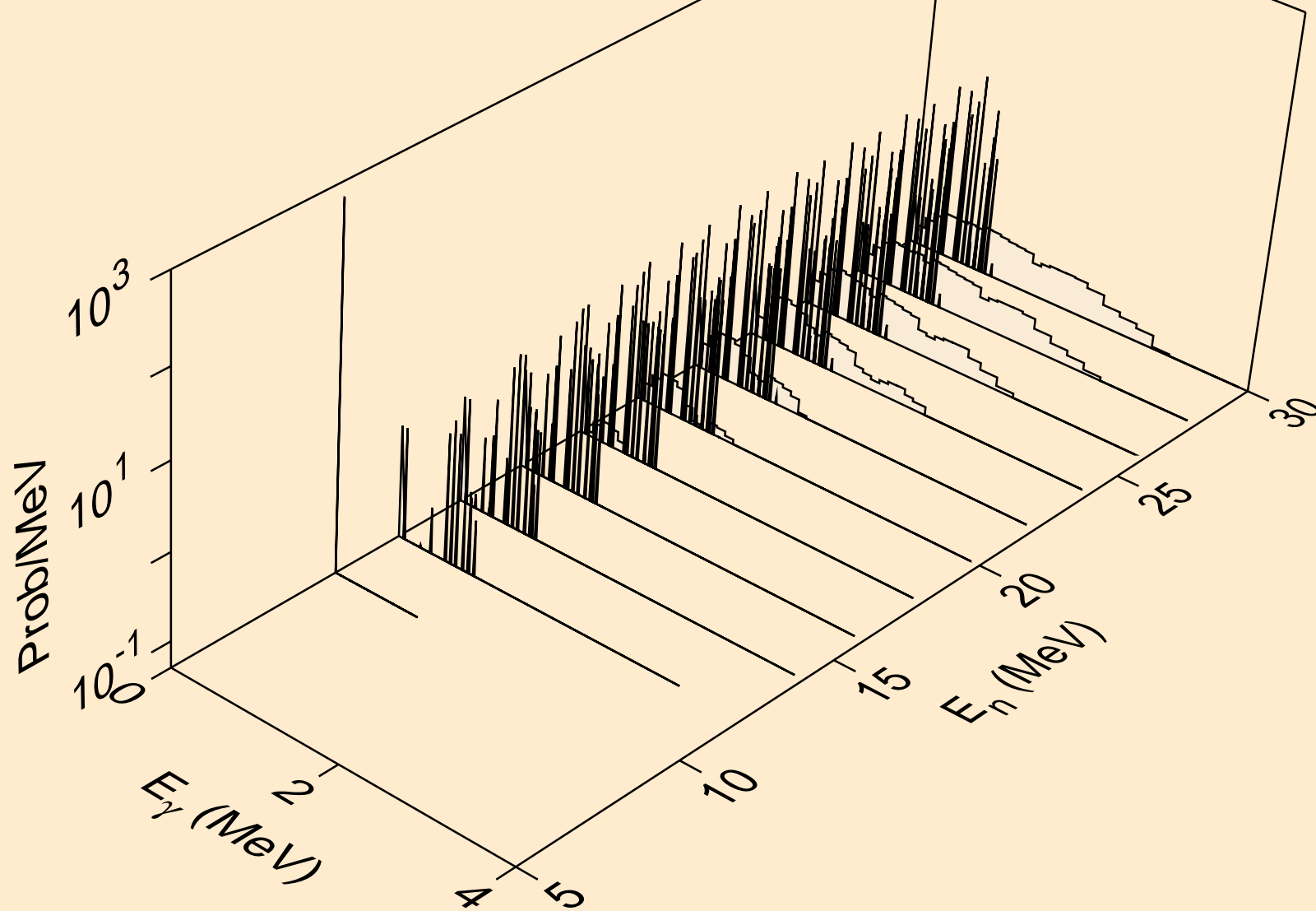

CS116M NEUTRON ACER TENDL-2021 LIBRARY; T=293.6K  
Photon emission for (n,2np)

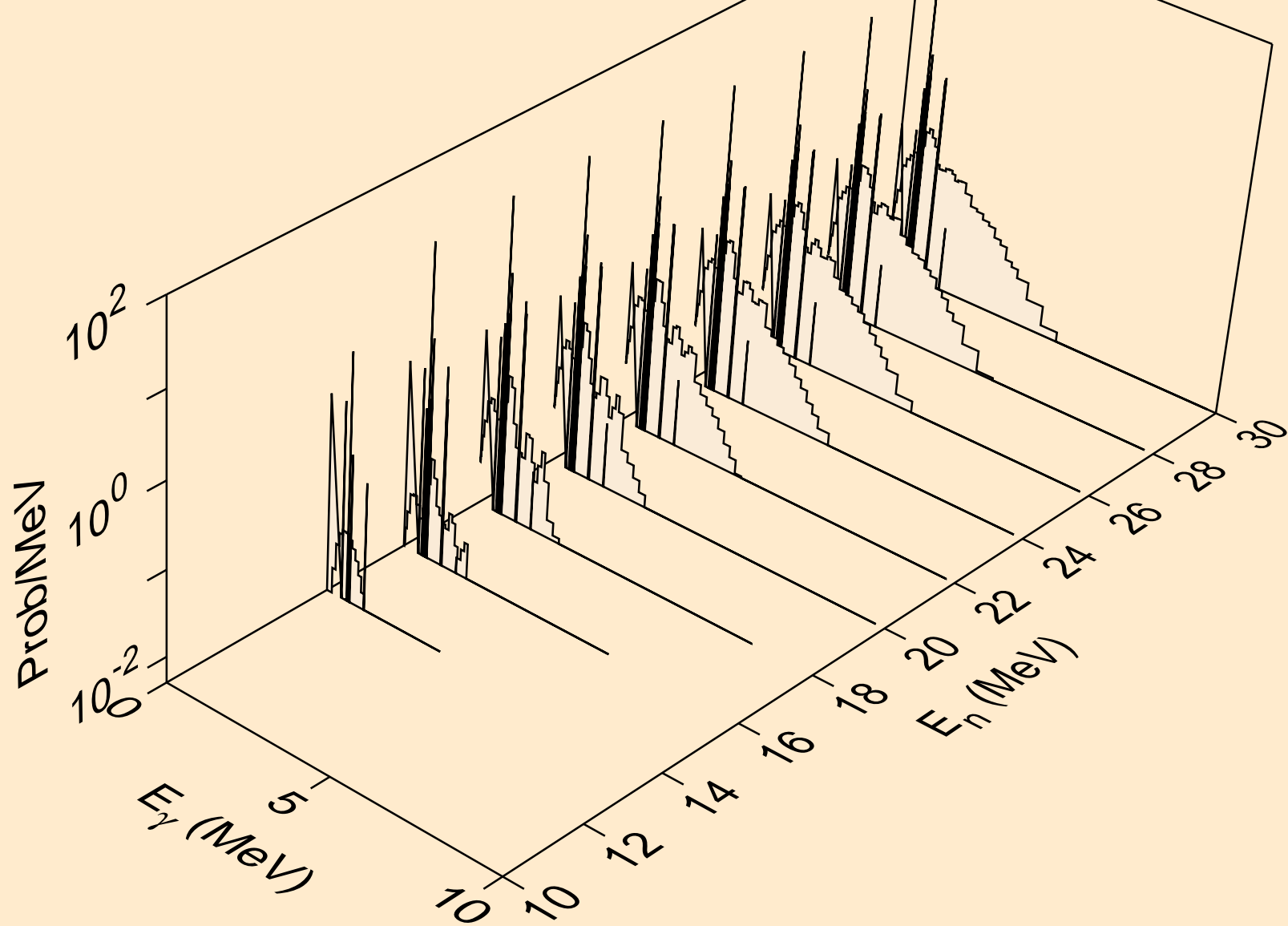

CS116M NEUTRON ACER TENDL-2021 LIBRARY; T=293.6K  
Photon emission for (n,3np)

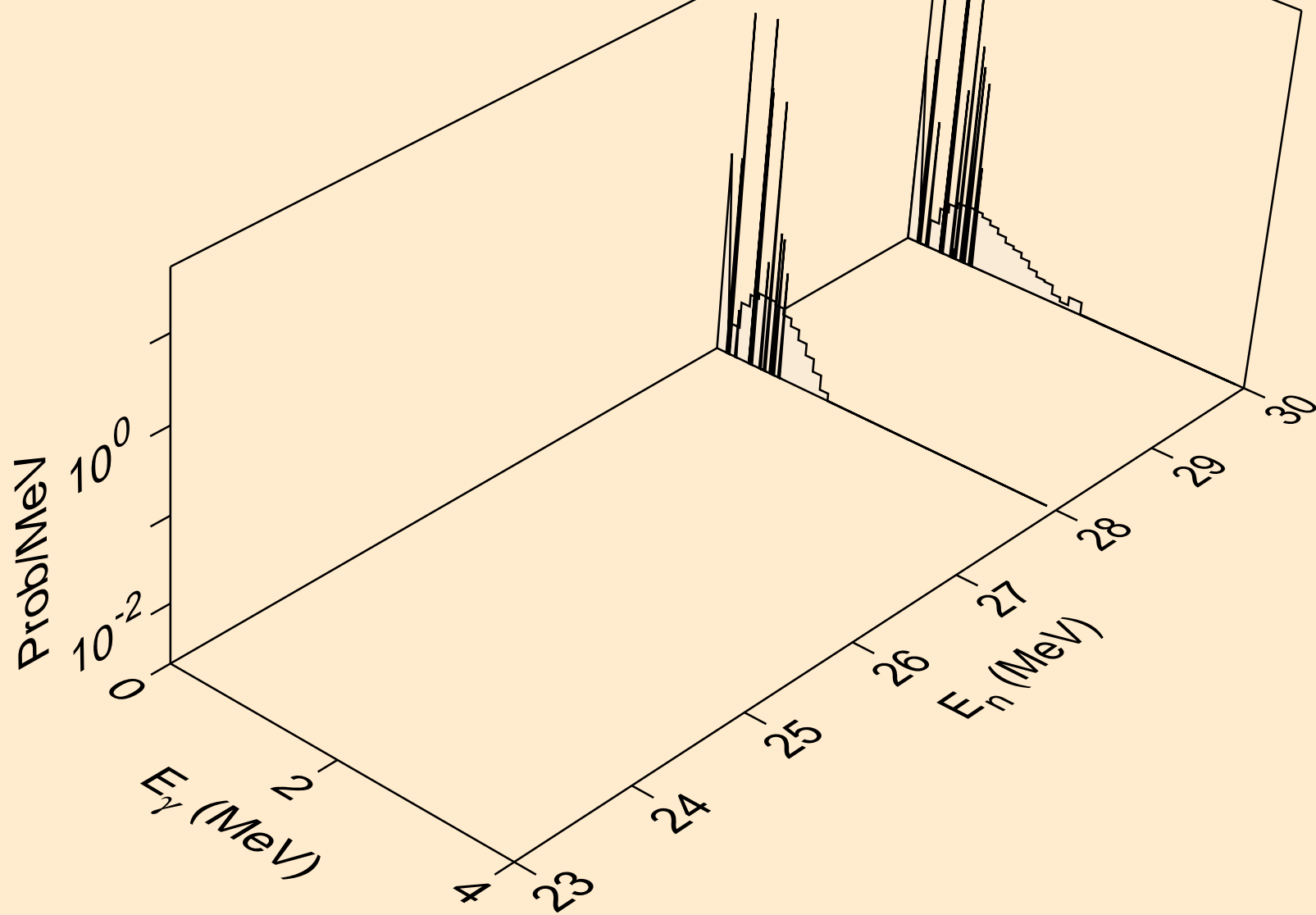



CS116M NEUTRON ACER TENDL-2021 LIBRARY; T=293.6K  
Photon emission for (n,2np)

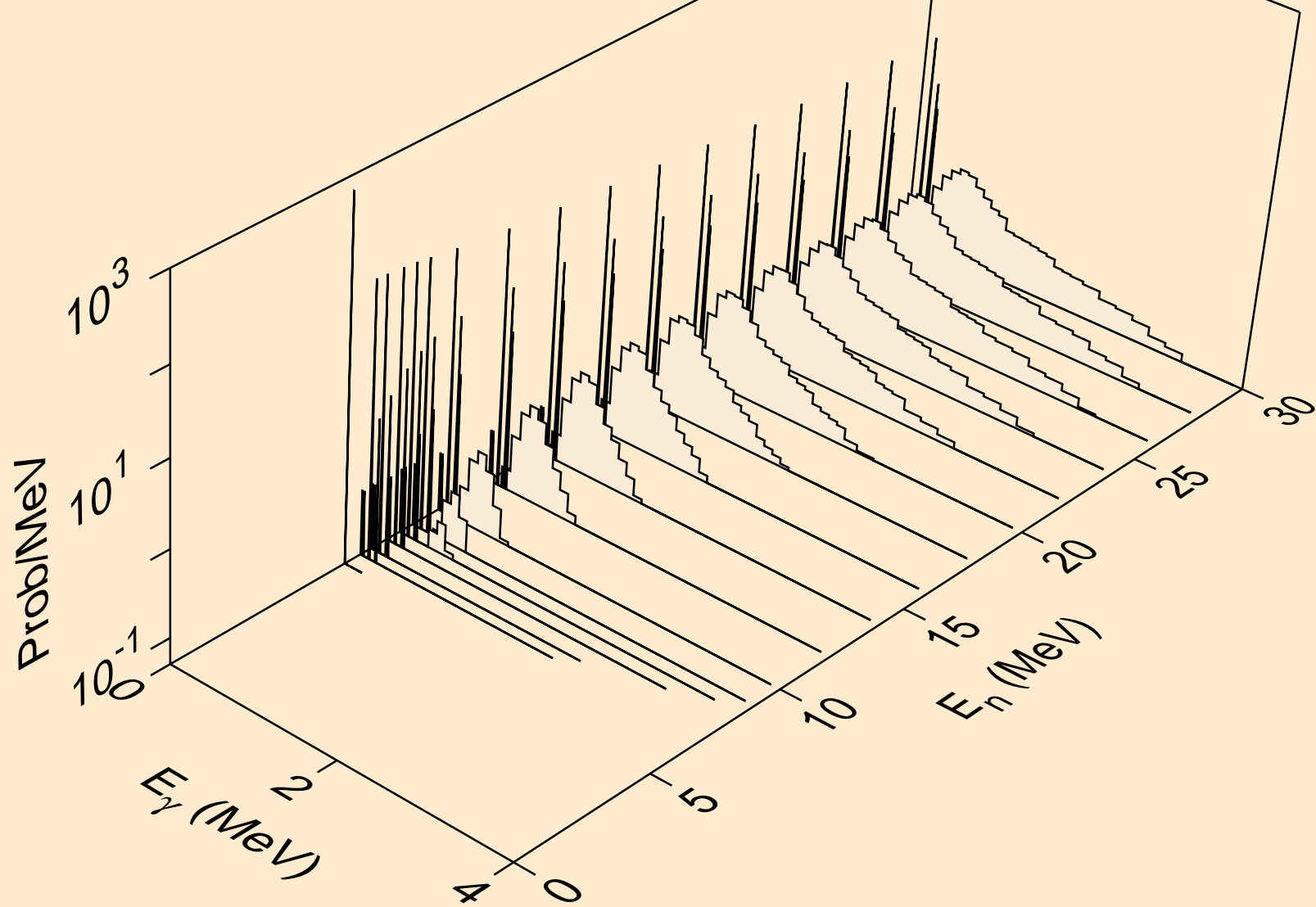

CS116M NEUTRON ACER TENDL-2021 LIBRARY; T=293.6K  
Photon emission for (n,npa)

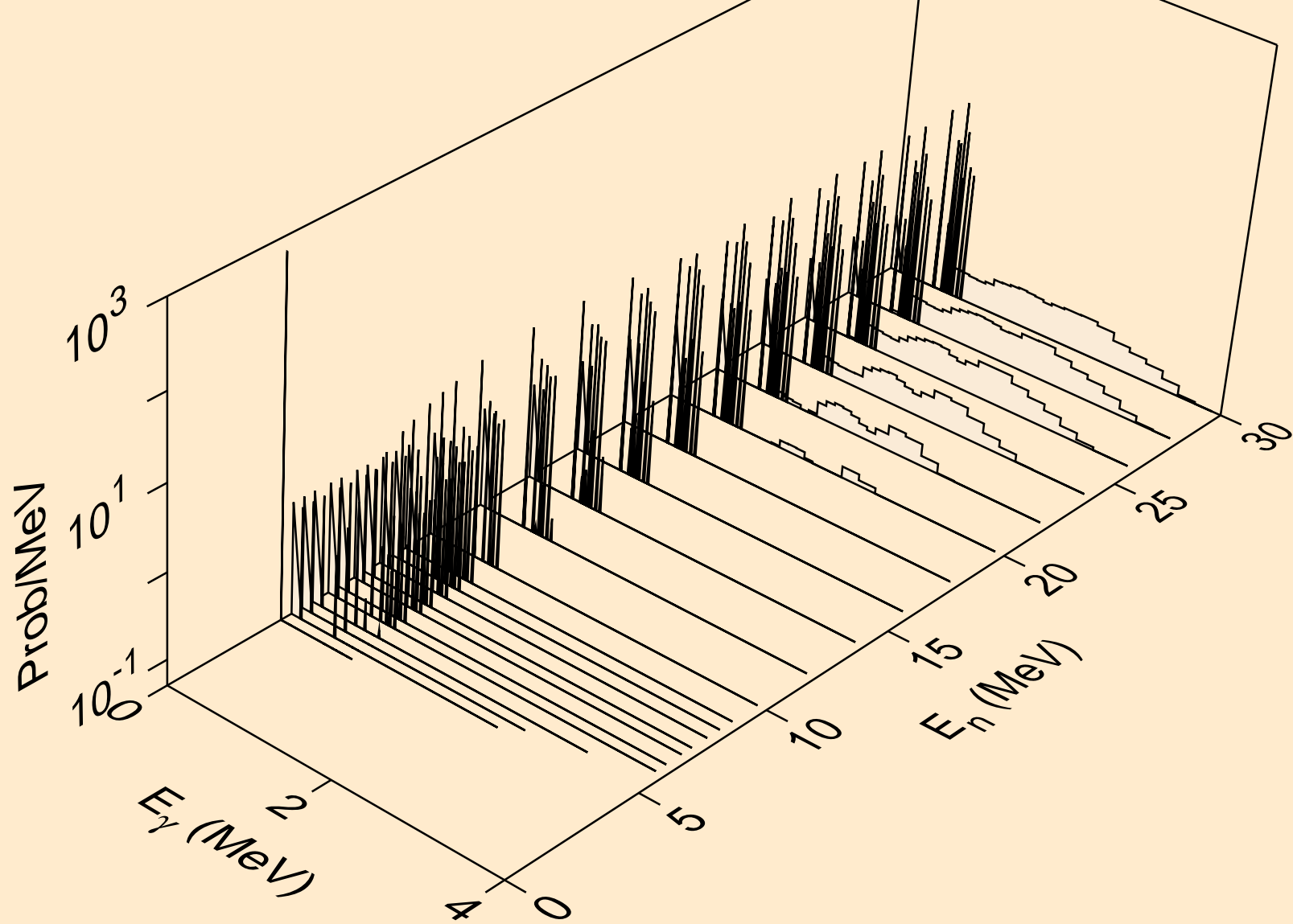

CS116M NEUTRON ACER TENDL-2021 LIBRARY; T=293.6K  
Photon emission for (n,n\*2)

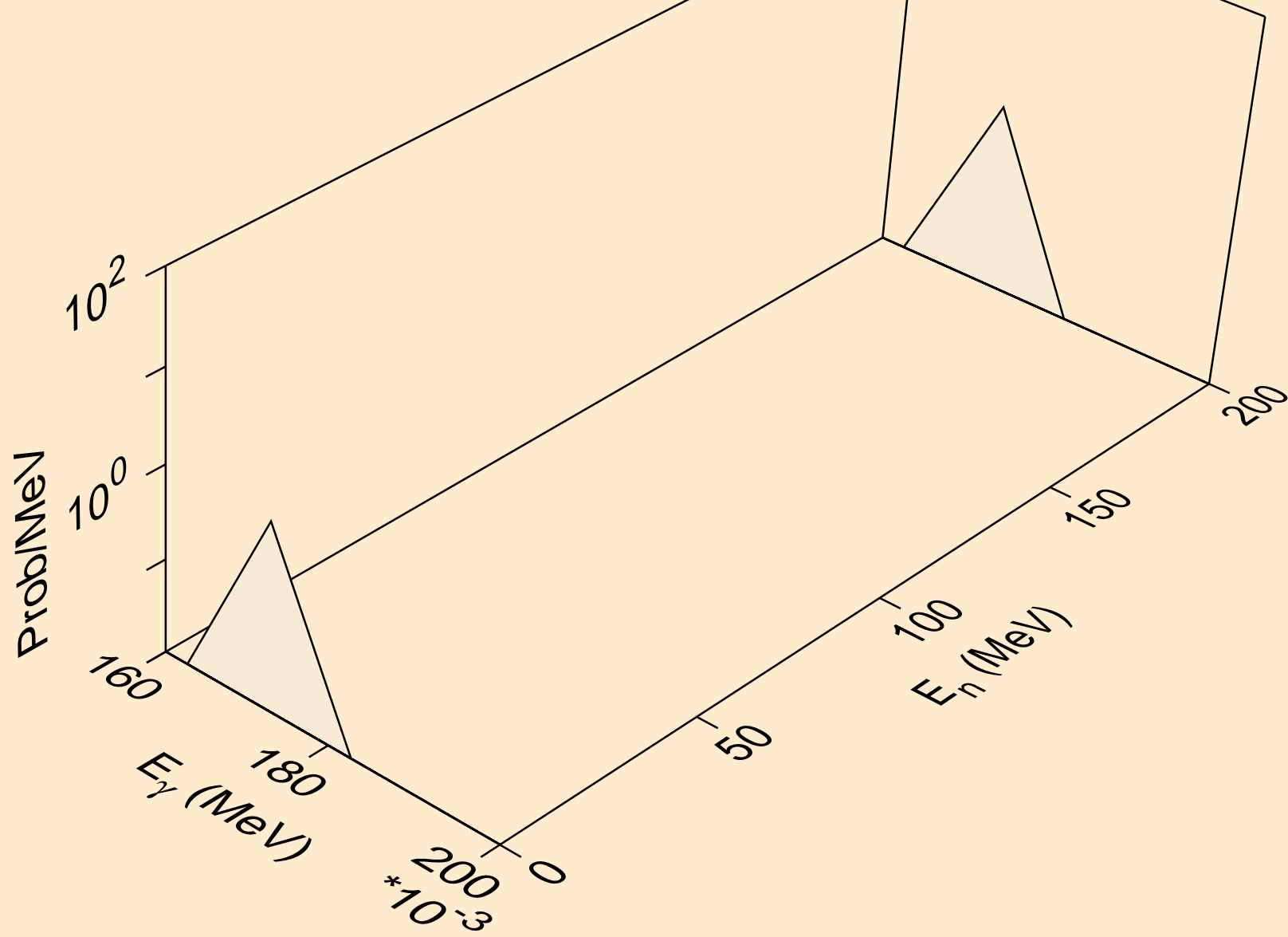

CS116M NEUTRON ACER TENDL-2021 LIBRARY; T=293.6K  
Photon emission for (n,n\*c)

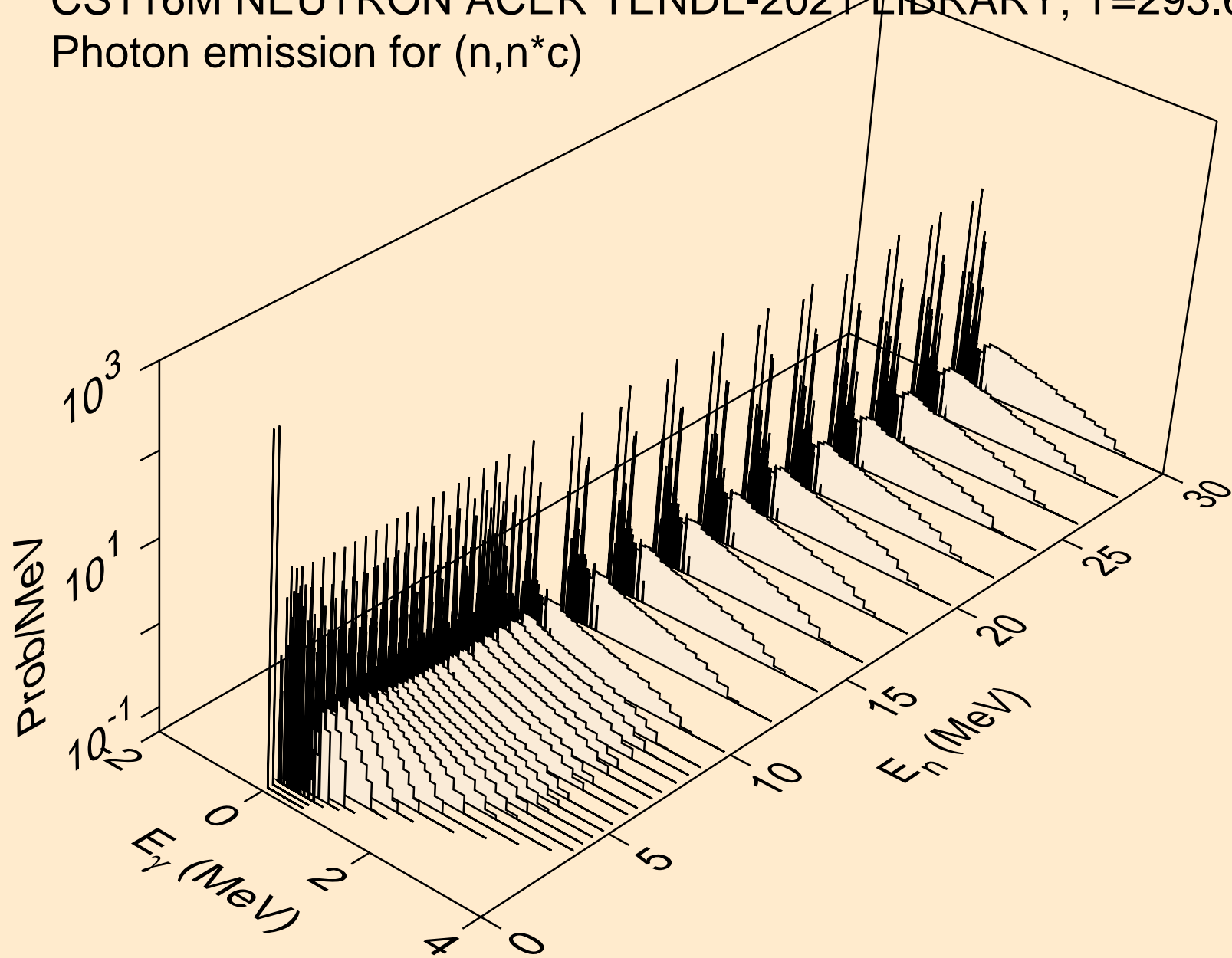

CS116M NEUTRON ACER TENDL-2021 LIBRARY; T=293.6K  
Photon emission for (n,gma)

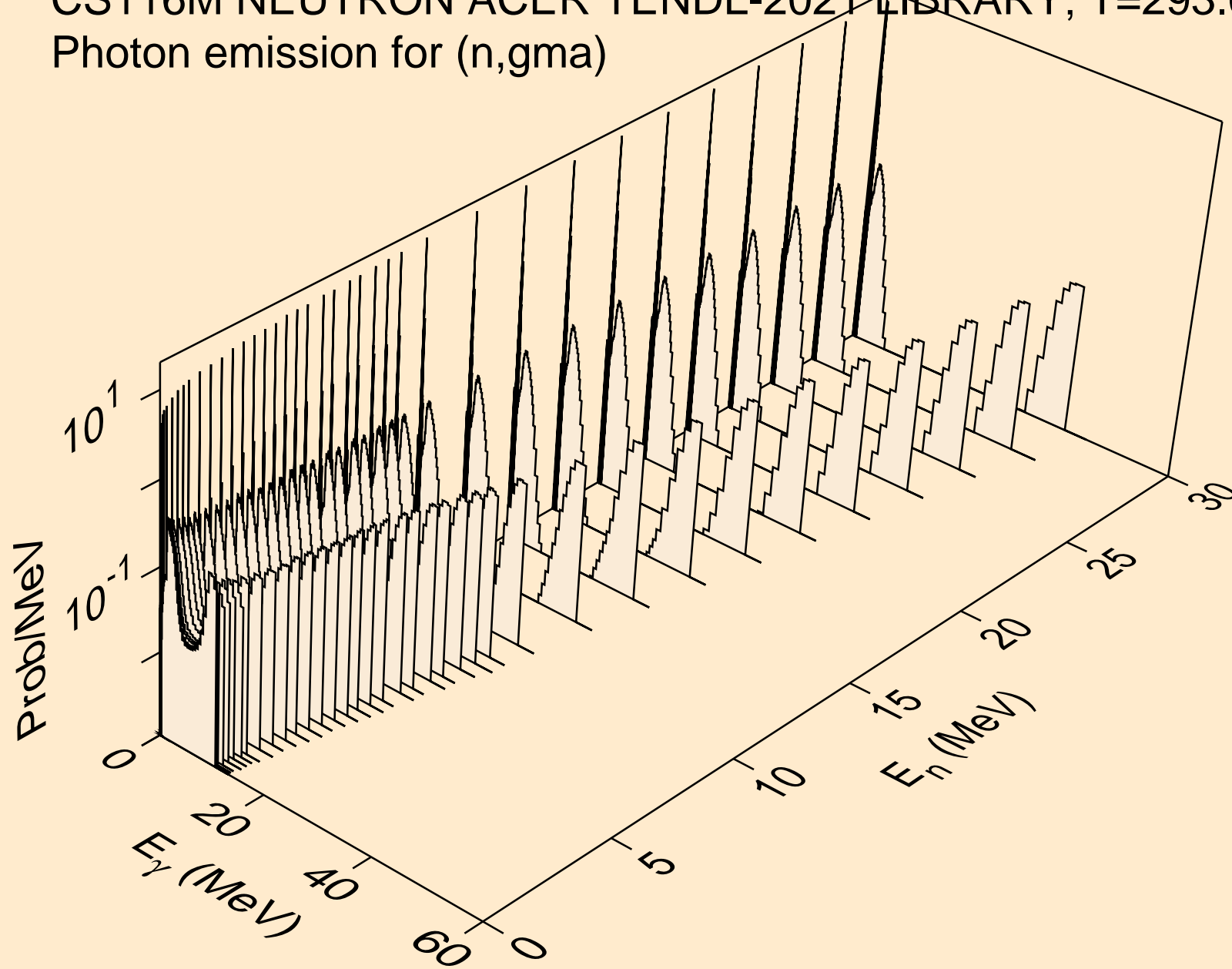

CS116M NEUTRON ACER TENDL-2021 LIBRARY; T=293.6K  
Photon emission for (n,p)

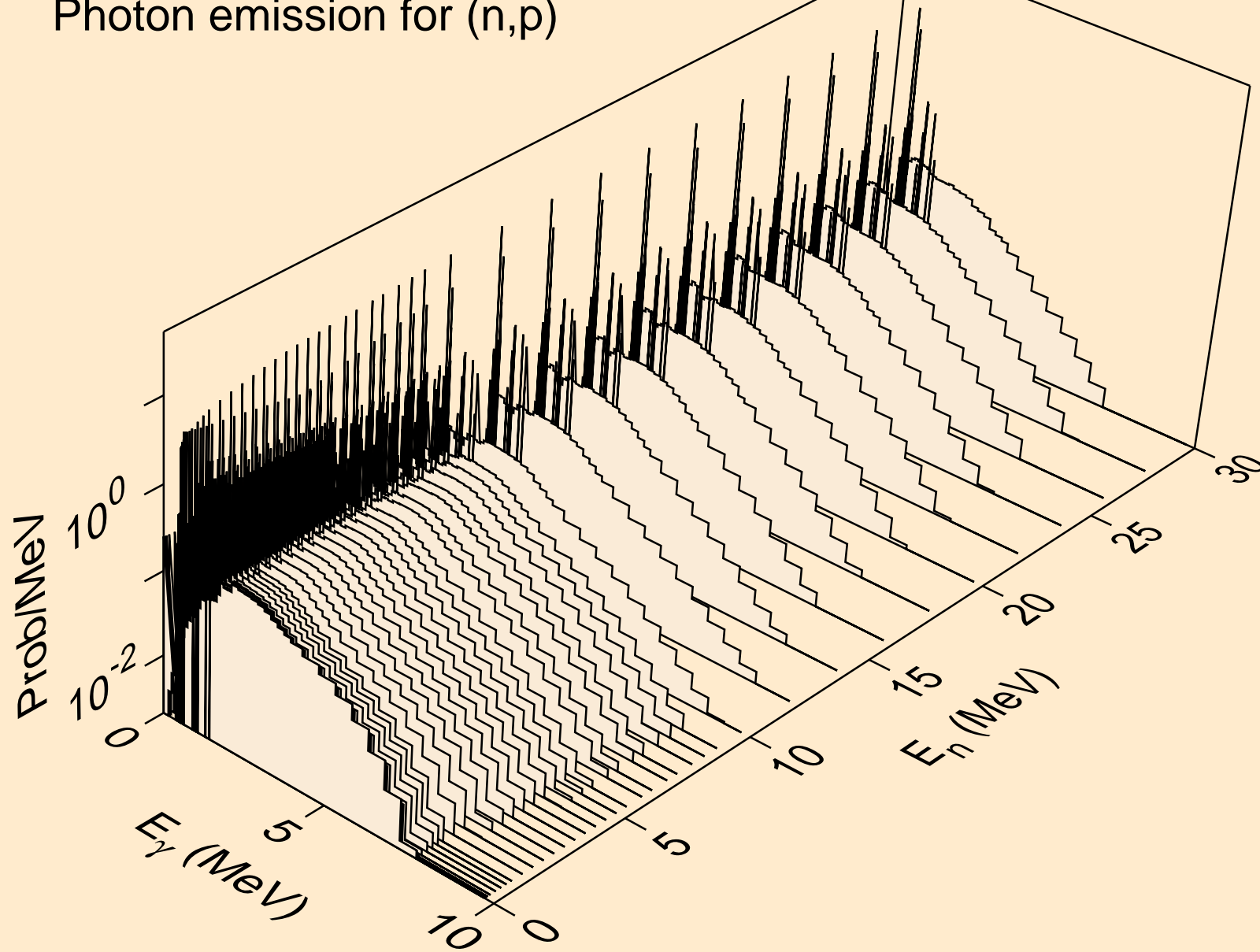

CS116M NEUTRON ACER TENDL-2021 LIBRARY; T=293.6K  
Photon emission for (n,d)

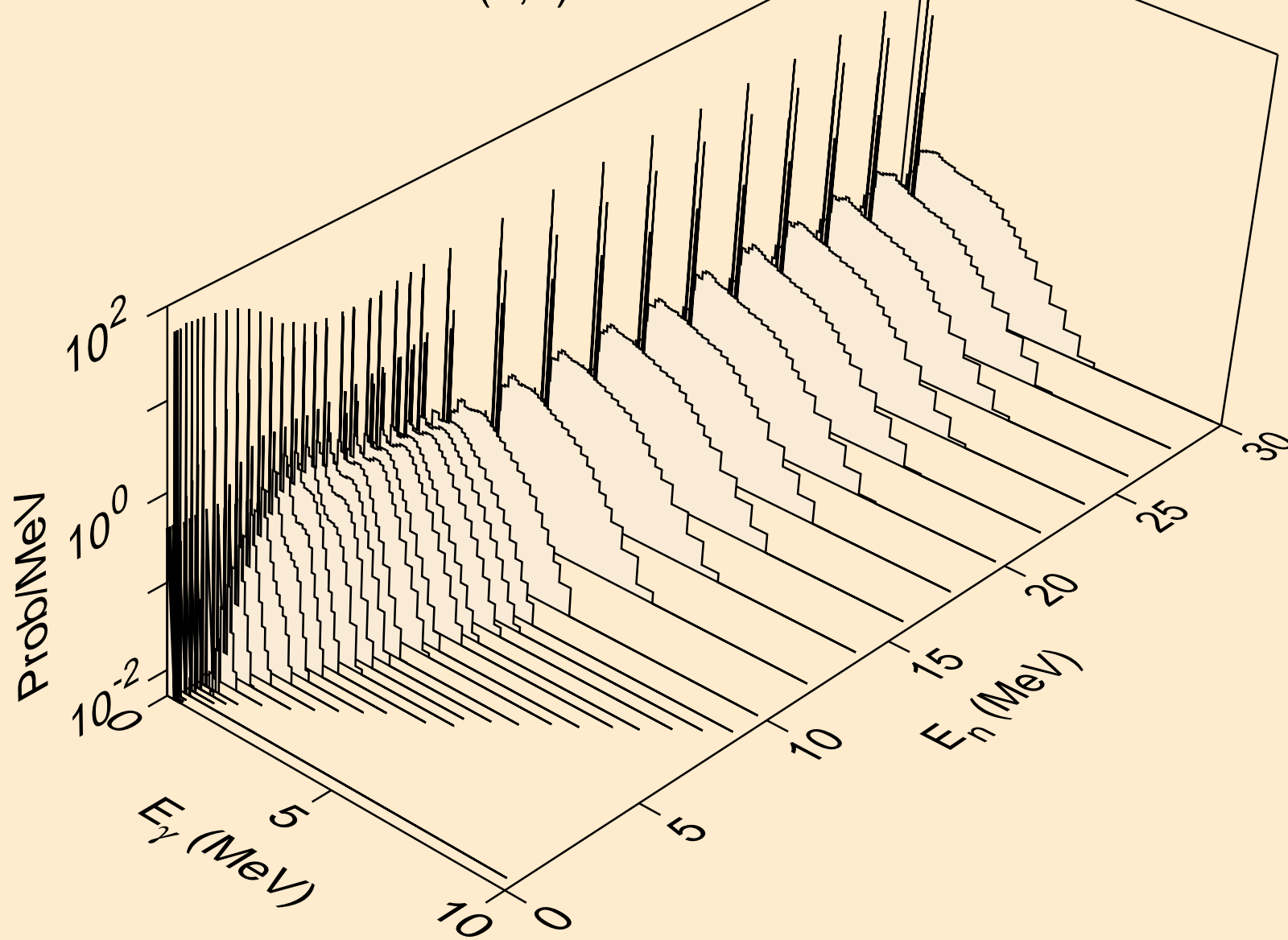

CS116M NEUTRON ACER TENDL-2021 LIBRARY; T=293.6K  
Photon emission for (n,t)

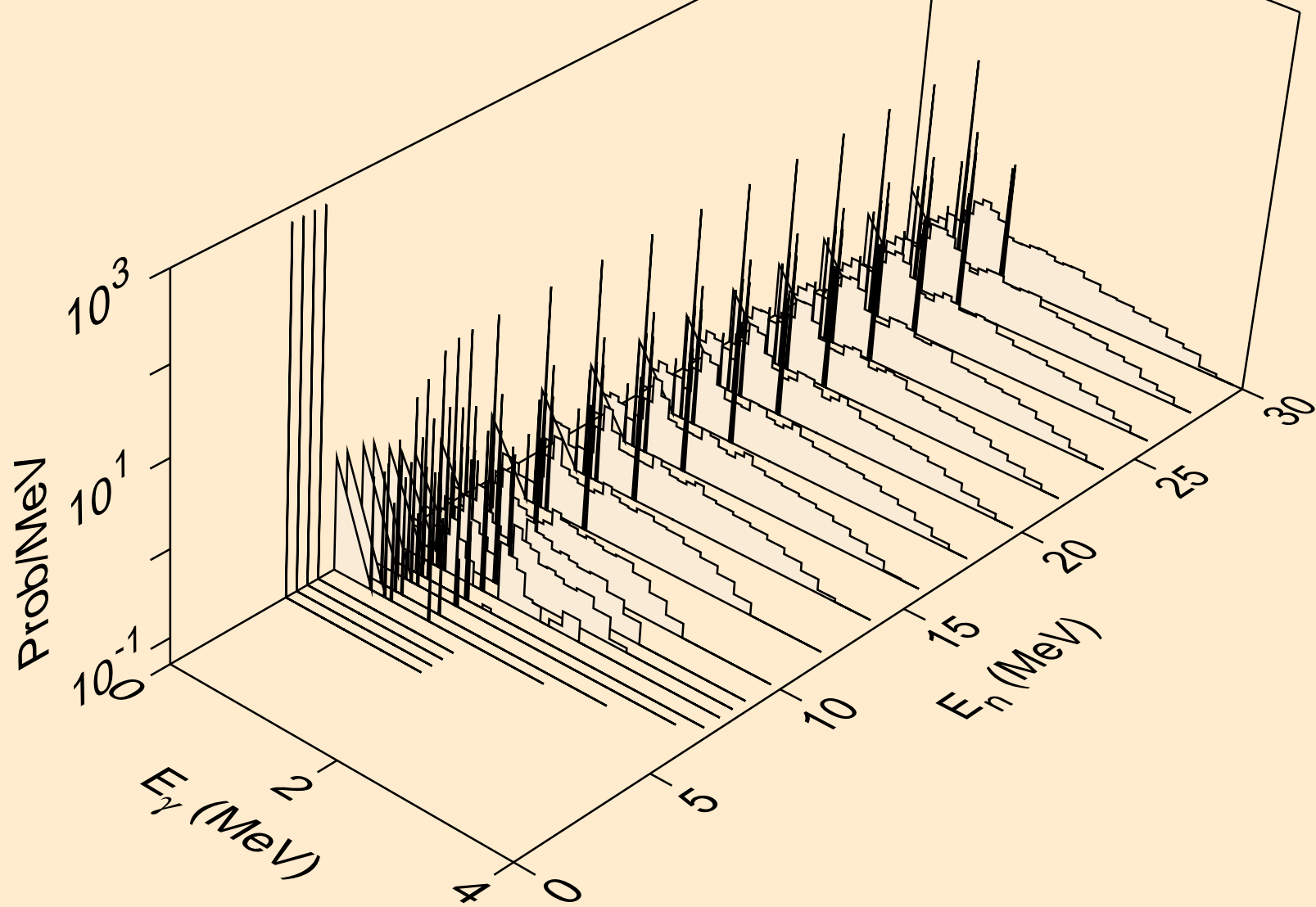



CS116M NEUTRON ACER TENDL-2021 LIBRARY; T=293.6K  
Photon emission for (n,he3)

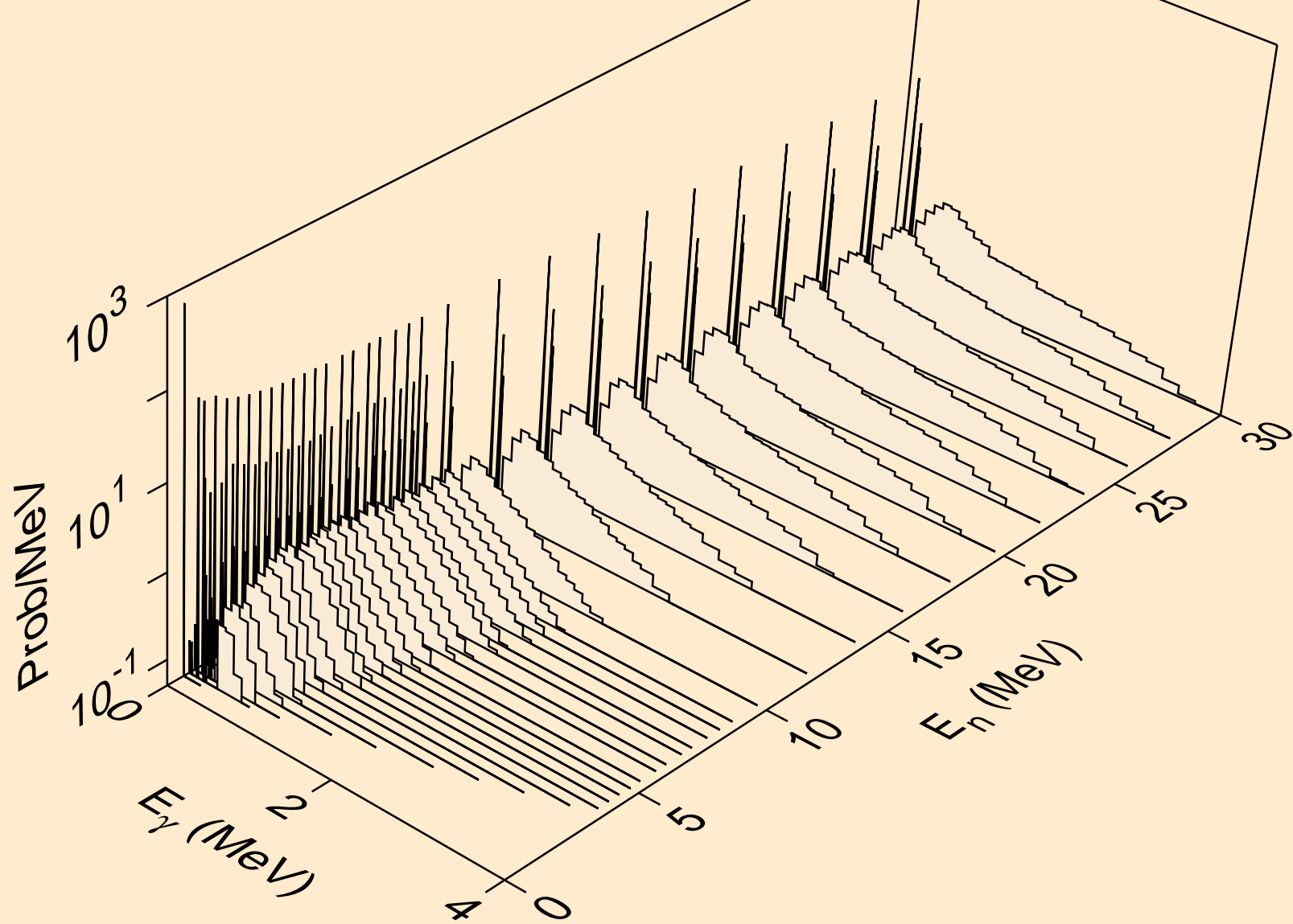

CS116M NEUTRON ACER TENDL-2021 LIBRARY; T=293.6K  
Photon emission for (n,a)

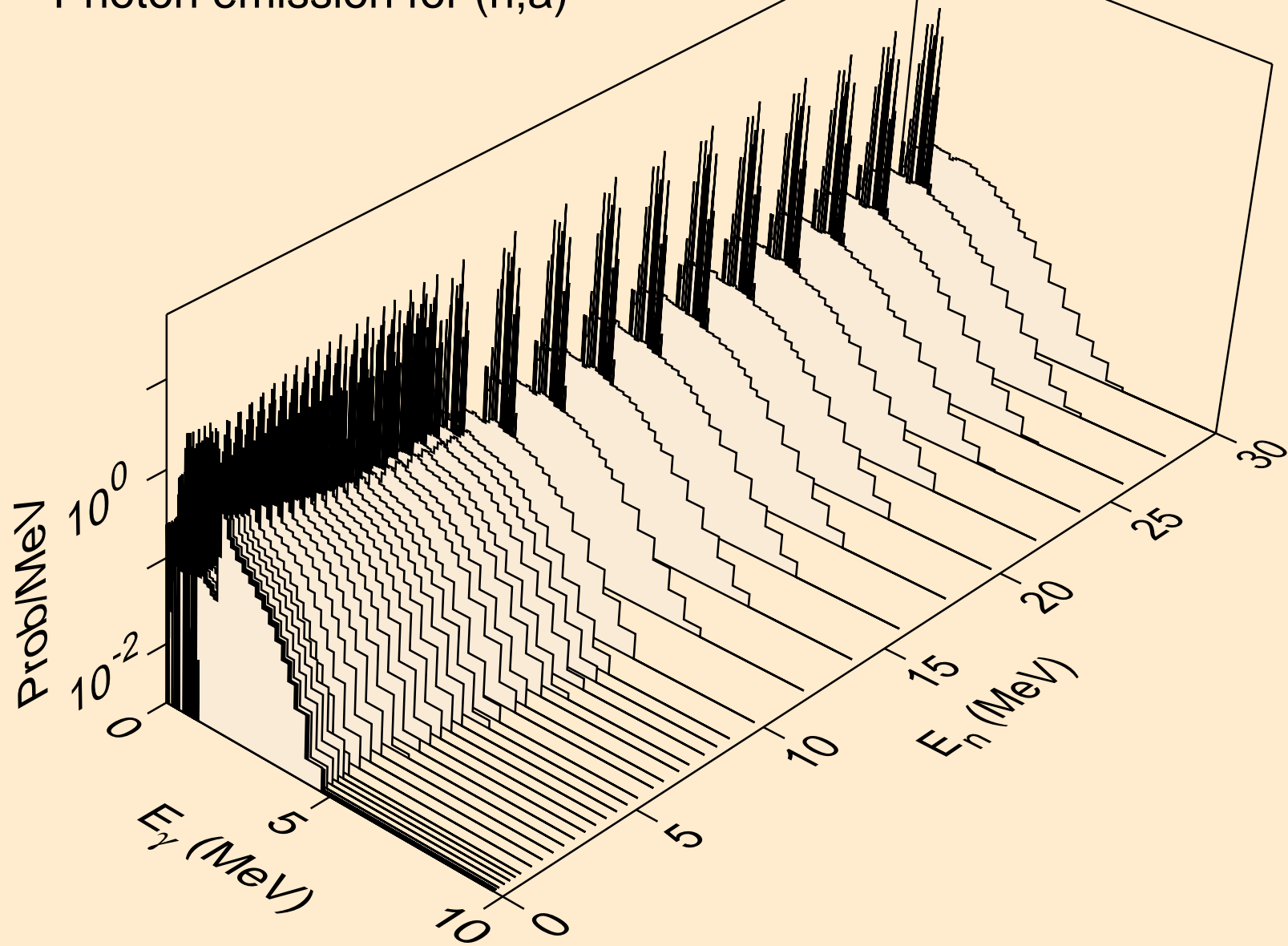

CS116M NEUTRON ACER TENDL-2021 LIBRARY; T=293.6K  
Photon emission for (n,2a)

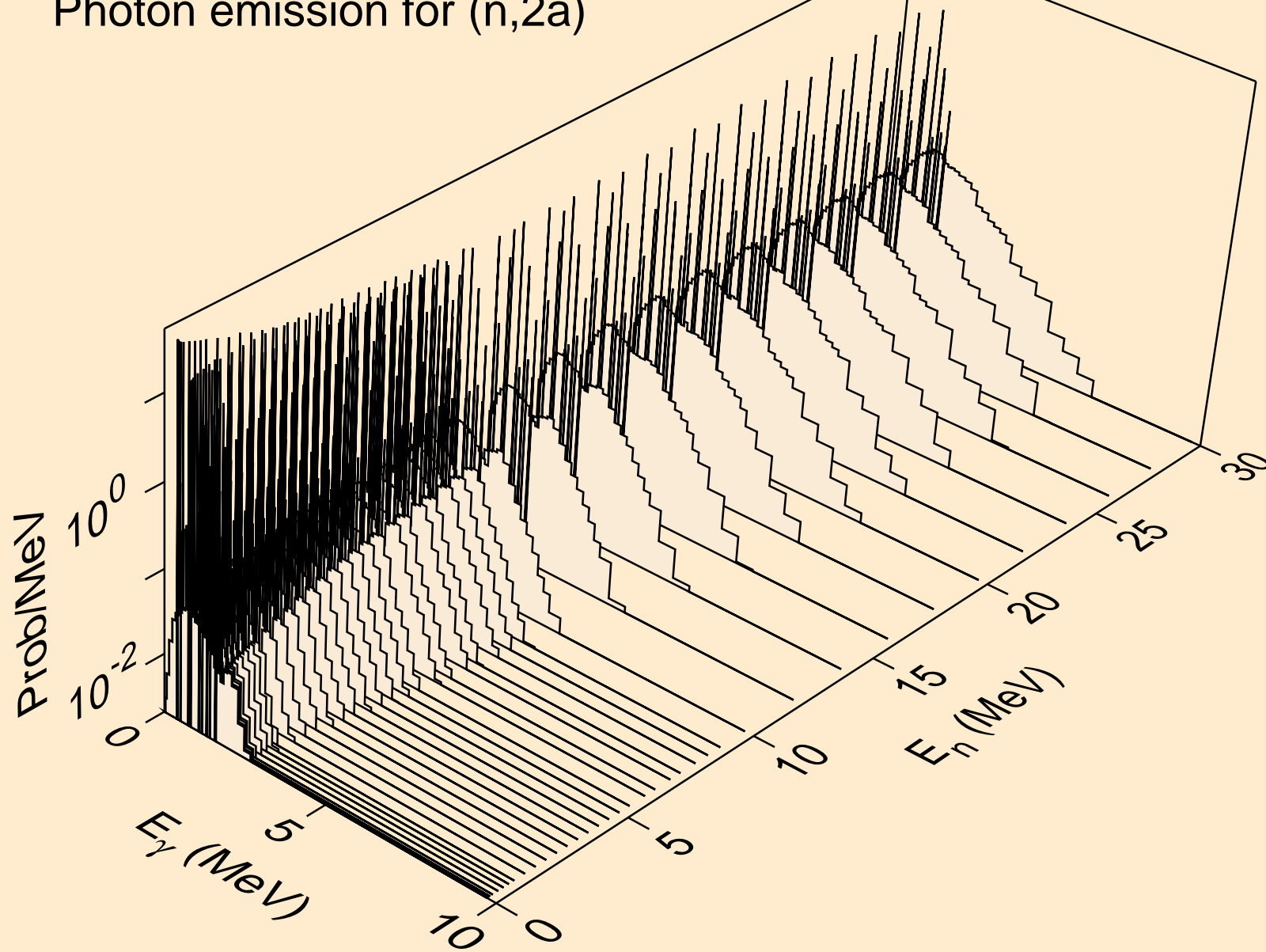

CS116M NEUTRON ACER TENDL-2021 LIBRARY; T=293.6K  
Photon emission for (n,3a)

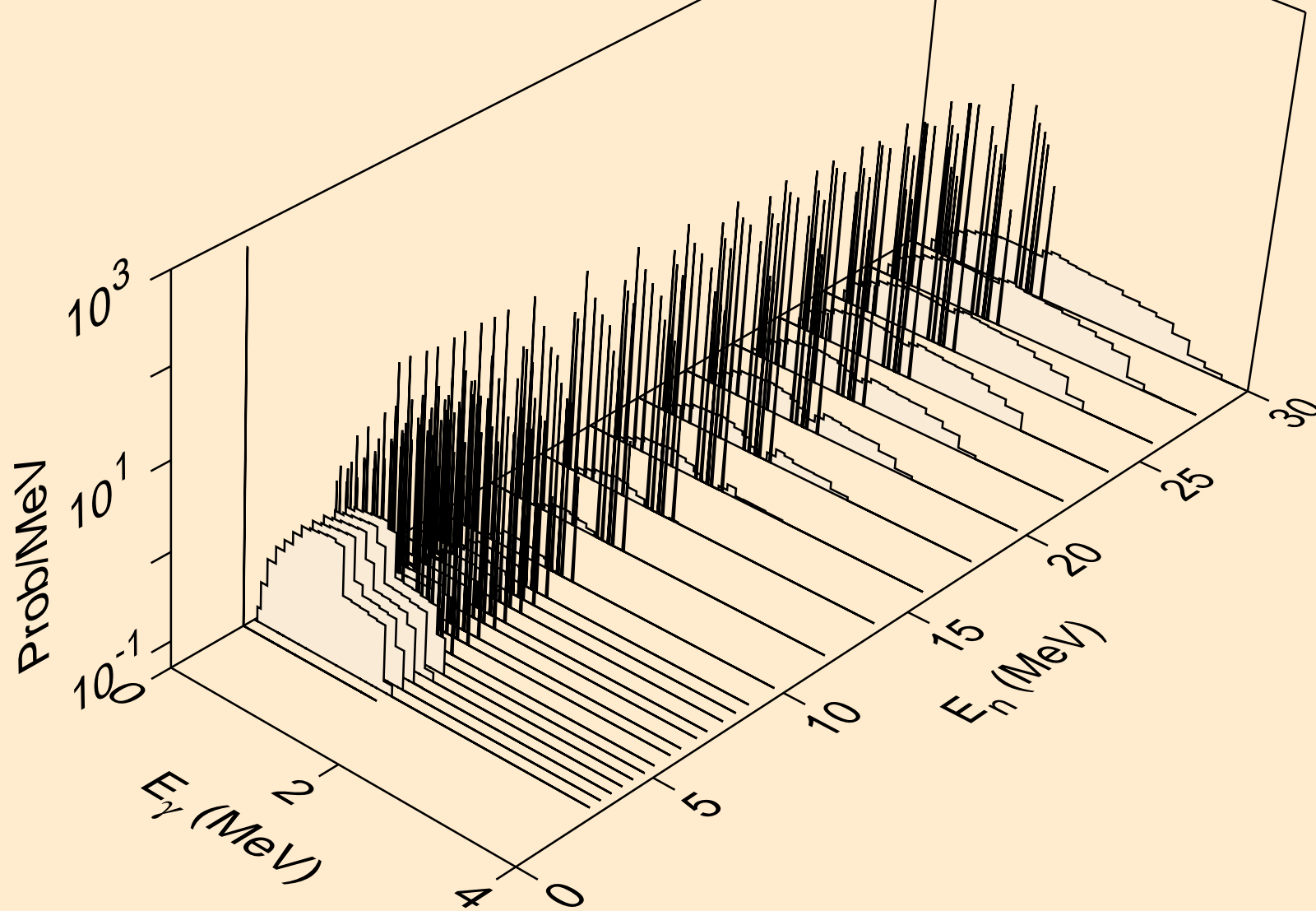

CS116M NEUTRON ACER TENDL-2021 LIBRARY; T=293.6K  
Photon emission for (n,2p)

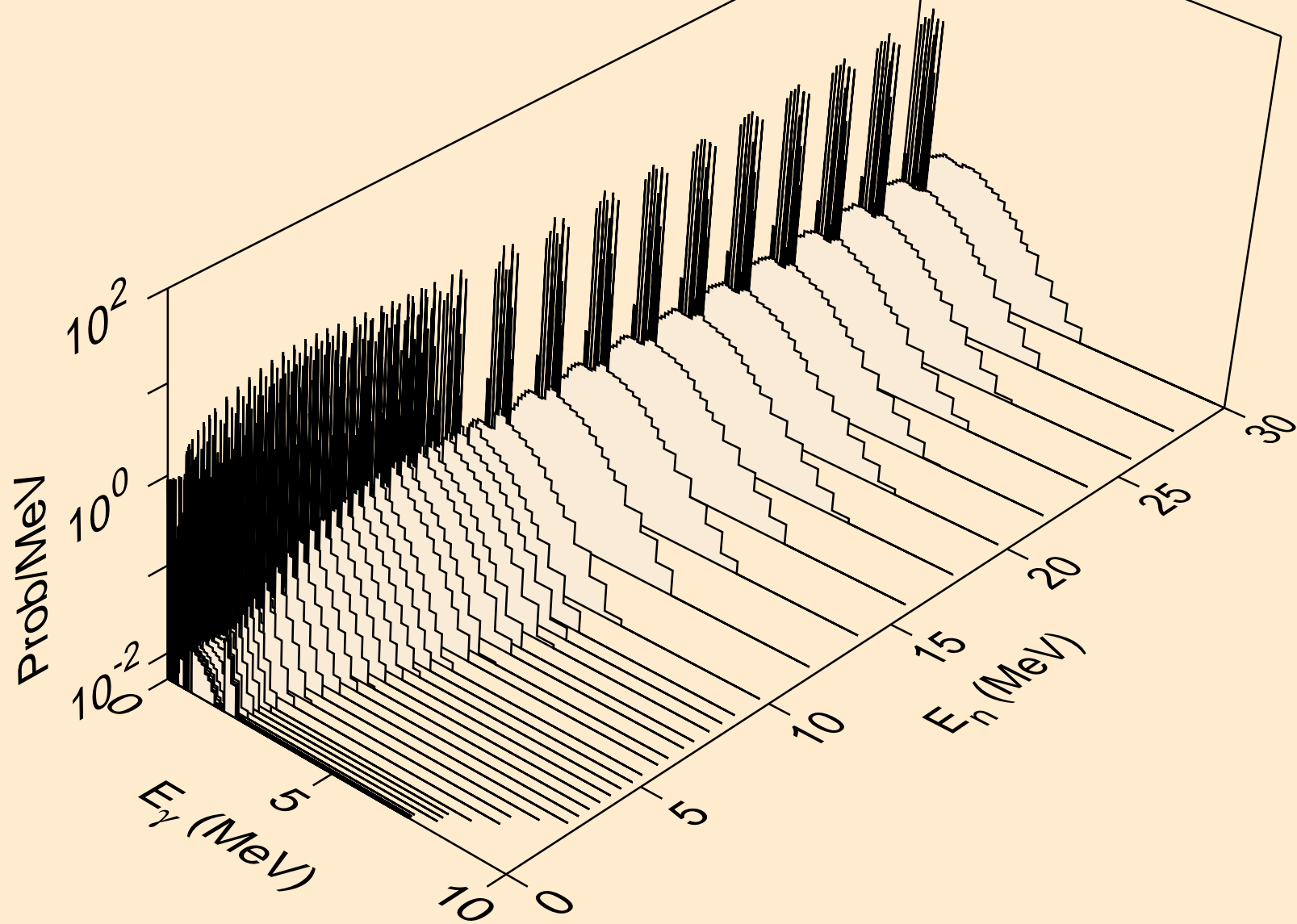

CS116M NEUTRON ACER TENDL-2021 LIBRARY; T=293.6K  
Photon emission for (n,p $\alpha$ )

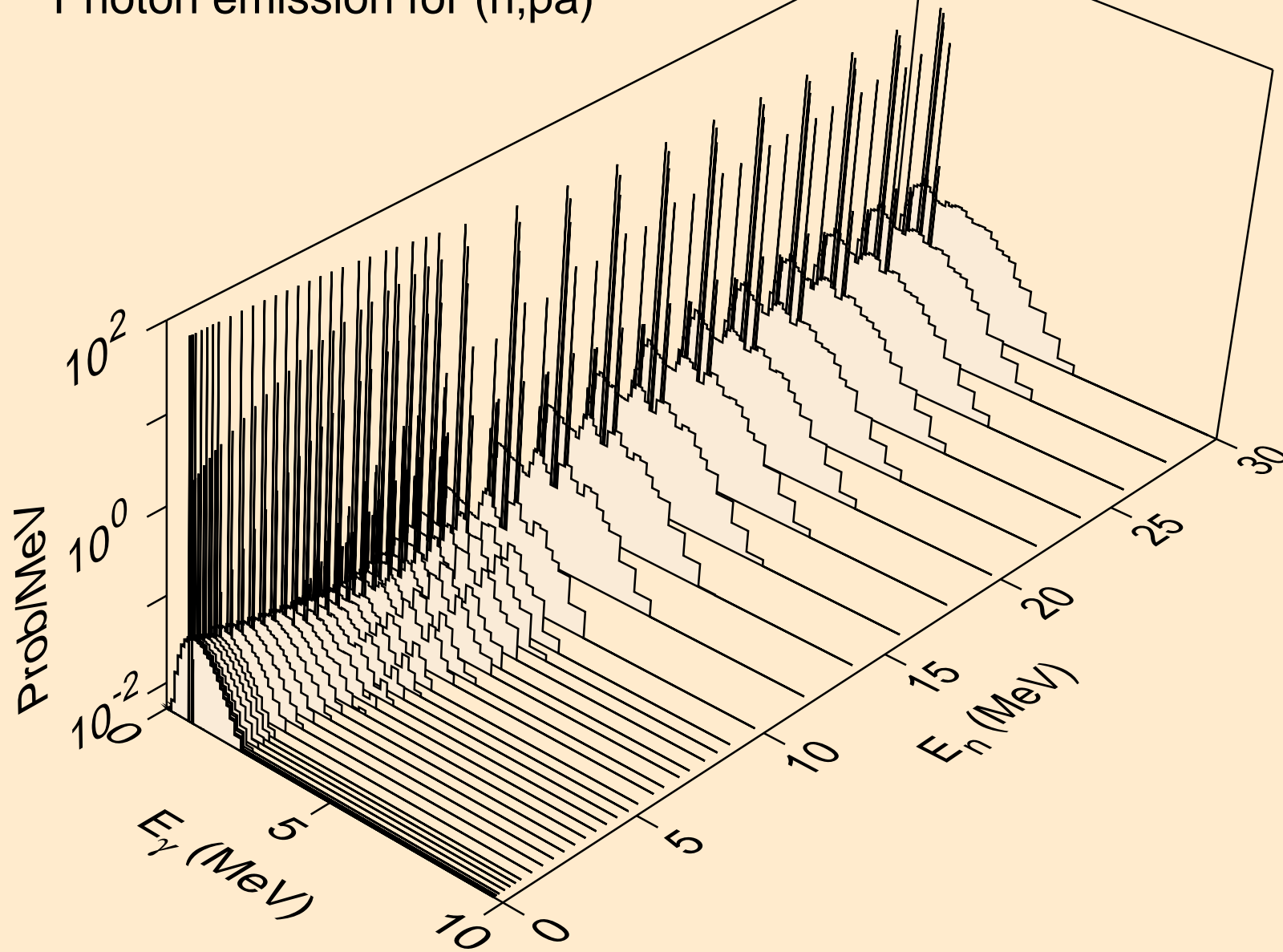

CS116M NEUTRON ACER TENDL-2021 LIBRARY; T=293.6K  
Photon emission for (n,t2a)

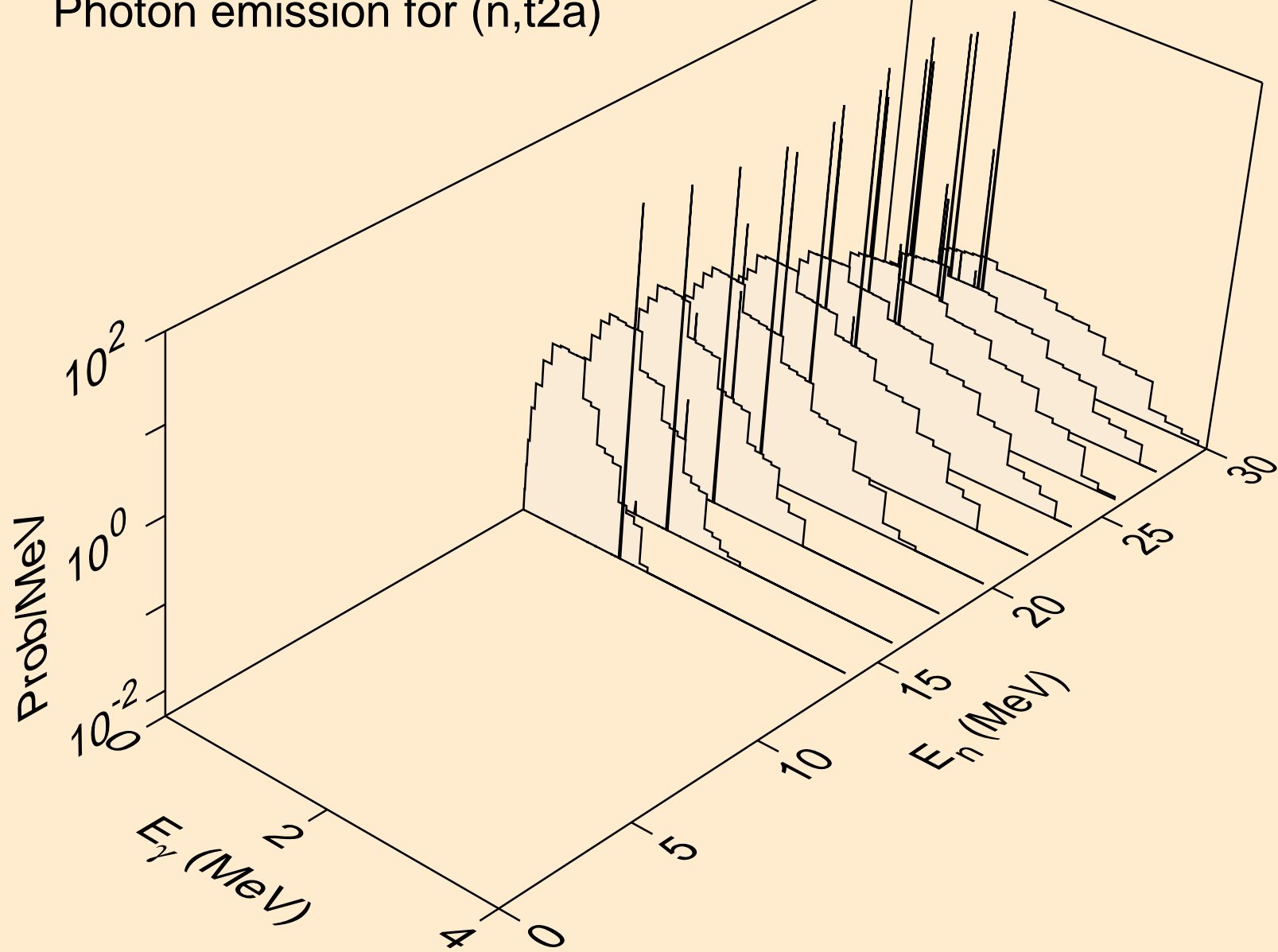

CS116M NEUTRON ACER TENDL-2021 LIBRARY; T=293.6K  
Photon emission for (n,d2a)

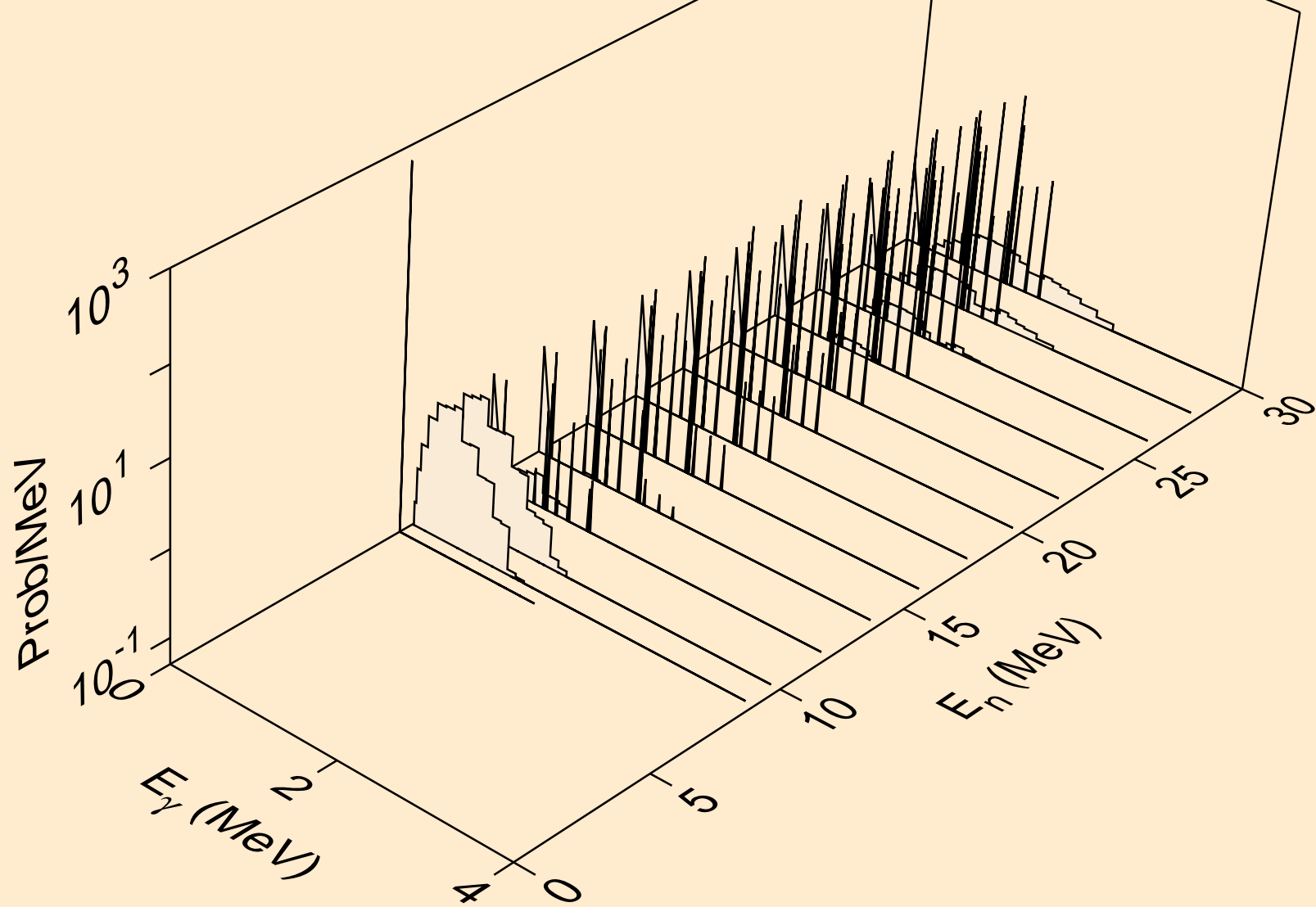



CS116M NEUTRON ACER TENDL-2021 LIBRARY; T=293.6K  
Photon emission for (n,pd)

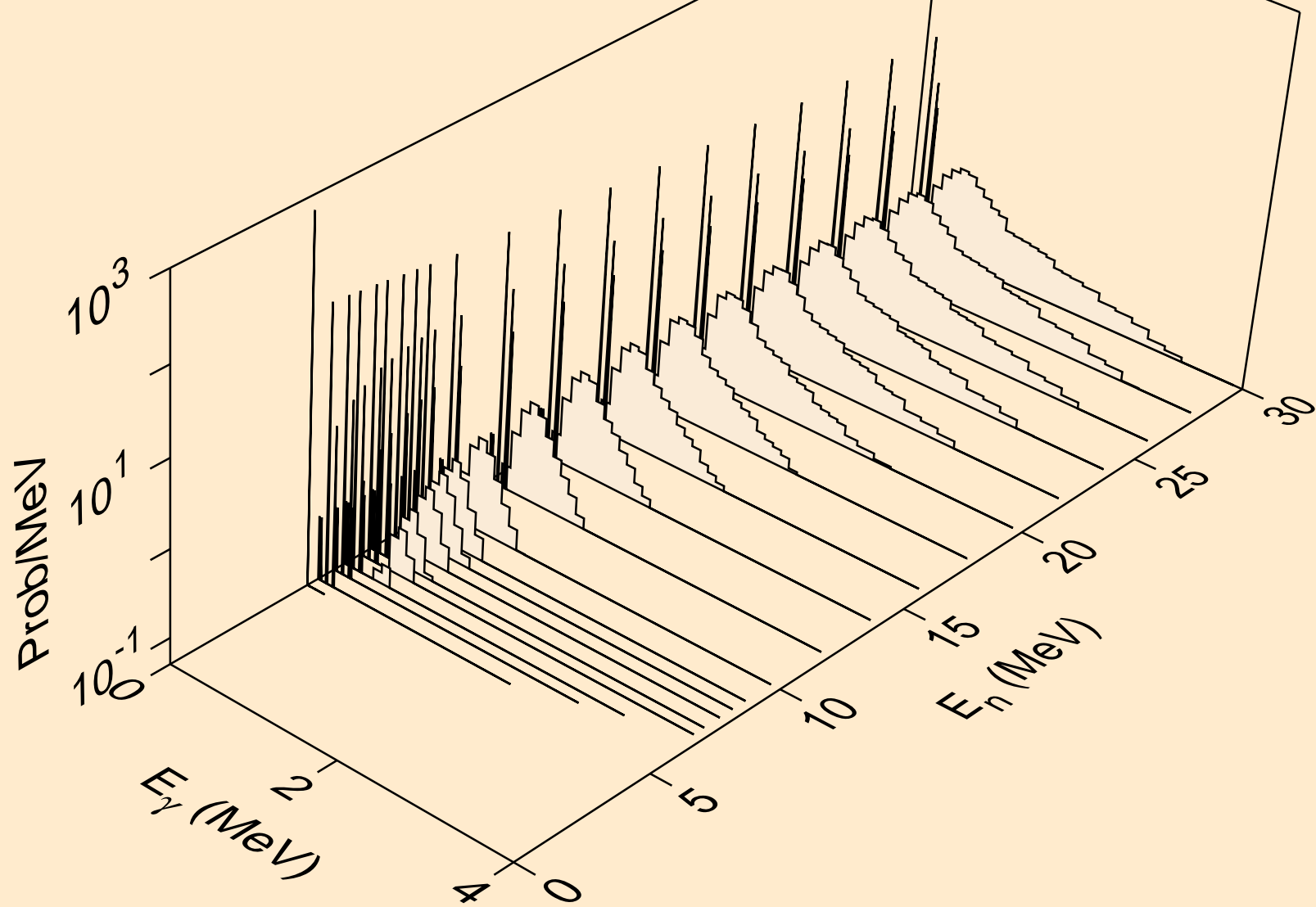

CS116M NEUTRON ACER TENDL-2021 LIBRARY; T=293.6K  
Photon emission for (n,pt)

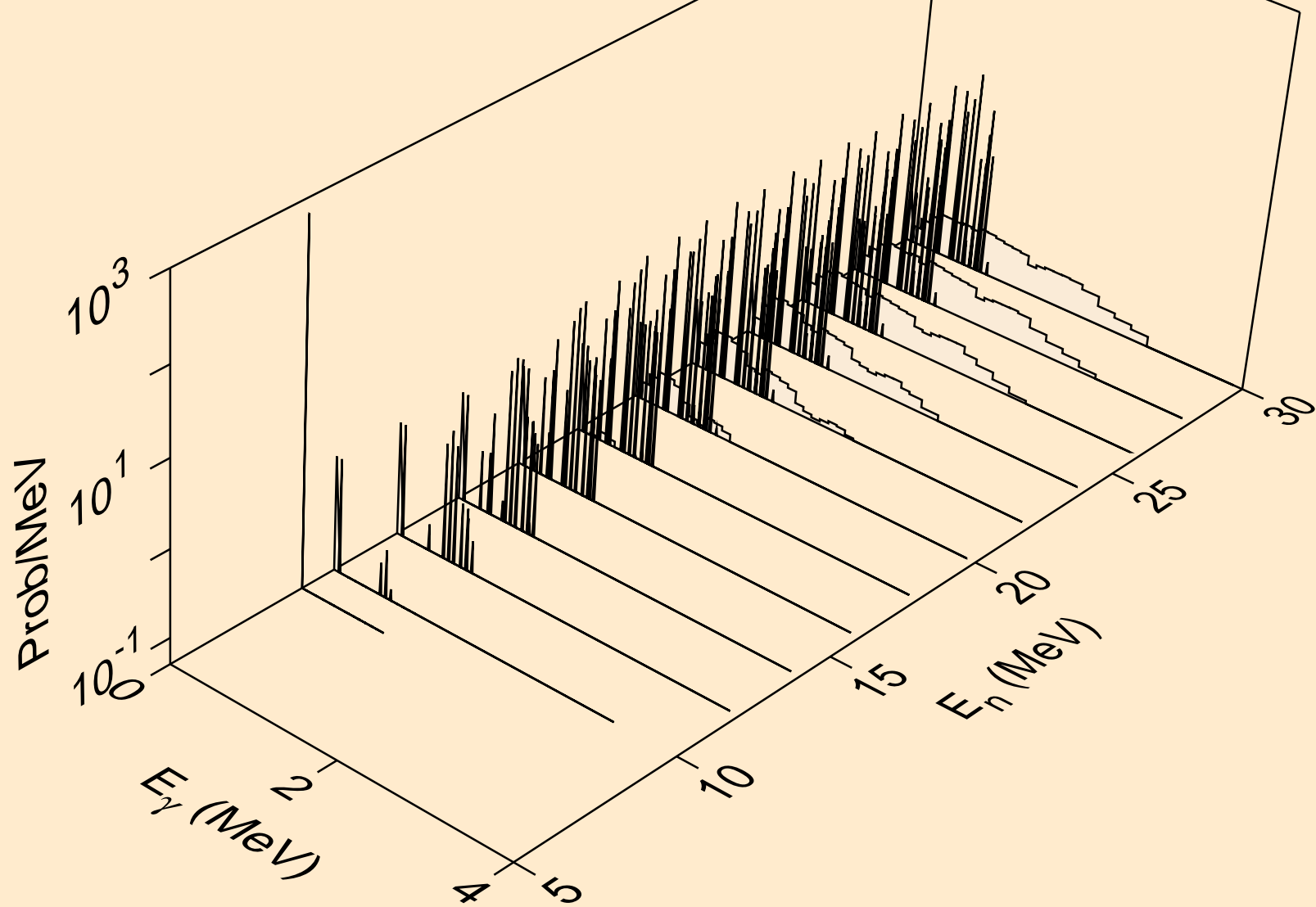

CS116M NEUTRON ACER TENDL-2021 LIBRARY; T=293.6K  
Photon emission for (n,da)

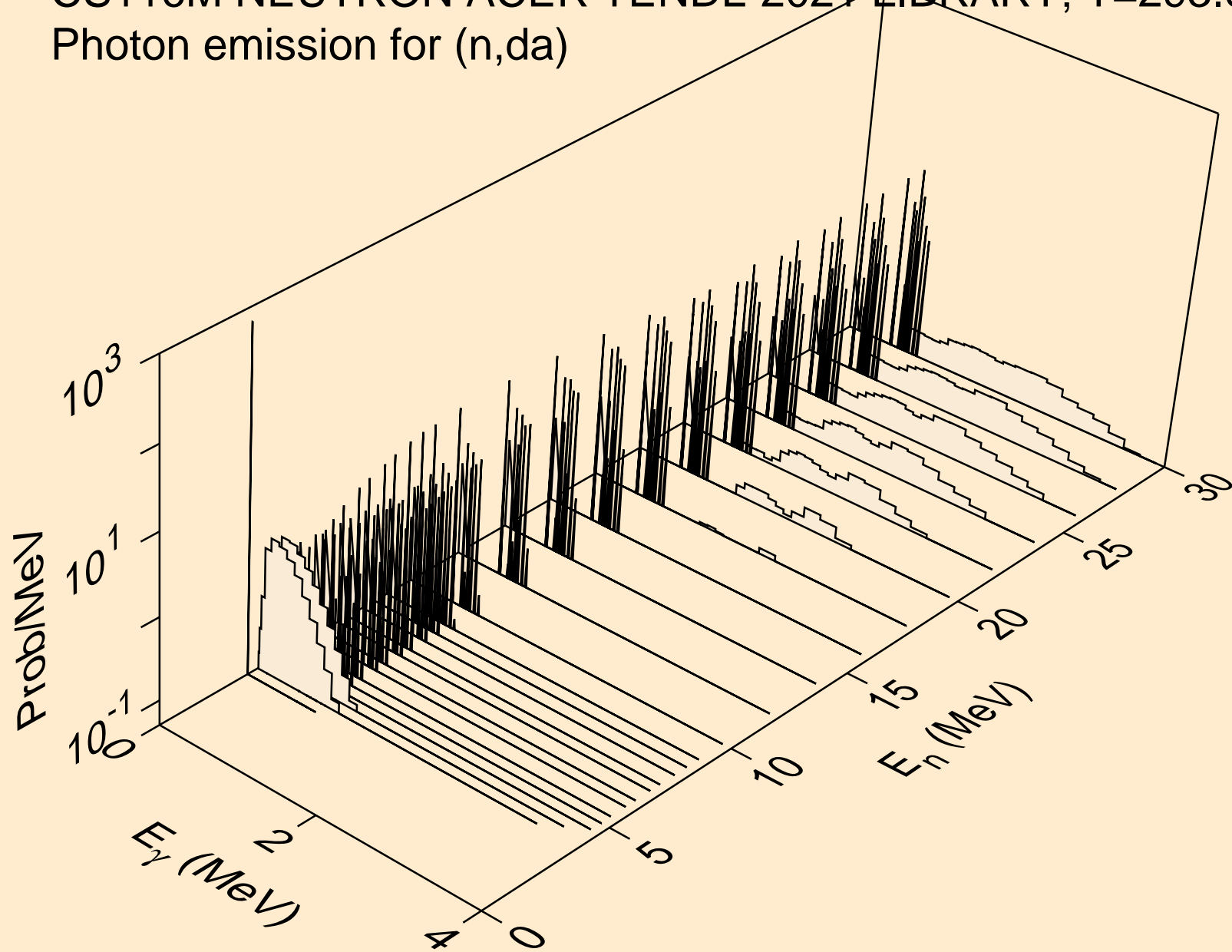

CS116M NEUTRON ACER TENDL-2021 LIBRARY; T=293.6K  
thermal capture photon spectrum

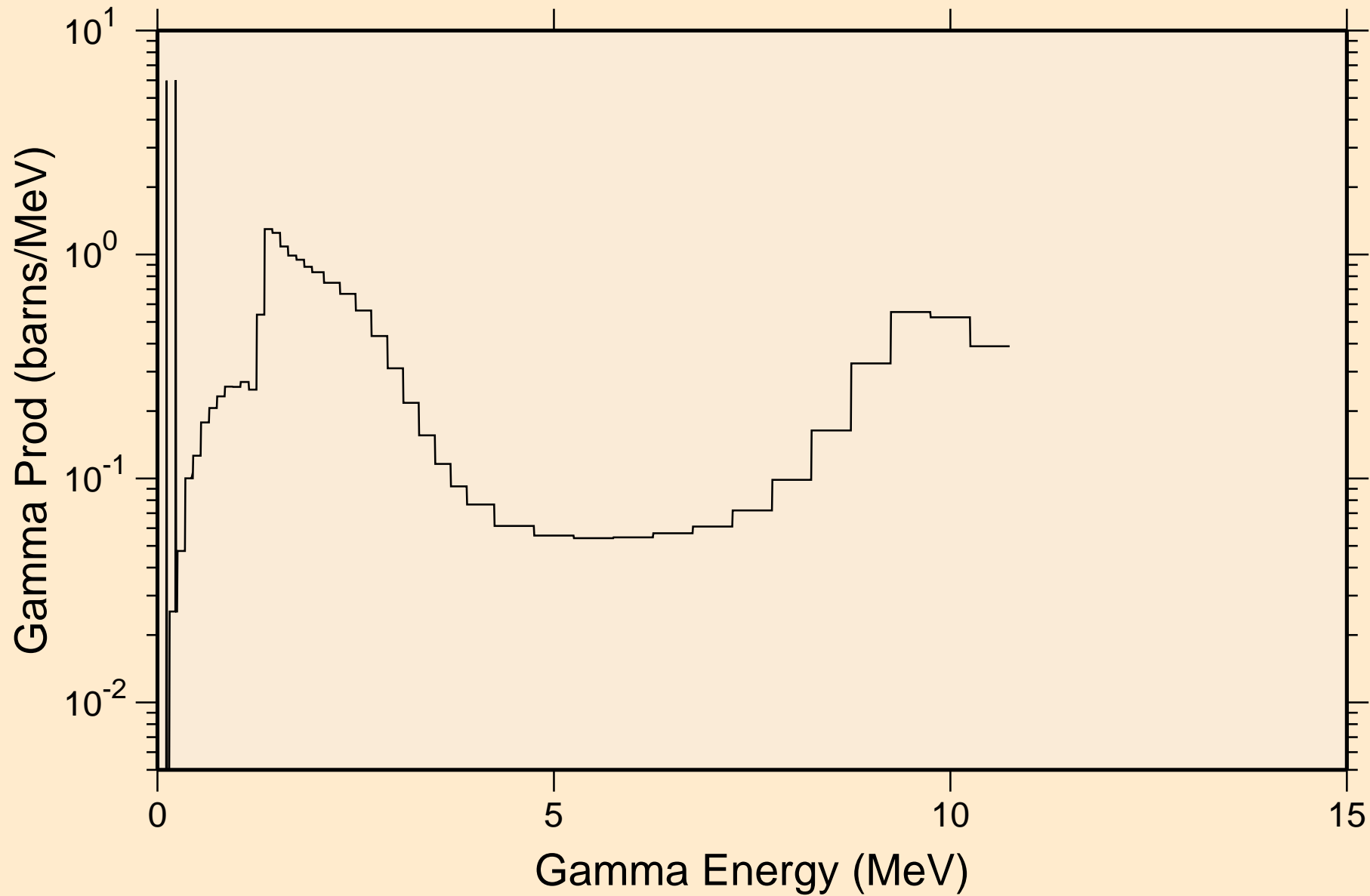

CS116M NEUTRON ACER TENDL-2021 LIBRARY; T=293.6K  
14 MeV photon spectrum

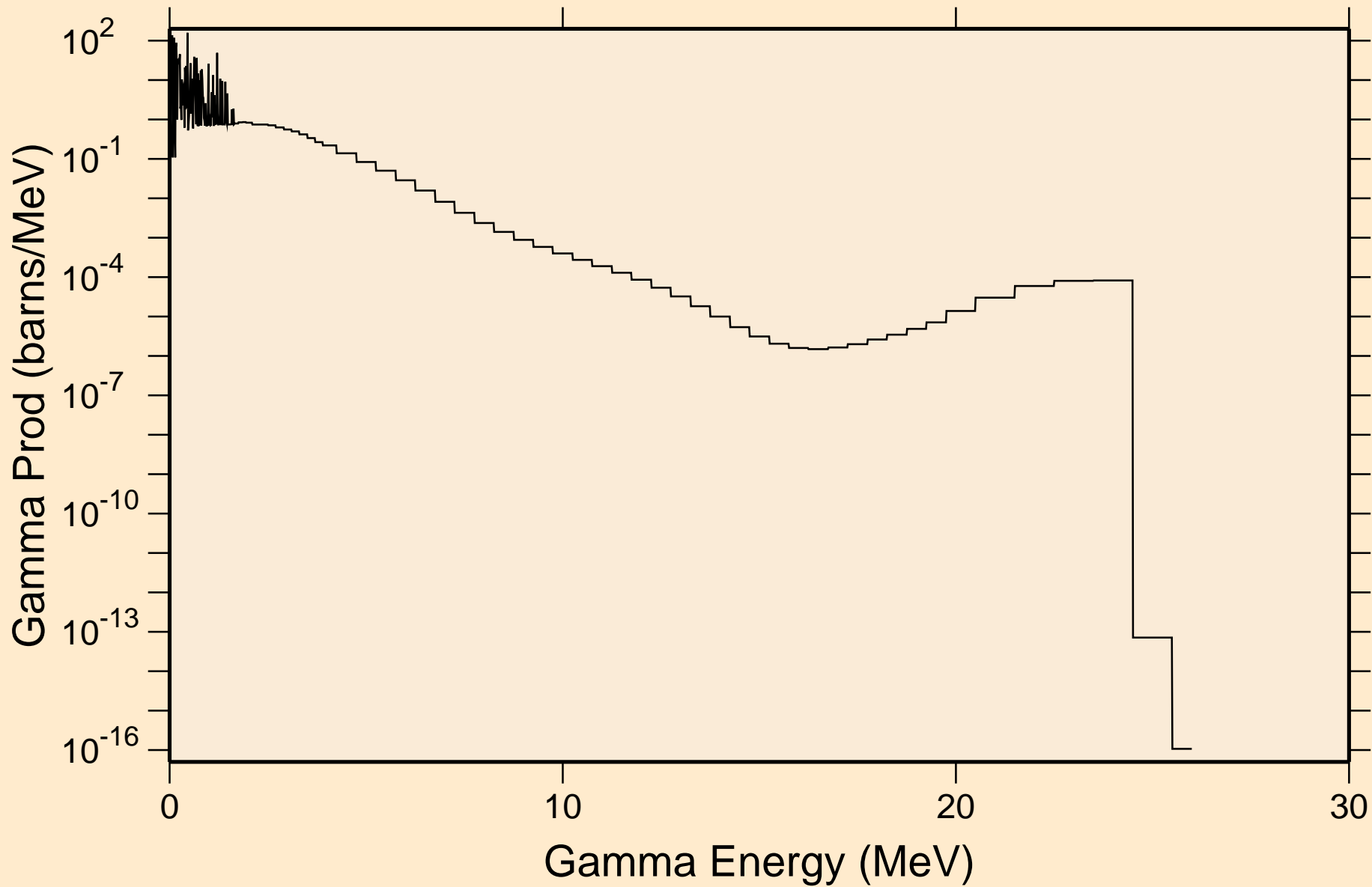

# CS116M NEUTRON ACER TENDL-2021 LIBRARY; T=293.6K

## Particle heating contributions

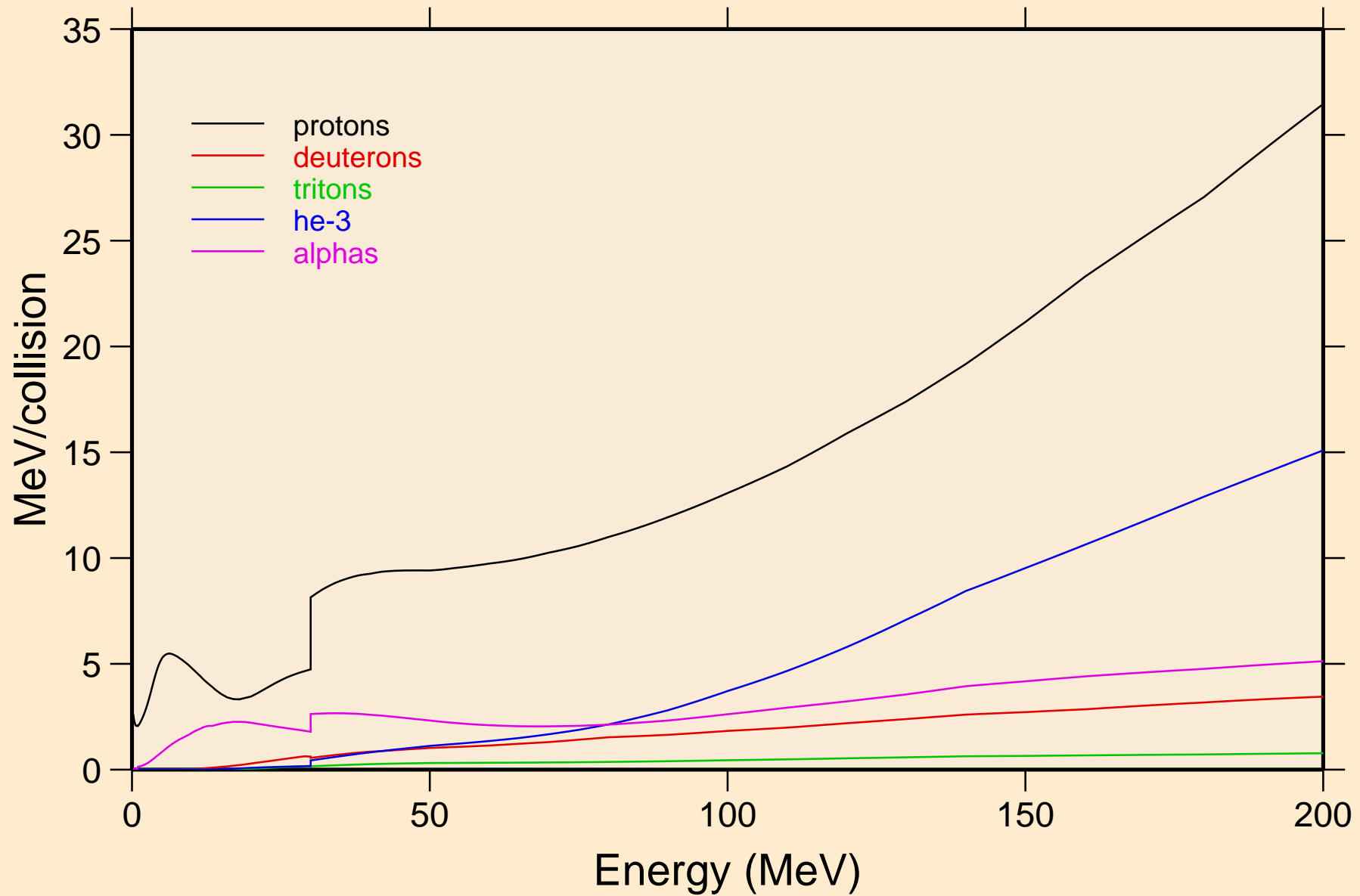

CS116M NEUTRON ACER TENDL-2021 LIBRARY; T=293.6K  
Recoil Heating

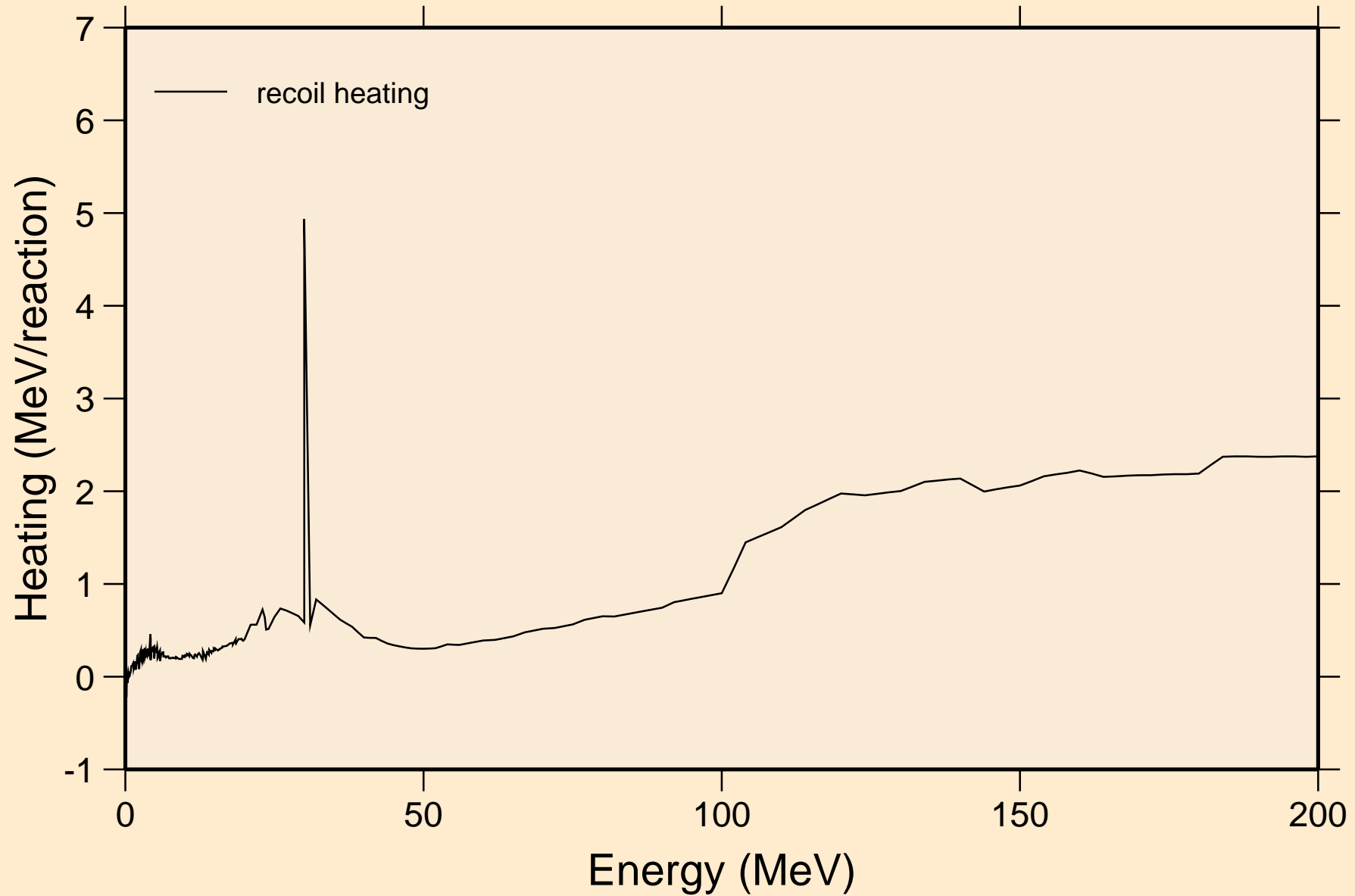

CS116M NEUTRON ACER TENDL-2021 LIBRARY; T=293.6K  
Particle production cross sections

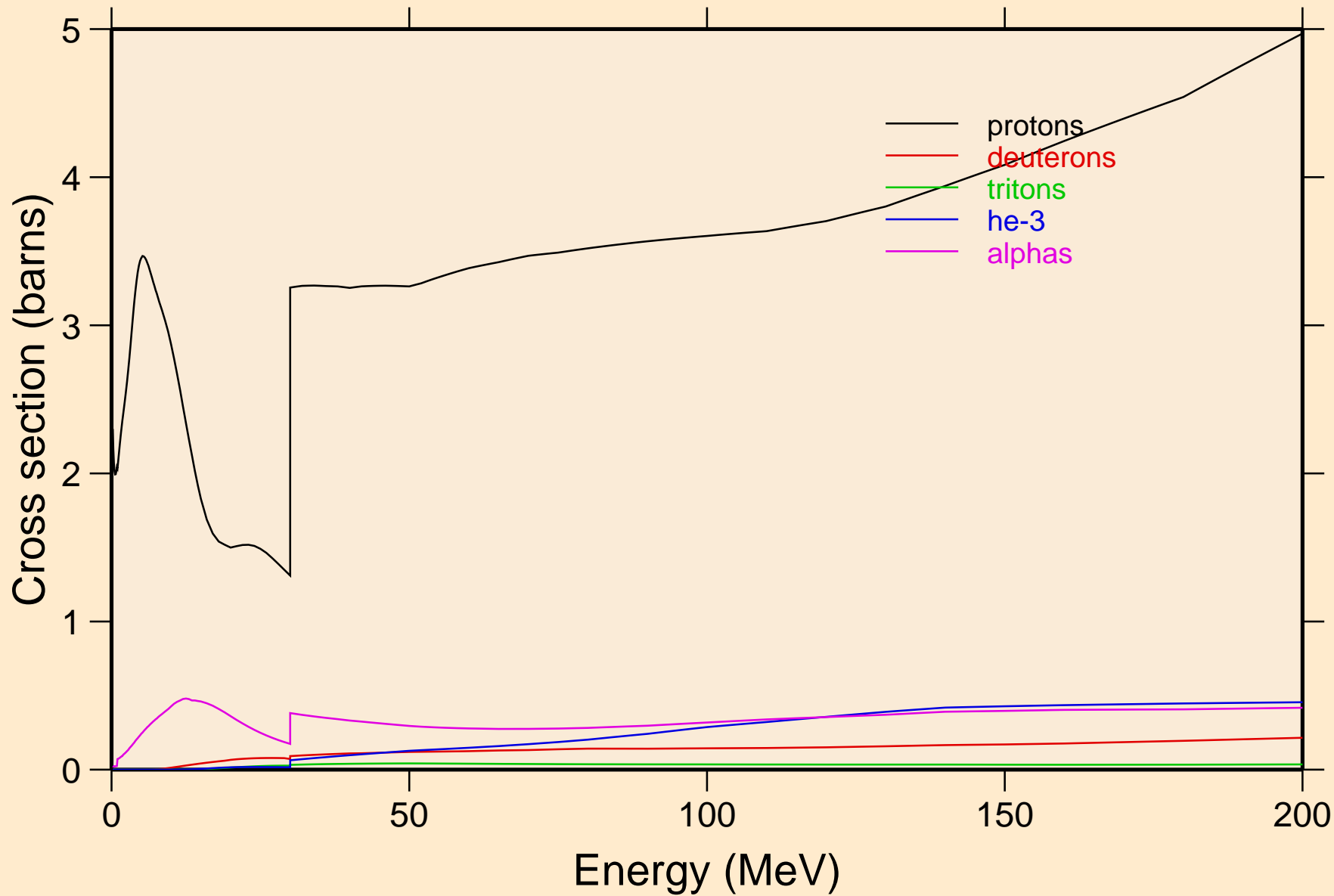



CS116M NEUTRON ACER TENDL-2021 LIBRARY; T=293.6K  
protons from (n,x)

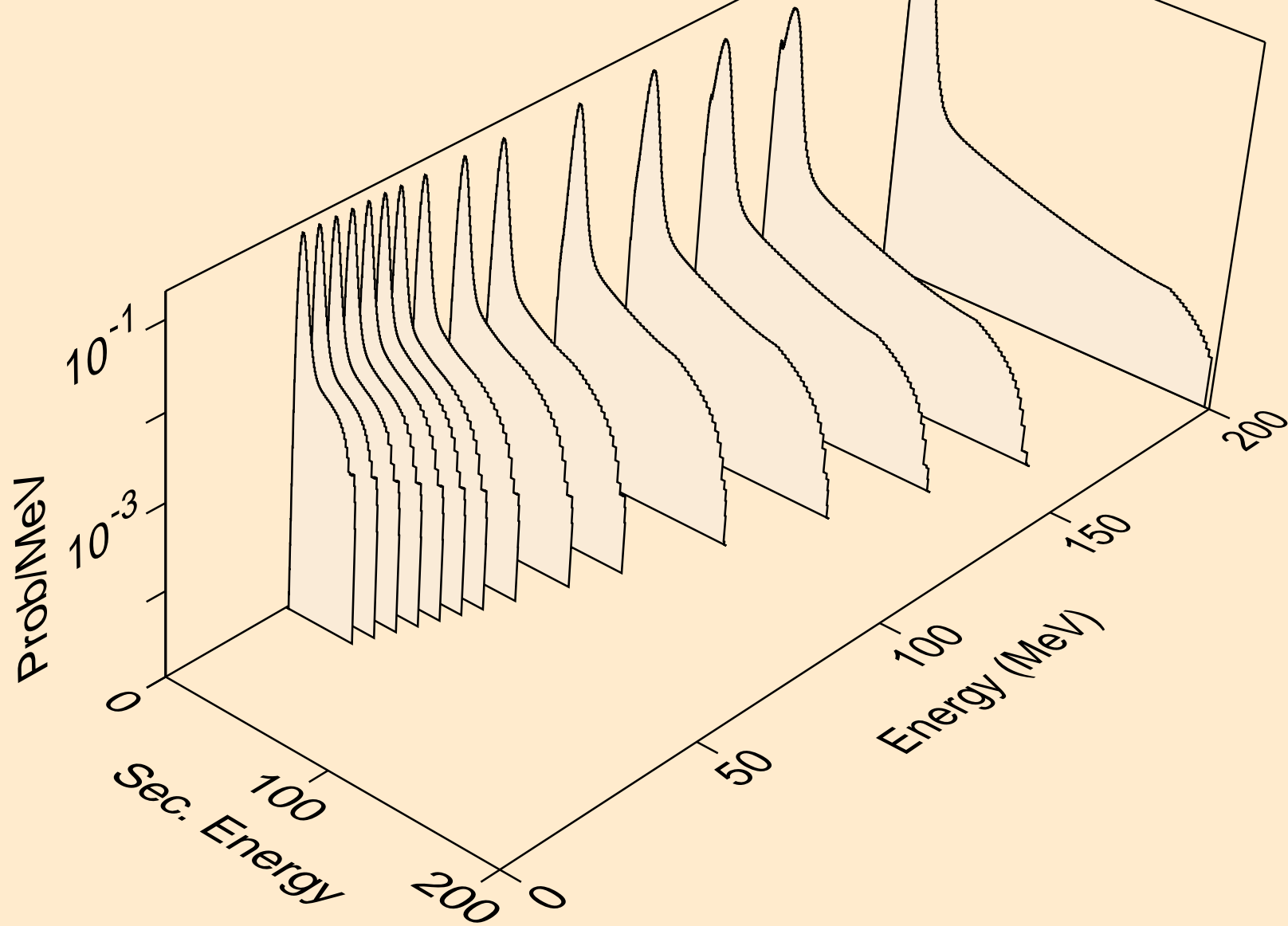

CS116M NEUTRON ACER TENDL-2021 LIBRARY; T=293.6K  
protons from (n,n\*)p

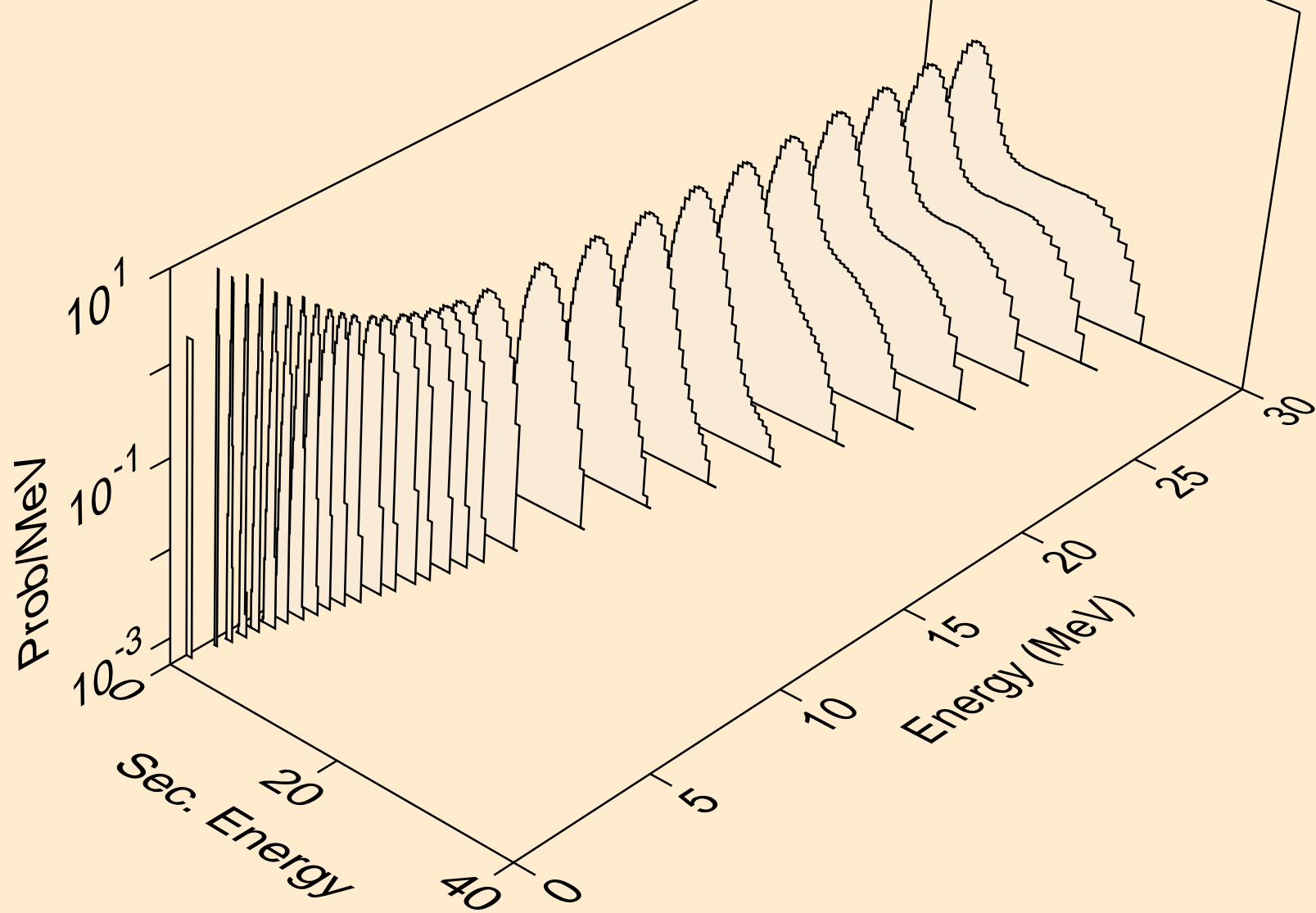

CS116M NEUTRON ACER TENDL-2021 LIBRARY; T=293.6K  
protons from (n,2np)

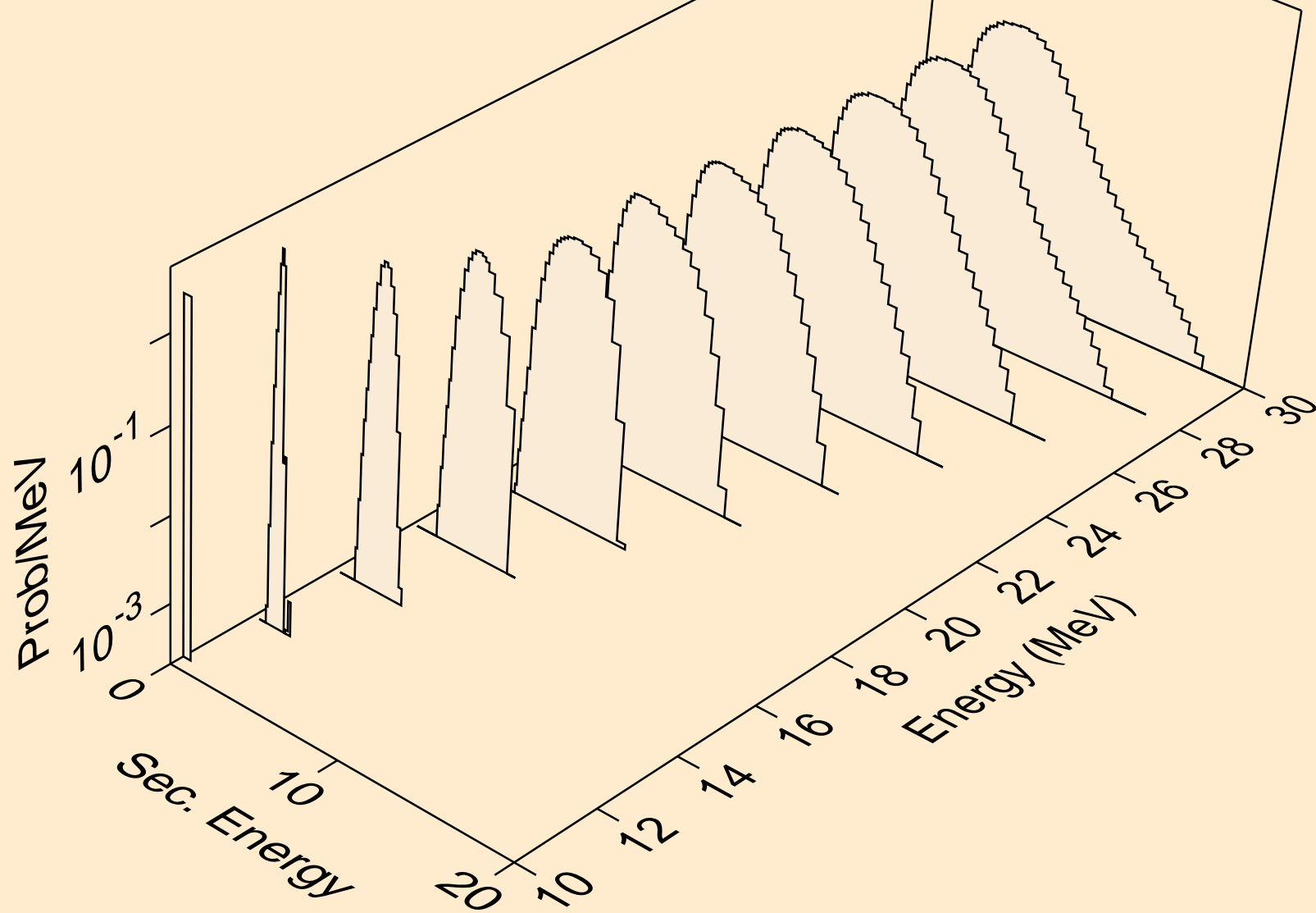

CS116M NEUTRON ACER TENDL-2021 LIBRARY; T=293.6K  
protons from (n,3np)

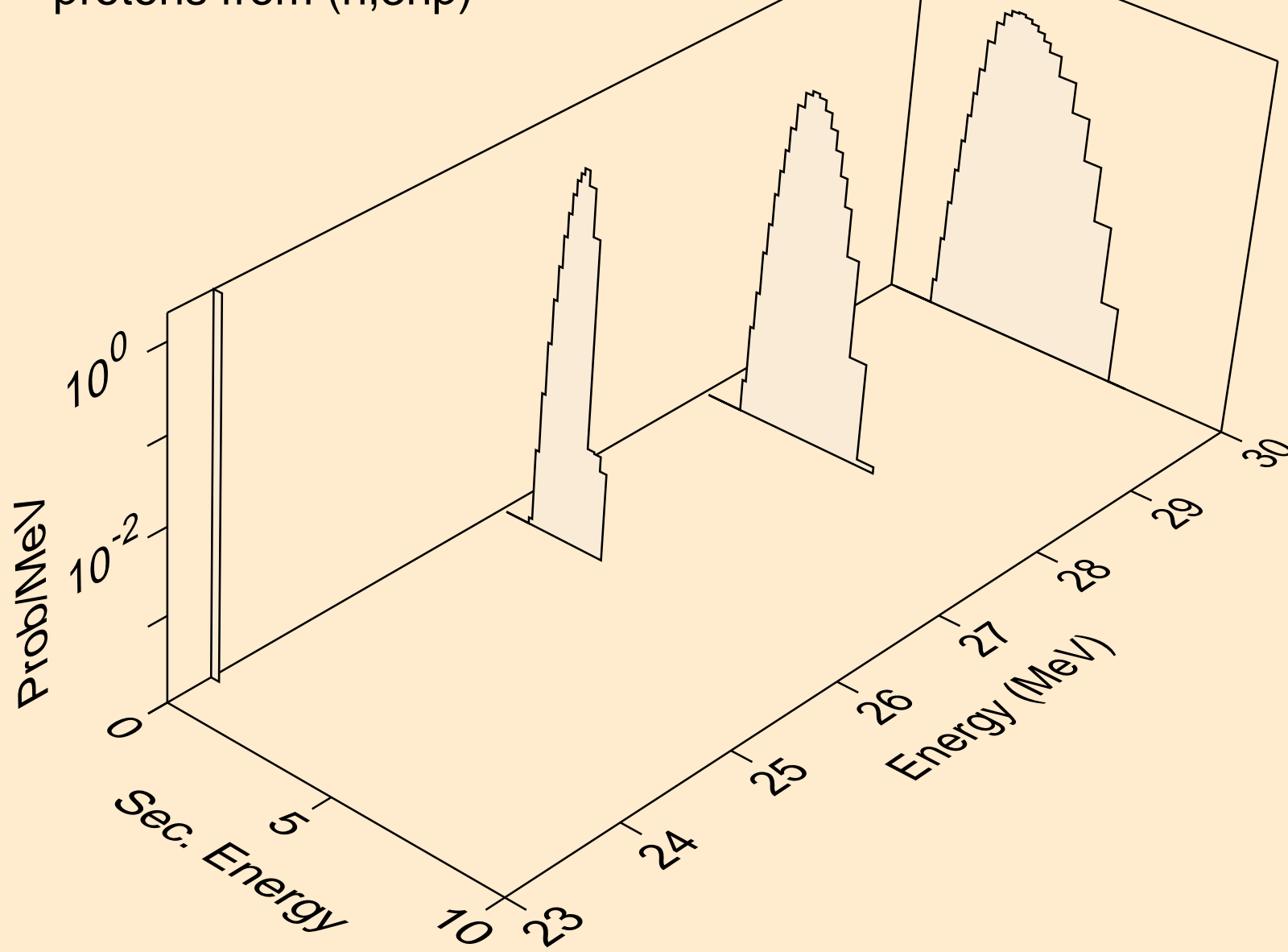

CS116M NEUTRON ACER TENDL-2021 LIBRARY; T=293.6K  
protons from (n,2np)

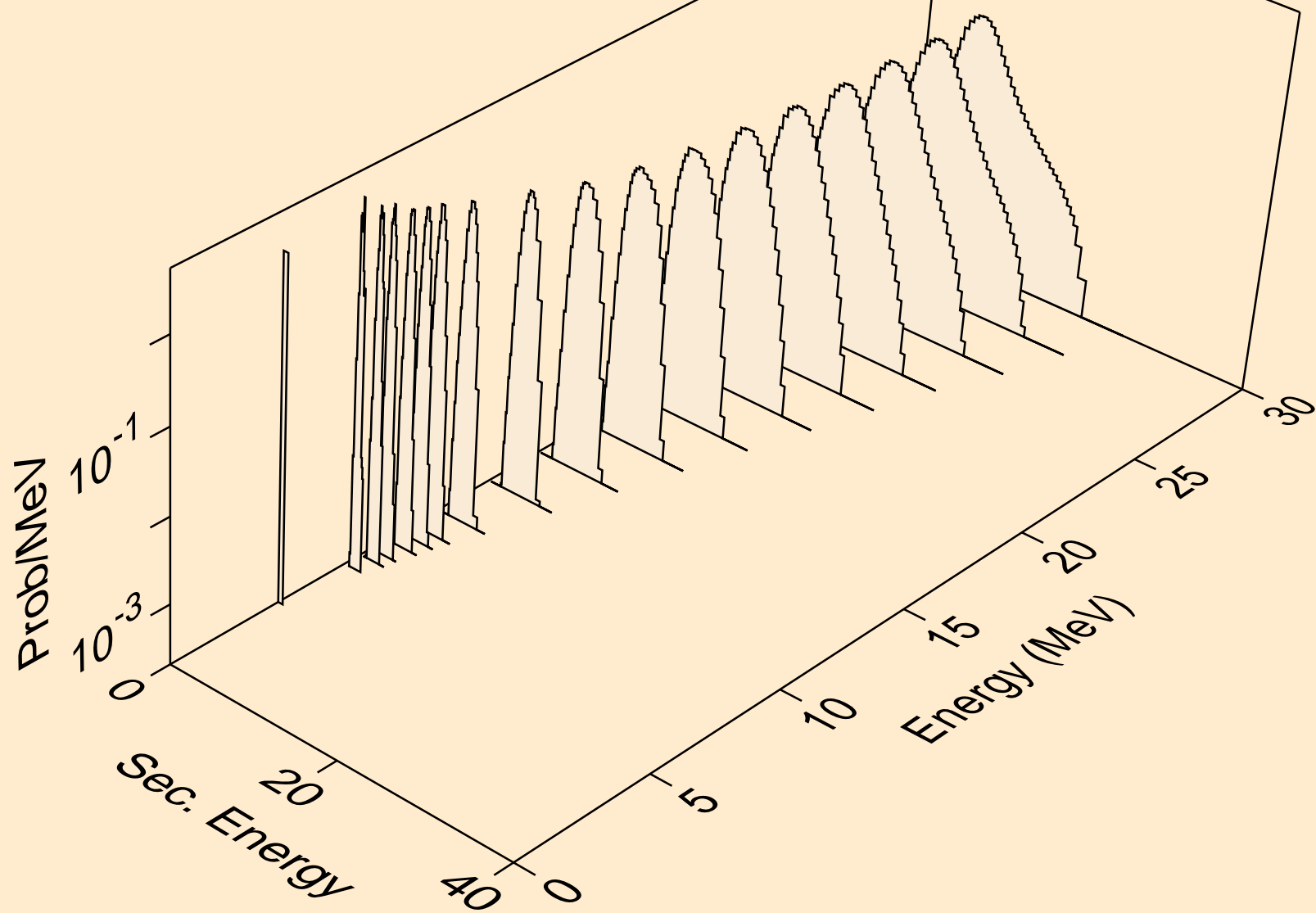

CS116M NEUTRON ACER TENDL-2021 LIBRARY; T=293.6K  
protons from (n,npa)

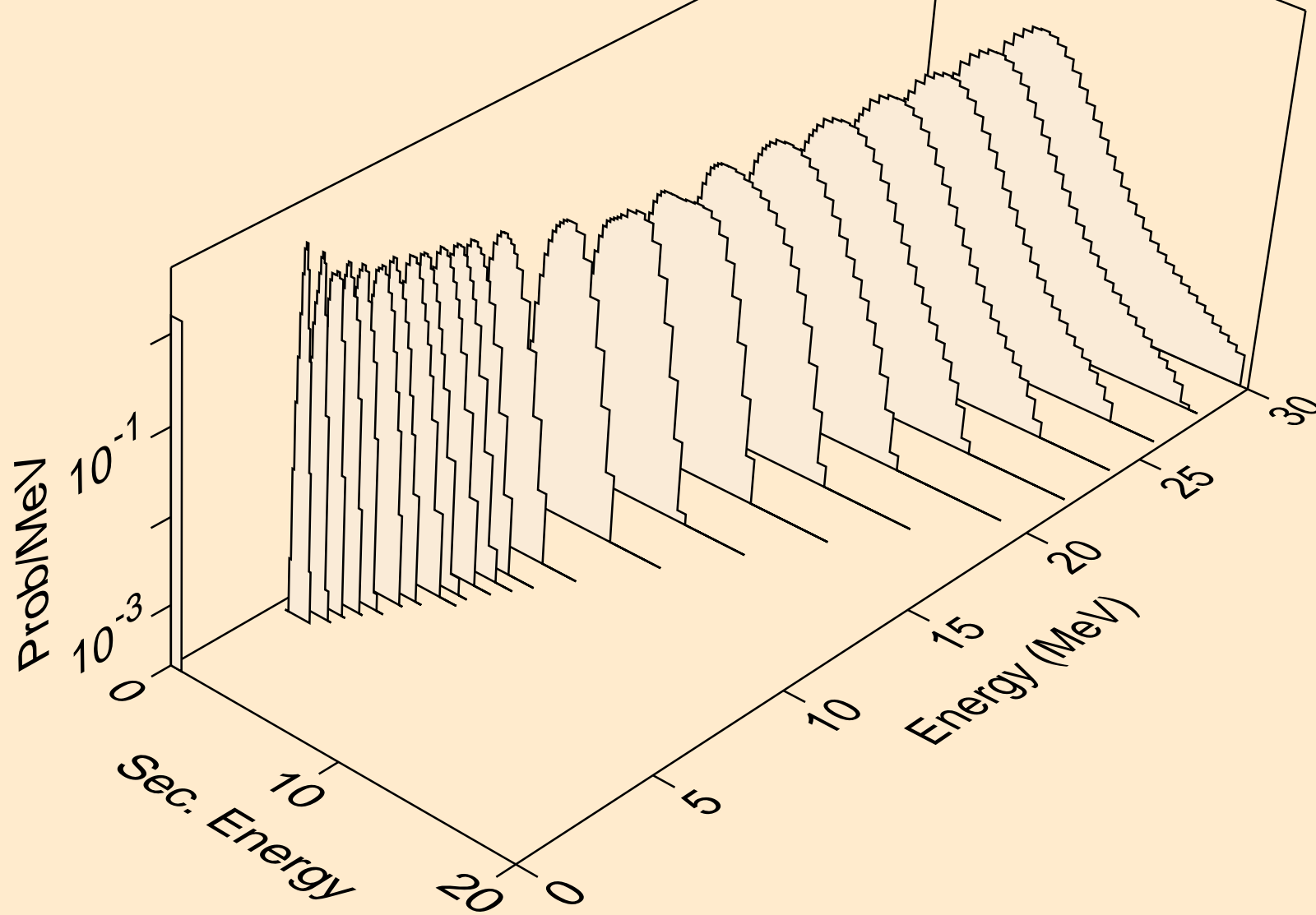

CS116M NEUTRON ACER TENDL-2021 LIBRARY; T=293.6K  
protons from (n,p)

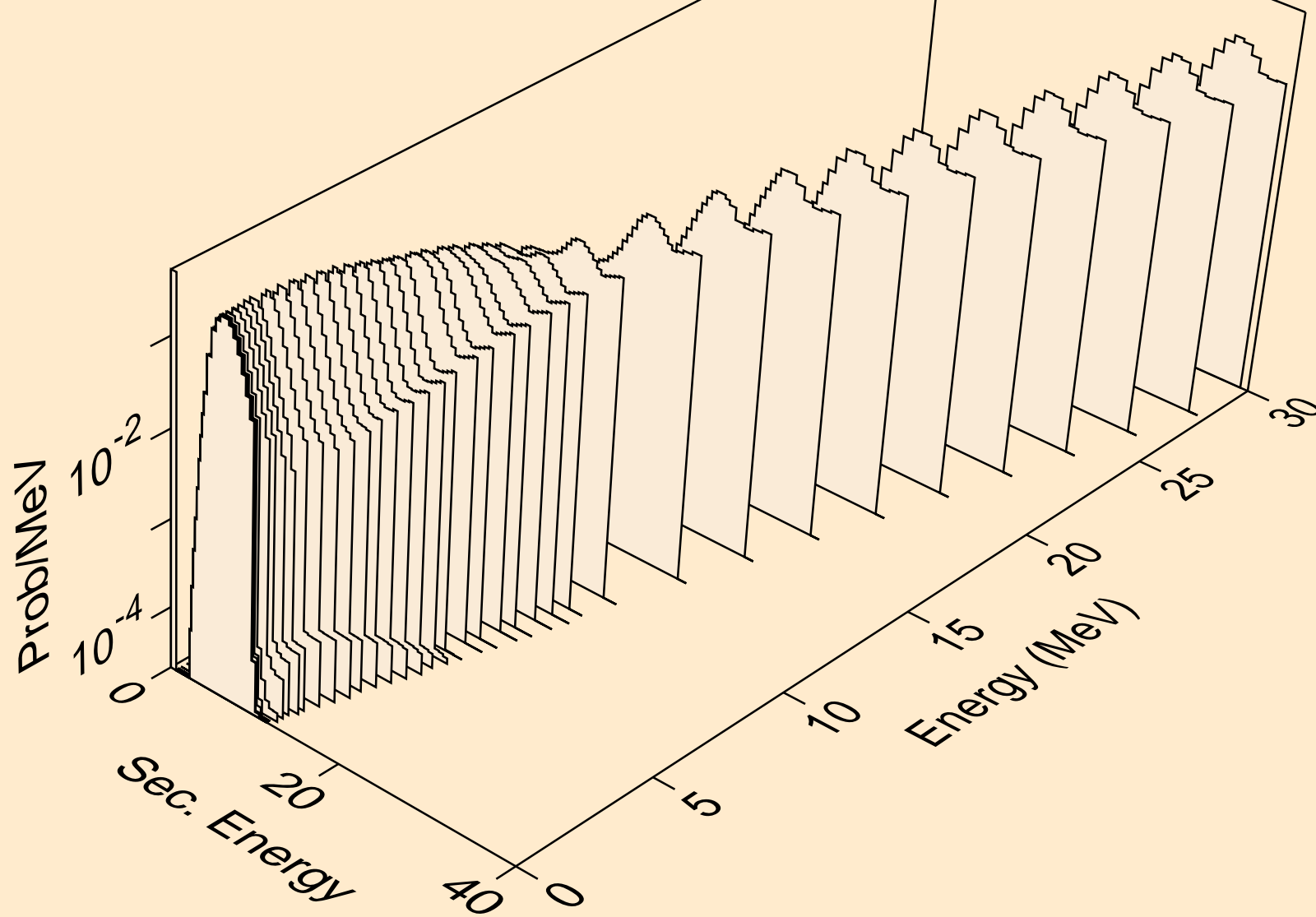

CS116M NEUTRON ACER TENDL-2021 LIBRARY; T=293.6K  
protons from (n,2p)

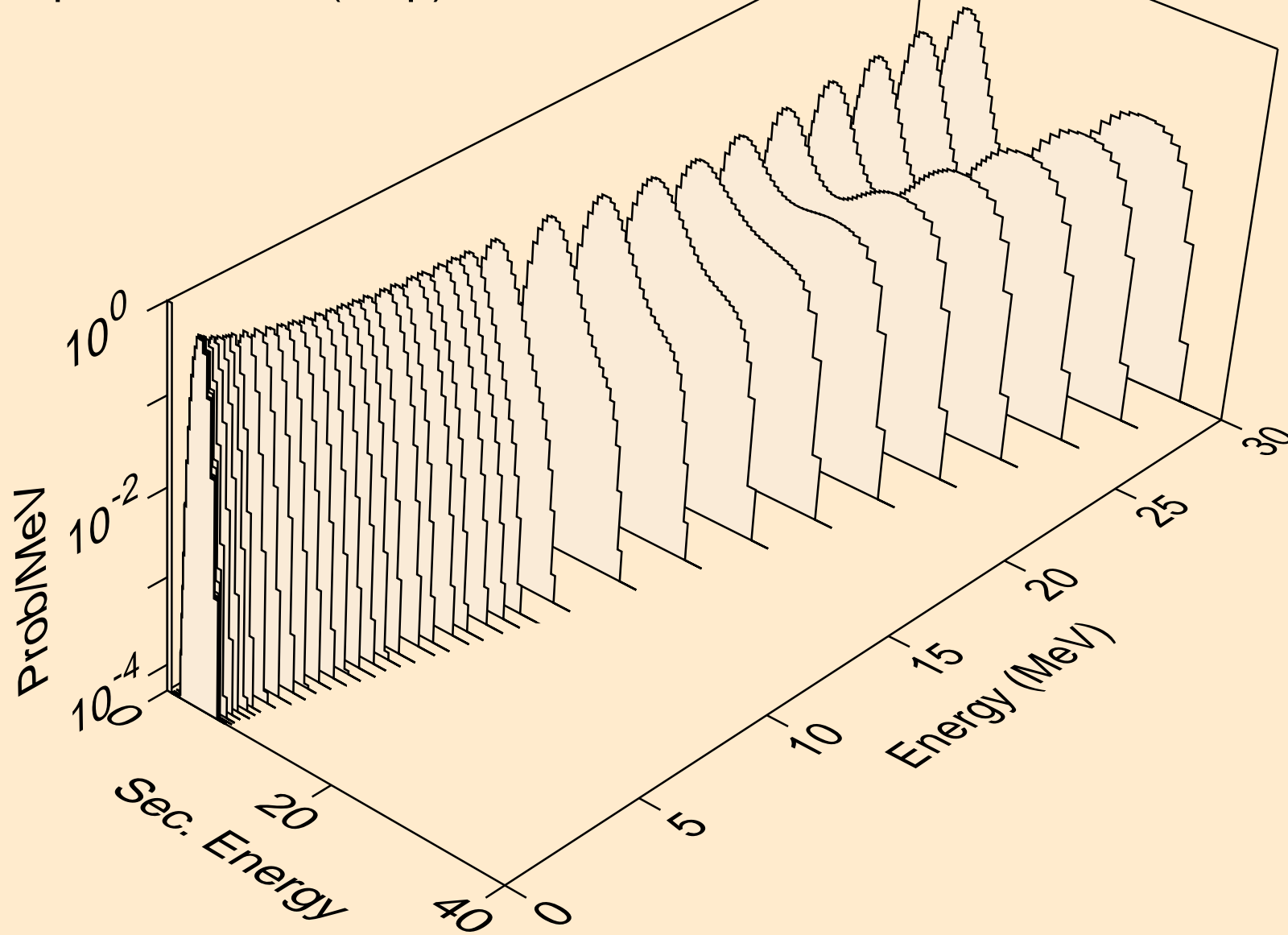



CS116M NEUTRON ACER TENDL-2021 LIBRARY; T=293.6K  
protons from (n,p)

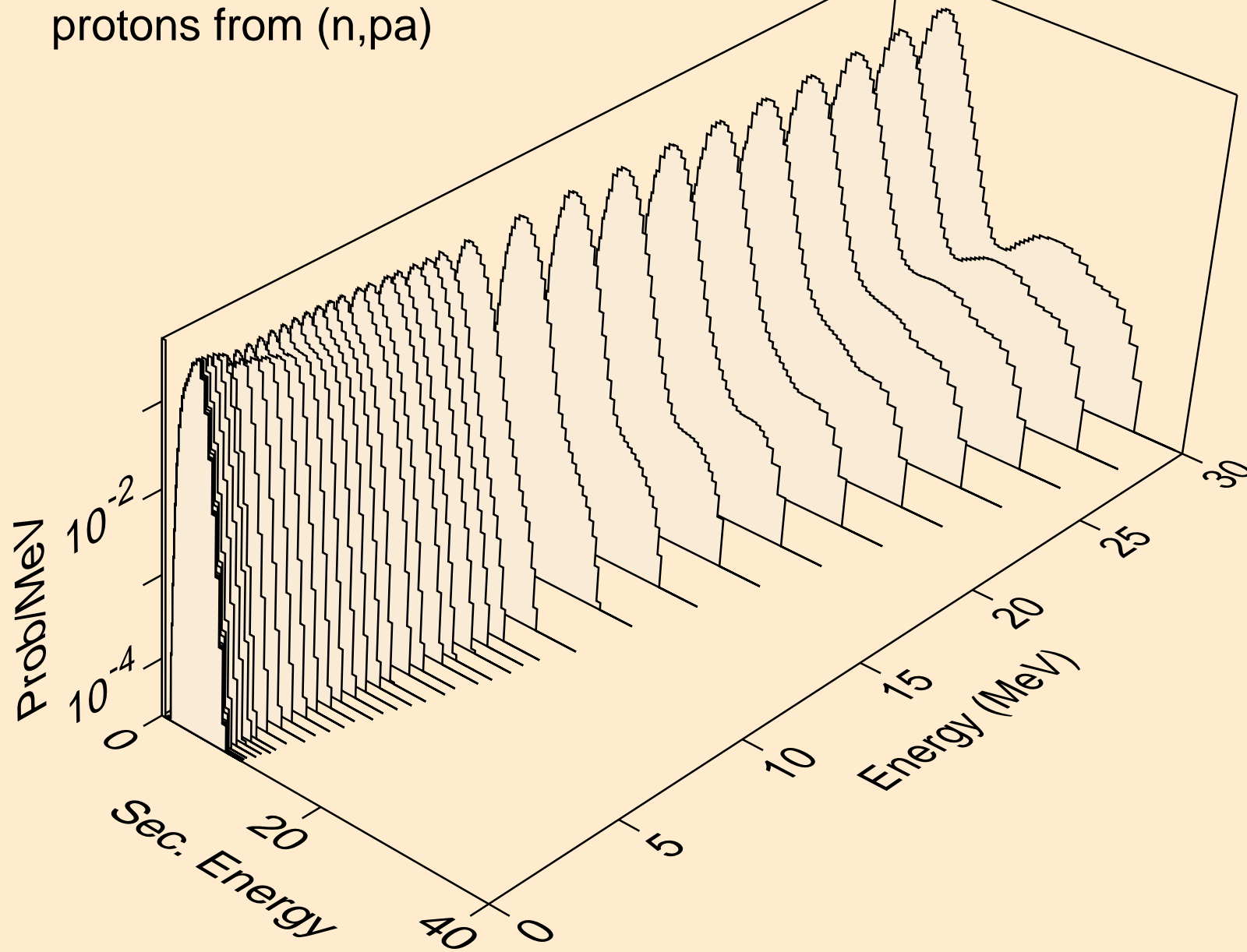

CS116M NEUTRON ACER TENDL-2021 LIBRARY; T=293.6K  
protons from (n,pd)

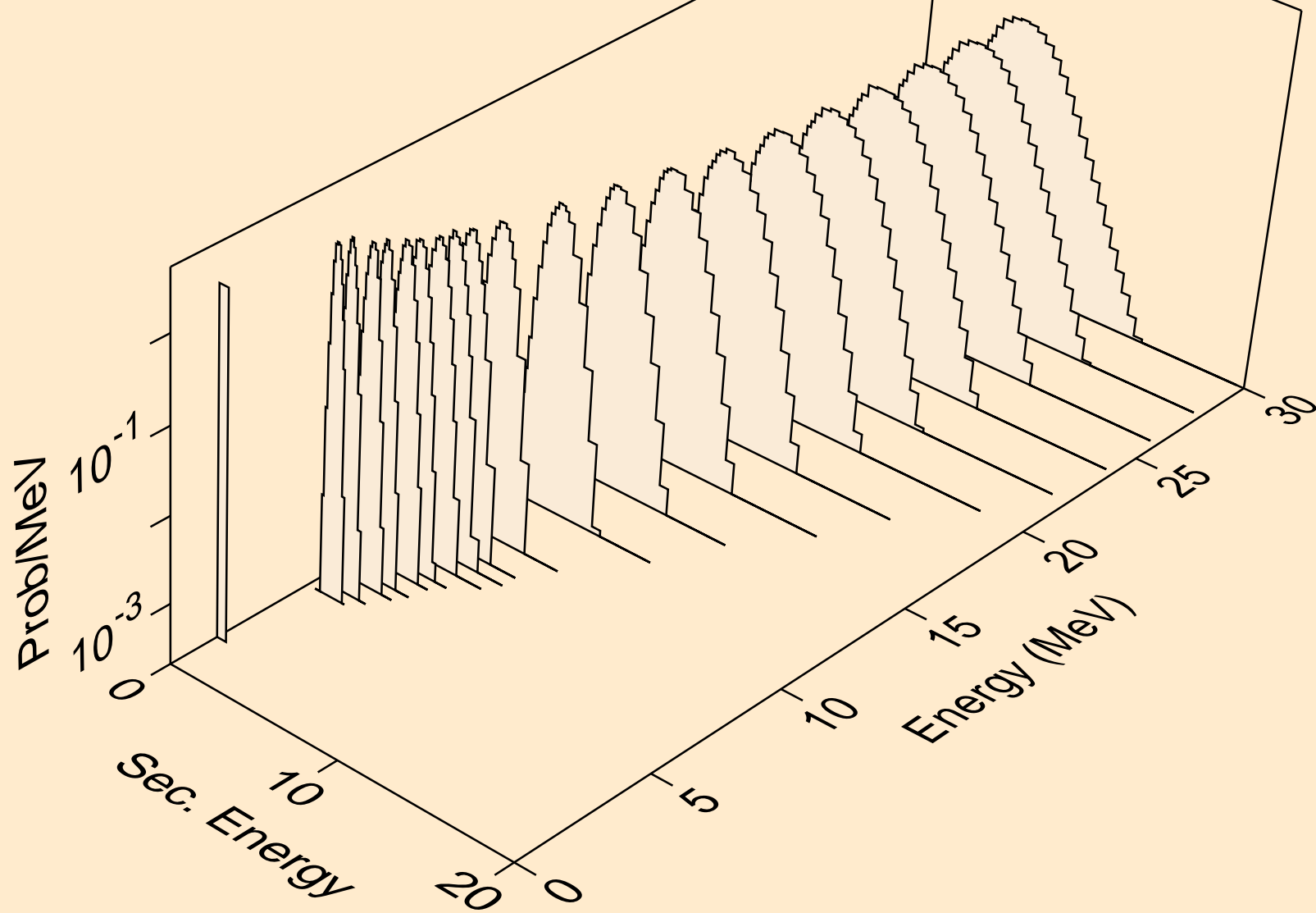

CS116M NEUTRON ACER TENDL-2021 LIBRARY; T=293.6K  
protons from (n,pt)

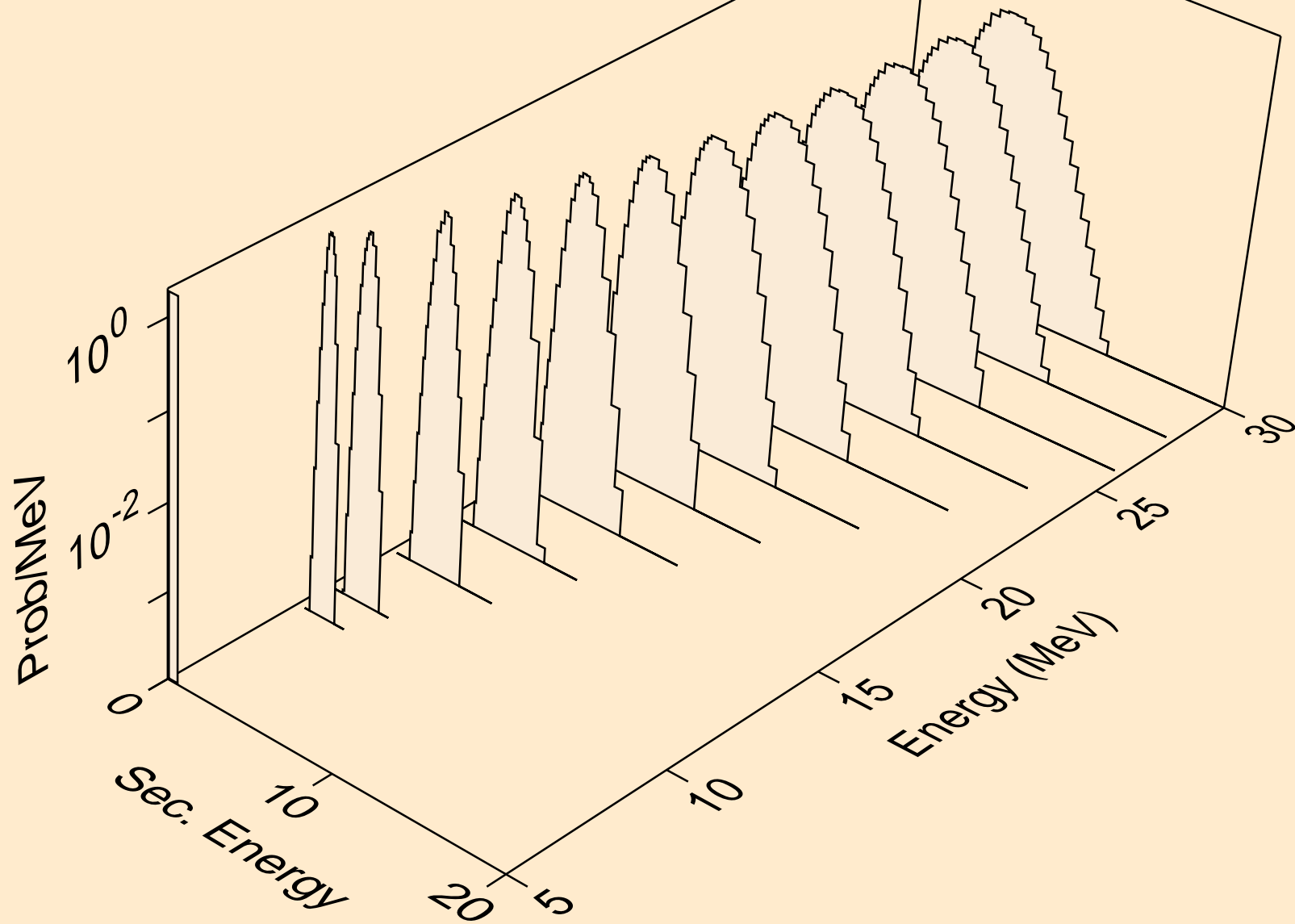

CS116M NEUTRON ACER TENDL-2021 LIBRARY; T=293.6K  
deuterons from (n,x)

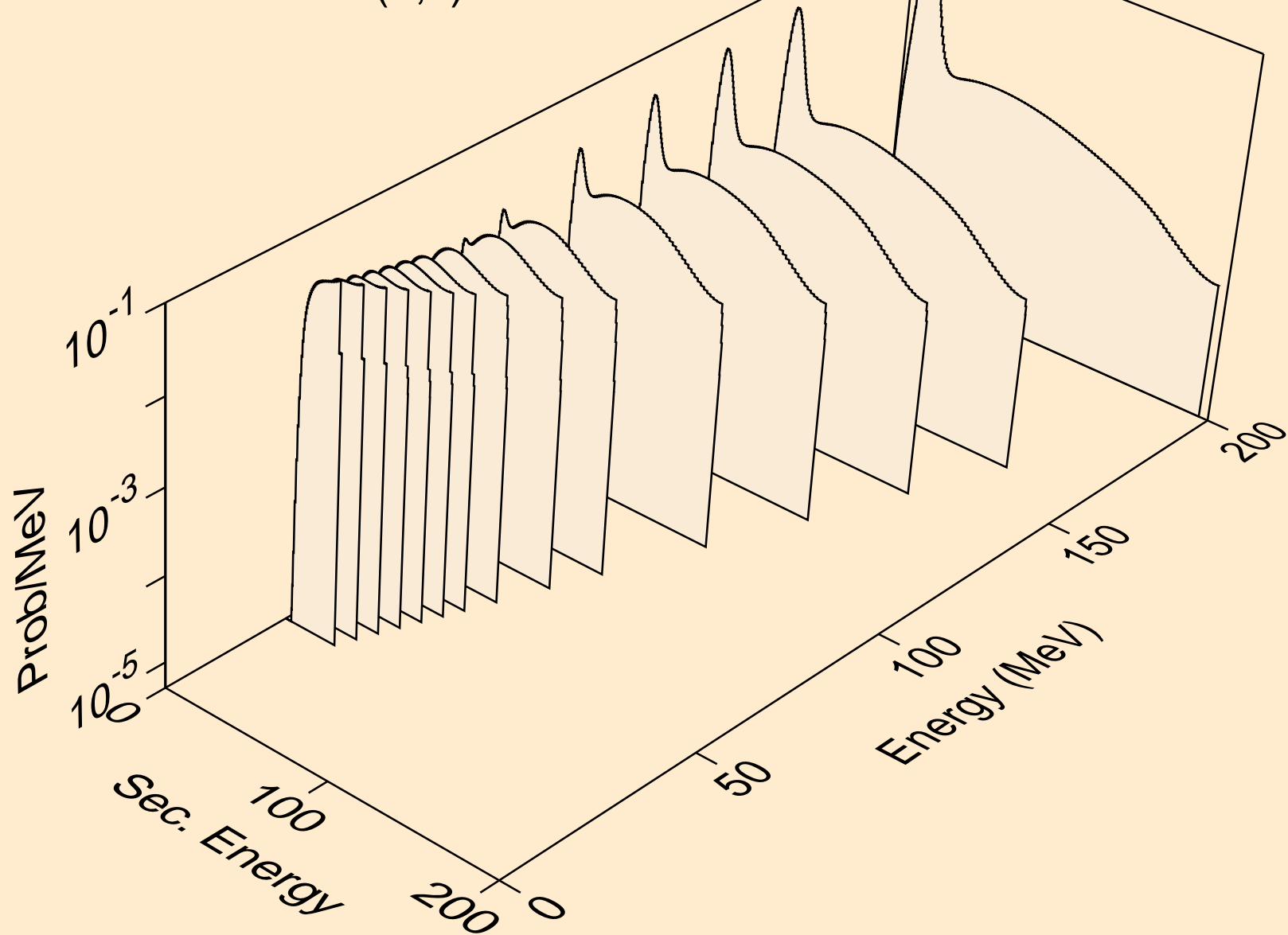

CS116M NEUTRON ACER TENDL-2021 LIBRARY; T=293.6K  
deuterons from (n,2nd)

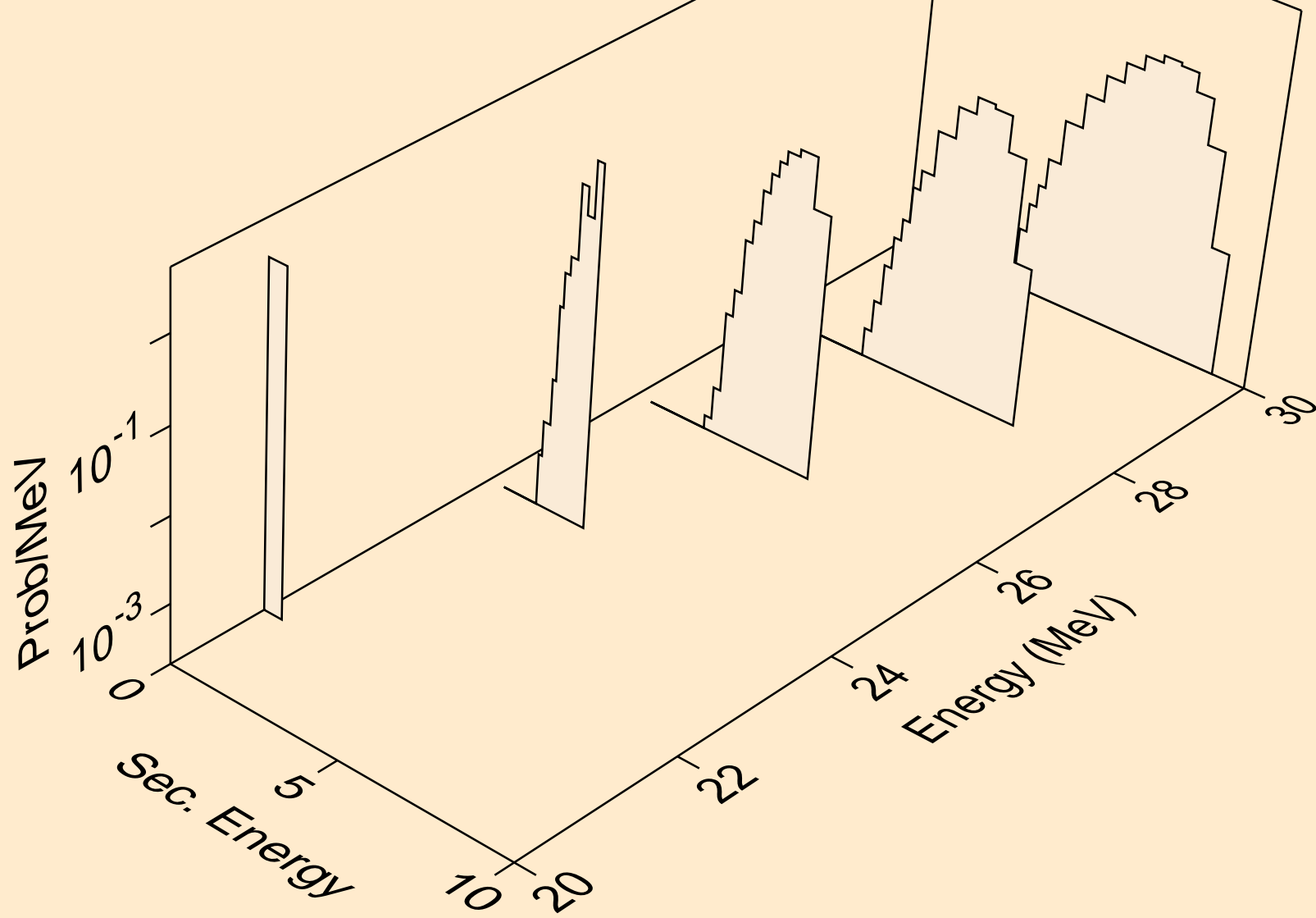

CS116M NEUTRON ACER TENDL-2021 LIBRARY; T=293.6K  
deuterons from (n,n\*)d

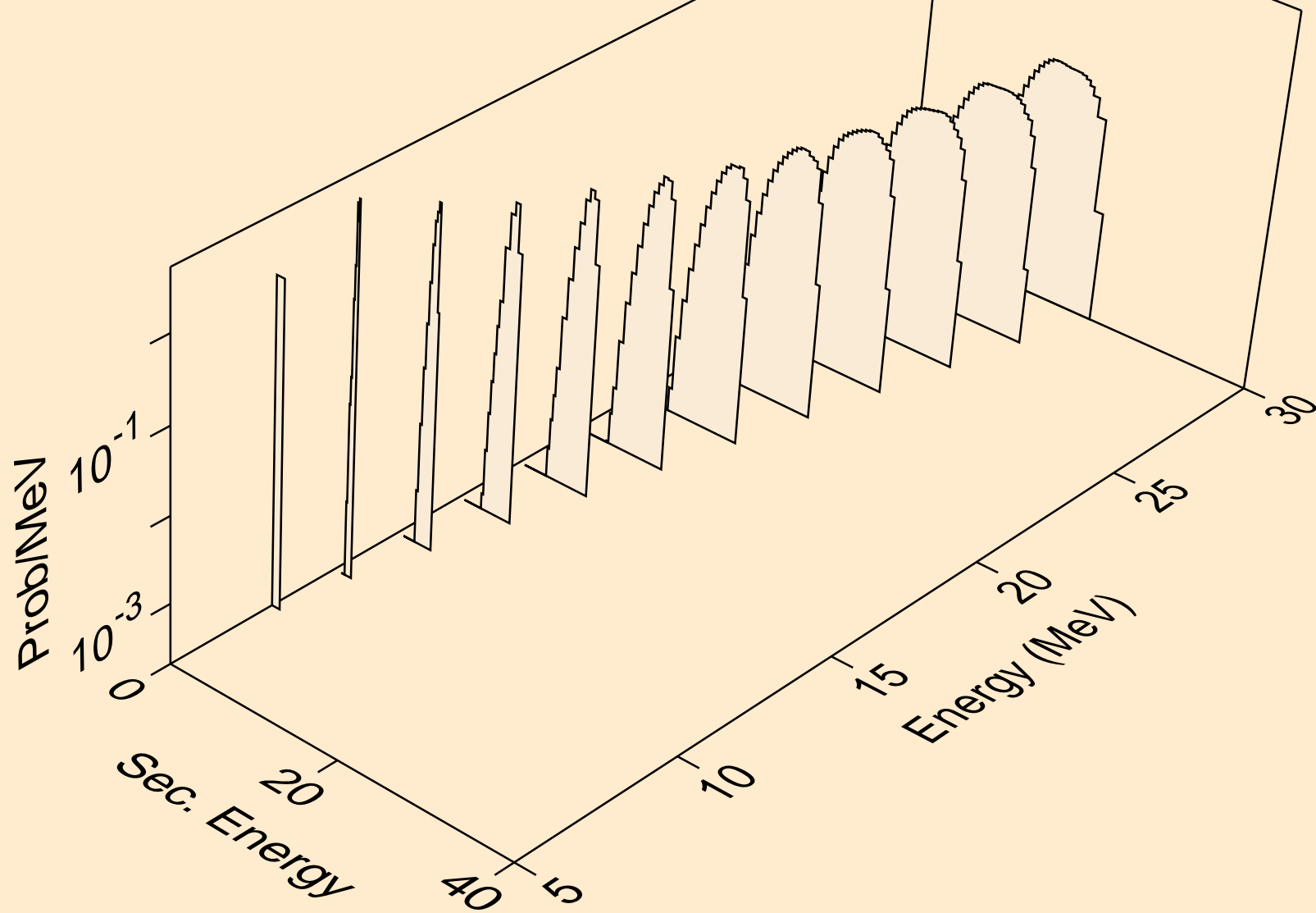

CS116M NEUTRON ACER TENDL-2021 LIBRARY; T=293.6K  
deuterons from (n,d)

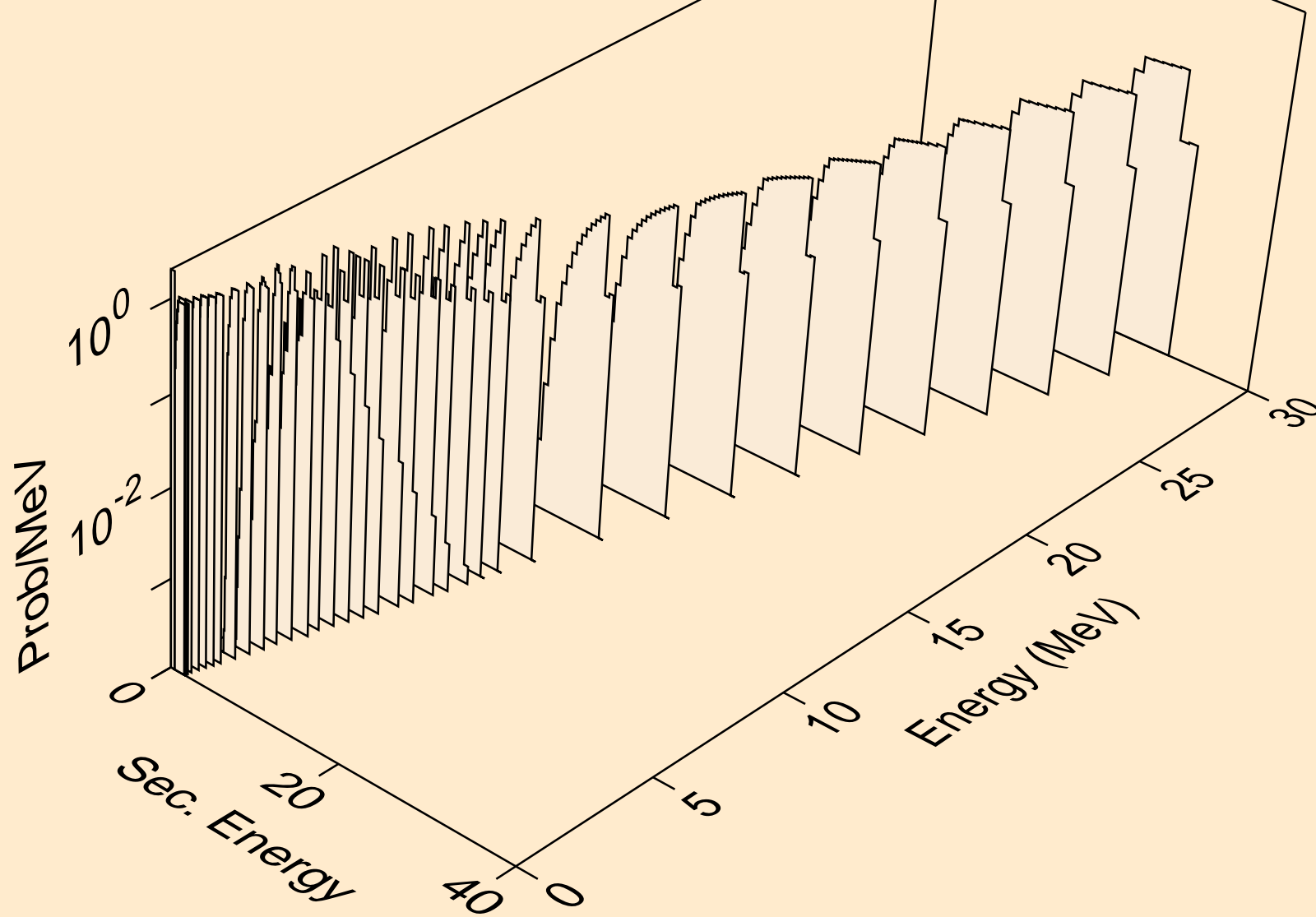

CS116M NEUTRON ACER TENDL-2021 LIBRARY; T=293.6K  
deuterons from (n,d2a)

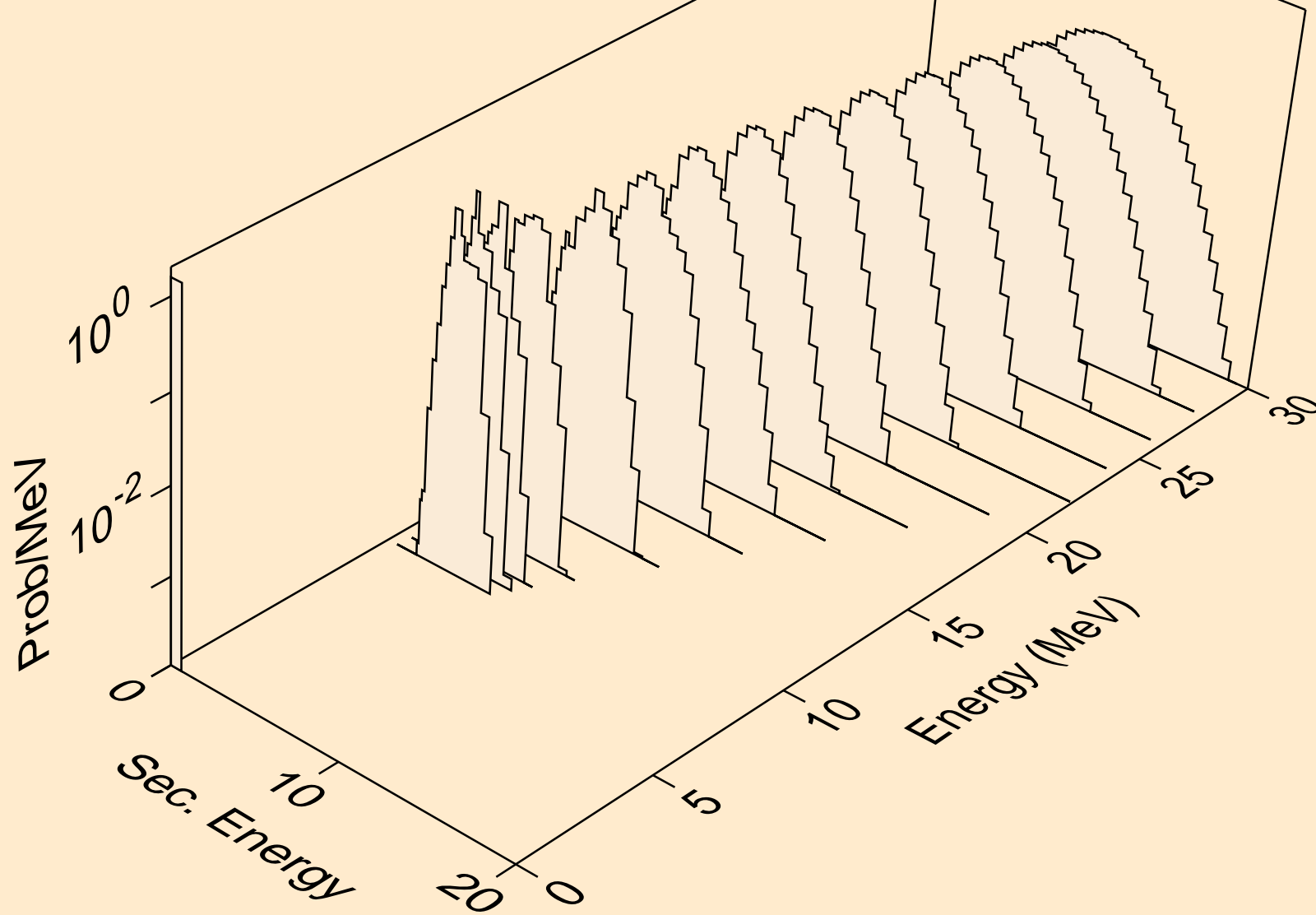



CS116M NEUTRON ACER TENDL-2021 LIBRARY; T=293.6K  
deuterons from (n,pd)

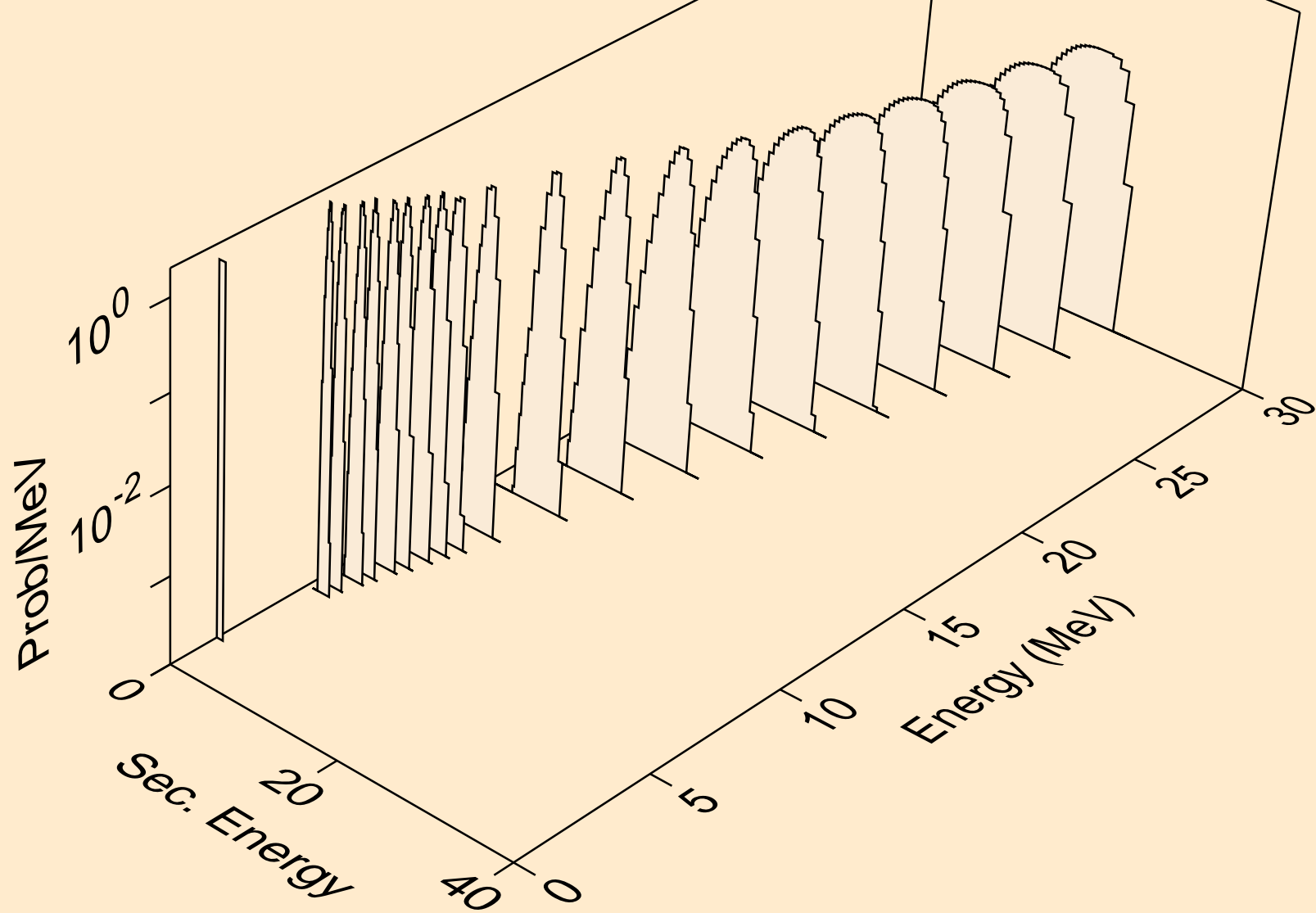

CS116M NEUTRON ACER TENDL-2021 LIBRARY; T=293.6K  
deuterons from (n,da)

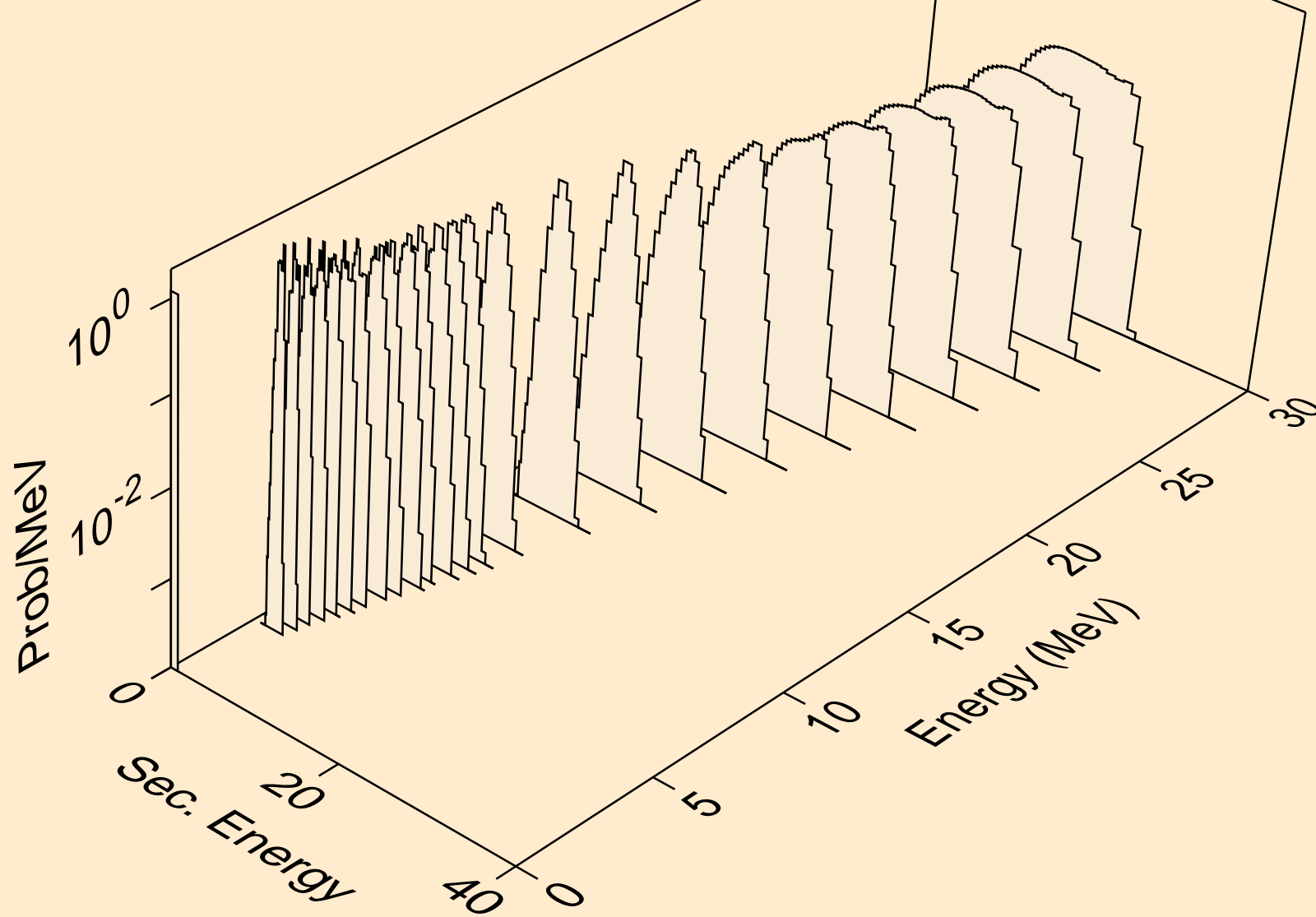

CS116M NEUTRON ACER TENDL-2021 LIBRARY; T=293.6K  
tritons from (n,x)

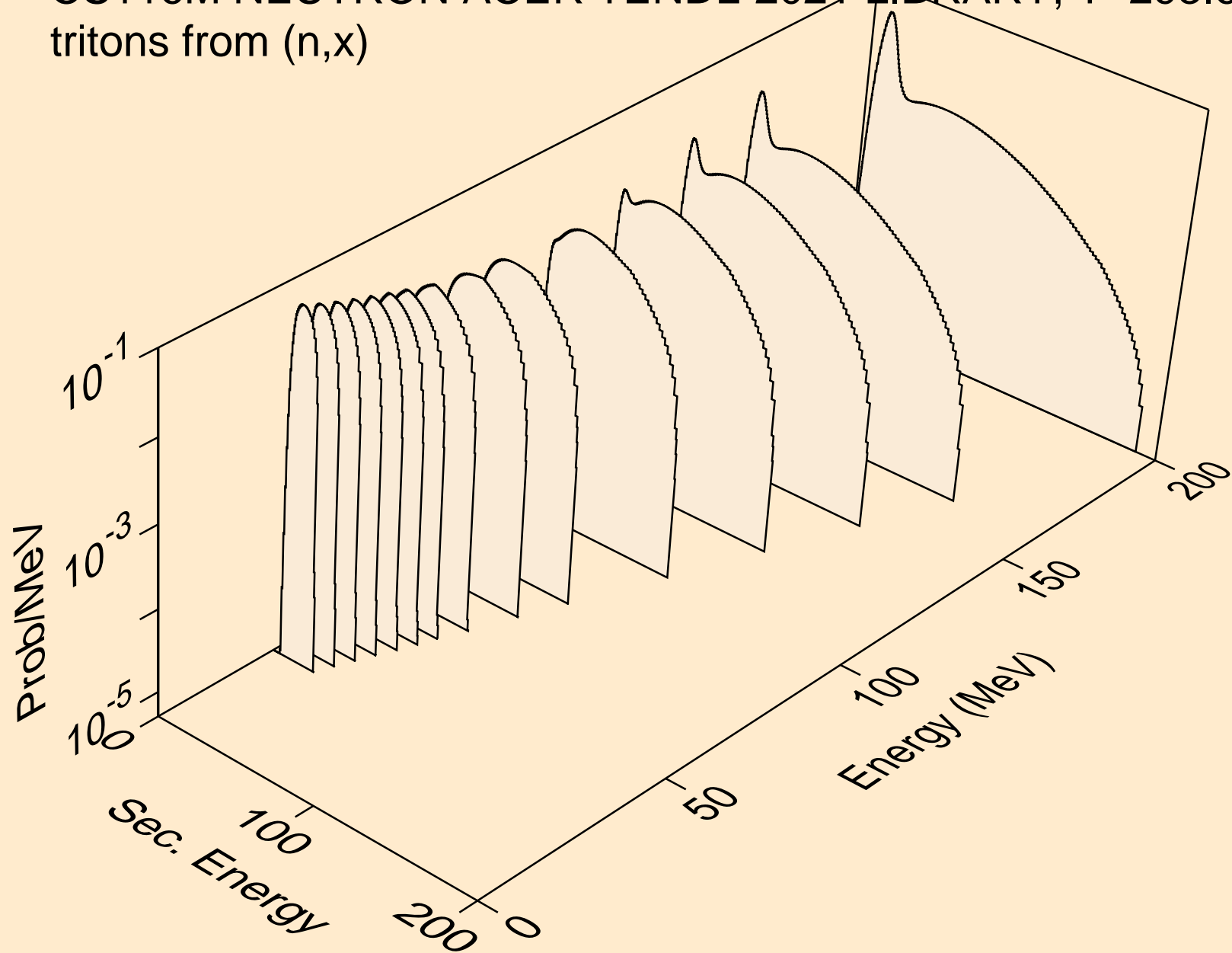

CS116M NEUTRON ACER TENDL-2021 LIBRARY; T=293.6K  
tritons from (n,n\*)t

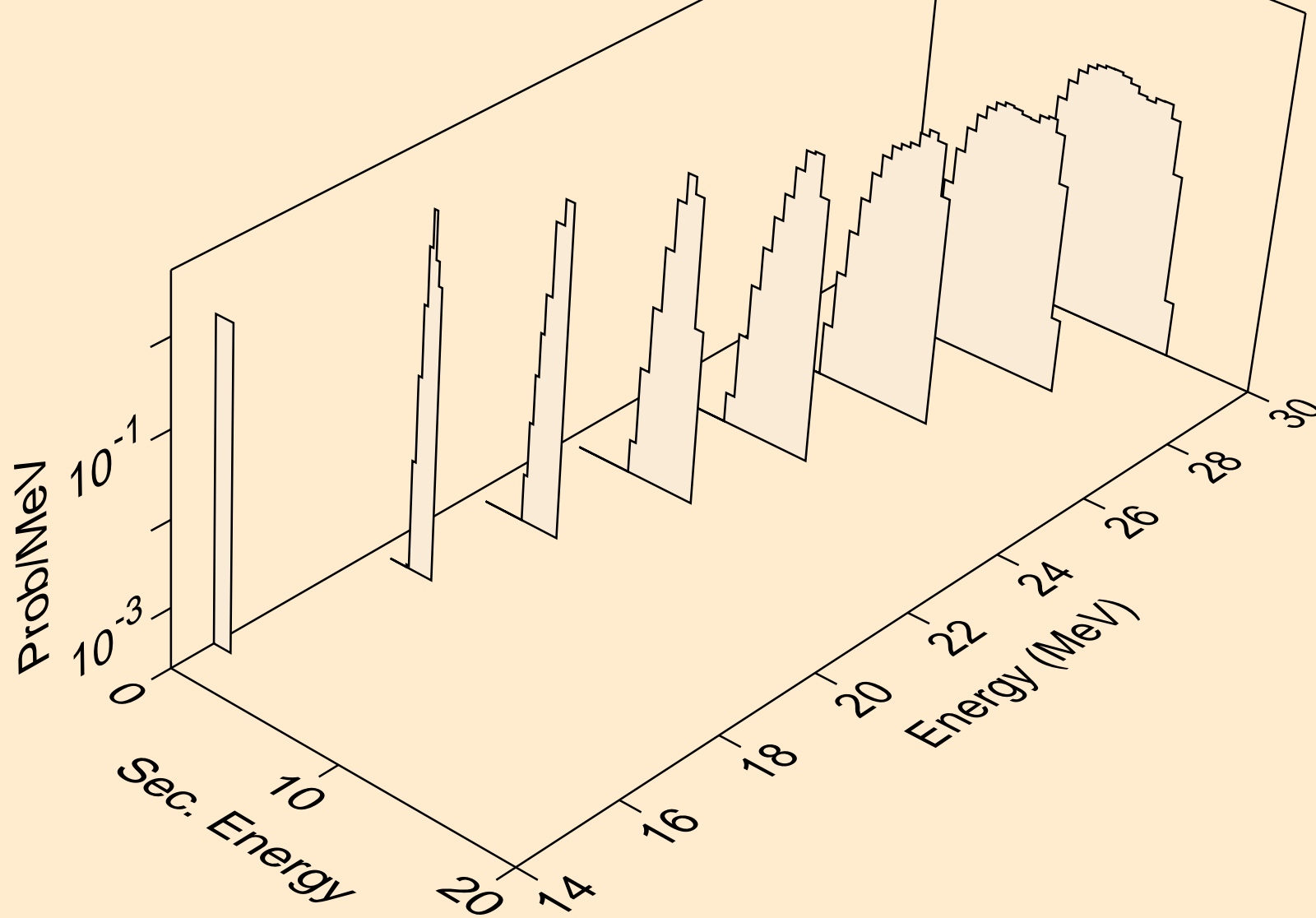

CS116M NEUTRON ACER TENDL-2021 LIBRARY; T=293.6K  
tritons from (n,t)

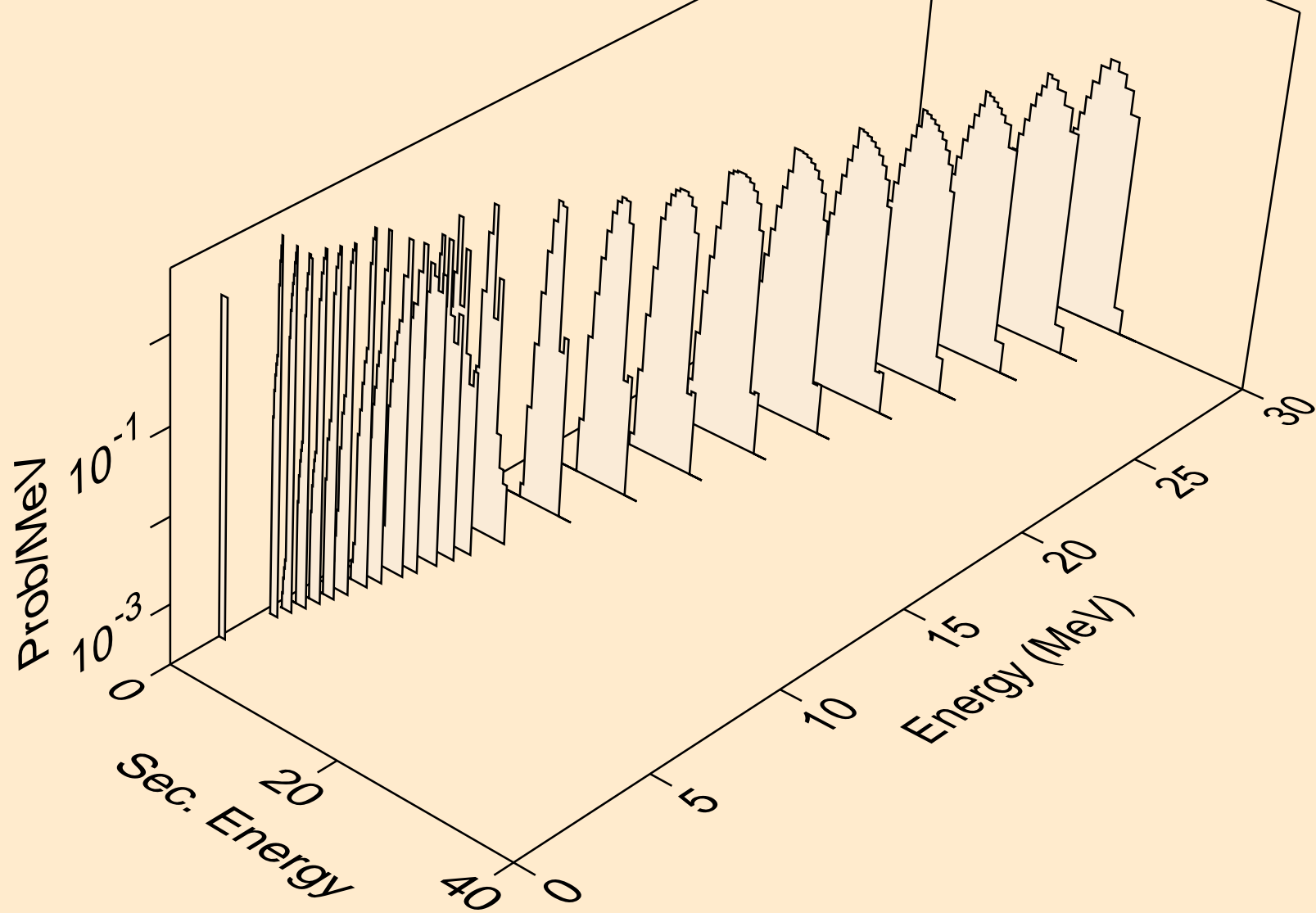

CS116M NEUTRON ACER TENDL-2021 LIBRARY; T=293.6K  
tritons from (n,t2a)

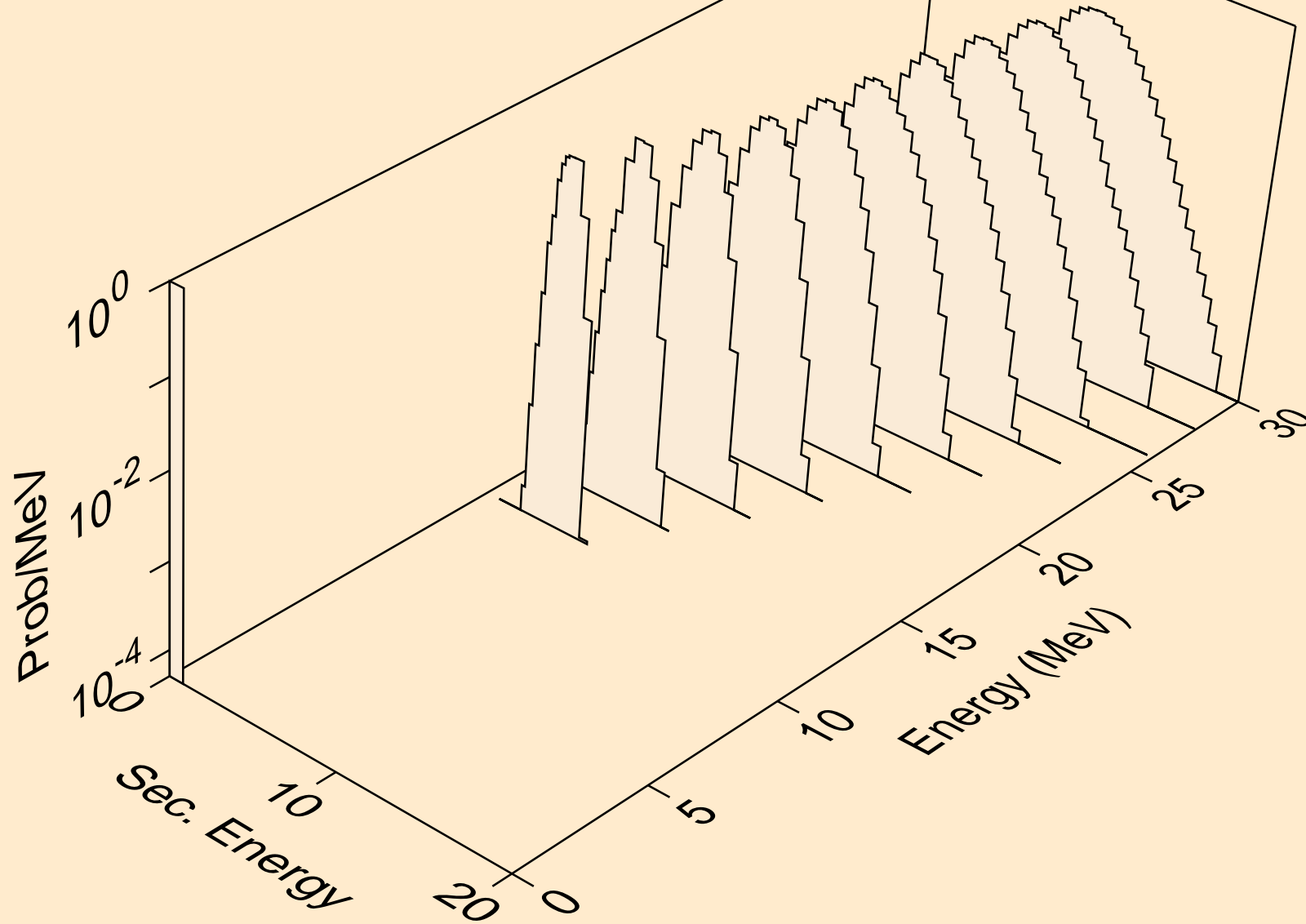

CS116M NEUTRON ACER TENDL-2021 LIBRARY; T=293.6K  
tritons from (n,pt)

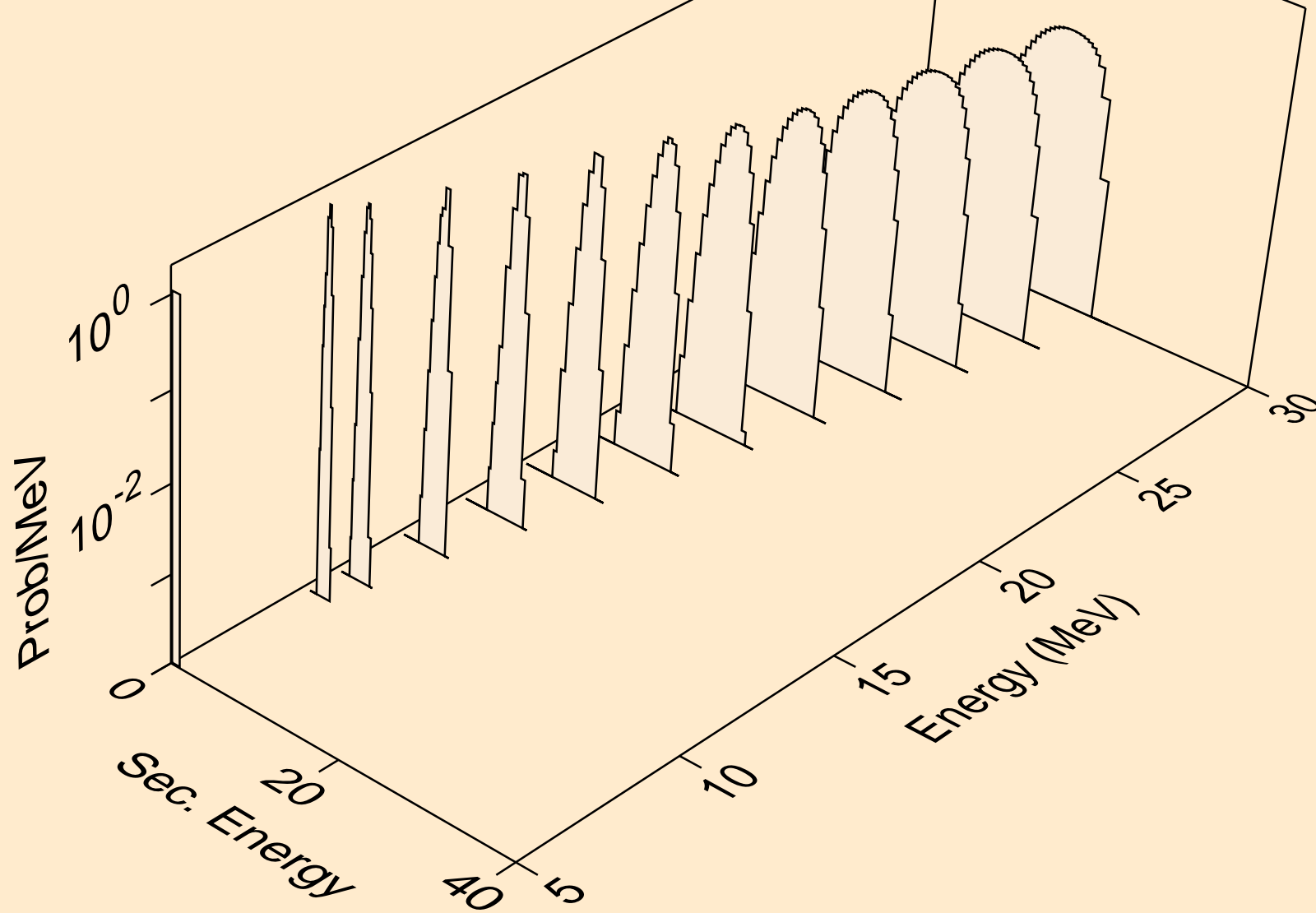

CS116M NEUTRON ACER TENDL-2021 LIBRARY; T=293.6K  
he3s from (n,x)

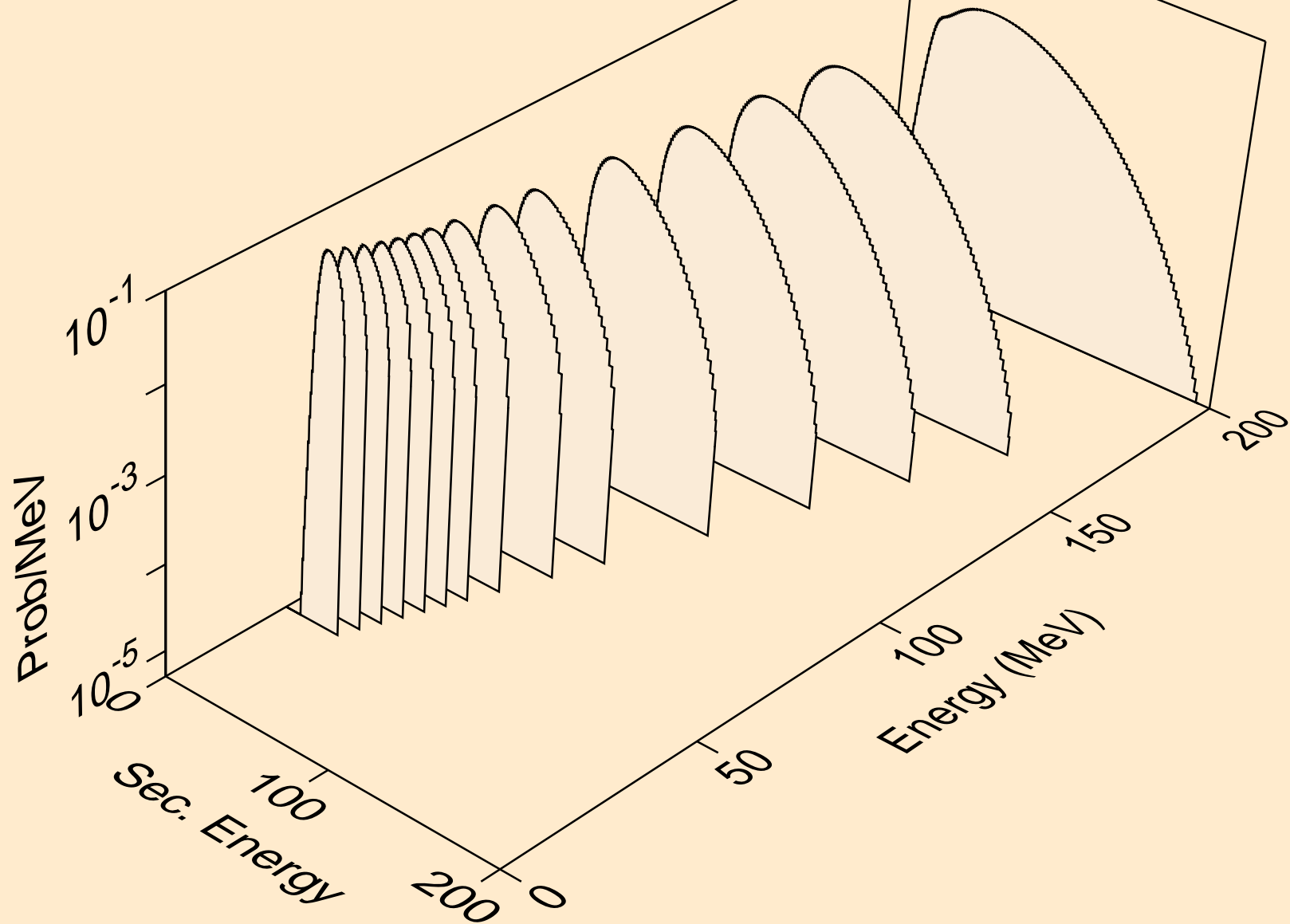



CS116M NEUTRON ACER TENDL-2021 LIBRARY; T=293.6K  
he3s from (n,n\*)he3

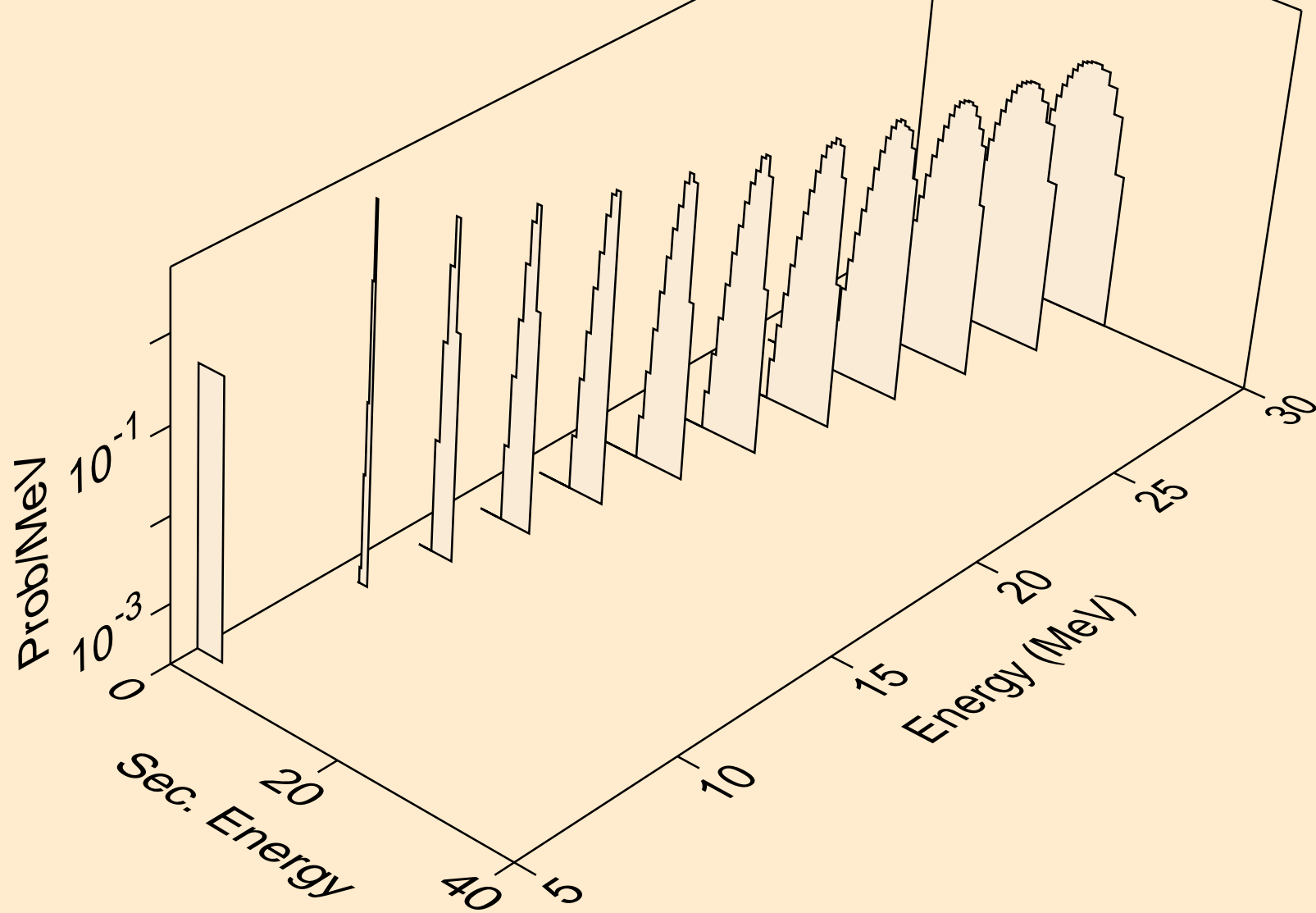

CS116M NEUTRON ACER TENDL-2021 LIBRARY; T=293.6K  
he3s from (n,he3)

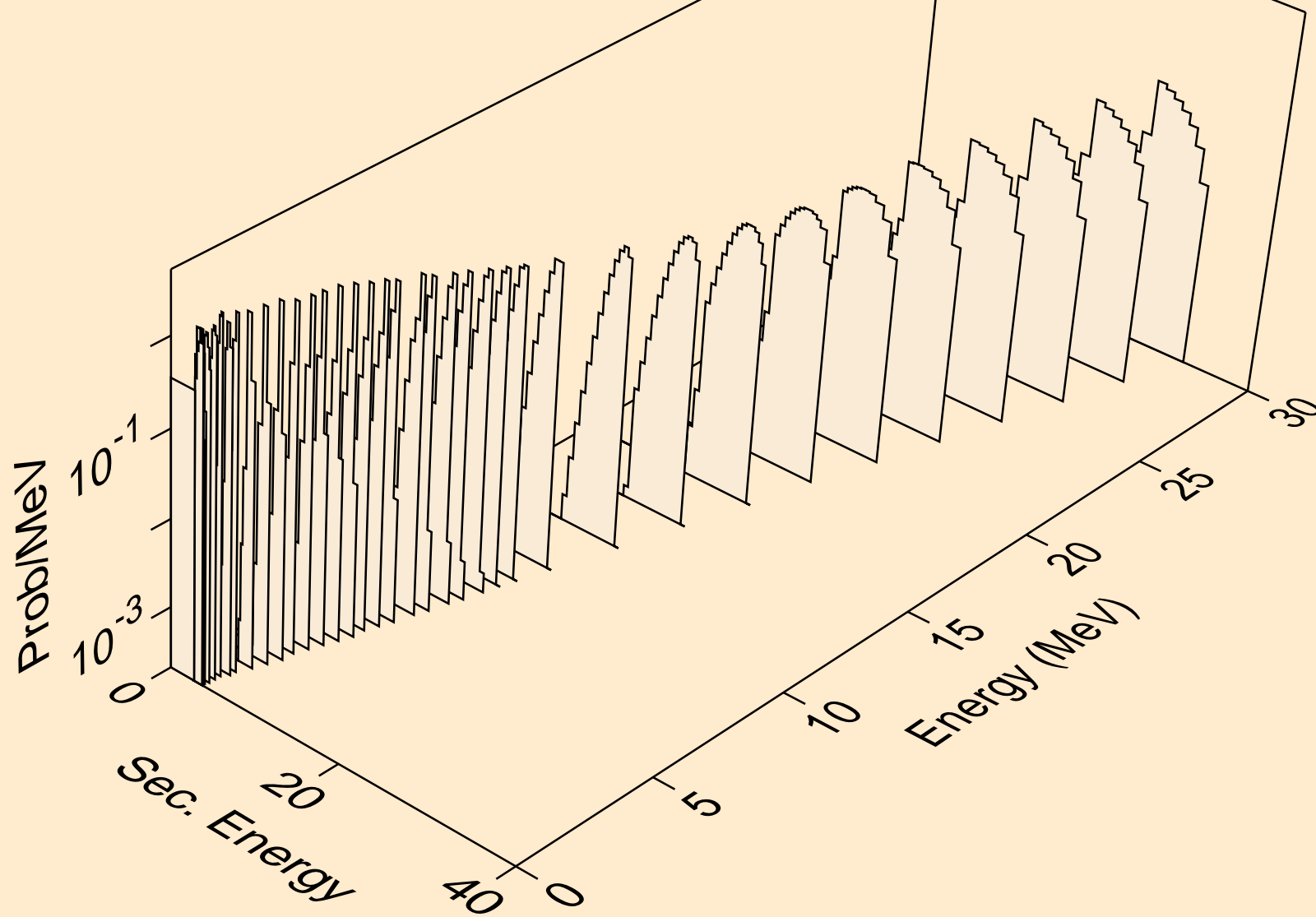

CS116M NEUTRON ACER TENDL-2021 LIBRARY; T=293.6K  
alphas from (n,x)

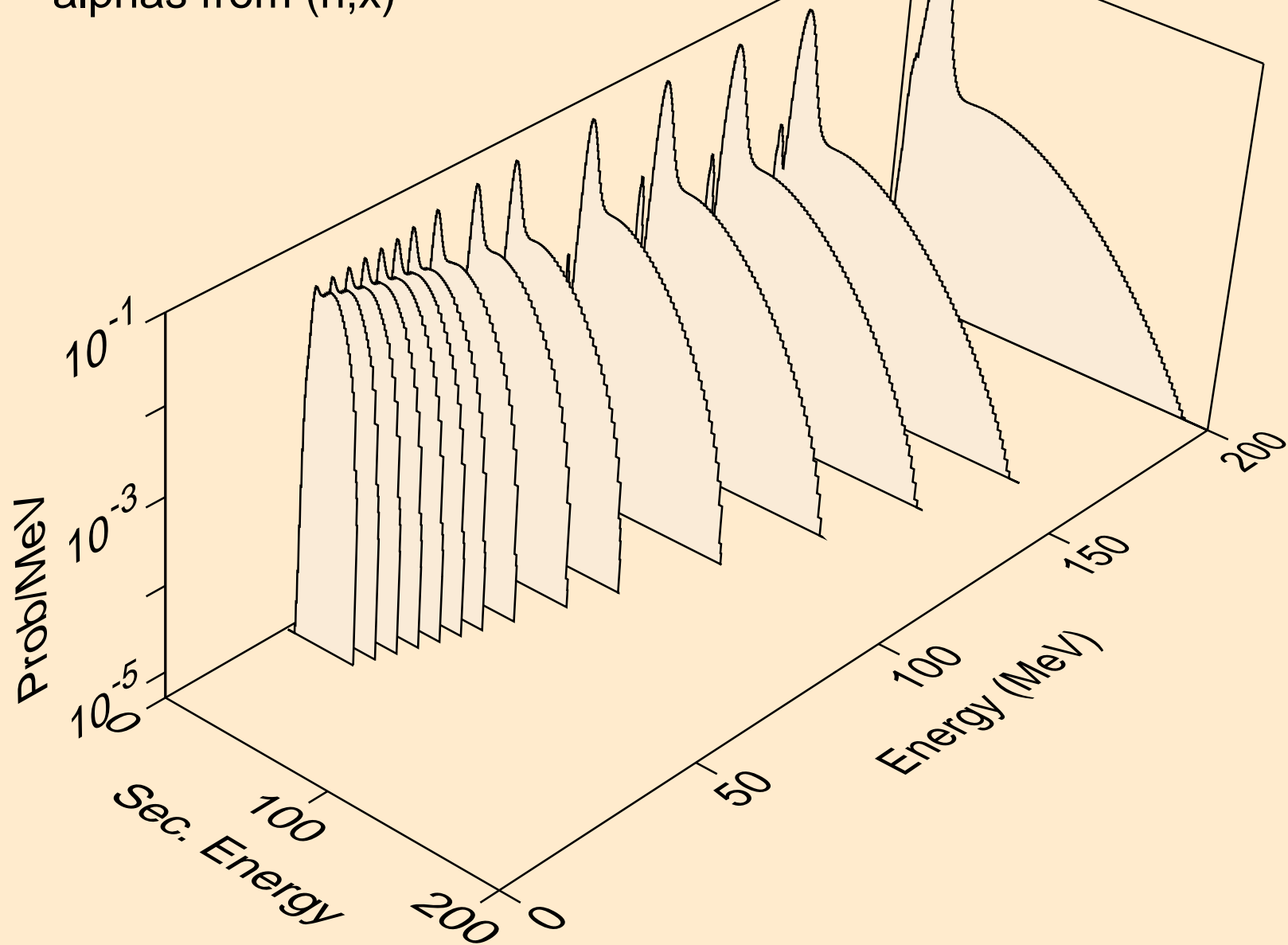

CS116M NEUTRON ACER TENDL-2021 LIBRARY; T=293.6K  
alphas from (n,n\*)a

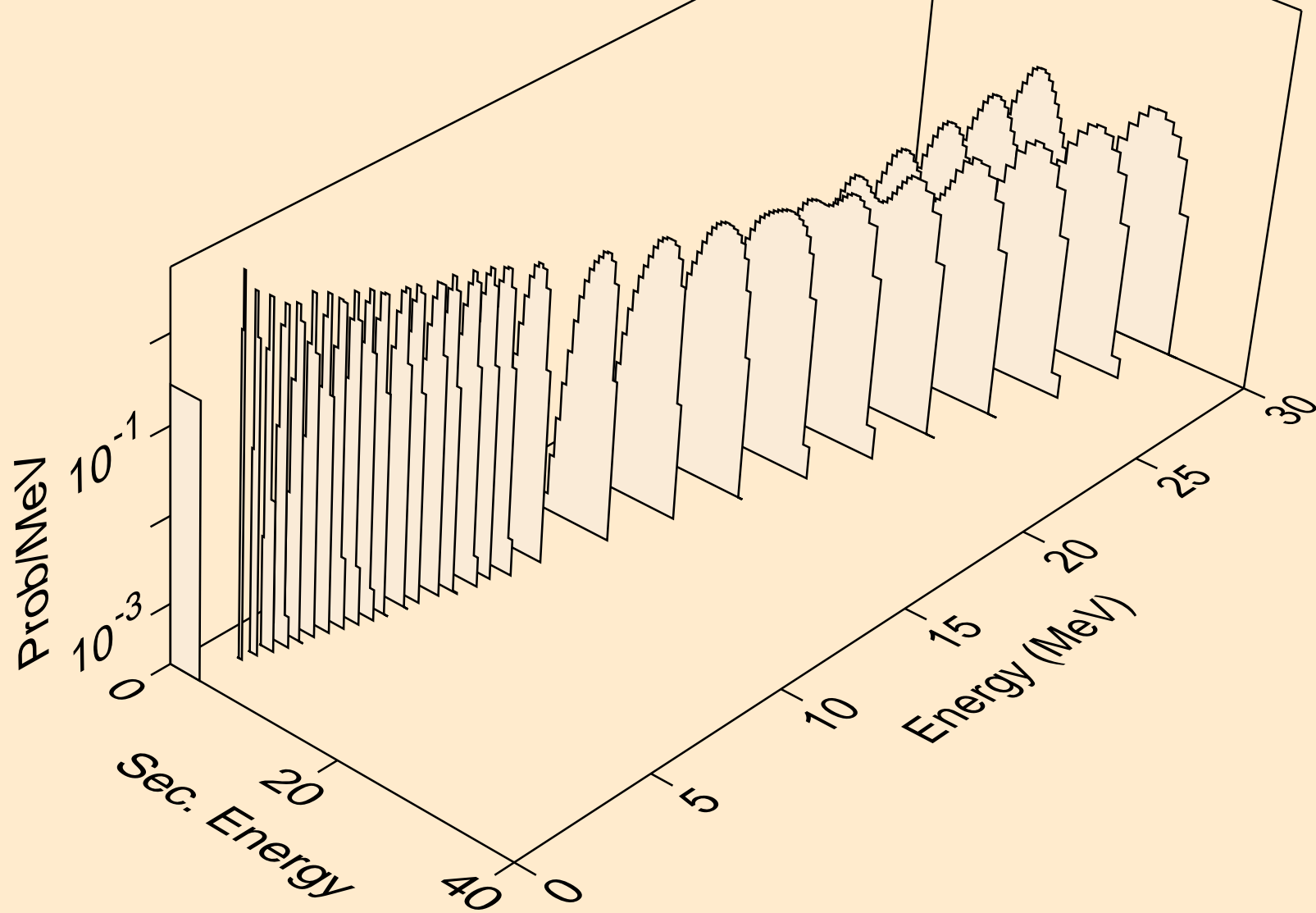

CS116M NEUTRON ACER TENDL-2021 LIBRARY; T=293.6K  
alphas from (n,n\*)3a

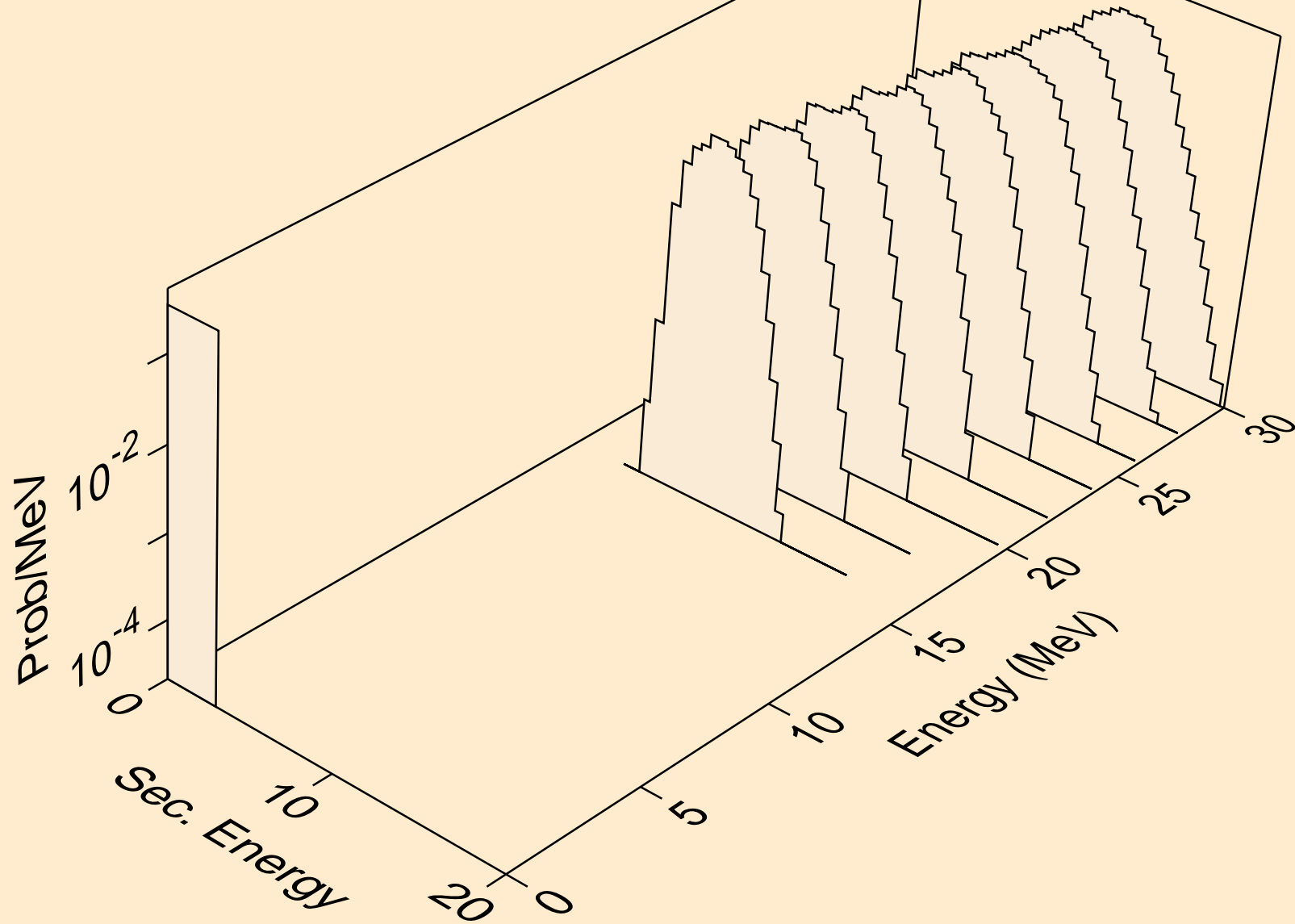

CS116M NEUTRON ACER TENDL-2021 LIBRARY; T=293.6K  
alphas from (n,2n)a

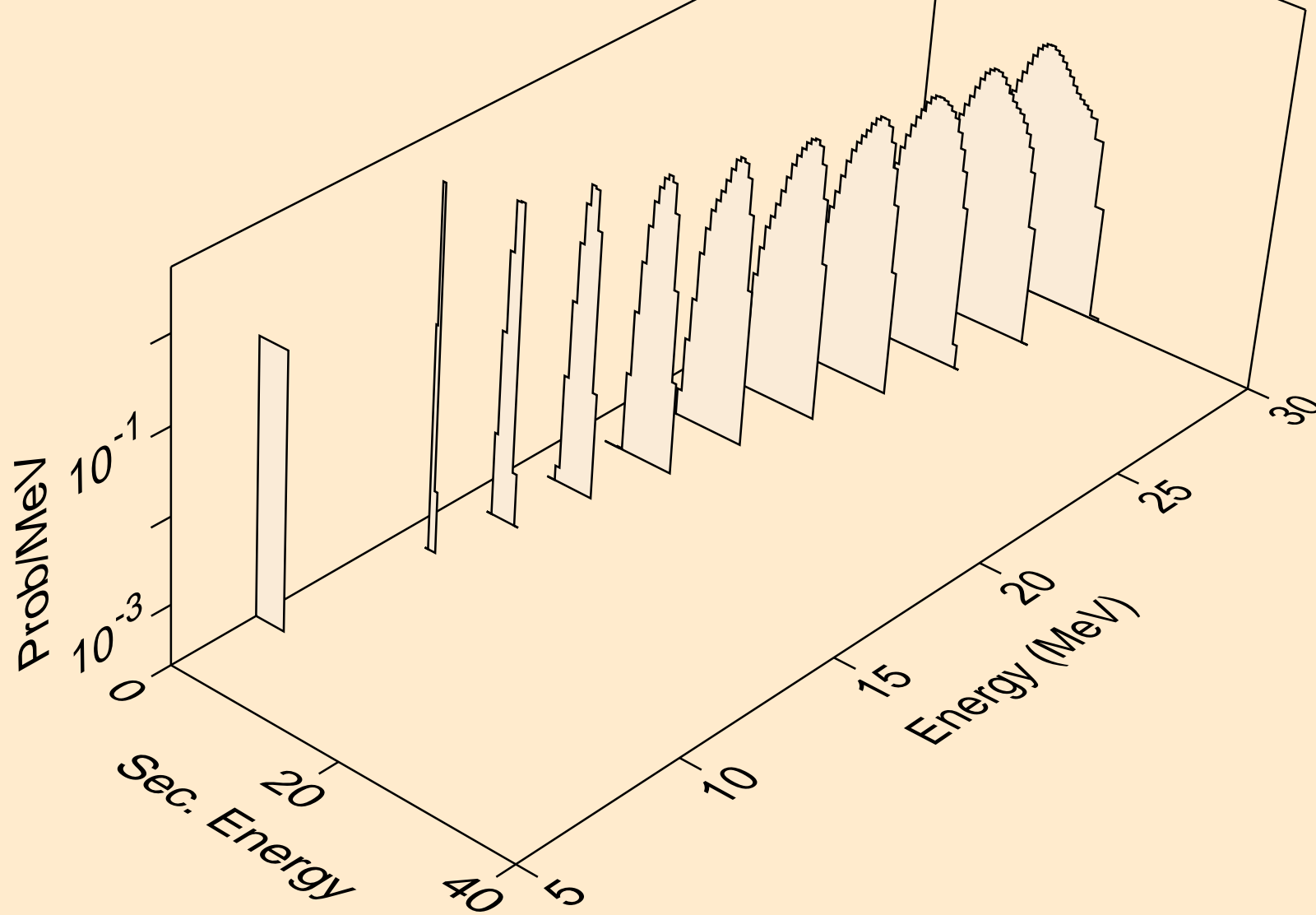

CS116M NEUTRON ACER TENDL-2021 LIBRARY; T=293.6K  
alphas from (n,n\*)2a

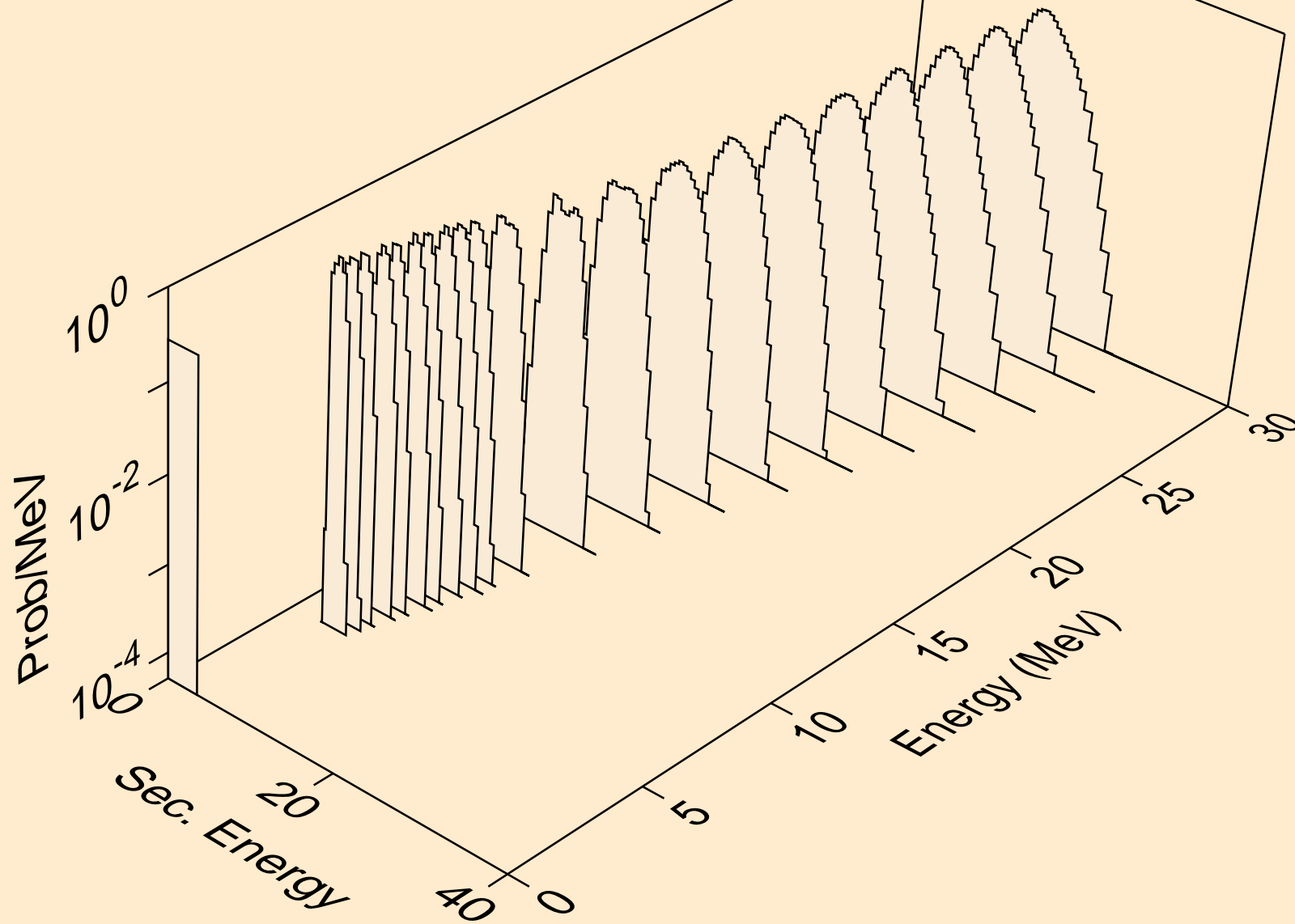

CS116M NEUTRON ACER TENDL-2021 LIBRARY; T=293.6K  
alphas from (n,2n)2a

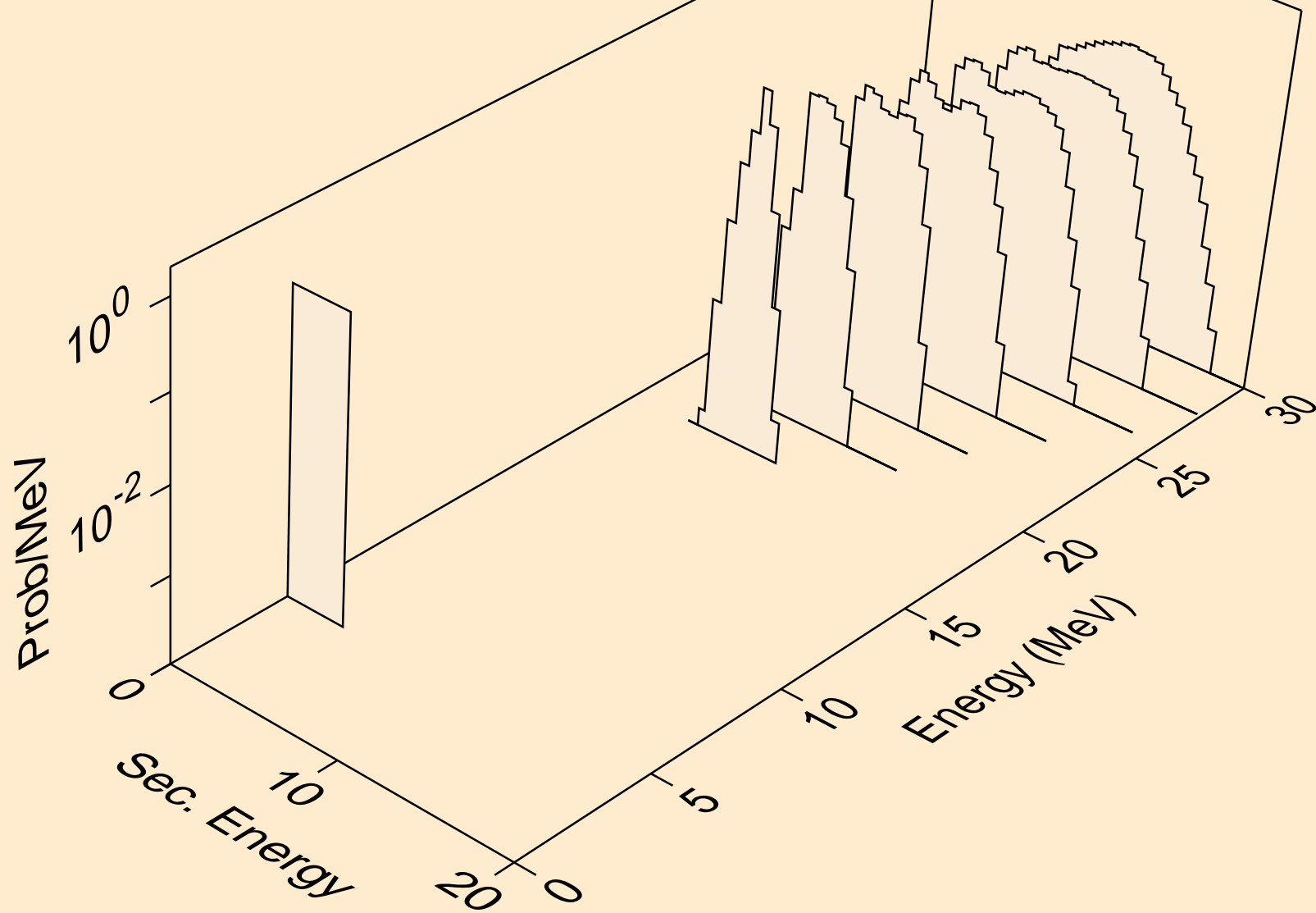



CS116M NEUTRON ACER TENDL-2021 LIBRARY; T=293.6K  
alphas from (n,npa)

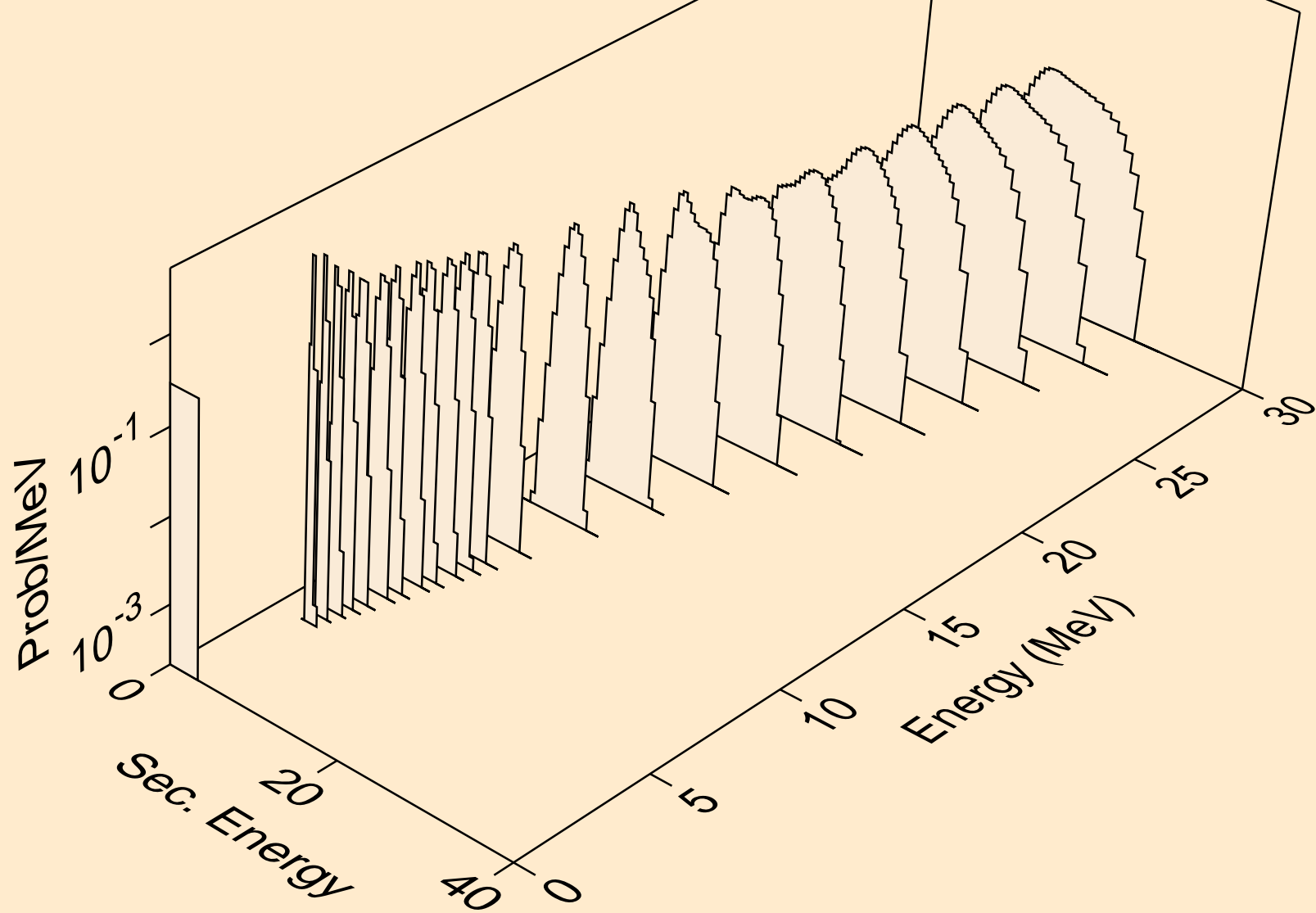

CS116M NEUTRON ACER TENDL-2021 LIBRARY; T=293.6K  
alphas from (n,a)

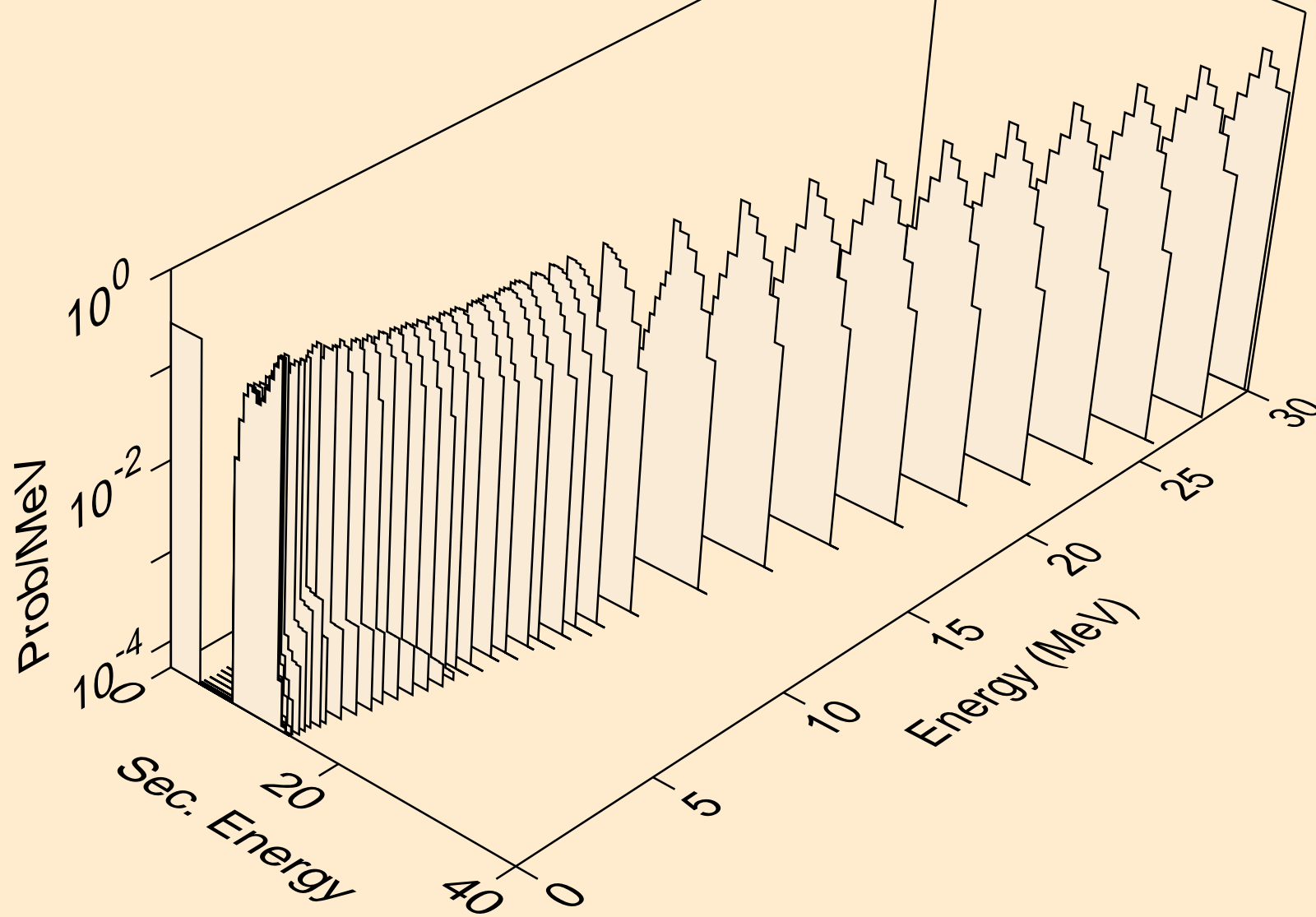

CS116M NEUTRON ACER TENDL-2021 LIBRARY; T=293.6K  
alphas from (n,2a)

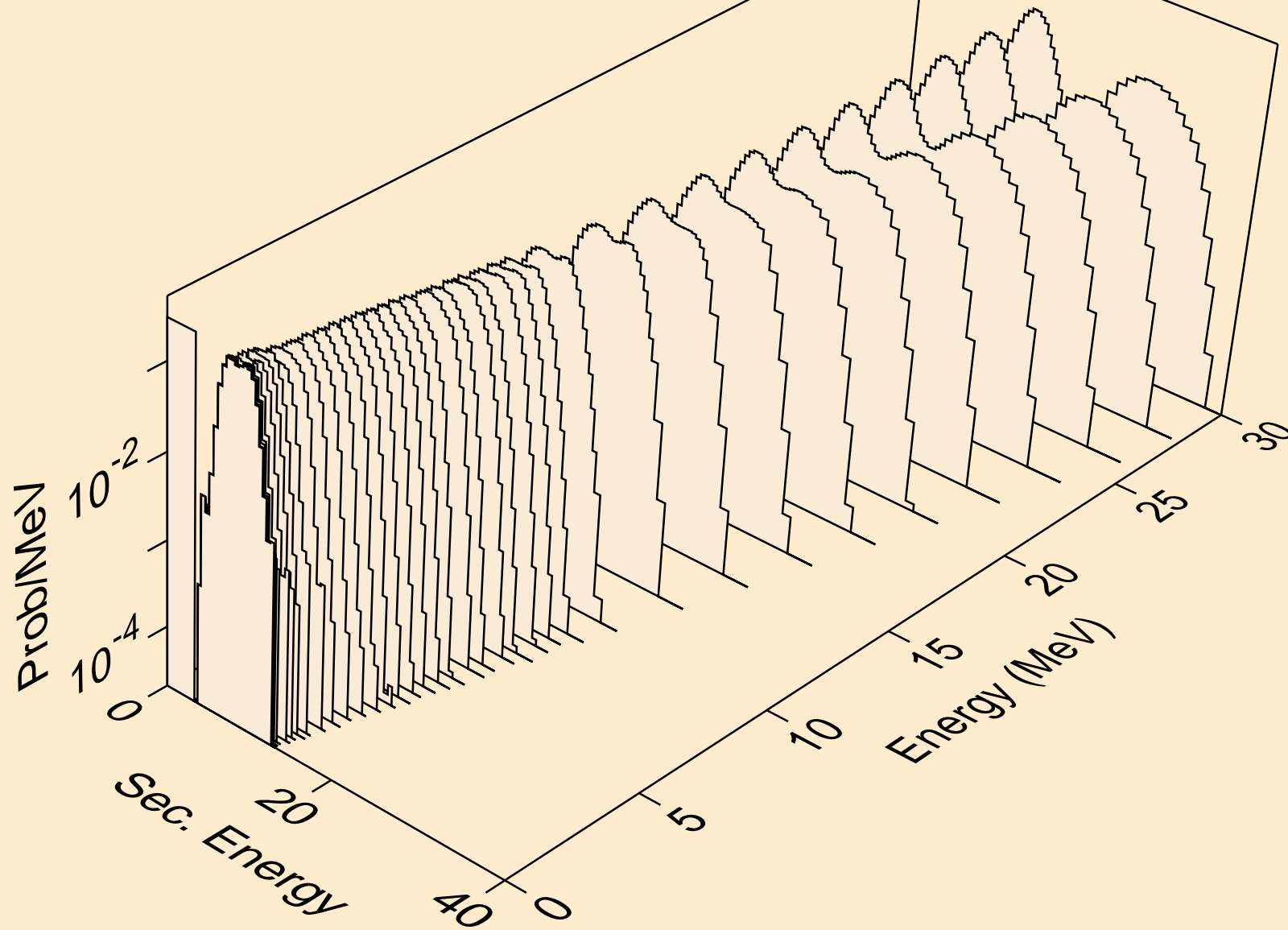

CS116M NEUTRON ACER TENDL-2021 LIBRARY; T=293.6K  
alphas from (n,3a)

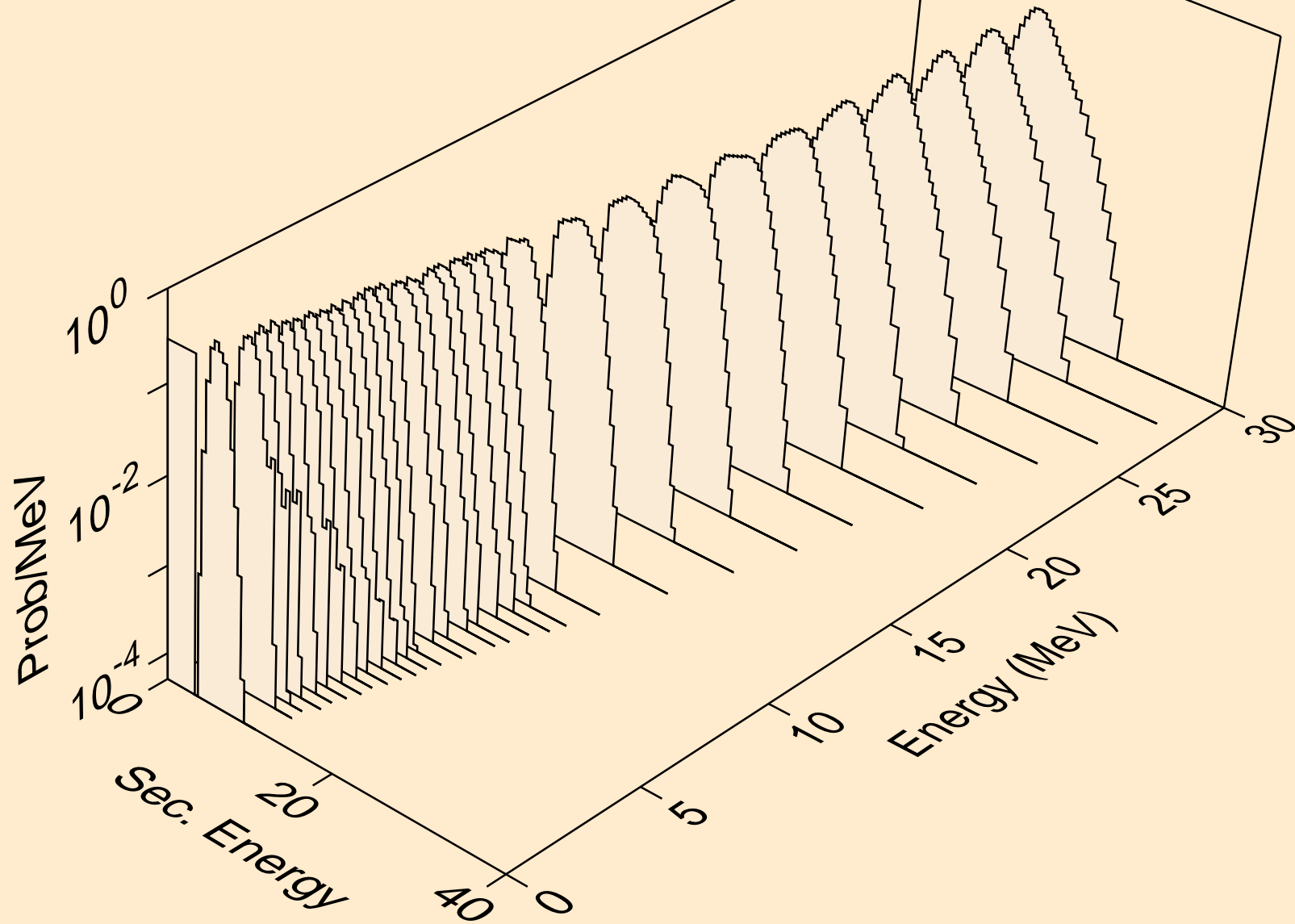

CS116M NEUTRON ACER TENDL-2021 LIBRARY; T=293.6K  
alphas from (n,pa)

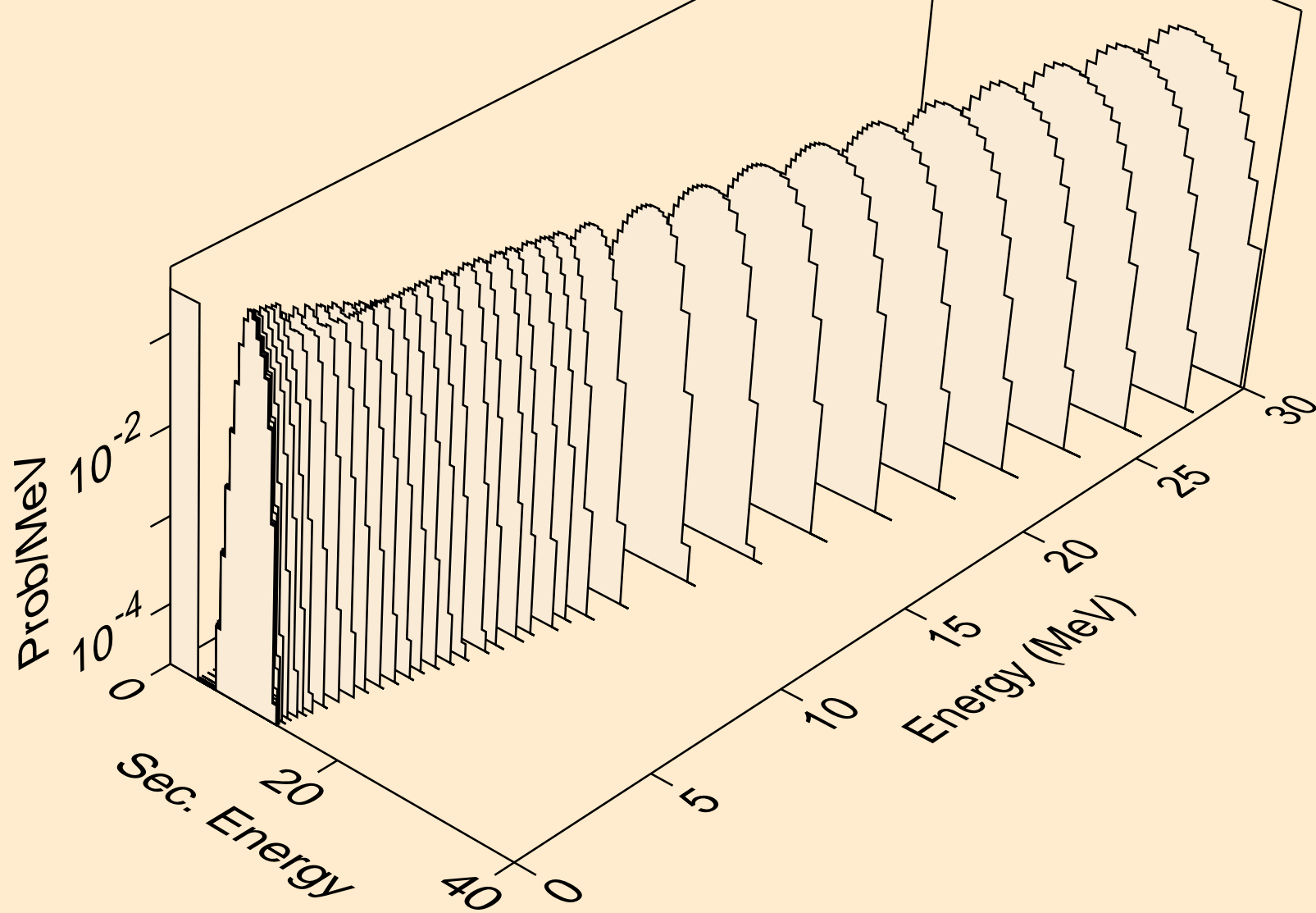

CS116M NEUTRON ACER TENDL-2021 LIBRARY; T=293.6K  
alphas from (n,t2a)

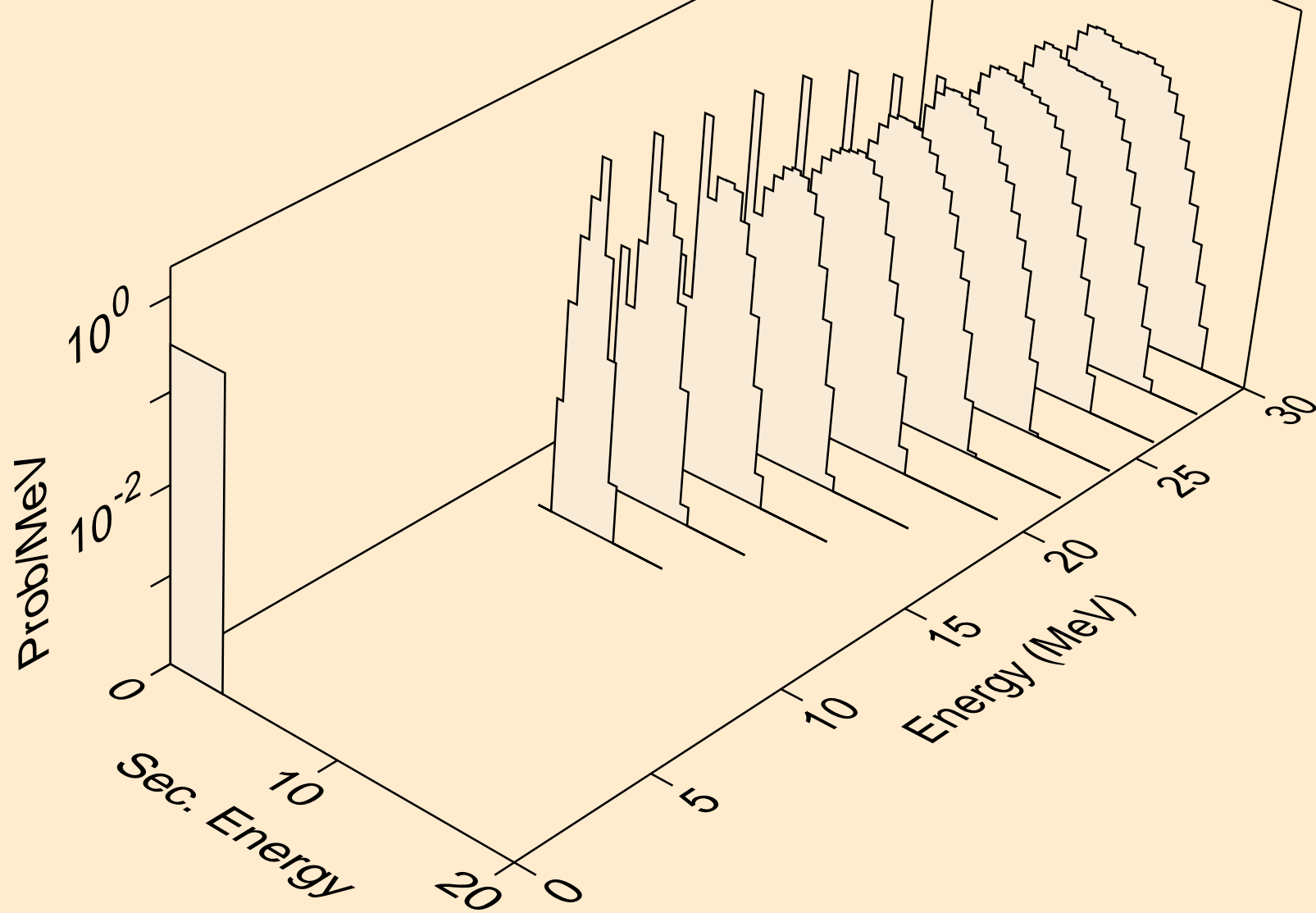

CS116M NEUTRON ACER TENDL-2021 LIBRARY; T=293.6K  
alphas from (n,d2a)

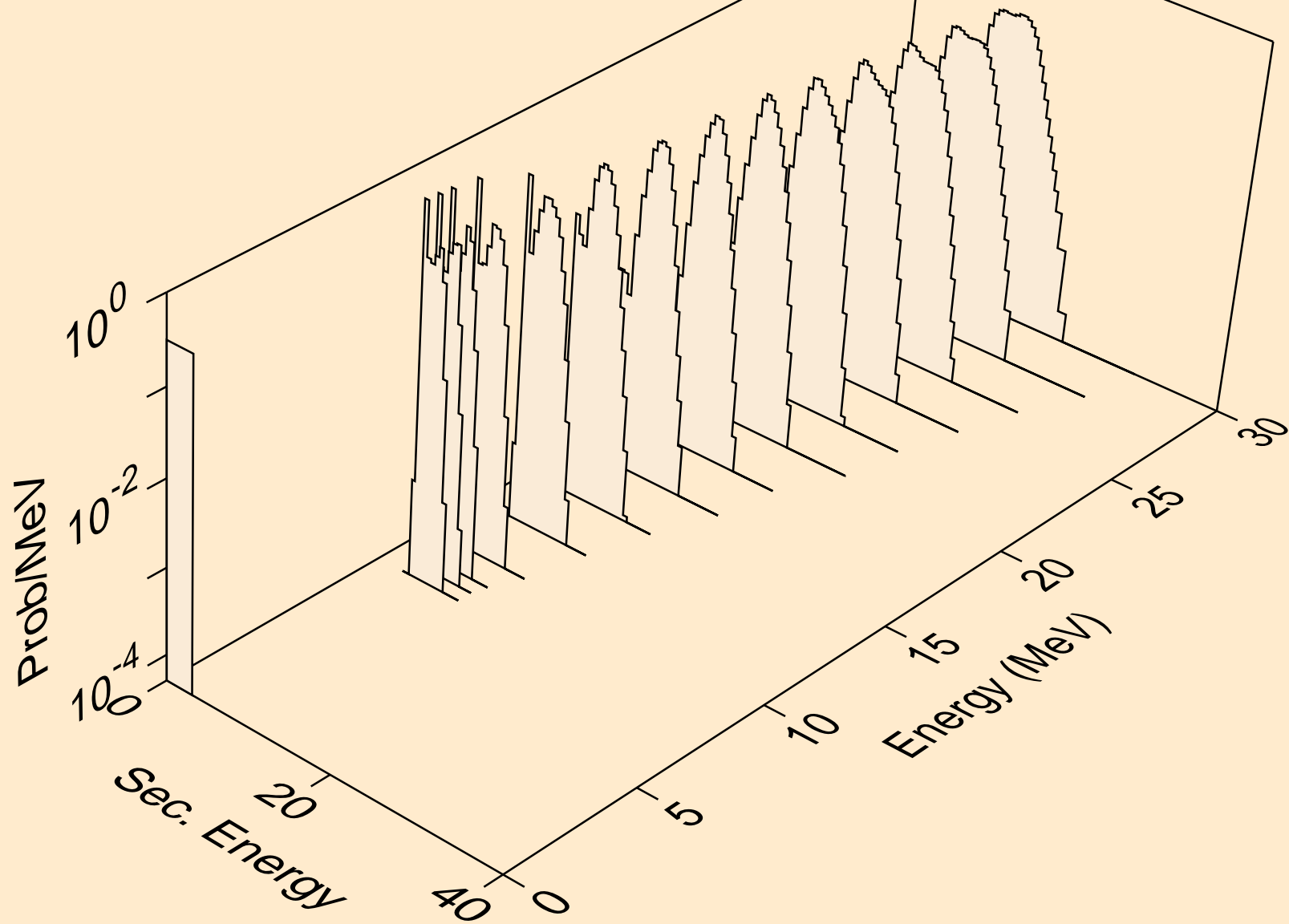

CS116M NEUTRON ACER TENDL-2021 LIBRARY; T=293.6K  
alphas from (n,da)

