

Program EVALPLOT  
(Version 2018-1)

by

Dermott E. Cullen  
(Present Contact Information)

Dermott E. Cullen  
1466 Hudson Way  
Livermore, CA 94550  
U.S.A.

Tele: 925-443-1911

E.Mail:redcullen1@comcast.net

Web:redcullen1.net/HOMEPAGE.NEW

Press Mouse Button to Start

MAT 5549

Major

293 Kelvin Cross Sections

55-Cs-141

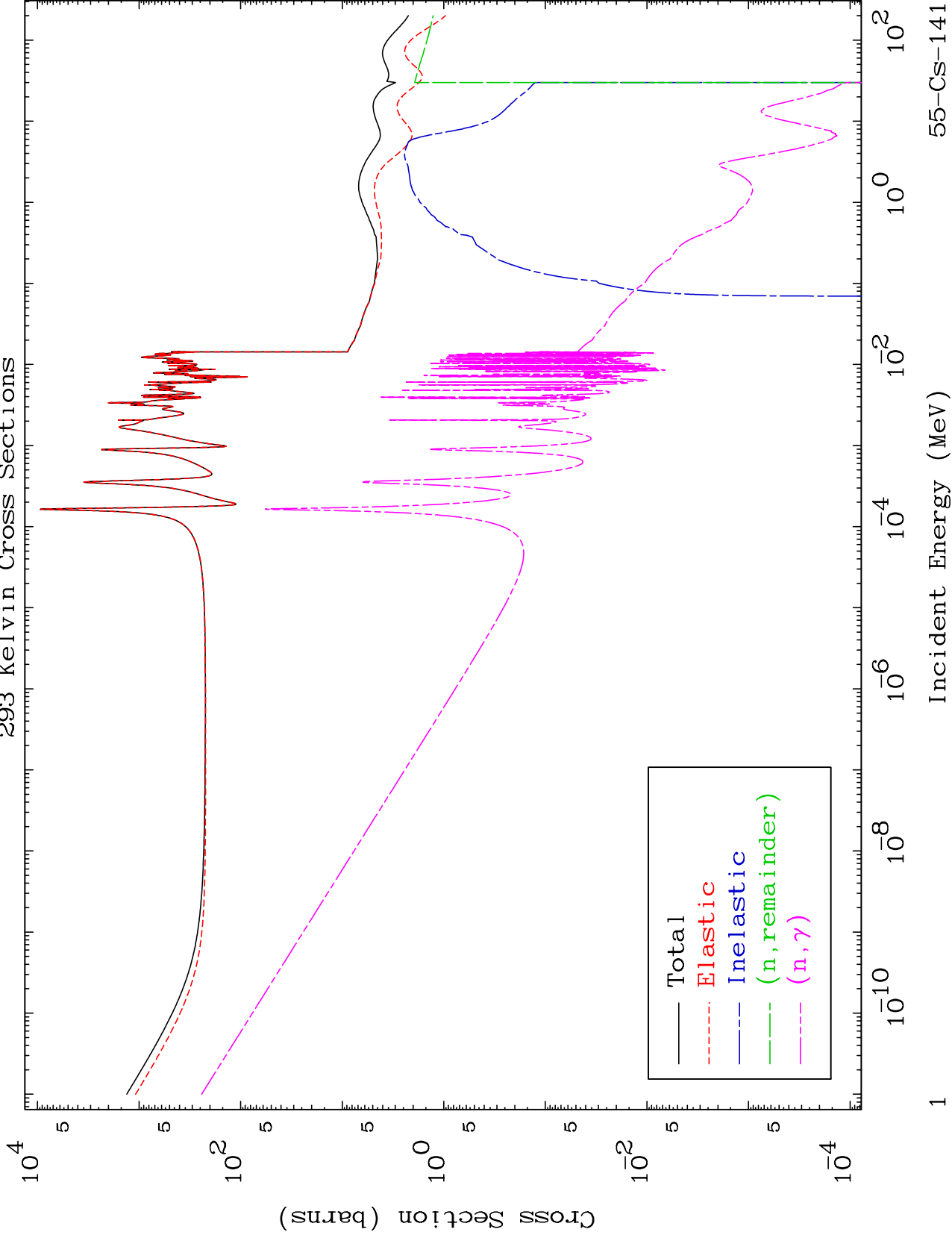

1

Incident Energy (MeV)

55-Cs-141

MAT 5549

Neutron Production  
293 Kelvin Cross Sections

55-Cs-141

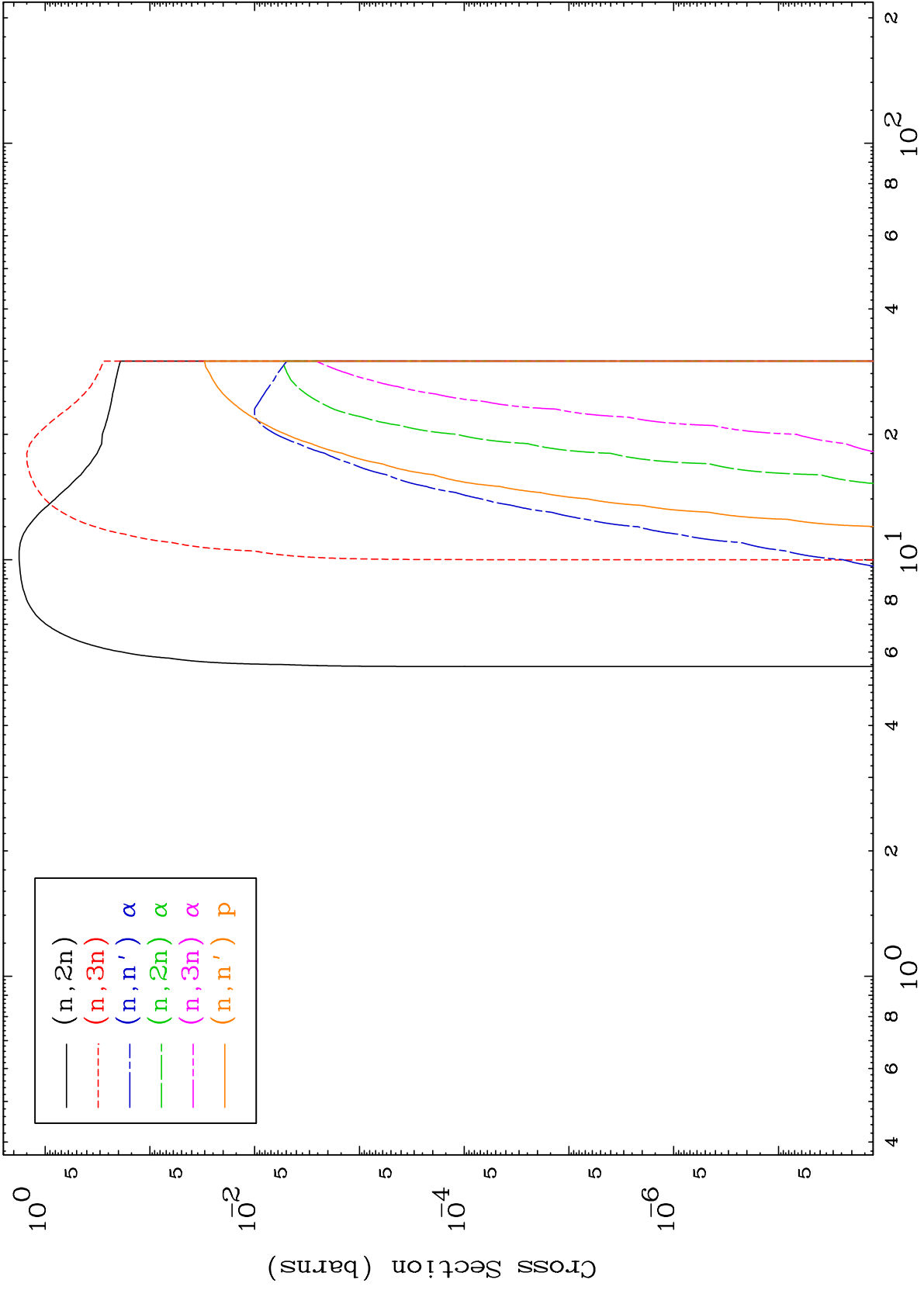

2

Incident Energy (MeV)

55-Cs-141

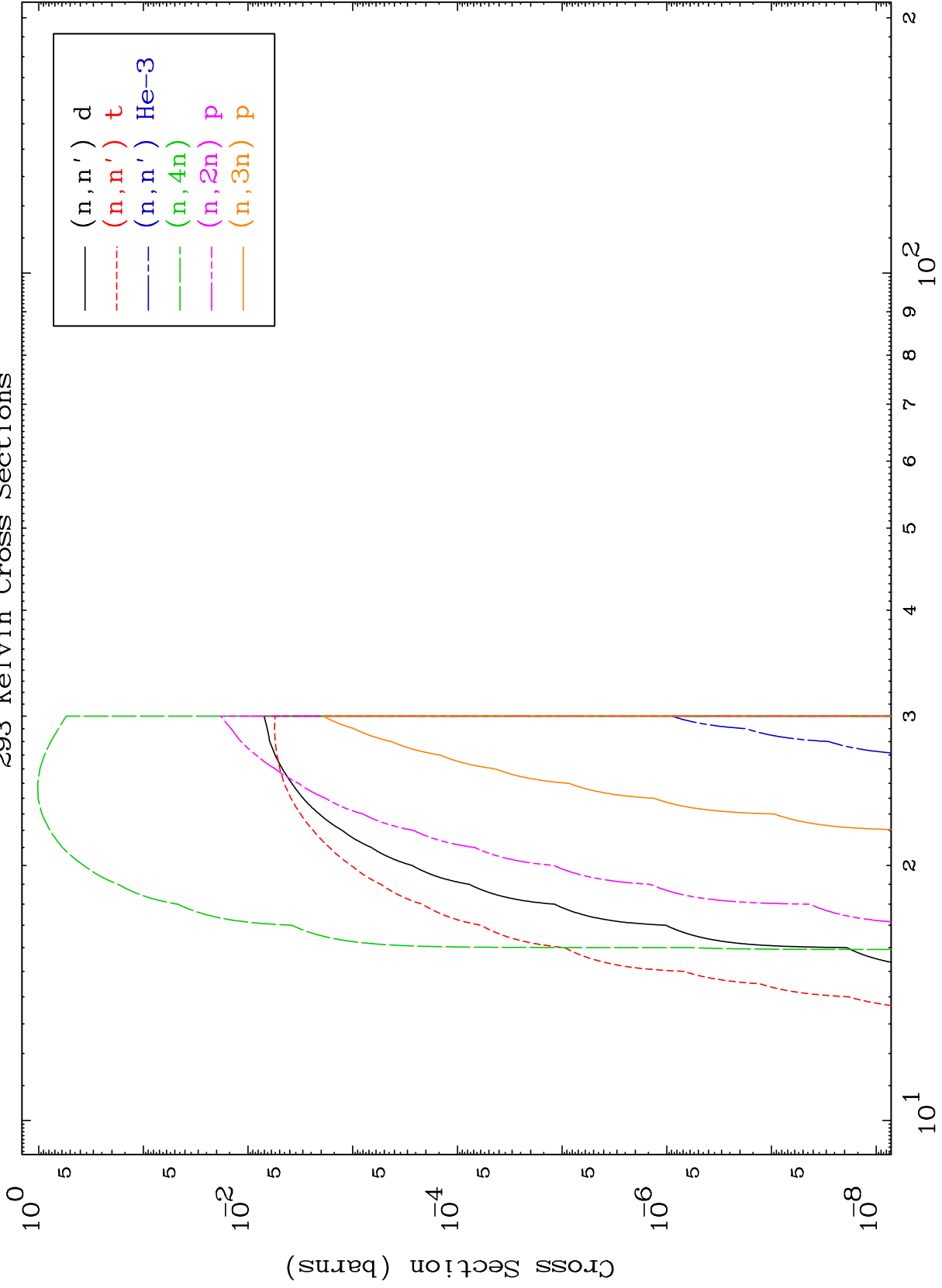

MAT 5549

Charged Particle  
293 Kelvin Cross Sections

55-Cs-141

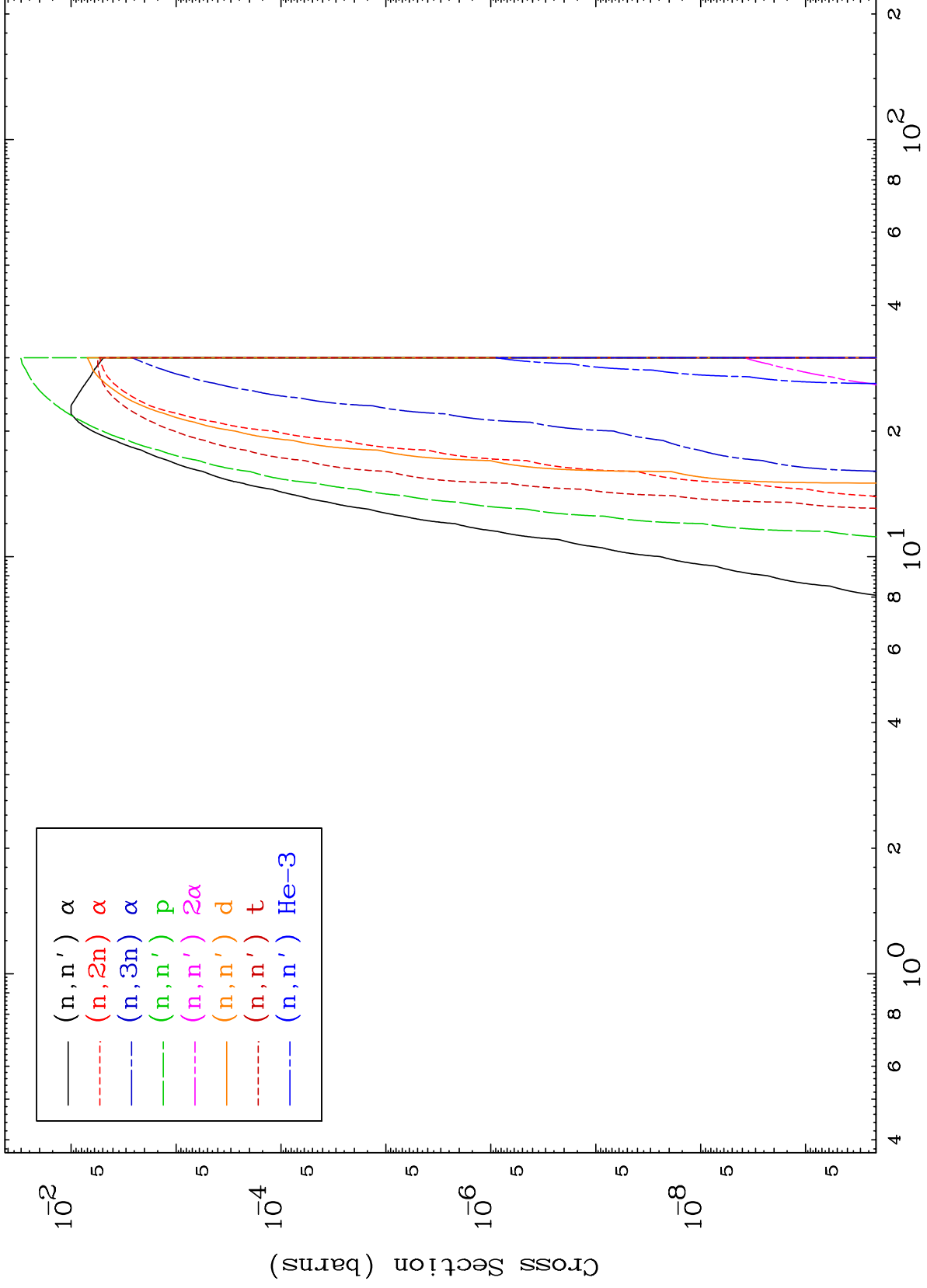

4

Incident Energy (MeV)

55-Cs-141

MAT 5549

Charged Particle  
293 Kelvin Cross Sections

55-Cs-141

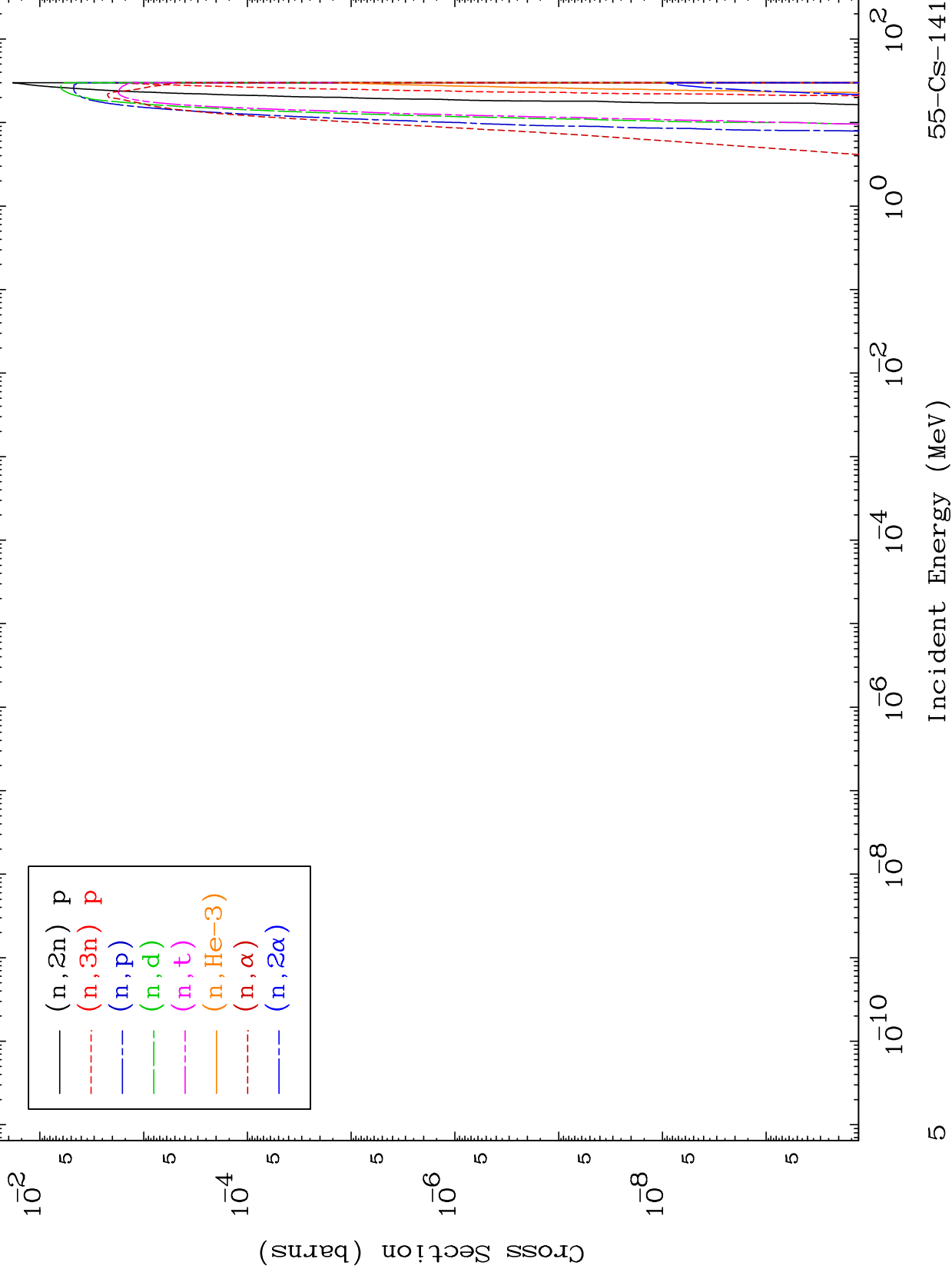

MAT 5549

Particle Production  
293 Kelvin Cross Sections

55-Cs-141

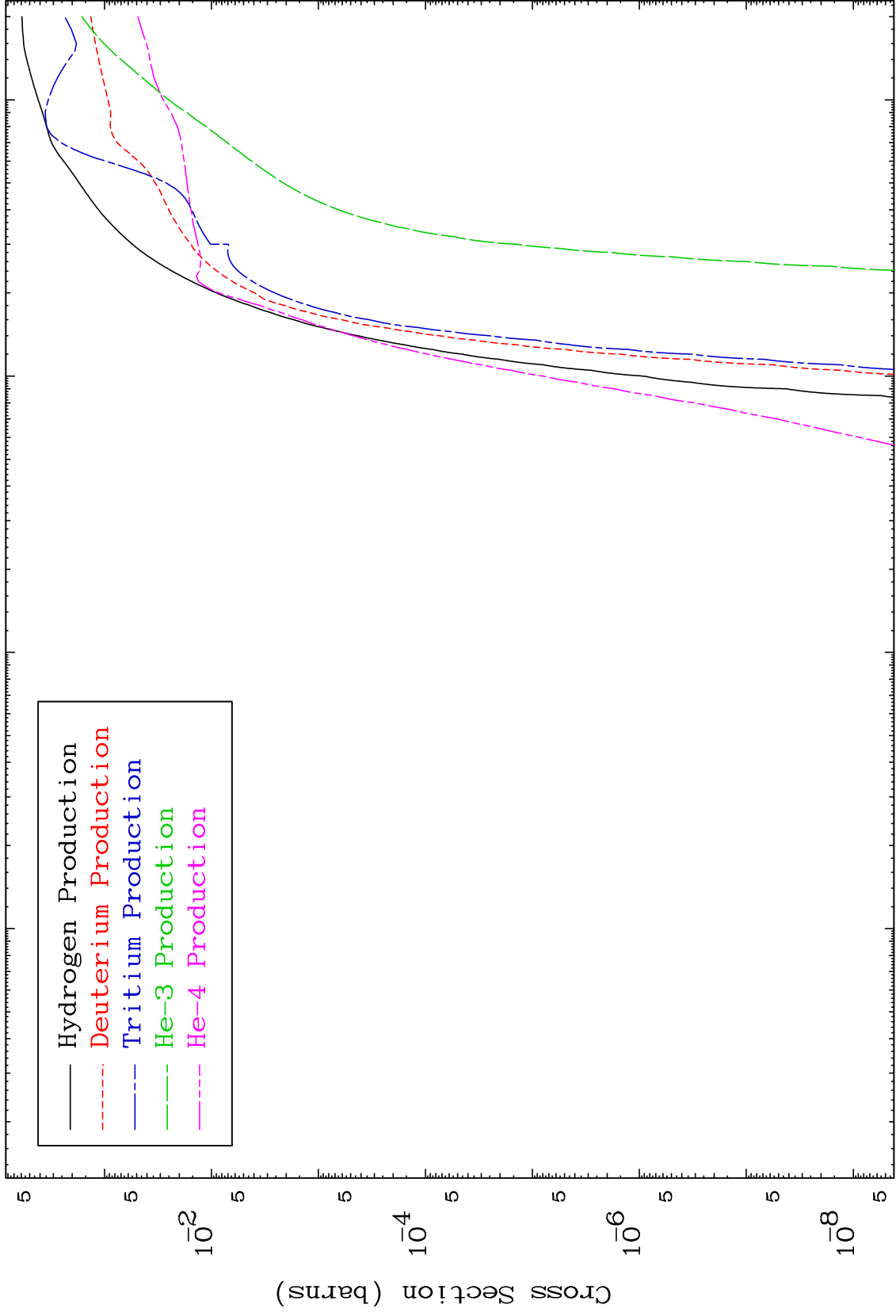

6

Incident Energy (MeV)

55-Cs-141

293 Kelvin Cross Sections

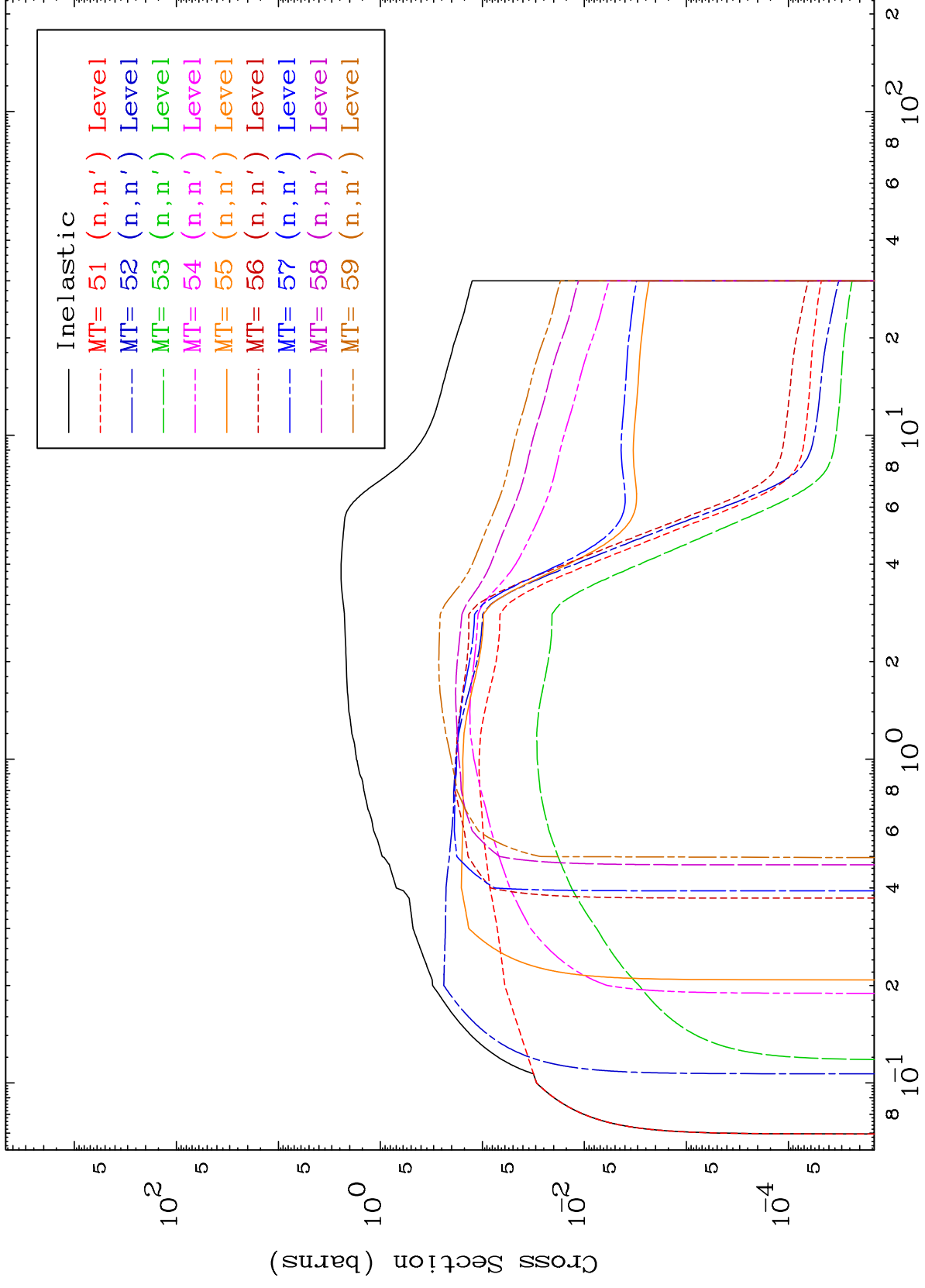



MAT 5549

(n,n') Level

55-Cs-141

293 Kelvin Cross Sections

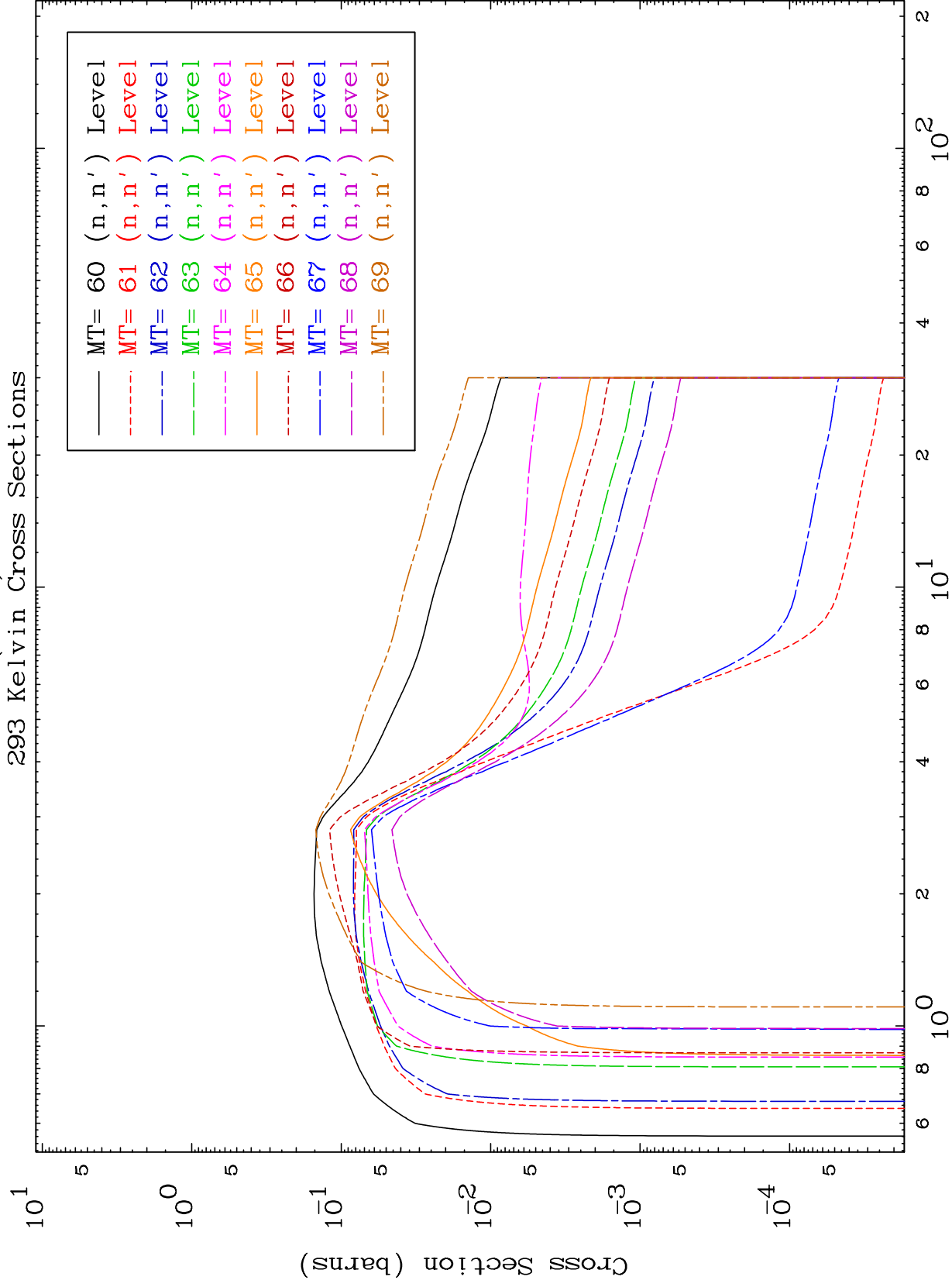

8

Incident Energy (MeV)

55-Cs-141

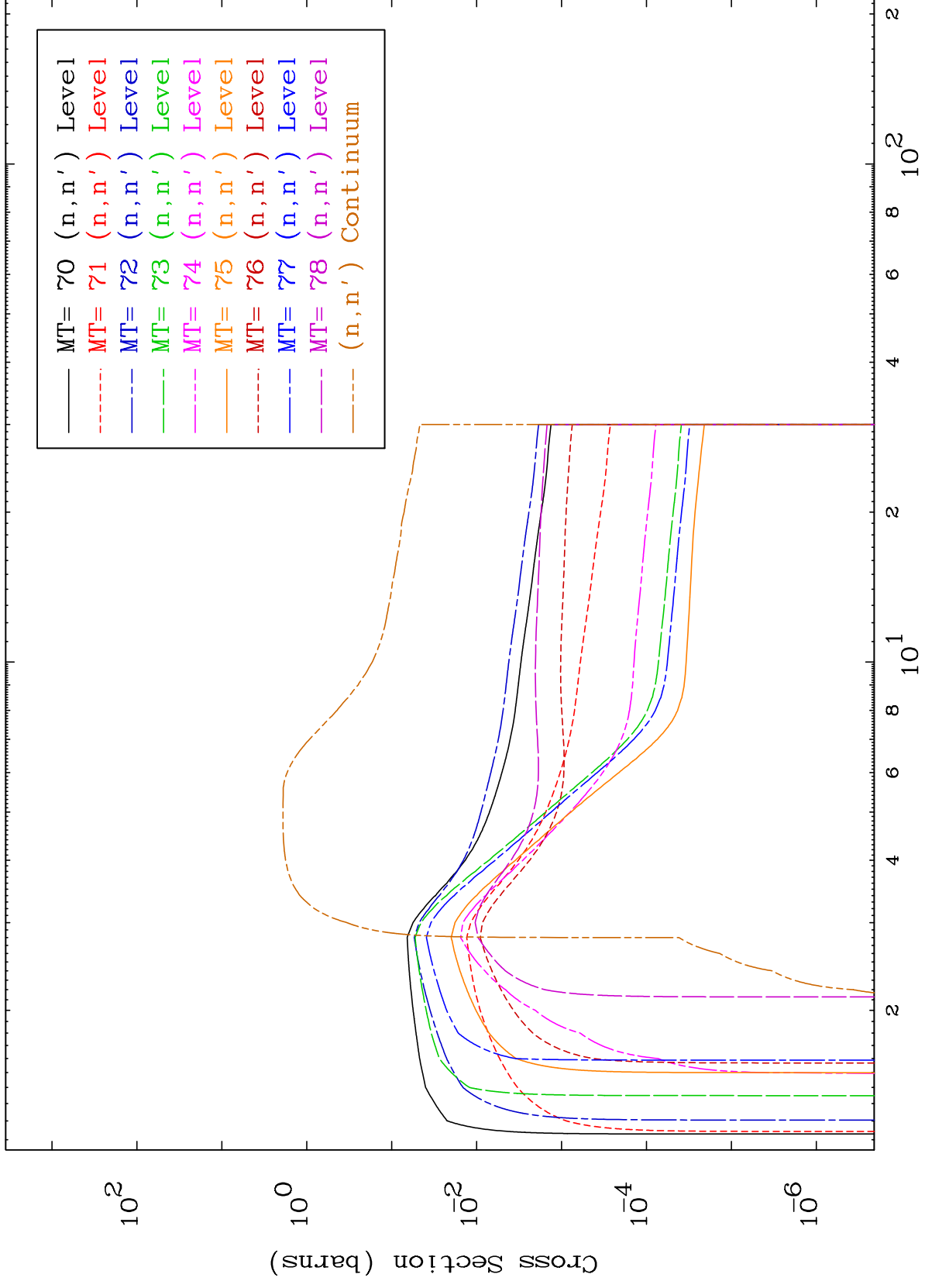

MAT 5549

(n,p) Levels  
293 Kelvin Cross Sections

55-Cs-141

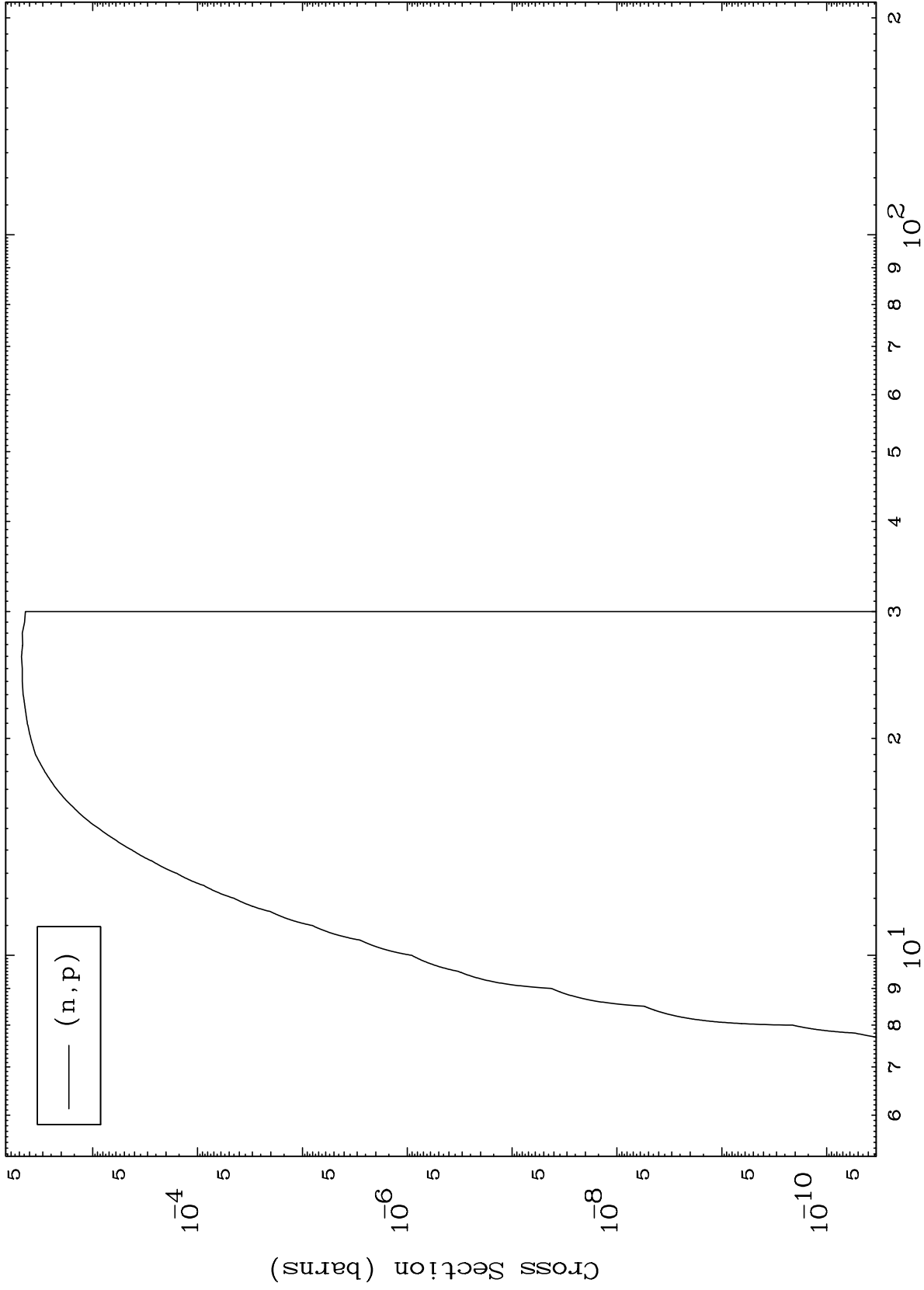

10

Incident Energy (MeV)

55-Cs-141

MAT 5549

(n,d) Levels  
293 Kelvin Cross Sections

55-Cs-141

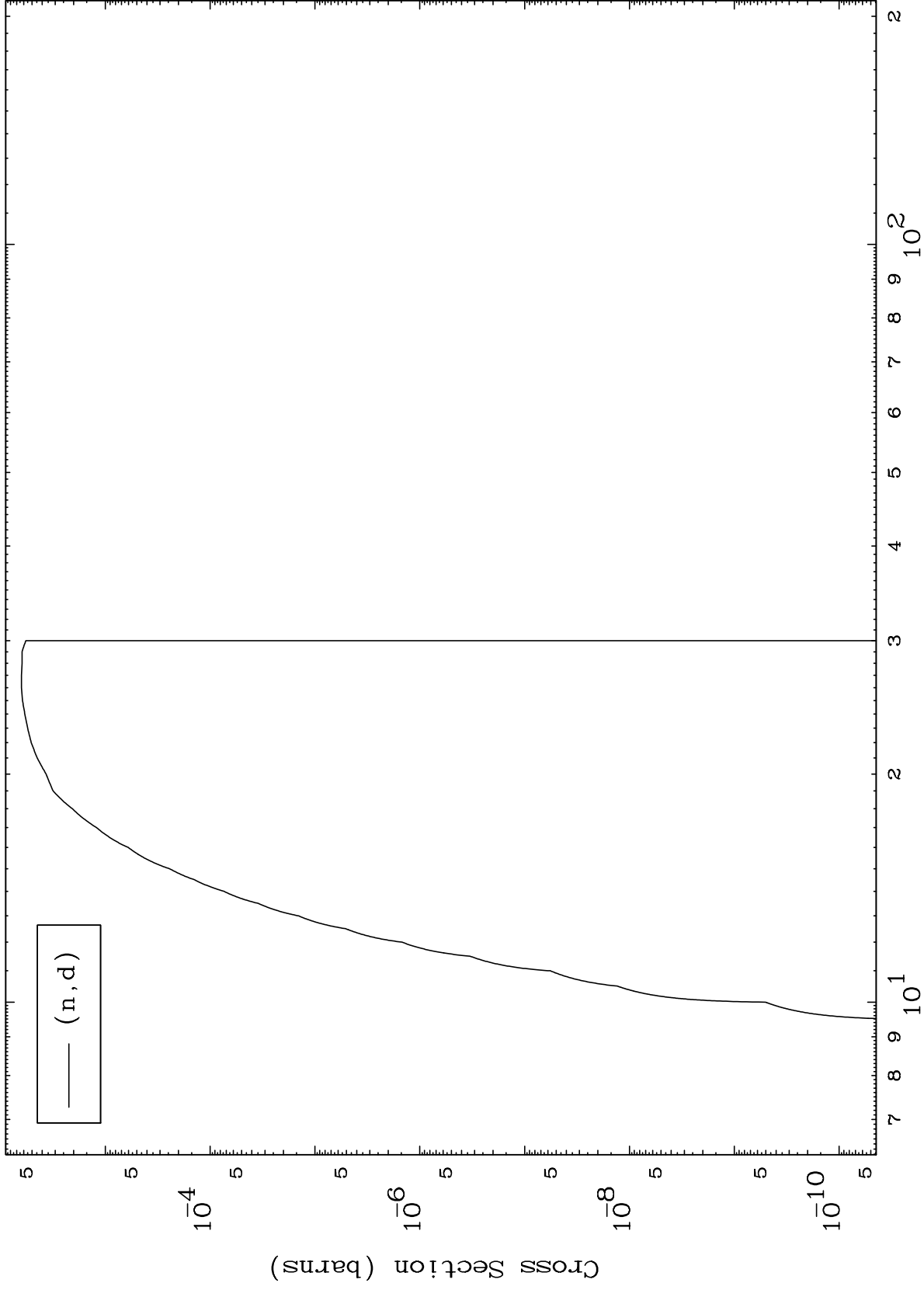

11

Incident Energy (MeV)

55-Cs-141

MAT 5549

(n,t) Levels  
293 Kelvin Cross Sections

55-Cs-141

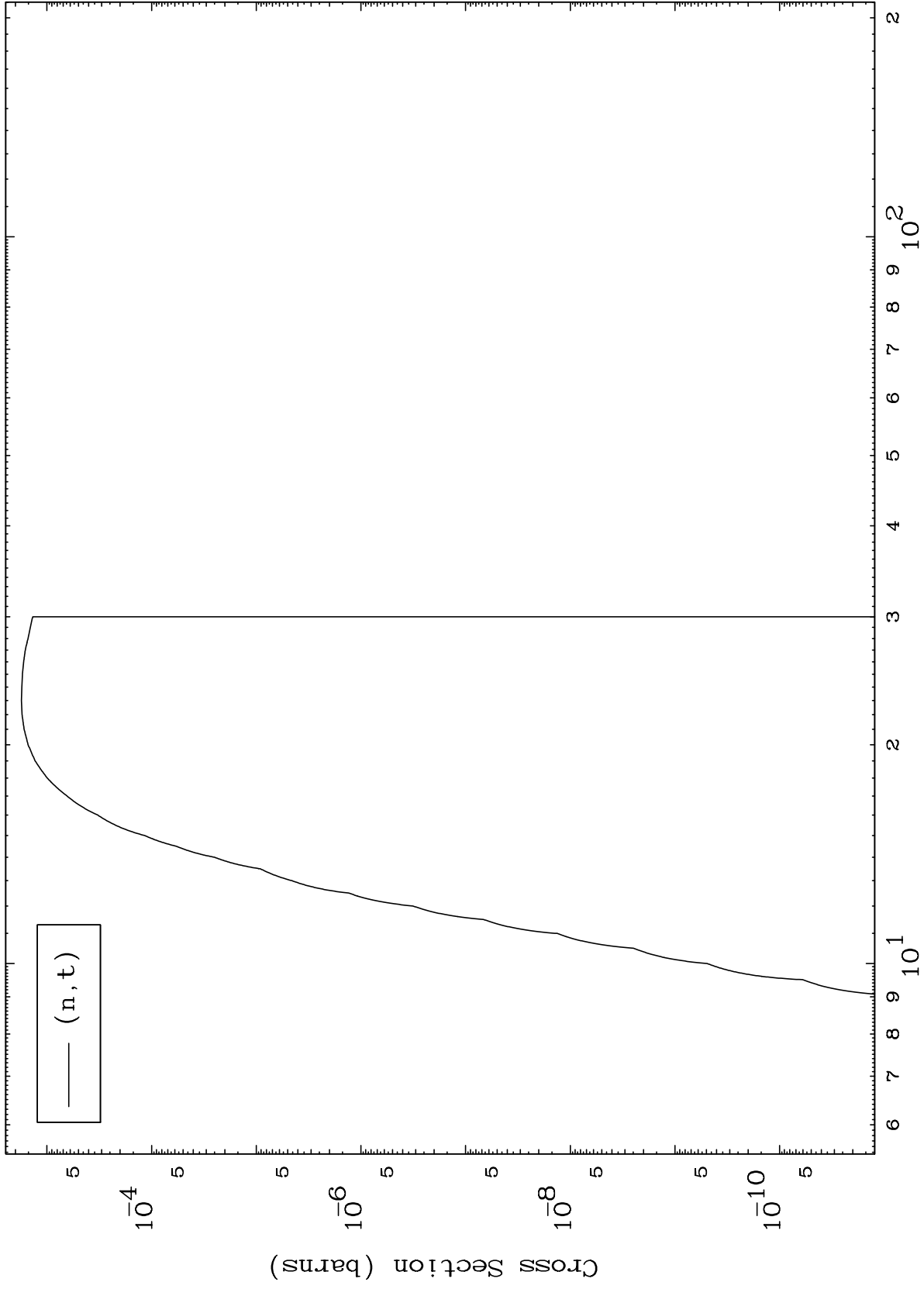

12

Incident Energy (MeV)

55-Cs-141

MAT 5549

(n,He3) Levels  
293 Kelvin Cross Sections

55-Cs-141

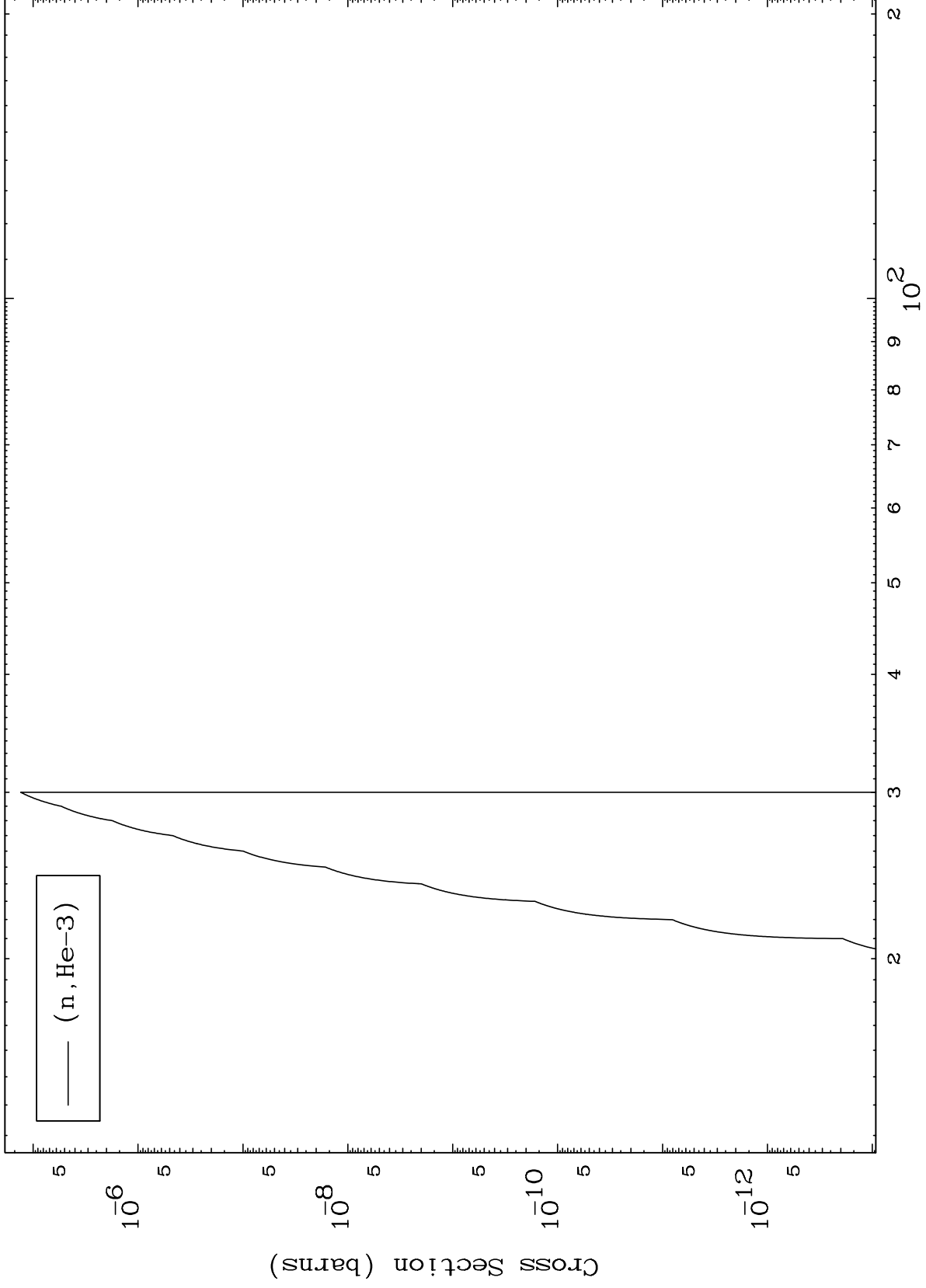

MAT 5549

(n,  $\alpha$ ) Levels  
293 Kelvin Cross Sections

55-Cs-141

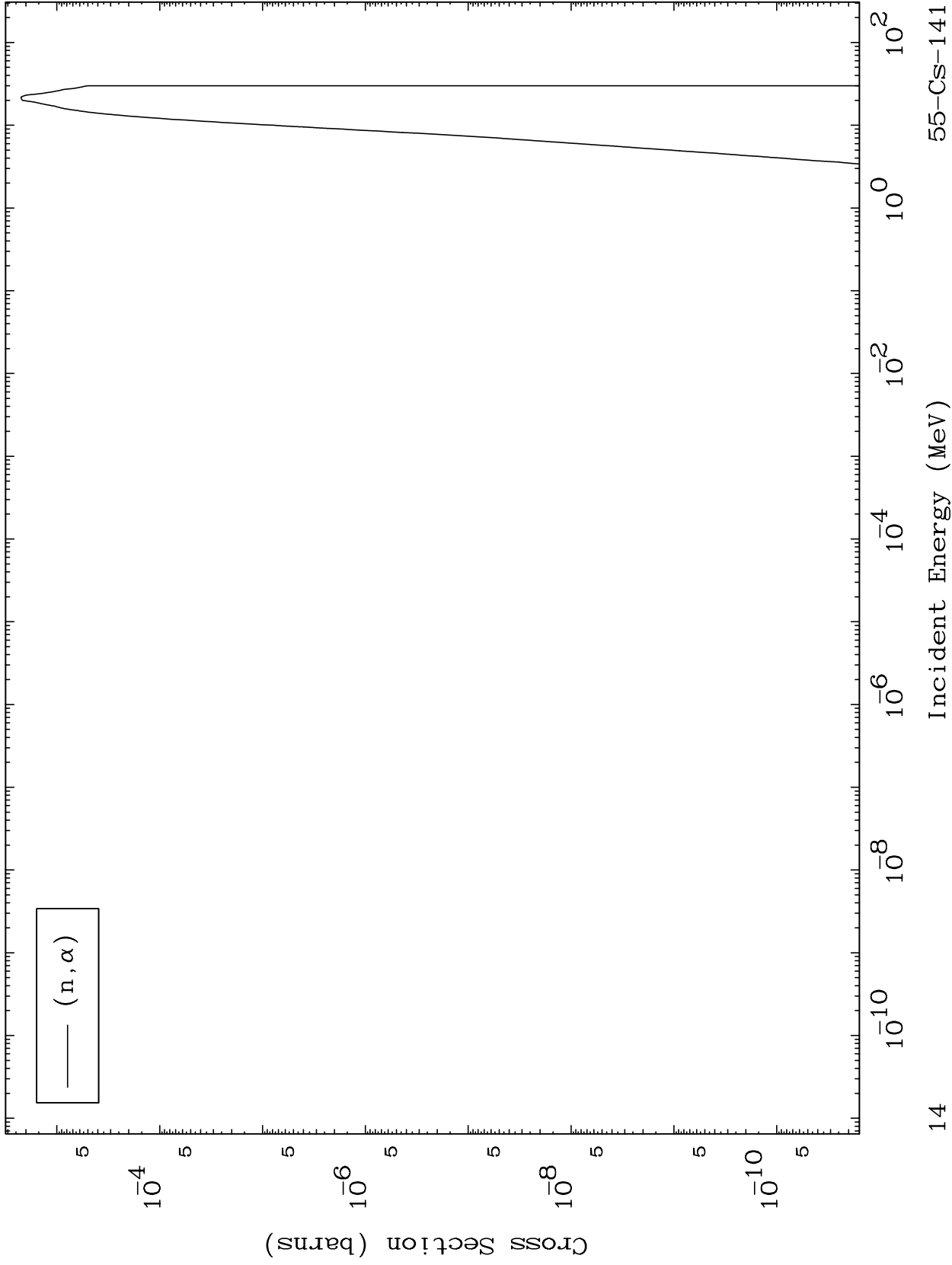

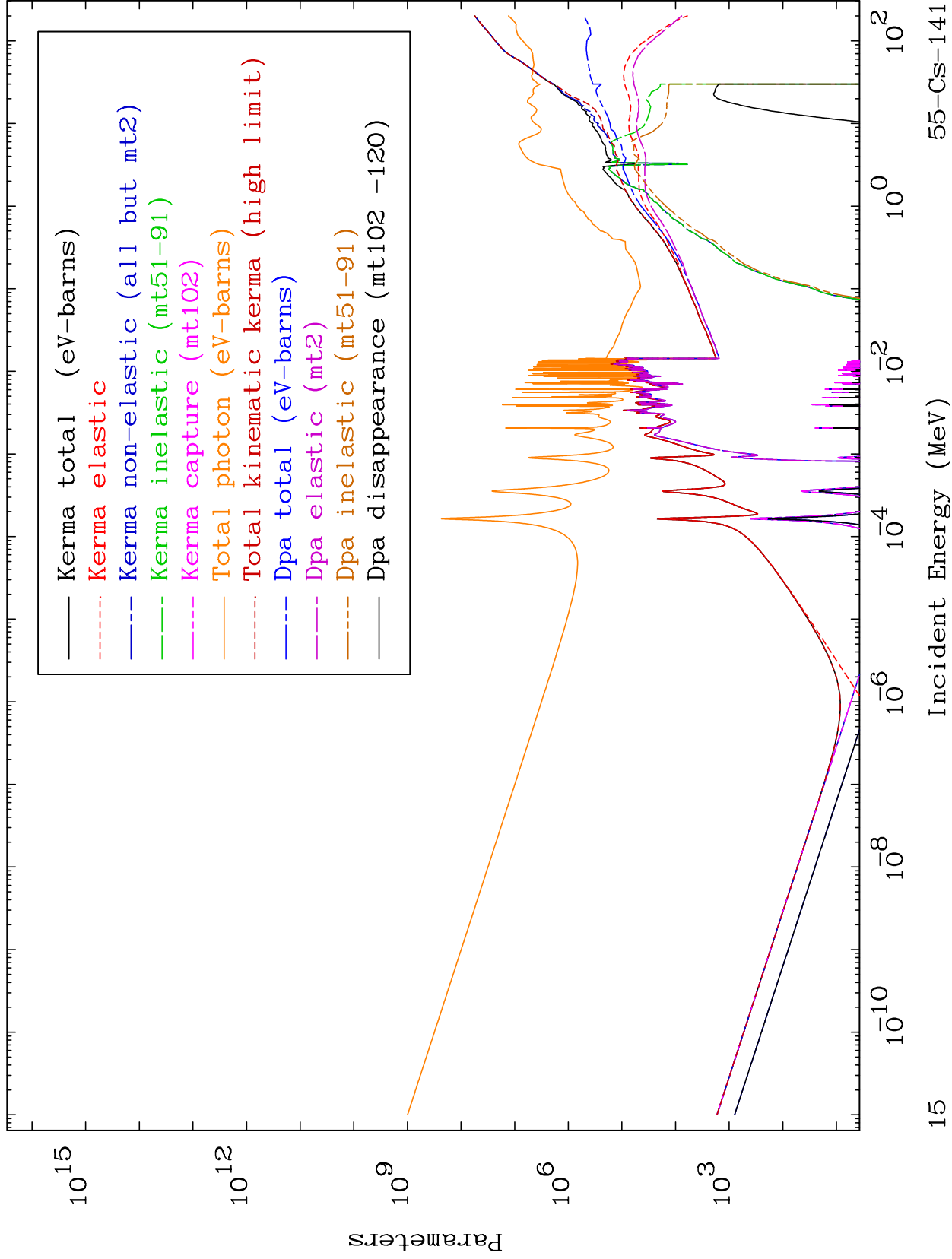



MAT 5549

55-Cs-141

Elastic Legendre Coefficients

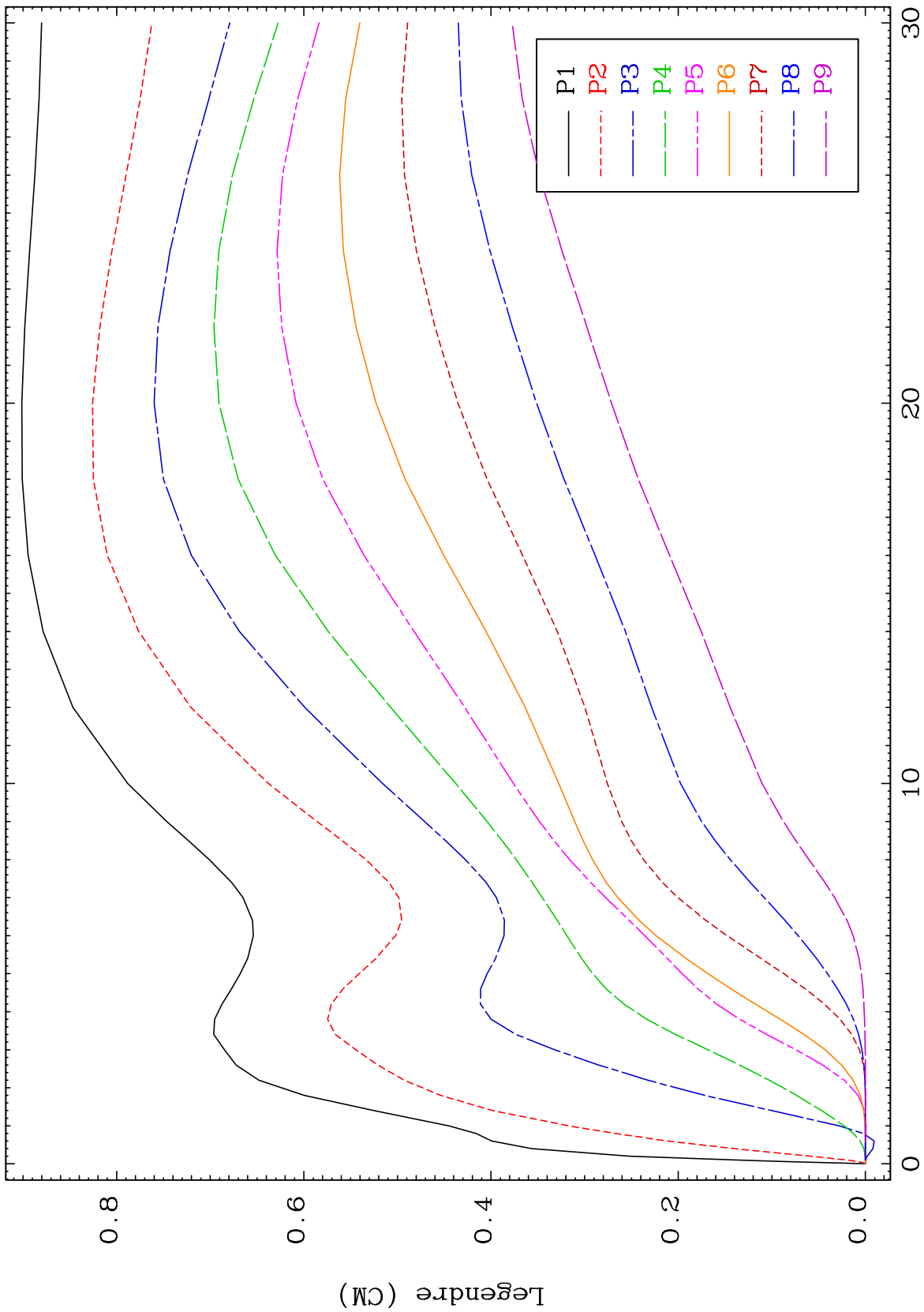

16

Incident Energy (MeV)

55-Cs-141

MAT 5549

Elastic Legendre Coefficients

55-Cs-141

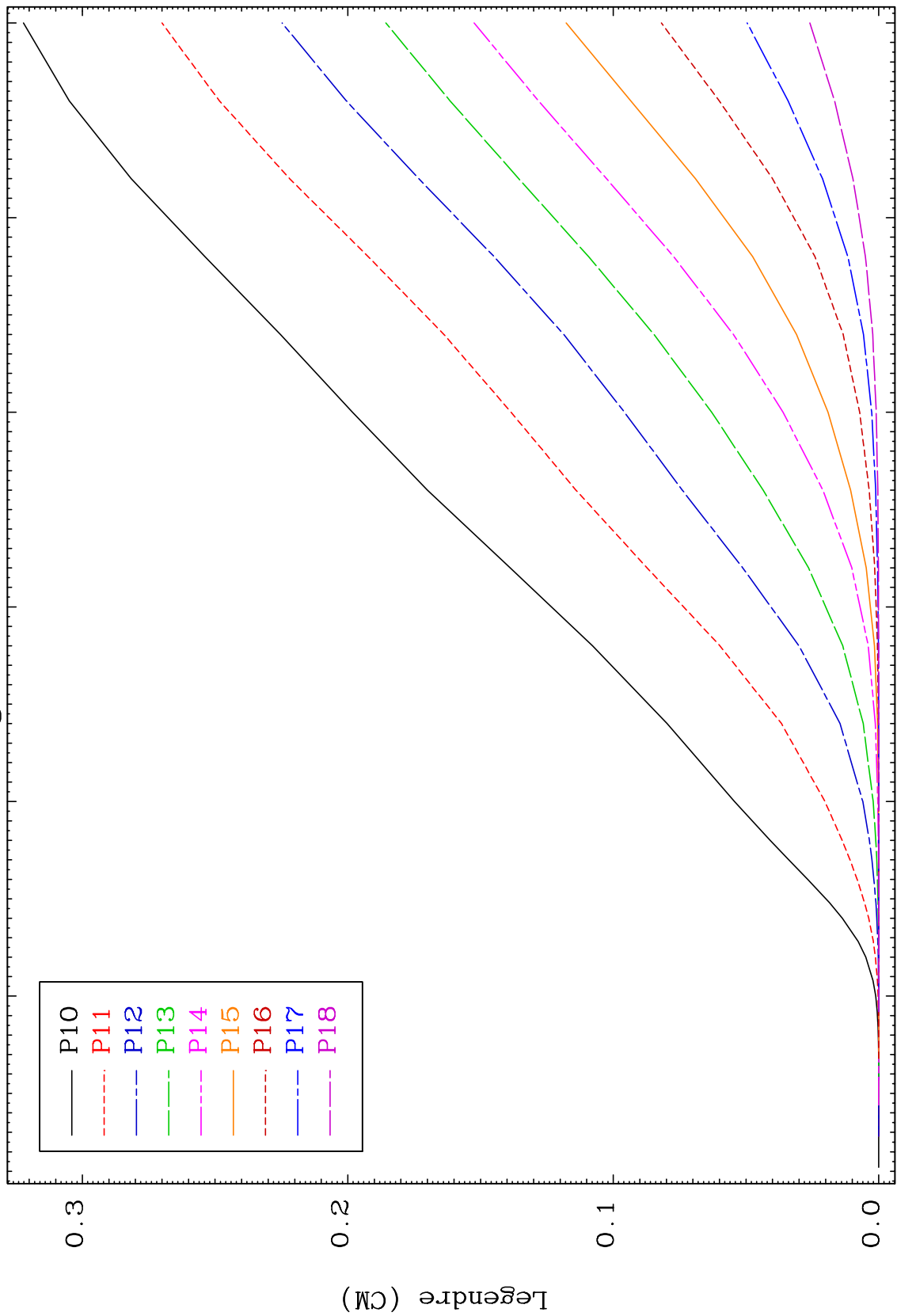

17

55-Cs-141

Incident Energy (MeV)

MAT 5549

Elastic Legendre Coefficients

55-Cs-141

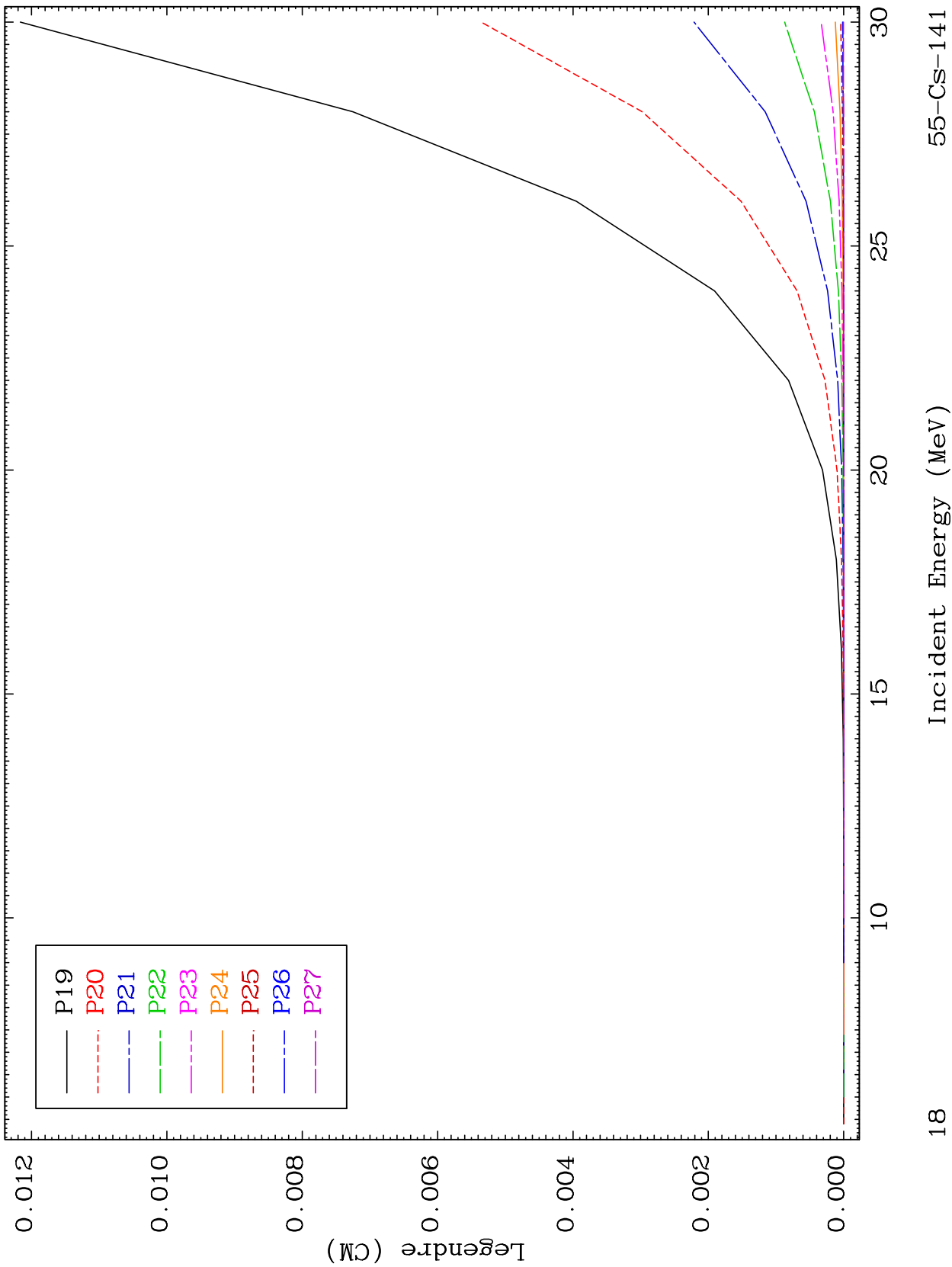

18

Incident Energy (MeV)

55-Cs-141

30

MAT 5549

Elastic Legendre Coefficients

55-Cs-141

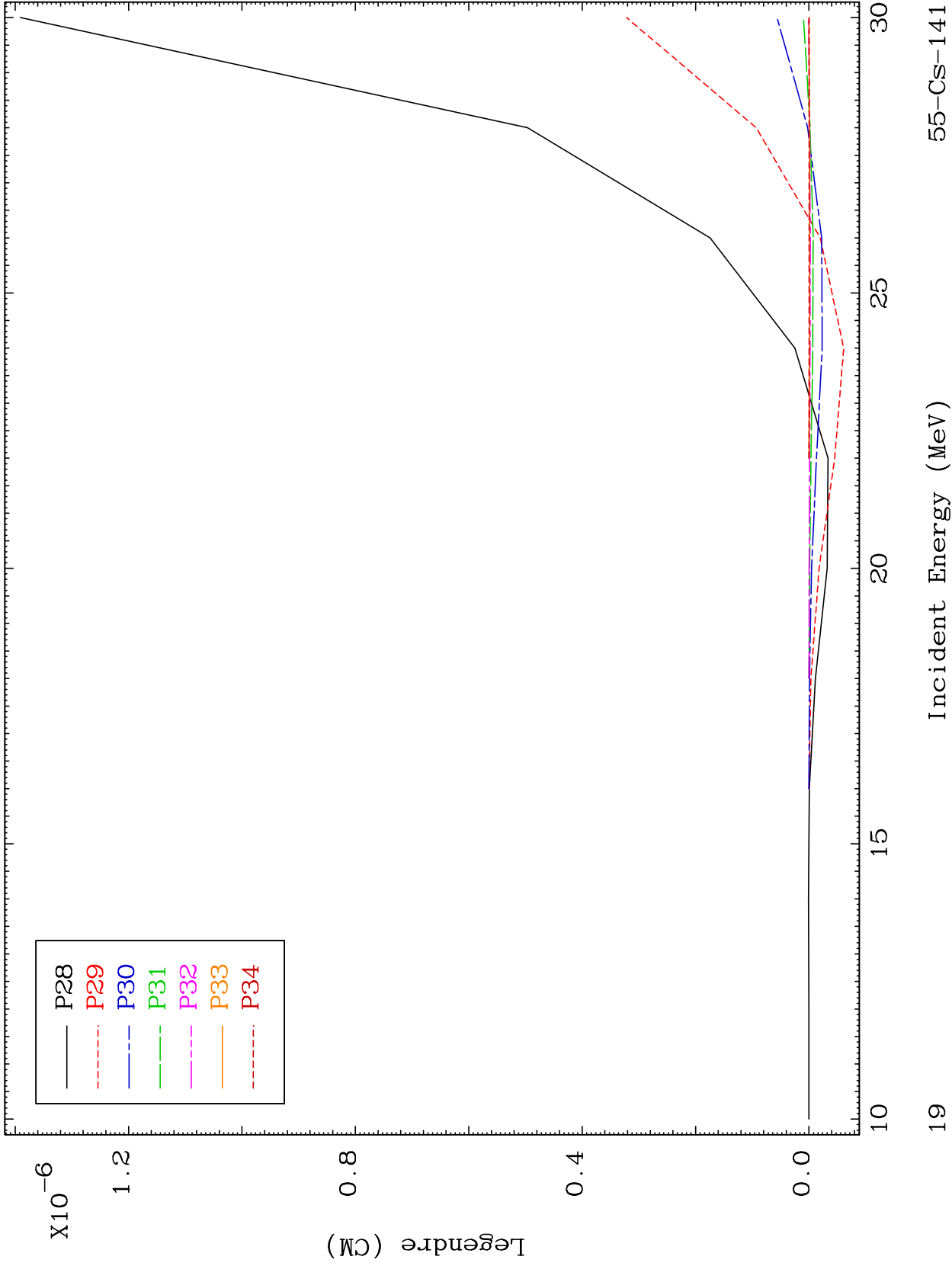

19

Incident Energy (MeV)

55-Cs-141

MAT 5549

MT= 51 (n,n') Level  
Legendre Coefficients

55-Cs-141

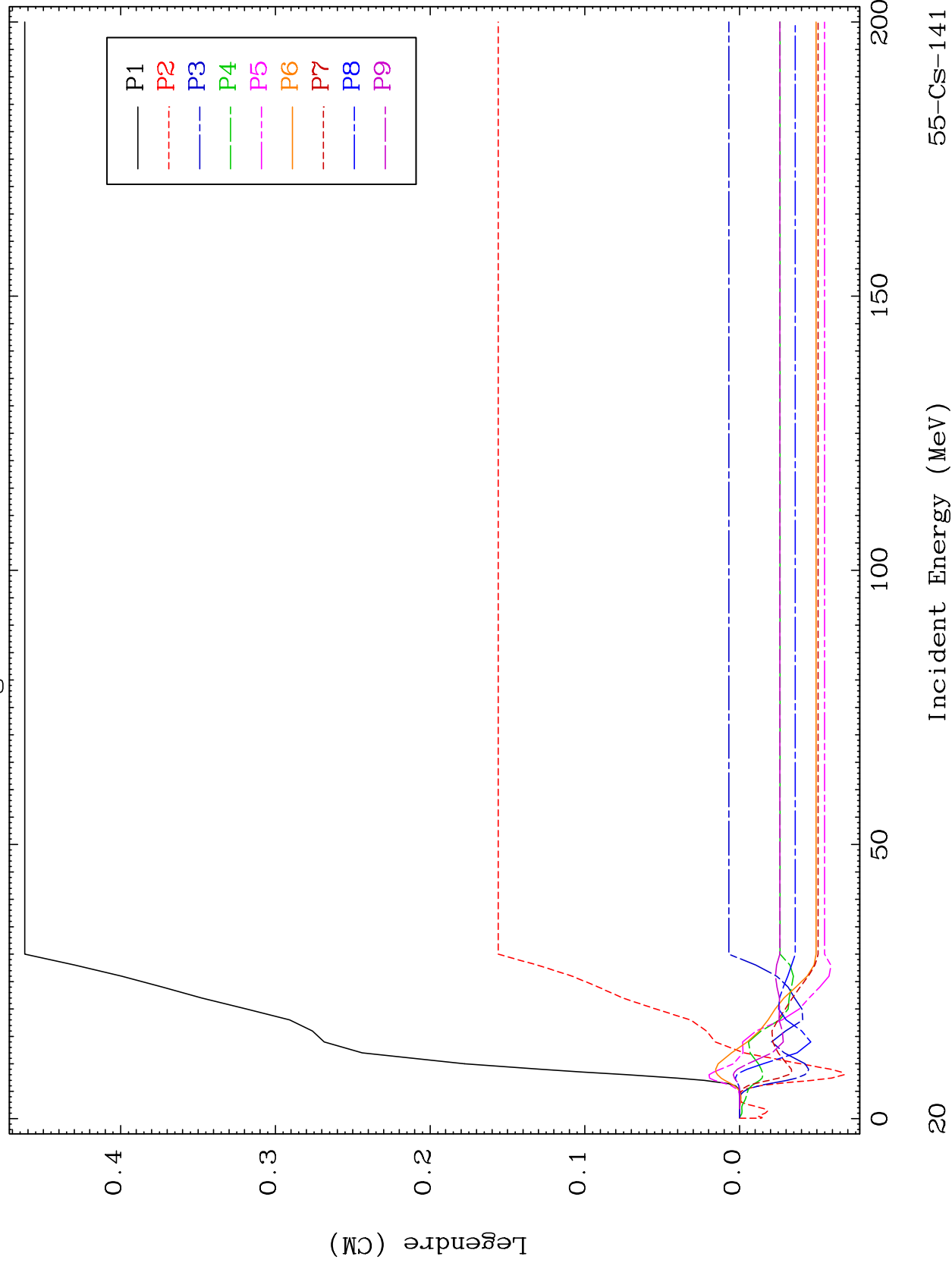

55-Cs-141

Incident Energy (MeV)

0

MAT 5549

MT= 51 (n,n') Level  
Legendre Coefficients

55-Cs-141

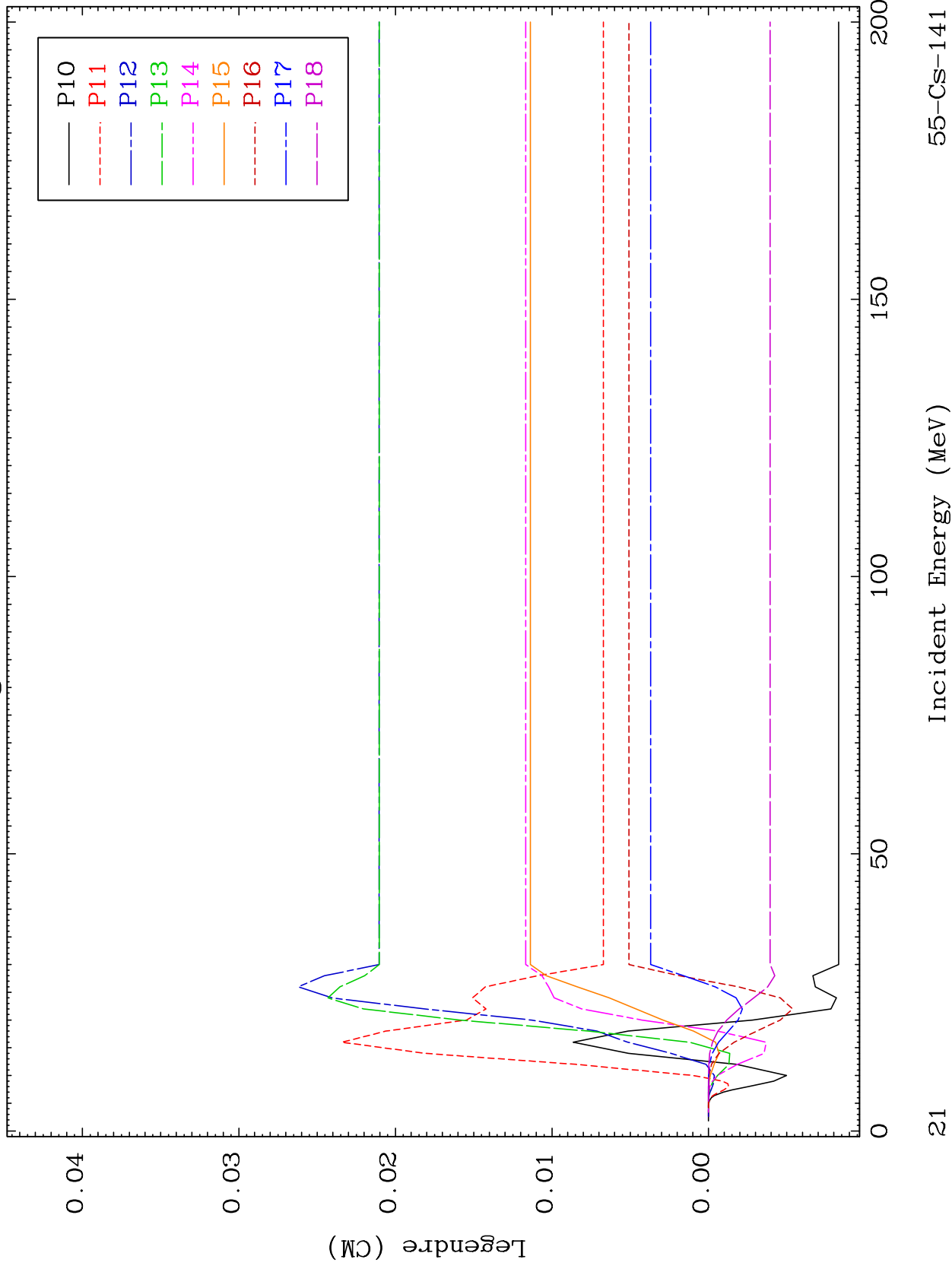

MAT 5549

MT= 51 (n,n') Level  
Legendre Coefficients

55-Cs-141

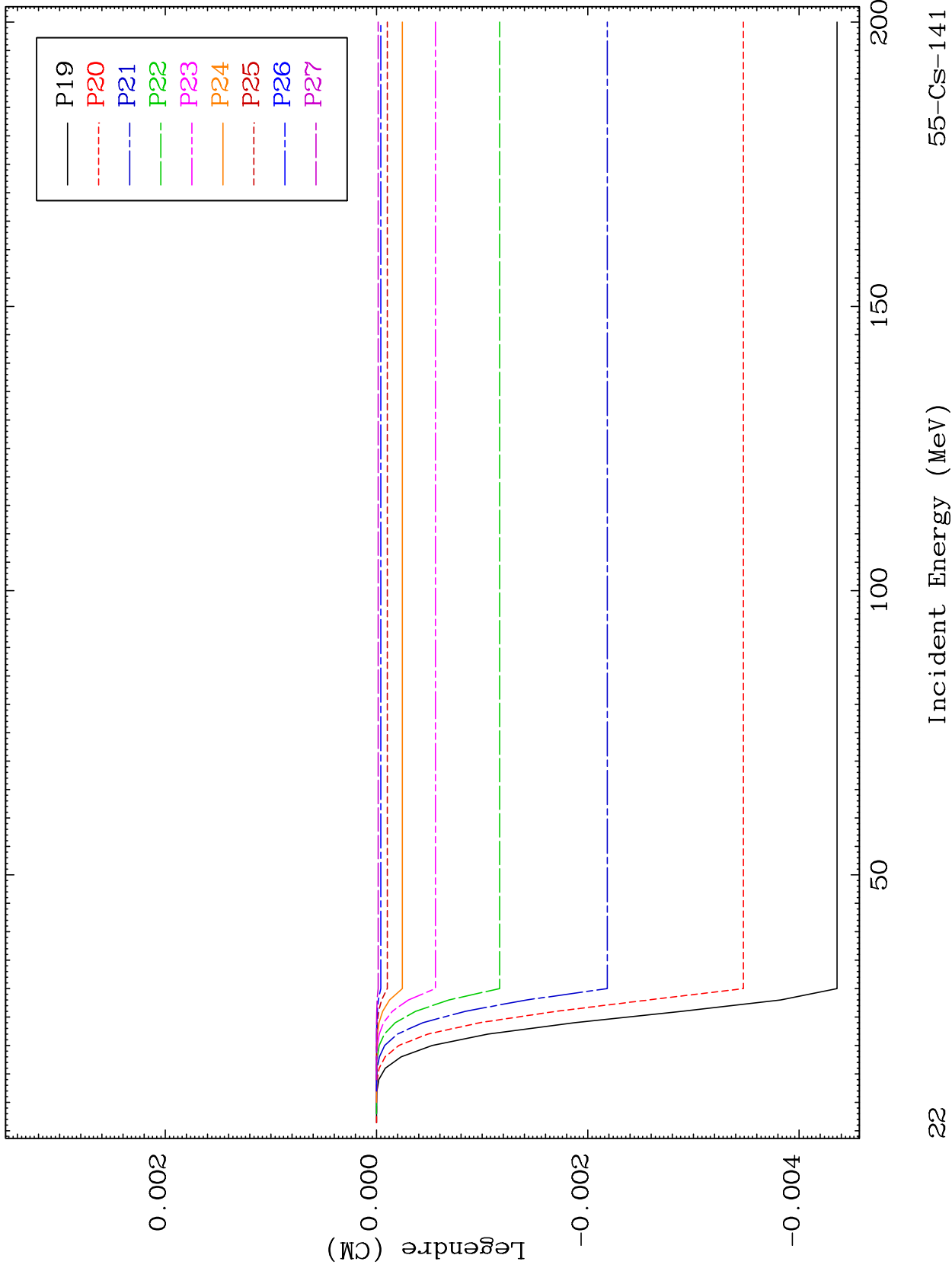

22

Incident Energy (MeV)

55-Cs-141

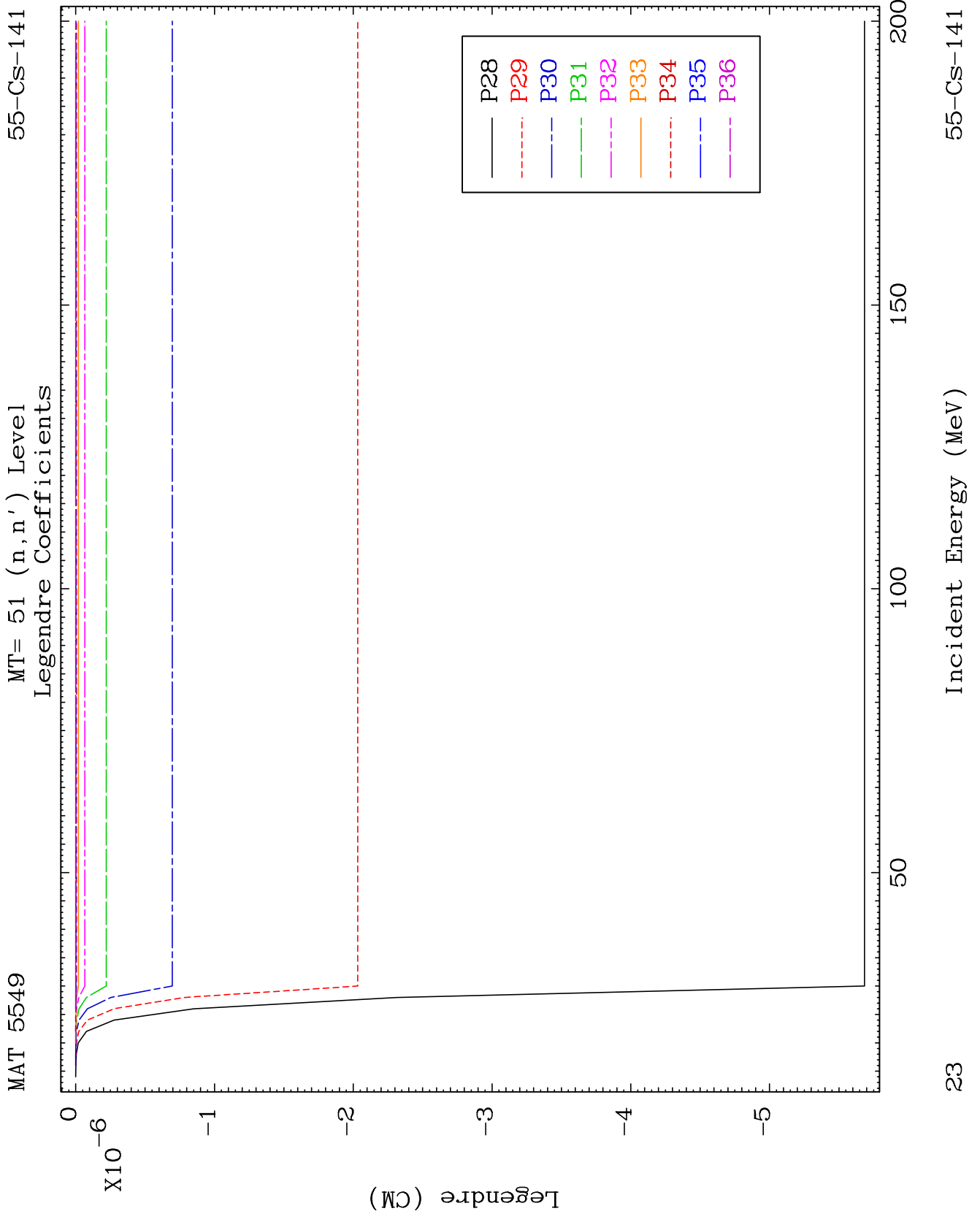





MAT 5549

MT= 52 (n,n') Level  
Legendre Coefficients

55-Cs-141

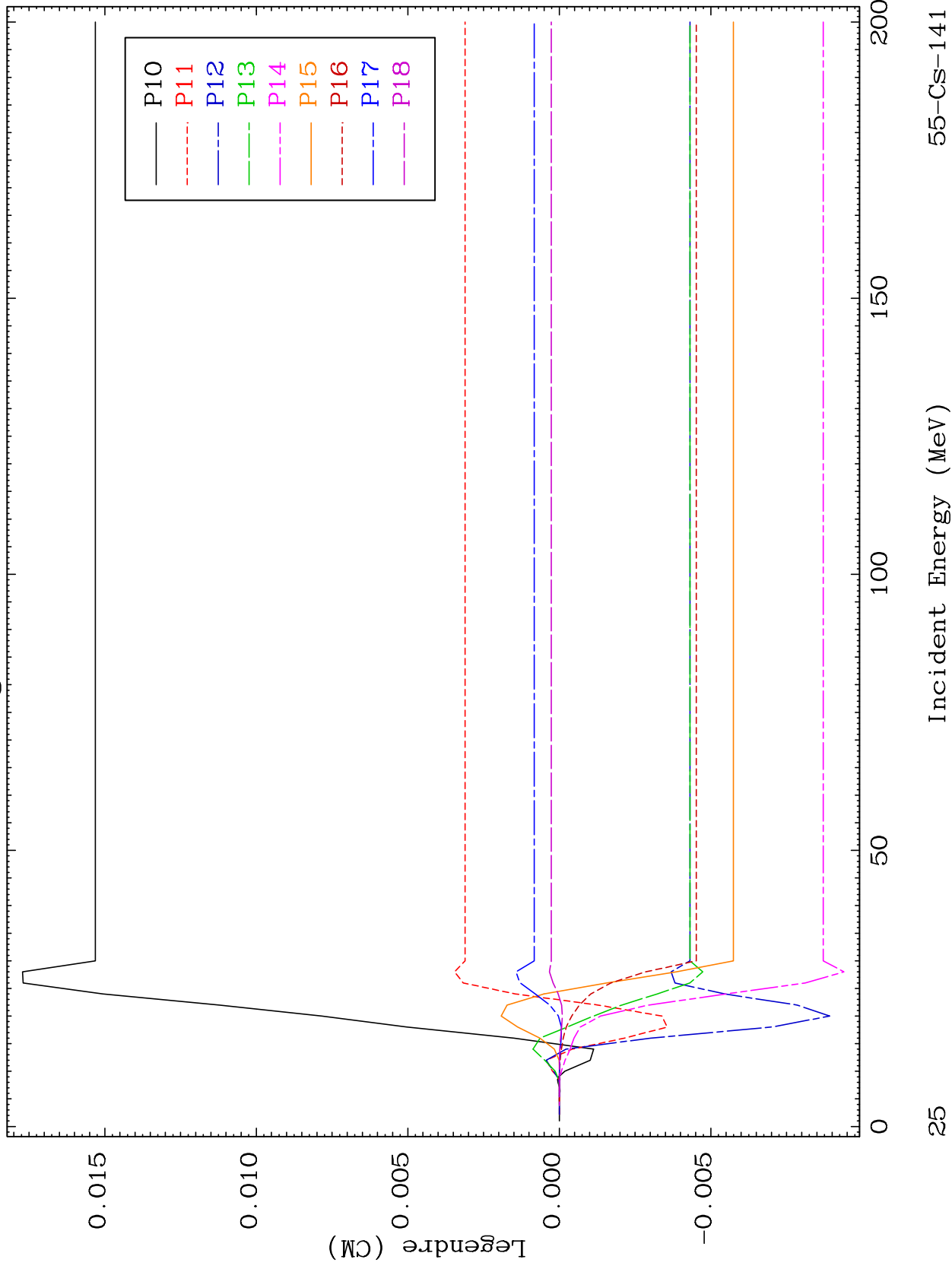

55-Cs-141

Incident Energy (MeV)

25

MAT 5549

MT= 52 (n,n') Level  
Legendre Coefficients

55-Cs-141

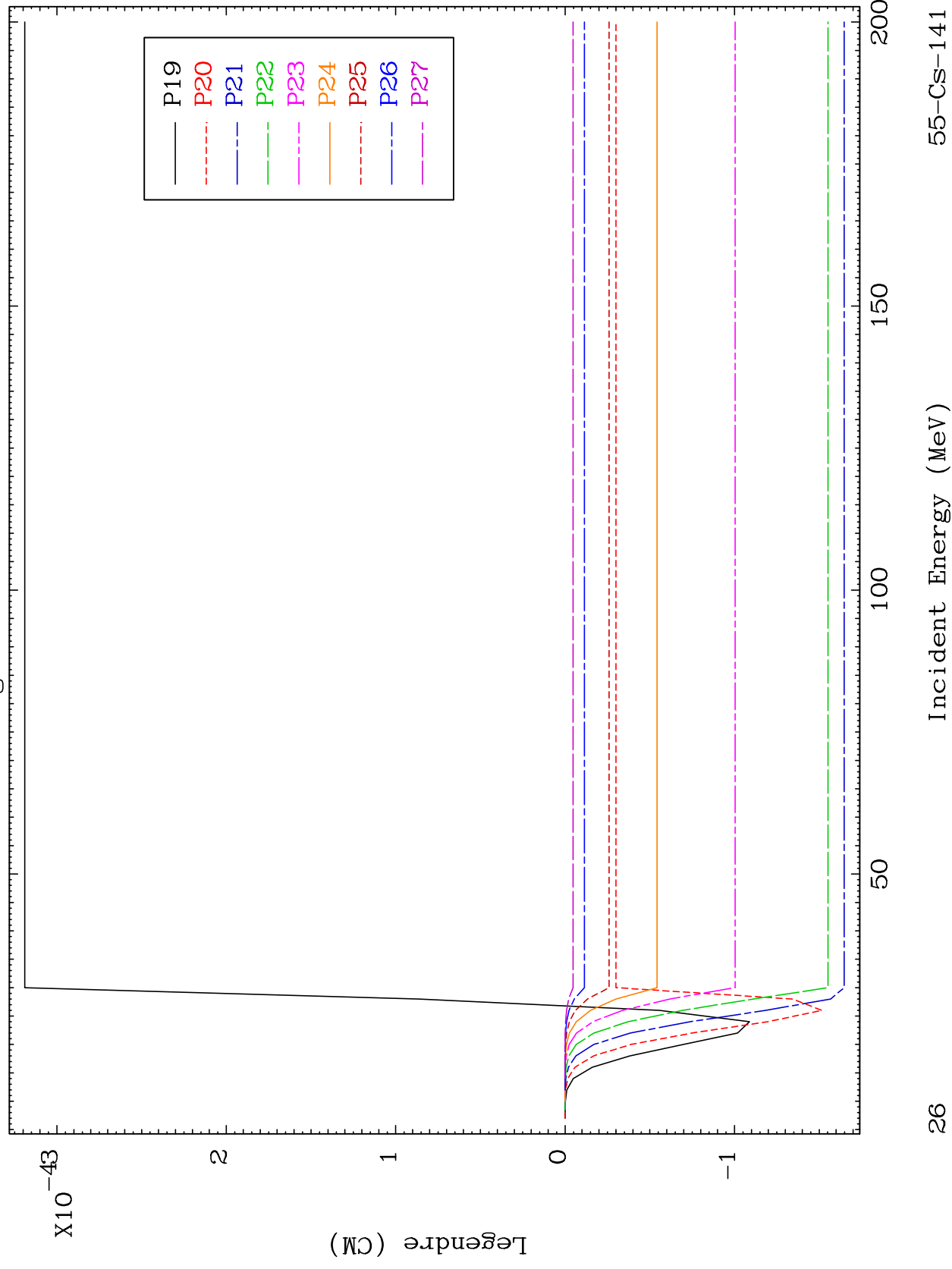



MAT 5549

MT= 53 (n,n') Level  
Legendre Coefficients

55-Cs-141

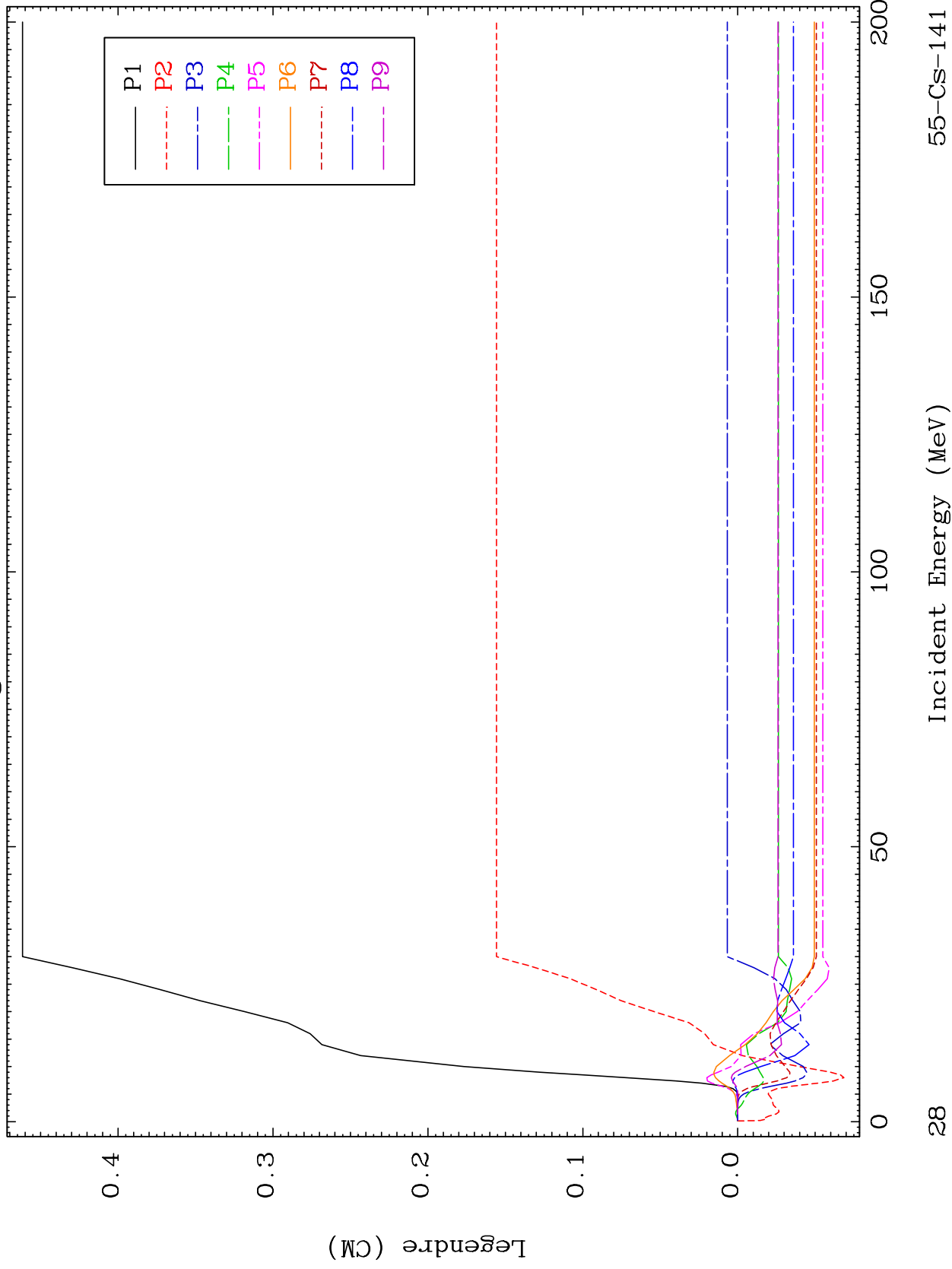

55-Cs-141

Incident Energy (MeV)

28

MAT 5549

MT= 53 (n,n') Level  
Legendre Coefficients

55-Cs-141

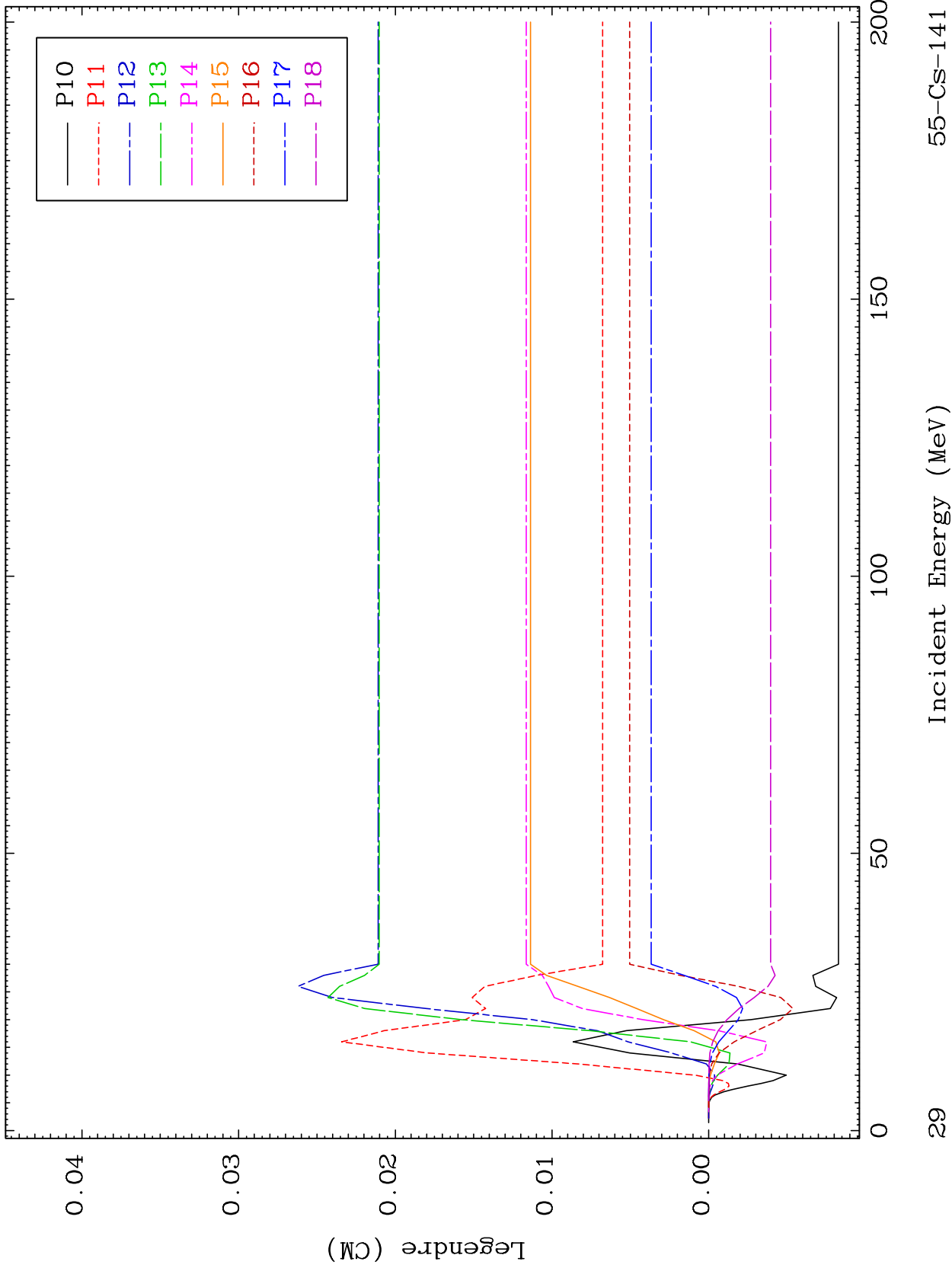

29

Incident Energy (MeV)

55-Cs-141

MAT 5549

MT= 53 (n,n') Level  
Legendre Coefficients

55-Cs-141

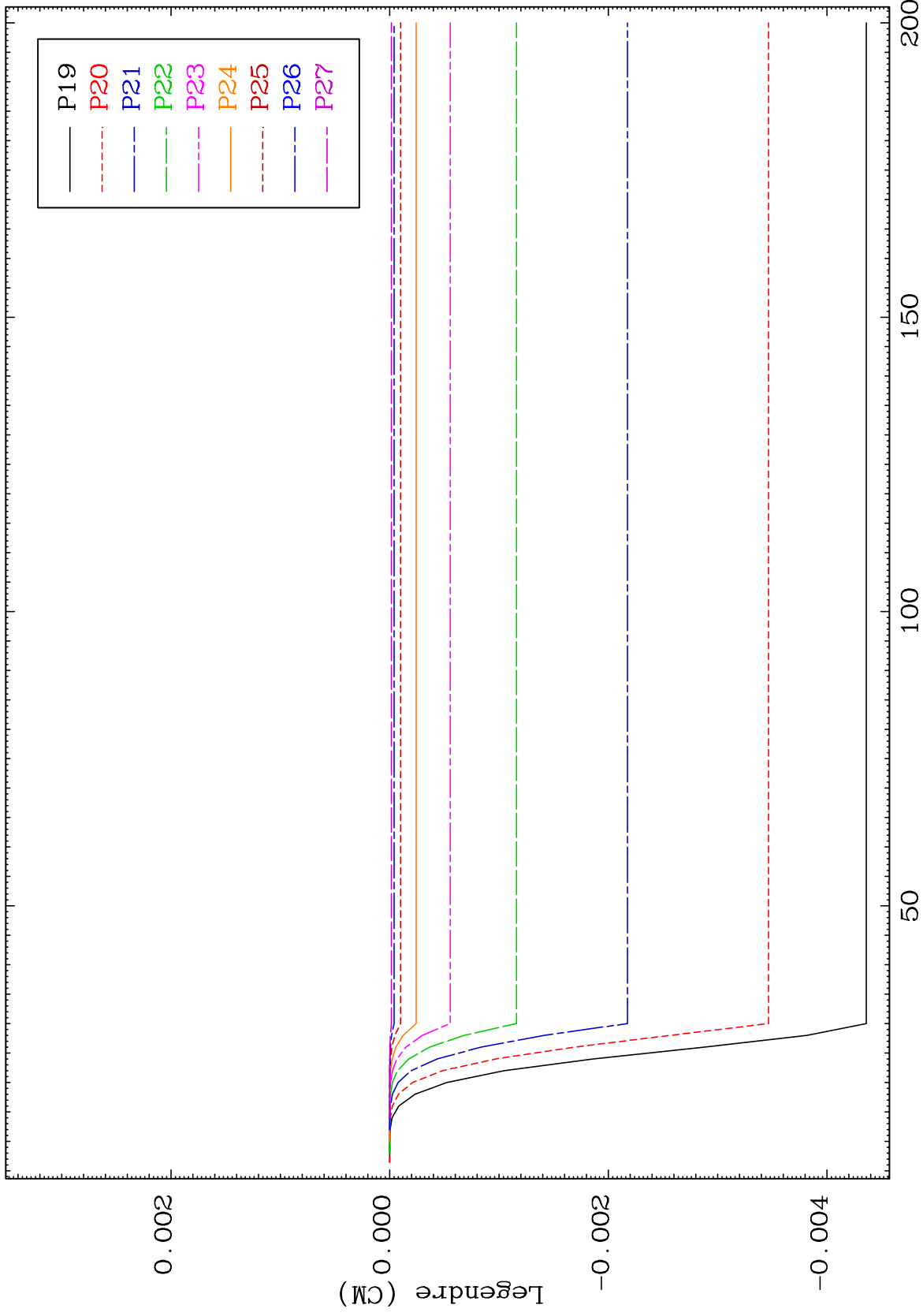

30

Incident Energy (MeV)

55-Cs-141

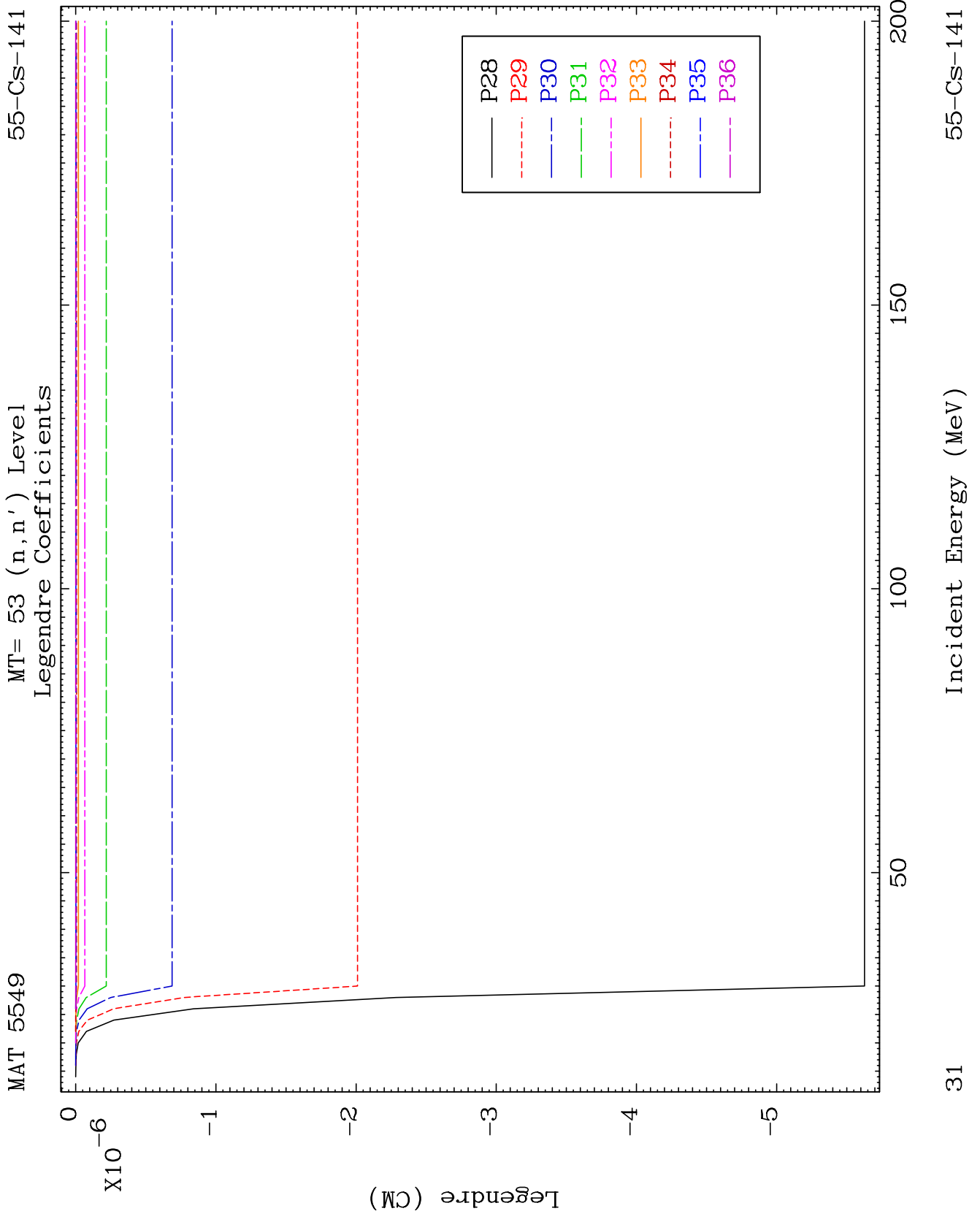



MAT 5549

MT= 54 (n,n') Level  
Legendre Coefficients

55-Cs-141

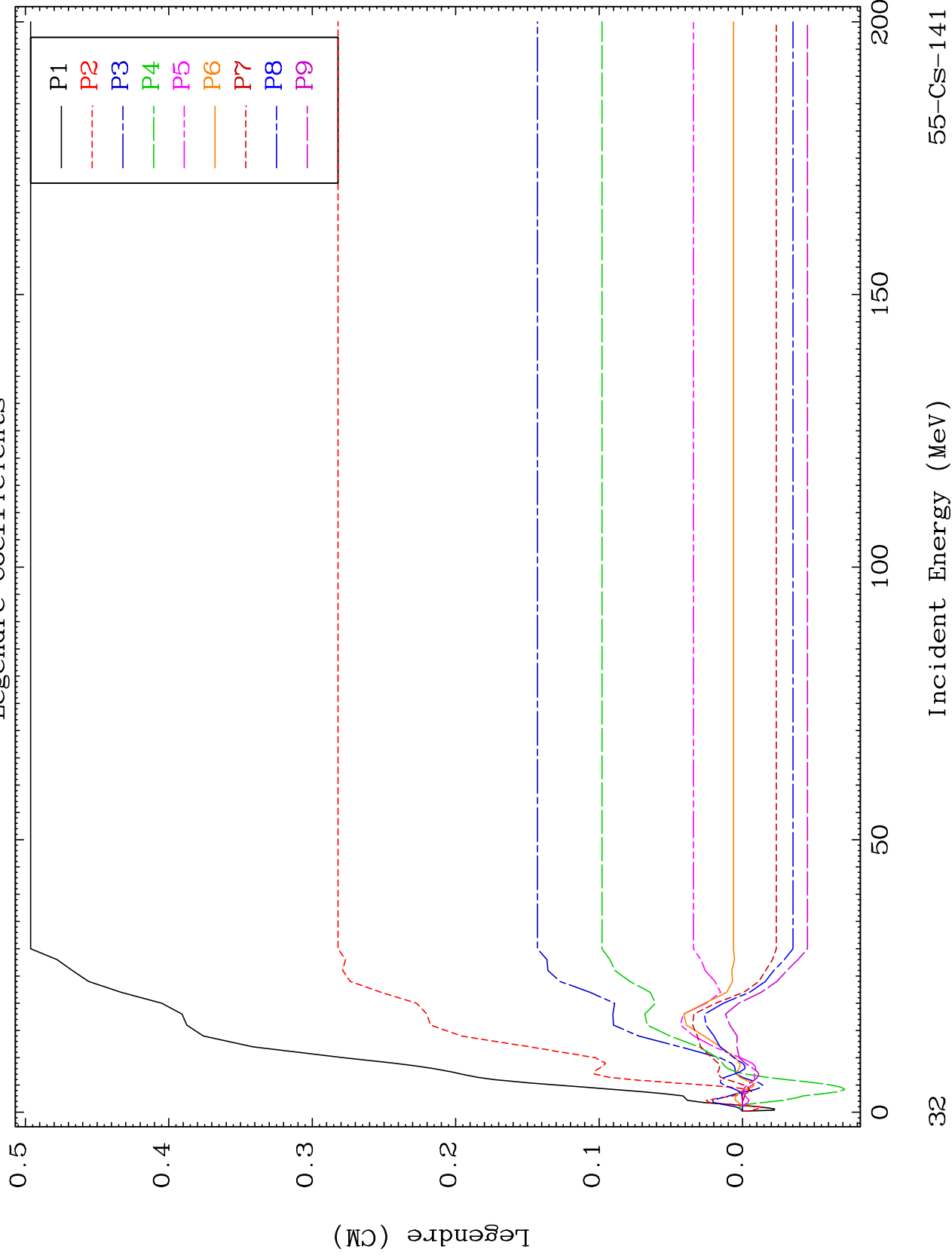

32

Incident Energy (MeV)

55-Cs-141

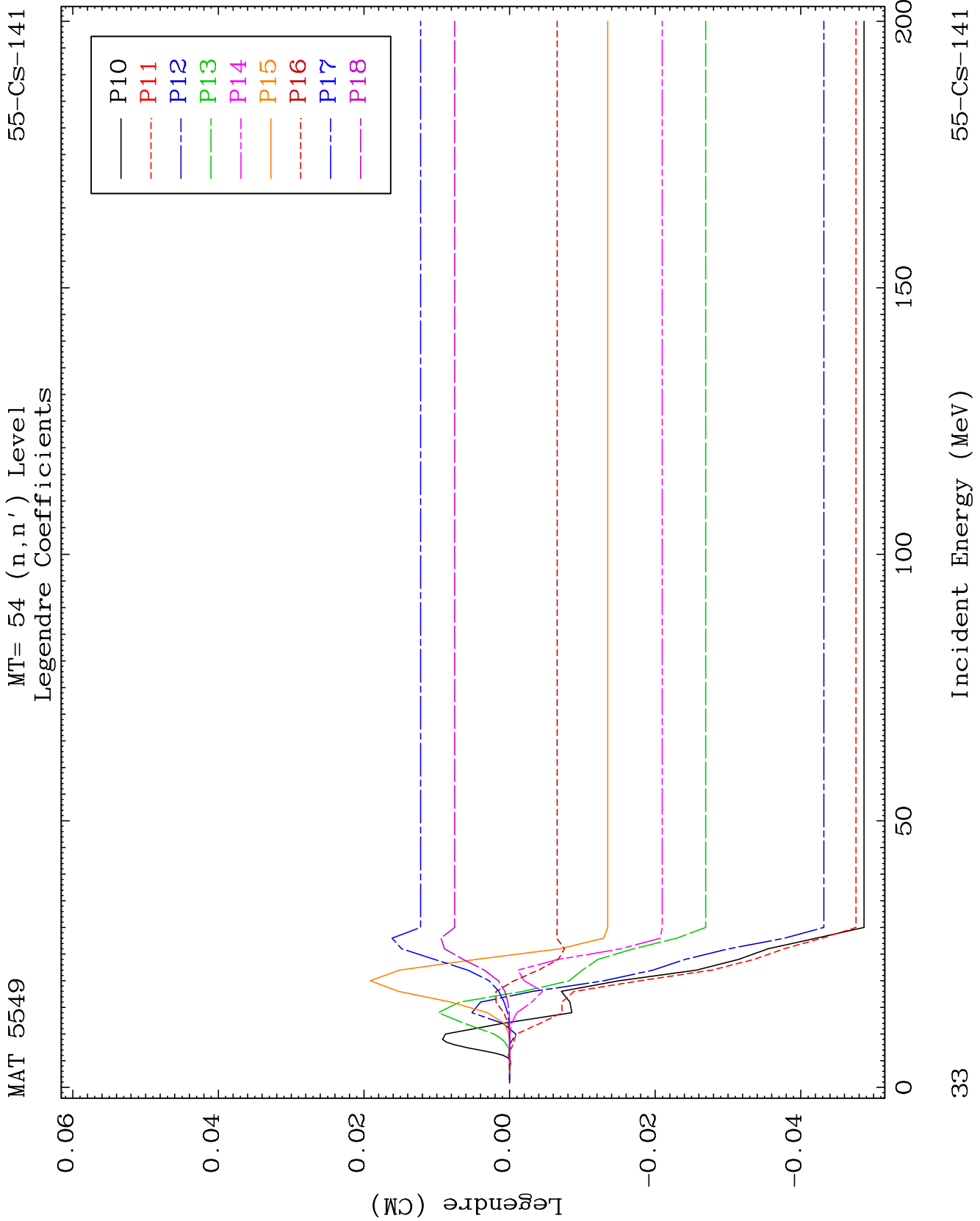

MAT 5549

MT= 54 (n,n') Level  
Legendre Coefficients

55-Cs-141

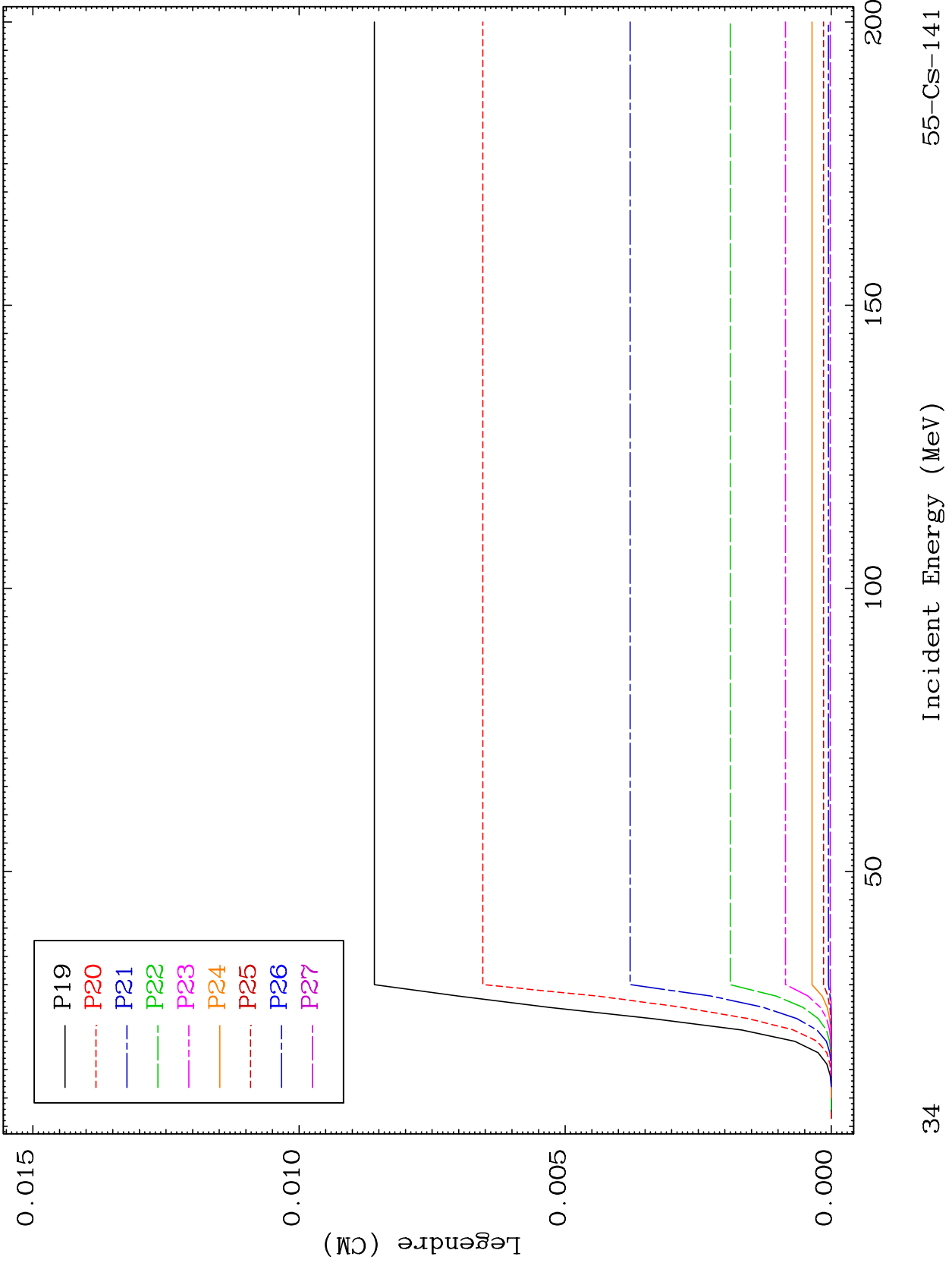

34

Incident Energy (MeV)

55-Cs-141

MAT 5549

MT= 54 (n,n') Level  
Legendre Coefficients

55-Cs-141

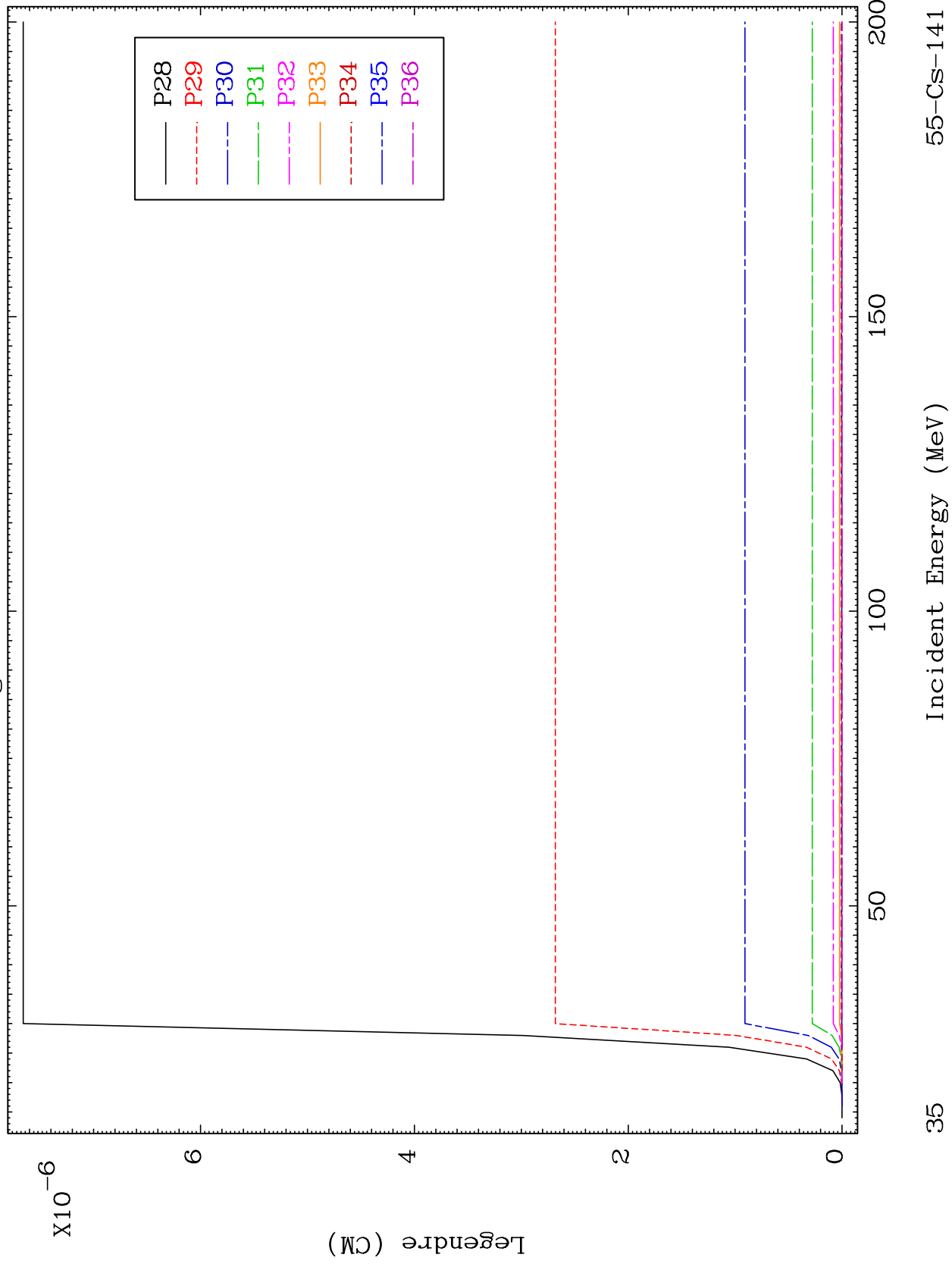

35

Incident Energy (MeV)

55-Cs-141

MAT 5549

MT= 55 (n,n') Level  
Legendre Coefficients

55-Cs-141

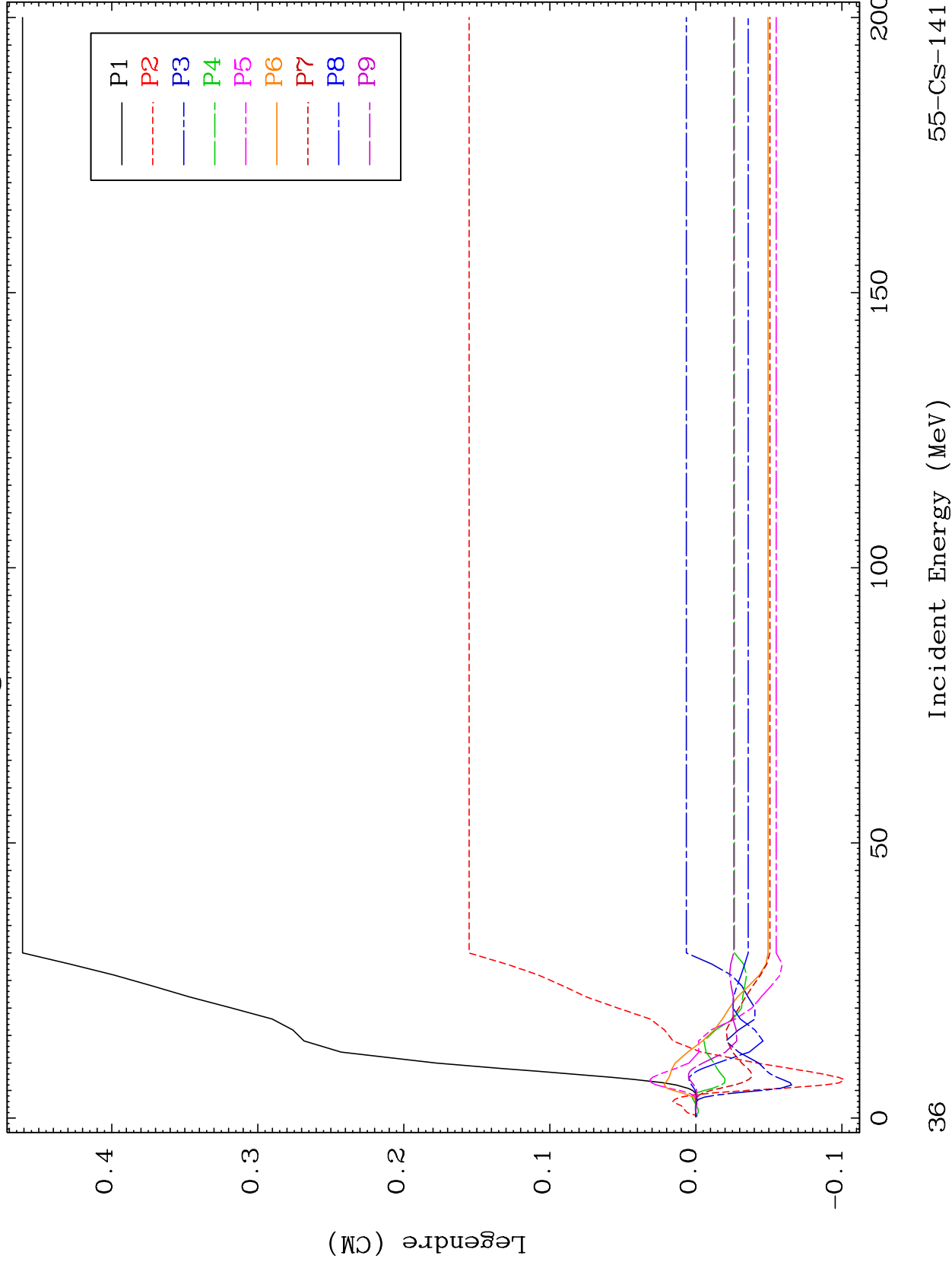

55-Cs-141

Incident Energy (MeV)

36

MAT 5549

MT= 55 (n,n') Level  
Legendre Coefficients

55-Cs-141

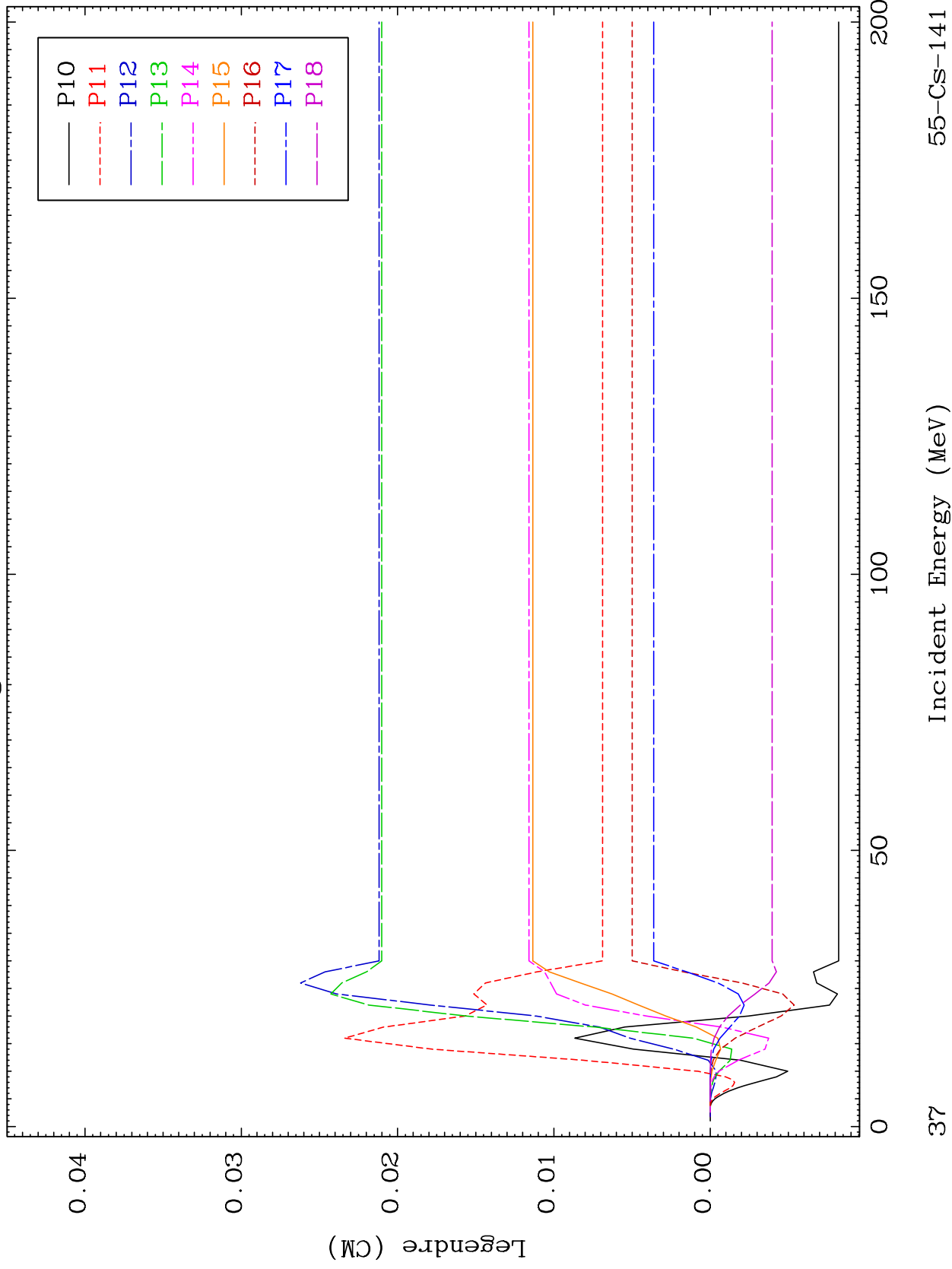

37

Incident Energy (MeV)

55-Cs-141

MAT 5549

MT= 55 (n,n') Level  
Legendre Coefficients

55-Cs-141

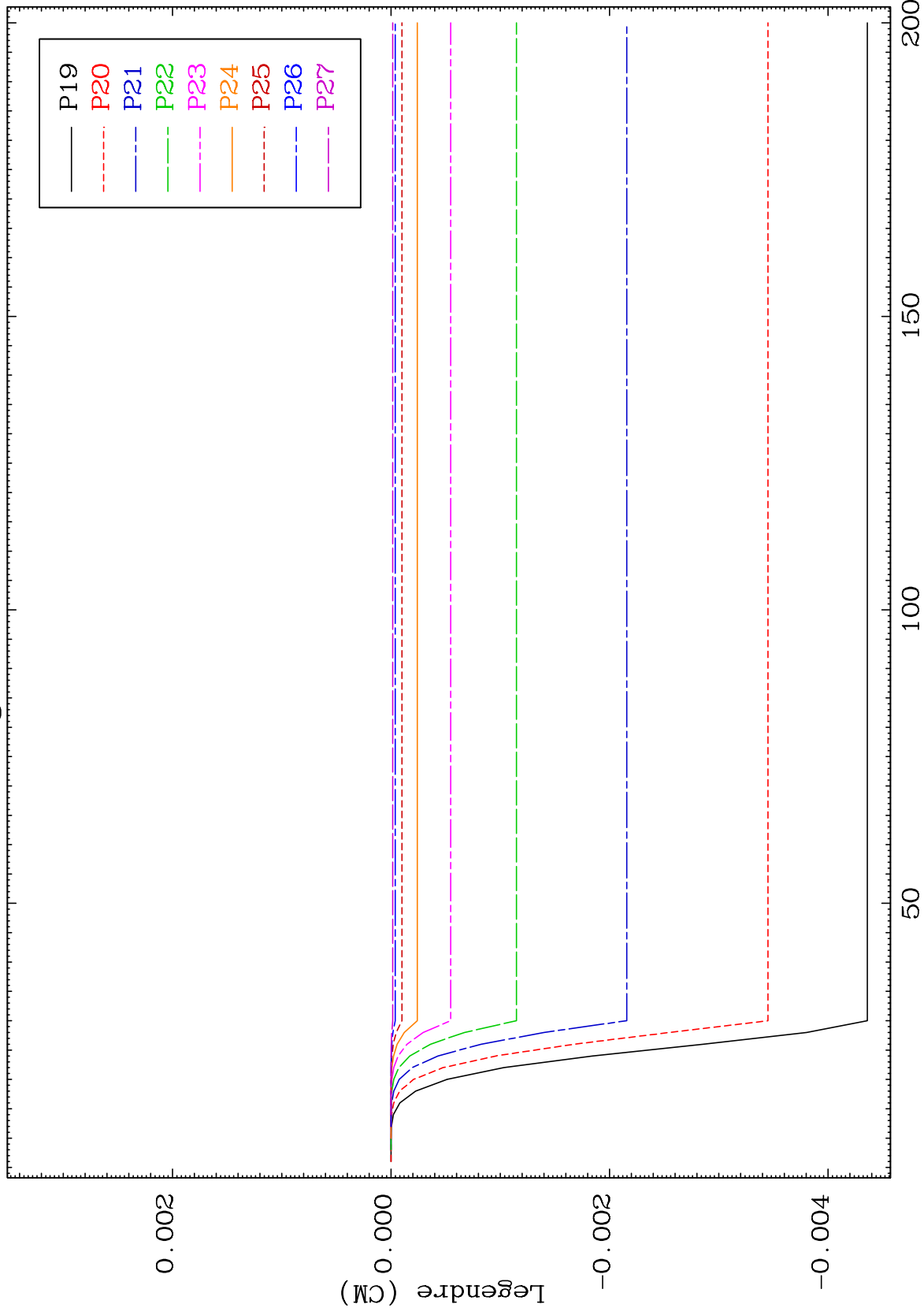

38

Incident Energy (MeV)

55-Cs-141

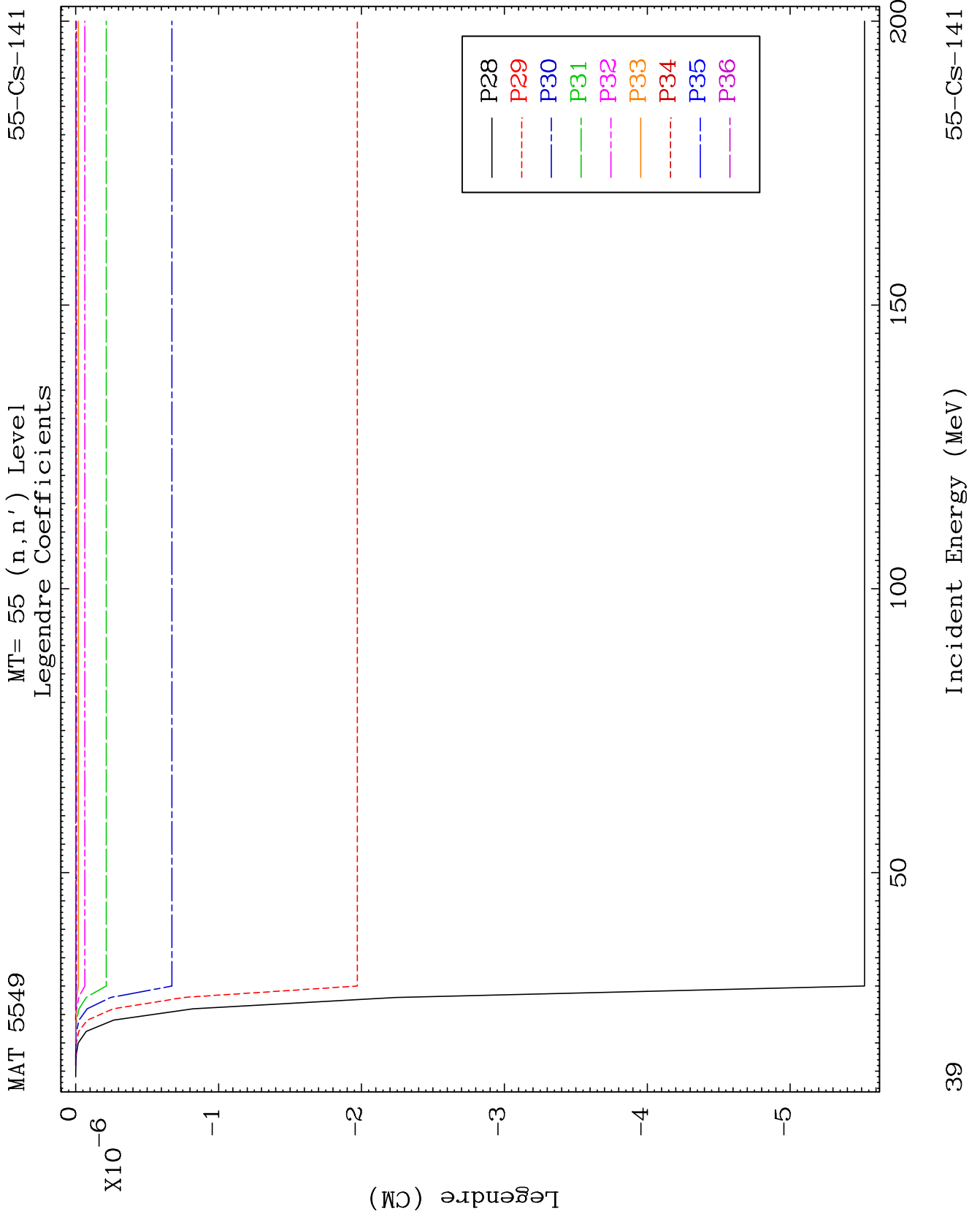



MAT 5549

MT= 56 (n,n') Level  
Legendre Coefficients

55-Cs-141

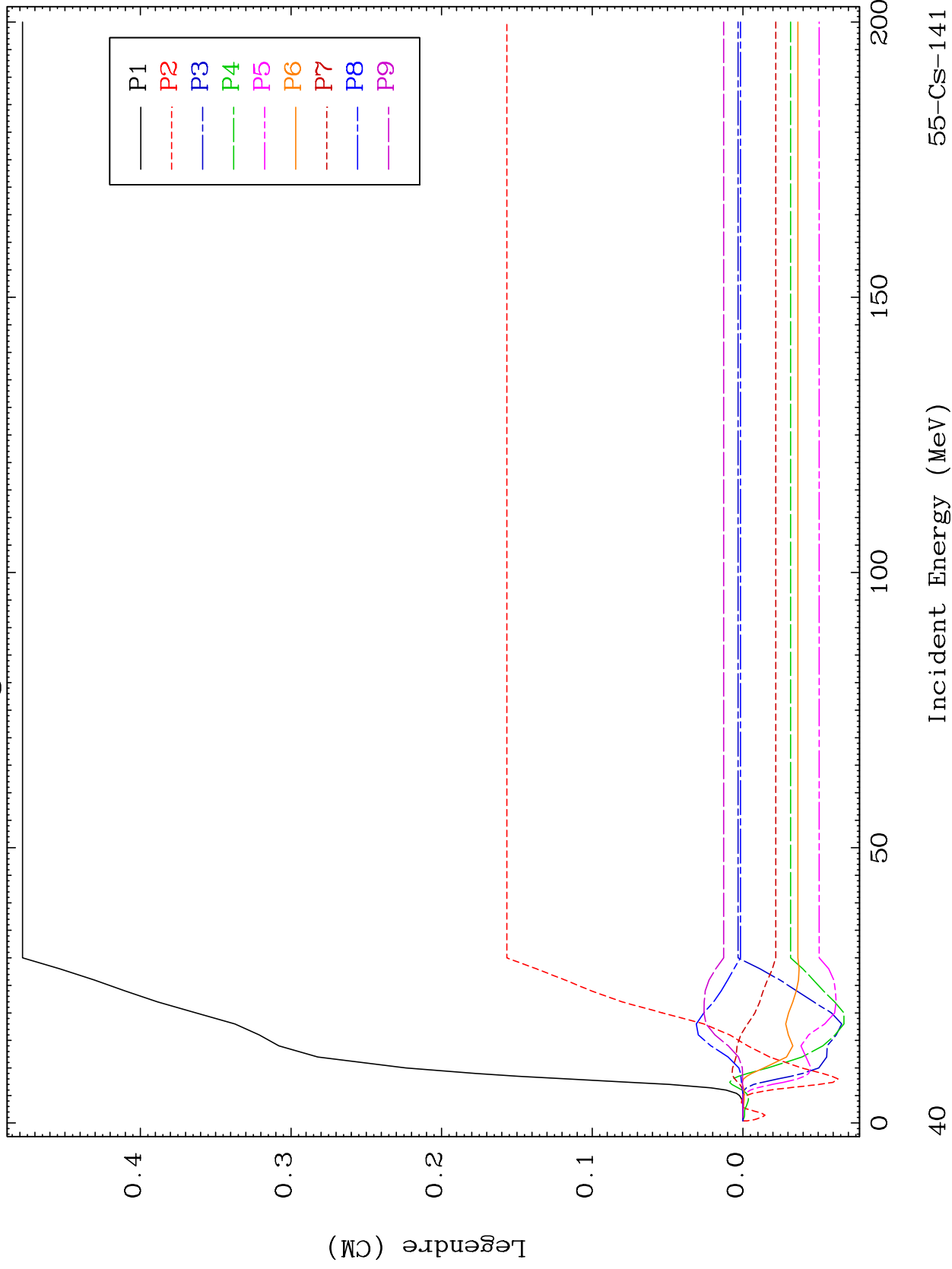

55-Cs-141

MAT 5549

MT= 56 (n,n') Level  
Legendre Coefficients

55-Cs-141

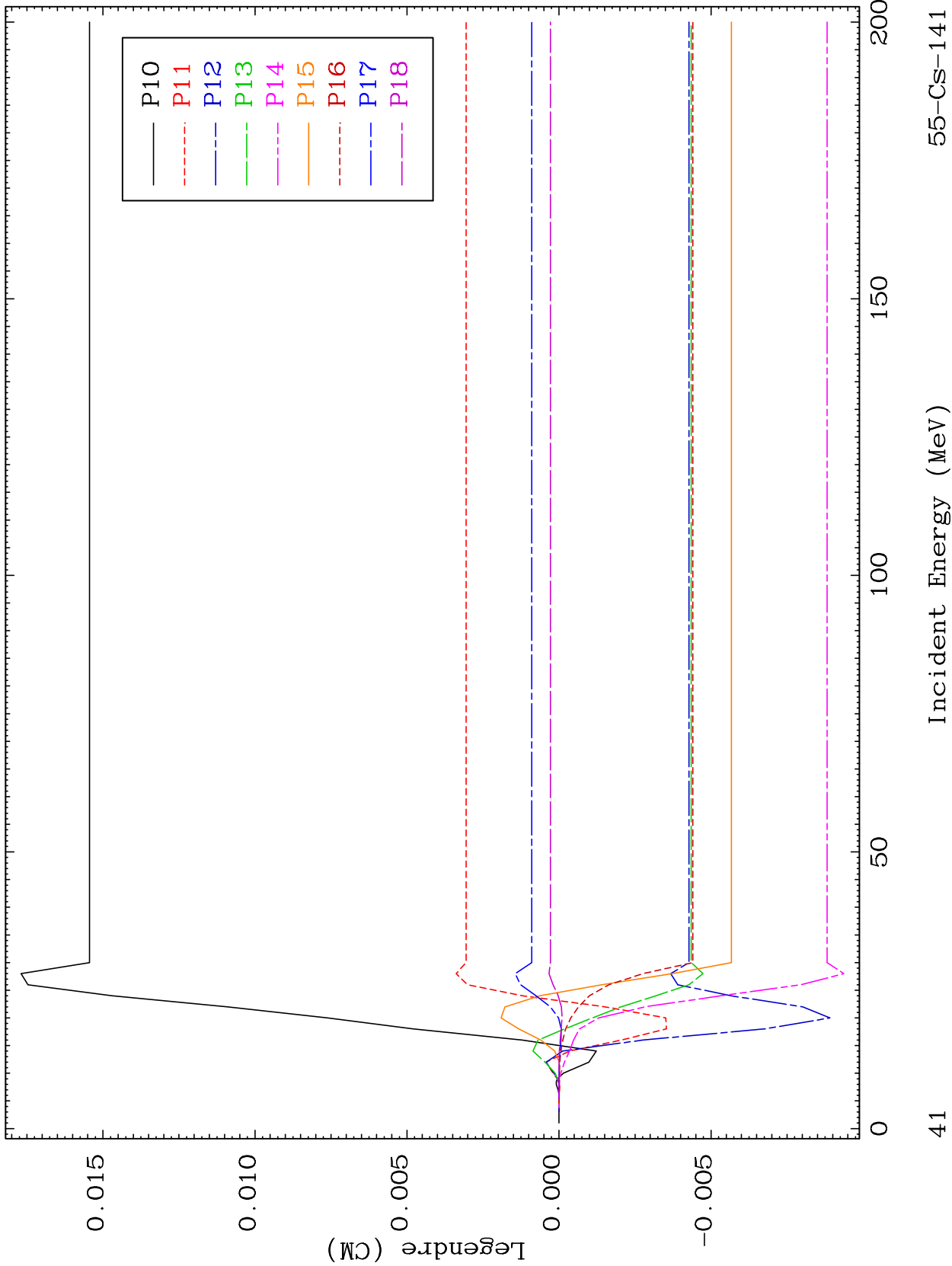

41

Incident Energy (MeV)

55-Cs-141

MAT 5549

MT= 56 (n,n') Level  
Legendre Coefficients

55-Cs-141

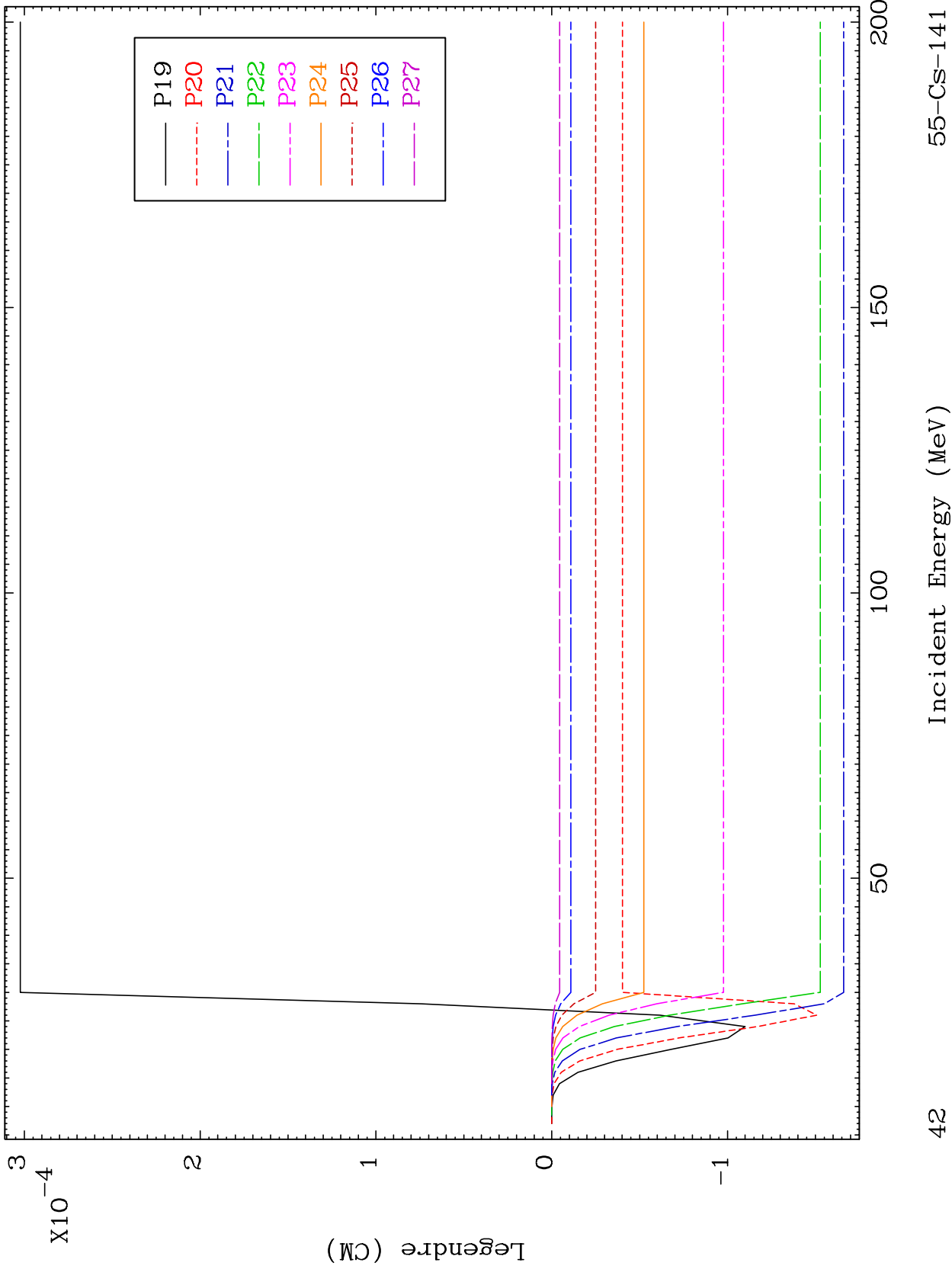

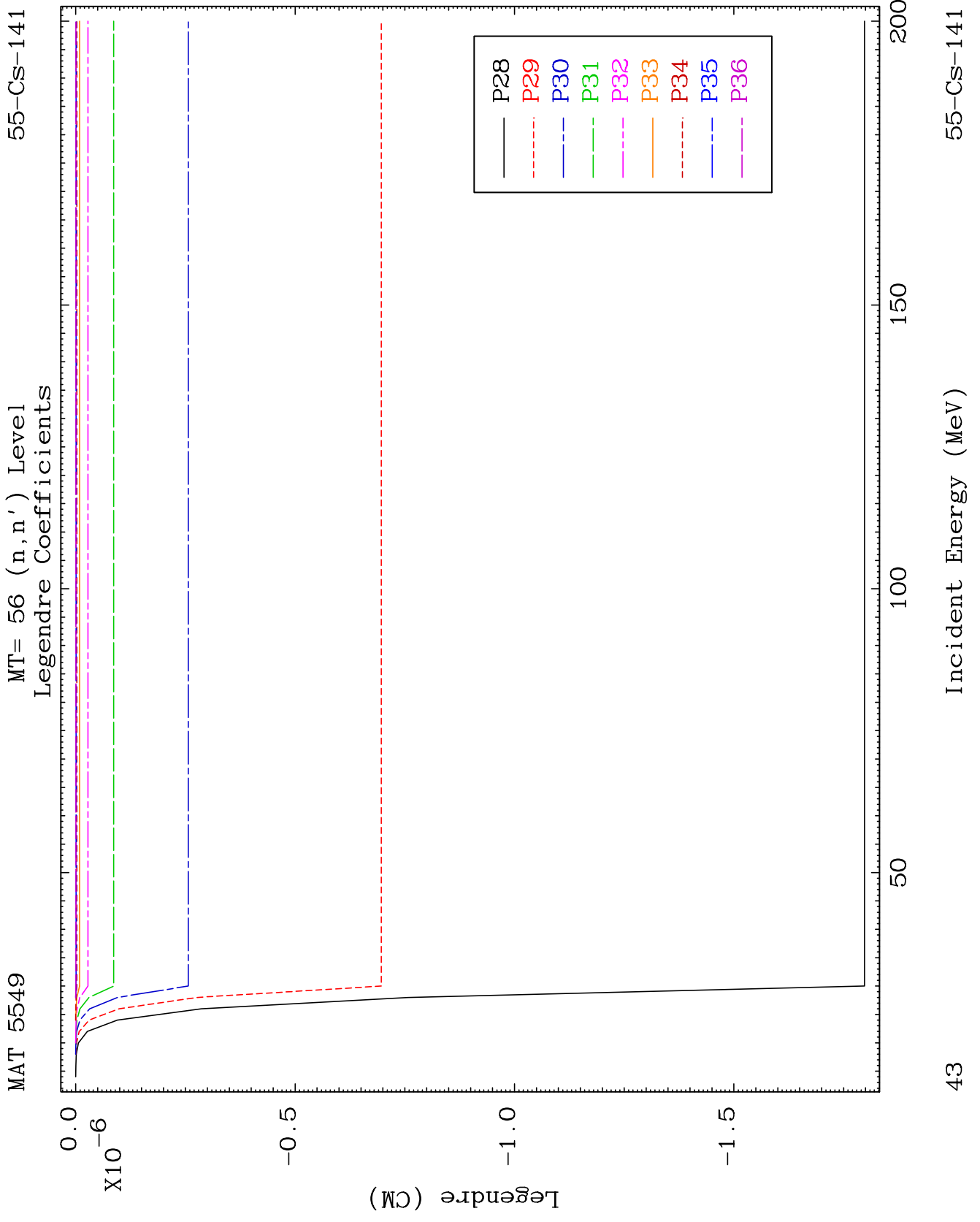

MAT 5549

MT= 57 (n,n') Level  
Legendre Coefficients

55-Cs-141

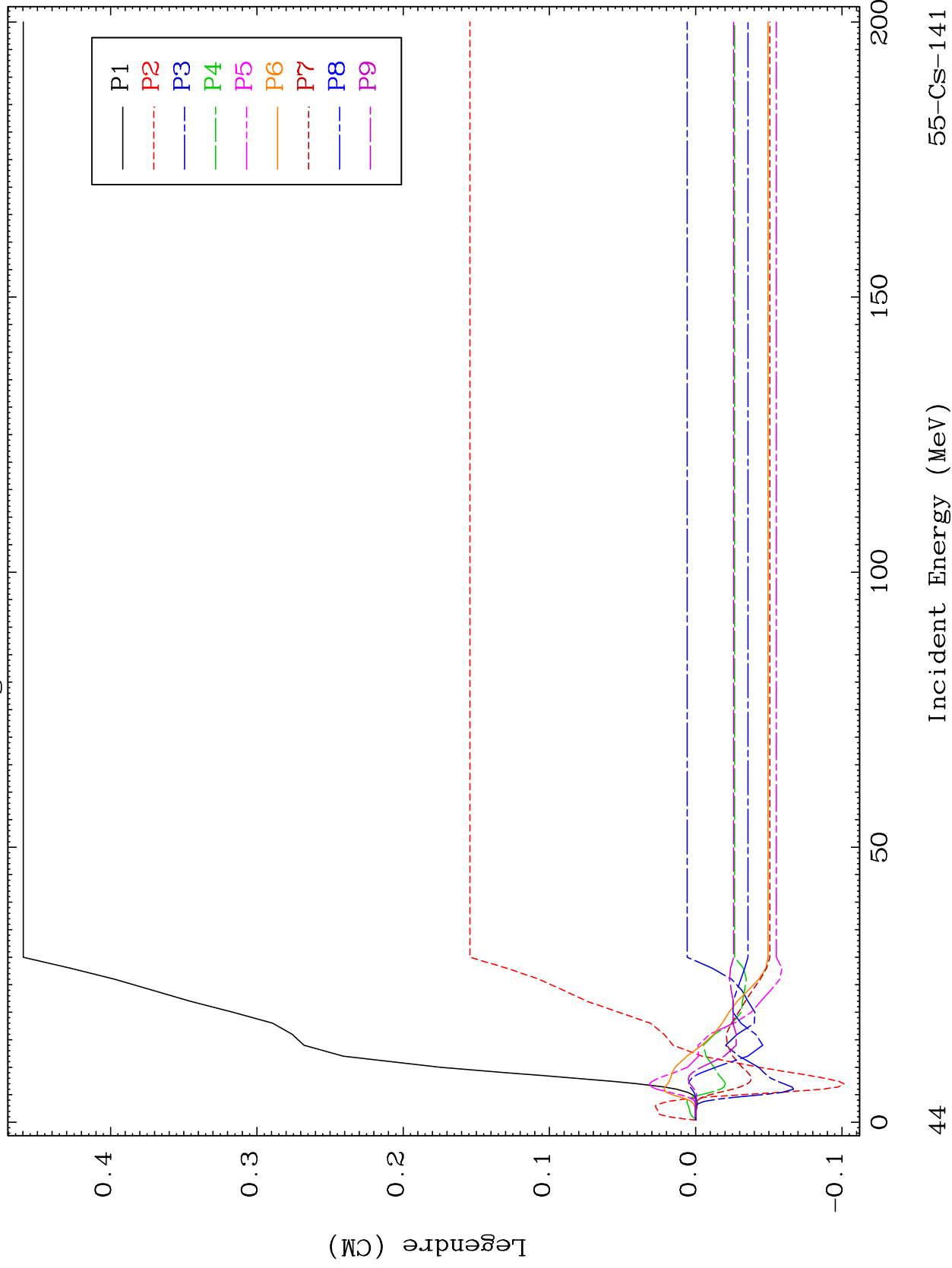

55-Cs-141

Incident Energy (MeV)

44

MAT 5549

MT= 57 (n,n') Level  
Legendre Coefficients

55-Cs-141

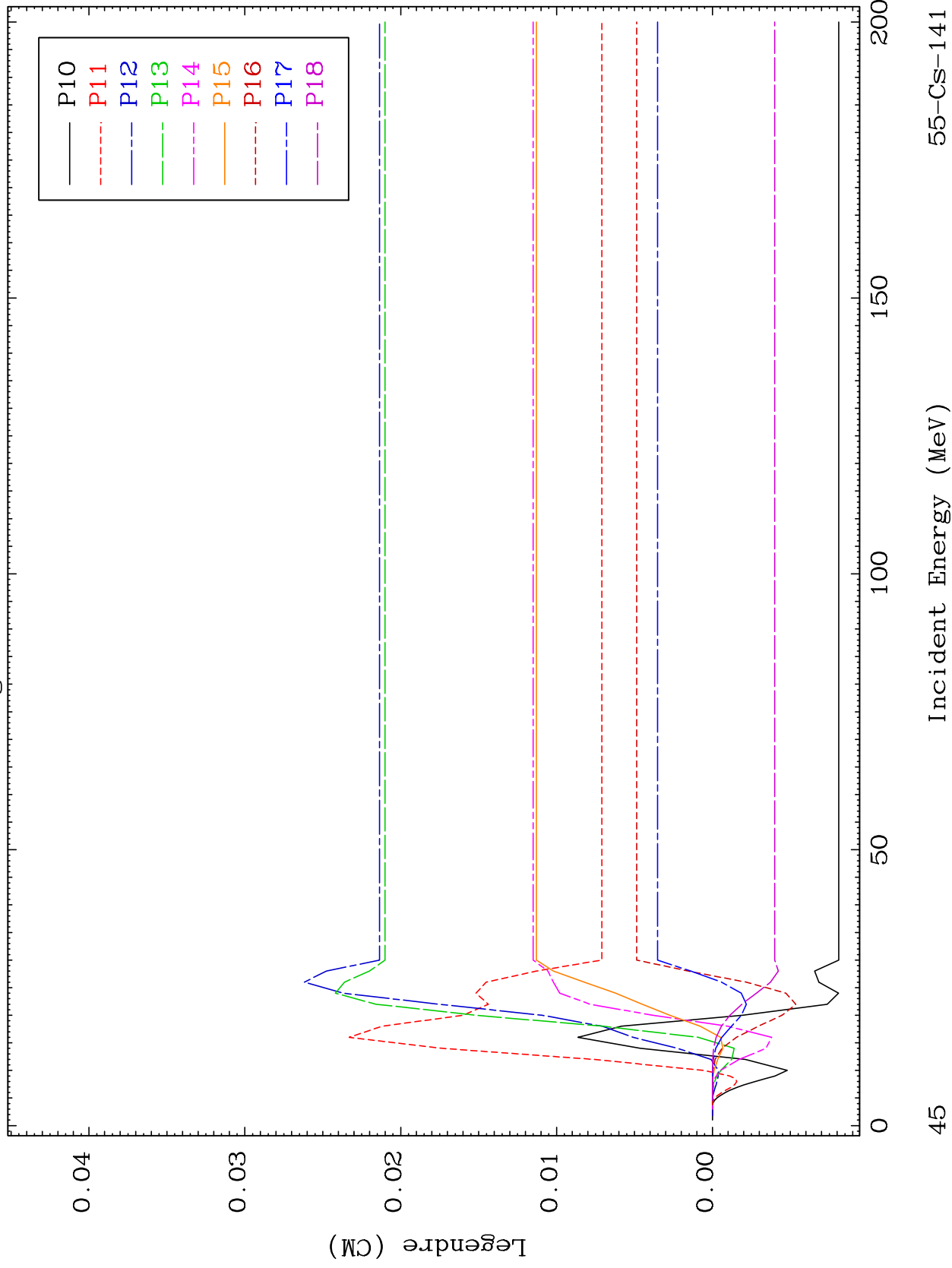

55-Cs-141

Incident Energy (MeV)

45

MAT 5549

MT= 57 (n,n') Level  
Legendre Coefficients

55-Cs-141

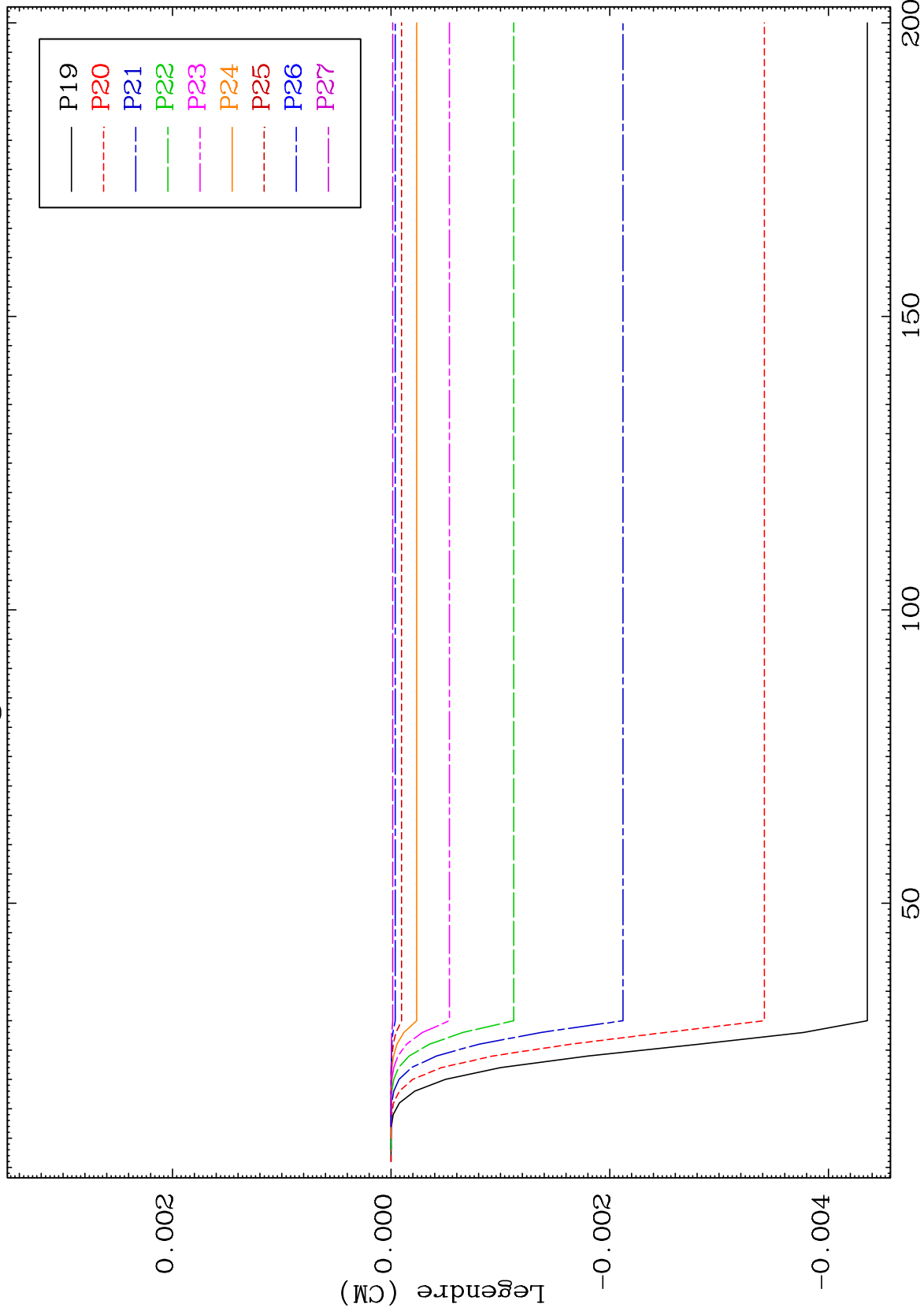

46

Incident Energy (MeV)

55-Cs-141





MAT 5549

MT= 58 (n,n') Level  
Legendre Coefficients

55-Cs-141

48

Incident Energy (MeV)

55-Cs-141

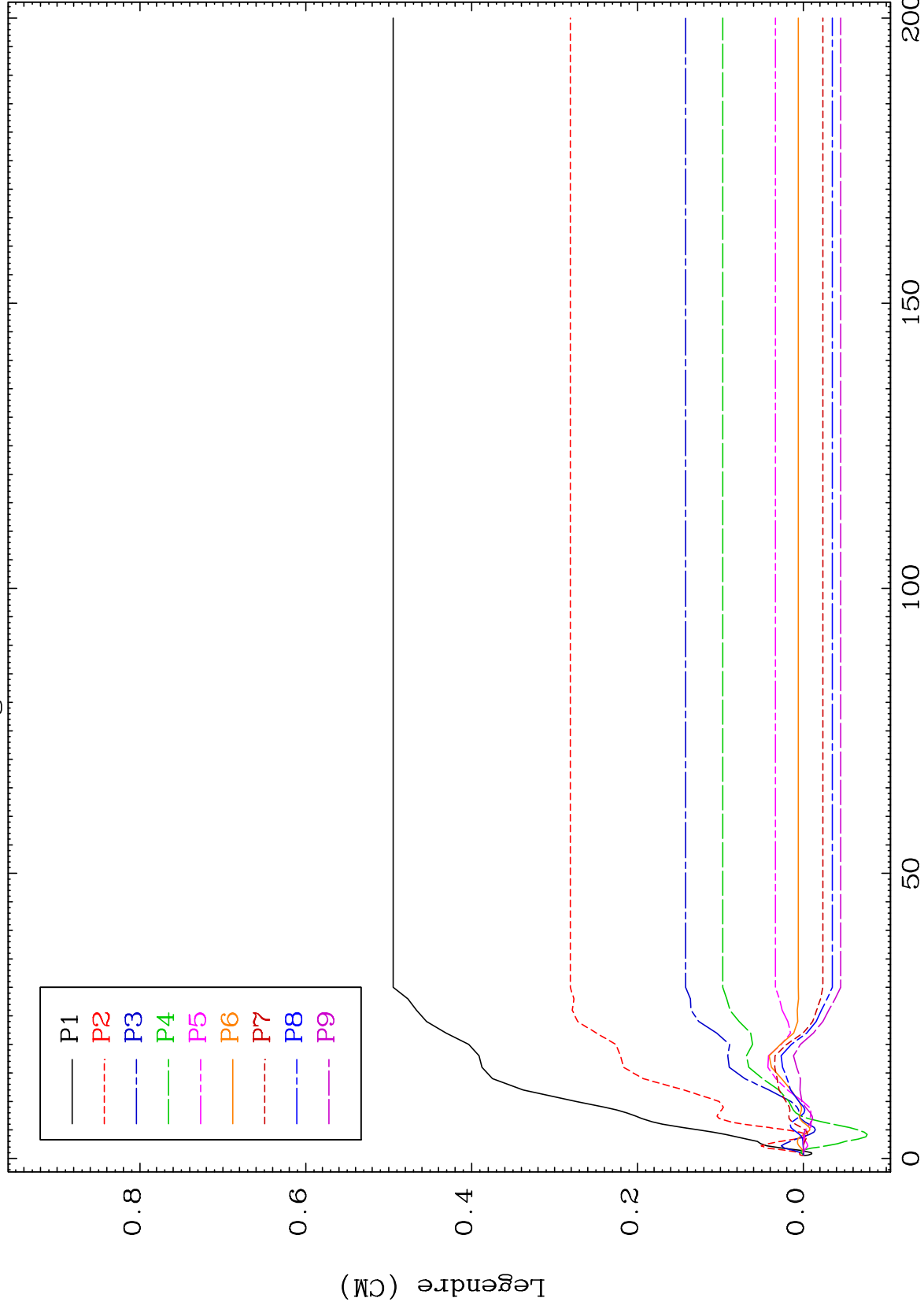

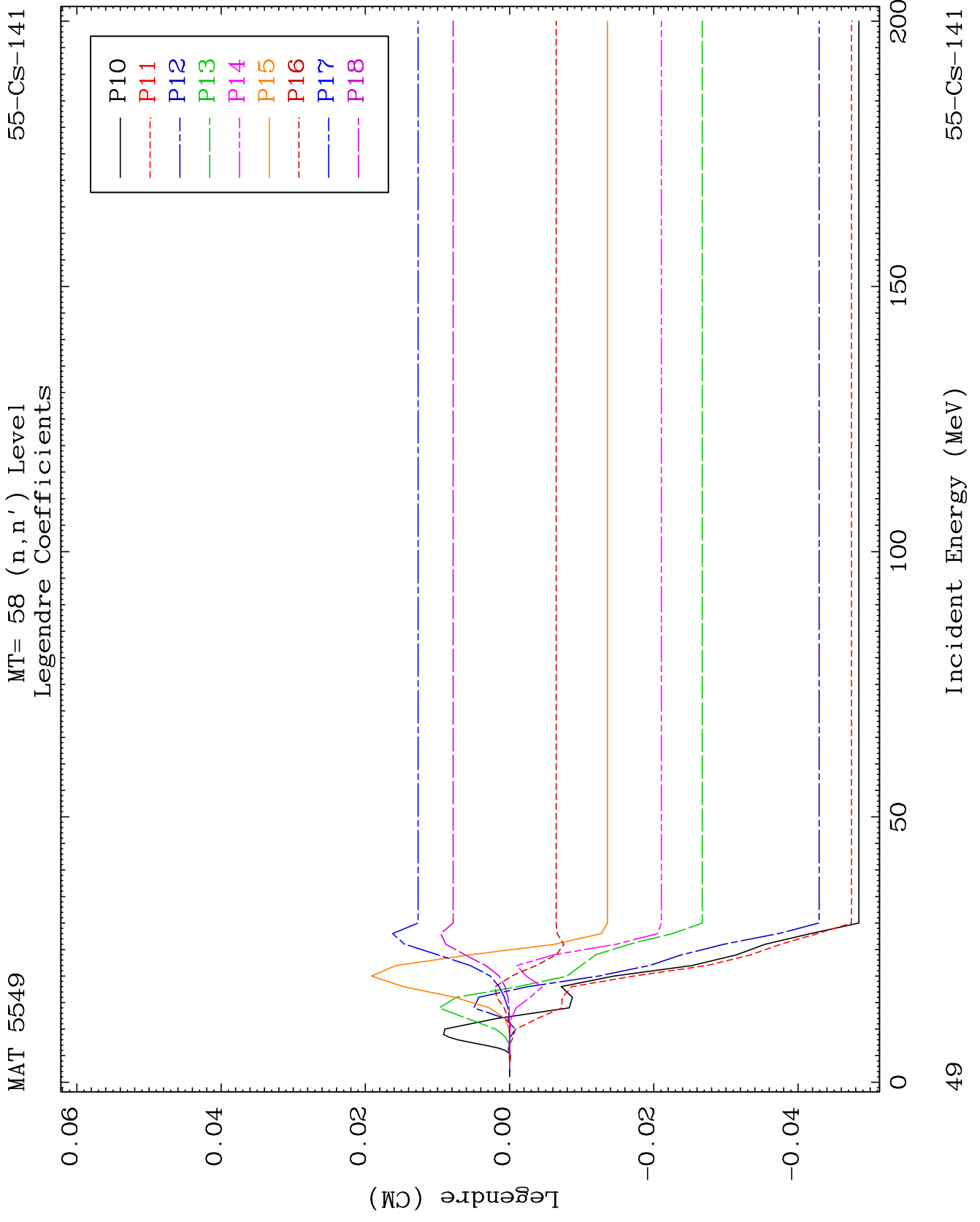

MAT 5549

MT= 58 (n,n') Level  
Legendre Coefficients

55-Cs-141

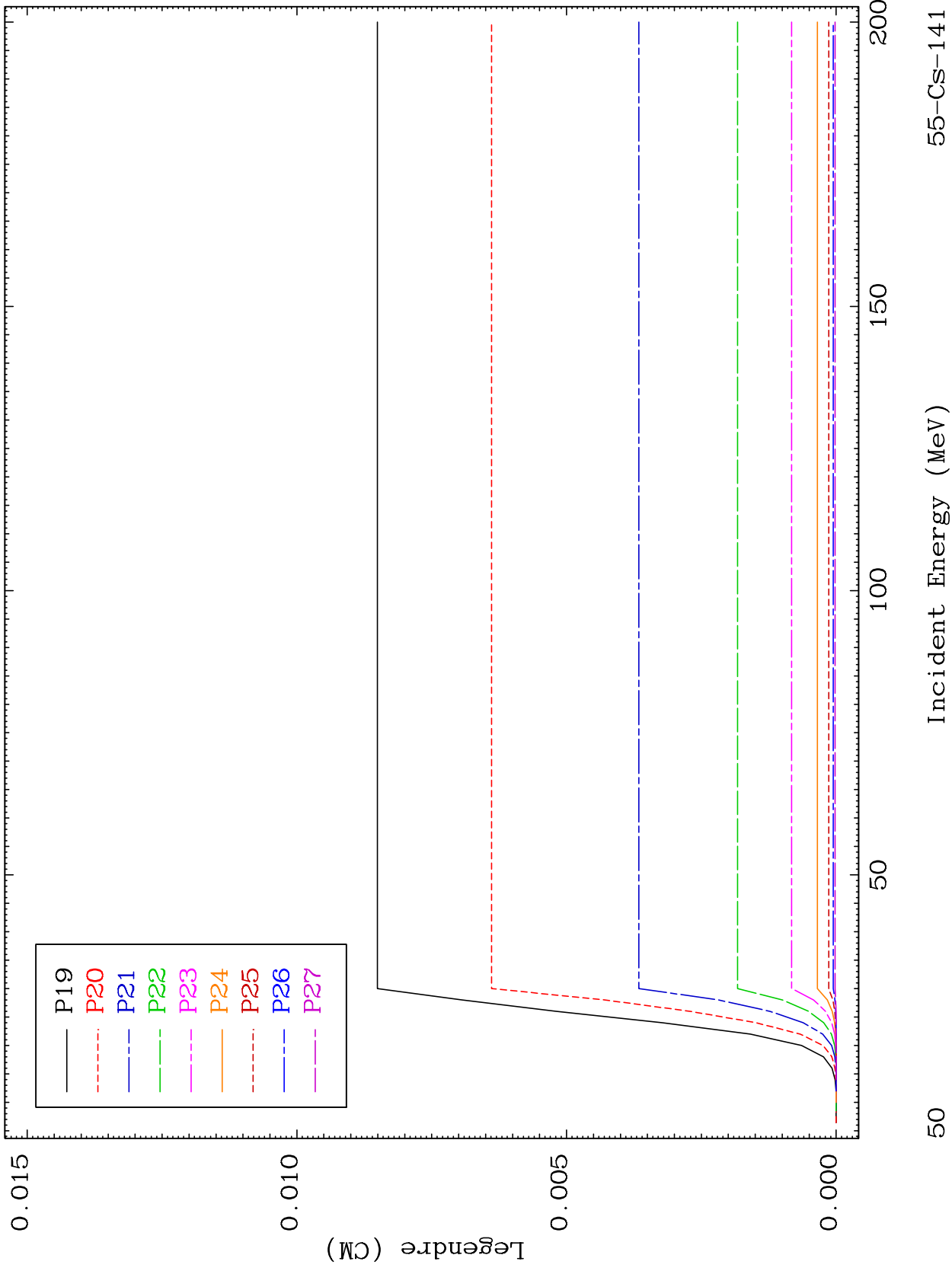

55-Cs-141

Incident Energy (MeV)

50

MAT 5549

MT= 58 (n,n') Level  
Legendre Coefficients

55-Cs-141

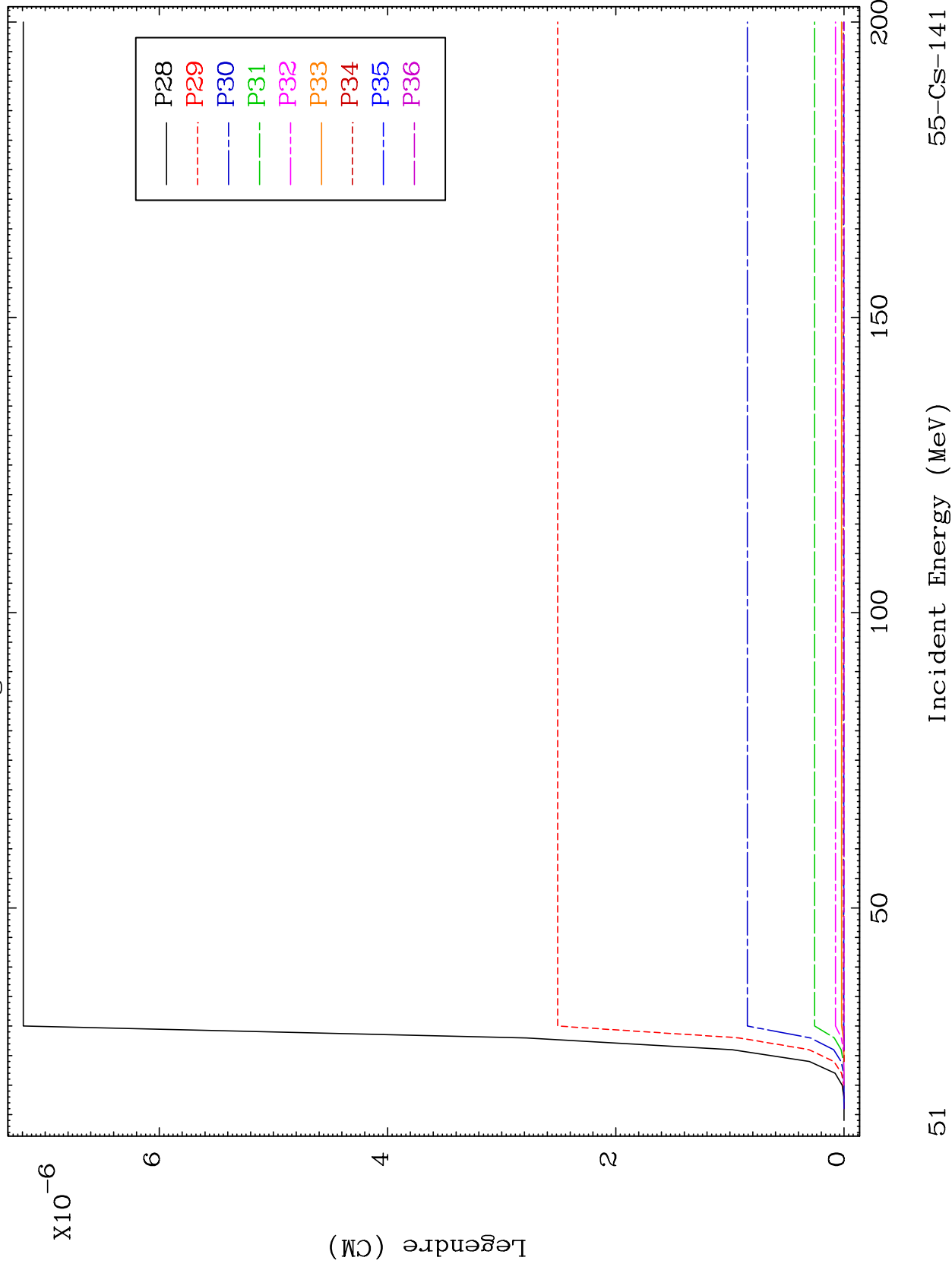

MAT 5549

MT= 59 (n,n') Level  
Legendre Coefficients

55-Cs-141

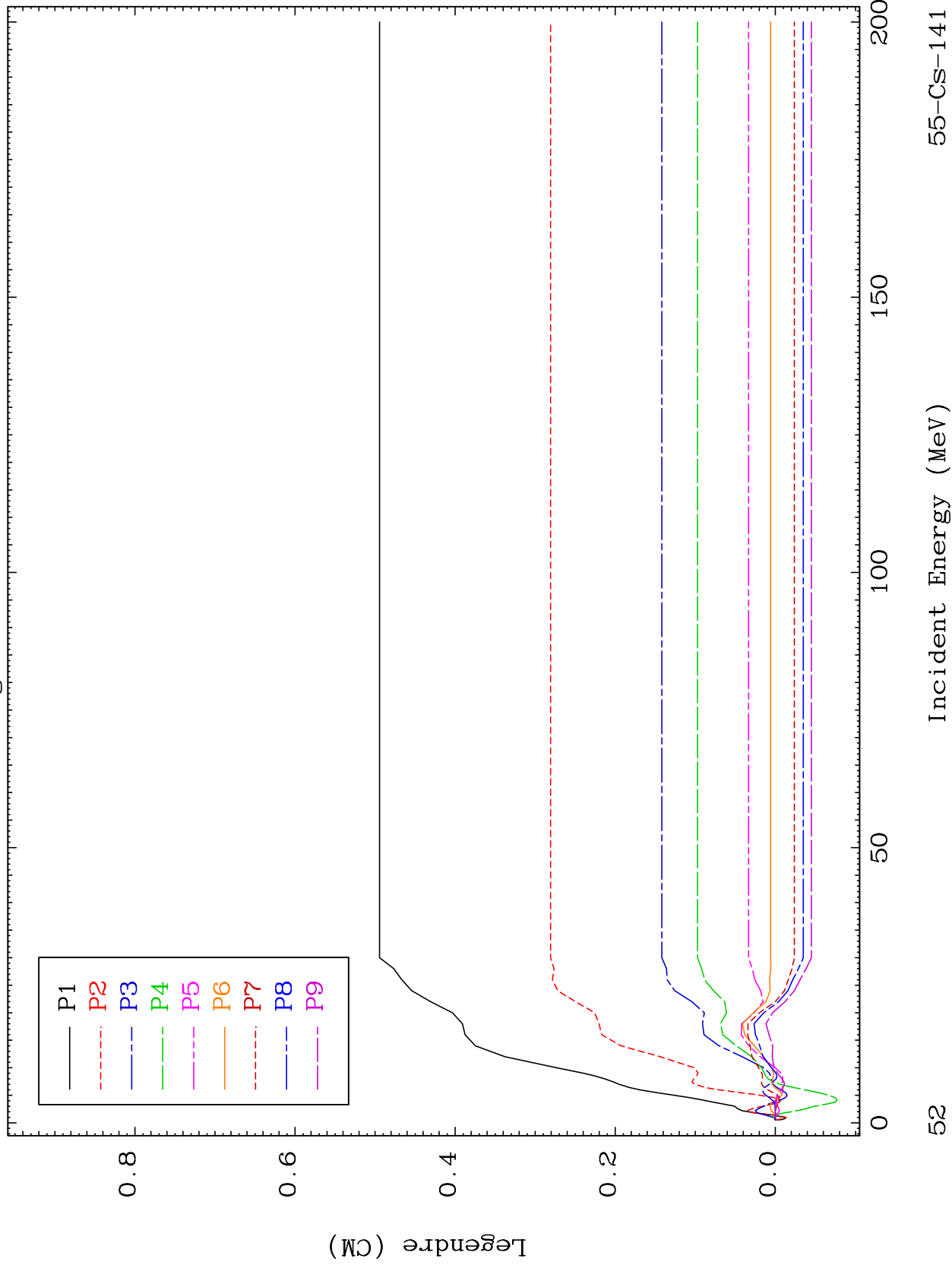

52

55-Cs-141

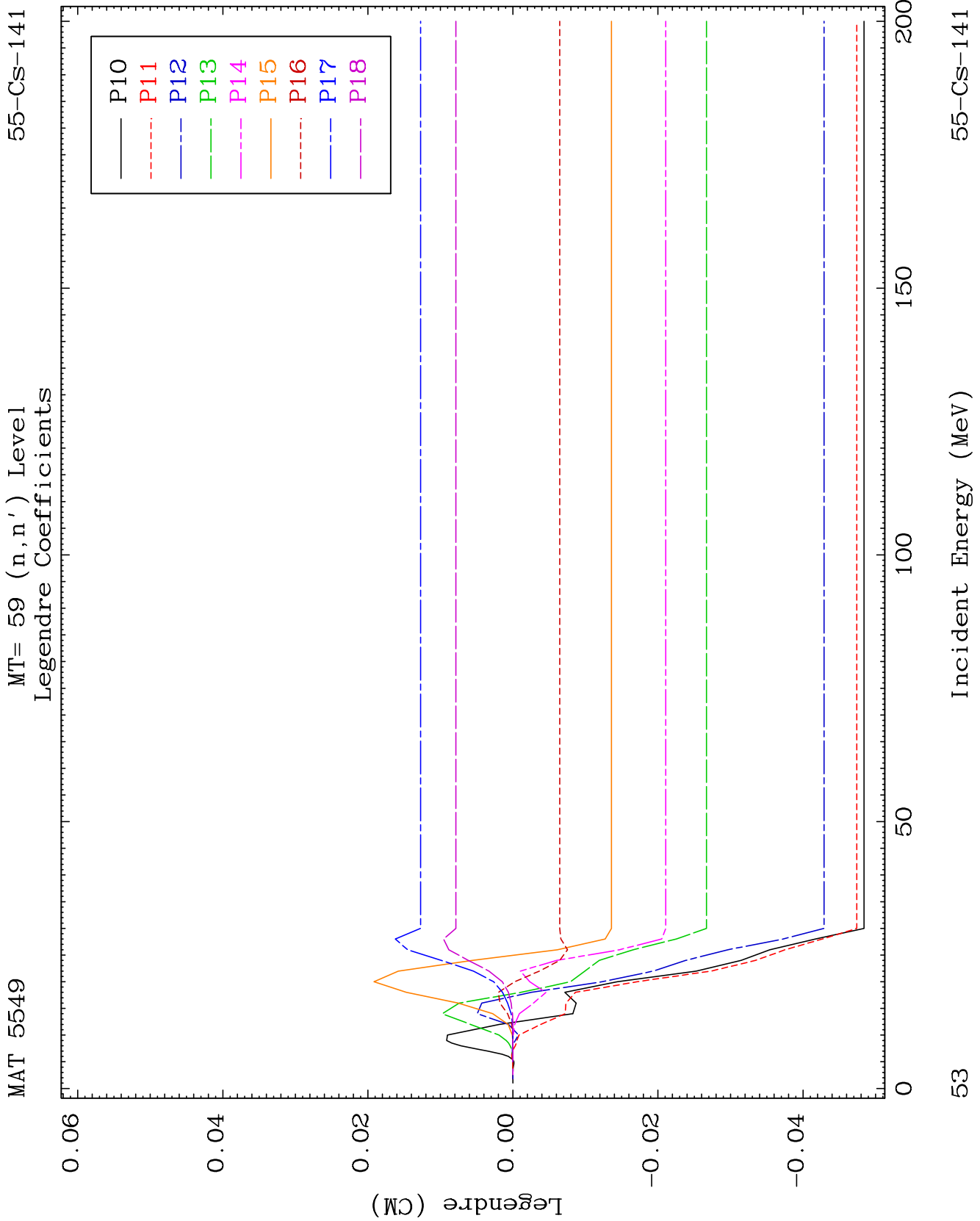

MAT 5549

MT= 59 (n,n') Level  
Legendre Coefficients

55-Cs-141

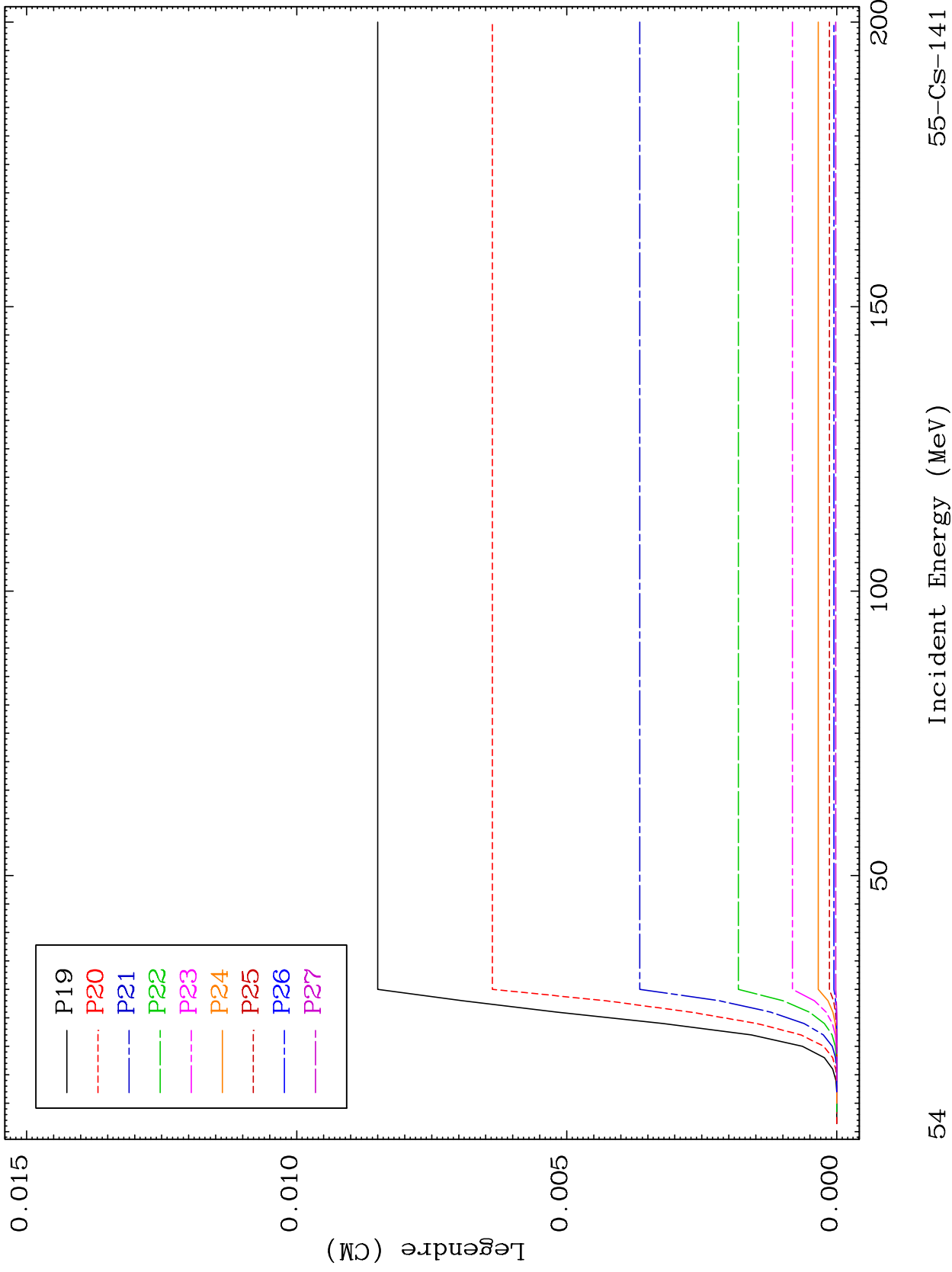

54

Incident Energy (MeV)

55-Cs-141

MAT 5549

MT= 59 (n,n') Level  
Legendre Coefficients

55-Cs-141

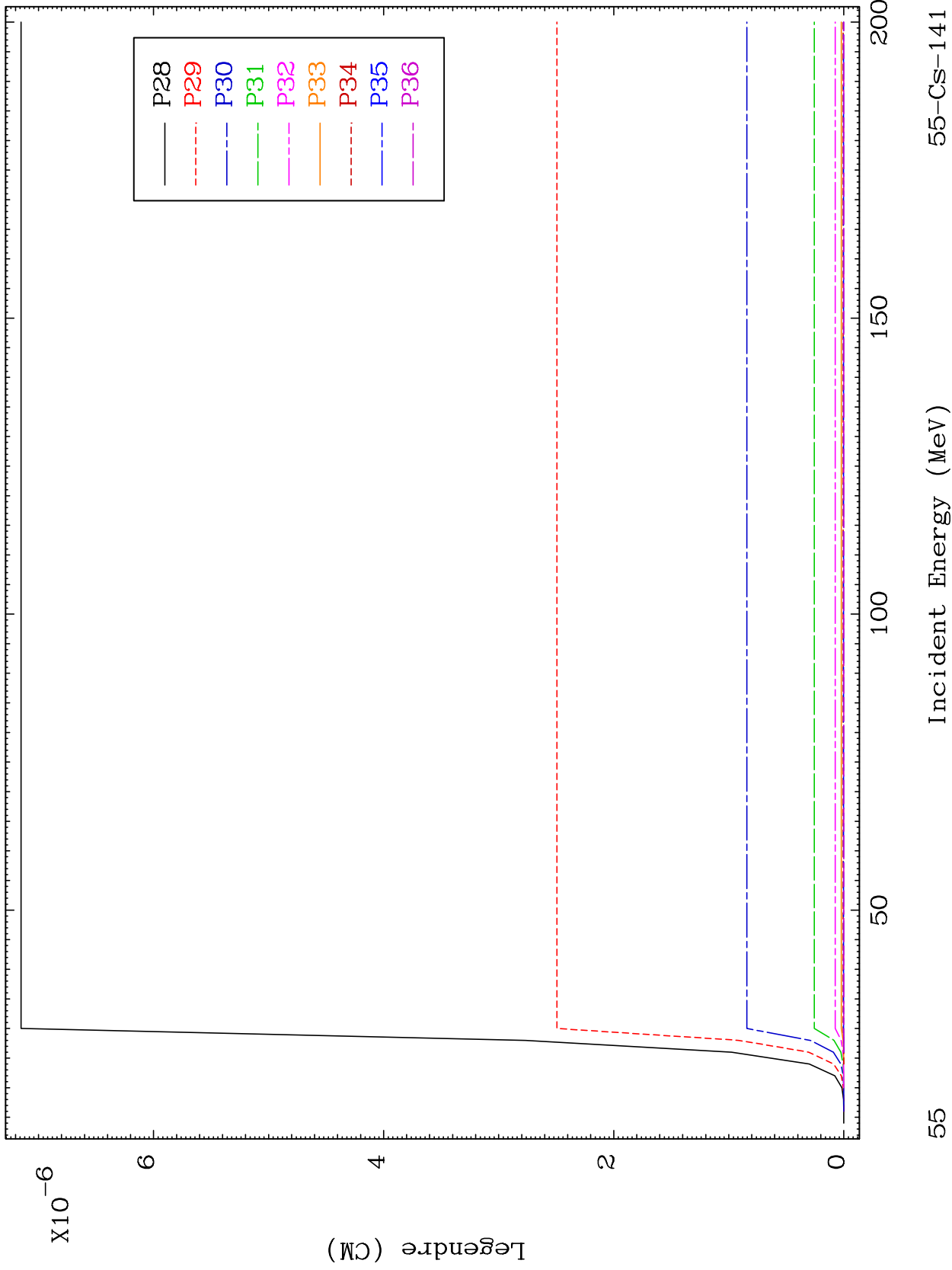



MAT 5549

MT= 60 (n,n') Level  
Legendre Coefficients

55-Cs-141

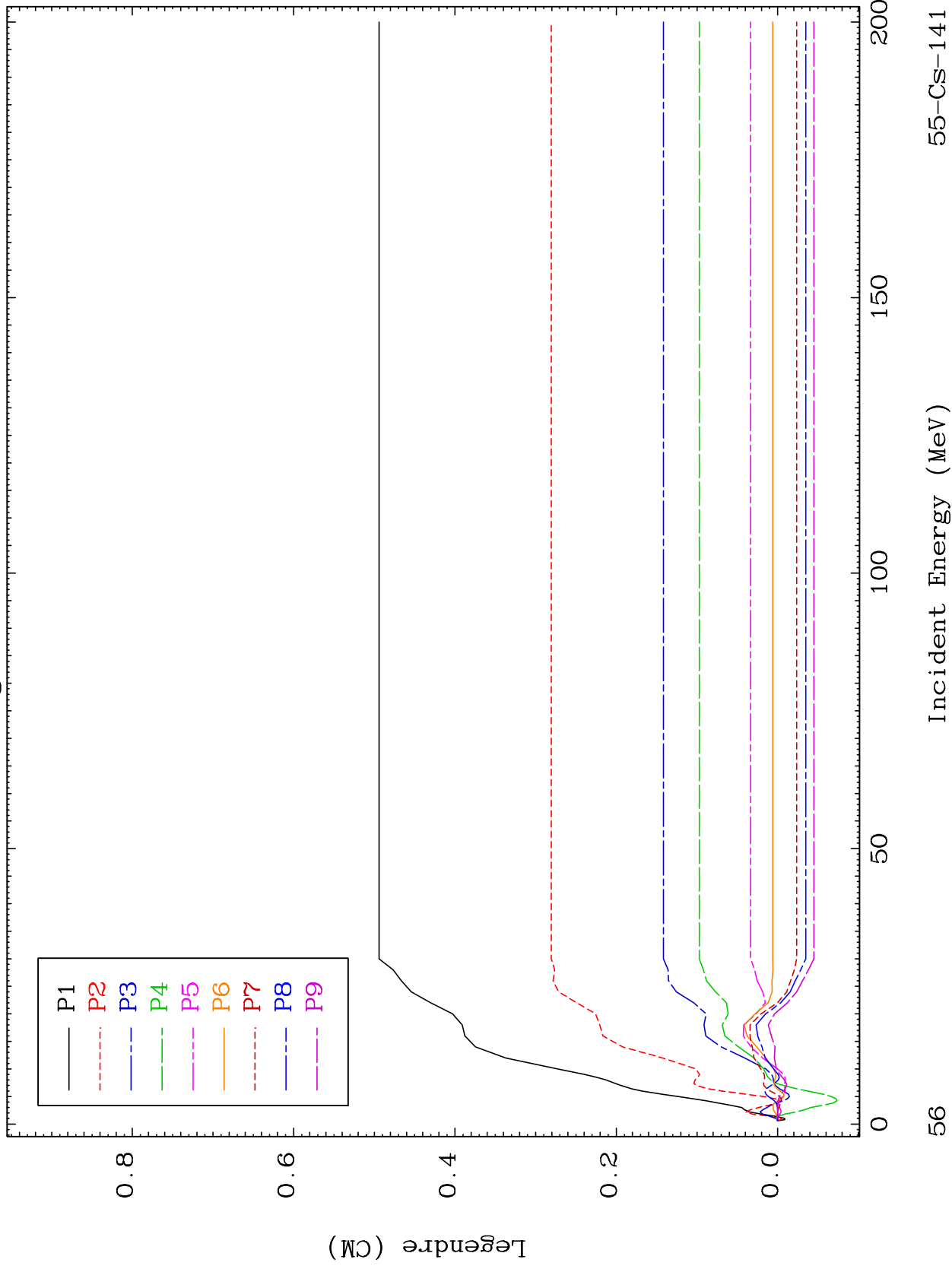

55-Cs-141

Incident Energy (MeV)

56

MAT 5549

MT= 60 (n,n') Level  
Legendre Coefficients

55-Cs-141

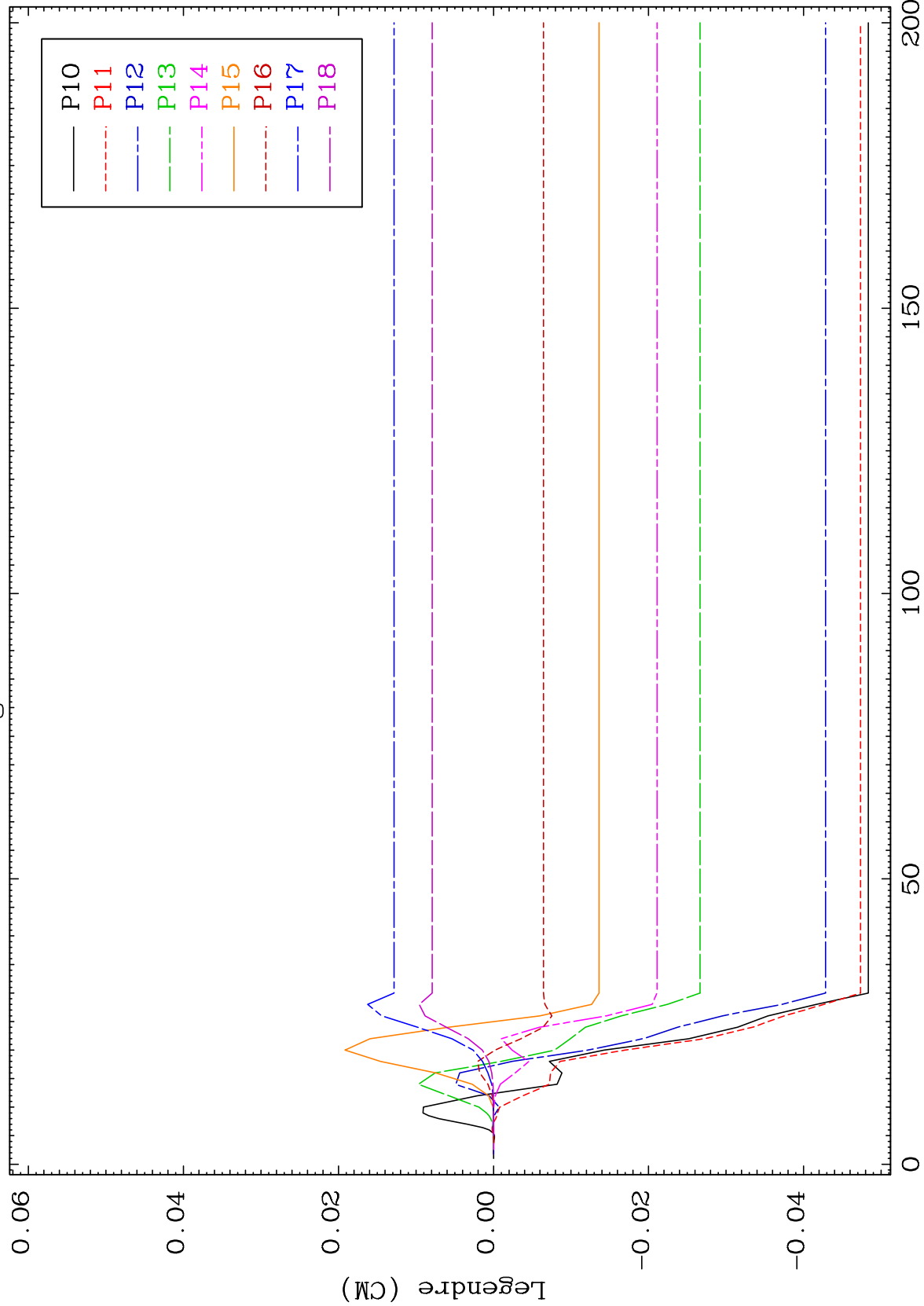

57

Incident Energy (MeV)

55-Cs-141

MAT 5549

MT= 60 (n,n') Level  
Legendre Coefficients

55-Cs-141

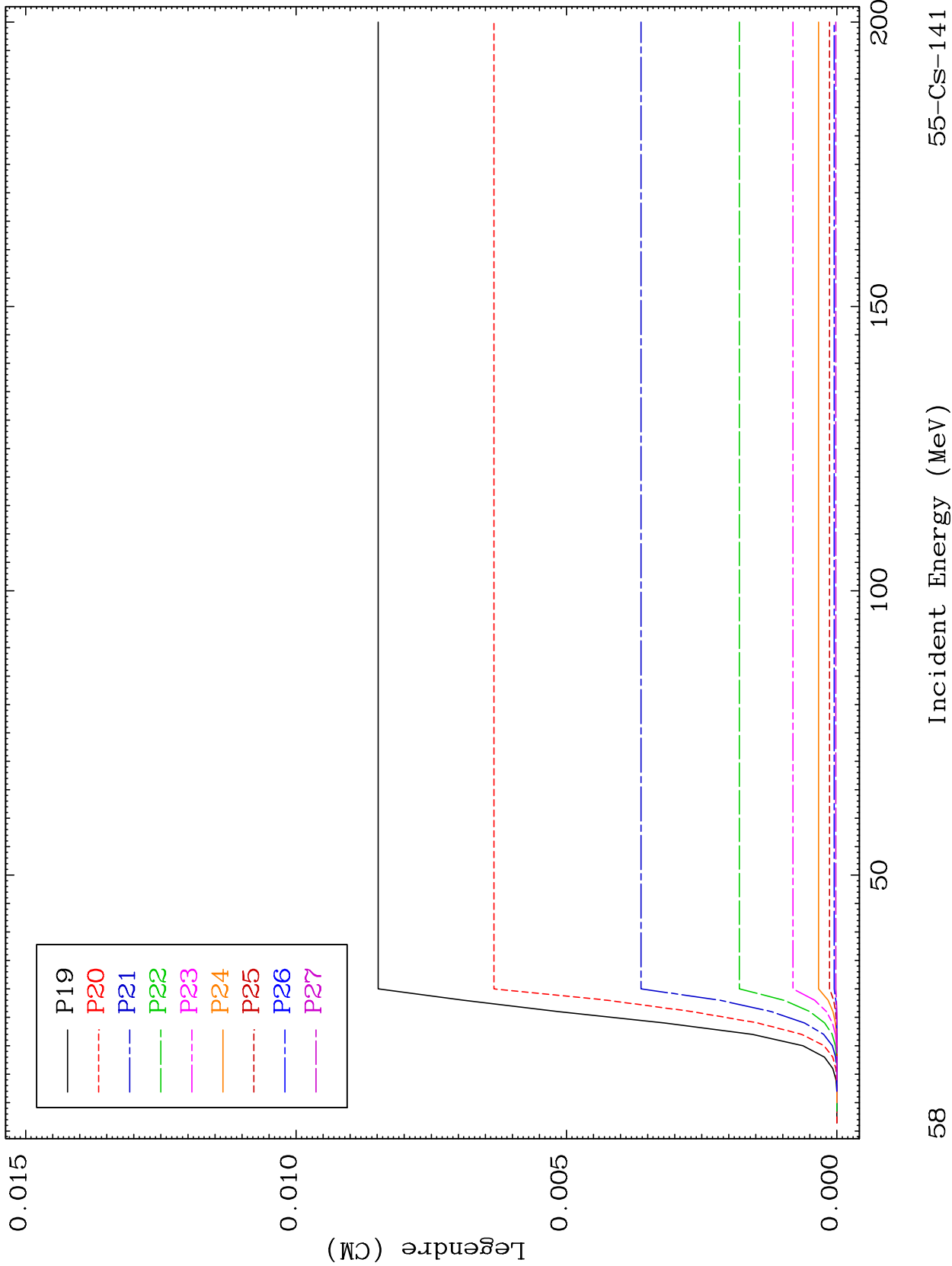

58

Incident Energy (MeV)

55-Cs-141

MAT 5549

MT= 60 (n,n') Level  
Legendre Coefficients

55-Cs-141

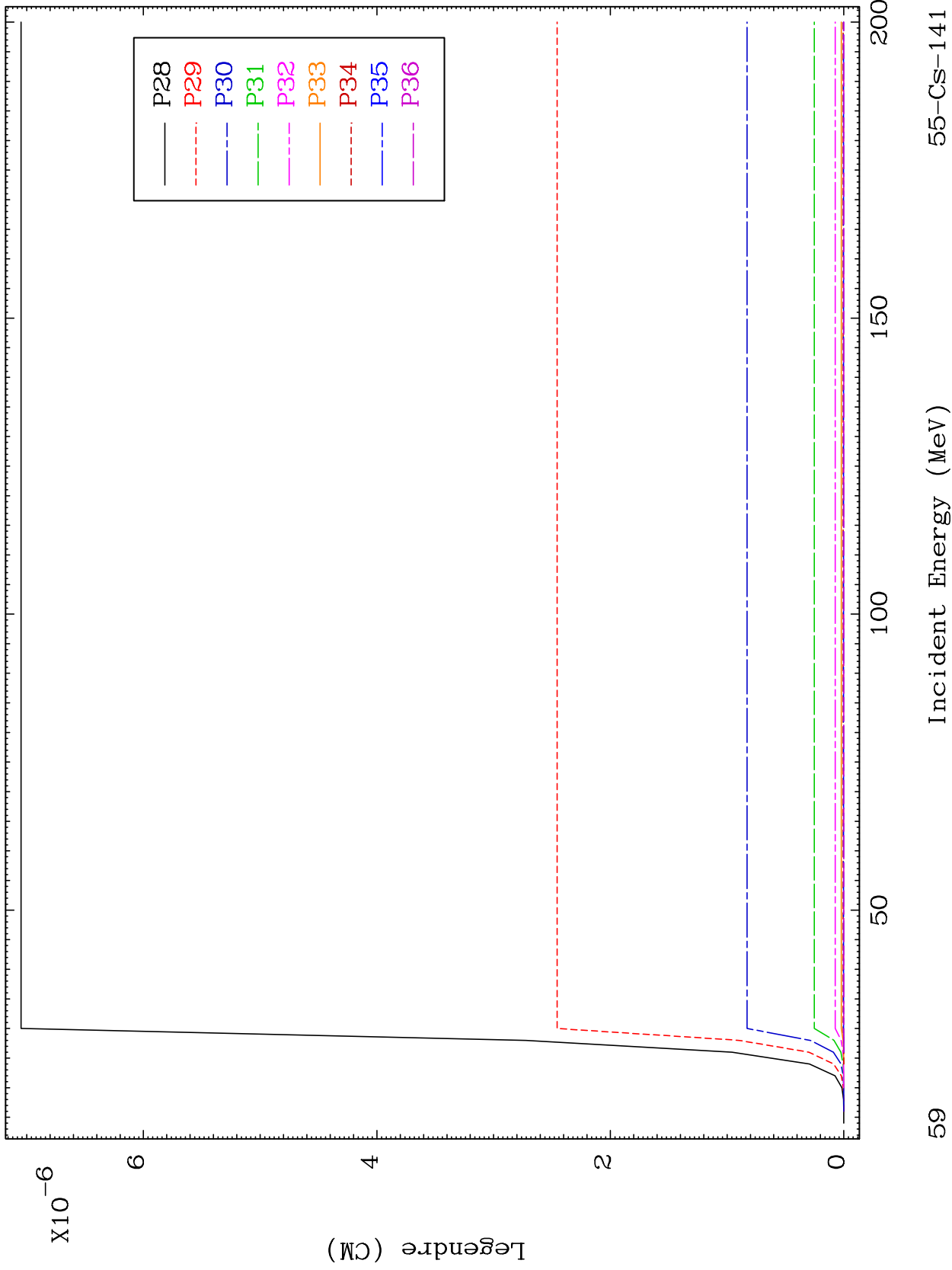

59

Incident Energy (MeV)

55-Cs-141

MAT 5549

MT= 61 (n,n') Level  
Legendre Coefficients

55-Cs-141

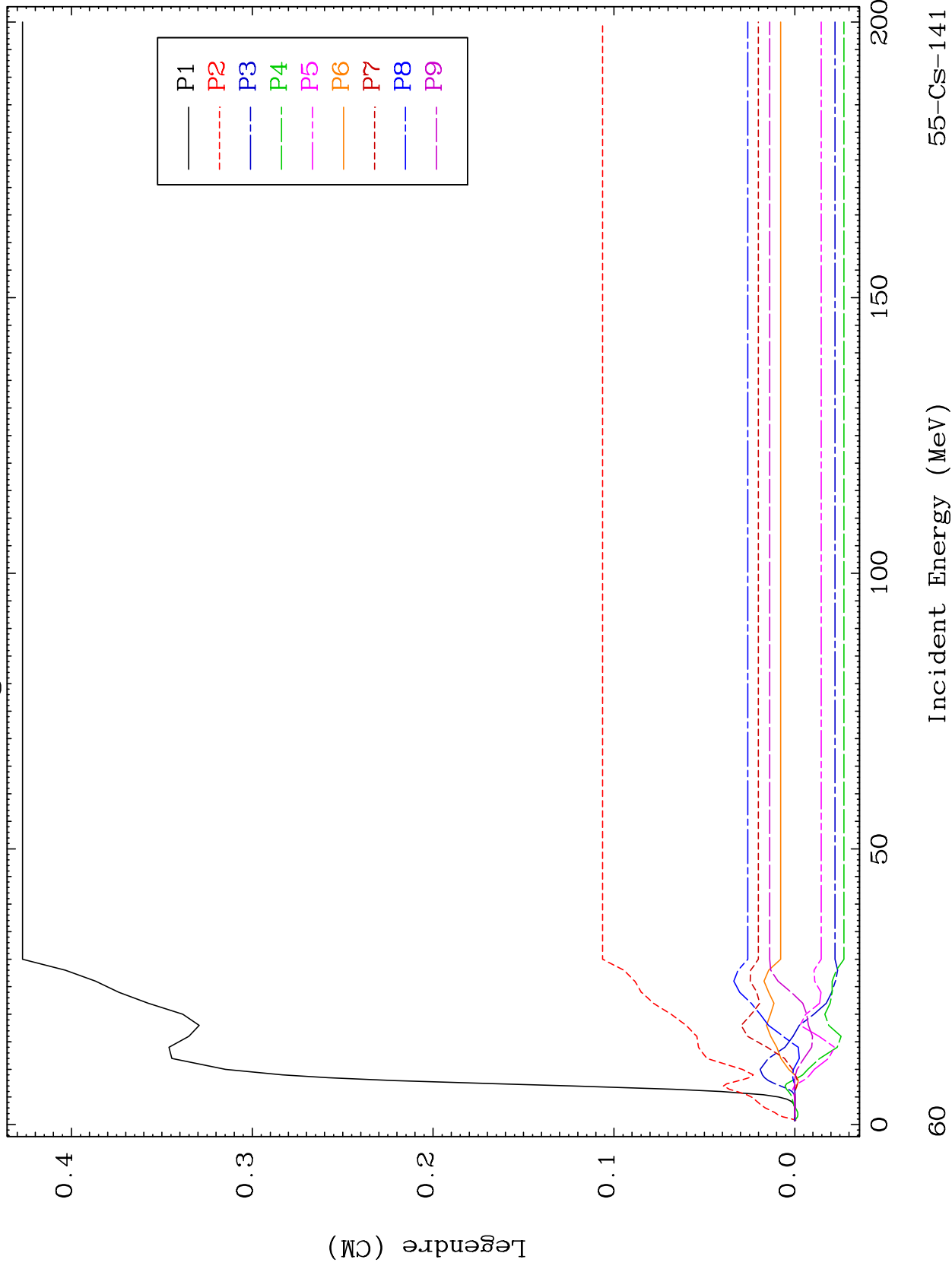

55-Cs-141

Incident Energy (MeV)

60

MAT 5549

MT= 61 (n,n') Level Legendre Coefficients

55-Cs-141

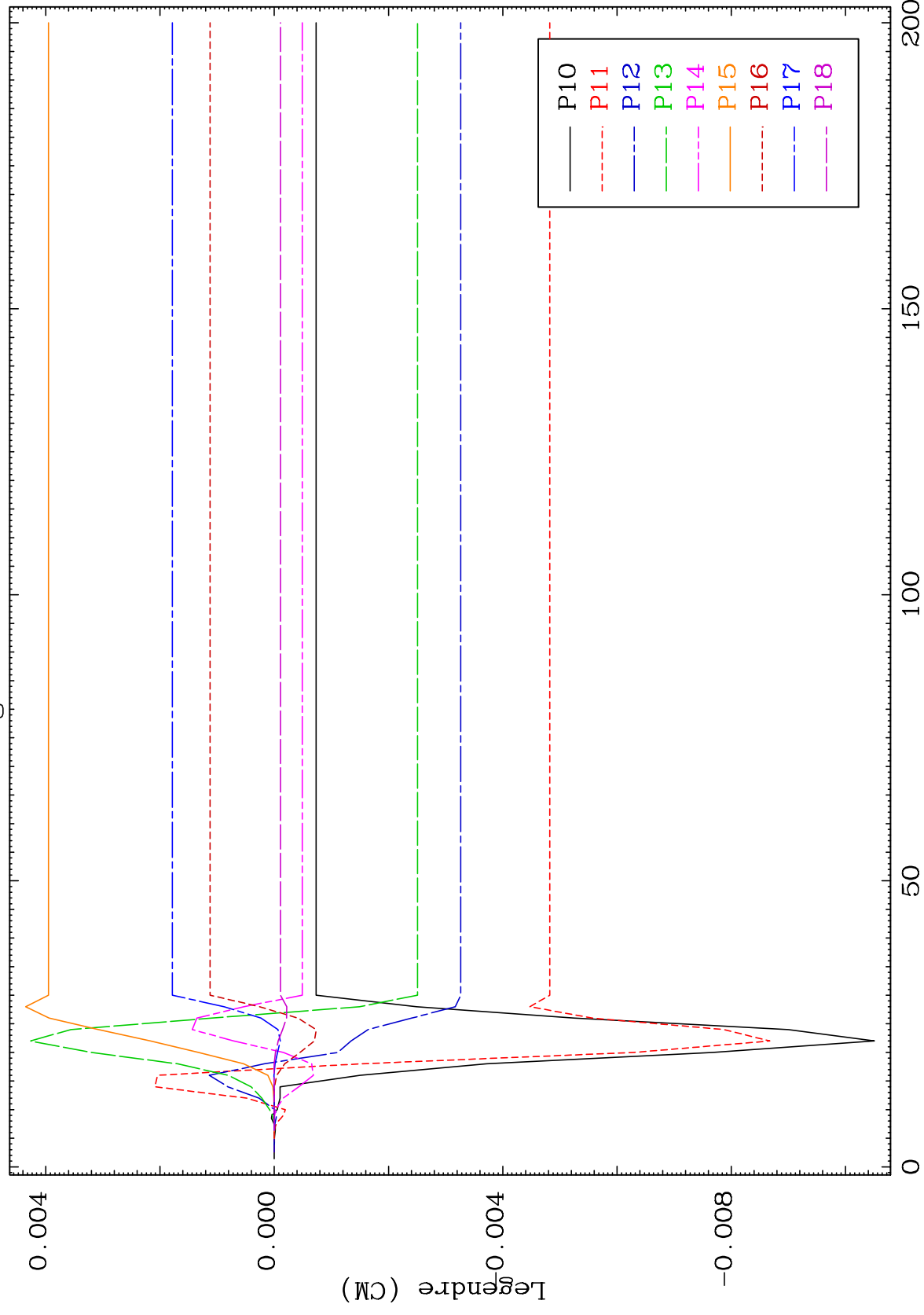

55-Cs-141

Incident Energy (MeV)

61

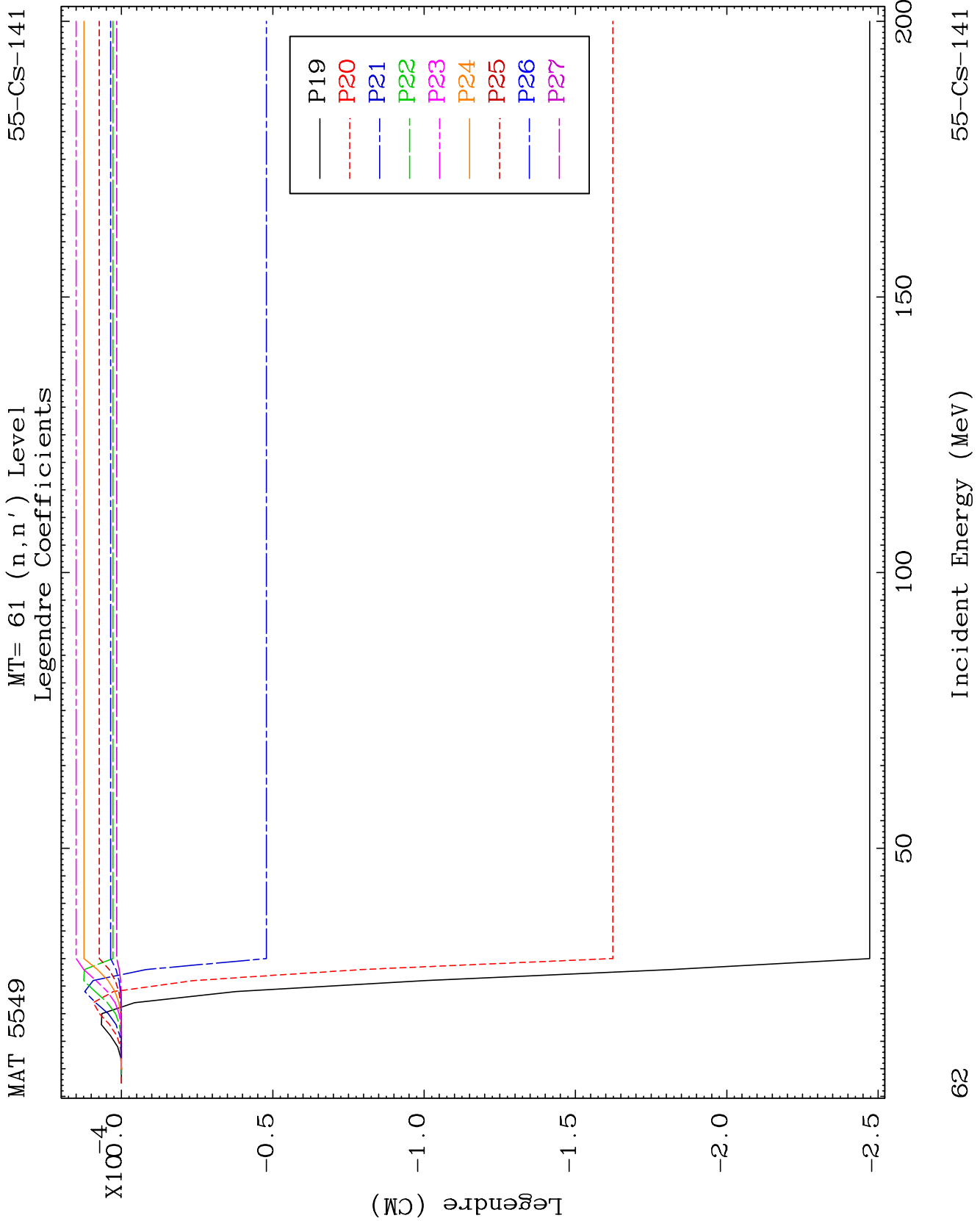

MAT 5549

MT= 61 (n,n') Level  
Legendre Coefficients

55-Cs-141

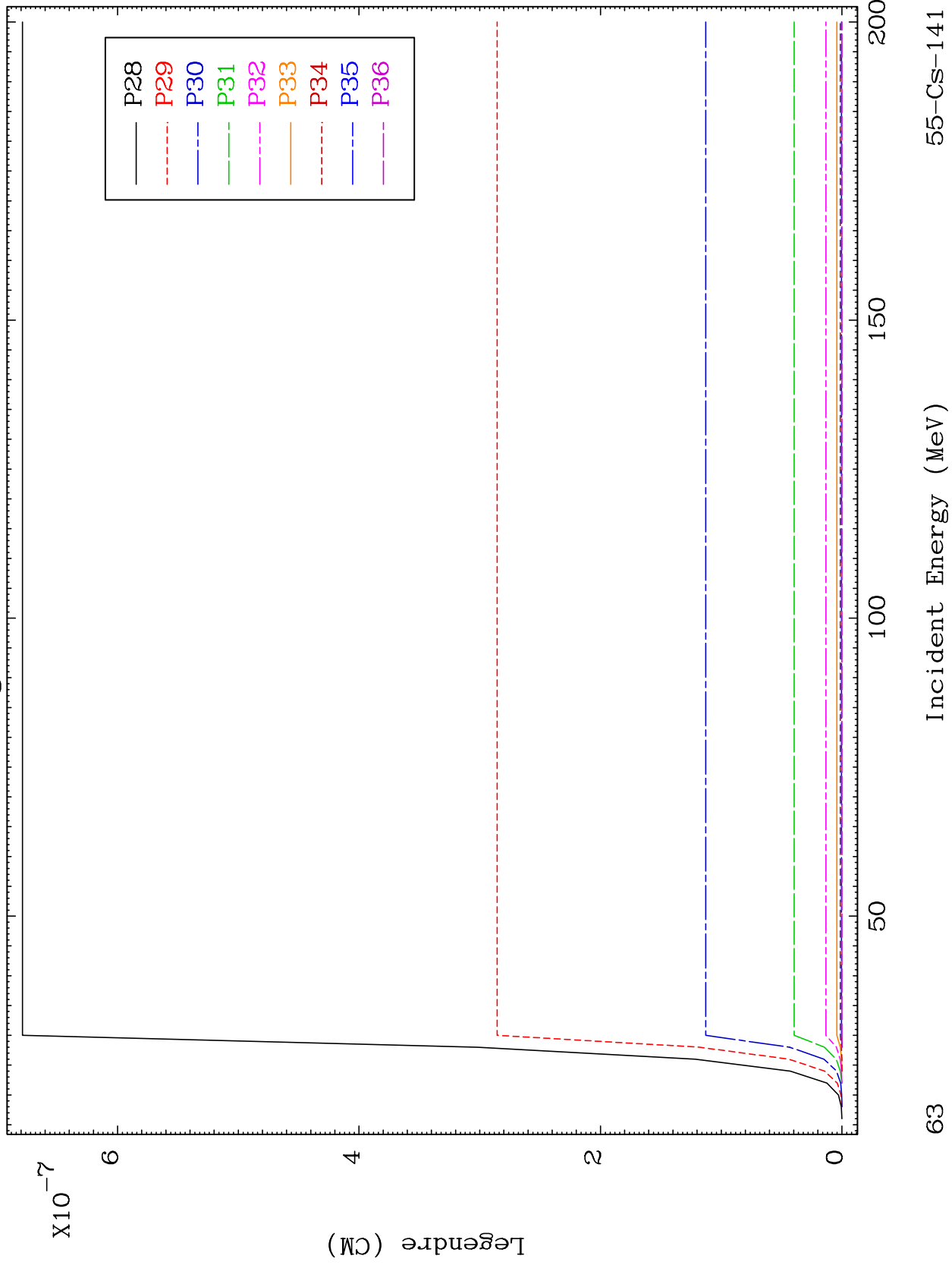



MAT 5549

MT= 62 (n,n') Level  
Legendre Coefficients

55-Cs-141

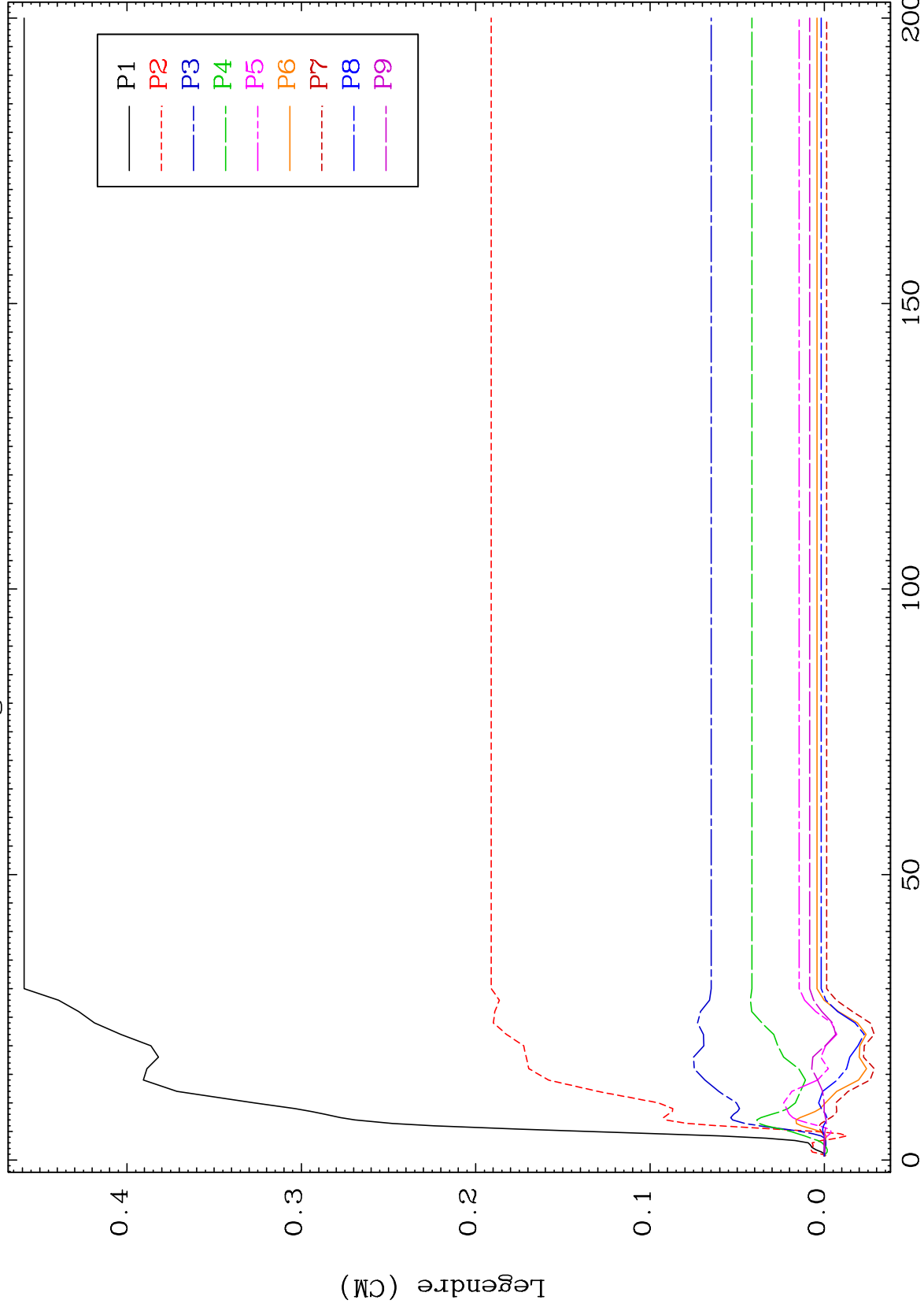

55-Cs-141

Incident Energy (MeV)

64

MAT 5549

MT= 62 (n,n') Level  
Legendre Coefficients

55-Cs-141

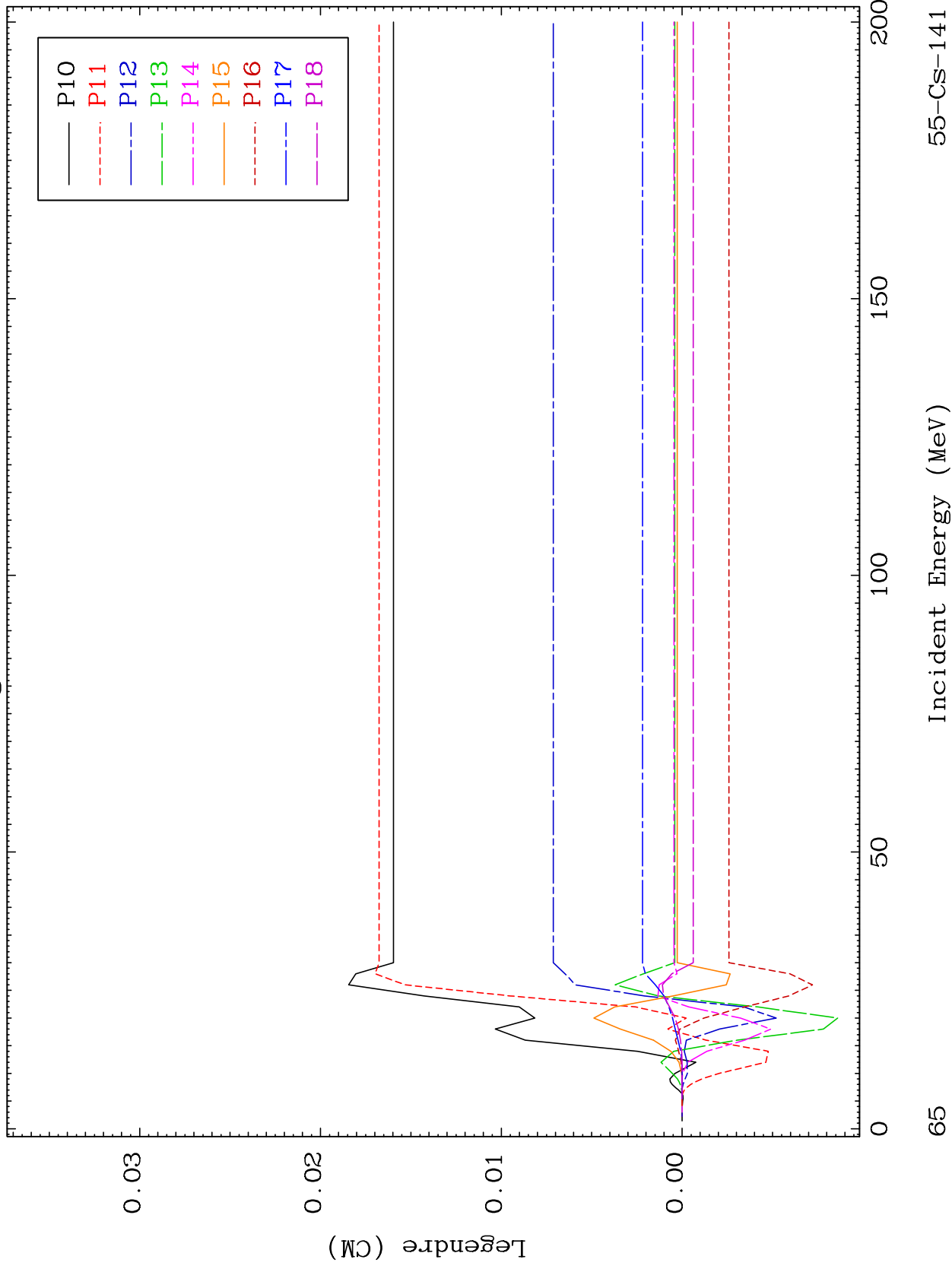

55-Cs-141

Incident Energy (MeV)

65

MAT 5549

MT= 62 (n,n') Level  
Legendre Coefficients

55-Cs-141

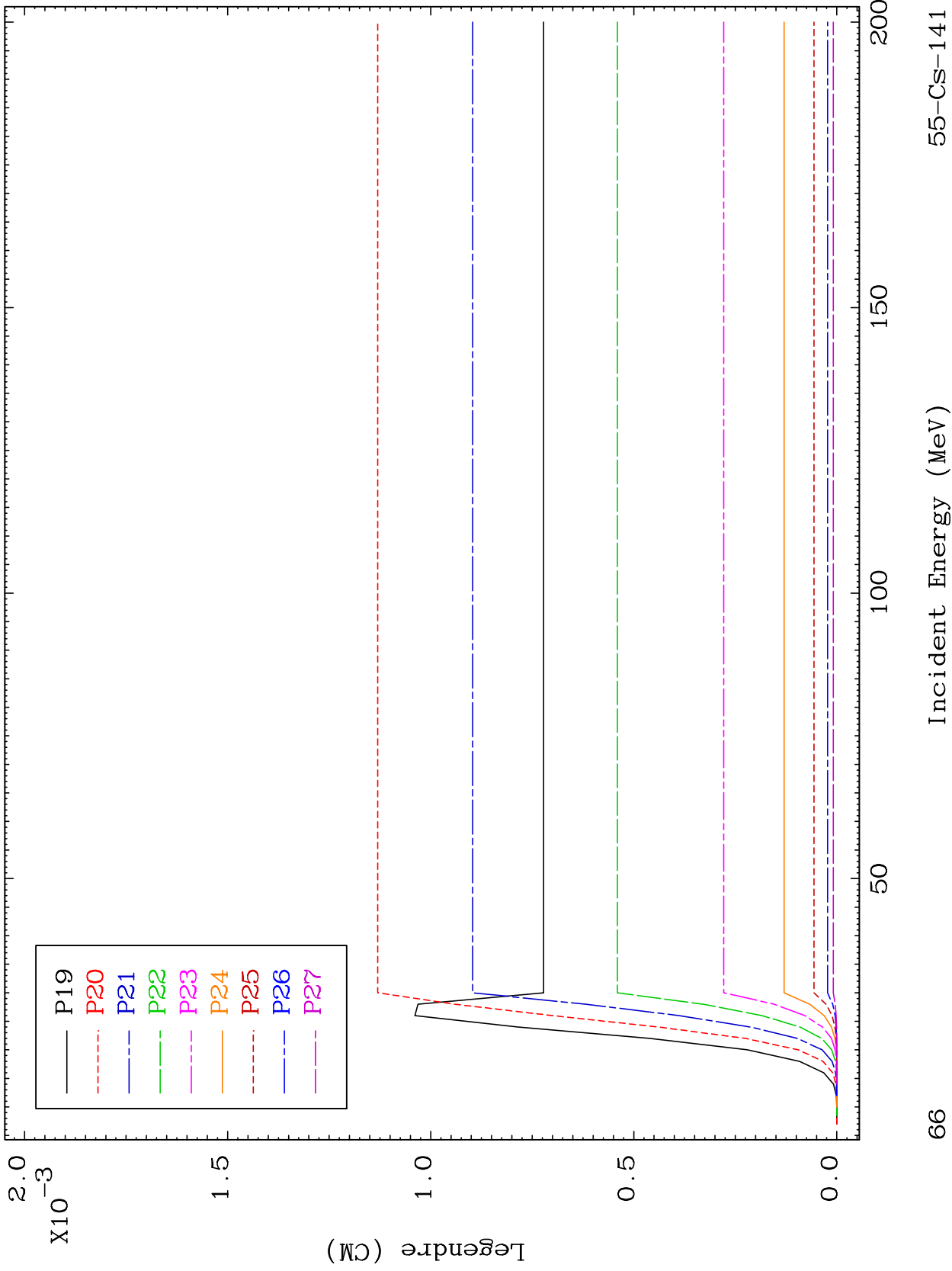

MAT 5549

MT= 62 (n,n') Level  
Legendre Coefficients

55-Cs-141

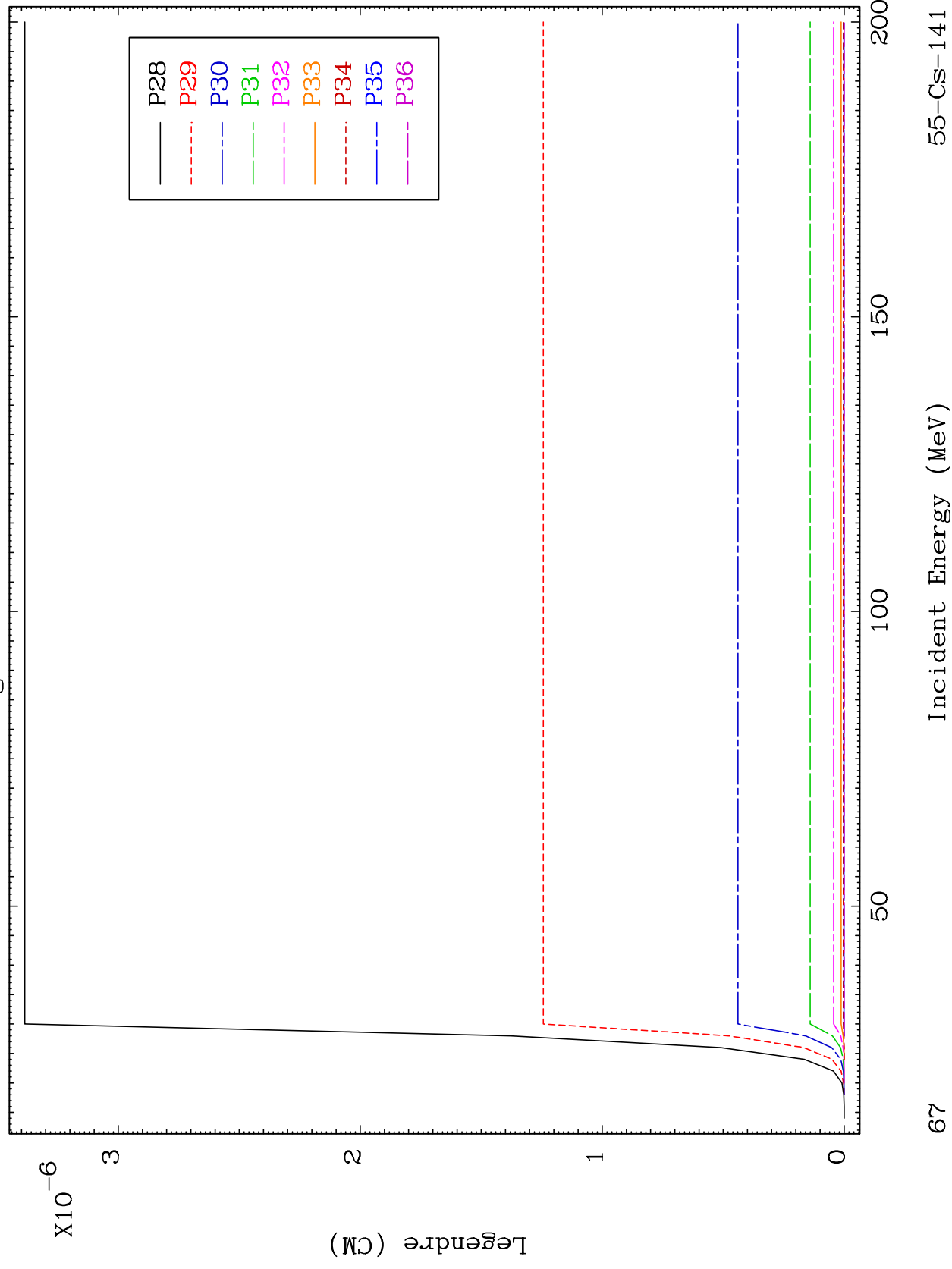

MAT 5549

MT= 63 (n,n') Level  
Legendre Coefficients

55-Cs-141

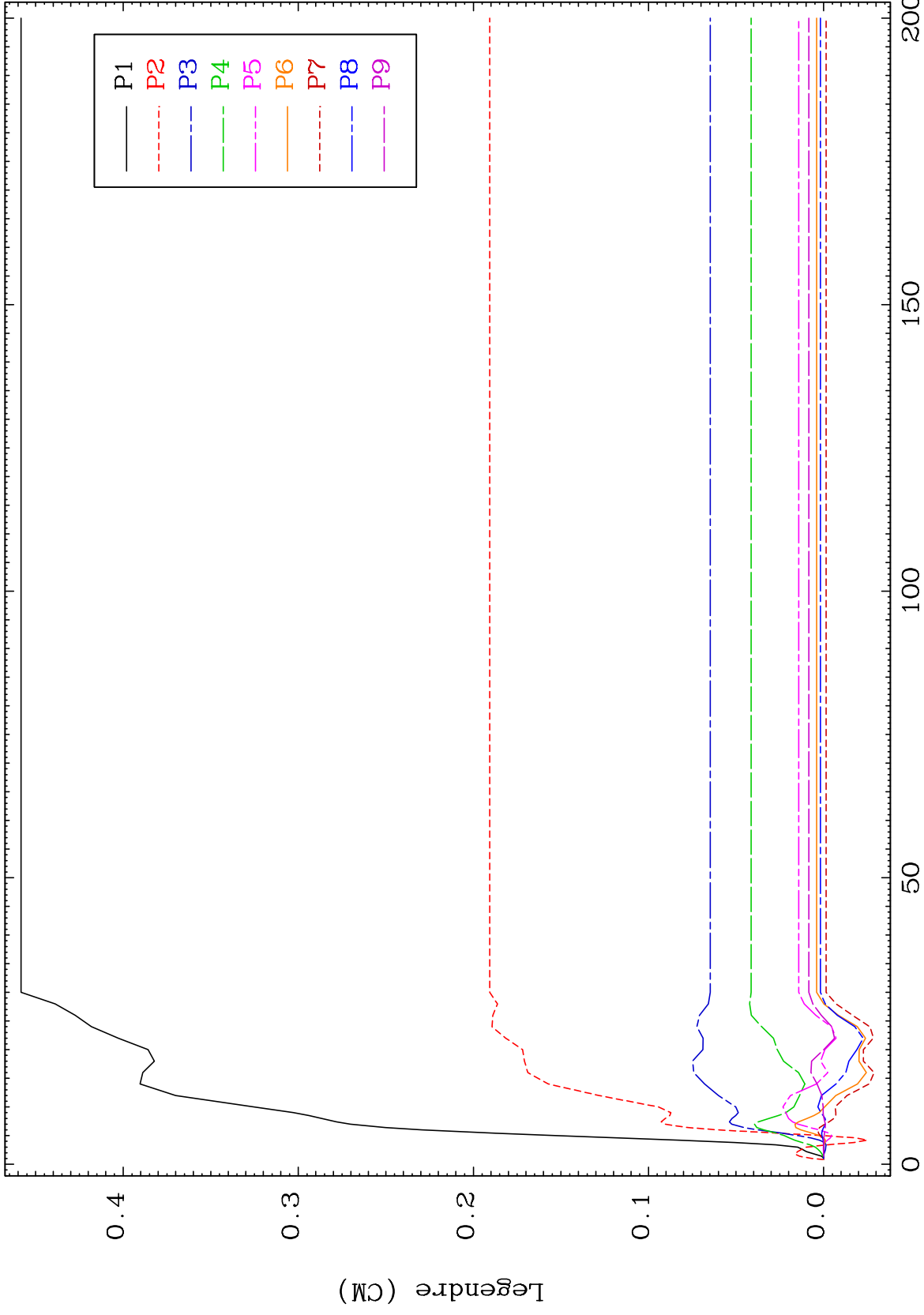

68

Incident Energy (MeV)

55-Cs-141

MAT 5549

MT= 63 (n,n') Level  
Legendre Coefficients

55-Cs-141

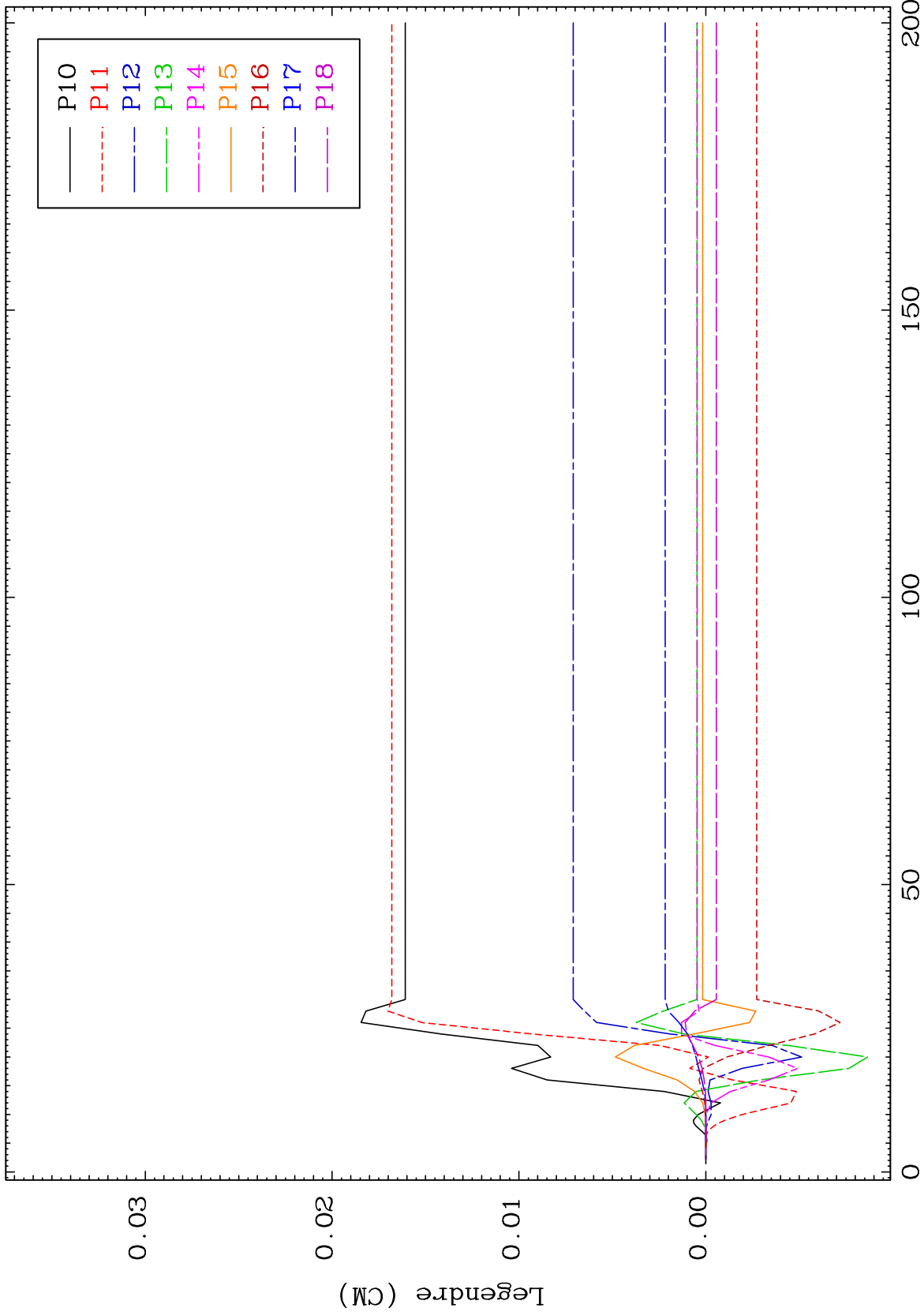

69

Incident Energy (MeV)

55-Cs-141

MAT 5549

MT= 63 (n,n') Level  
Legendre Coefficients

55-Cs-141

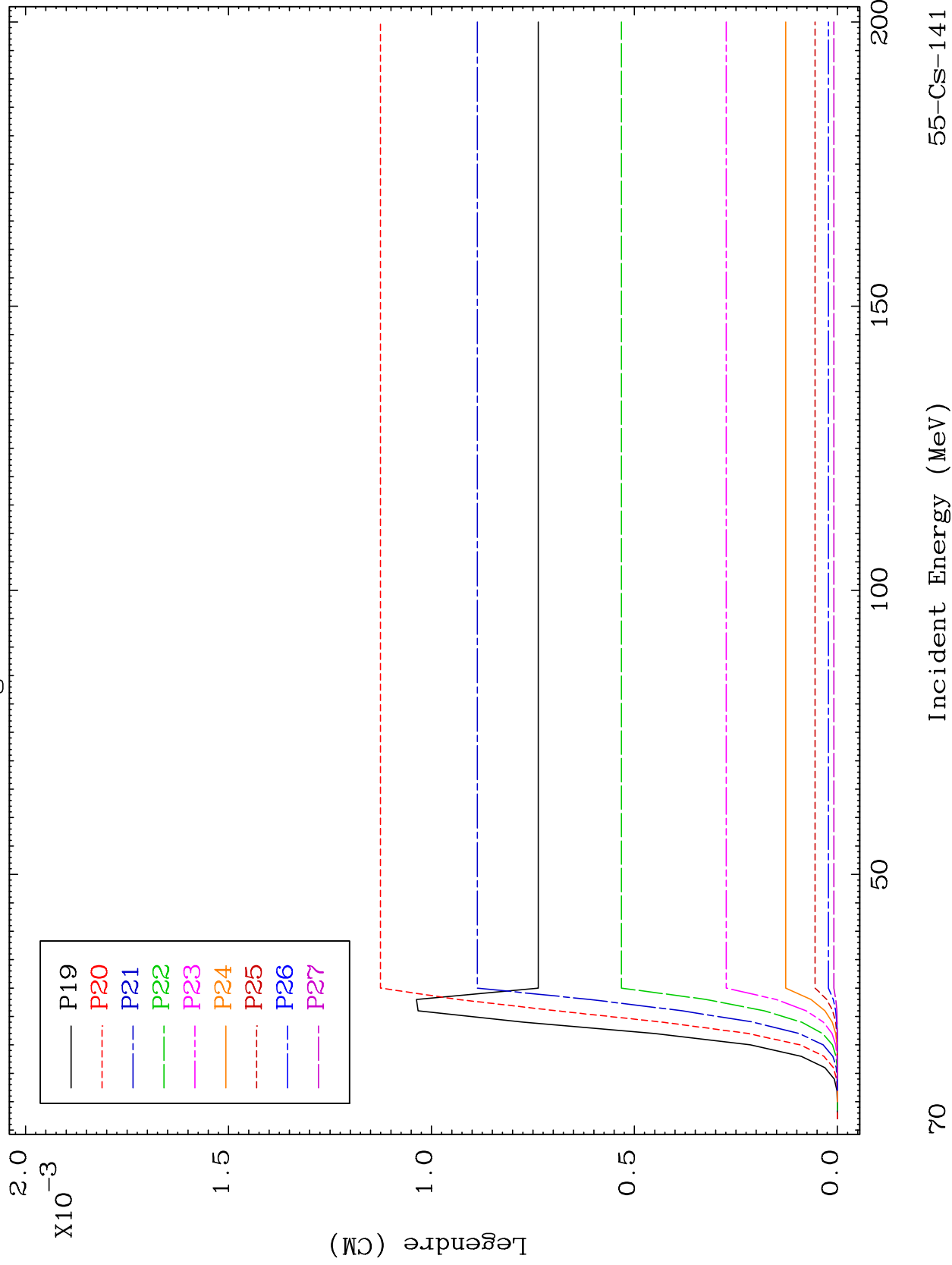

MAT 5549

MT= 63 (n,n') Level  
Legendre Coefficients

55-Cs-141

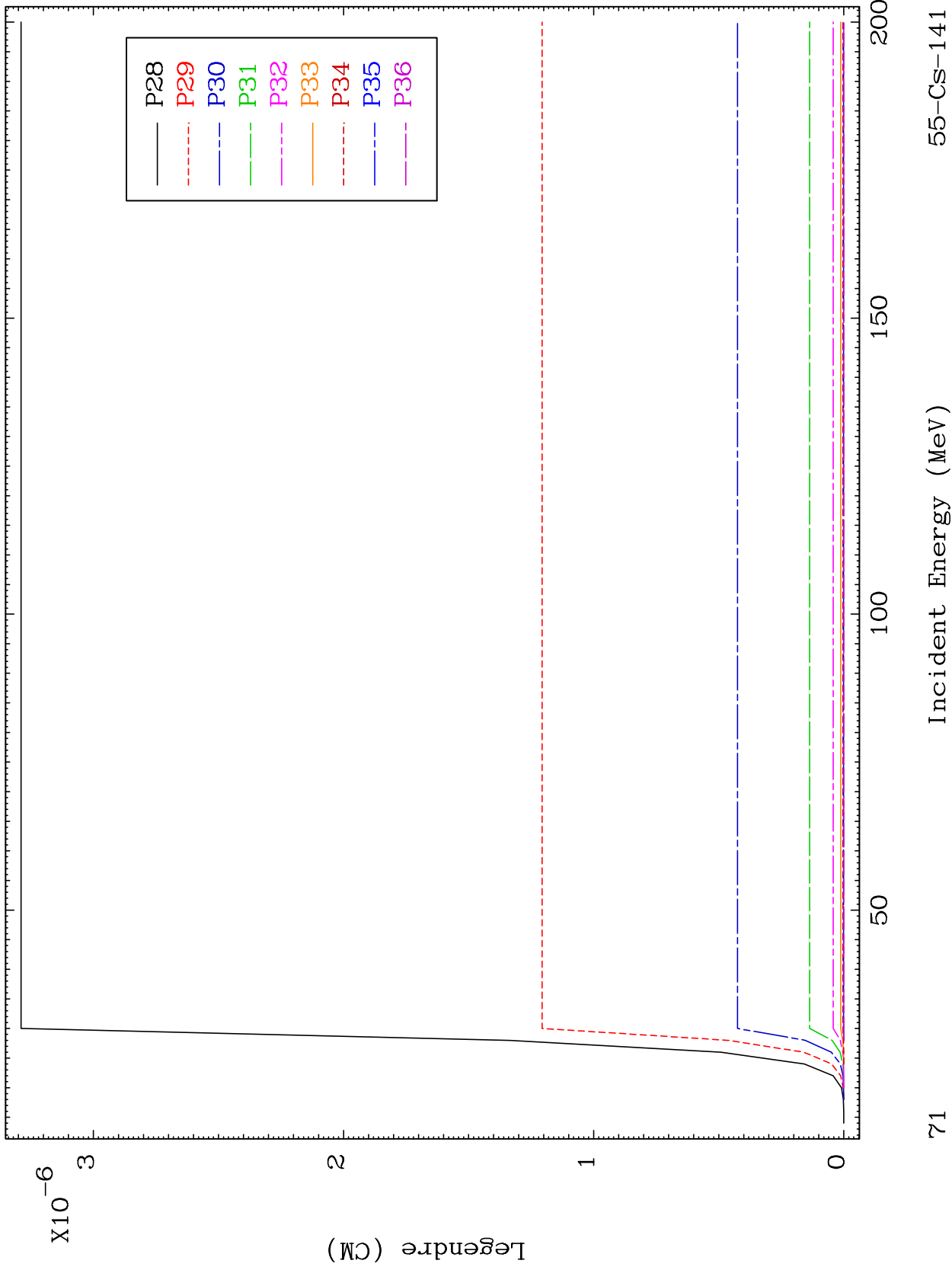



MAT 5549

MT= 64 (n,n') Level  
Legendre Coefficients

55-Cs-141

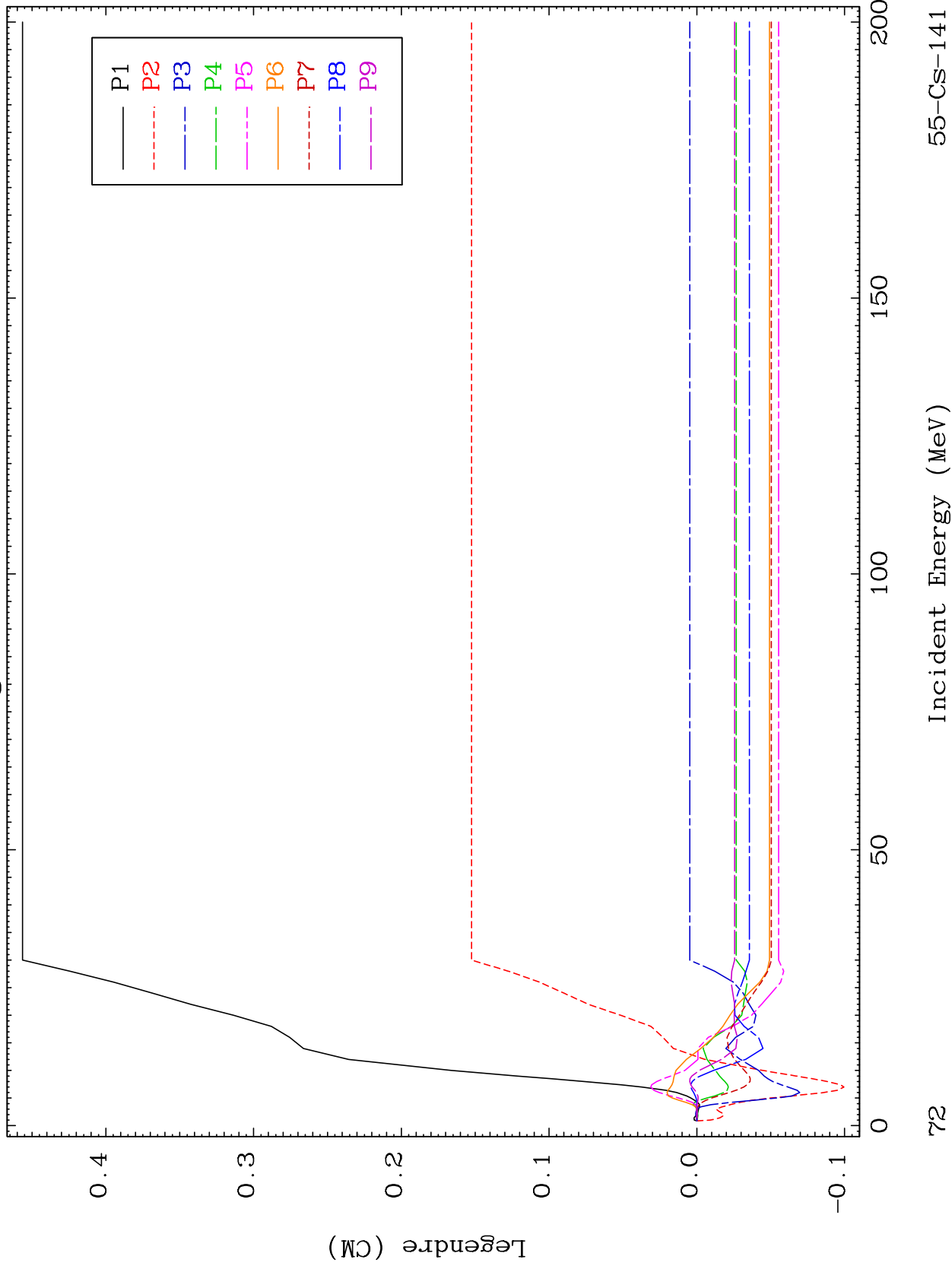

55-Cs-141

Incident Energy (MeV)

72

MAT 5549

MT= 64 (n,n') Level  
Legendre Coefficients

55-Cs-141

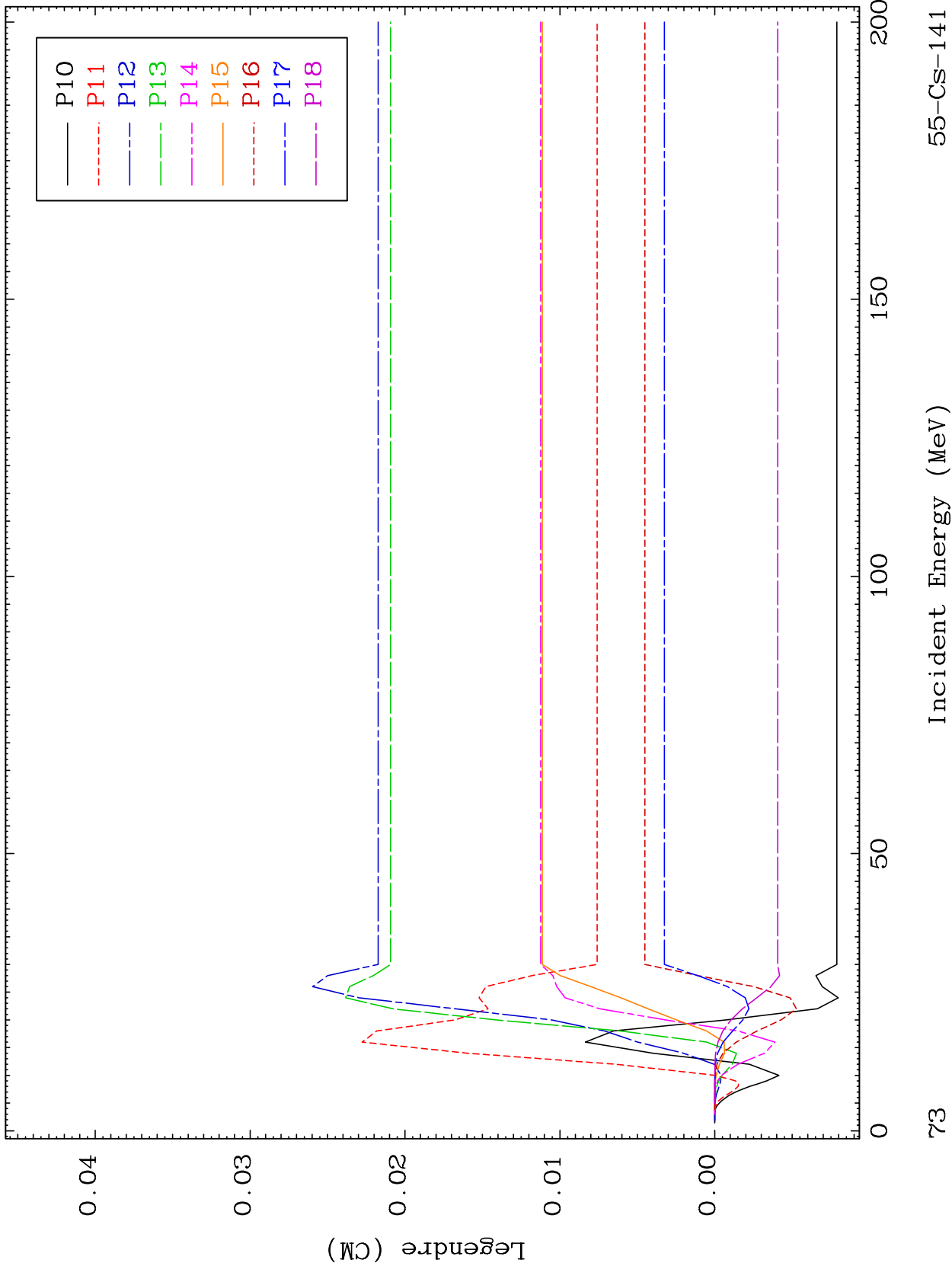

MAT 5549

MT= 64 (n,n') Level  
Legendre Coefficients

55-Cs-141

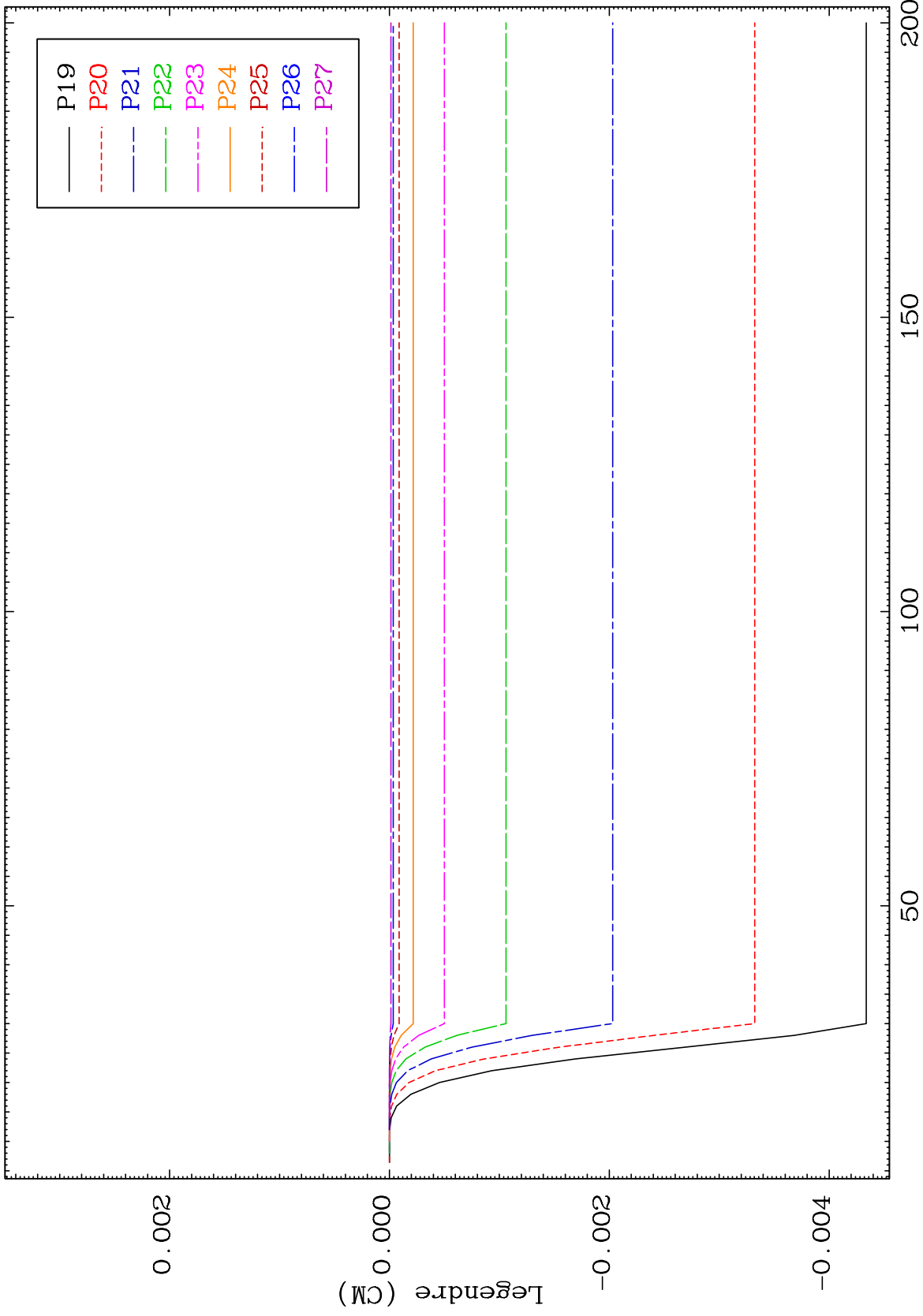

74

Incident Energy (MeV)

55-Cs-141

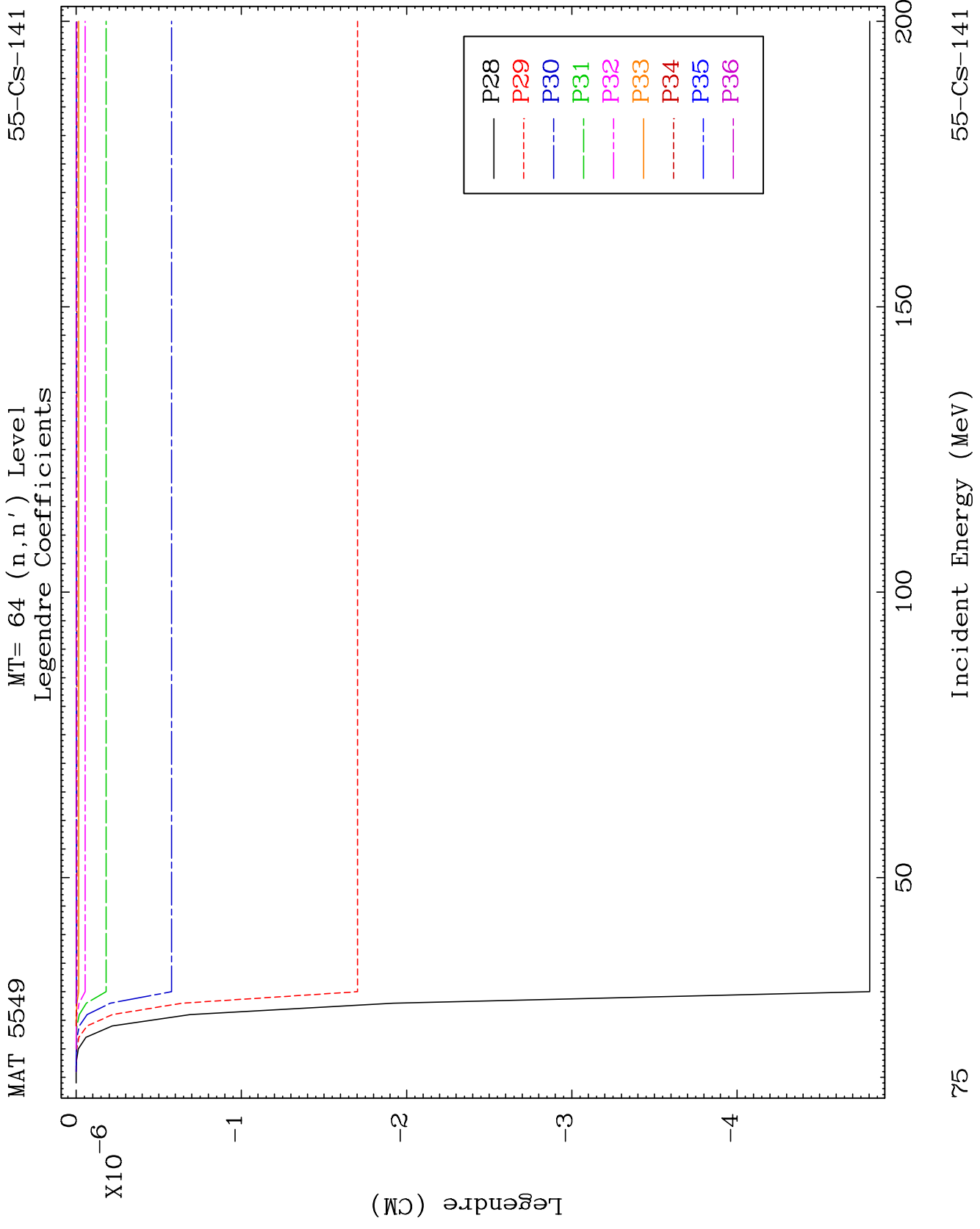

MAT 5549

MT= 65 (n,n') Level  
Legendre Coefficients

55-Cs-141

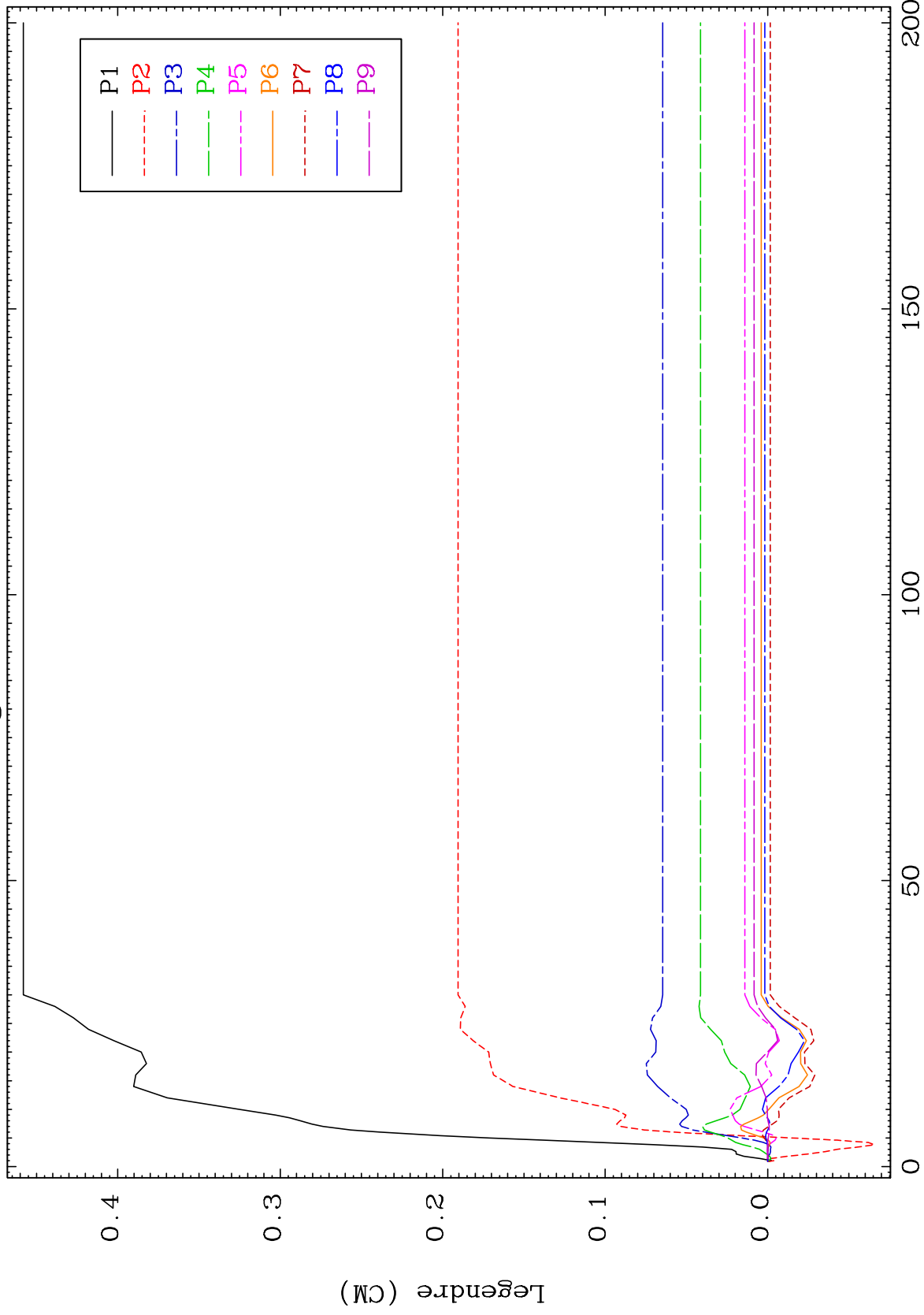

76

Incident Energy (MeV)

55-Cs-141

MAT 5549

MT= 65 (n,n') Level  
Legendre Coefficients

55-Cs-141

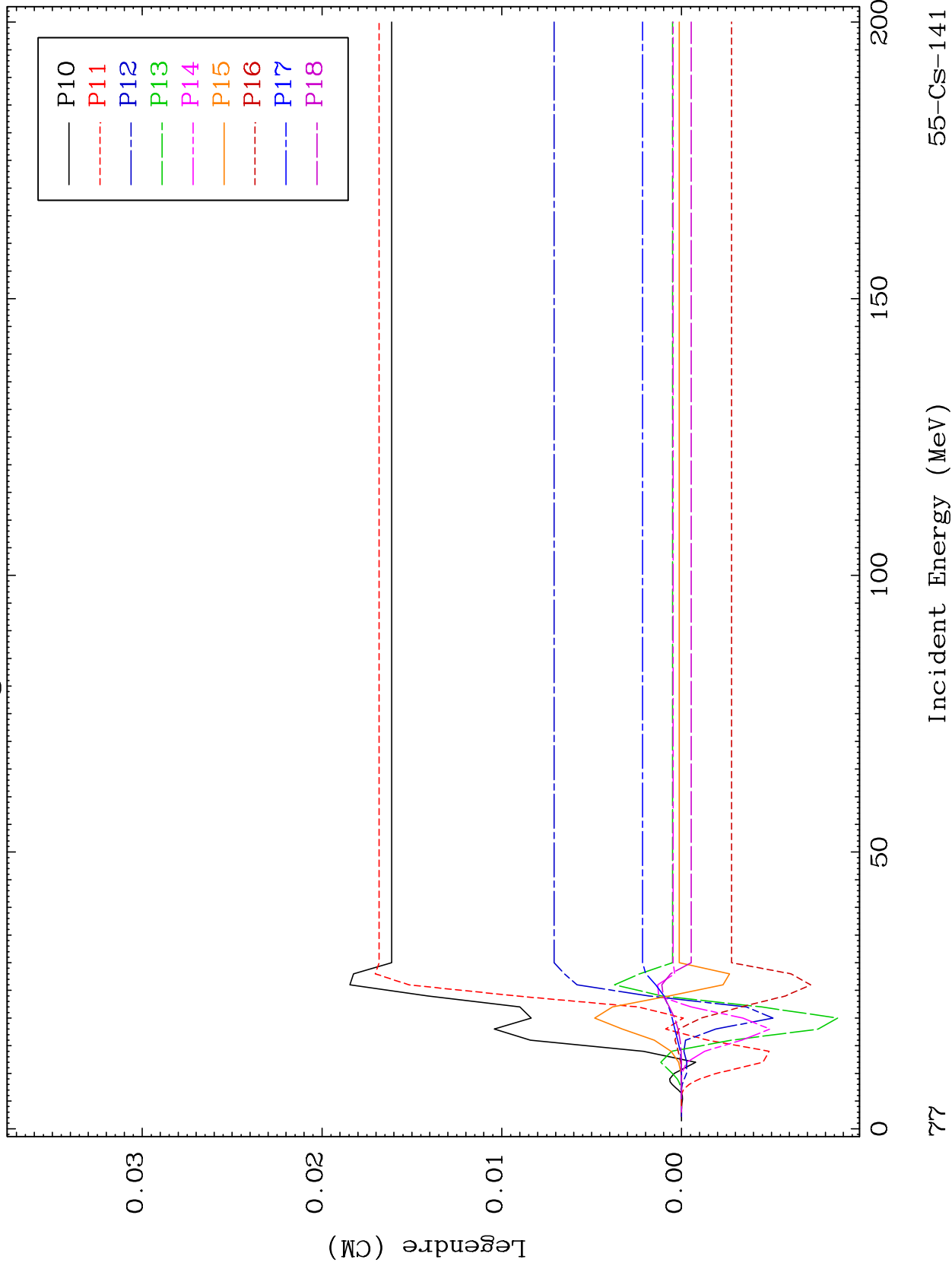

55-Cs-141

Incident Energy (MeV)

77

MAT 5549

MT= 65 (n,n') Level  
Legendre Coefficients

55-Cs-141

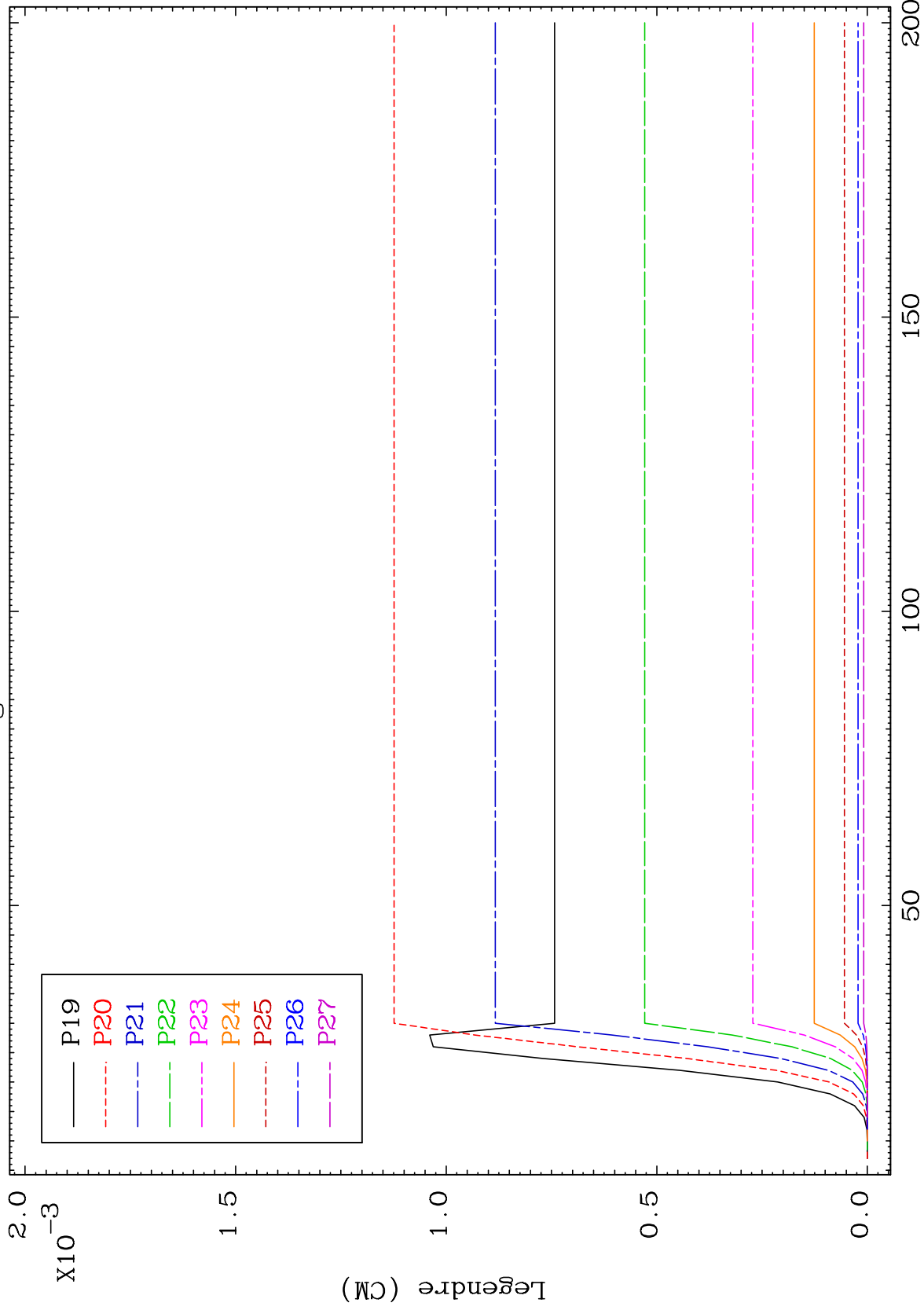

78

Incident Energy (MeV)

55-Cs-141

MAT 5549

MT= 65 (n,n') Level  
Legendre Coefficients

55-Cs-141

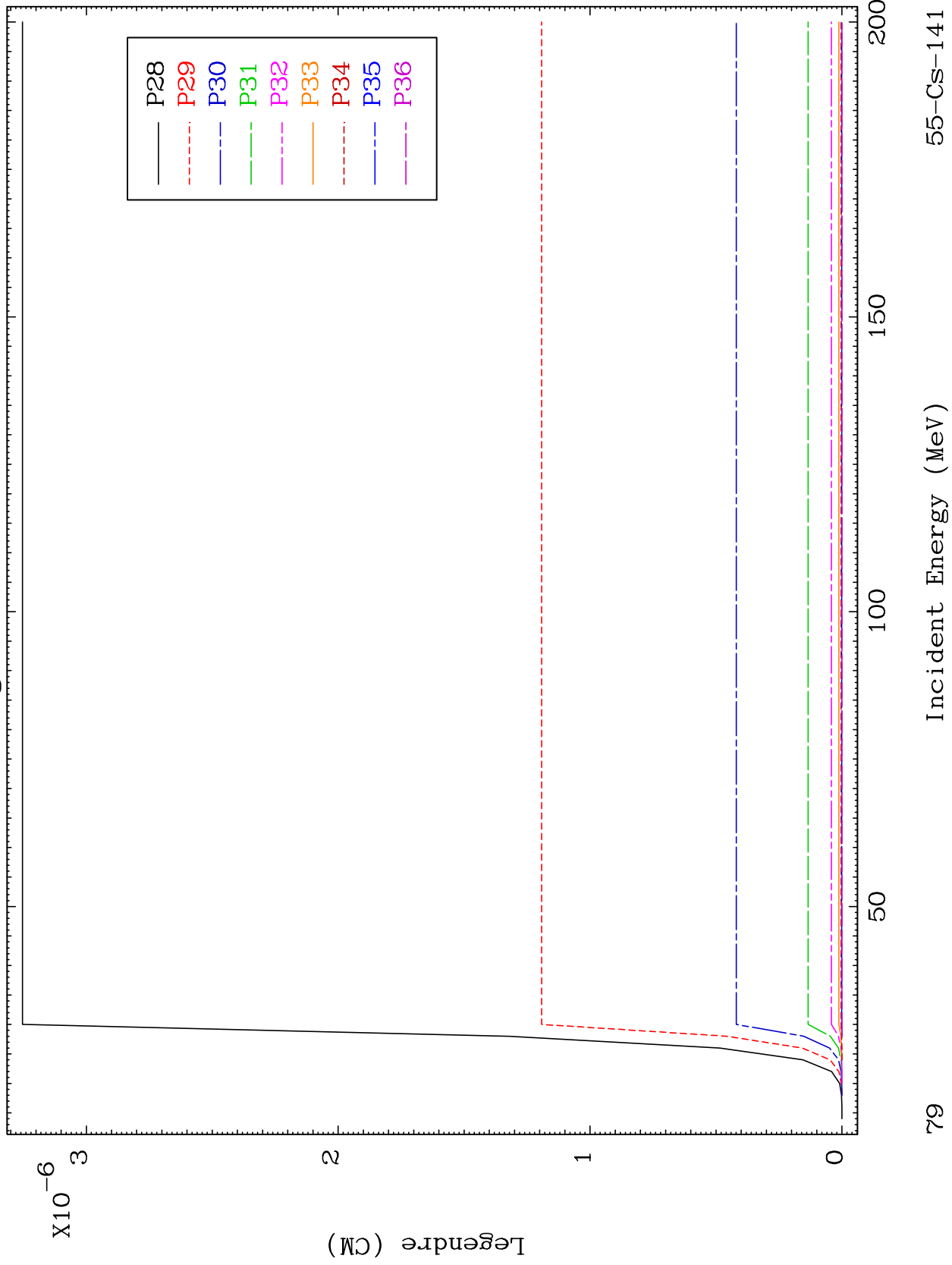



MAT 5549

MT= 66 (n,n') Level  
Legendre Coefficients

55-Cs-141

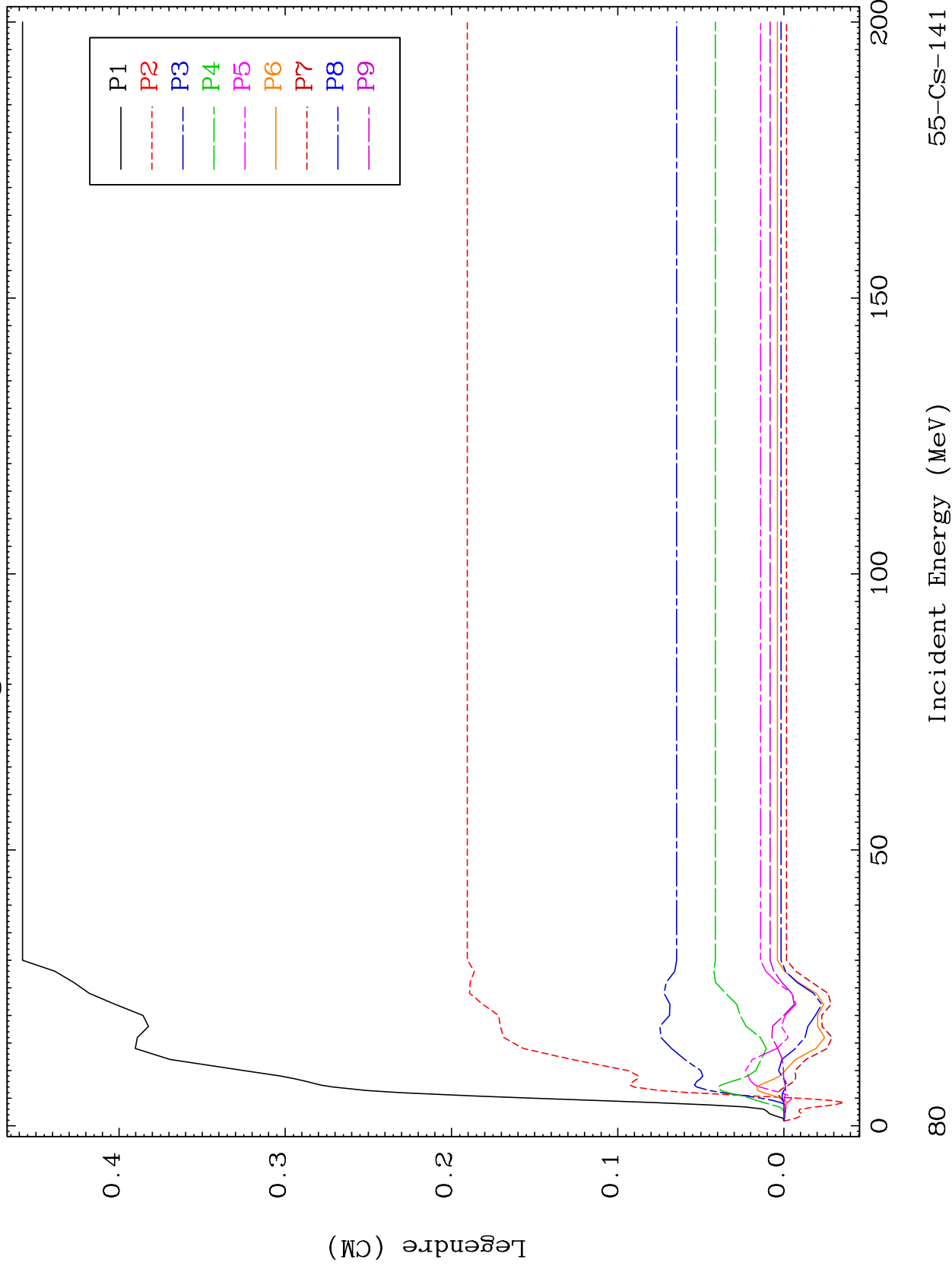

MAT 5549

MT= 66 (n,n') Level  
Legendre Coefficients

55-Cs-141

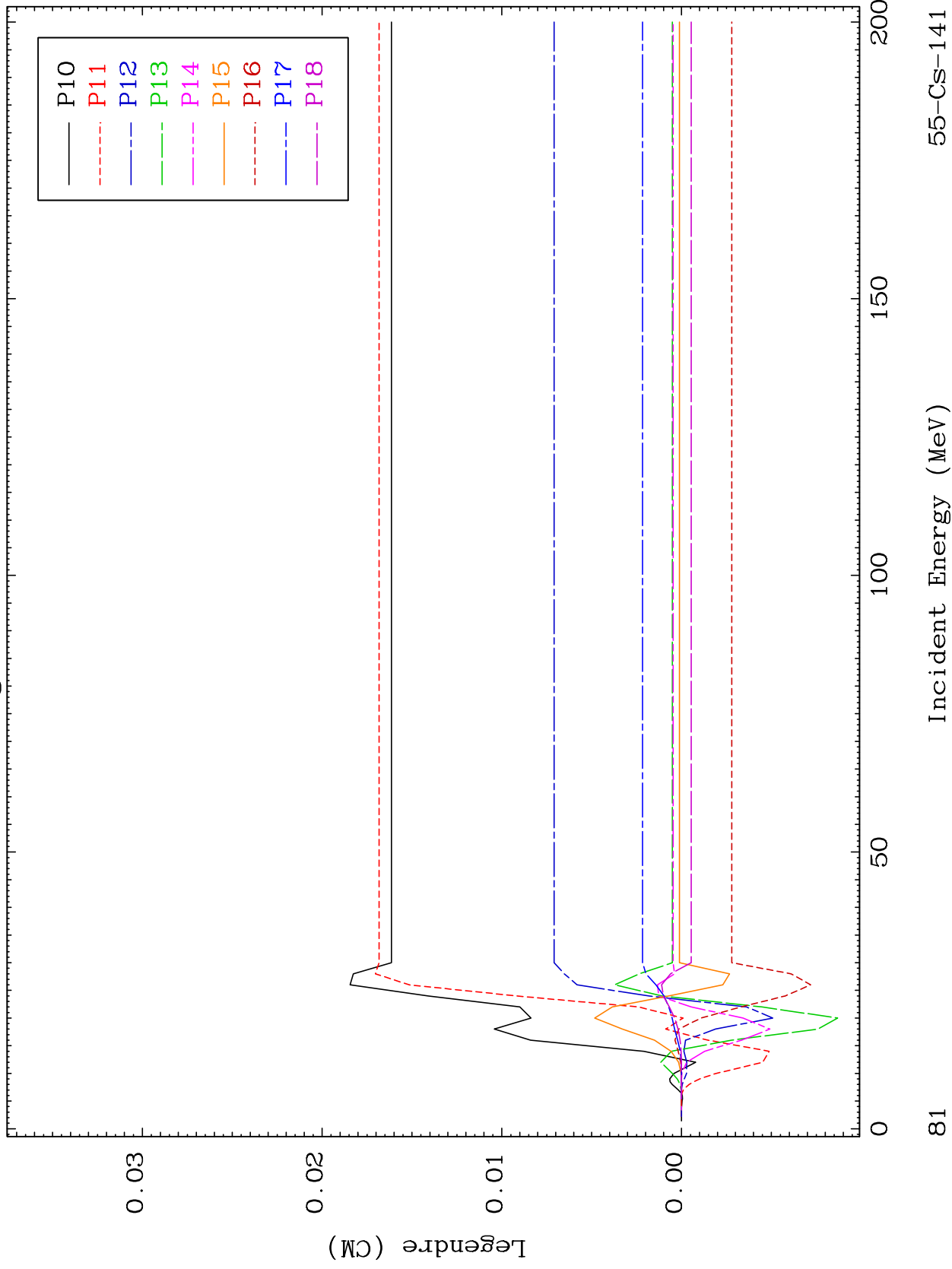

55-Cs-141

Incident Energy (MeV)

81

MAT 5549

MT= 66 (n,n') Level  
Legendre Coefficients

55-Cs-141

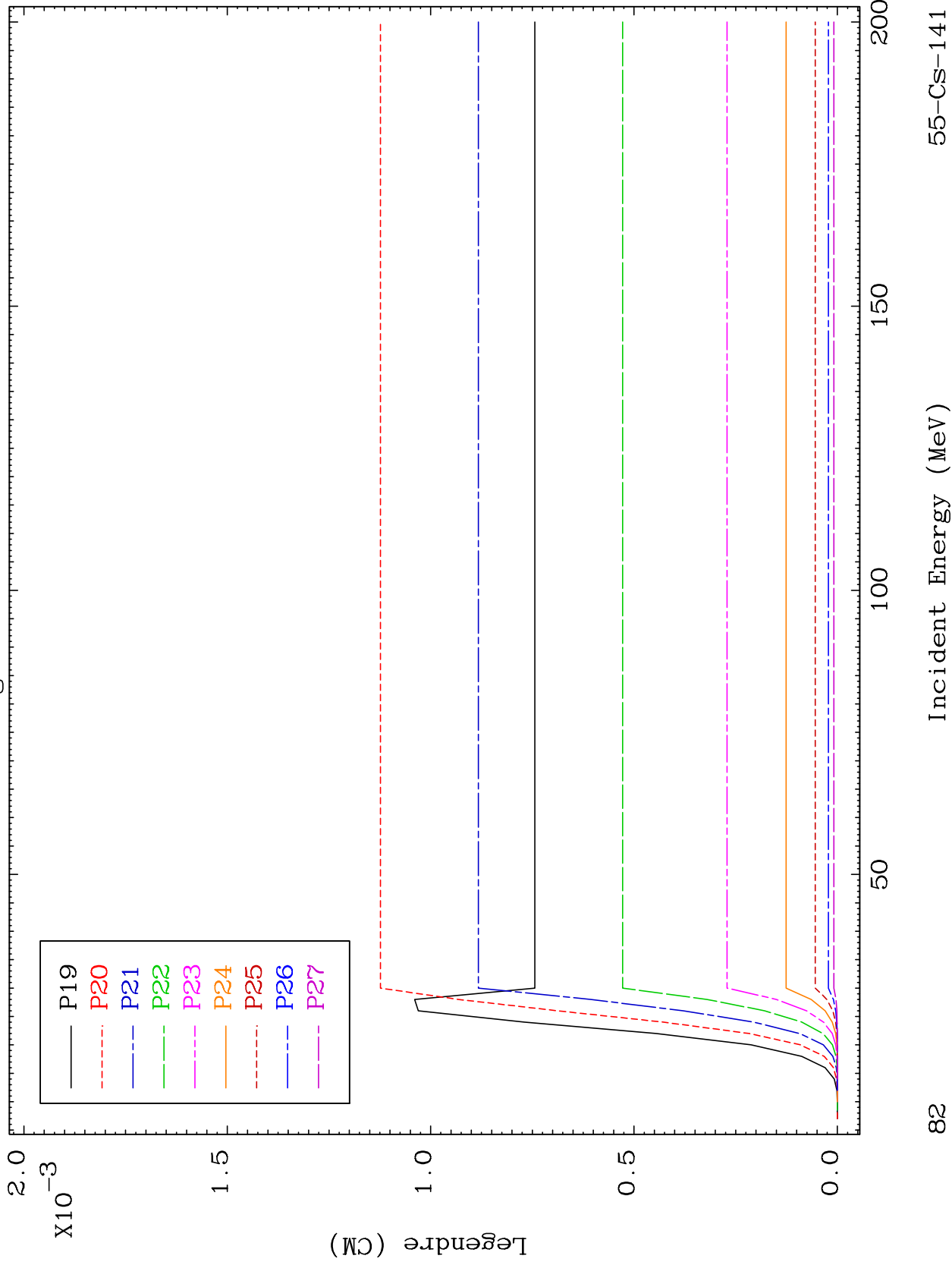

MAT 5549

MT= 66 (n,n') Level  
Legendre Coefficients

55-Cs-141

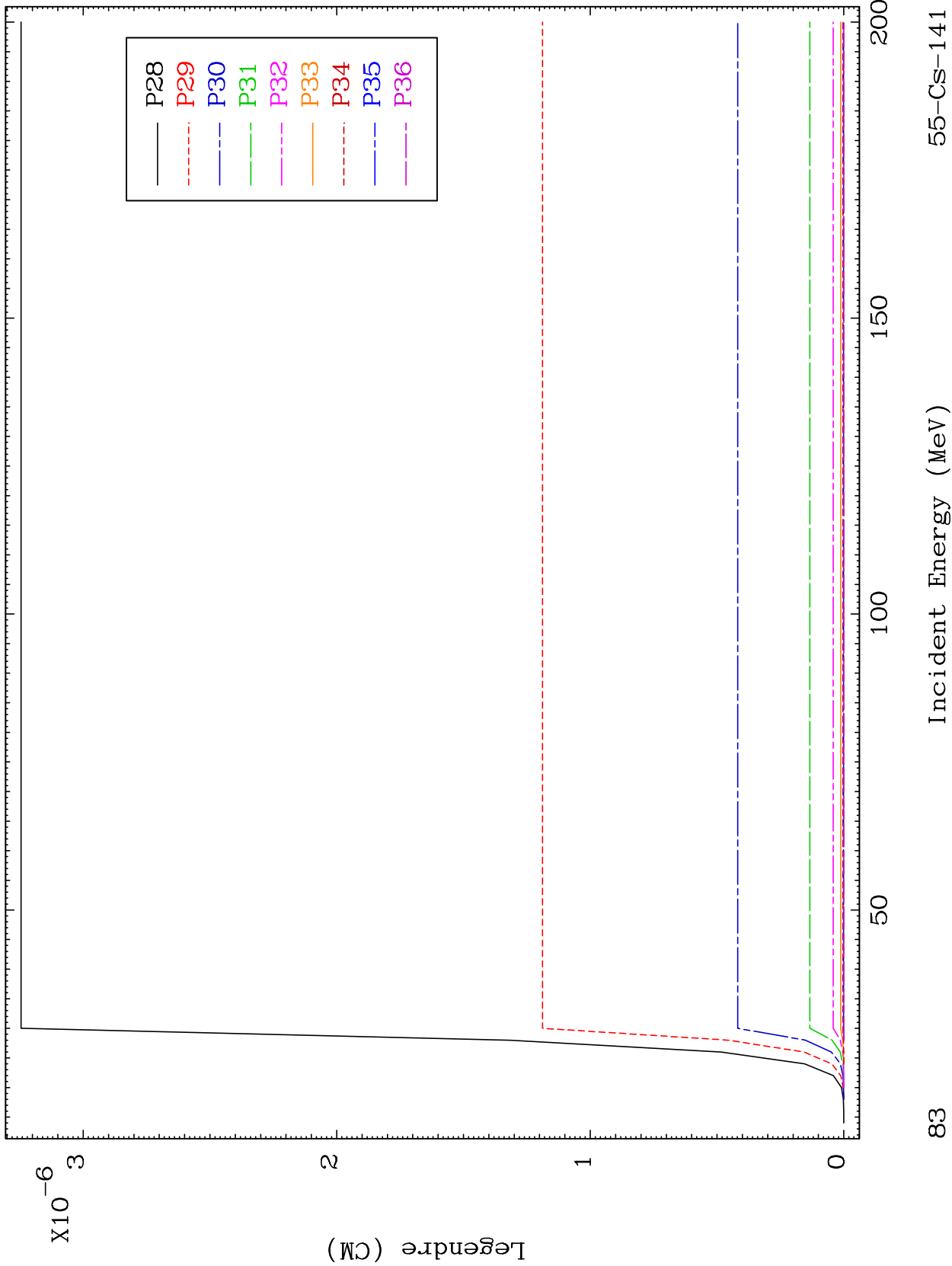

MAT 5549

MT= 67 (n,n') Level  
Legendre Coefficients

55-Cs-141

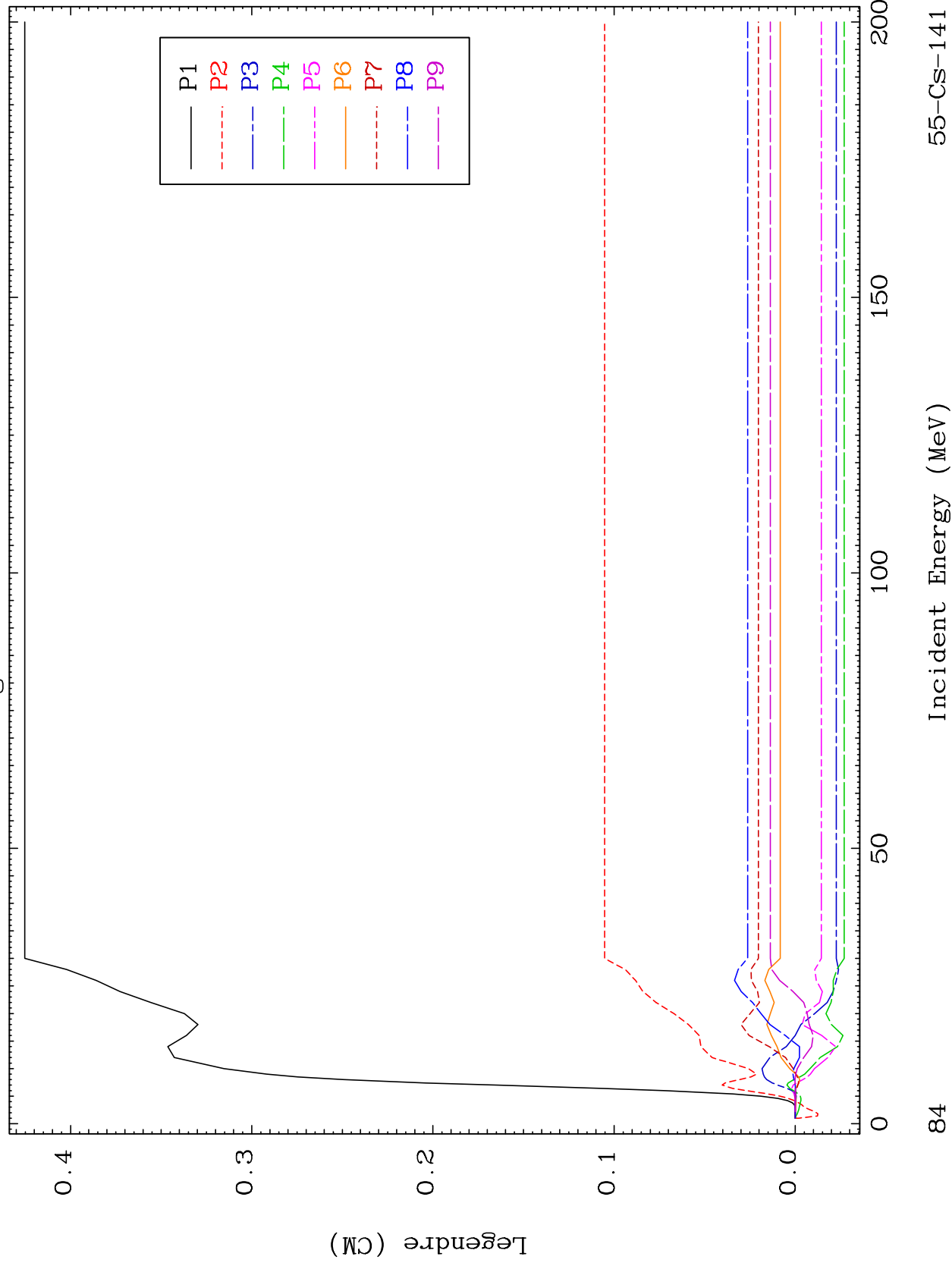

84

Incident Energy (MeV)

55-Cs-141

MAT 5549

MT= 67 (n,n') Level  
Legendre Coefficients

55-Cs-141

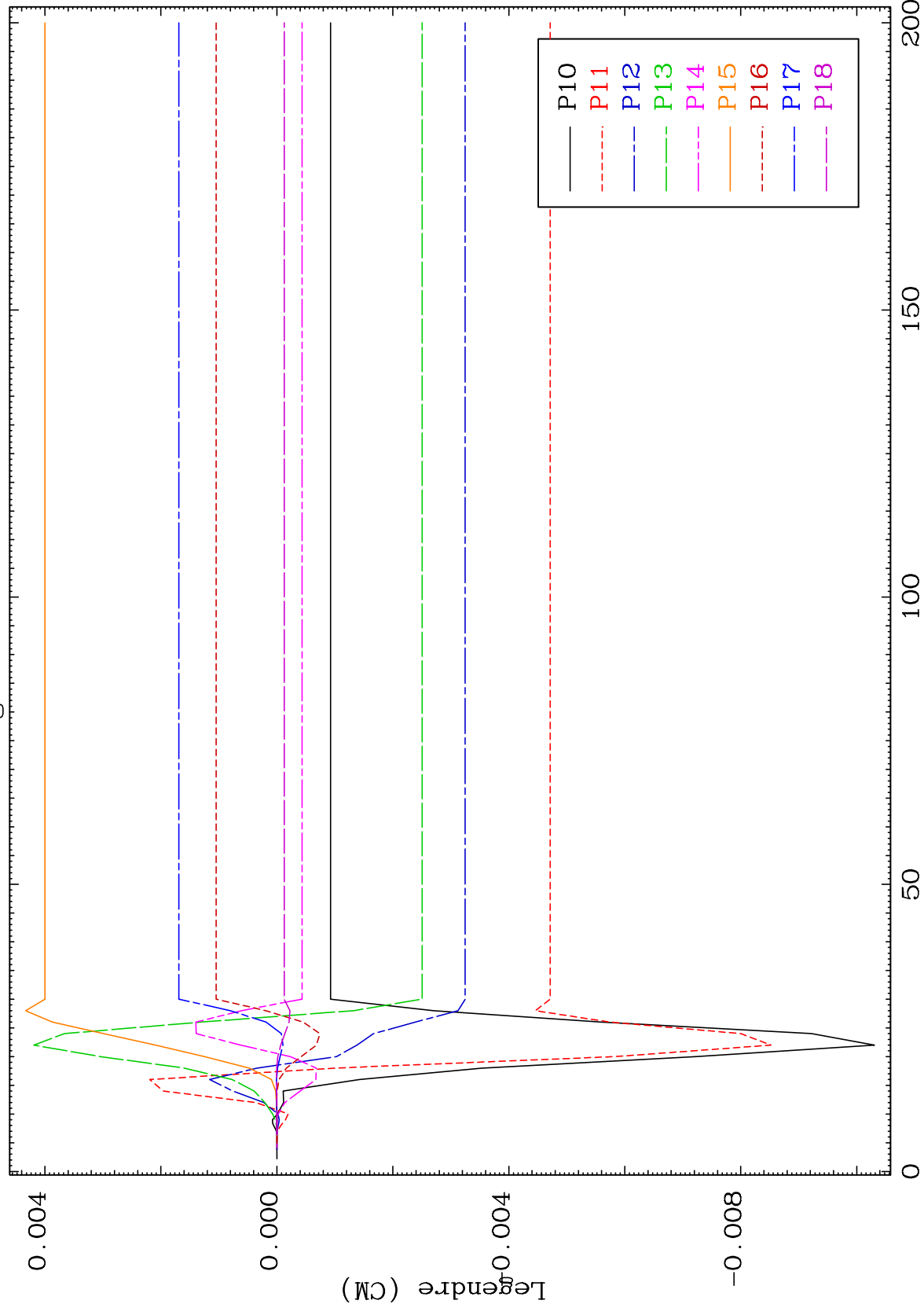

85

Incident Energy (MeV)

55-Cs-141

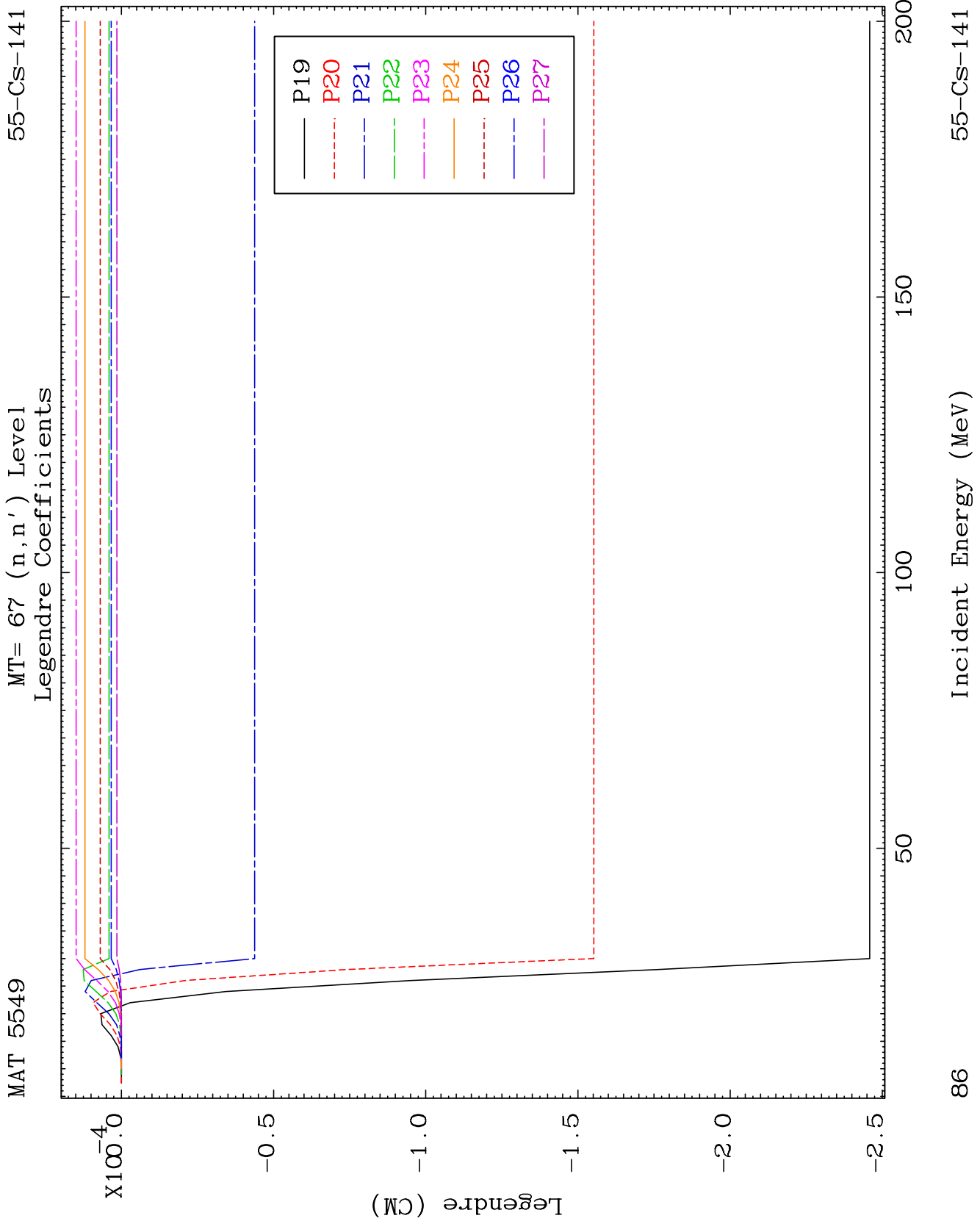

MAT 5549

MT= 67 (n,n') Level  
Legendre Coefficients

55-Cs-141

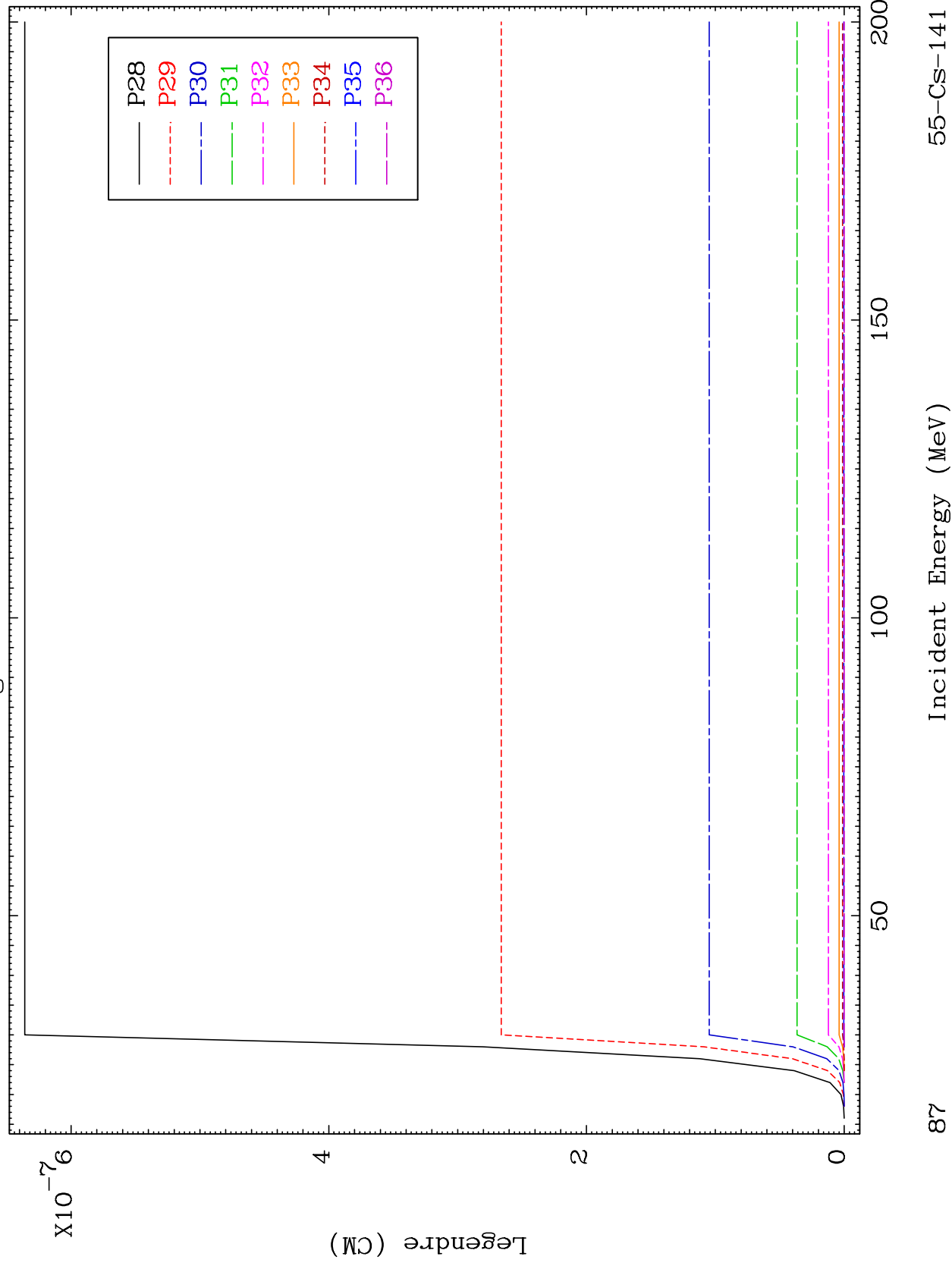

87

Incident Energy (MeV)

55-Cs-141



MAT 5549

MT= 68 (n,n') Level  
Legendre Coefficients

55-Cs-141

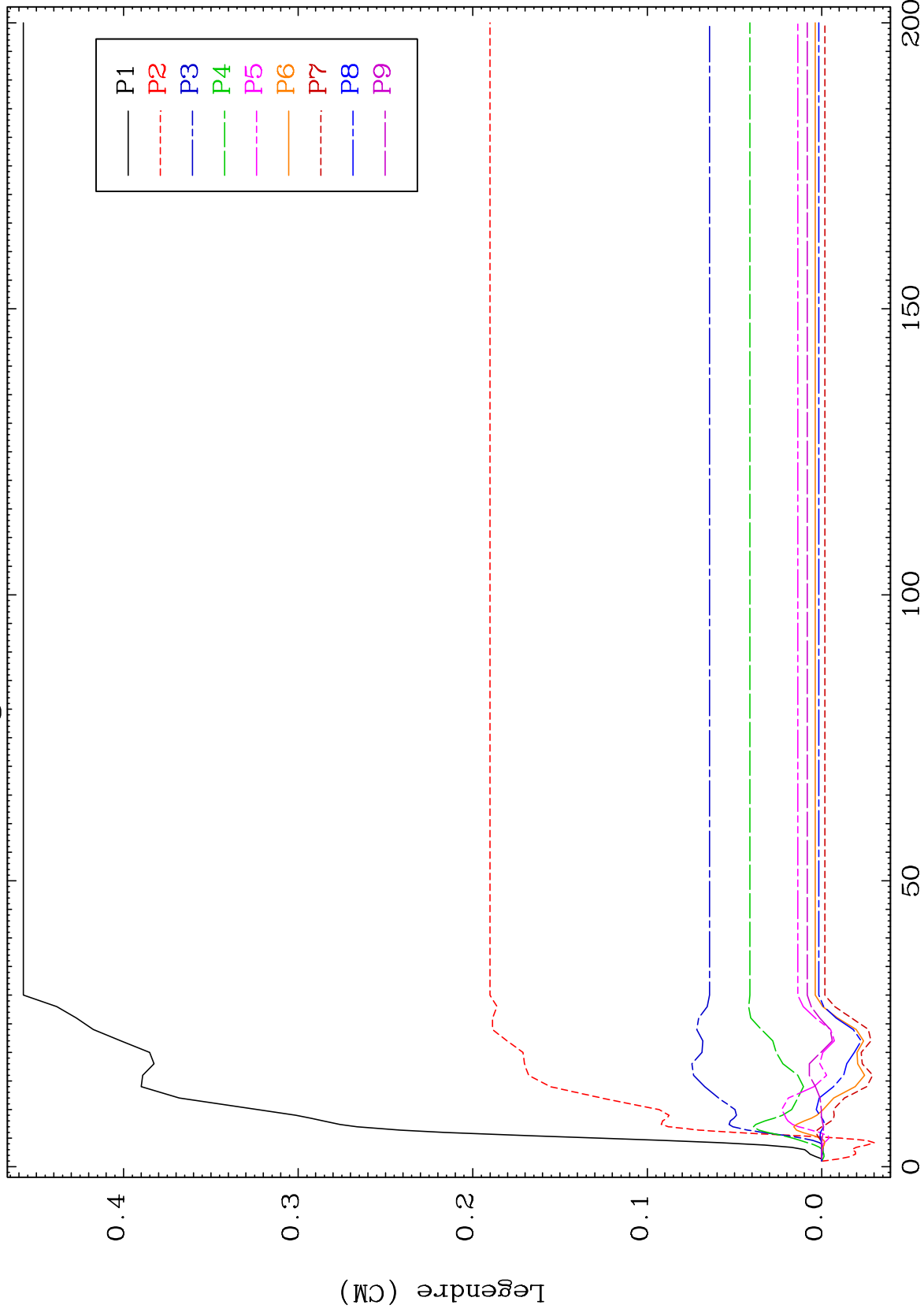

88

Incident Energy (MeV)

55-Cs-141

MAT 5549

MT= 68 (n,n') Level  
Legendre Coefficients

55-Cs-141

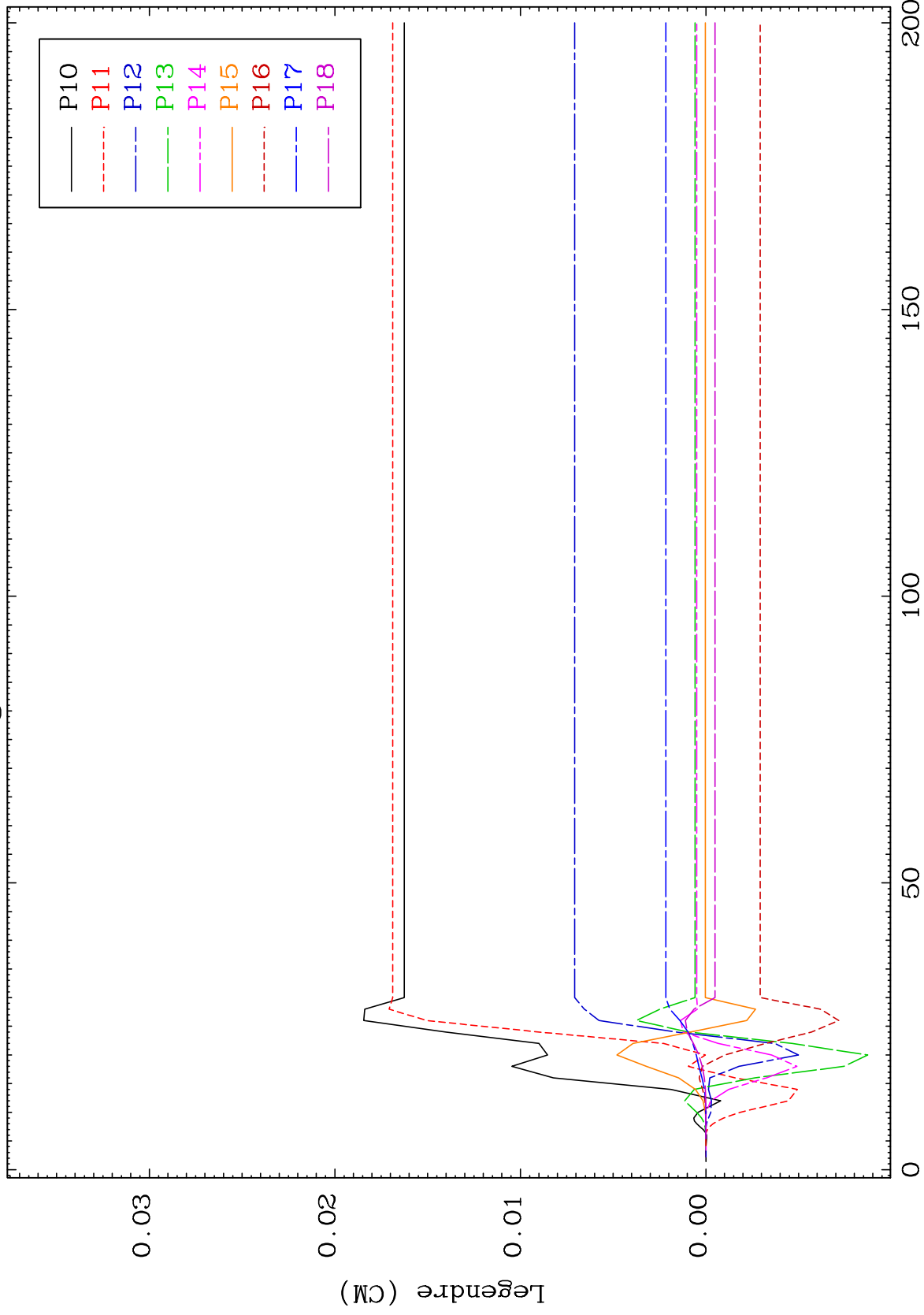

55-Cs-141

Incident Energy (MeV)

89

MAT 5549

MT= 68 (n,n') Level  
Legendre Coefficients

55-Cs-141

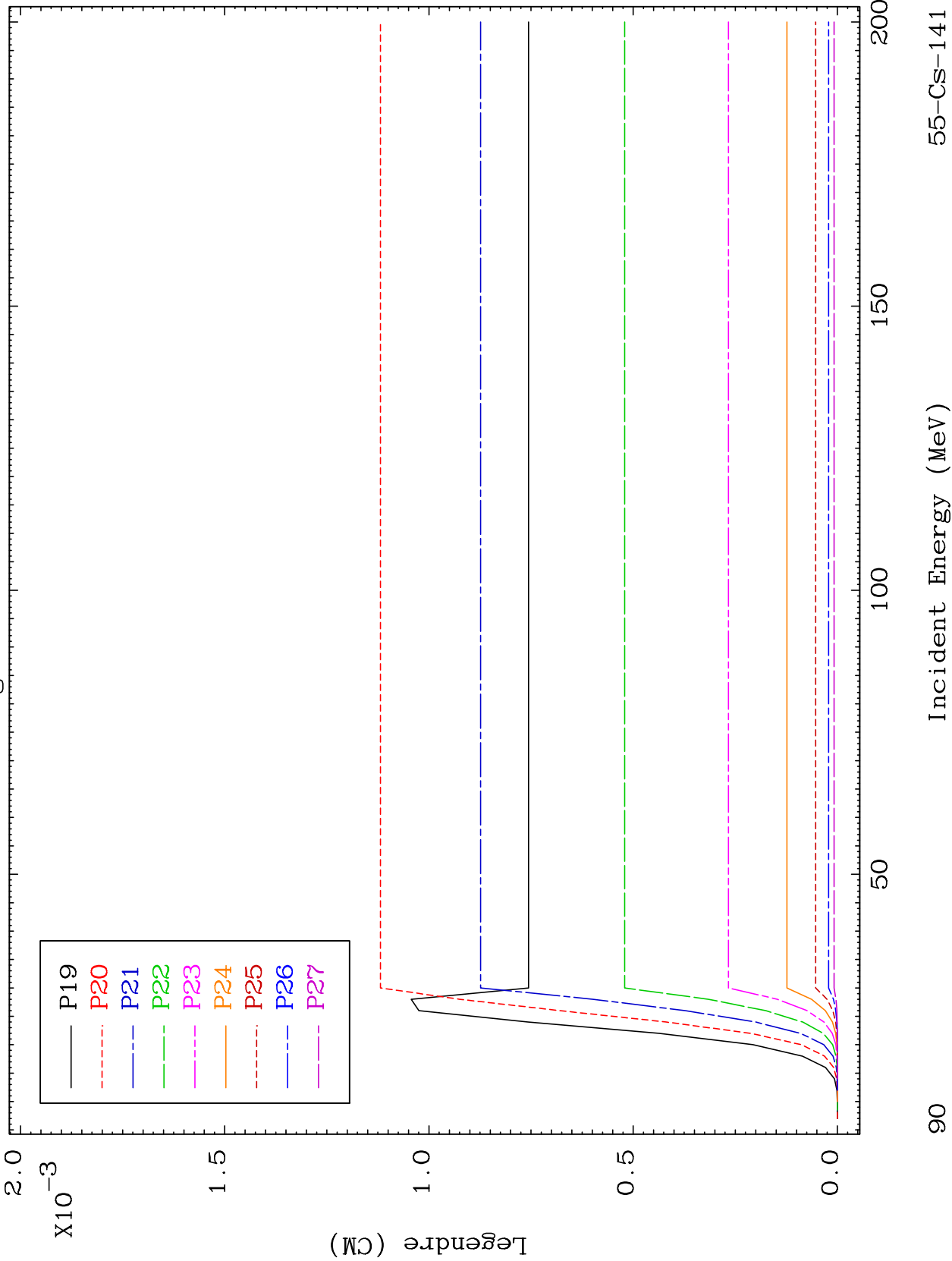

55-Cs-141

Incident Energy (MeV)

90

MAT 5549

MT= 68 (n,n') Level  
Legendre Coefficients

55-Cs-141

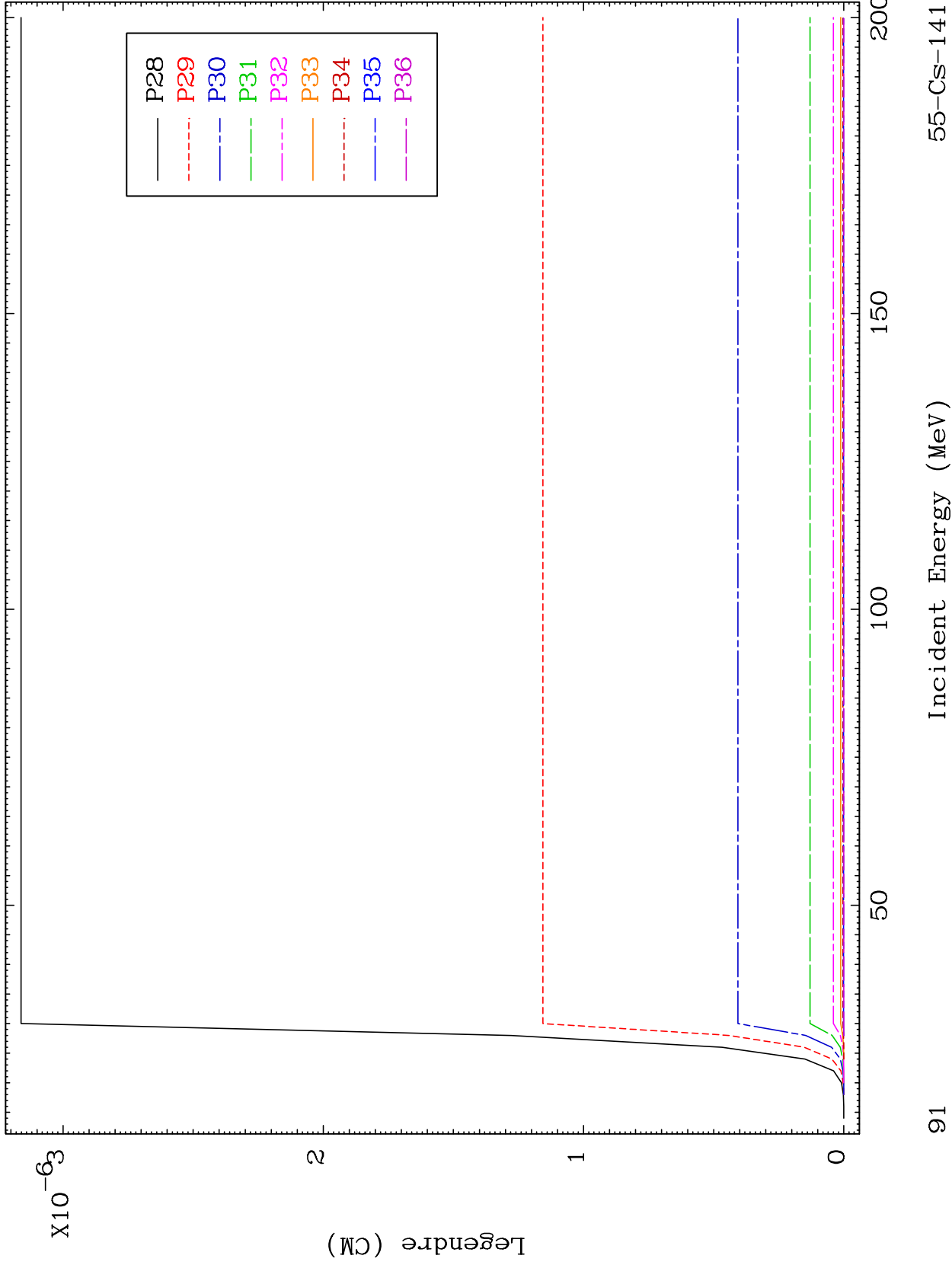

91

Incident Energy (MeV)

55-Cs-141



MAT 5549

MT= 69 (n,n') Level  
Legendre Coefficients

55-Cs-141

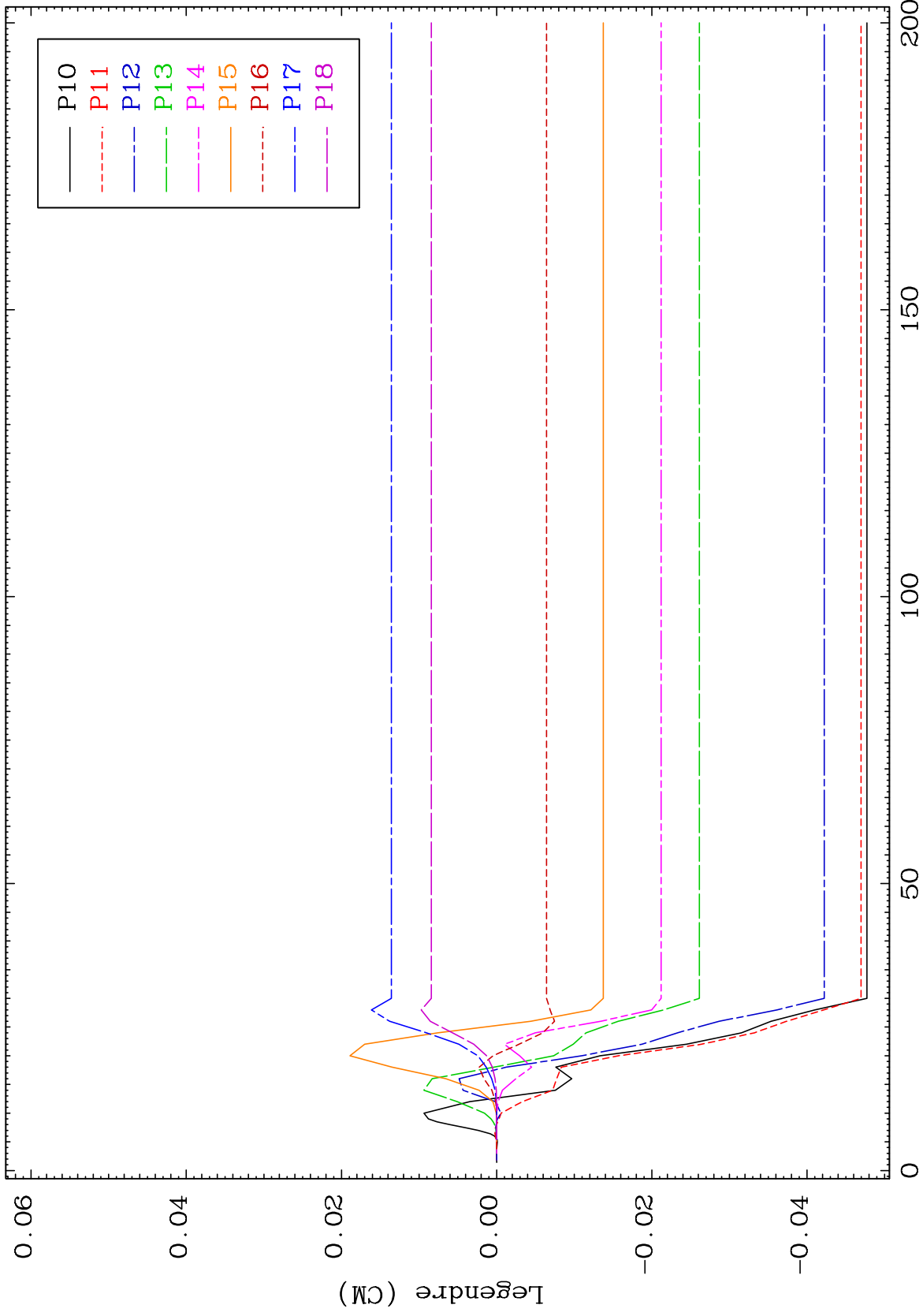

93

Incident Energy (MeV)

55-Cs-141

MAT 5549

MT= 69 (n,n') Level  
Legendre Coefficients

55-Cs-141

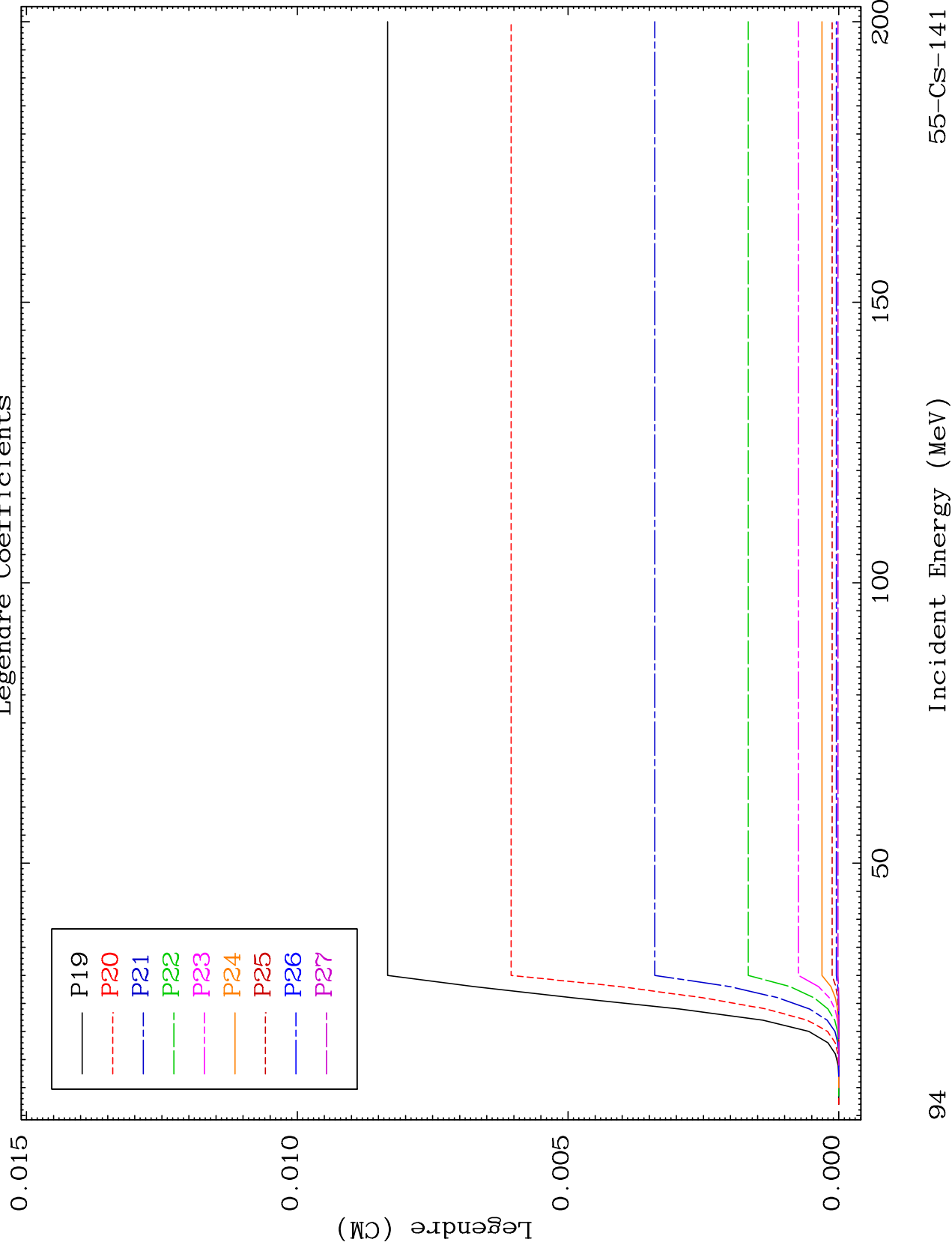

94

55-Cs-141

MAT 5549

MT= 69 (n,n') Level  
Legendre Coefficients

55-Cs-141

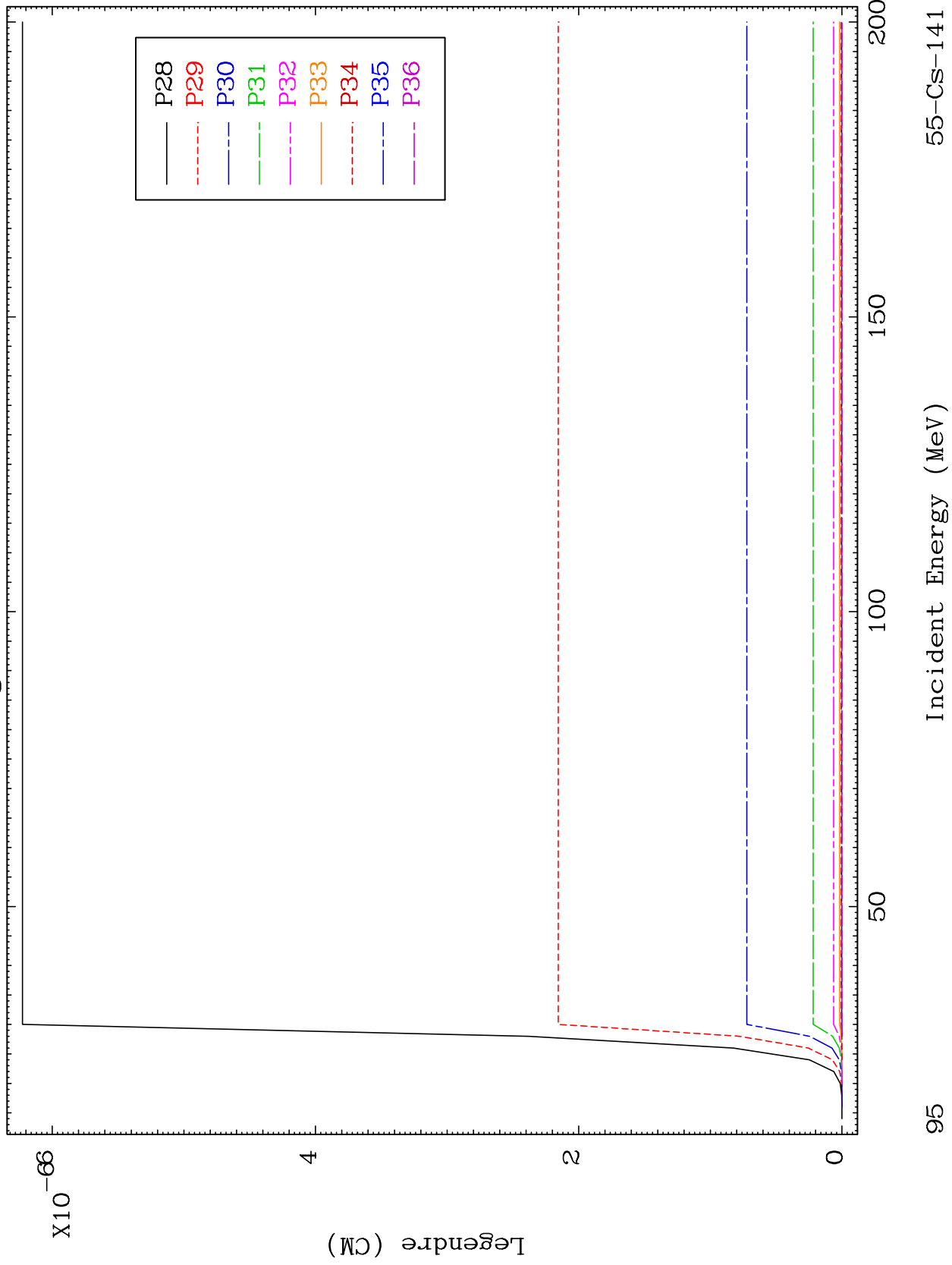

95

Incident Energy (MeV)

55-Cs-141



MAT 5549

MT= 70 (n,n') Level  
Legendre Coefficients

55-Cs-141

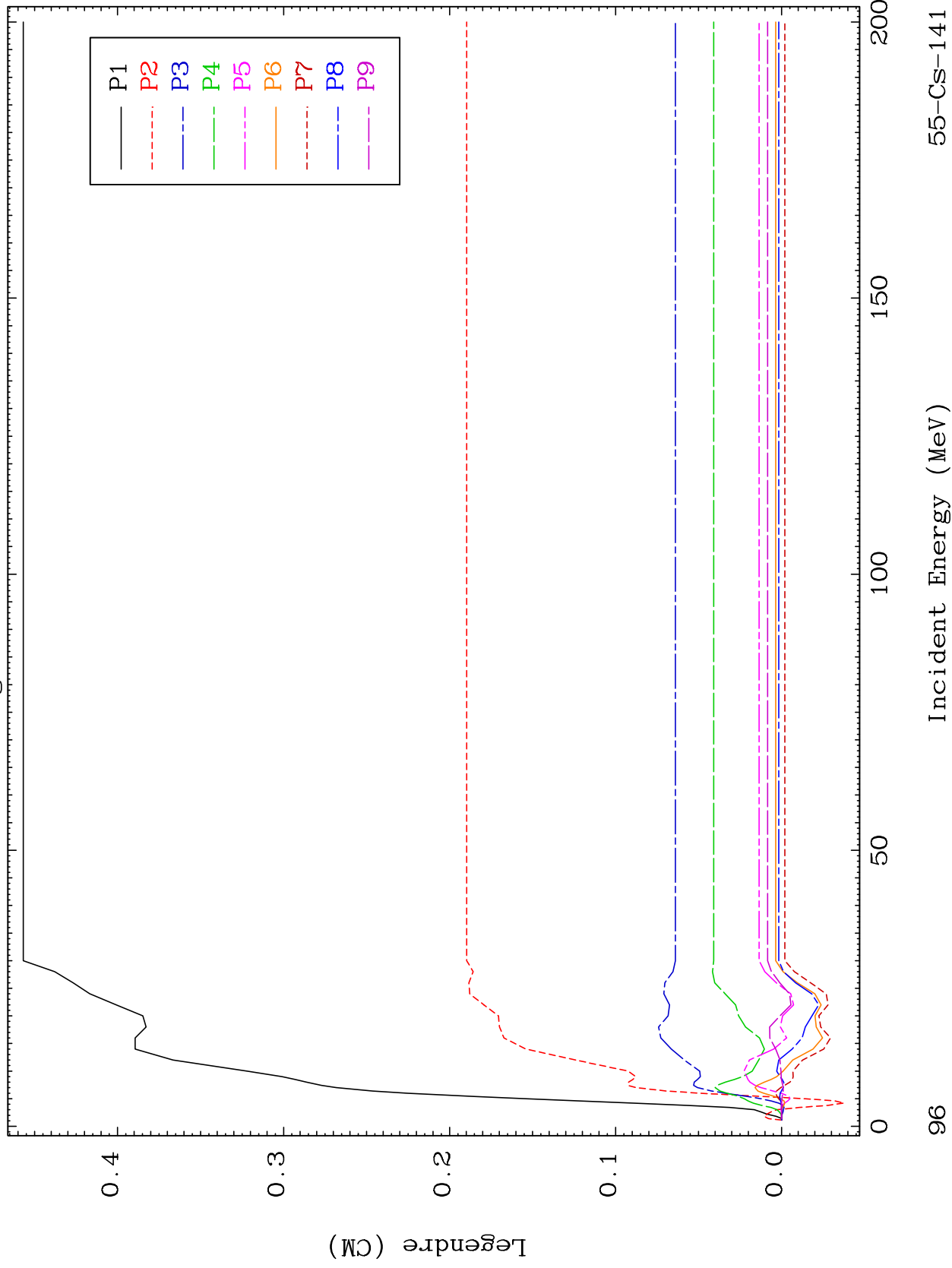

55-Cs-141

Incident Energy (MeV)

96

MAT 5549

MT= 70 (n,n') Level  
Legendre Coefficients

55-Cs-141

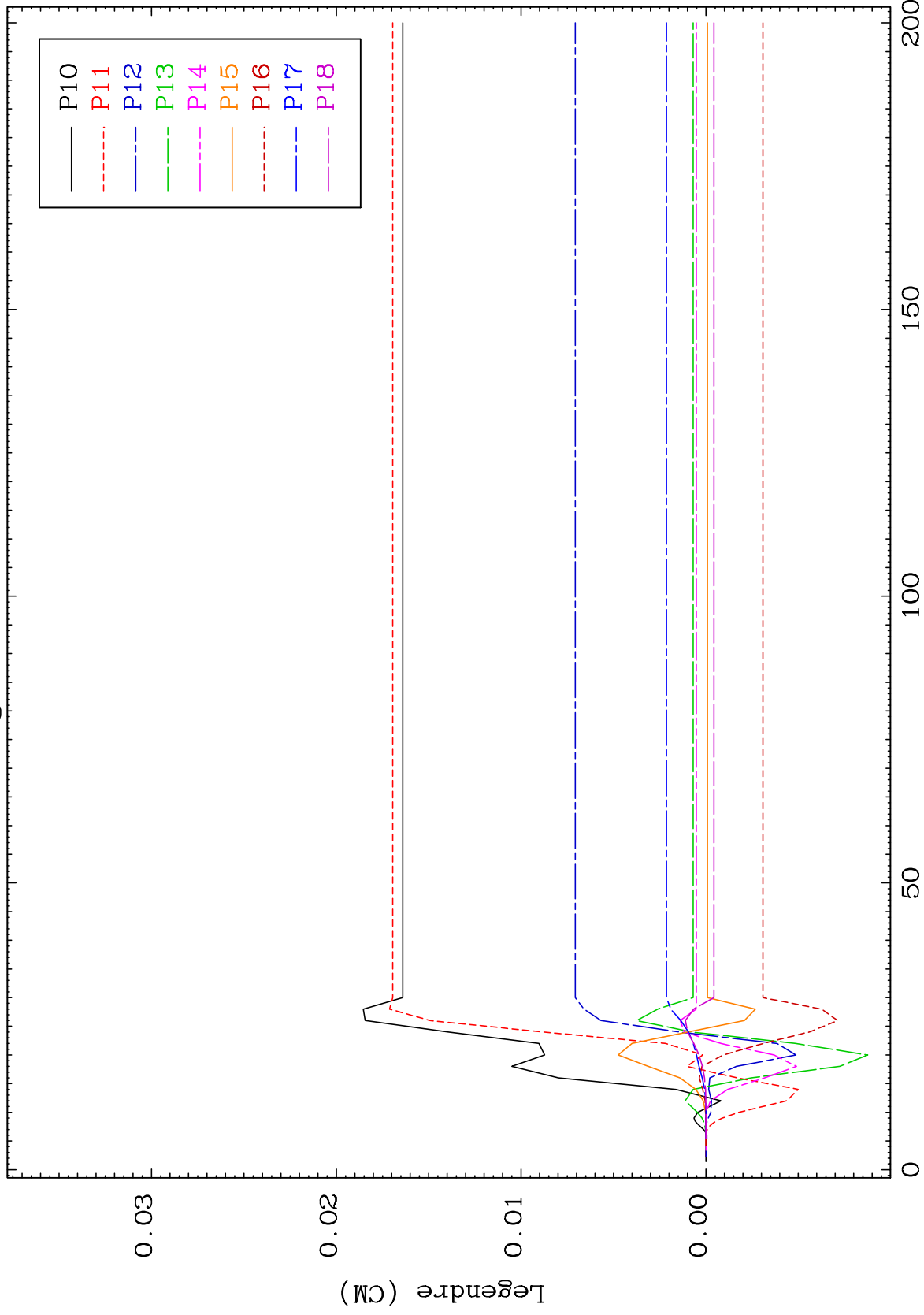

97

Incident Energy (MeV)

55-Cs-141

MAT 5549

MT= 70 (n,n') Level  
Legendre Coefficients

55-Cs-141

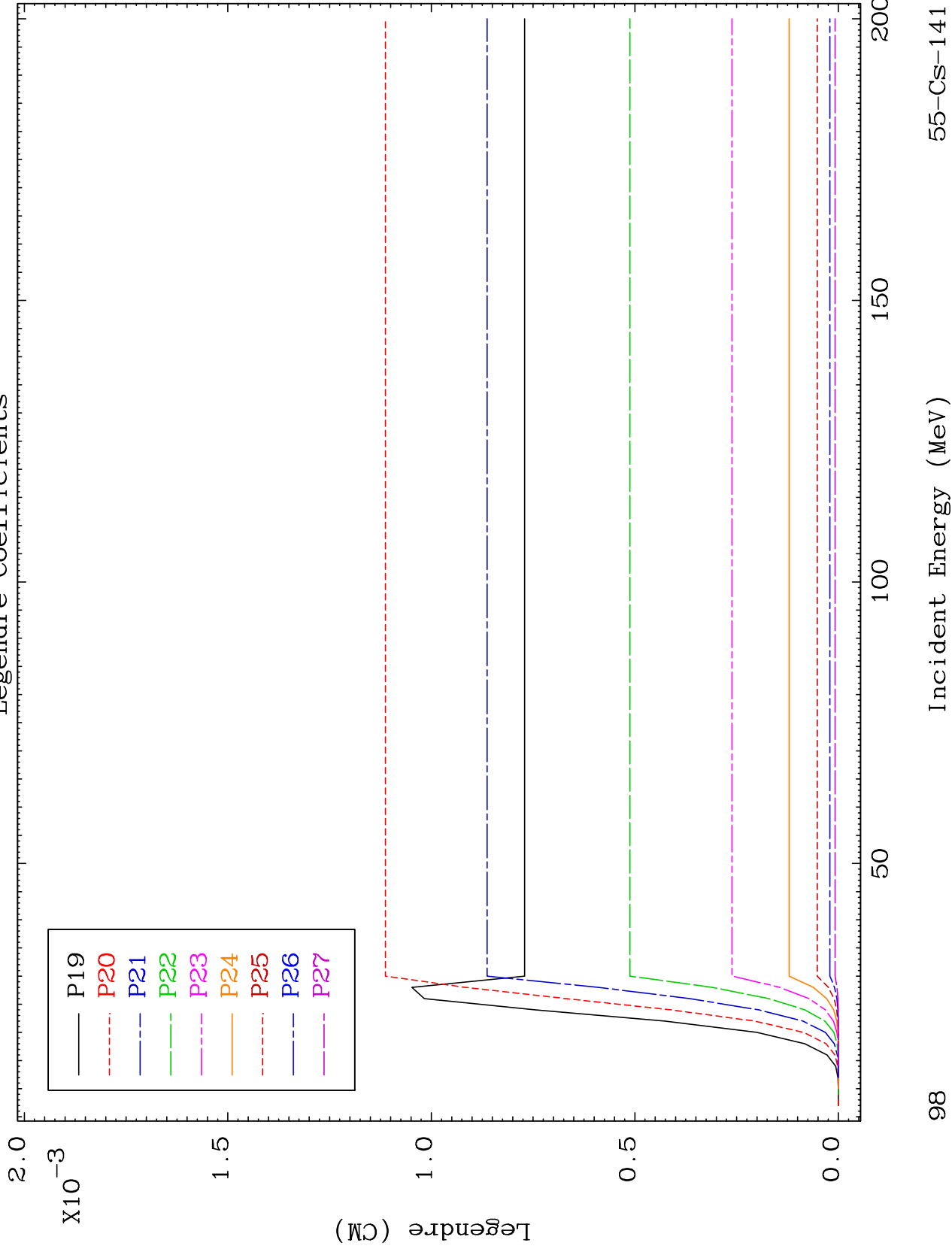

98

Incident Energy (MeV)

55-Cs-141

MAT 5549

MT= 70 (n,n') Level  
Legendre Coefficients

55-Cs-141

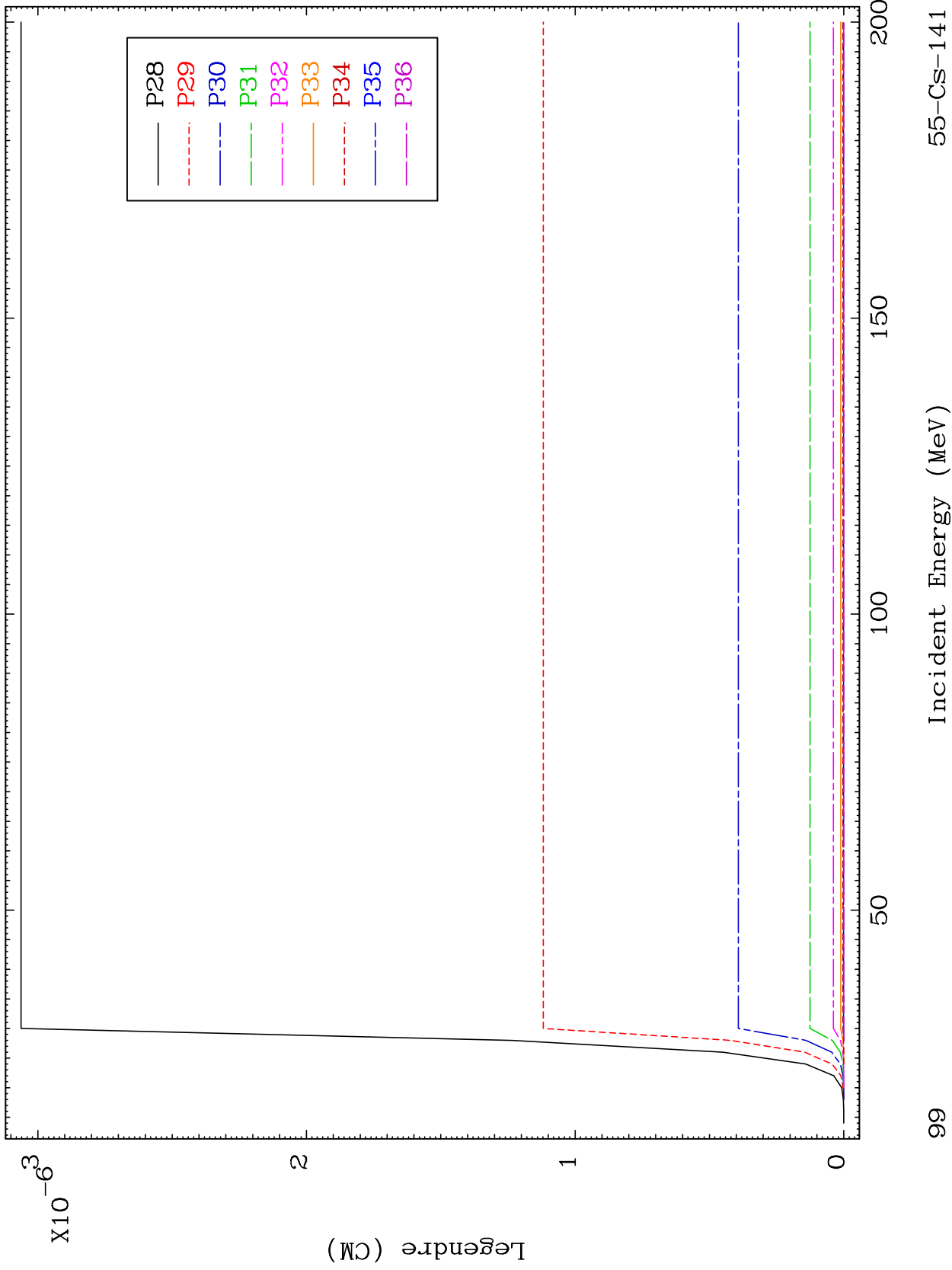

MAT 5549

MT= 71 (n,n') Level  
Legendre Coefficients

55-Cs-141

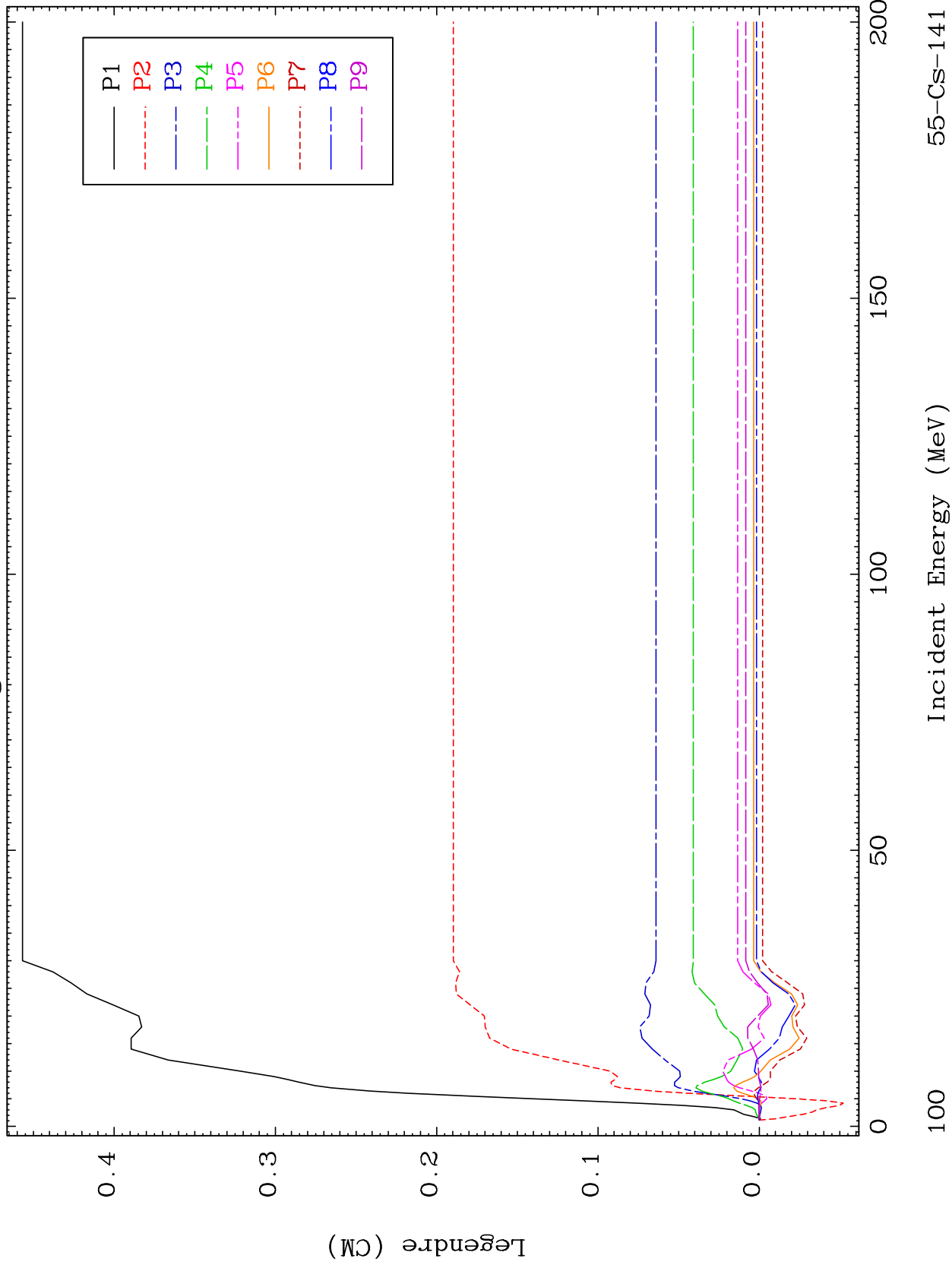

55-Cs-141

MAT 5549

MT= 71 (n,n') Level  
Legendre Coefficients

55-Cs-141

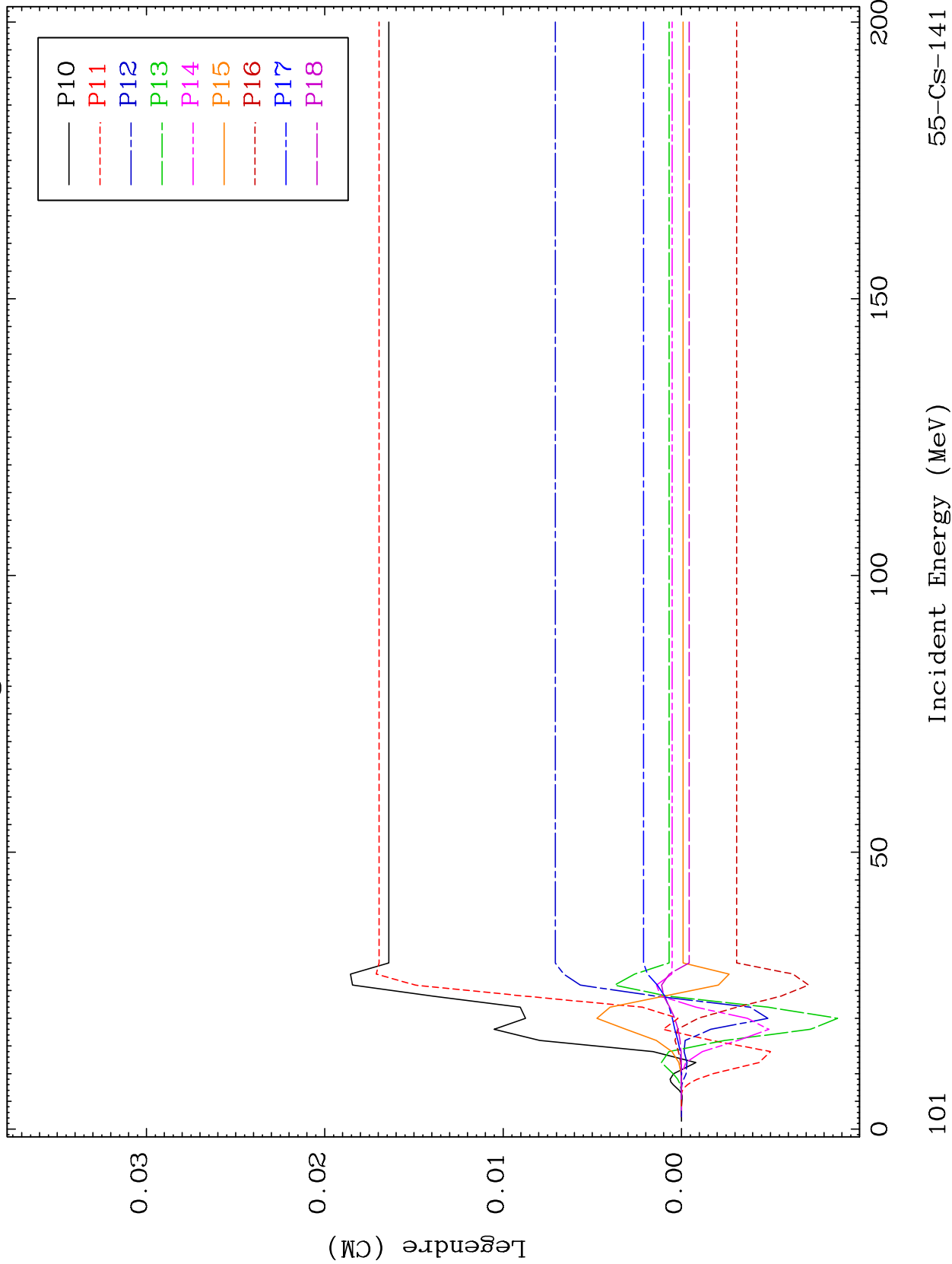

55-Cs-141

Incident Energy (MeV)

101

MAT 5549

MT= 71 (n,n') Level  
Legendre Coefficients

55-Cs-141

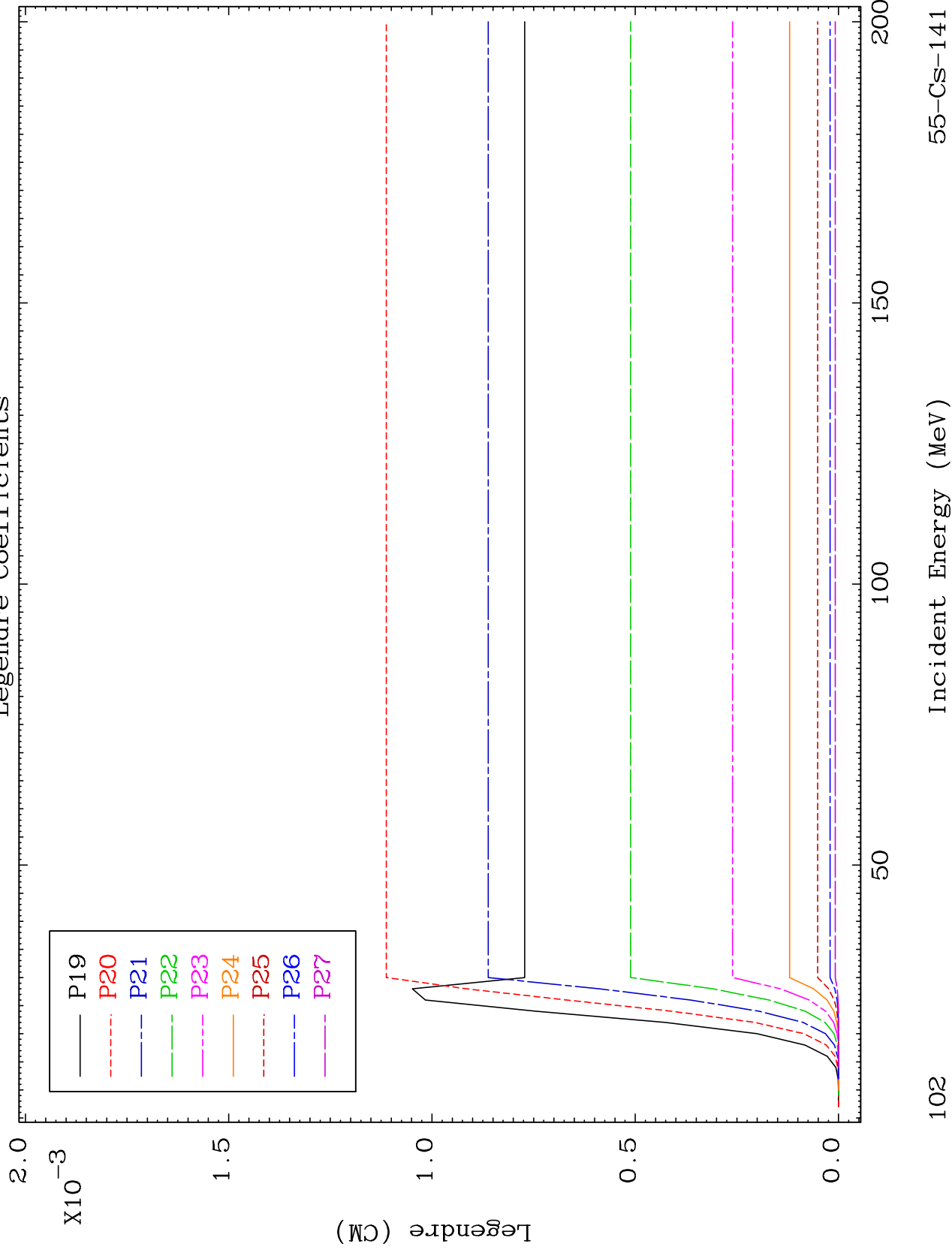

MAT 5549

MT= 71 (n,n') Level  
Legendre Coefficients

55-Cs-141

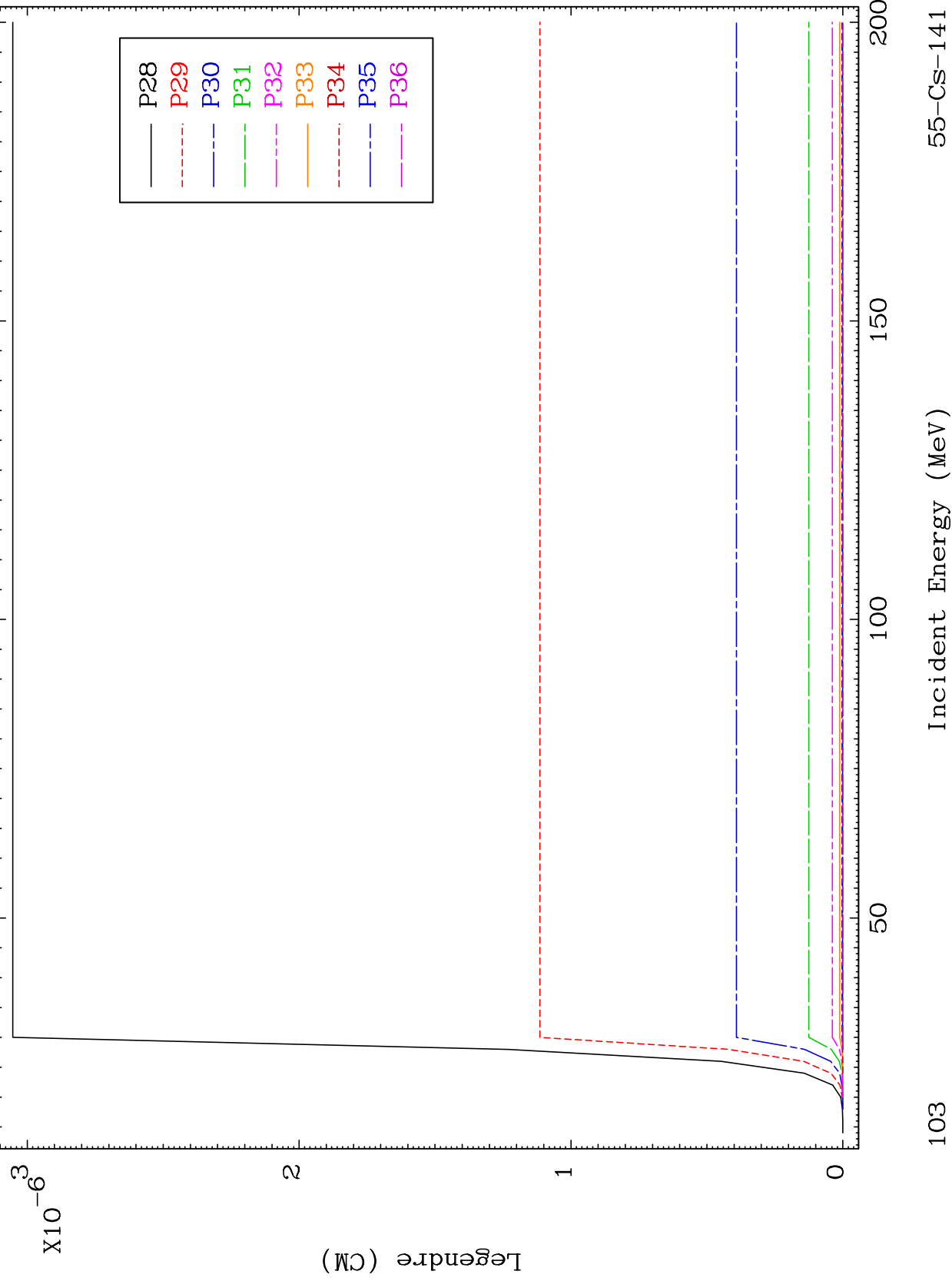

103

Incident Energy (MeV)

55-Cs-141





MAT 5549

MT= 72 (n,n') Level  
Legendre Coefficients

55-Cs-141

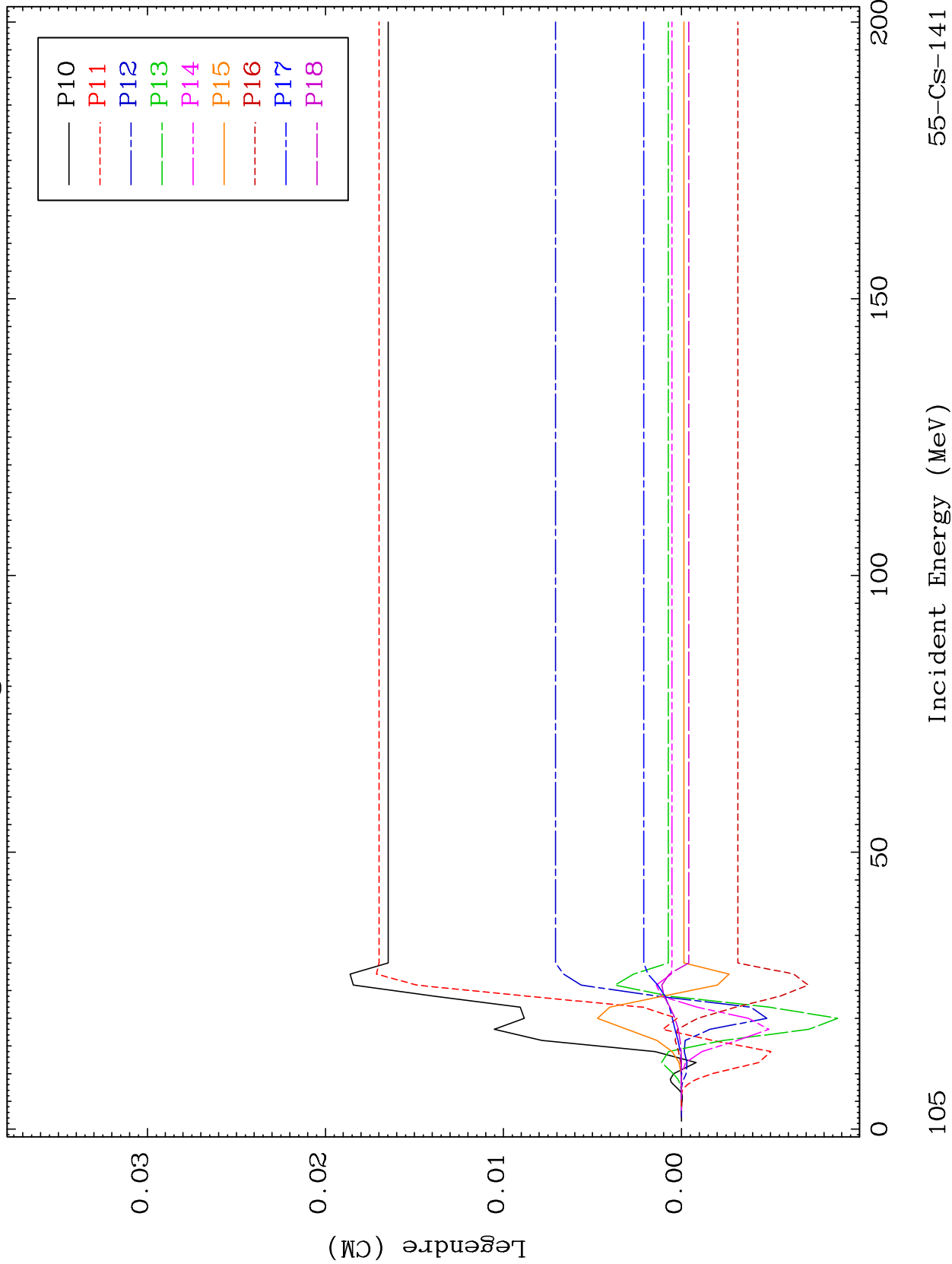

55-Cs-141

Incident Energy (MeV)

105

MAT 5549

MT= 72 (n,n') Level  
Legendre Coefficients

55-Cs-141

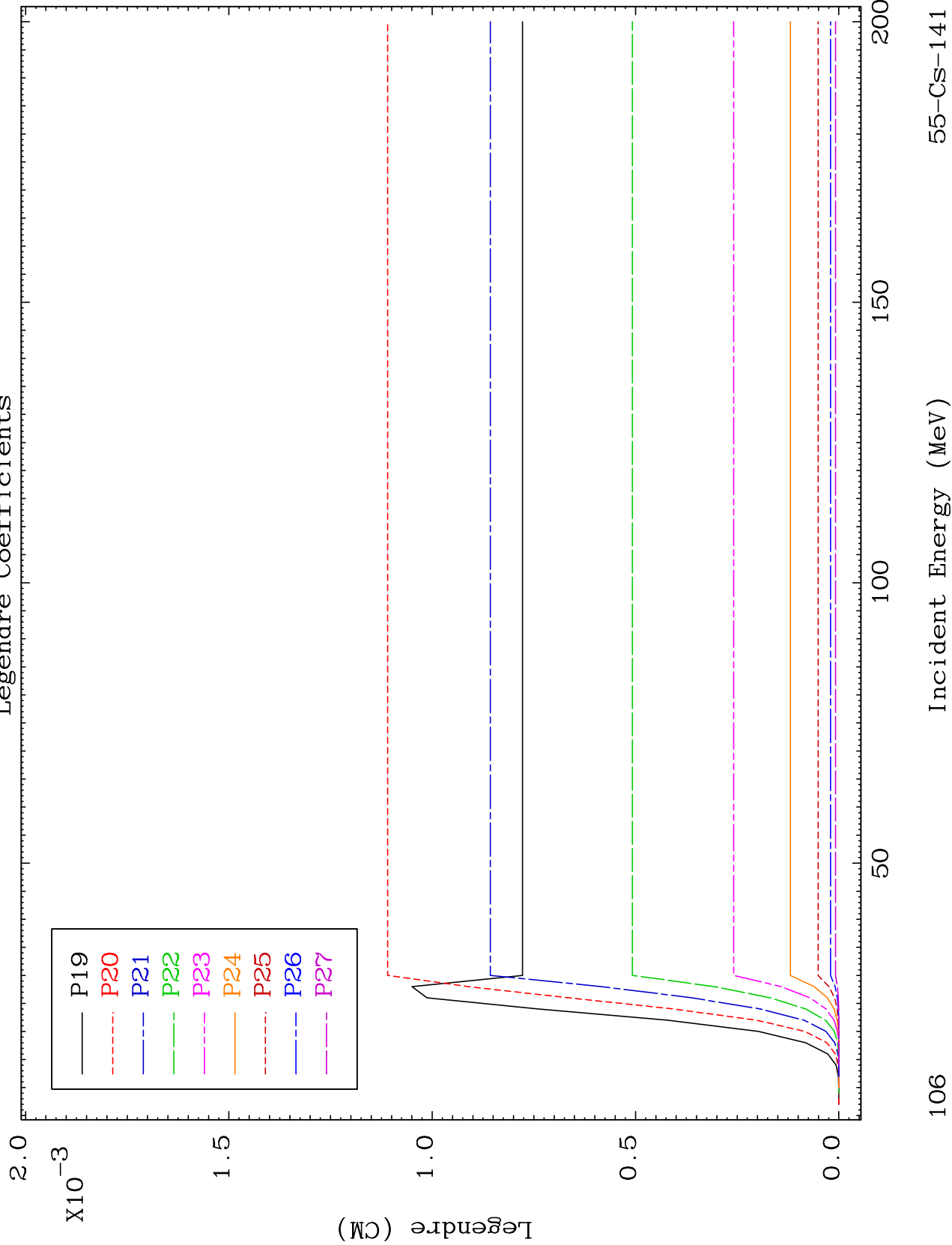

106

Incident Energy (MeV)

55-Cs-141

MAT 5549

MT= 72 (n,n') Level  
Legendre Coefficients

55-Cs-141

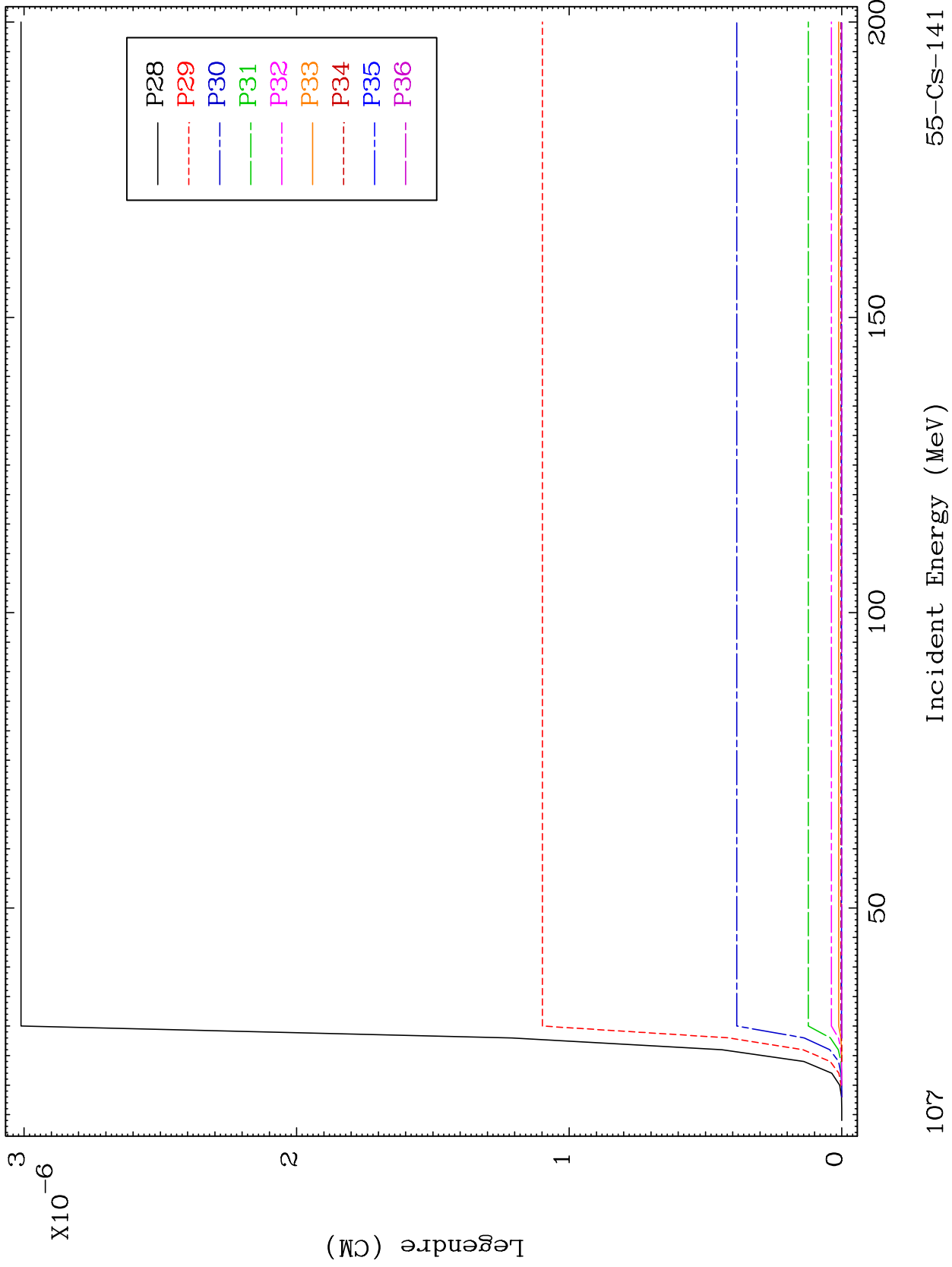

107

55-Cs-141

MAT 5549

MT= 73 (n,n') Level  
Legendre Coefficients

55-Cs-141

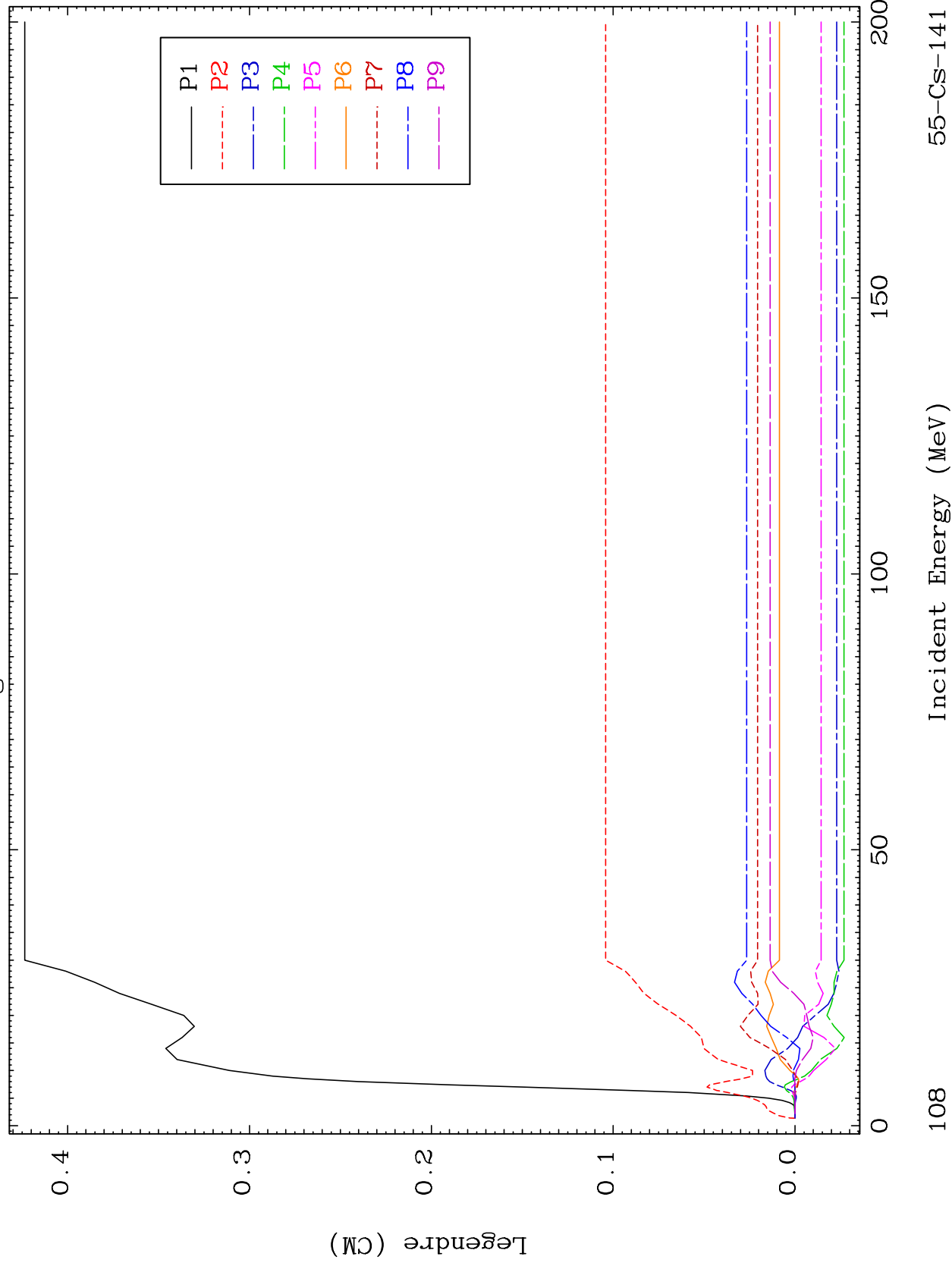

55-Cs-141

Incident Energy (MeV)

108

MAT 5549

MT= 73 (n,n') Level  
Legendre Coefficients

55-Cs-141

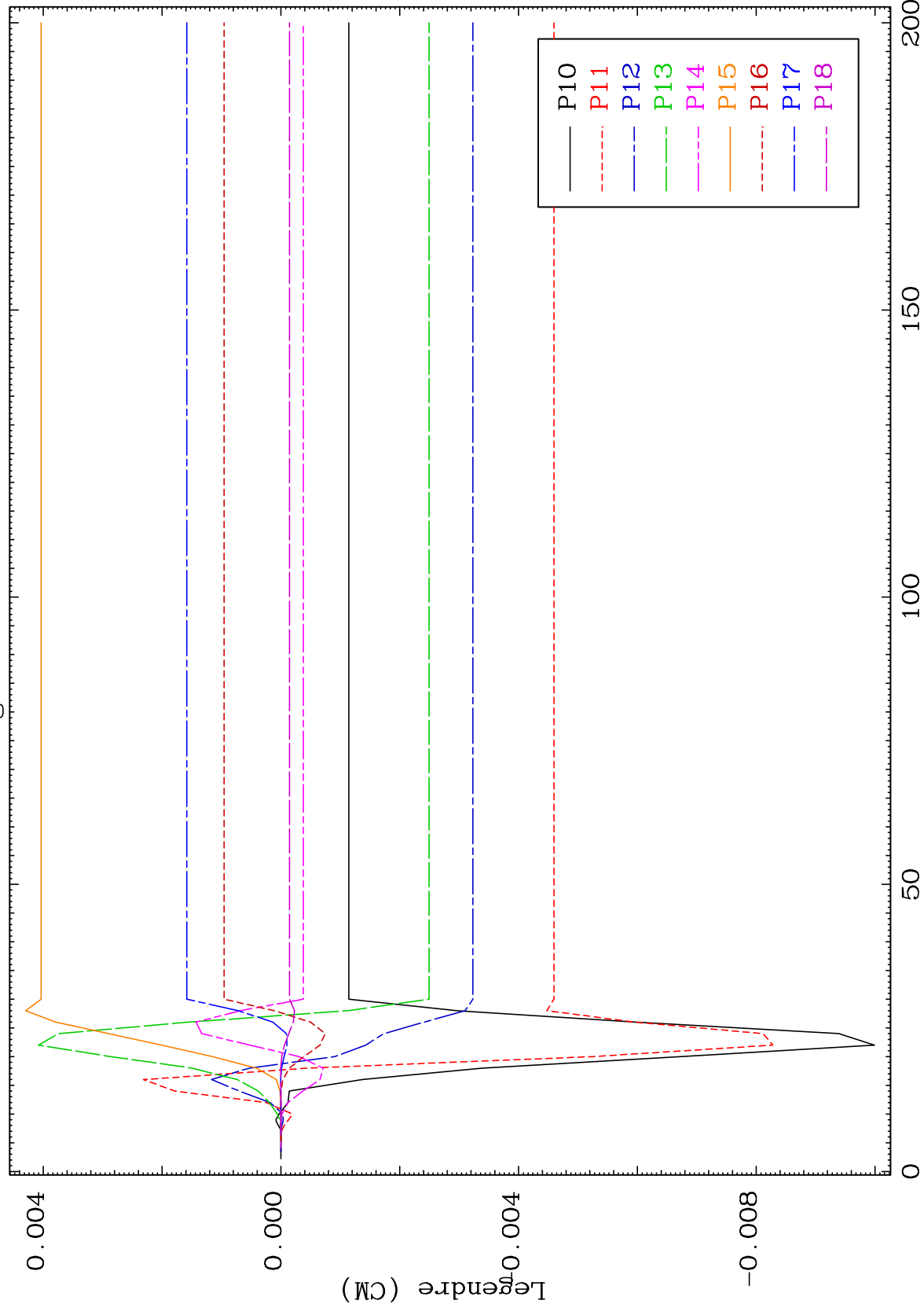

109

55-Cs-141

55-Cs-141

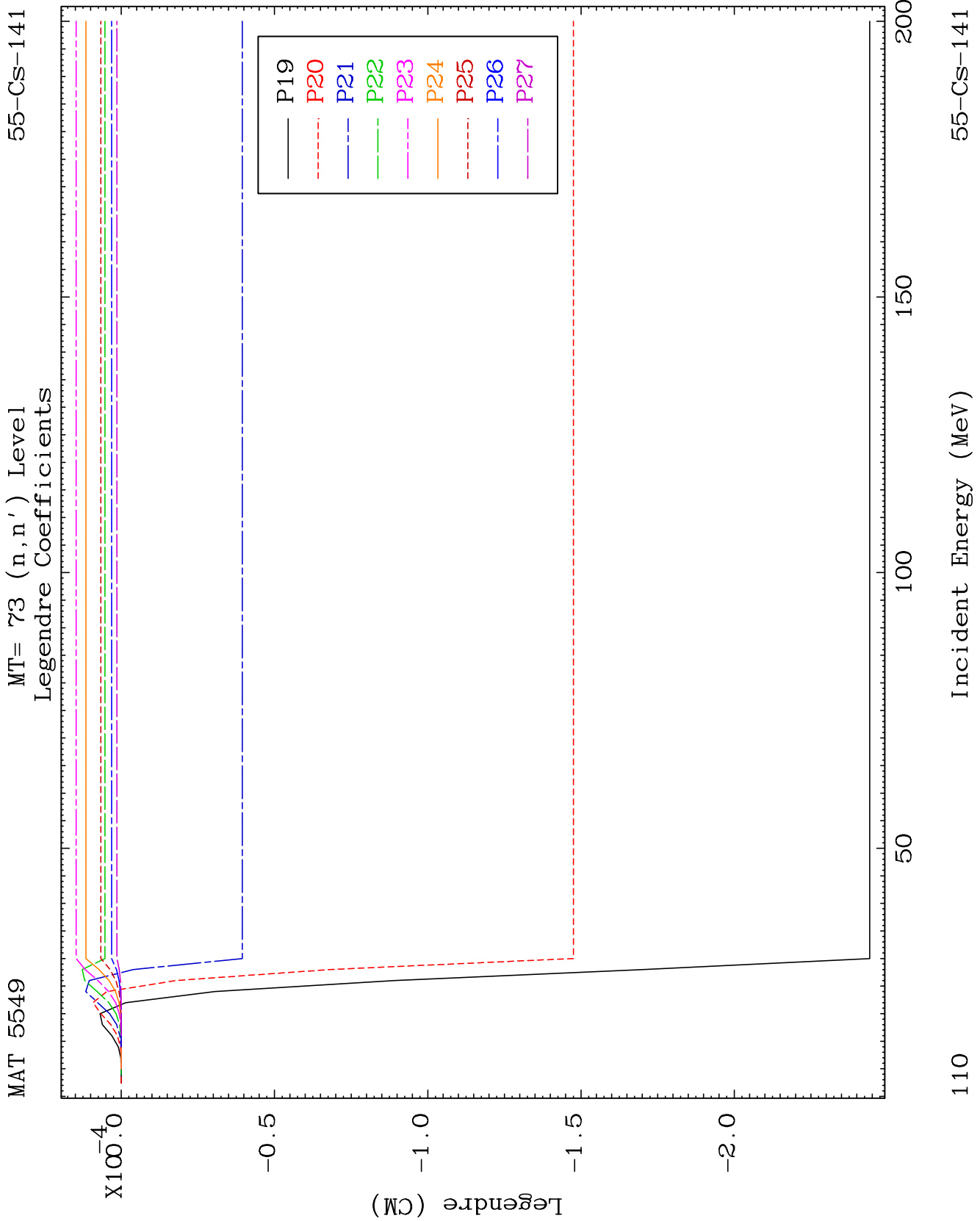

MAT 5549

MT= 73 (n,n') Level  
Legendre Coefficients

55-Cs-141

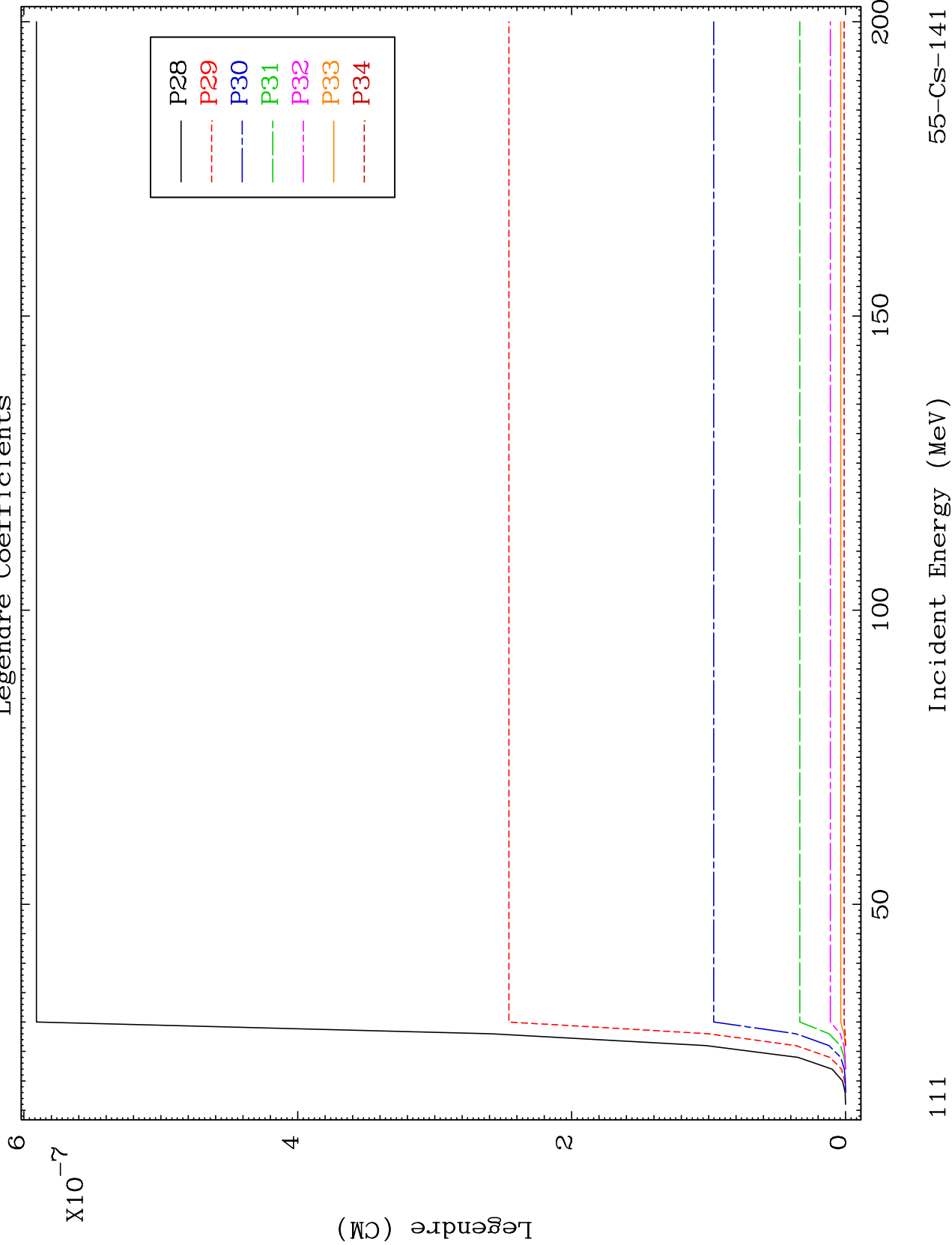



MAT 5549

MT= 74 (n,n') Level  
Legendre Coefficients

55-Cs-141

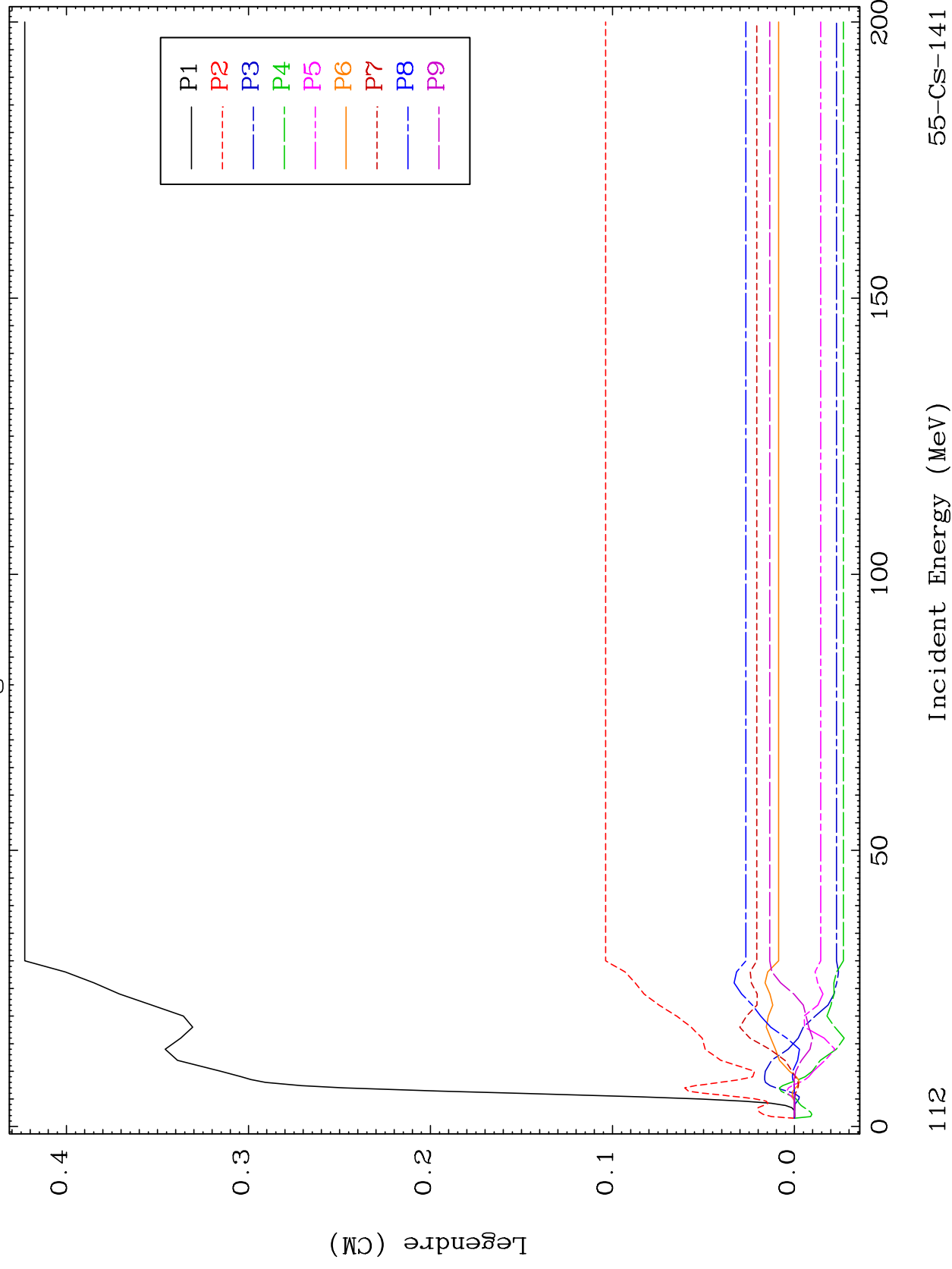

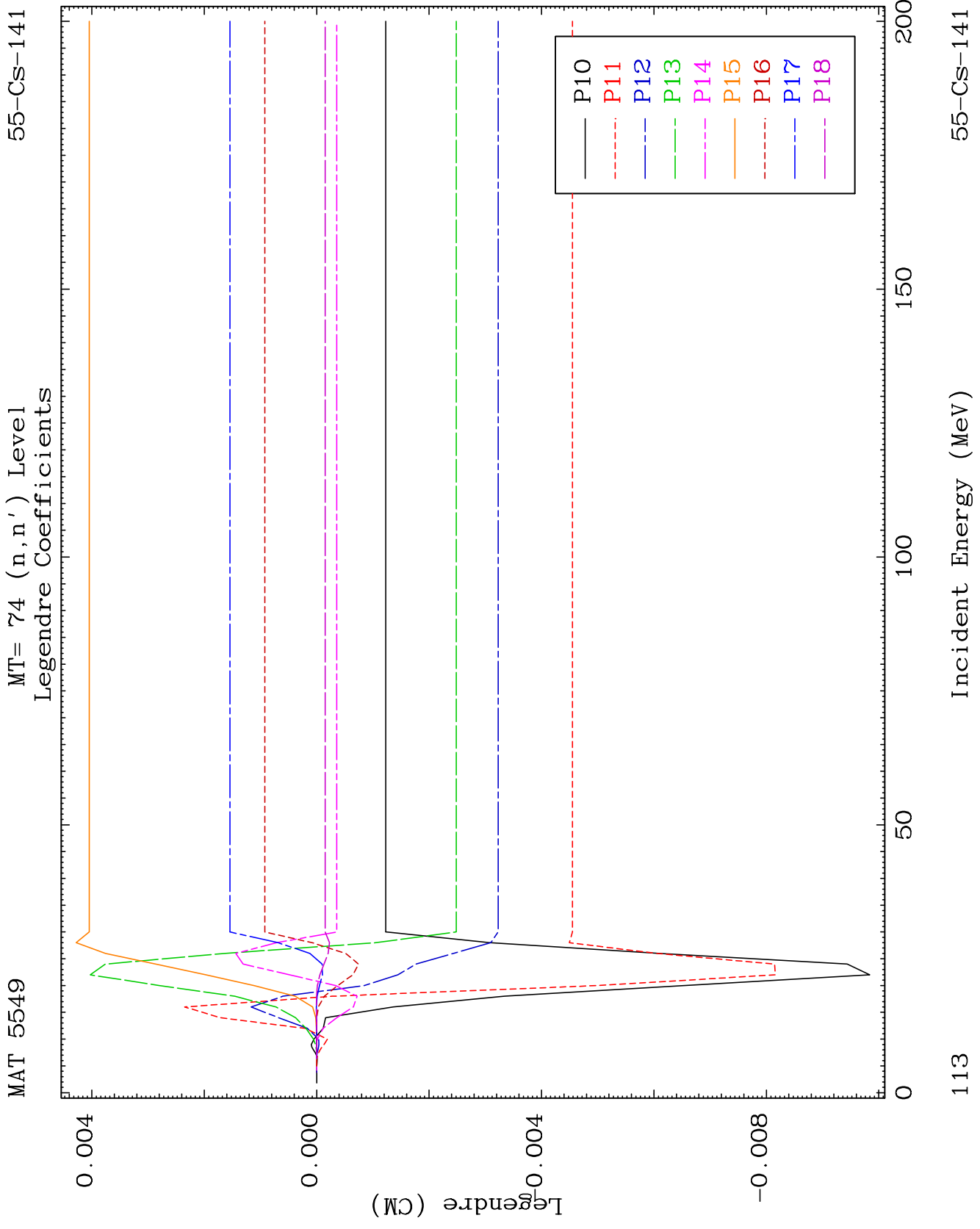

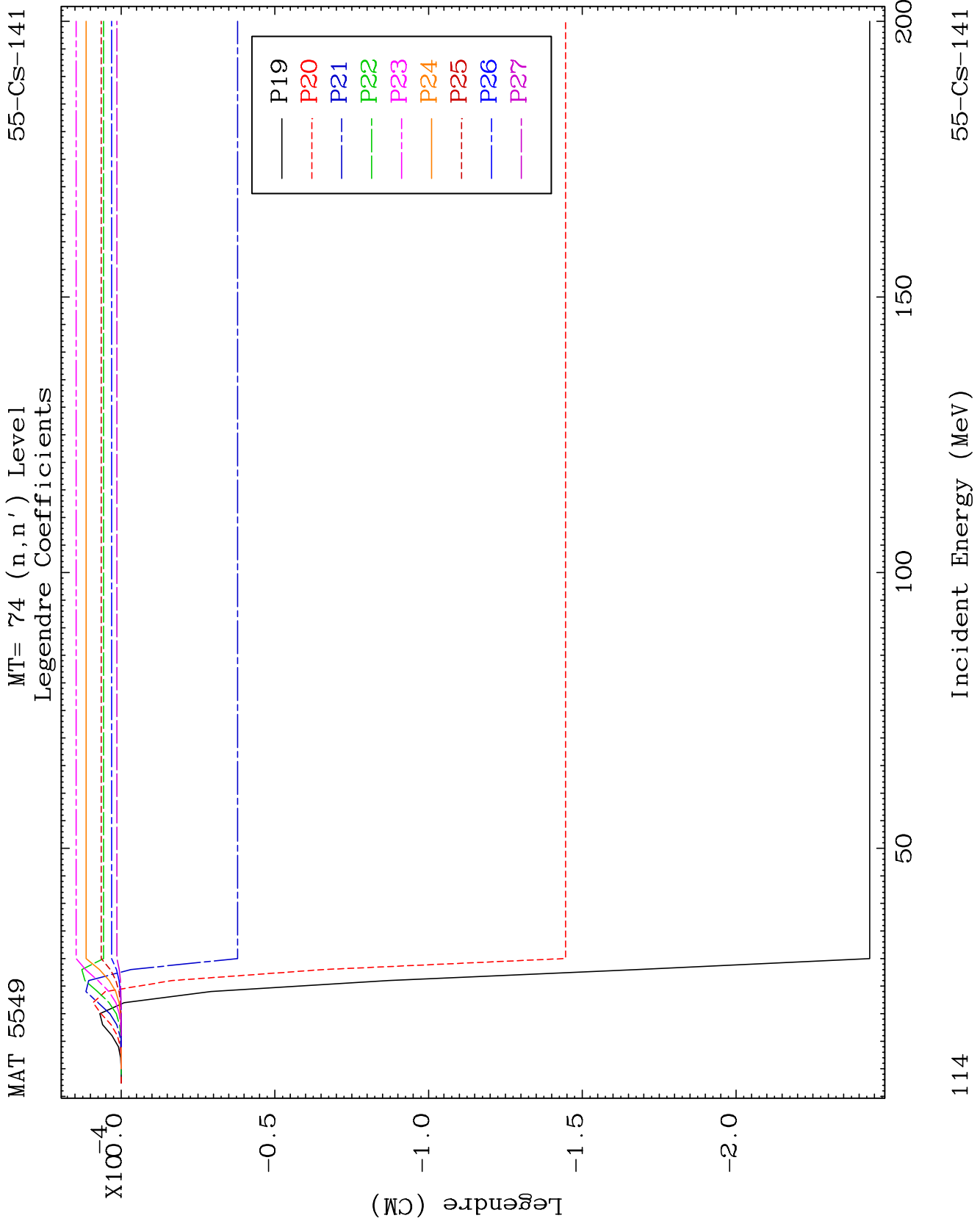

MAT 5549

MT= 74 (n,n') Level  
Legendre Coefficients

55-Cs-141

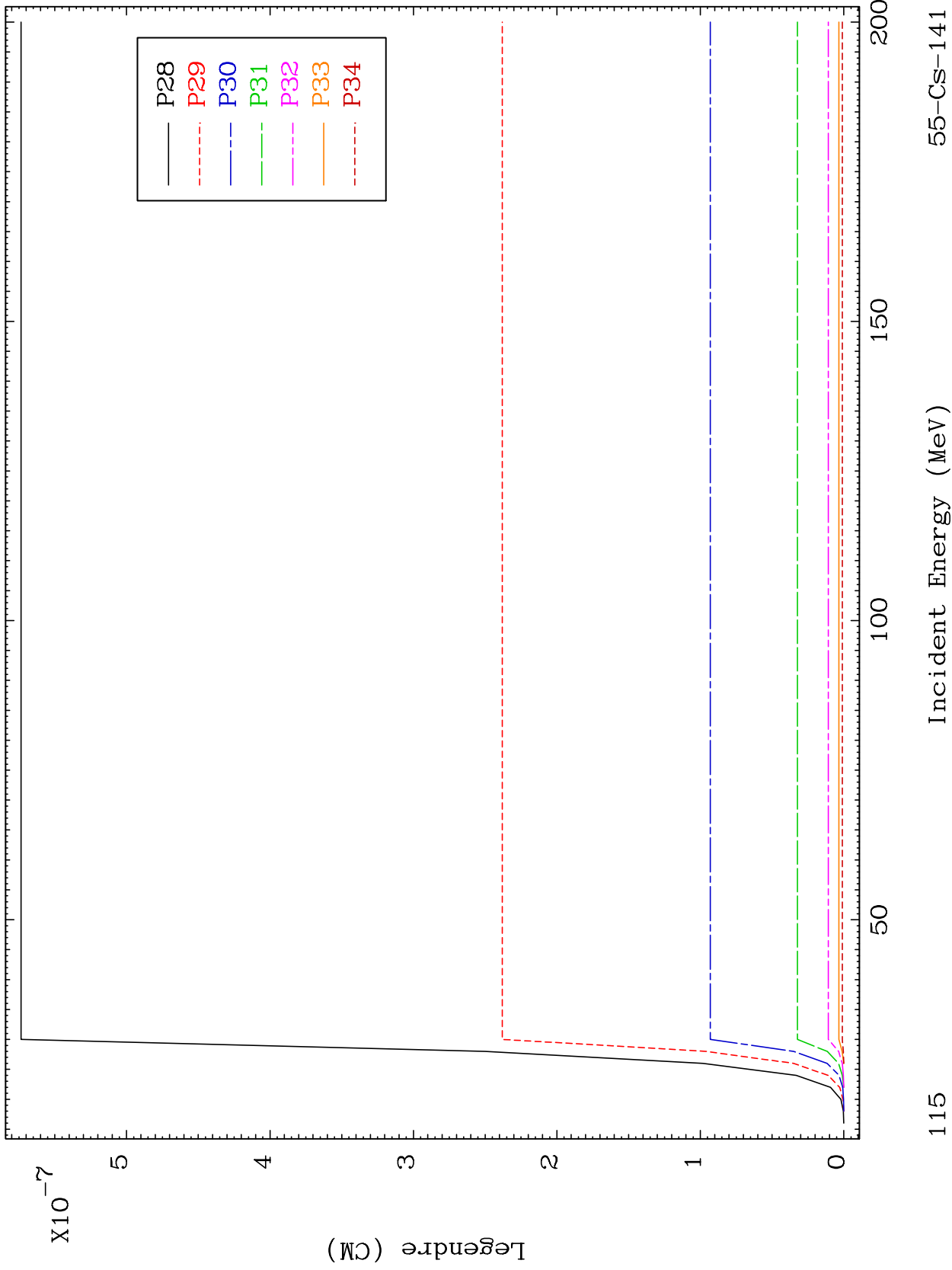

115

Incident Energy (MeV)

55-Cs-141

MAT 5549

MT= 75 (n,n') Level  
Legendre Coefficients

55-Cs-141

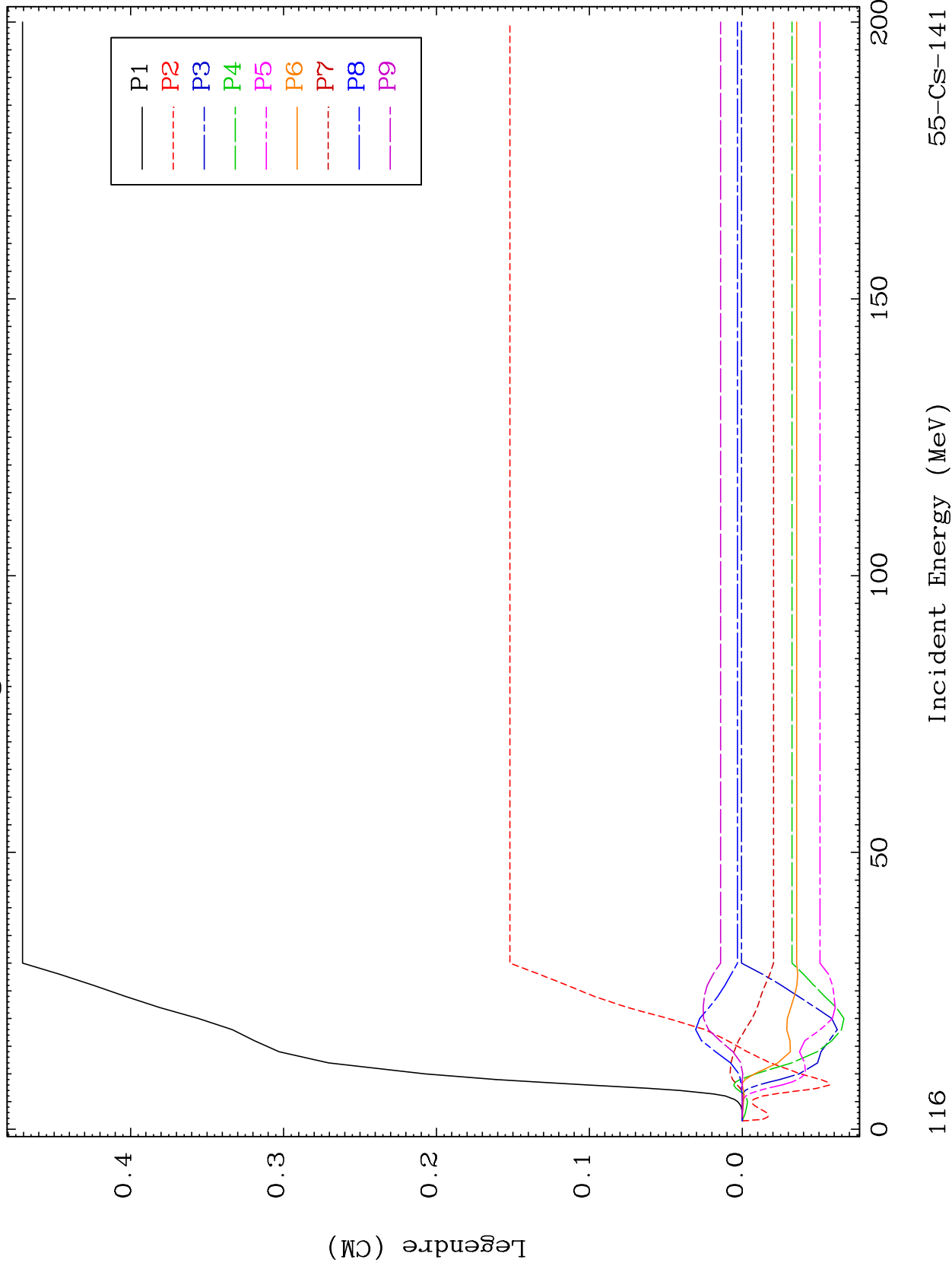

55-Cs-141

Incident Energy (MeV)

116

MAT 5549

MT= 75 (n,n') Level  
Legendre Coefficients

55-Cs-141

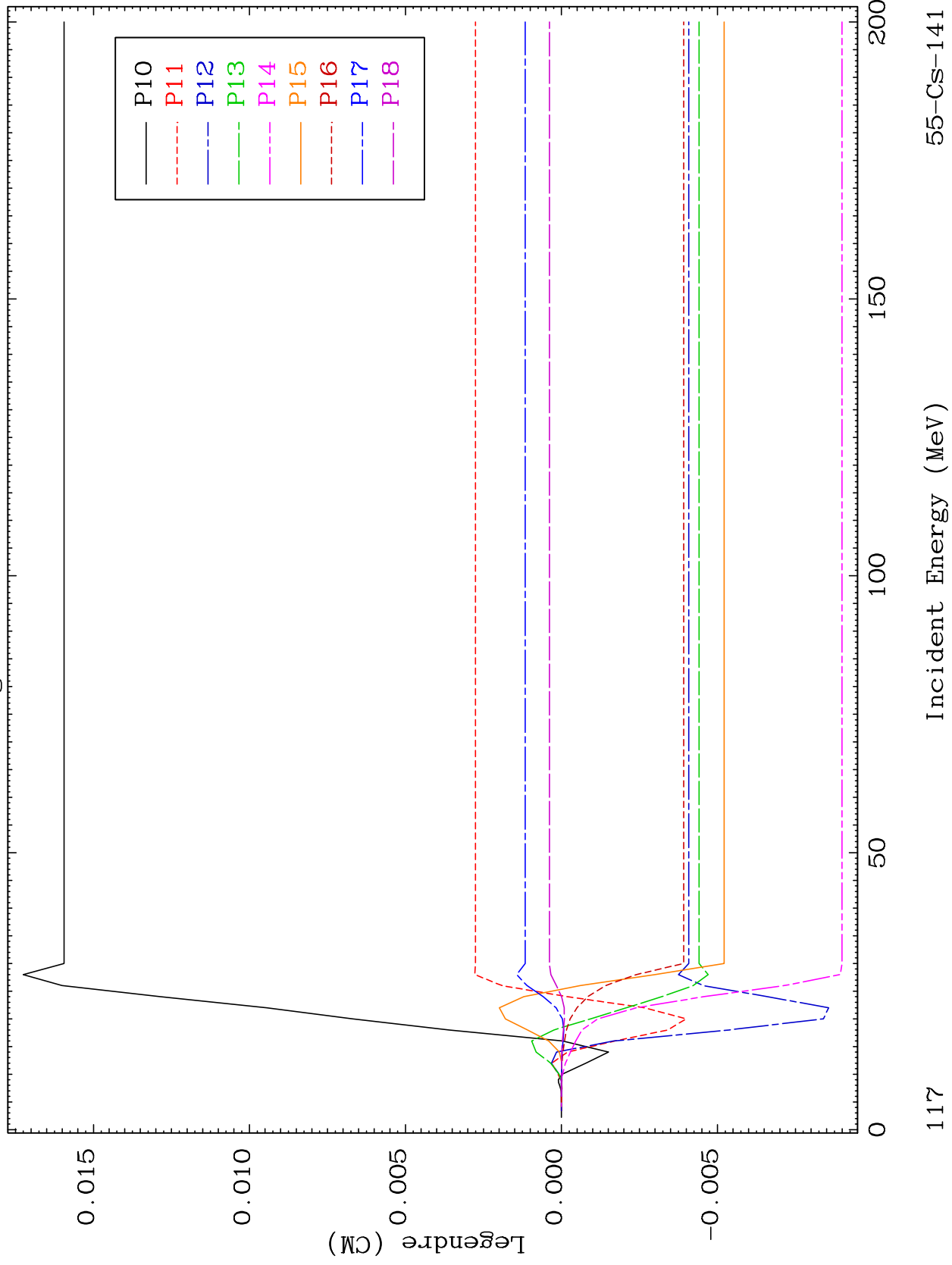

117

Incident Energy (MeV)

55-Cs-141

MAT 5549

MT= 75 (n,n') Level  
Legendre Coefficients

55-Cs-141

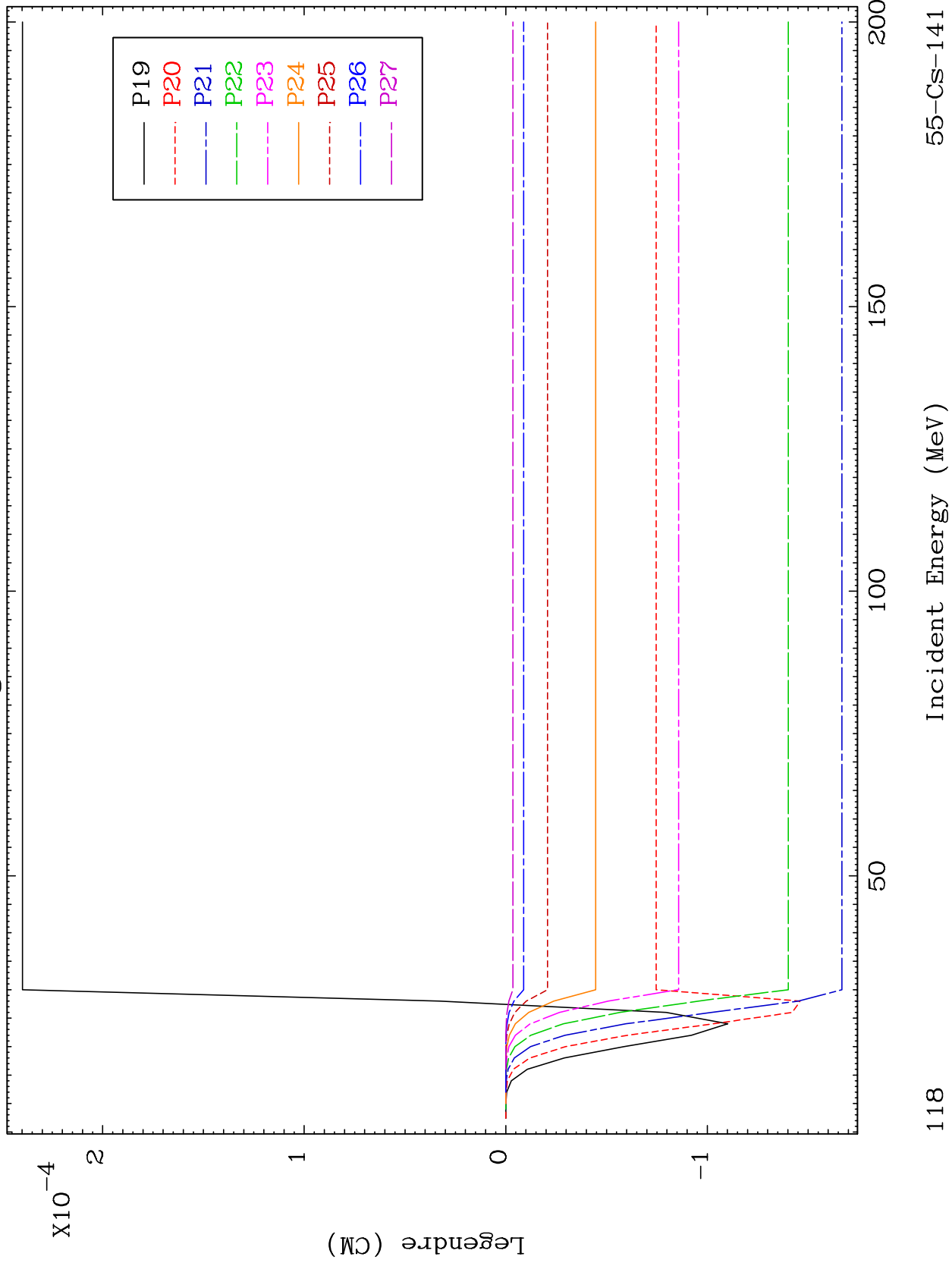

118

55-Cs-141

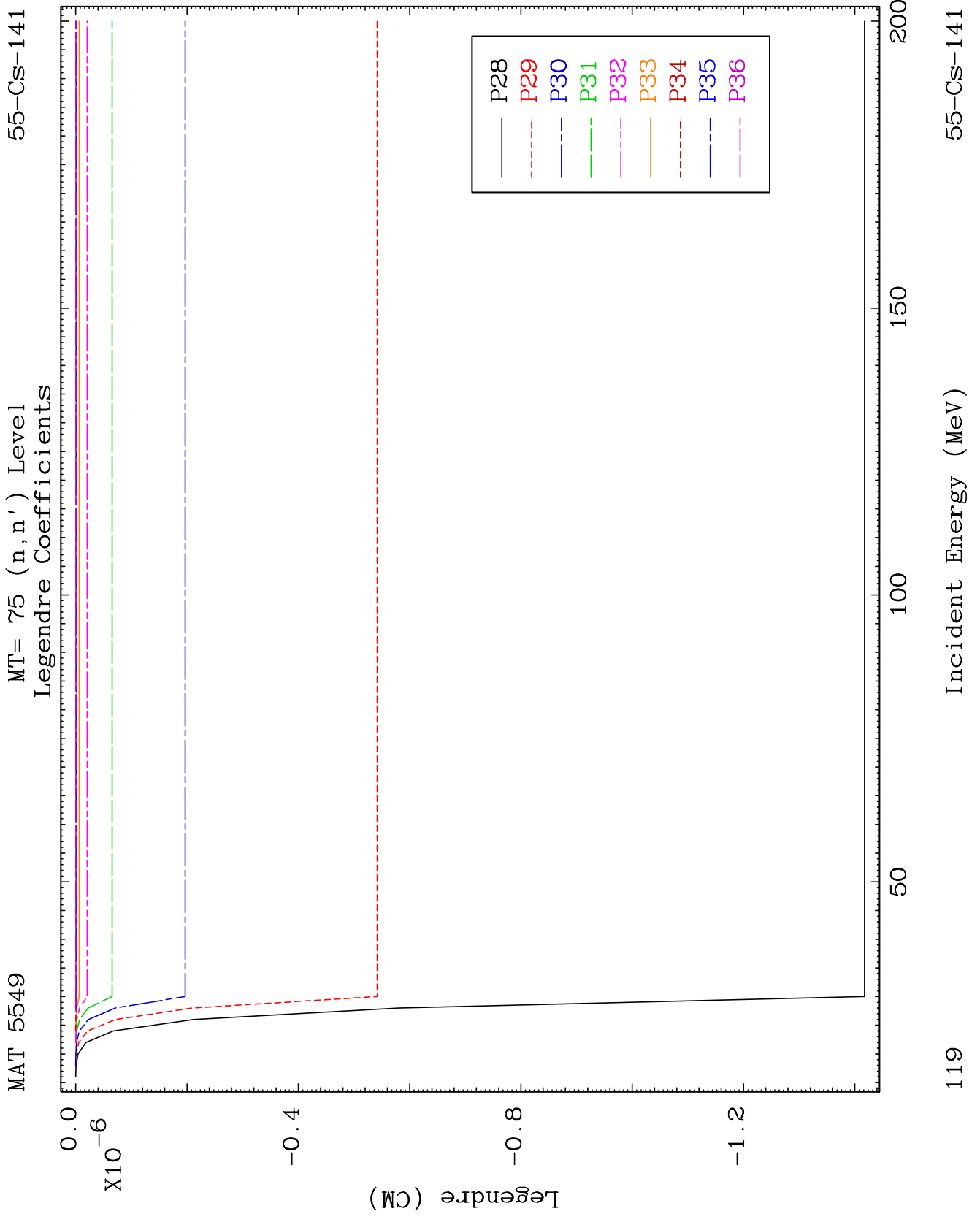



MAT 5549

MT= 76 (n,n') Level  
Legendre Coefficients

55-Cs-141

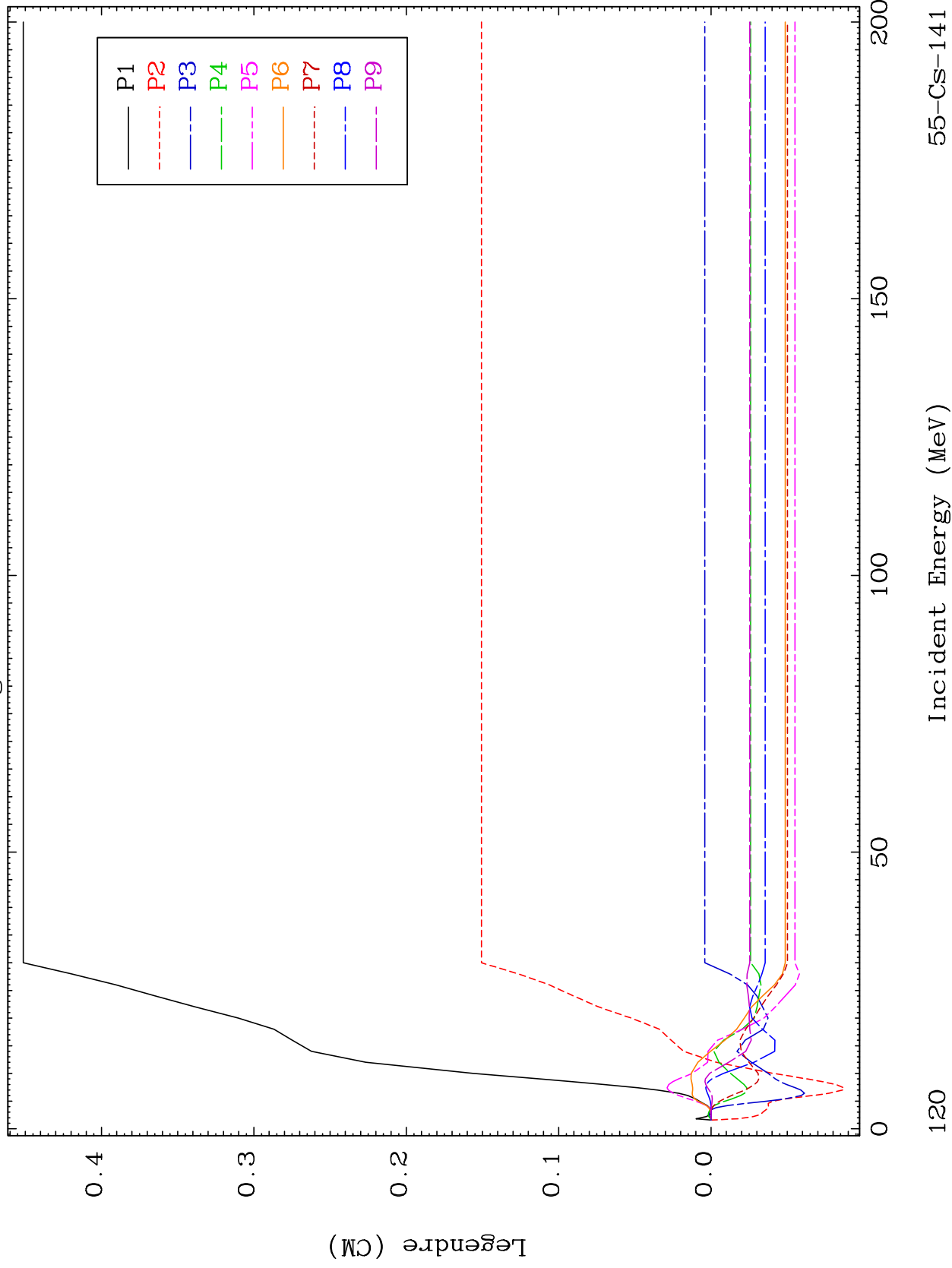

55-Cs-141

Incident Energy (MeV)

120

MAT 5549

MT= 76 (n,n') Level  
Legendre Coefficients

55-Cs-141

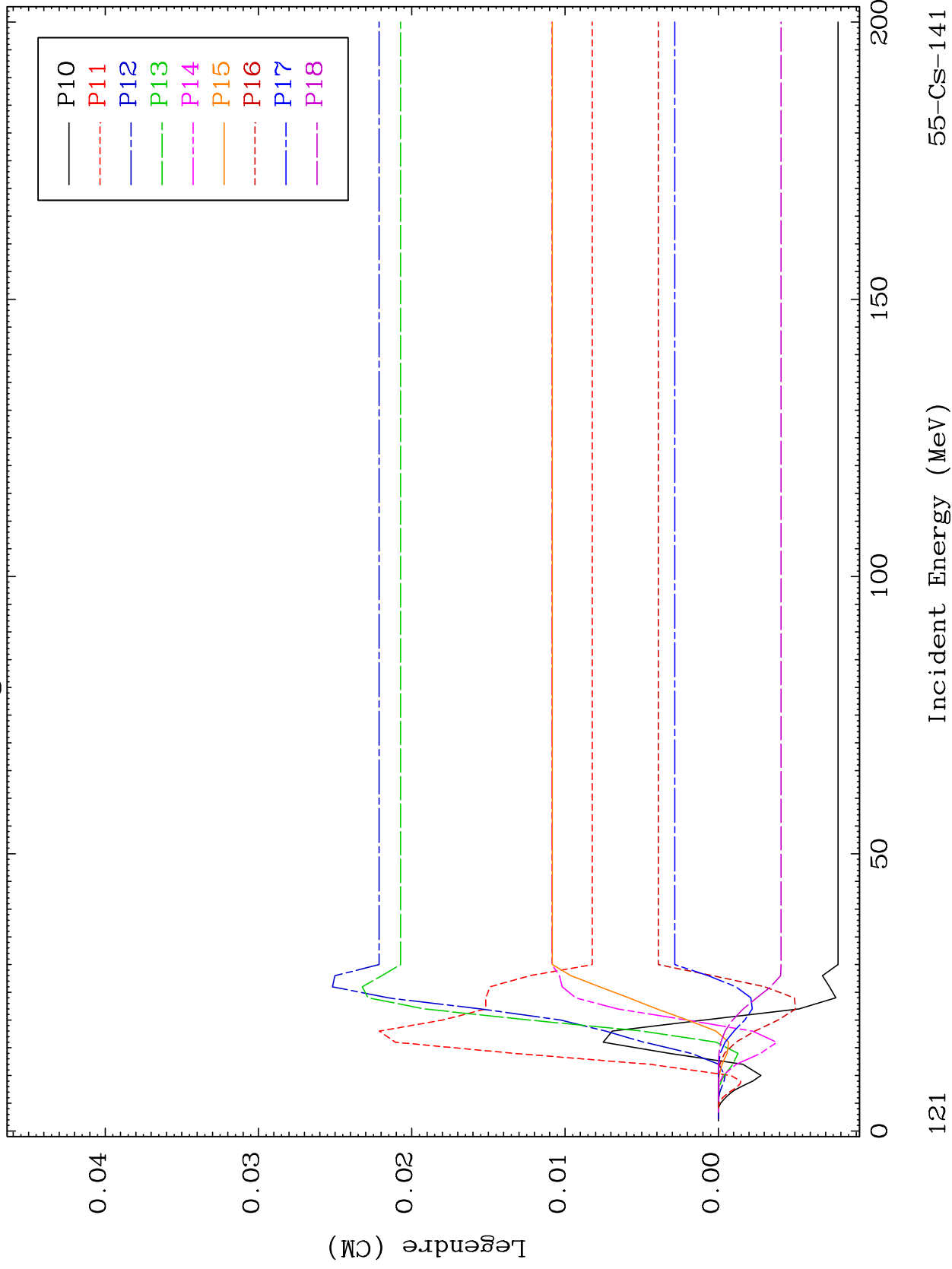

121

Incident Energy (MeV)

55-Cs-141

MAT 5549

MT= 76 (n,n') Level  
Legendre Coefficients

55-Cs-141

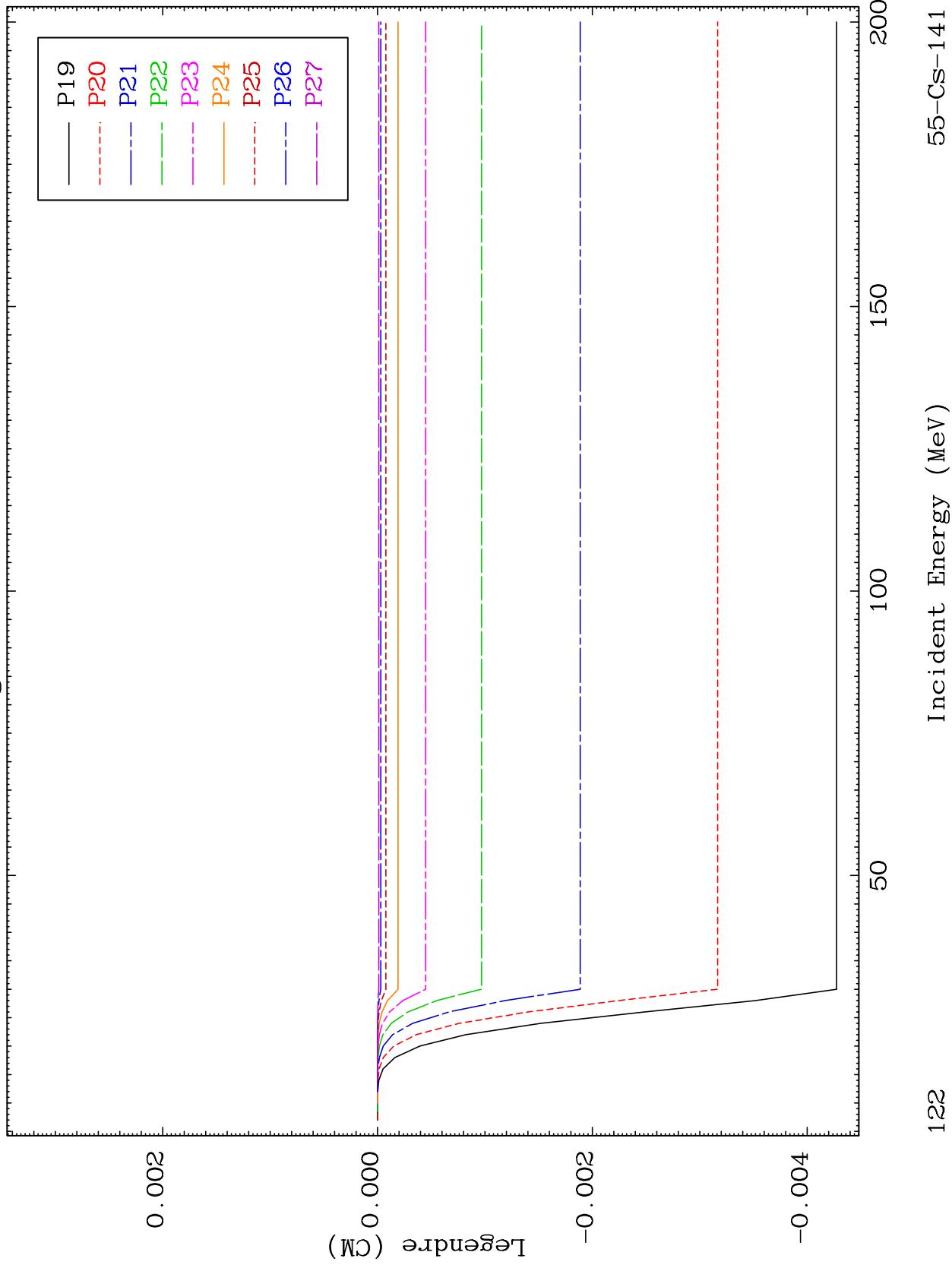

122

55-Cs-141

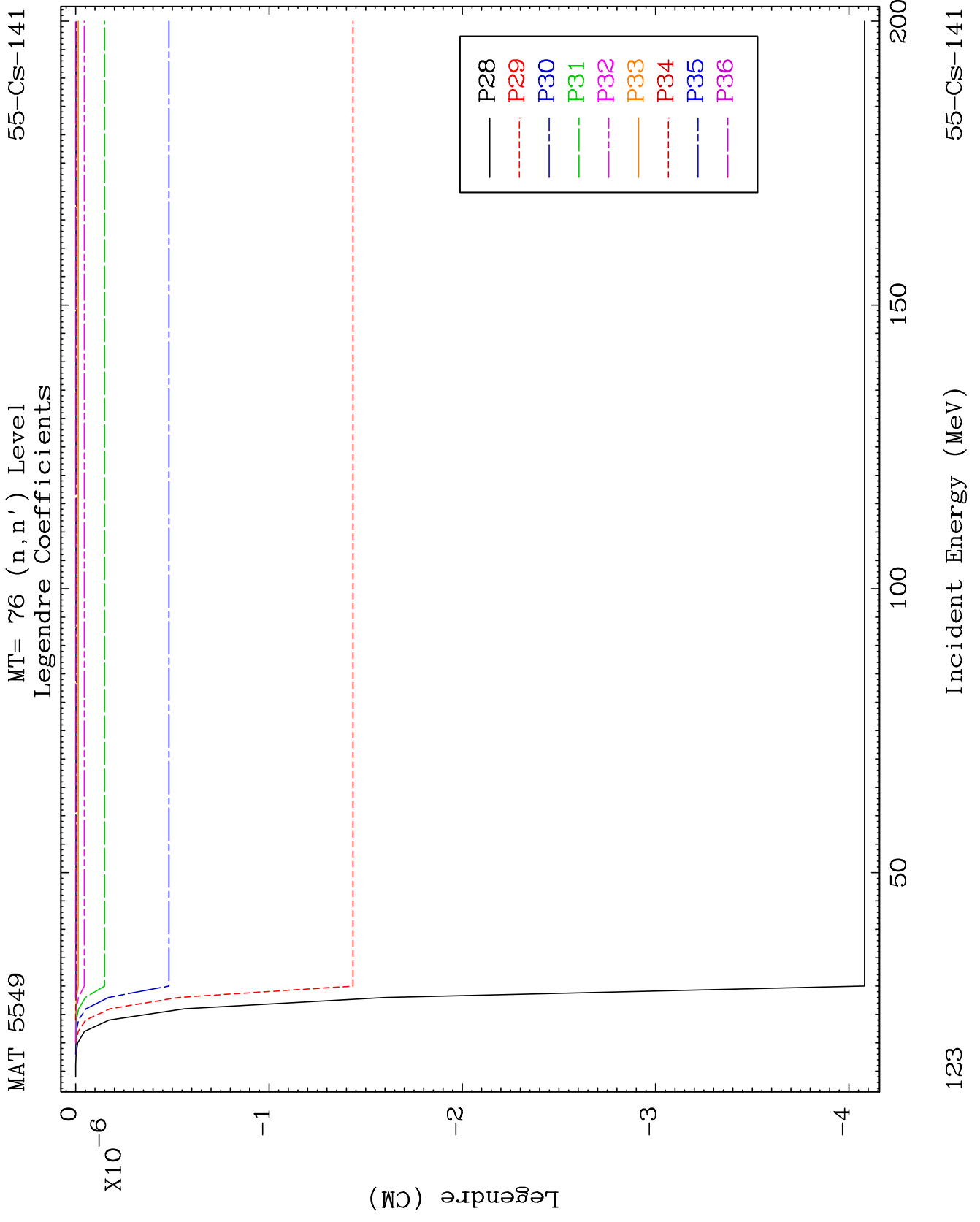

MAT 5549

MT= 77 (n,n') Level  
Legendre Coefficients

55-Cs-141

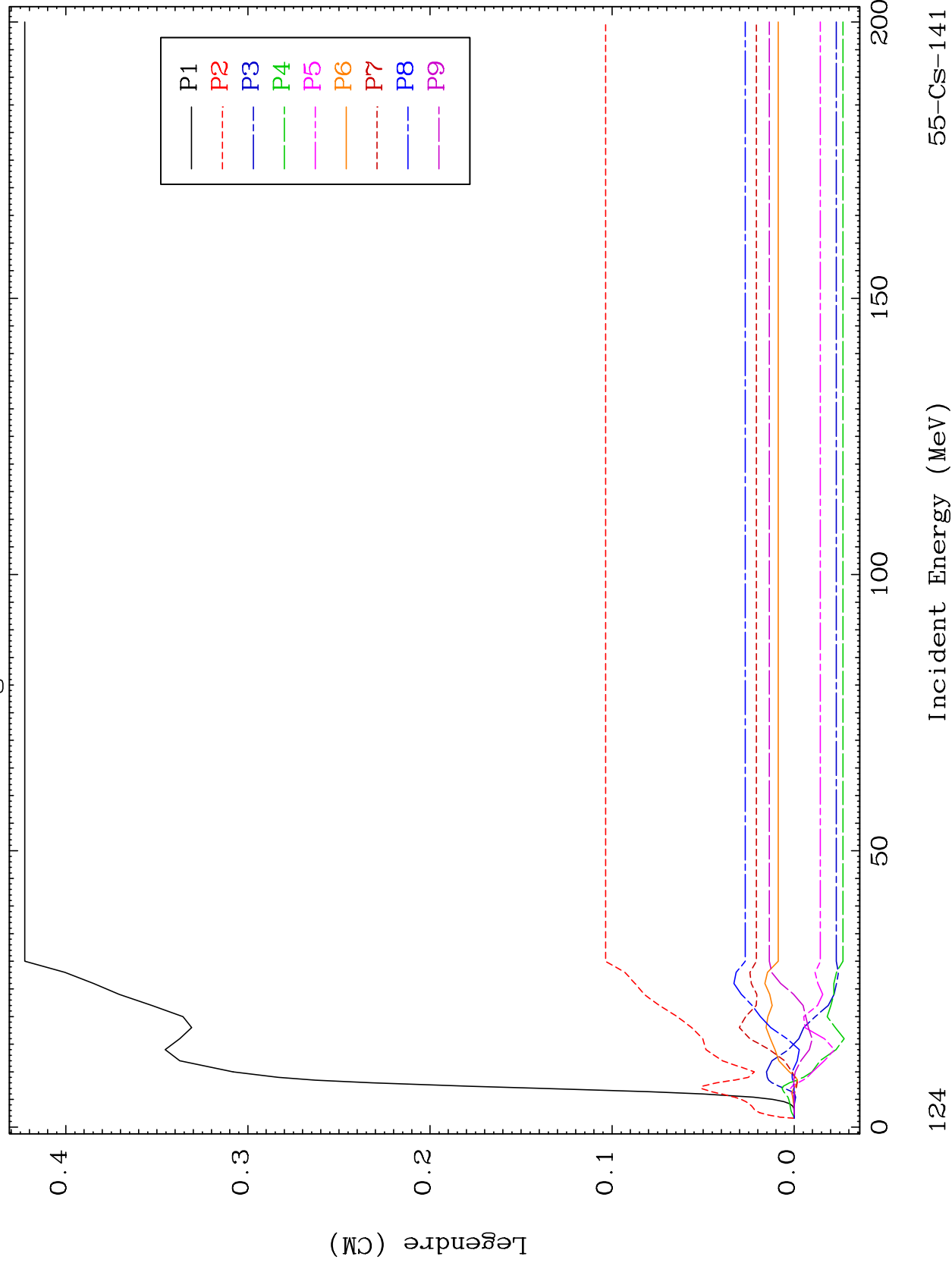

55-Cs-141

Incident Energy (MeV)

124

MAT 5549

MT= 77 (n,n') Level  
Legendre Coefficients

55-Cs-141

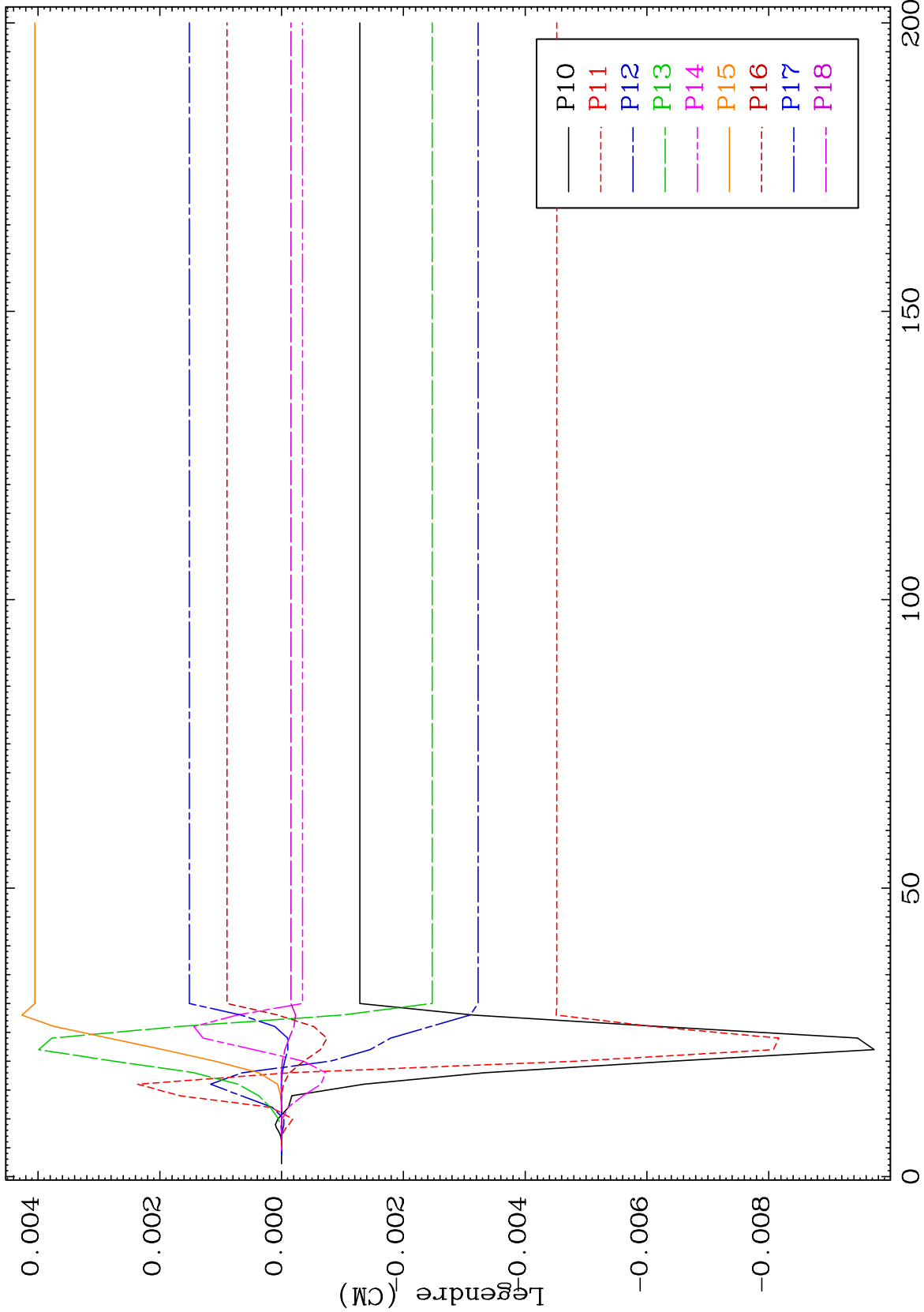

125

Incident Energy (MeV)

55-Cs-141

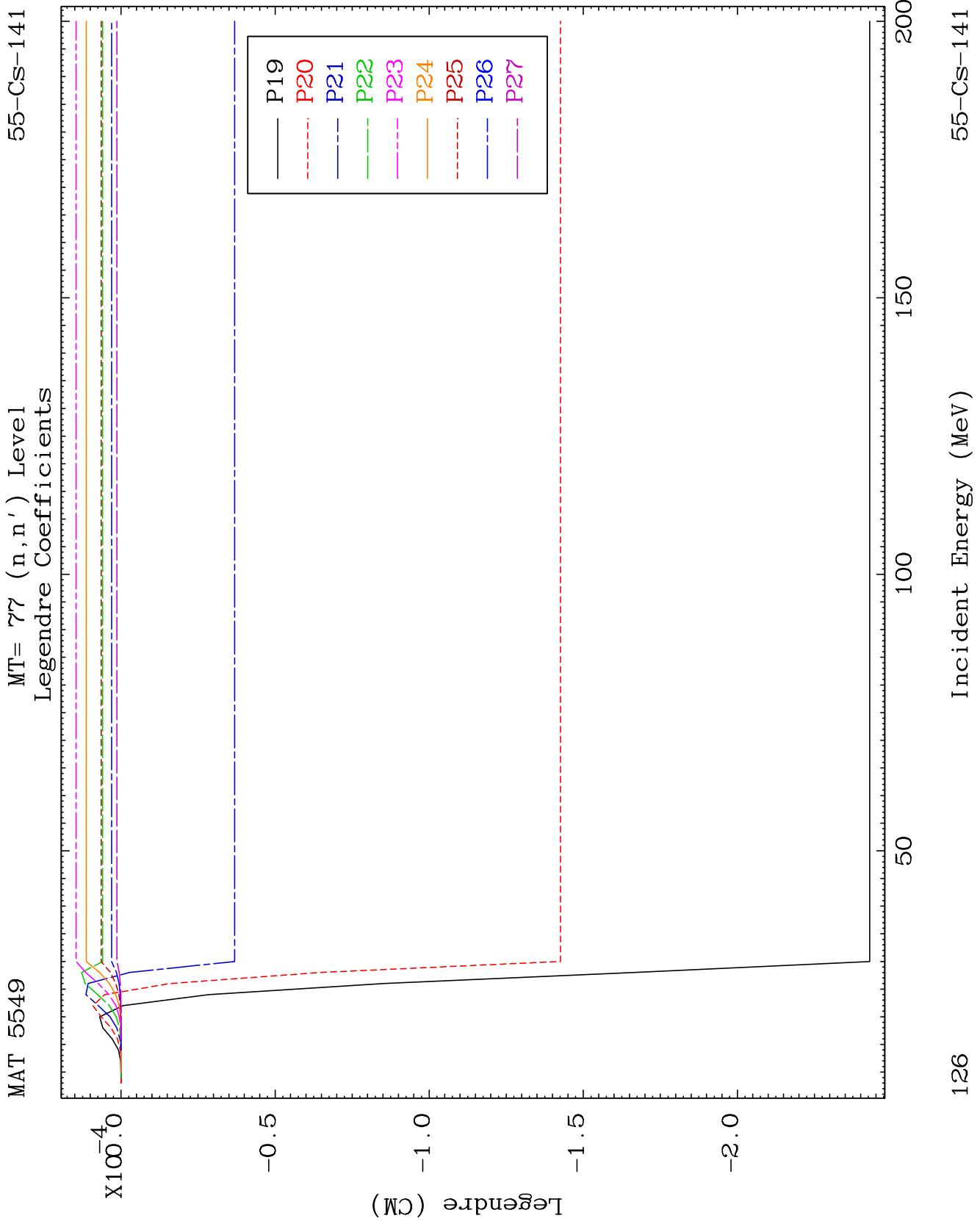

MAT 5549

MT= 77 (n,n') Level  
Legendre Coefficients

55-Cs-141

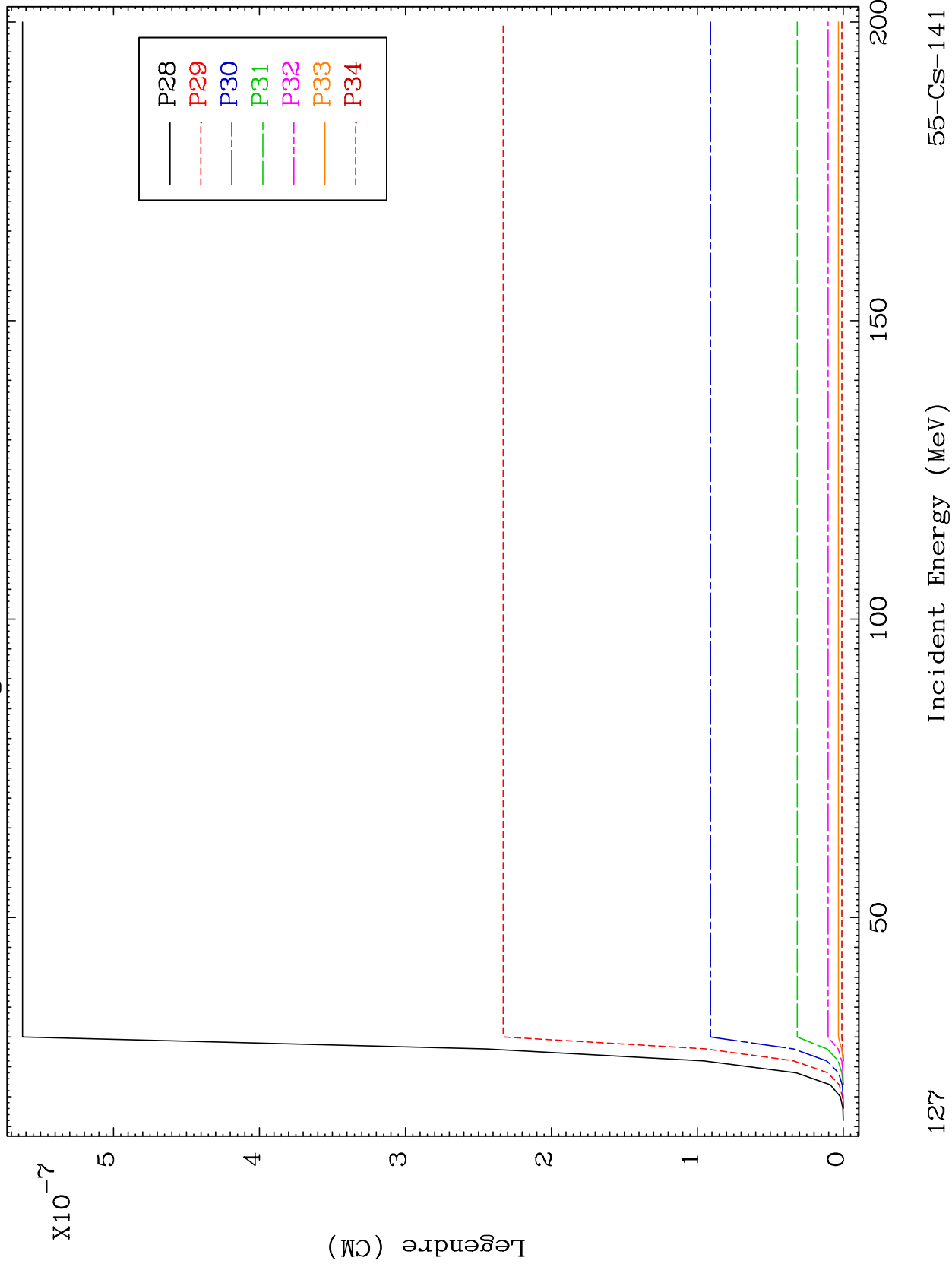

127

Incident Energy (MeV)

55-Cs-141



MAT 5549

MT= 78 (n,n') Level  
Legendre Coefficients

55-Cs-141

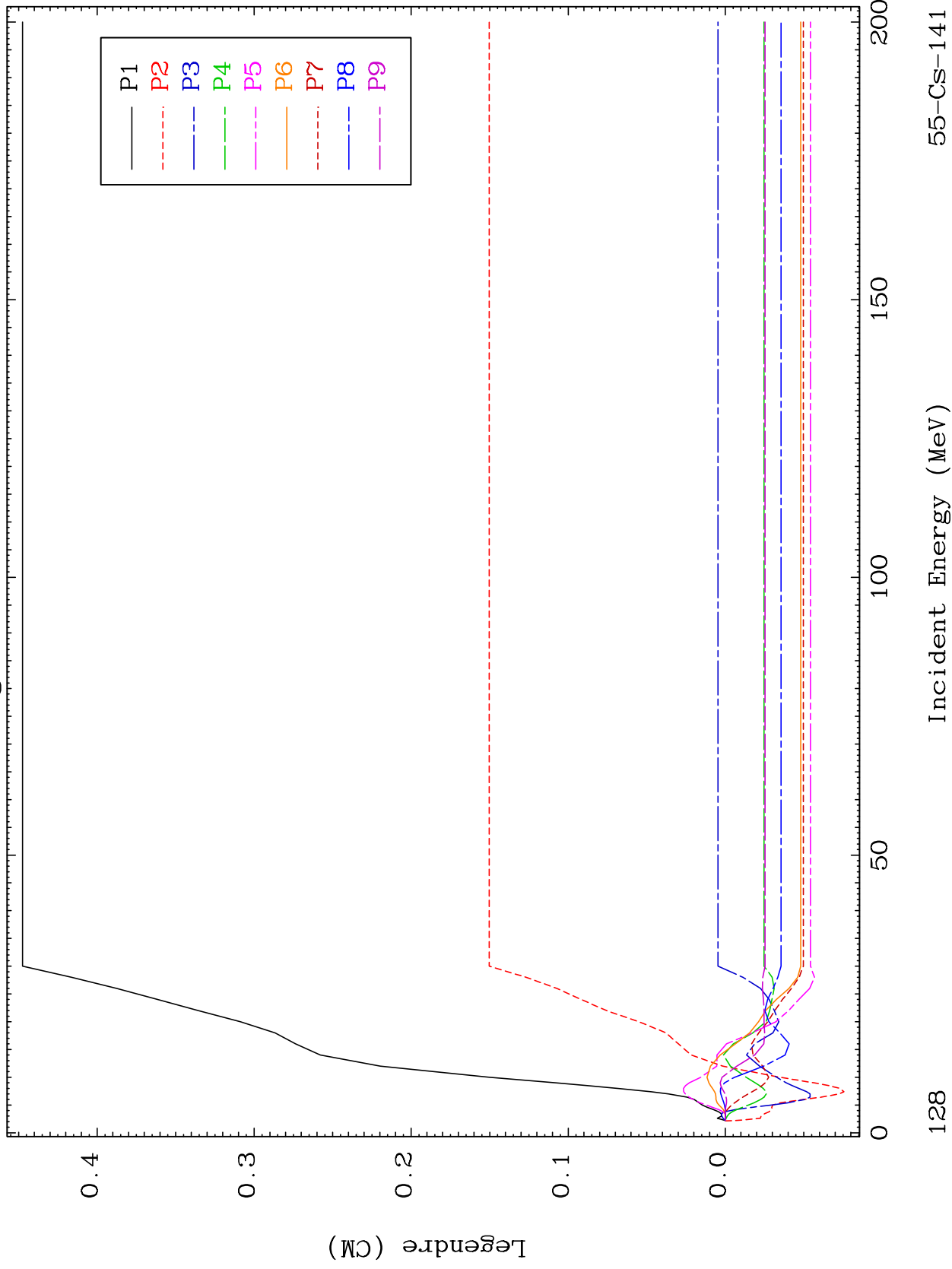

55-Cs-141

Incident Energy (MeV)

128

MAT 5549

MT= 78 (n,n') Level  
Legendre Coefficients

55-Cs-141

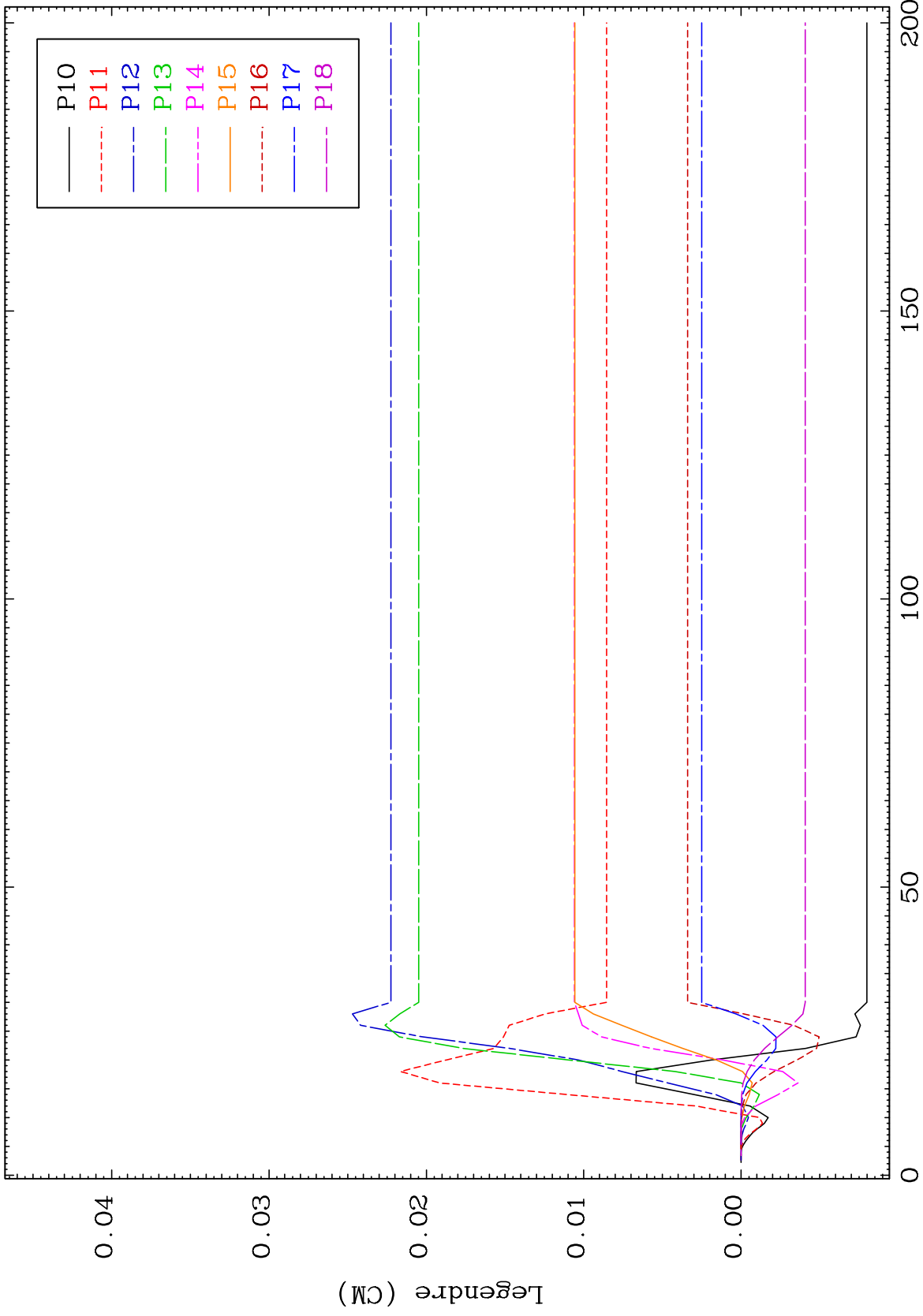

129

Incident Energy (MeV)

55-Cs-141

MAT 5549

MT= 78 (n,n') Level  
Legendre Coefficients

55-Cs-141

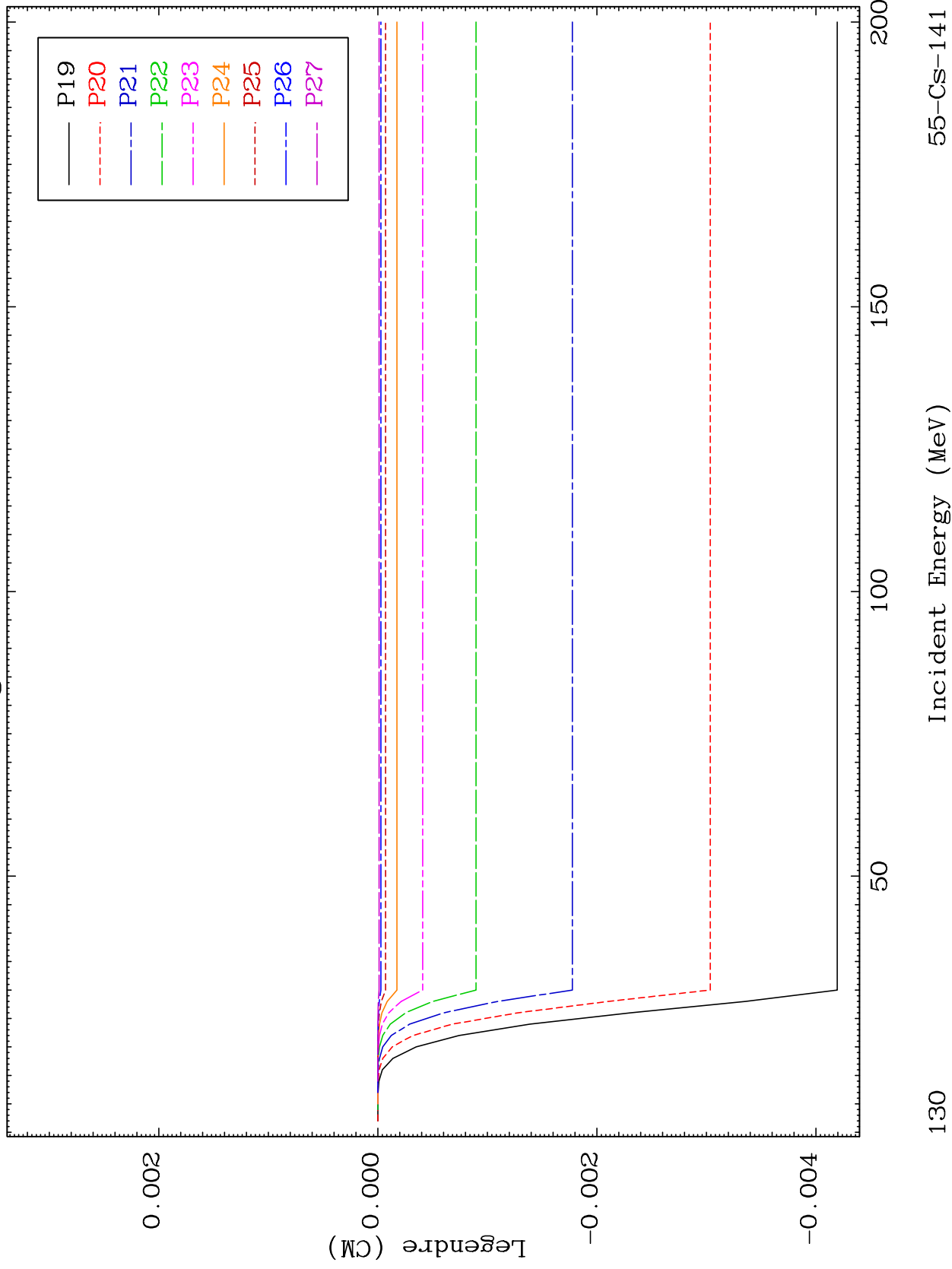

130

Incident Energy (MeV)

55-Cs-141

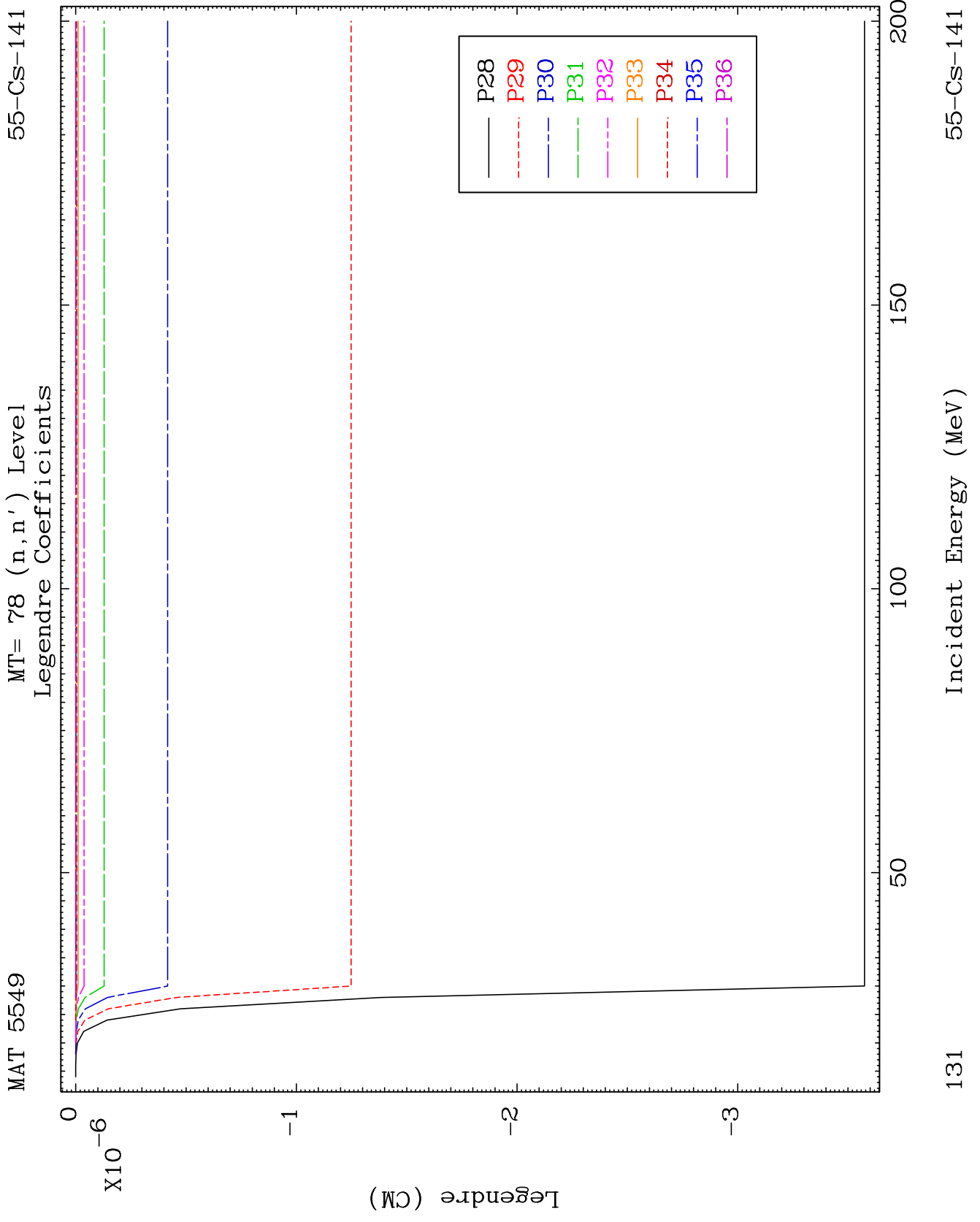

MAT 5549

55-Cs-141

(n,2n)  $\alpha$

Radionuclide Production Cross Section

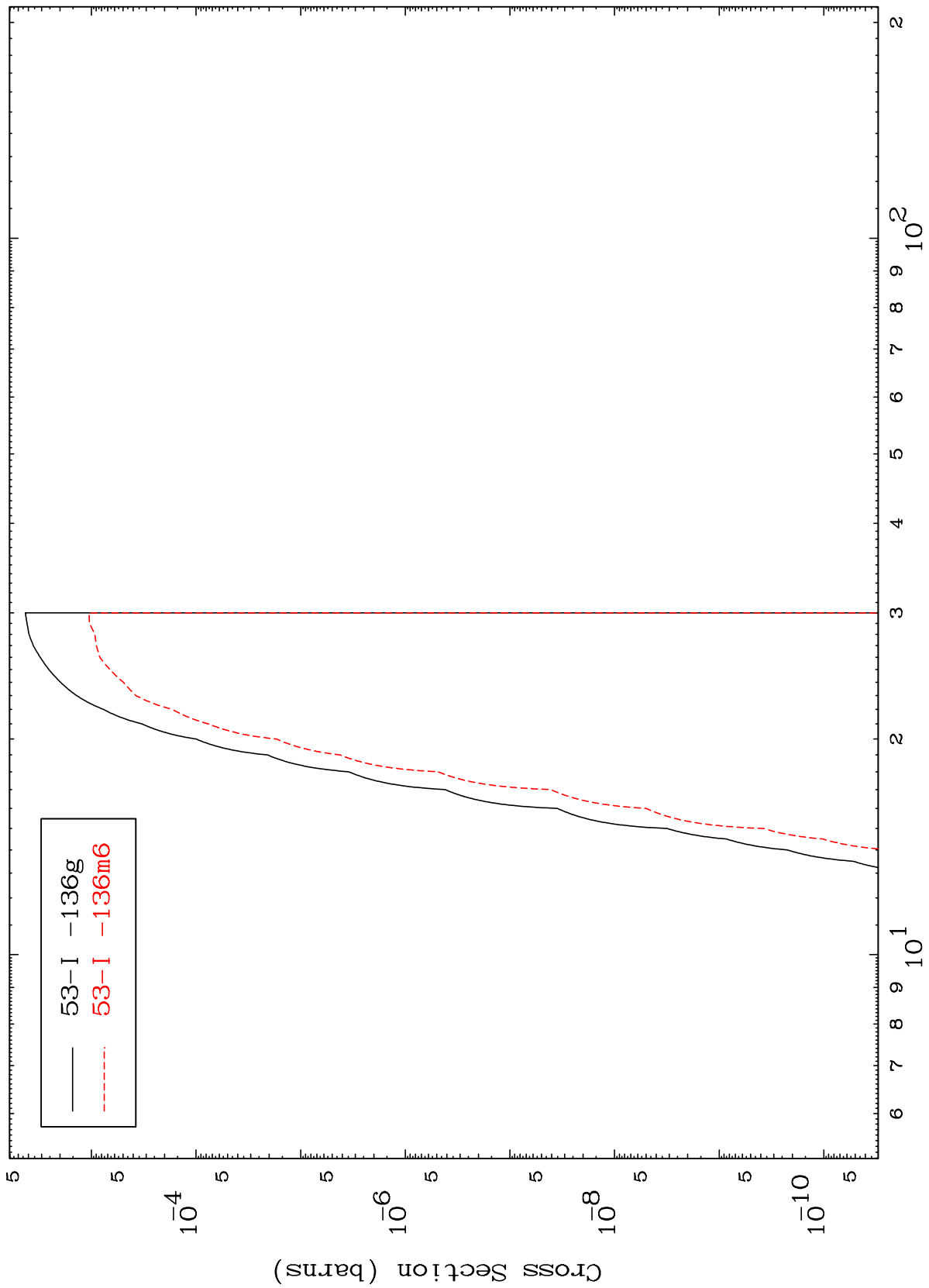

53-I -136g  
53-I -136m6

132

Incident Energy (MeV)

55-Cs-141

MAT 5549

(n,4n)

55-Cs-141

Radionuclide Production Cross Section

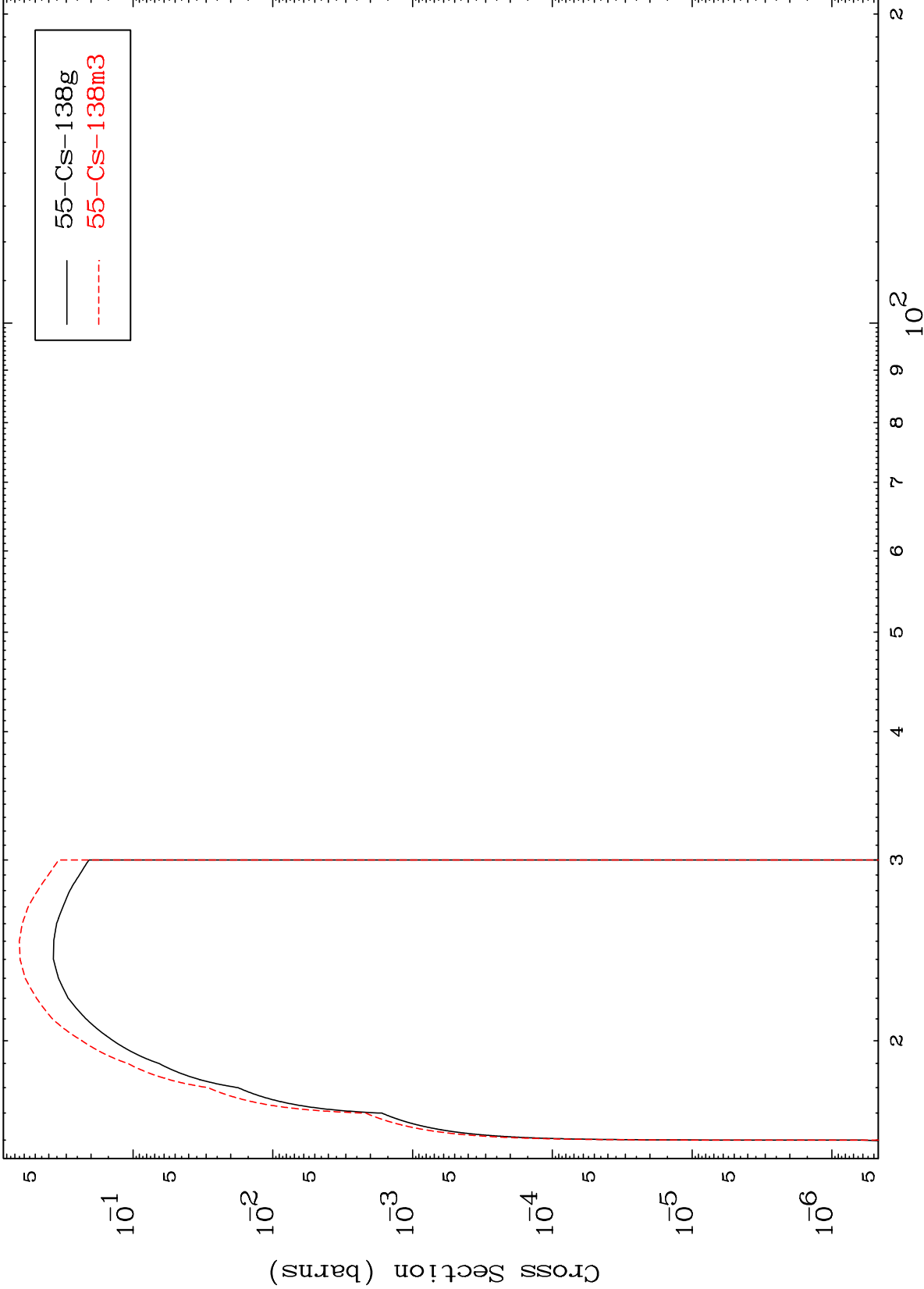

55-Cs-138g  
55-Cs-138m3

133

Incident Energy (MeV)

55-Cs-141

MAT 5549

(n,2α)

55-Cs-141

Radionuclide Production Cross Section

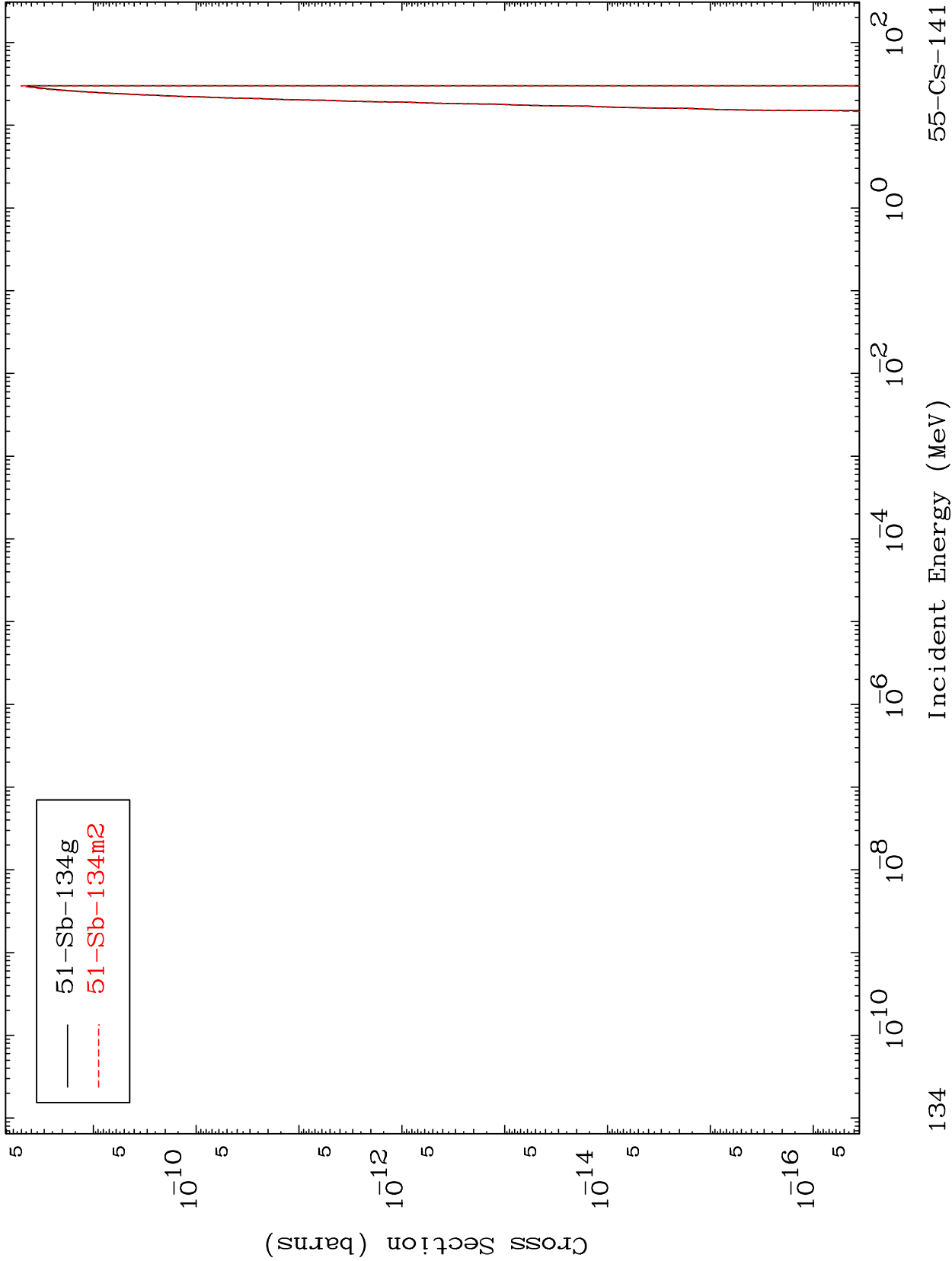

134

Incident Energy (MeV)

55-Cs-141