

CU073 NEUTRON ACER TENDL-2021 LIBRARY; T=293.6K
Principal cross sections

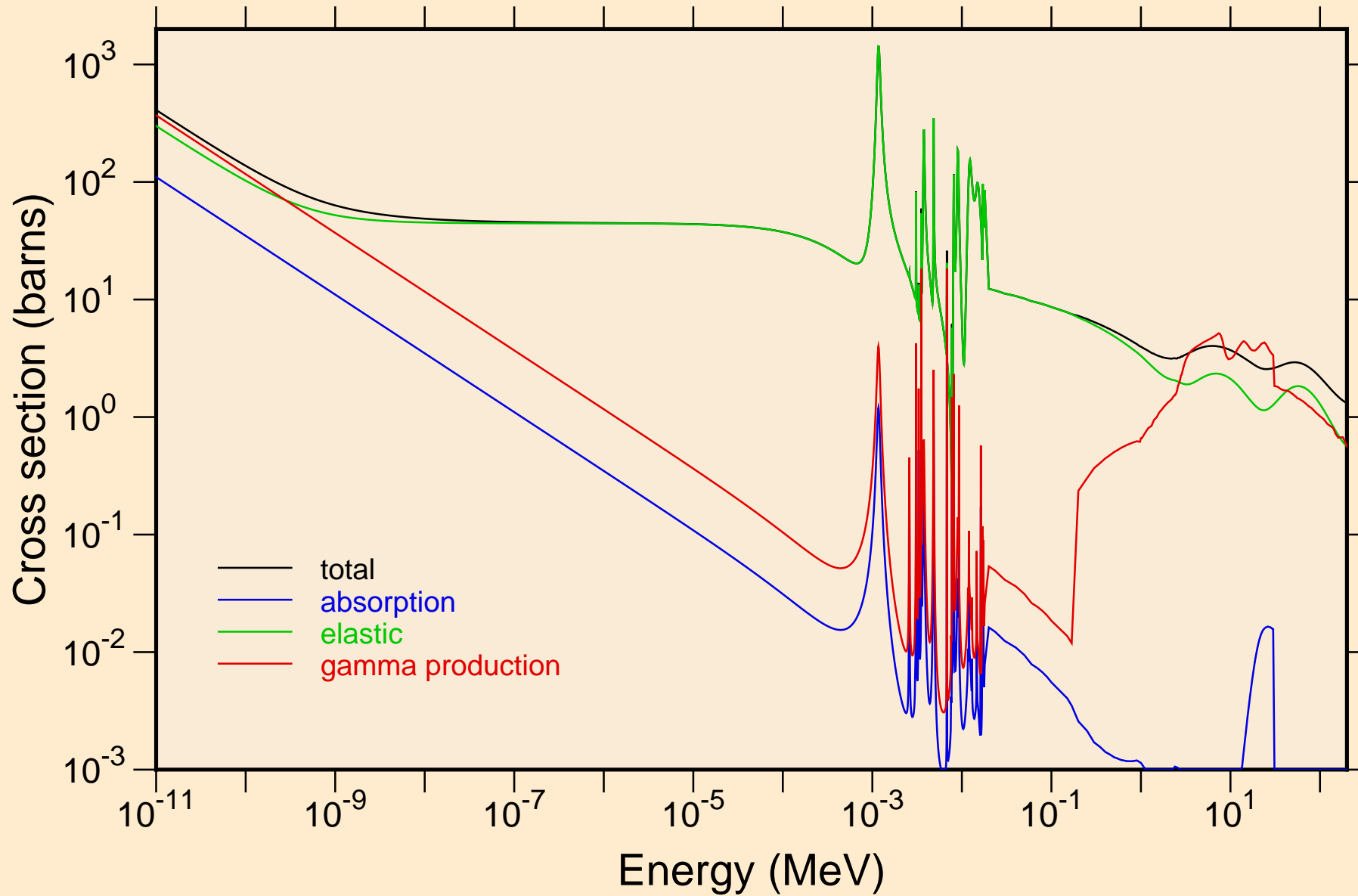

CU073 NEUTRON ACER TENDL-2021 LIBRARY; T=293.6K
resonance total cross section

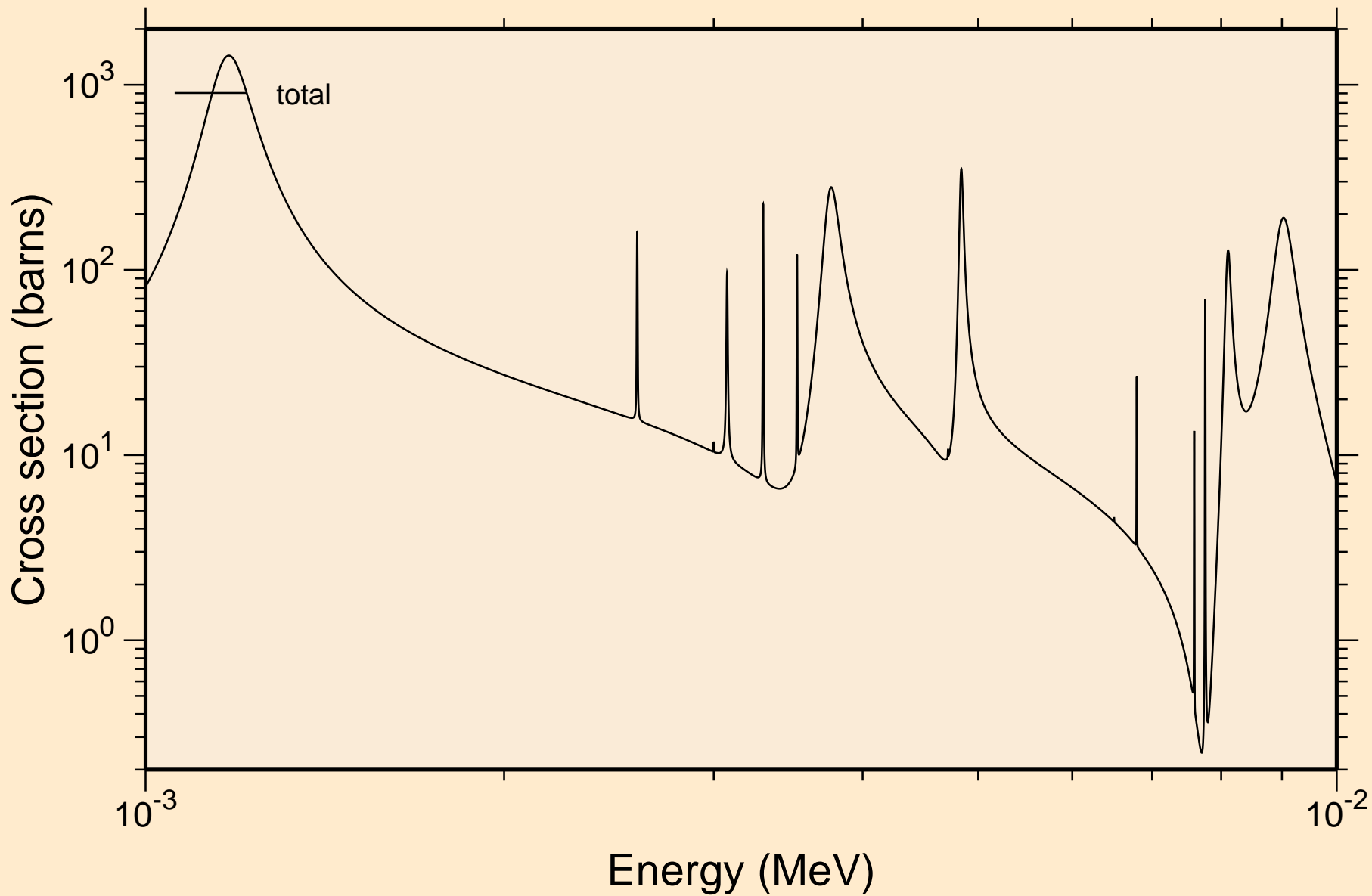

CU073 NEUTRON ACER TENDL-2021 LIBRARY; T=293.6K
resonance total cross section

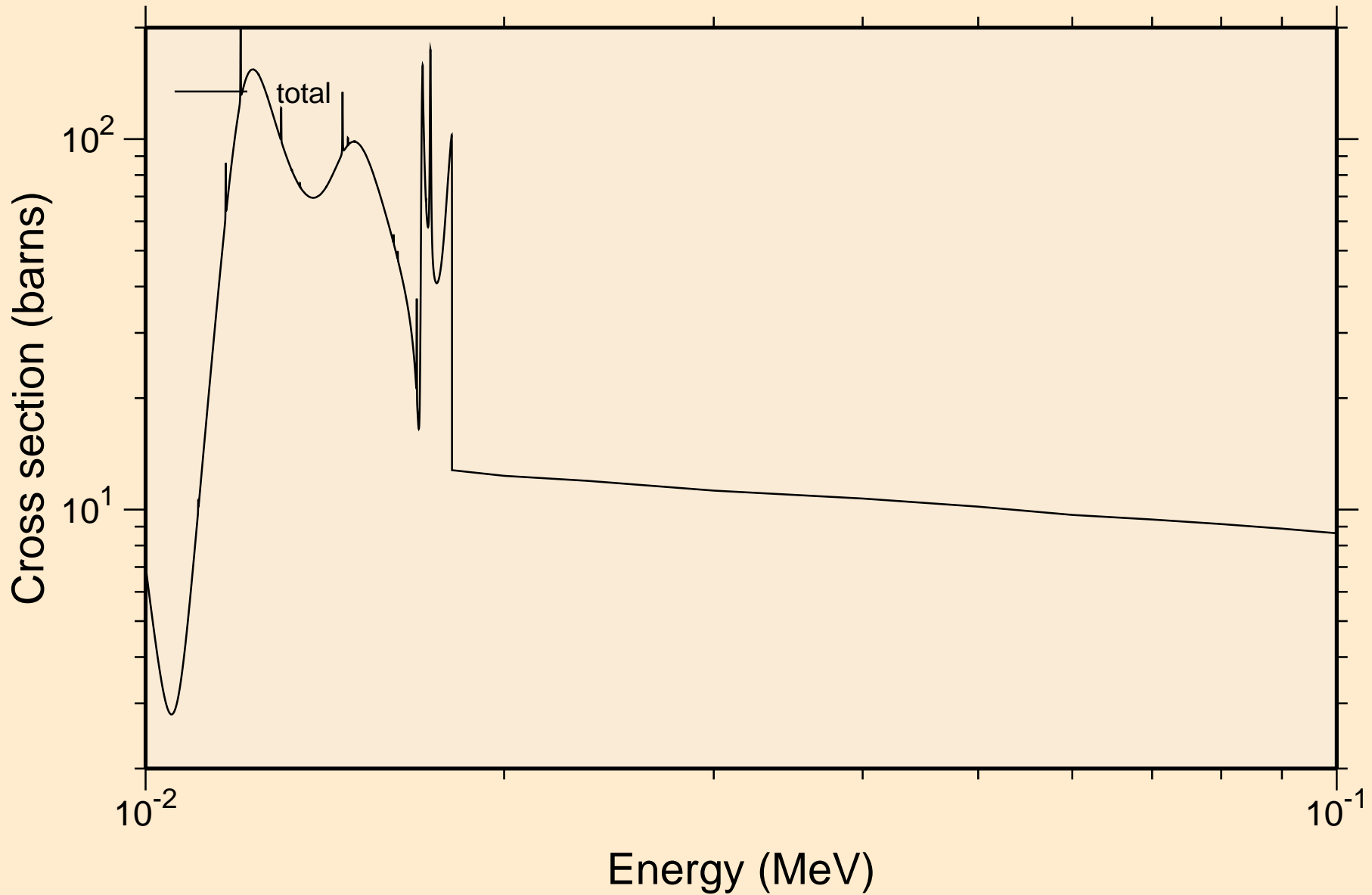

CU073 NEUTRON ACER TENDL-2021 LIBRARY; T=293.6K
resonance total cross section

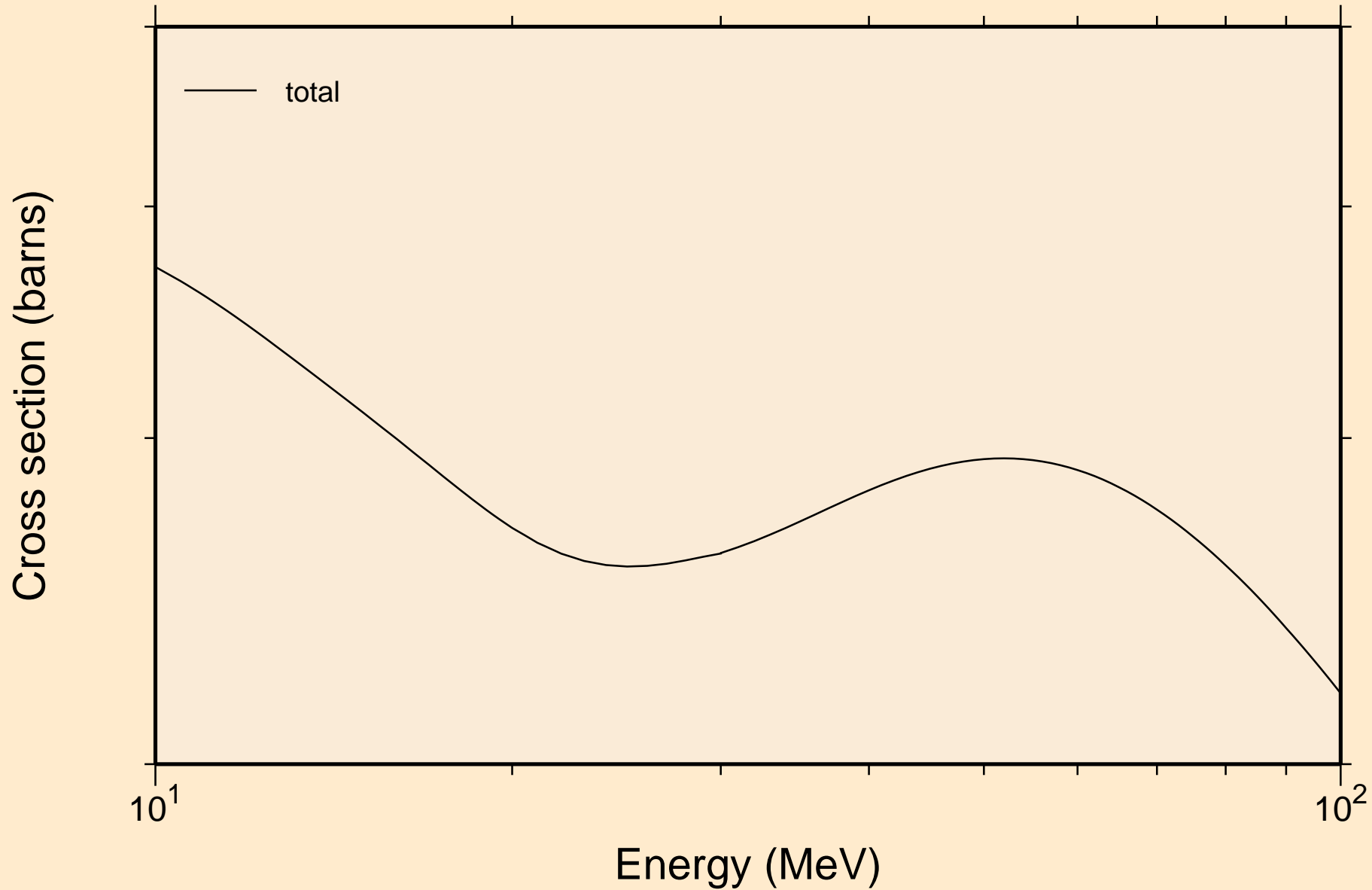

CU073 NEUTRON ACER TENDL-2021 LIBRARY; T=293.6K
resonance absorption cross sections

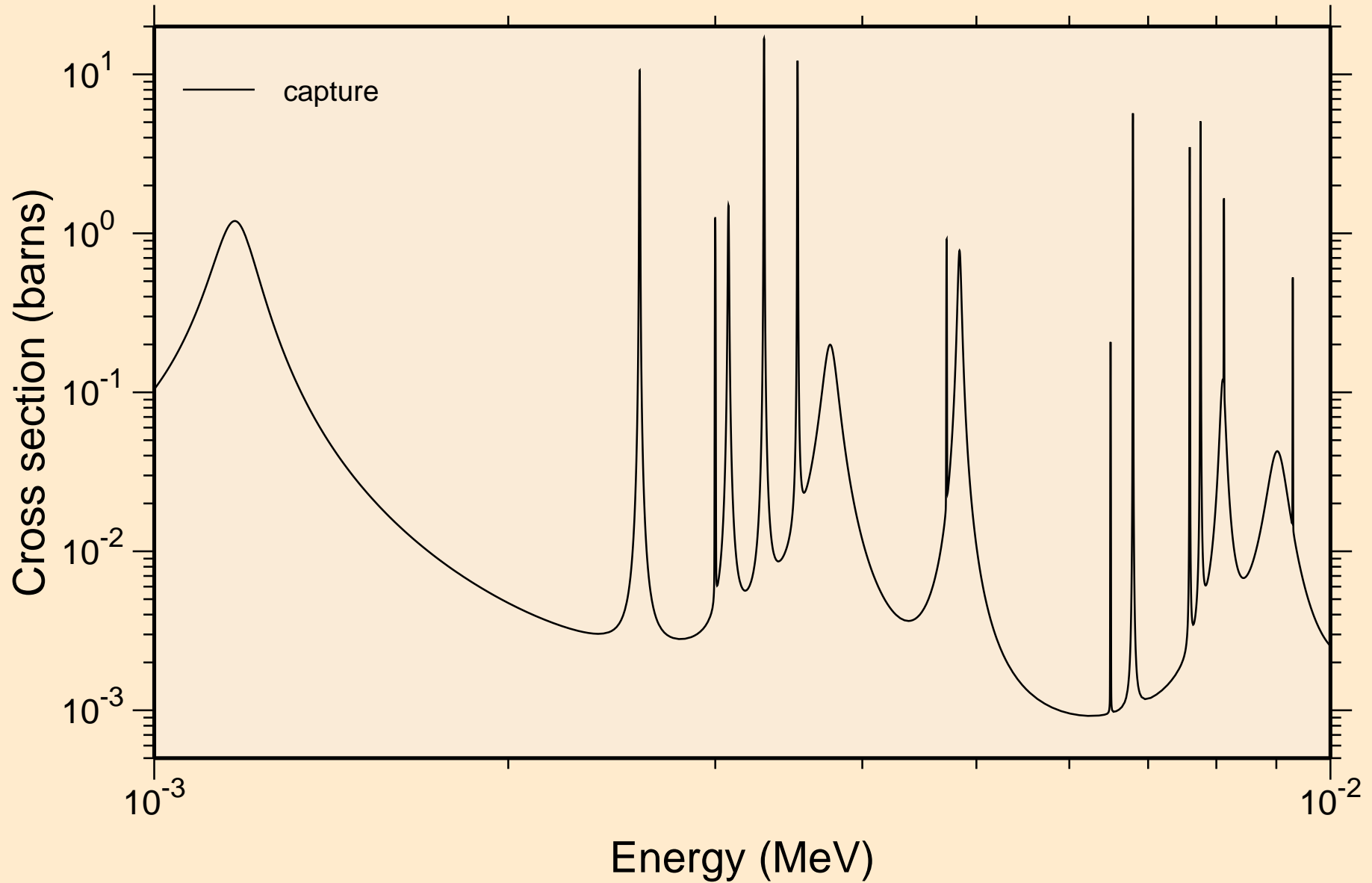

CU073 NEUTRON ACER TENDL-2021 LIBRARY; T=293.6K
resonance absorption cross sections

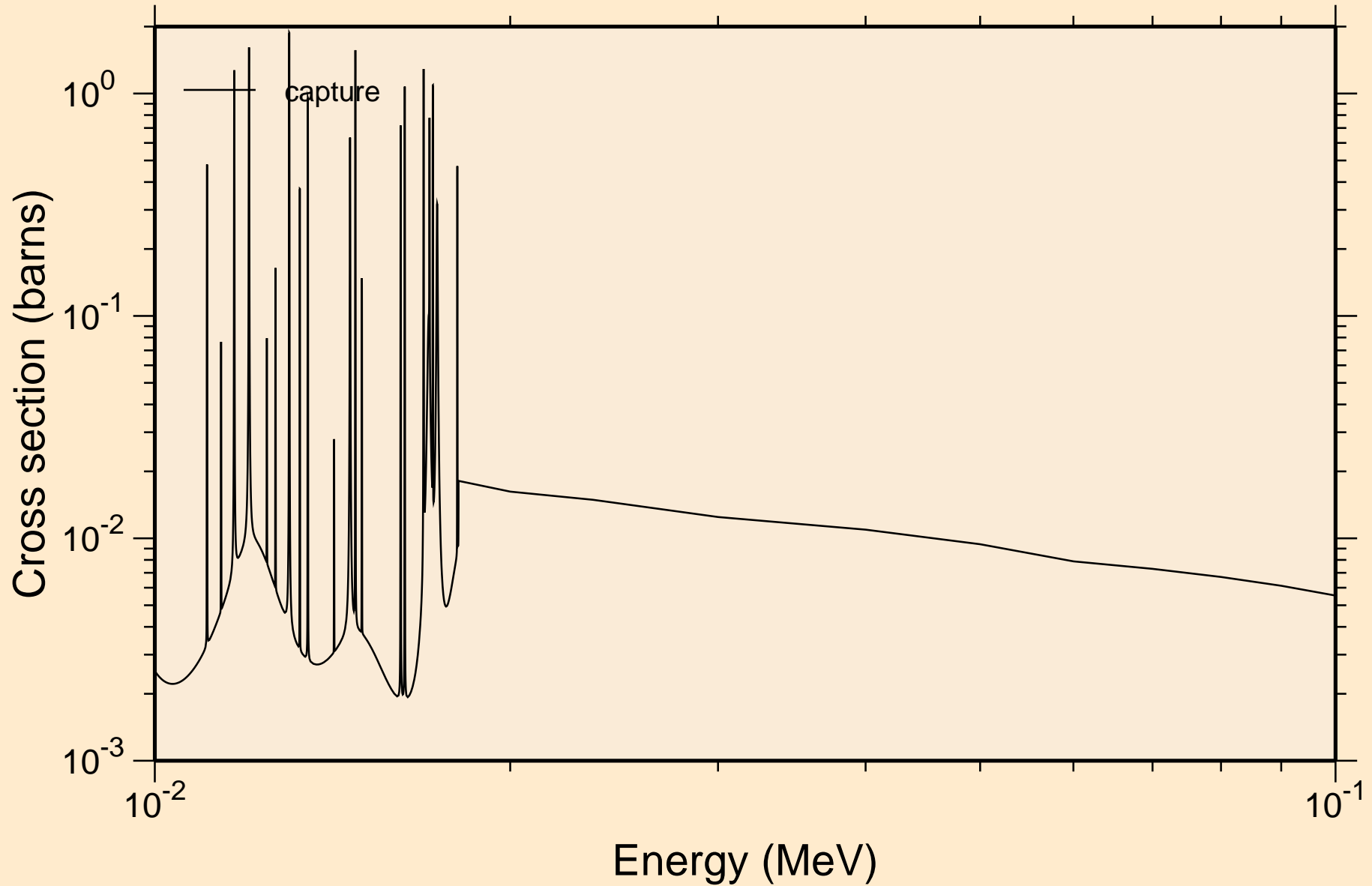

CU073 NEUTRON ACER TENDL-2021 LIBRARY; T=293.6K
resonance absorption cross sections

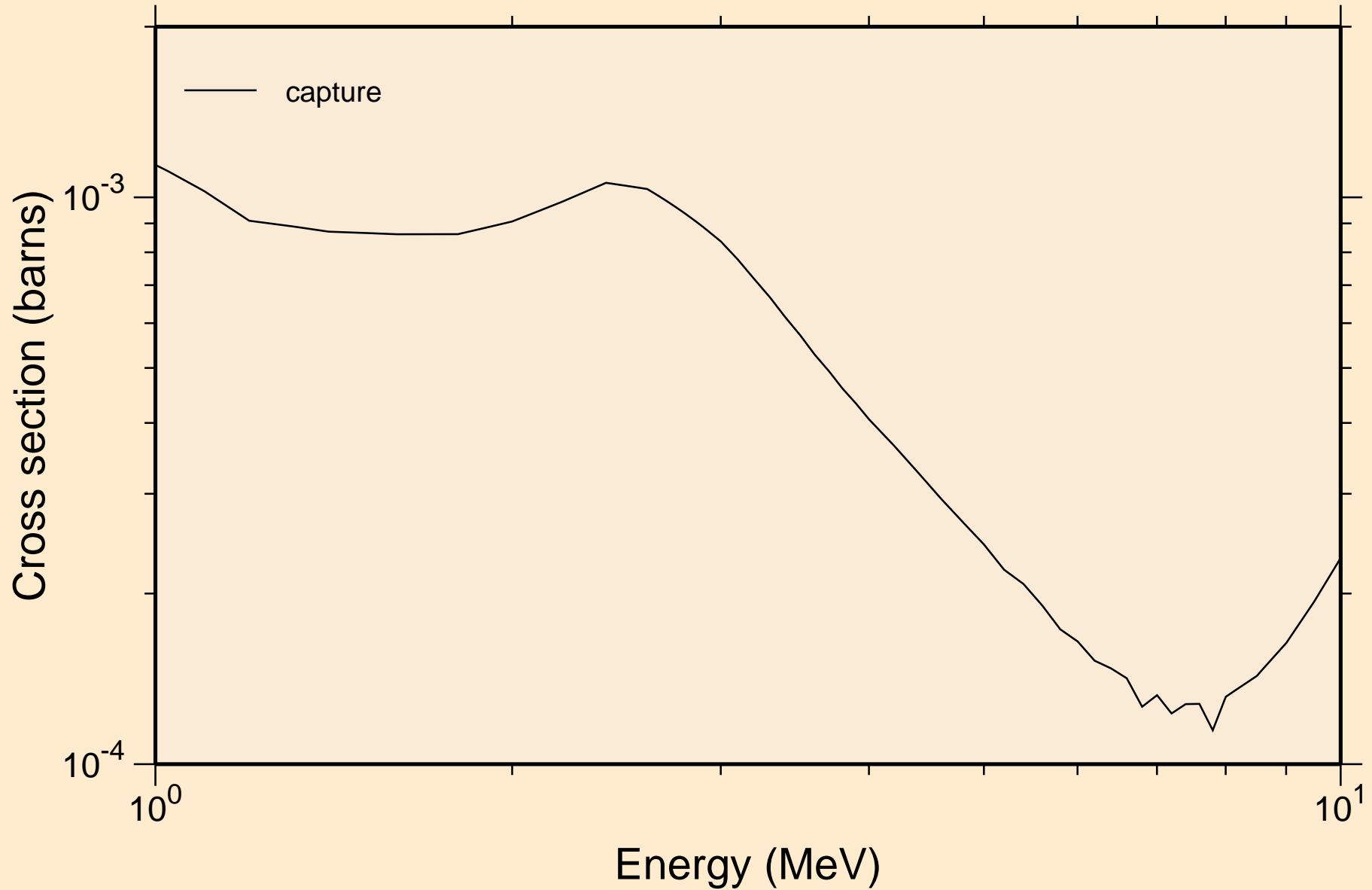

CU073 NEUTRON ACER TENDL-2021 LIBRARY; T=293.6K
Heating

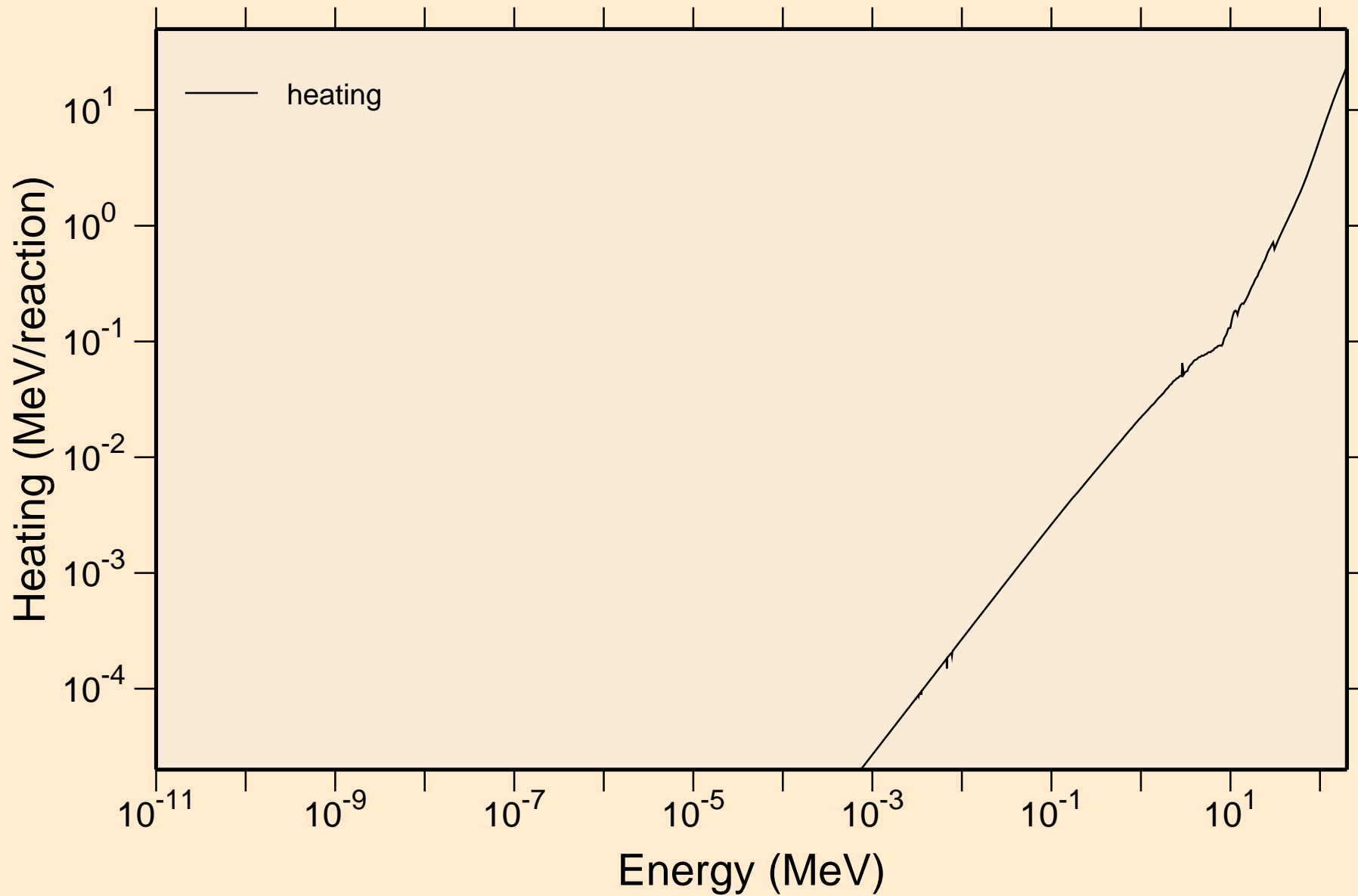

CU073 NEUTRON ACER TENDL-2021 LIBRARY; T=293.6K
Damage

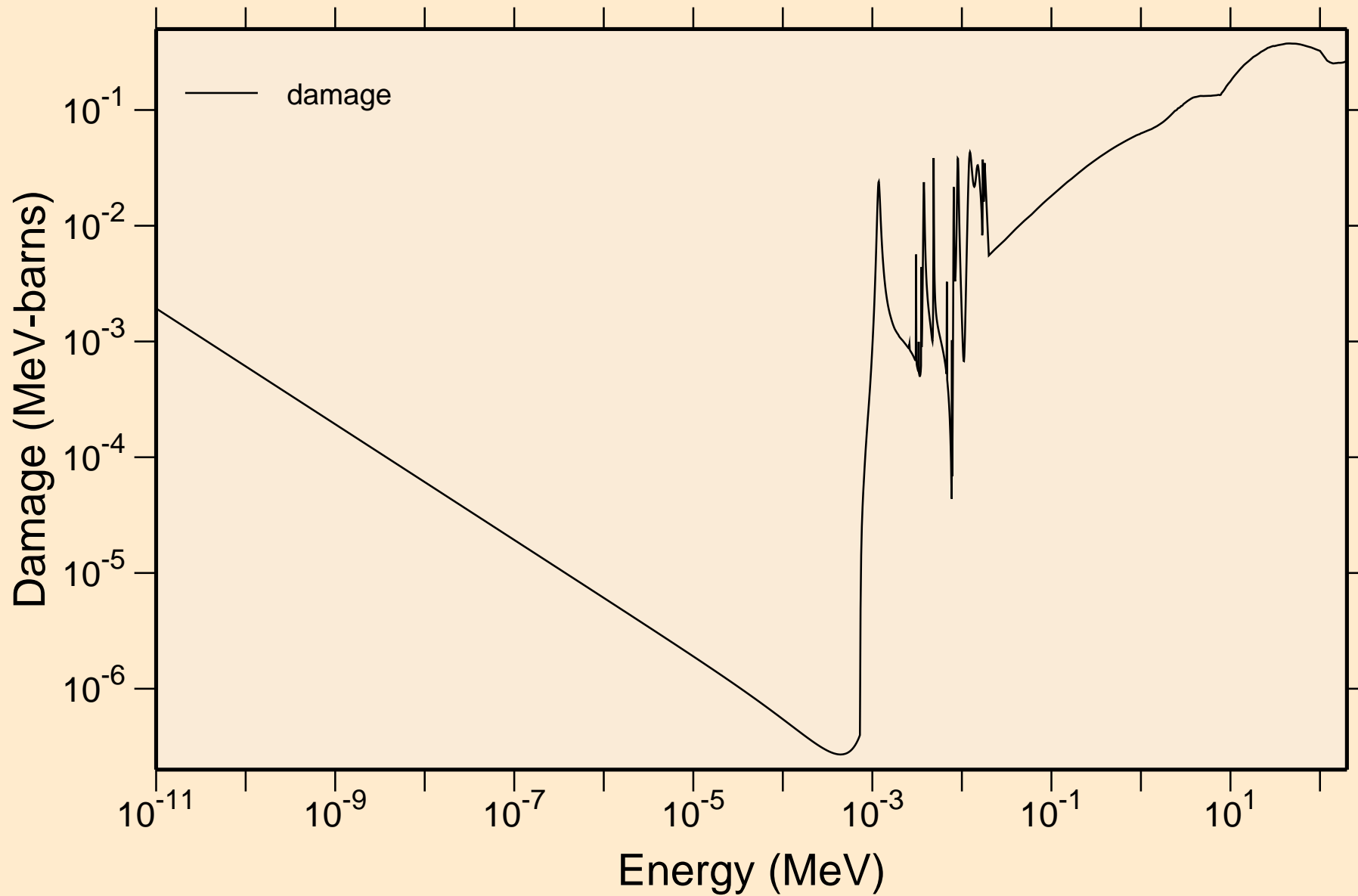

CU073 NEUTRON ACER TENDL-2021 LIBRARY; T=293.6K
Non-threshold reactions

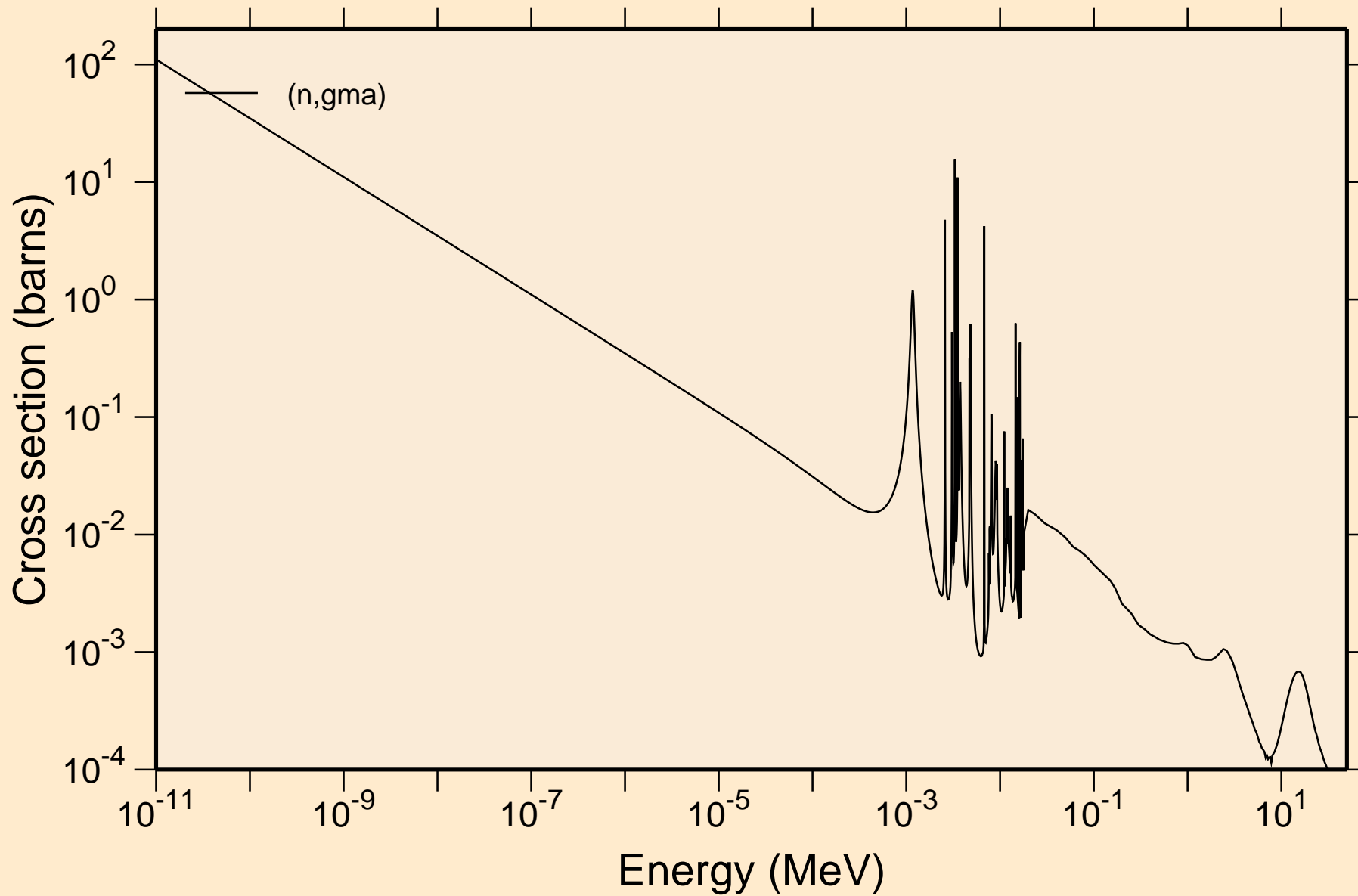

CU073 NEUTRON ACER TENDL-2021 LIBRARY; T=293.6K

Principal cross sections

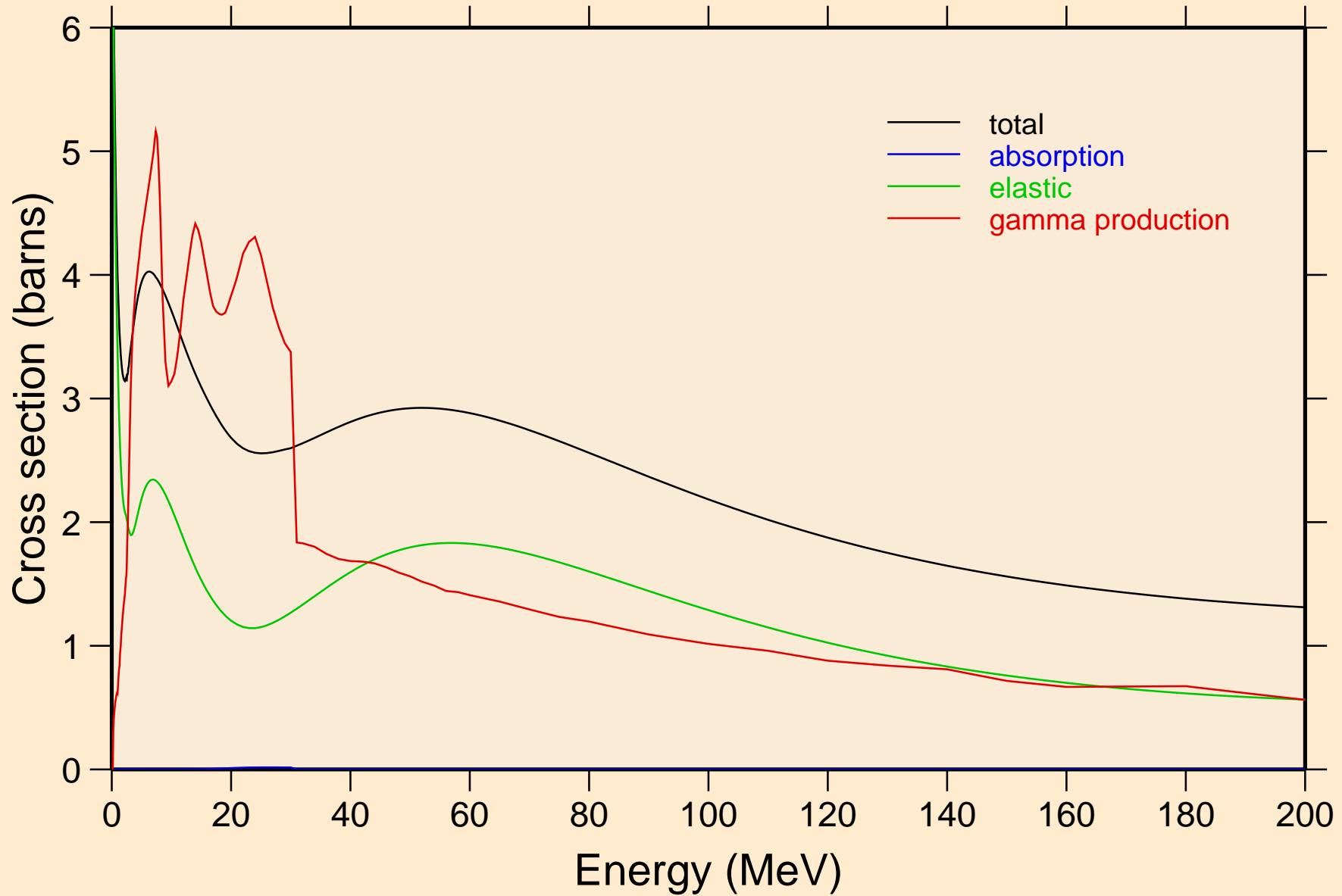

CU073 NEUTRON ACER TENDL-2021 LIBRARY; T=293.6K
Heating

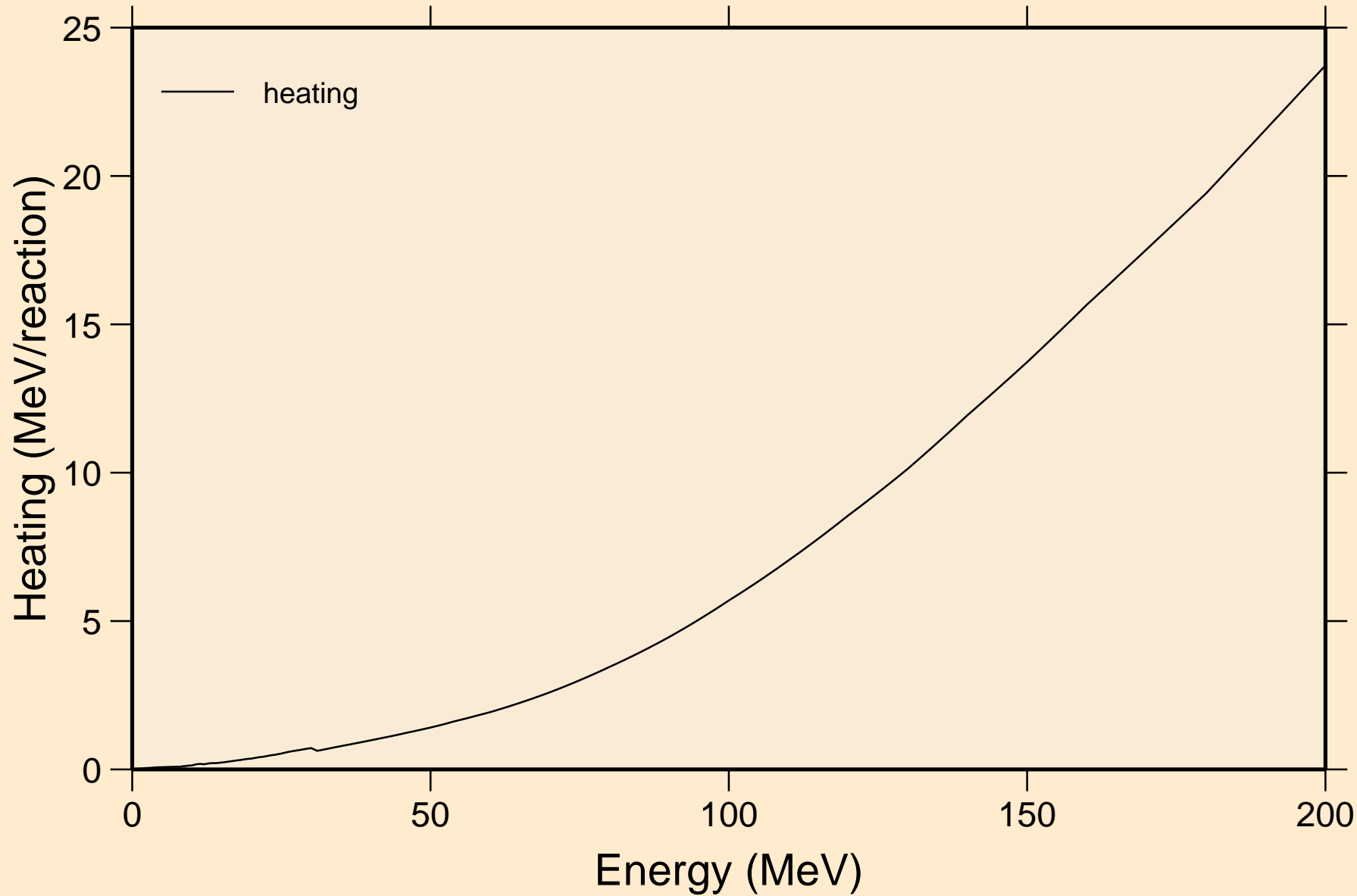

CU073 NEUTRON ACER TENDL-2021 LIBRARY; T=293.6K
Damage

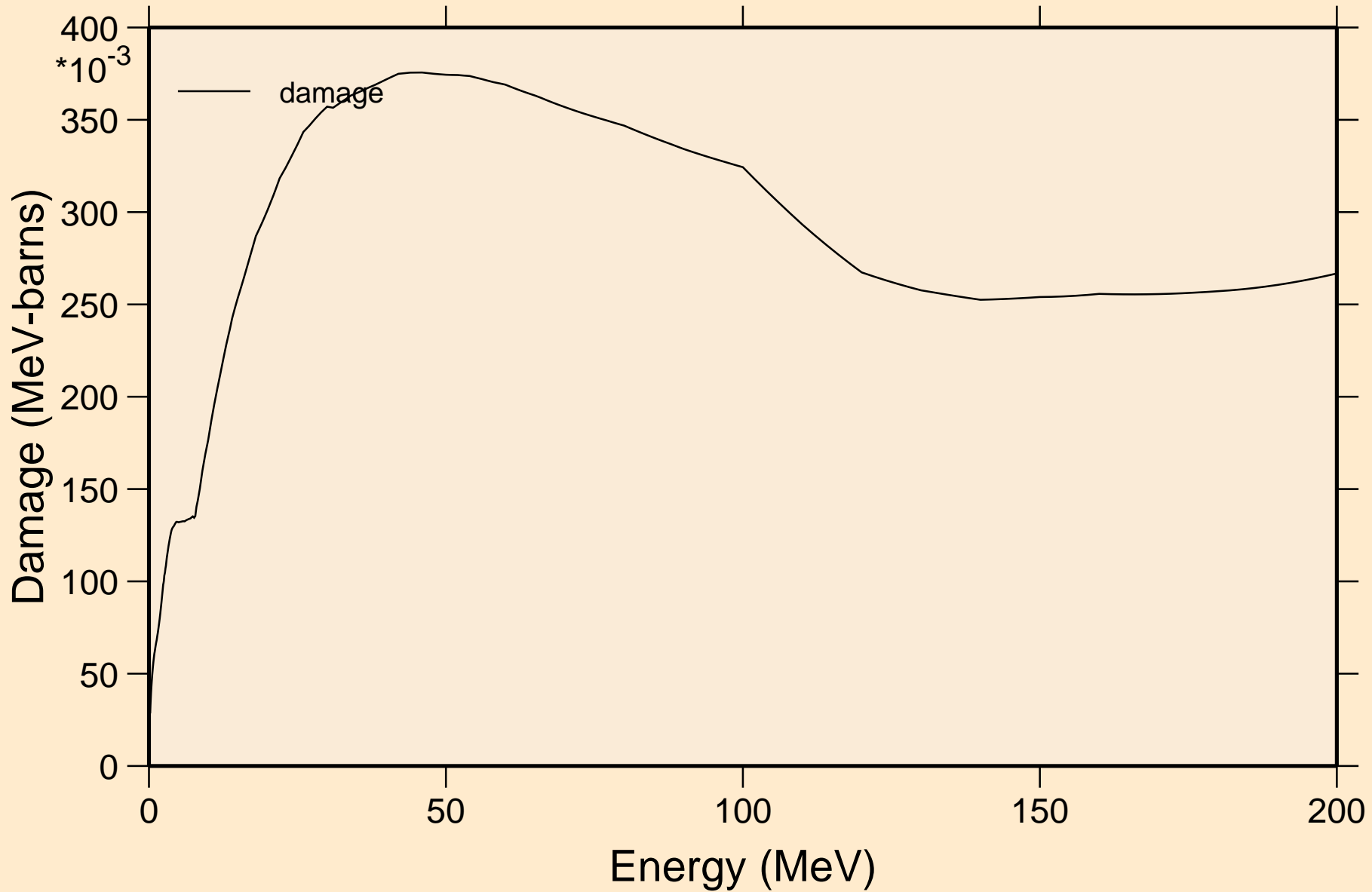

CU073 NEUTRON ACER TENDL-2021 LIBRARY; T=293.6K
Non-threshold reactions

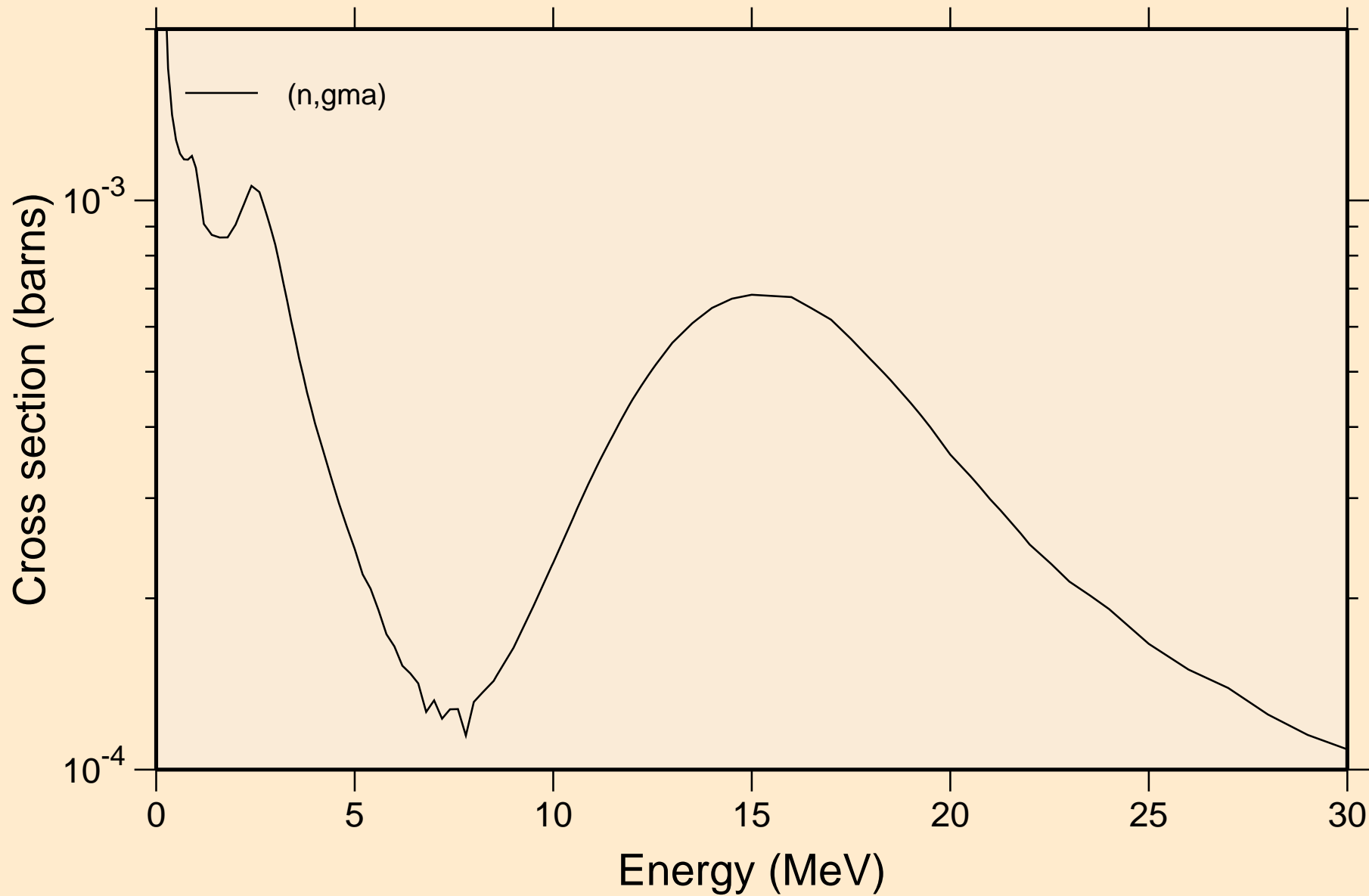

CU073 NEUTRON ACER TENDL-2021 LIBRARY; T=293.6K
Inelastic levels

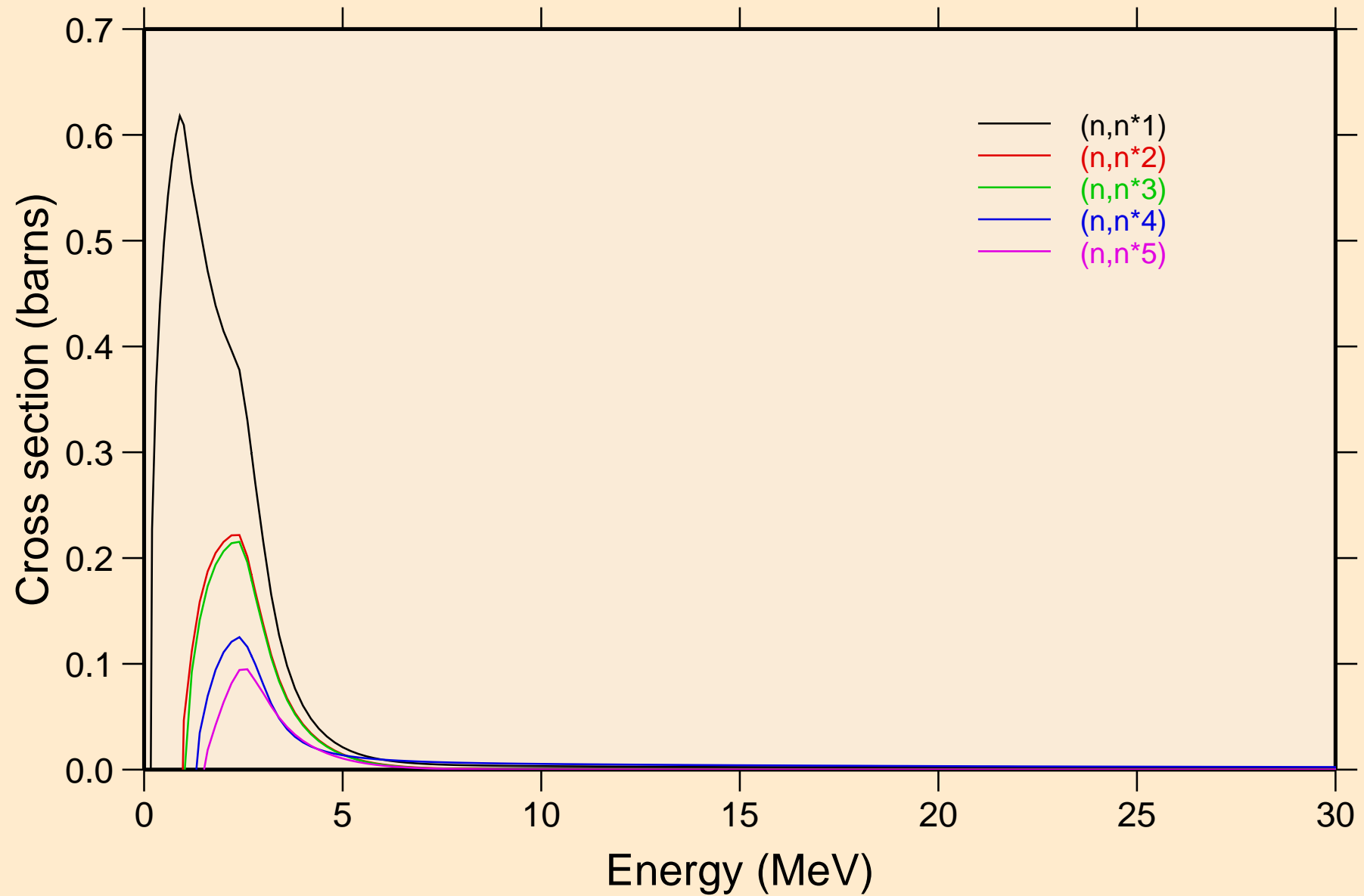

CU073 NEUTRON ACER TENDL-2021 LIBRARY; T=293.6K
Inelastic levels

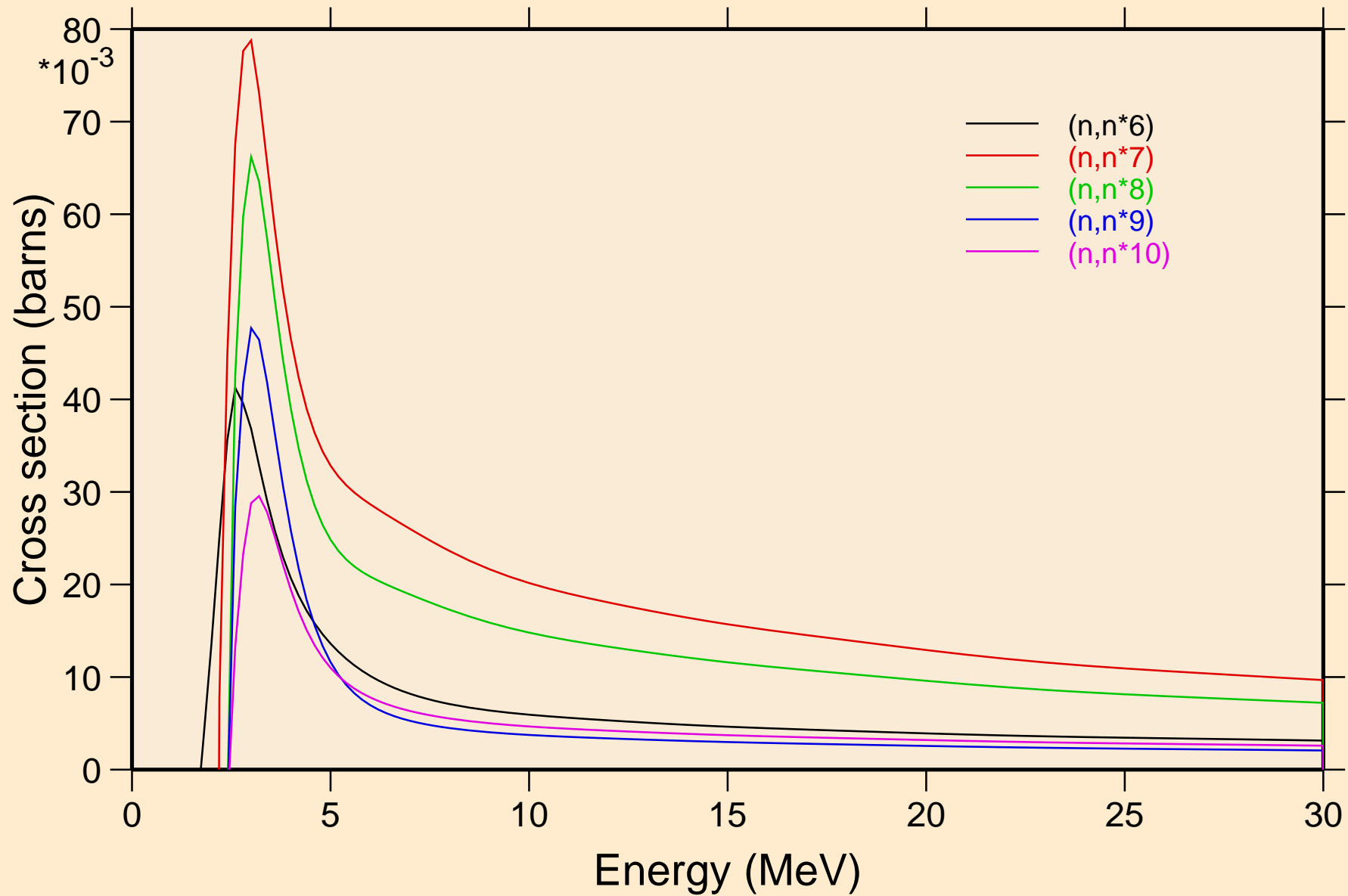

CU073 NEUTRON ACER TENDL-2021 LIBRARY; T=293.6K
Inelastic levels

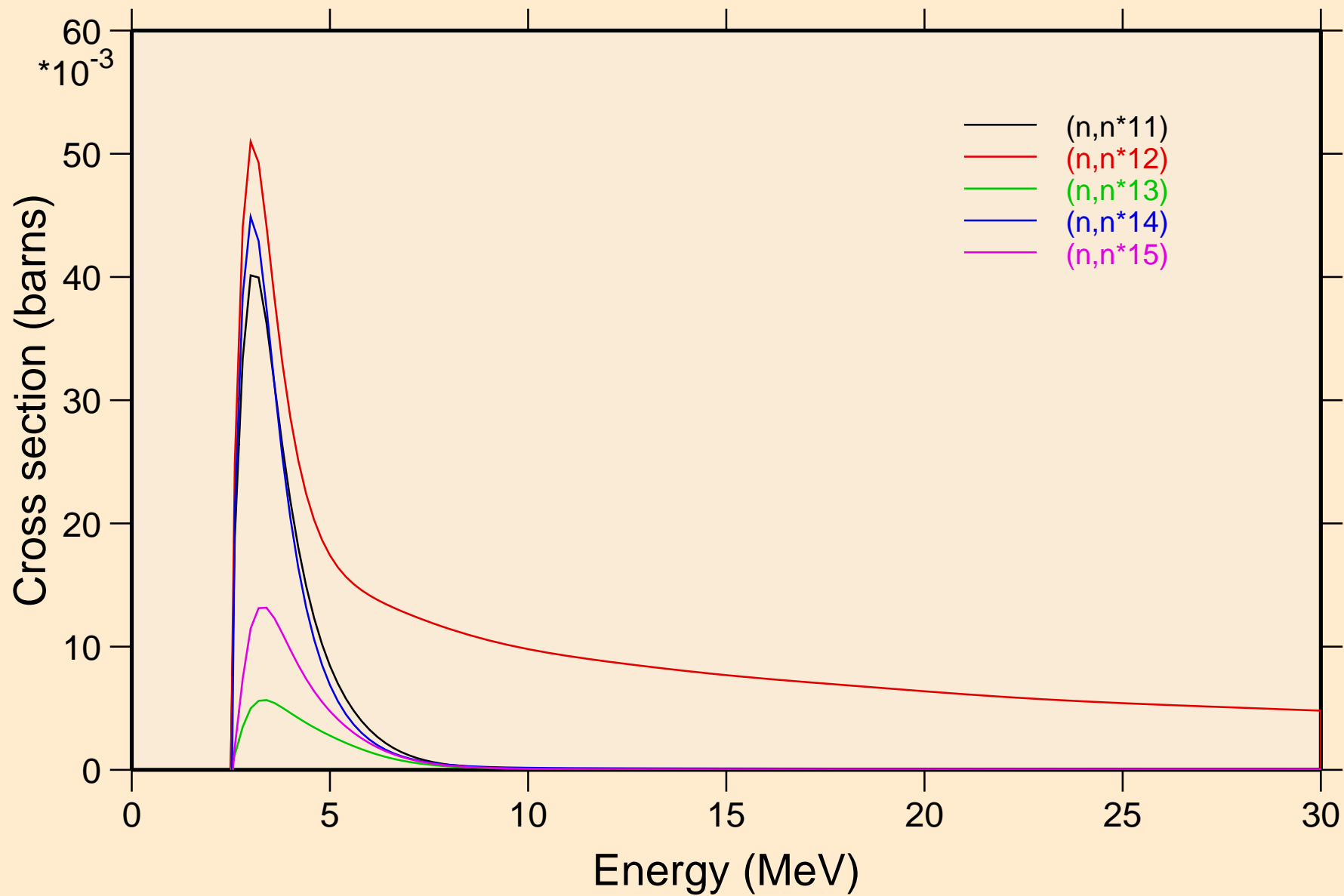

CU073 NEUTRON ACER TENDL-2021 LIBRARY; T=293.6K
Inelastic levels

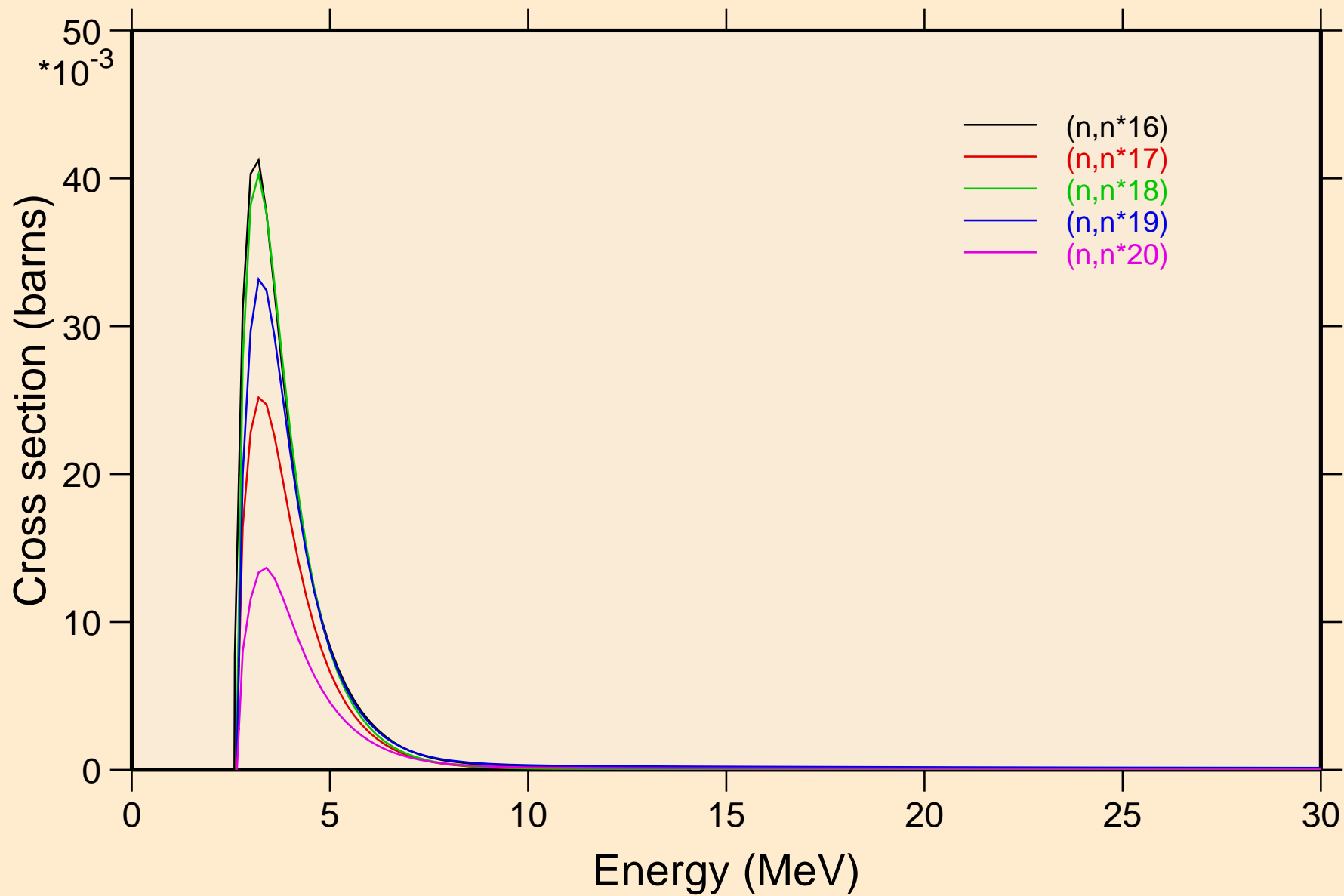

CU073 NEUTRON ACER TENDL-2021 LIBRARY; T=293.6K
Inelastic levels

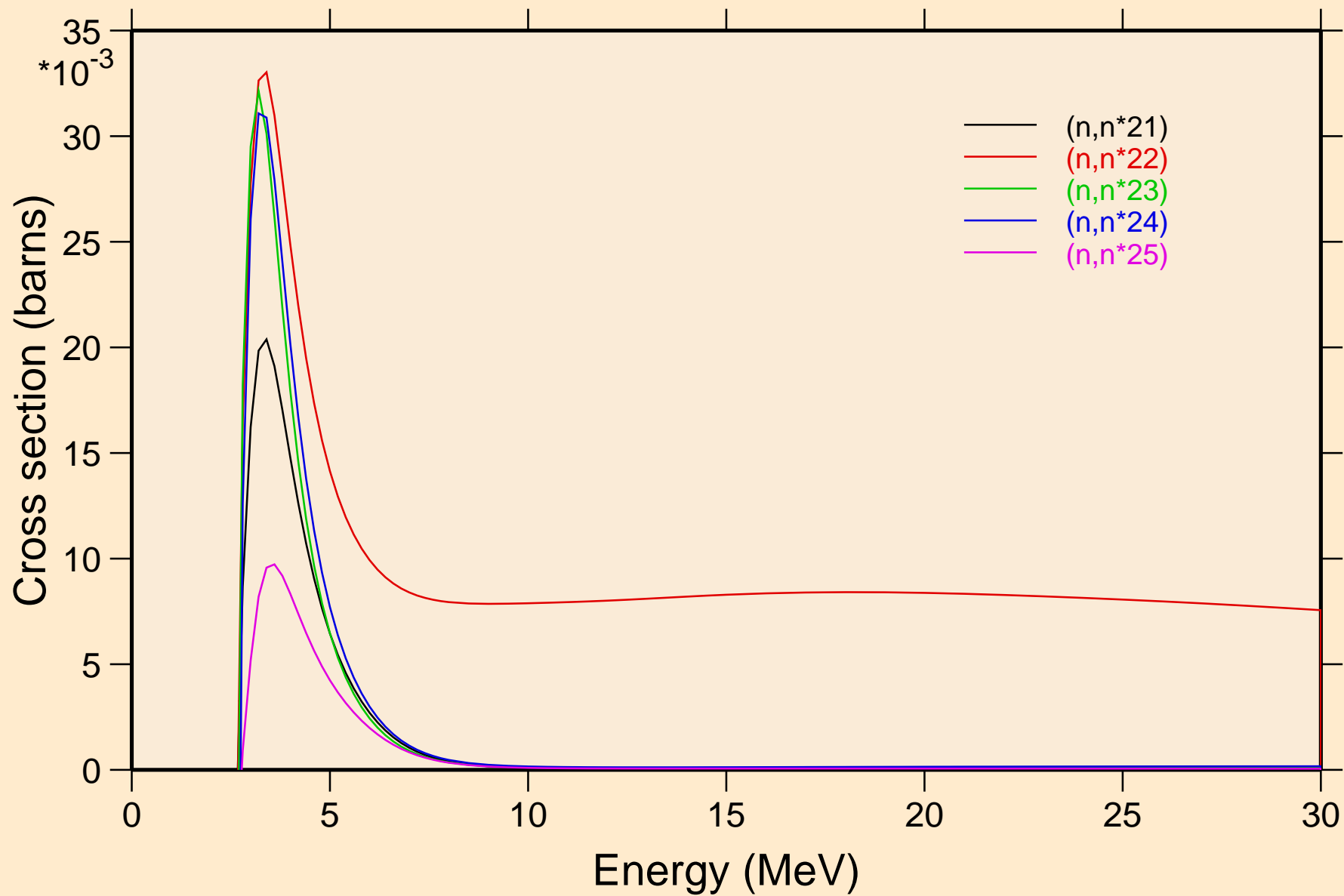

CU073 NEUTRON ACER TENDL-2021 LIBRARY; T=293.6K
Inelastic levels

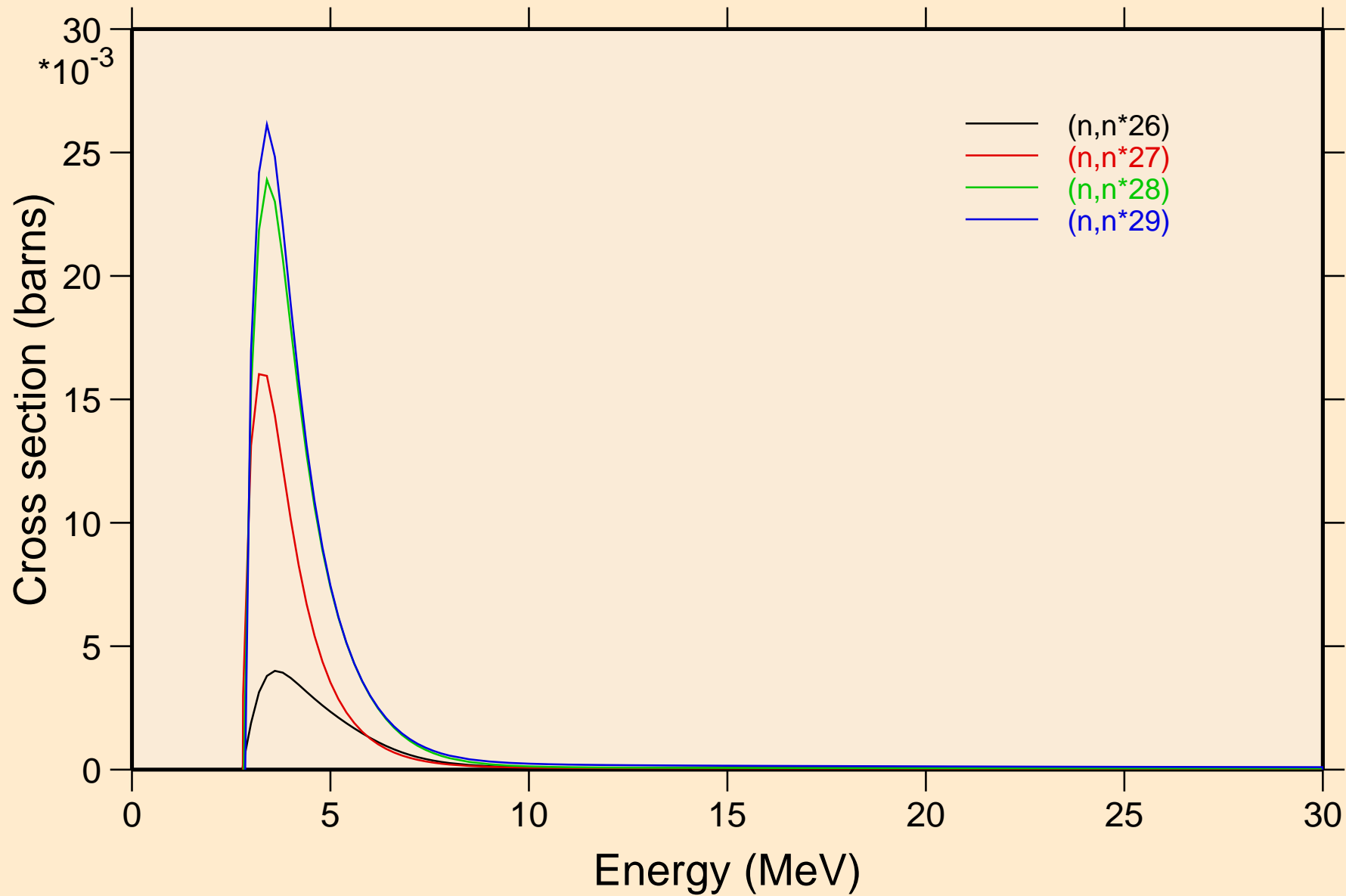

CU073 NEUTRON ACER TENDL-2021 LIBRARY; T=293.6K
Threshold reactions

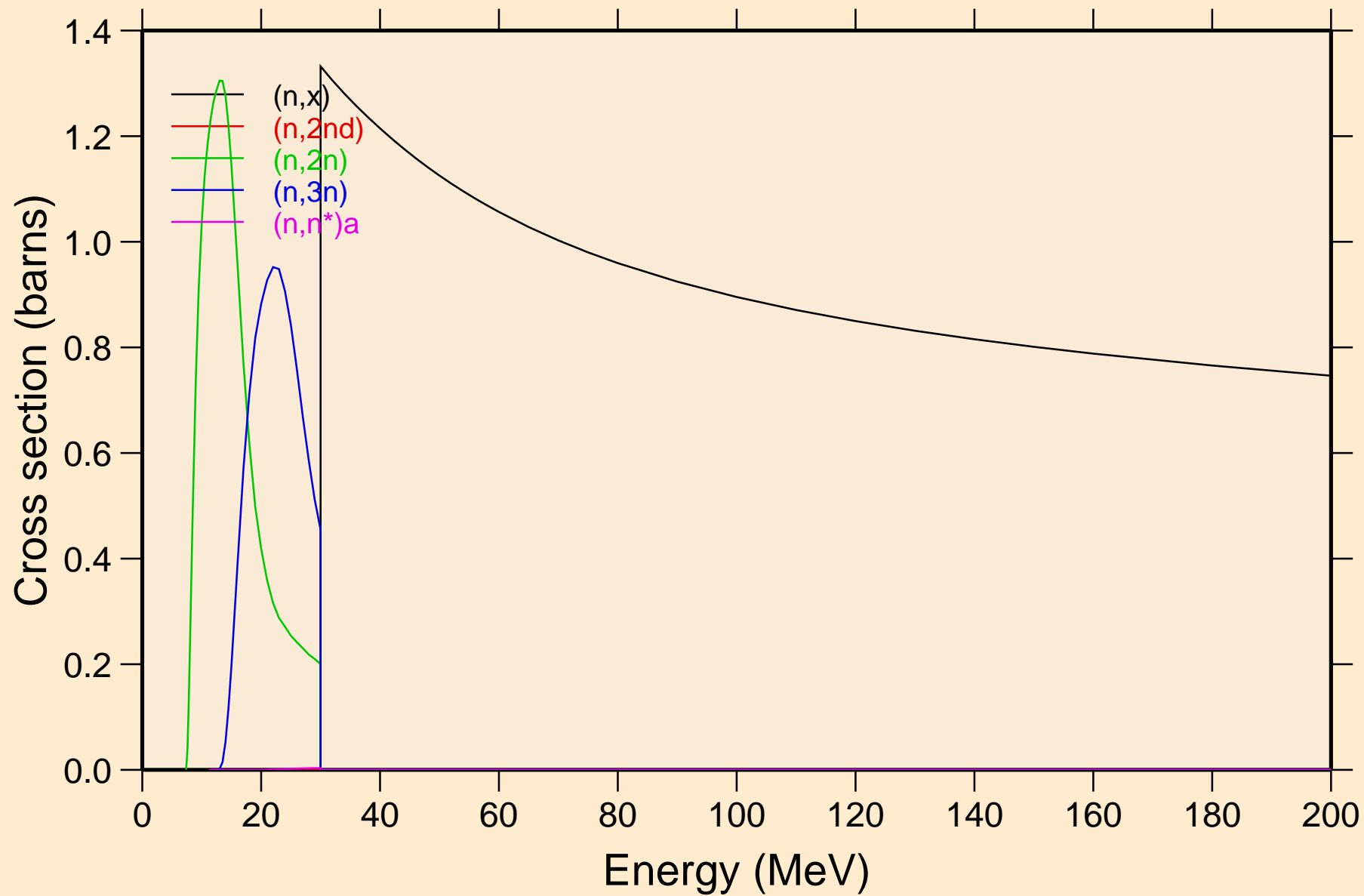

CU073 NEUTRON ACER TENDL-2021 LIBRARY; T=293.6K
Threshold reactions

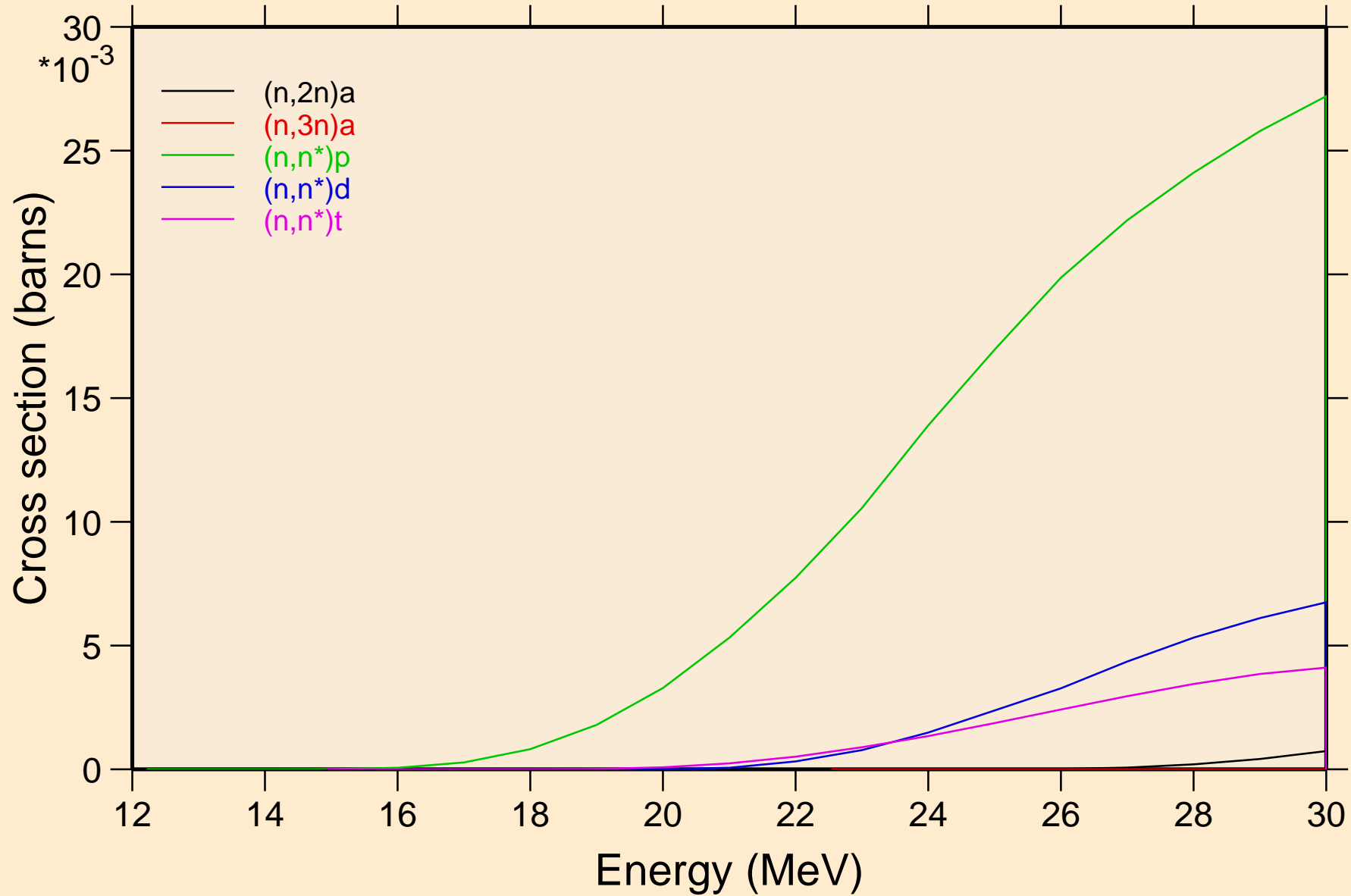

CU073 NEUTRON ACER TENDL-2021 LIBRARY; T=293.6K
Threshold reactions

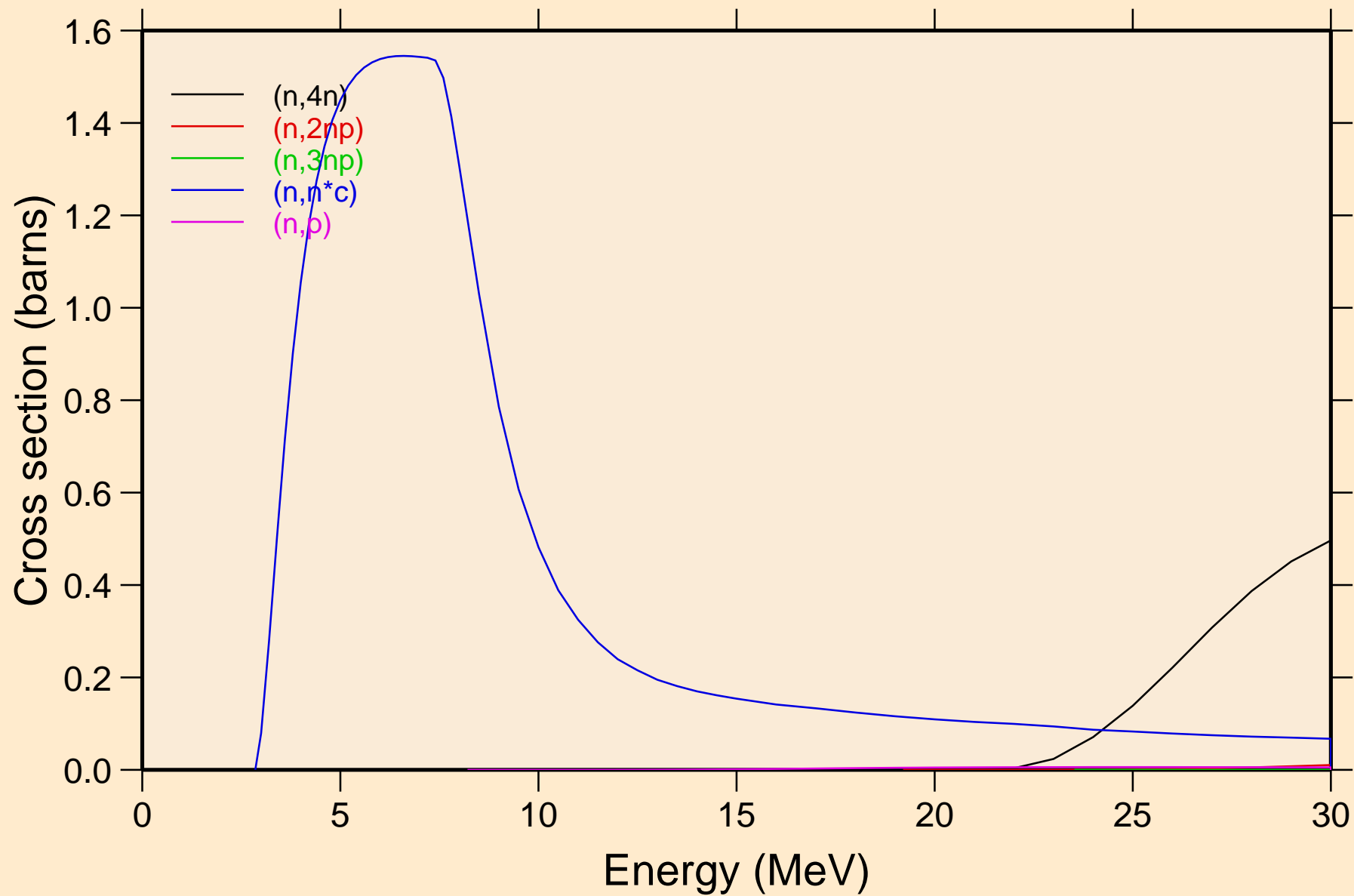

CU073 NEUTRON ACER TENDL-2021 LIBRARY; T=293.6K
Threshold reactions

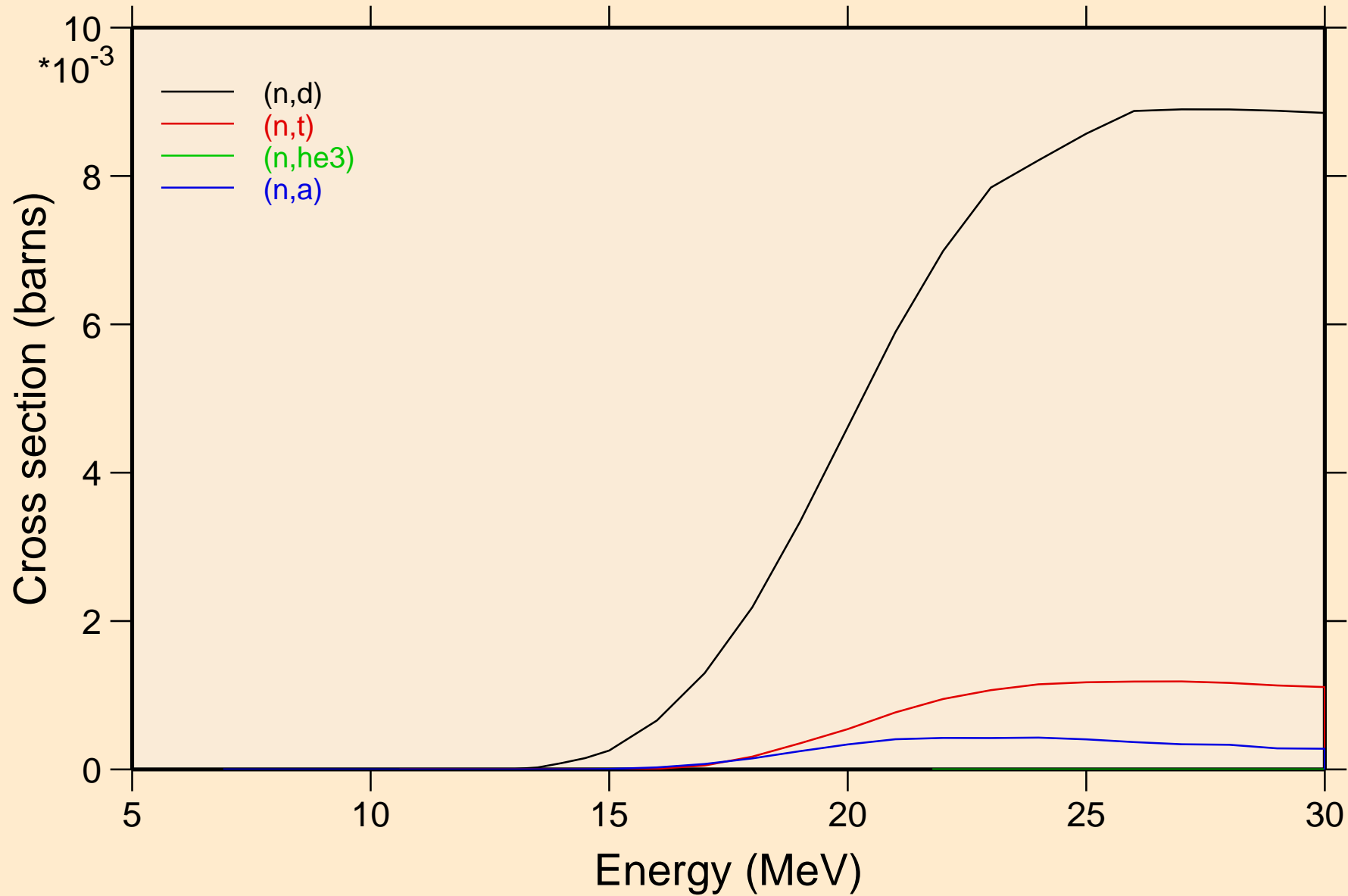

CU073 NEUTRON ACER TENDL-2021 LIBRARY; T=293.6K

Threshold reactions

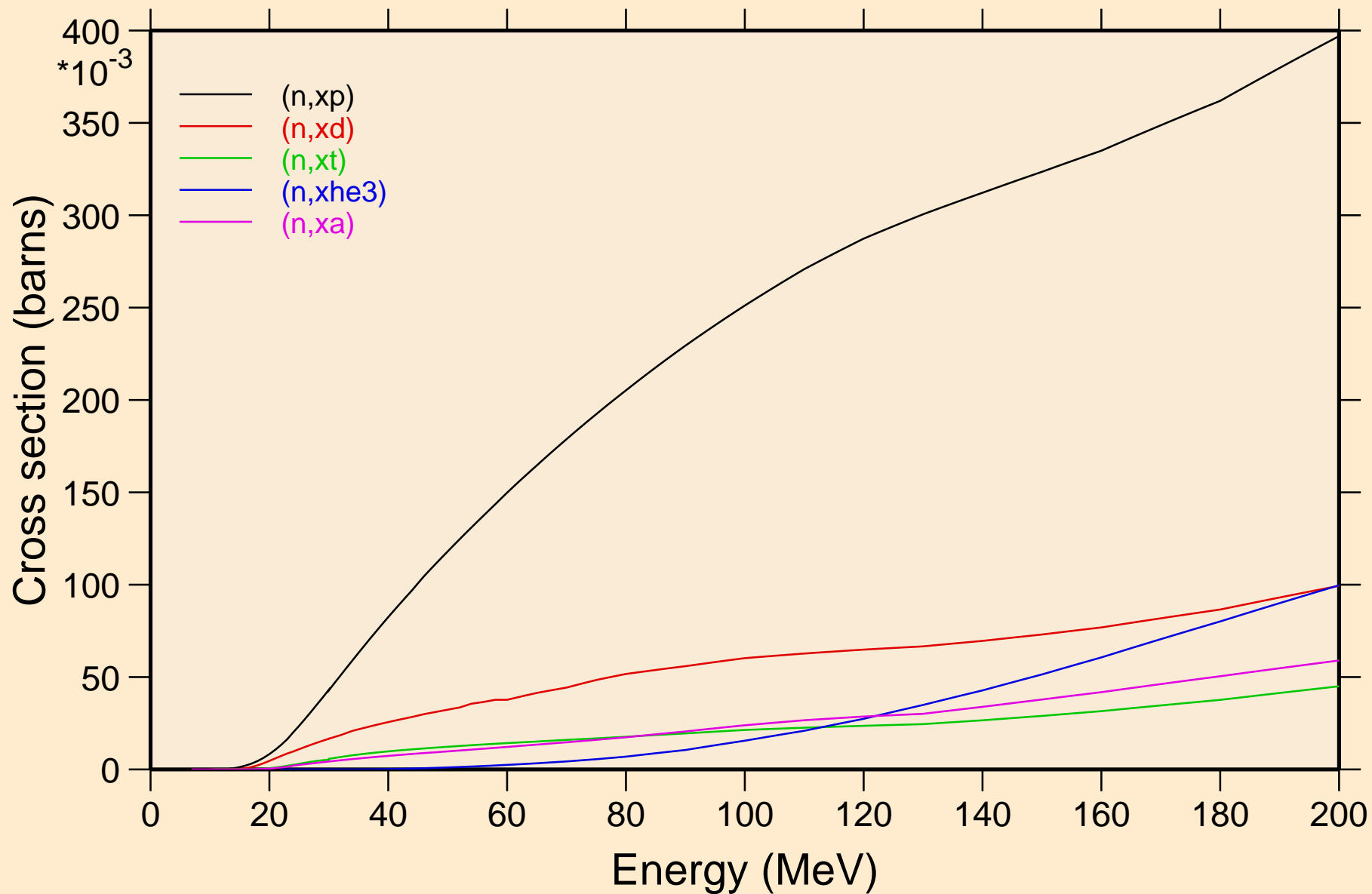

CU073 NEUTRON ACER TENDL-2021 LIBRARY; T=293.6K
angular distribution for elastic

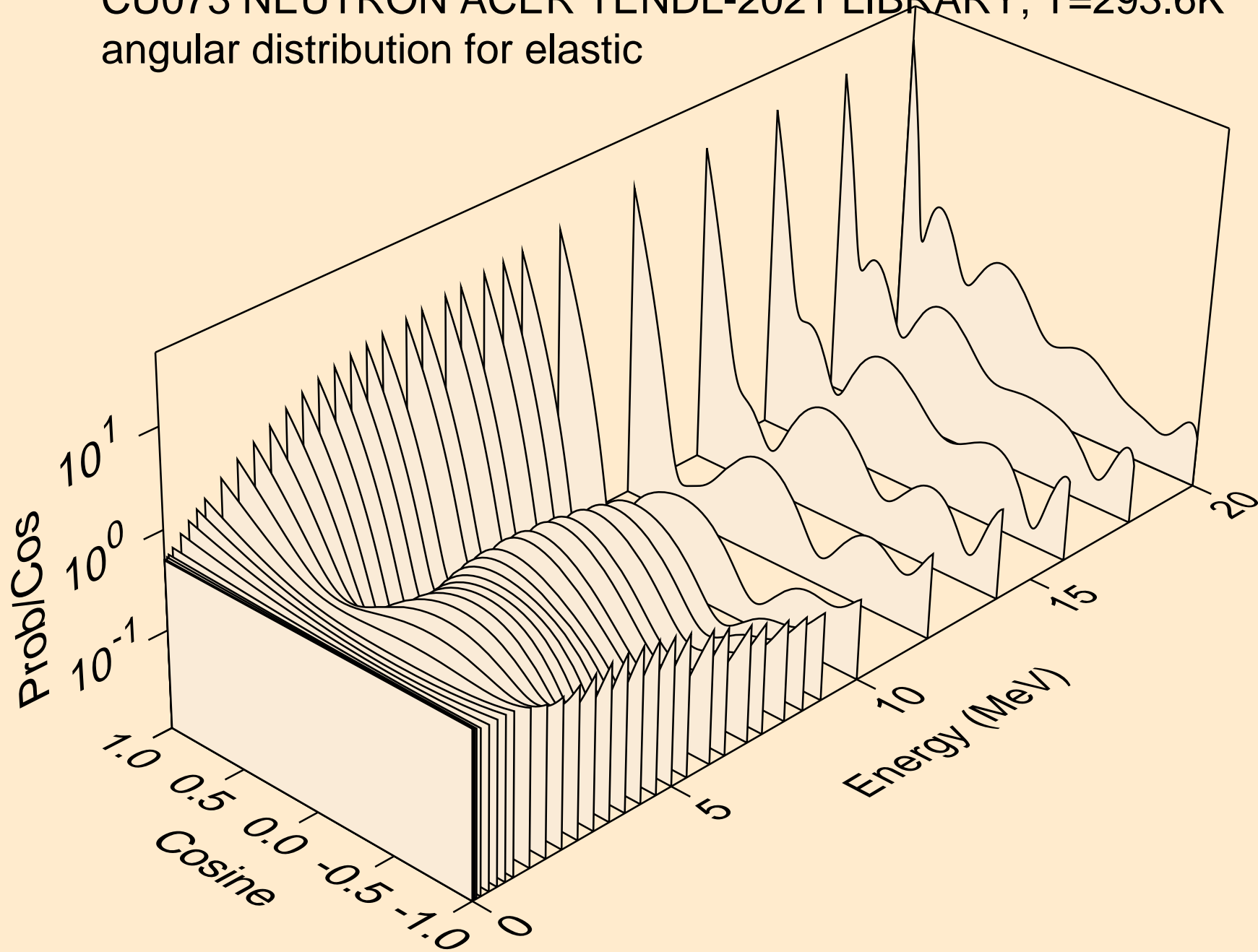

CU073 NEUTRON ACER TENDL-2021 LIBRARY; T=293.6K
angular distribution for elastic

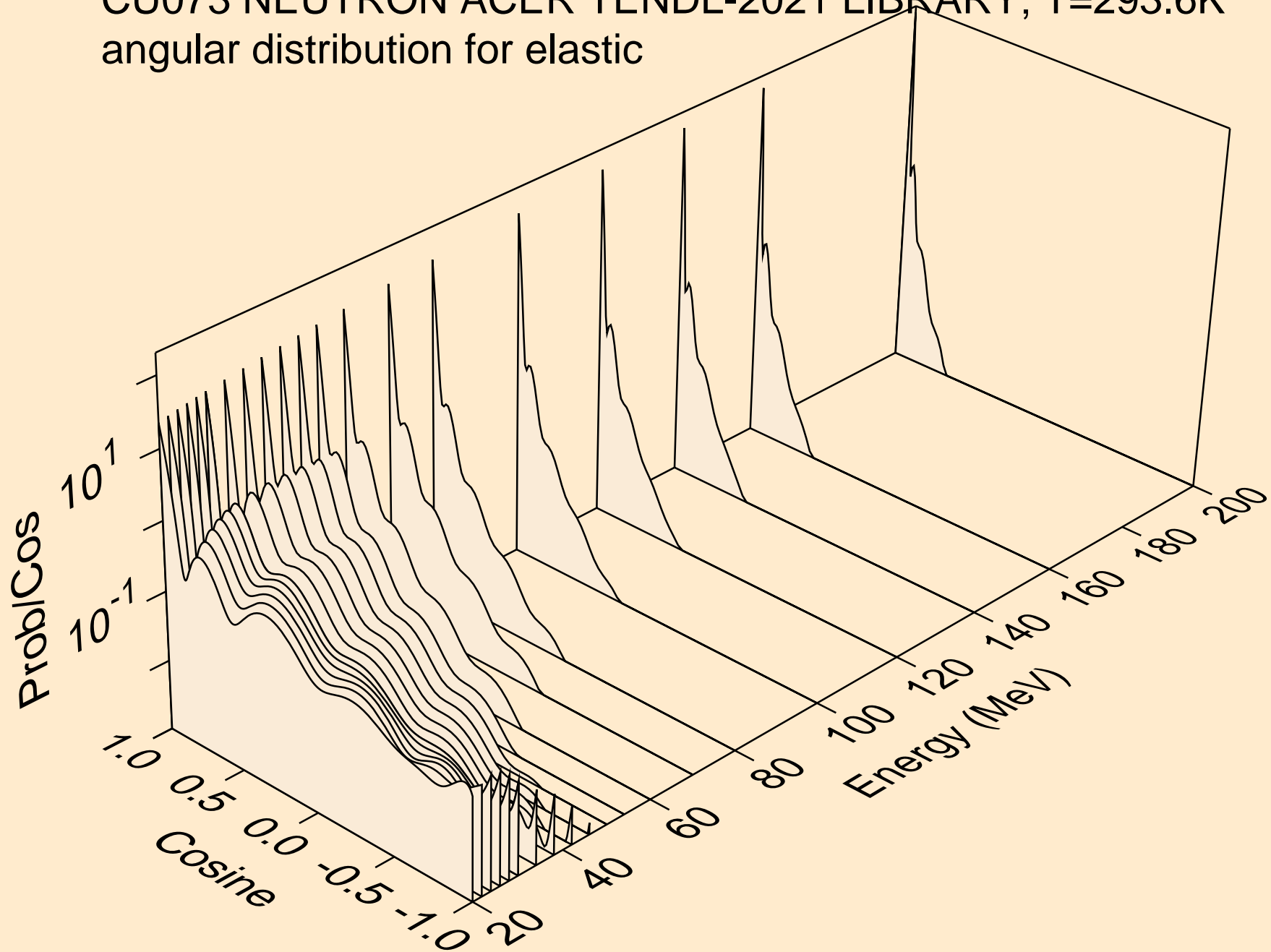

CU073 NEUTRON ACER TENDL-2021 LIBRARY; T=293.6K
angular distribution for (n,n*1)

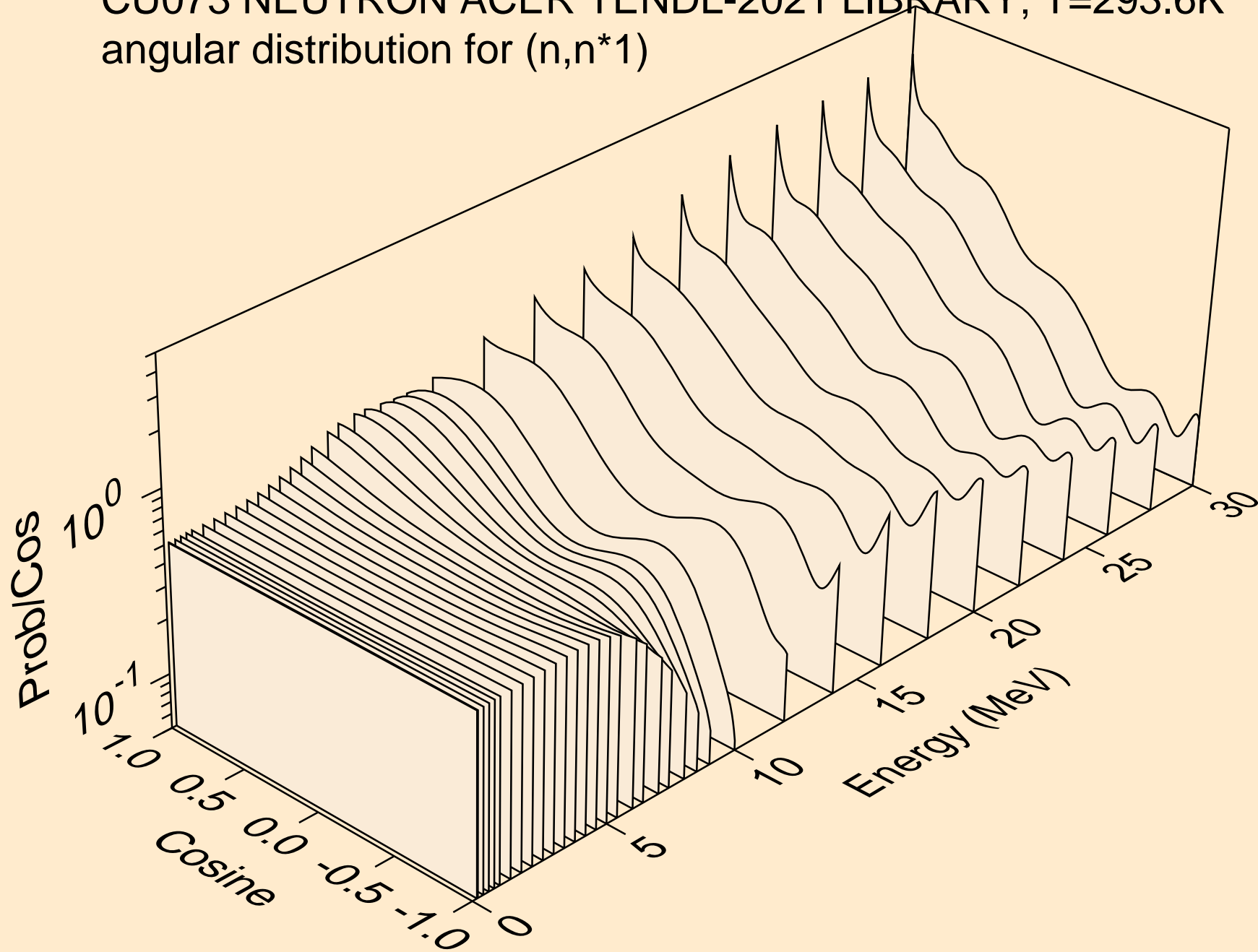

CU073 NEUTRON ACER TENDL-2021 LIBRARY; T=293.6K
angular distribution for (n,n*2)

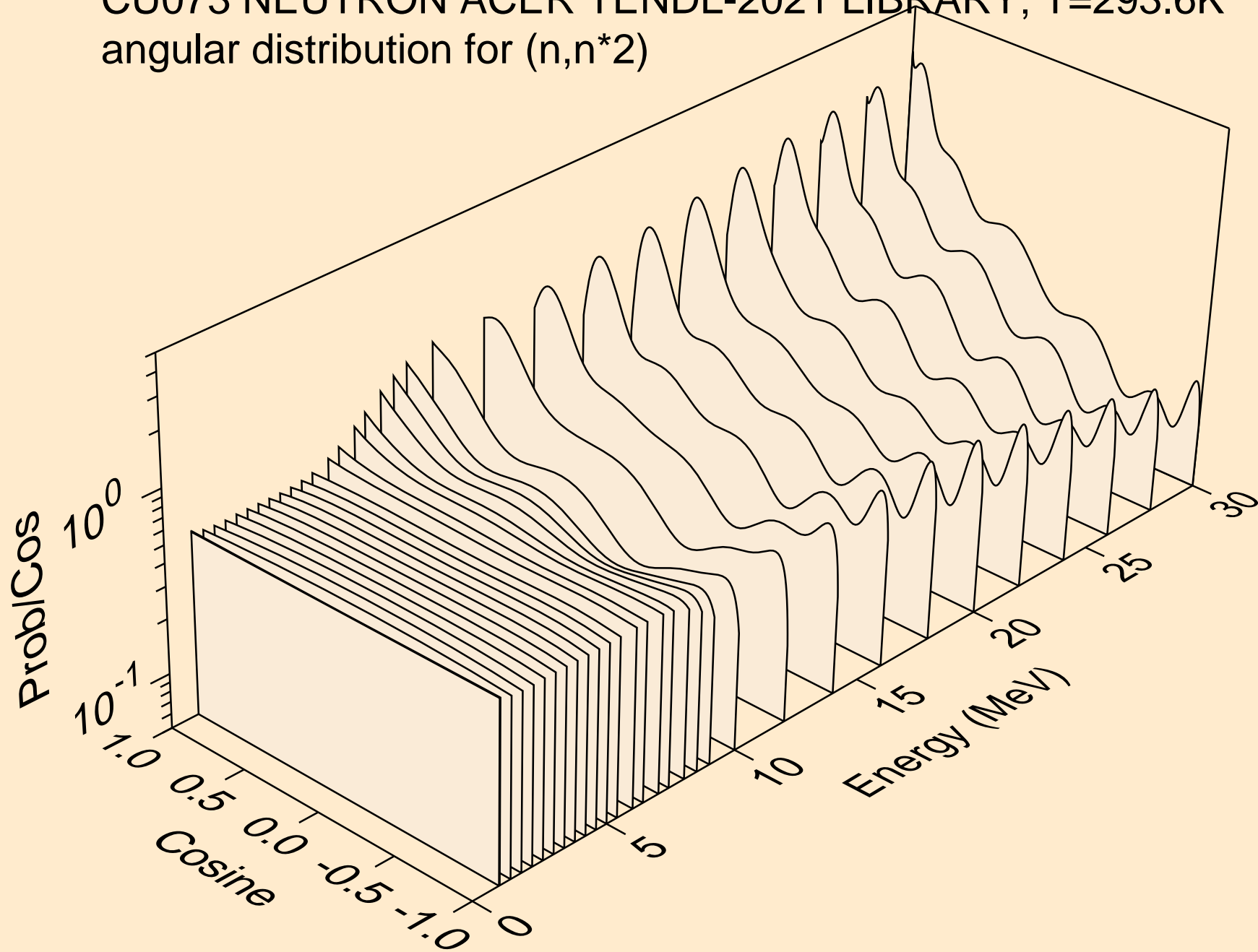

CU073 NEUTRON ACER TENDL-2021 LIBRARY; T=293.6K
angular distribution for (n,n*3)

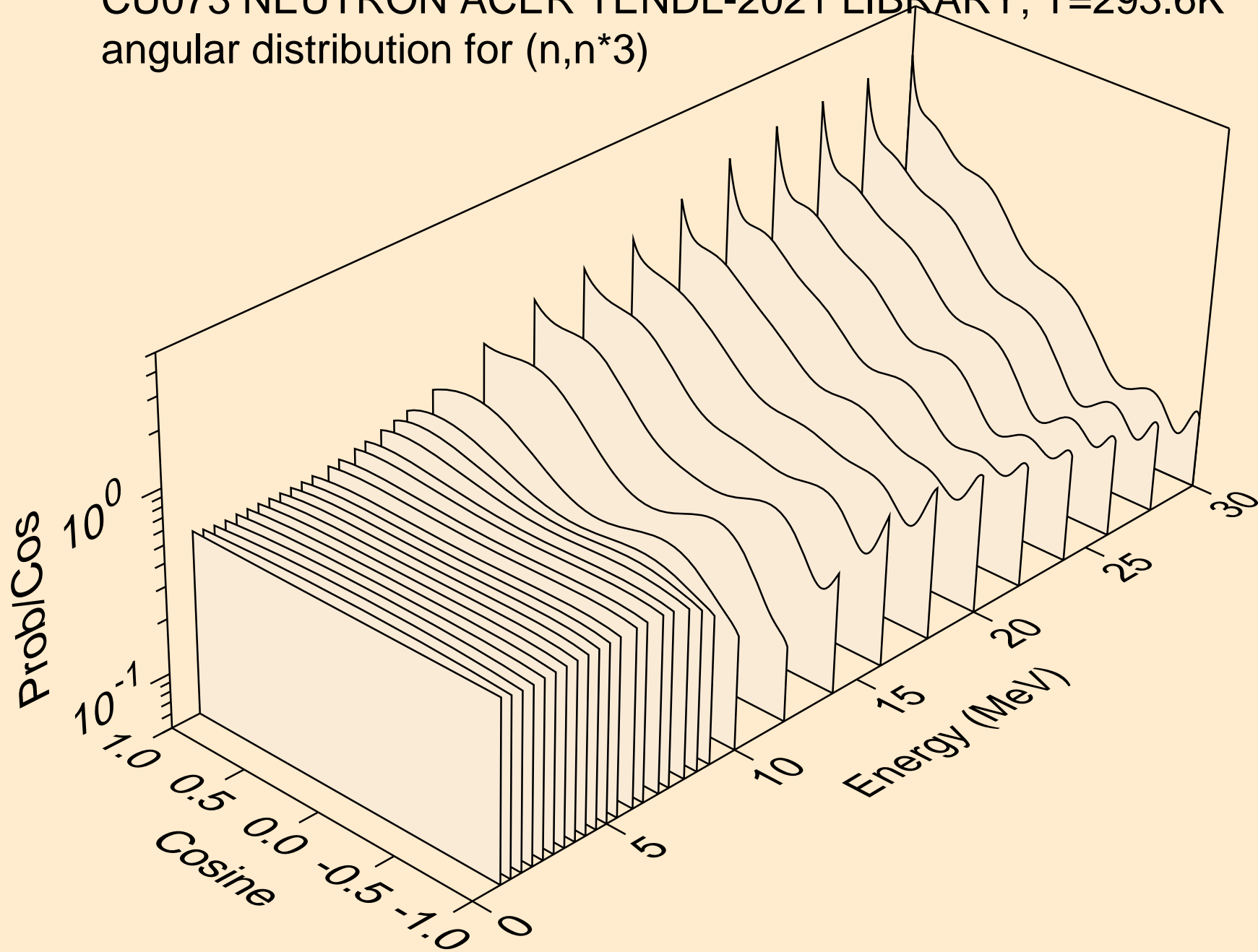

CU073 NEUTRON ACER TENDL-2021 LIBRARY; T=293.6K
angular distribution for (n,n*4)

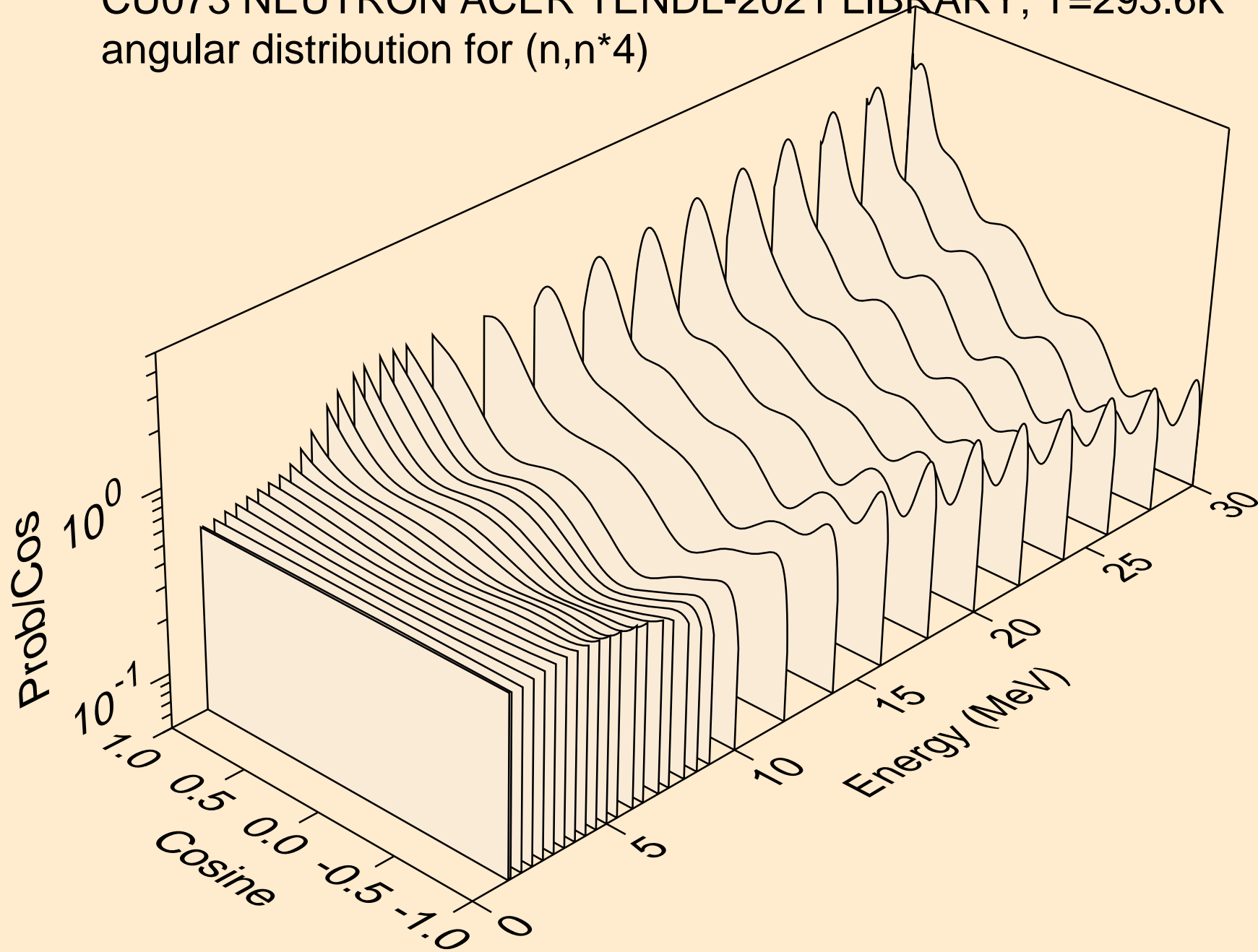

CU073 NEUTRON ACER TENDL-2021 LIBRARY; T=293.6K
angular distribution for (n,n*5)

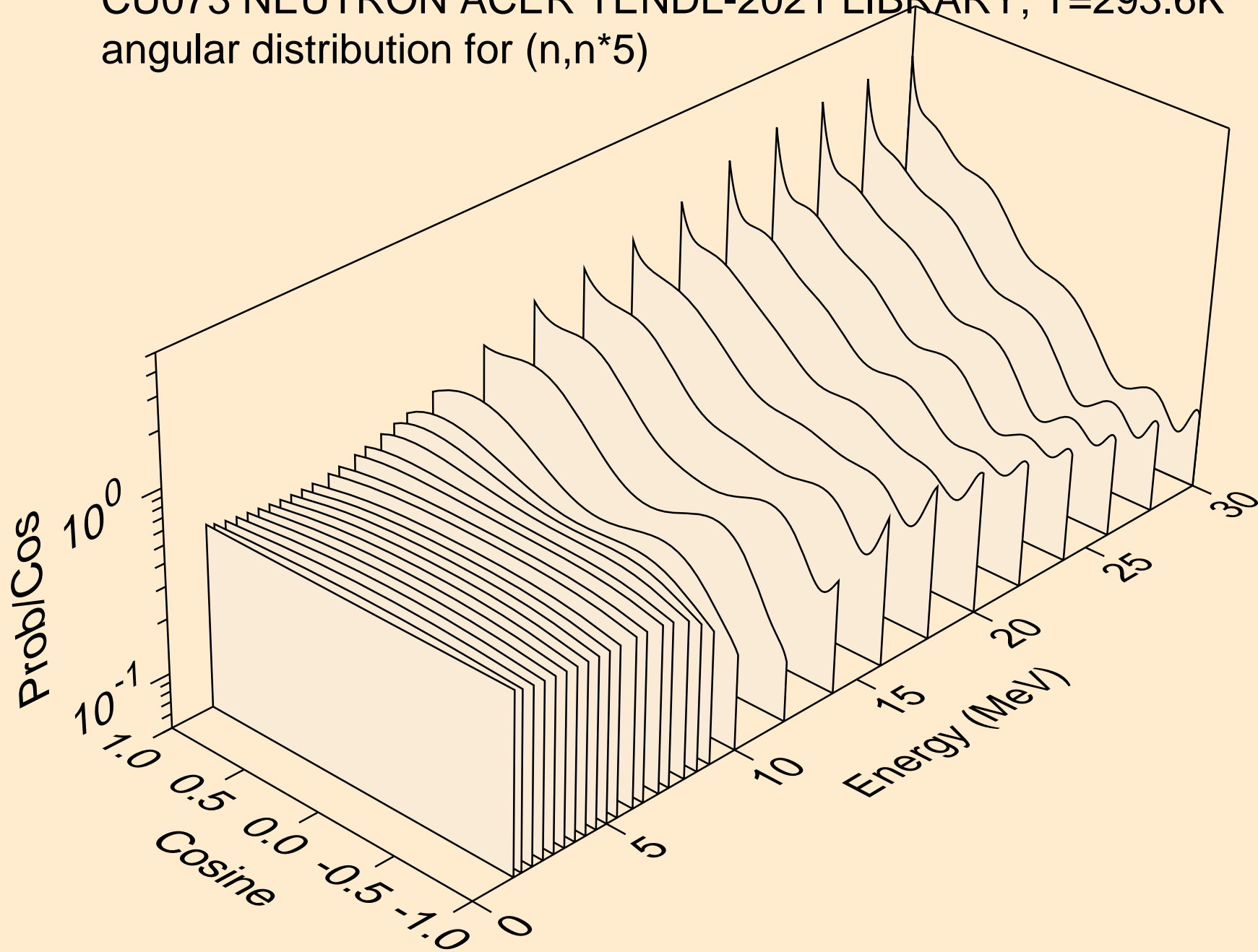

CU073 NEUTRON ACER TENDL-2021 LIBRARY; T=293.6K
angular distribution for (n,n*6)

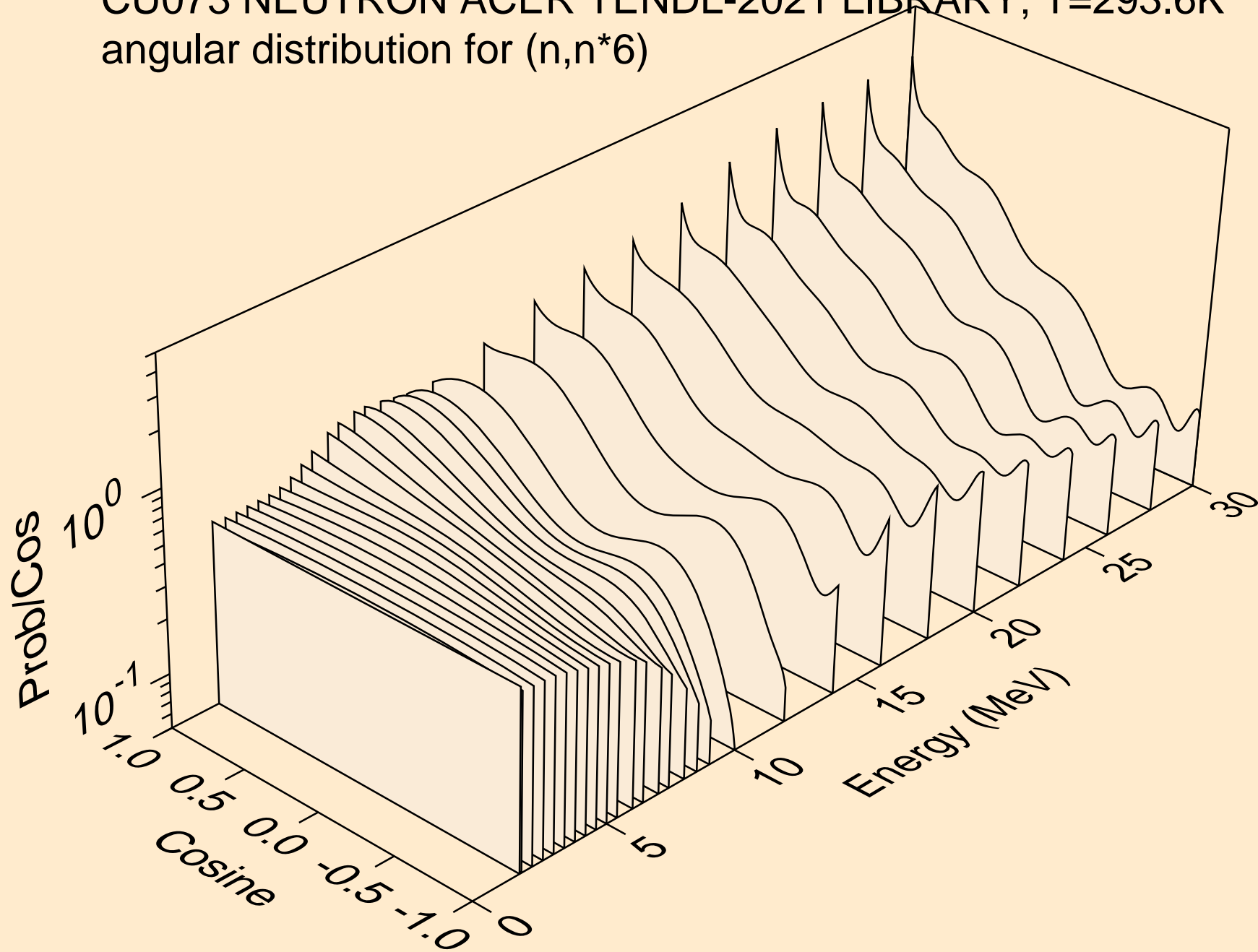

CU073 NEUTRON ACER TENDL-2021 LIBRARY; T=293.6K
angular distribution for (n,n*7)

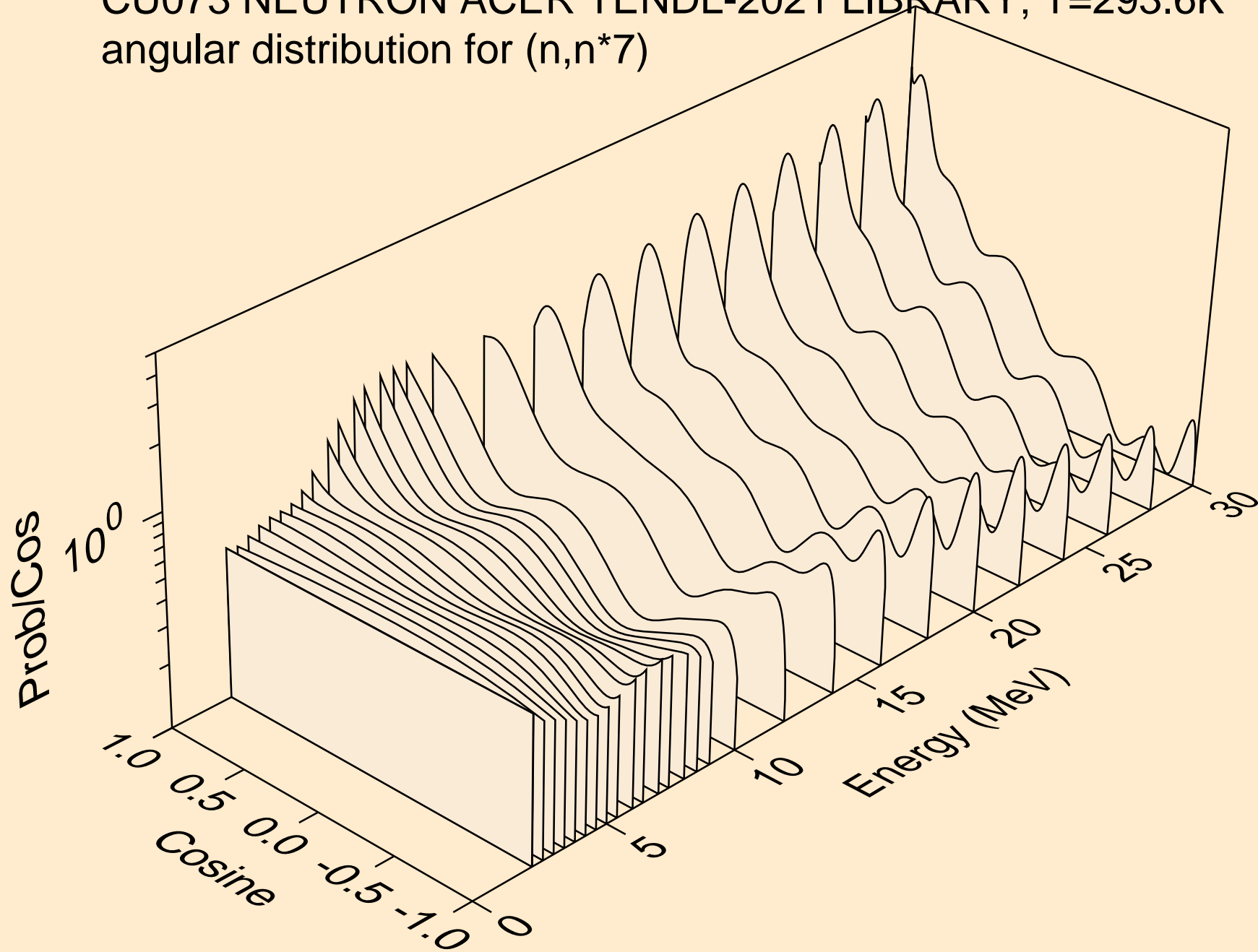

CU073 NEUTRON ACER TENDL-2021 LIBRARY; T=293.6K
angular distribution for (n,n*8)

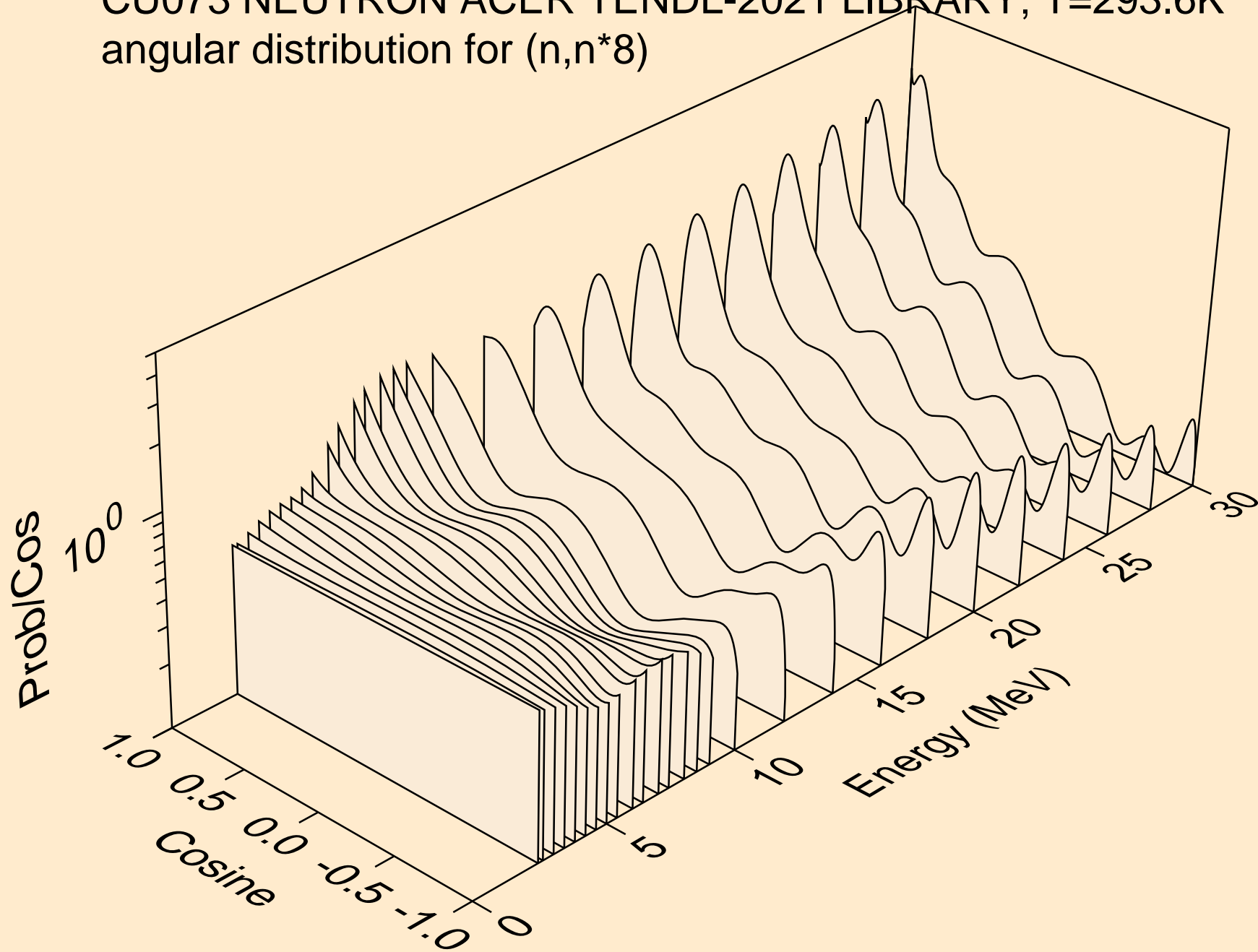

CU073 NEUTRON ACER TENDL-2021 LIBRARY; T=293.6K
angular distribution for (n,n*9)

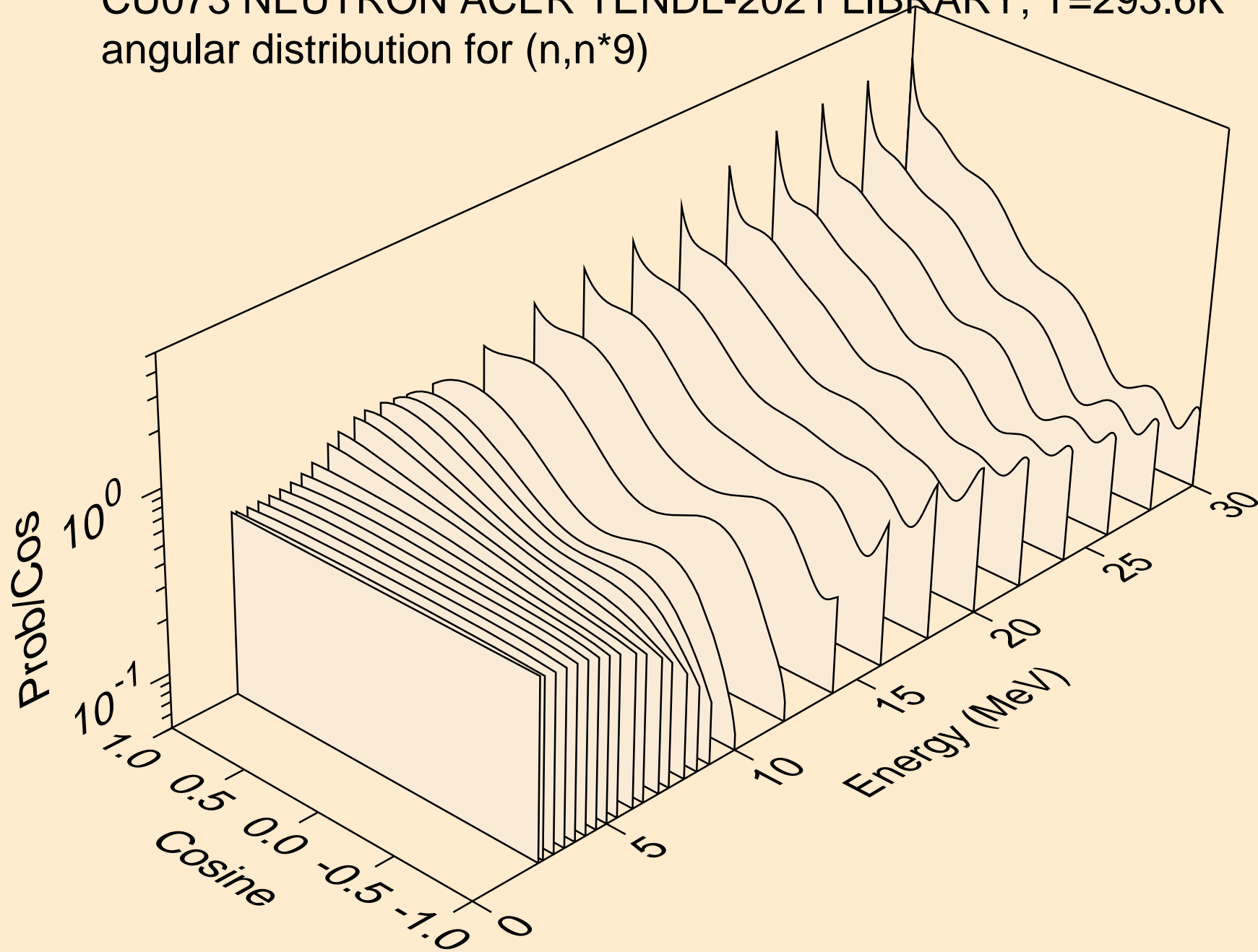

CU073 NEUTRON ACER TENDL-2021 LIBRARY; T=293.6K
angular distribution for (n,n*10)

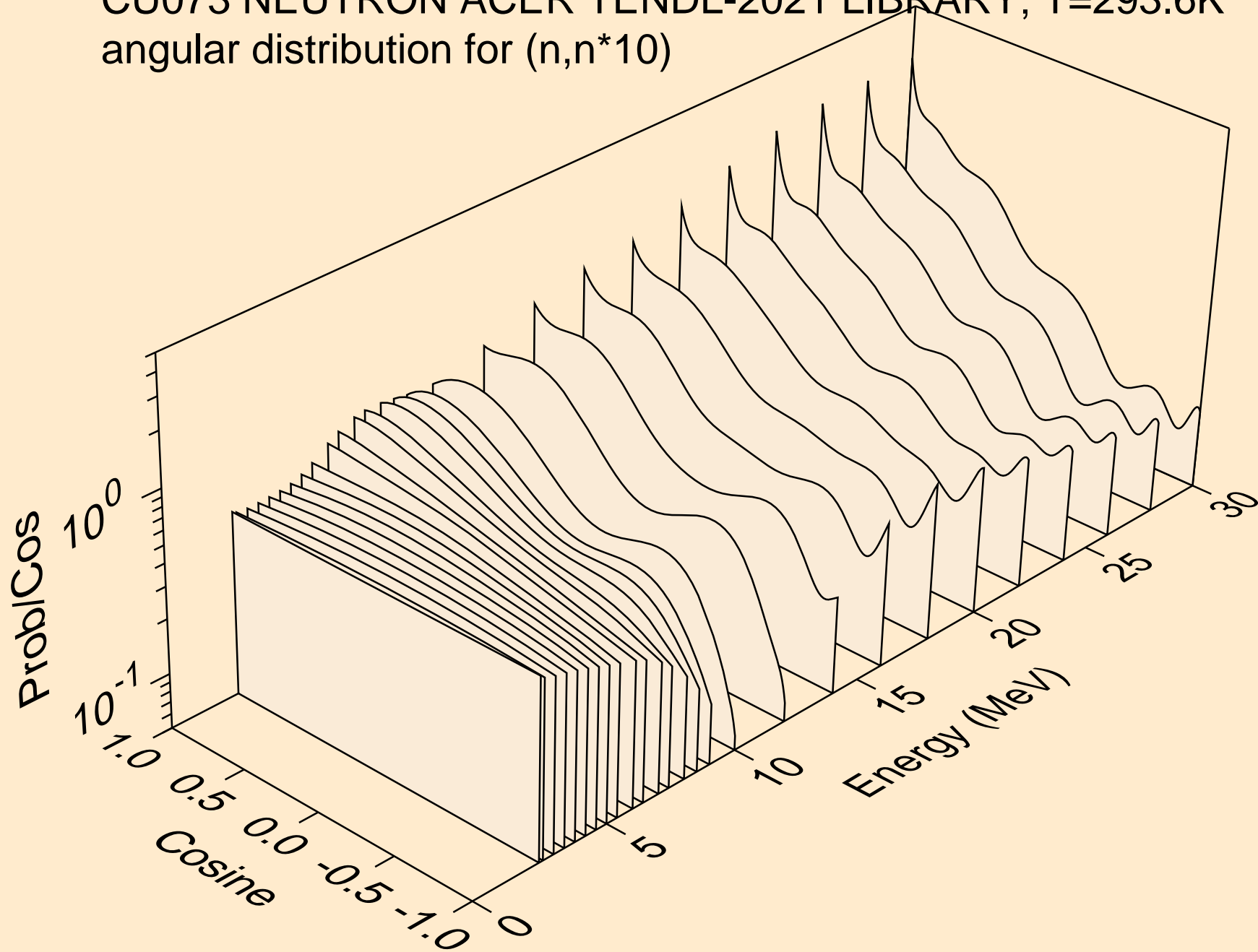

CU073 NEUTRON ACER TENDL-2021 LIBRARY; T=293.6K
angular distribution for (n,n*11)

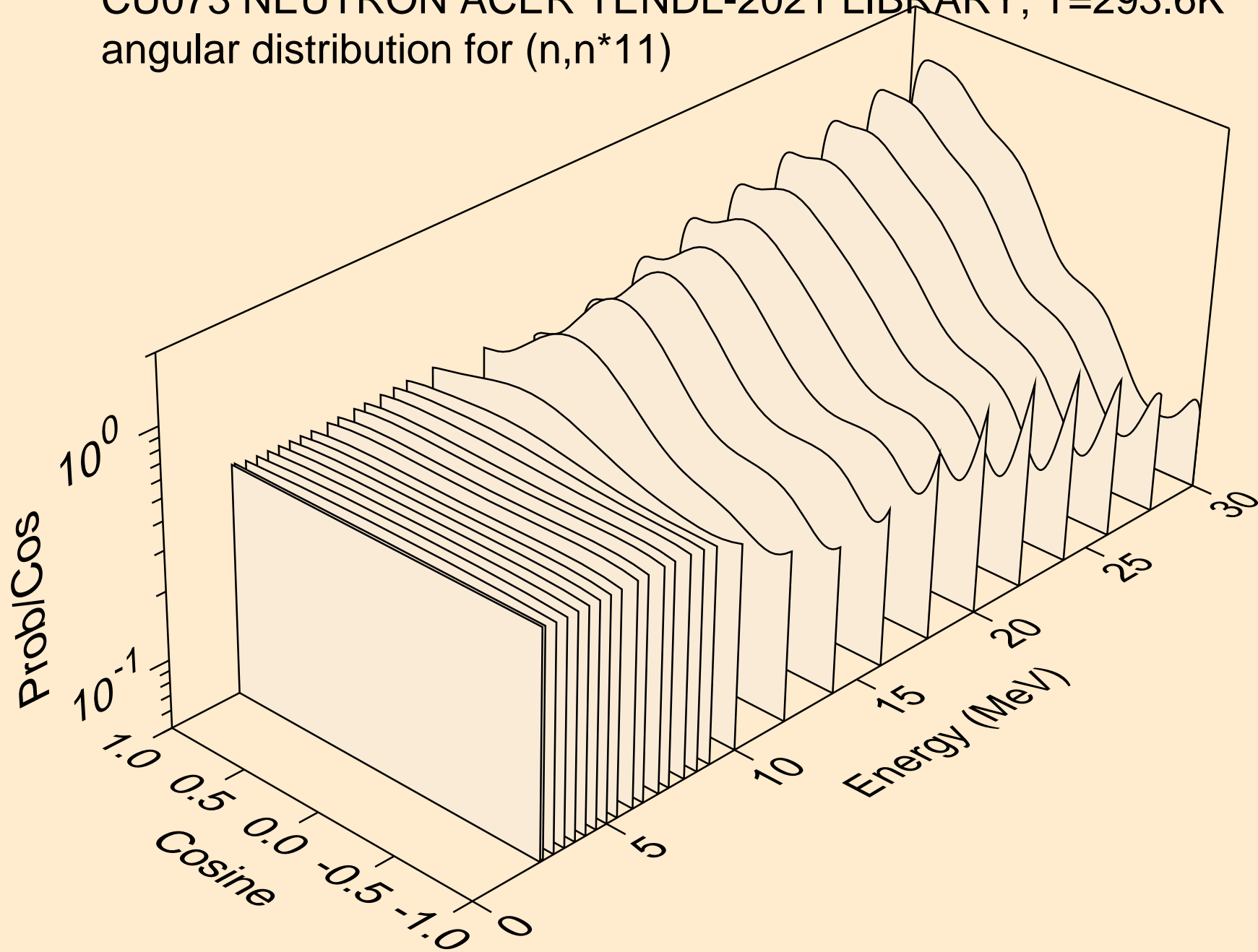

CU073 NEUTRON ACER TENDL-2021 LIBRARY; T=293.6K
angular distribution for (n,n*12)

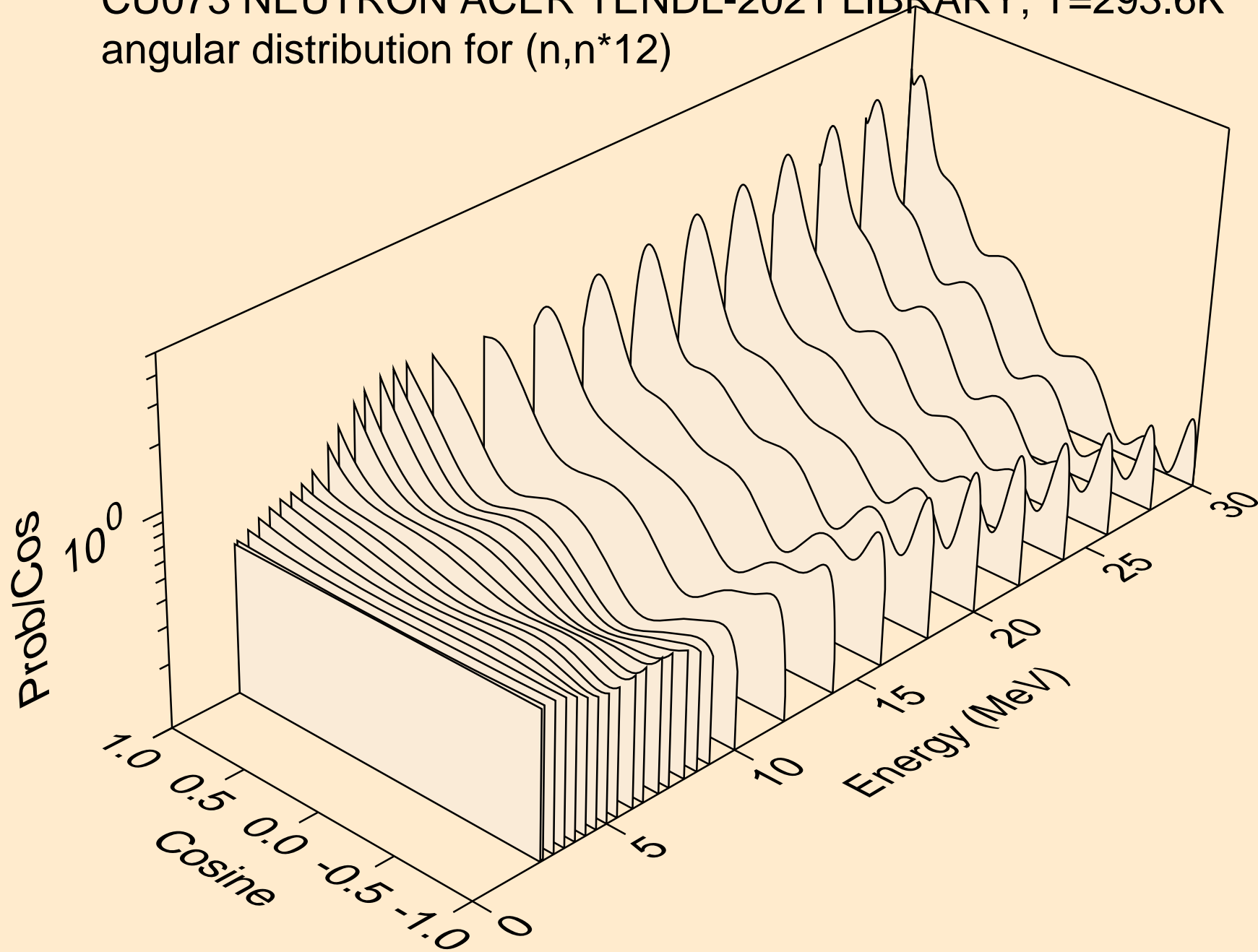

CU073 NEUTRON ACER TENDL-2021 LIBRARY; T=293.6K
angular distribution for (n,n*13)

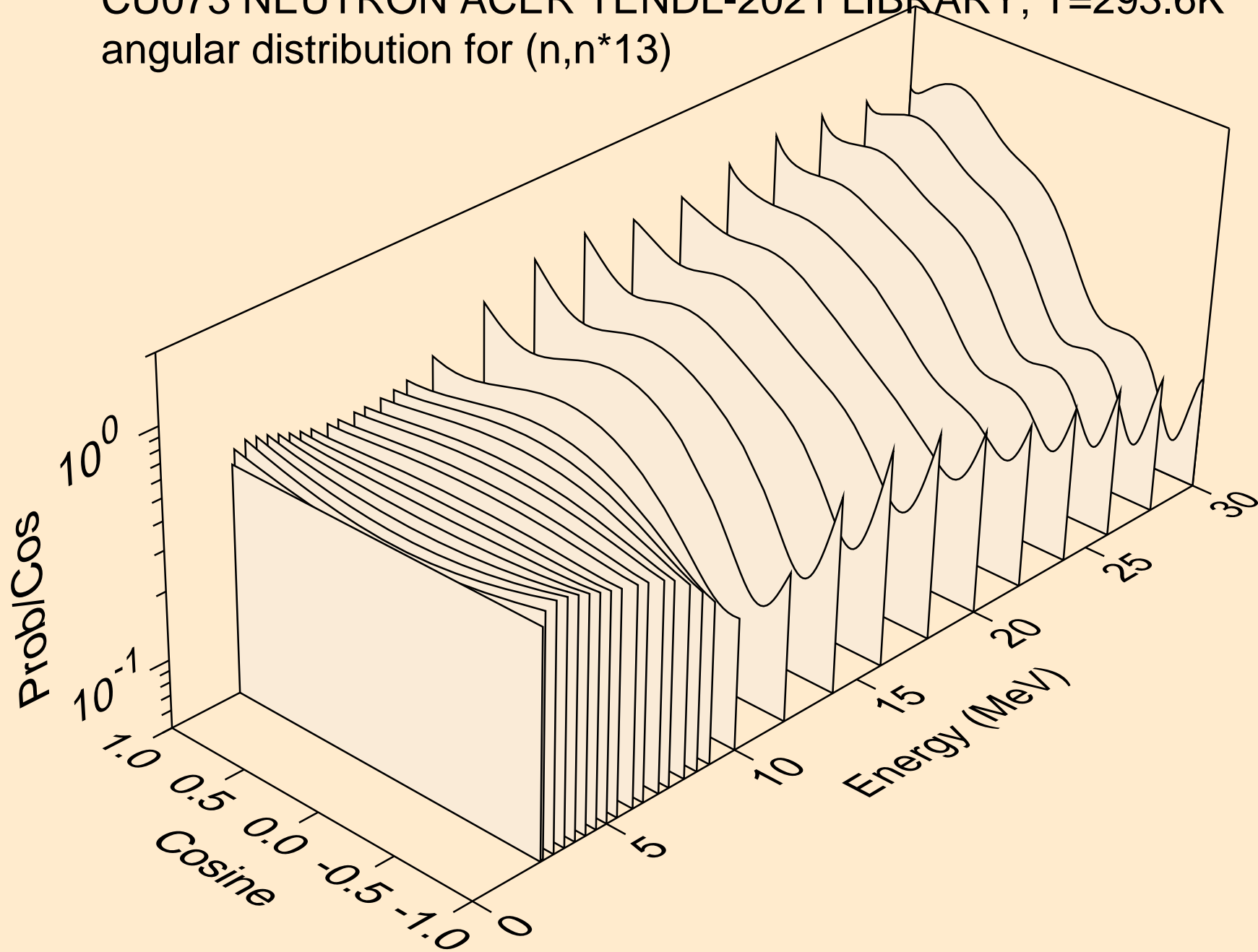

CU073 NEUTRON ACER TENDL-2021 LIBRARY; T=293.6K
angular distribution for (n,n*14)

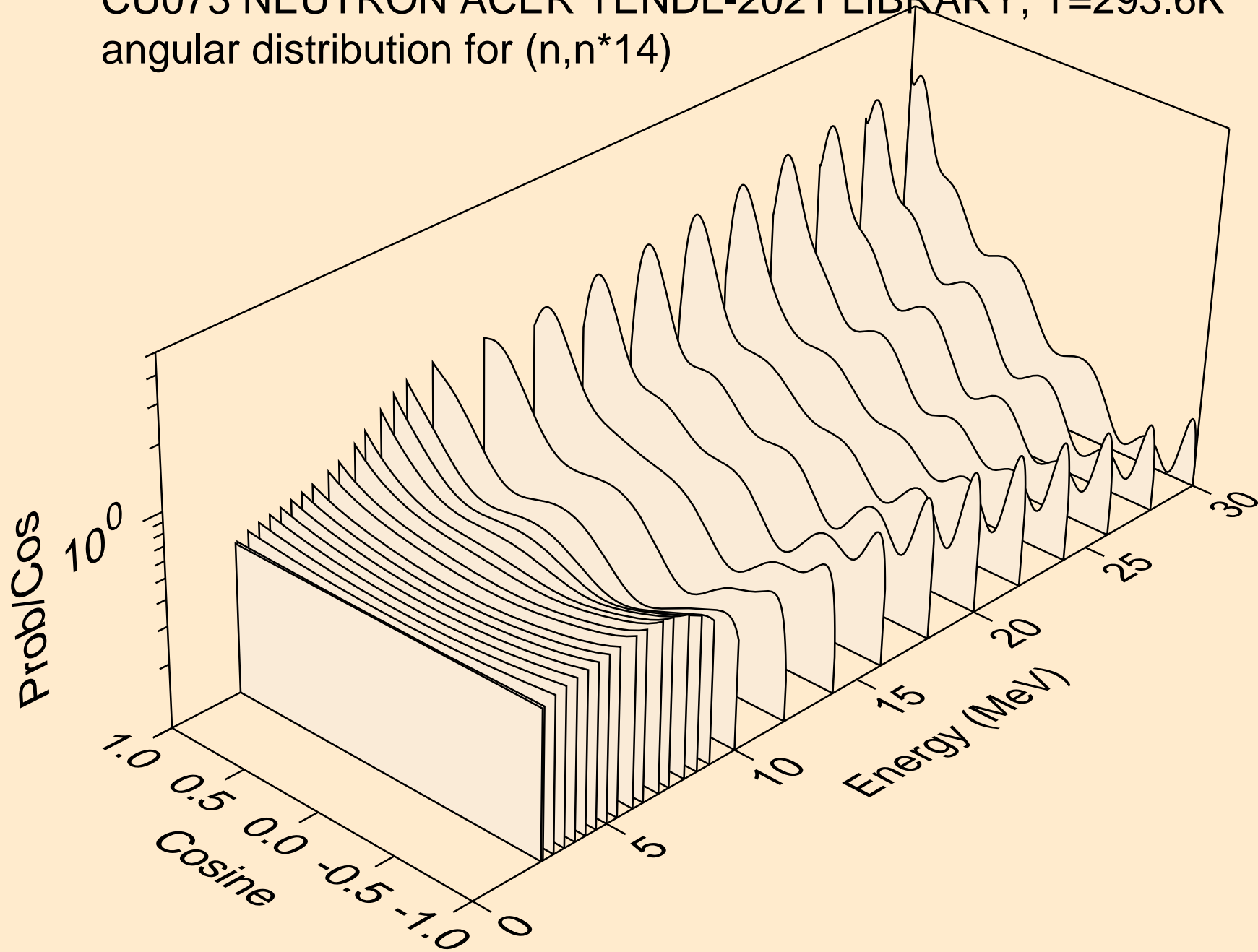

CU073 NEUTRON ACER TENDL-2021 LIBRARY; T=293.6K
angular distribution for (n,n*15)

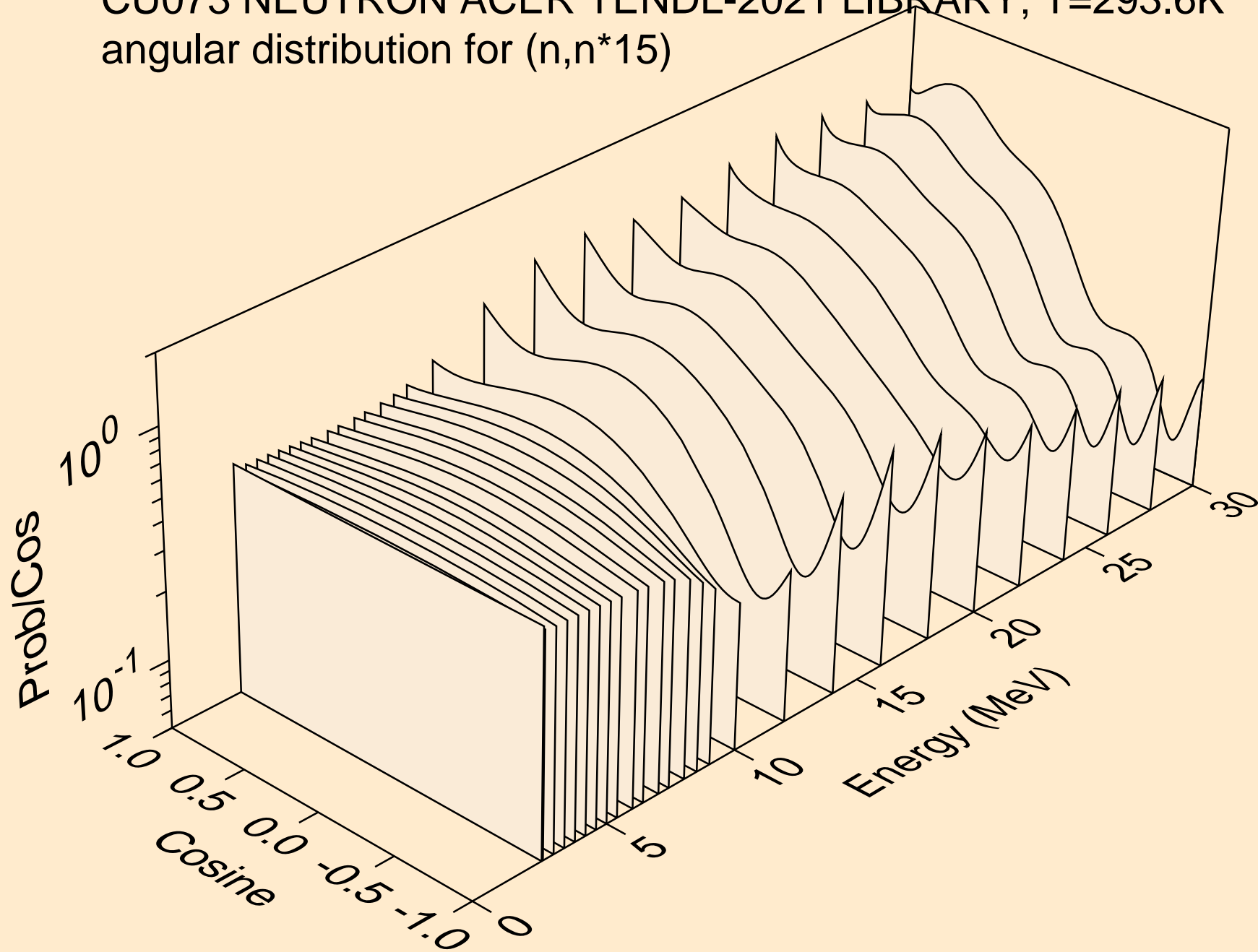

CU073 NEUTRON ACER TENDL-2021 LIBRARY; T=293.6K
angular distribution for (n,n*16)

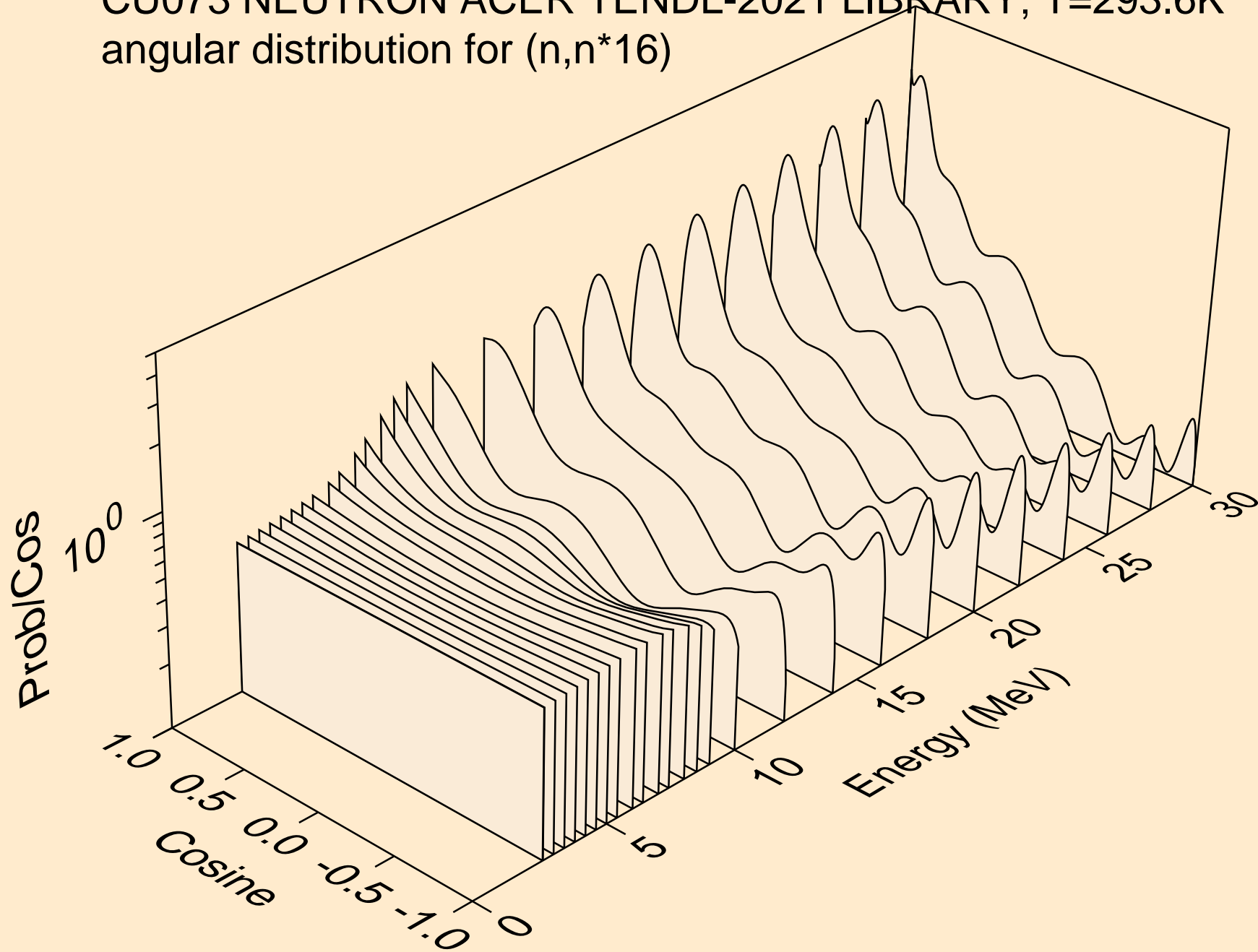

CU073 NEUTRON ACER TENDL-2021 LIBRARY; T=293.6K
angular distribution for (n,n*17)

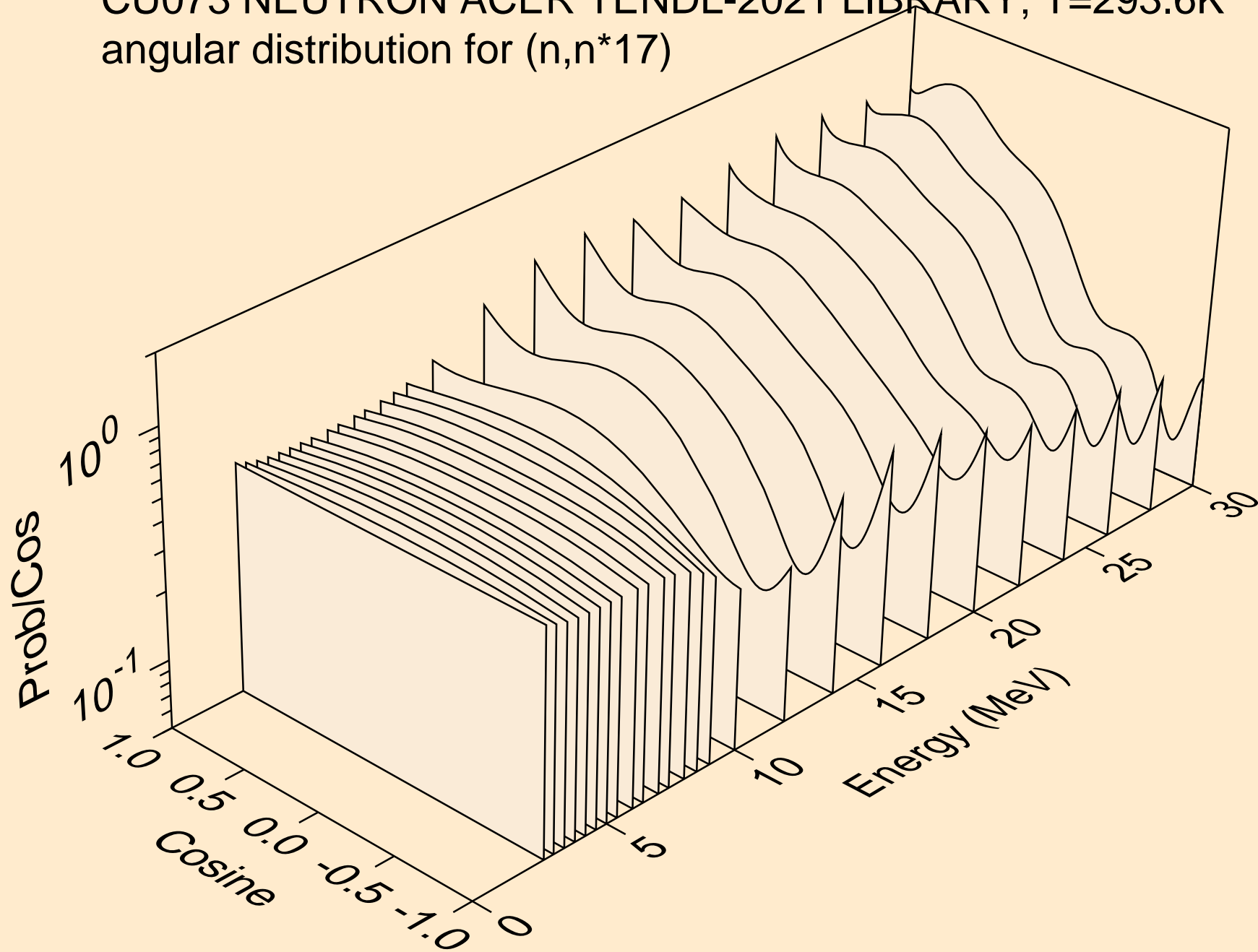

CU073 NEUTRON ACER TENDL-2021 LIBRARY; T=293.6K
angular distribution for (n,n*18)

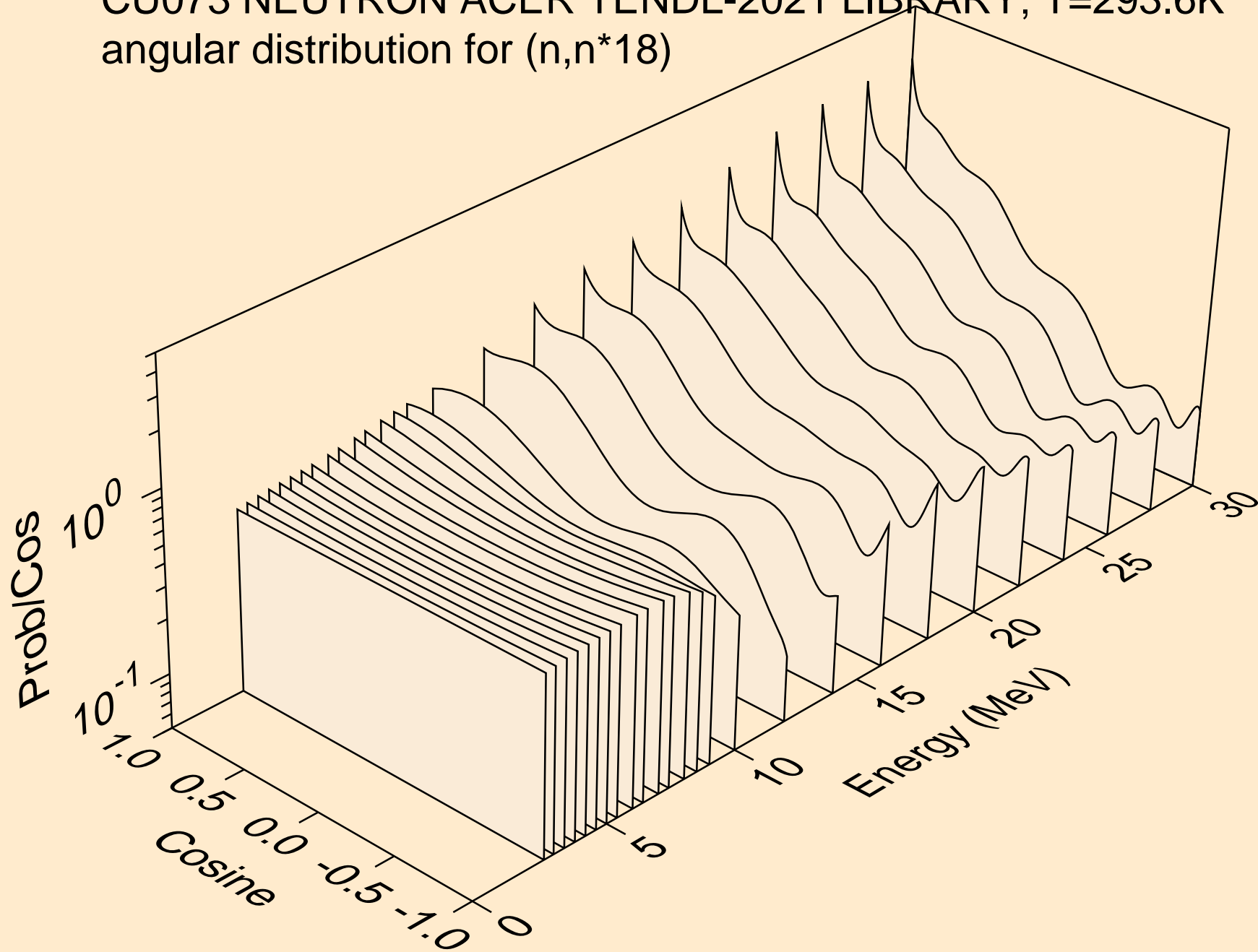

CU073 NEUTRON ACER TENDL-2021 LIBRARY; T=293.6K
angular distribution for (n,n*19)

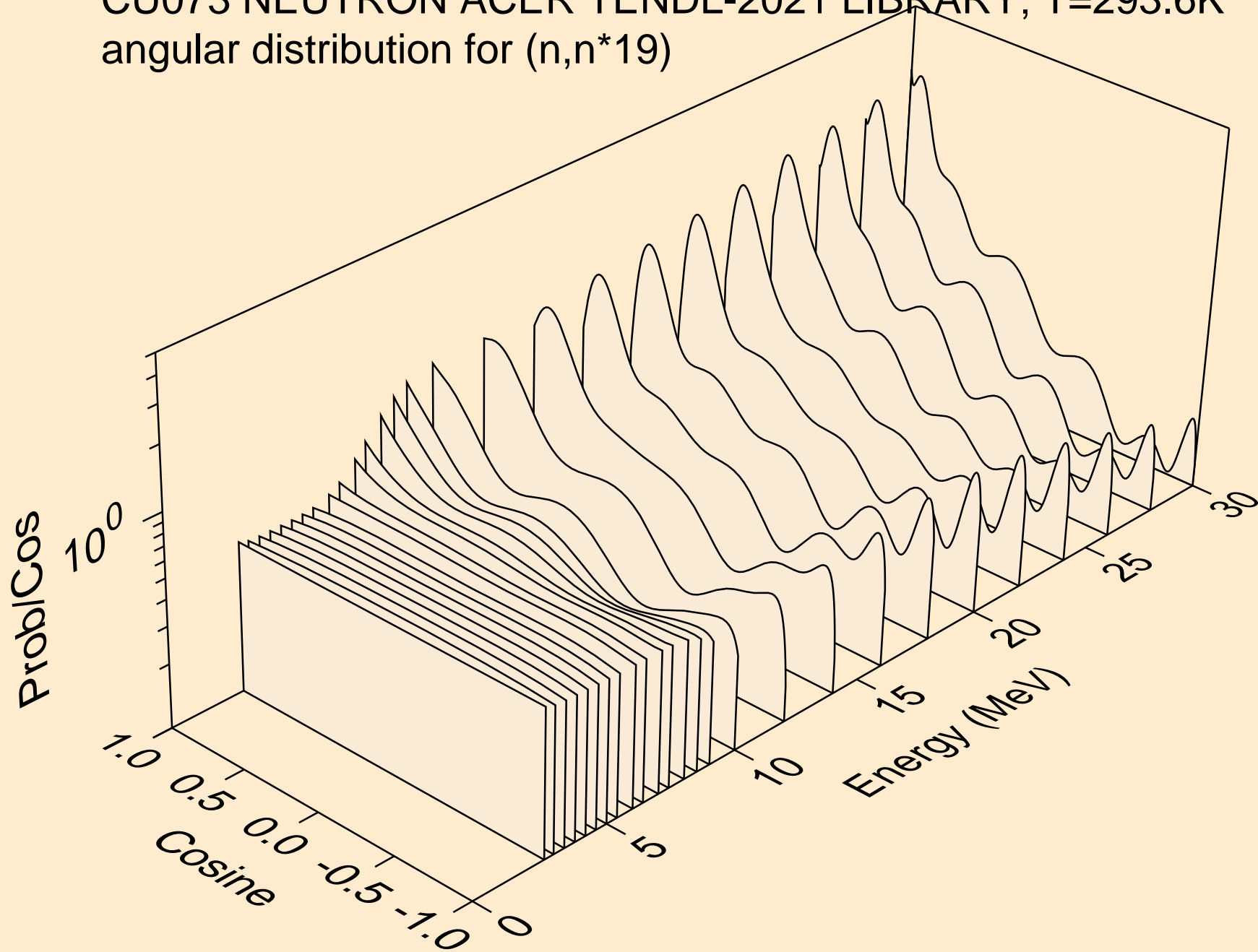

CU073 NEUTRON ACER TENDL-2021 LIBRARY; T=293.6K
angular distribution for (n,n*20)

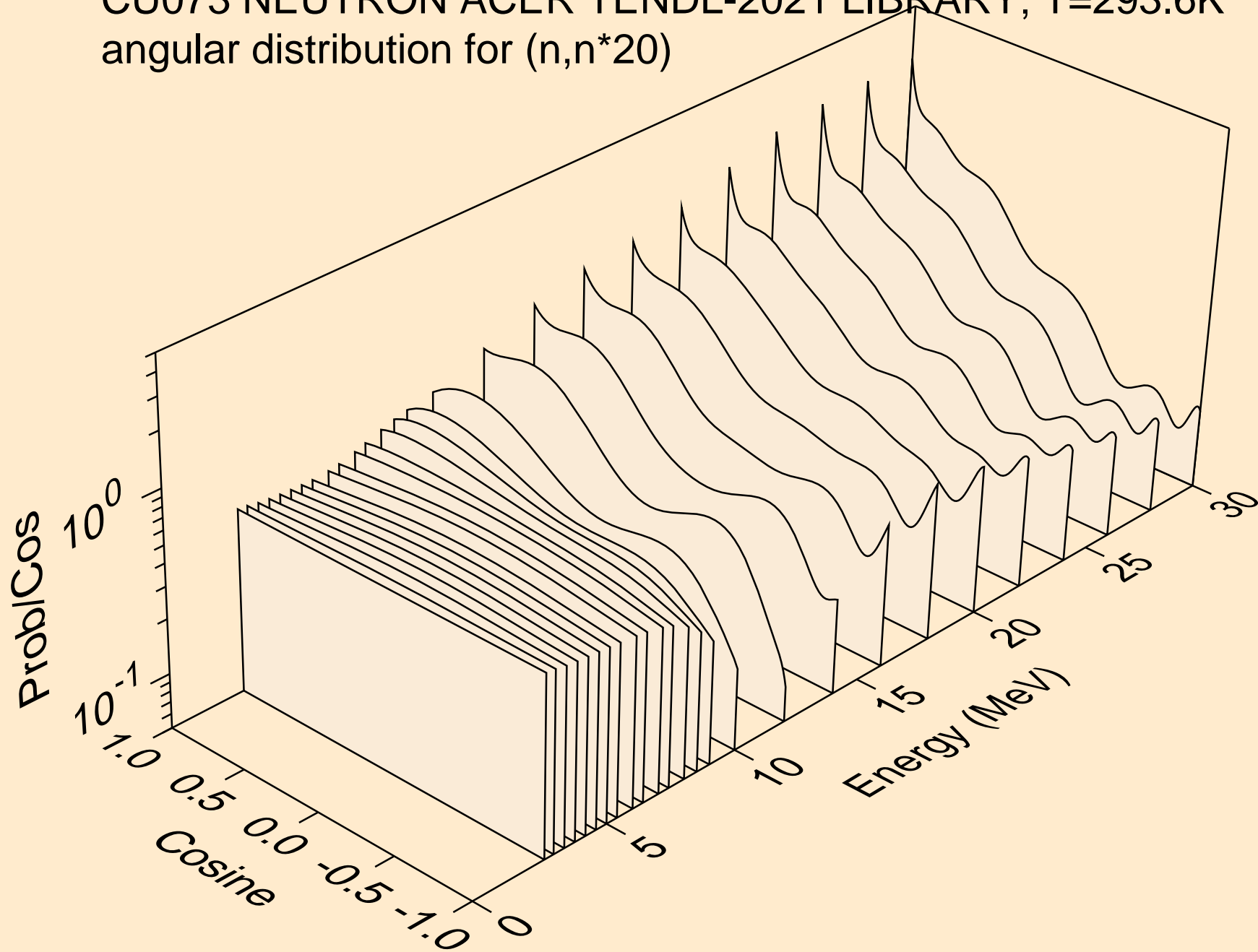

CU073 NEUTRON ACER TENDL-2021 LIBRARY; T=293.6K
angular distribution for (n,n*21)

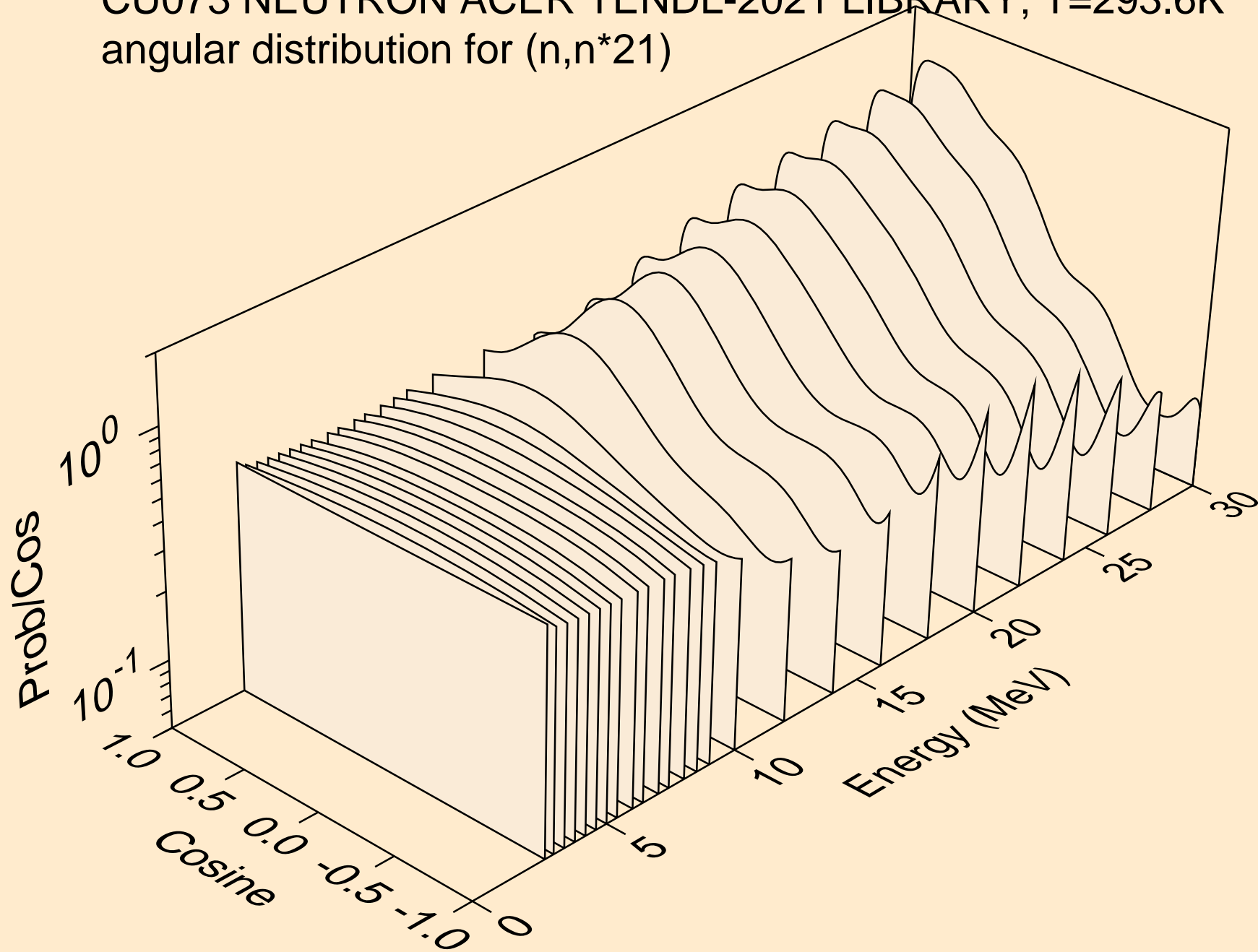

CU073 NEUTRON ACER TENDL-2021 LIBRARY; T=293.6K
angular distribution for (n,n*22)

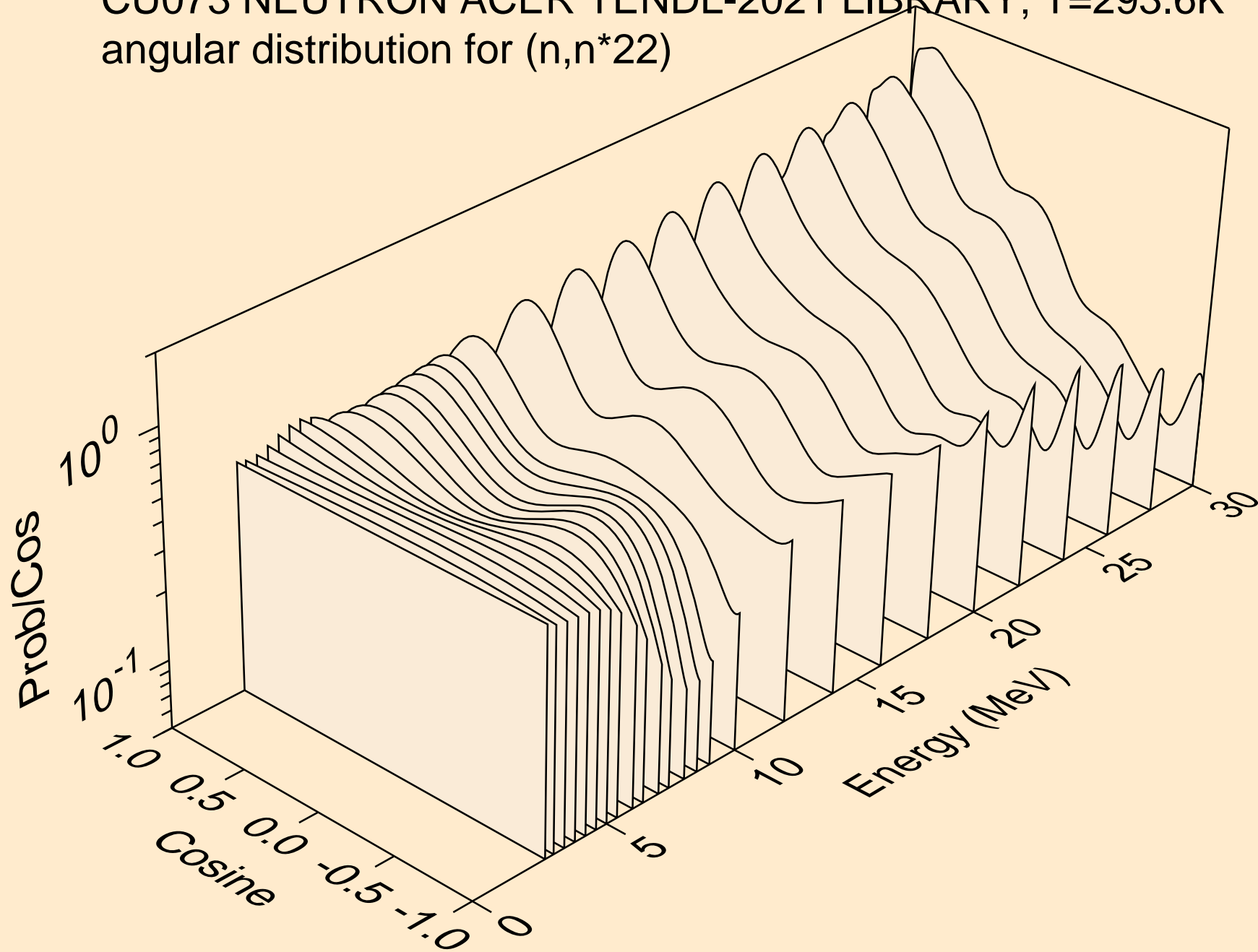

CU073 NEUTRON ACER TENDL-2021 LIBRARY; T=293.6K
angular distribution for (n,n*23)

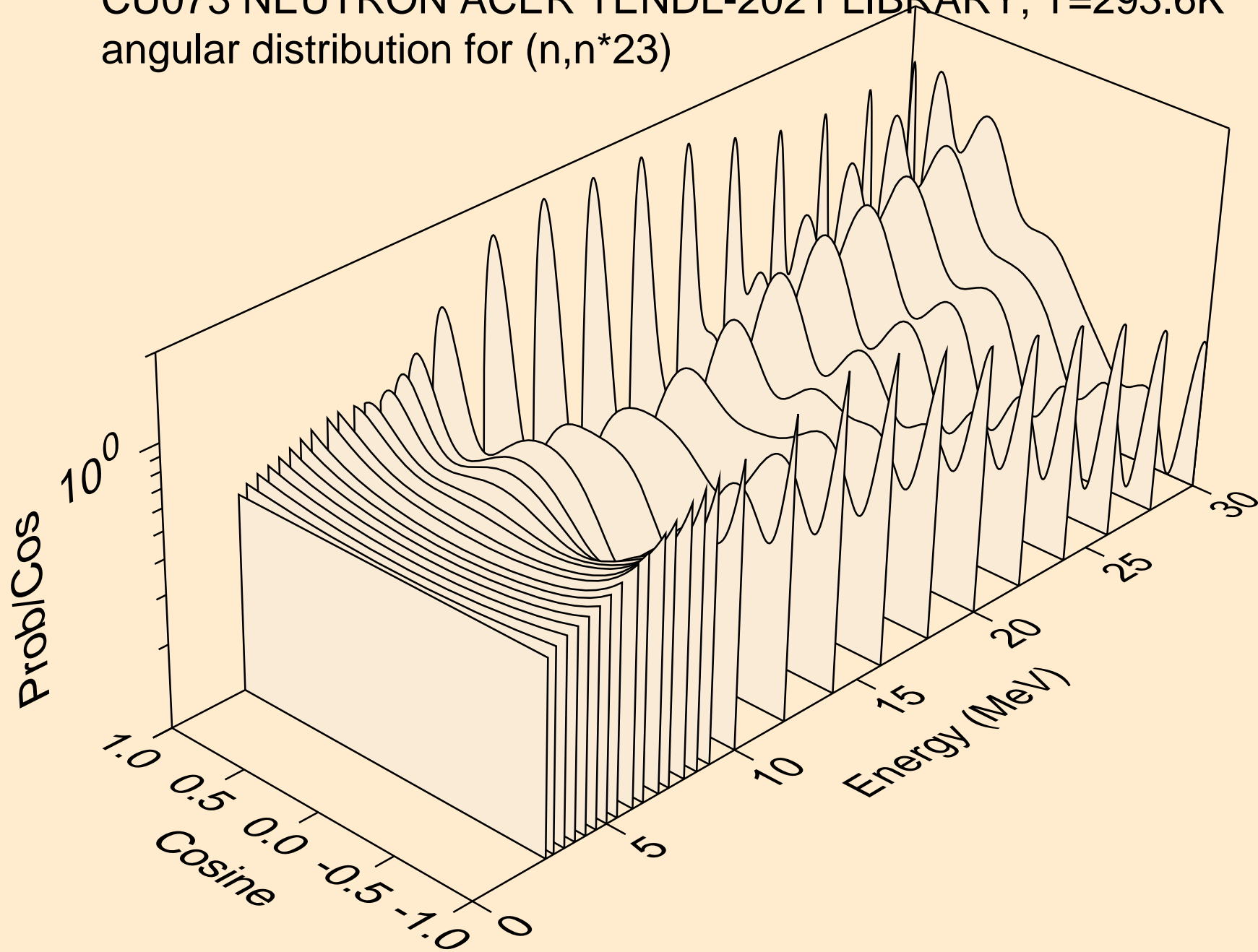

CU073 NEUTRON ACER TENDL-2021 LIBRARY; T=293.6K
angular distribution for (n,n*24)

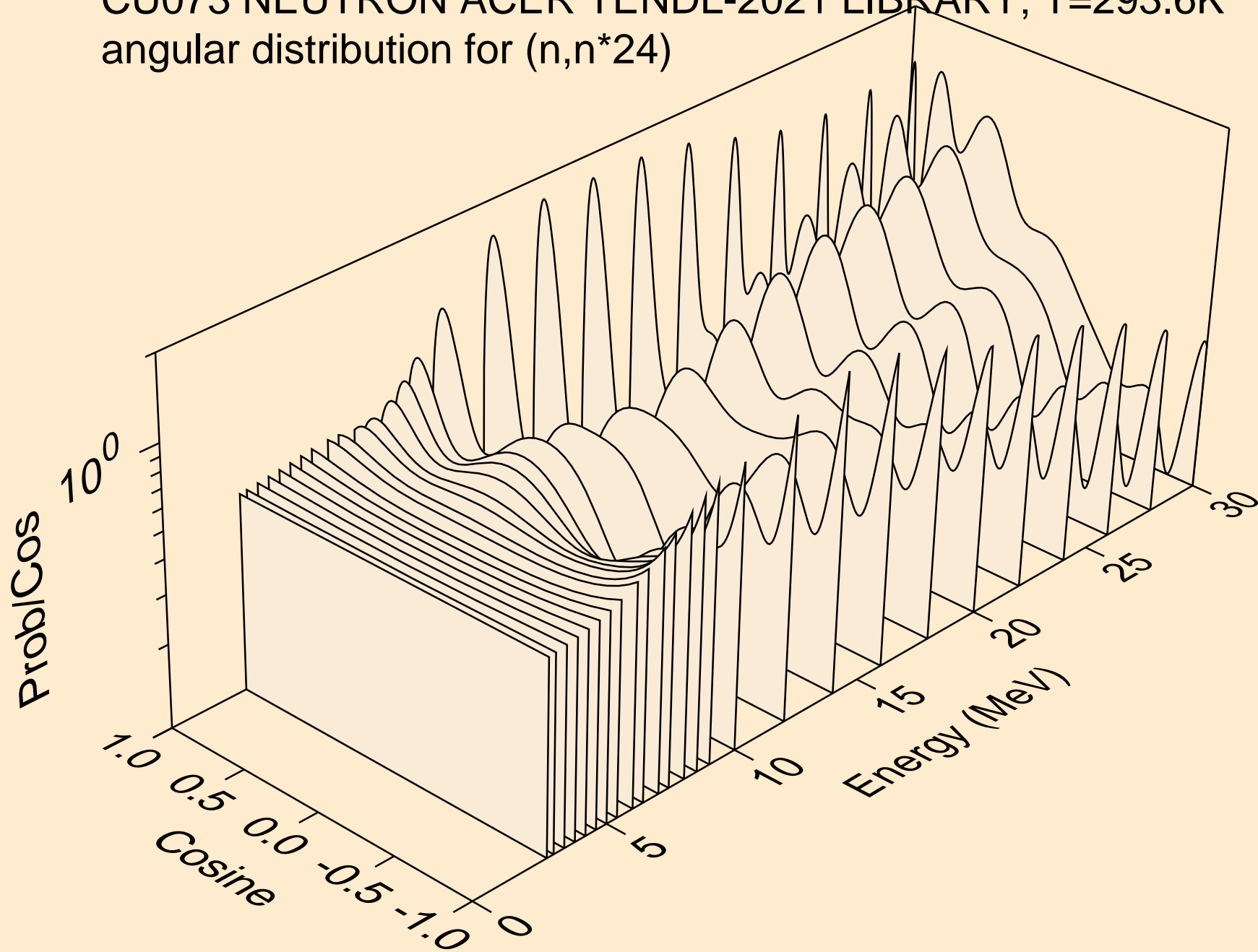

CU073 NEUTRON ACER TENDL-2021 LIBRARY; T=293.6K
angular distribution for (n,n*25)

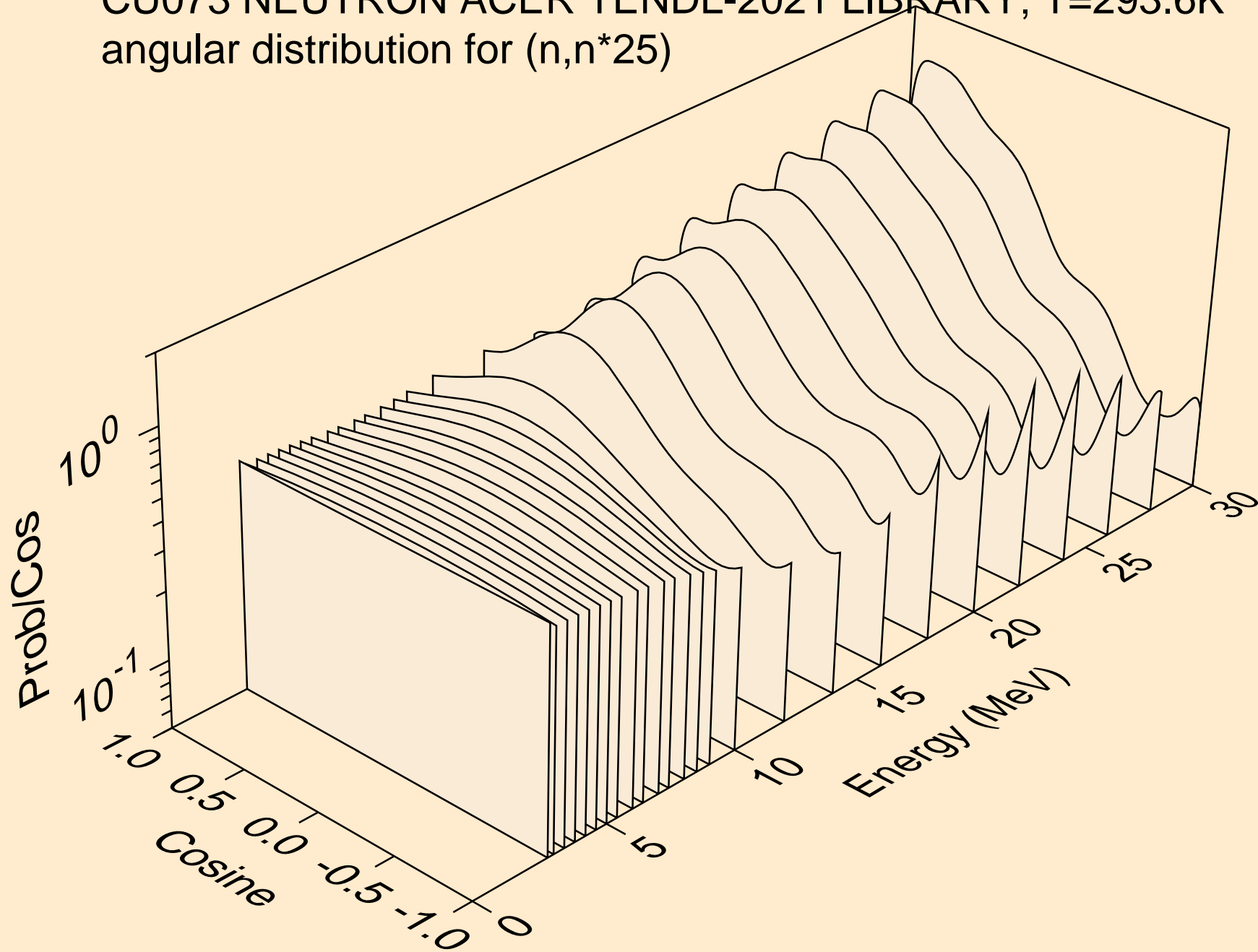

CU073 NEUTRON ACER TENDL-2021 LIBRARY; T=293.6K
angular distribution for (n,n*26)

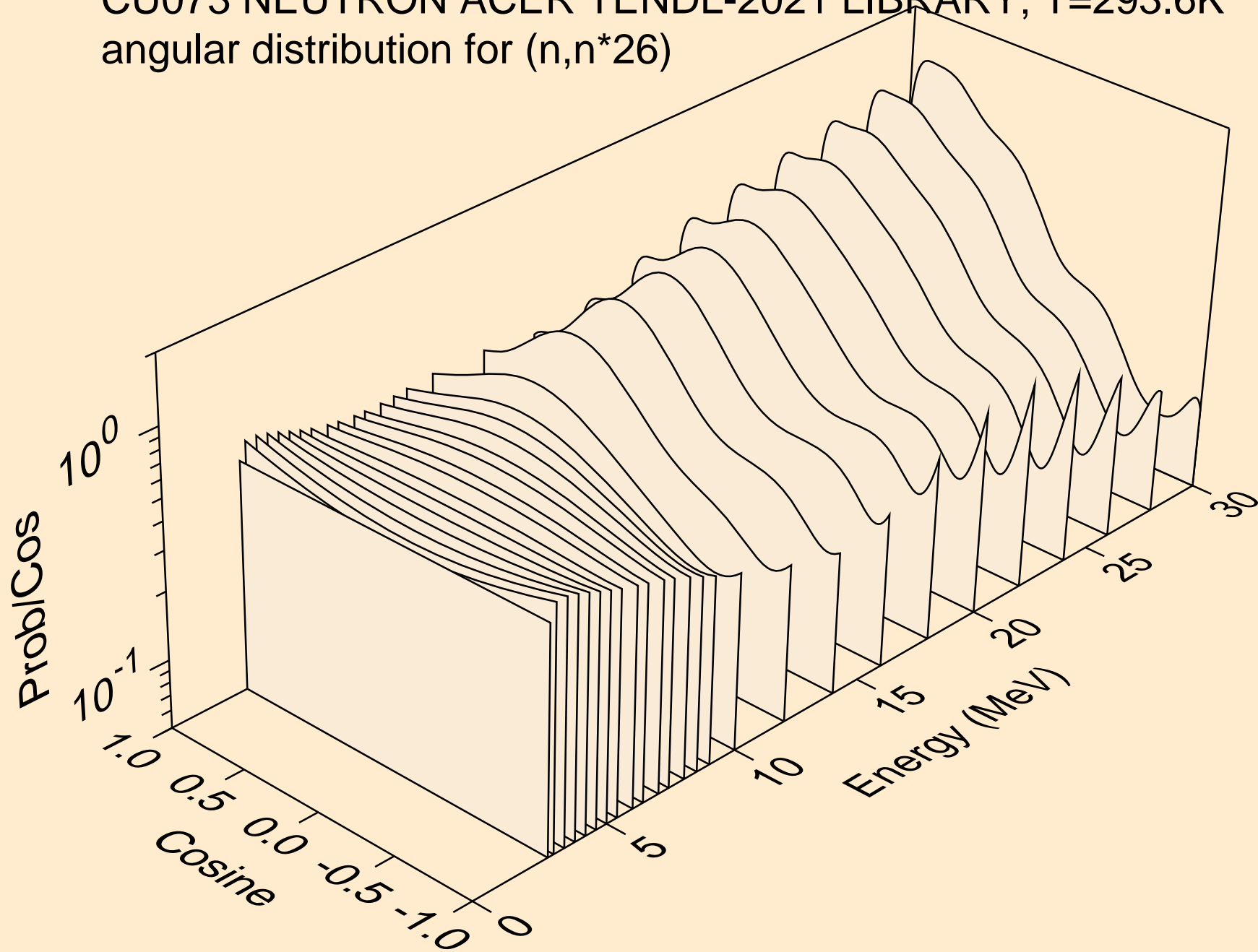

CU073 NEUTRON ACER TENDL-2021 LIBRARY; T=293.6K
angular distribution for (n,n*27)

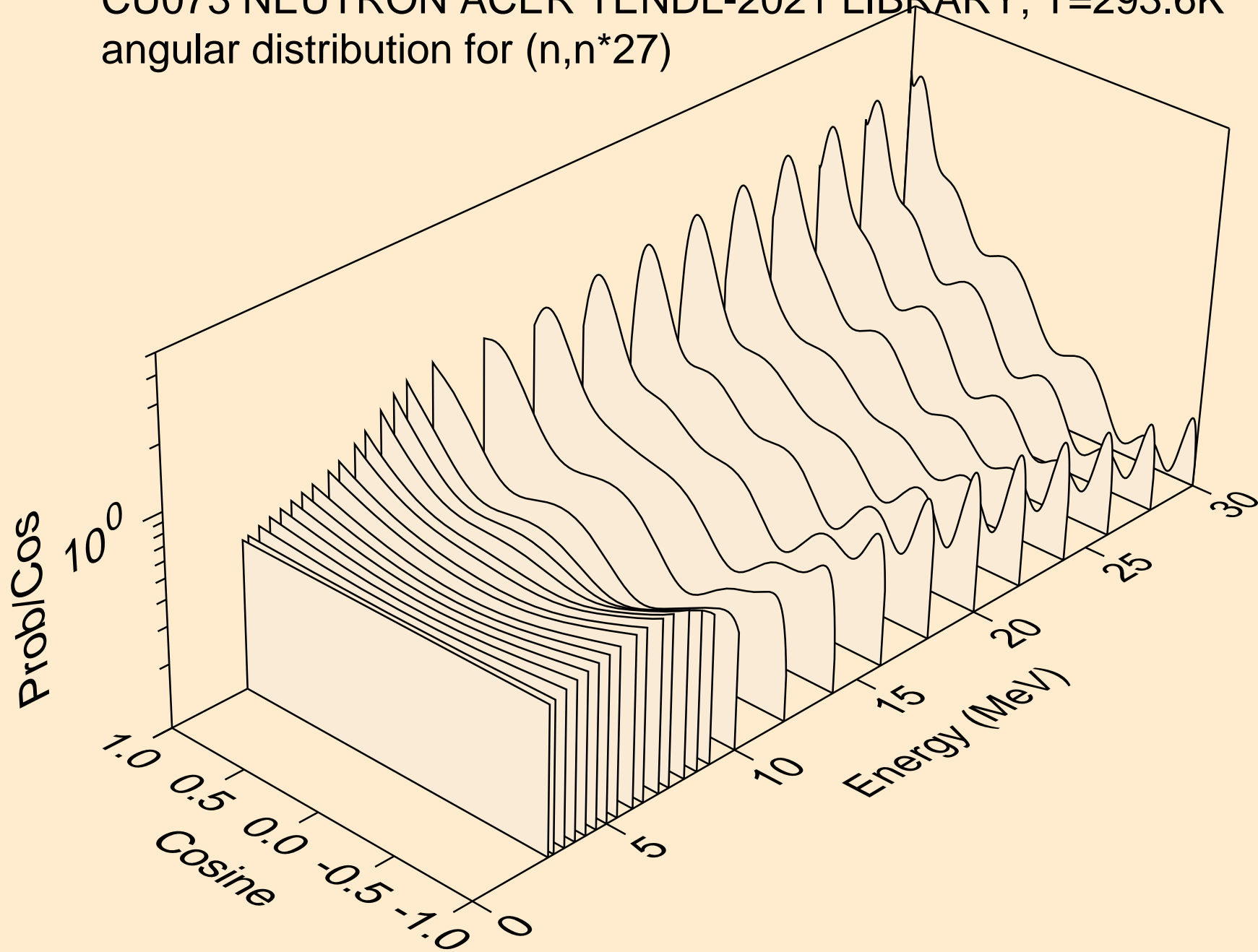

CU073 NEUTRON ACER TENDL-2021 LIBRARY; T=293.6K
angular distribution for (n,n*28)

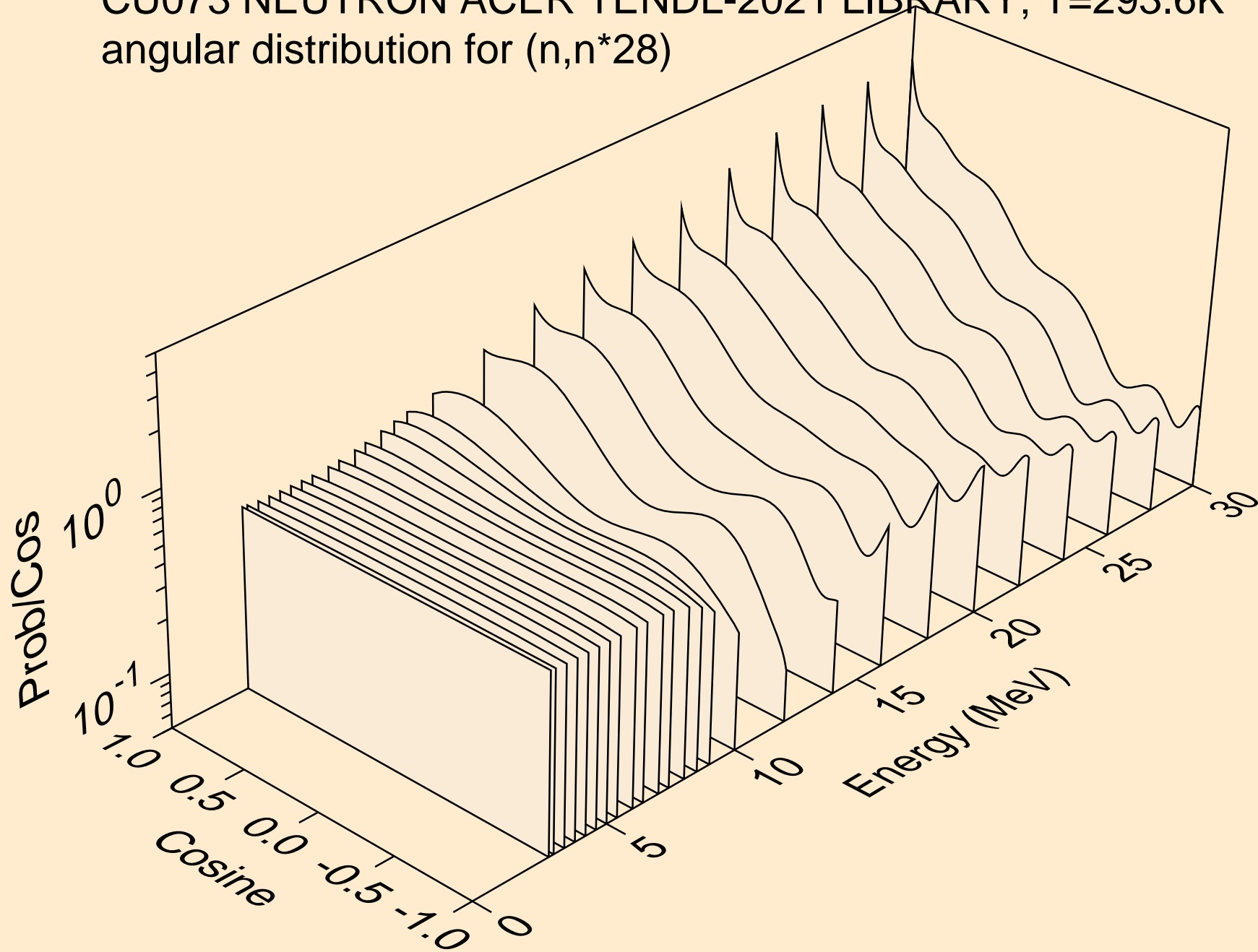

CU073 NEUTRON ACER TENDL-2021 LIBRARY; T=293.6K
angular distribution for (n,n*29)

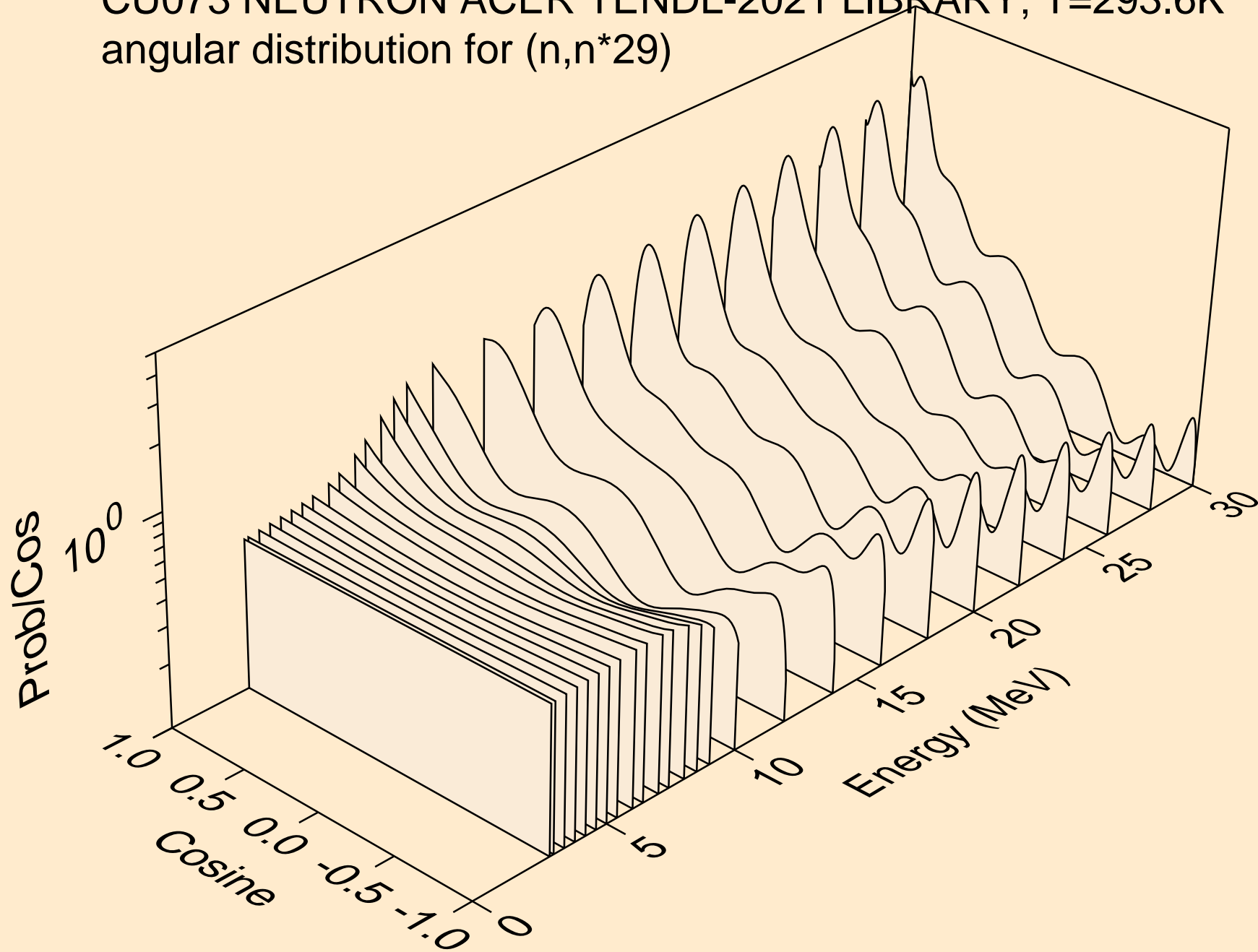

CU073 NEUTRON ACER TENDL-2021 LIBRARY; T=293.6K
Neutron emission for (n,x)

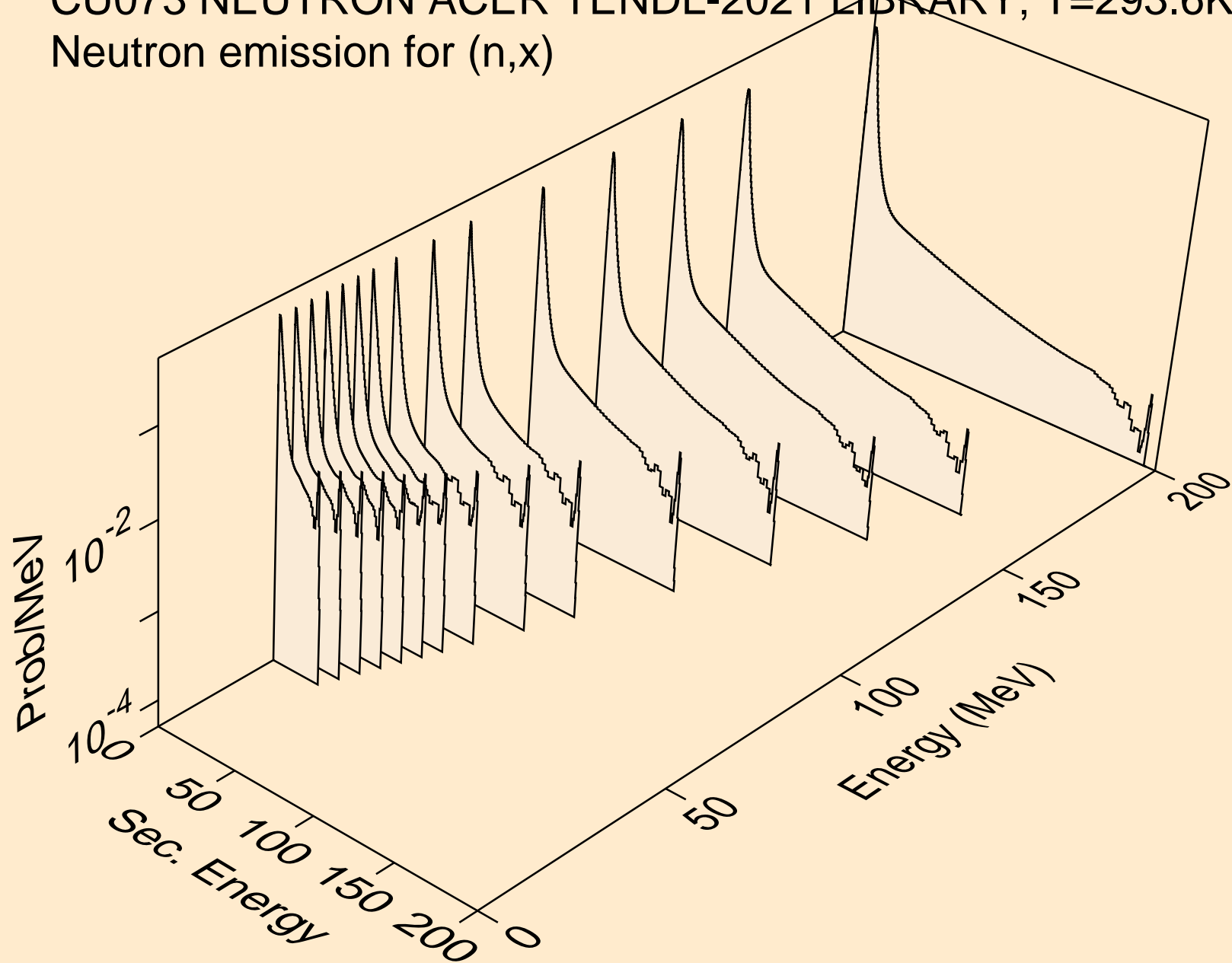

CU073 NEUTRON ACER TENDL-2021 LIBRARY; T=293.6K
Neutron emission for (n,2nd)

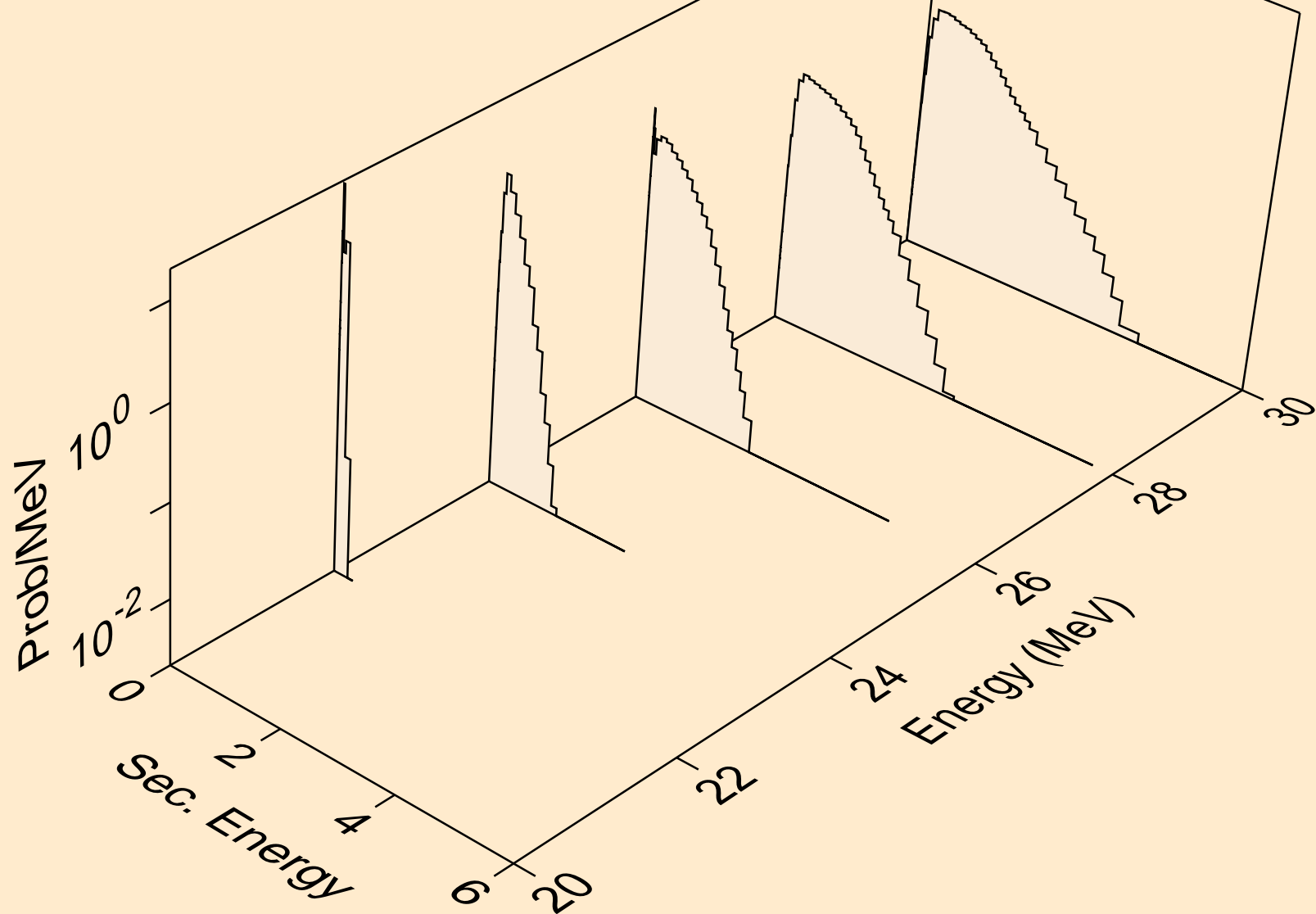

CU073 NEUTRON ACER TENDL-2021 LIBRARY; T=293.6K
Neutron emission for (n,2n)

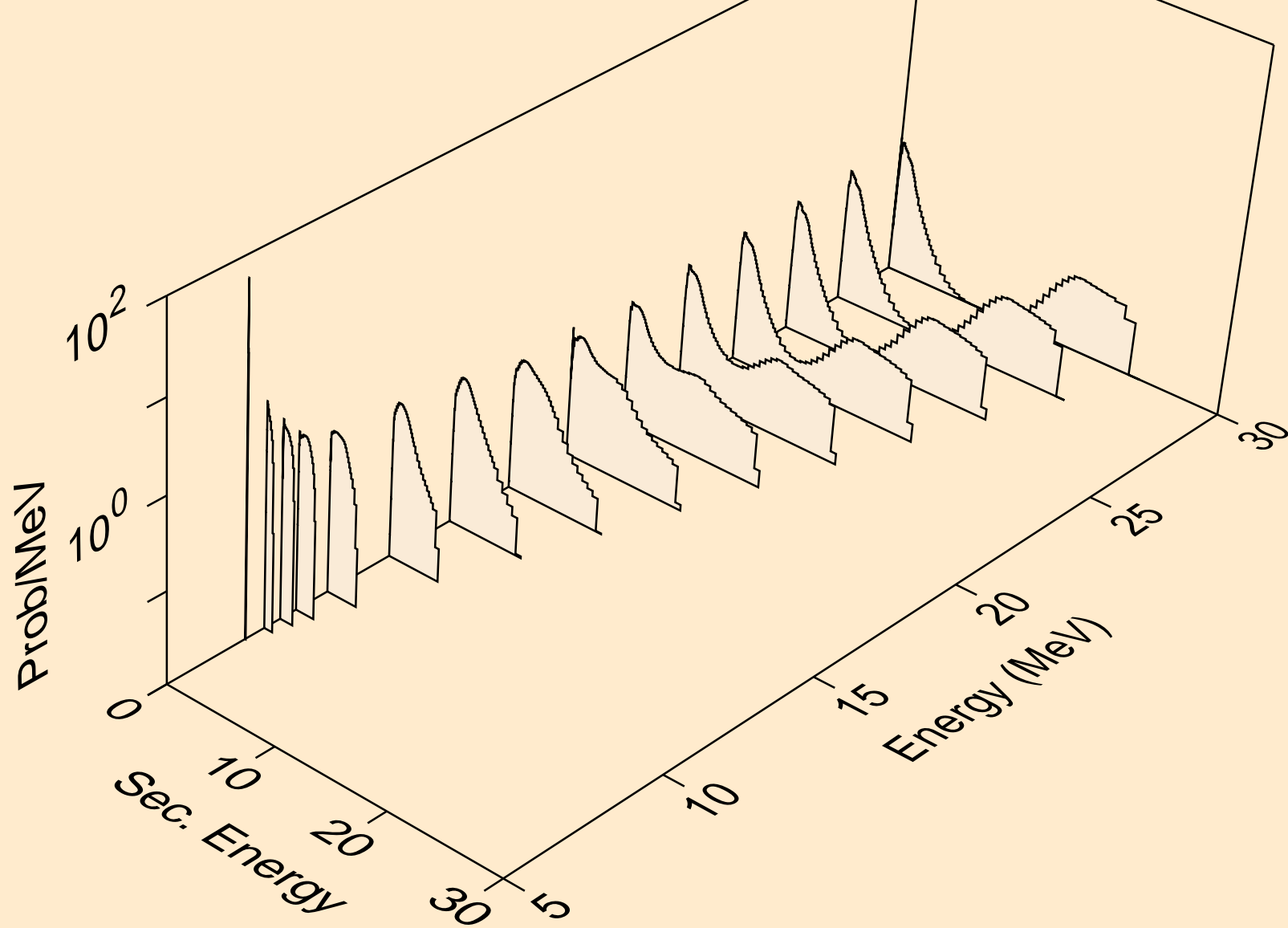

CU073 NEUTRON ACER TENDL-2021 LIBRARY; T=293.6K
Neutron emission for (n,3n)

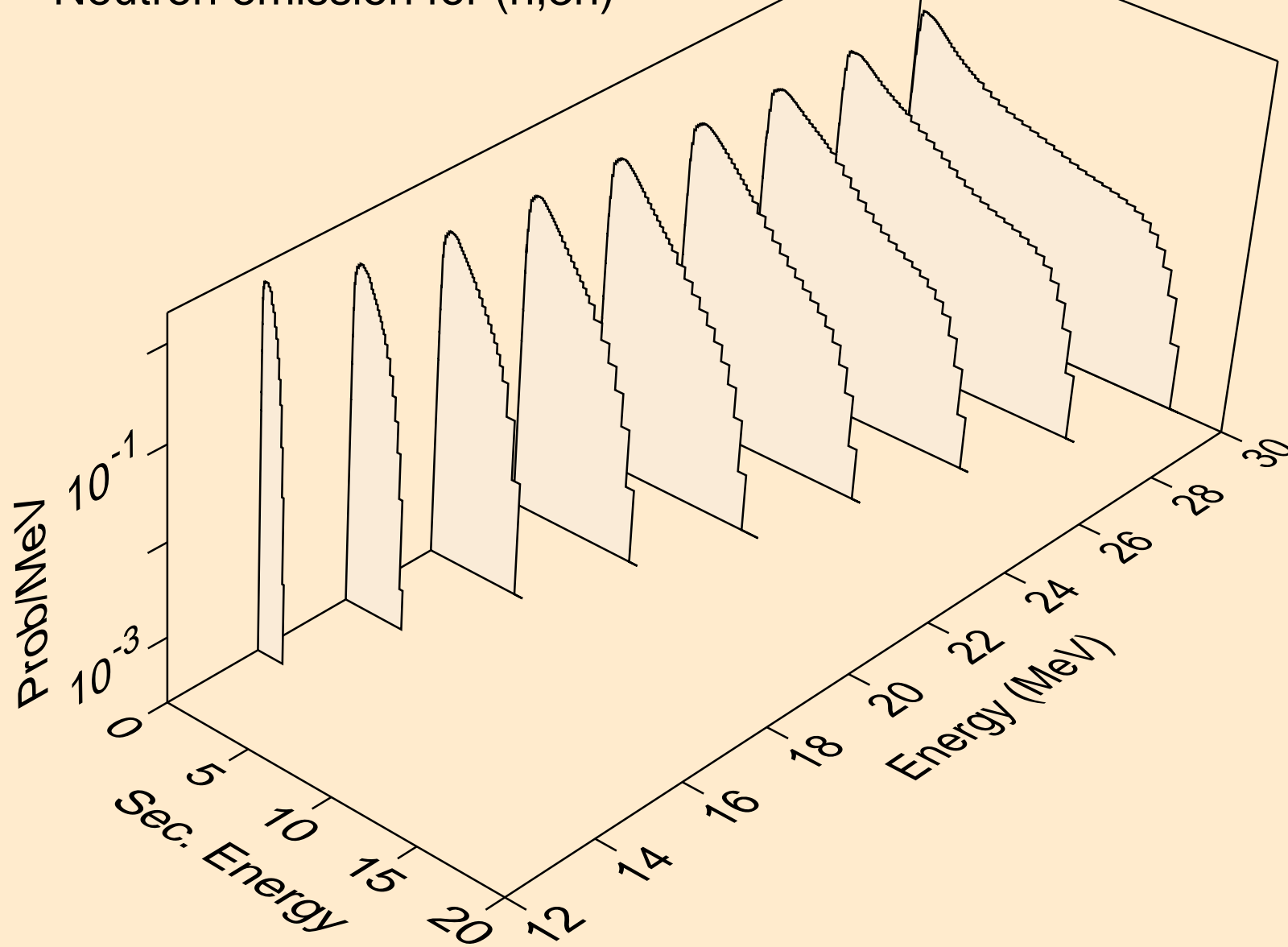

CU073 NEUTRON ACER TENDL-2021 LIBRARY; T=293.6K
Neutron emission for (n,n*)a

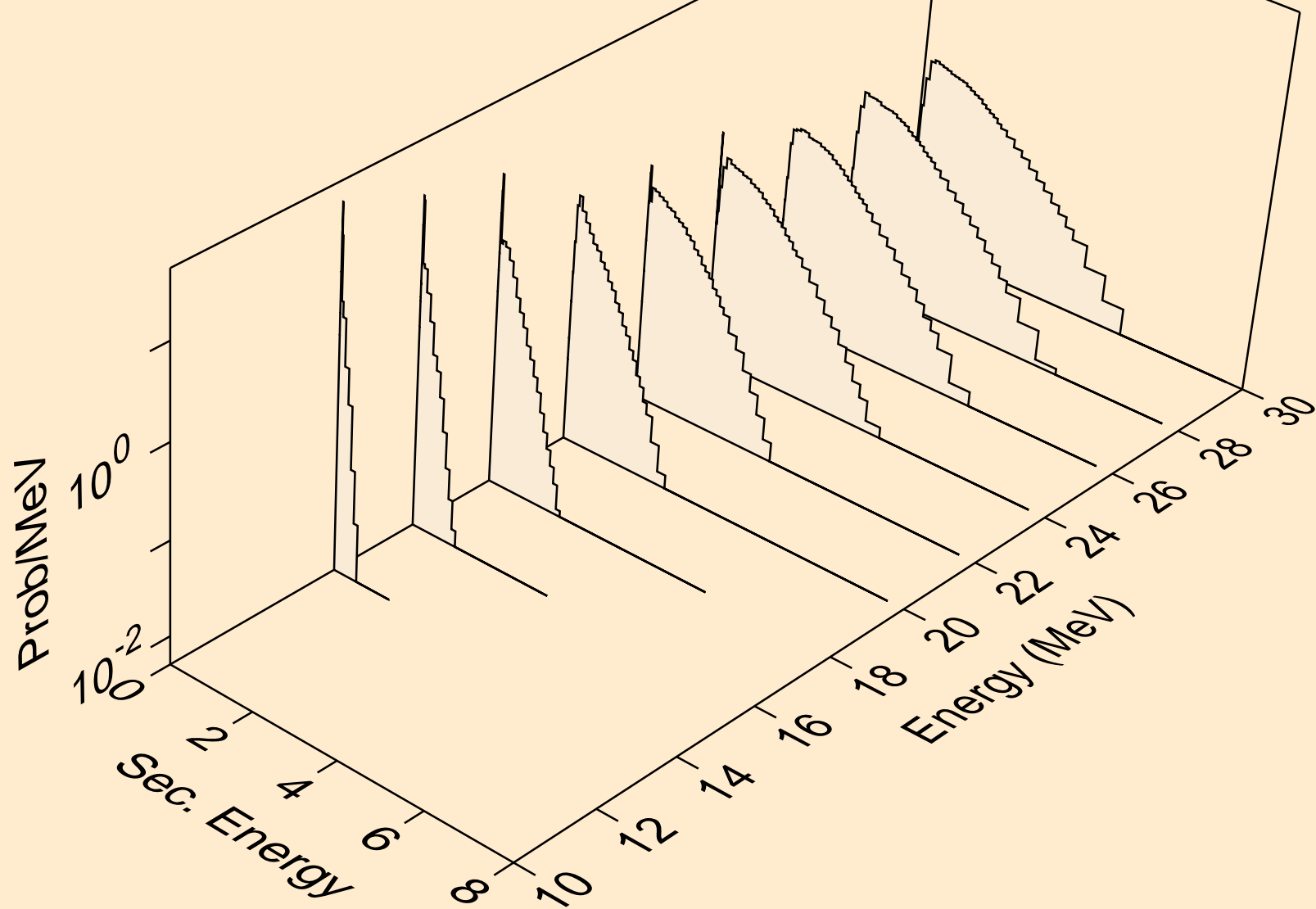

CU073 NEUTRON ACER TENDL-2021 LIBRARY; T=293.6K
Neutron emission for (n,2n)a

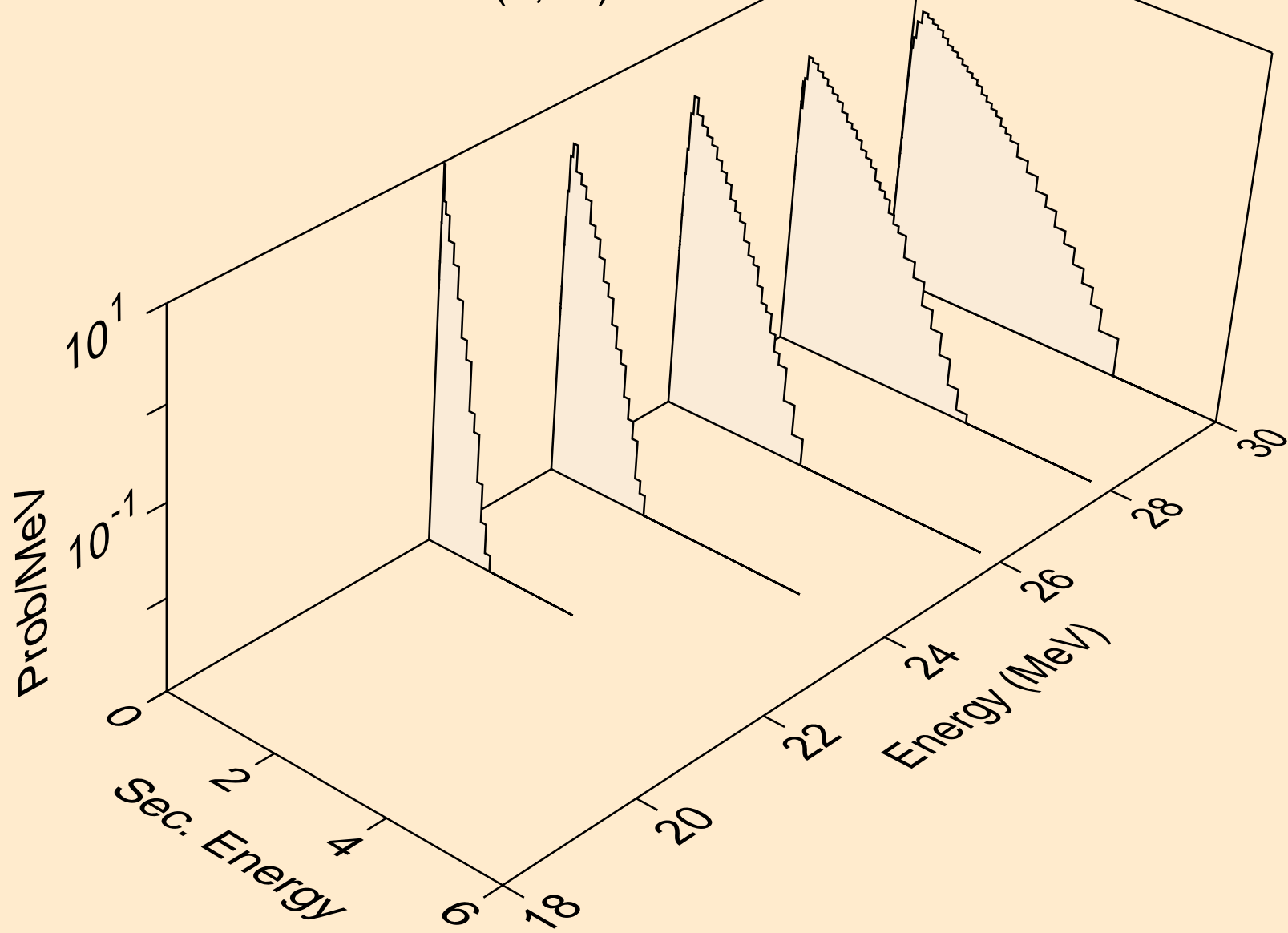

CU073 NEUTRON ACER TENDL-2021 LIBRARY; T=293.6K
Neutron emission for (n,3n)a

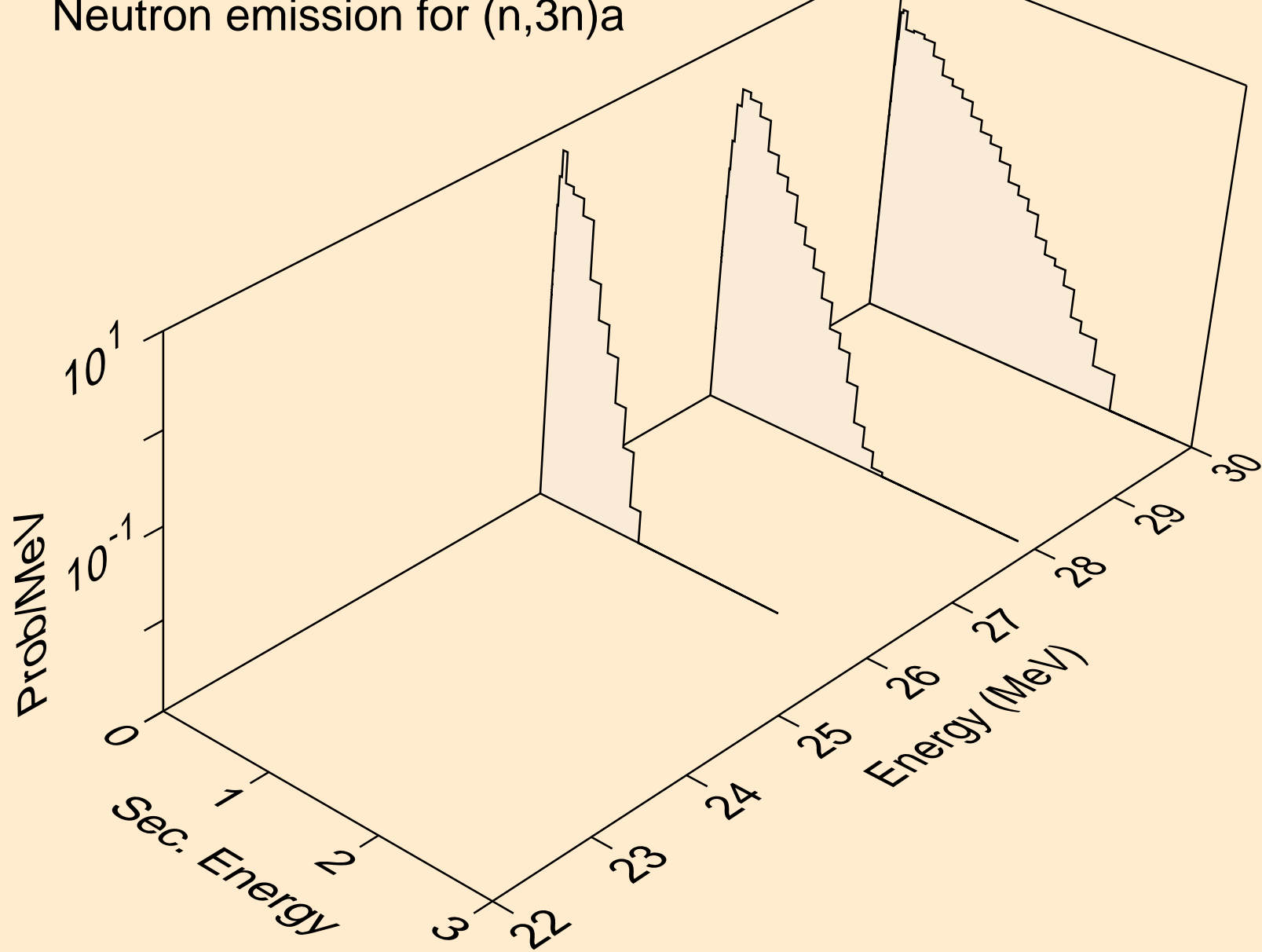

CU073 NEUTRON ACER TENDL-2021 LIBRARY; T=293.6K
Neutron emission for (n,n*)p

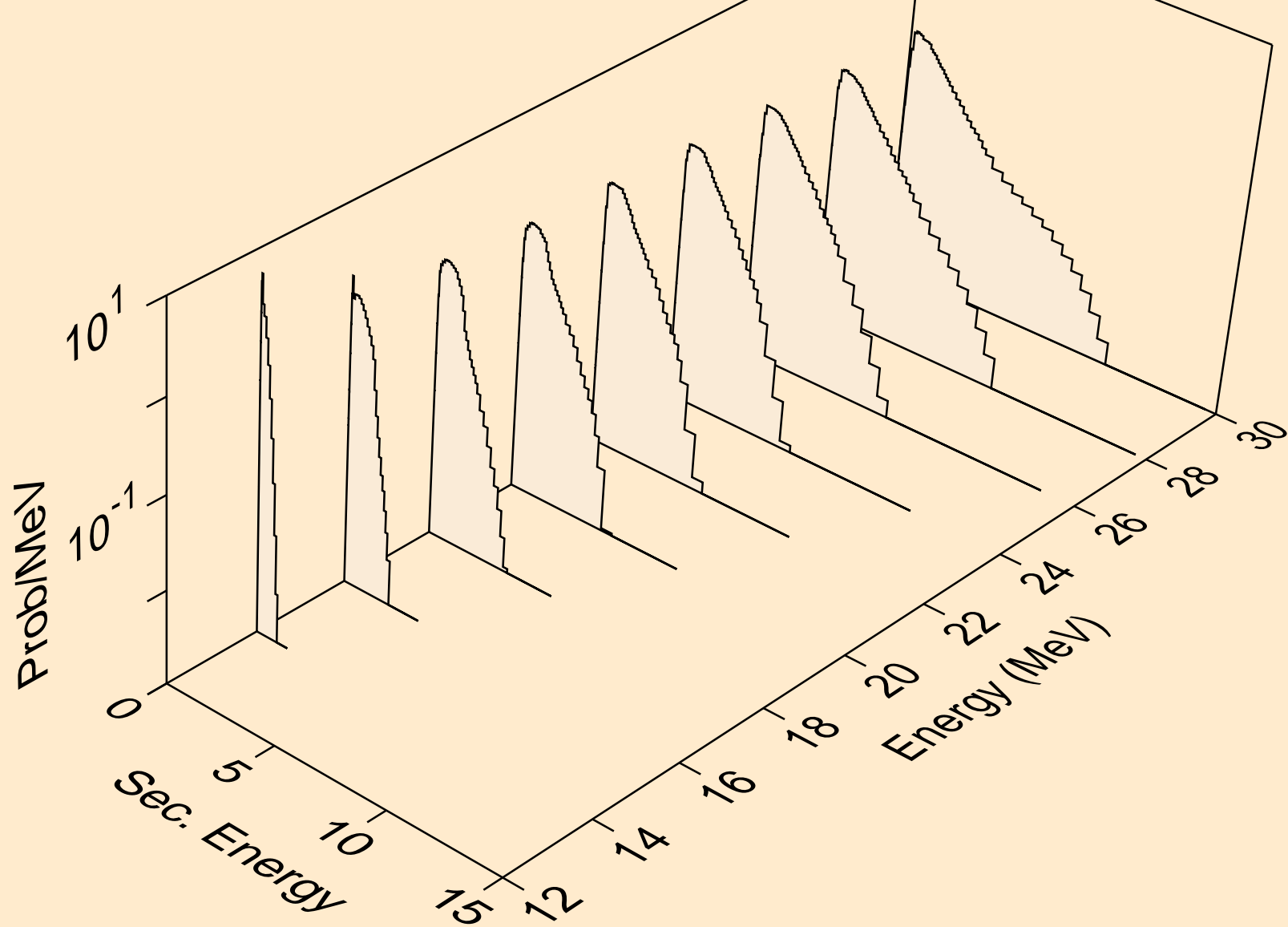

CU073 NEUTRON ACER TENDL-2021 LIBRARY; T=293.6K
Neutron emission for (n,n*)d

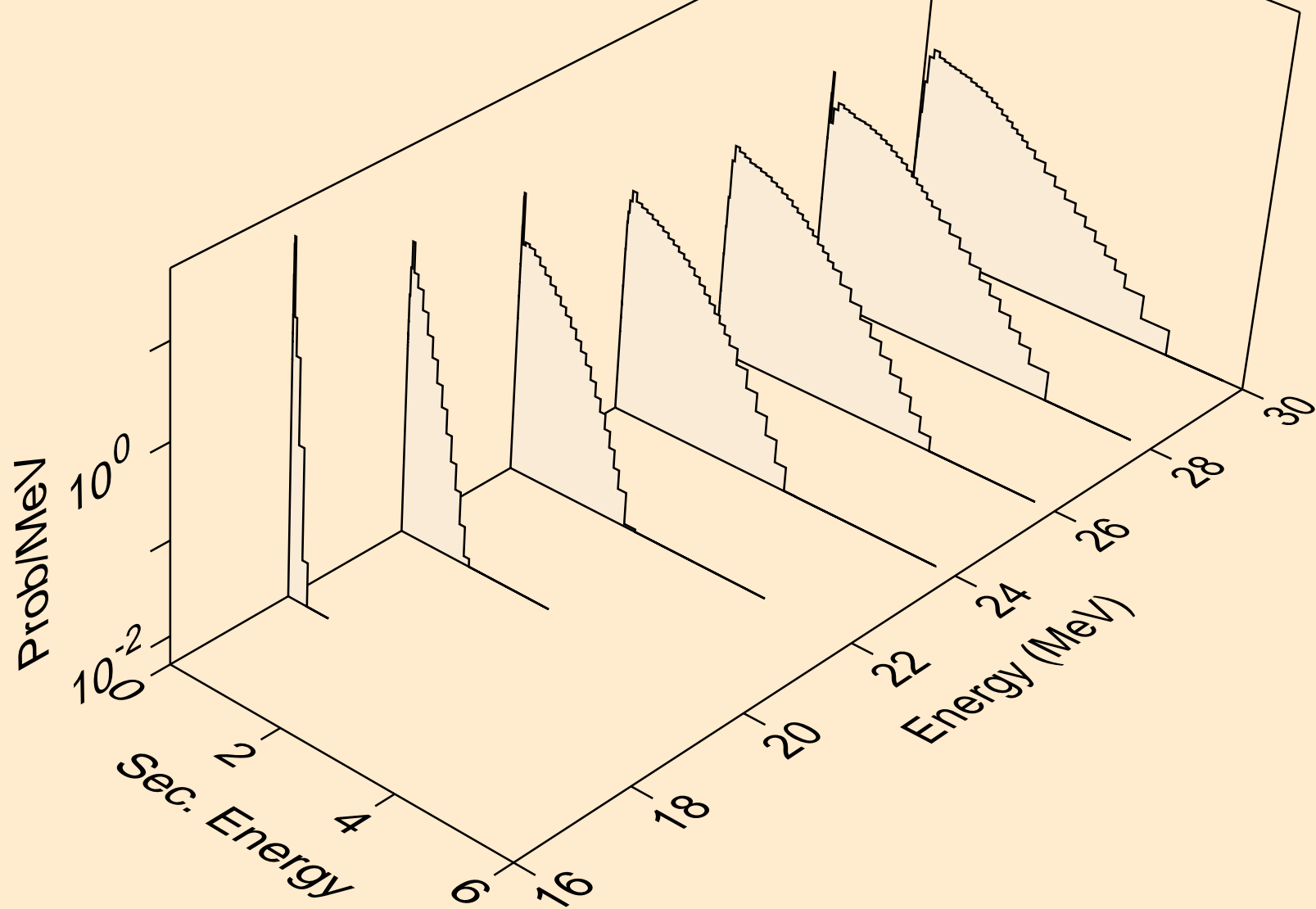

CU073 NEUTRON ACER TENDL-2021 LIBRARY; T=293.6K
Neutron emission for (n,n*)t

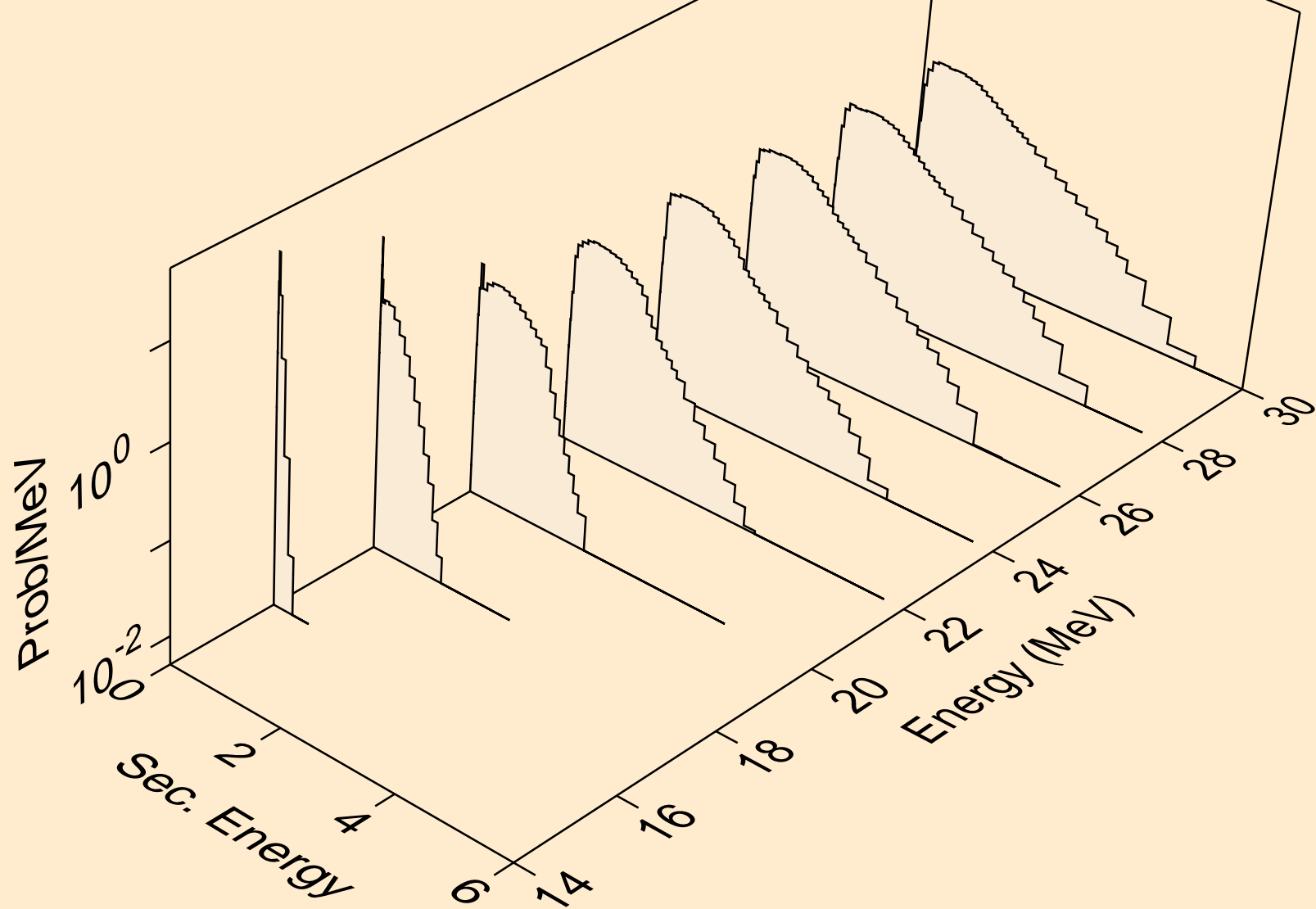

CU073 NEUTRON ACER TENDL-2021 LIBRARY; T=293.6K
Neutron emission for (n,4n)

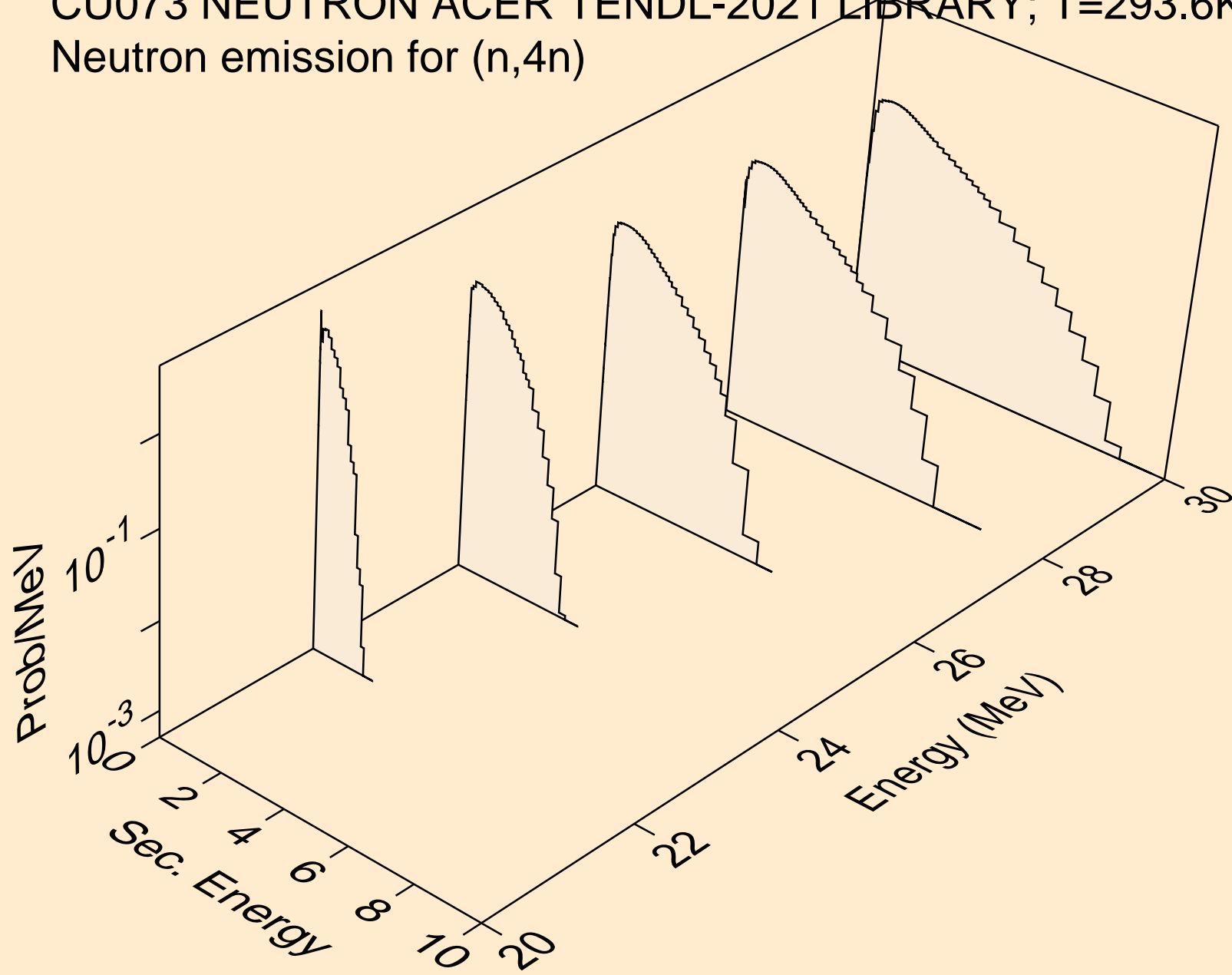

CU073 NEUTRON ACER TENDL-2021 LIBRARY; T=293.6K
Neutron emission for (n,2np)

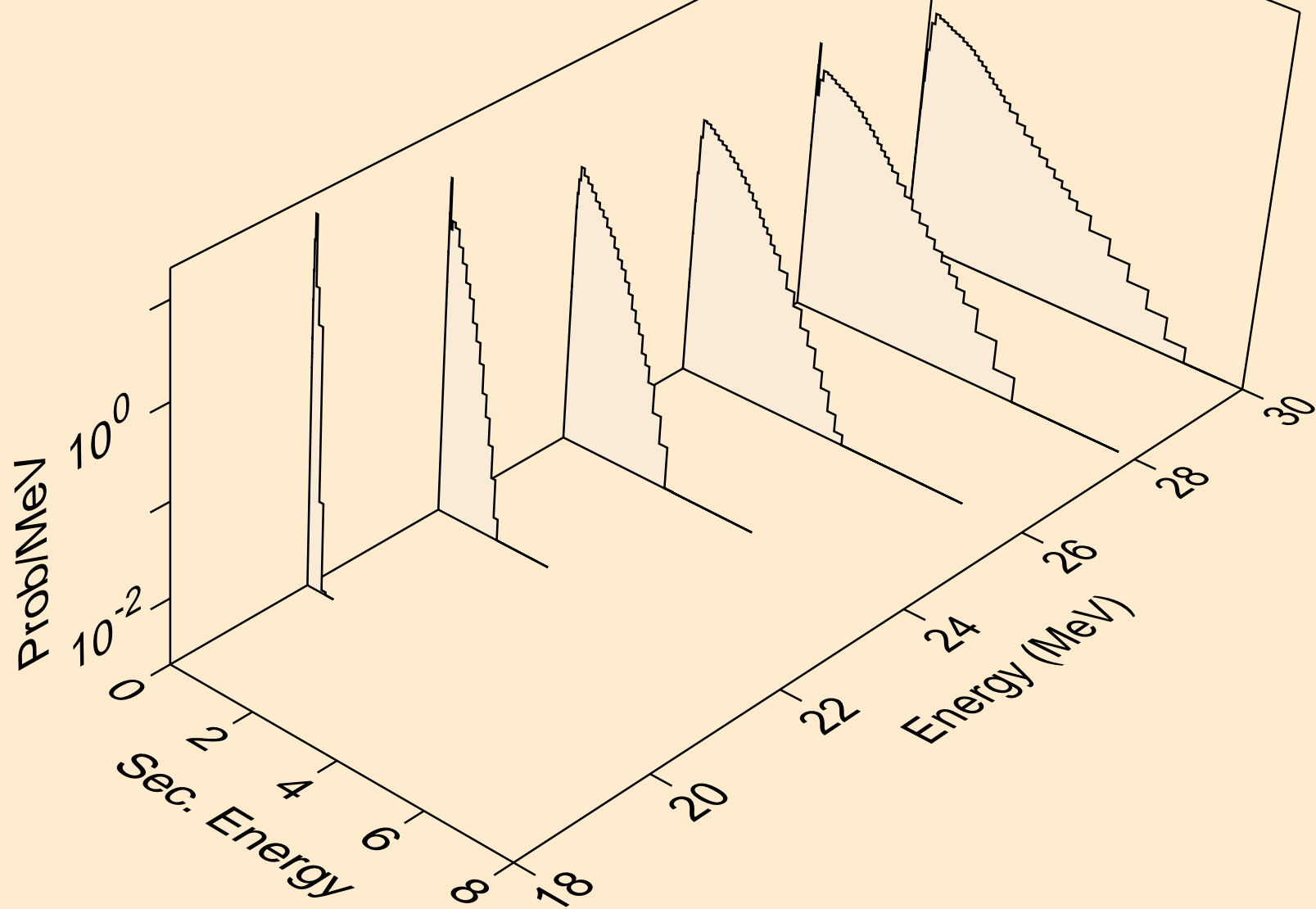

CU073 NEUTRON ACER TENDL-2021 LIBRARY; T=293.6K
Neutron emission for (n,3np)

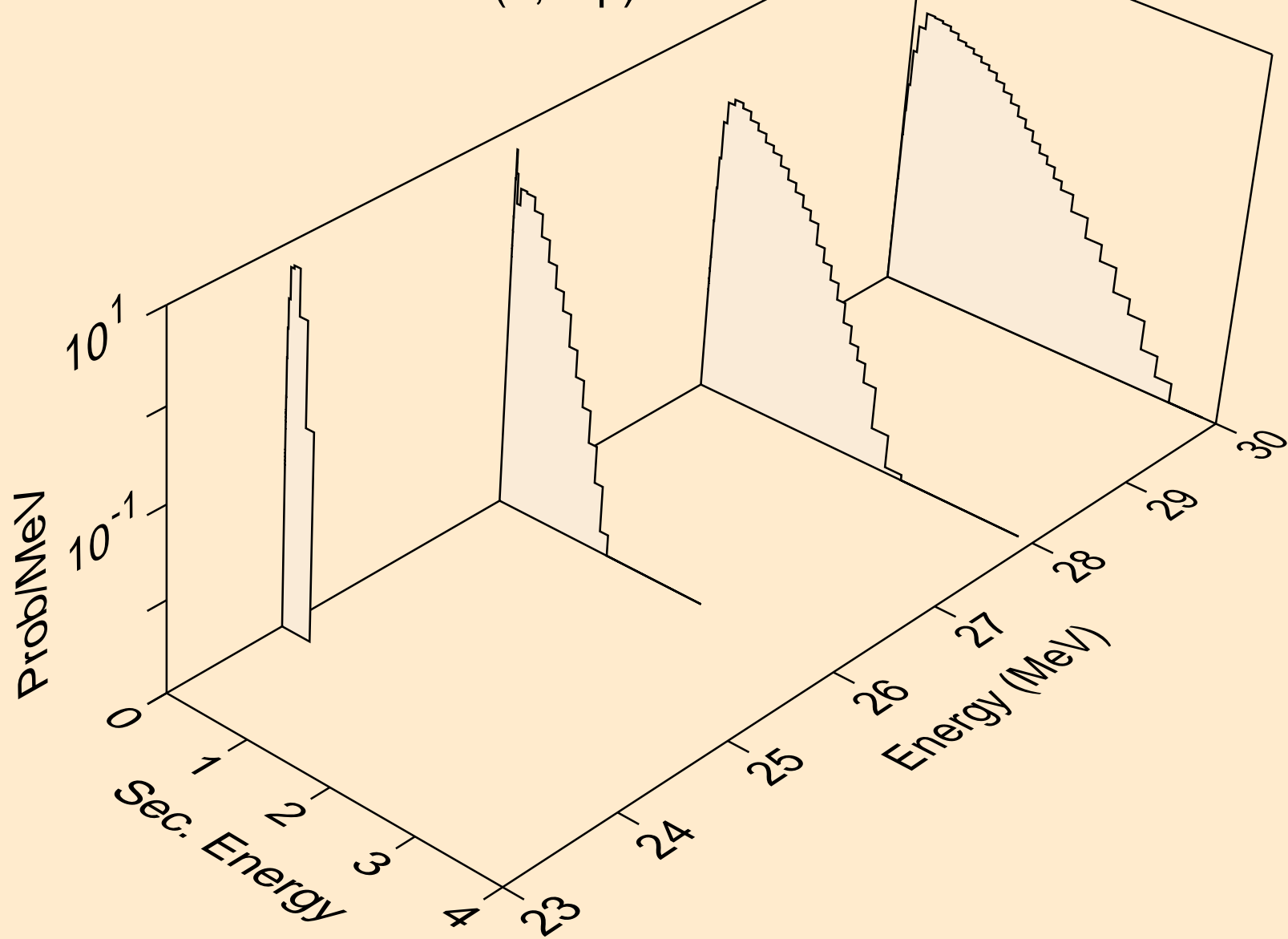

CU073 NEUTRON ACER TENDL-2021 LIBRARY; T=293.6K
Neutron emission for (n,n*c)

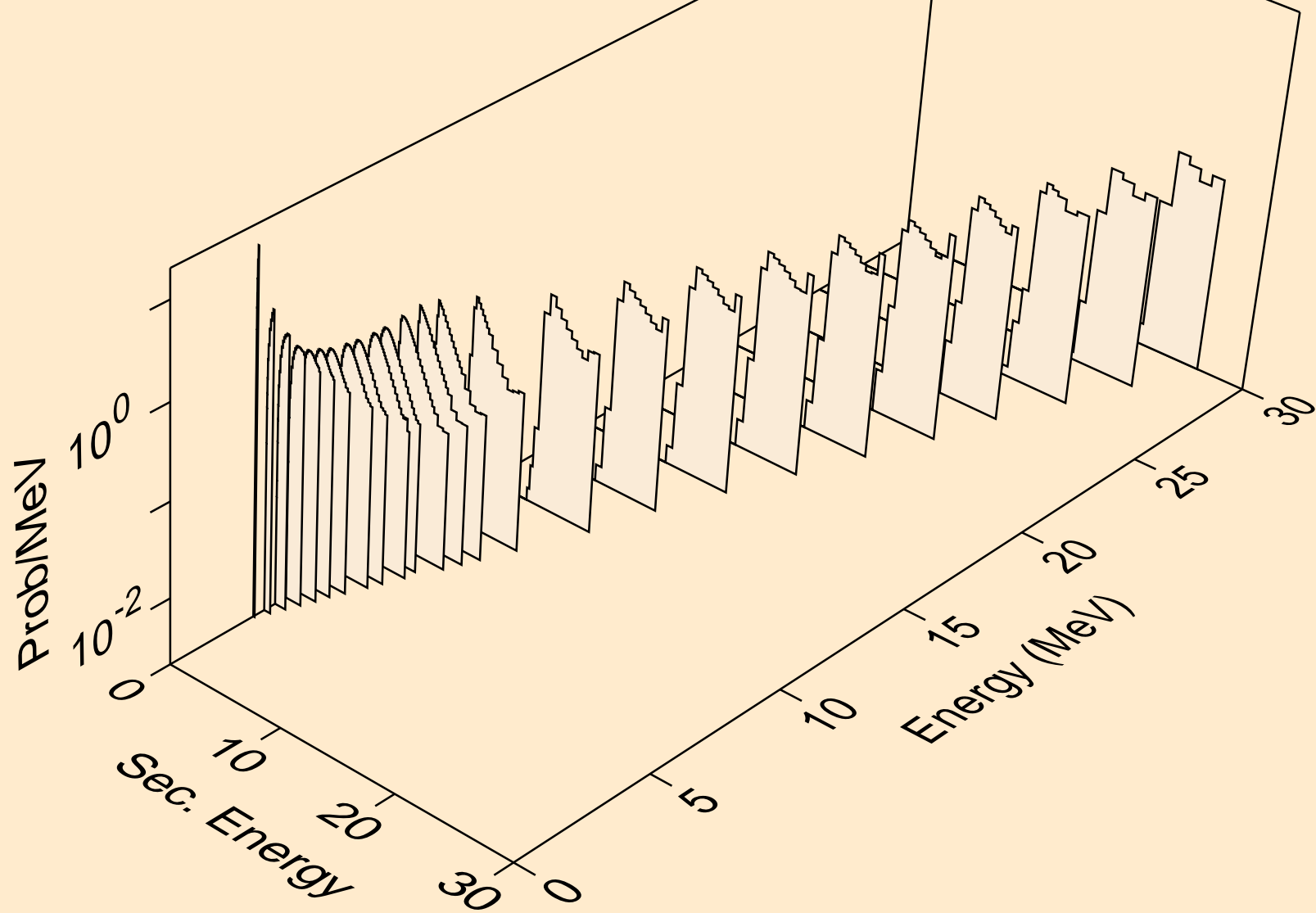

CU073 NEUTRON ACER TENDL-2021 LIBRARY; T=293.6K
Photon emission for (n,x)

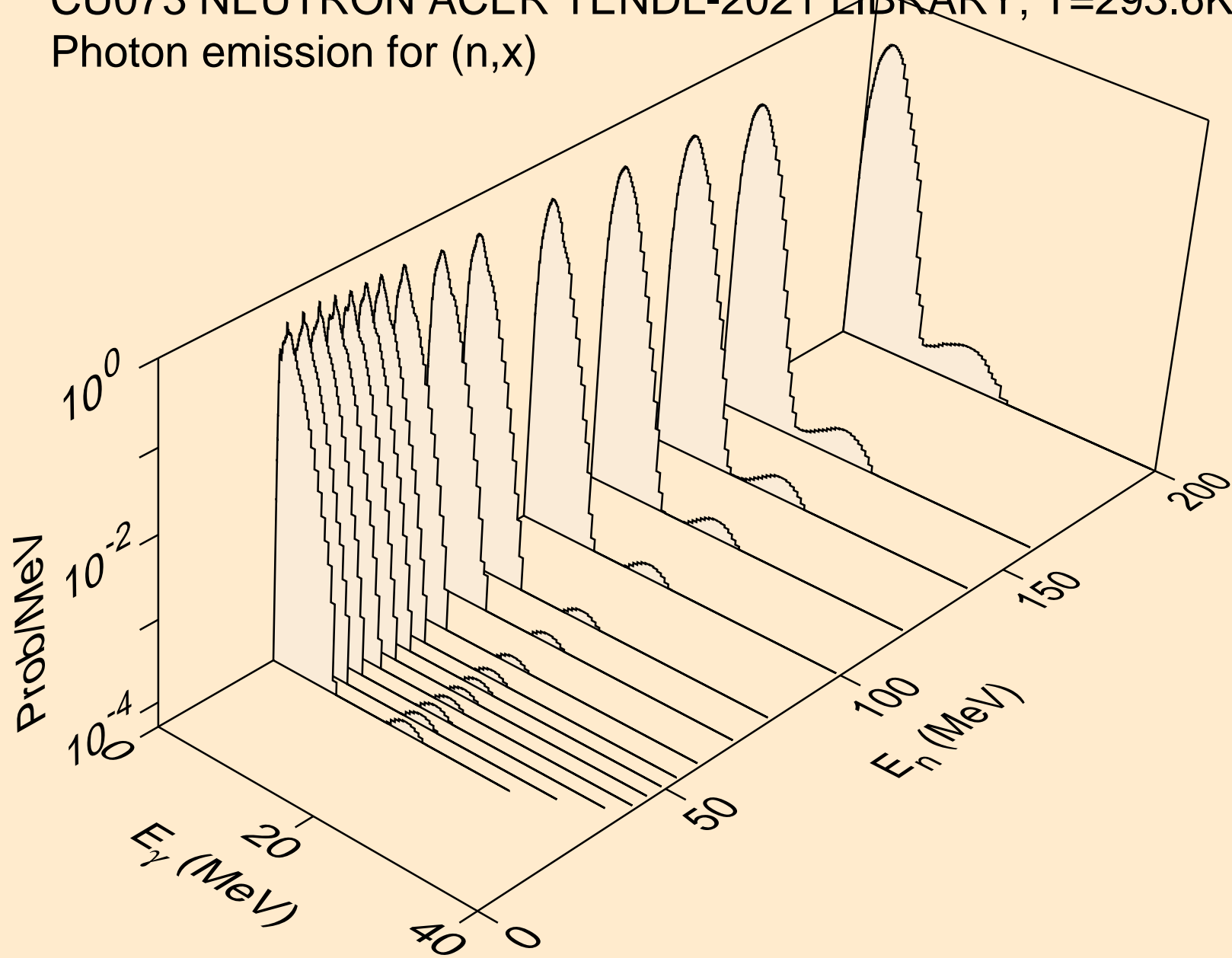

CU073 NEUTRON ACER TENDL-2021 LIBRARY; T=293.6K
Photon emission for (n,2nd)

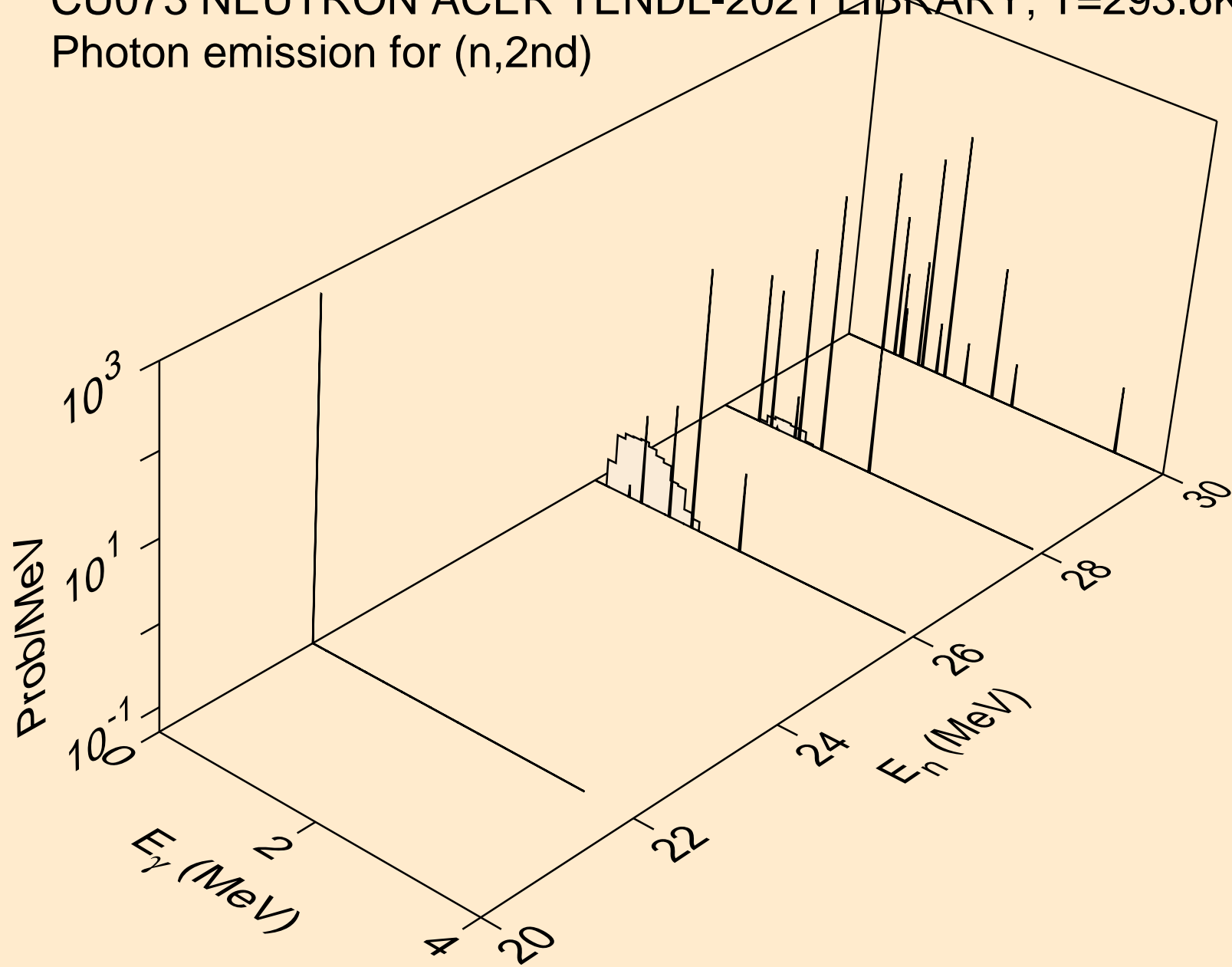

CU073 NEUTRON ACER TENDL-2021 LIBRARY; T=293.6K
Photon emission for (n,2n)

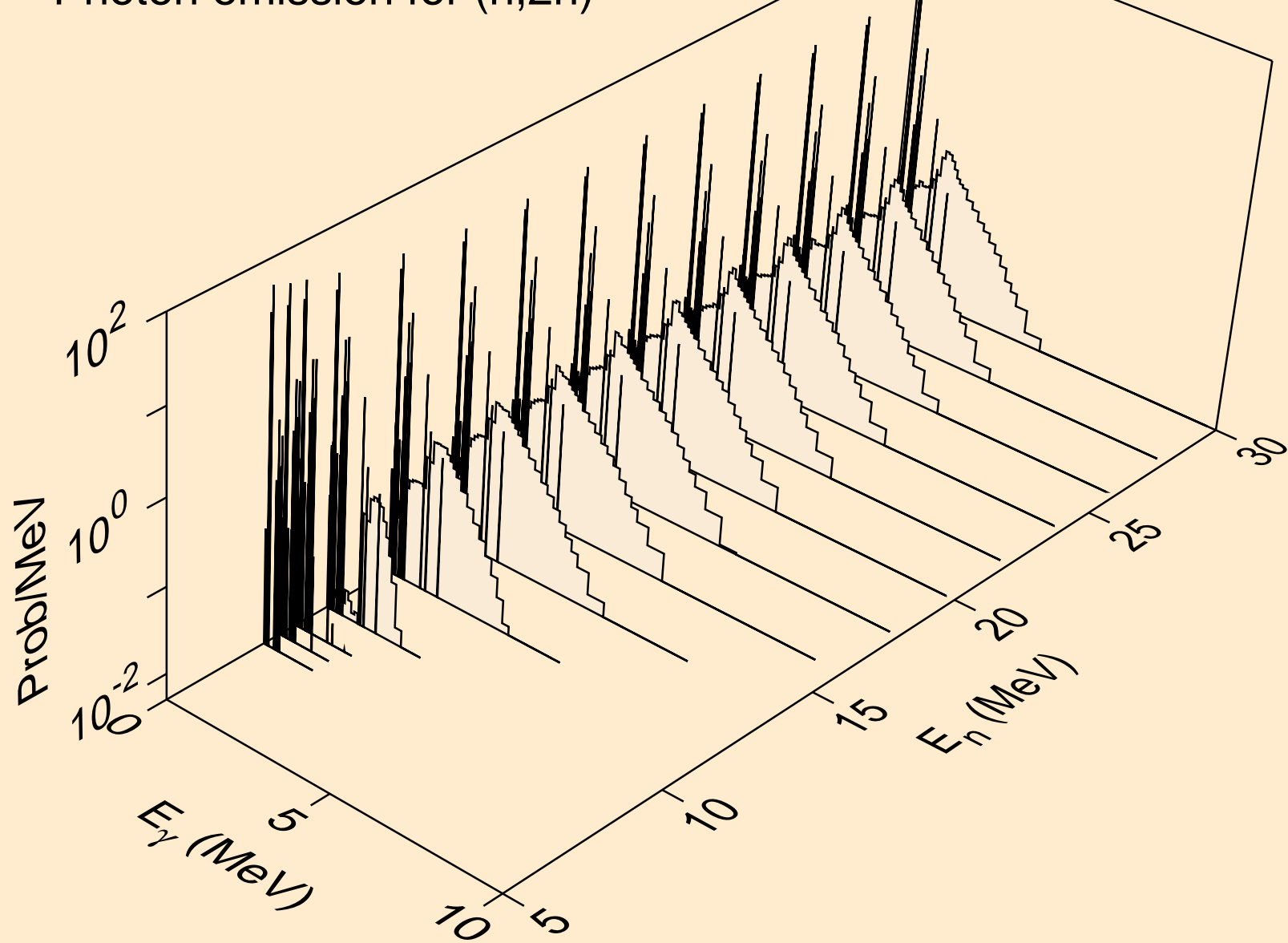

CU073 NEUTRON ACER TENDL-2021 LIBRARY; T=293.6K
Photon emission for (n,3n)

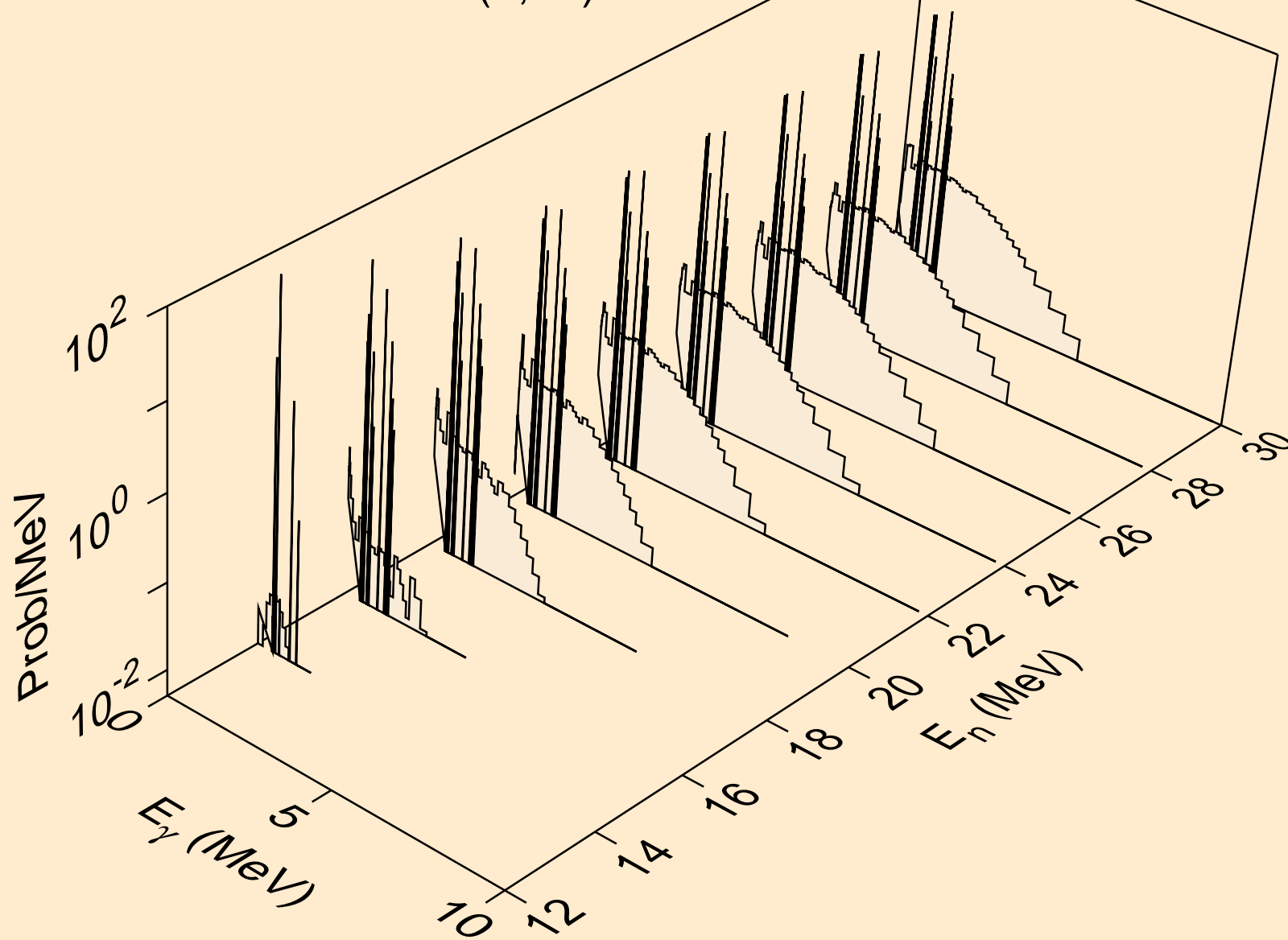

CU073 NEUTRON ACER TENDL-2021 LIBRARY; T=293.6K
Photon emission for (n,n*)a

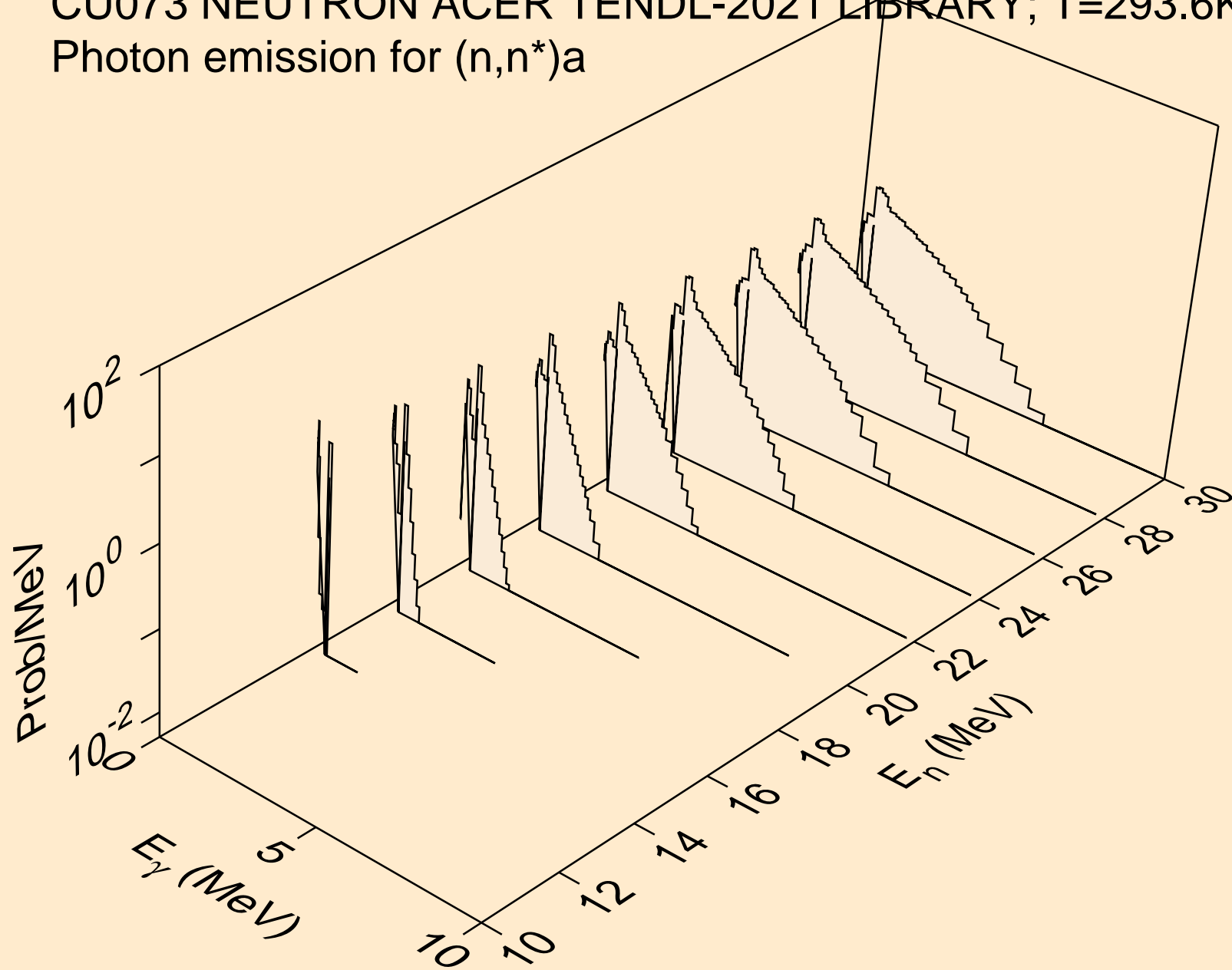

CU073 NEUTRON ACER TENDL-2021 LIBRARY; T=293.6K
Photon emission for (n,2n)a

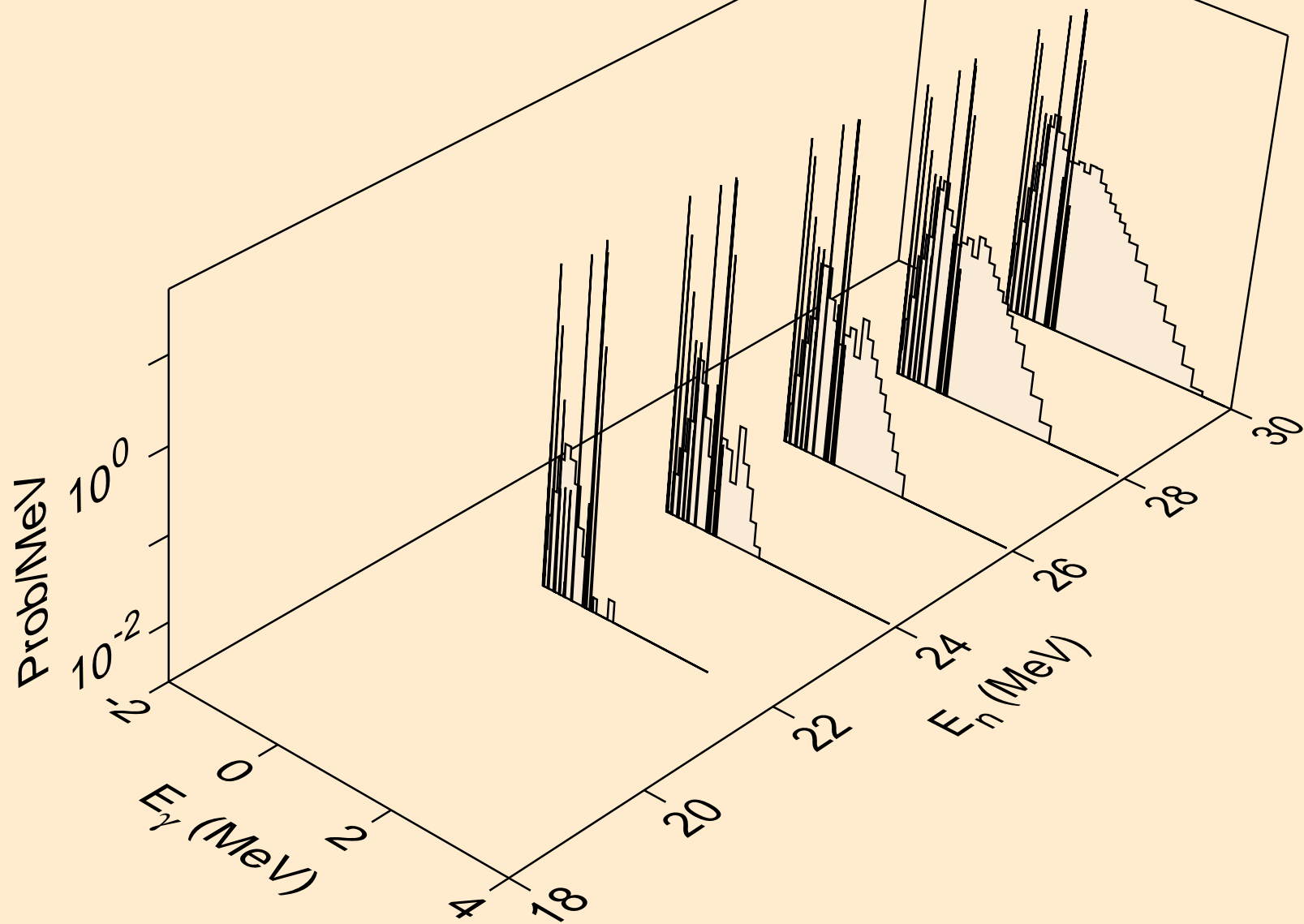

CU073 NEUTRON ACER TENDL-2021 LIBRARY; T=293.6K
Photon emission for (n,3n)a

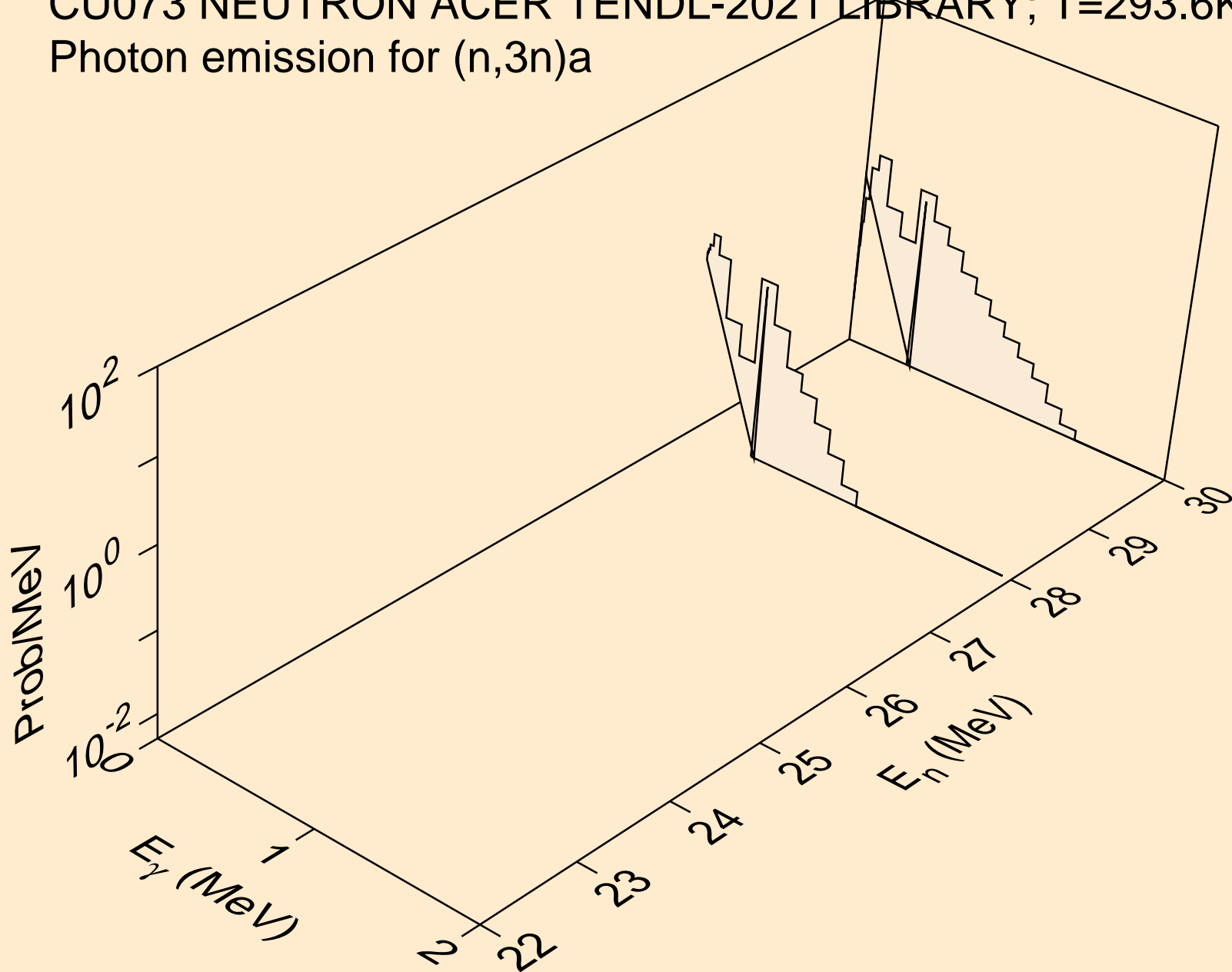

CU073 NEUTRON ACER TENDL-2021 LIBRARY; T=293.6K
Photon emission for (n,n*)p

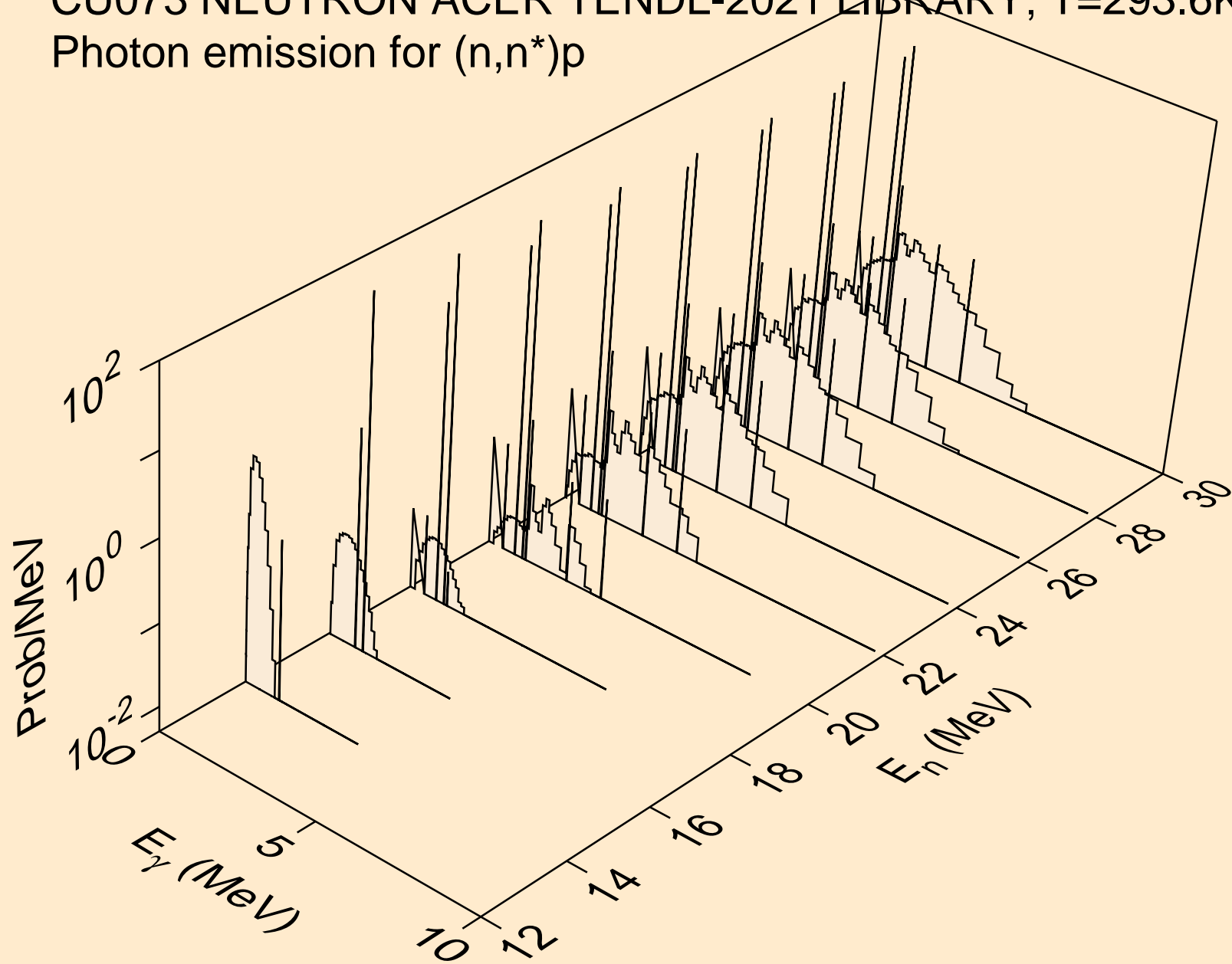

CU073 NEUTRON ACER TENDL-2021 LIBRARY; T=293.6K
Photon emission for (n,n*)d

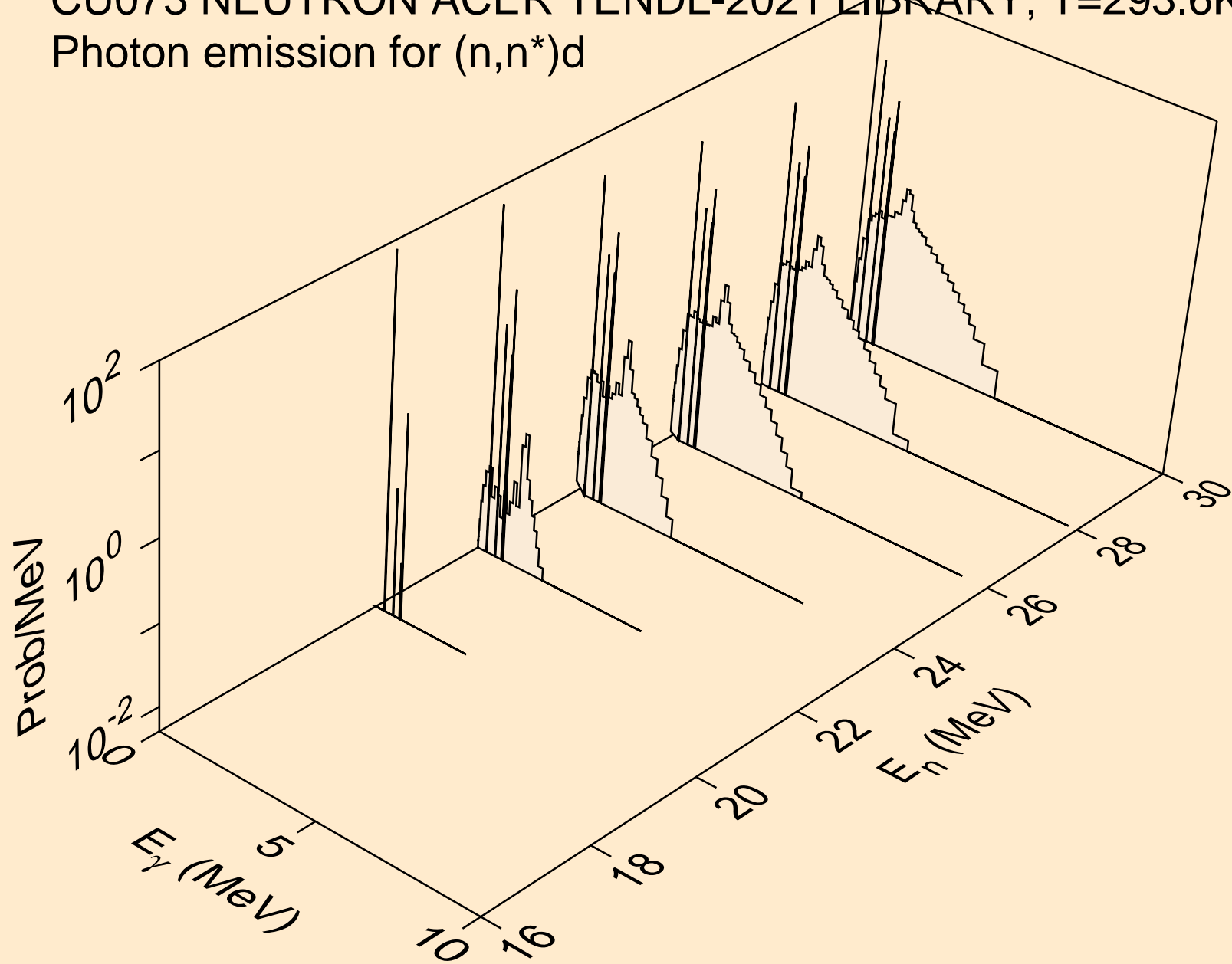

CU073 NEUTRON ACER TENDL-2021 LIBRARY; T=293.6K
Photon emission for (n,n*)t

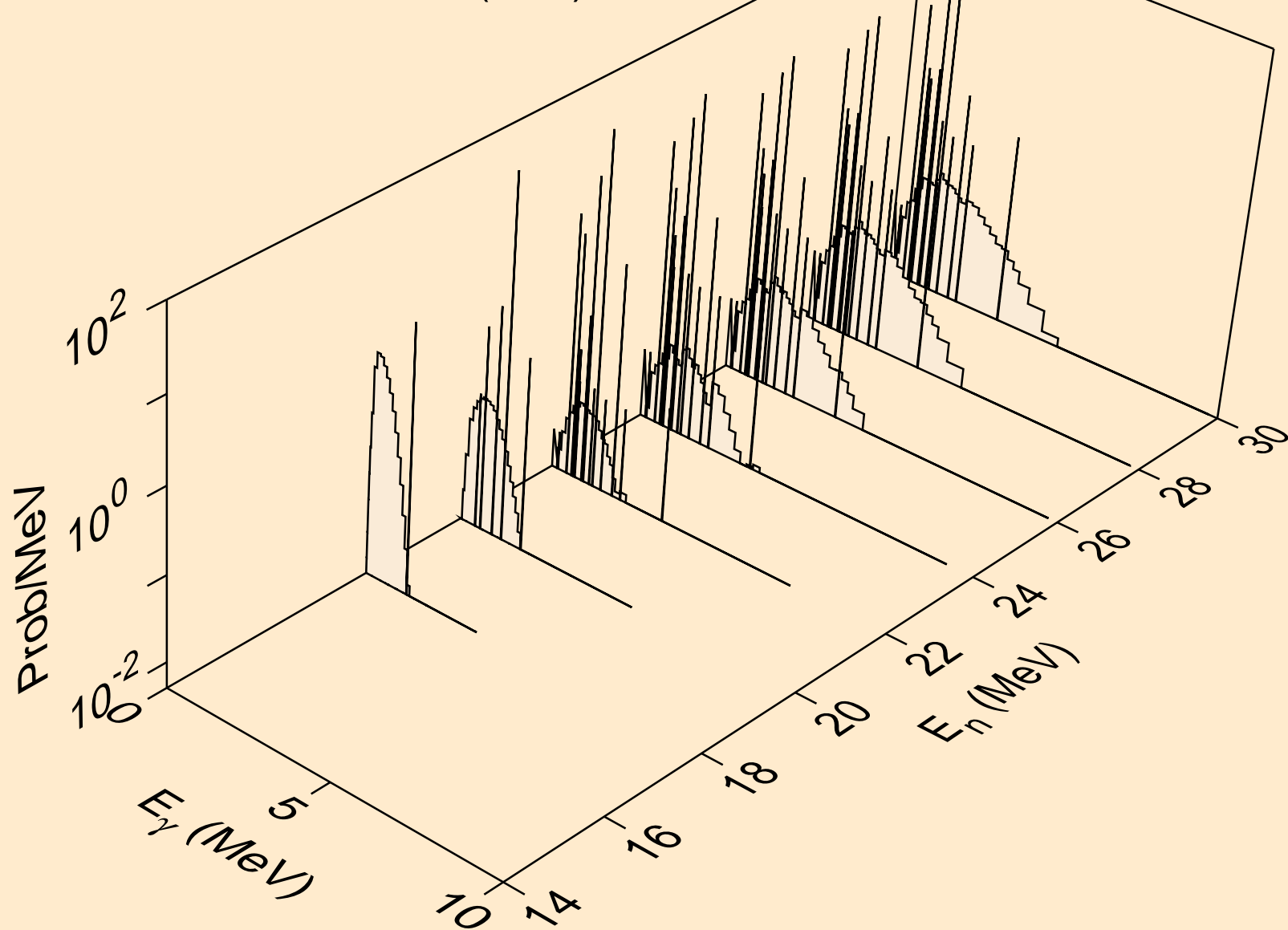

CU073 NEUTRON ACER TENDL-2021 LIBRARY; T=293.6K
Photon emission for (n,4n)

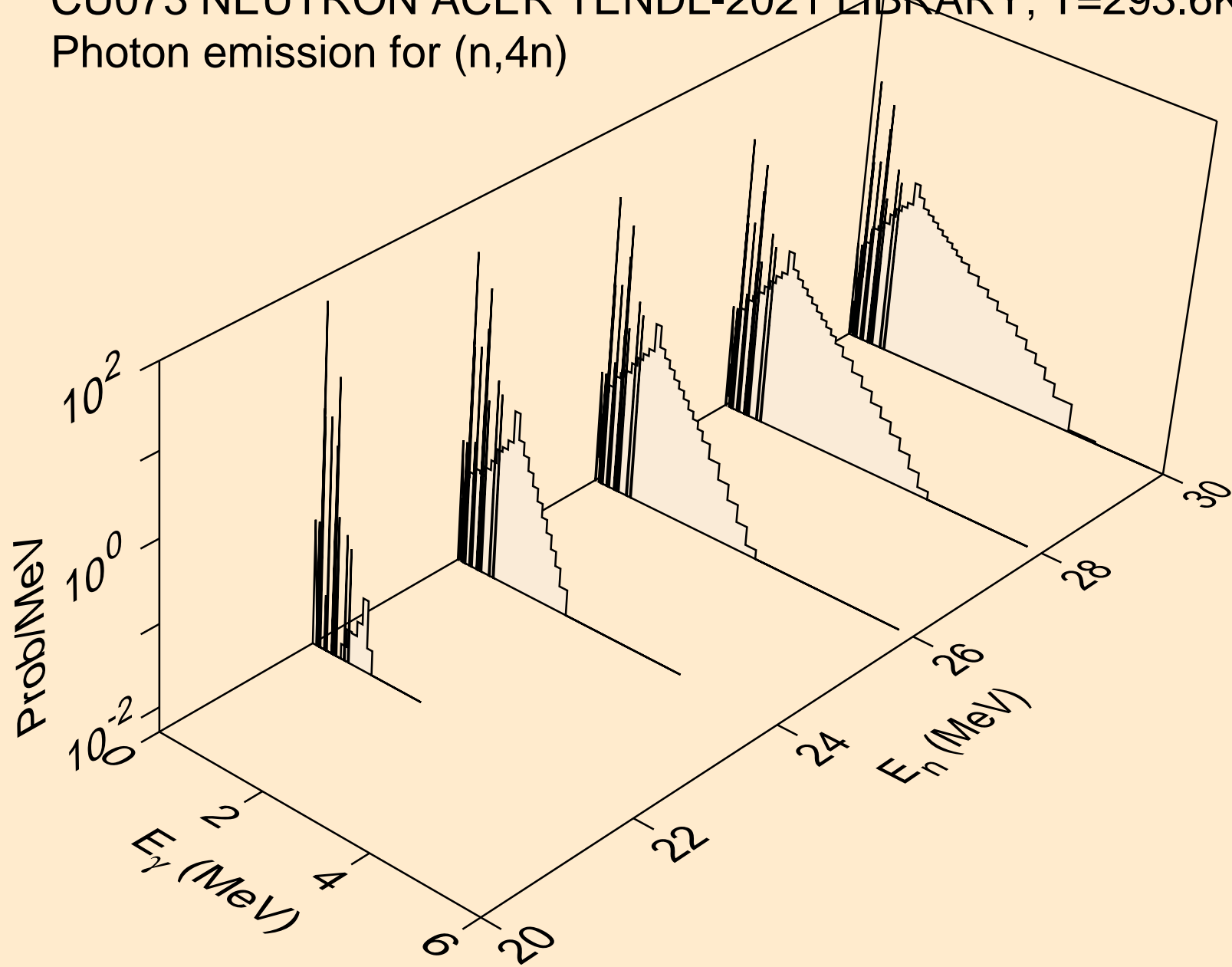

CU073 NEUTRON ACER TENDL-2021 LIBRARY; T=293.6K
Photon emission for (n,2np)

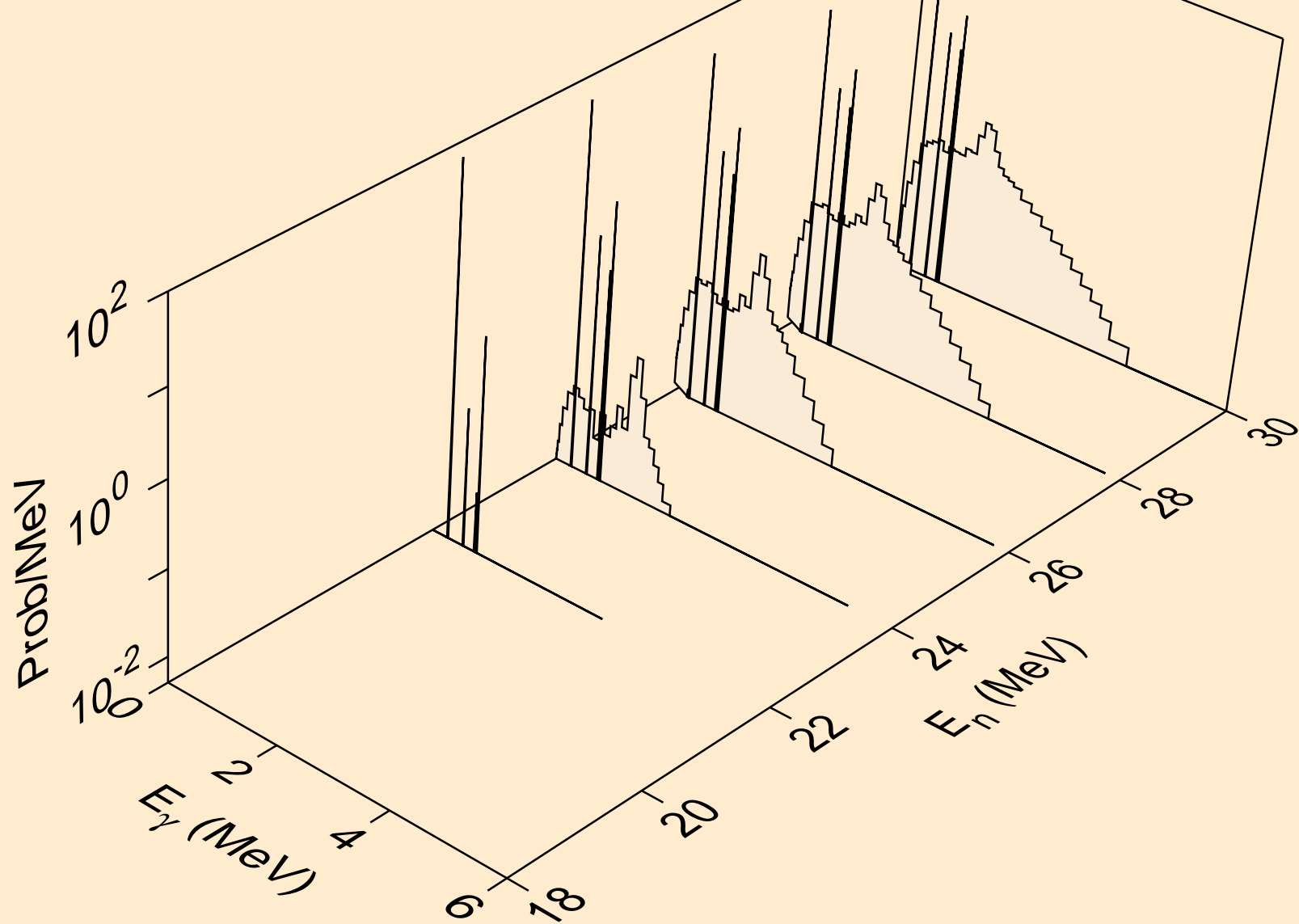

CU073 NEUTRON ACER TENDL-2021 LIBRARY; T=293.6K
Photon emission for (n,3np)

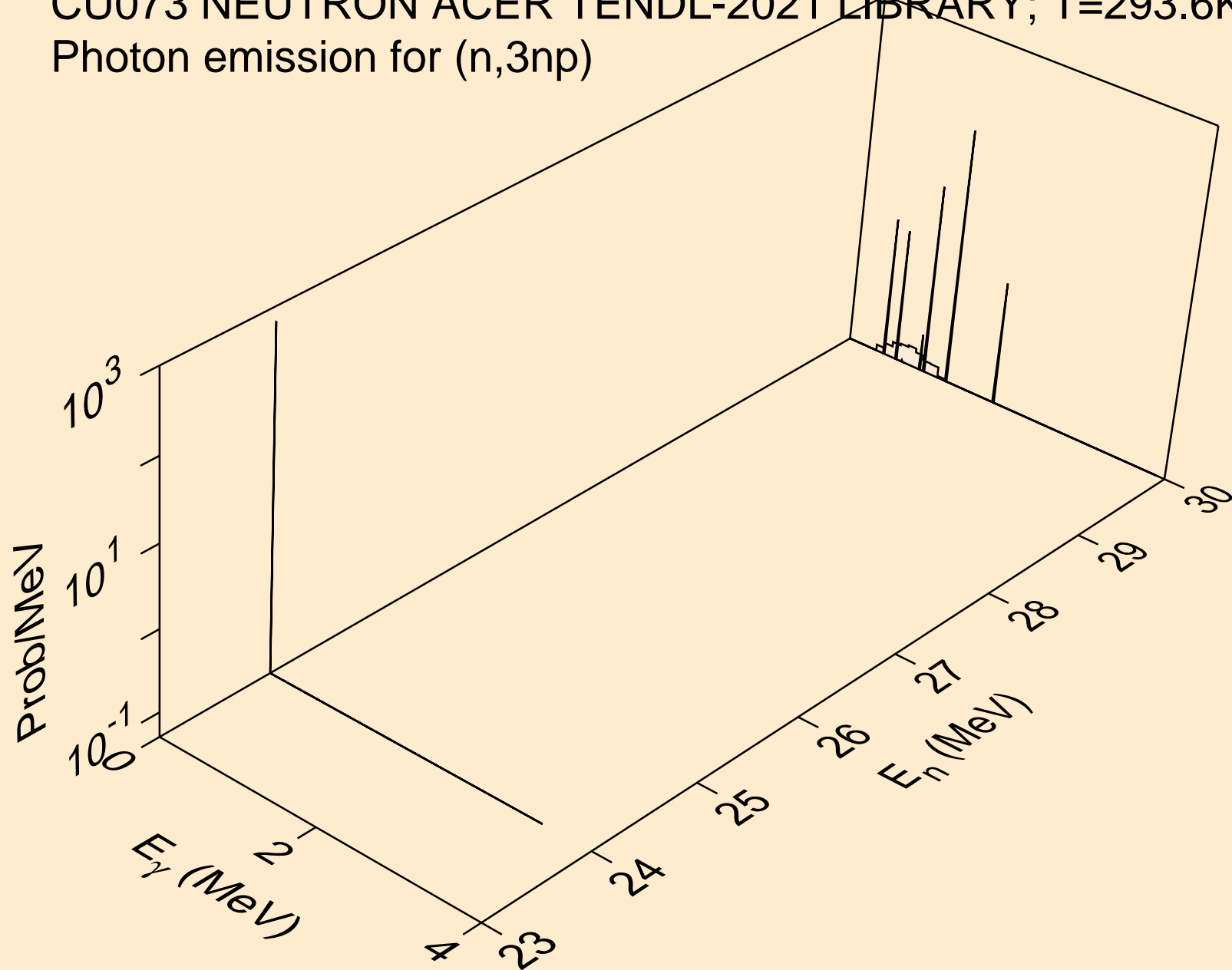

CU073 NEUTRON ACER TENDL-2021 LIBRARY; T=293.6K
Photon emission for (n,n*c)

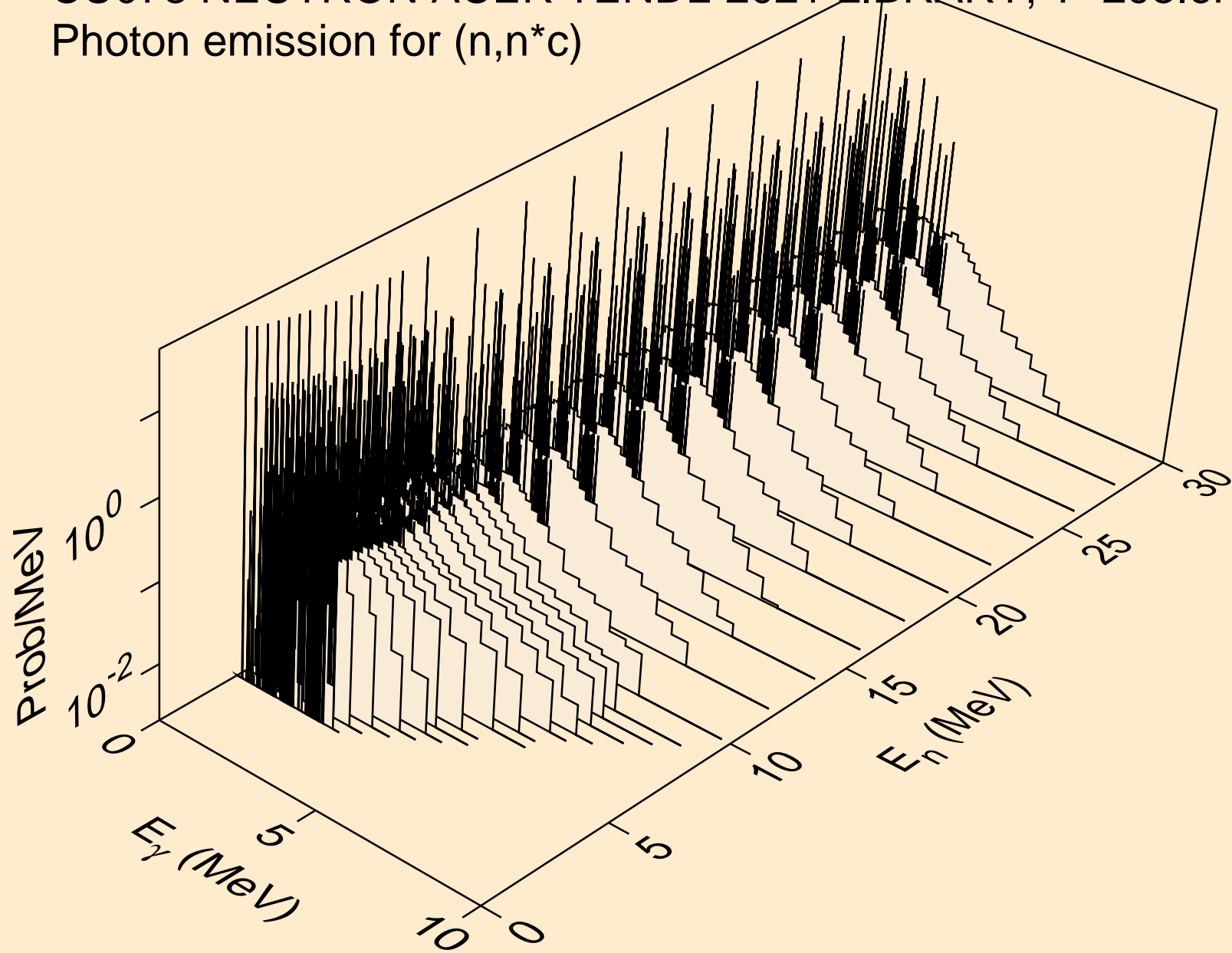

CU073 NEUTRON ACER TENDL-2021 LIBRARY; T=293.6K
Photon emission for (n,gma)

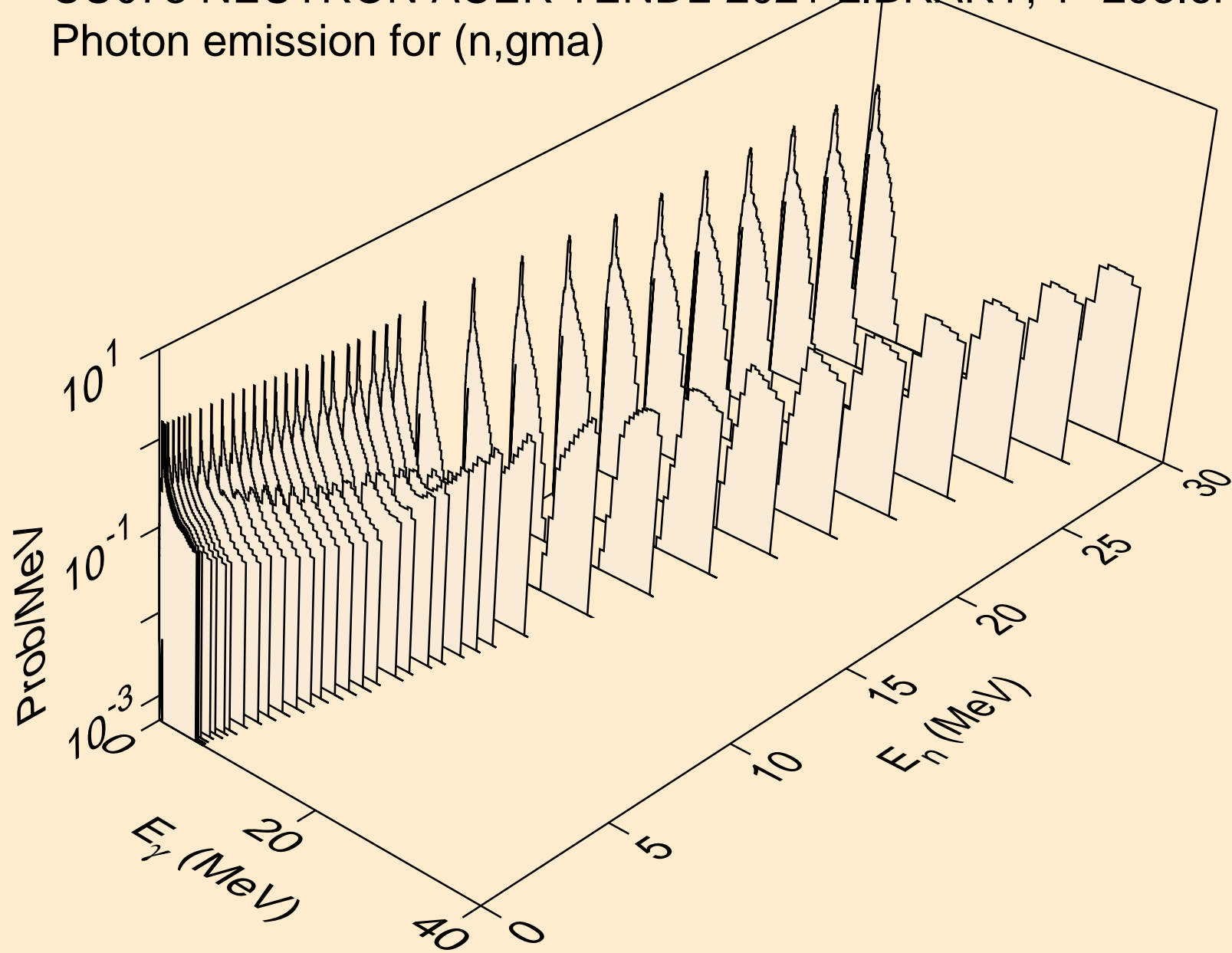

CU073 NEUTRON ACER TENDL-2021 LIBRARY; T=293.6K
Photon emission for (n,p)

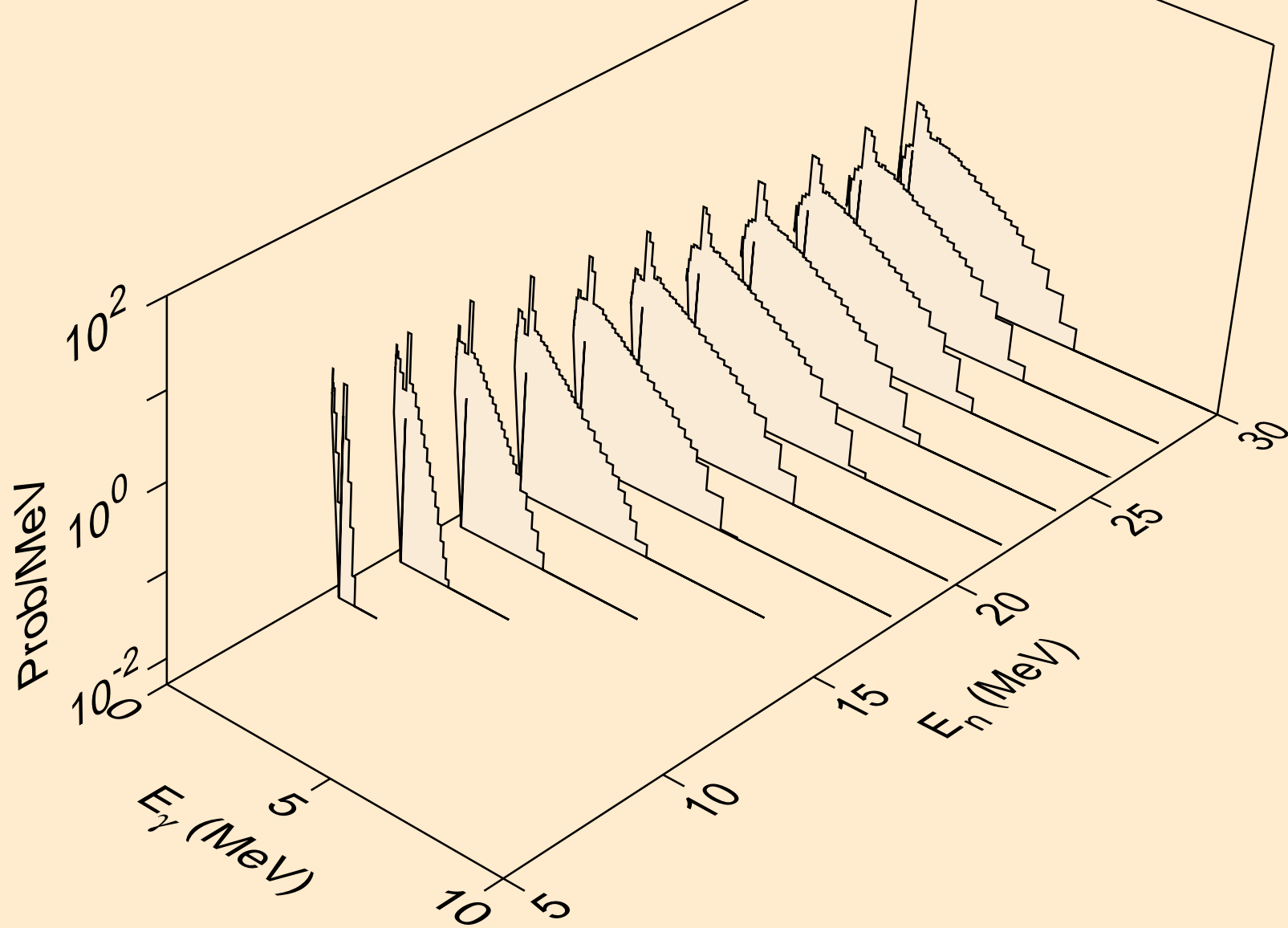

CU073 NEUTRON ACER TENDL-2021 LIBRARY; T=293.6K
Photon emission for (n,d)

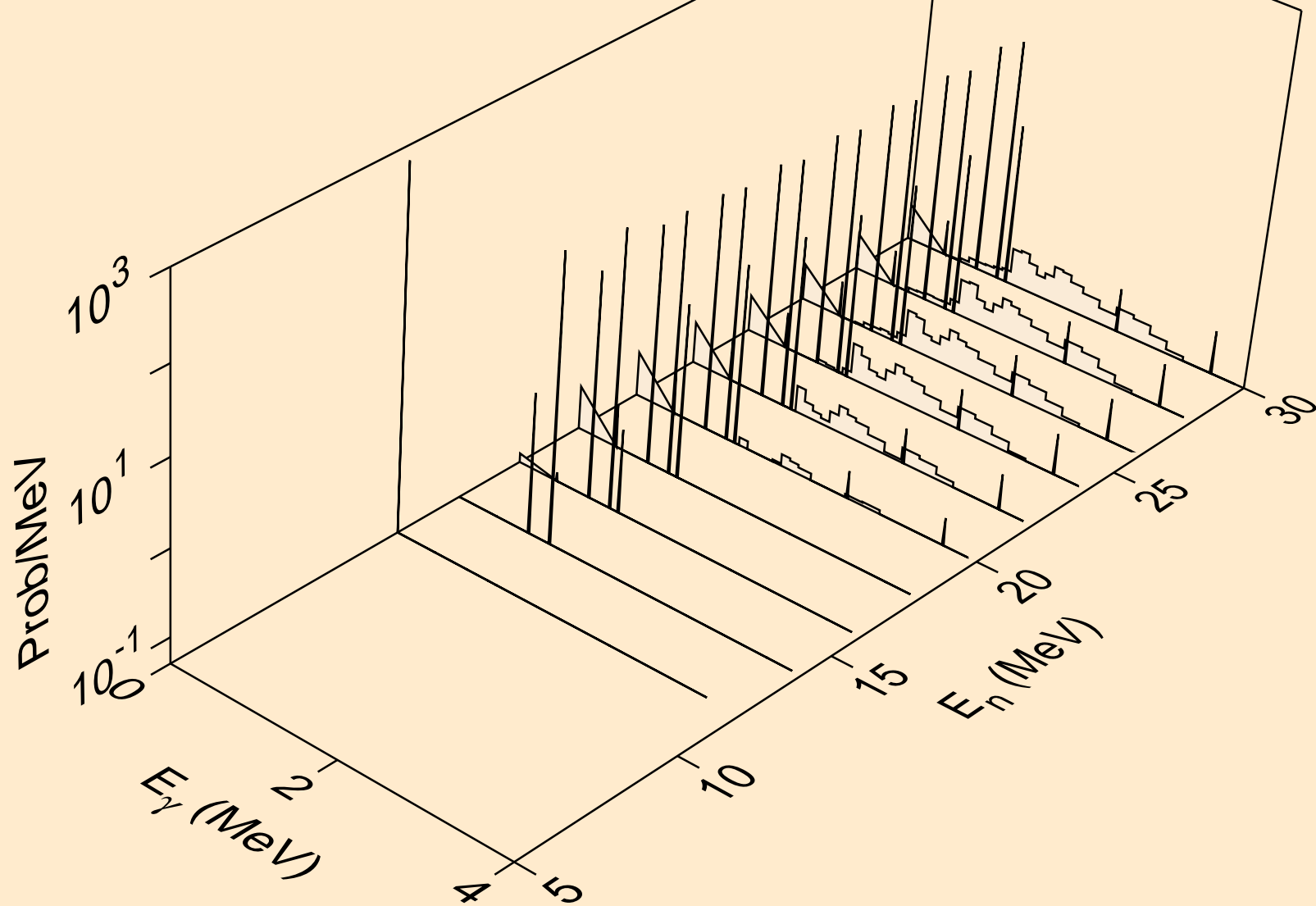

CU073 NEUTRON ACER TENDL-2021 LIBRARY; T=293.6K
Photon emission for (n,t)

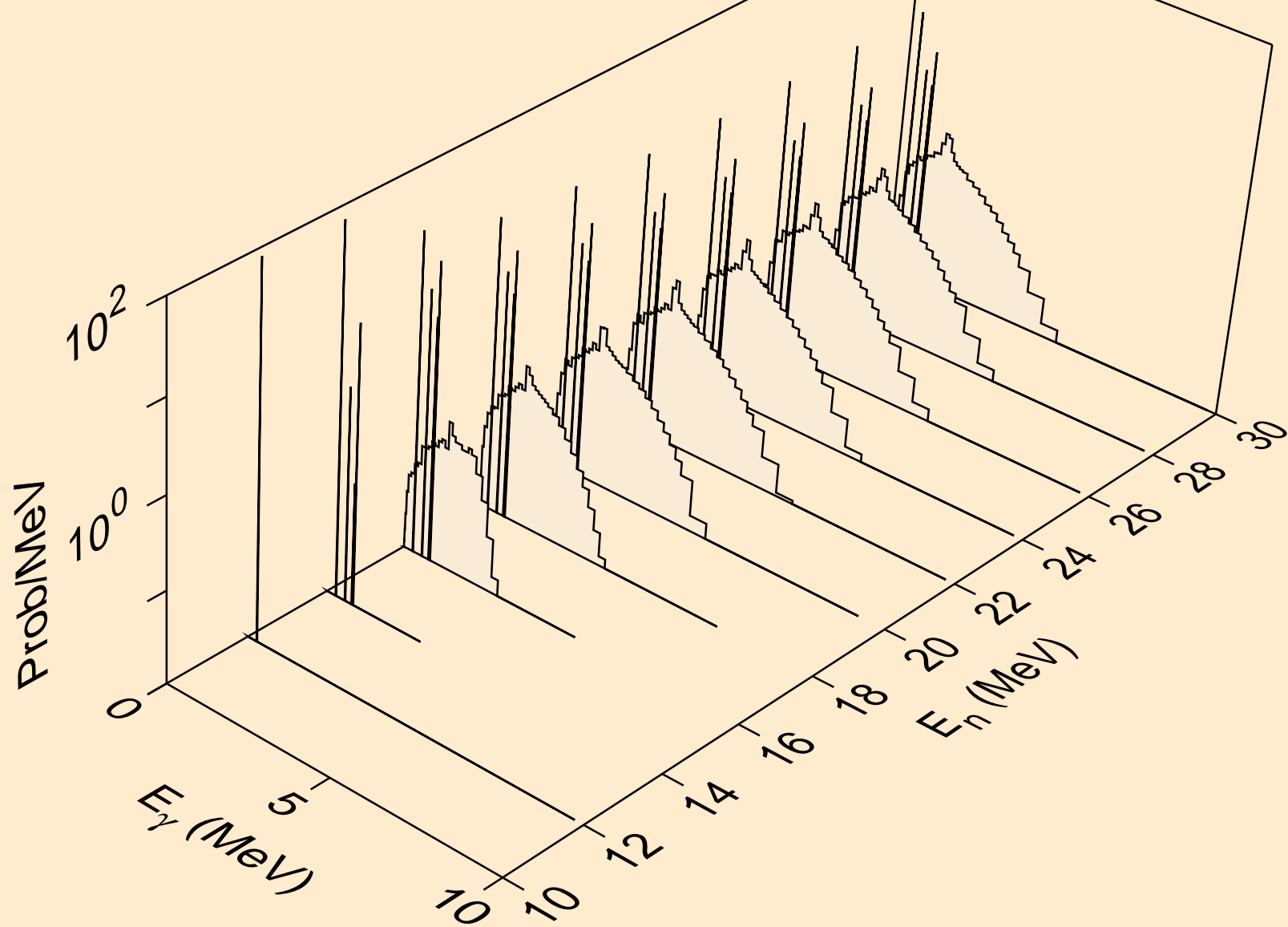

CU073 NEUTRON ACER TENDL-2021 LIBRARY; T=293.6K
Photon emission for (n,he3)

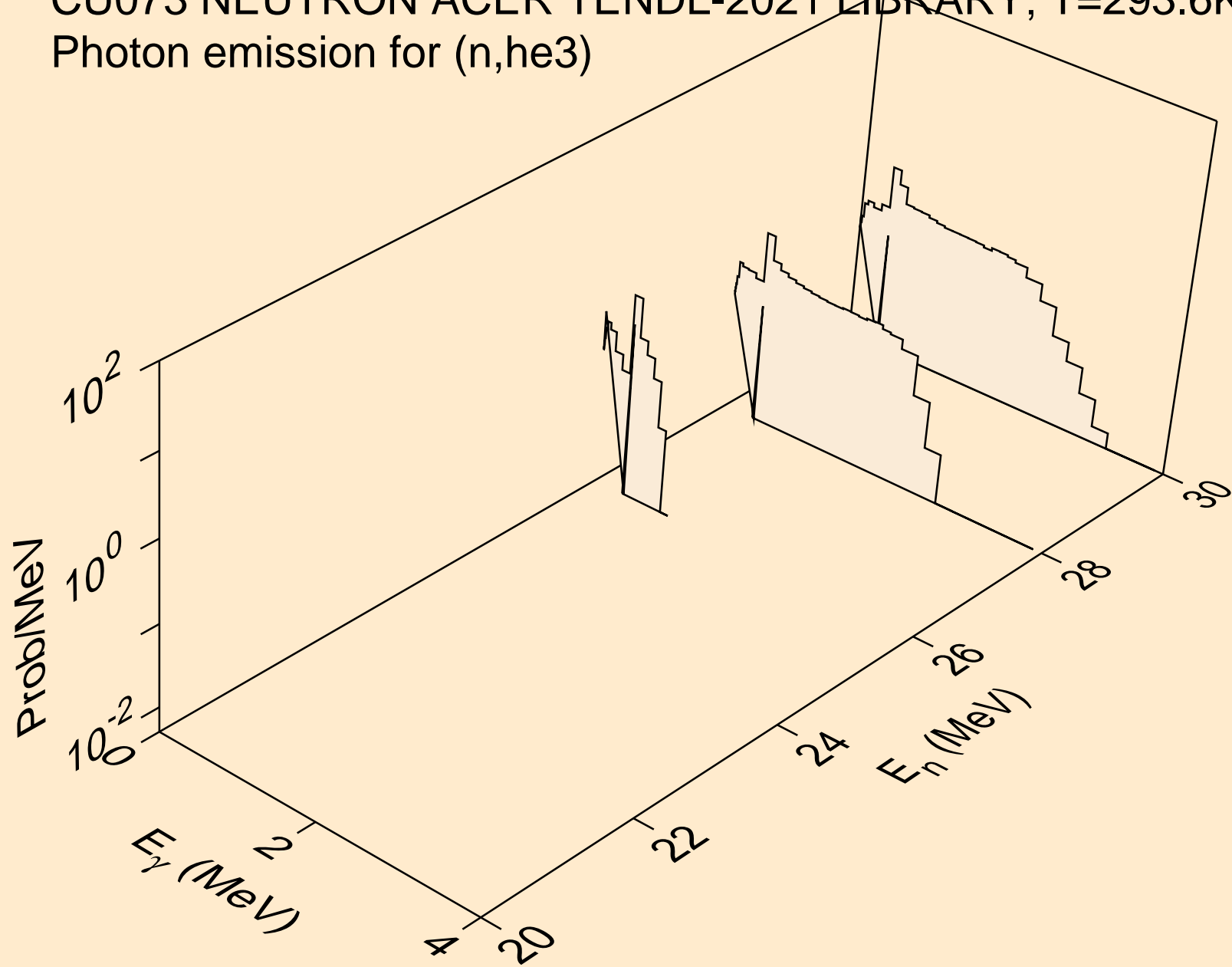

CU073 NEUTRON ACER TENDL-2021 LIBRARY; T=293.6K
Photon emission for (n,a)

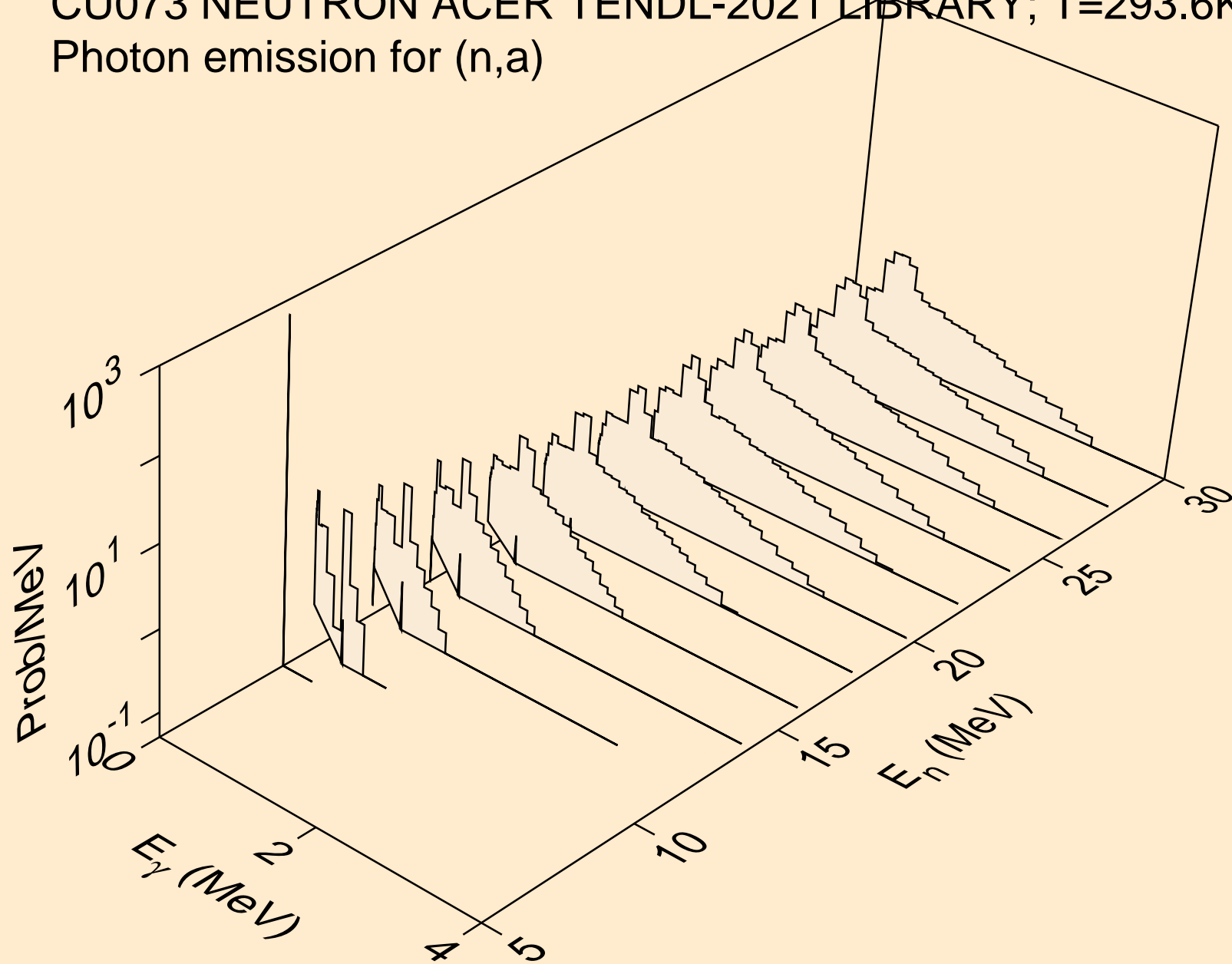

CU073 NEUTRON ACER TENDL-2021 LIBRARY; T=293.6K
thermal capture photon spectrum

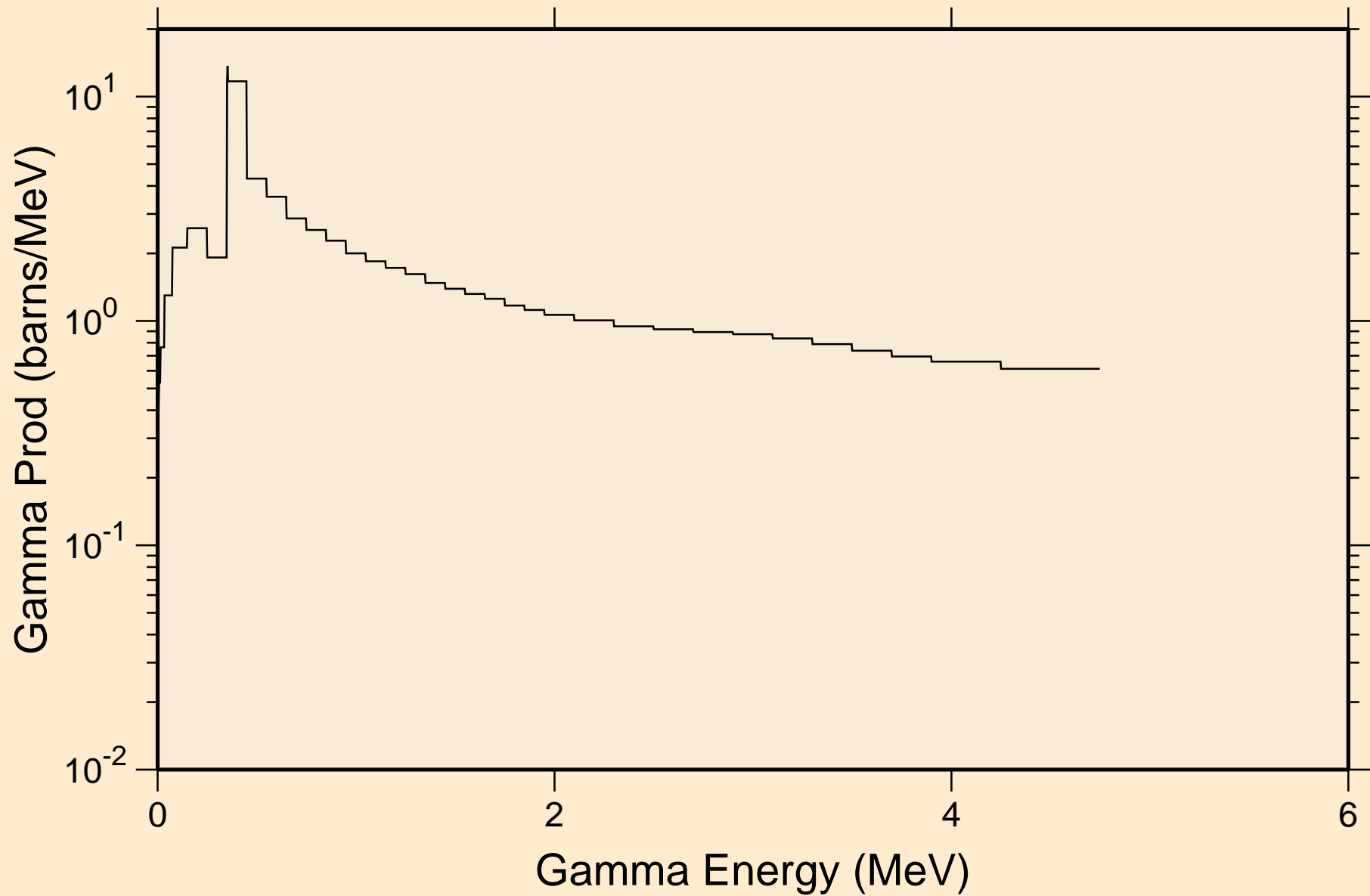

CU073 NEUTRON ACER TENDL-2021 LIBRARY; T=293.6K
14 MeV photon spectrum

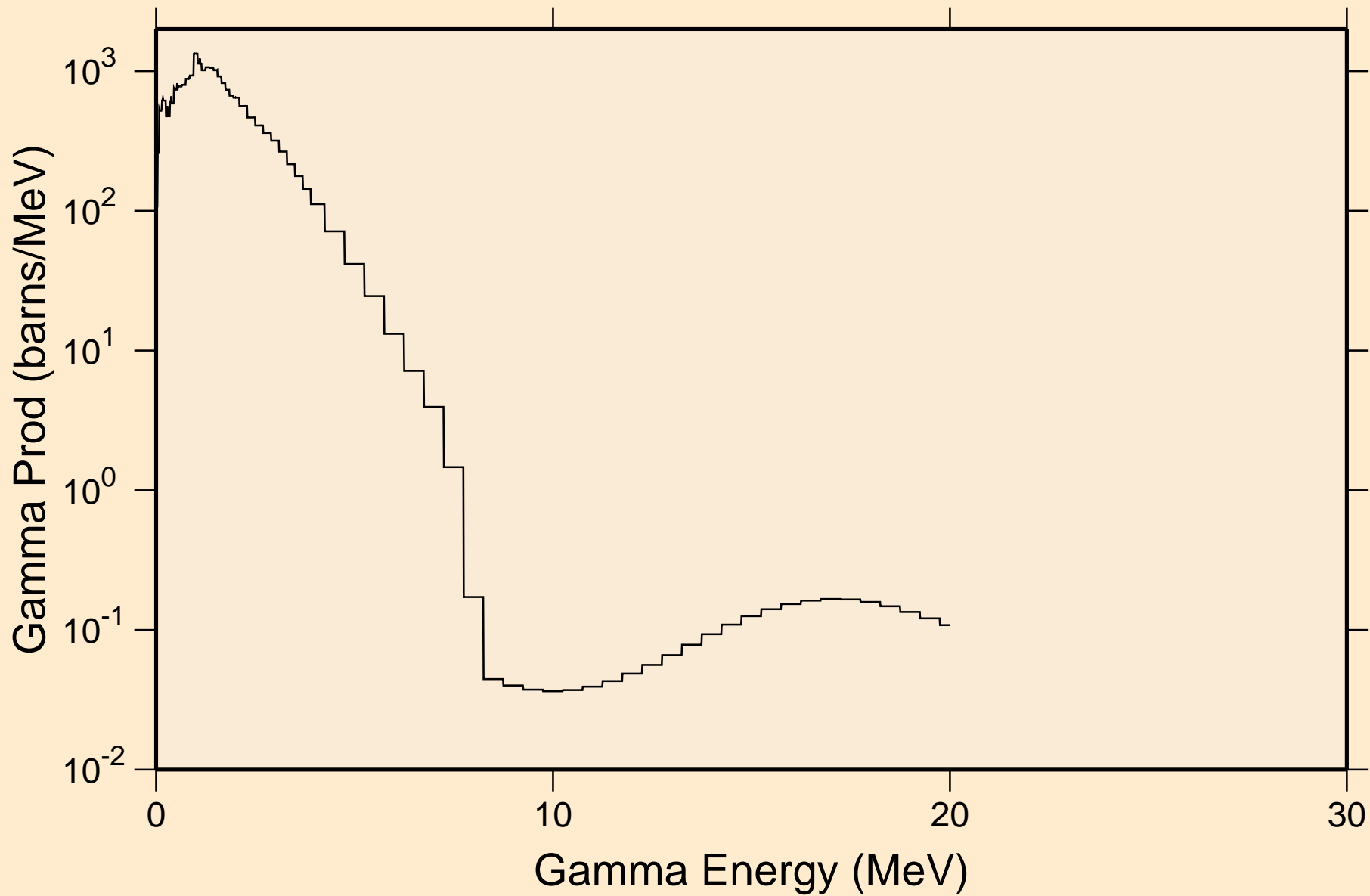

CU073 NEUTRON ACER TENDL-2021 LIBRARY; T=293.6K
Particle heating contributions

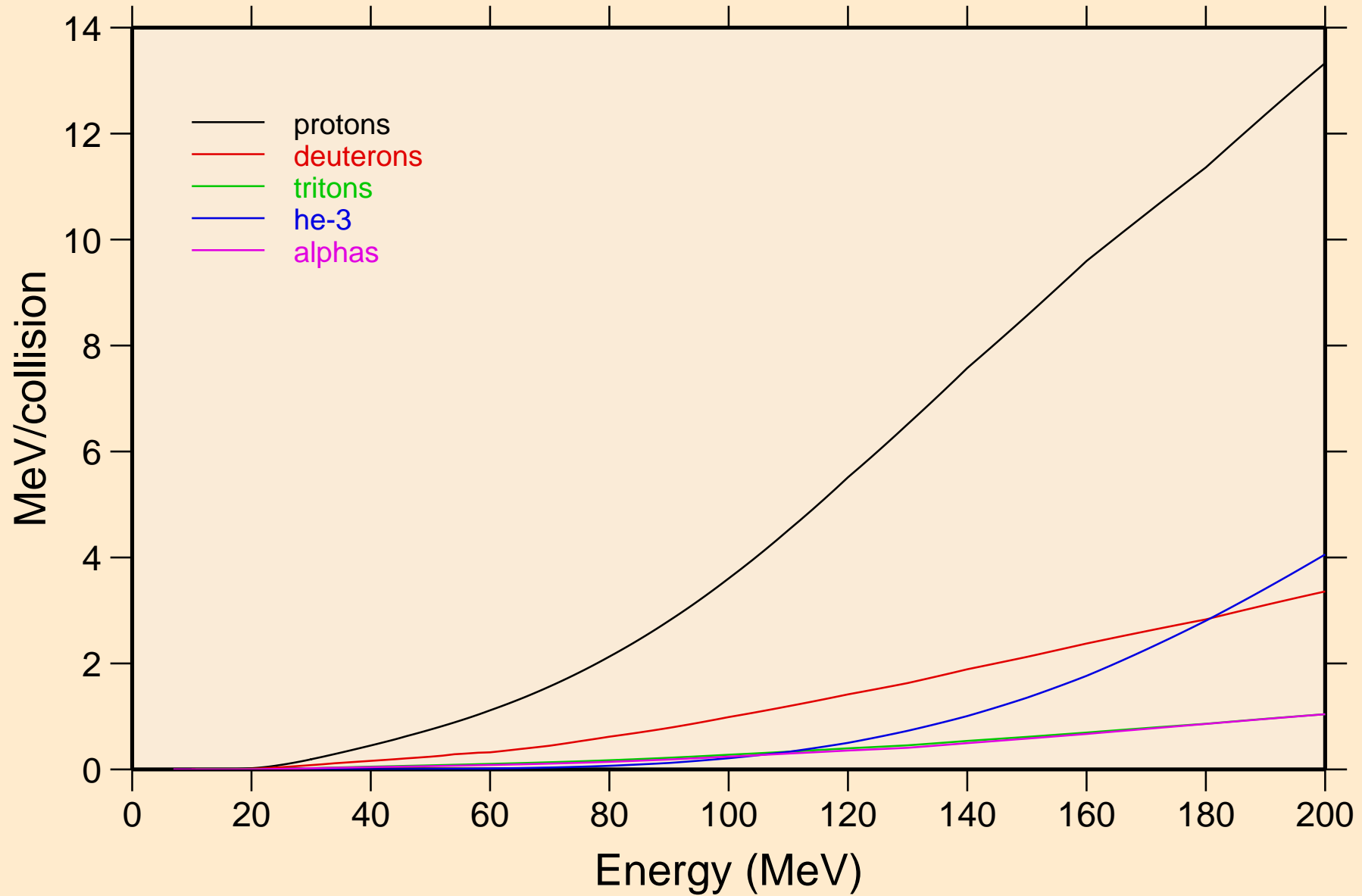

CU073 NEUTRON ACER TENDL-2021 LIBRARY; T=293.6K
Recoil Heating

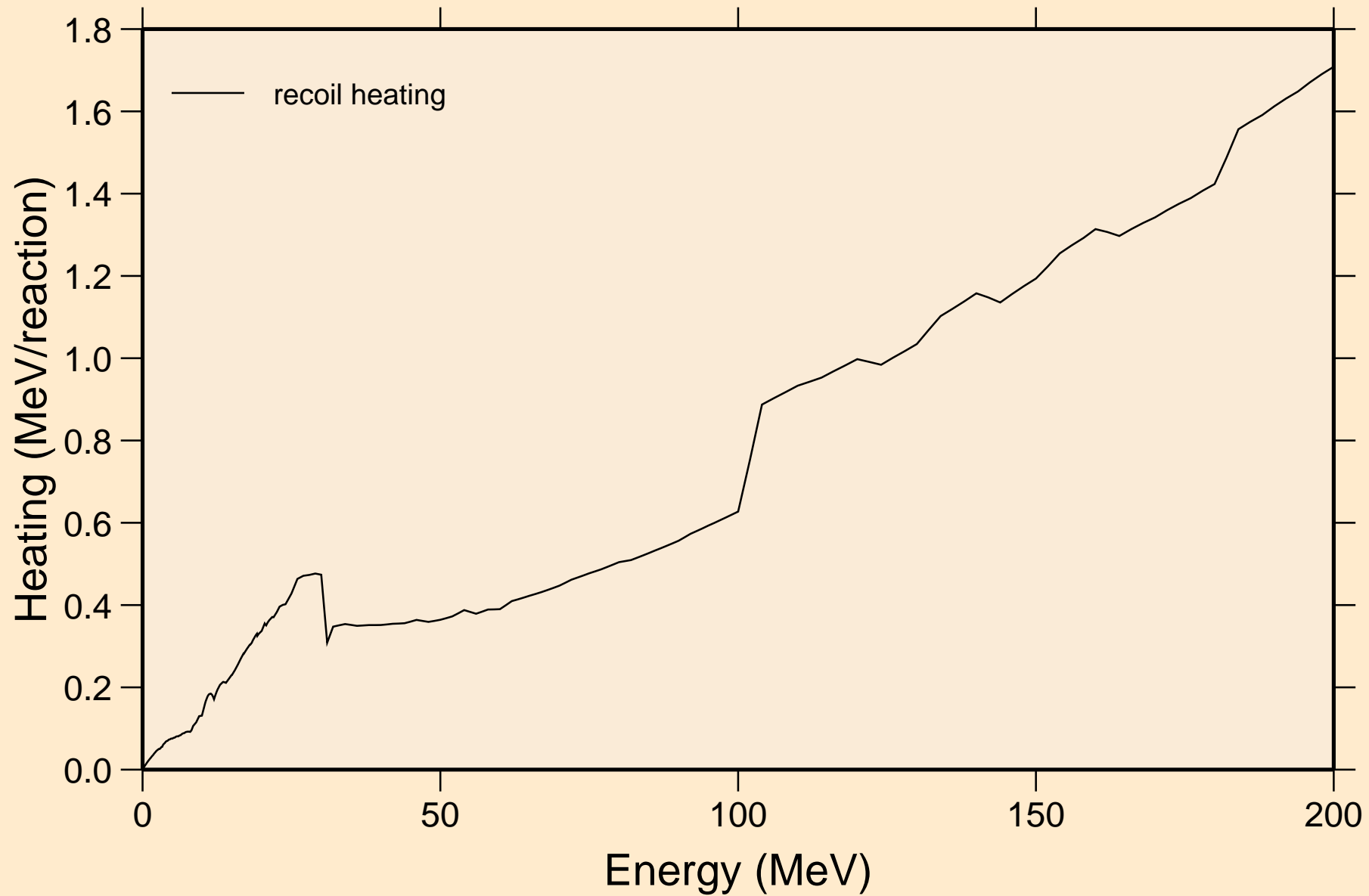

CU073 NEUTRON ACER TENDL-2021 LIBRARY; T=293.6K
Particle production cross sections

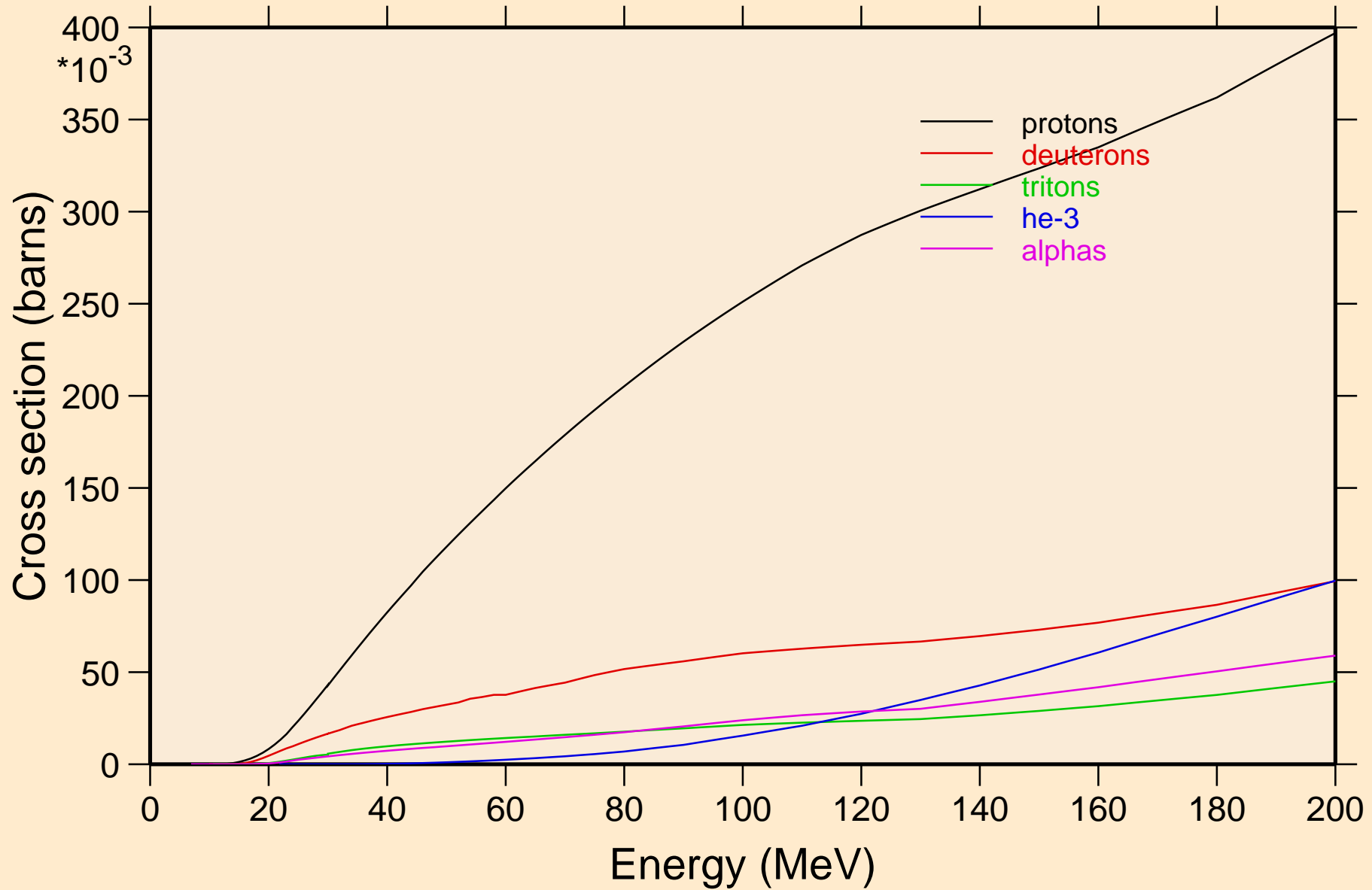

CU073 NEUTRON ACER TENDL-2021 LIBRARY; T=293.6K
protons from (n,x)

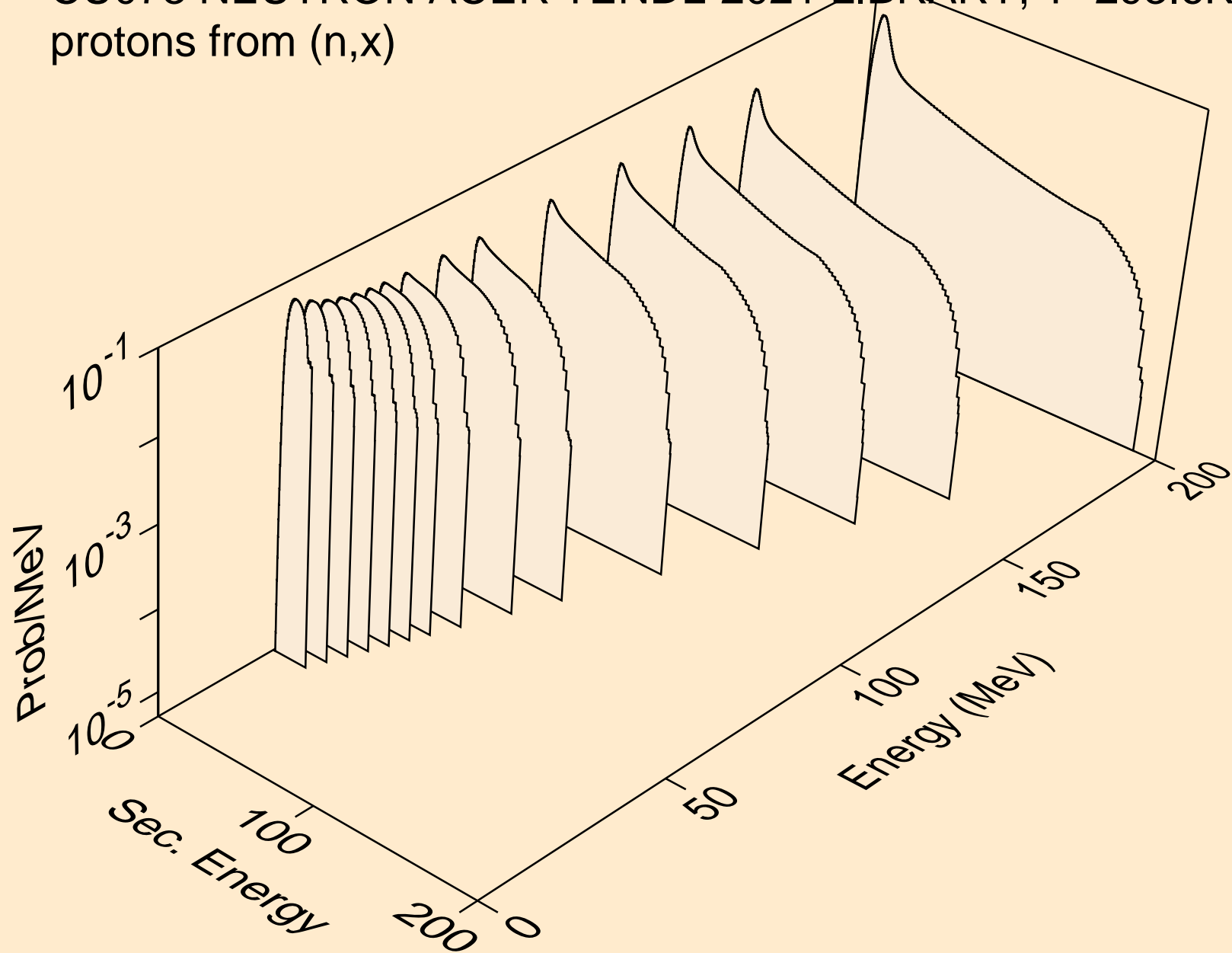

CU073 NEUTRON ACER TENDL-2021 LIBRARY; T=293.6K
protons from (n,n*)p

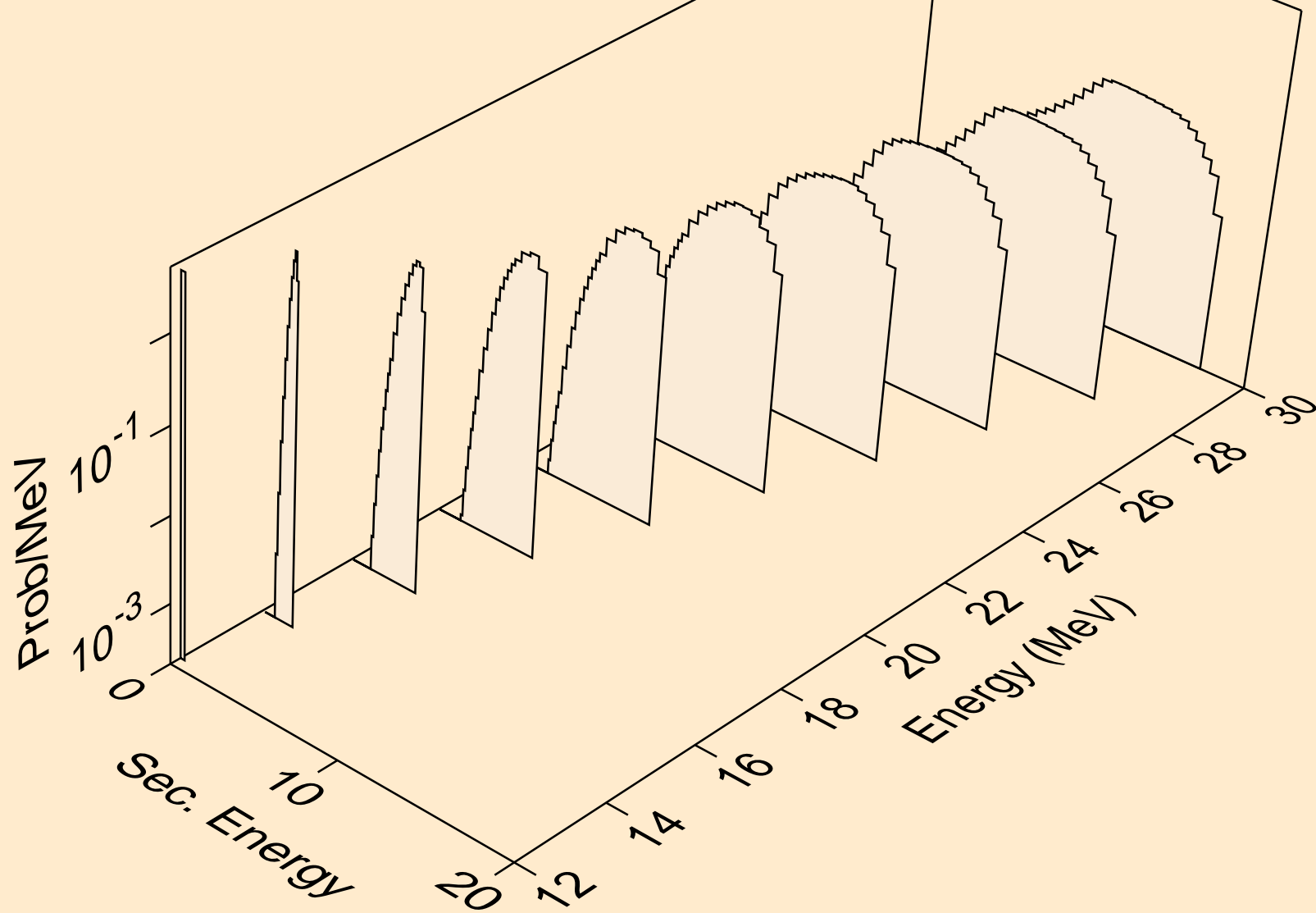

CU073 NEUTRON ACER TENDL-2021 LIBRARY; T=293.6K
protons from (n,2np)

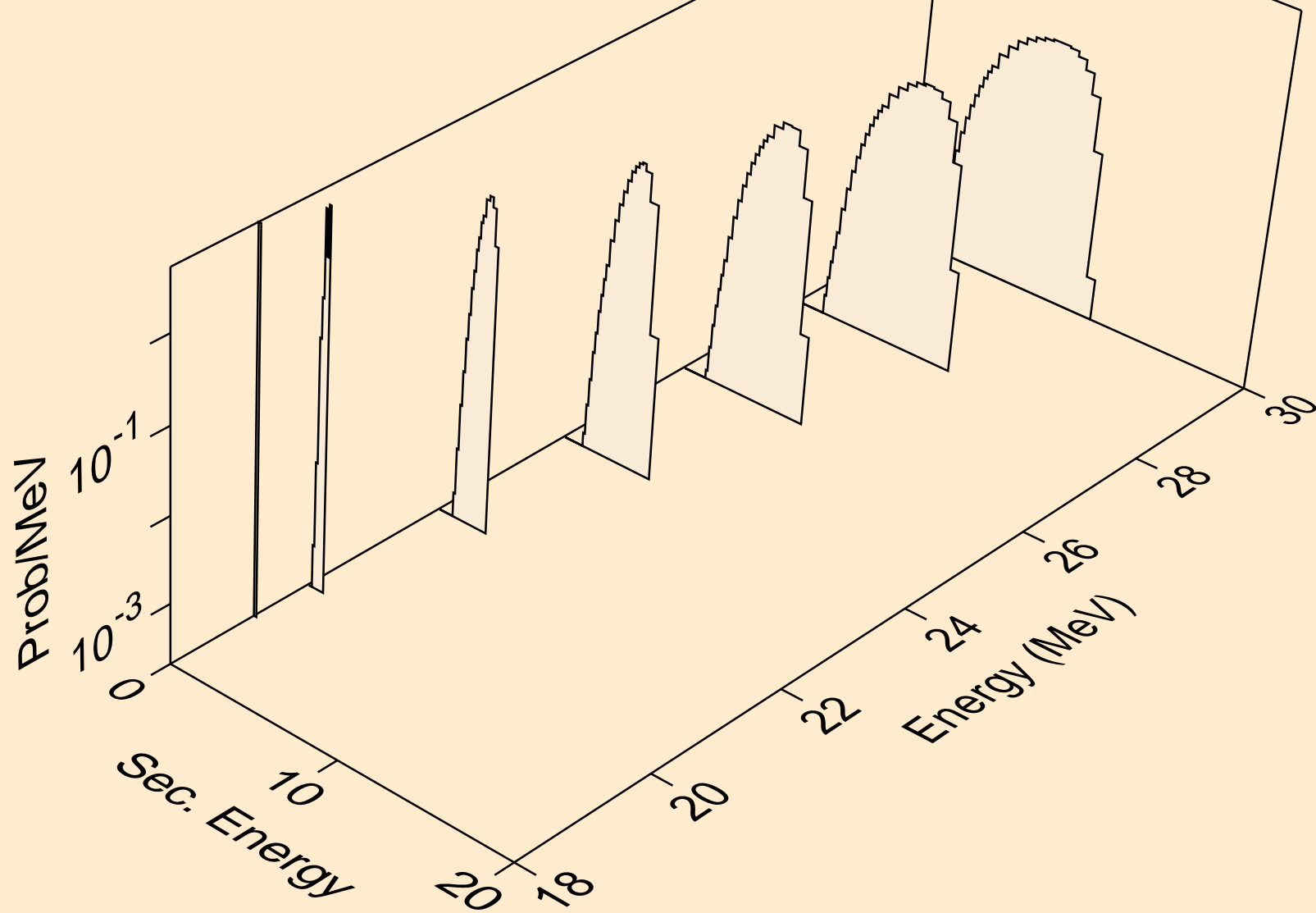

CU073 NEUTRON ACER TENDL-2021 LIBRARY; T=293.6K
protons from (n,3np)

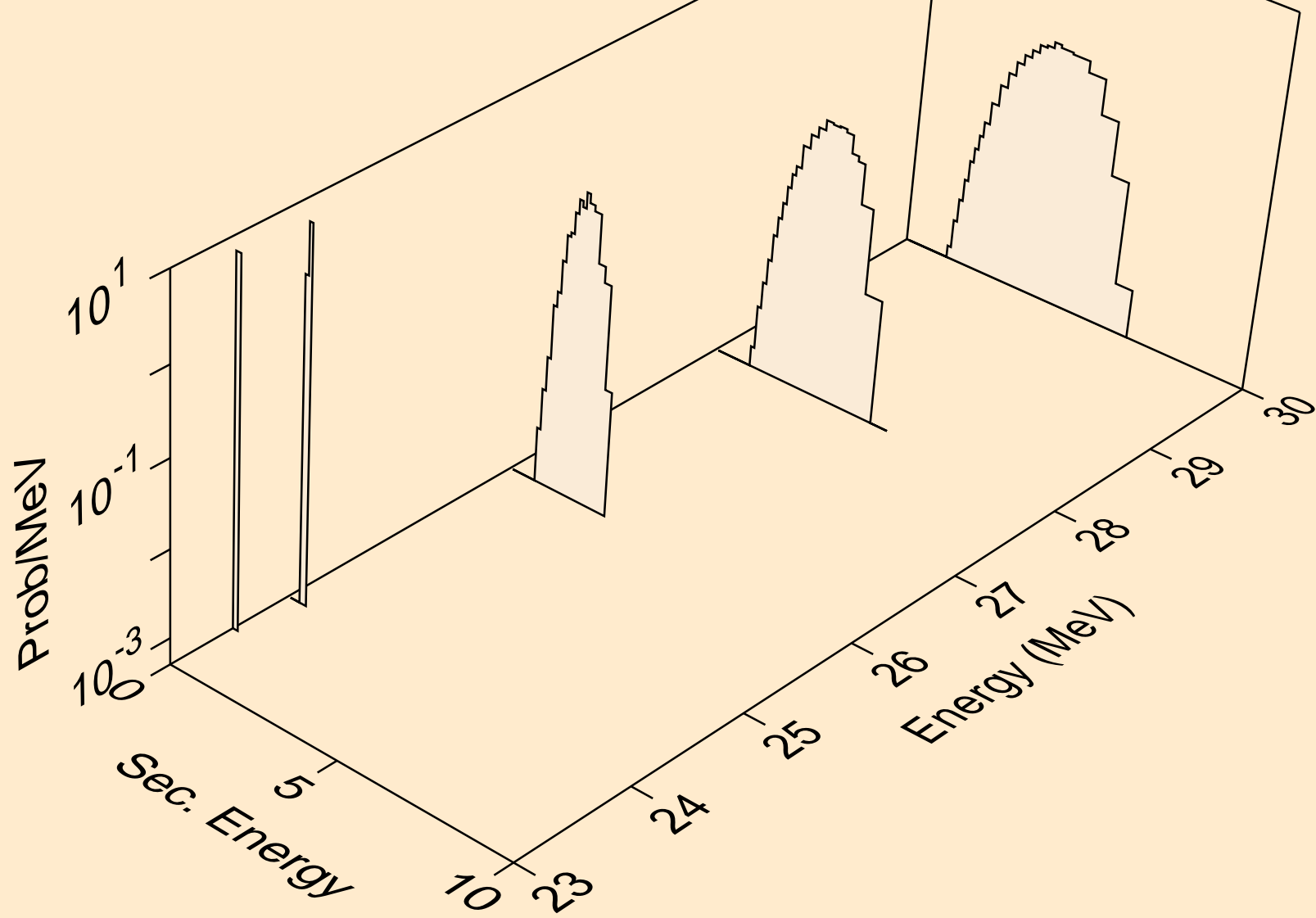

CU073 NEUTRON ACER TENDL-2021 LIBRARY; T=293.6K
protons from (n,p)

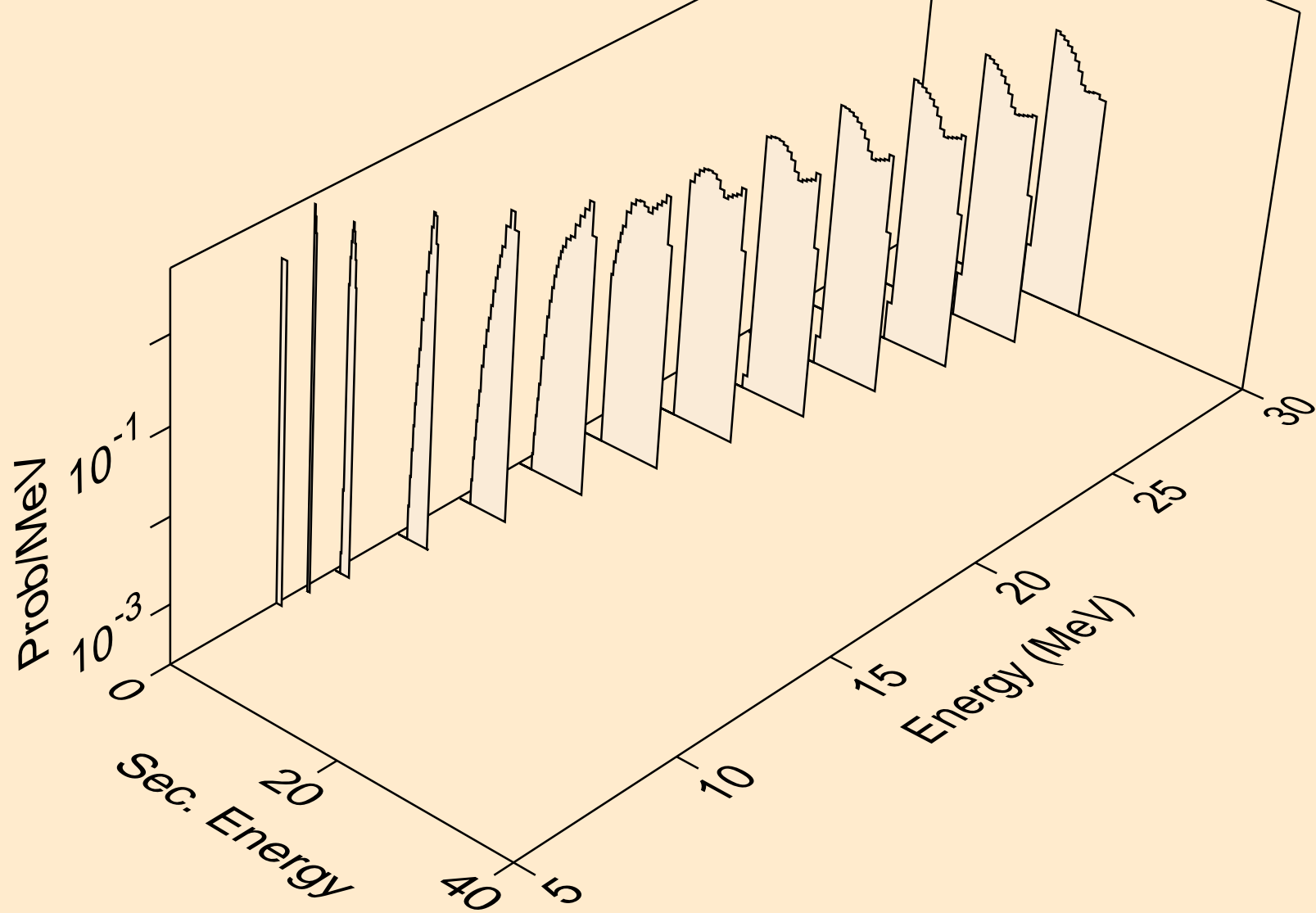

CU073 NEUTRON ACER TENDL-2021 LIBRARY; T=293.6K
deuterons from (n,x)

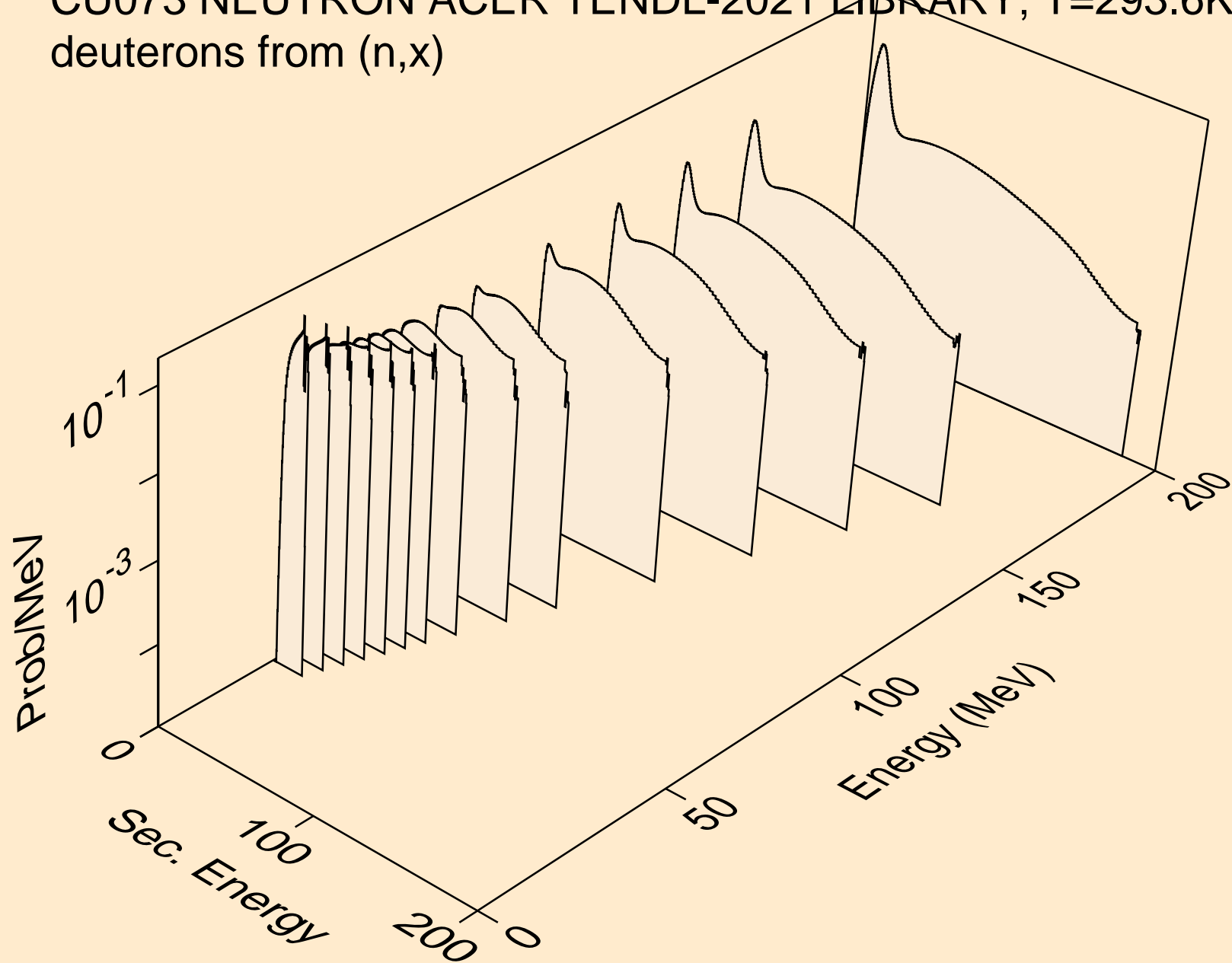

CU073 NEUTRON ACER TENDL-2021 LIBRARY; T=293.6K
deuterons from (n,2nd)

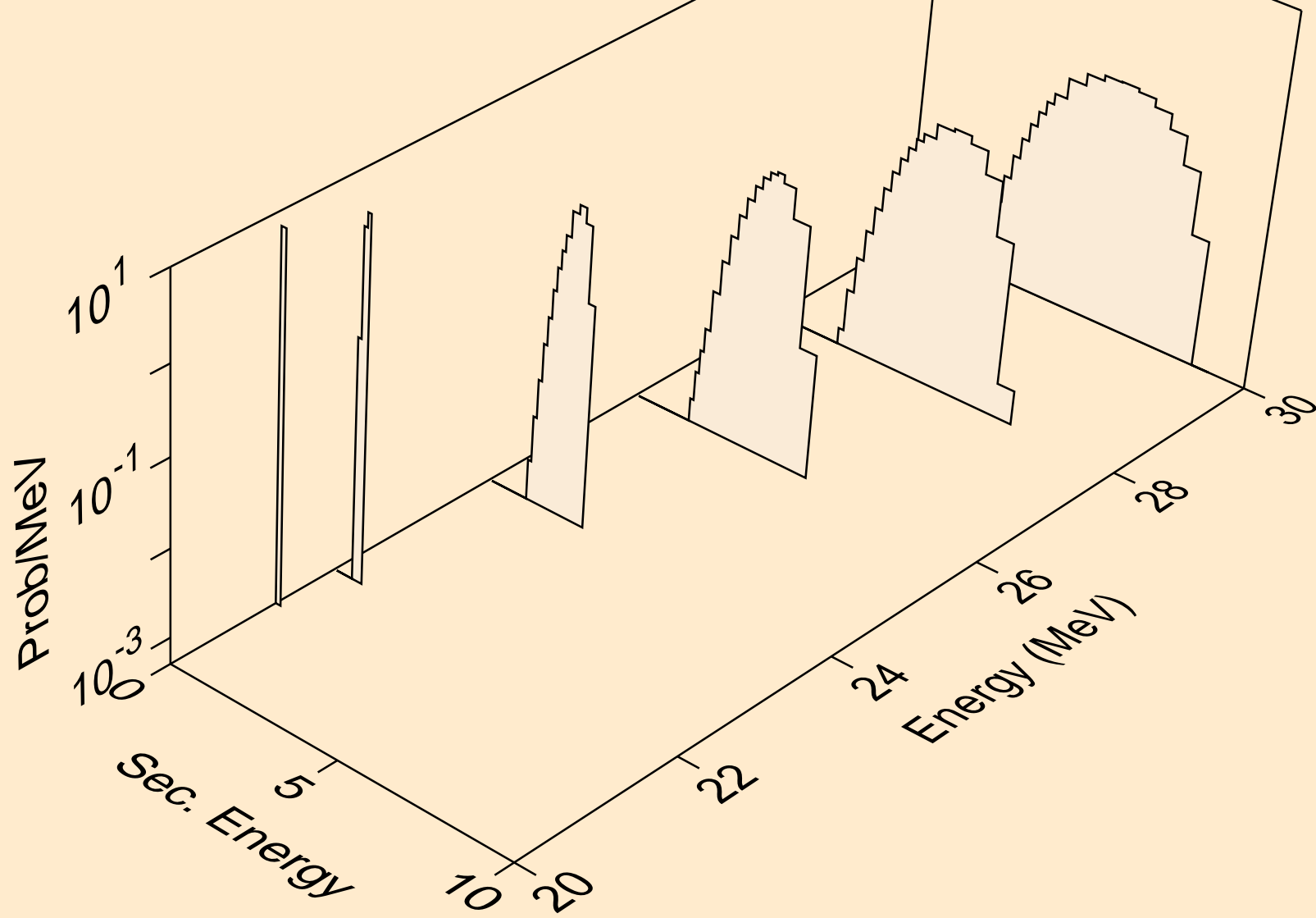

CU073 NEUTRON ACER TENDL-2021 LIBRARY; T=293.6K
deuterons from (n,n*)d

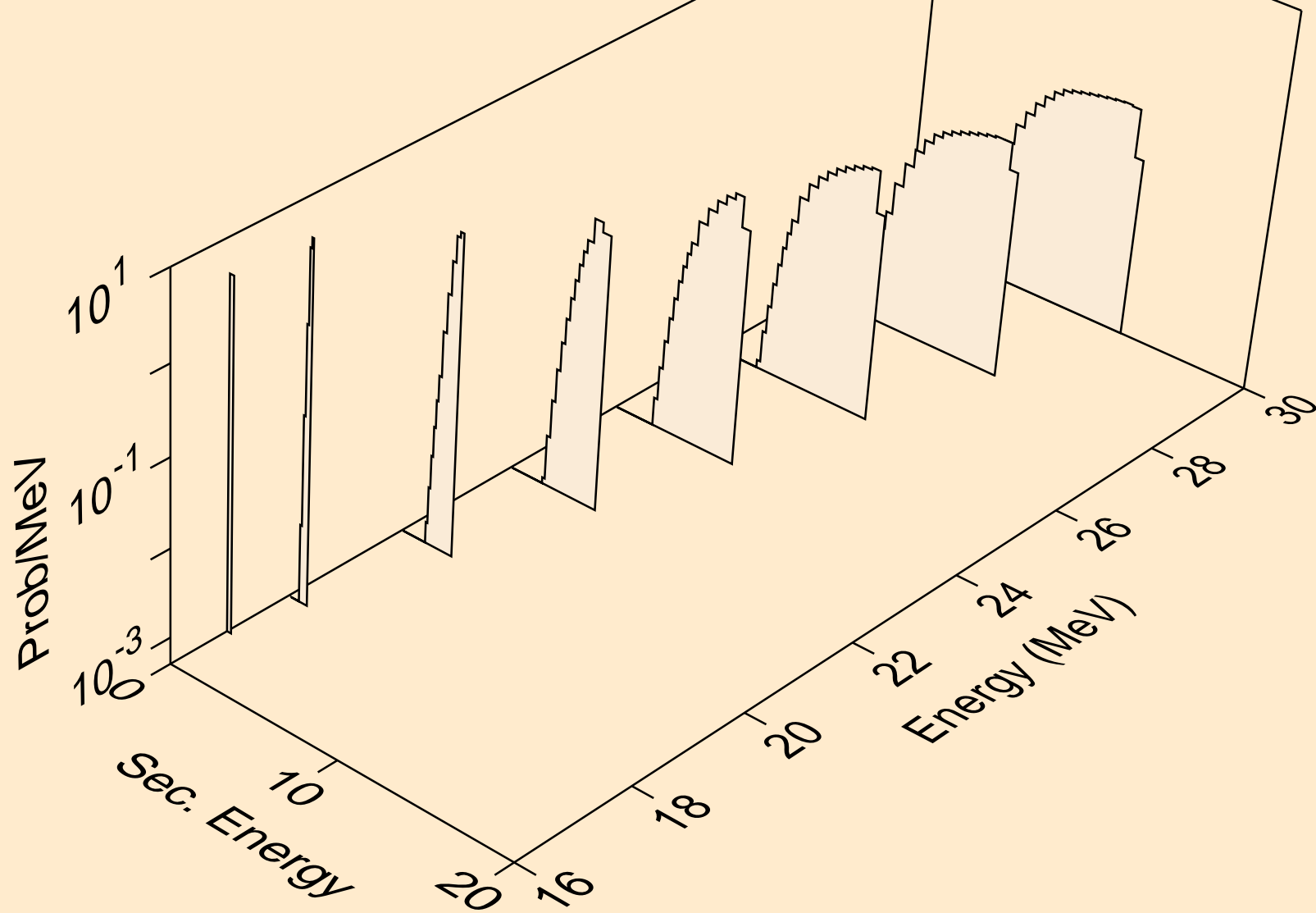

CU073 NEUTRON ACER TENDL-2021 LIBRARY; T=293.6K
deuterons from (n,d)

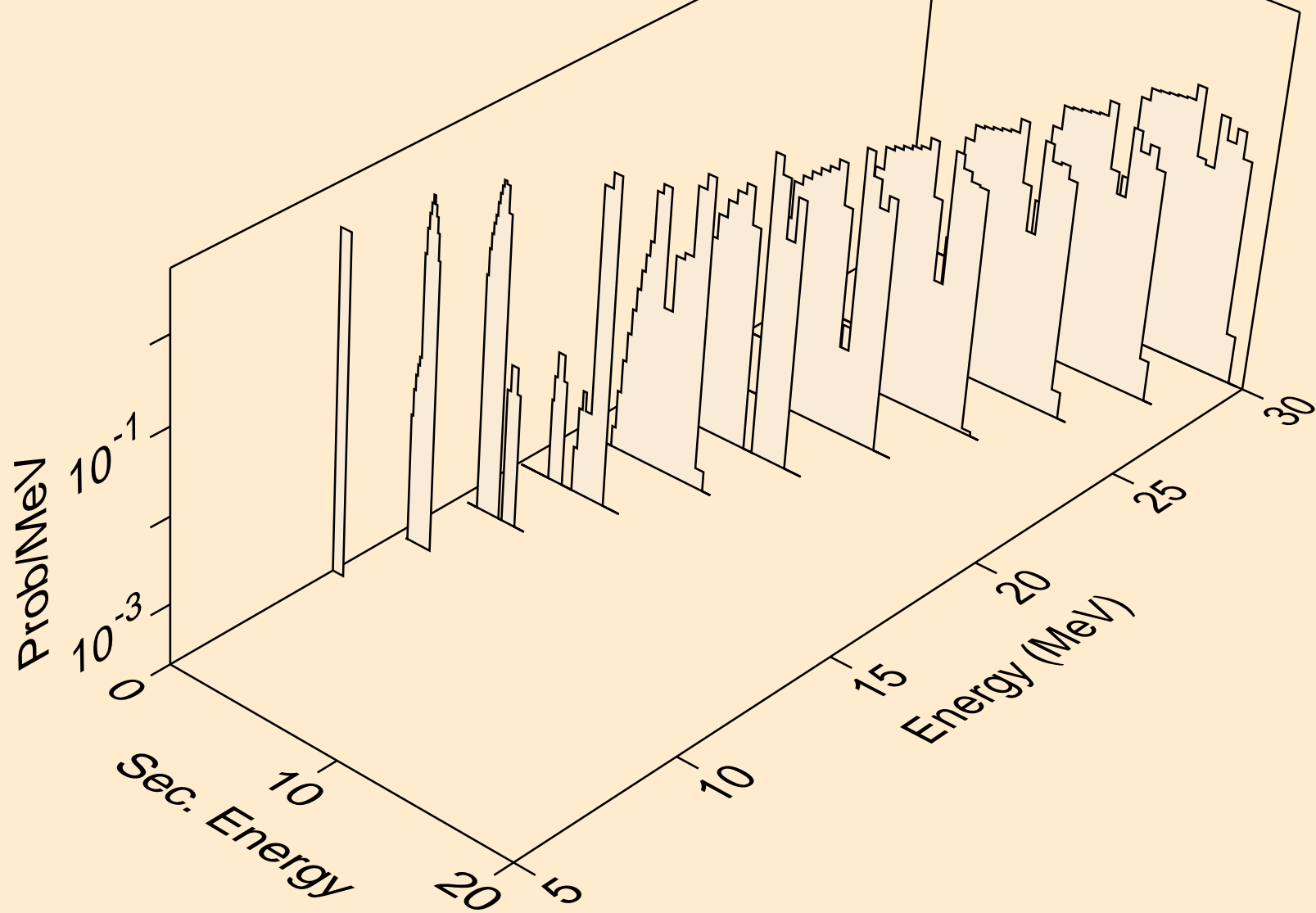

CU073 NEUTRON ACER TENDL-2021 LIBRARY; T=293.6K
tritons from (n,x)

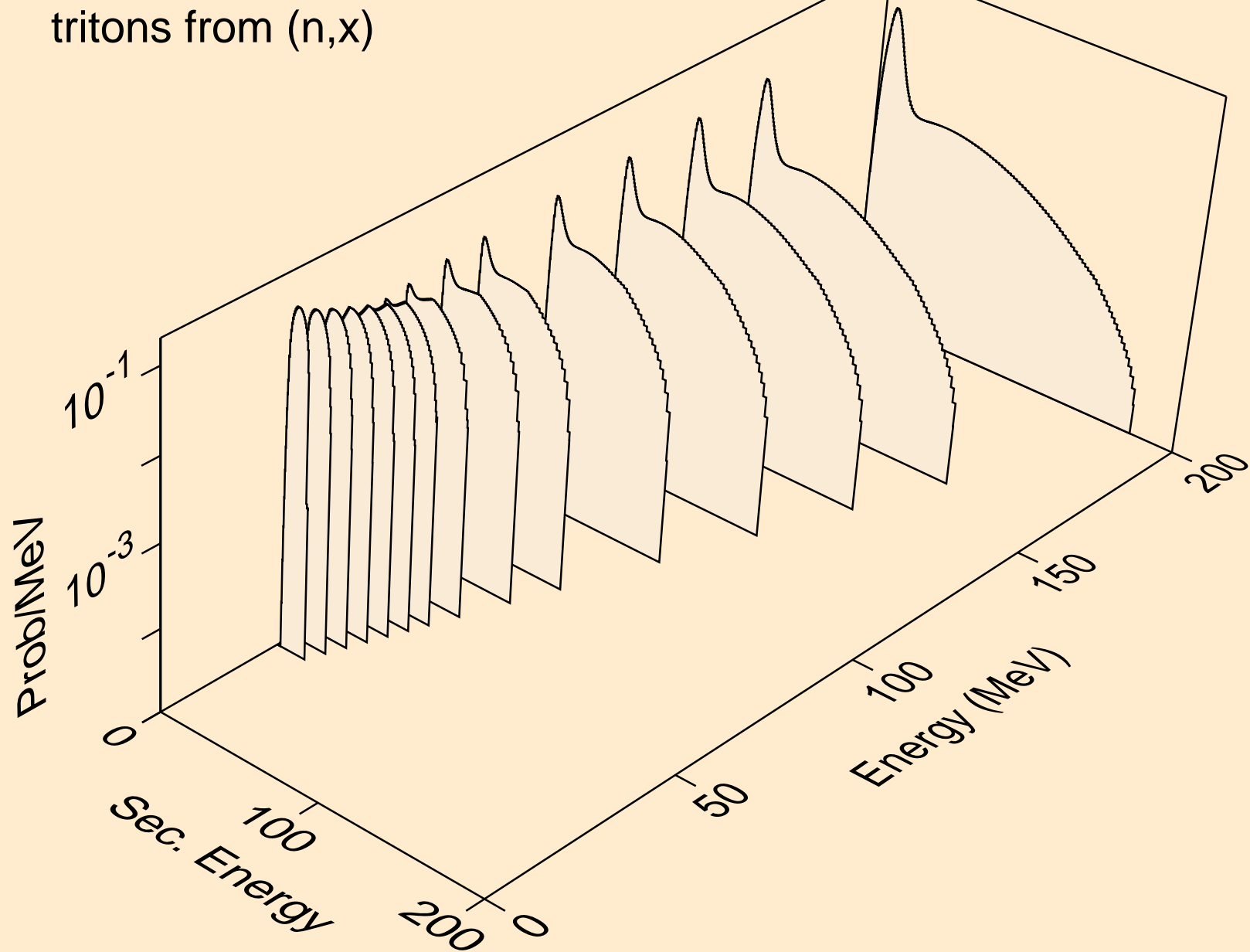

CU073 NEUTRON ACER TENDL-2021 LIBRARY; T=293.6K
tritons from (n,n*)t

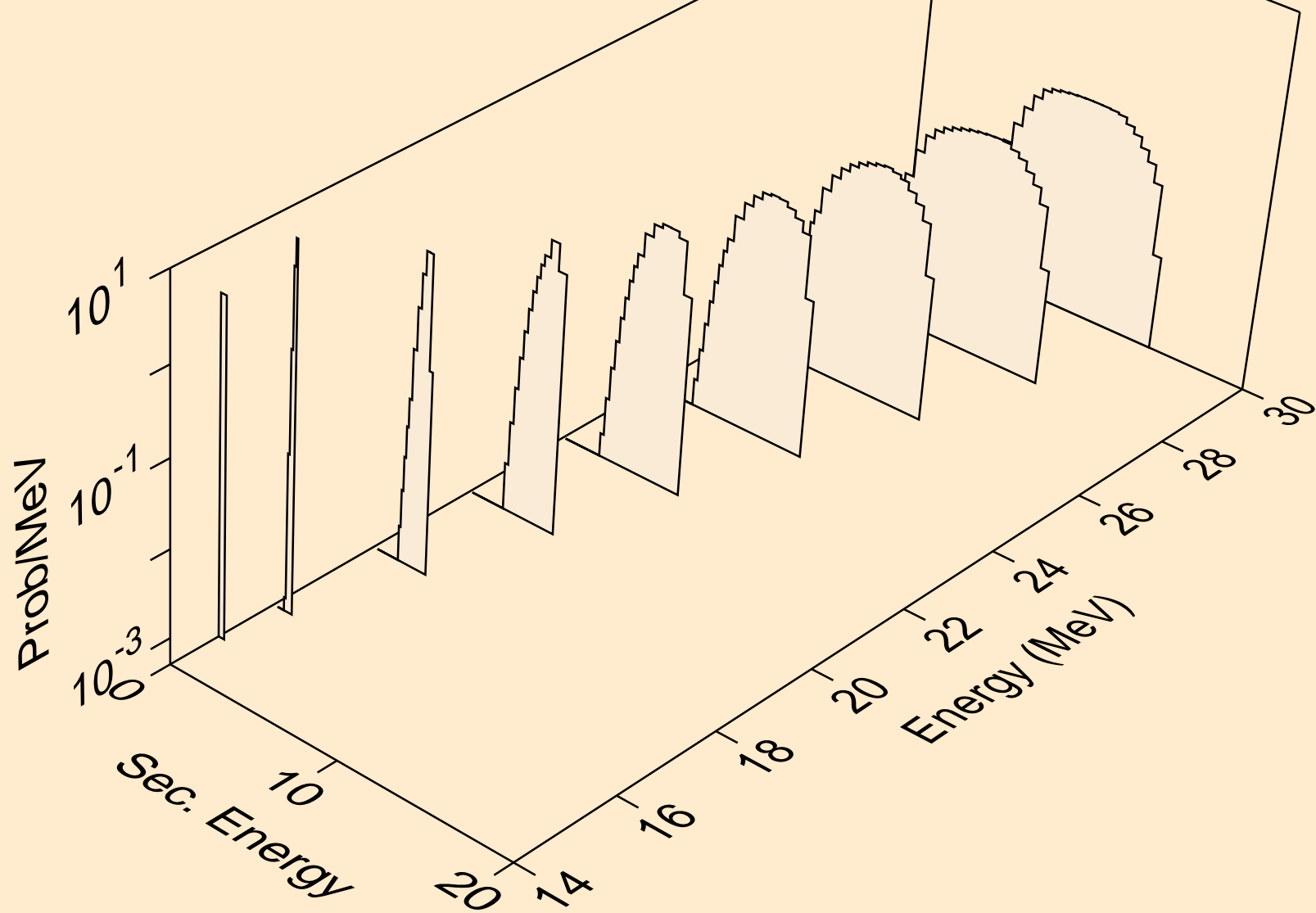

CU073 NEUTRON ACER TENDL-2021 LIBRARY; T=293.6K
tritons from (n,t)

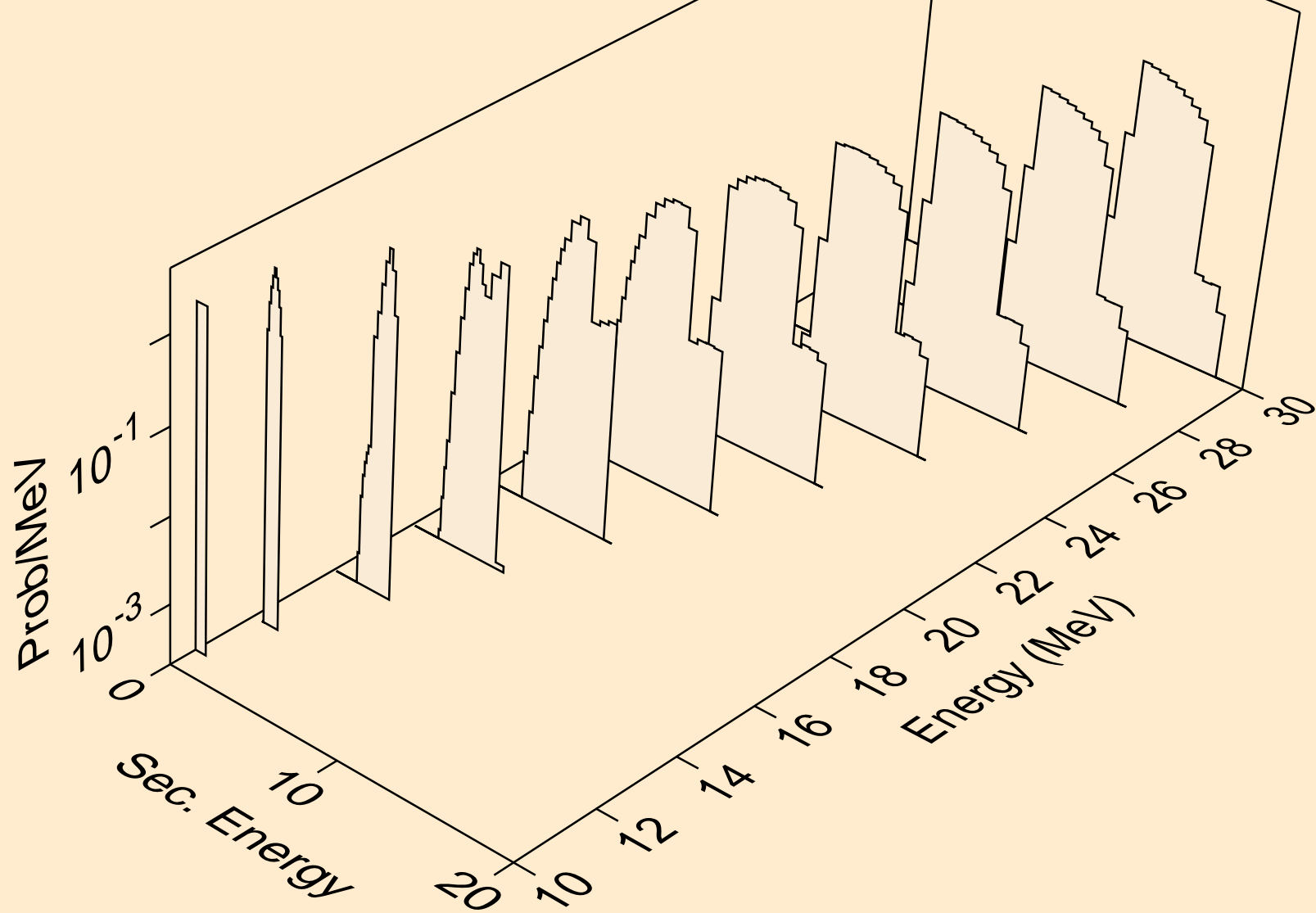

CU073 NEUTRON ACER TENDL-2021 LIBRARY; T=293.6K
he3s from (n,x)

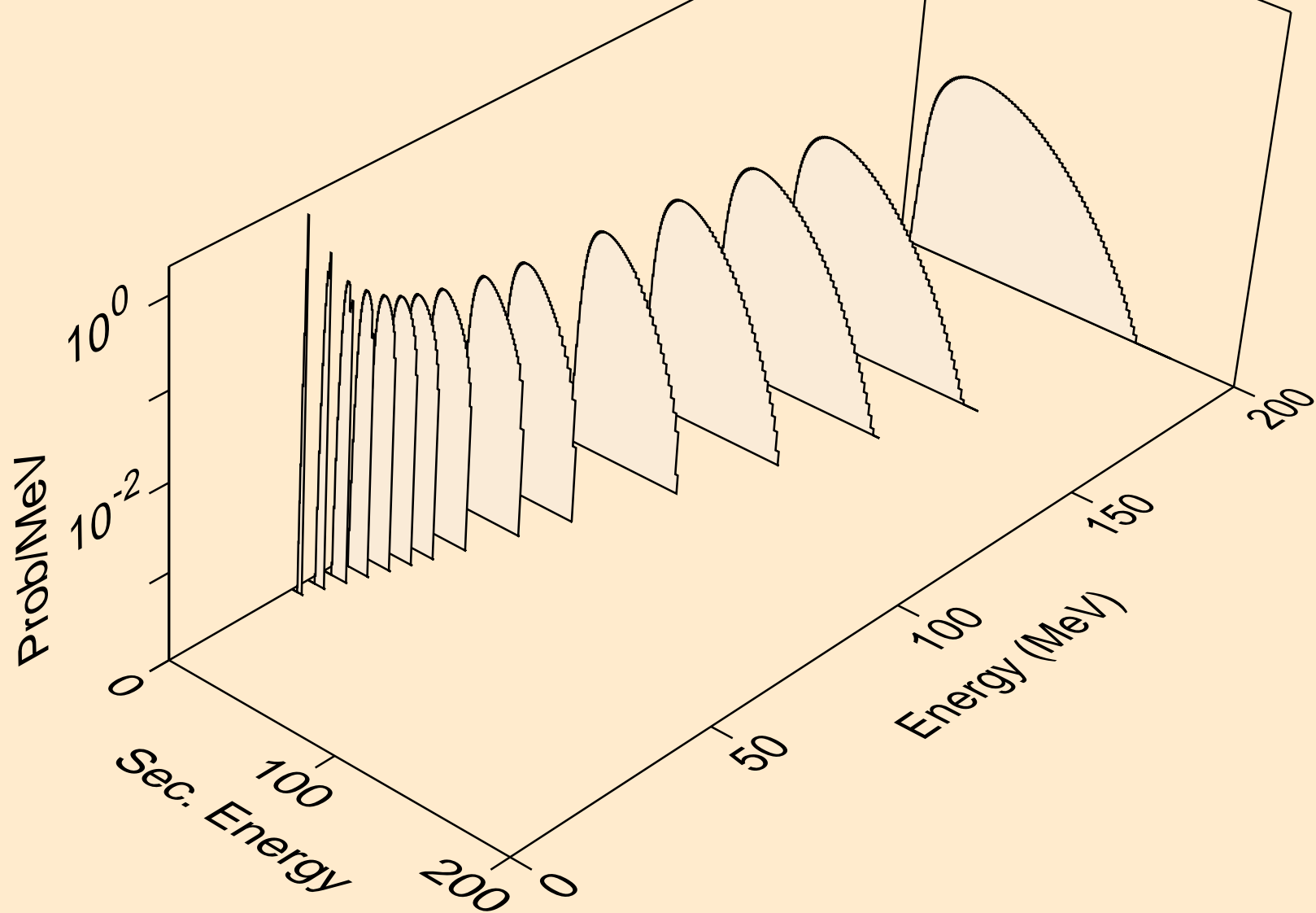

CU073 NEUTRON ACER TENDL-2021 LIBRARY; T=293.6K
he3s from (n,he3)

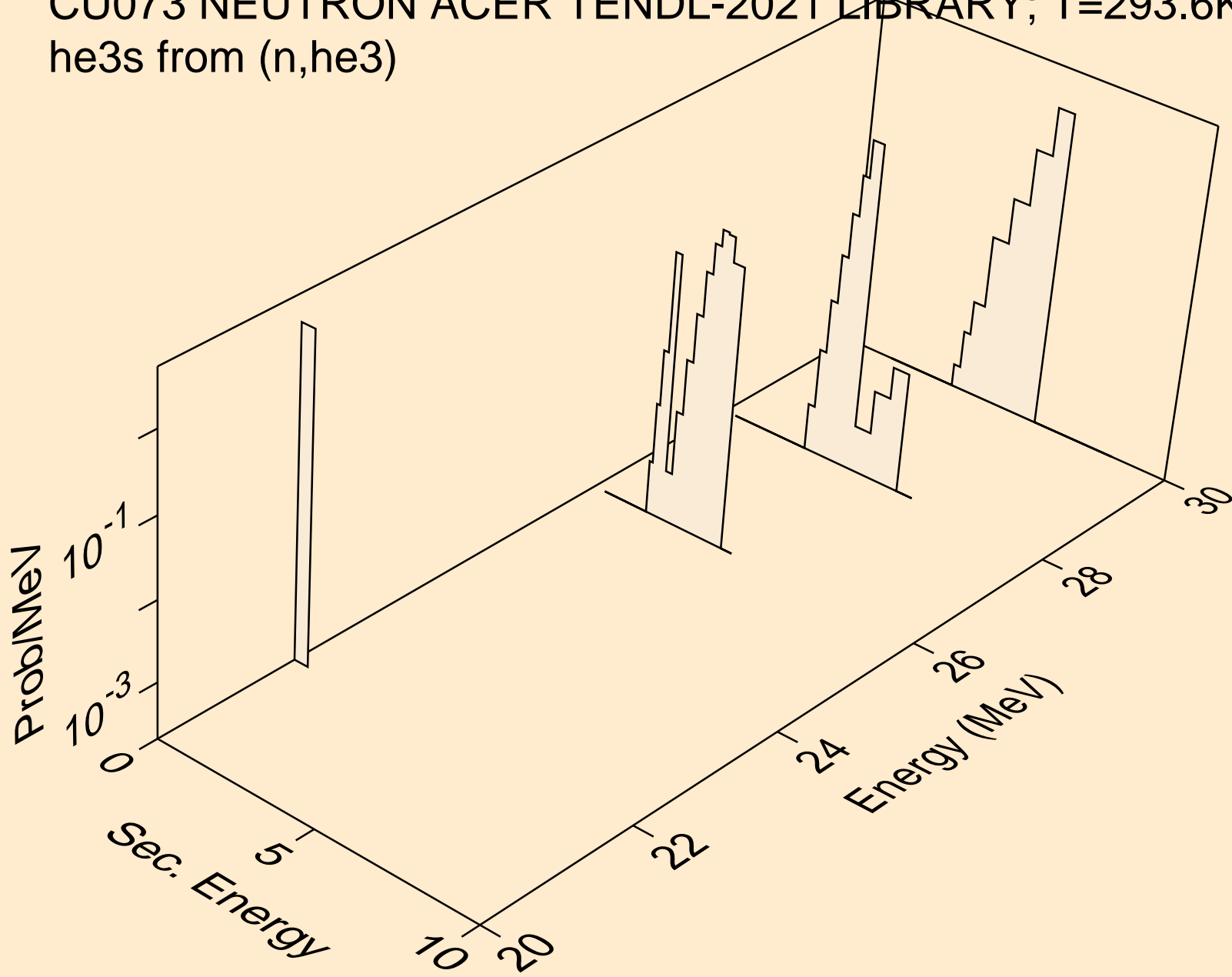

CU073 NEUTRON ACER TENDL-2021 LIBRARY; T=293.6K
alphas from (n,x)

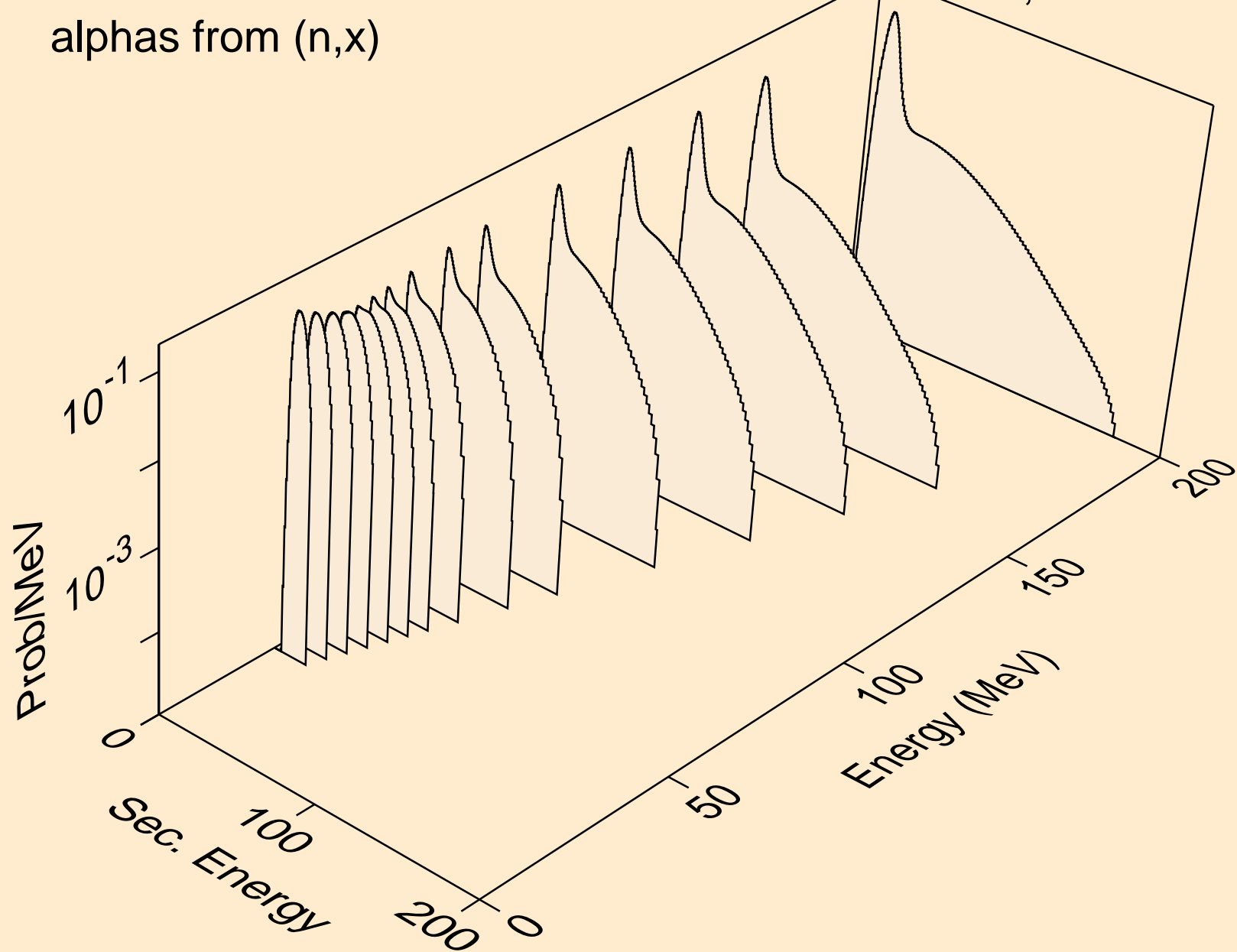

CU073 NEUTRON ACER TENDL-2021 LIBRARY; T=293.6K
alphas from (n,n*)a

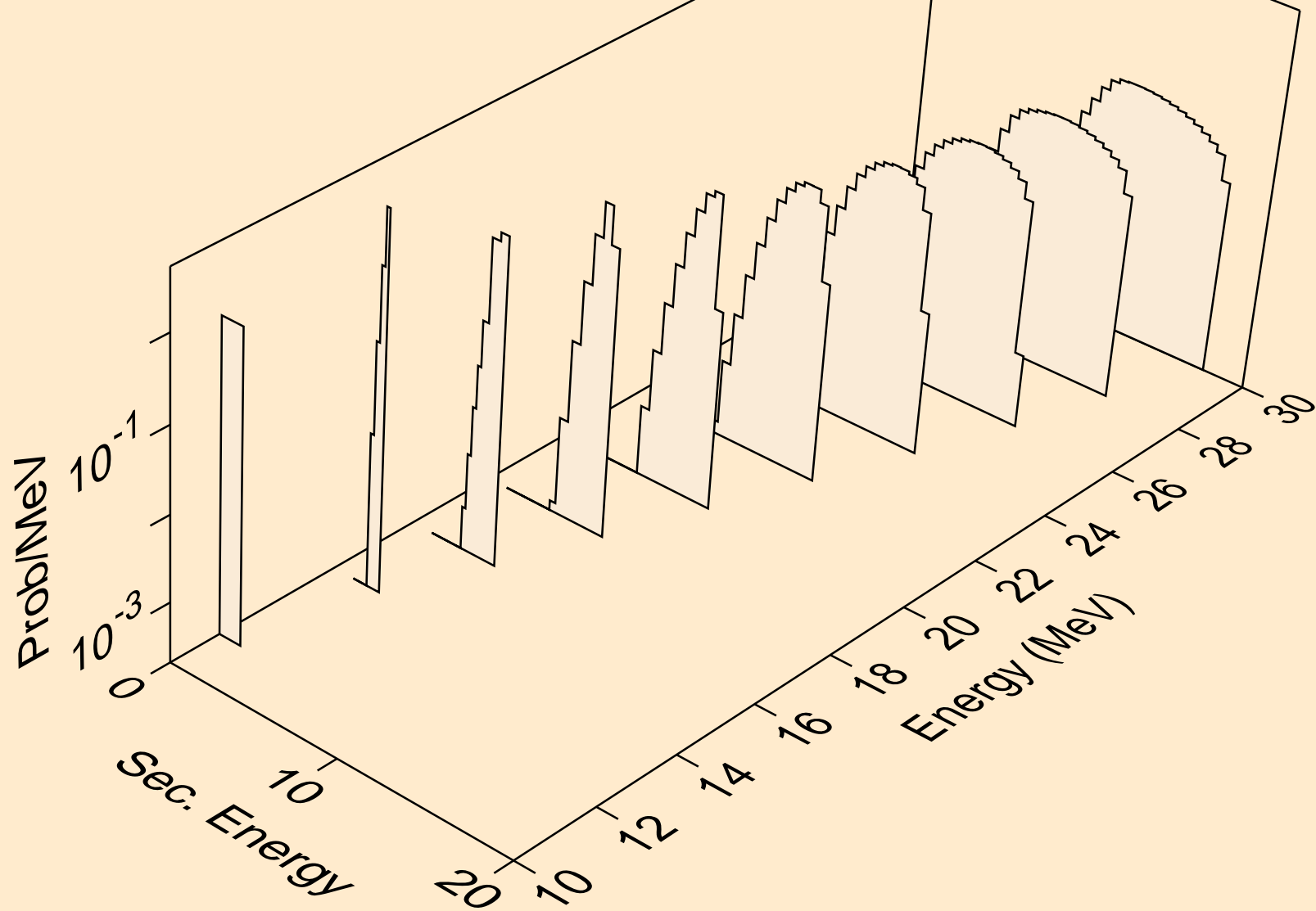

CU073 NEUTRON ACER TENDL-2021 LIBRARY; T=293.6K
alphas from (n,2n)a

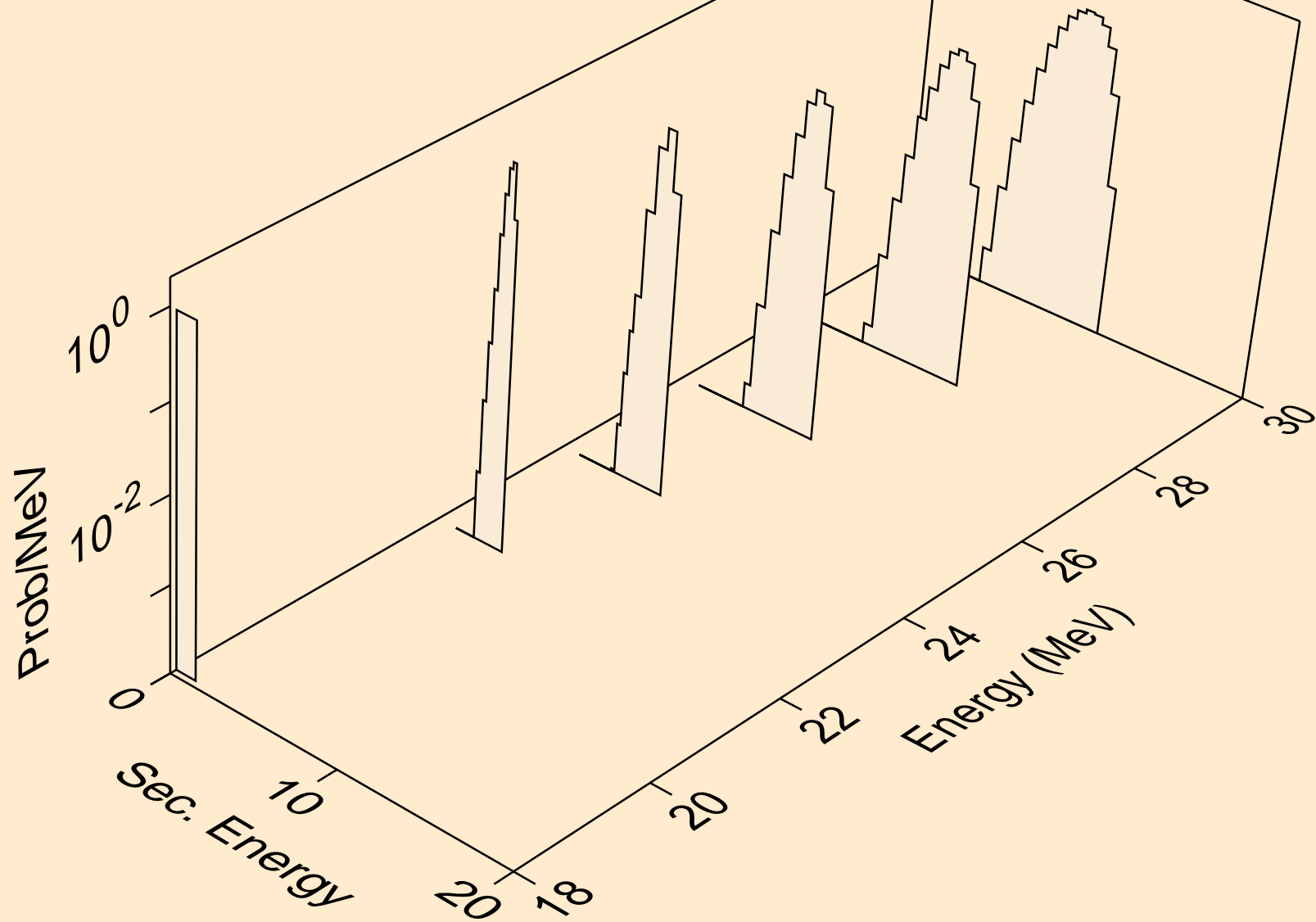

CU073 NEUTRON ACER TENDL-2021 LIBRARY; T=293.6K
alphas from (n,3n)a

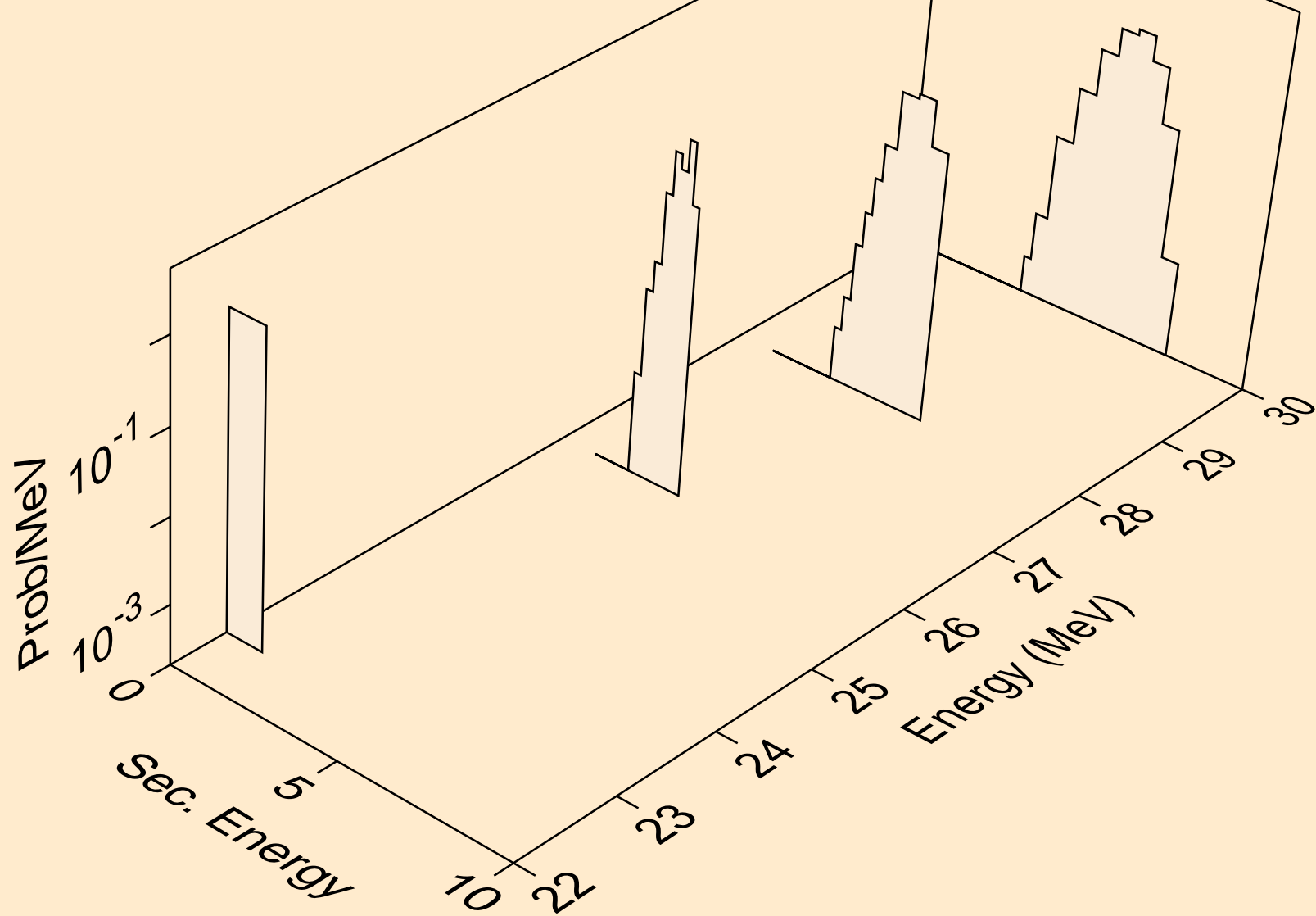

CU073 NEUTRON ACER TENDL-2021 LIBRARY; T=293.6K
alphas from (n,a)

