

DB262 NEUTRON ACER TENDL-2021 LIBRARY; T=293.6K
Principal cross sections

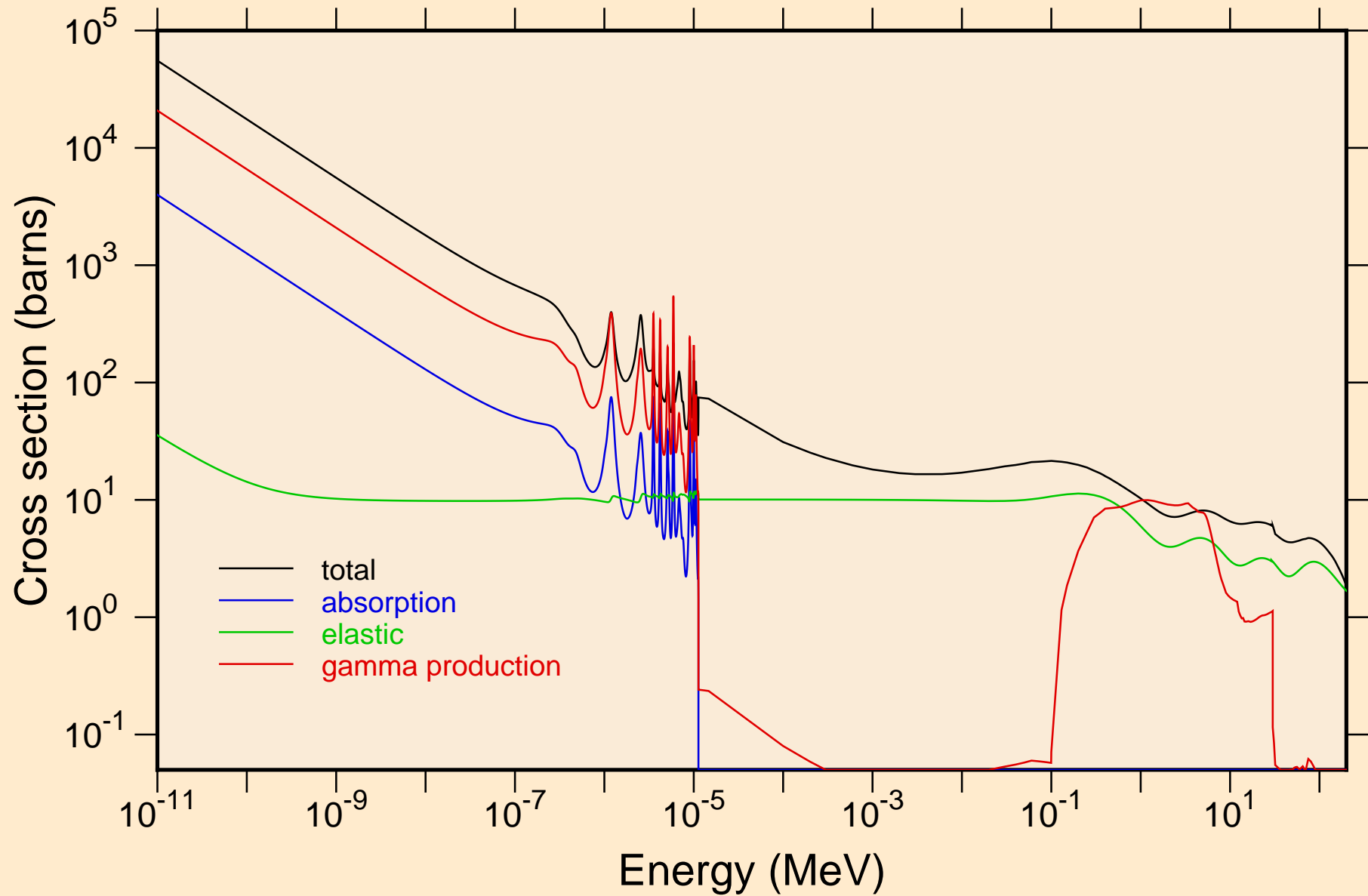

DB262 NEUTRON ACER TENDL-2021 LIBRARY; T=293.6K
resonance total cross section

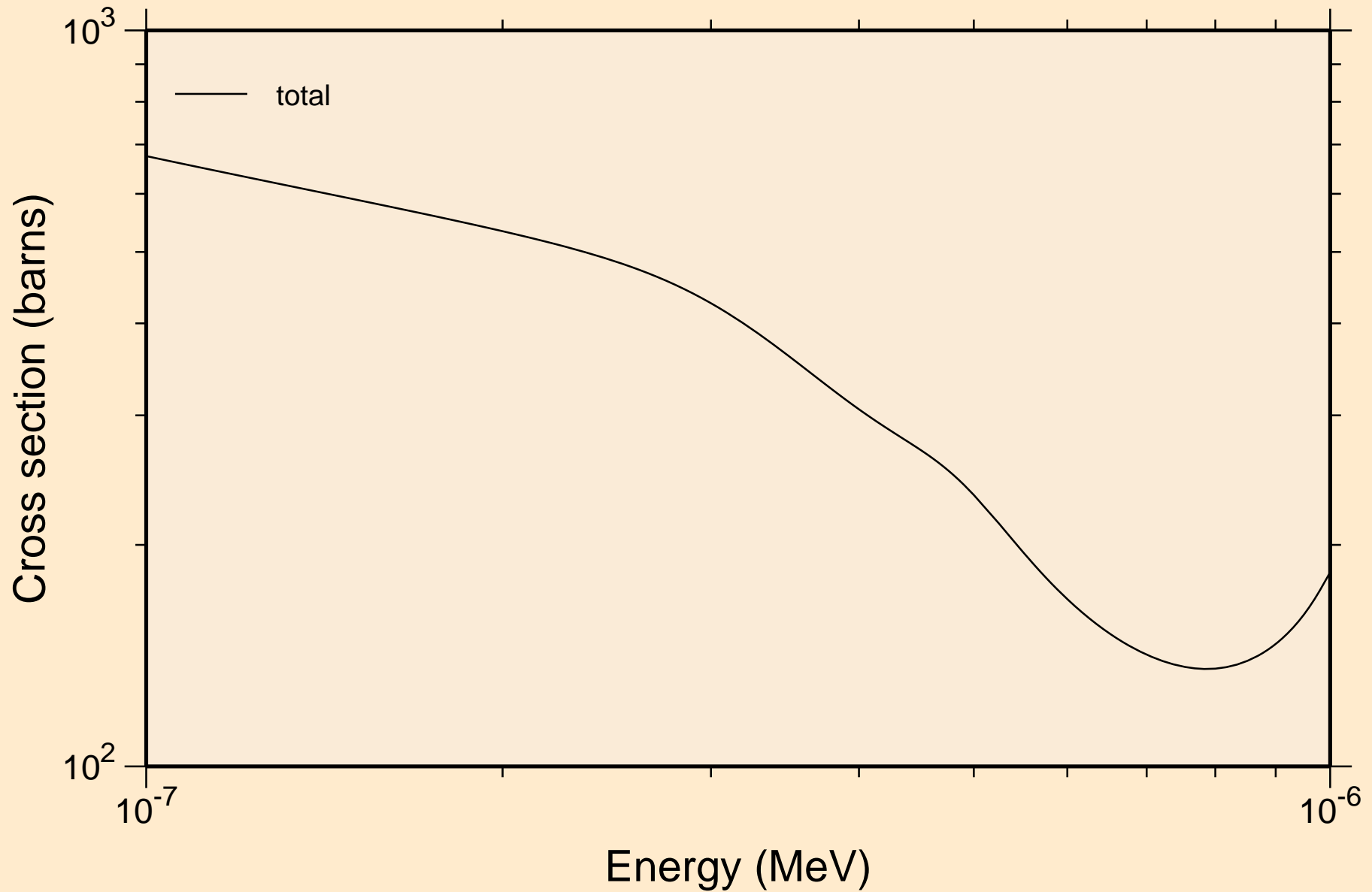

DB262 NEUTRON ACER TENDL-2021 LIBRARY; T=293.6K
resonance total cross section

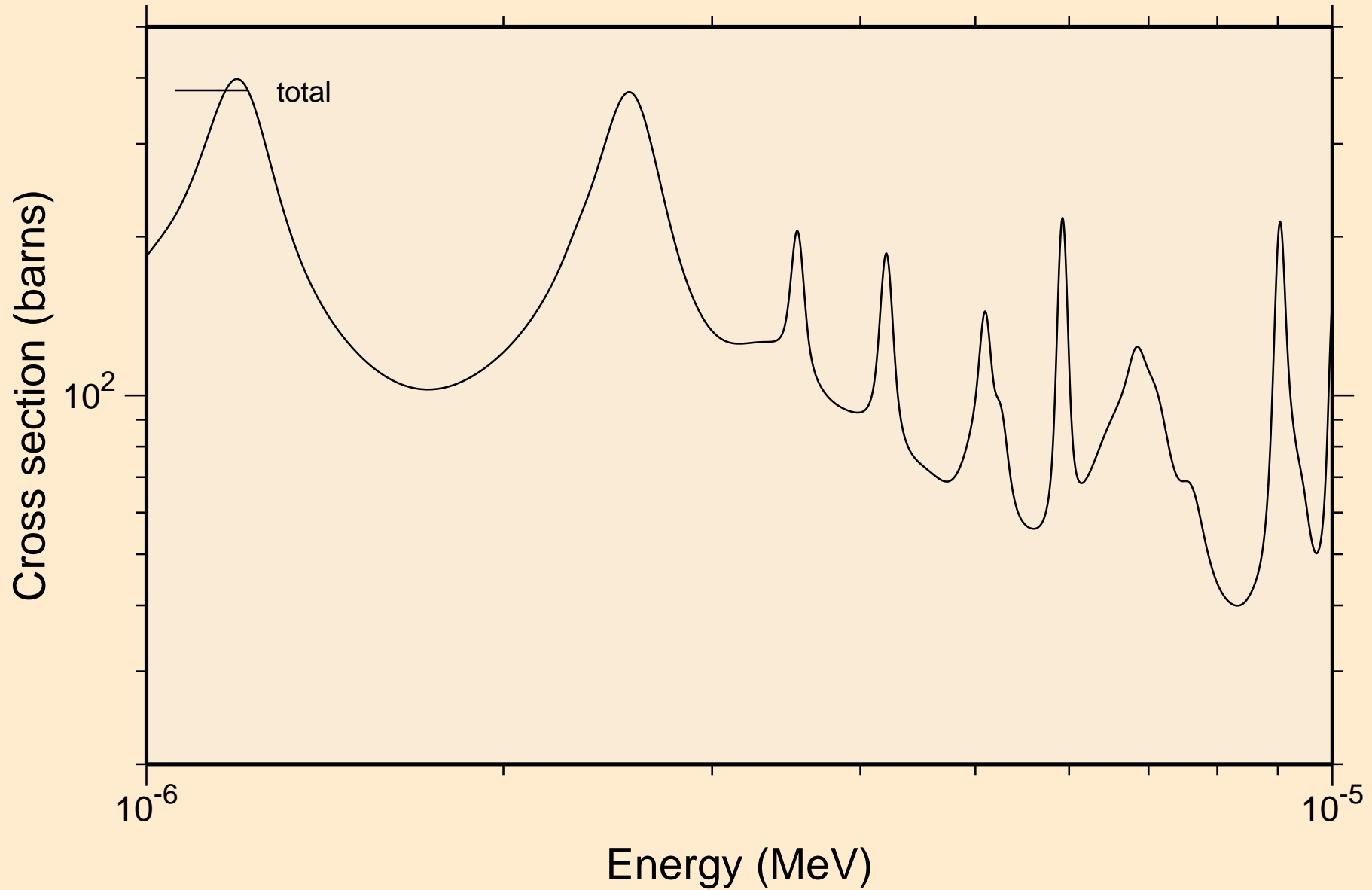

DB262 NEUTRON ACER TENDL-2021 LIBRARY; T=293.6K
resonance total cross section

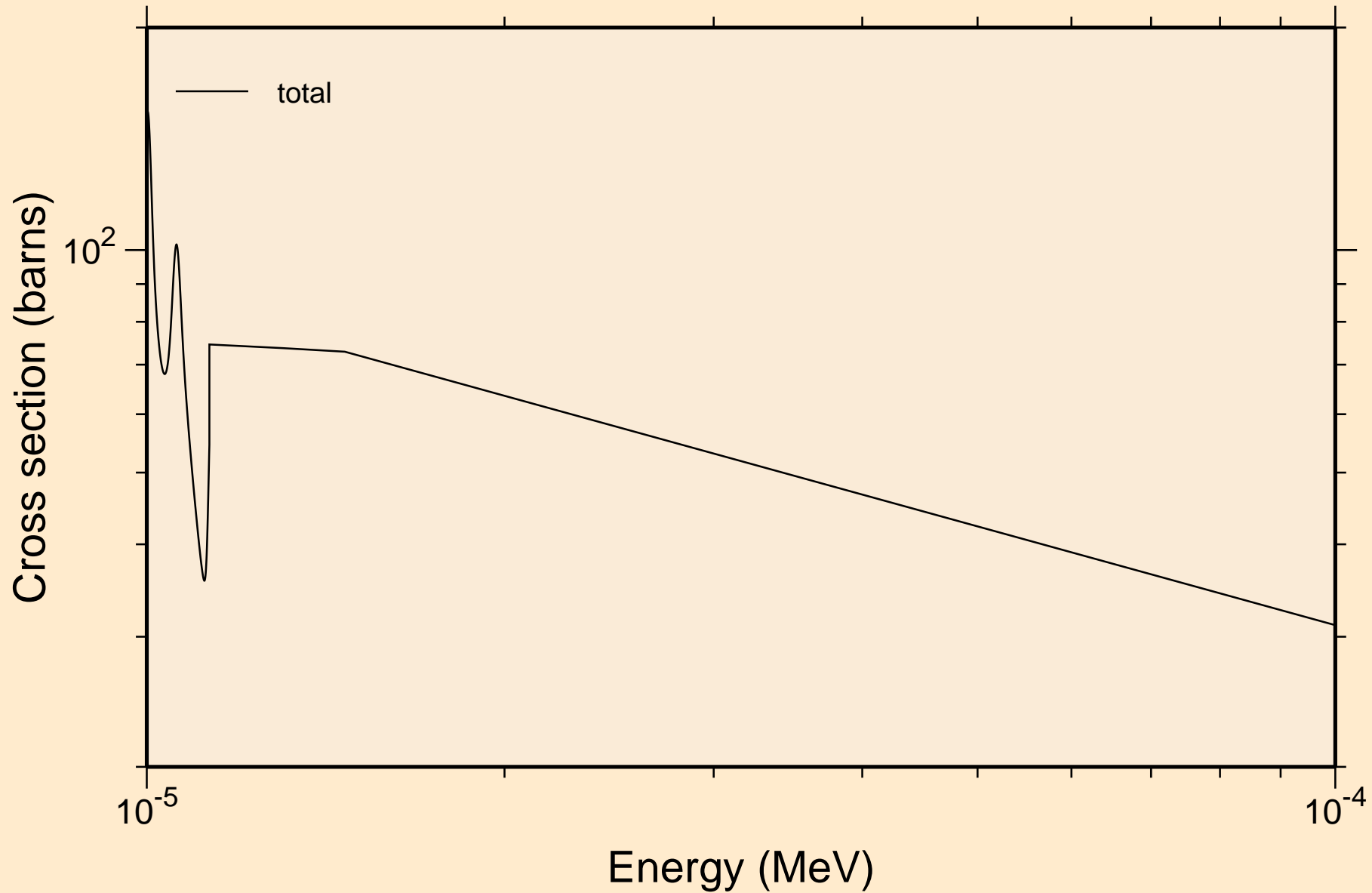

DB262 NEUTRON ACER TENDL-2021 LIBRARY; T=293.6K
resonance total cross section

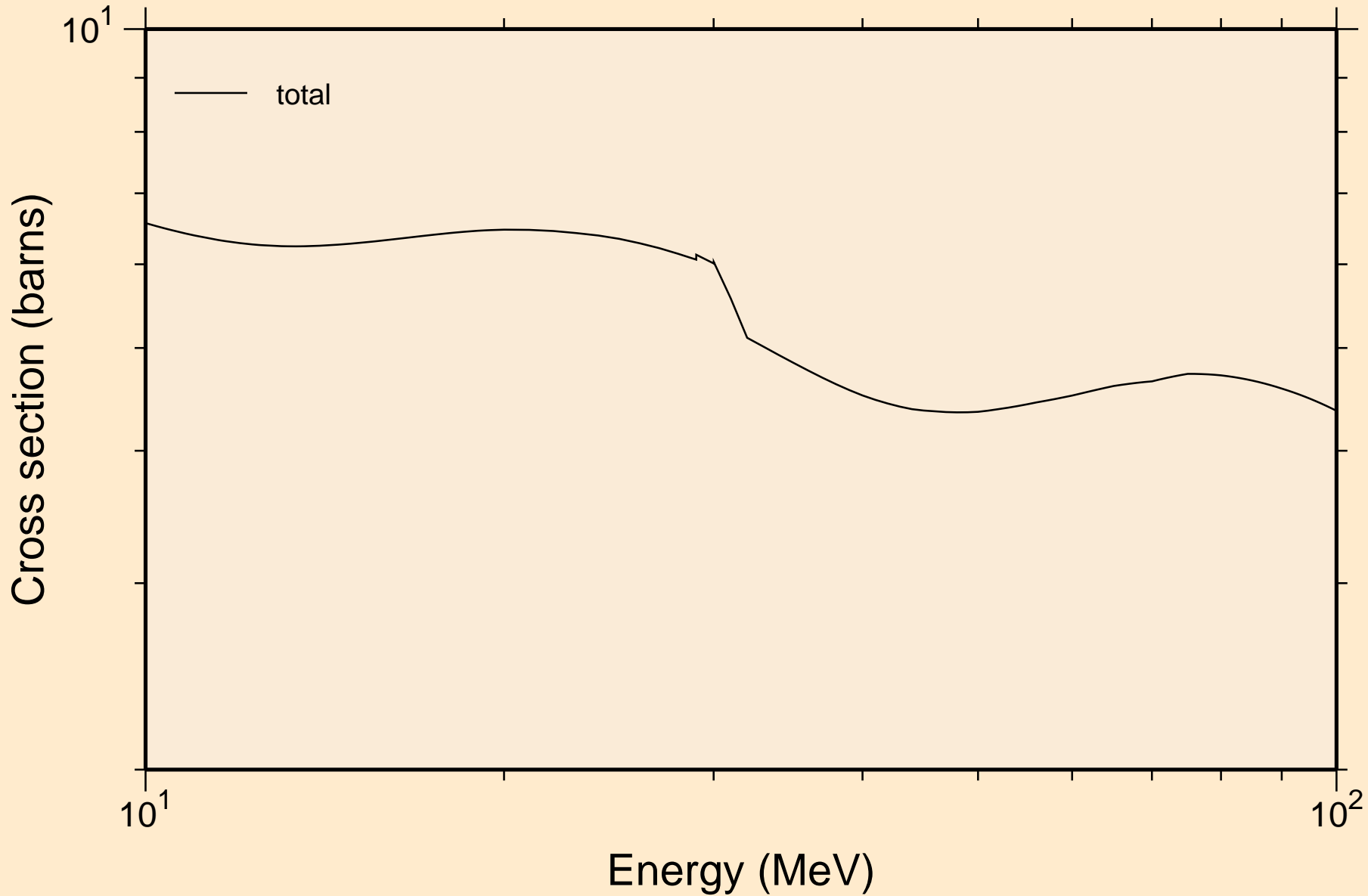

DB262 NEUTRON ACER TENDL-2021 LIBRARY; T=293.6K
resonance absorption cross sections

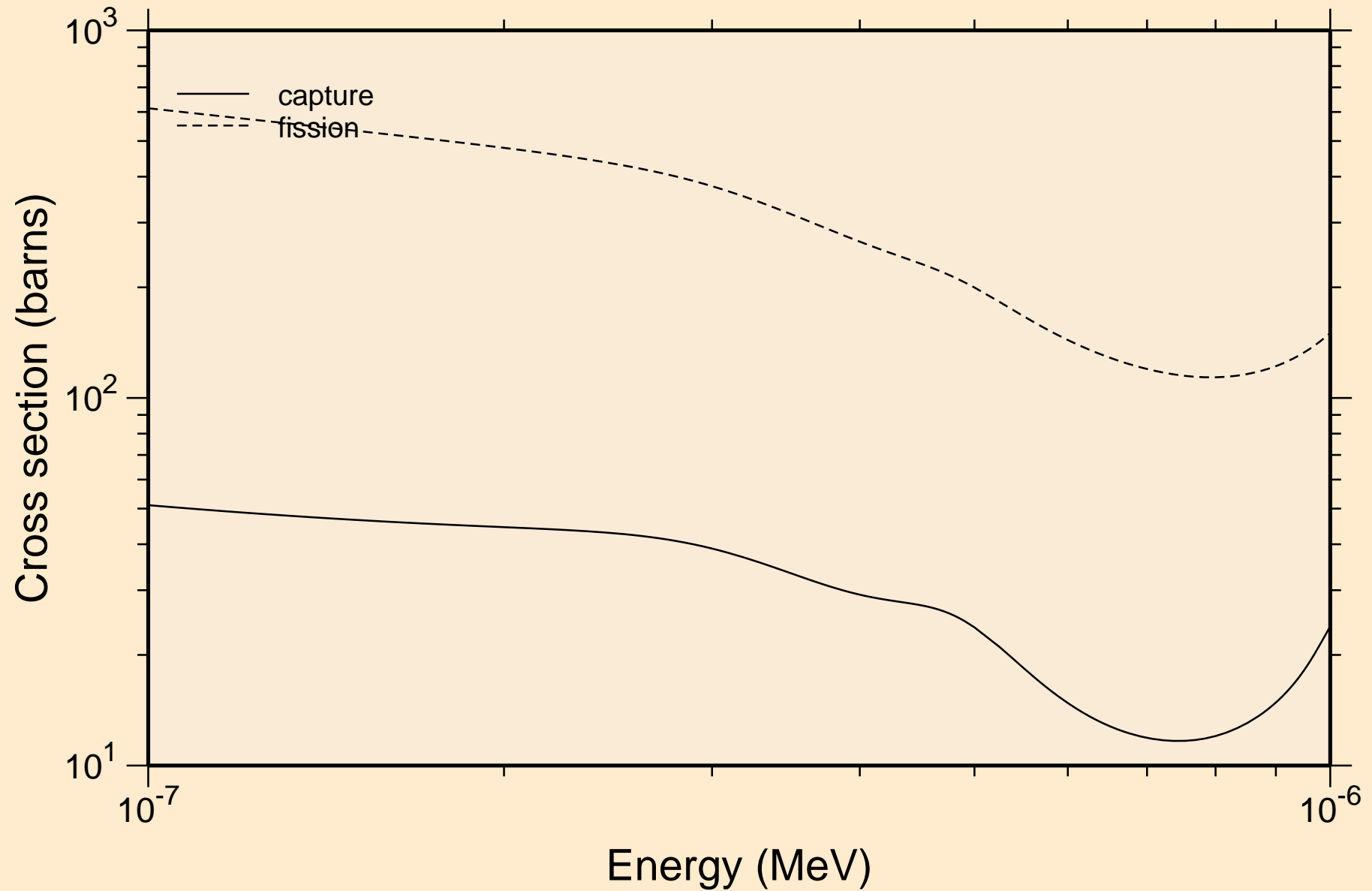

DB262 NEUTRON ACER TENDL-2021 LIBRARY; T=293.6K
resonance absorption cross sections

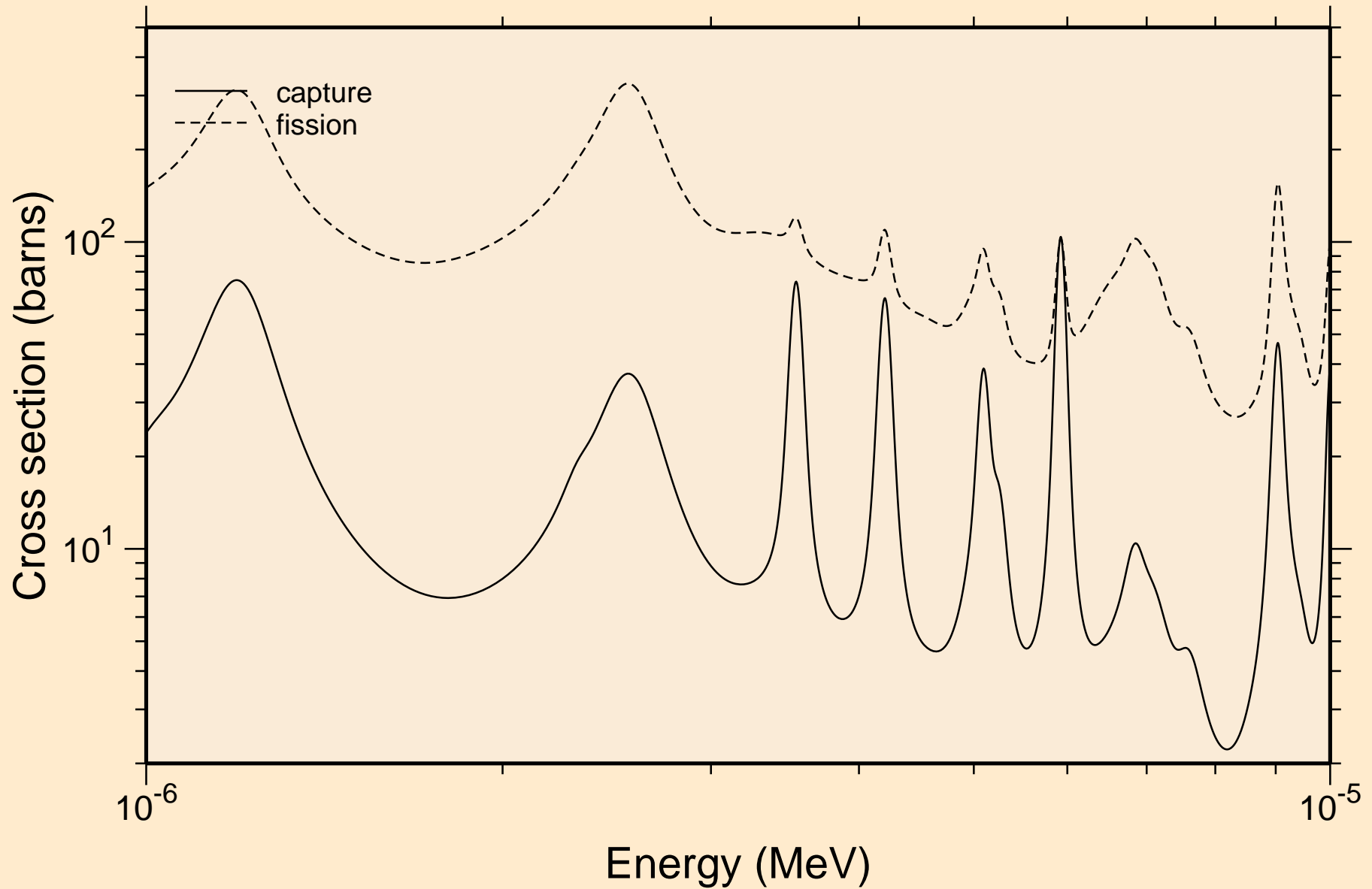

DB262 NEUTRON ACER TENDL-2021 LIBRARY; T=293.6K
resonance absorption cross sections

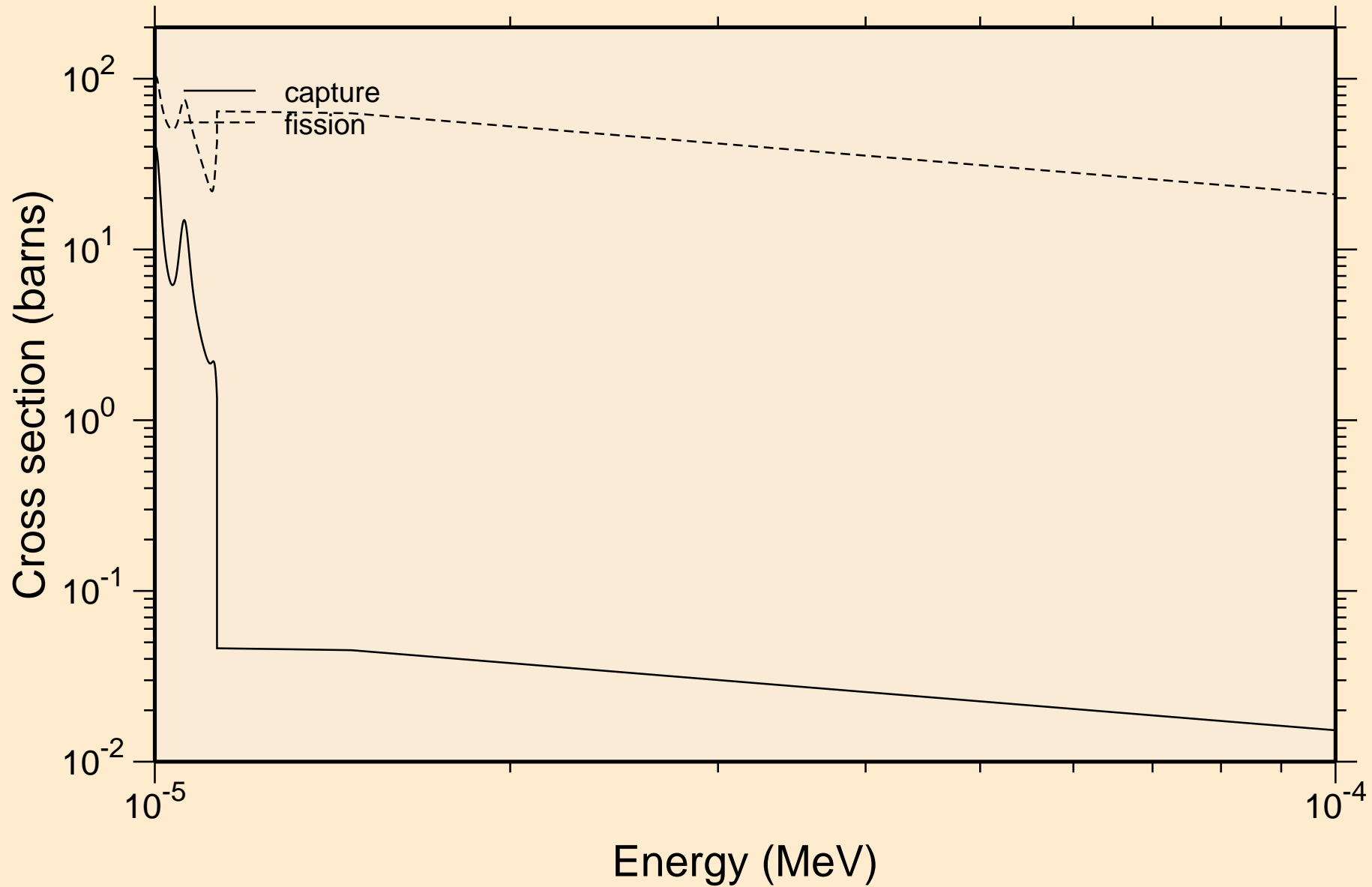

DB262 NEUTRON ACER TENDL-2021 LIBRARY; T=293.6K
resonance absorption cross sections

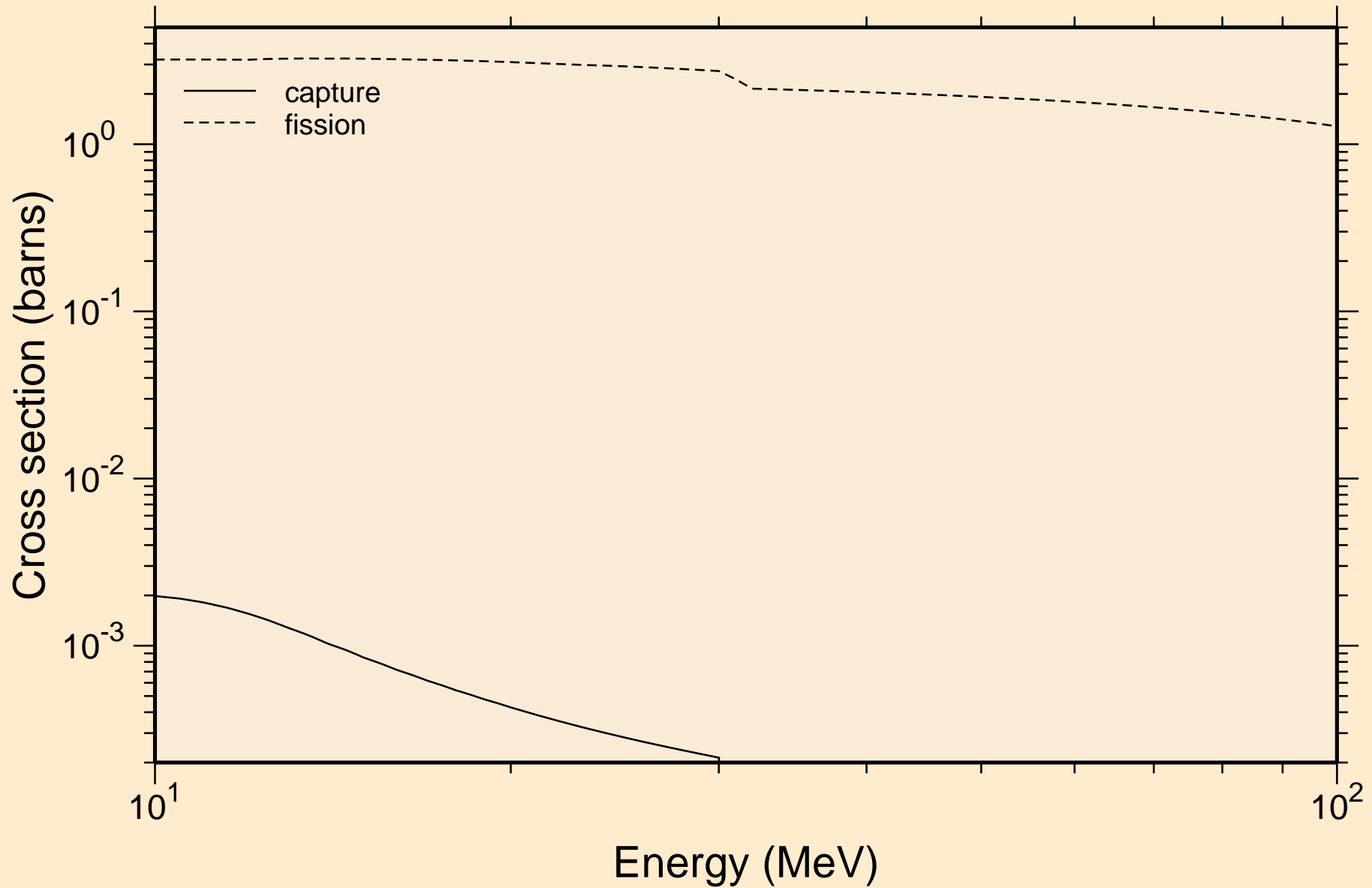

DB262 NEUTRON ACER TENDL-2021 LIBRARY; T=293.6K
Heating

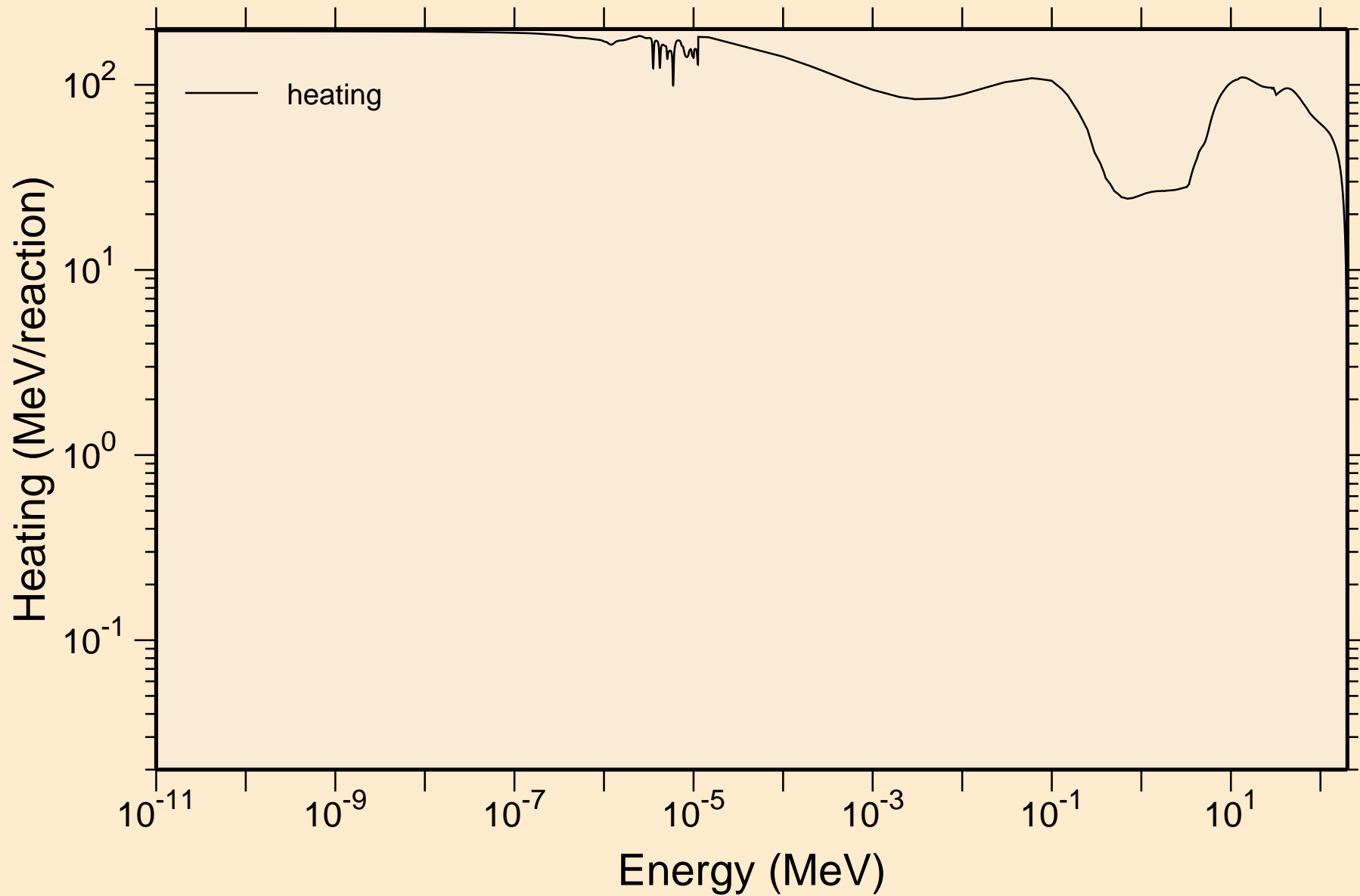

DB262 NEUTRON ACER TENDL-2021 LIBRARY; T=293.6K
Damage

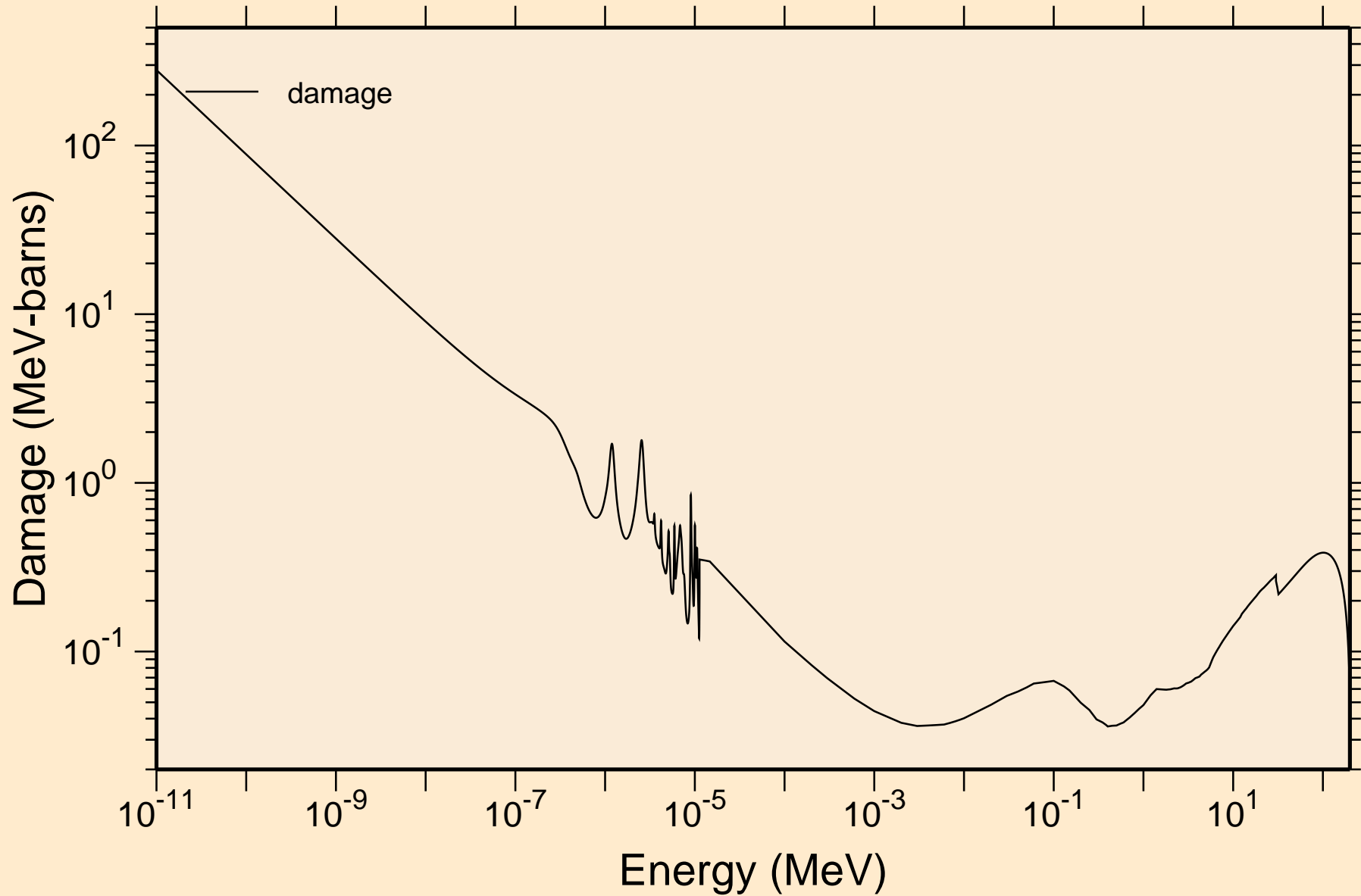

DB262 NEUTRON ACER TENDL-2021 LIBRARY; T=293.6K
Non-threshold reactions

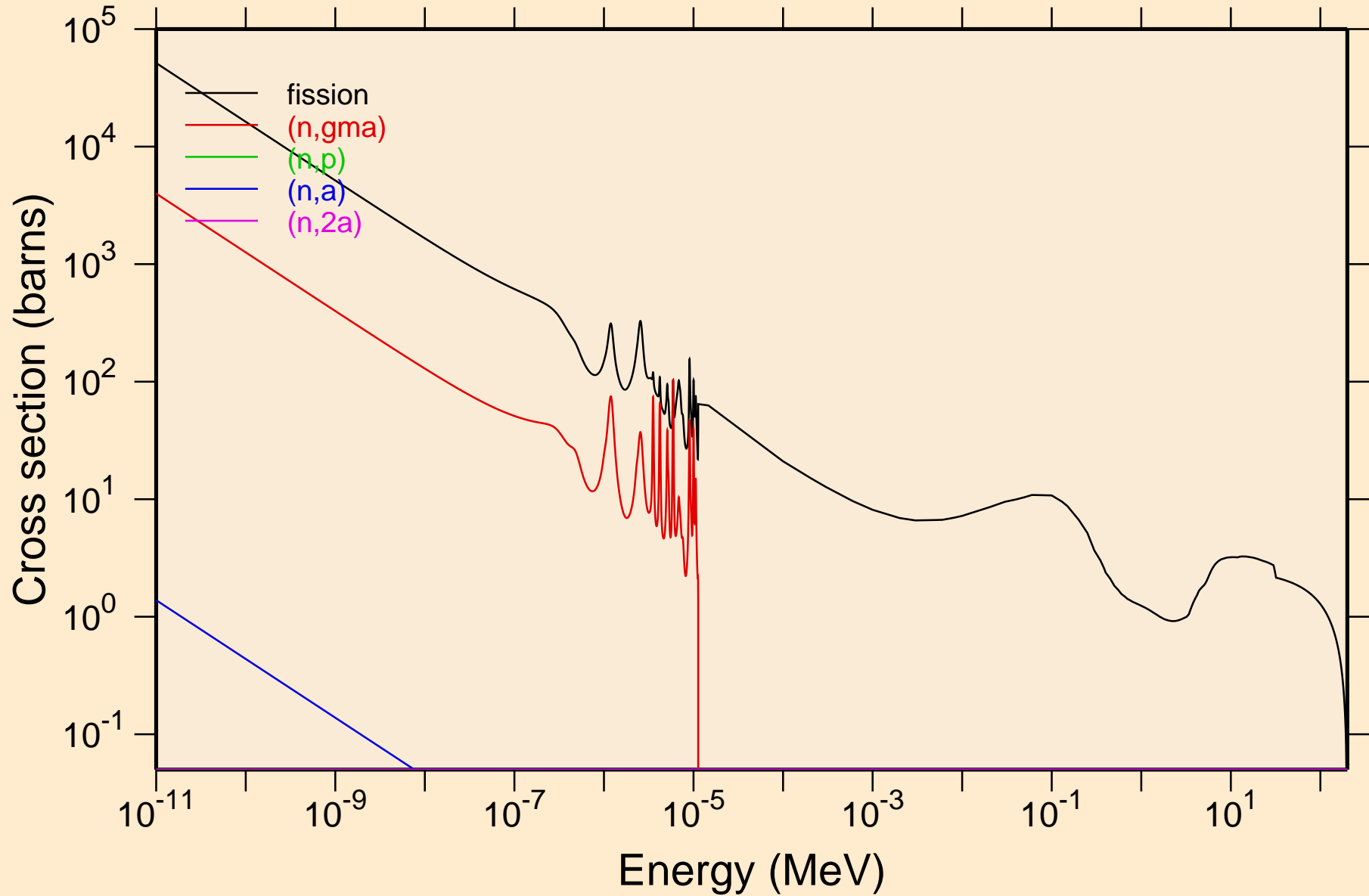

DB262 NEUTRON ACER TENDL-2021 LIBRARY; T=293.6K
Non-threshold reactions

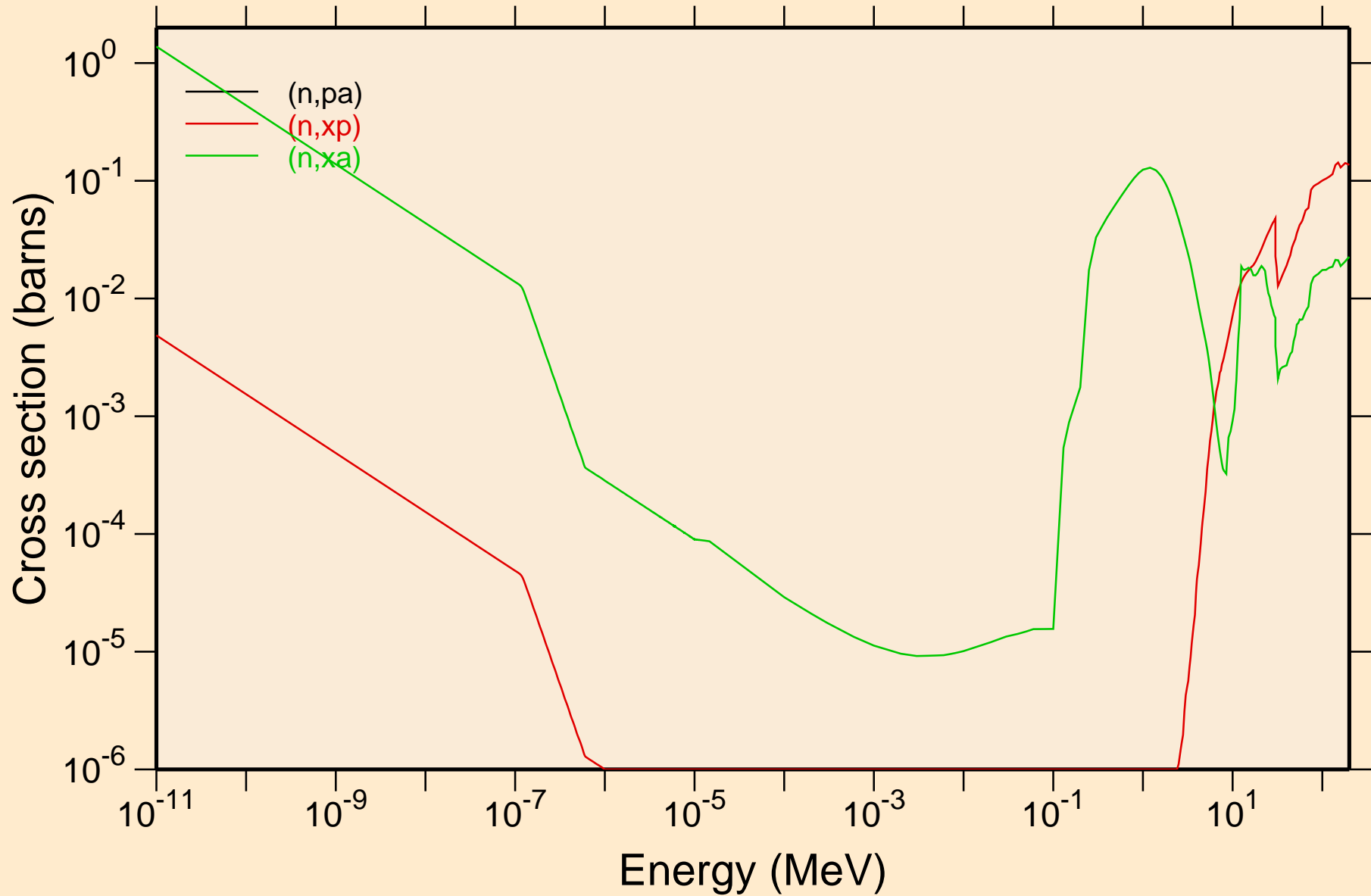

DB262 NEUTRON ACER TENDL-2021 LIBRARY; T=293.6K
Principal cross sections

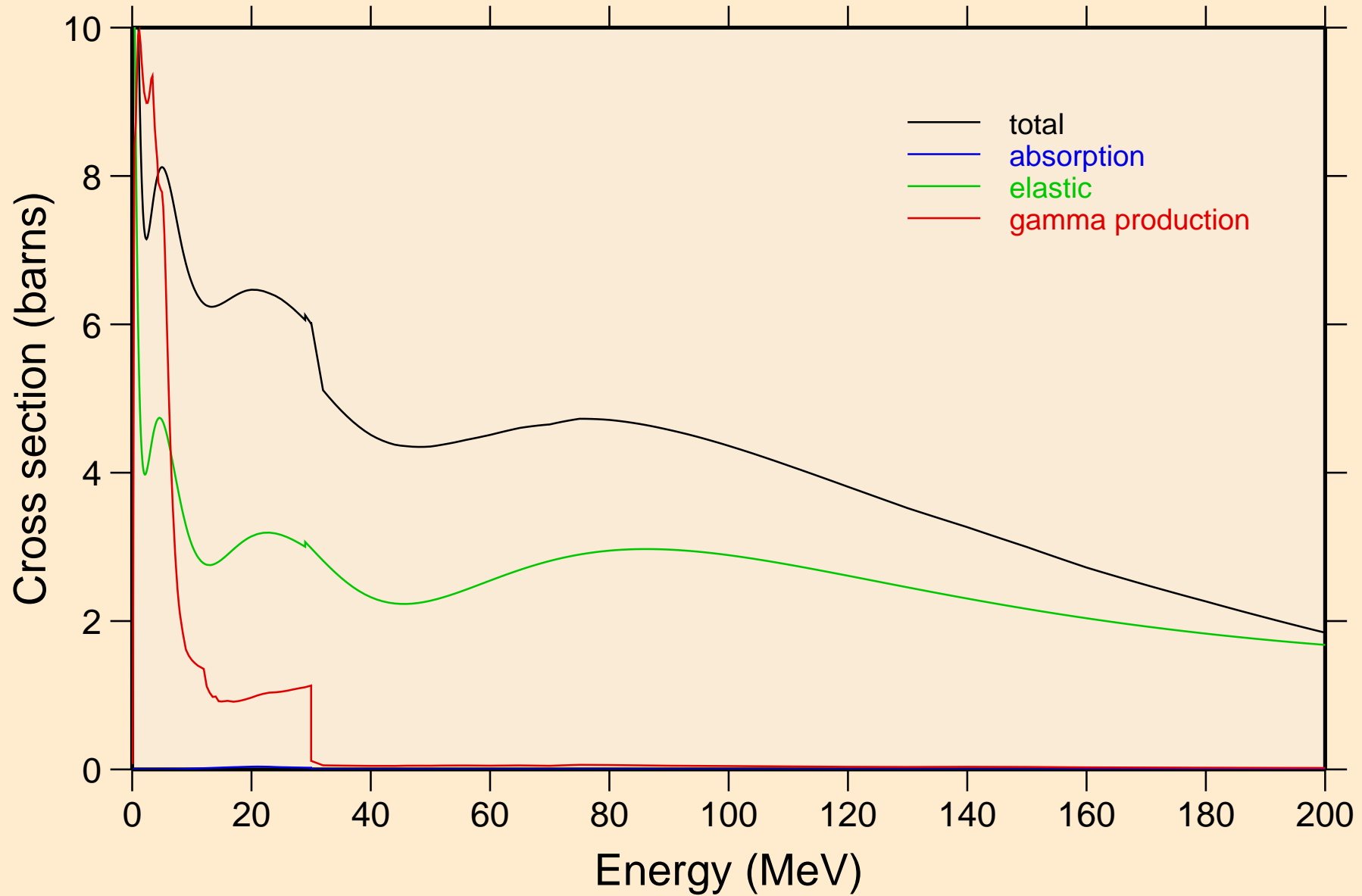

DB262 NEUTRON ACER TENDL-2021 LIBRARY; T=293.6K
Heating

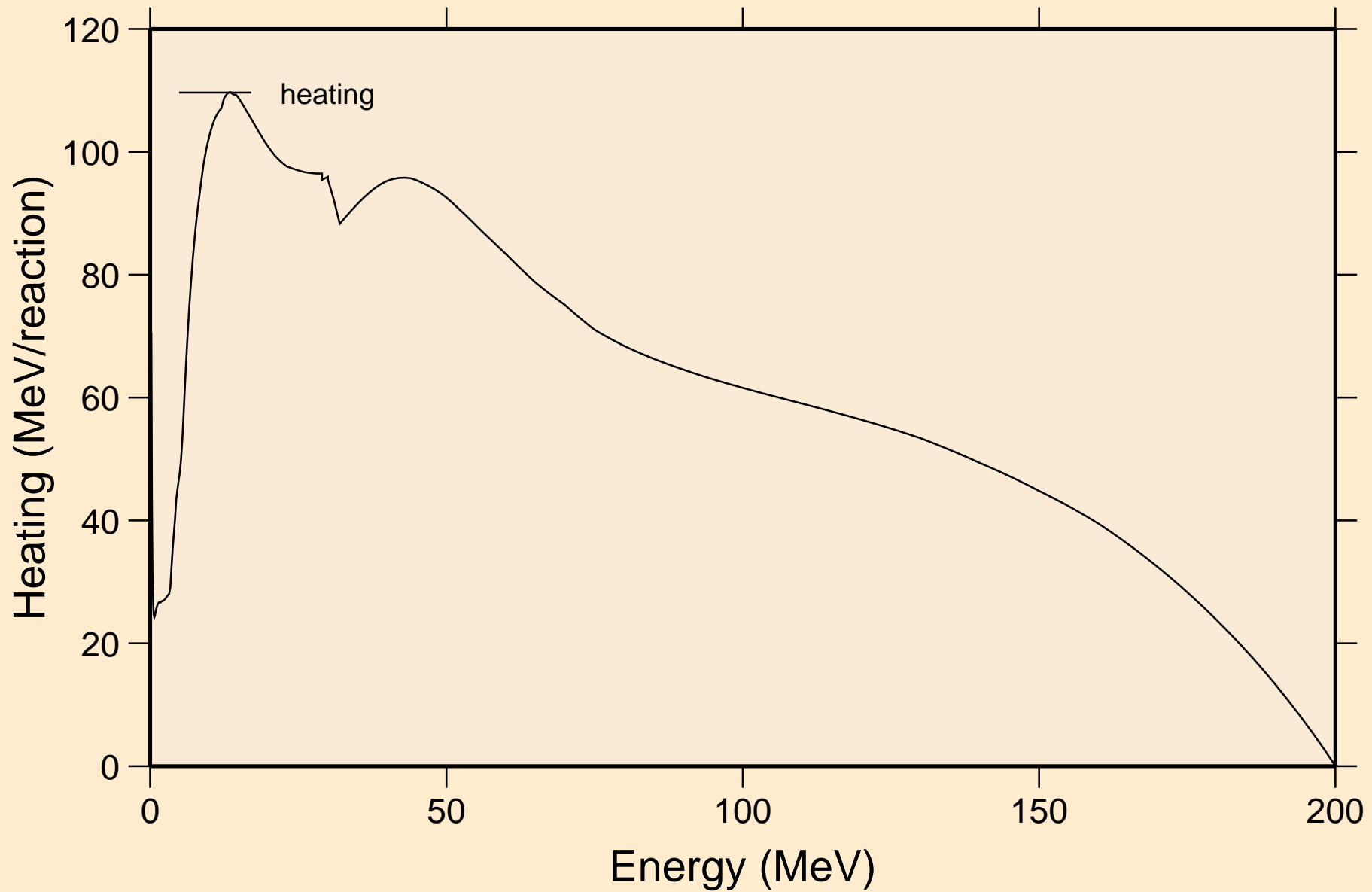

DB262 NEUTRON ACER TENDL-2021 LIBRARY; T=293.6K
Damage

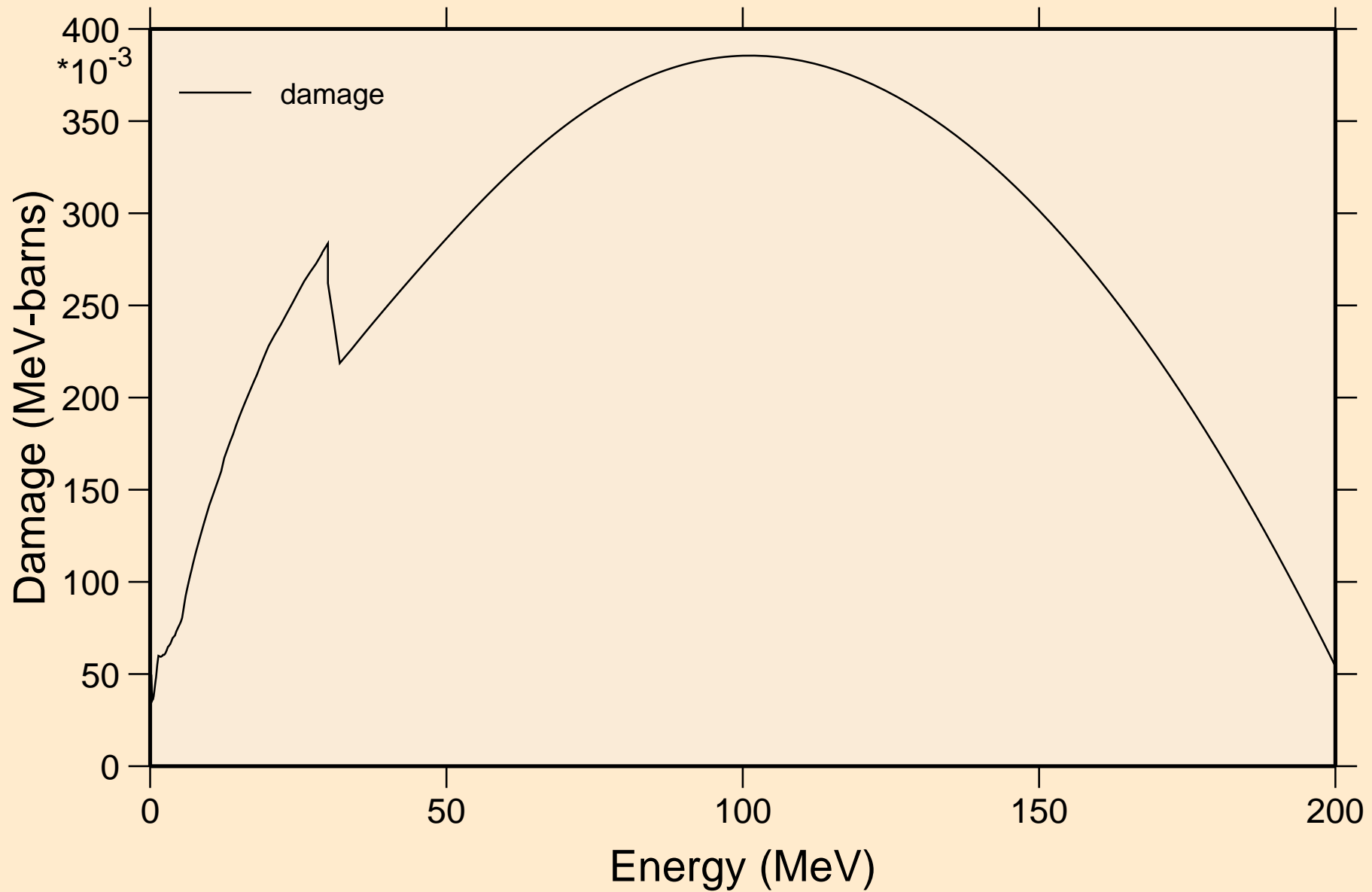

DB262 NEUTRON ACER TENDL-2021 LIBRARY; T=293.6K
Non-threshold reactions

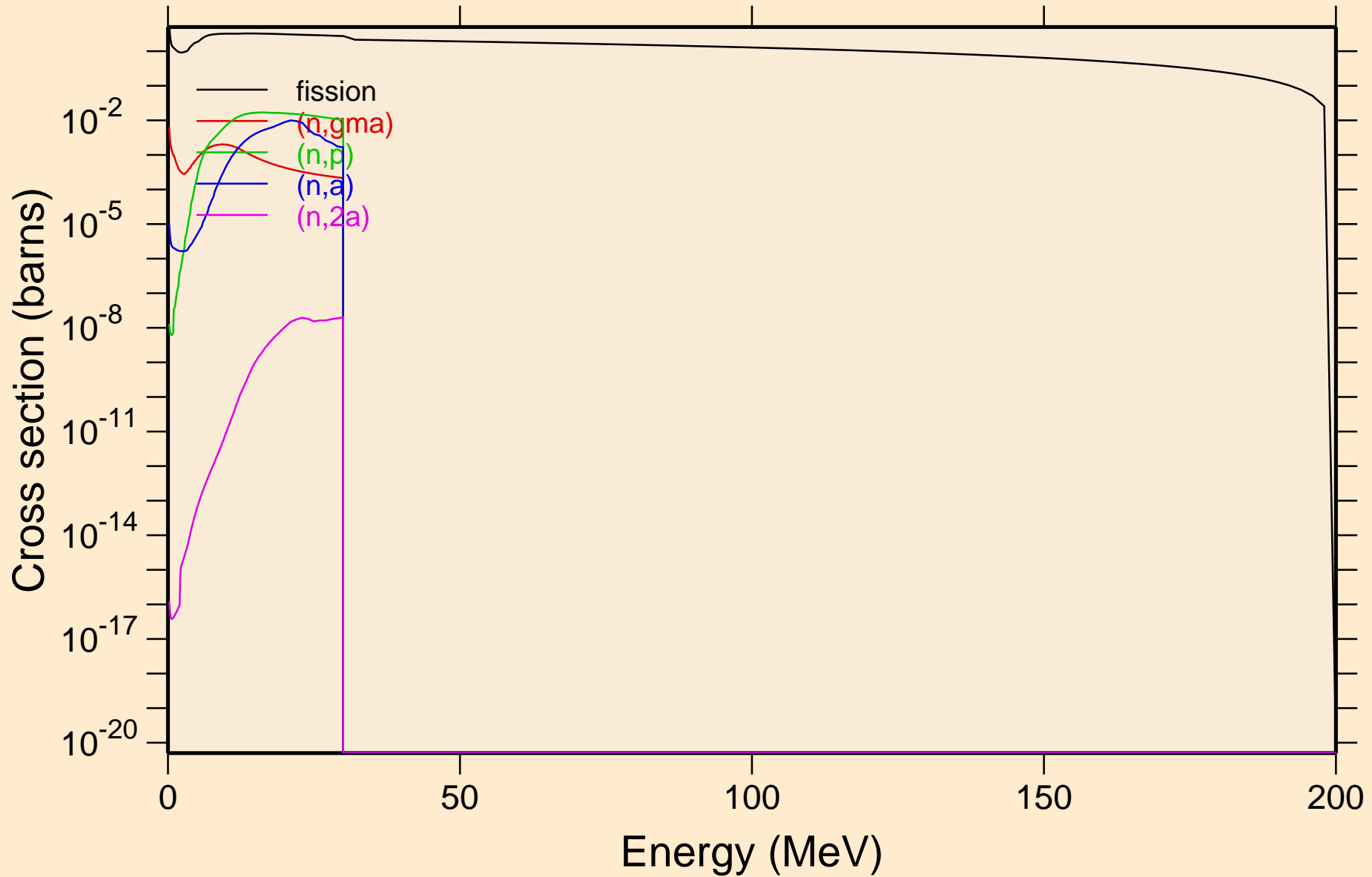

DB262 NEUTRON ACER TENDL-2021 LIBRARY; T=293.6K
Non-threshold reactions

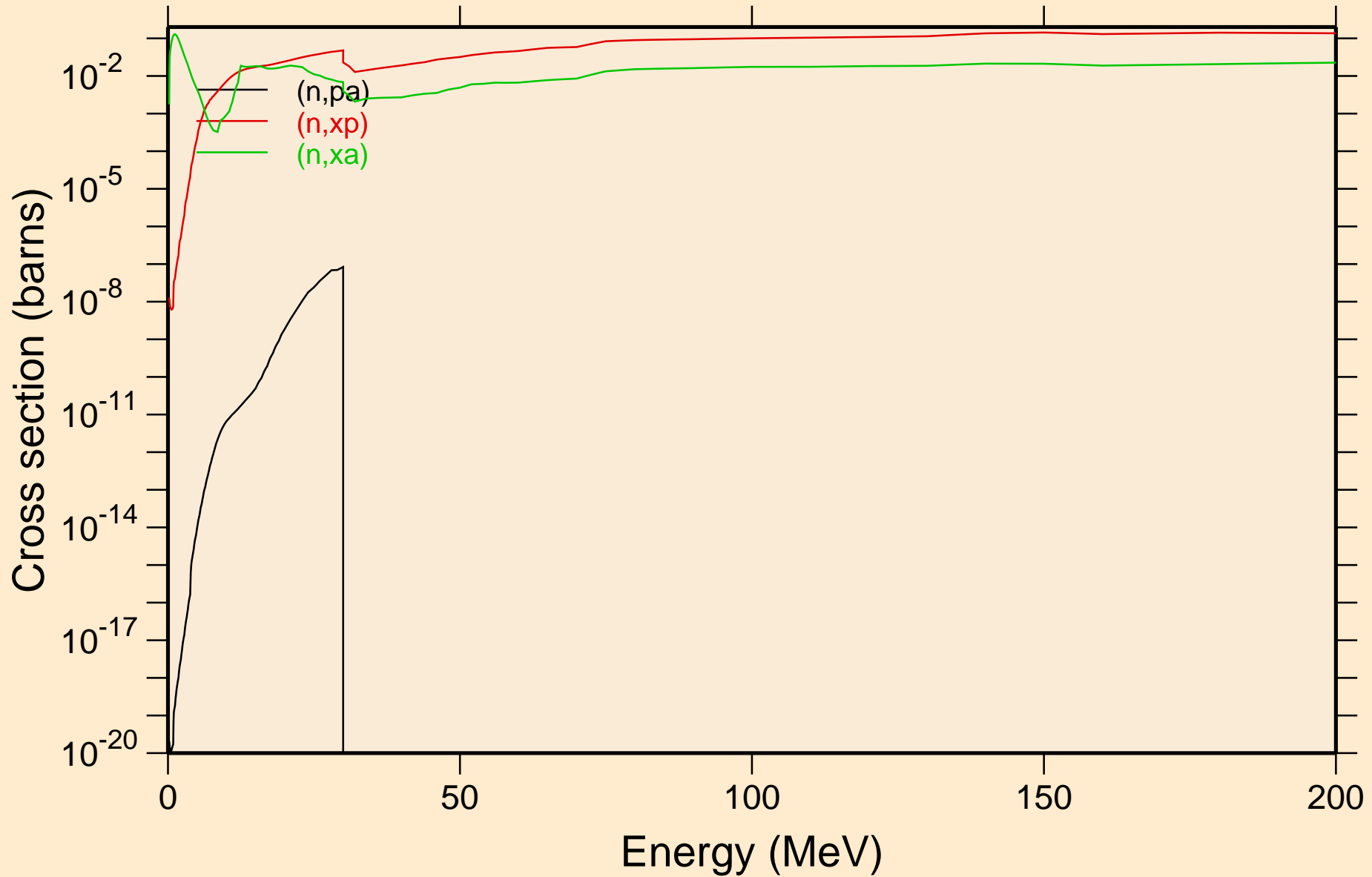

DB262 NEUTRON ACER TENDL-2021 LIBRARY; T=293.6K
Inelastic levels

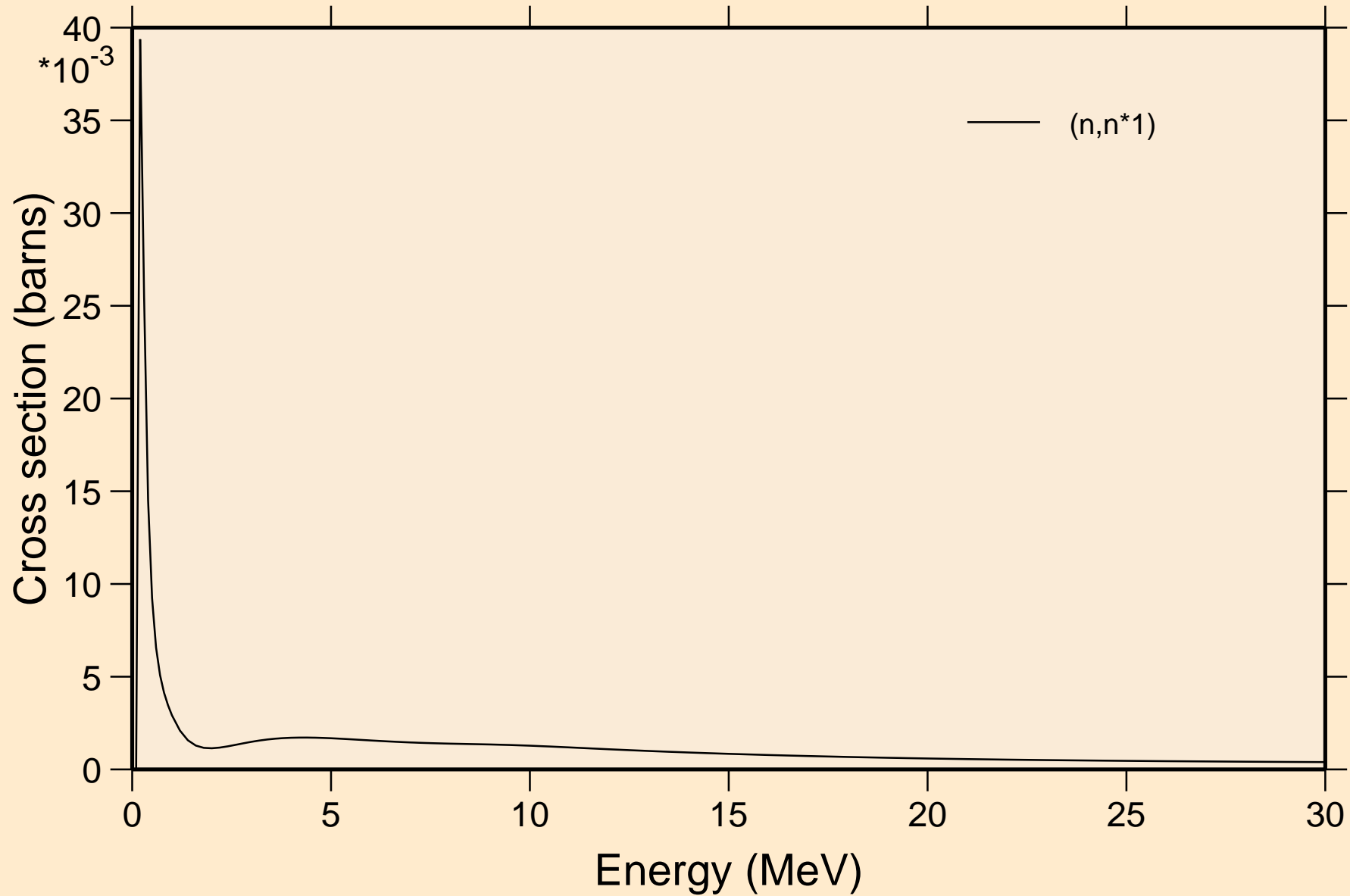

DB262 NEUTRON ACER TENDL-2021 LIBRARY; T=293.6K
Threshold reactions

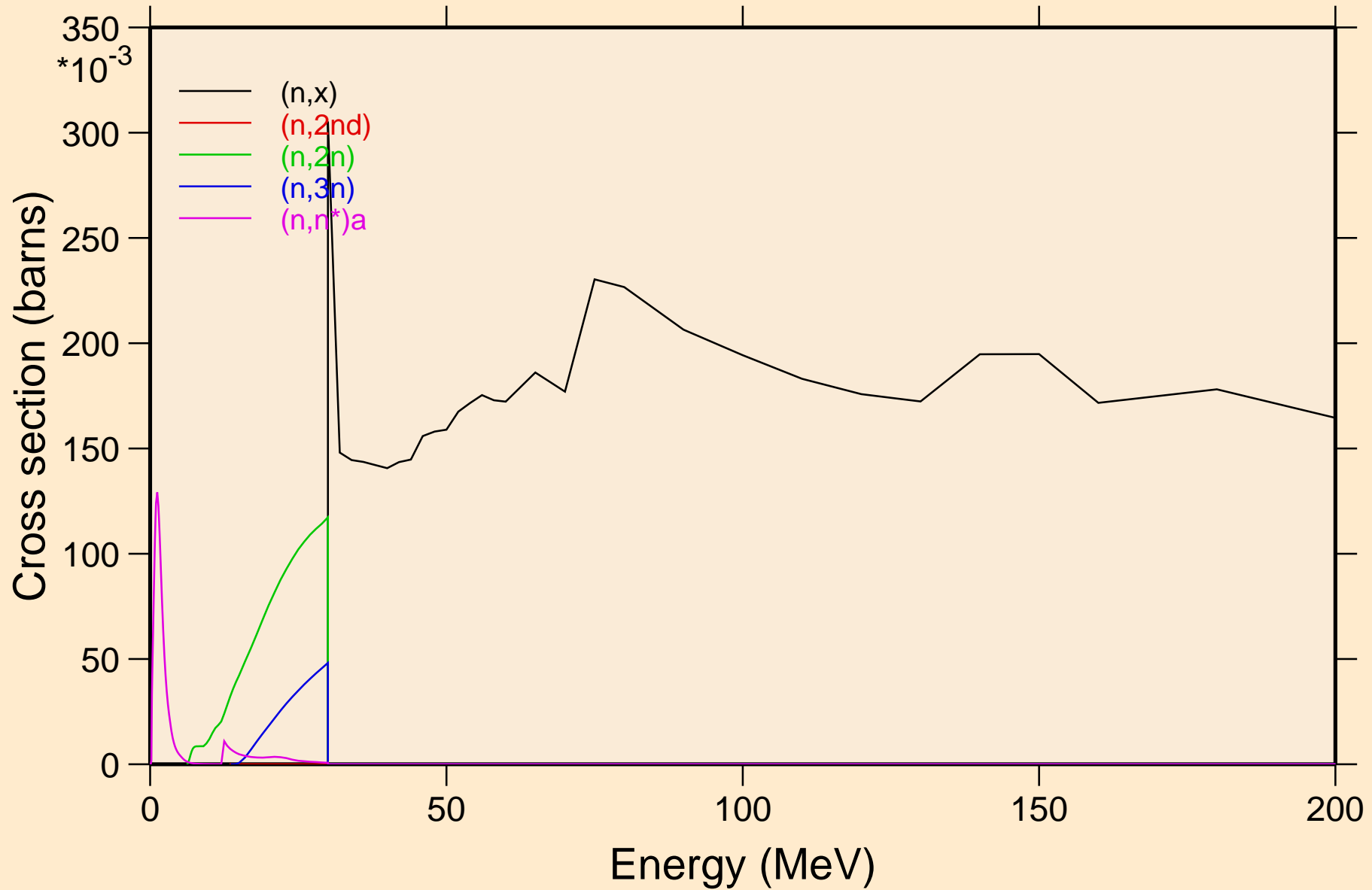

DB262 NEUTRON ACER TENDL-2021 LIBRARY; T=293.6K
Threshold reactions

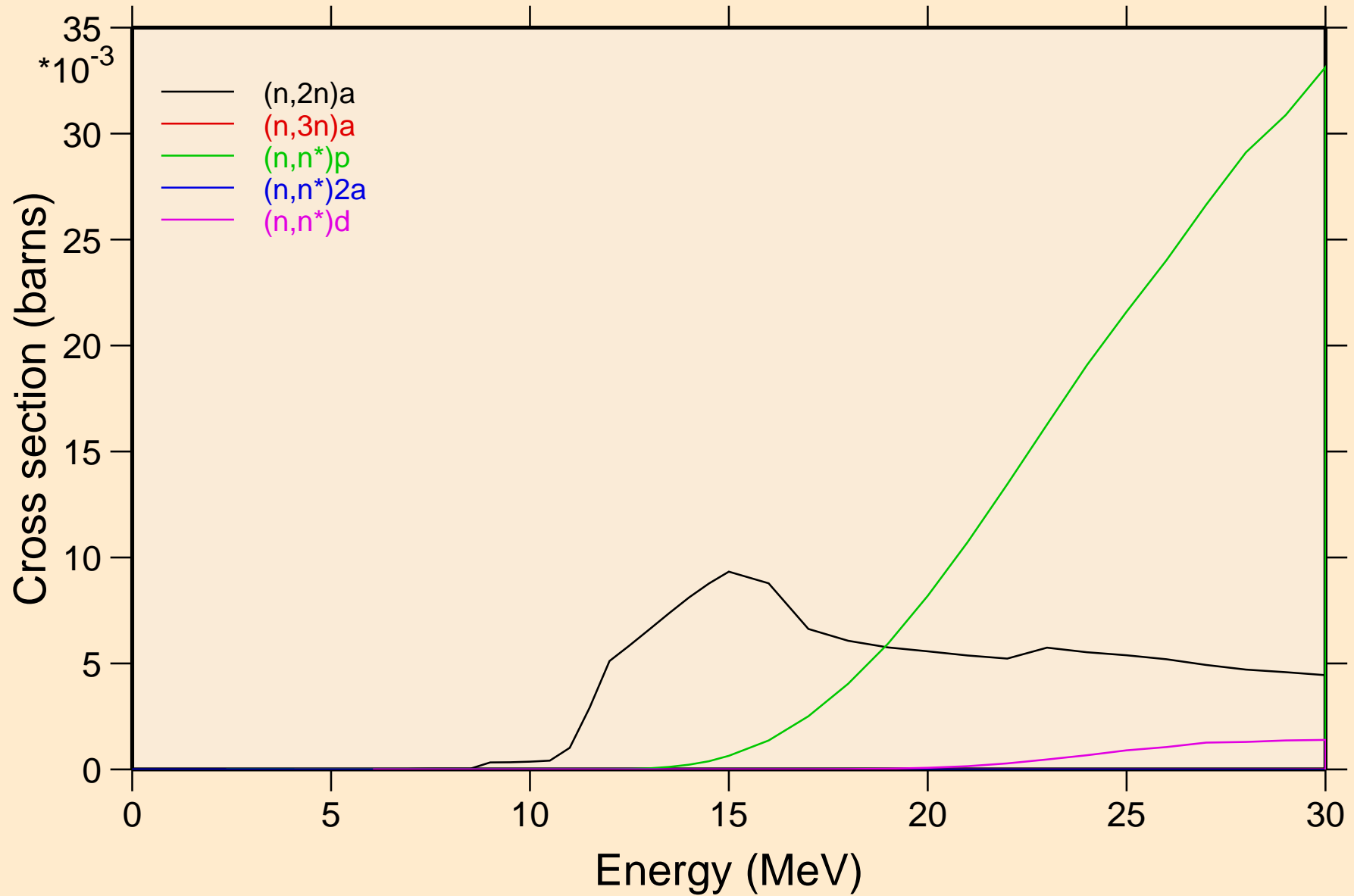

DB262 NEUTRON ACER TENDL-2021 LIBRARY; T=293.6K
Threshold reactions

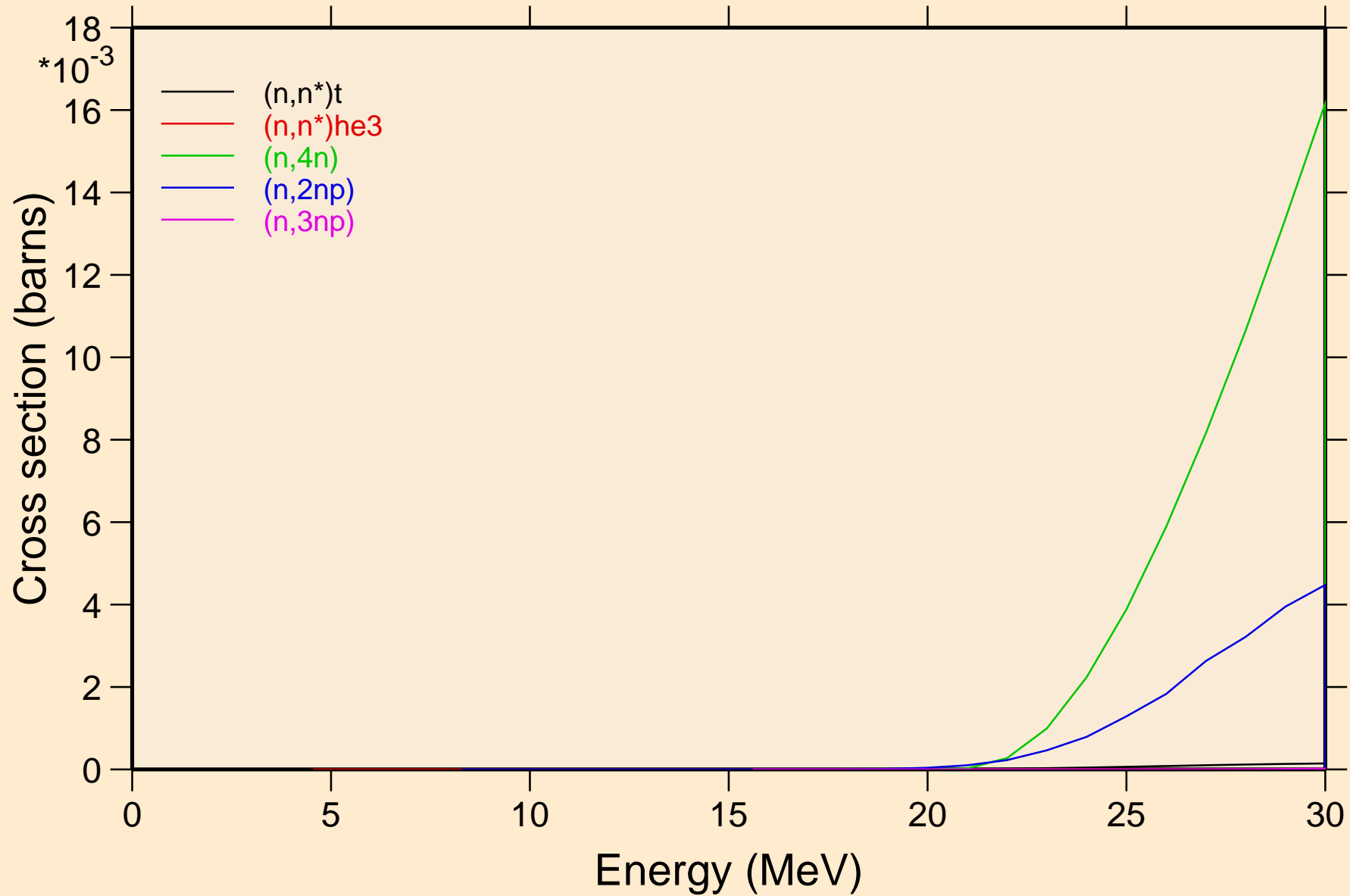

DB262 NEUTRON ACER TENDL-2021 LIBRARY; T=293.6K
Threshold reactions

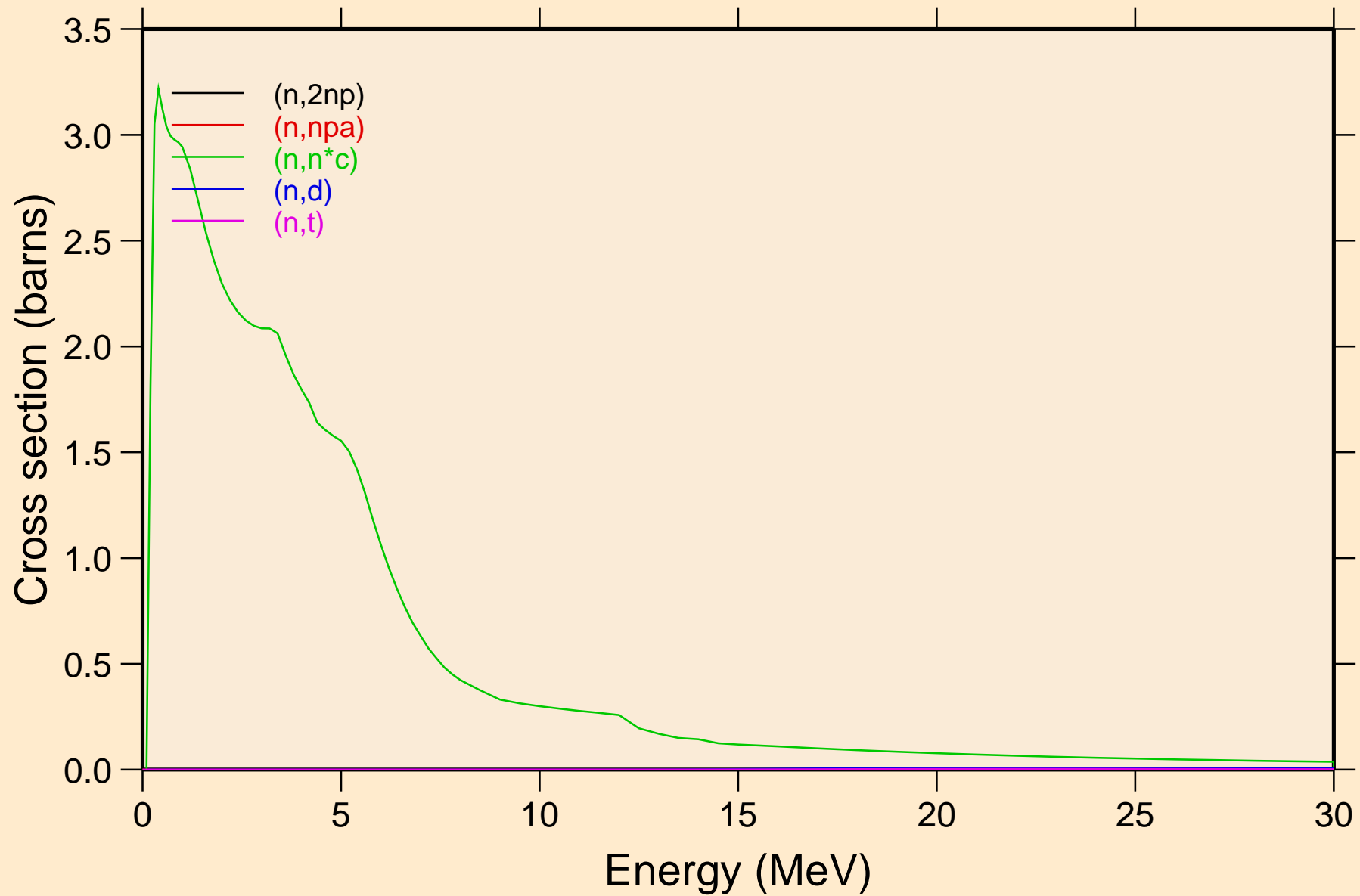

DB262 NEUTRON ACER TENDL-2021 LIBRARY; T=293.6K
Threshold reactions

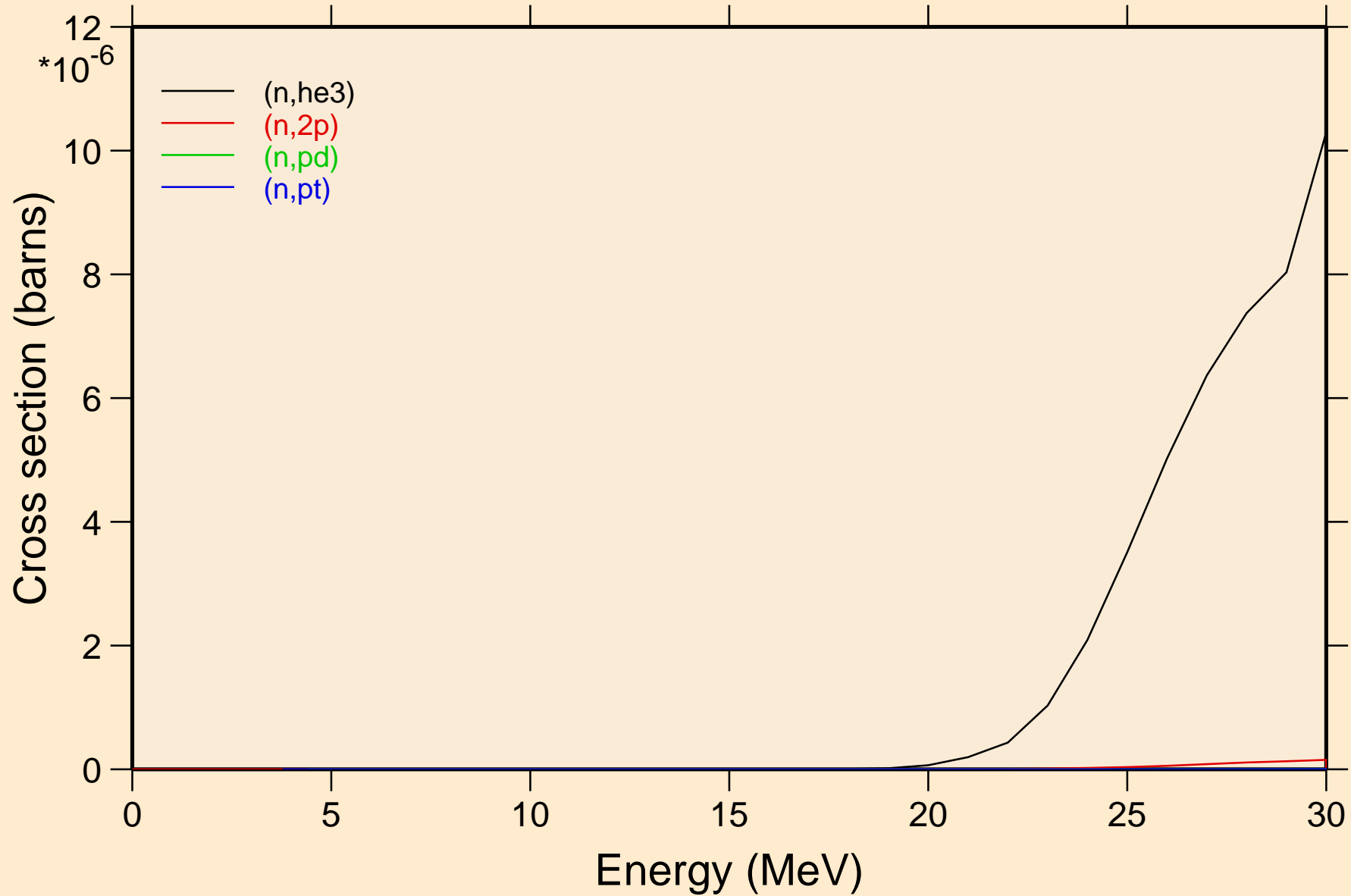

DB262 NEUTRON ACER TENDL-2021 LIBRARY; T=293.6K
Threshold reactions

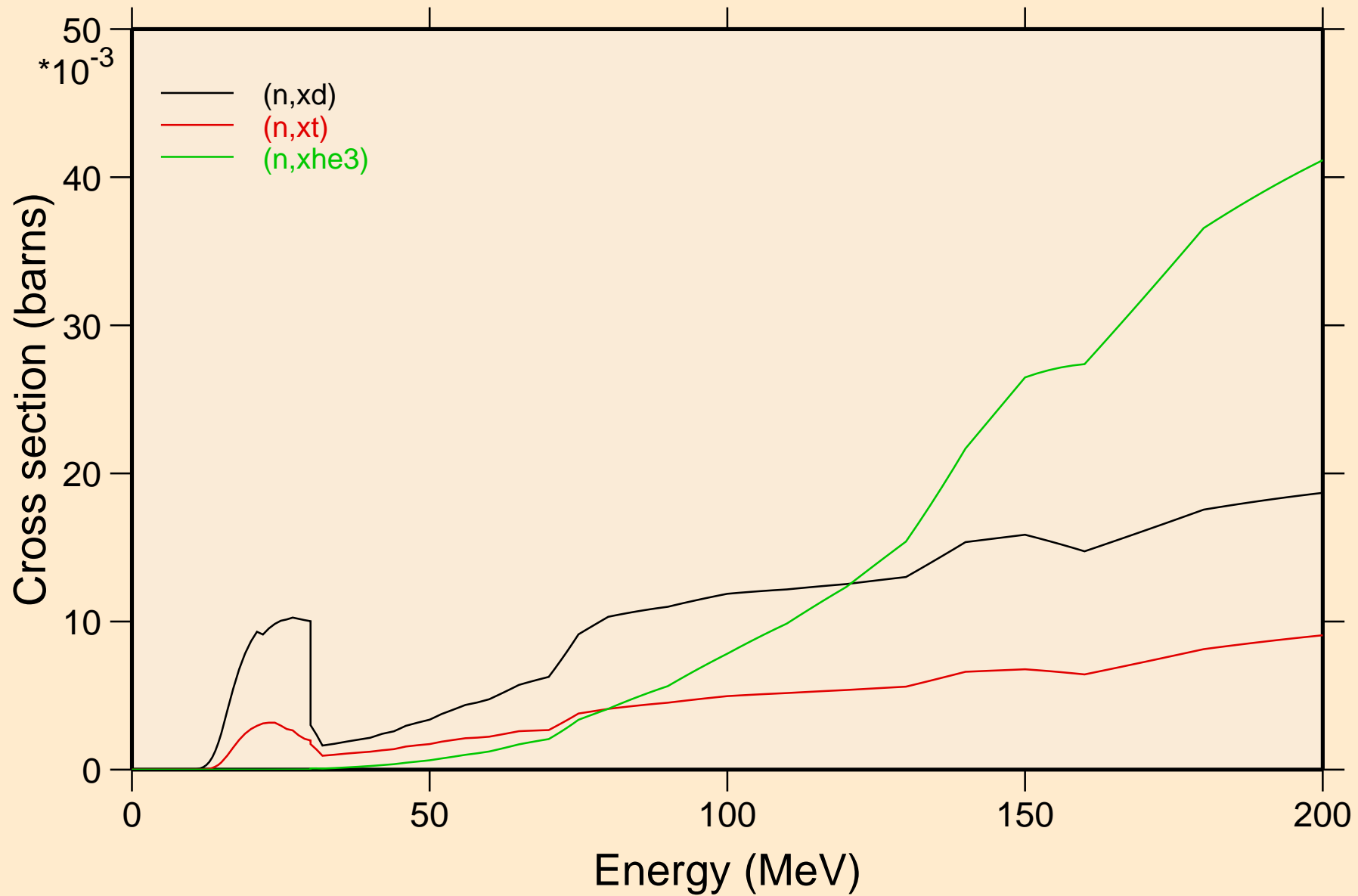

DB262 NEUTRON ACER TENDL-2021 LIBRARY; T=293.6K
angular distribution for elastic

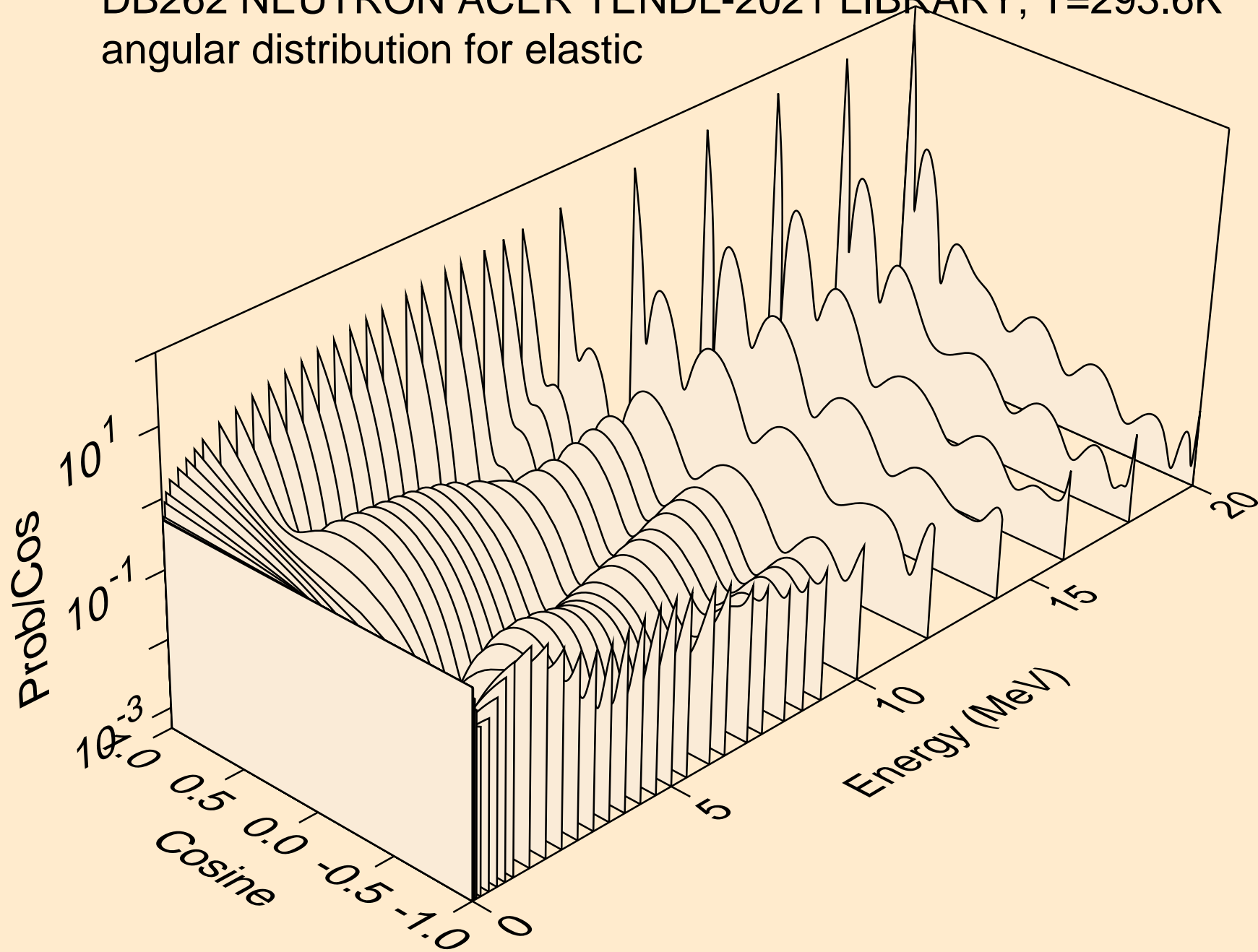

DB262 NEUTRON ACER TENDL-2021 LIBRARY; T=293.6K
angular distribution for elastic

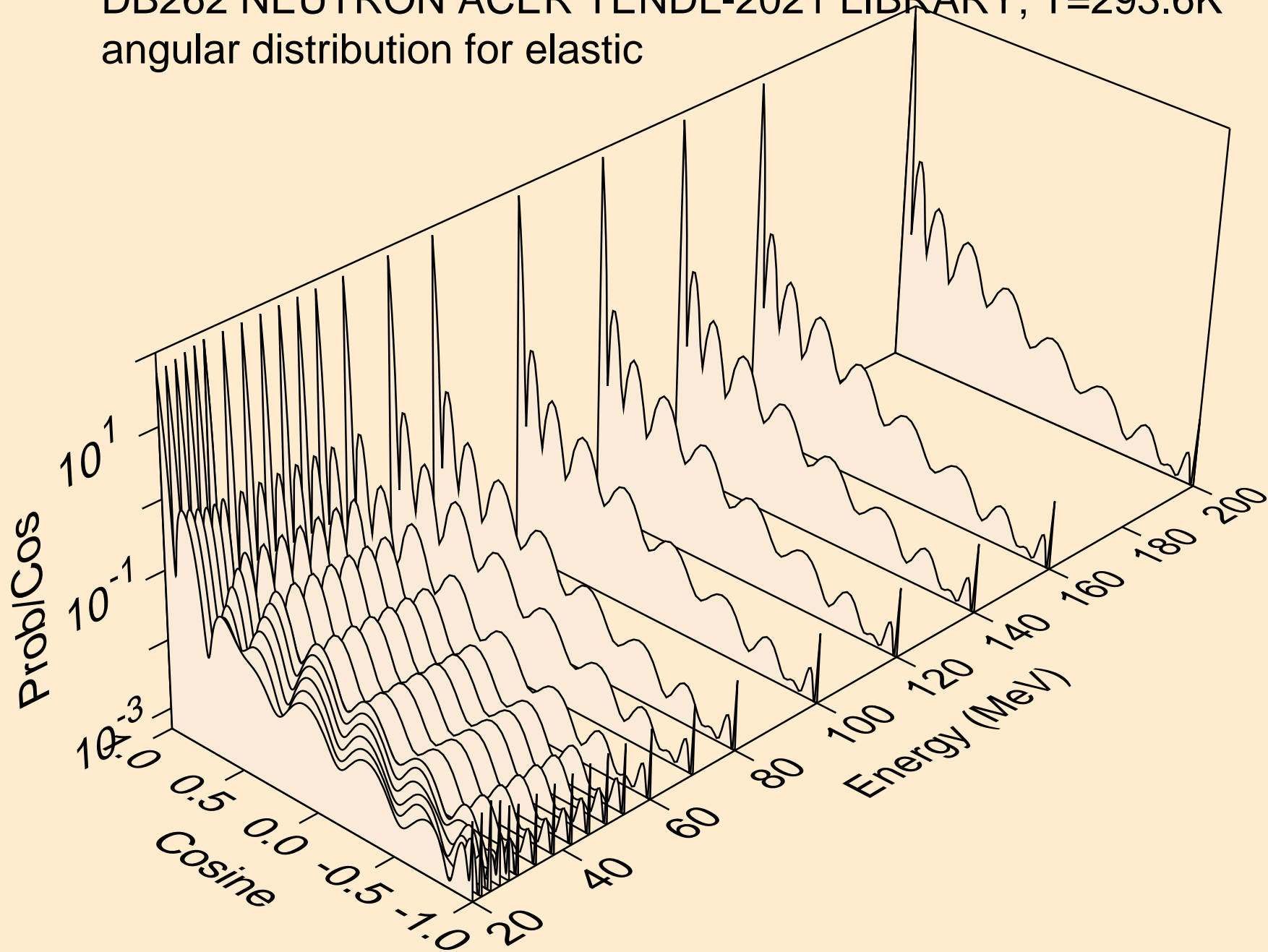

DB262 NEUTRON ACER TENDL-2021 LIBRARY; T=293.6K
angular distribution for (n,n*1)

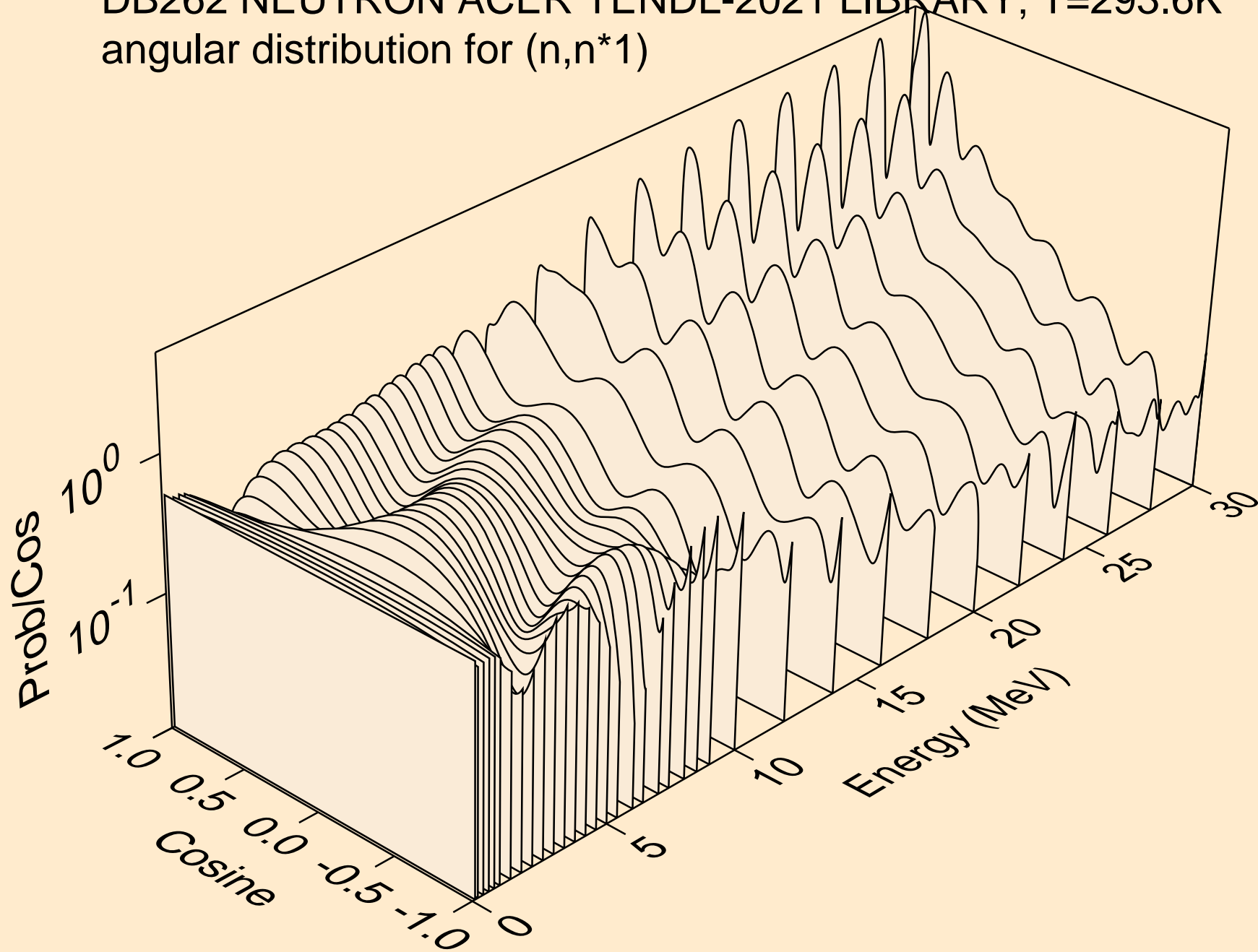

DB262 NEUTRON ACER TENDL-2021 LIBRARY; T=293.6K
Total fission nubar

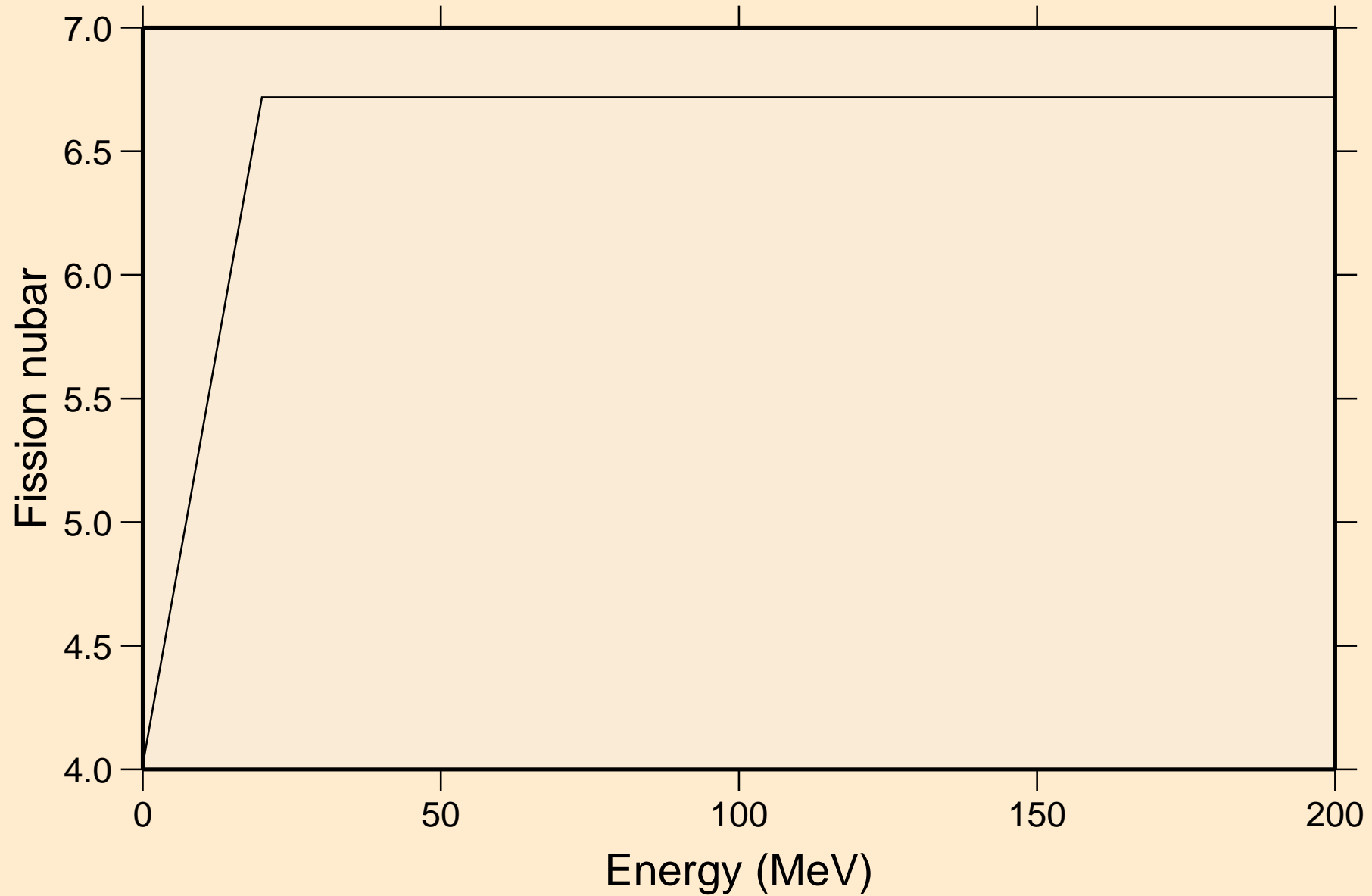

DB262 NEUTRON ACER TENDL-2021 LIBRARY; T=293.6K
Neutron emission for (n,x)

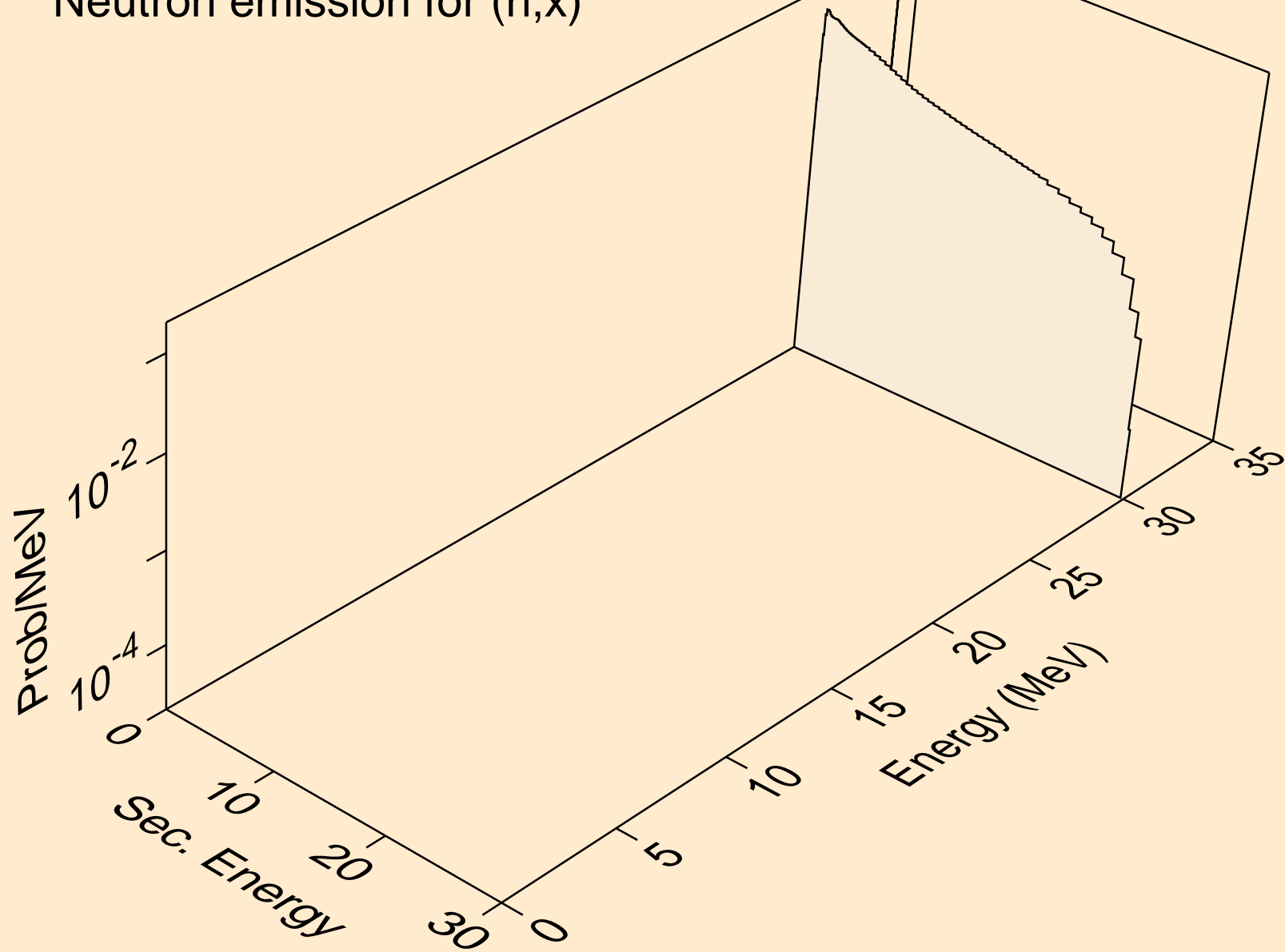

DB262 NEUTRON ACER TENDL-2021 LIBRARY; T=293.6K
Neutron emission for (n,2nd)

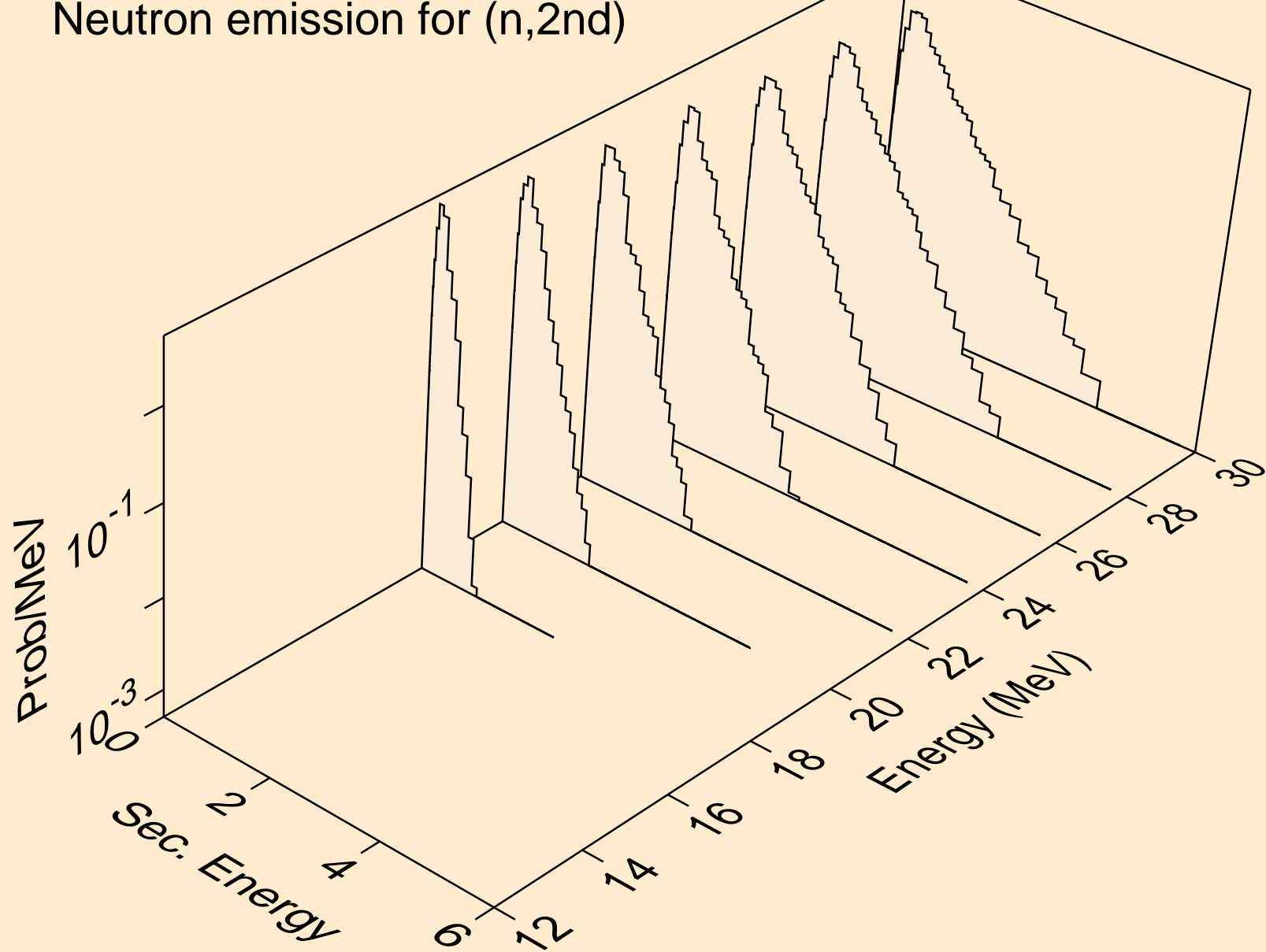

DB262 NEUTRON ACER TENDL-2021 LIBRARY; T=293.6K
Neutron emission for (n,2n)

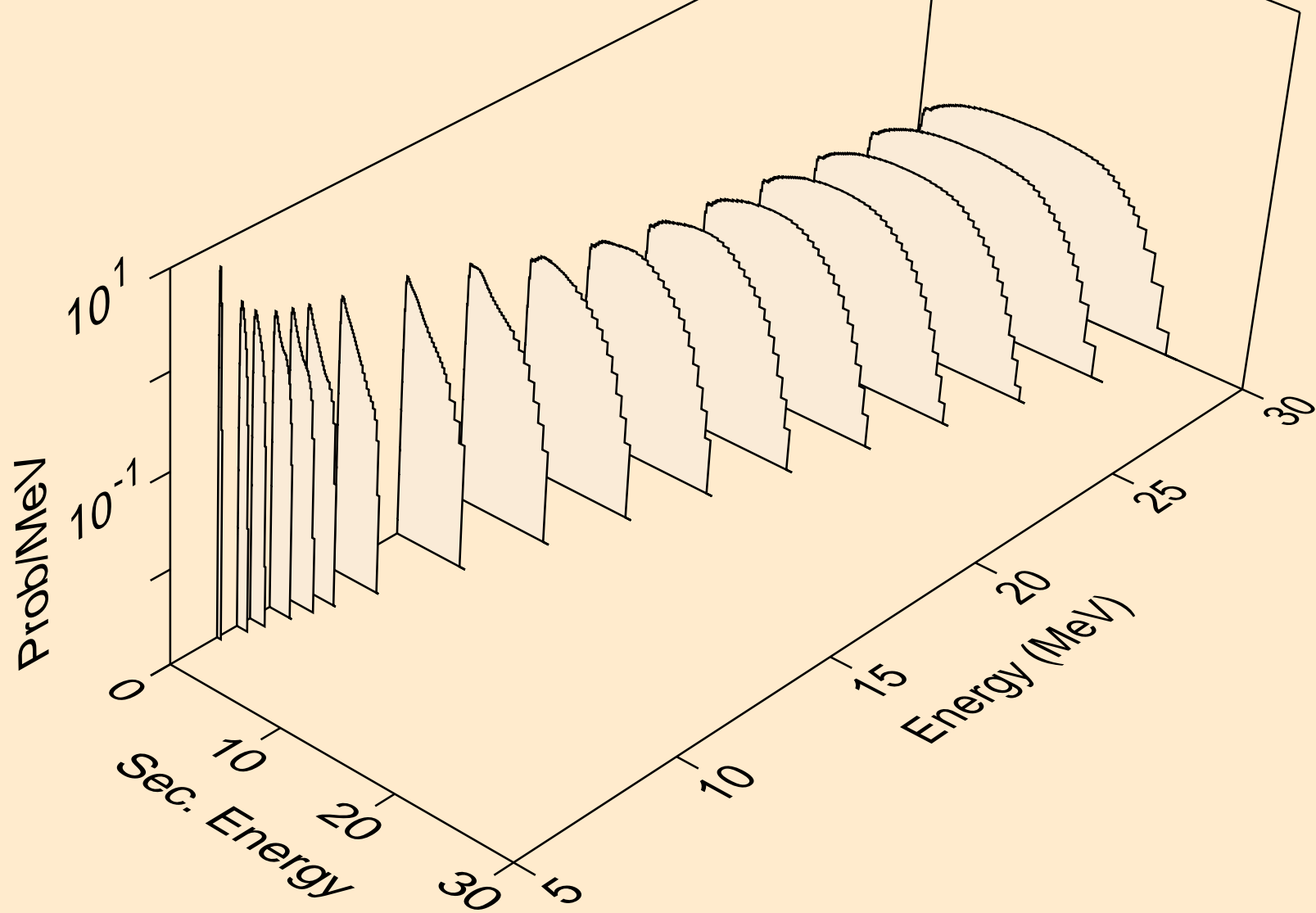

DB262 NEUTRON ACER TENDL-2021 LIBRARY; T=293.6K
Neutron emission for (n,3n)

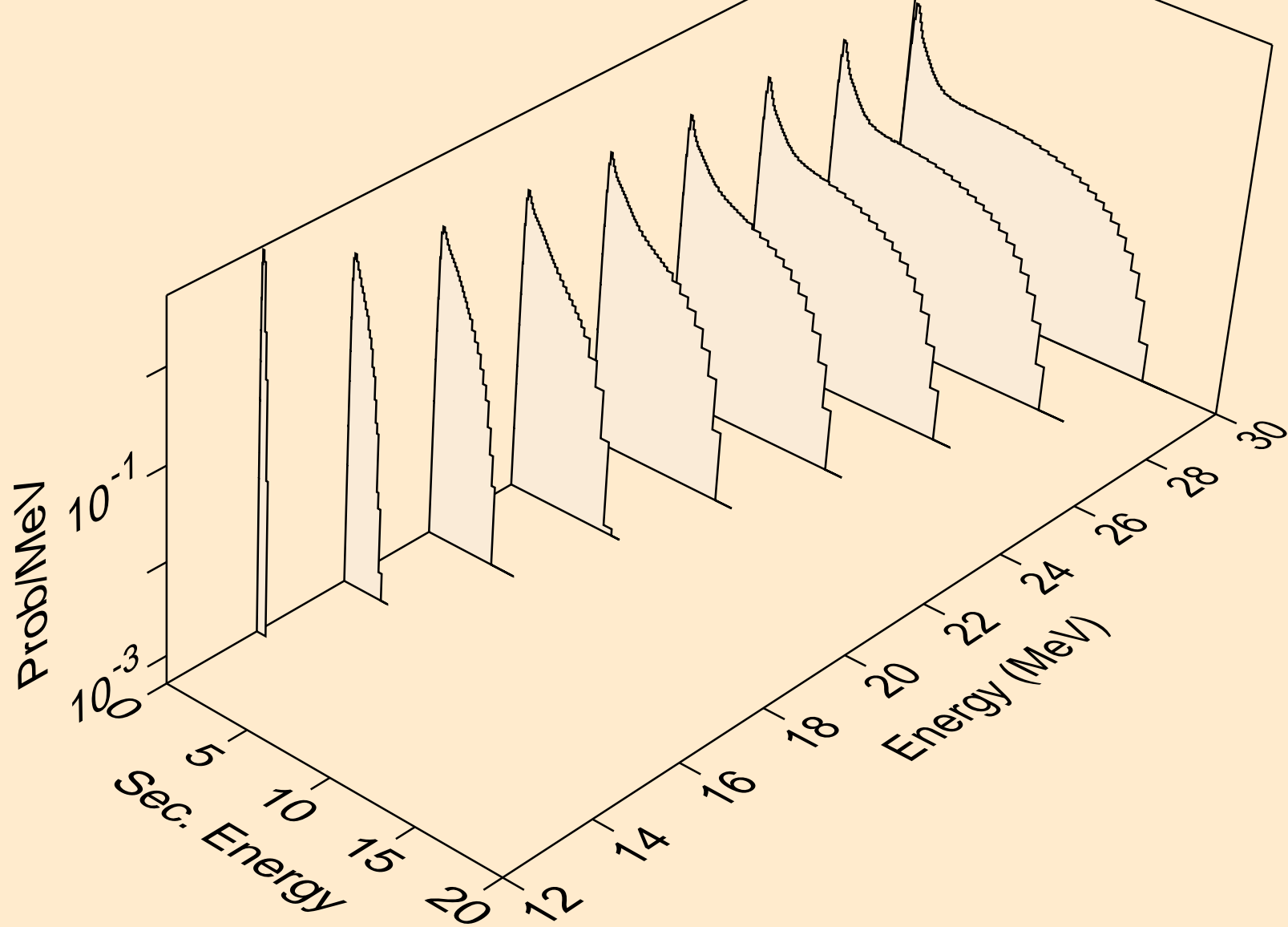

DB262 NEUTRON ACER TENDL-2021 LIBRARY; T=293.6K
Neutron emission for fission

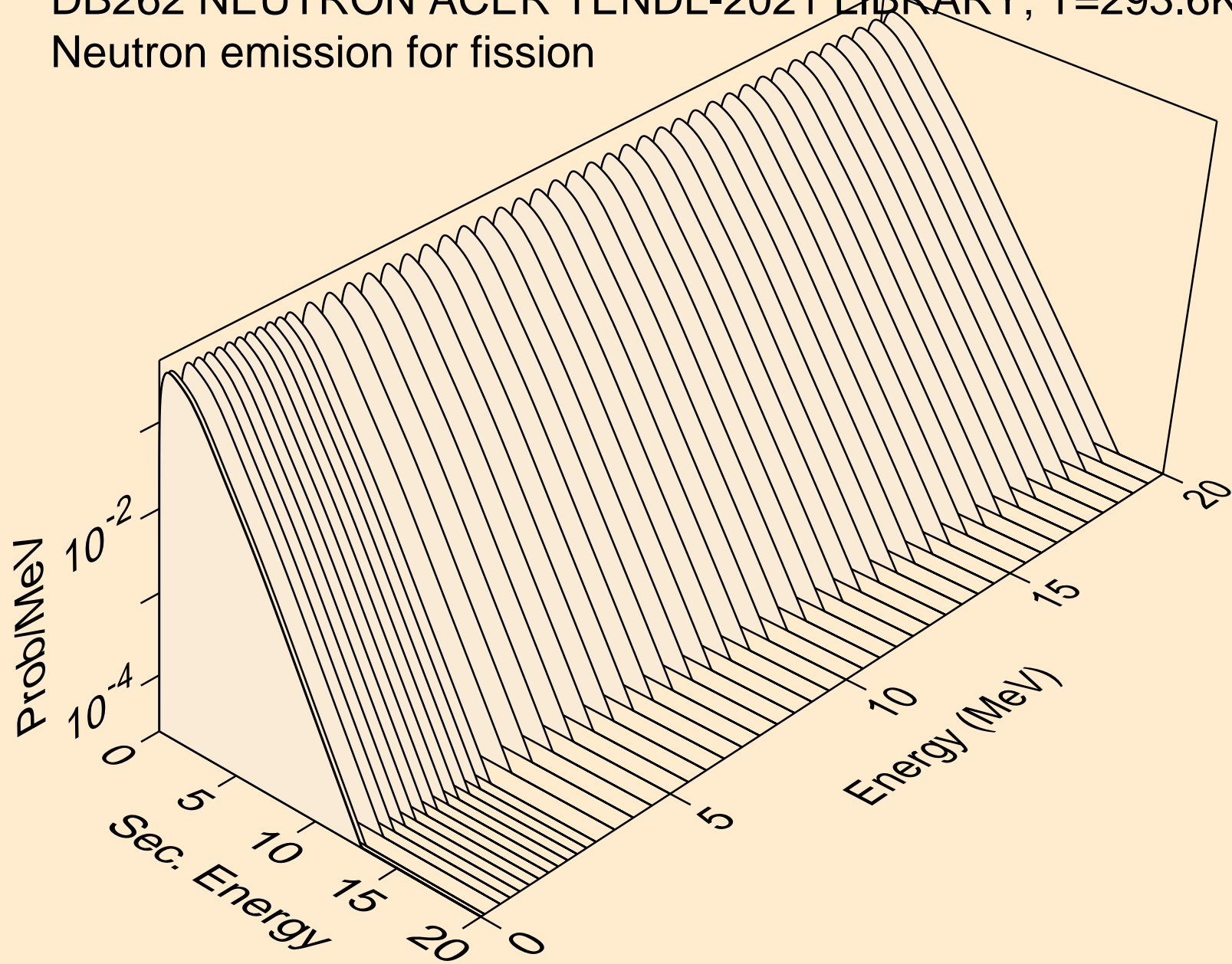

DB262 NEUTRON ACER TENDL-2021 LIBRARY; T=293.6K
Neutron emission for (n,n*)a

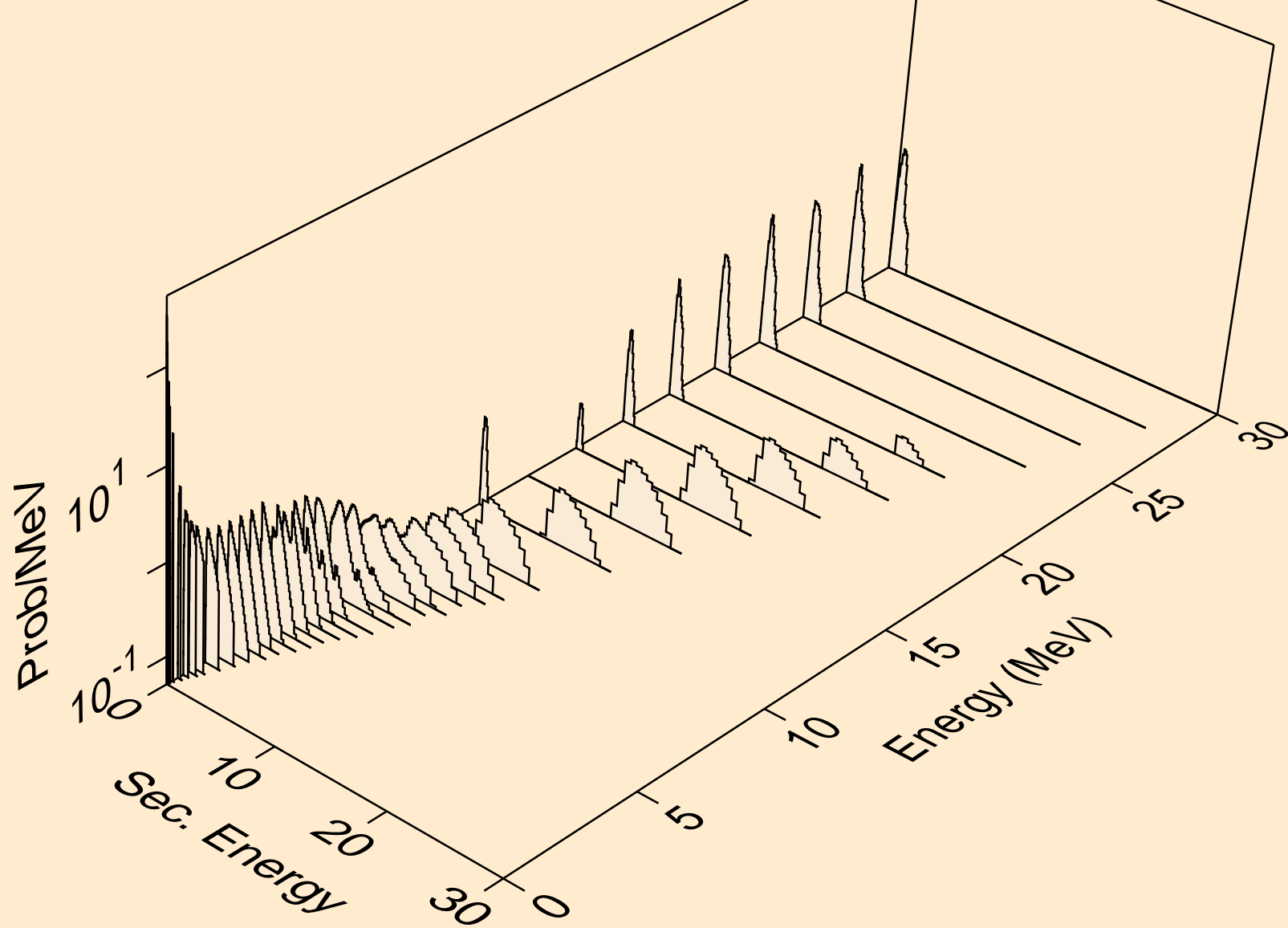

DB262 NEUTRON ACER TENDL-2021 LIBRARY; T=293.6K
Neutron emission for (n,2n)a

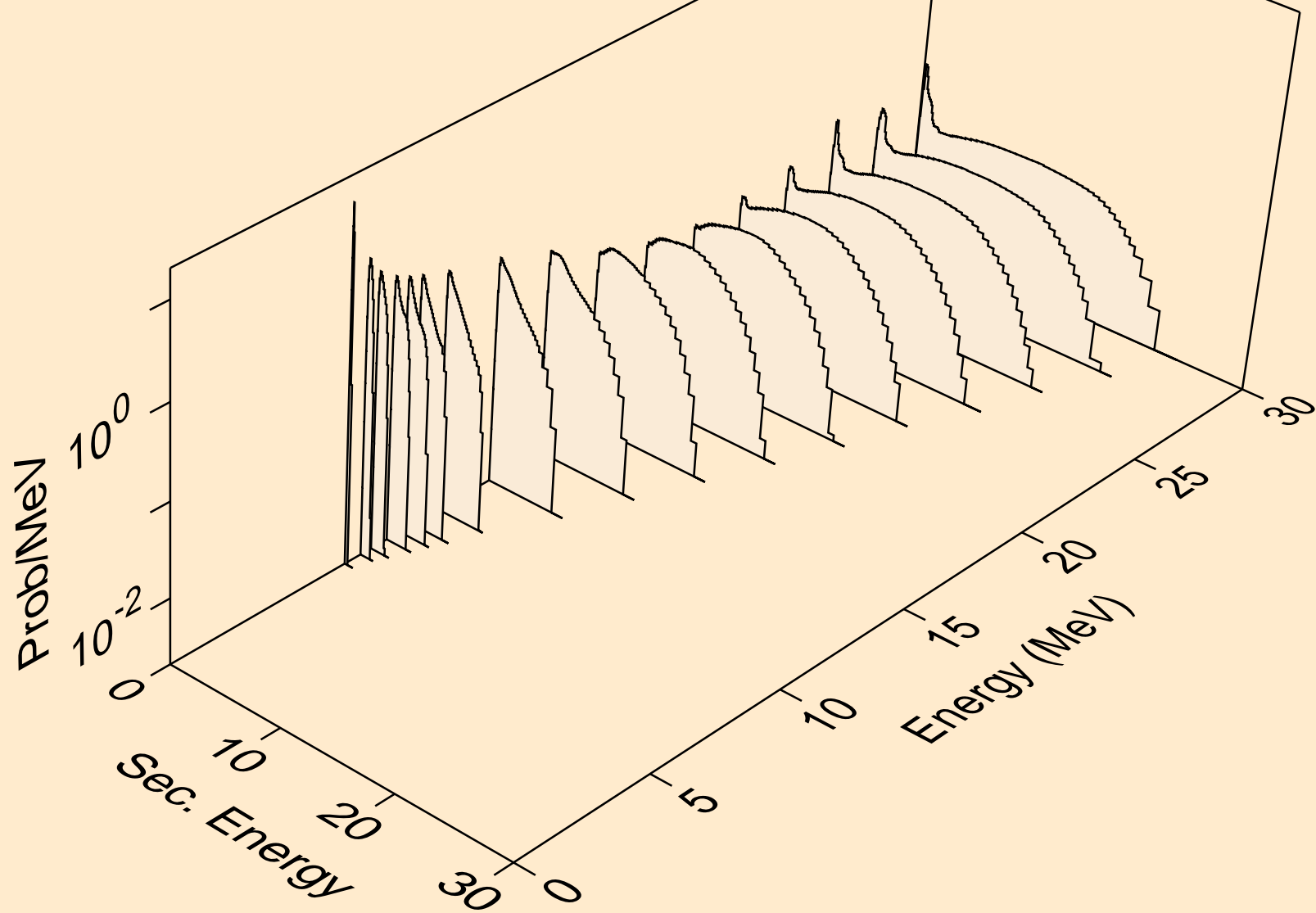

DB262 NEUTRON ACER TENDL-2021 LIBRARY; T=293.6K
Neutron emission for (n,3n)a

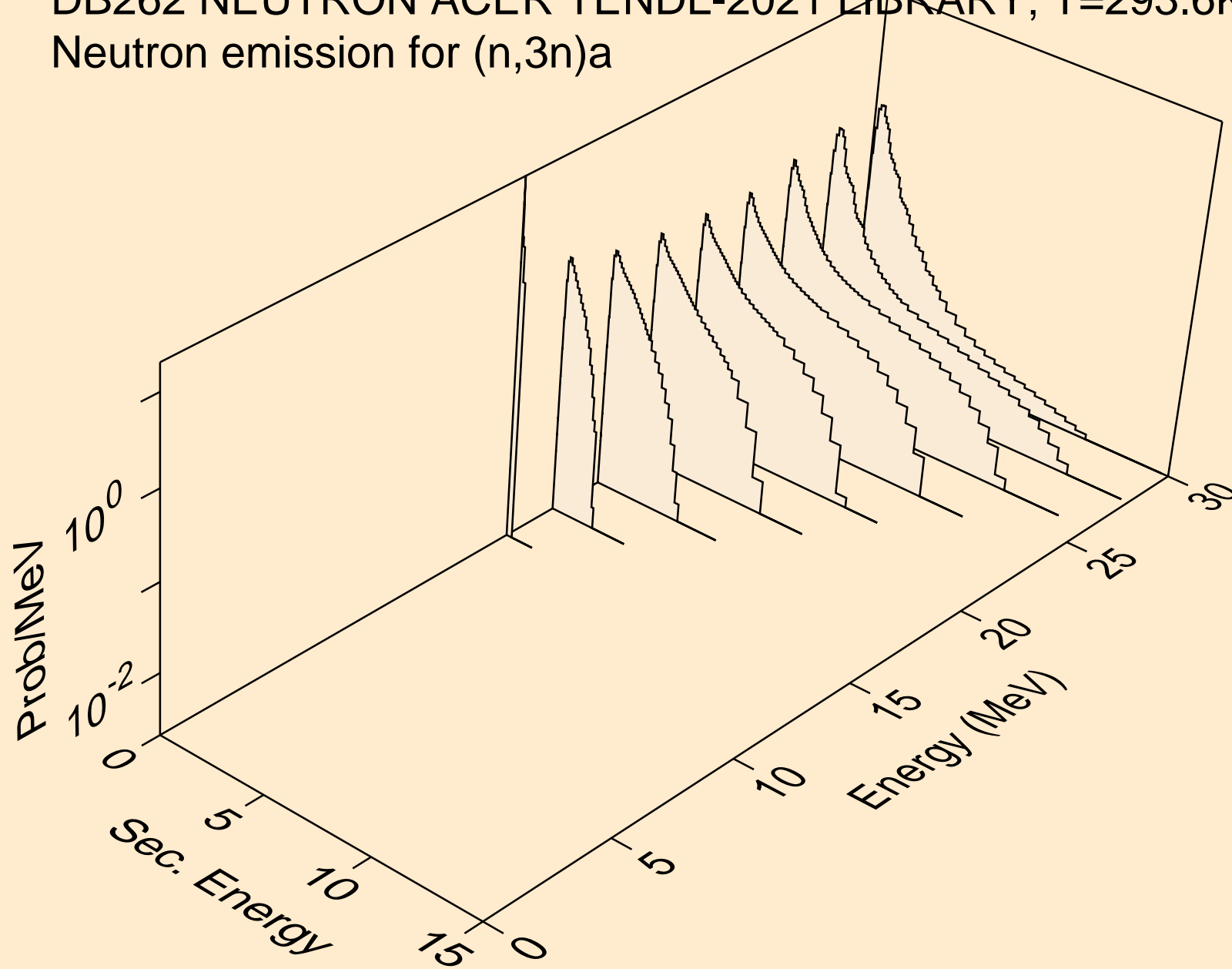

DB262 NEUTRON ACER TENDL-2021 LIBRARY; T=293.6K
Neutron emission for (n,n*)p

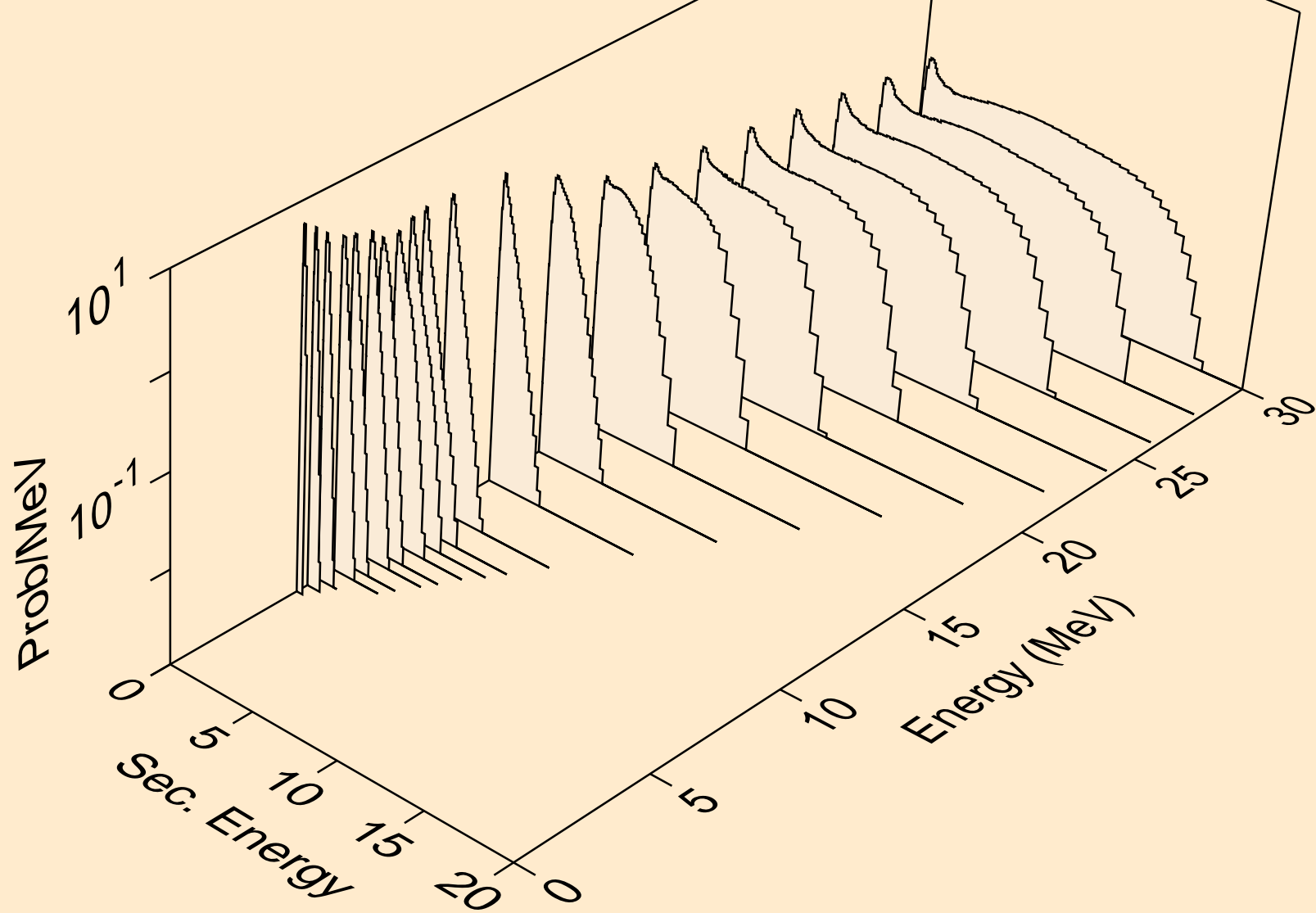

DB262 NEUTRON ACER TENDL-2021 LIBRARY; T=293.6K
Neutron emission for (n,n*)2a

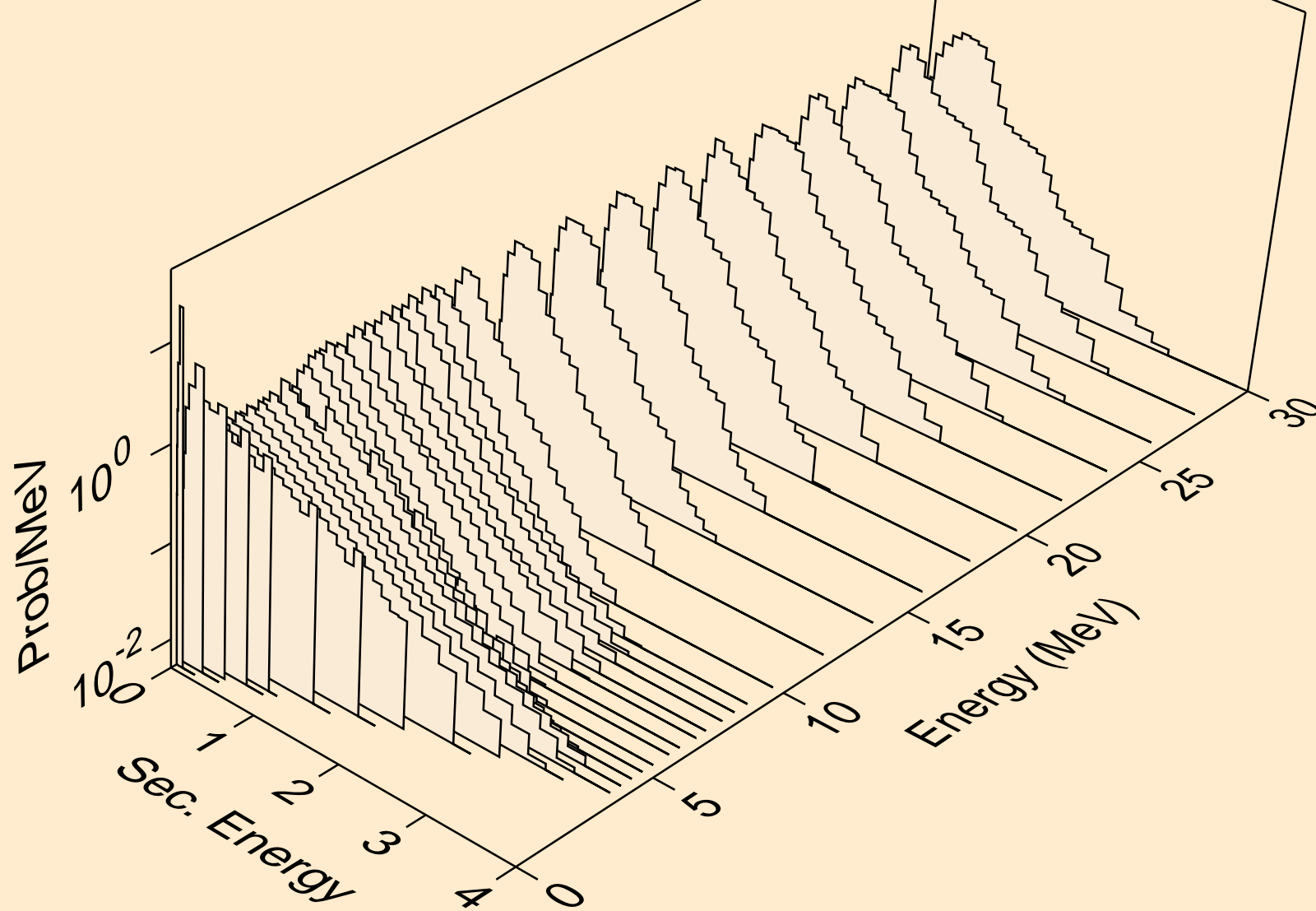

DB262 NEUTRON ACER TENDL-2021 LIBRARY; T=293.6K
Neutron emission for (n,n*)d

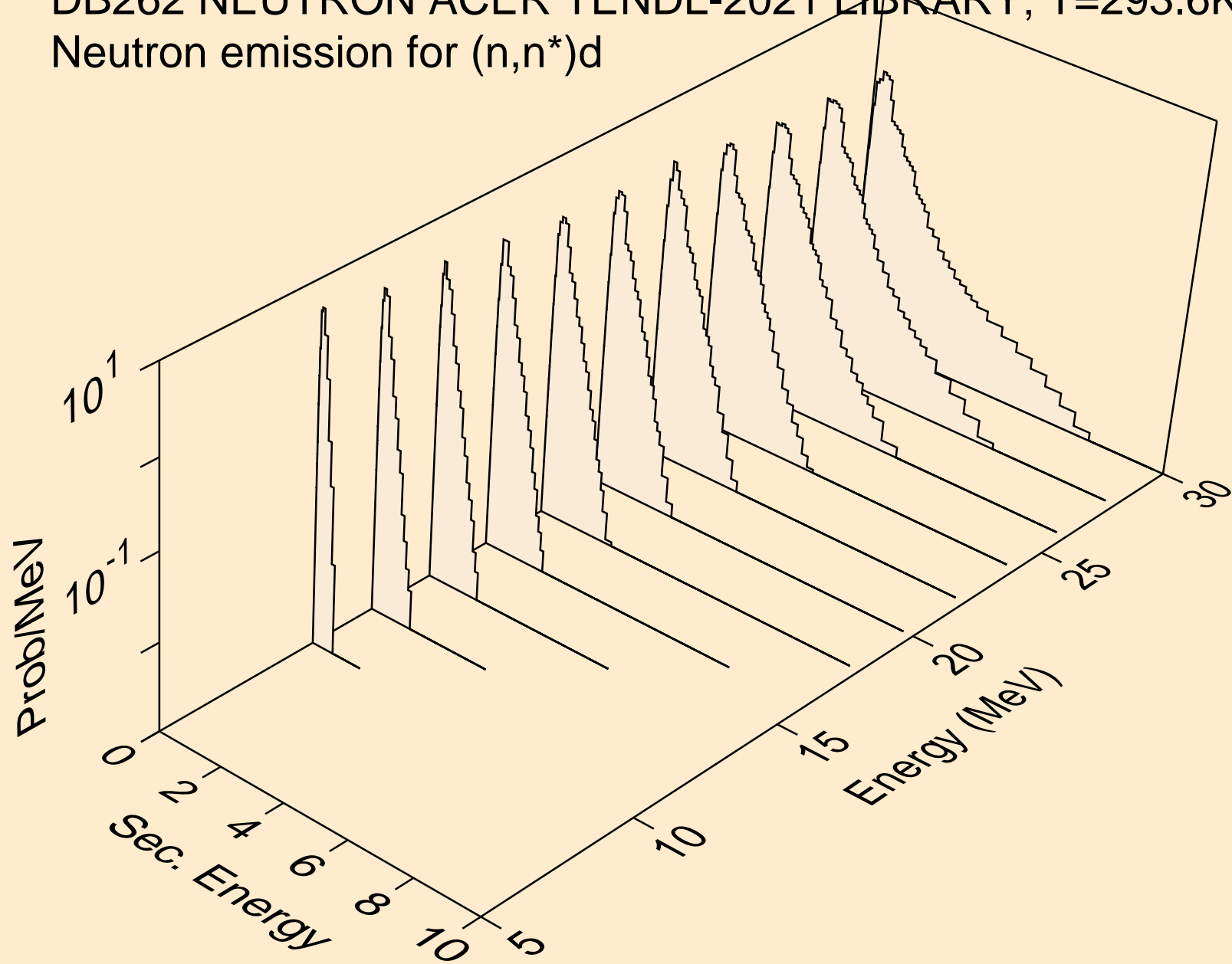

DB262 NEUTRON ACER TENDL-2021 LIBRARY; T=293.6K
Neutron emission for (n,n*)t

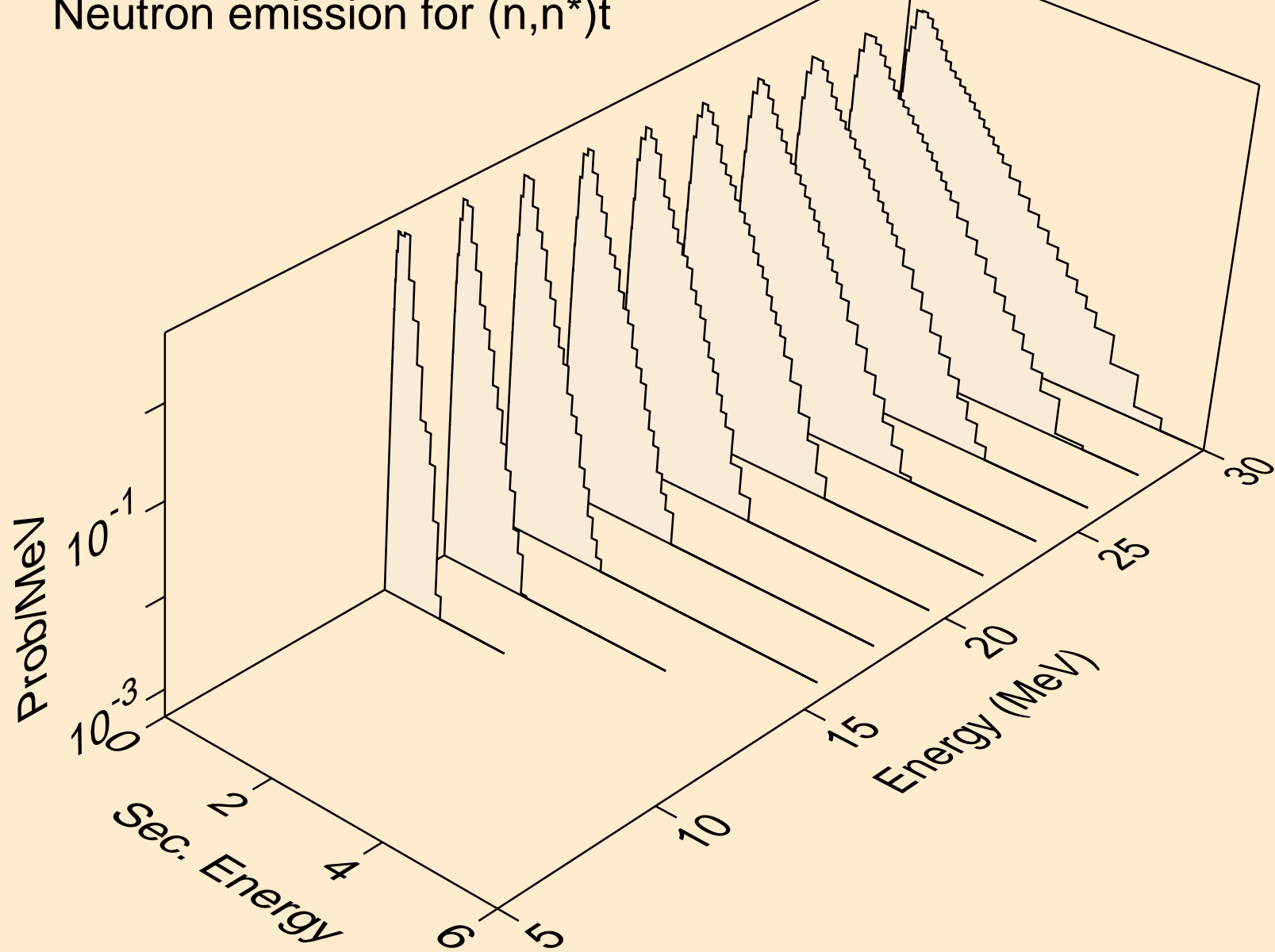

DB262 NEUTRON ACER TENDL-2021 LIBRARY; T=293.6K
Neutron emission for (n,n*)he3

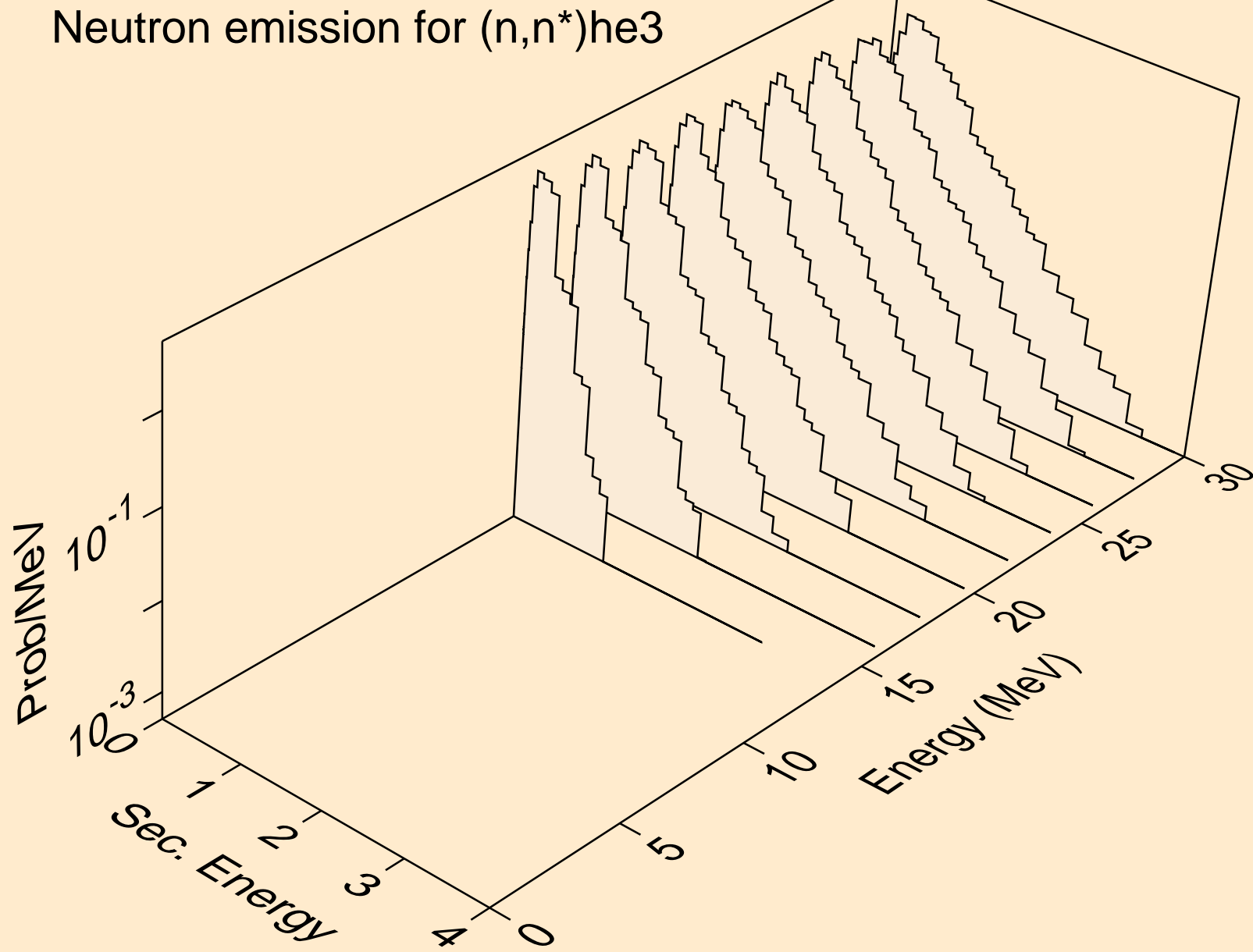

DB262 NEUTRON ACER TENDL-2021 LIBRARY; T=293.6K
Neutron emission for (n,4n)

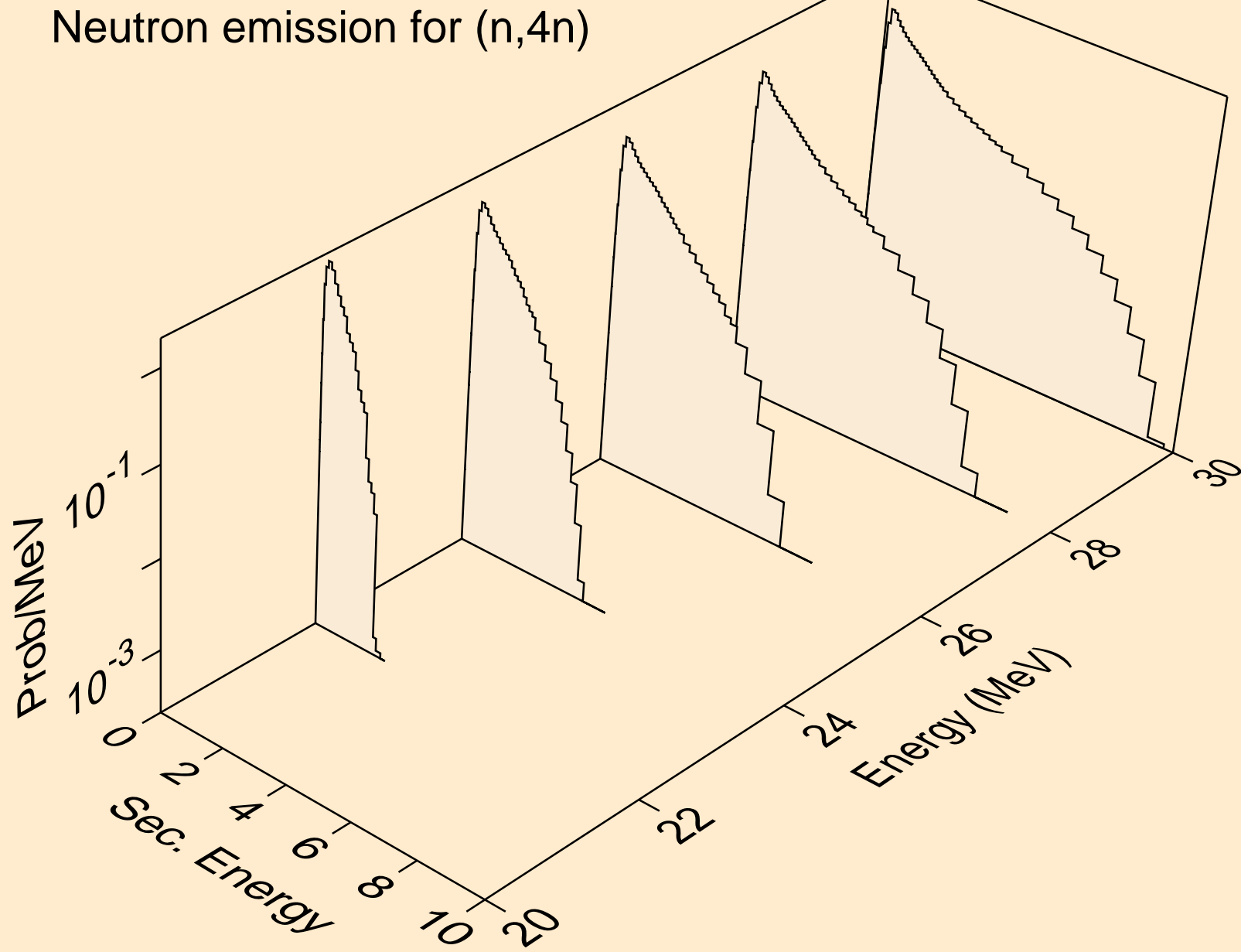

DB262 NEUTRON ACER TENDL-2021 LIBRARY; T=293.6K
Neutron emission for (n,2np)

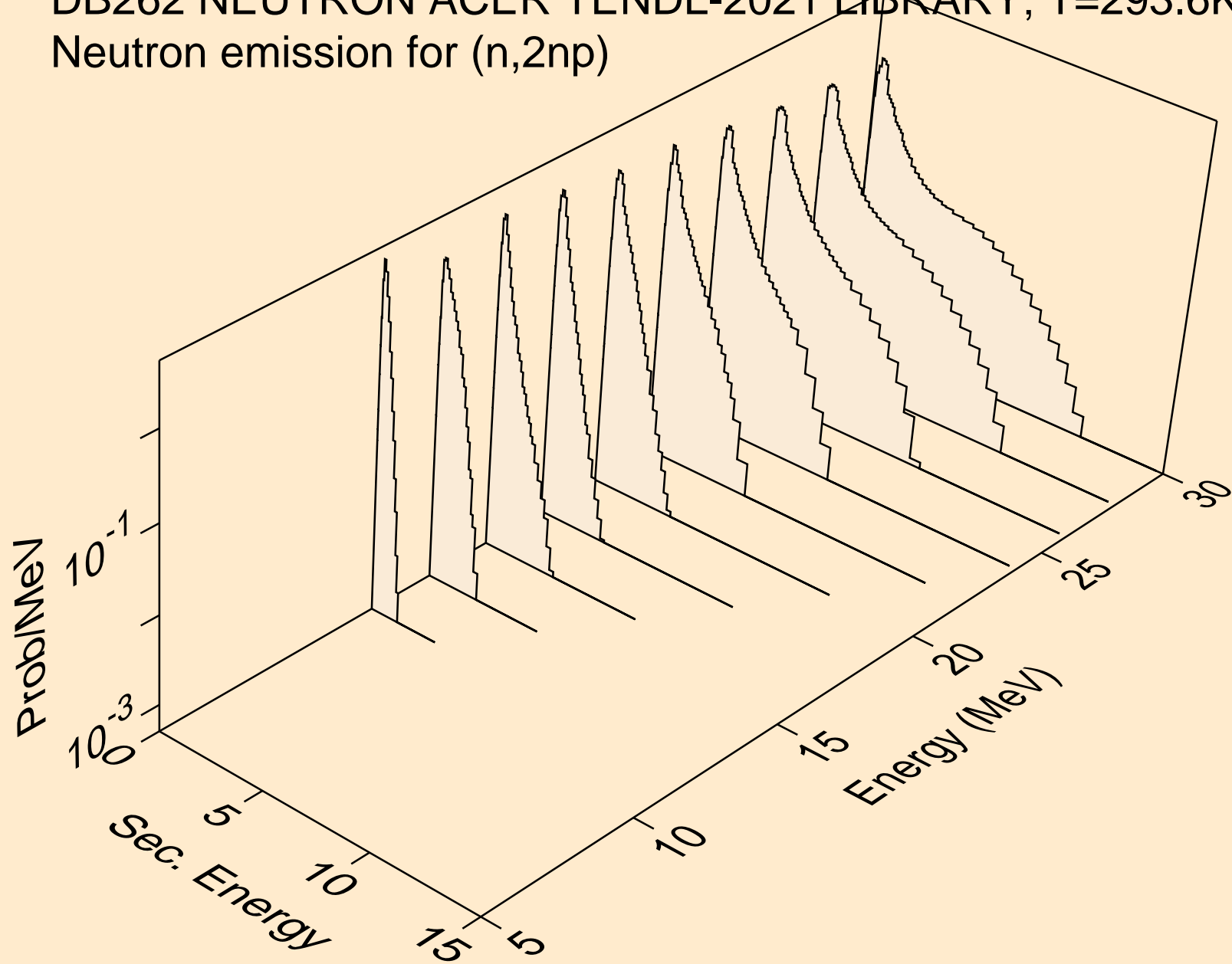

DB262 NEUTRON ACER TENDL-2021 LIBRARY; T=293.6K
Neutron emission for (n,3np)

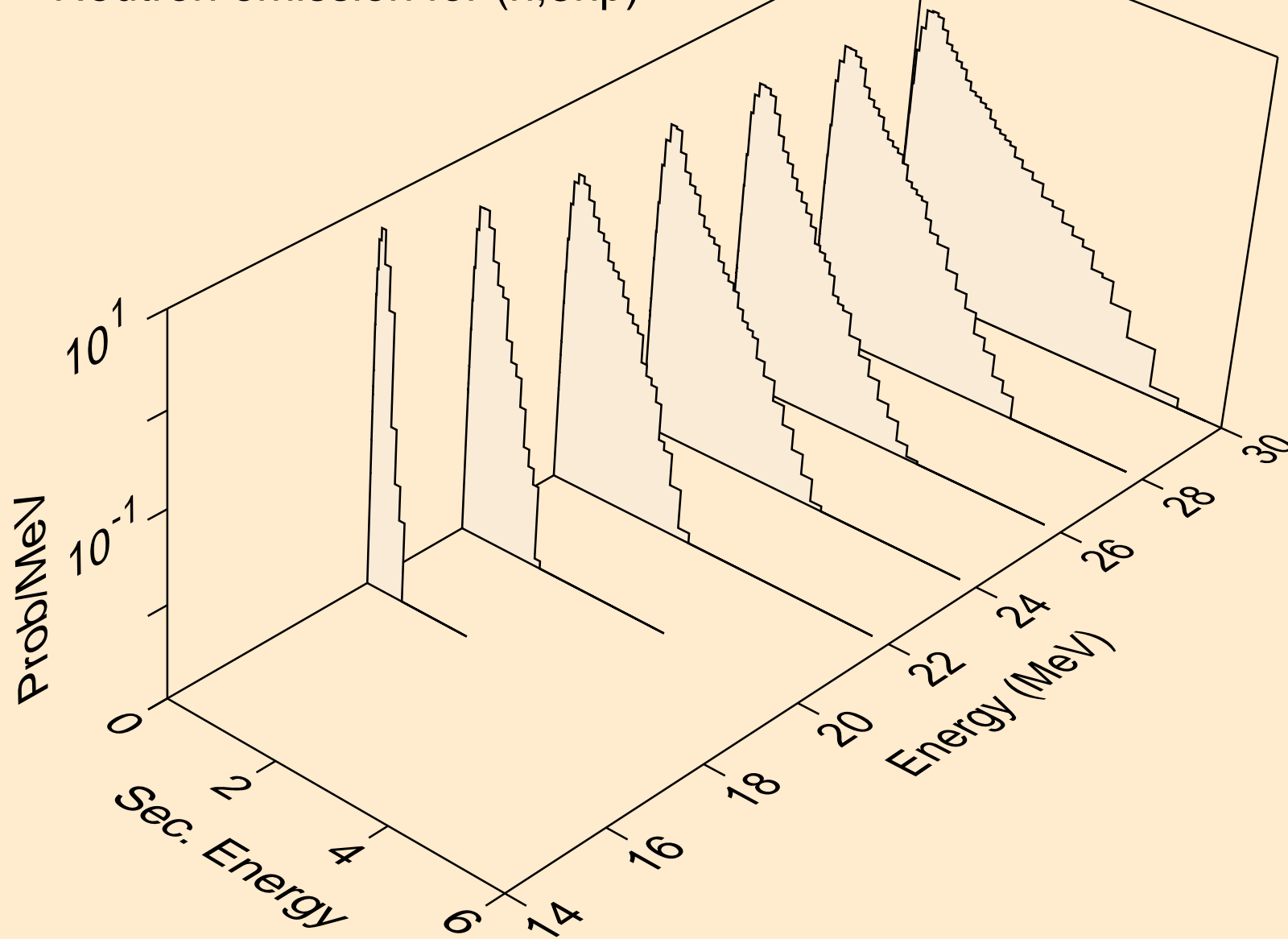

DB262 NEUTRON ACER TENDL-2021 LIBRARY; T=293.6K
Neutron emission for (n,2np)

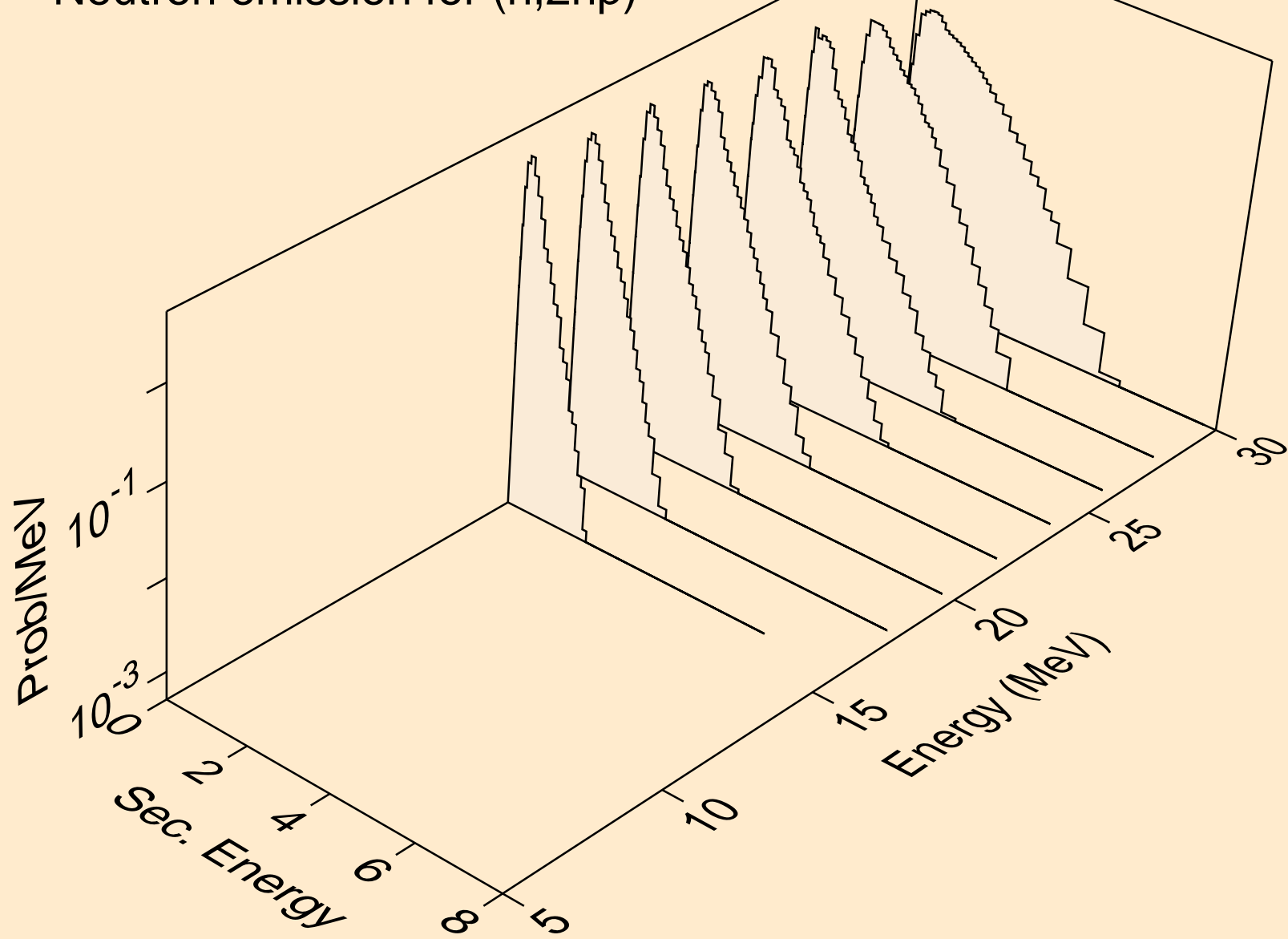

DB262 NEUTRON ACER TENDL-2021 LIBRARY; T=293.6K
Neutron emission for (n,npa)

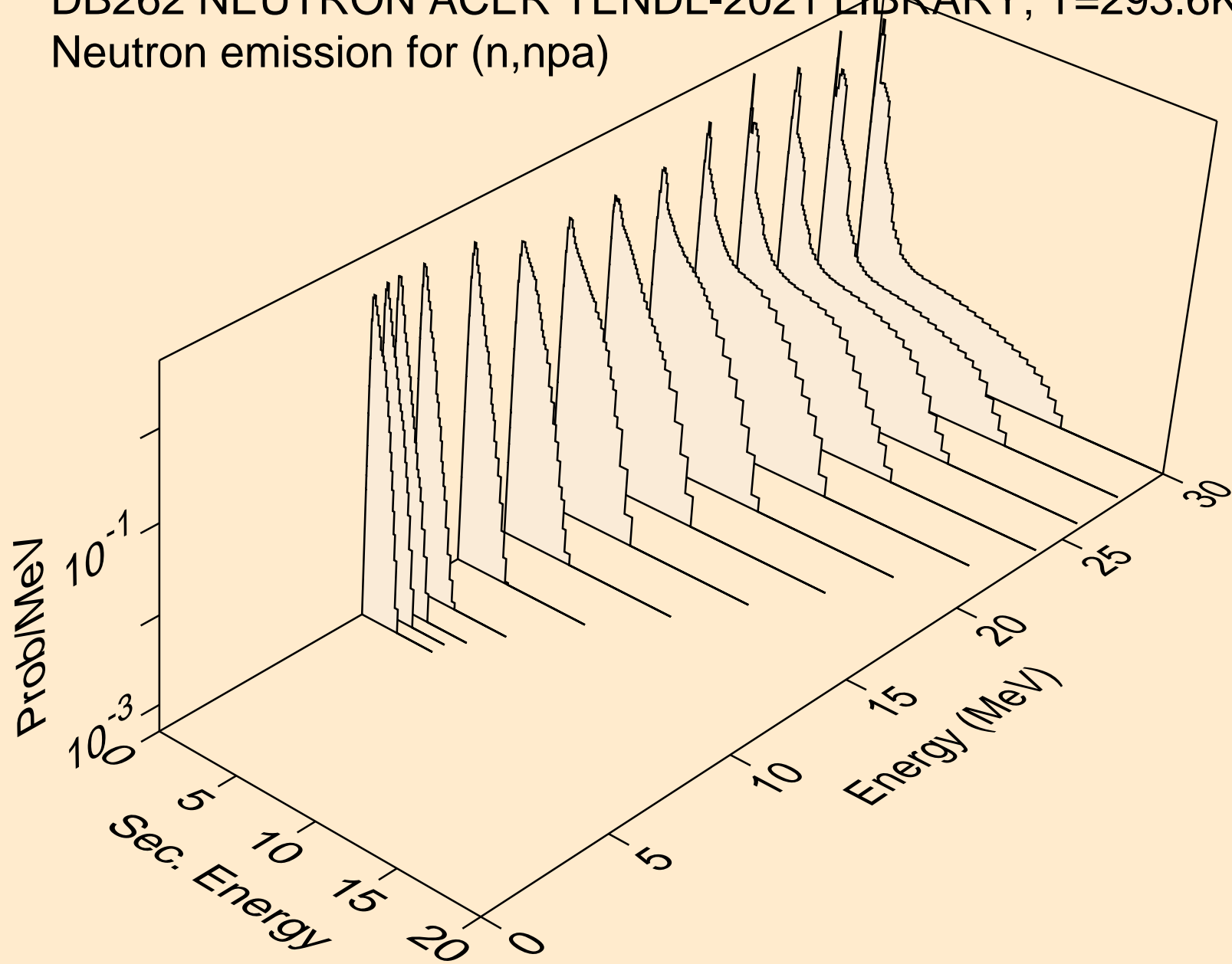

DB262 NEUTRON ACER TENDL-2021 LIBRARY; T=293.6K
Neutron emission for (n,n*c)

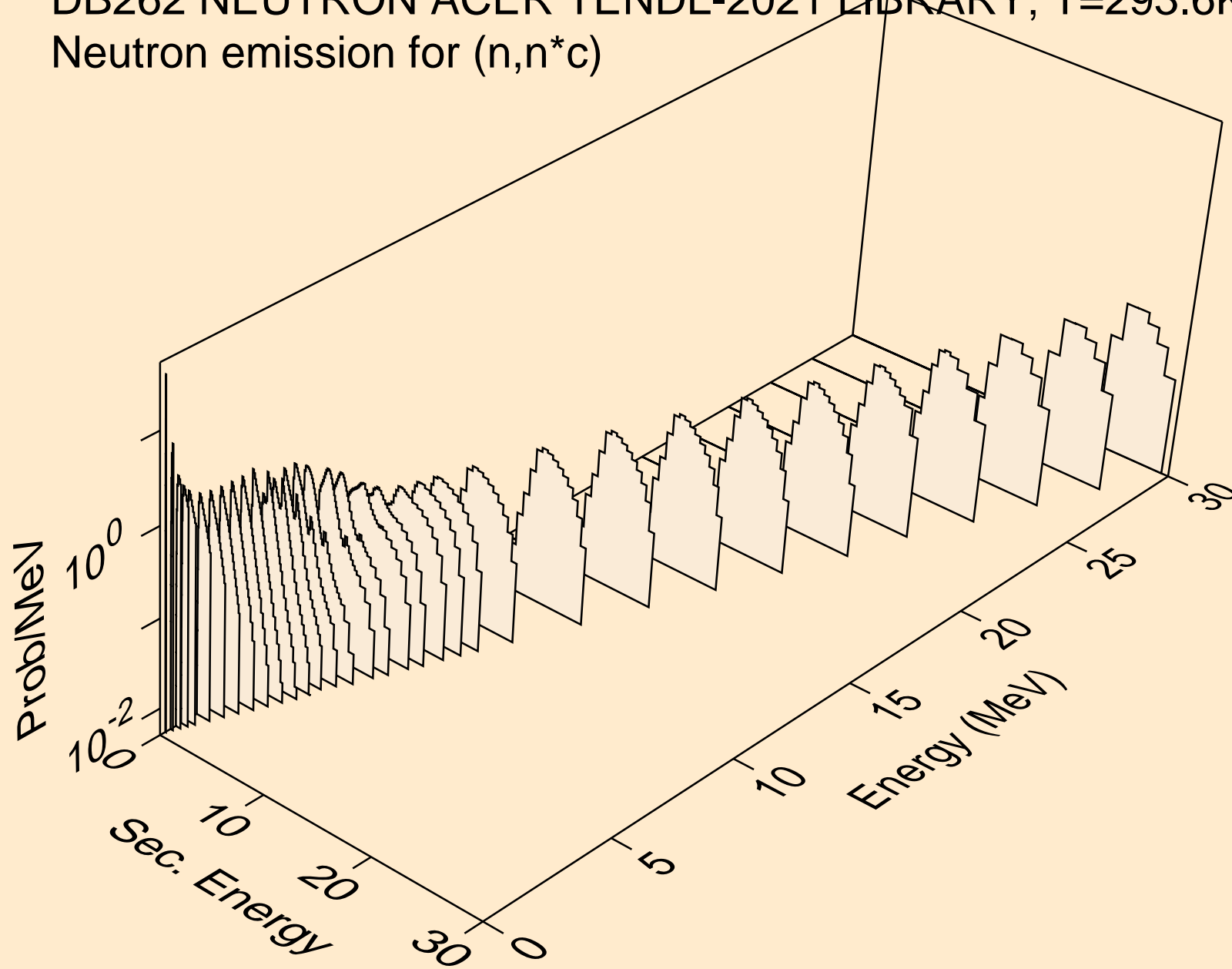

DB262 NEUTRON ACER TENDL-2021 LIBRARY; T=293.6K

Delayed nubar

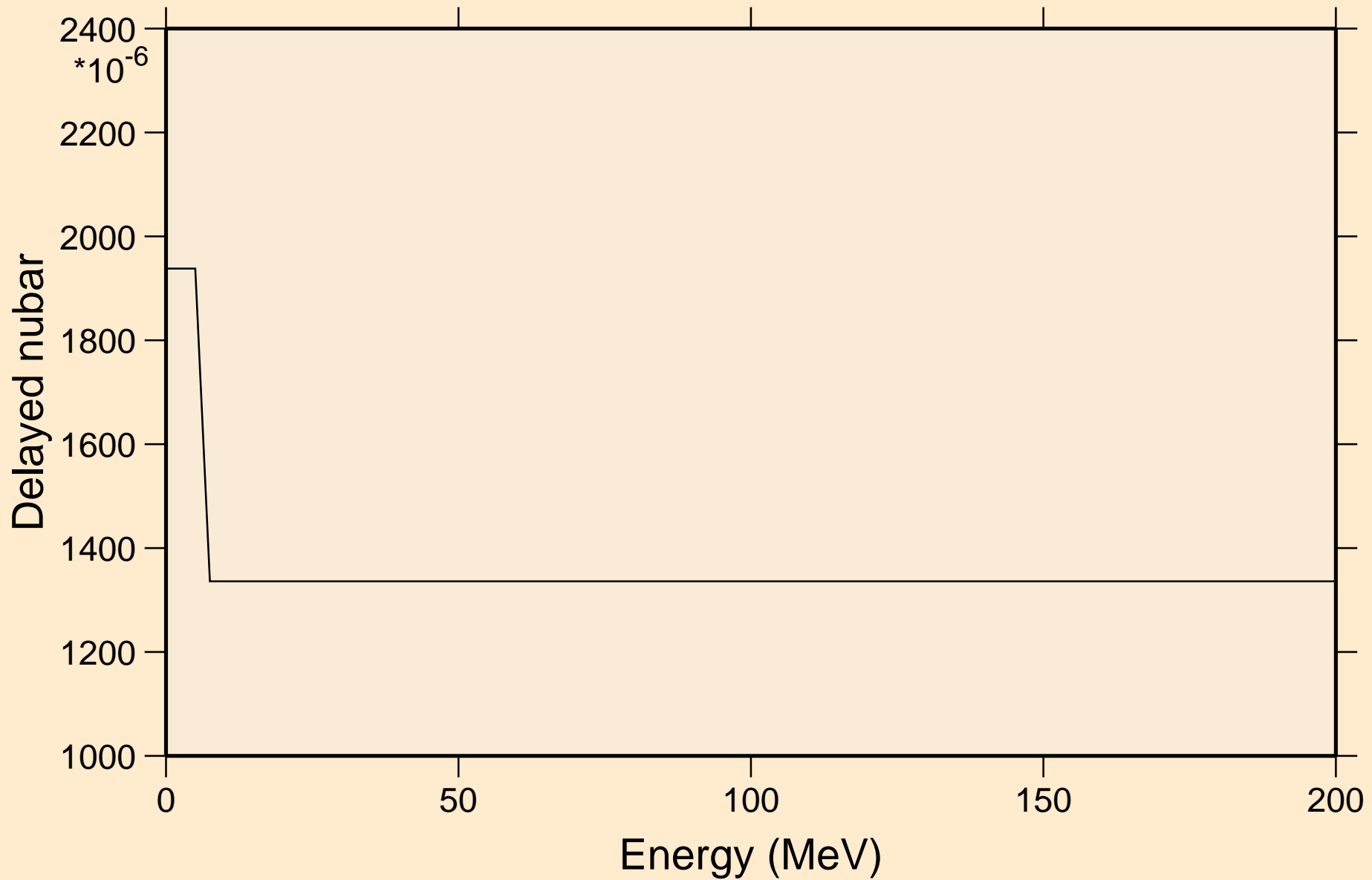

DB262 NEUTRON ACER TENDL-2021 LIBRARY; T=293.6K

Delayed neutron spectra

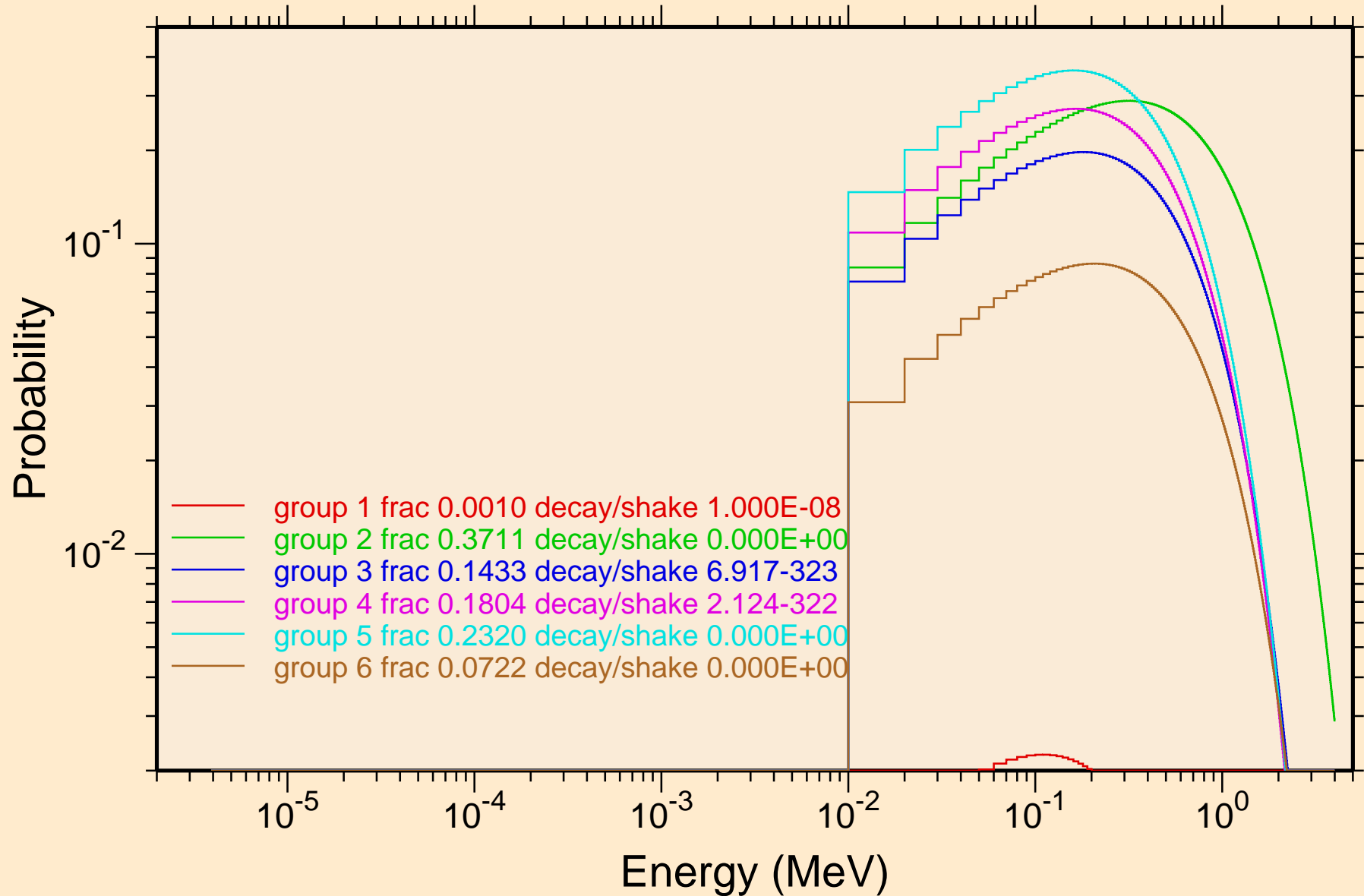

DB262 NEUTRON ACER TENDL-2021 LIBRARY; T=293.6K
Photon emission for (n,x)

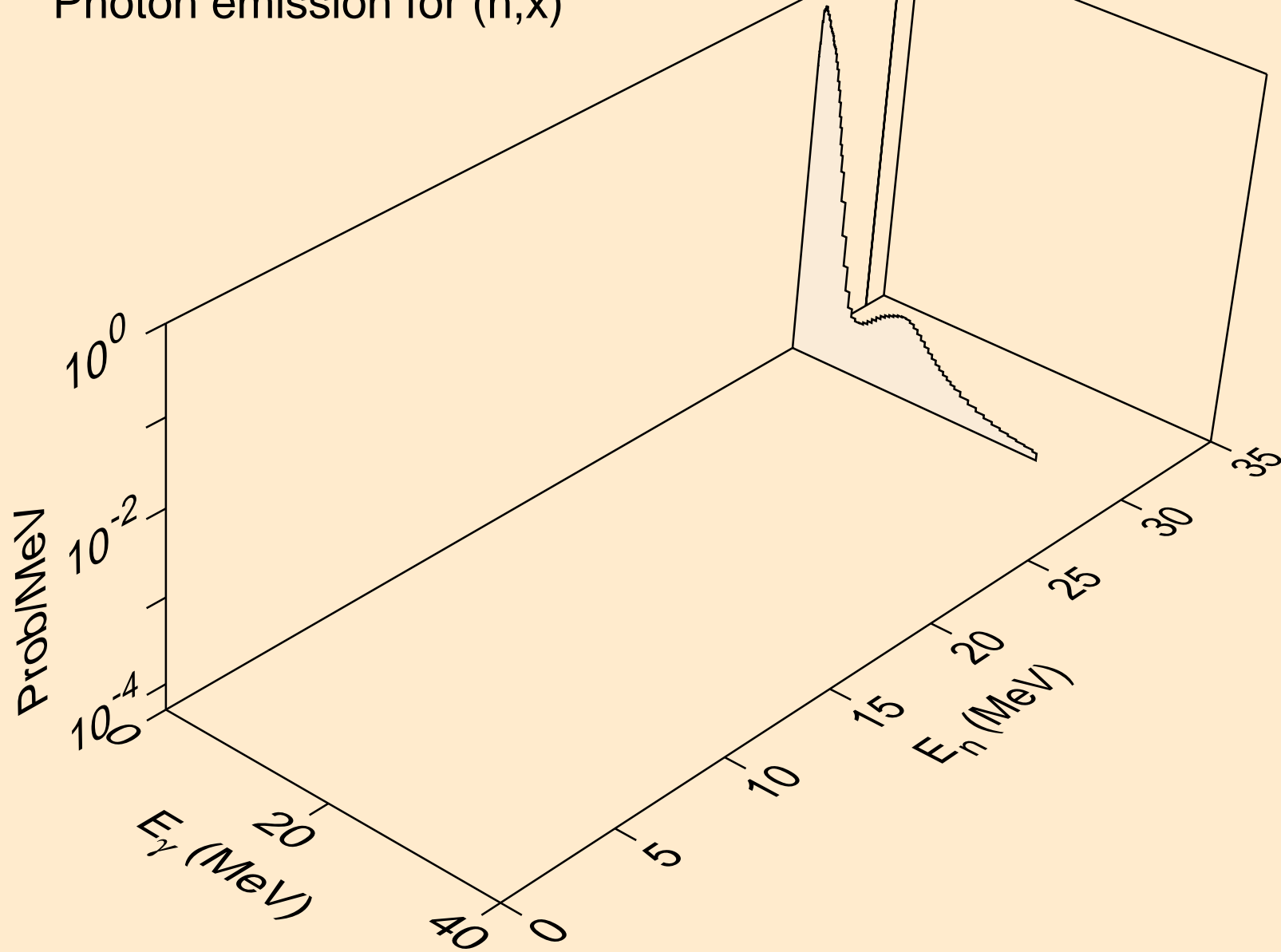

DB262 NEUTRON ACER TENDL-2021 LIBRARY; T=293.6K
Photon emission for (n,2nd)

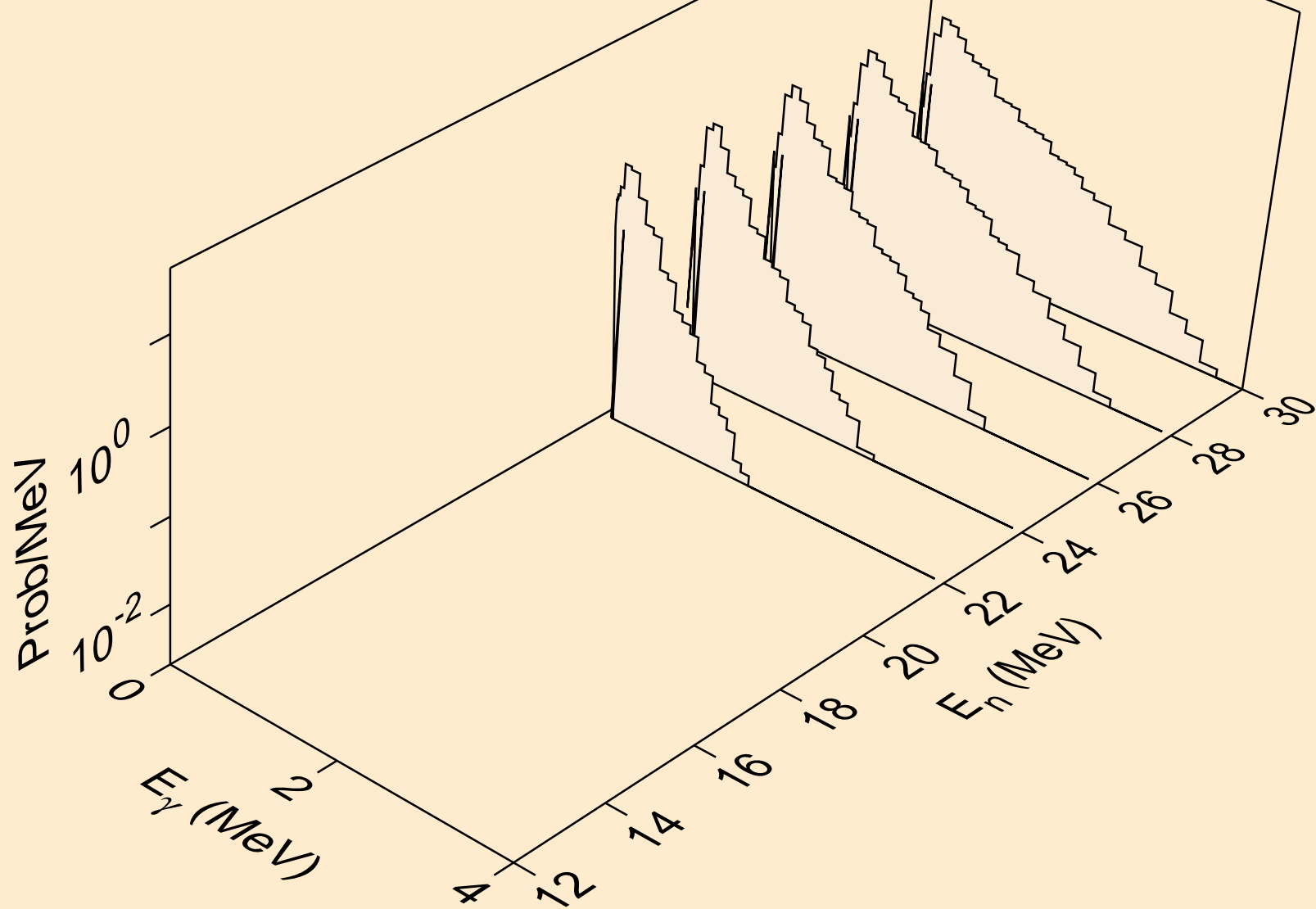

DB262 NEUTRON ACER TENDL-2021 LIBRARY; T=293.6K
Photon emission for (n,2n)

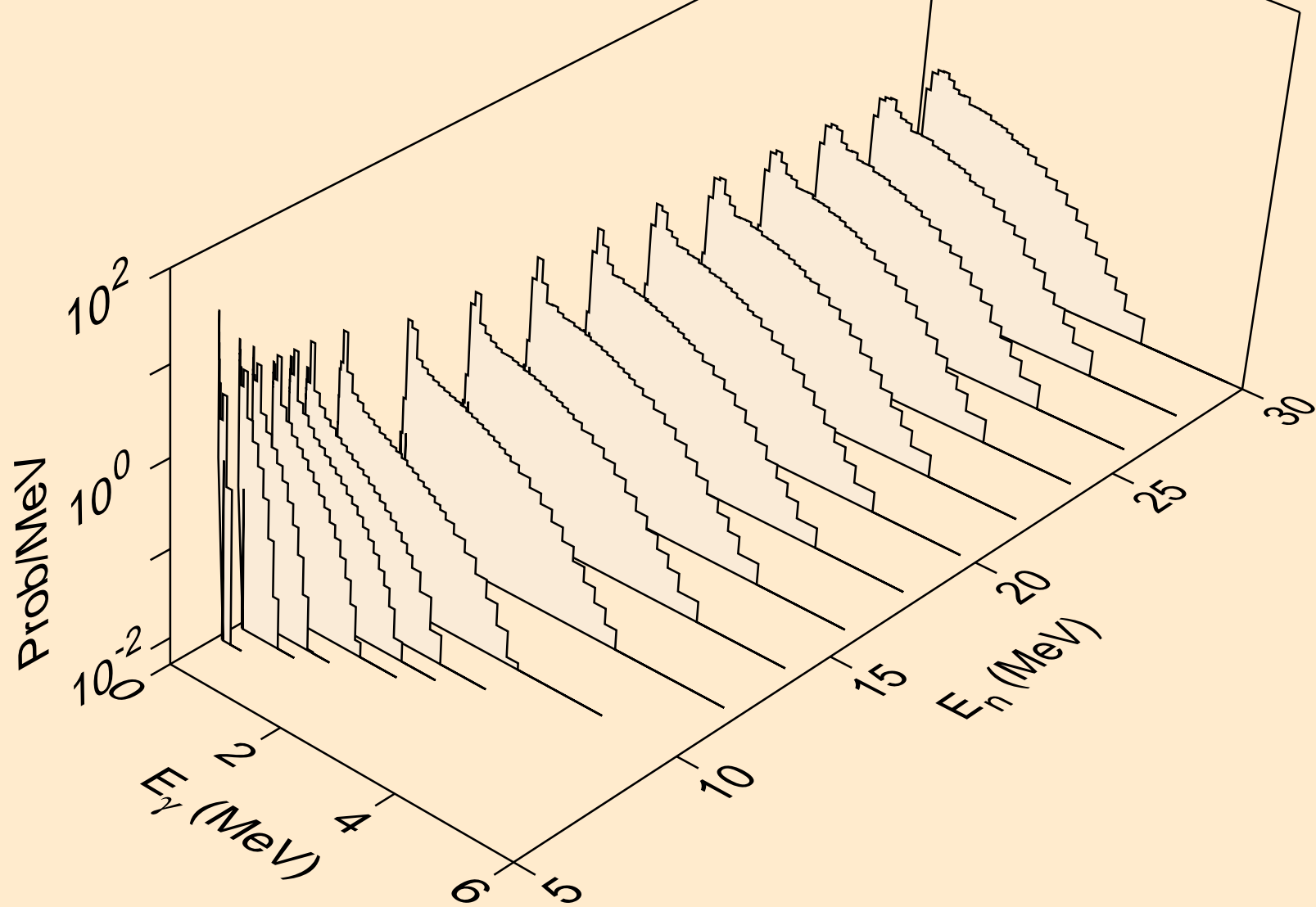

DB262 NEUTRON ACER TENDL-2021 LIBRARY; T=293.6K
Photon emission for (n,3n)

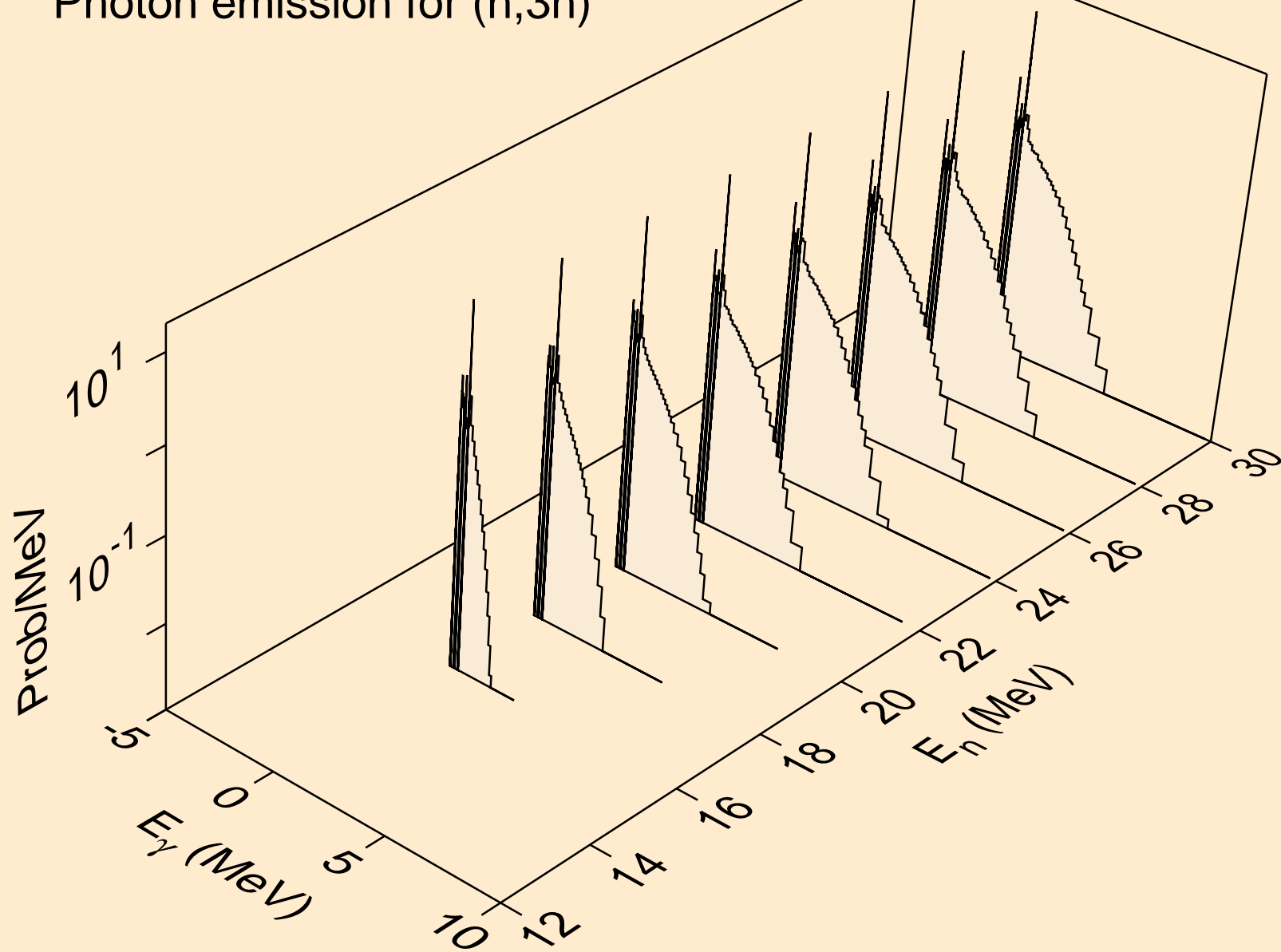

DB262 NEUTRON ACER TENDL-2021 LIBRARY; T=293.6K
Photon emission for (n,n*)a

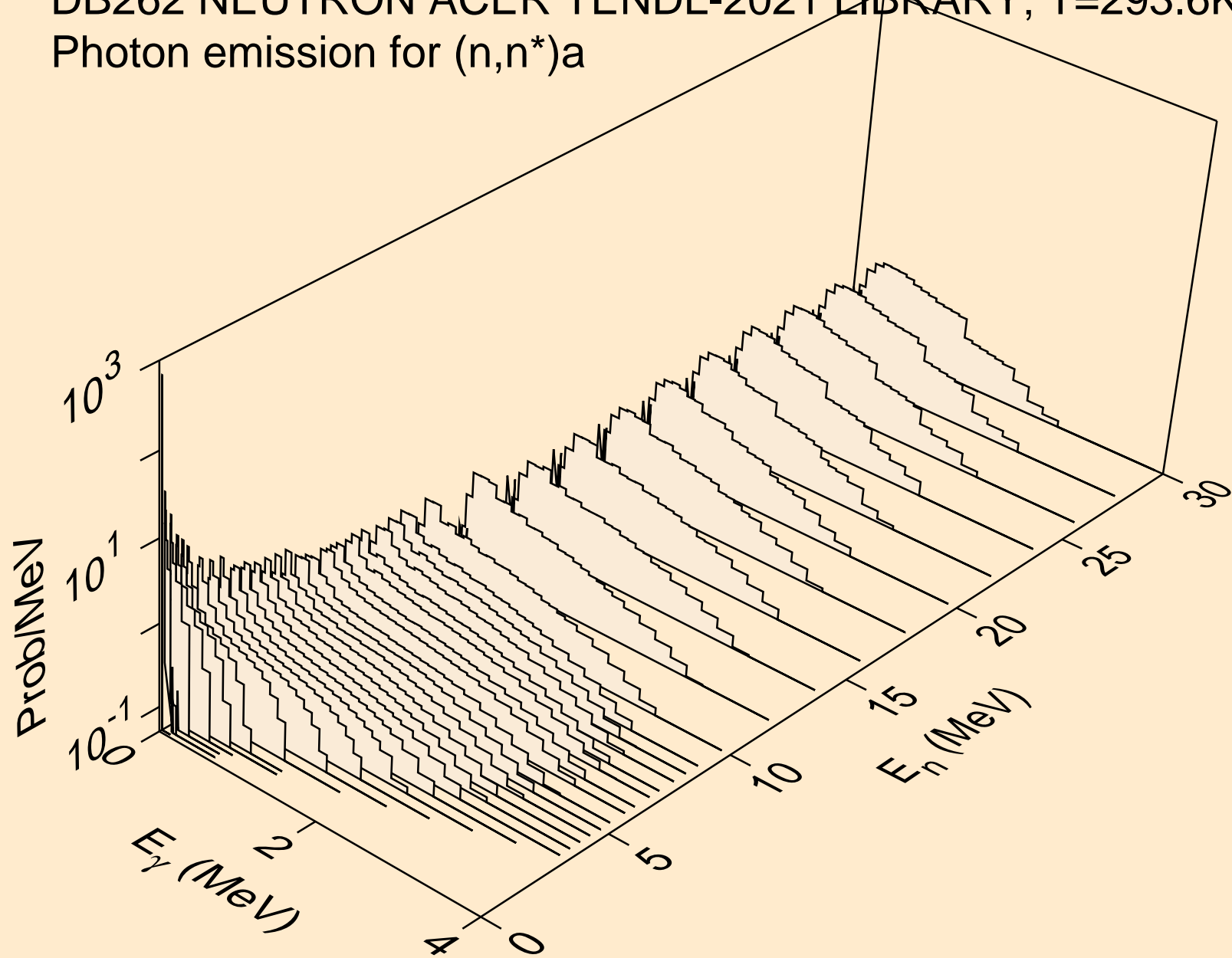

DB262 NEUTRON ACER TENDL-2021 LIBRARY; T=293.6K
Photon emission for (n,2n)a

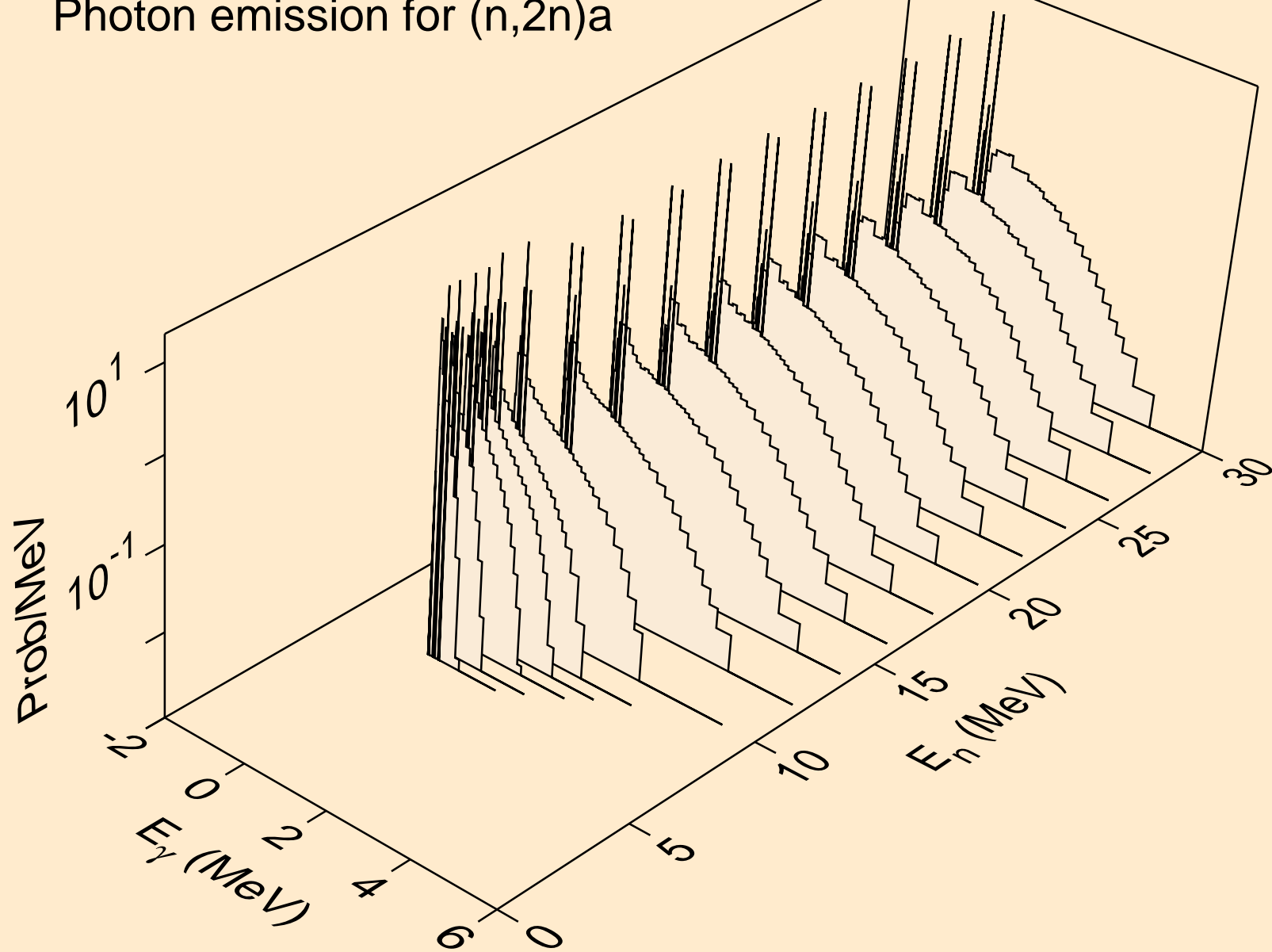

DB262 NEUTRON ACER TENDL-2021 LIBRARY; T=293.6K
Photon emission for (n,3n)a

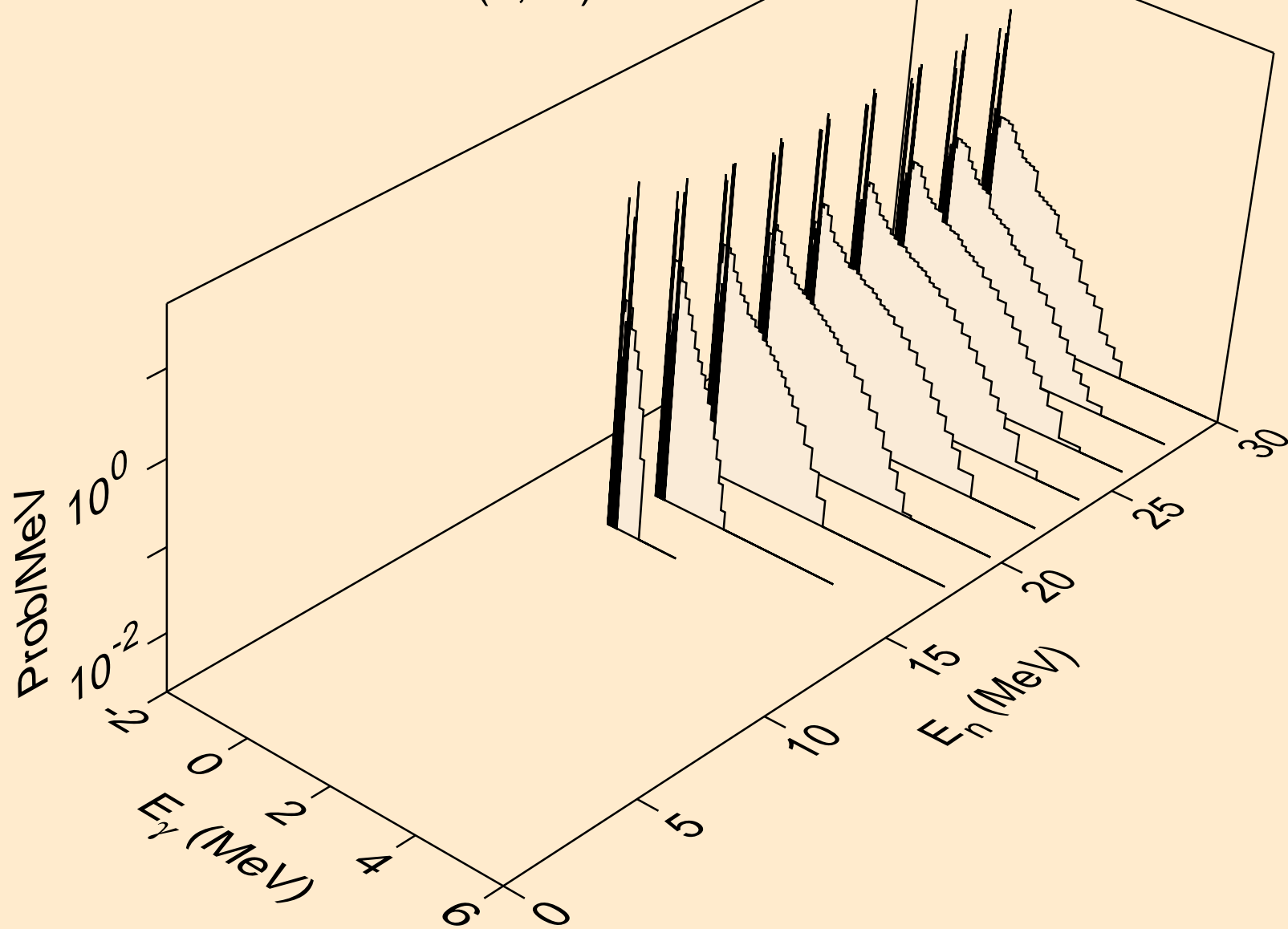

DB262 NEUTRON ACER TENDL-2021 LIBRARY; T=293.6K
Photon emission for (n,n*)p

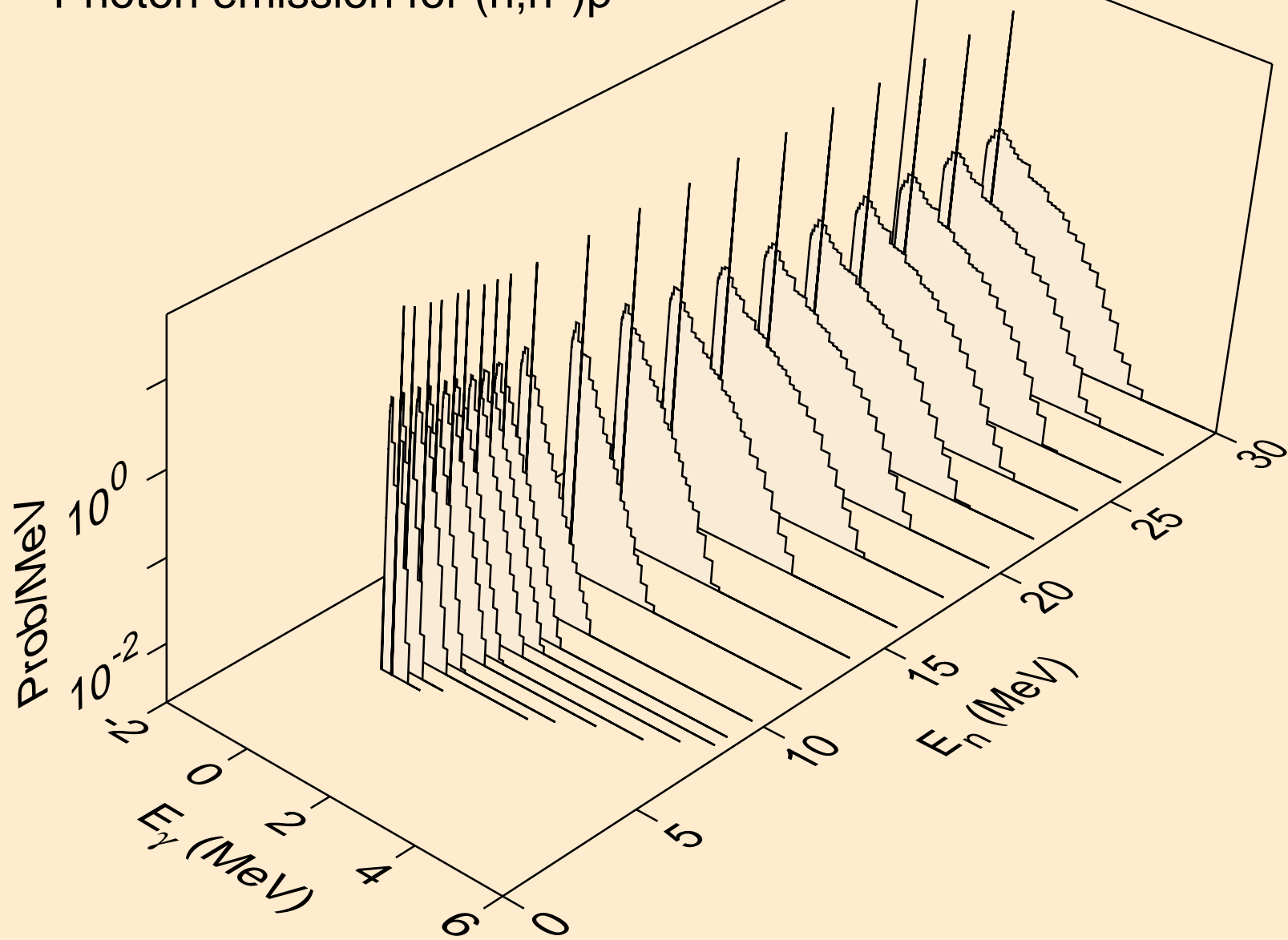

DB262 NEUTRON ACER TENDL-2021 LIBRARY; T=293.6K
Photon emission for (n,n*)2a

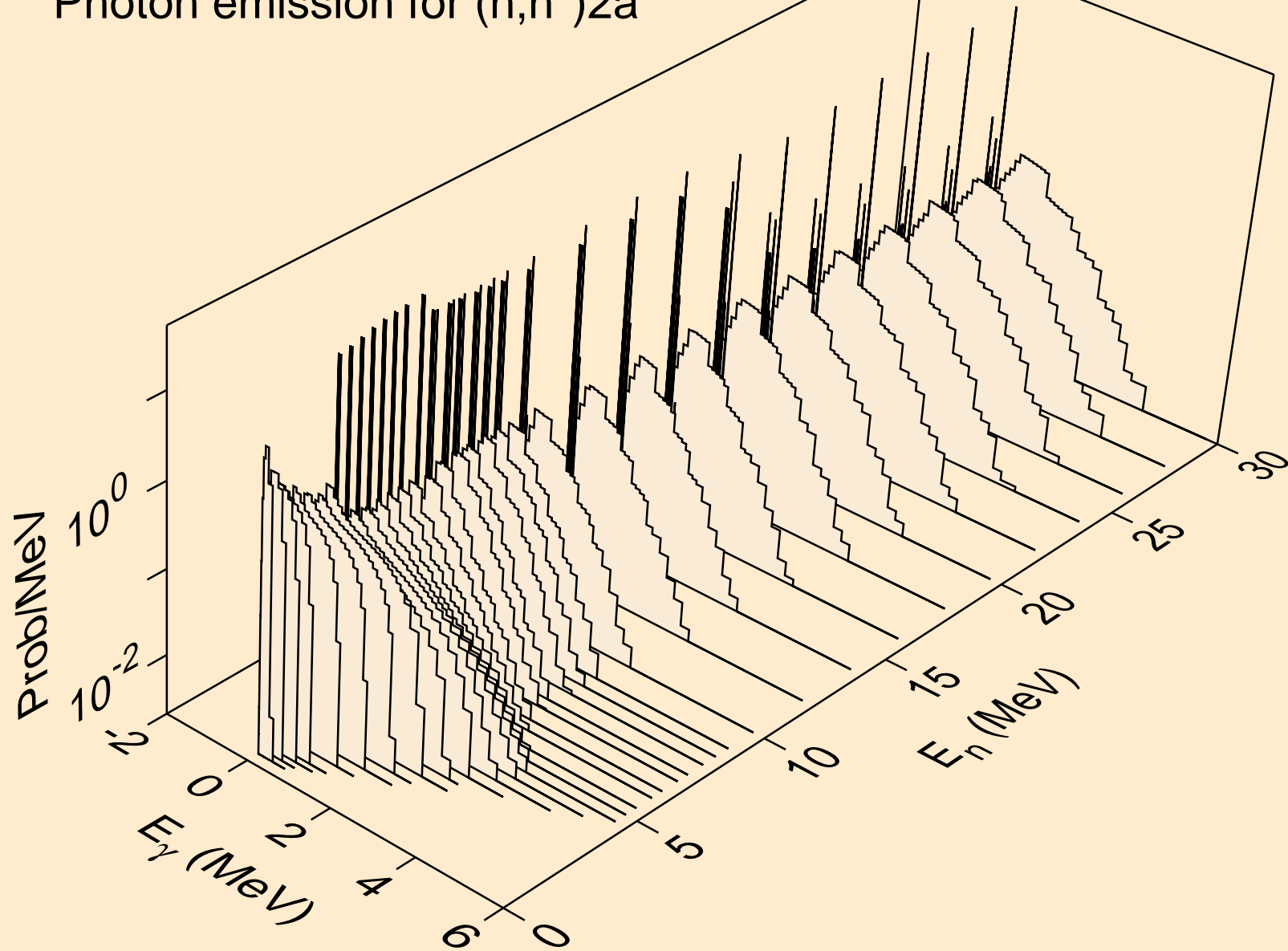

DB262 NEUTRON ACER TENDL-2021 LIBRARY; T=293.6K
Photon emission for (n,n*)d

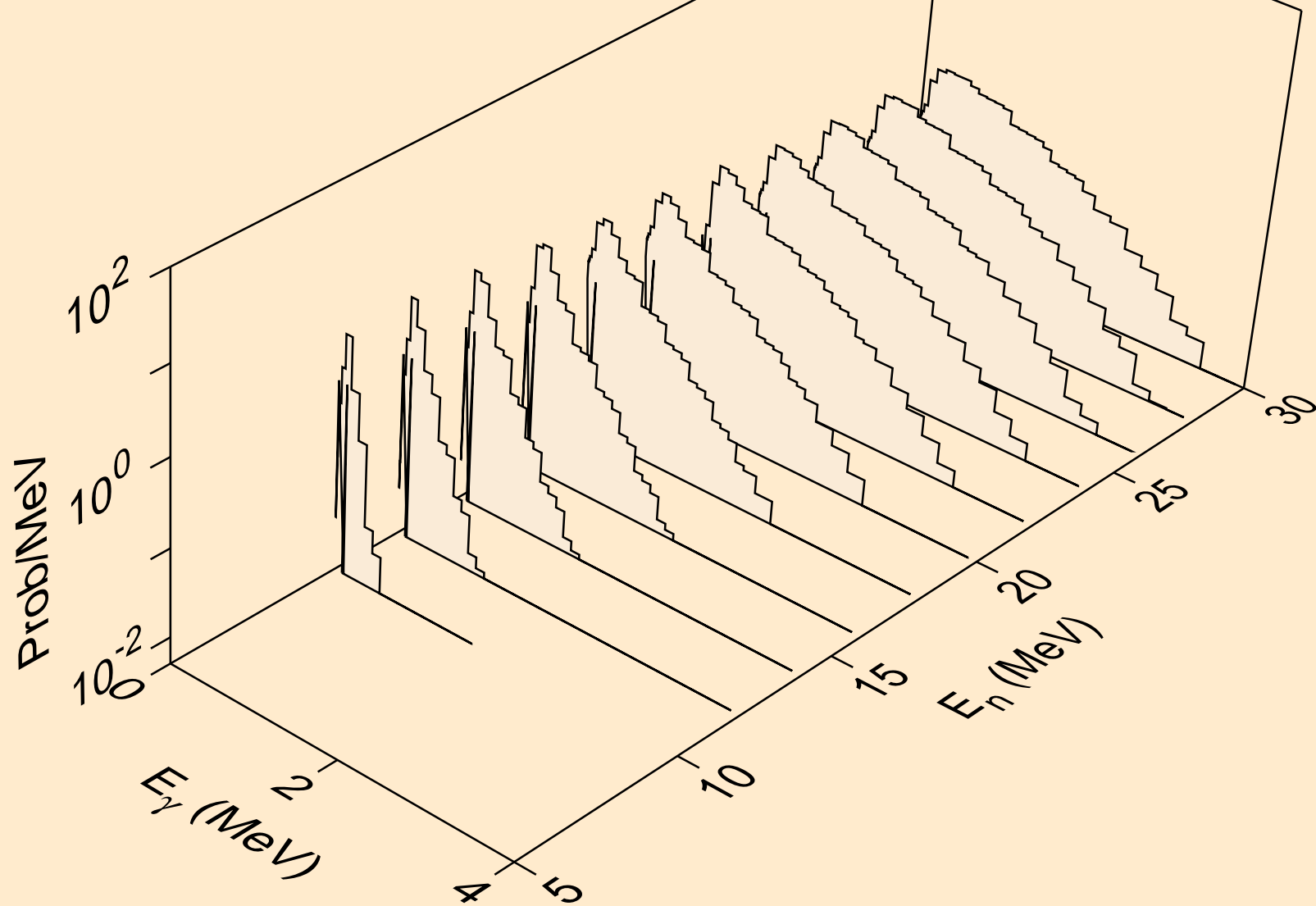

DB262 NEUTRON ACER TENDL-2021 LIBRARY; T=293.6K
Photon emission for (n,n*)t

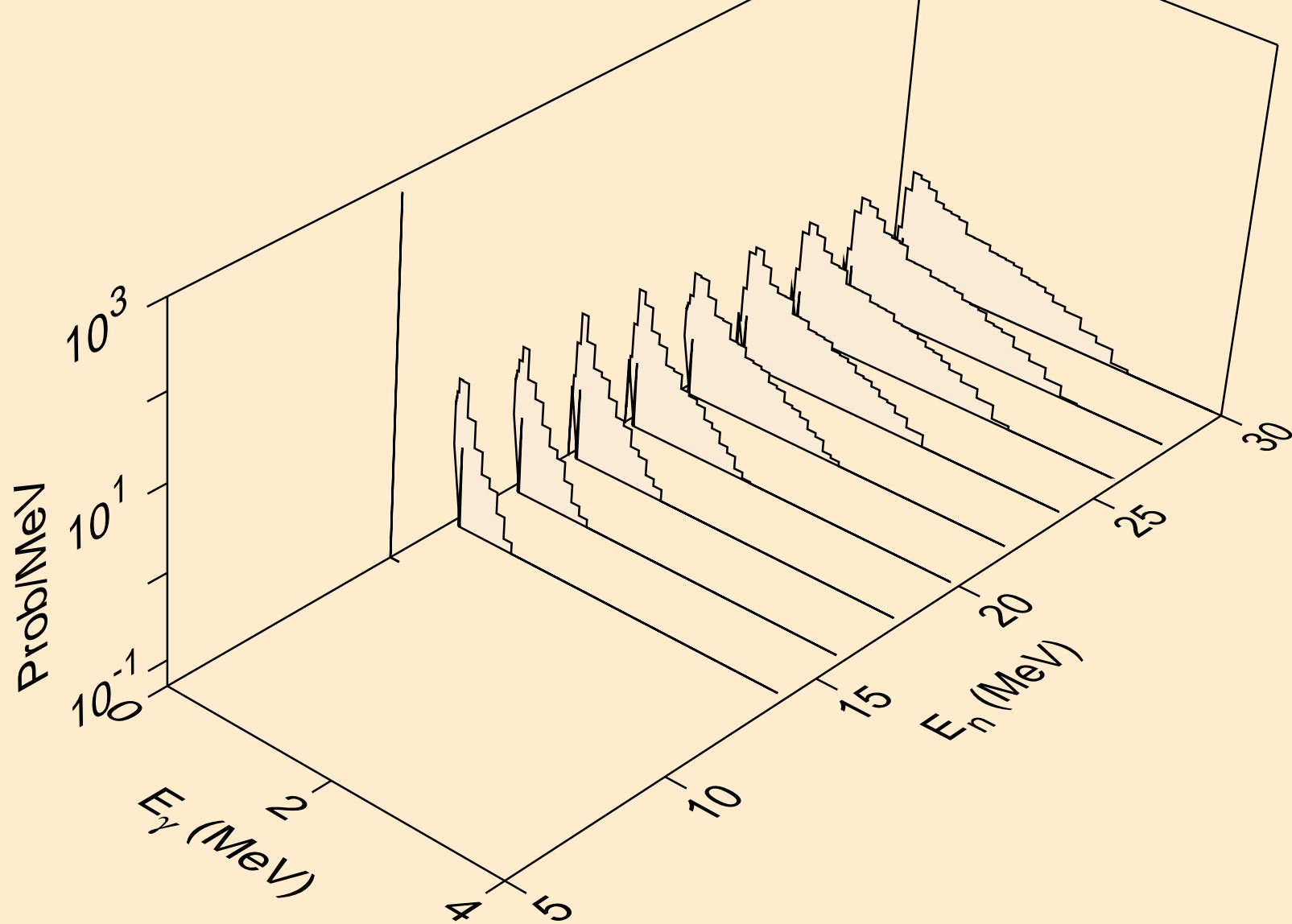

DB262 NEUTRON ACER TENDL-2021 LIBRARY; T=293.6K
Photon emission for (n,n*)he3

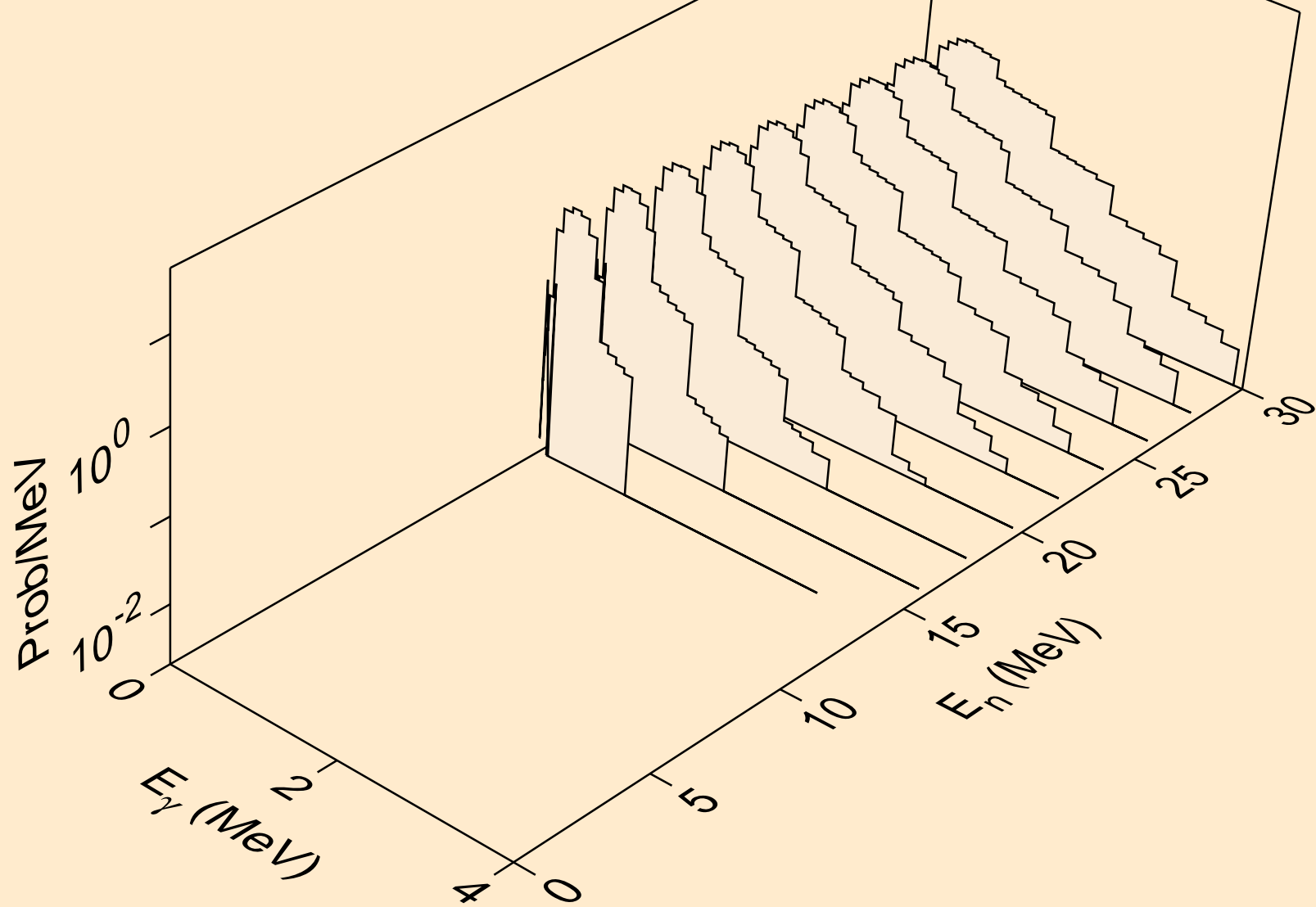

DB262 NEUTRON ACER TENDL-2021 LIBRARY; T=293.6K
Photon emission for (n,4n)

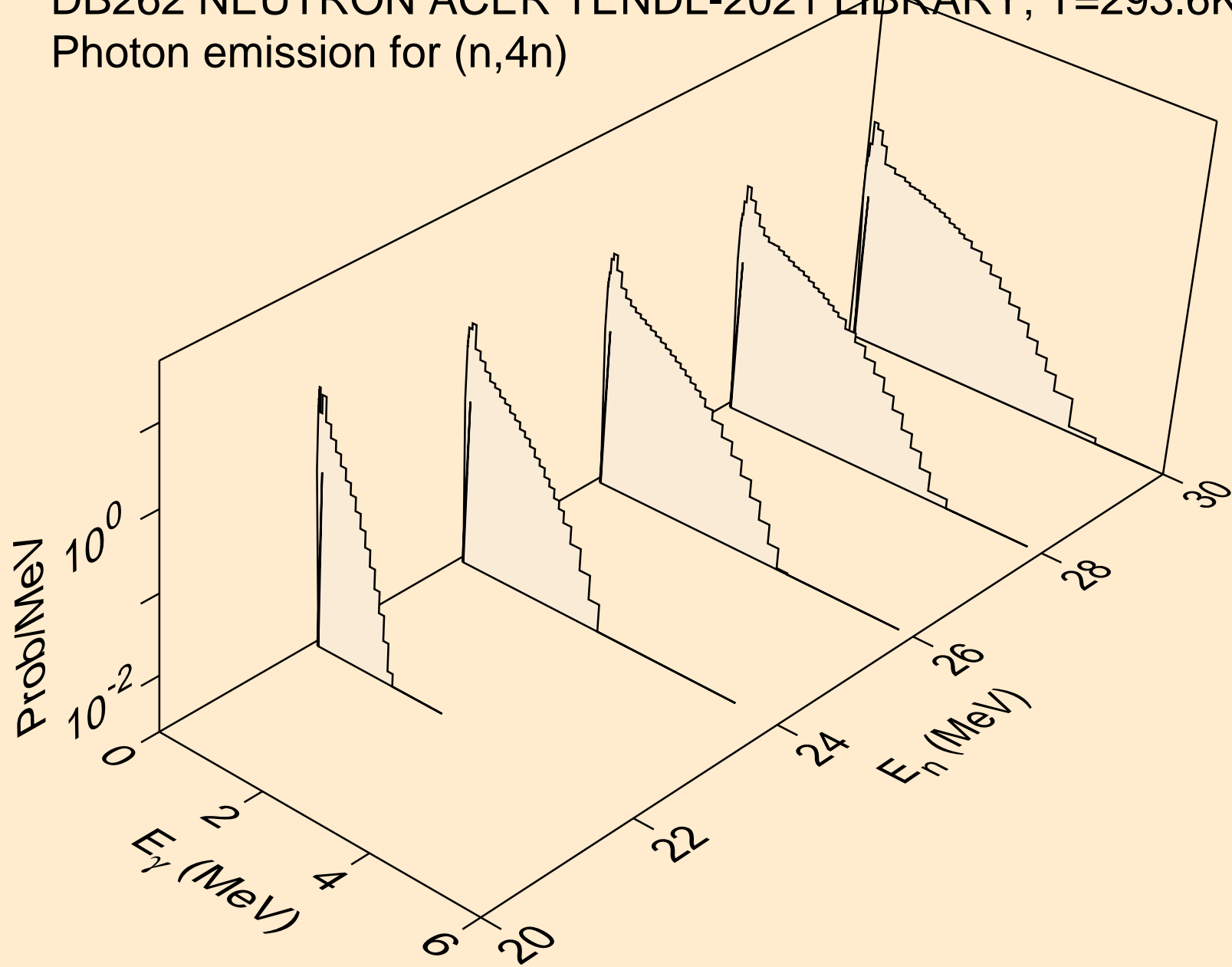

DB262 NEUTRON ACER TENDL-2021 LIBRARY; T=293.6K
Photon emission for (n,2np)

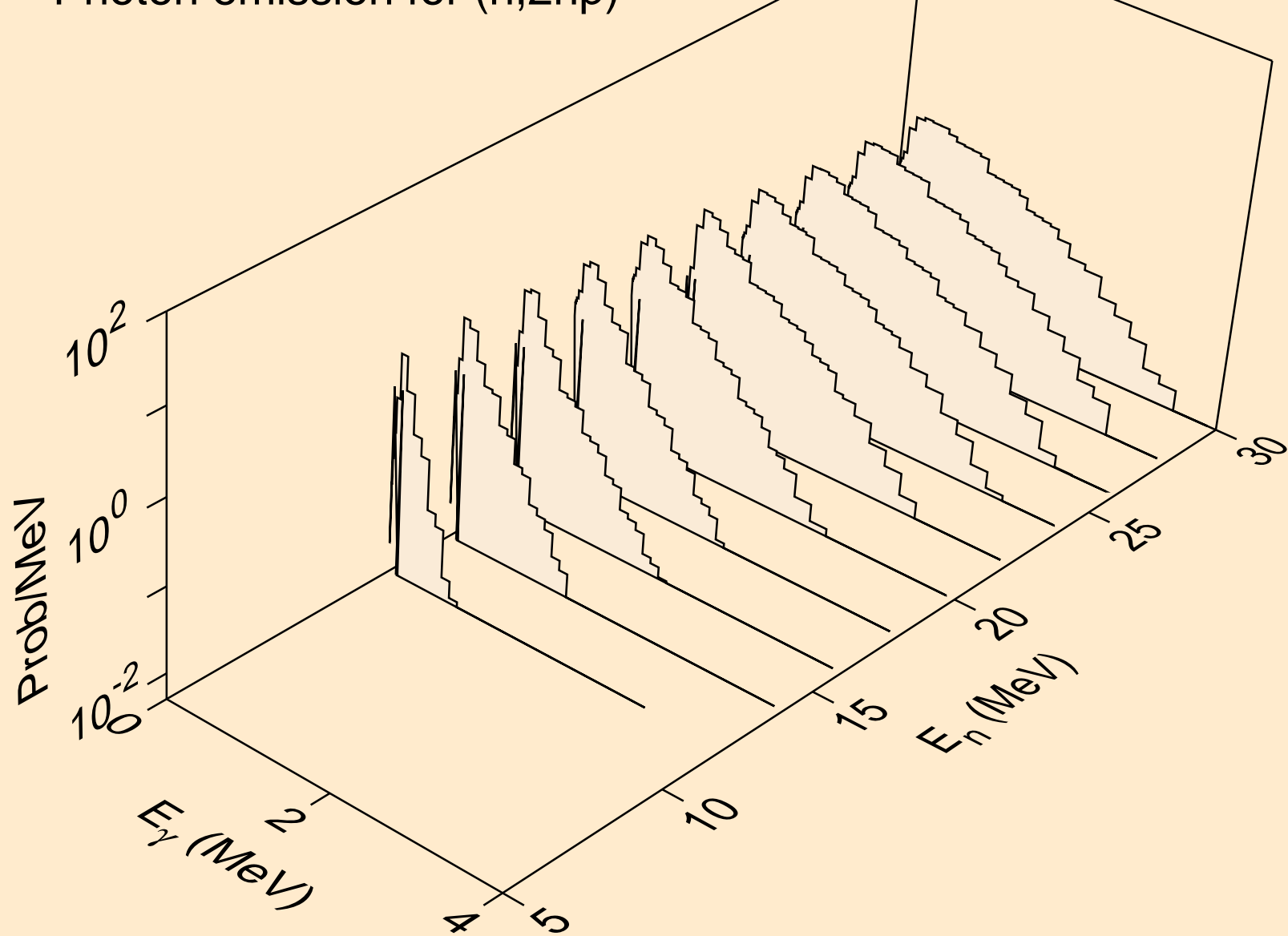

DB262 NEUTRON ACER TENDL-2021 LIBRARY; T=293.6K
Photon emission for (n,3np)

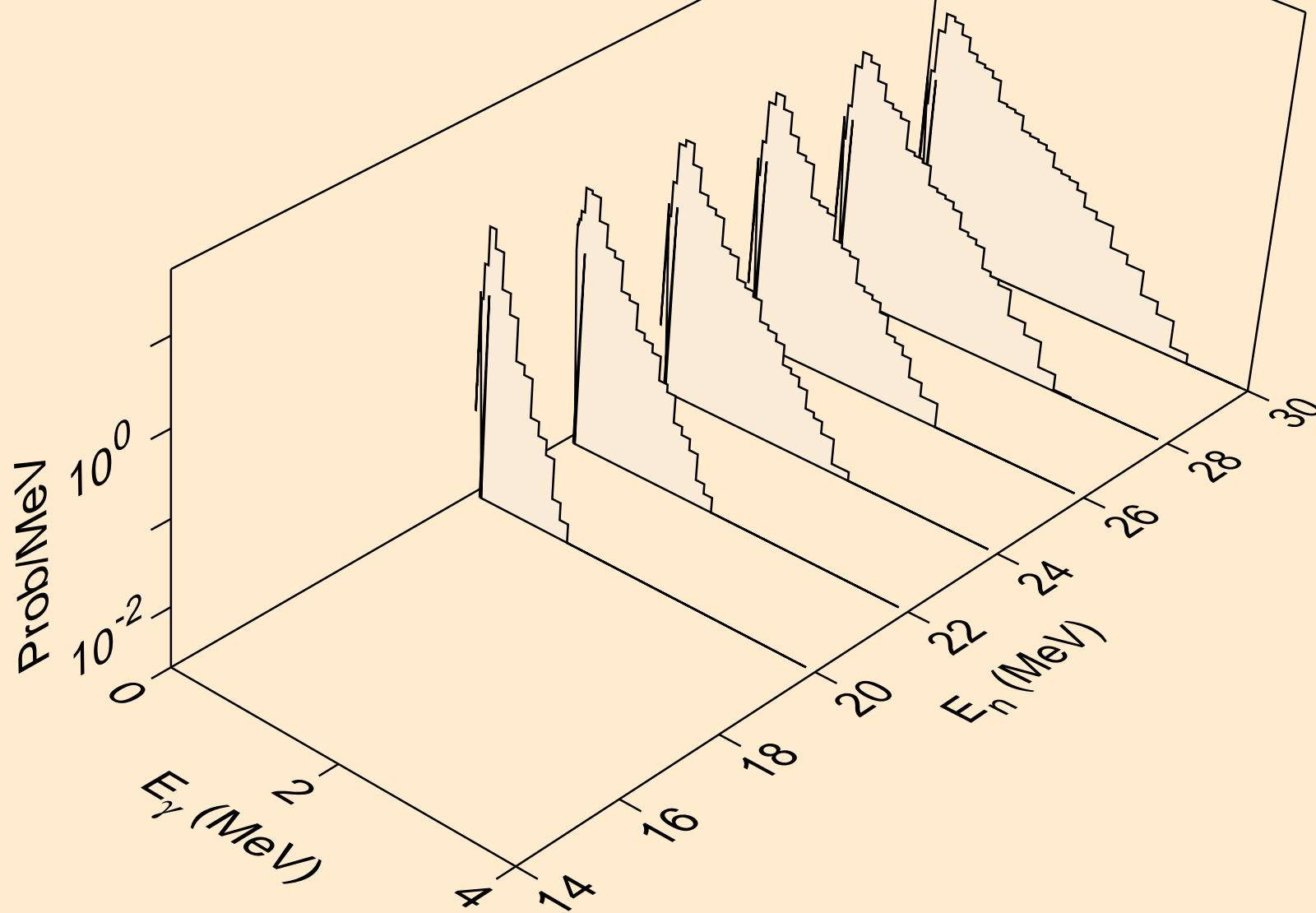

DB262 NEUTRON ACER TENDL-2021 LIBRARY; T=293.6K
Photon emission for (n,2np)

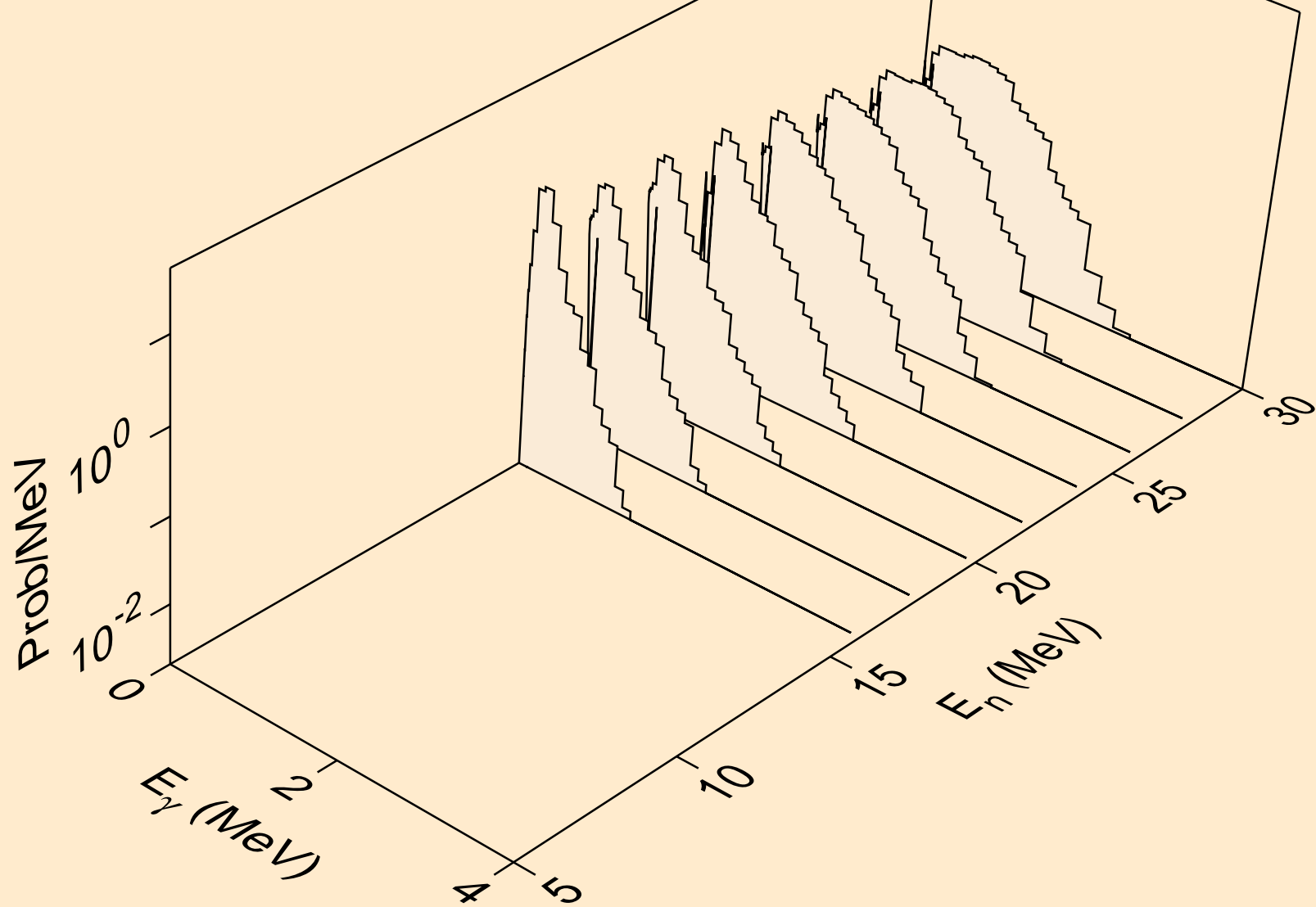

DB262 NEUTRON ACER TENDL-2021 LIBRARY; T=293.6K
Photon emission for (n,npa)

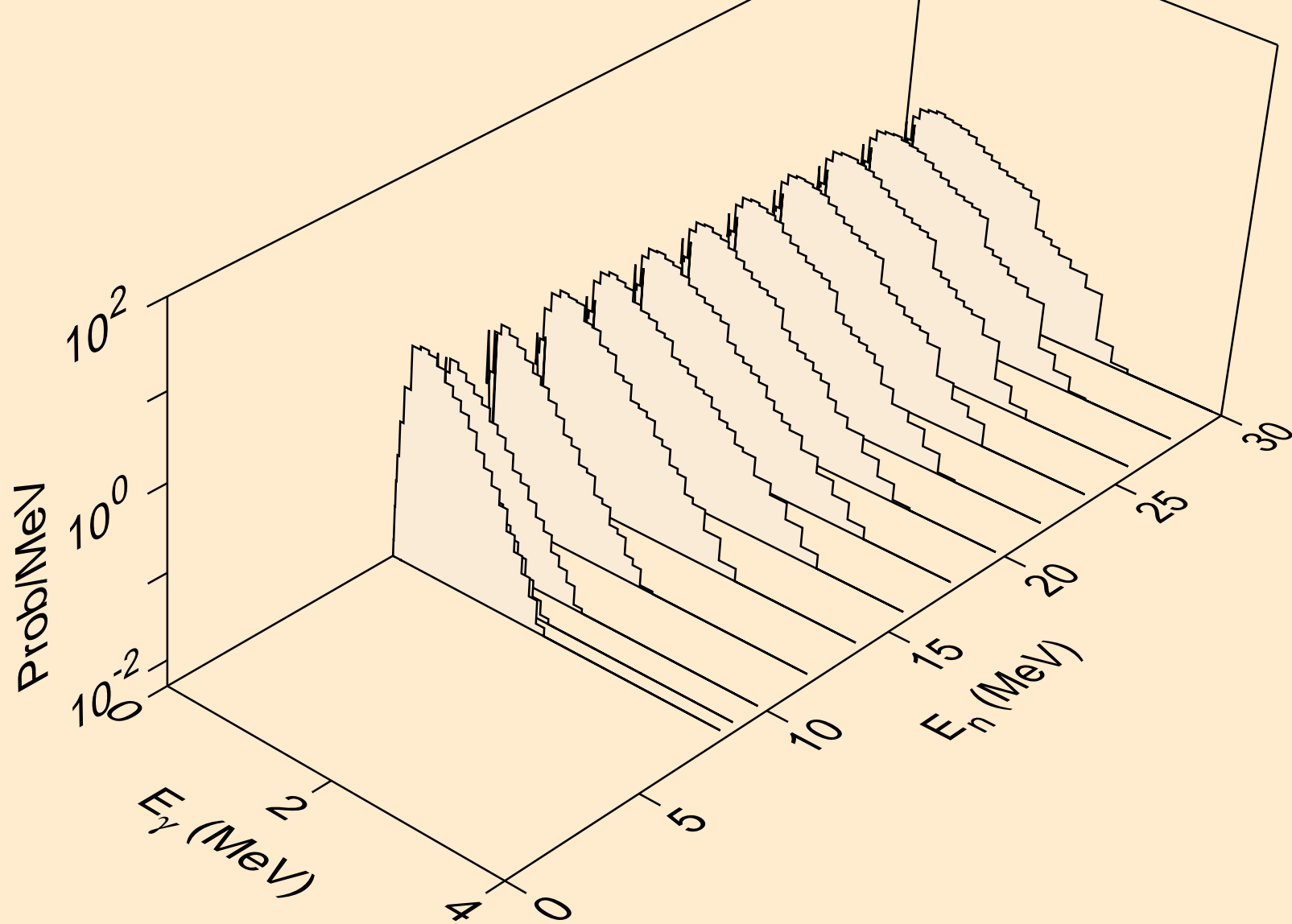

DB262 NEUTRON ACER TENDL-2021 LIBRARY; T=293.6K
Photon emission for (n,n*c)

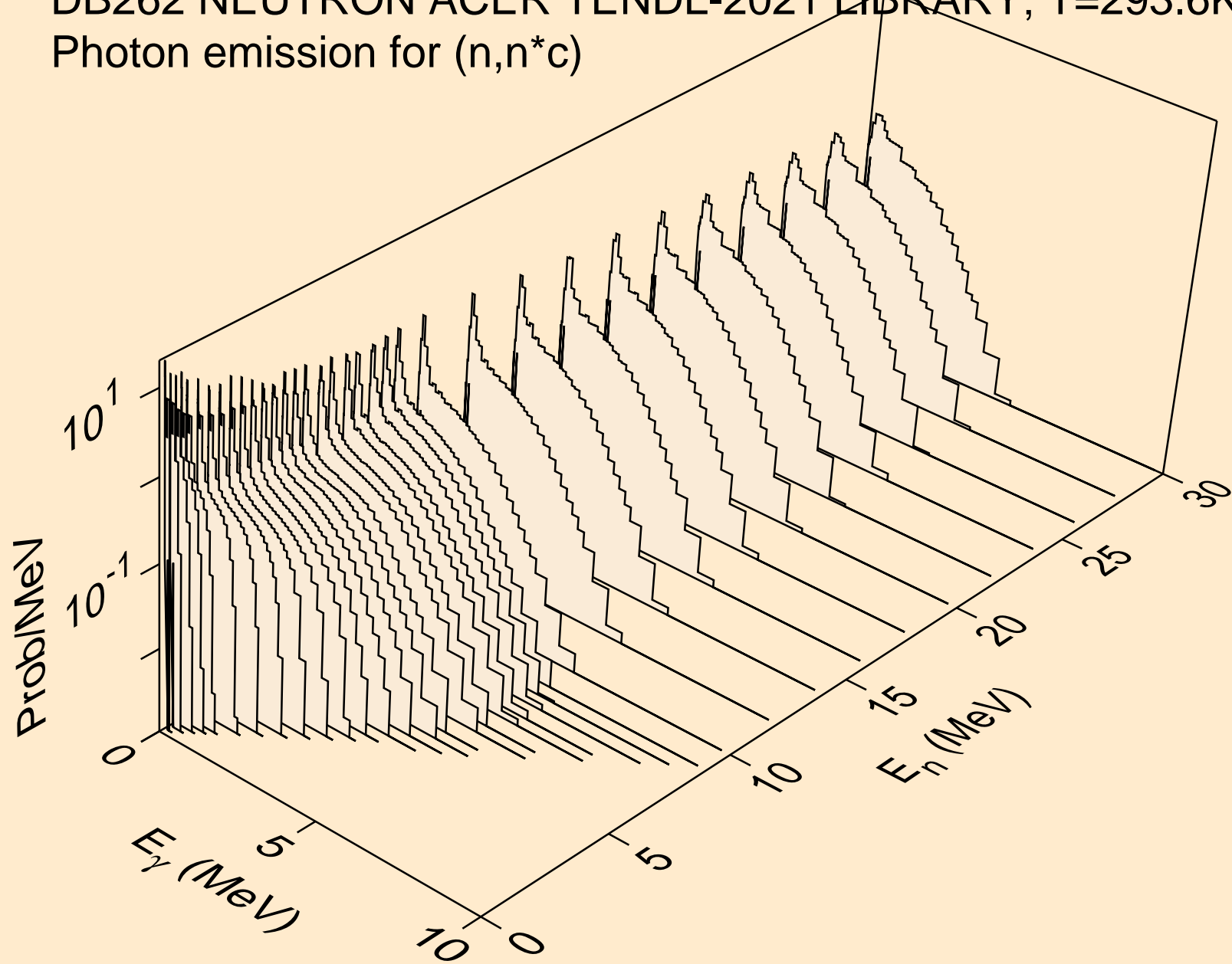

DB262 NEUTRON ACER TENDL-2021 LIBRARY; T=293.6K
Photon emission for (n,gma)

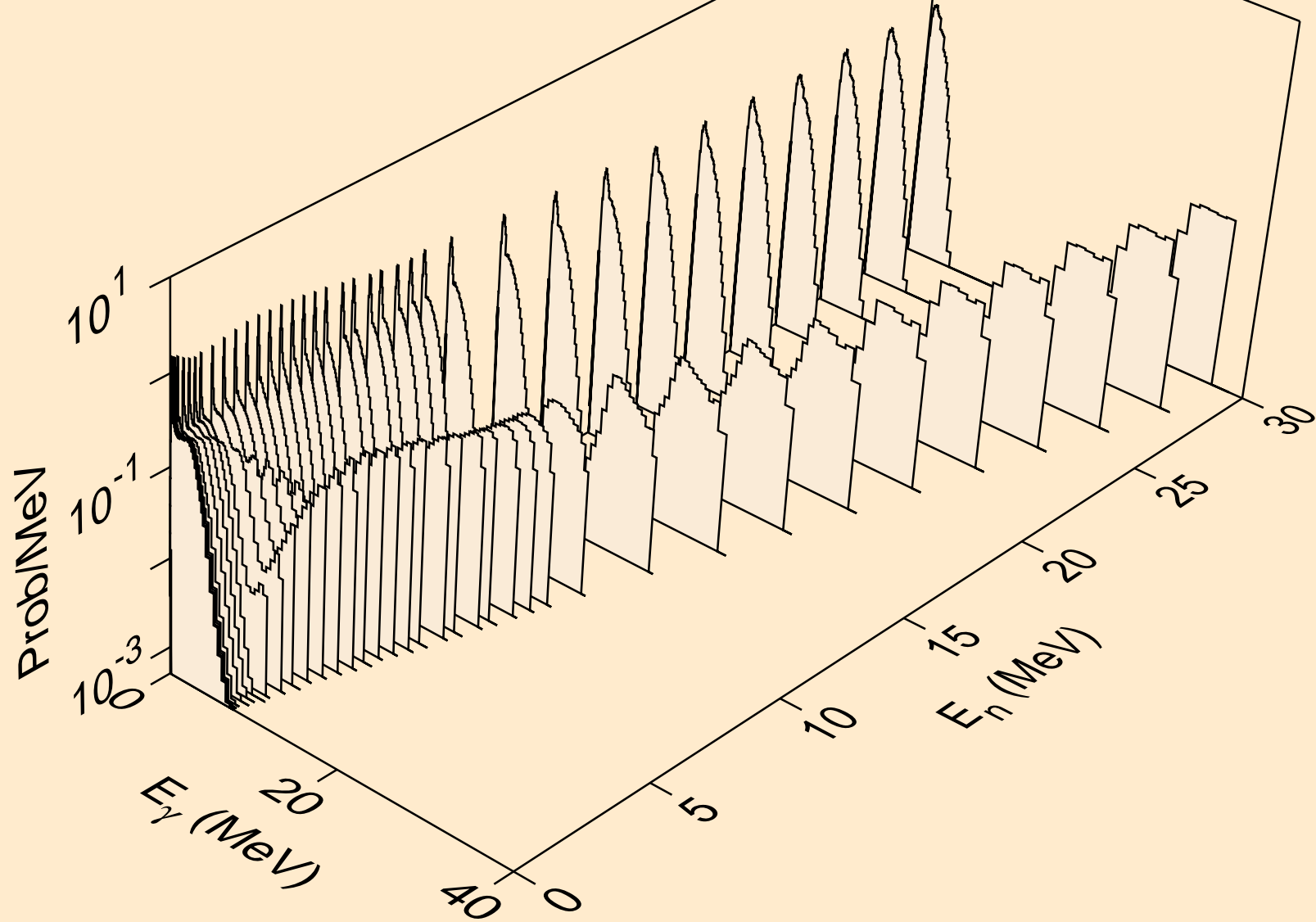

DB262 NEUTRON ACER TENDL-2021 LIBRARY; T=293.6K
Photon emission for (n,p)

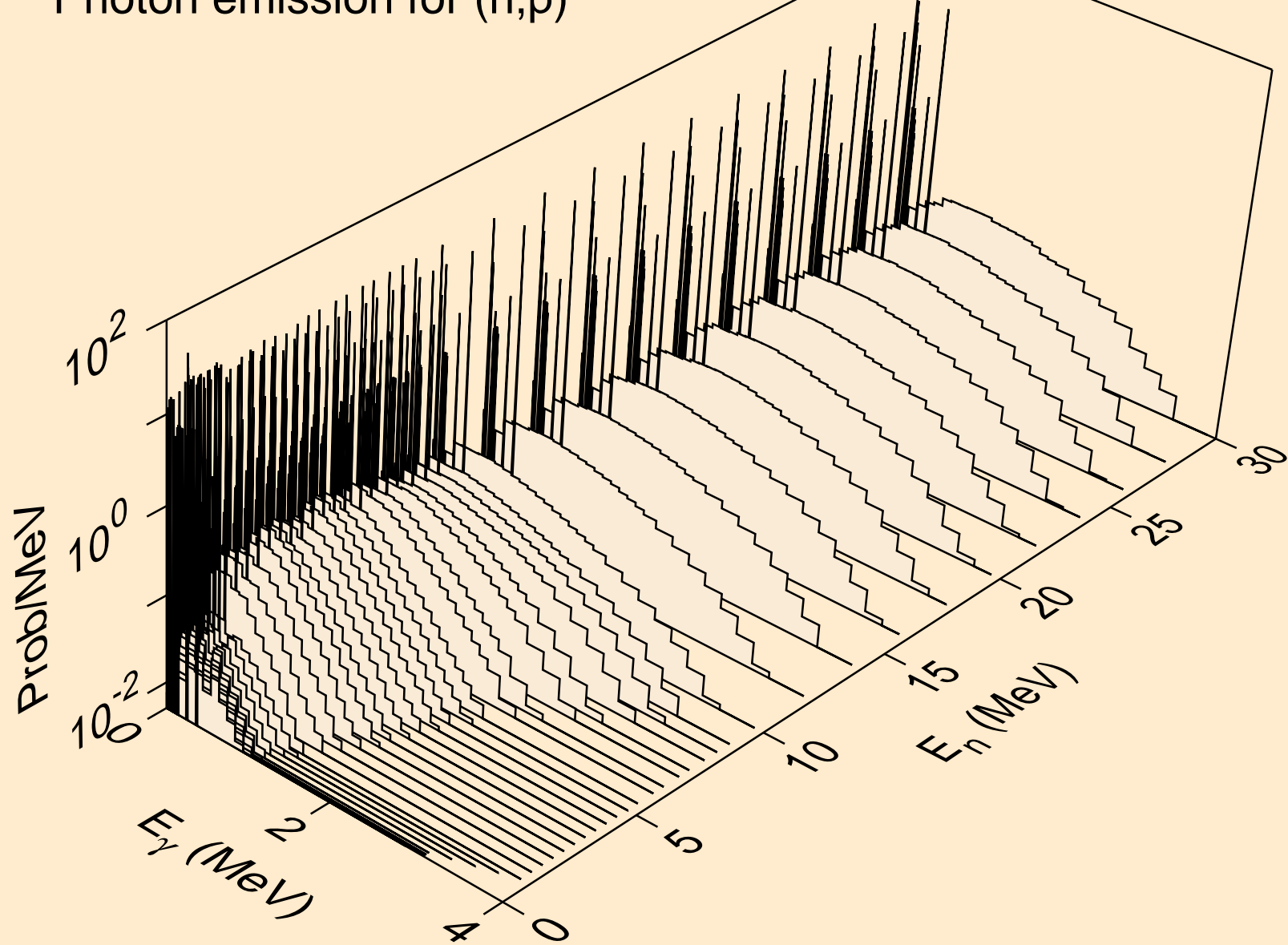

DB262 NEUTRON ACER TENDL-2021 LIBRARY; T=293.6K
Photon emission for (n,d)

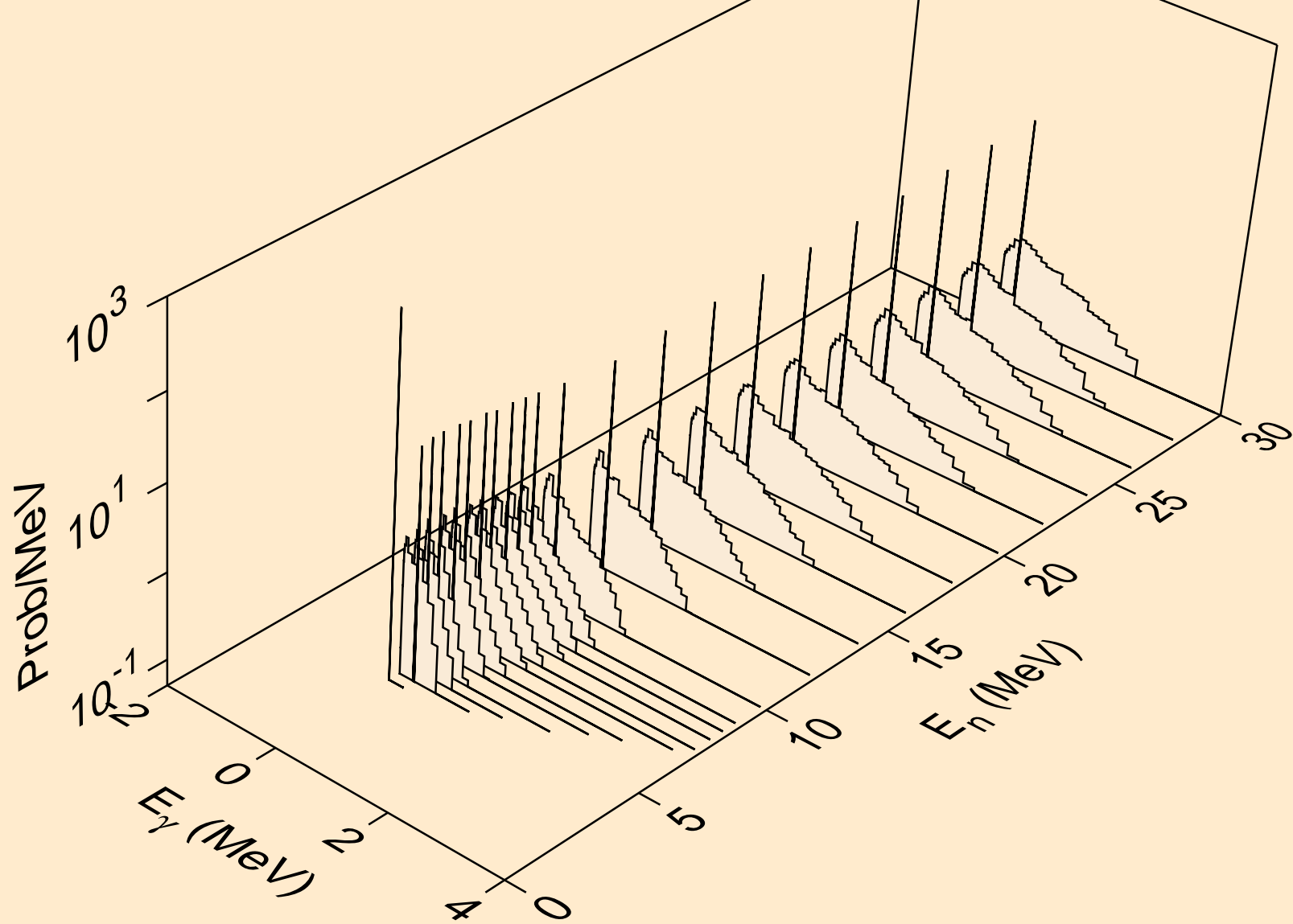

DB262 NEUTRON ACER TENDL-2021 LIBRARY; T=293.6K
Photon emission for (n,t)

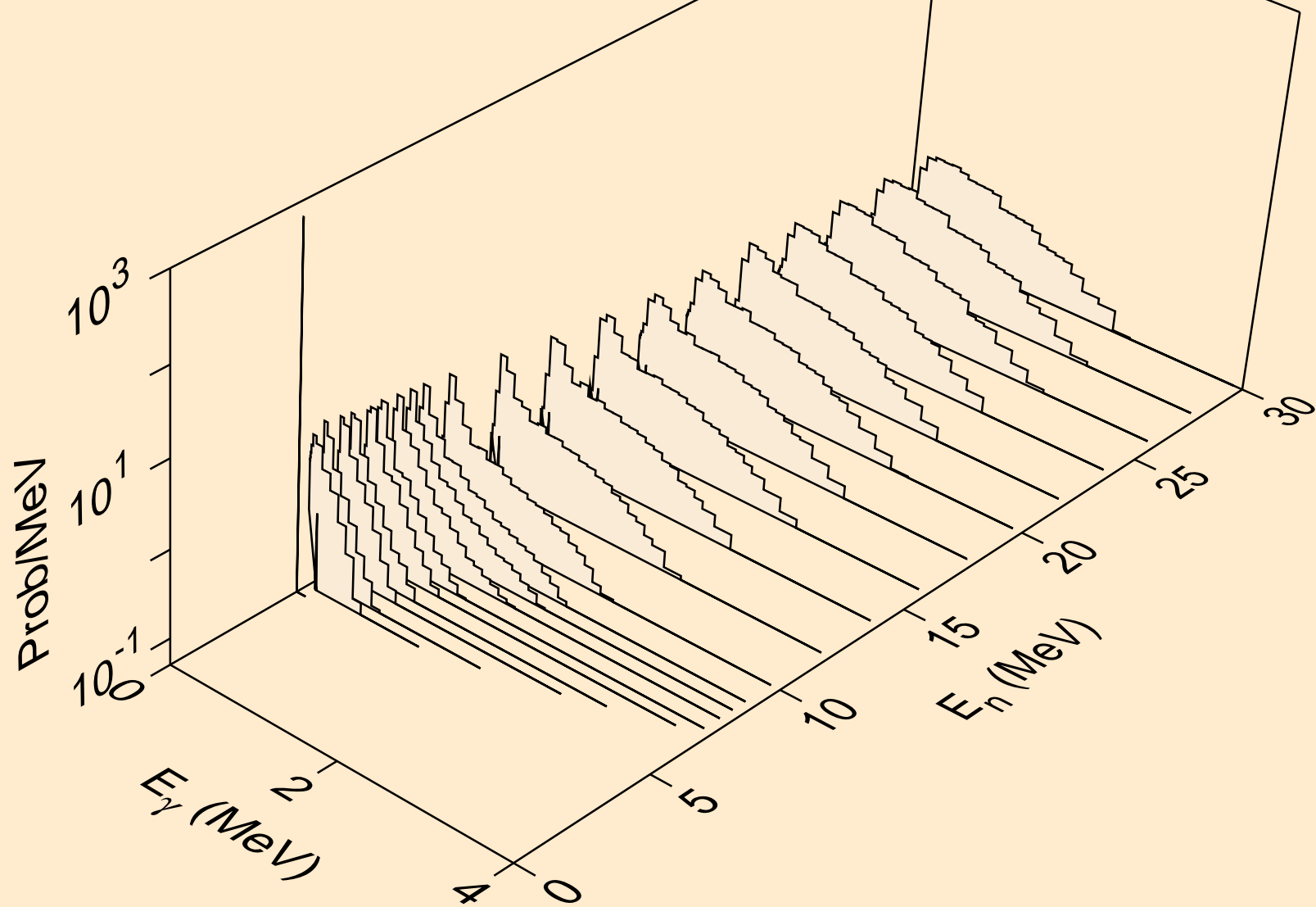

DB262 NEUTRON ACER TENDL-2021 LIBRARY; T=293.6K
Photon emission for (n,he3)

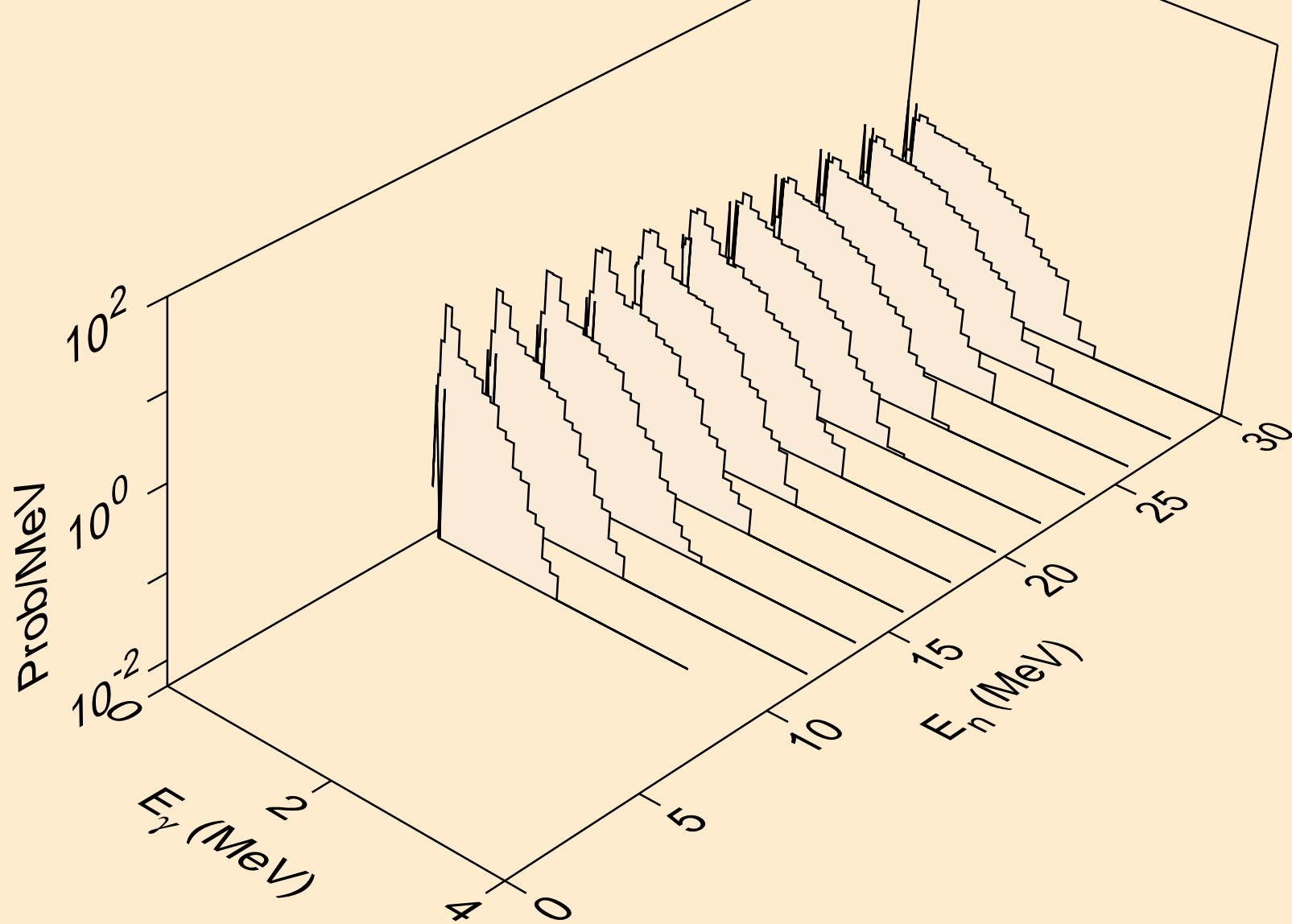

DB262 NEUTRON ACER TENDL-2021 LIBRARY; T=293.6K
Photon emission for (n,a)

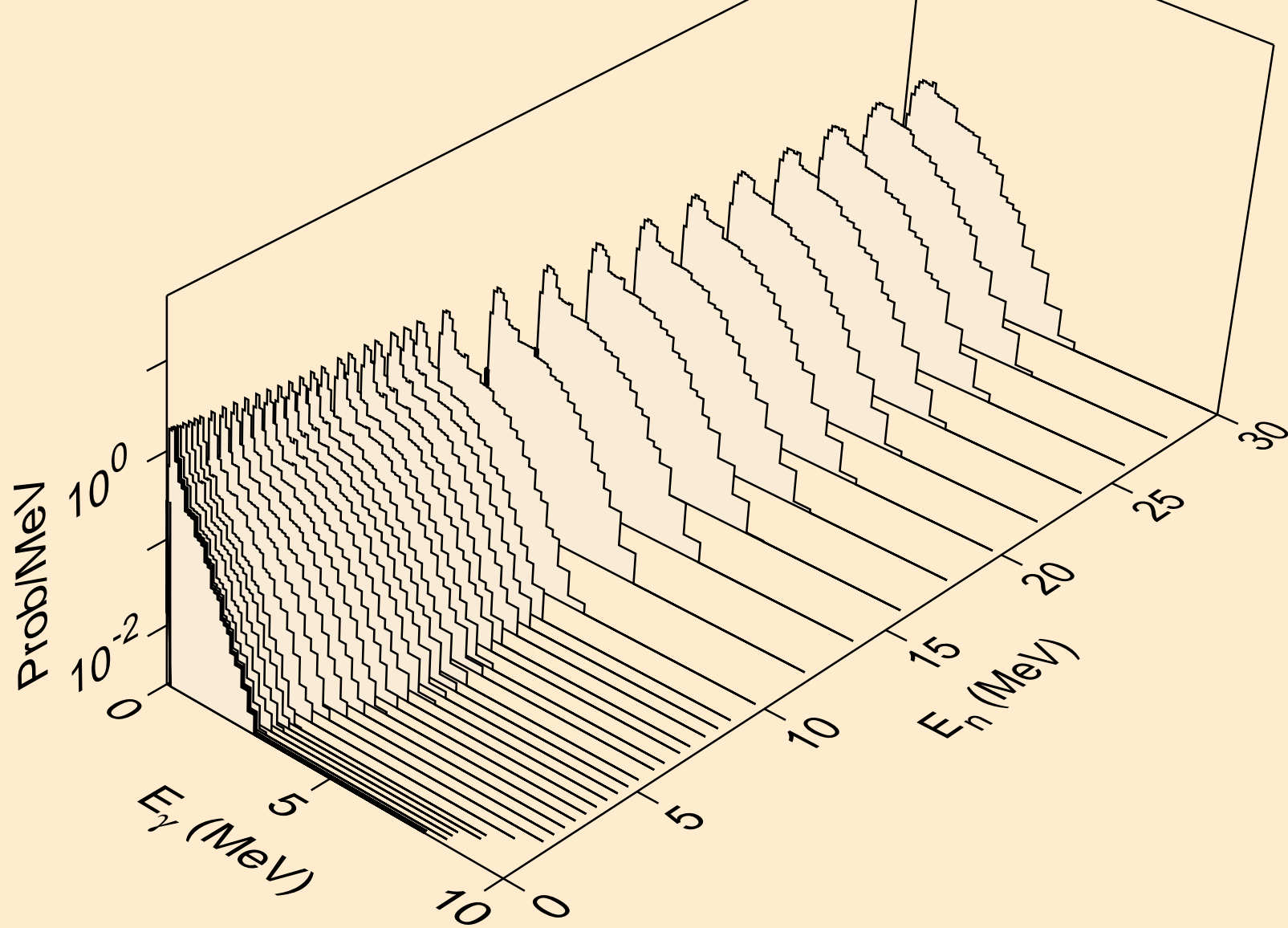

DB262 NEUTRON ACER TENDL-2021 LIBRARY; T=293.6K
Photon emission for (n,2a)

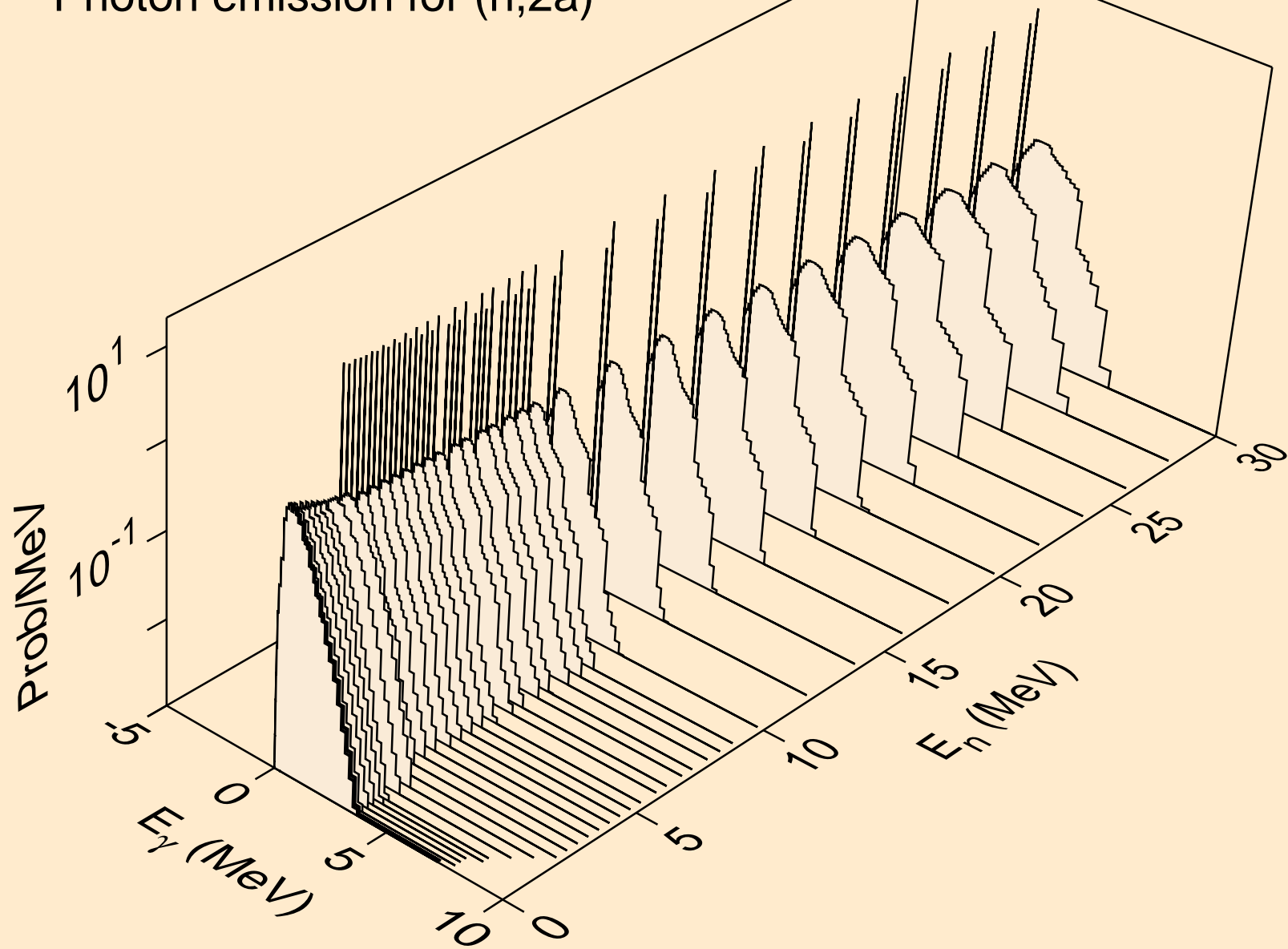

DB262 NEUTRON ACER TENDL-2021 LIBRARY; T=293.6K
Photon emission for (n,2p)

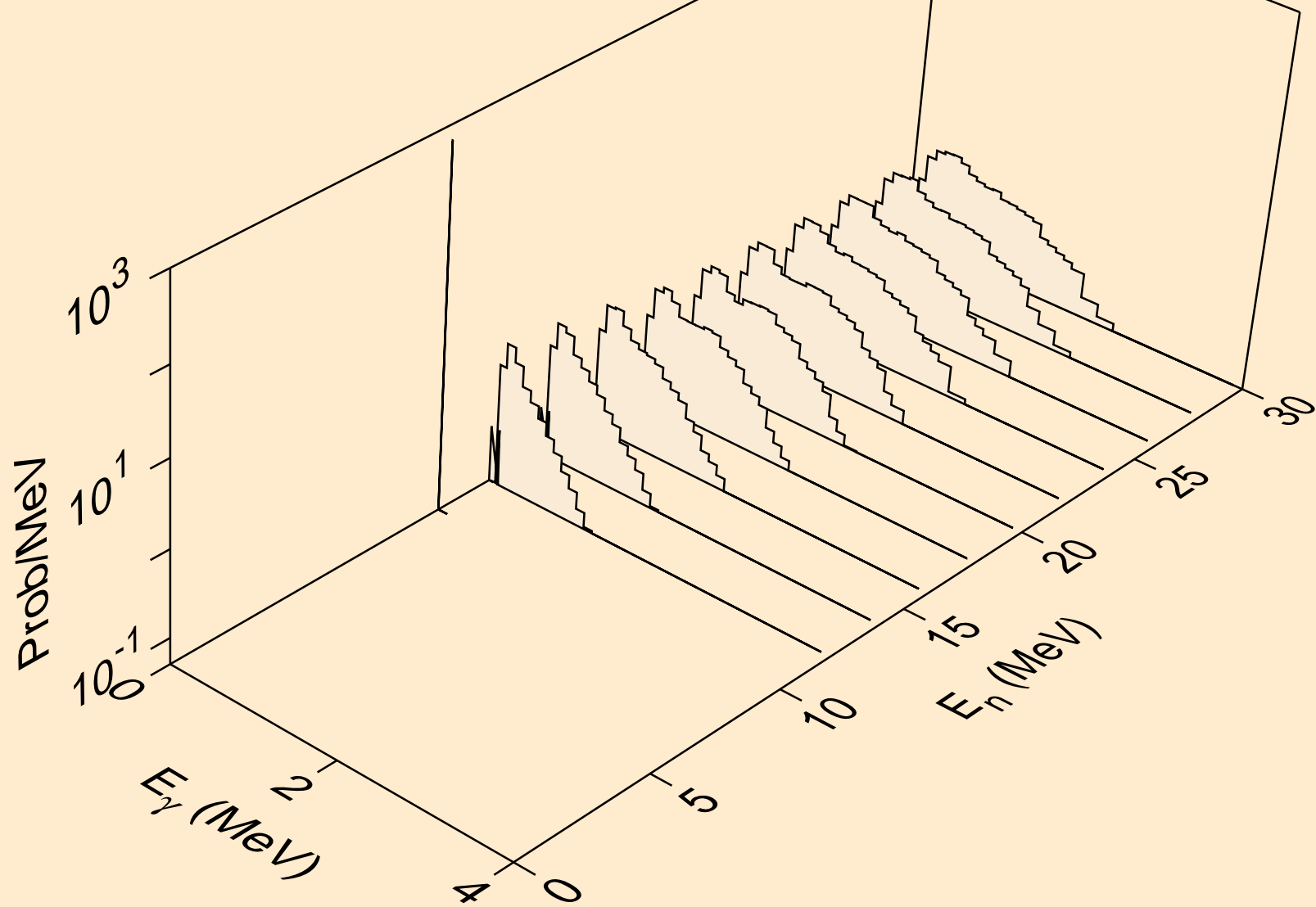

DB262 NEUTRON ACER TENDL-2021 LIBRARY; T=293.6K
Photon emission for (n,p)

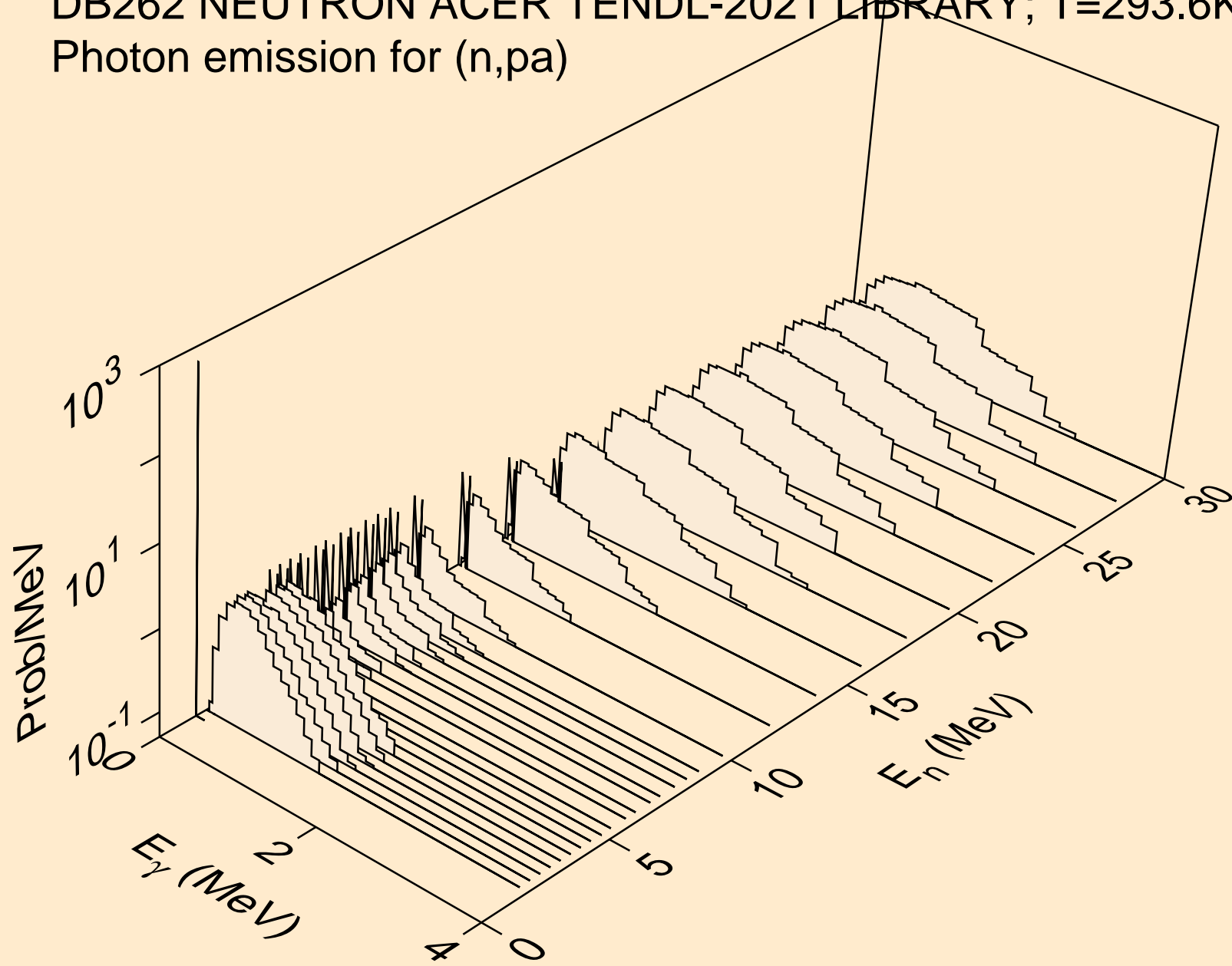

DB262 NEUTRON ACER TENDL-2021 LIBRARY; T=293.6K
Photon emission for (n,pd)

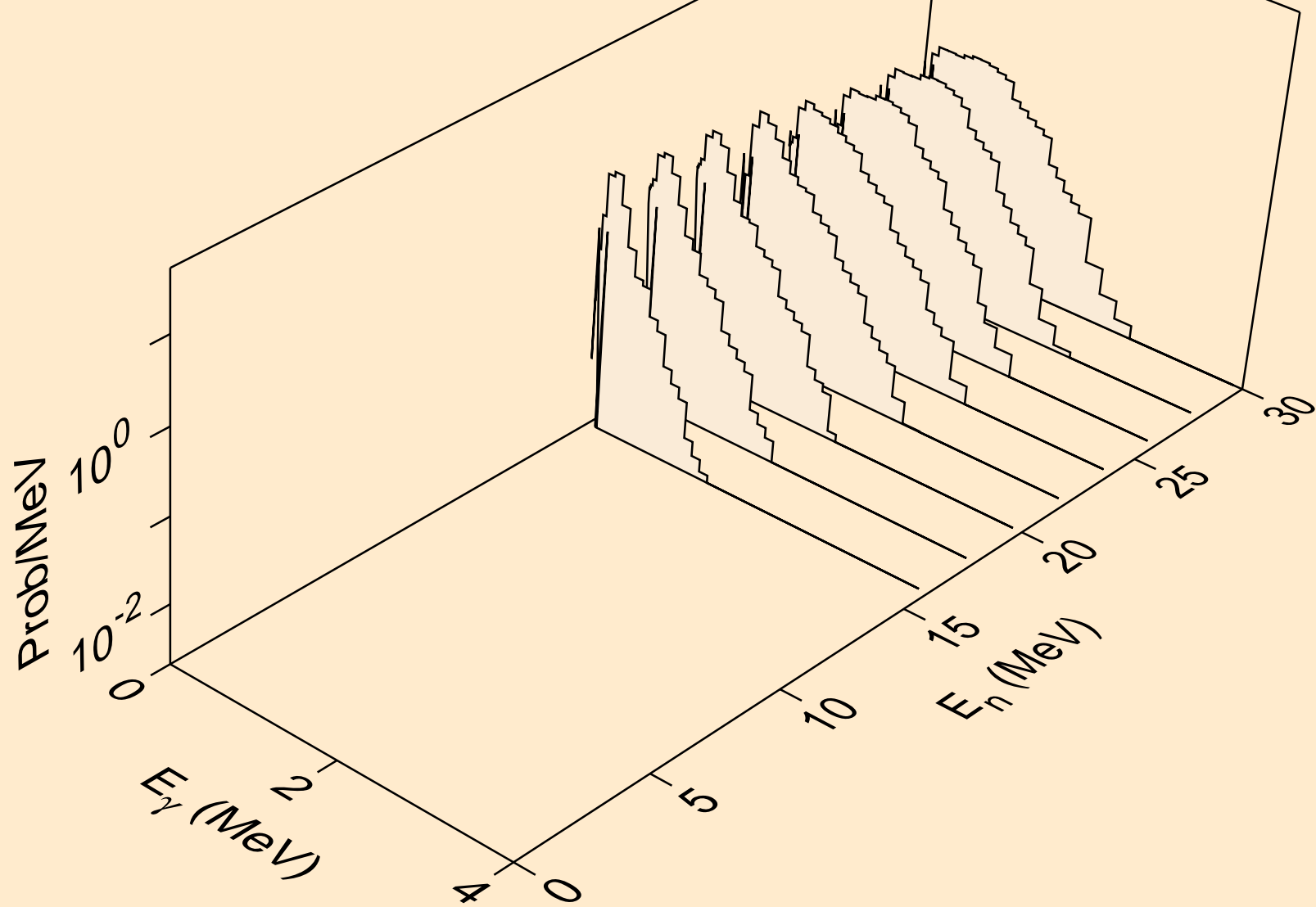

DB262 NEUTRON ACER TENDL-2021 LIBRARY; T=293.6K
Photon emission for (n,pt)

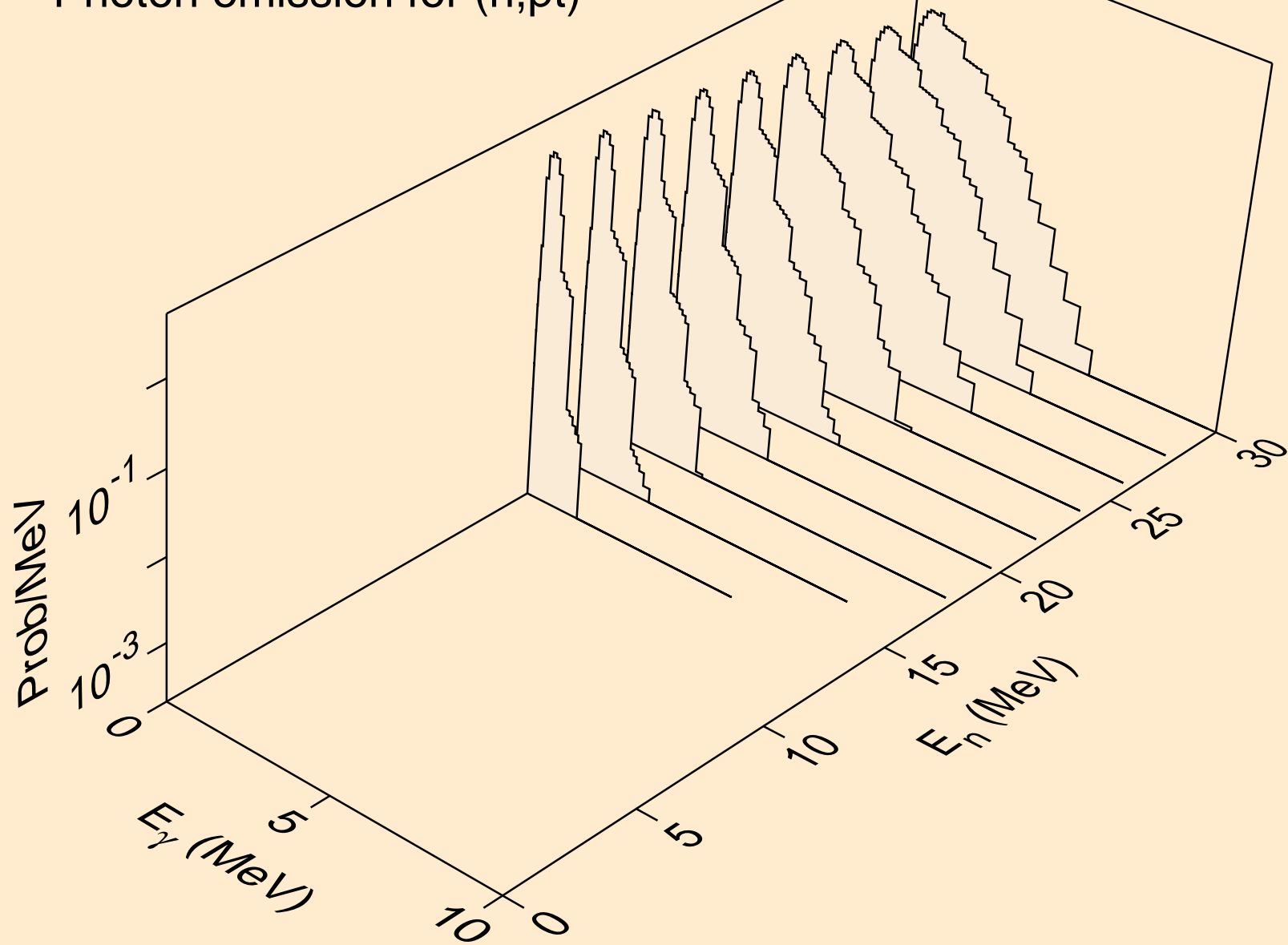

DB262 NEUTRON ACER TENDL-2021 LIBRARY; T=293.6K
thermal capture photon spectrum

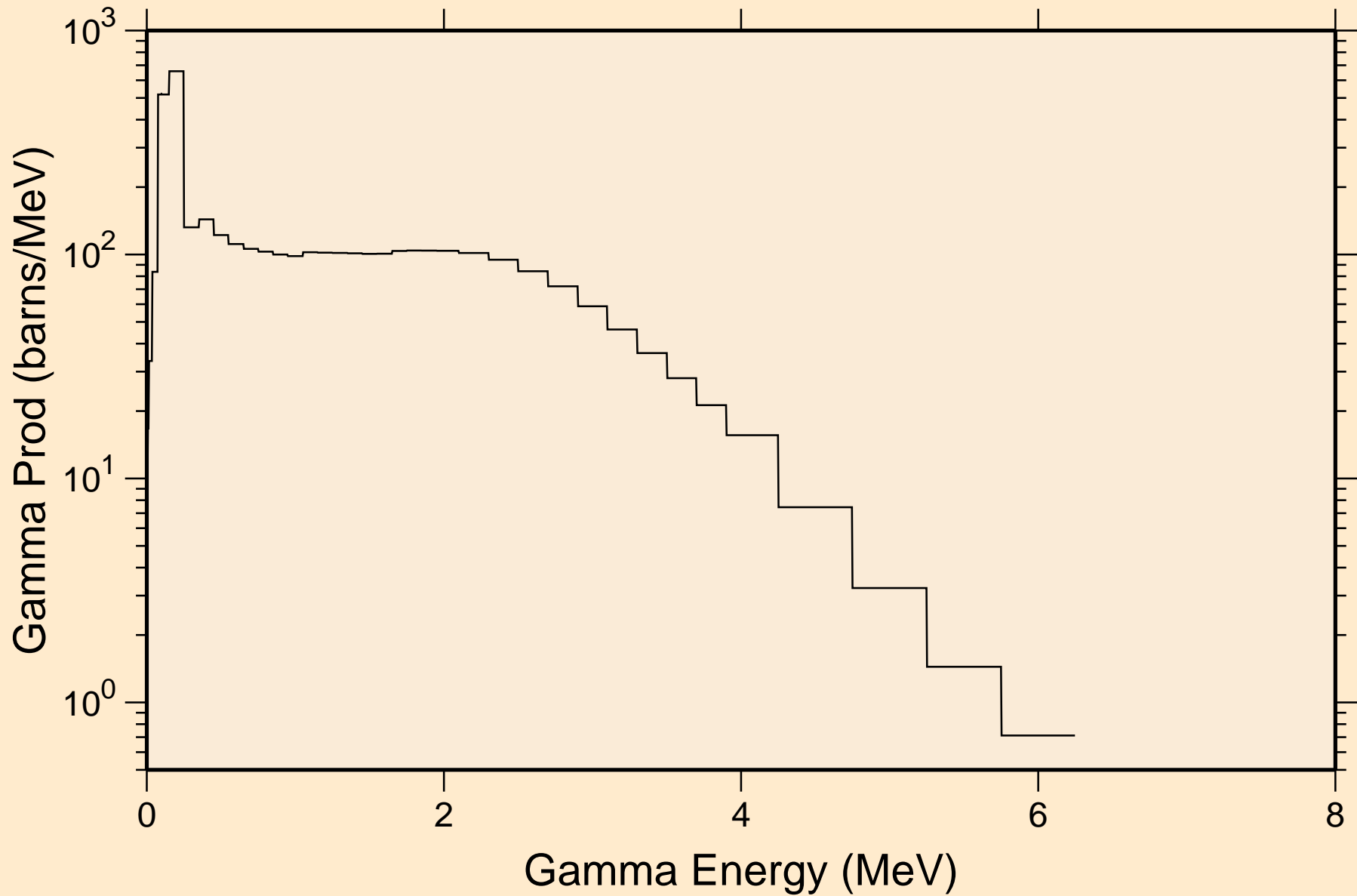

DB262 NEUTRON ACER TENDL-2021 LIBRARY; T=293.6K
14 MeV photon spectrum

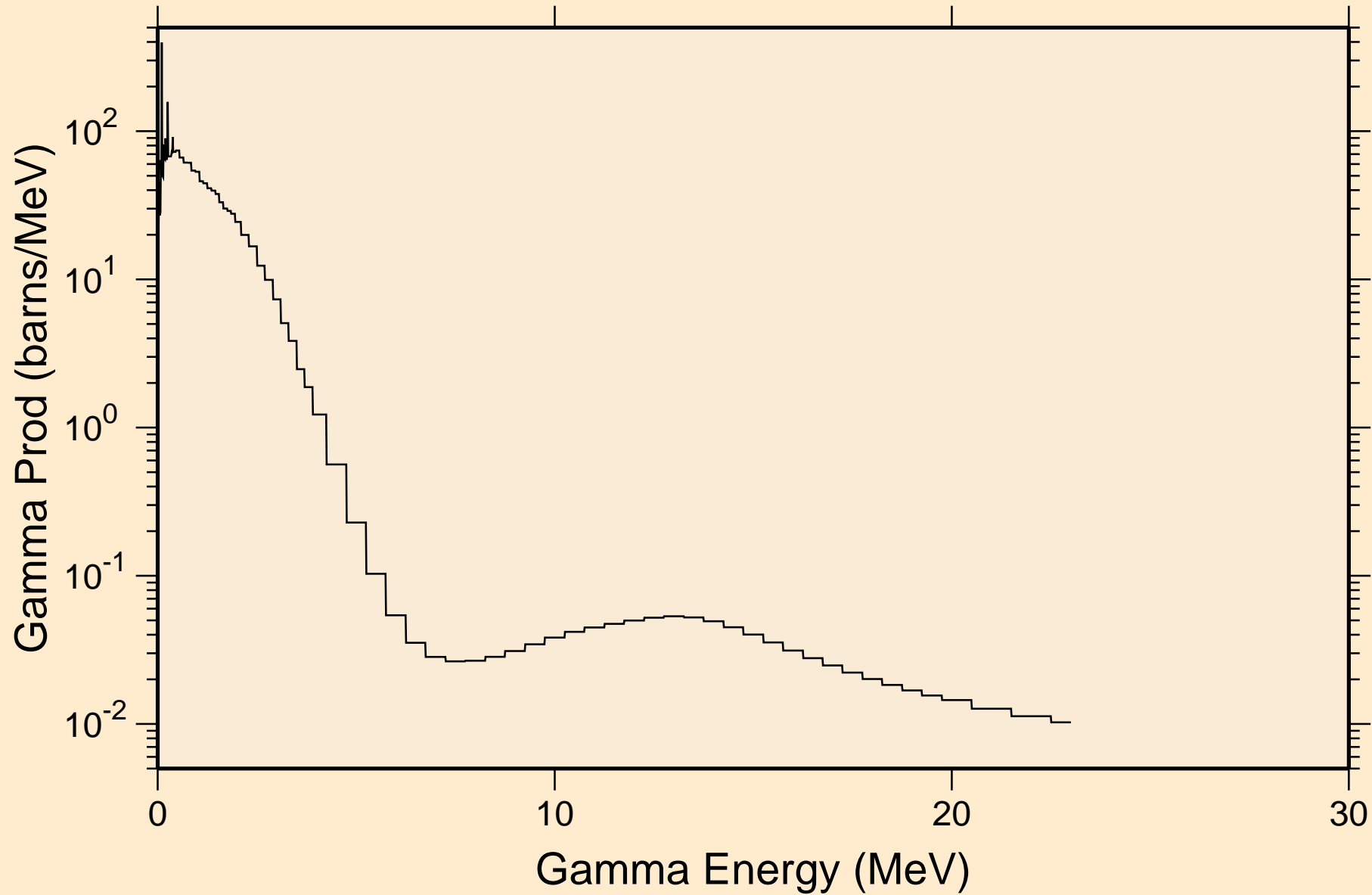

DB262 NEUTRON ACER TENDL-2021 LIBRARY; T=293.6K

Particle heating contributions

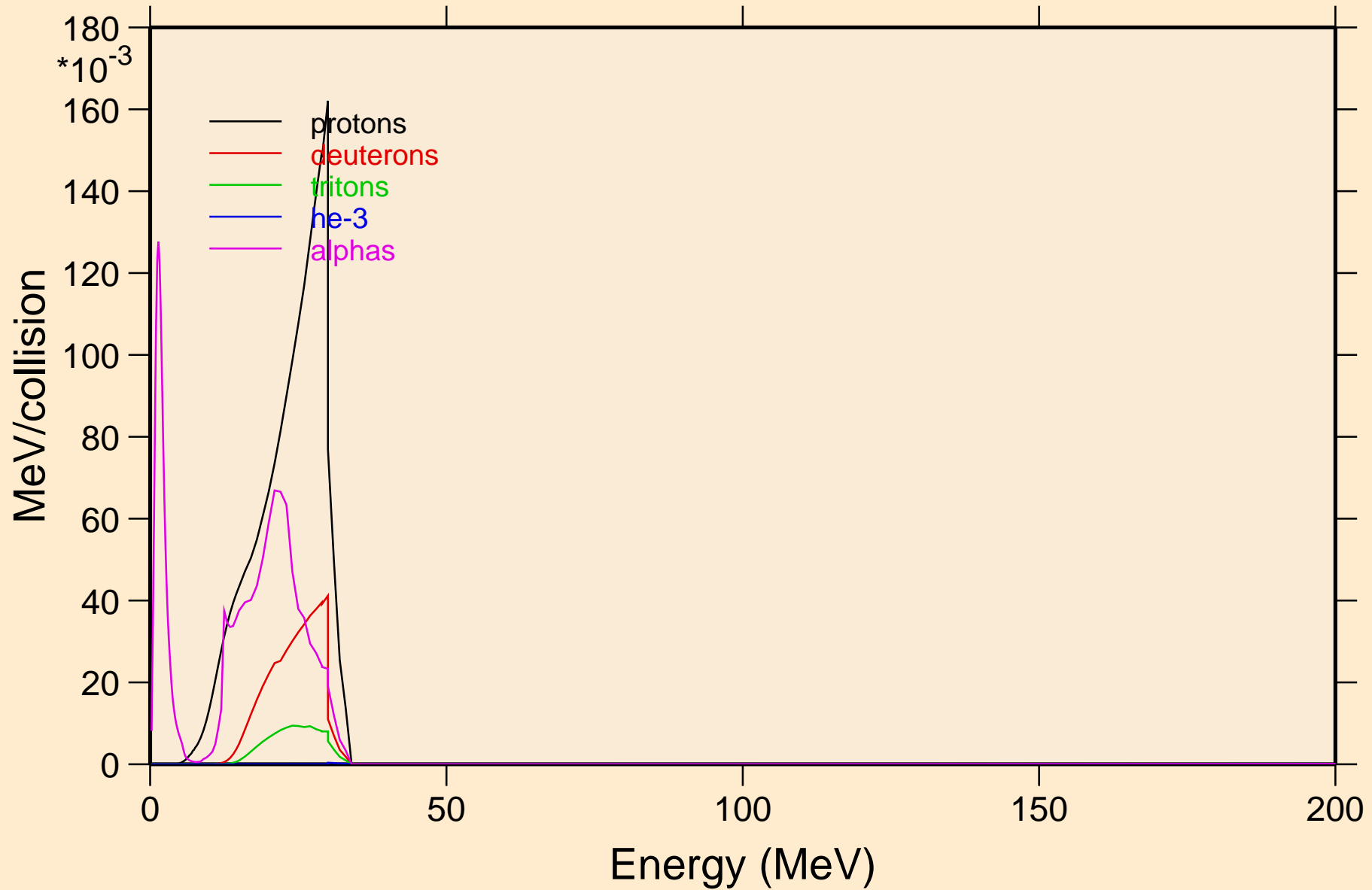

DB262 NEUTRON ACER TENDL-2021 LIBRARY; T=293.6K
Recoil Heating

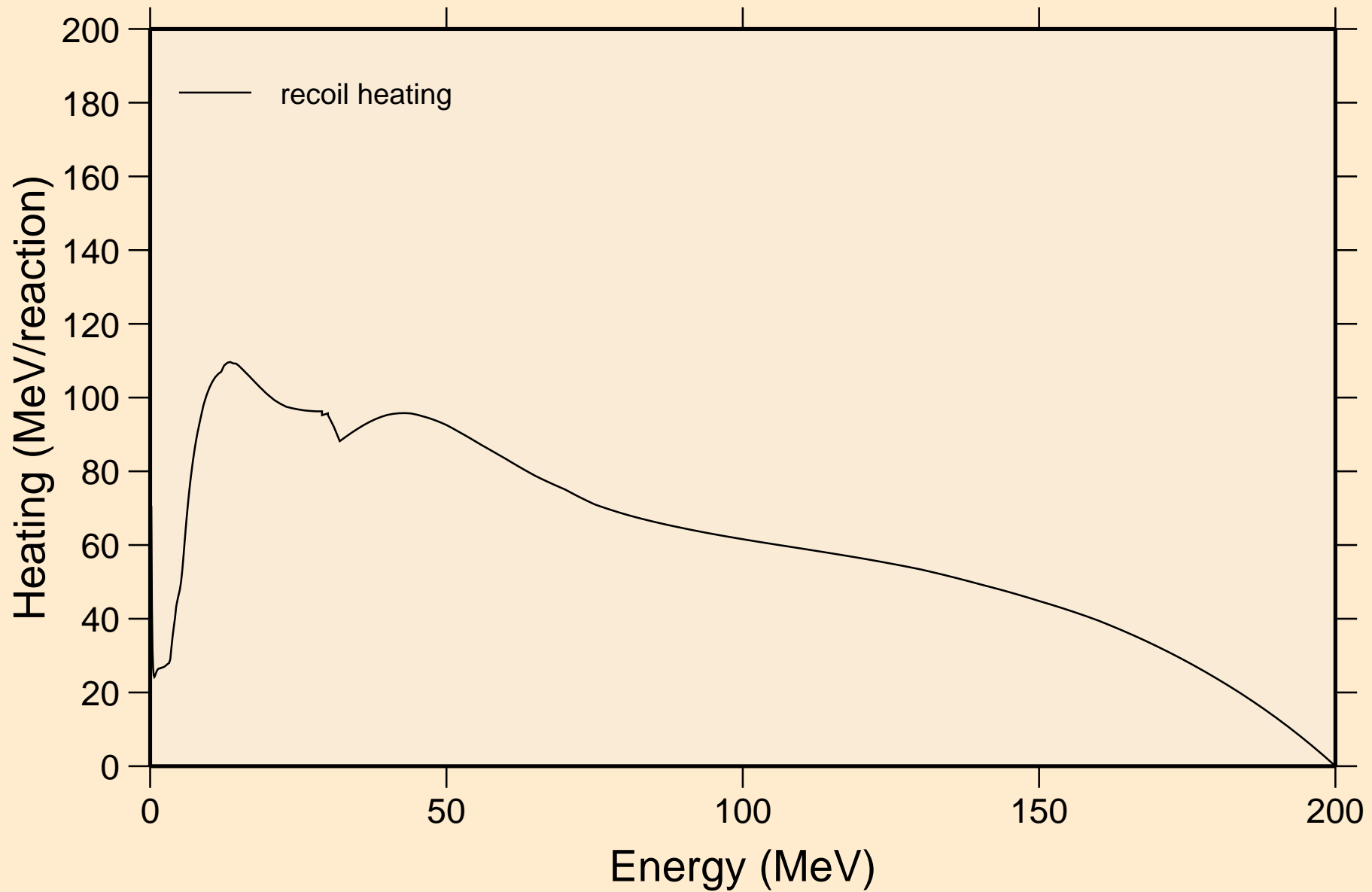

DB262 NEUTRON ACER TENDL-2021 LIBRARY; T=293.6K

Particle production cross sections

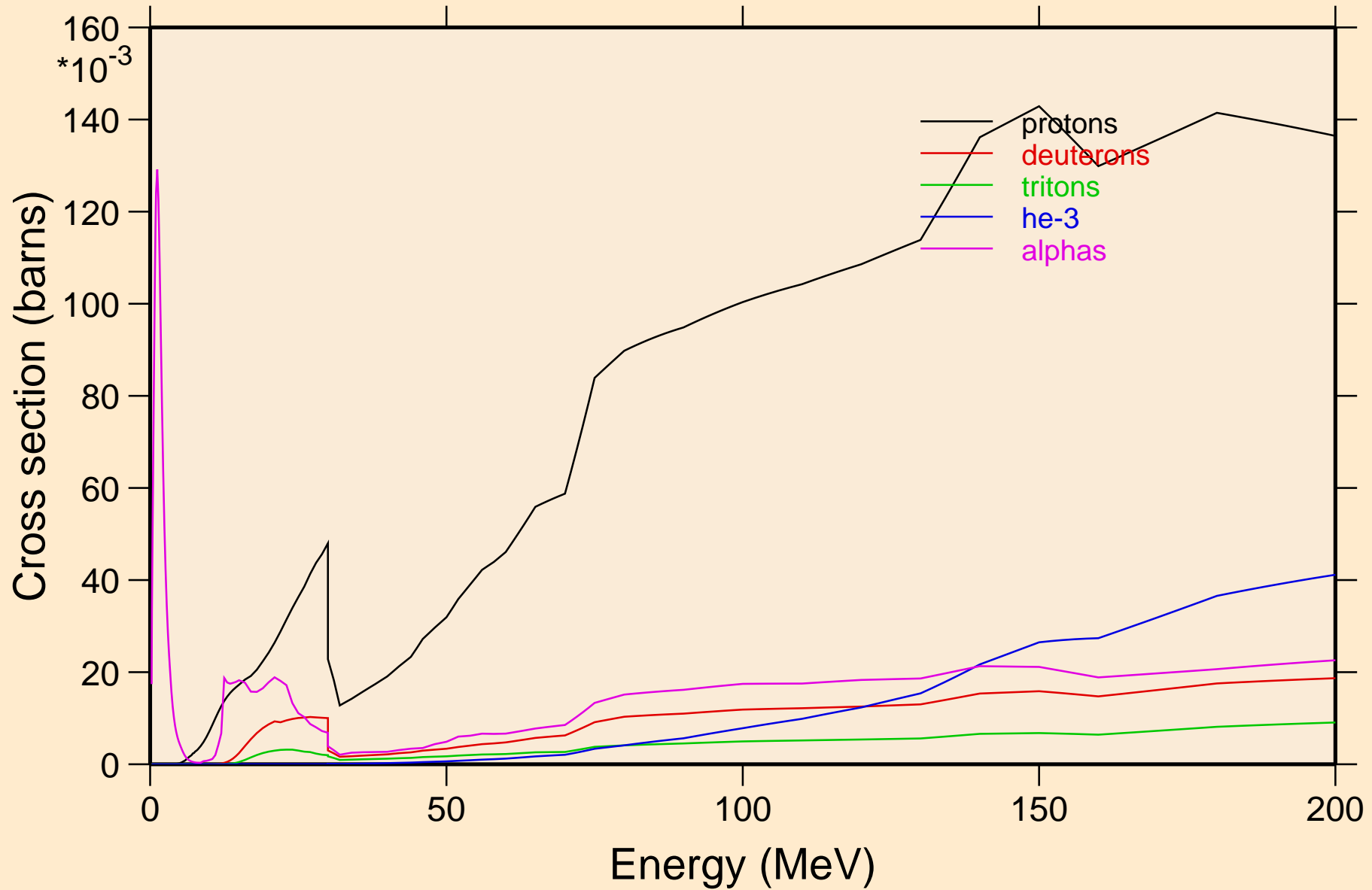

DB262 NEUTRON ACER TENDL-2021 LIBRARY; T=293.6K
protons from (n,x)

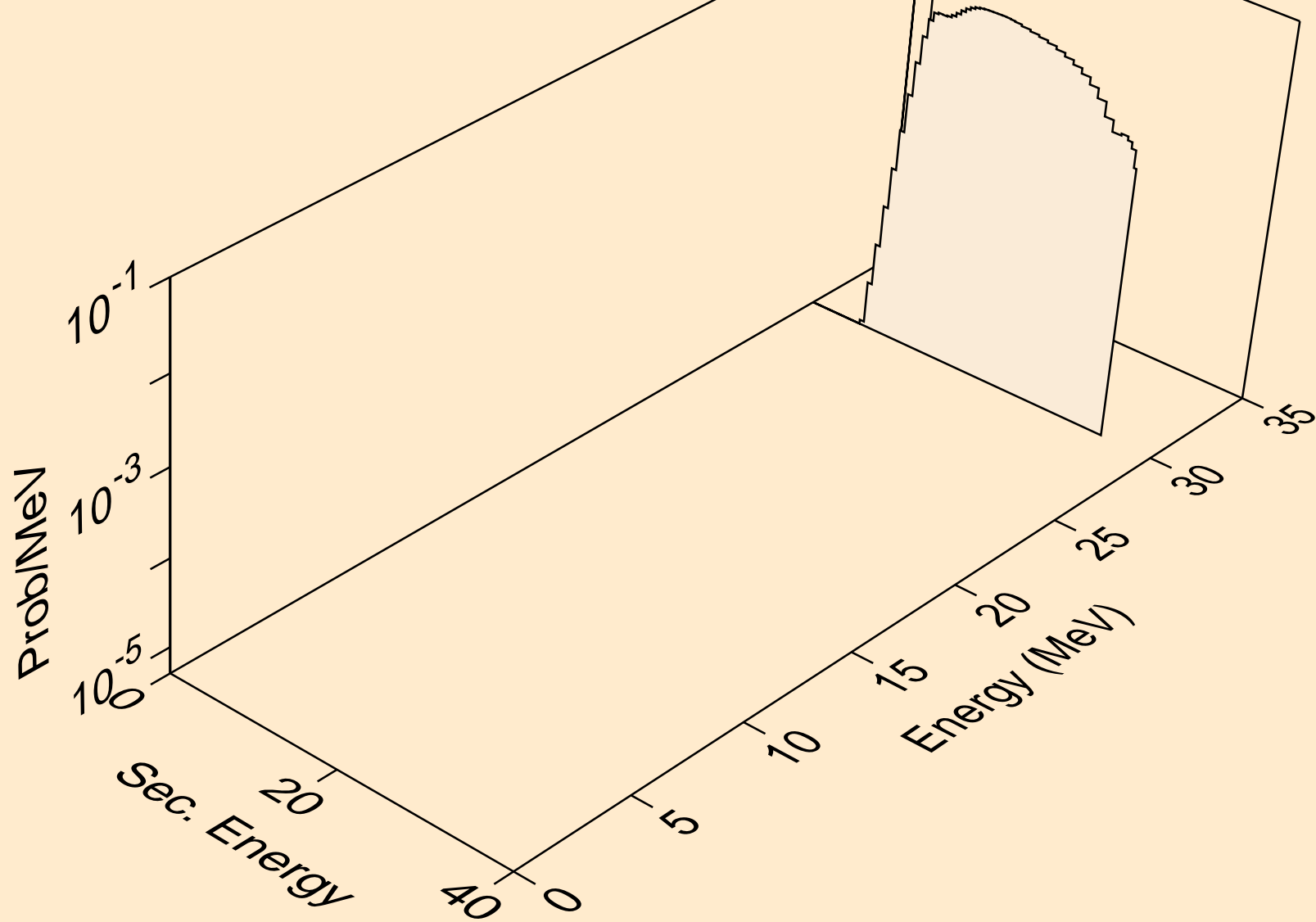

DB262 NEUTRON ACER TENDL-2021 LIBRARY; T=293.6K
protons from (n,n*)p

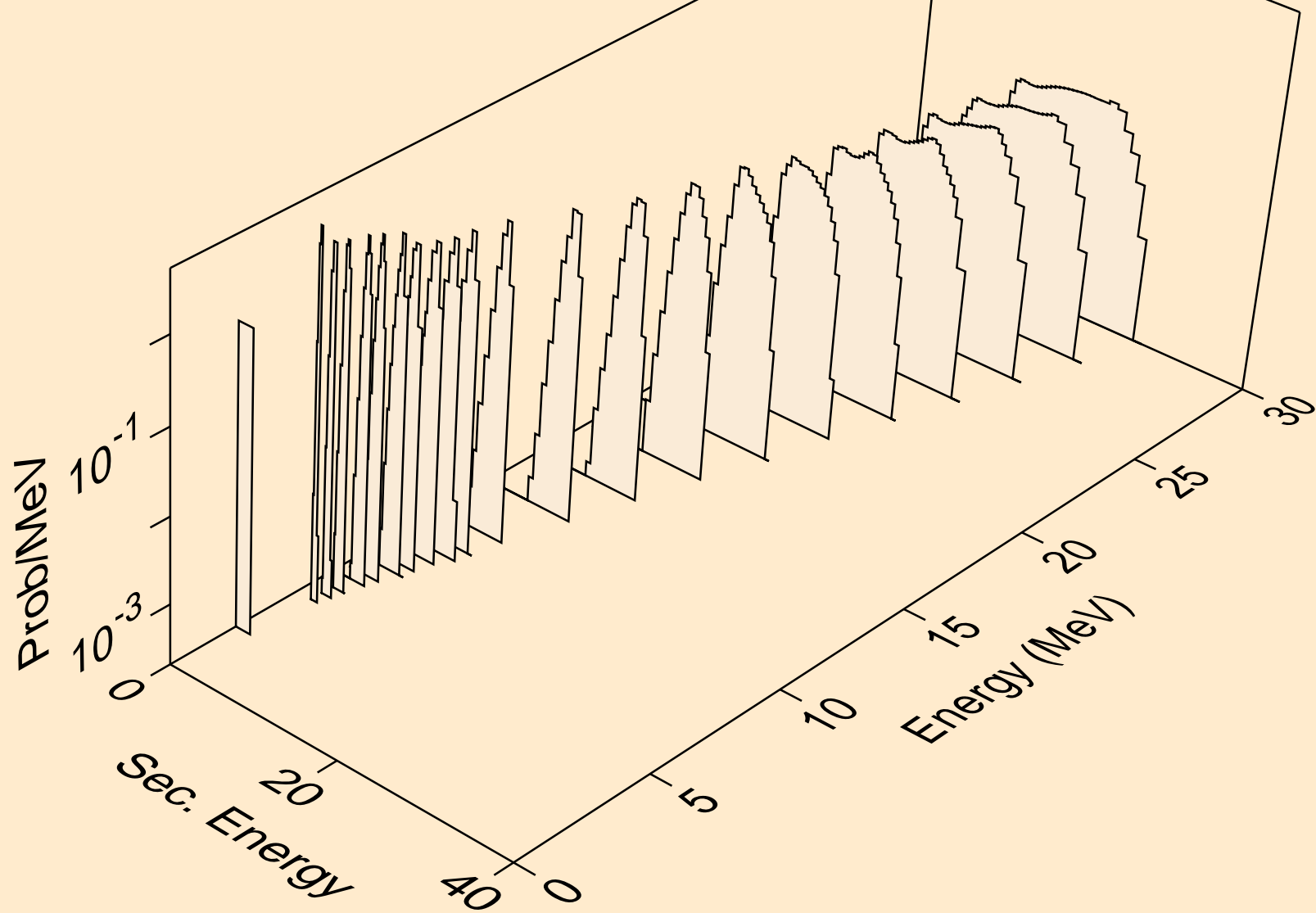

DB262 NEUTRON ACER TENDL-2021 LIBRARY; T=293.6K
protons from (n,2np)

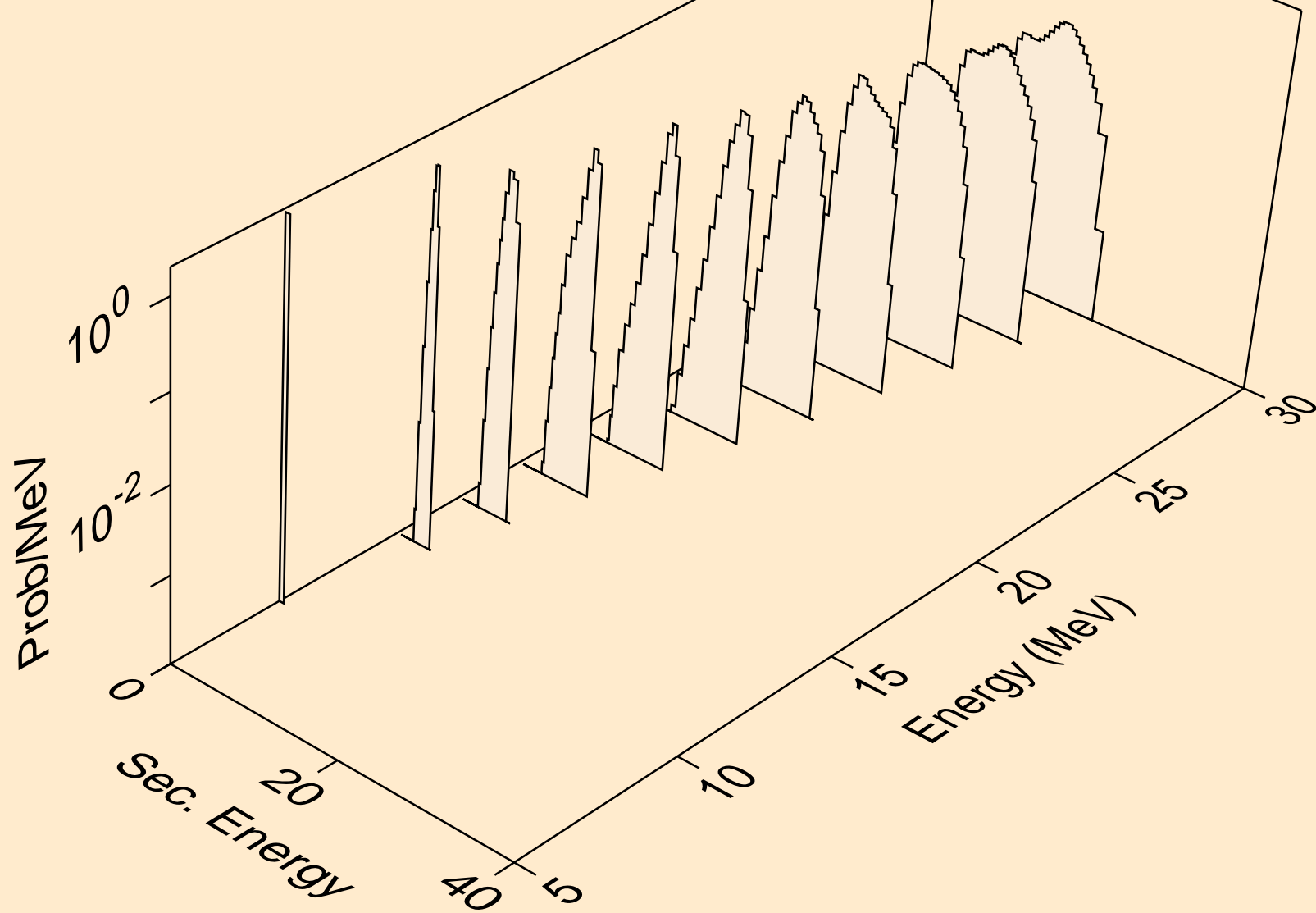

DB262 NEUTRON ACER TENDL-2021 LIBRARY; T=293.6K
protons from (n,3np)

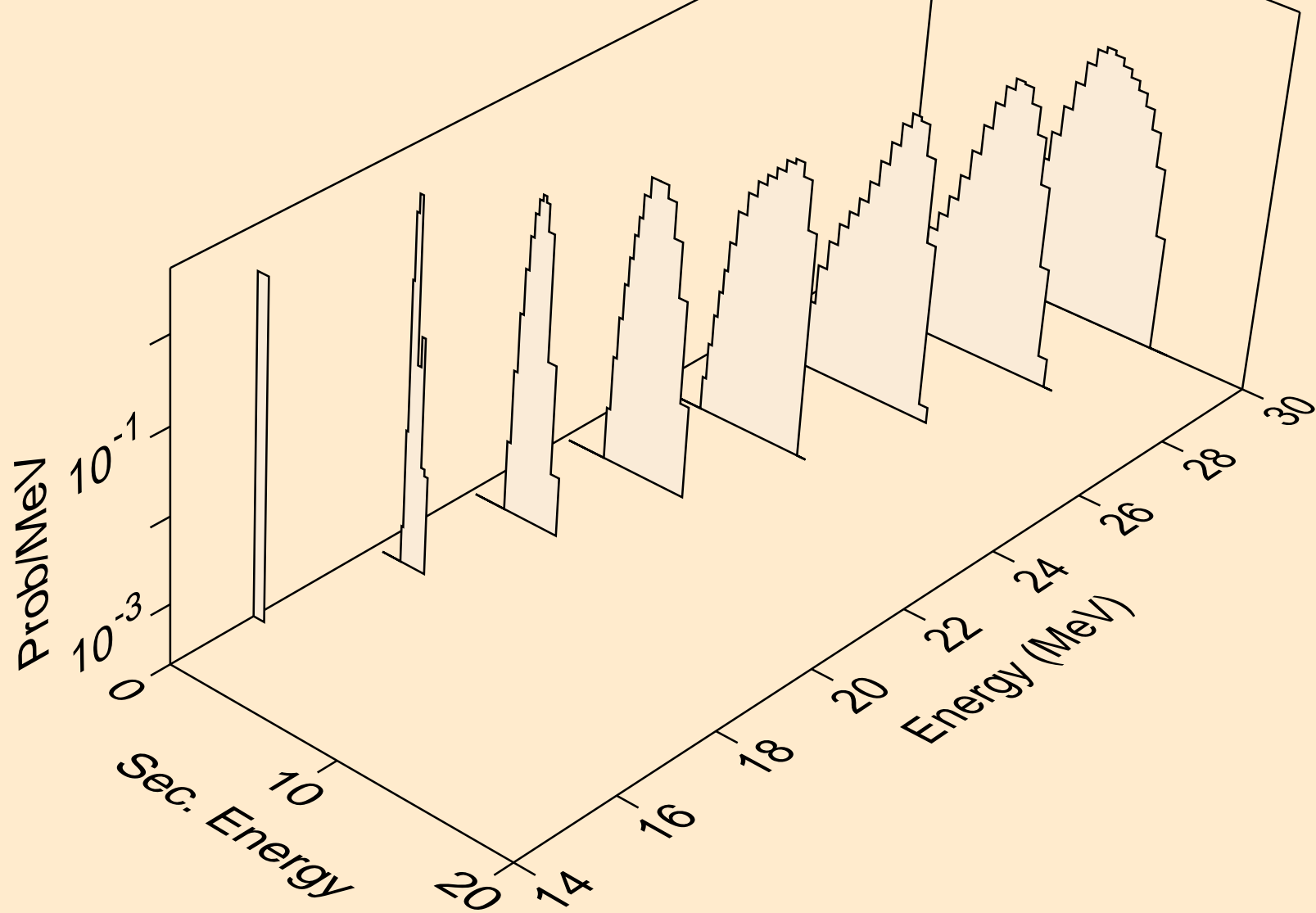

DB262 NEUTRON ACER TENDL-2021 LIBRARY; T=293.6K
protons from (n,2np)

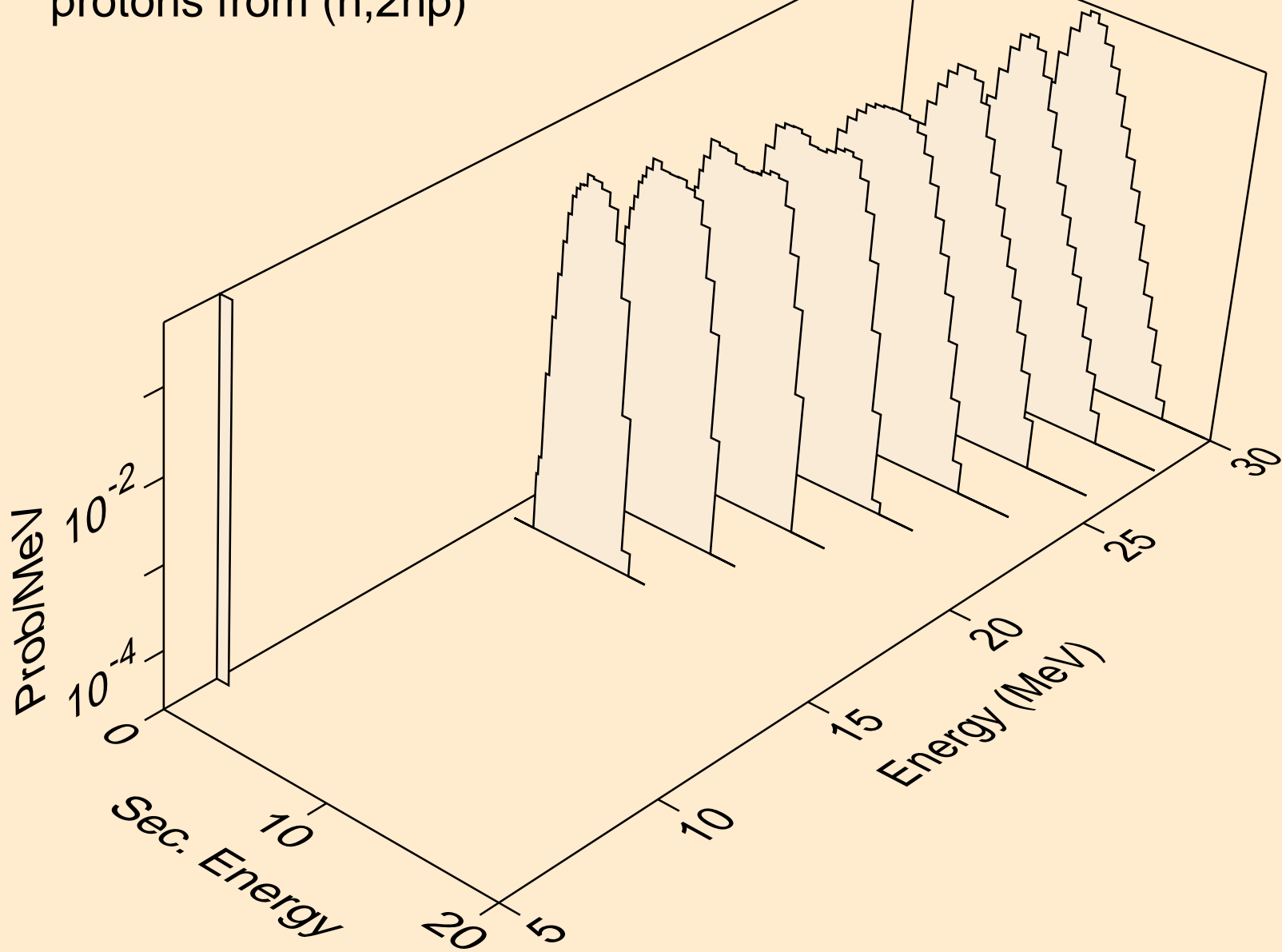

DB262 NEUTRON ACER TENDL-2021 LIBRARY; T=293.6K
protons from (n,npa)

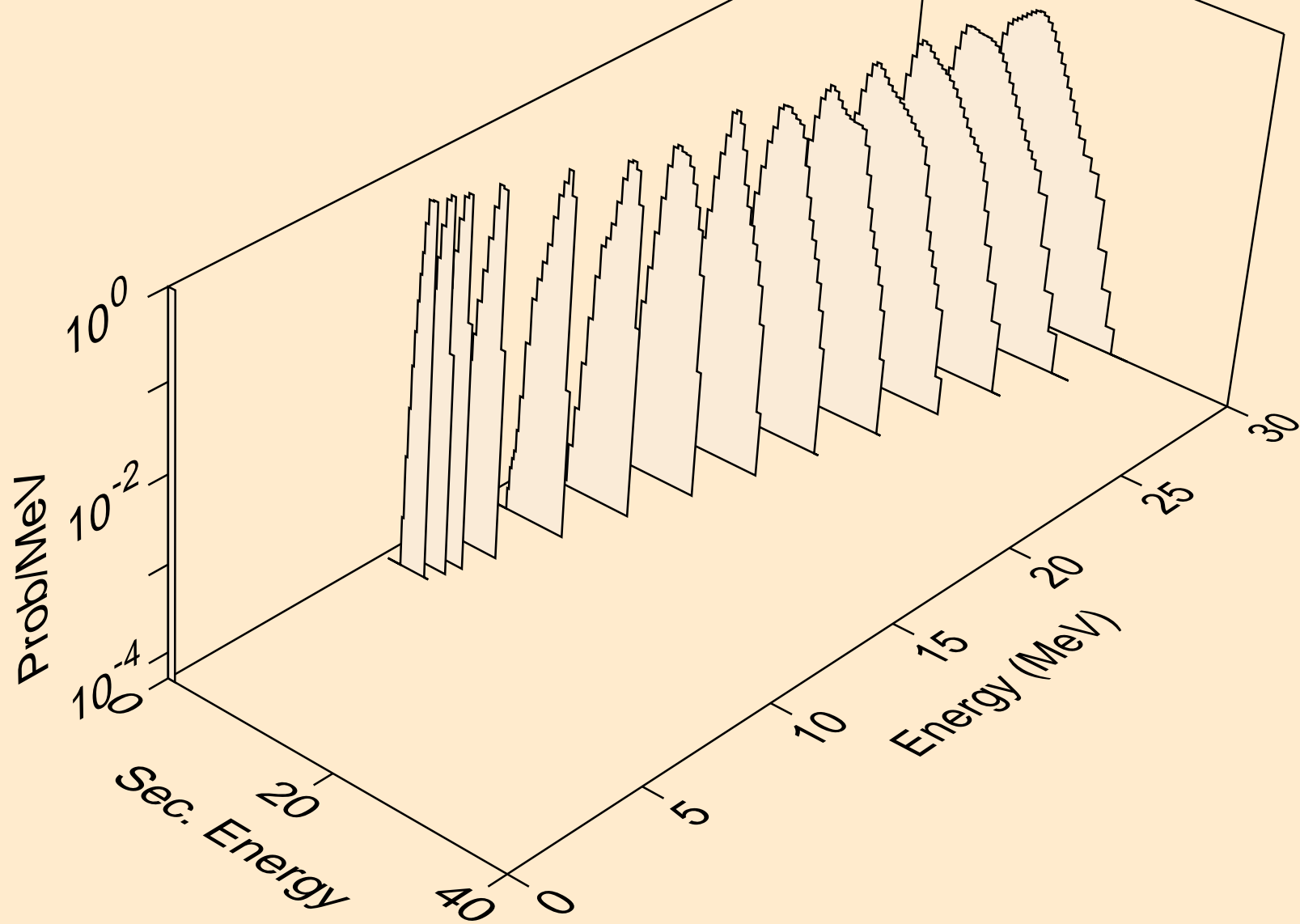

DB262 NEUTRON ACER TENDL-2021 LIBRARY; T=293.6K
protons from (n,p)

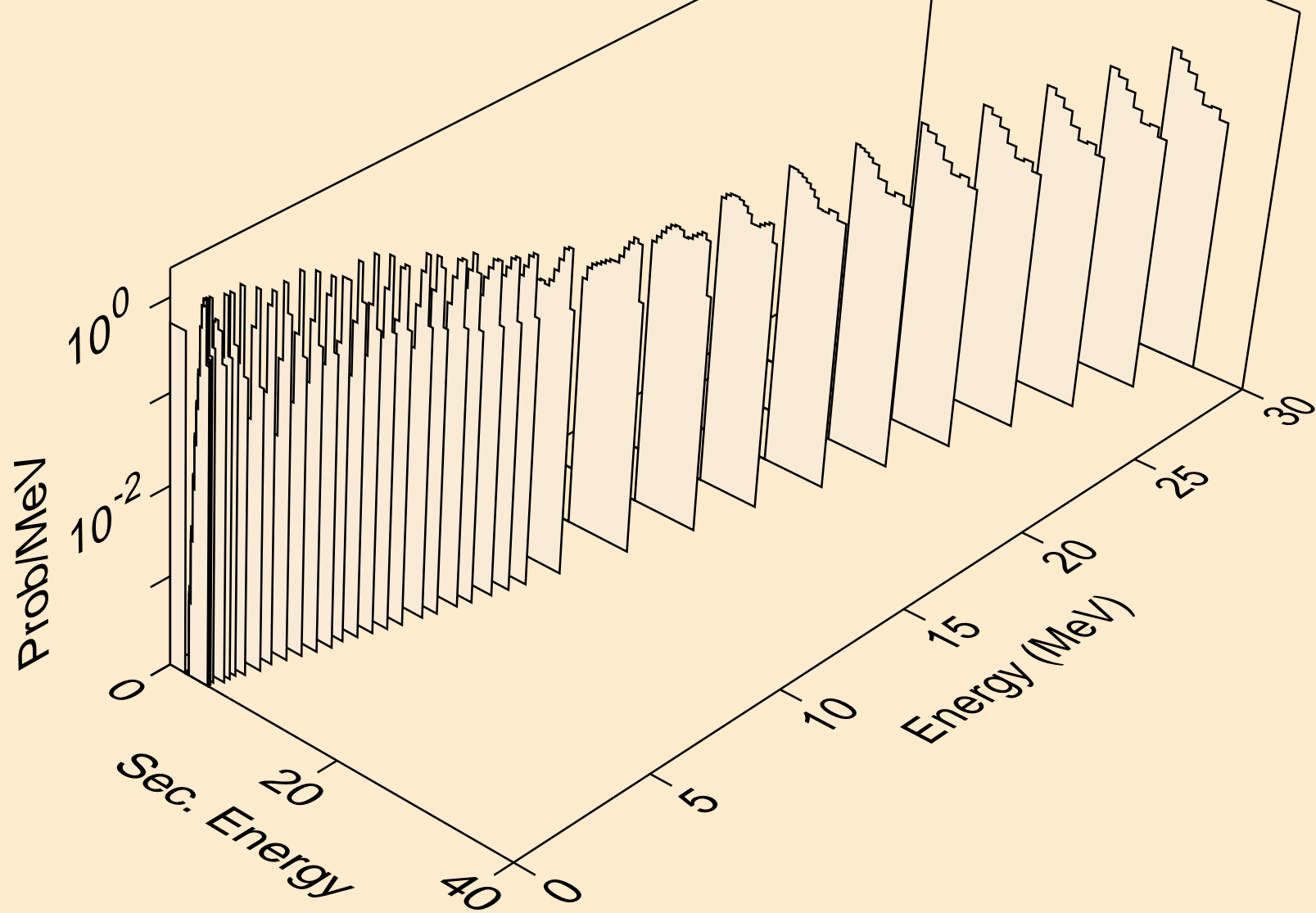

DB262 NEUTRON ACER TENDL-2021 LIBRARY; T=293.6K
protons from (n,2p)

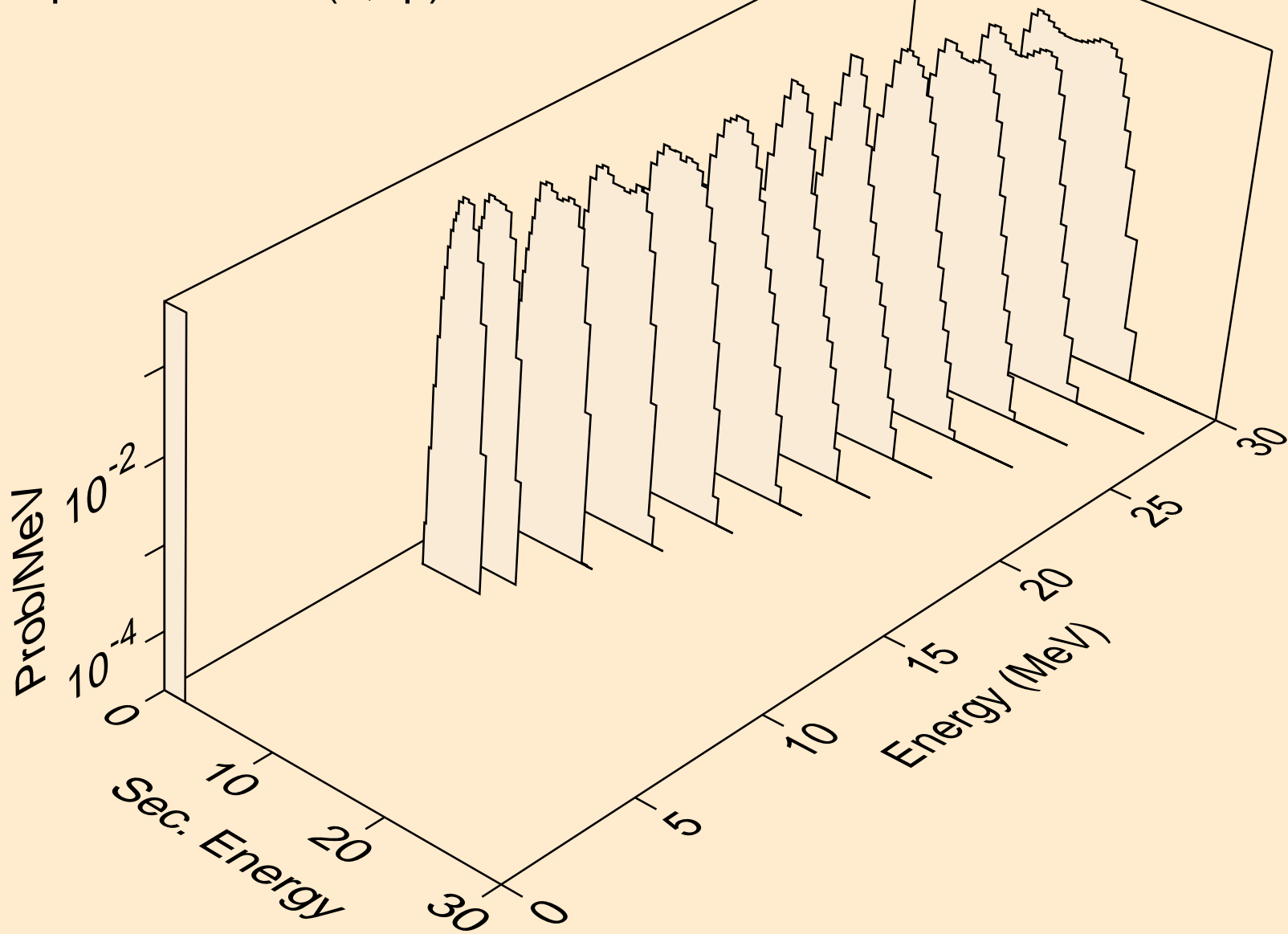

DB262 NEUTRON ACER TENDL-2021 LIBRARY; T=293.6K
protons from (n,p)

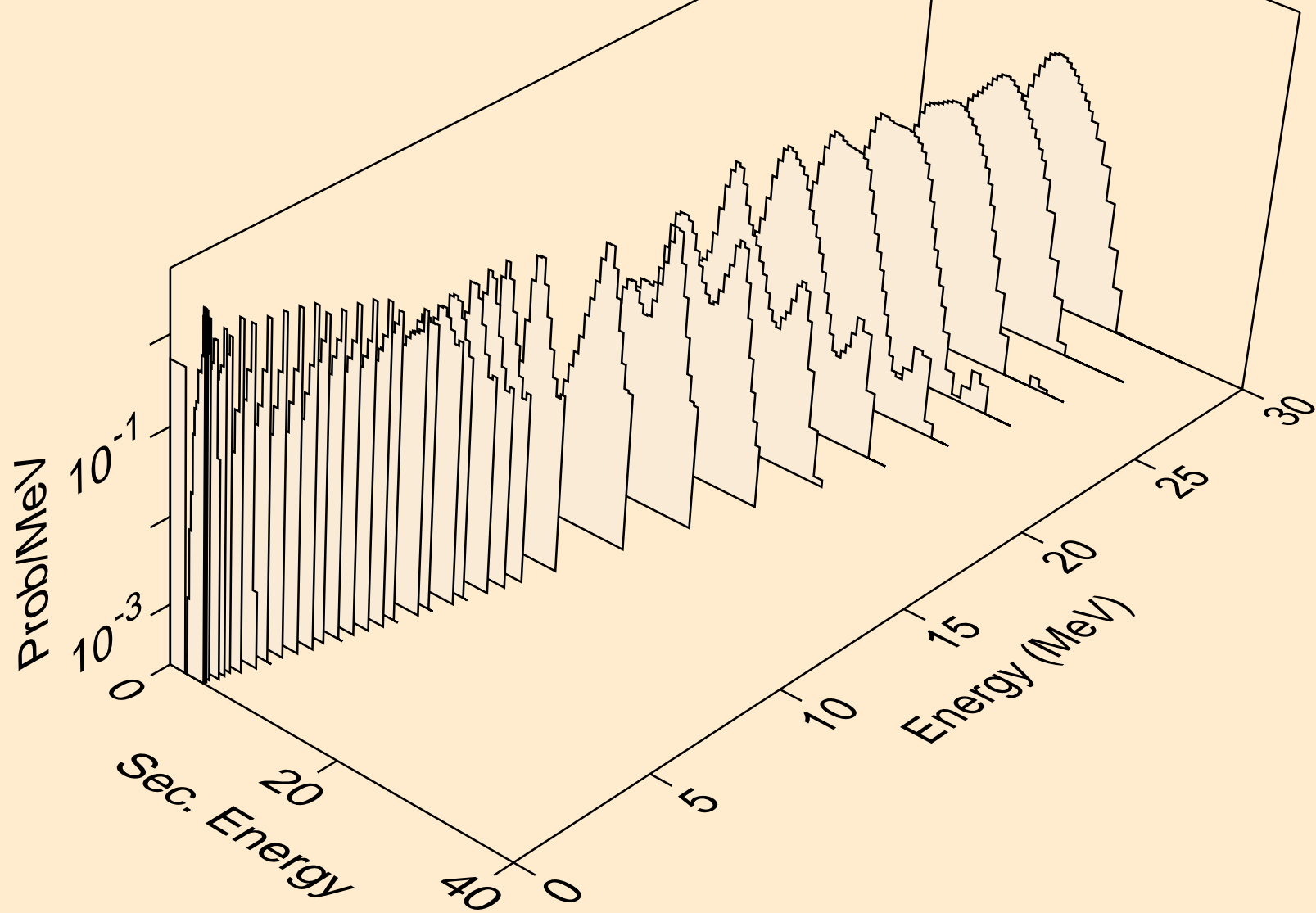

DB262 NEUTRON ACER TENDL-2021 LIBRARY; T=293.6K
protons from (n,pd)

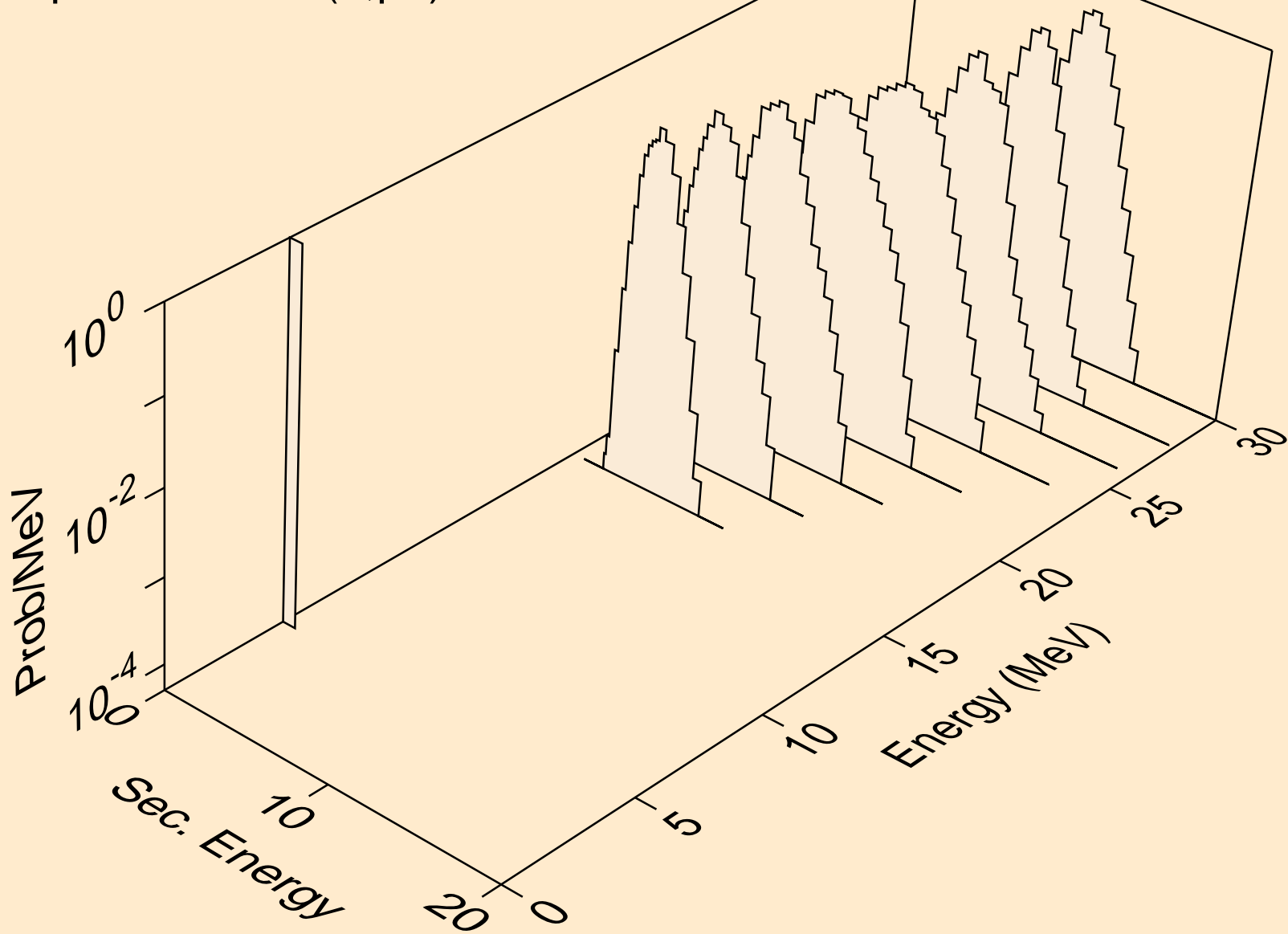

DB262 NEUTRON ACER TENDL-2021 LIBRARY; T=293.6K
protons from (n,pt)

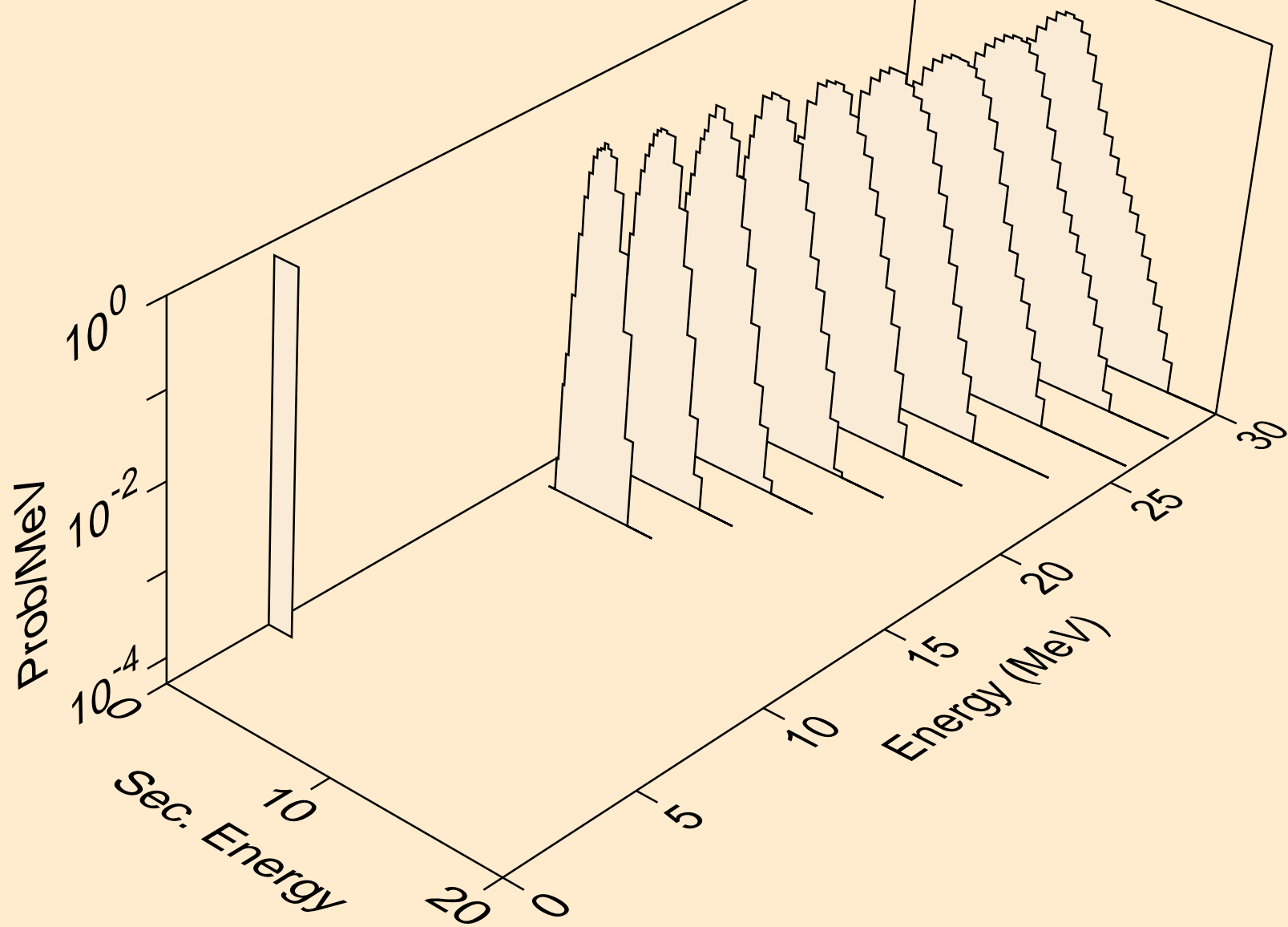

DB262 NEUTRON ACER TENDL-2021 LIBRARY; T=293.6K
deuterons from (n,x)

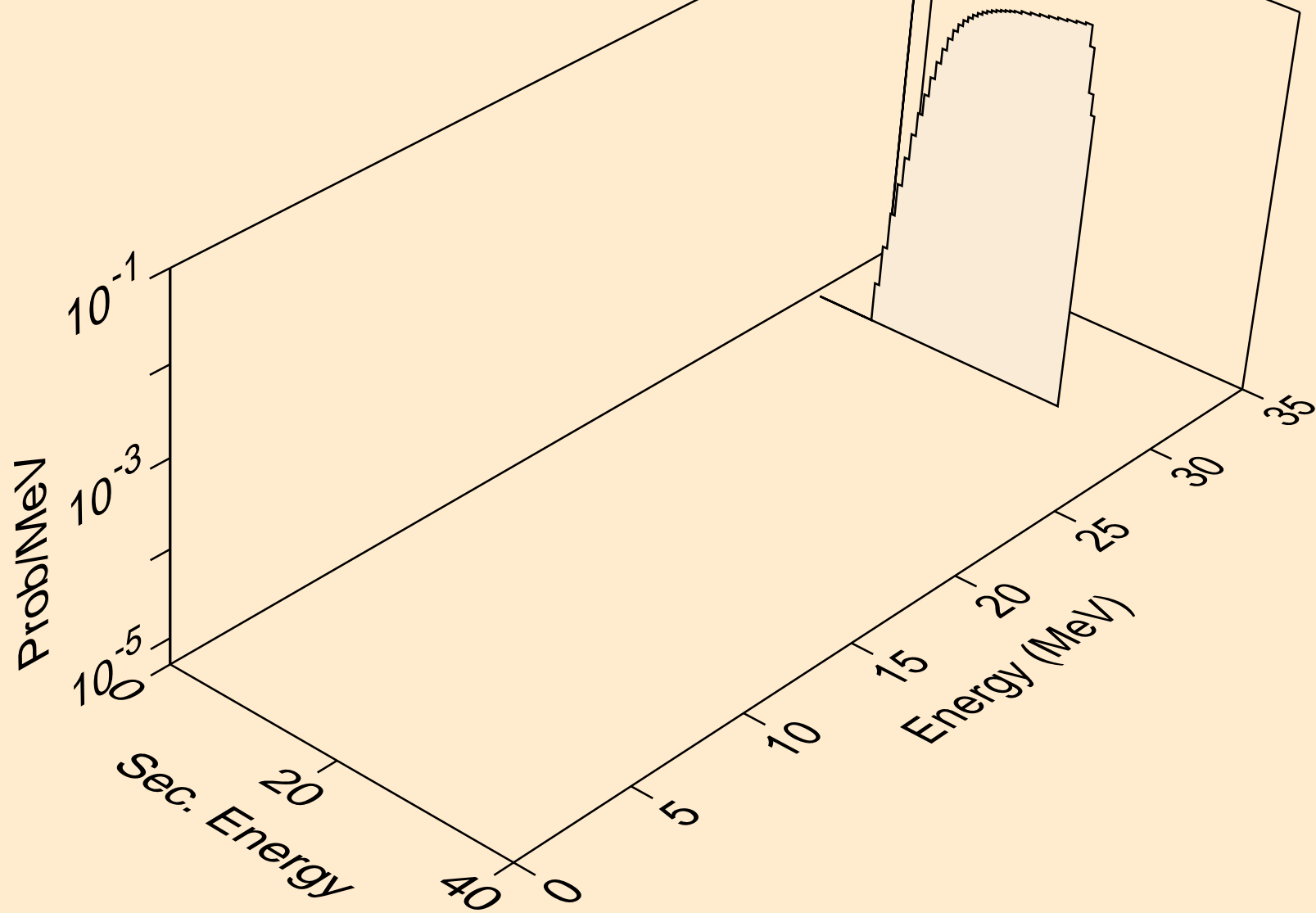

DB262 NEUTRON ACER TENDL-2021 LIBRARY; T=293.6K
deuterons from (n,2nd)

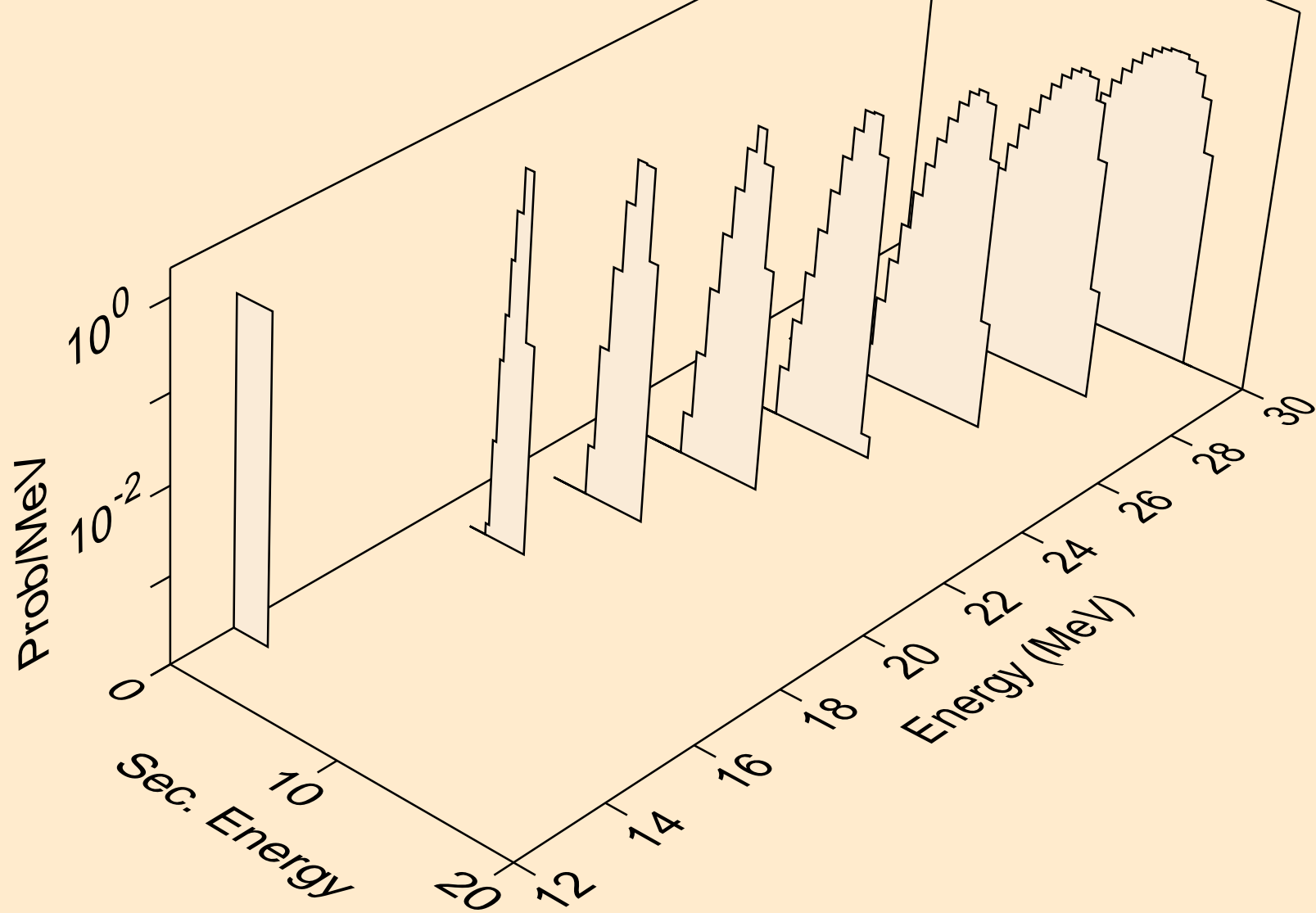

DB262 NEUTRON ACER TENDL-2021 LIBRARY; T=293.6K
deuterons from (n,n*)d

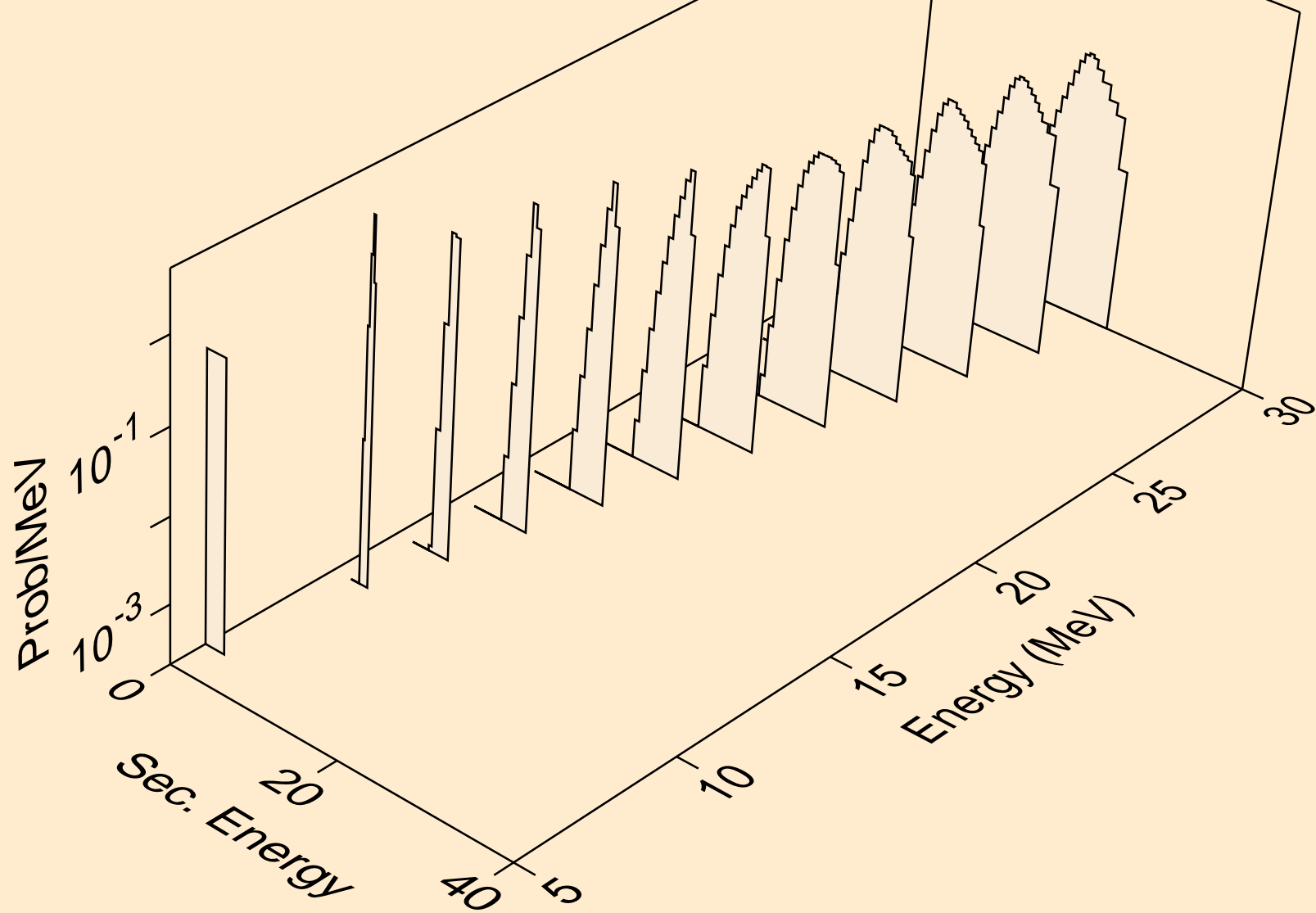

DB262 NEUTRON ACER TENDL-2021 LIBRARY; T=293.6K
deuterons from (n,d)

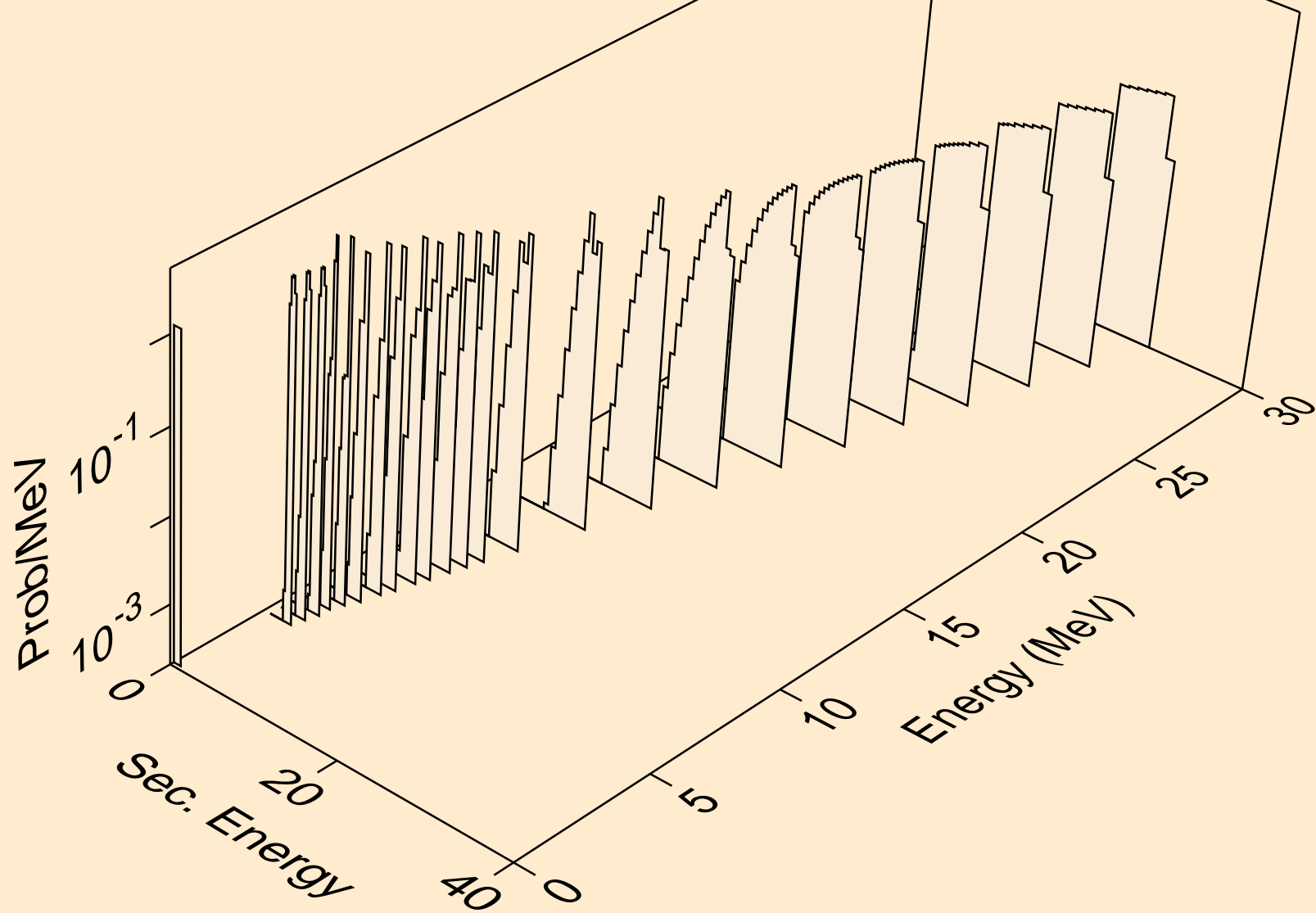

DB262 NEUTRON ACER TENDL-2021 LIBRARY; T=293.6K
deuterons from (n,pd)

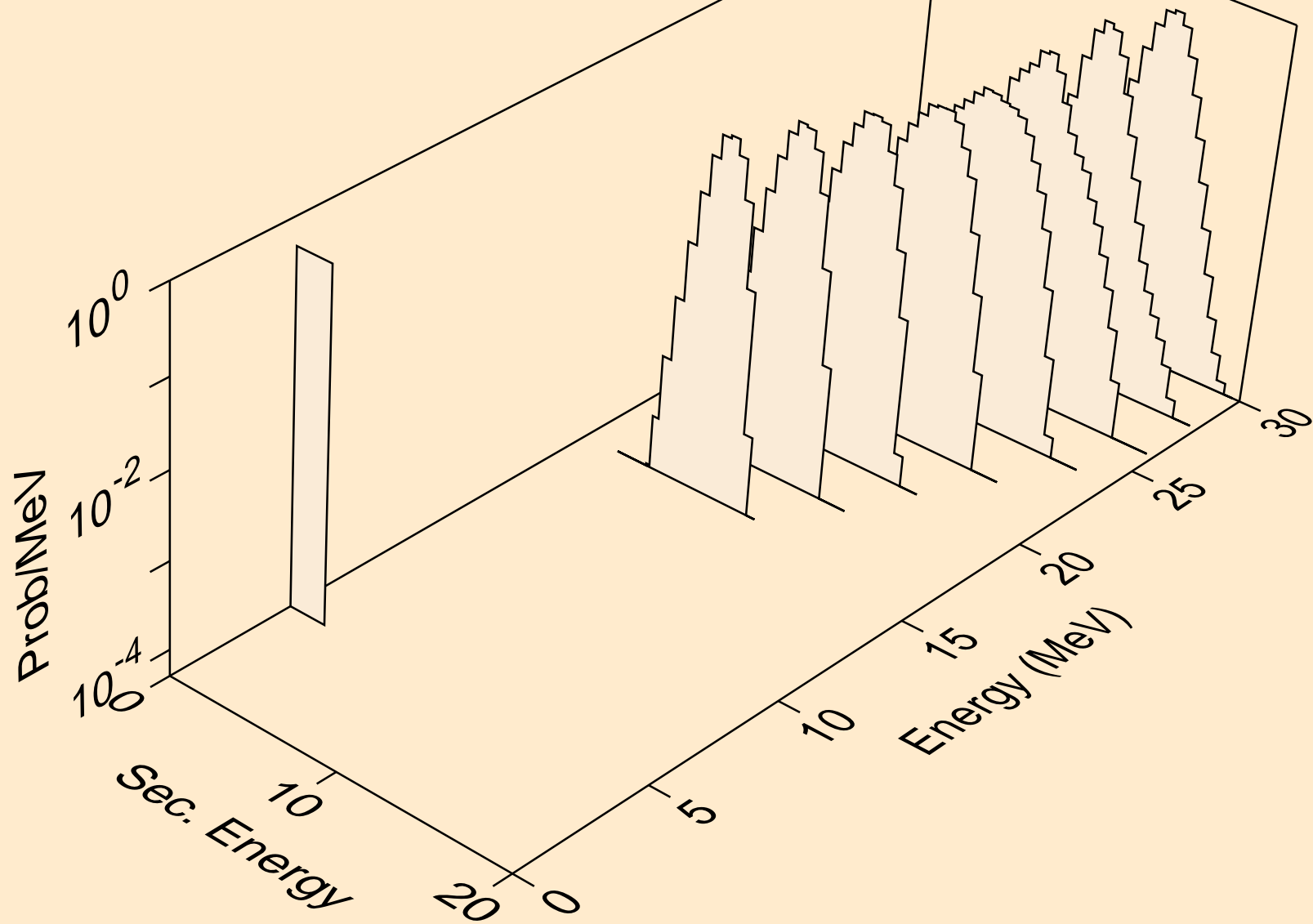

DB262 NEUTRON ACER TENDL-2021 LIBRARY; T=293.6K
tritons from (n,x)

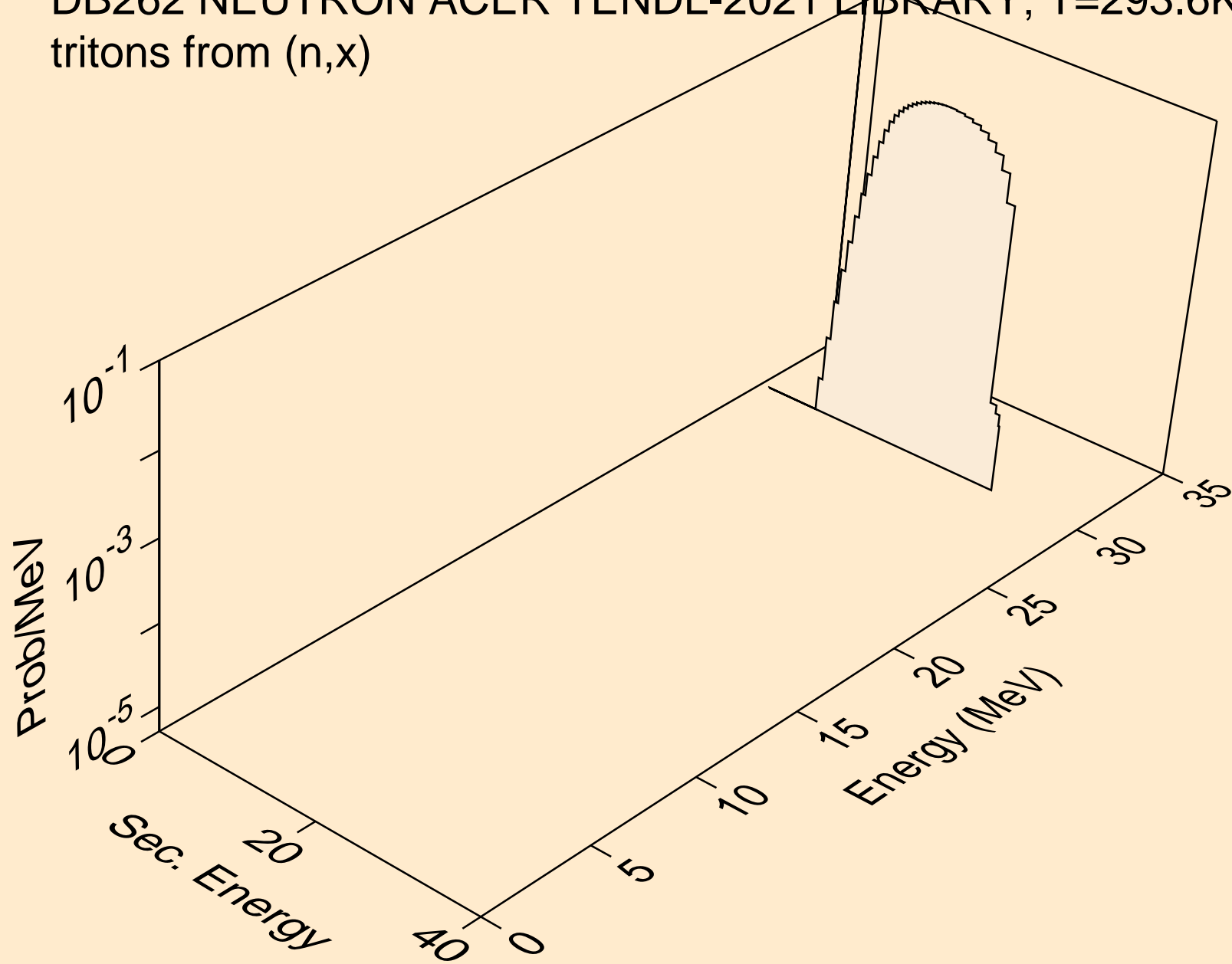

DB262 NEUTRON ACER TENDL-2021 LIBRARY; T=293.6K
tritons from (n,n*)t

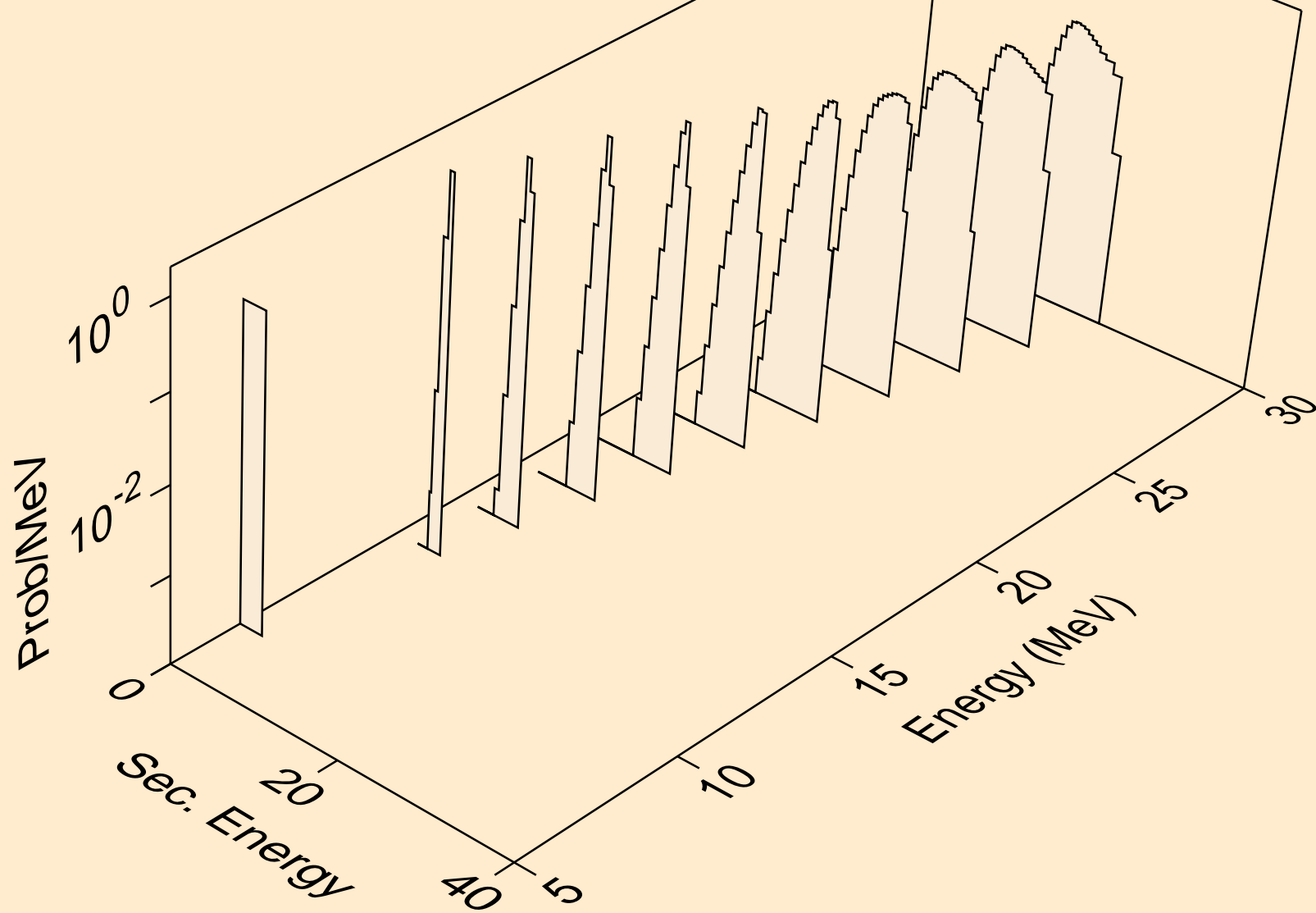

DB262 NEUTRON ACER TENDL-2021 LIBRARY; T=293.6K
tritons from (n,t)

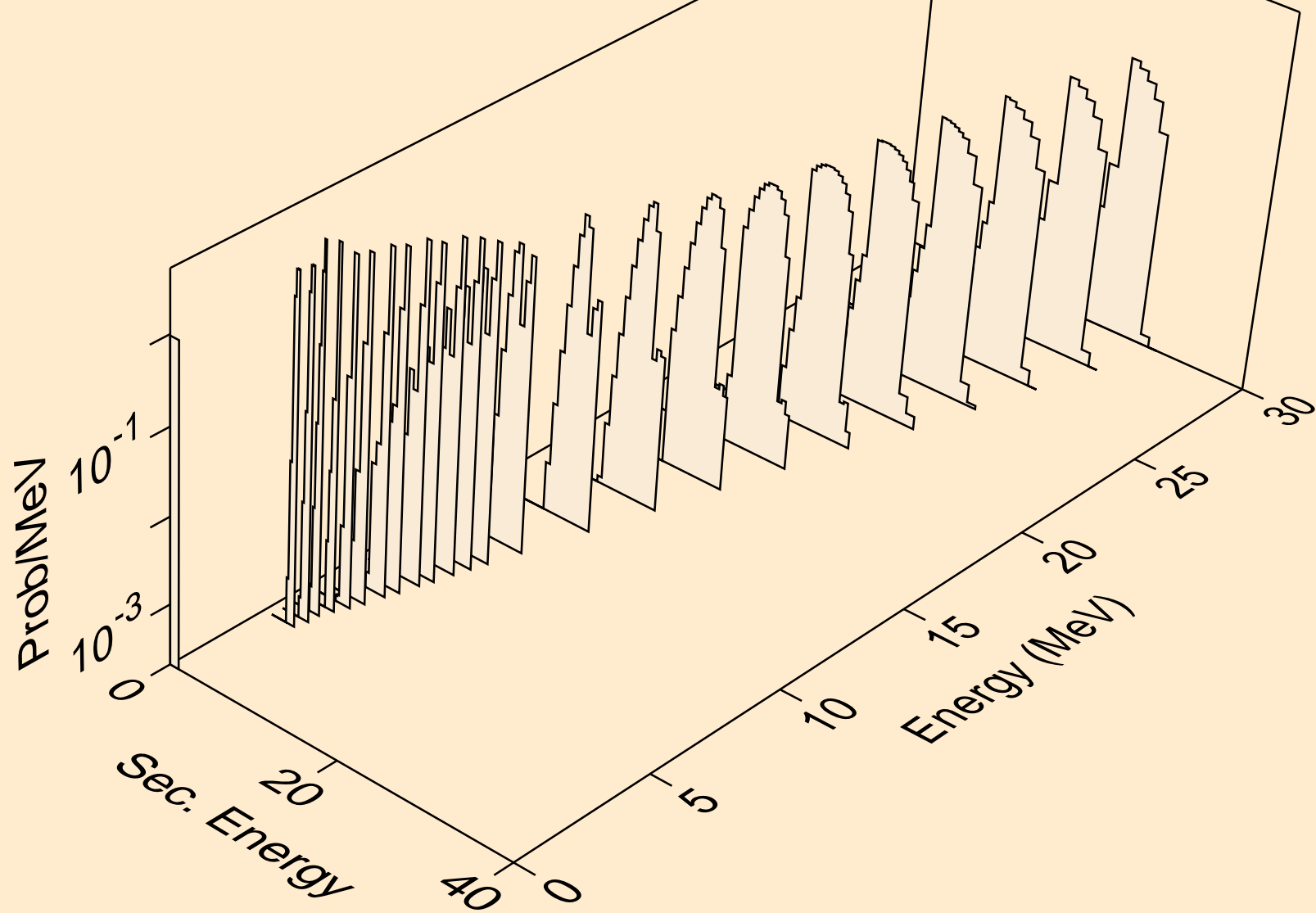

DB262 NEUTRON ACER TENDL-2021 LIBRARY; T=293.6K
tritons from (n,pt)

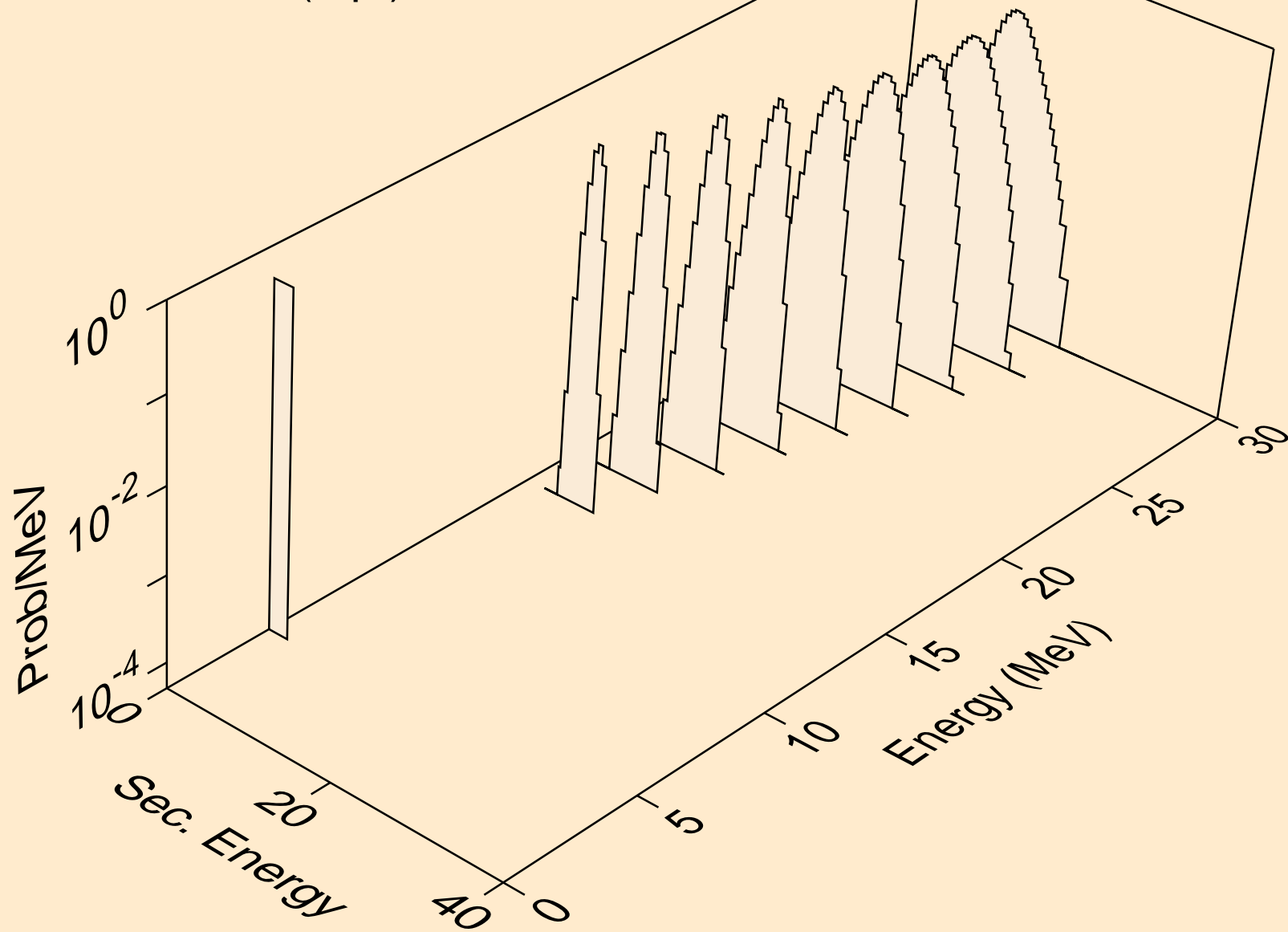

DB262 NEUTRON ACER TENDL-2021 LIBRARY; T=293.6K
he3s from (n,x)

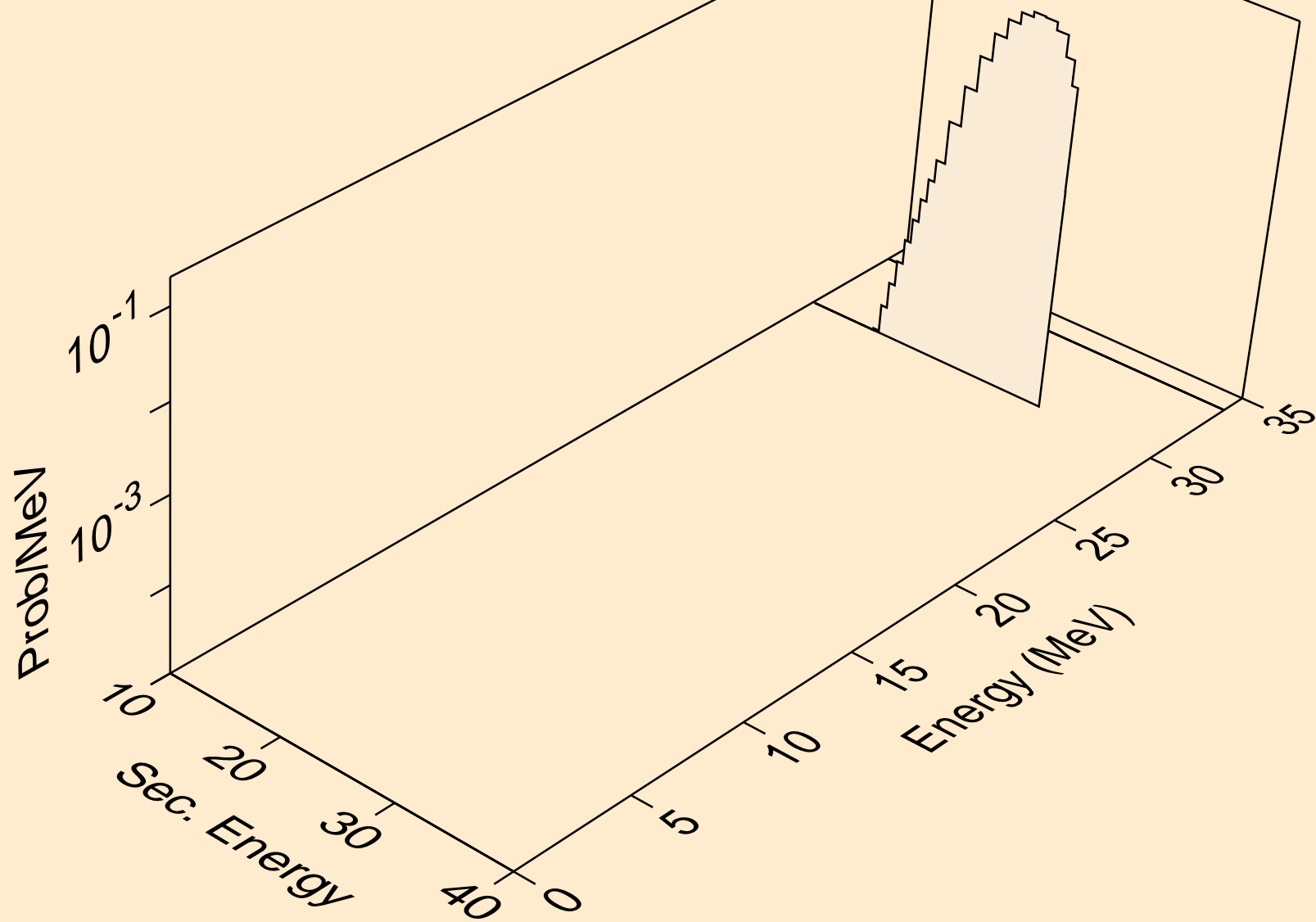

DB262 NEUTRON ACER TENDL-2021 LIBRARY; T=293.6K
he3s from (n,n*)he3

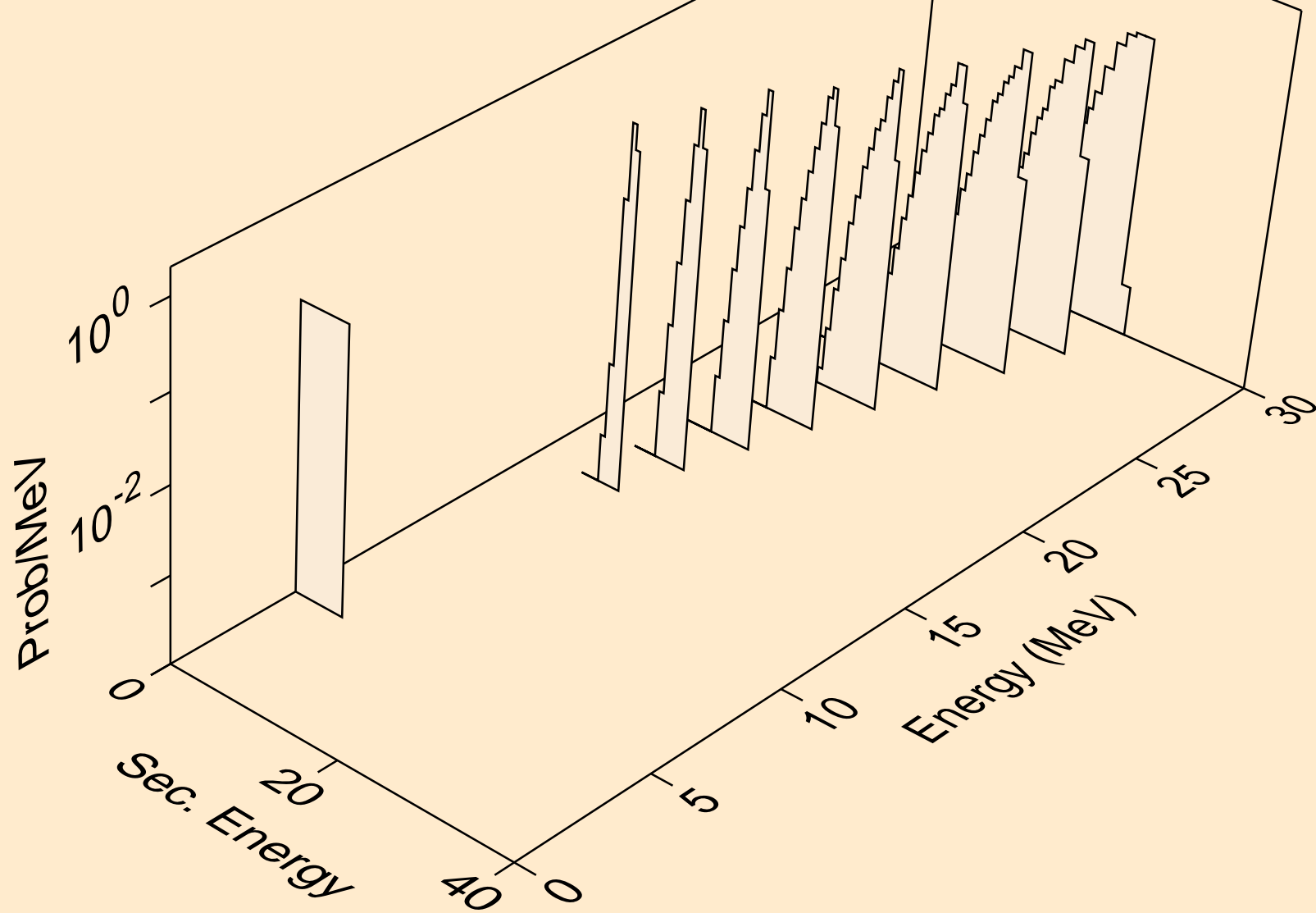

DB262 NEUTRON ACER TENDL-2021 LIBRARY; T=293.6K
he3s from (n,he3)

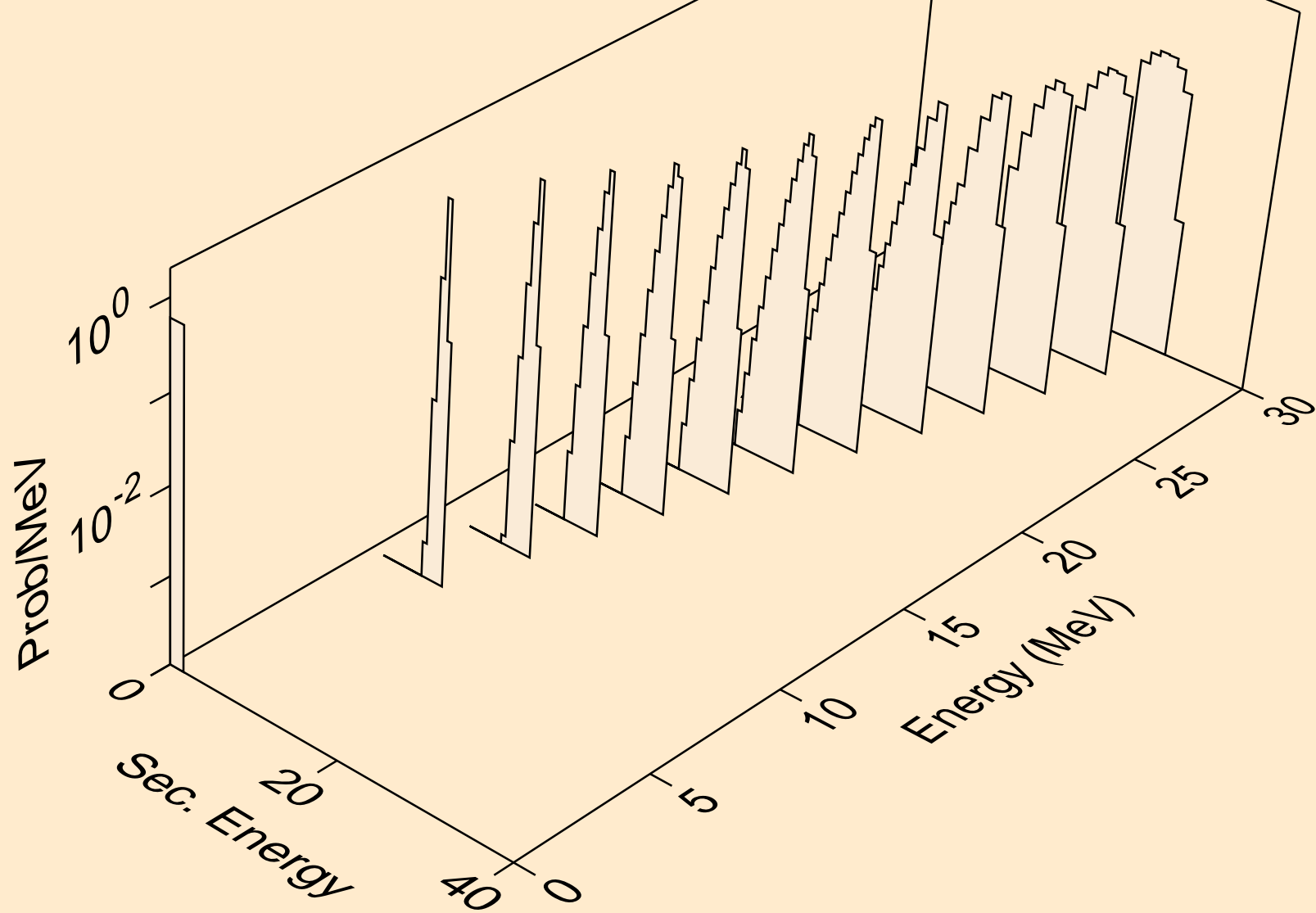

DB262 NEUTRON ACER TENDL-2021 LIBRARY; T=293.6K
alphas from (n,x)

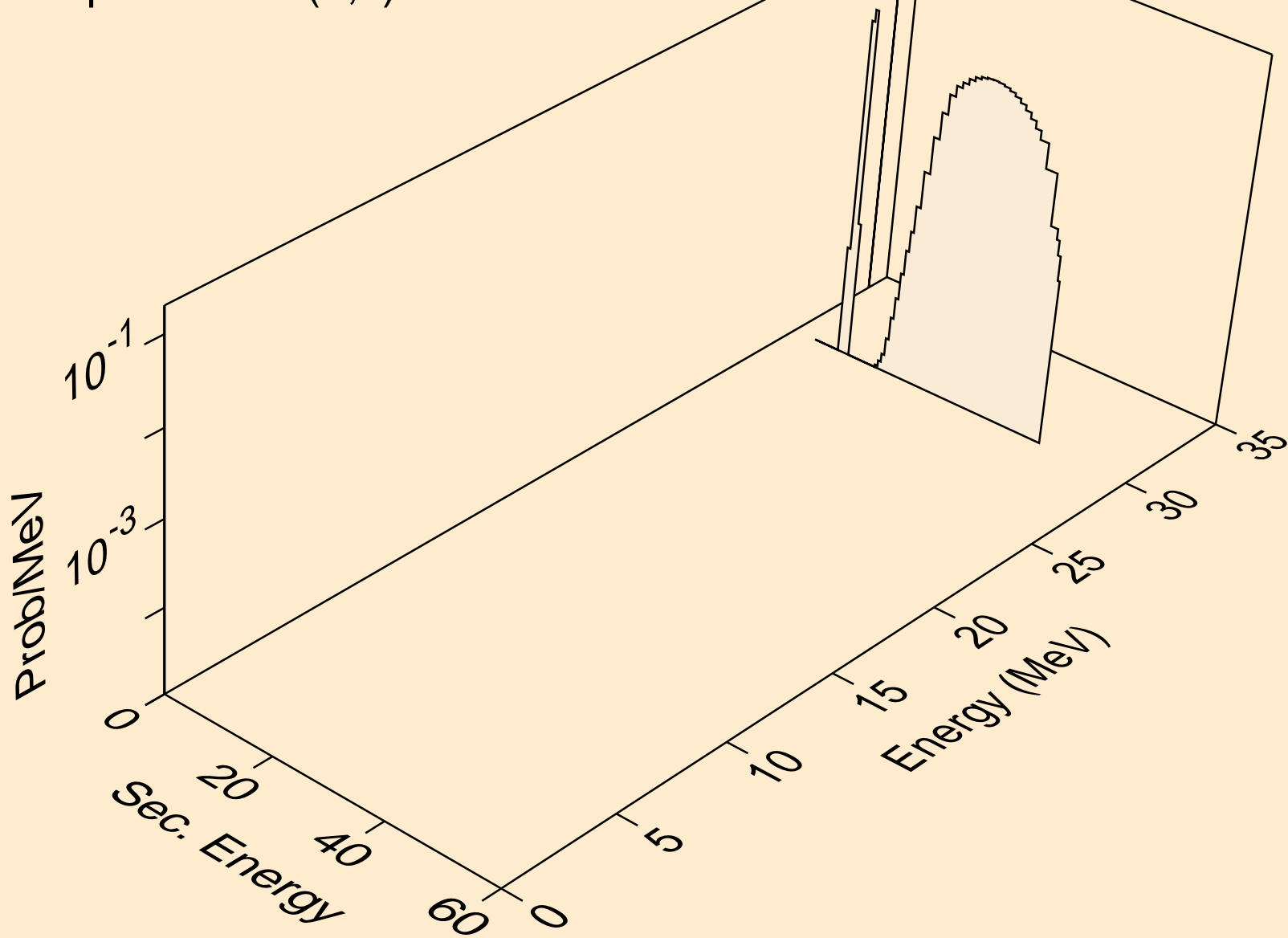

DB262 NEUTRON ACER TENDL-2021 LIBRARY; T=293.6K
alphas from (n,n*)a

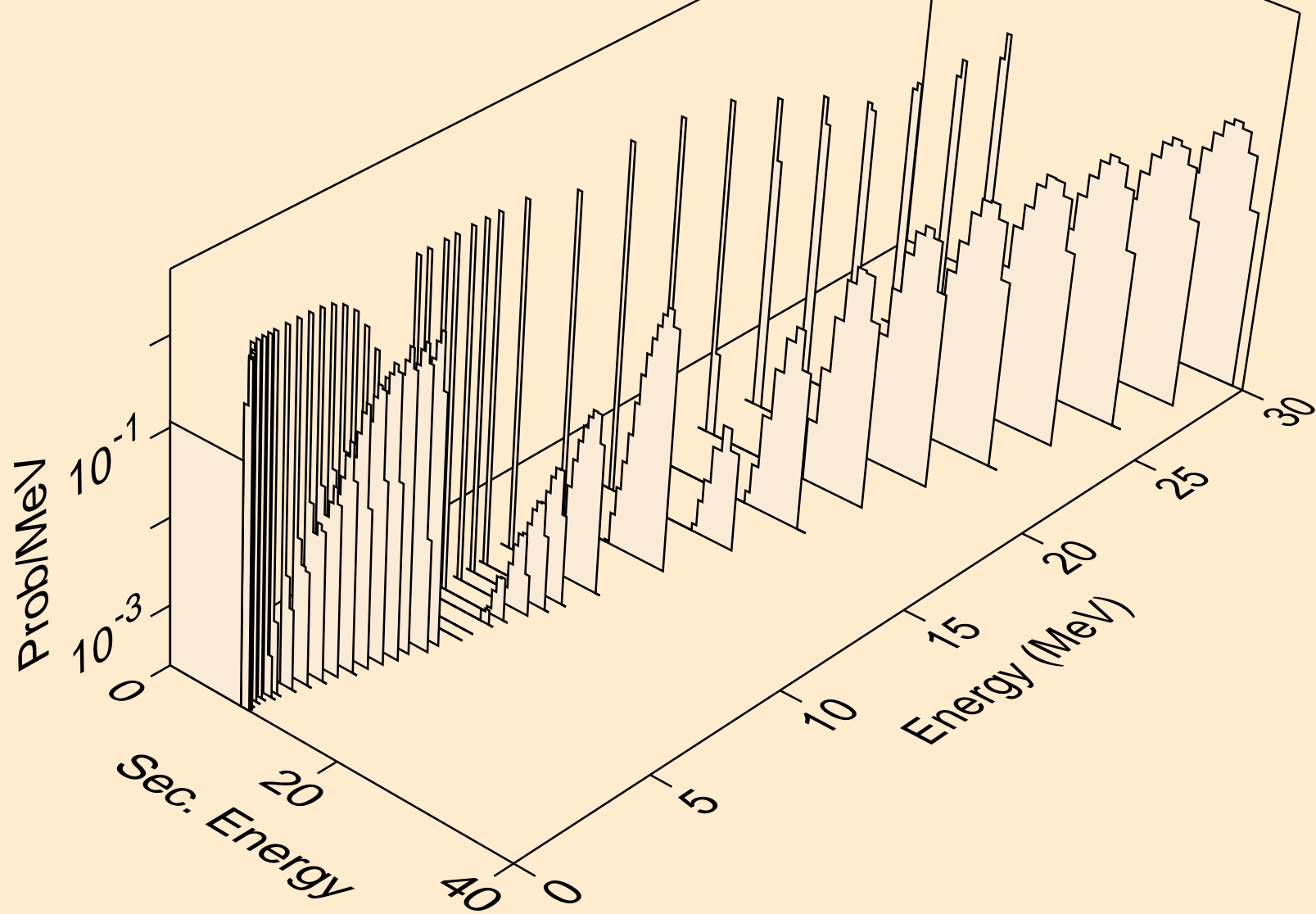

DB262 NEUTRON ACER TENDL-2021 LIBRARY; T=293.6K
alphas from (n,2n)a

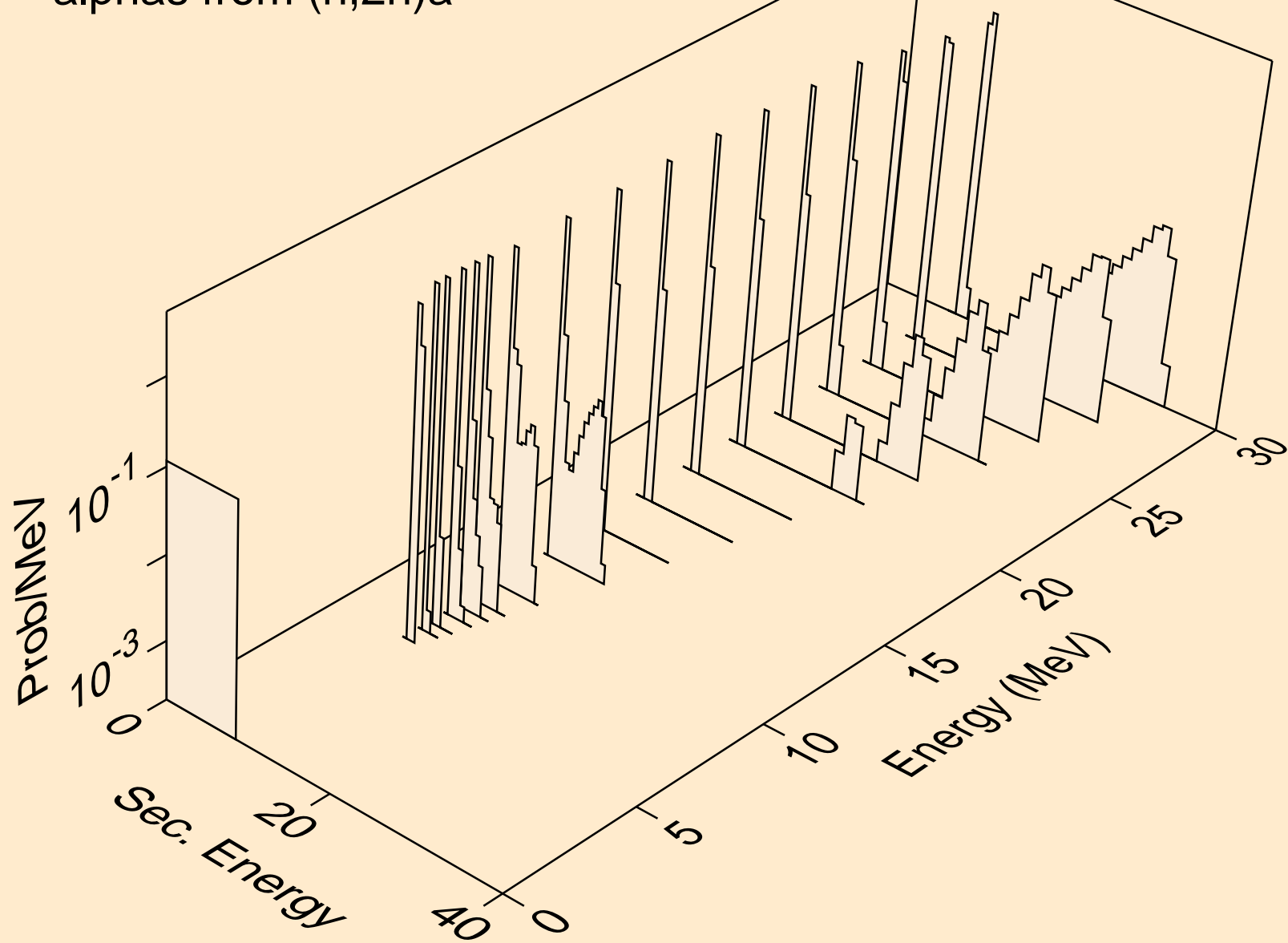

DB262 NEUTRON ACER TENDL-2021 LIBRARY; T=293.6K
alphas from (n,3n)a

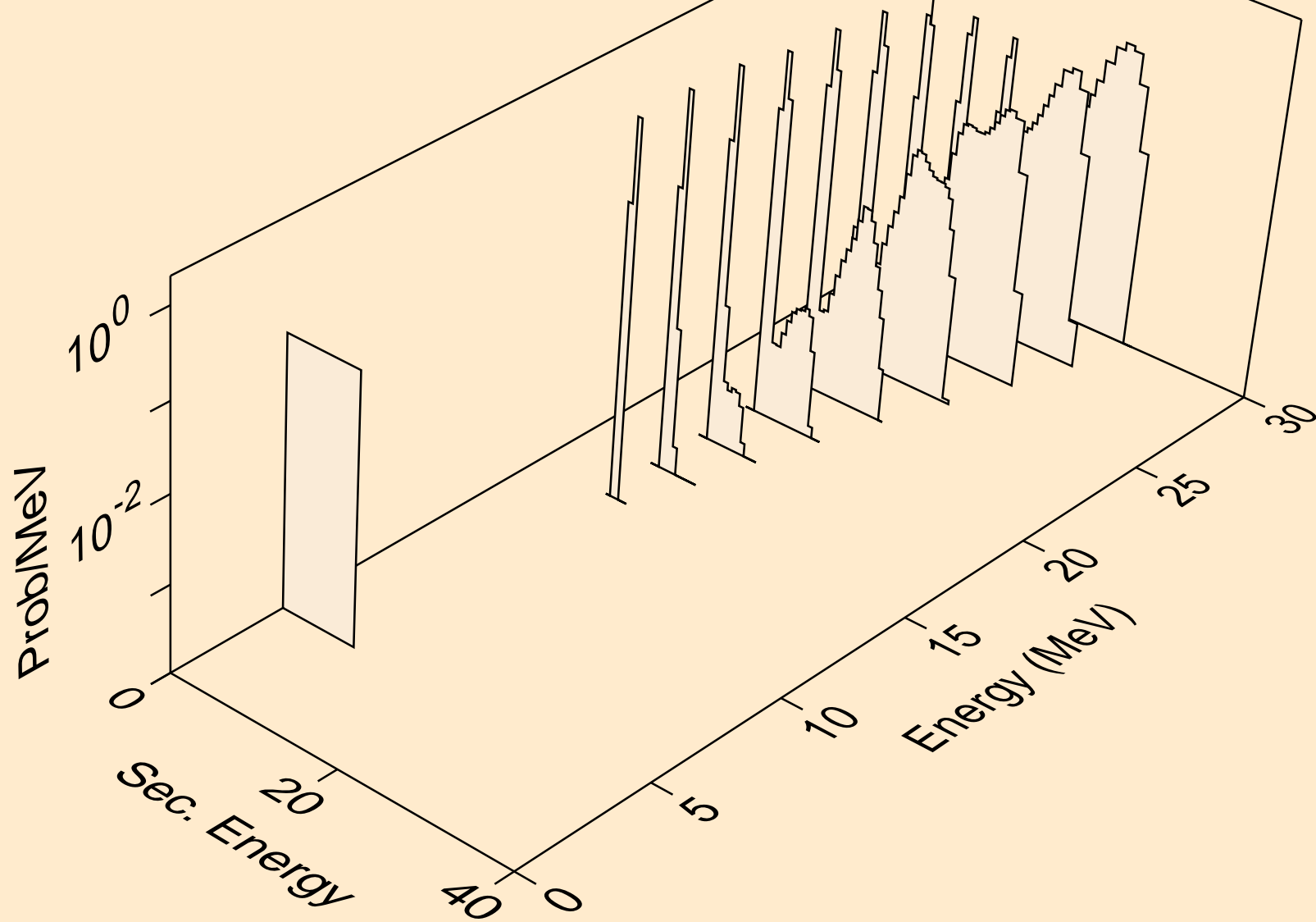

DB262 NEUTRON ACER TENDL-2021 LIBRARY; T=293.6K
alphas from (n,n*)2a

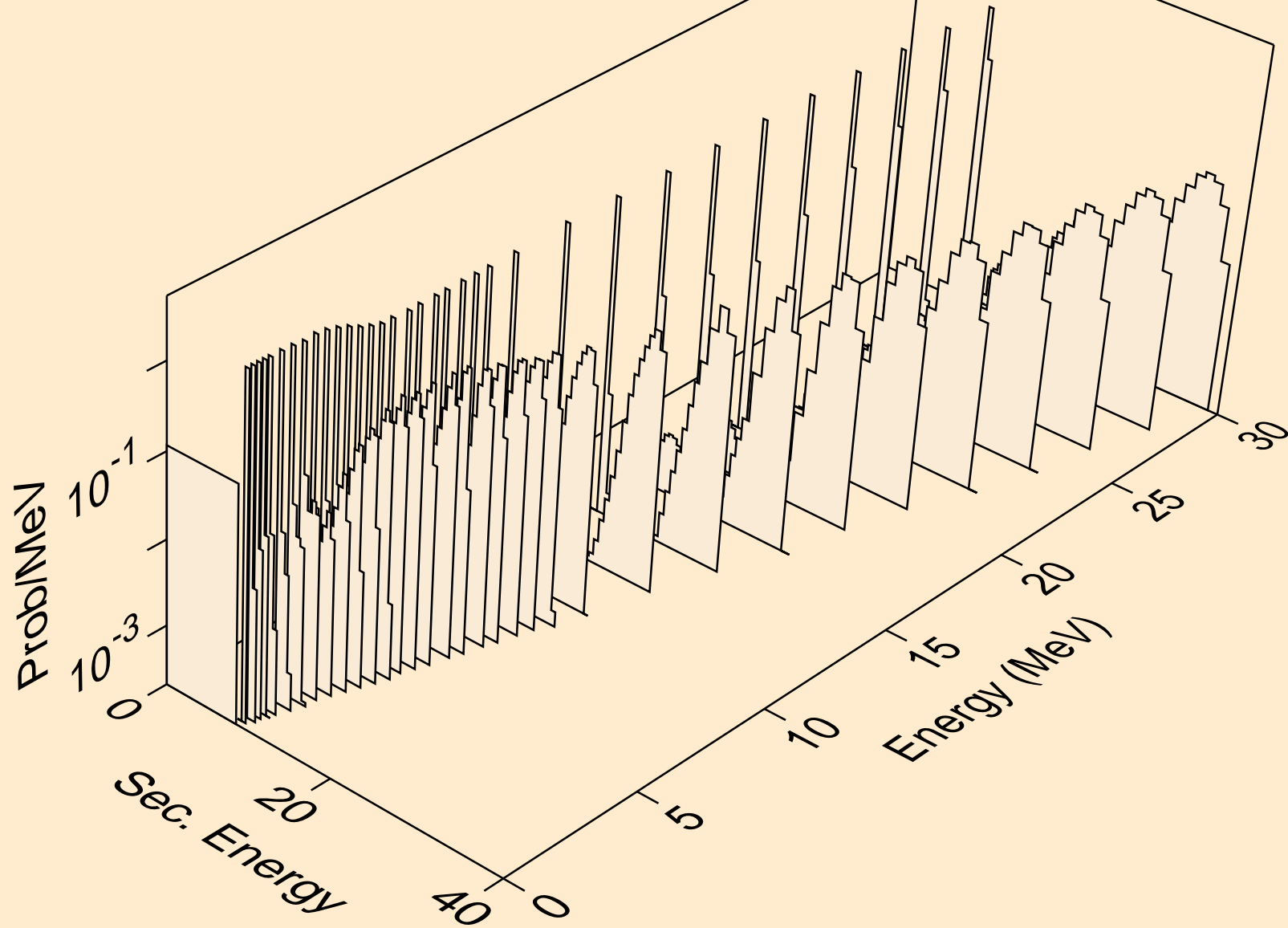

DB262 NEUTRON ACER TENDL-2021 LIBRARY; T=293.6K
alphas from (n,npa)

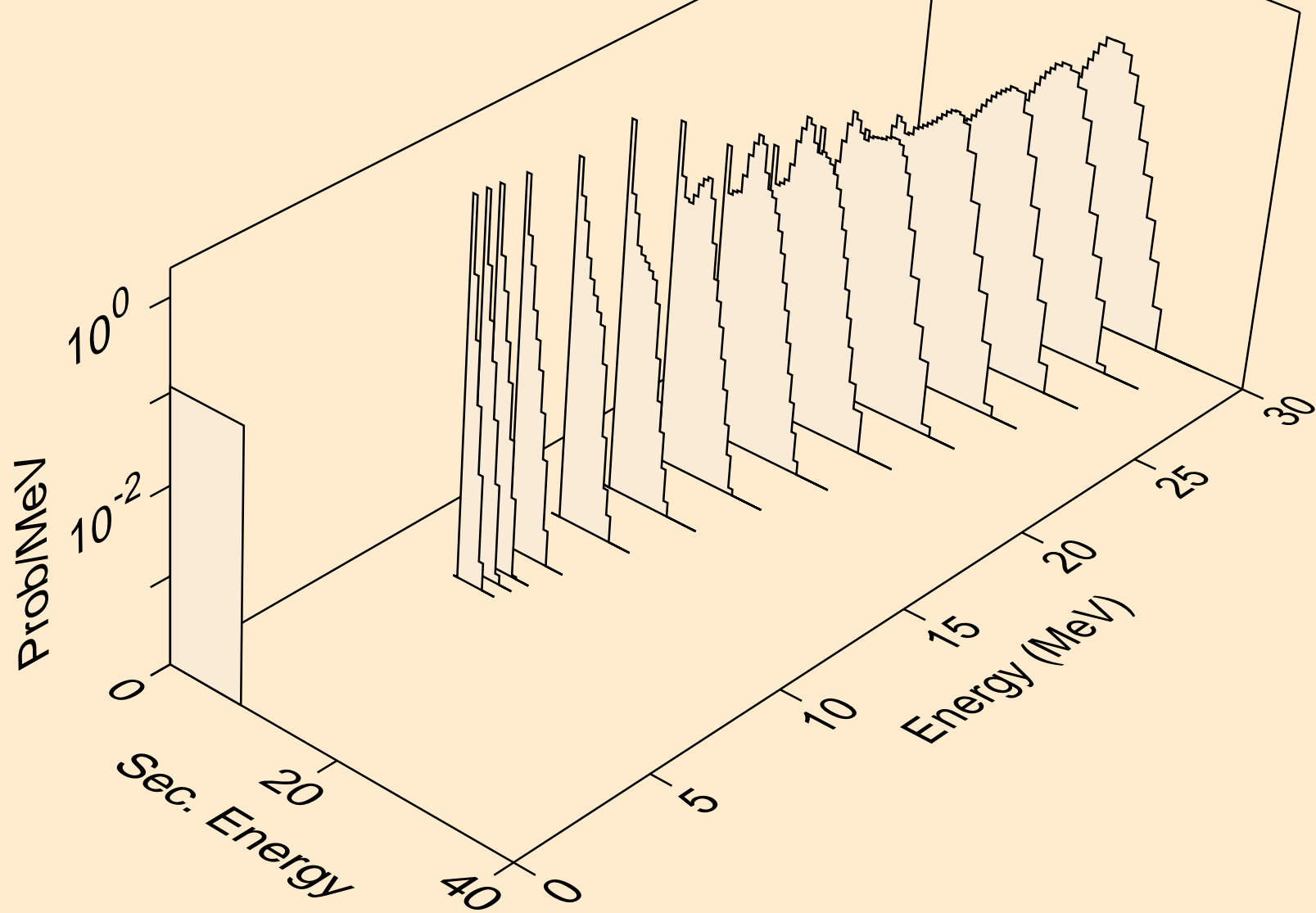

DB262 NEUTRON ACER TENDL-2021 LIBRARY; T=293.6K
alphas from (n,a)

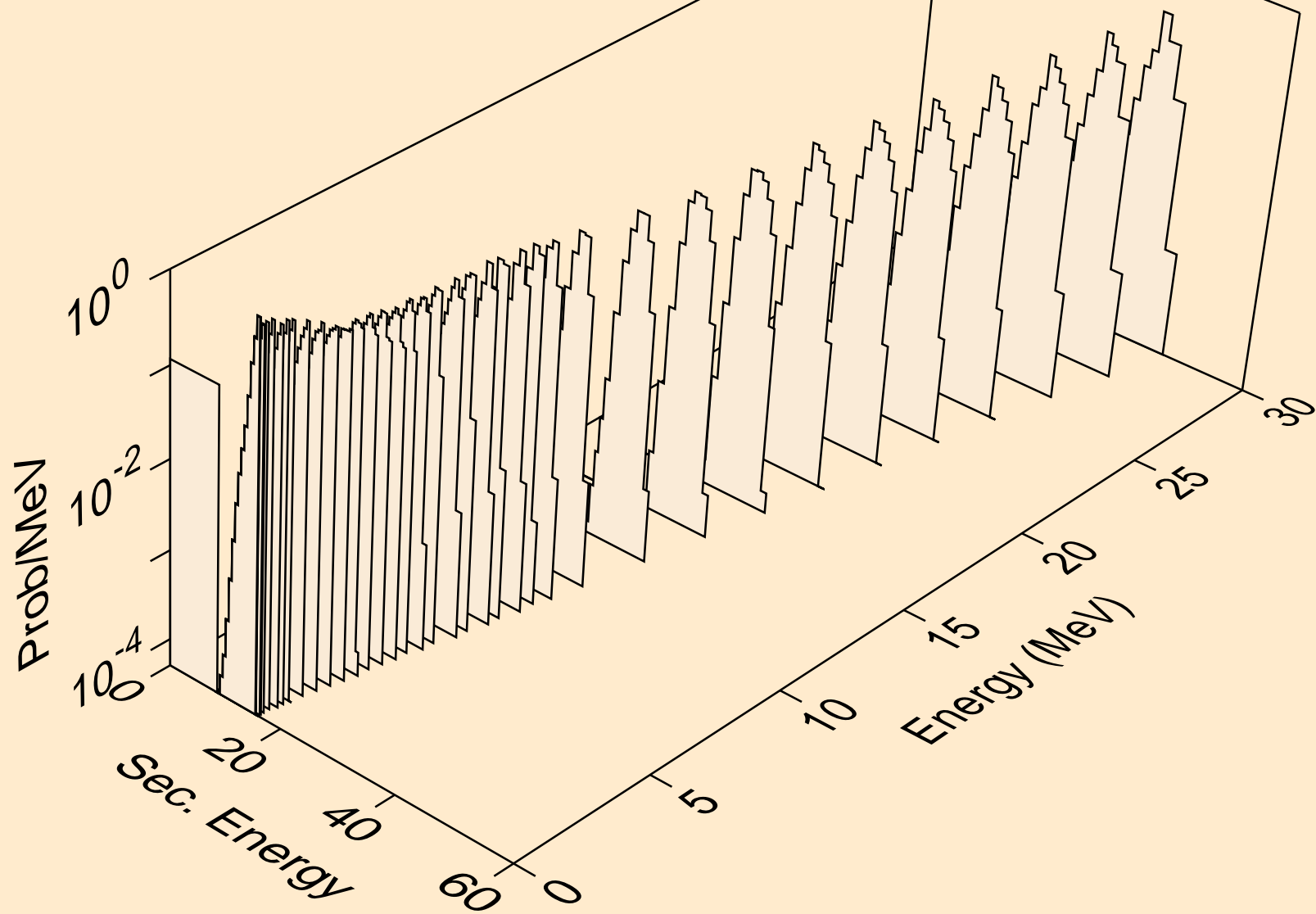

DB262 NEUTRON ACER TENDL-2021 LIBRARY; T=293.6K
alphas from (n,2a)

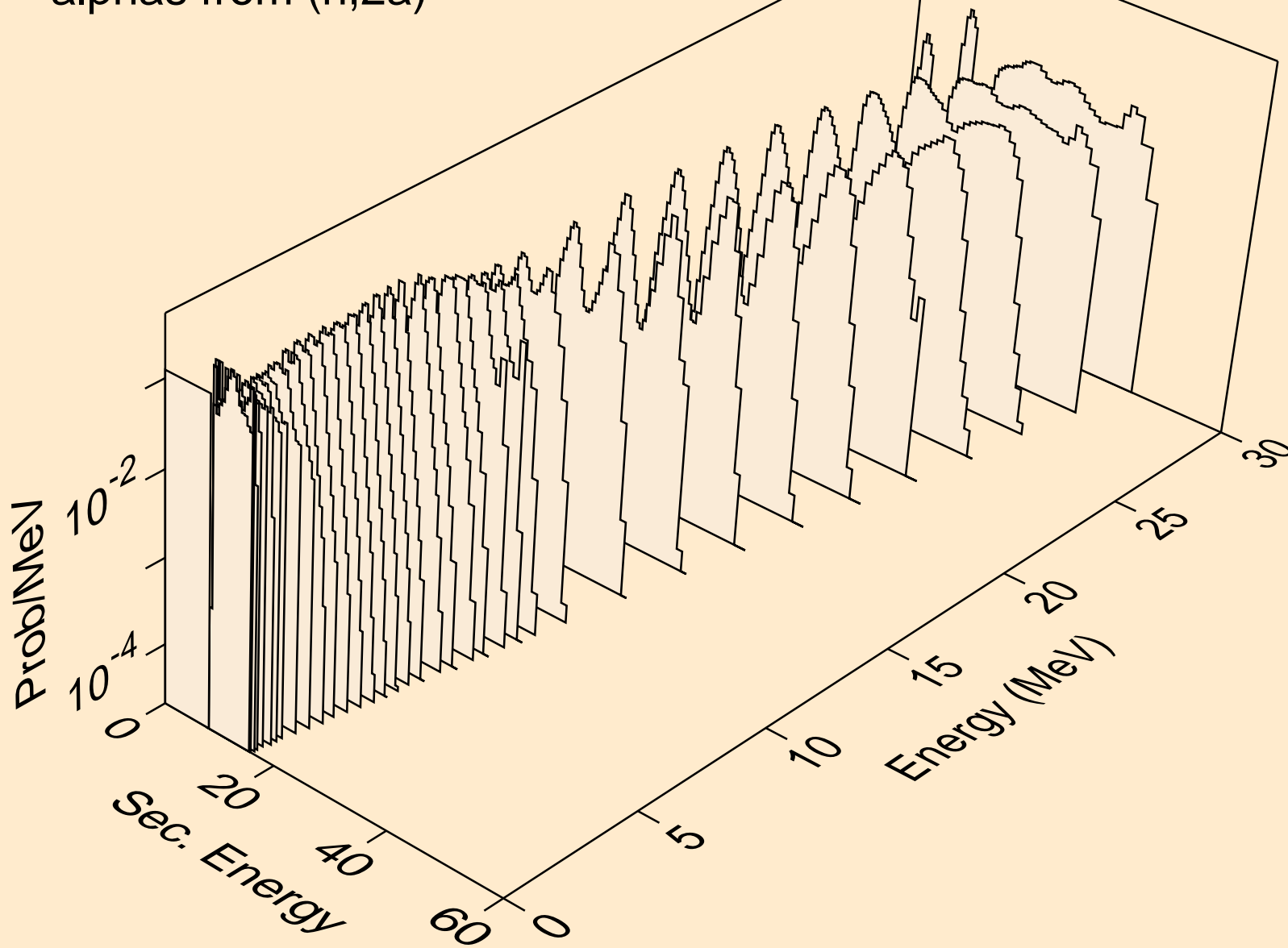

DB262 NEUTRON ACER TENDL-2021 LIBRARY; T=293.6K
alphas from (n,pa)

