

DB270 NEUTRON ACER TENDL-2021 LIBRARY; T=293.6K
Principal cross sections

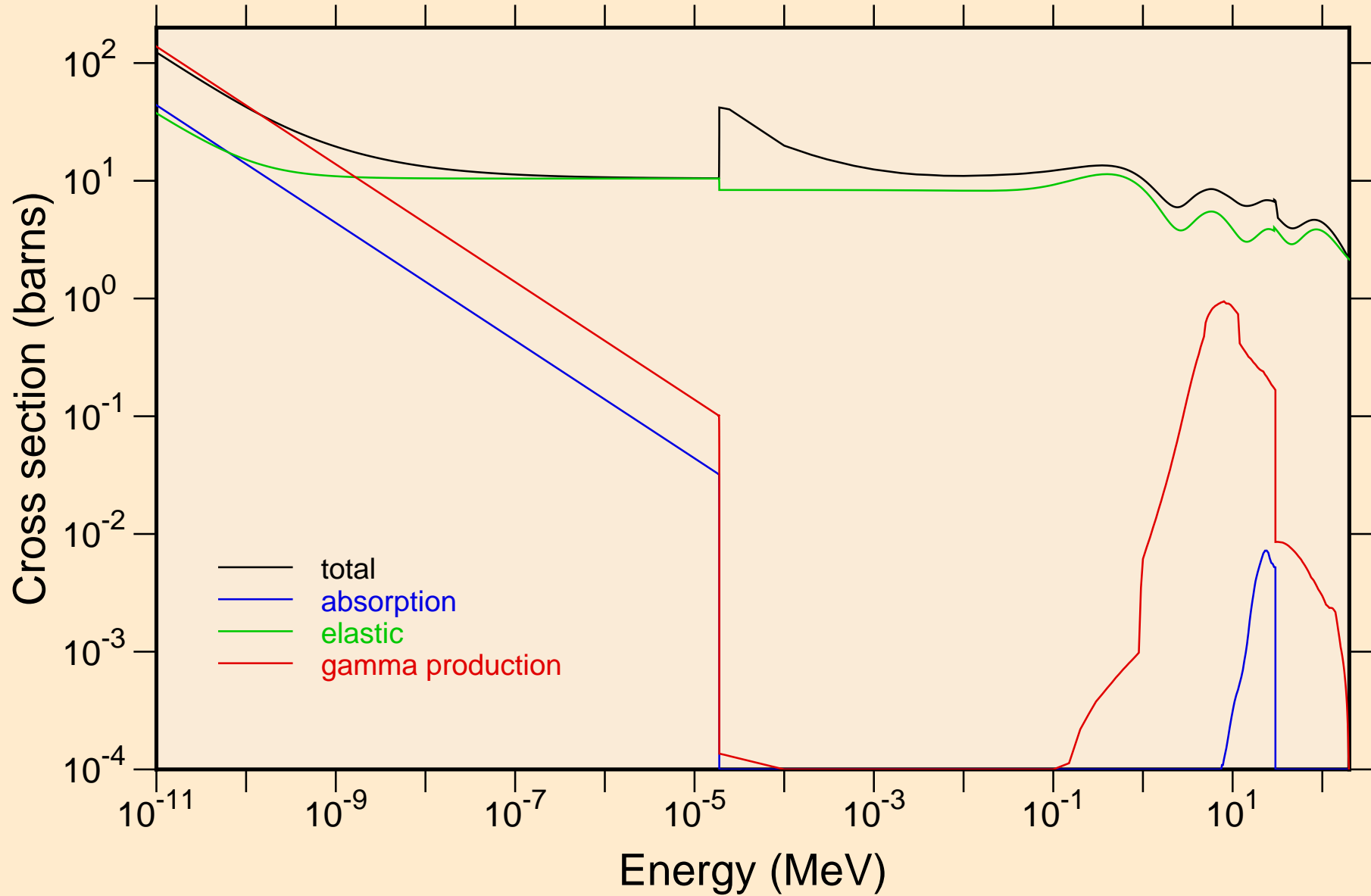

DB270 NEUTRON ACER TENDL-2021 LIBRARY; T=293.6K
Heating

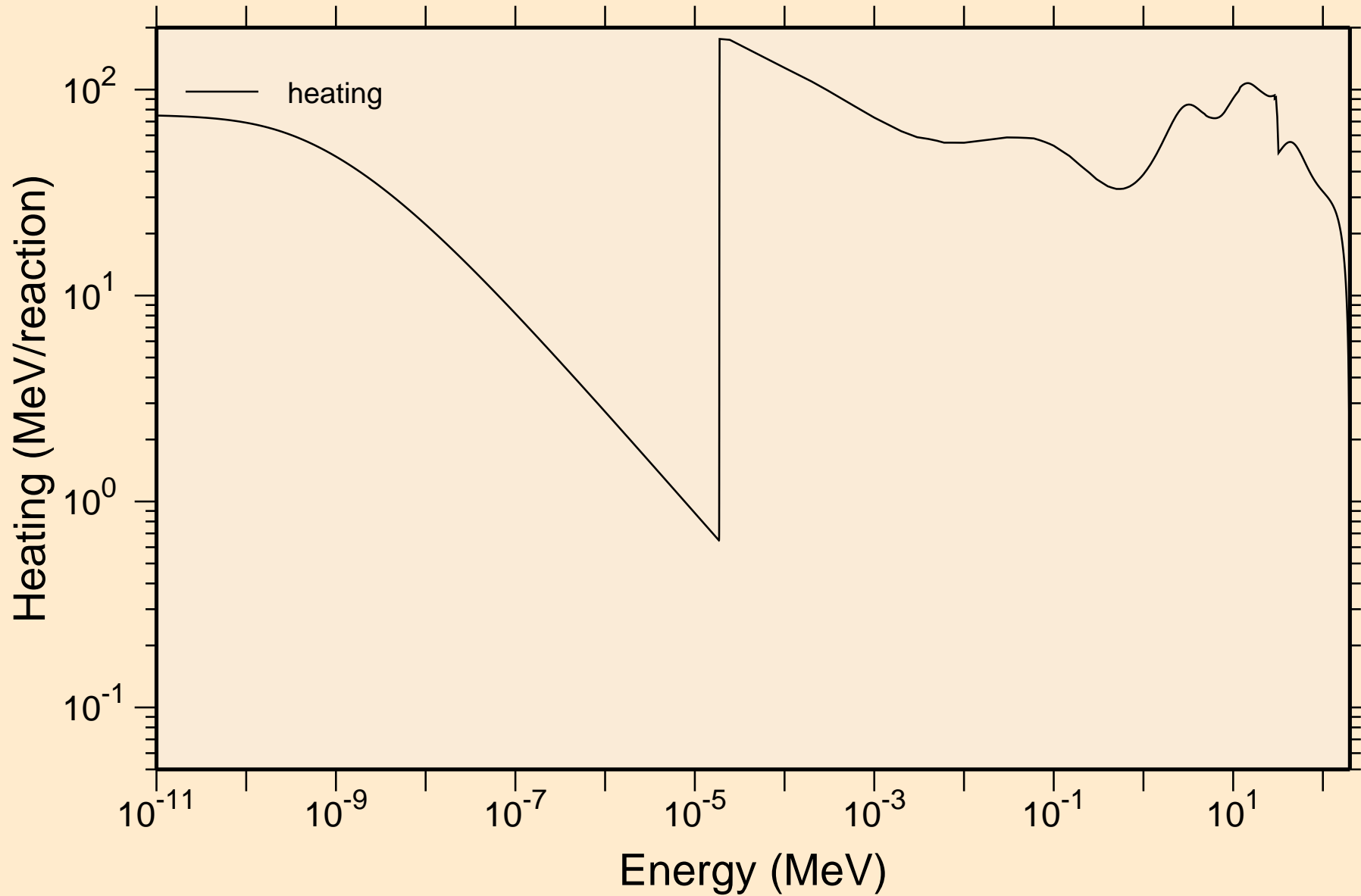

DB270 NEUTRON ACER TENDL-2021 LIBRARY; T=293.6K
Damage

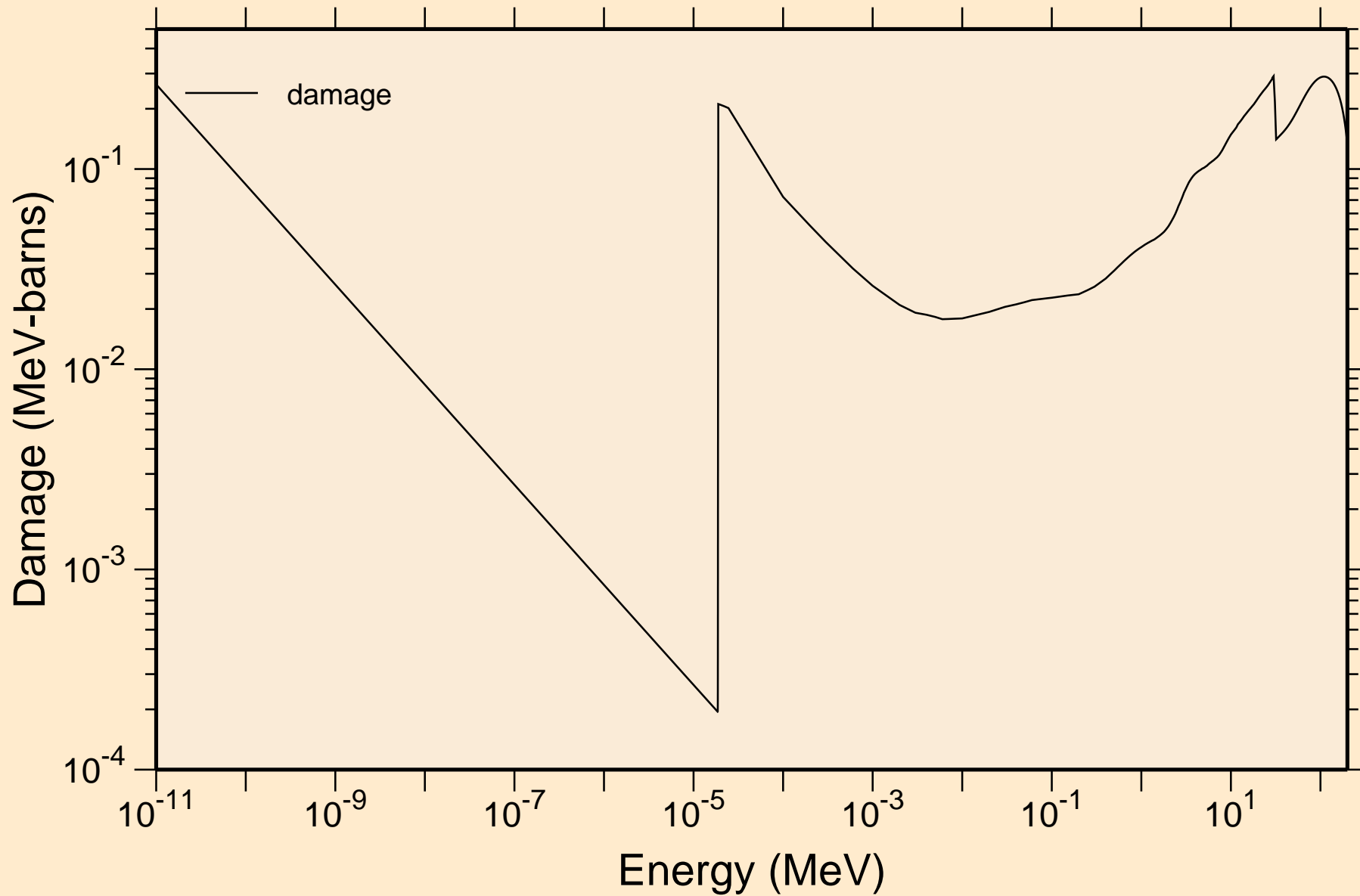

DB270 NEUTRON ACER TENDL-2021 LIBRARY; T=293.6K
Non-threshold reactions

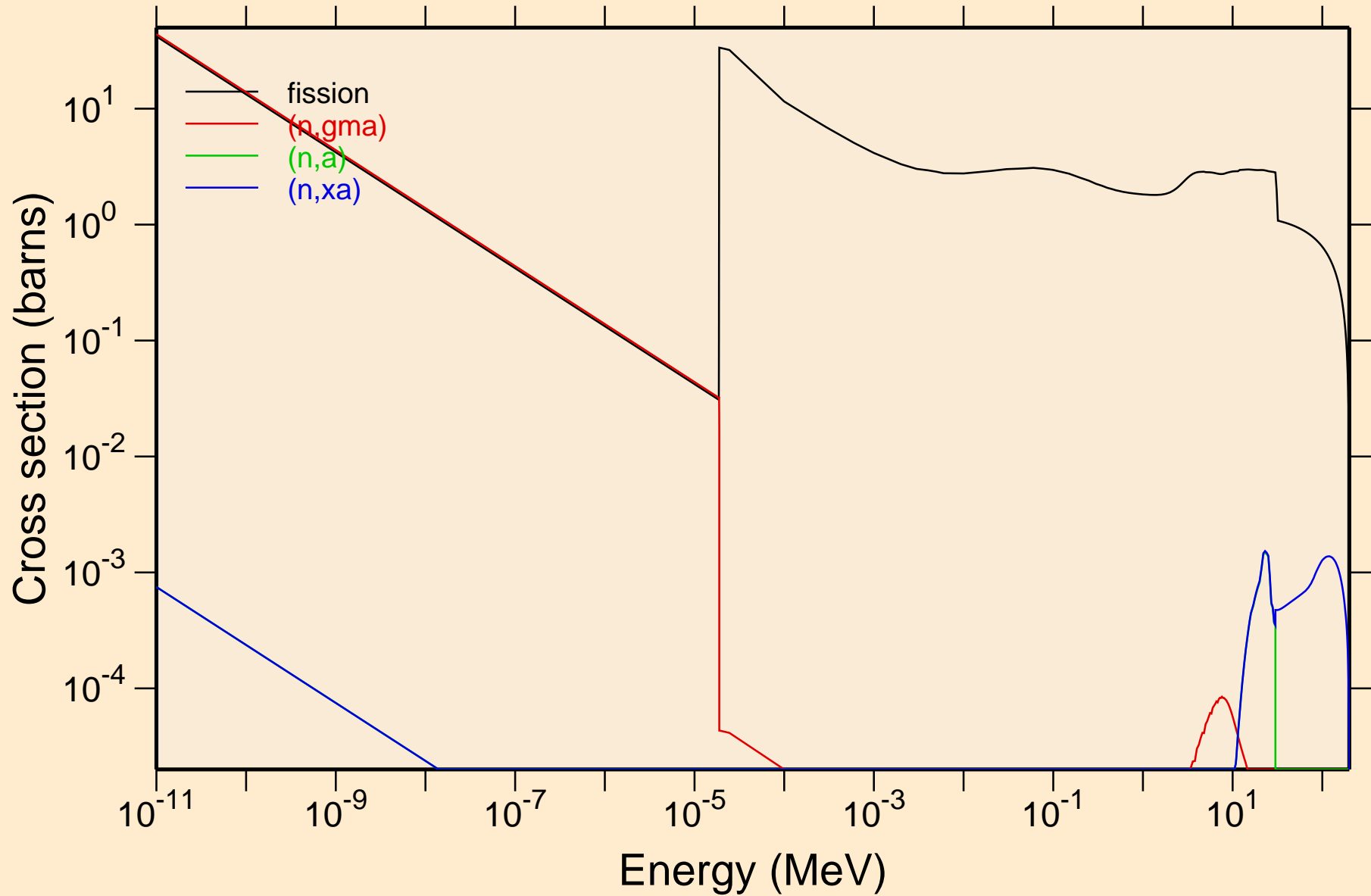

DB270 NEUTRON ACER TENDL-2021 LIBRARY; T=293.6K
Principal cross sections

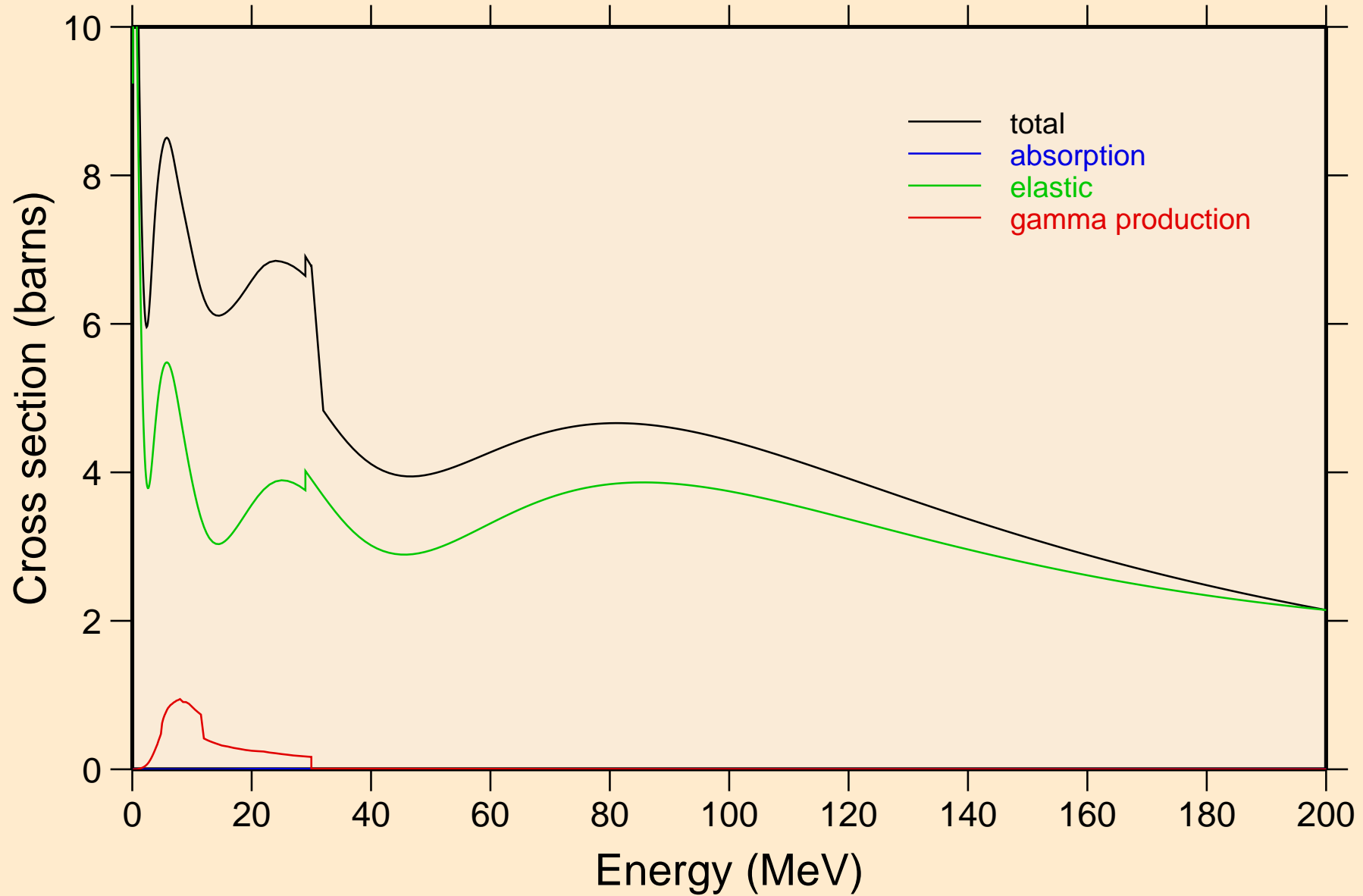

DB270 NEUTRON ACER TENDL-2021 LIBRARY; T=293.6K
Heating

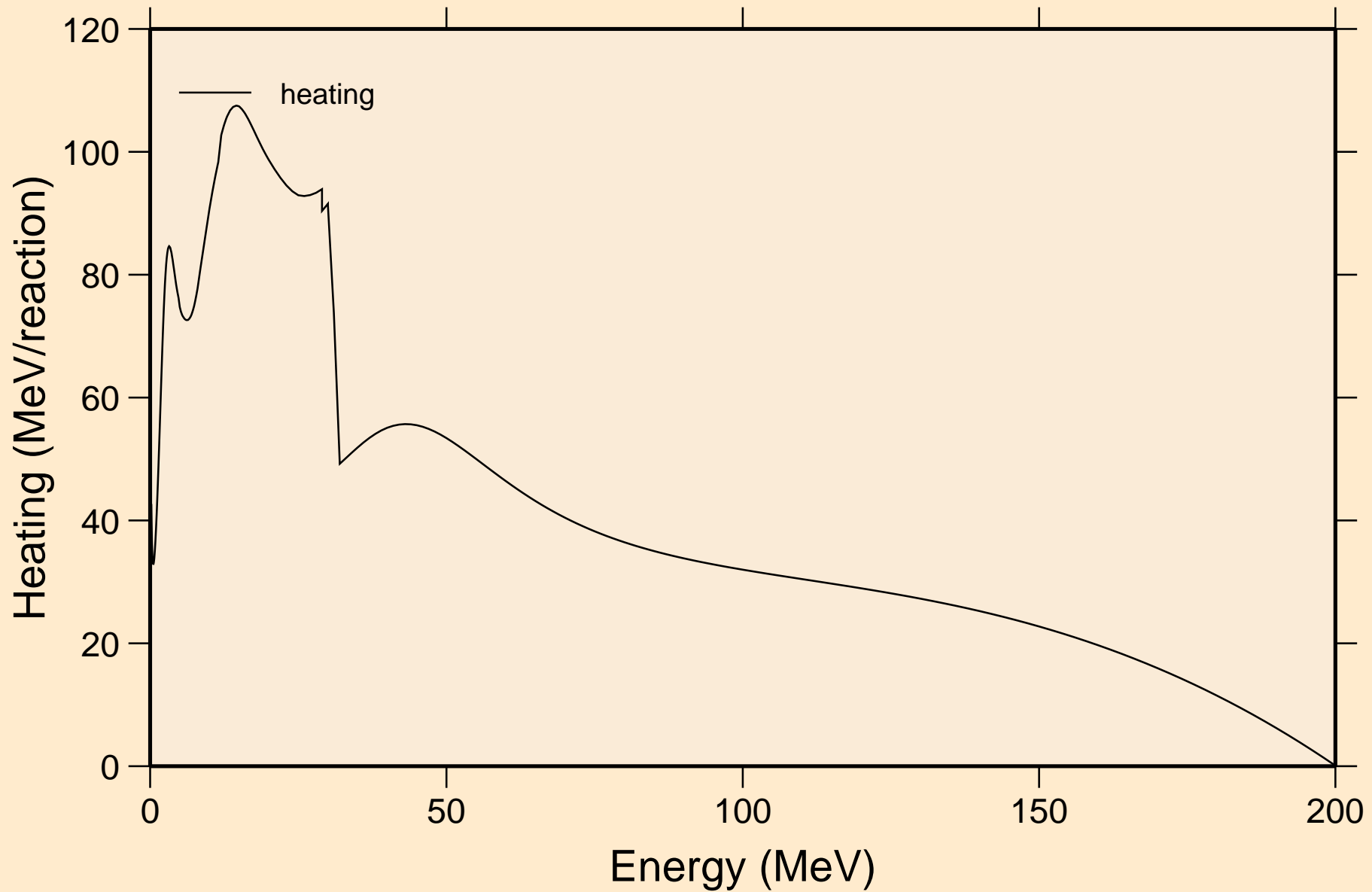

DB270 NEUTRON ACER TENDL-2021 LIBRARY; T=293.6K
Damage

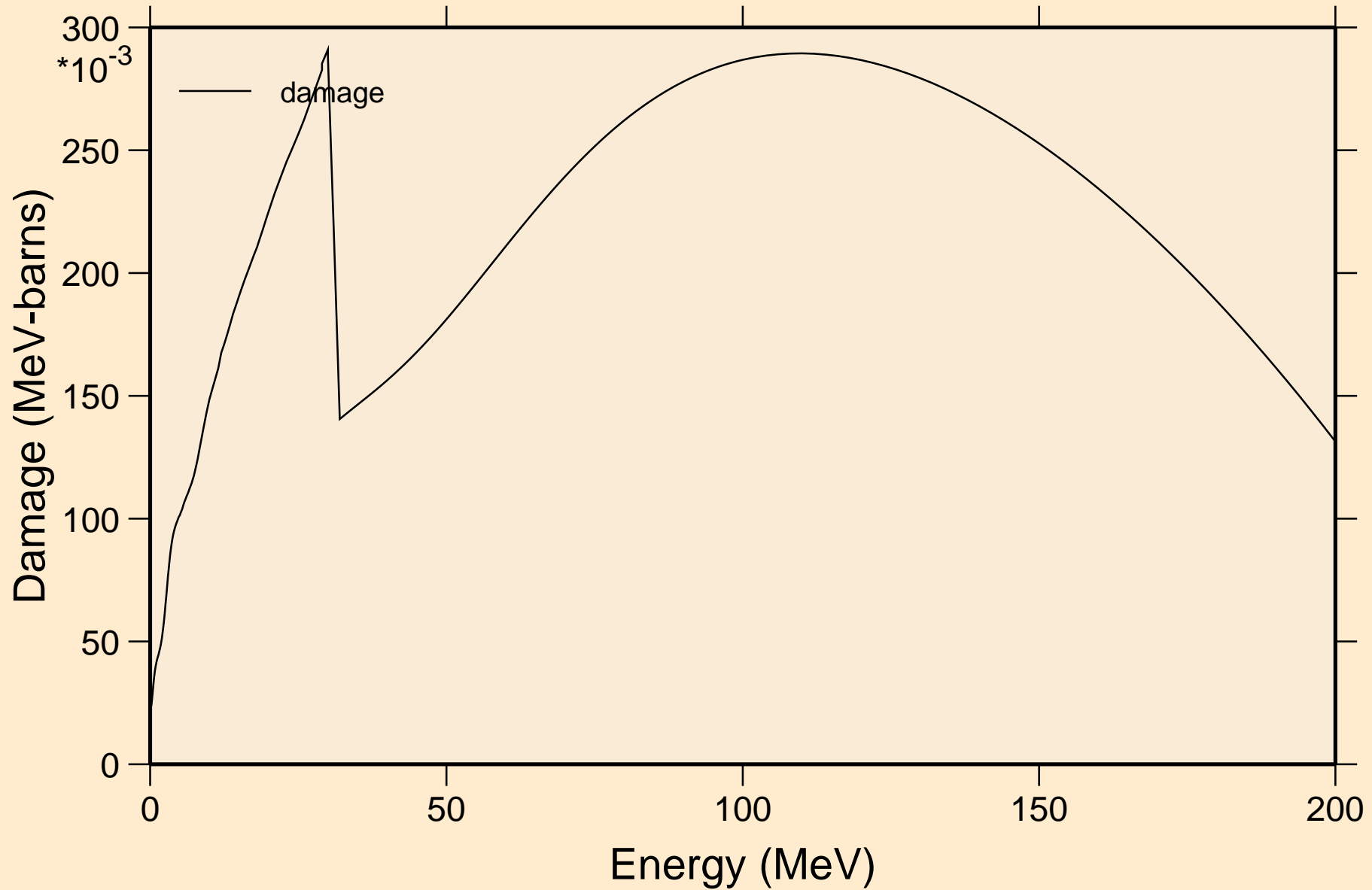

DB270 NEUTRON ACER TENDL-2021 LIBRARY; T=293.6K
Non-threshold reactions

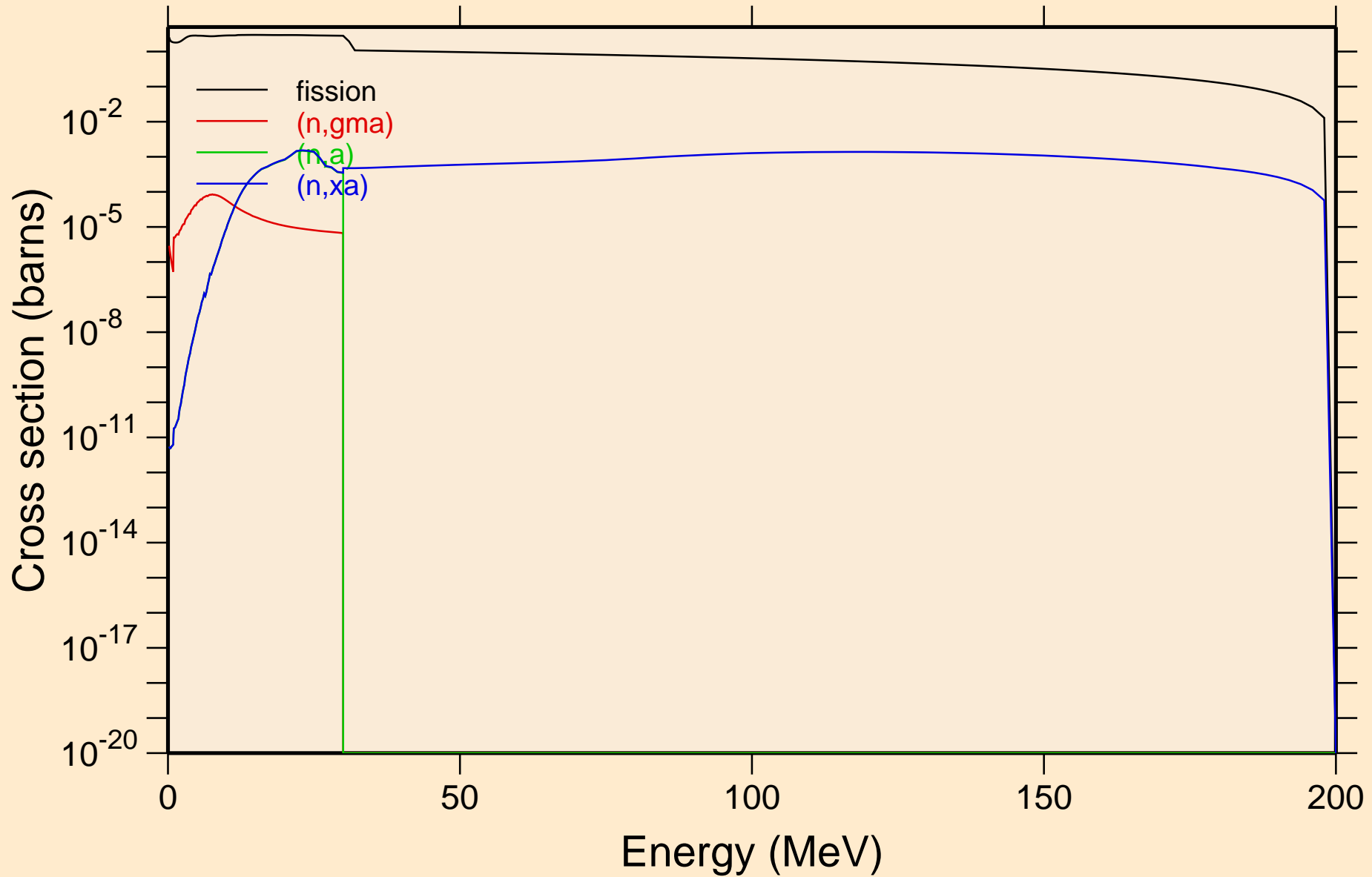

DB270 NEUTRON ACER TENDL-2021 LIBRARY; T=293.6K
Inelastic levels

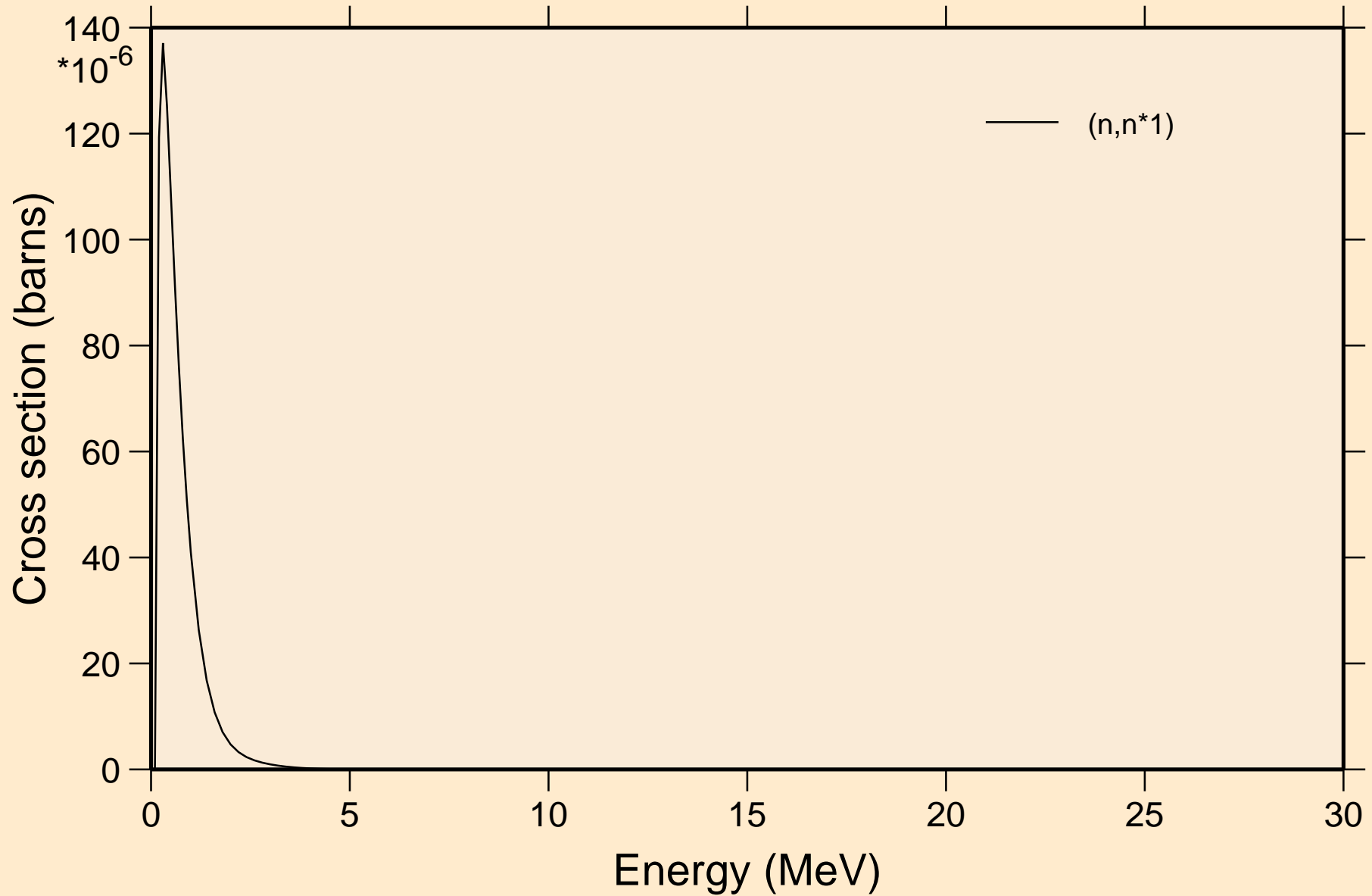

DB270 NEUTRON ACER TENDL-2021 LIBRARY; T=293.6K
Threshold reactions

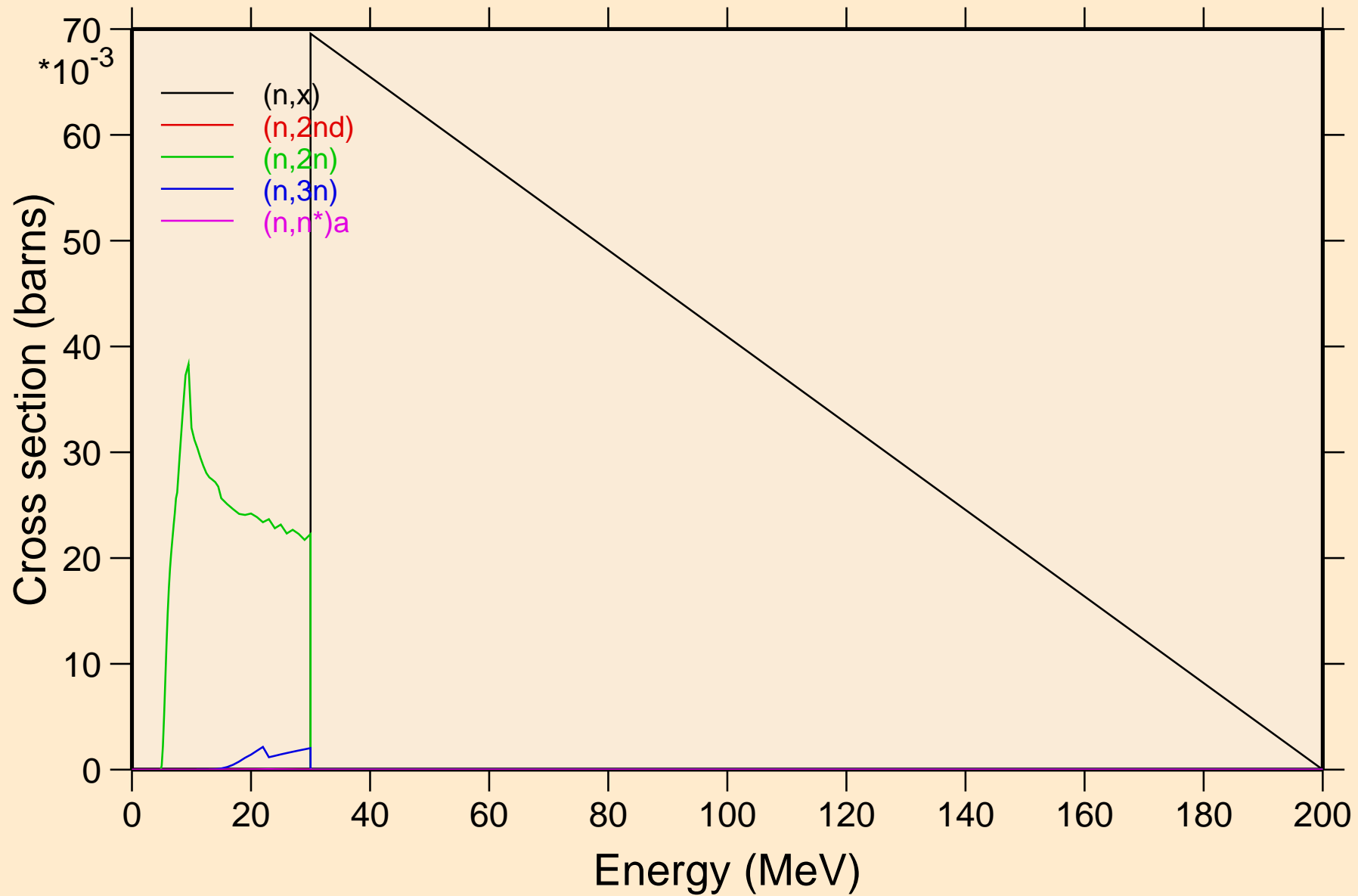

DB270 NEUTRON ACER TENDL-2021 LIBRARY; T=293.6K
Threshold reactions

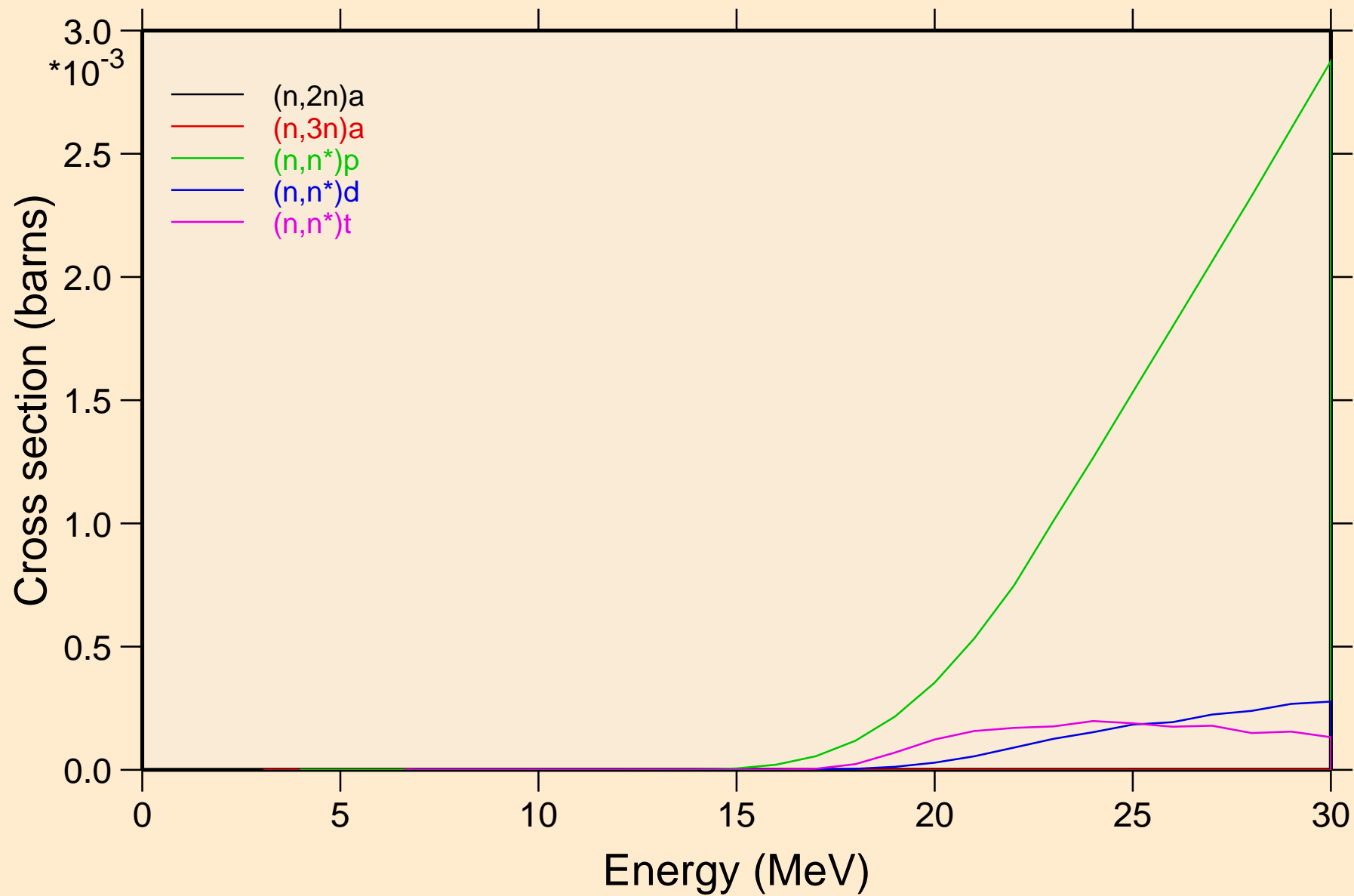

DB270 NEUTRON ACER TENDL-2021 LIBRARY; T=293.6K
Threshold reactions

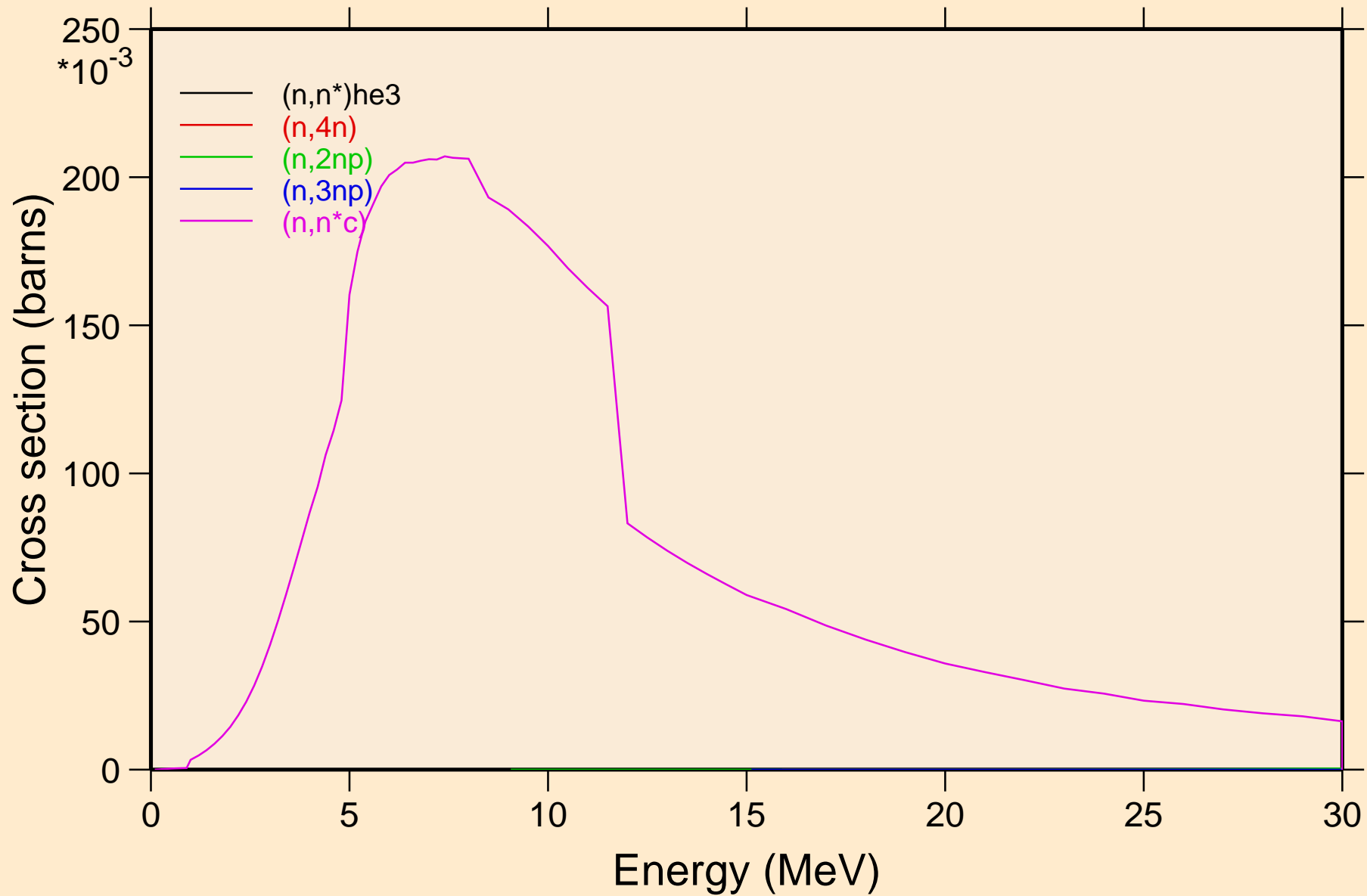

DB270 NEUTRON ACER TENDL-2021 LIBRARY; T=293.6K
Threshold reactions

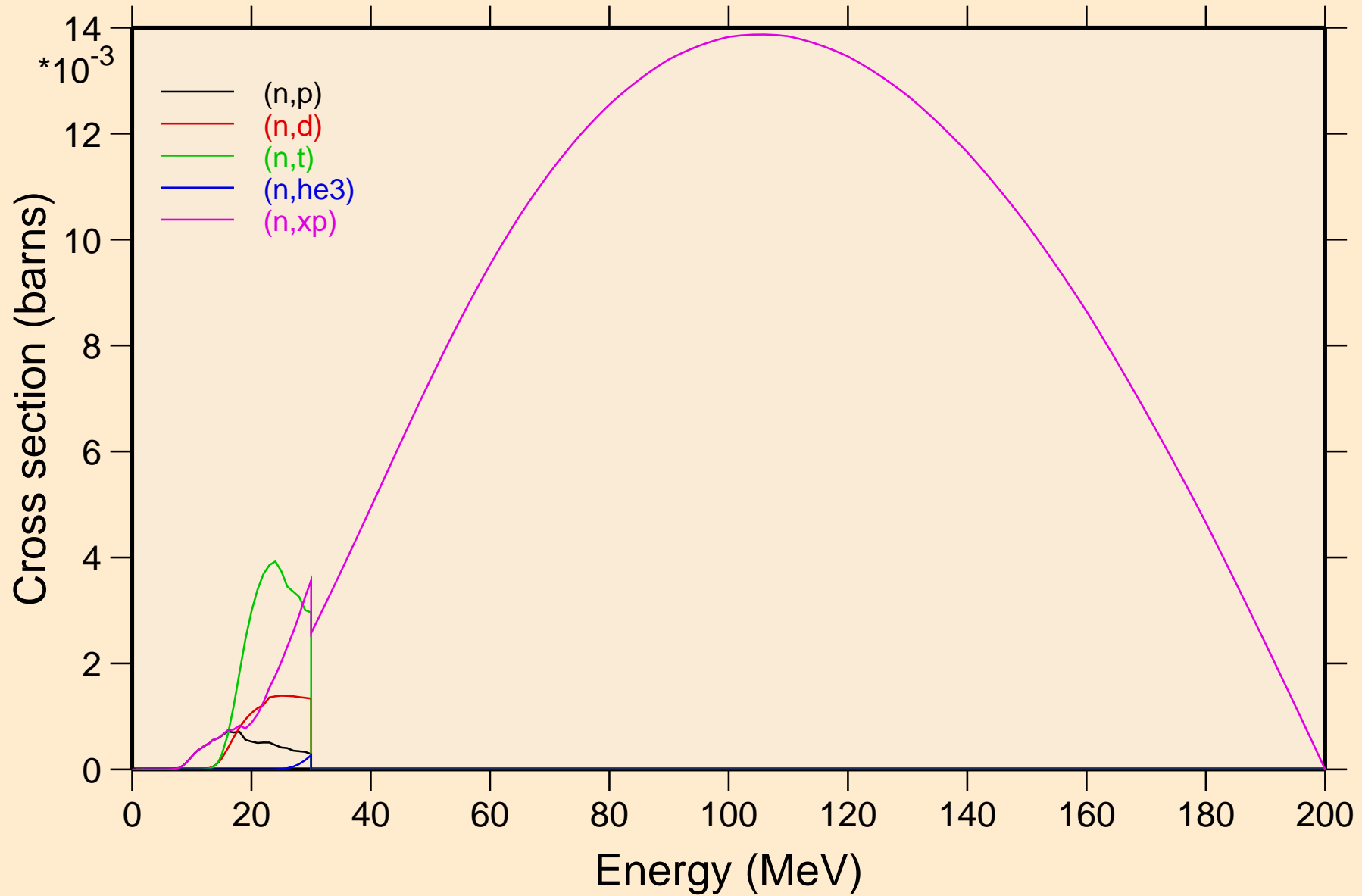

DB270 NEUTRON ACER TENDL-2021 LIBRARY; T=293.6K
Threshold reactions

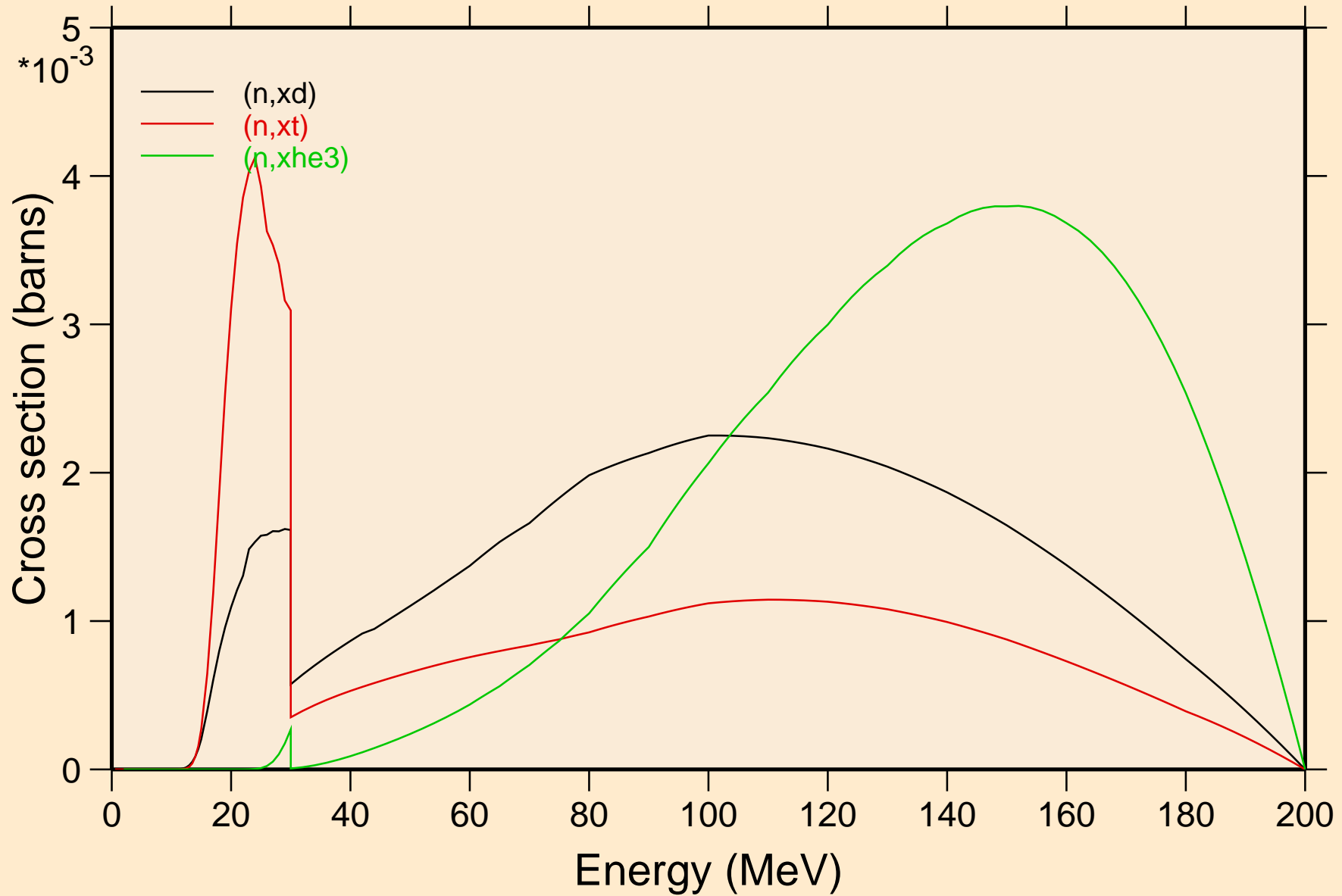

DB270 NEUTRON ACER TENDL-2021 LIBRARY; T=293.6K
angular distribution for elastic

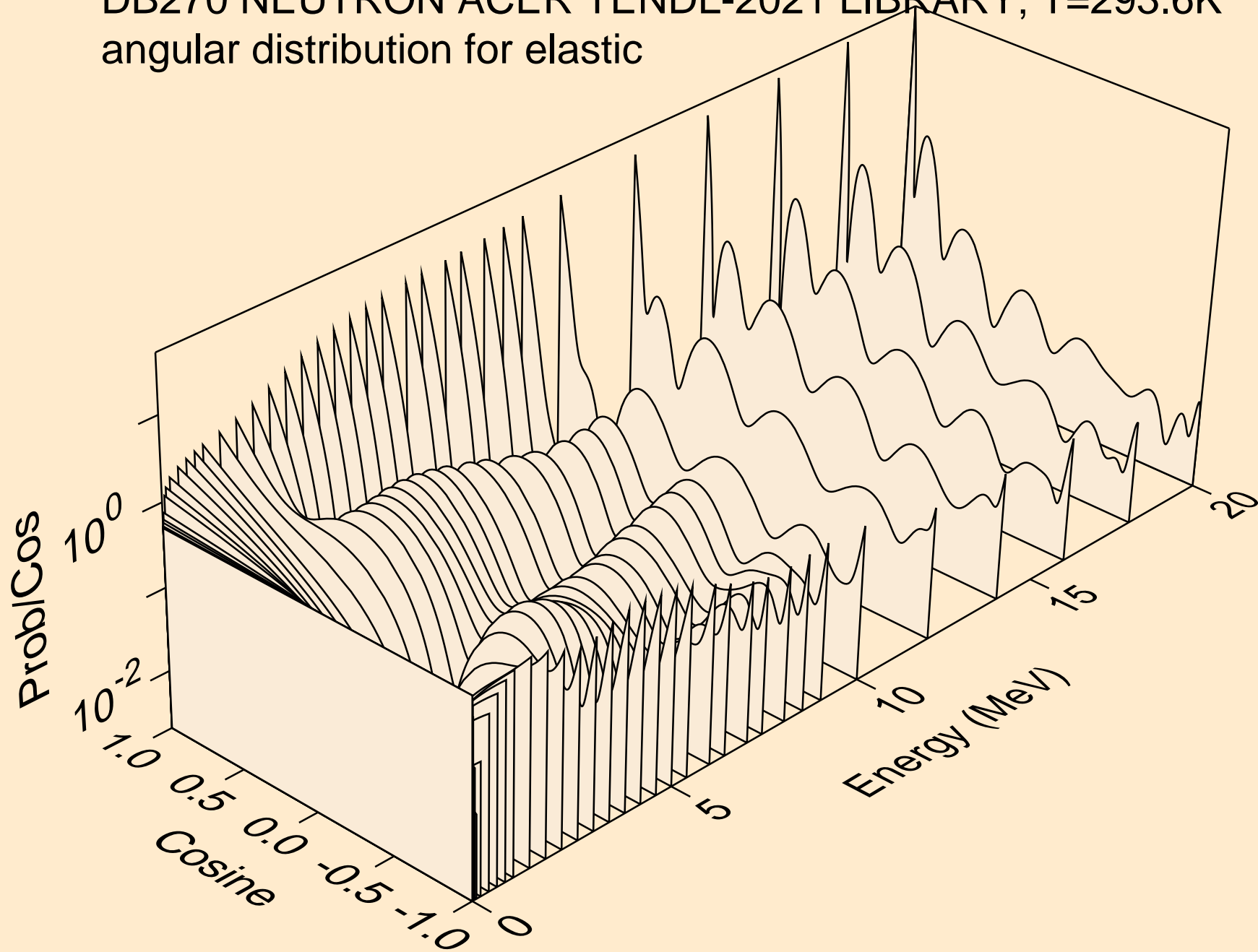

DB270 NEUTRON ACER TENDL-2021 LIBRARY; T=293.6K
angular distribution for elastic

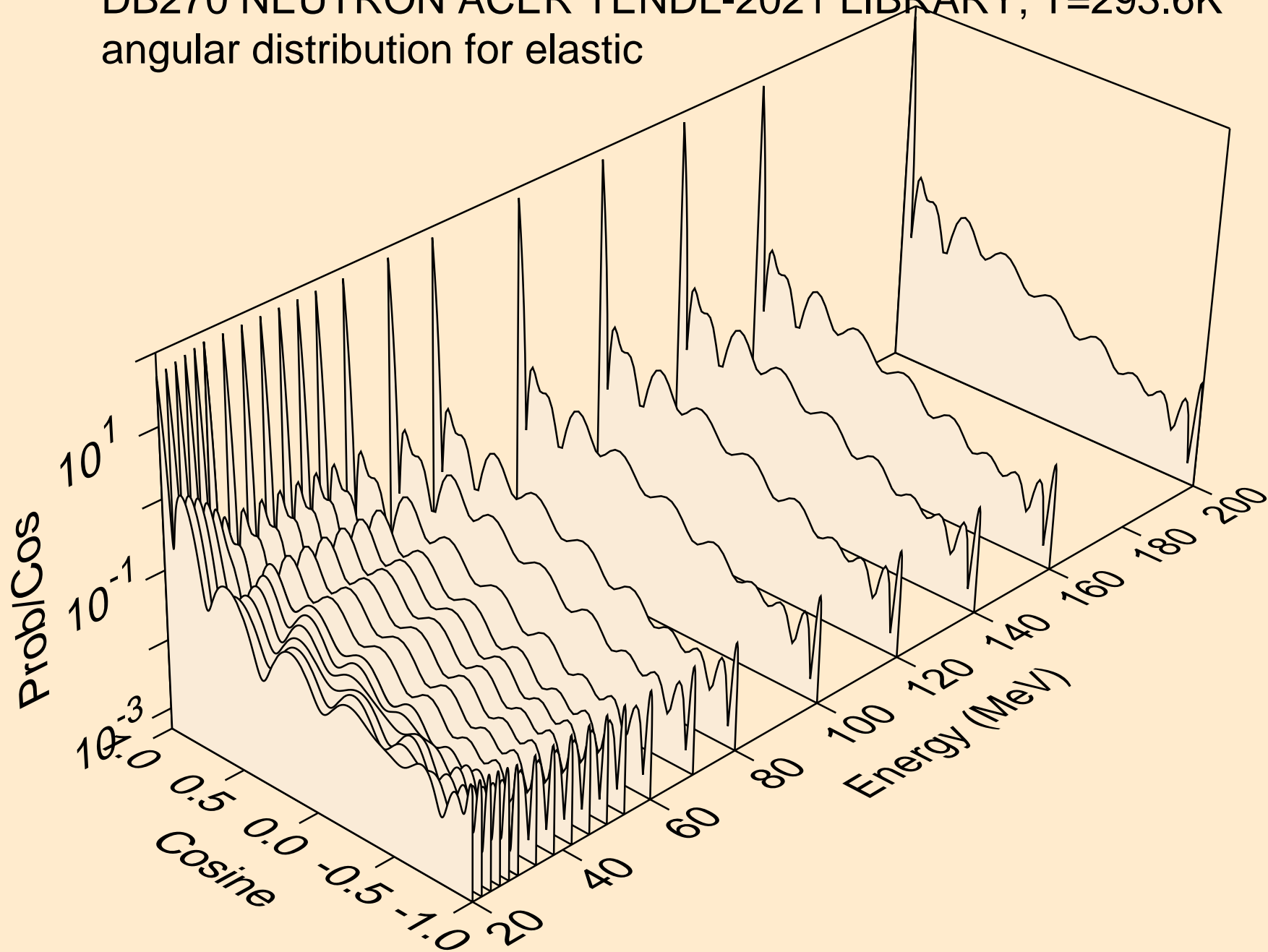

DB270 NEUTRON ACER TENDL-2021 LIBRARY; T=293.6K
angular distribution for (n,n*1)

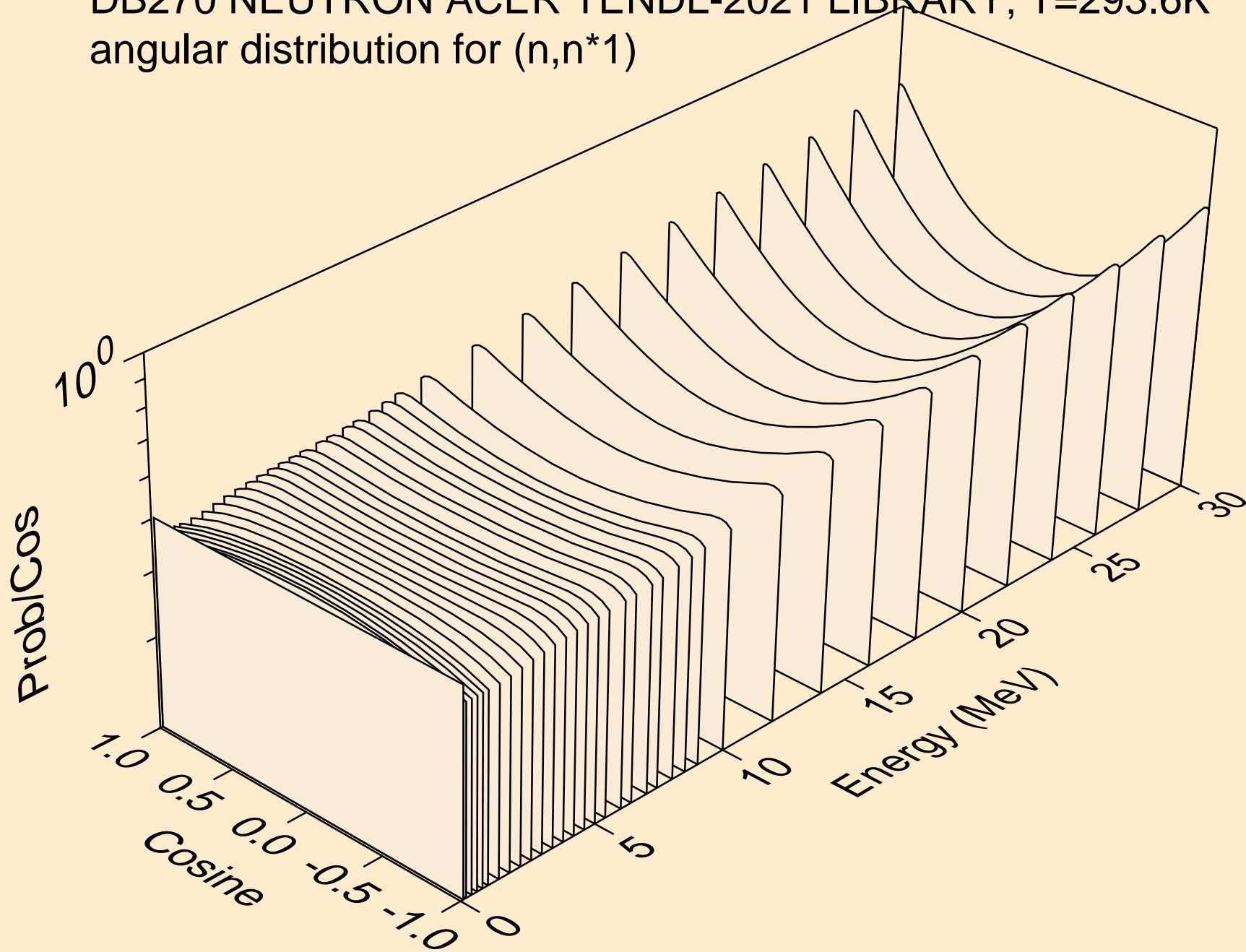

DB270 NEUTRON ACER TENDL-2021 LIBRARY; T=293.6K
Total fission nubar

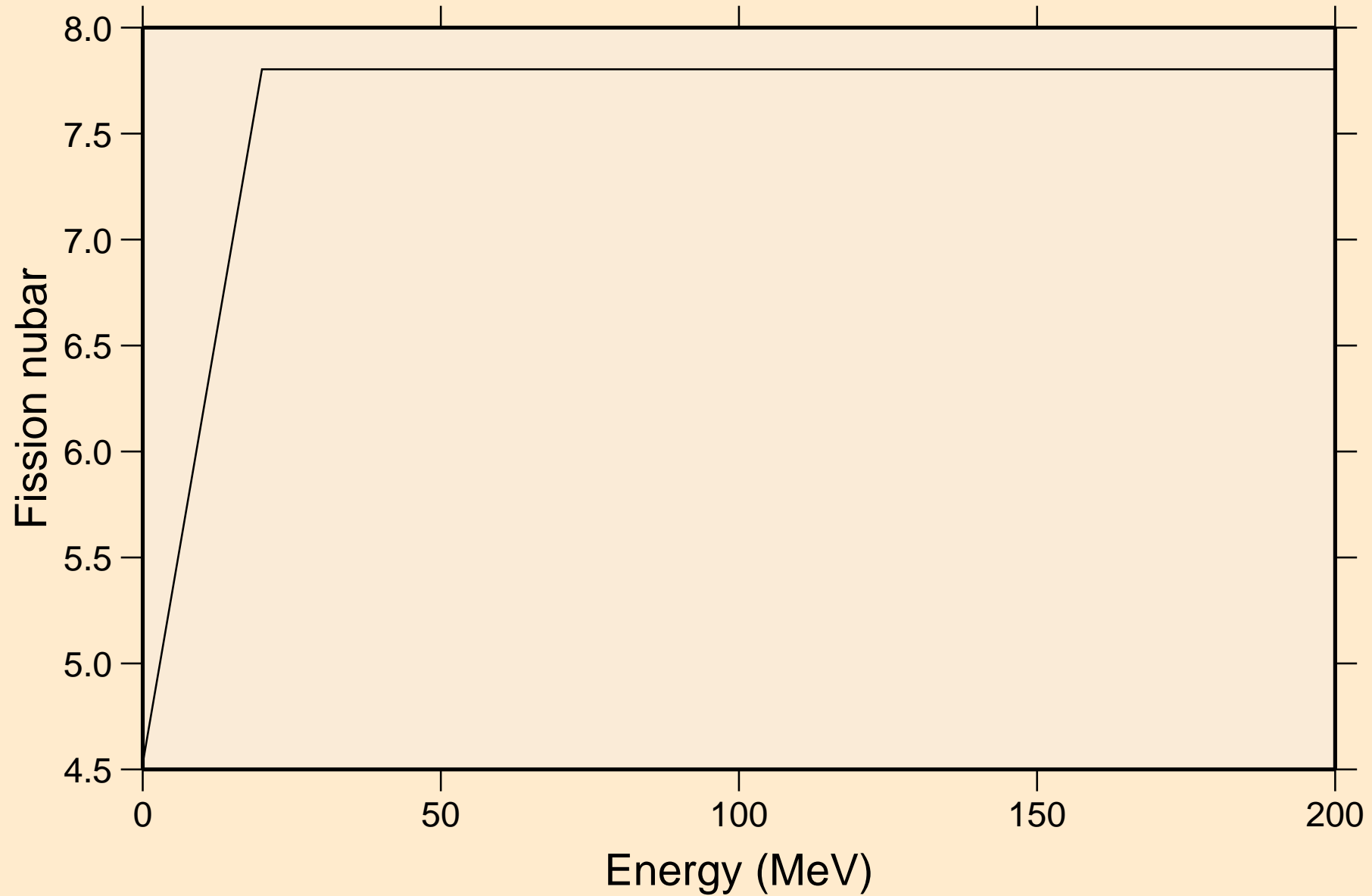

DB270 NEUTRON ACER TENDL-2021 LIBRARY; T=293.6K
Neutron emission for (n,x)

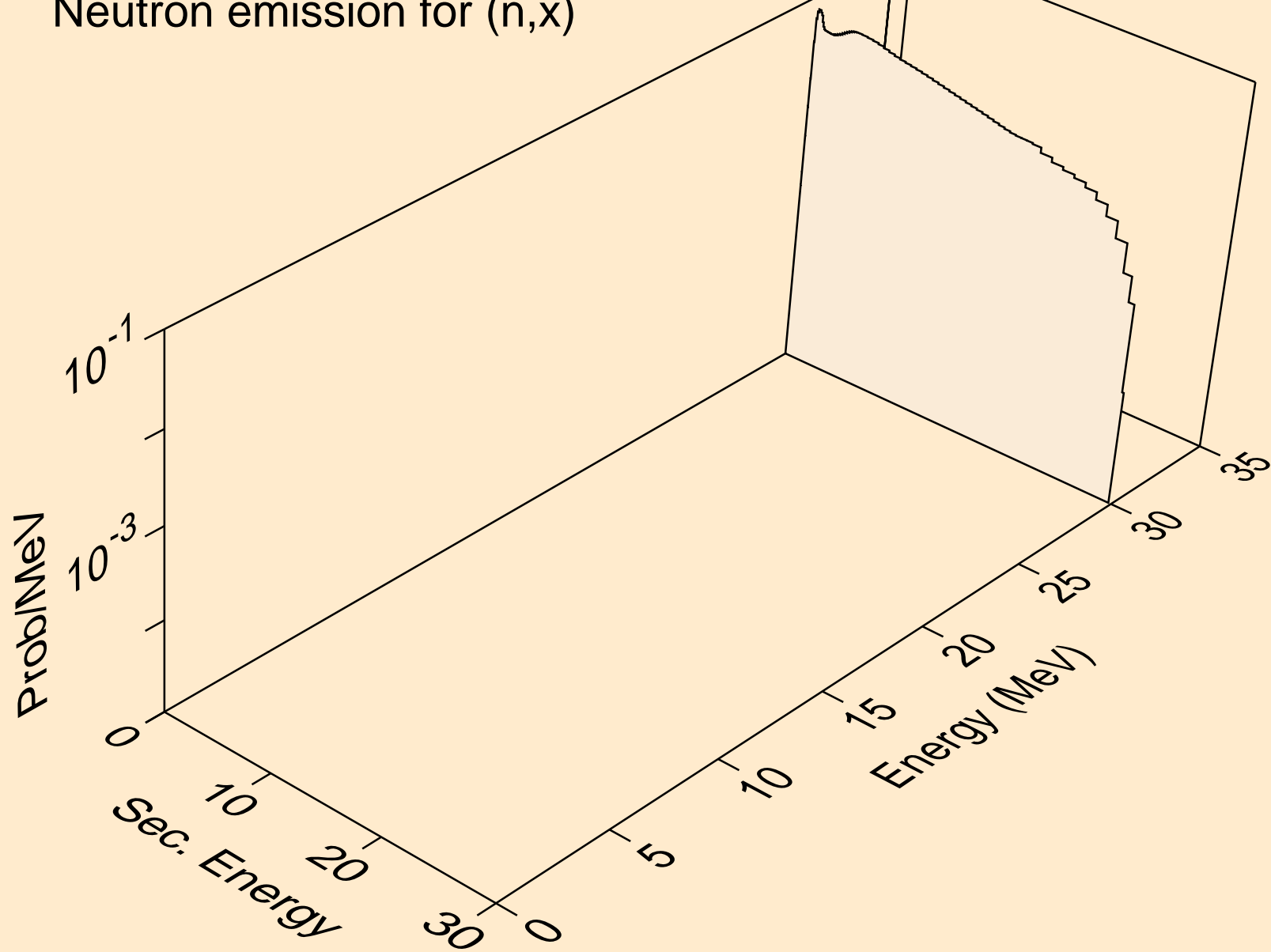

DB270 NEUTRON ACER TENDL-2021 LIBRARY; T=293.6K
Neutron emission for (n,2nd)

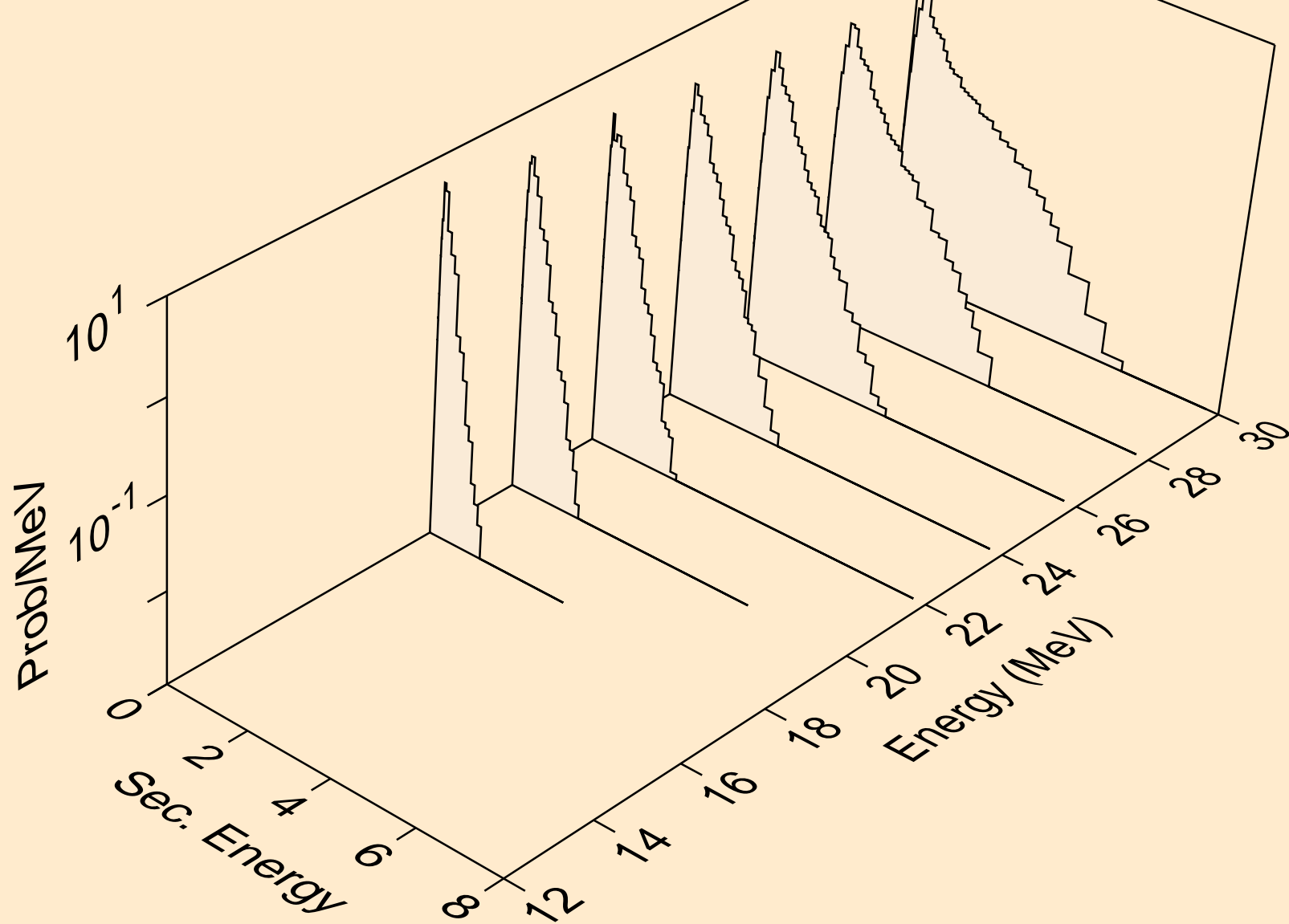

DB270 NEUTRON ACER TENDL-2021 LIBRARY; T=293.6K
Neutron emission for (n,2n)

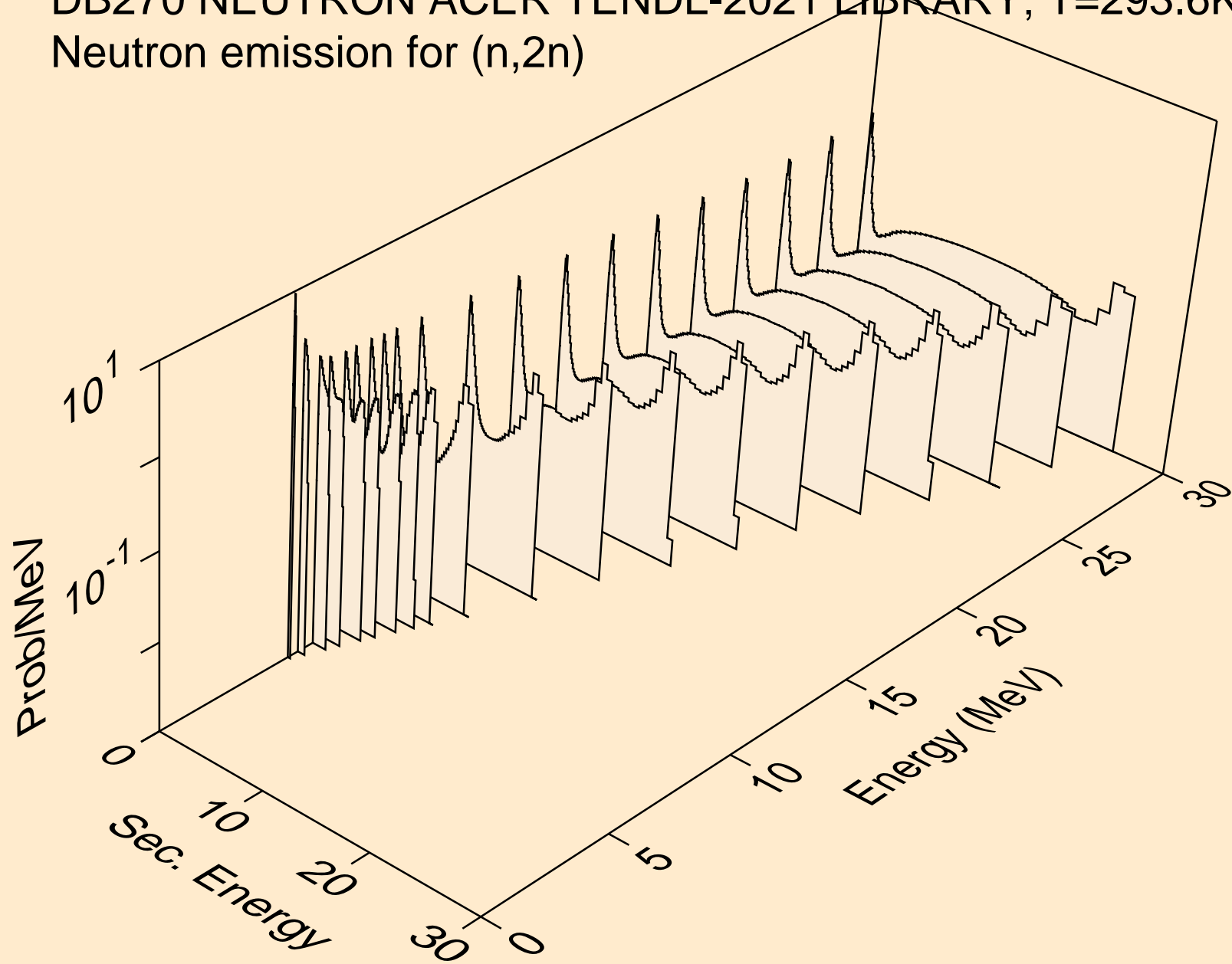

DB270 NEUTRON ACER TENDL-2021 LIBRARY; T=293.6K
Neutron emission for (n,3n)

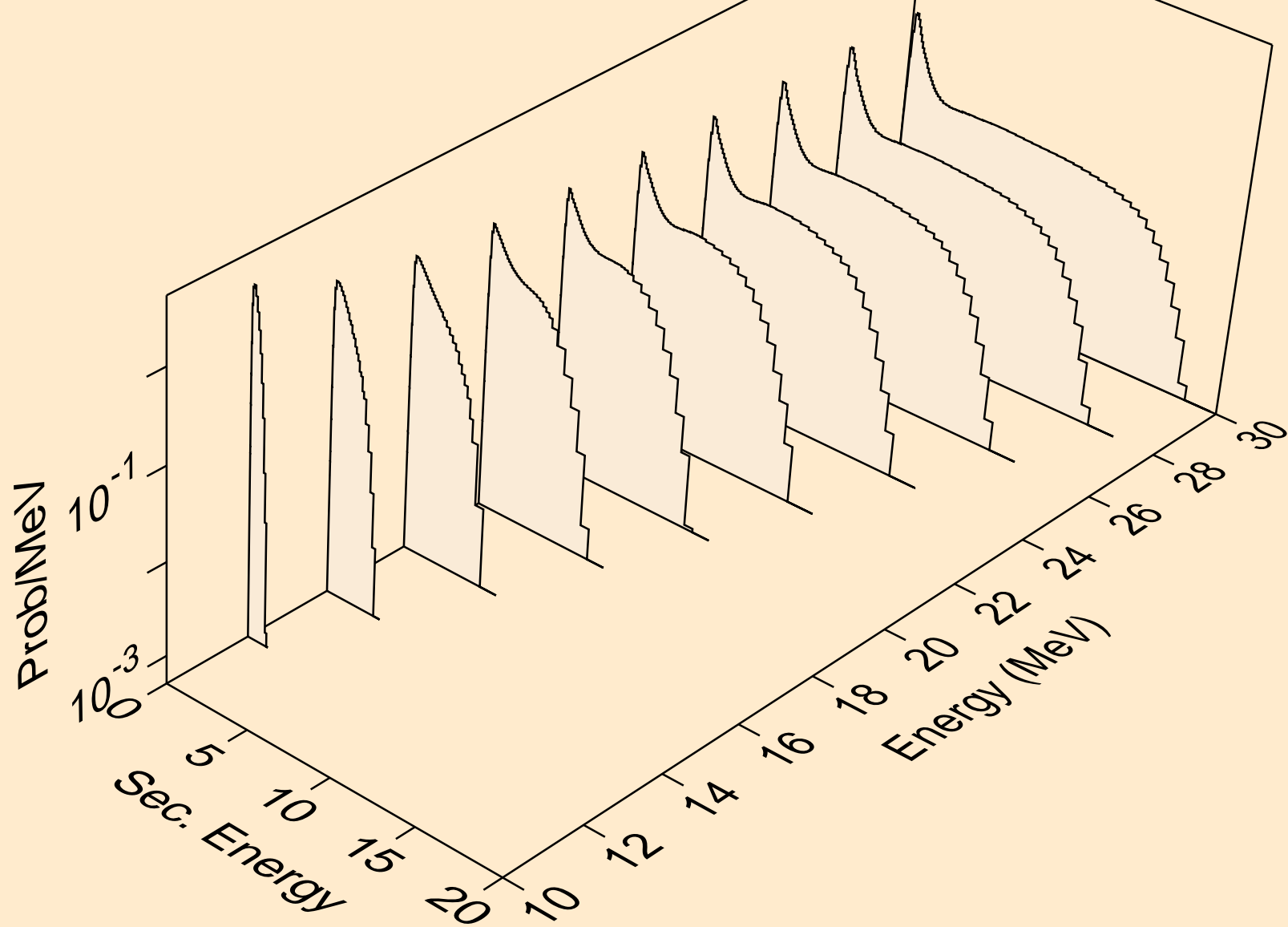

DB270 NEUTRON ACER TENDL-2021 LIBRARY; T=293.6K
Neutron emission for fission

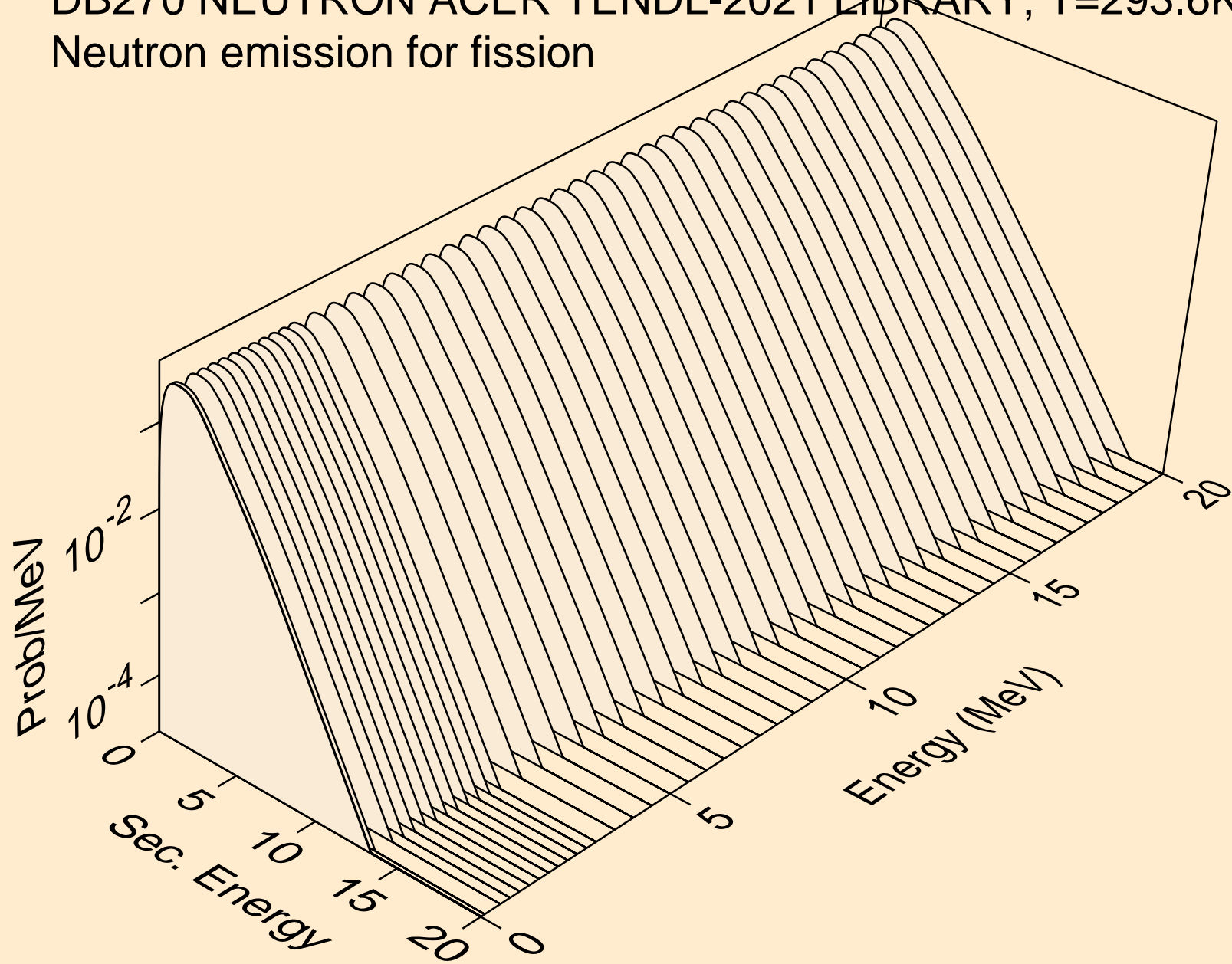

DB270 NEUTRON ACER TENDL-2021 LIBRARY; T=293.6K
Neutron emission for (n,n*)a

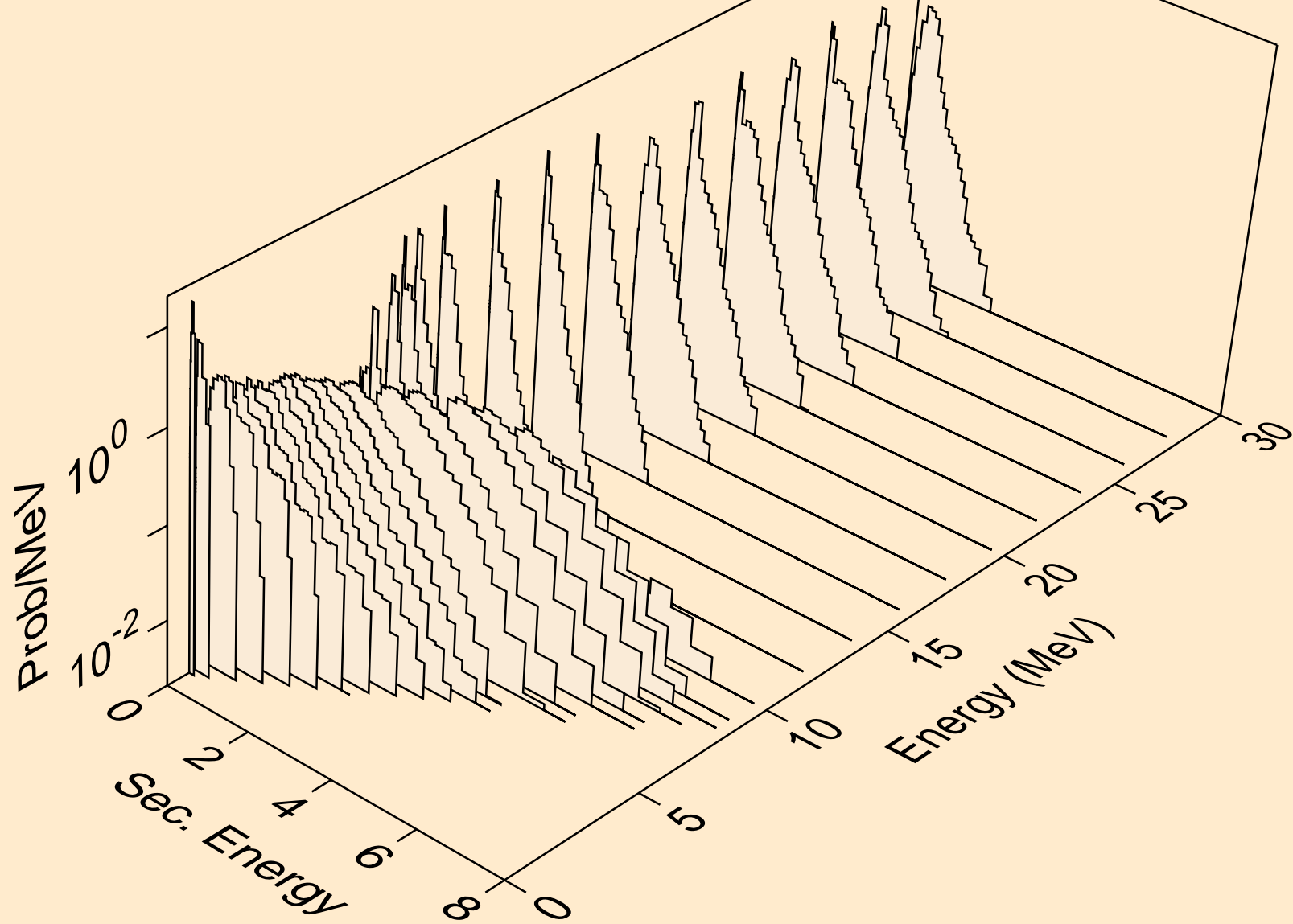

DB270 NEUTRON ACER TENDL-2021 LIBRARY; T=293.6K
Neutron emission for (n,2n)a

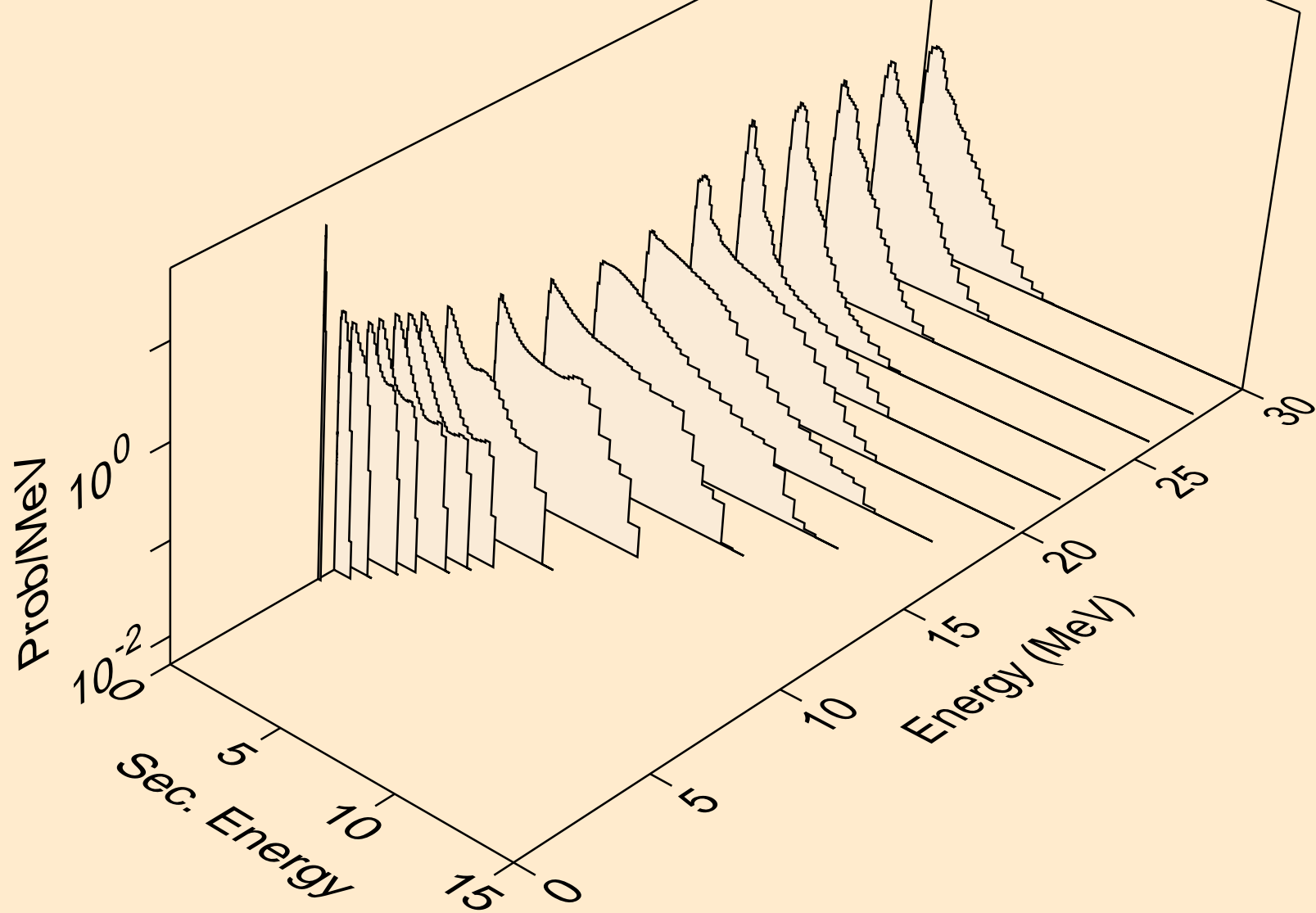

DB270 NEUTRON ACER TENDL-2021 LIBRARY; T=293.6K
Neutron emission for (n,3n)a

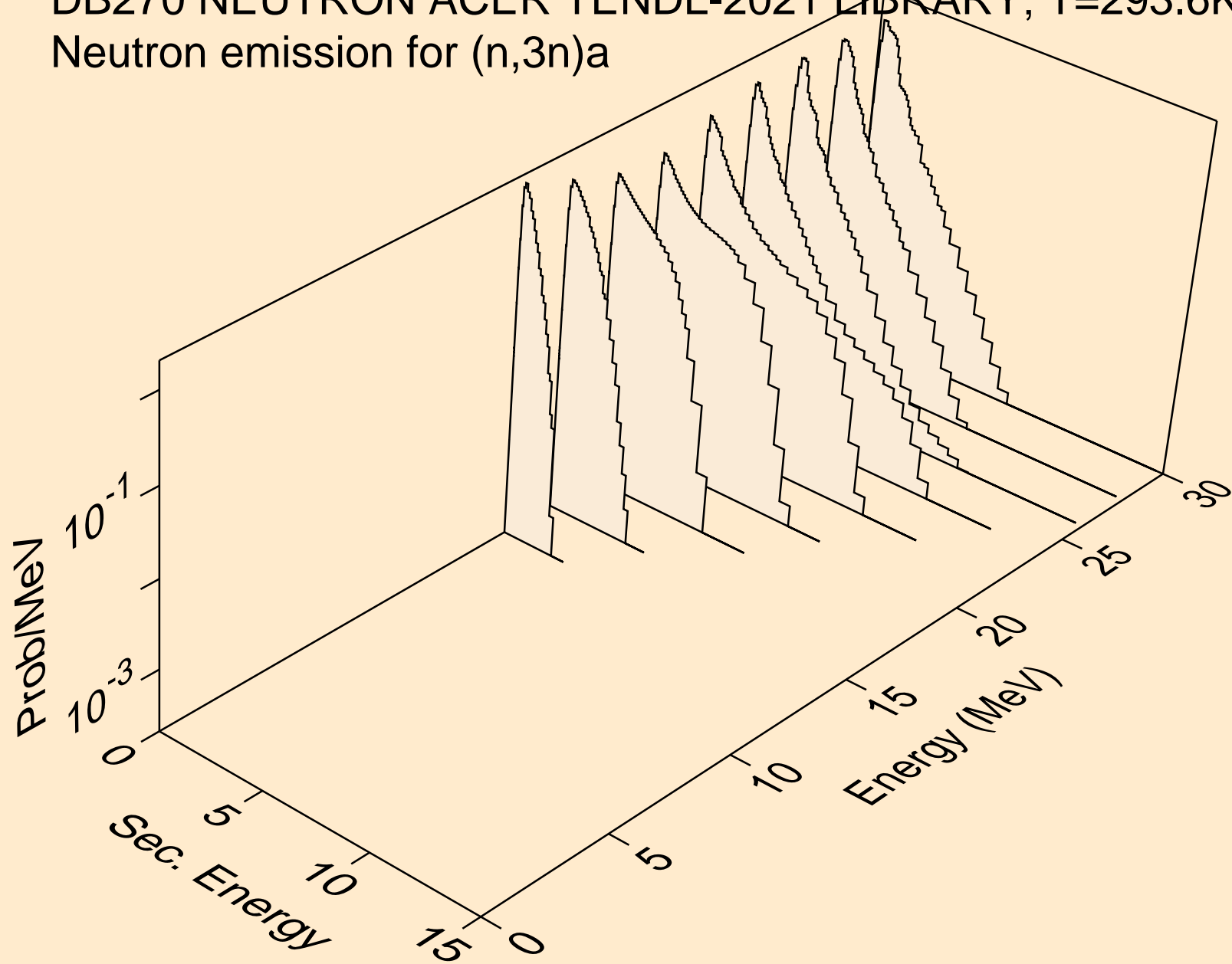

DB270 NEUTRON ACER TENDL-2021 LIBRARY; T=293.6K
Neutron emission for (n,n*)p

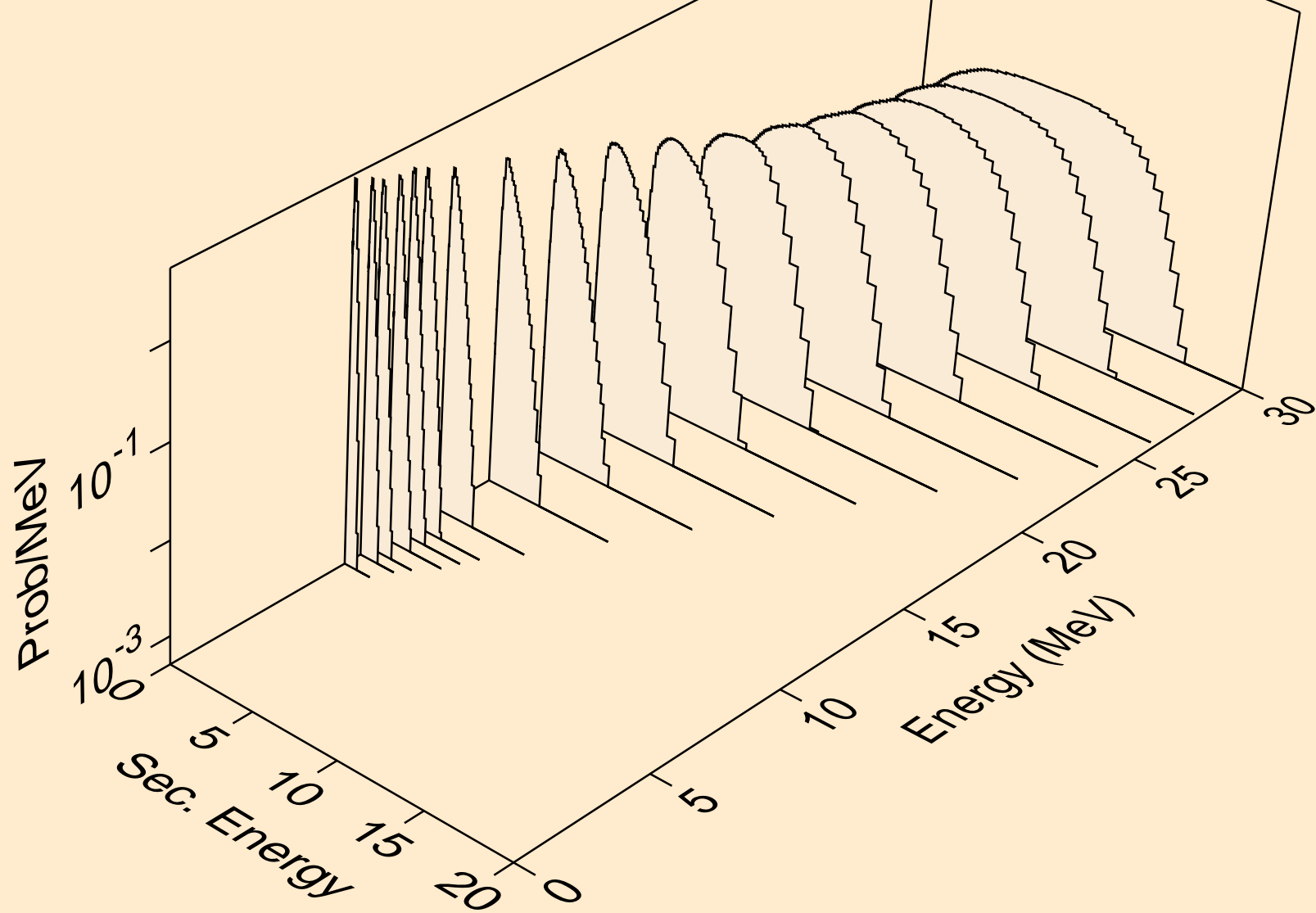

DB270 NEUTRON ACER TENDL-2021 LIBRARY; T=293.6K
Neutron emission for (n,n*)d

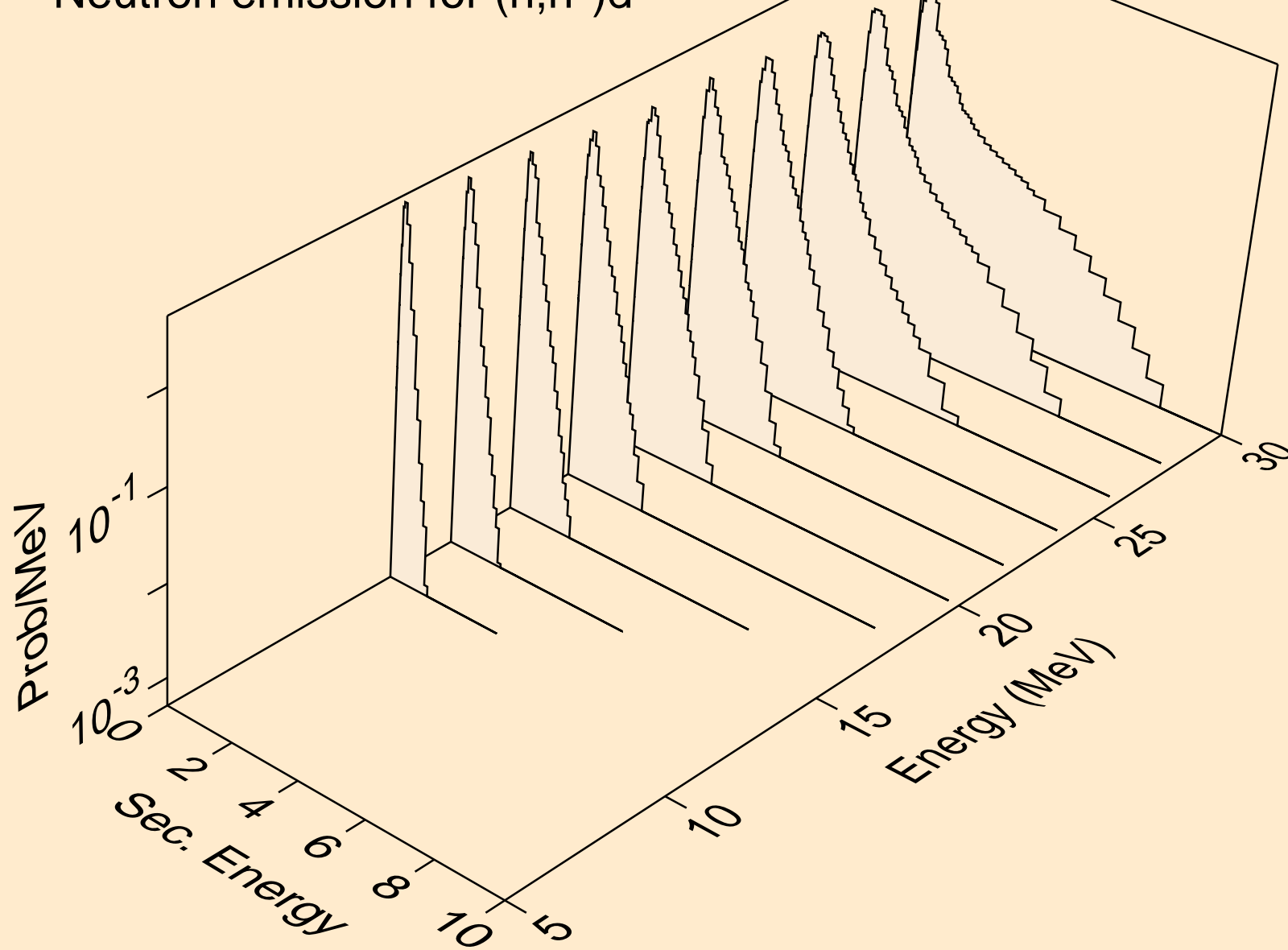

DB270 NEUTRON ACER TENDL-2021 LIBRARY; T=293.6K
Neutron emission for (n,n*)t

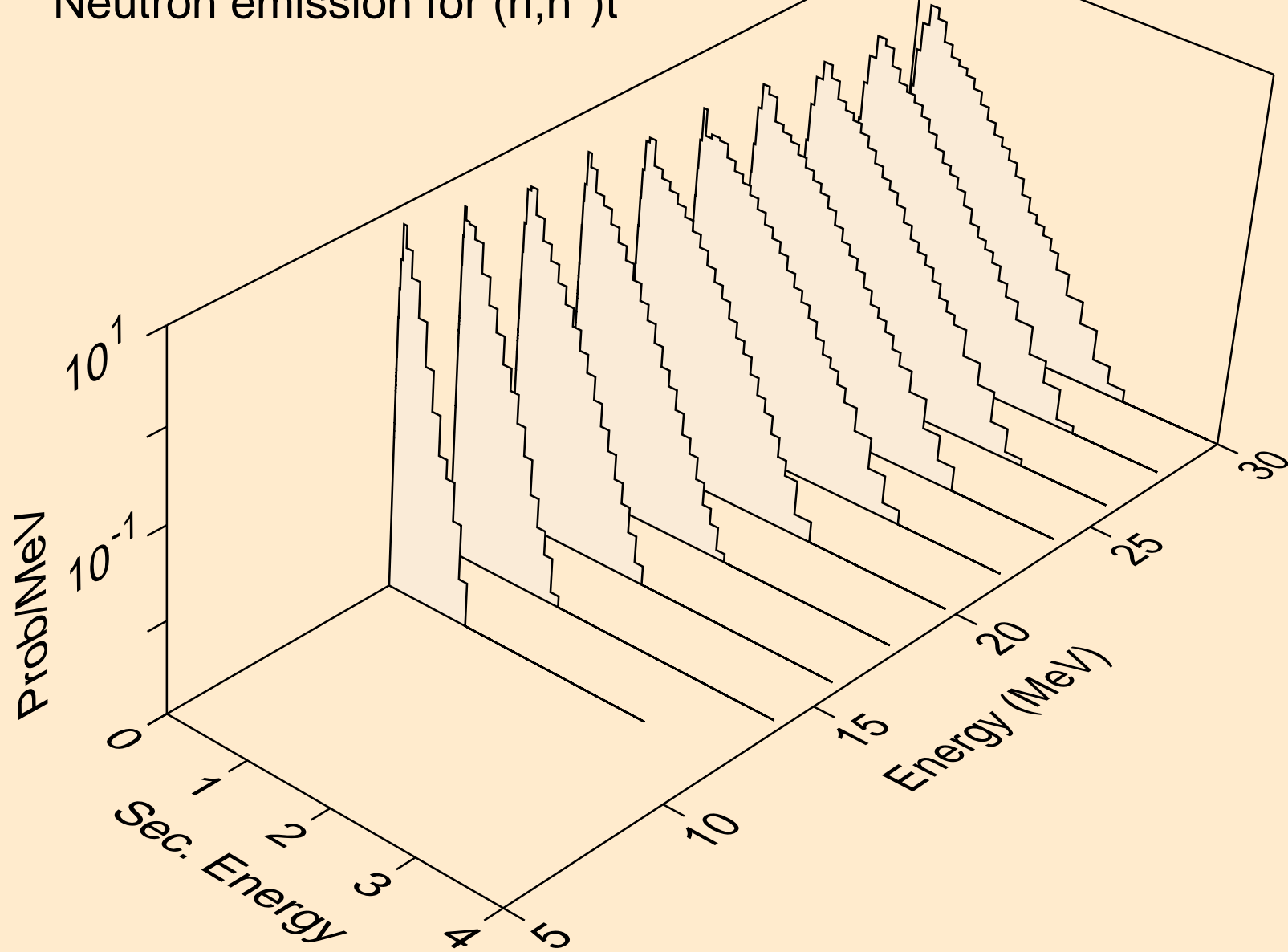

DB270 NEUTRON ACER TENDL-2021 LIBRARY; T=293.6K
Neutron emission for (n,n*)he3

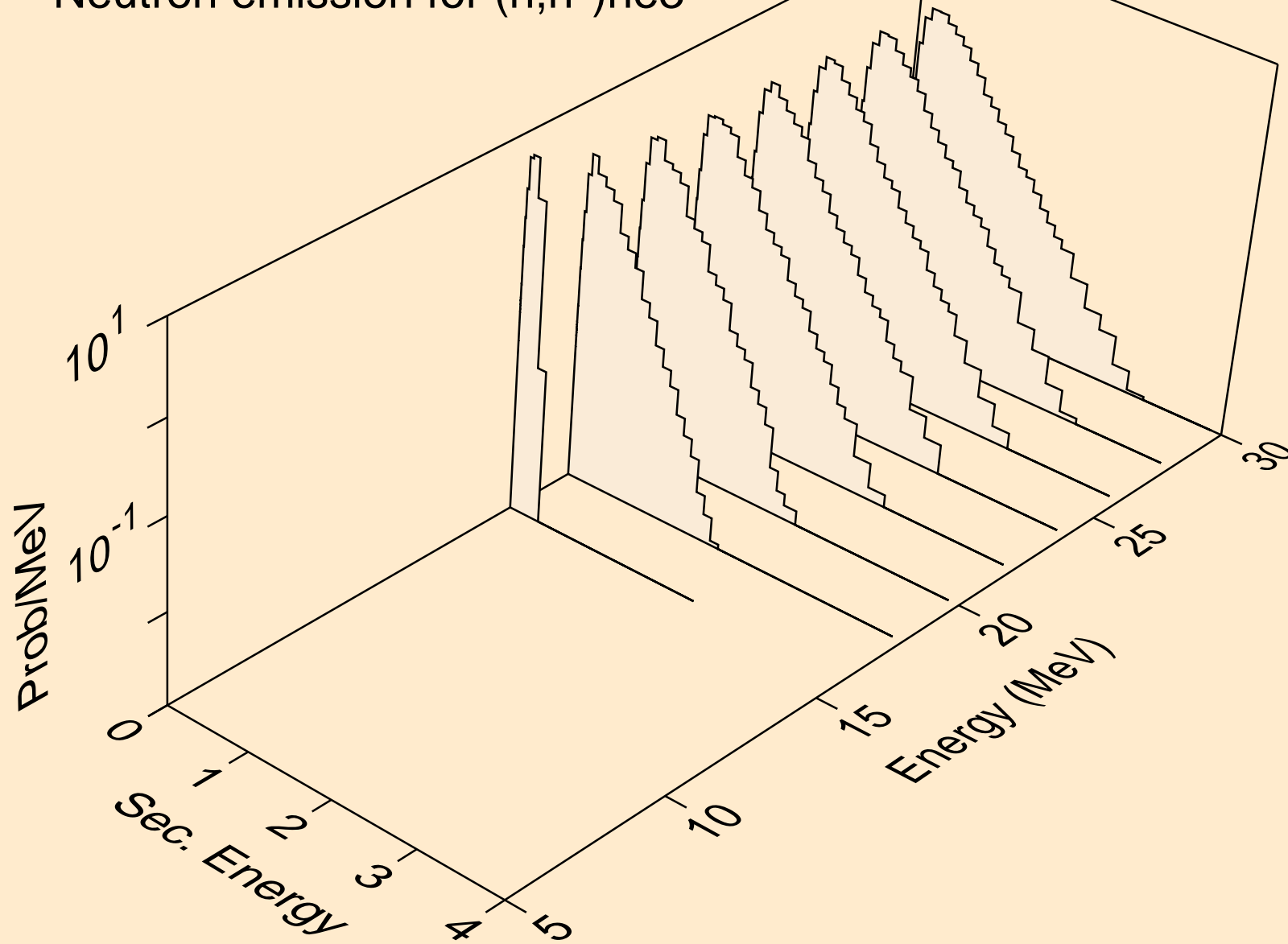

DB270 NEUTRON ACER TENDL-2021 LIBRARY; T=293.6K
Neutron emission for (n,4n)

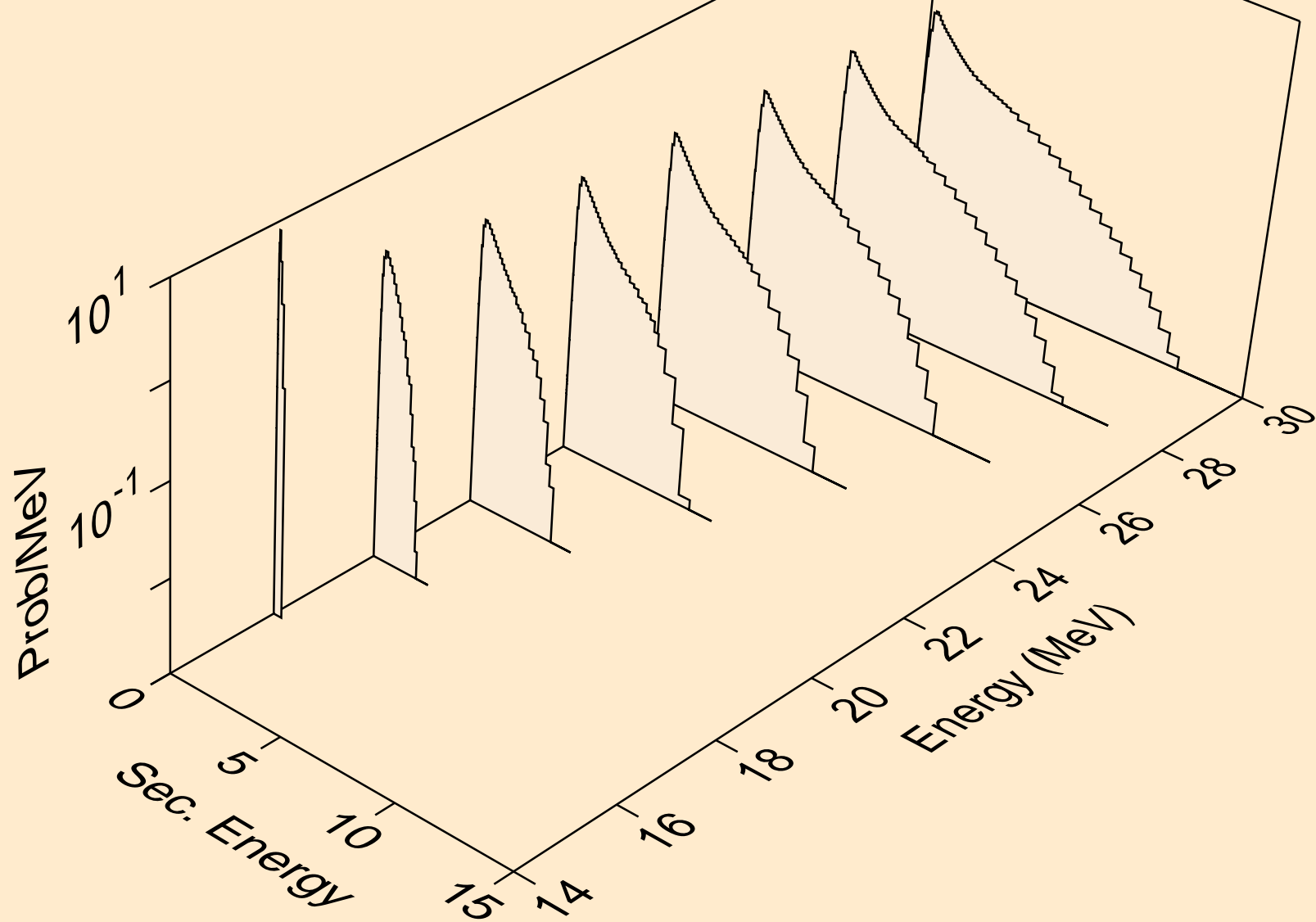

DB270 NEUTRON ACER TENDL-2021 LIBRARY; T=293.6K
Neutron emission for (n,2np)

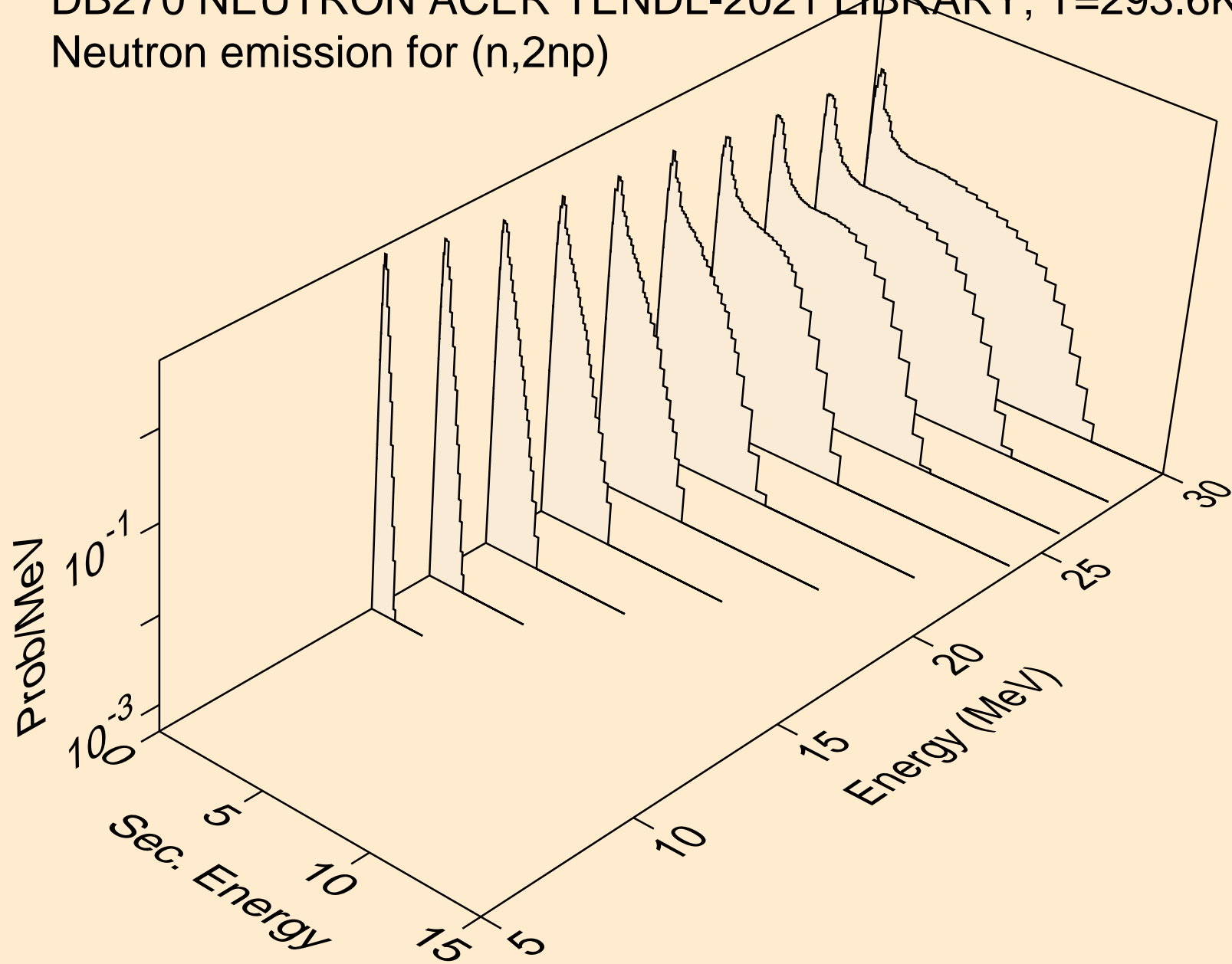

DB270 NEUTRON ACER TENDL-2021 LIBRARY; T=293.6K
Neutron emission for (n,3np)

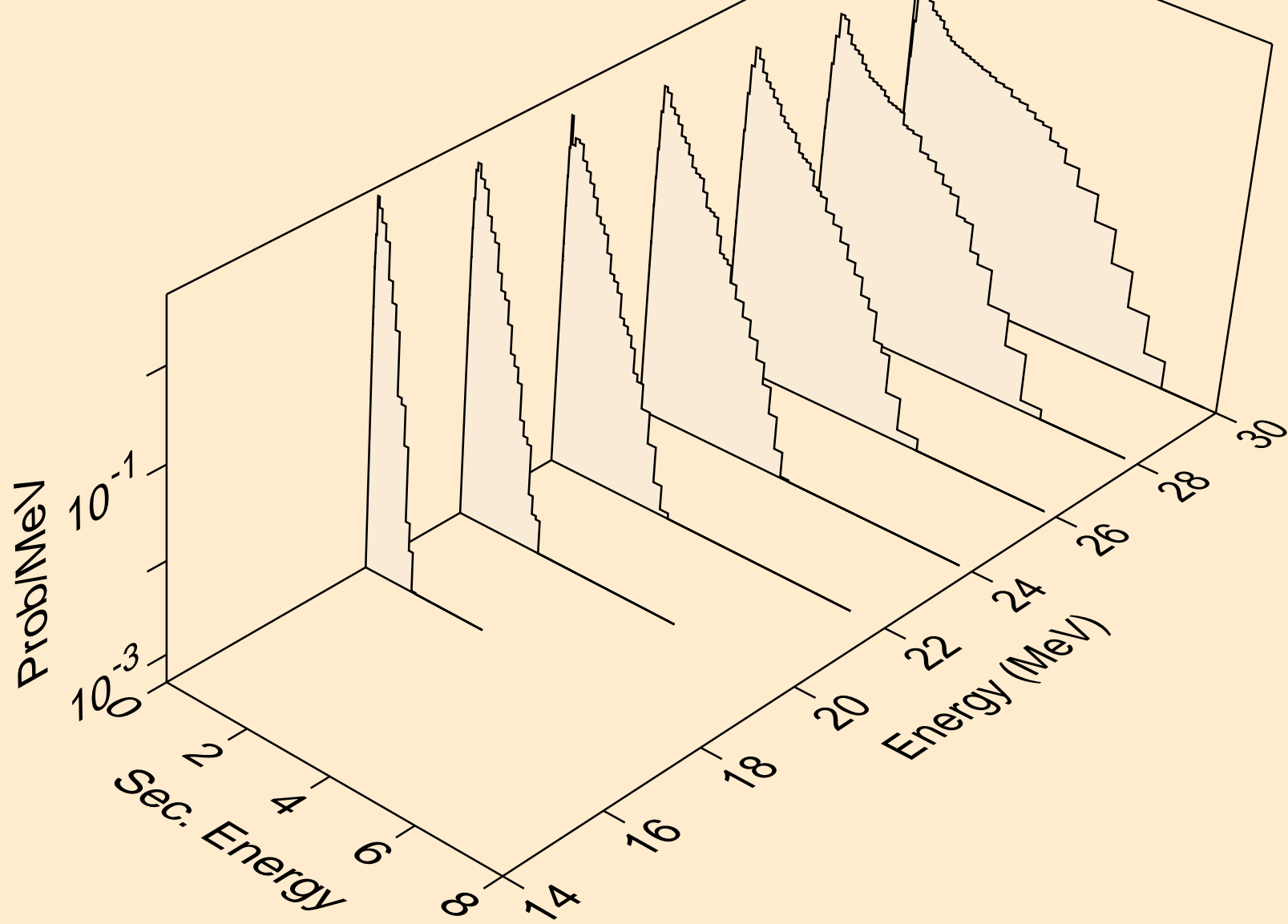

DB270 NEUTRON ACER TENDL-2021 LIBRARY; T=293.6K
Neutron emission for (n,n*c)

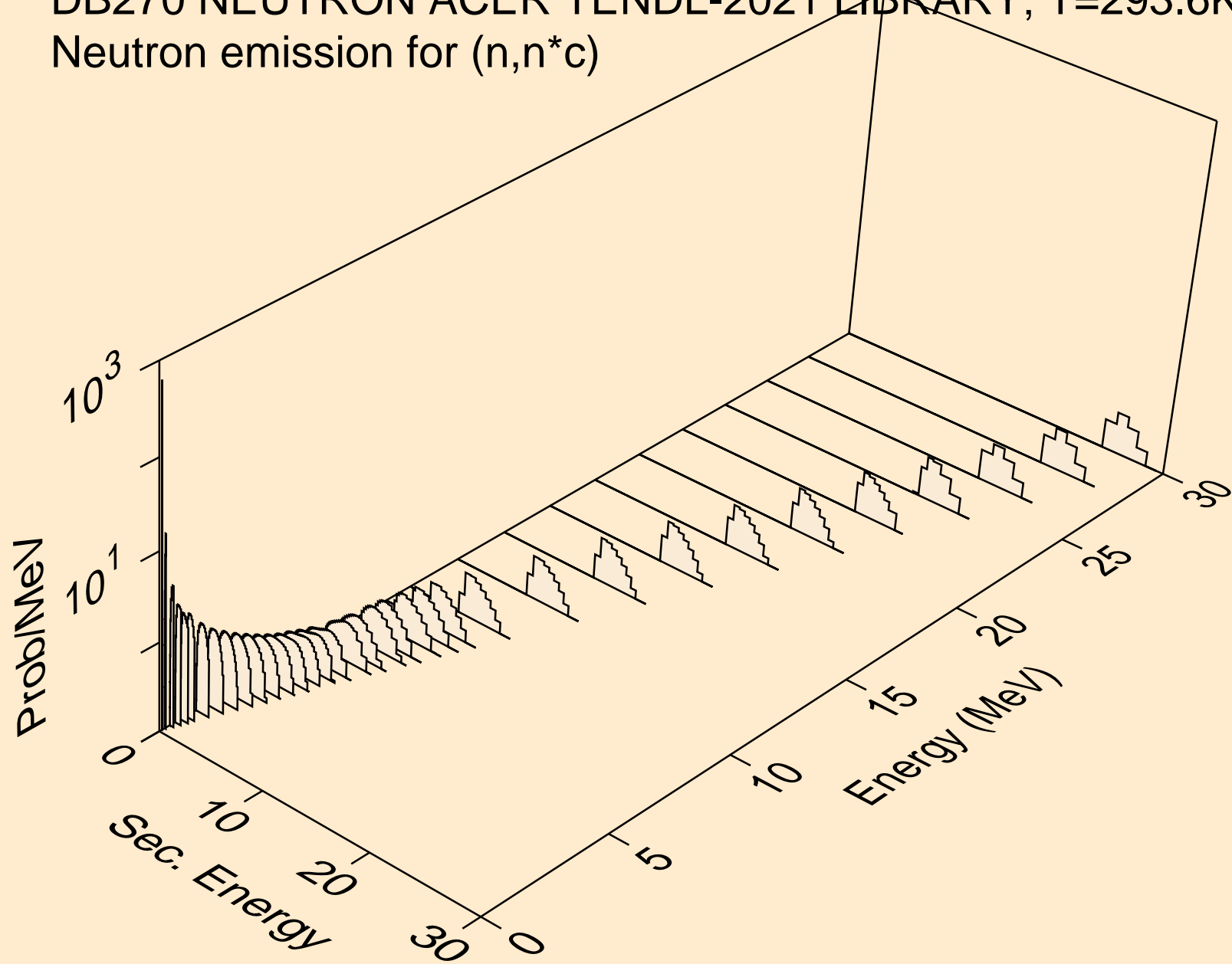

DB270 NEUTRON ACER TENDL-2021 LIBRARY; T=293.6K

Delayed nubar

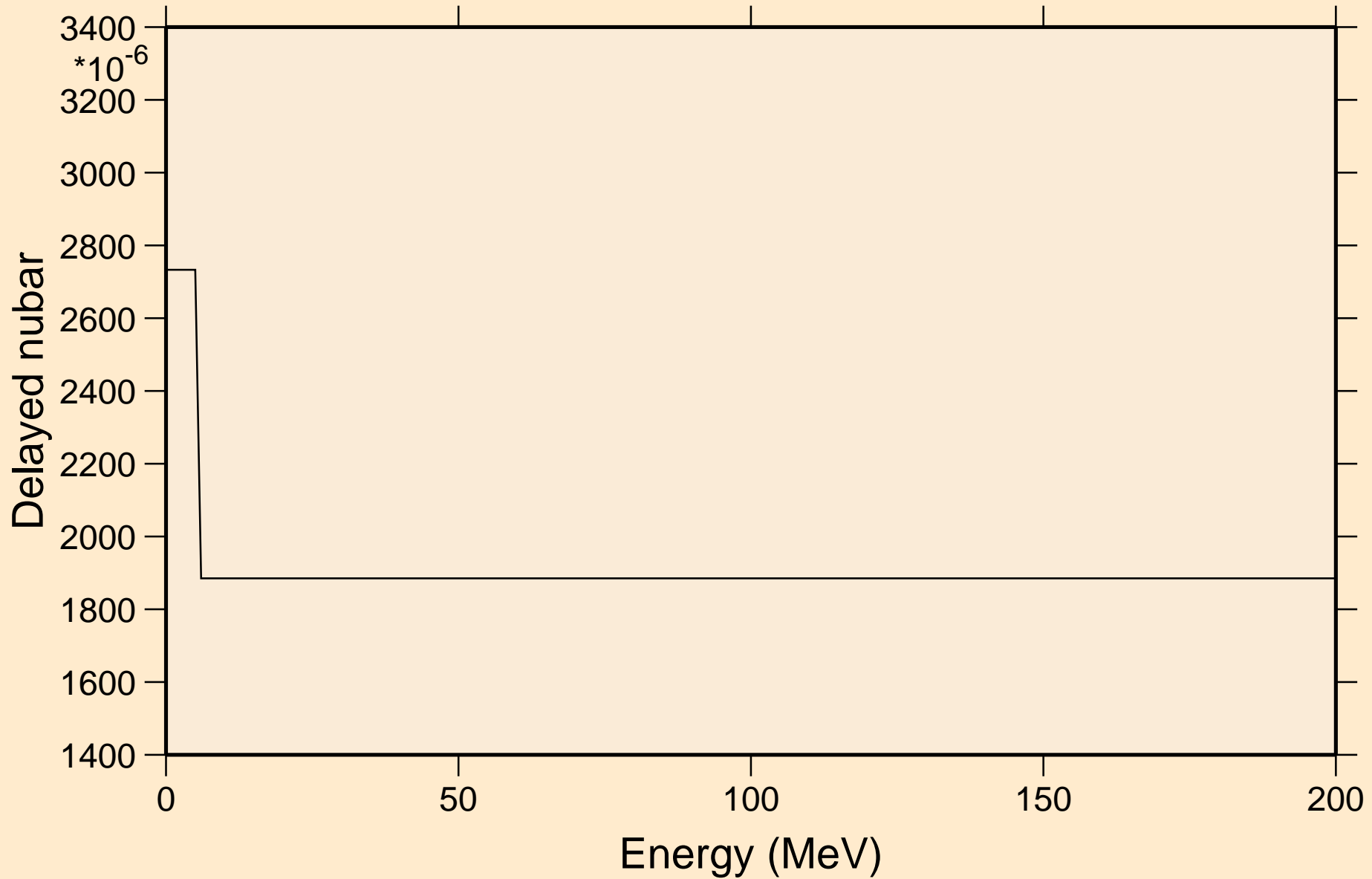

DB270 NEUTRON ACER TENDL-2021 LIBRARY; T=293.6K

Delayed neutron spectra

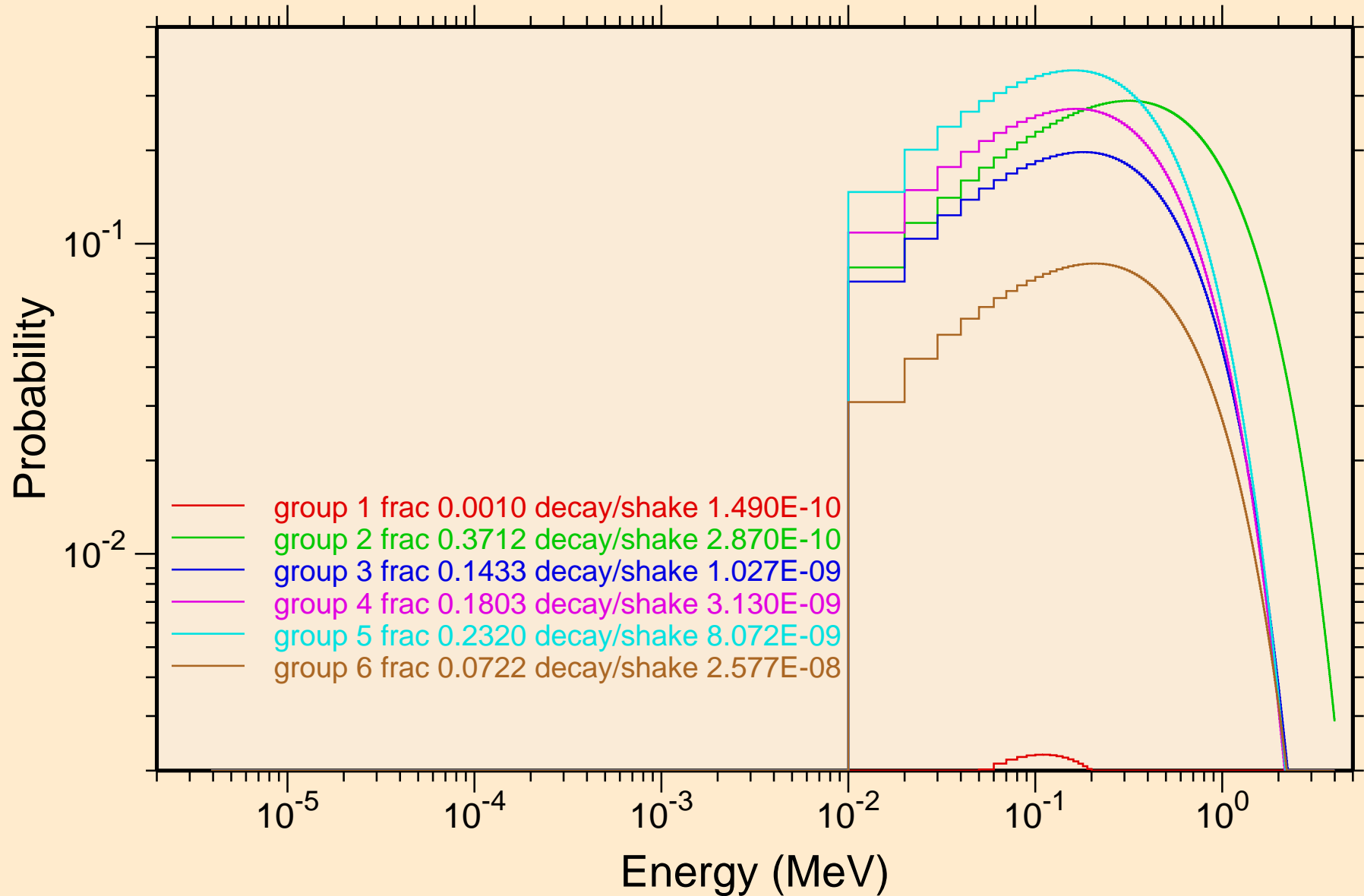

DB270 NEUTRON ACER TENDL-2021 LIBRARY; T=293.6K
Photon emission for (n,x)

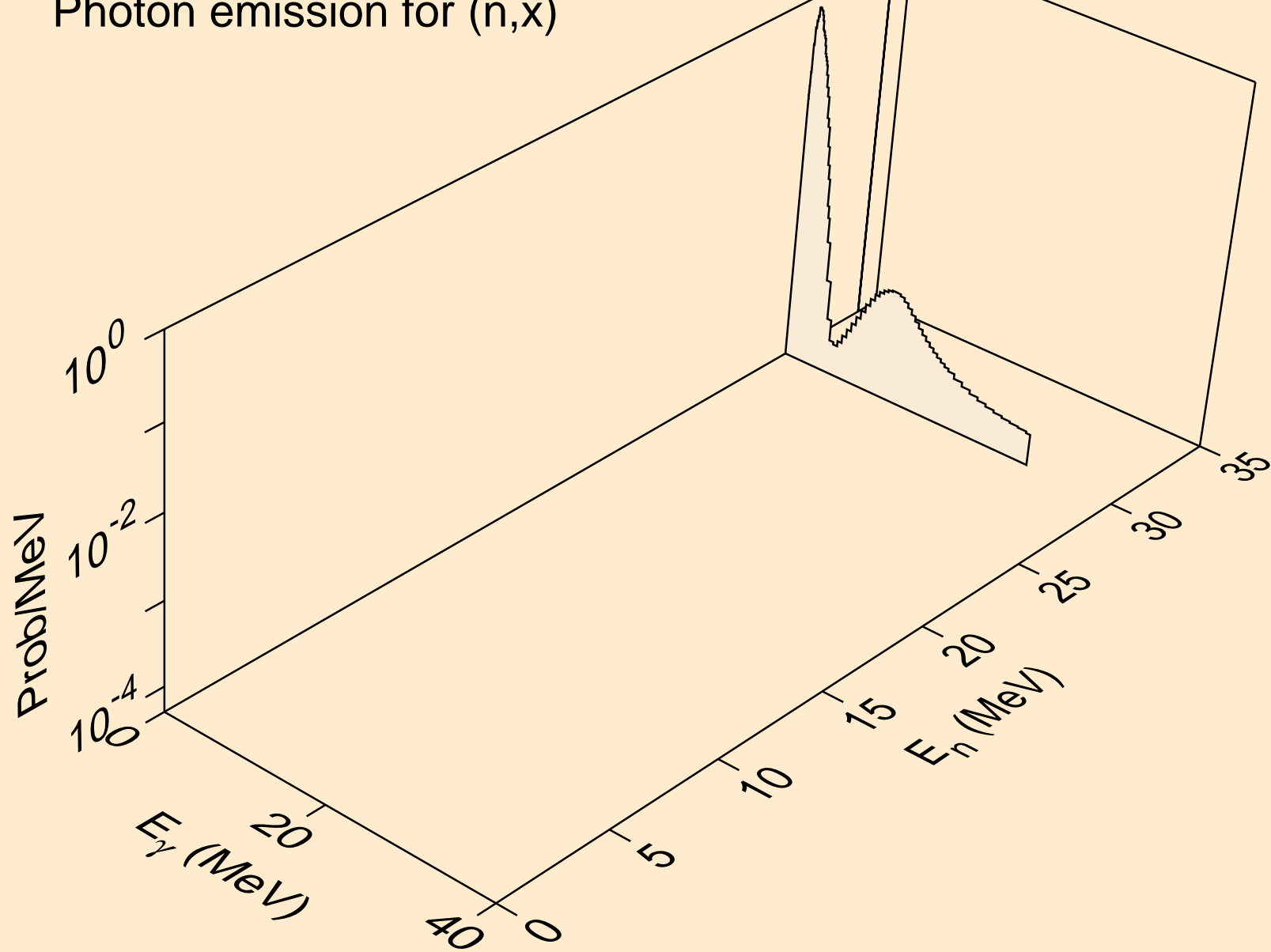

DB270 NEUTRON ACER TENDL-2021 LIBRARY; T=293.6K
Photon emission for (n,2nd)

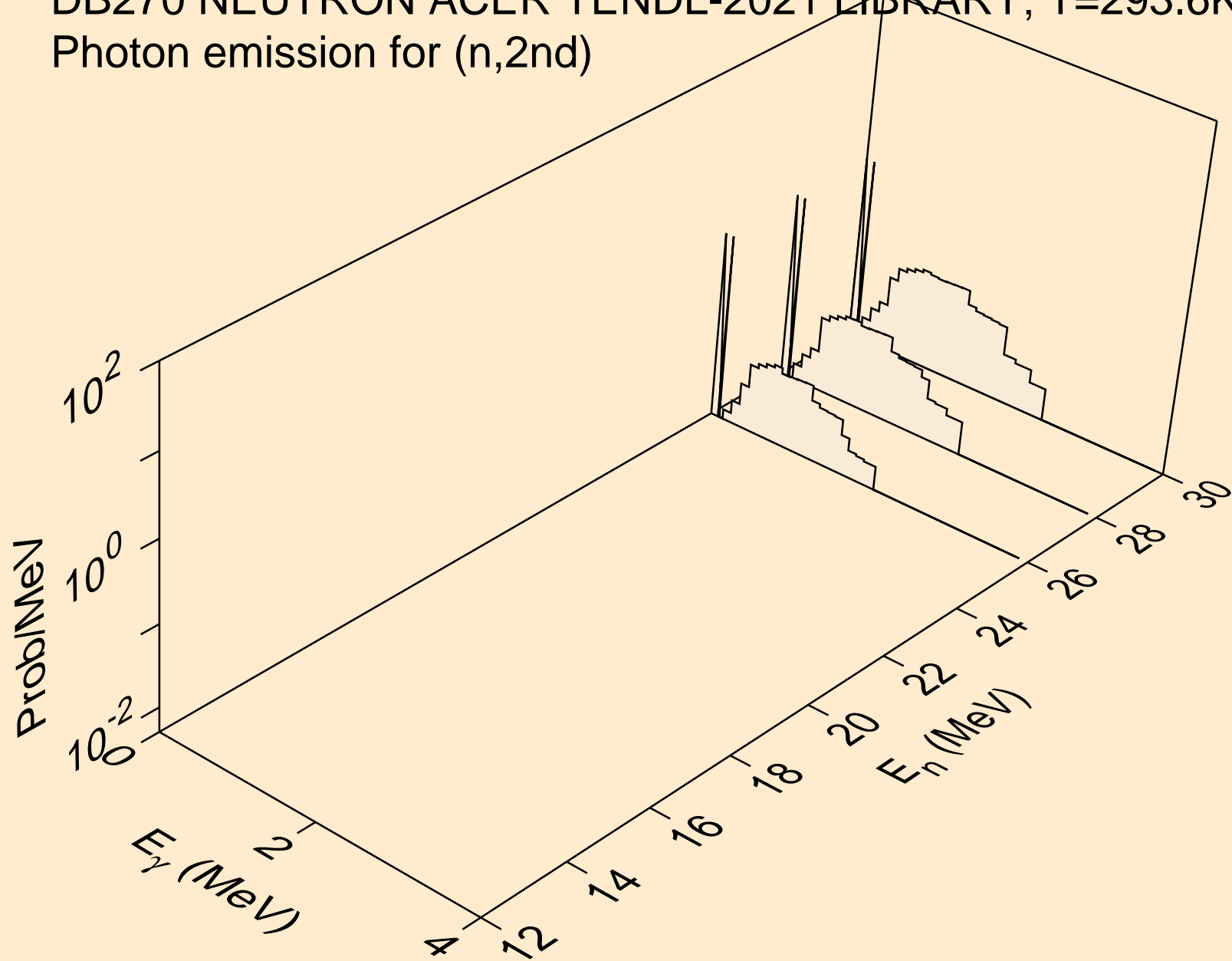

DB270 NEUTRON ACER TENDL-2021 LIBRARY; T=293.6K
Photon emission for (n,2n)

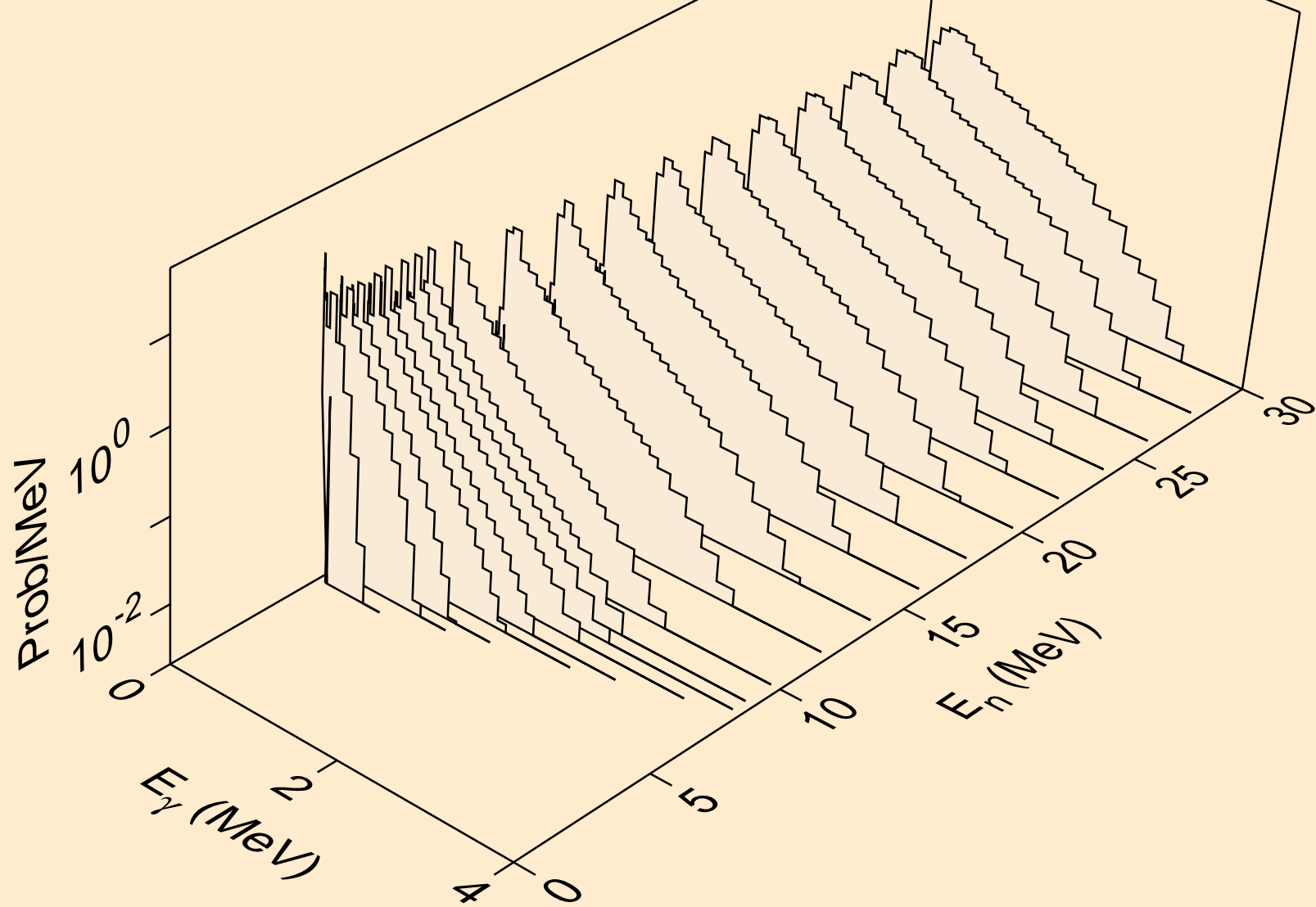

DB270 NEUTRON ACER TENDL-2021 LIBRARY; T=293.6K
Photon emission for (n,3n)

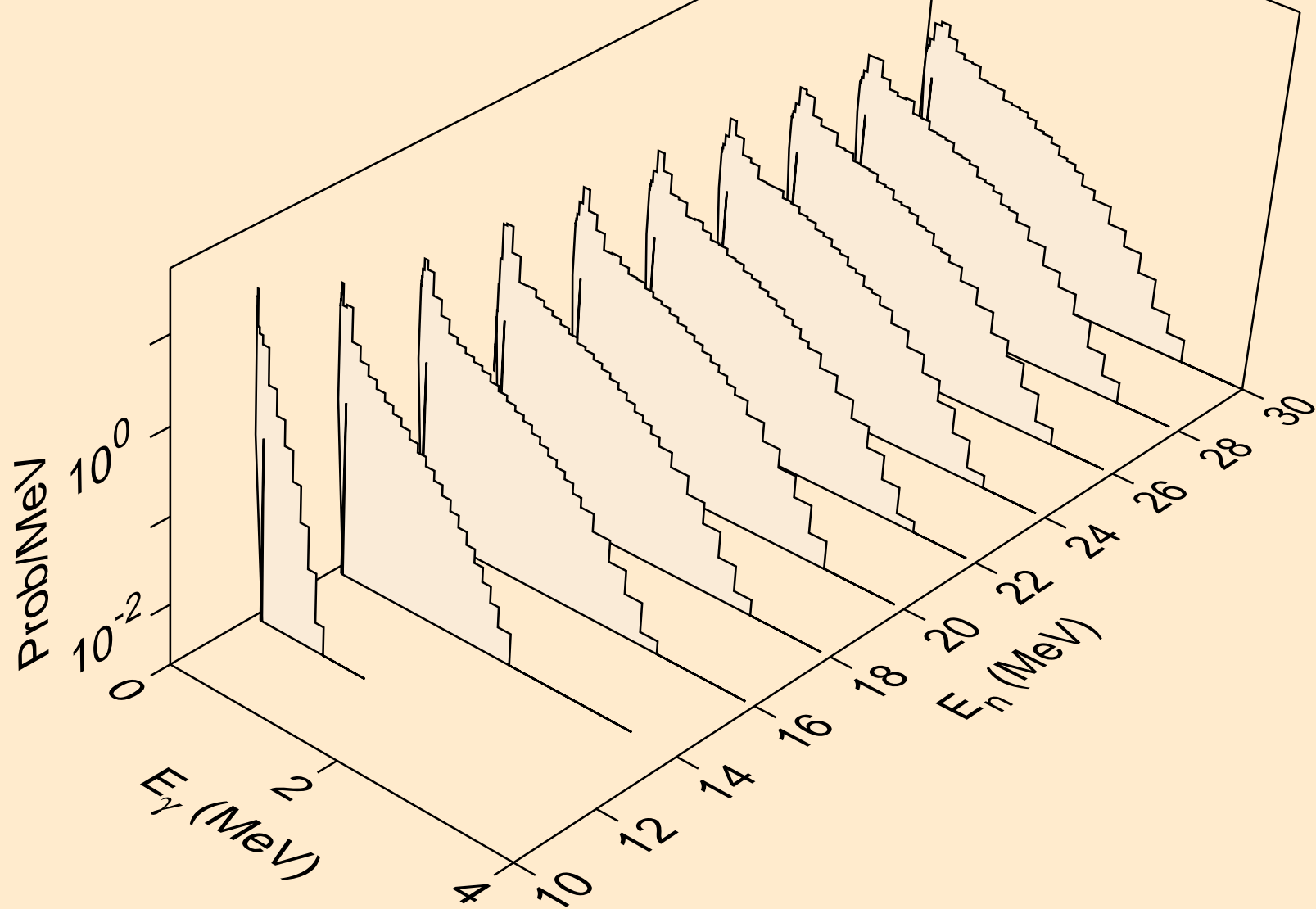

DB270 NEUTRON ACER TENDL-2021 LIBRARY; T=293.6K
Photon emission for (n,n*)a

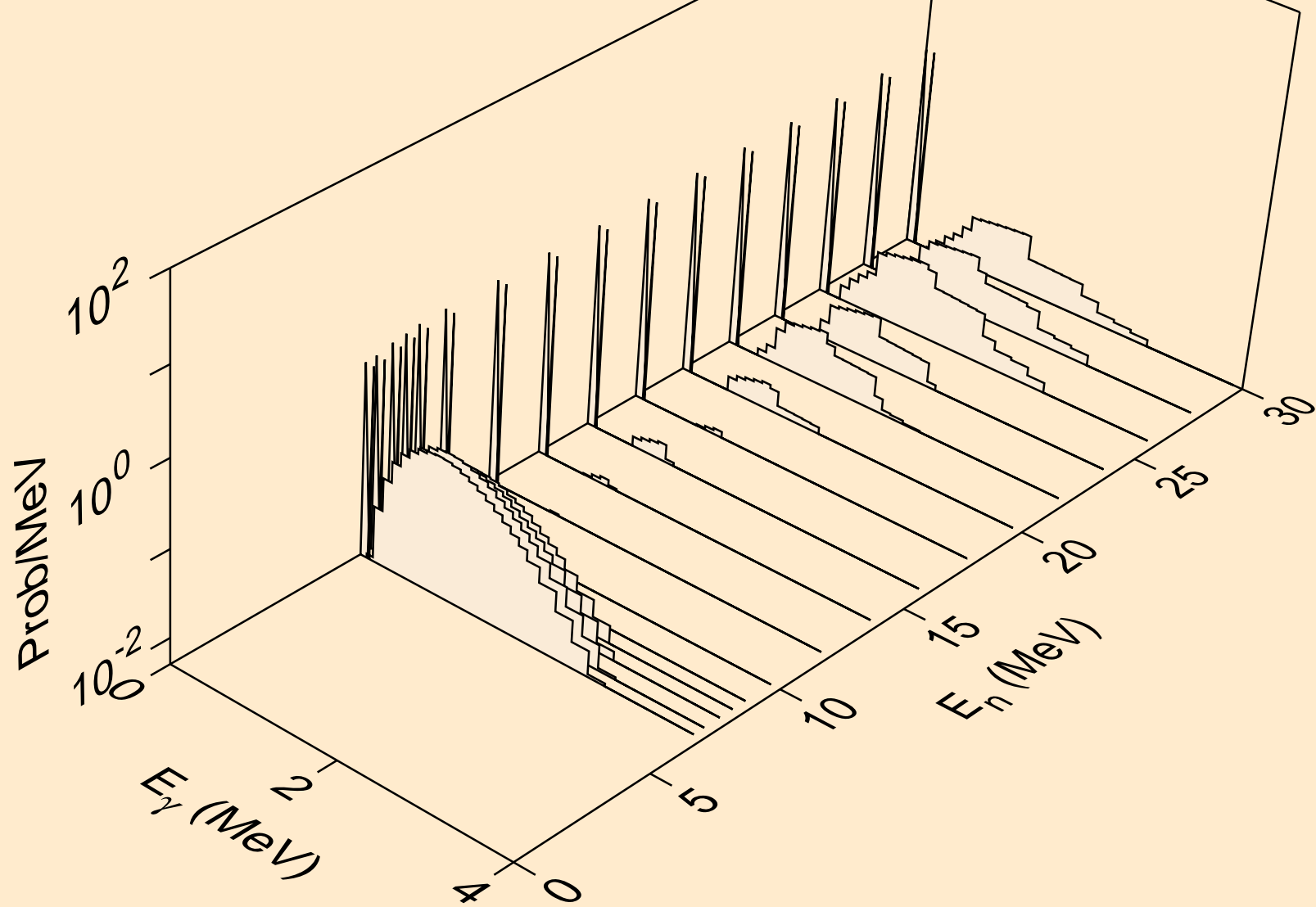

DB270 NEUTRON ACER TENDL-2021 LIBRARY; T=293.6K
Photon emission for (n,2n)a

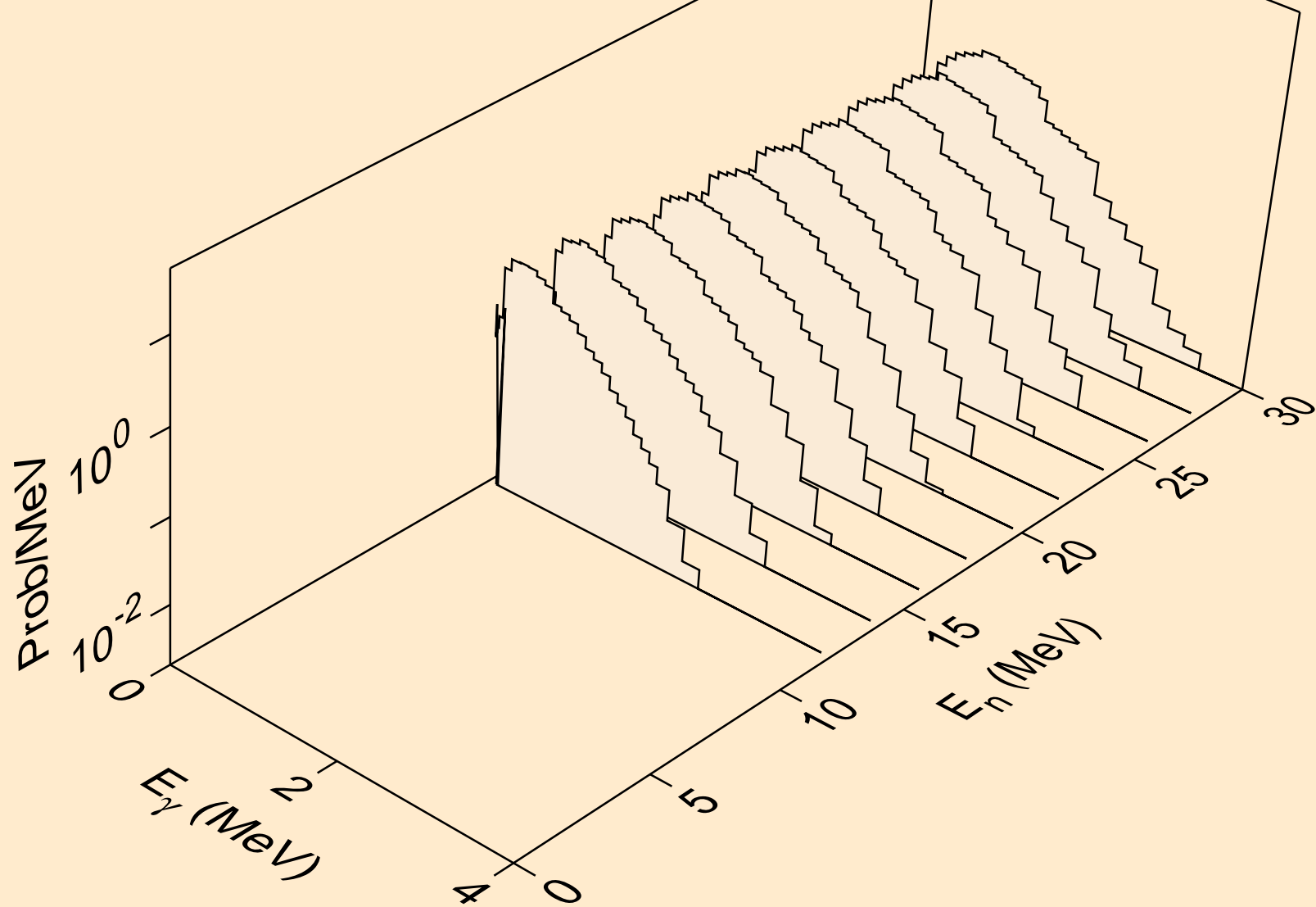

DB270 NEUTRON ACER TENDL-2021 LIBRARY; T=293.6K
Photon emission for (n,3n)a

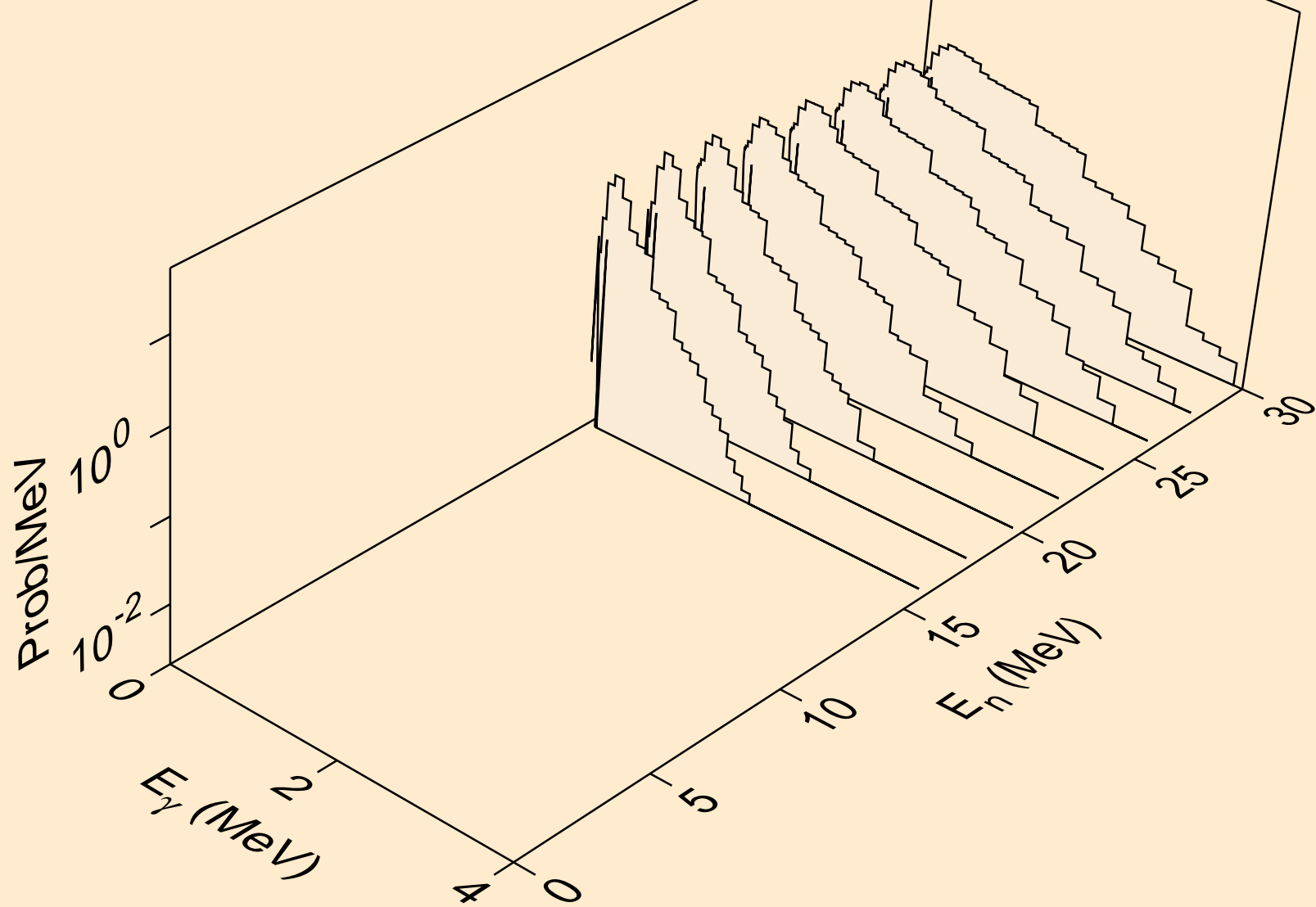

DB270 NEUTRON ACER TENDL-2021 LIBRARY; T=293.6K
Photon emission for (n,n*)p

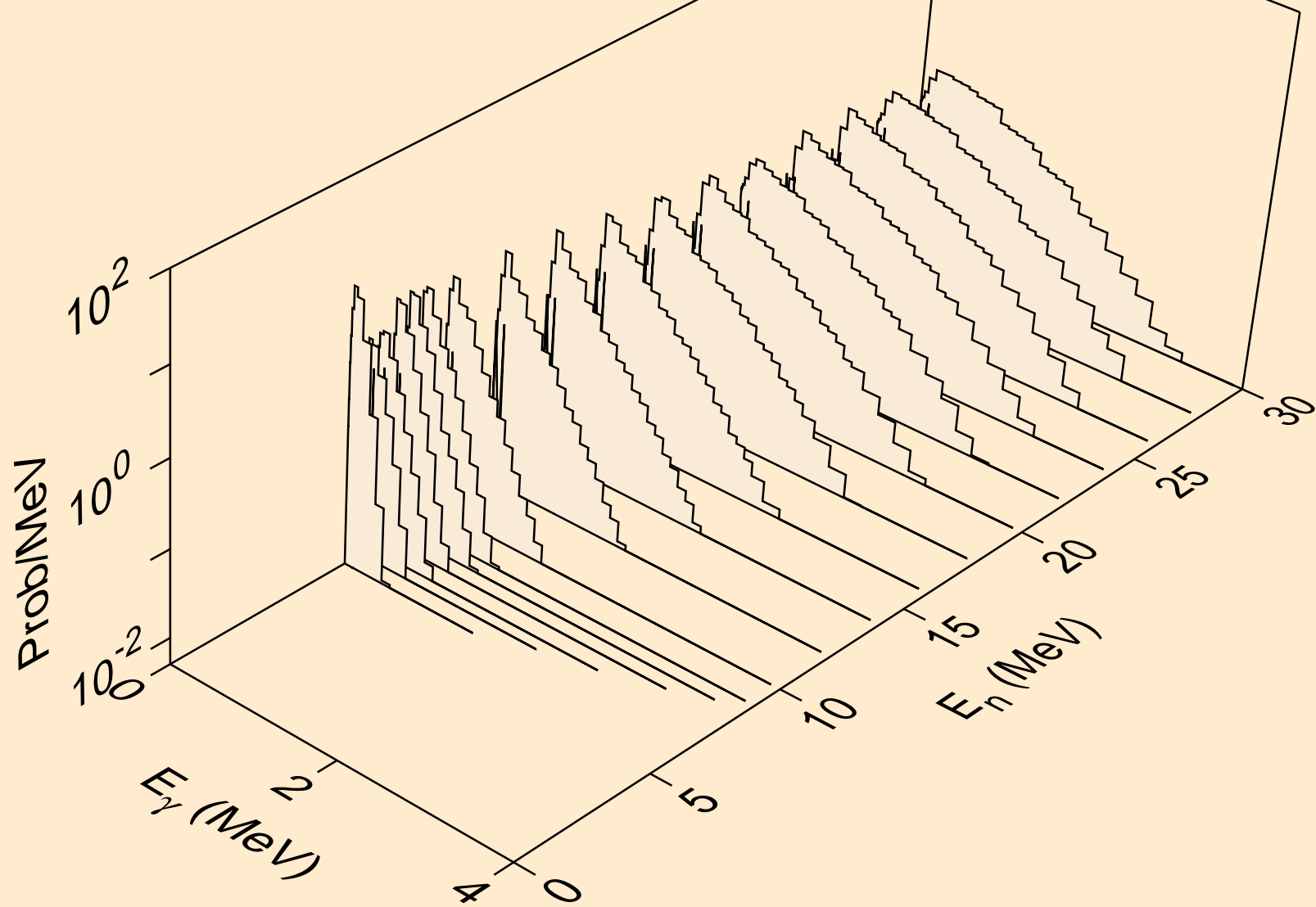

DB270 NEUTRON ACER TENDL-2021 LIBRARY; T=293.6K
Photon emission for (n,n*)d

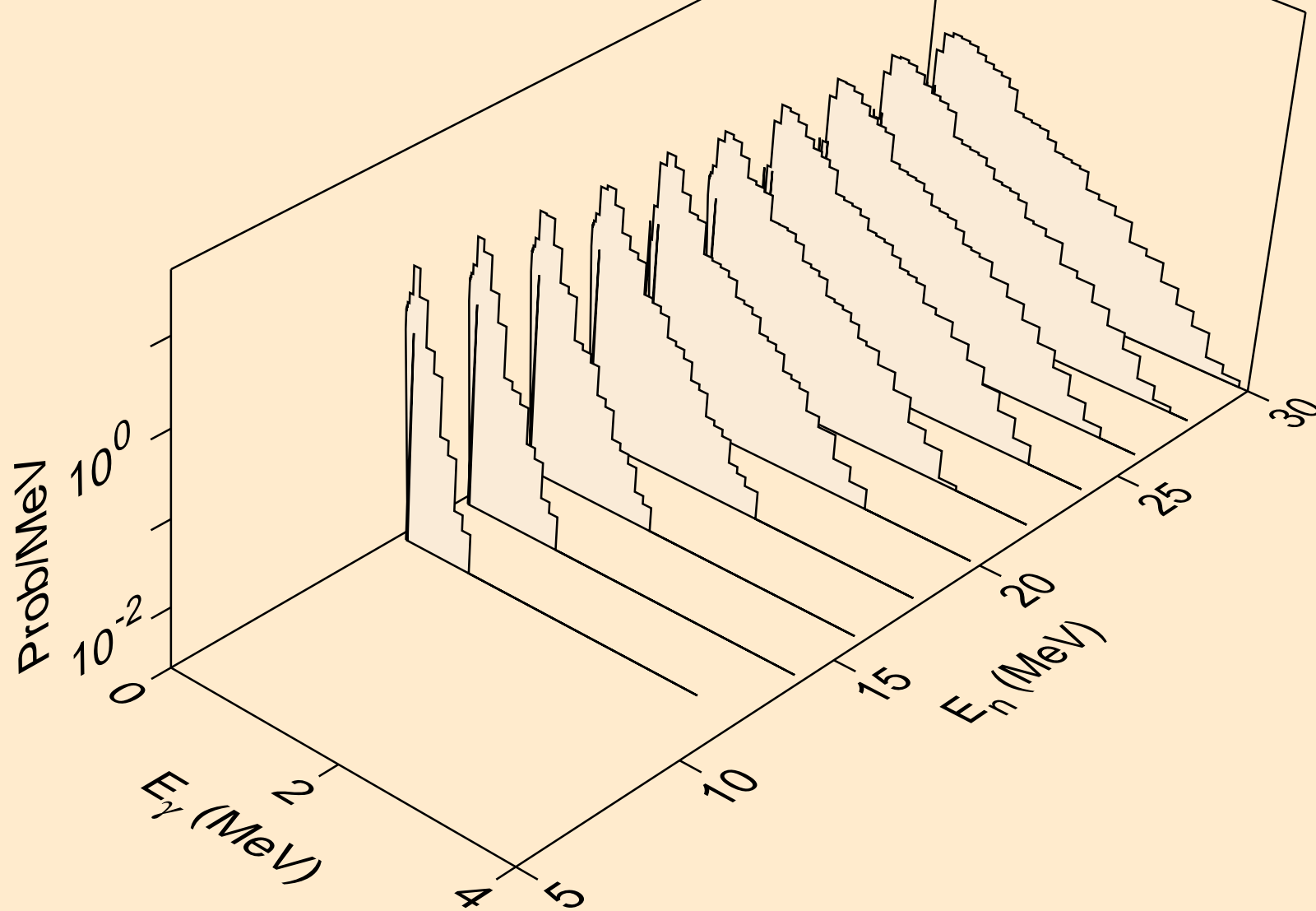

DB270 NEUTRON ACER TENDL-2021 LIBRARY; T=293.6K
Photon emission for (n,n*)t

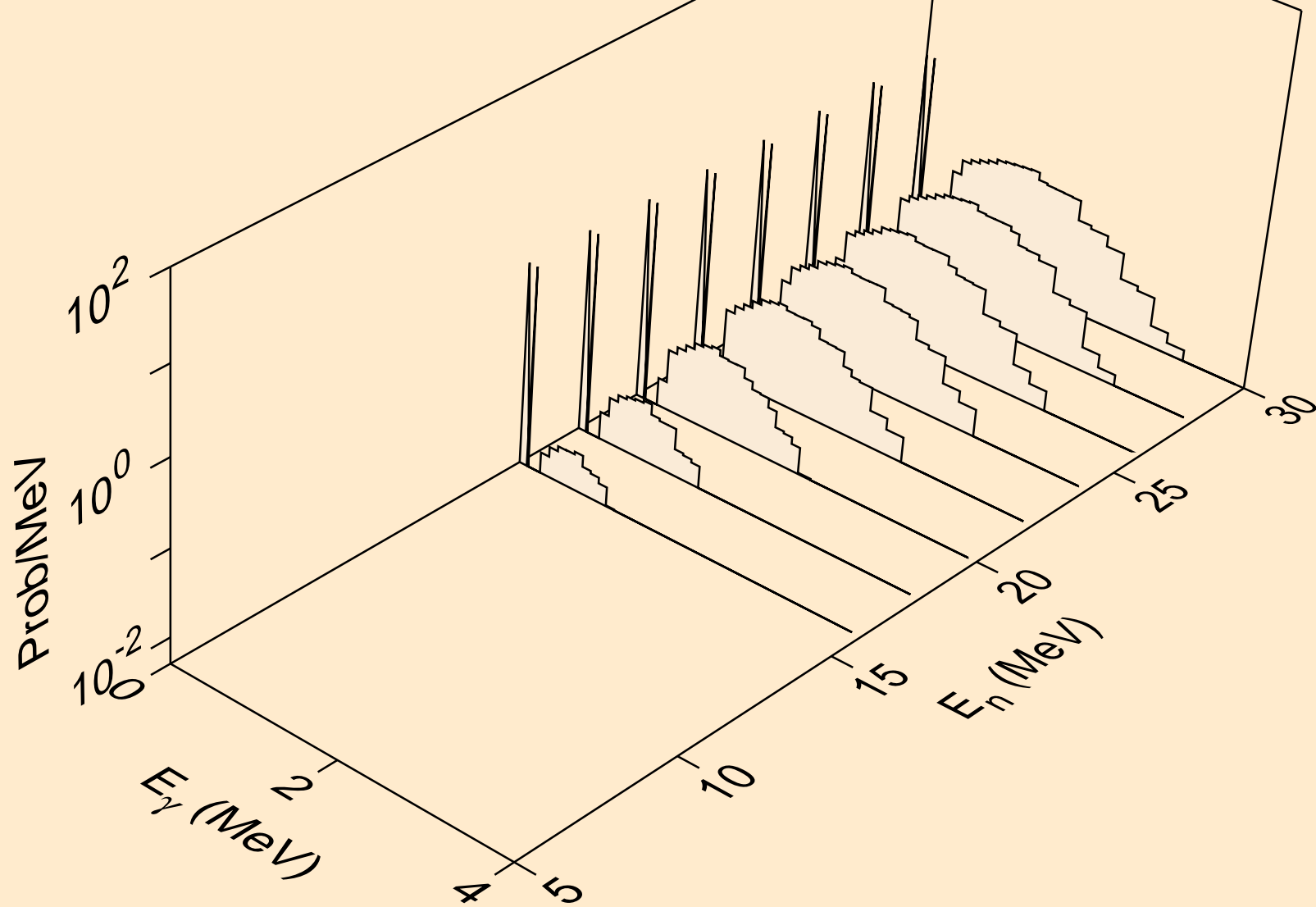

DB270 NEUTRON ACER TENDL-2021 LIBRARY; T=293.6K
Photon emission for (n,n*)he3

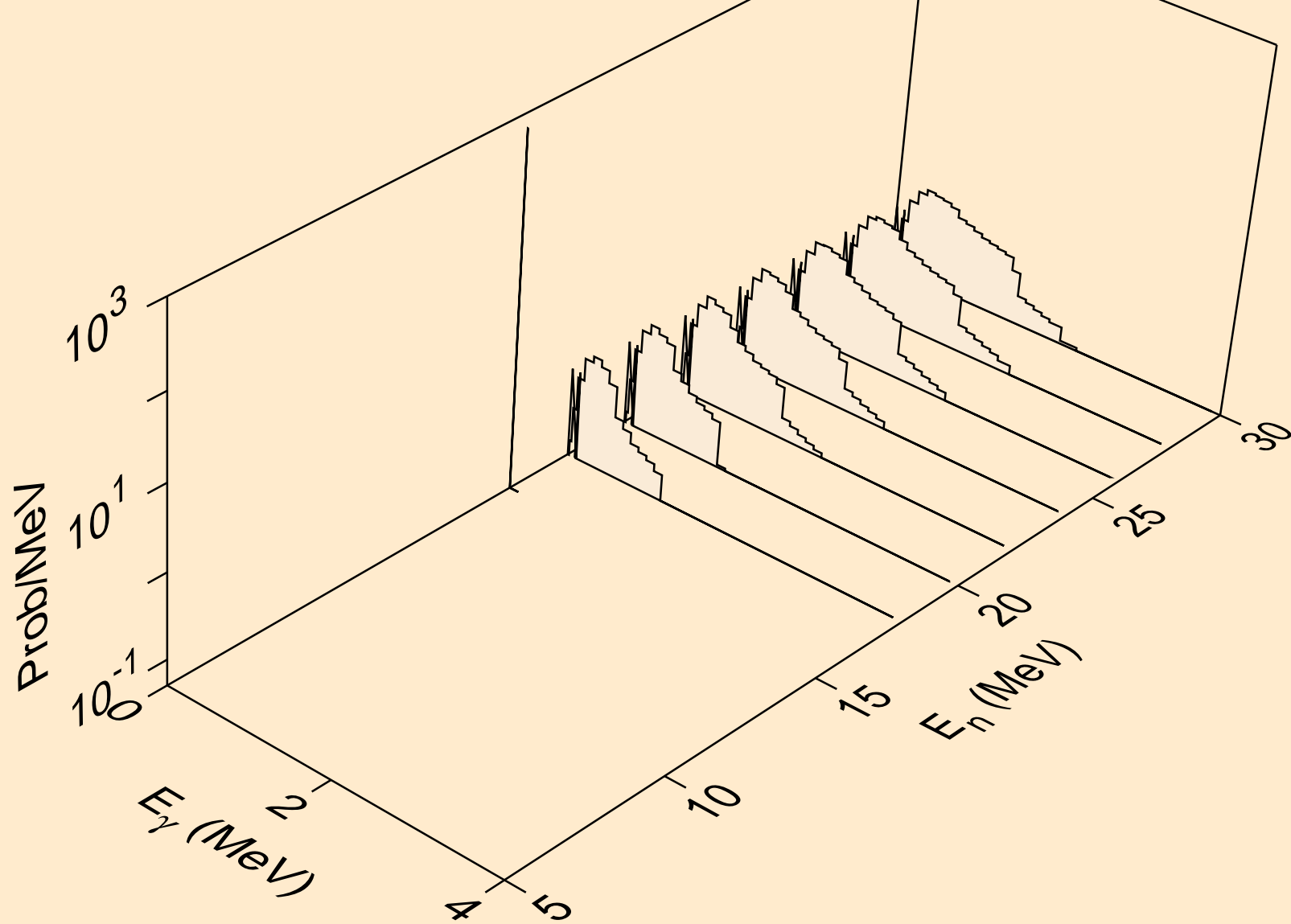

DB270 NEUTRON ACER TENDL-2021 LIBRARY; T=293.6K
Photon emission for (n,4n)

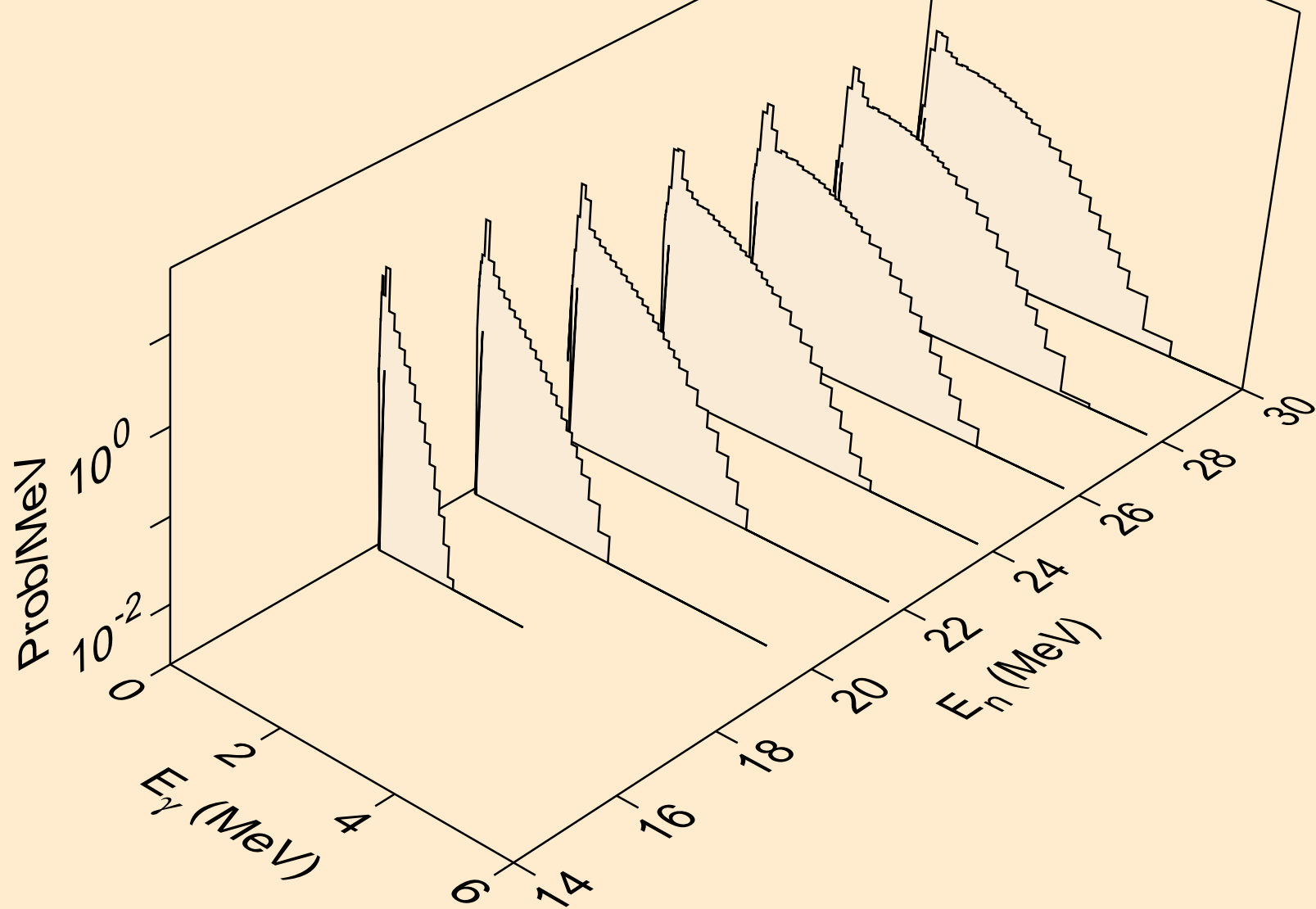

DB270 NEUTRON ACER TENDL-2021 LIBRARY; T=293.6K
Photon emission for (n,2np)

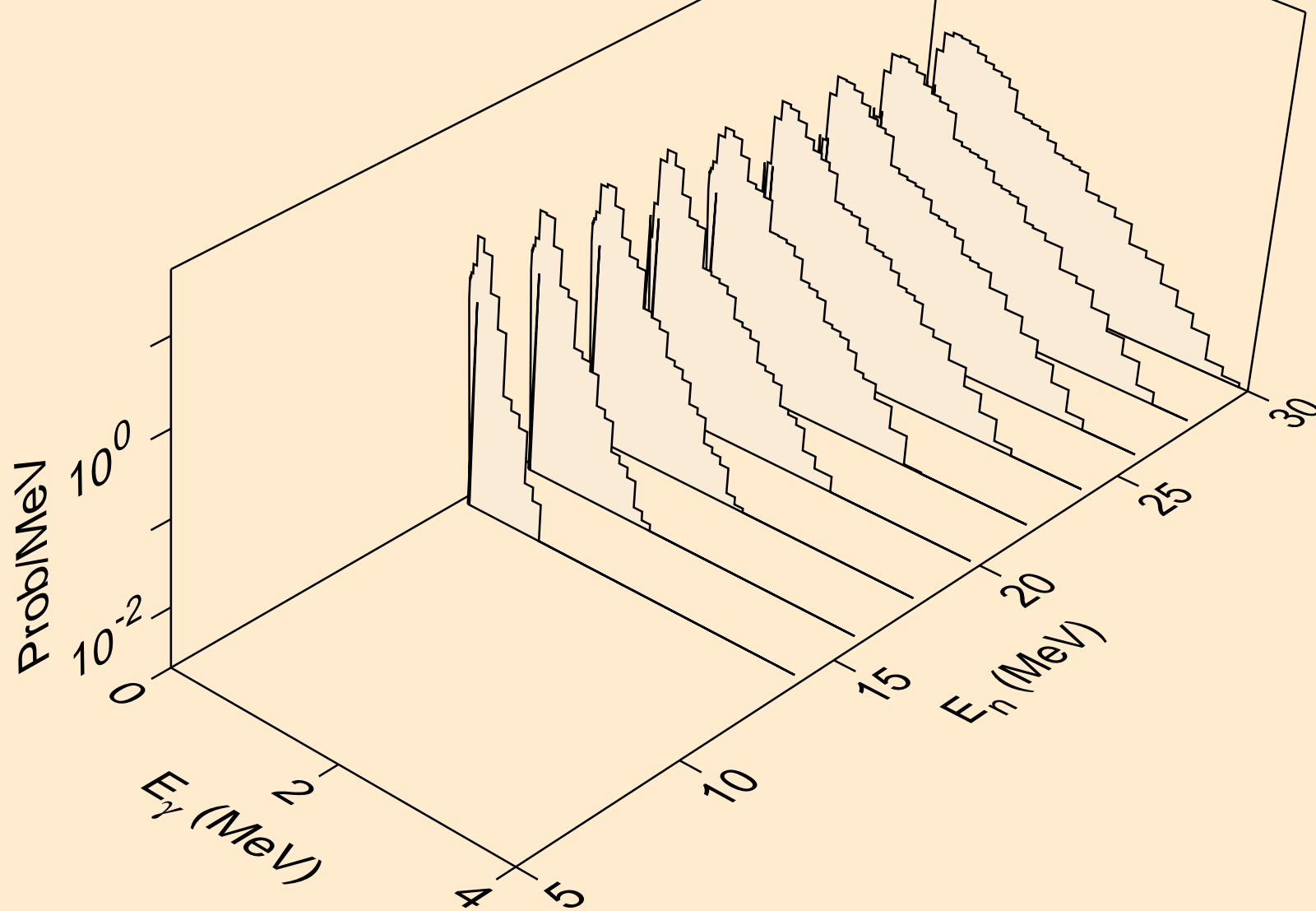

DB270 NEUTRON ACER TENDL-2021 LIBRARY; T=293.6K
Photon emission for (n,3np)

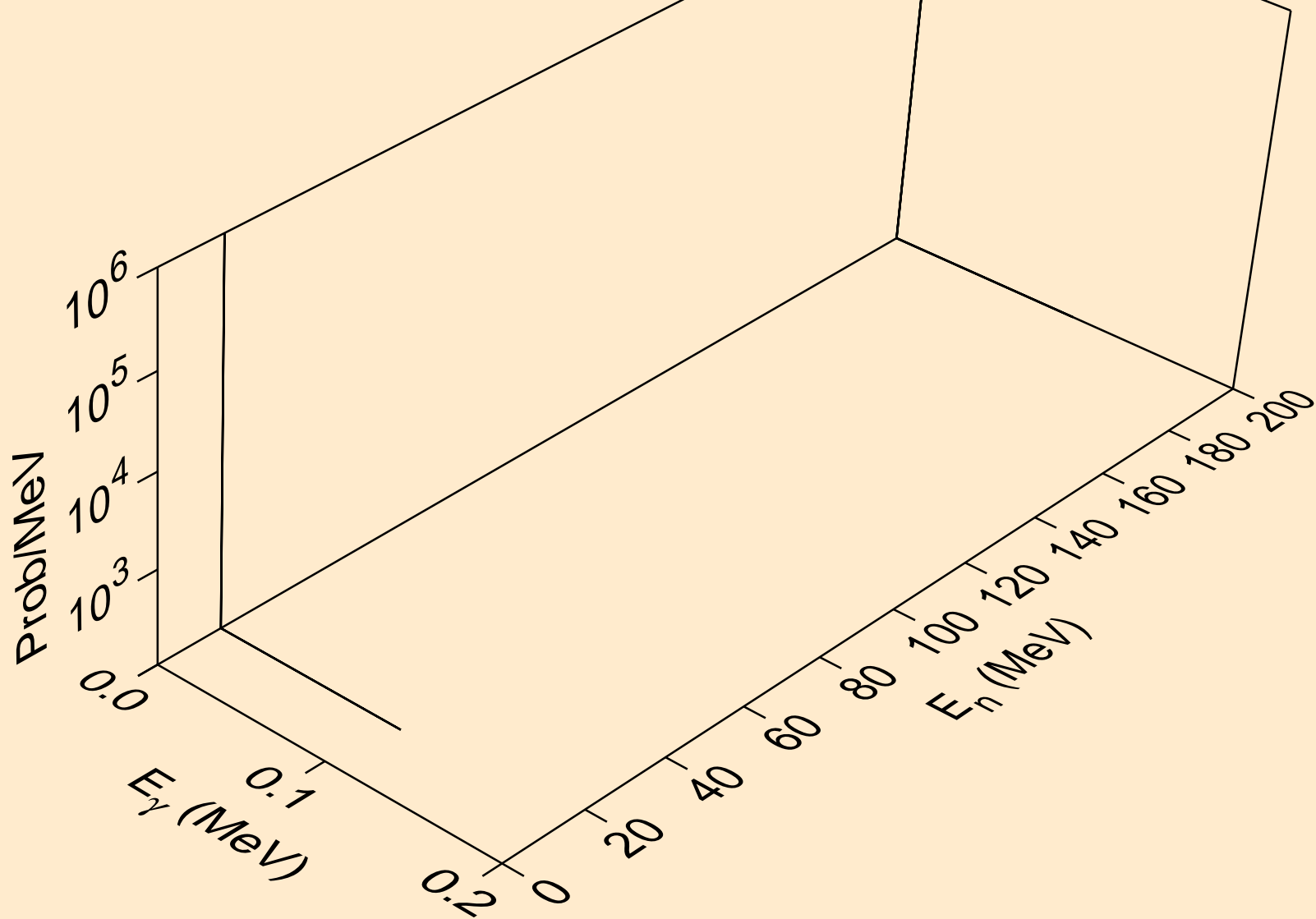

DB270 NEUTRON ACER TENDL-2021 LIBRARY; T=293.6K
Photon emission for (n,n*c)

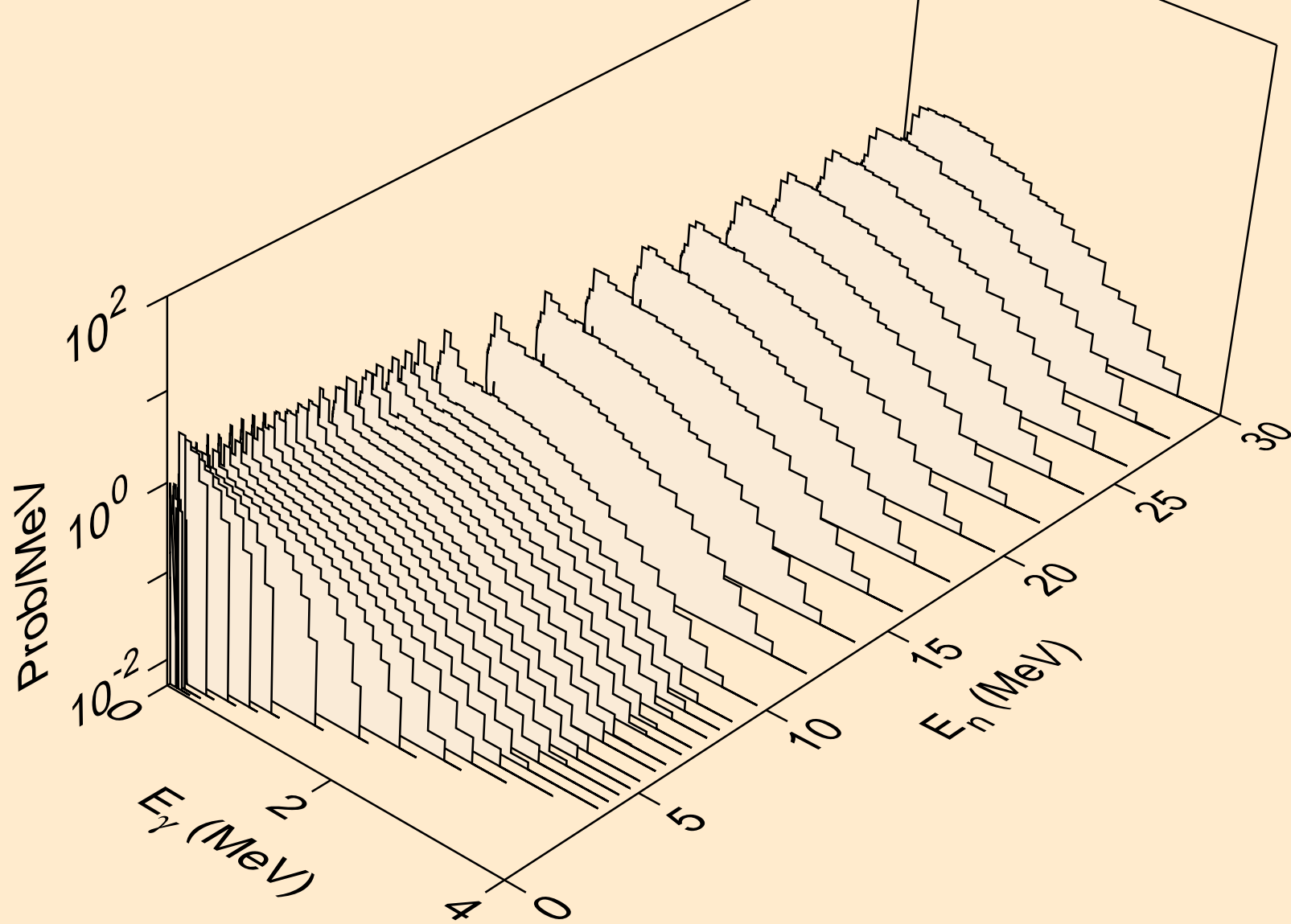

DB270 NEUTRON ACER TENDL-2021 LIBRARY; T=293.6K
Photon emission for (n,gma)

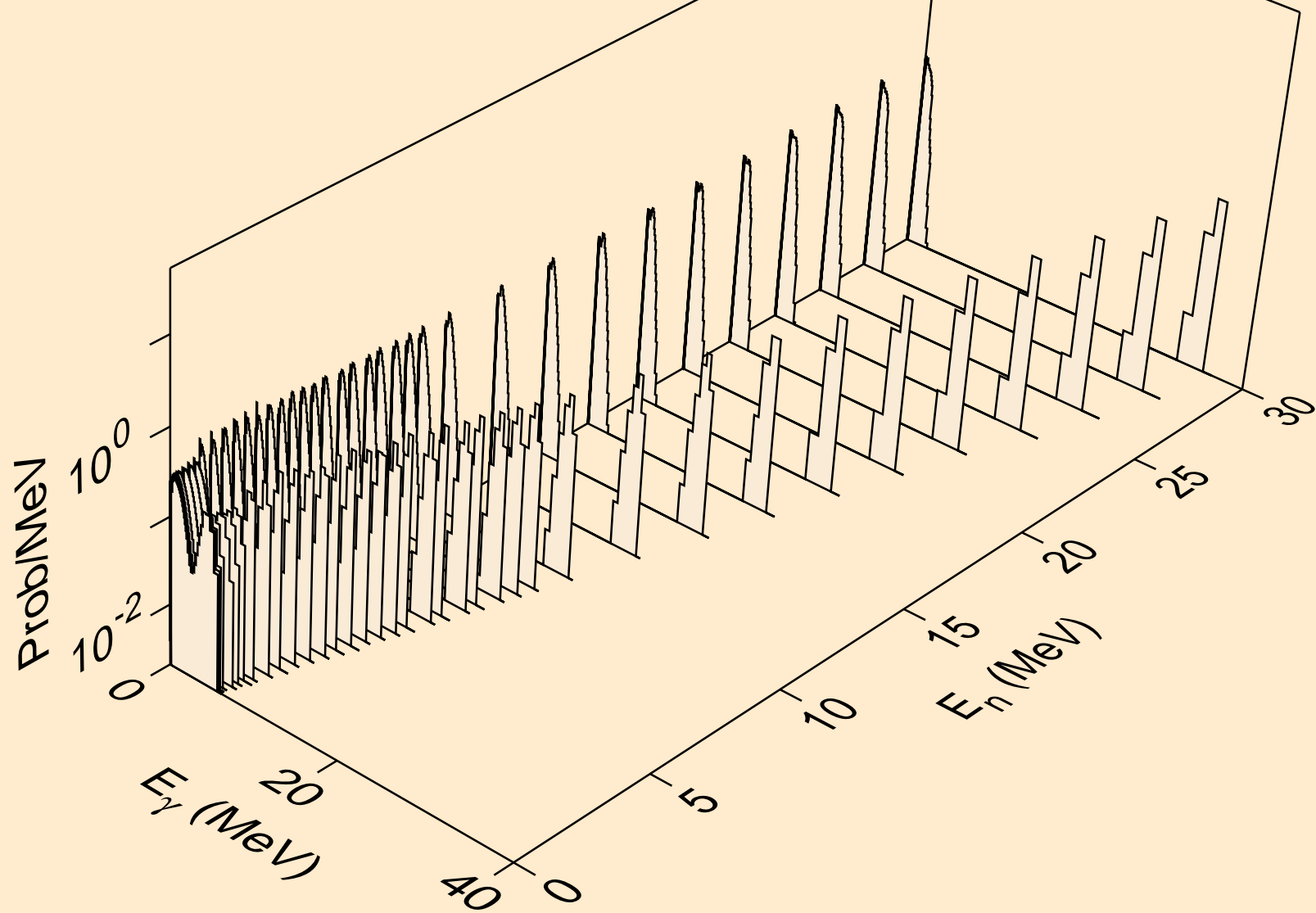

DB270 NEUTRON ACER TENDL-2021 LIBRARY; T=293.6K
Photon emission for (n,p)

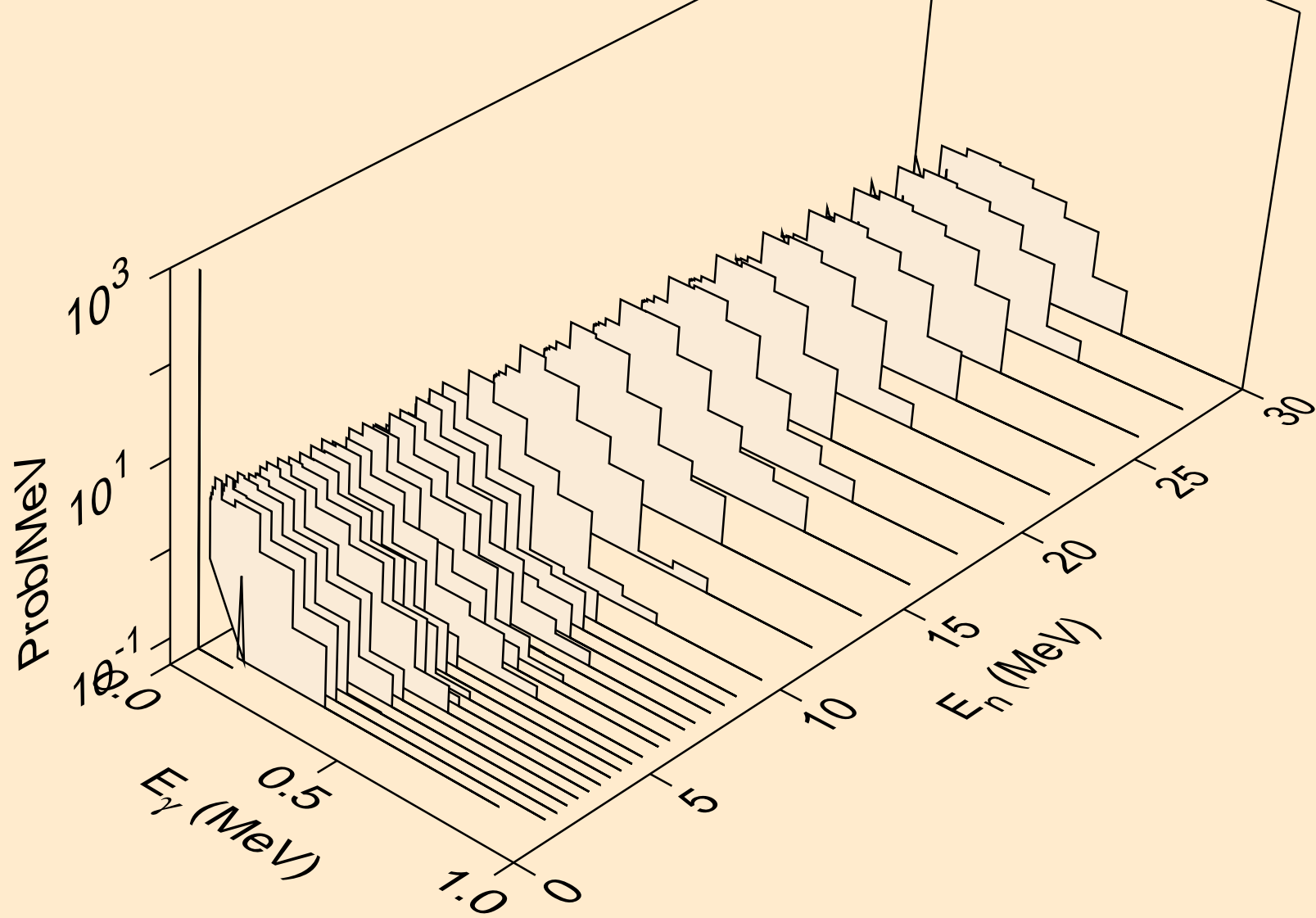

DB270 NEUTRON ACER TENDL-2021 LIBRARY; T=293.6K
Photon emission for (n,d)

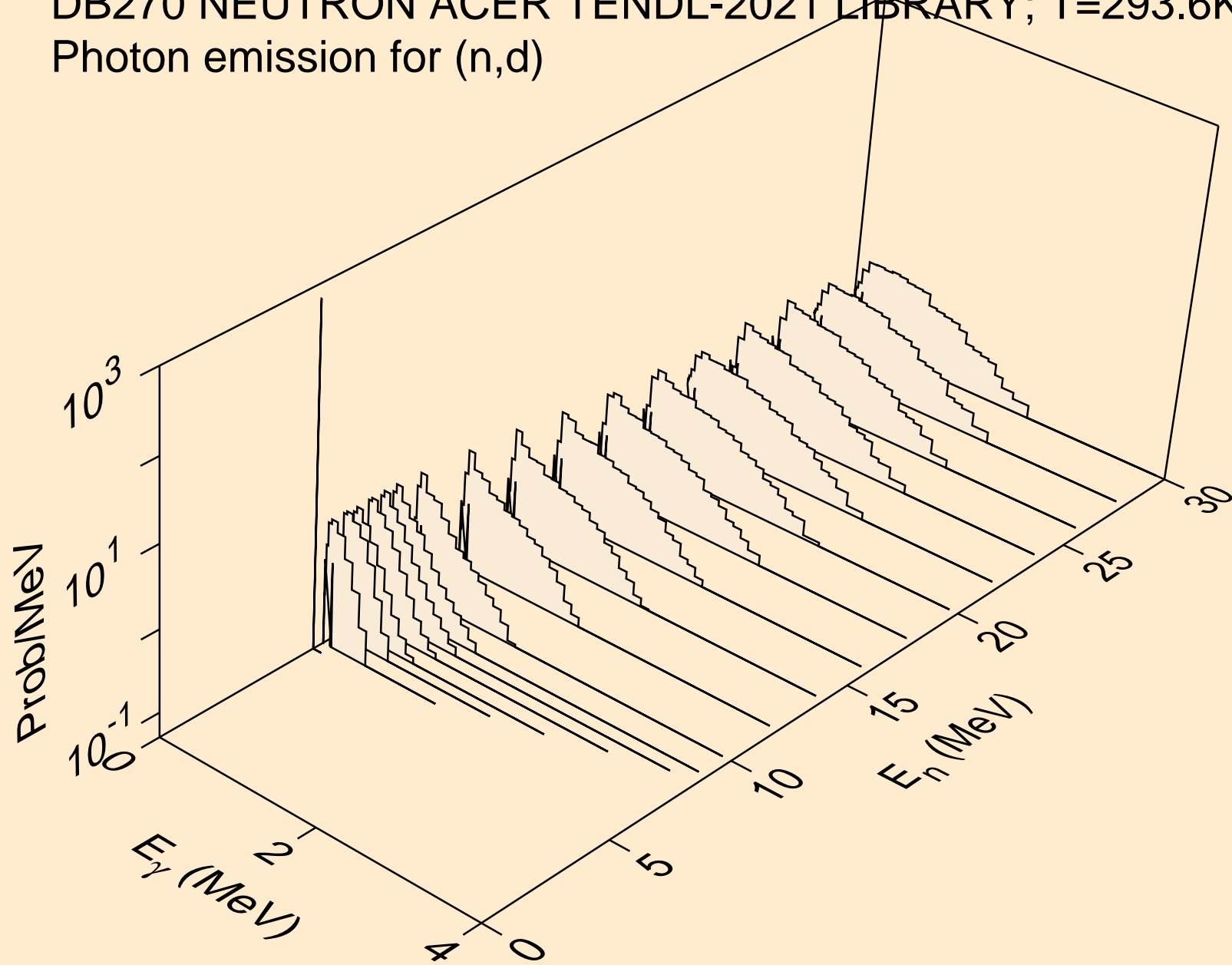

DB270 NEUTRON ACER TENDL-2021 LIBRARY; T=293.6K
Photon emission for (n,t)

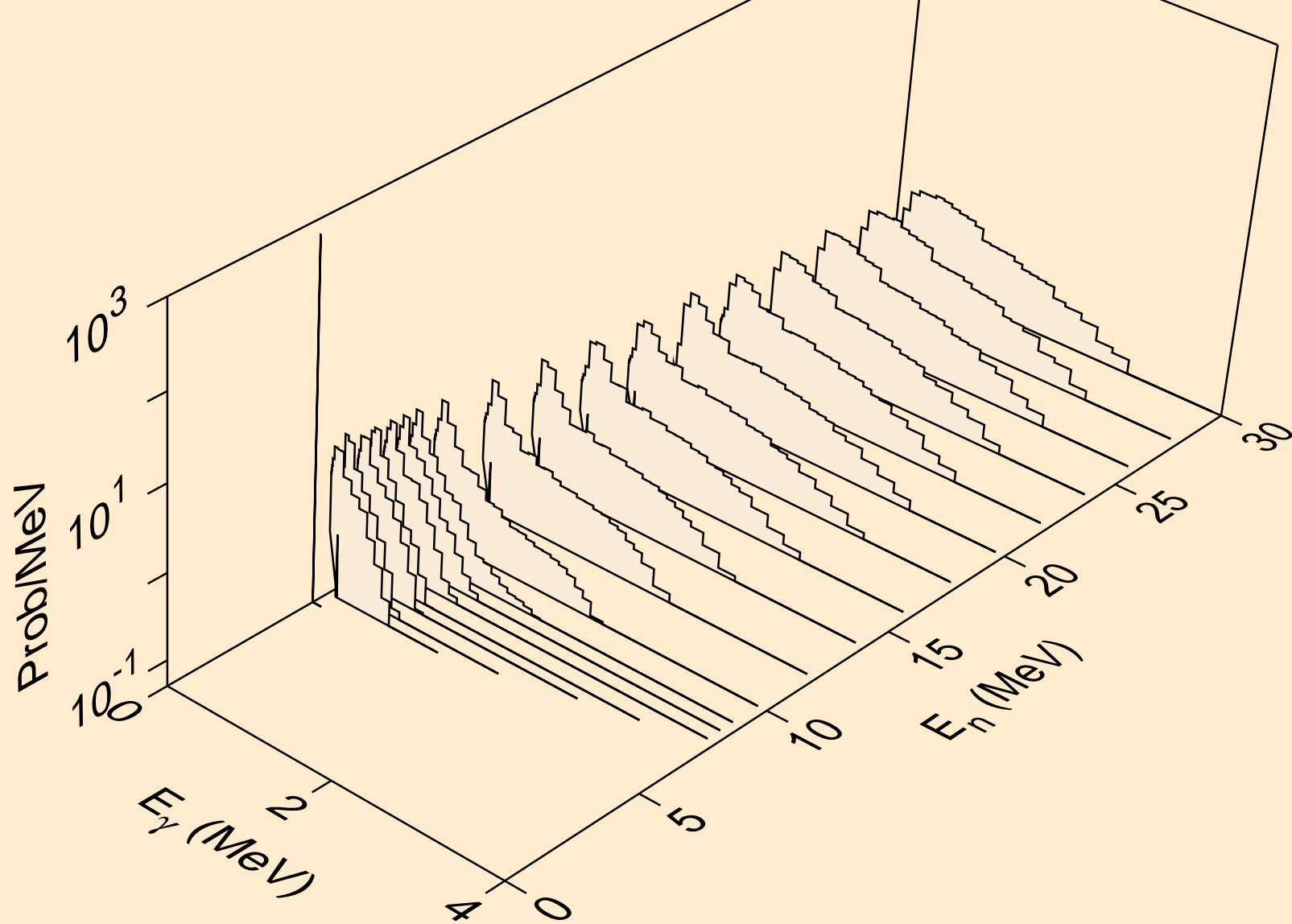

DB270 NEUTRON ACER TENDL-2021 LIBRARY; T=293.6K
Photon emission for (n,he3)

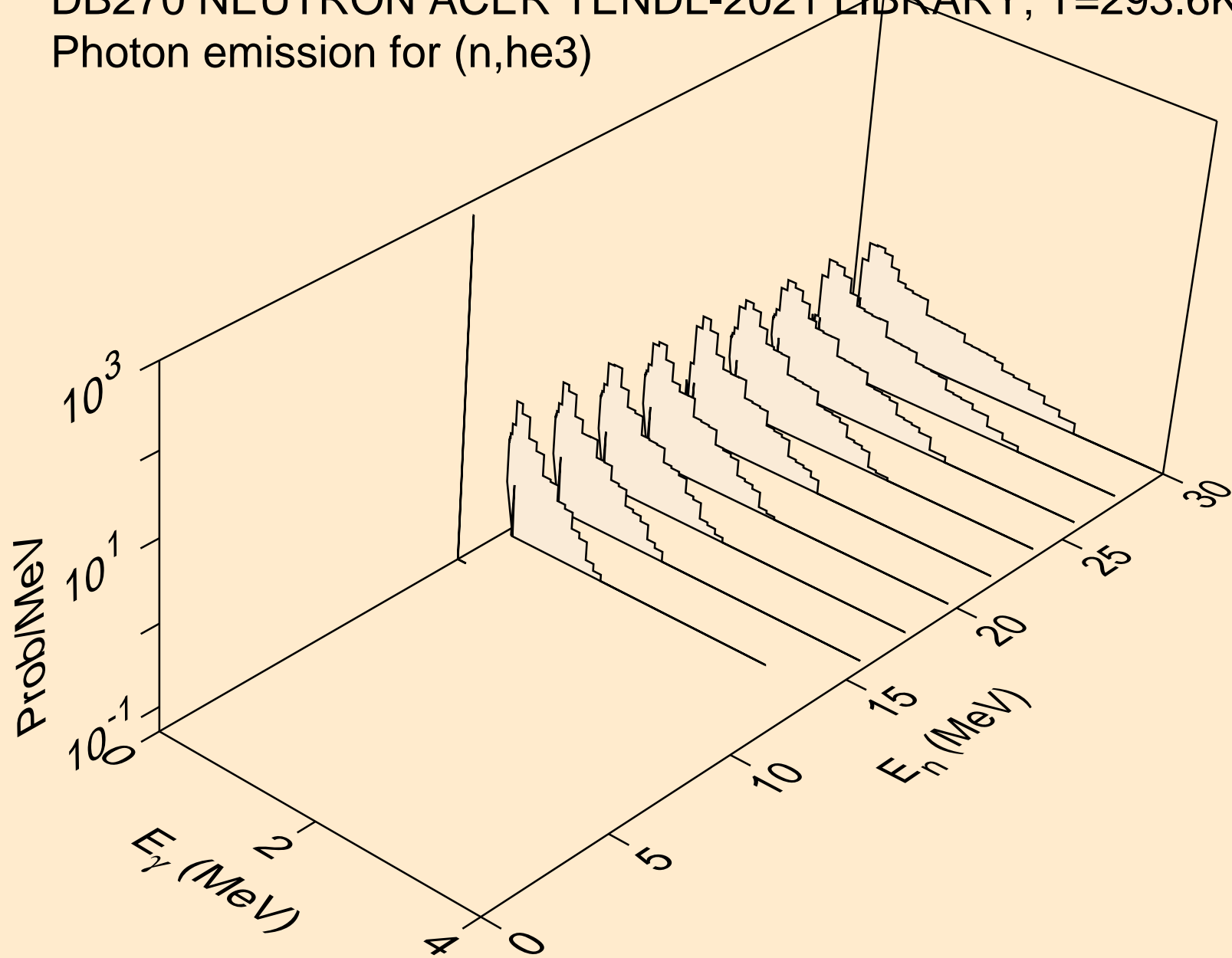

DB270 NEUTRON ACER TENDL-2021 LIBRARY; T=293.6K
Photon emission for (n,a)

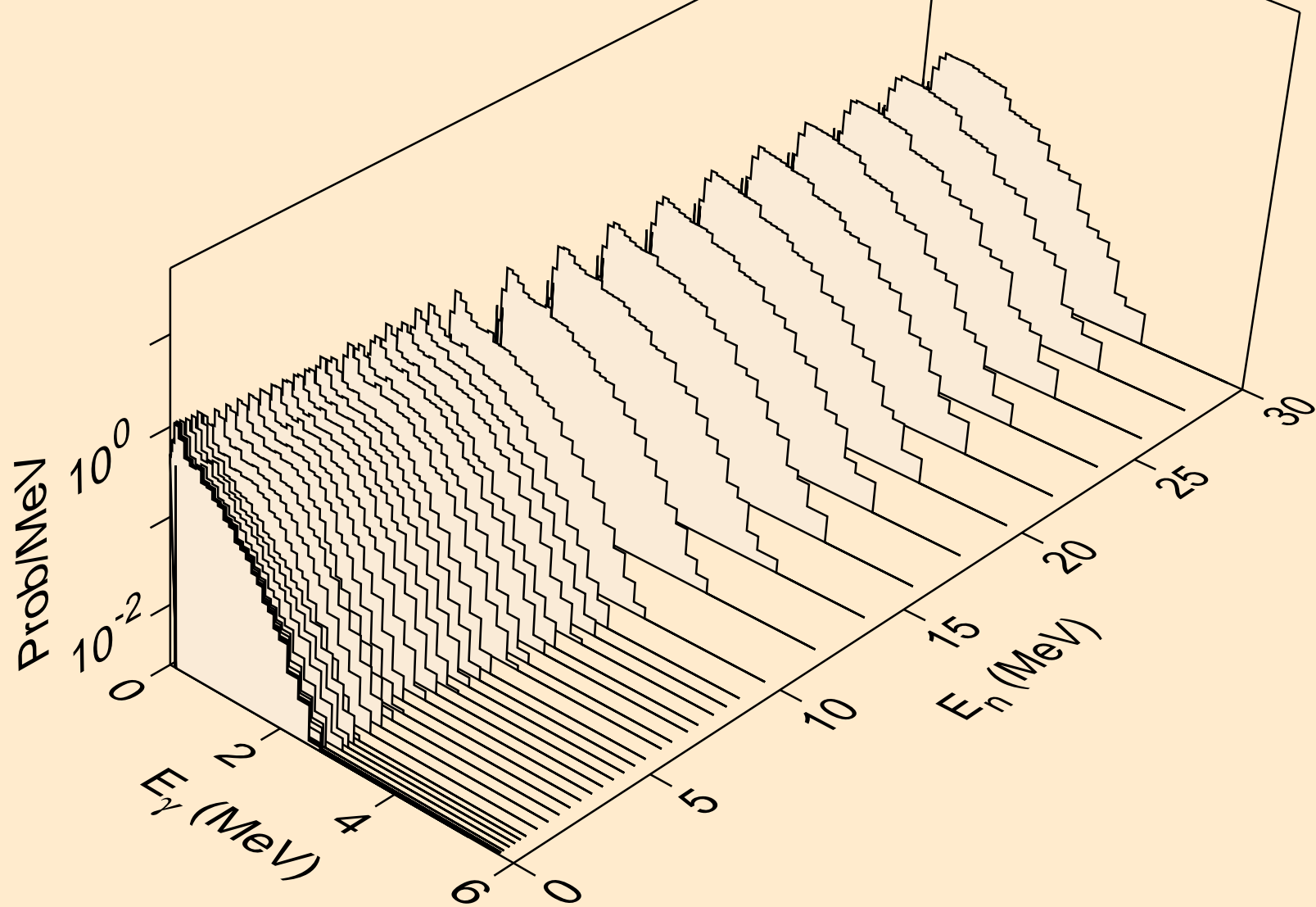

DB270 NEUTRON ACER TENDL-2021 LIBRARY; T=293.6K
thermal capture photon spectrum

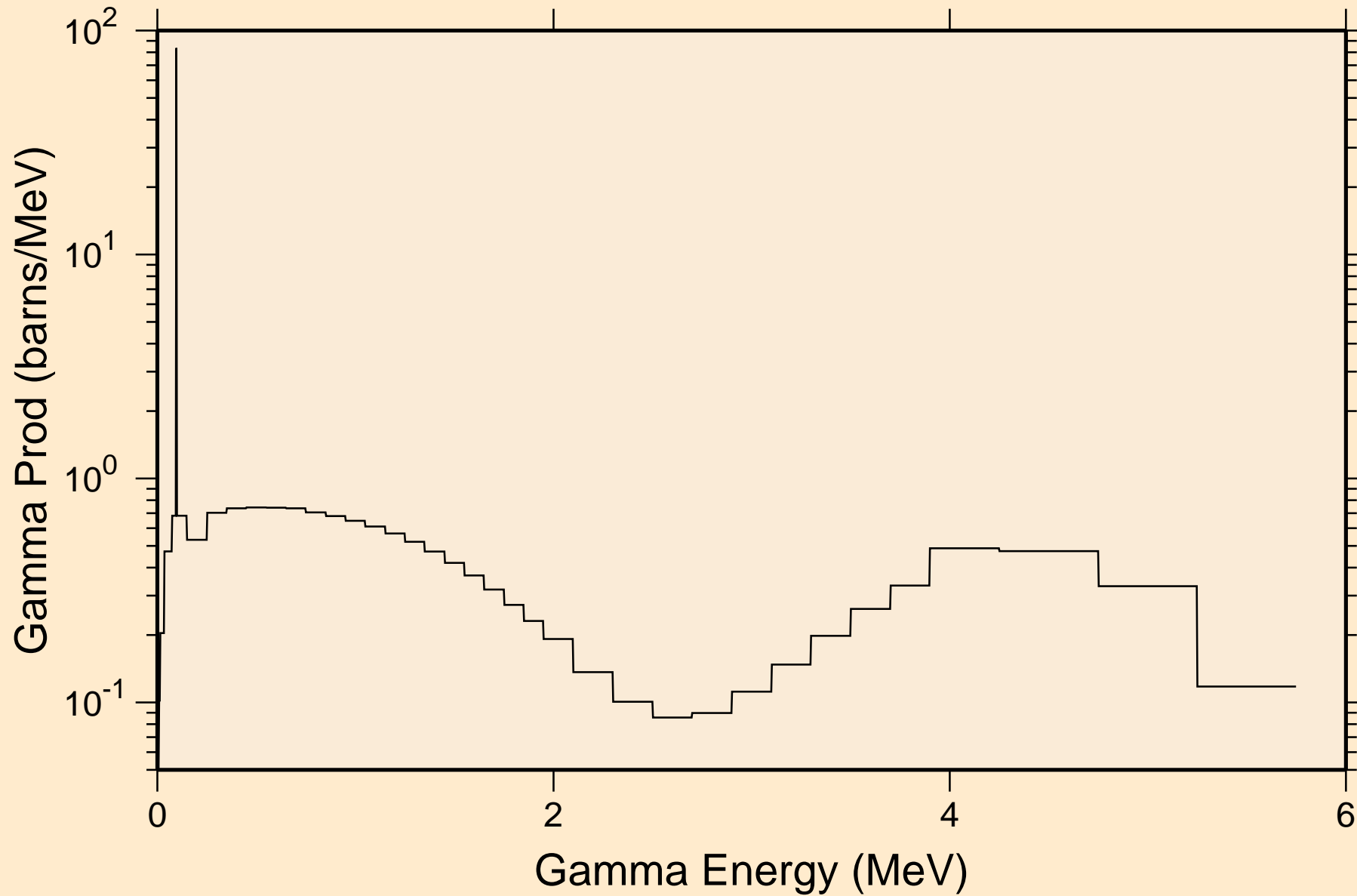

DB270 NEUTRON ACER TENDL-2021 LIBRARY; T=293.6K
14 MeV photon spectrum

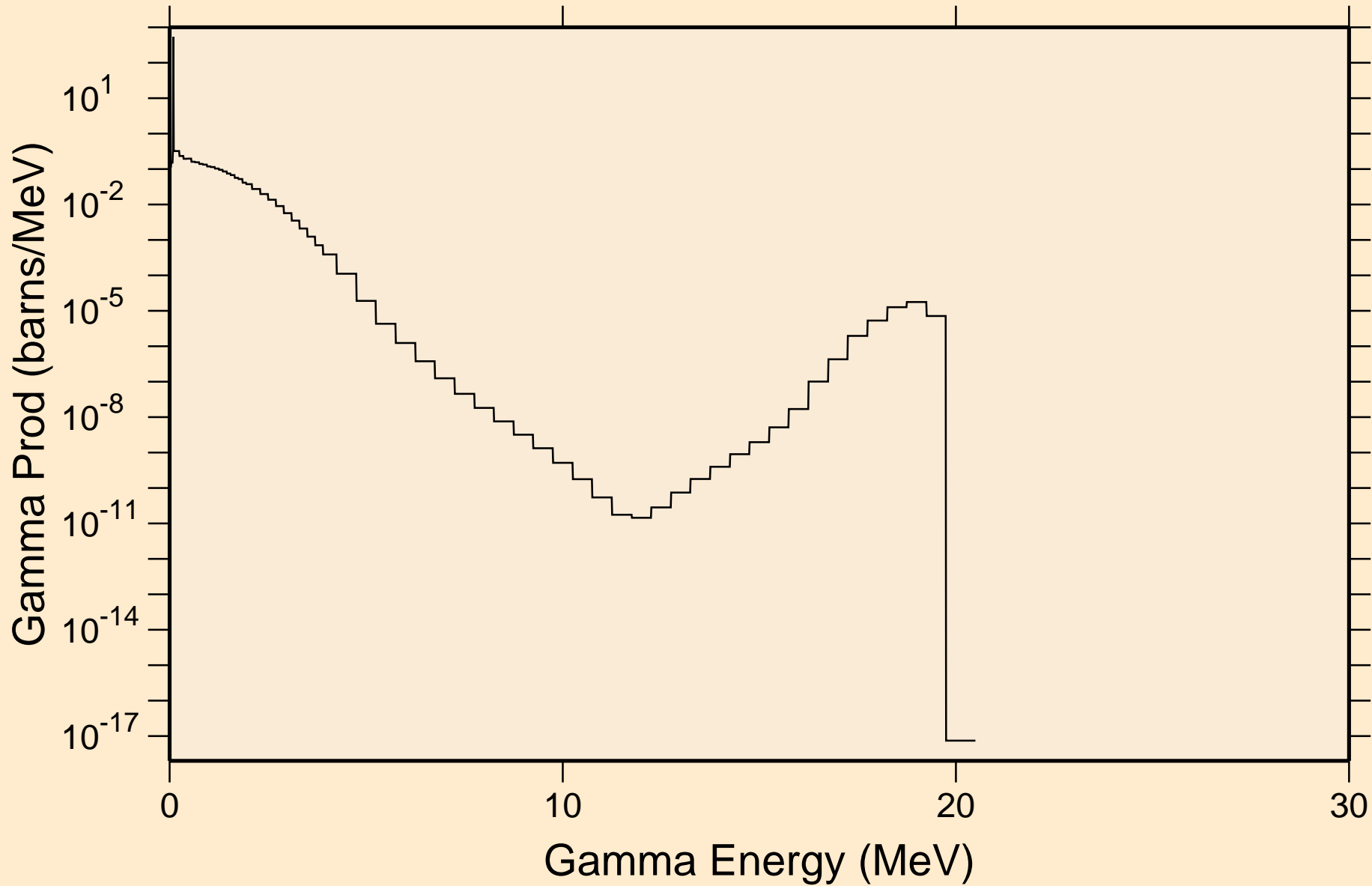

DB270 NEUTRON ACER TENDL-2021 LIBRARY; T=293.6K
Particle heating contributions

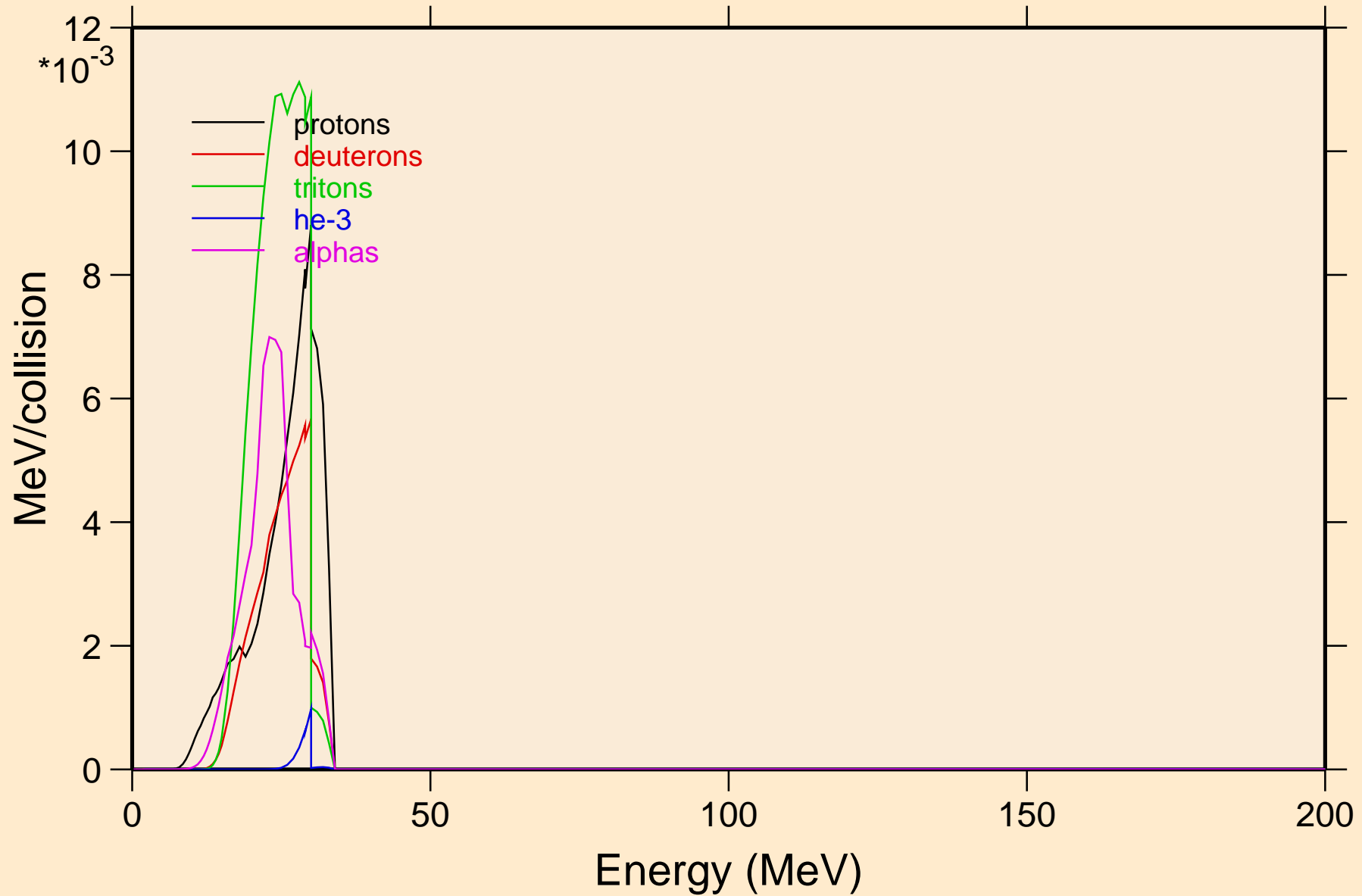

DB270 NEUTRON ACER TENDL-2021 LIBRARY; T=293.6K
Recoil Heating

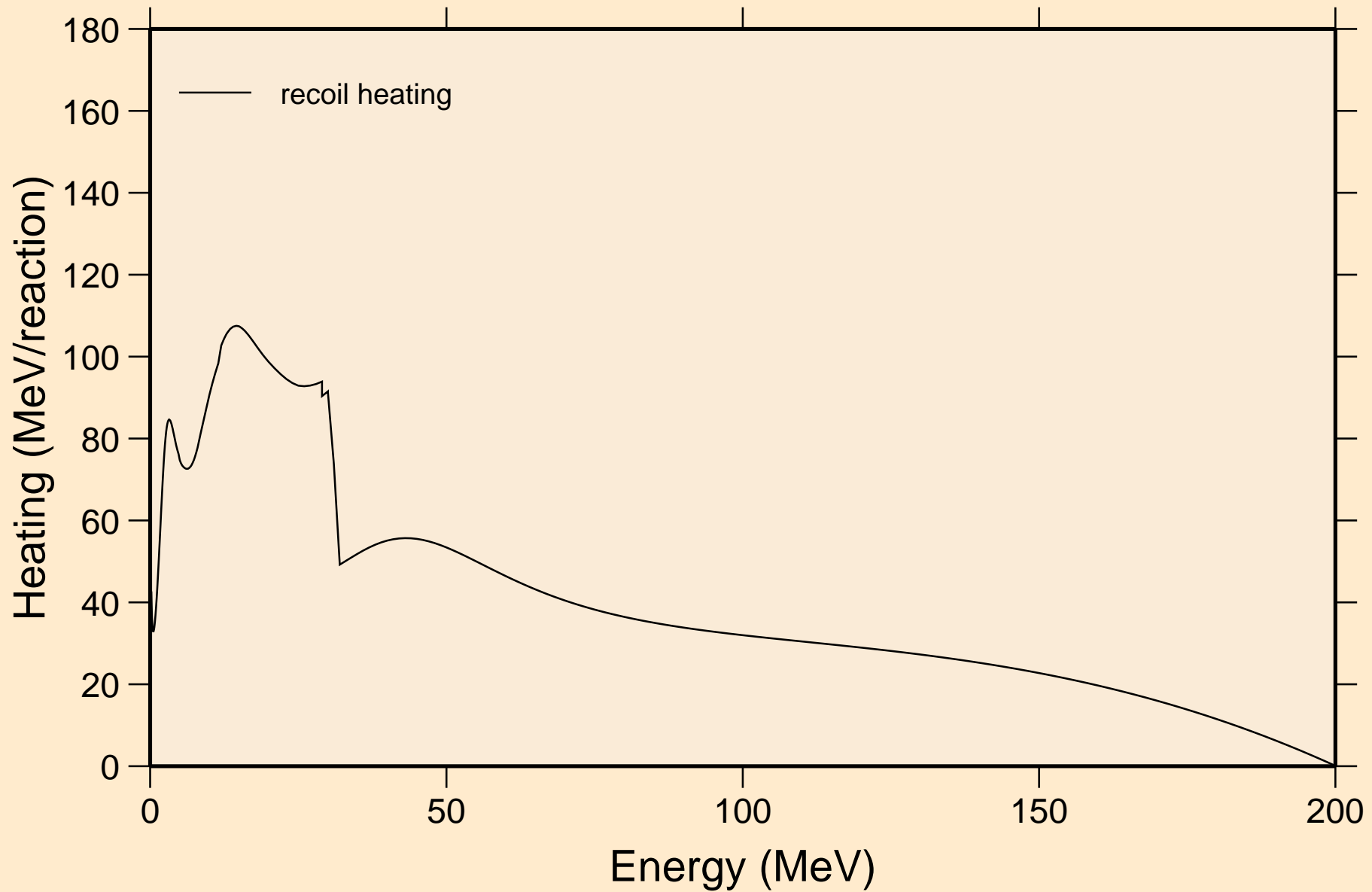

DB270 NEUTRON ACER TENDL-2021 LIBRARY; T=293.6K
Particle production cross sections

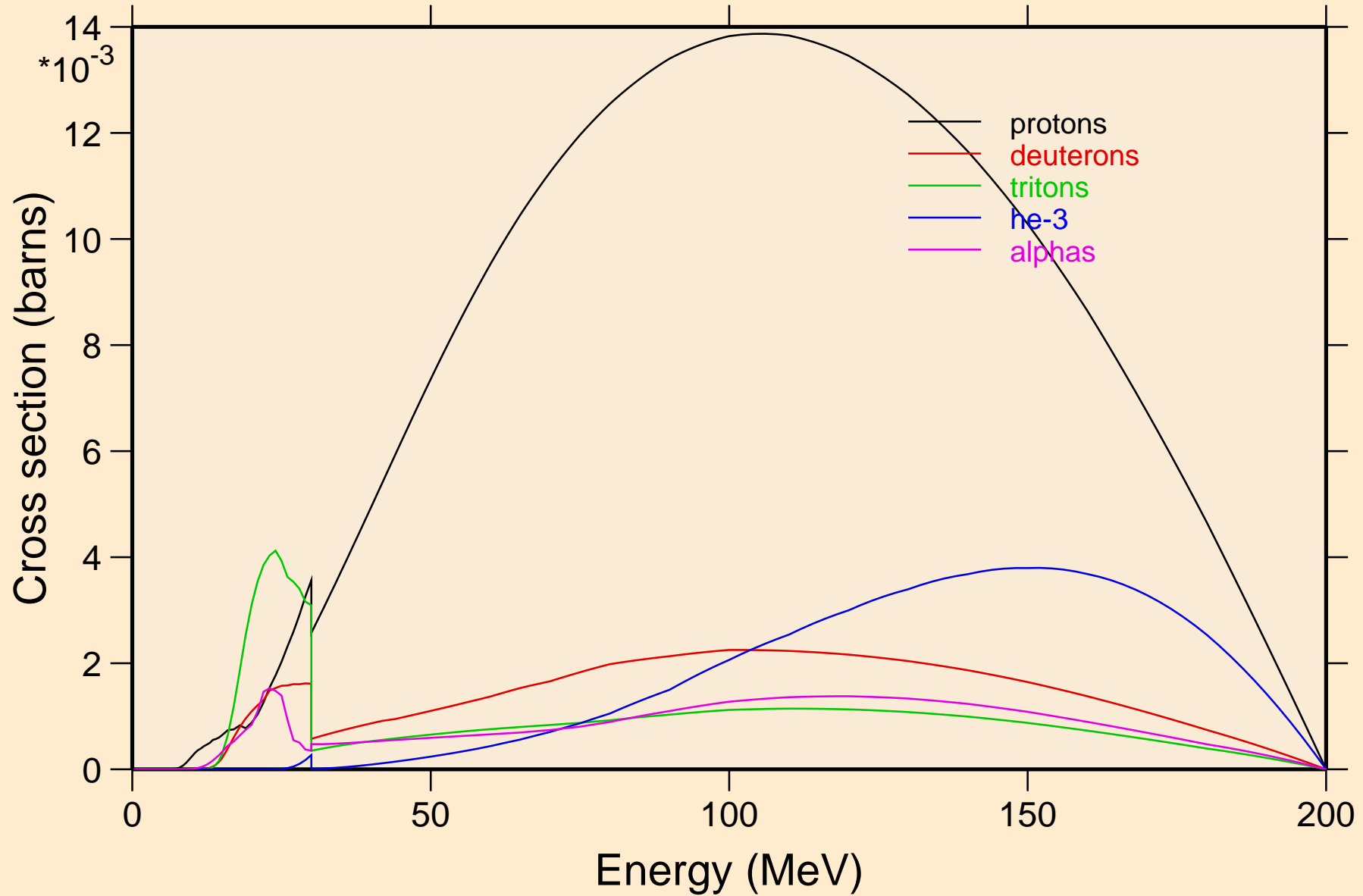

DB270 NEUTRON ACER TENDL-2021 LIBRARY; T=293.6K
protons from (n,x)

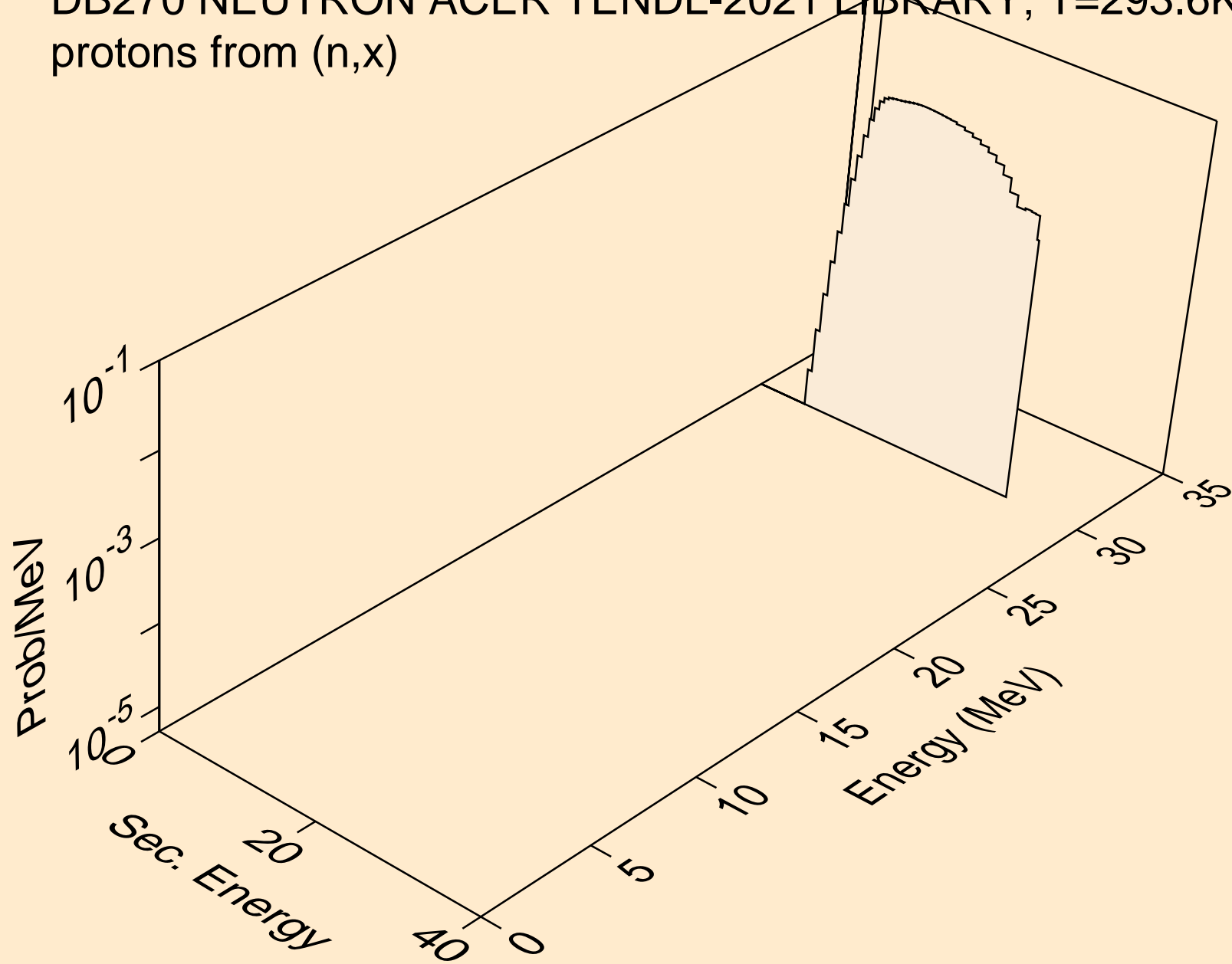

DB270 NEUTRON ACER TENDL-2021 LIBRARY; T=293.6K
protons from (n,n*)p

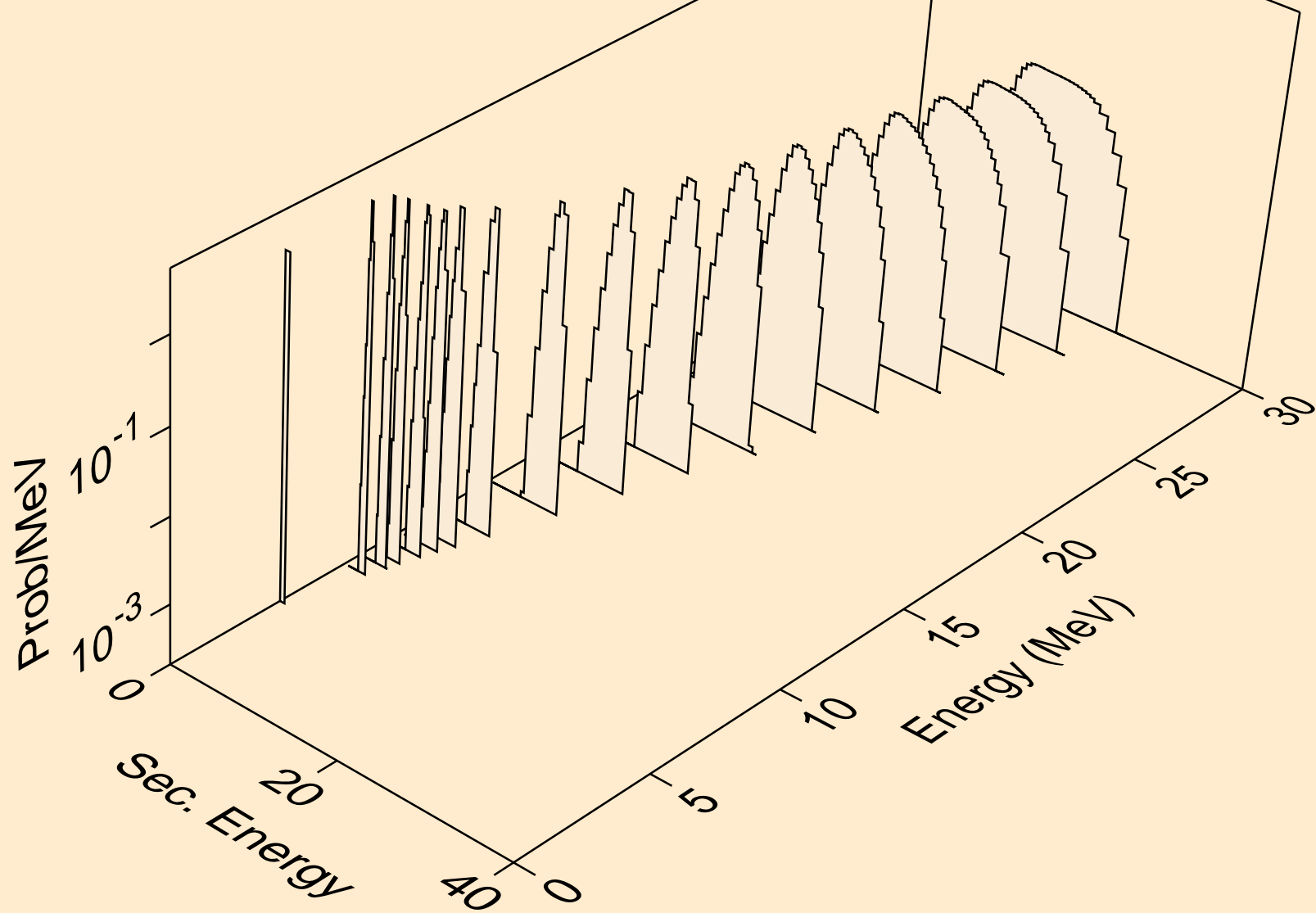

DB270 NEUTRON ACER TENDL-2021 LIBRARY; T=293.6K
protons from (n,2np)

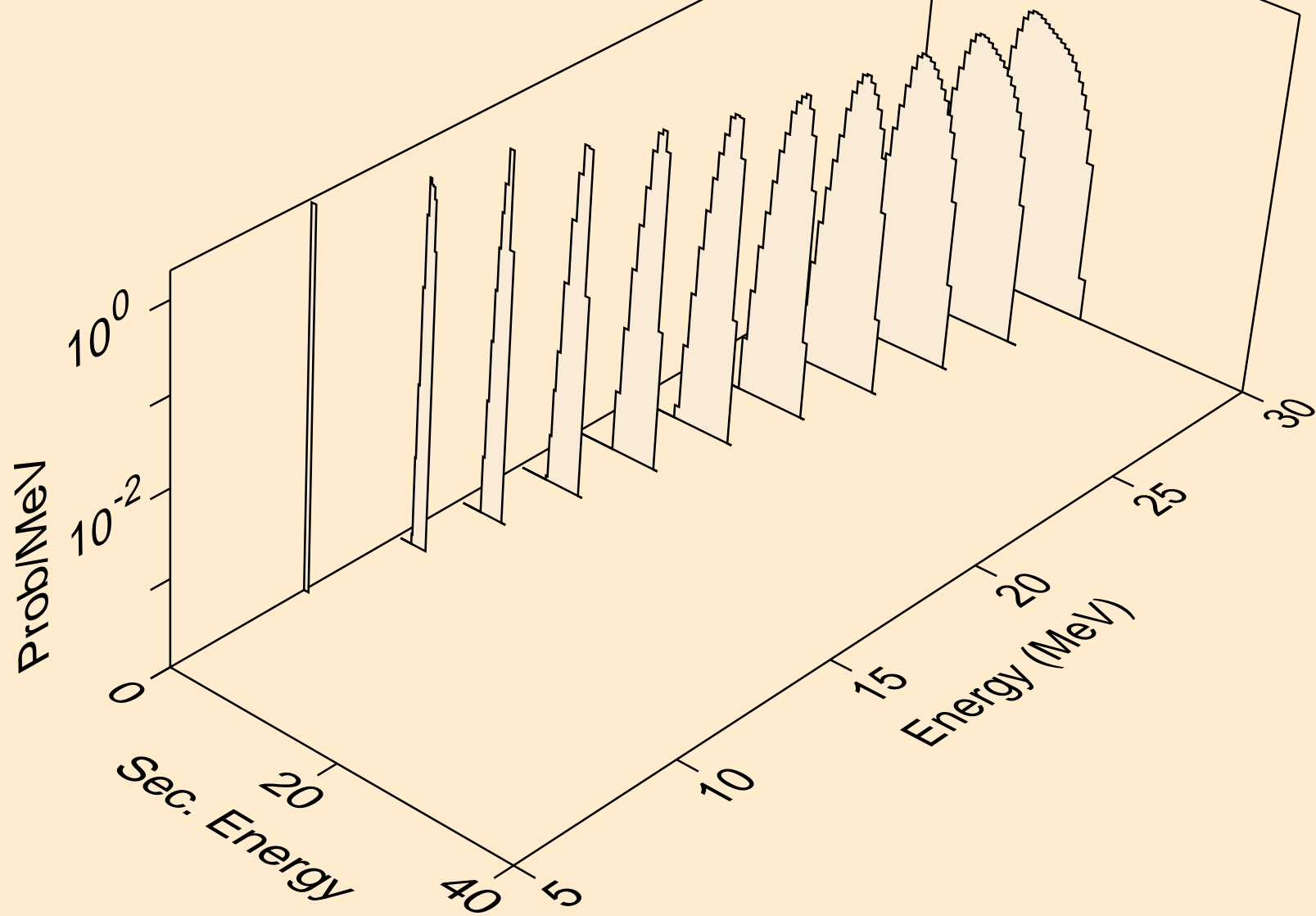

DB270 NEUTRON ACER TENDL-2021 LIBRARY; T=293.6K
protons from (n,3np)

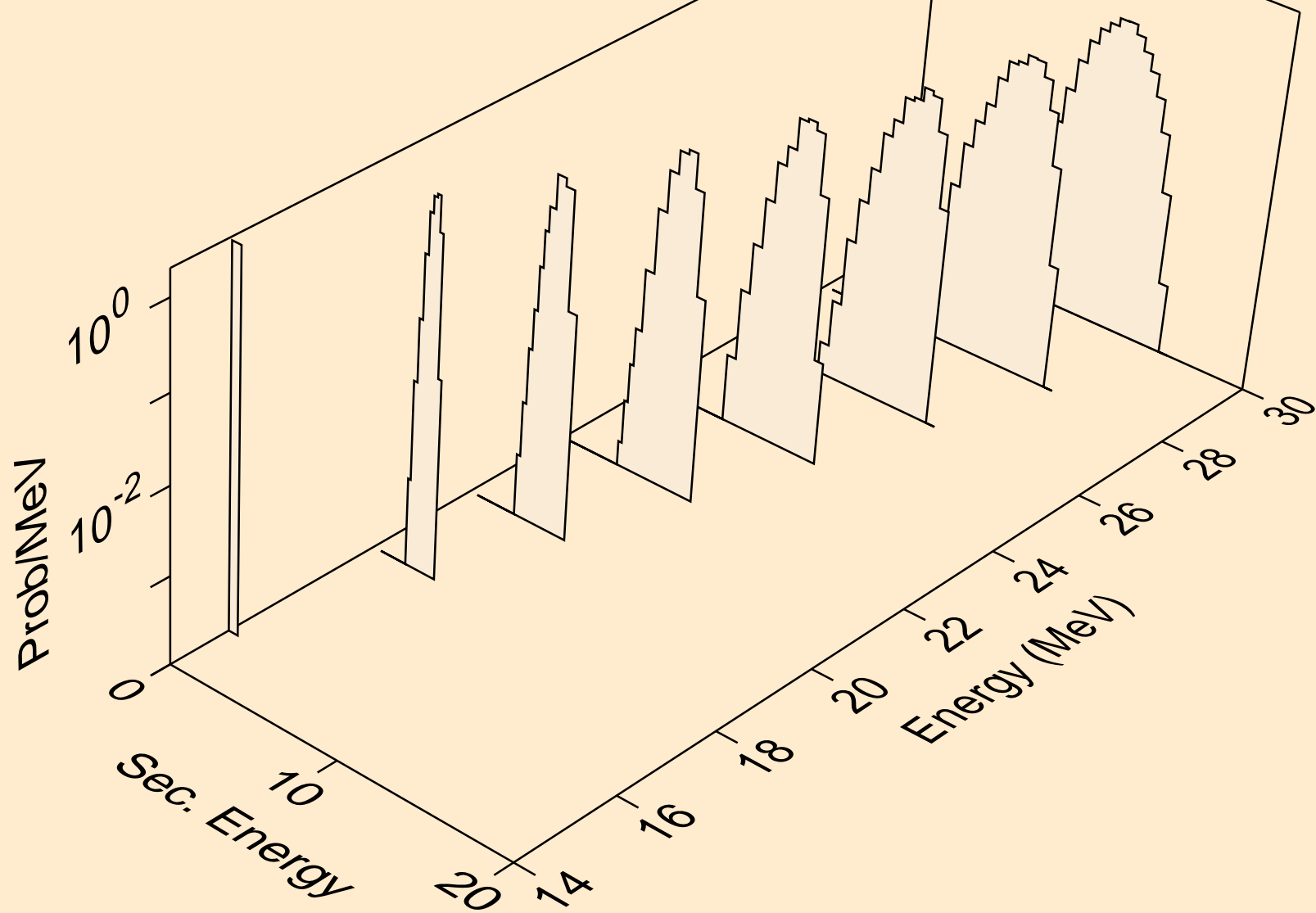

DB270 NEUTRON ACER TENDL-2021 LIBRARY; T=293.6K
protons from (n,p)

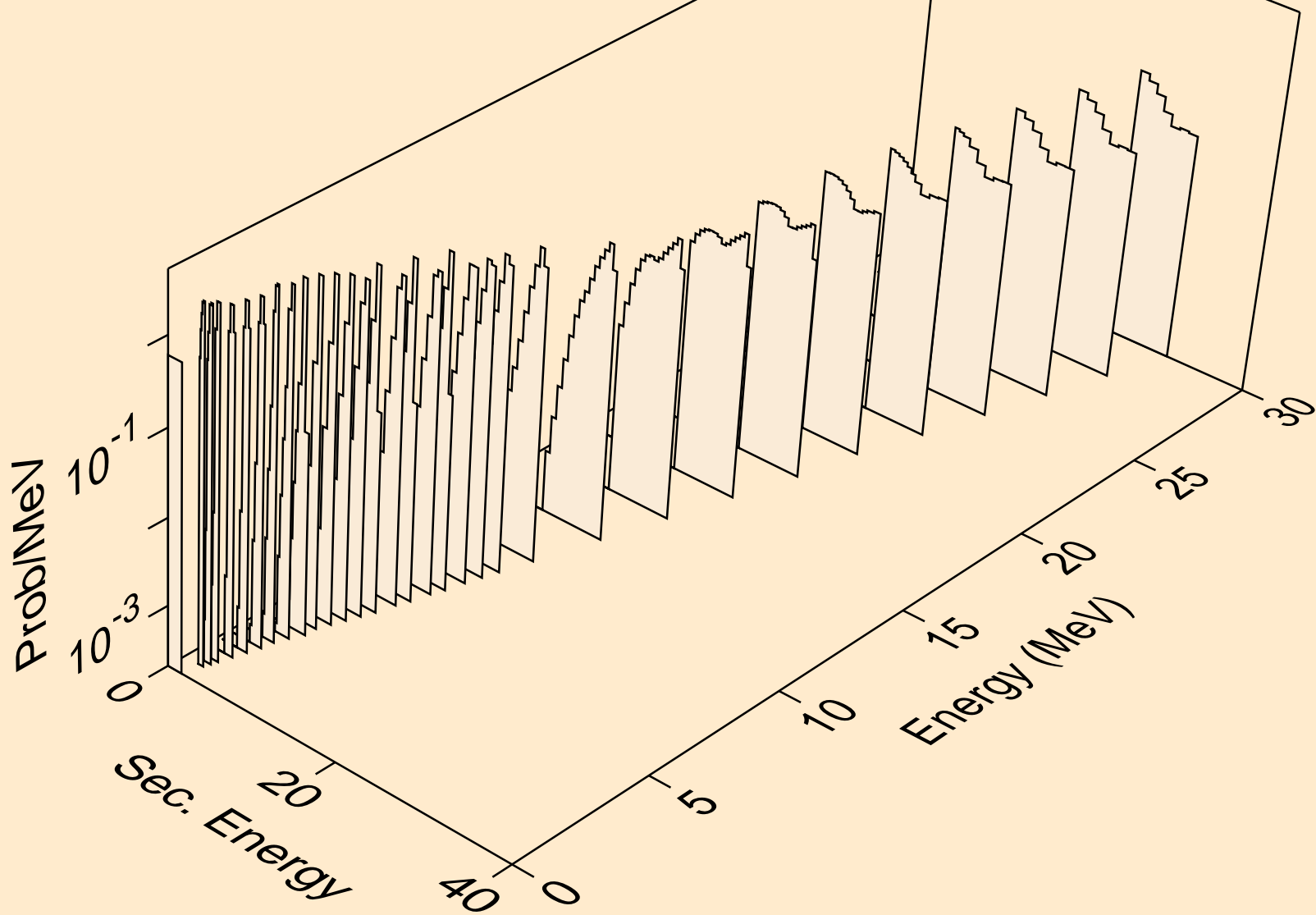

DB270 NEUTRON ACER TENDL-2021 LIBRARY; T=293.6K
deuterons from (n,x)

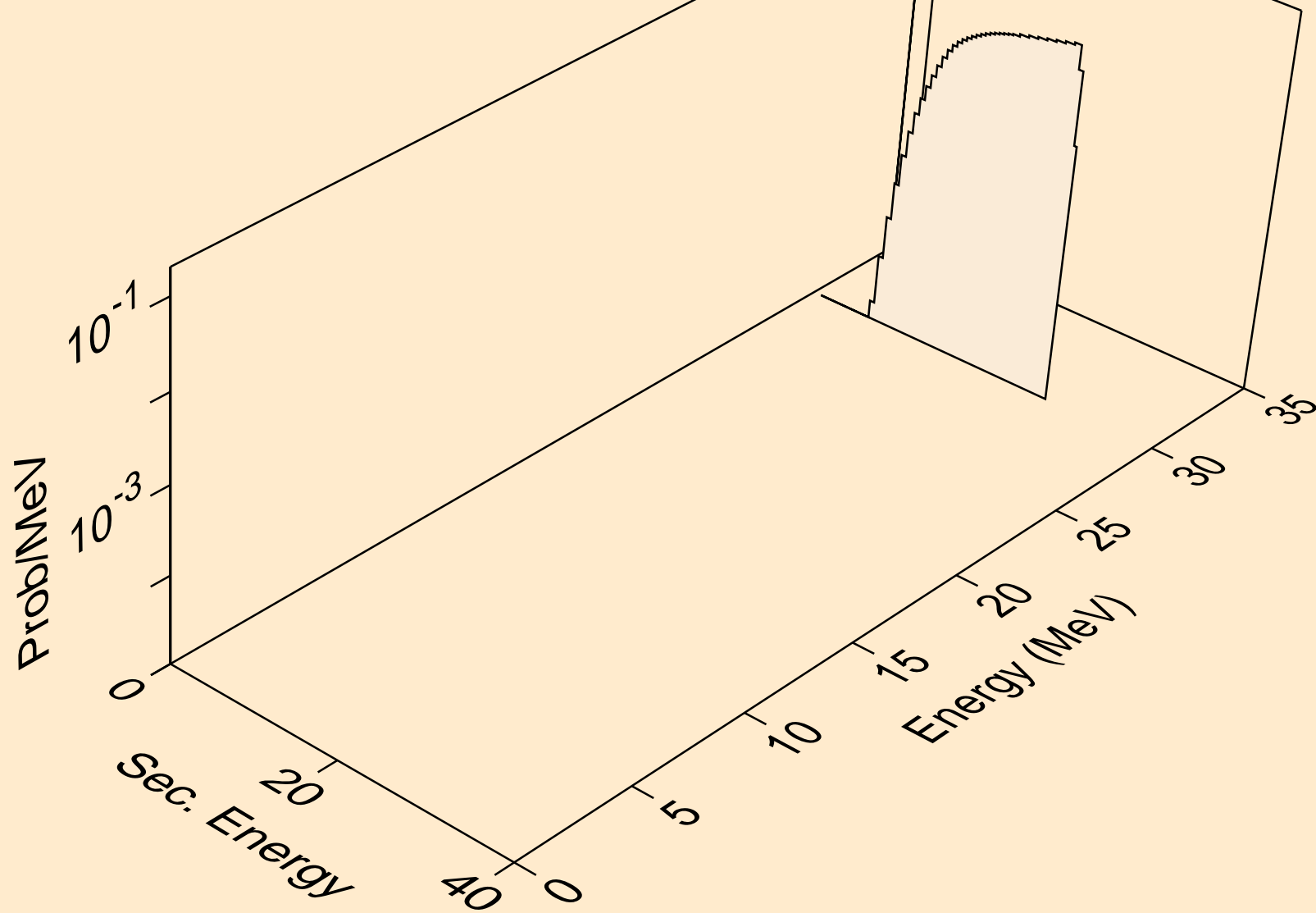

DB270 NEUTRON ACER TENDL-2021 LIBRARY; T=293.6K
deuterons from (n,2nd)

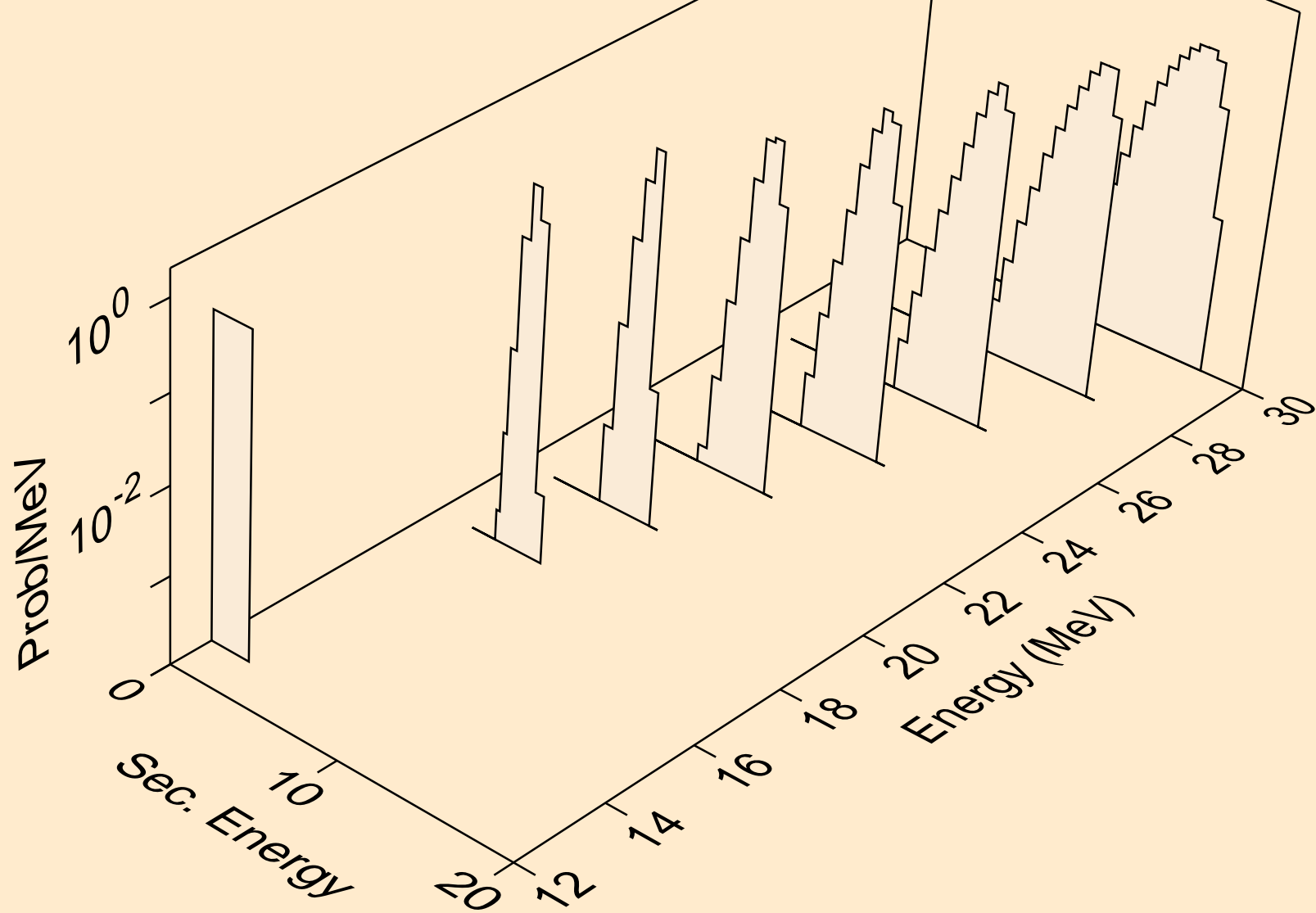

DB270 NEUTRON ACER TENDL-2021 LIBRARY; T=293.6K
deuterons from (n,n*)d

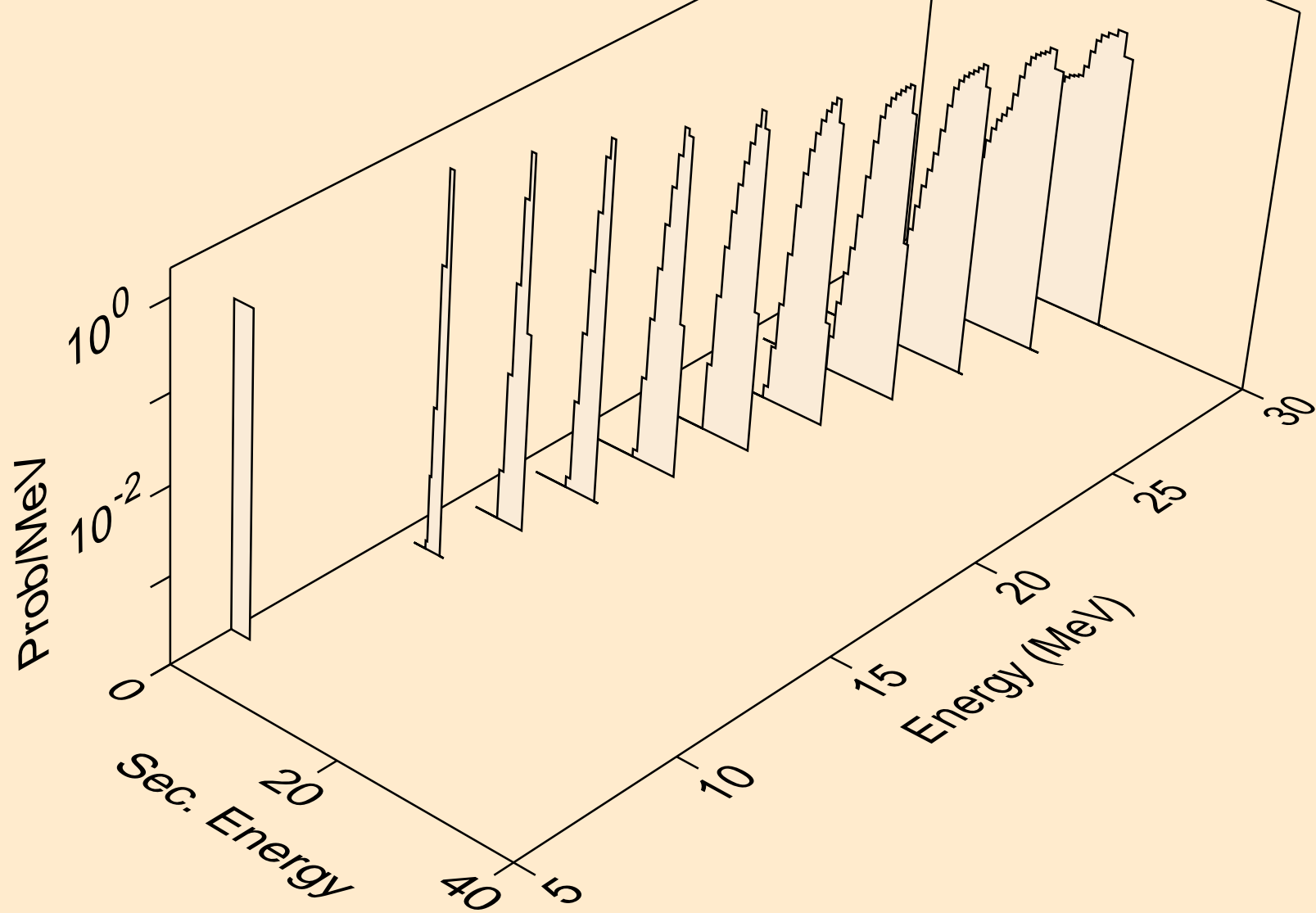

DB270 NEUTRON ACER TENDL-2021 LIBRARY; T=293.6K
deuterons from (n,d)

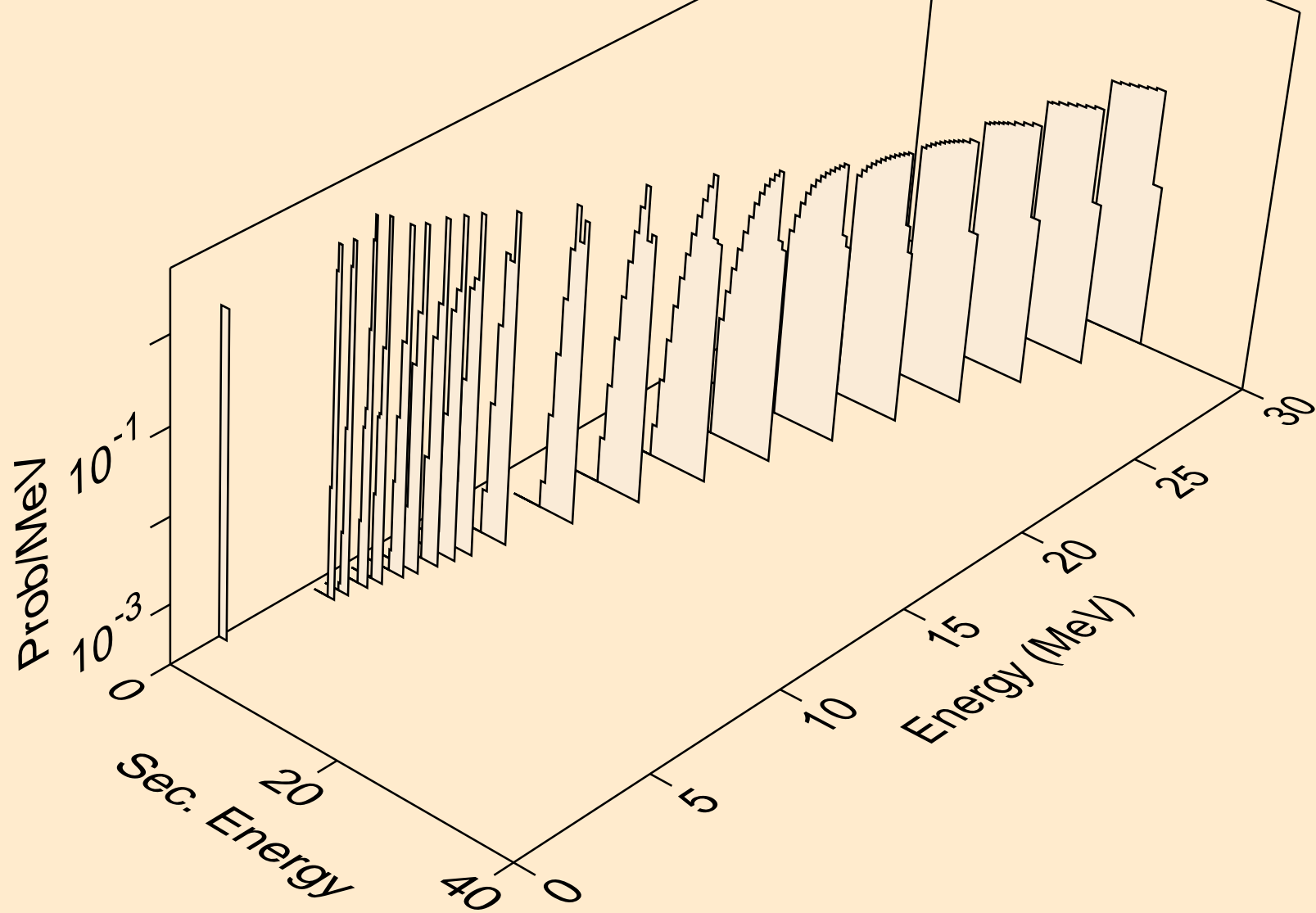

DB270 NEUTRON ACER TENDL-2021 LIBRARY; T=293.6K
tritons from (n,x)

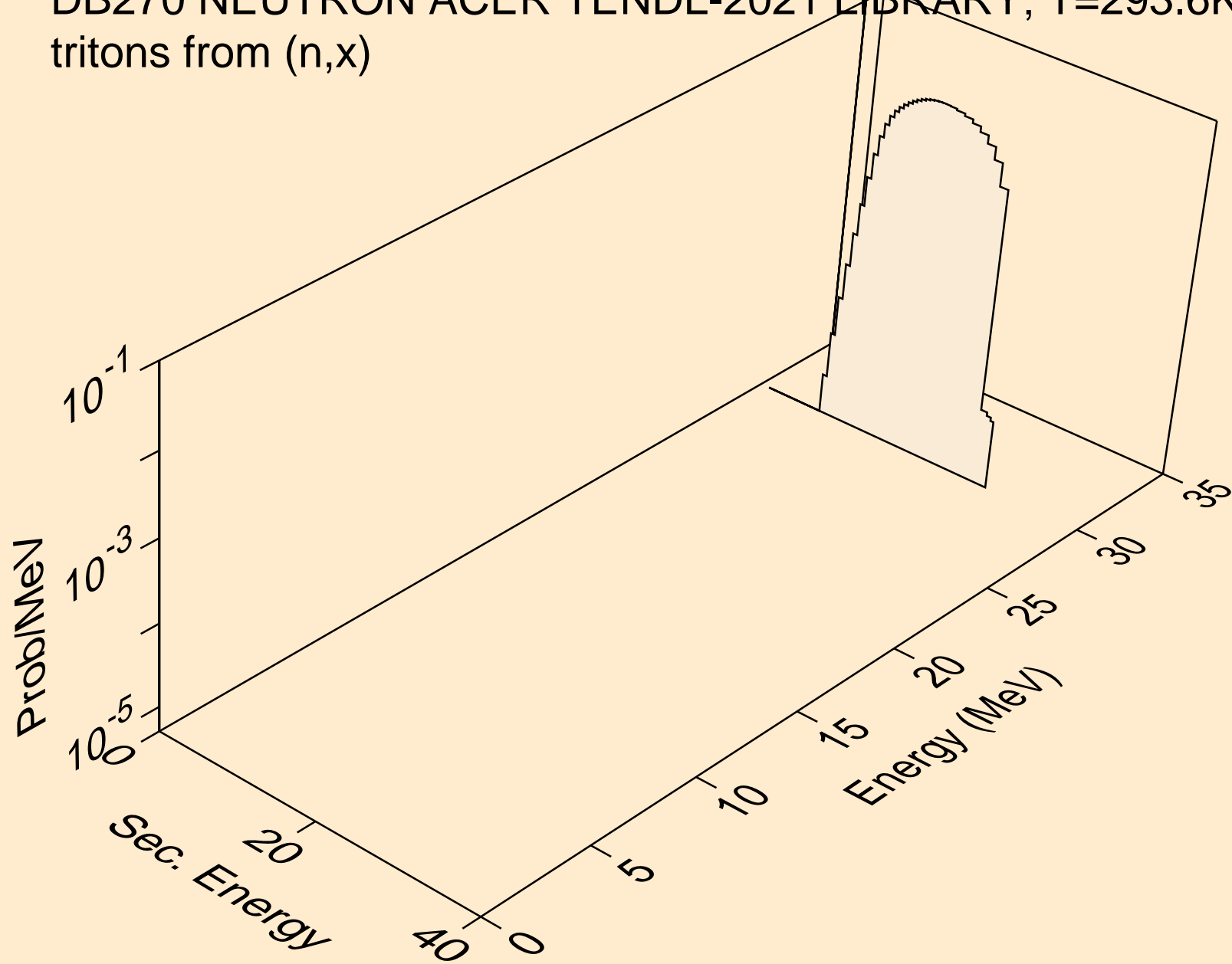

DB270 NEUTRON ACER TENDL-2021 LIBRARY; T=293.6K
tritons from (n,n*)t

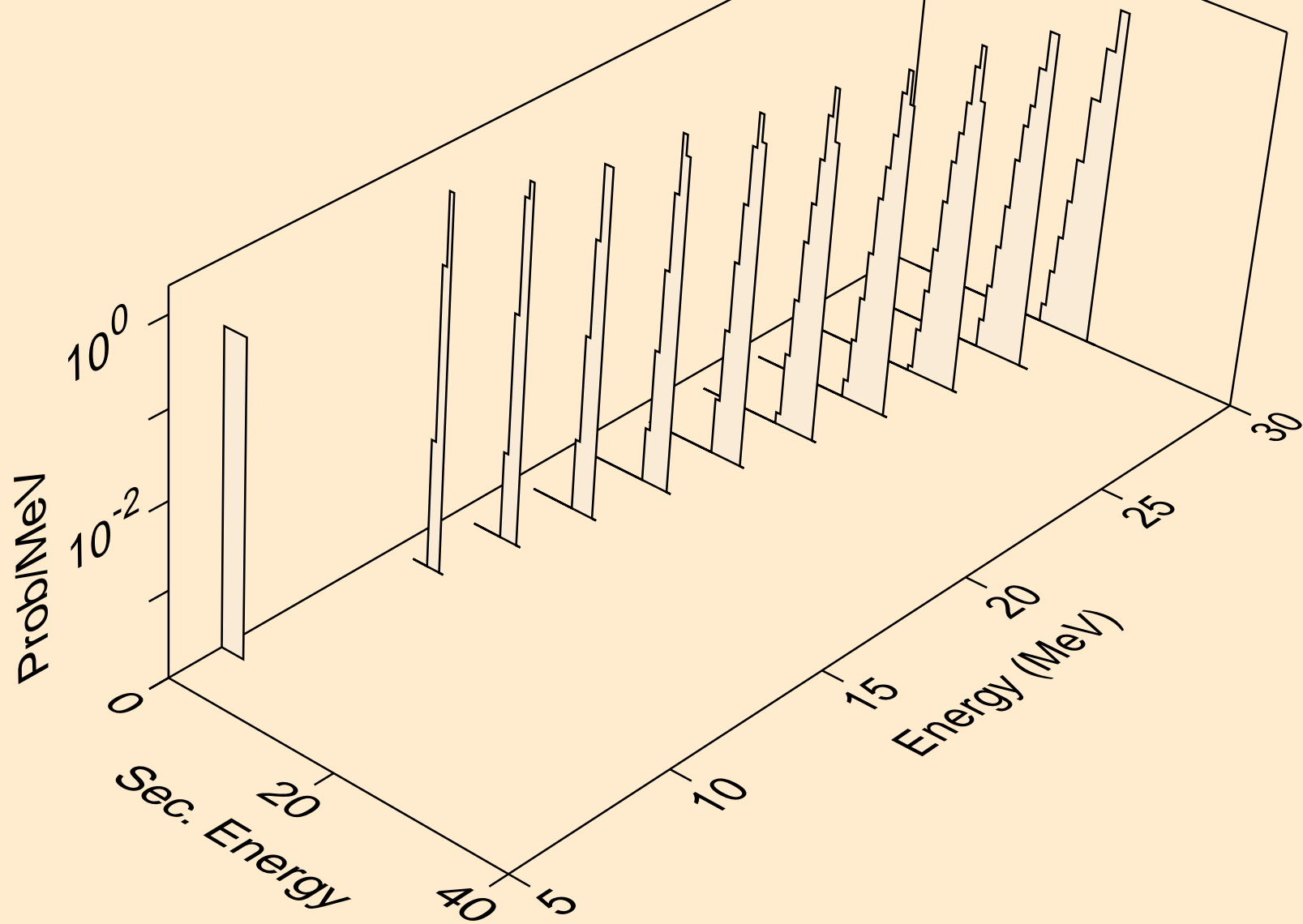

DB270 NEUTRON ACER TENDL-2021 LIBRARY; T=293.6K
tritons from (n,t)

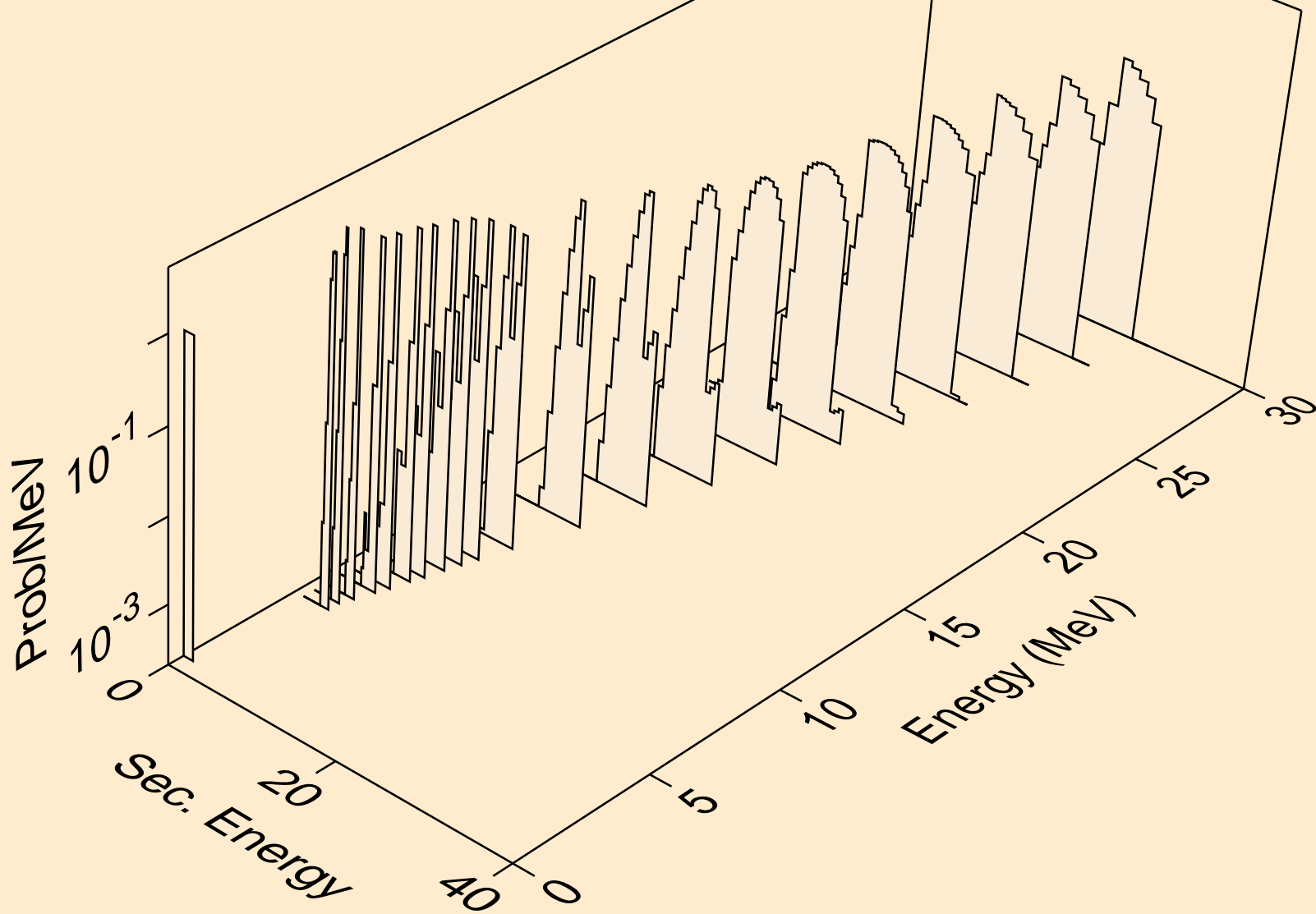

DB270 NEUTRON ACER TENDL-2021 LIBRARY; T=293.6K
he3s from (n,x)

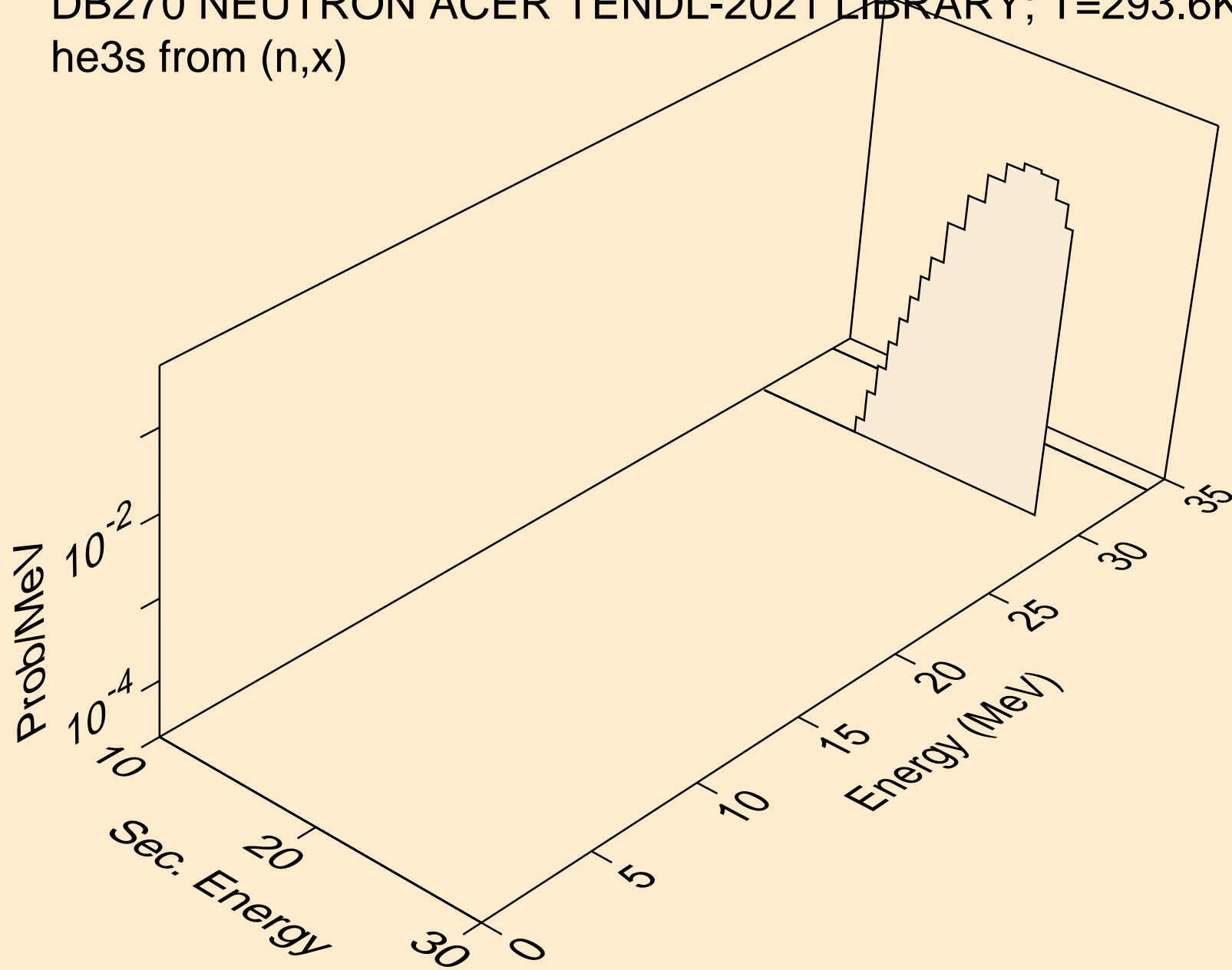

DB270 NEUTRON ACER TENDL-2021 LIBRARY; T=293.6K
he3s from (n,n*)he3

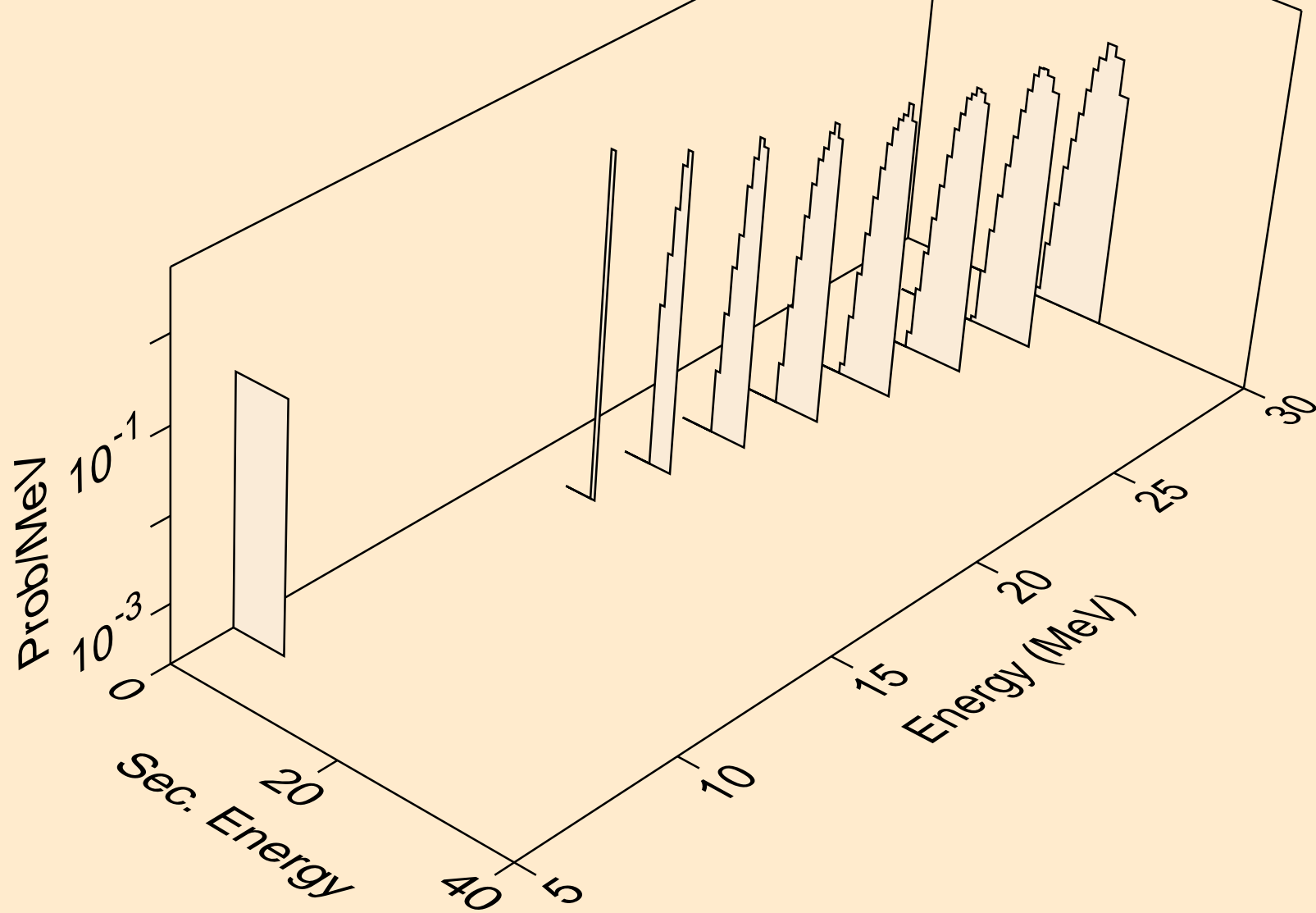

DB270 NEUTRON ACER TENDL-2021 LIBRARY; T=293.6K
he3s from (n,he3)

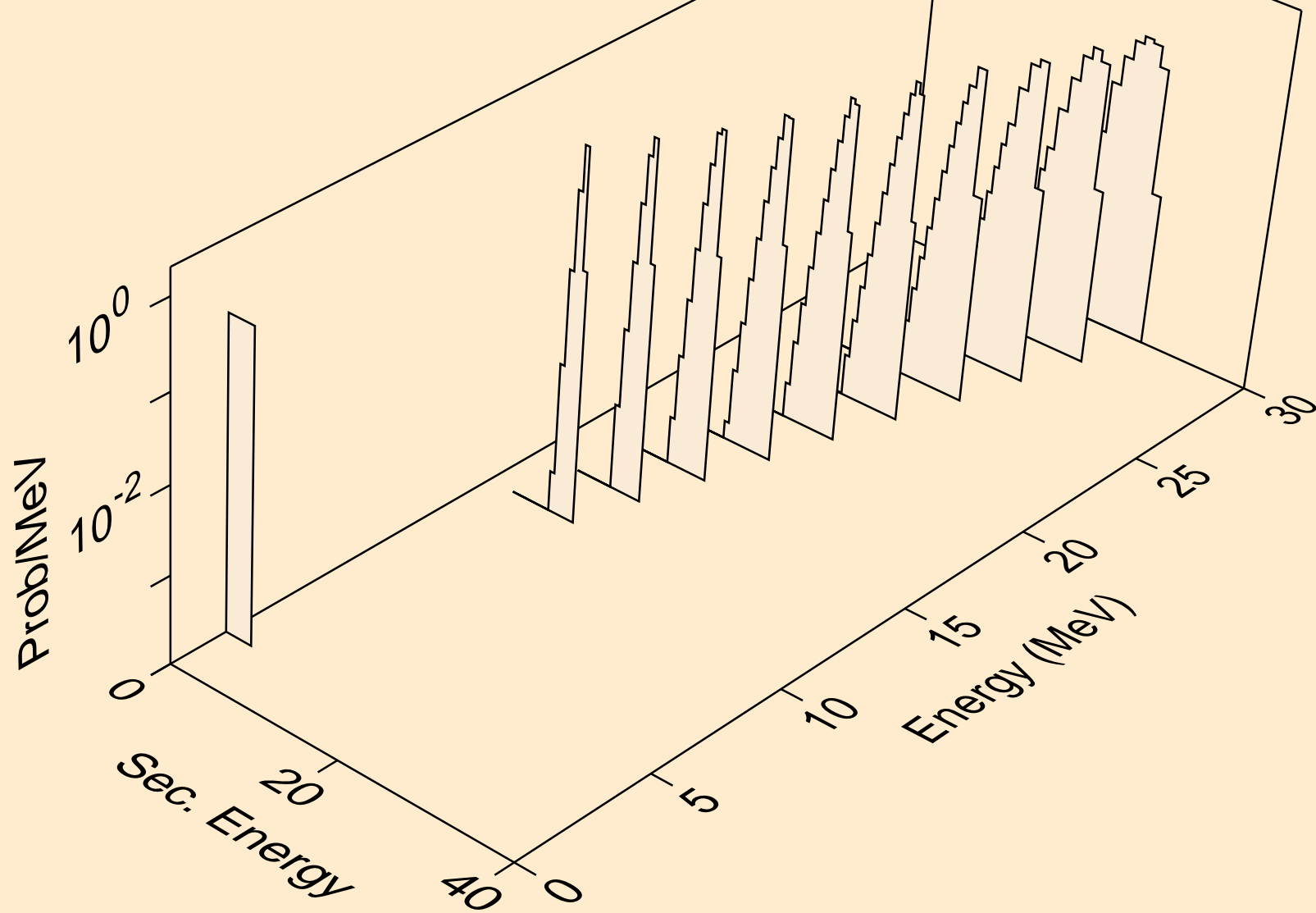

DB270 NEUTRON ACER TENDL-2021 LIBRARY; T=293.6K
alphas from (n,x)

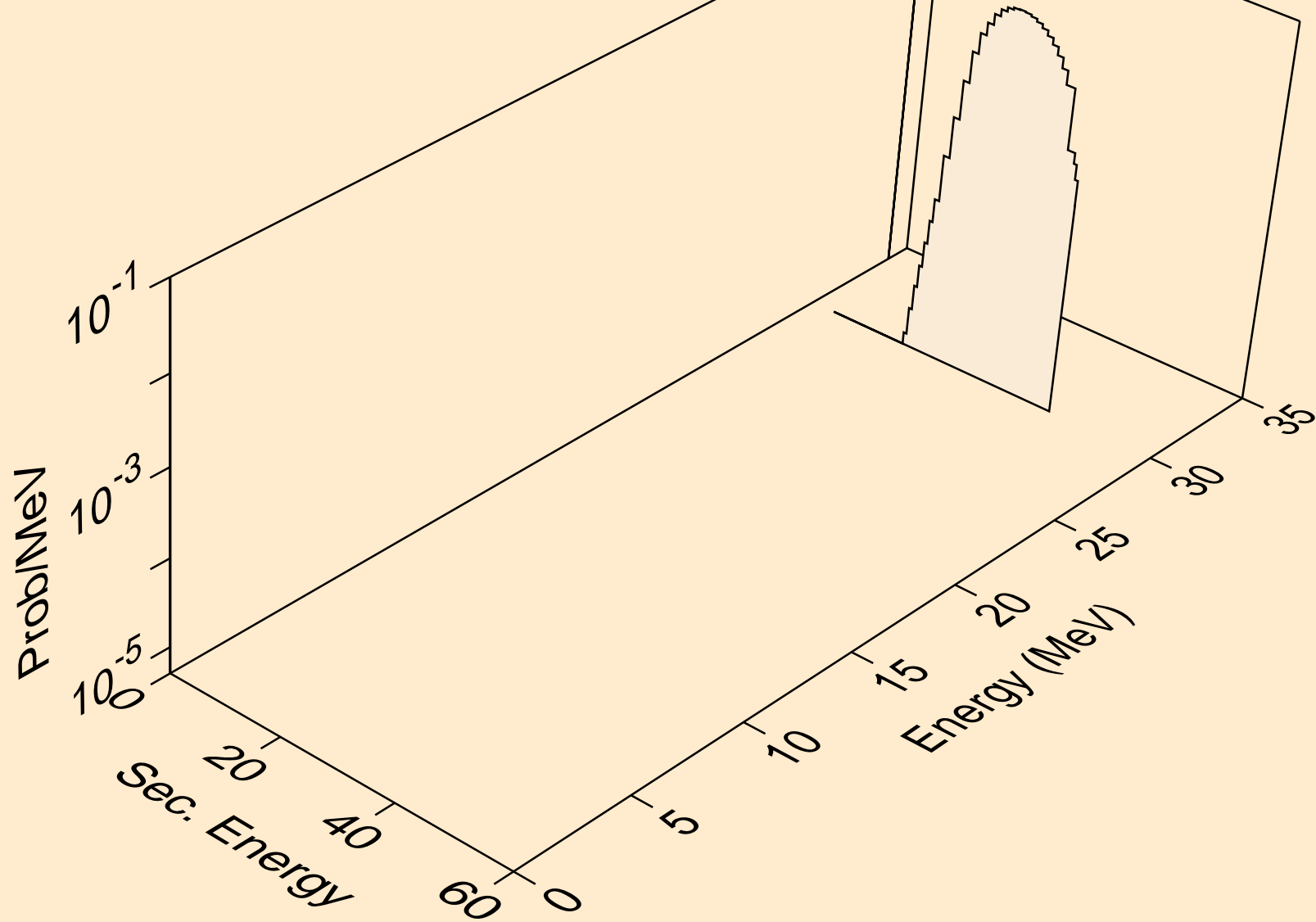

DB270 NEUTRON ACER TENDL-2021 LIBRARY; T=293.6K
alphas from (n,n*)a

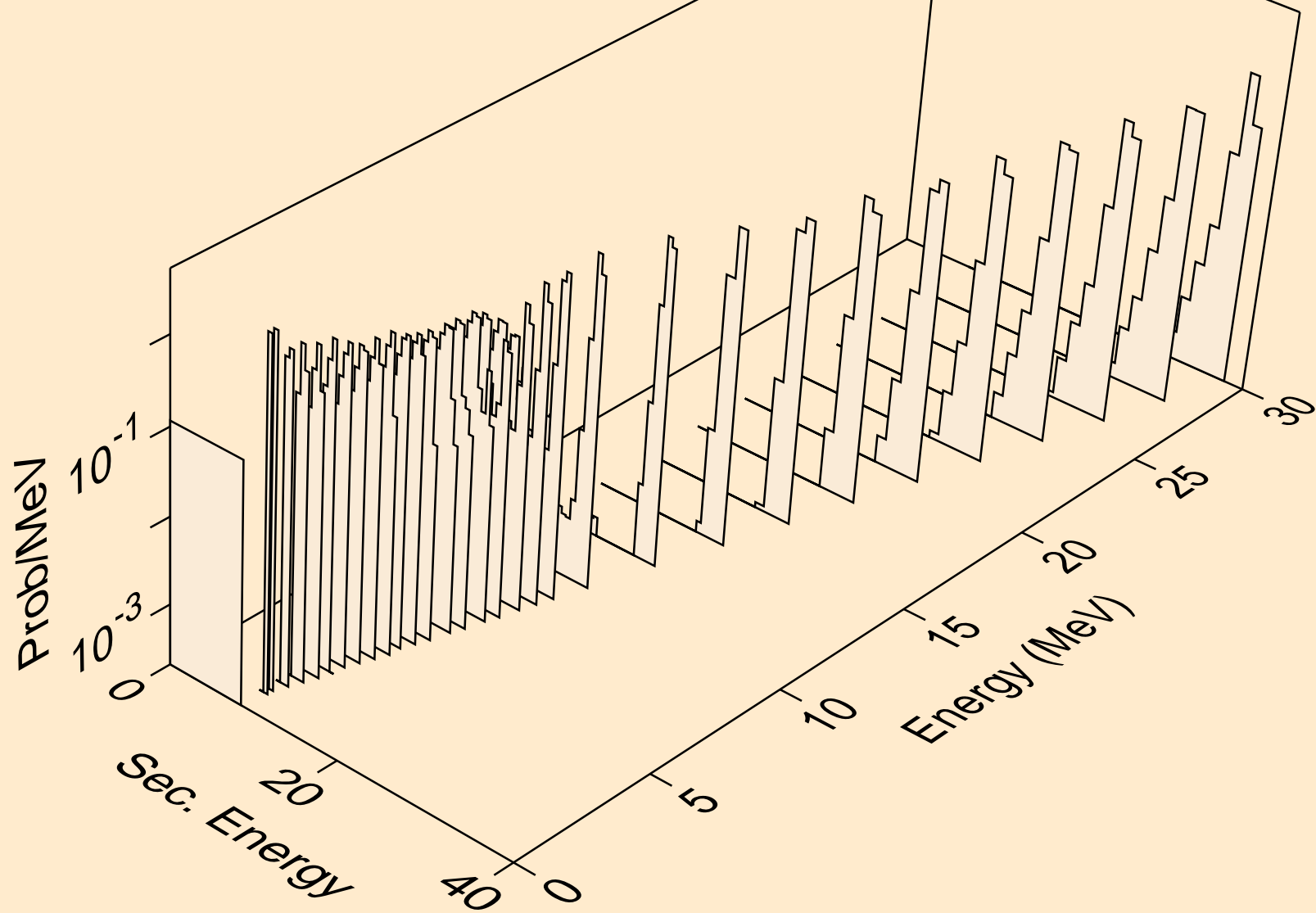

DB270 NEUTRON ACER TENDL-2021 LIBRARY; T=293.6K
alphas from (n,2n)a

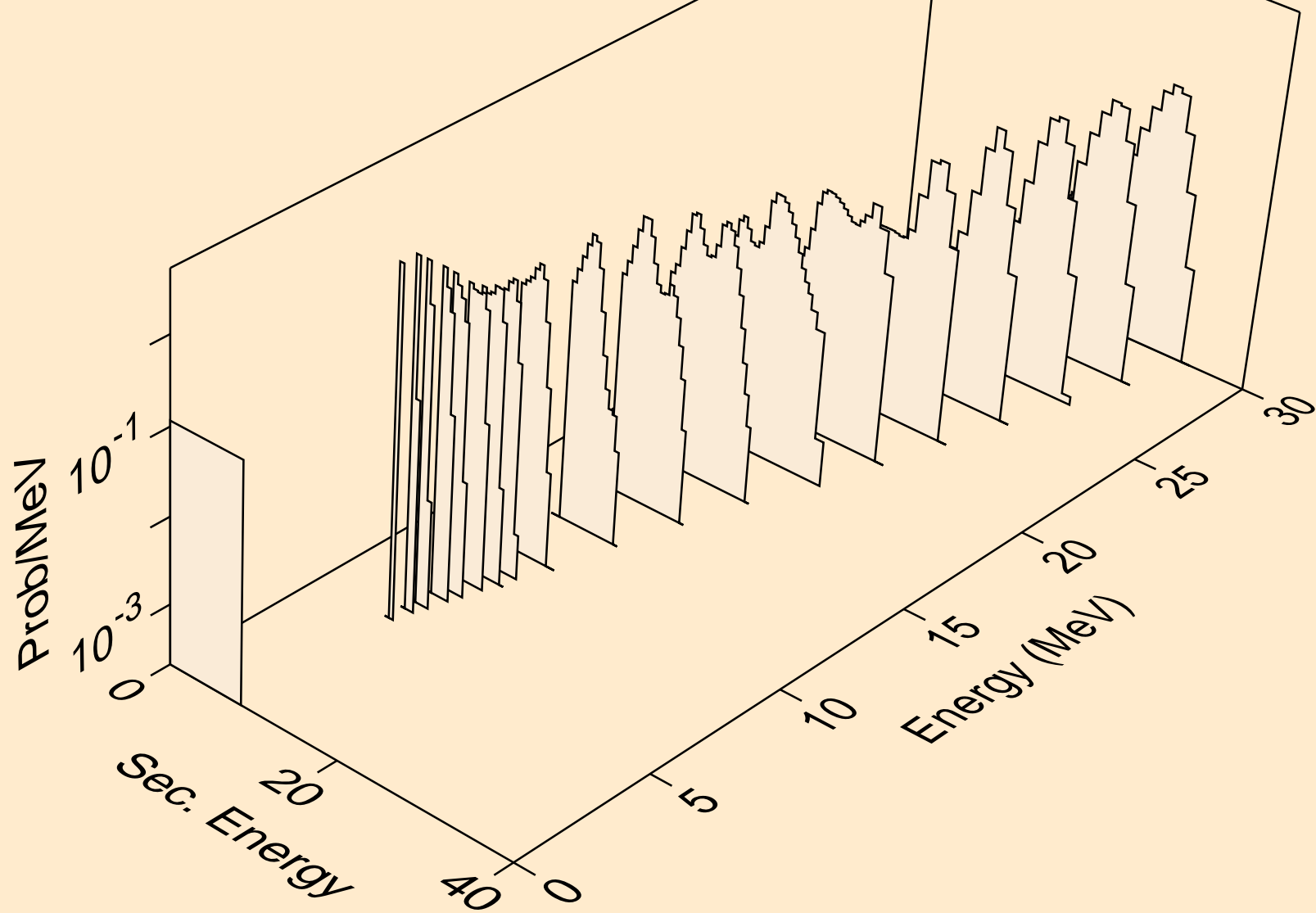

DB270 NEUTRON ACER TENDL-2021 LIBRARY; T=293.6K
alphas from (n,3n)a

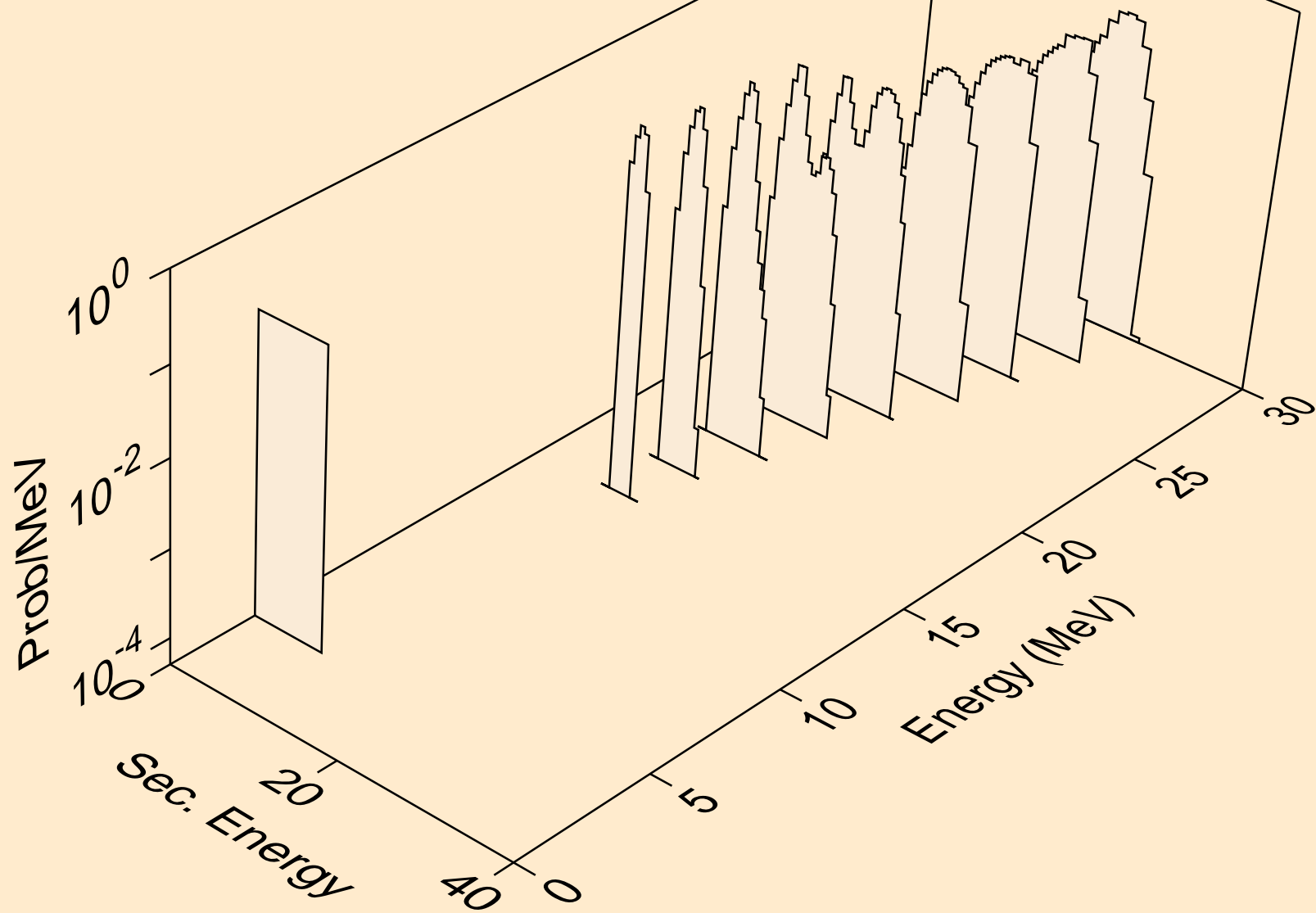

DB270 NEUTRON ACER TENDL-2021 LIBRARY; T=293.6K
alphas from (n,a)

