

DY145M NEUTRON ACER TENDL-2021 LIBRARY; T=293.6K
Principal cross sections

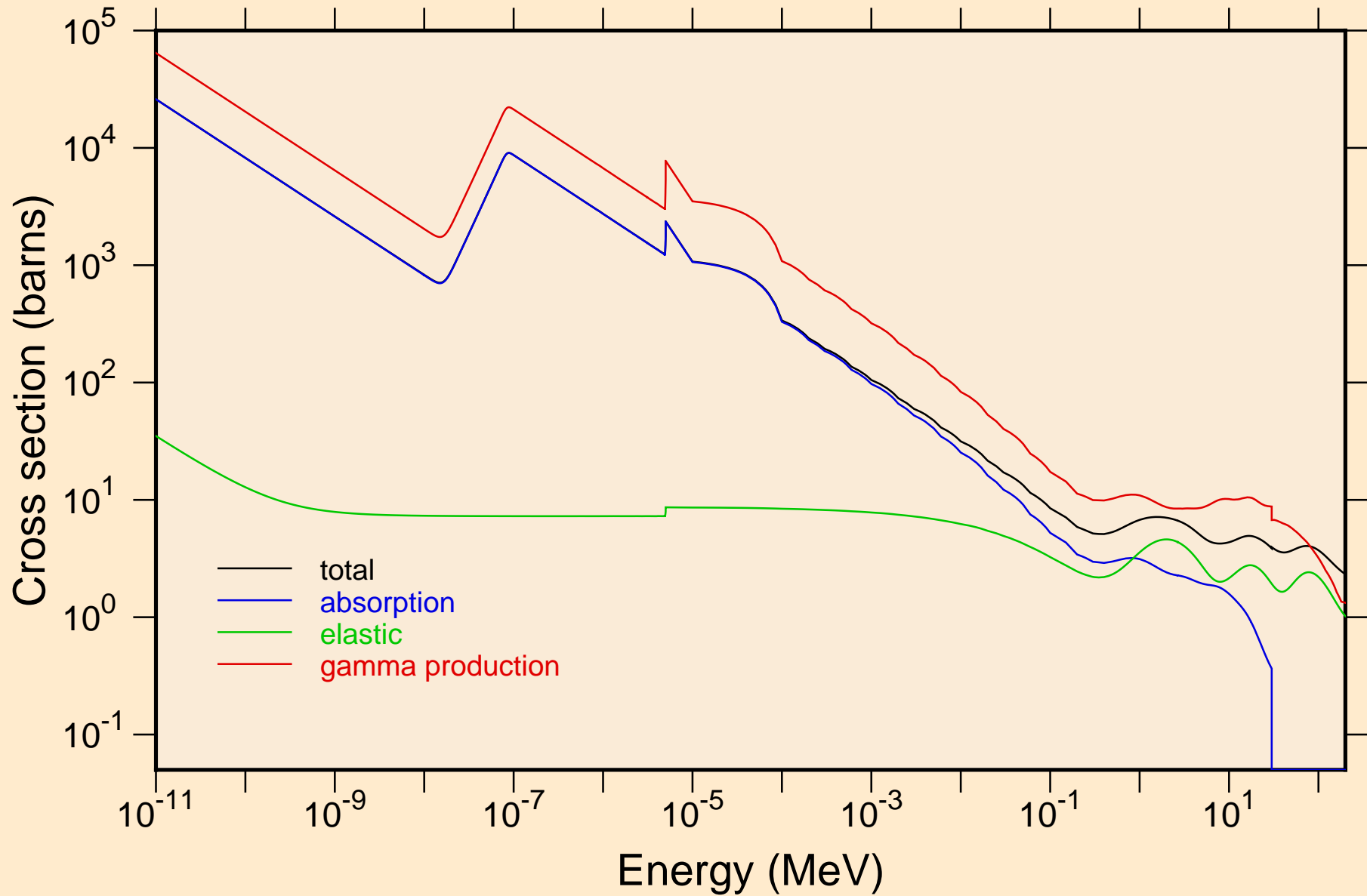

DY145M NEUTRON ACER TENDL-2021 LIBRARY; T=293.6K
Heating

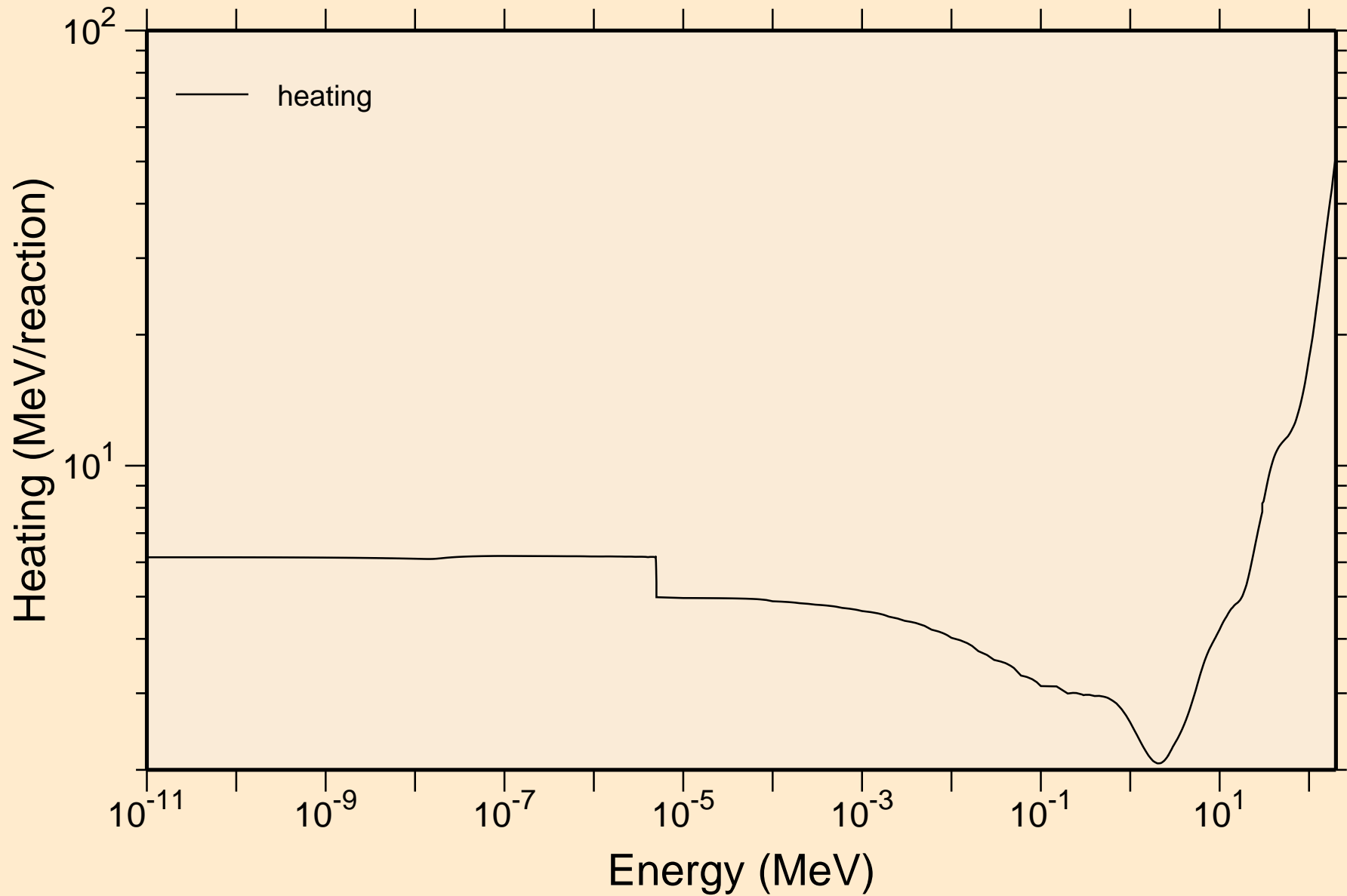

DY145M NEUTRON ACER TENDL-2021 LIBRARY; T=293.6K
Damage

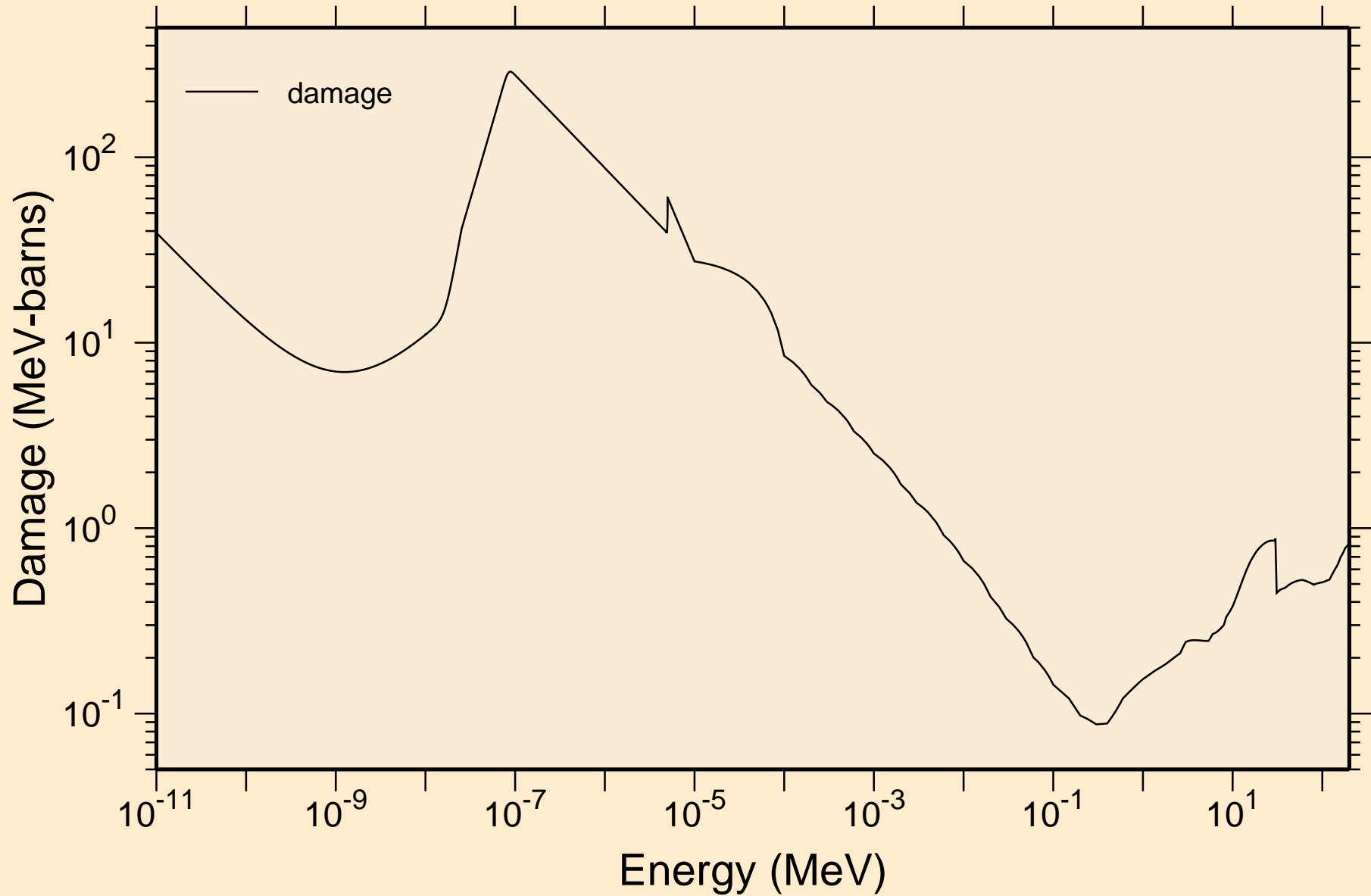

DY145M NEUTRON ACER TENDL-2021 LIBRARY; T=293.6K
Non-threshold reactions

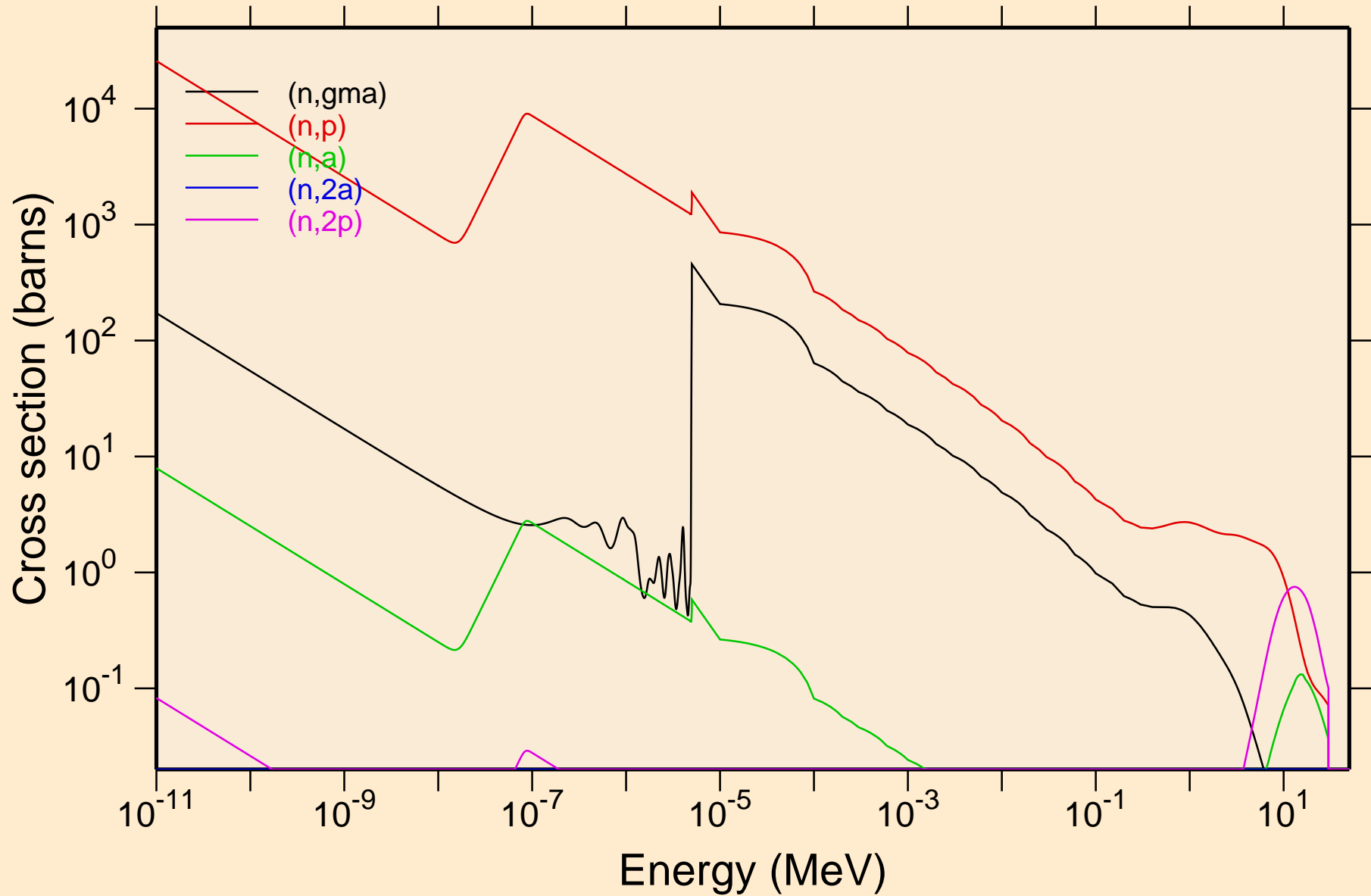

DY145M NEUTRON ACER TENDL-2021 LIBRARY; T=293.6K
Non-threshold reactions

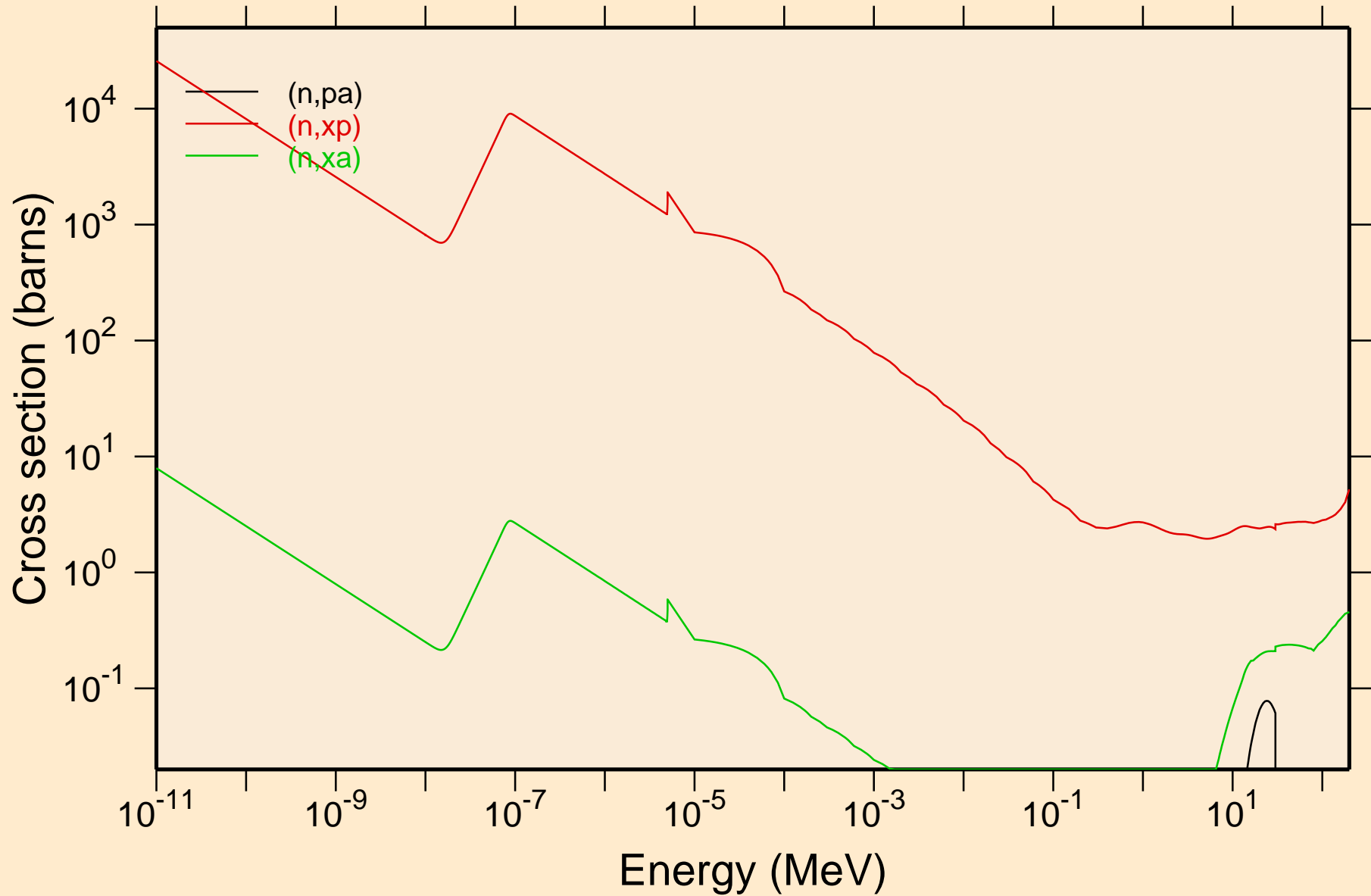

DY145M NEUTRON ACER TENDL-2021 LIBRARY; T=293.6K
Principal cross sections

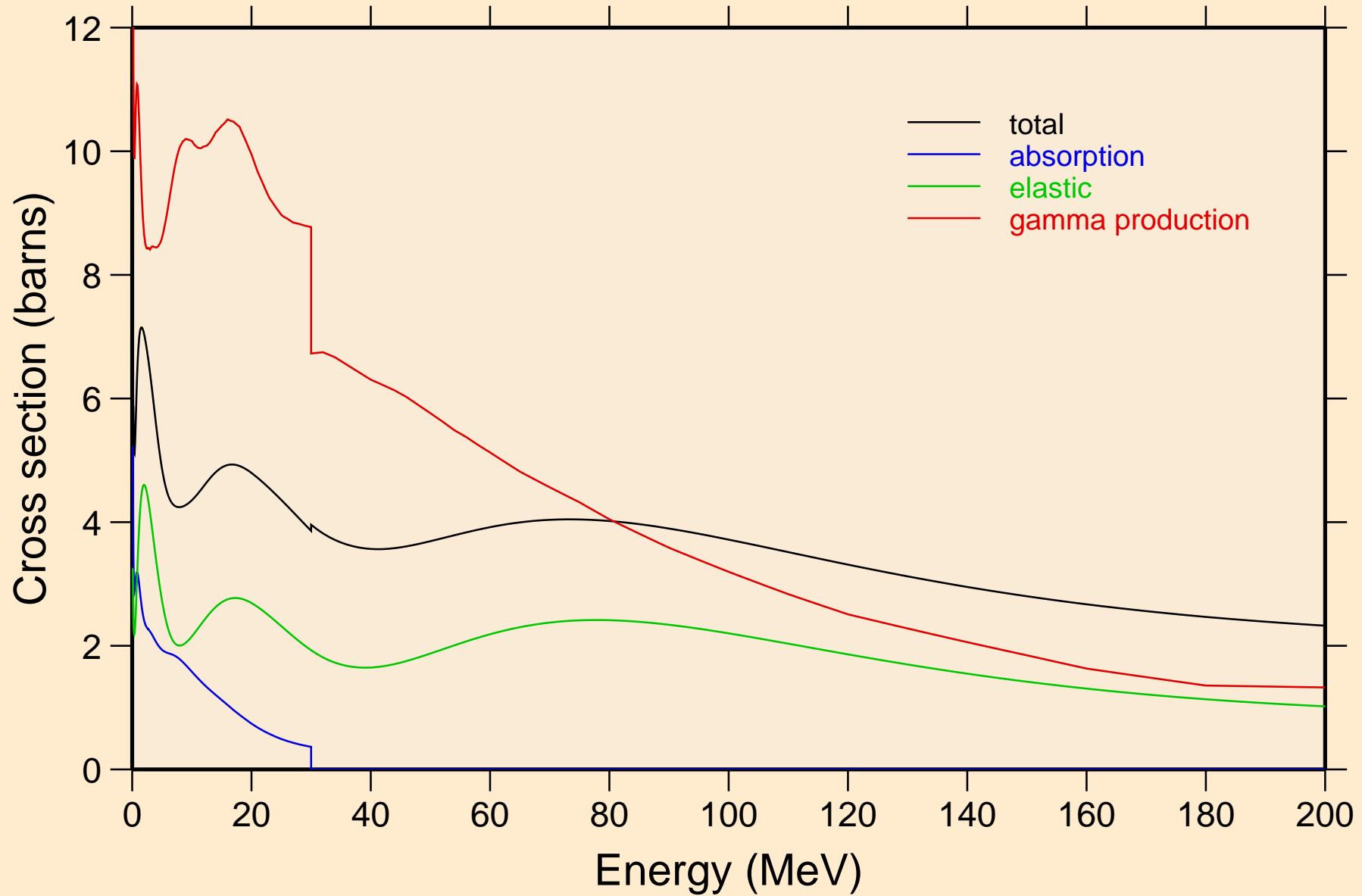

DY145M NEUTRON ACER TENDL-2021 LIBRARY; T=293.6K
Heating

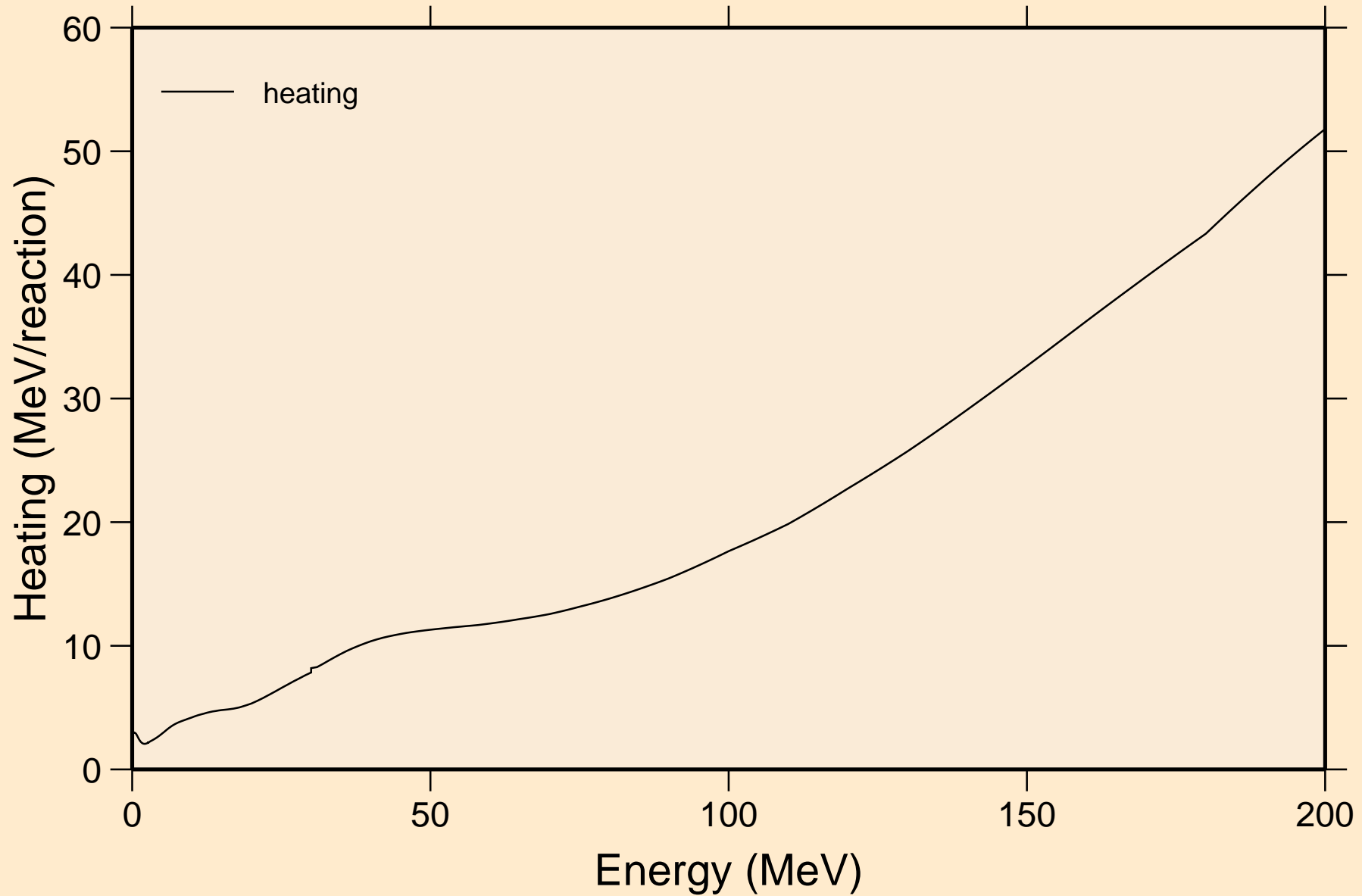

DY145M NEUTRON ACER TENDL-2021 LIBRARY; T=293.6K
Damage

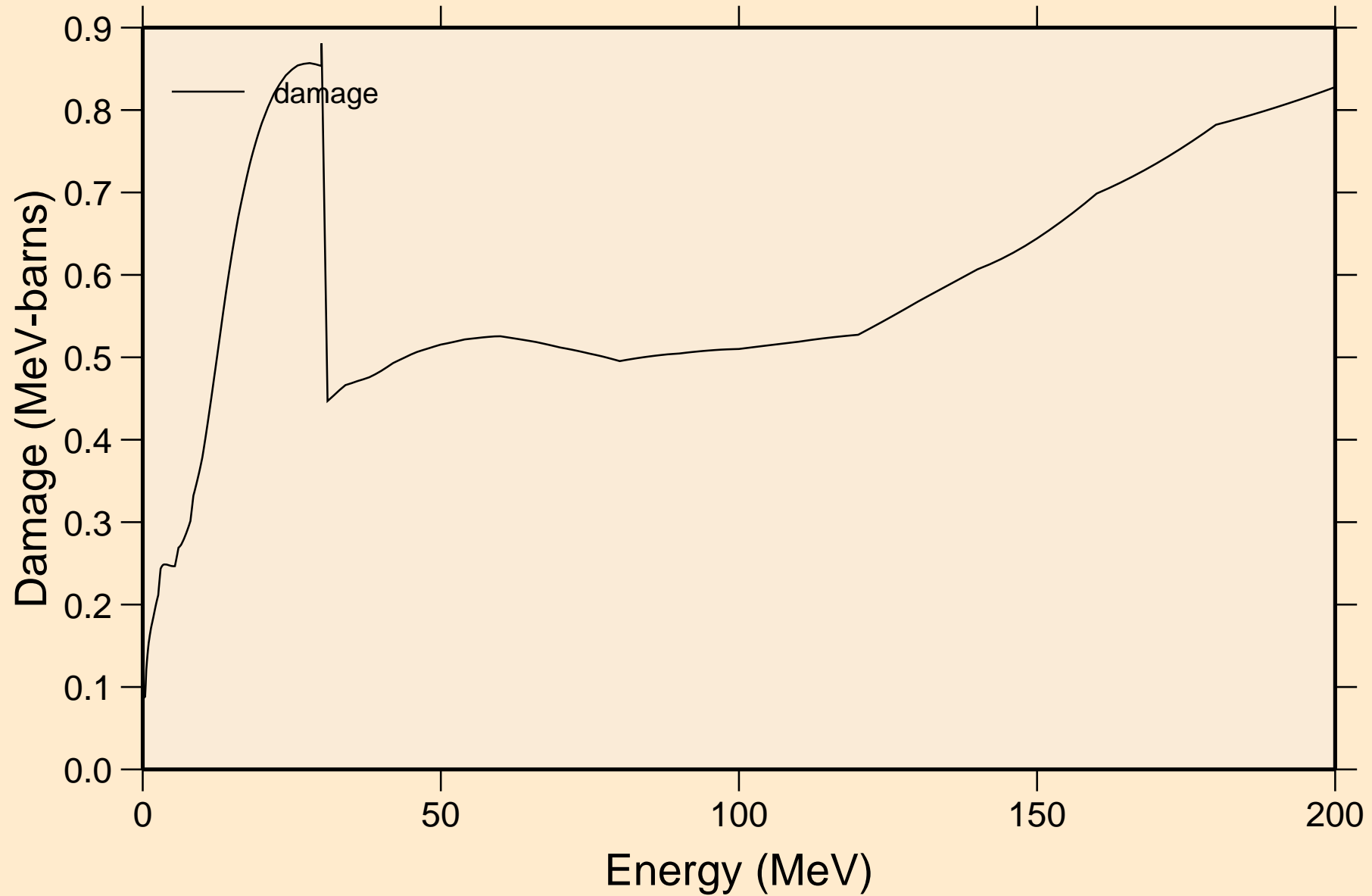

DY145M NEUTRON ACER TENDL-2021 LIBRARY; T=293.6K
Non-threshold reactions

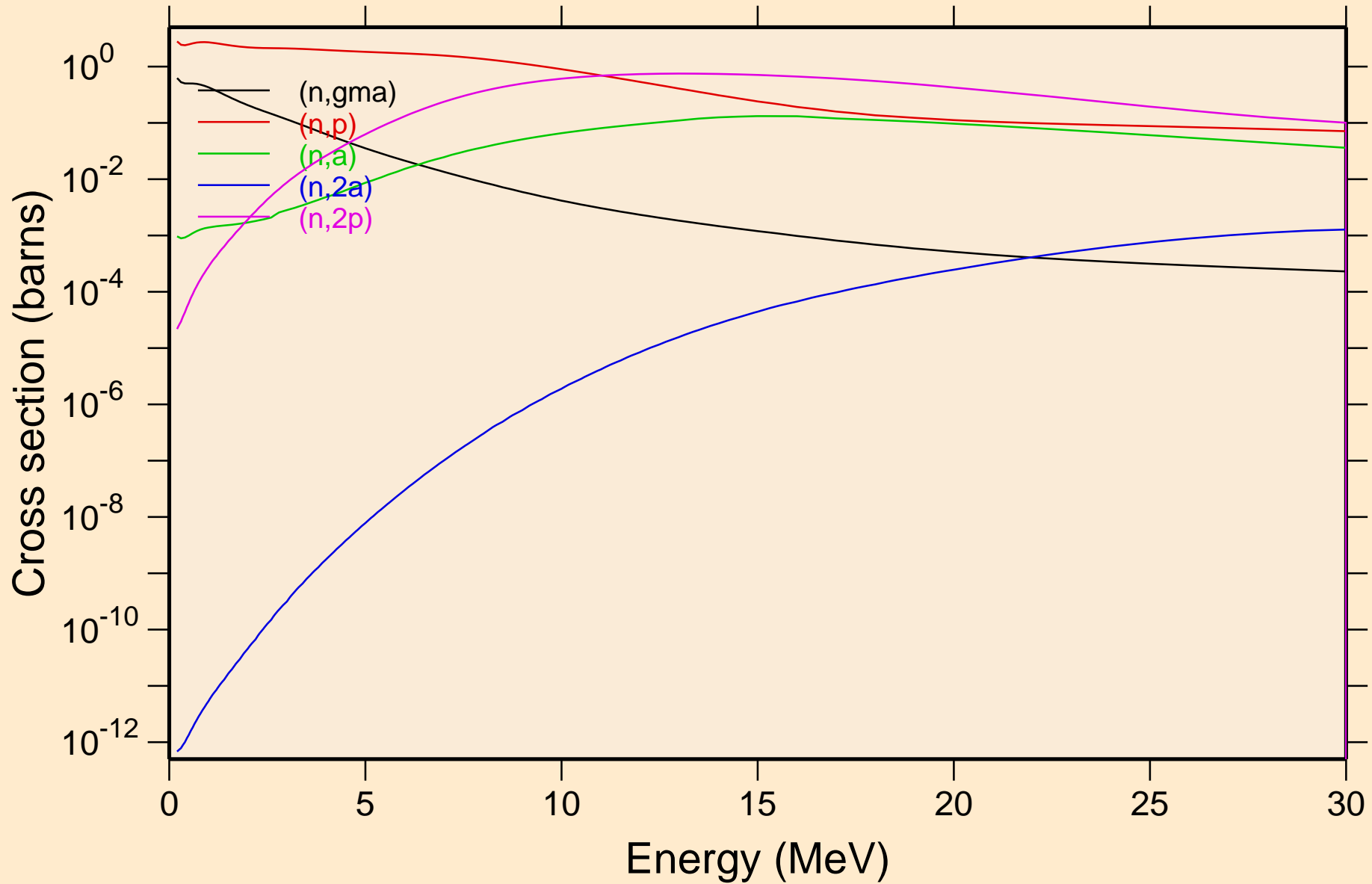

DY145M NEUTRON ACER TENDL-2021 LIBRARY; T=293.6K
Non-threshold reactions

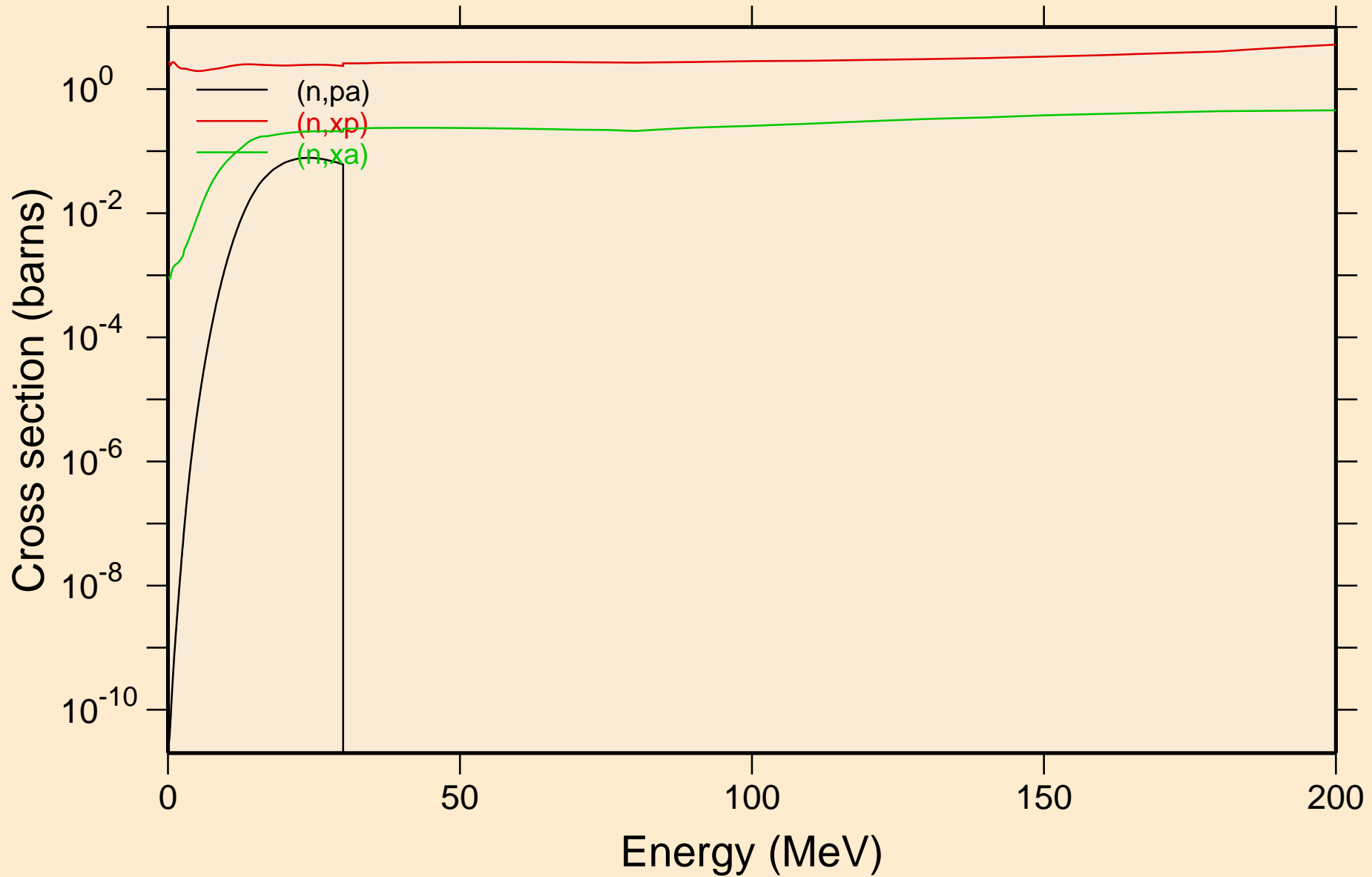

DY145M NEUTRON ACER TENDL-2021 LIBRARY; T=293.6K
Inelastic levels

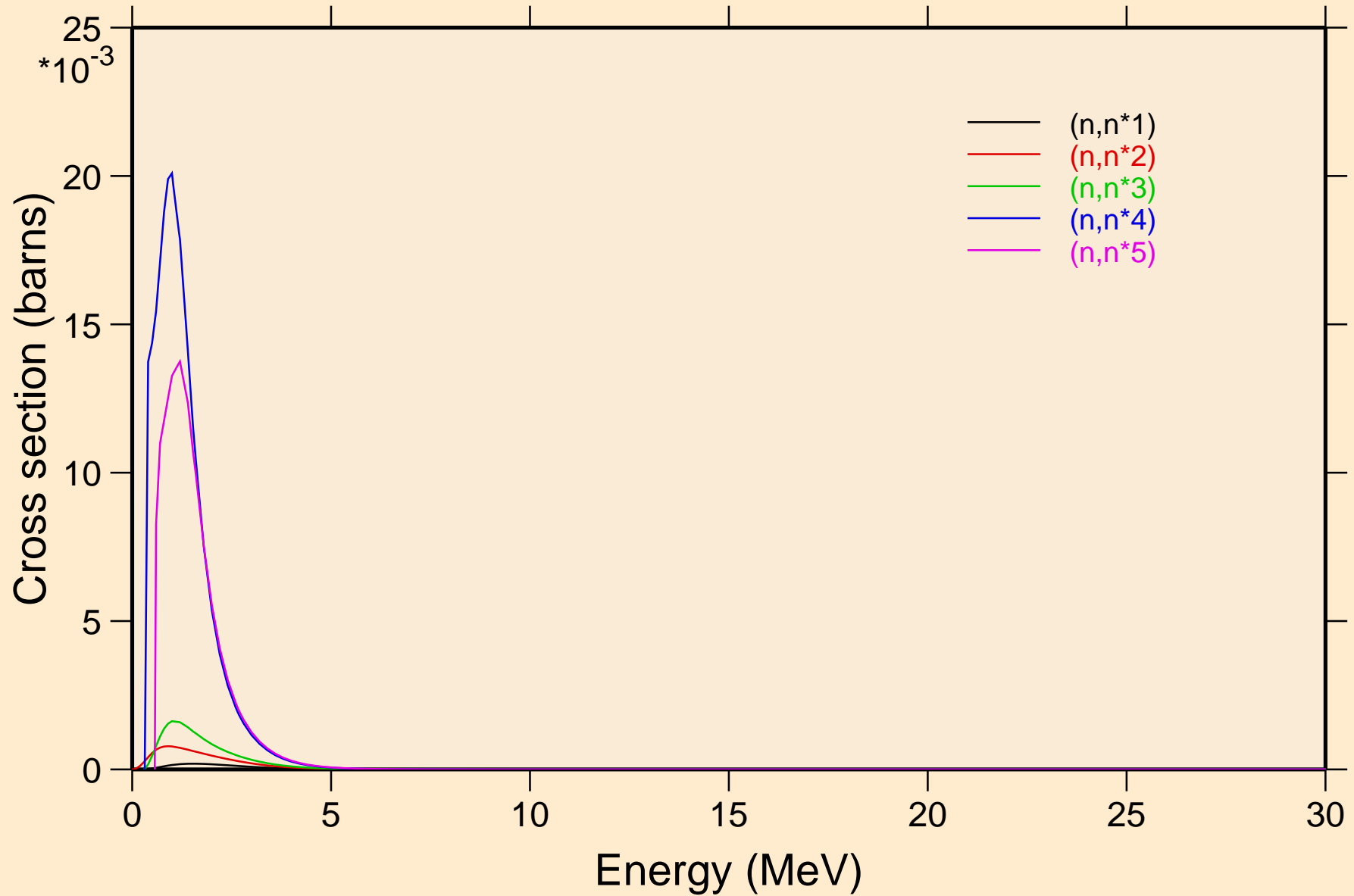

DY145M NEUTRON ACER TENDL-2021 LIBRARY; T=293.6K
Inelastic levels

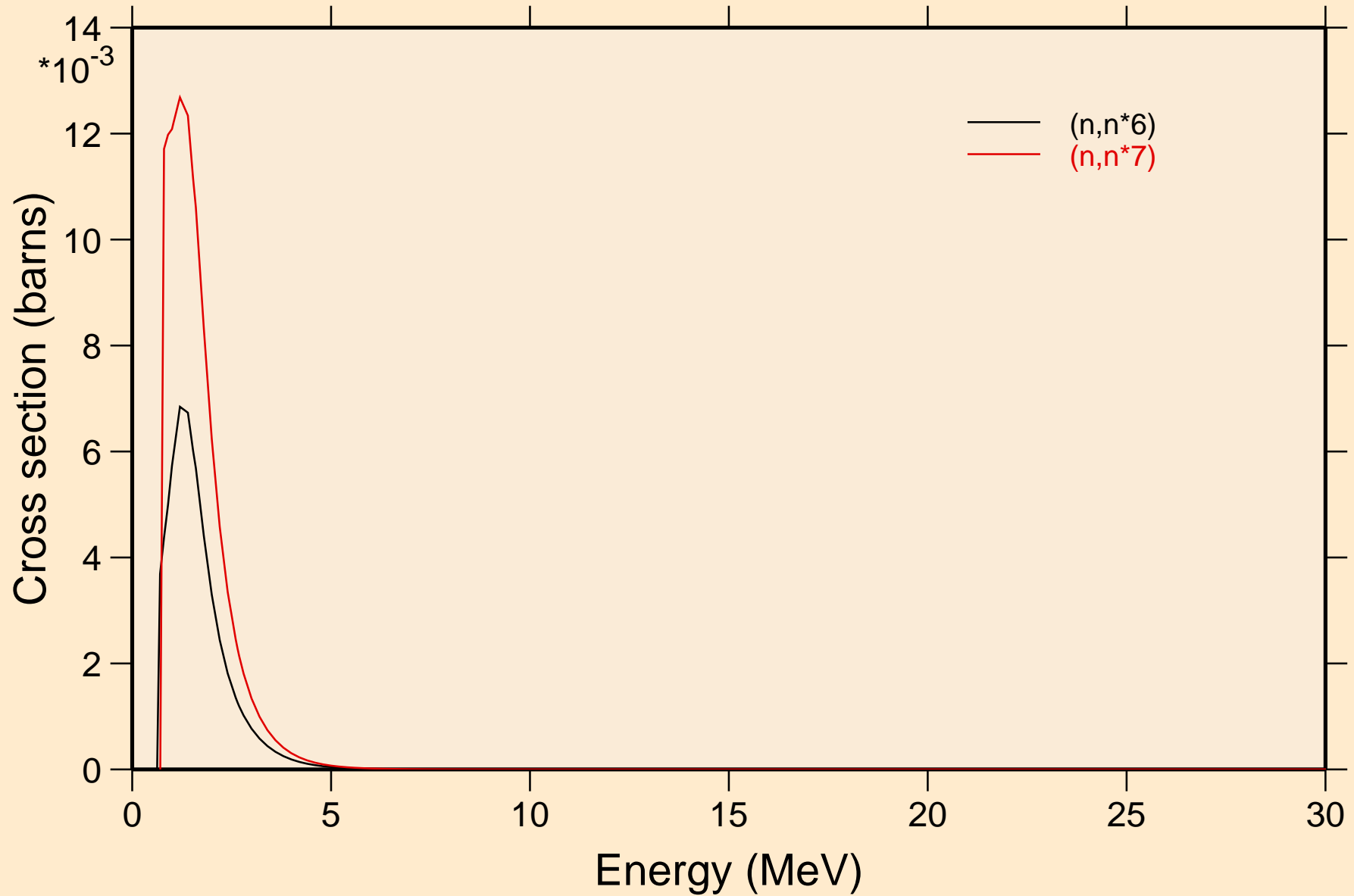

DY145M NEUTRON ACER TENDL-2021 LIBRARY; T=293.6K
Threshold reactions

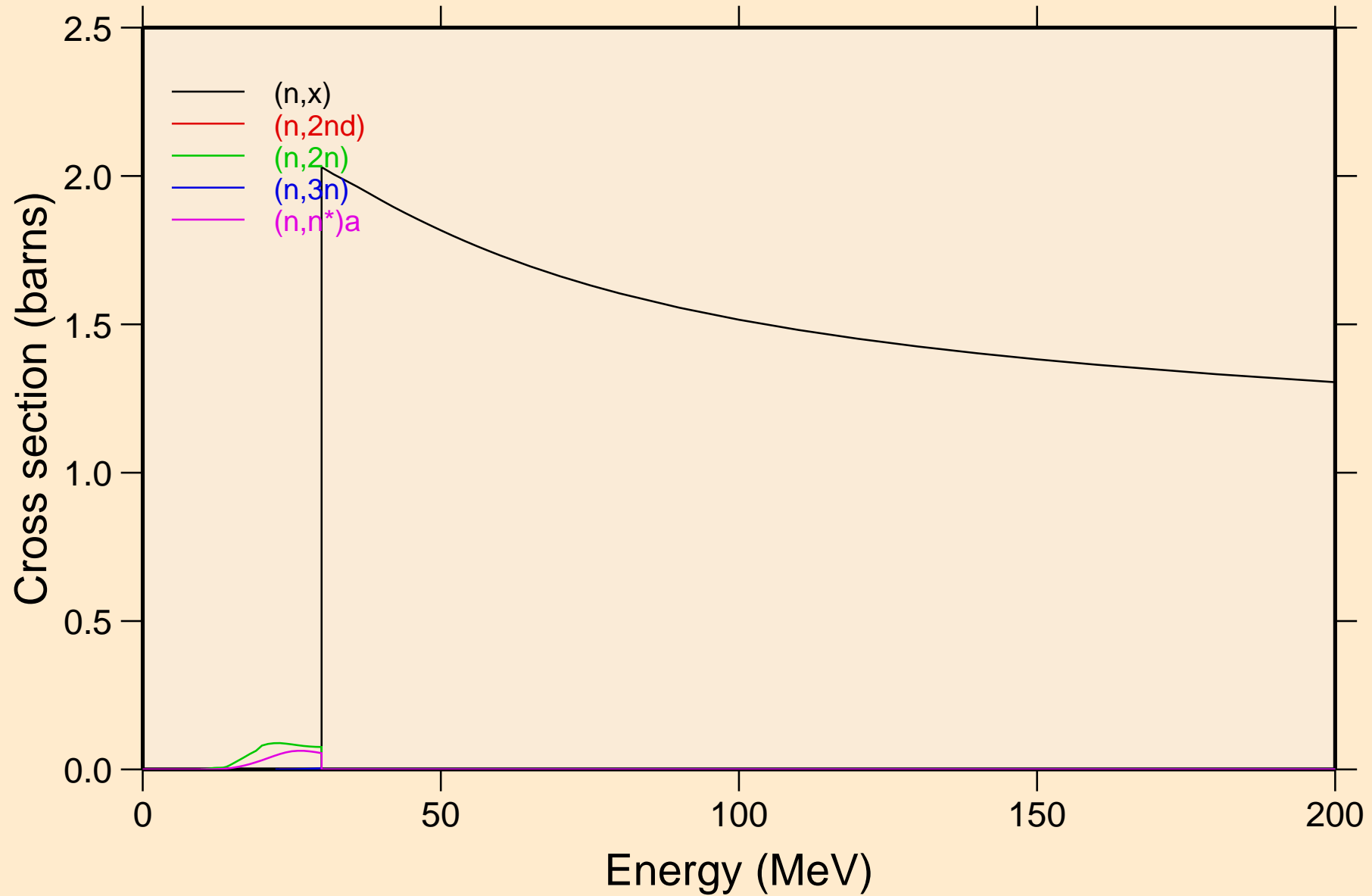

DY145M NEUTRON ACER TENDL-2021 LIBRARY; T=293.6K
Threshold reactions

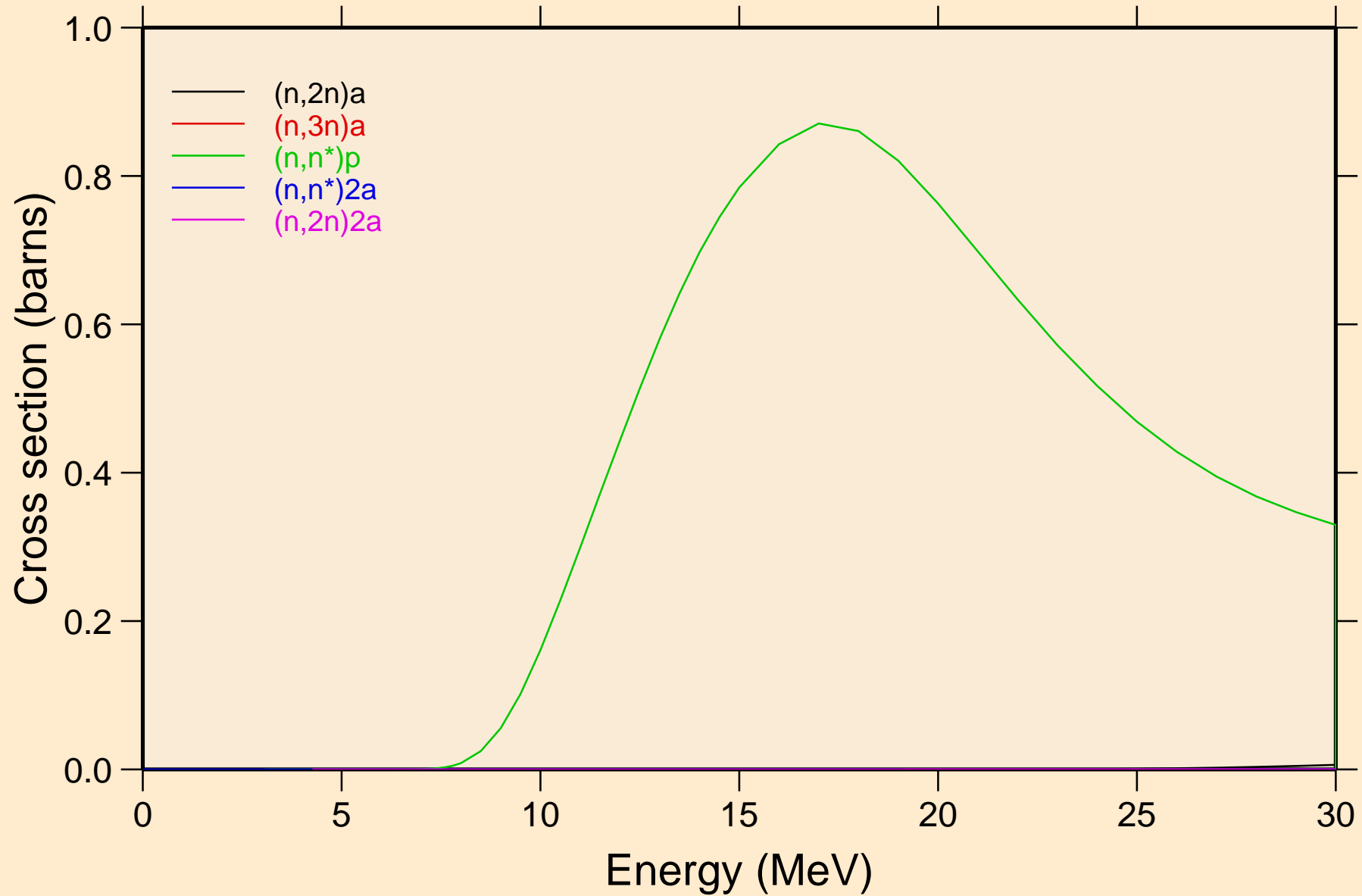

DY145M NEUTRON ACER TENDL-2021 LIBRARY; T=293.6K
Threshold reactions

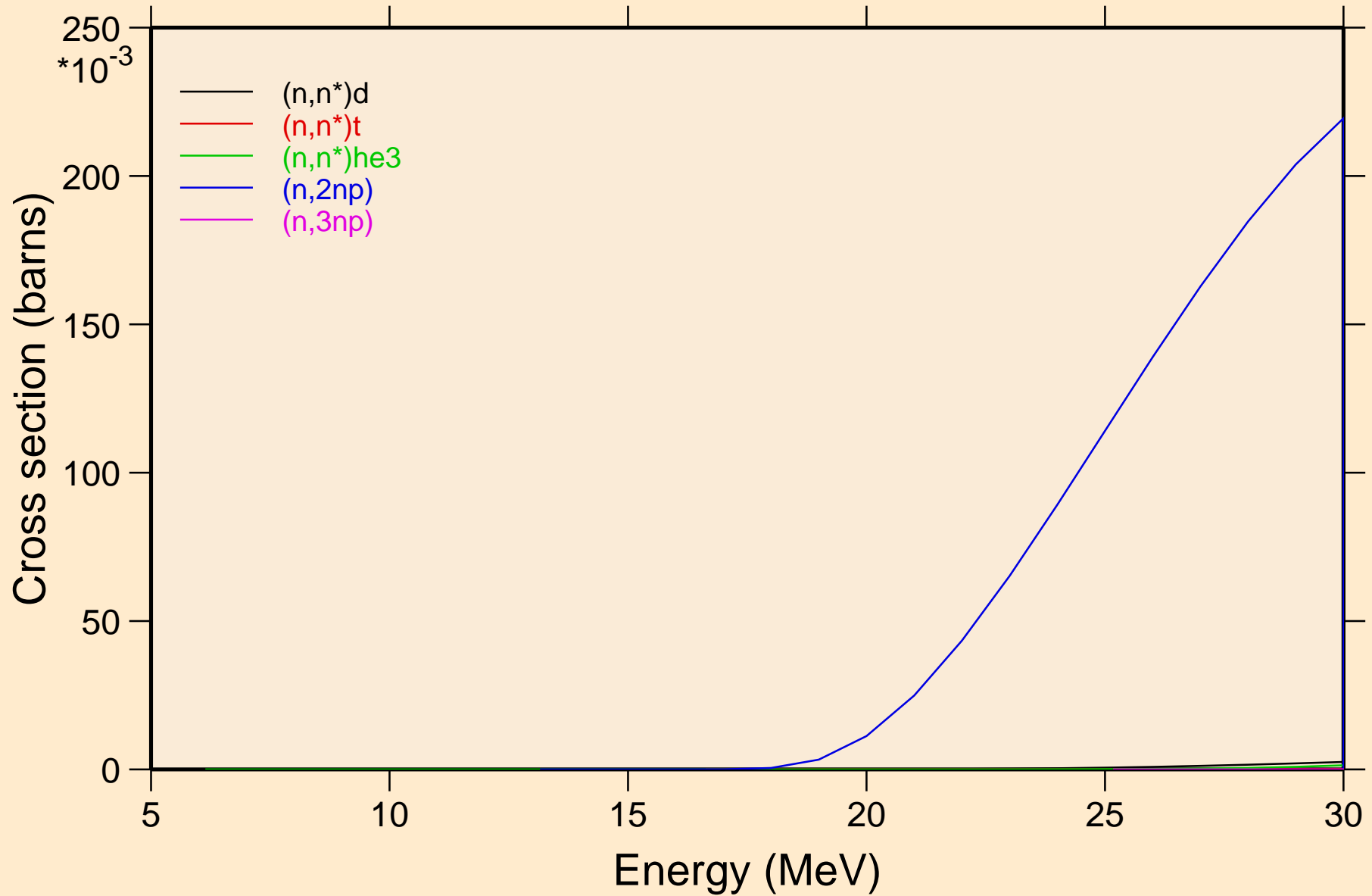

DY145M NEUTRON ACER TENDL-2021 LIBRARY; T=293.6K
Threshold reactions

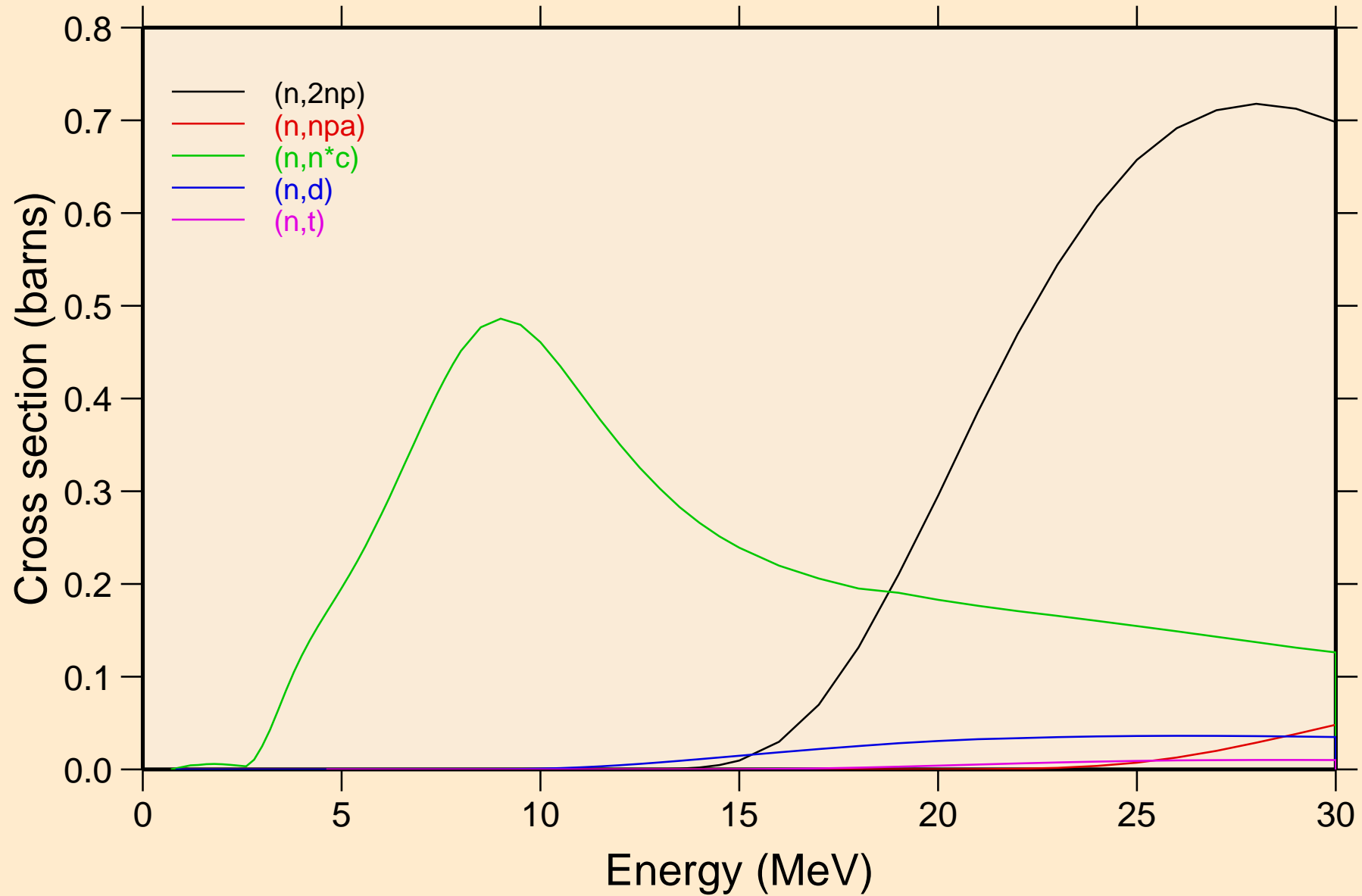

DY145M NEUTRON ACER TENDL-2021 LIBRARY; T=293.6K
Threshold reactions

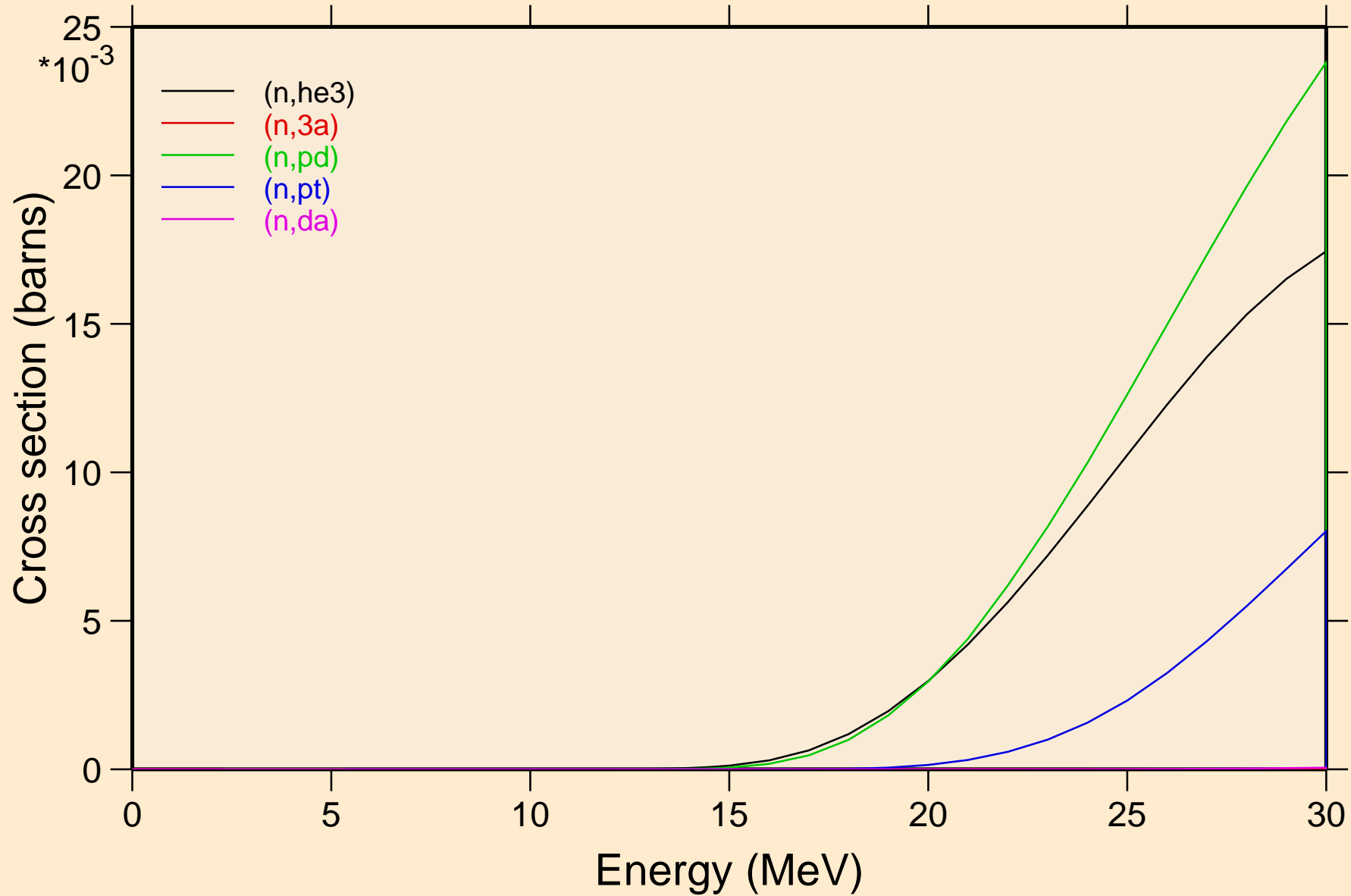

DY145M NEUTRON ACER TENDL-2021 LIBRARY; T=293.6K
Threshold reactions

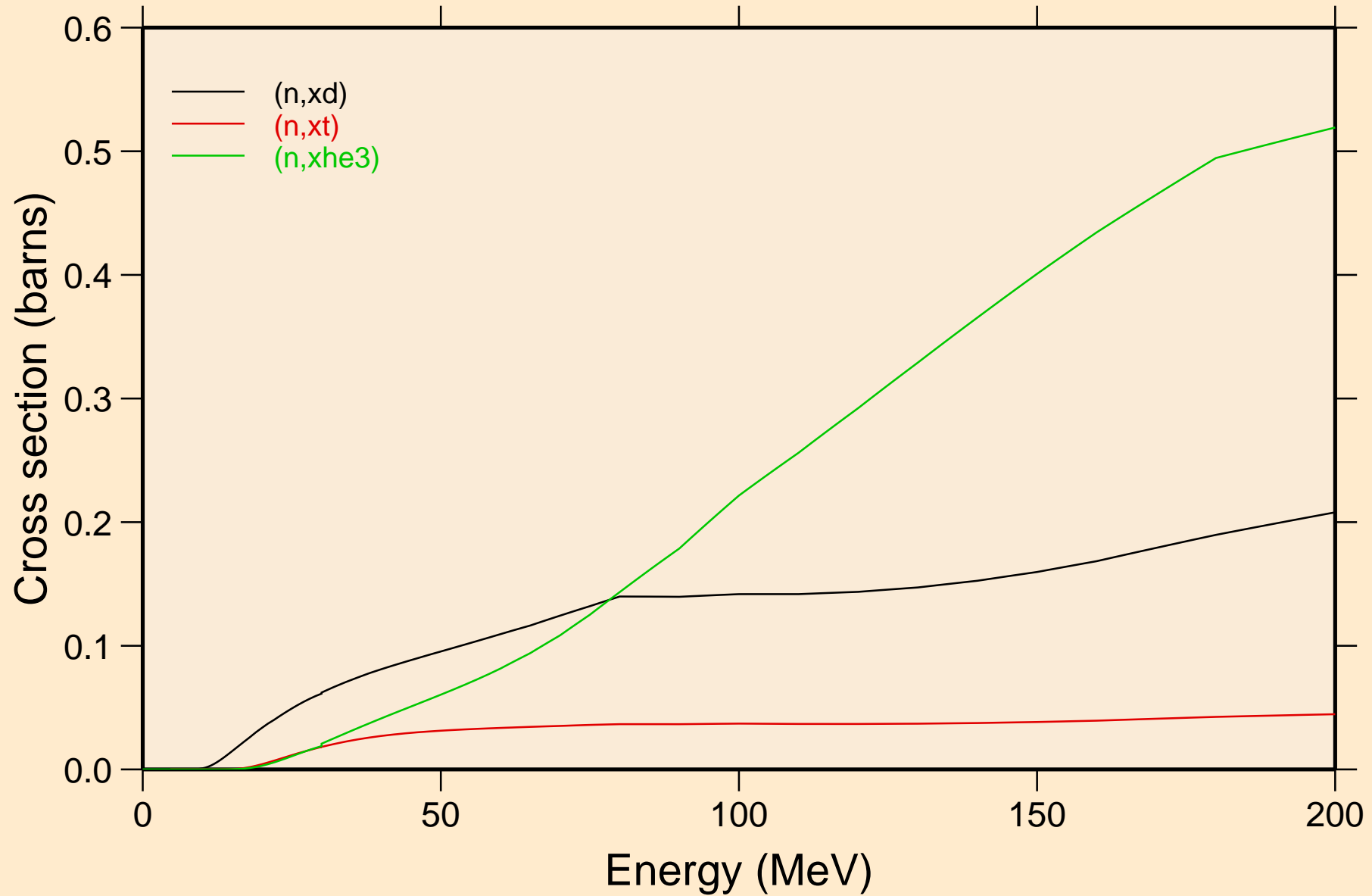

DY145M NEUTRON ACER TENDL-2021 LIBRARY; T=293.6K
angular distribution for elastic

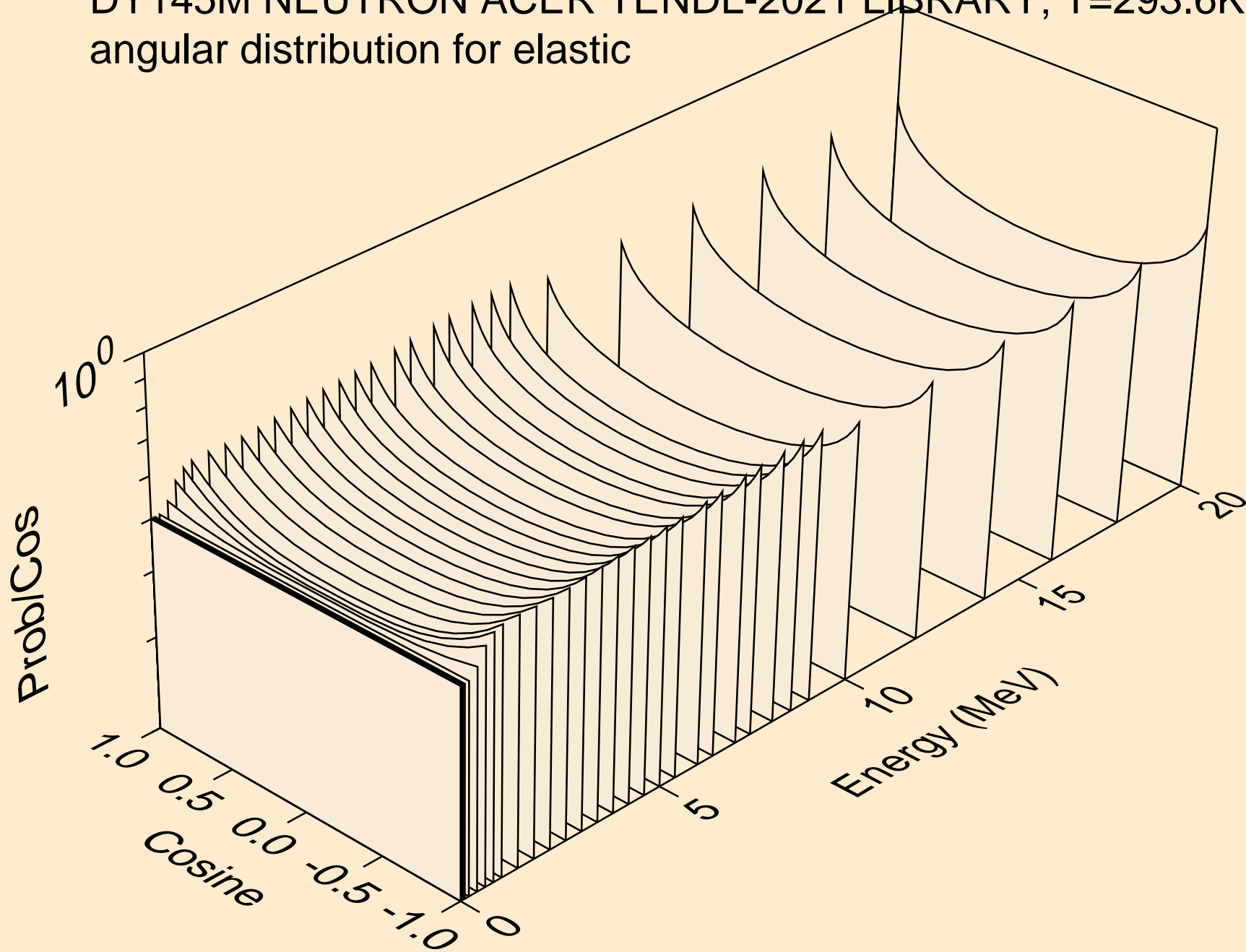

DY145M NEUTRON ACER TENDL-2021 LIBRARY; T=293.6K
angular distribution for elastic

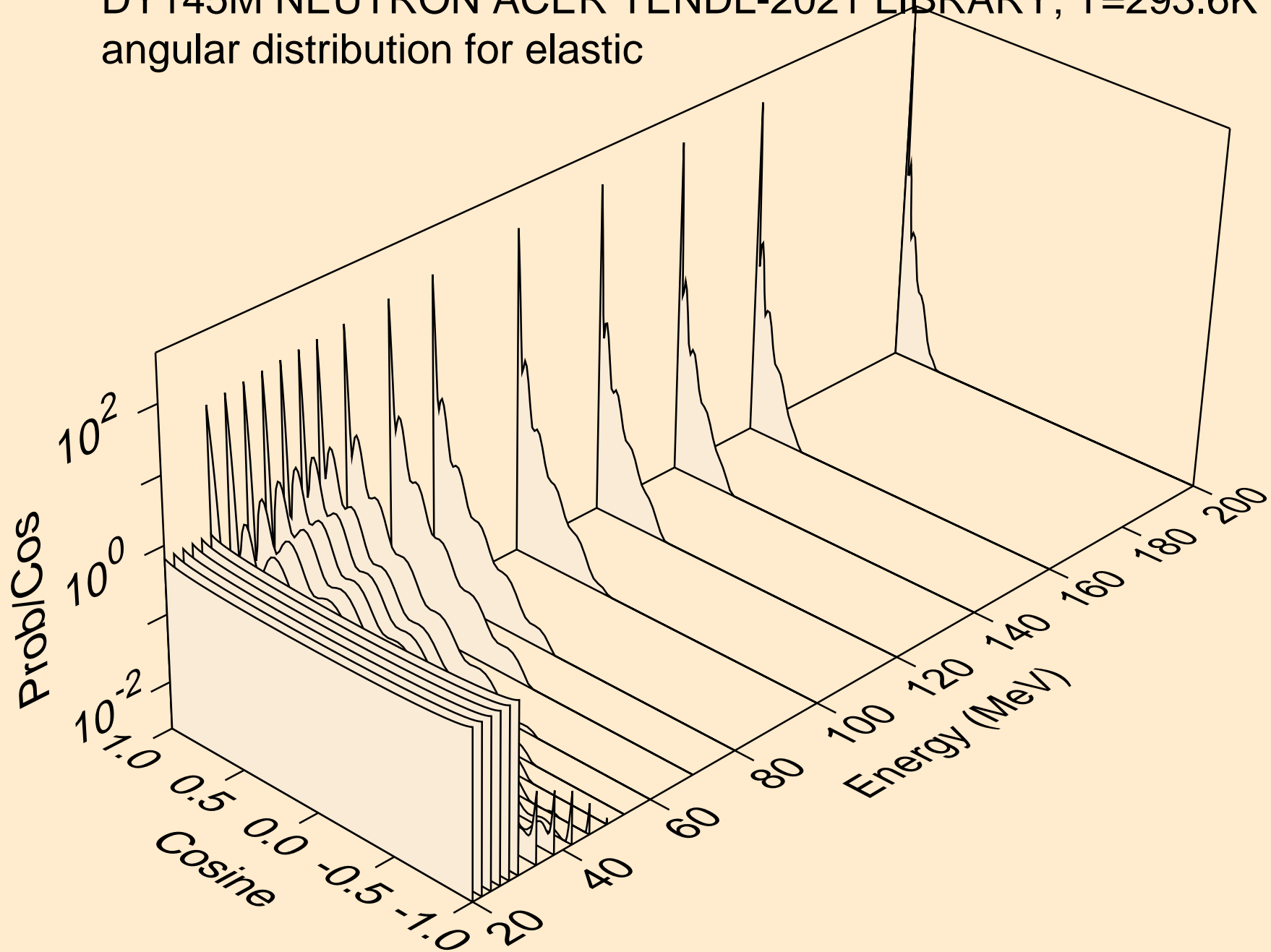

DY145M NEUTRON ACER TENDL-2021 LIBRARY; T=293.6K
angular distribution for (n,n*1)

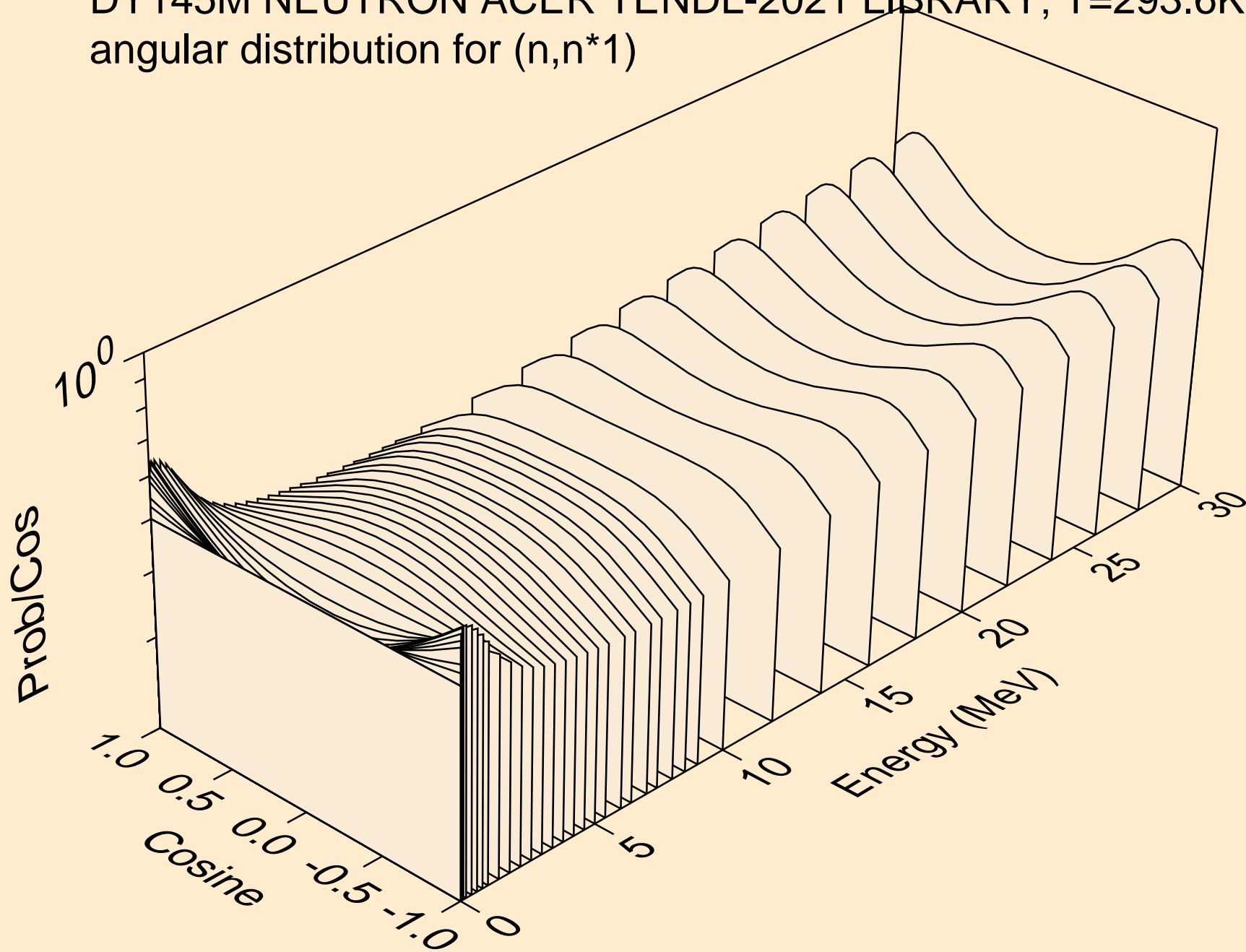

DY145M NEUTRON ACER TENDL-2021 LIBRARY; T=293.6K
angular distribution for (n,n*2)

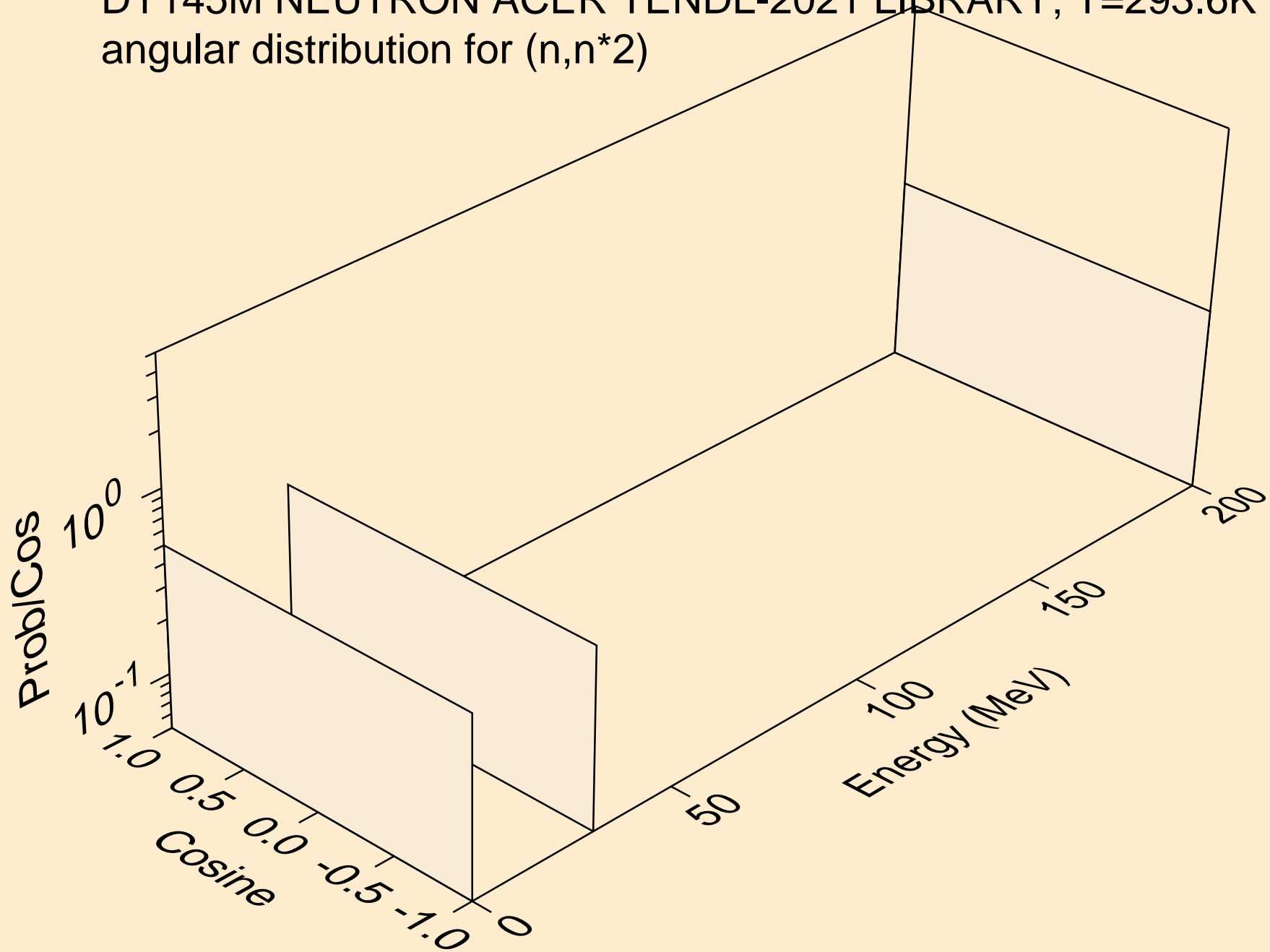

DY145M NEUTRON ACER TENDL-2021 LIBRARY; T=293.6K
angular distribution for (n,n*3)

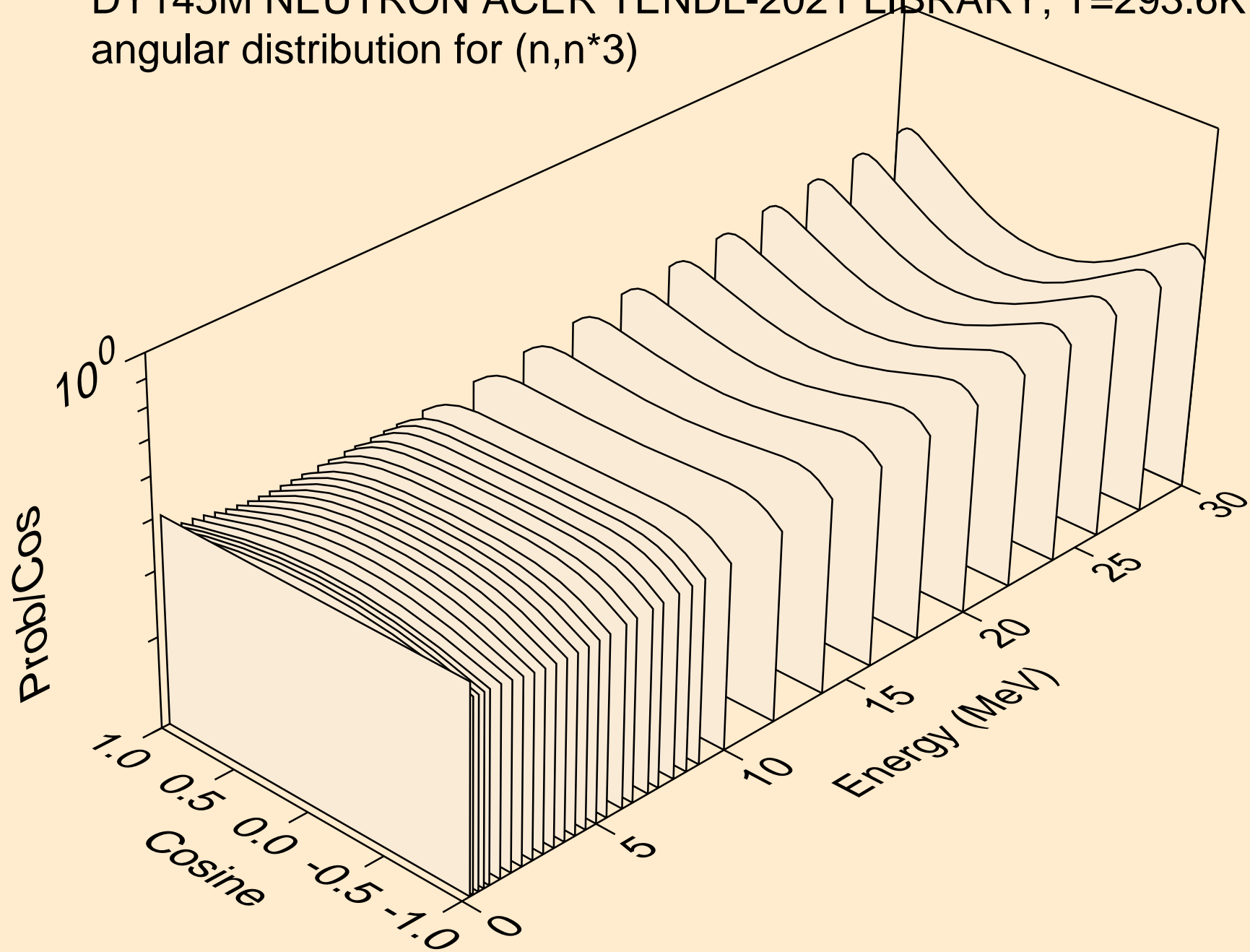

DY145M NEUTRON ACER TENDL-2021 LIBRARY; T=293.6K
angular distribution for (n,n*4)

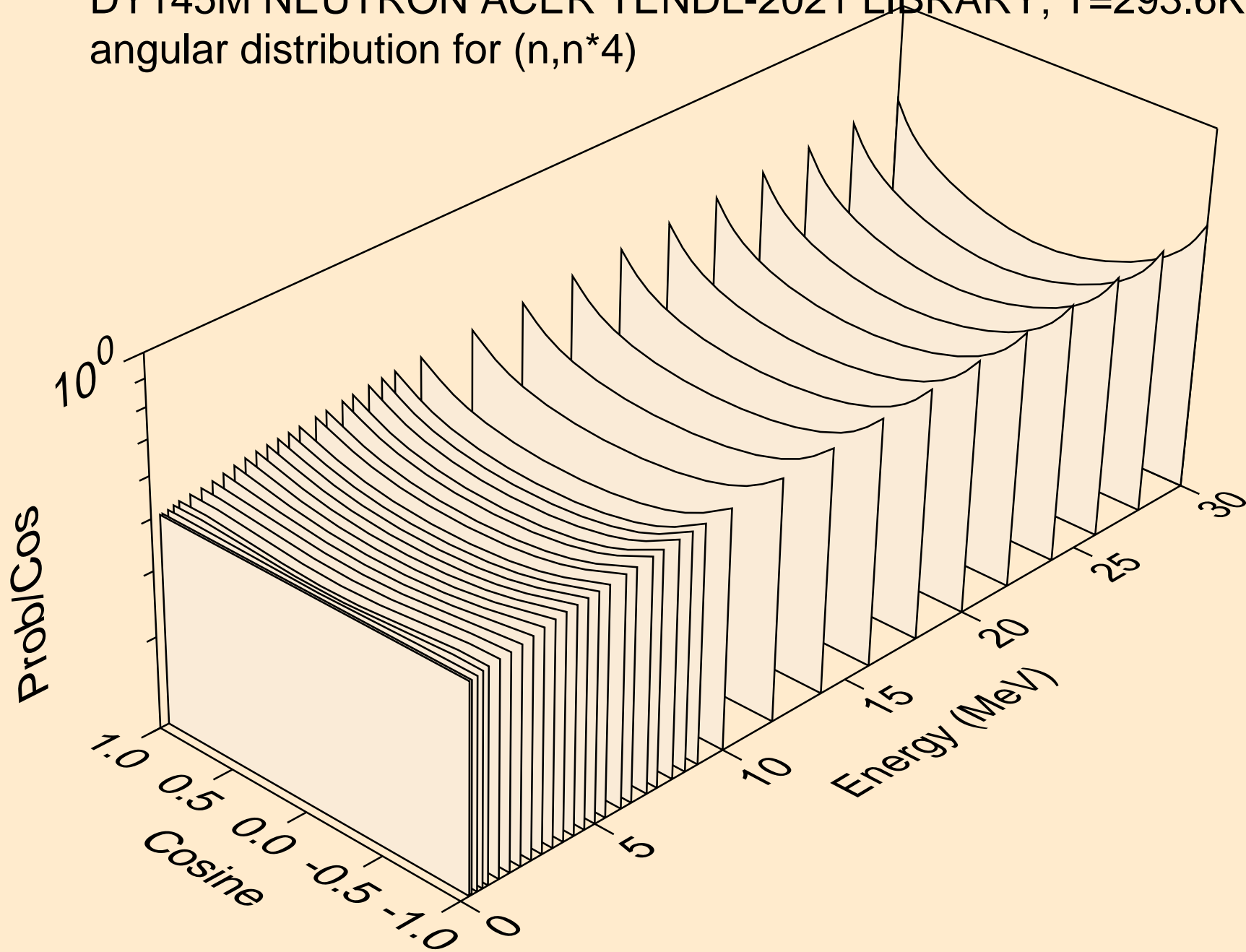

DY145M NEUTRON ACER TENDL-2021 LIBRARY; T=293.6K
angular distribution for (n,n*5)

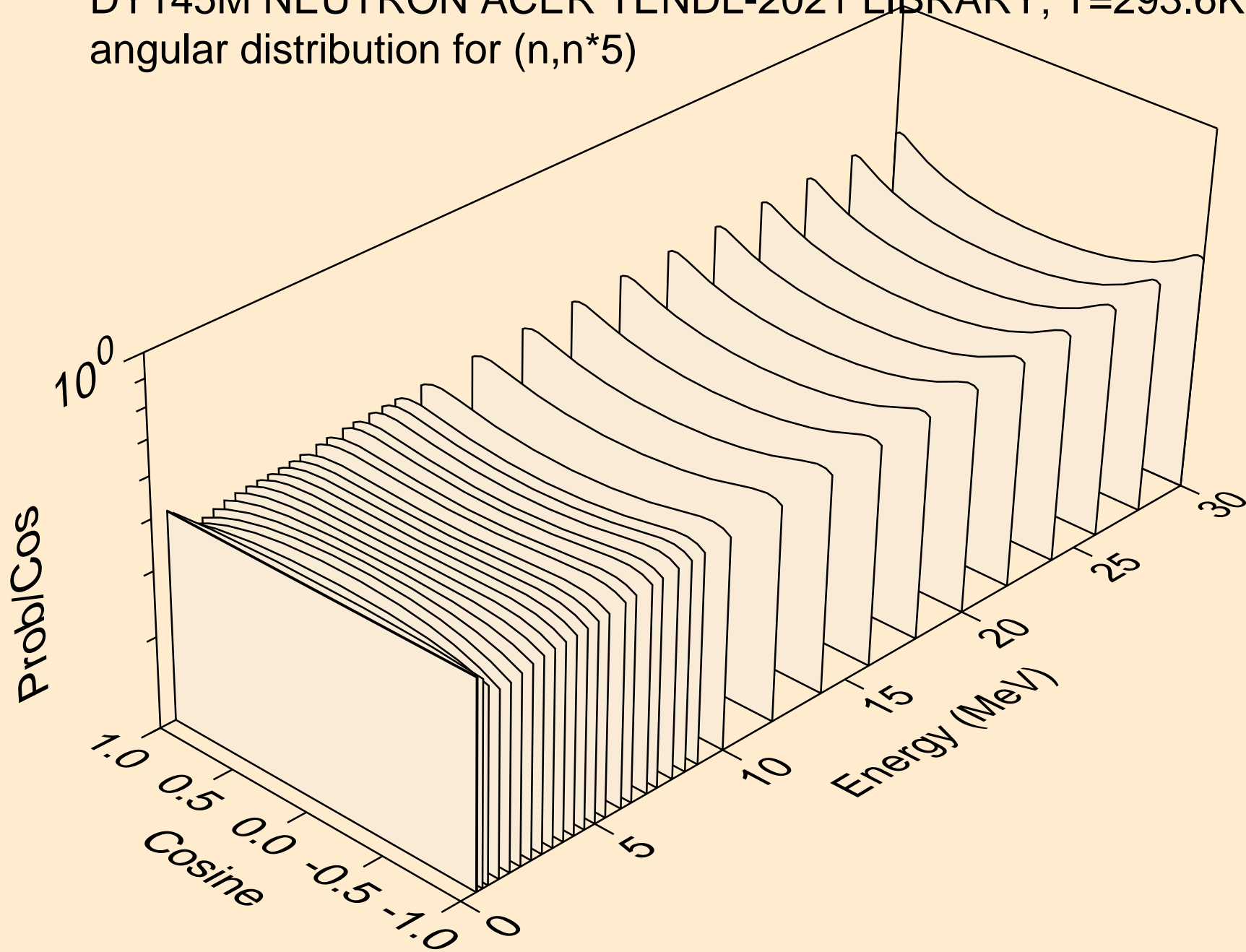

DY145M NEUTRON ACER TENDL-2021 LIBRARY; T=293.6K
angular distribution for (n,n*6)

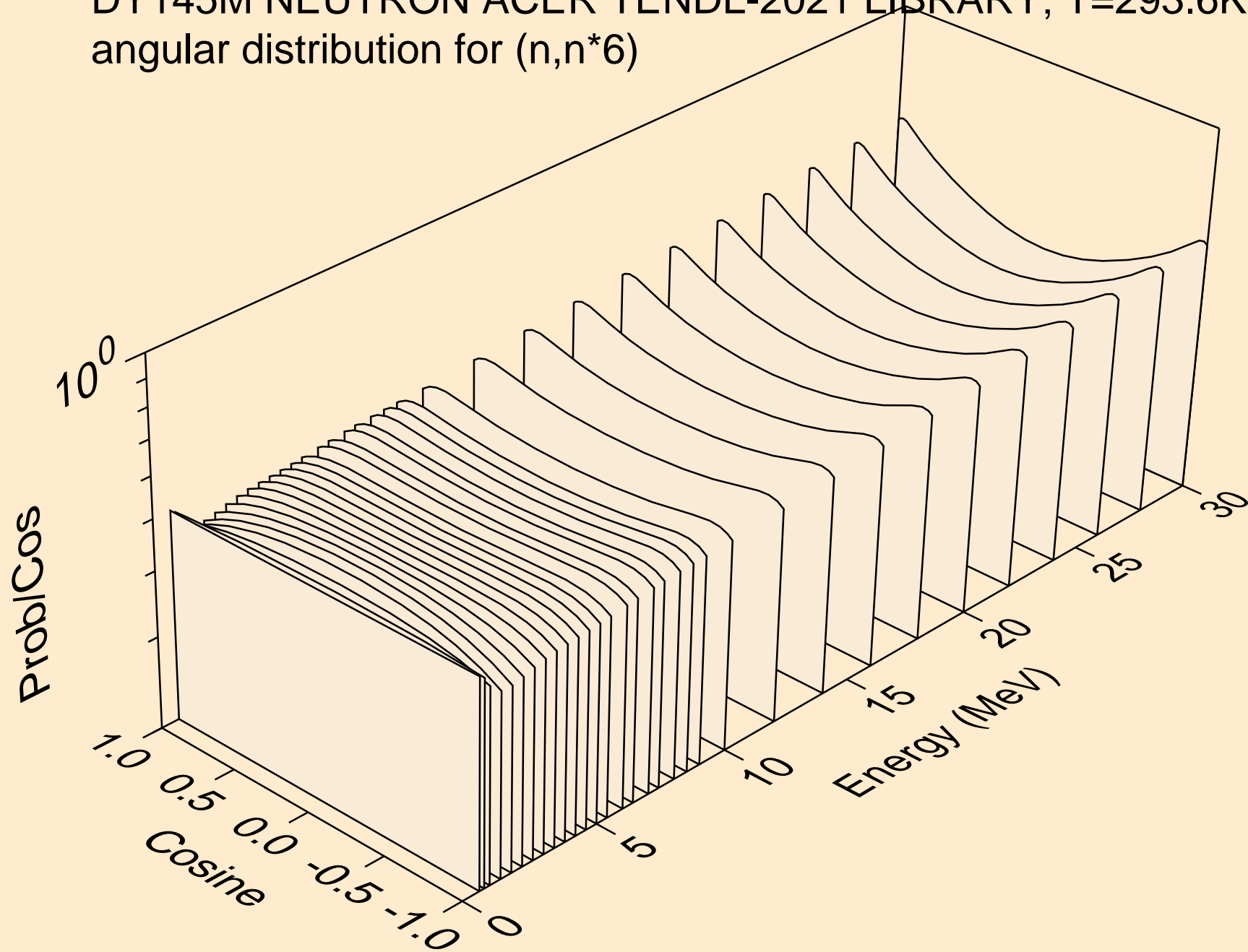

DY145M NEUTRON ACER TENDL-2021 LIBRARY; T=293.6K
angular distribution for (n,n*7)

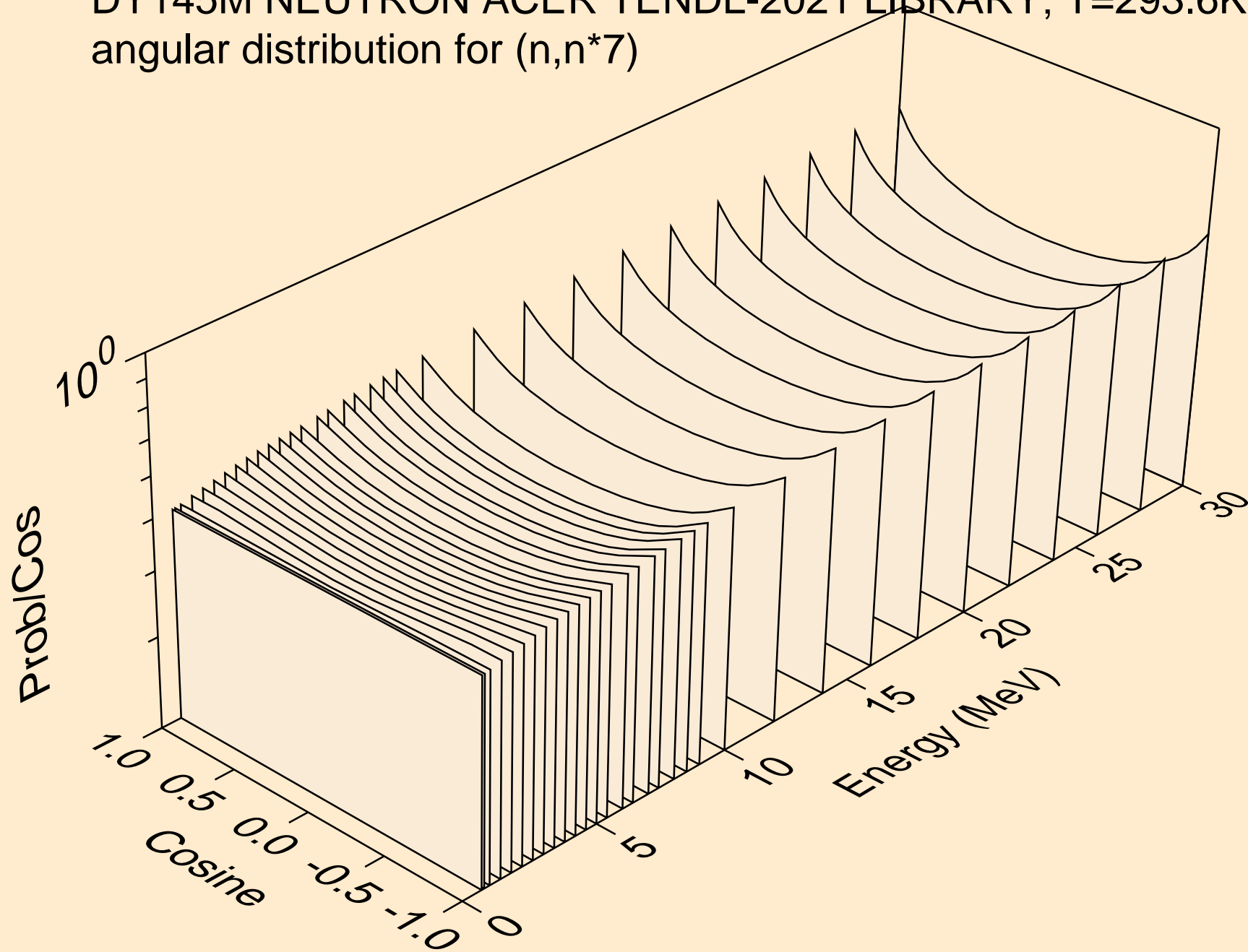

DY145M NEUTRON ACER TENDL-2021 LIBRARY; T=293.6K
Neutron emission for (n,x)

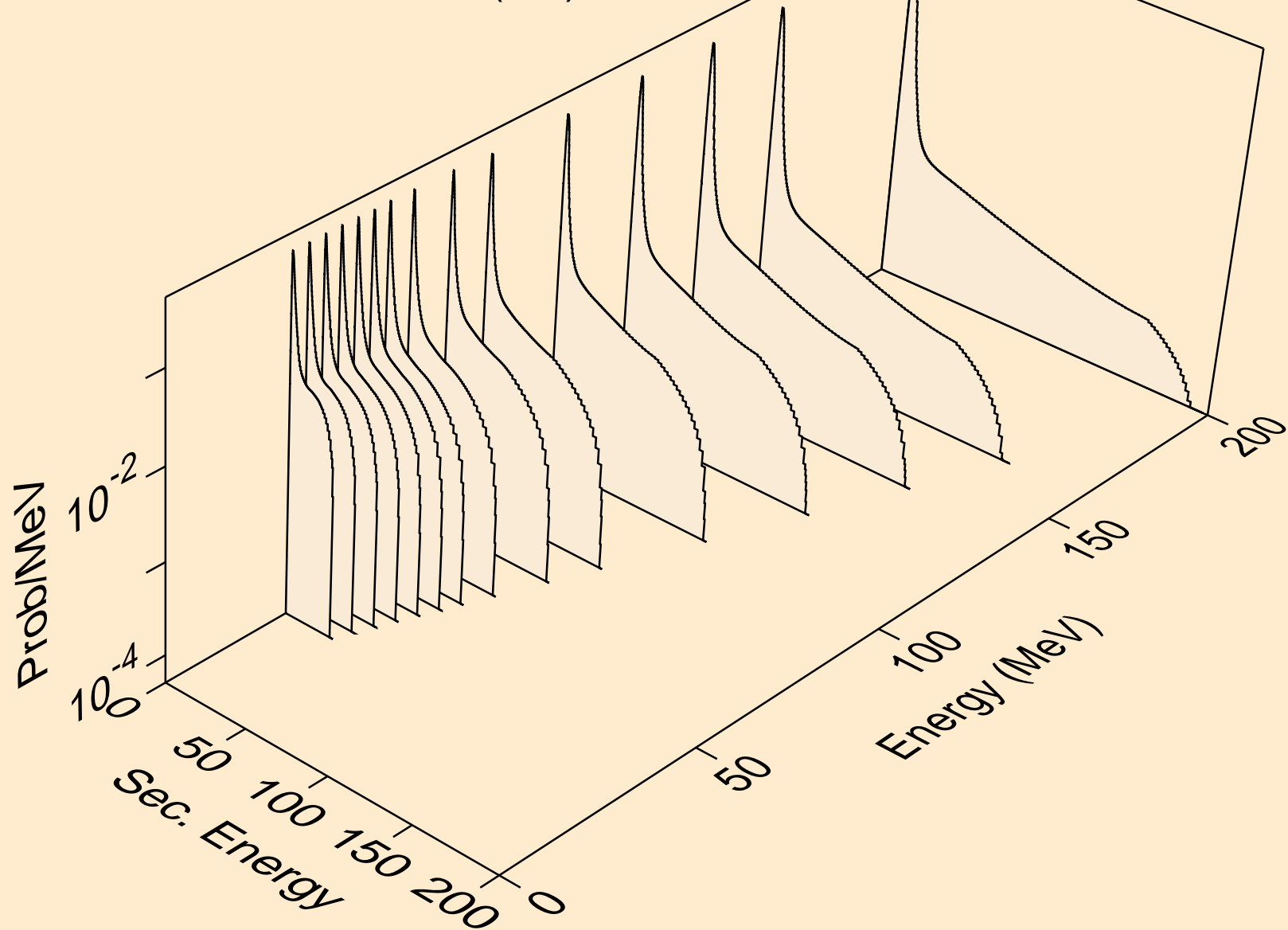

DY145M NEUTRON ACER TENDL-2021 LIBRARY; T=293.6K
Neutron emission for (n,2nd)

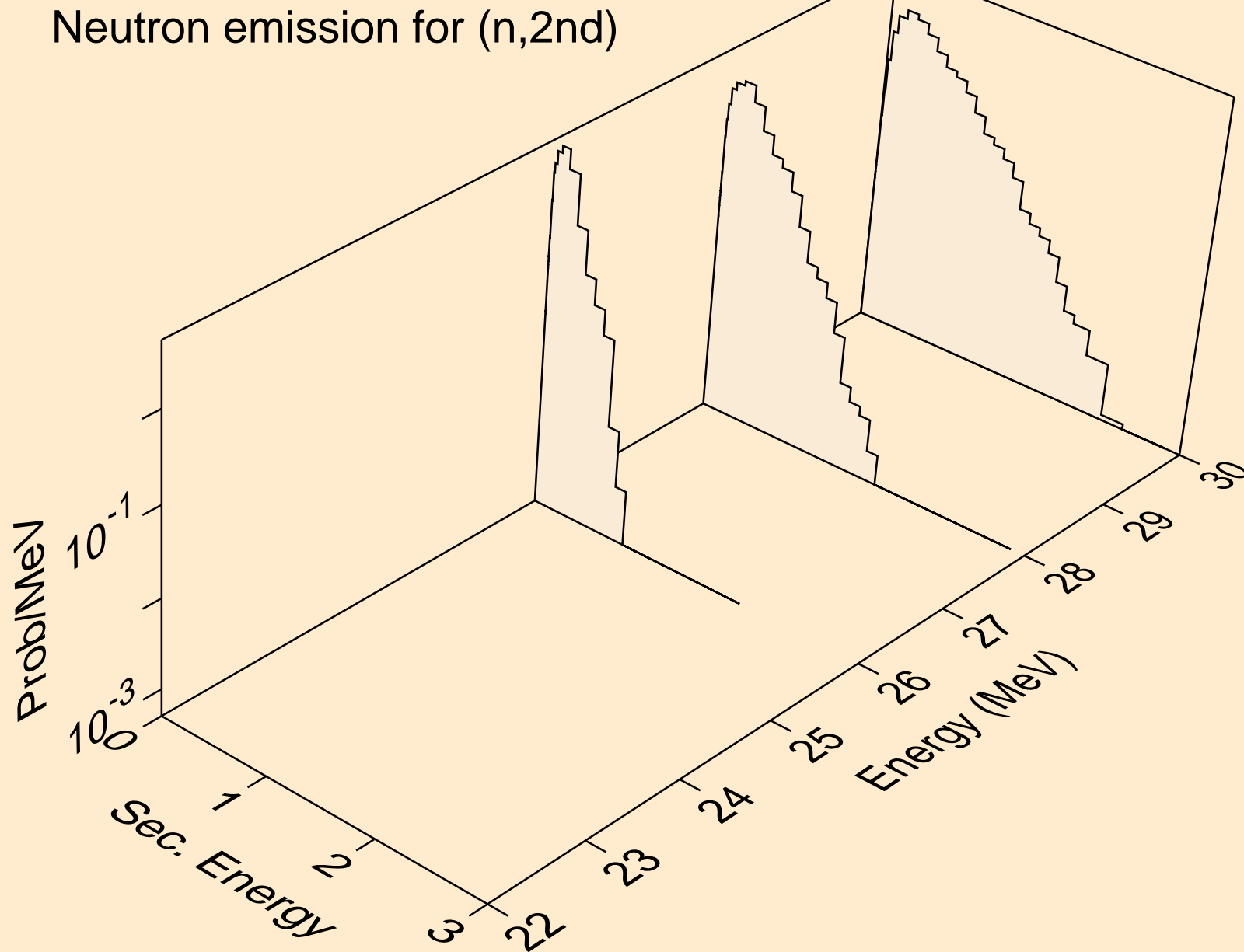

DY145M NEUTRON ACER TENDL-2021 LIBRARY; T=293.6K
Neutron emission for (n,2n)

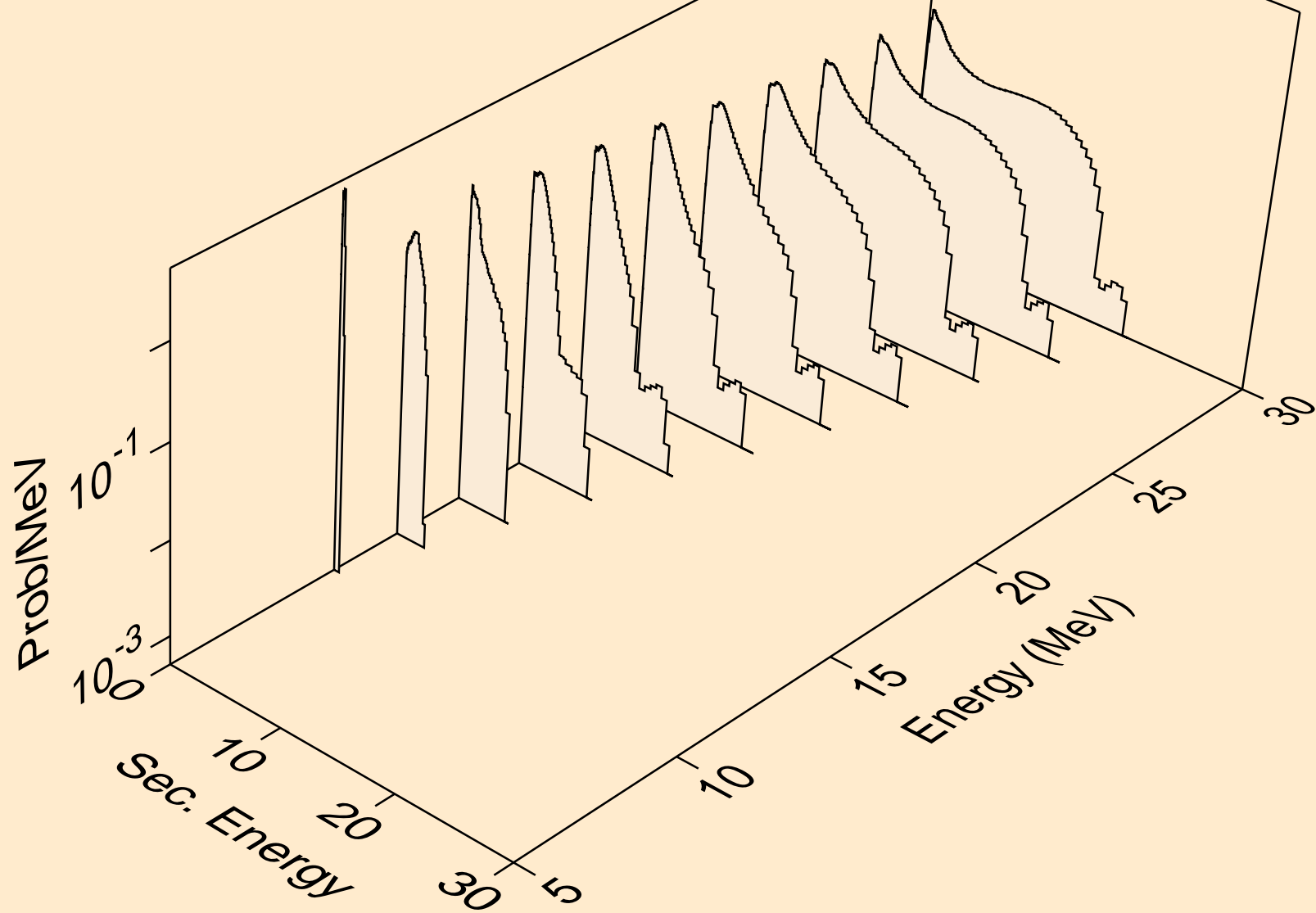

DY145M NEUTRON ACER TENDL-2021 LIBRARY; T=293.6K
Neutron emission for (n,3n)

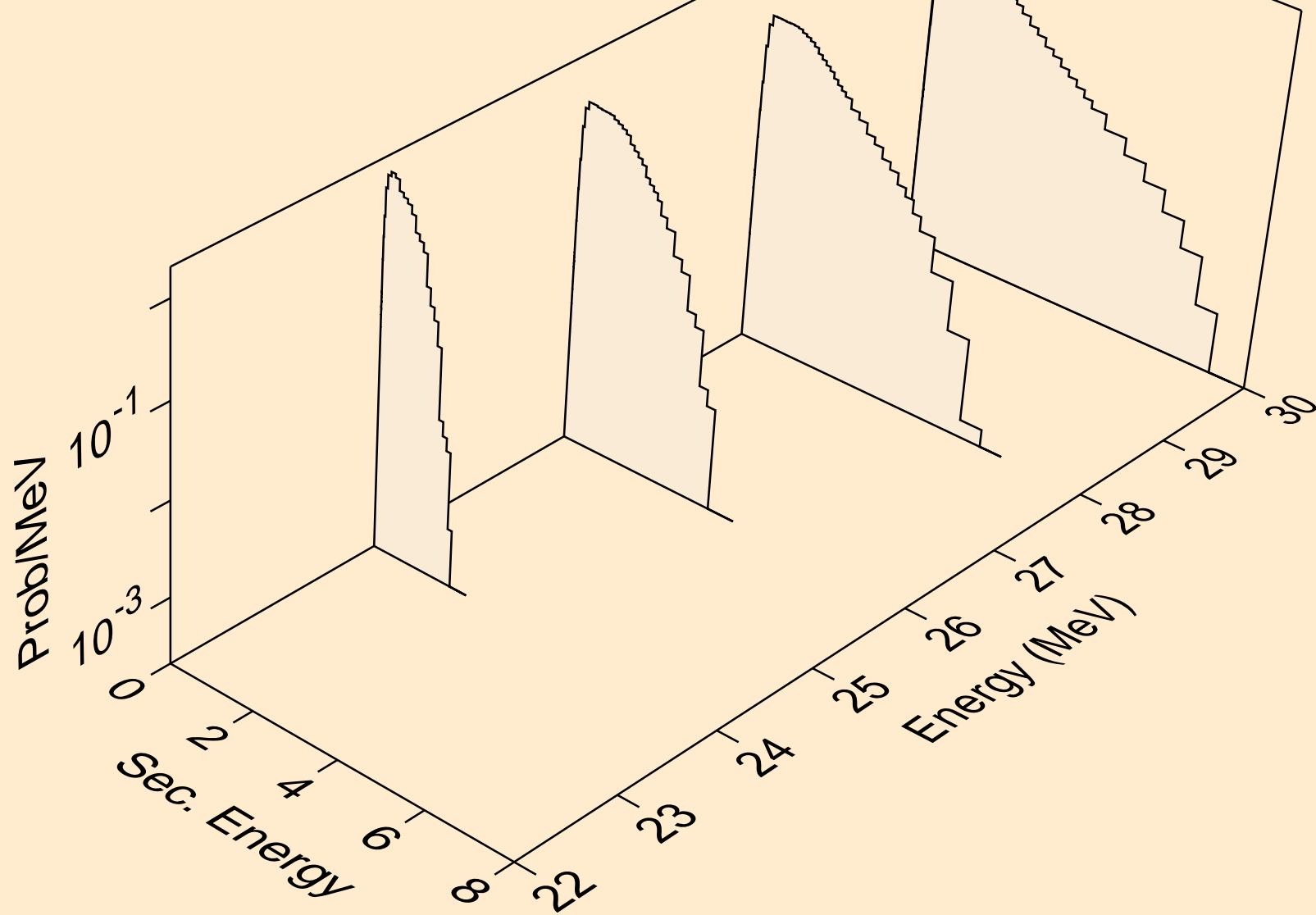

DY145M NEUTRON ACER TENDL-2021 LIBRARY; T=293.6K
Neutron emission for (n,n*)a

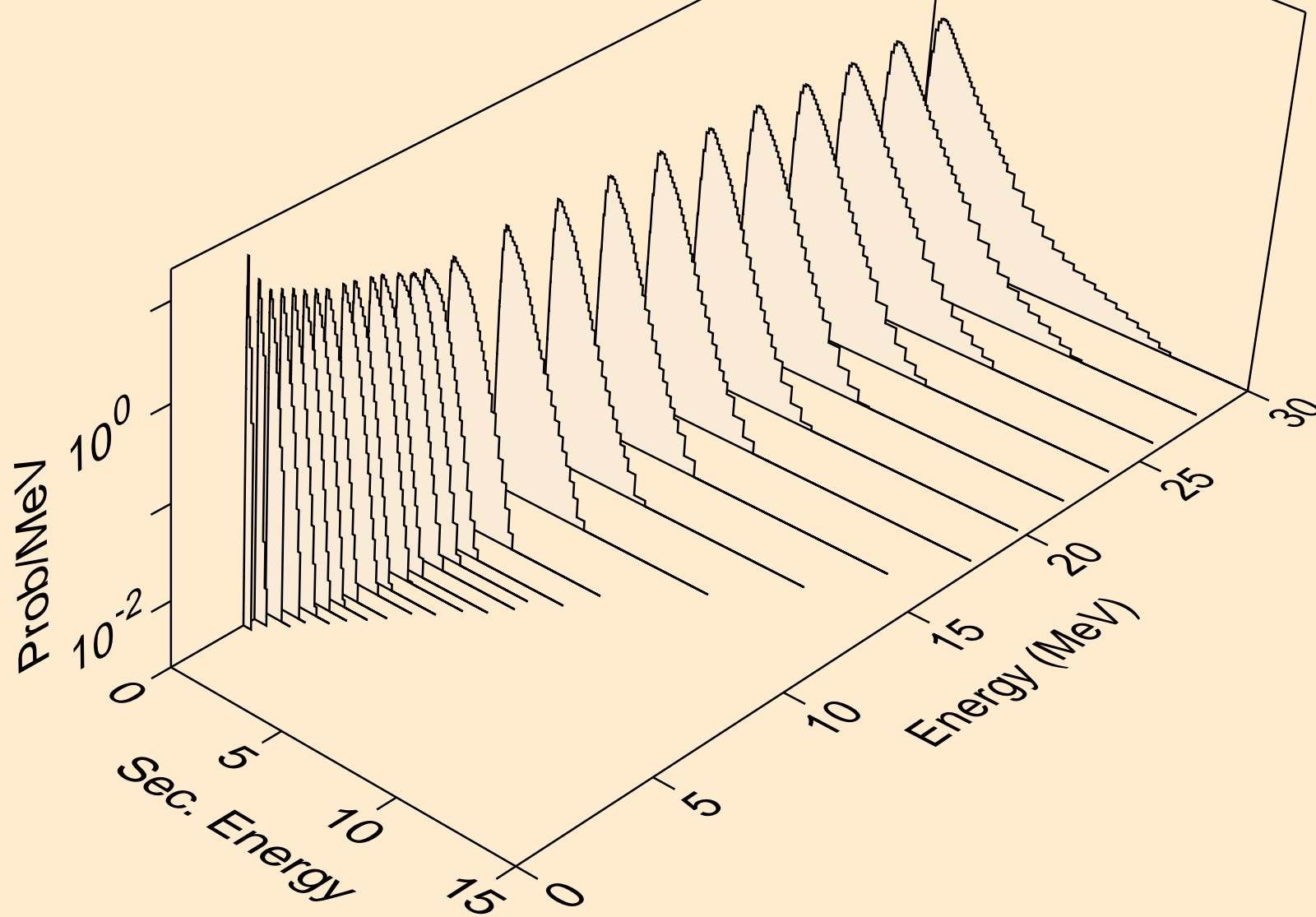

DY145M NEUTRON ACER TENDL-2021 LIBRARY; T=293.6K
Neutron emission for (n,2n)_a

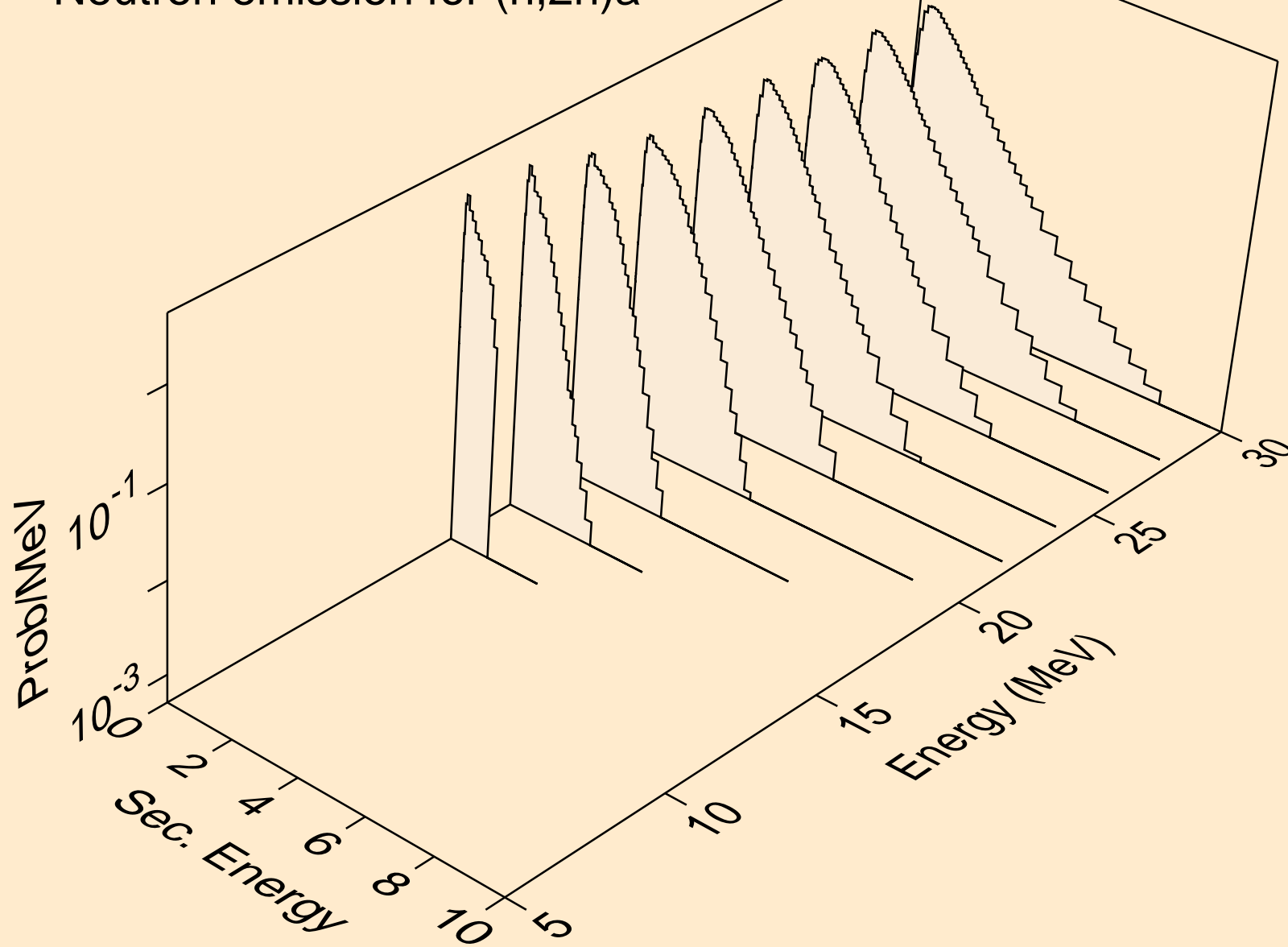

DY145M NEUTRON ACER TENDL-2021 LIBRARY; T=293.6K
Neutron emission for (n,3n)a

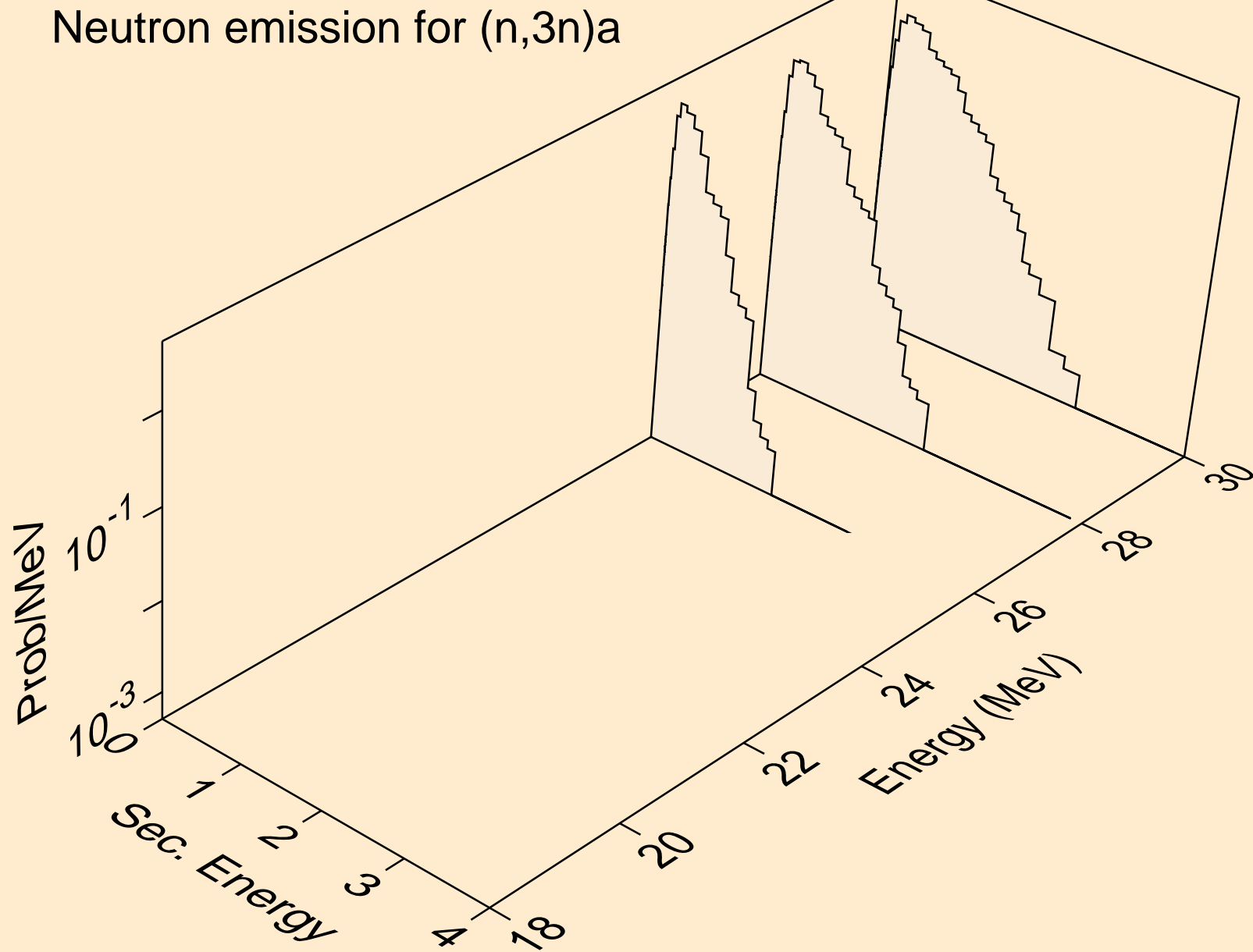

DY145M NEUTRON ACER TENDL-2021 LIBRARY; T=293.6K
Neutron emission for (n,n*)p

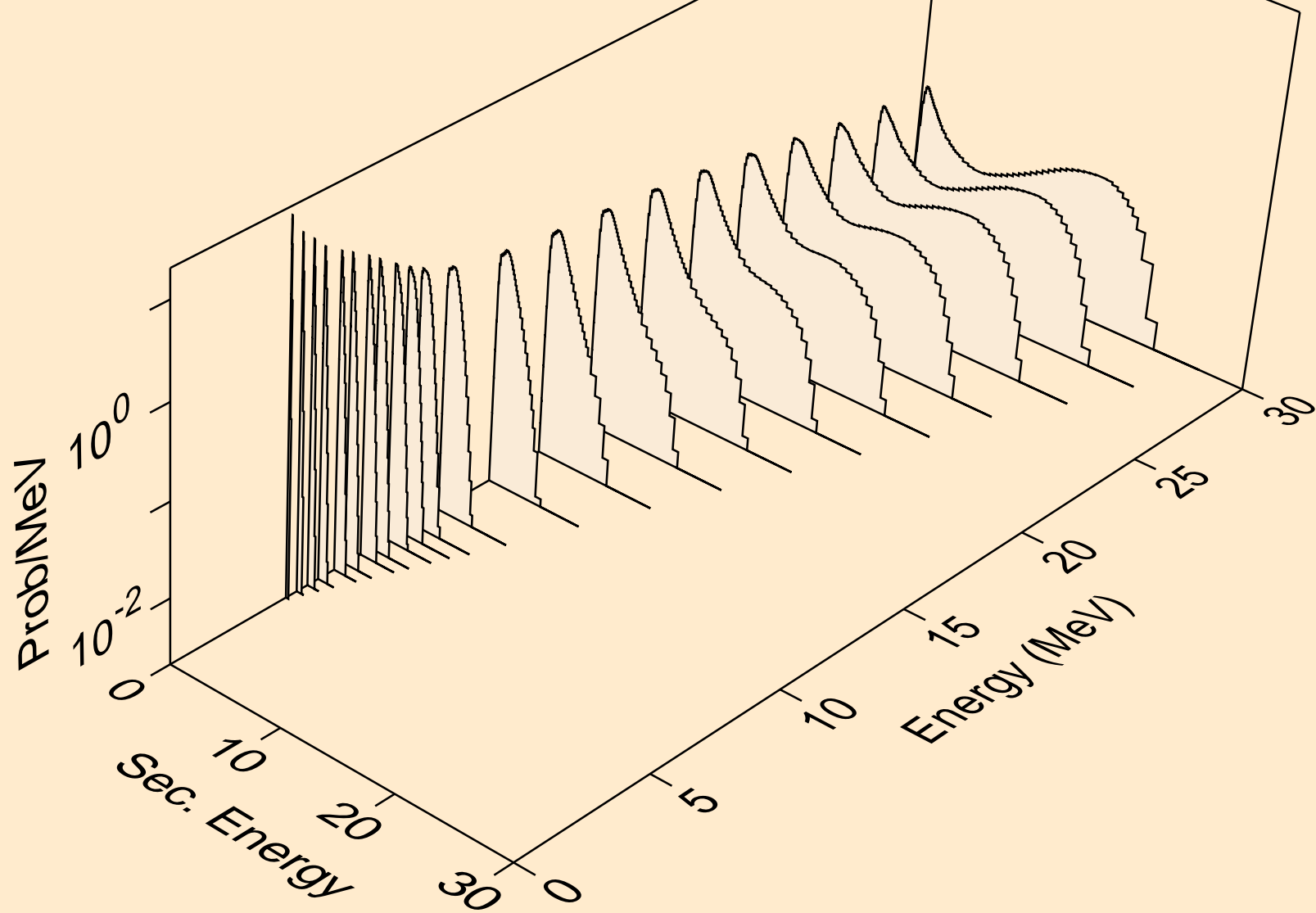

DY145M NEUTRON ACER TENDL-2021 LIBRARY; T=293.6K
Neutron emission for (n,n*)2a

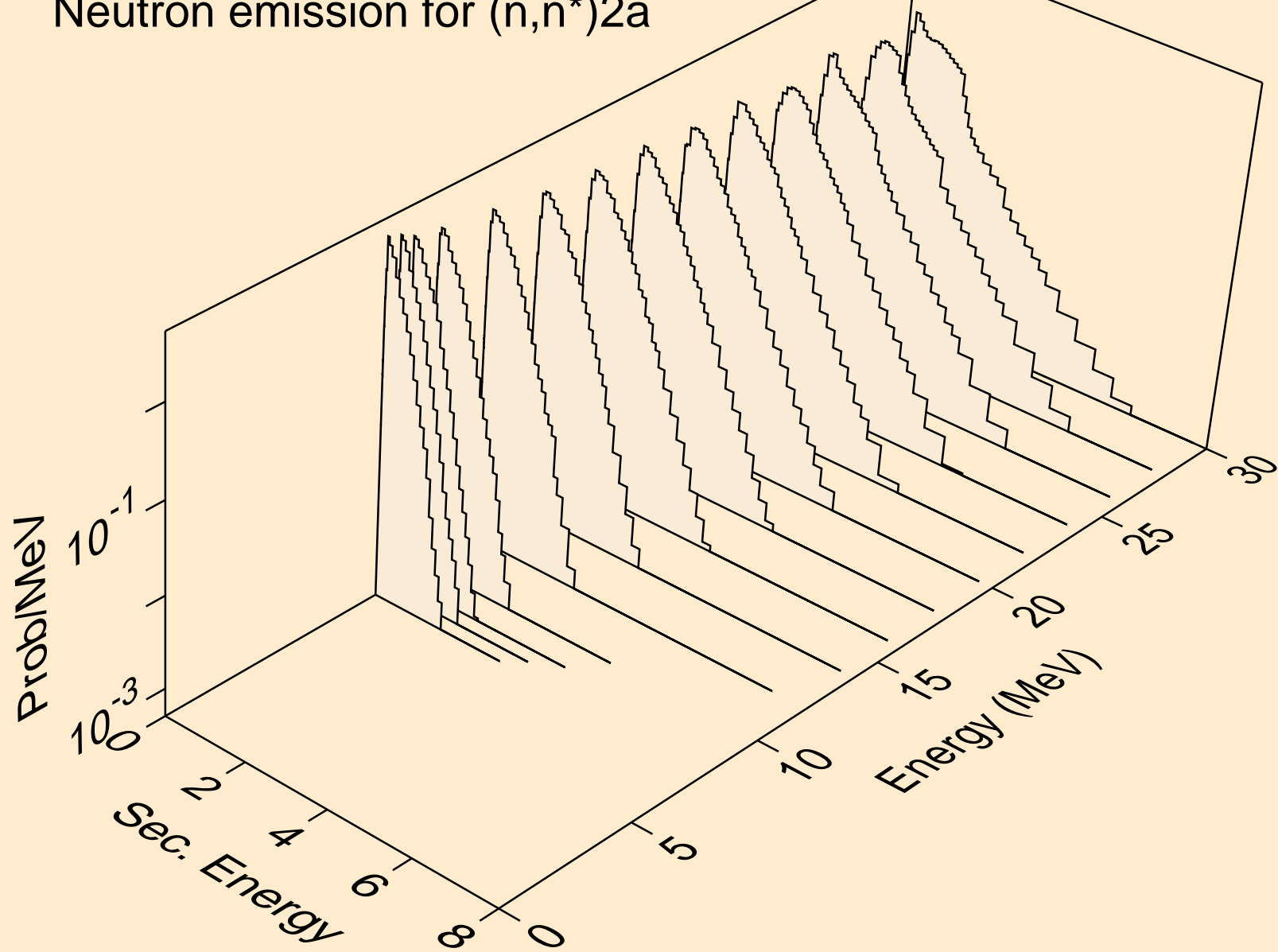

DY145M NEUTRON ACER TENDL-2021 LIBRARY; T=293.6K
Neutron emission for (n,2n)2a

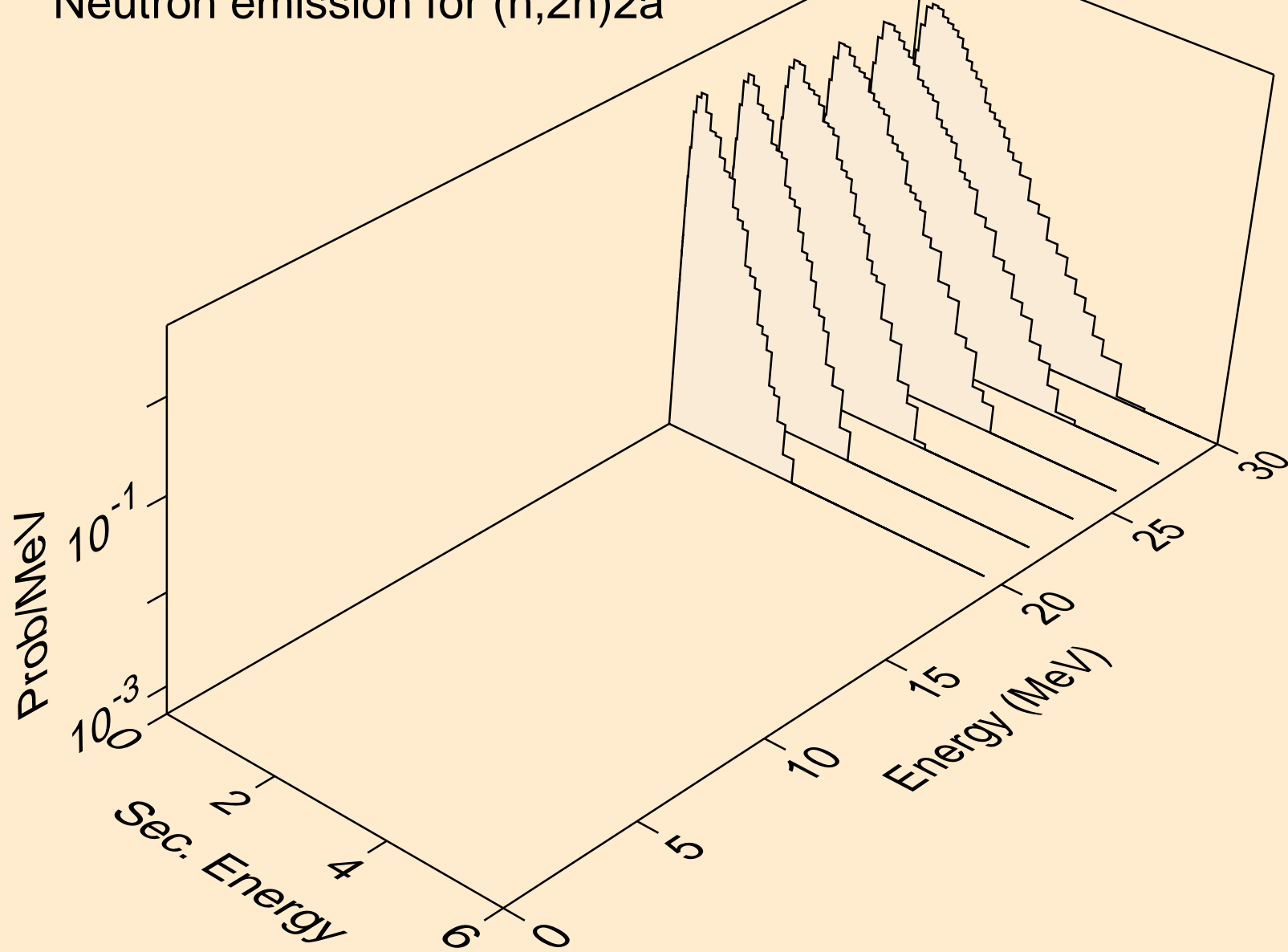

DY145M NEUTRON ACER TENDL-2021 LIBRARY; T=293.6K
Neutron emission for (n,n*)d

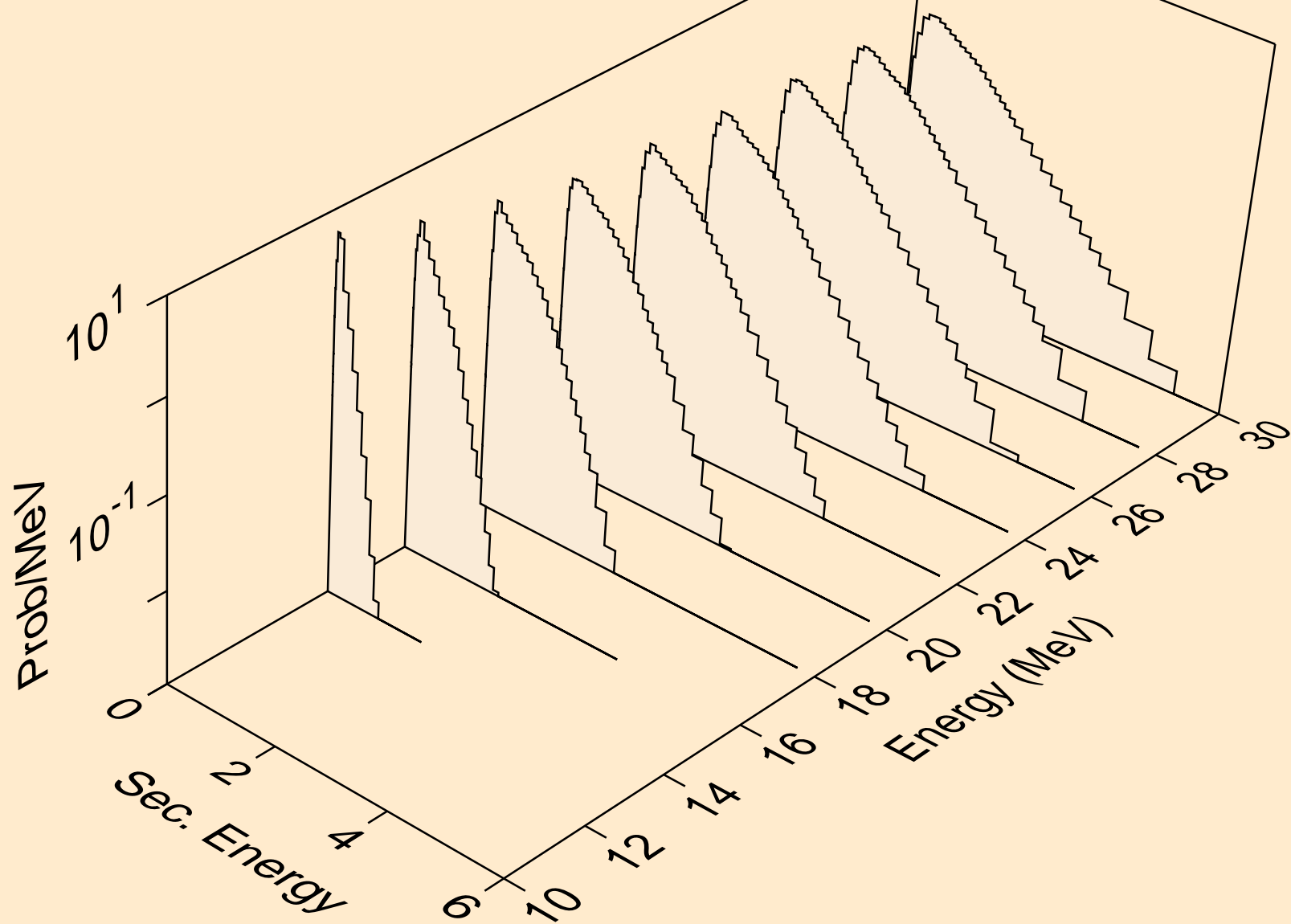

DY145M NEUTRON ACER TENDL-2021 LIBRARY; T=293.6K
Neutron emission for (n,n*)t

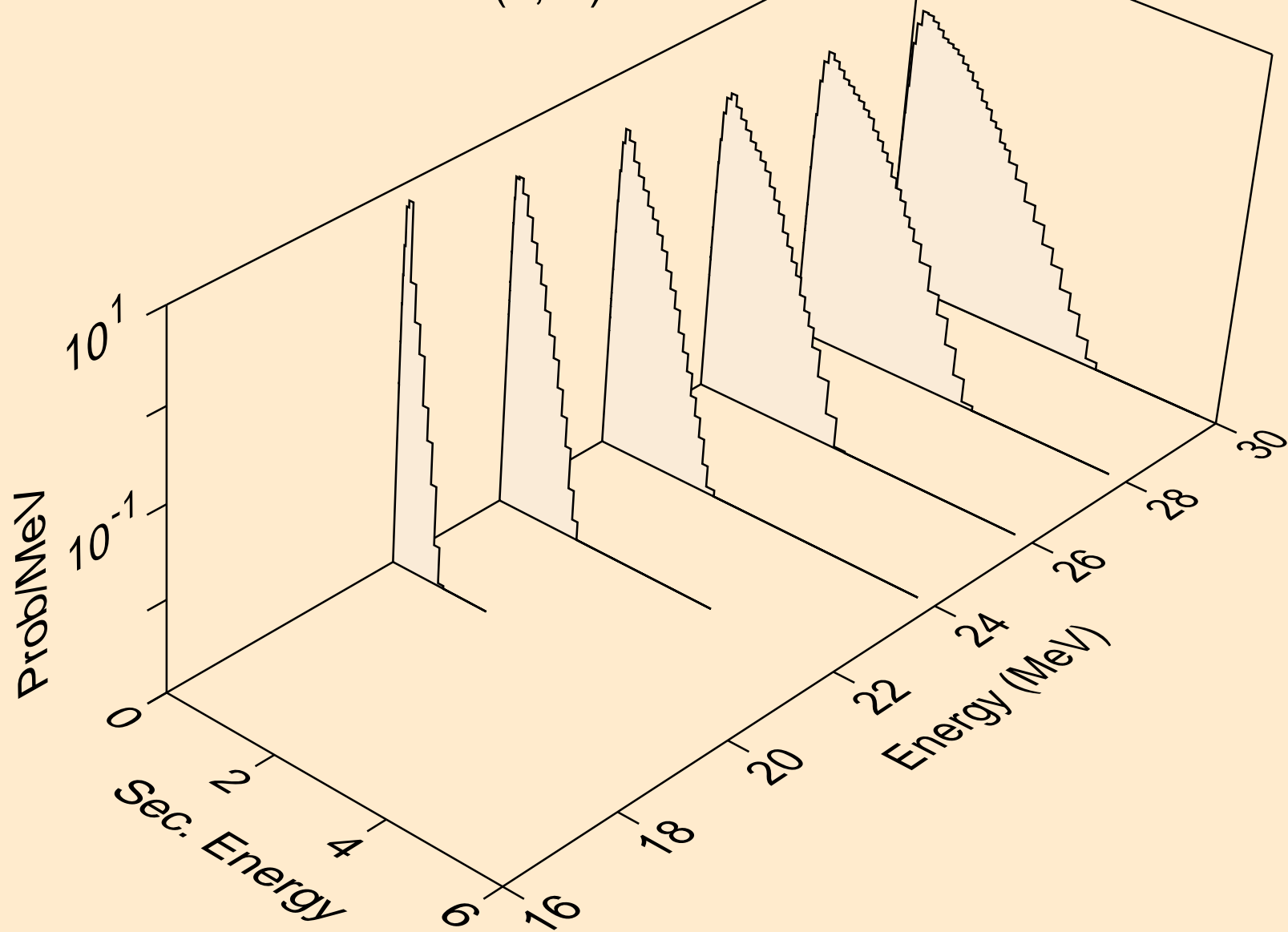

DY145M NEUTRON ACER TENDL-2021 LIBRARY; T=293.6K
Neutron emission for (n,n*)he3

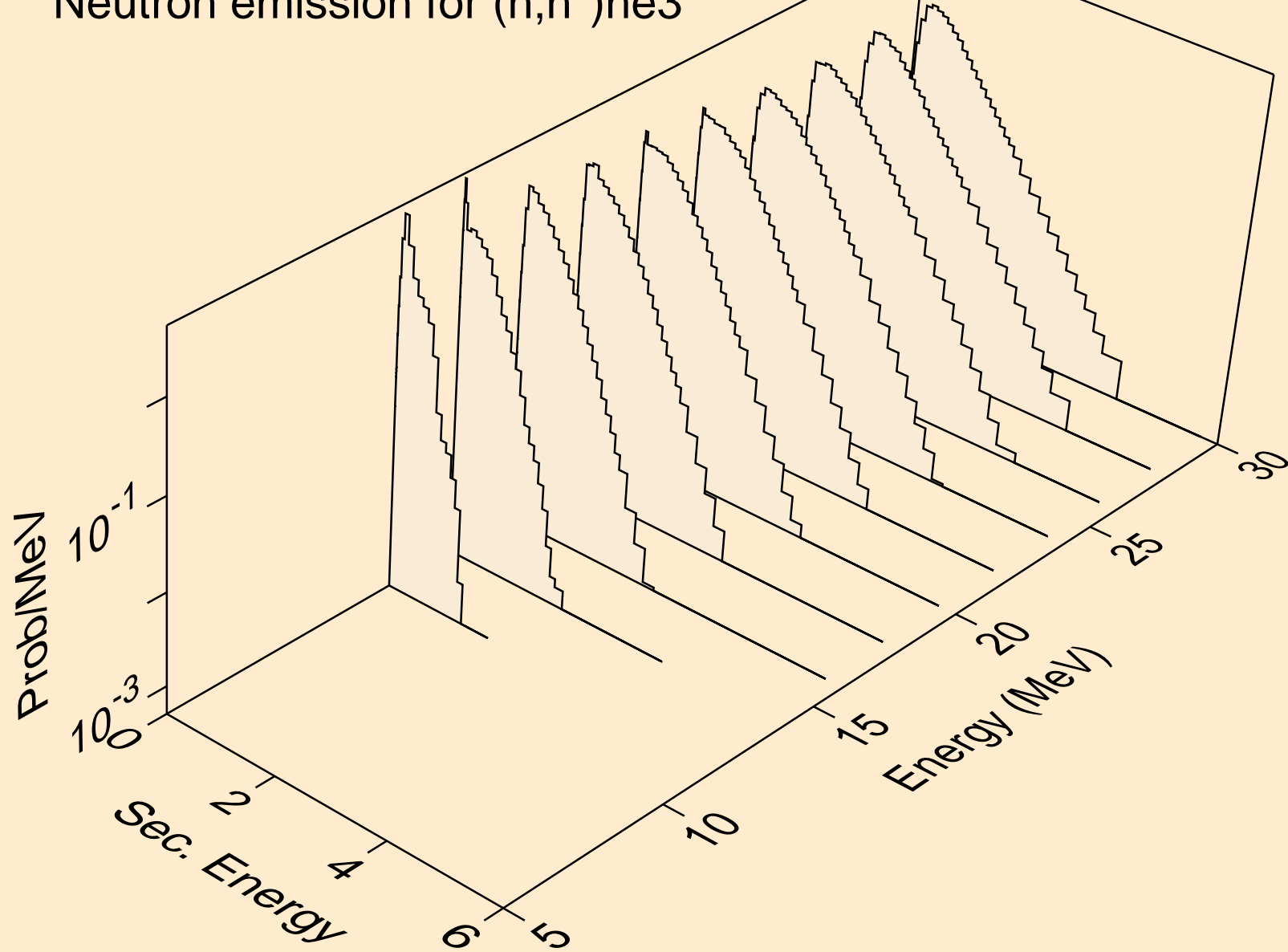

DY145M NEUTRON ACER TENDL-2021 LIBRARY; T=293.6K
Neutron emission for (n,2np)

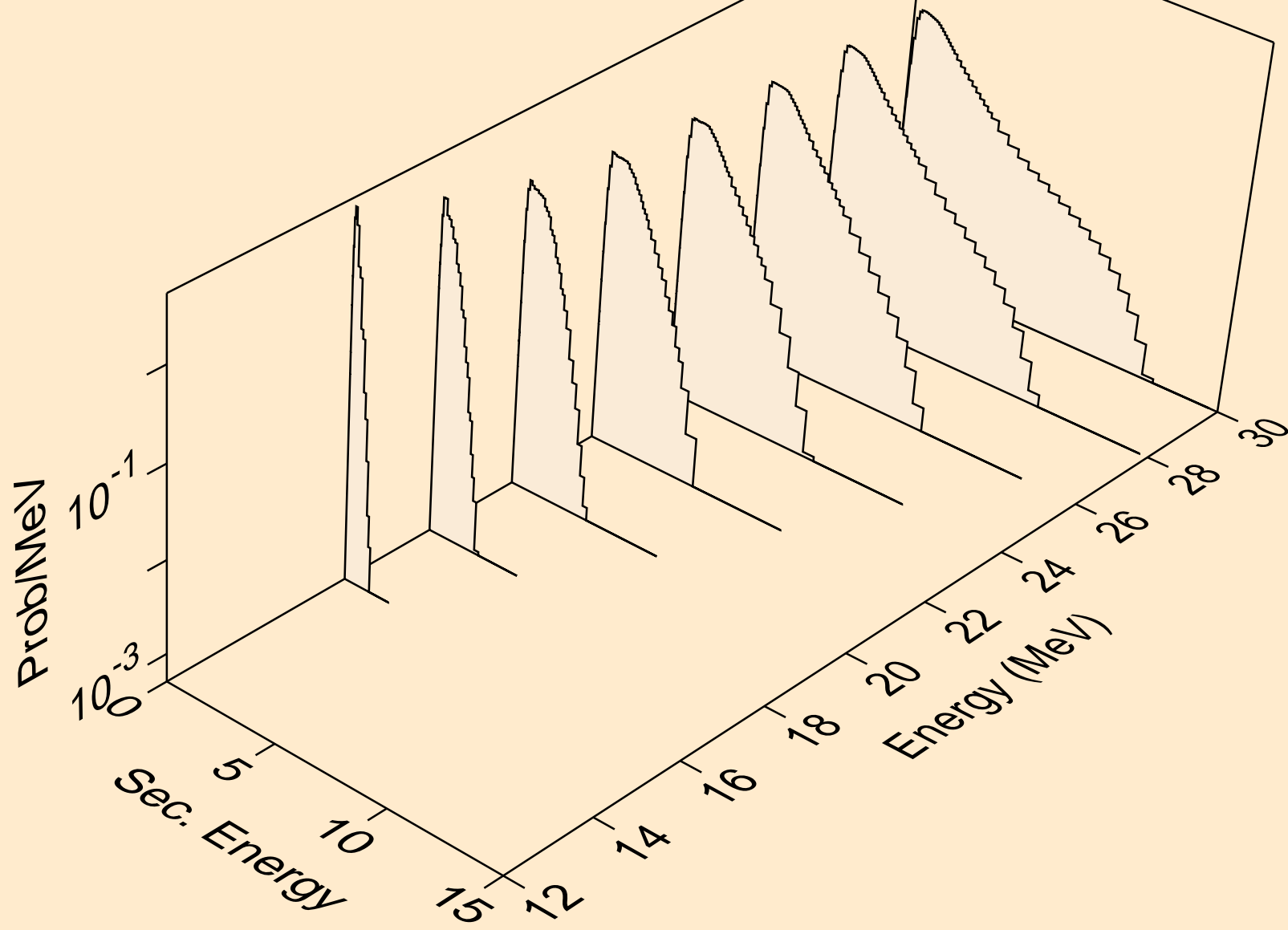

DY145M NEUTRON ACER TENDL-2021 LIBRARY; T=293.6K
Neutron emission for (n,3np)

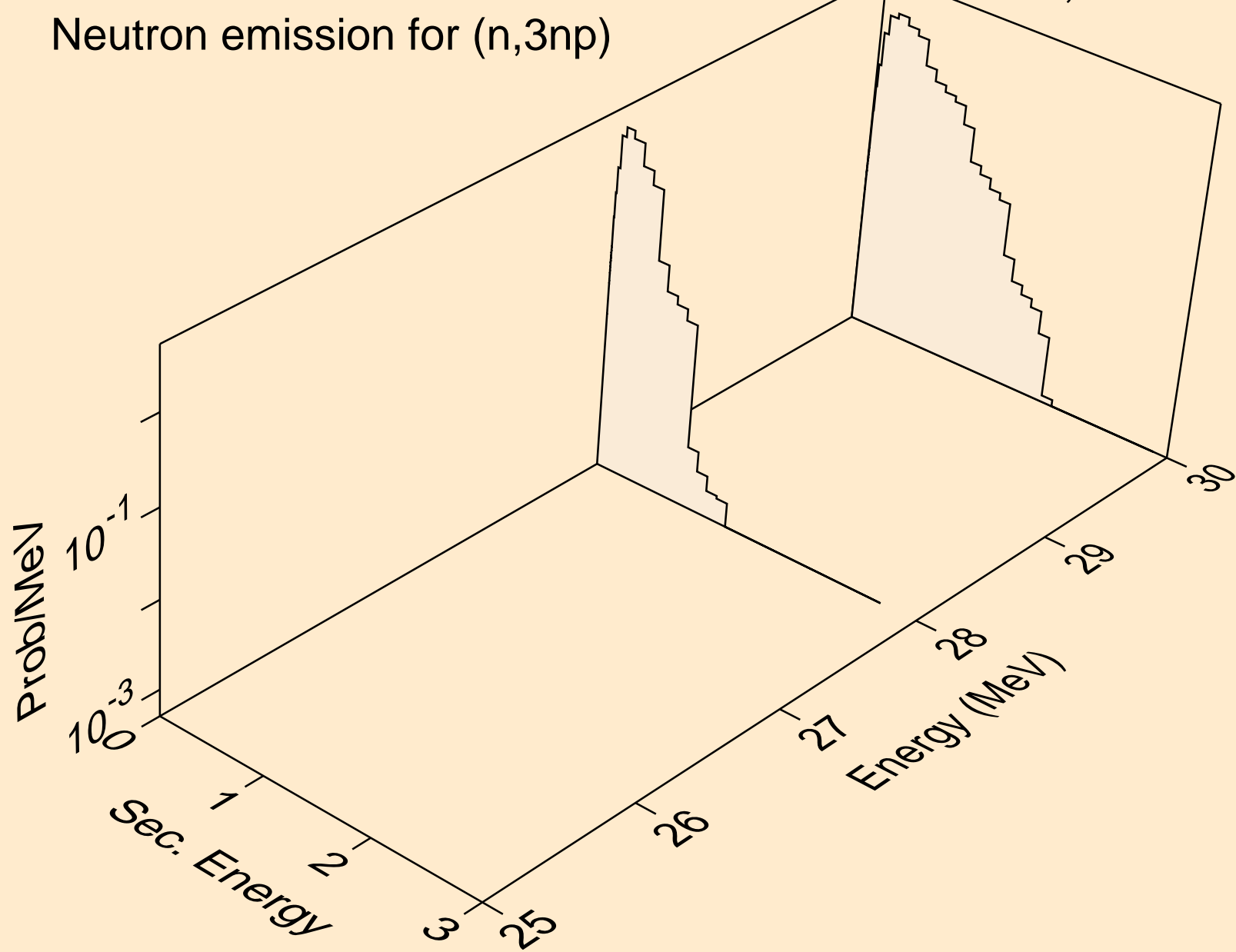

DY145M NEUTRON ACER TENDL-2021 LIBRARY; T=293.6K
Neutron emission for (n,2np)

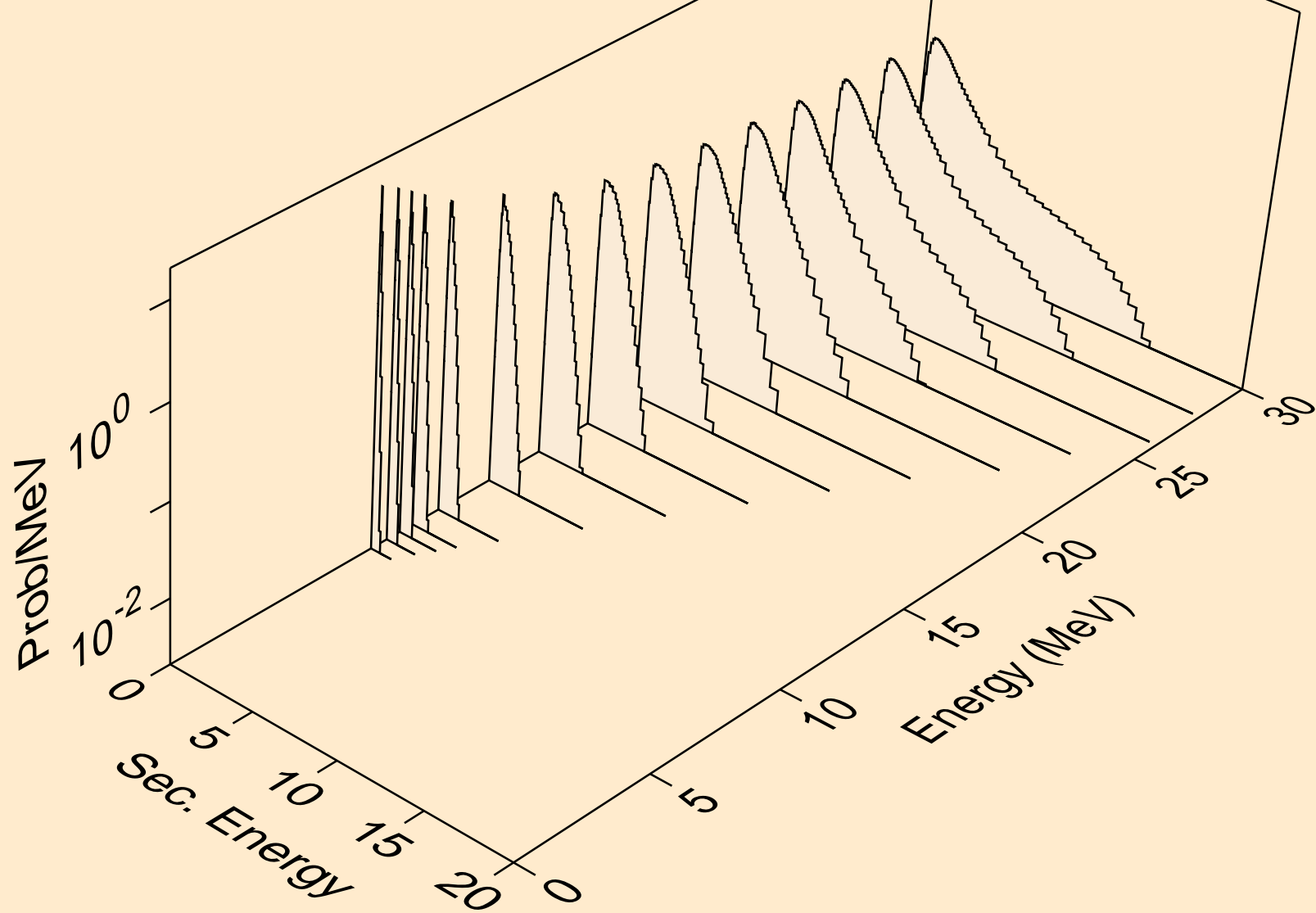

DY145M NEUTRON ACER TENDL-2021 LIBRARY; T=293.6K
Neutron emission for (n,npa)

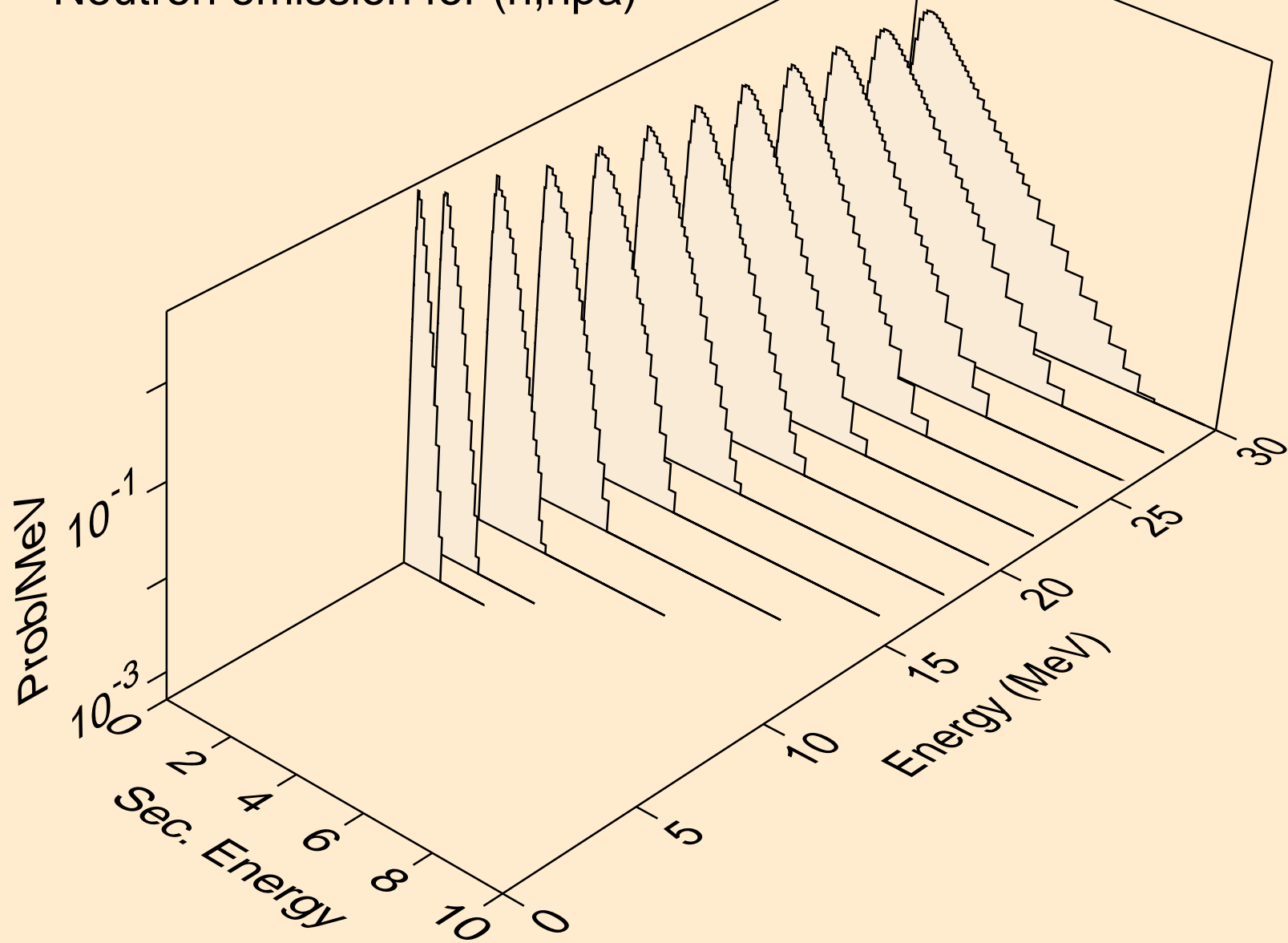

DY145M NEUTRON ACER TENDL-2021 LIBRARY; T=293.6K
Neutron emission for (n,n*c)

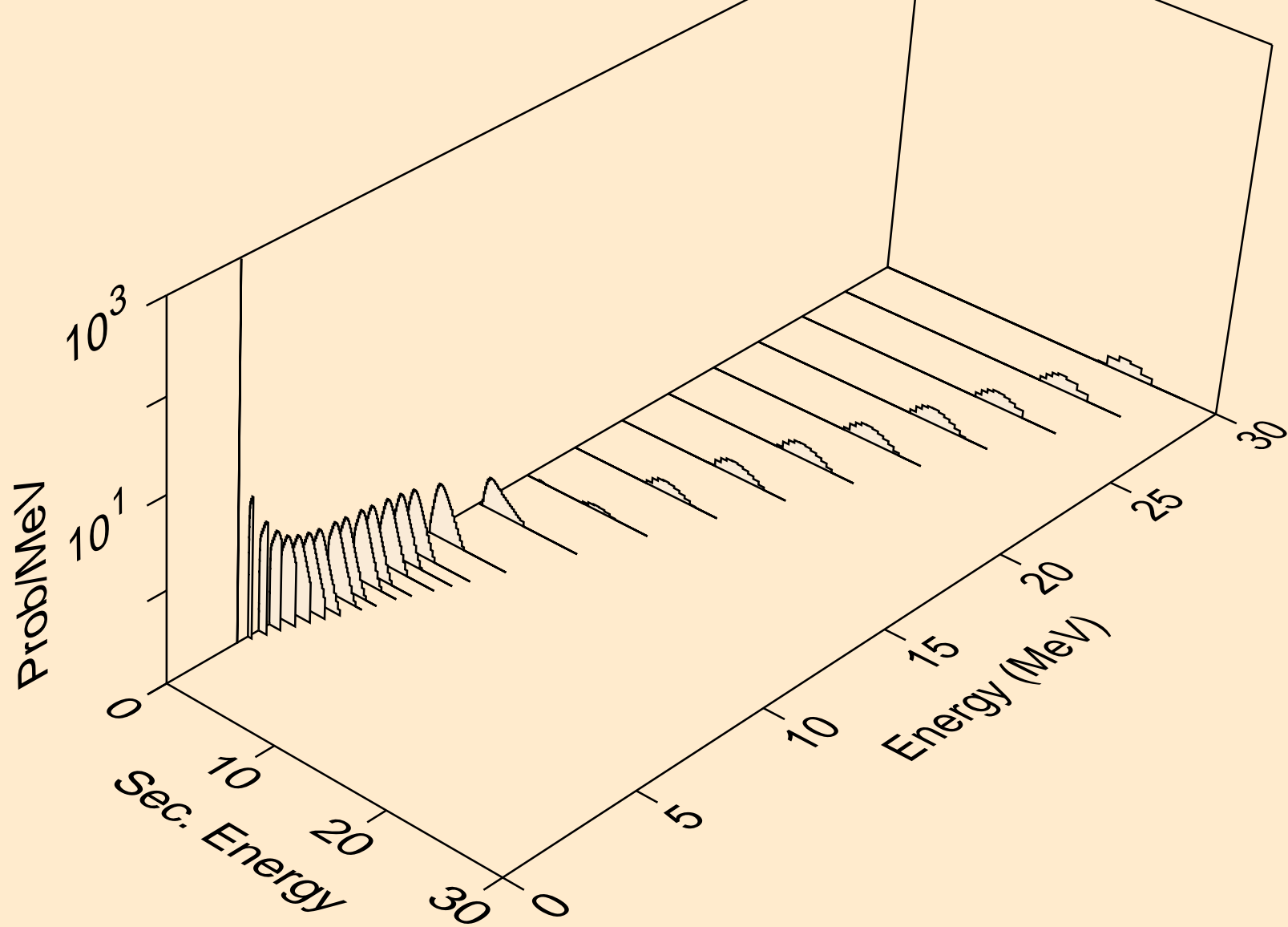

DY145M NEUTRON ACER TENDL-2021 LIBRARY; T=293.6K
Photon emission for (n,x)

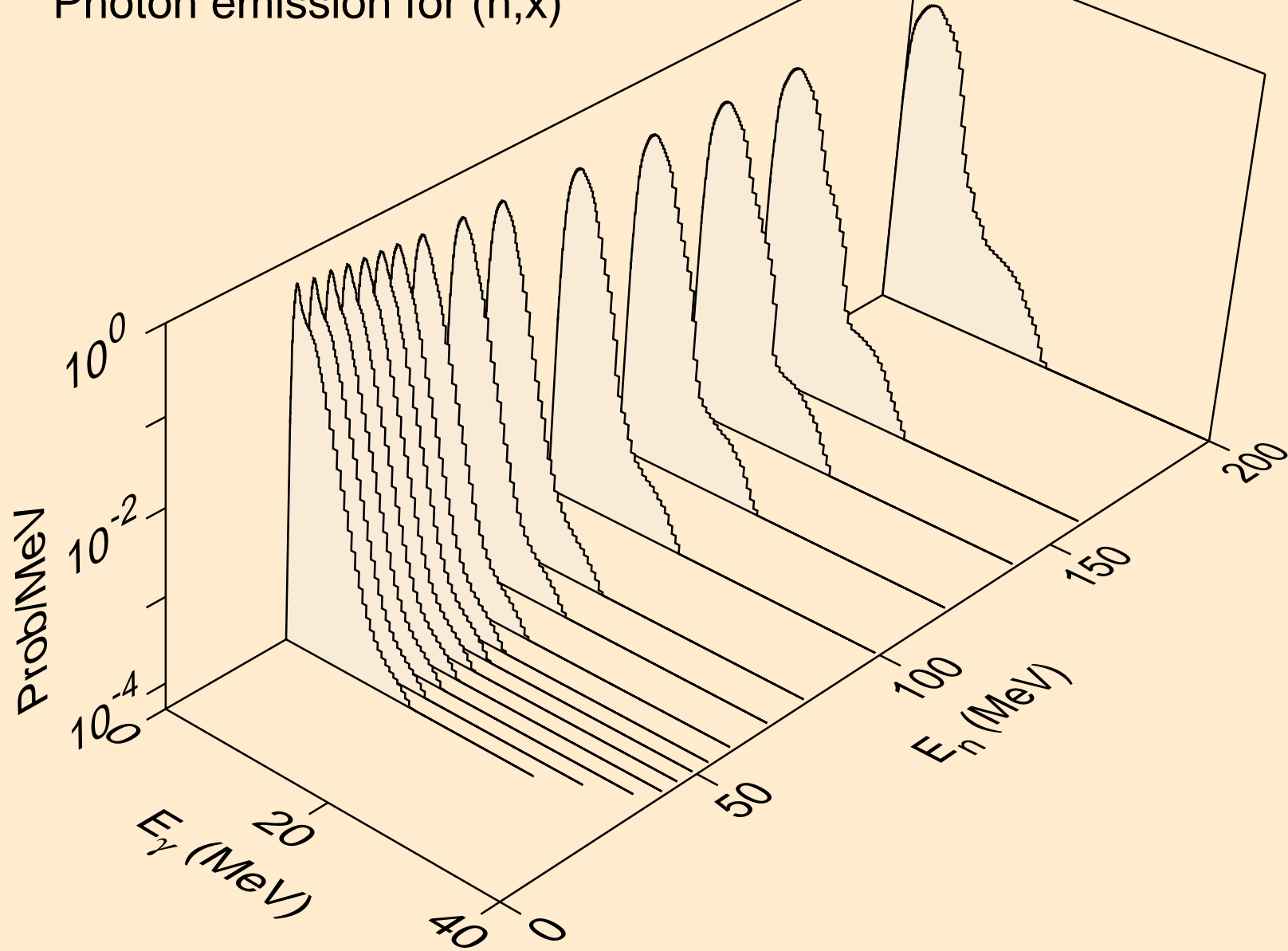

DY145M NEUTRON ACER TENDL-2021 LIBRARY; T=293.6K
Photon emission for (n,2nd)

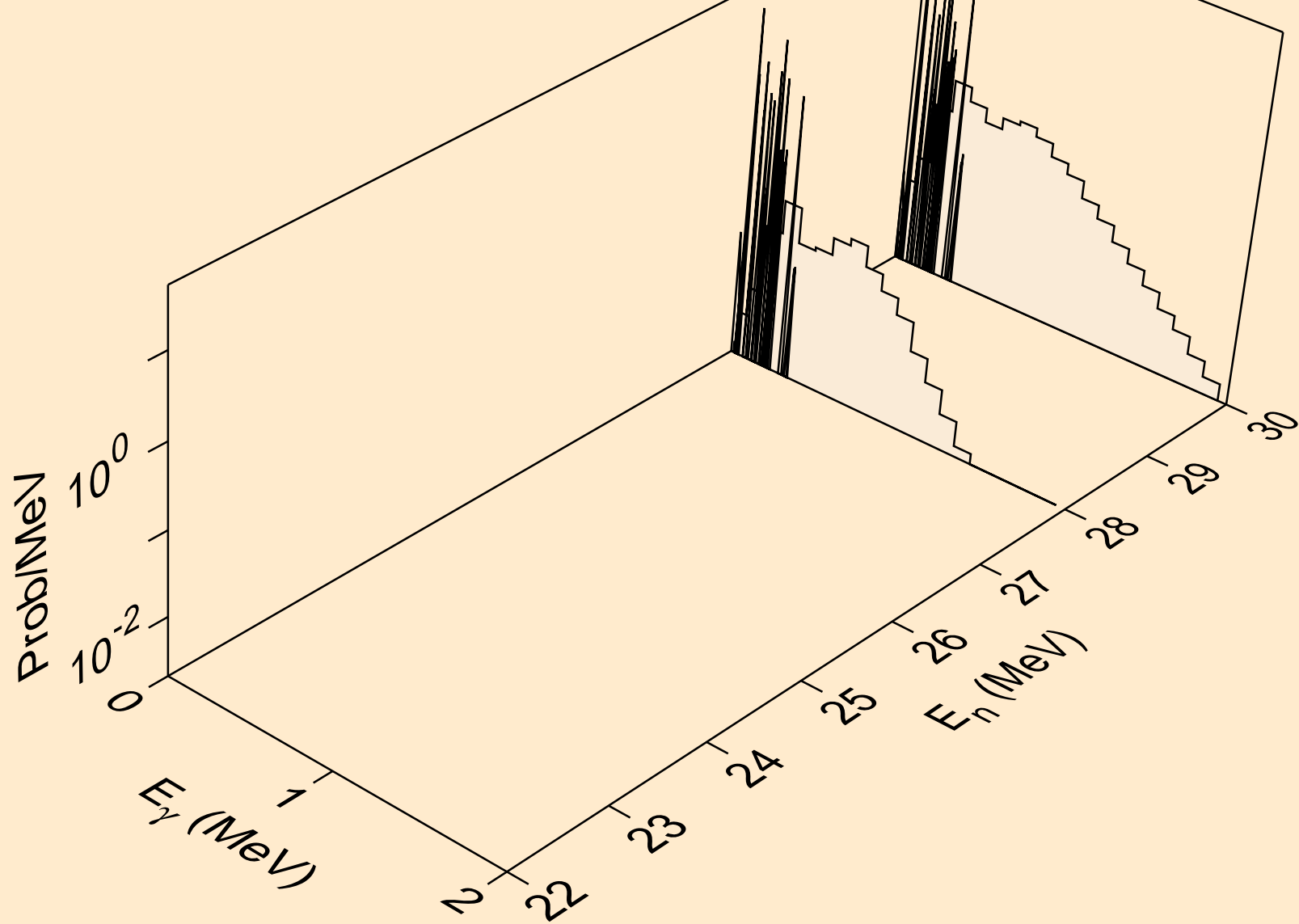

DY145M NEUTRON ACER TENDL-2021 LIBRARY; T=293.6K
Photon emission for (n,2n)

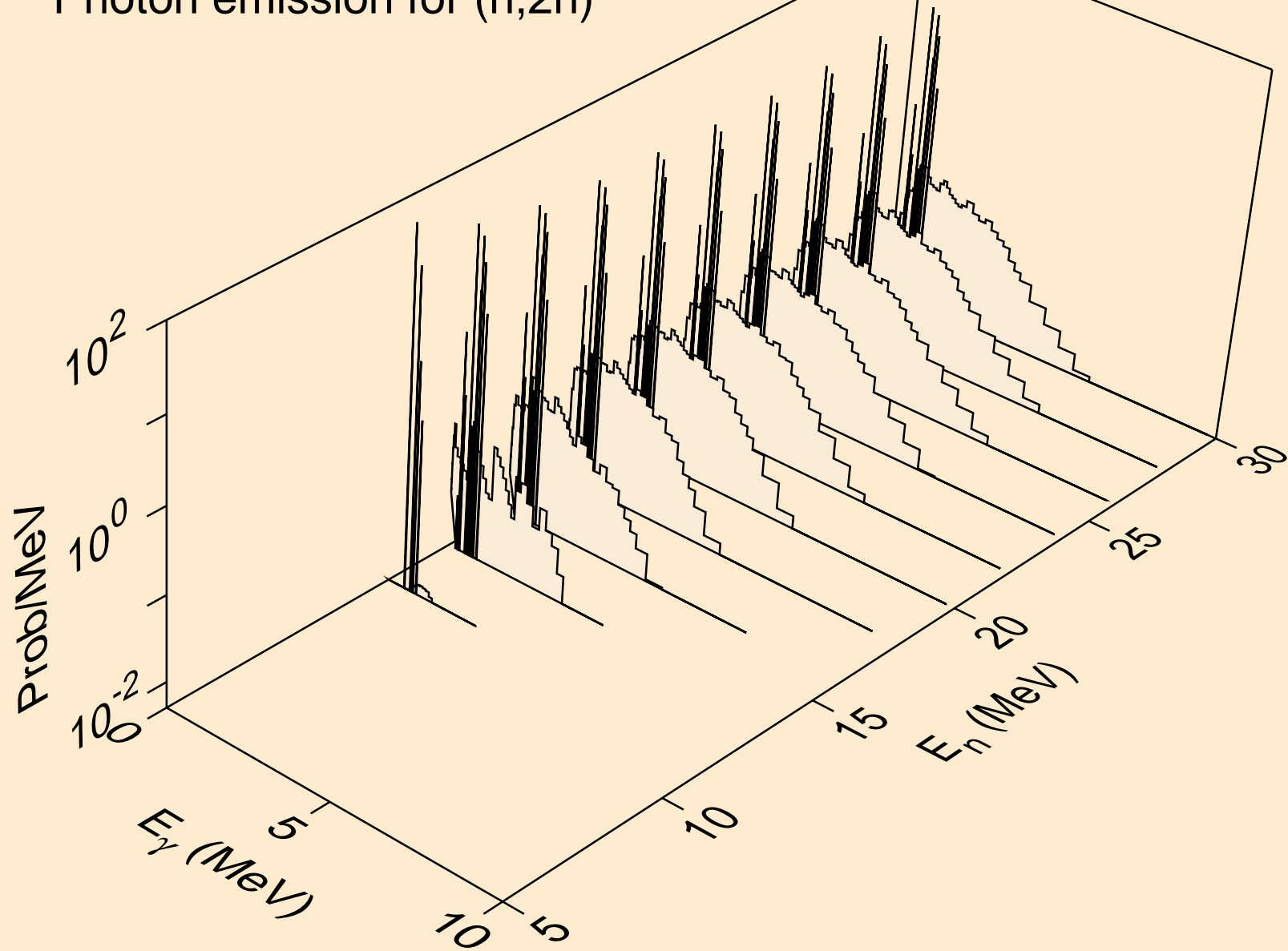

DY145M NEUTRON ACER TENDL-2021 LIBRARY; T=293.6K
Photon emission for (n,3n)

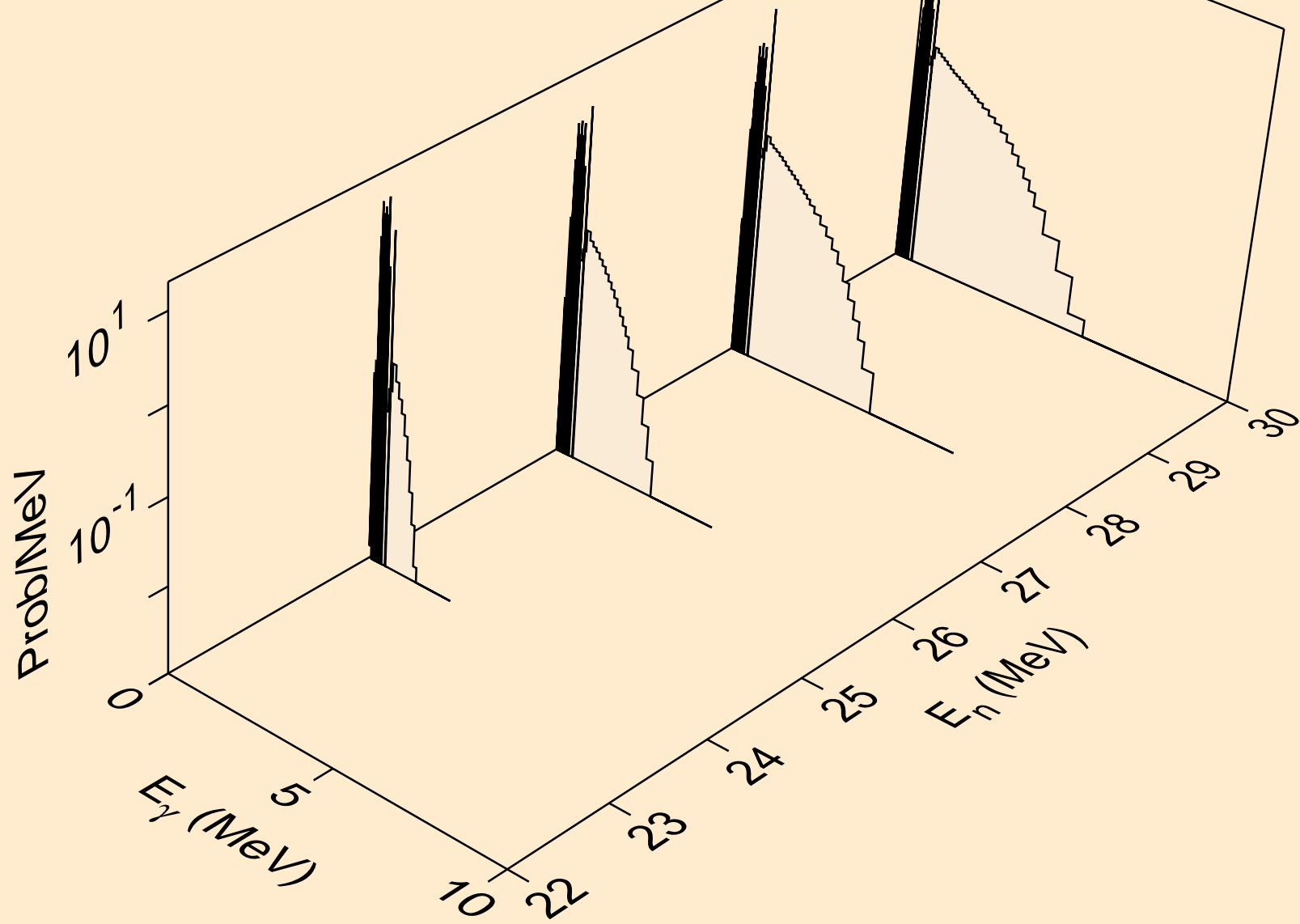

DY145M NEUTRON ACER TENDL-2021 LIBRARY; T=293.6K
Photon emission for (n,n*)a

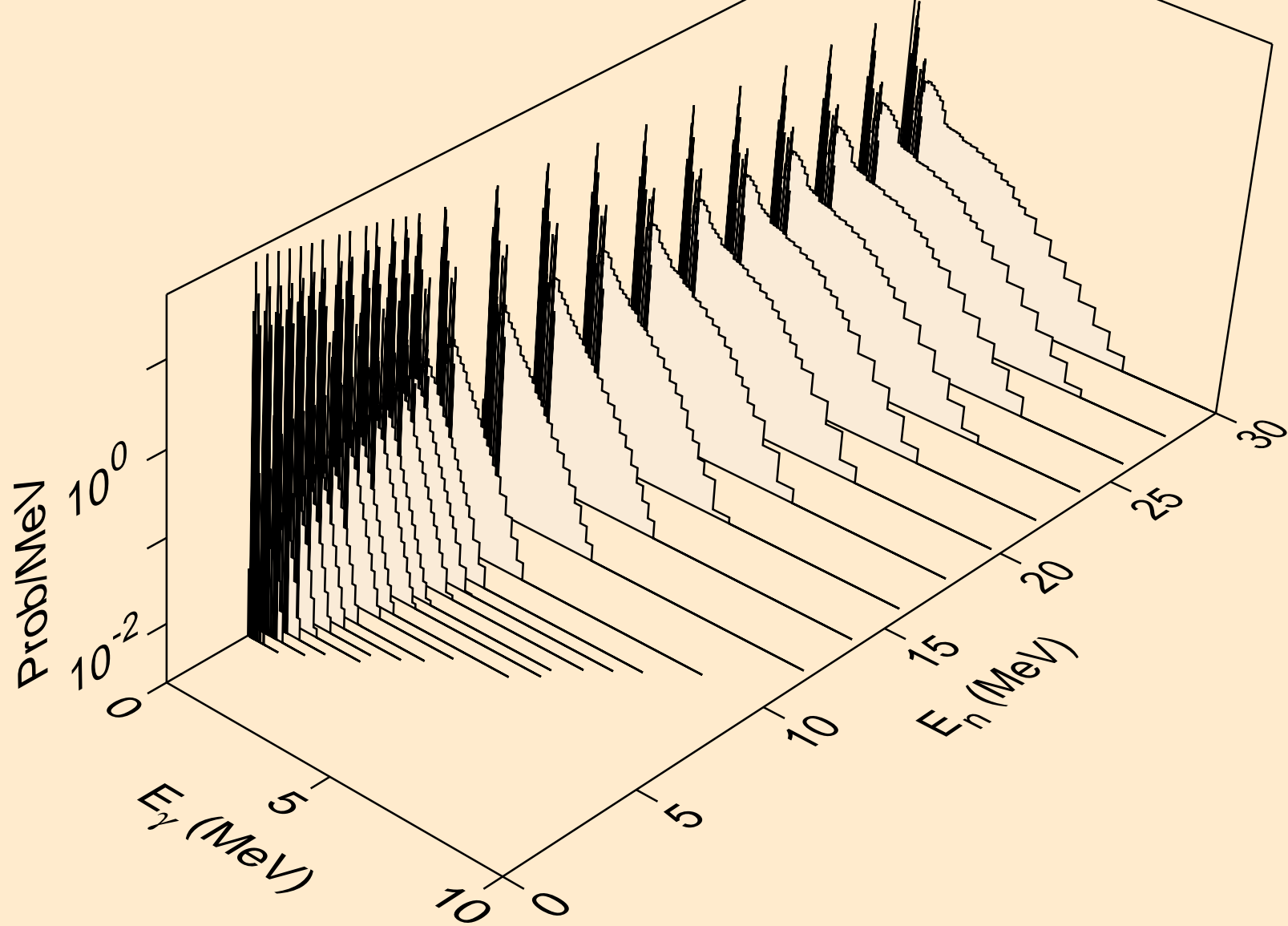

DY145M NEUTRON ACER TENDL-2021 LIBRARY; T=293.6K
Photon emission for (n,2n)a

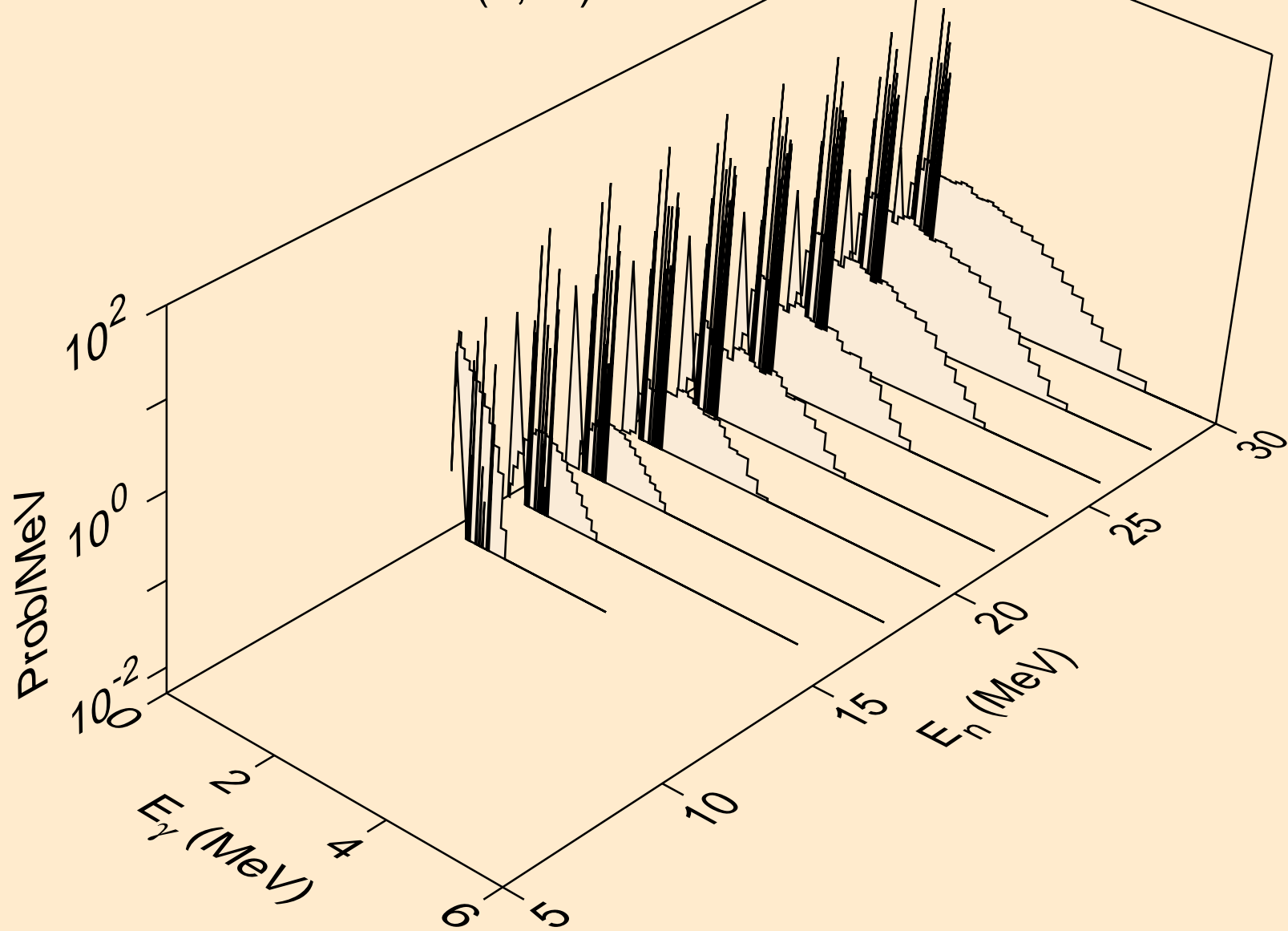

DY145M NEUTRON ACER TENDL-2021 LIBRARY; T=293.6K
Photon emission for (n,3n)a

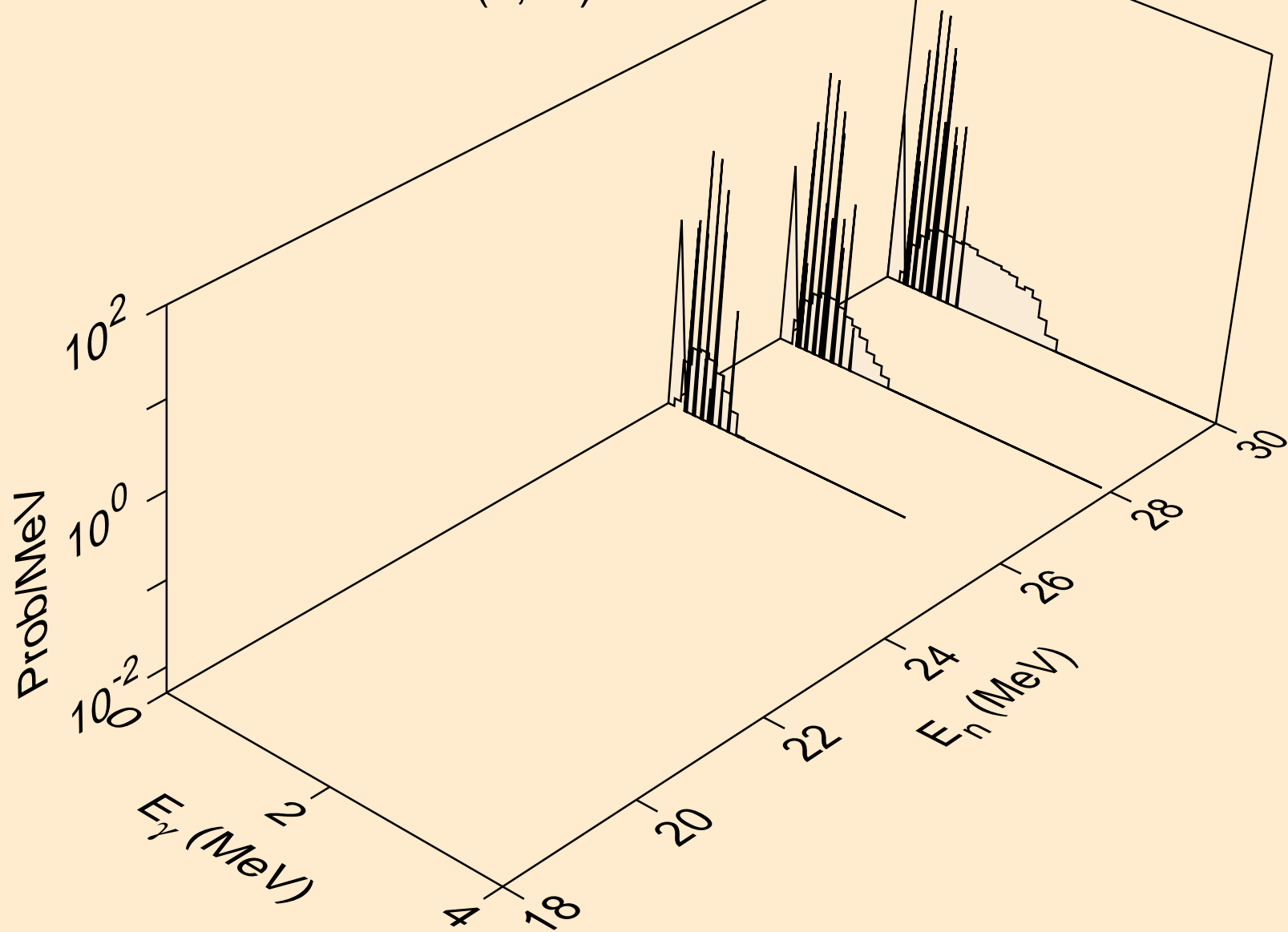

DY145M NEUTRON ACER TENDL-2021 LIBRARY; T=293.6K
Photon emission for (n,n*)p

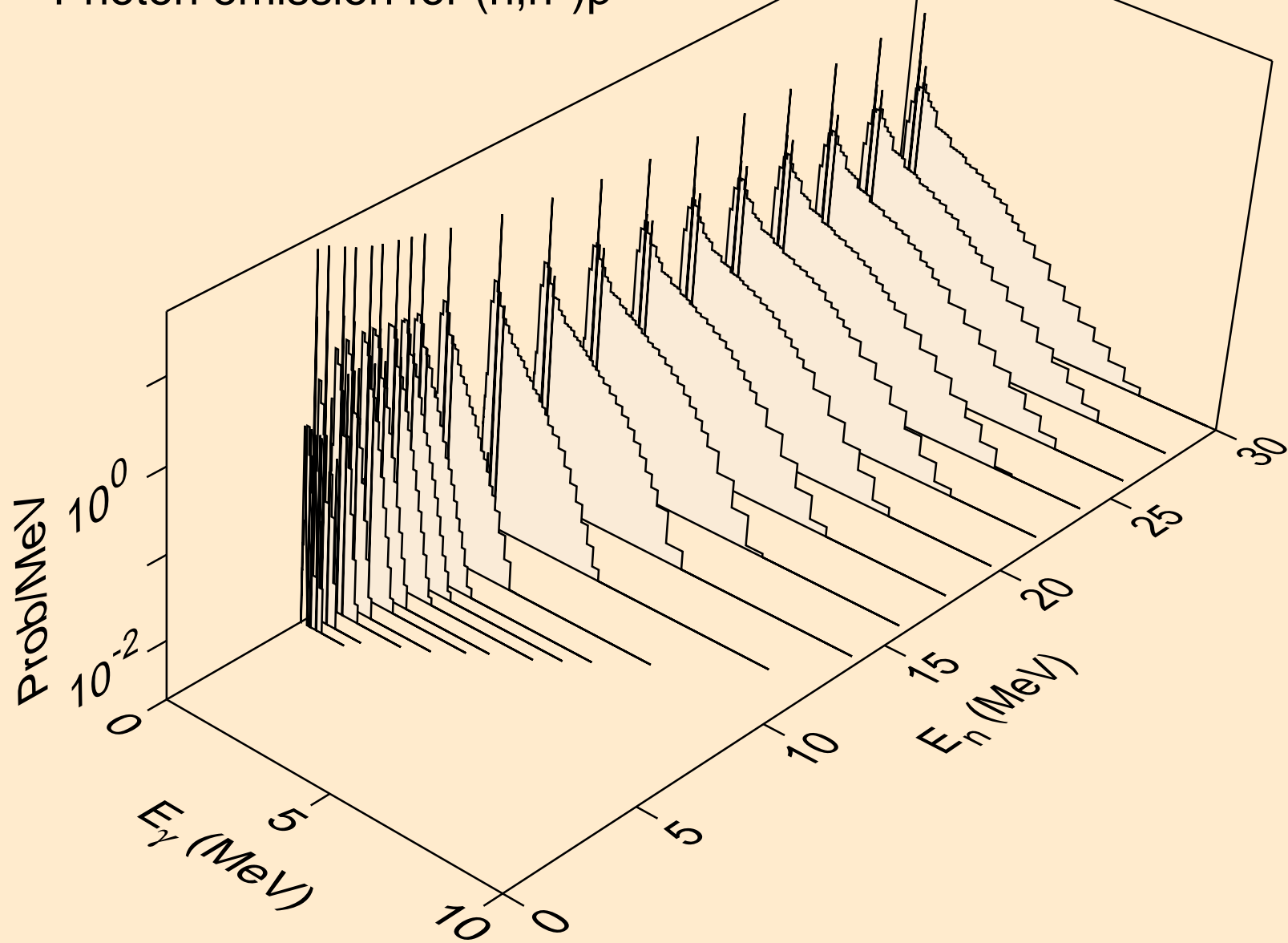

DY145M NEUTRON ACER TENDL-2021 LIBRARY; T=293.6K
Photon emission for (n,n*)2a

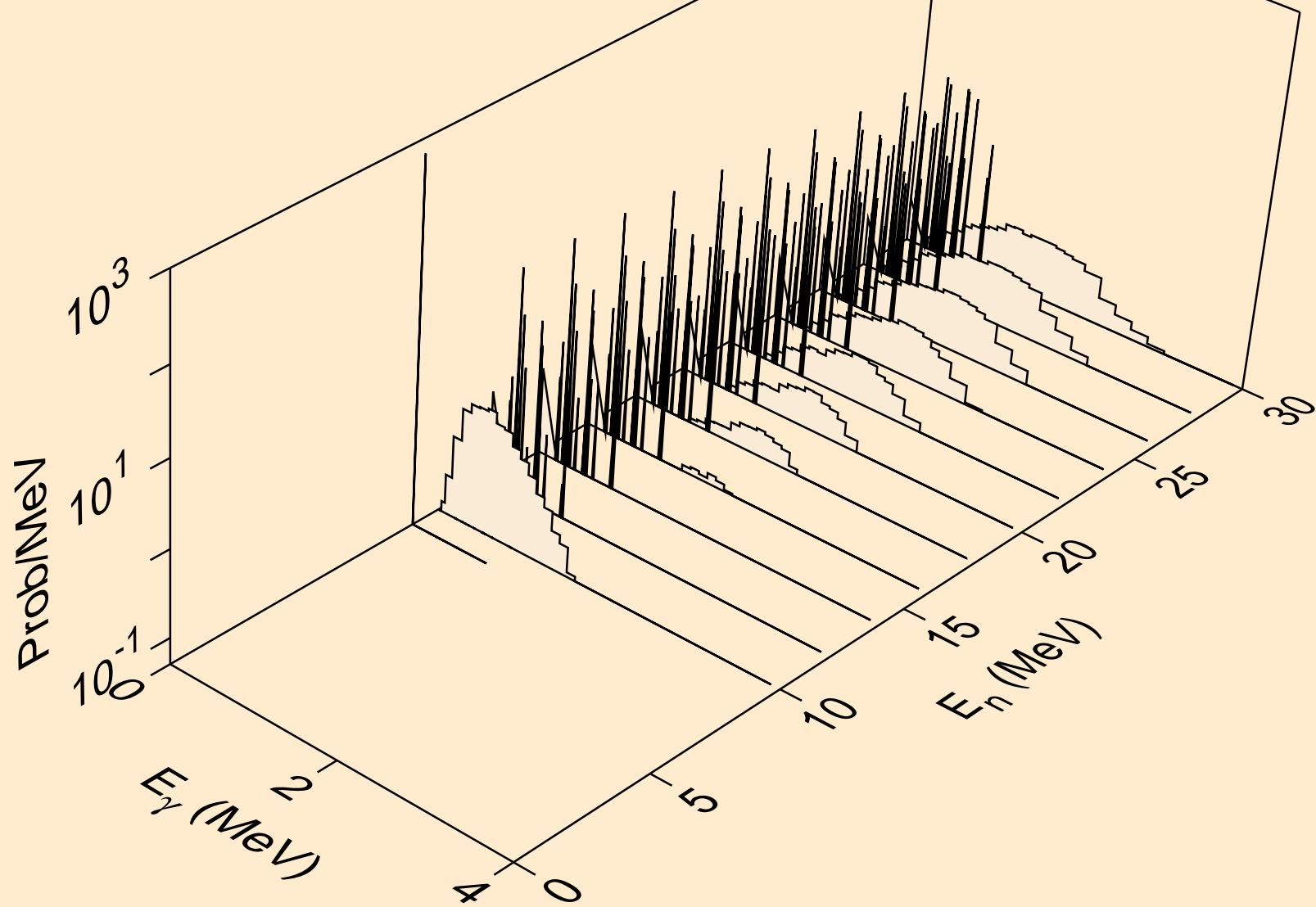

DY145M NEUTRON ACER TENDL-2021 LIBRARY; T=293.6K
Photon emission for (n,2n)2a

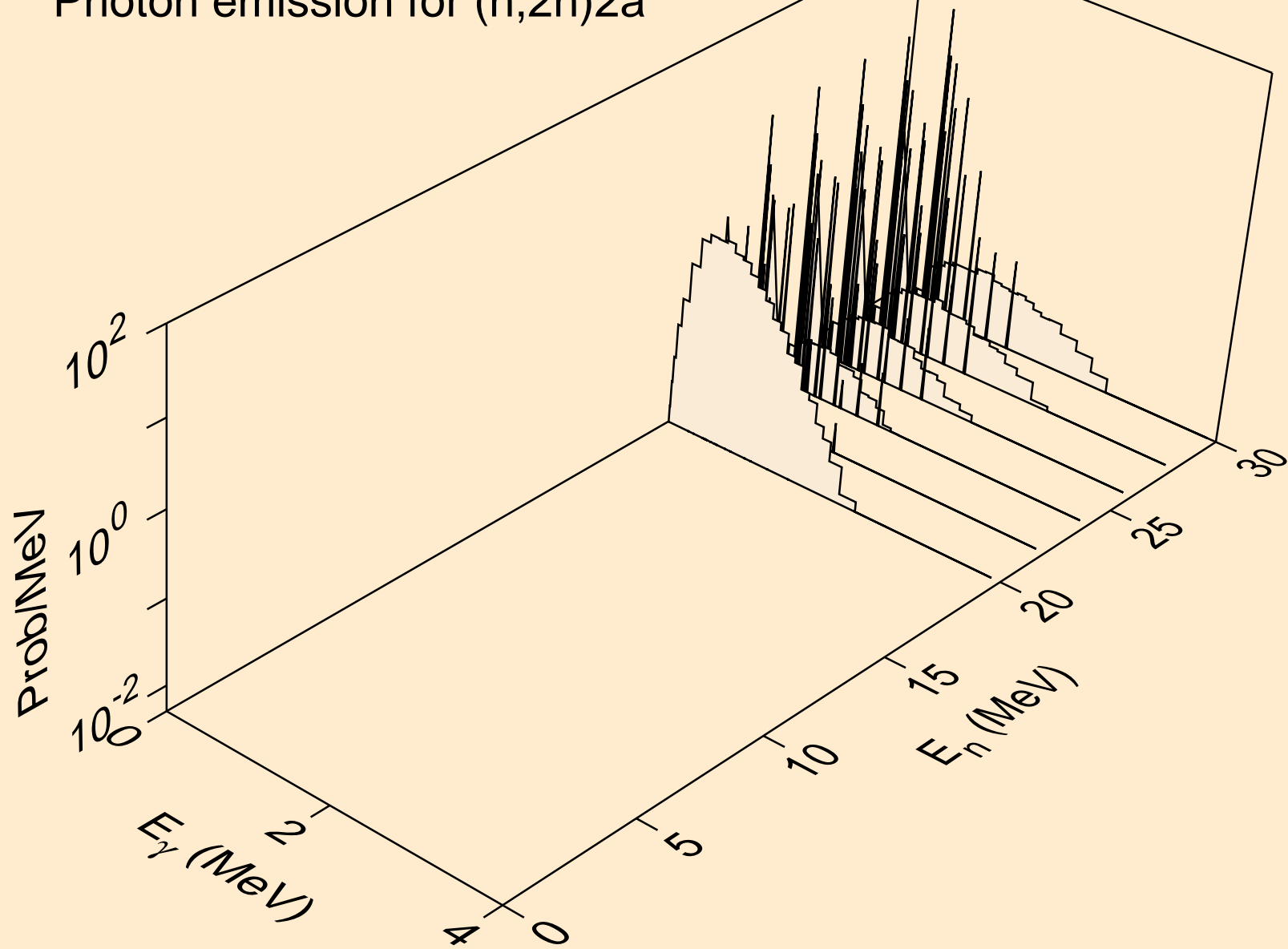

DY145M NEUTRON ACER TENDL-2021 LIBRARY; T=293.6K
Photon emission for (n,n*)d

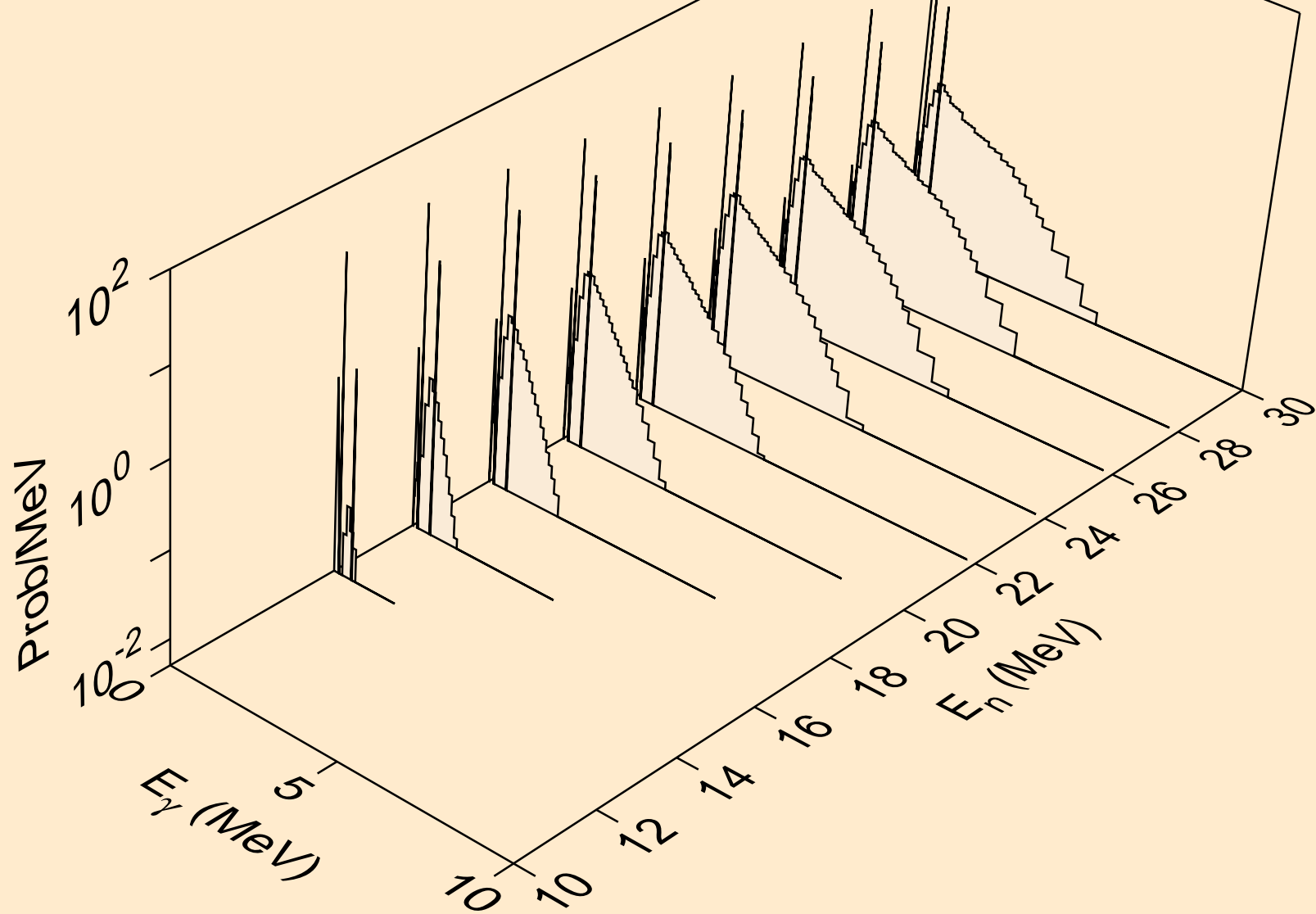

DY145M NEUTRON ACER TENDL-2021 LIBRARY; T=293.6K
Photon emission for (n,n*)t

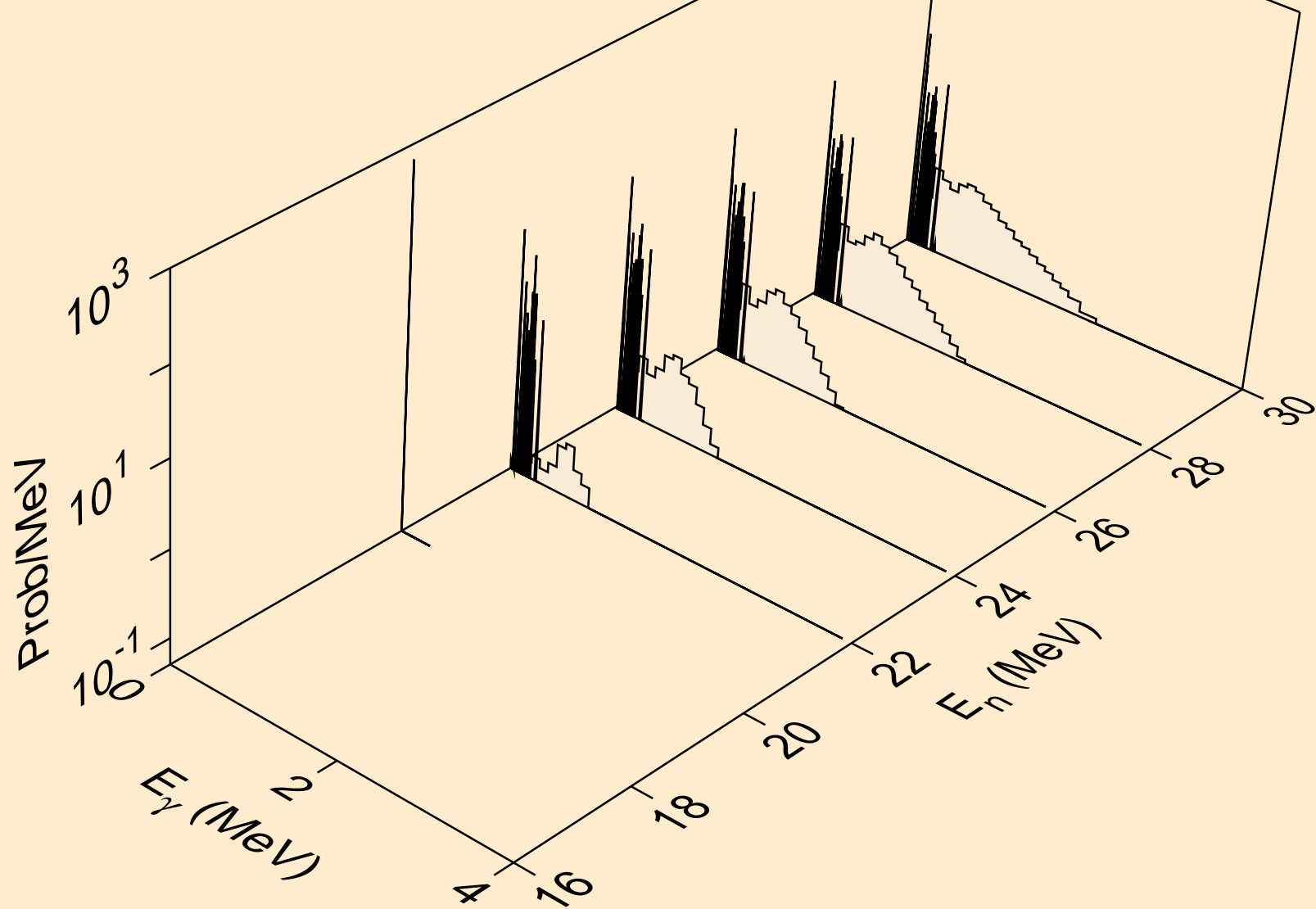

DY145M NEUTRON ACER TENDL-2021 LIBRARY; T=293.6K
Photon emission for (n,n*)he3

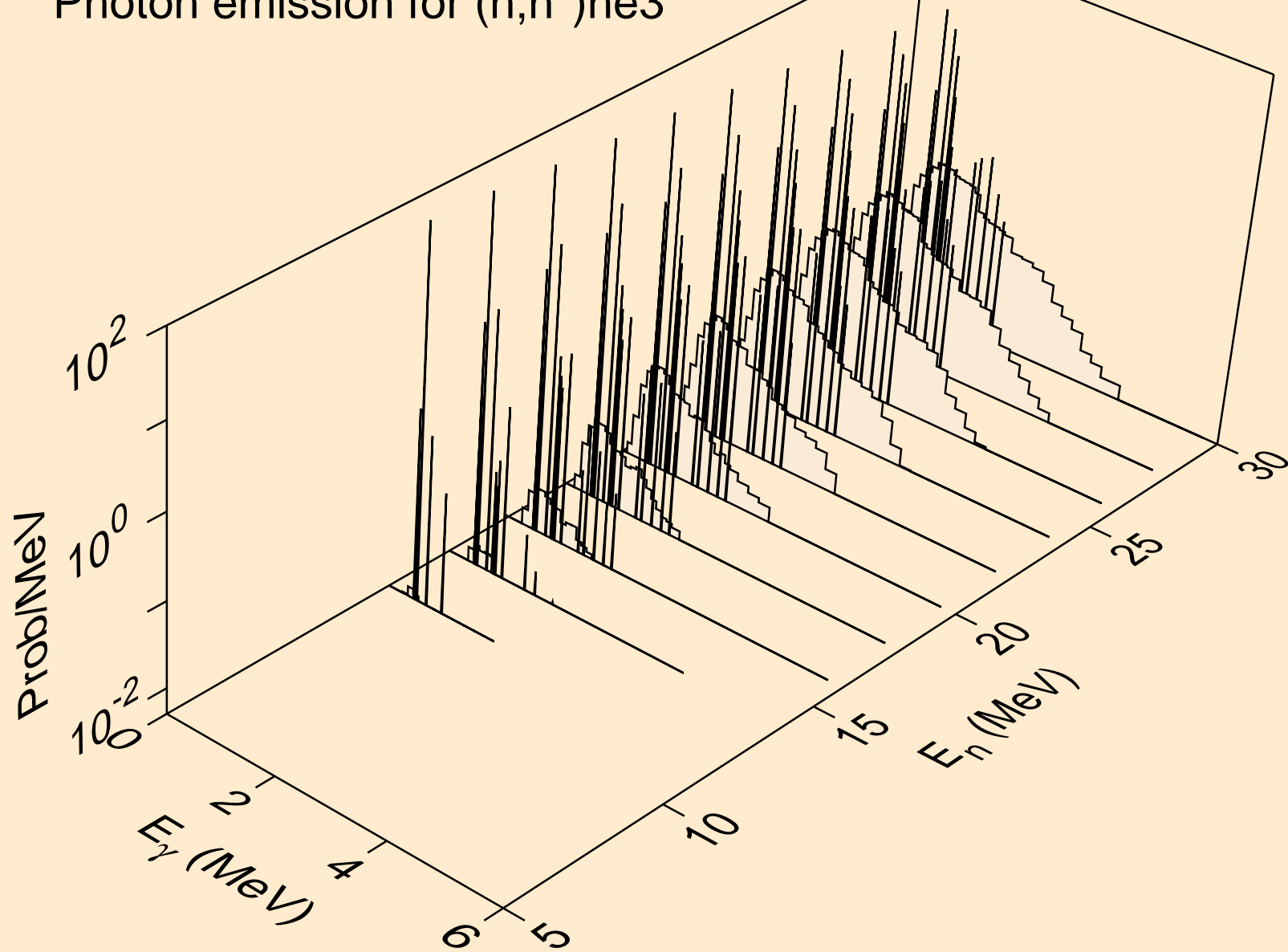

DY145M NEUTRON ACER TENDL-2021 LIBRARY; T=293.6K
Photon emission for (n,2np)

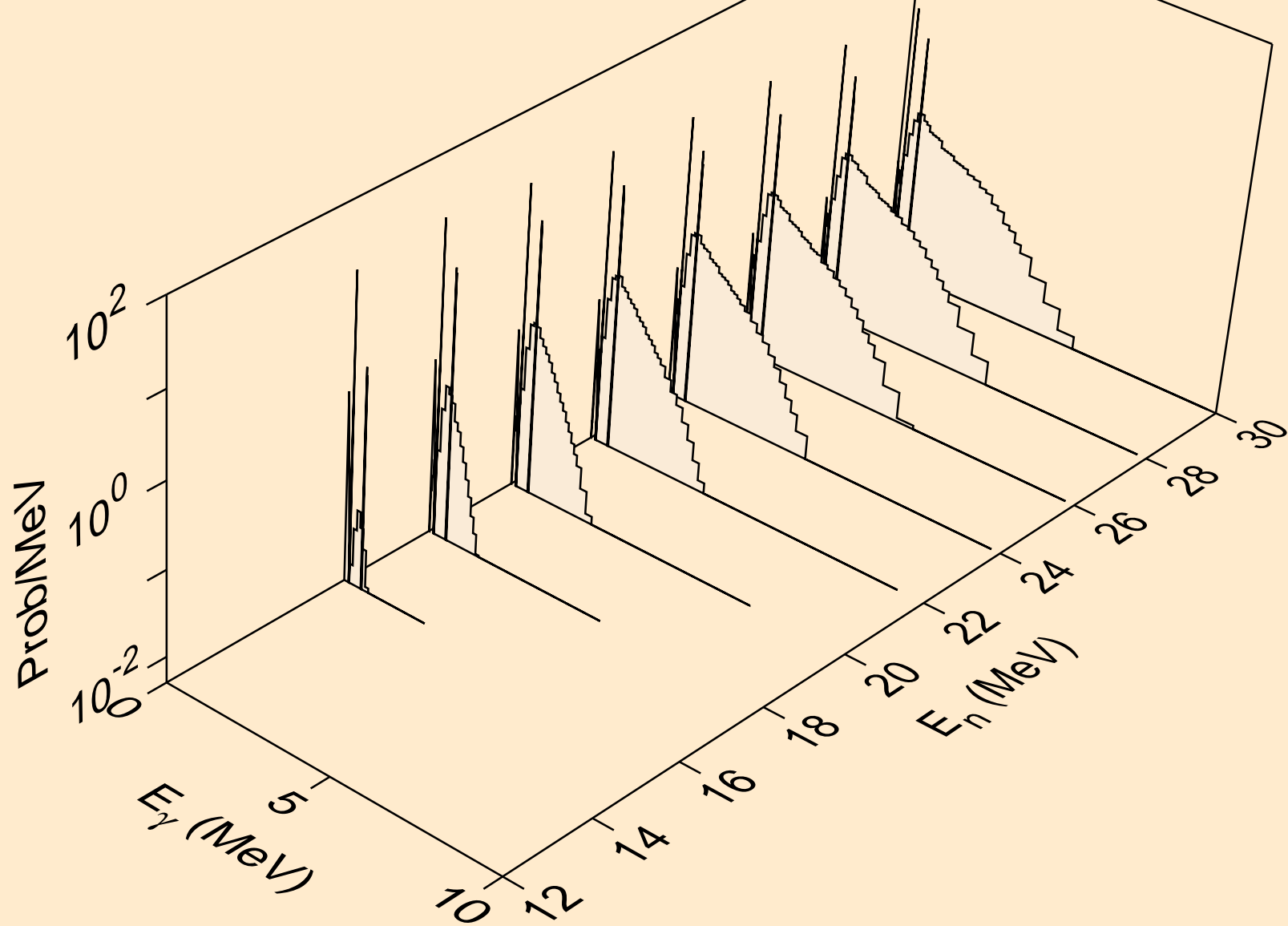

DY145M NEUTRON ACER TENDL-2021 LIBRARY; T=293.6K
Photon emission for (n,3np)

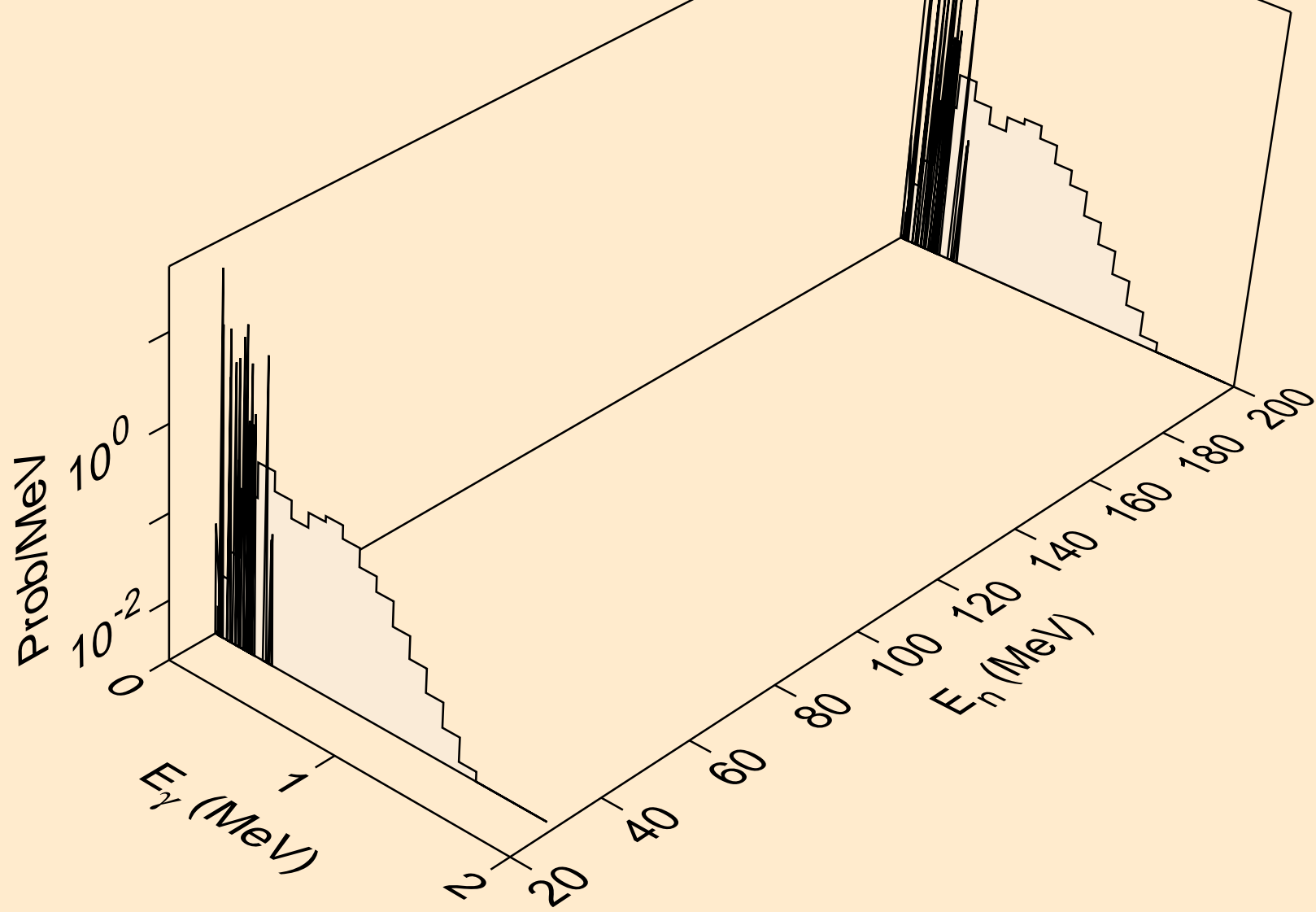

DY145M NEUTRON ACER TENDL-2021 LIBRARY; T=293.6K
Photon emission for (n,2np)

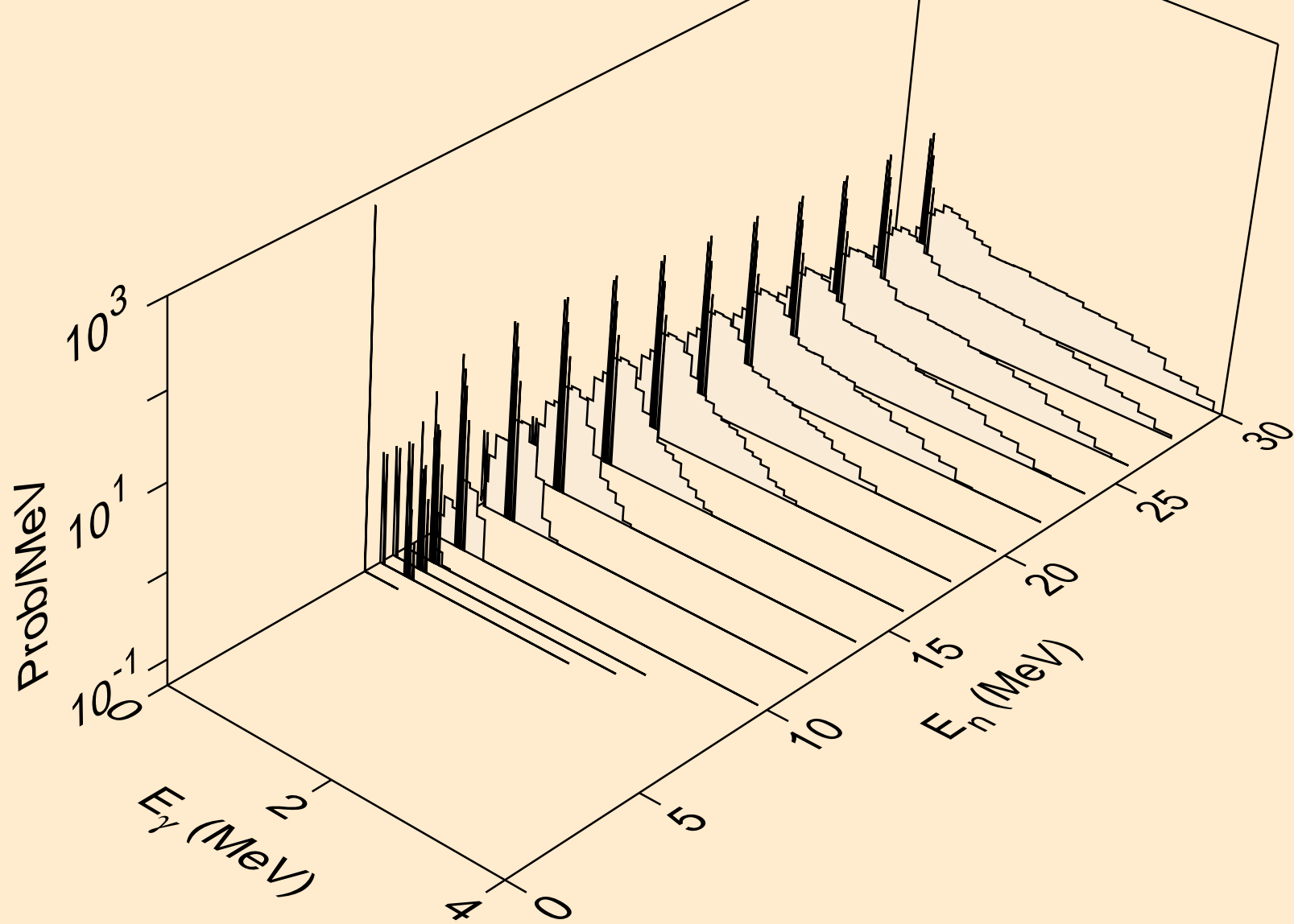

DY145M NEUTRON ACER TENDL-2021 LIBRARY; T=293.6K
Photon emission for (n,npa)

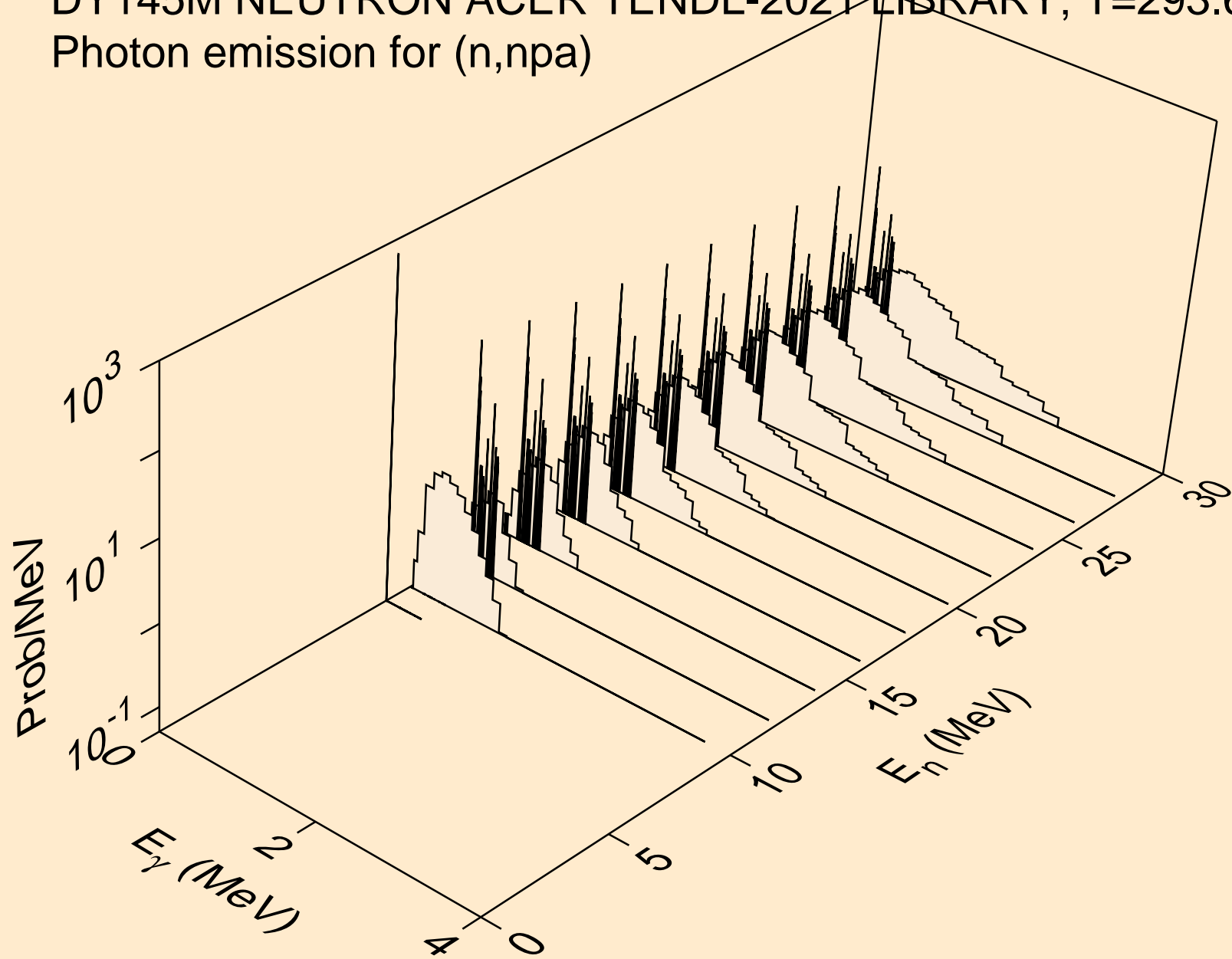

DY145M NEUTRON ACER TENDL-2021 LIBRARY; T=293.6K
Photon emission for (n,n*1)

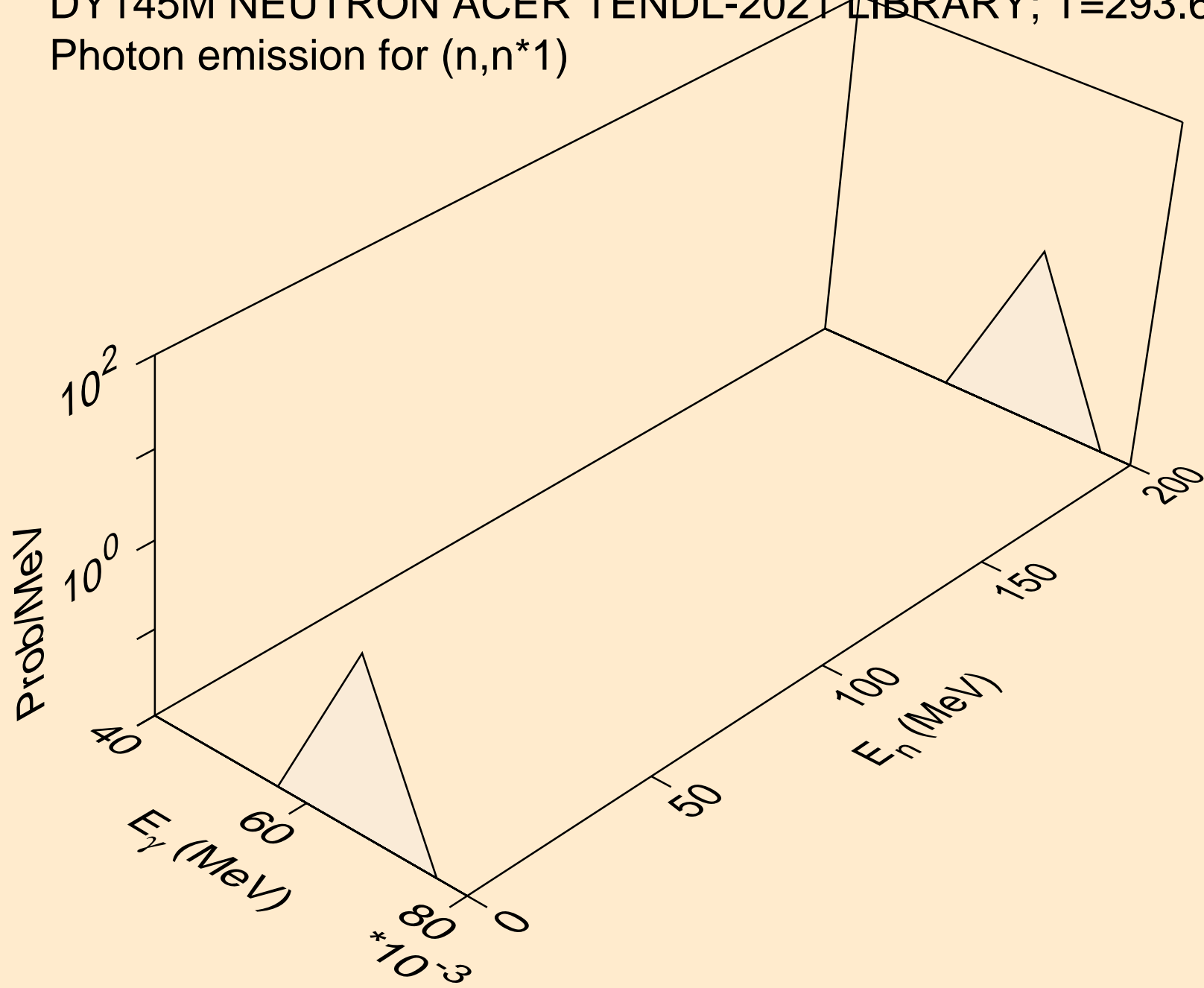

DY145M NEUTRON ACER TENDL-2021 LIBRARY; T=293.6K
Photon emission for (n,n*3)

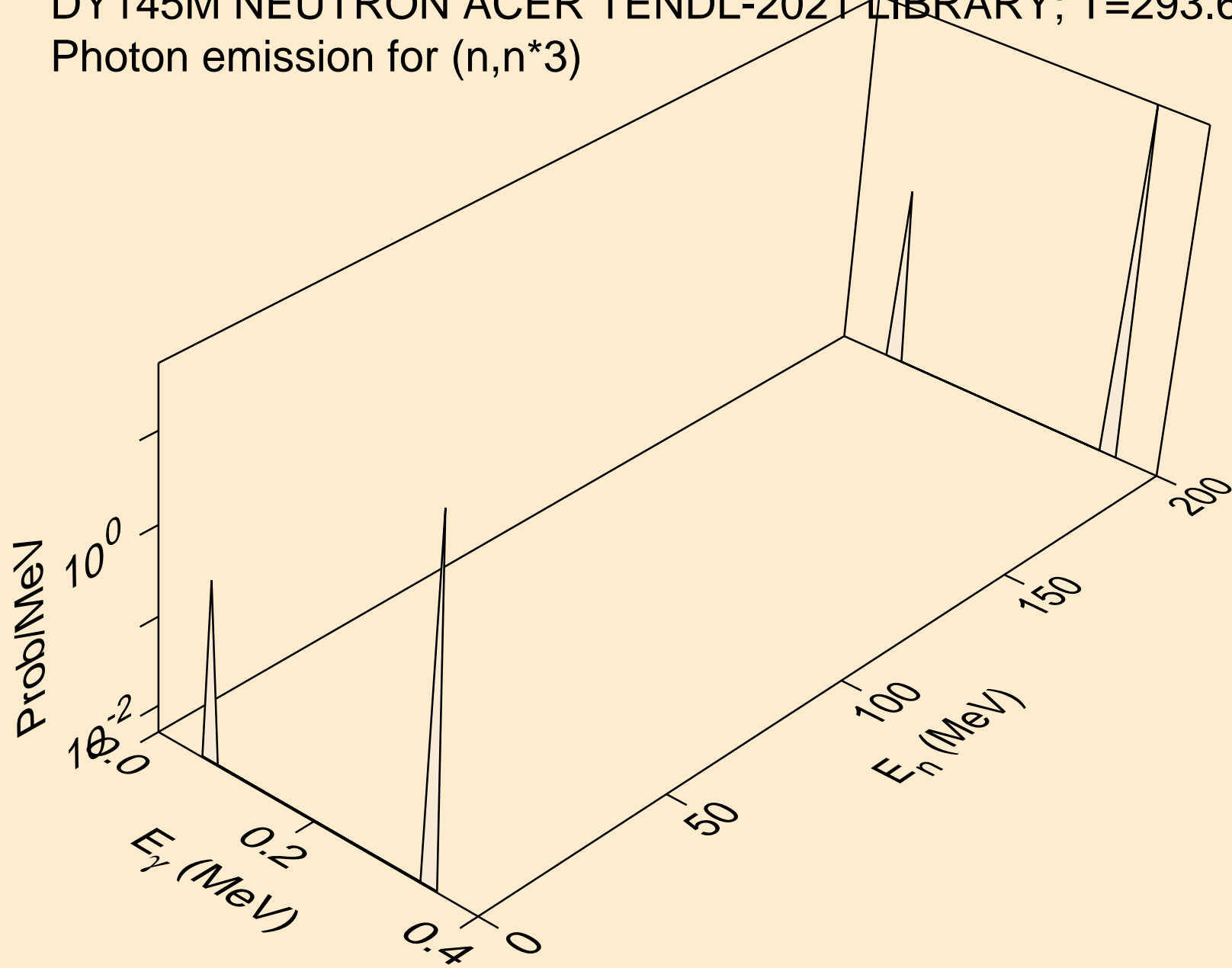

DY145M NEUTRON ACER TENDL-2021 LIBRARY; T=293.6K
Photon emission for (n,n*4)

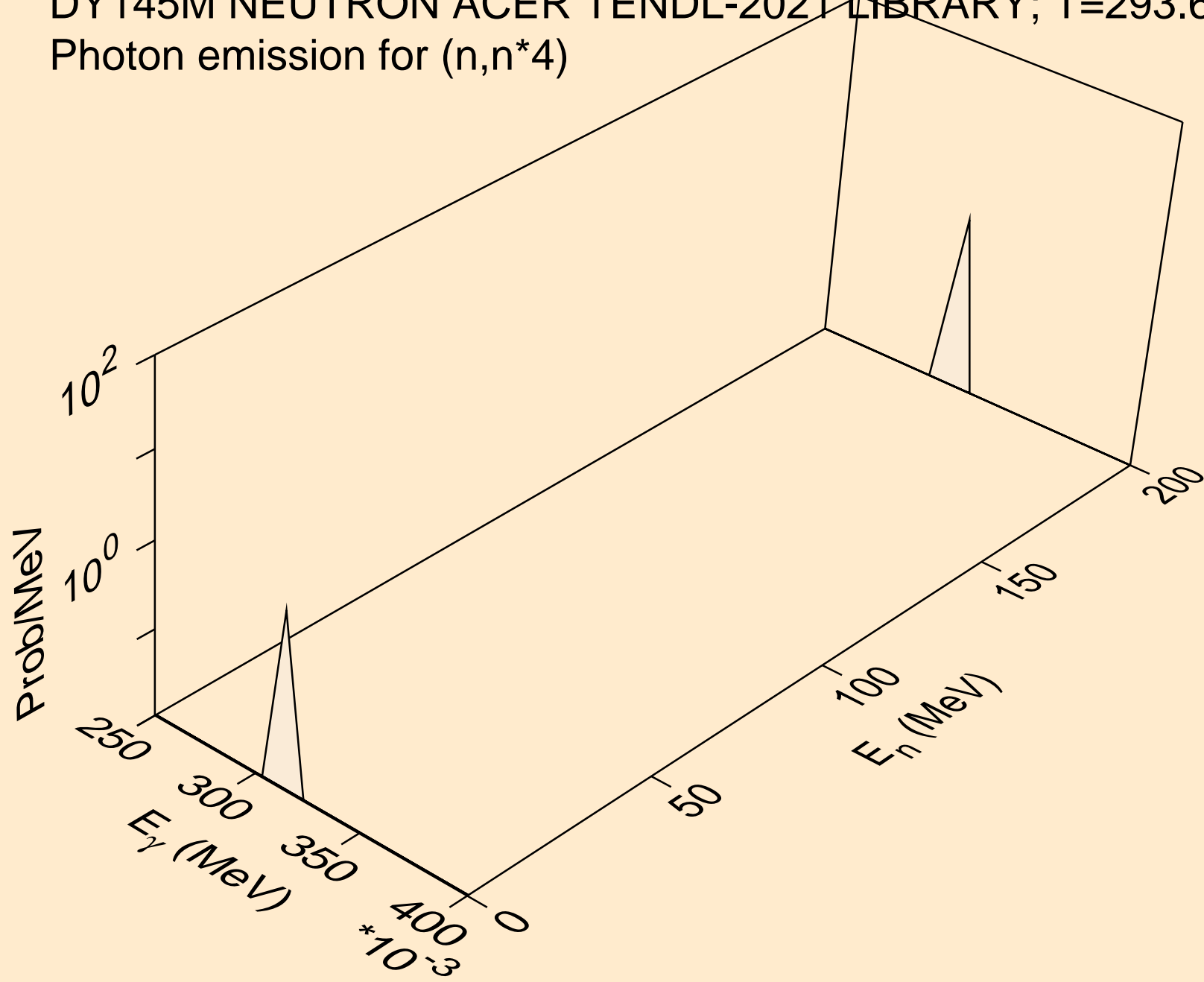

DY145M NEUTRON ACER TENDL-2021 LIBRARY; T=293.6K
Photon emission for (n,n*5)

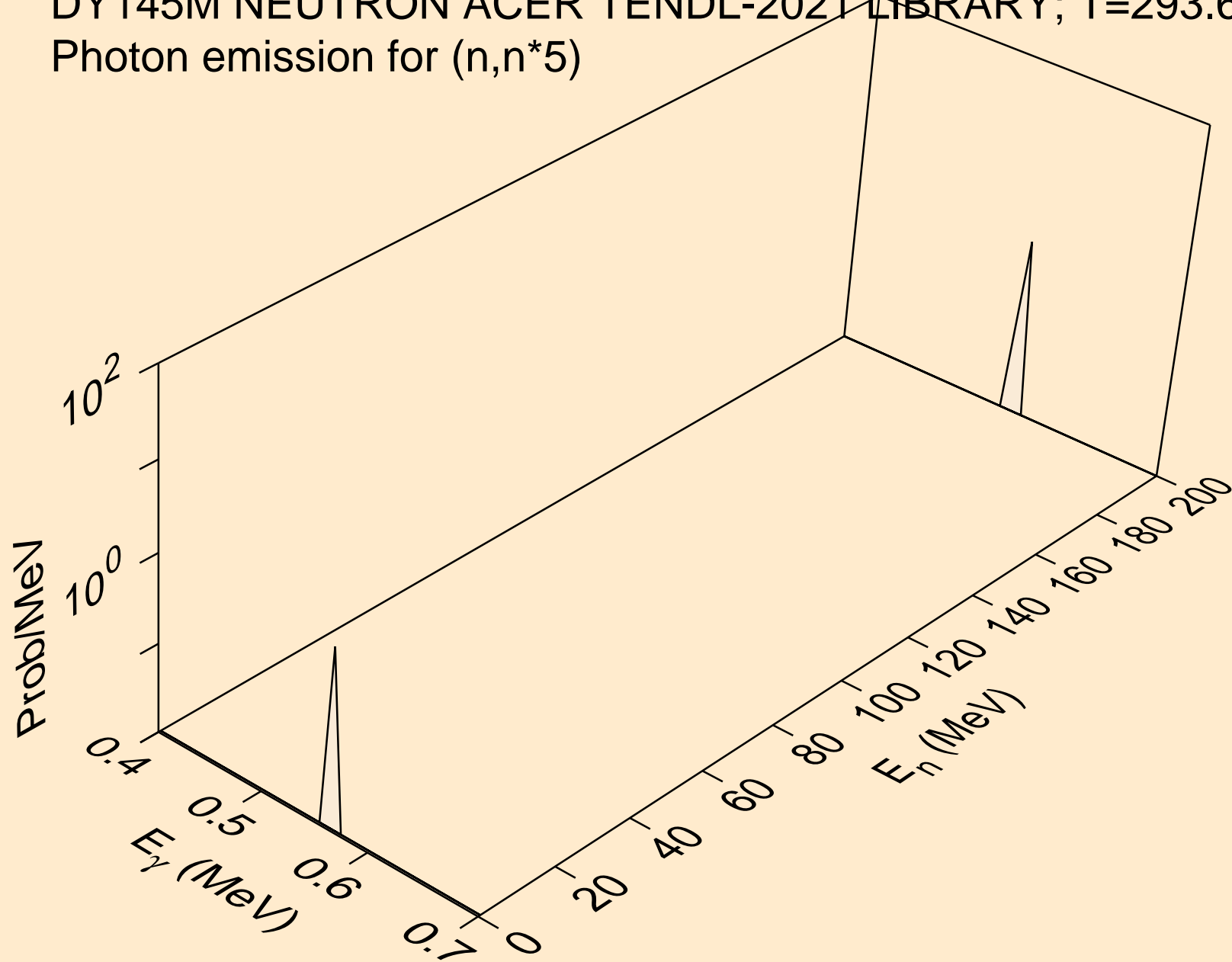

DY145M NEUTRON ACER TENDL-2021 LIBRARY; T=293.6K
Photon emission for (n,n*6)

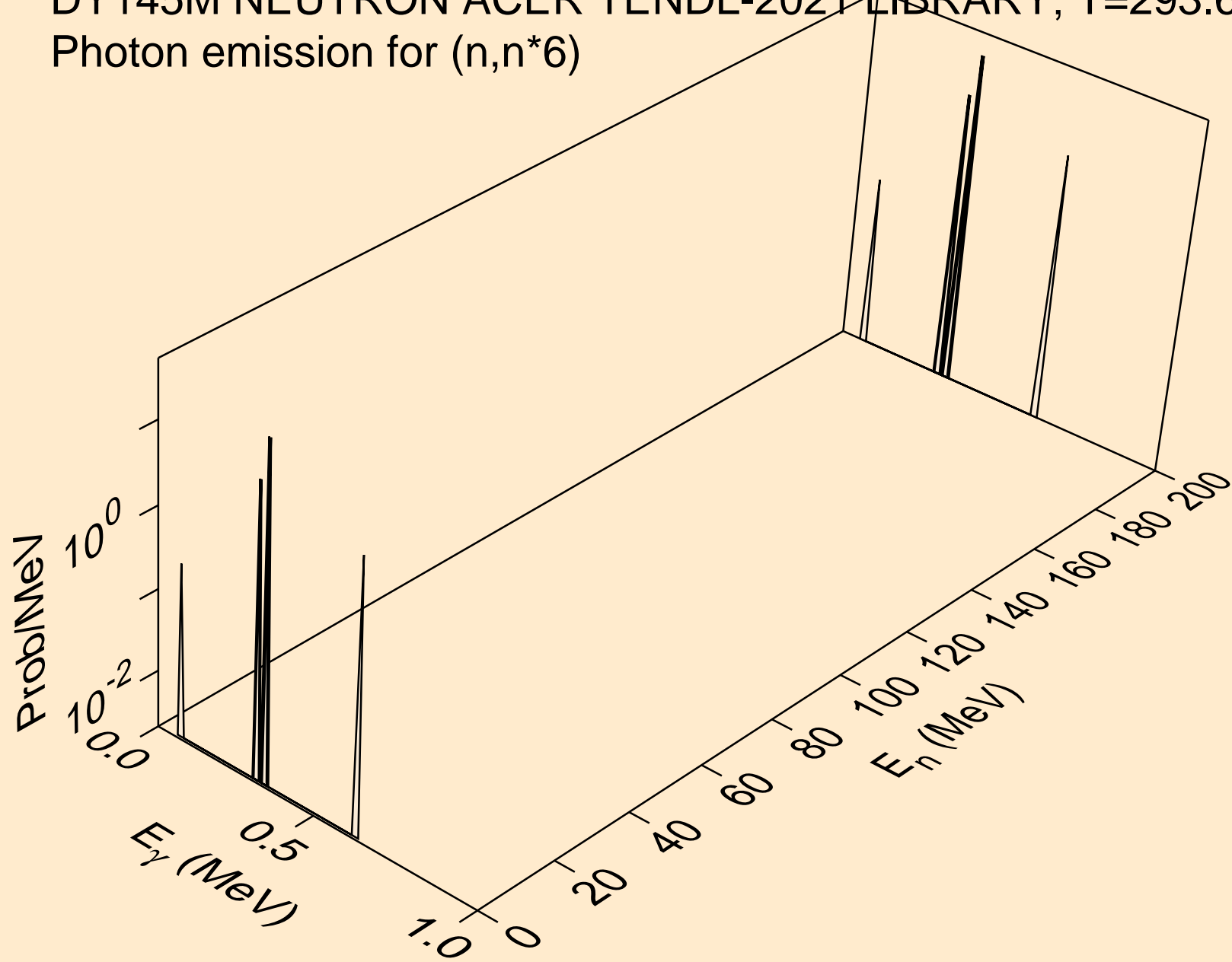

DY145M NEUTRON ACER TENDL-2021 LIBRARY; T=293.6K
Photon emission for (n,n*7)

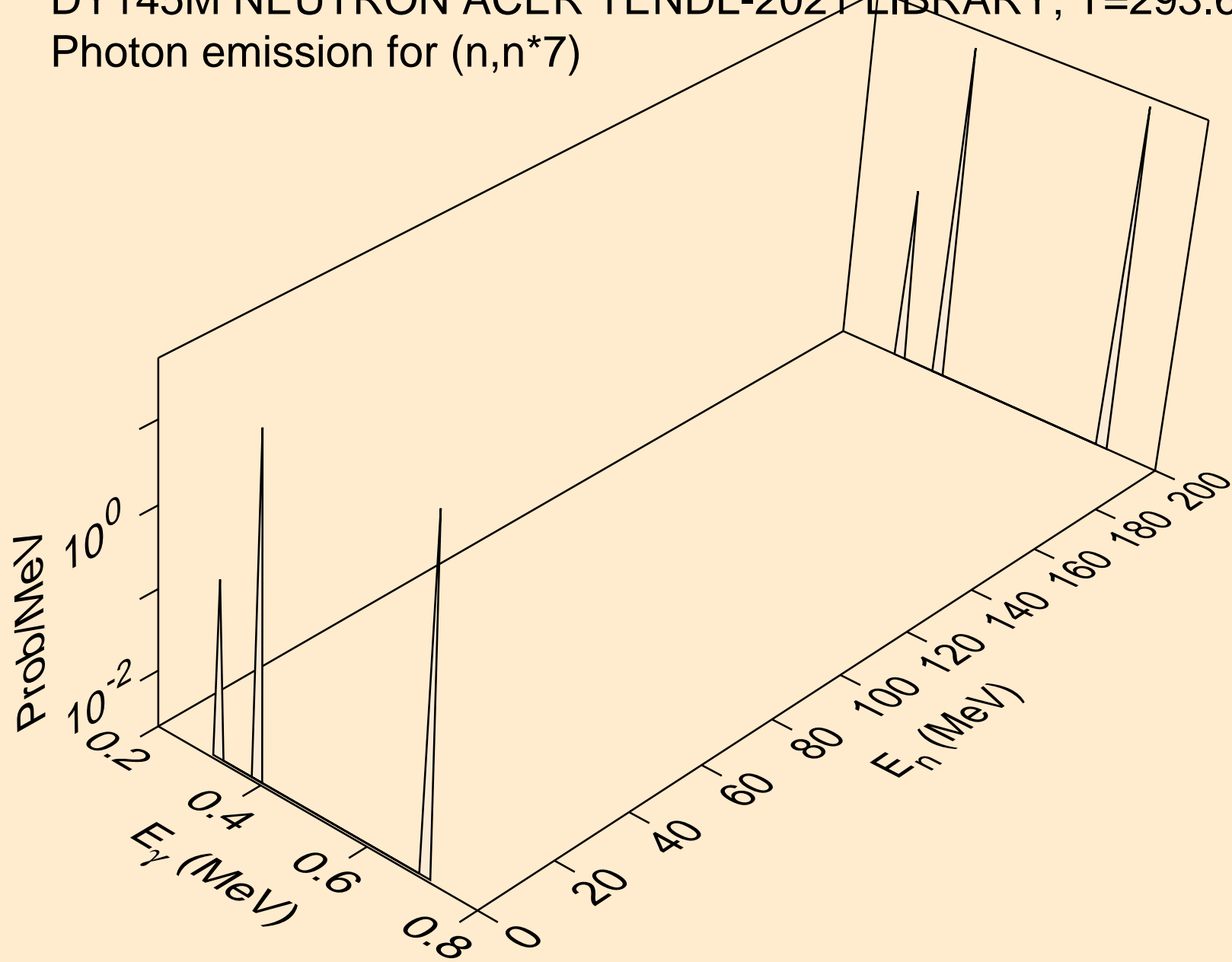

DY145M NEUTRON ACER TENDL-2021 LIBRARY; T=293.6K
Photon emission for (n,n*c)

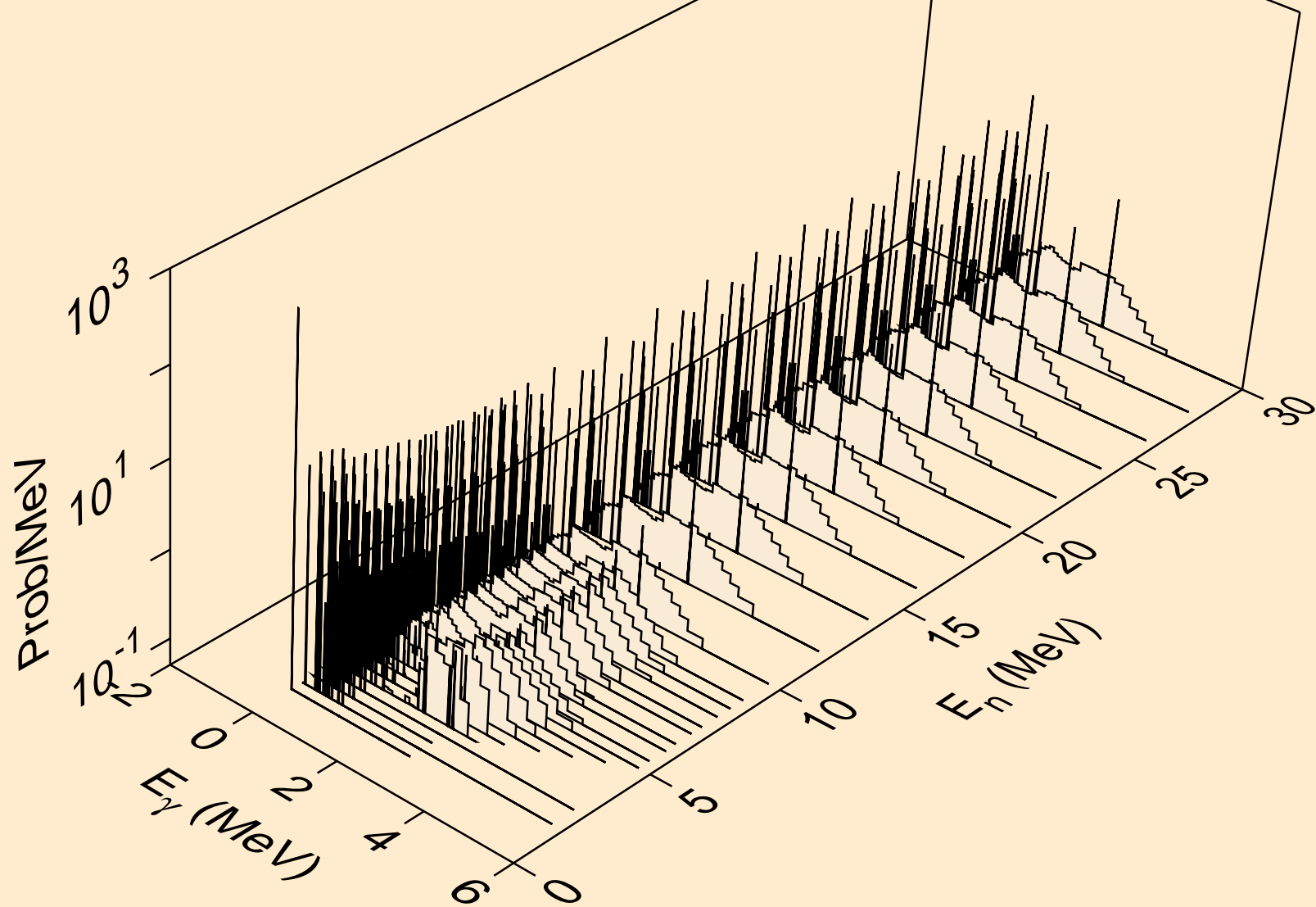

DY145M NEUTRON ACER TENDL-2021 LIBRARY; T=293.6K
Photon emission for (n,gma)

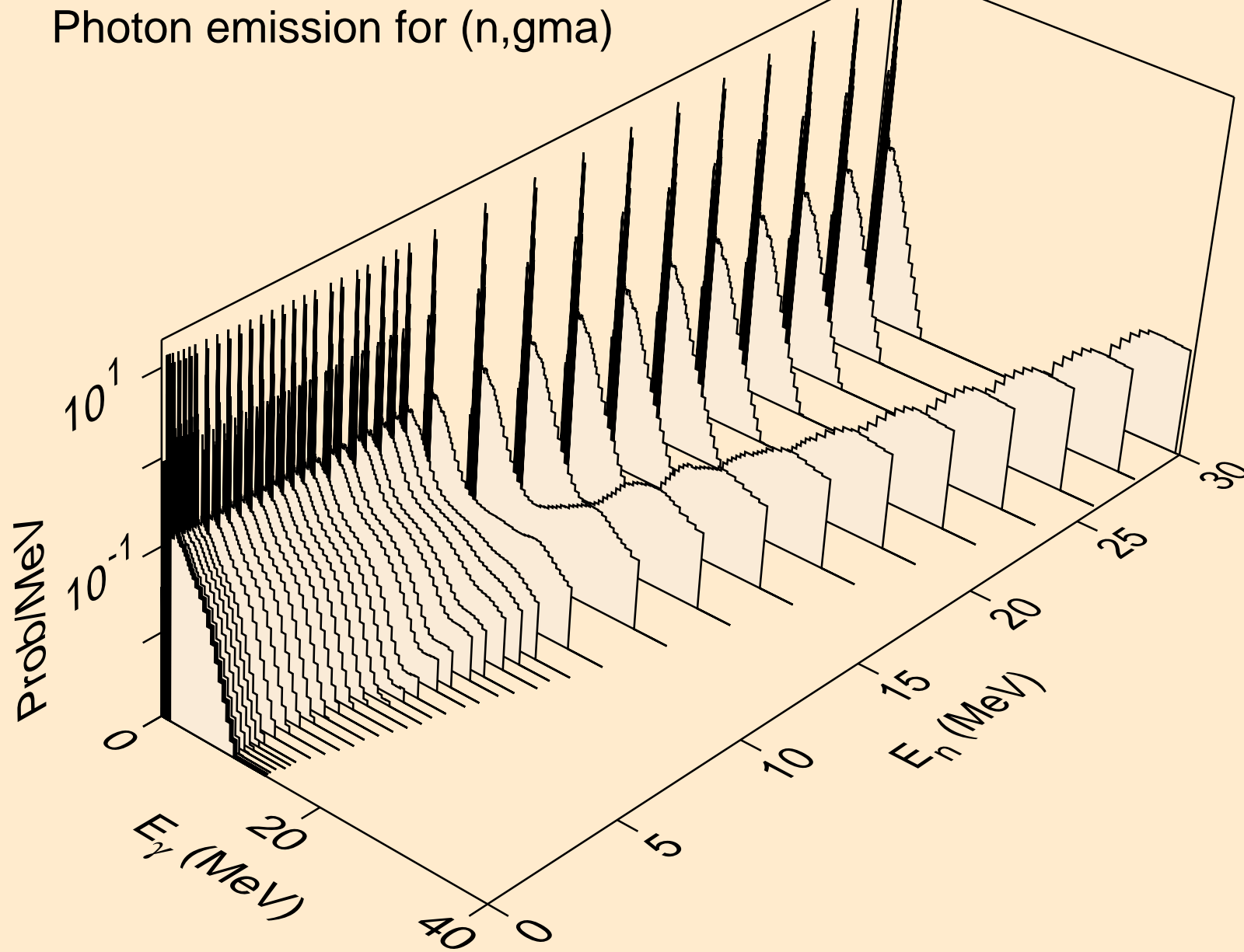

DY145M NEUTRON ACER TENDL-2021 LIBRARY; T=293.6K
Photon emission for (n,p)

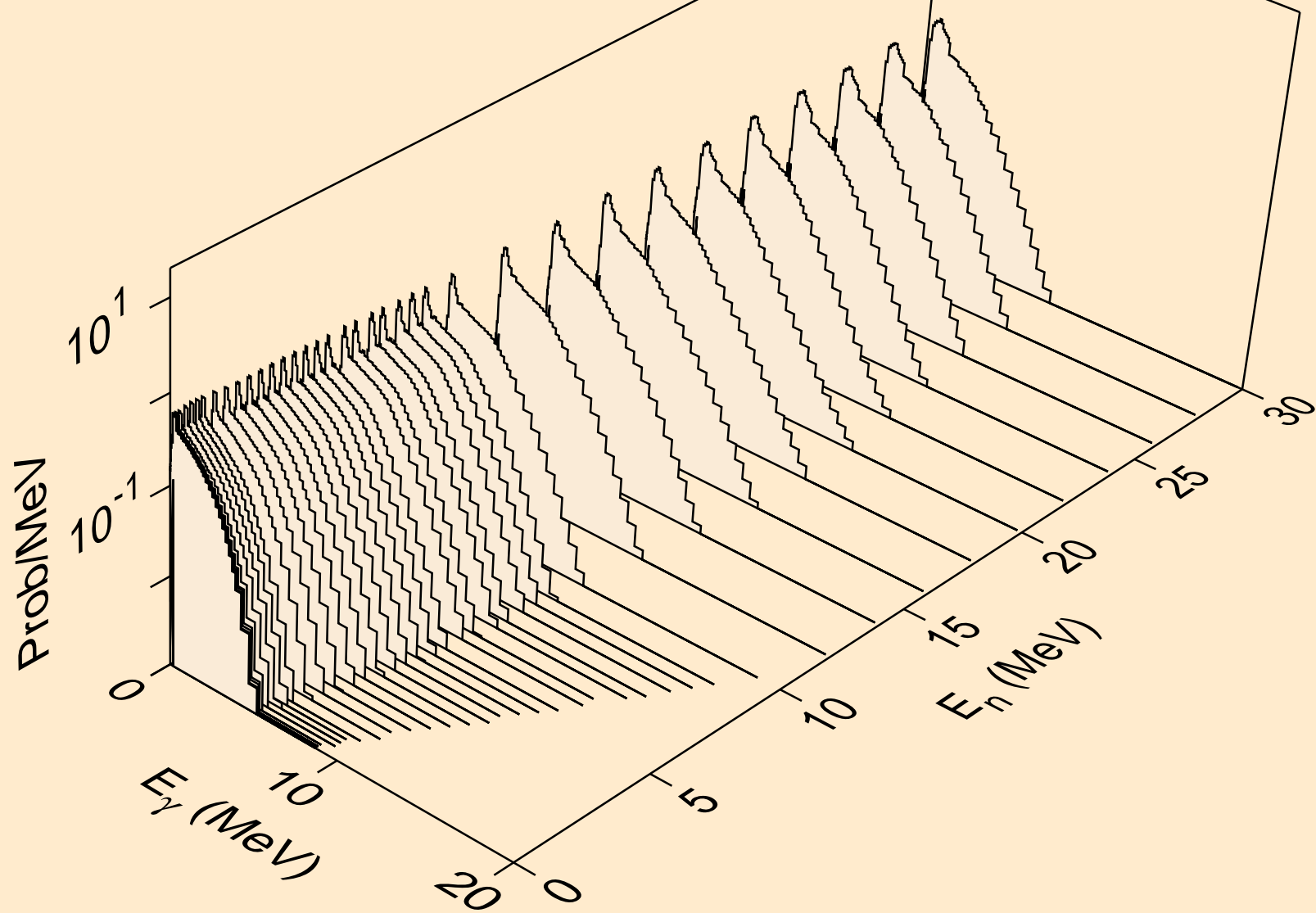

DY145M NEUTRON ACER TENDL-2021 LIBRARY; T=293.6K
Photon emission for (n,d)

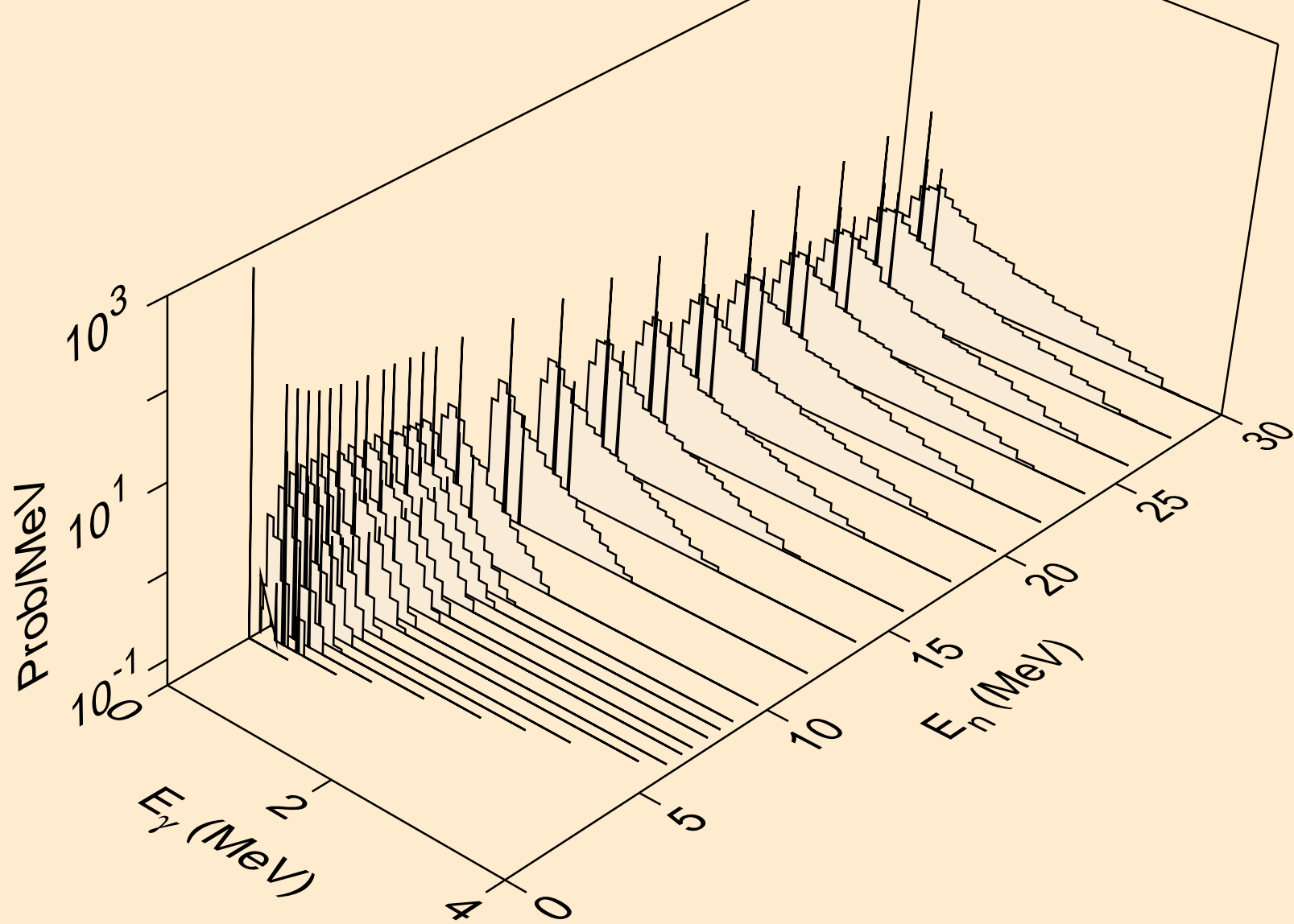

DY145M NEUTRON ACER TENDL-2021 LIBRARY; T=293.6K
Photon emission for (n,t)

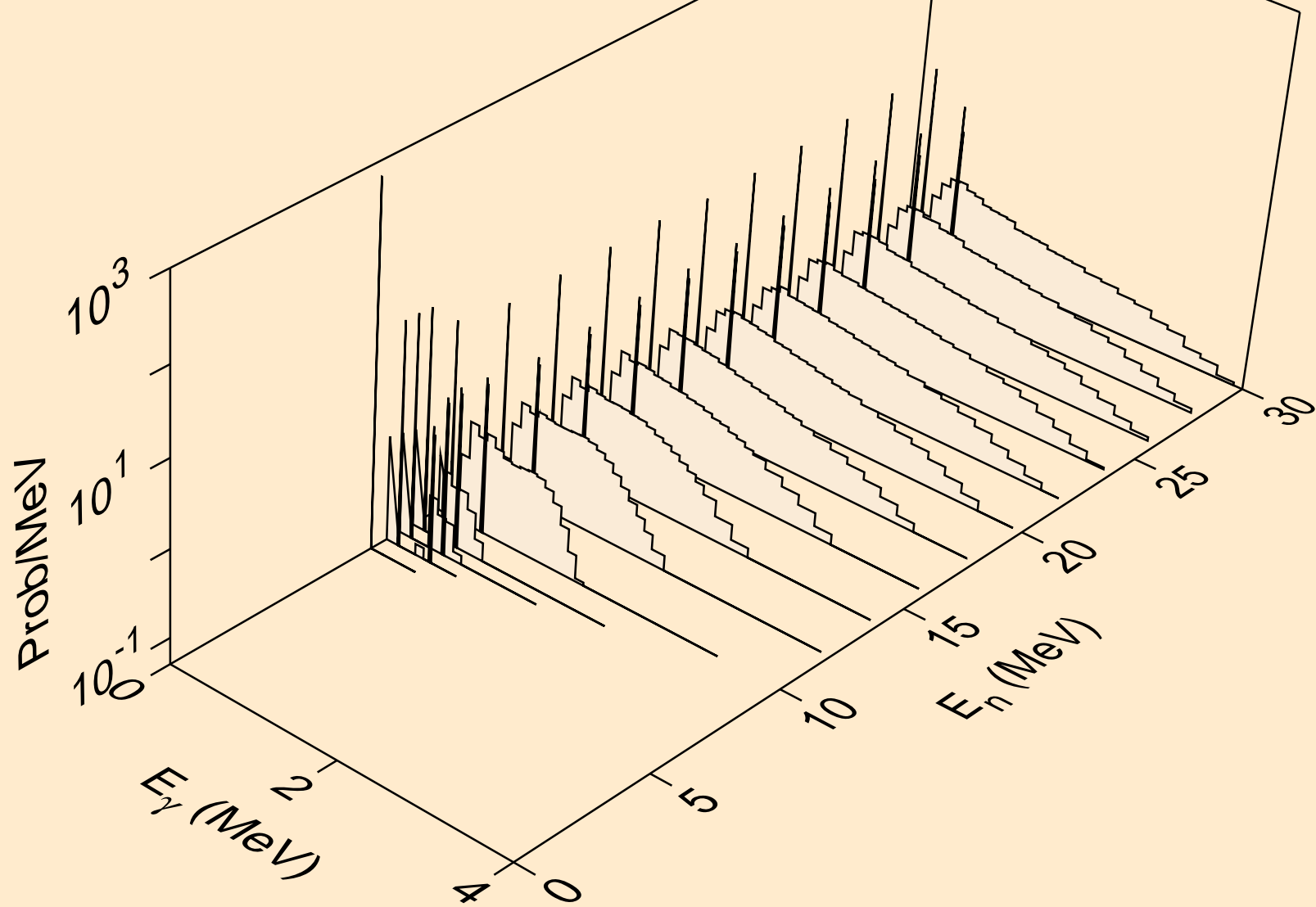

DY145M NEUTRON ACER TENDL-2021 LIBRARY; T=293.6K
Photon emission for (n,he3)

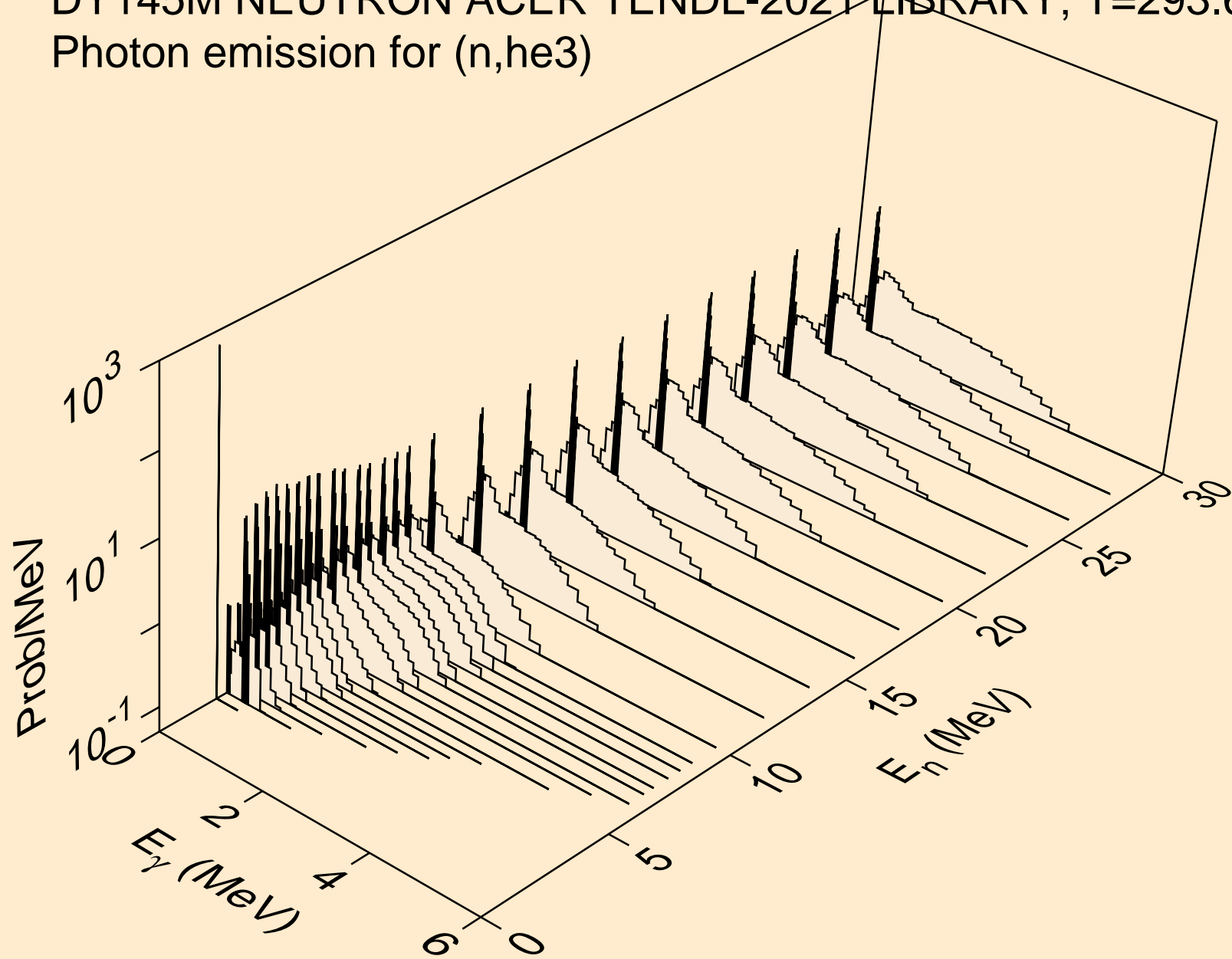

DY145M NEUTRON ACER TENDL-2021 LIBRARY; T=293.6K
Photon emission for (n,a)

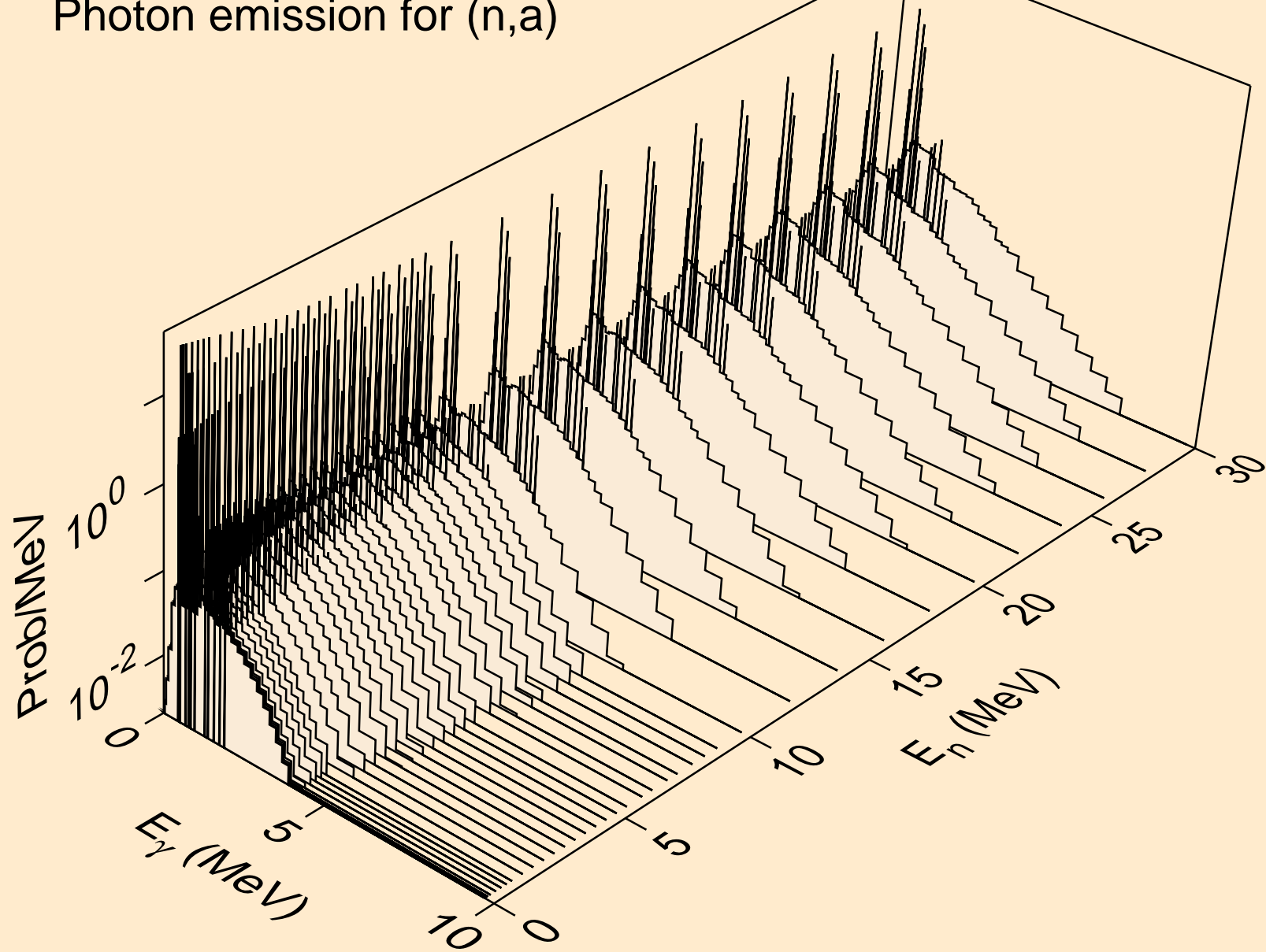

DY145M NEUTRON ACER TENDL-2021 LIBRARY; T=293.6K
Photon emission for (n,2a)

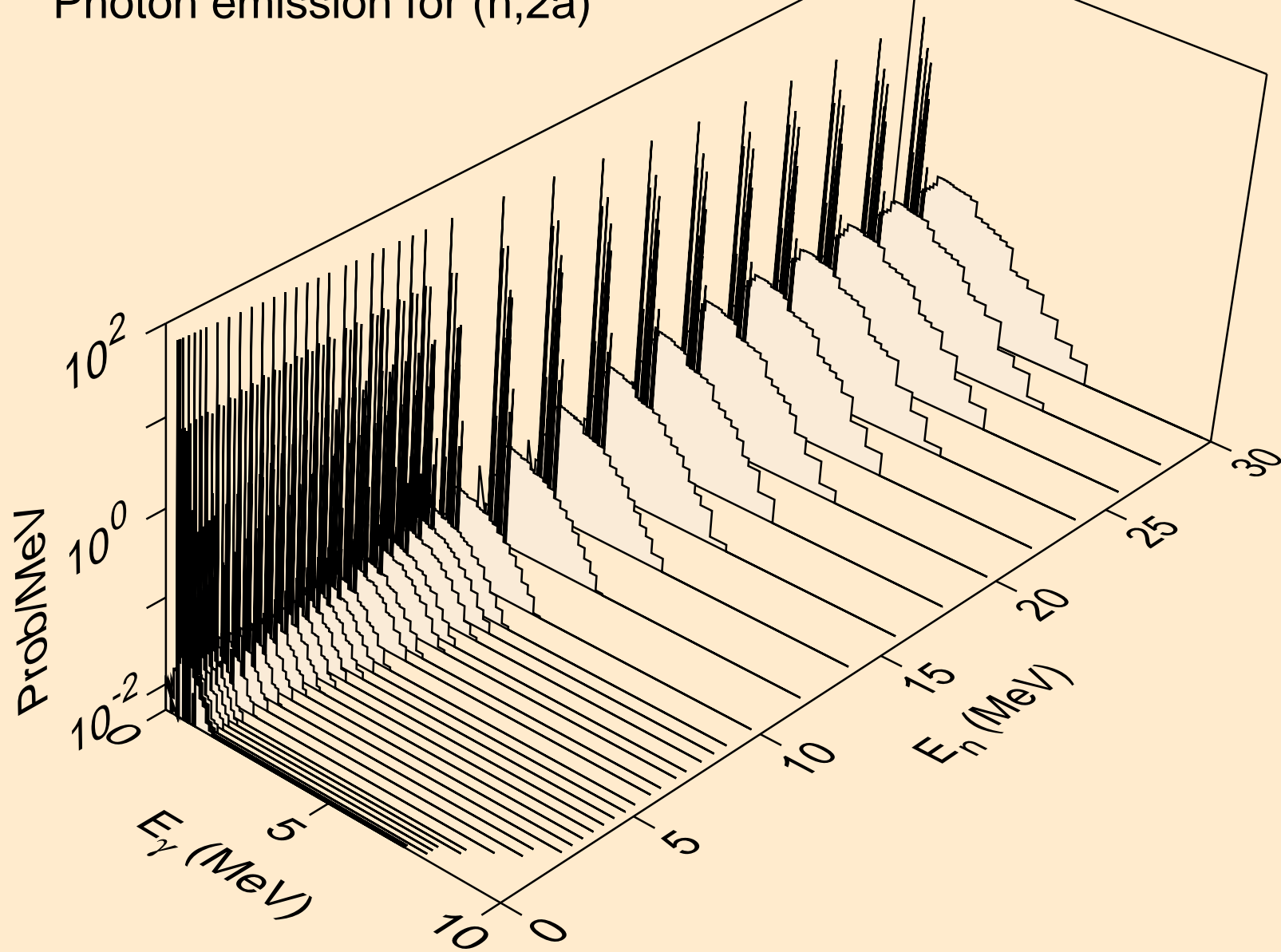

DY145M NEUTRON ACER TENDL-2021 LIBRARY; T=293.6K
Photon emission for (n,3a)

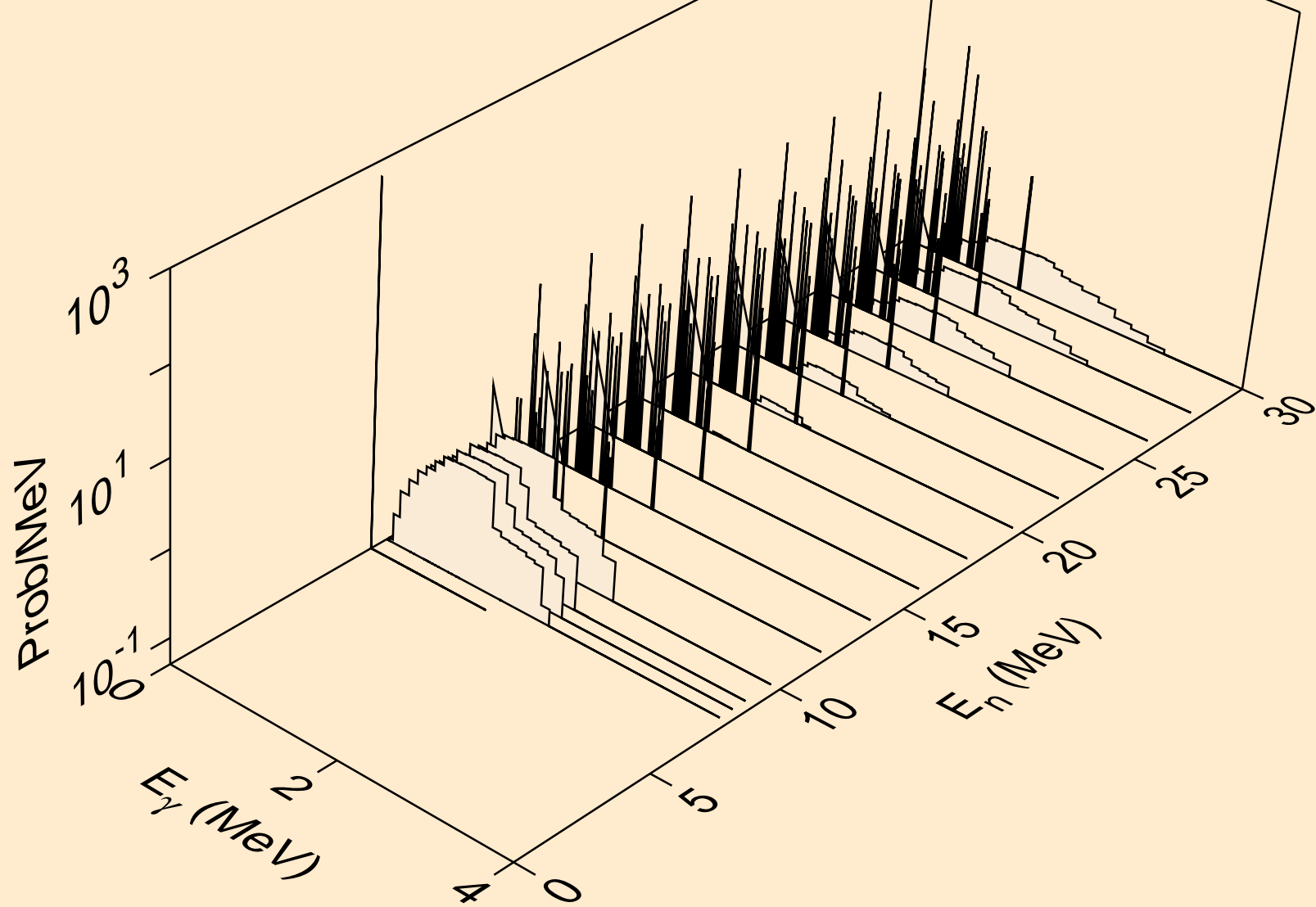

DY145M NEUTRON ACER TENDL-2021 LIBRARY; T=293.6K
Photon emission for (n,2p)

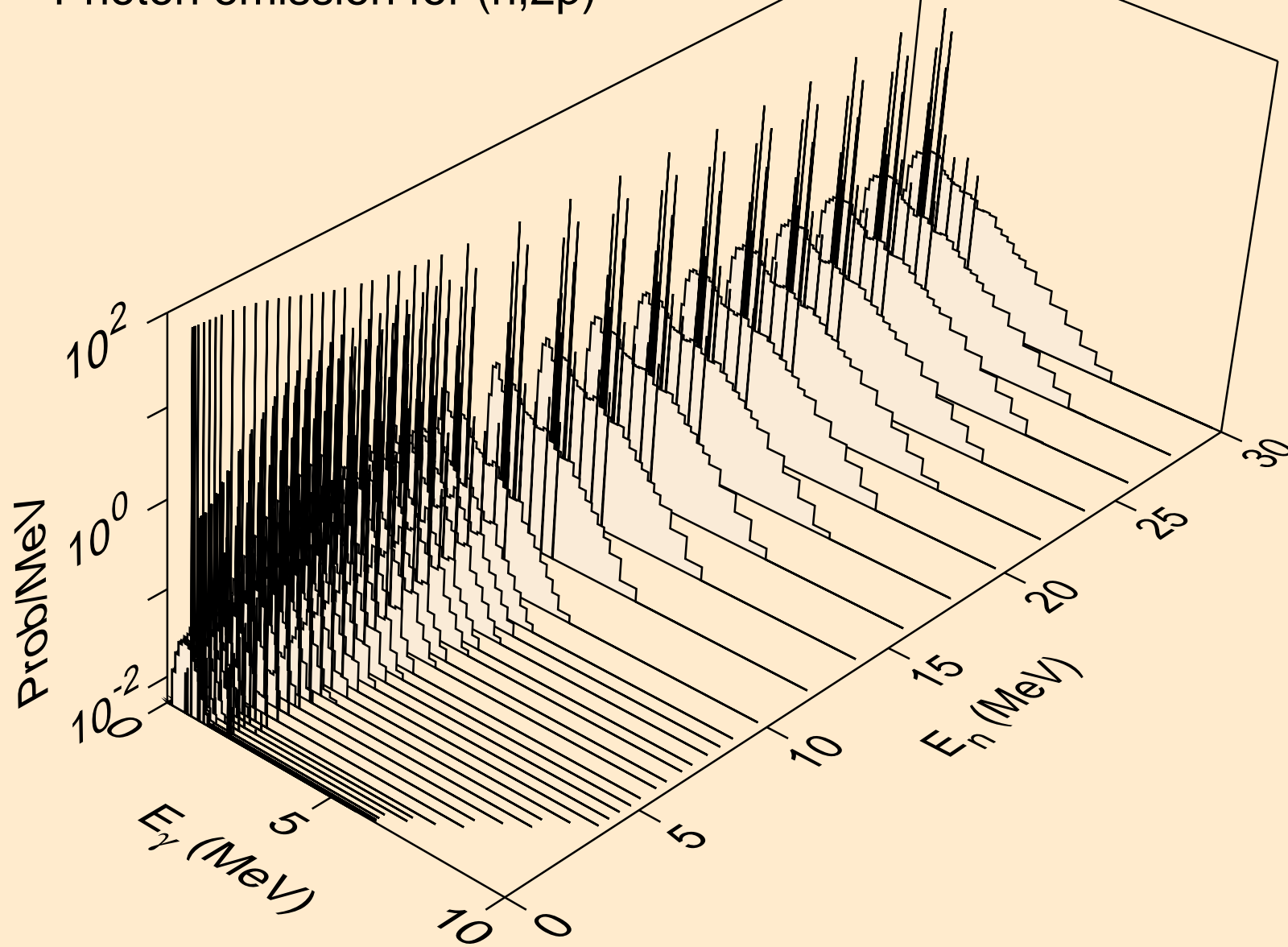

DY145M NEUTRON ACER TENDL-2021 LIBRARY; T=293.6K
Photon emission for (n,p)

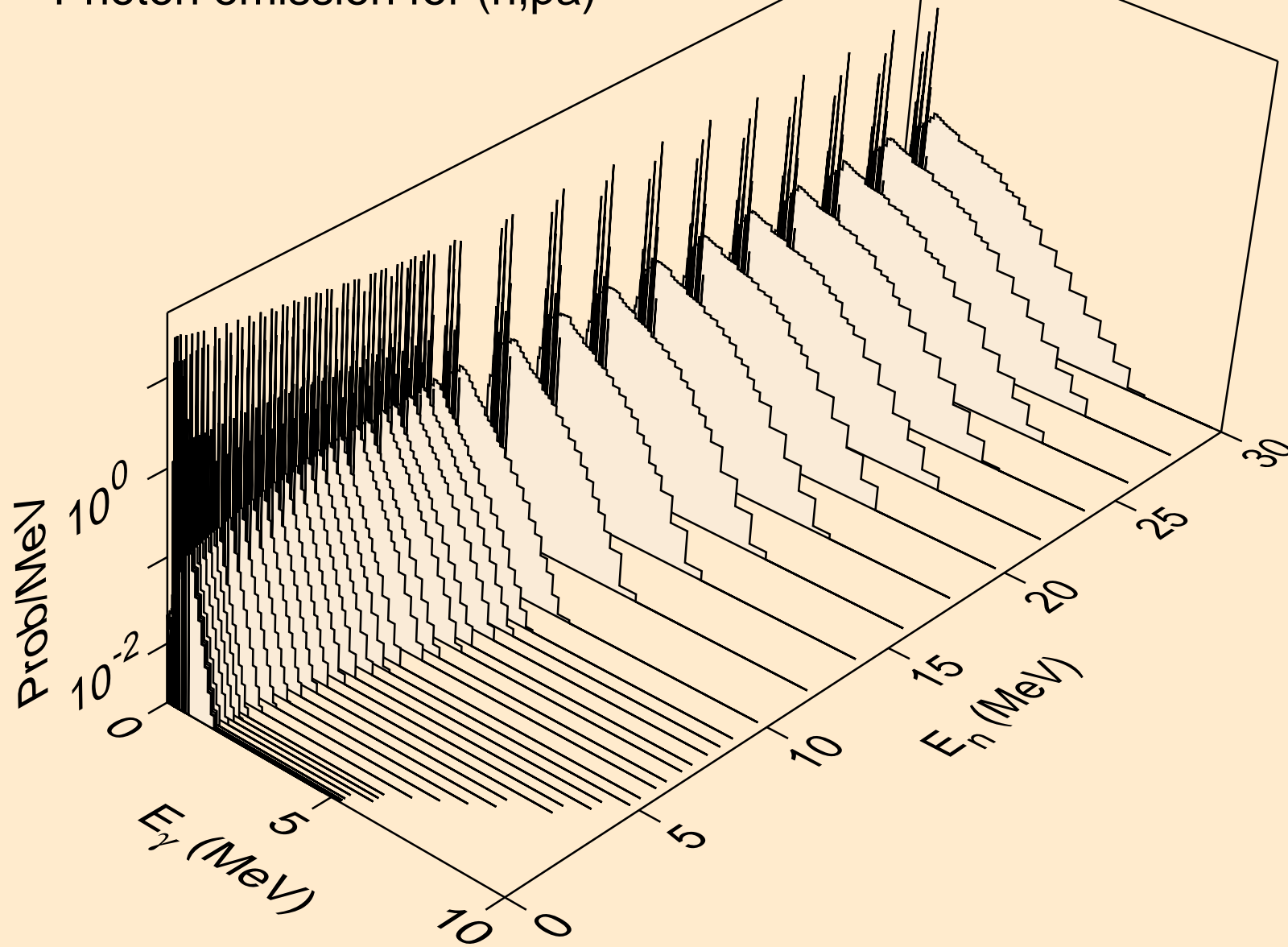

DY145M NEUTRON ACER TENDL-2021 LIBRARY; T=293.6K
Photon emission for (n,pd)

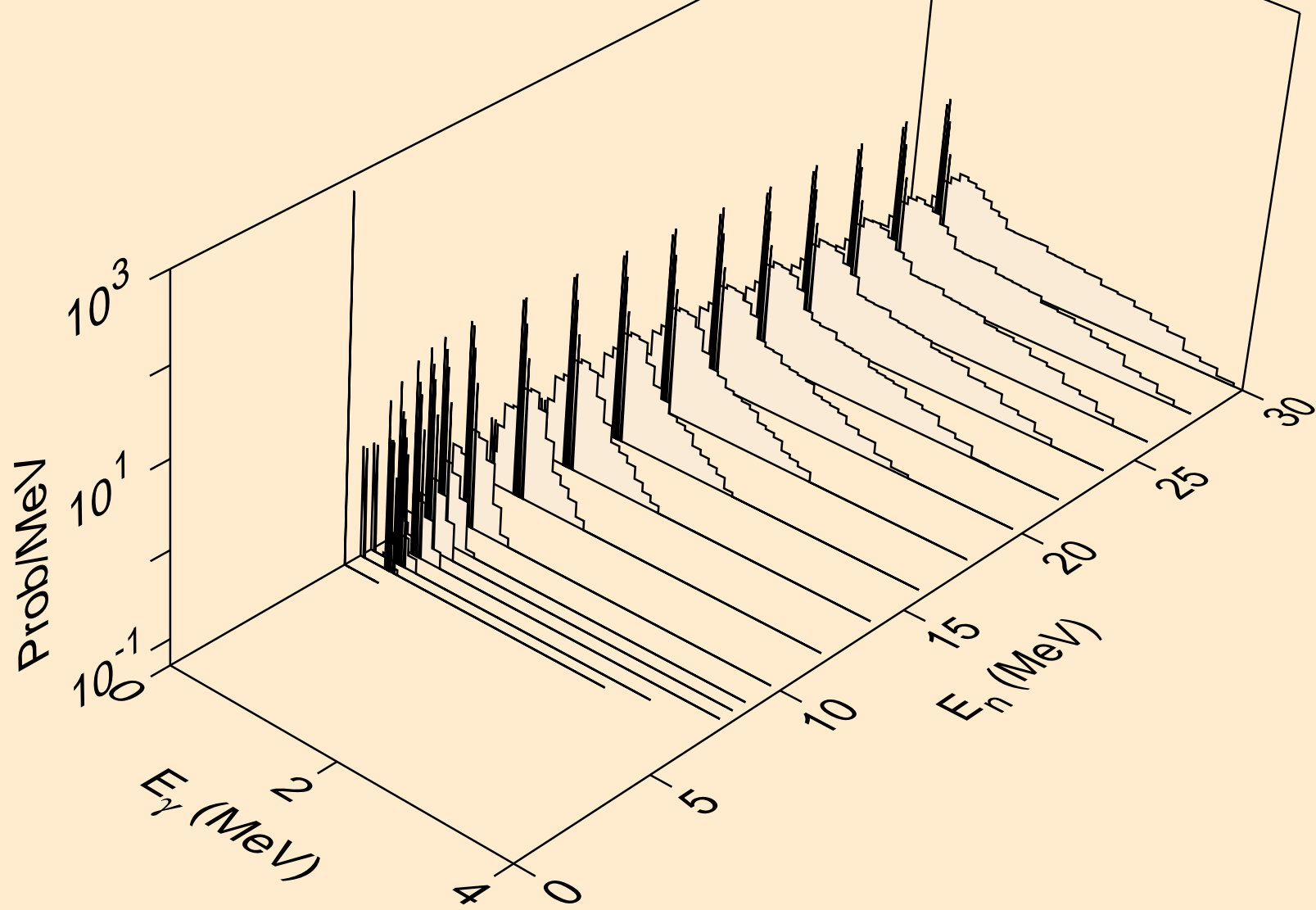

DY145M NEUTRON ACER TENDL-2021 LIBRARY; T=293.6K
Photon emission for (n,pt)

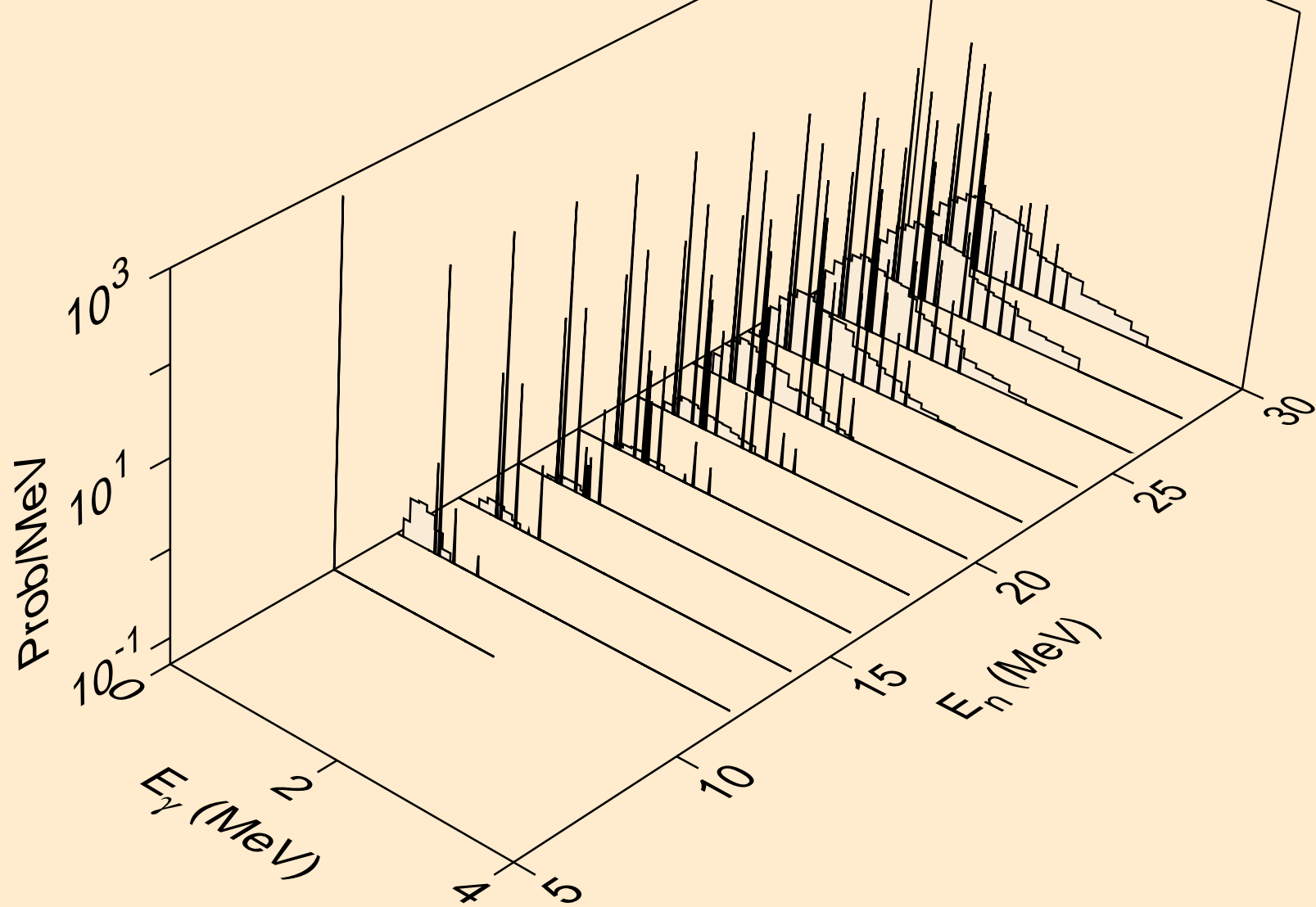

DY145M NEUTRON ACER TENDL-2021 LIBRARY; T=293.6K
Photon emission for (n,da)

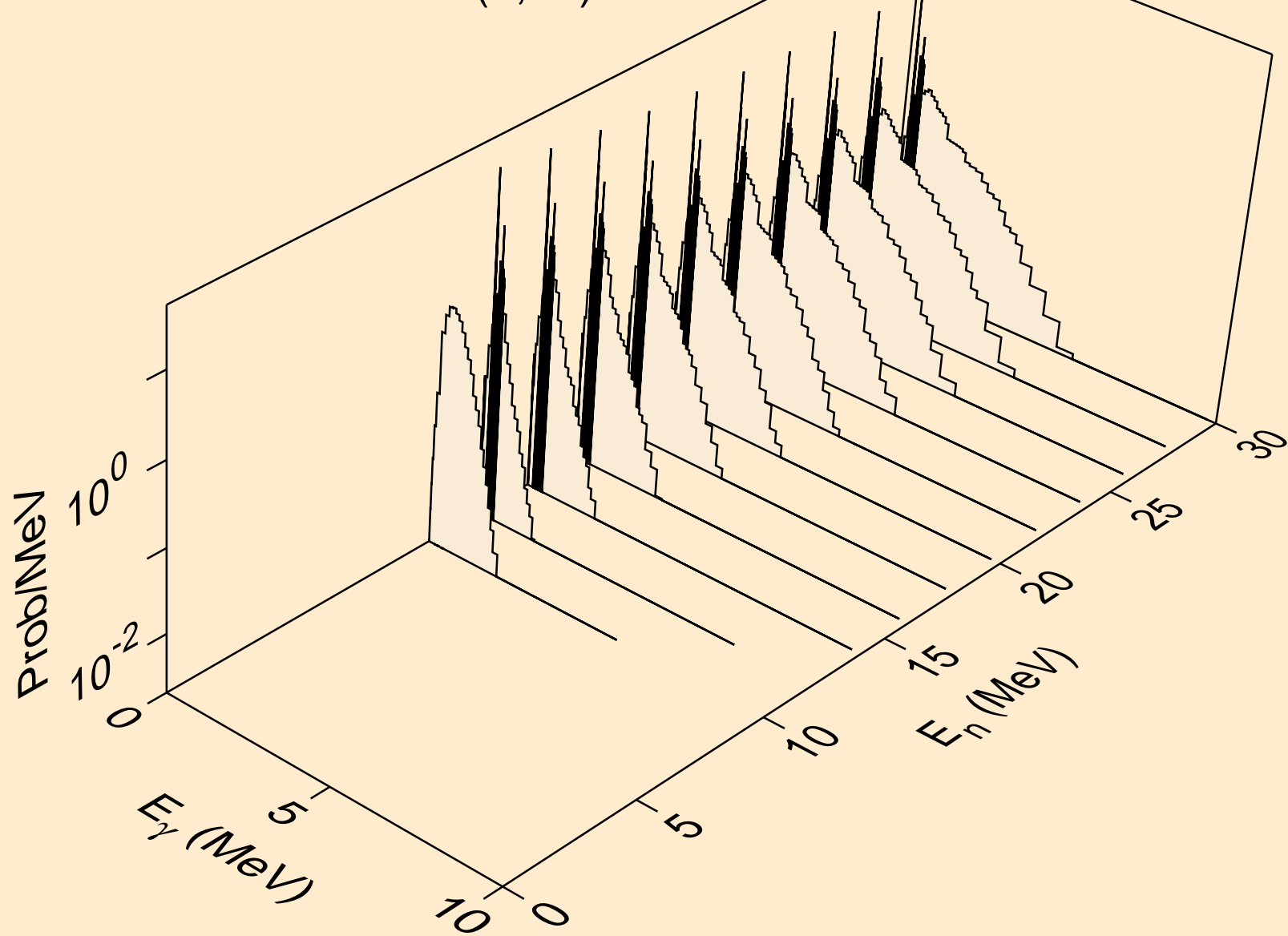

DY145M NEUTRON ACER TENDL-2021 LIBRARY; T=293.6K
thermal capture photon spectrum

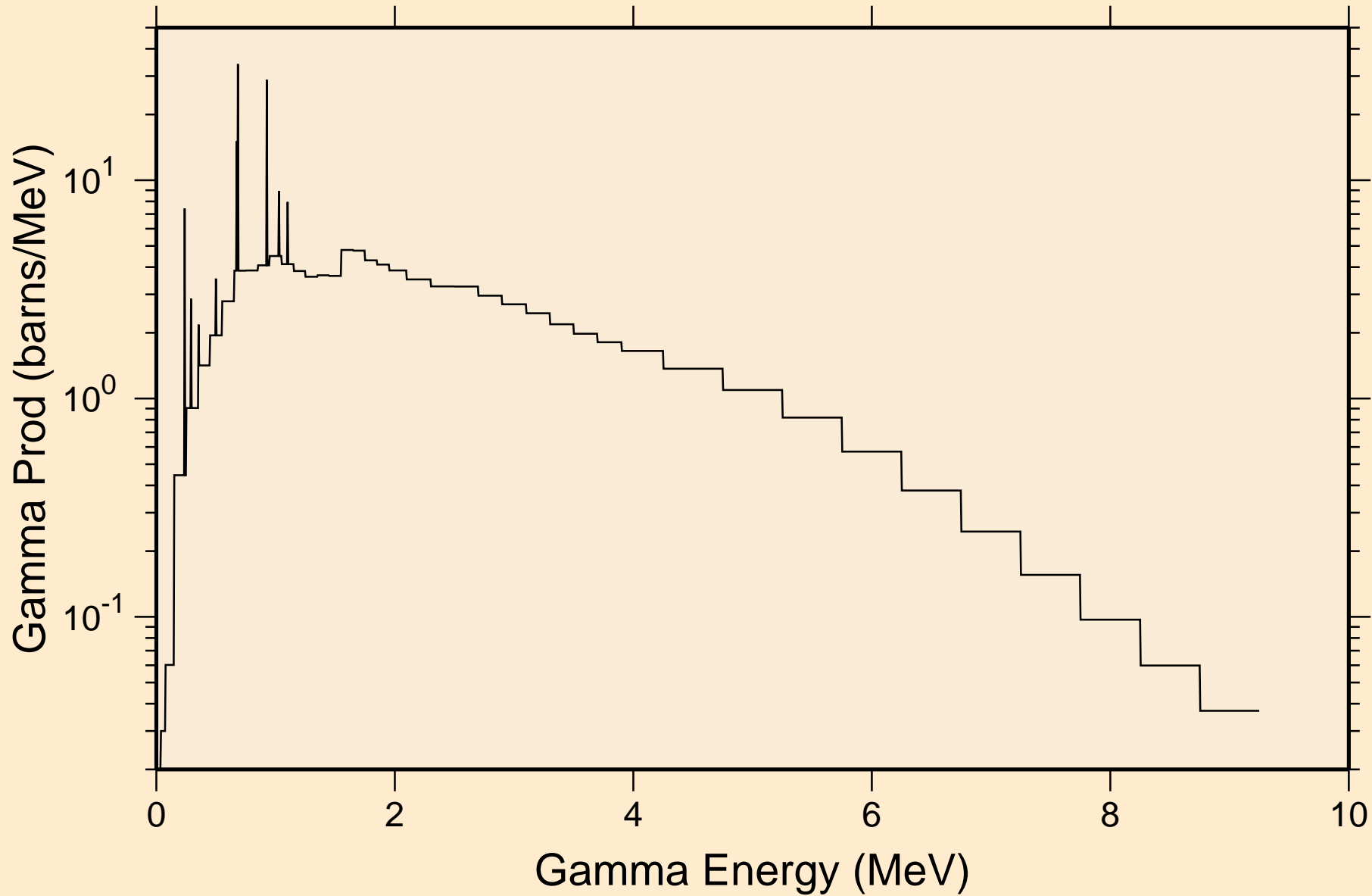

DY145M NEUTRON ACER TENDL-2021 LIBRARY; T=293.6K
14 MeV photon spectrum

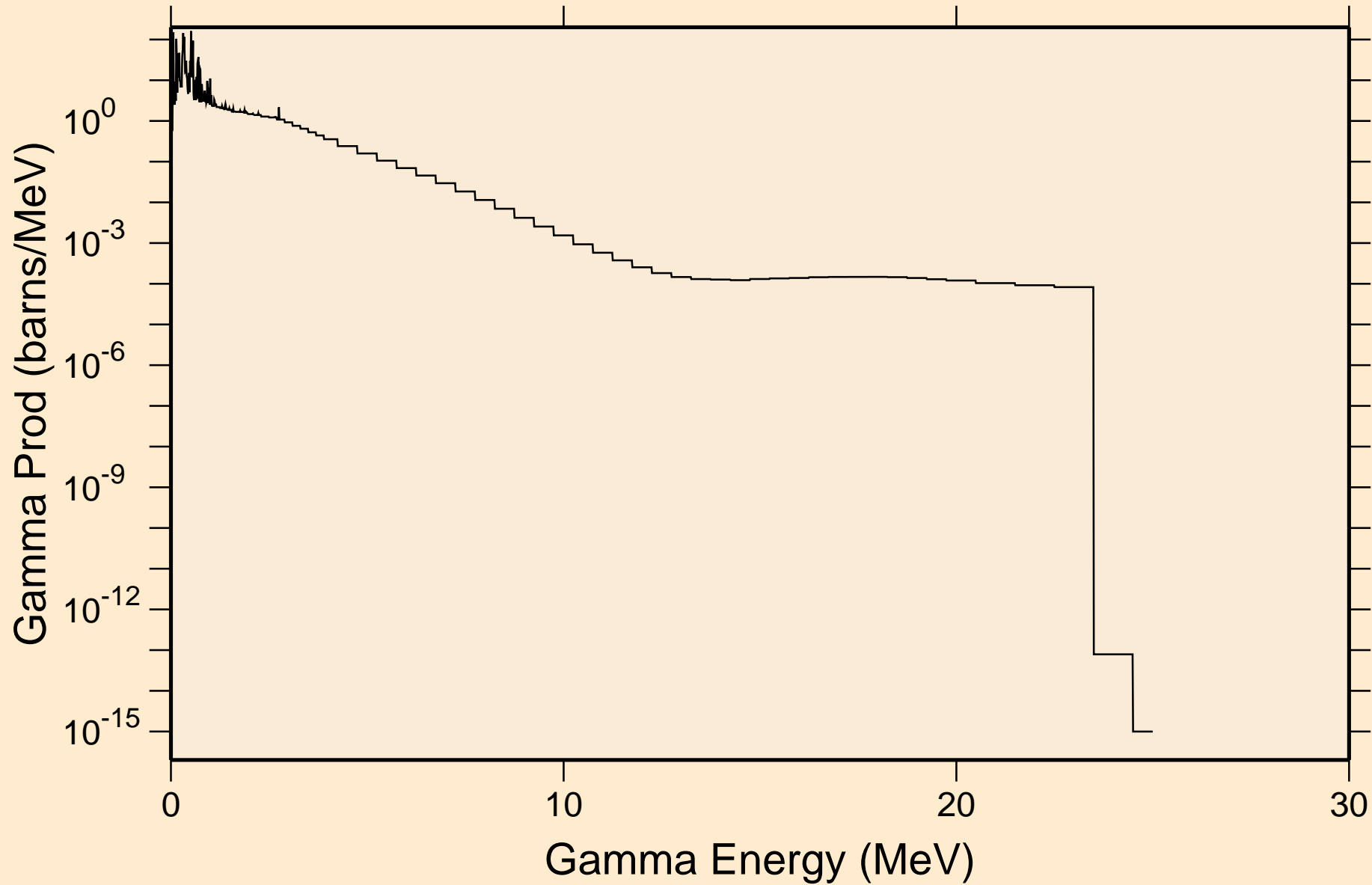

DY145M NEUTRON ACER TENDL-2021 LIBRARY; T=293.6K

Particle heating contributions

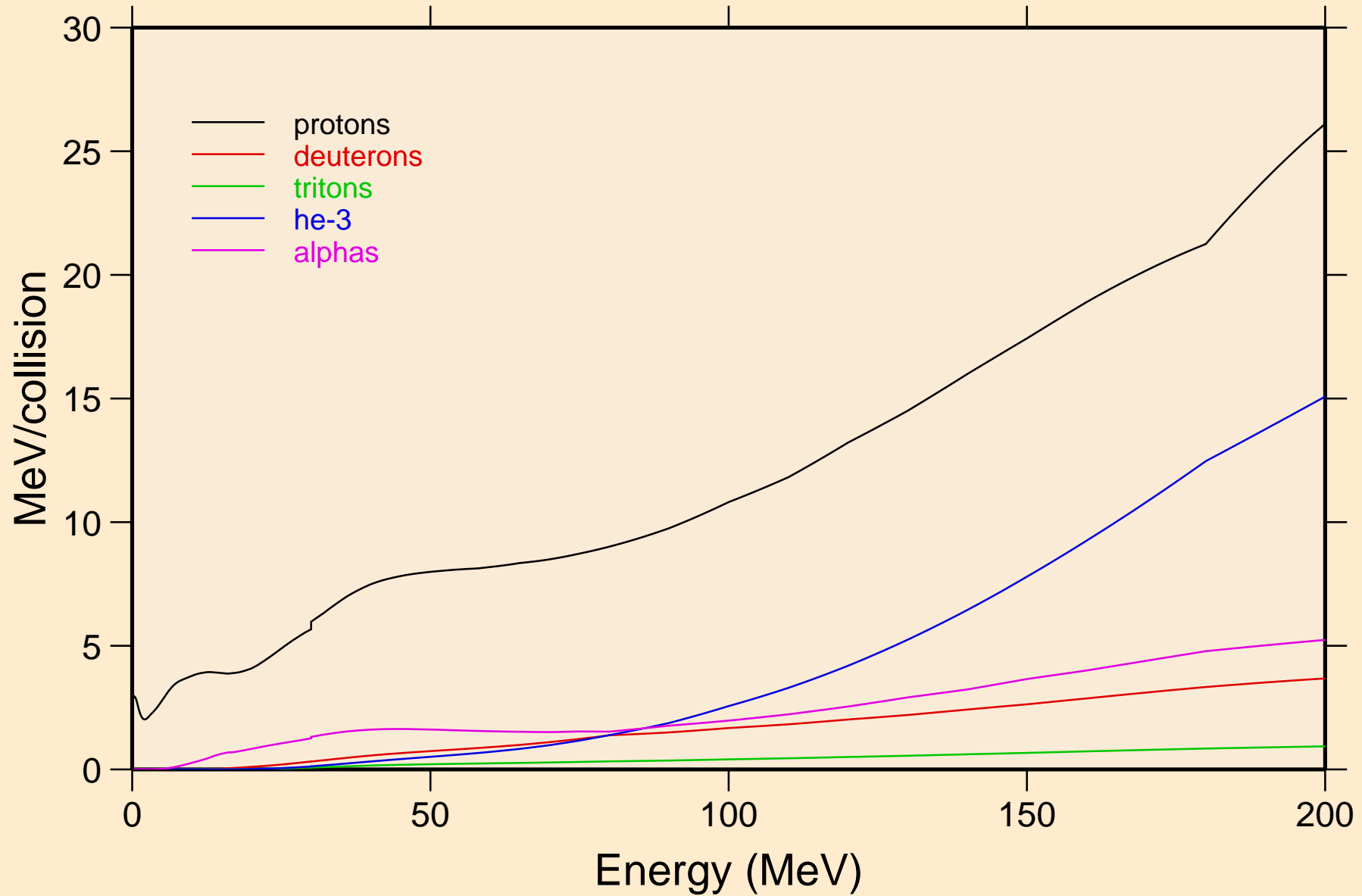

DY145M NEUTRON ACER TENDL-2021 LIBRARY; T=293.6K
Recoil Heating

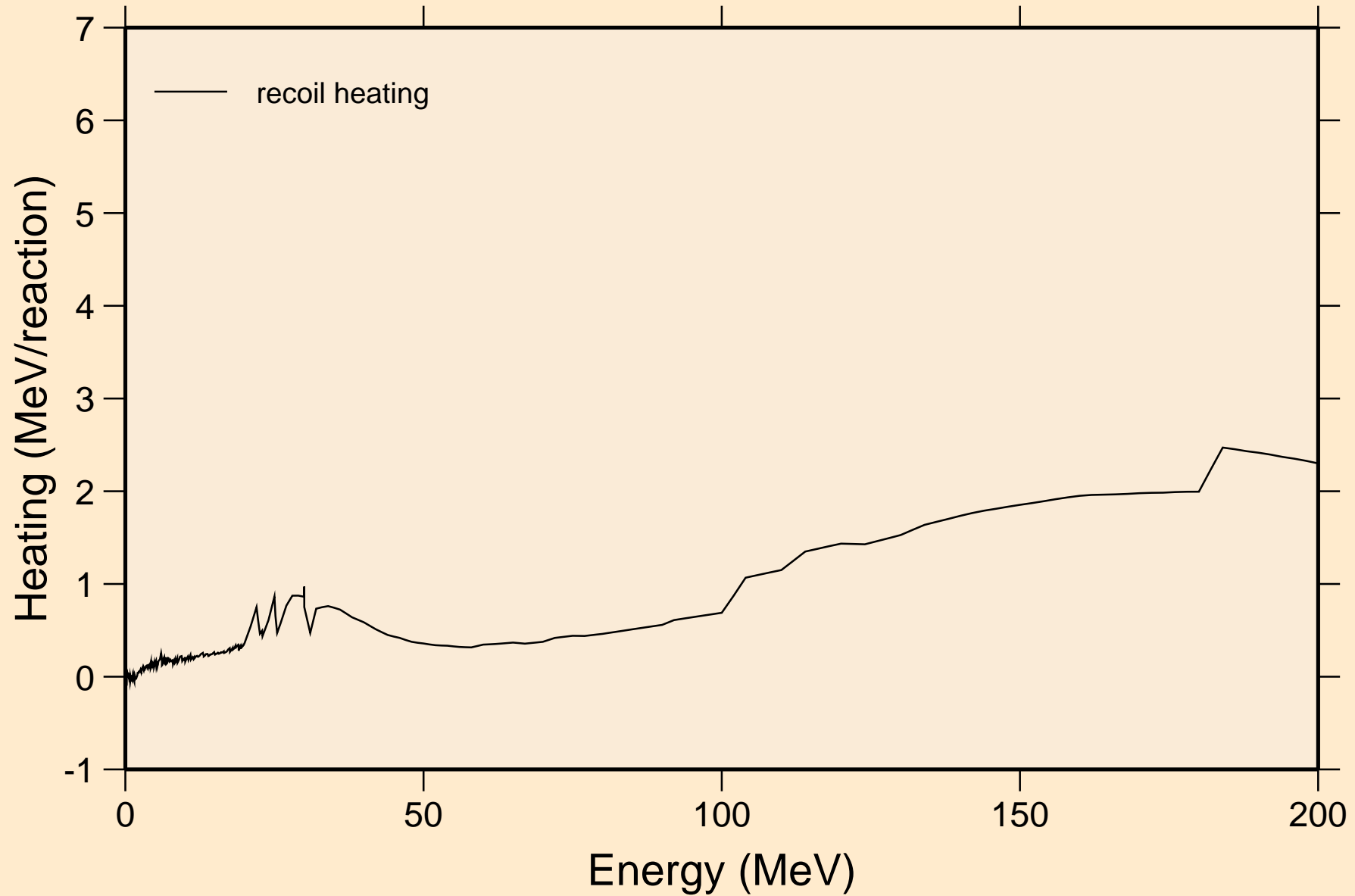

DY145M NEUTRON ACER TENDL-2021 LIBRARY; T=293.6K
Particle production cross sections

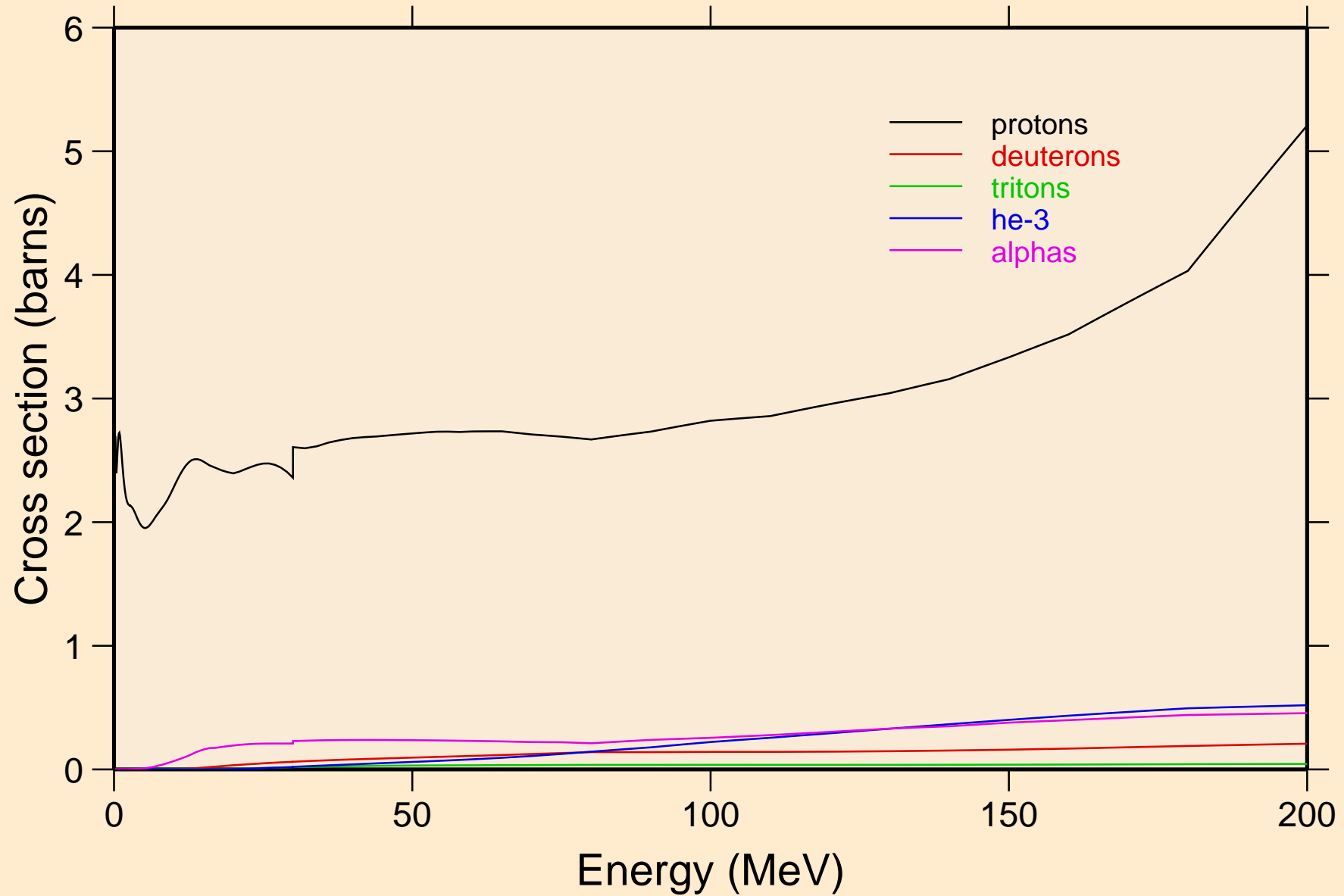

DY145M NEUTRON ACER TENDL-2021 LIBRARY; T=293.6K
protons from (n,x)

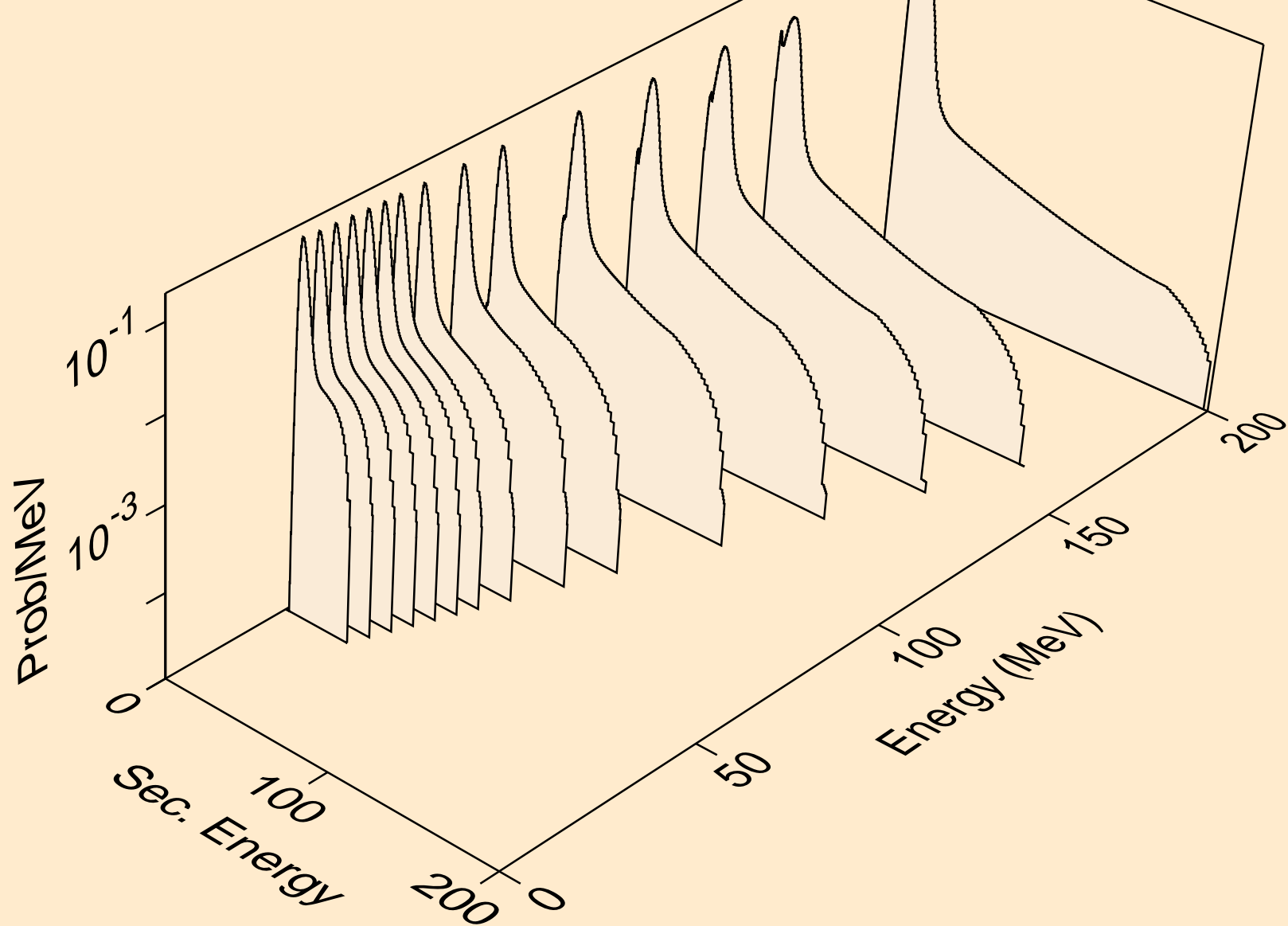

DY145M NEUTRON ACER TENDL-2021 LIBRARY; T=293.6K
protons from (n,n*)p

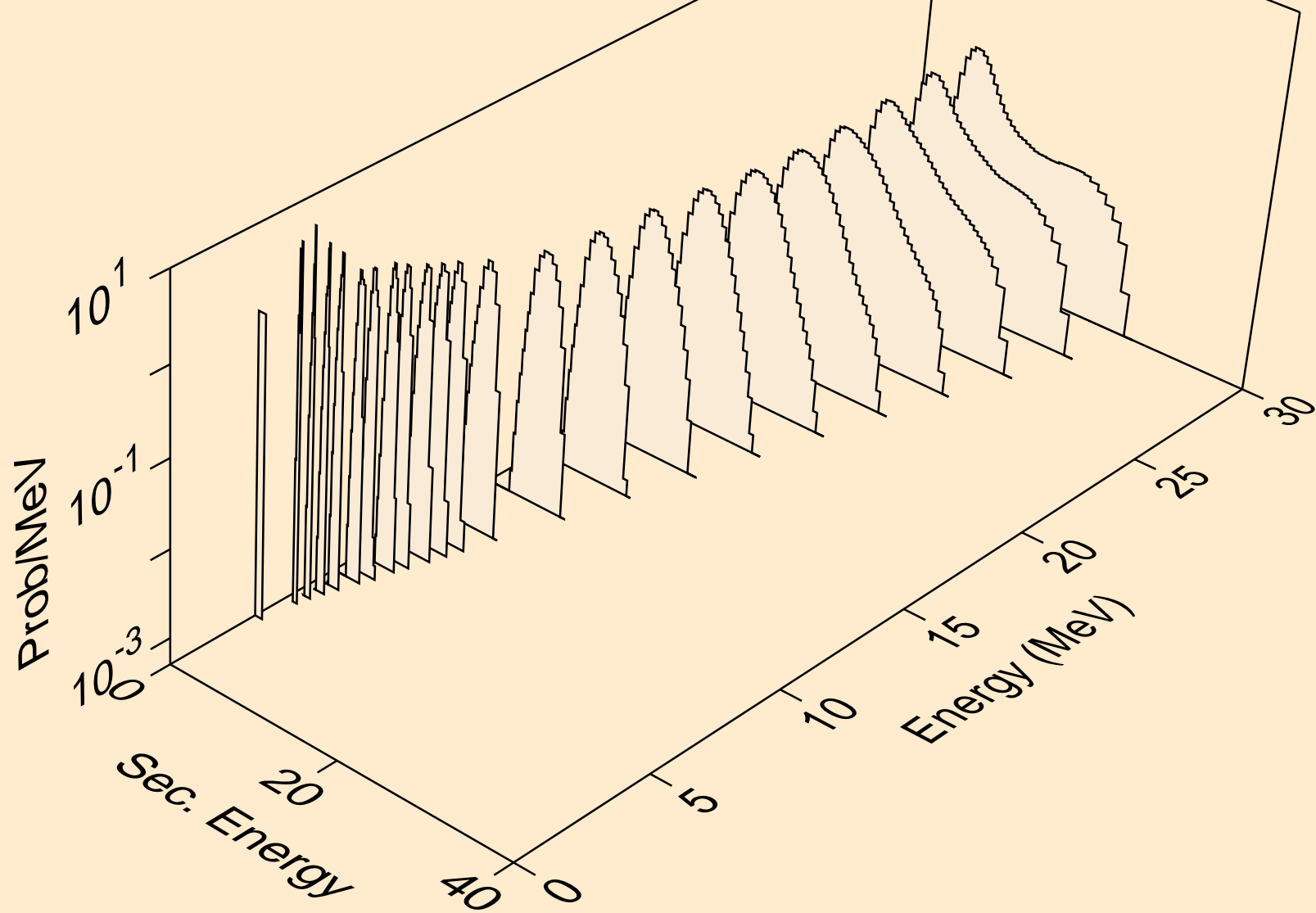

DY145M NEUTRON ACER TENDL-2021 LIBRARY; T=293.6K
protons from (n,2np)

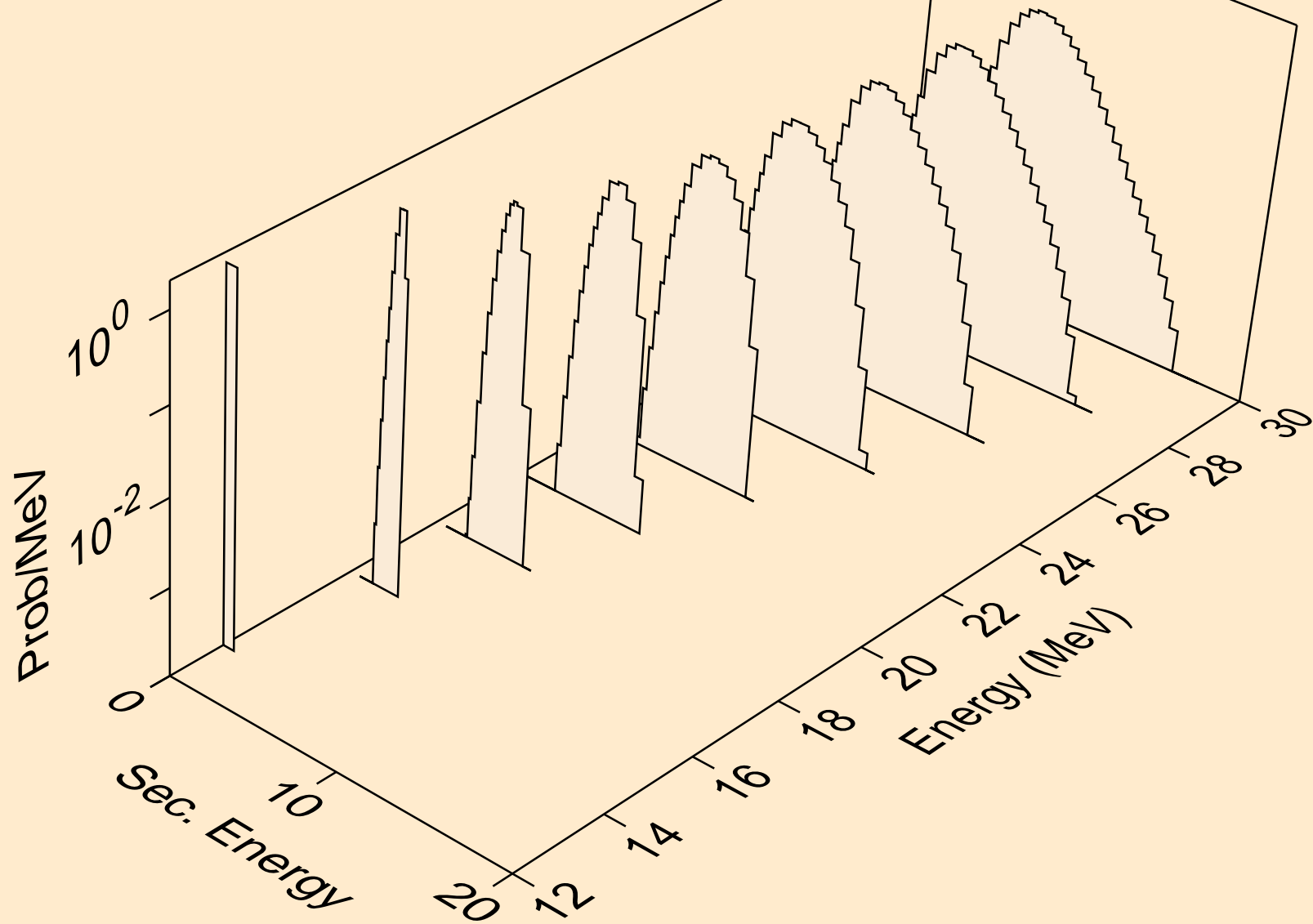

DY145M NEUTRON ACER TENDL-2021 LIBRARY; T=293.6K
protons from (n,3np)

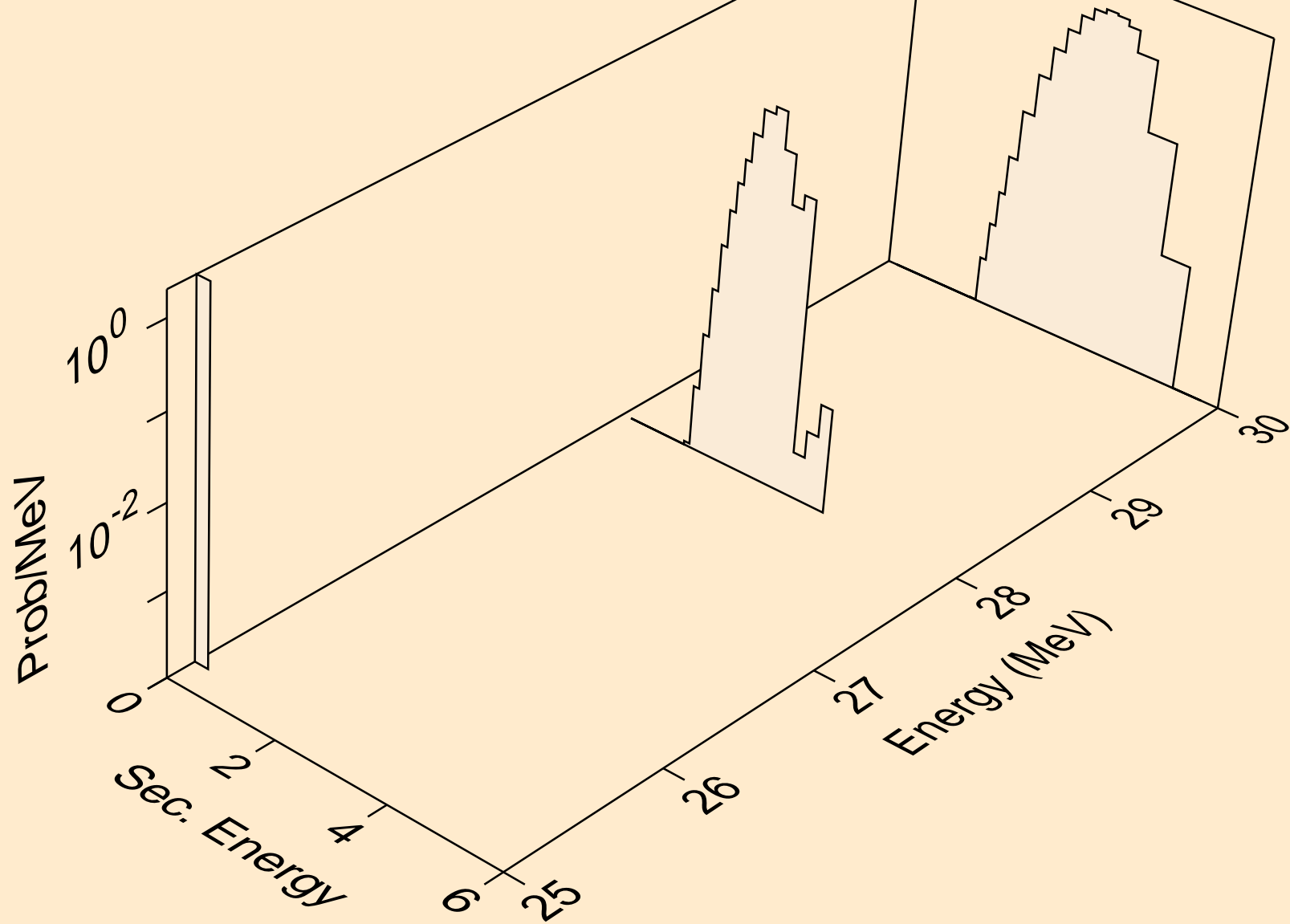

DY145M NEUTRON ACER TENDL-2021 LIBRARY; T=293.6K
protons from (n,2np)

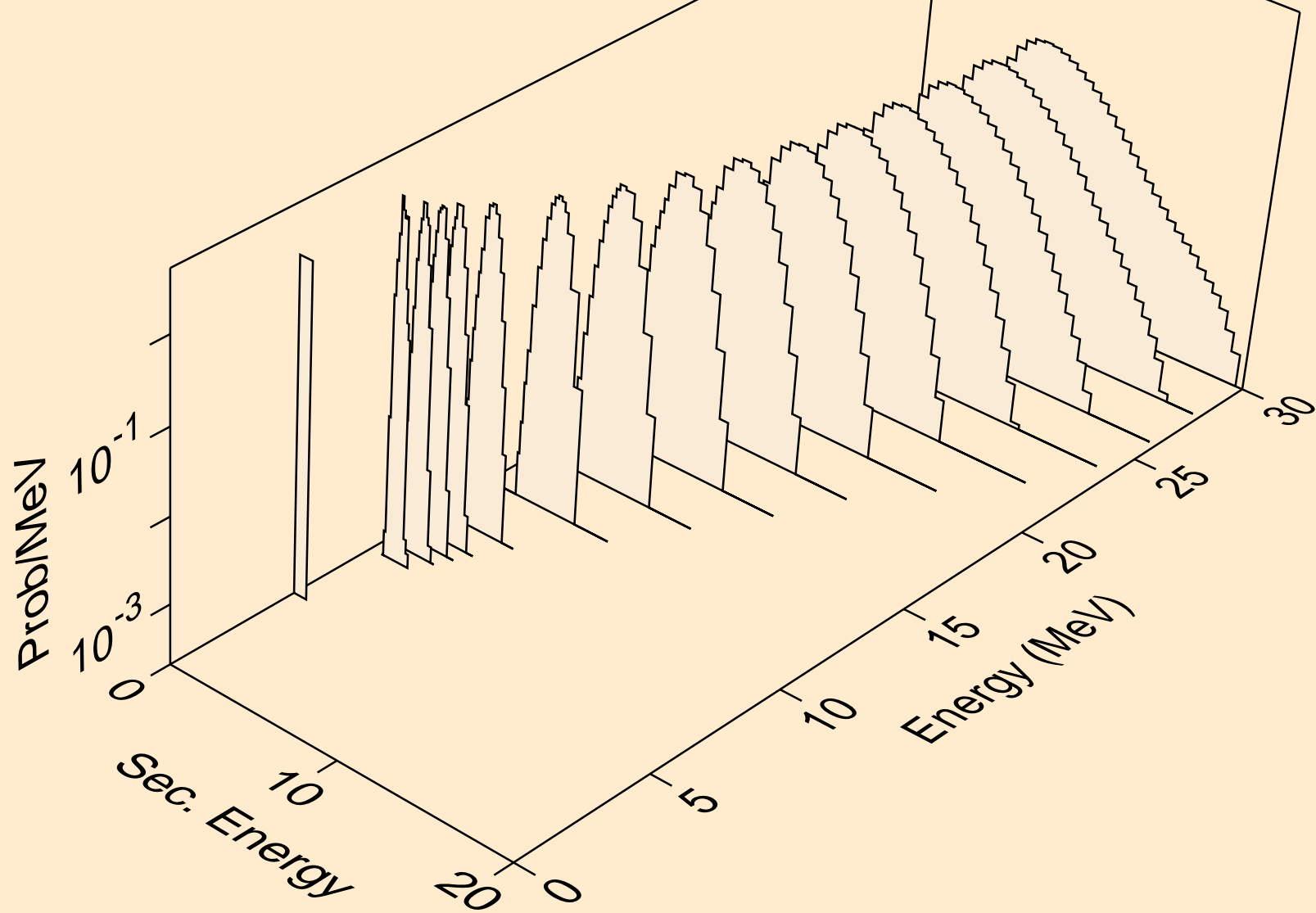

DY145M NEUTRON ACER TENDL-2021 LIBRARY; T=293.6K
protons from (n,npa)

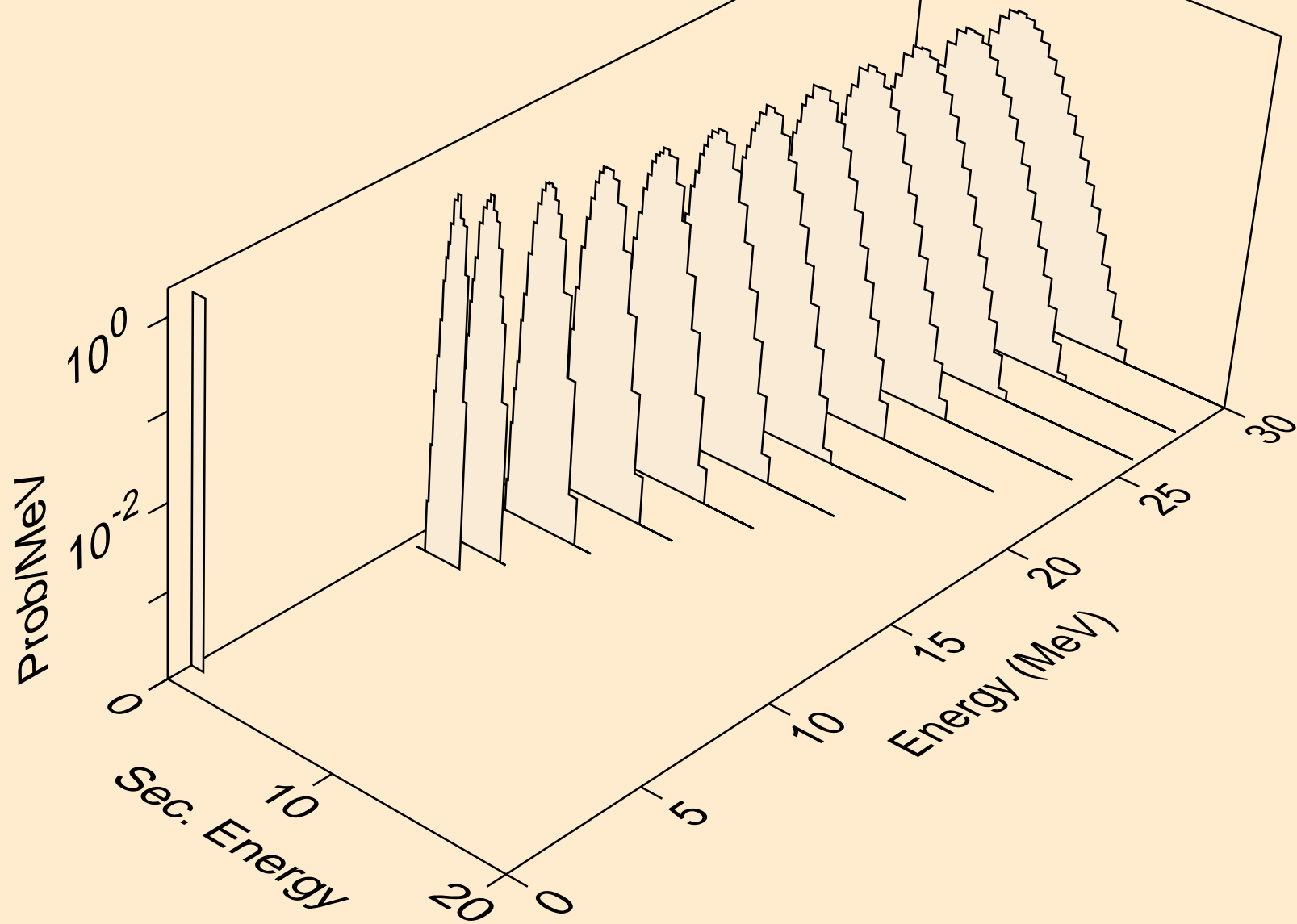

DY145M NEUTRON ACER TENDL-2021 LIBRARY; T=293.6K
protons from (n,p)

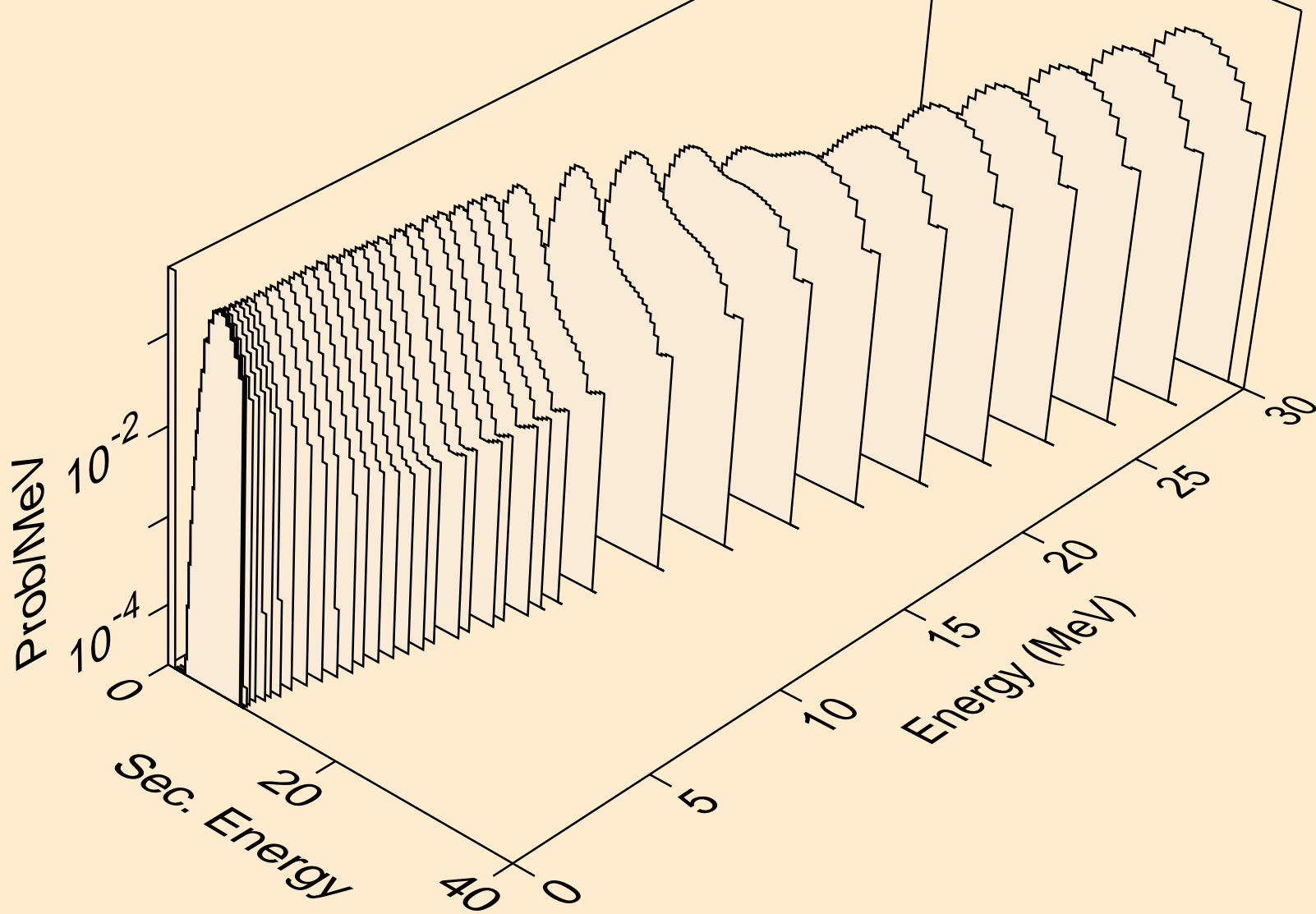

DY145M NEUTRON ACER TENDL-2021 LIBRARY; T=293.6K
protons from (n,2p)

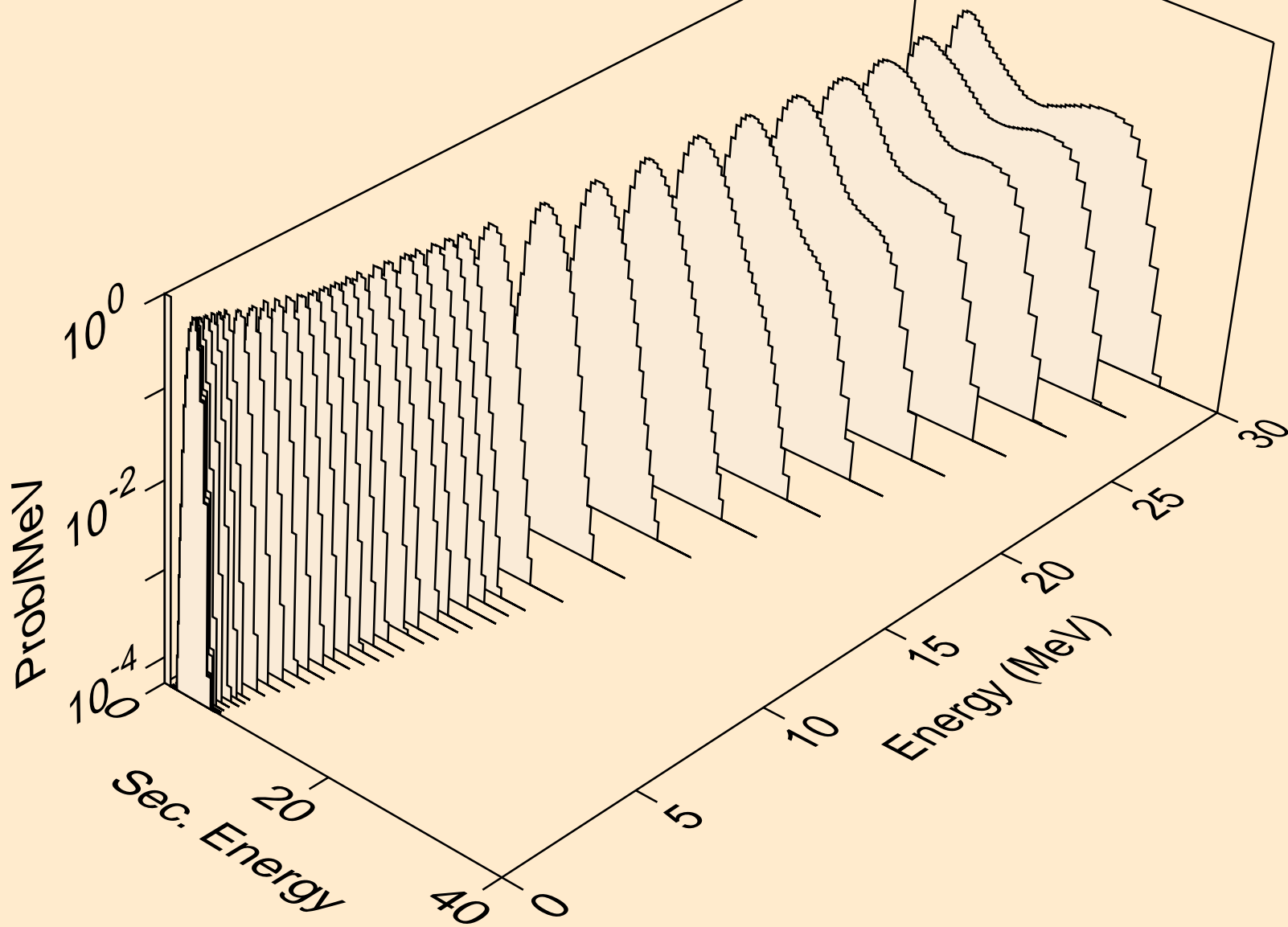

DY145M NEUTRON ACER TENDL-2021 LIBRARY; T=293.6K
protons from (n,p)

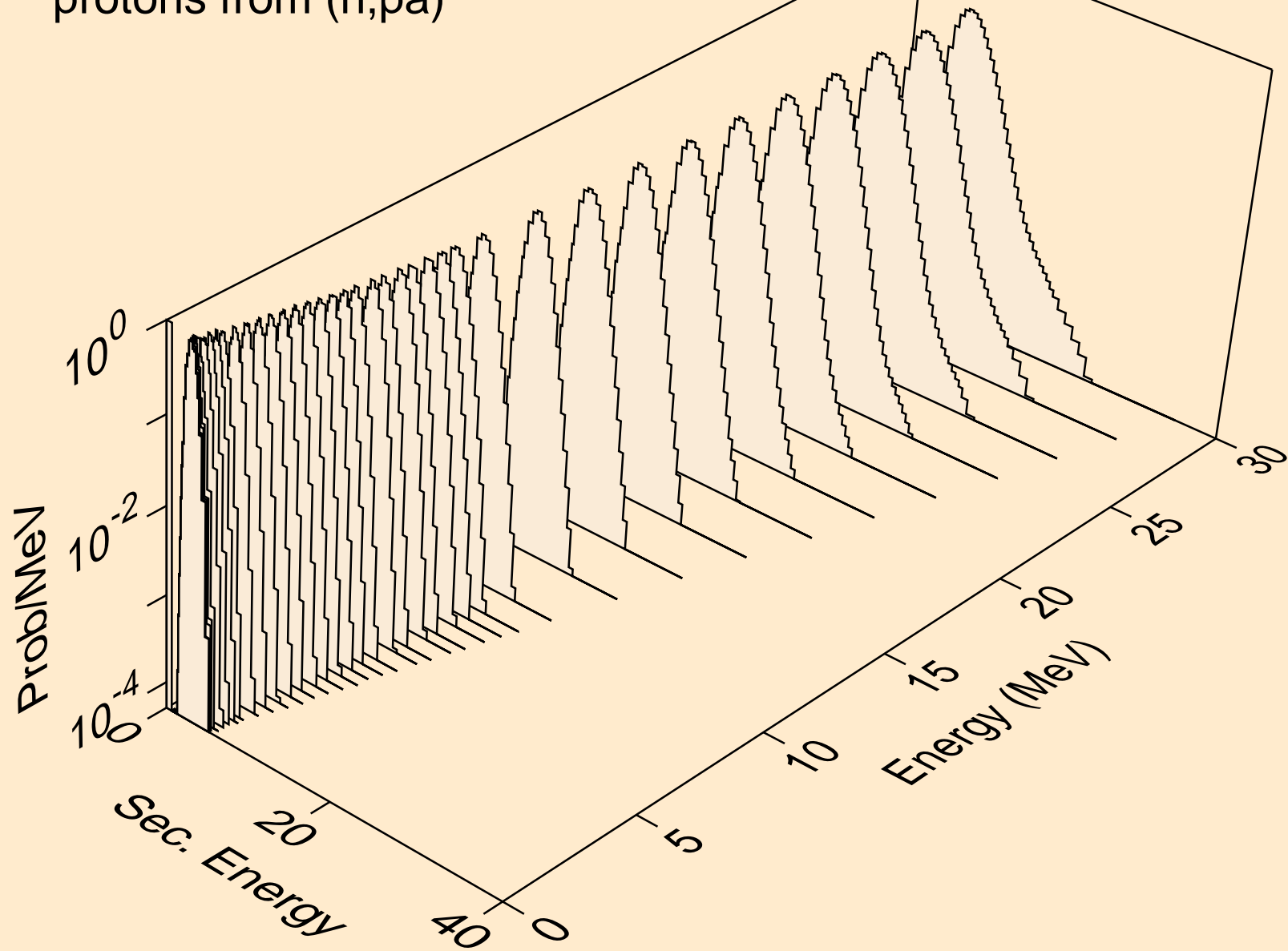

DY145M NEUTRON ACER TENDL-2021 LIBRARY; T=293.6K
protons from (n,pd)

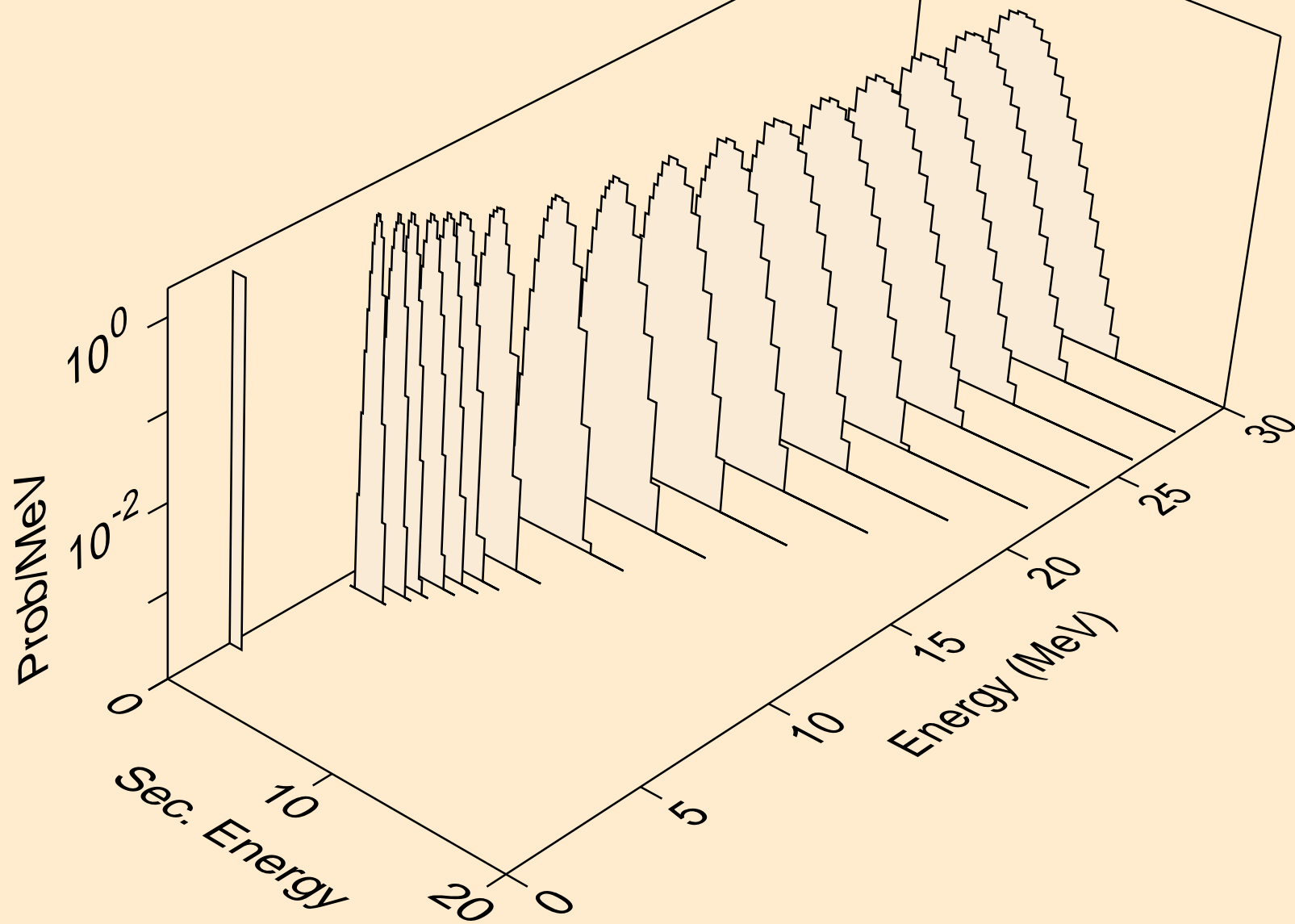

DY145M NEUTRON ACER TENDL-2021 LIBRARY; T=293.6K
protons from (n,pt)

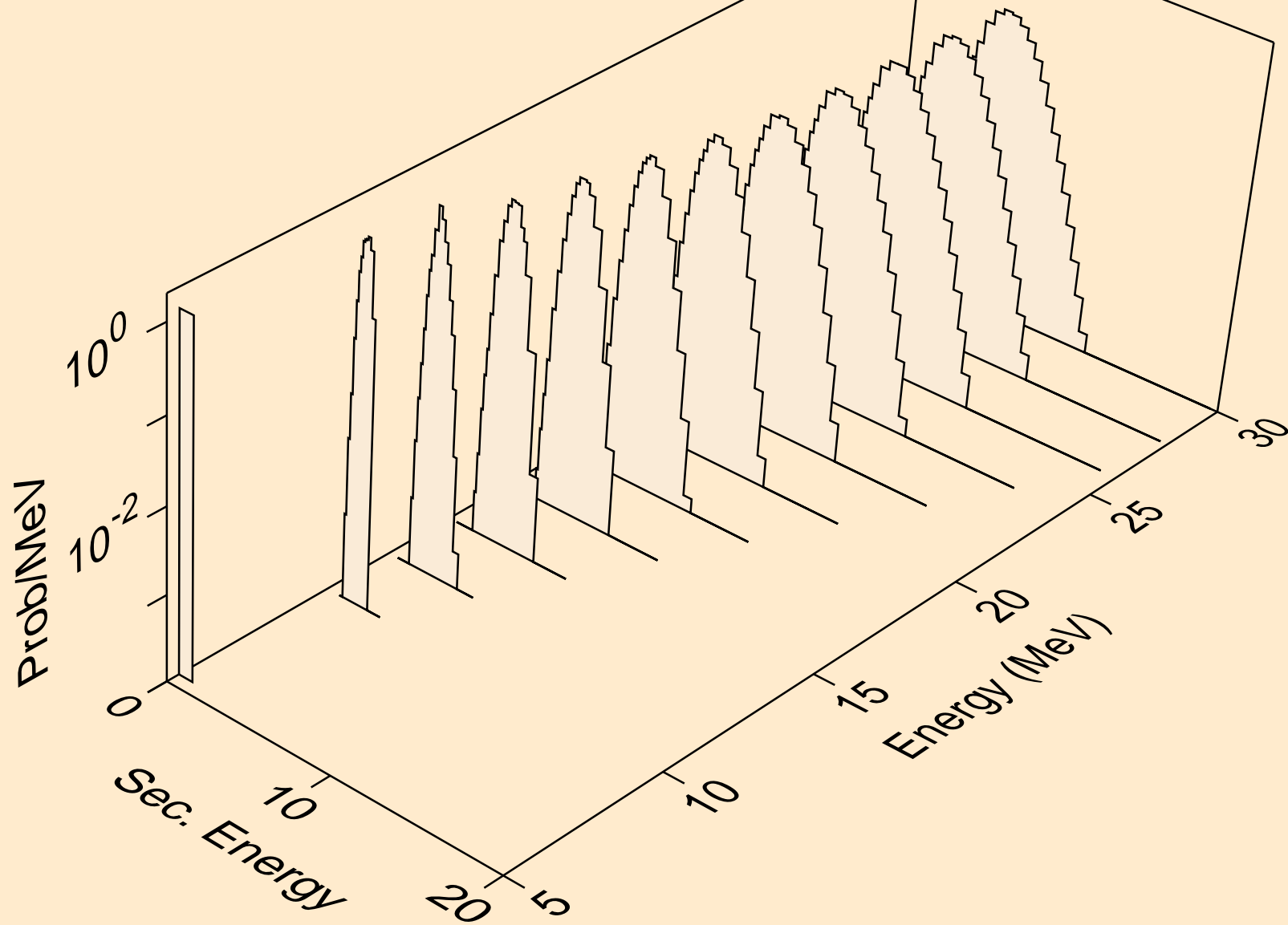

DY145M NEUTRON ACER TENDL-2021 LIBRARY; T=293.6K
deuterons from (n,x)

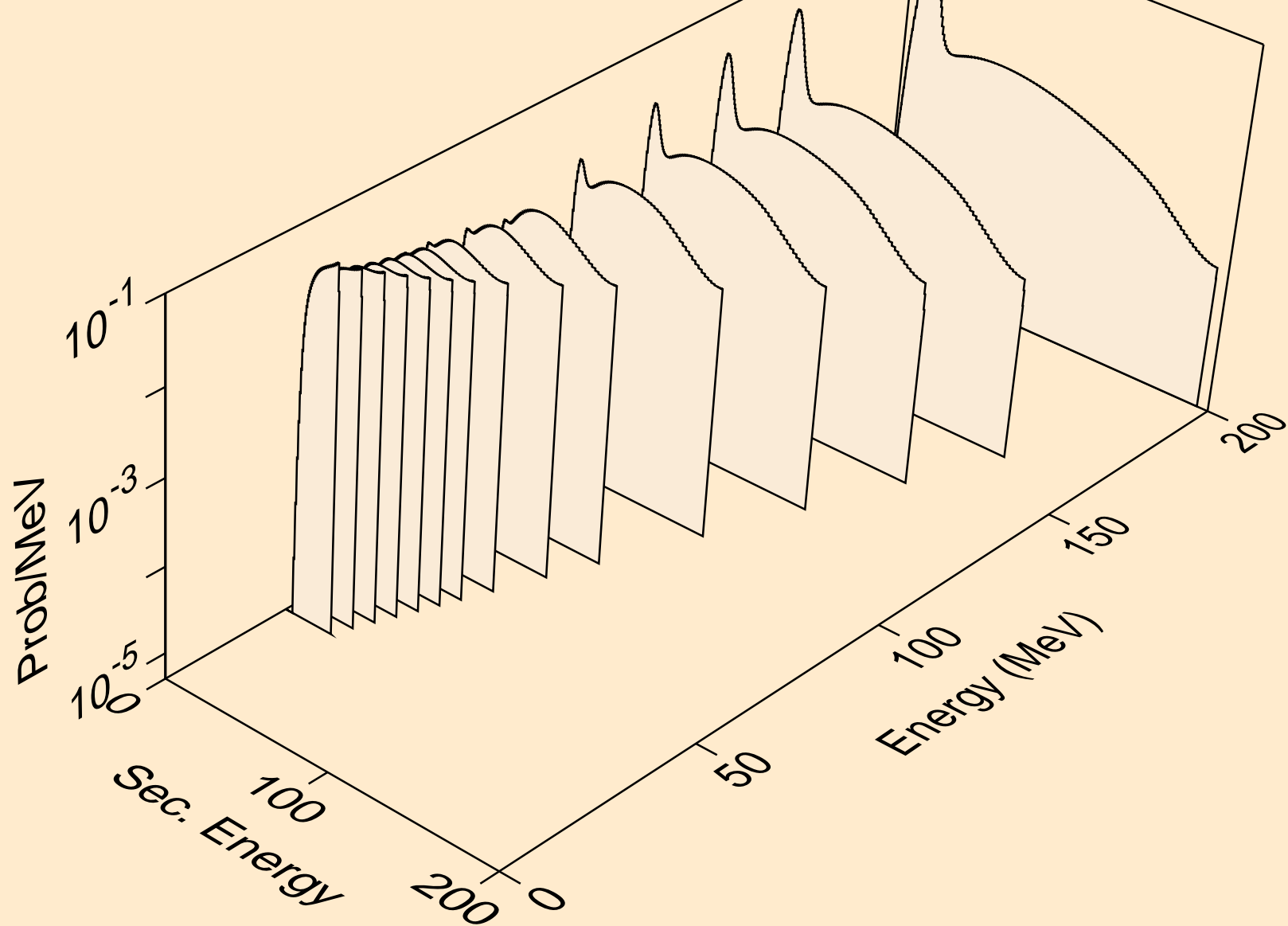

DY145M NEUTRON ACER TENDL-2021 LIBRARY; T=293.6K
deuterons from (n,2nd)

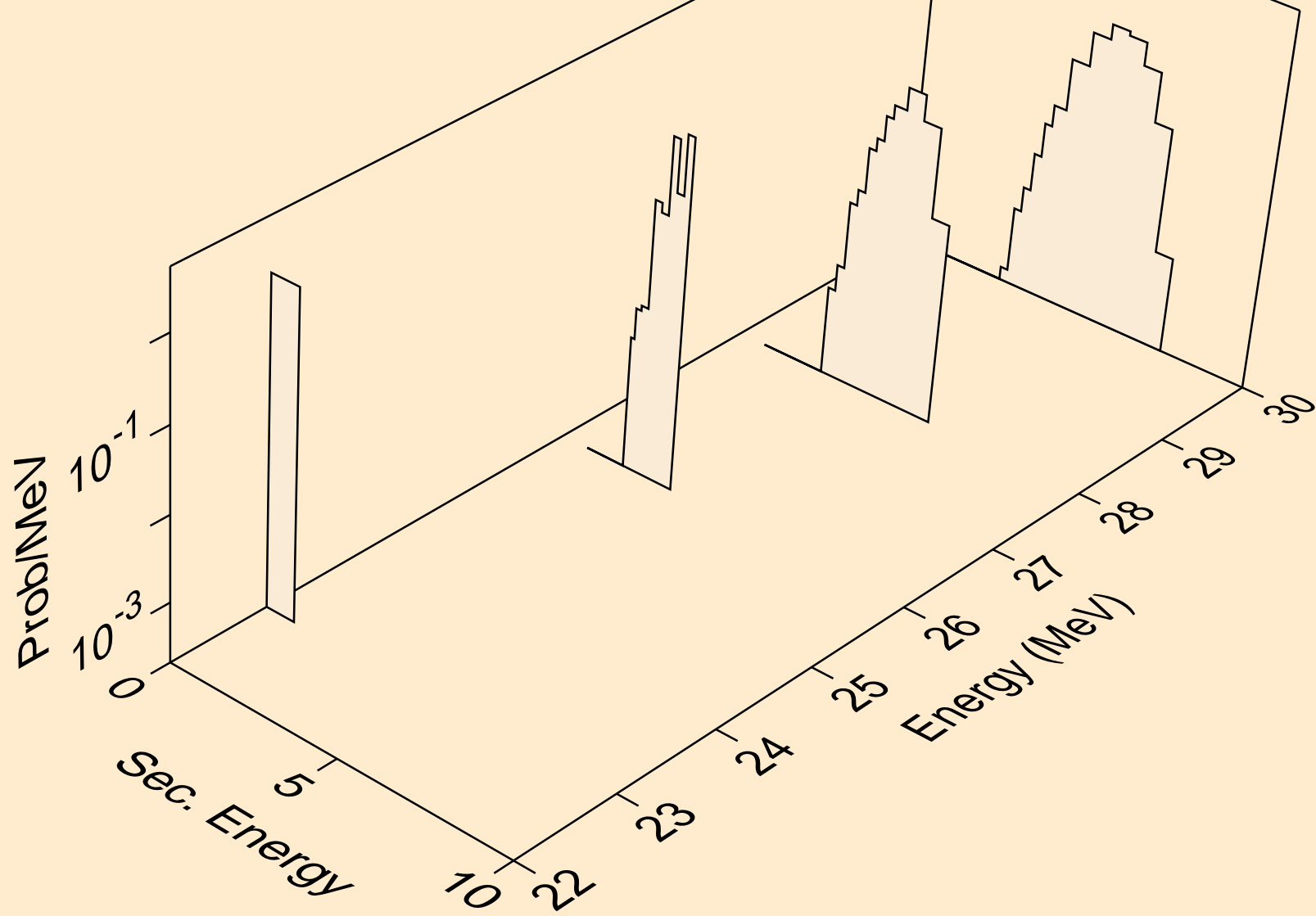

DY145M NEUTRON ACER TENDL-2021 LIBRARY; T=293.6K
deuterons from (n,n*)d

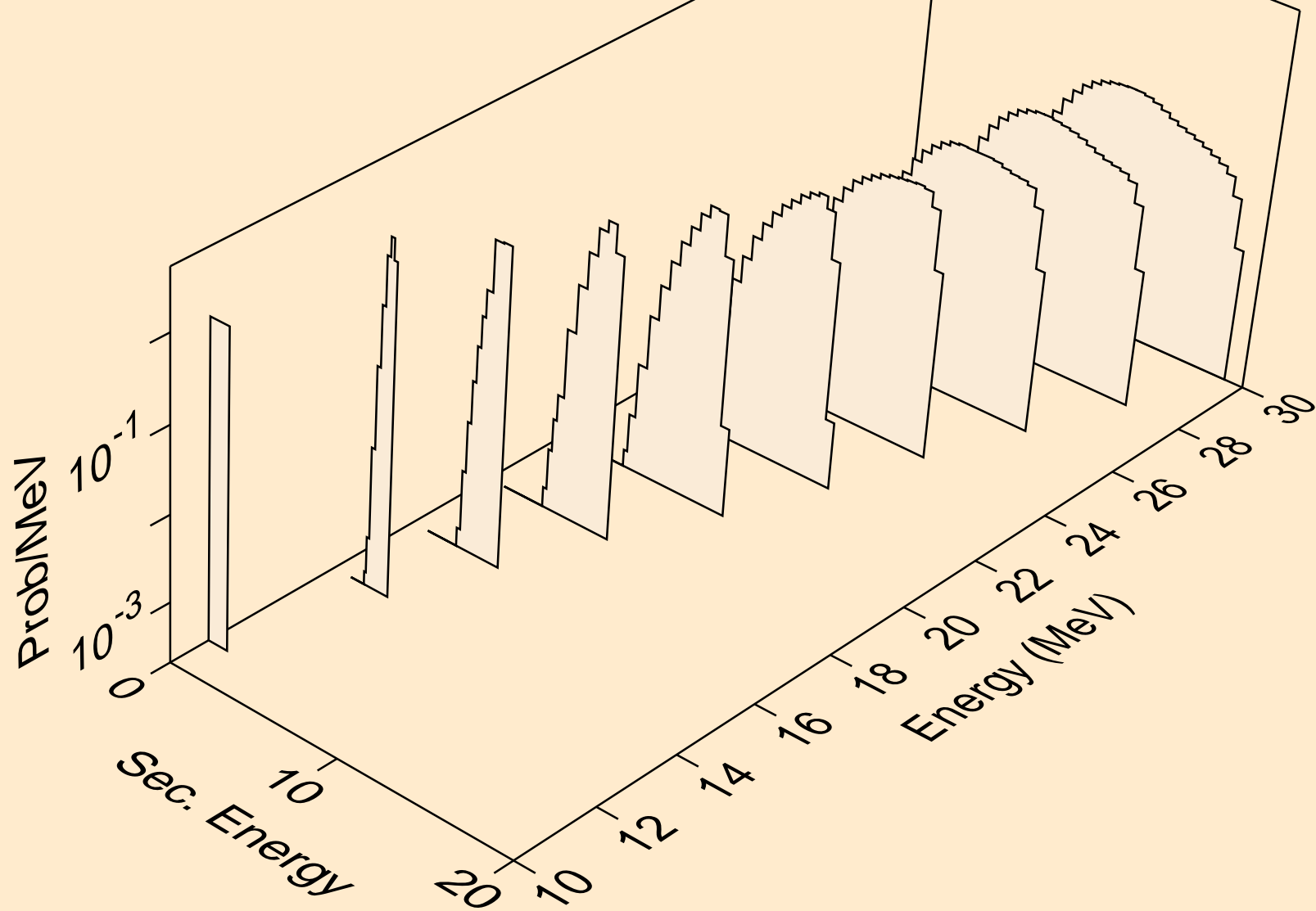

DY145M NEUTRON ACER TENDL-2021 LIBRARY; T=293.6K
deuterons from (n,d)

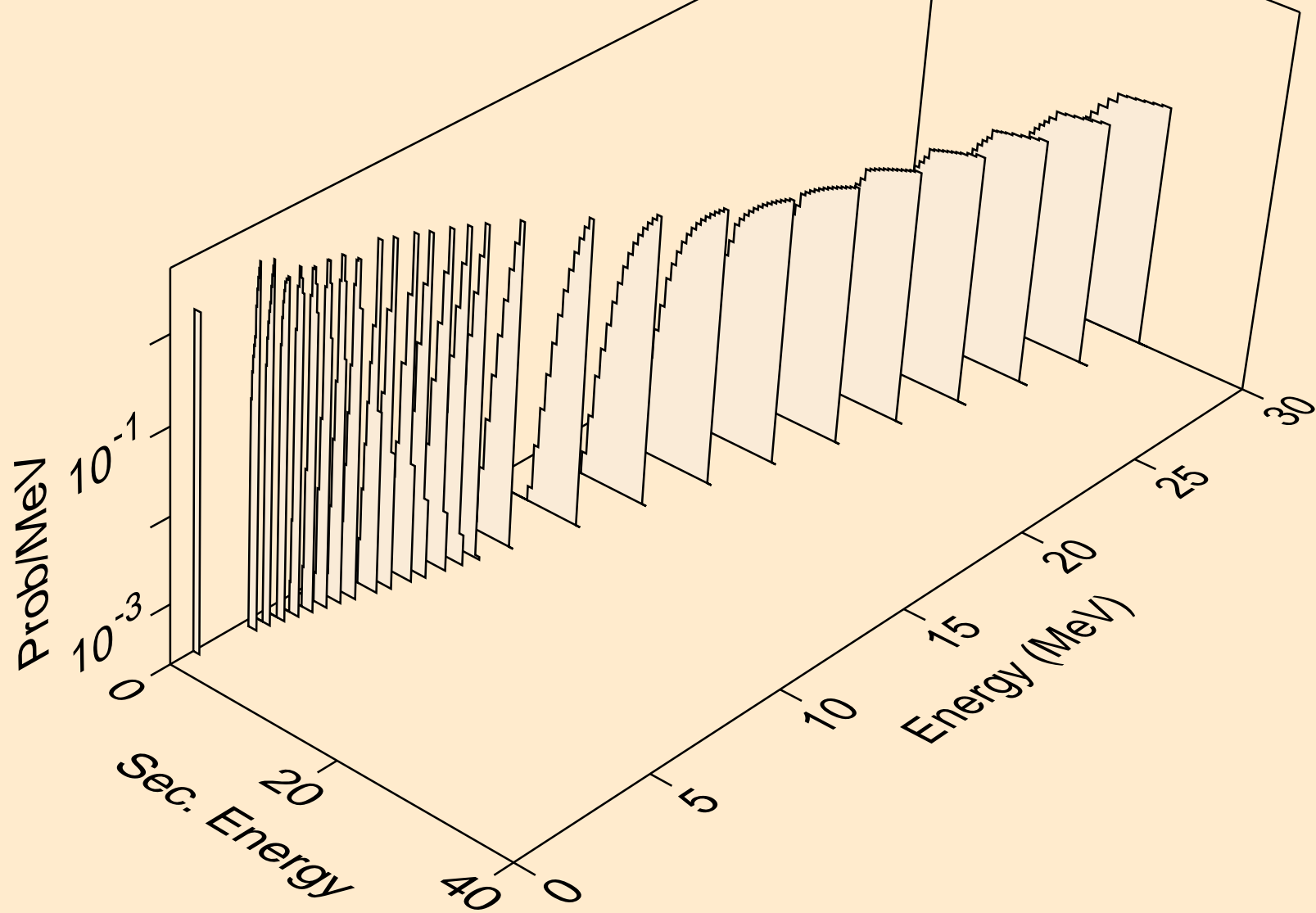

DY145M NEUTRON ACER TENDL-2021 LIBRARY; T=293.6K
deuterons from (n,pd)

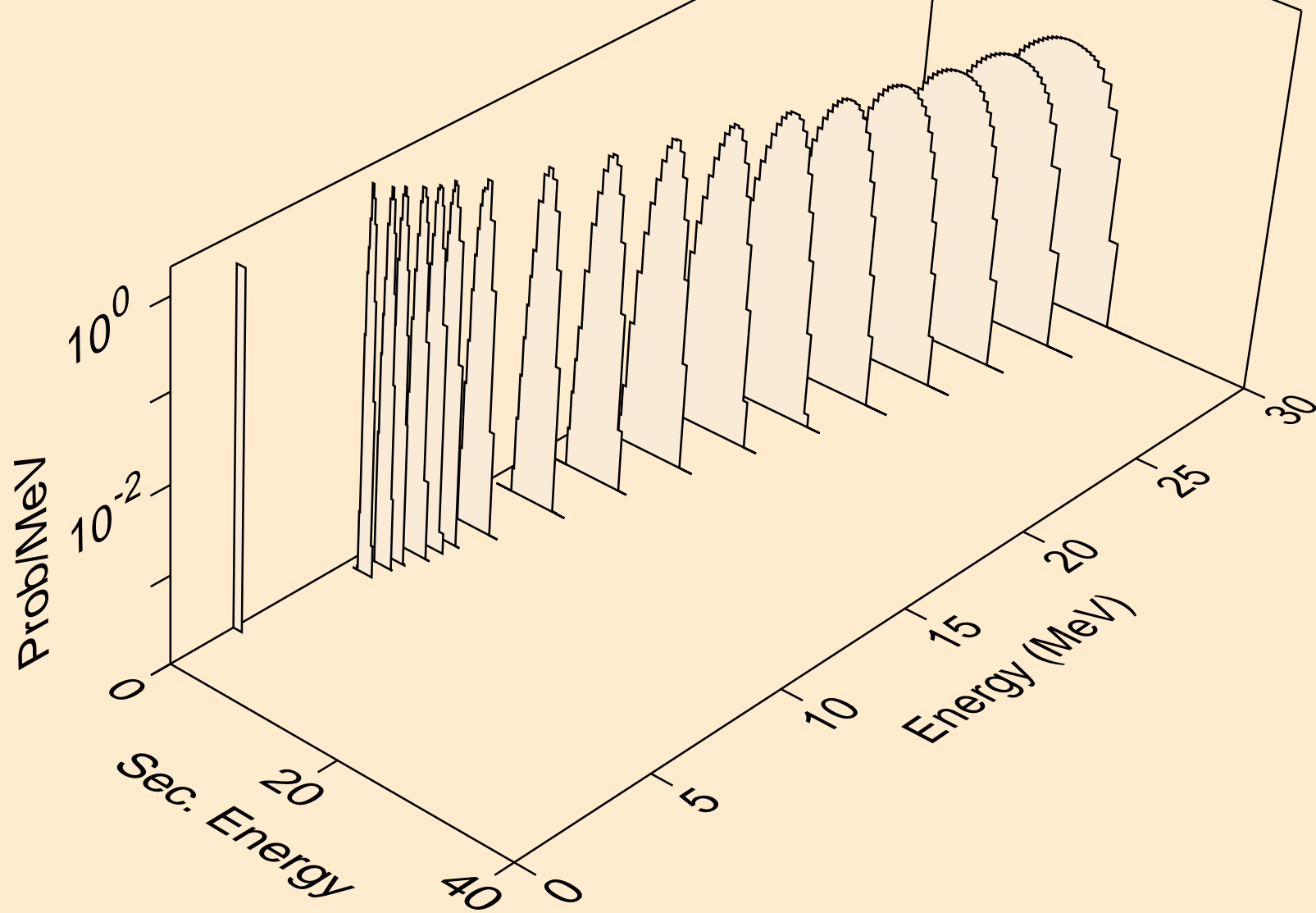

DY145M NEUTRON ACER TENDL-2021 LIBRARY; T=293.6K
deuterons from (n,da)

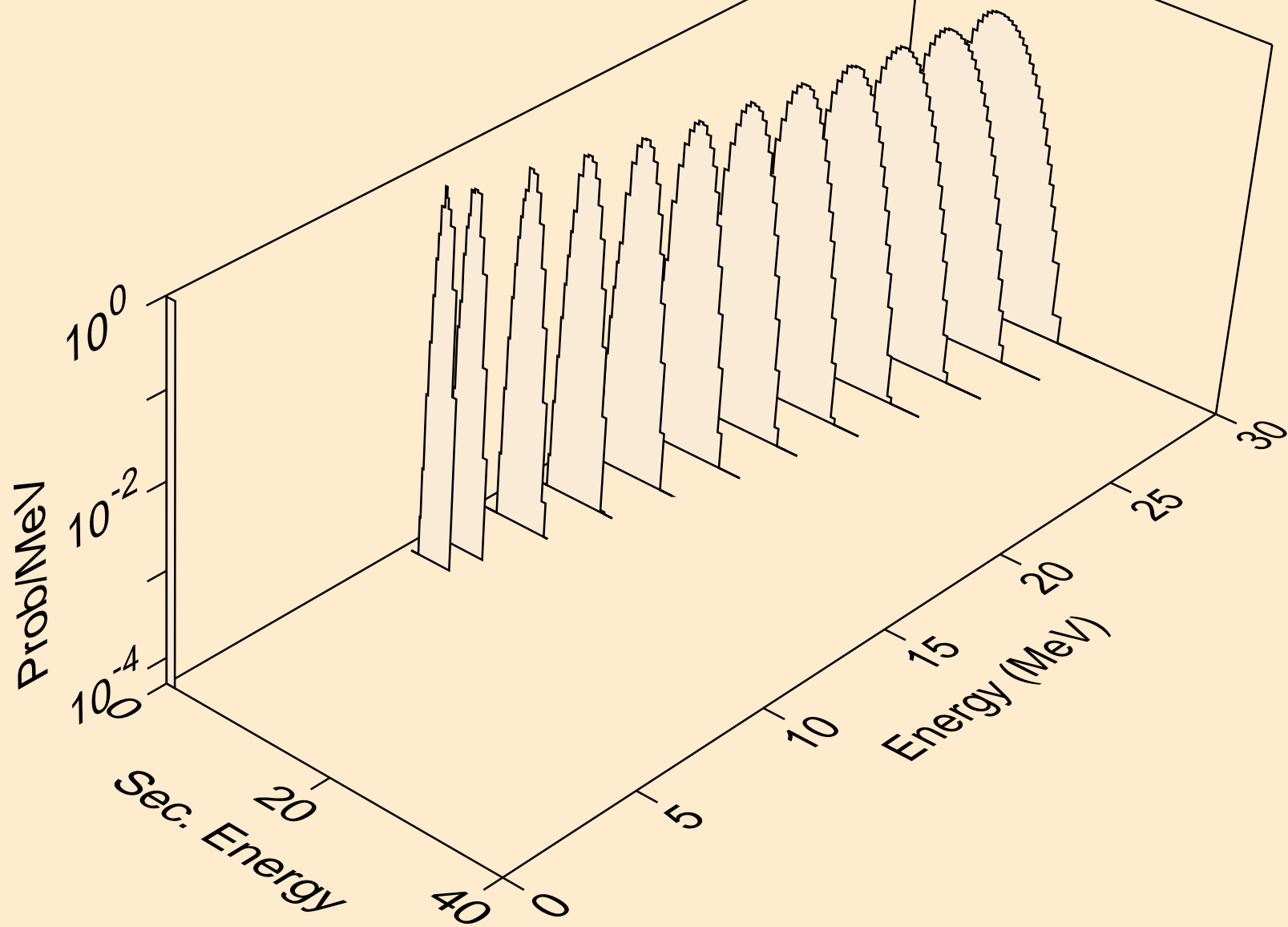

DY145M NEUTRON ACER TENDL-2021 LIBRARY; T=293.6K
tritons from (n,x)

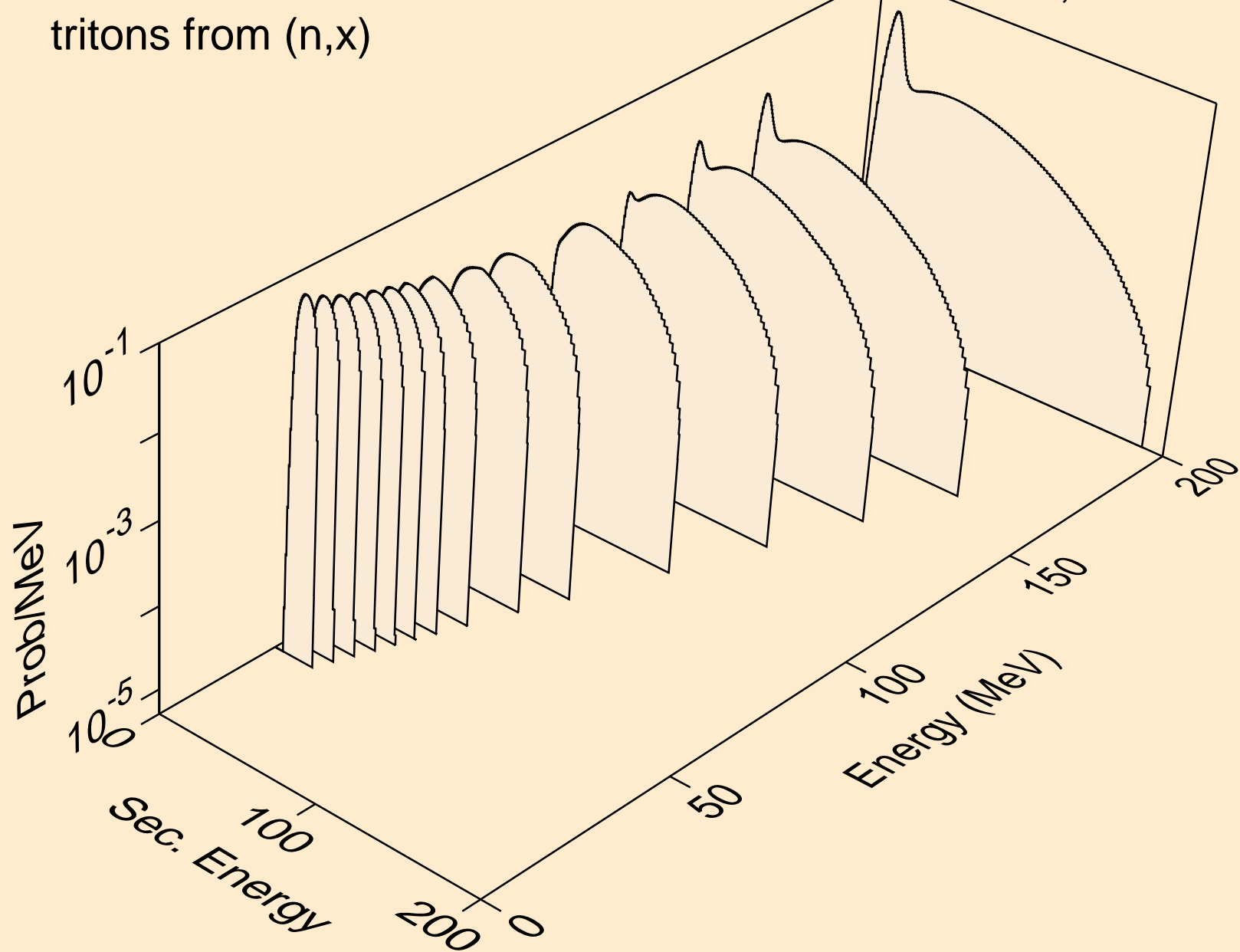

DY145M NEUTRON ACER TENDL-2021 LIBRARY; T=293.6K
tritons from (n,n*)t

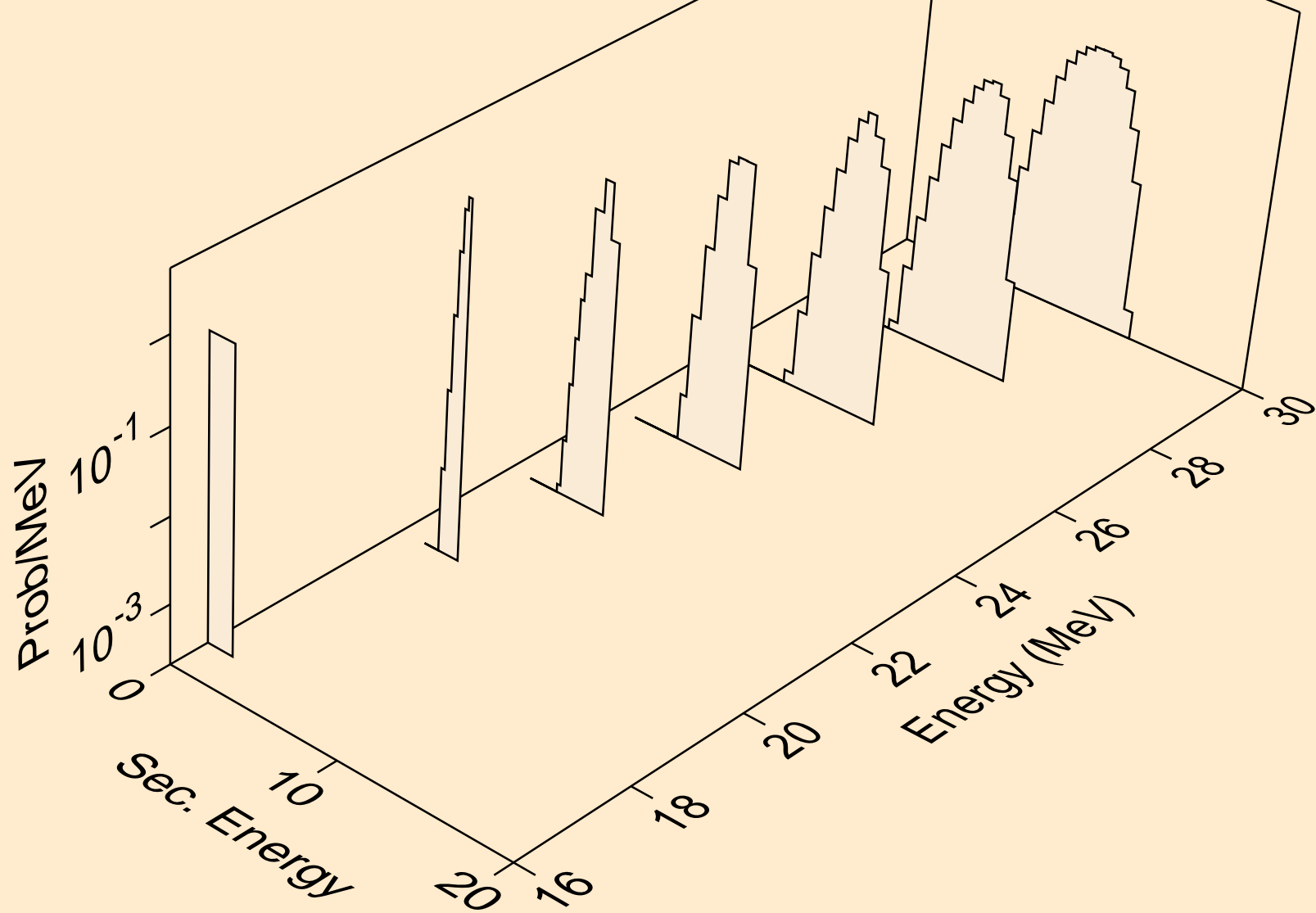

DY145M NEUTRON ACER TENDL-2021 LIBRARY; T=293.6K
tritons from (n,t)

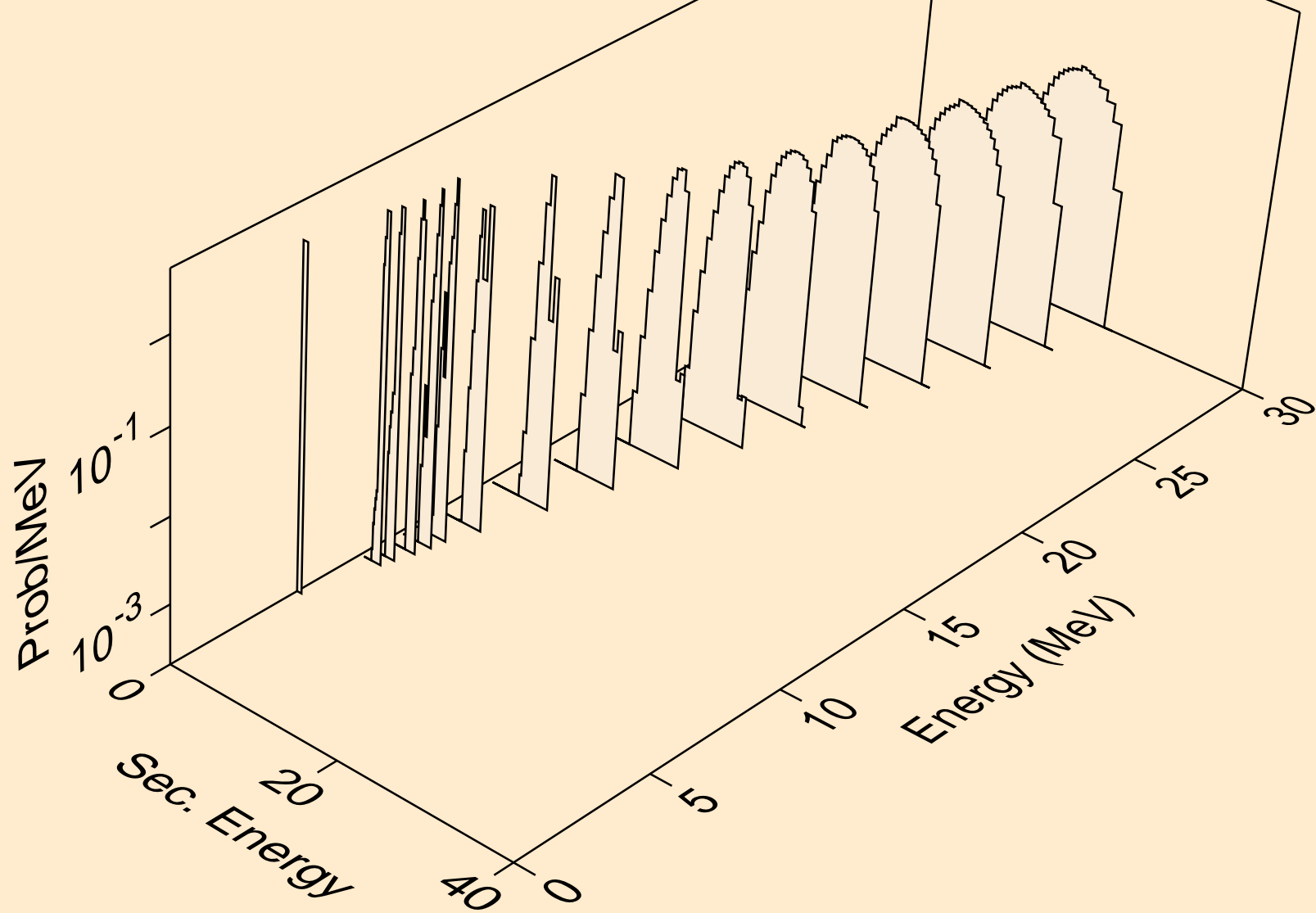

DY145M NEUTRON ACER TENDL-2021 LIBRARY; T=293.6K
tritons from (n,pt)

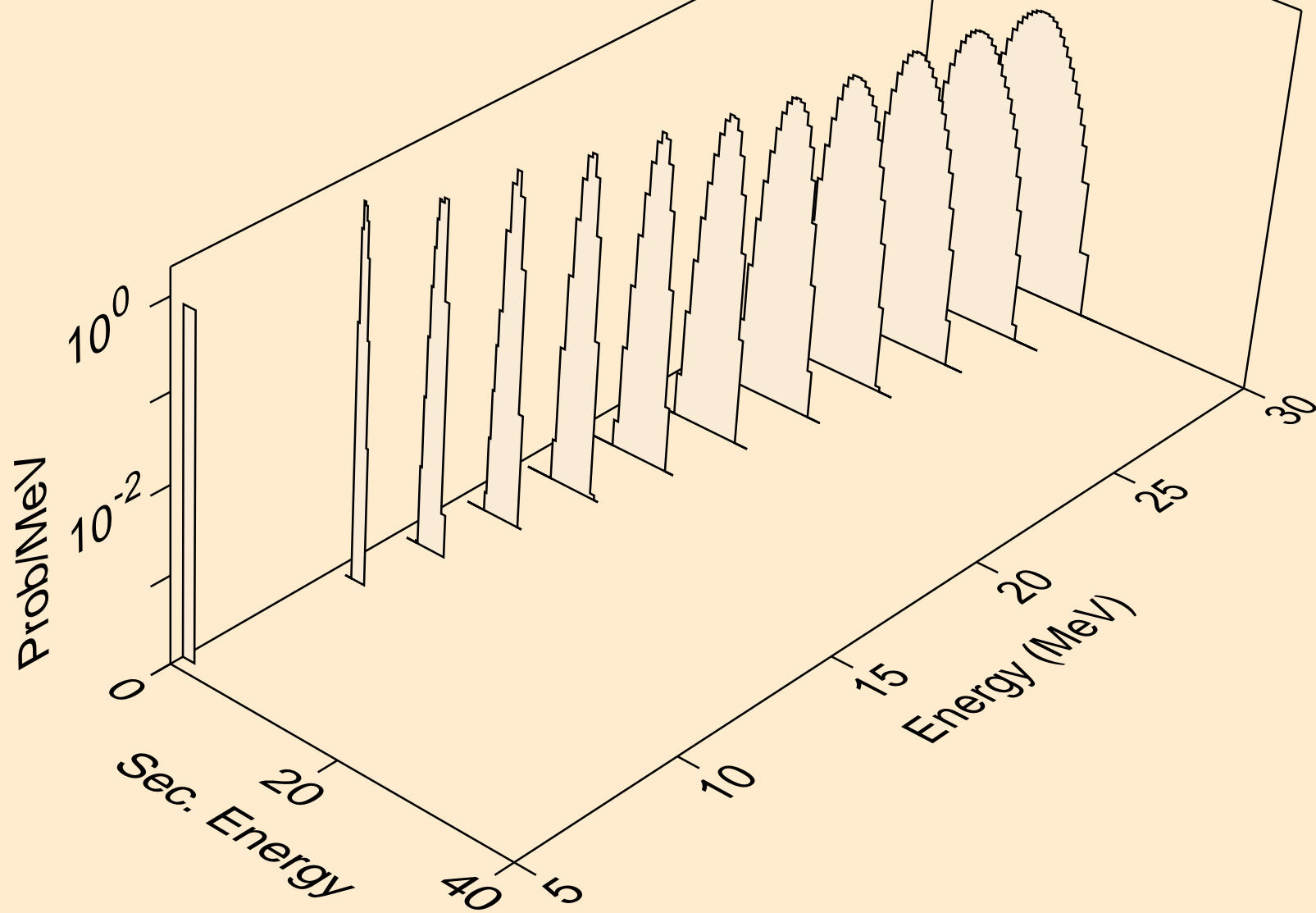

DY145M NEUTRON ACER TENDL-2021 LIBRARY; T=293.6K
he3s from (n,x)

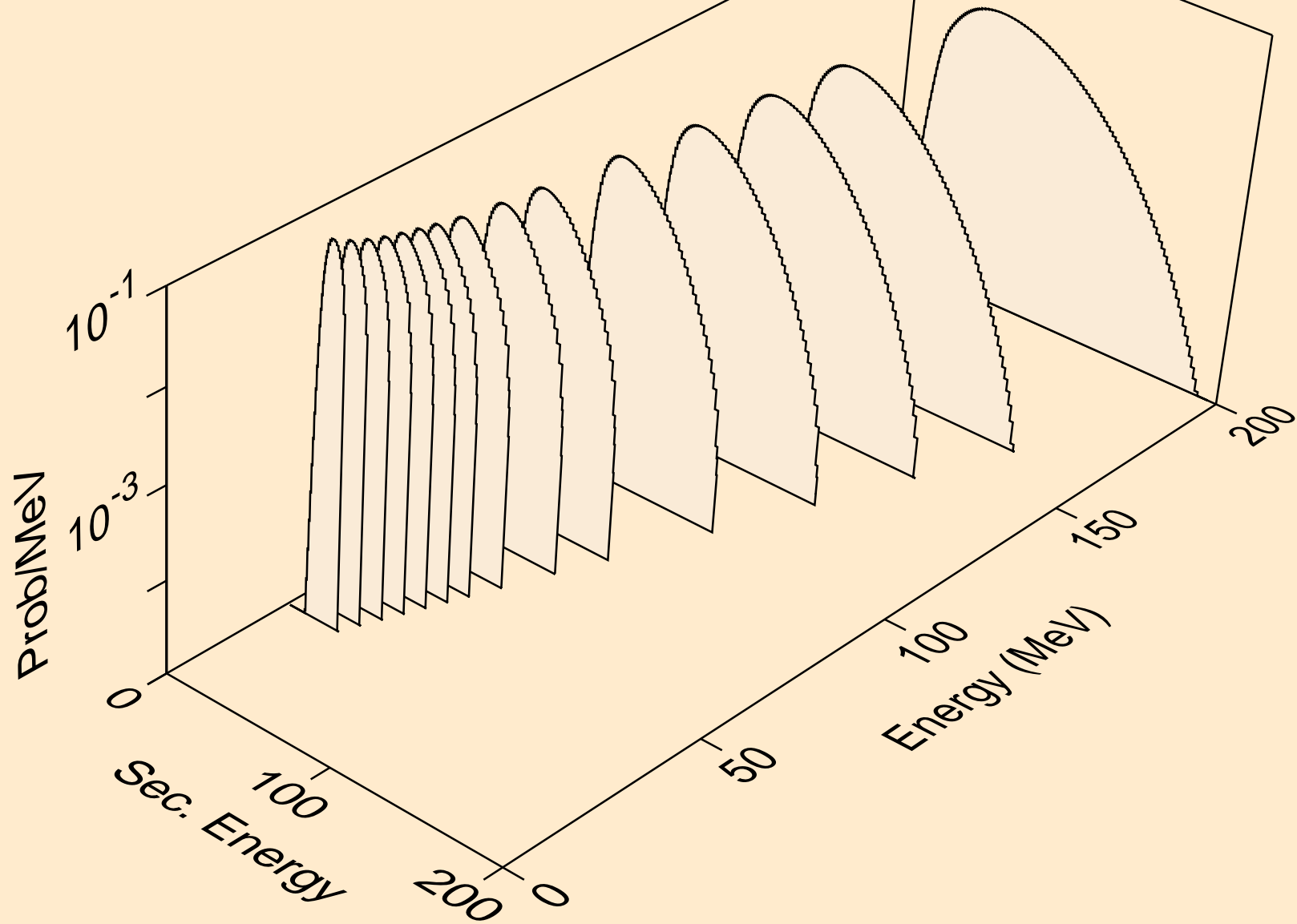

DY145M NEUTRON ACER TENDL-2021 LIBRARY; T=293.6K
he3s from (n,n*)he3

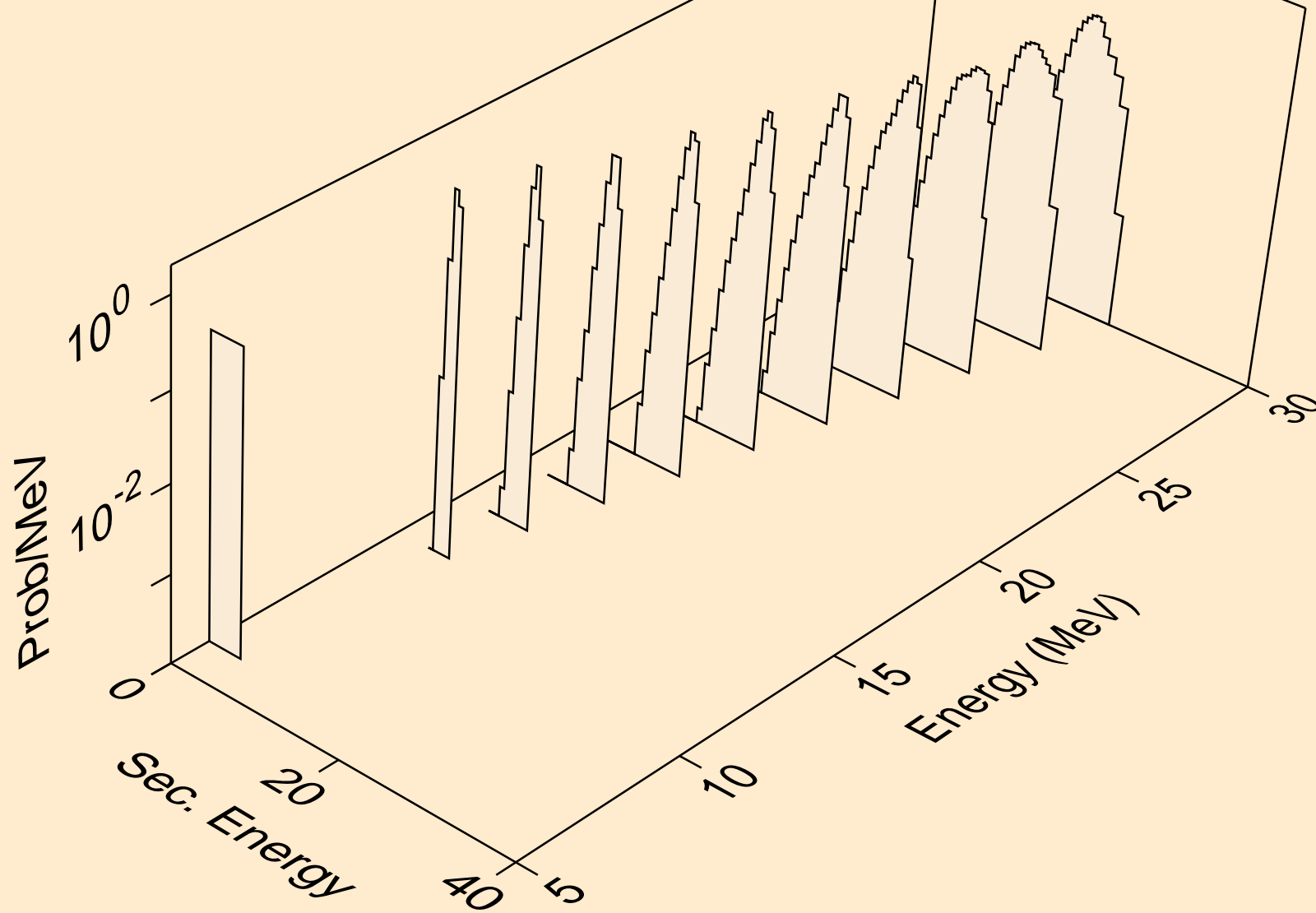

DY145M NEUTRON ACER TENDL-2021 LIBRARY; T=293.6K
he3s from (n,he3)

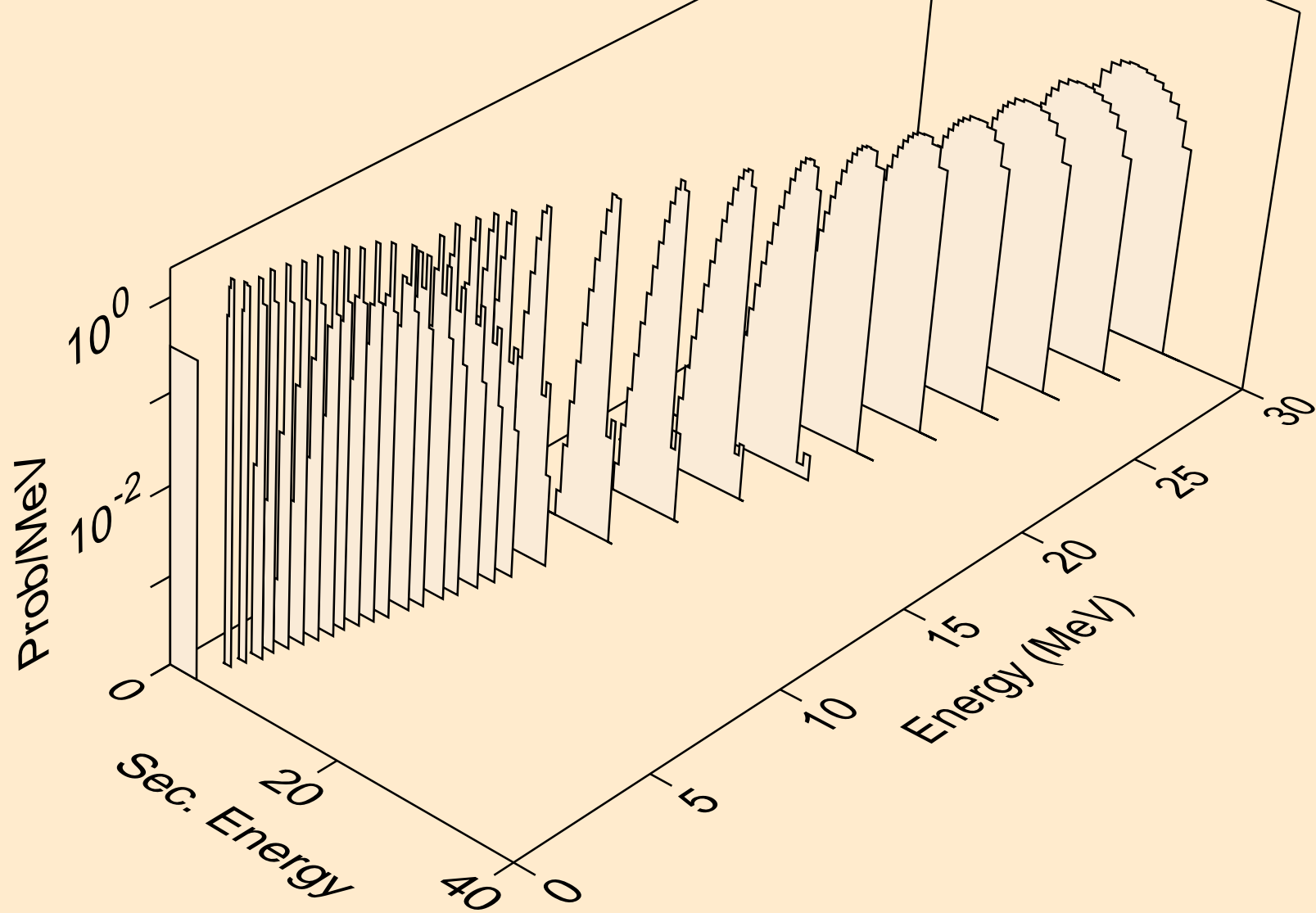

DY145M NEUTRON ACER TENDL-2021 LIBRARY; T=293.6K
alphas from (n,x)

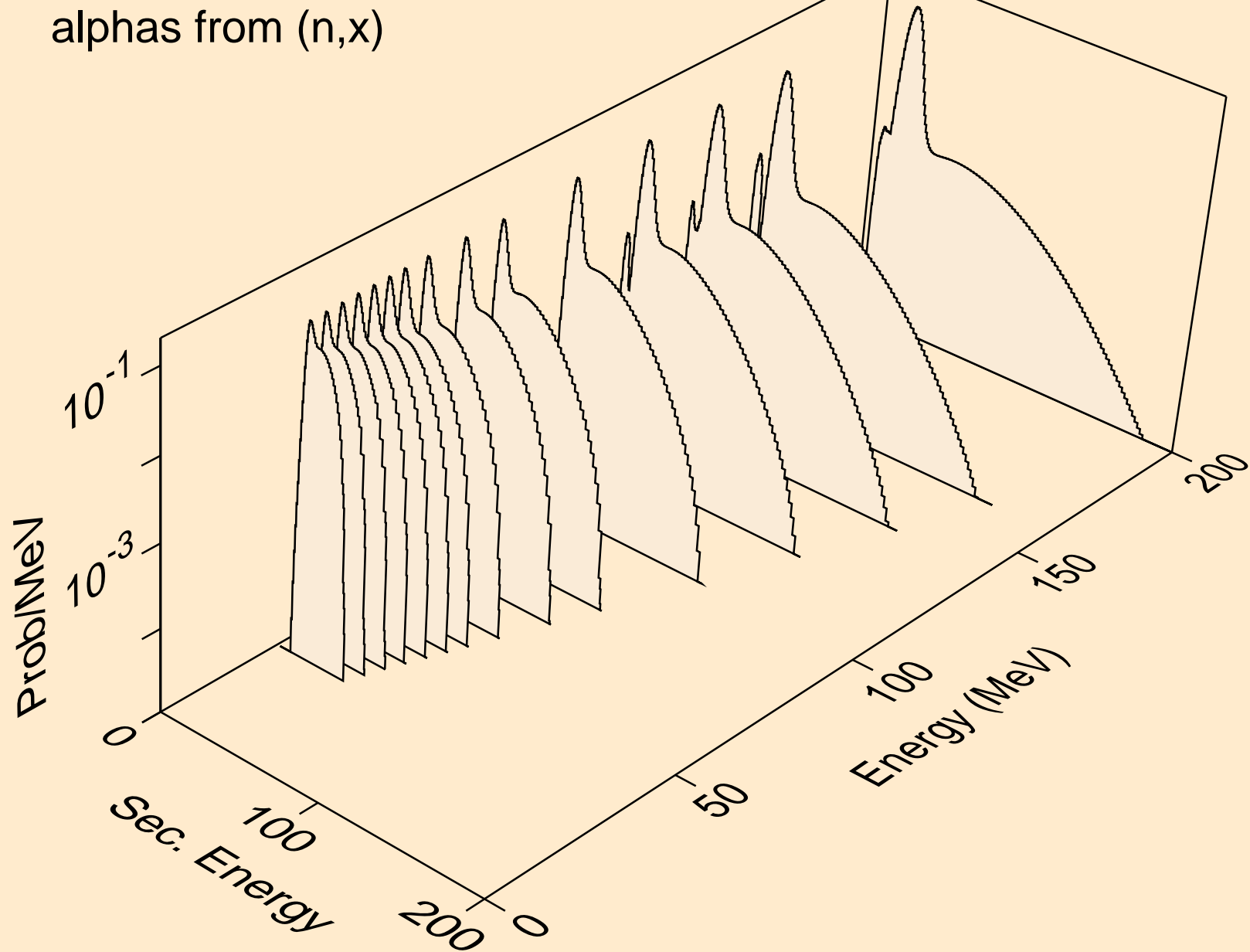

DY145M NEUTRON ACER TENDL-2021 LIBRARY; T=293.6K
alphas from (n,n*)a

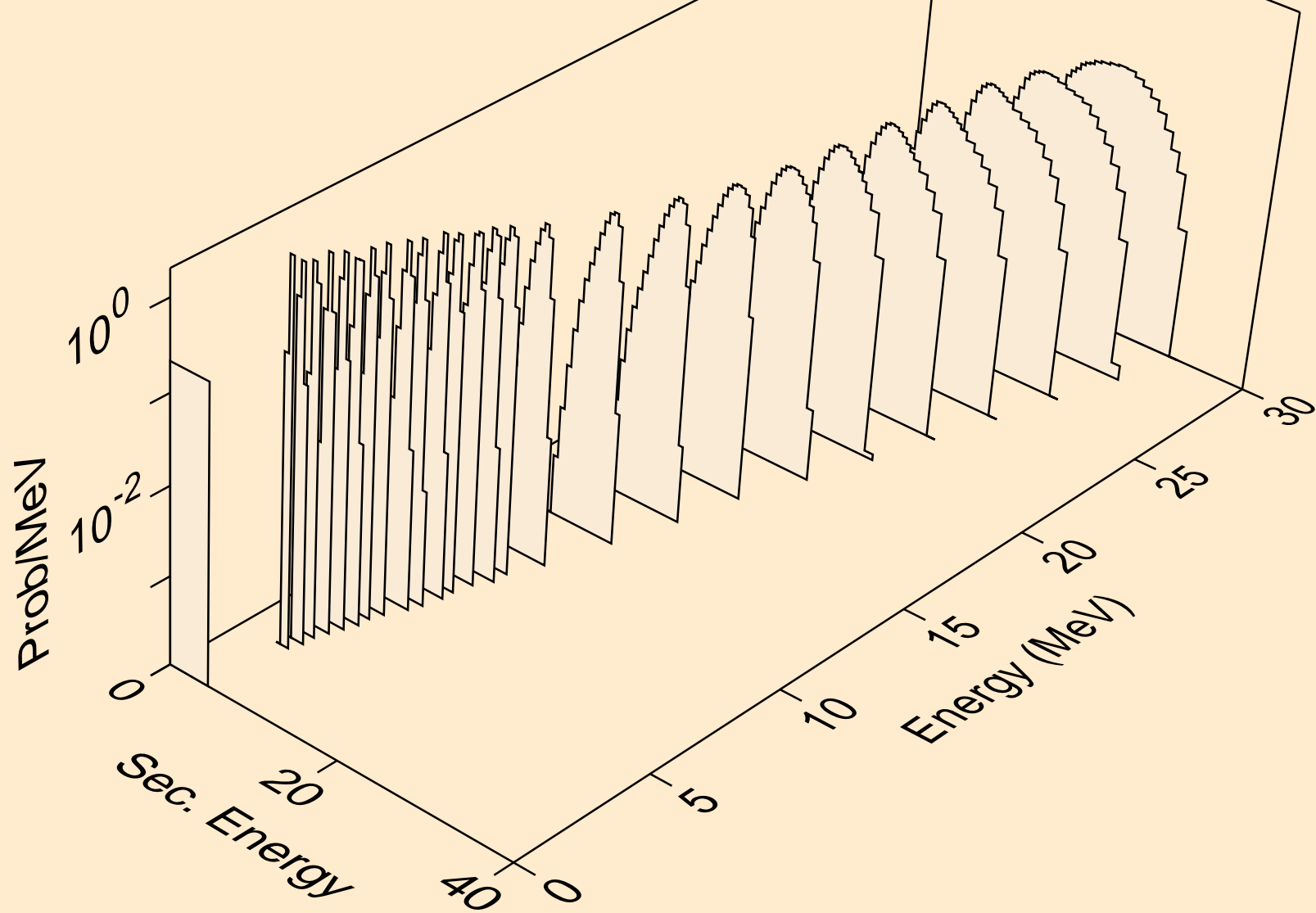

DY145M NEUTRON ACER TENDL-2021 LIBRARY; T=293.6K
alphas from (n,2n)a

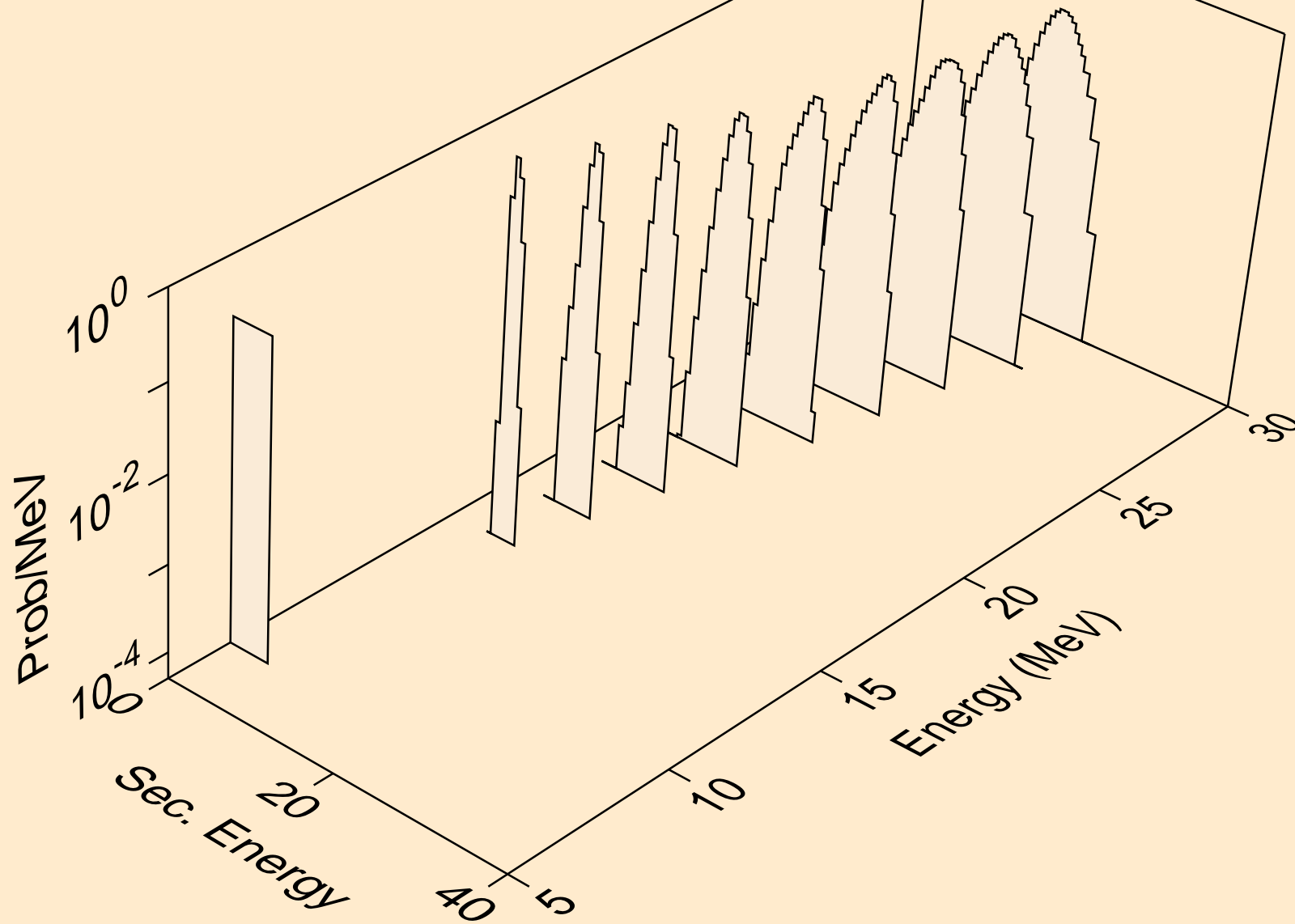

DY145M NEUTRON ACER TENDL-2021 LIBRARY; T=293.6K
alphas from (n,3n)a

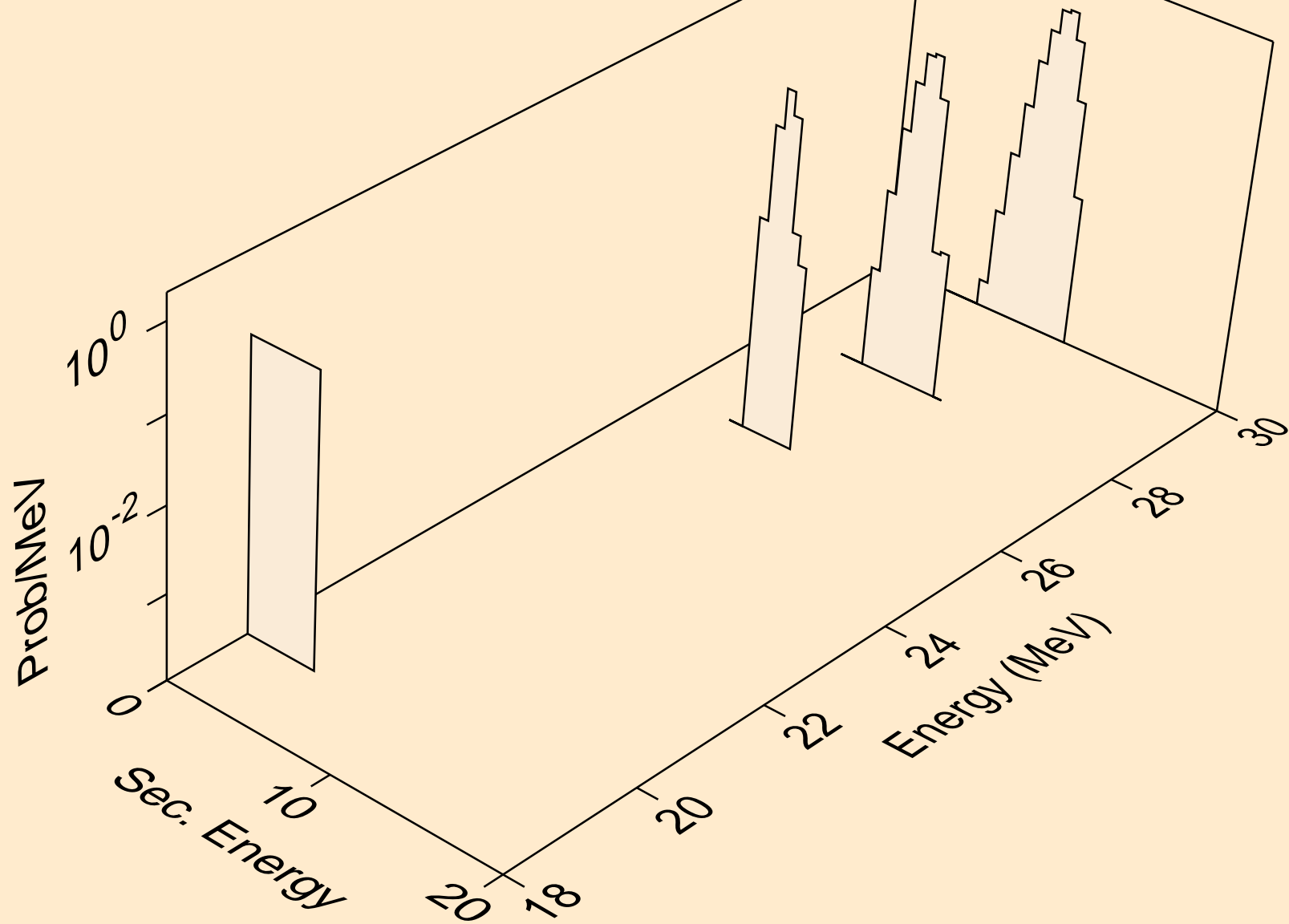

DY145M NEUTRON ACER TENDL-2021 LIBRARY; T=293.6K
alphas from (n,n*)2a

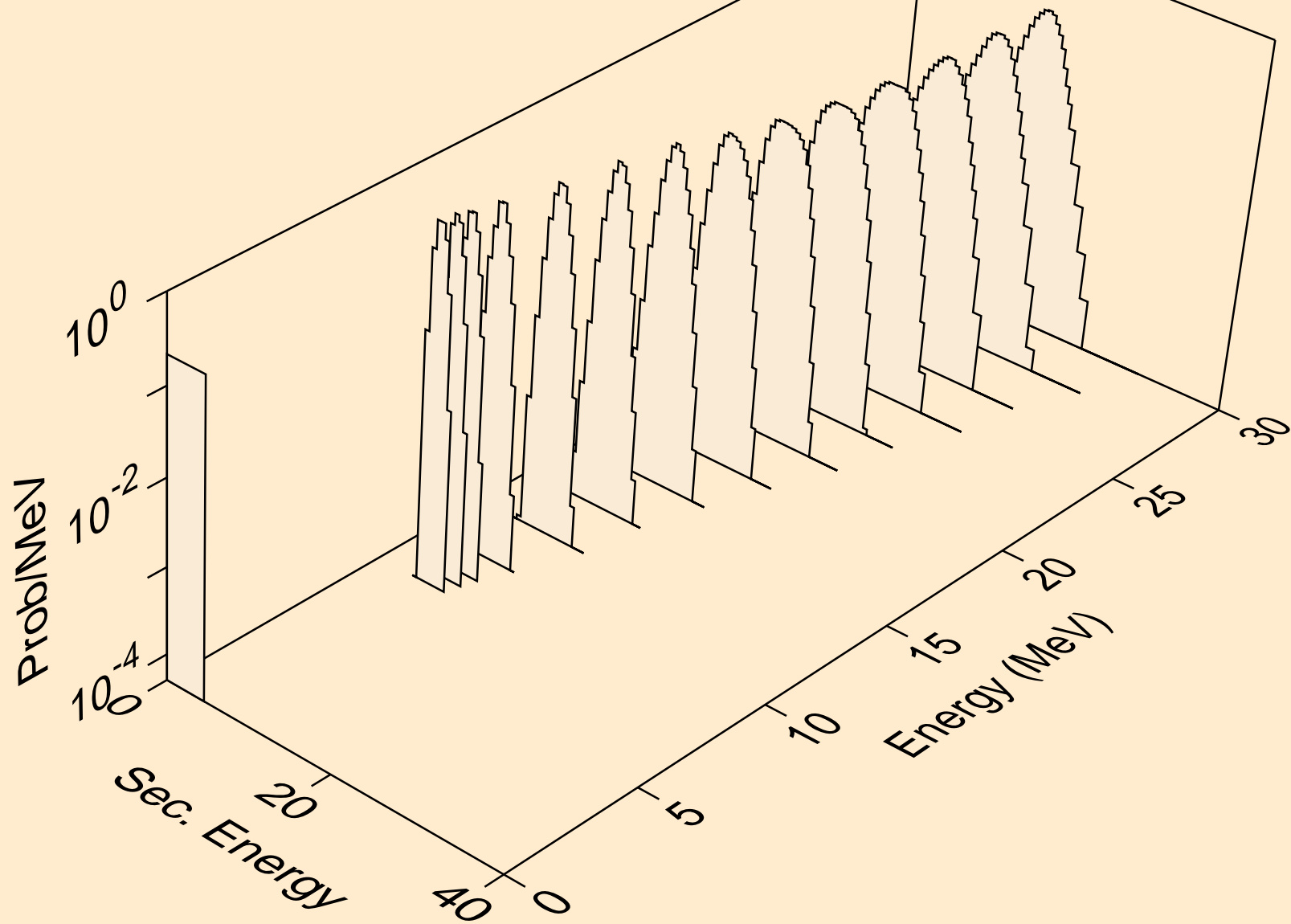

DY145M NEUTRON ACER TENDL-2021 LIBRARY; T=293.6K
alphas from (n,2n)2a

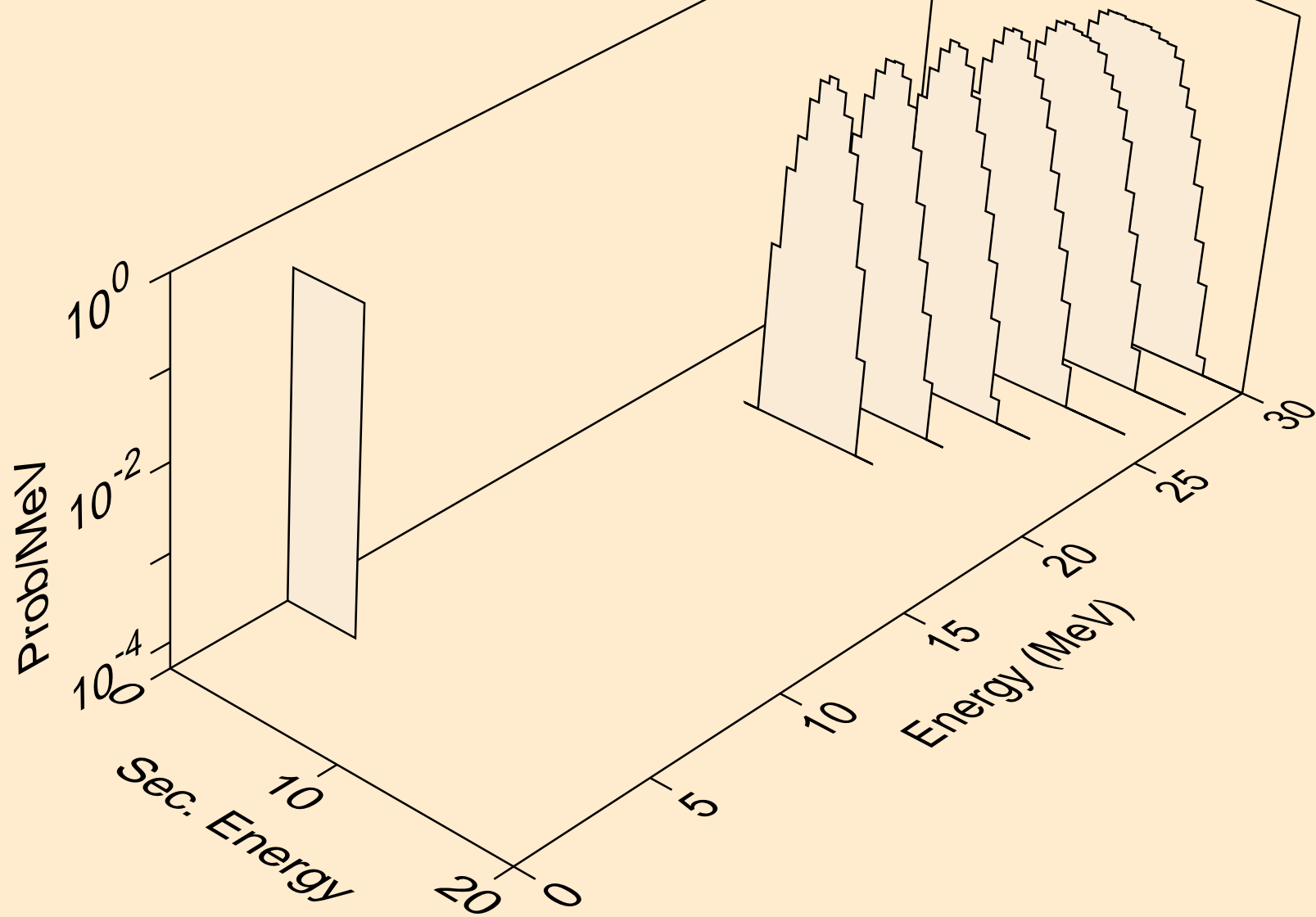

DY145M NEUTRON ACER TENDL-2021 LIBRARY; T=293.6K
alphas from (n,npa)

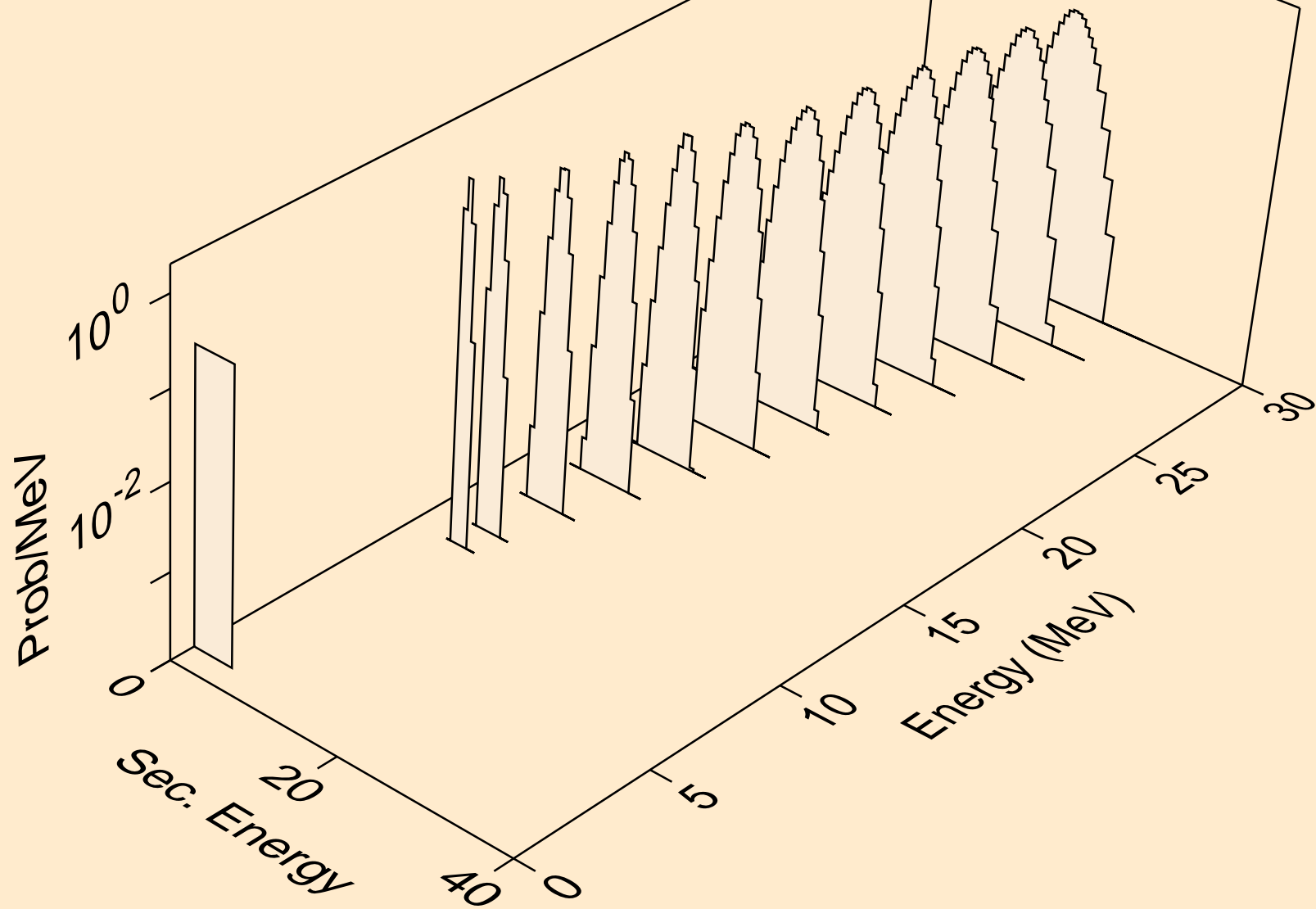

DY145M NEUTRON ACER TENDL-2021 LIBRARY; T=293.6K
alphas from (n,a)

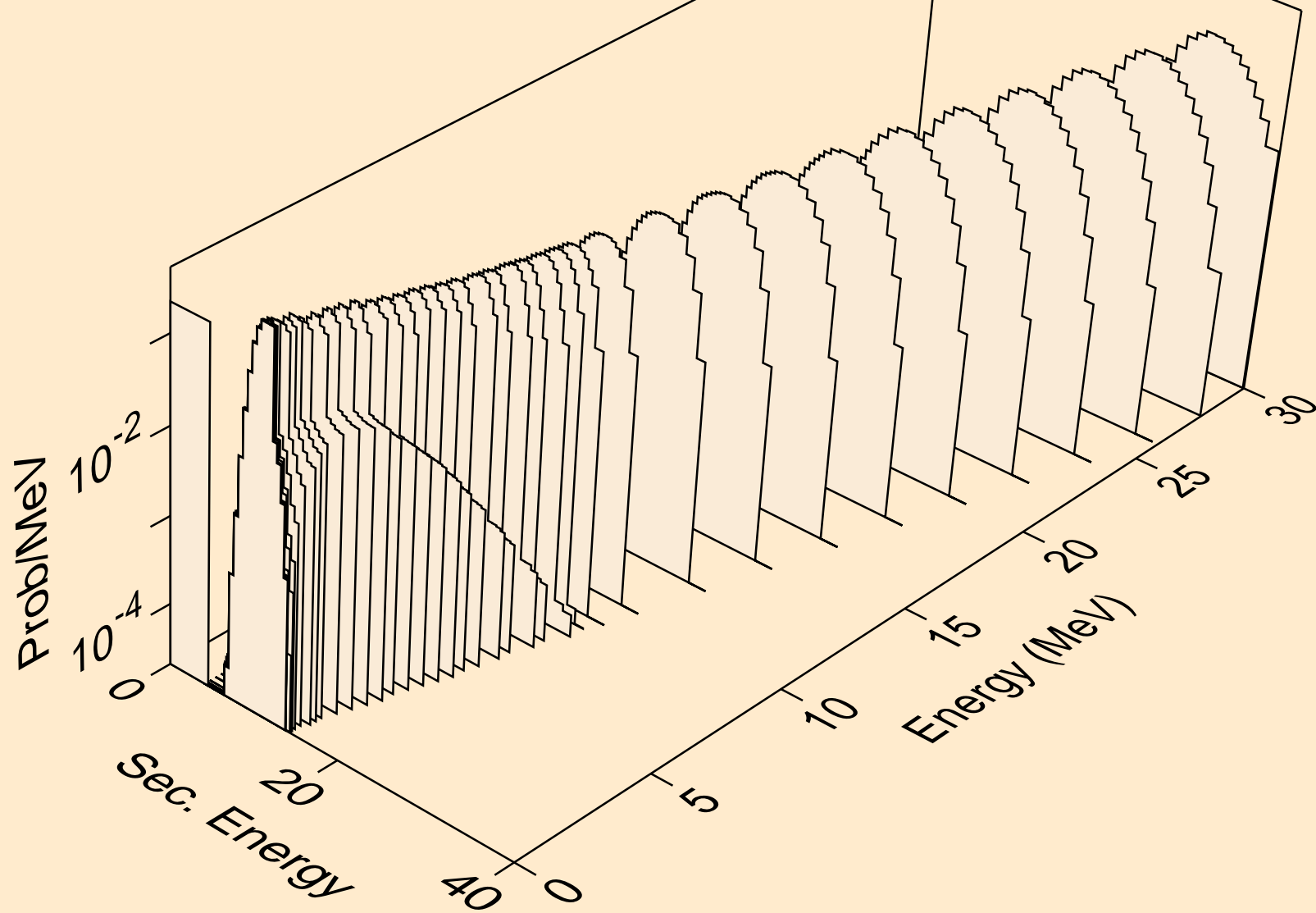

DY145M NEUTRON ACER TENDL-2021 LIBRARY; T=293.6K
alphas from (n,2a)

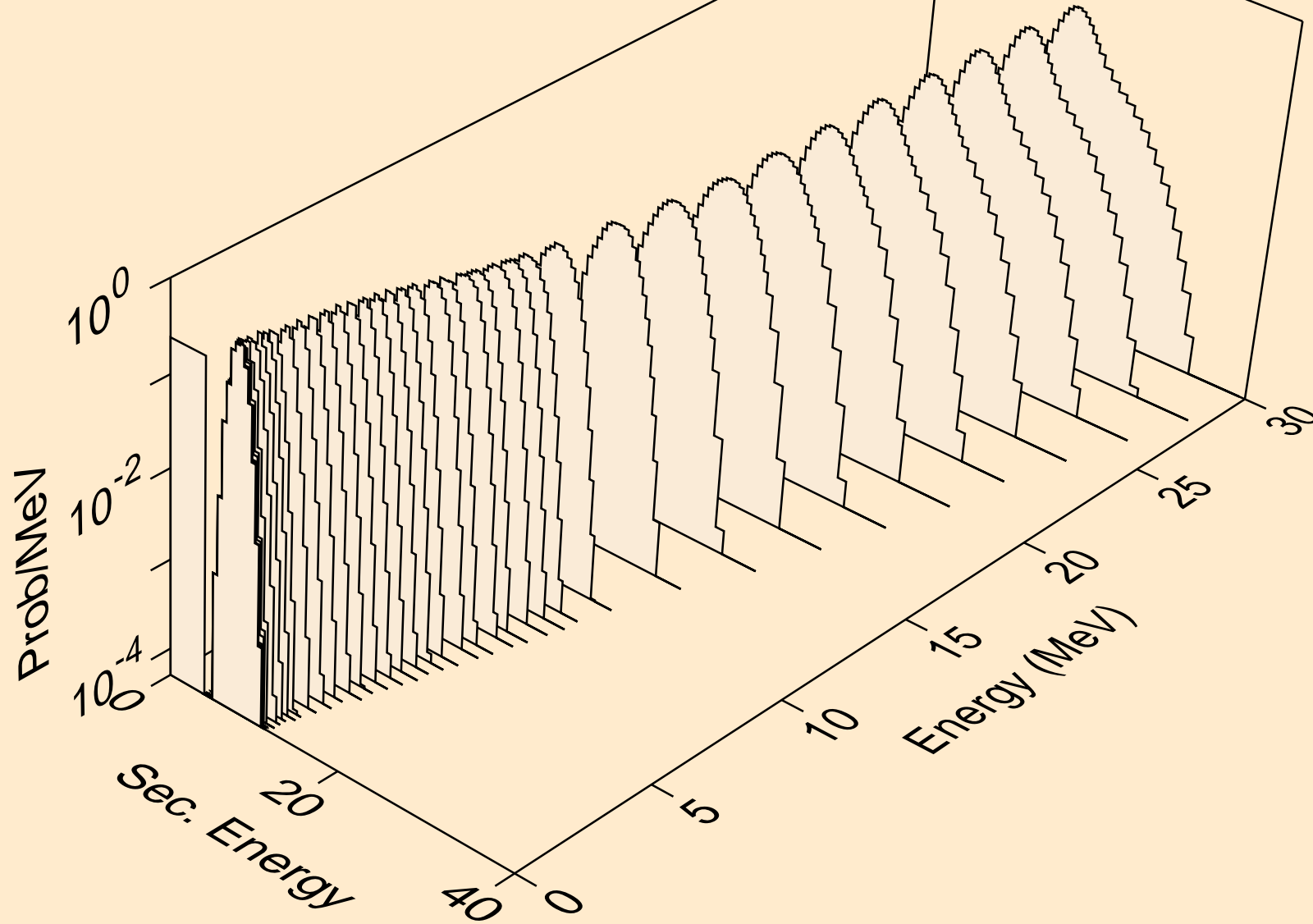

DY145M NEUTRON ACER TENDL-2021 LIBRARY; T=293.6K
alphas from (n,3a)

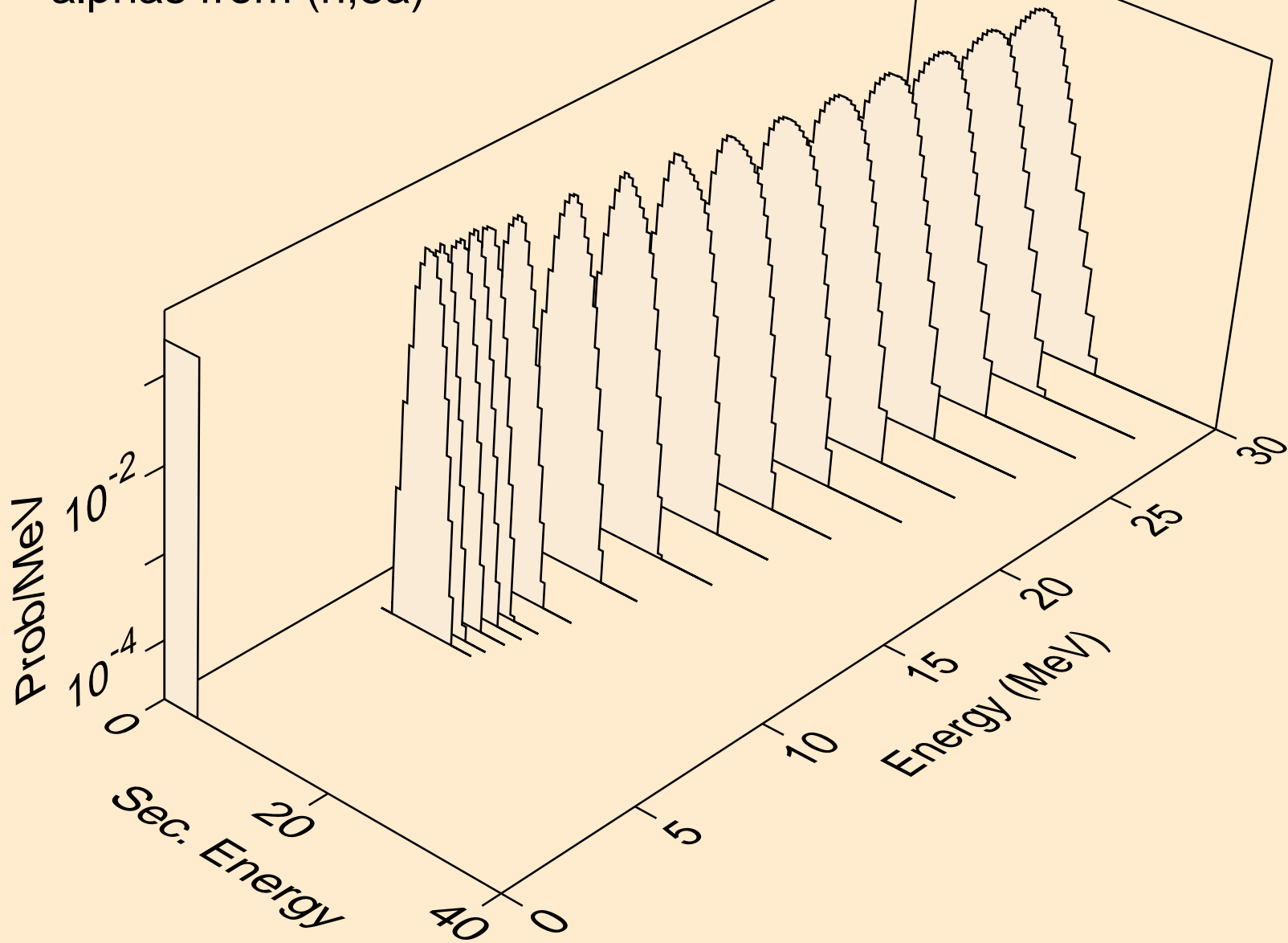

DY145M NEUTRON ACER TENDL-2021 LIBRARY; T=293.6K
alphas from (n,p)

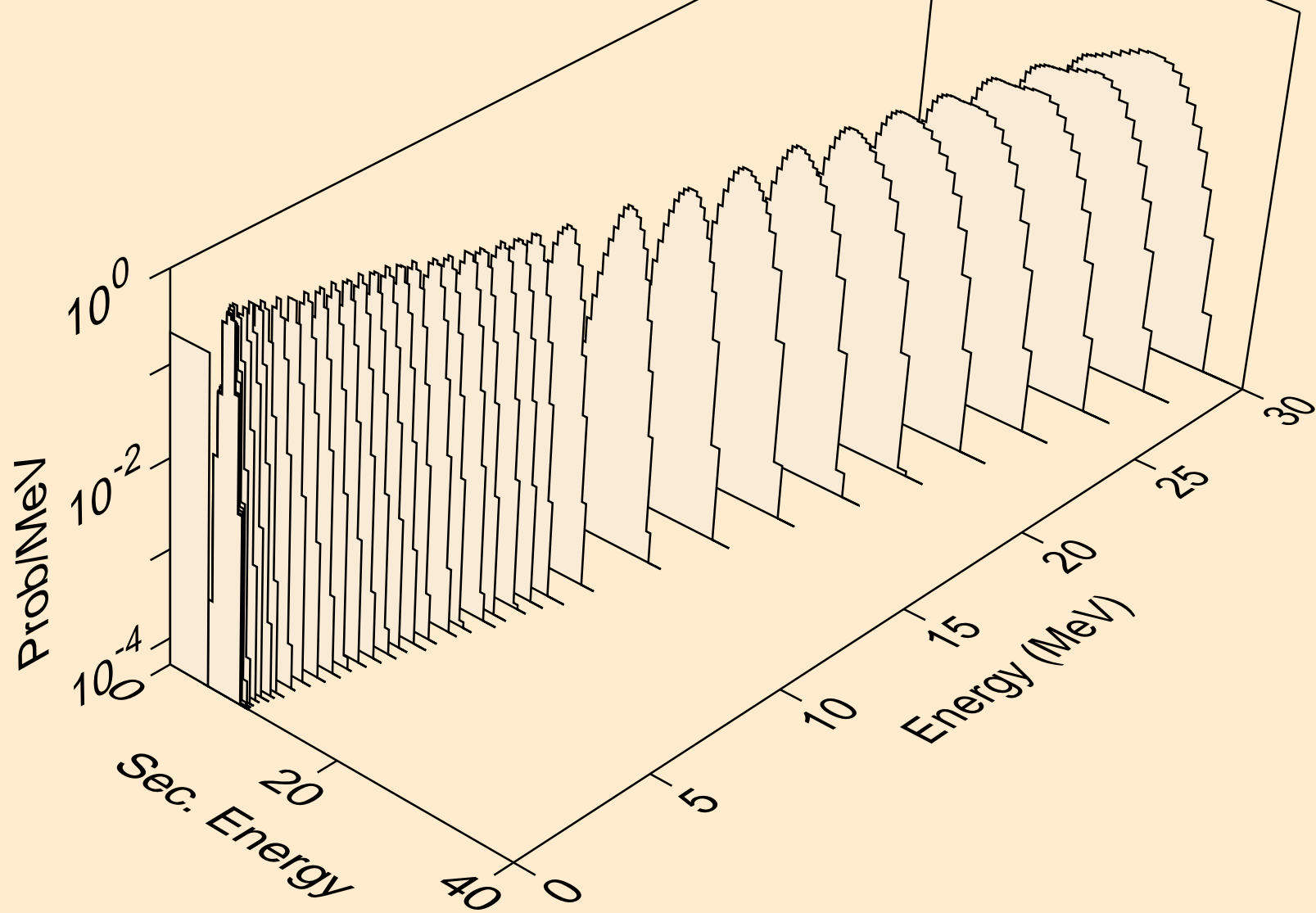

DY145M NEUTRON ACER TENDL-2021 LIBRARY; T=293.6K
alphas from (n,da)

