

DY169 NEUTRON ACER TENDL-2021 LIBRARY; T=293.6K
Principal cross sections

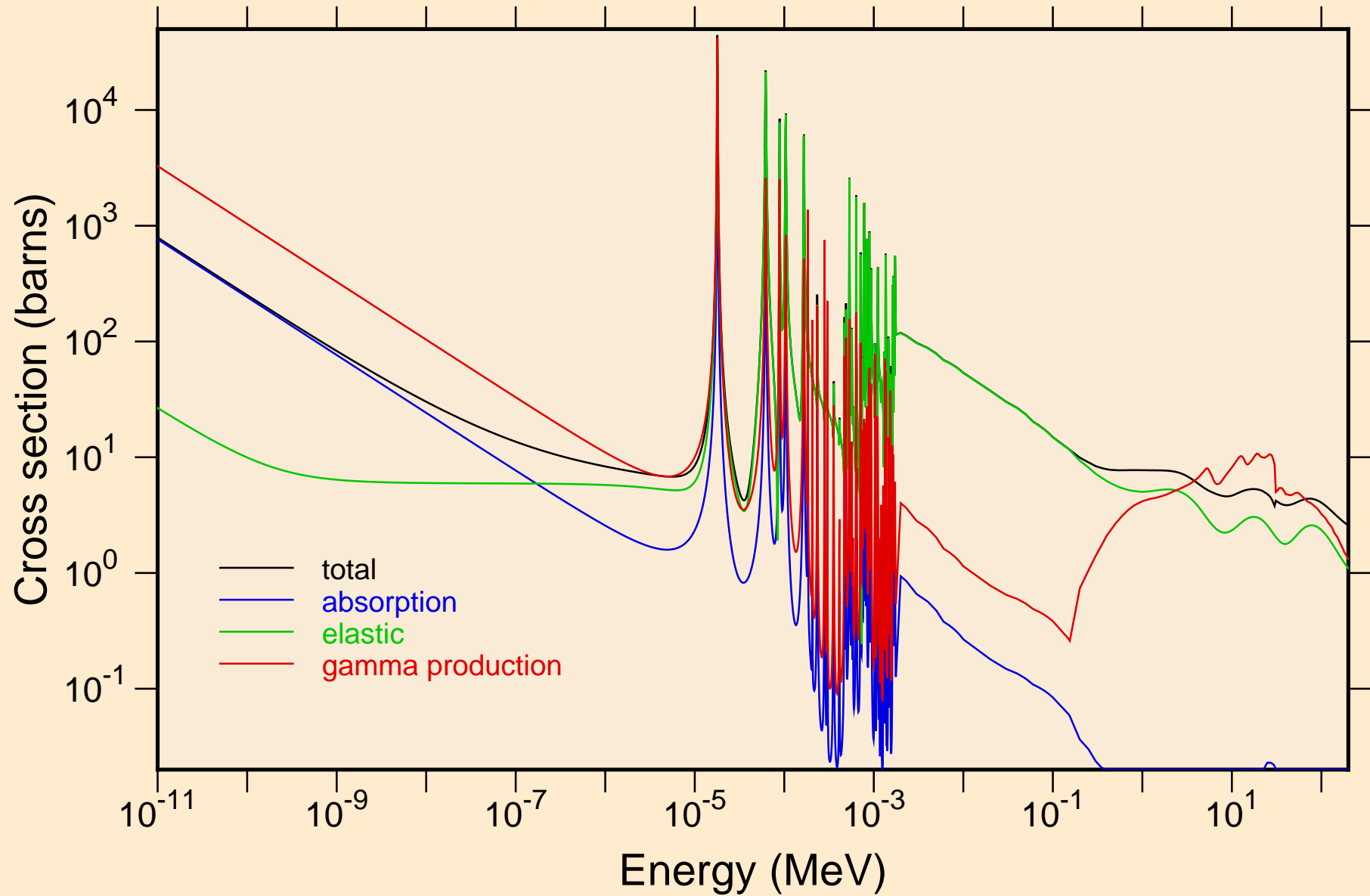

DY169 NEUTRON ACER TENDL-2021 LIBRARY; T=293.6K
resonance total cross section

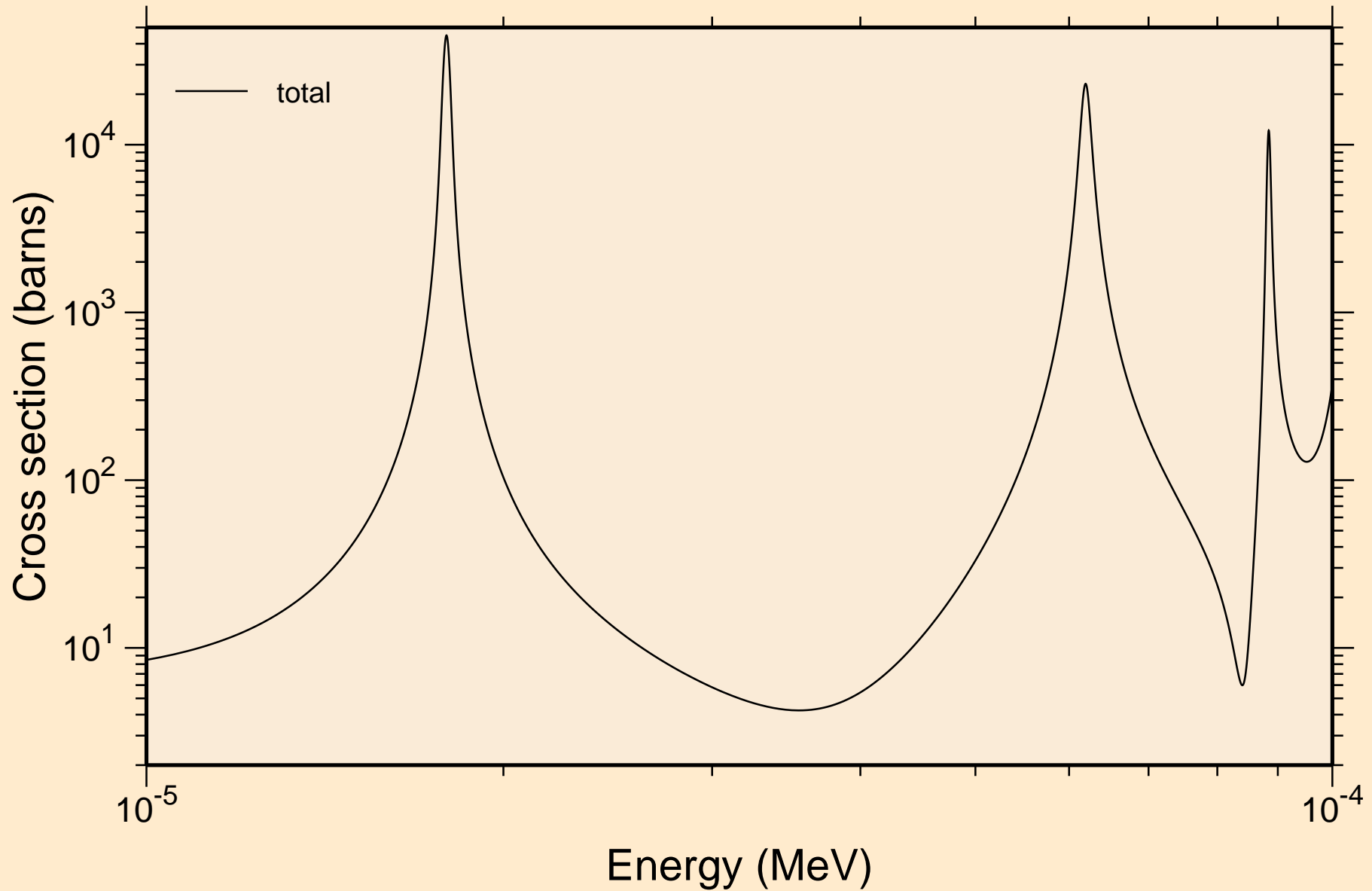

DY169 NEUTRON ACER TENDL-2021 LIBRARY; T=293.6K
resonance total cross section

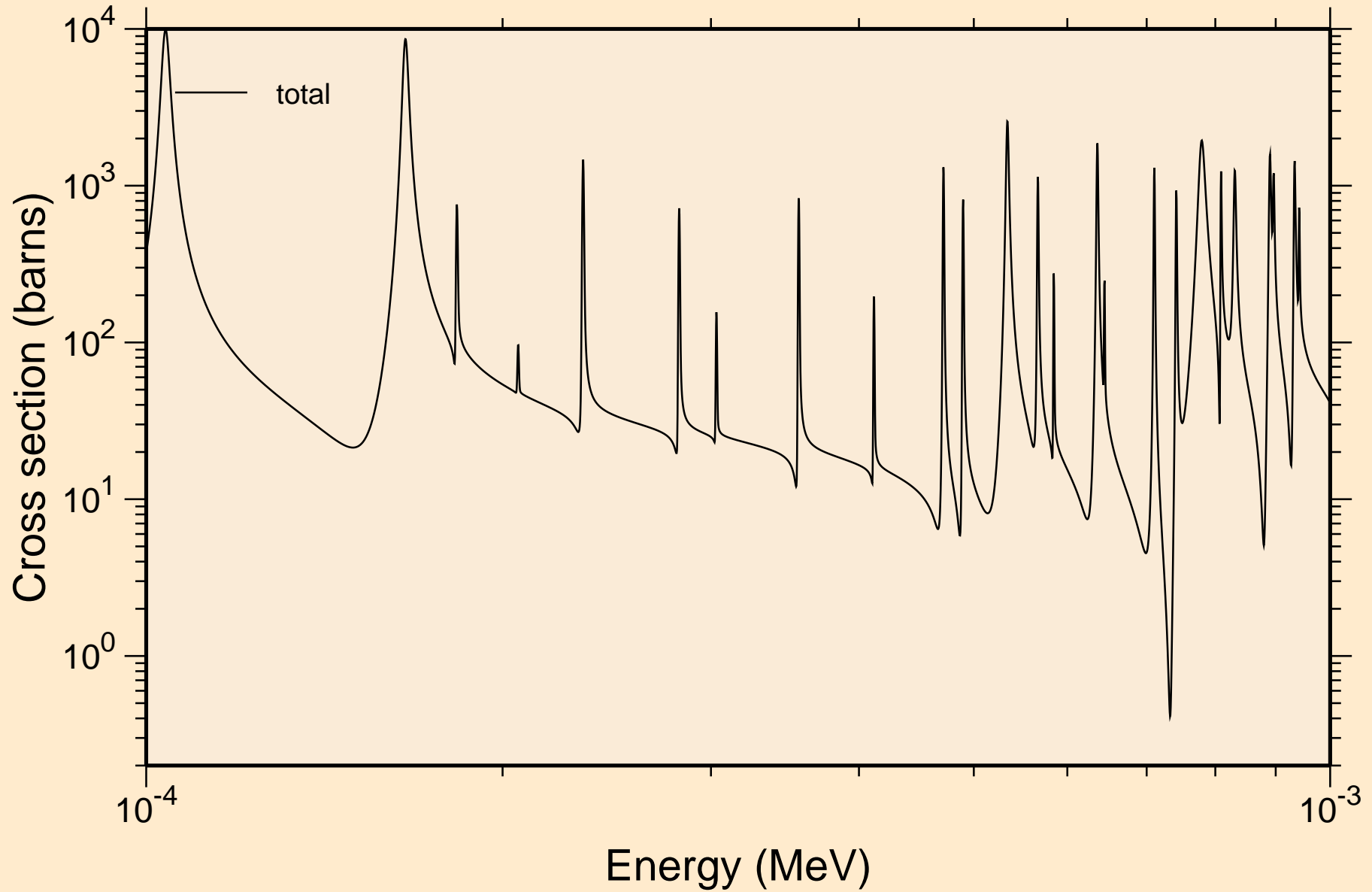

DY169 NEUTRON ACER TENDL-2021 LIBRARY; T=293.6K
resonance total cross section

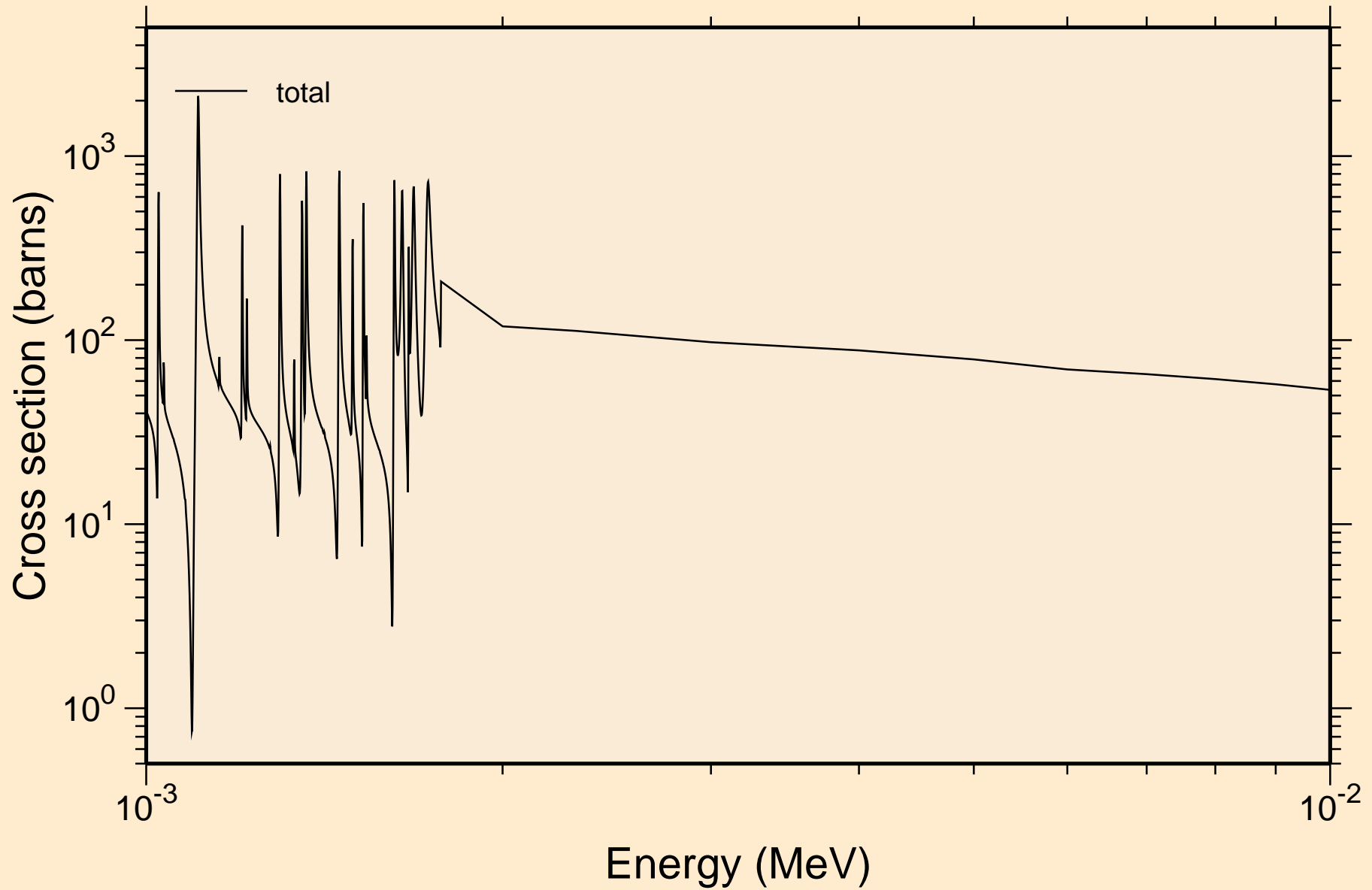

DY169 NEUTRON ACER TENDL-2021 LIBRARY; T=293.6K
resonance total cross section

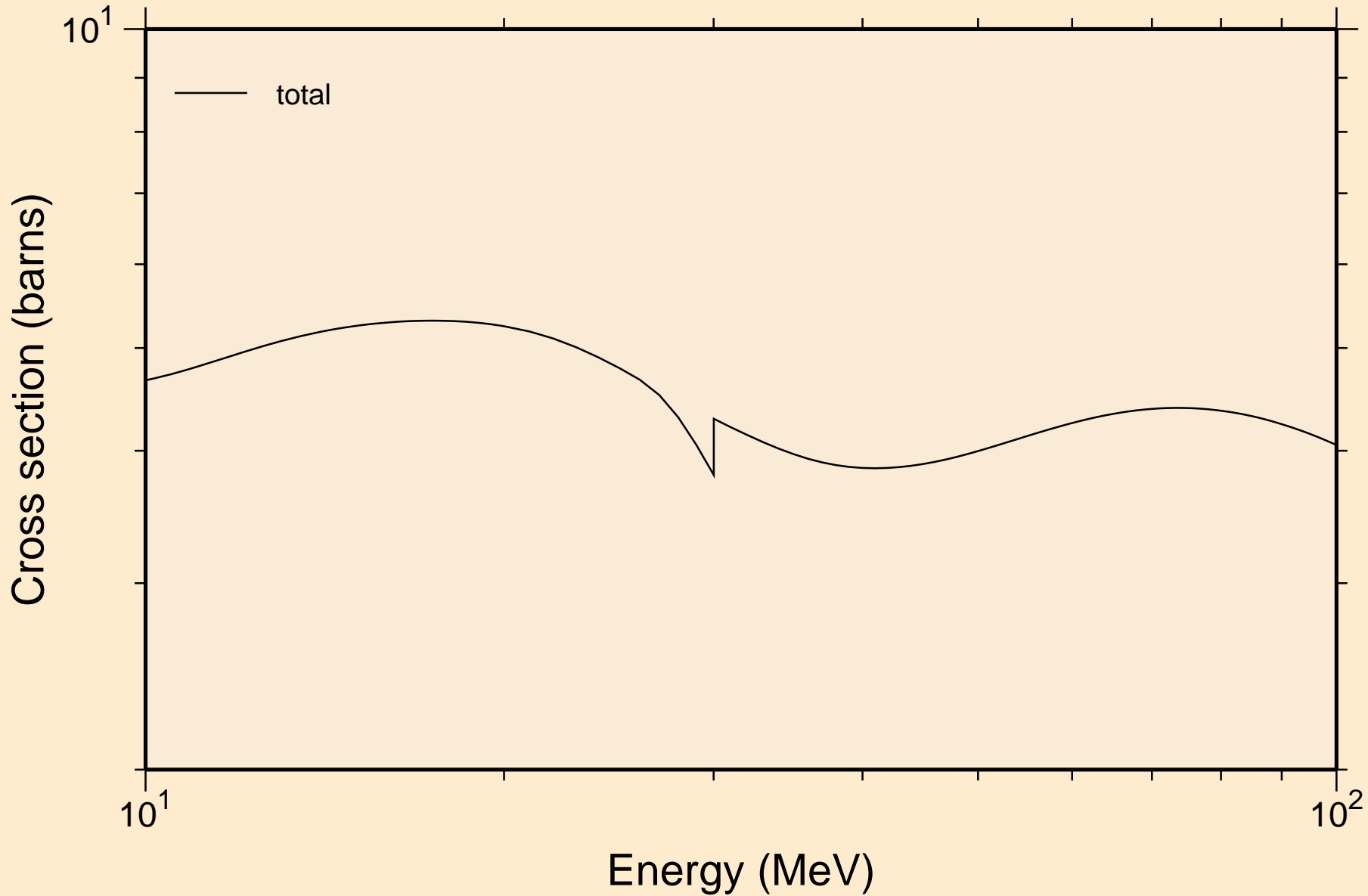

DY169 NEUTRON ACER TENDL-2021 LIBRARY; T=293.6K
resonance absorption cross sections

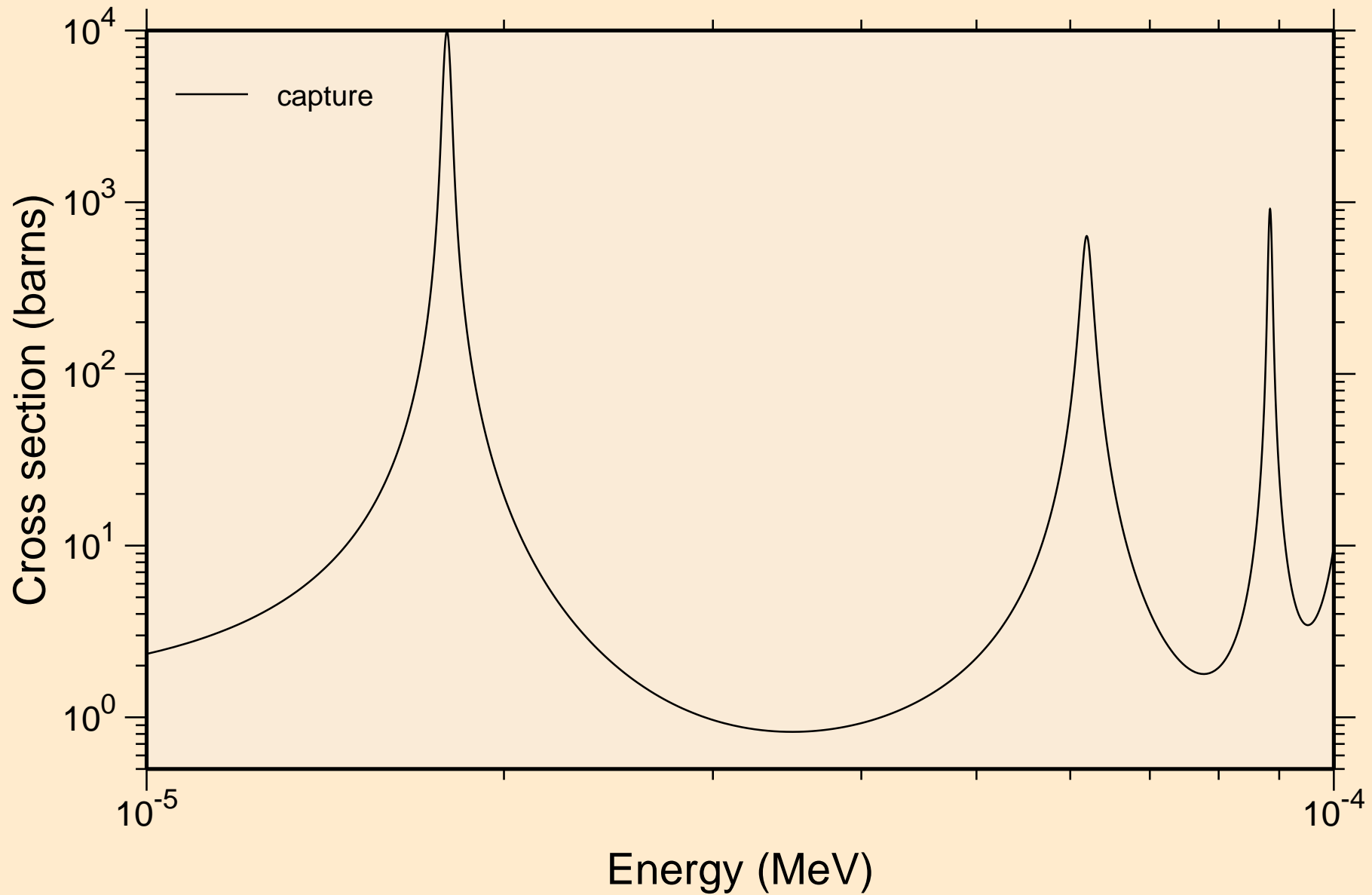

DY169 NEUTRON ACER TENDL-2021 LIBRARY; T=293.6K
resonance absorption cross sections

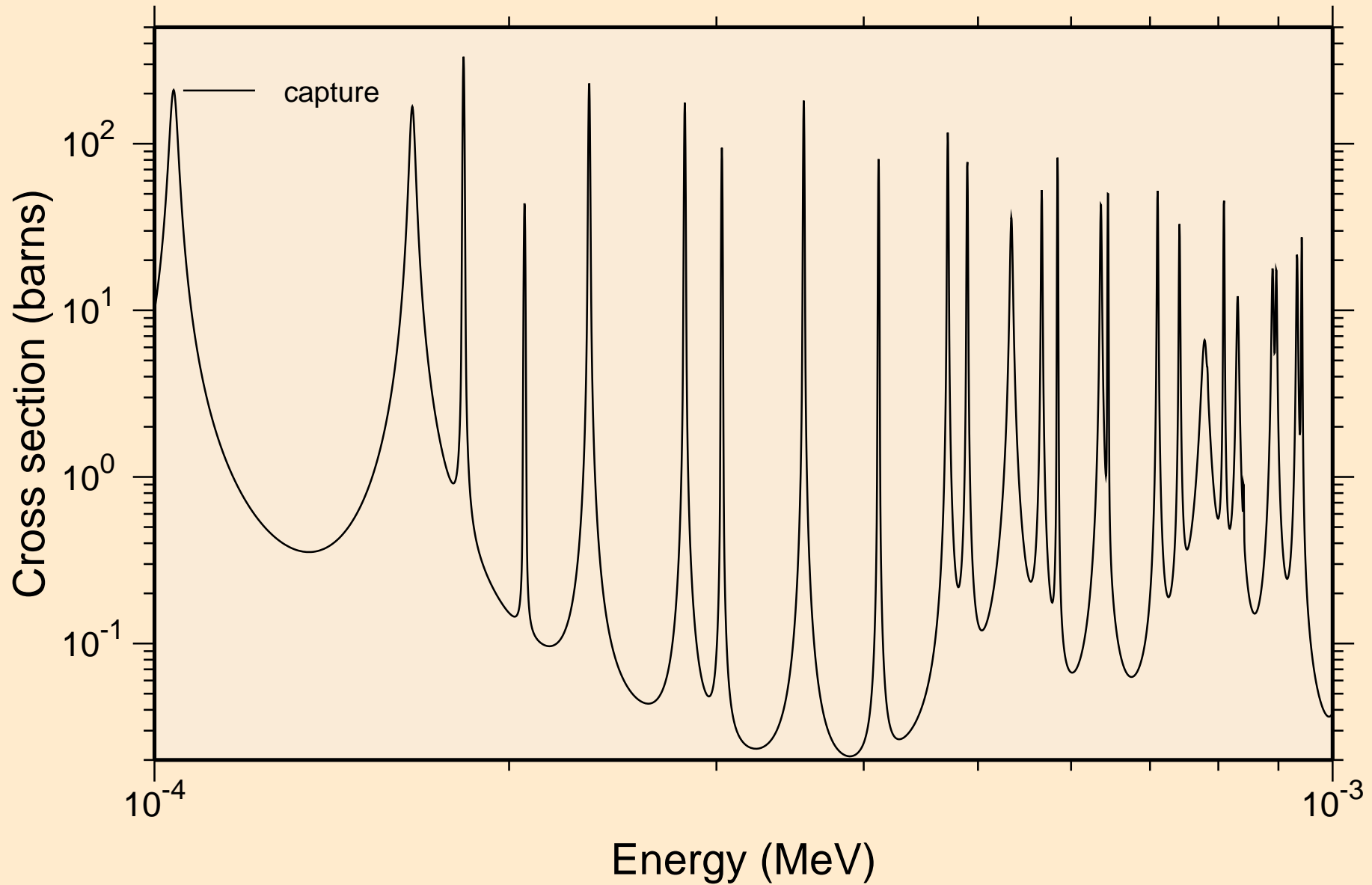

DY169 NEUTRON ACER TENDL-2021 LIBRARY; T=293.6K
resonance absorption cross sections

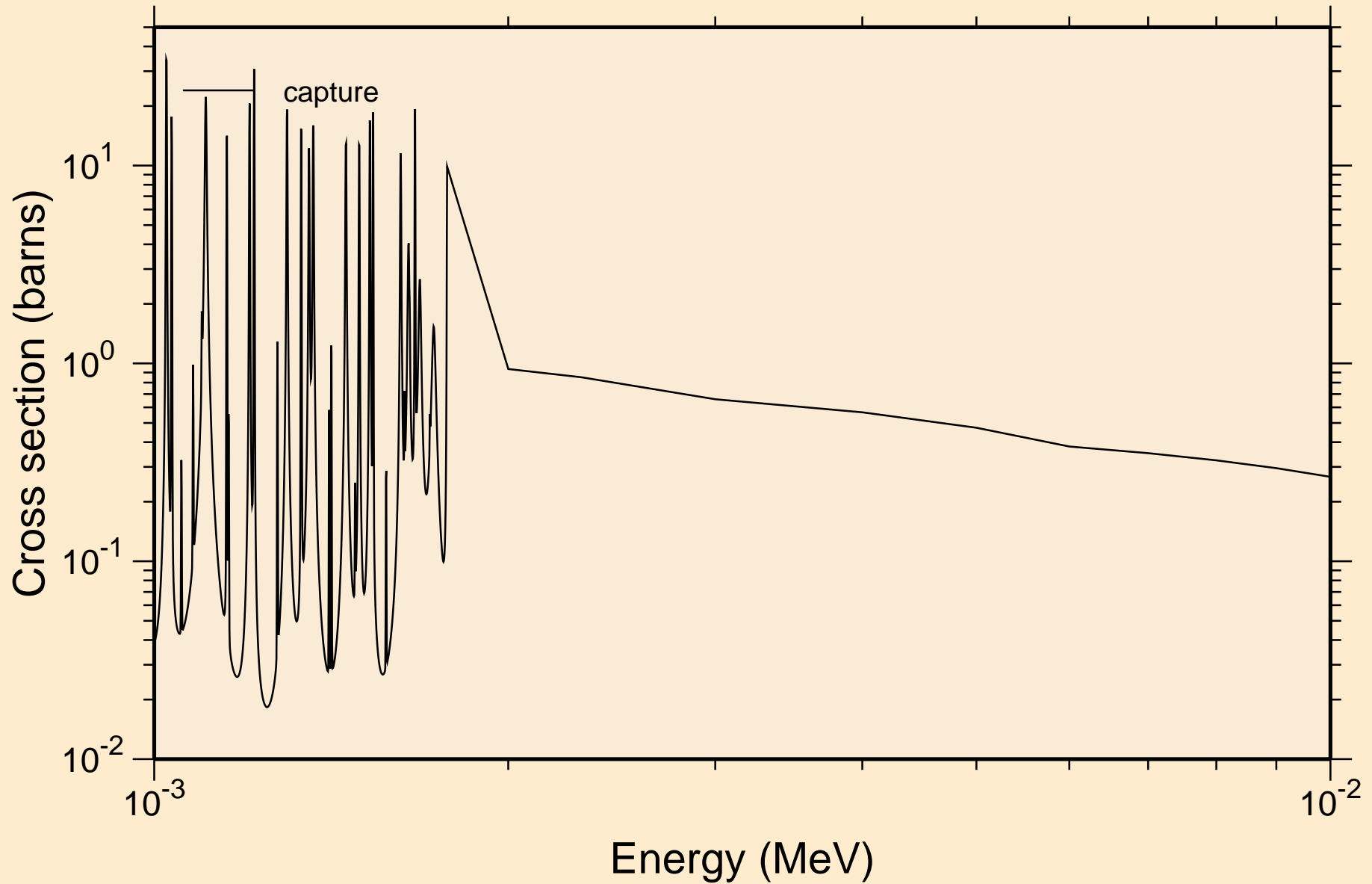

DY169 NEUTRON ACER TENDL-2021 LIBRARY; T=293.6K
resonance absorption cross sections

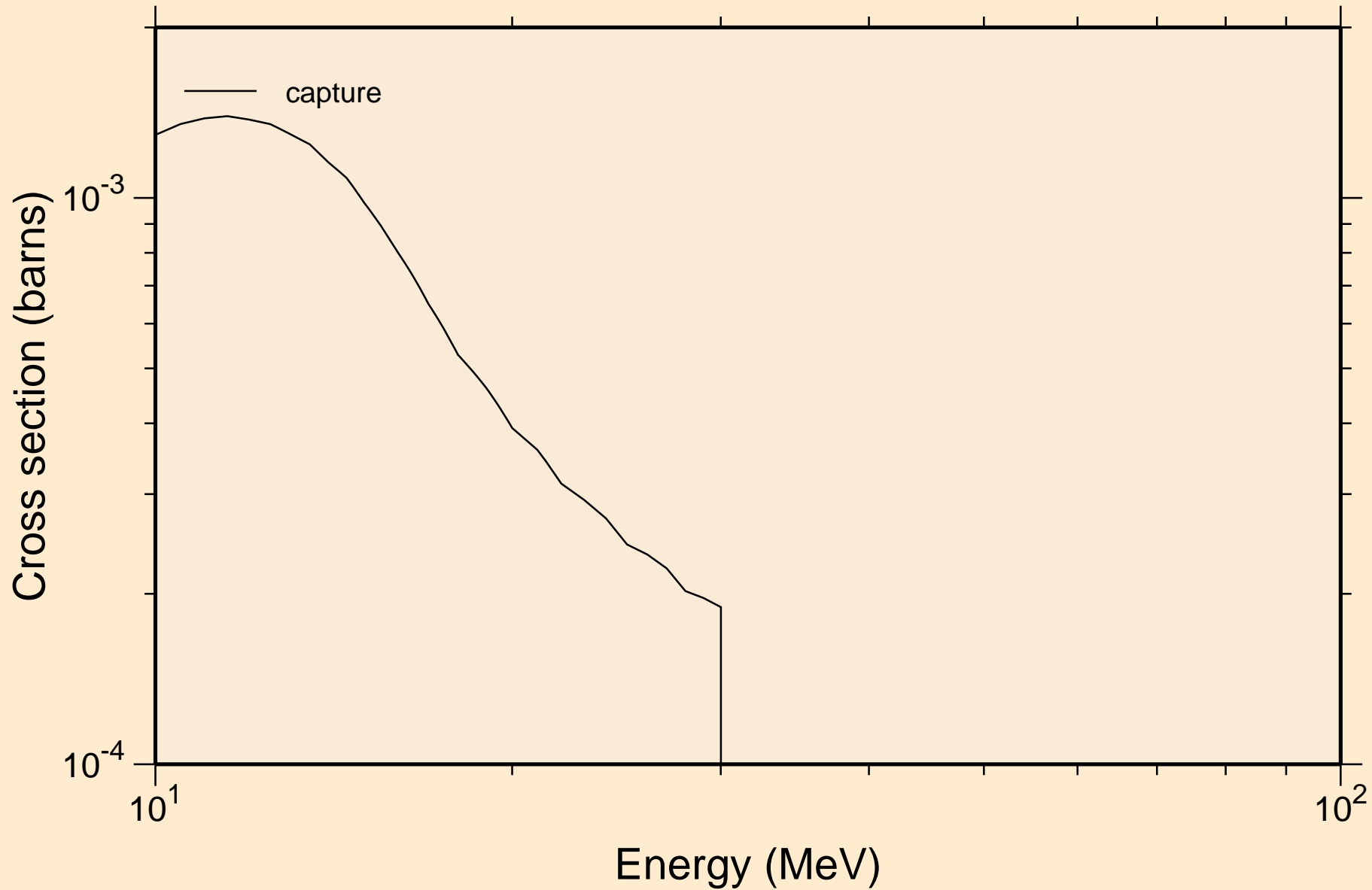

DY169 NEUTRON ACER TENDL-2021 LIBRARY; T=293.6K
Heating

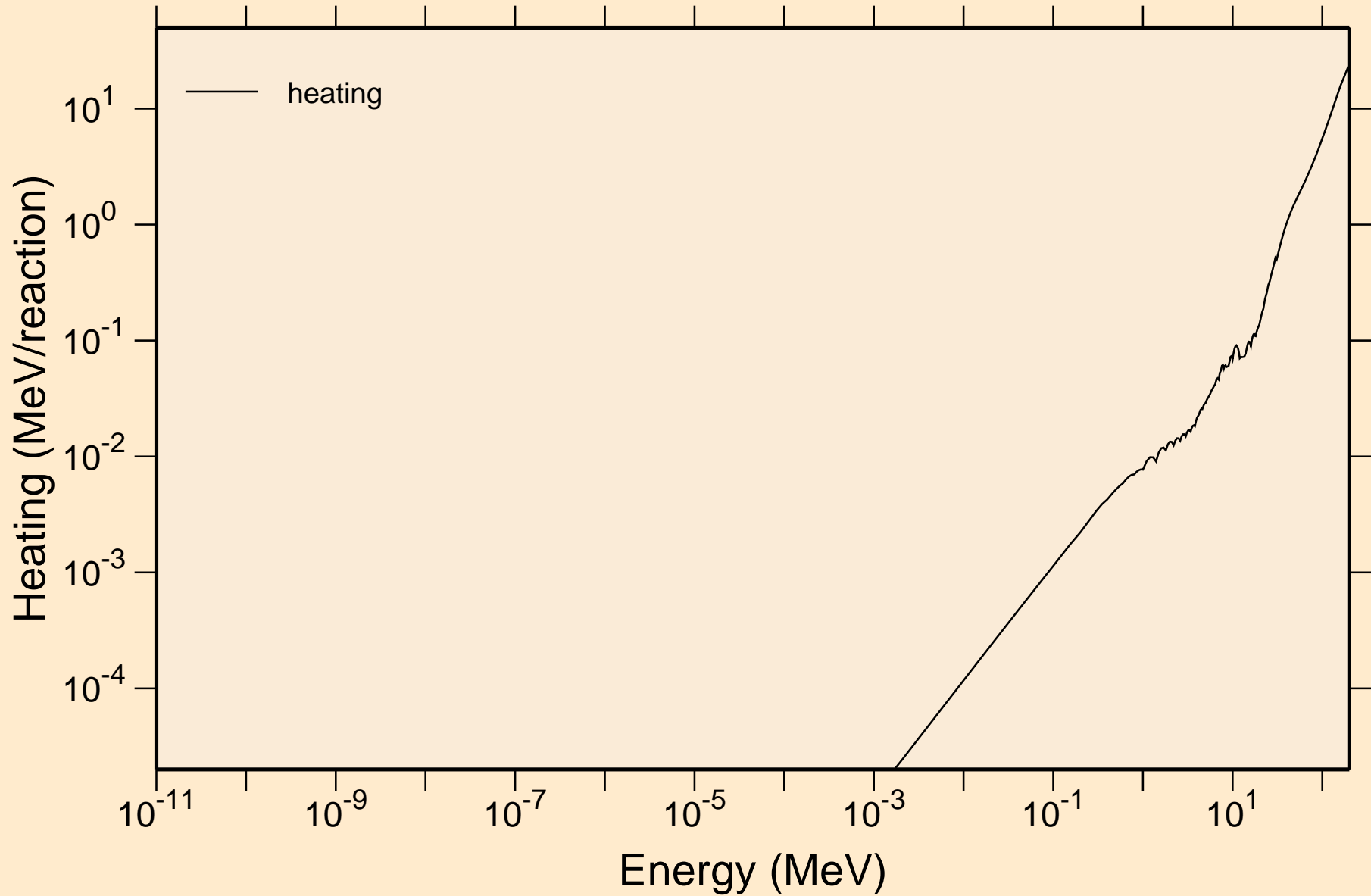

DY169 NEUTRON ACER TENDL-2021 LIBRARY; T=293.6K

Damage

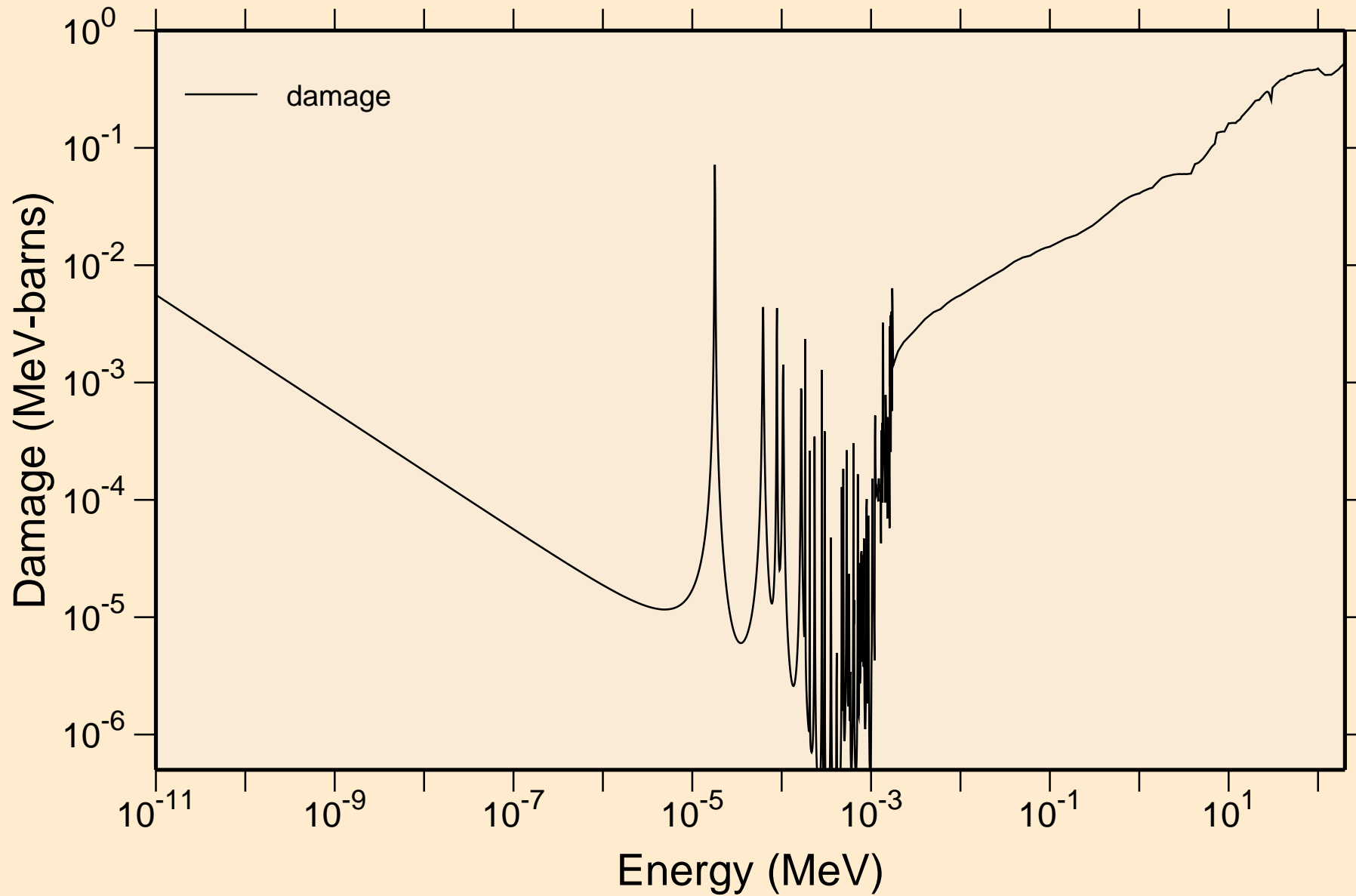

DY169 NEUTRON ACER TENDL-2021 LIBRARY; T=293.6K
Non-threshold reactions

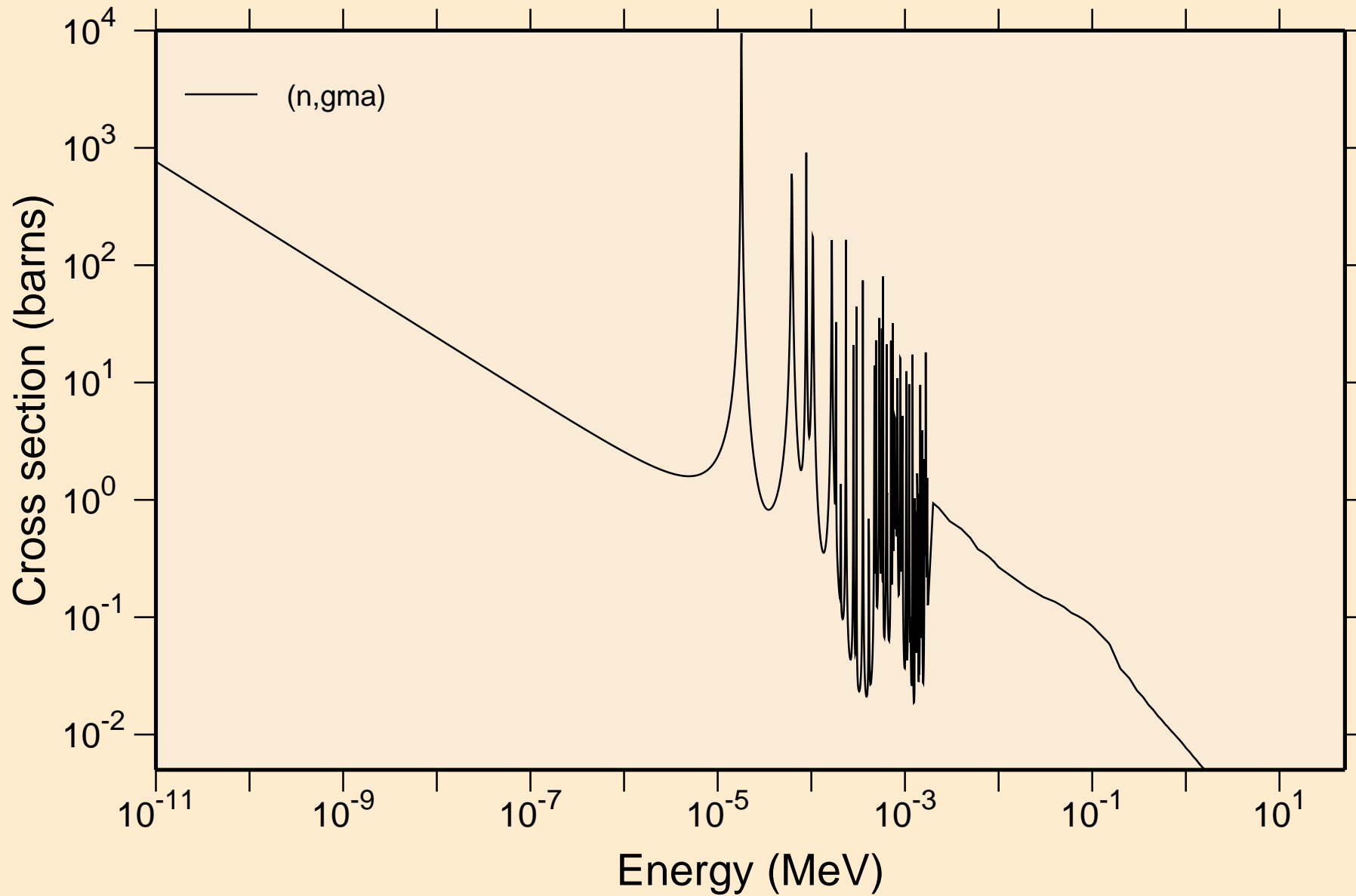

DY169 NEUTRON ACER TENDL-2021 LIBRARY; T=293.6K
Principal cross sections

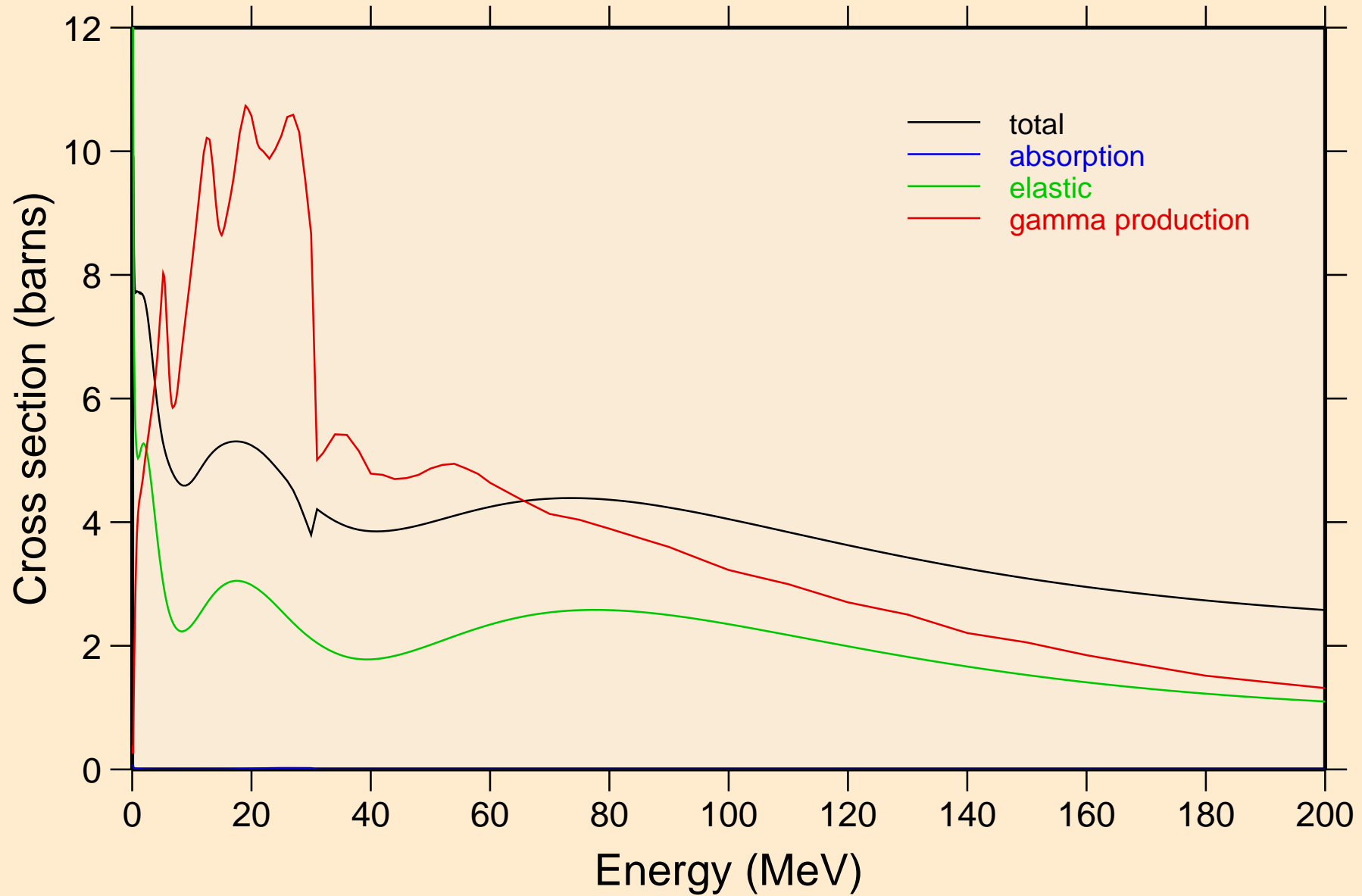

DY169 NEUTRON ACER TENDL-2021 LIBRARY; T=293.6K
Heating

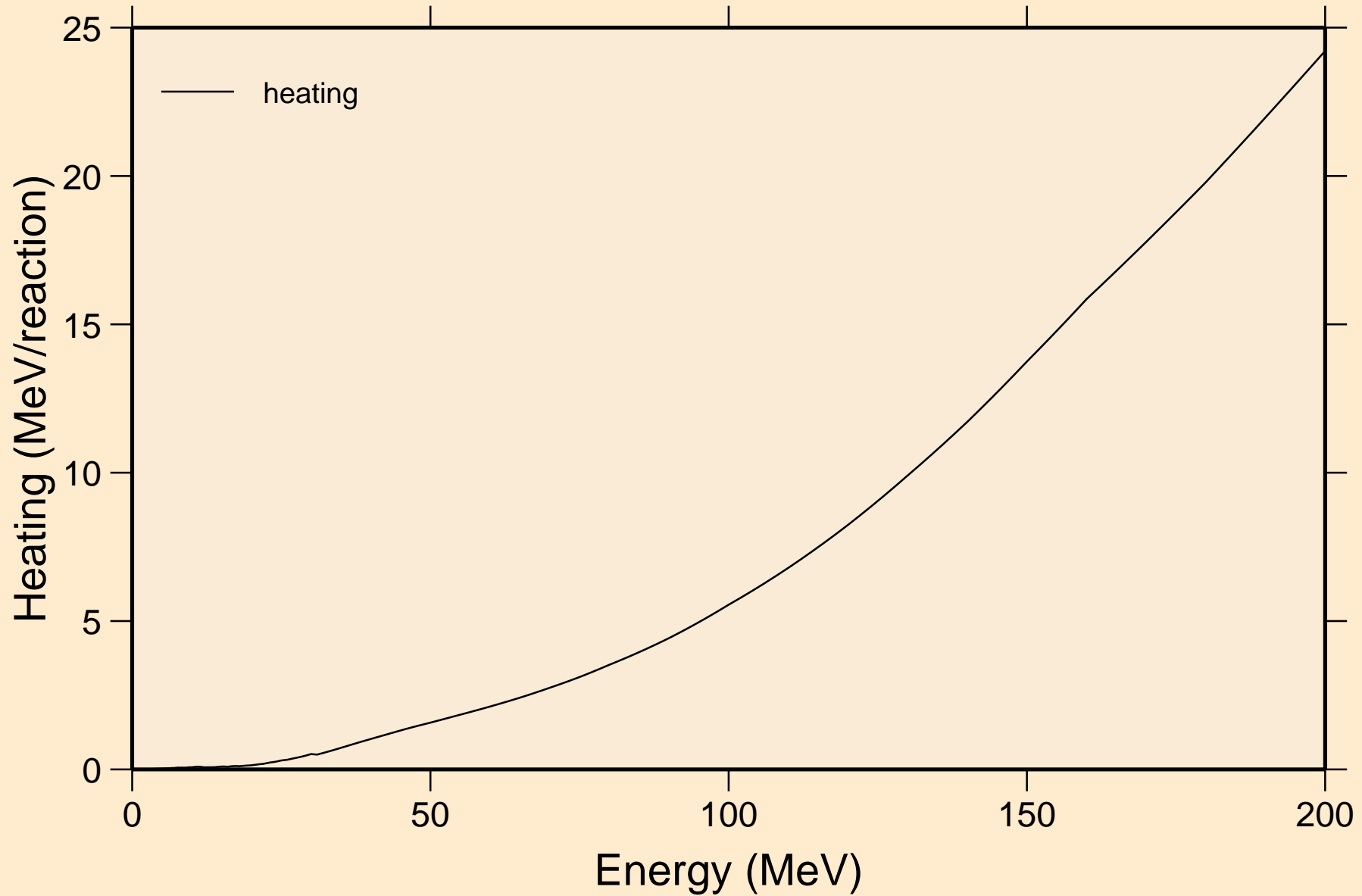

DY169 NEUTRON ACER TENDL-2021 LIBRARY; T=293.6K
Damage

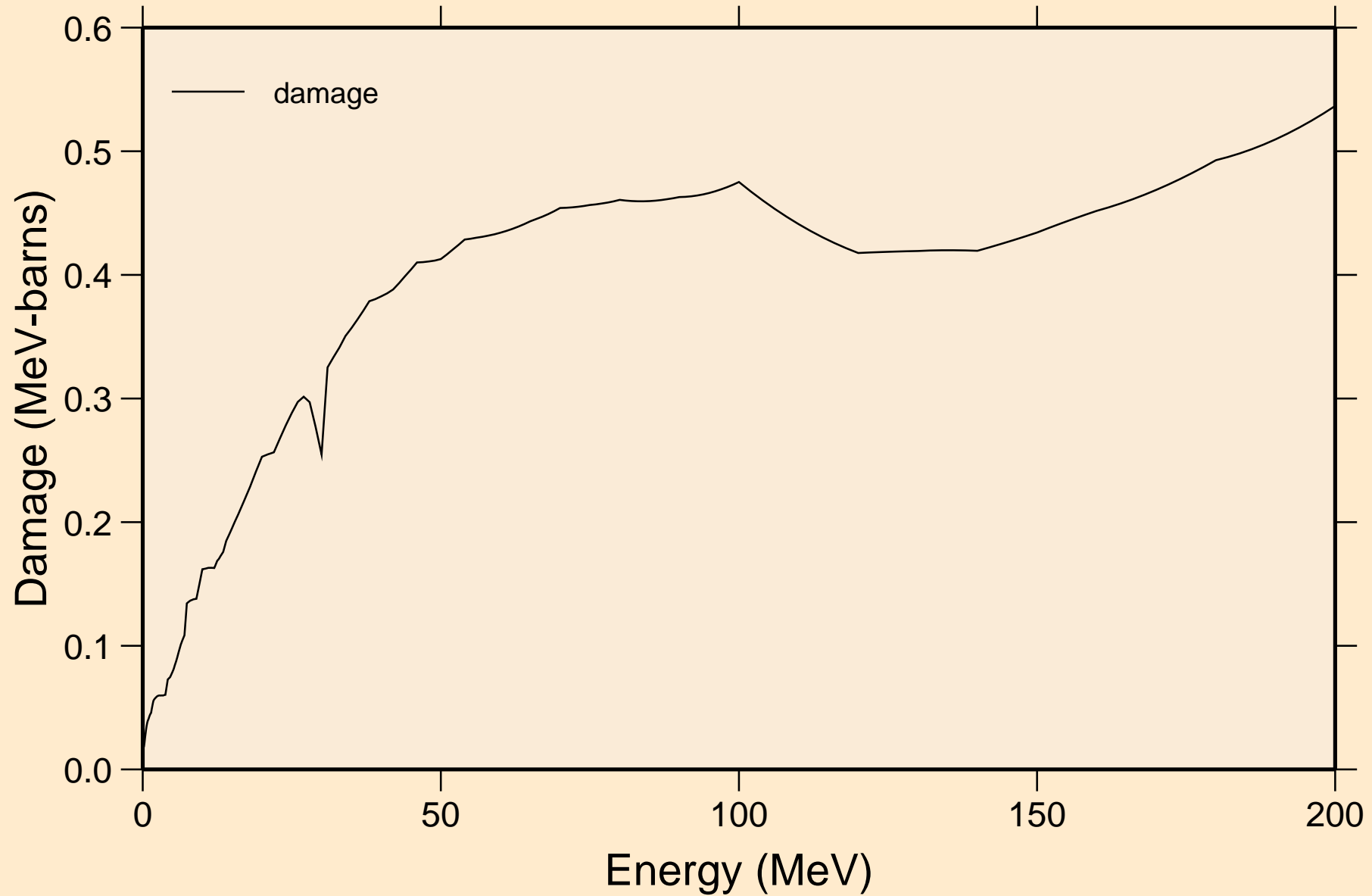

DY169 NEUTRON ACER TENDL-2021 LIBRARY; T=293.6K
Non-threshold reactions

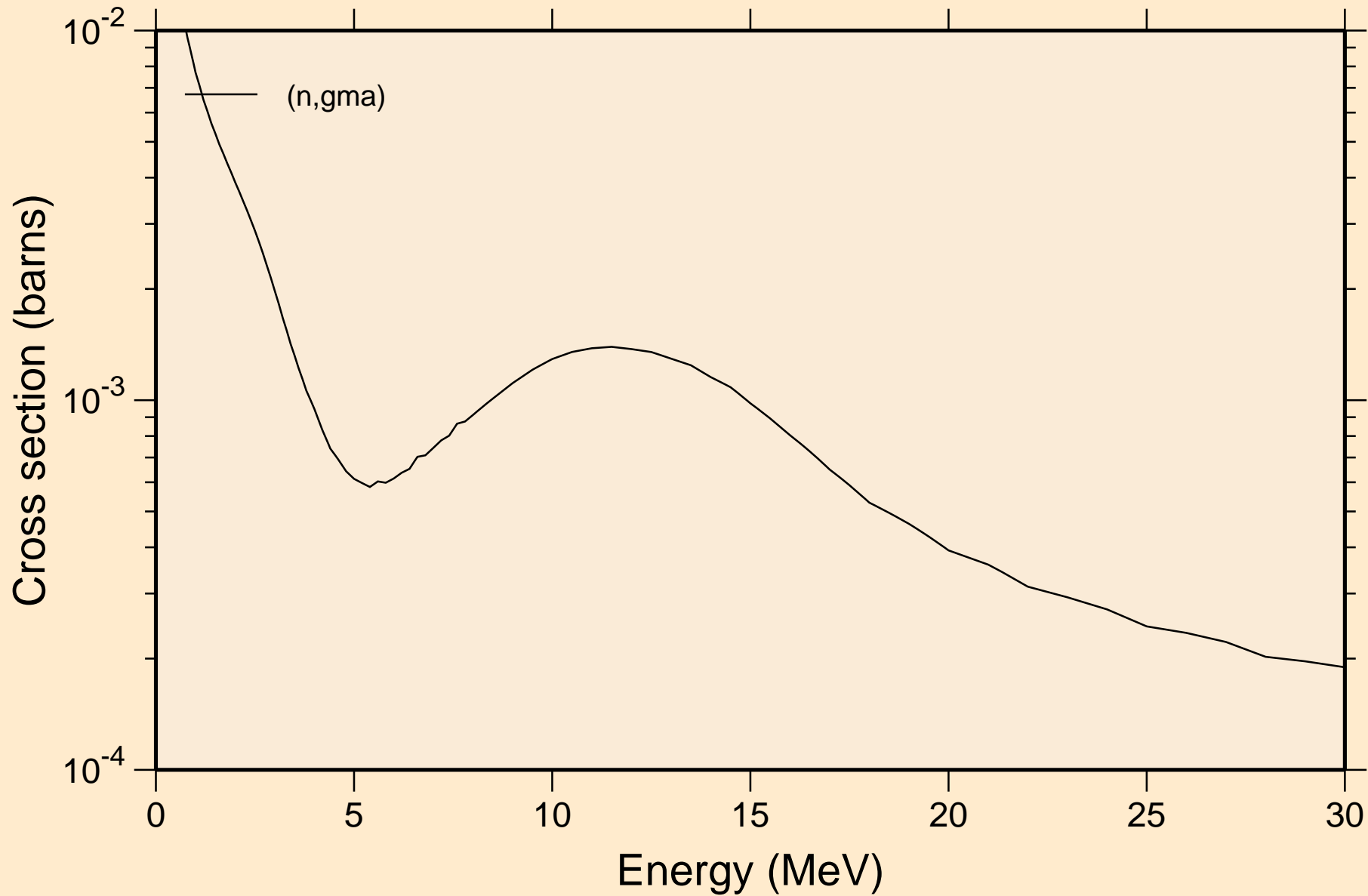

DY169 NEUTRON ACER TENDL-2021 LIBRARY; T=293.6K
Inelastic levels

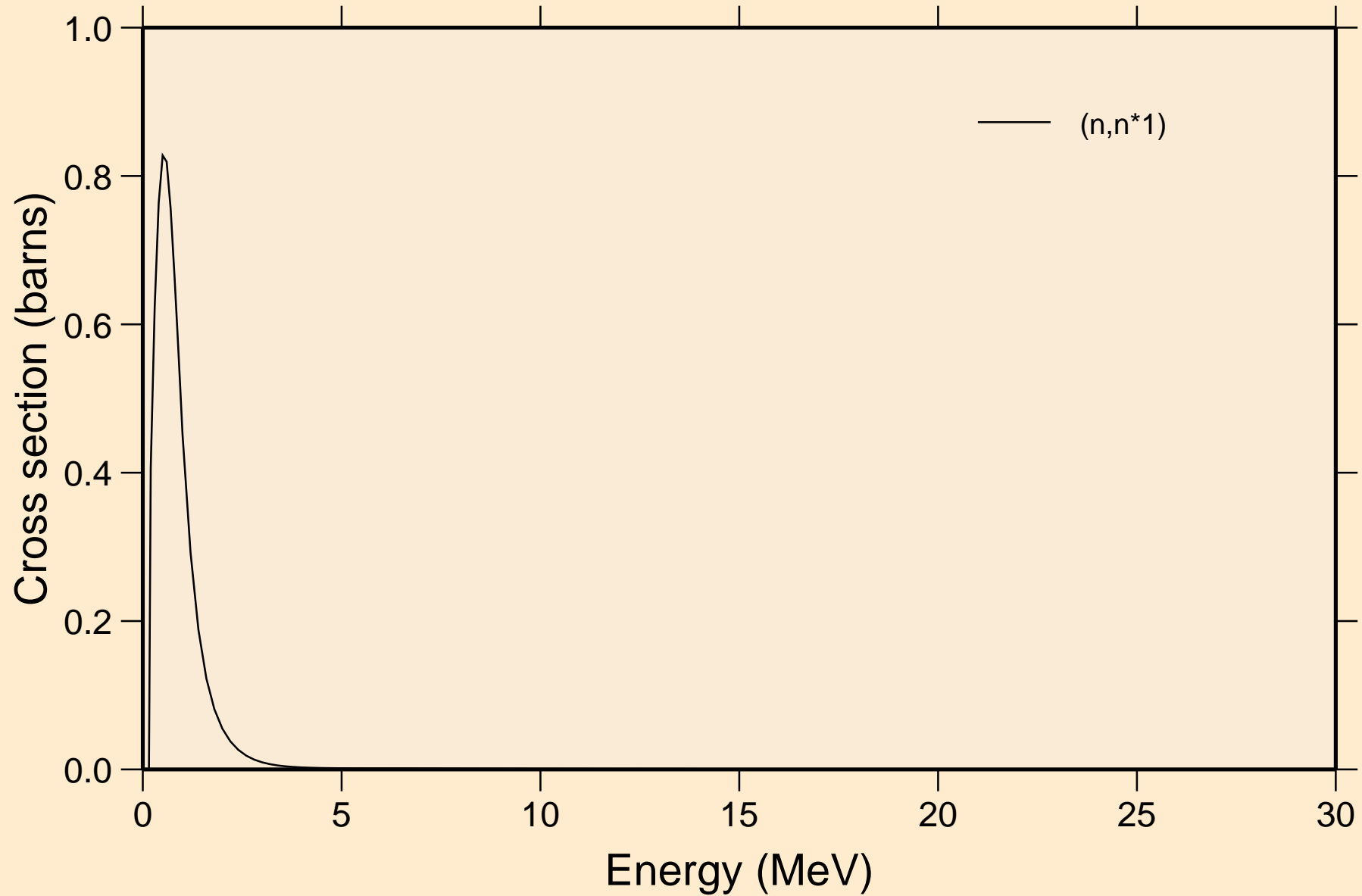

DY169 NEUTRON ACER TENDL-2021 LIBRARY; T=293.6K
Threshold reactions

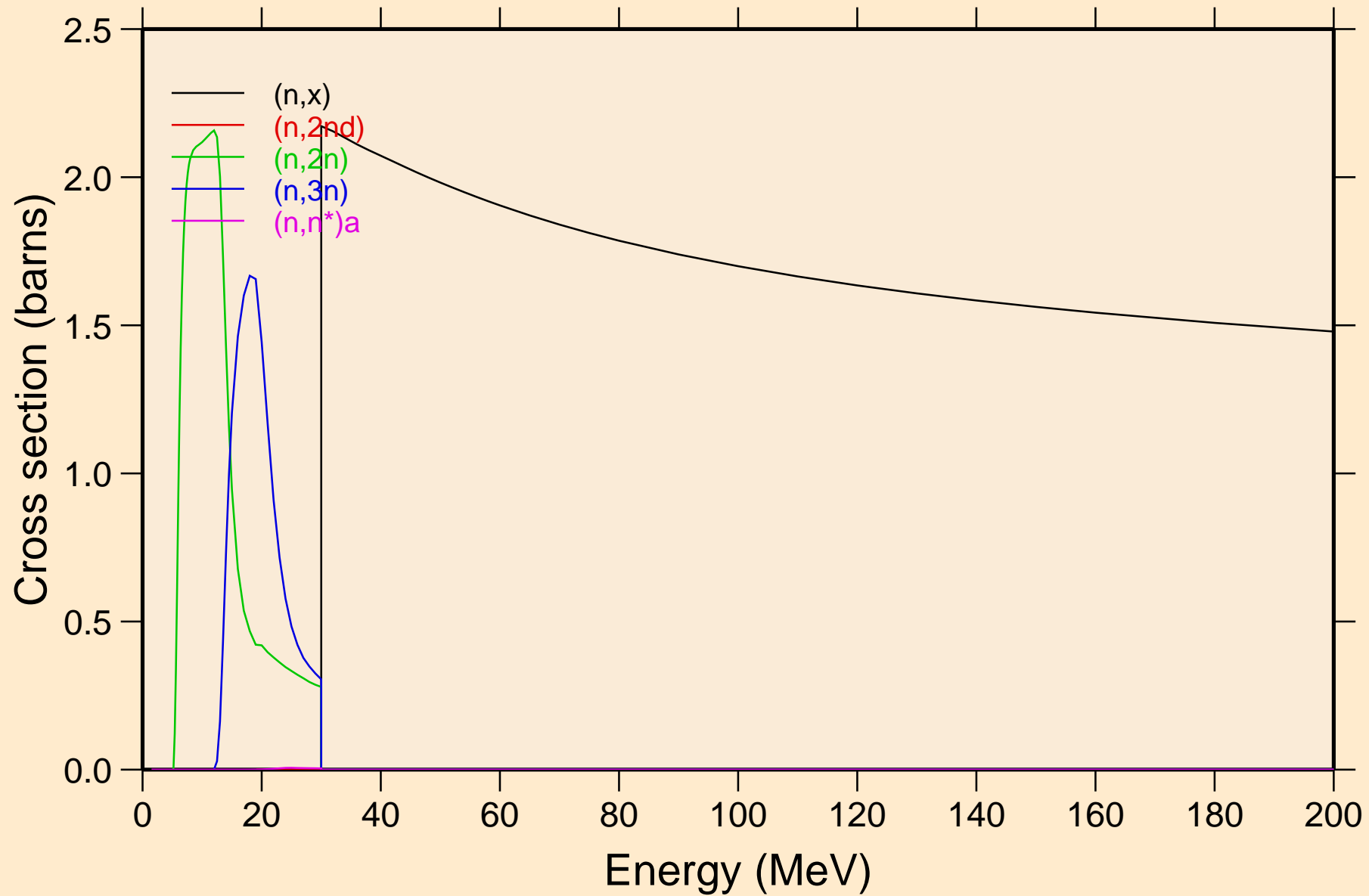

DY169 NEUTRON ACER TENDL-2021 LIBRARY; T=293.6K
Threshold reactions

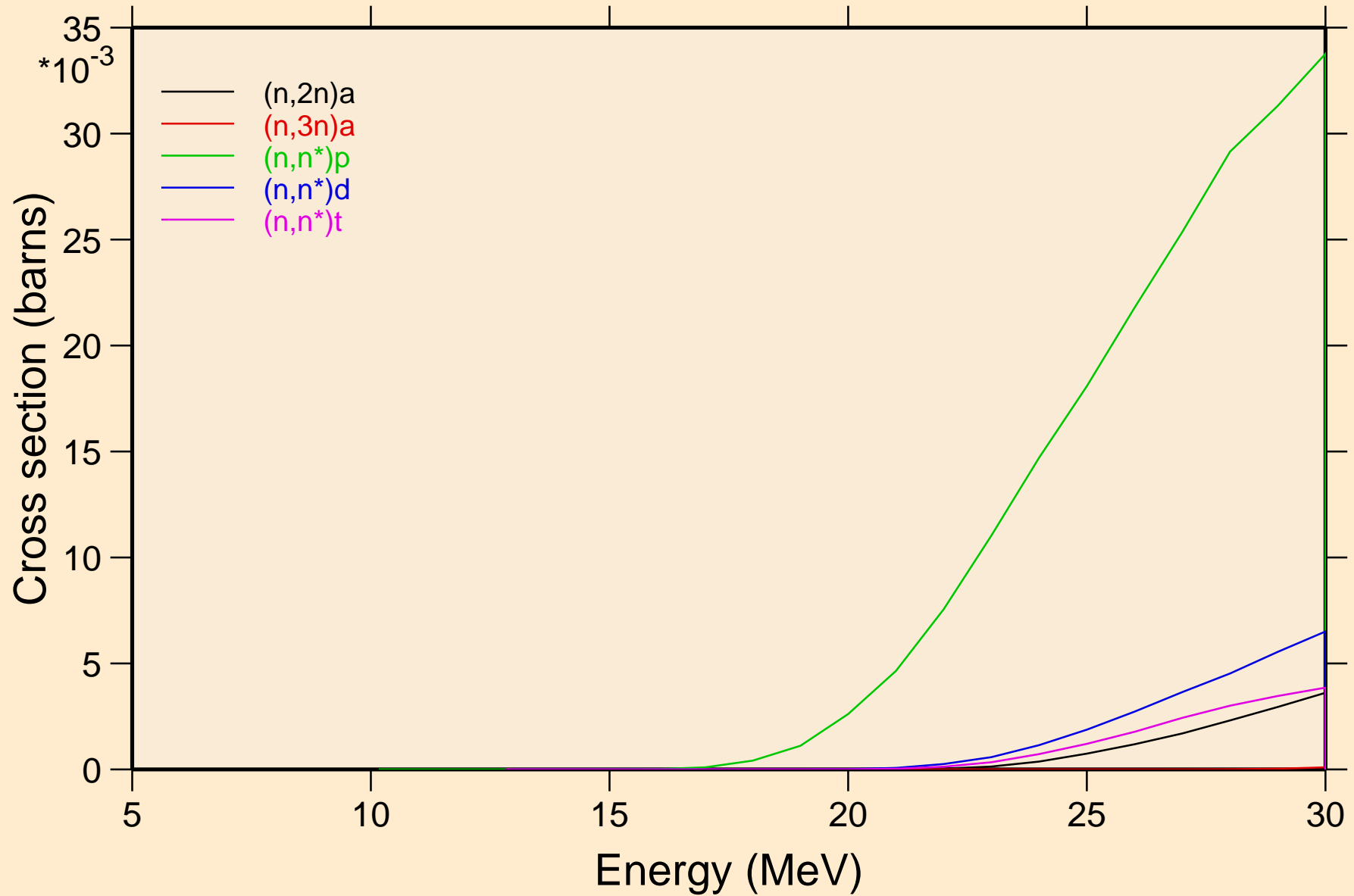

DY169 NEUTRON ACER TENDL-2021 LIBRARY; T=293.6K
Threshold reactions

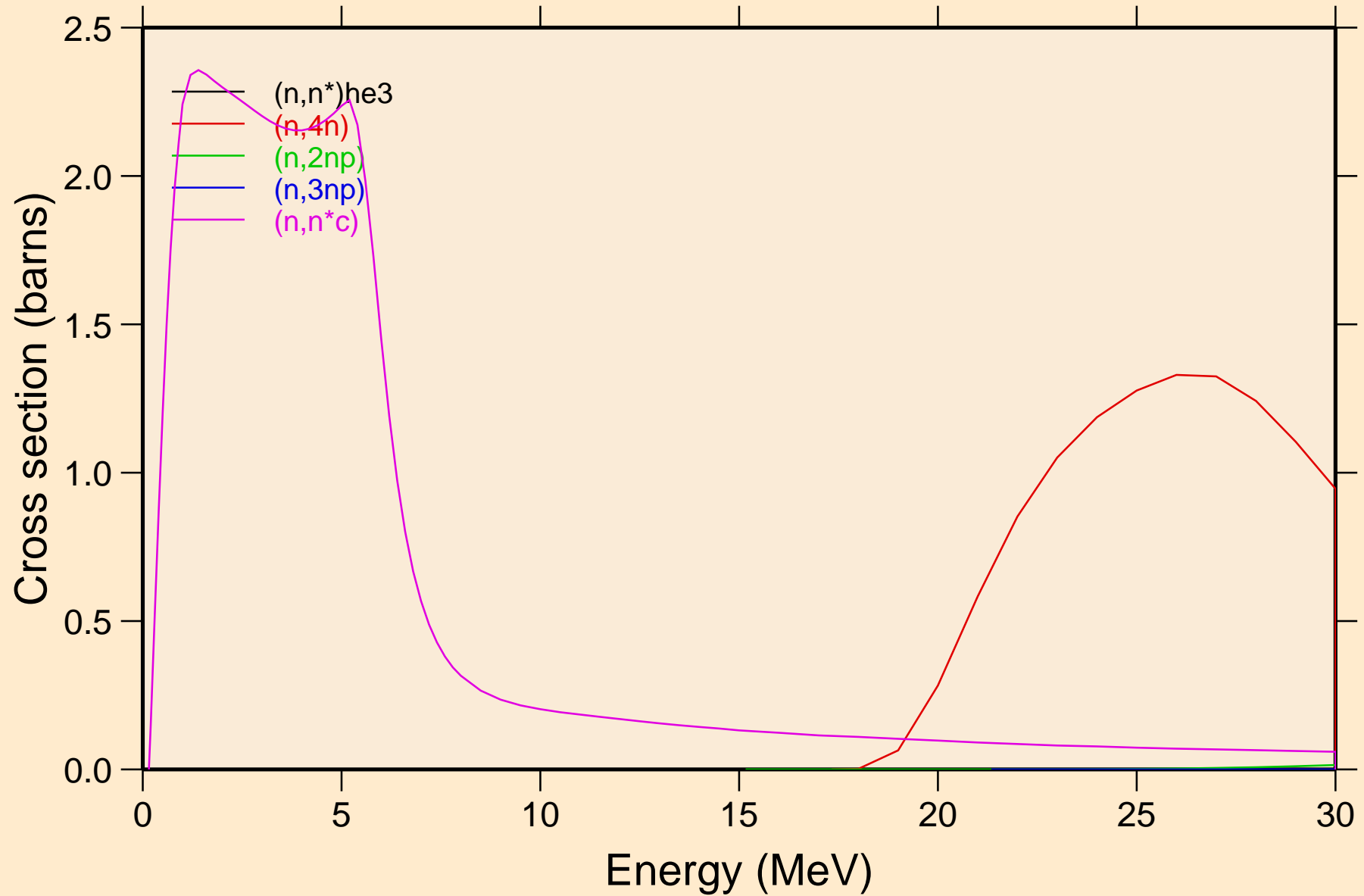

DY169 NEUTRON ACER TENDL-2021 LIBRARY; T=293.6K
Threshold reactions

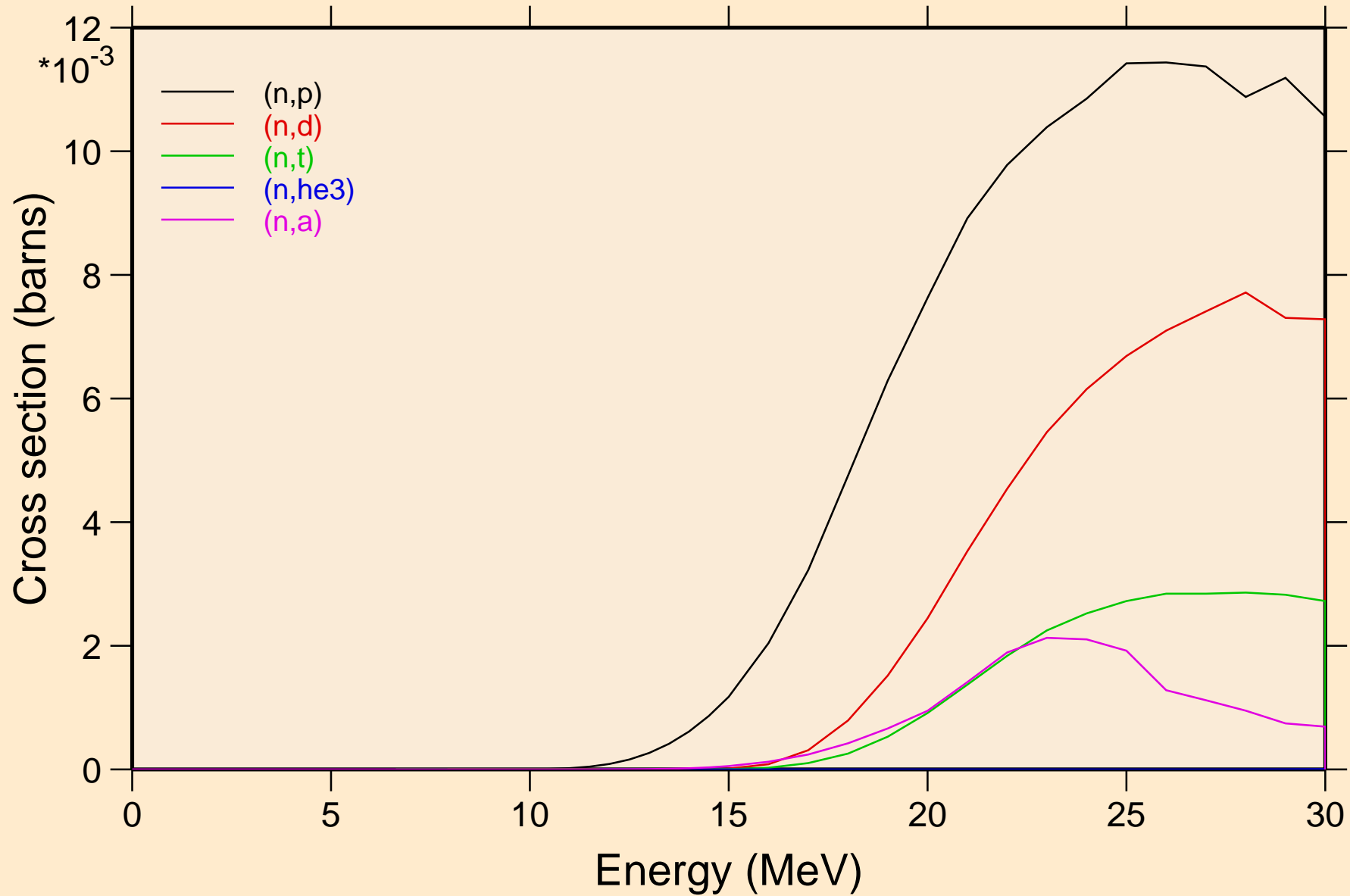

DY169 NEUTRON ACER TENDL-2021 LIBRARY; T=293.6K
Threshold reactions

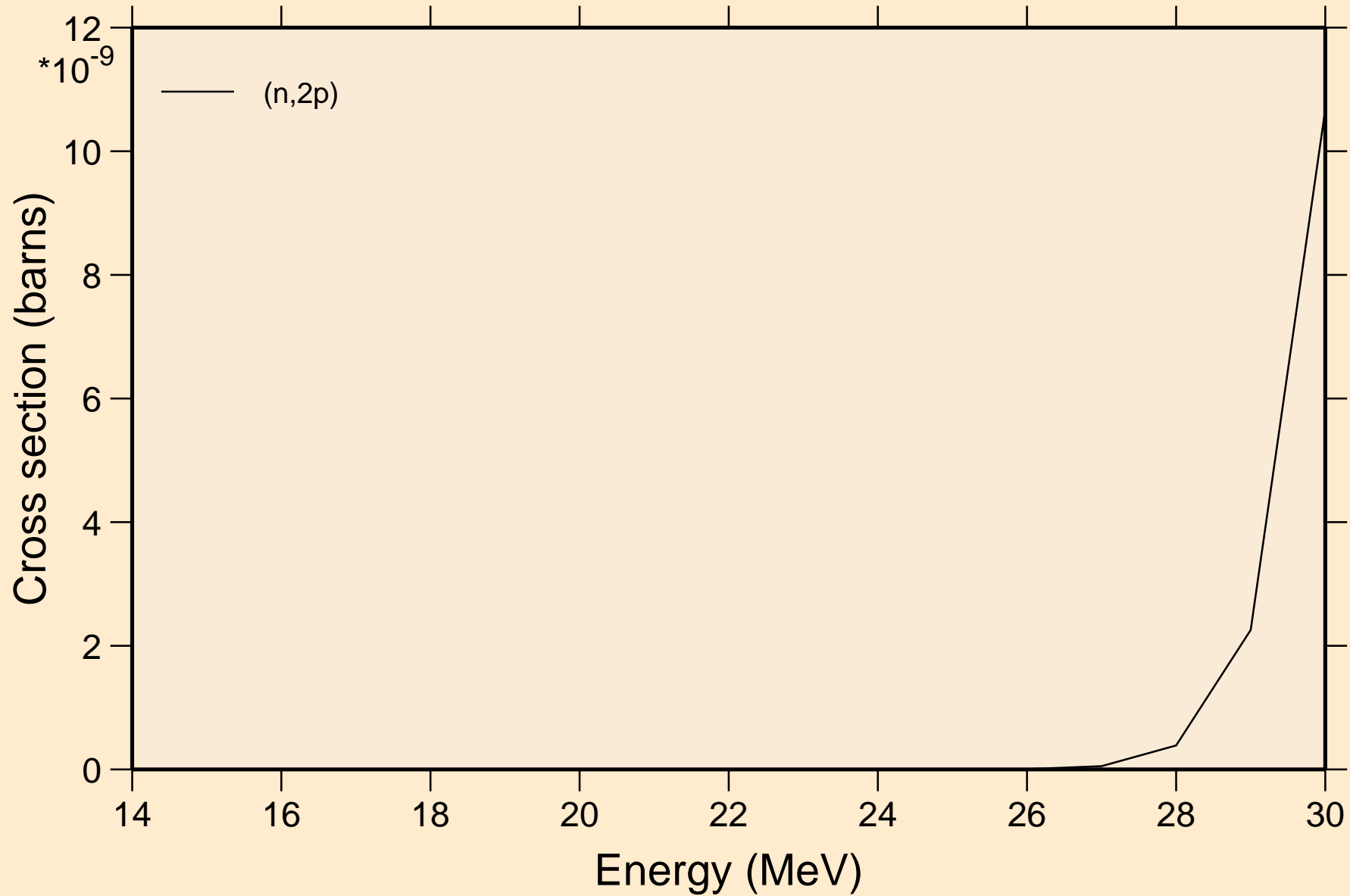

DY169 NEUTRON ACER TENDL-2021 LIBRARY; T=293.6K
Threshold reactions

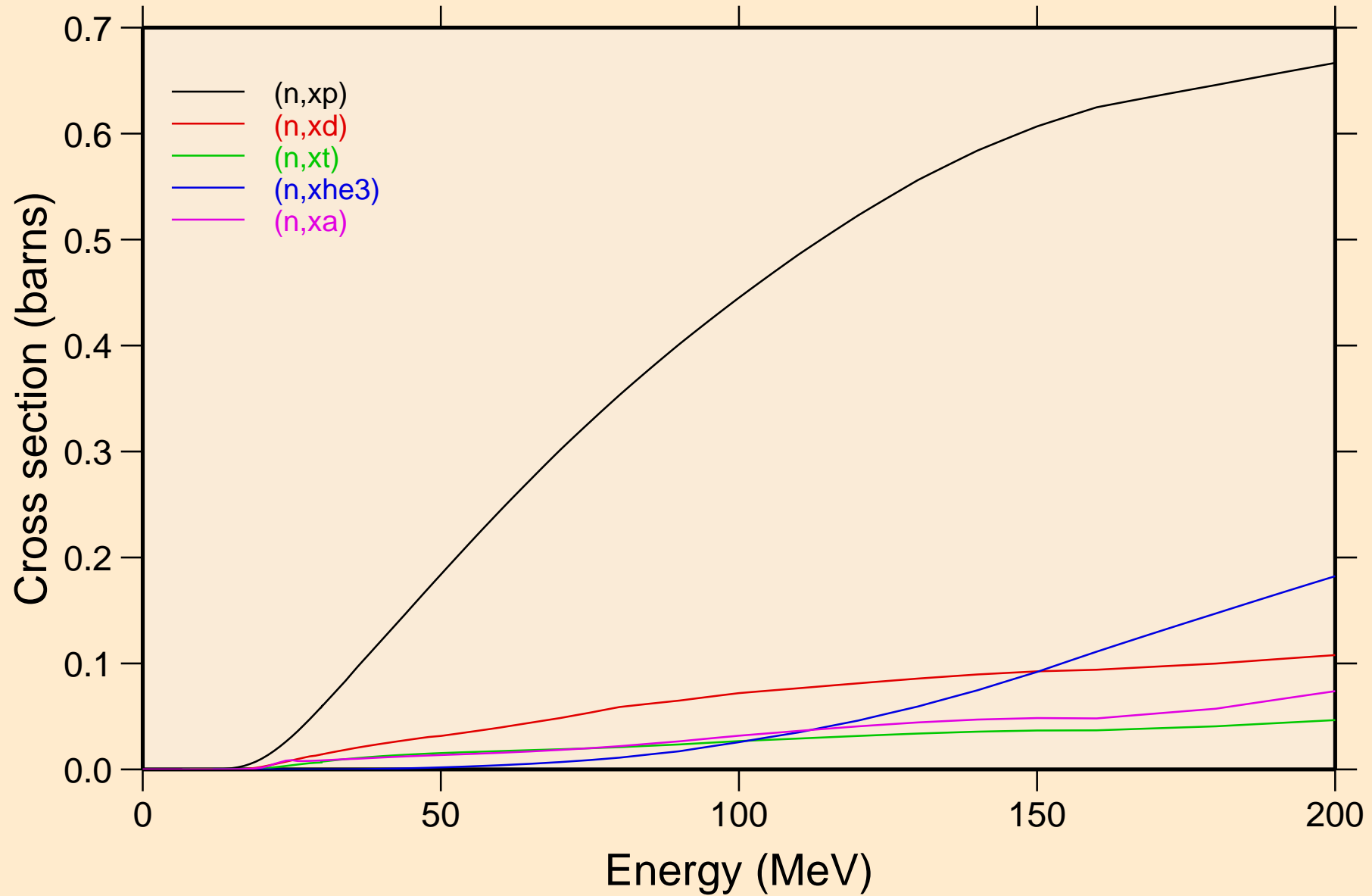

DY169 NEUTRON ACER TENDL-2021 LIBRARY; T=293.6K
angular distribution for elastic

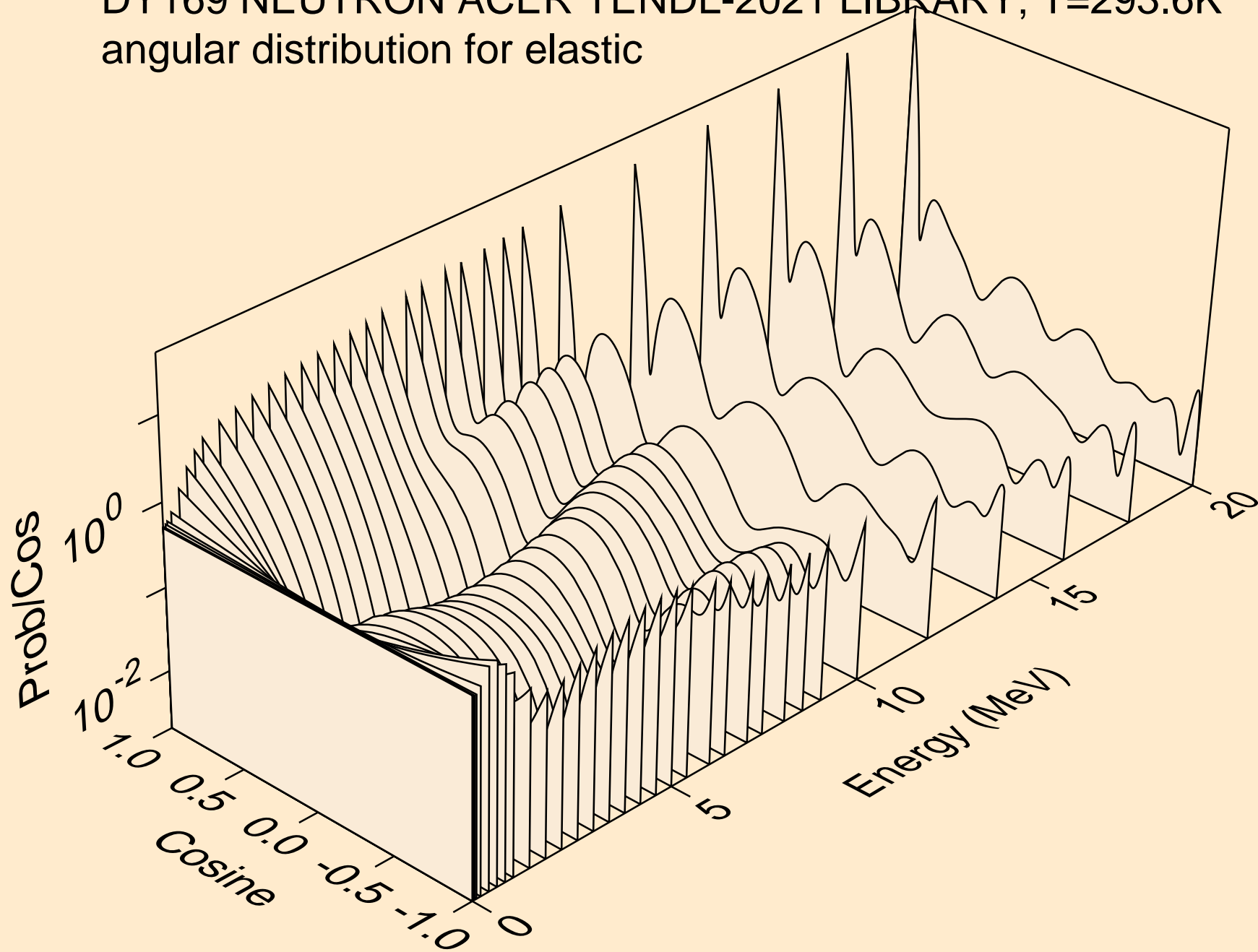

DY169 NEUTRON ACER TENDL-2021 LIBRARY; T=293.6K
angular distribution for elastic

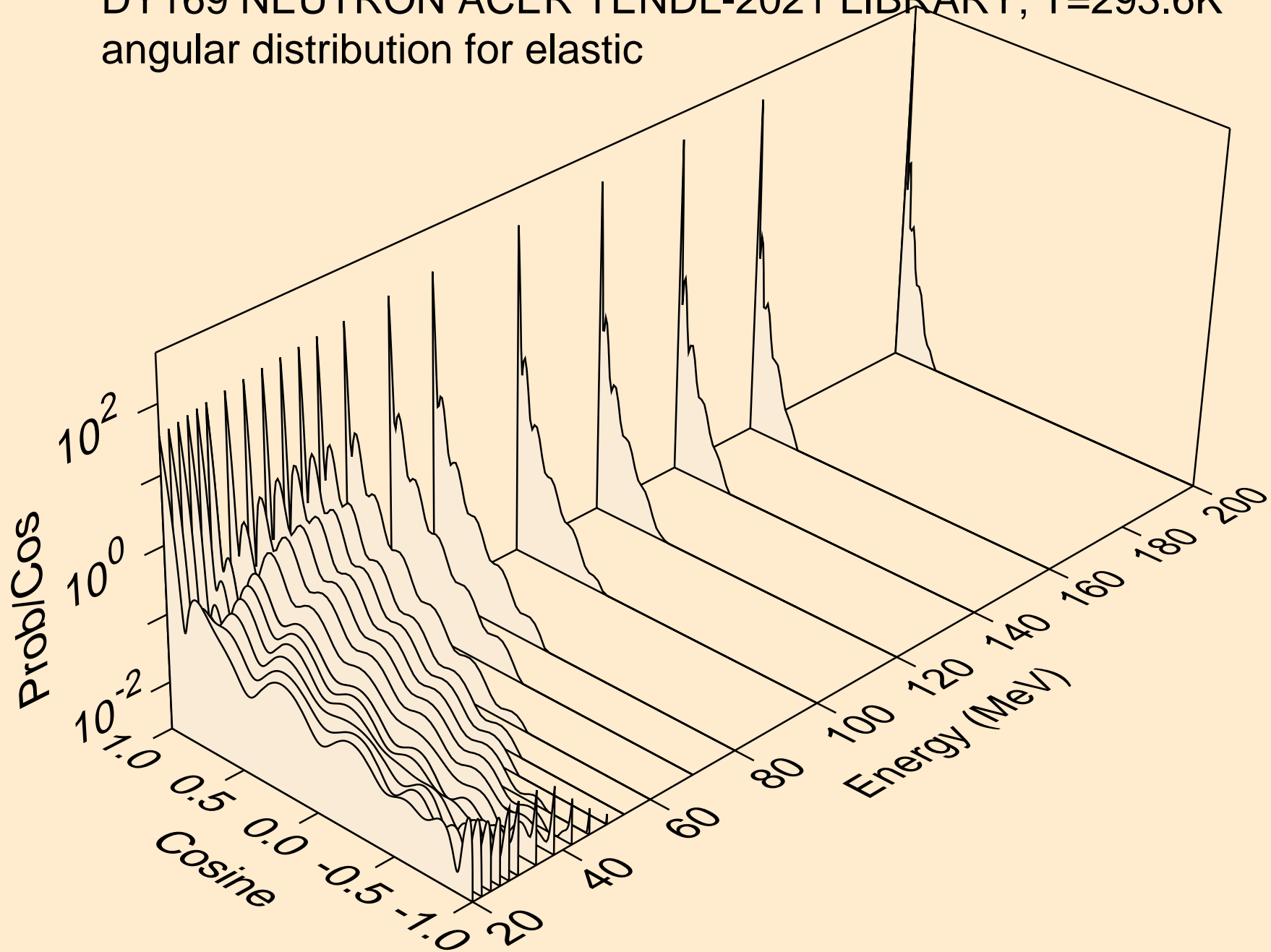

DY169 NEUTRON ACER TENDL-2021 LIBRARY; T=293.6K
angular distribution for (n,n*1)

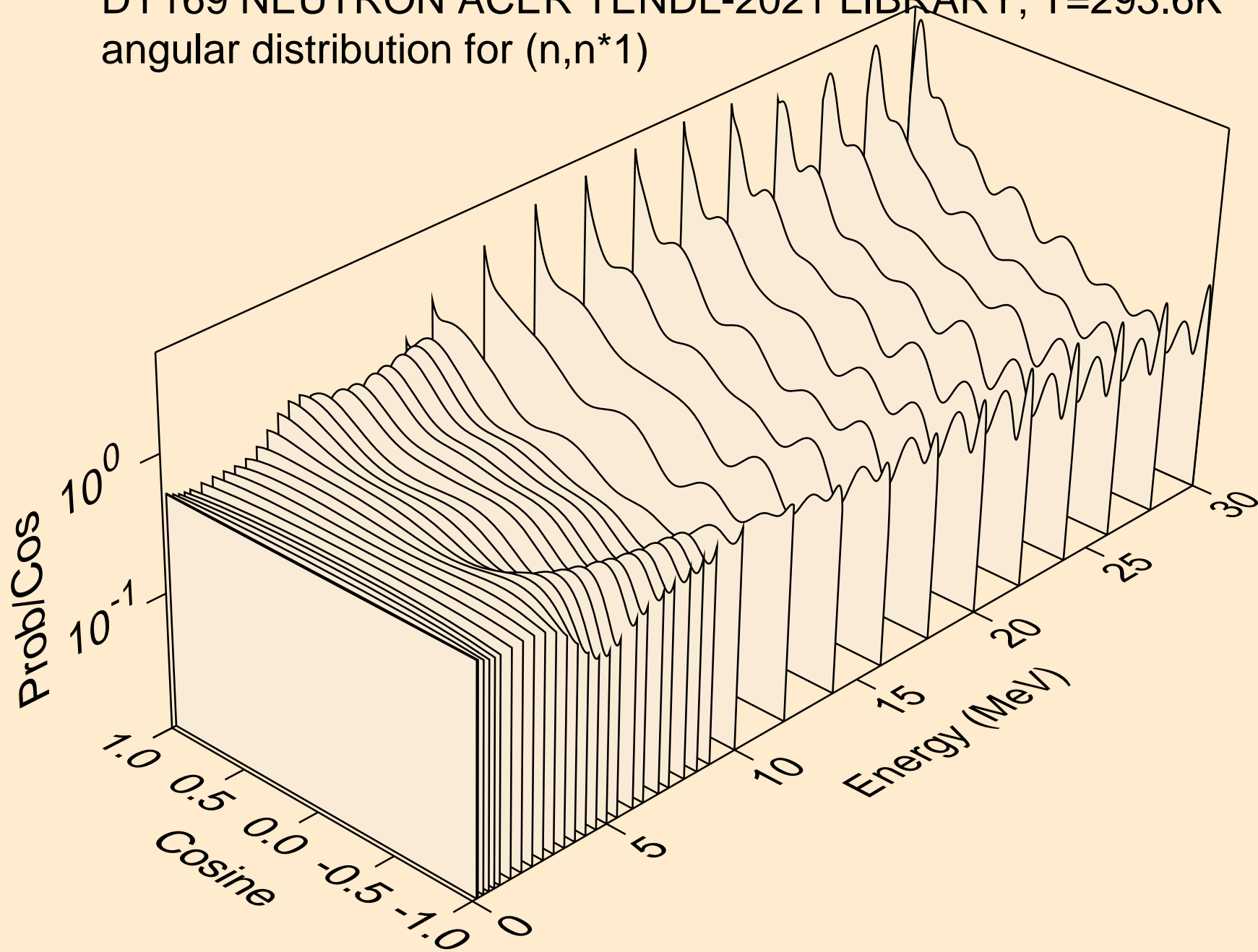

DY169 NEUTRON ACER TENDL-2021 LIBRARY; T=293.6K
Neutron emission for (n,x)

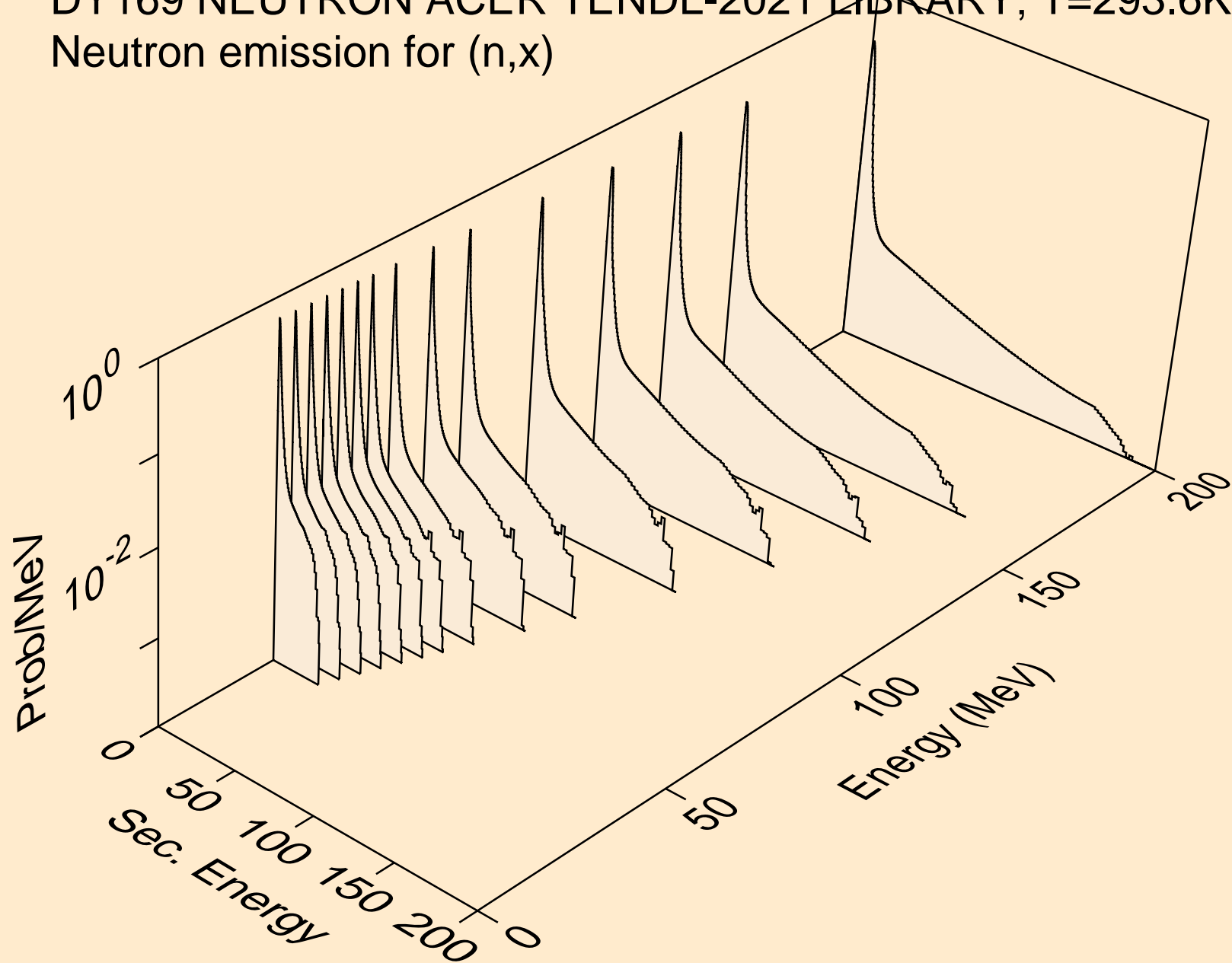

DY169 NEUTRON ACER TENDL-2021 LIBRARY; T=293.6K
Neutron emission for (n,2nd)

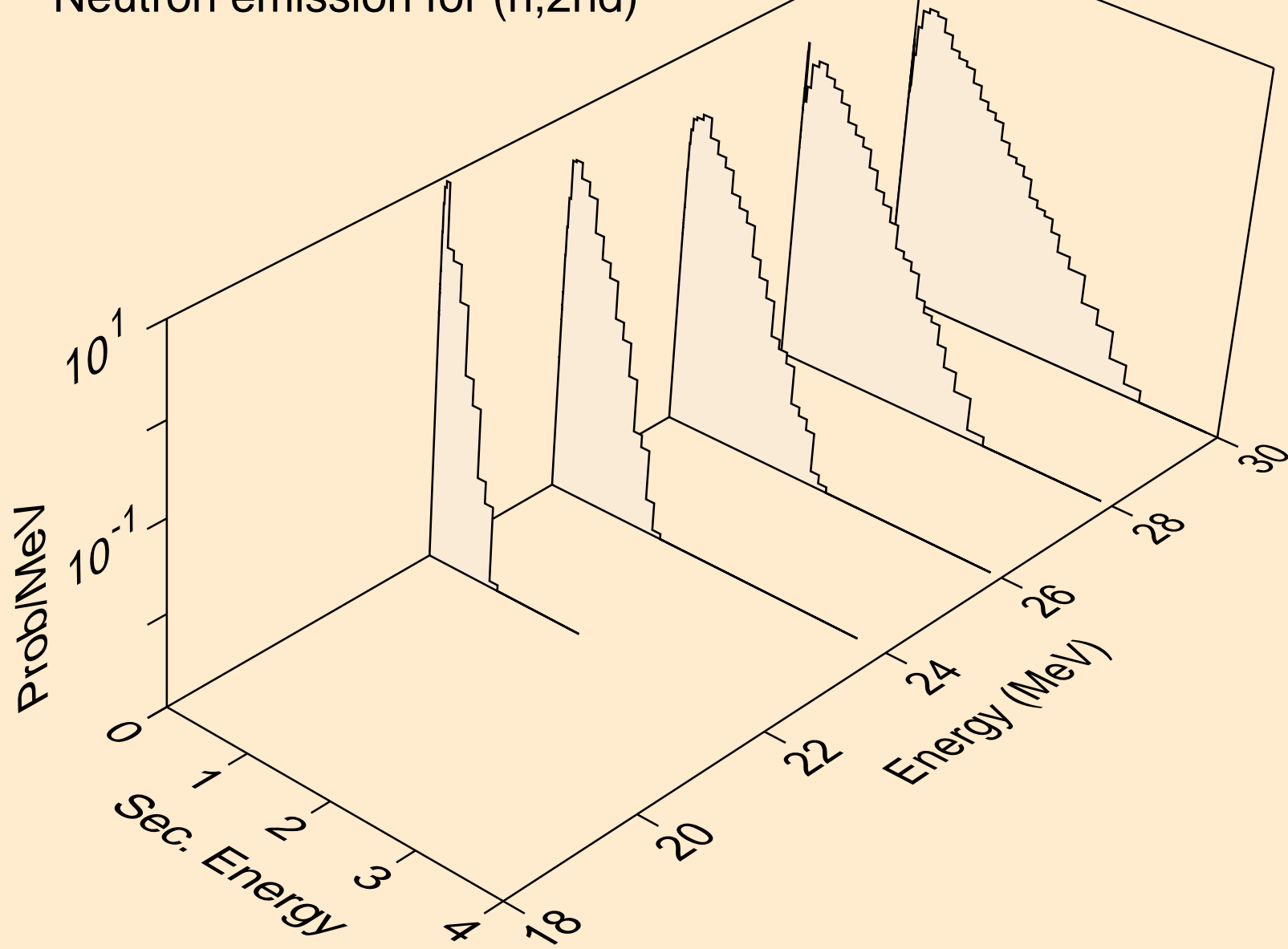

DY169 NEUTRON ACER TENDL-2021 LIBRARY; T=293.6K
Neutron emission for (n,2n)

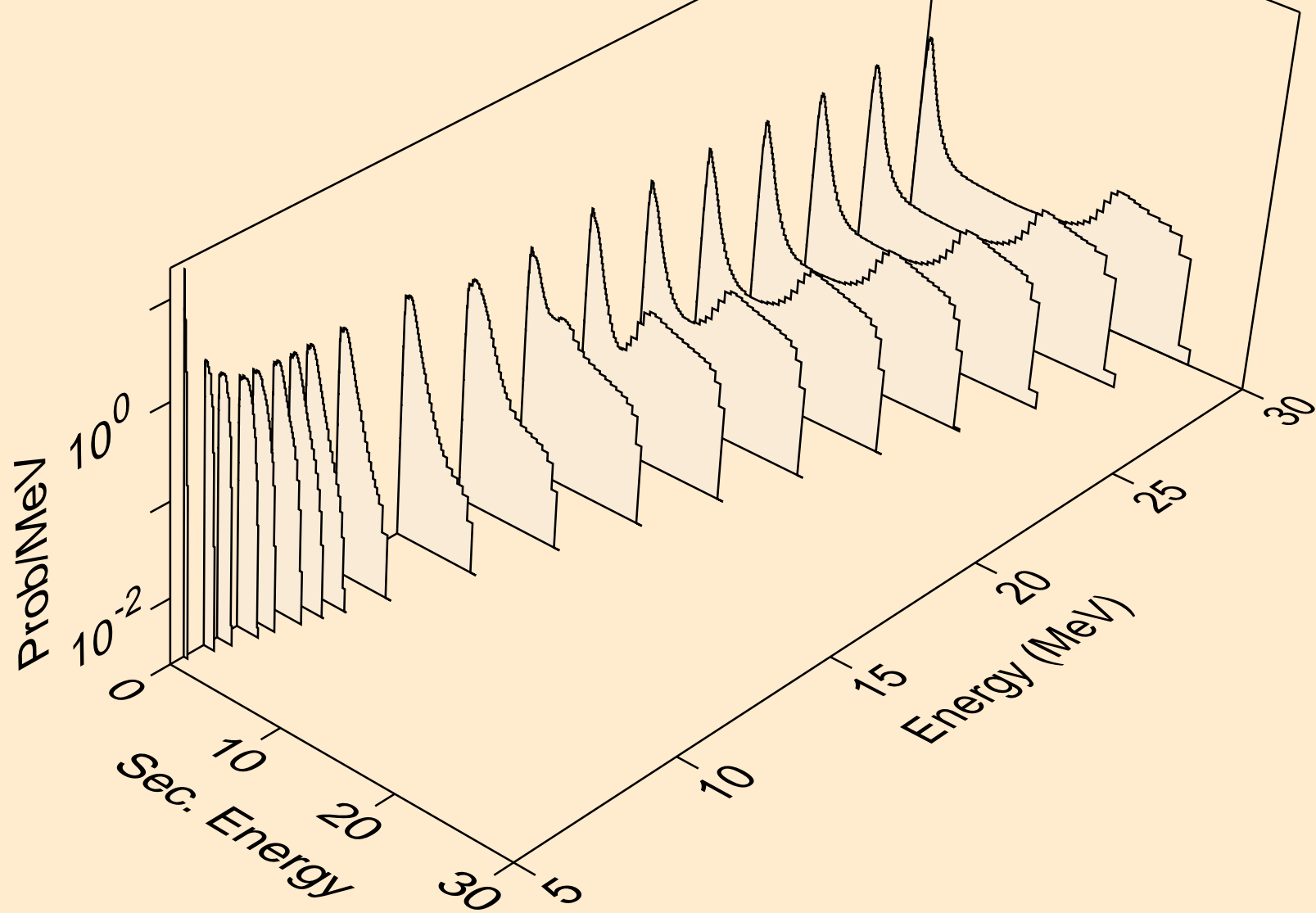

DY169 NEUTRON ACER TENDL-2021 LIBRARY; T=293.6K
Neutron emission for (n,3n)

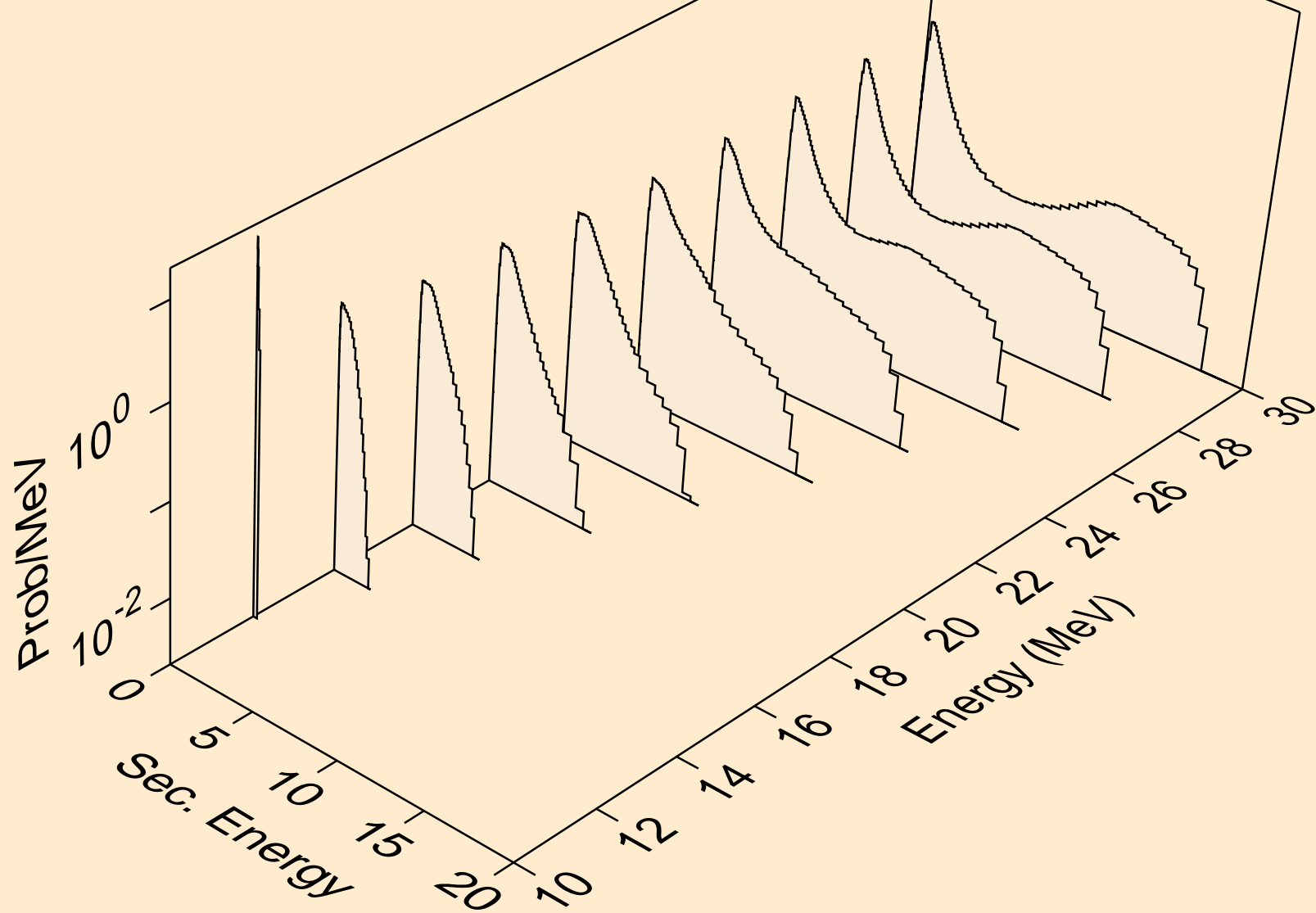

DY169 NEUTRON ACER TENDL-2021 LIBRARY; T=293.6K
Neutron emission for (n,n*)a

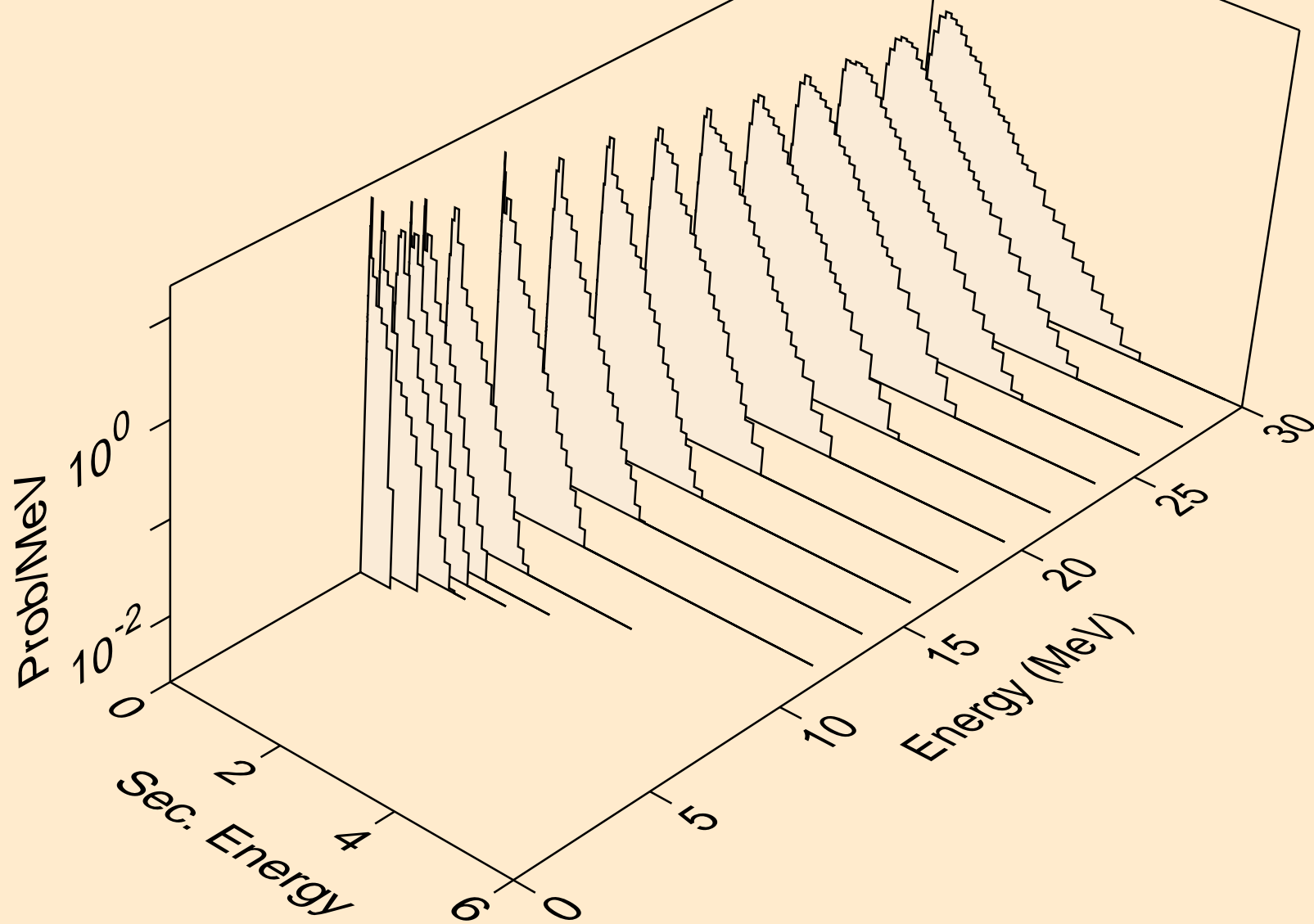

DY169 NEUTRON ACER TENDL-2021 LIBRARY; T=293.6K
Neutron emission for (n,2n)a

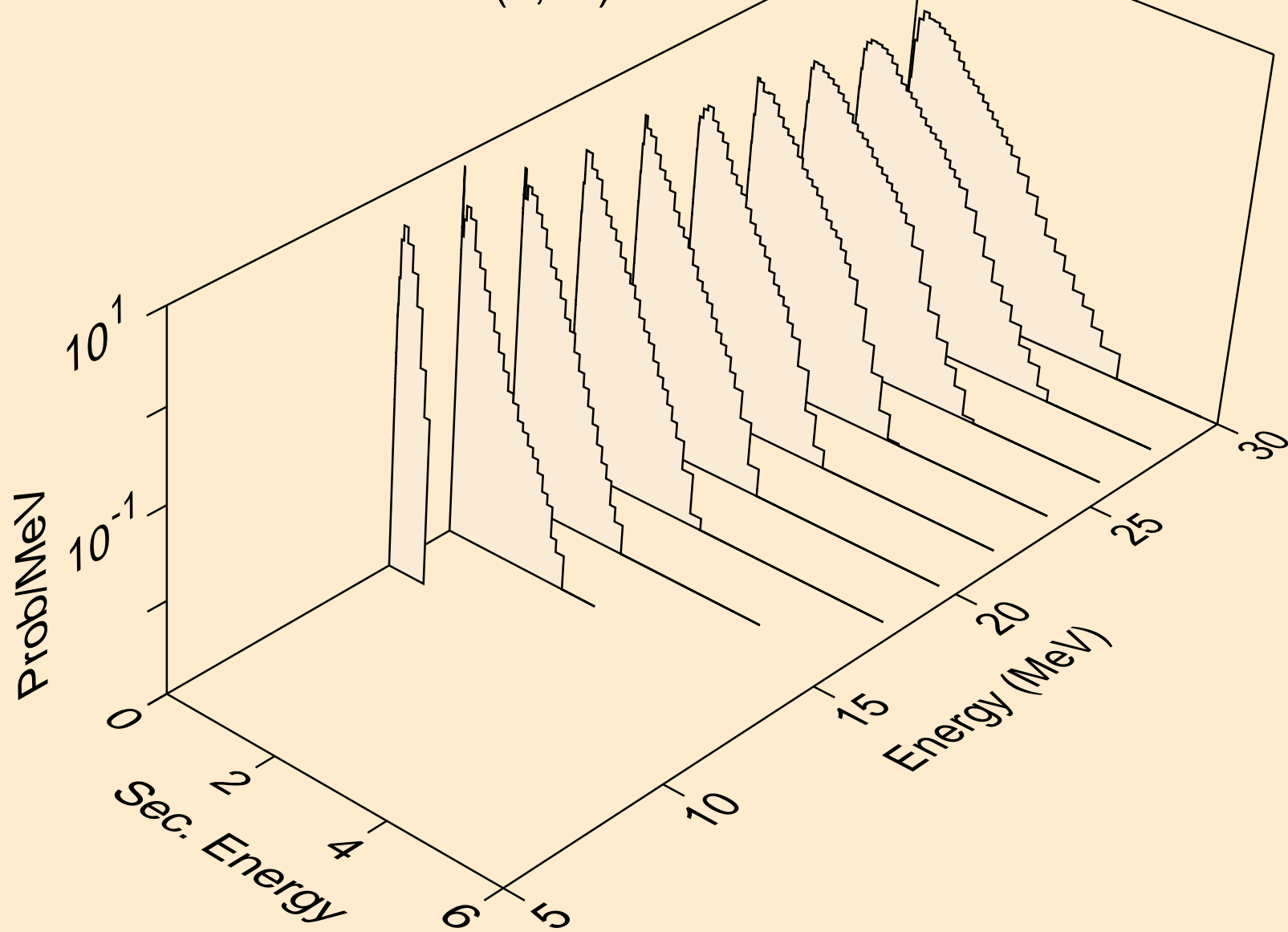

DY169 NEUTRON ACER TENDL-2021 LIBRARY; T=293.6K
Neutron emission for (n,3n)a

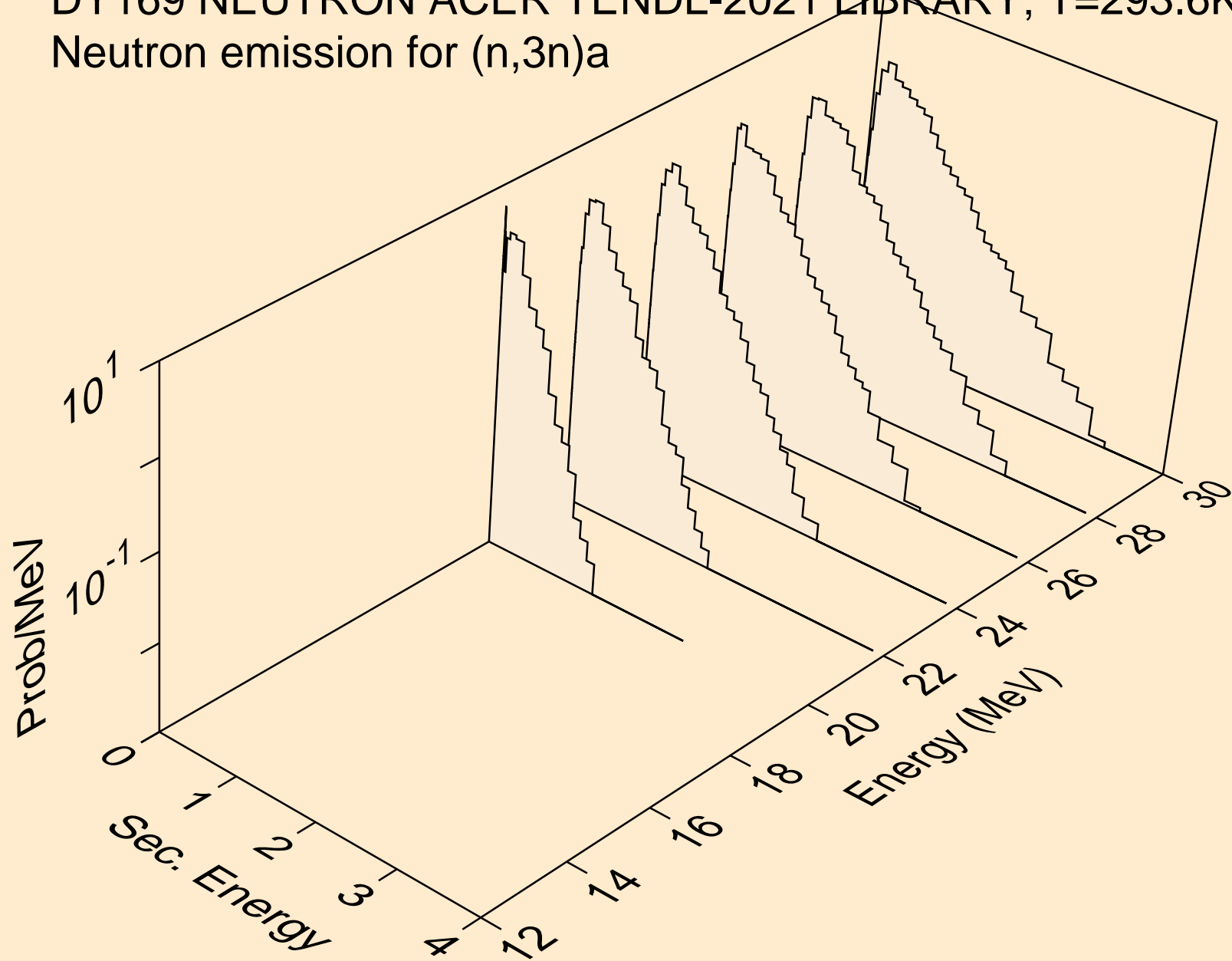

DY169 NEUTRON ACER TENDL-2021 LIBRARY; T=293.6K
Neutron emission for (n,n*)p

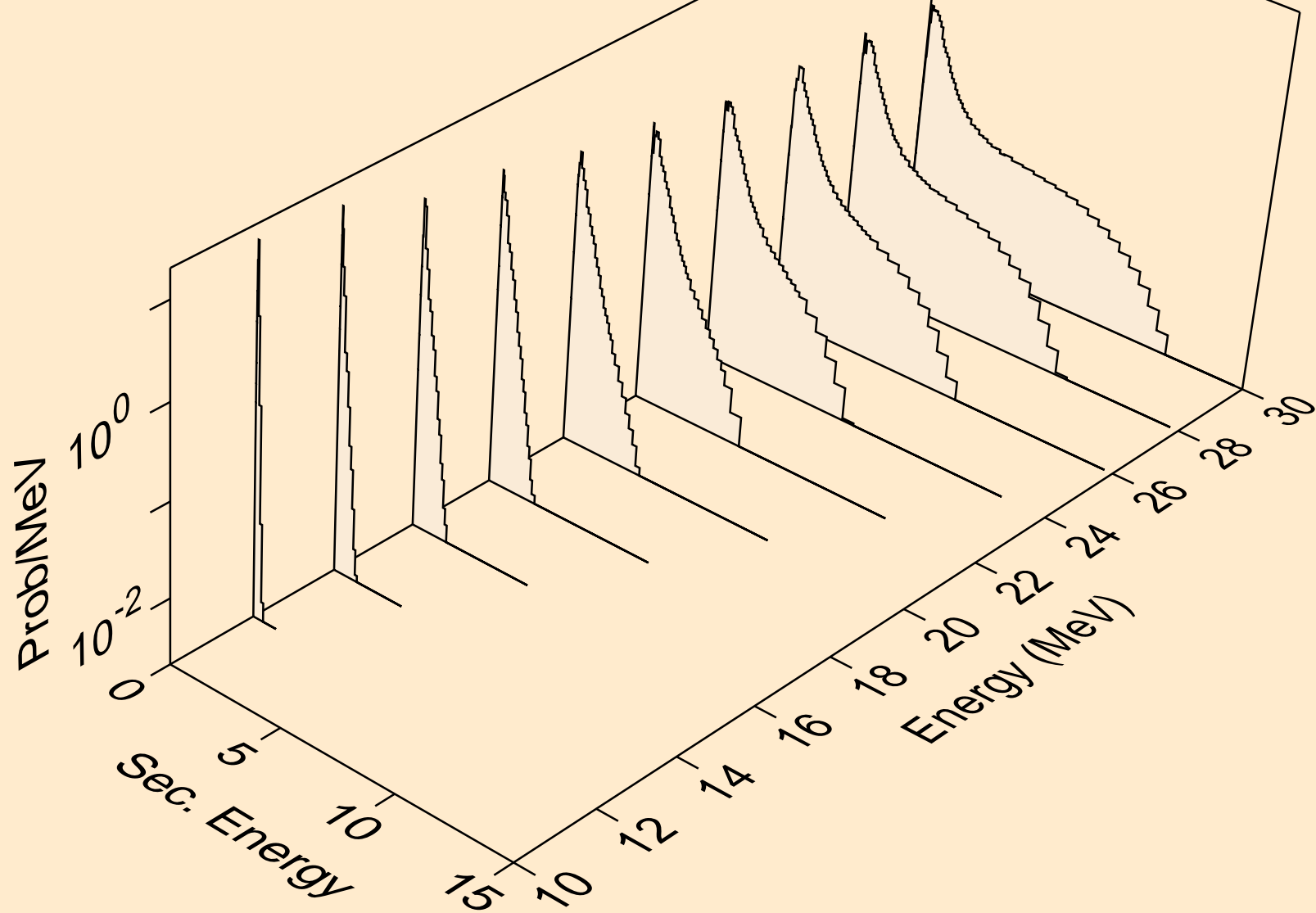

DY169 NEUTRON ACER TENDL-2021 LIBRARY; T=293.6K
Neutron emission for (n,n*)d

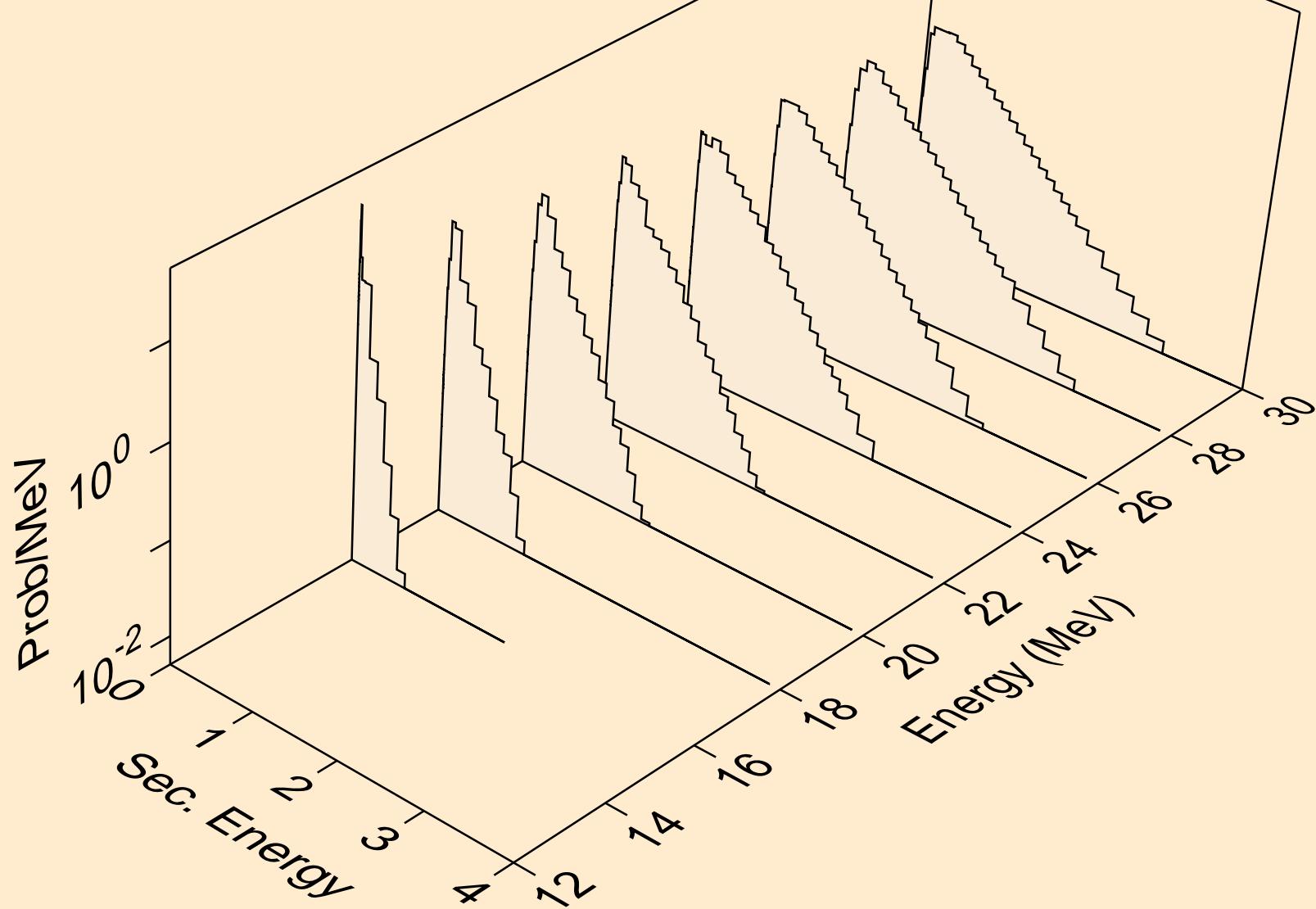

DY169 NEUTRON ACER TENDL-2021 LIBRARY; T=293.6K
Neutron emission for (n,n*)t

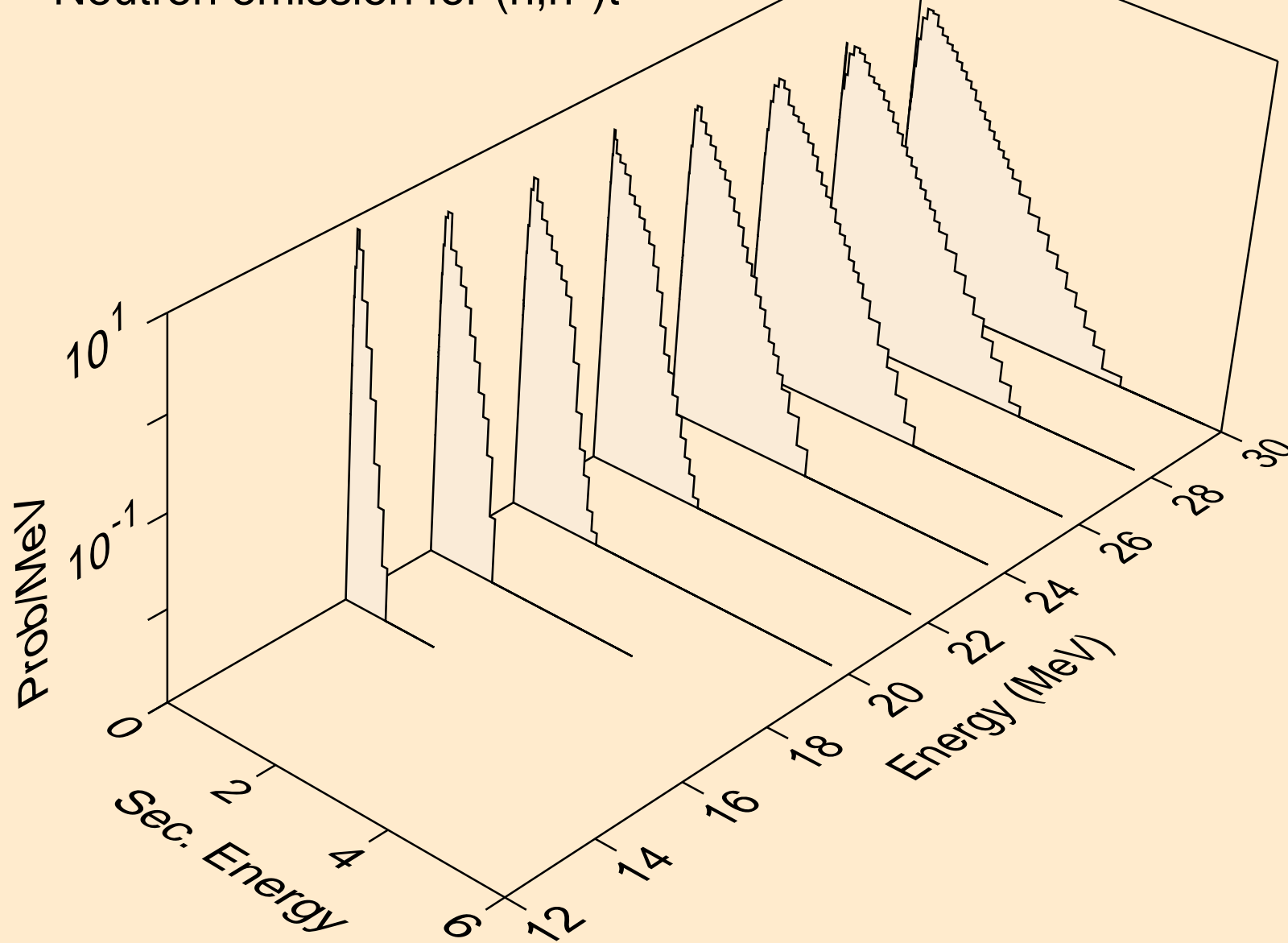

DY169 NEUTRON ACER TENDL-2021 LIBRARY; T=293.6K
Neutron emission for (n,n*)he3

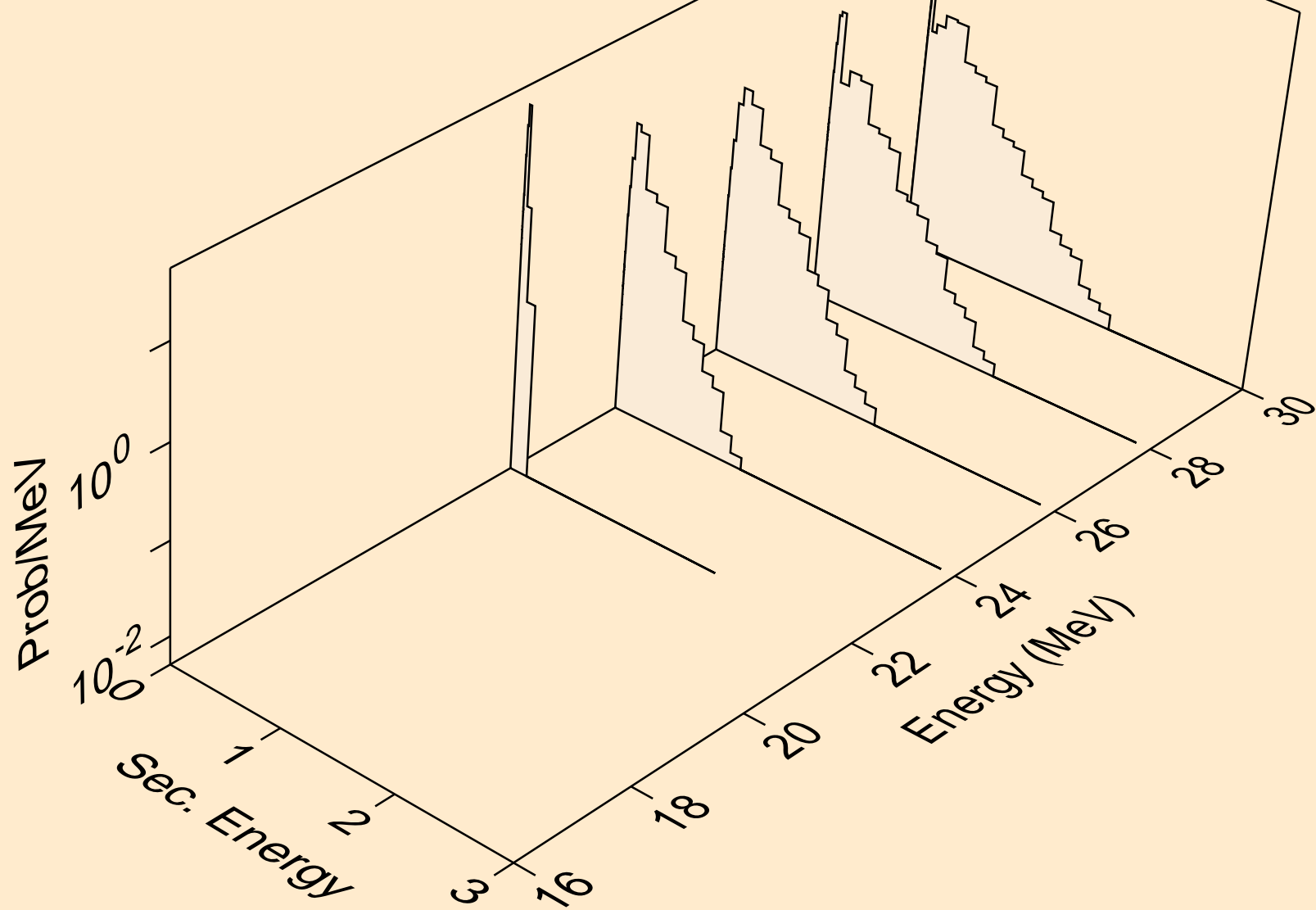

DY169 NEUTRON ACER TENDL-2021 LIBRARY; T=293.6K
Neutron emission for (n,4n)

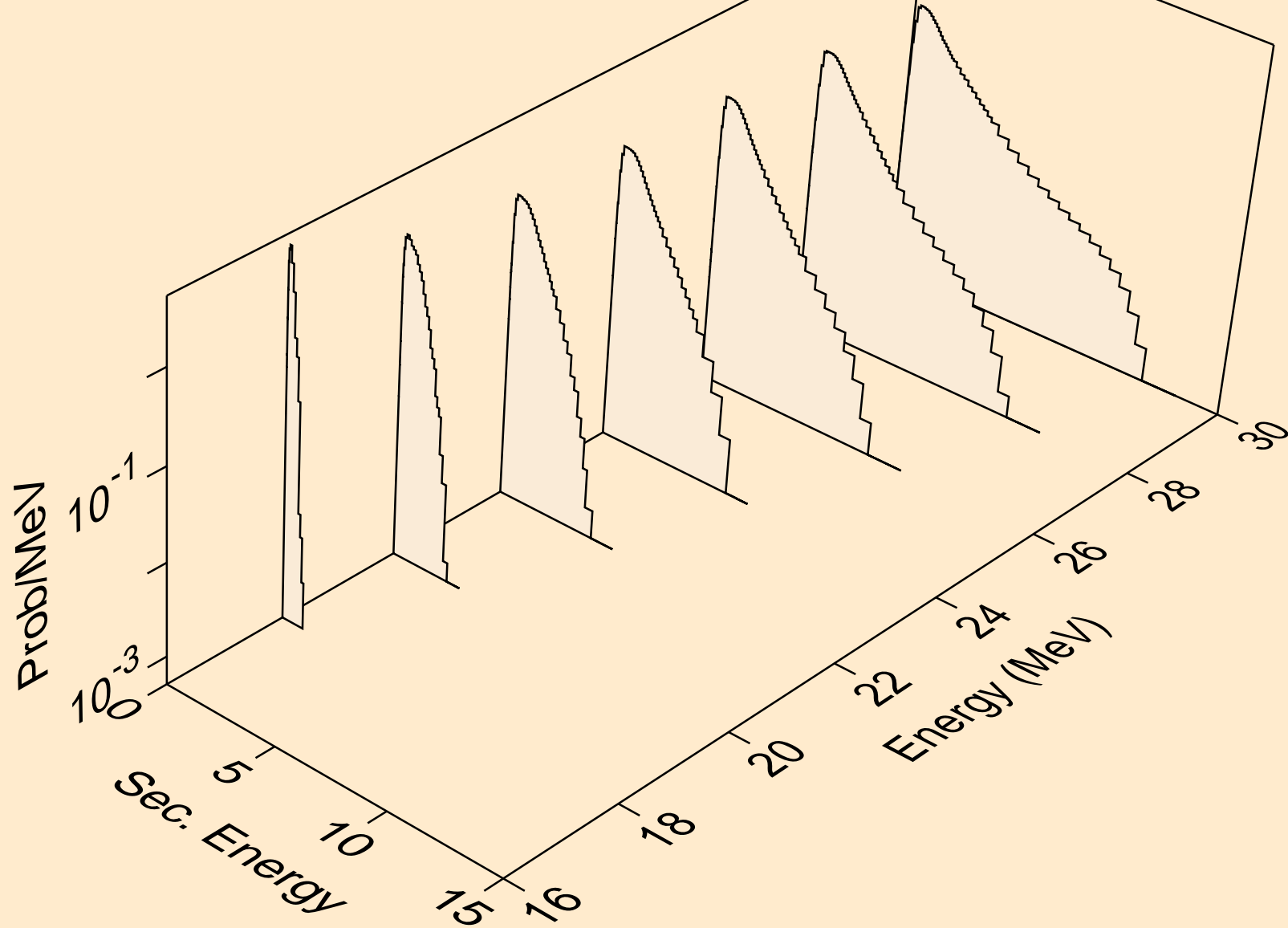

DY169 NEUTRON ACER TENDL-2021 LIBRARY; T=293.6K
Neutron emission for (n,2np)

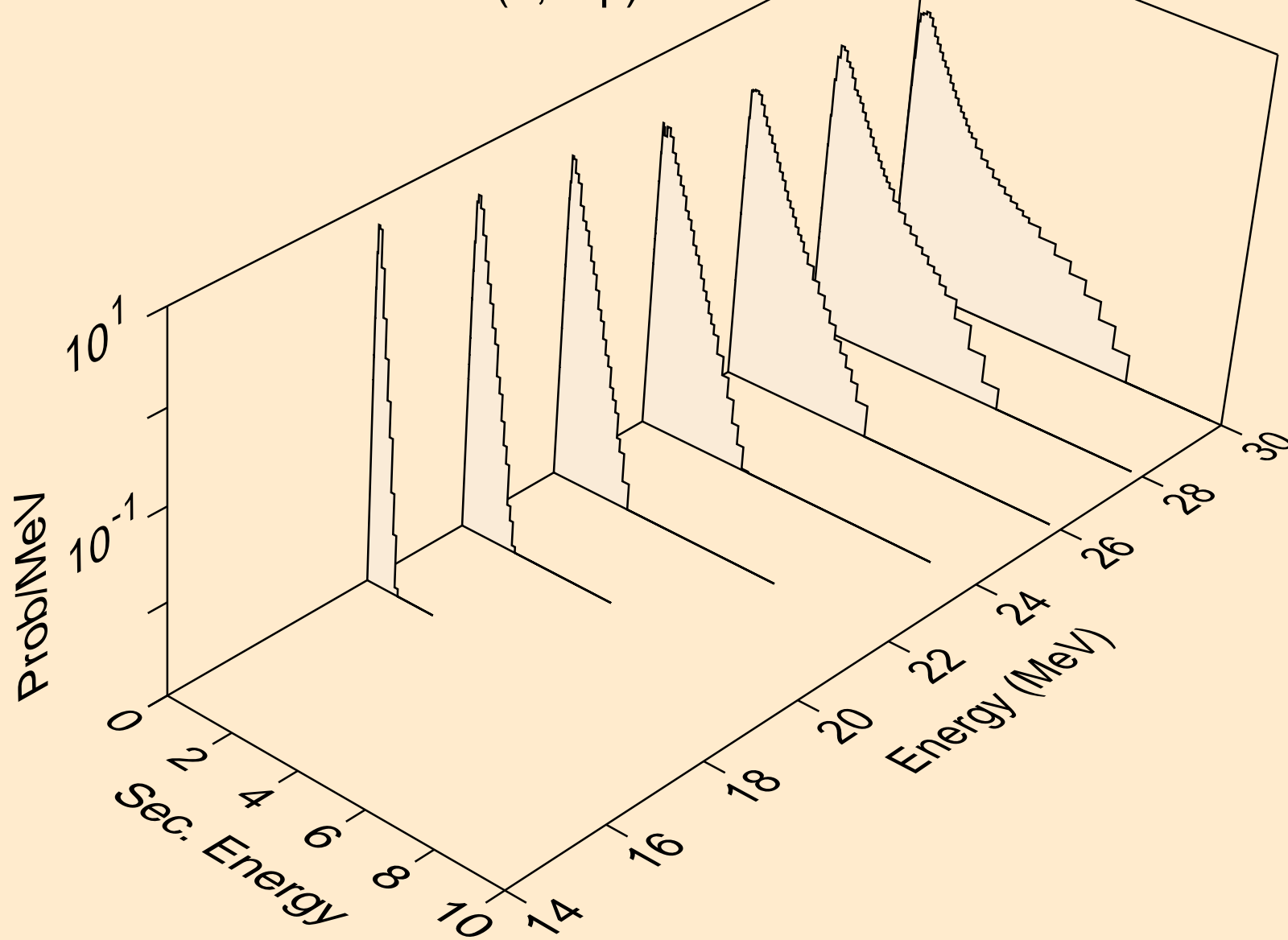

DY169 NEUTRON ACER TENDL-2021 LIBRARY; T=293.6K
Neutron emission for (n,3np)

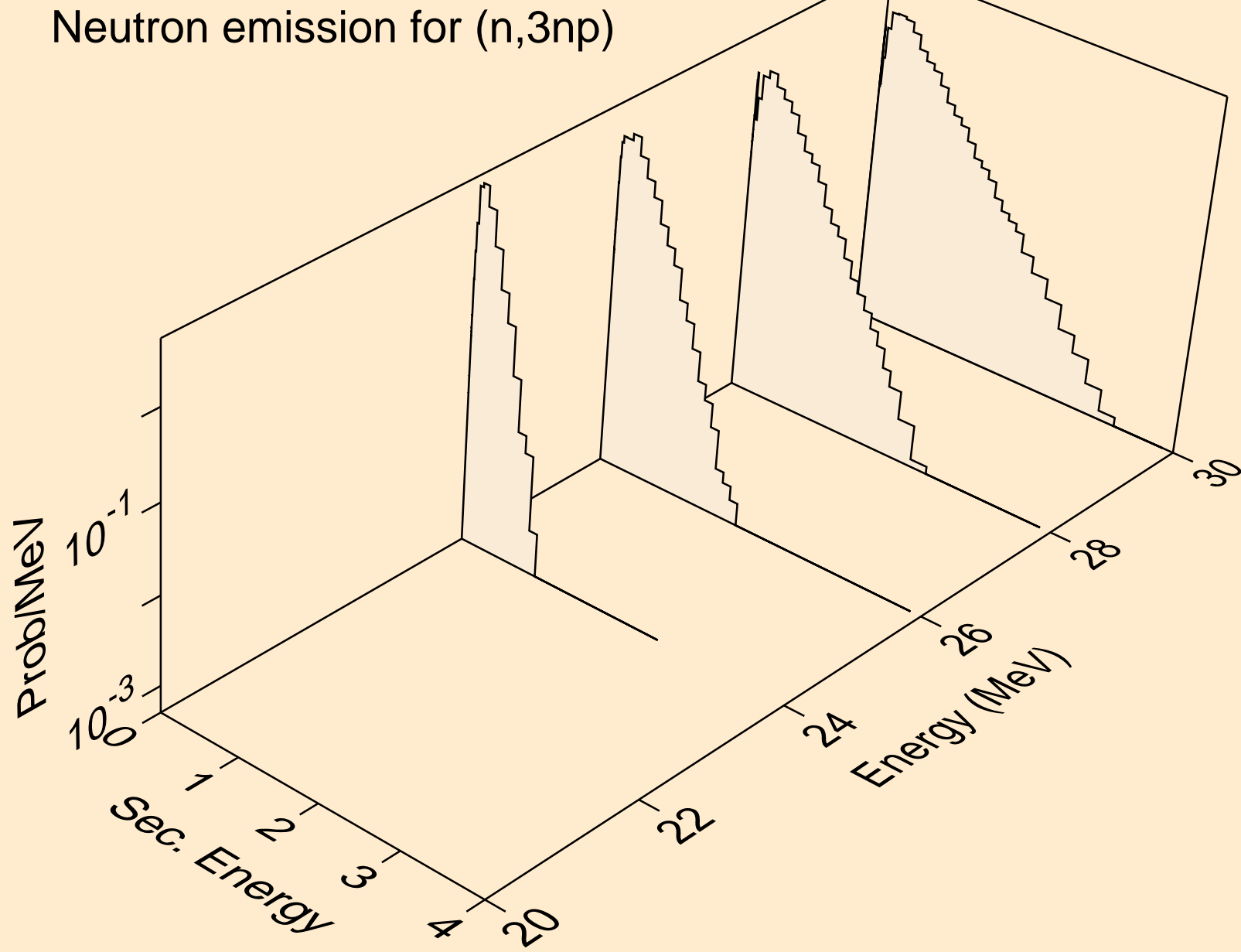

DY169 NEUTRON ACER TENDL-2021 LIBRARY; T=293.6K
Neutron emission for (n,n*c)

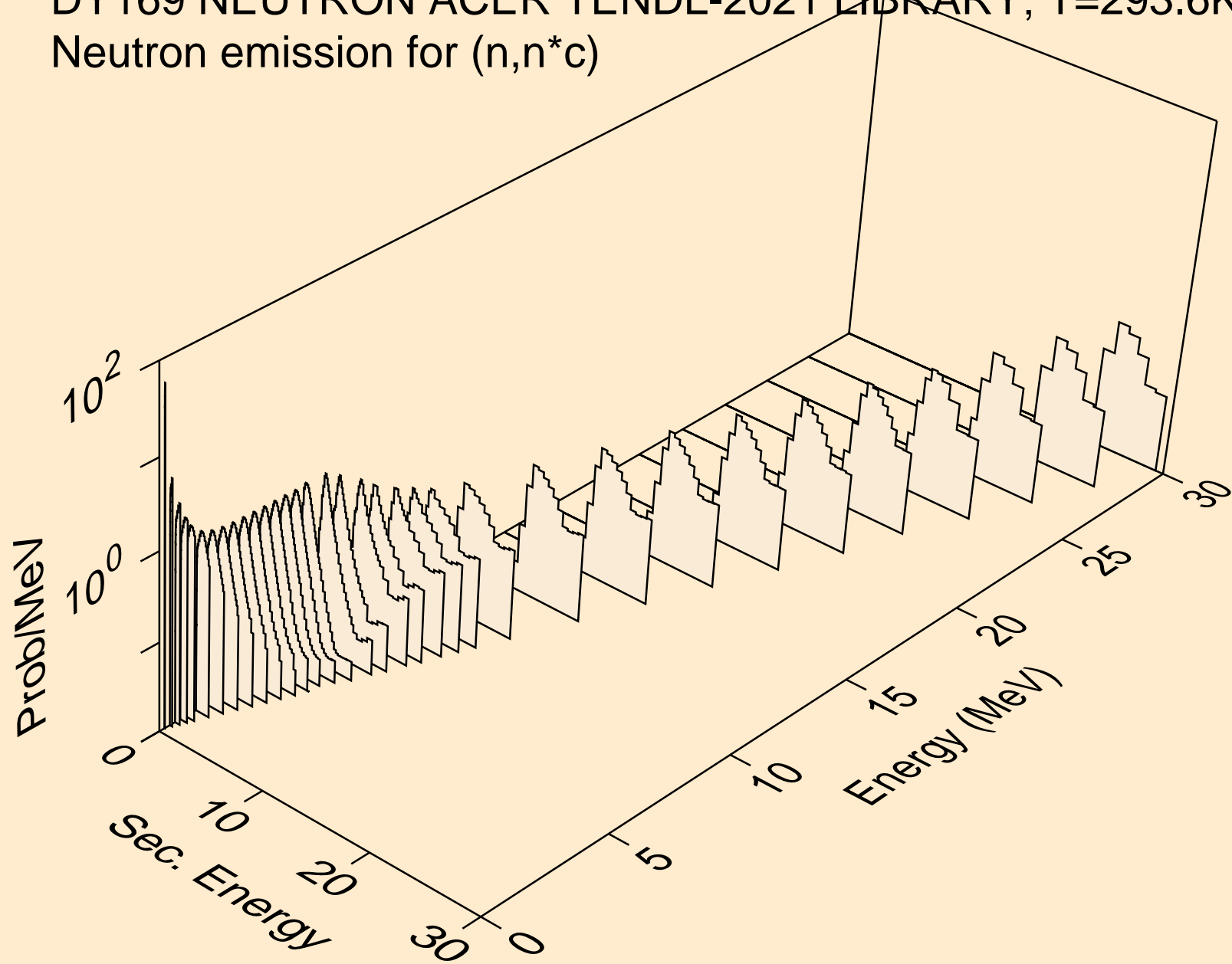

DY169 NEUTRON ACER TENDL-2021 LIBRARY; T=293.6K
Photon emission for (n,x)

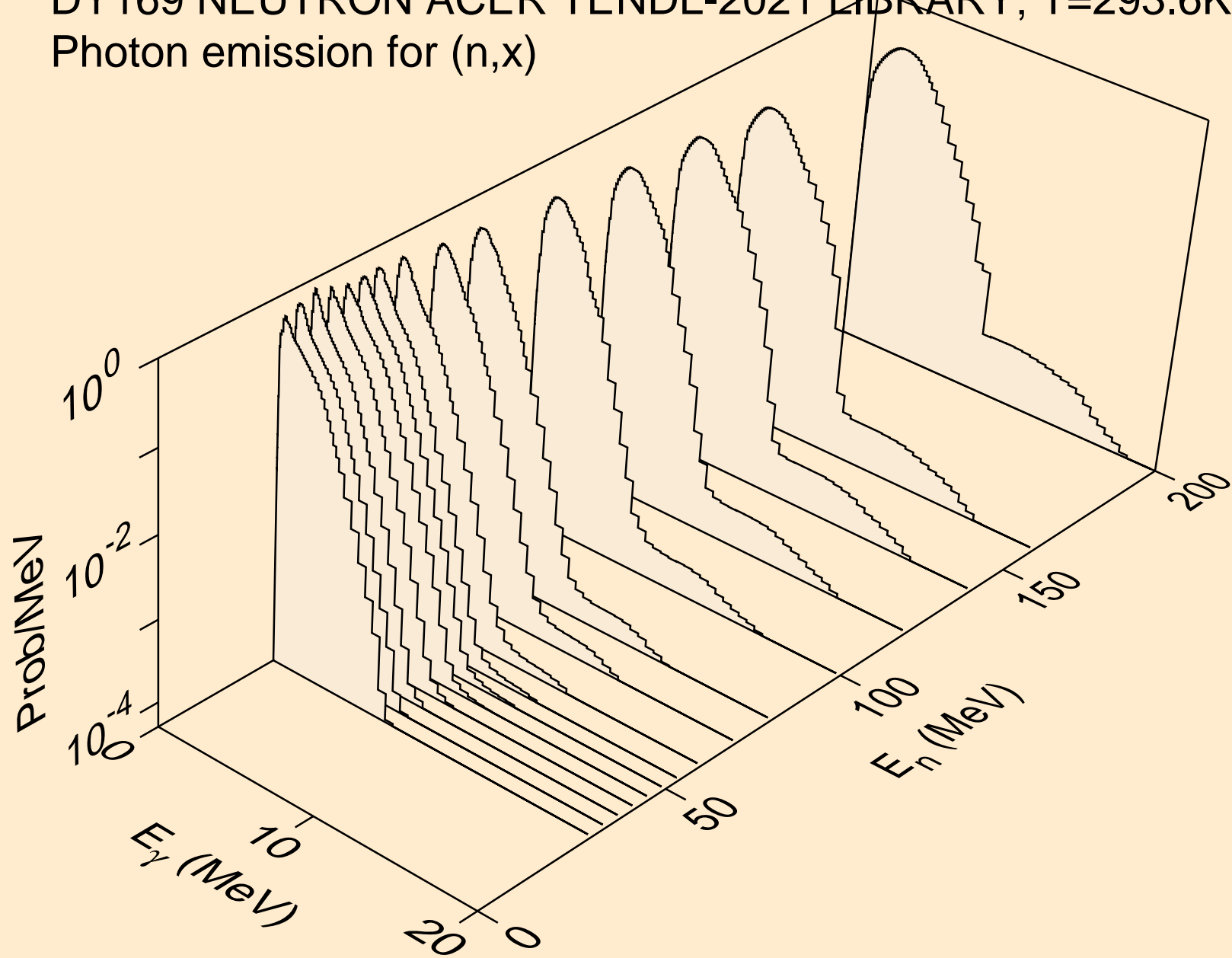

DY169 NEUTRON ACER TENDL-2021 LIBRARY; T=293.6K
Photon emission for (n,2nd)

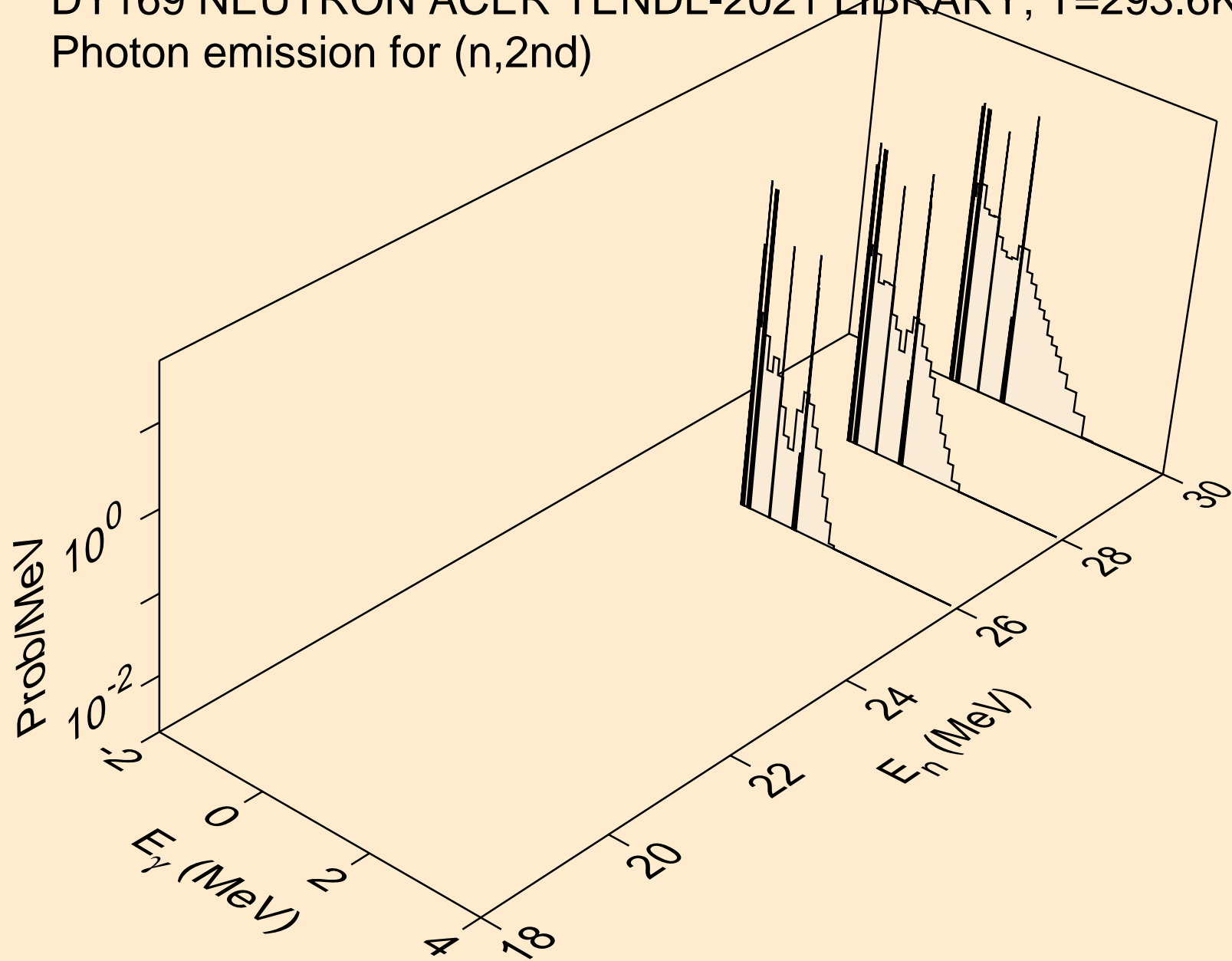

DY169 NEUTRON ACER TENDL-2021 LIBRARY; T=293.6K
Photon emission for (n,2n)

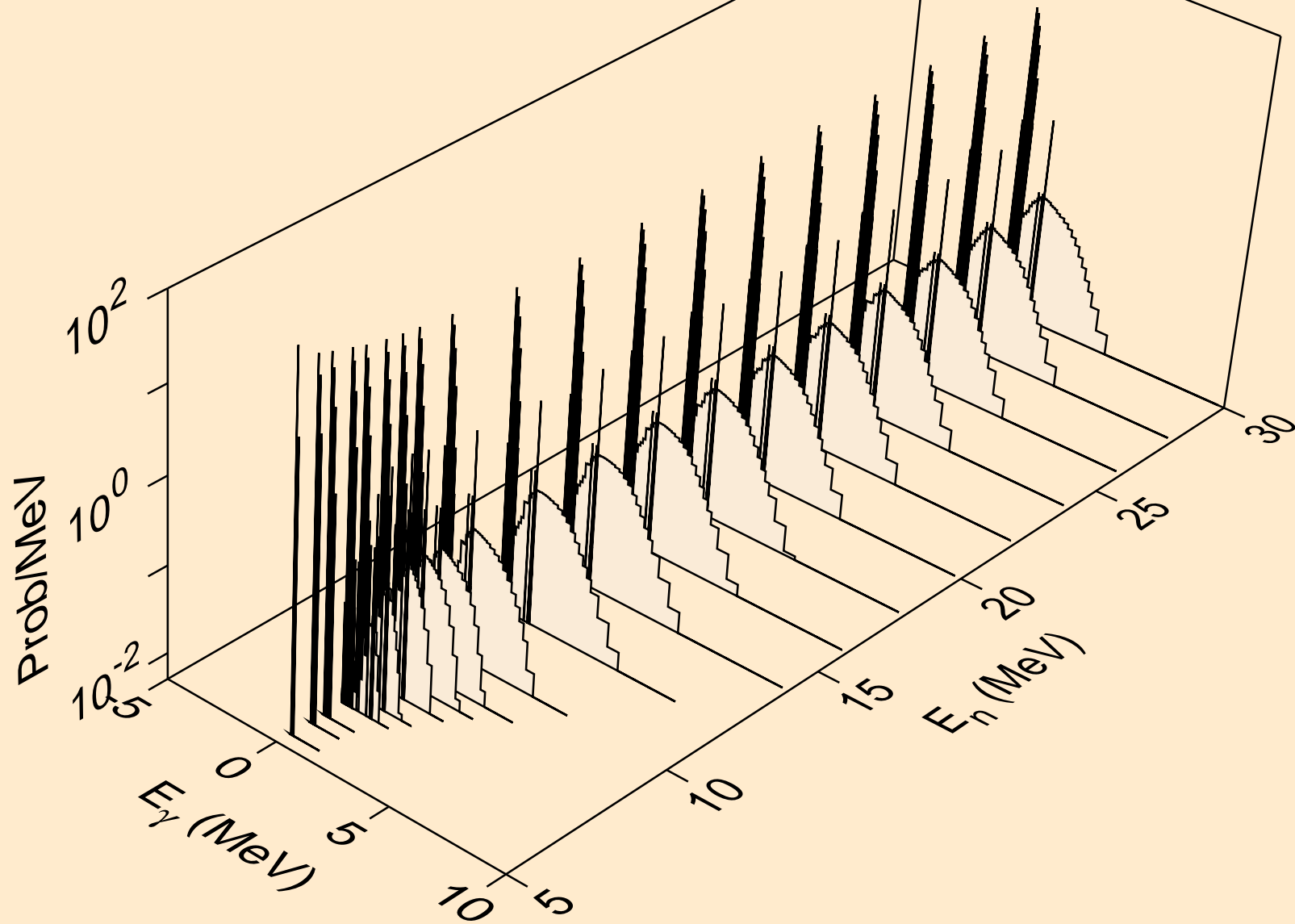

DY169 NEUTRON ACER TENDL-2021 LIBRARY; T=293.6K
Photon emission for (n,3n)

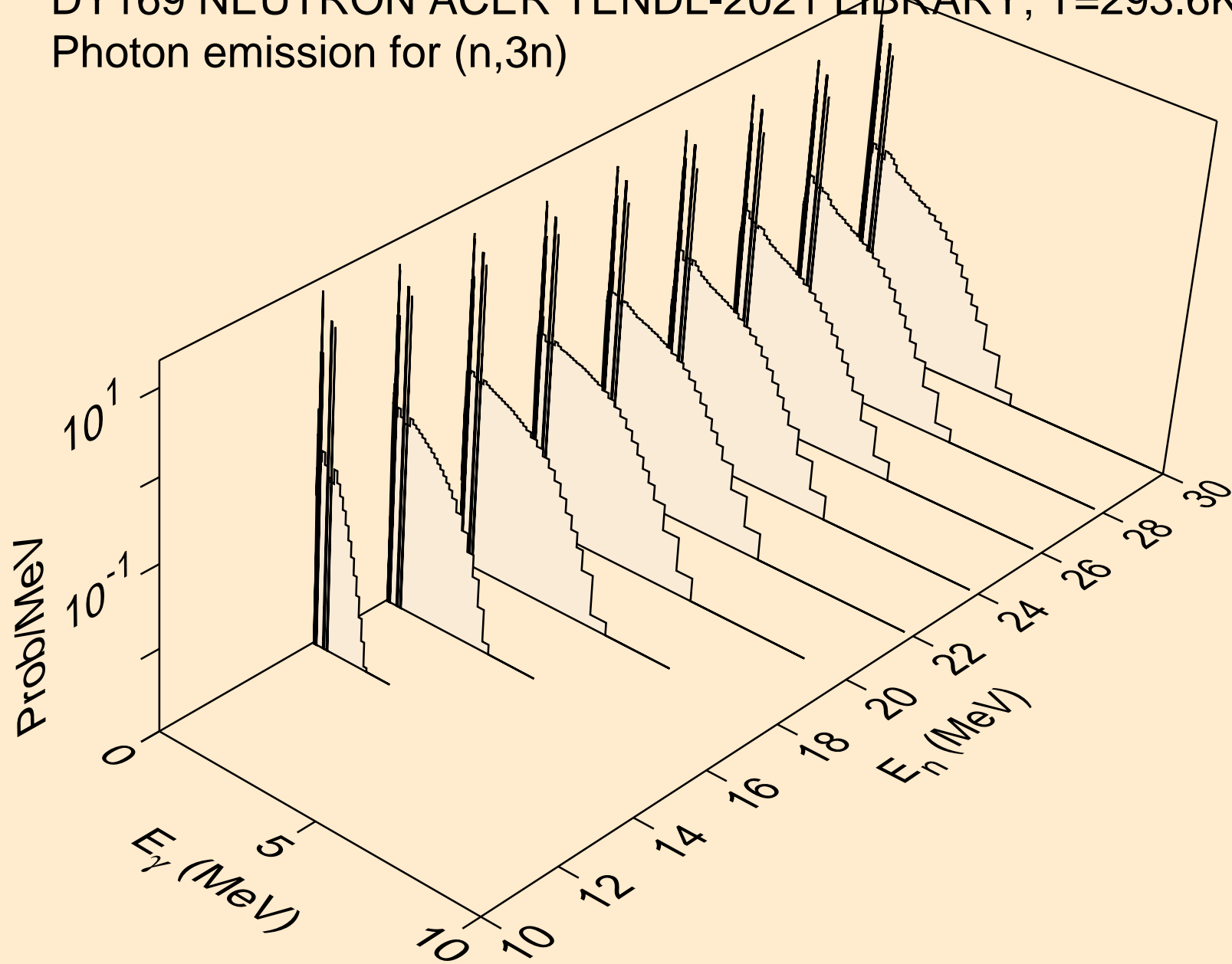

DY169 NEUTRON ACER TENDL-2021 LIBRARY; T=293.6K
Photon emission for (n,n*)a

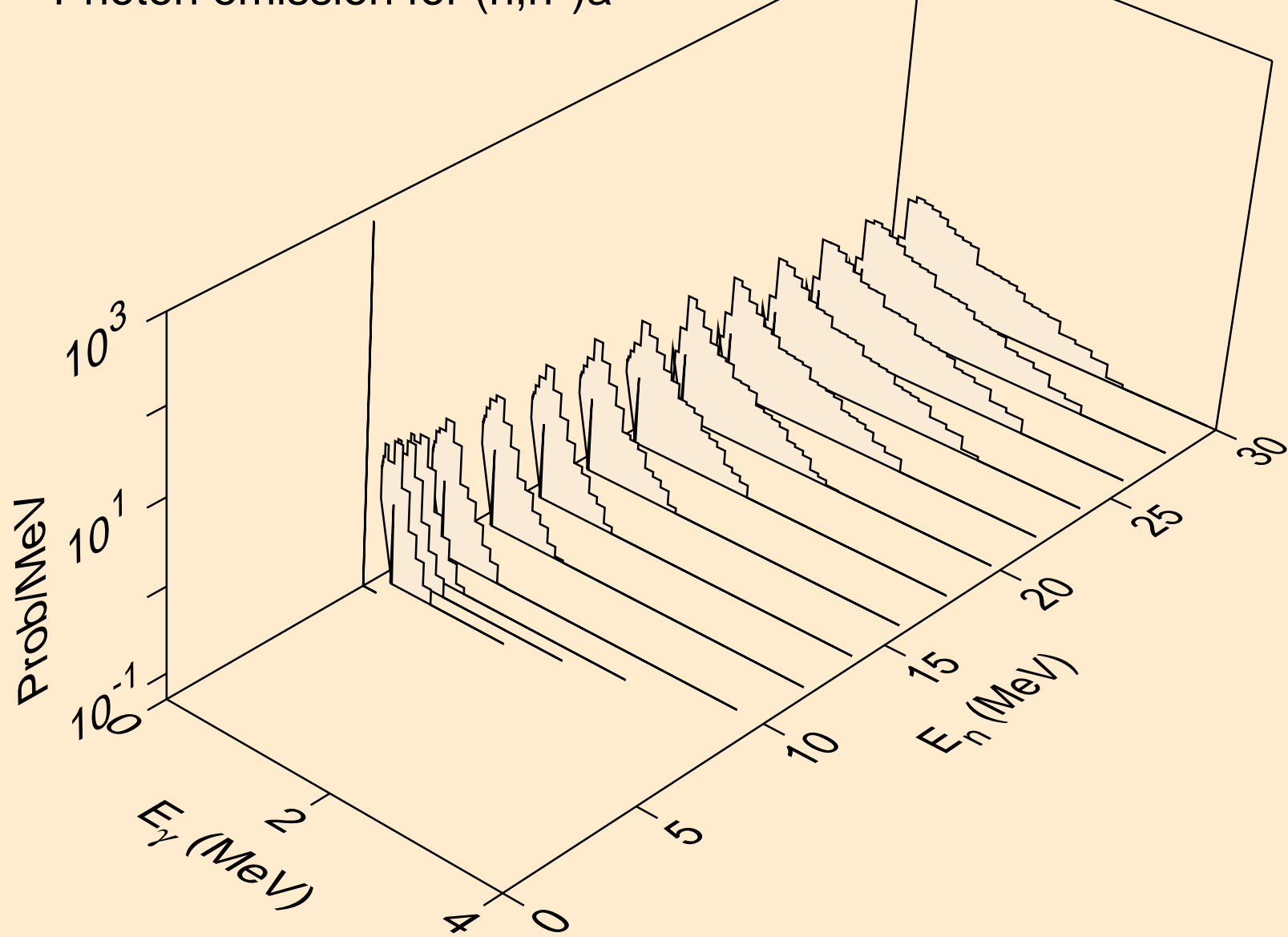

DY169 NEUTRON ACER TENDL-2021 LIBRARY; T=293.6K
Photon emission for (n,2n)a

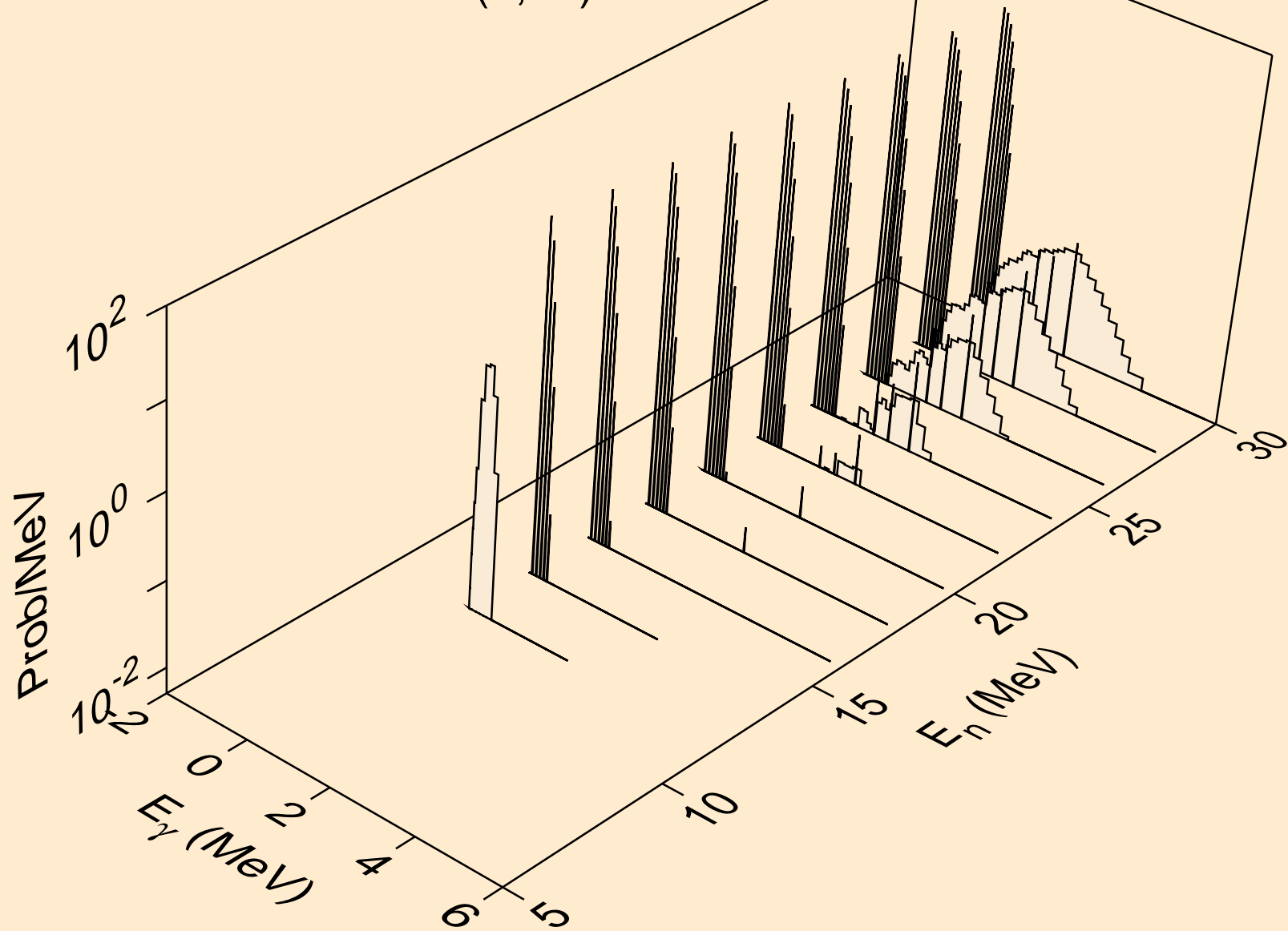

DY169 NEUTRON ACER TENDL-2021 LIBRARY; T=293.6K
Photon emission for (n,3n)a

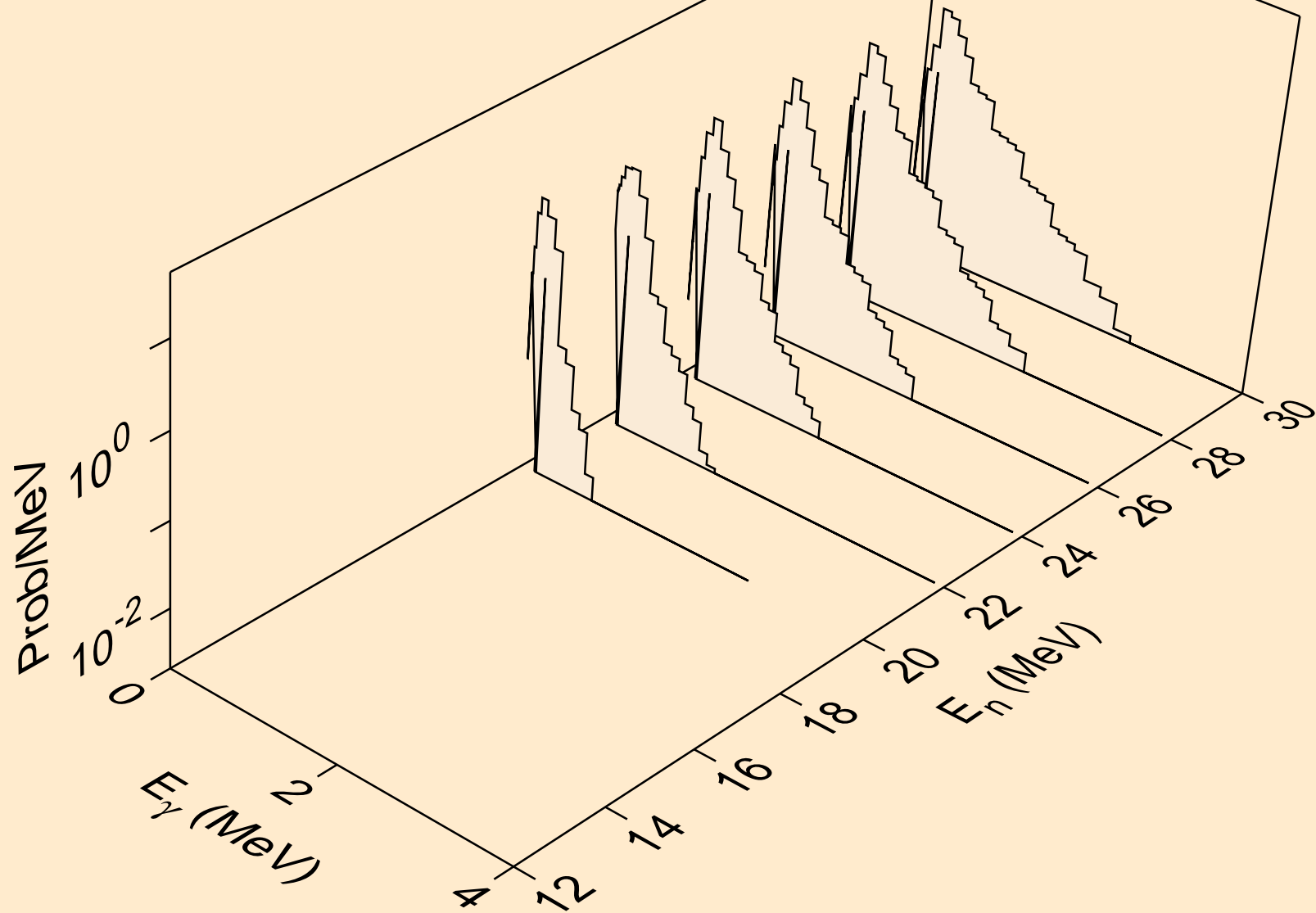

DY169 NEUTRON ACER TENDL-2021 LIBRARY; T=293.6K
Photon emission for (n,n*)p

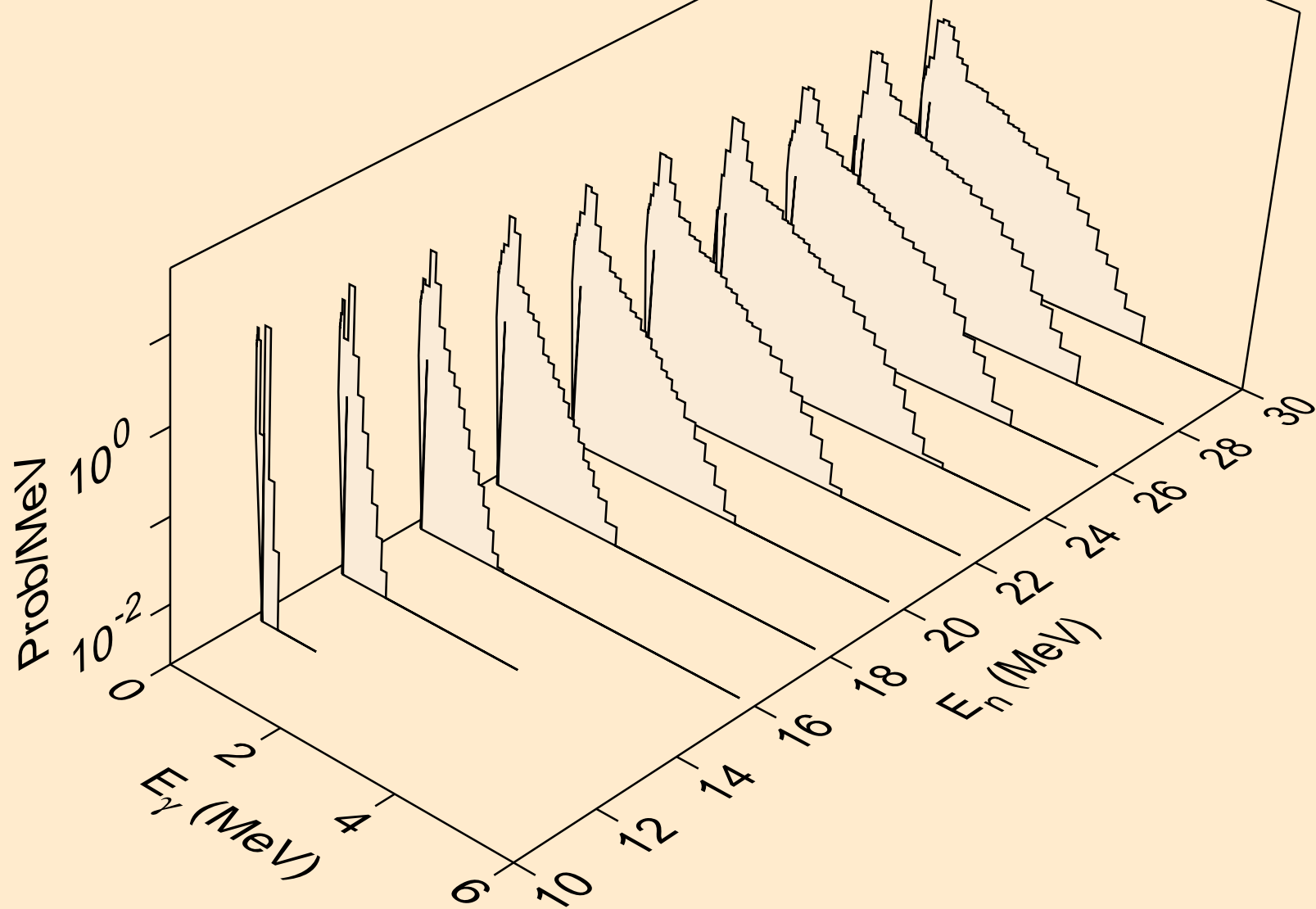

DY169 NEUTRON ACER TENDL-2021 LIBRARY; T=293.6K
Photon emission for (n,n*)d

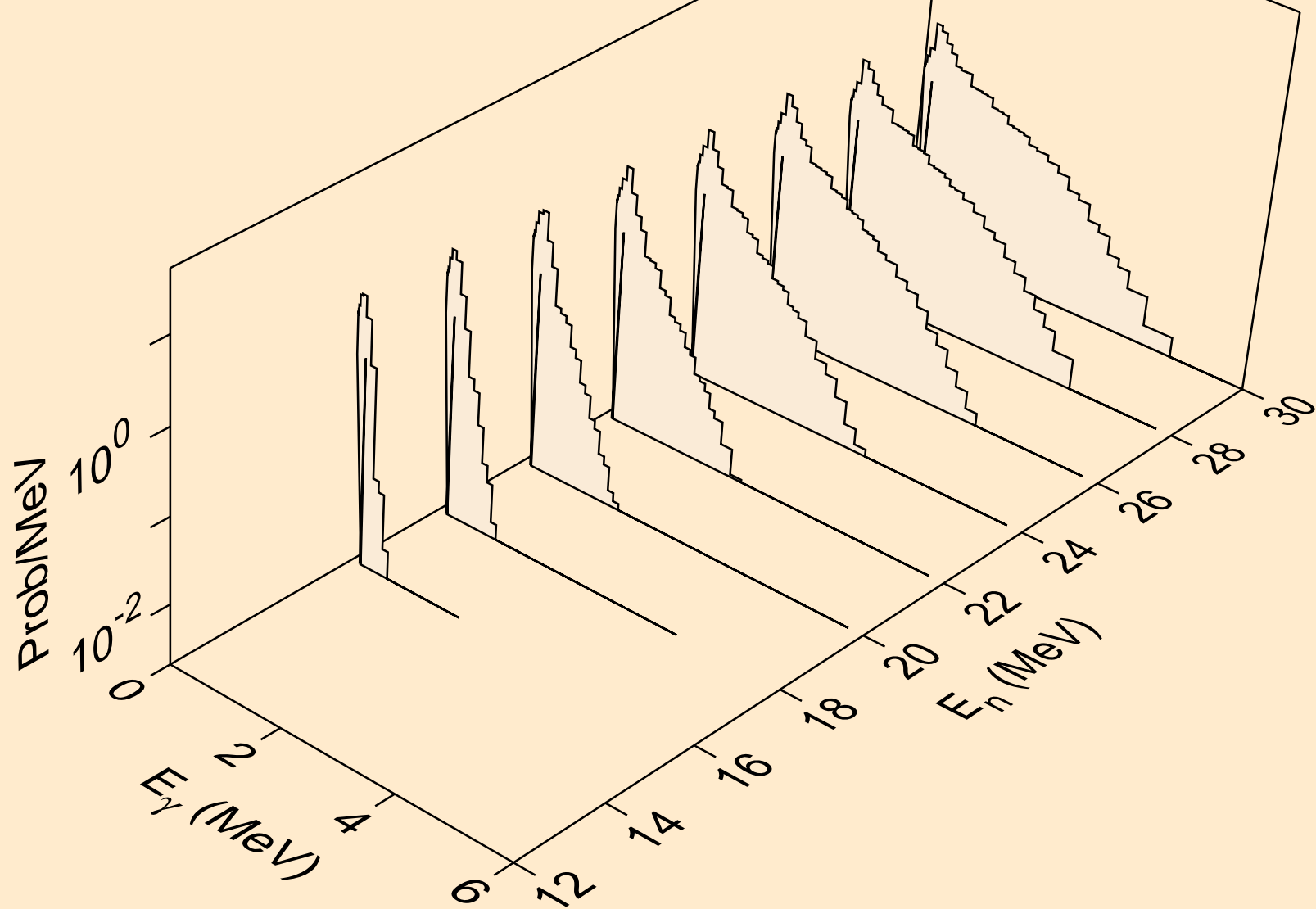

DY169 NEUTRON ACER TENDL-2021 LIBRARY; T=293.6K
Photon emission for (n,n*)t

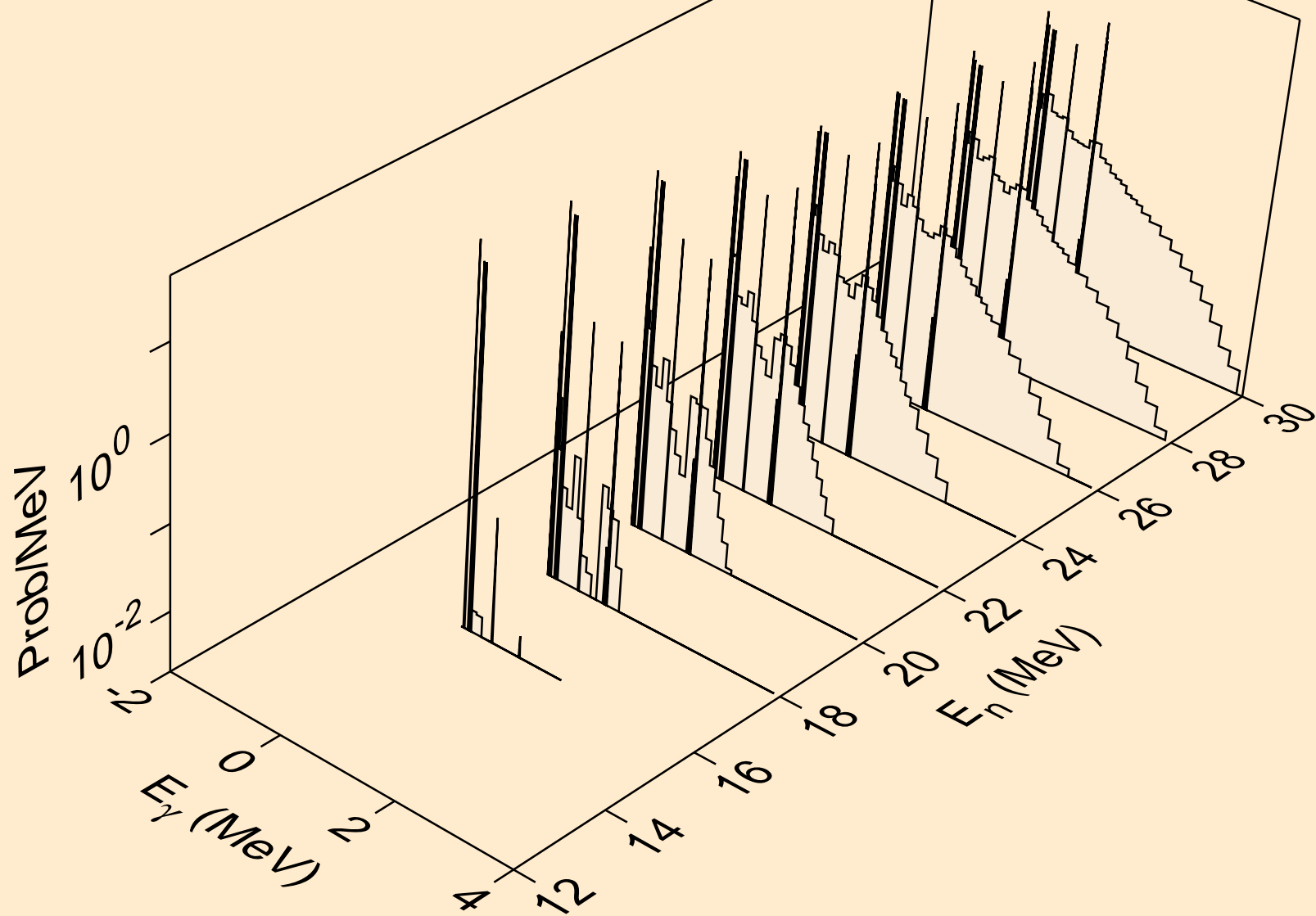

DY169 NEUTRON ACER TENDL-2021 LIBRARY; T=293.6K
Photon emission for (n,n*)he3

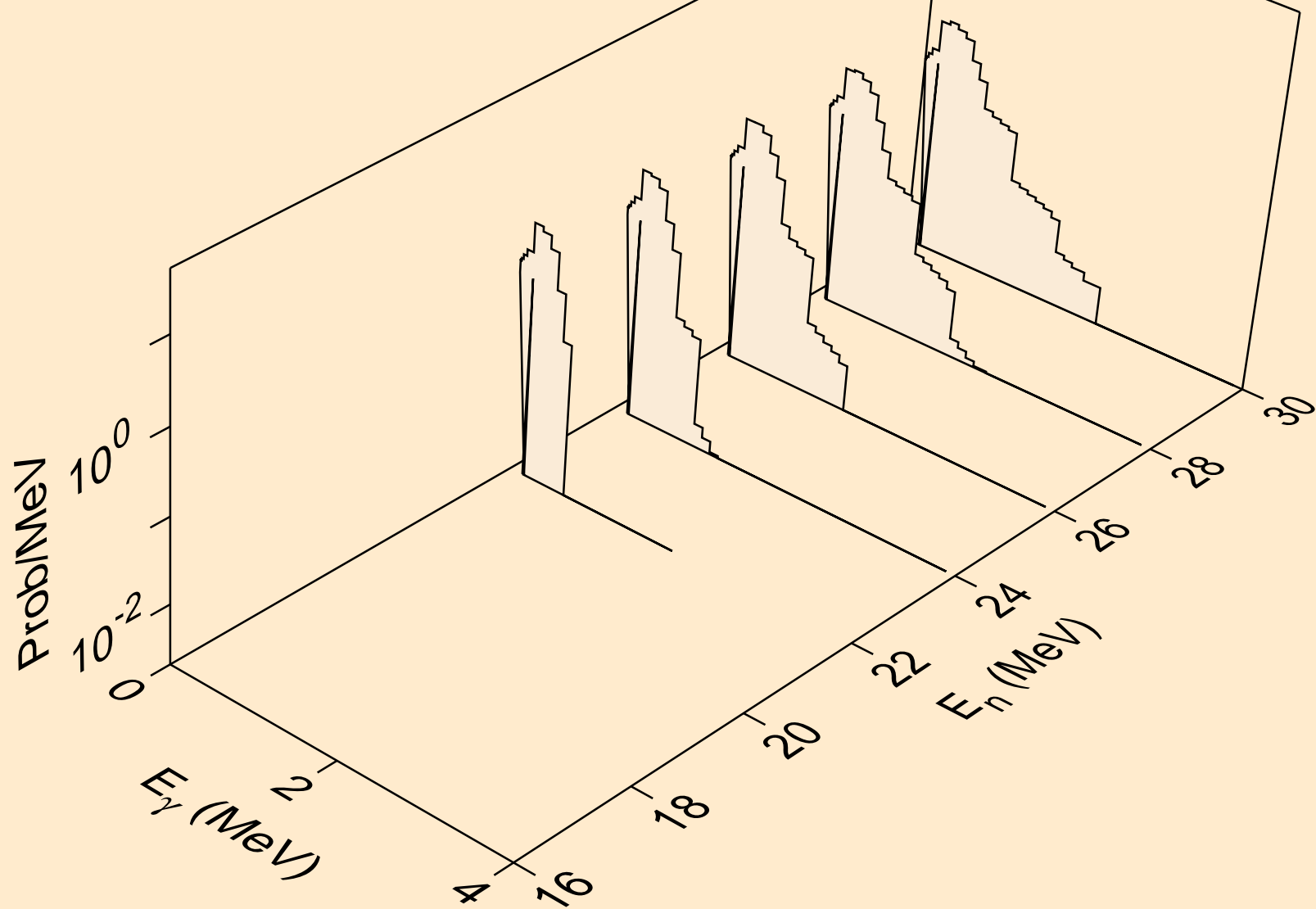

DY169 NEUTRON ACER TENDL-2021 LIBRARY; T=293.6K
Photon emission for (n,4n)

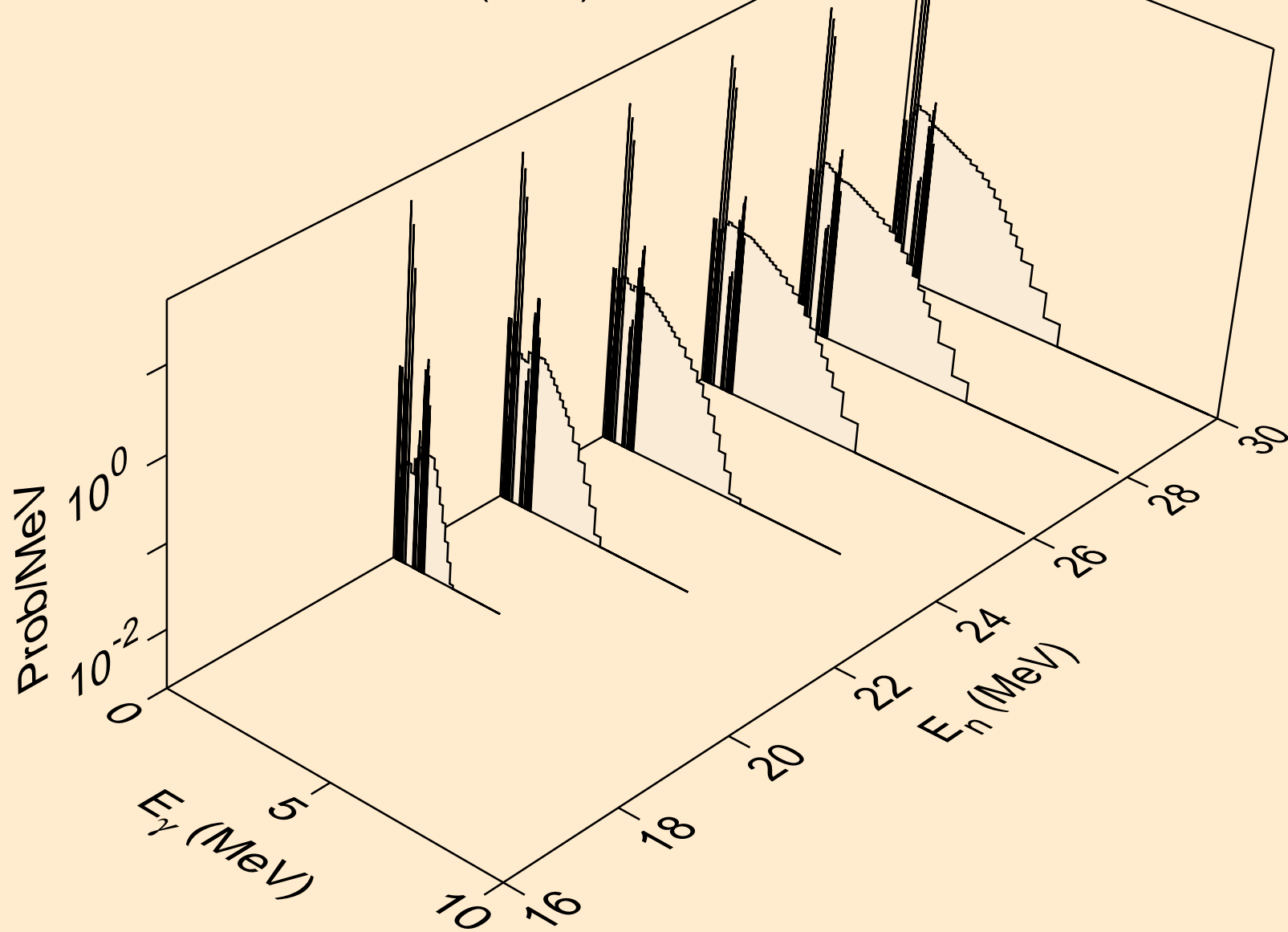

DY169 NEUTRON ACER TENDL-2021 LIBRARY; T=293.6K
Photon emission for (n,2np)

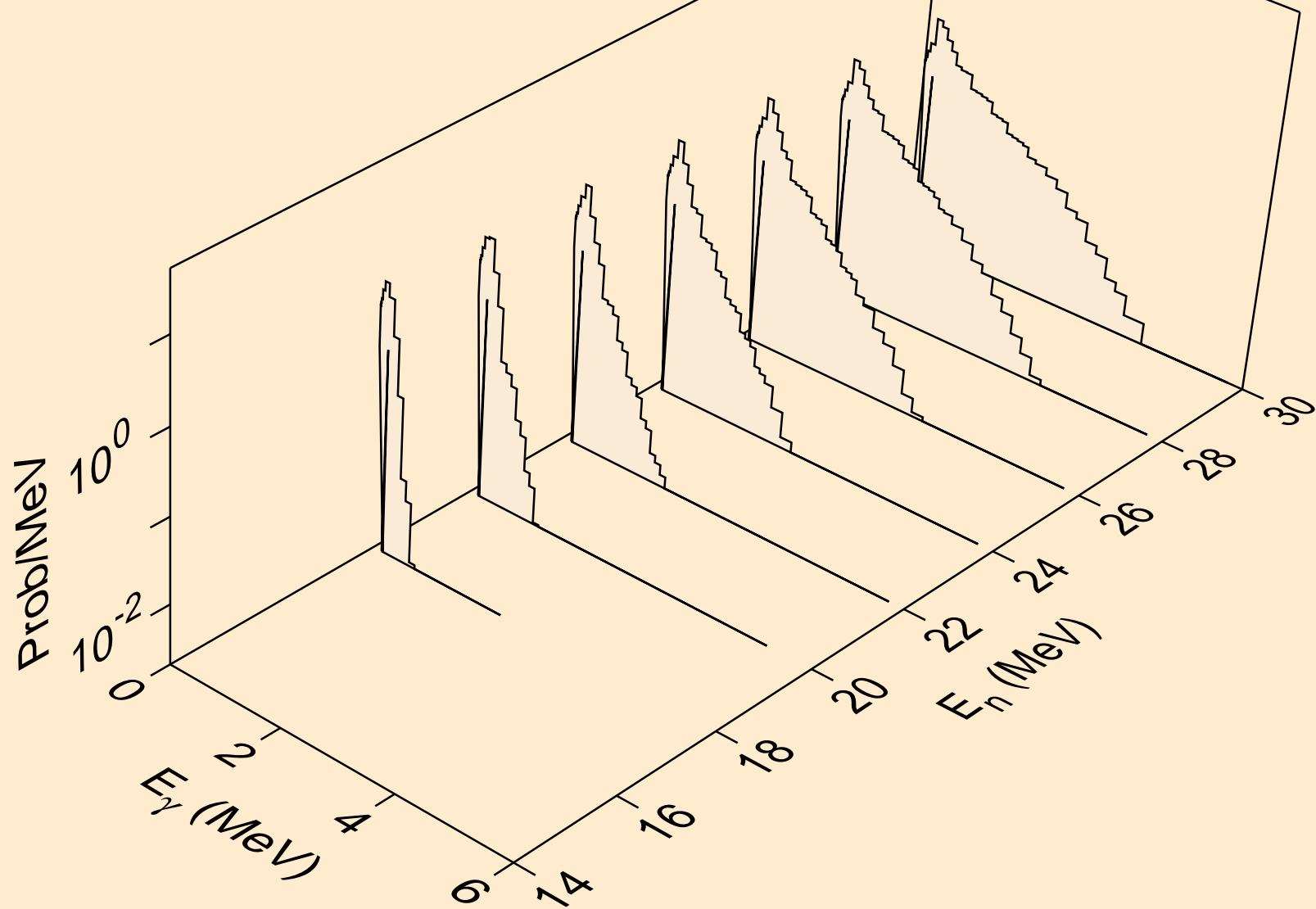

DY169 NEUTRON ACER TENDL-2021 LIBRARY; T=293.6K
Photon emission for (n,3np)

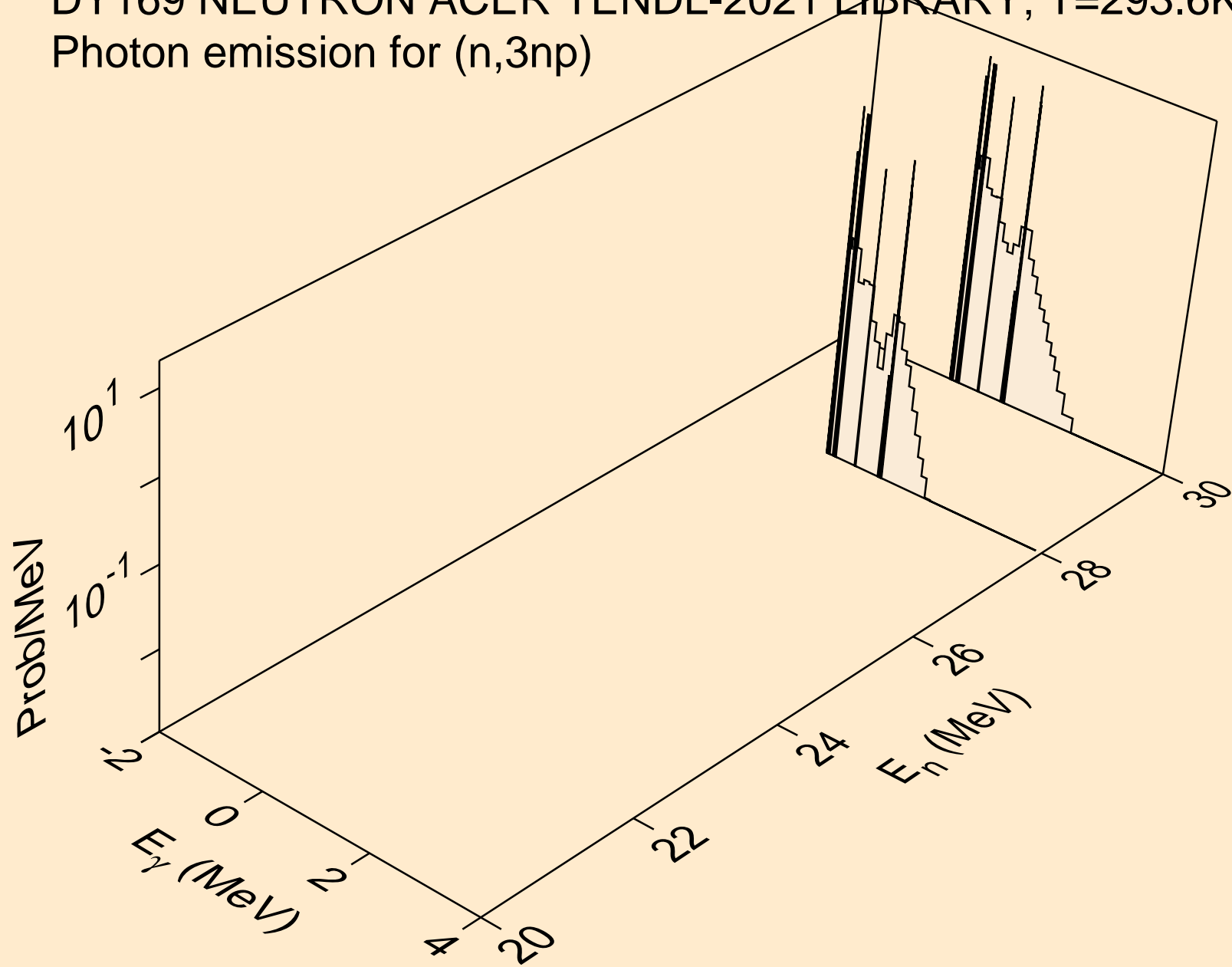

DY169 NEUTRON ACER TENDL-2021 LIBRARY; T=293.6K
Photon emission for (n,n*c)

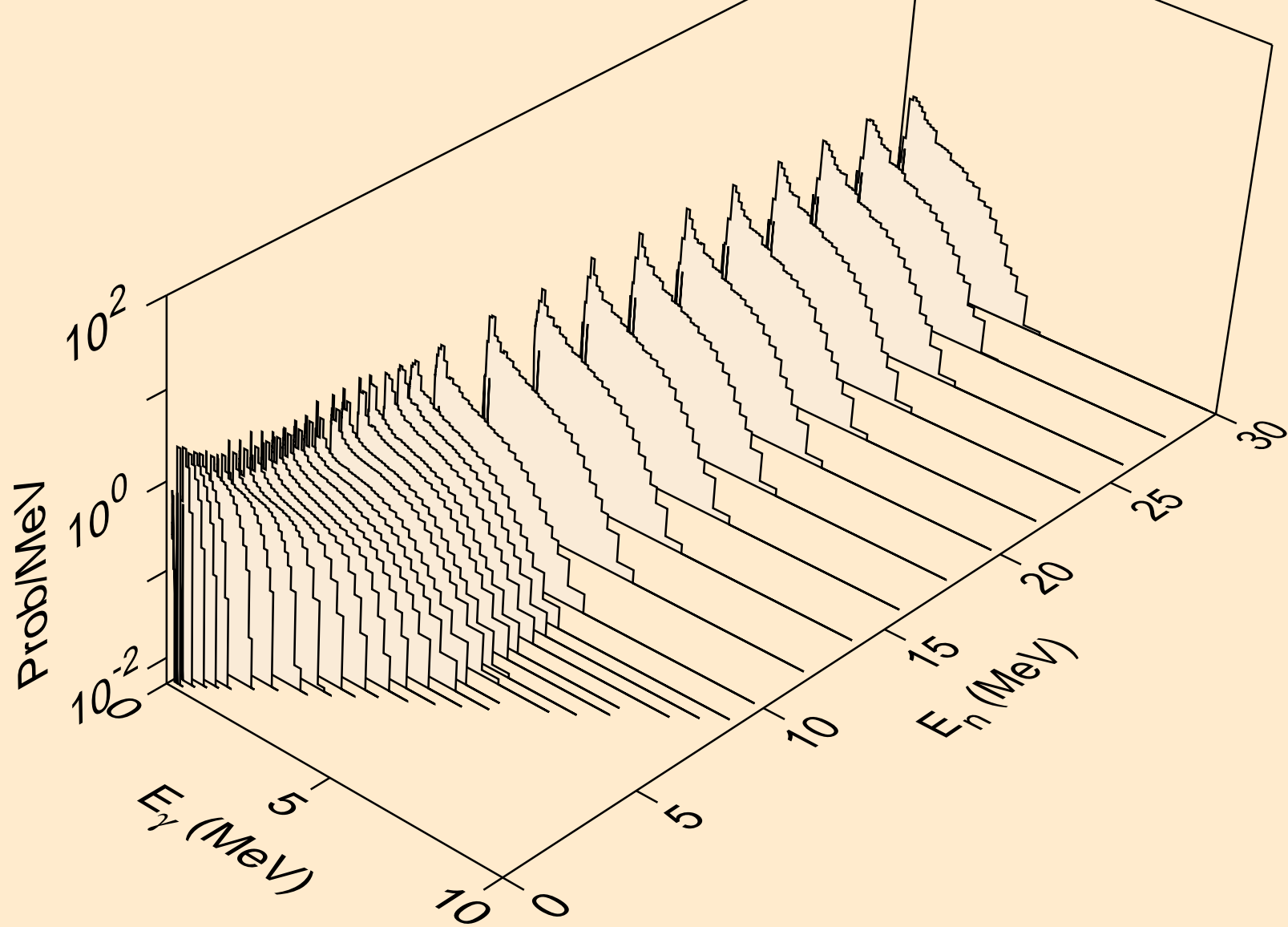

DY169 NEUTRON ACER TENDL-2021 LIBRARY; T=293.6K
Photon emission for (n,gma)

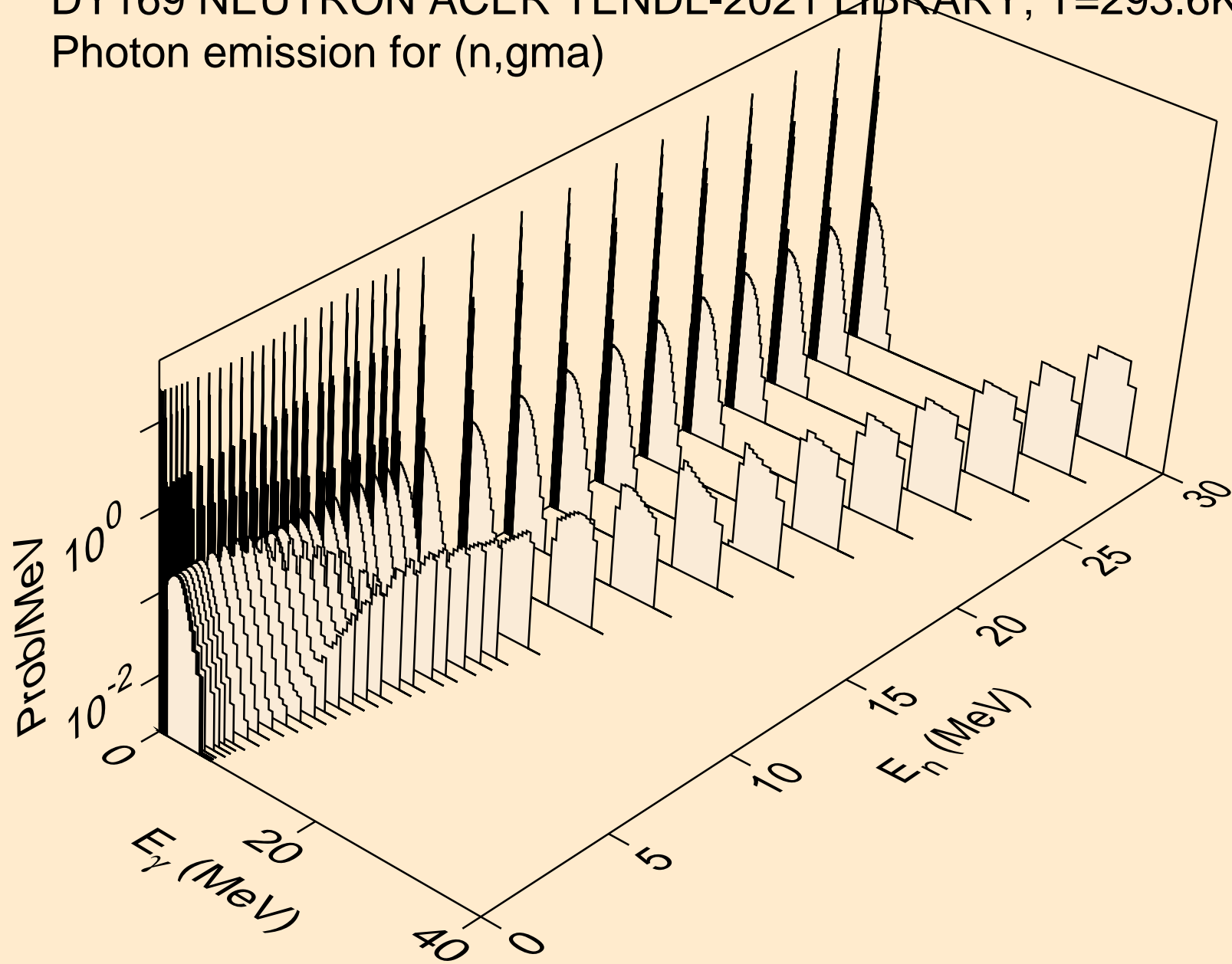

DY169 NEUTRON ACER TENDL-2021 LIBRARY; T=293.6K
Photon emission for (n,p)

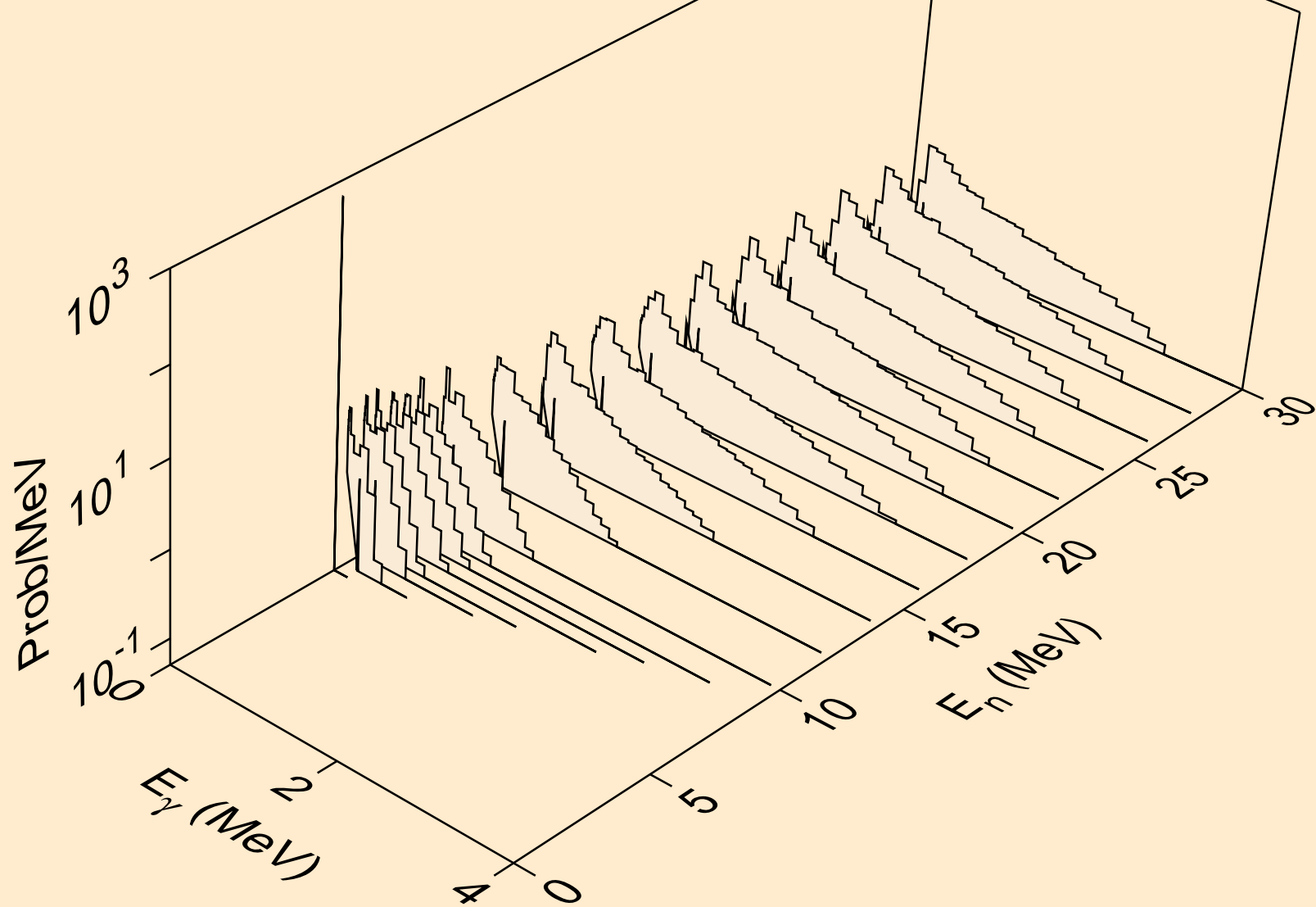

DY169 NEUTRON ACER TENDL-2021 LIBRARY; T=293.6K
Photon emission for (n,d)

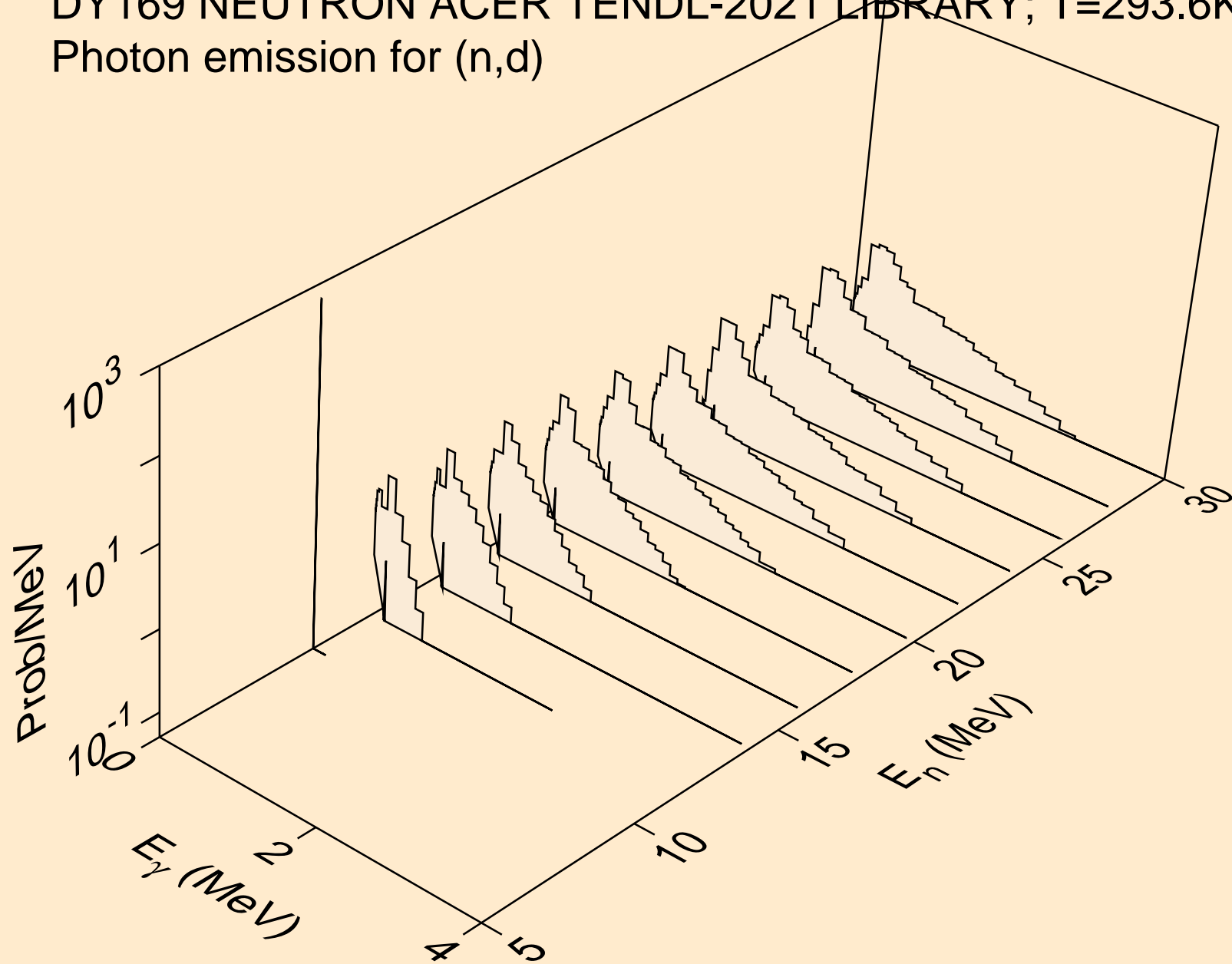

DY169 NEUTRON ACER TENDL-2021 LIBRARY; T=293.6K
Photon emission for (n,t)

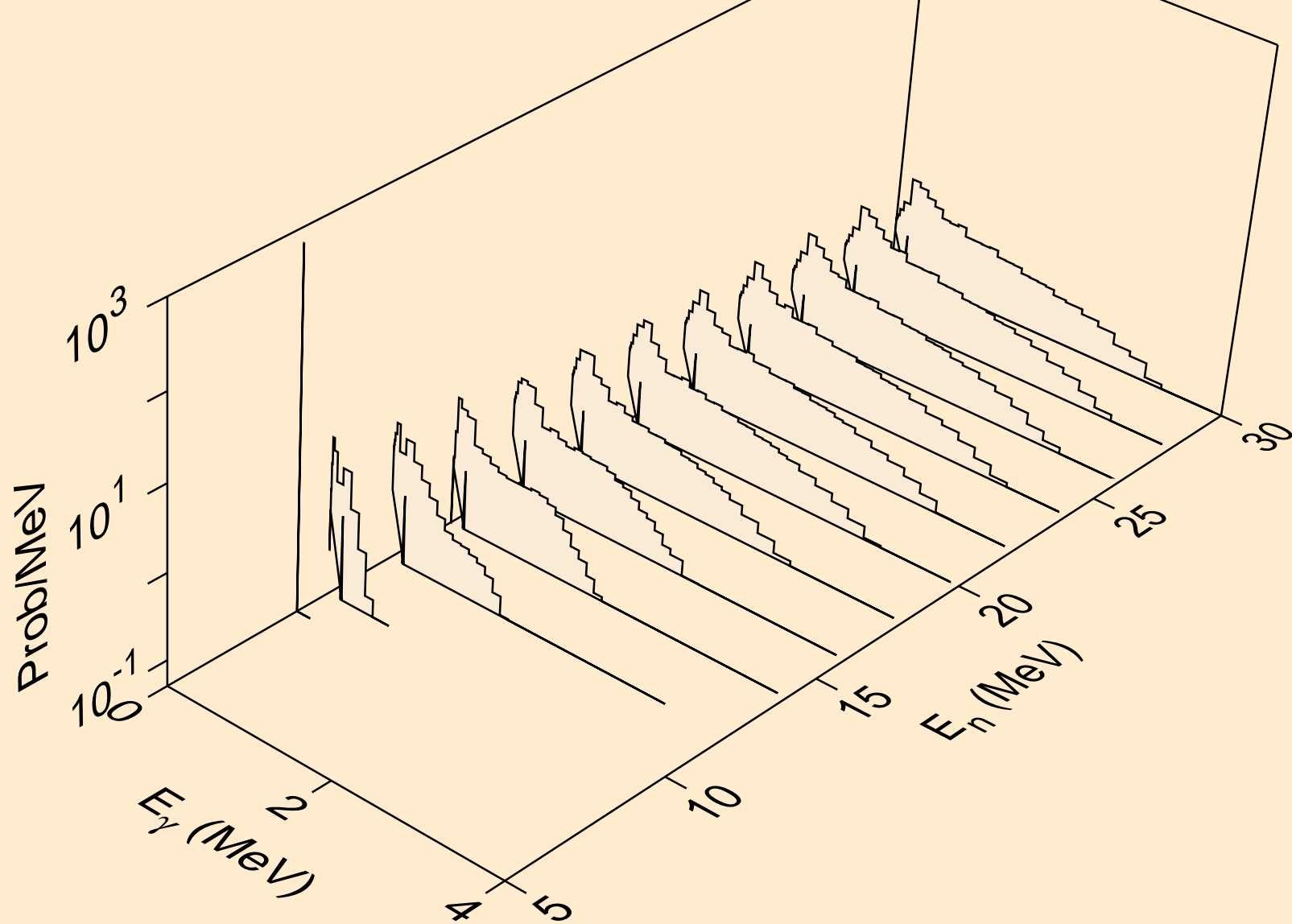

DY169 NEUTRON ACER TENDL-2021 LIBRARY; T=293.6K
Photon emission for (n,he3)

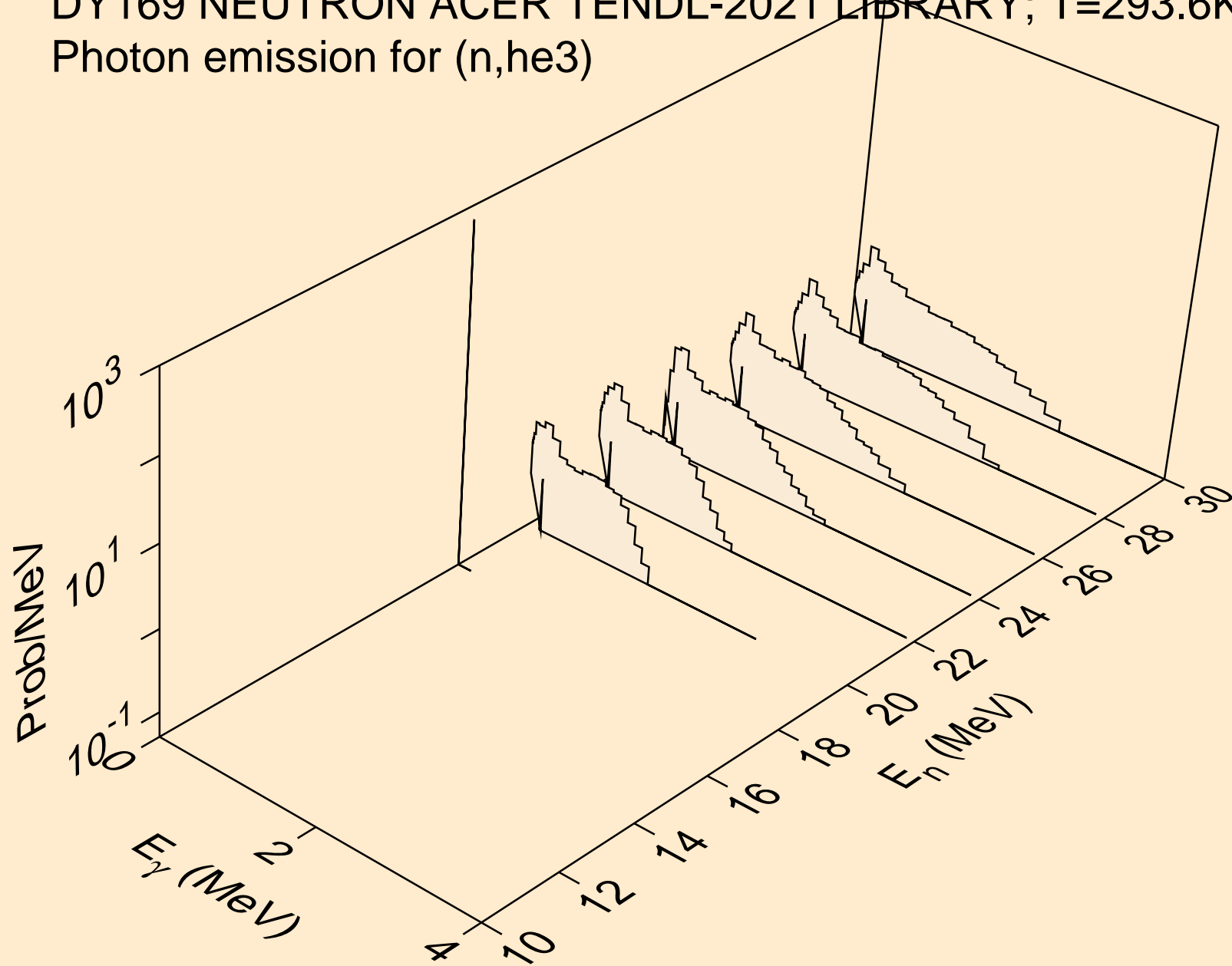

DY169 NEUTRON ACER TENDL-2021 LIBRARY; T=293.6K
Photon emission for (n,a)

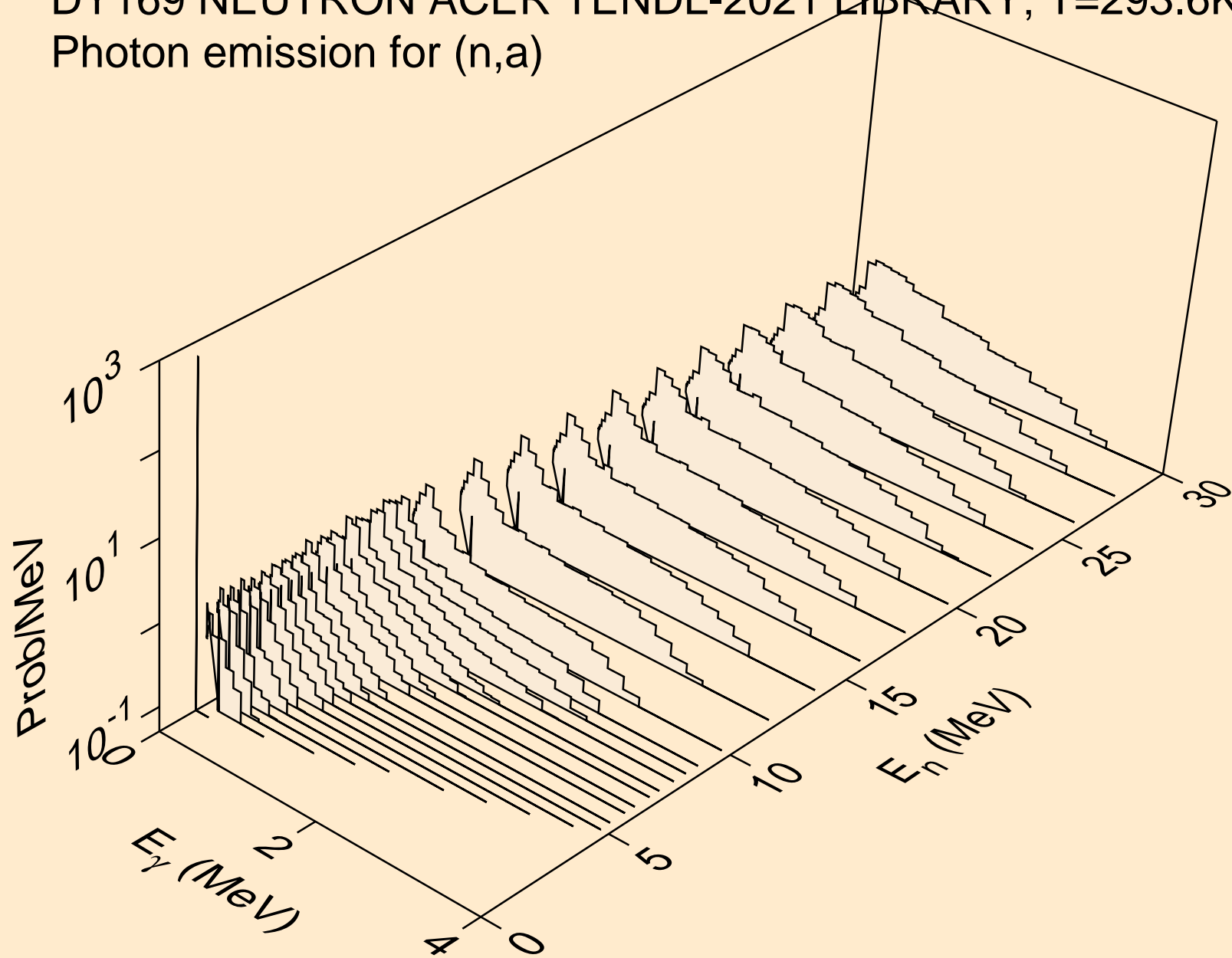

DY169 NEUTRON ACER TENDL-2021 LIBRARY; T=293.6K
Photon emission for (n,2p)

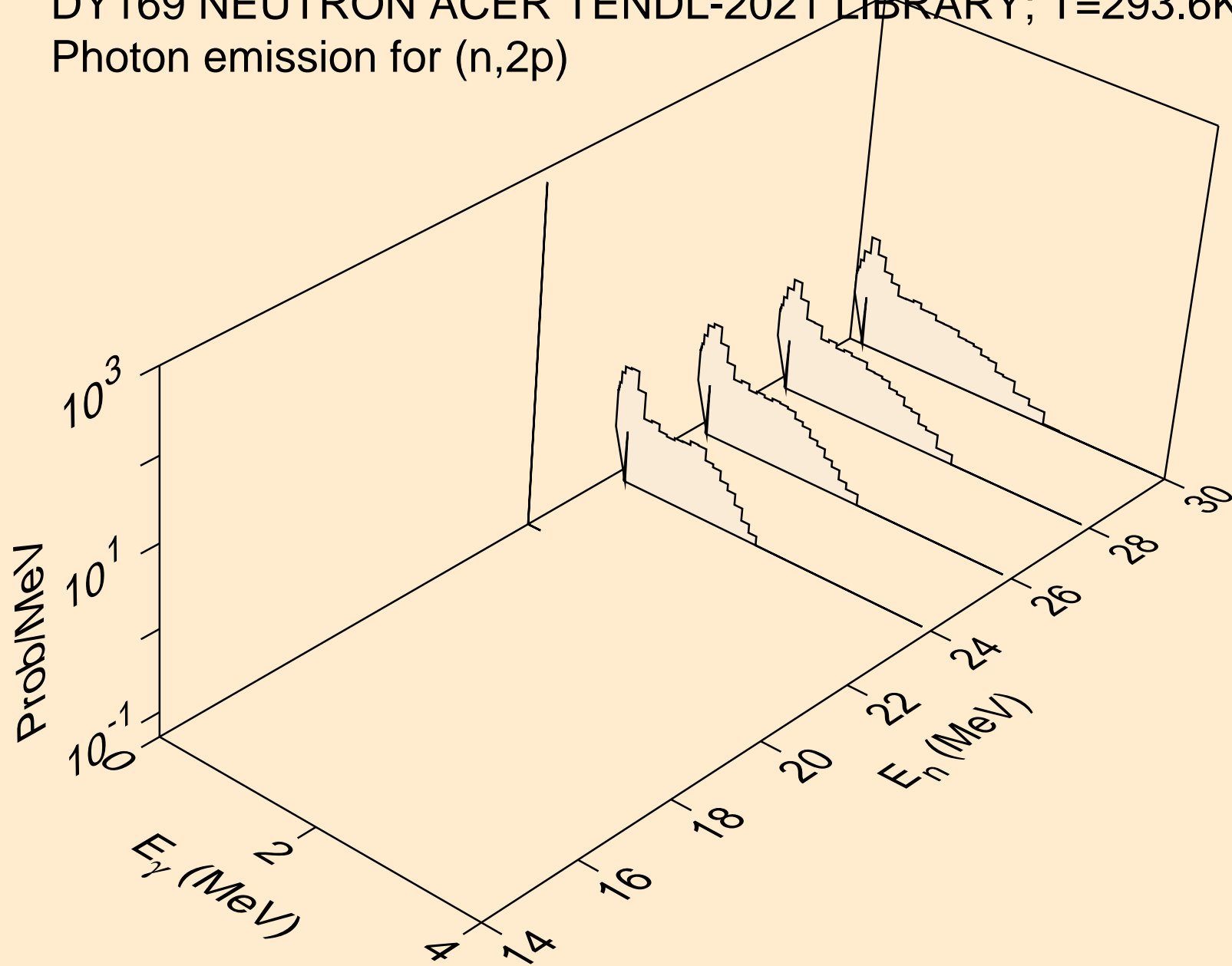

DY169 NEUTRON ACER TENDL-2021 LIBRARY; T=293.6K
thermal capture photon spectrum

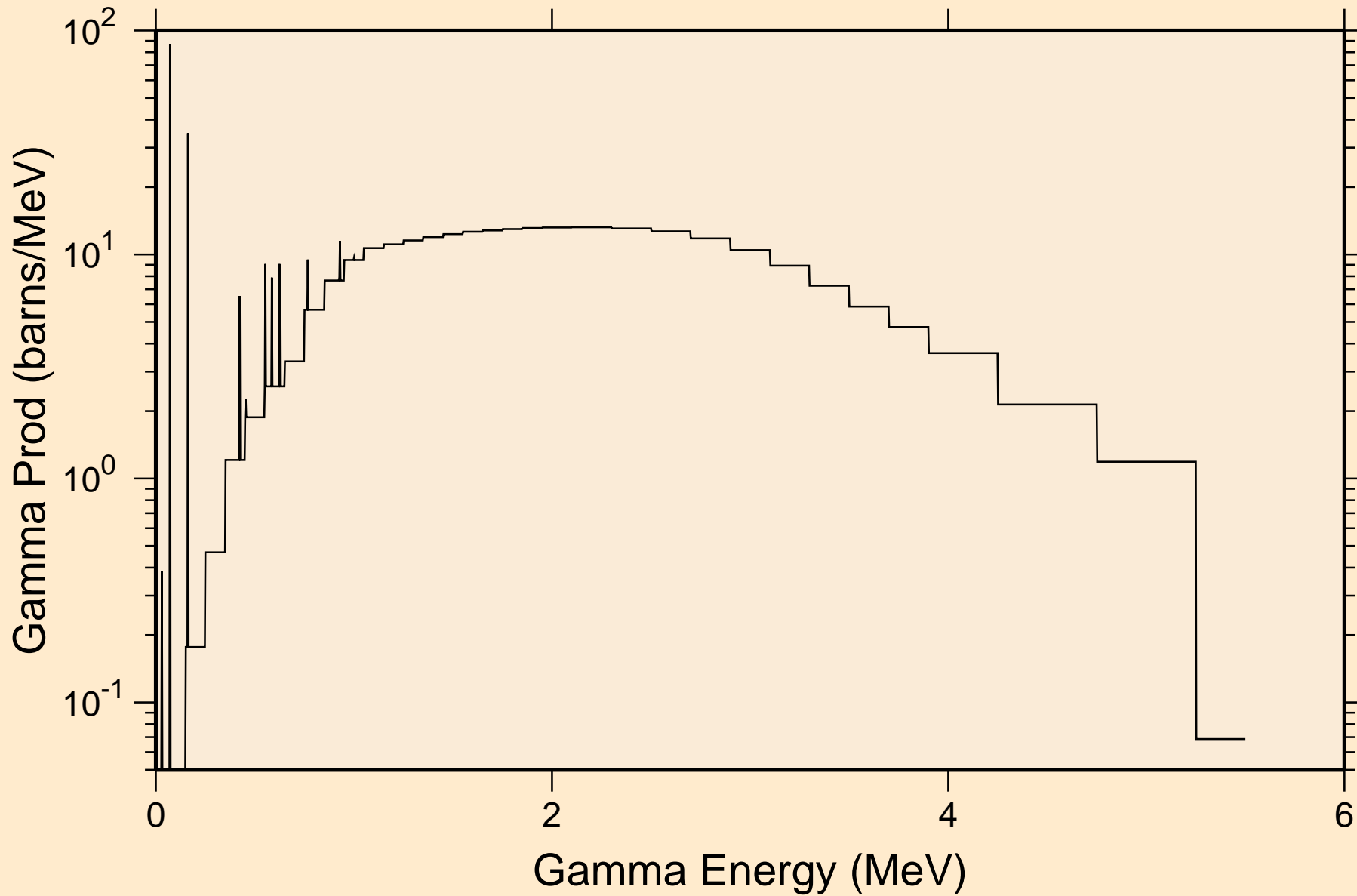

DY169 NEUTRON ACER TENDL-2021 LIBRARY; T=293.6K
14 MeV photon spectrum

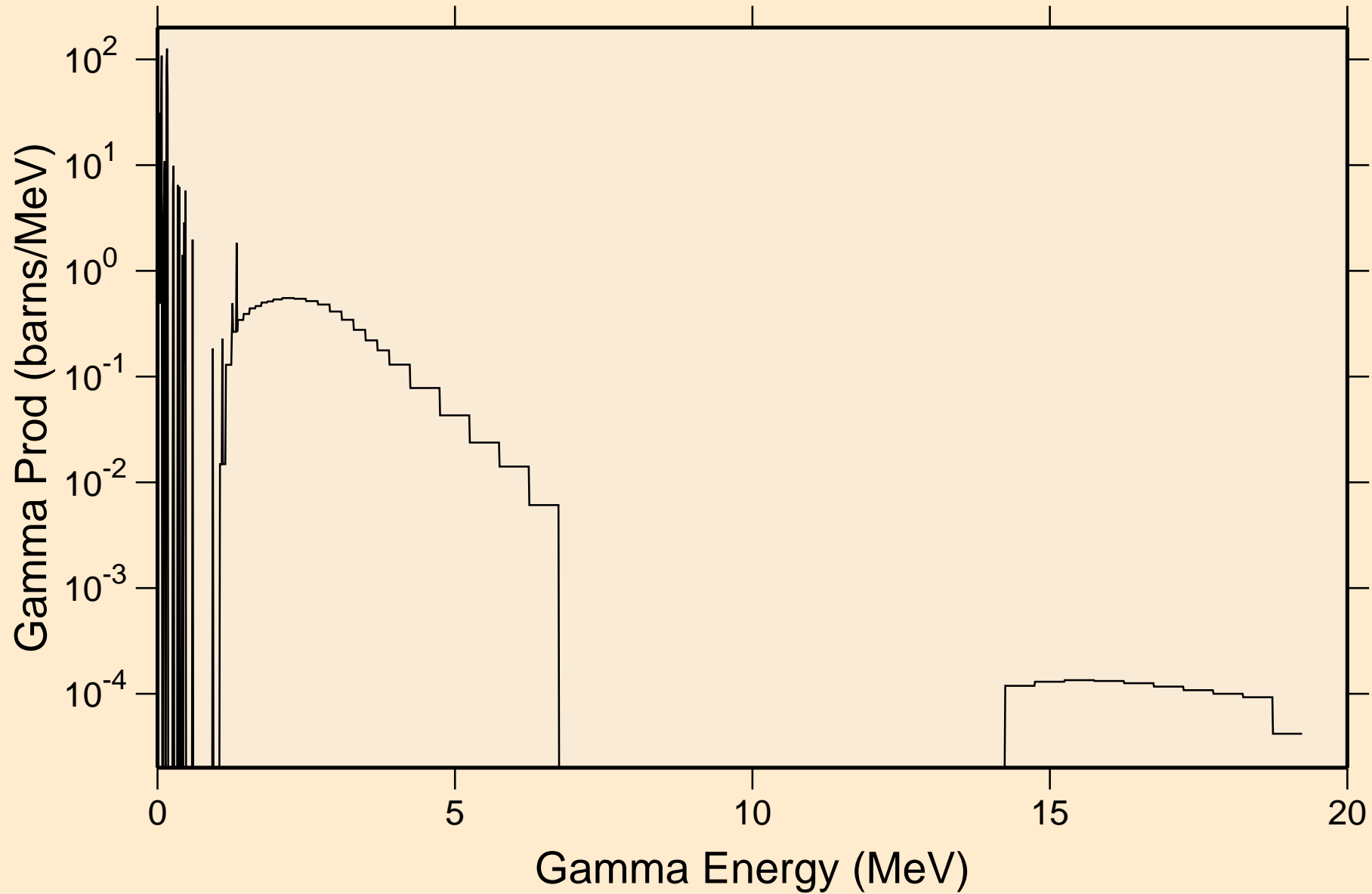

DY169 NEUTRON ACER TENDL-2021 LIBRARY; T=293.6K
Particle heating contributions

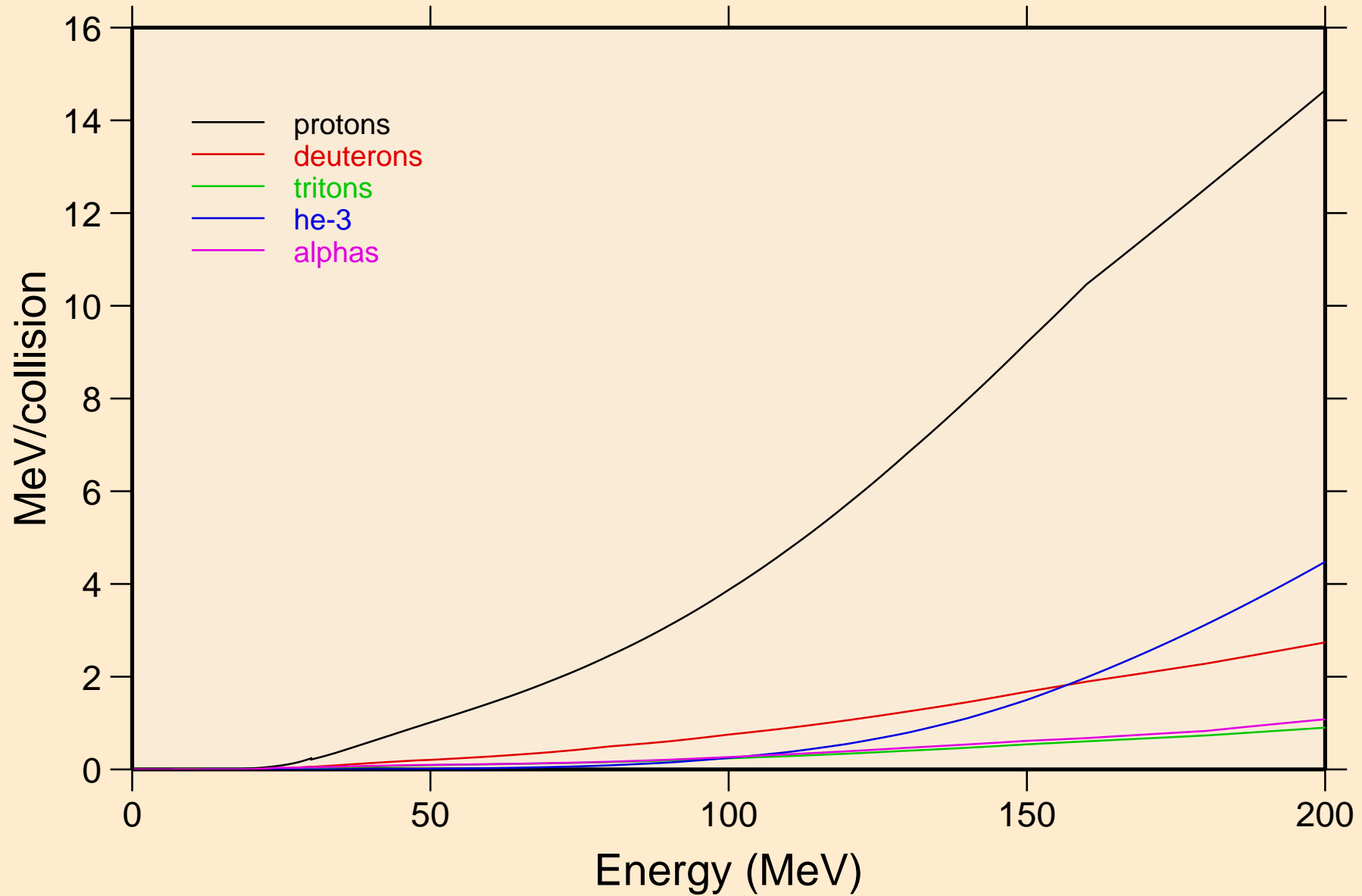

DY169 NEUTRON ACER TENDL-2021 LIBRARY; T=293.6K
Recoil Heating

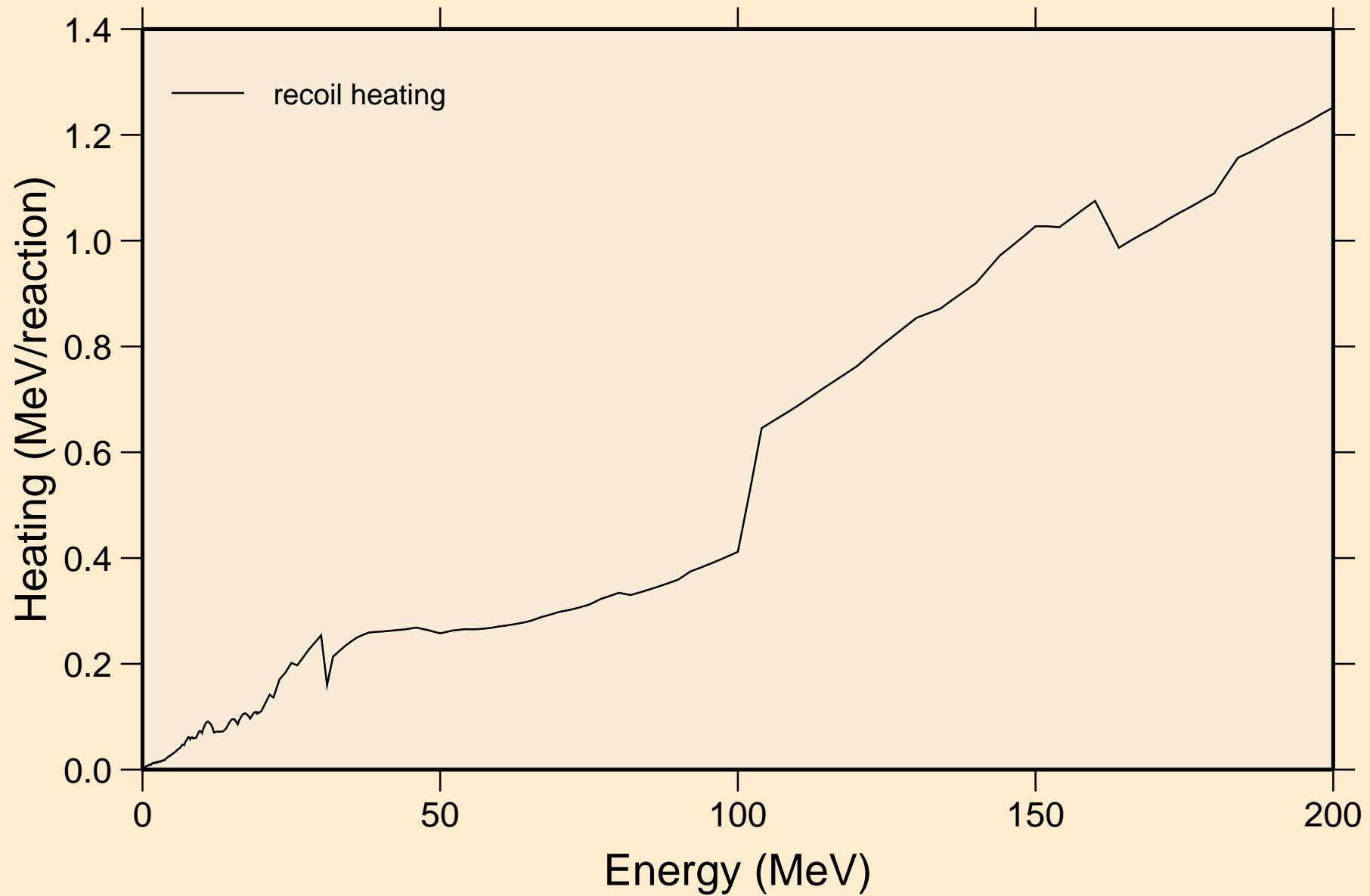

DY169 NEUTRON ACER TENDL-2021 LIBRARY; T=293.6K
Particle production cross sections

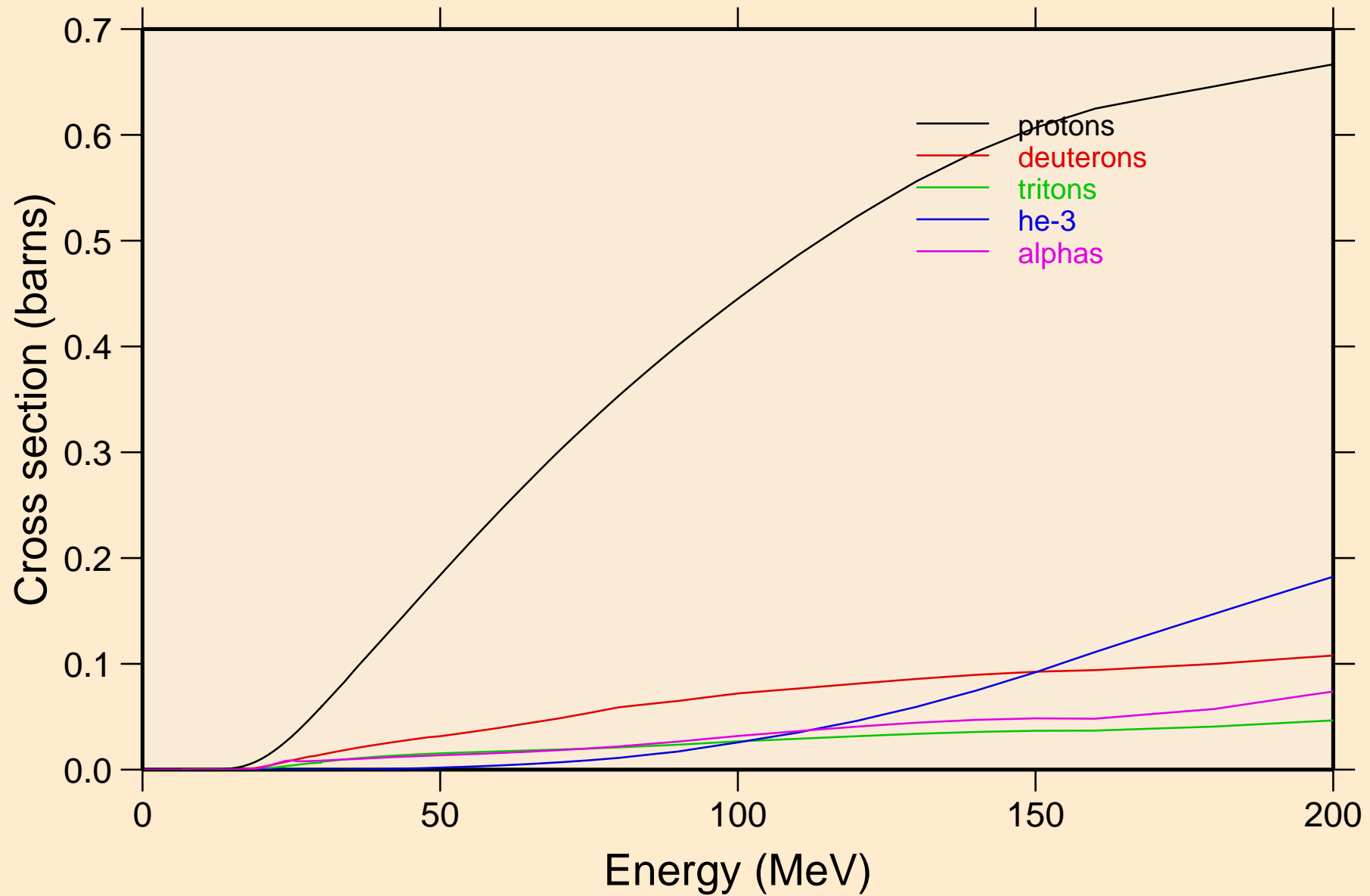

DY169 NEUTRON ACER TENDL-2021 LIBRARY; T=293.6K
protons from (n,x)

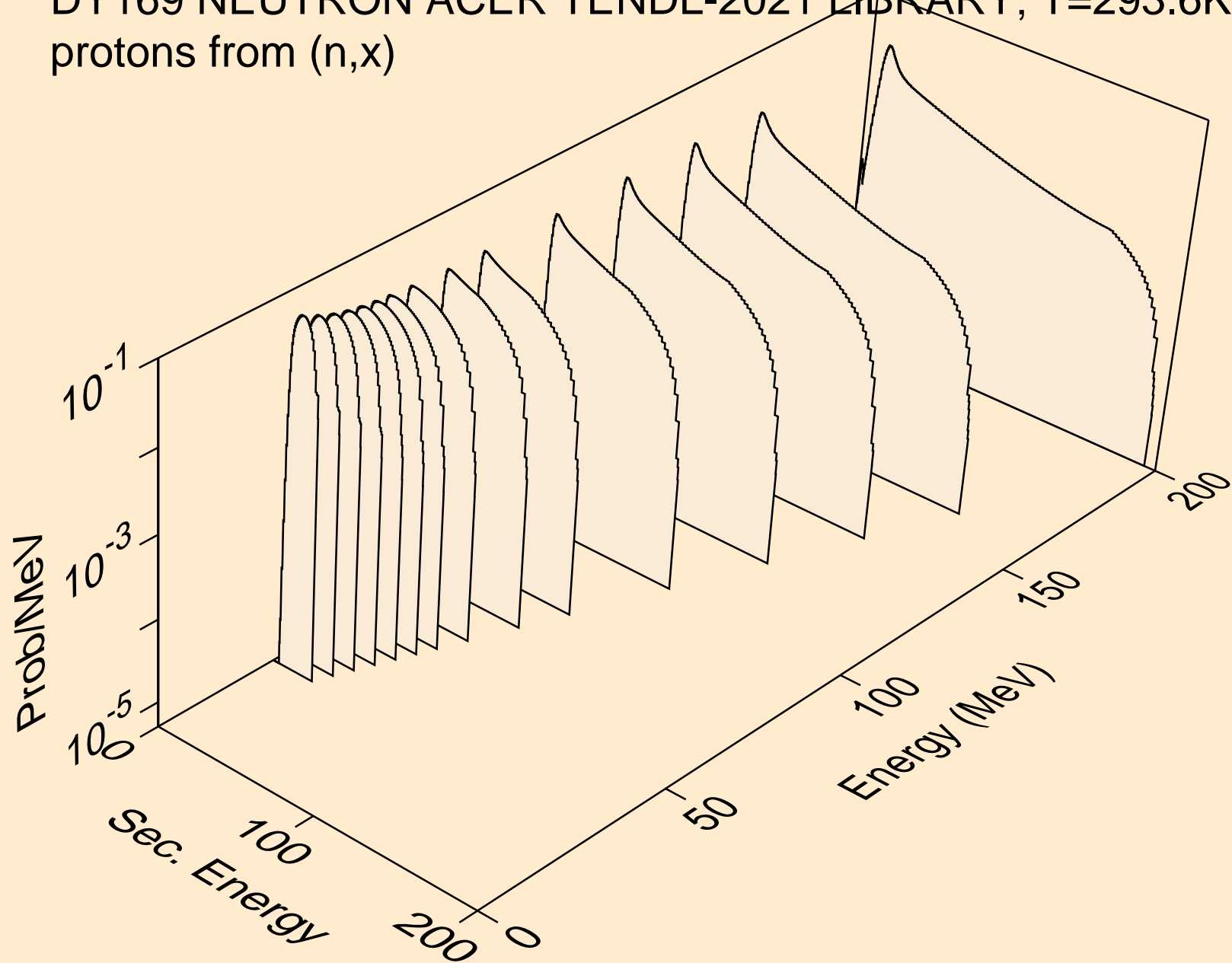

DY169 NEUTRON ACER TENDL-2021 LIBRARY; T=293.6K
protons from (n,n*)p

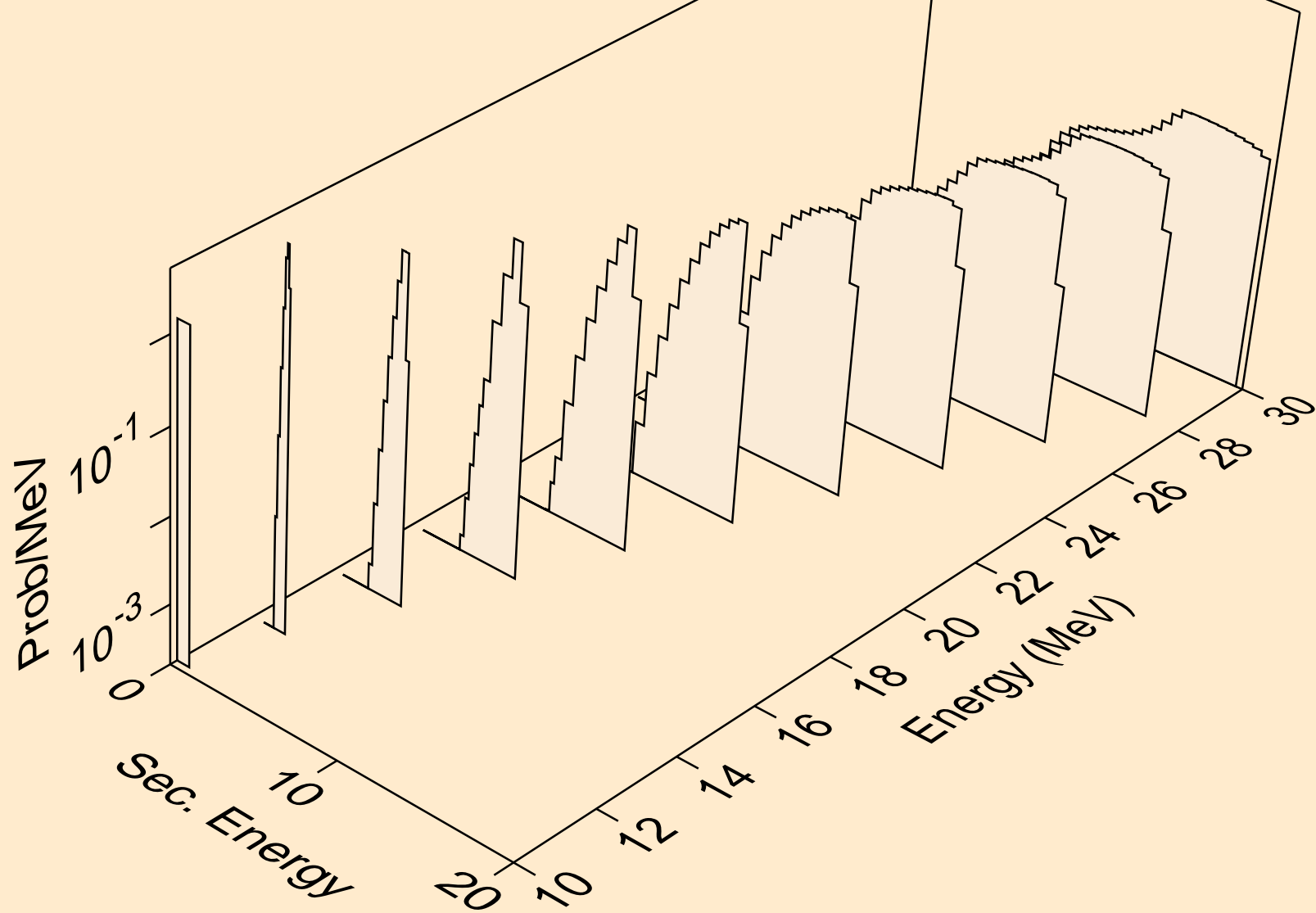

DY169 NEUTRON ACER TENDL-2021 LIBRARY; T=293.6K
protons from (n,2np)

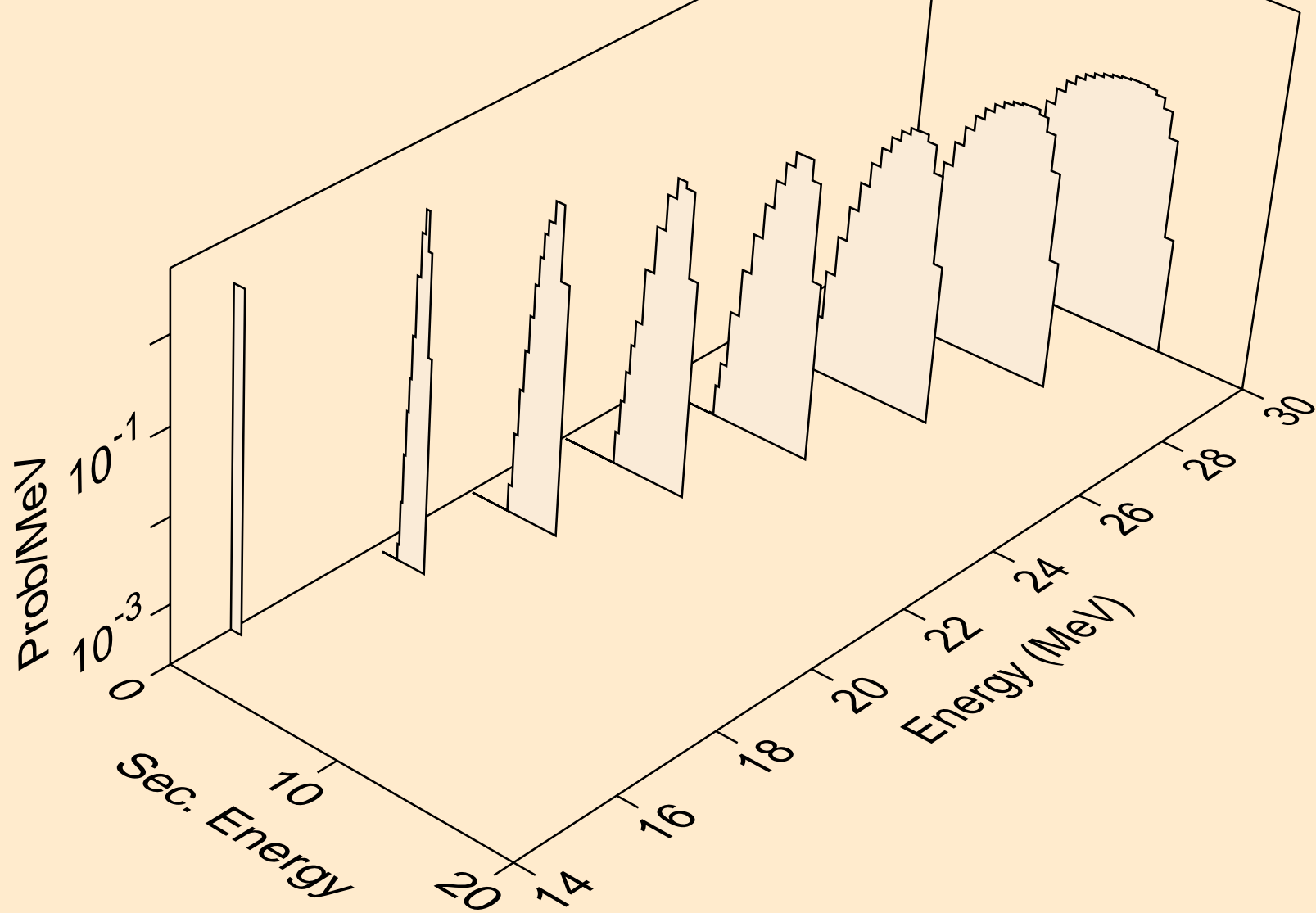

DY169 NEUTRON ACER TENDL-2021 LIBRARY; T=293.6K
protons from (n,3np)

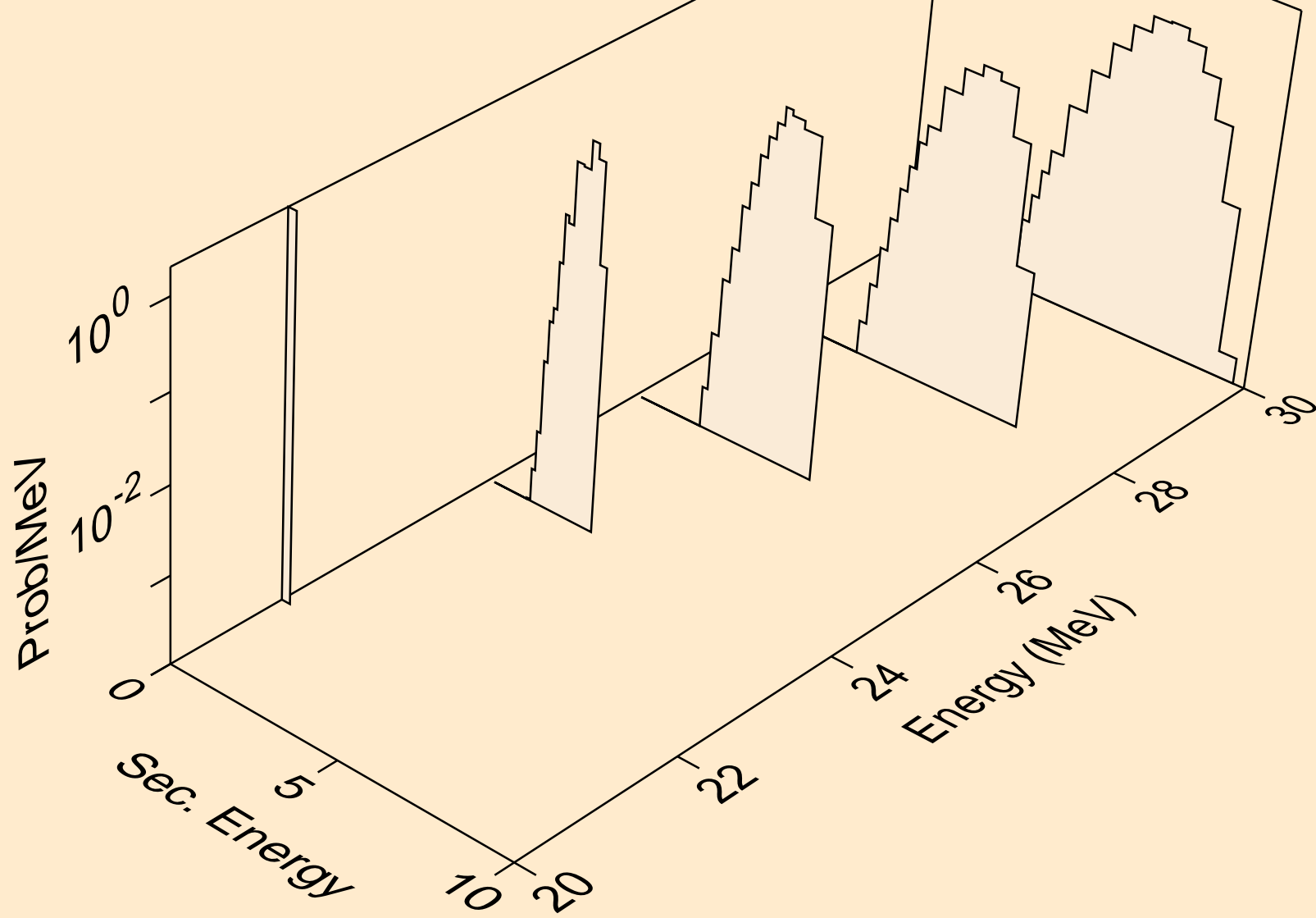

DY169 NEUTRON ACER TENDL-2021 LIBRARY; T=293.6K
protons from (n,p)

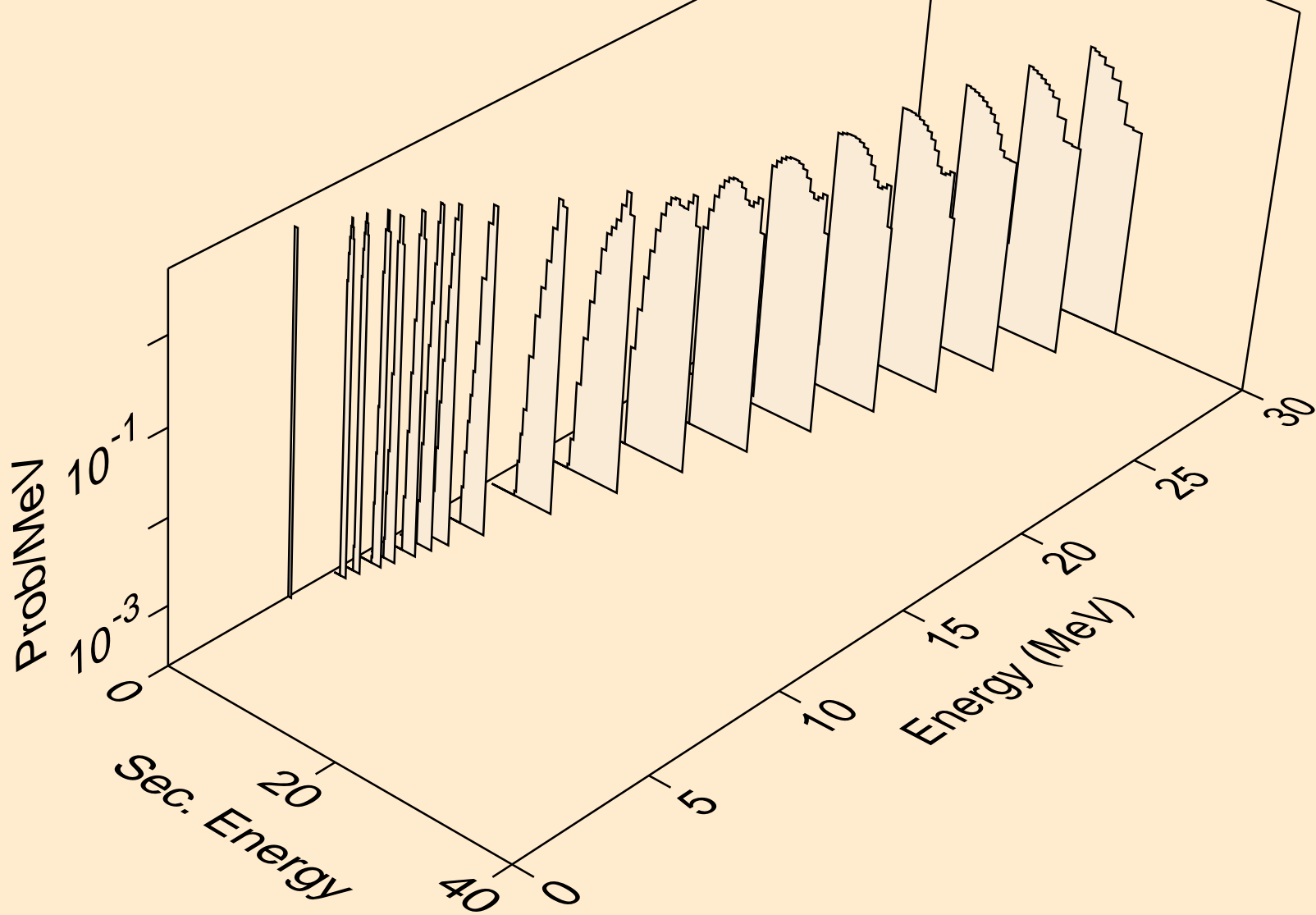

DY169 NEUTRON ACER TENDL-2021 LIBRARY; T=293.6K
protons from (n,2p)

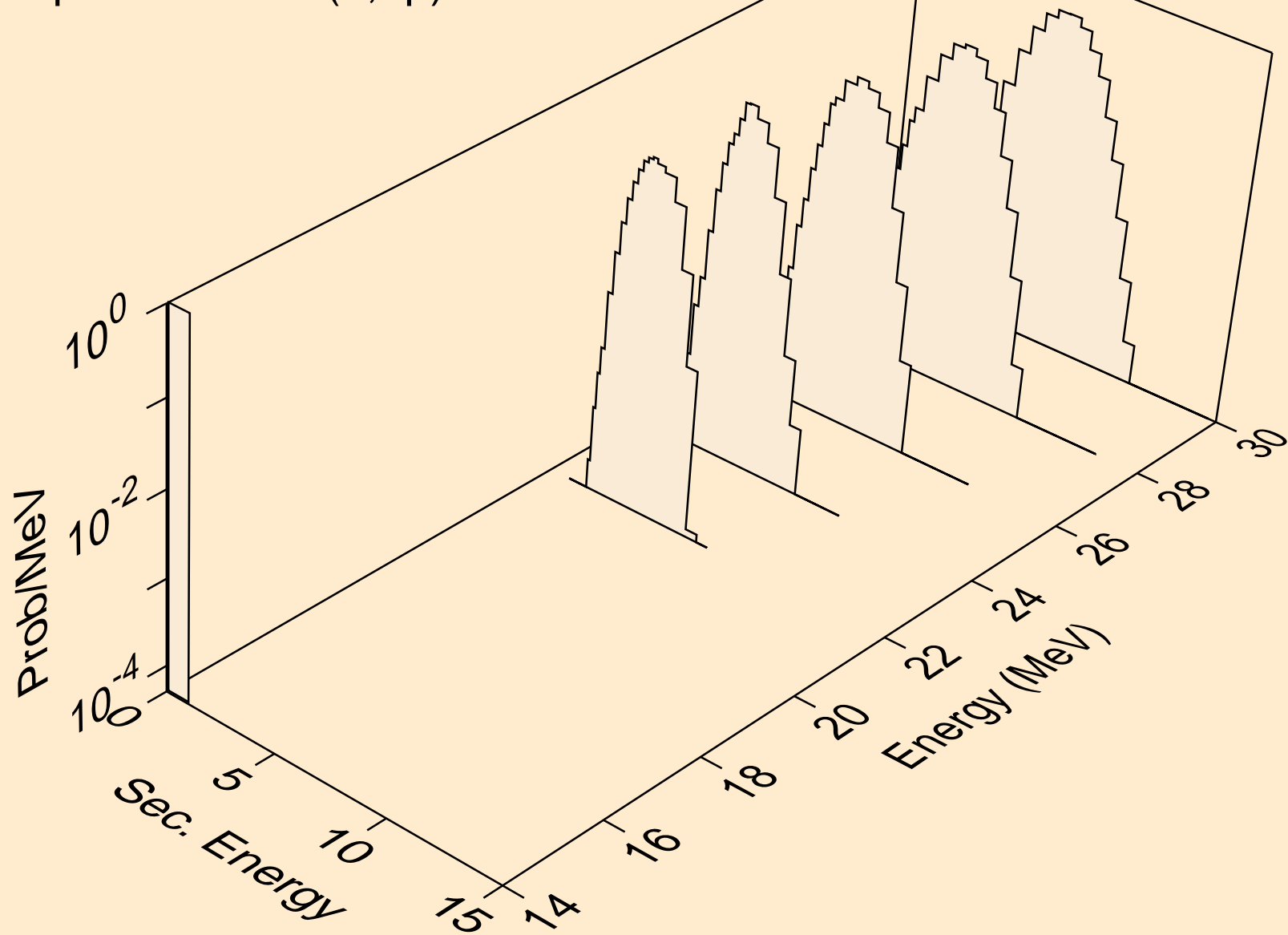

DY169 NEUTRON ACER TENDL-2021 LIBRARY; T=293.6K
deuterons from (n,x)

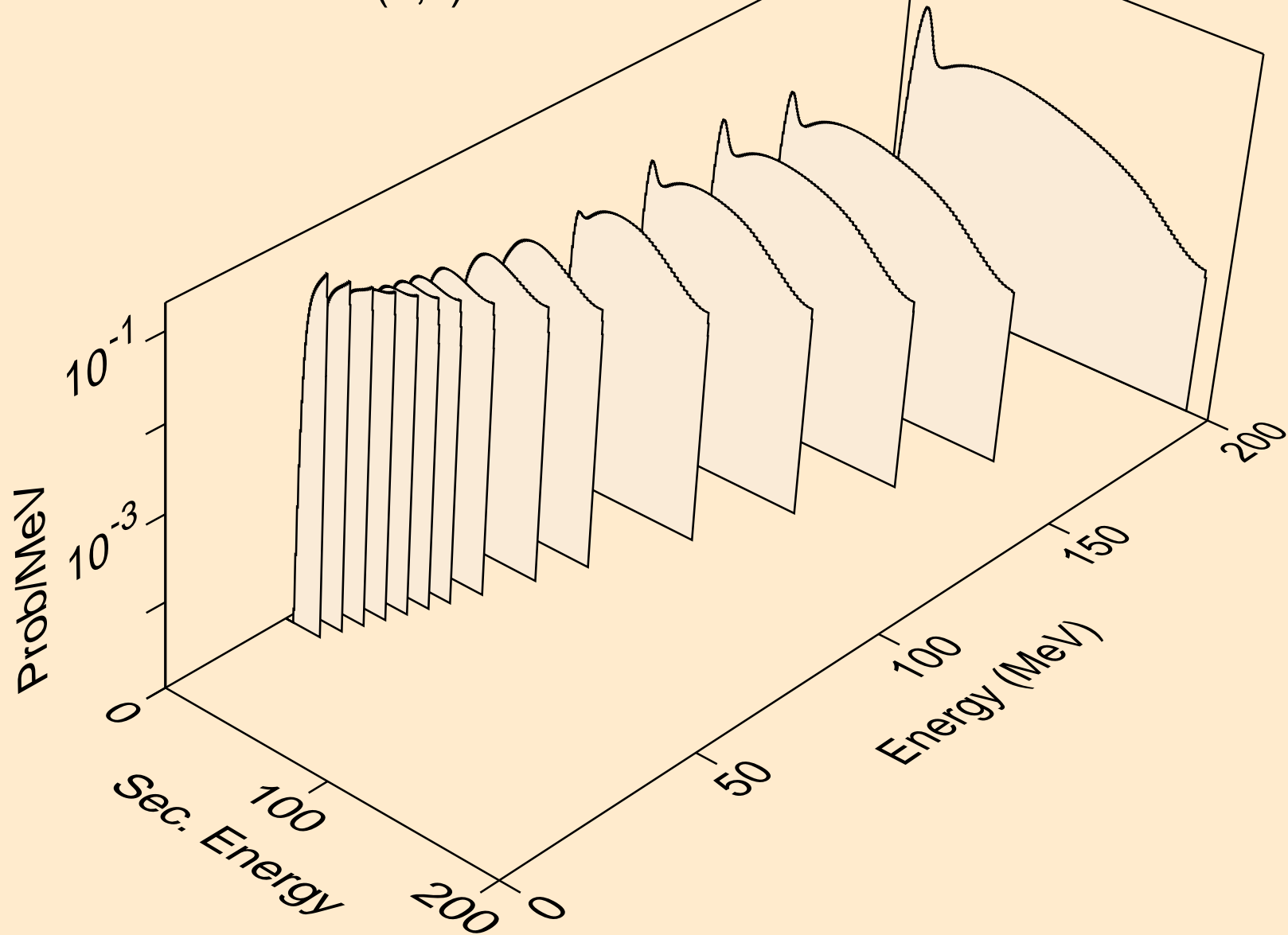

DY169 NEUTRON ACER TENDL-2021 LIBRARY; T=293.6K
deuterons from (n,2nd)

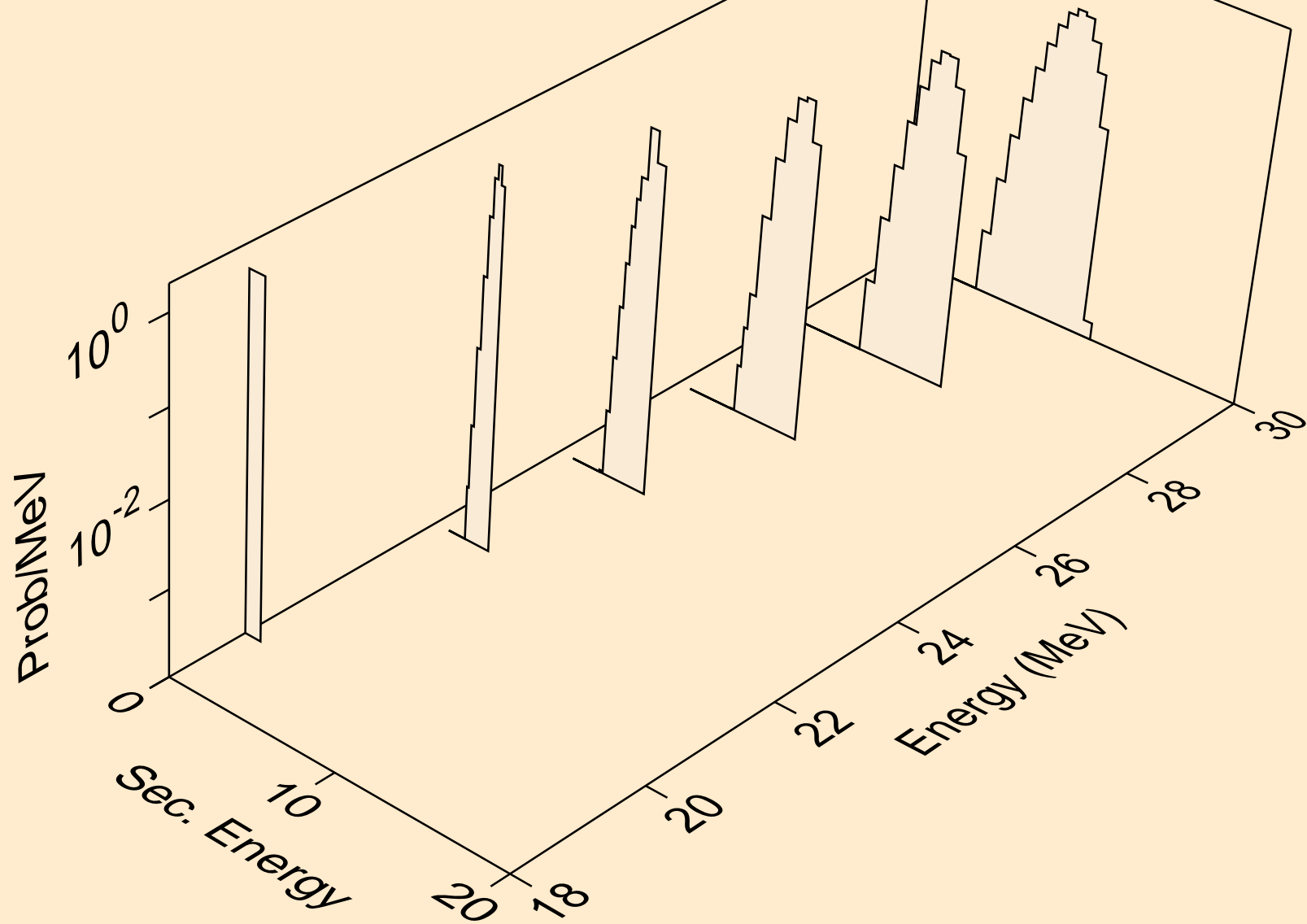

DY169 NEUTRON ACER TENDL-2021 LIBRARY; T=293.6K
deuterons from (n,n*)d

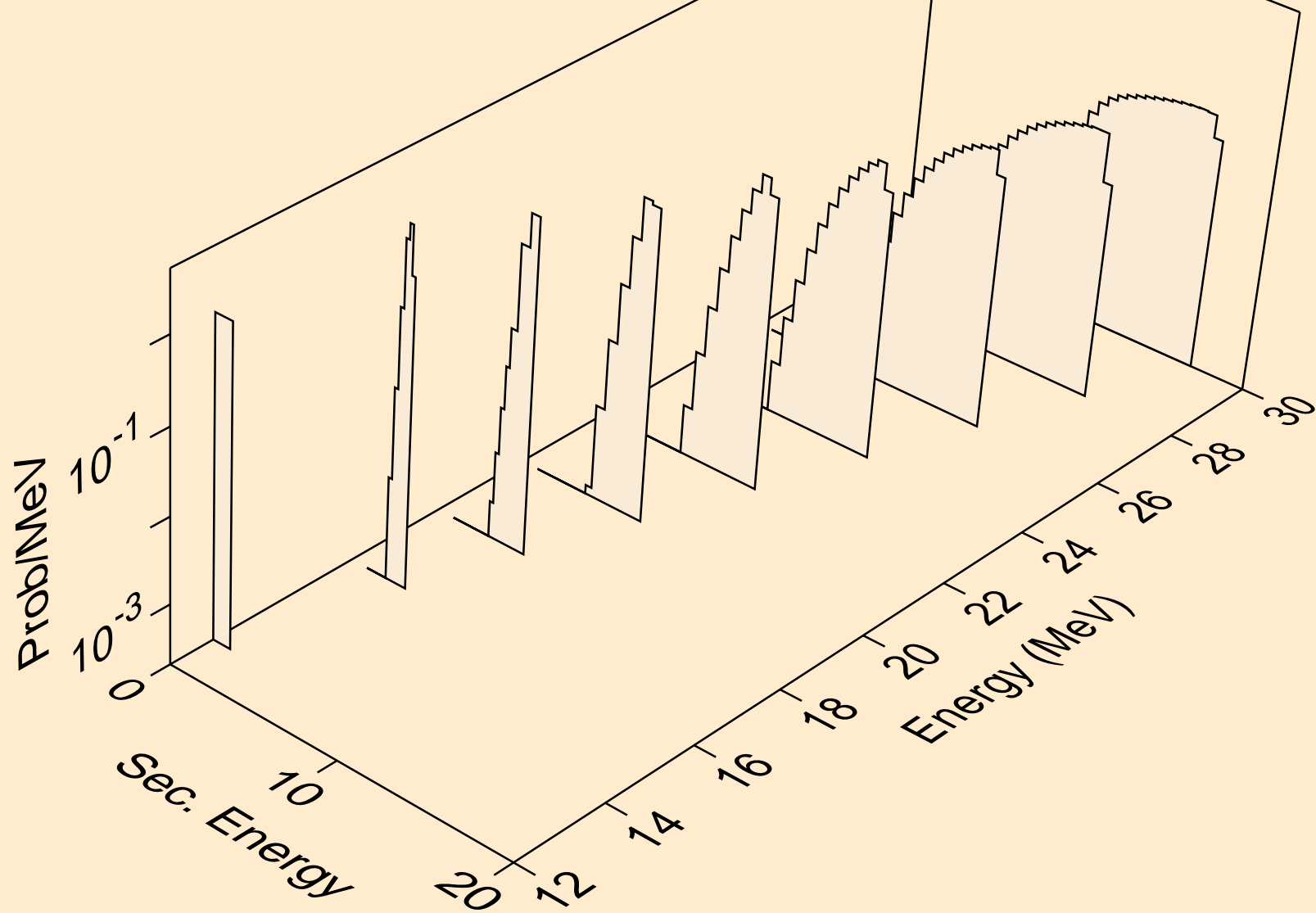

DY169 NEUTRON ACER TENDL-2021 LIBRARY; T=293.6K
deuterons from (n,d)

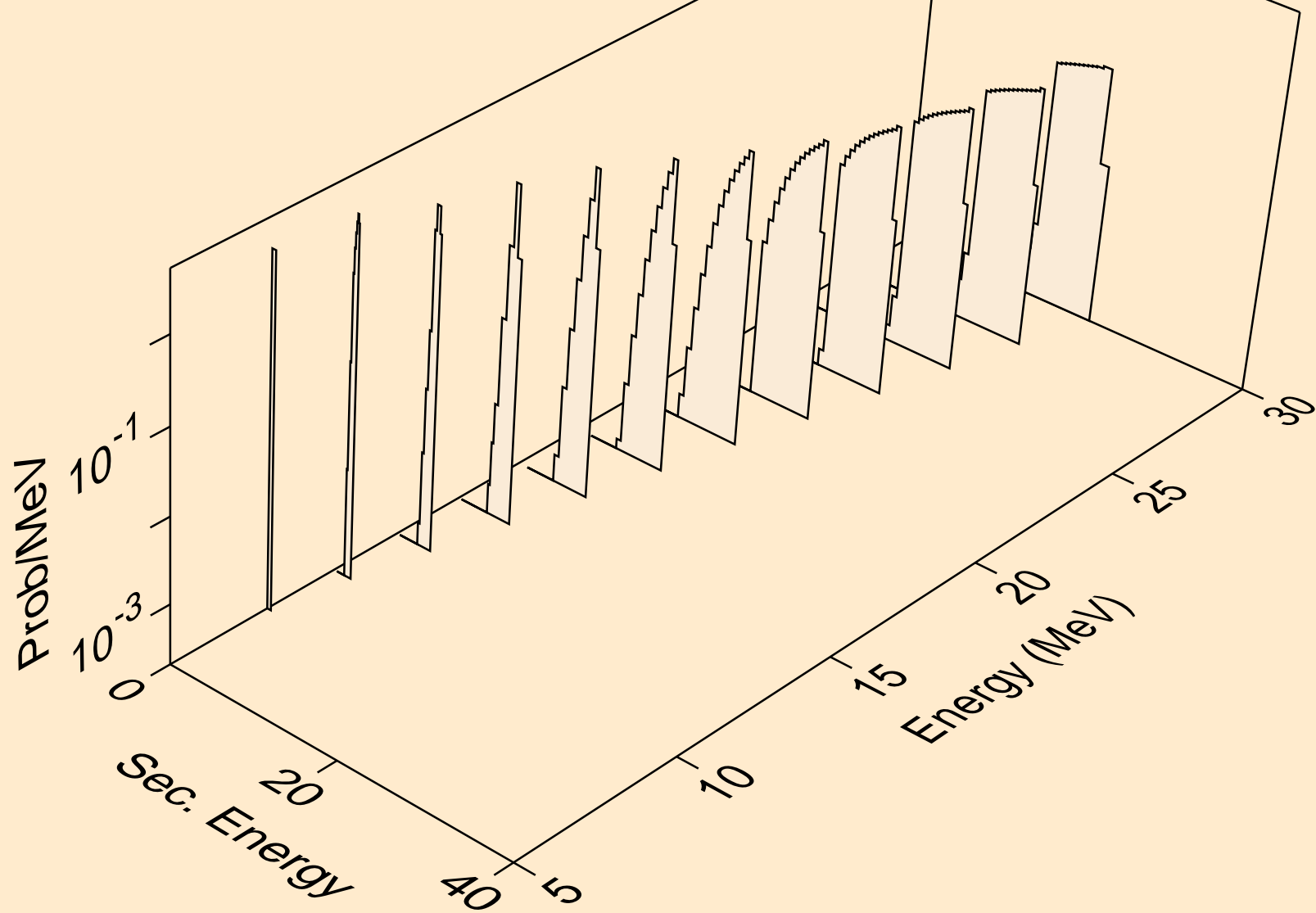

DY169 NEUTRON ACER TENDL-2021 LIBRARY; T=293.6K
tritons from (n,x)

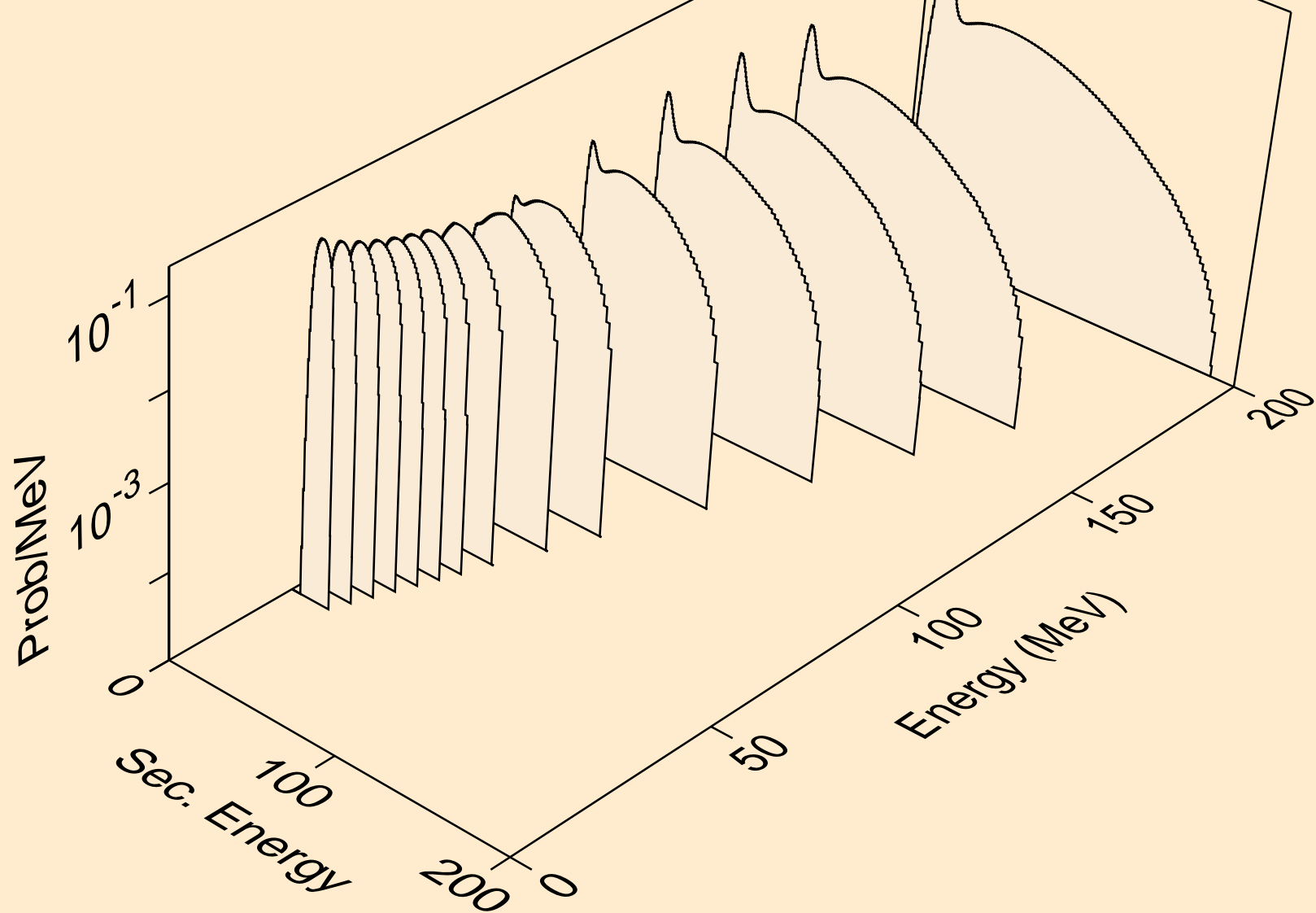

DY169 NEUTRON ACER TENDL-2021 LIBRARY; T=293.6K
tritons from (n,n*)t

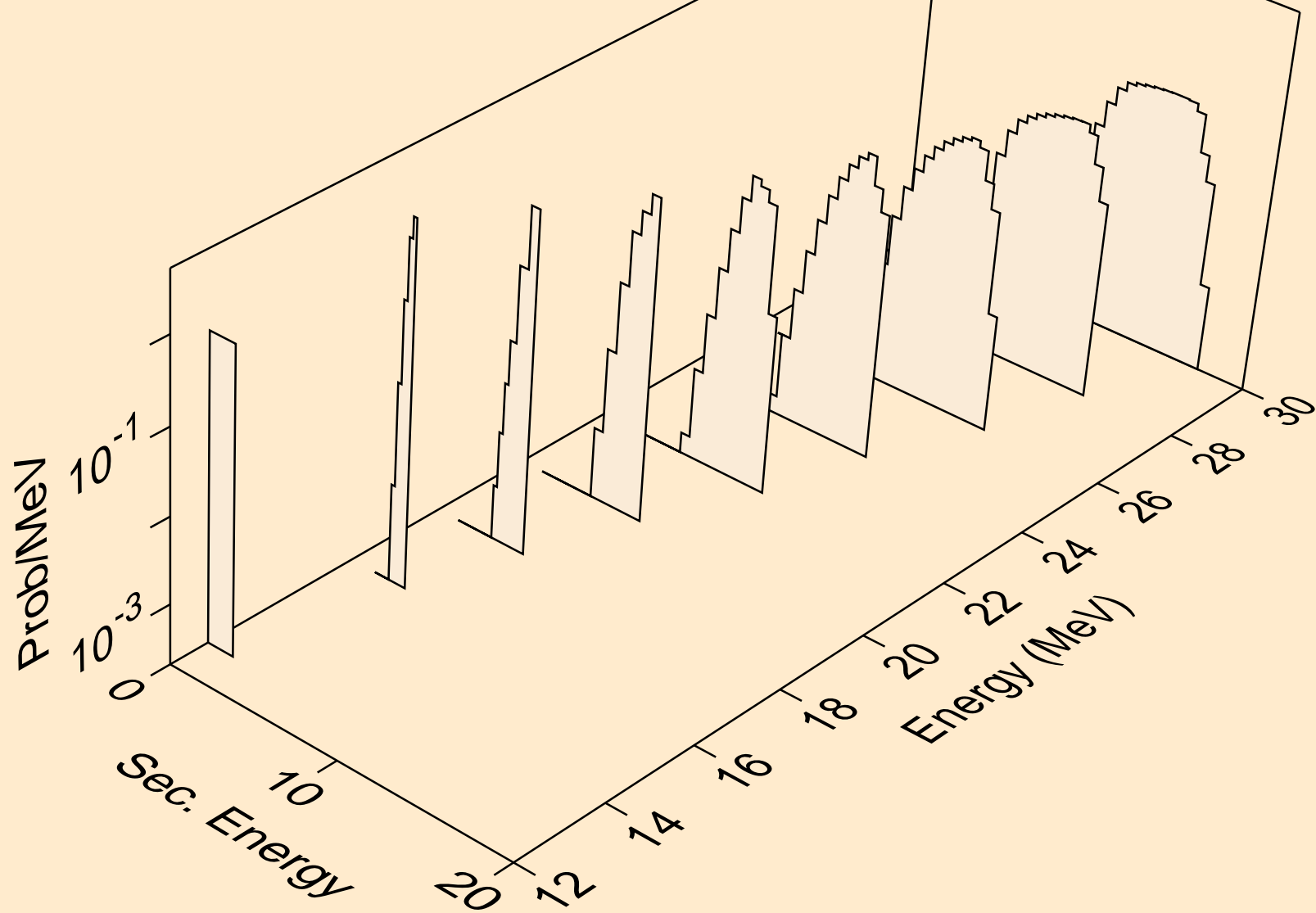

DY169 NEUTRON ACER TENDL-2021 LIBRARY; T=293.6K
tritons from (n,t)

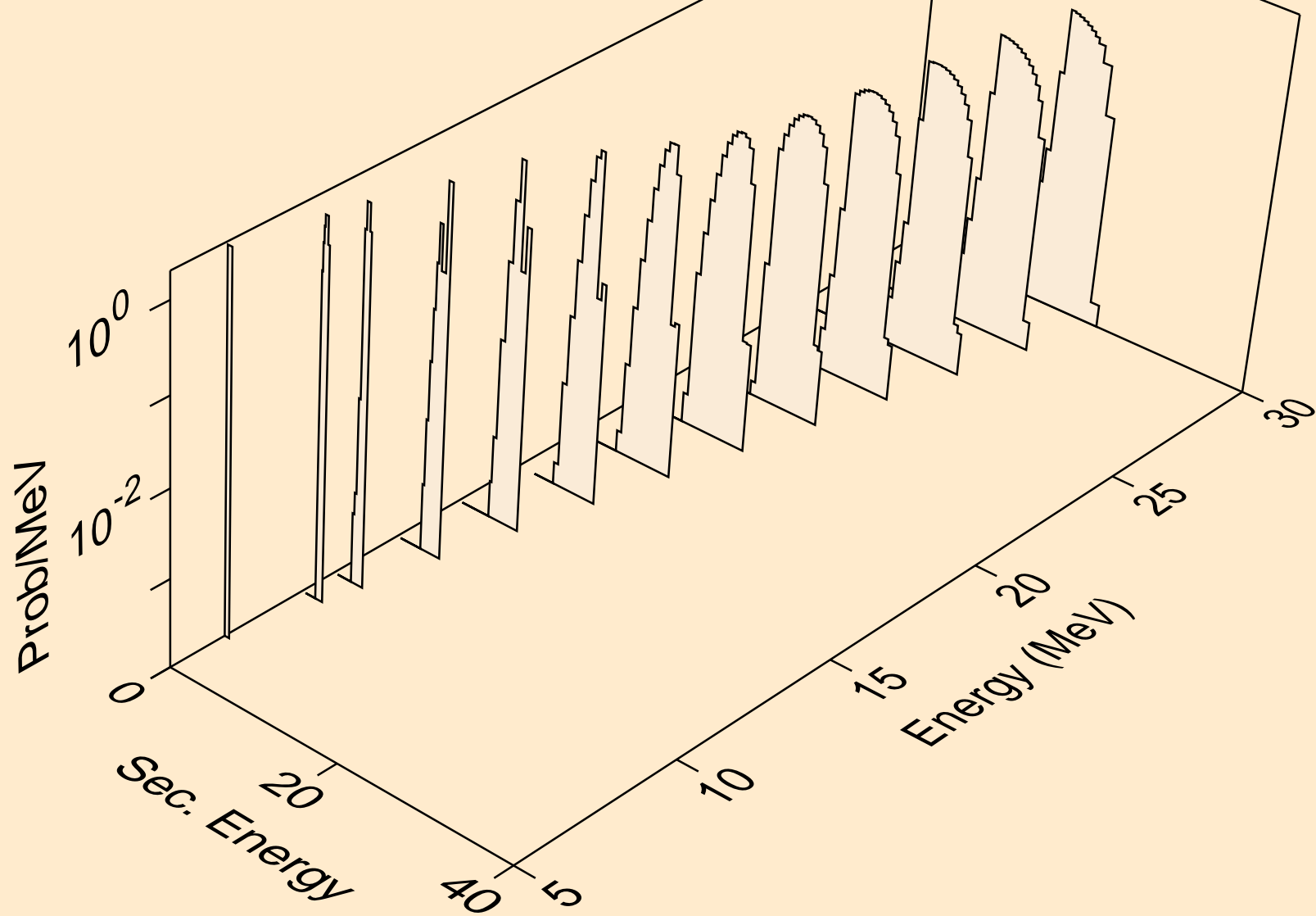

DY169 NEUTRON ACER TENDL-2021 LIBRARY; T=293.6K
he3s from (n,x)

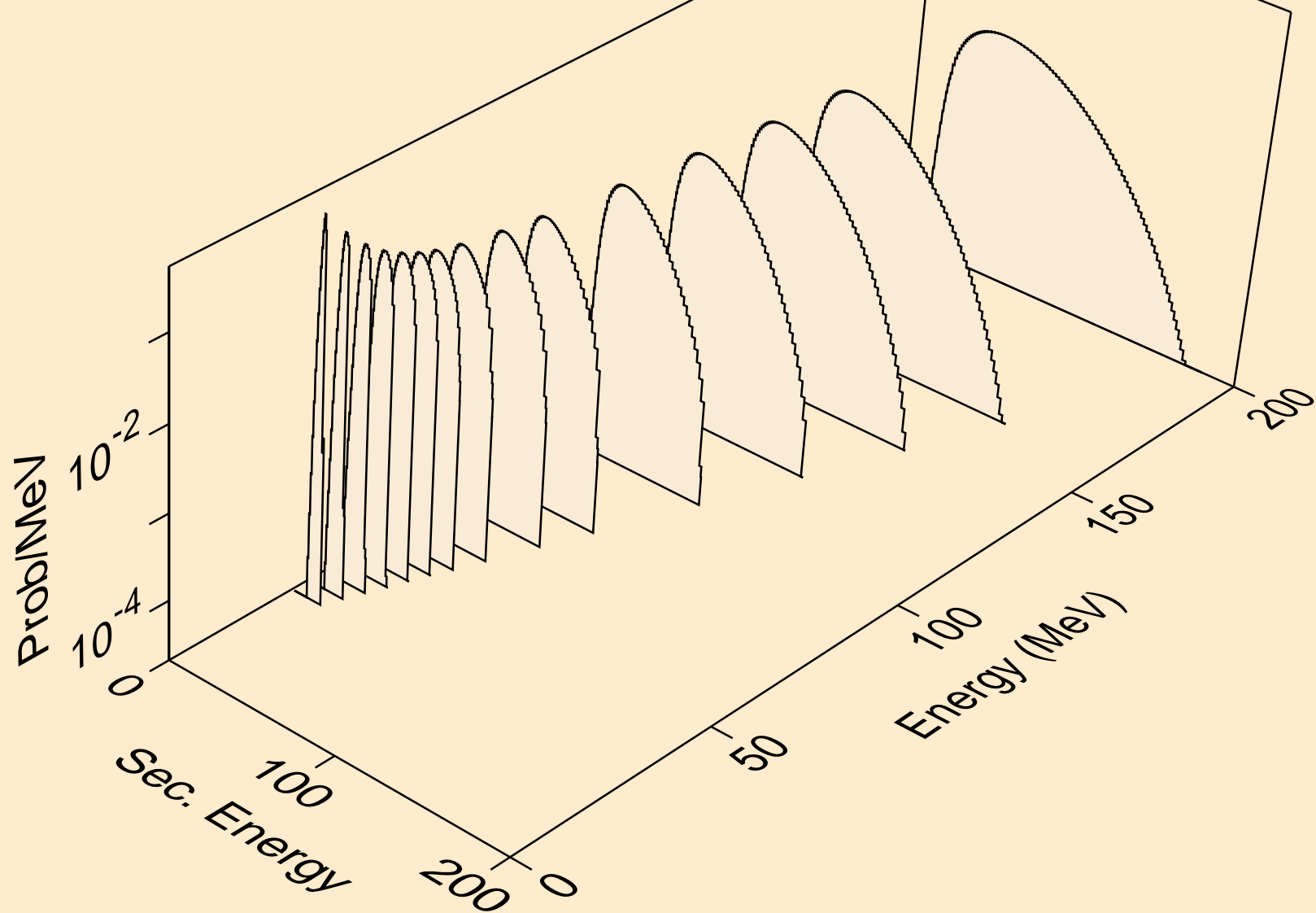

DY169 NEUTRON ACER TENDL-2021 LIBRARY; T=293.6K
he3s from (n,n*)he3

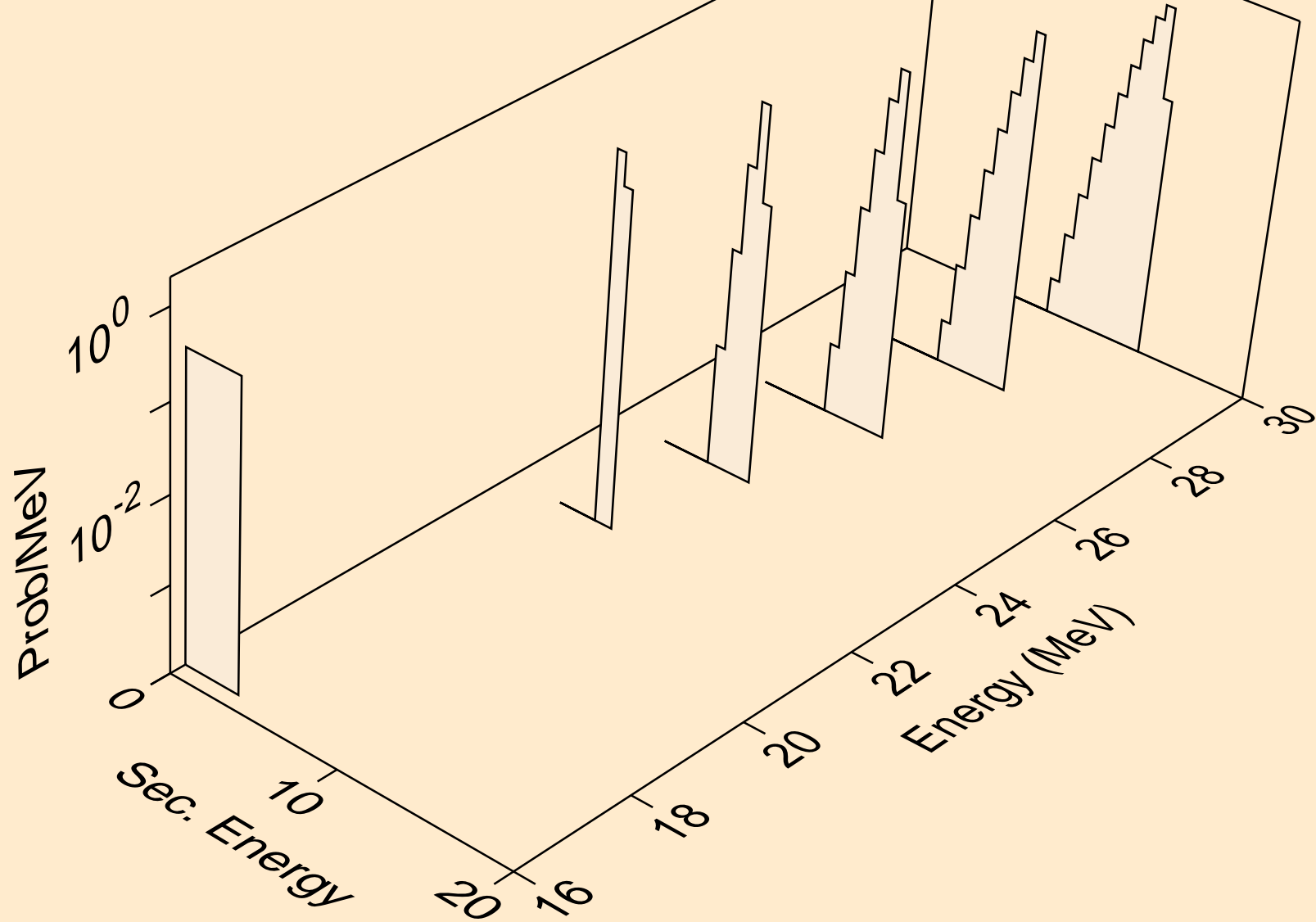

DY169 NEUTRON ACER TENDL-2021 LIBRARY; T=293.6K
he3s from (n,he3)

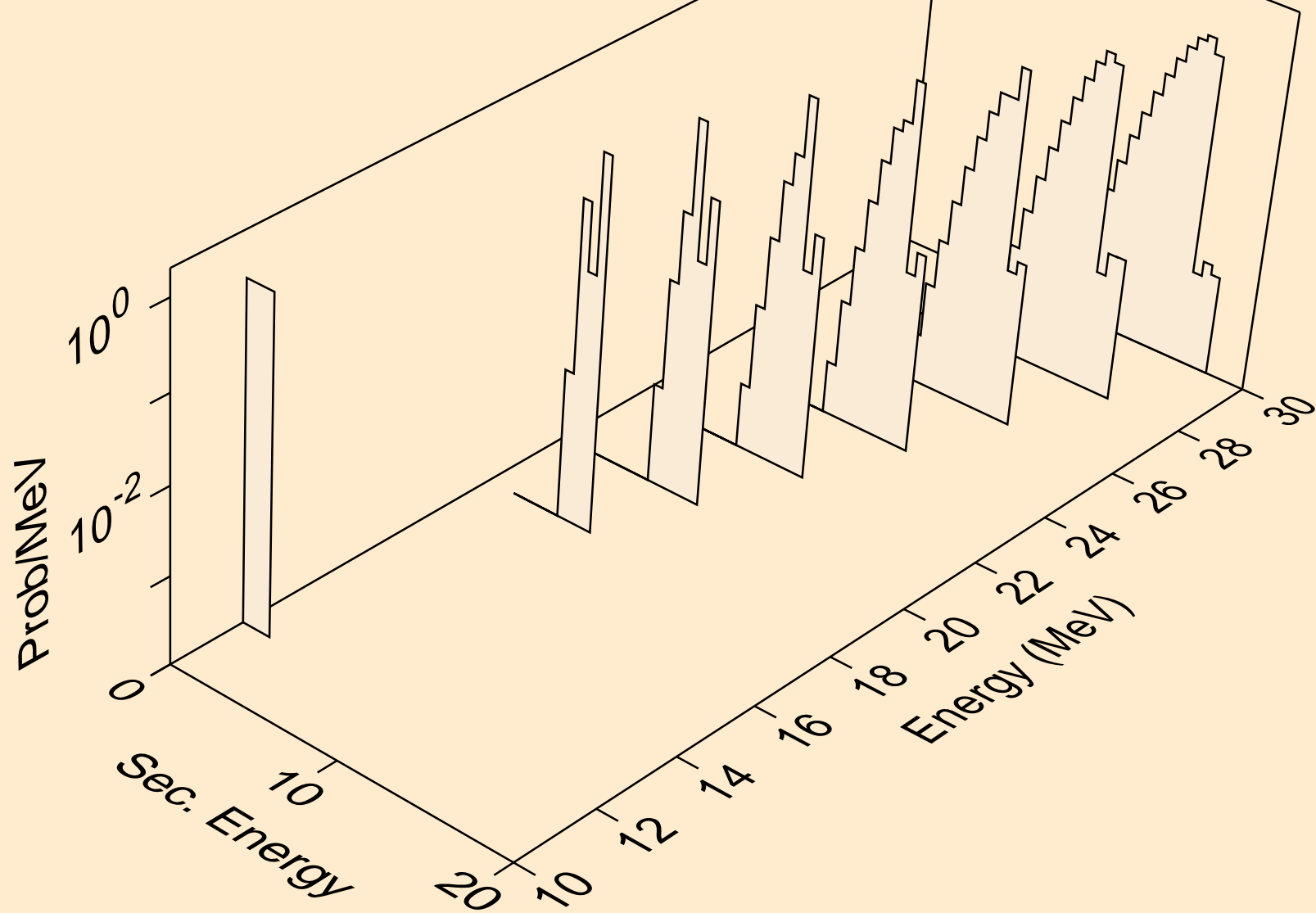

DY169 NEUTRON ACER TENDL-2021 LIBRARY; T=293.6K
alphas from (n,x)

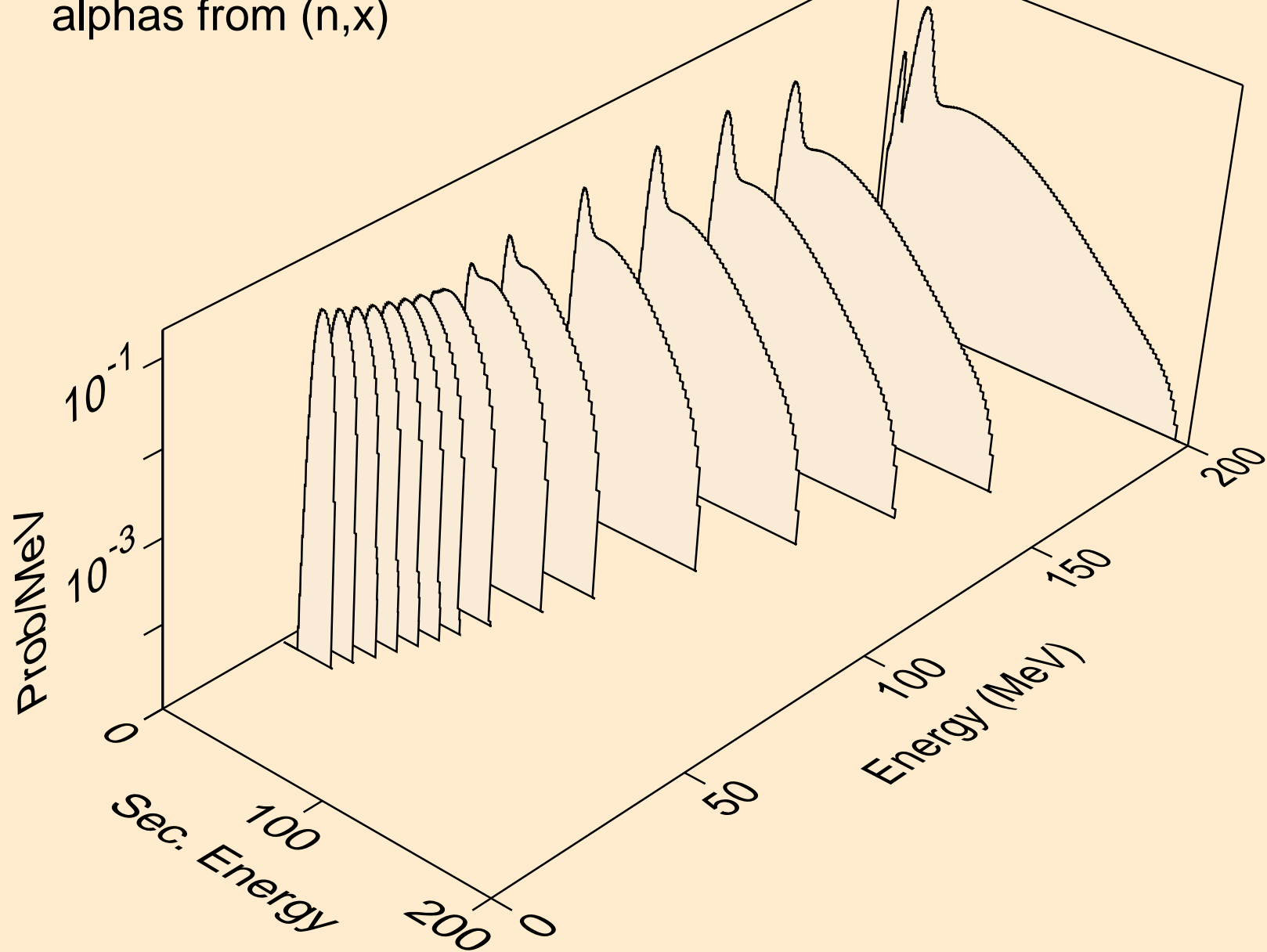

DY169 NEUTRON ACER TENDL-2021 LIBRARY; T=293.6K
alphas from (n,n*)a

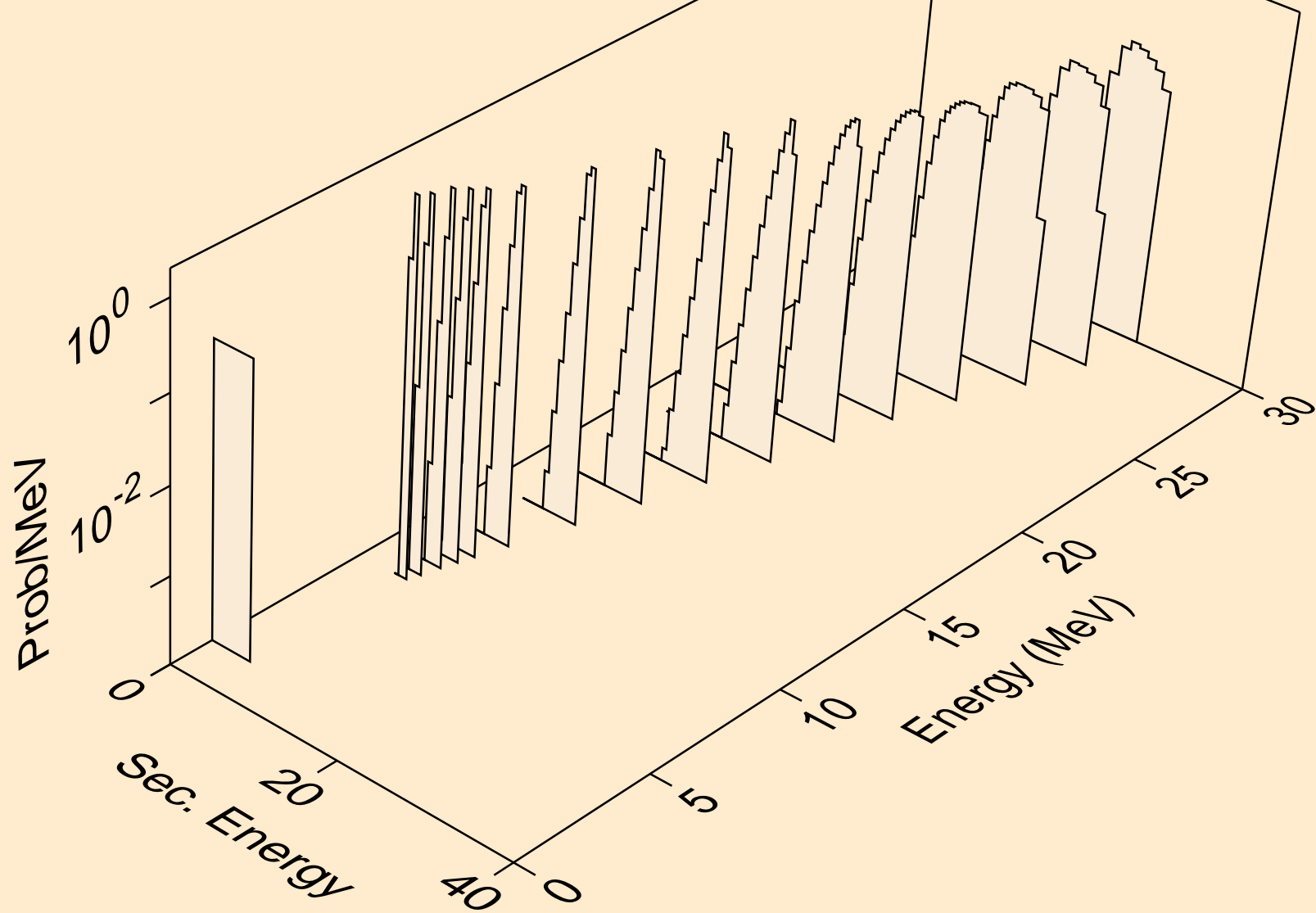

DY169 NEUTRON ACER TENDL-2021 LIBRARY; T=293.6K
alphas from (n,2n)a

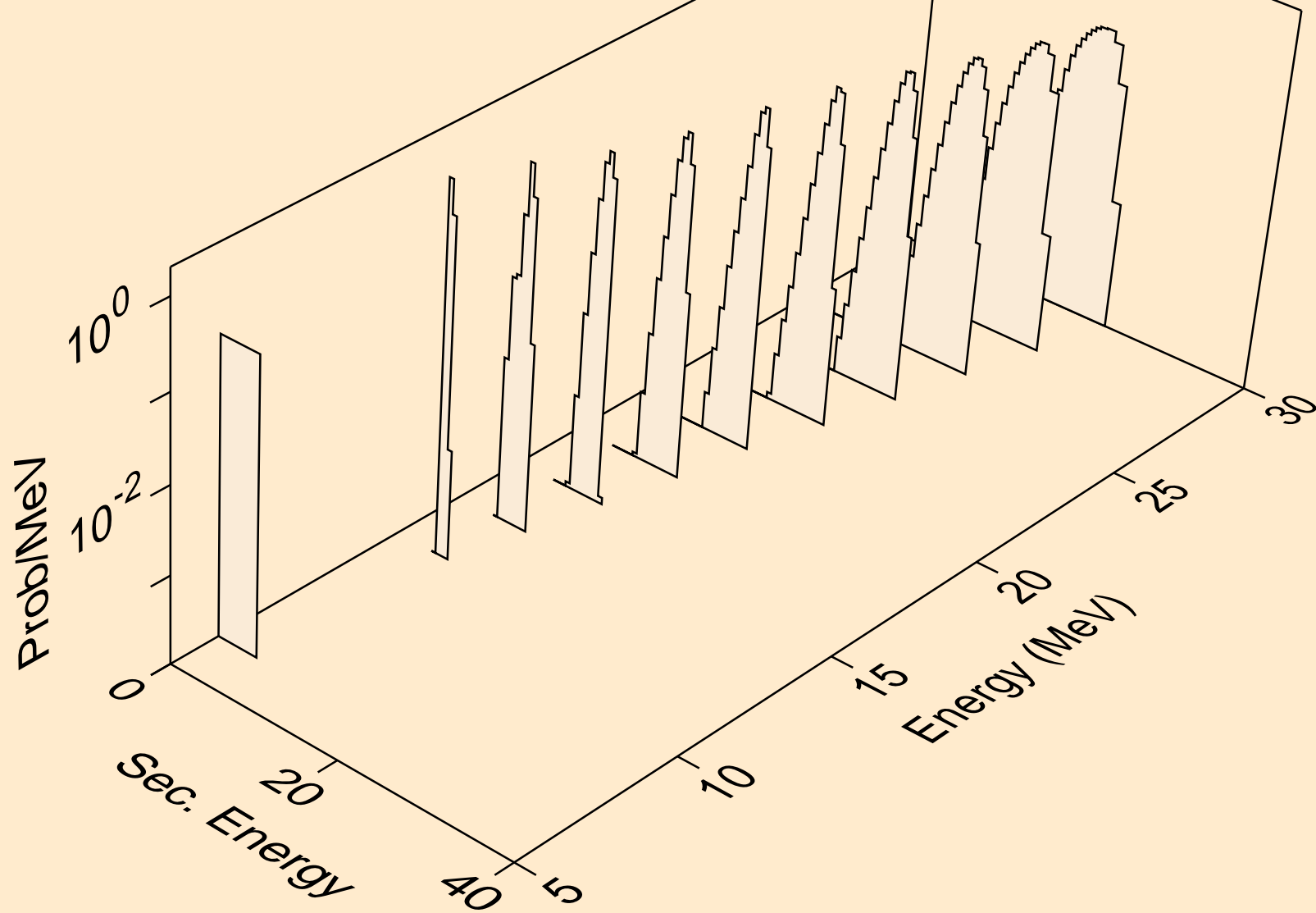

DY169 NEUTRON ACER TENDL-2021 LIBRARY; T=293.6K
alphas from (n,3n)a

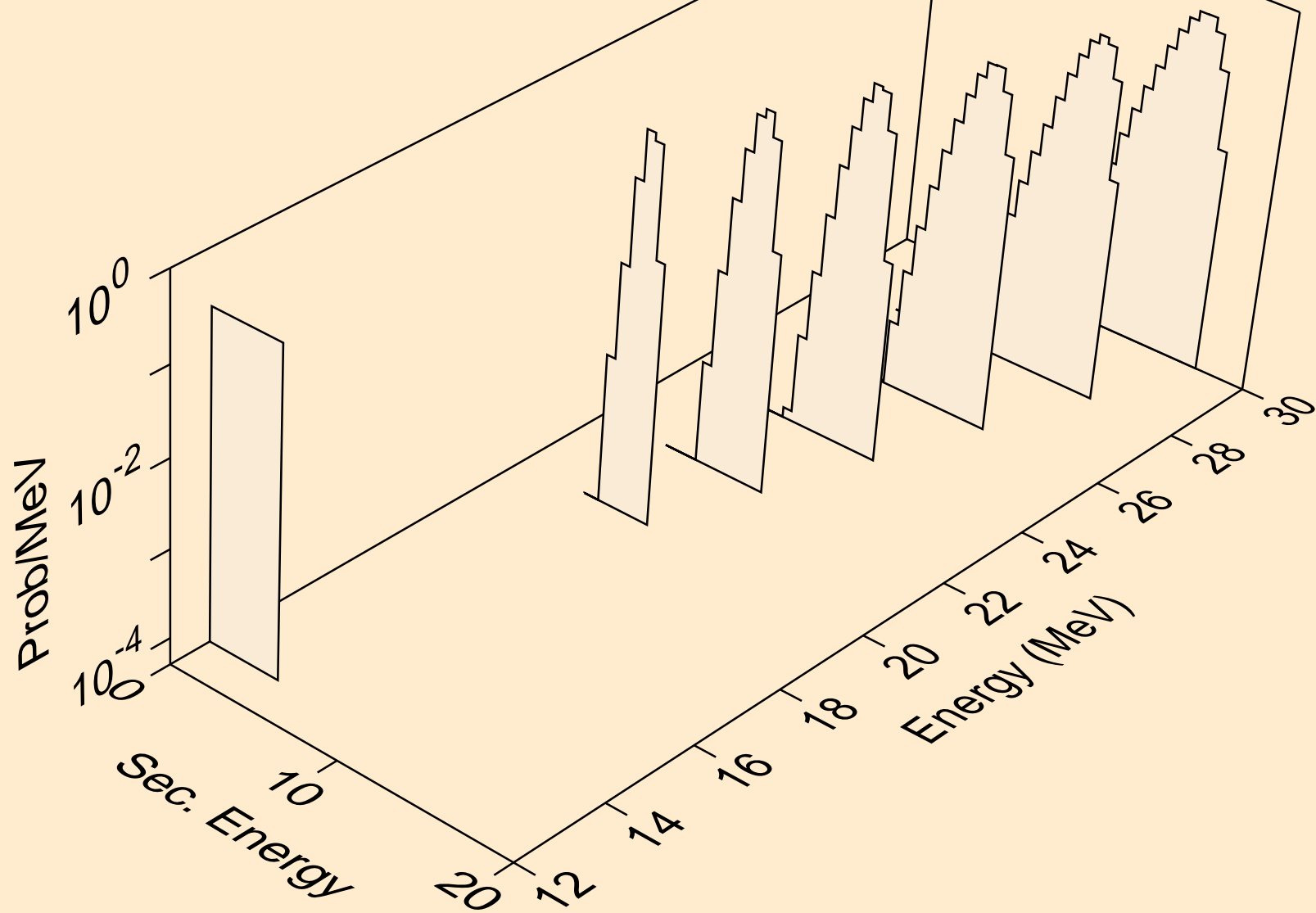

DY169 NEUTRON ACER TENDL-2021 LIBRARY; T=293.6K
alphas from (n,a)

