

DY170 NEUTRON ACER TENDL-2021 LIBRARY; T=293.6K
Principal cross sections

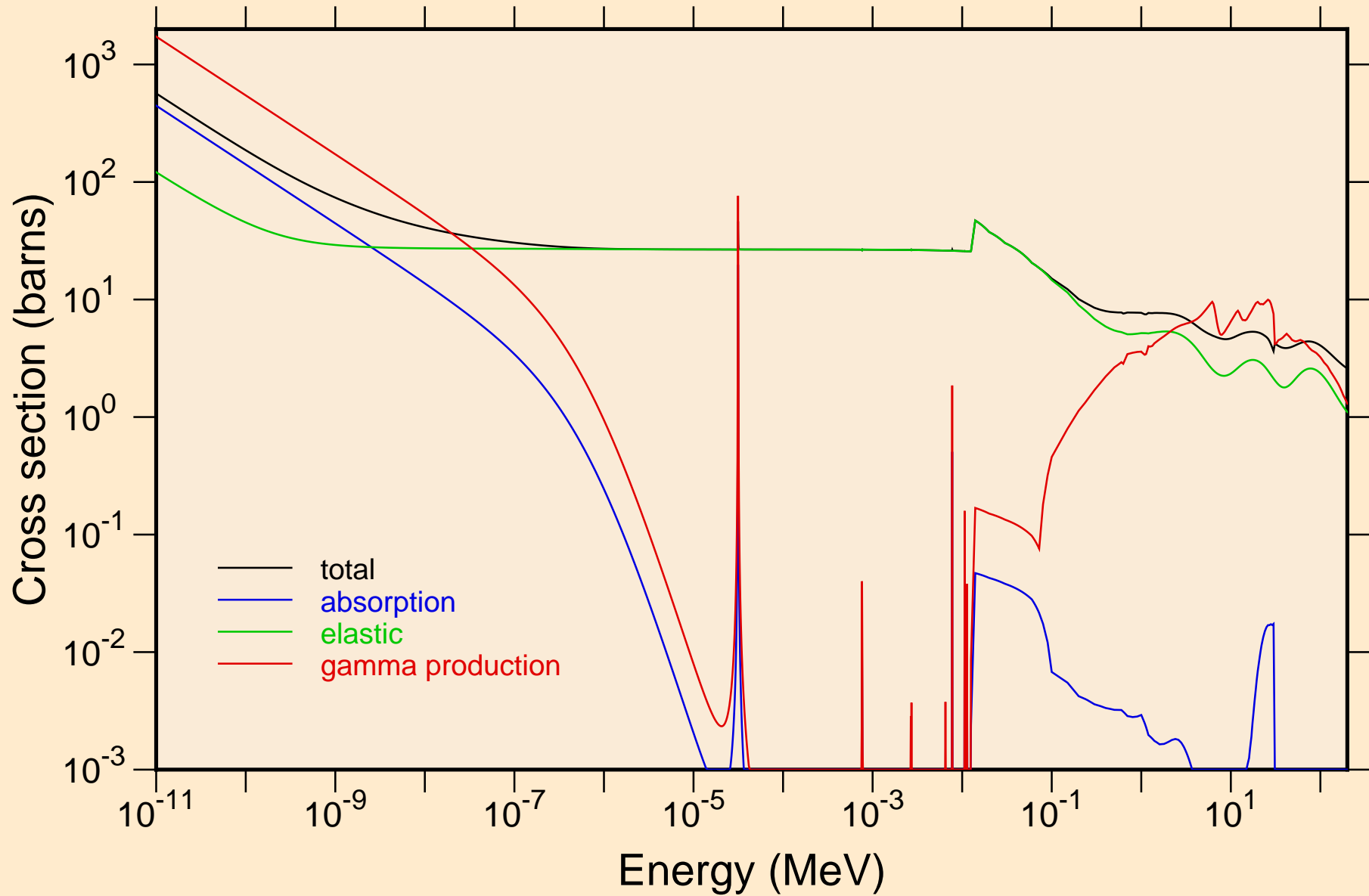

DY170 NEUTRON ACER TENDL-2021 LIBRARY; T=293.6K
resonance total cross section

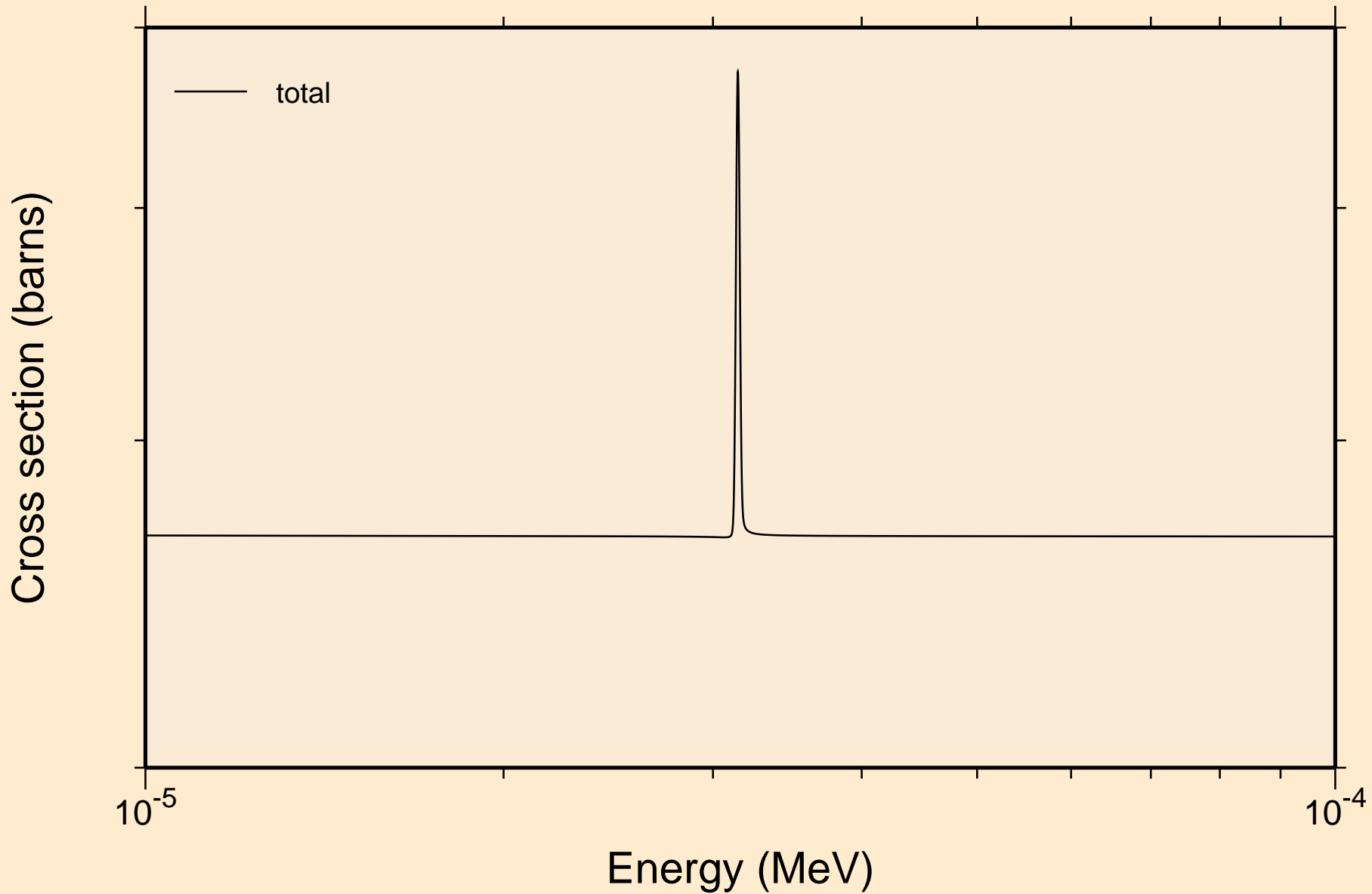

DY170 NEUTRON ACER TENDL-2021 LIBRARY; T=293.6K
resonance total cross section

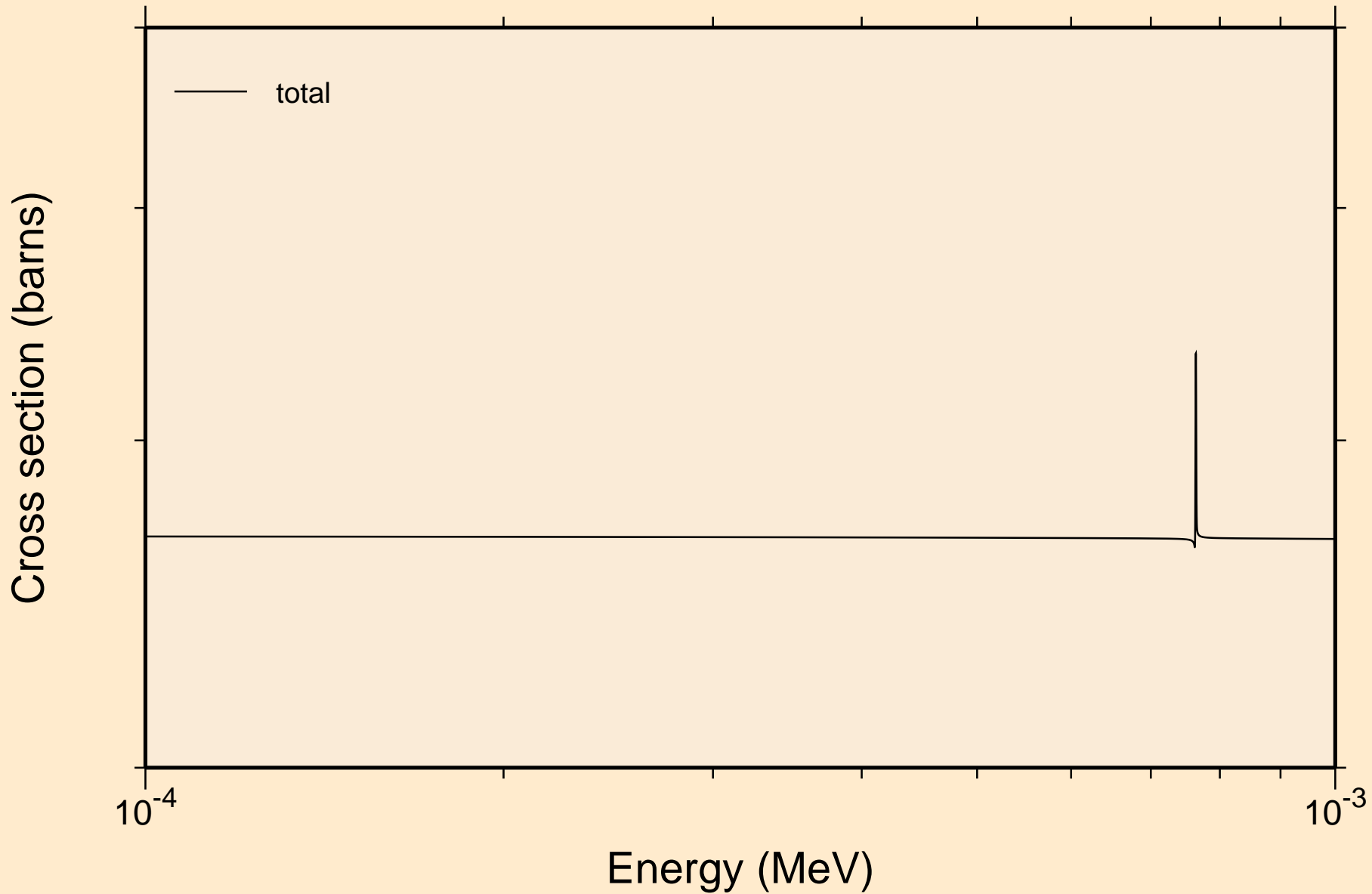

DY170 NEUTRON ACER TENDL-2021 LIBRARY; T=293.6K
resonance total cross section

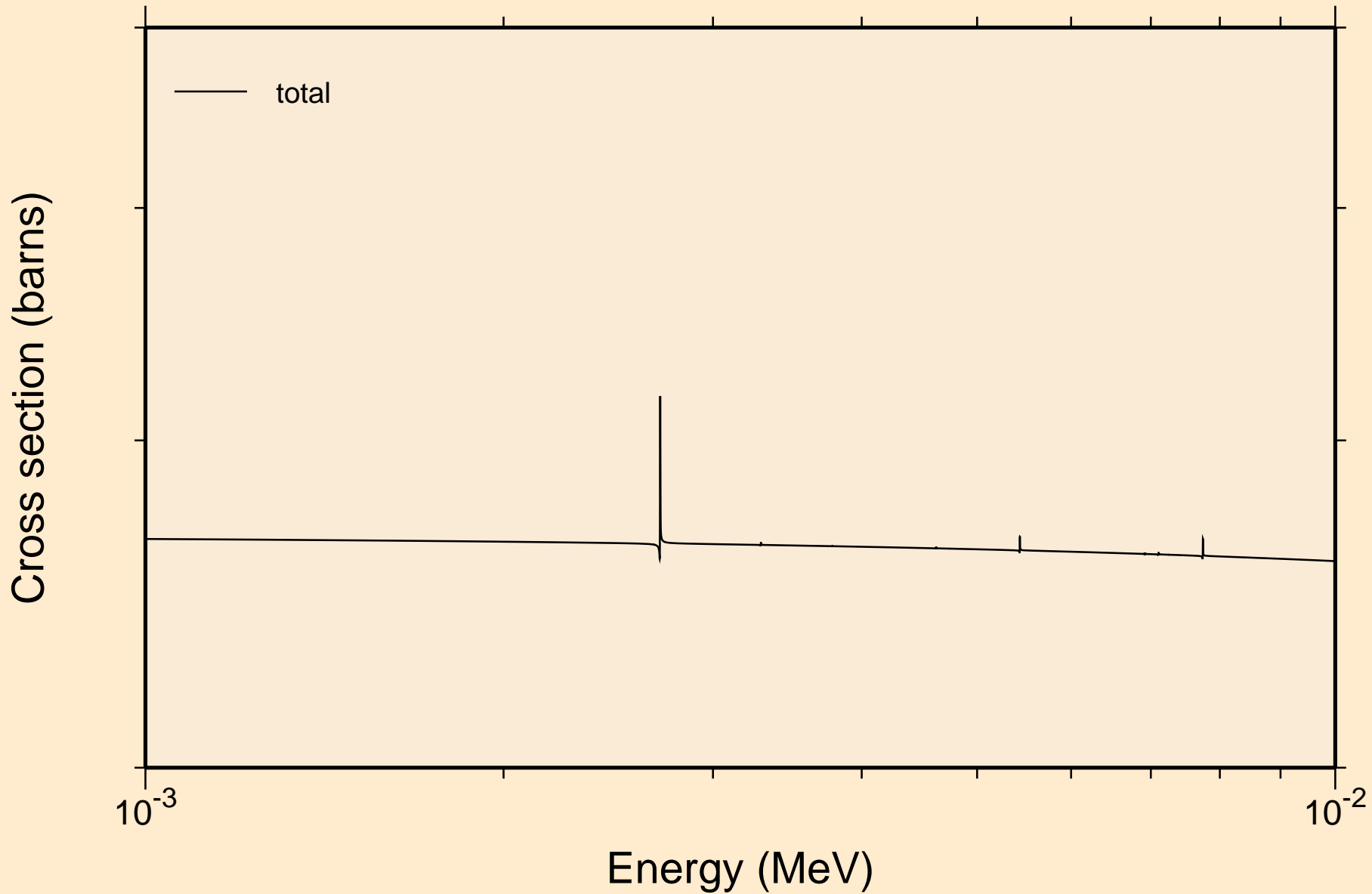

DY170 NEUTRON ACER TENDL-2021 LIBRARY; T=293.6K
resonance total cross section

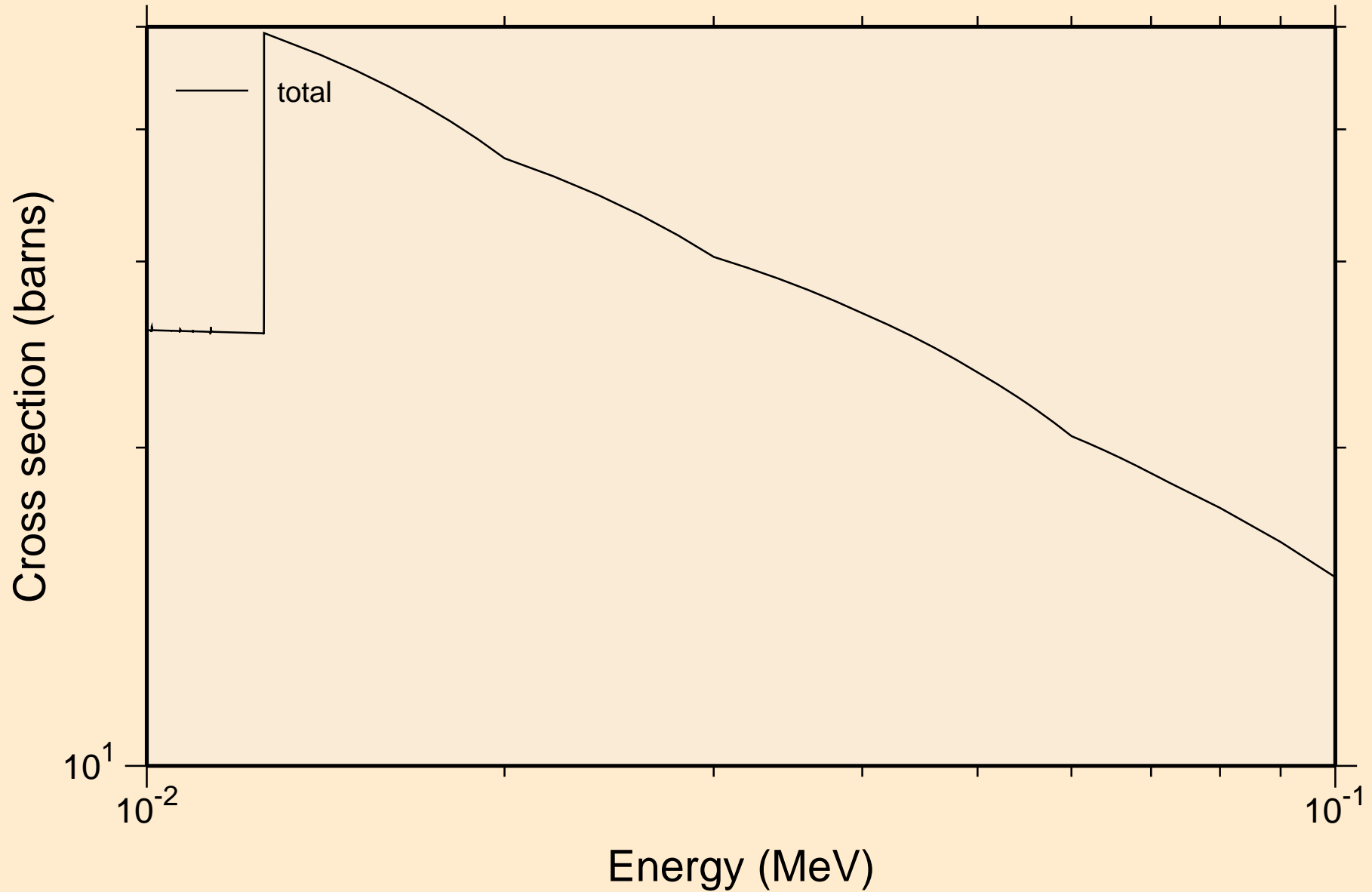

DY170 NEUTRON ACER TENDL-2021 LIBRARY; T=293.6K
resonance total cross section

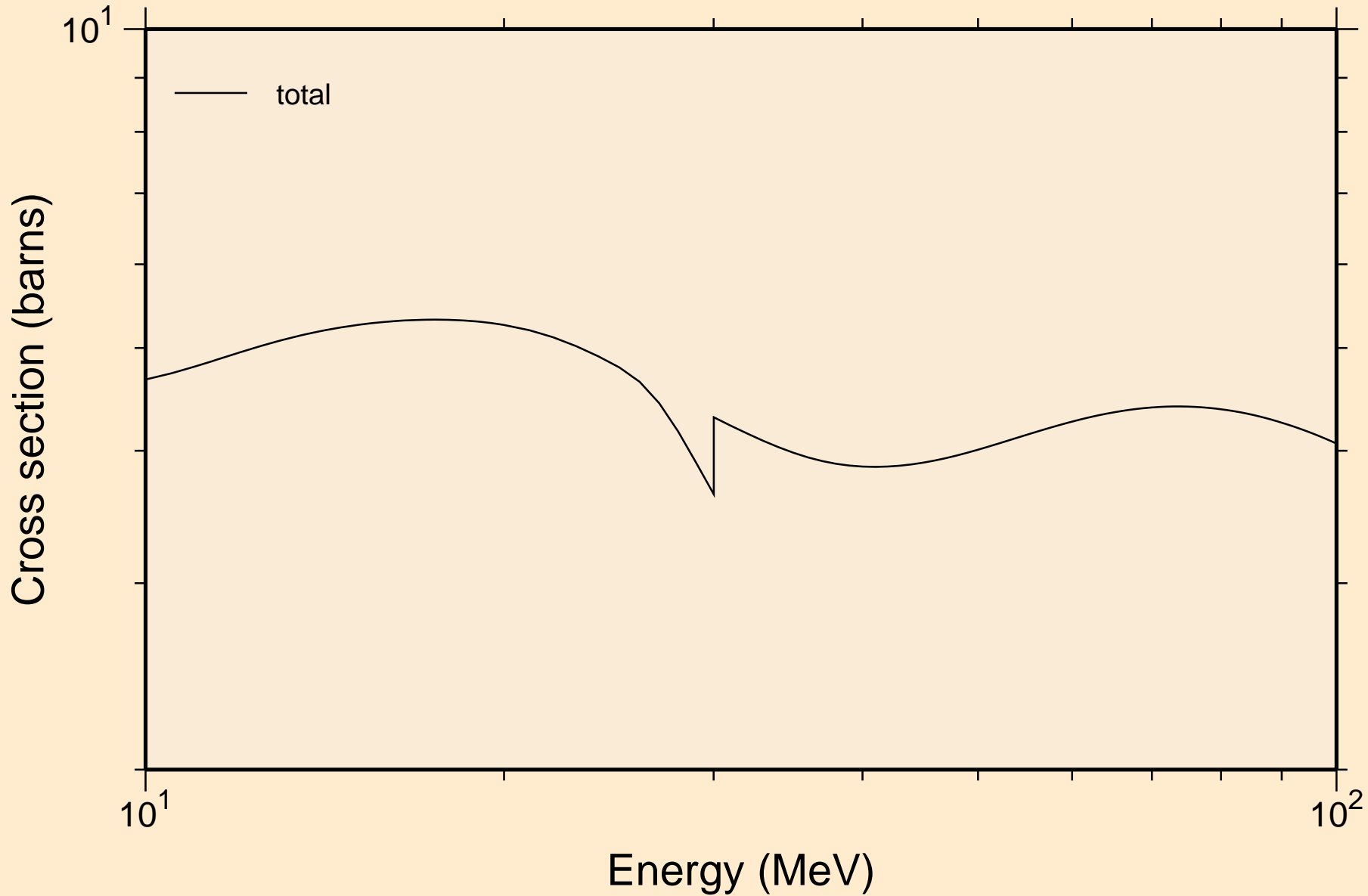

DY170 NEUTRON ACER TENDL-2021 LIBRARY; T=293.6K
resonance absorption cross sections

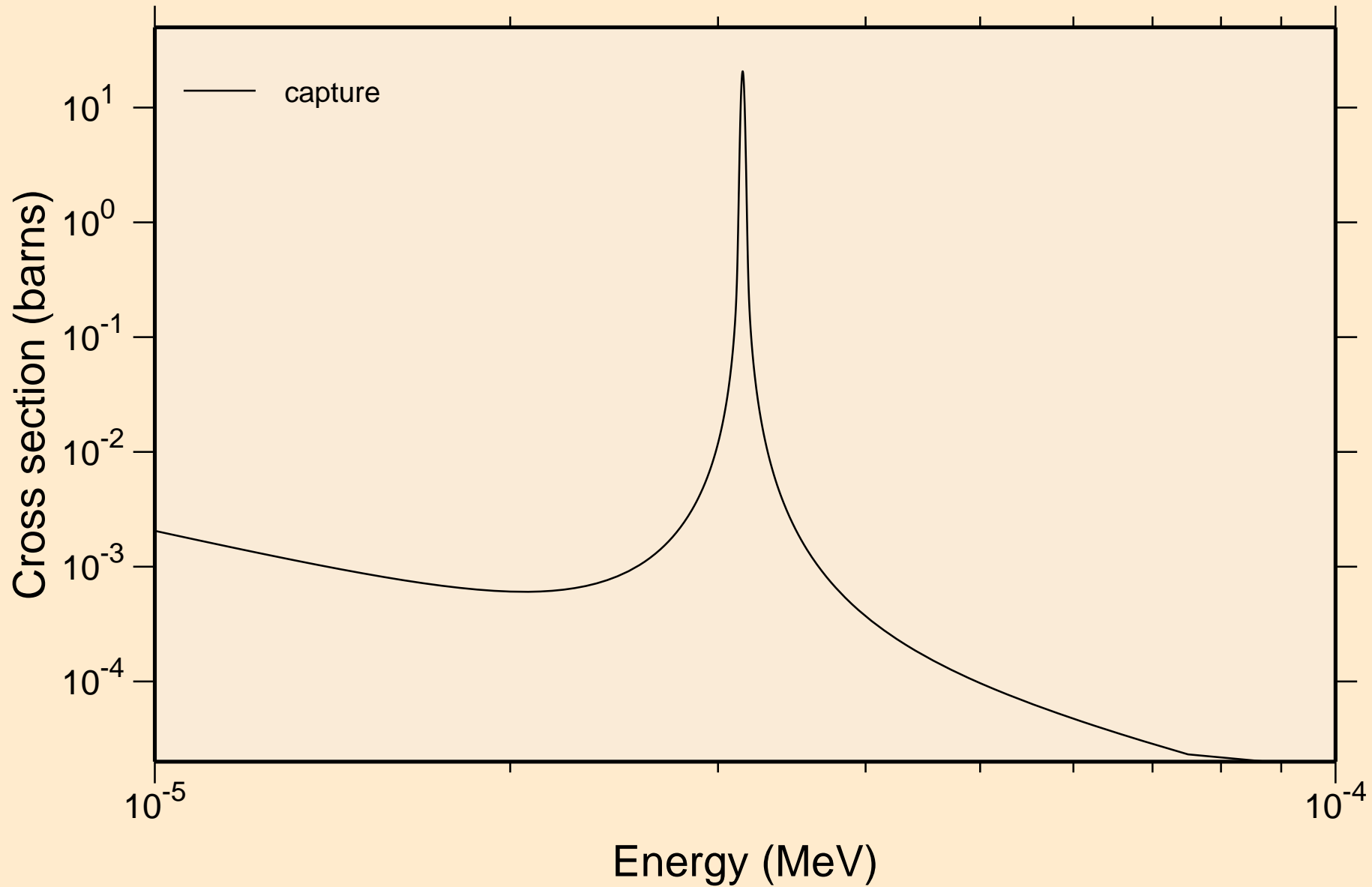

DY170 NEUTRON ACER TENDL-2021 LIBRARY; T=293.6K
resonance absorption cross sections

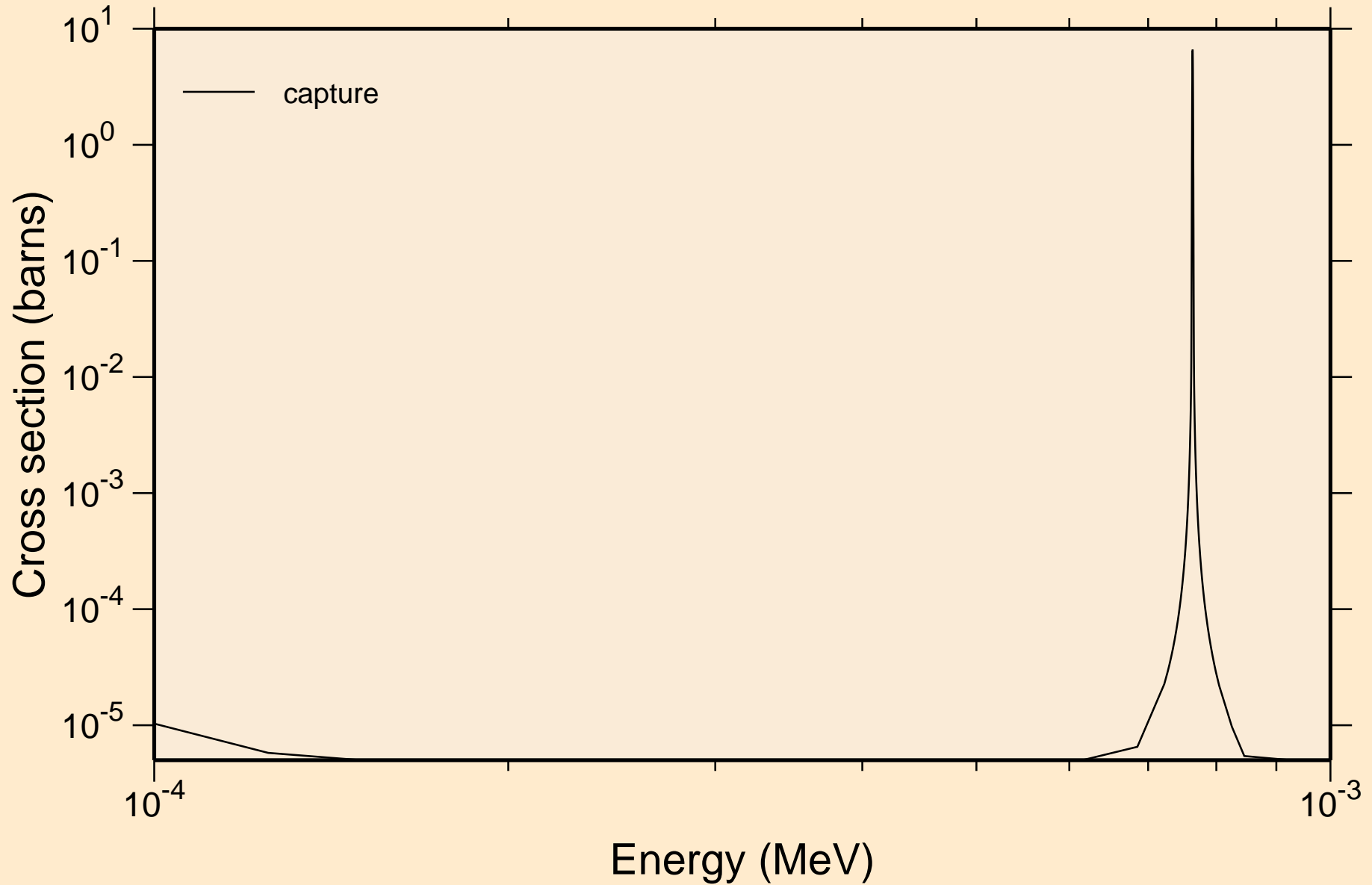

DY170 NEUTRON ACER TENDL-2021 LIBRARY; T=293.6K
resonance absorption cross sections

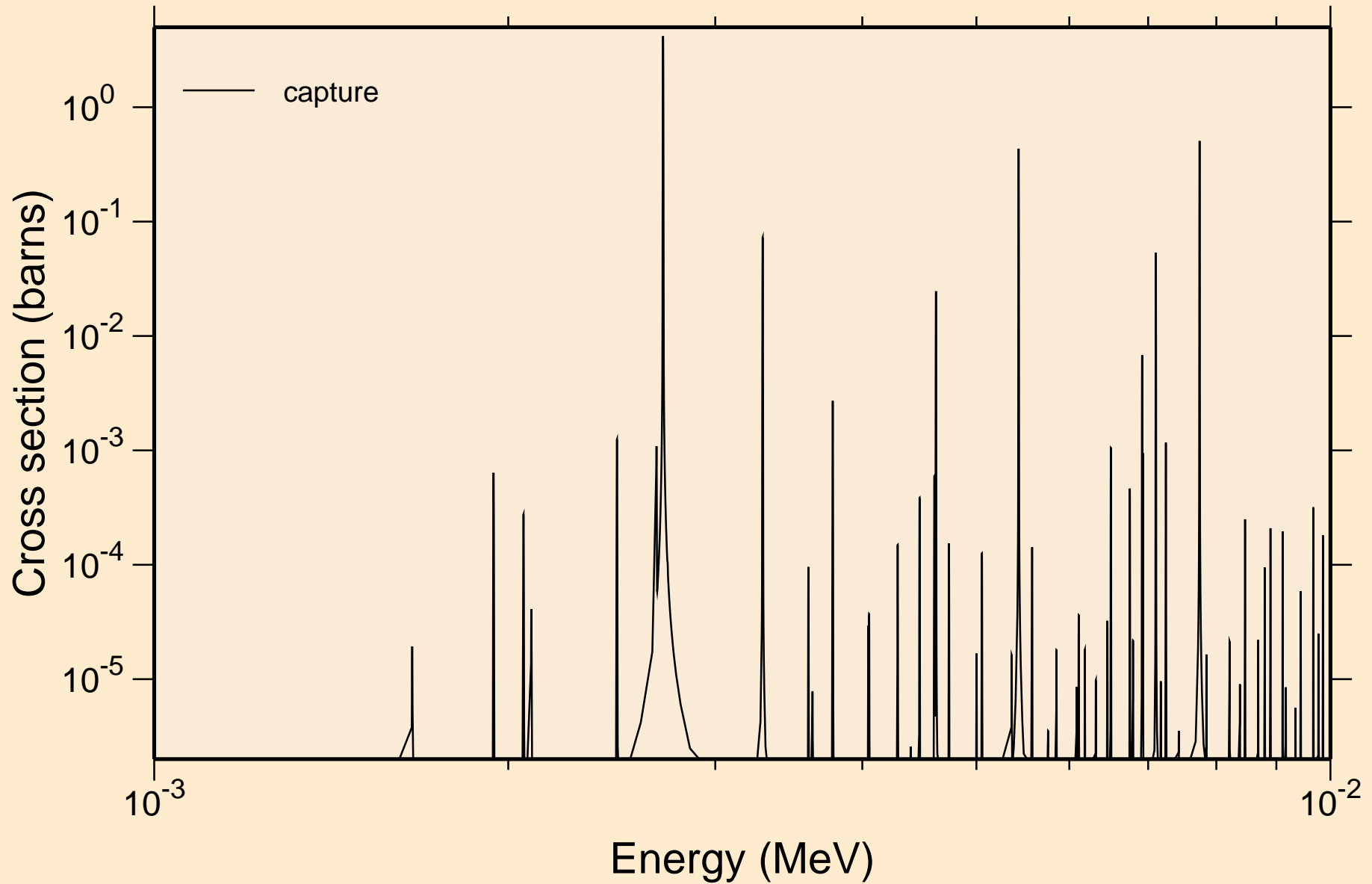

DY170 NEUTRON ACER TENDL-2021 LIBRARY; T=293.6K
resonance absorption cross sections

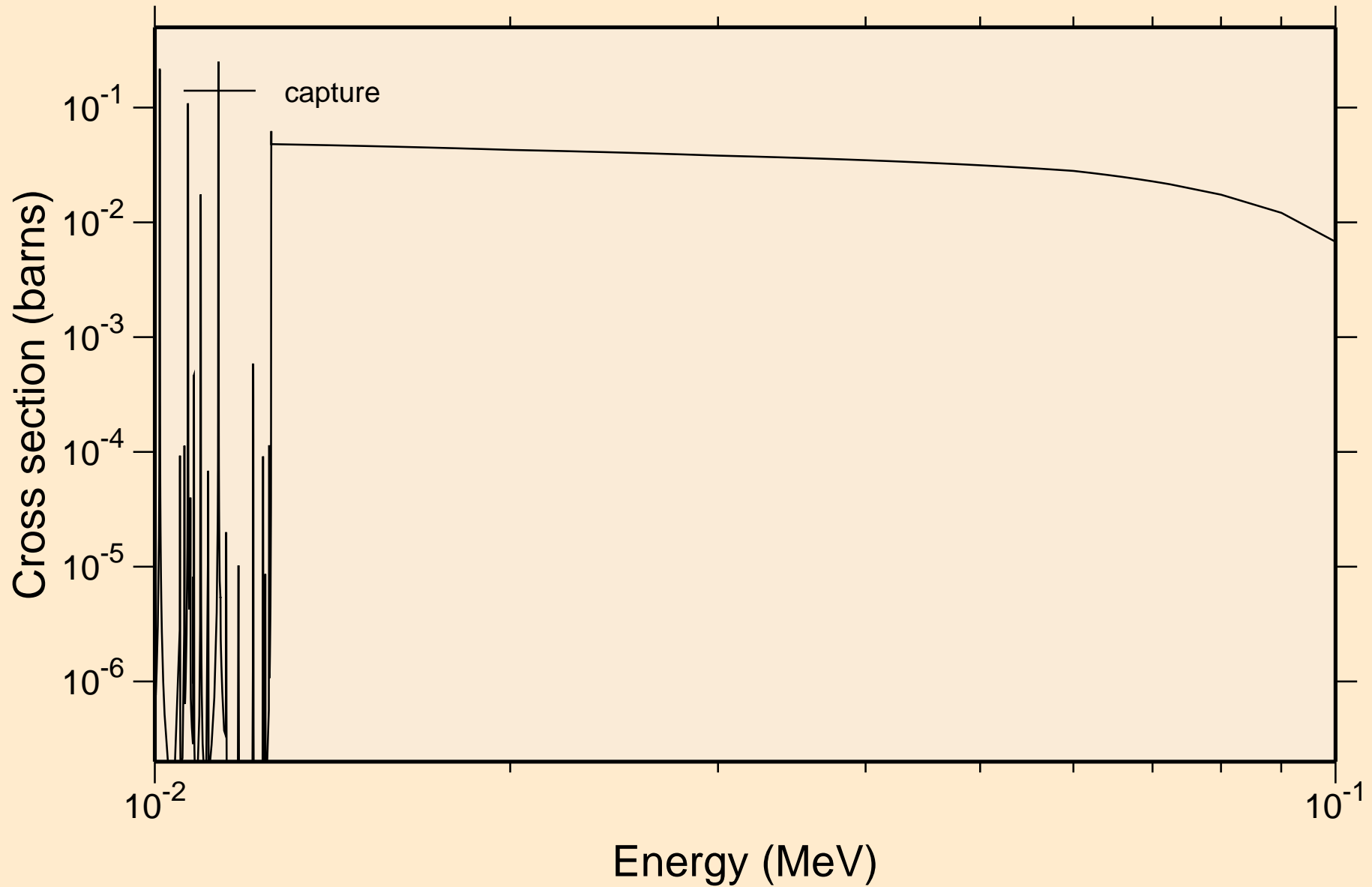

DY170 NEUTRON ACER TENDL-2021 LIBRARY; T=293.6K
resonance absorption cross sections

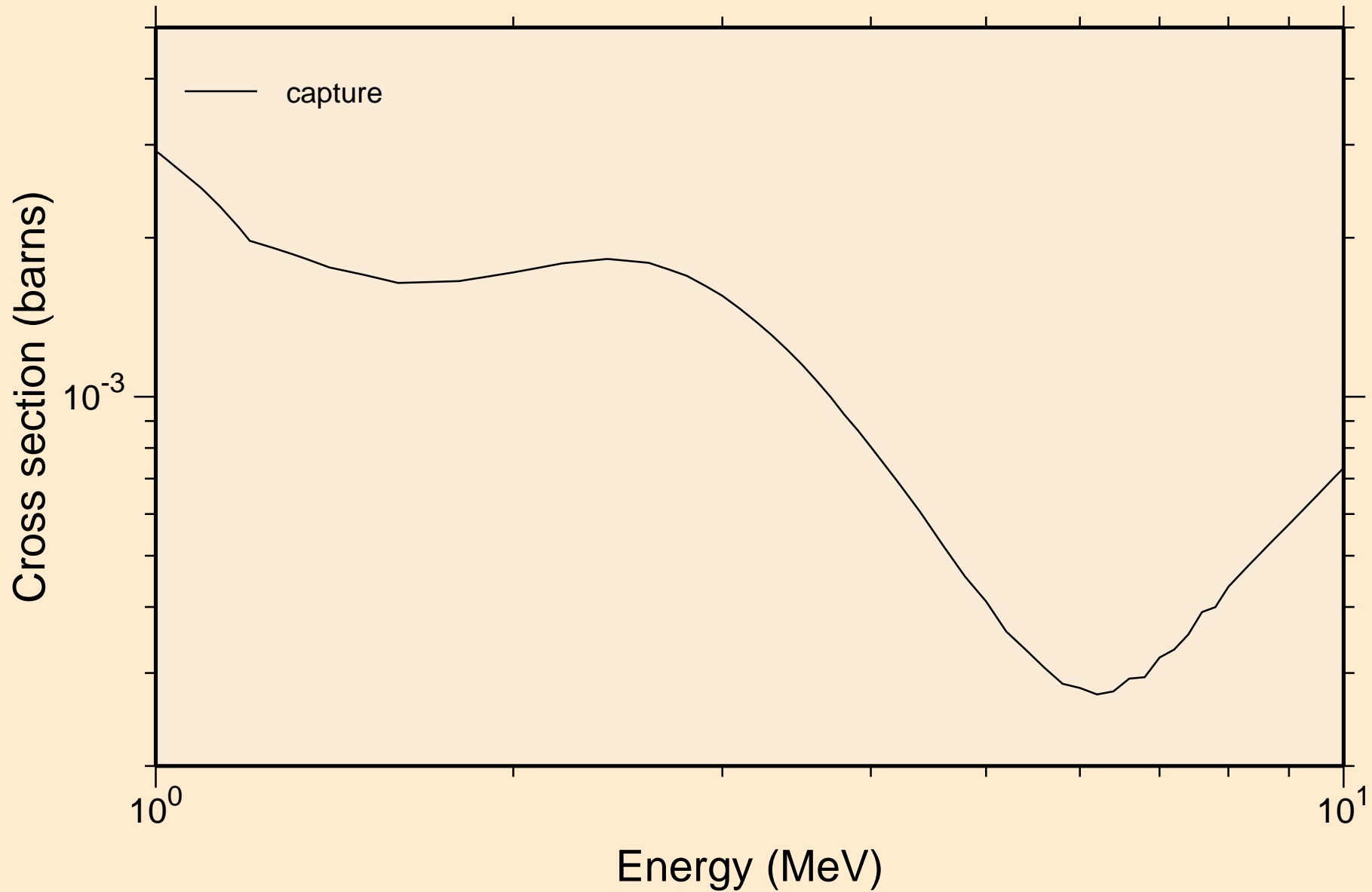

DY170 NEUTRON ACER TENDL-2021 LIBRARY; T=293.6K
Heating

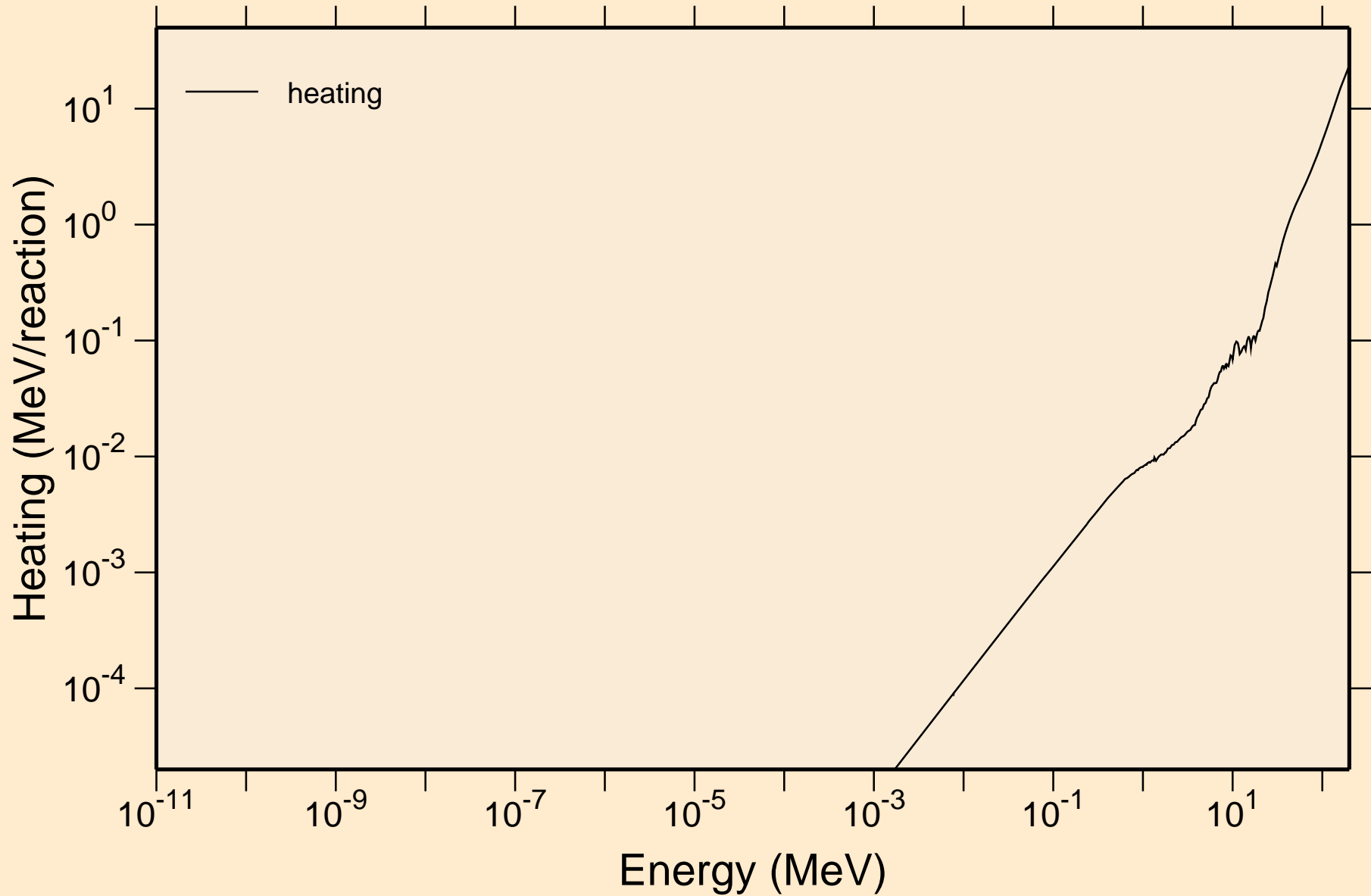

DY170 NEUTRON ACER TENDL-2021 LIBRARY; T=293.6K
Damage

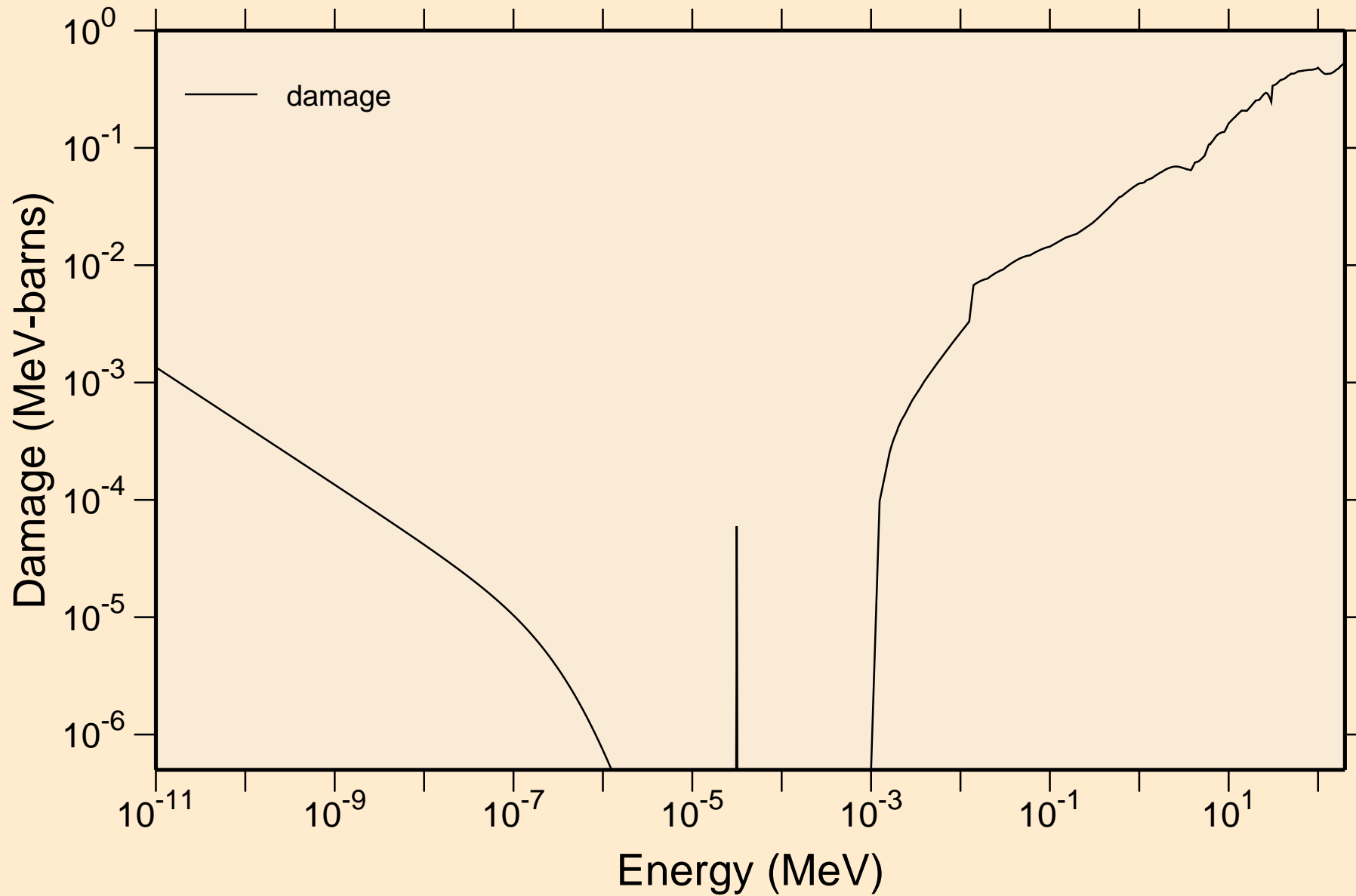

DY170 NEUTRON ACER TENDL-2021 LIBRARY; T=293.6K
Non-threshold reactions

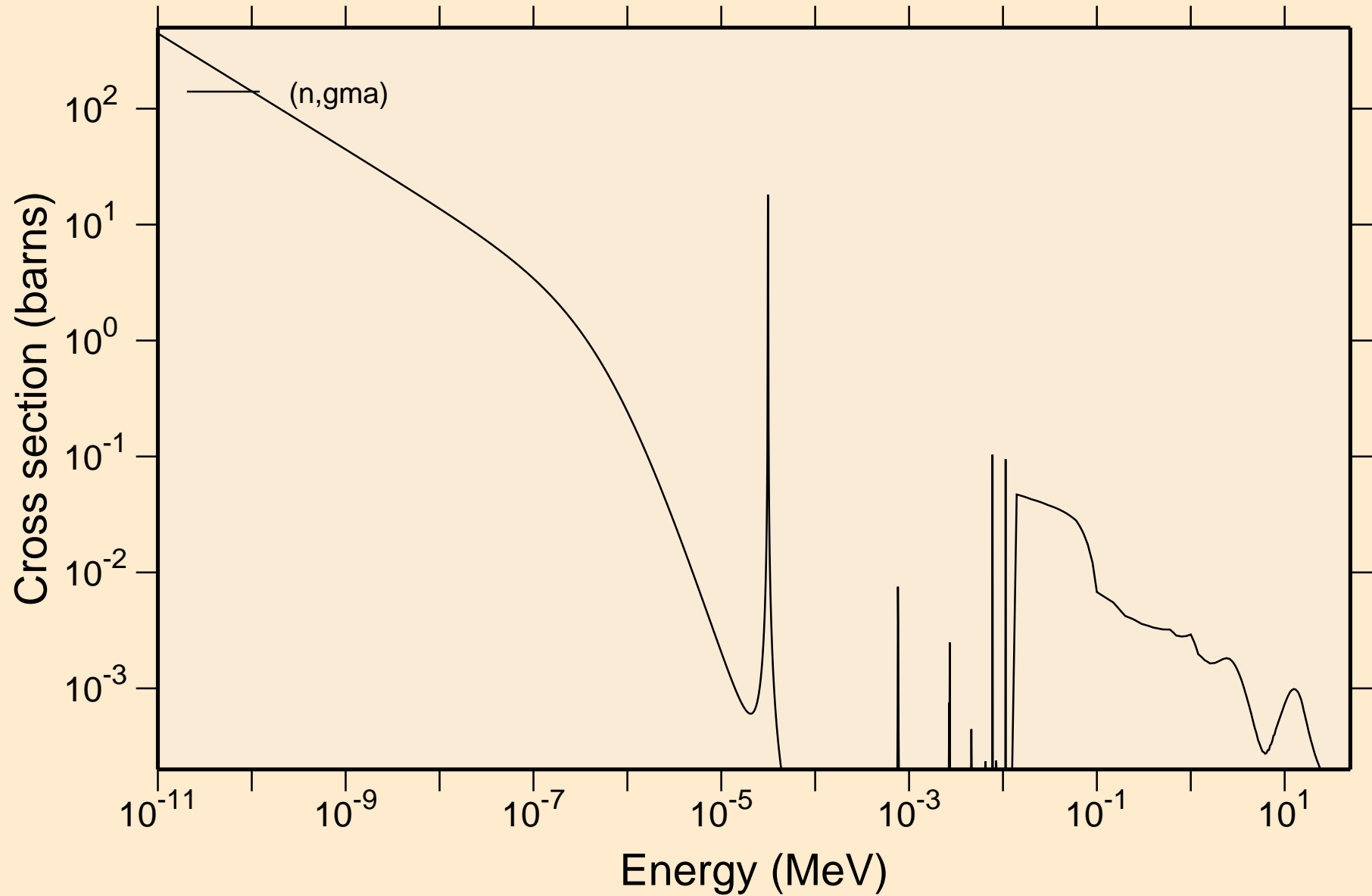

DY170 NEUTRON ACER TENDL-2021 LIBRARY; T=293.6K
Principal cross sections

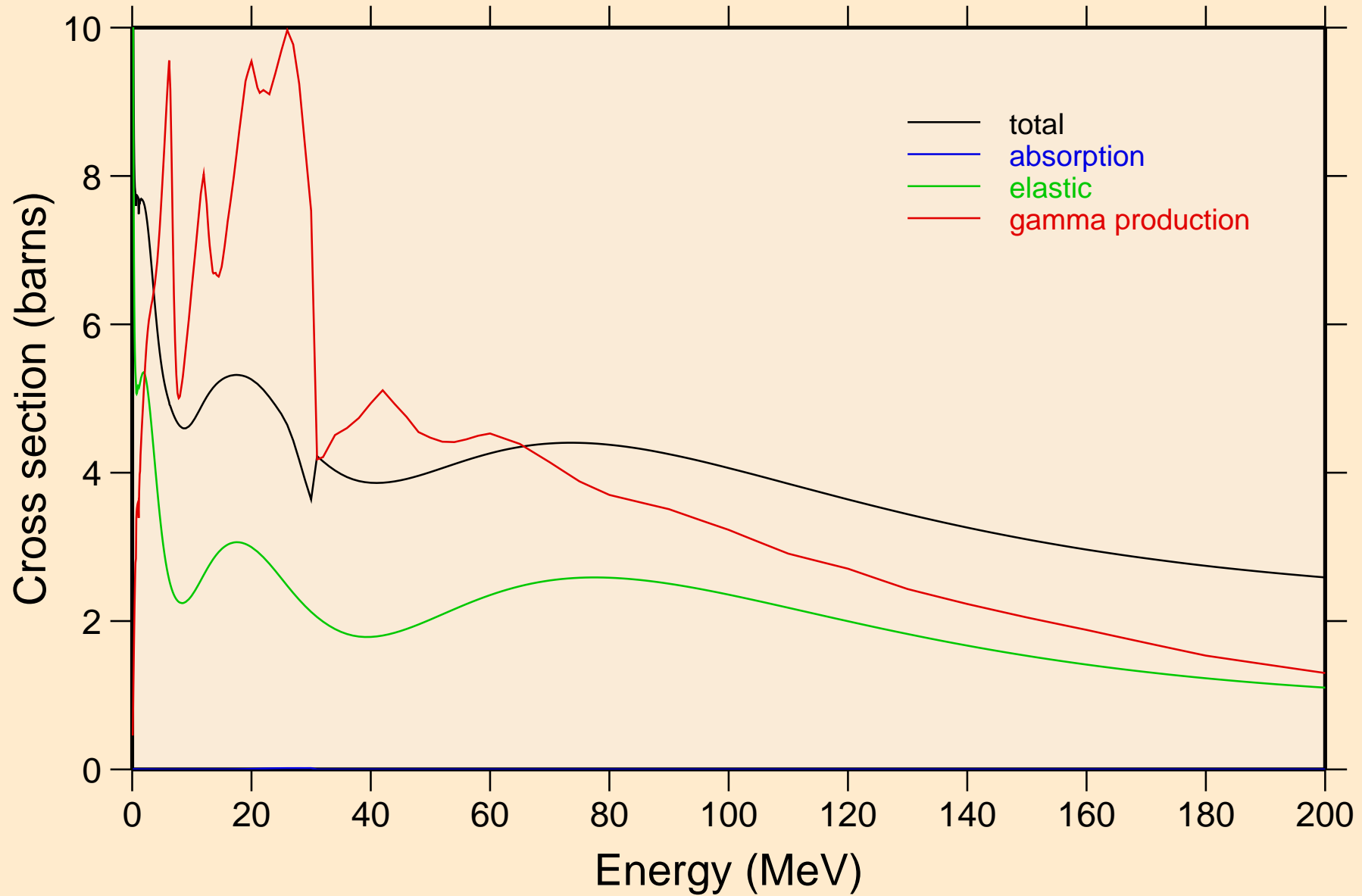

DY170 NEUTRON ACER TENDL-2021 LIBRARY; T=293.6K
Heating

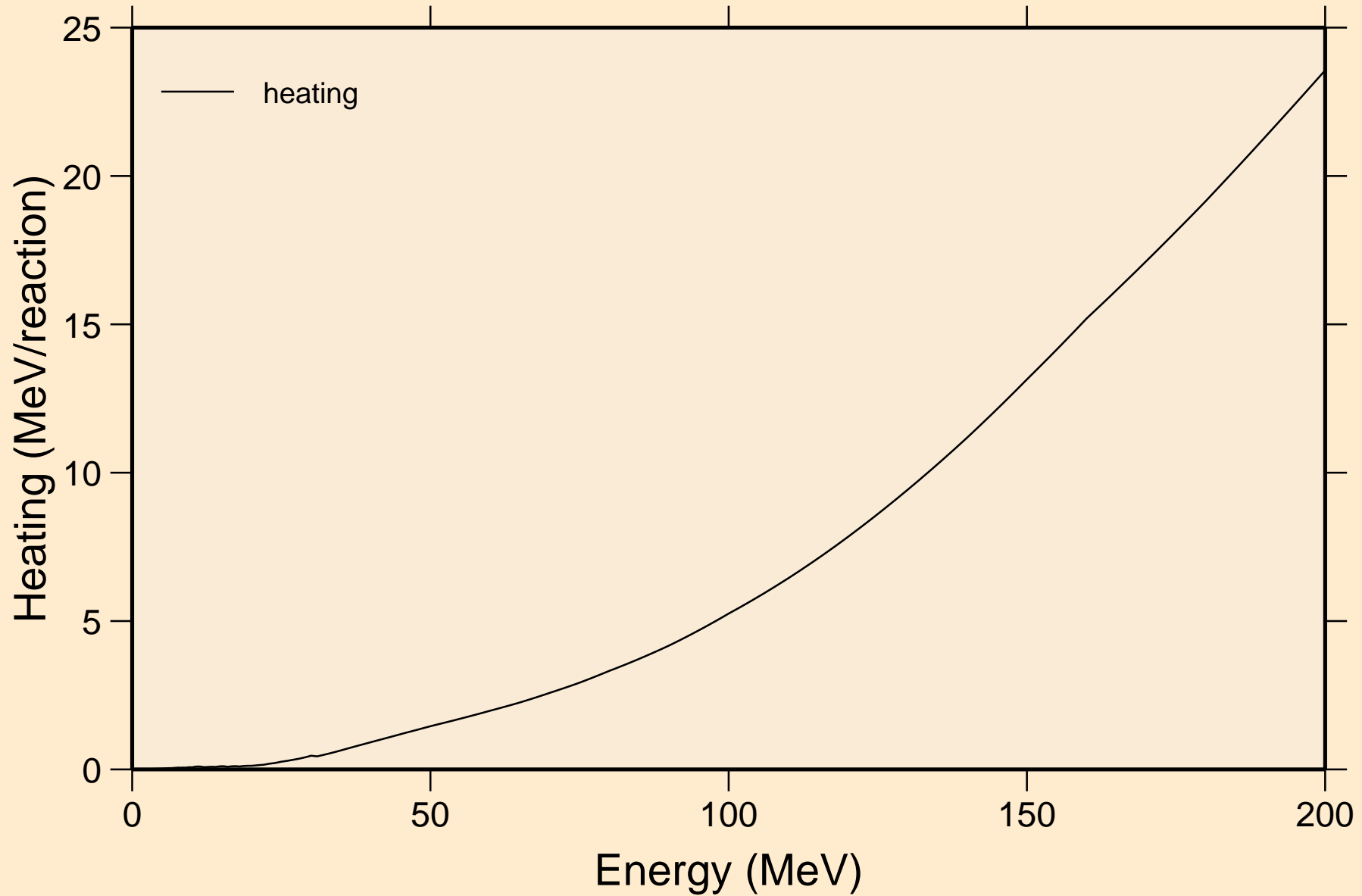

DY170 NEUTRON ACER TENDL-2021 LIBRARY; T=293.6K
Damage

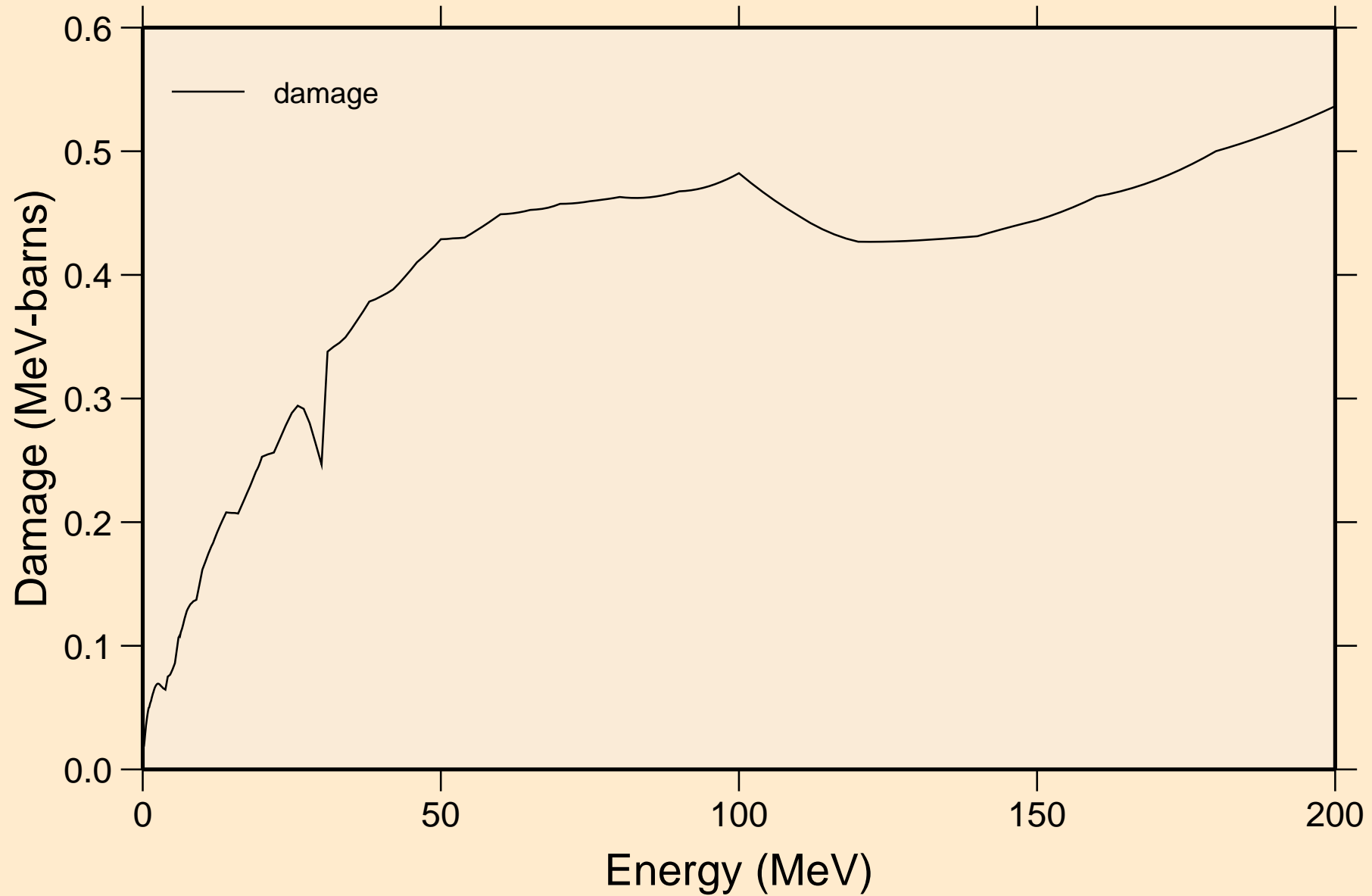

DY170 NEUTRON ACER TENDL-2021 LIBRARY; T=293.6K
Non-threshold reactions

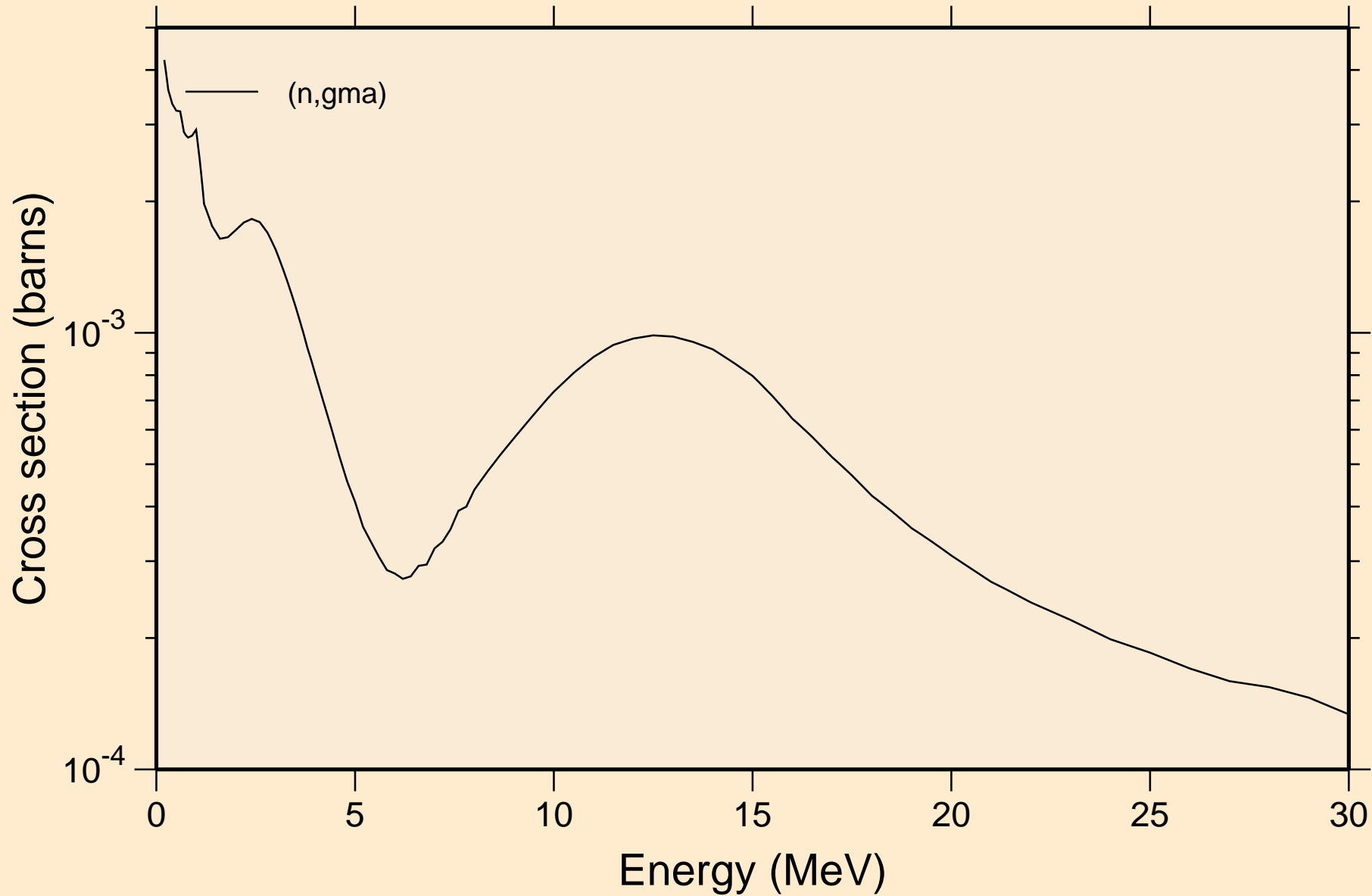

DY170 NEUTRON ACER TENDL-2021 LIBRARY; T=293.6K
Inelastic levels

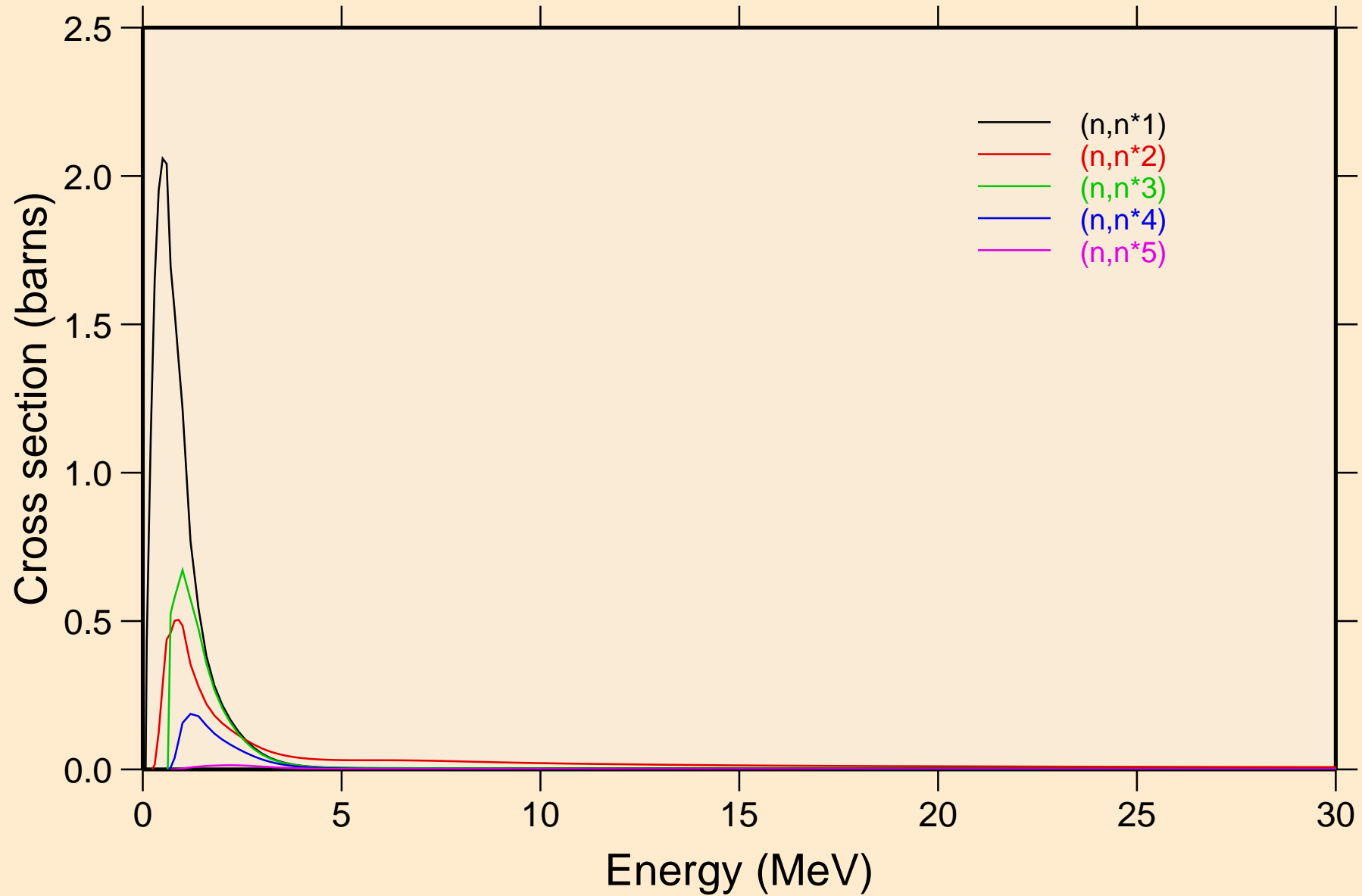

DY170 NEUTRON ACER TENDL-2021 LIBRARY; T=293.6K
Inelastic levels

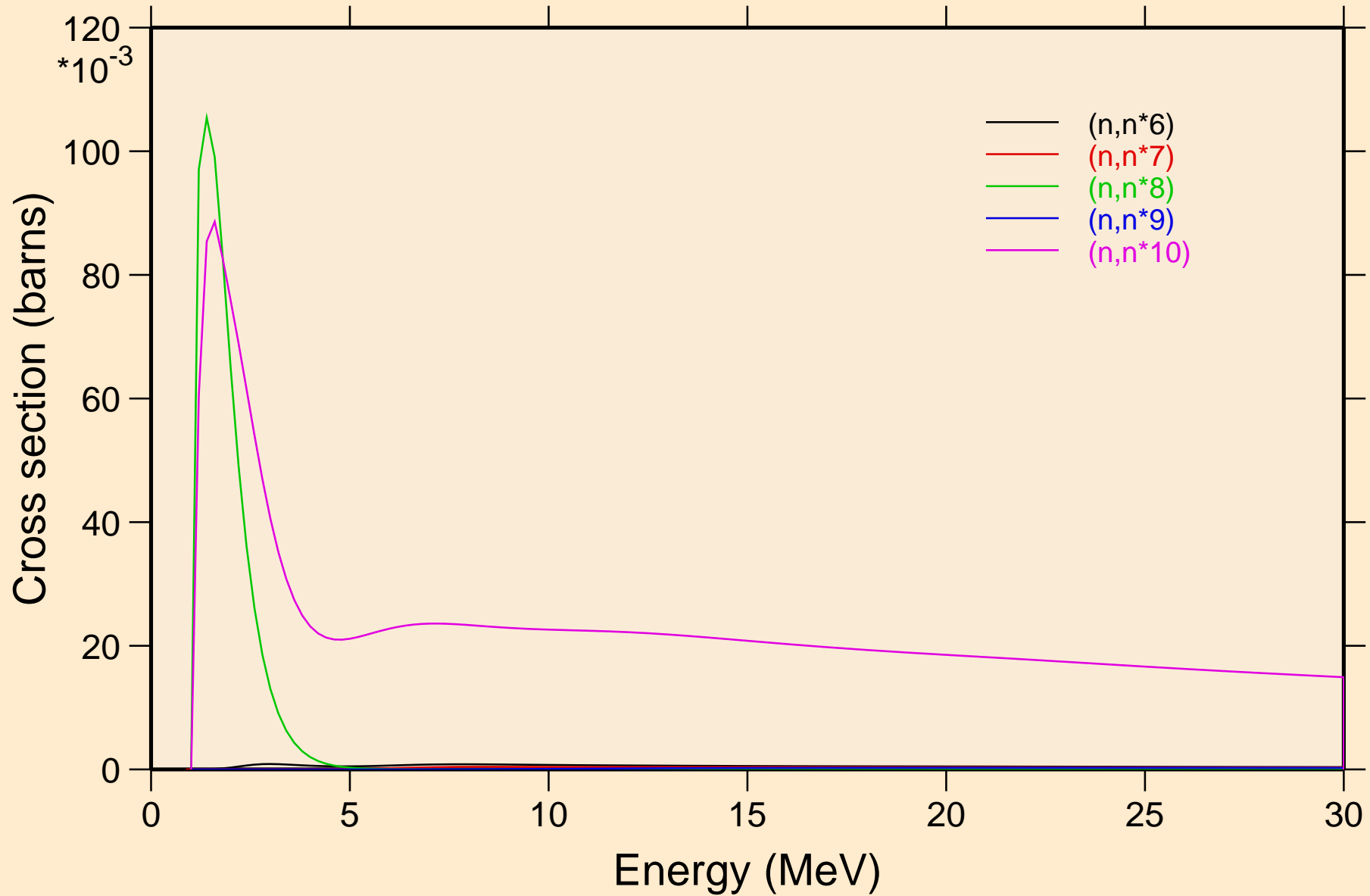

DY170 NEUTRON ACER TENDL-2021 LIBRARY; T=293.6K
Inelastic levels

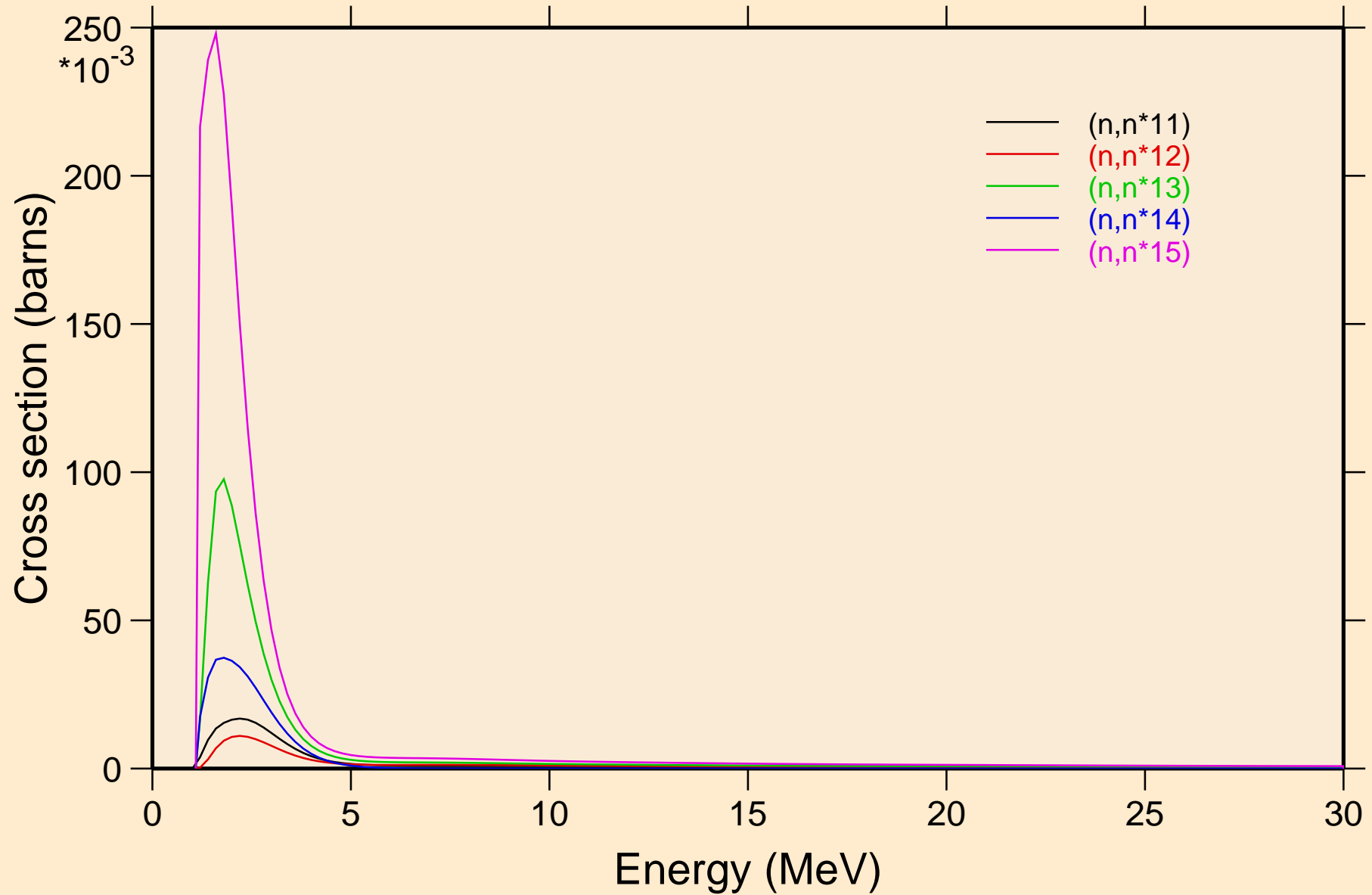

DY170 NEUTRON ACER TENDL-2021 LIBRARY; T=293.6K
Inelastic levels

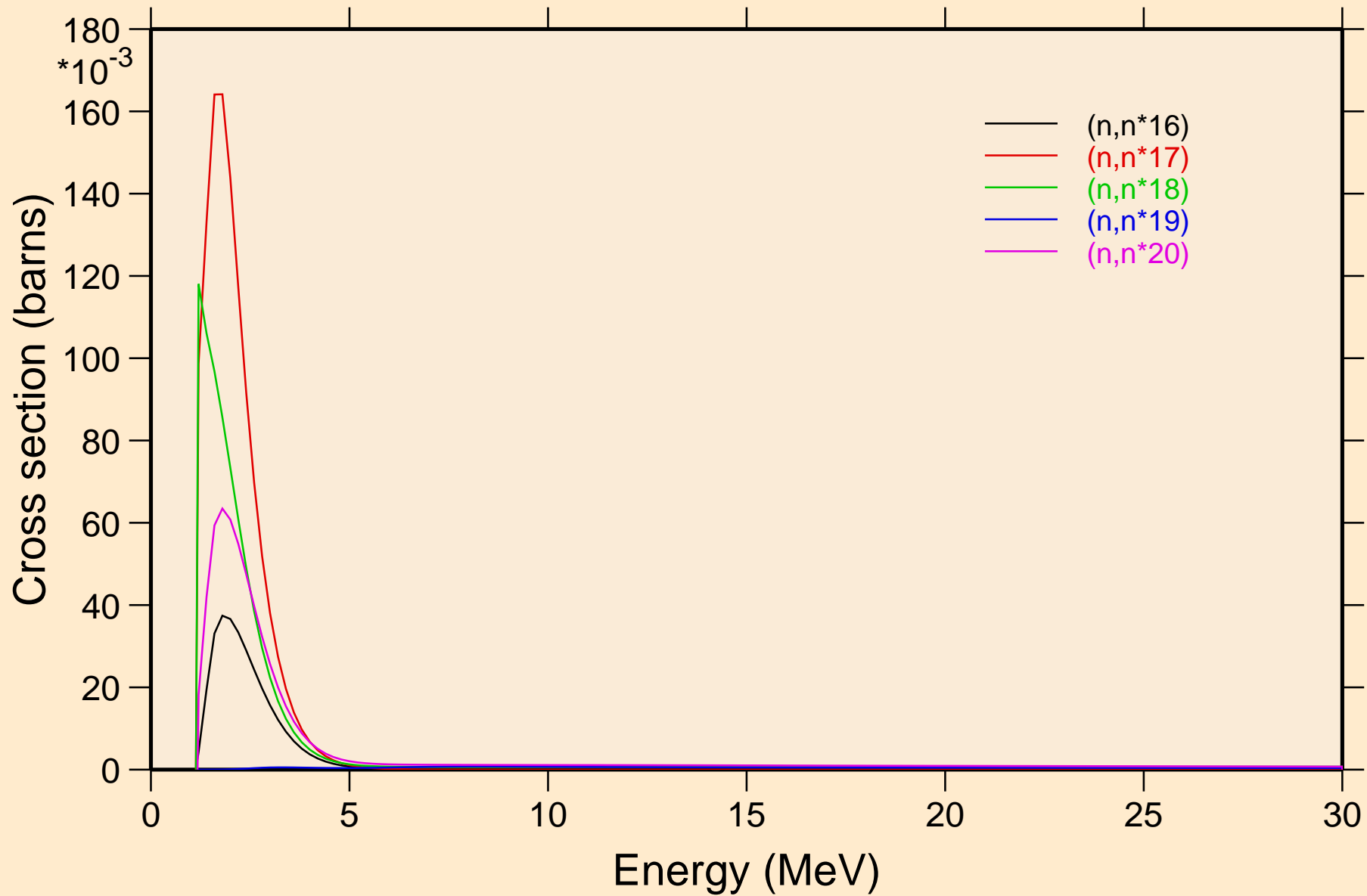

DY170 NEUTRON ACER TENDL-2021 LIBRARY; T=293.6K
Inelastic levels

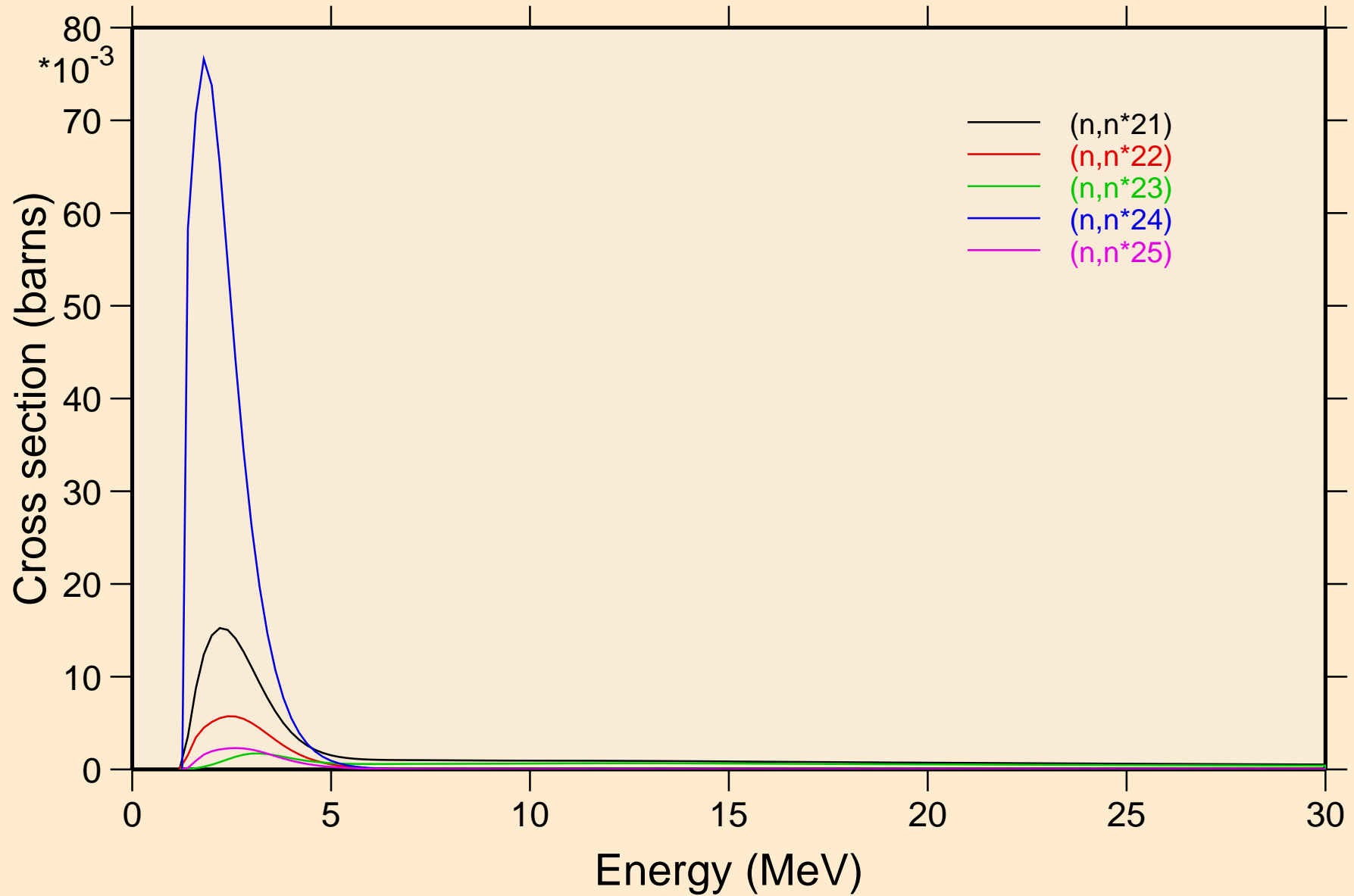

DY170 NEUTRON ACER TENDL-2021 LIBRARY; T=293.6K
Inelastic levels

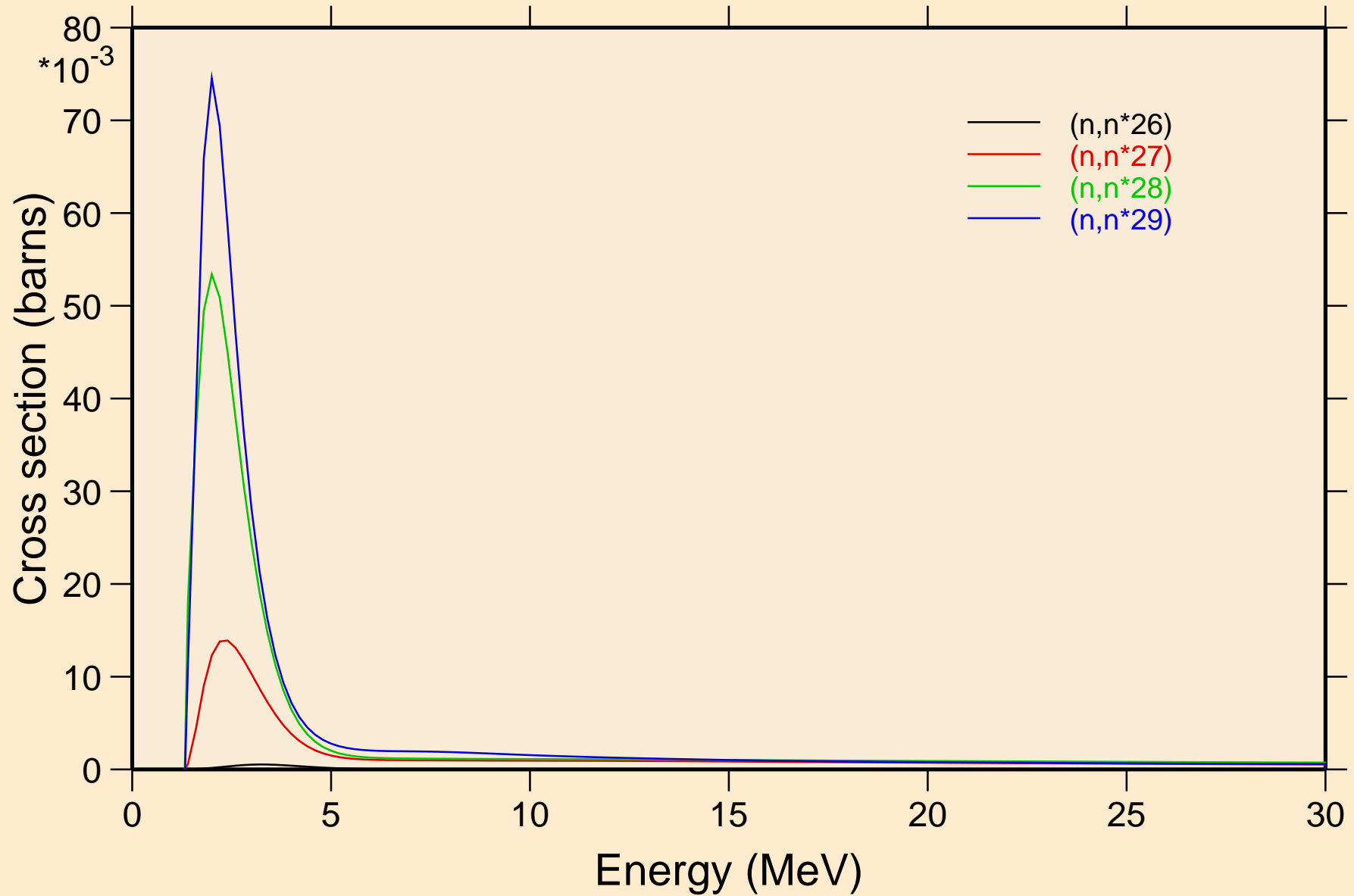

DY170 NEUTRON ACER TENDL-2021 LIBRARY; T=293.6K
Threshold reactions

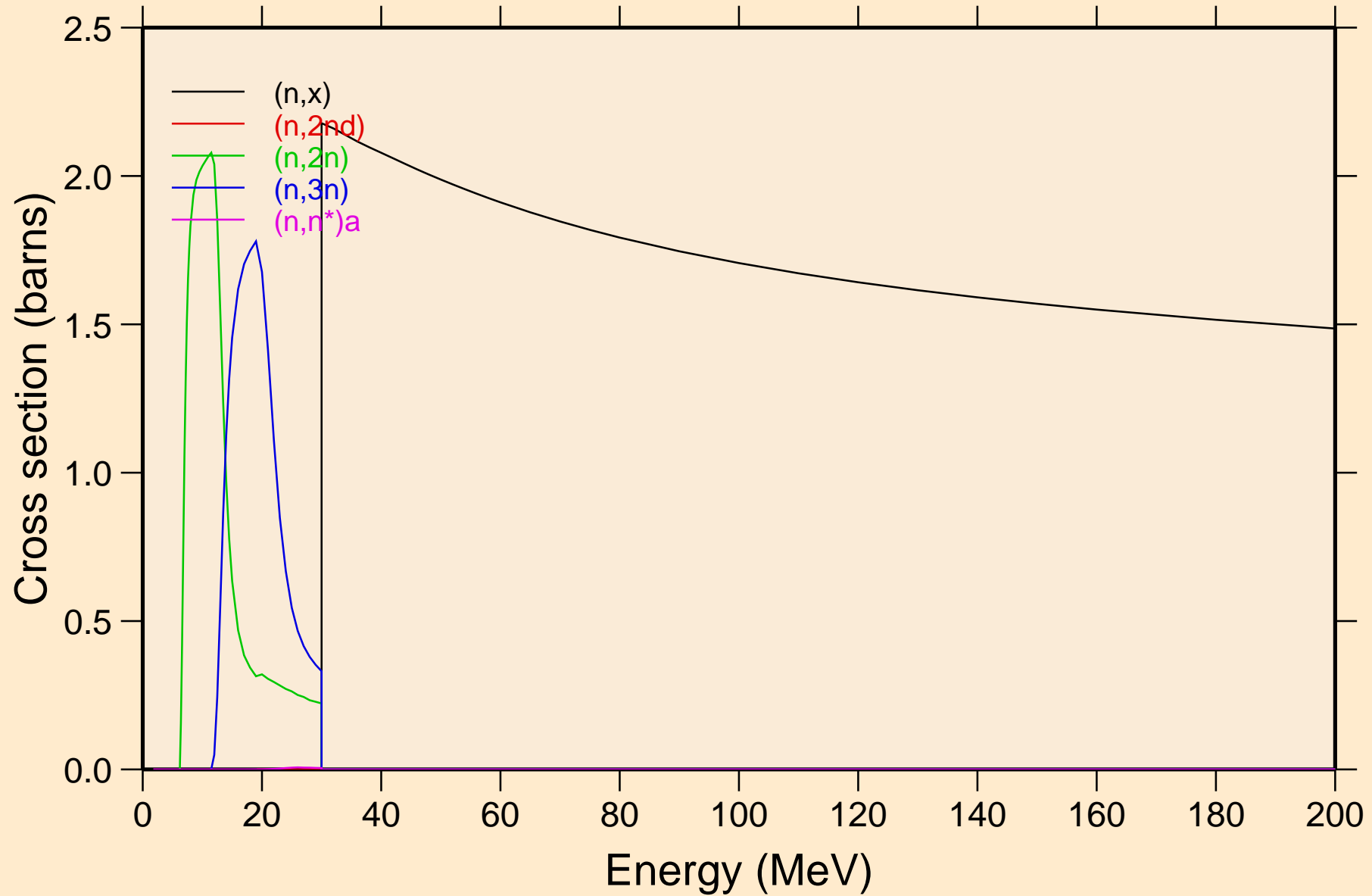

DY170 NEUTRON ACER TENDL-2021 LIBRARY; T=293.6K
Threshold reactions

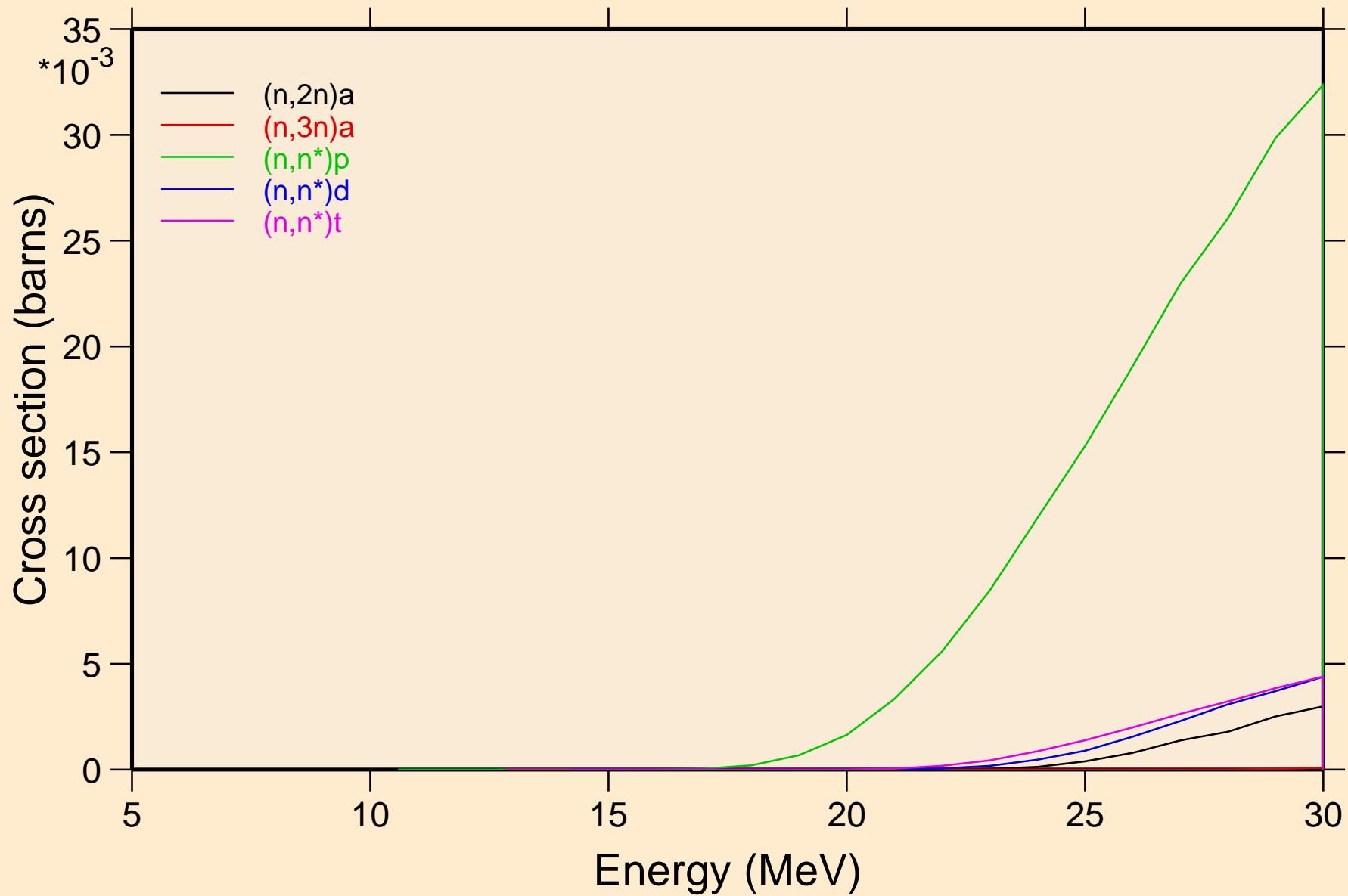

DY170 NEUTRON ACER TENDL-2021 LIBRARY; T=293.6K
Threshold reactions

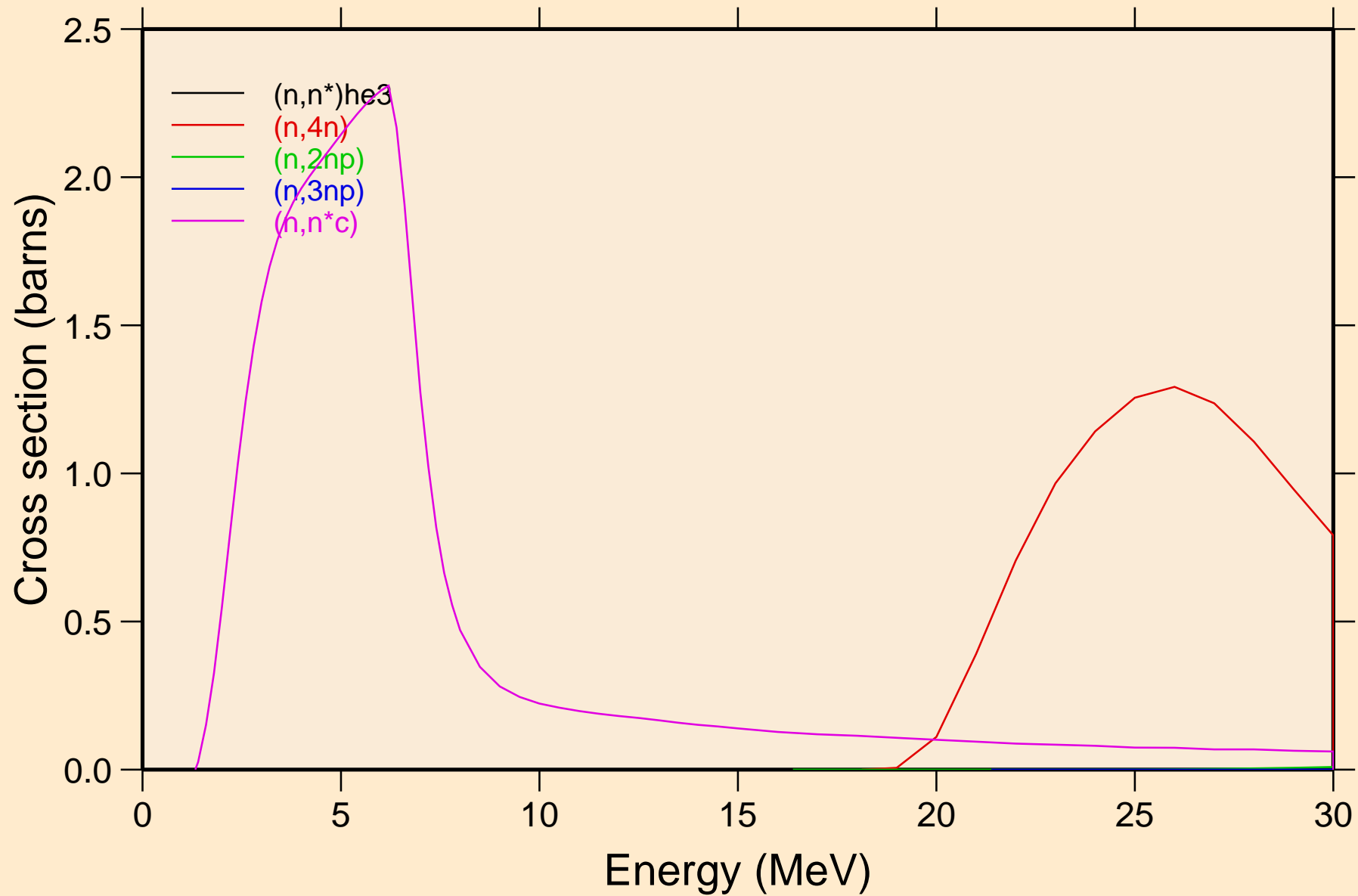

DY170 NEUTRON ACER TENDL-2021 LIBRARY; T=293.6K
Threshold reactions

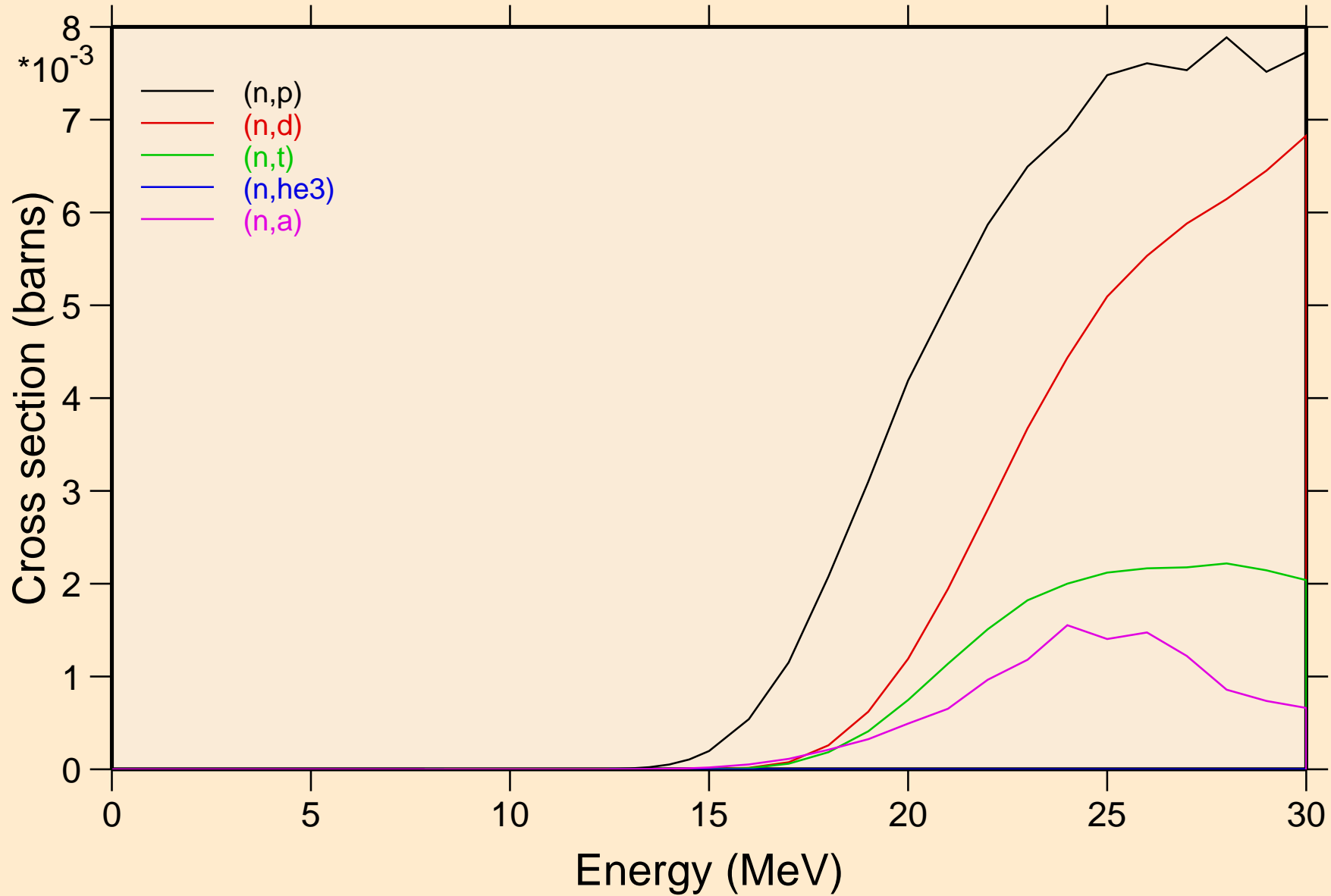

DY170 NEUTRON ACER TENDL-2021 LIBRARY; T=293.6K
Threshold reactions

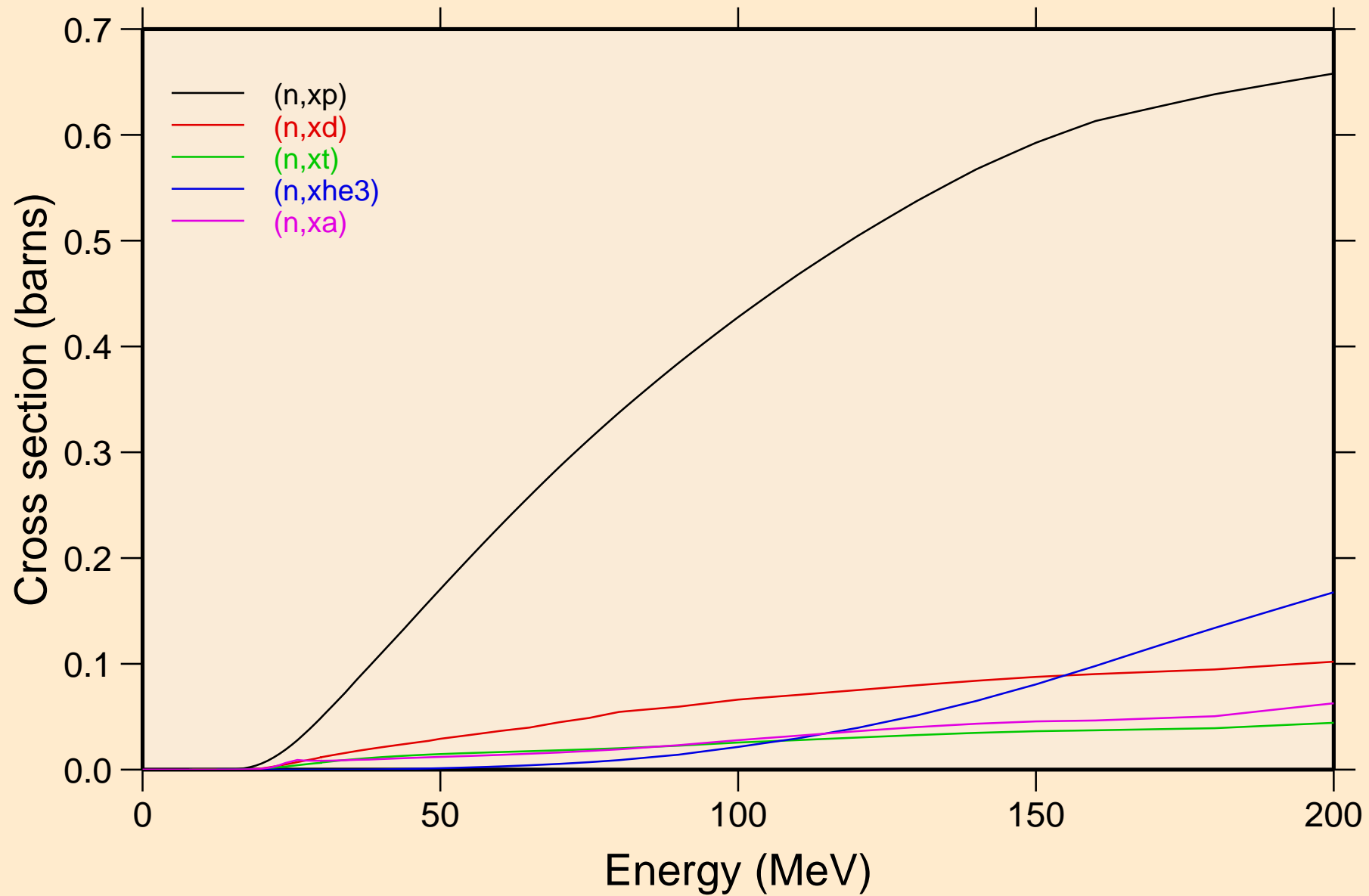

DY170 NEUTRON ACER TENDL-2021 LIBRARY; T=293.6K
angular distribution for elastic

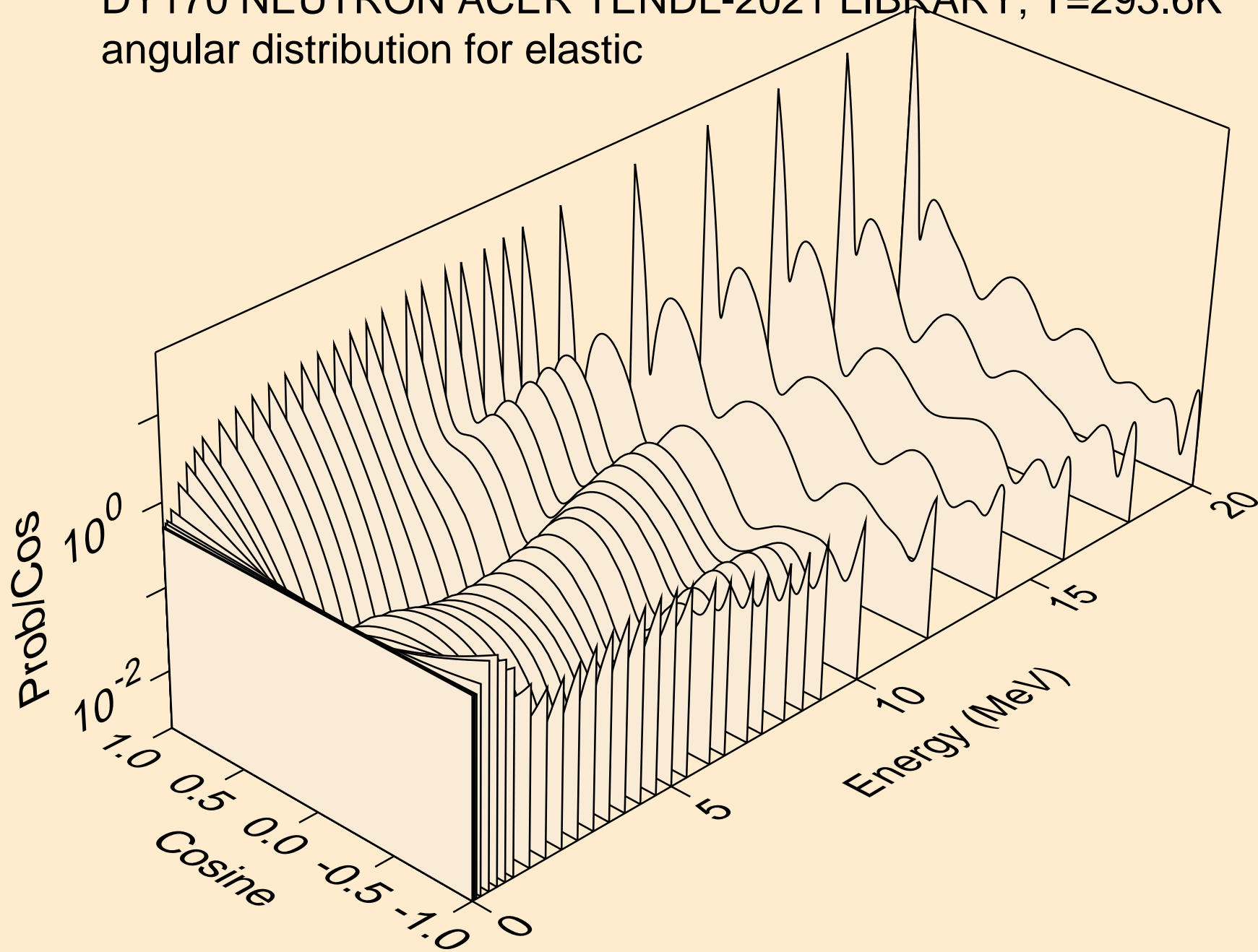

DY170 NEUTRON ACER TENDL-2021 LIBRARY; T=293.6K
angular distribution for elastic

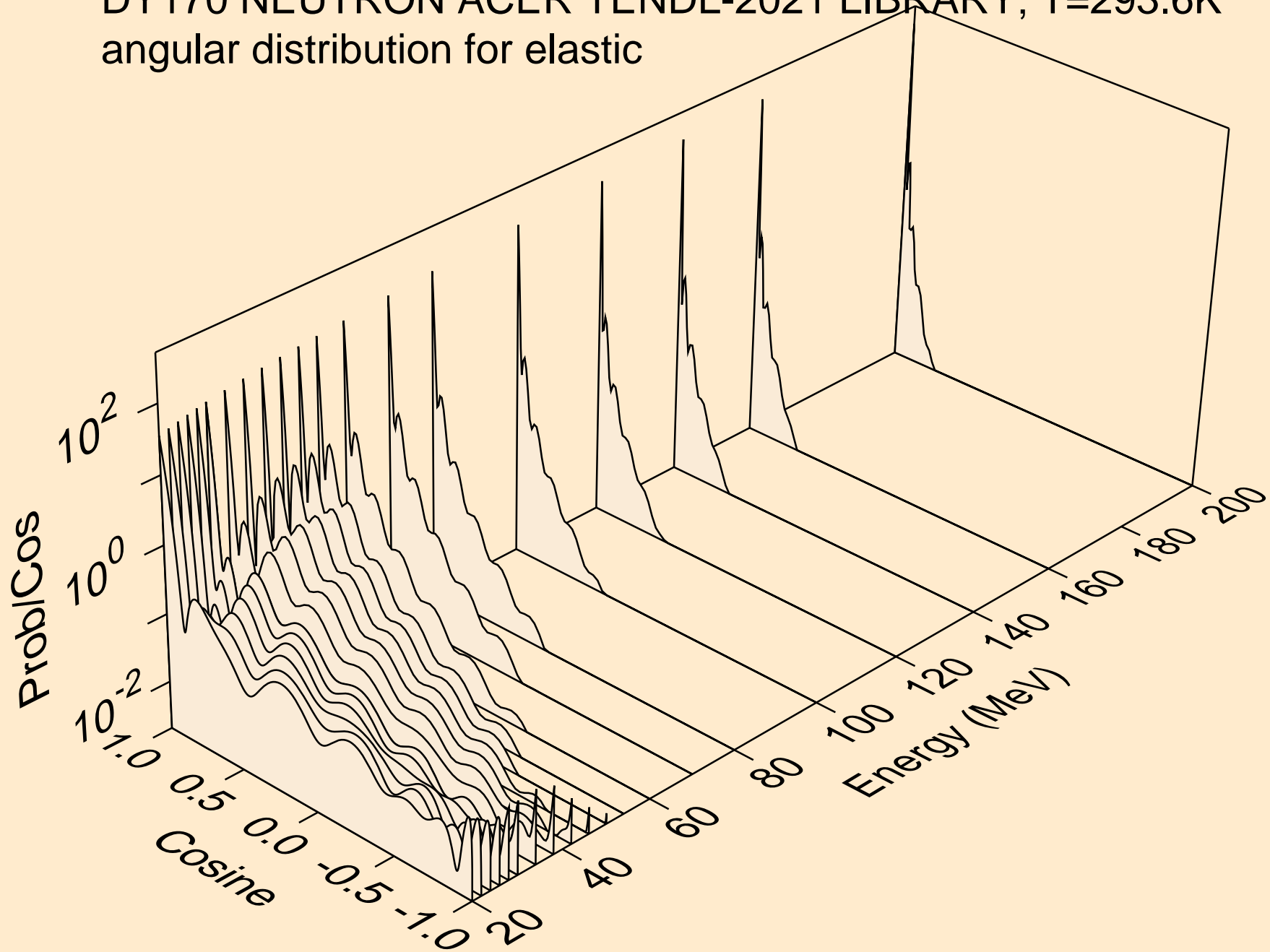

DY170 NEUTRON ACER TENDL-2021 LIBRARY; T=293.6K
angular distribution for (n,n*1)

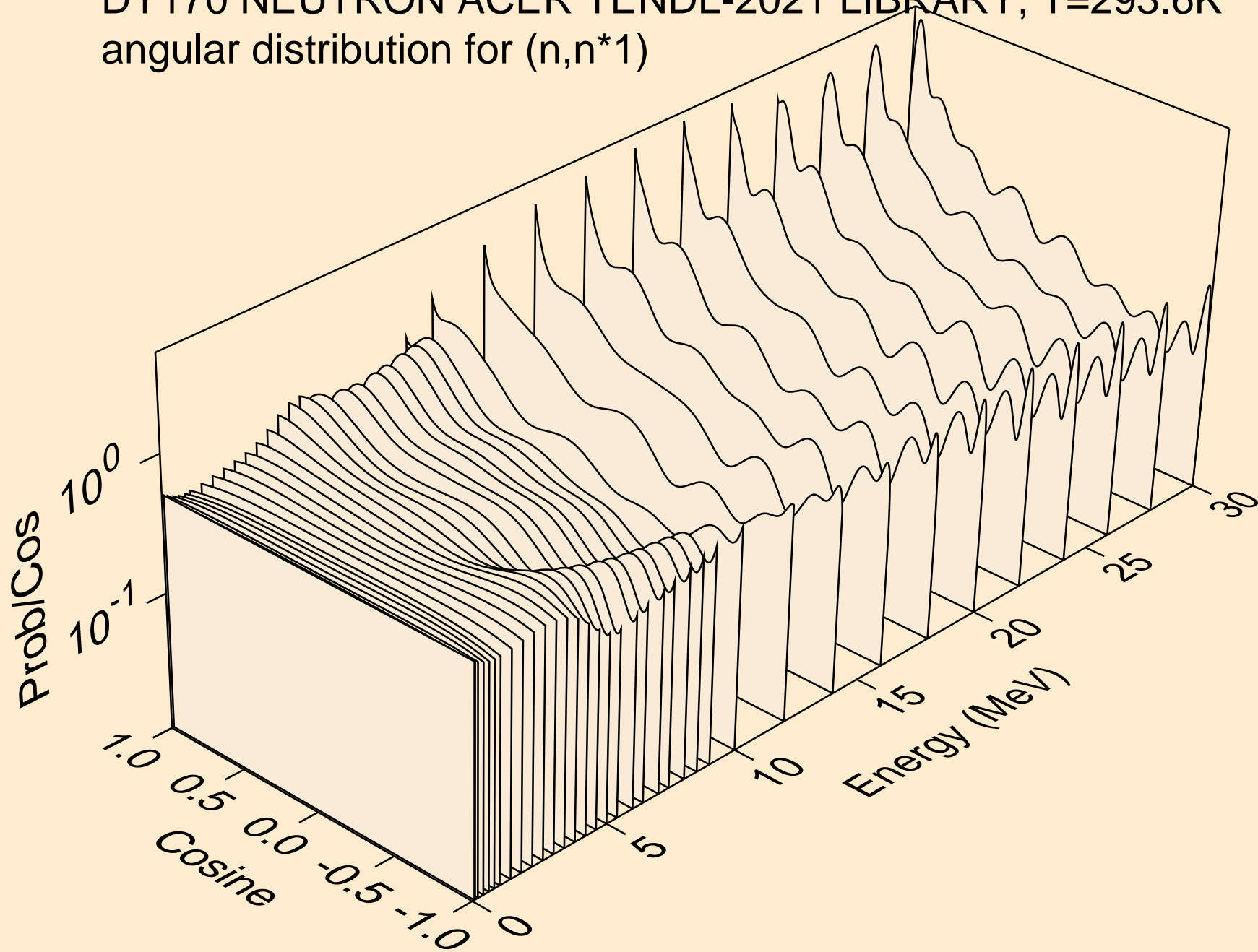

DY170 NEUTRON ACER TENDL-2021 LIBRARY; T=293.6K
angular distribution for (n,n*2)

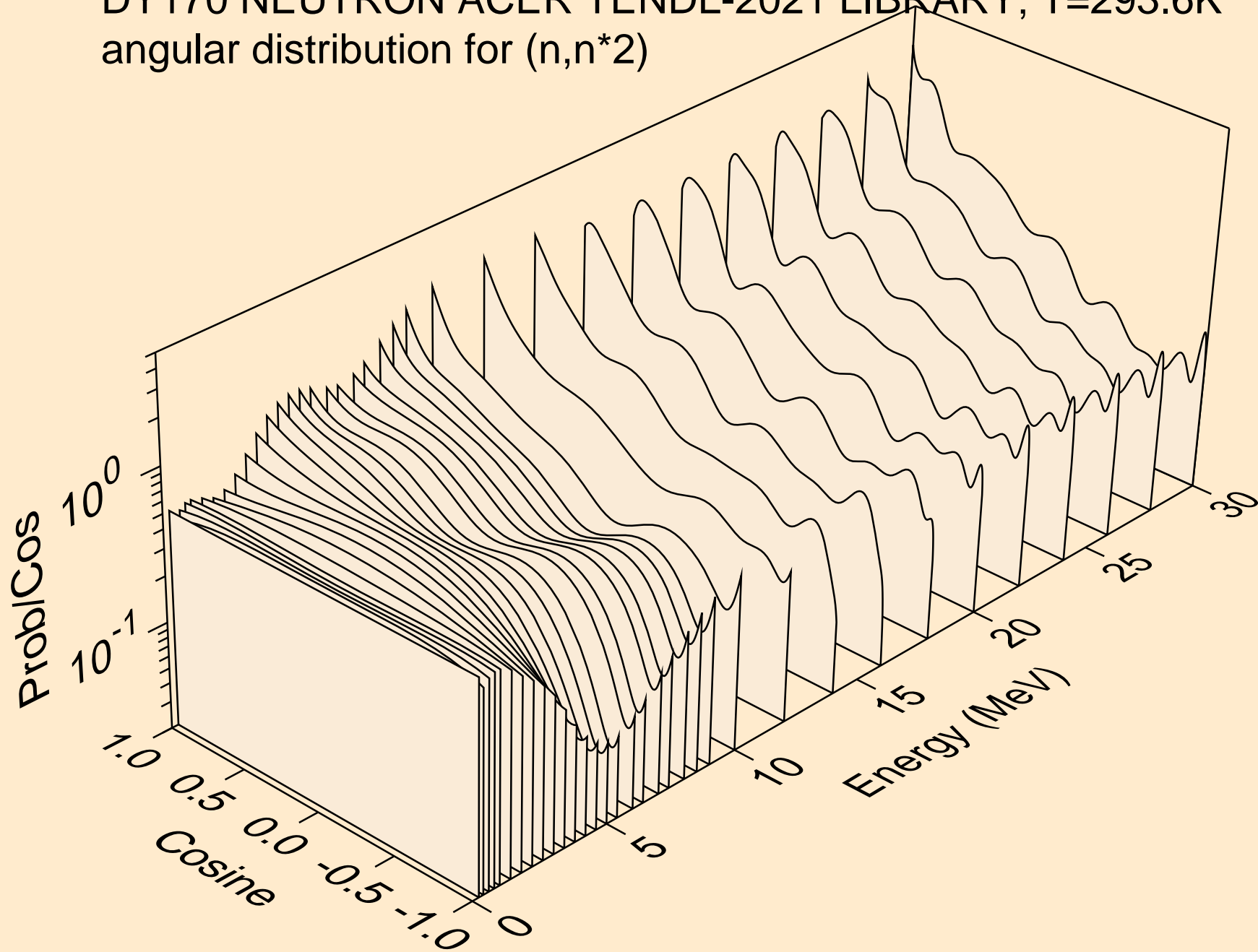

DY170 NEUTRON ACER TENDL-2021 LIBRARY; T=293.6K
angular distribution for (n,n*3)

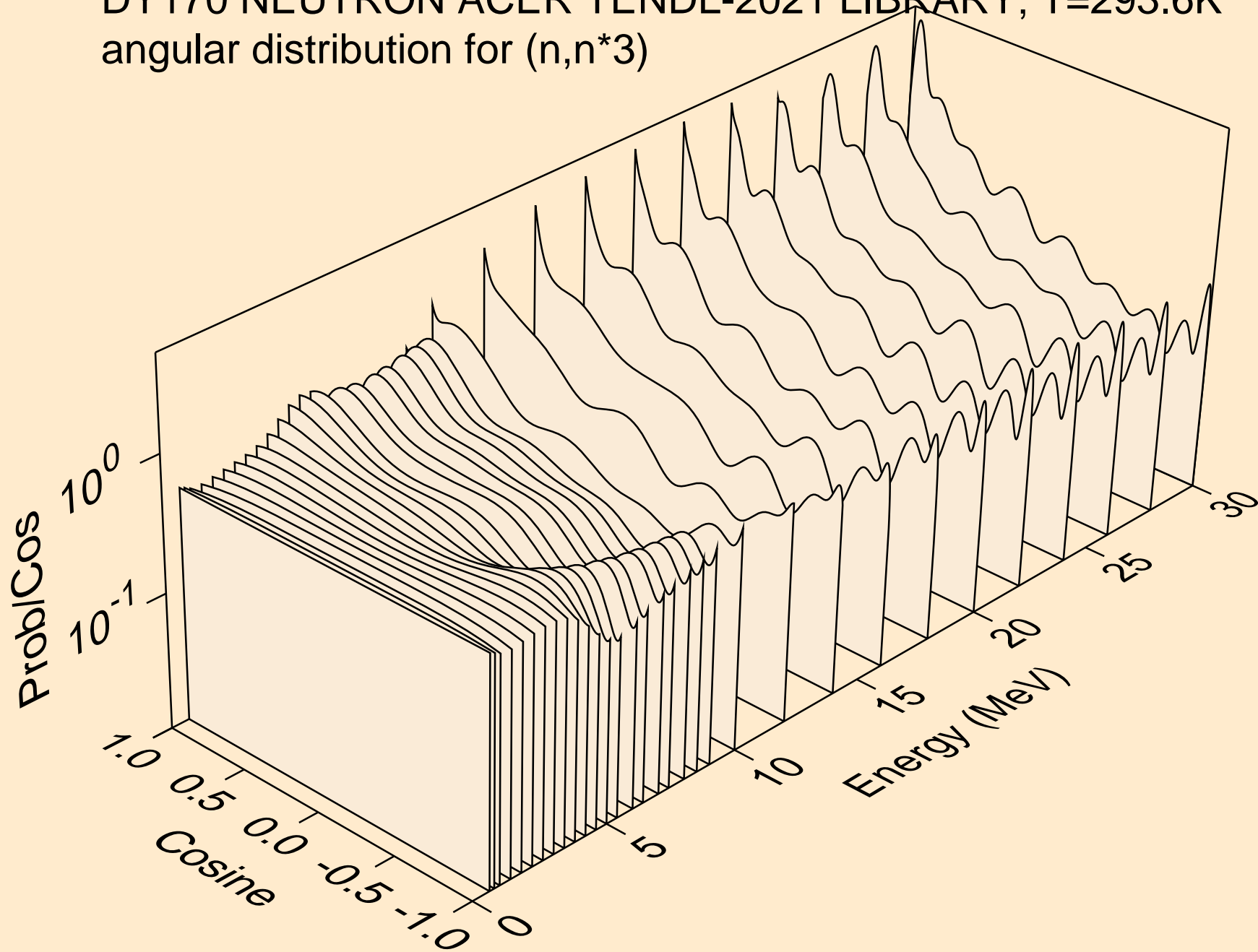

DY170 NEUTRON ACER TENDL-2021 LIBRARY; T=293.6K
angular distribution for (n,n*4)

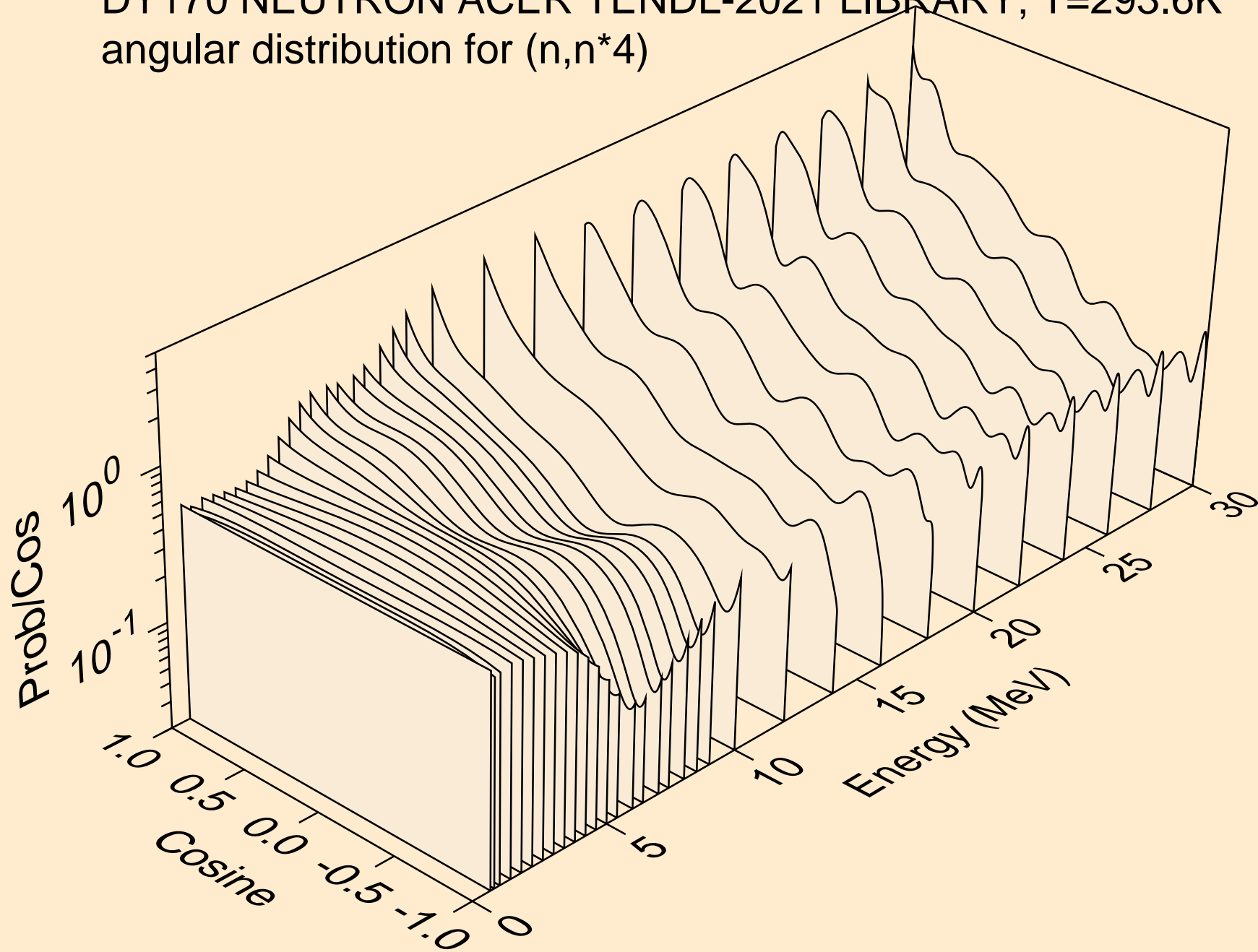

DY170 NEUTRON ACER TENDL-2021 LIBRARY; T=293.6K
angular distribution for (n,n*5)

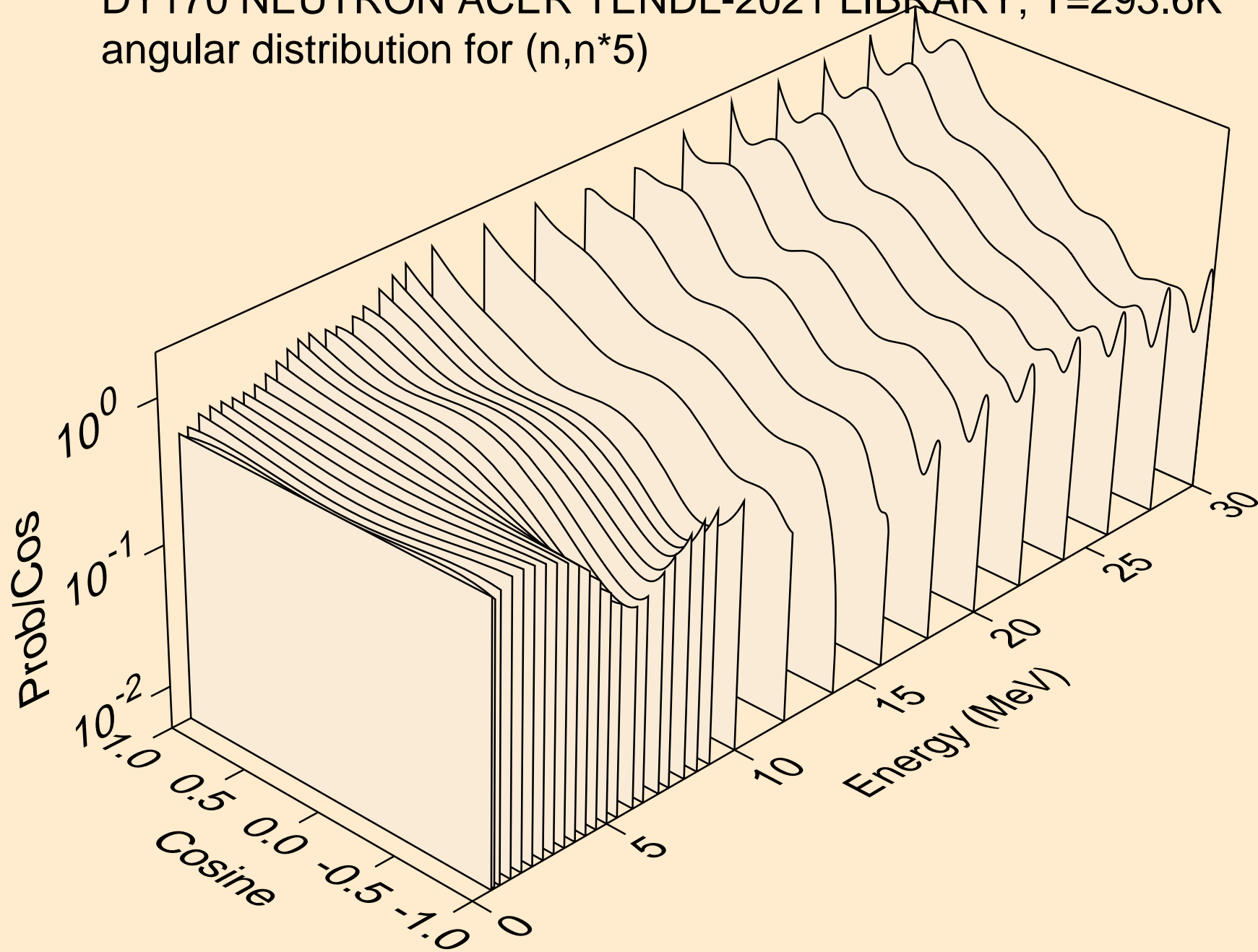

DY170 NEUTRON ACER TENDL-2021 LIBRARY; T=293.6K
angular distribution for (n,n*6)

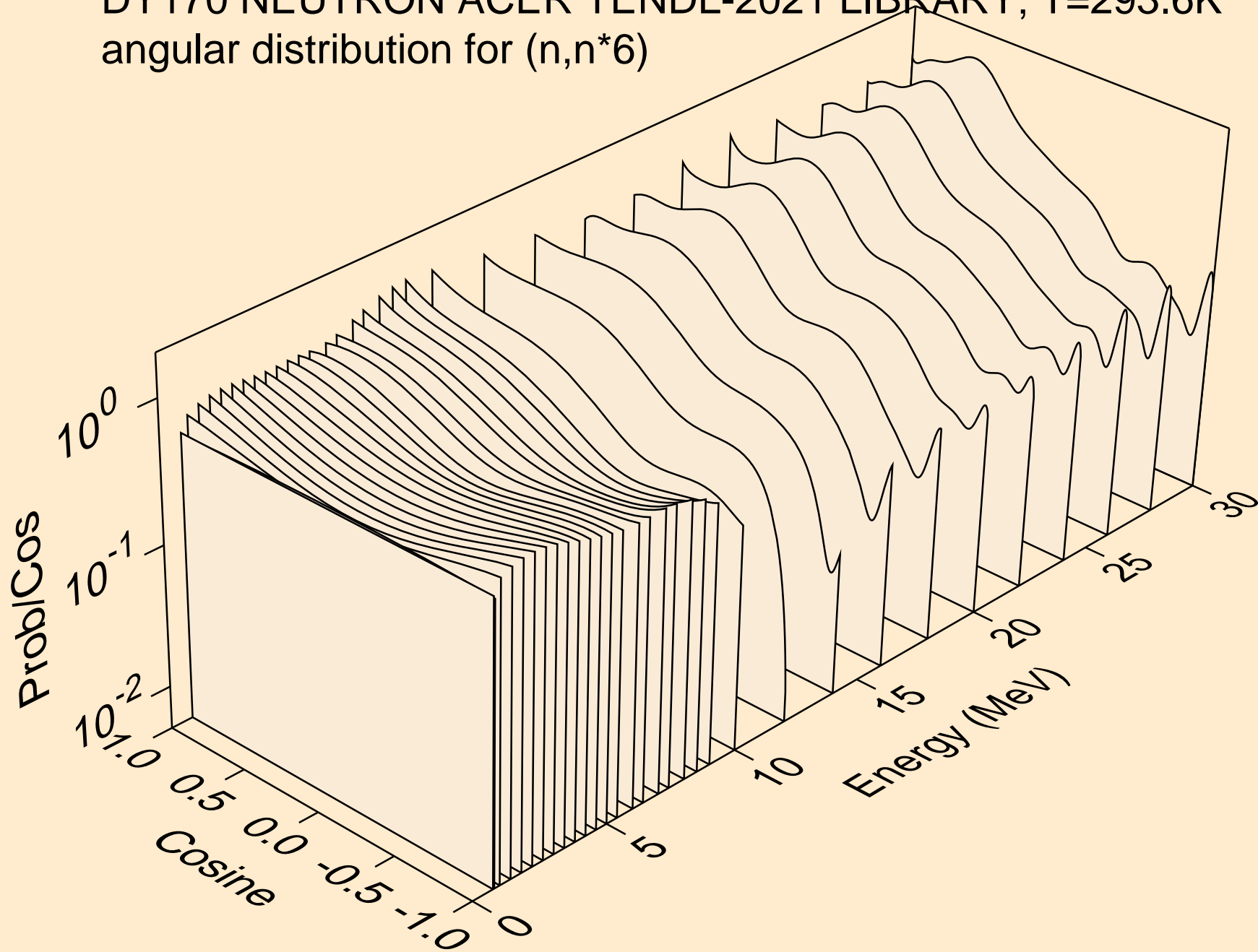

DY170 NEUTRON ACER TENDL-2021 LIBRARY; T=293.6K
angular distribution for (n,n*7)

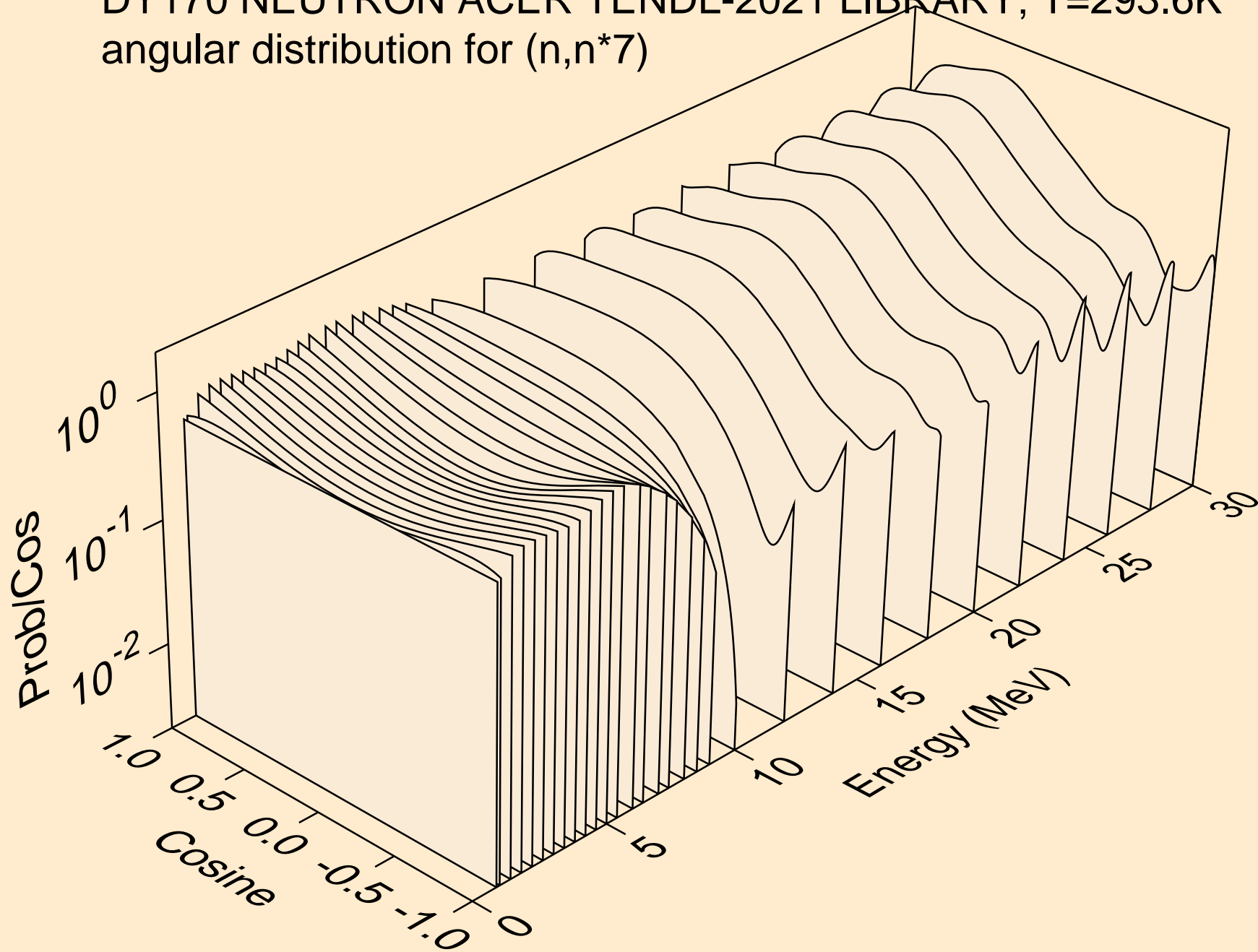

DY170 NEUTRON ACER TENDL-2021 LIBRARY; T=293.6K
angular distribution for (n,n*8)

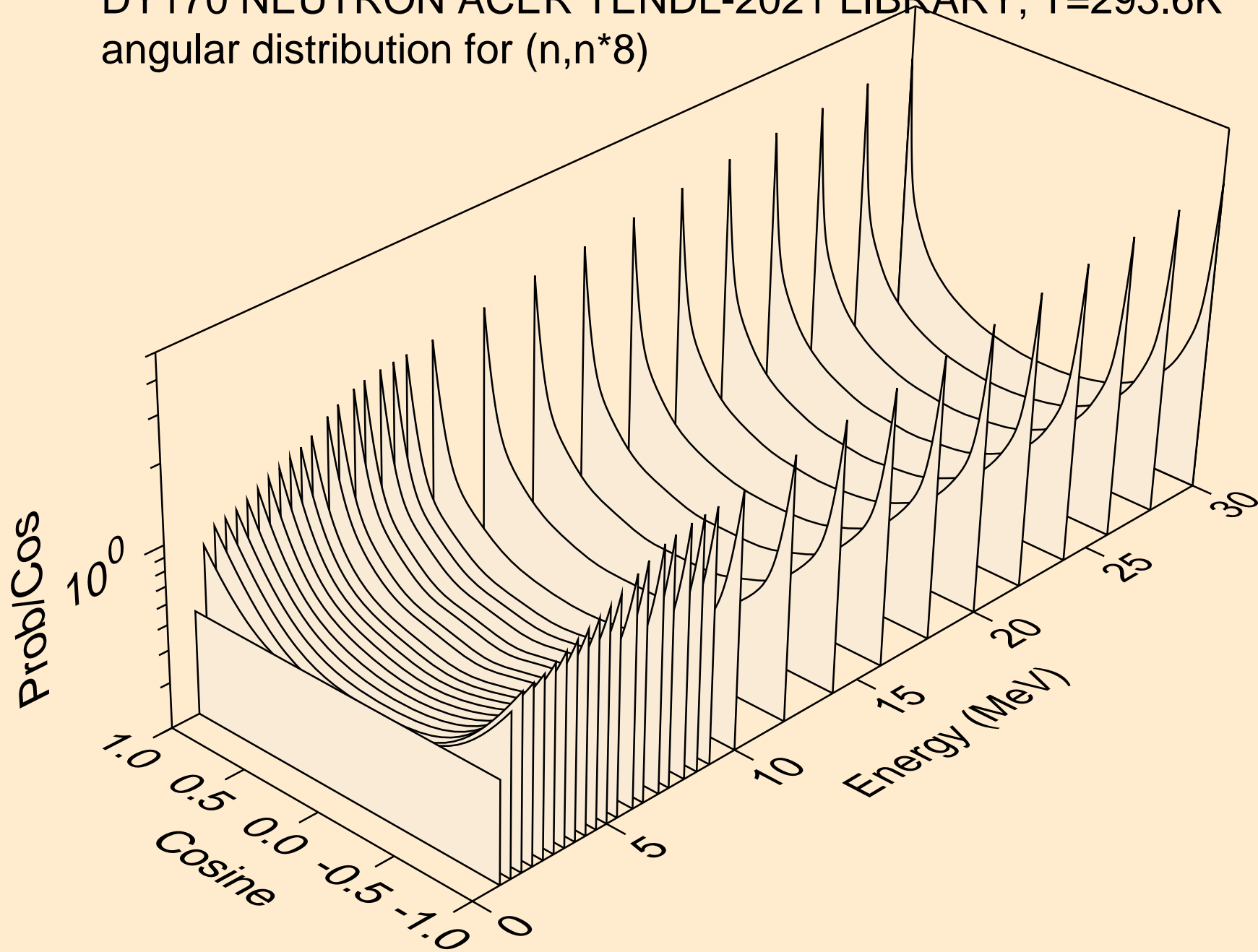

DY170 NEUTRON ACER TENDL-2021 LIBRARY; T=293.6K
angular distribution for (n,n*9)

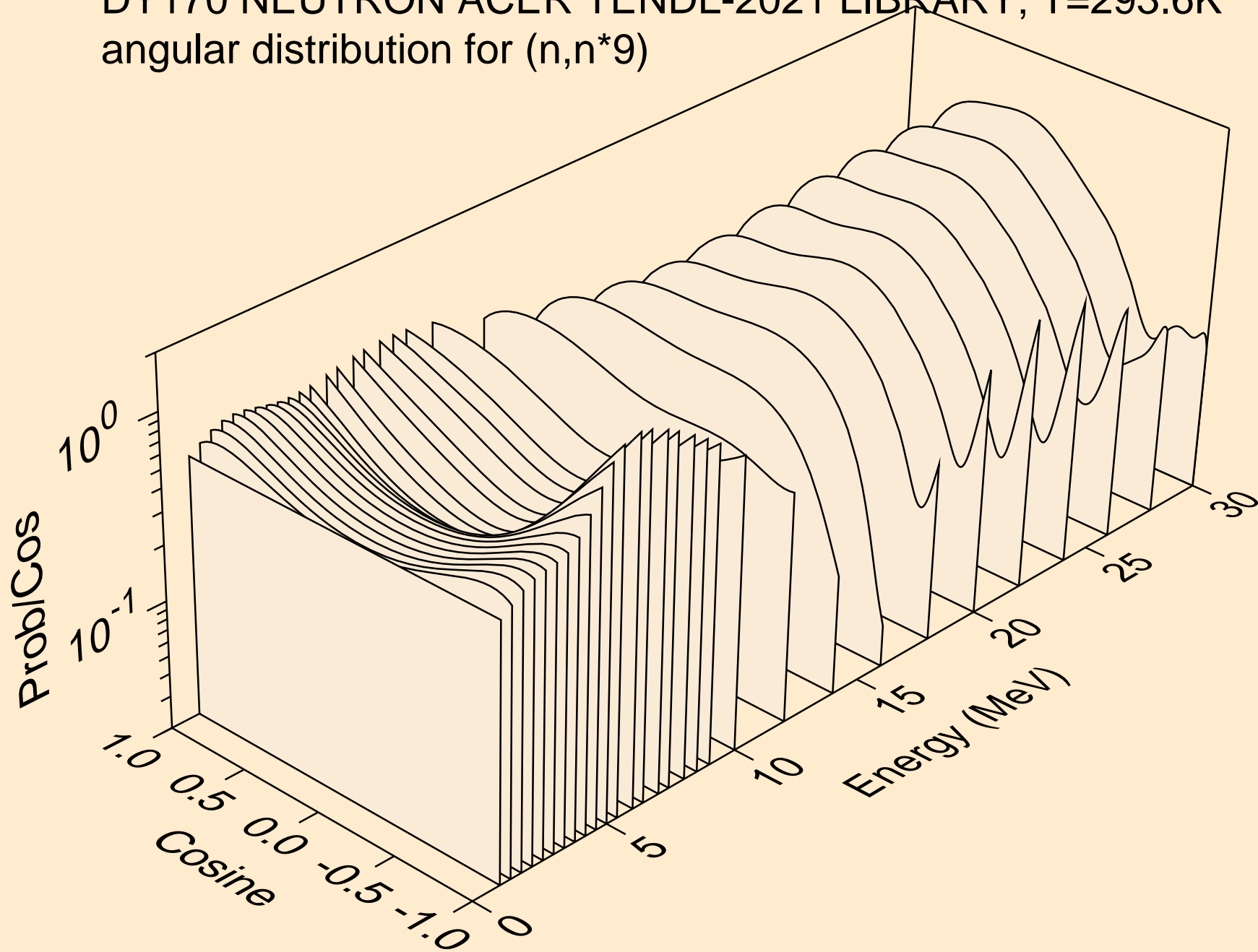

DY170 NEUTRON ACER TENDL-2021 LIBRARY; T=293.6K
angular distribution for (n,n*10)

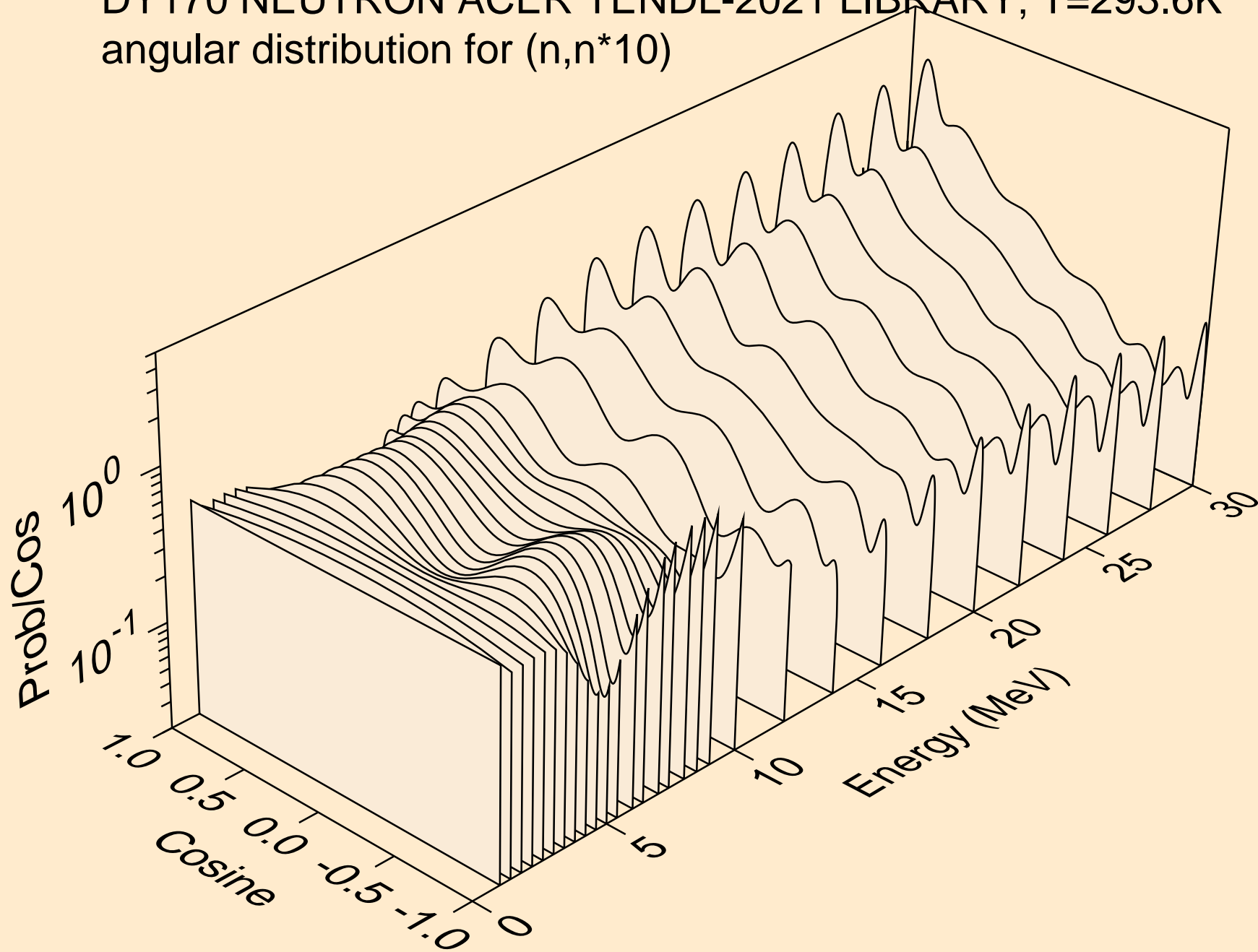

DY170 NEUTRON ACER TENDL-2021 LIBRARY; T=293.6K
angular distribution for (n,n*11)

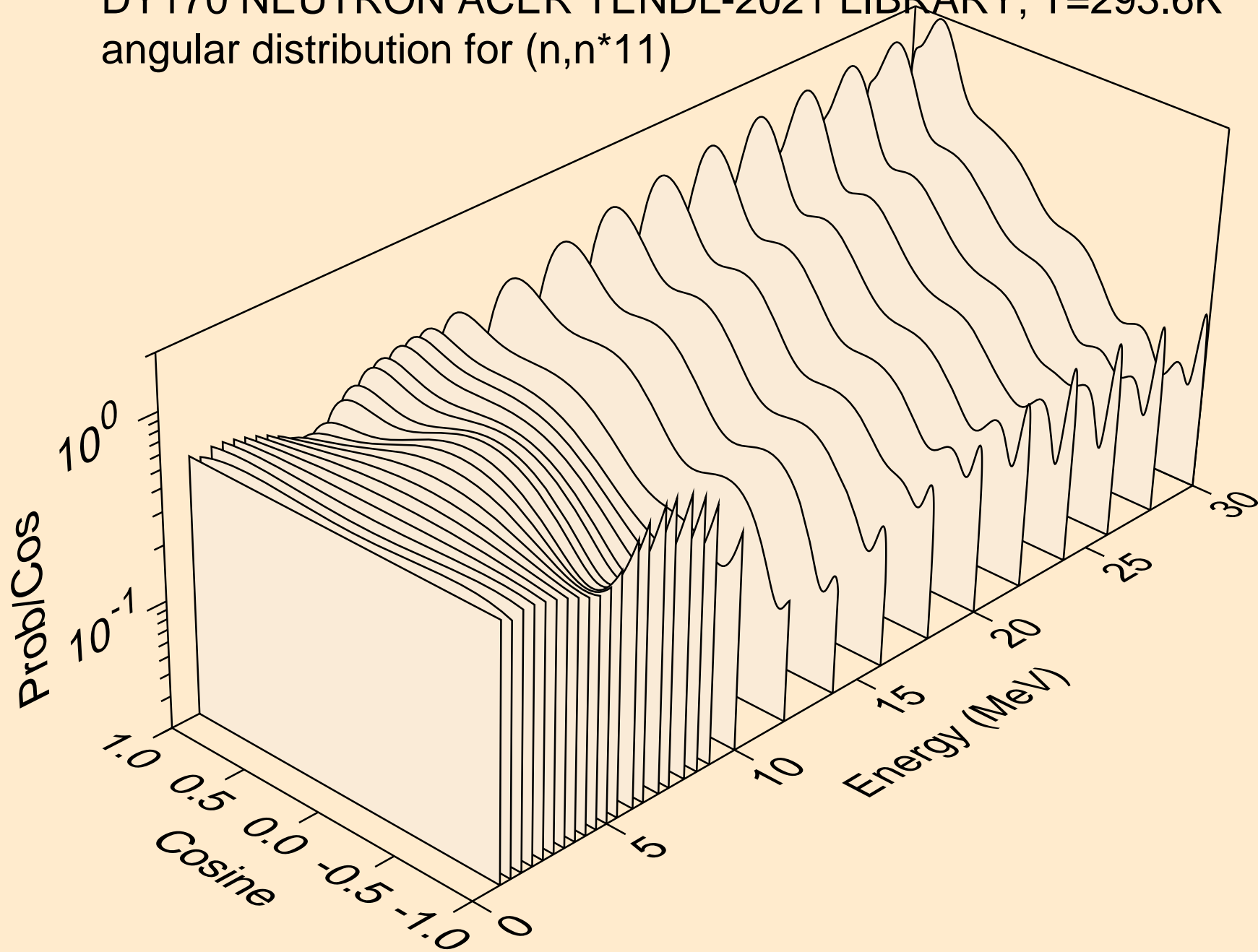

DY170 NEUTRON ACER TENDL-2021 LIBRARY; T=293.6K
angular distribution for (n,n*12)

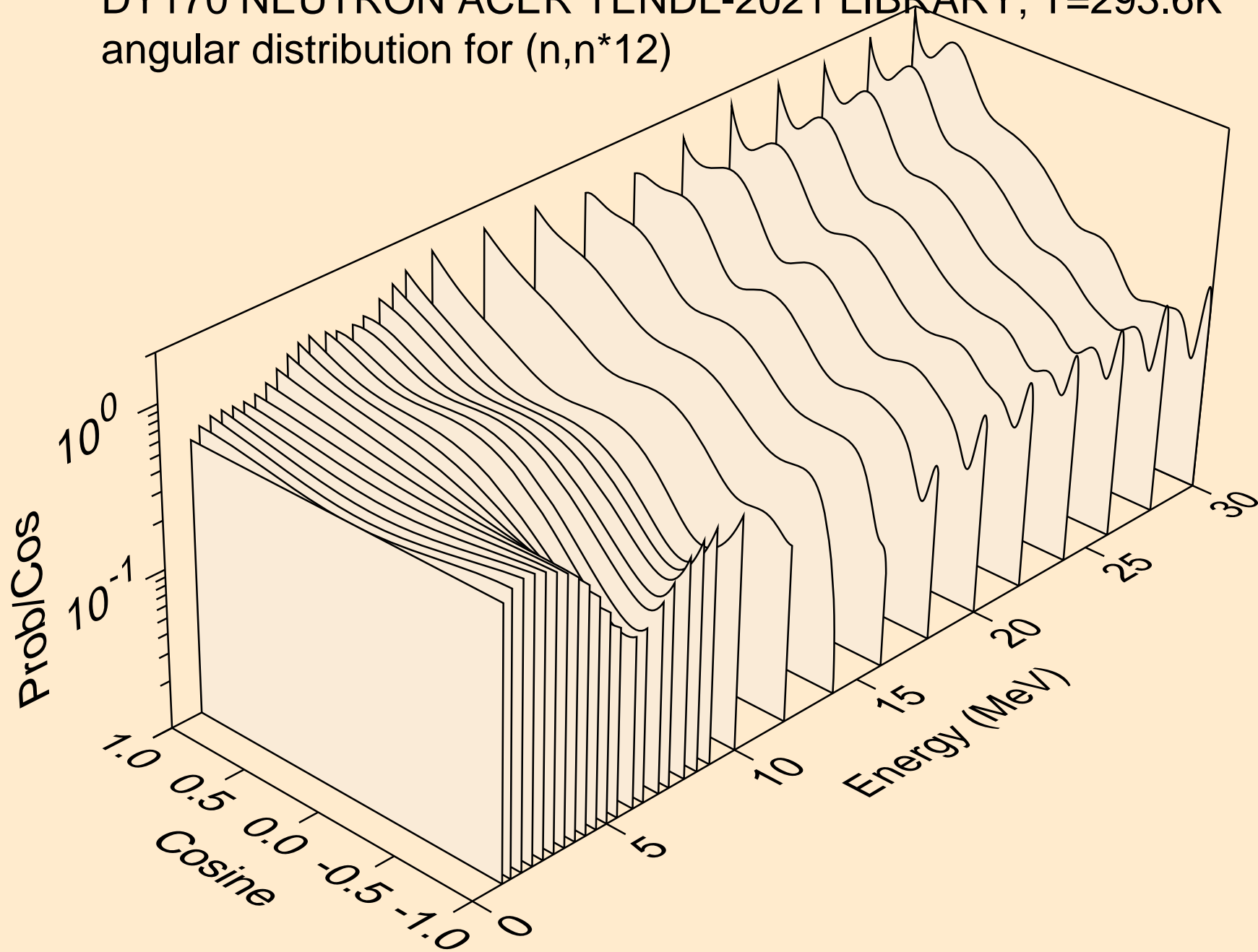

DY170 NEUTRON ACER TENDL-2021 LIBRARY; T=293.6K
angular distribution for (n,n*13)

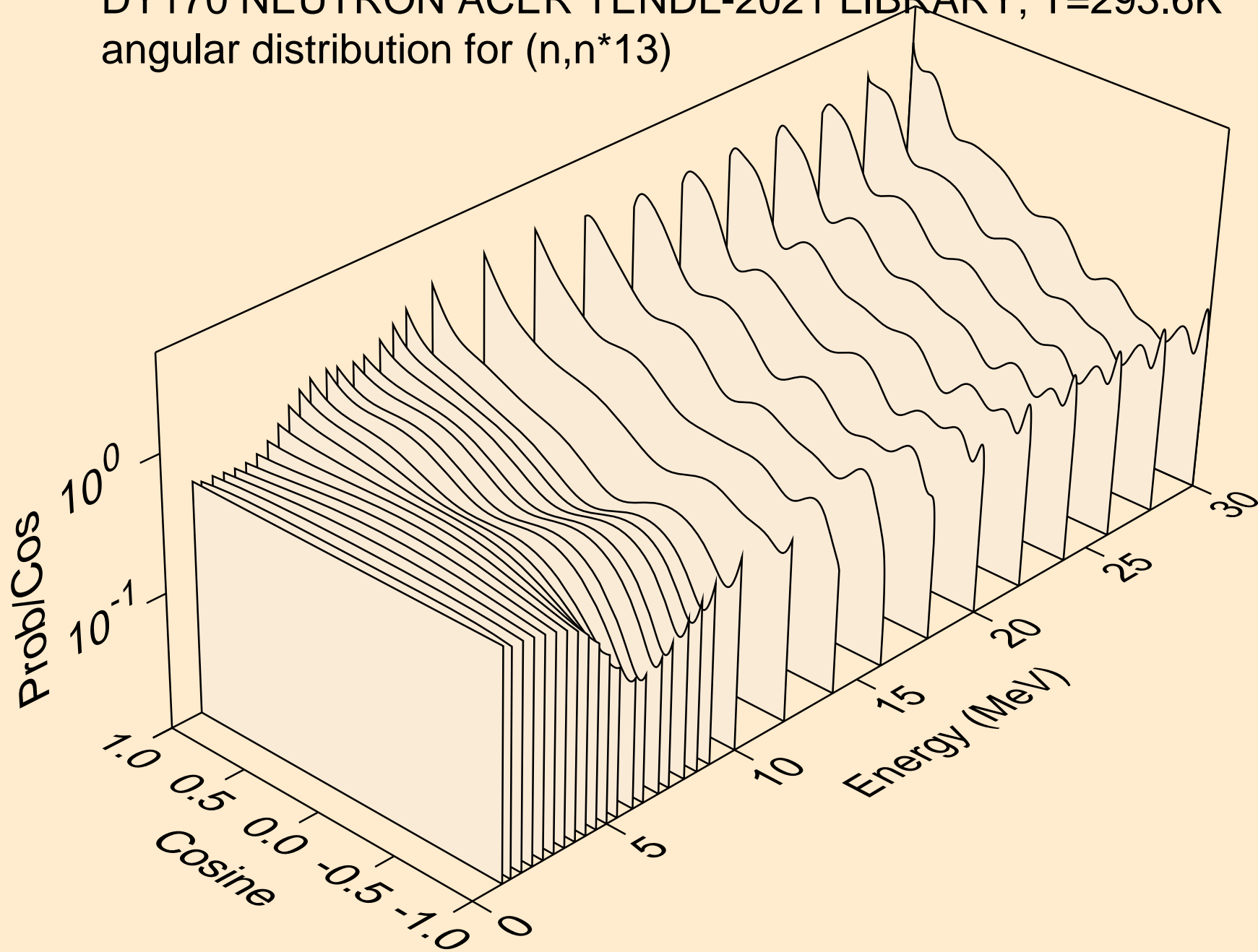

DY170 NEUTRON ACER TENDL-2021 LIBRARY; T=293.6K
angular distribution for (n,n*14)

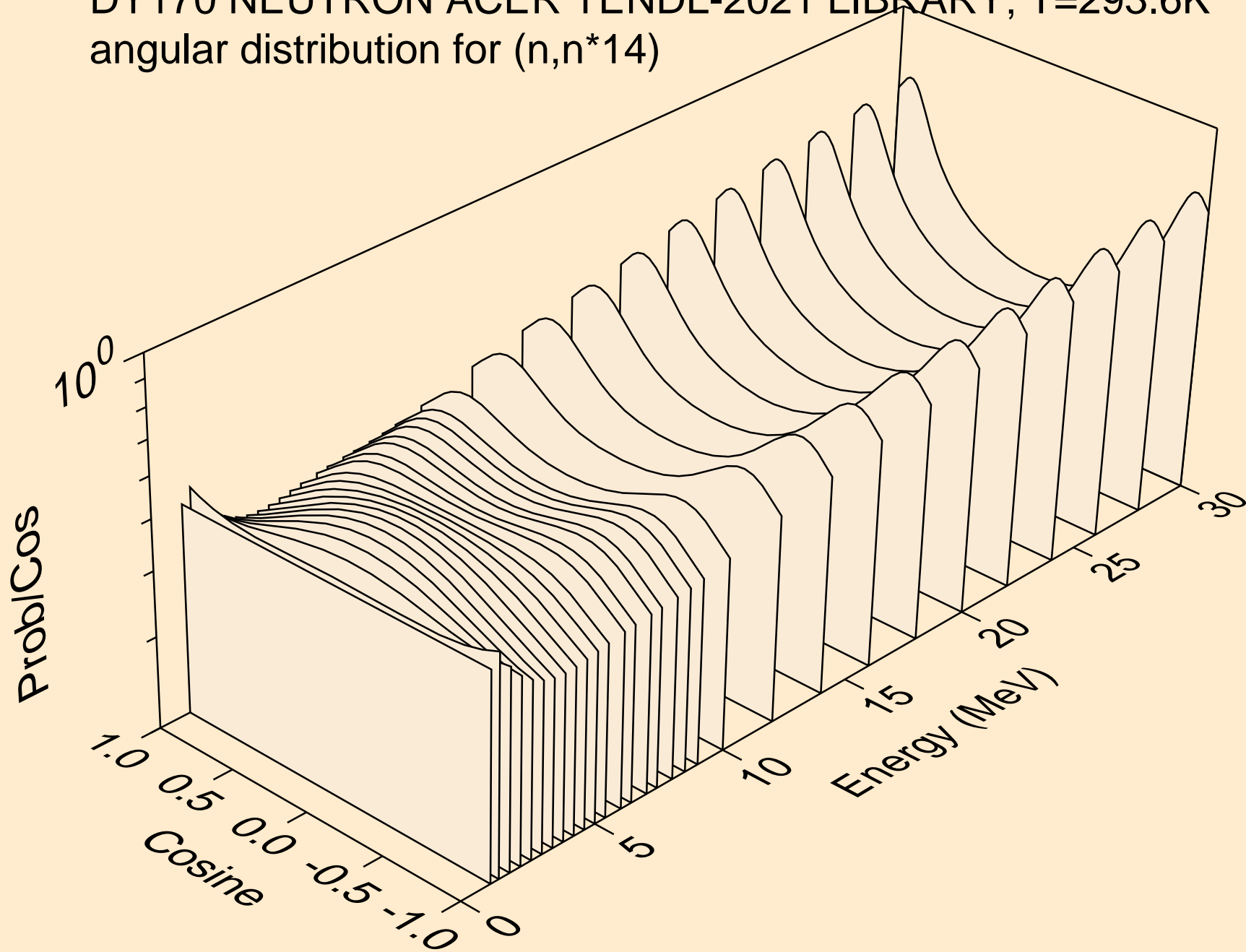

DY170 NEUTRON ACER TENDL-2021 LIBRARY; T=293.6K
angular distribution for (n,n*15)

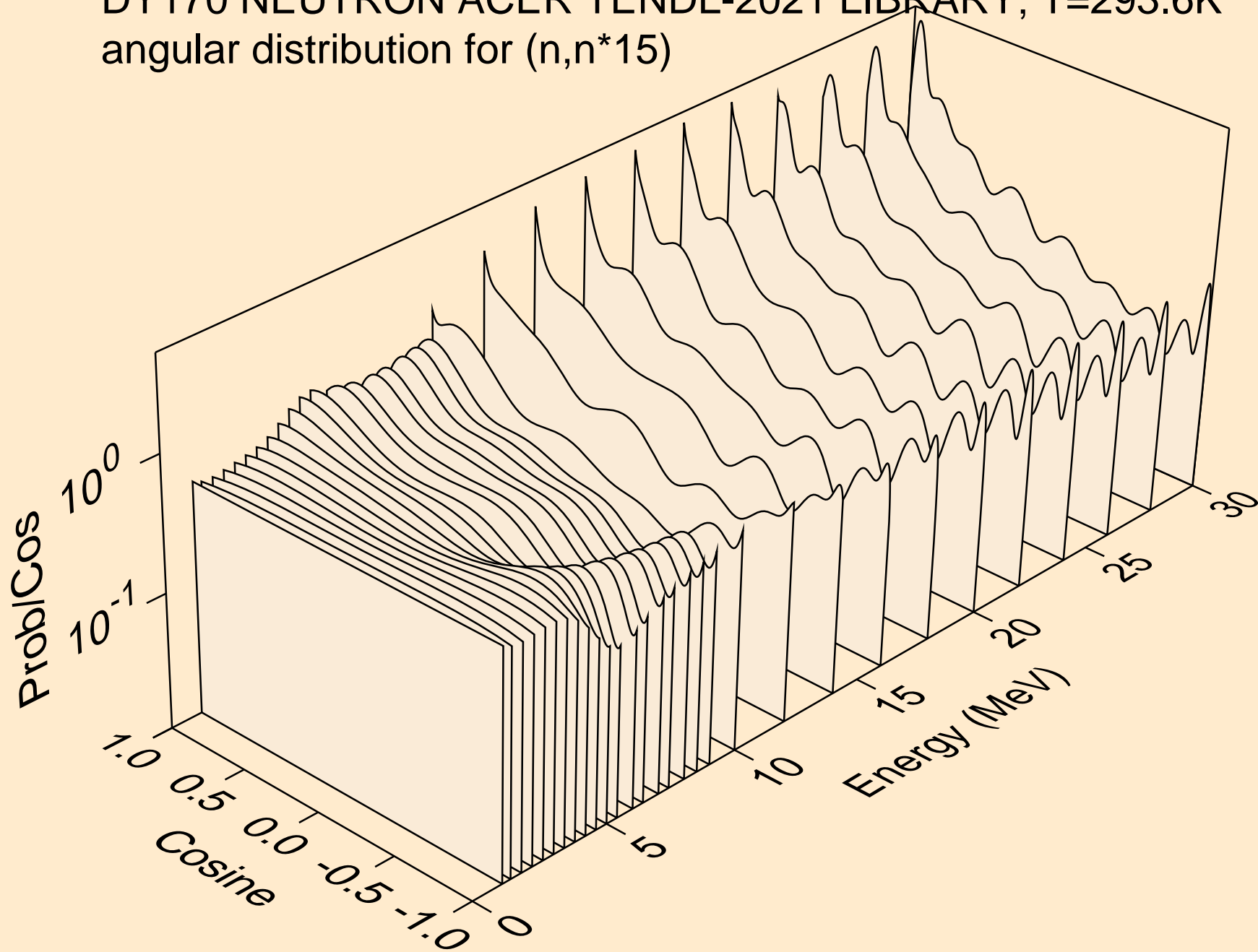

DY170 NEUTRON ACER TENDL-2021 LIBRARY; T=293.6K
angular distribution for (n,n*16)

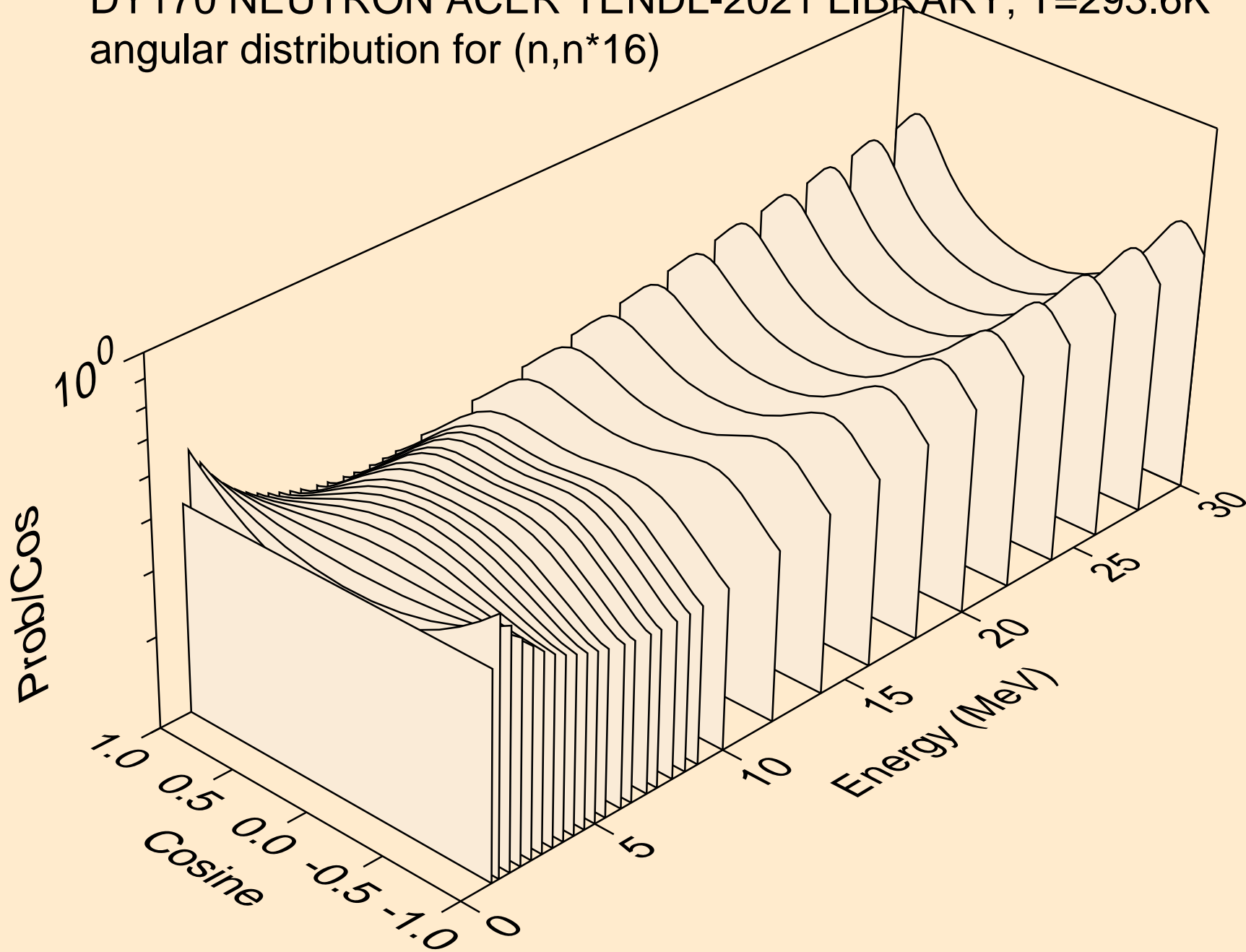

DY170 NEUTRON ACER TENDL-2021 LIBRARY; T=293.6K
angular distribution for (n,n*17)

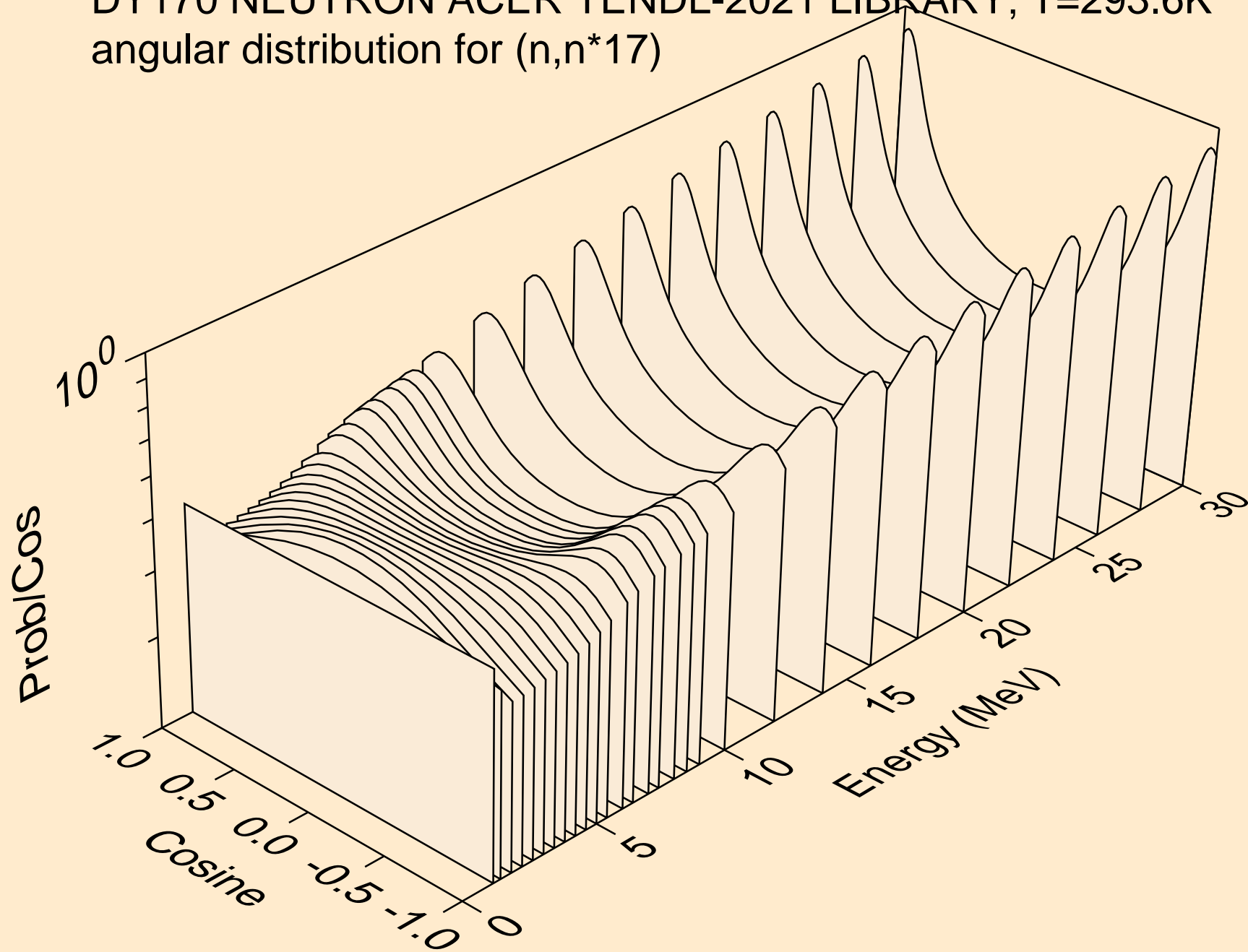

DY170 NEUTRON ACER TENDL-2021 LIBRARY; T=293.6K
angular distribution for (n,n*18)

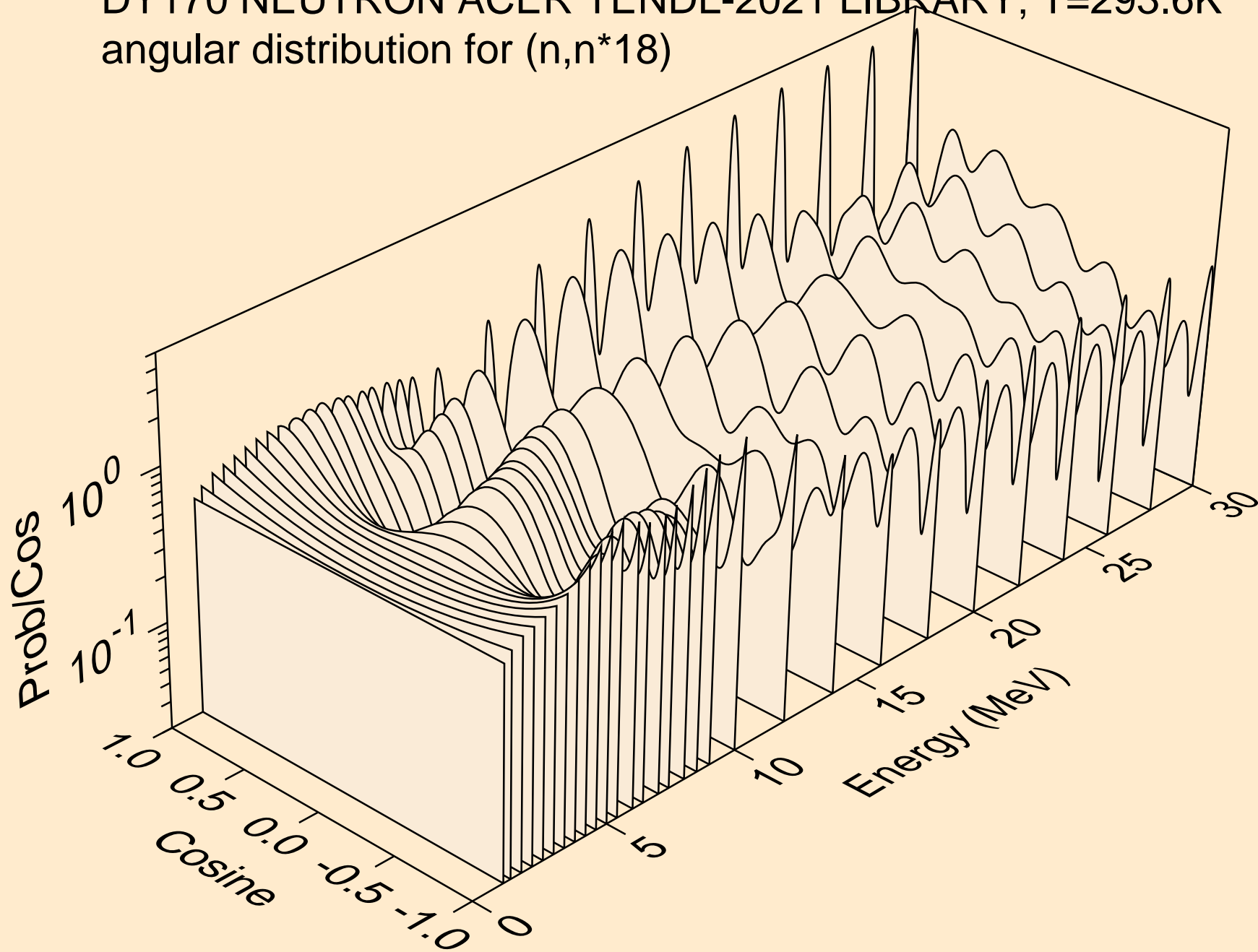

DY170 NEUTRON ACER TENDL-2021 LIBRARY; T=293.6K
angular distribution for (n,n*19)

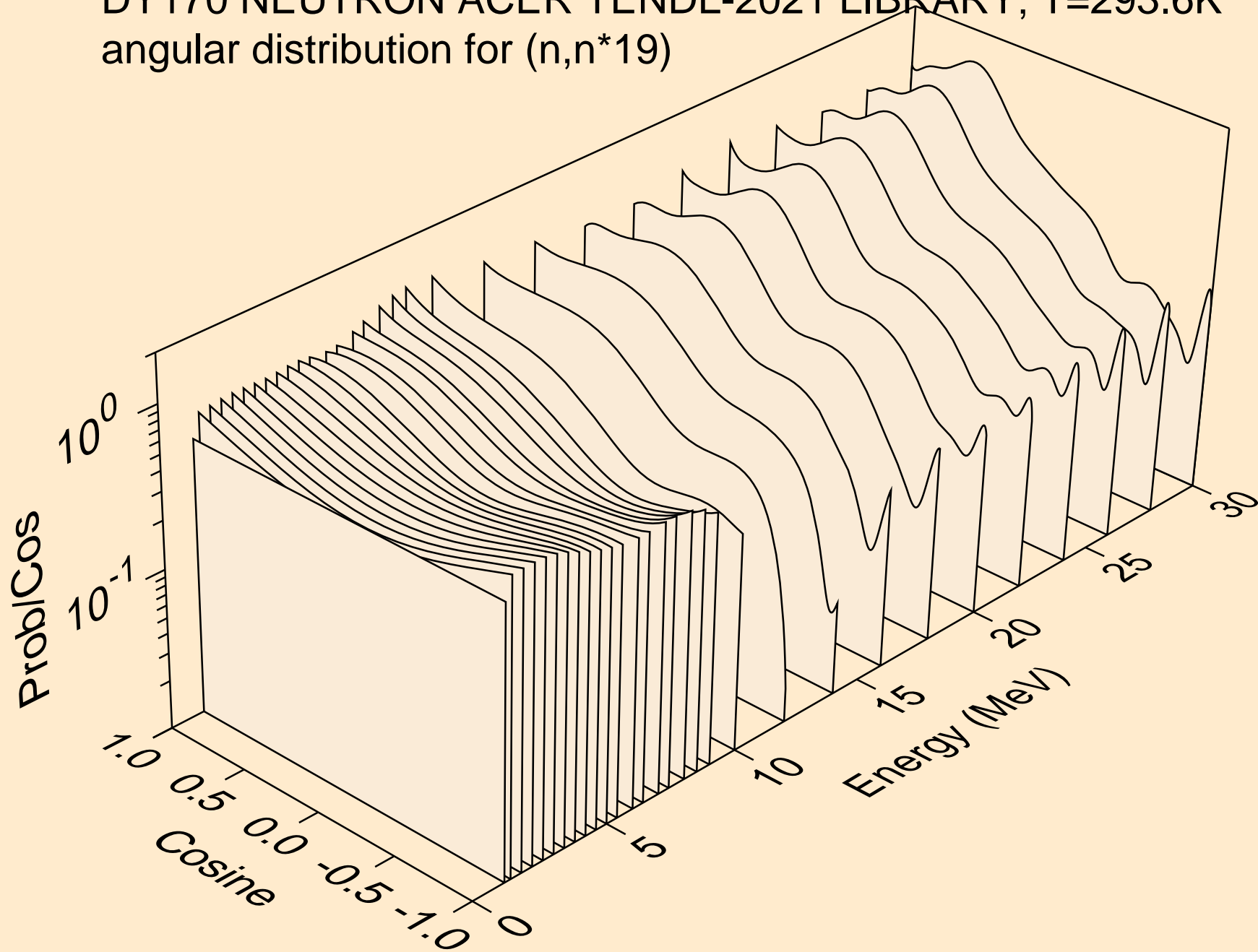

DY170 NEUTRON ACER TENDL-2021 LIBRARY; T=293.6K
angular distribution for (n,n*20)

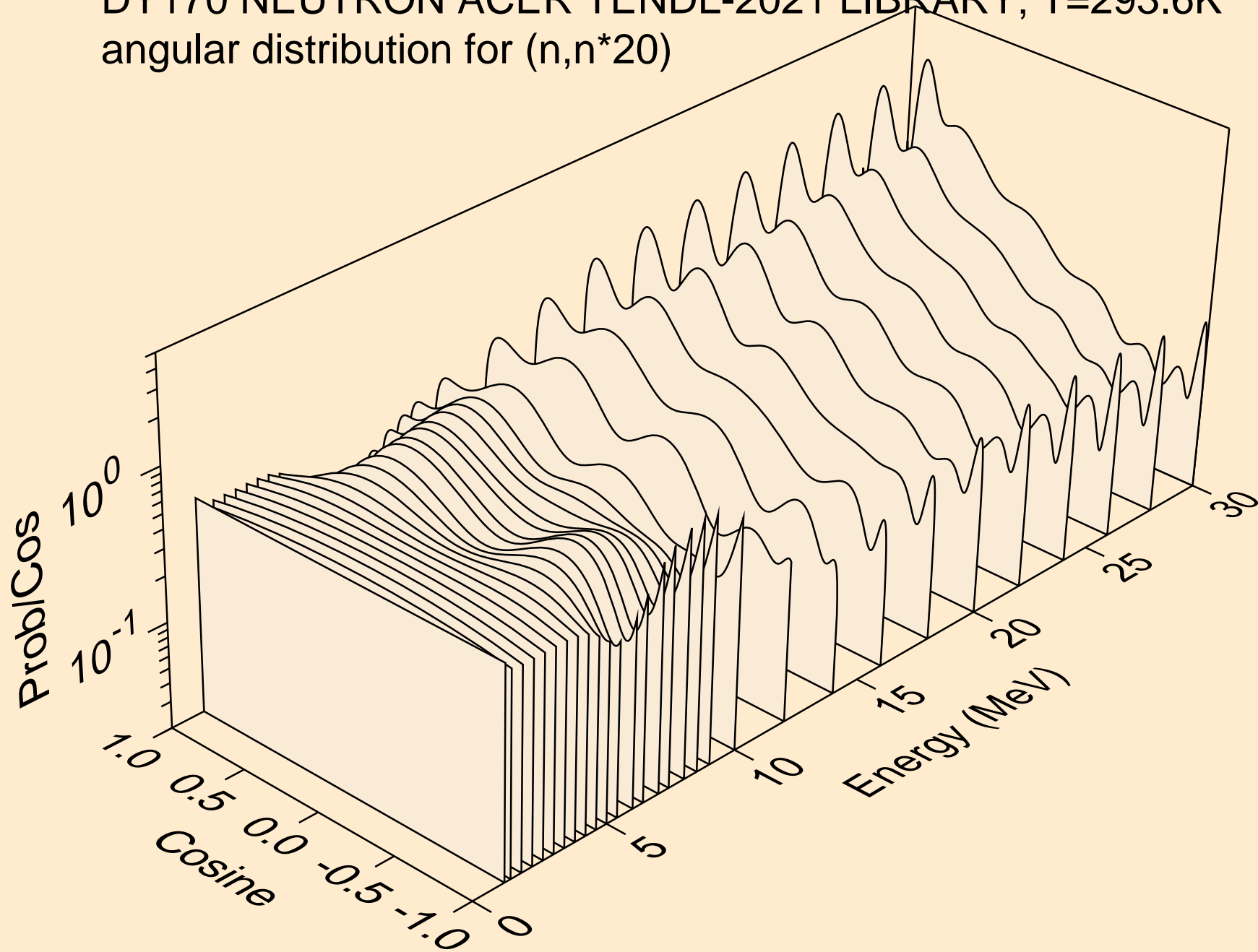

DY170 NEUTRON ACER TENDL-2021 LIBRARY; T=293.6K
angular distribution for (n,n*21)

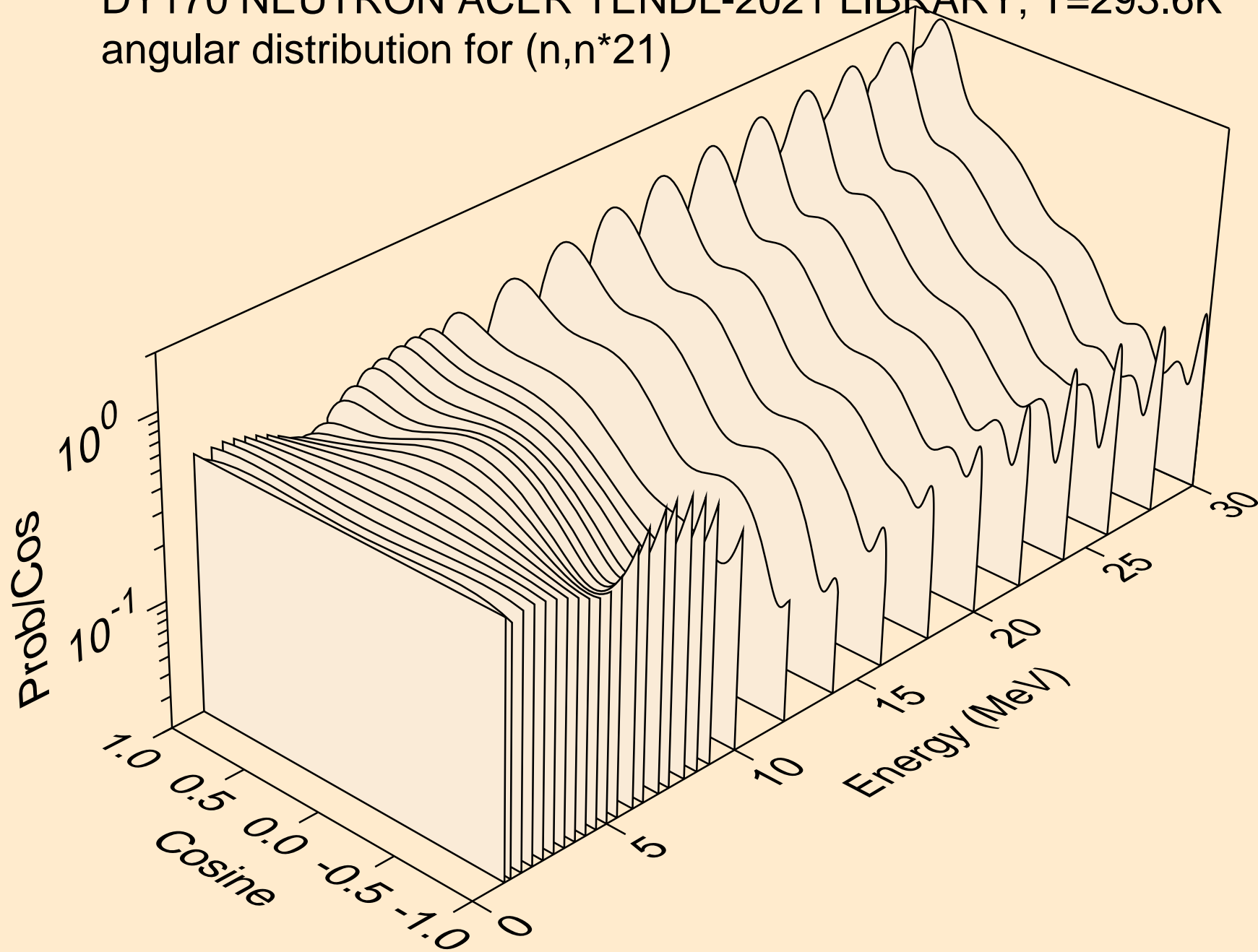

DY170 NEUTRON ACER TENDL-2021 LIBRARY; T=293.6K
angular distribution for (n,n*22)

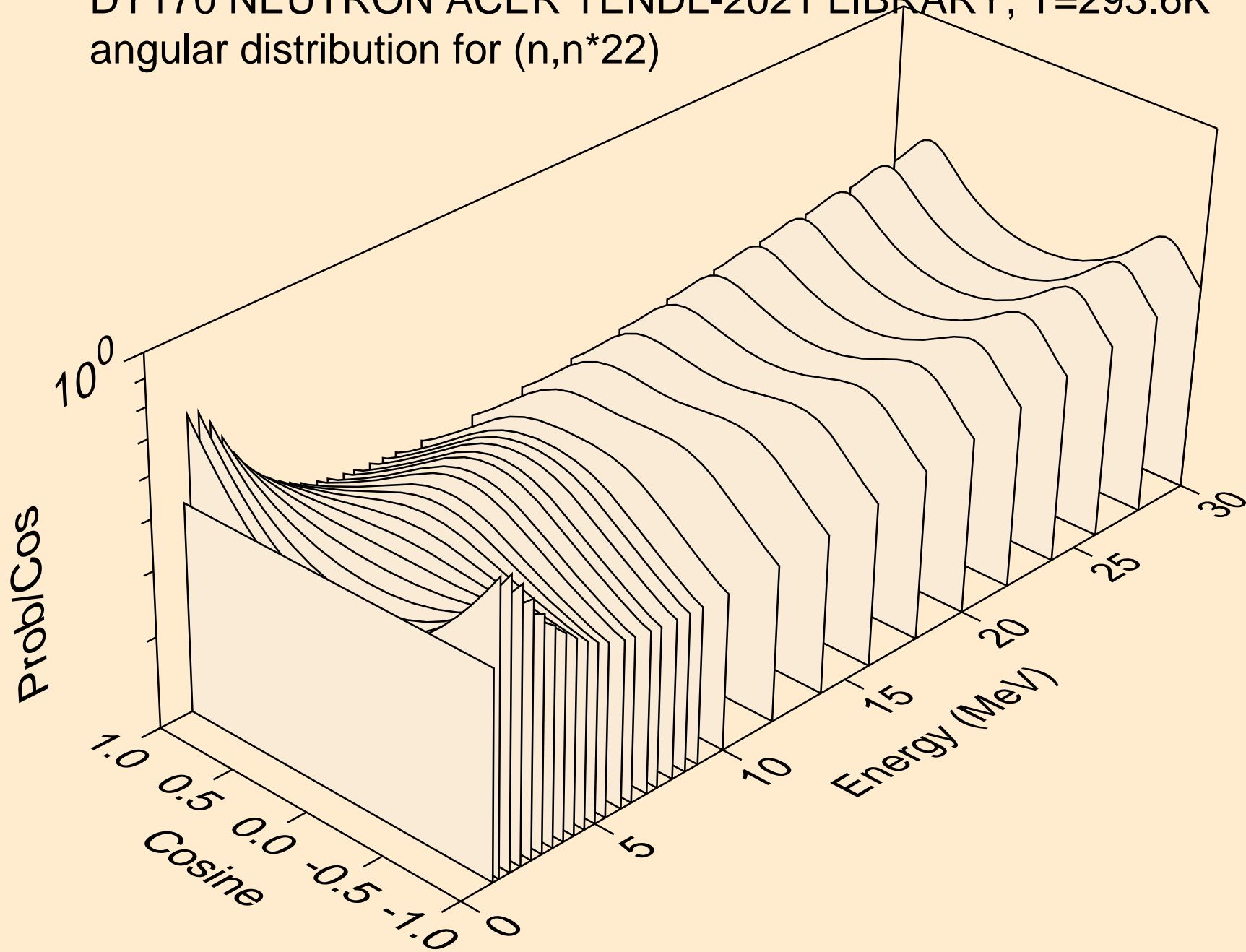

DY170 NEUTRON ACER TENDL-2021 LIBRARY; T=293.6K
angular distribution for (n,n*23)

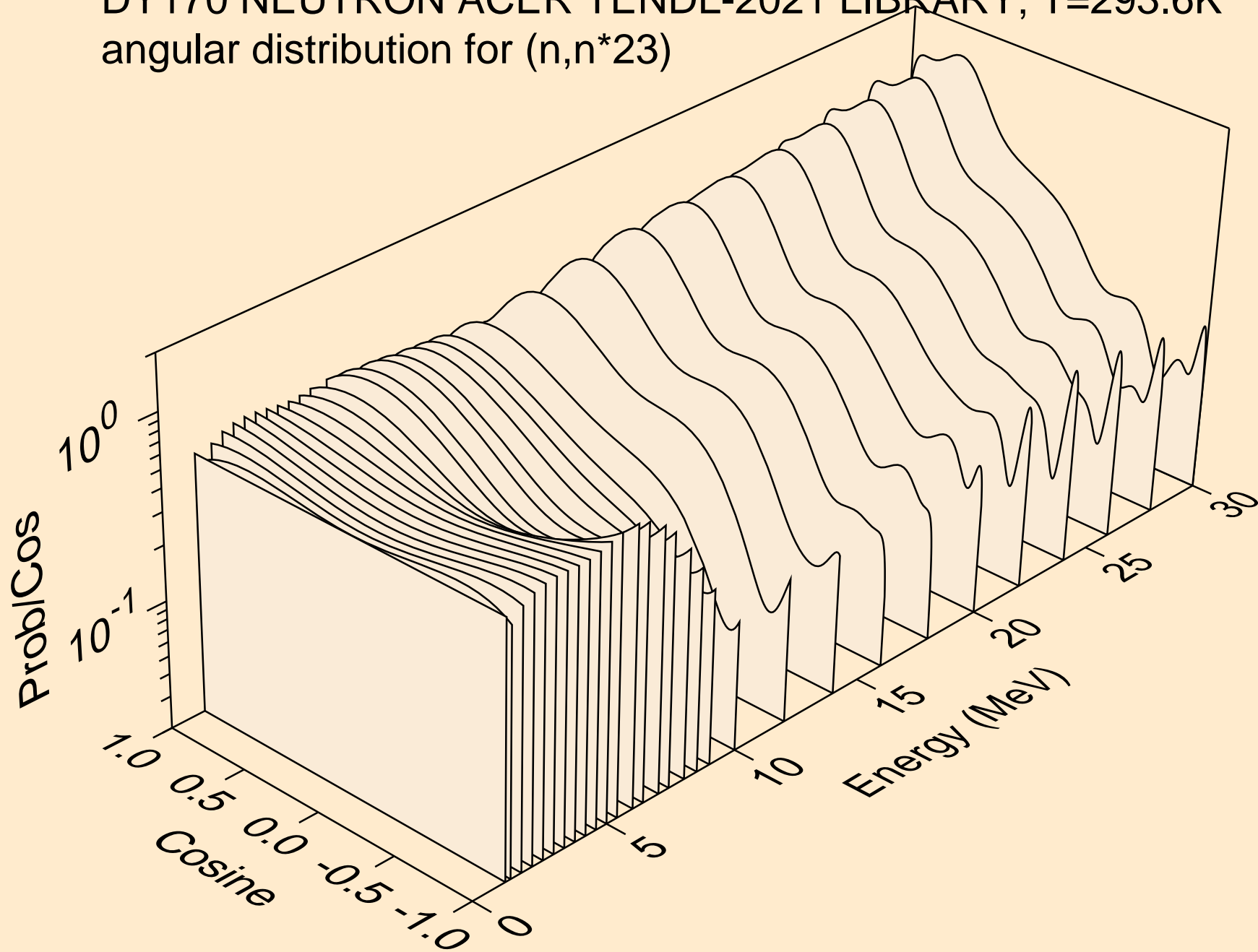

DY170 NEUTRON ACER TENDL-2021 LIBRARY; T=293.6K
angular distribution for (n,n*24)

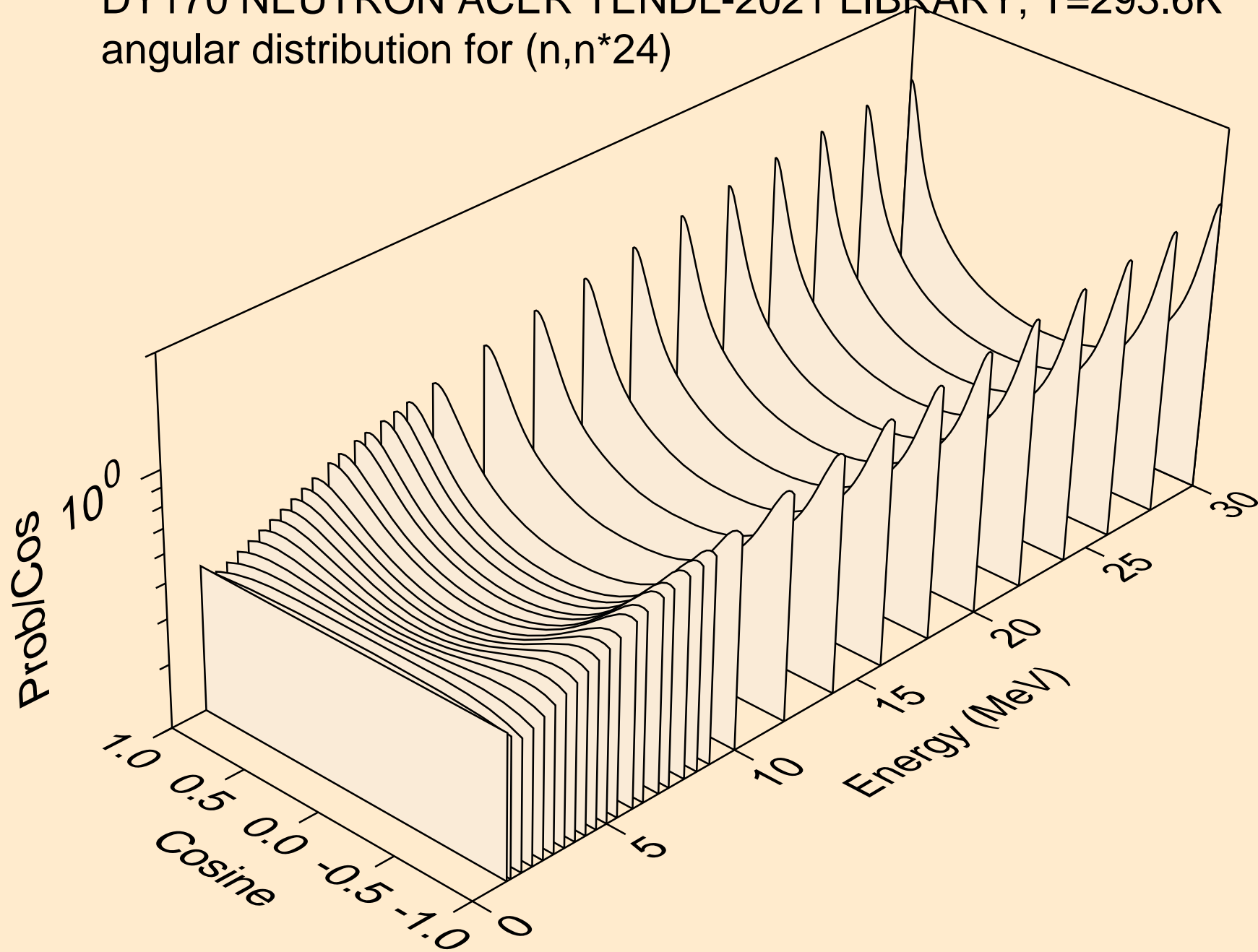

DY170 NEUTRON ACER TENDL-2021 LIBRARY; T=293.6K
angular distribution for (n,n*25)

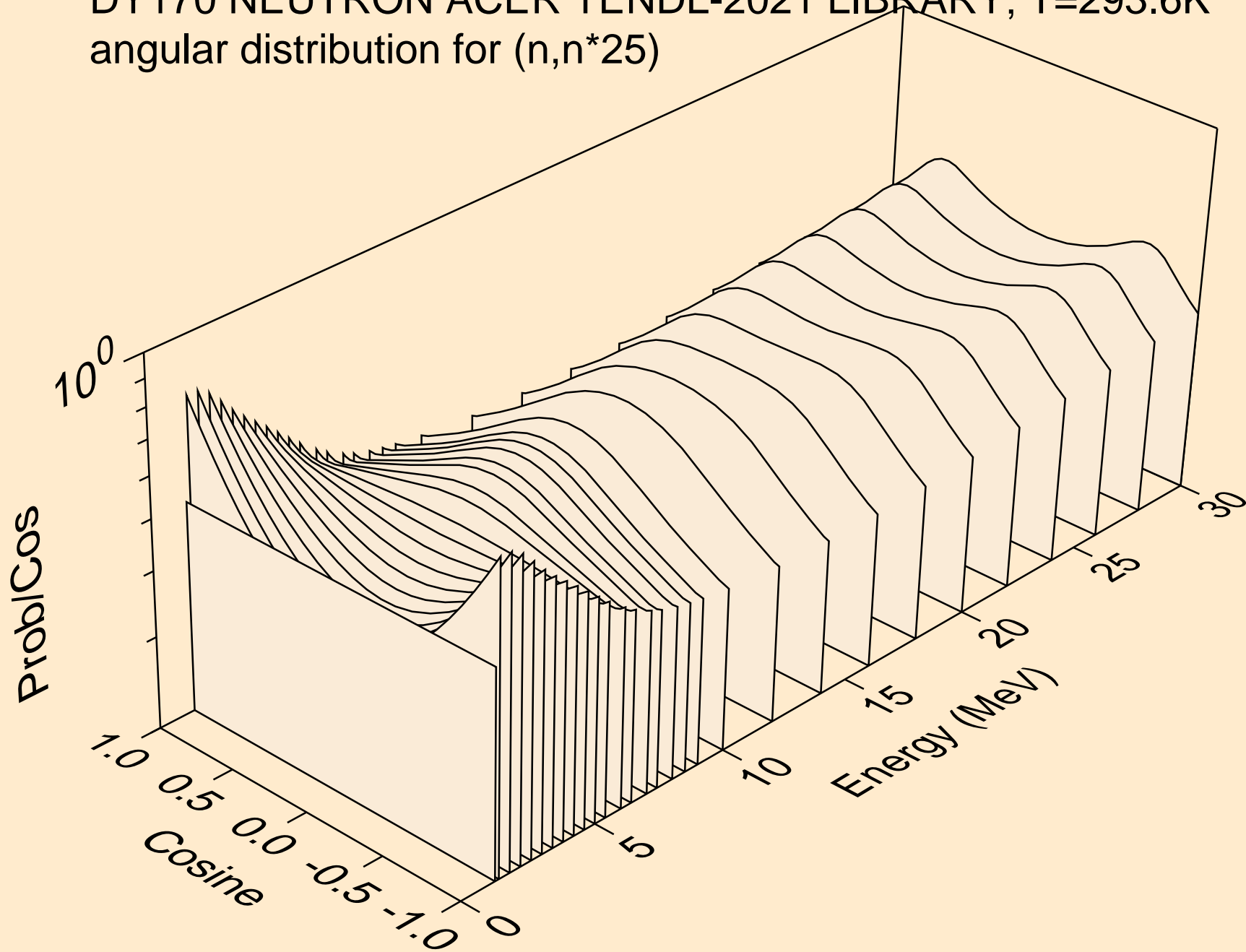

DY170 NEUTRON ACER TENDL-2021 LIBRARY; T=293.6K
angular distribution for (n,n*26)

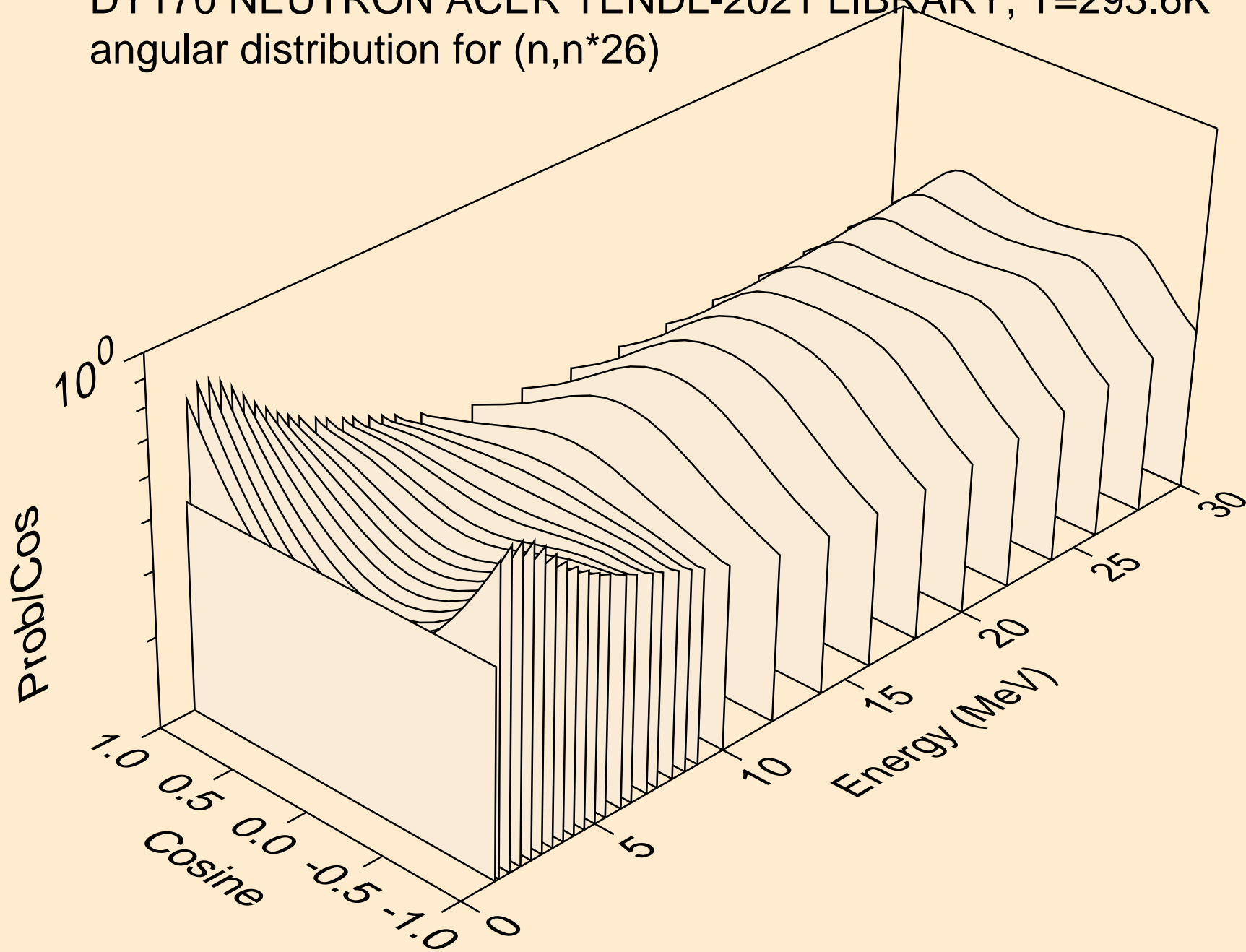

DY170 NEUTRON ACER TENDL-2021 LIBRARY; T=293.6K
angular distribution for (n,n*27)

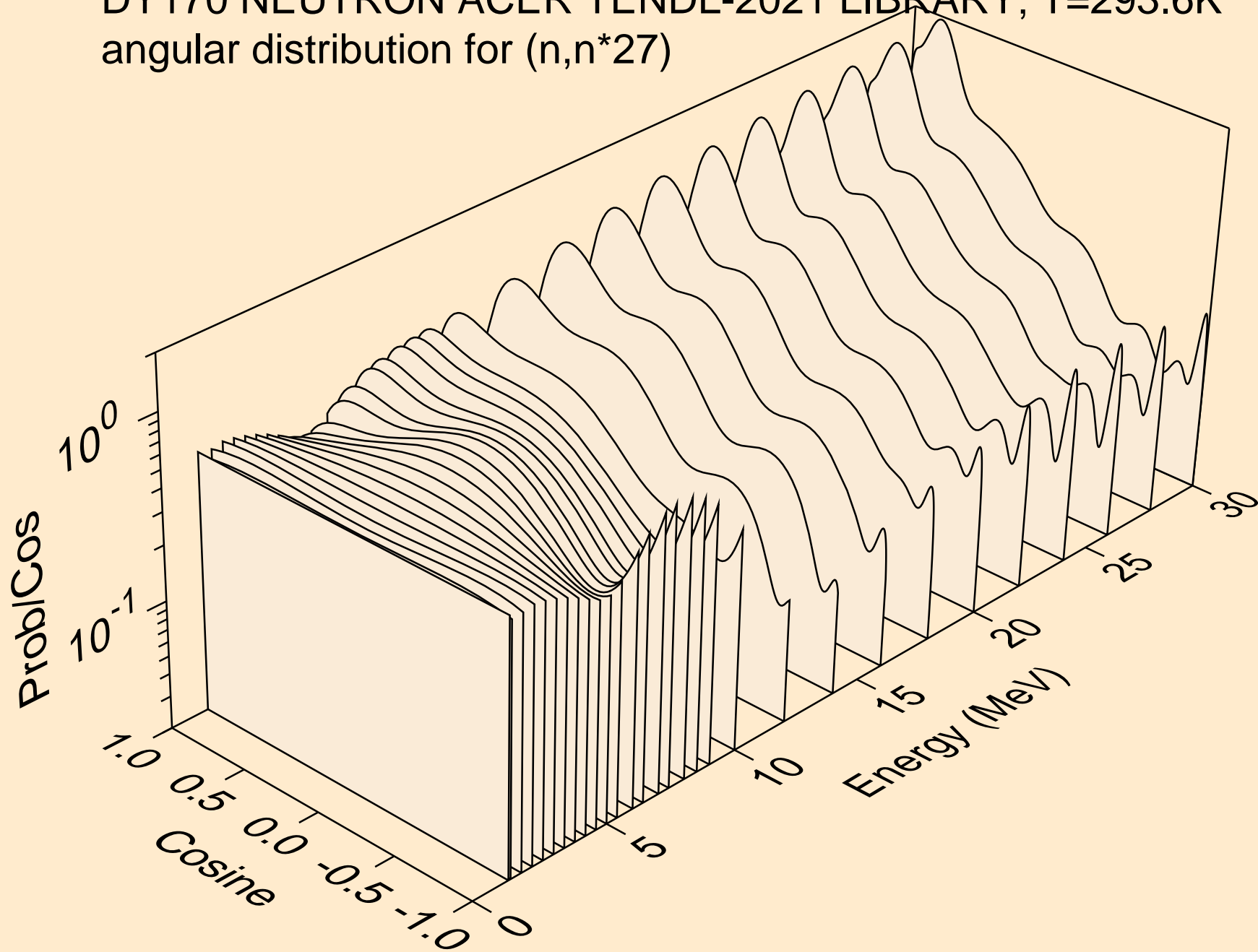

DY170 NEUTRON ACER TENDL-2021 LIBRARY; T=293.6K
angular distribution for (n,n*28)

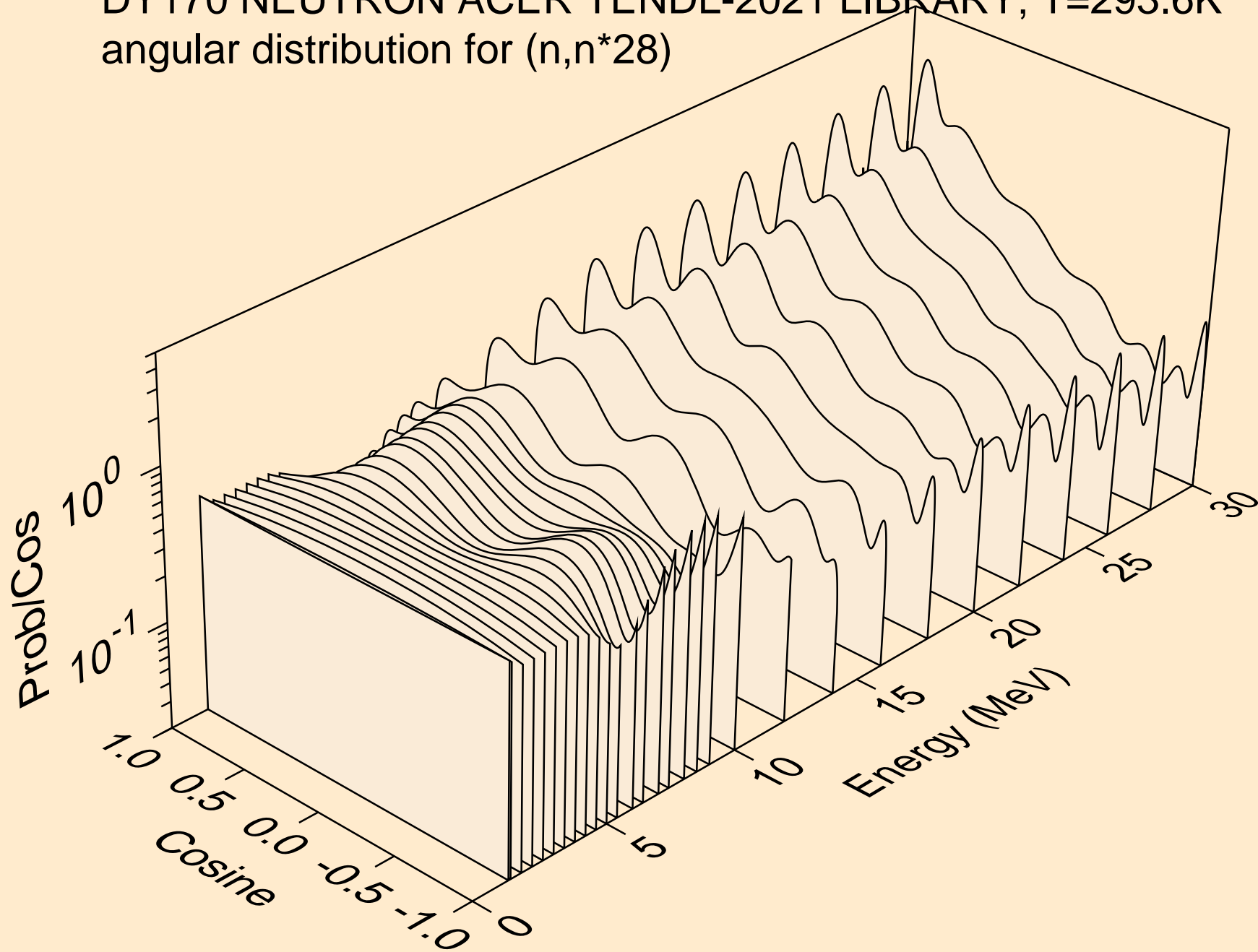

DY170 NEUTRON ACER TENDL-2021 LIBRARY; T=293.6K
angular distribution for (n,n*29)

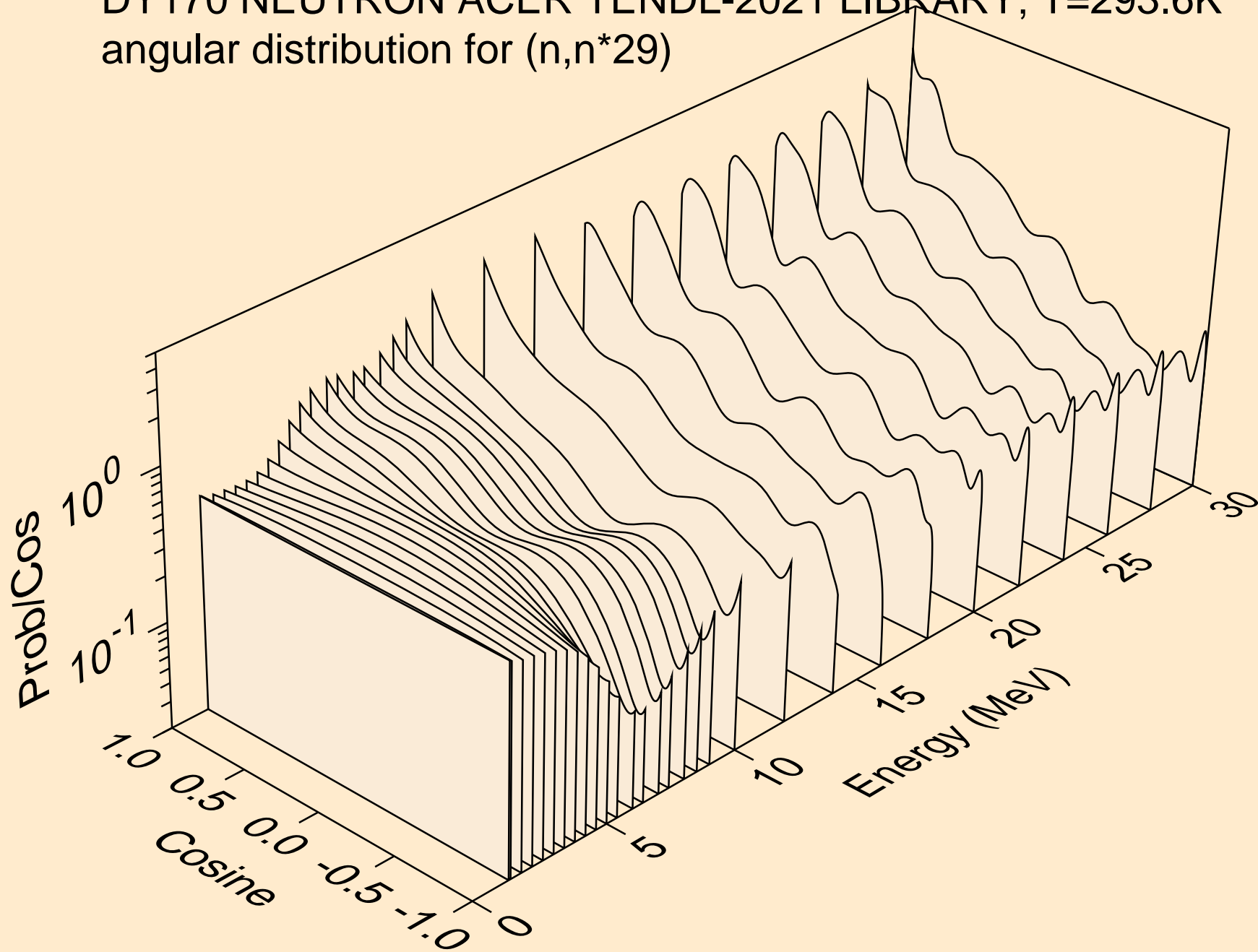

DY170 NEUTRON ACER TENDL-2021 LIBRARY; T=293.6K
Neutron emission for (n,x)

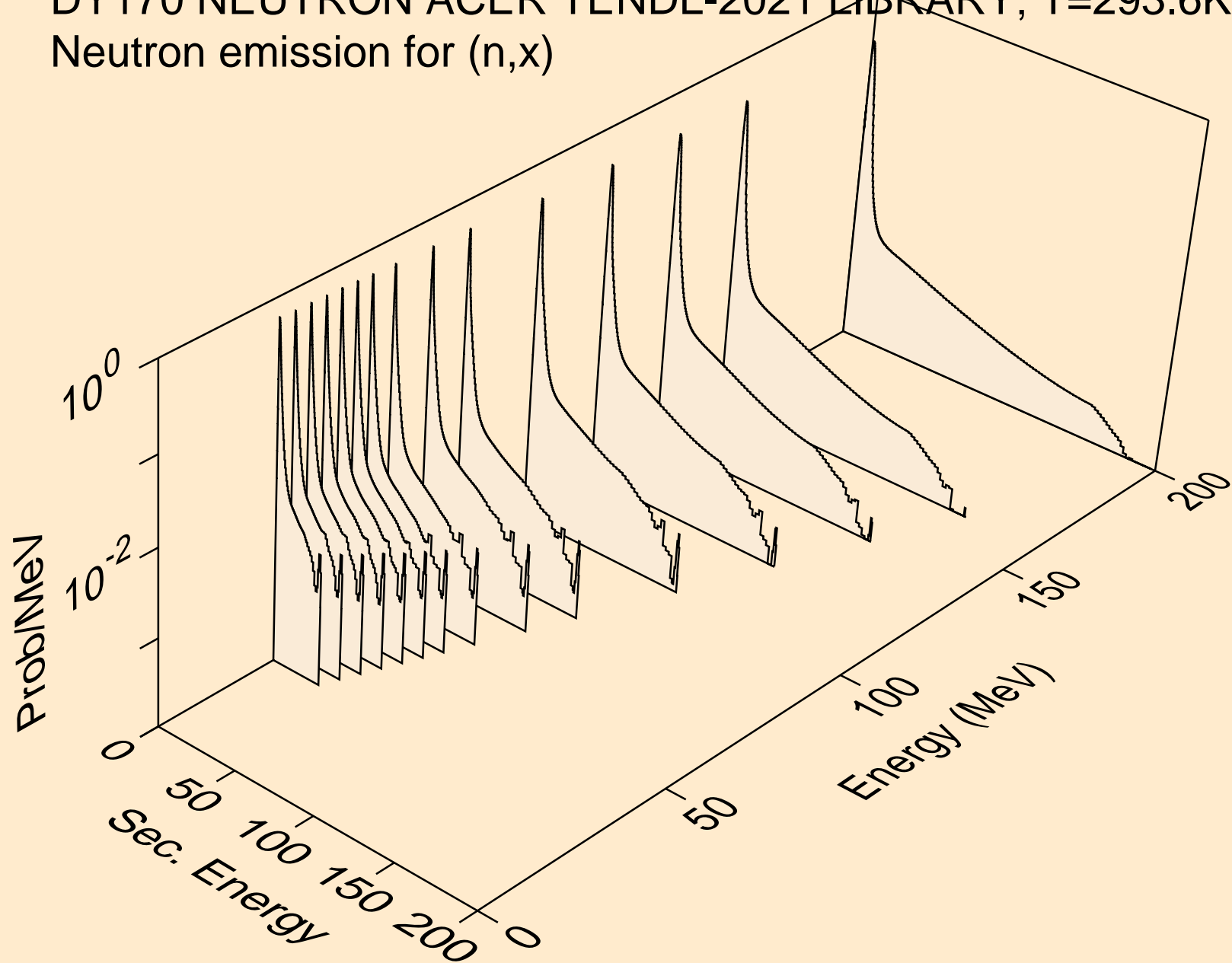

DY170 NEUTRON ACER TENDL-2021 LIBRARY; T=293.6K
Neutron emission for (n,2nd)

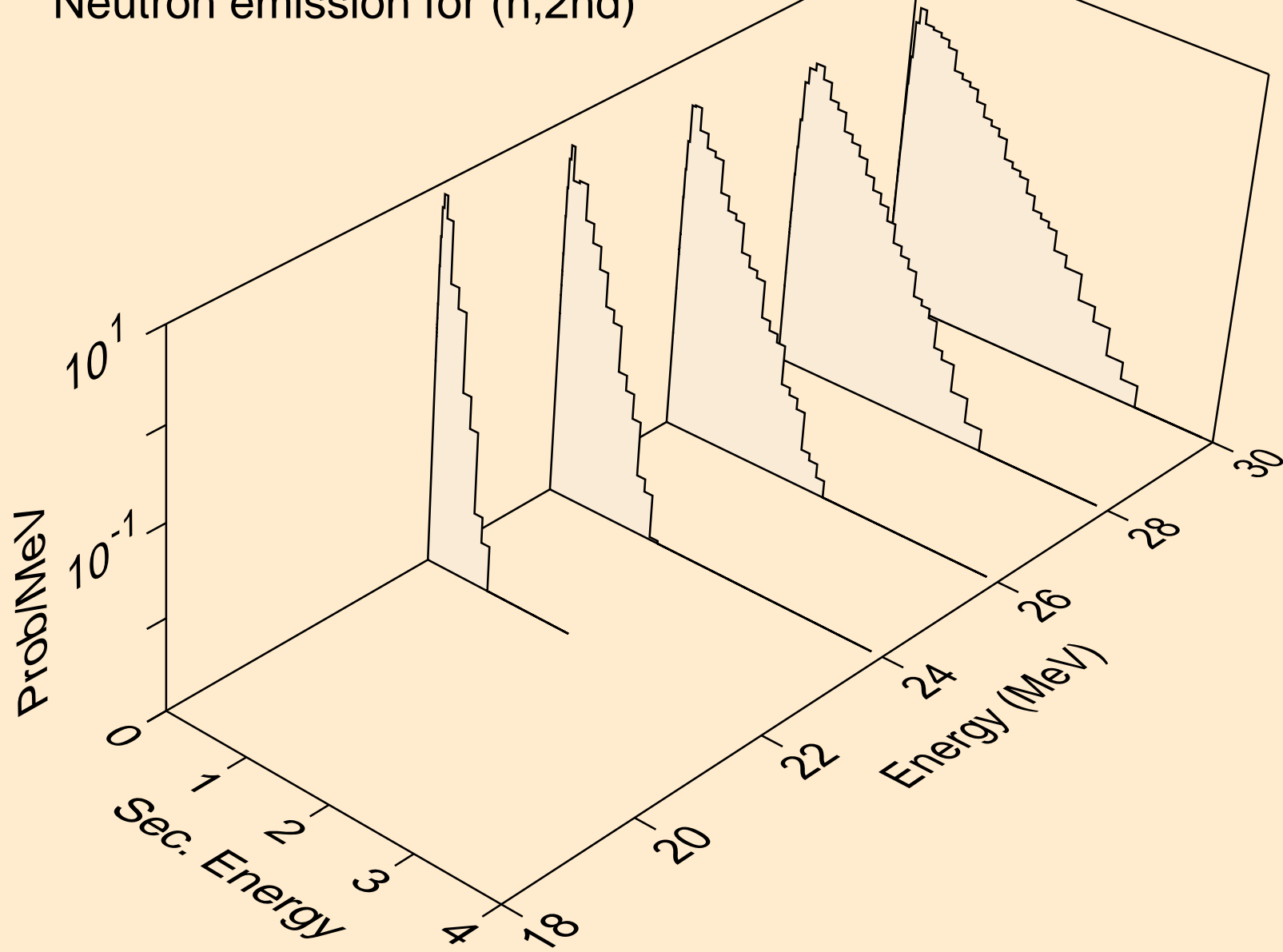

DY170 NEUTRON ACER TENDL-2021 LIBRARY; T=293.6K
Neutron emission for (n,2n)

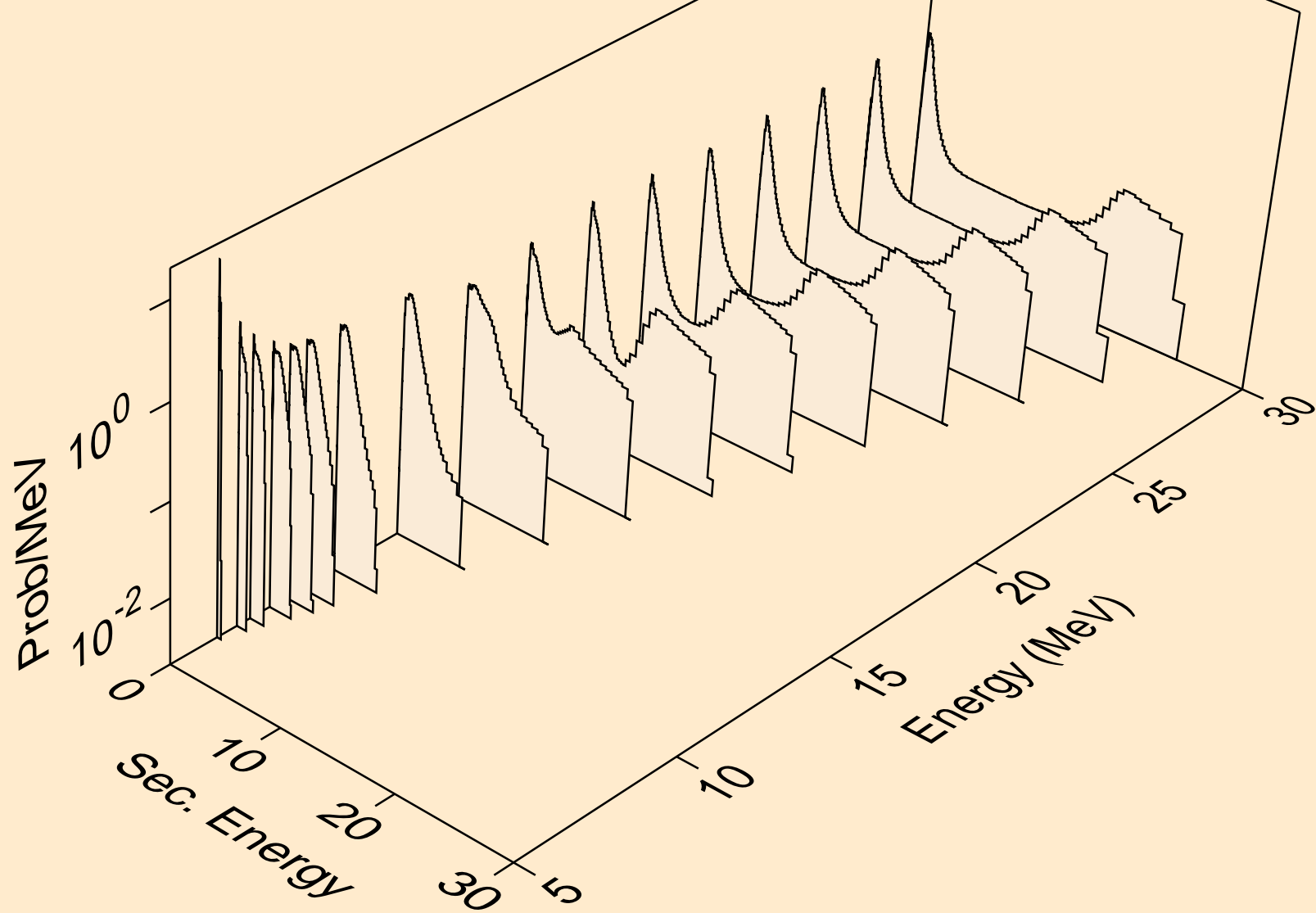

DY170 NEUTRON ACER TENDL-2021 LIBRARY; T=293.6K
Neutron emission for (n,3n)

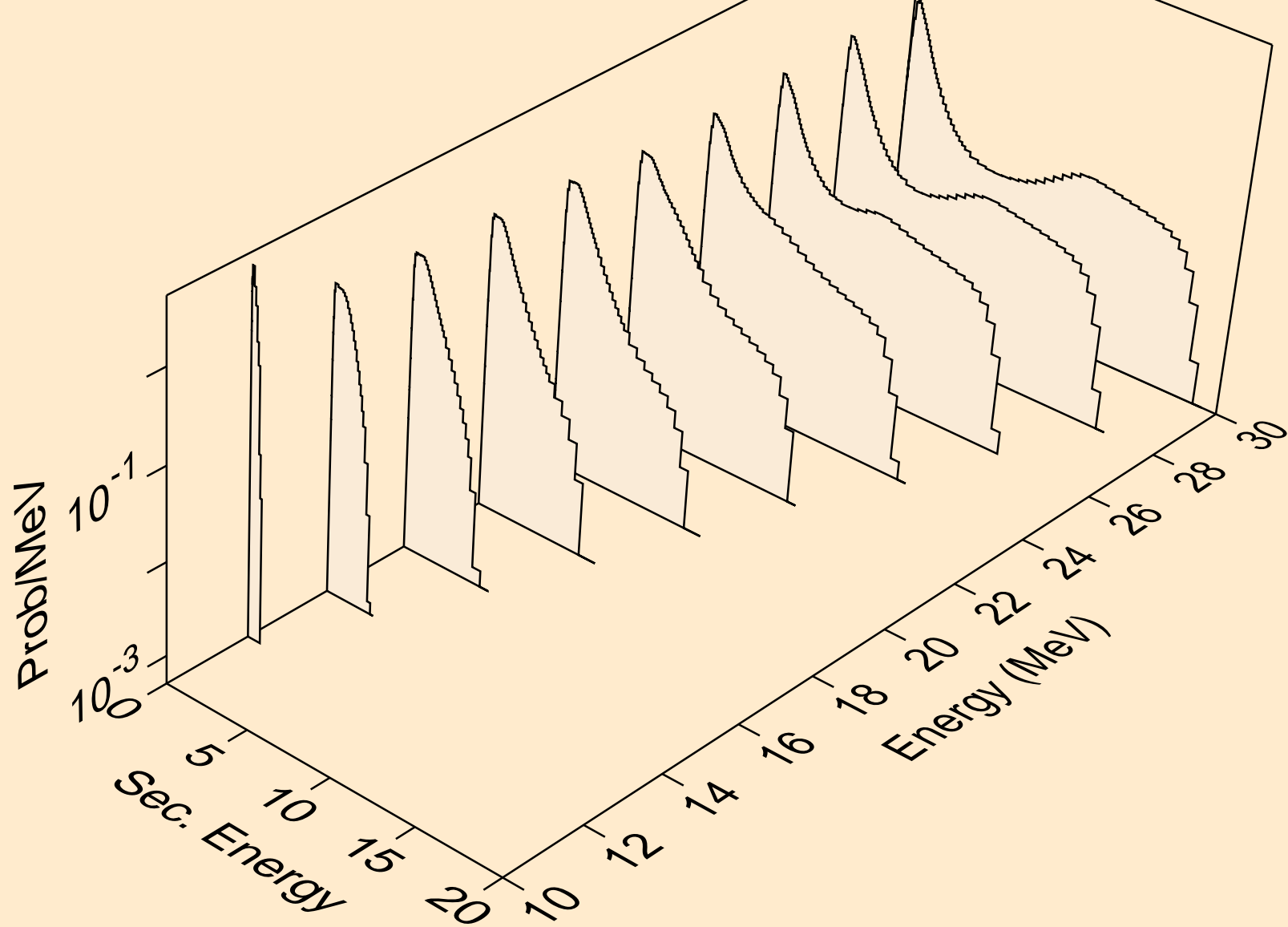

DY170 NEUTRON ACER TENDL-2021 LIBRARY; T=293.6K
Neutron emission for (n,n*)a

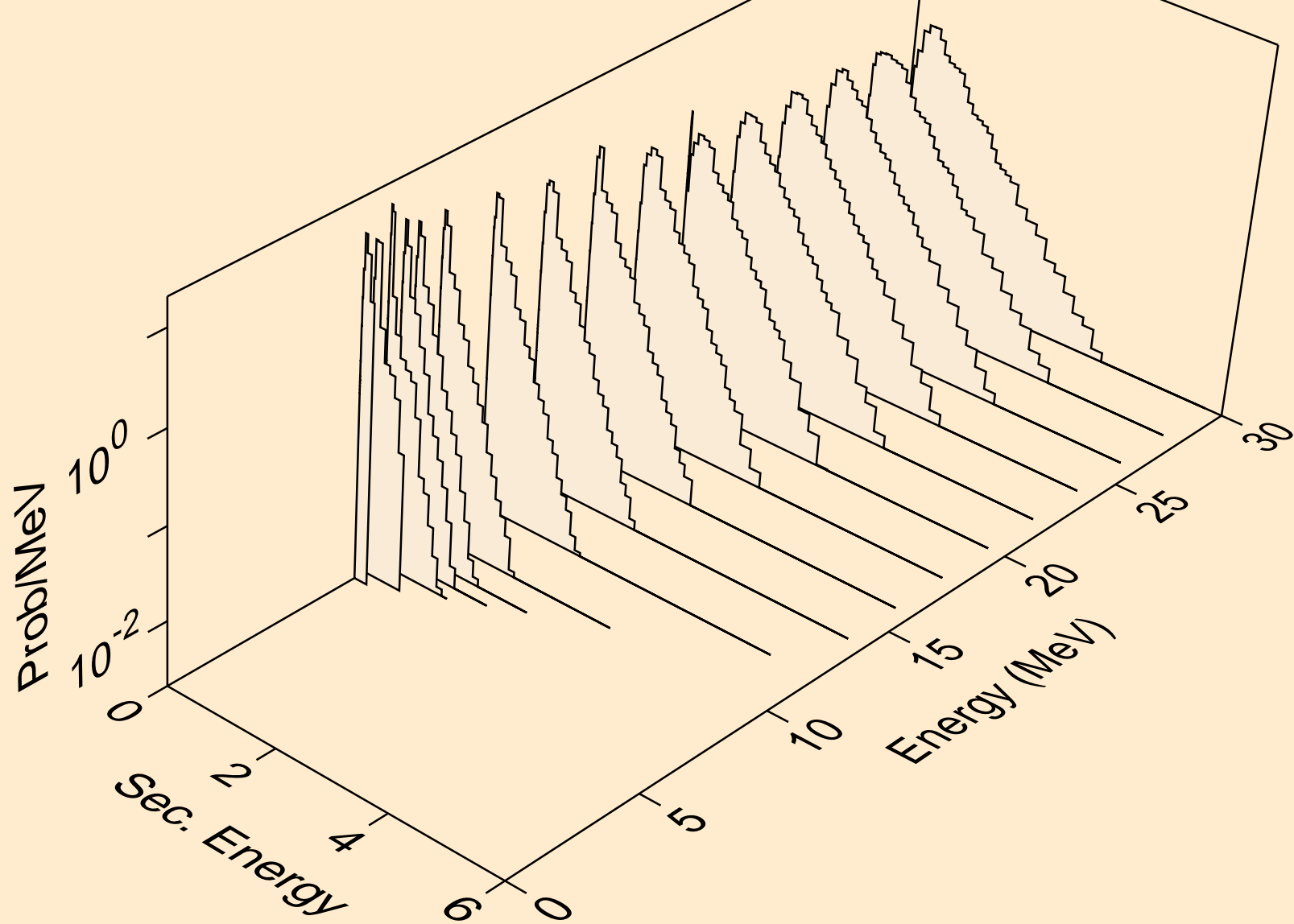

DY170 NEUTRON ACER TENDL-2021 LIBRARY; T=293.6K
Neutron emission for (n,2n)_a

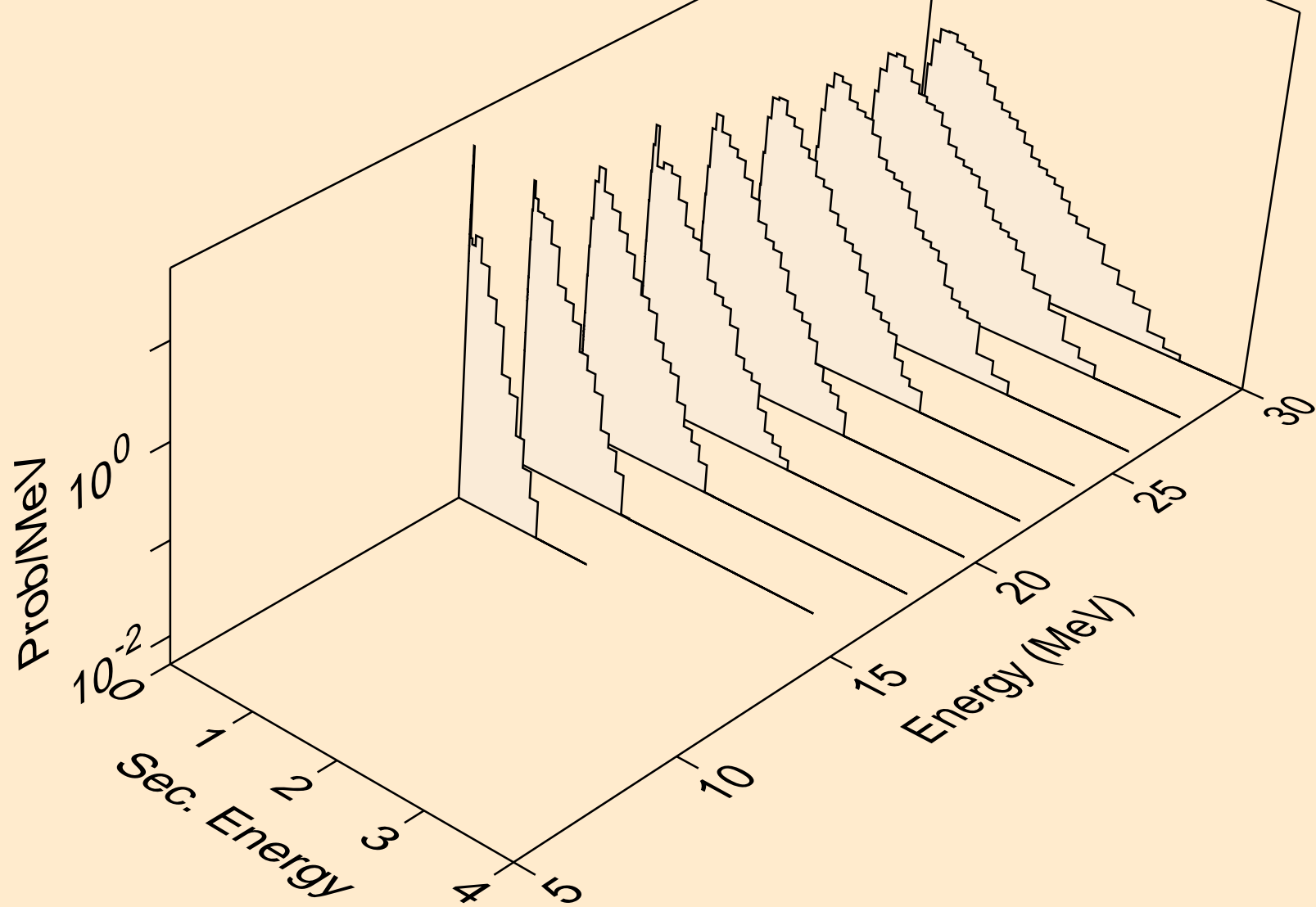

DY170 NEUTRON ACER TENDL-2021 LIBRARY; T=293.6K
Neutron emission for (n,3n)a

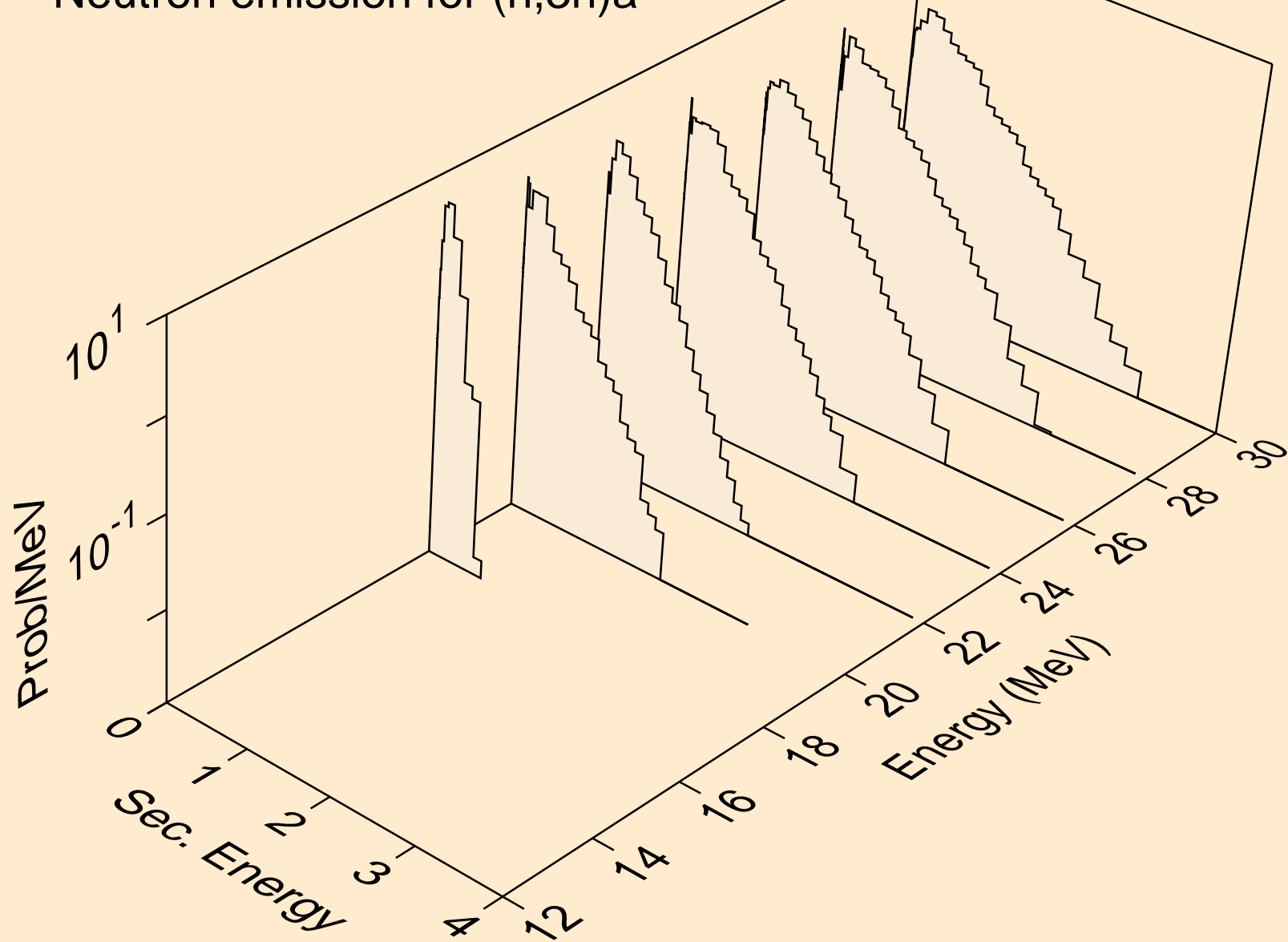

DY170 NEUTRON ACER TENDL-2021 LIBRARY; T=293.6K
Neutron emission for (n,n*)p

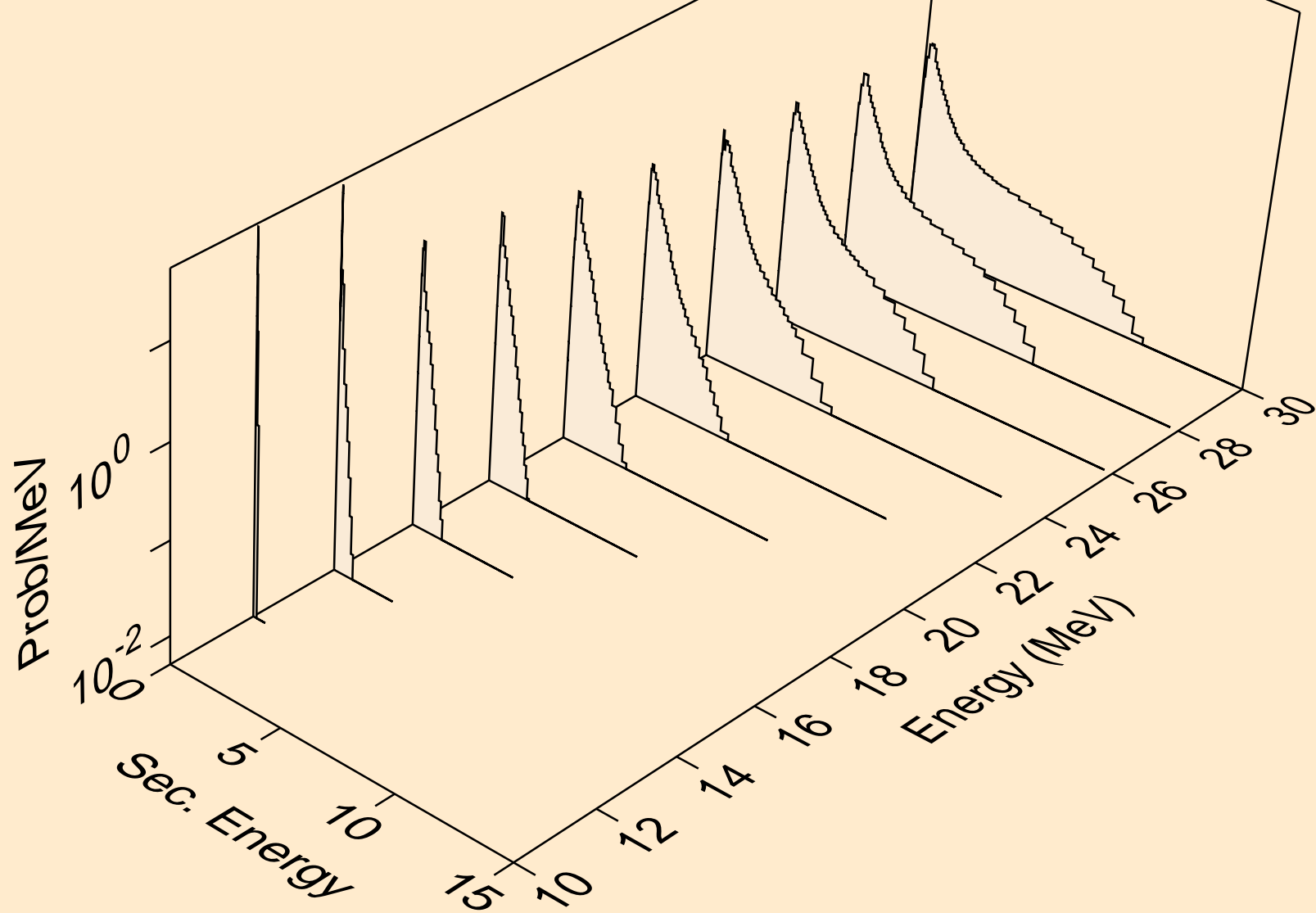

DY170 NEUTRON ACER TENDL-2021 LIBRARY; T=293.6K
Neutron emission for (n,n*)d

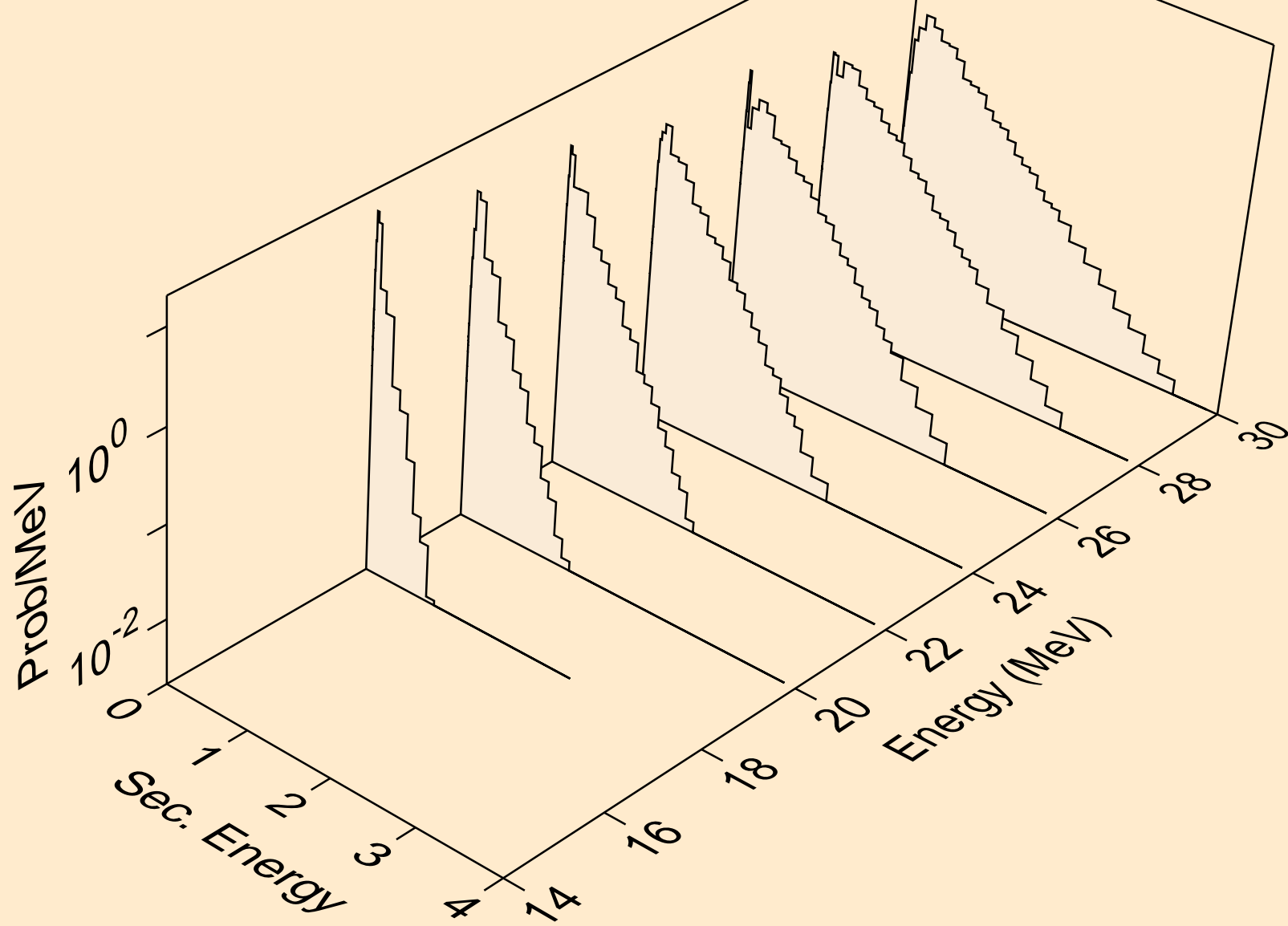

DY170 NEUTRON ACER TENDL-2021 LIBRARY; T=293.6K
Neutron emission for (n,n*)t

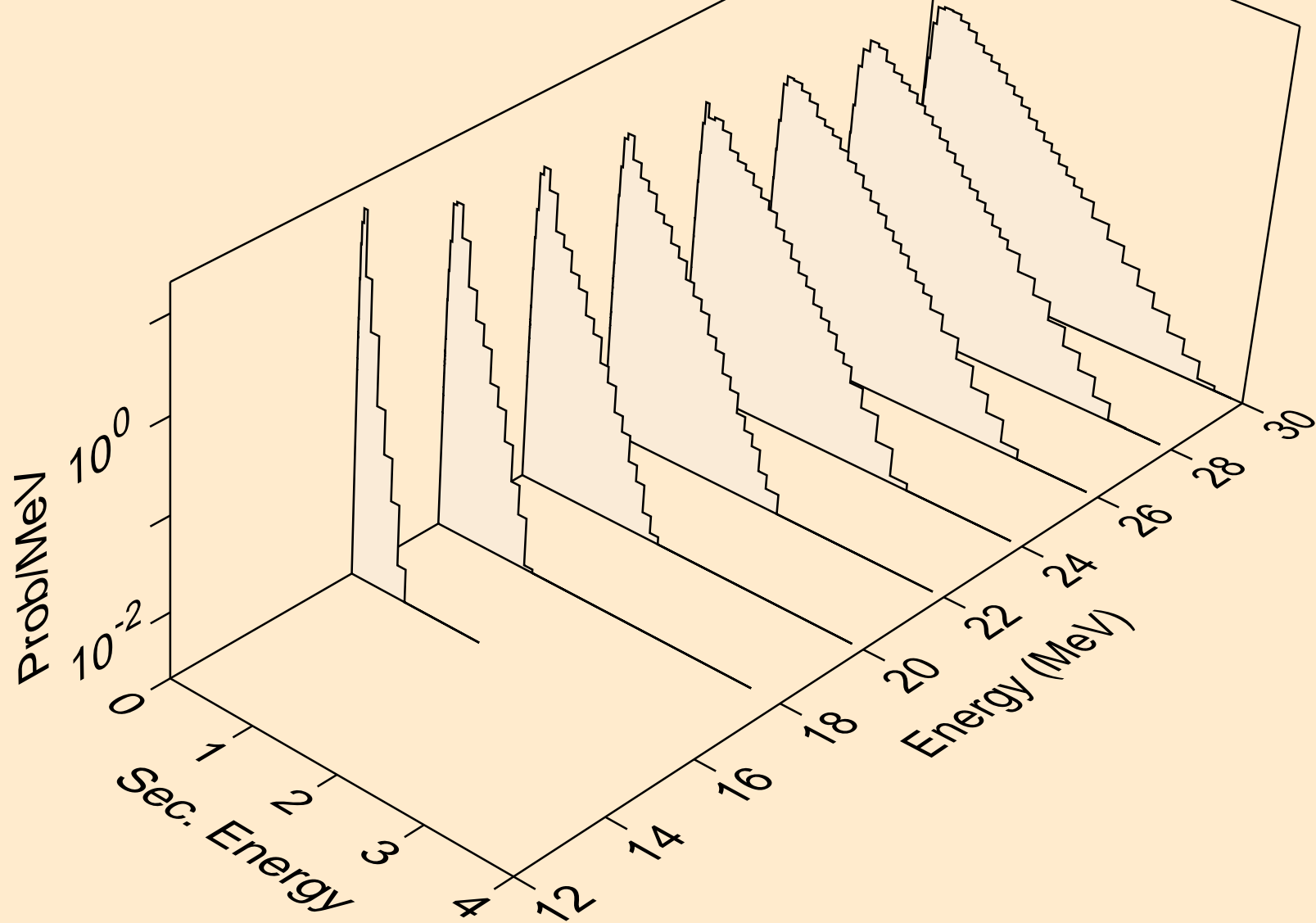

DY170 NEUTRON ACER TENDL-2021 LIBRARY; T=293.6K
Neutron emission for (n,n*)he3

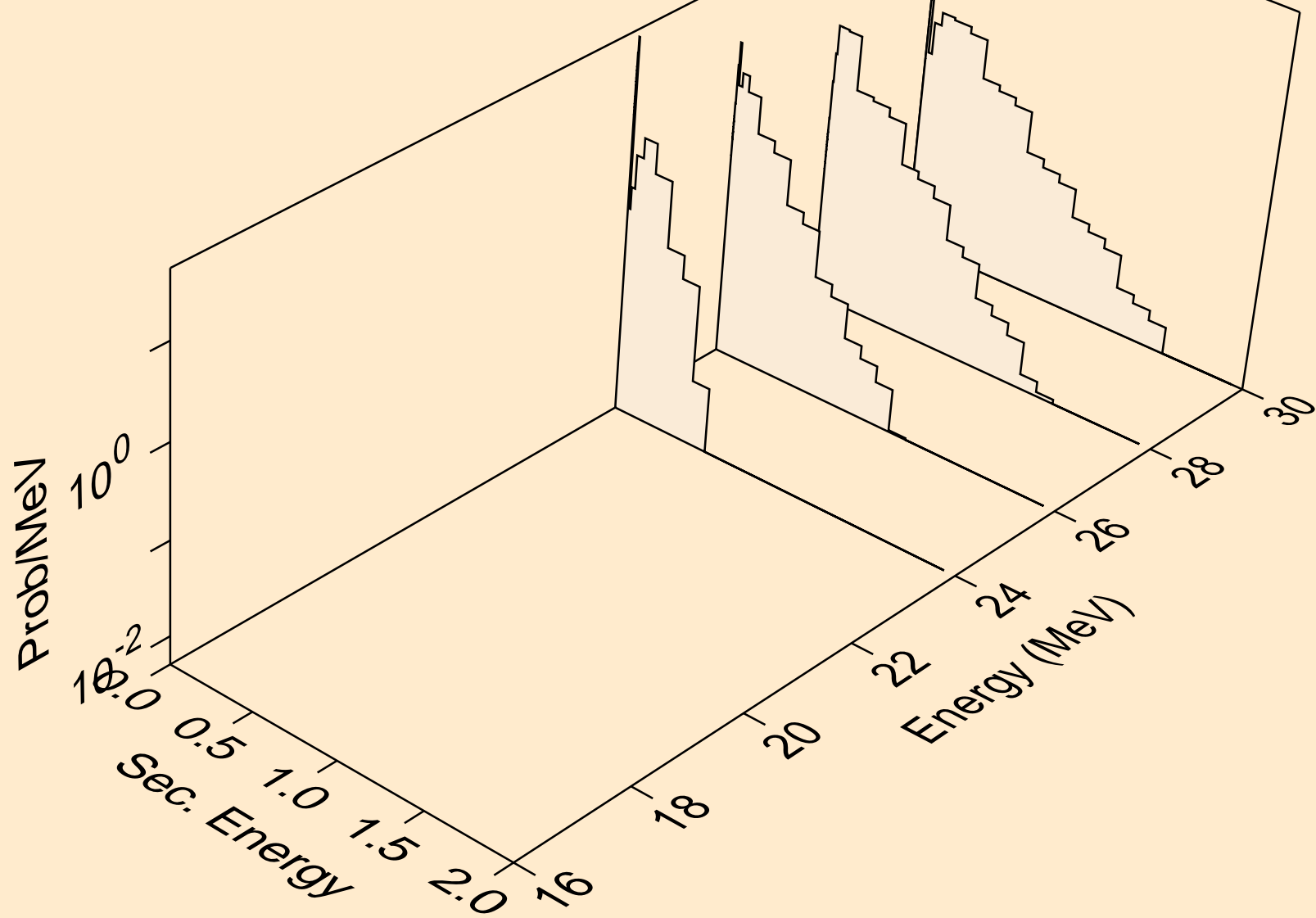

DY170 NEUTRON ACER TENDL-2021 LIBRARY; T=293.6K
Neutron emission for (n,4n)

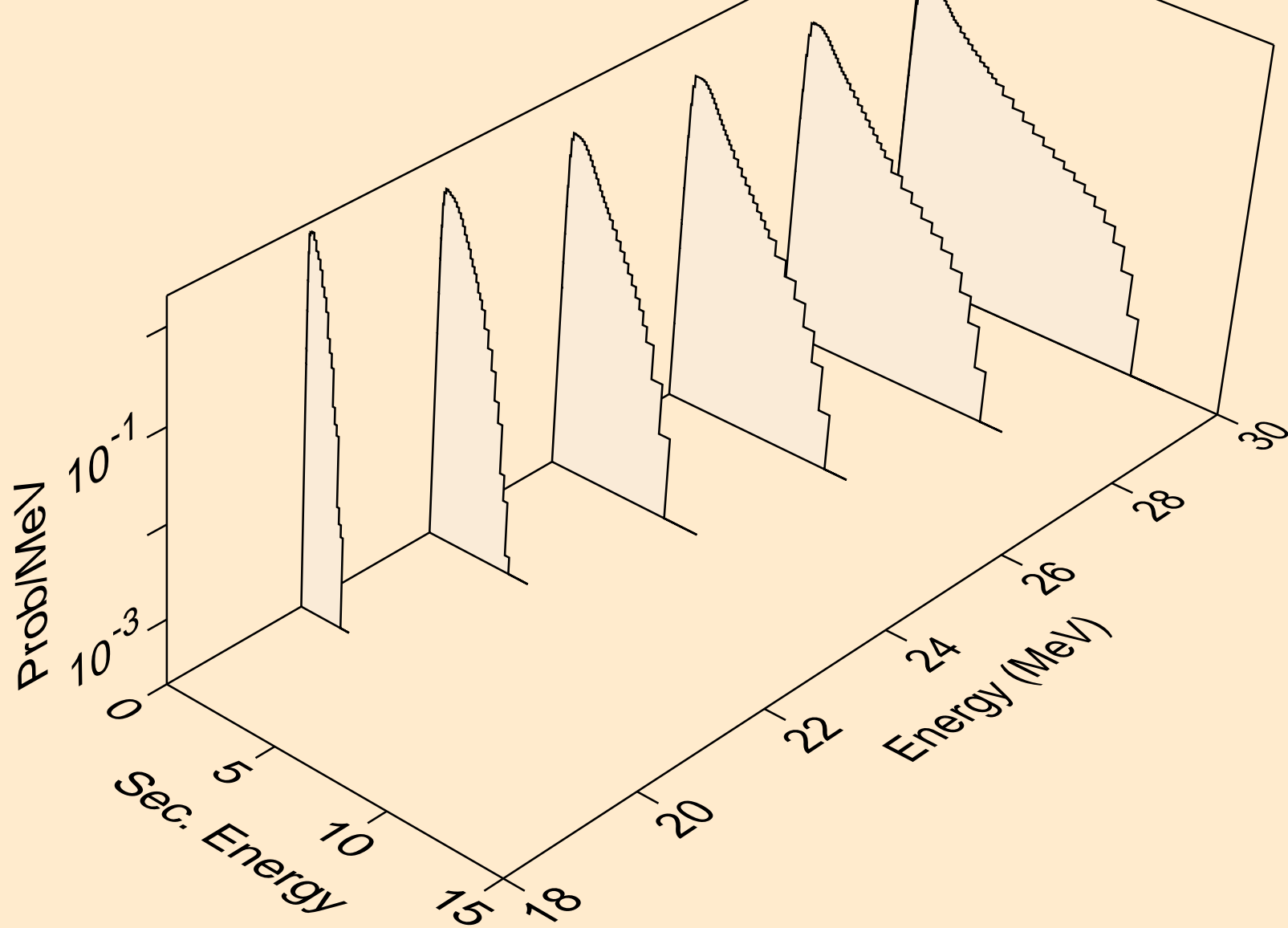

DY170 NEUTRON ACER TENDL-2021 LIBRARY; T=293.6K
Neutron emission for (n,2np)

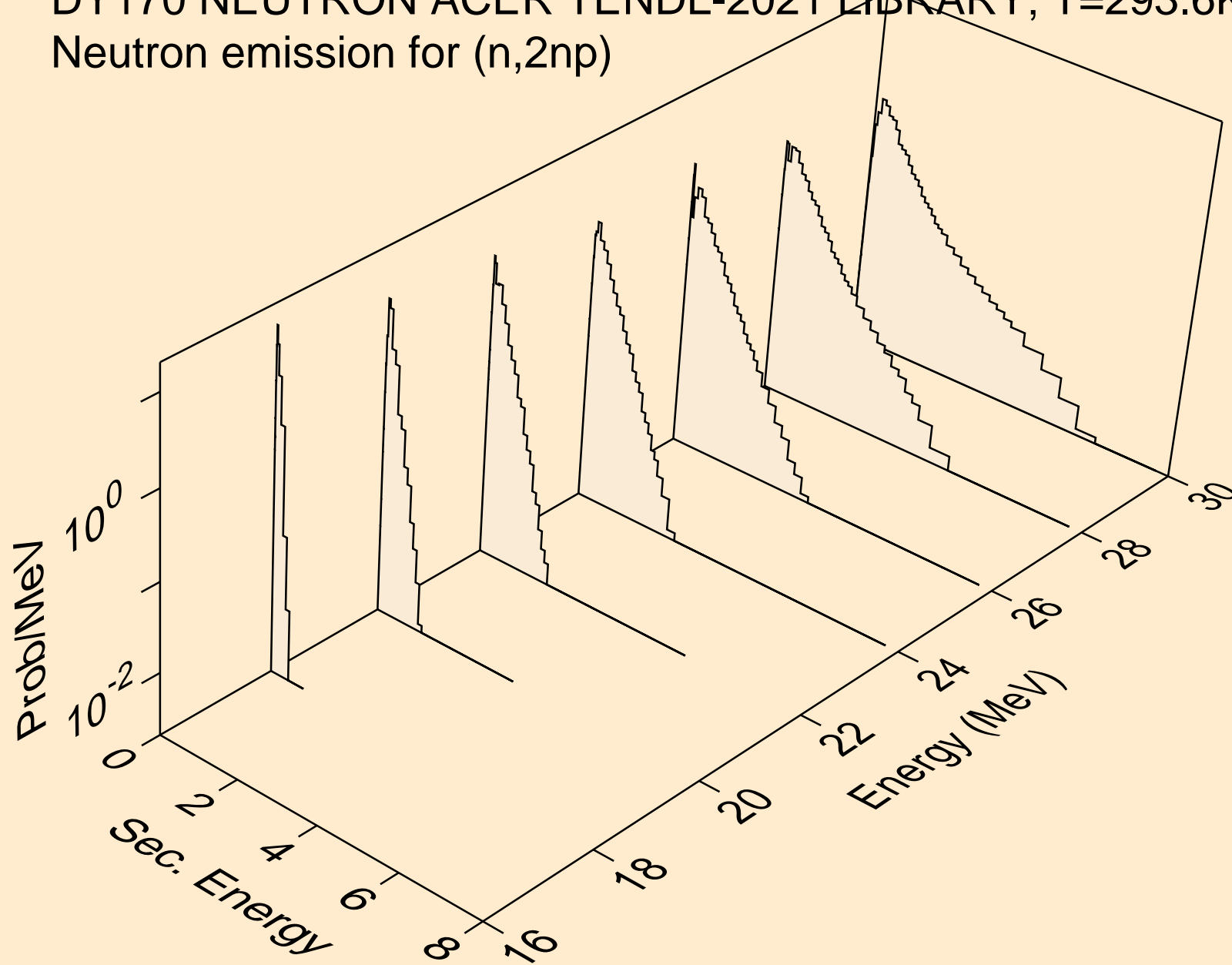

DY170 NEUTRON ACER TENDL-2021 LIBRARY; T=293.6K
Neutron emission for (n,3np)

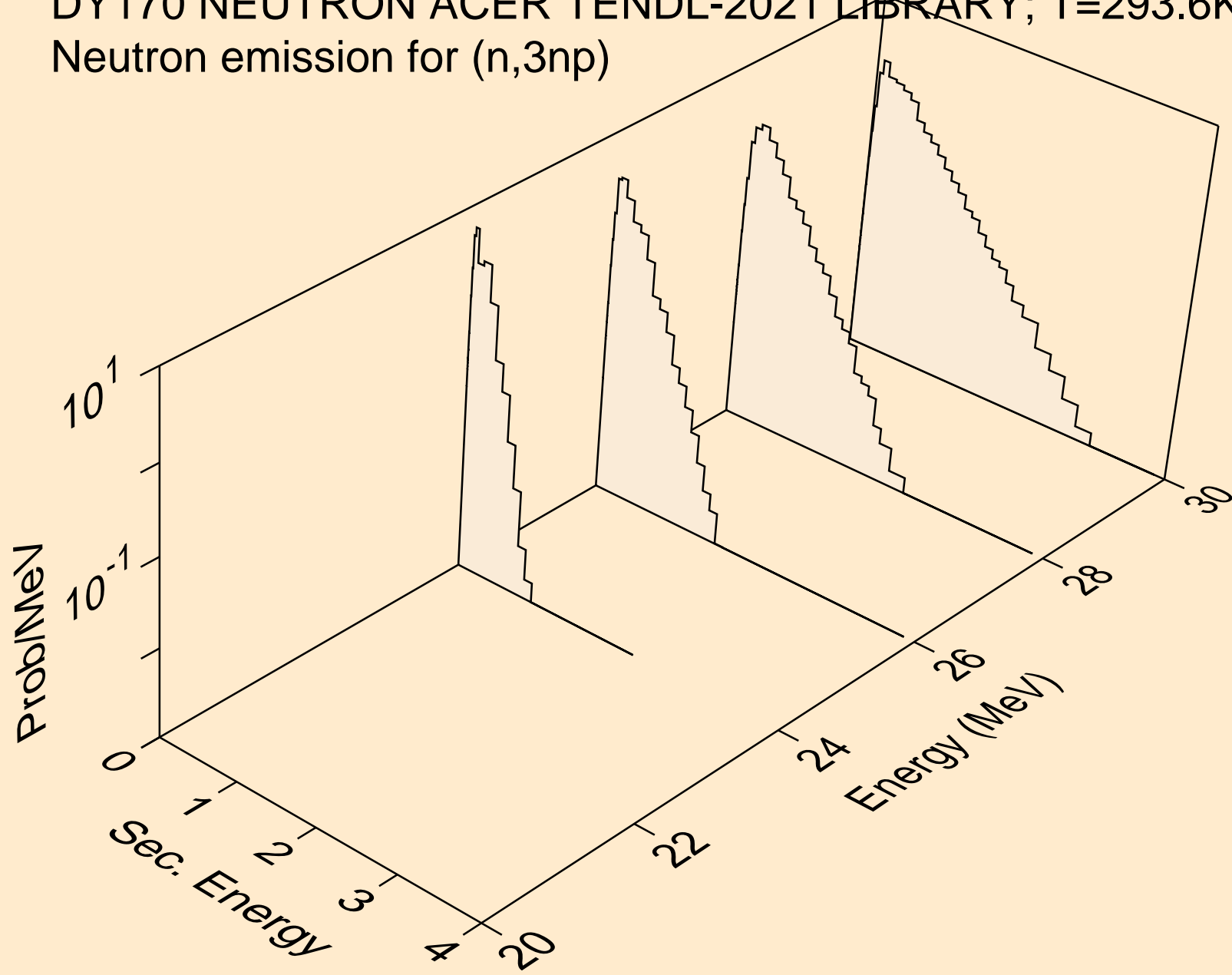

DY170 NEUTRON ACER TENDL-2021 LIBRARY; T=293.6K
Neutron emission for (n,n*c)

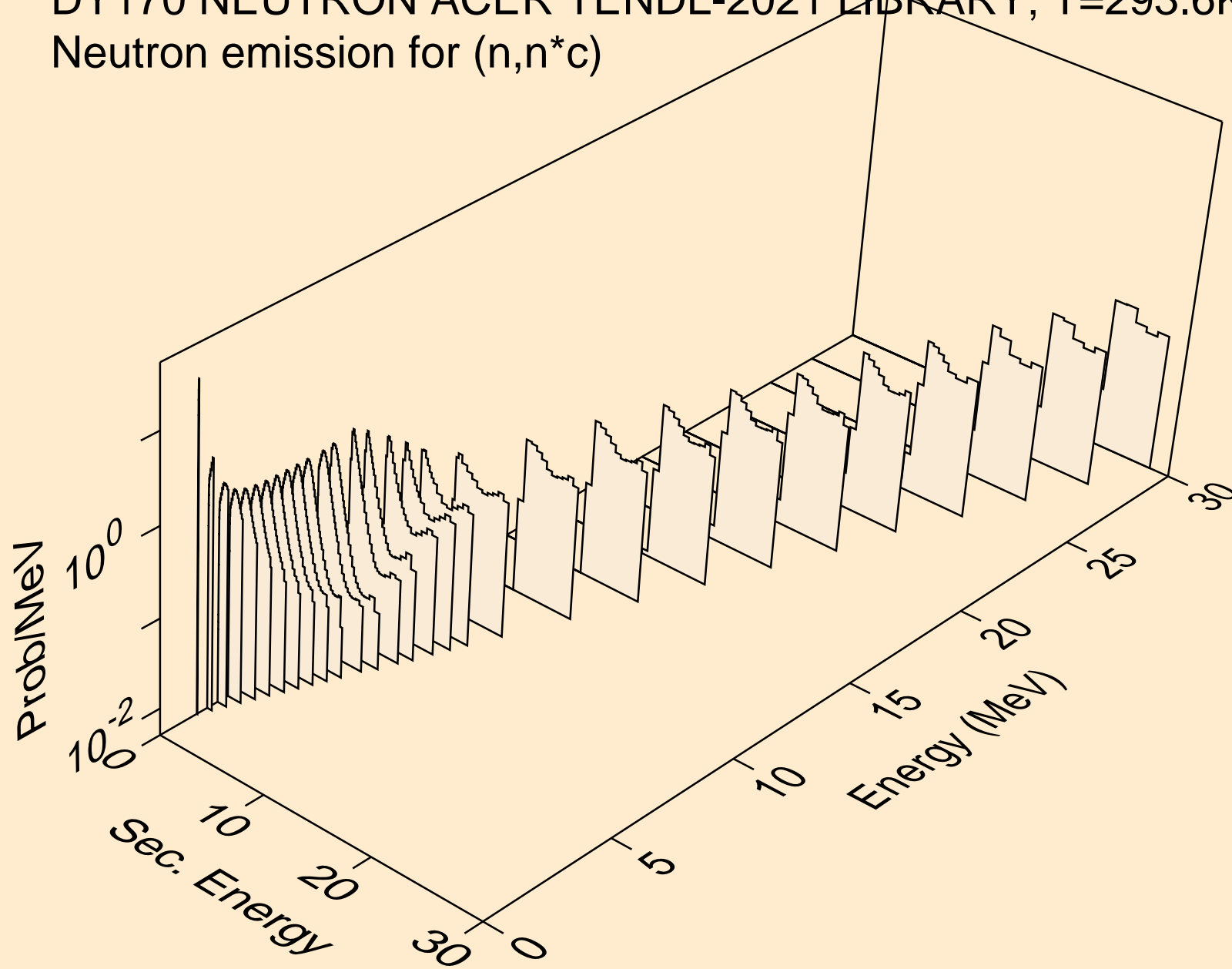

DY170 NEUTRON ACER TENDL-2021 LIBRARY; T=293.6K
Photon emission for (n,x)

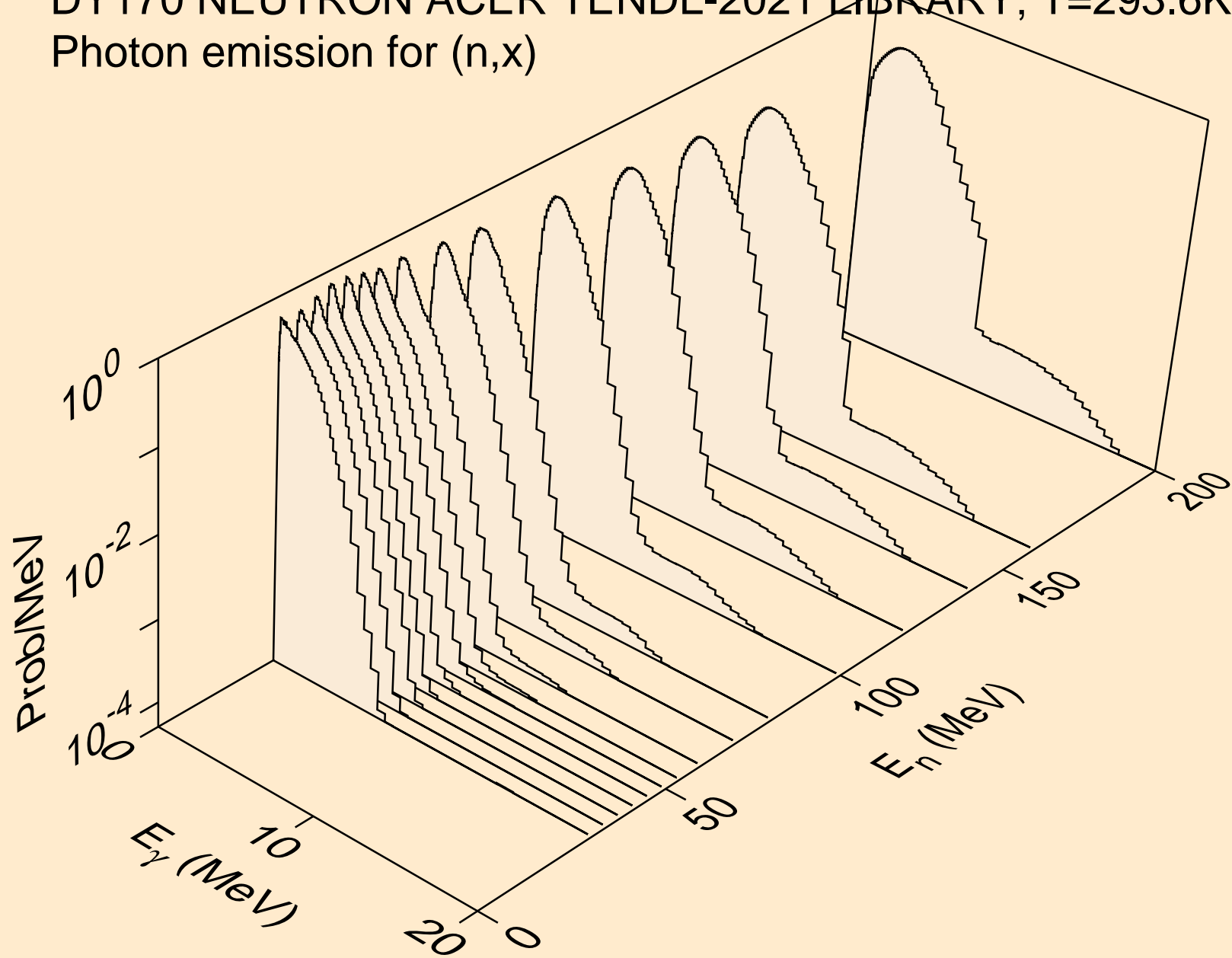

DY170 NEUTRON ACER TENDL-2021 LIBRARY; T=293.6K
Photon emission for (n,2nd)

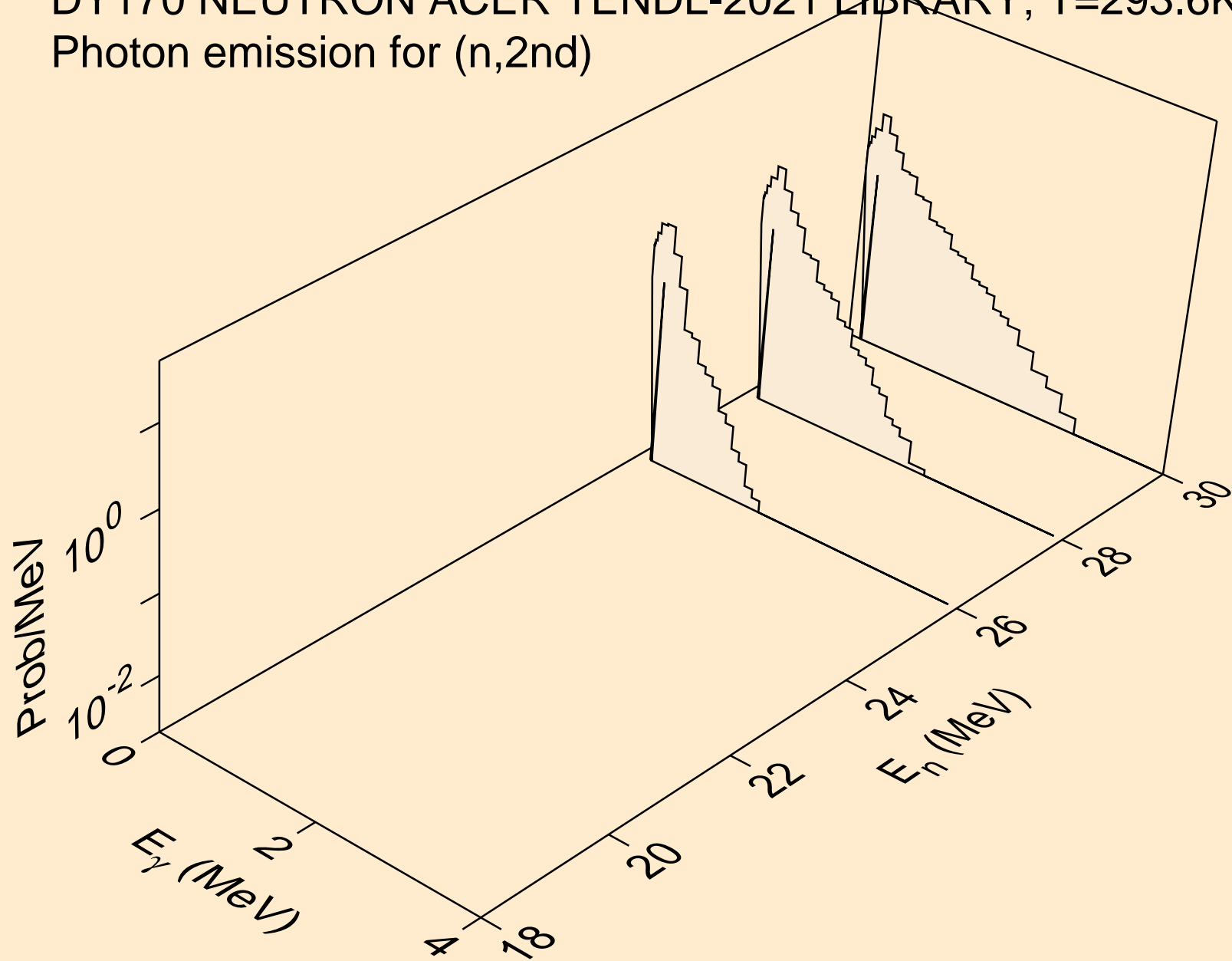

DY170 NEUTRON ACER TENDL-2021 LIBRARY; T=293.6K
Photon emission for (n,2n)

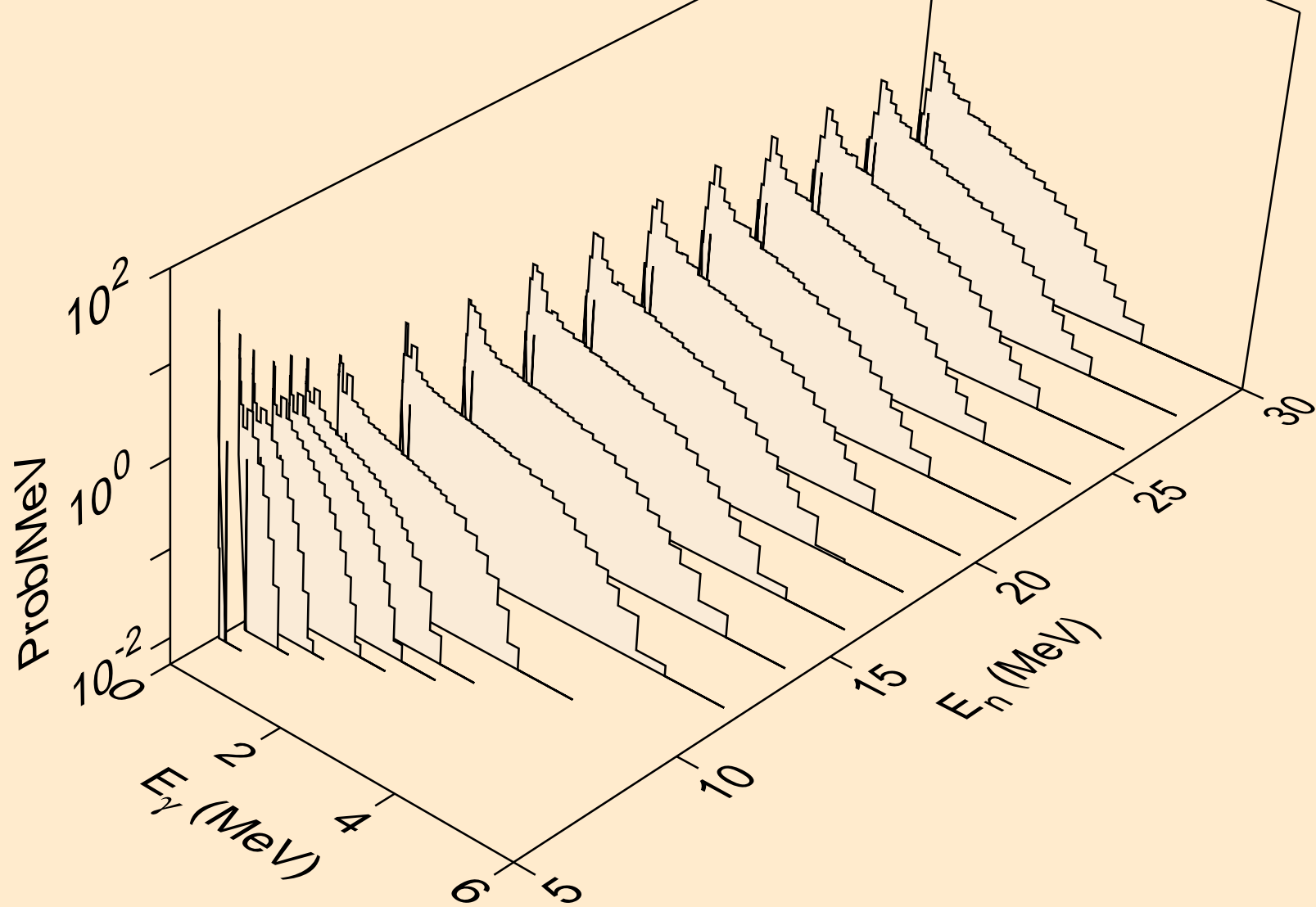

DY170 NEUTRON ACER TENDL-2021 LIBRARY; T=293.6K
Photon emission for (n,3n)

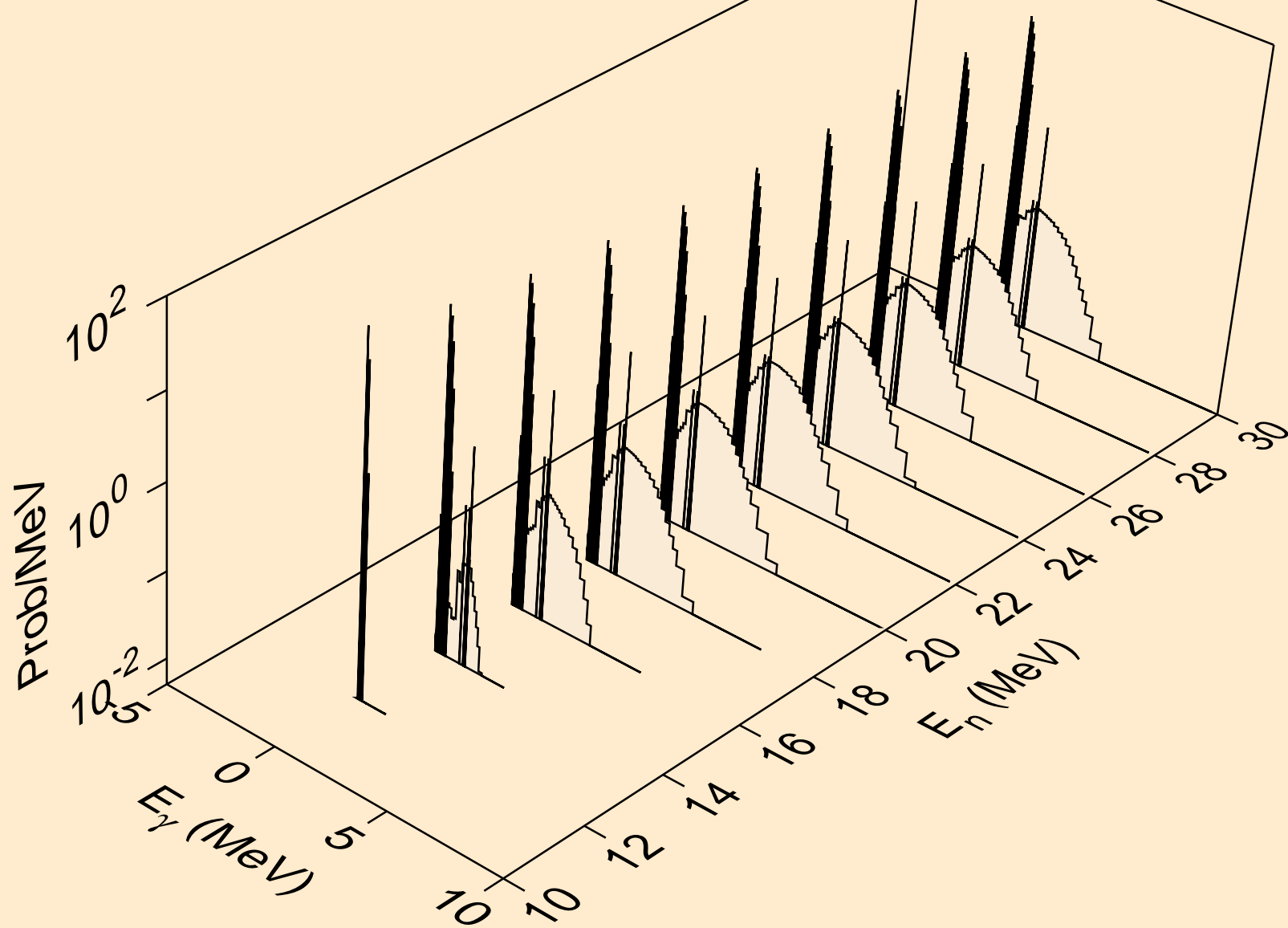

DY170 NEUTRON ACER TENDL-2021 LIBRARY; T=293.6K
Photon emission for (n,n*)a

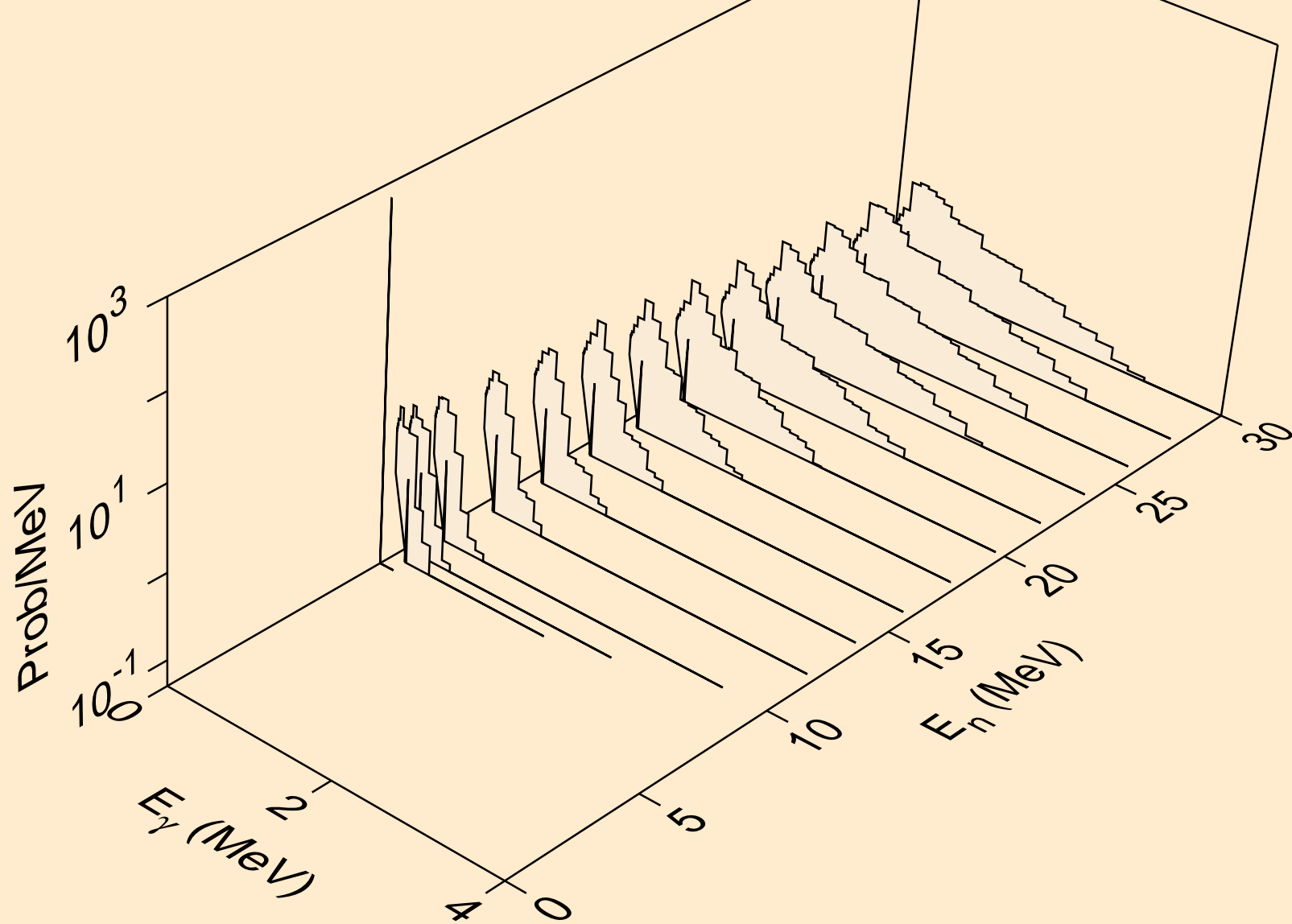

DY170 NEUTRON ACER TENDL-2021 LIBRARY; T=293.6K
Photon emission for (n,2n)a

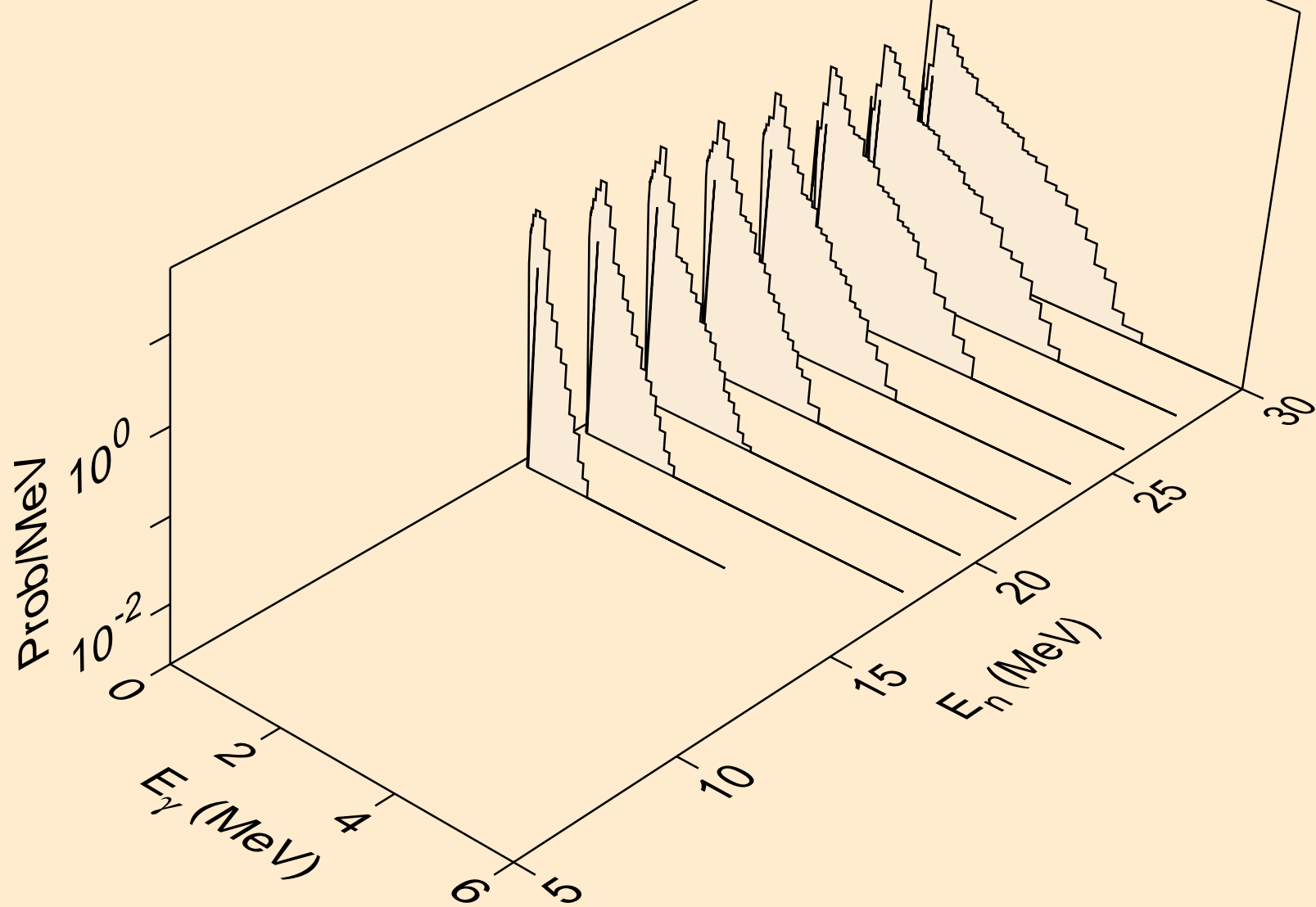

DY170 NEUTRON ACER TENDL-2021 LIBRARY; T=293.6K
Photon emission for (n,3n)a

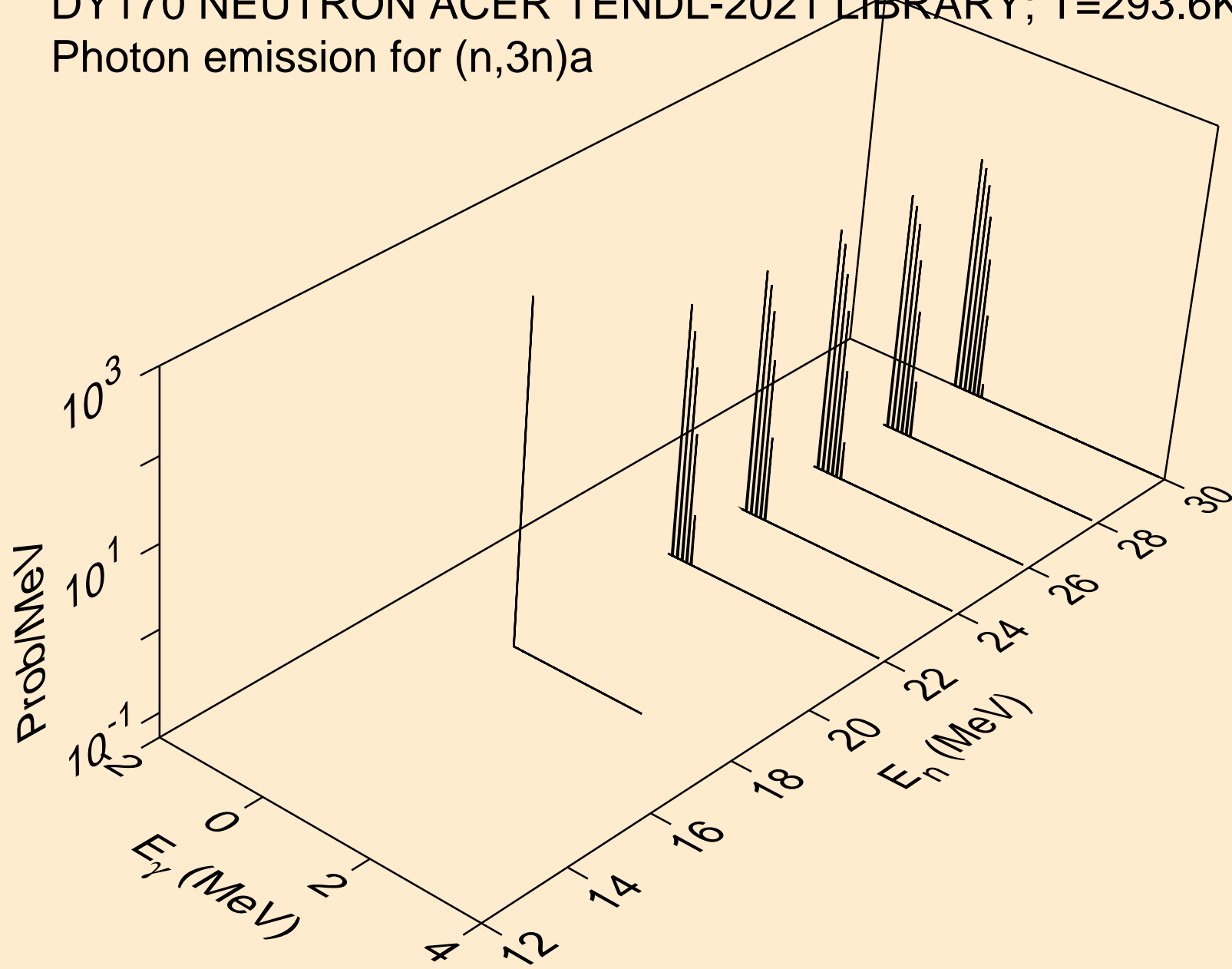

DY170 NEUTRON ACER TENDL-2021 LIBRARY; T=293.6K
Photon emission for (n,n*)p

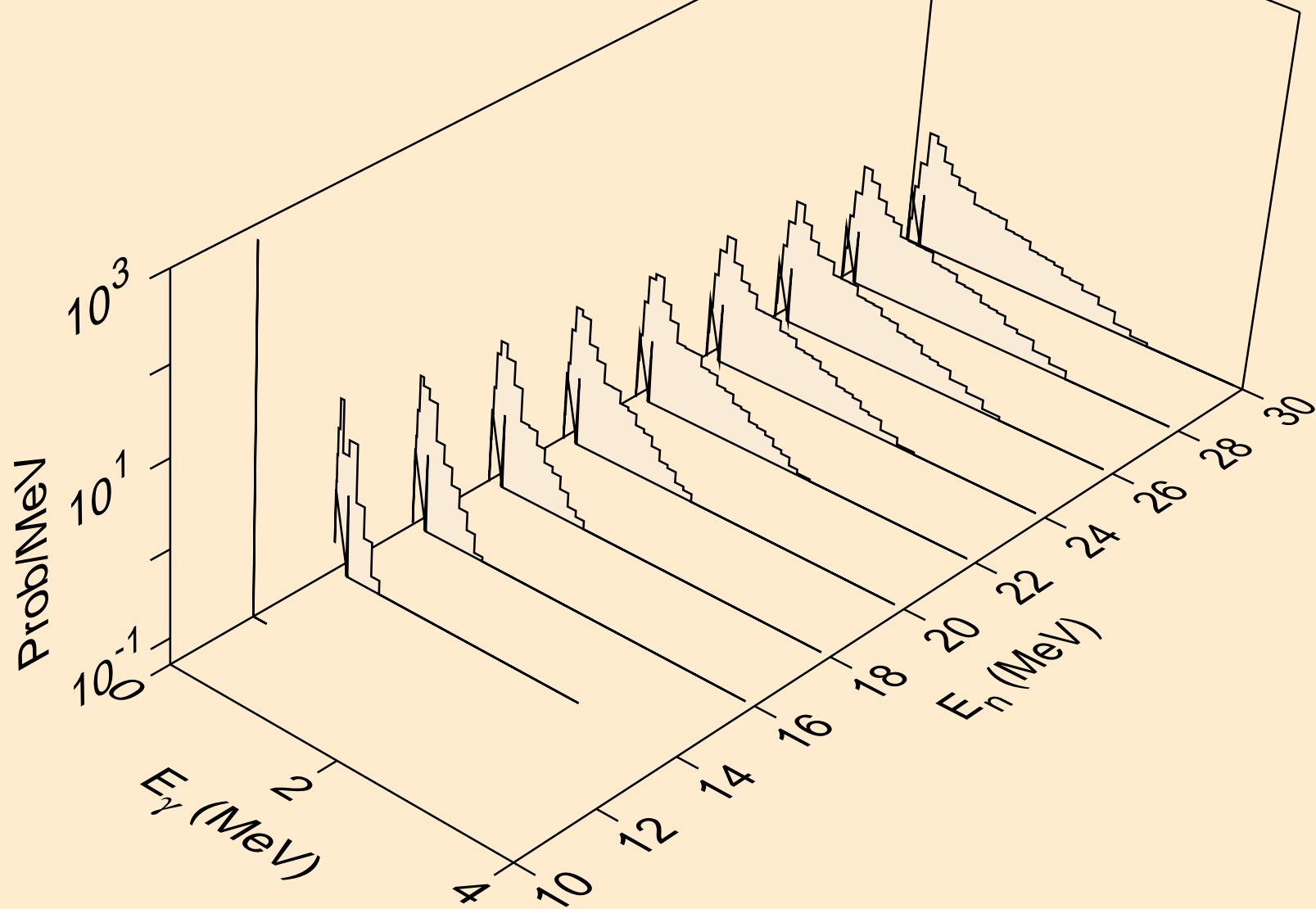

DY170 NEUTRON ACER TENDL-2021 LIBRARY; T=293.6K
Photon emission for (n,n*)d

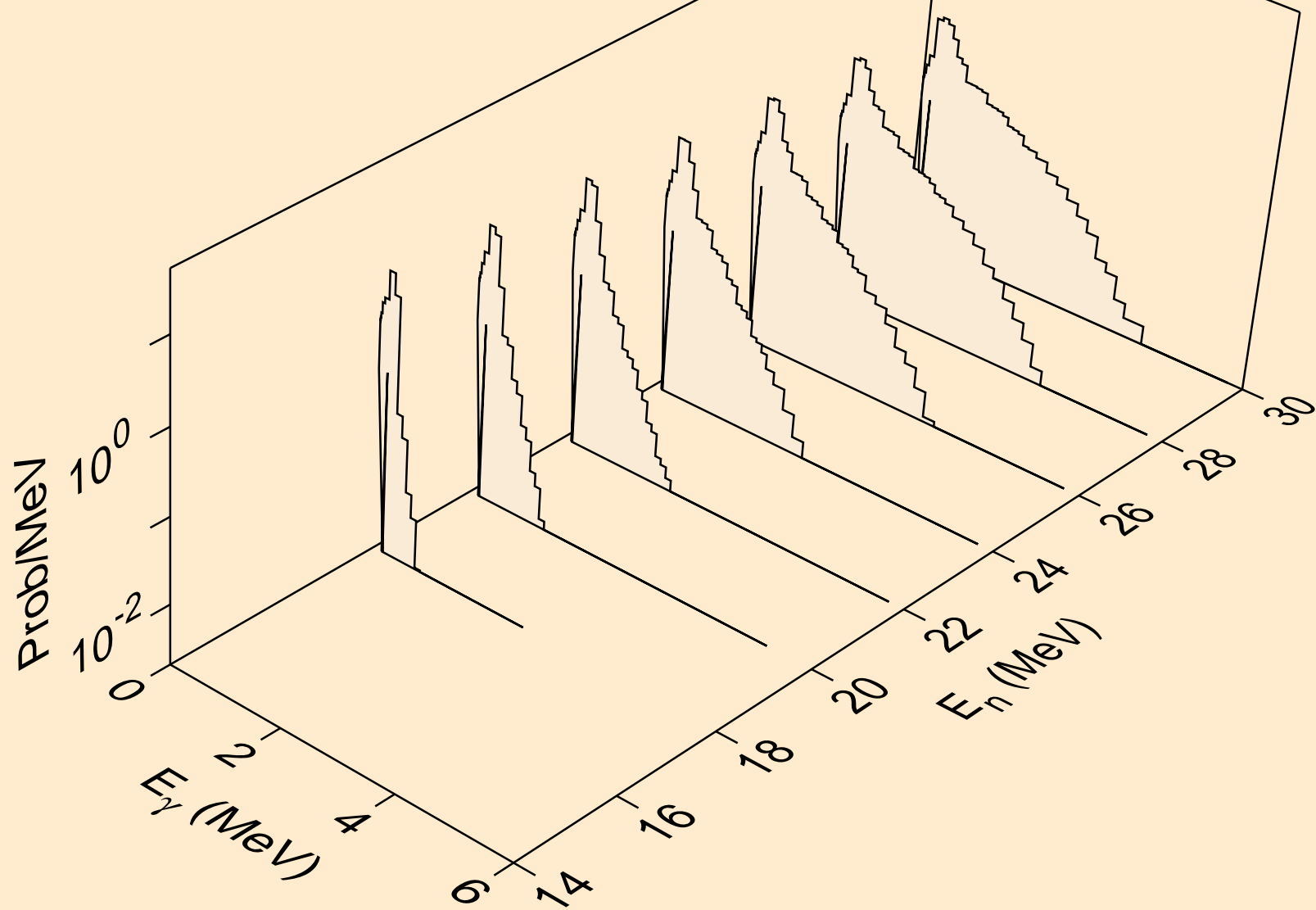

DY170 NEUTRON ACER TENDL-2021 LIBRARY; T=293.6K
Photon emission for (n,n*)t

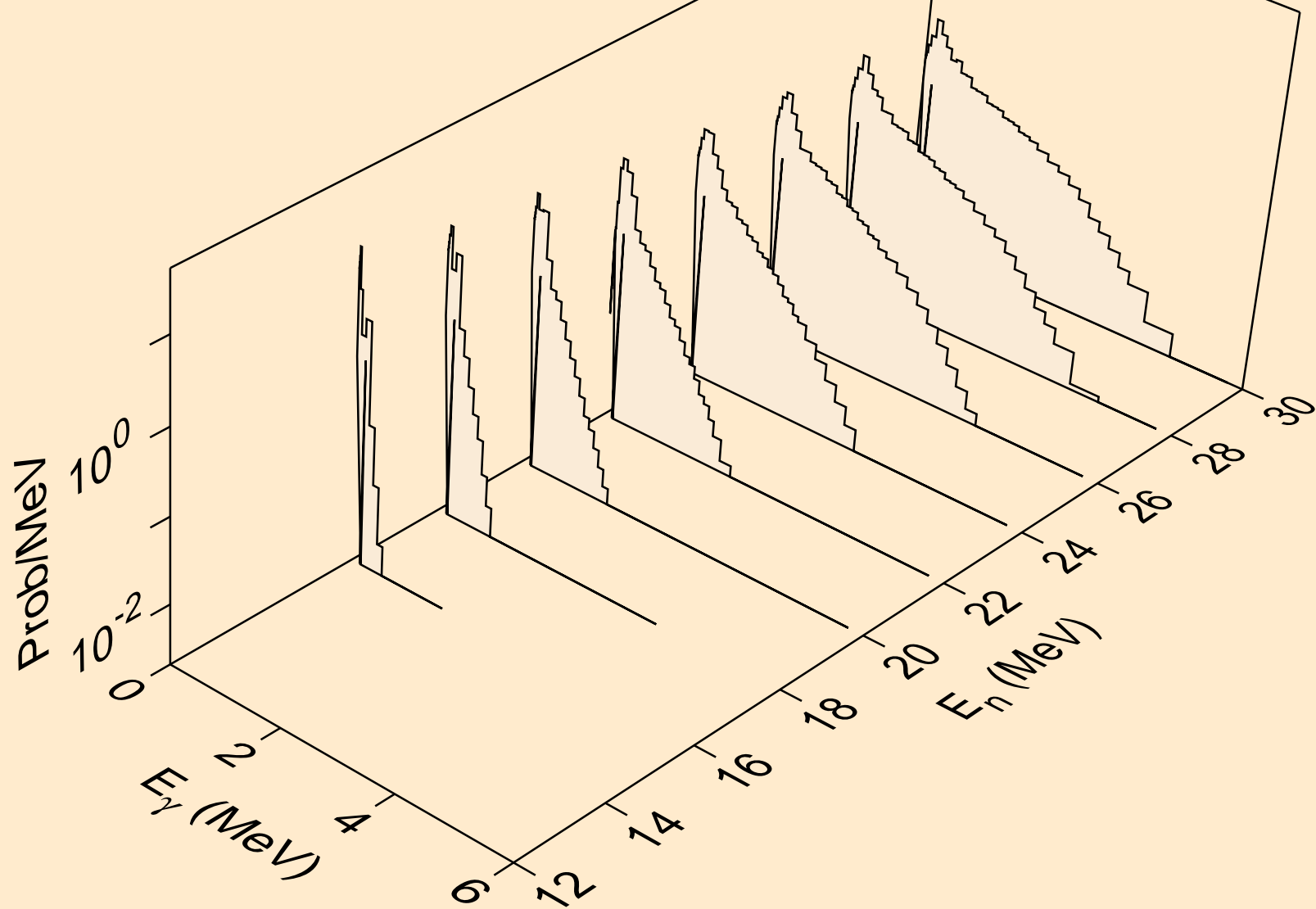

DY170 NEUTRON ACER TENDL-2021 LIBRARY; T=293.6K
Photon emission for (n,n*)he3

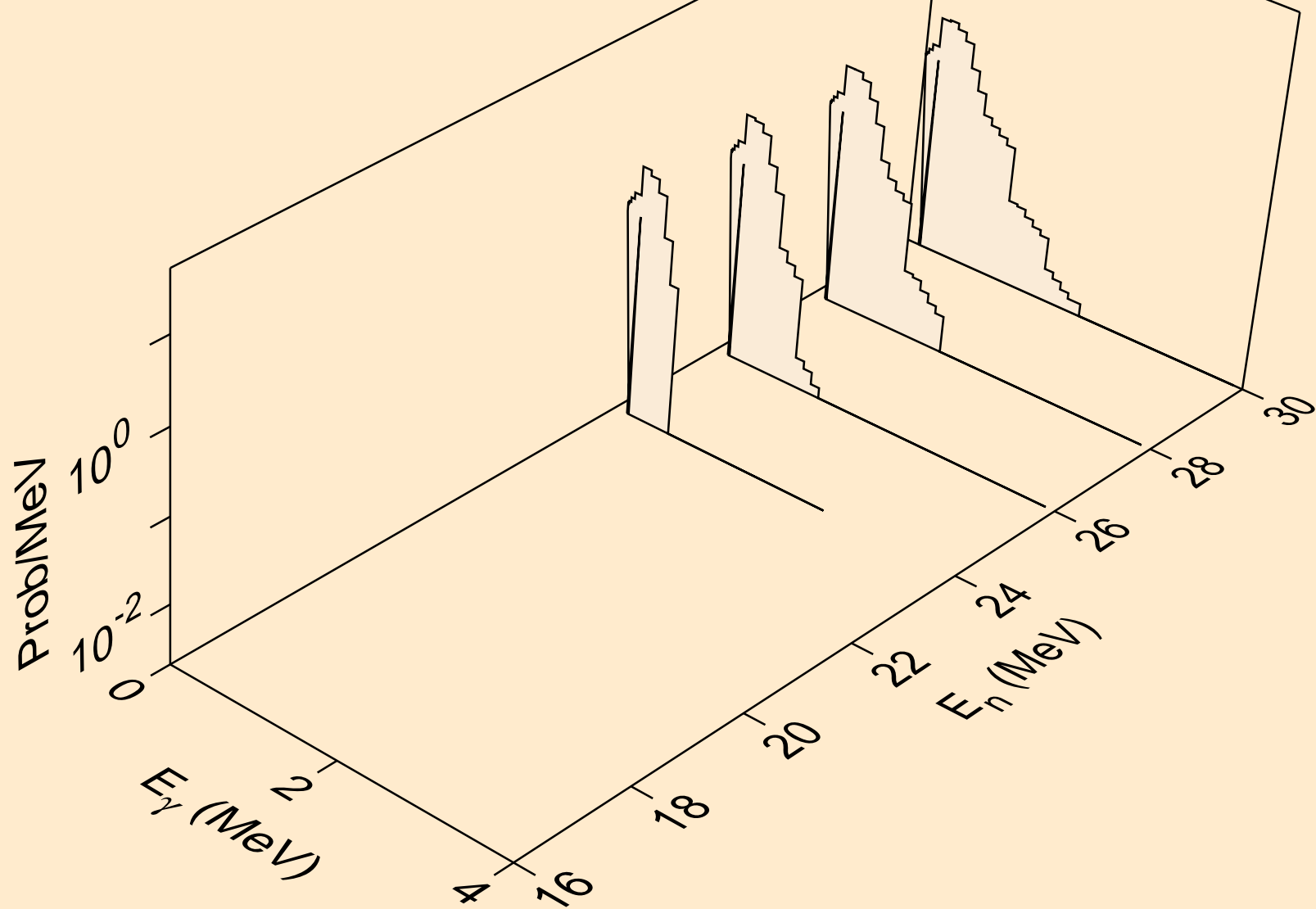

DY170 NEUTRON ACER TENDL-2021 LIBRARY; T=293.6K
Photon emission for (n,4n)

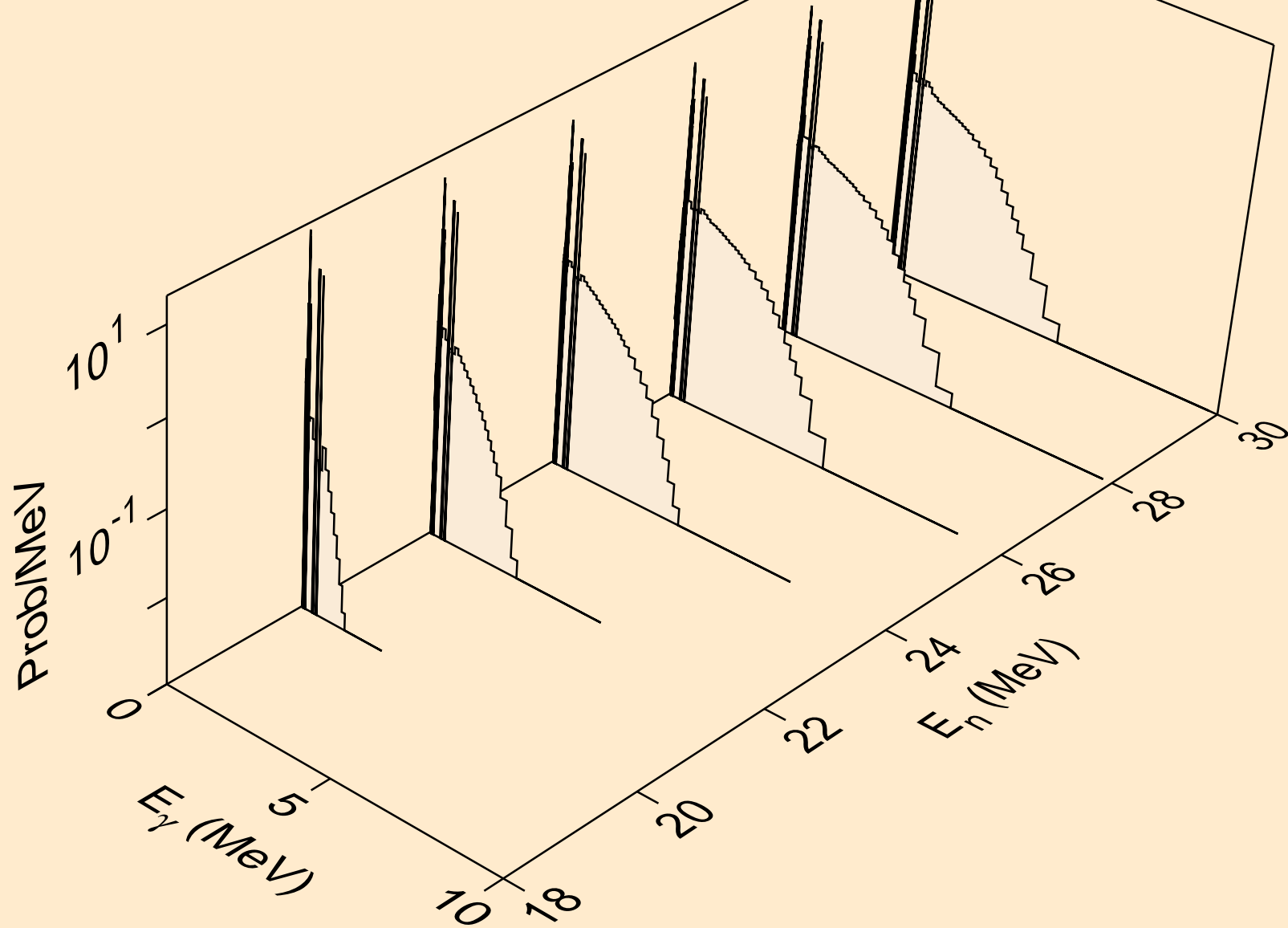

DY170 NEUTRON ACER TENDL-2021 LIBRARY; T=293.6K
Photon emission for (n,2np)

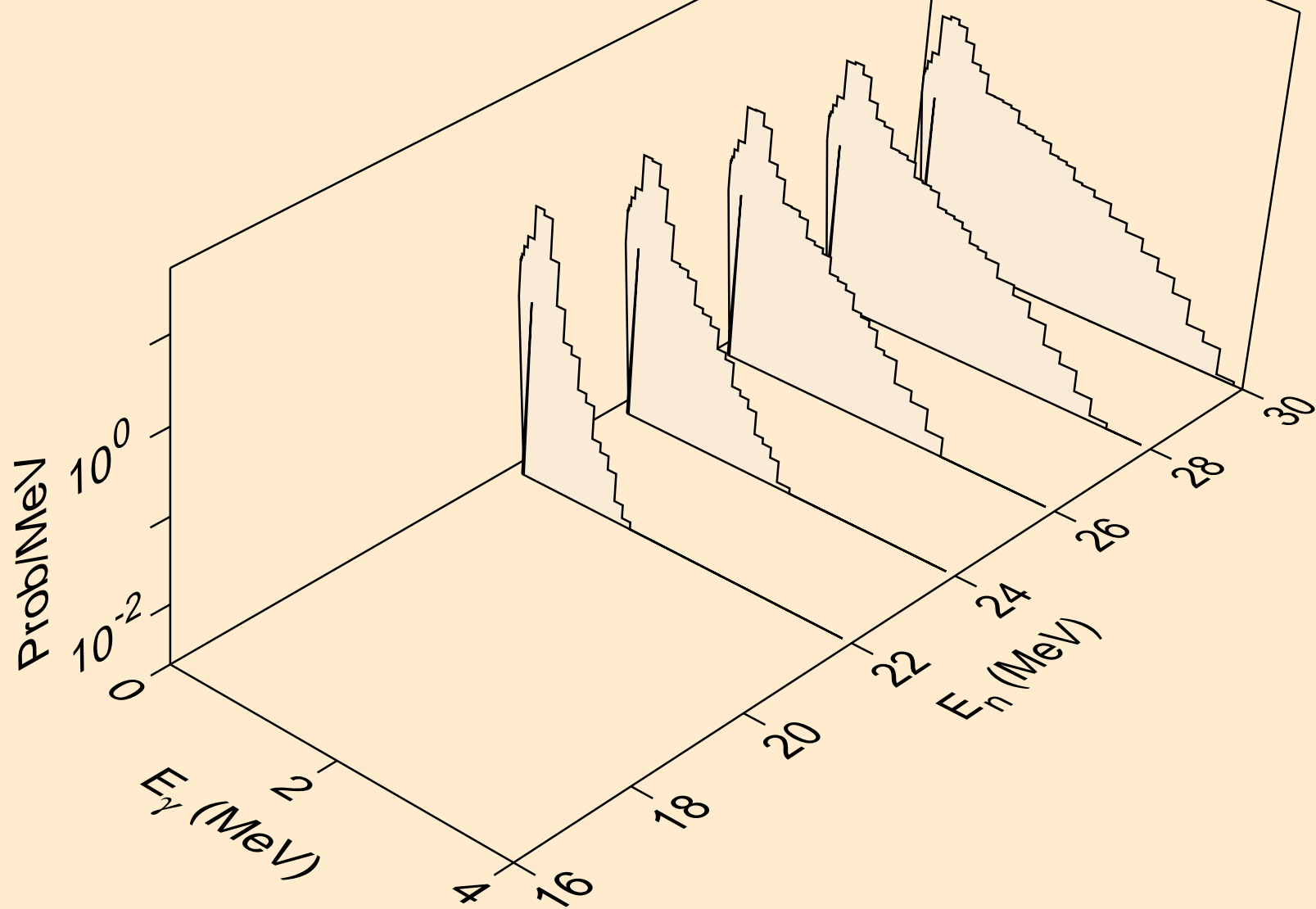

DY170 NEUTRON ACER TENDL-2021 LIBRARY; T=293.6K
Photon emission for (n,3np)

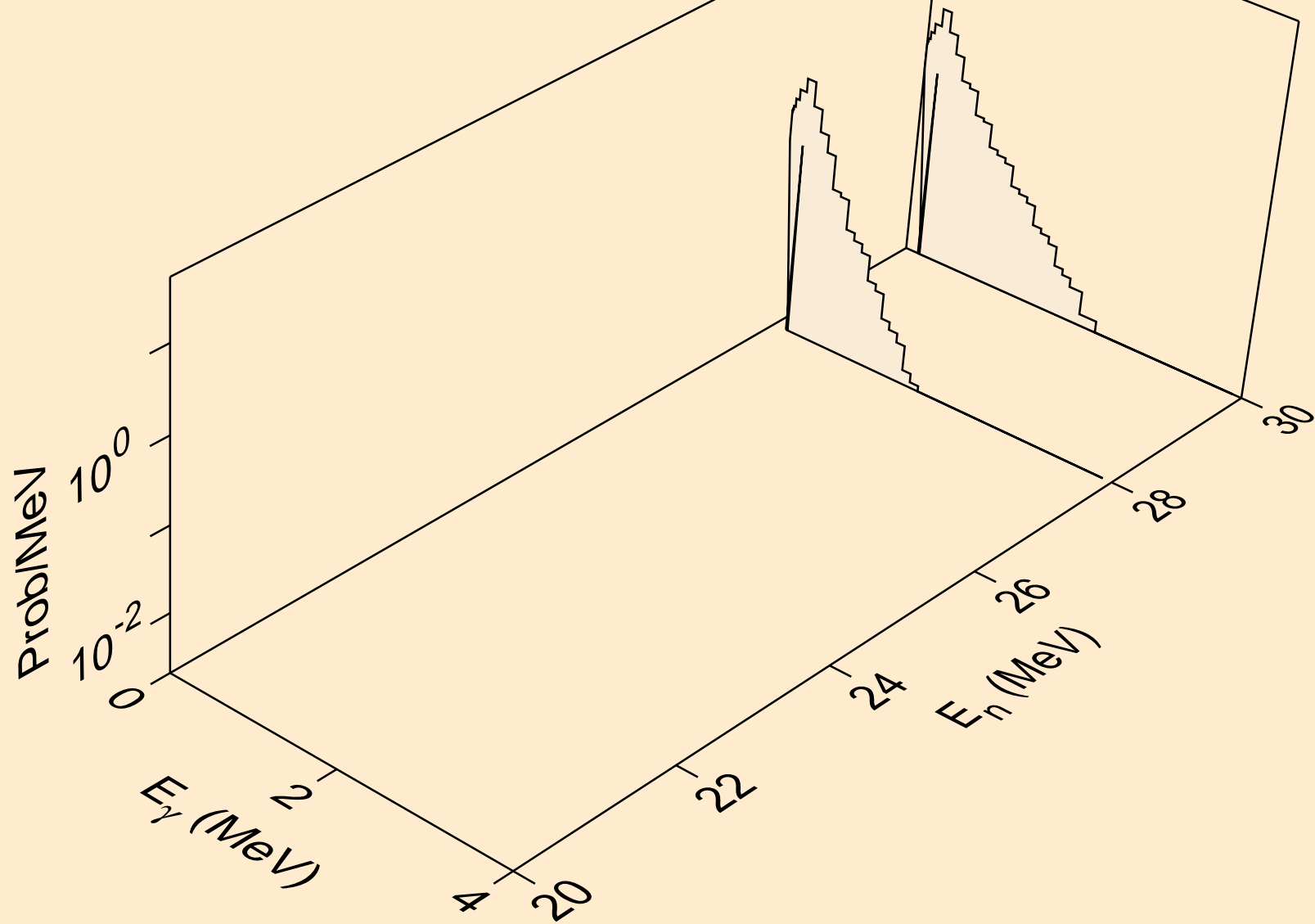

DY170 NEUTRON ACER TENDL-2021 LIBRARY; T=293.6K
Photon emission for (n,n*c)

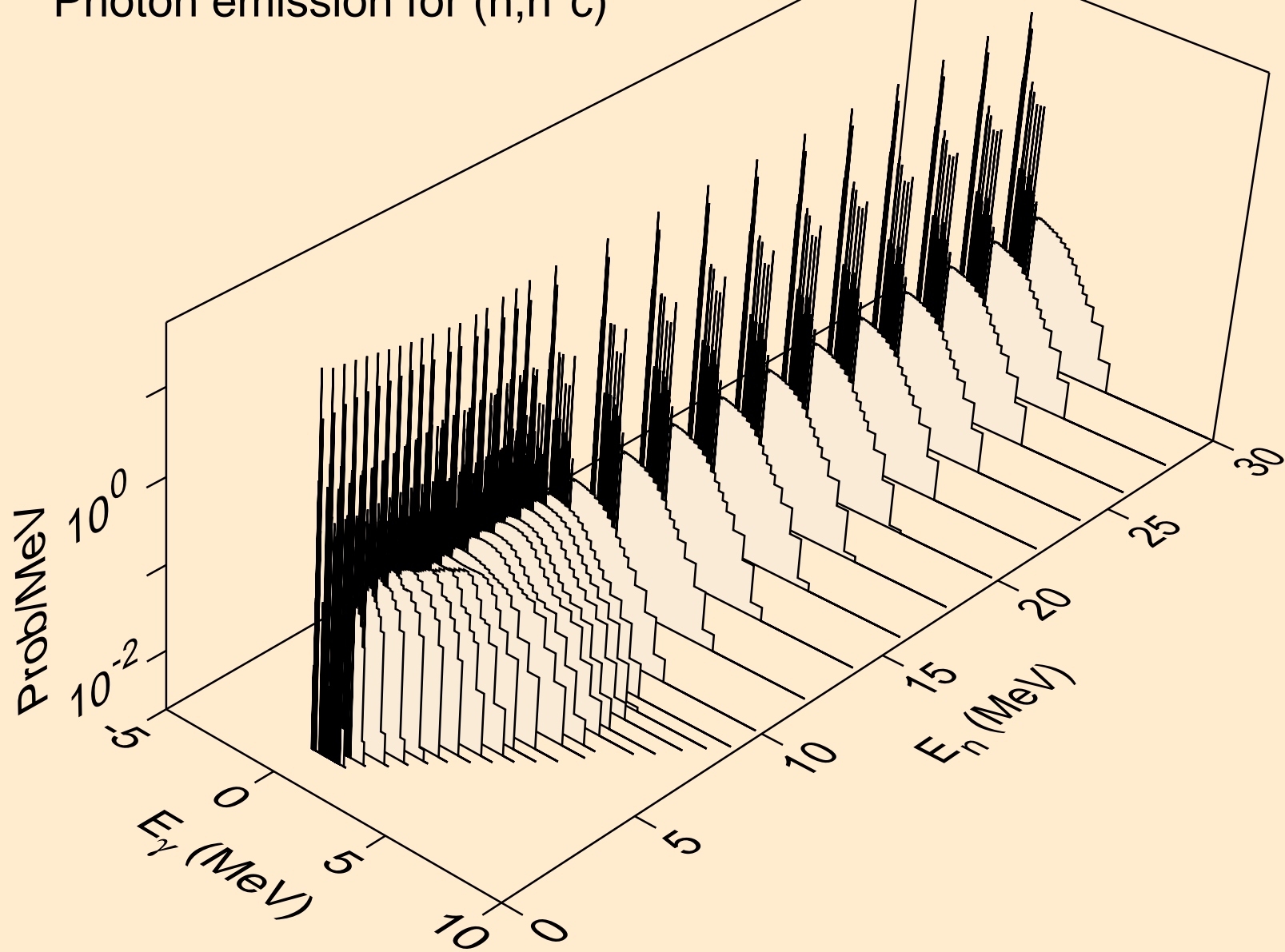

DY170 NEUTRON ACER TENDL-2021 LIBRARY; T=293.6K
Photon emission for (n,gma)

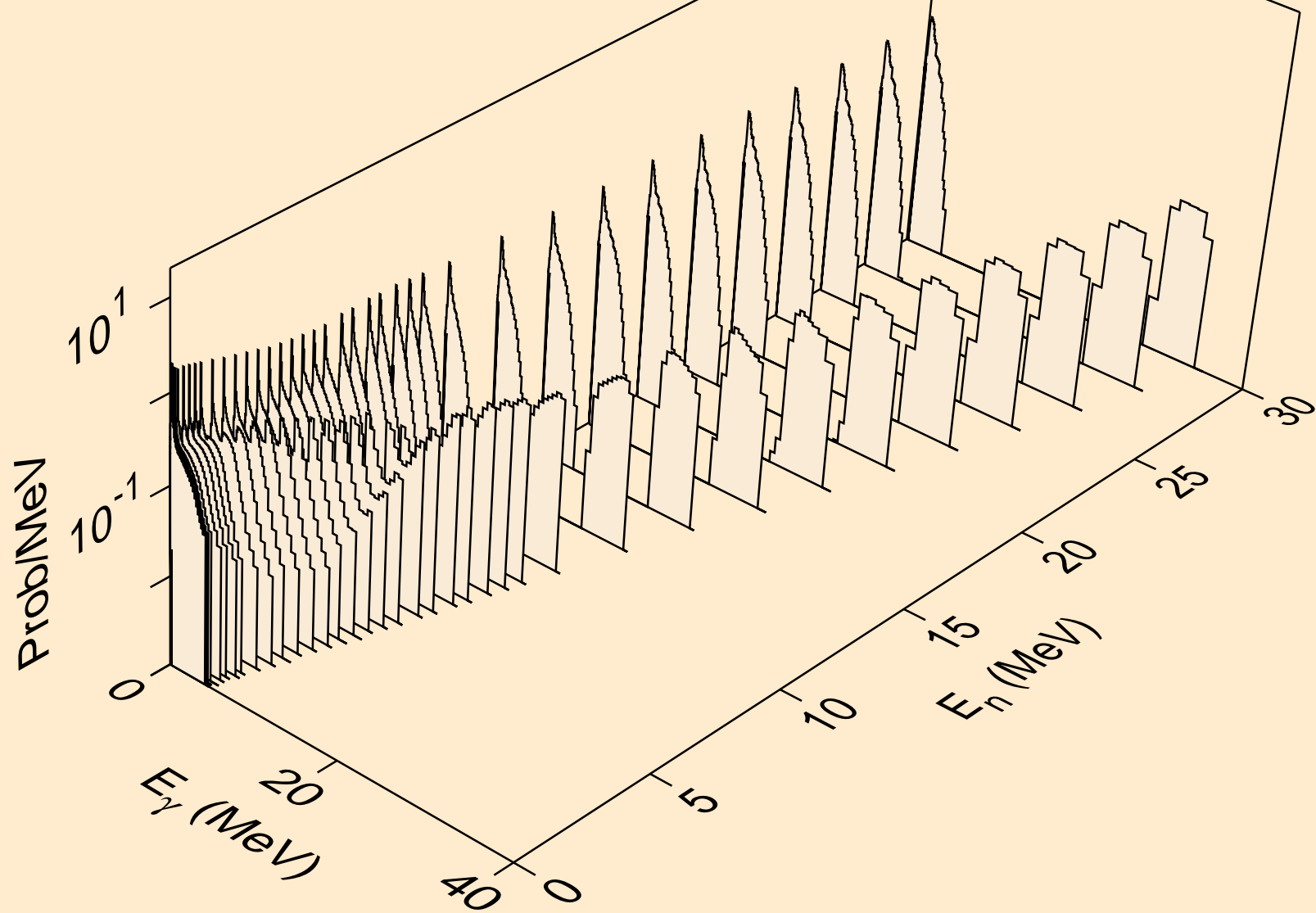

DY170 NEUTRON ACER TENDL-2021 LIBRARY; T=293.6K
Photon emission for (n,p)

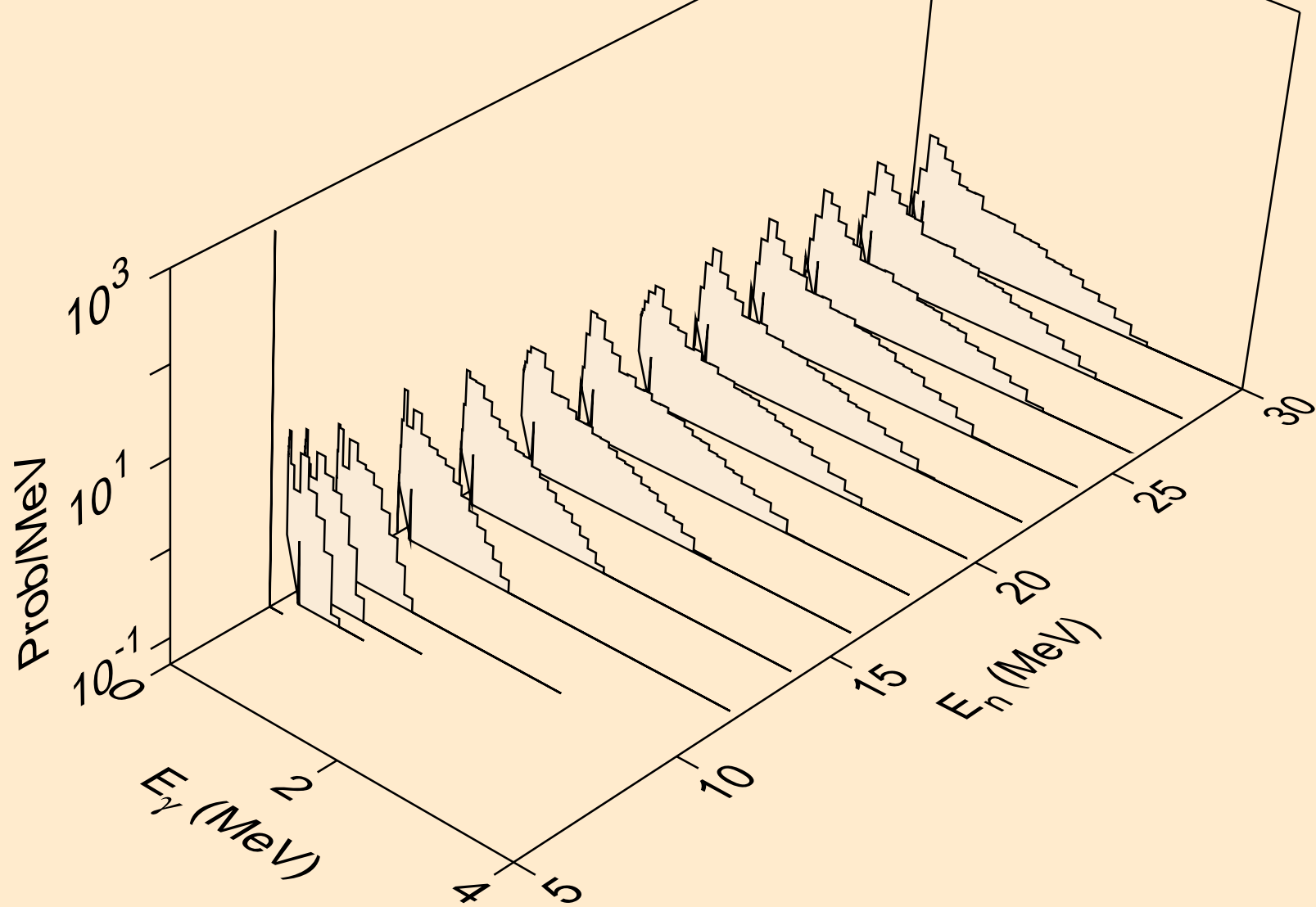

DY170 NEUTRON ACER TENDL-2021 LIBRARY; T=293.6K
Photon emission for (n,d)

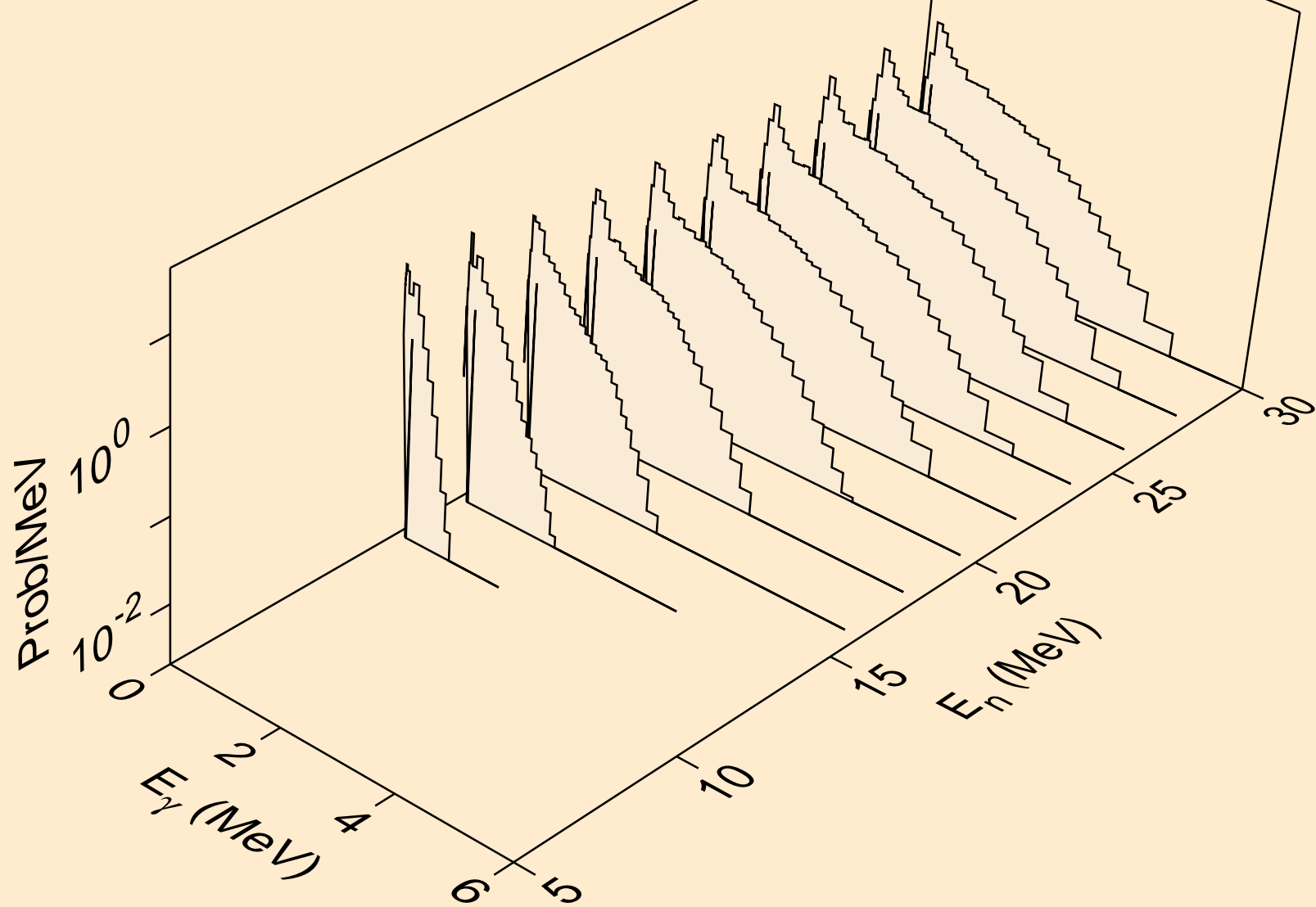

DY170 NEUTRON ACER TENDL-2021 LIBRARY; T=293.6K
Photon emission for (n,t)

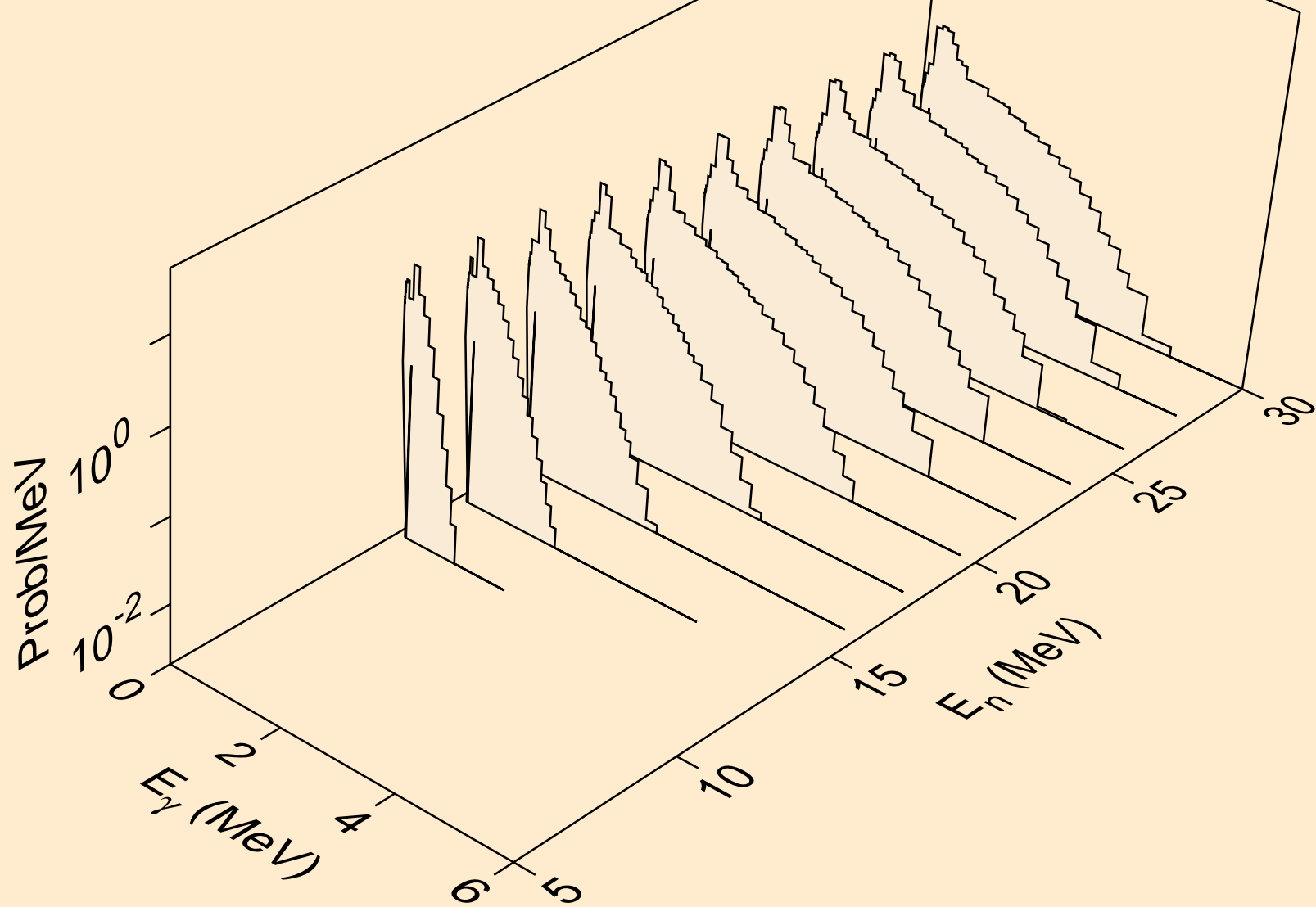

DY170 NEUTRON ACER TENDL-2021 LIBRARY; T=293.6K
Photon emission for (n,he3)

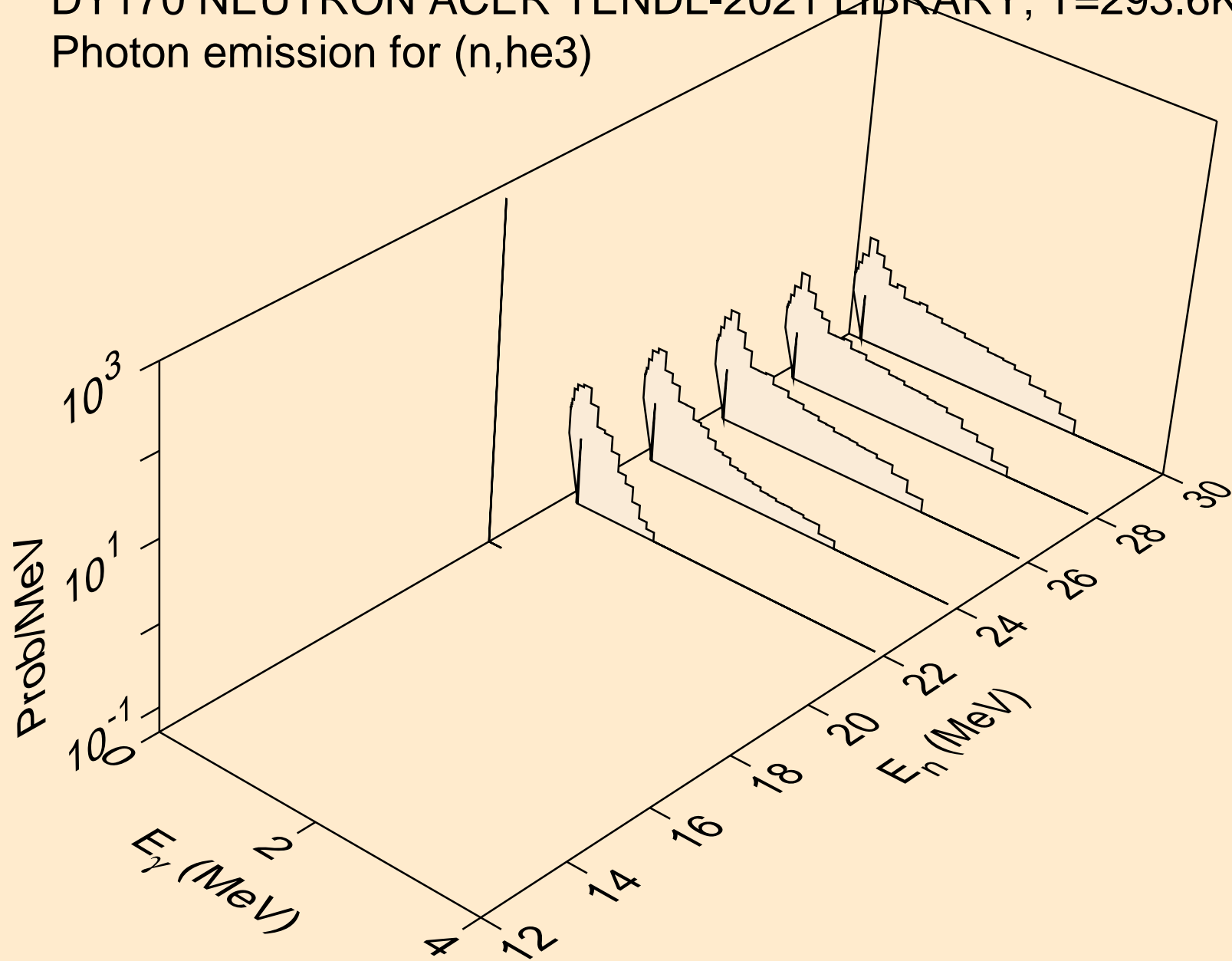

DY170 NEUTRON ACER TENDL-2021 LIBRARY; T=293.6K
Photon emission for (n,a)

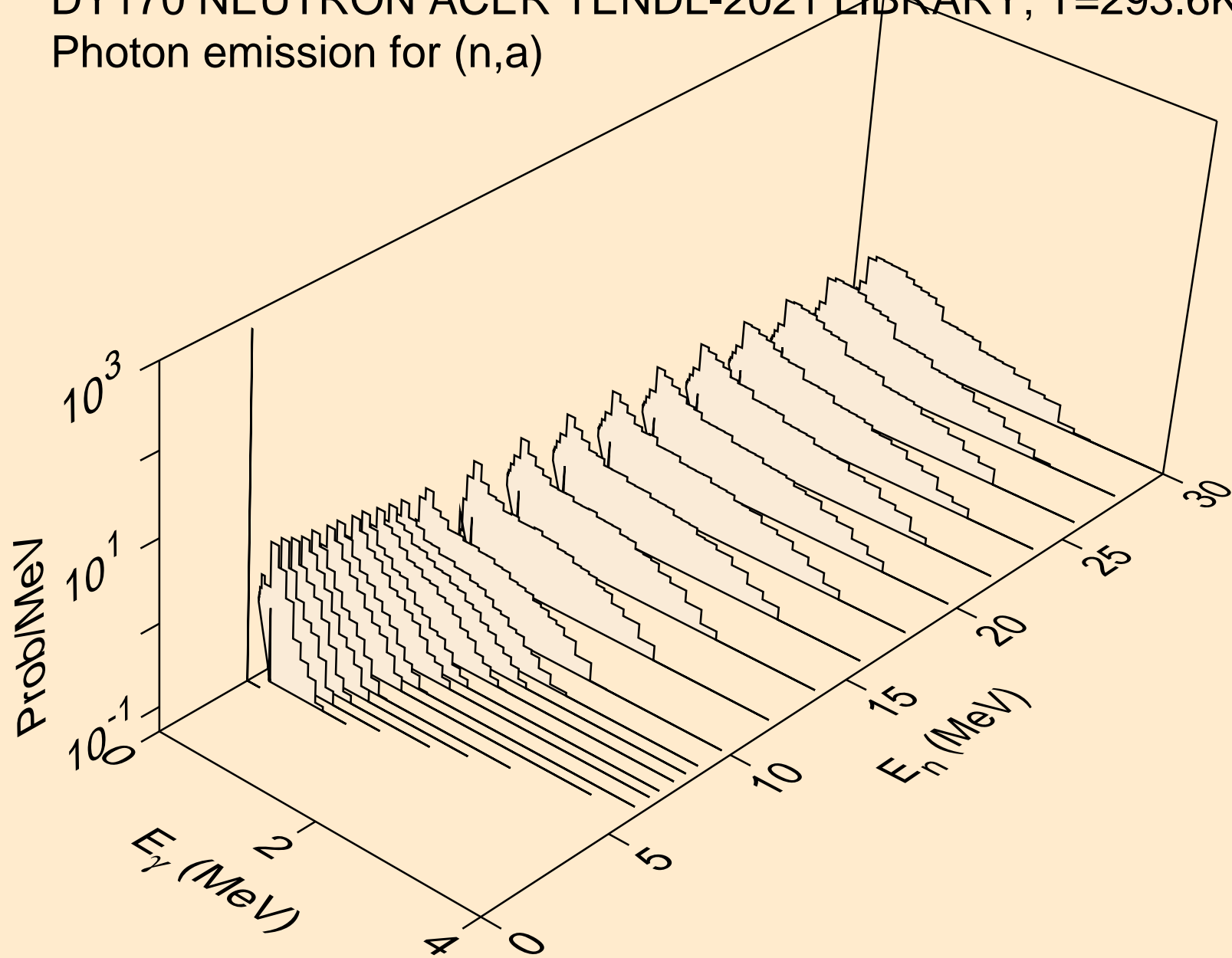

DY170 NEUTRON ACER TENDL-2021 LIBRARY; T=293.6K
thermal capture photon spectrum

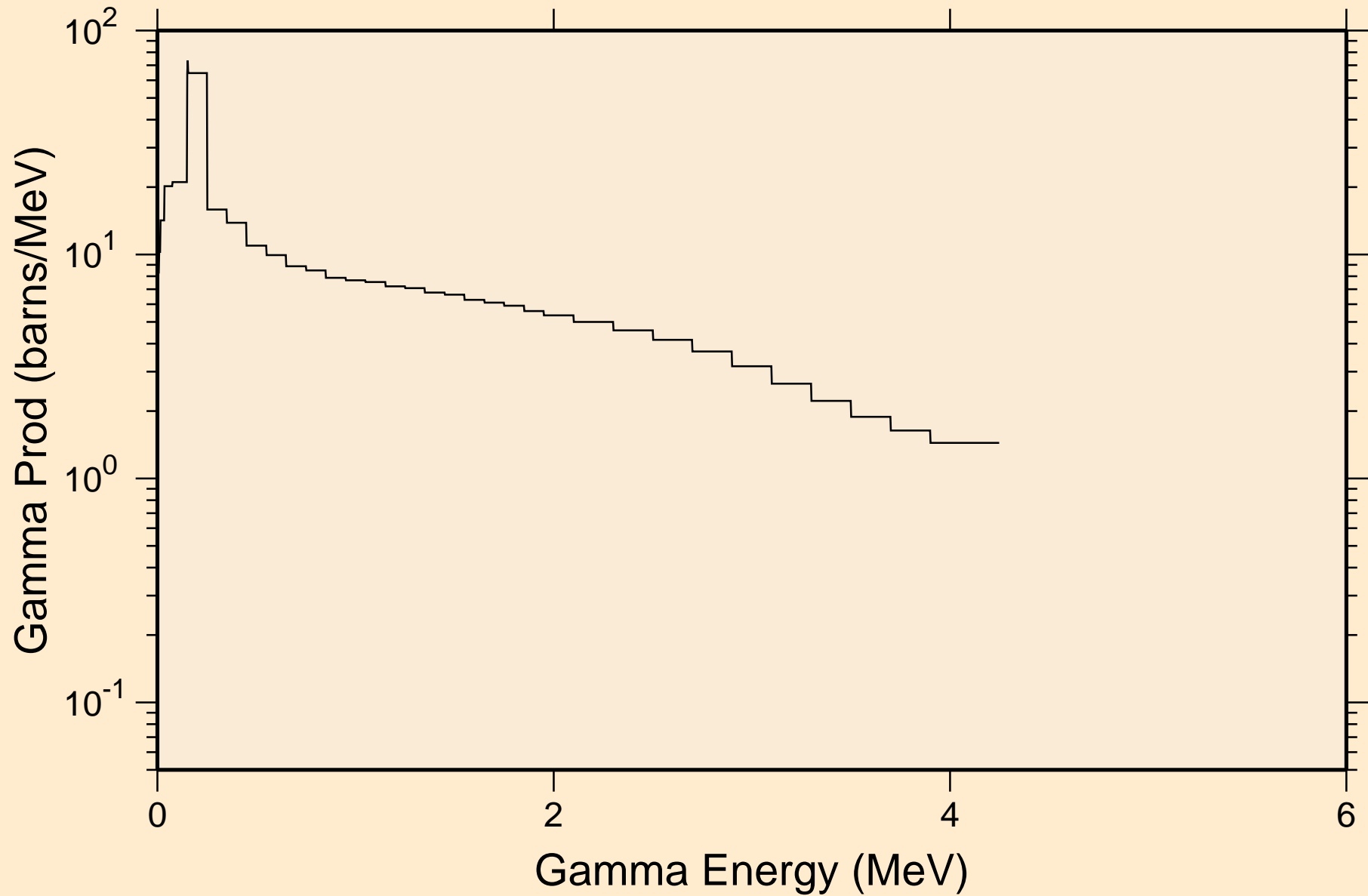

DY170 NEUTRON ACER TENDL-2021 LIBRARY; T=293.6K
14 MeV photon spectrum

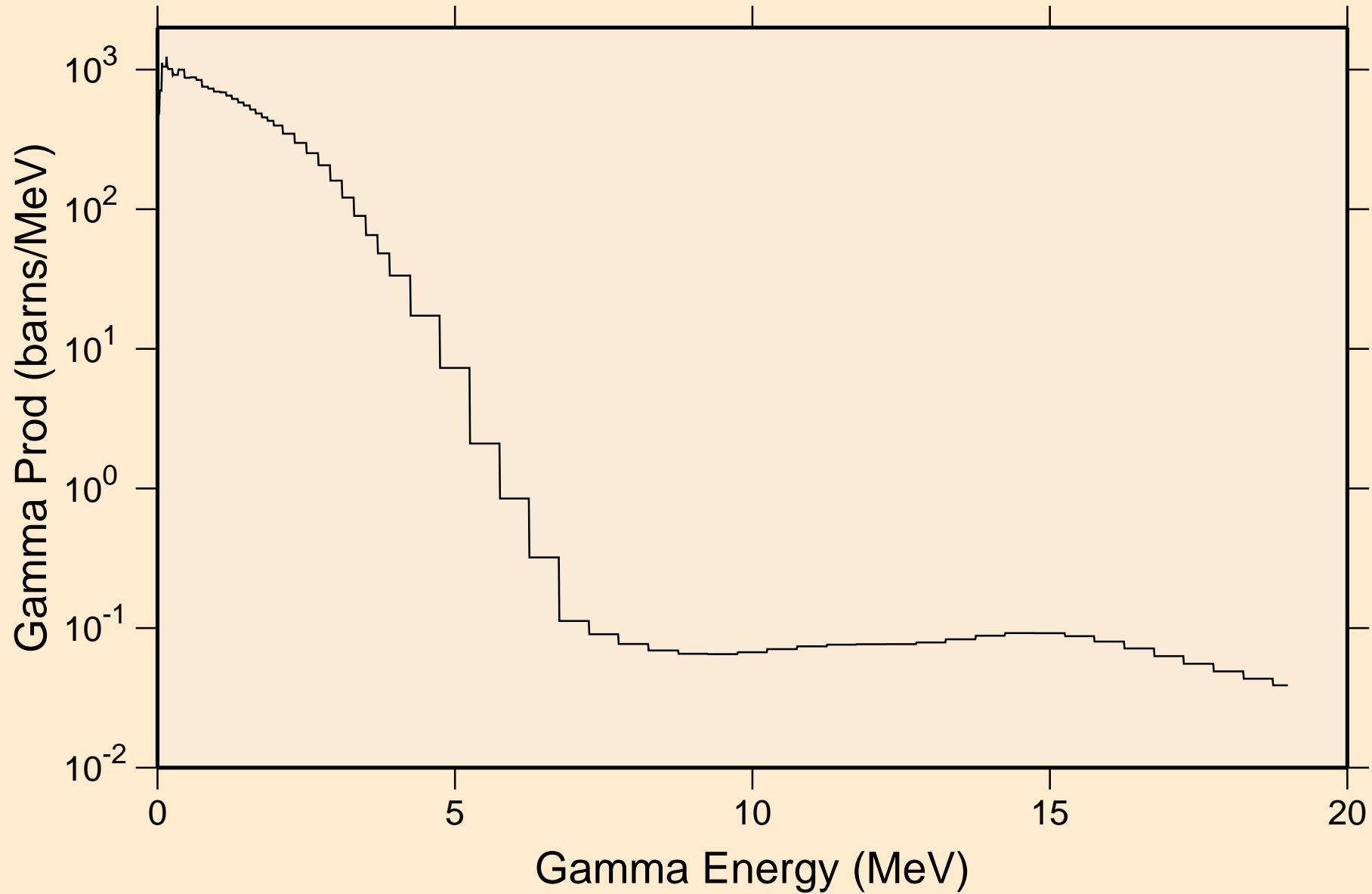

DY170 NEUTRON ACER TENDL-2021 LIBRARY; T=293.6K
Particle heating contributions

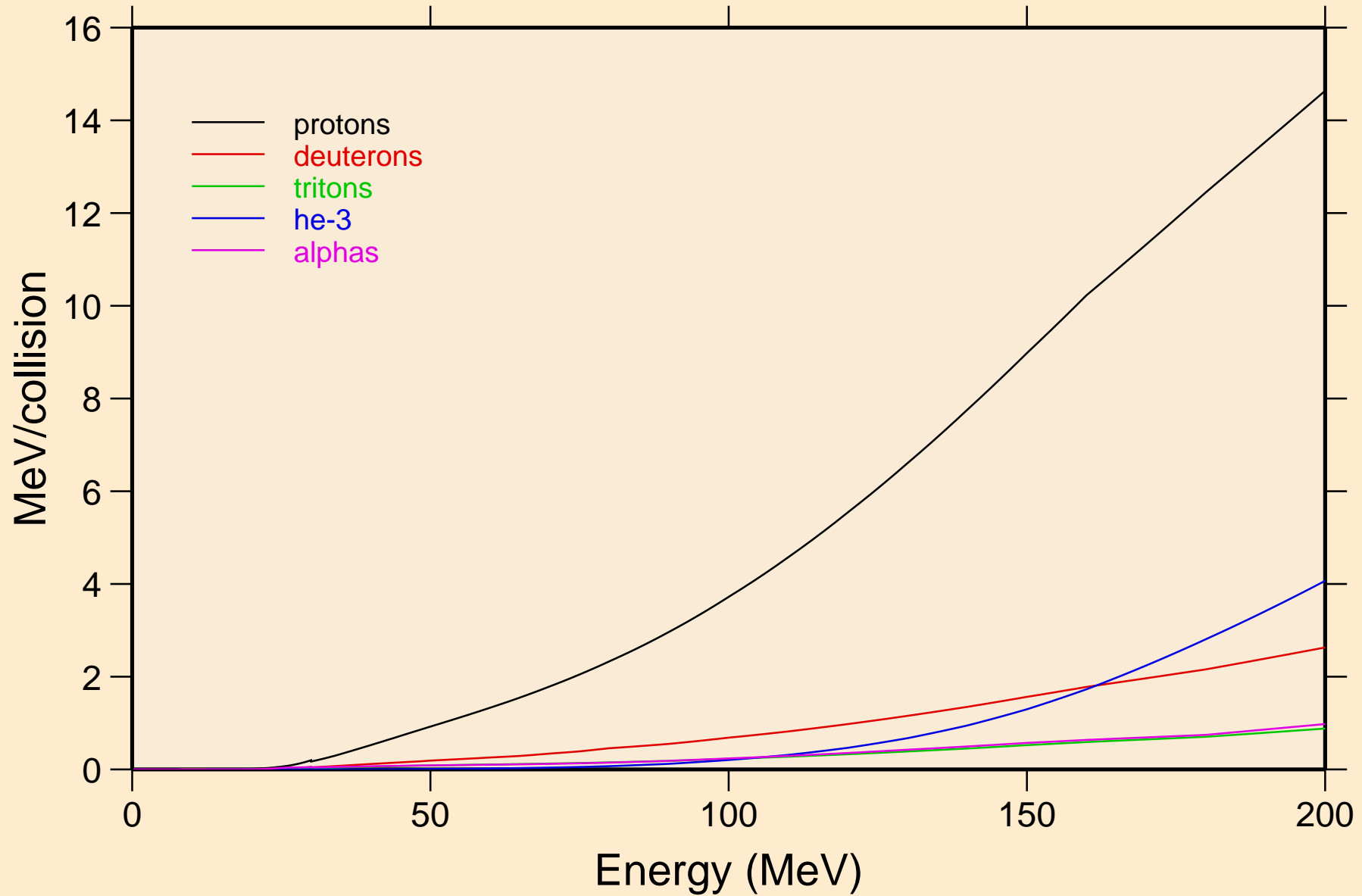

DY170 NEUTRON ACER TENDL-2021 LIBRARY; T=293.6K
Recoil Heating

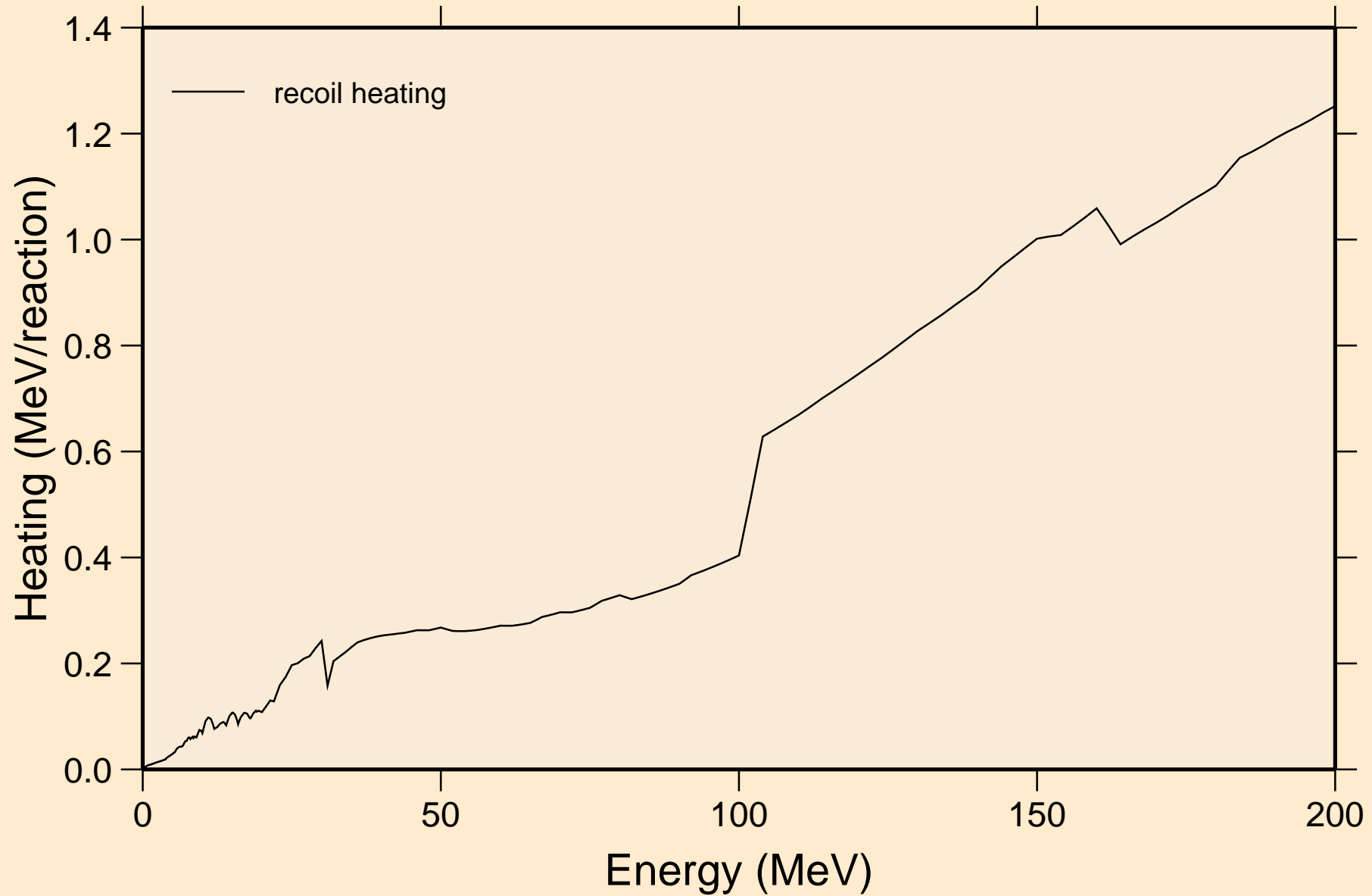

DY170 NEUTRON ACER TENDL-2021 LIBRARY; T=293.6K
Particle production cross sections

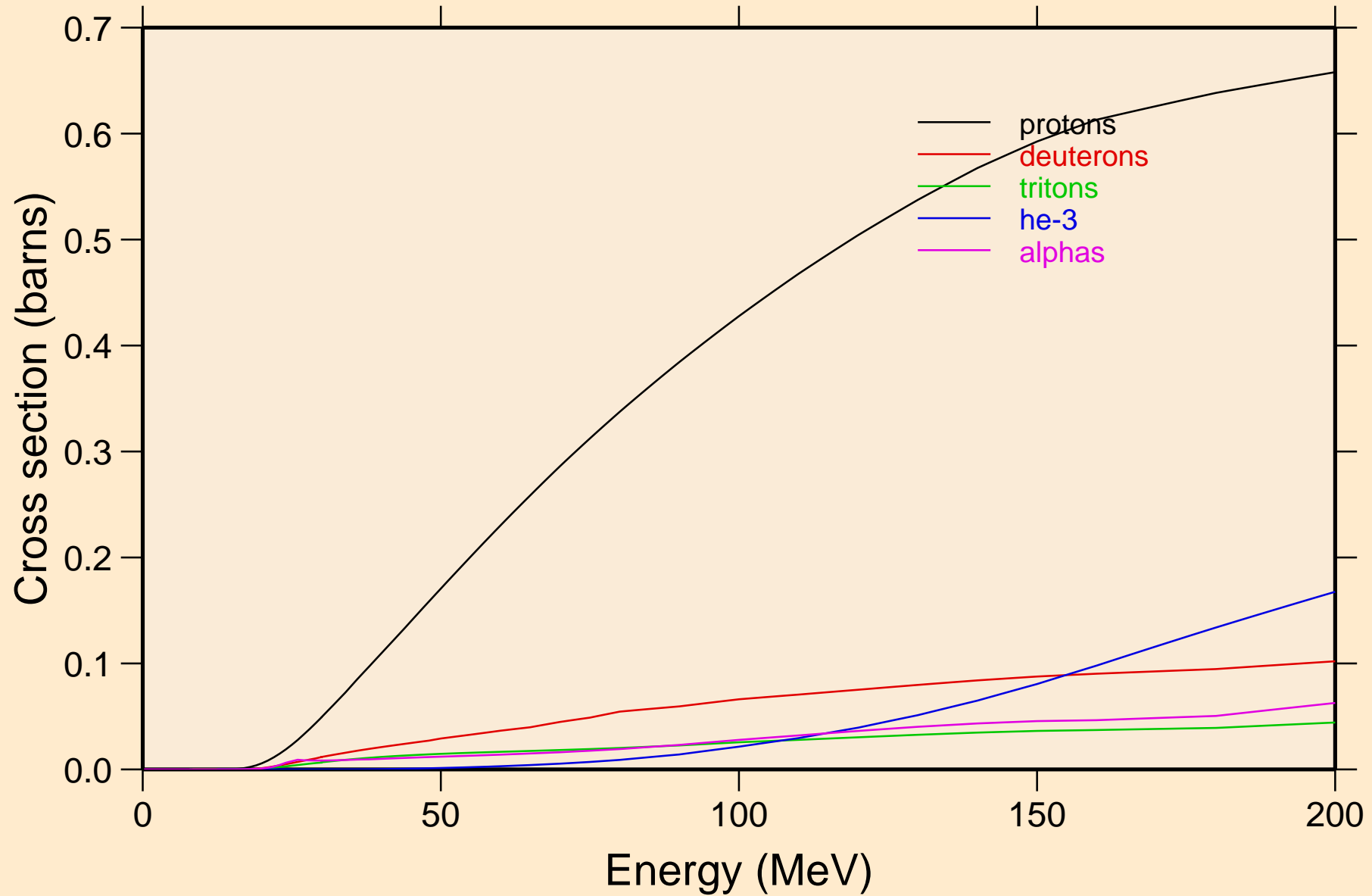

DY170 NEUTRON ACER TENDL-2021 LIBRARY; T=293.6K
protons from (n,x)

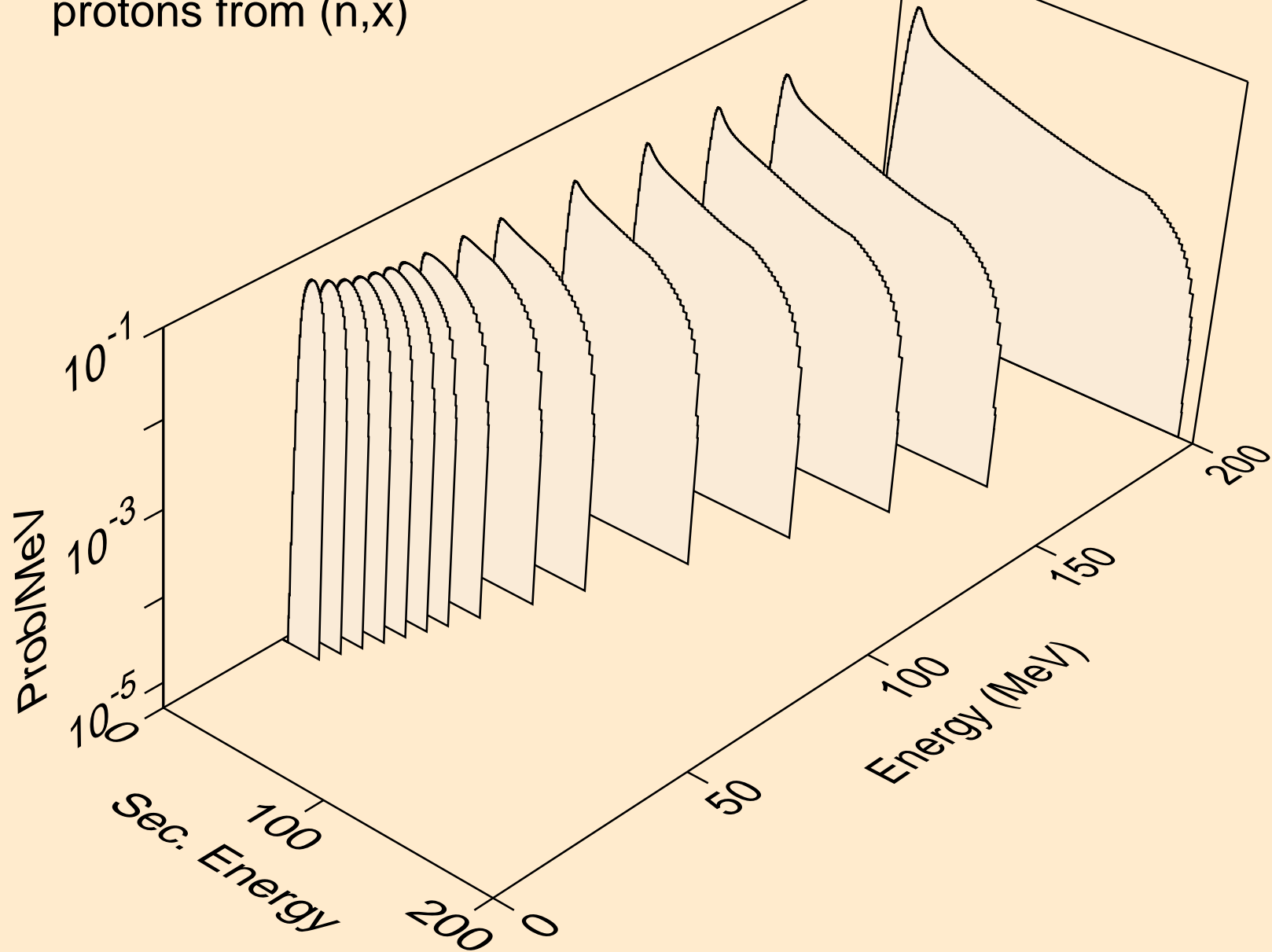

DY170 NEUTRON ACER TENDL-2021 LIBRARY; T=293.6K
protons from (n,n*)p

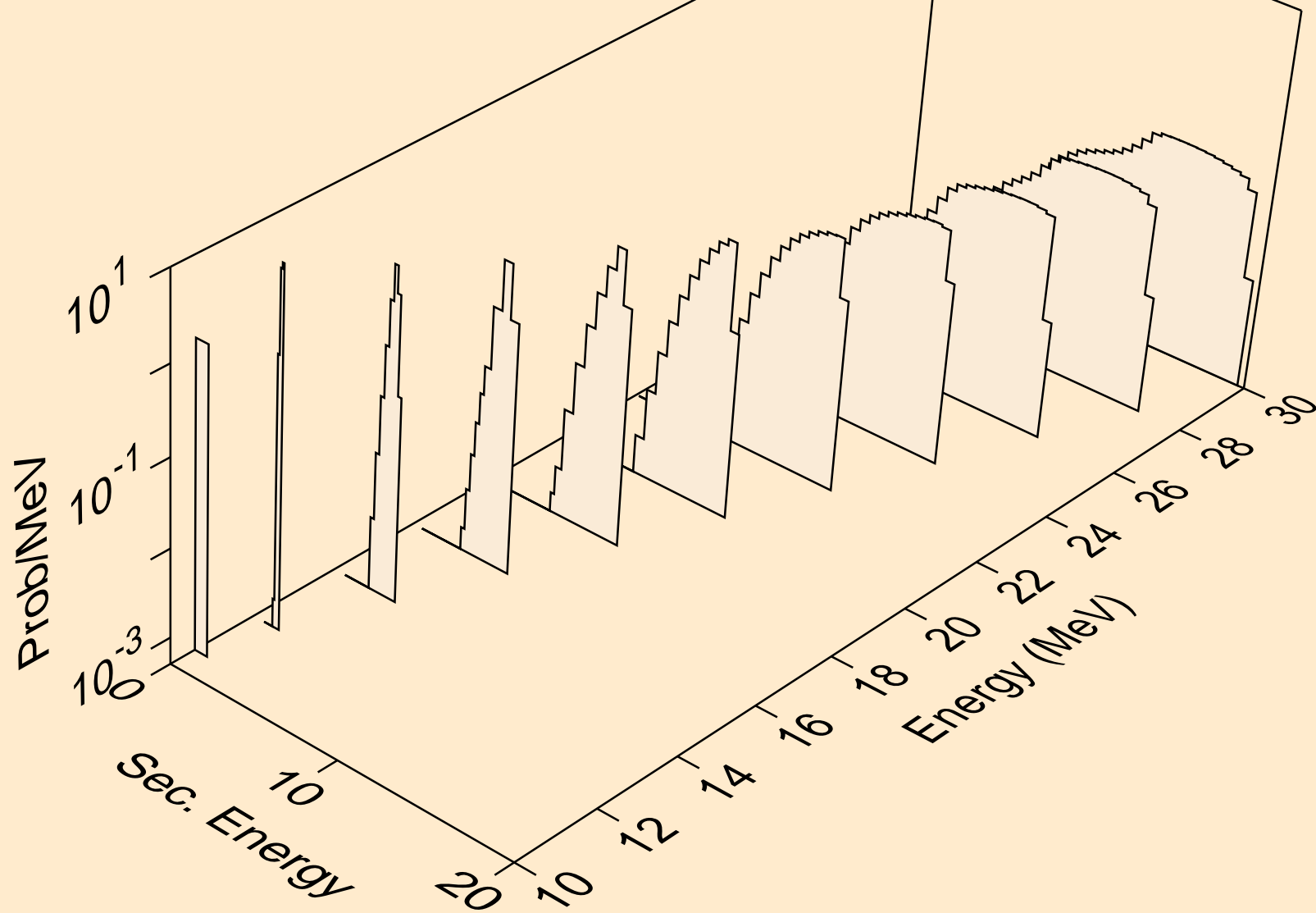

DY170 NEUTRON ACER TENDL-2021 LIBRARY; T=293.6K
protons from (n,2np)

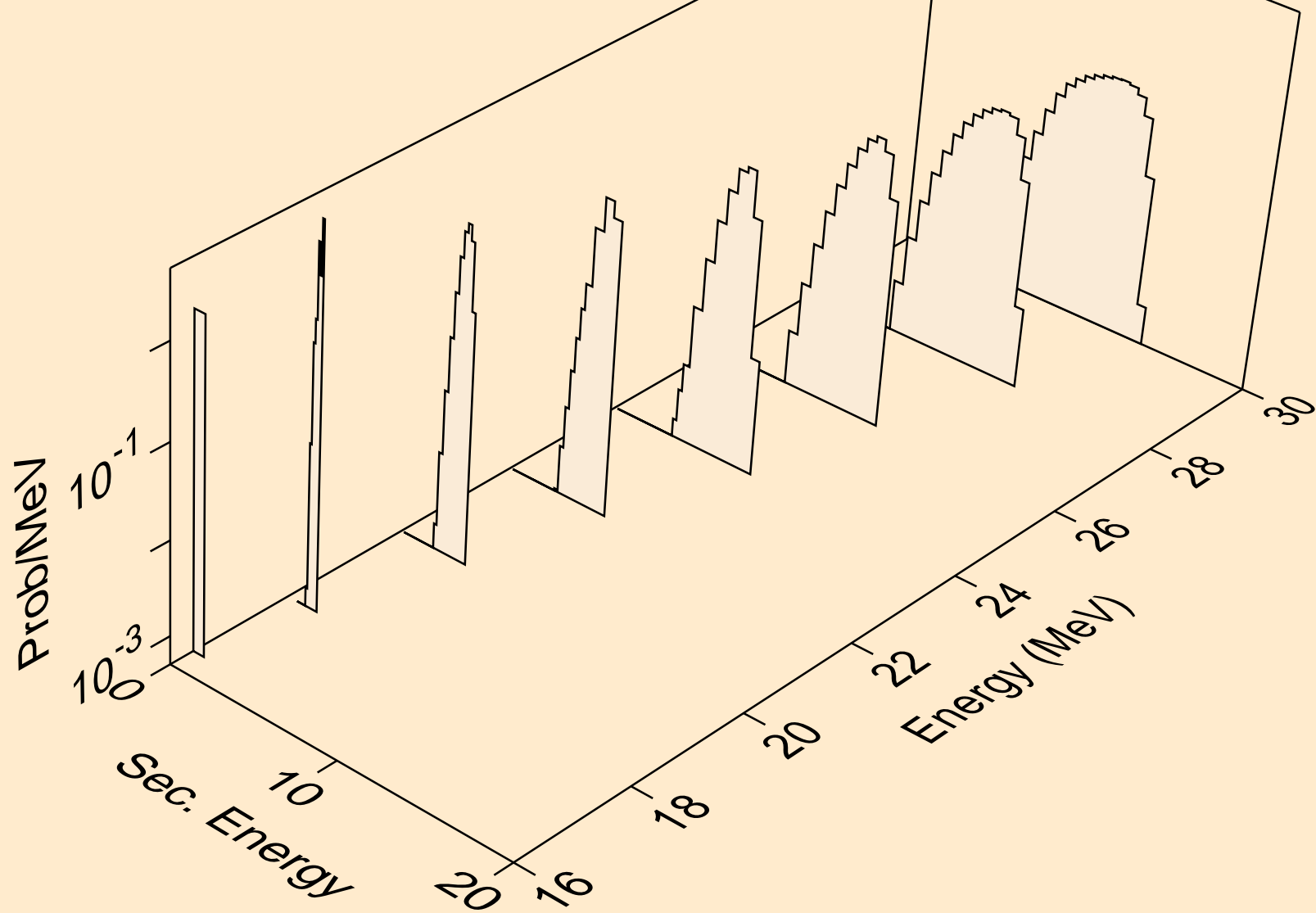

DY170 NEUTRON ACER TENDL-2021 LIBRARY; T=293.6K
protons from (n,3np)

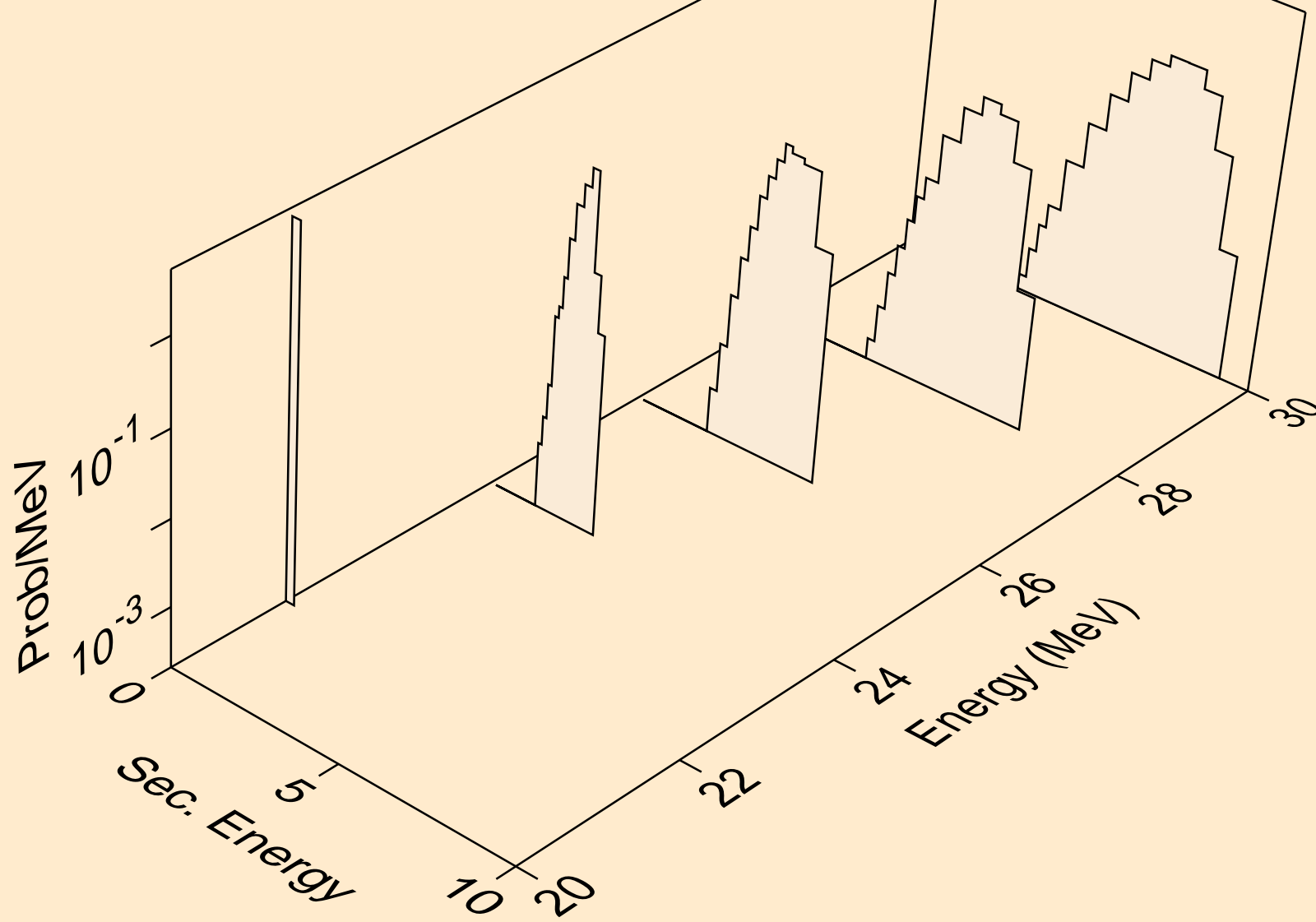

DY170 NEUTRON ACER TENDL-2021 LIBRARY; T=293.6K
protons from (n,p)

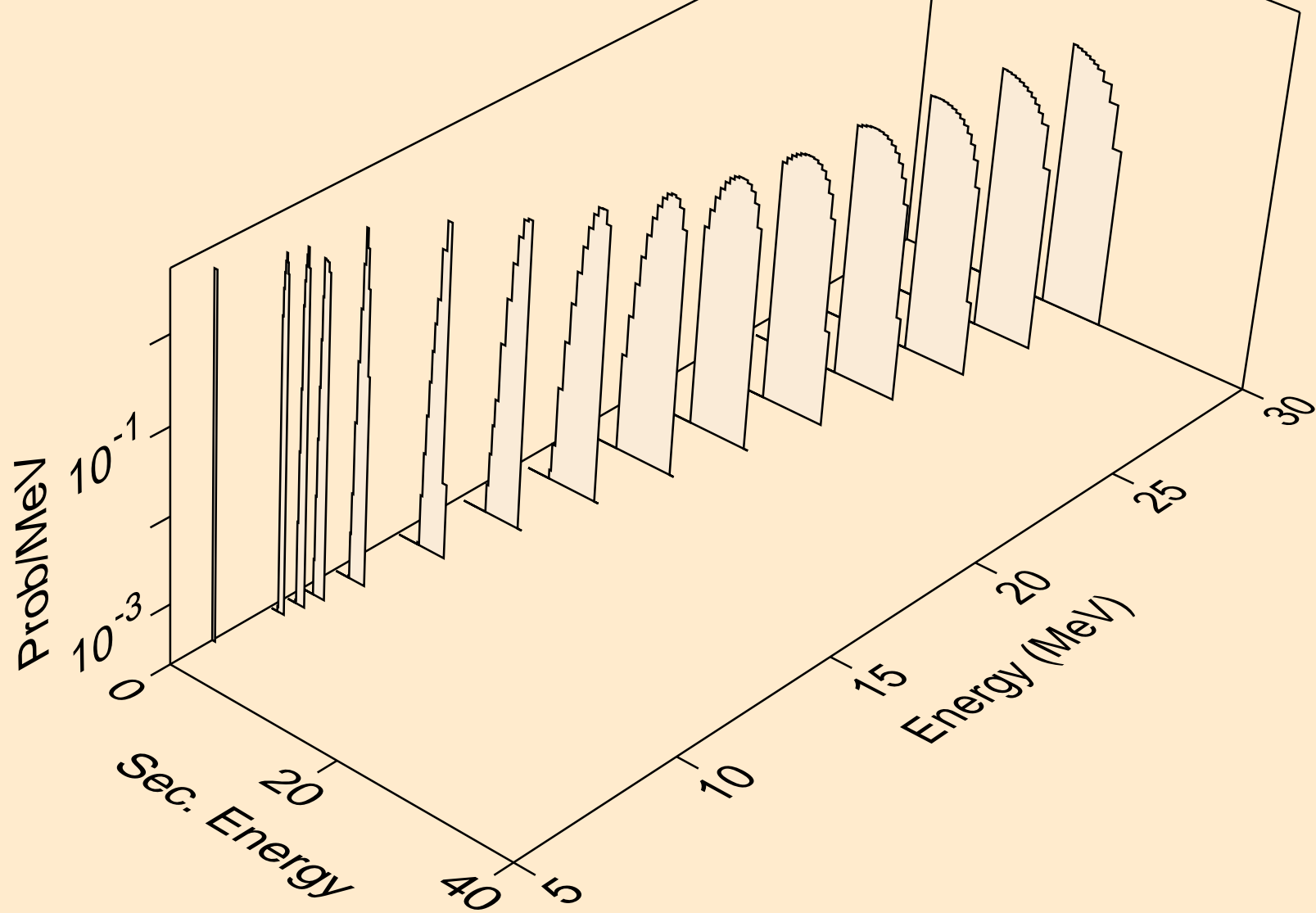

DY170 NEUTRON ACER TENDL-2021 LIBRARY; T=293.6K
deuterons from (n,x)

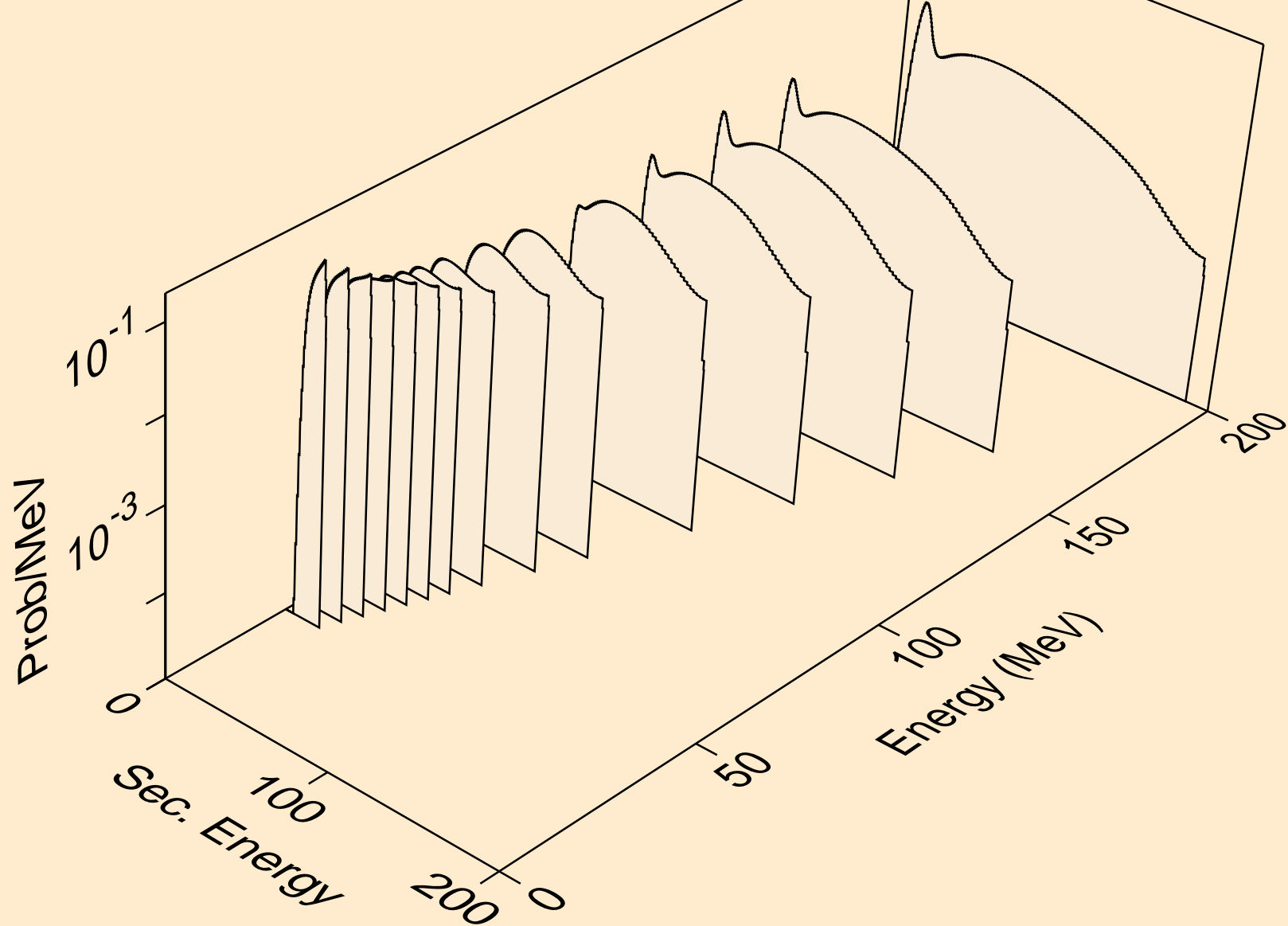

DY170 NEUTRON ACER TENDL-2021 LIBRARY; T=293.6K
deuterons from (n,2nd)

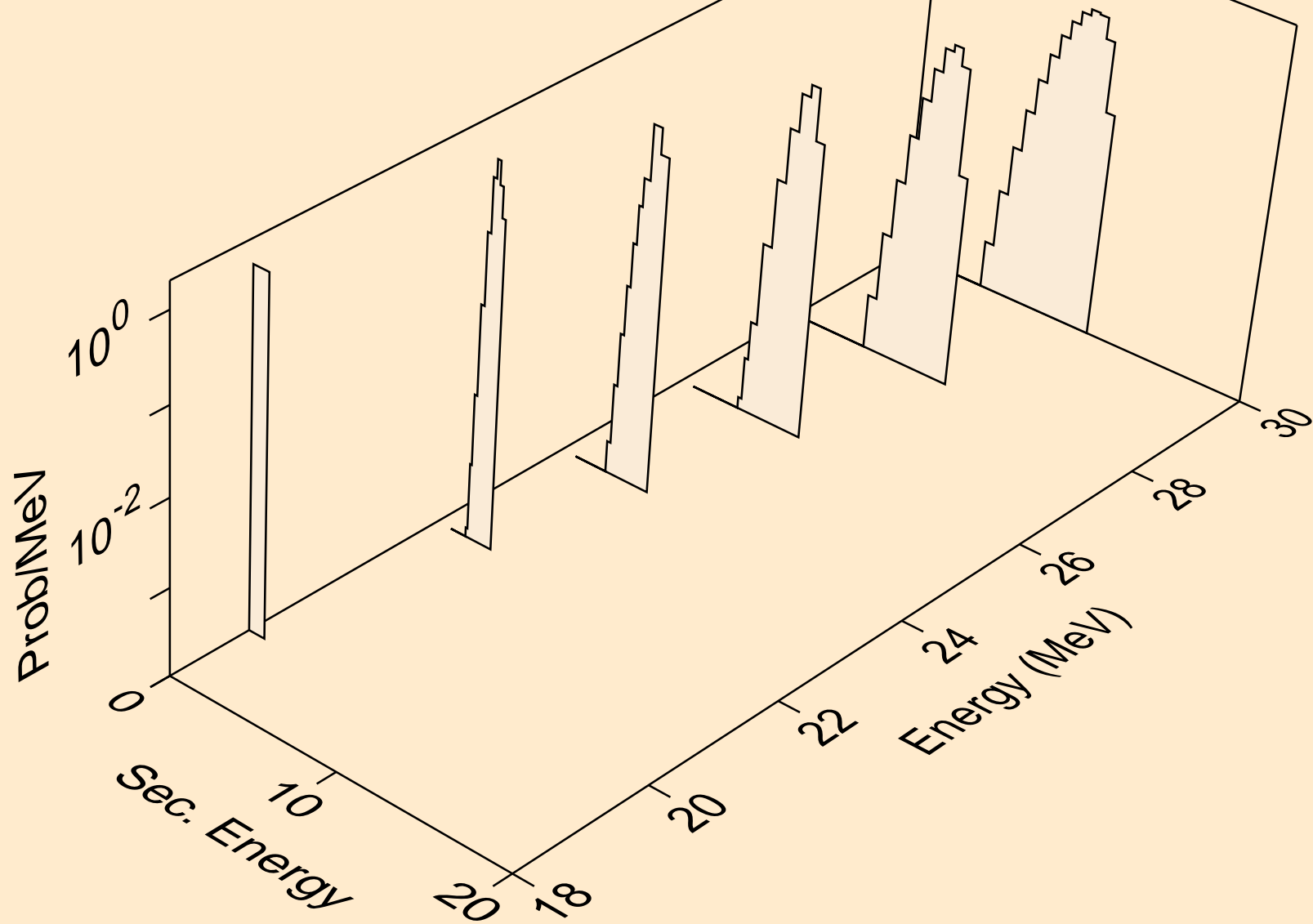

DY170 NEUTRON ACER TENDL-2021 LIBRARY; T=293.6K
deuterons from (n,n*)d

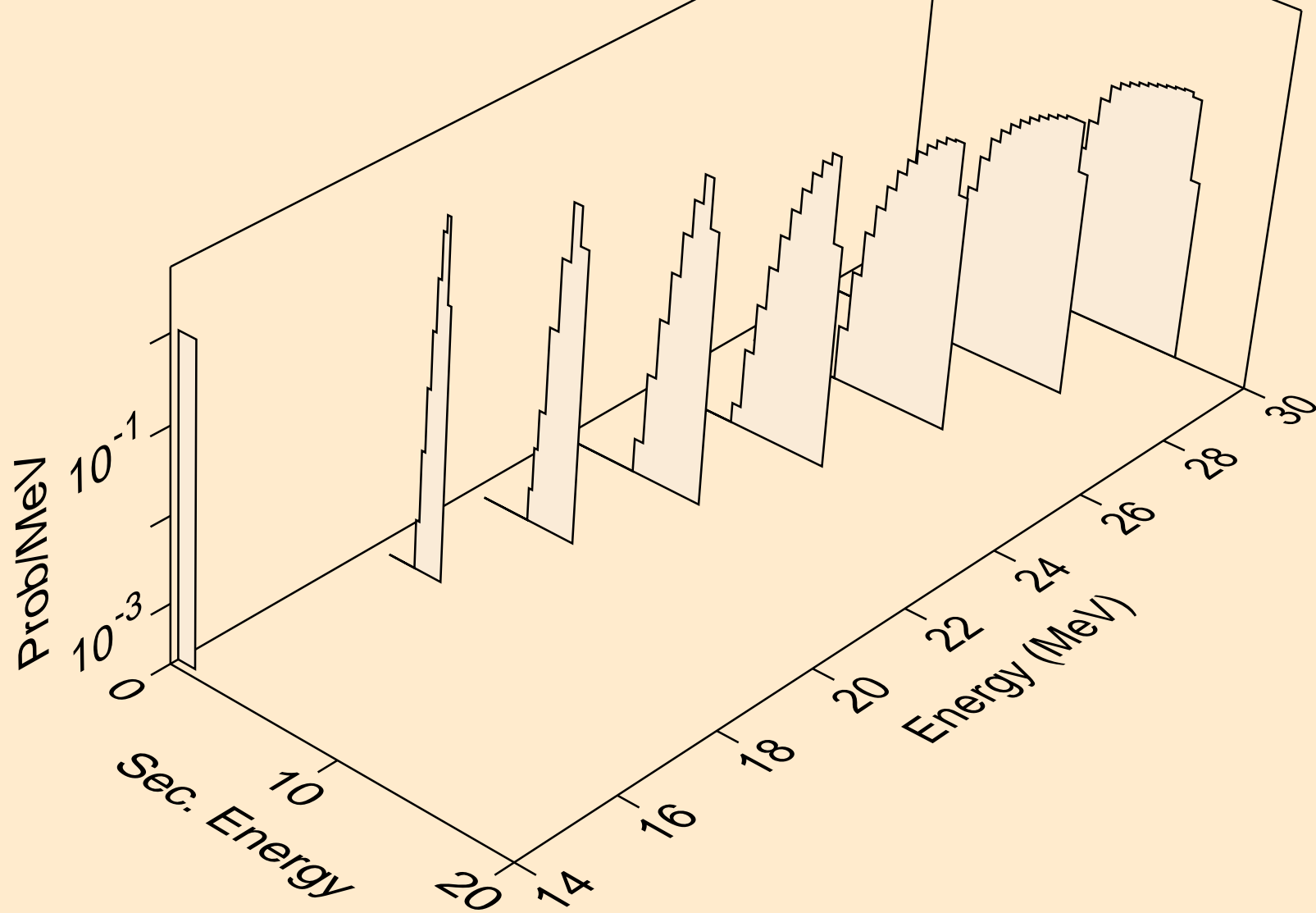

DY170 NEUTRON ACER TENDL-2021 LIBRARY; T=293.6K
deuterons from (n,d)

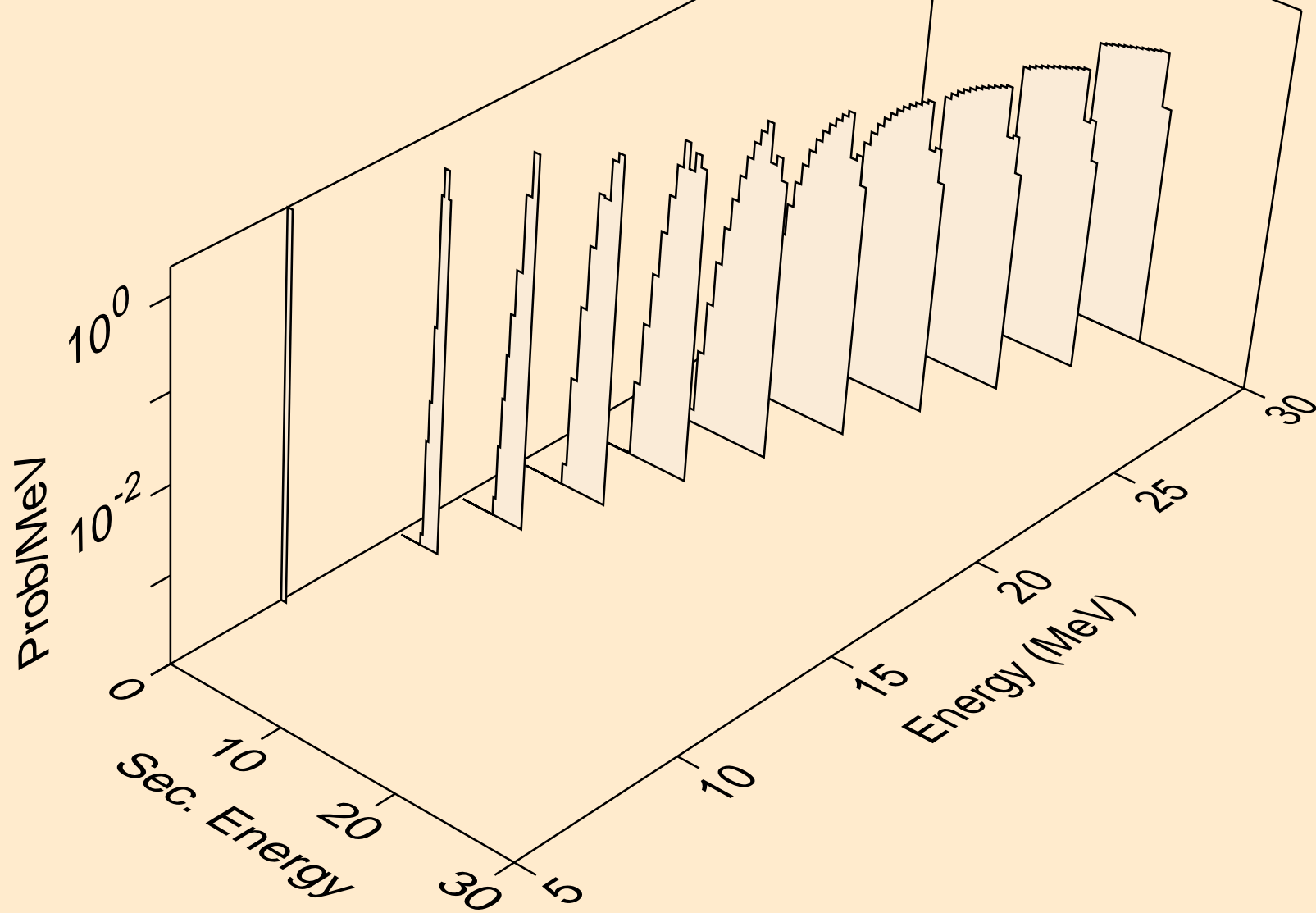

DY170 NEUTRON ACER TENDL-2021 LIBRARY; T=293.6K
tritons from (n,x)

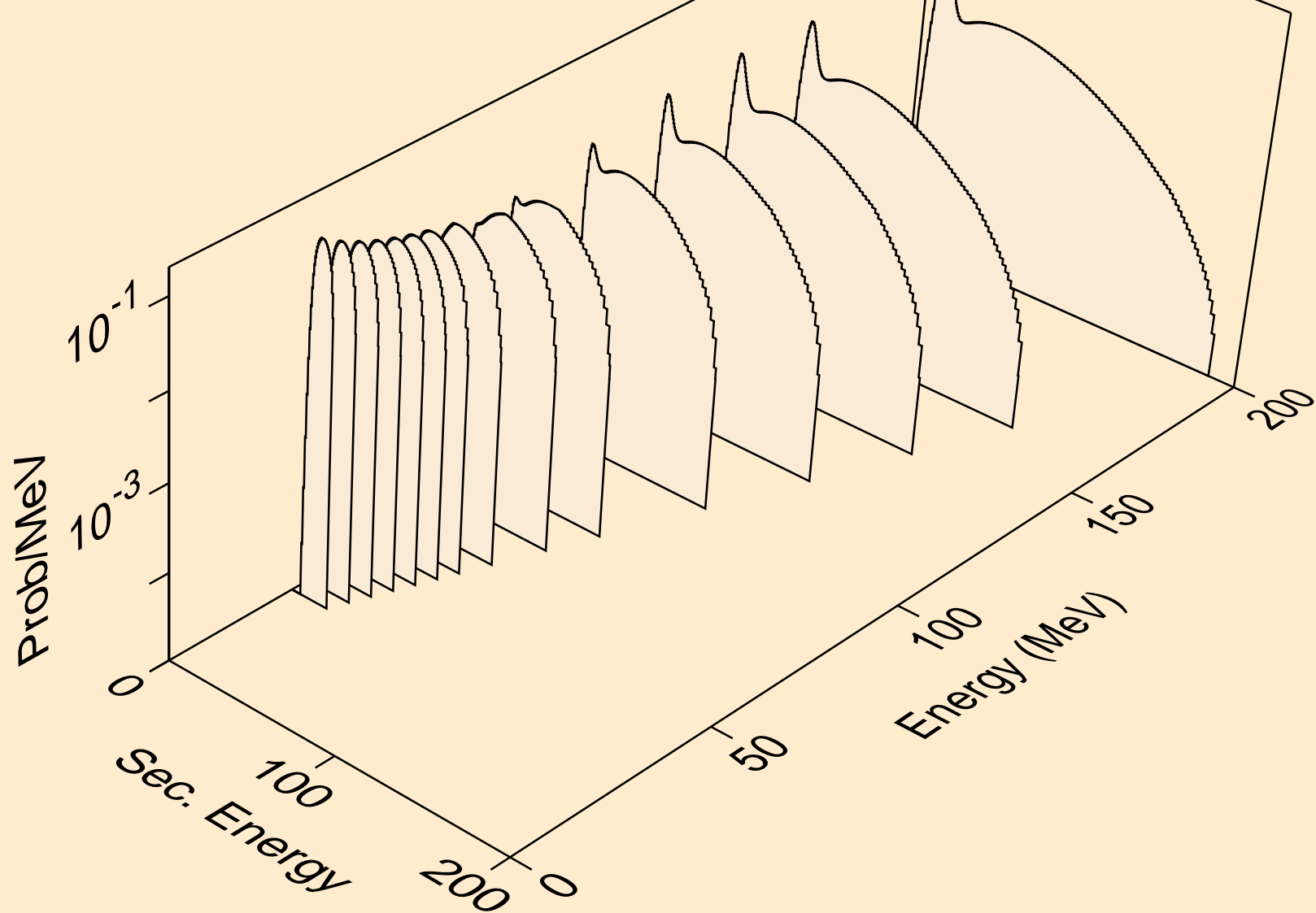

DY170 NEUTRON ACER TENDL-2021 LIBRARY; T=293.6K
tritons from (n,n*)t

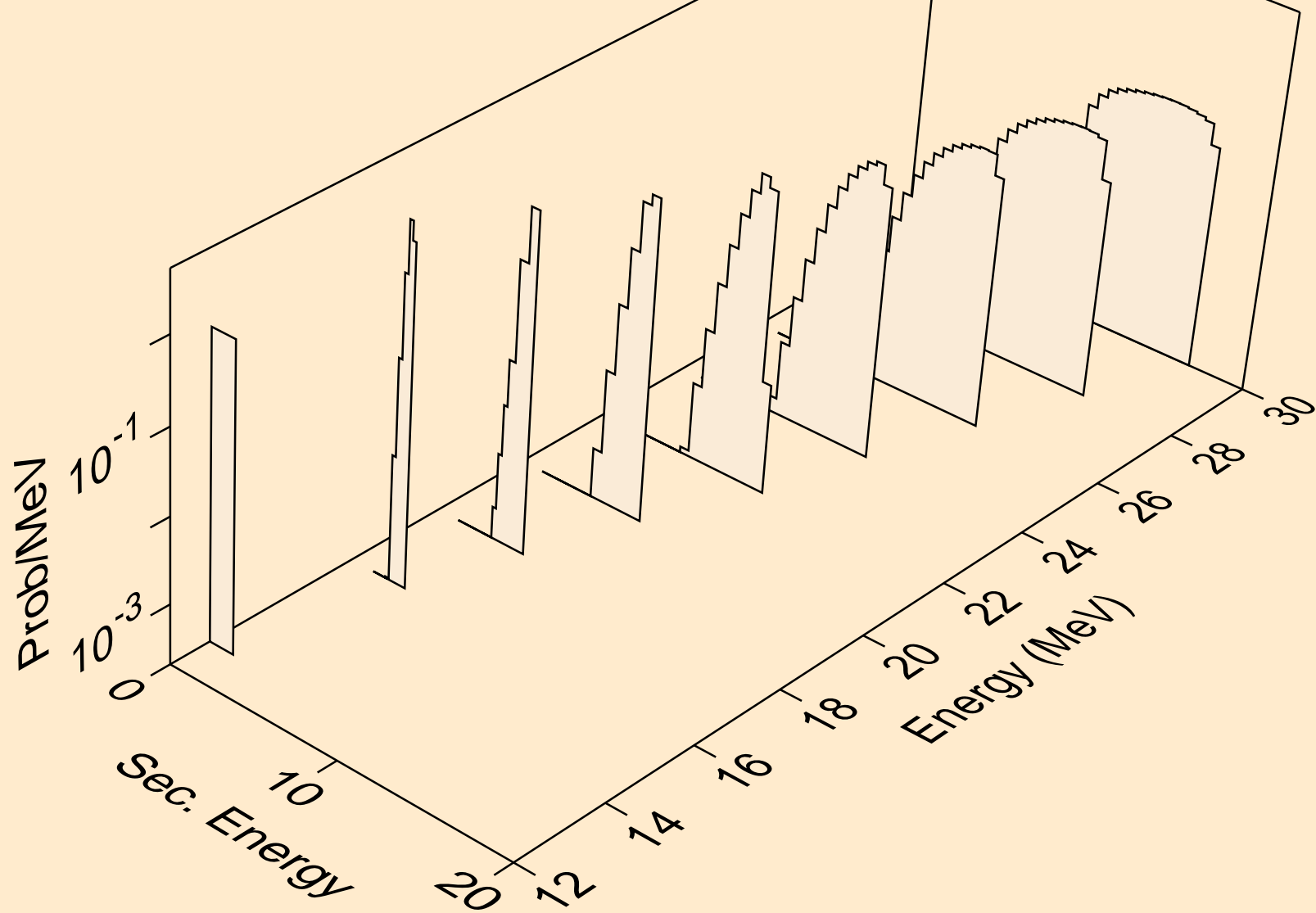

DY170 NEUTRON ACER TENDL-2021 LIBRARY; T=293.6K
tritons from (n,t)

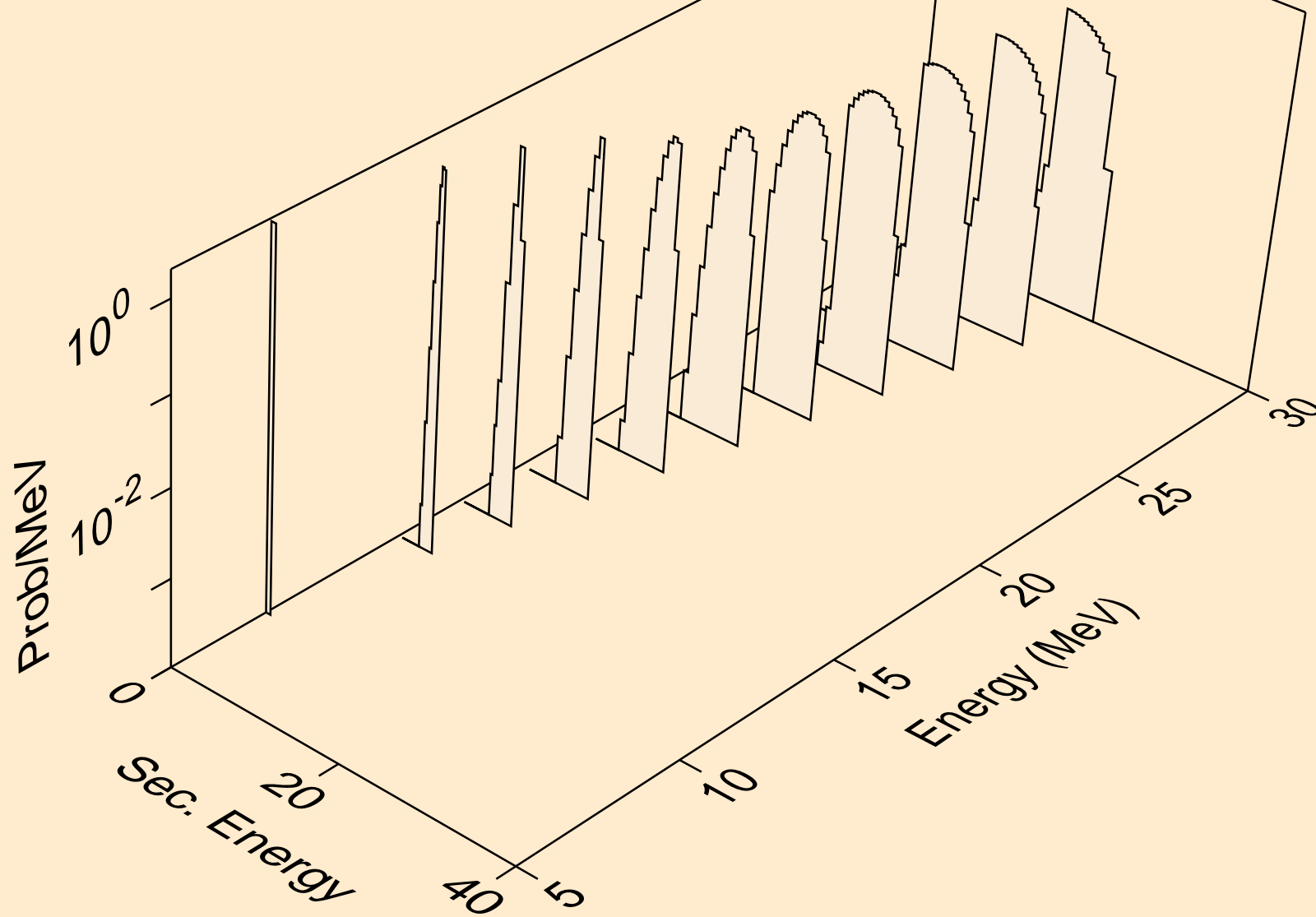

DY170 NEUTRON ACER TENDL-2021 LIBRARY; T=293.6K
he3s from (n,x)

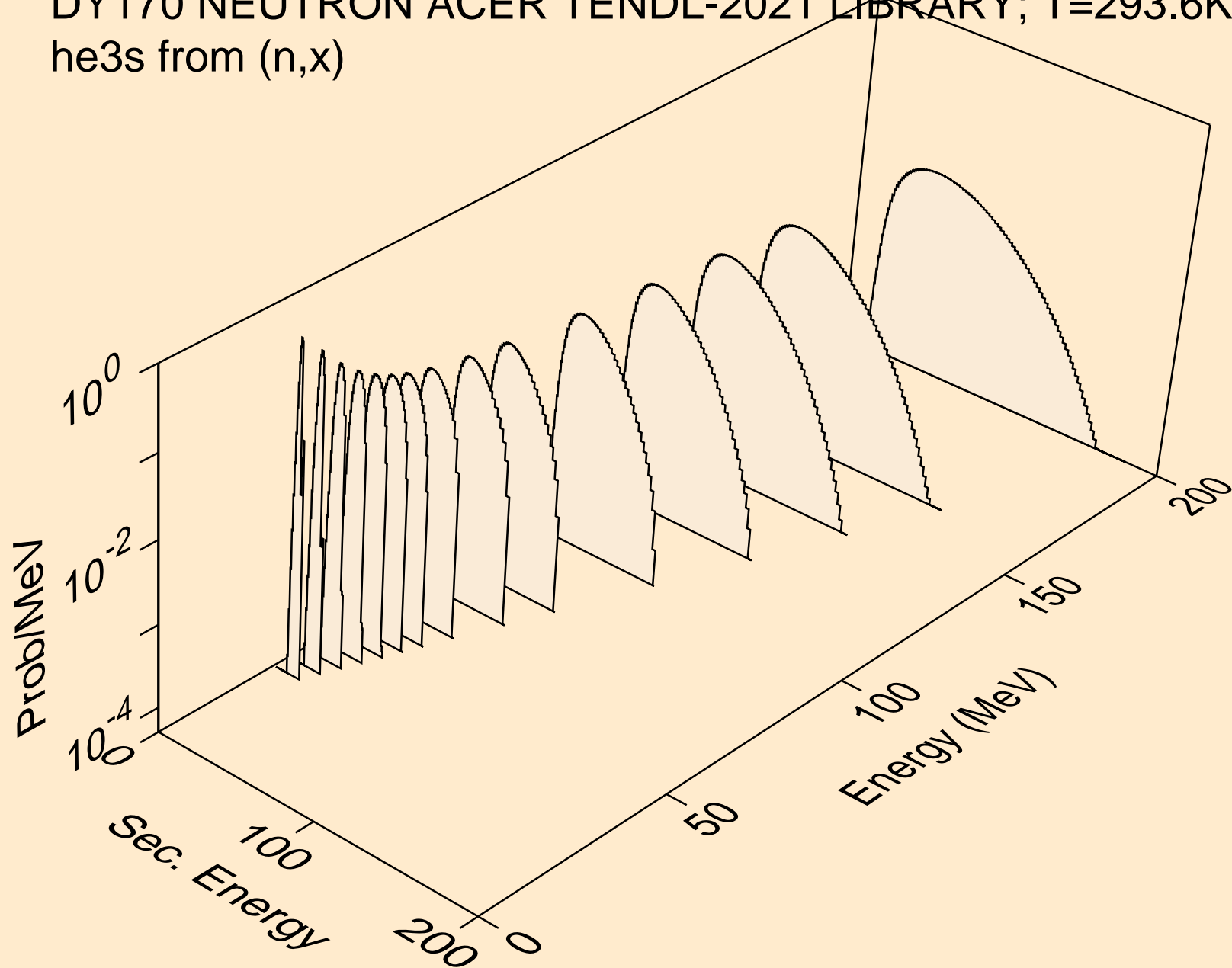

DY170 NEUTRON ACER TENDL-2021 LIBRARY; T=293.6K
he3s from (n,n*)he3

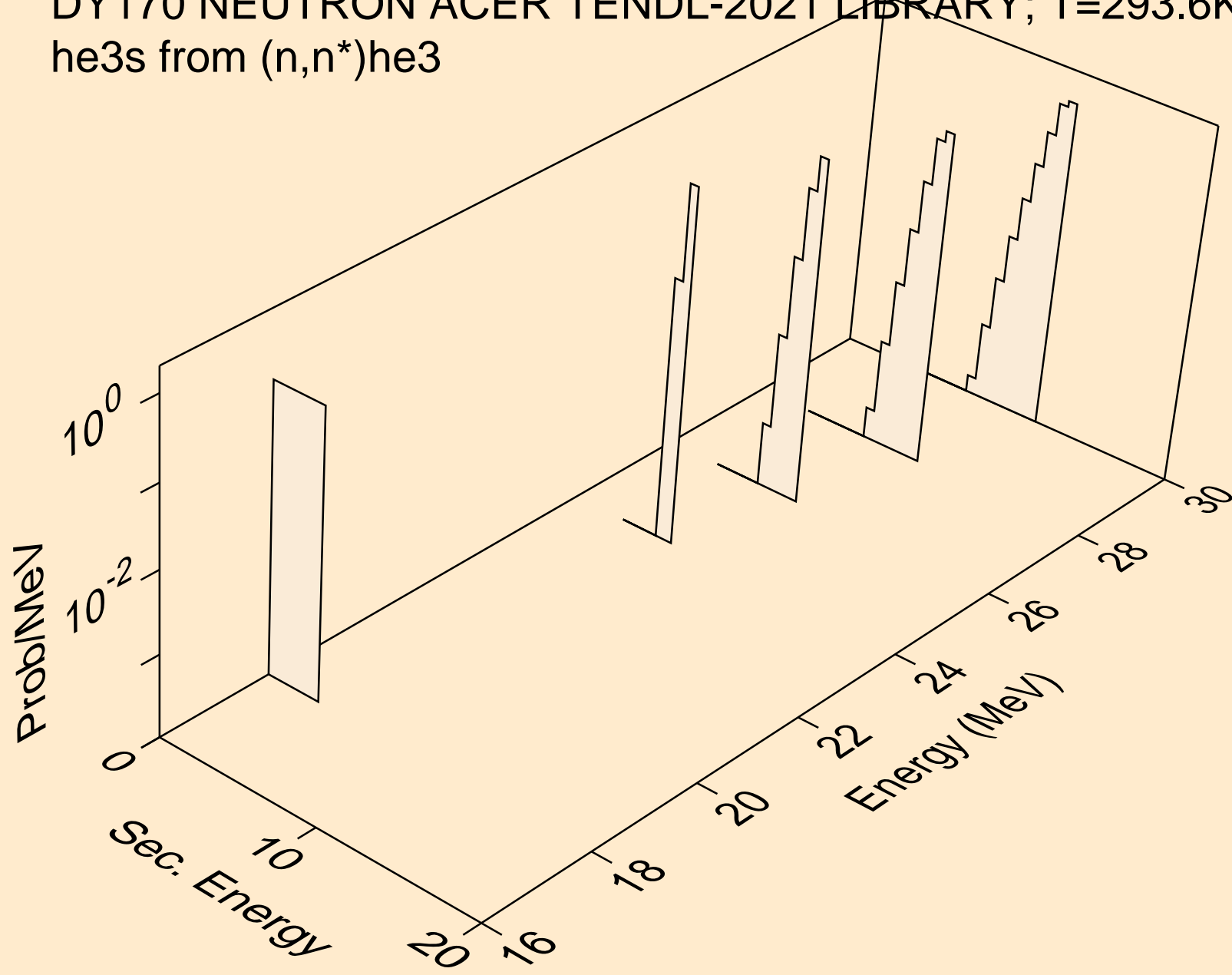

DY170 NEUTRON ACER TENDL-2021 LIBRARY; T=293.6K
he3s from (n,he3)

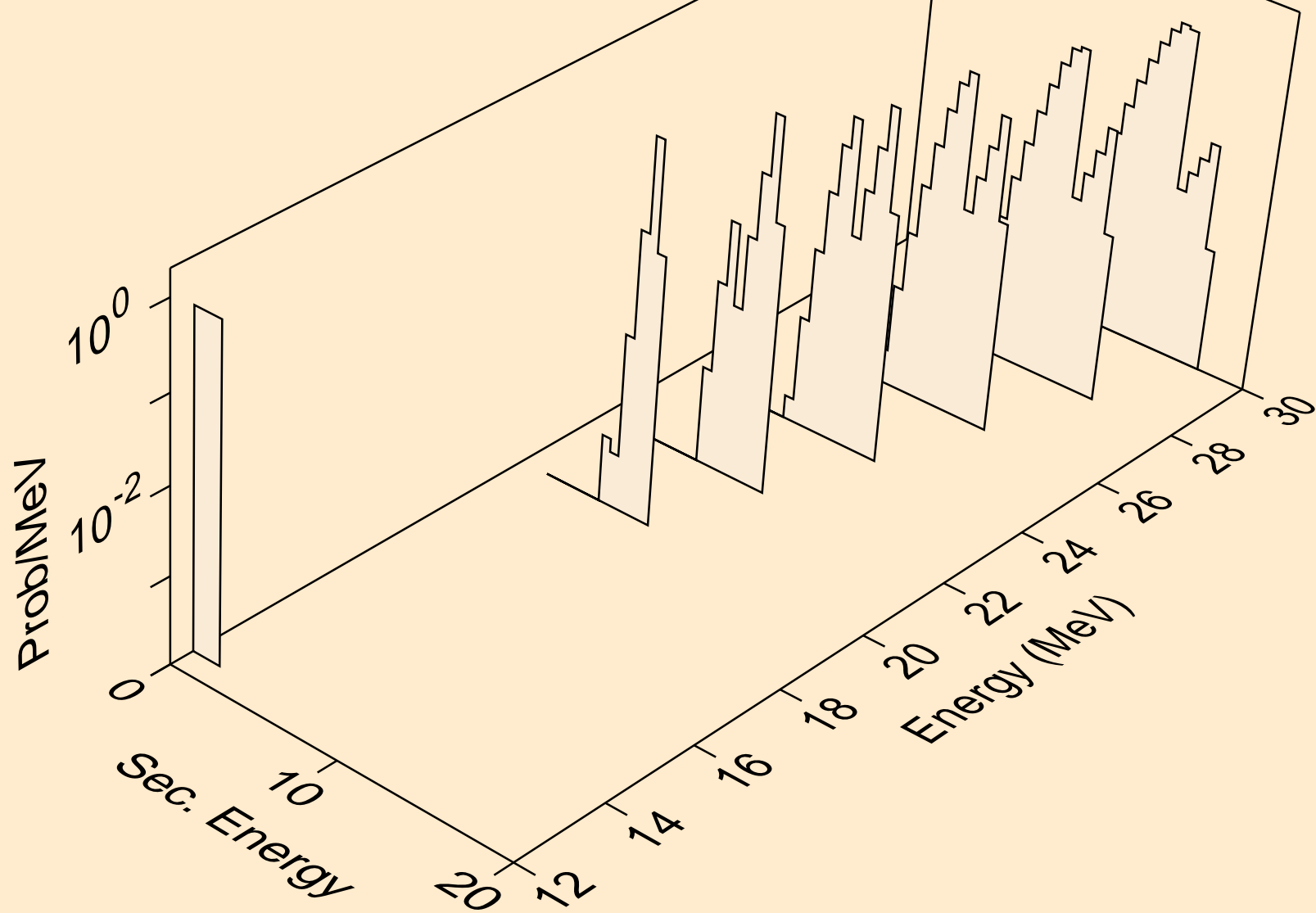

DY170 NEUTRON ACER TENDL-2021 LIBRARY; T=293.6K
alphas from (n,x)

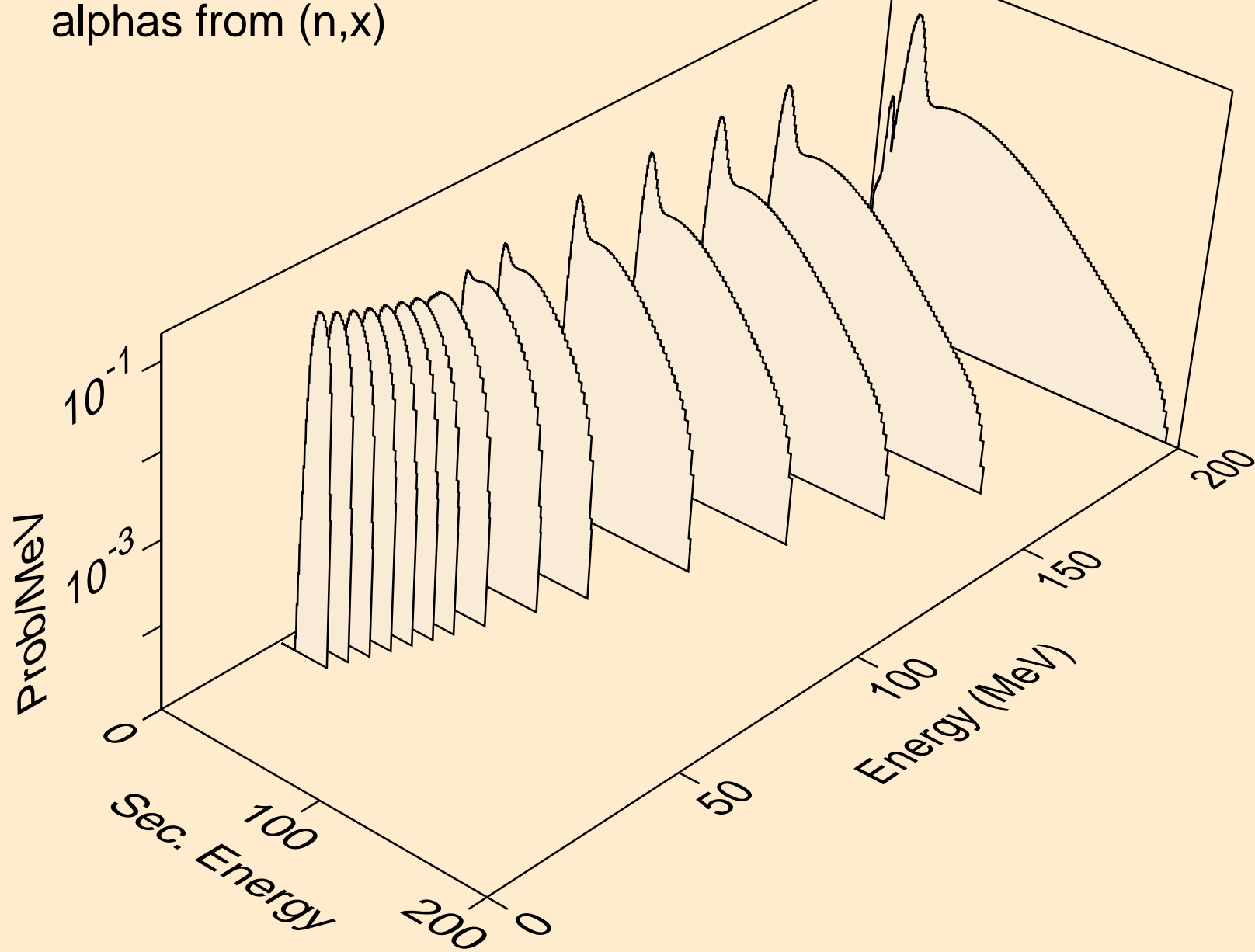

DY170 NEUTRON ACER TENDL-2021 LIBRARY; T=293.6K
alphas from (n,n*)a

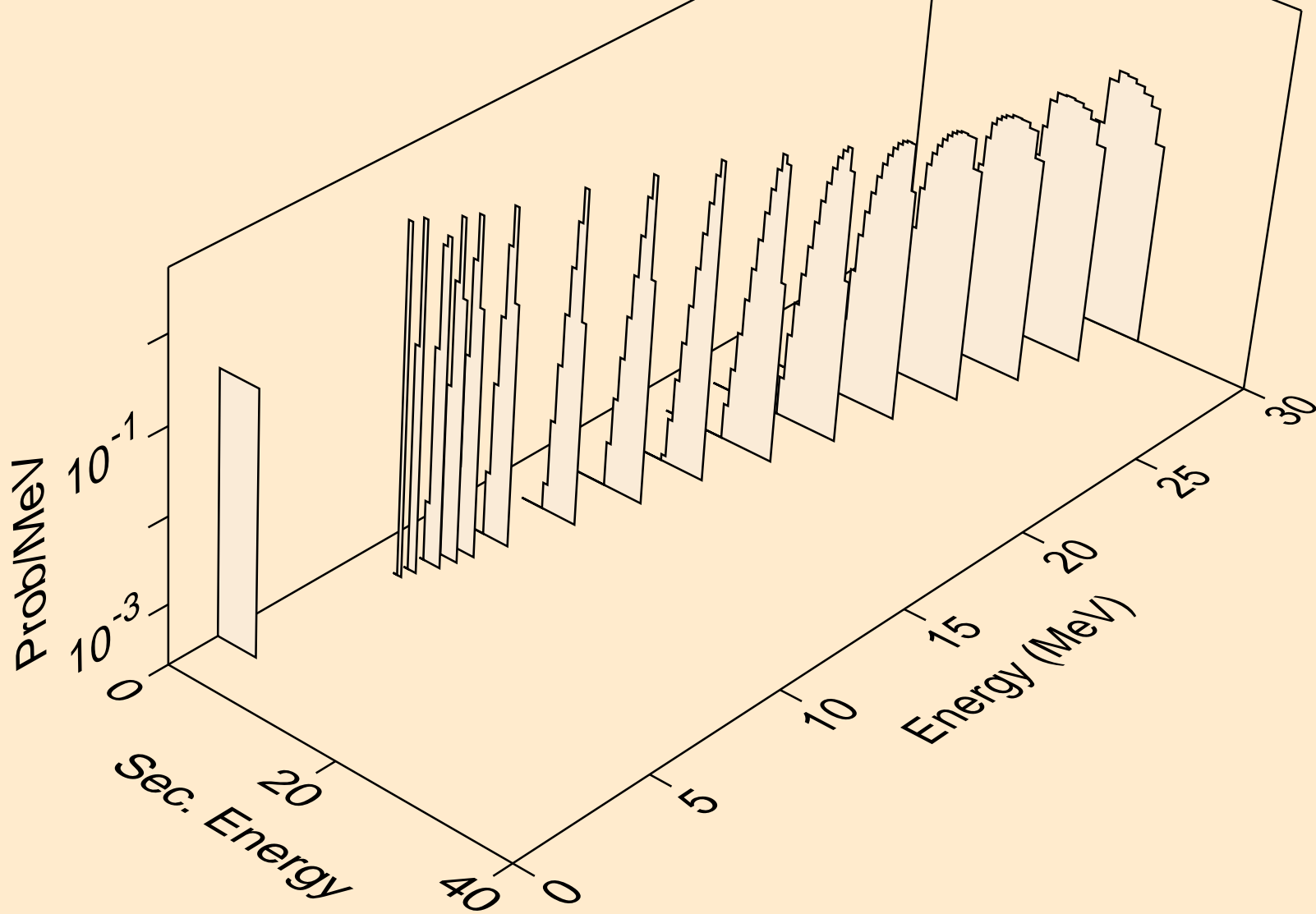

DY170 NEUTRON ACER TENDL-2021 LIBRARY; T=293.6K
alphas from (n,2n)a

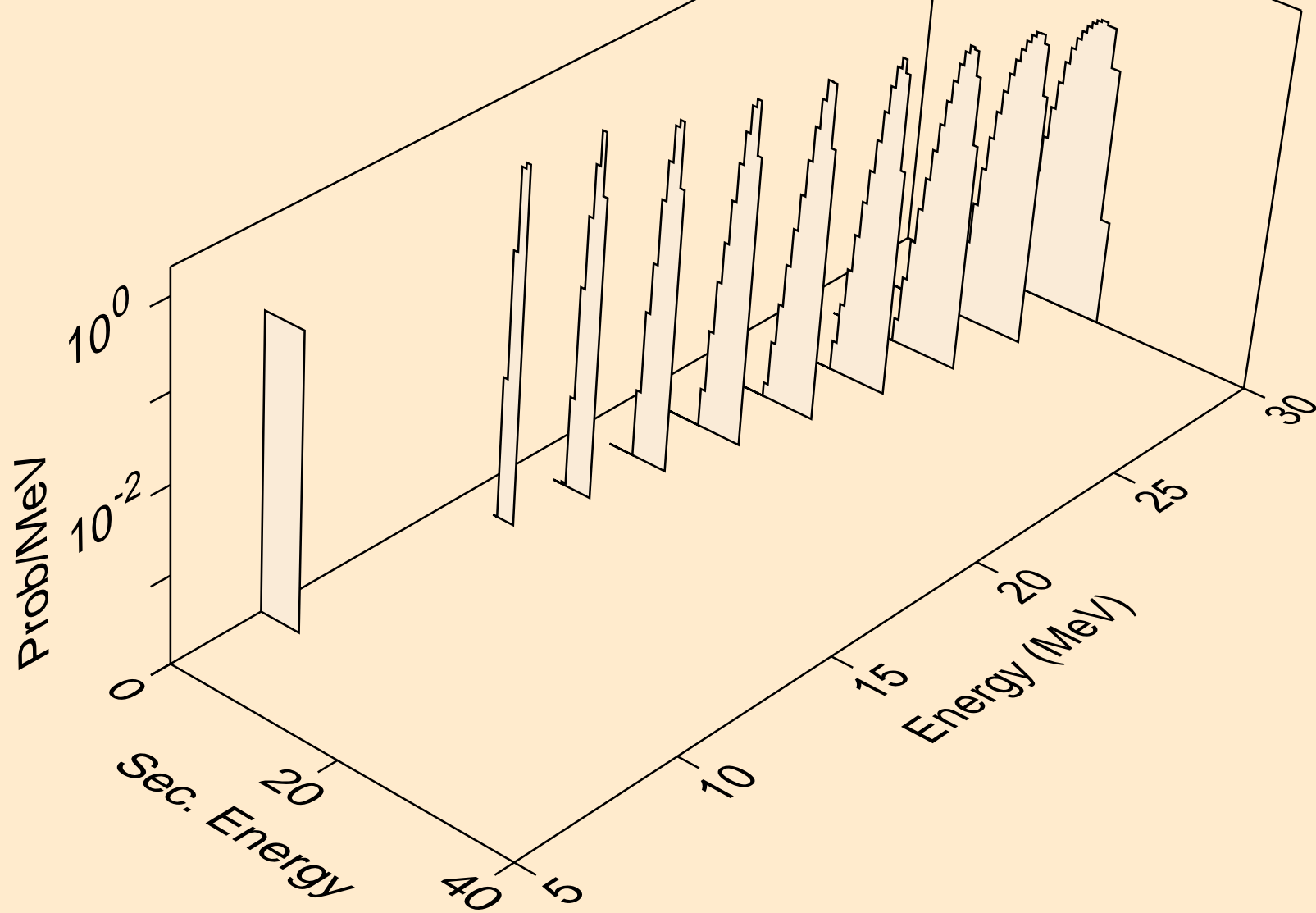

DY170 NEUTRON ACER TENDL-2021 LIBRARY; T=293.6K
alphas from (n,3n)a

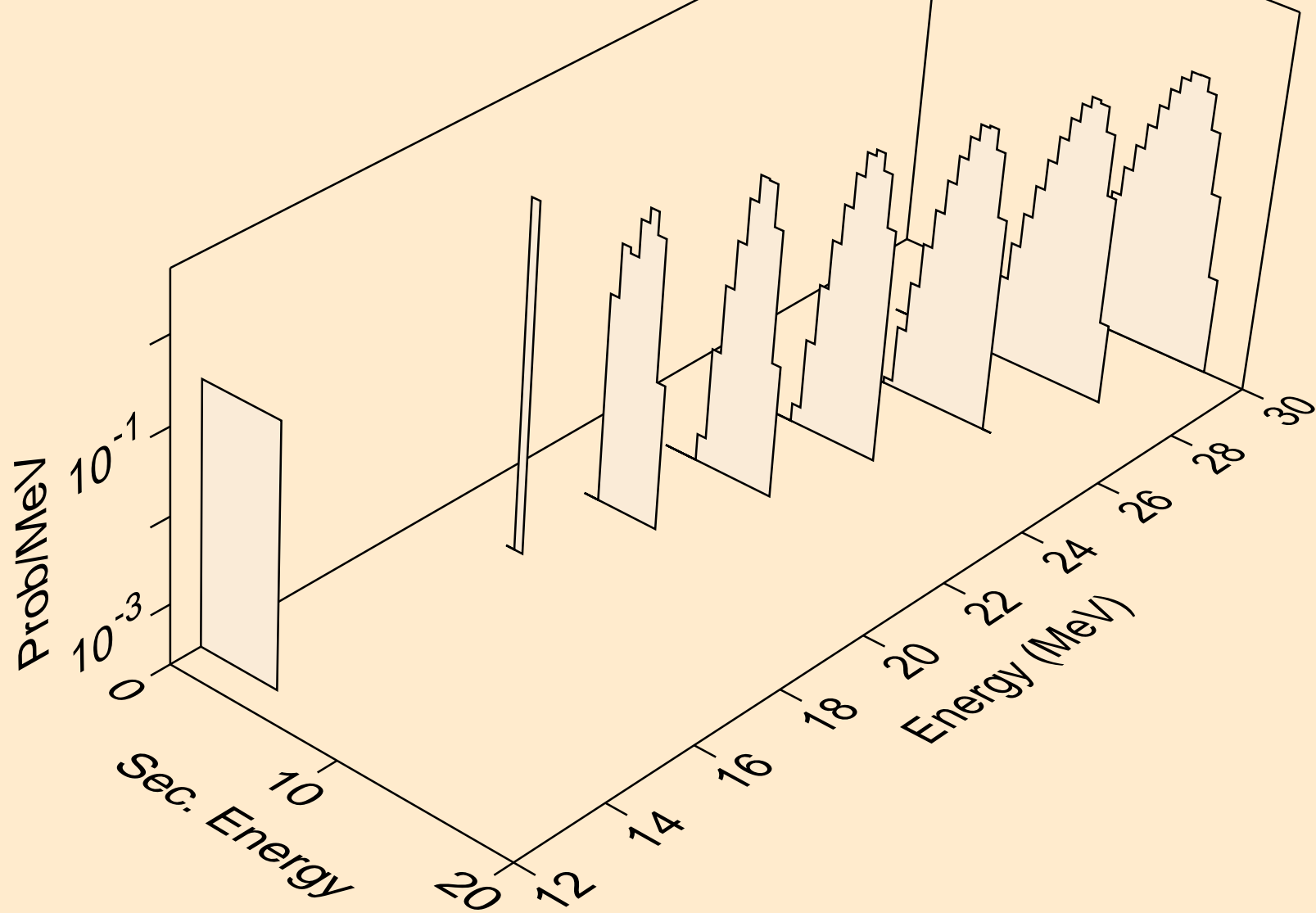

DY170 NEUTRON ACER TENDL-2021 LIBRARY; T=293.6K
alphas from (n,a)

