

ER147M NEUTRON ACER TENDL-2021 LIBRARY; T=293.6K
Principal cross sections

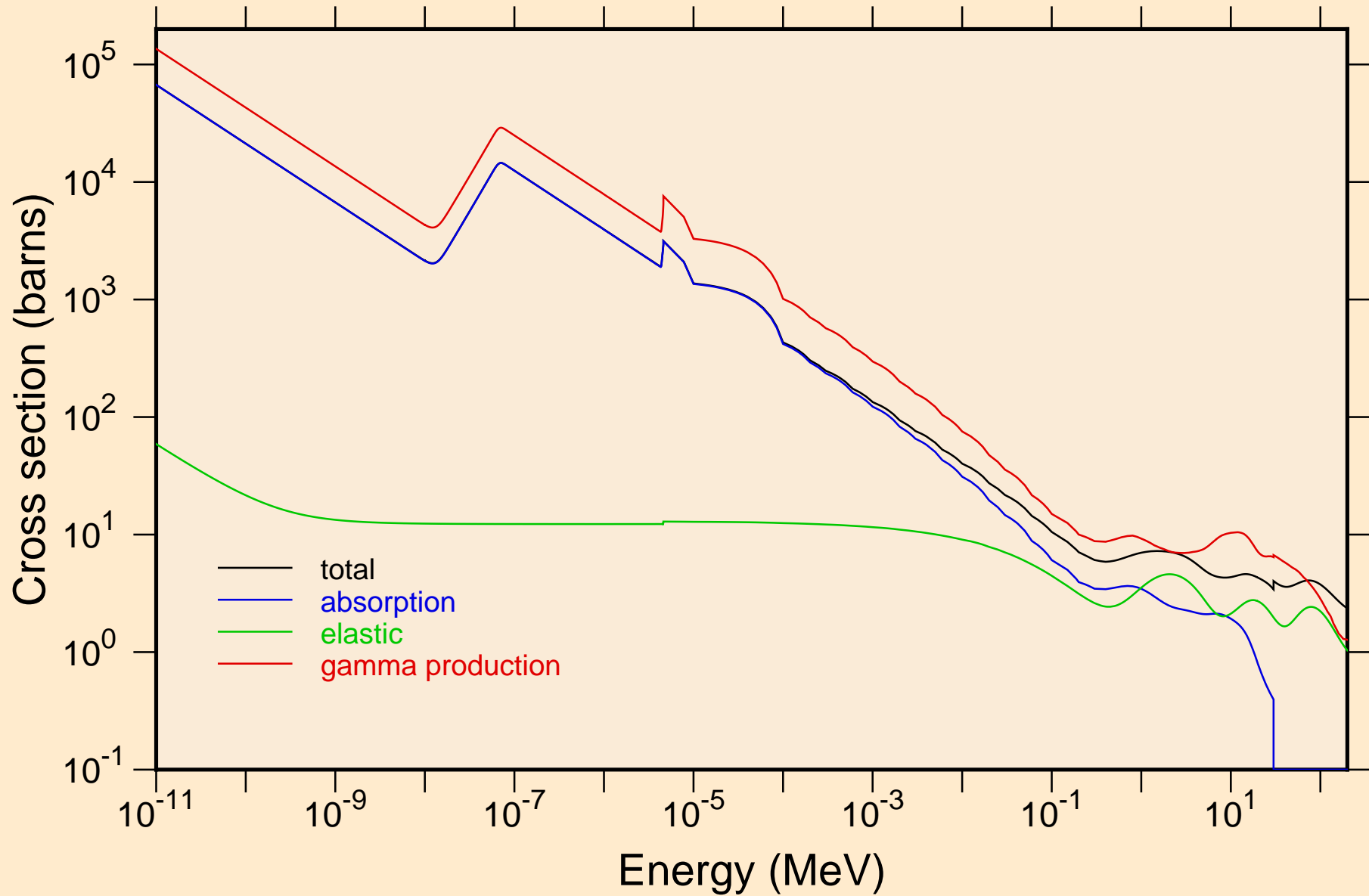

ER147M NEUTRON ACER TENDL-2021 LIBRARY; T=293.6K
Heating

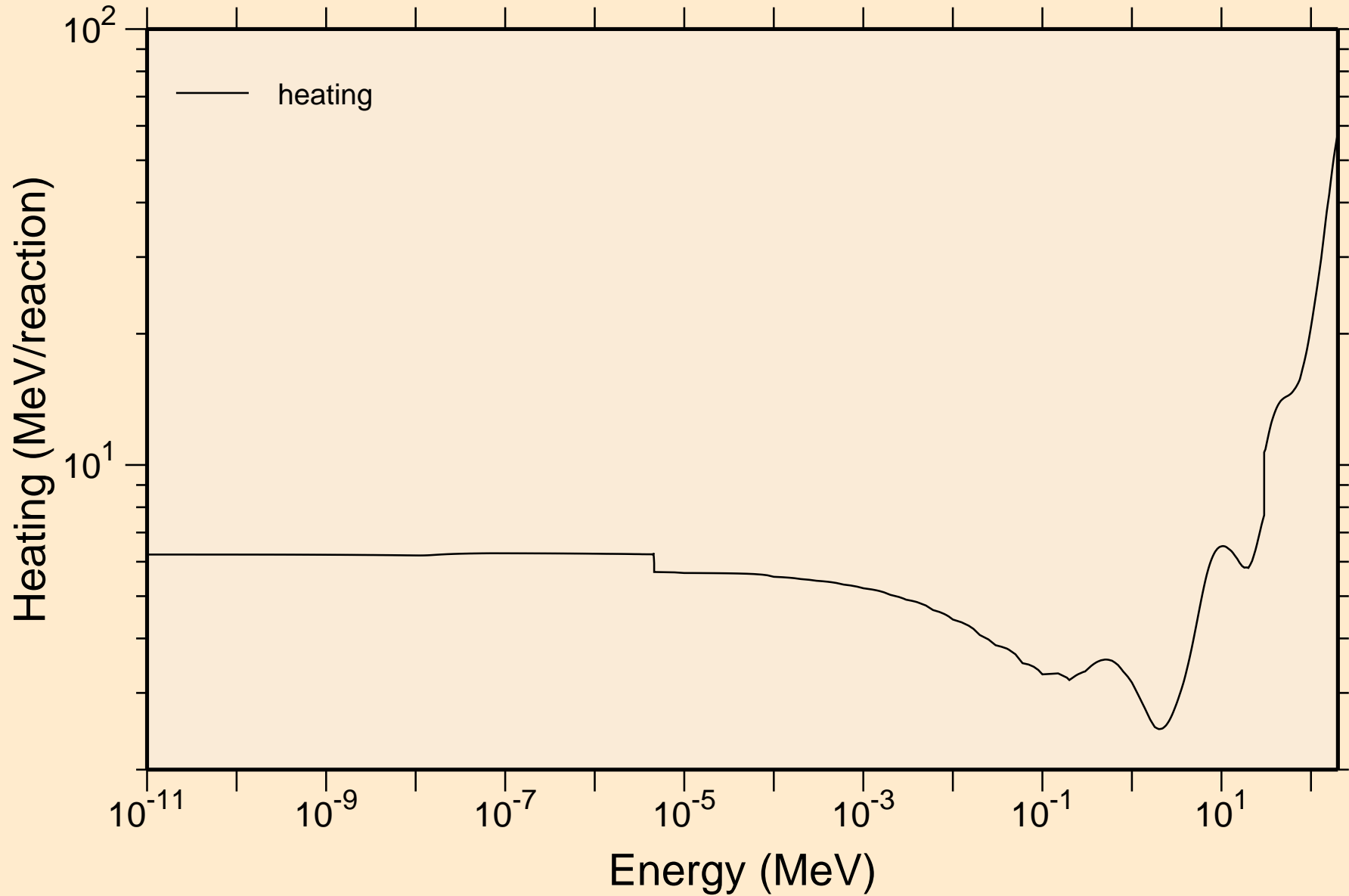

ER147M NEUTRON ACER TENDL-2021 LIBRARY; T=293.6K
Damage

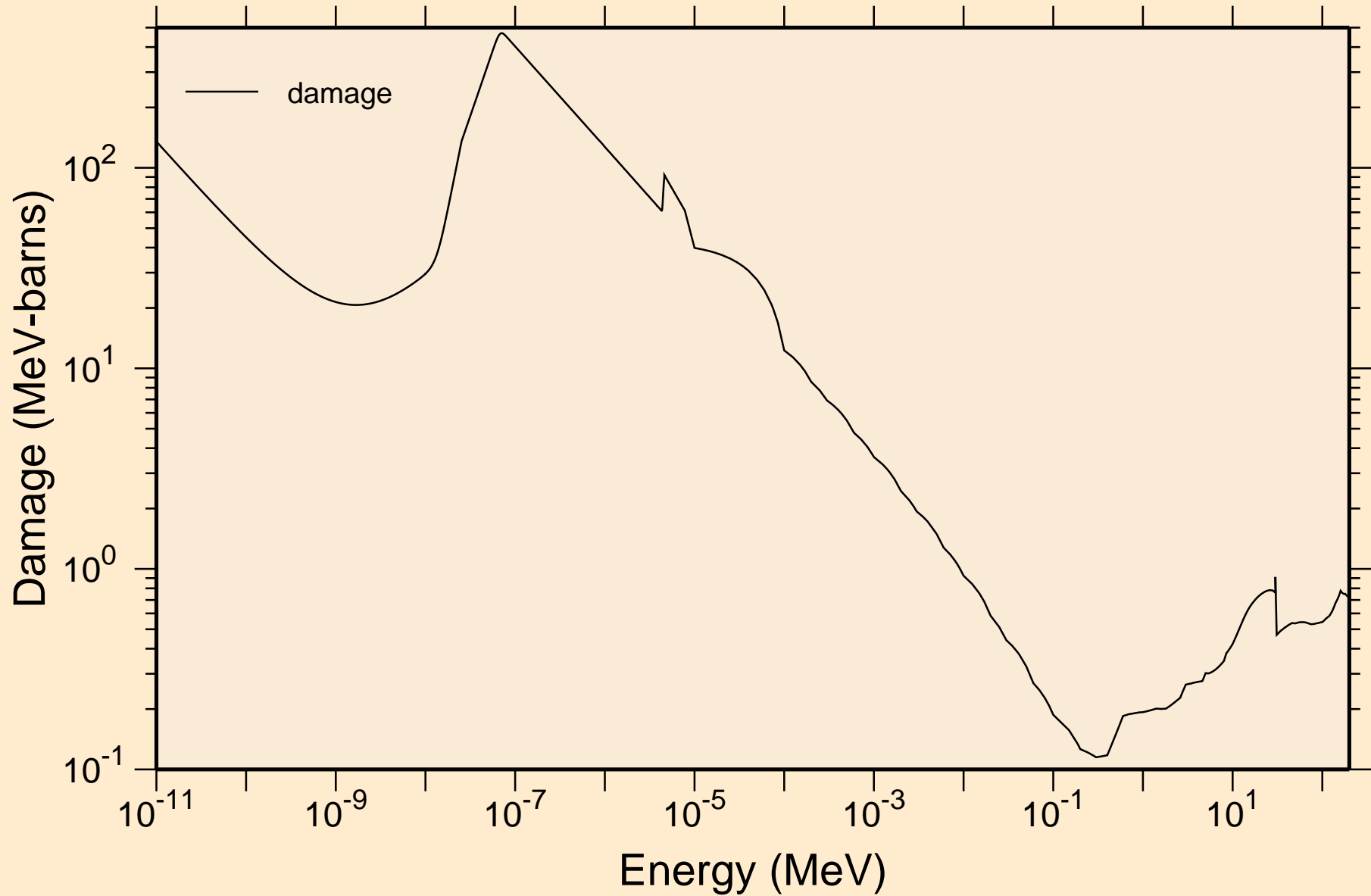

ER147M NEUTRON ACER TENDL-2021 LIBRARY; T=293.6K
Non-threshold reactions

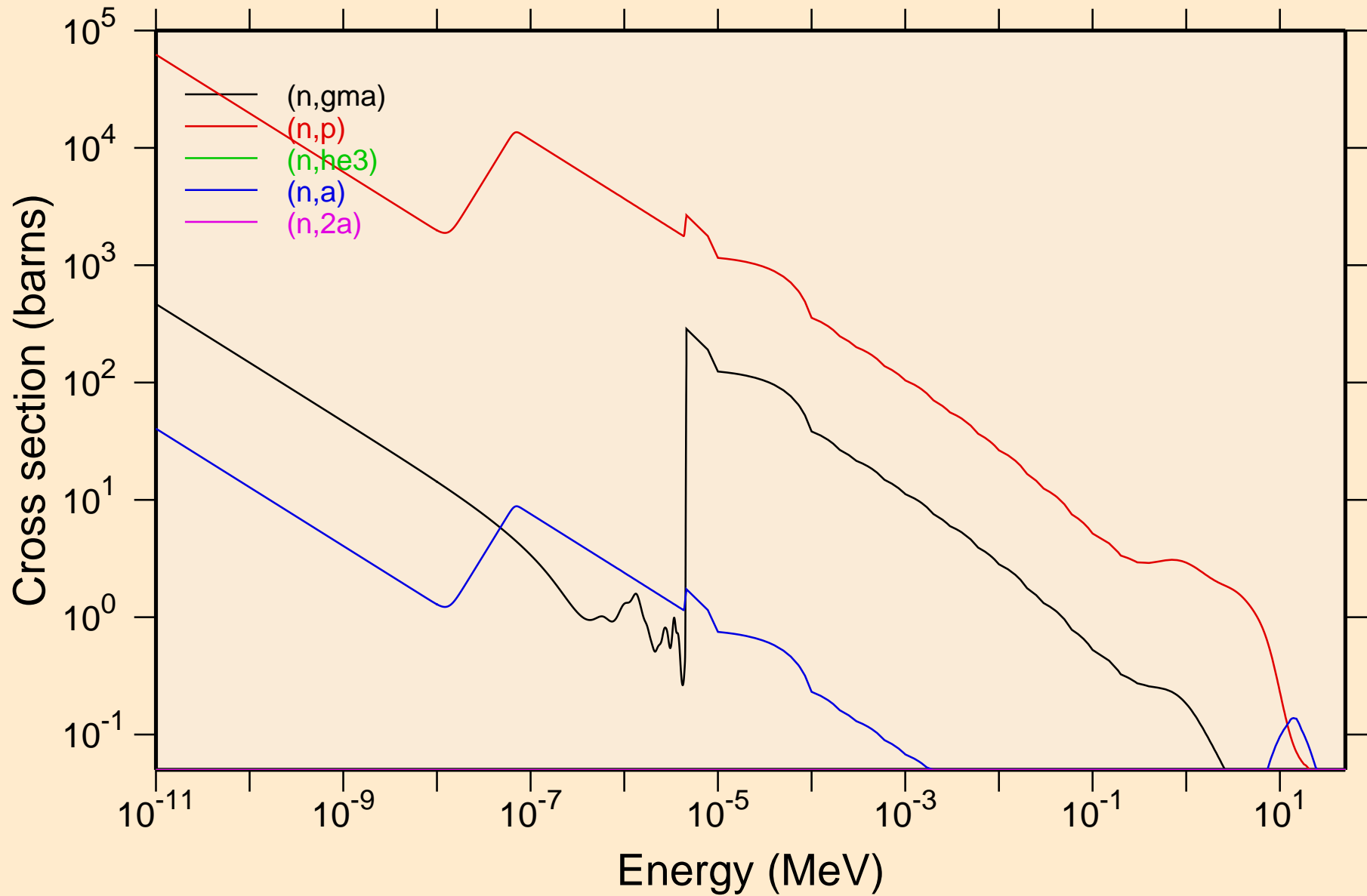

ER147M NEUTRON ACER TENDL-2021 LIBRARY; T=293.6K
Non-threshold reactions

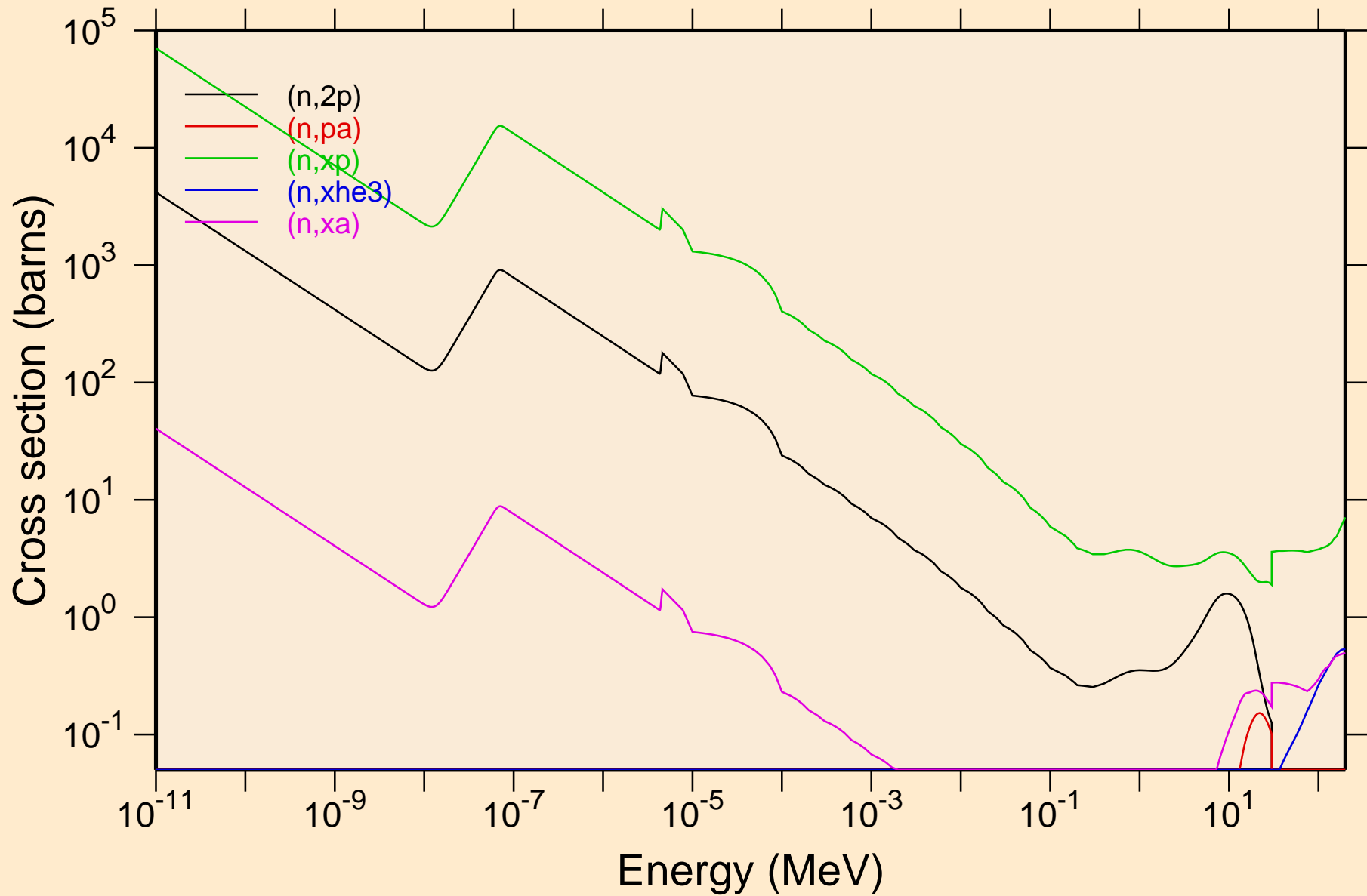

ER147M NEUTRON ACER TENDL-2021 LIBRARY; T=293.6K
Principal cross sections

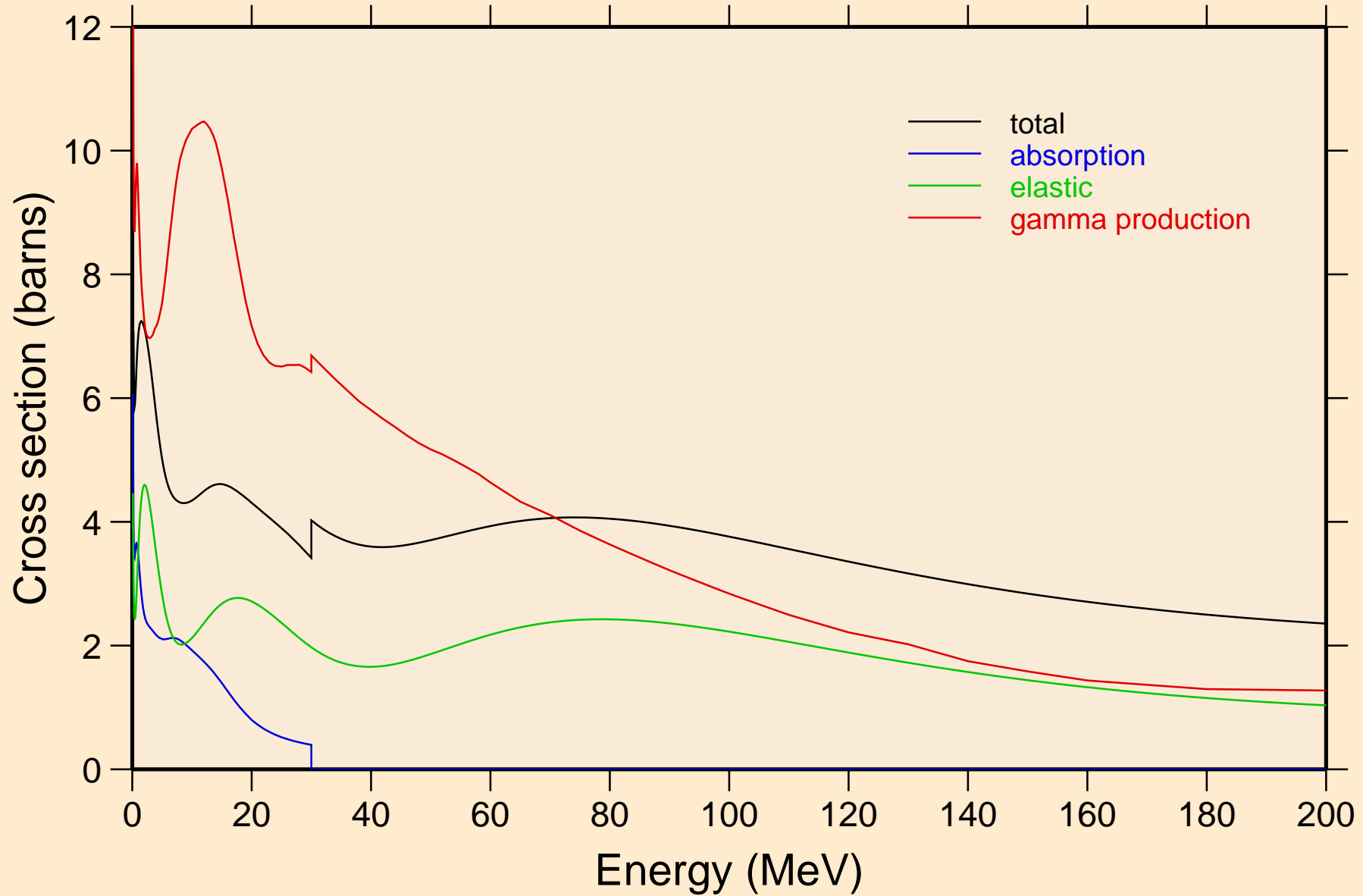

ER147M NEUTRON ACER TENDL-2021 LIBRARY; T=293.6K
Heating

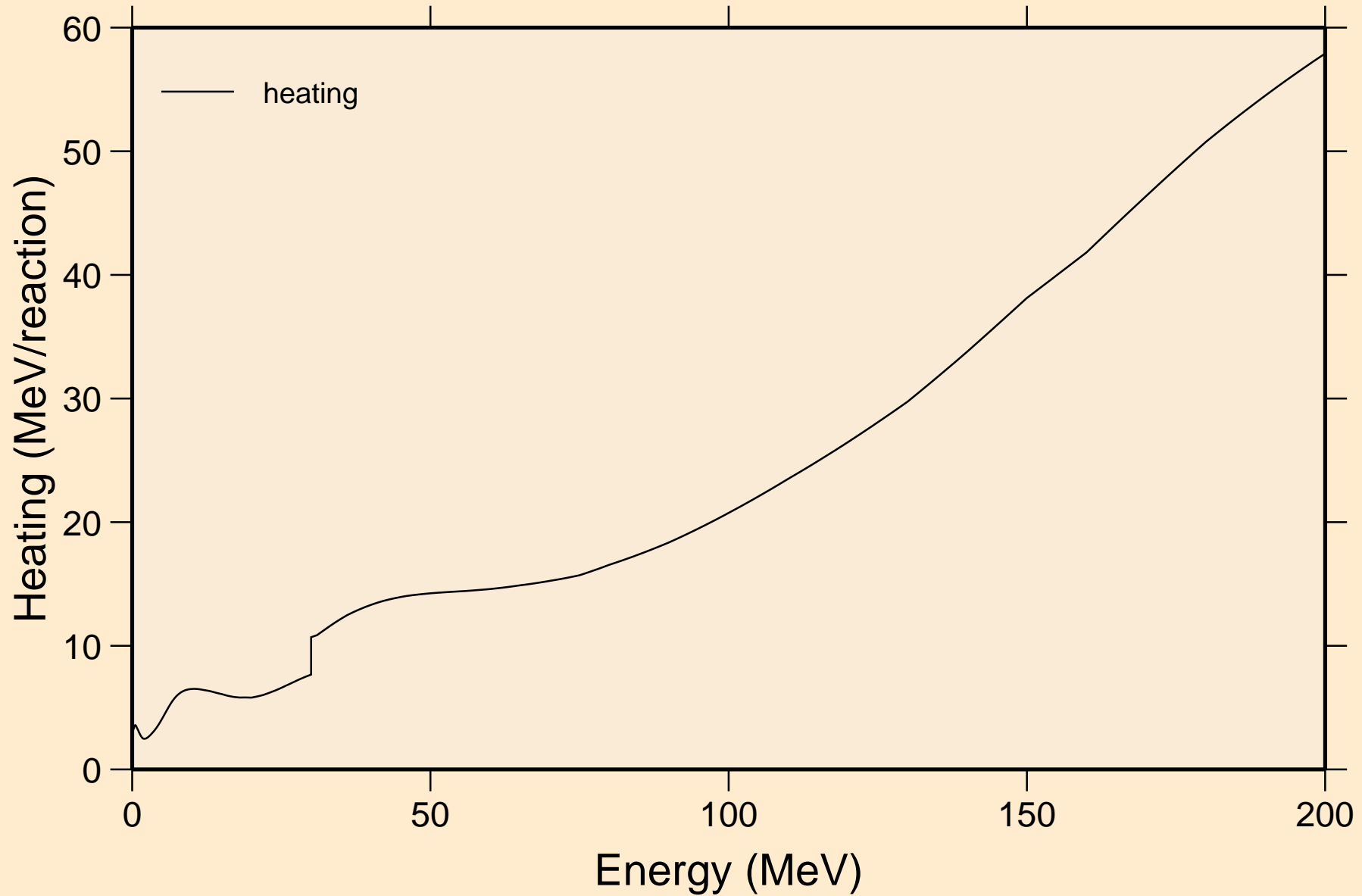

ER147M NEUTRON ACER TENDL-2021 LIBRARY; T=293.6K
Damage

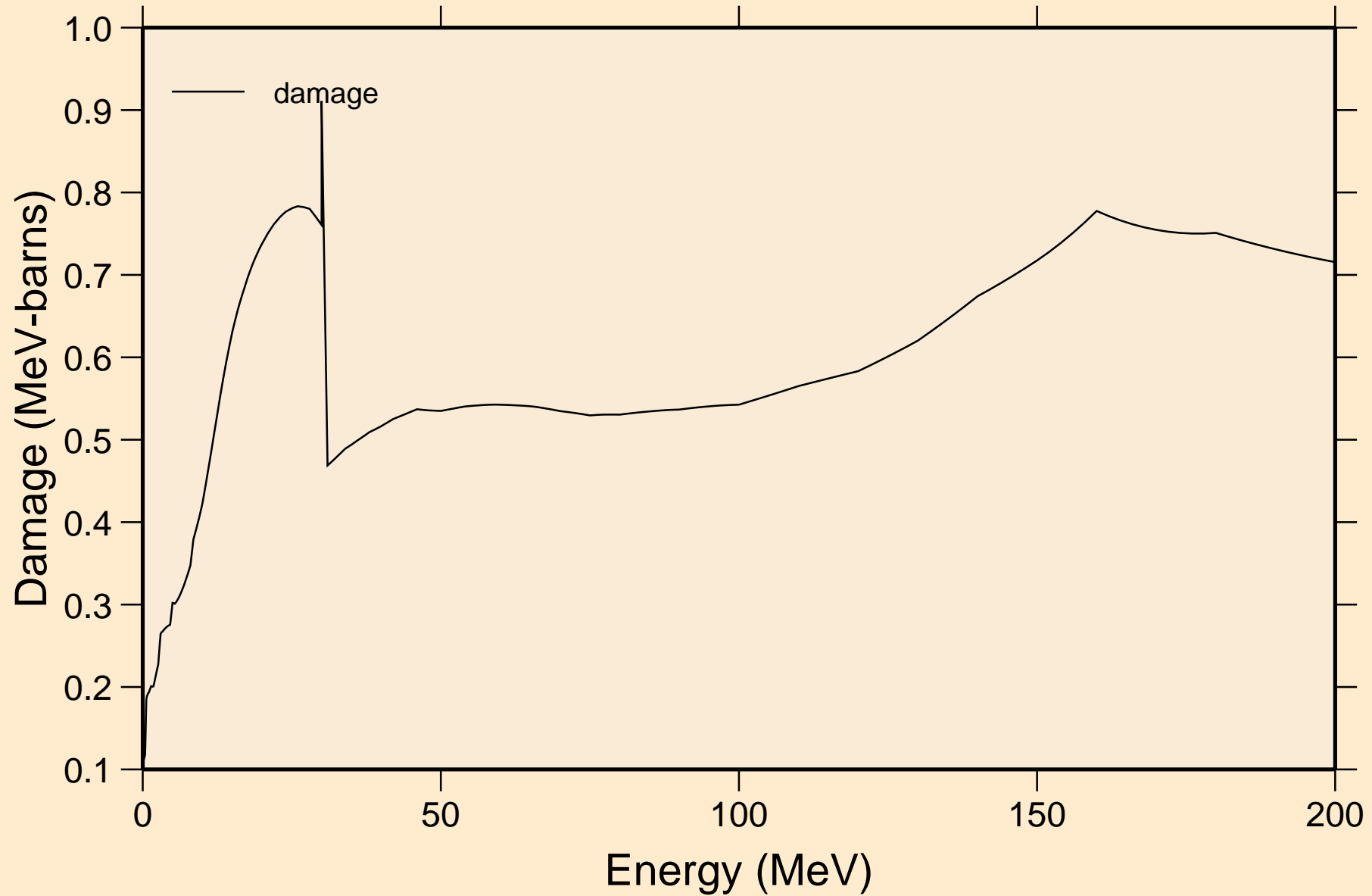

ER147M NEUTRON ACER TENDL-2021 LIBRARY; T=293.6K
Non-threshold reactions

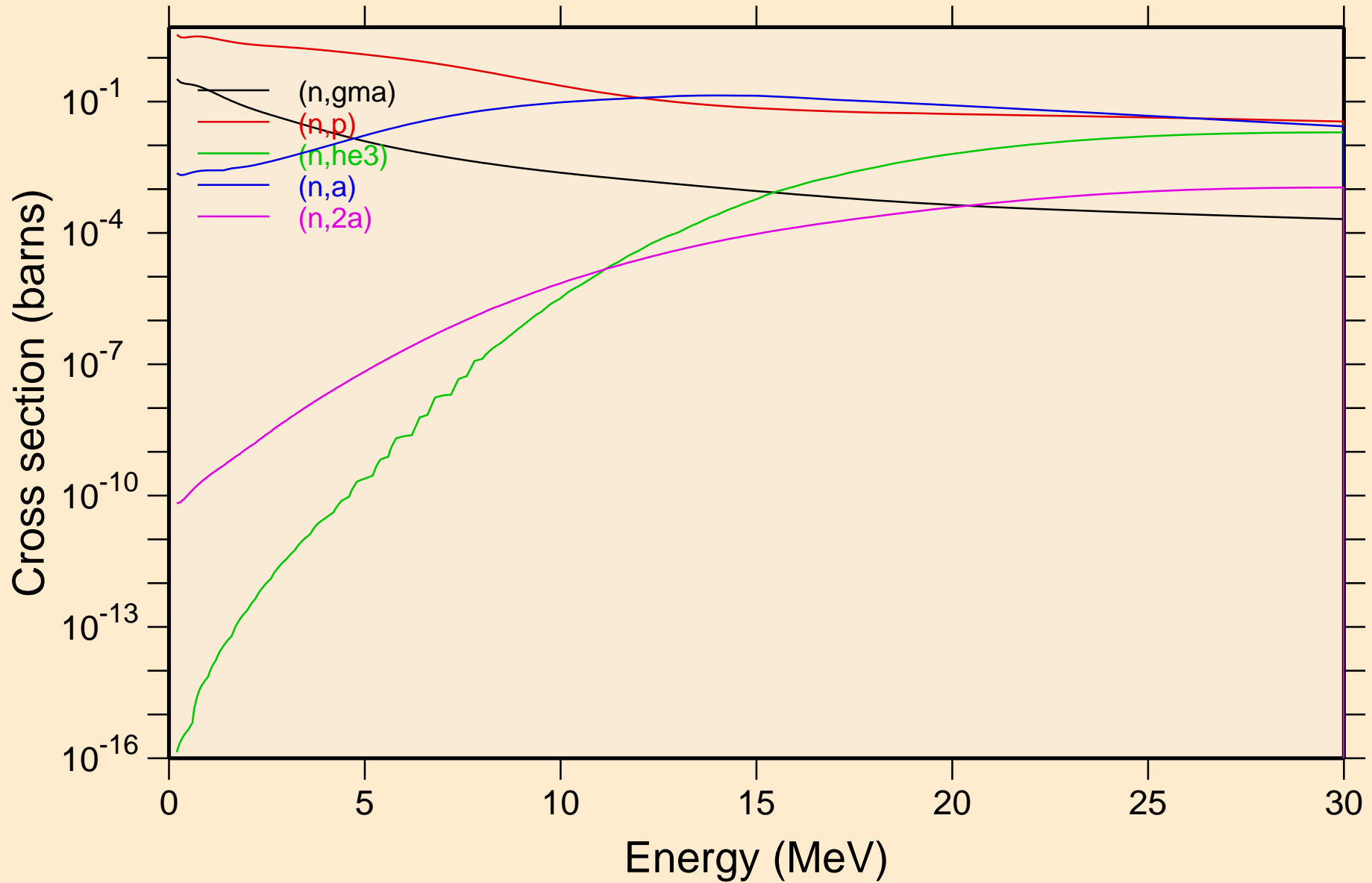

ER147M NEUTRON ACER TENDL-2021 LIBRARY; T=293.6K
Non-threshold reactions

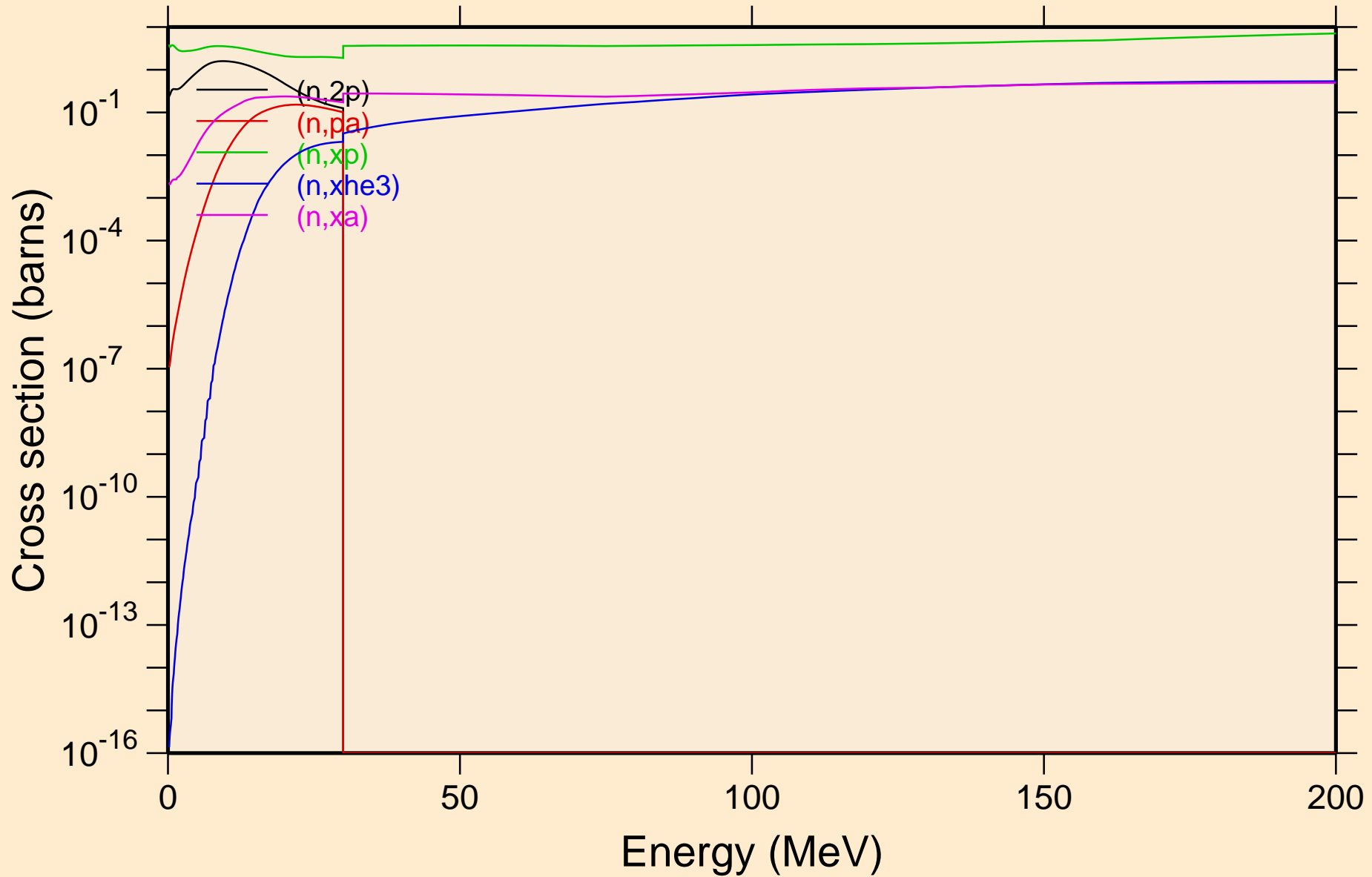

ER147M NEUTRON ACER TENDL-2021 LIBRARY; T=293.6K
Inelastic levels

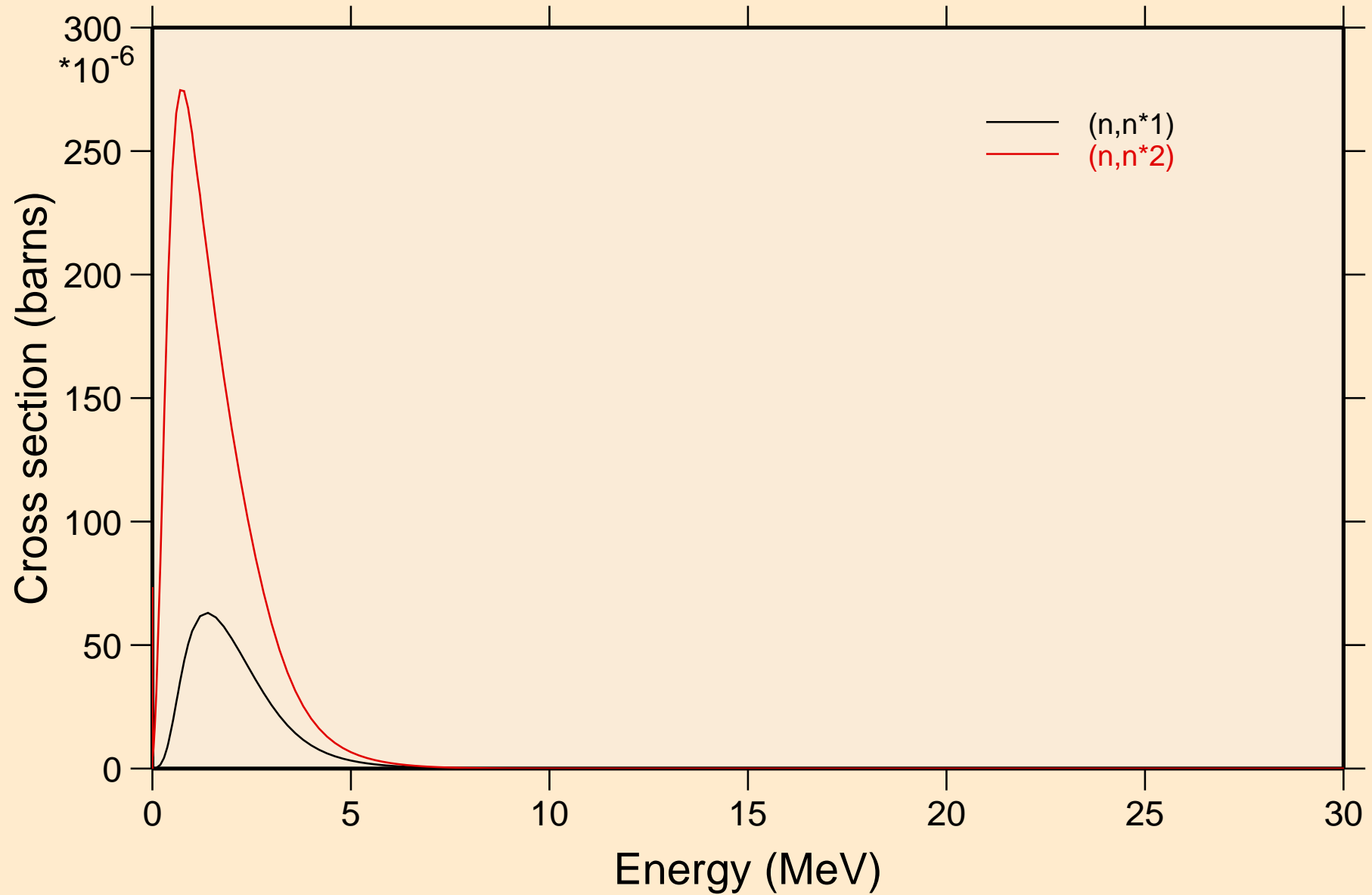

ER147M NEUTRON ACER TENDL-2021 LIBRARY; T=293.6K
Threshold reactions

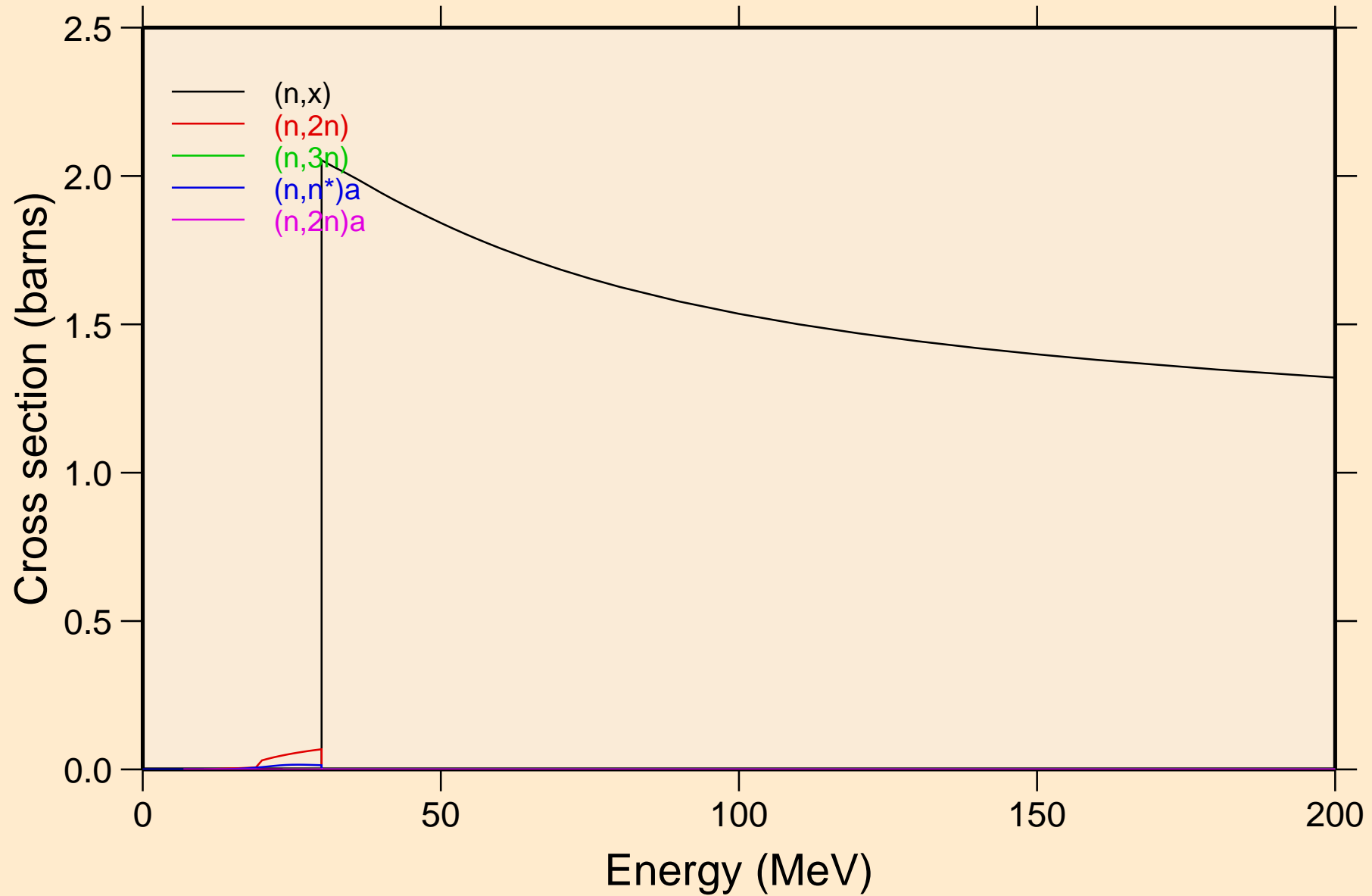

ER147M NEUTRON ACER TENDL-2021 LIBRARY; T=293.6K
Threshold reactions

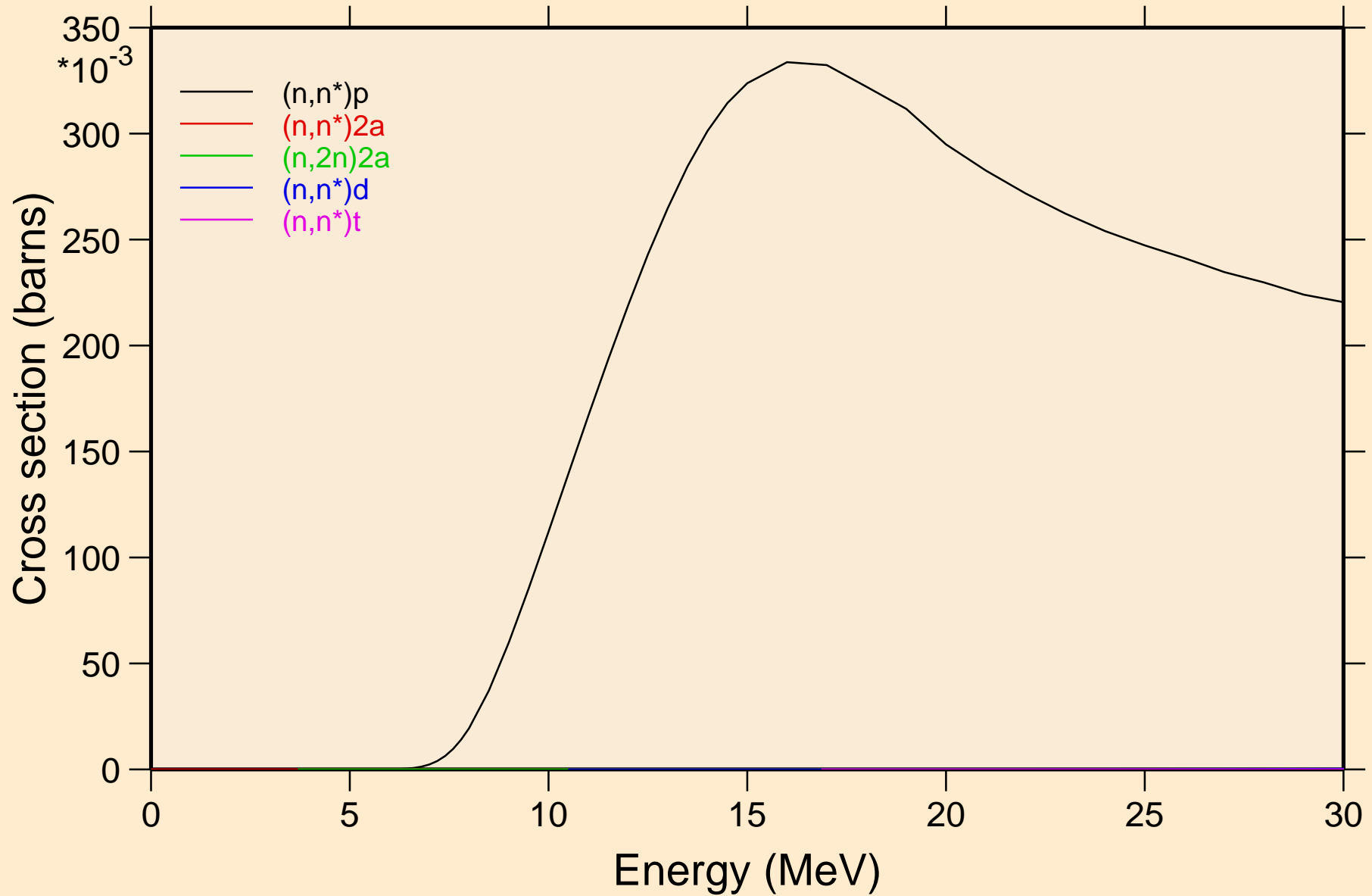

ER147M NEUTRON ACER TENDL-2021 LIBRARY; T=293.6K
Threshold reactions

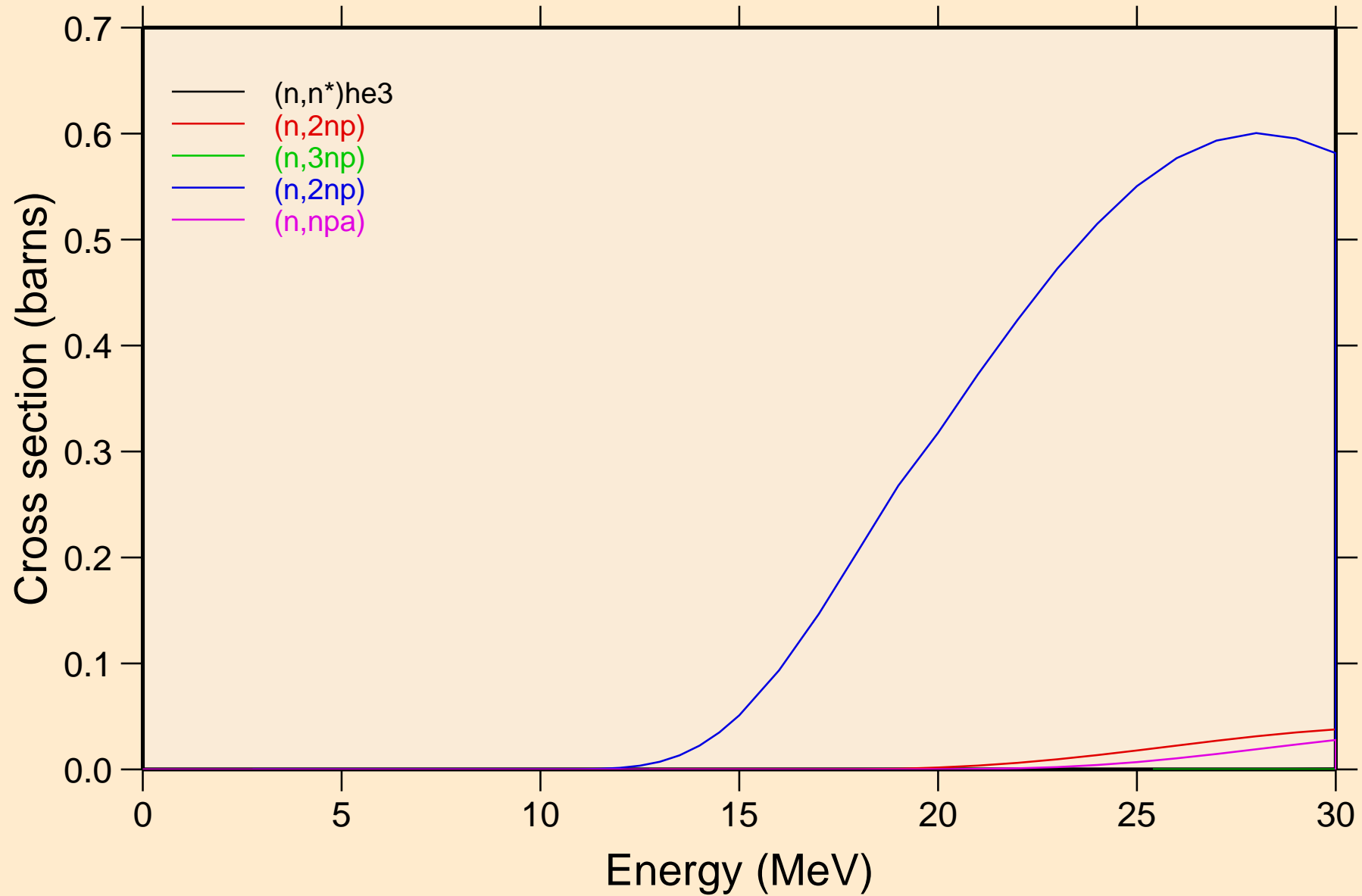

ER147M NEUTRON ACER TENDL-2021 LIBRARY; T=293.6K

Threshold reactions

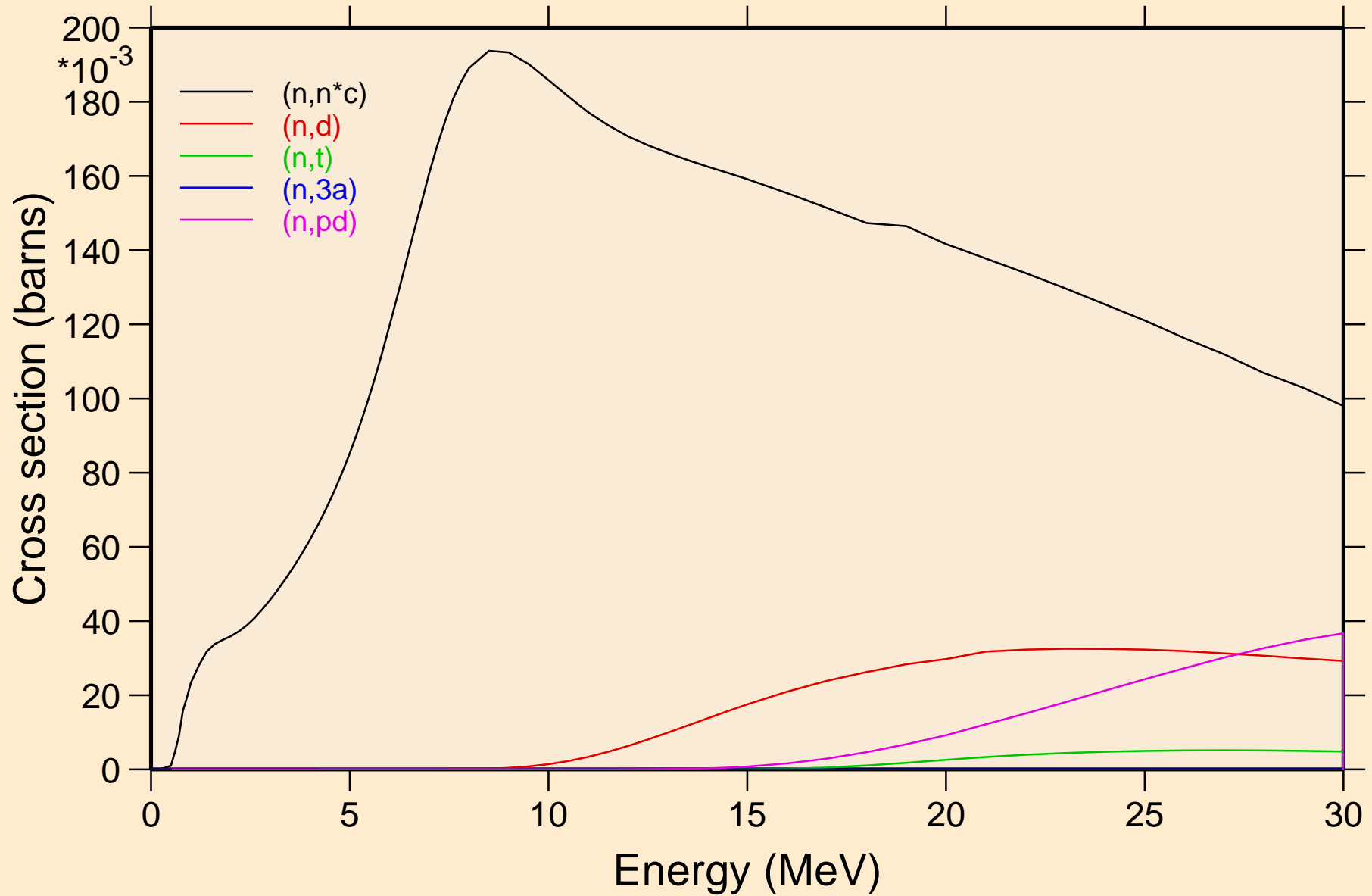

ER147M NEUTRON ACER TENDL-2021 LIBRARY; T=293.6K
Threshold reactions

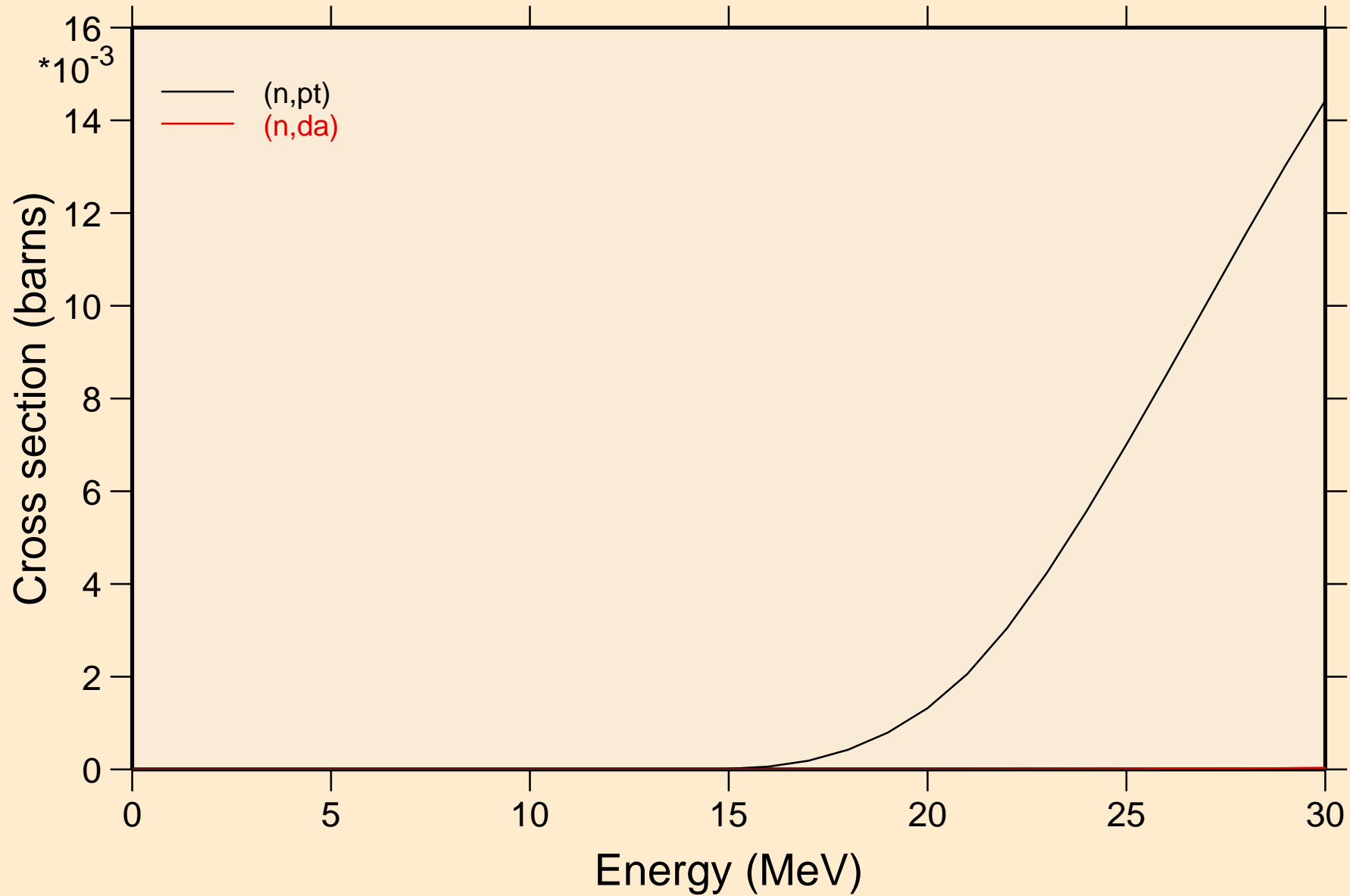

ER147M NEUTRON ACER TENDL-2021 LIBRARY; T=293.6K
Threshold reactions

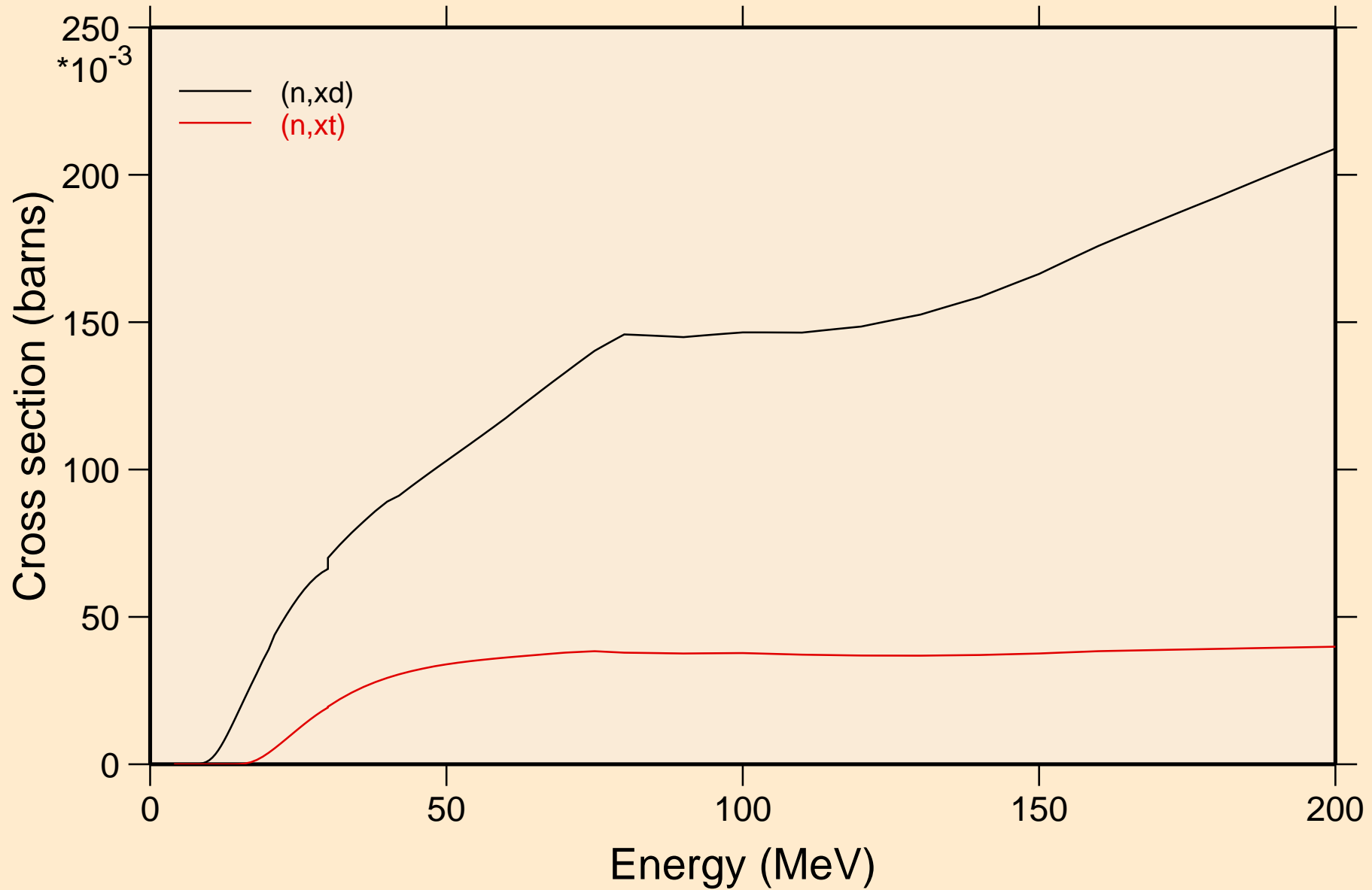

ER147M NEUTRON ACER TENDL-2021 LIBRARY; T=293.6K
angular distribution for elastic

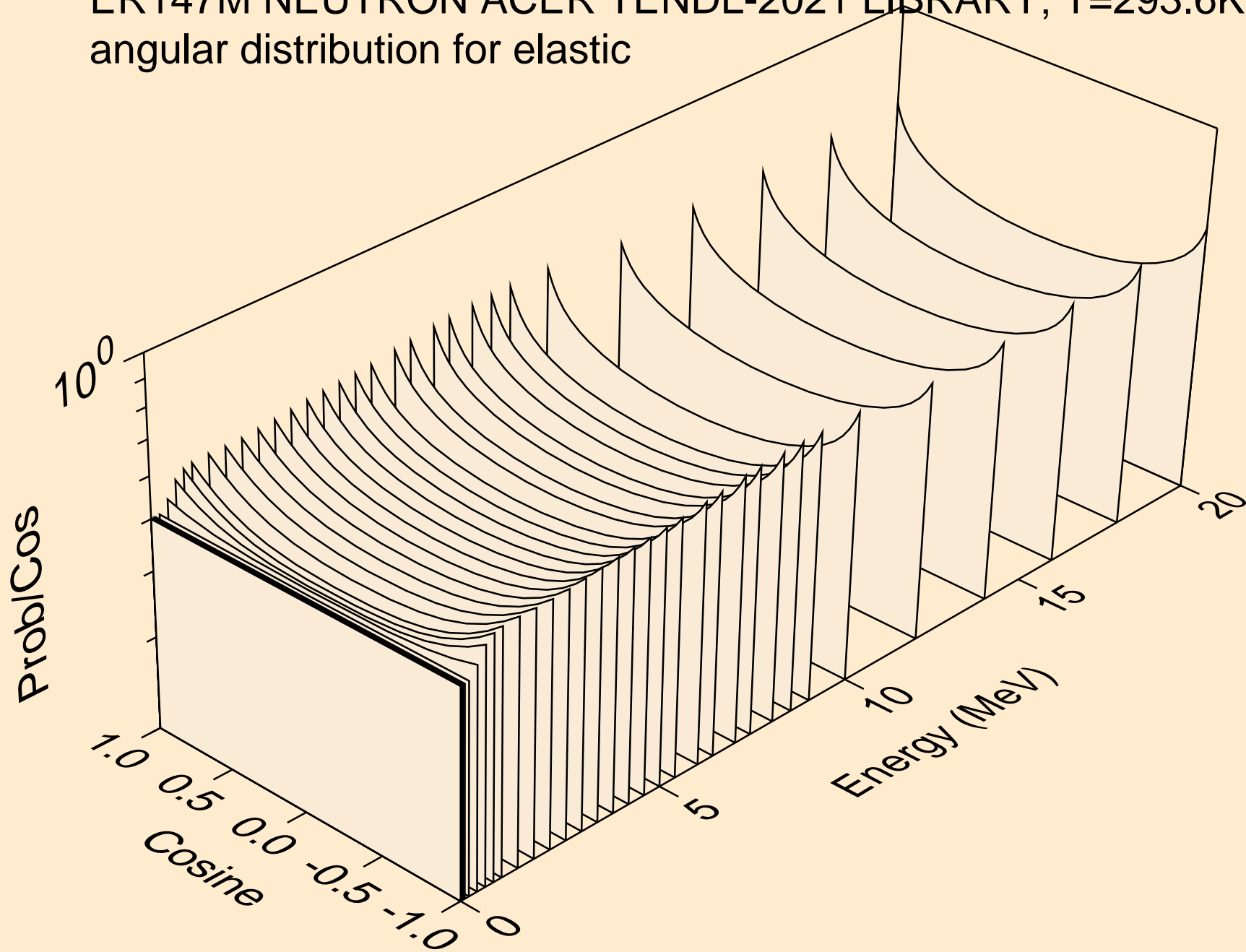

ER147M NEUTRON ACER TENDL-2021 LIBRARY; T=293.6K
angular distribution for elastic

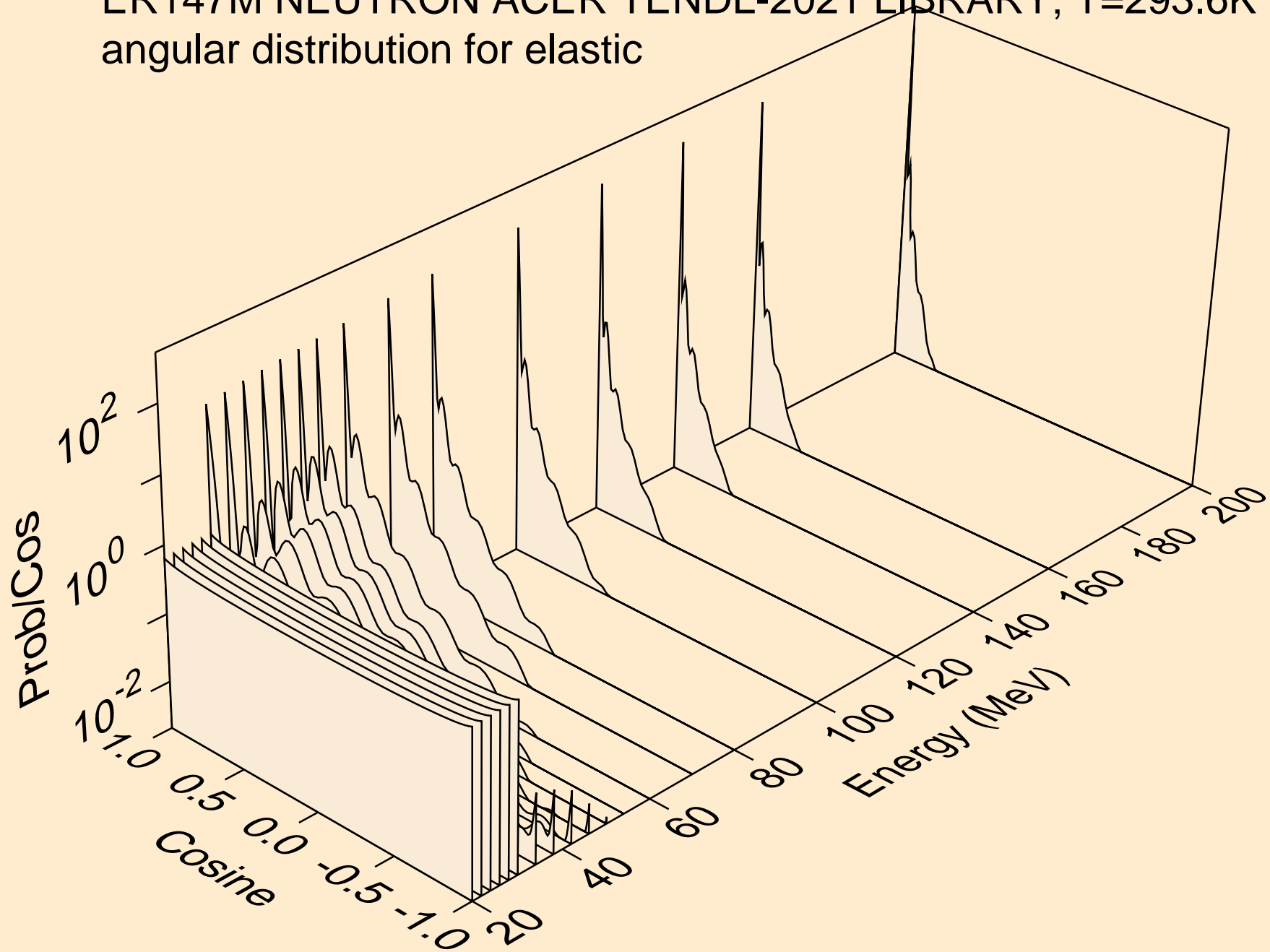

ER147M NEUTRON ACER TENDL-2021 LIBRARY; T=293.6K
angular distribution for (n,n*1)

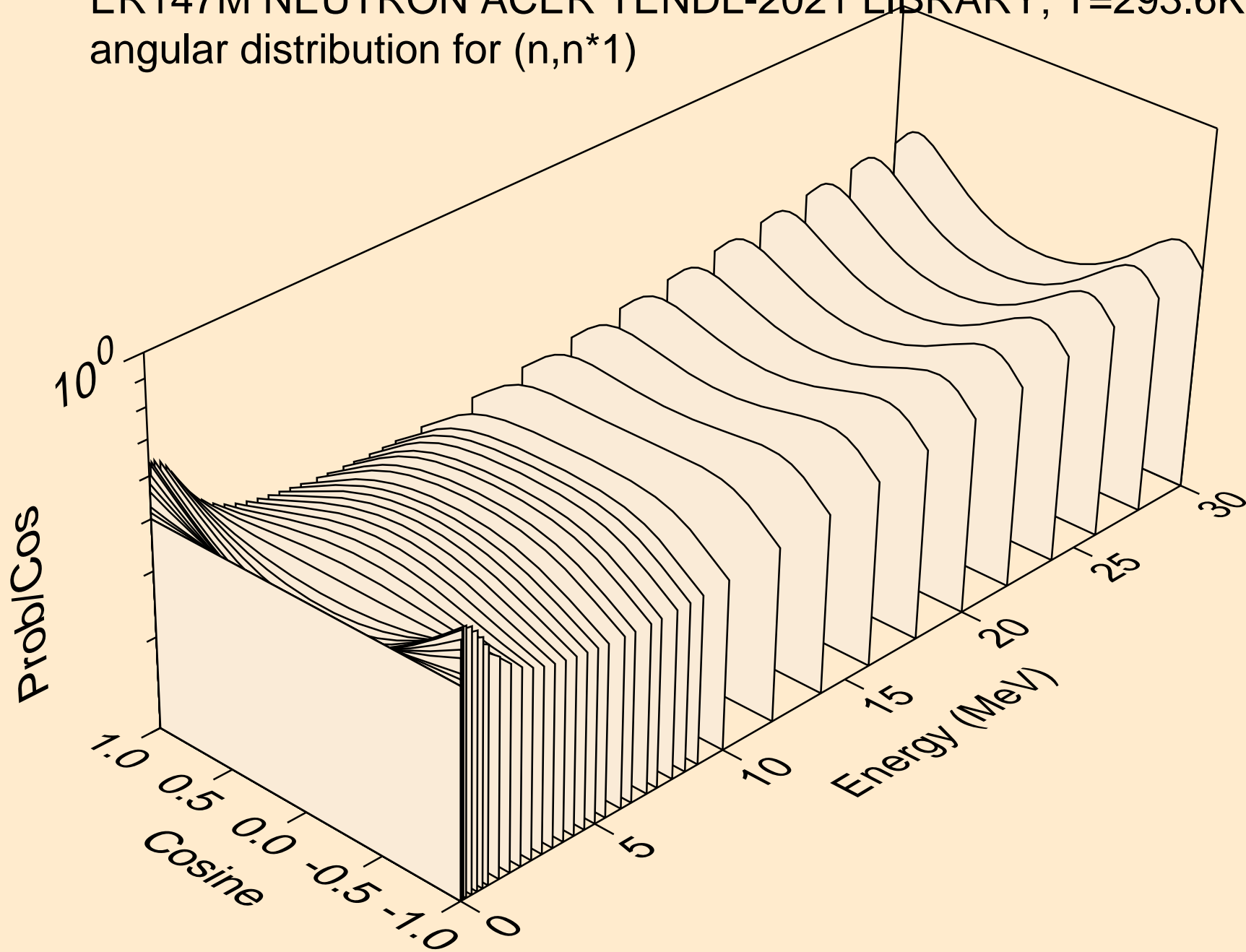

ER147M NEUTRON ACER TENDL-2021 LIBRARY; T=293.6K
angular distribution for (n,n*2)

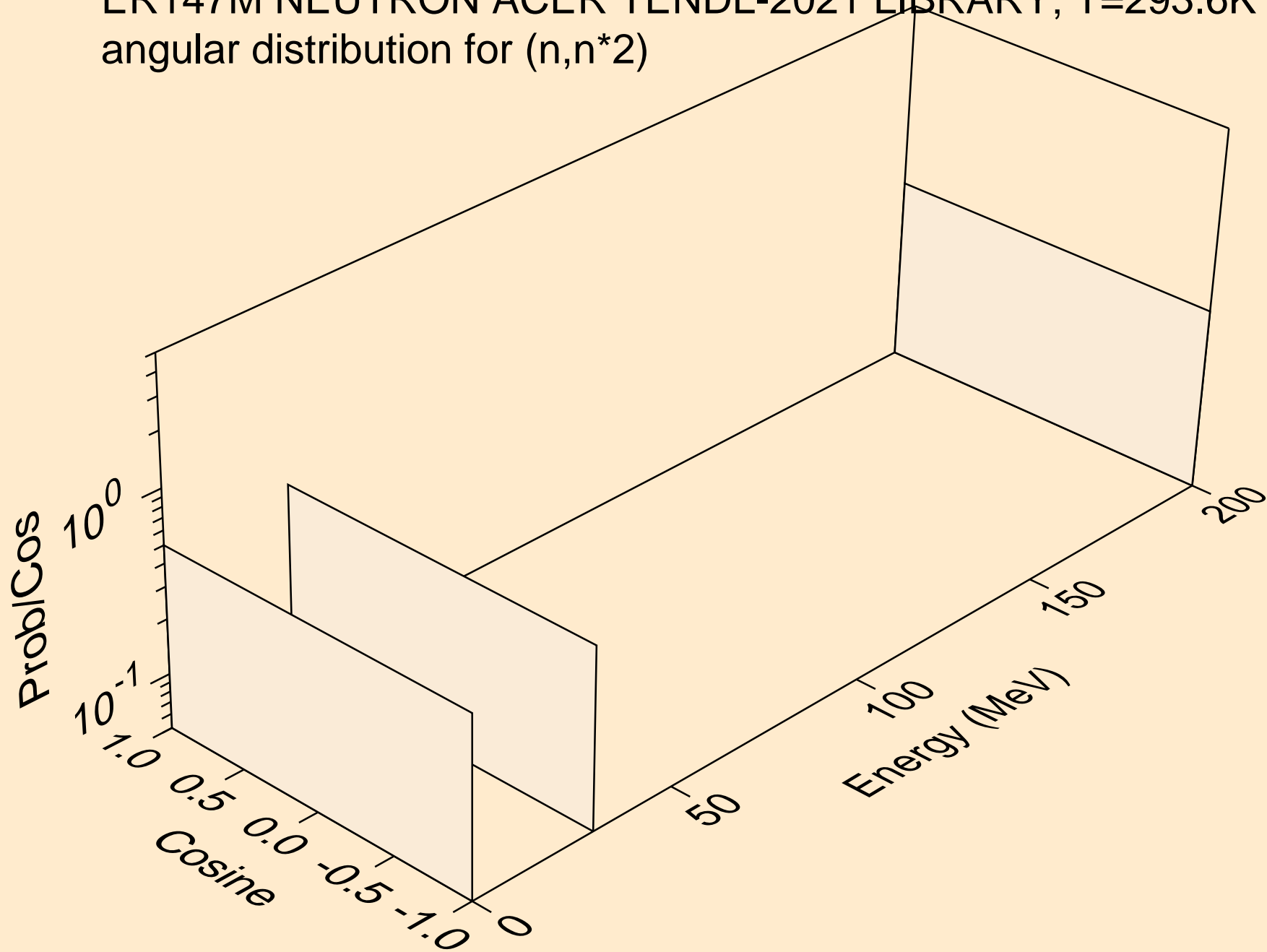

ER147M NEUTRON ACER TENDL-2021 LIBRARY; T=293.6K
Neutron emission for (n,x)

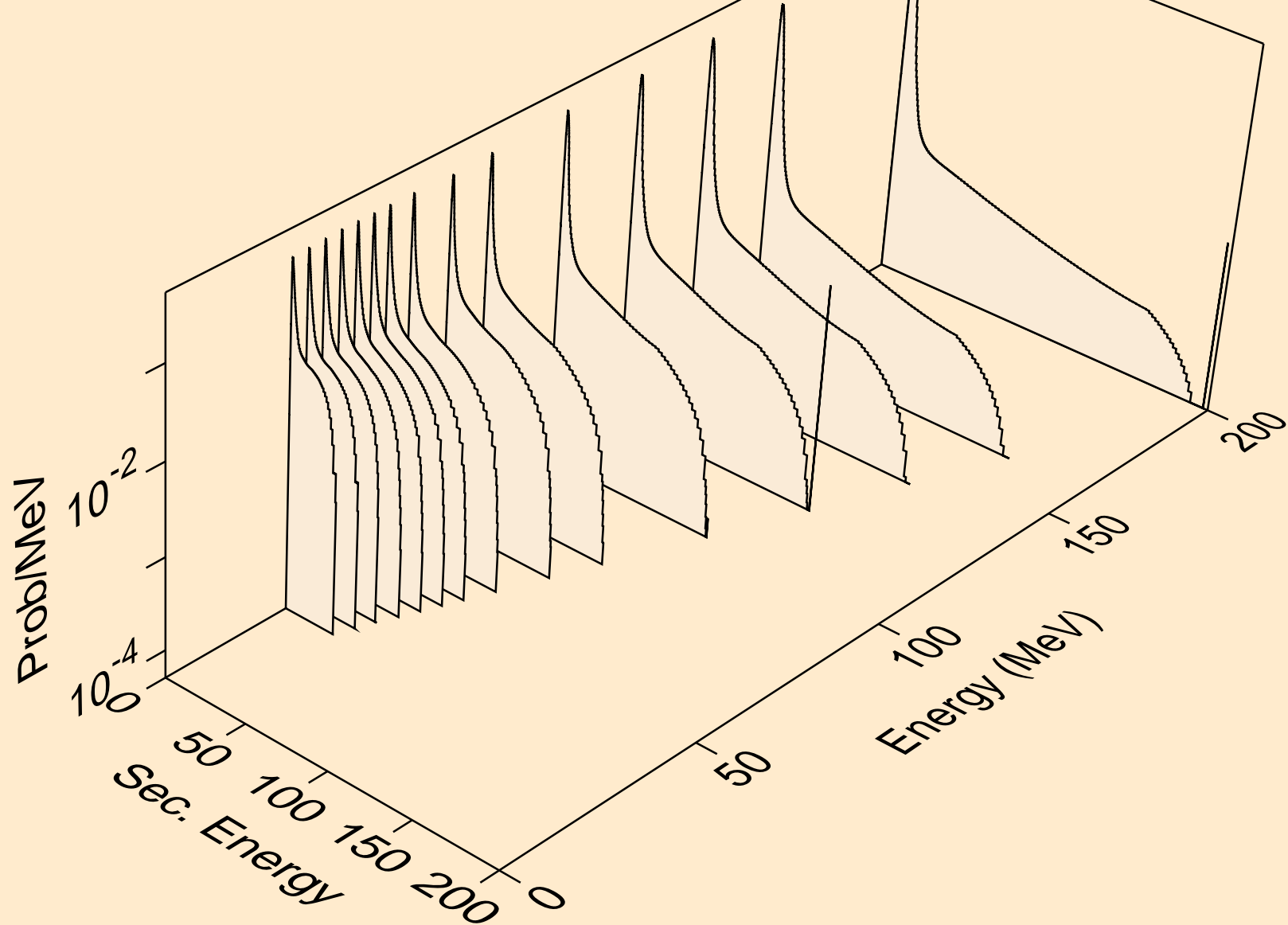

ER147M NEUTRON ACER TENDL-2021 LIBRARY; T=293.6K
Neutron emission for (n,2n)

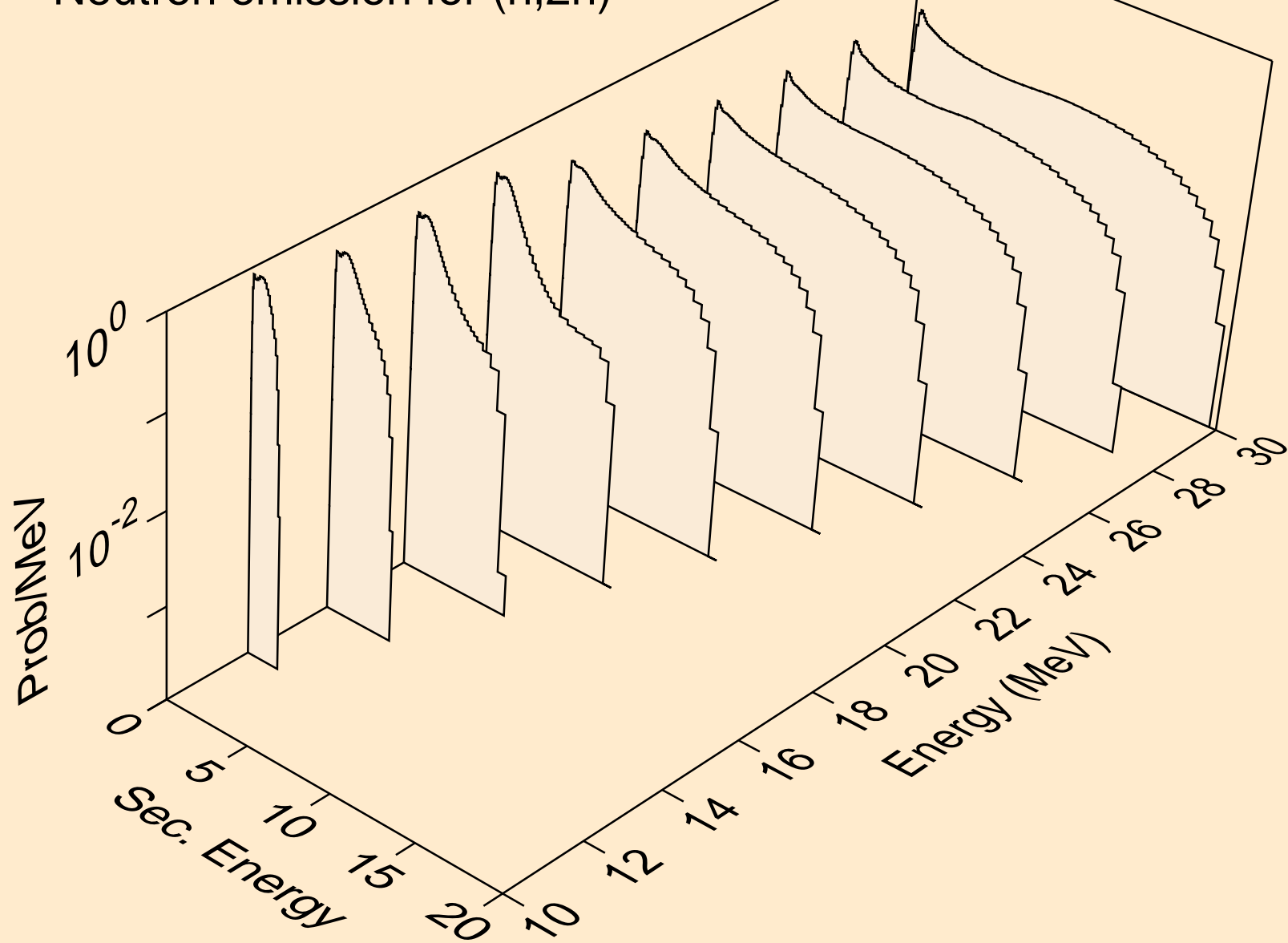

ER147M NEUTRON ACER TENDL-2021 LIBRARY; T=293.6K
Neutron emission for (n,3n)

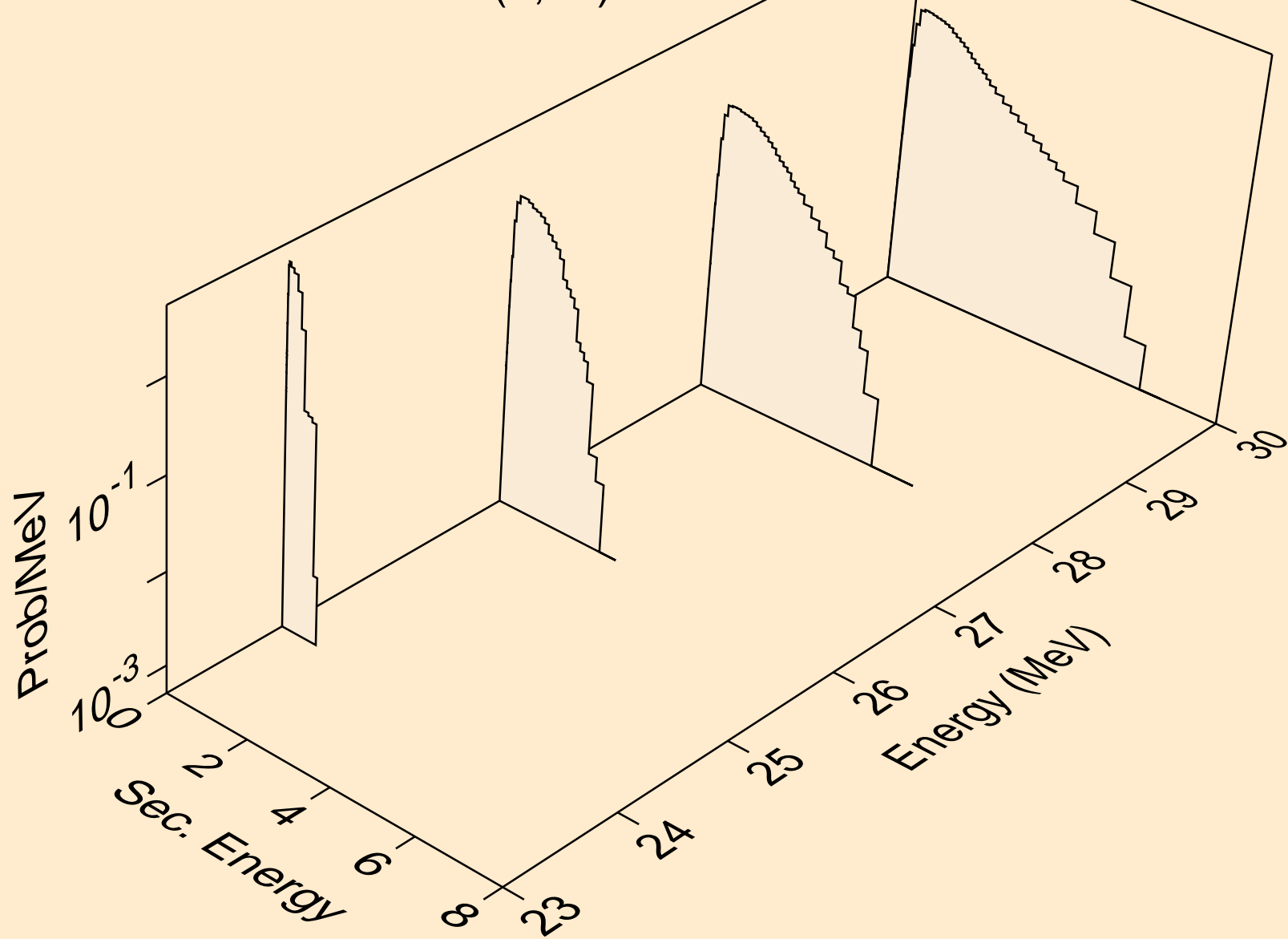

ER147M NEUTRON ACER TENDL-2021 LIBRARY; T=293.6K
Neutron emission for (n,n*)a

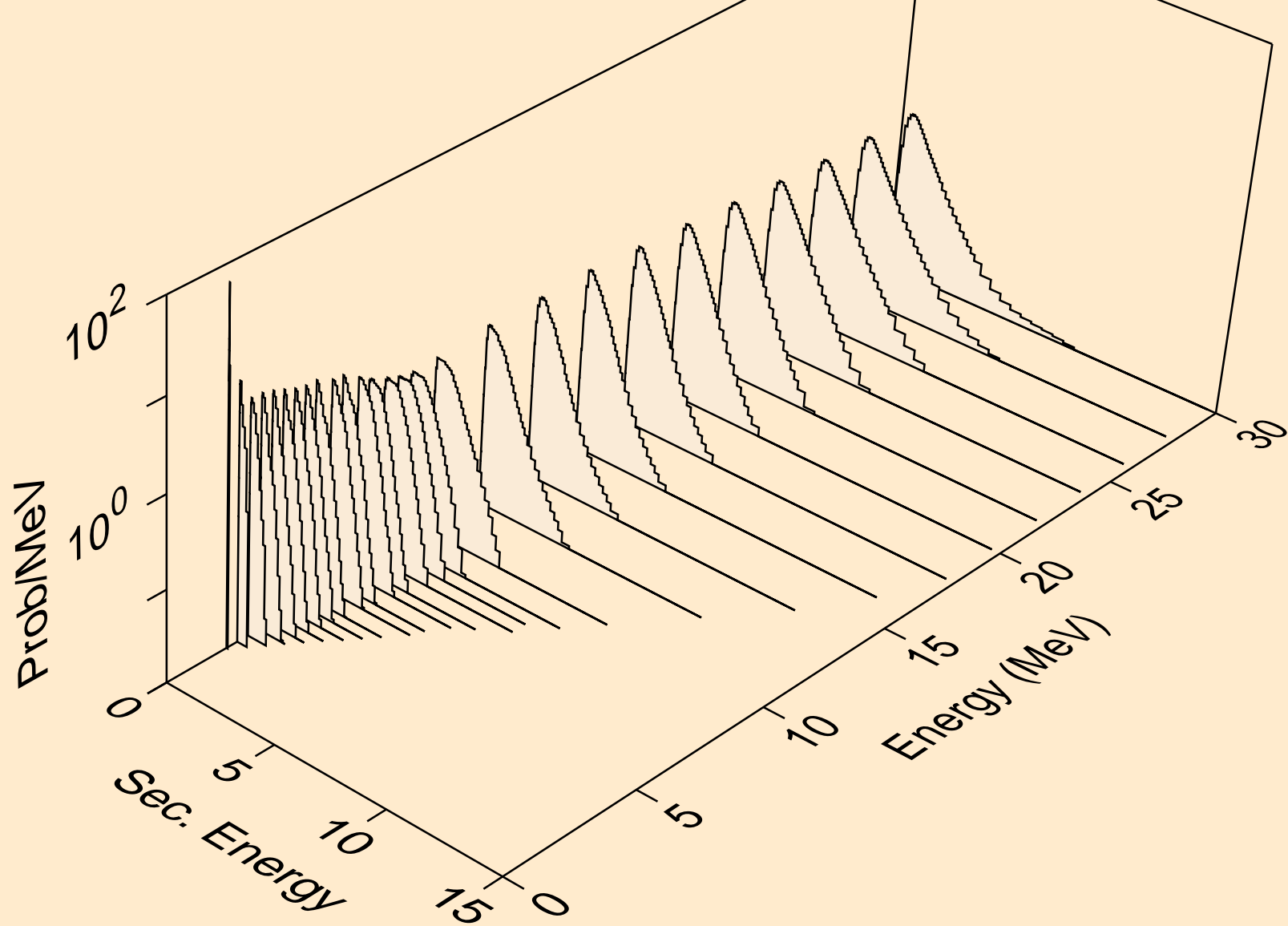

ER147M NEUTRON ACER TENDL-2021 LIBRARY; T=293.6K
Neutron emission for (n,2n)a

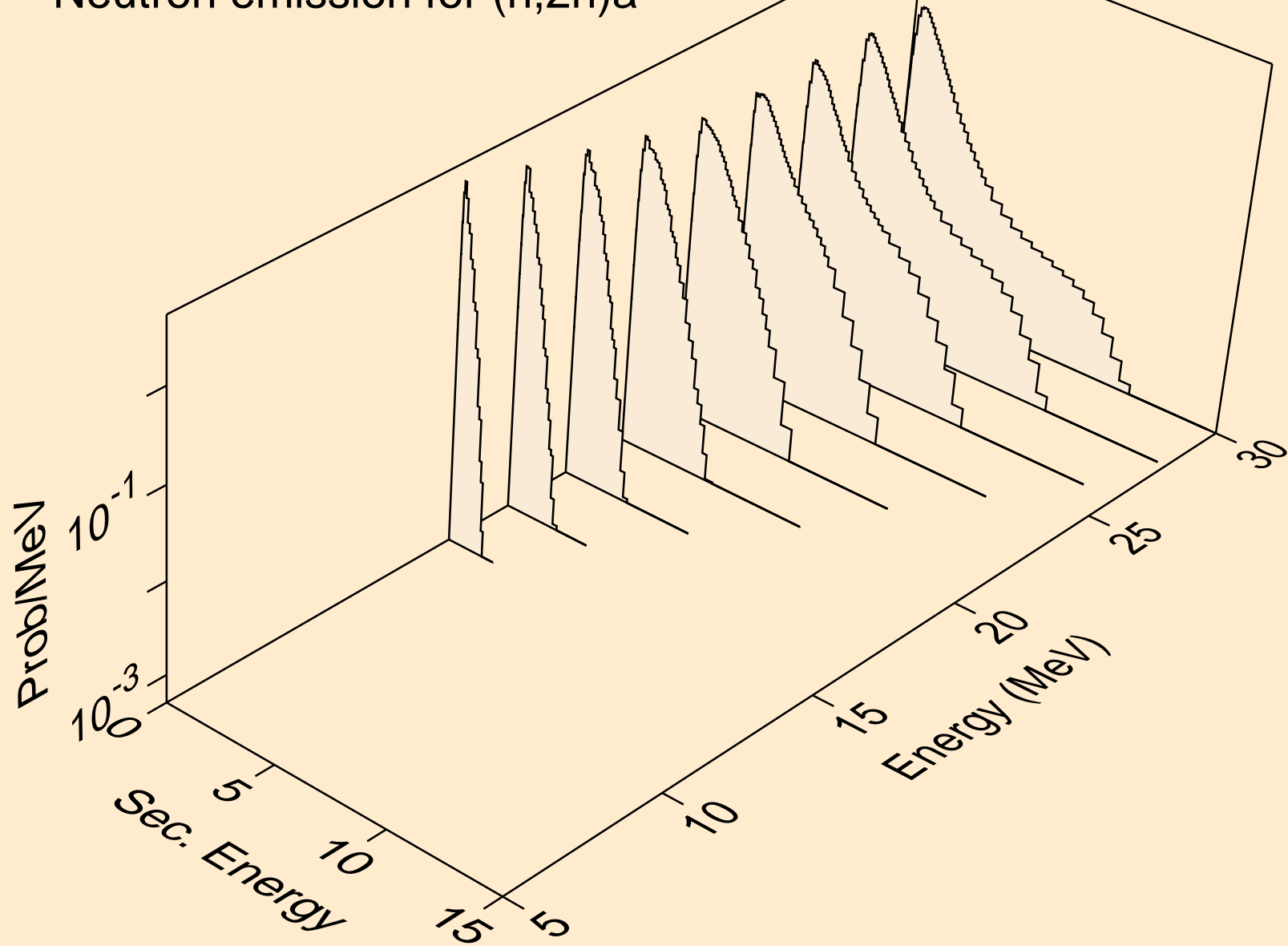

ER147M NEUTRON ACER TENDL-2021 LIBRARY; T=293.6K
Neutron emission for (n,n*)p

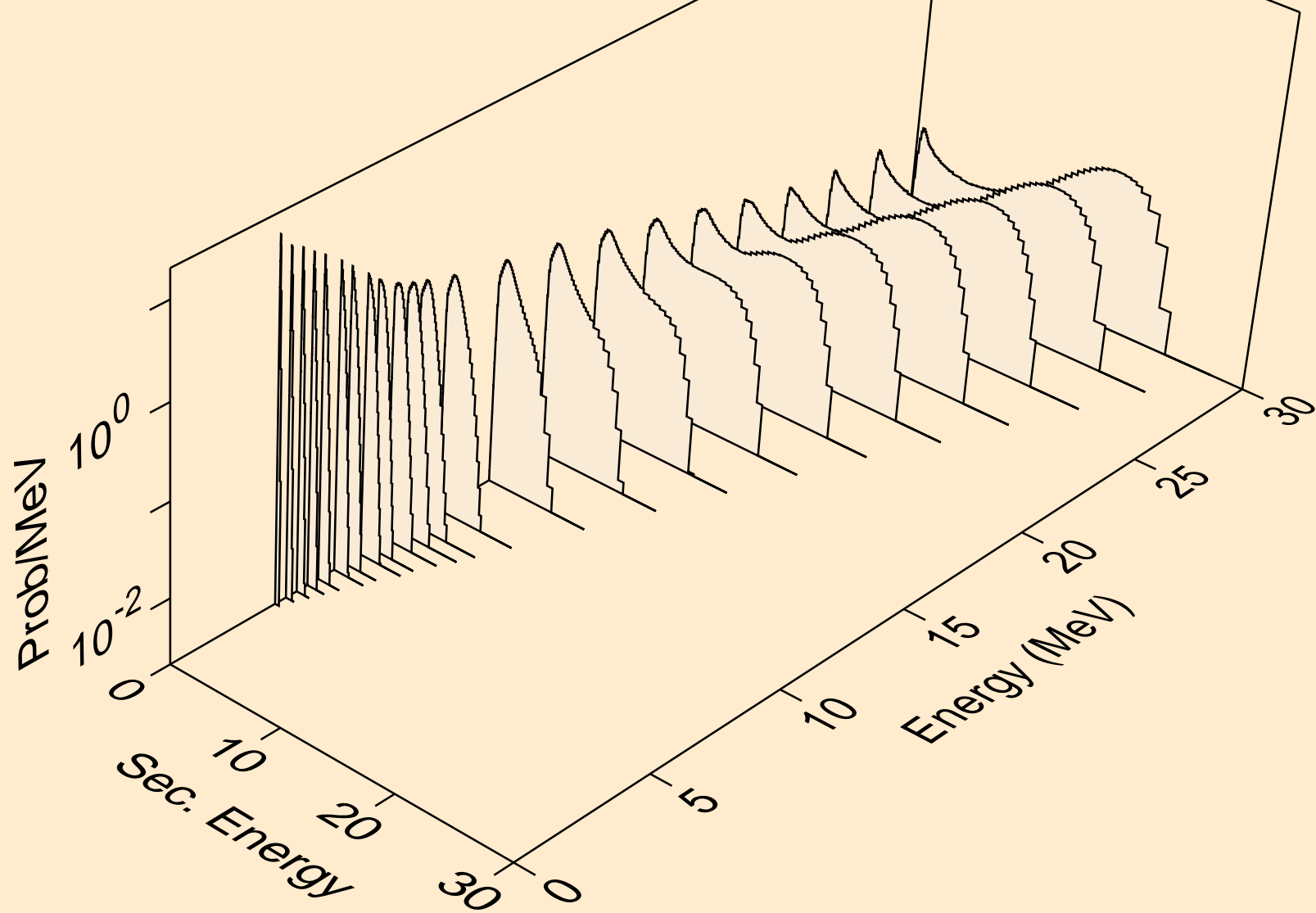

ER147M NEUTRON ACER TENDL-2021 LIBRARY; T=293.6K
Neutron emission for (n,n*)2a

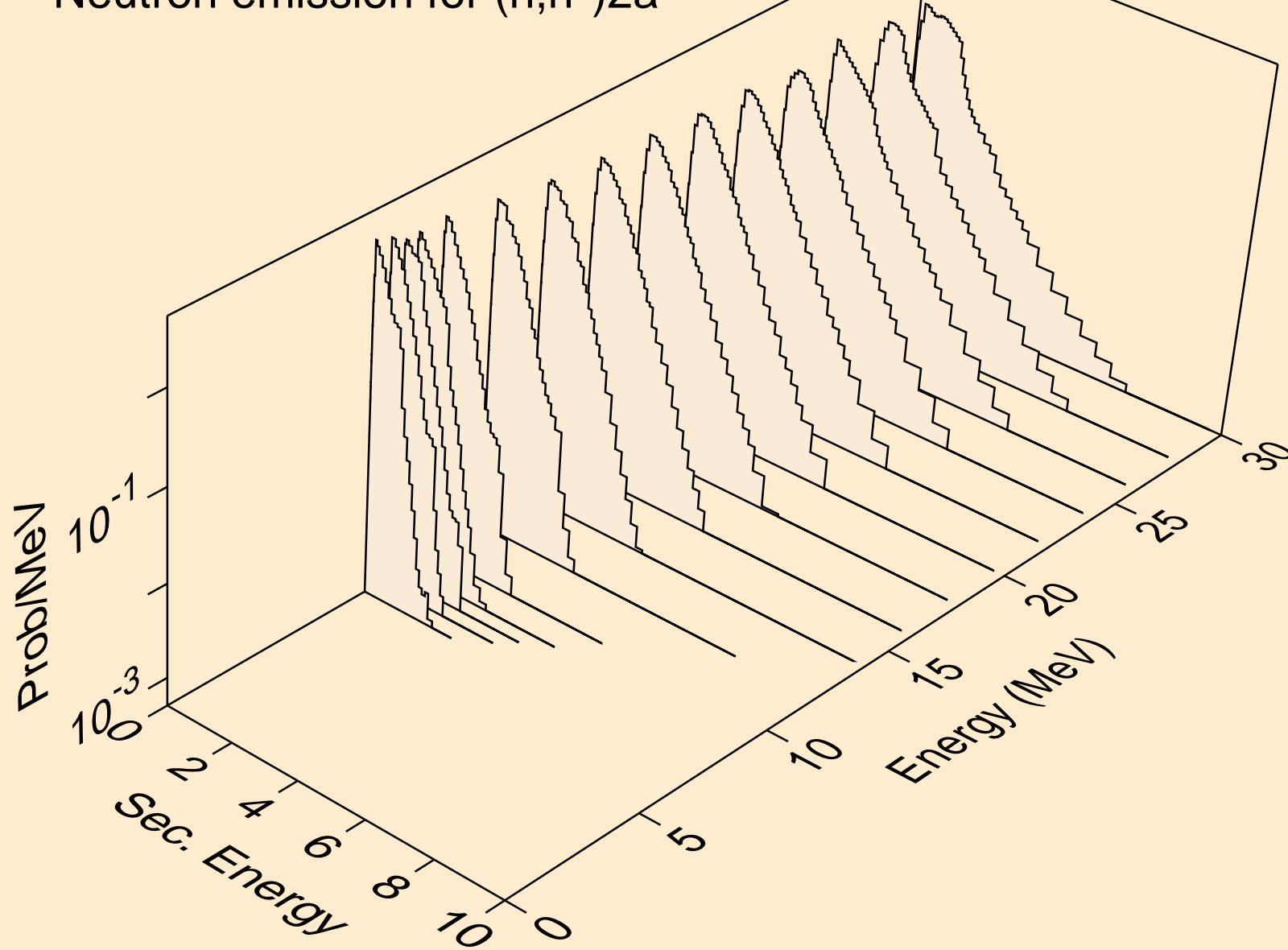

ER147M NEUTRON ACER TENDL-2021 LIBRARY; T=293.6K
Neutron emission for (n,2n)2a

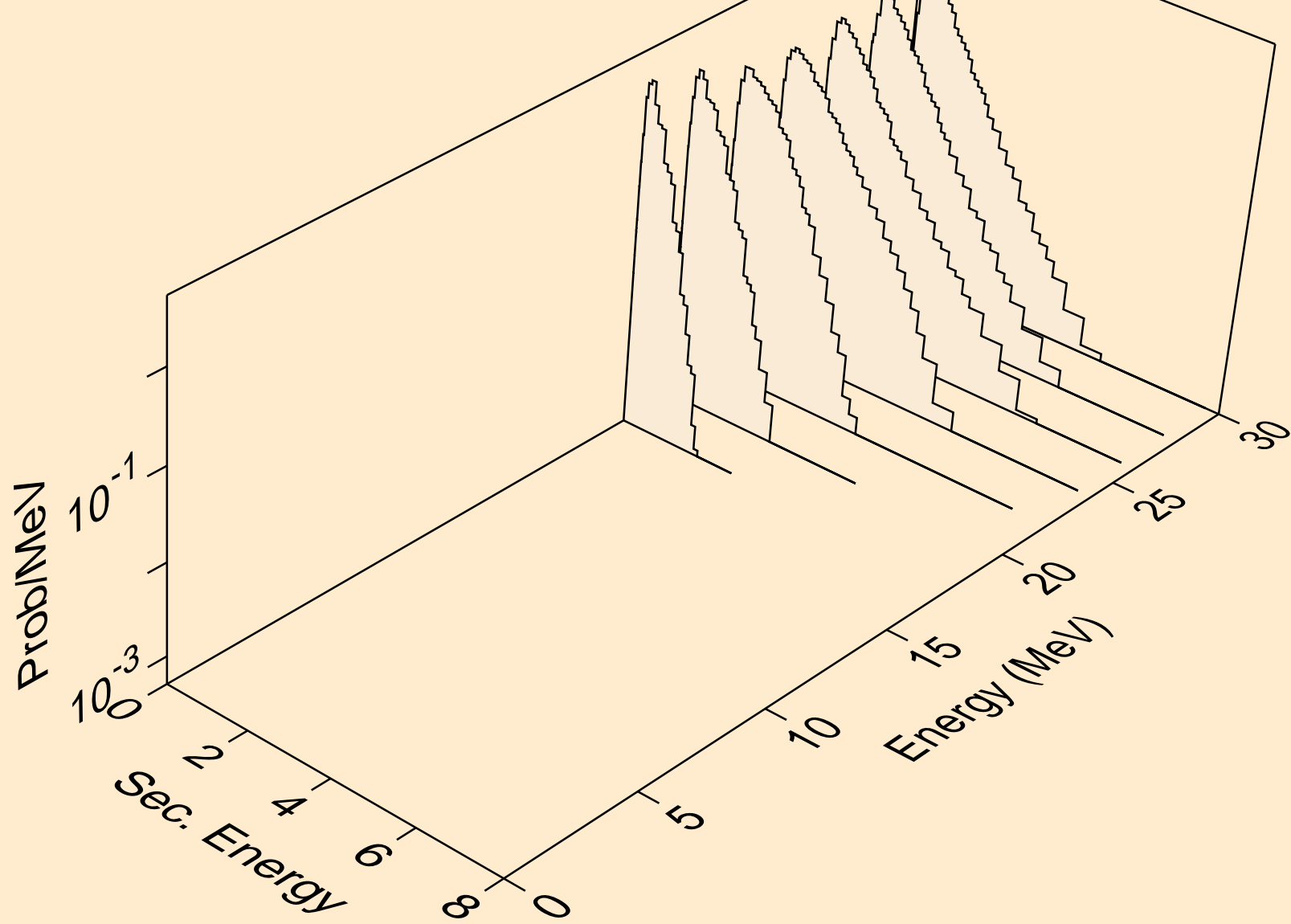

ER147M NEUTRON ACER TENDL-2021 LIBRARY; T=293.6K
Neutron emission for (n,n*)d

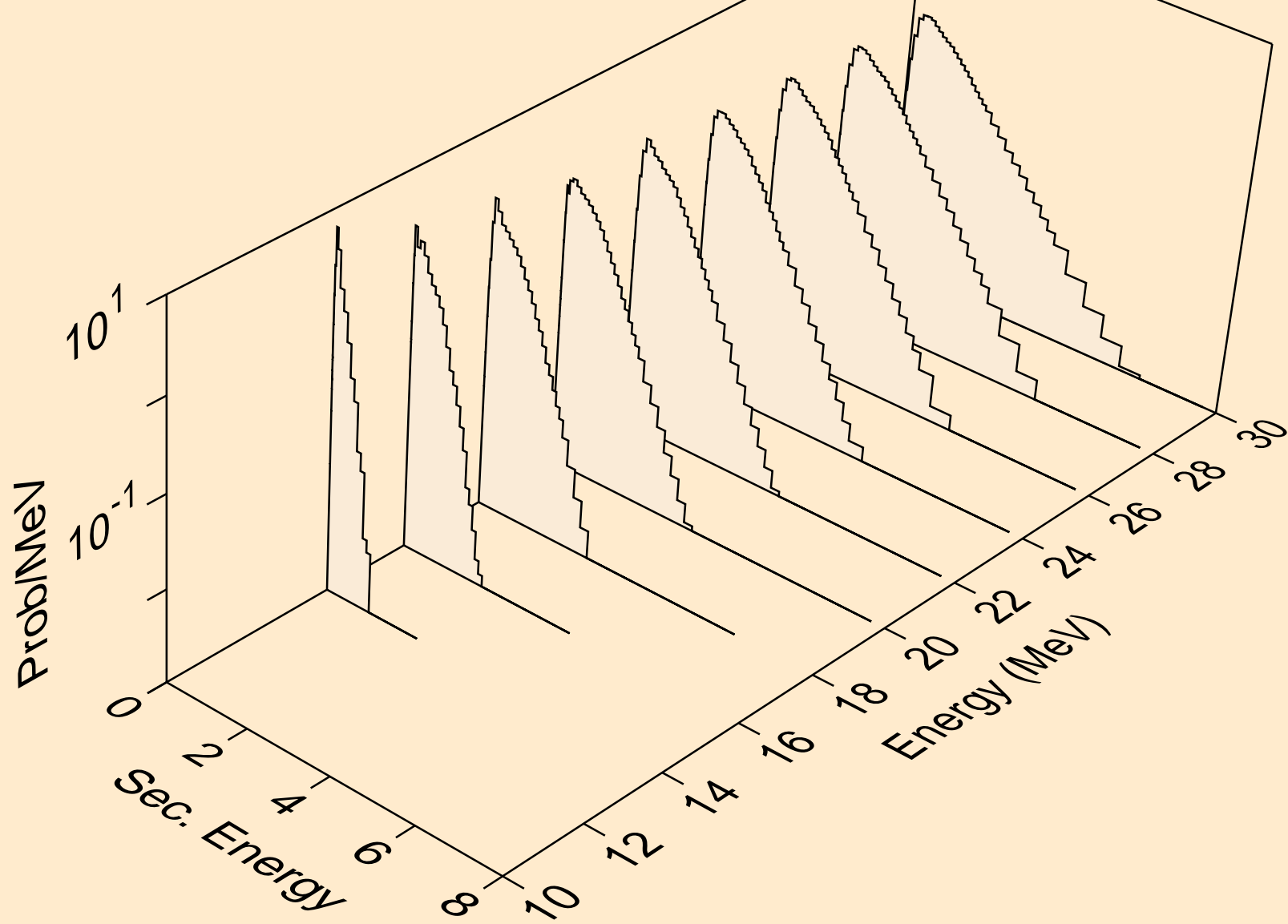

ER147M NEUTRON ACER TENDL-2021 LIBRARY; T=293.6K
Neutron emission for (n,n*)t

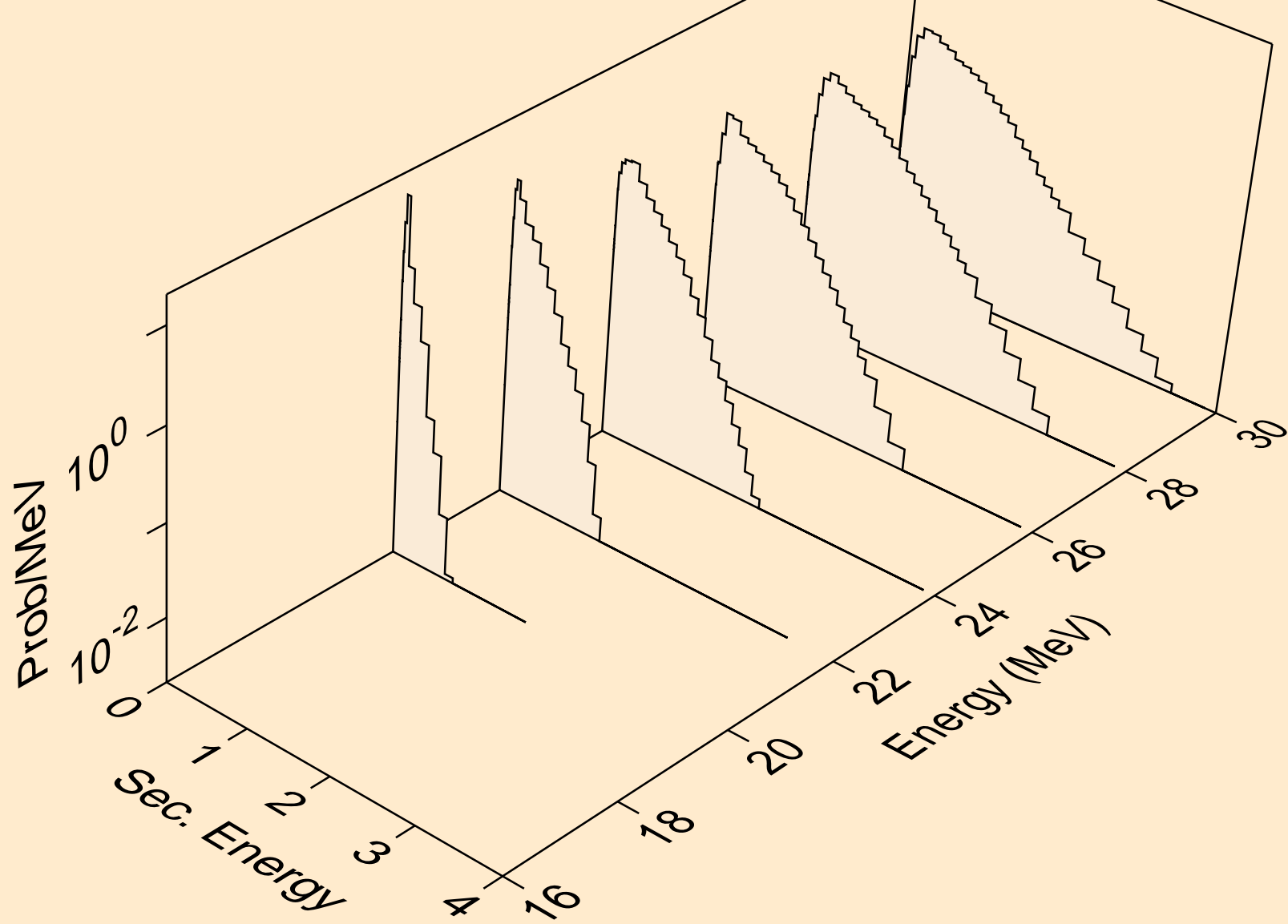

ER147M NEUTRON ACER TENDL-2021 LIBRARY; T=293.6K
Neutron emission for (n,n*)he3

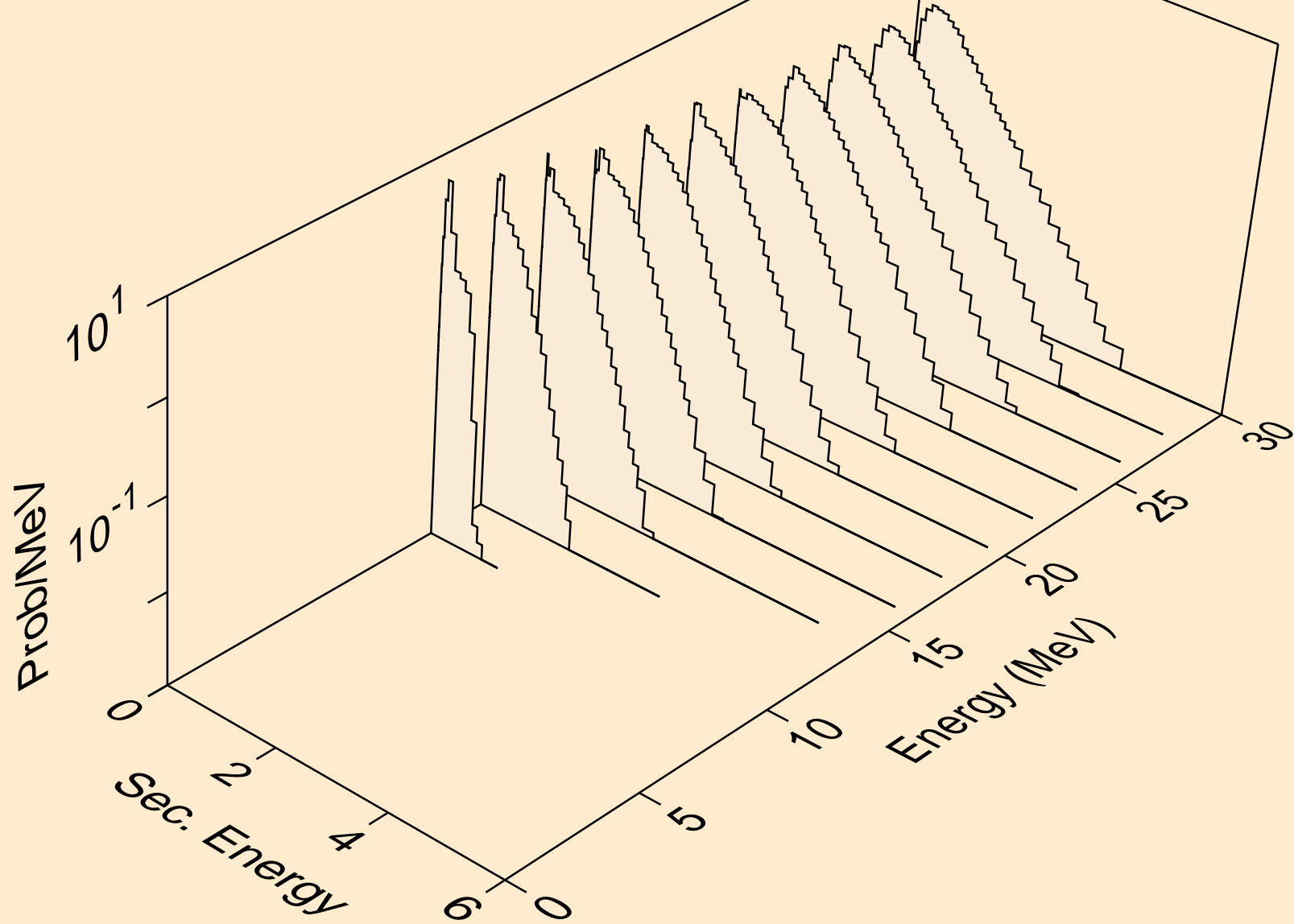

ER147M NEUTRON ACER TENDL-2021 LIBRARY; T=293.6K
Neutron emission for (n,2np)

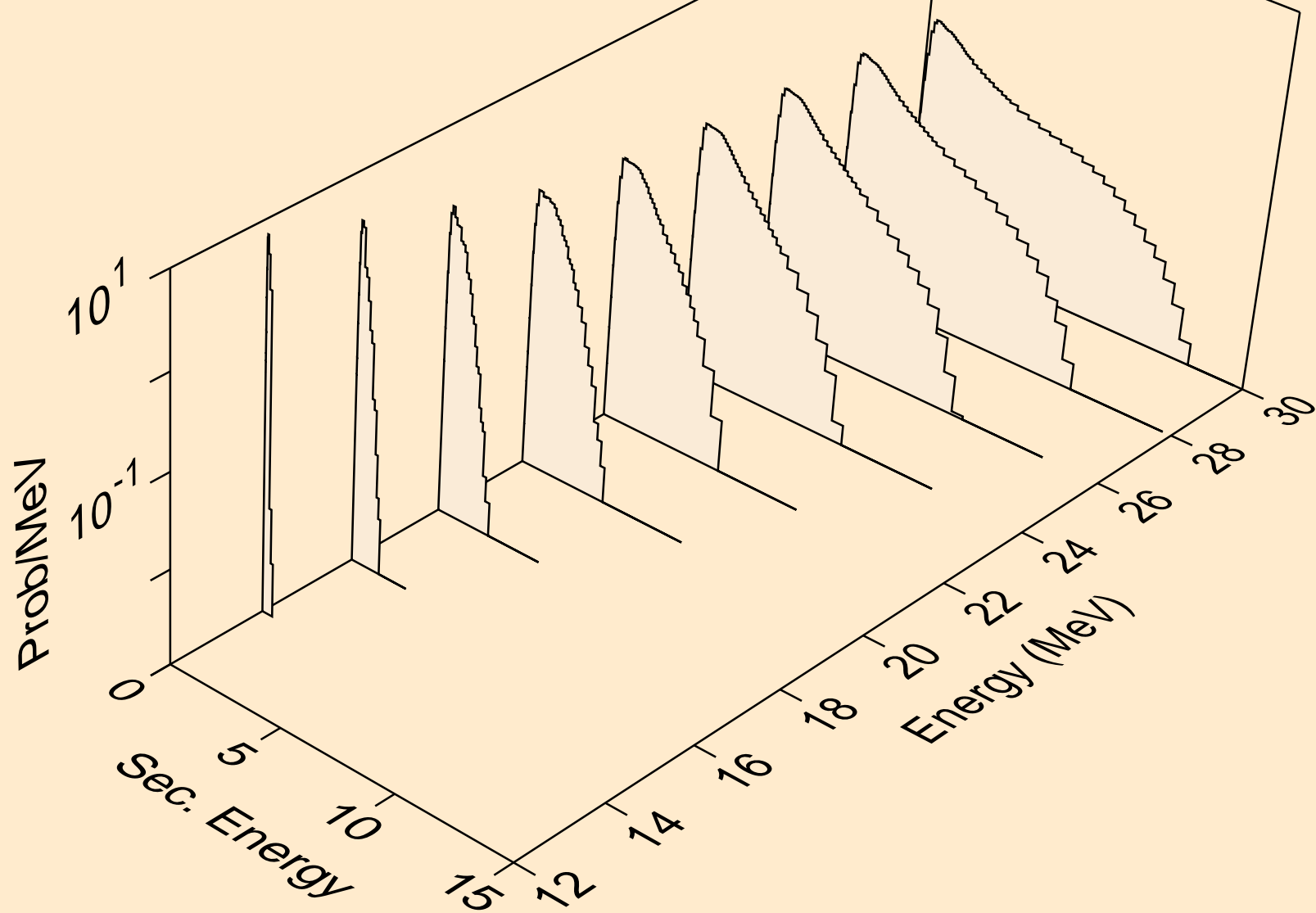

ER147M NEUTRON ACER TENDL-2021 LIBRARY; T=293.6K
Neutron emission for (n,3np)

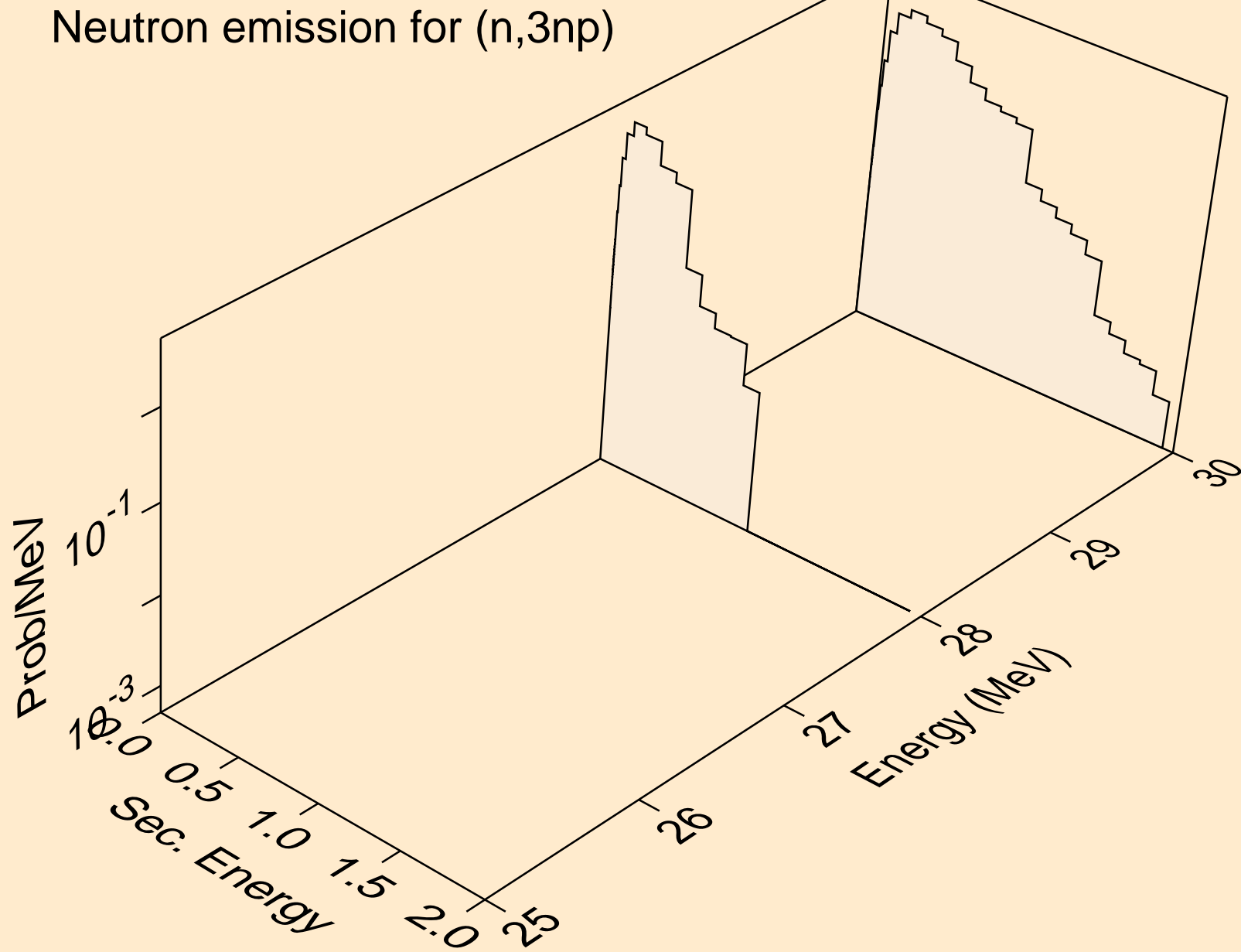

ER147M NEUTRON ACER TENDL-2021 LIBRARY; T=293.6K
Neutron emission for (n,2np)

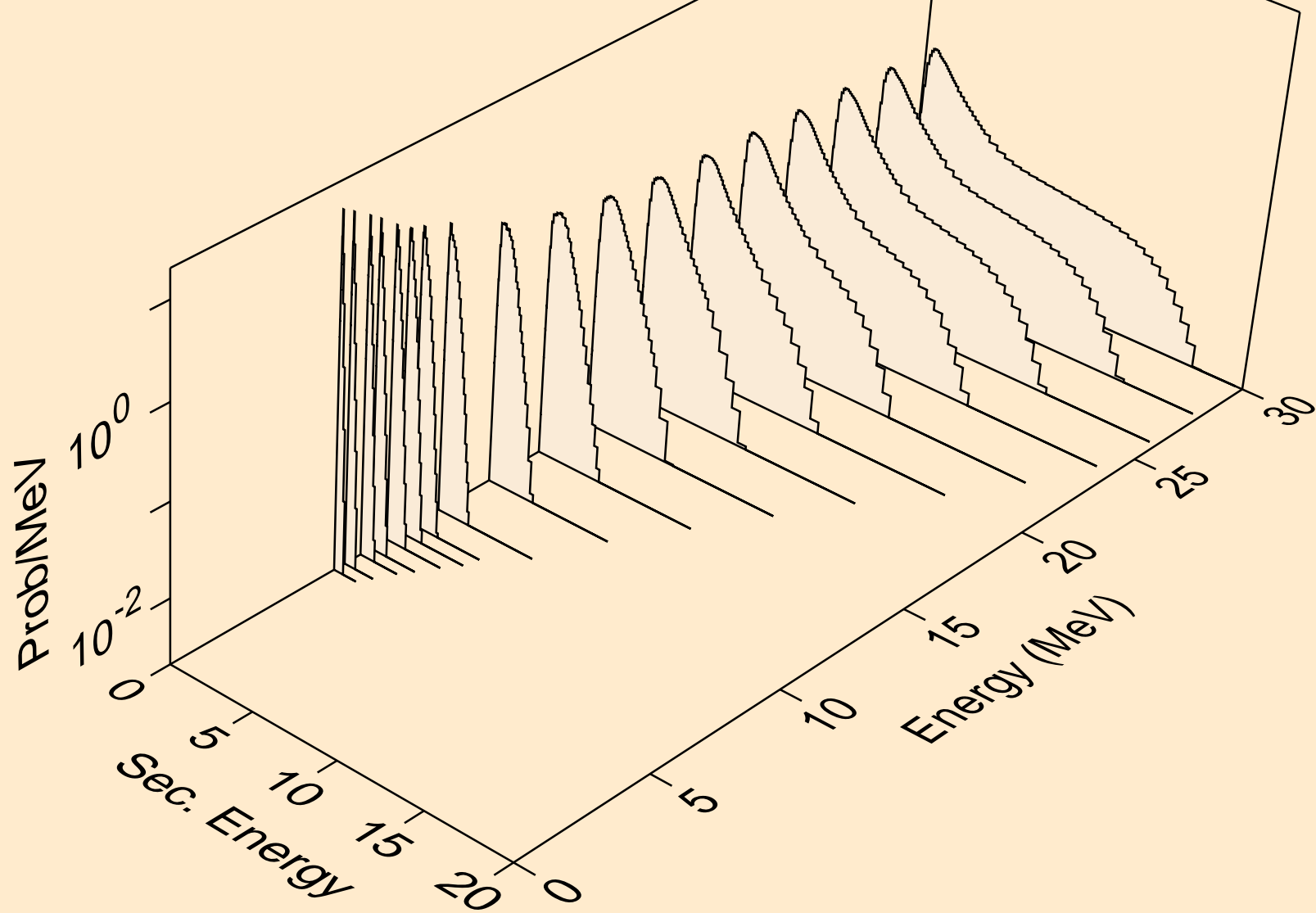

ER147M NEUTRON ACER TENDL-2021 LIBRARY; T=293.6K
Neutron emission for (n,npa)

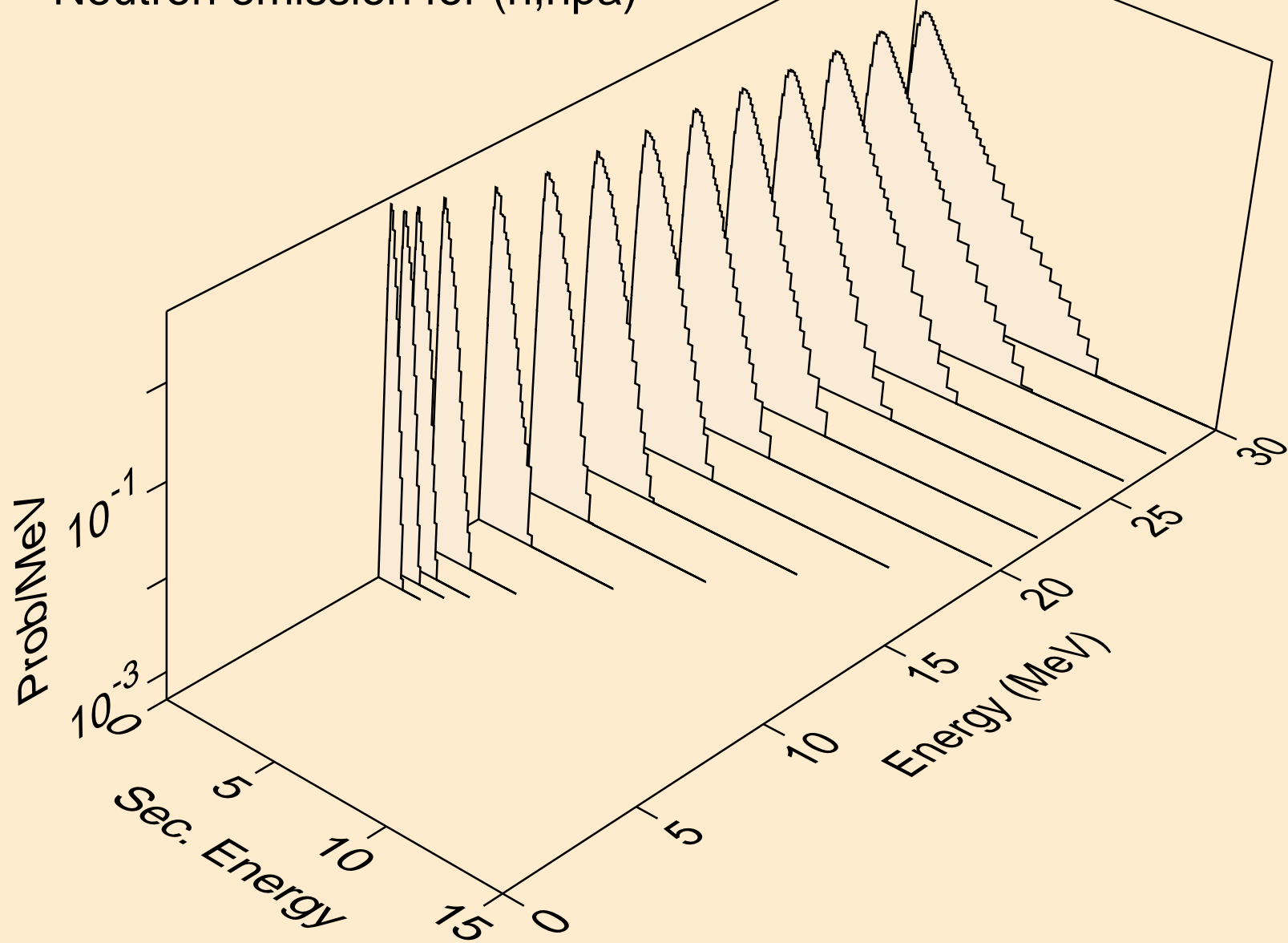

ER147M NEUTRON ACER TENDL-2021 LIBRARY; T=293.6K
Neutron emission for (n,n*c)

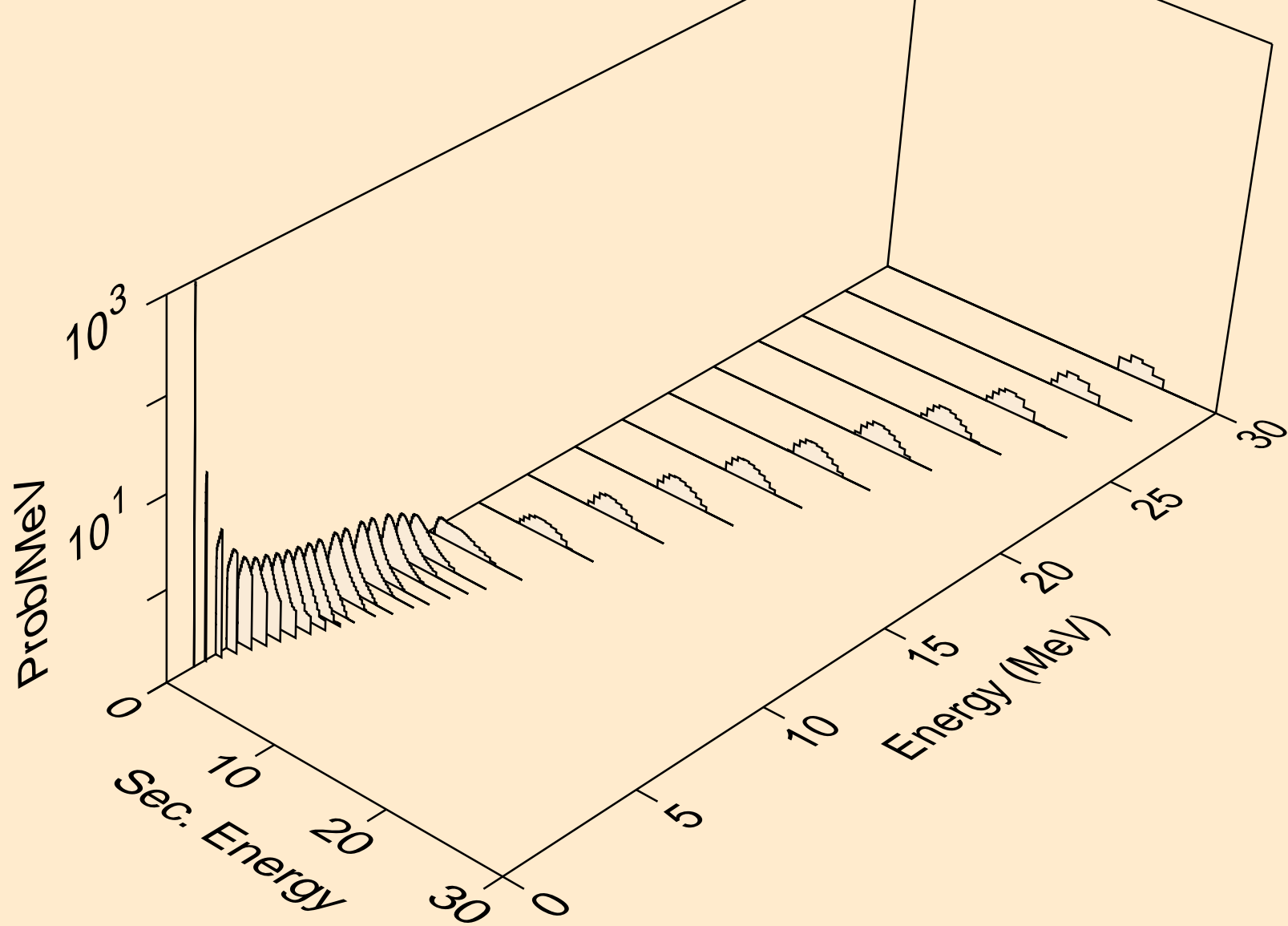

ER147M NEUTRON ACER TENDL-2021 LIBRARY; T=293.6K
Photon emission for (n,x)

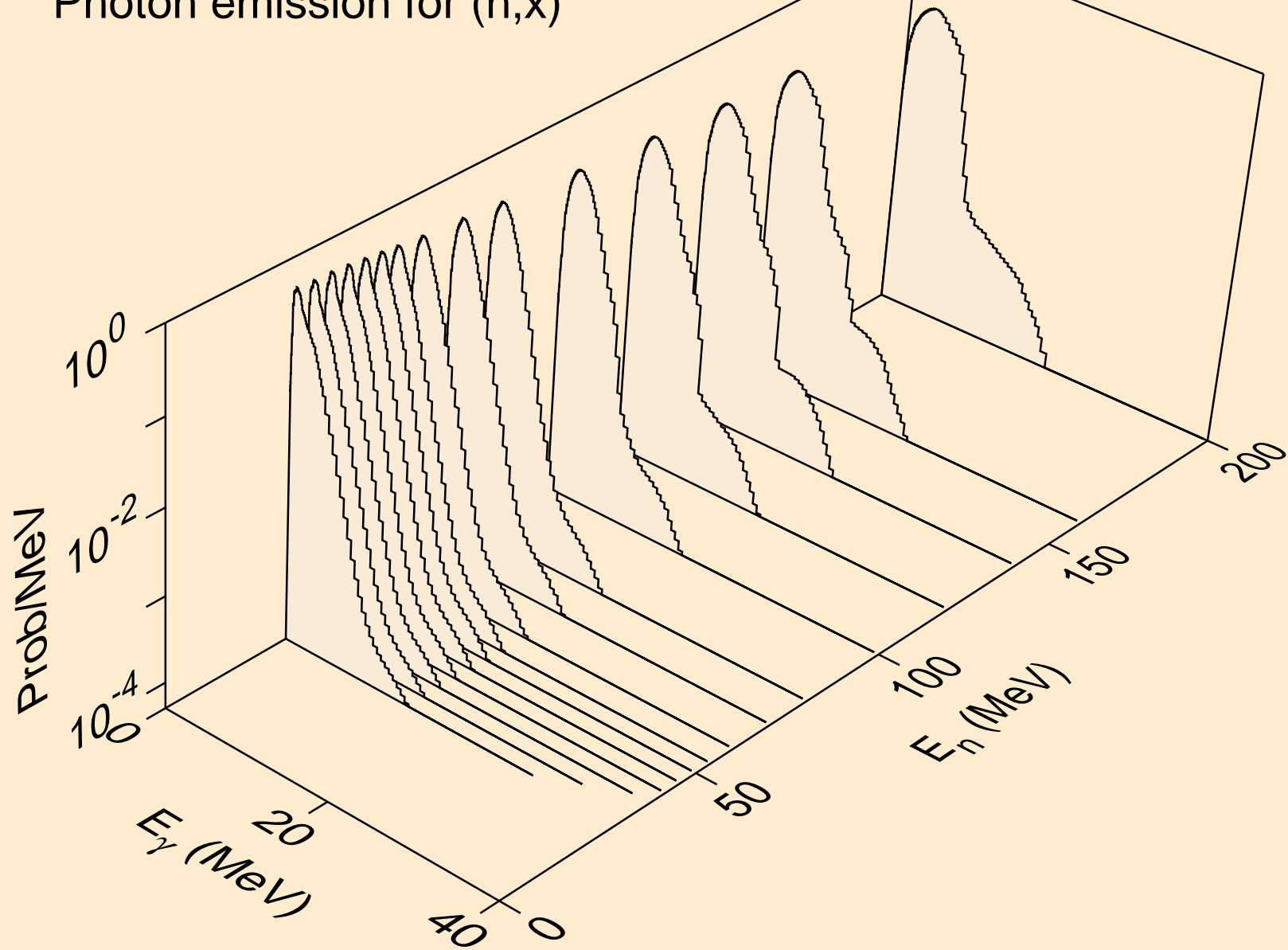

ER147M NEUTRON ACER TENDL-2021 LIBRARY; T=293.6K
Photon emission for (n,2n)

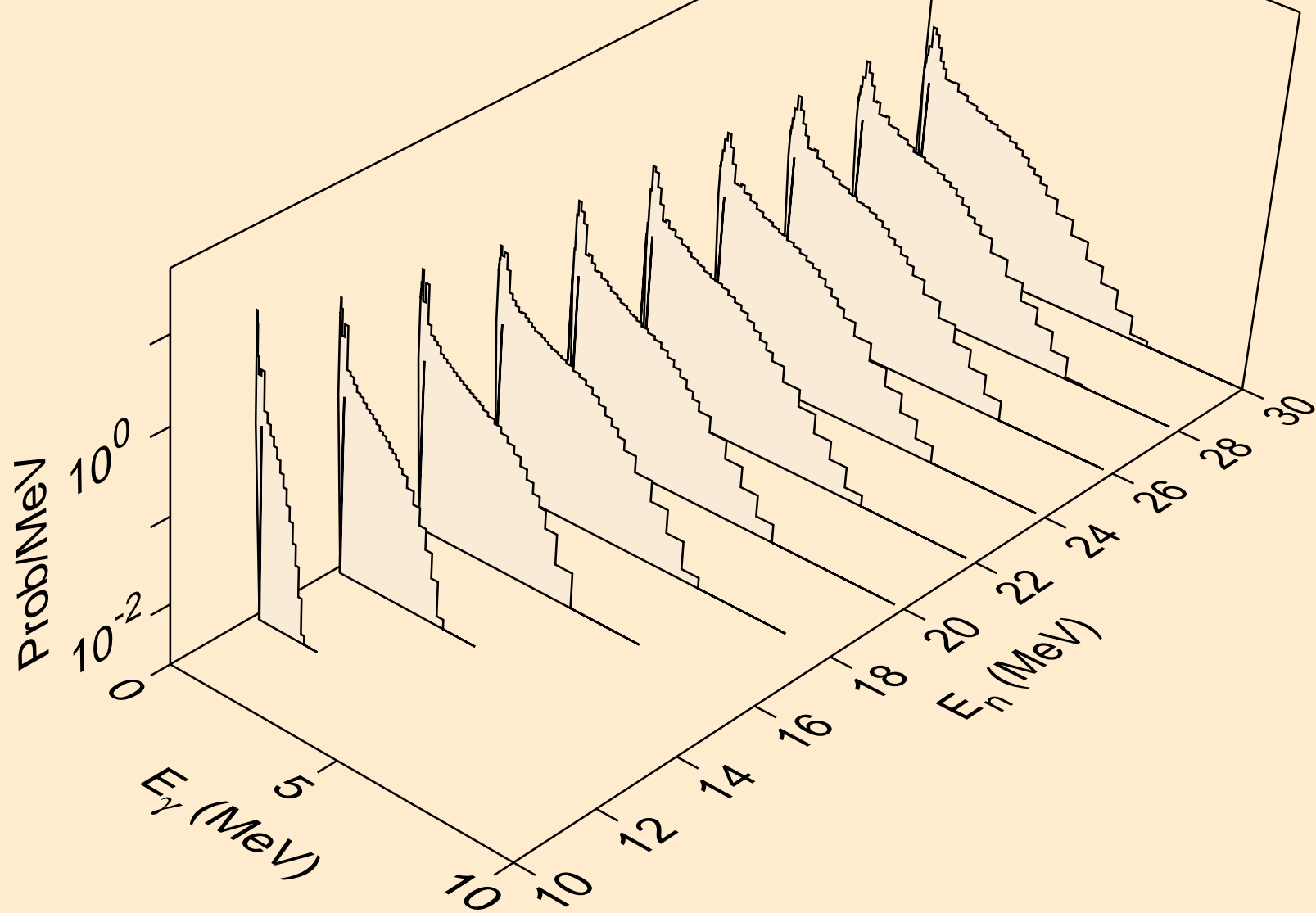

ER147M NEUTRON ACER TENDL-2021 LIBRARY; T=293.6K
Photon emission for (n,3n)

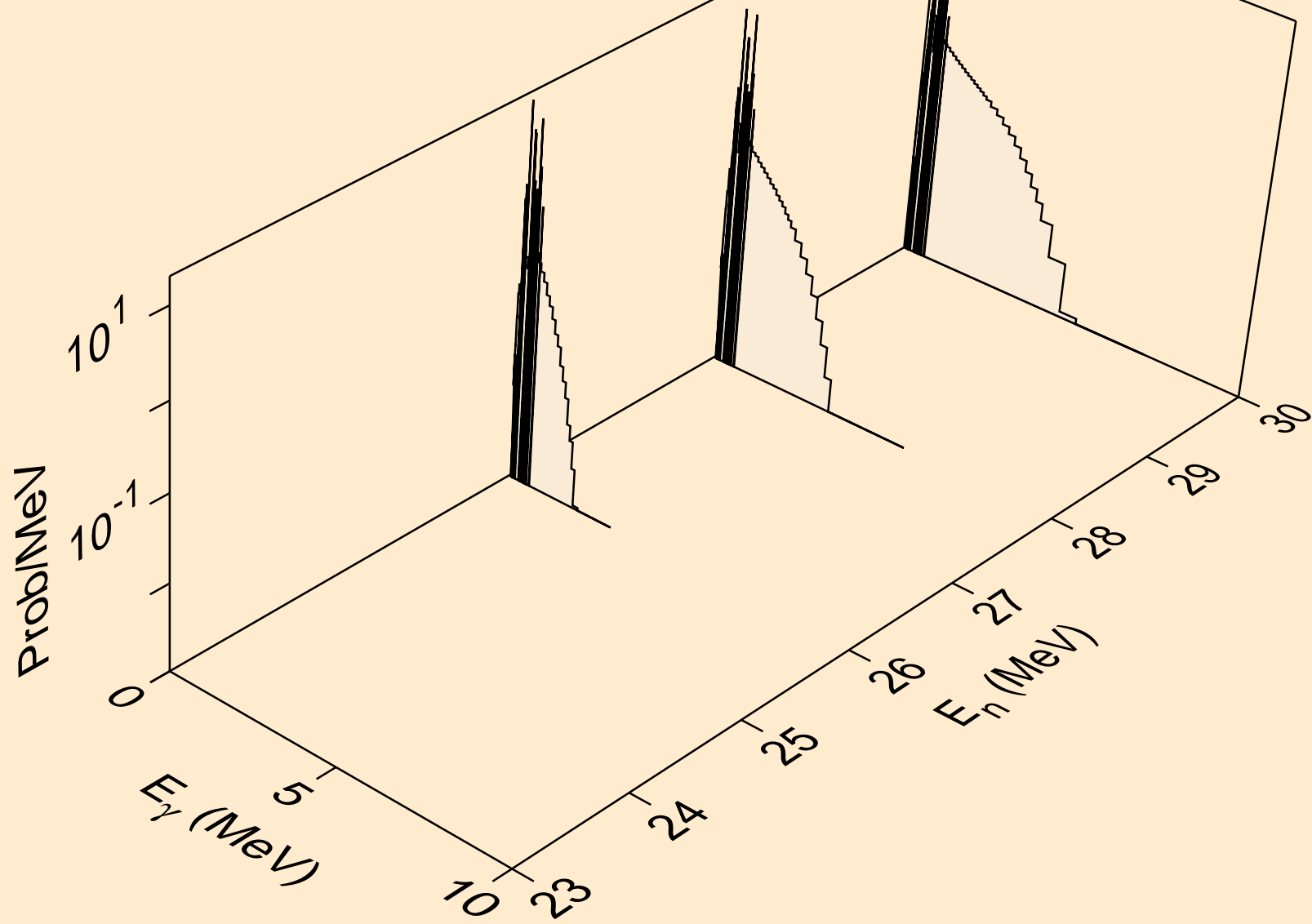

ER147M NEUTRON ACER TENDL-2021 LIBRARY; T=293.6K
Photon emission for (n,n*)a

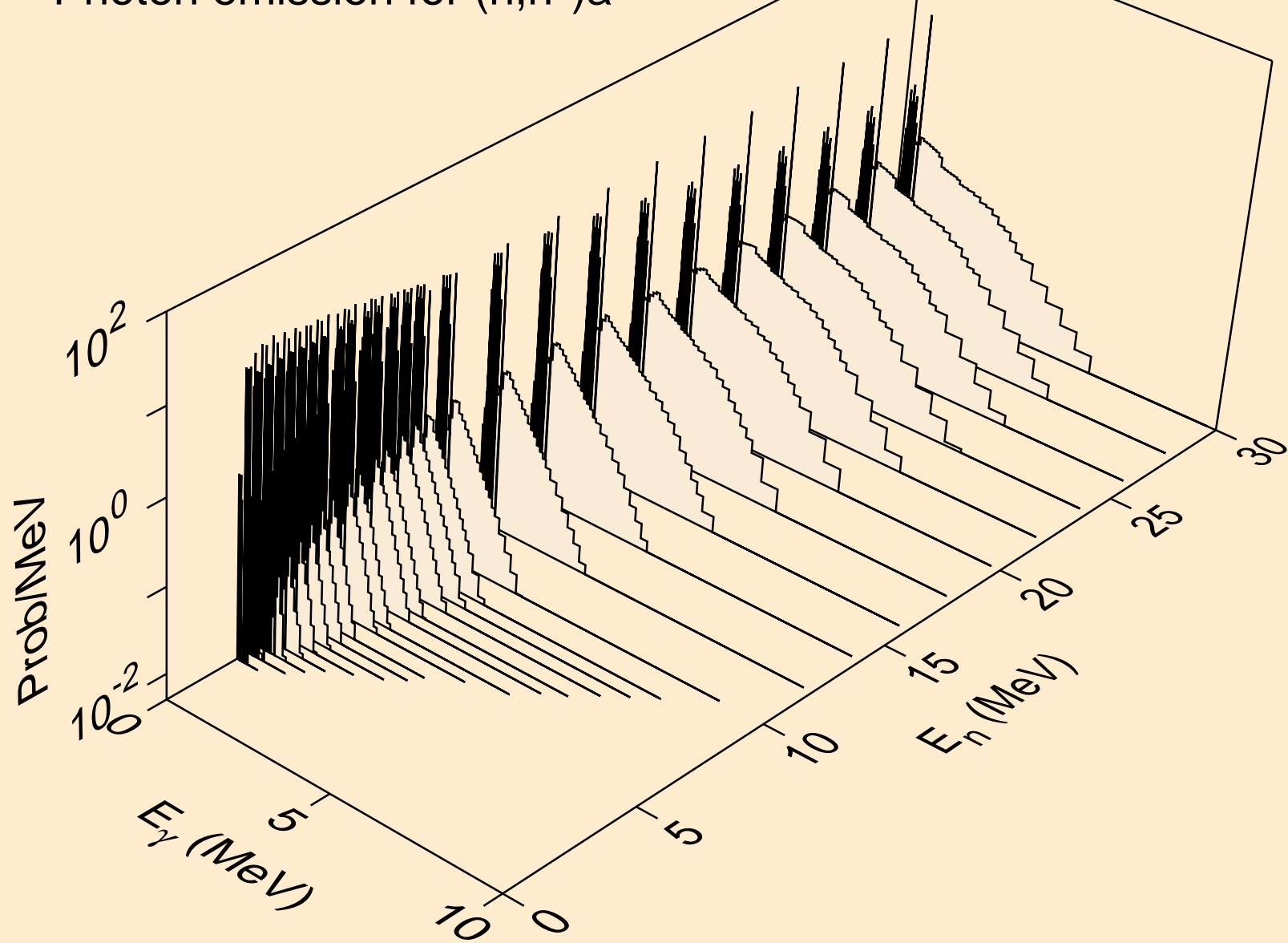

ER147M NEUTRON ACER TENDL-2021 LIBRARY; T=293.6K
Photon emission for (n,2n)a

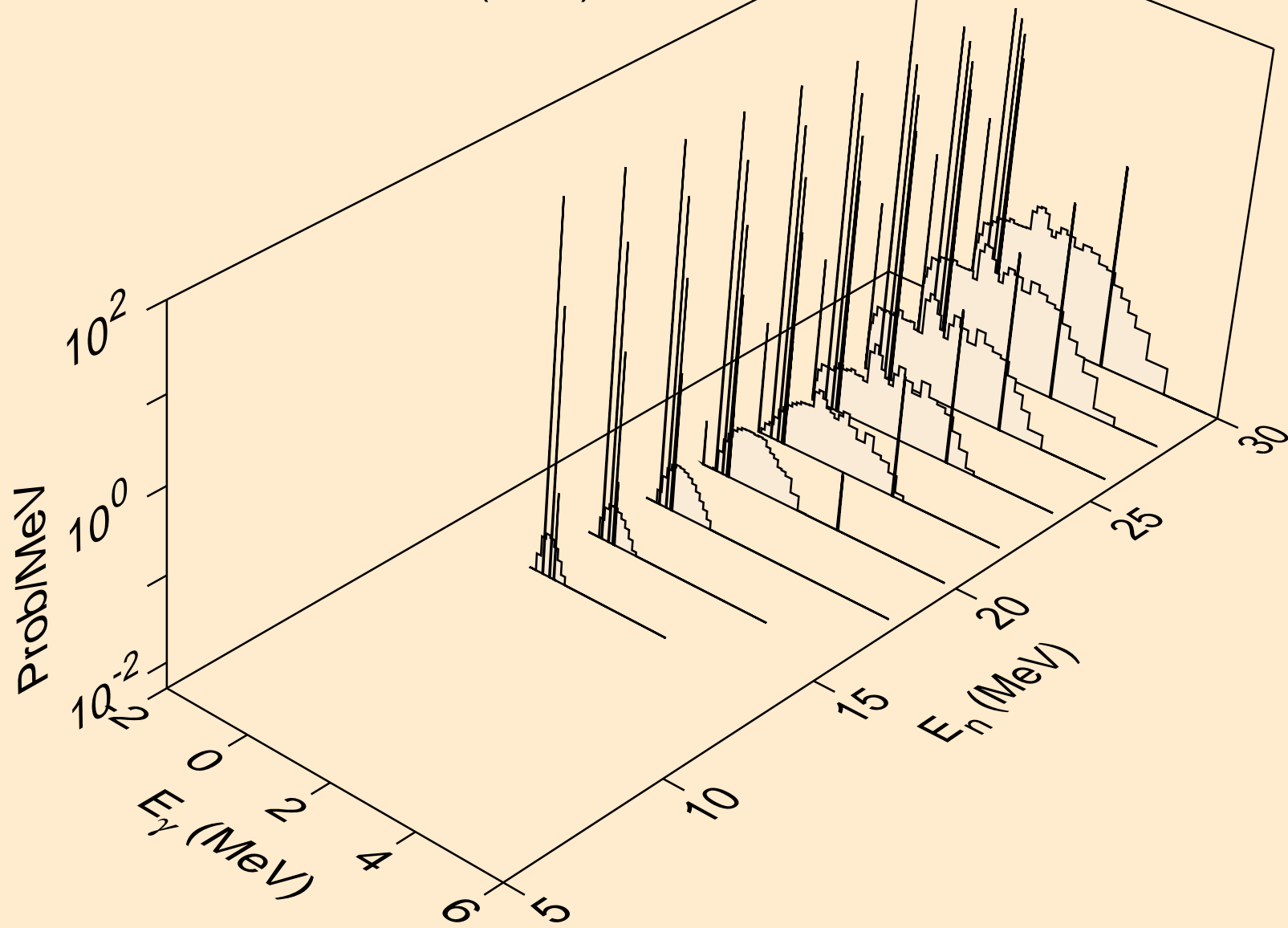

ER147M NEUTRON ACER TENDL-2021 LIBRARY; T=293.6K
Photon emission for (n,n*)p

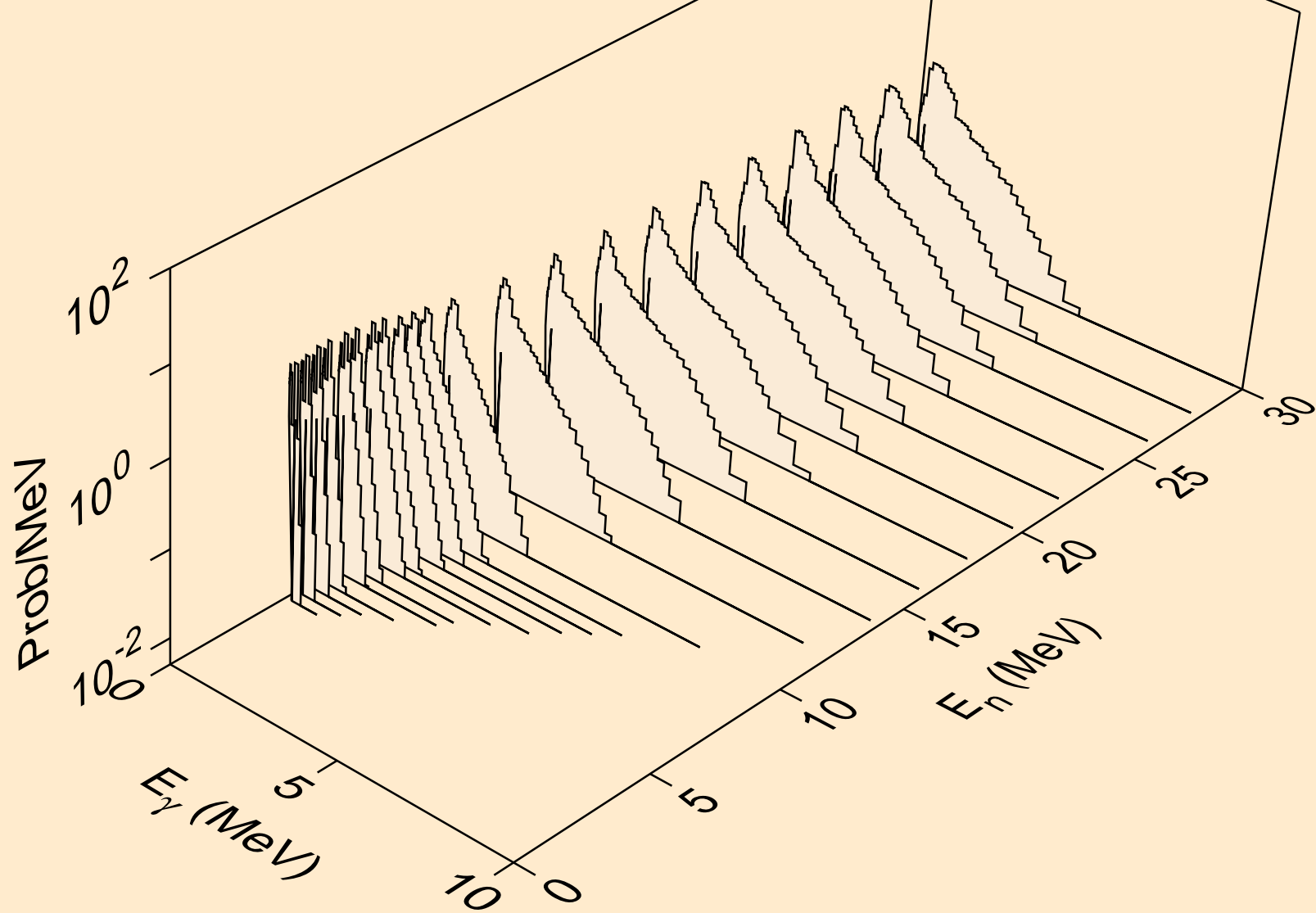

ER147M NEUTRON ACER TENDL-2021 LIBRARY; T=293.6K
Photon emission for (n,n*)2a

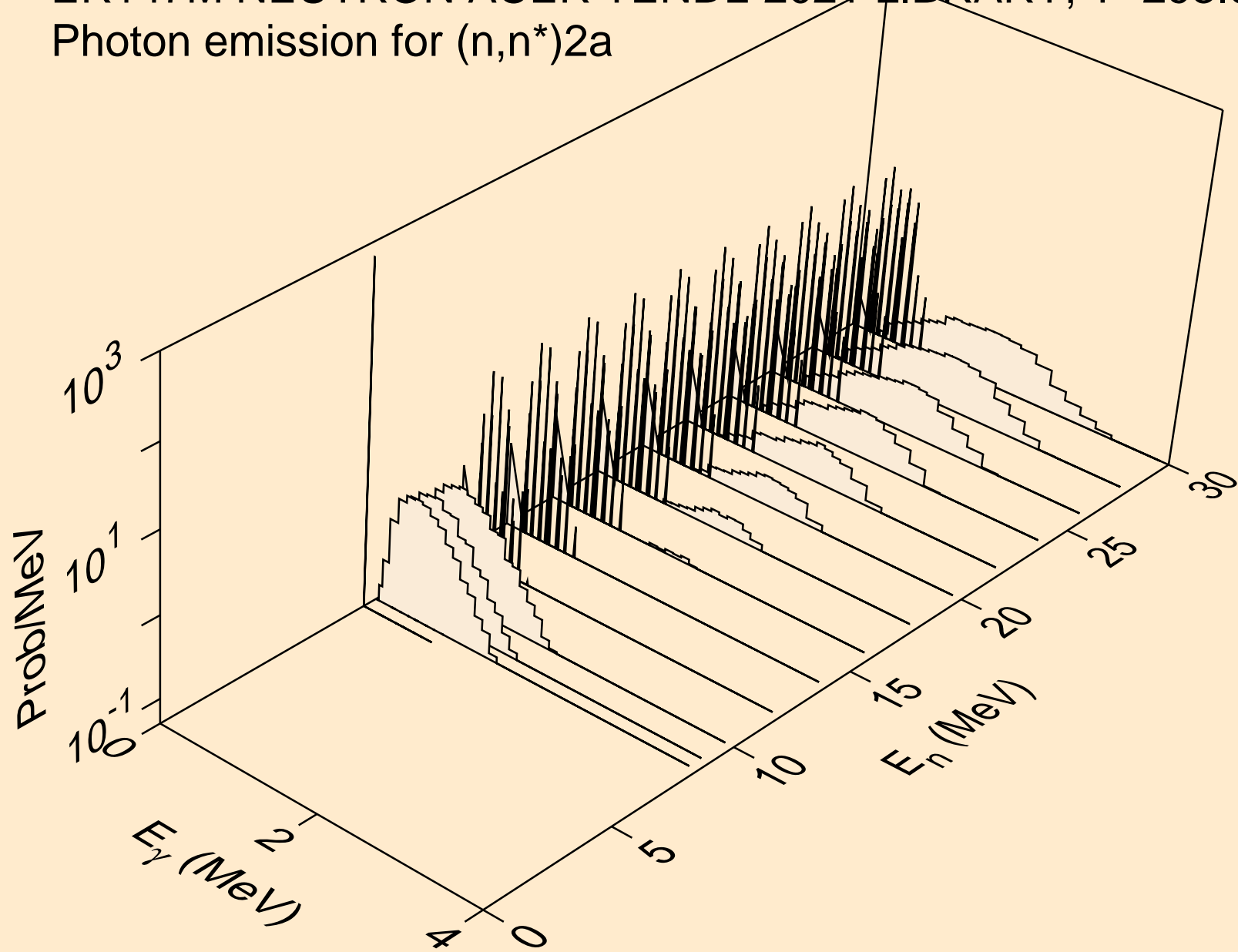

ER147M NEUTRON ACER TENDL-2021 LIBRARY; T=293.6K
Photon emission for (n,2n)2a

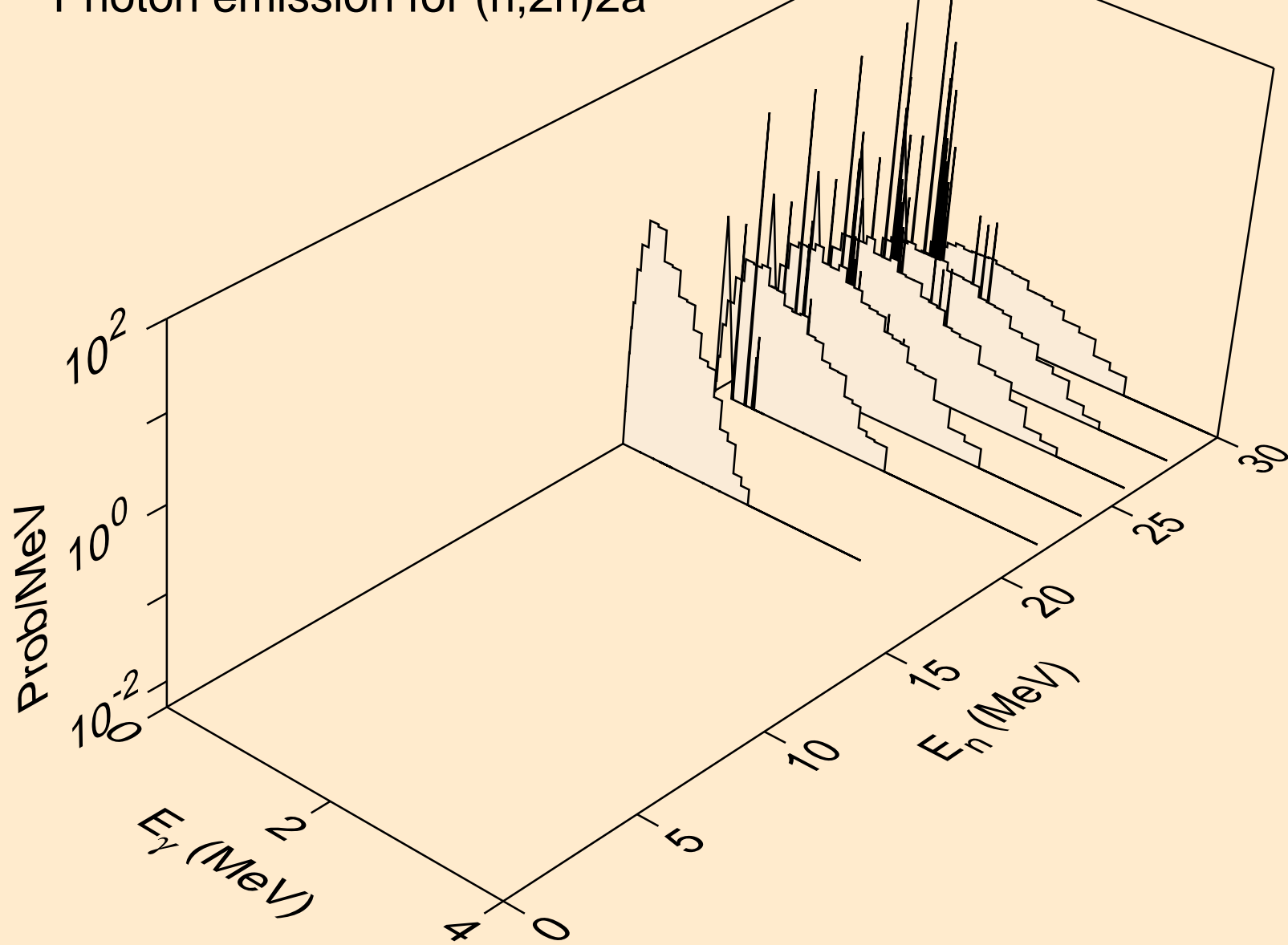

ER147M NEUTRON ACER TENDL-2021 LIBRARY; T=293.6K
Photon emission for (n,n*)d

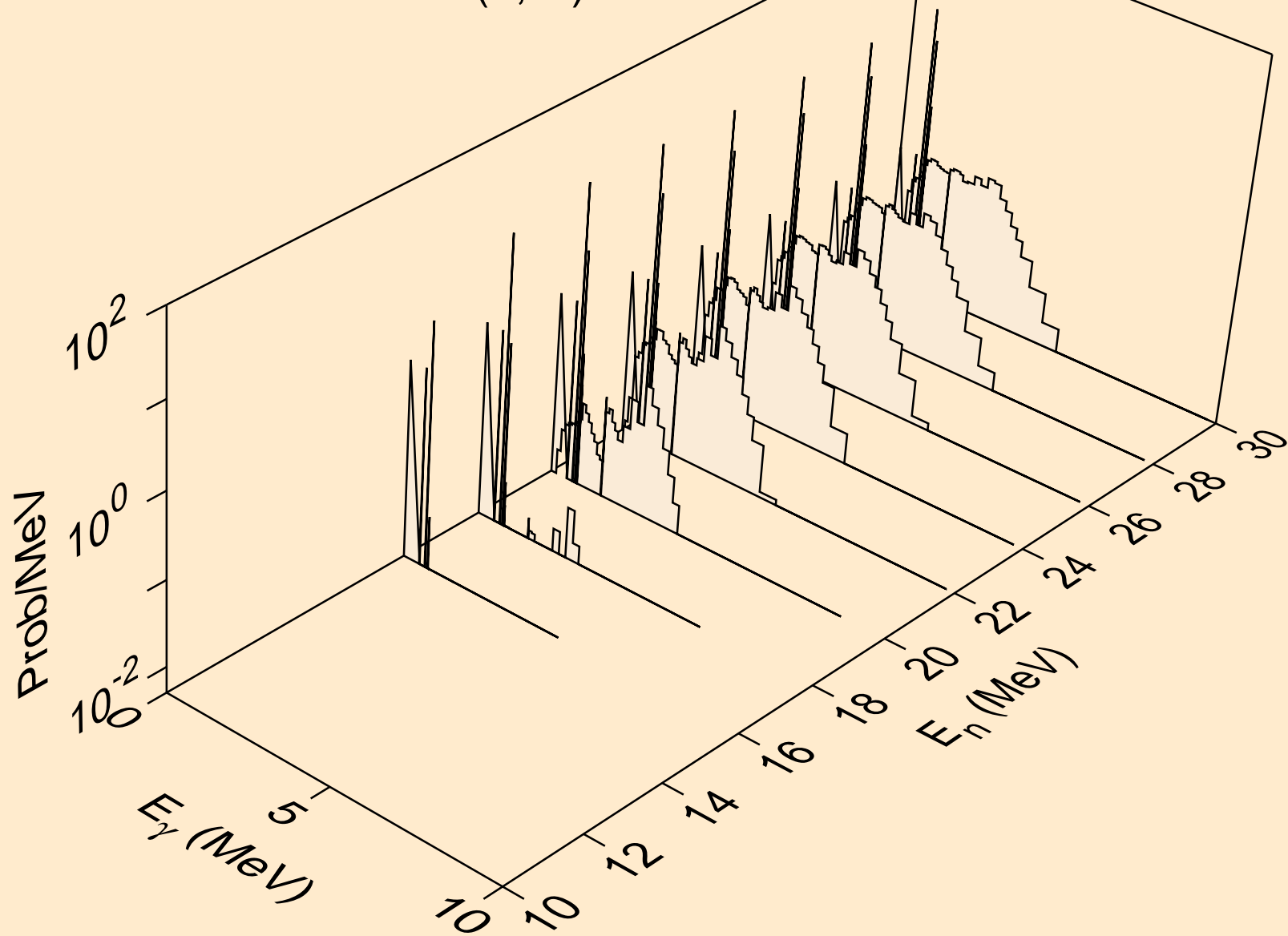

ER147M NEUTRON ACER TENDL-2021 LIBRARY; T=293.6K
Photon emission for (n,n*)t

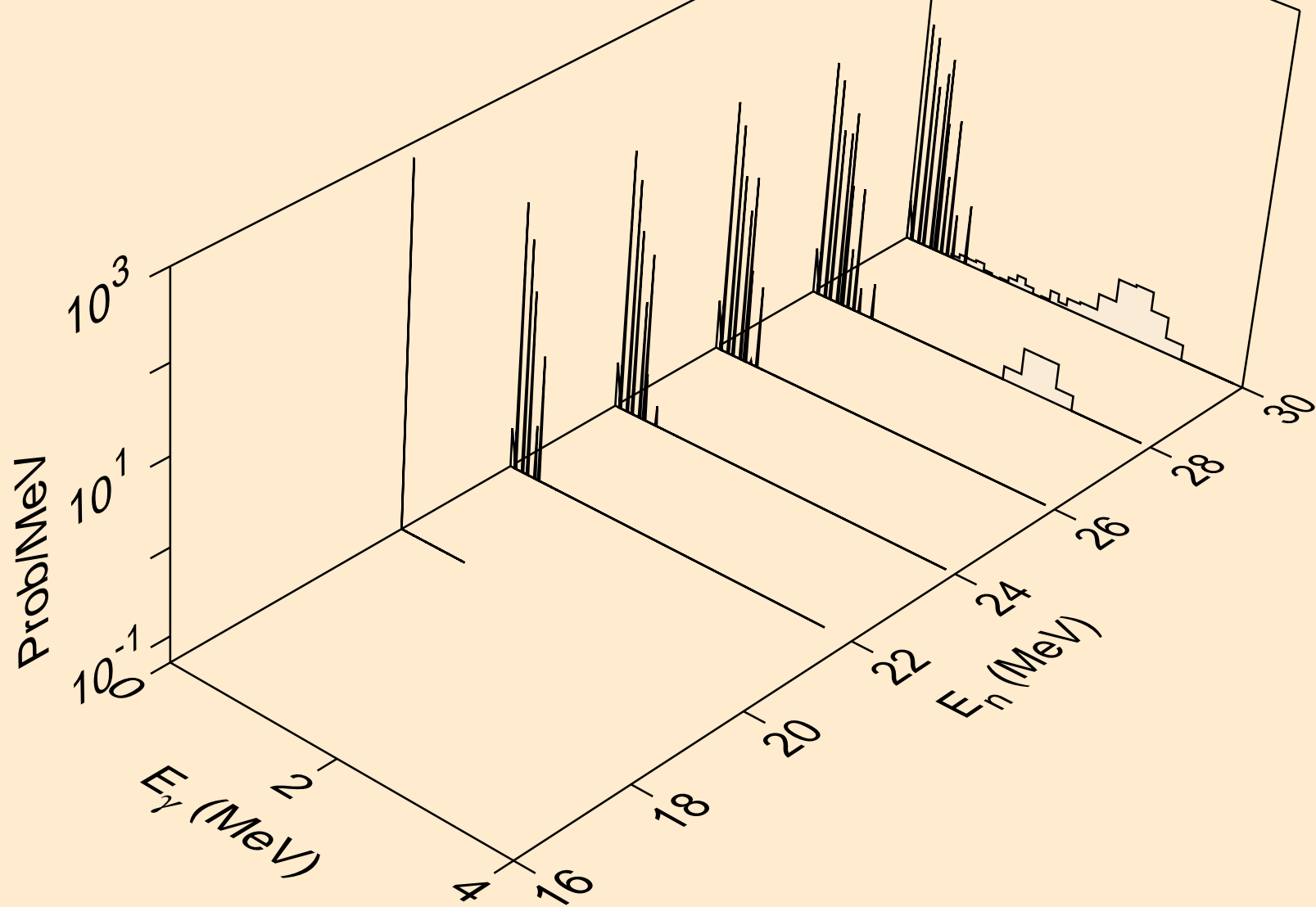

ER147M NEUTRON ACER TENDL-2021 LIBRARY; T=293.6K
Photon emission for (n,n*)he3

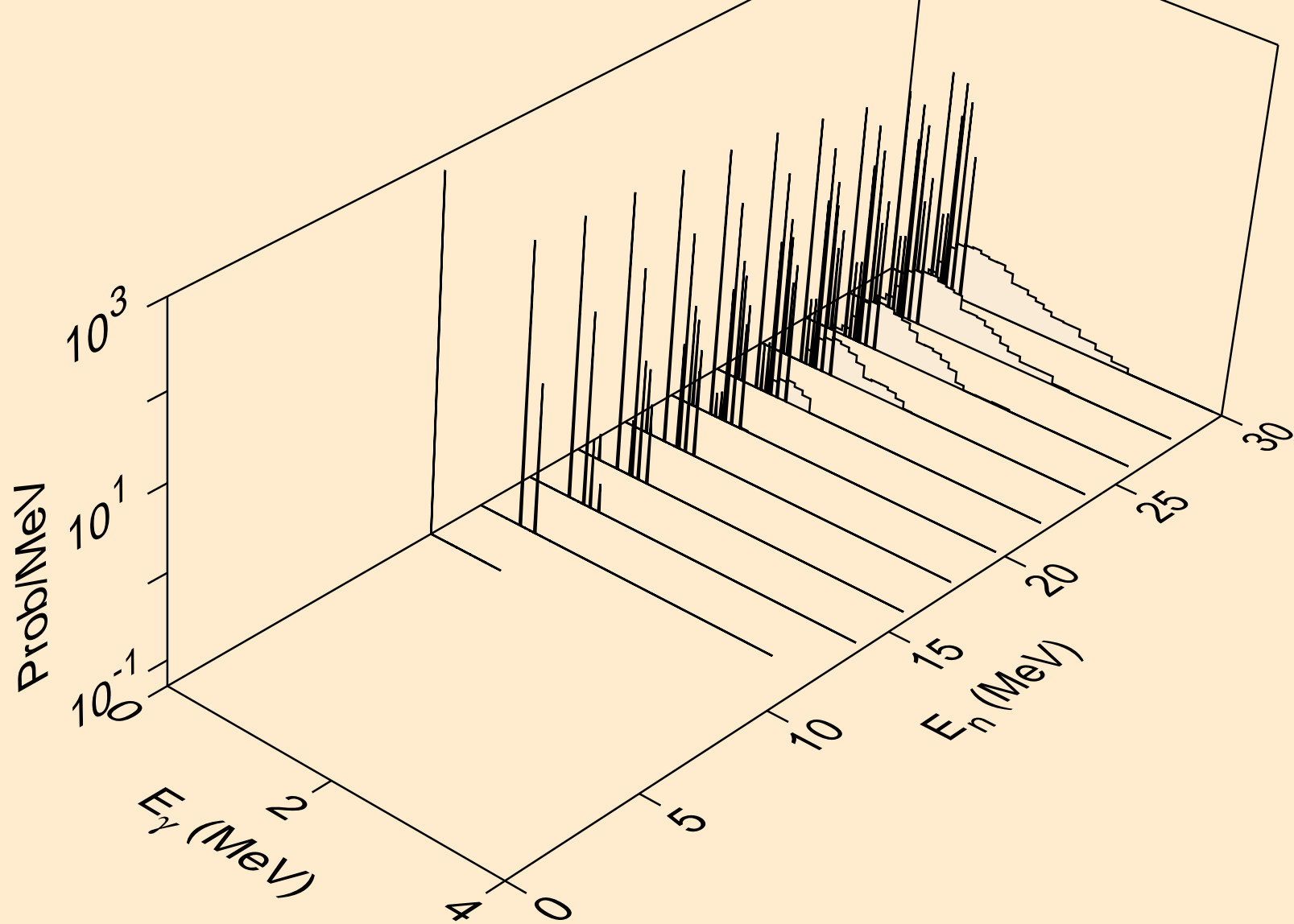

ER147M NEUTRON ACER TENDL-2021 LIBRARY; T=293.6K
Photon emission for (n,2np)

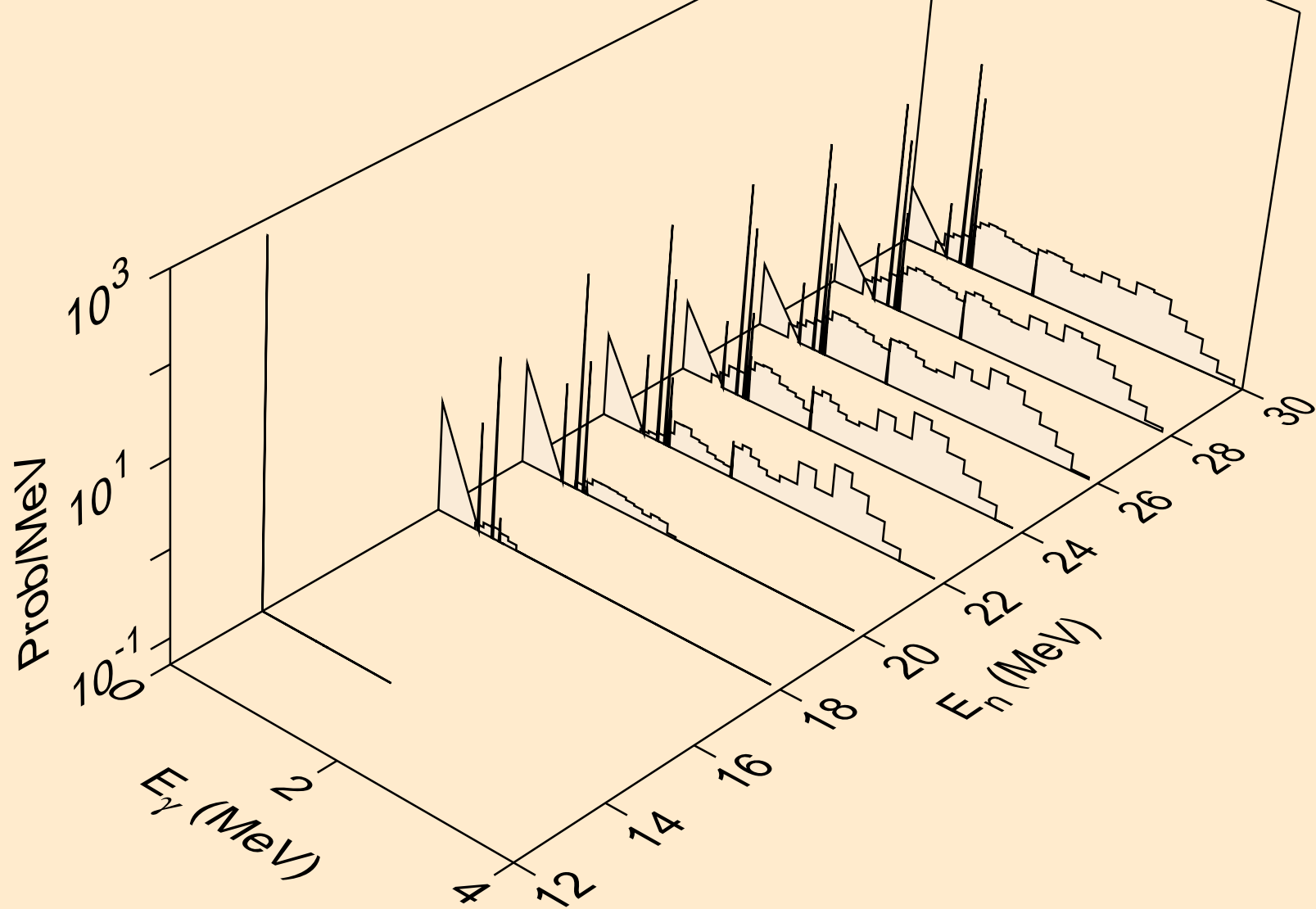

ER147M NEUTRON ACER TENDL-2021 LIBRARY; T=293.6K
Photon emission for (n,3np)

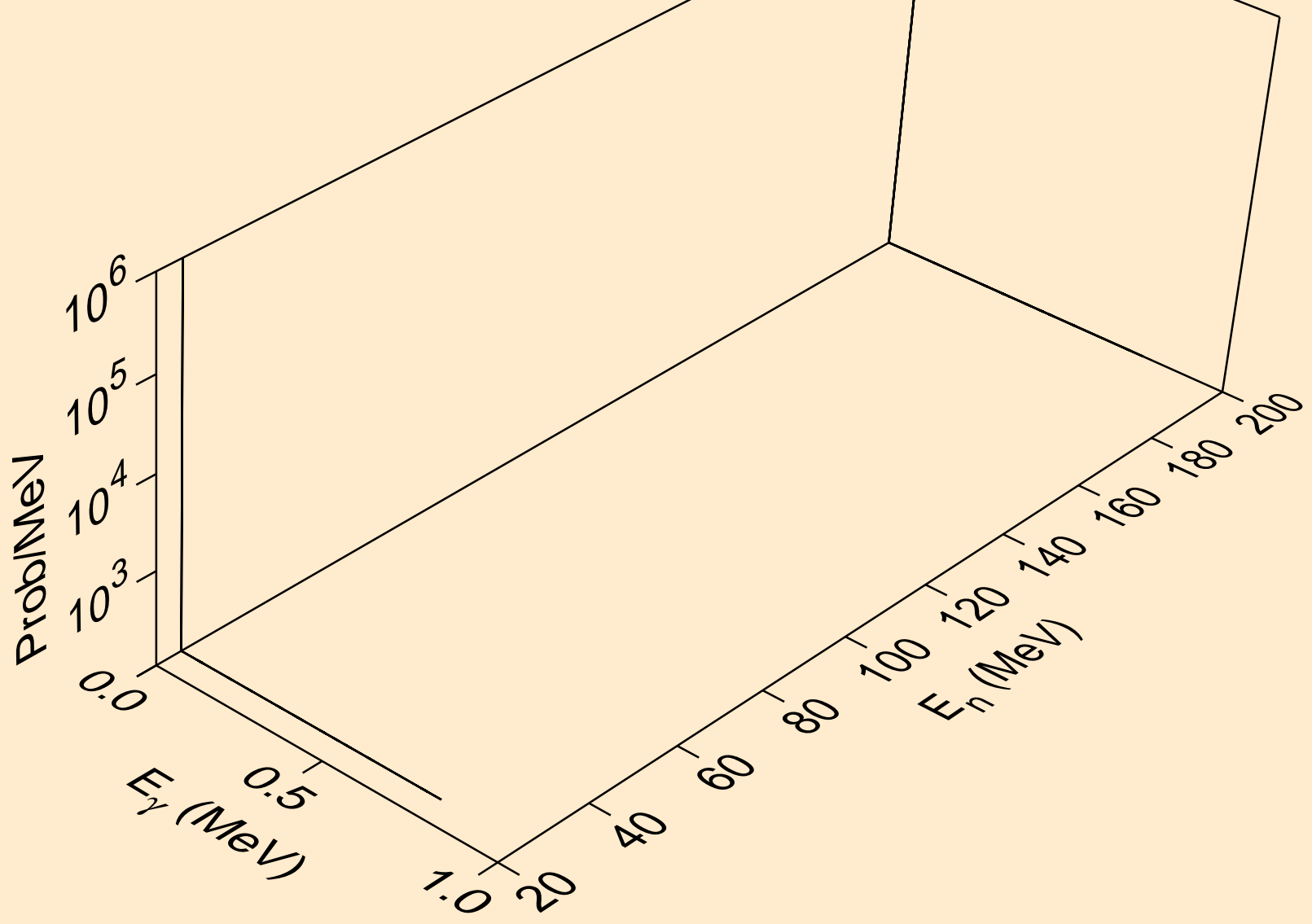

ER147M NEUTRON ACER TENDL-2021 LIBRARY; T=293.6K
Photon emission for (n,2np)

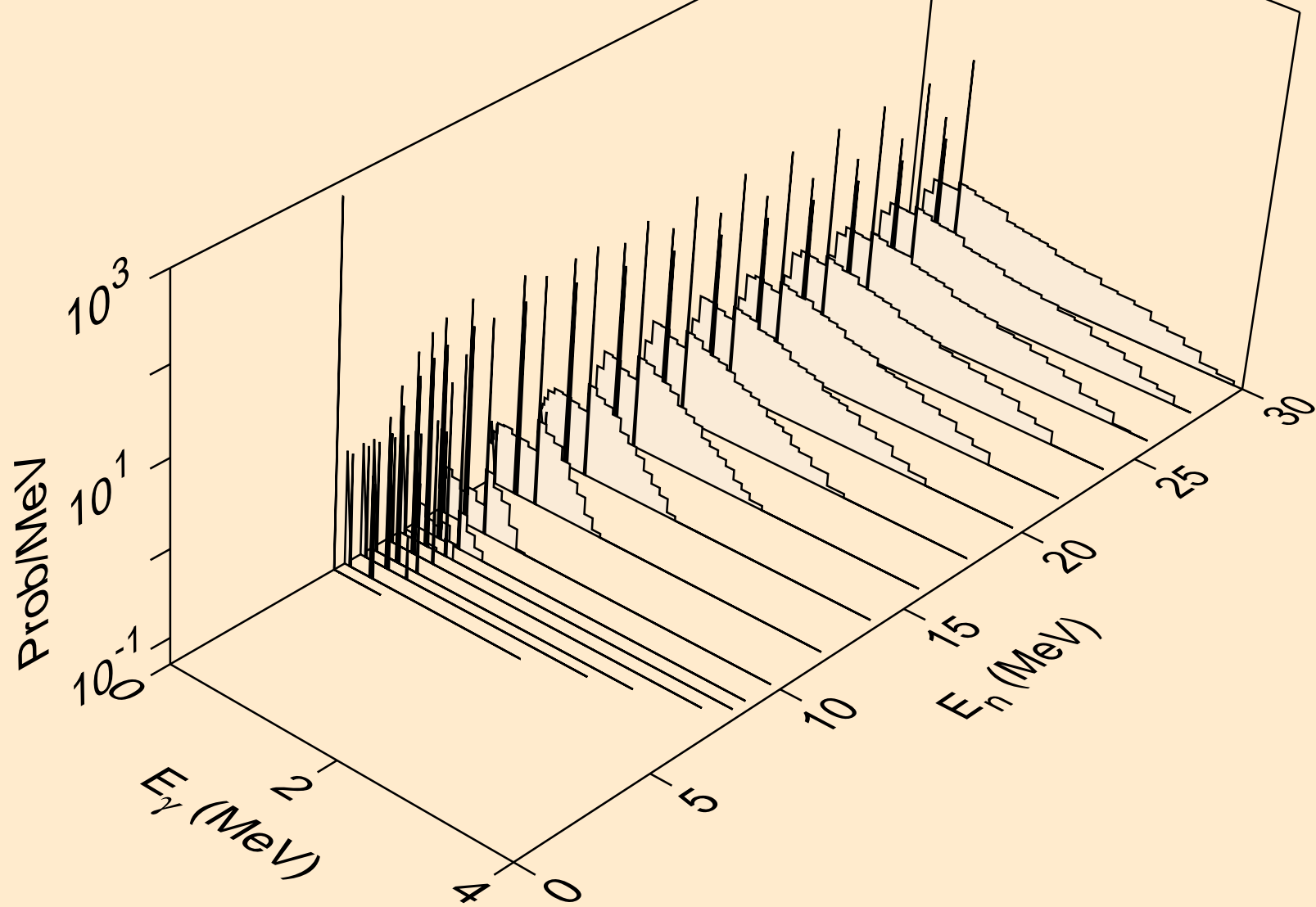

ER147M NEUTRON ACER TENDL-2021 LIBRARY; T=293.6K
Photon emission for (n,npa)

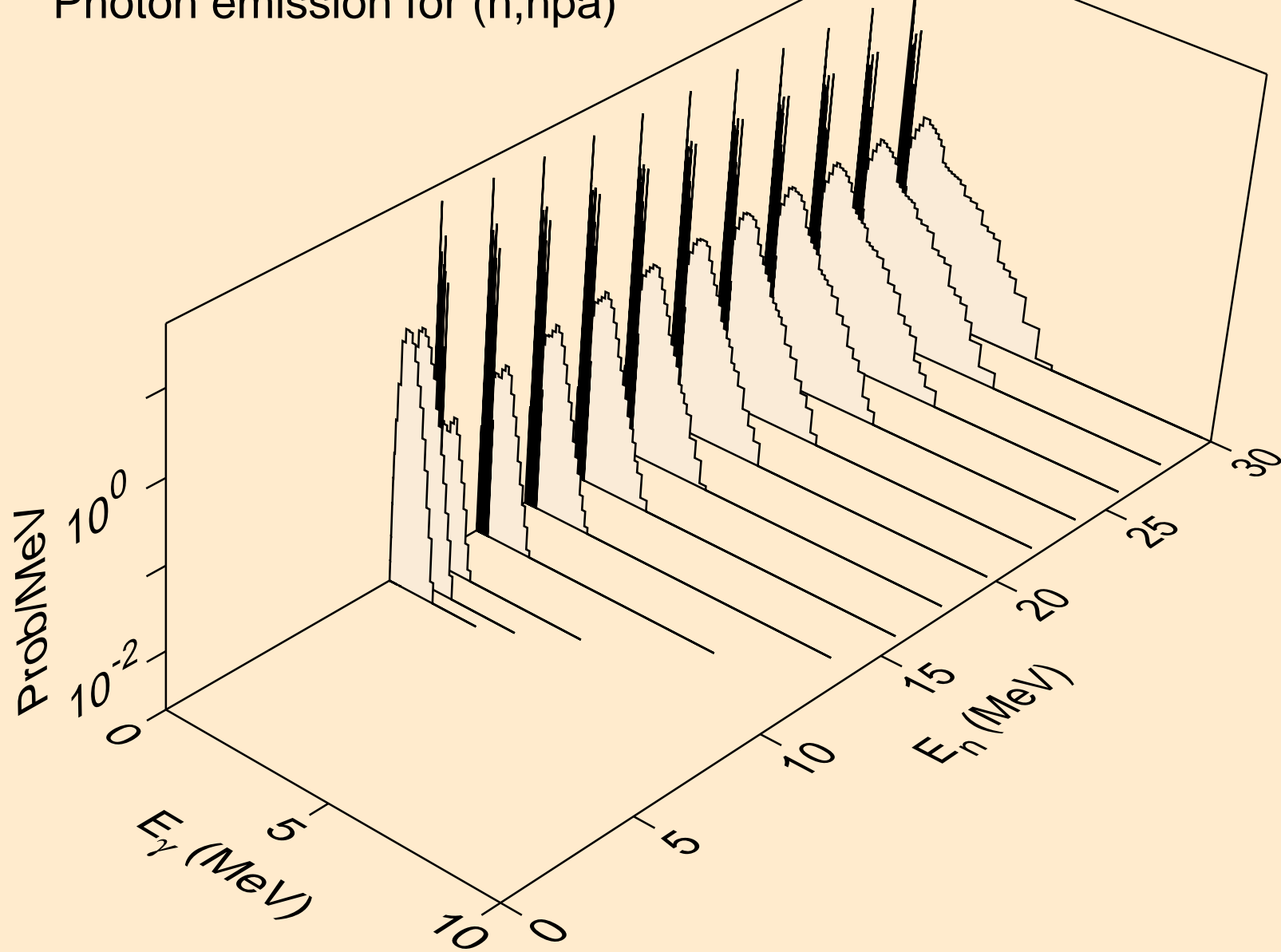

ER147M NEUTRON ACER TENDL-2021 LIBRARY; T=293.6K
Photon emission for (n,n*1)

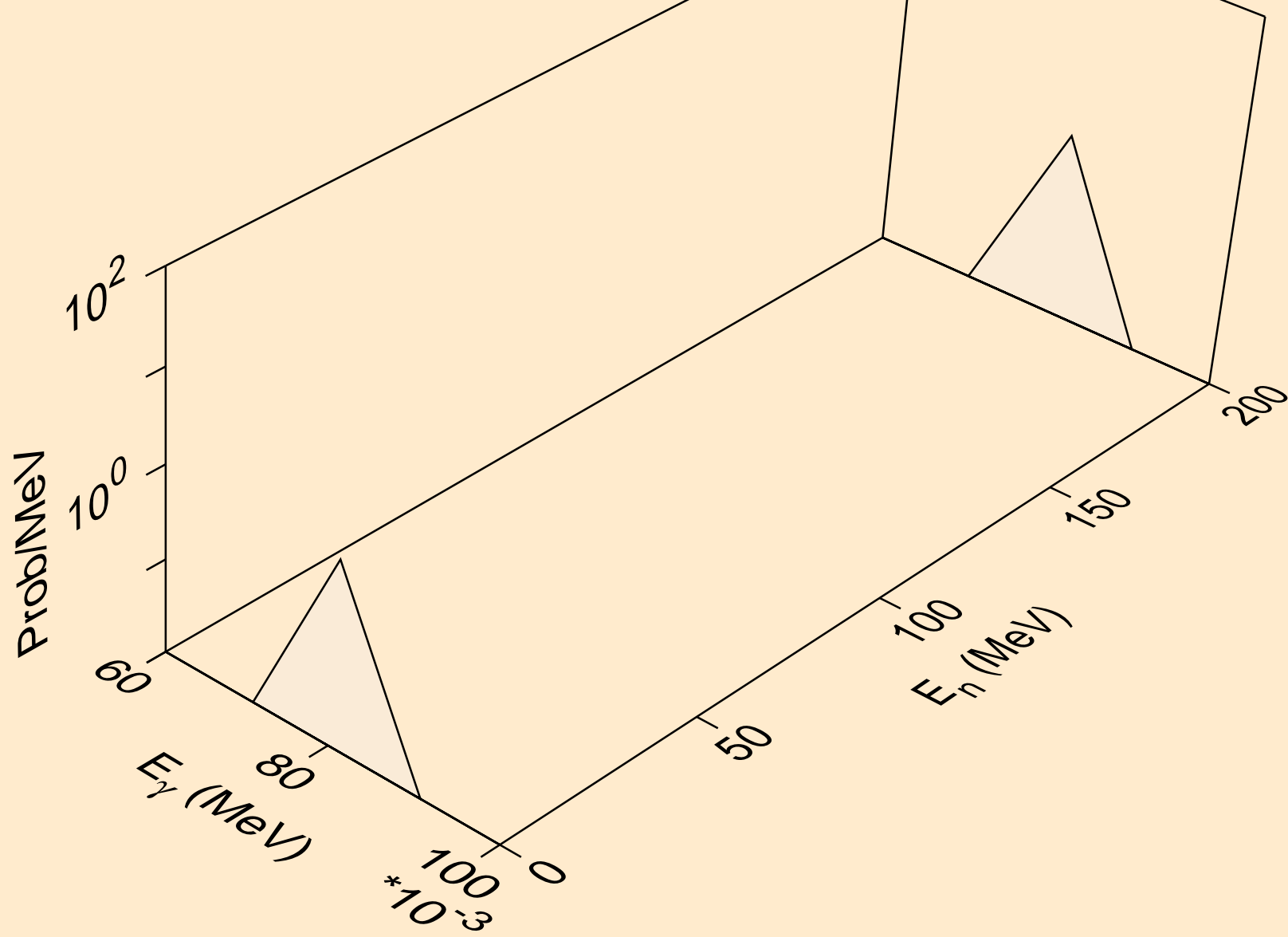

ER147M NEUTRON ACER TENDL-2021 LIBRARY; T=293.6K
Photon emission for (n,n*c)

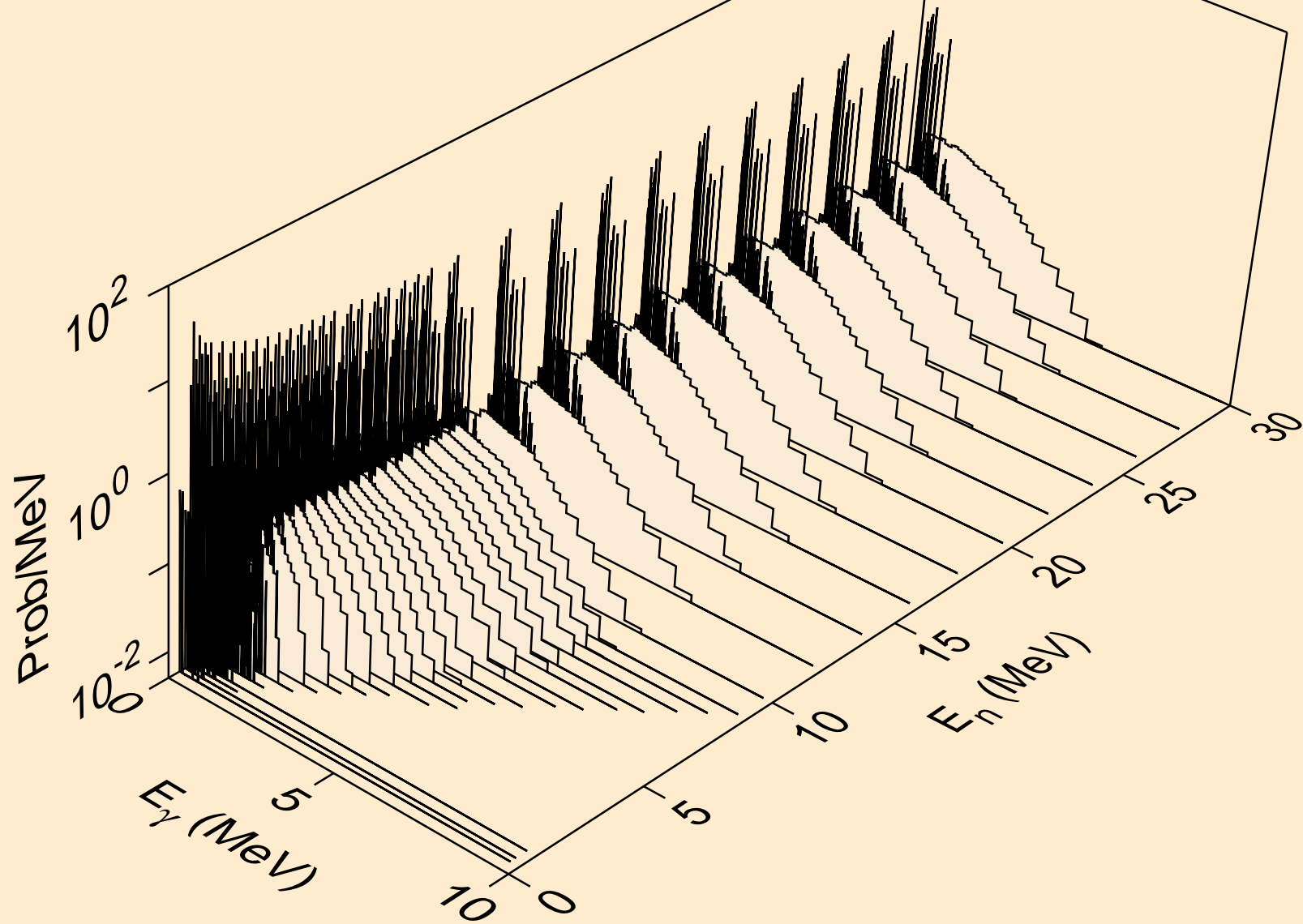

ER147M NEUTRON ACER TENDL-2021 LIBRARY; T=293.6K
Photon emission for (n,gma)

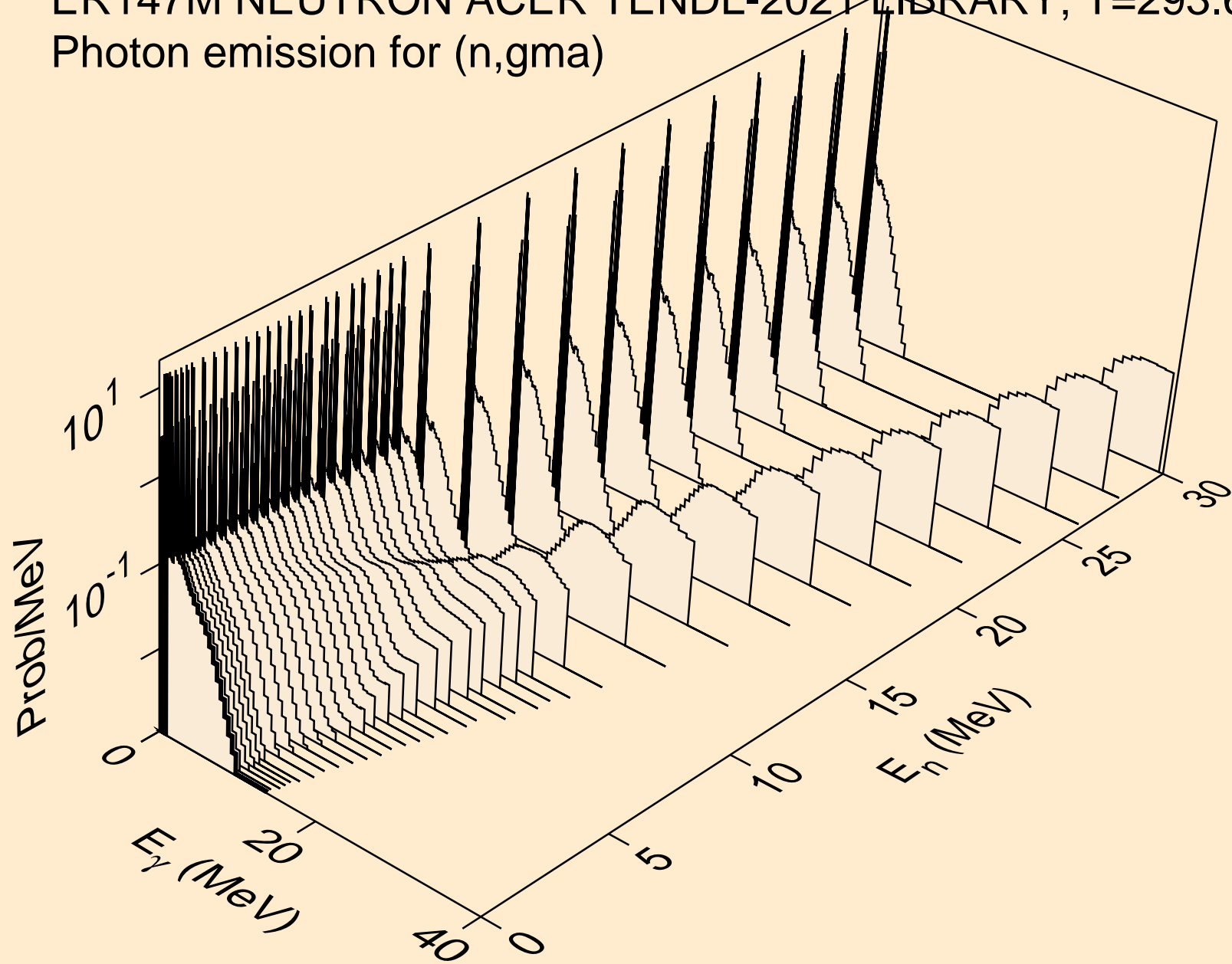

ER147M NEUTRON ACER TENDL-2021 LIBRARY; T=293.6K
Photon emission for (n,p)

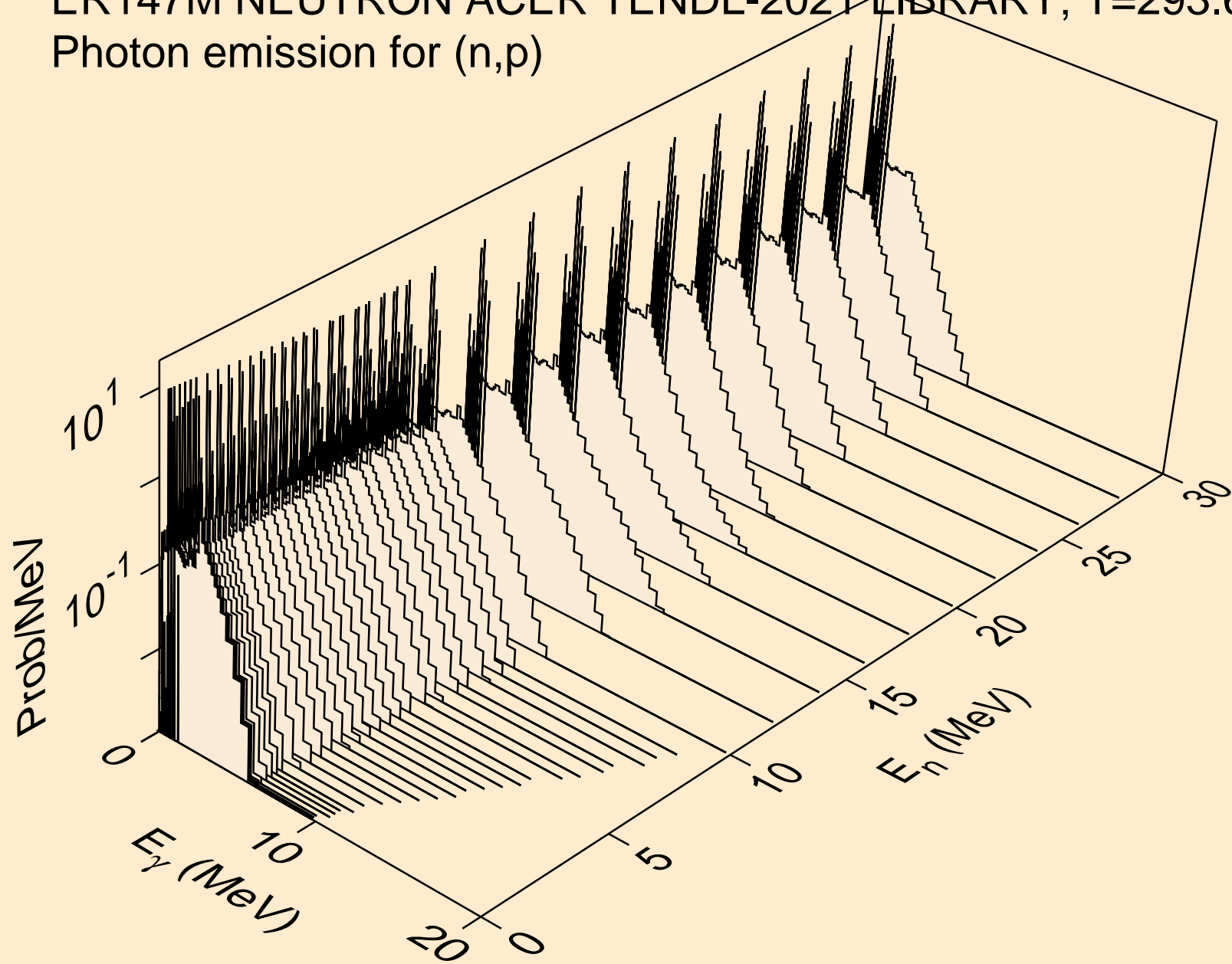

ER147M NEUTRON ACER TENDL-2021 LIBRARY; T=293.6K
Photon emission for (n,d)

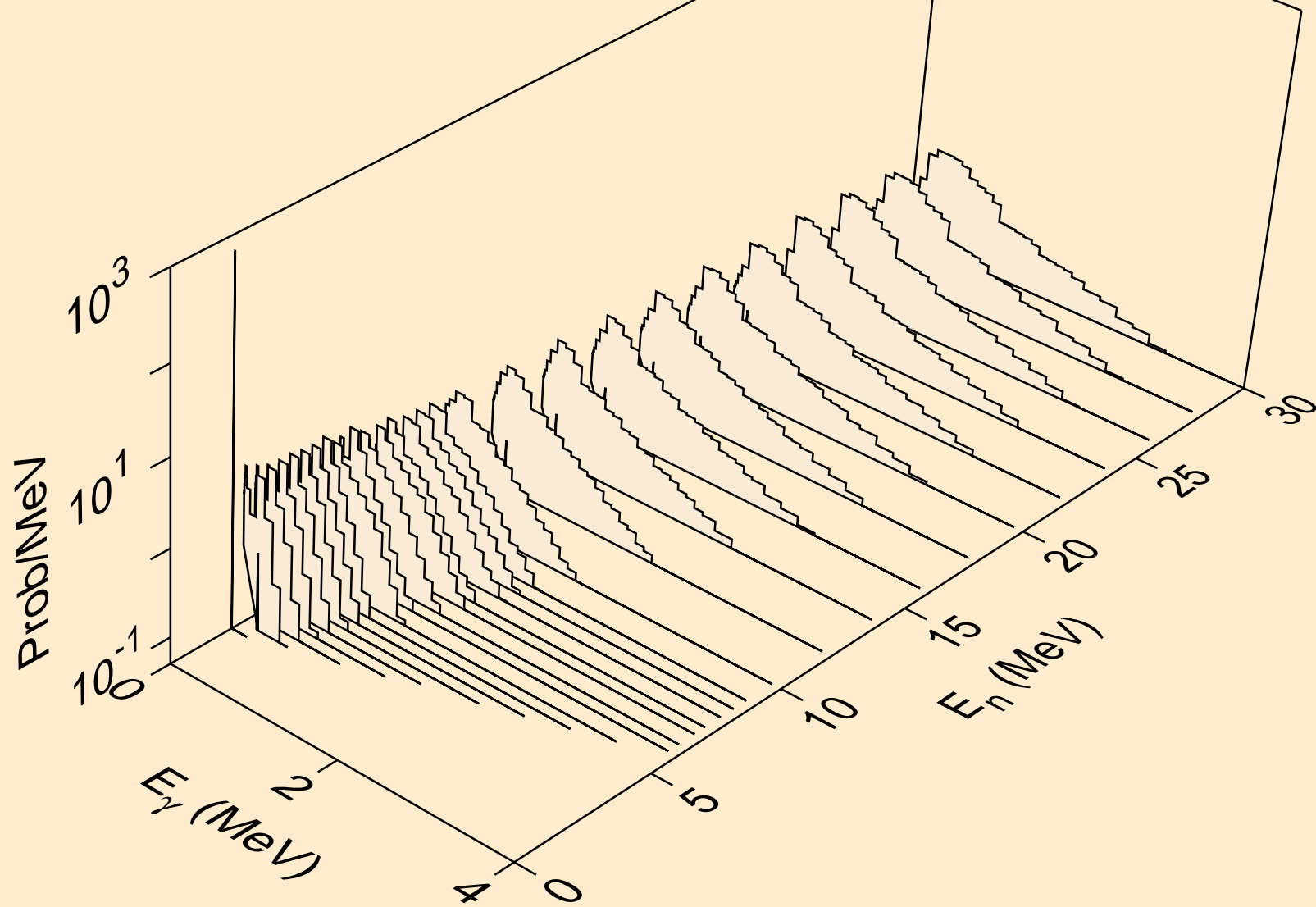

ER147M NEUTRON ACER TENDL-2021 LIBRARY; T=293.6K
Photon emission for (n,t)

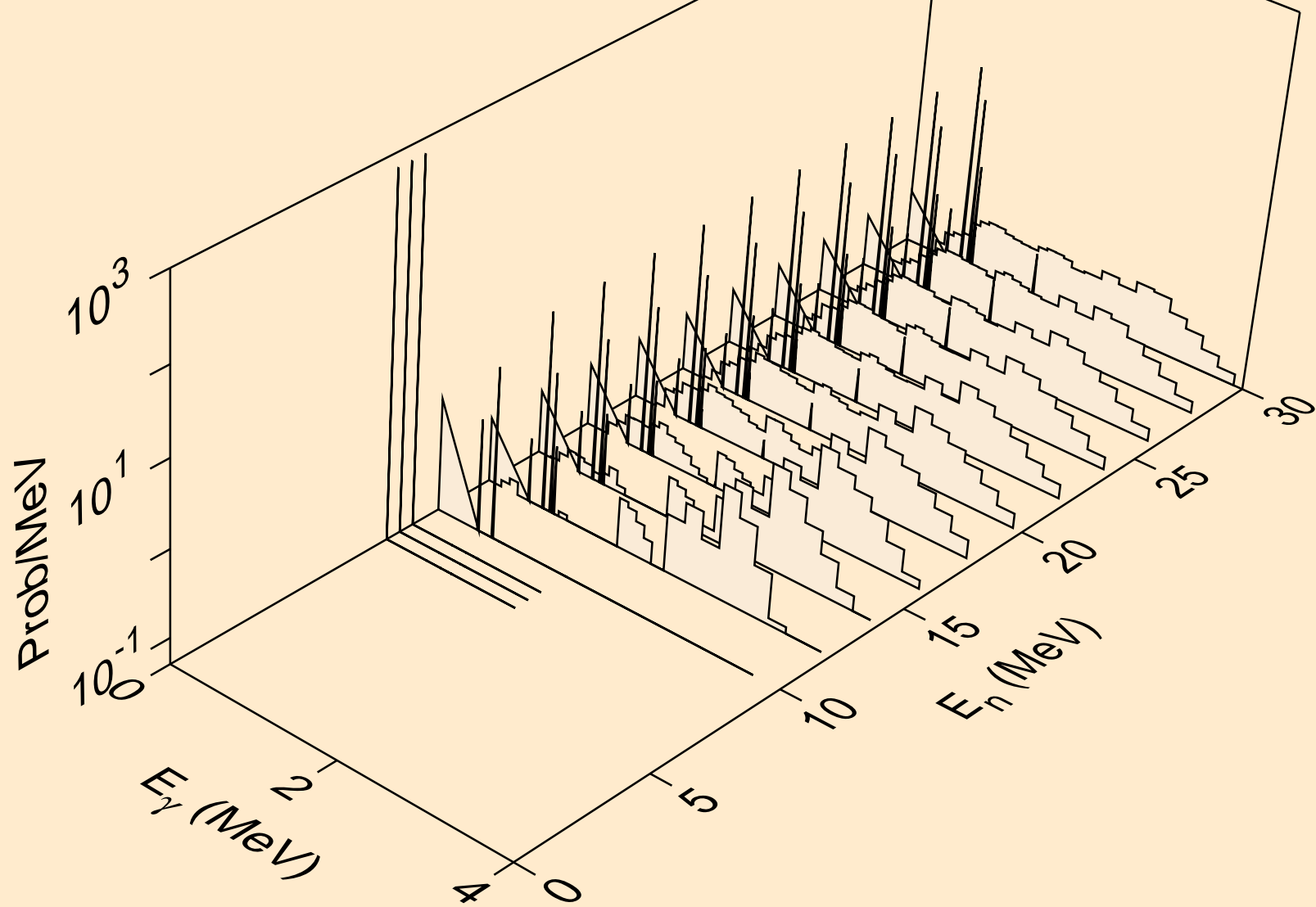

ER147M NEUTRON ACER TENDL-2021 LIBRARY; T=293.6K
Photon emission for (n,he3)

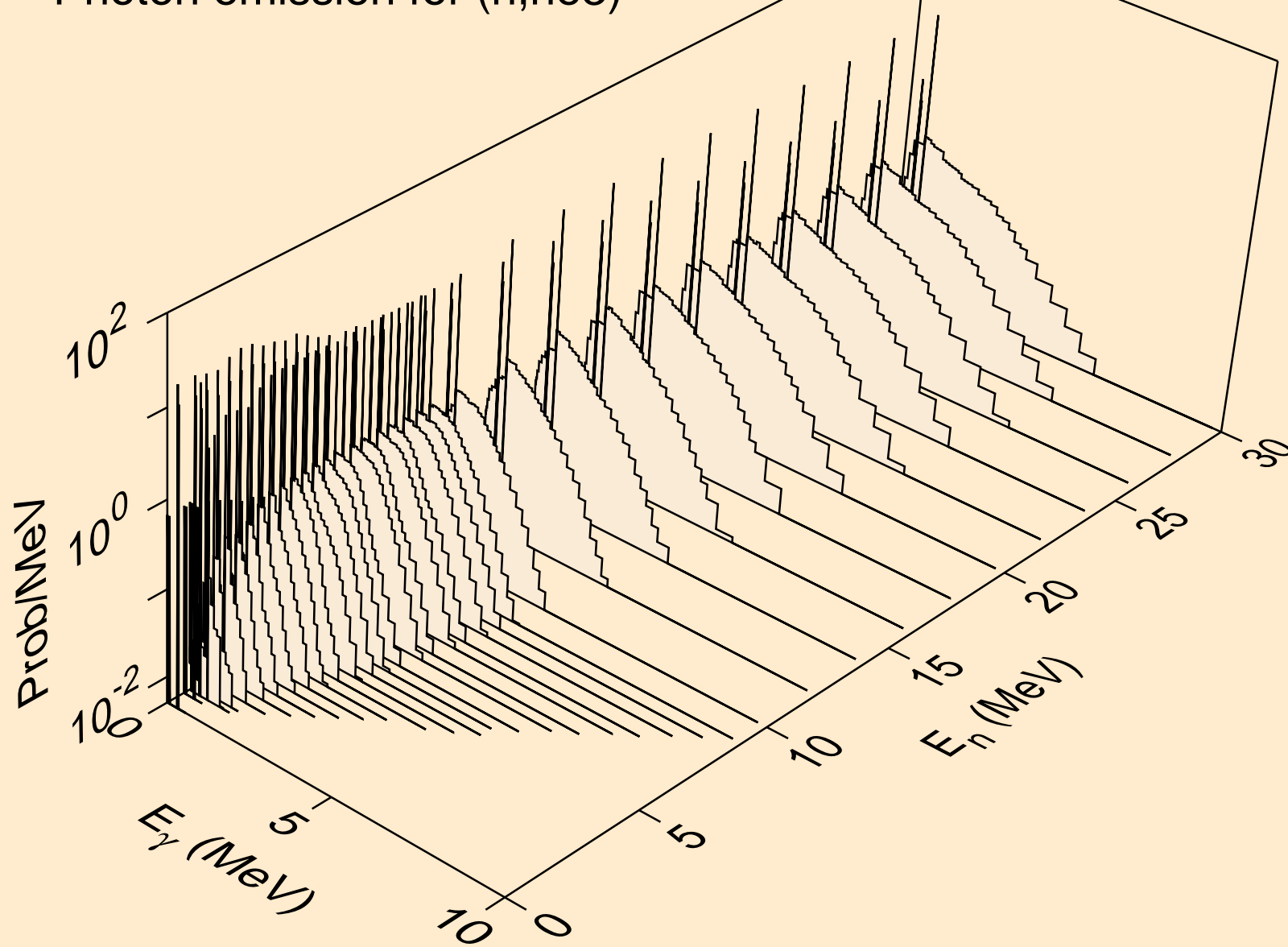

ER147M NEUTRON ACER TENDL-2021 LIBRARY; T=293.6K
Photon emission for (n,a)

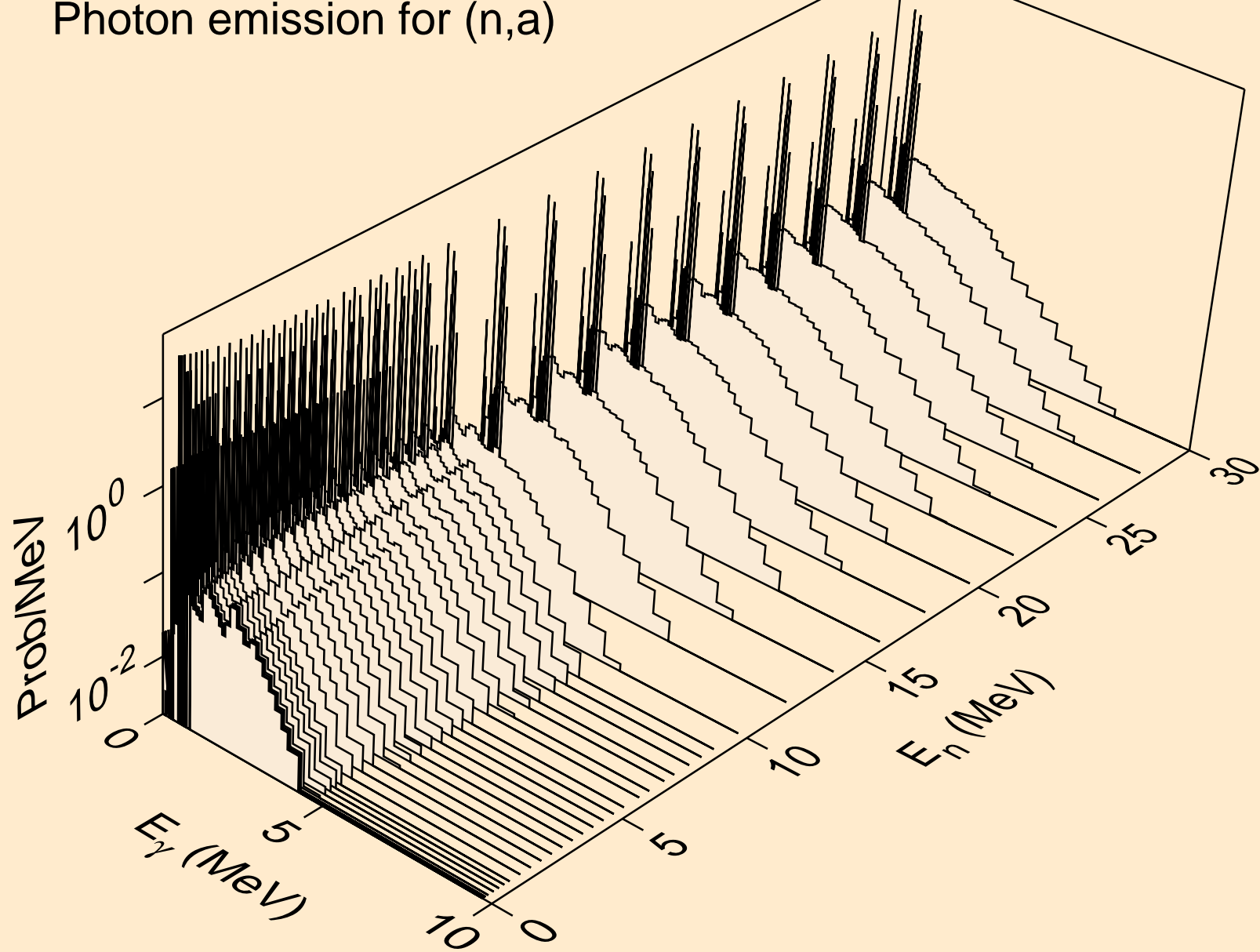

ER147M NEUTRON ACER TENDL-2021 LIBRARY; T=293.6K
Photon emission for (n,2a)

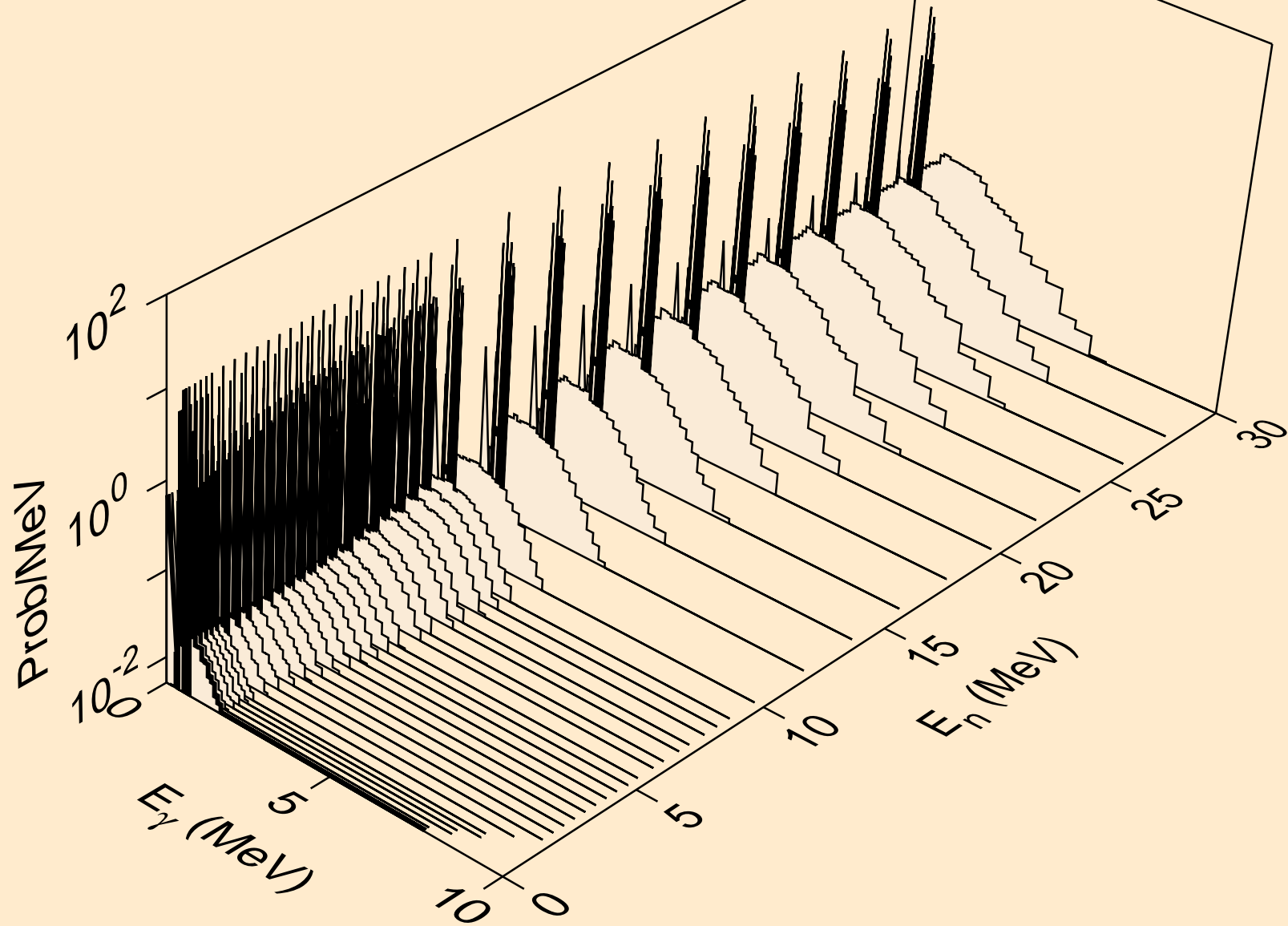

ER147M NEUTRON ACER TENDL-2021 LIBRARY; T=293.6K
Photon emission for (n,3a)

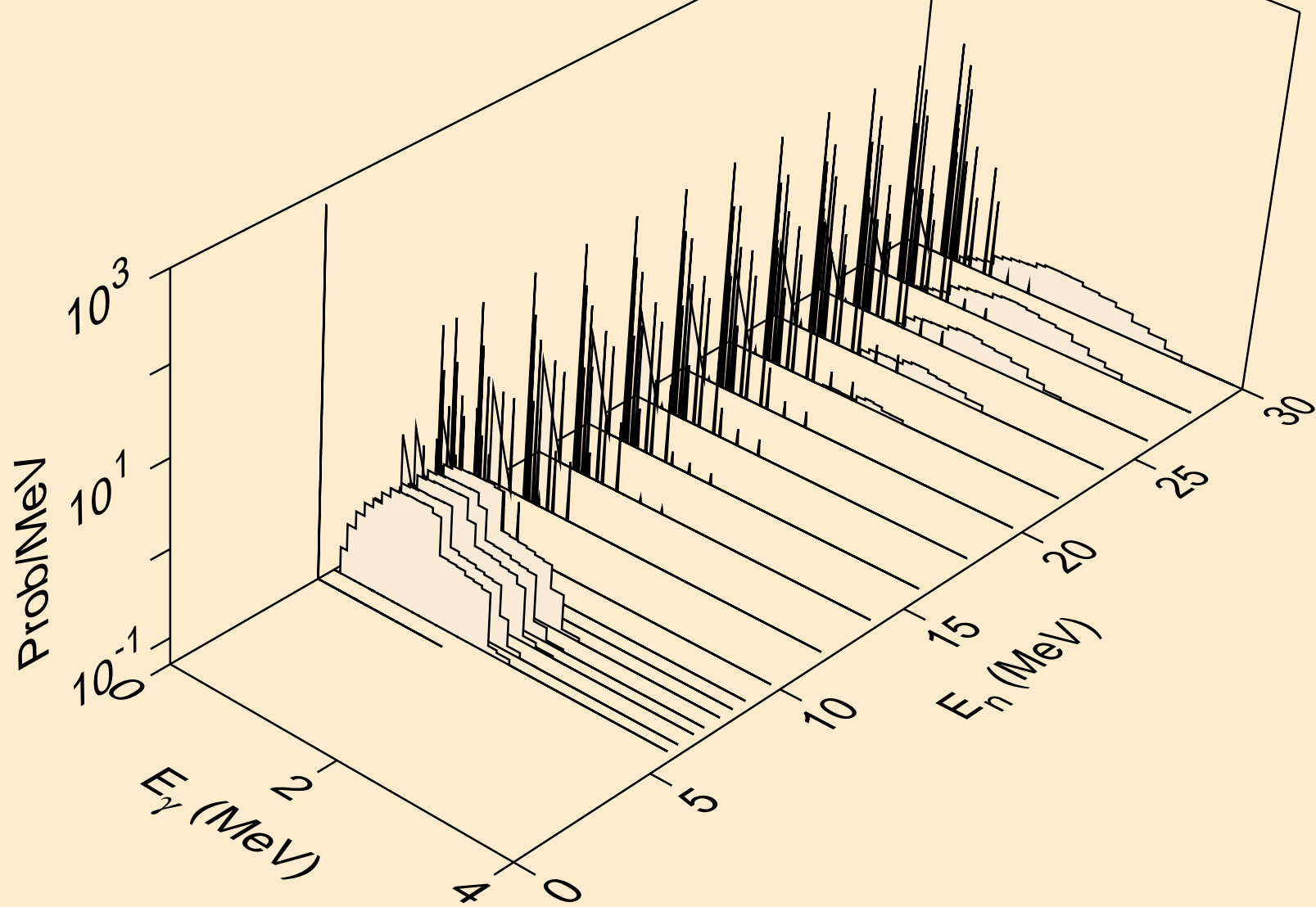

ER147M NEUTRON ACER TENDL-2021 LIBRARY; T=293.6K
Photon emission for (n,2p)

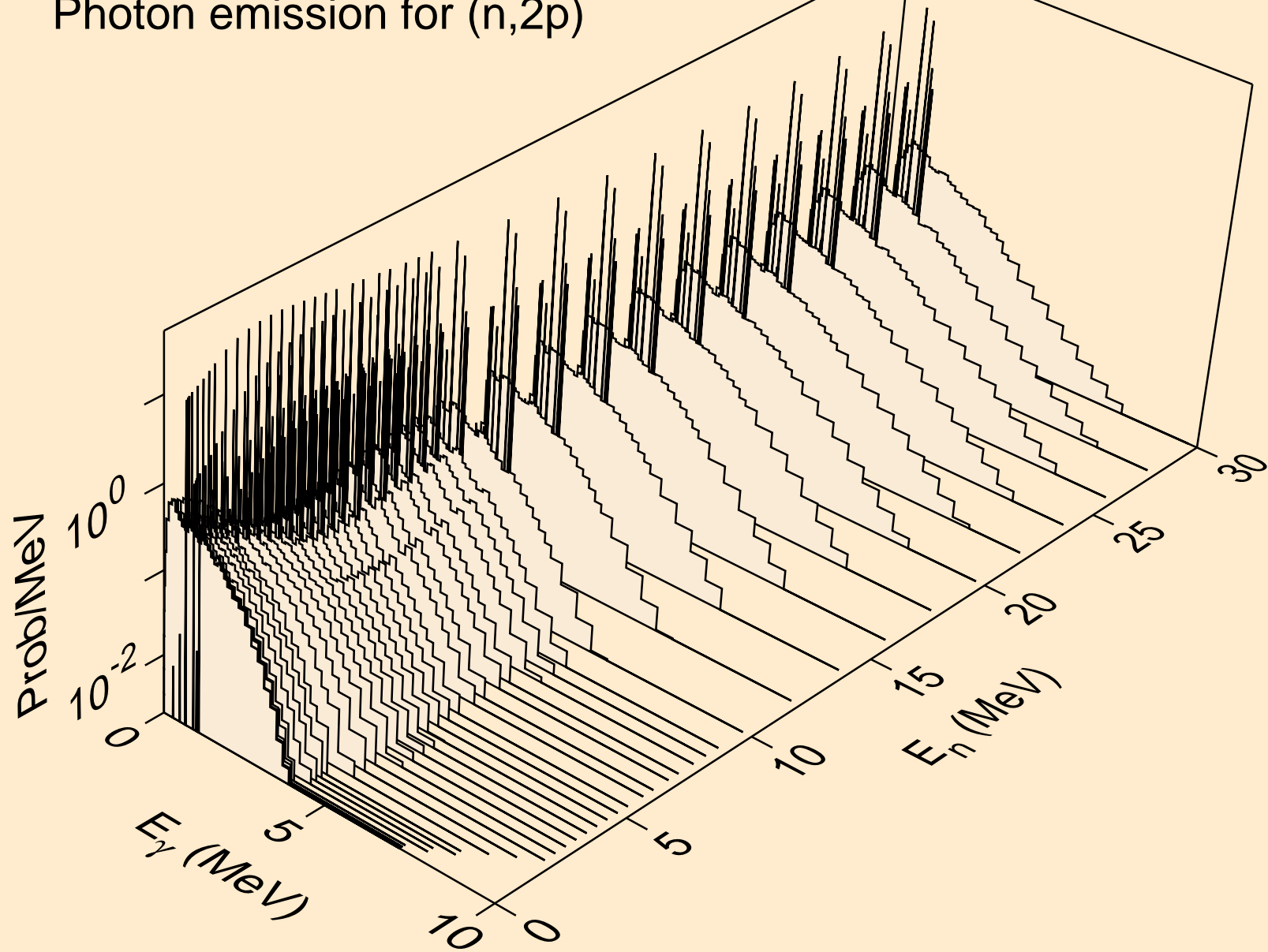

ER147M NEUTRON ACER TENDL-2021 LIBRARY; T=293.6K
Photon emission for (n,p)

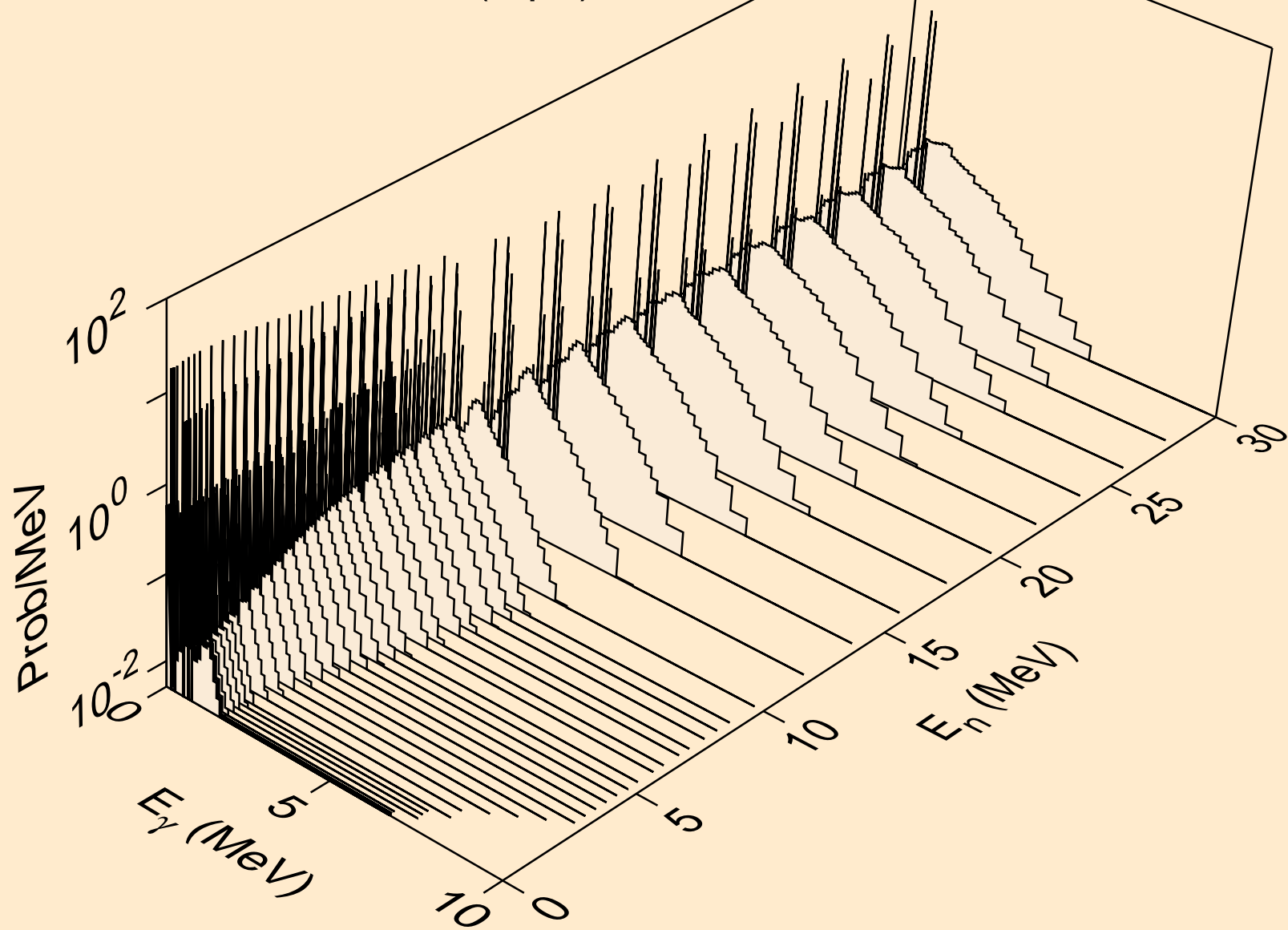

ER147M NEUTRON ACER TENDL-2021 LIBRARY; T=293.6K
Photon emission for (n,pd)

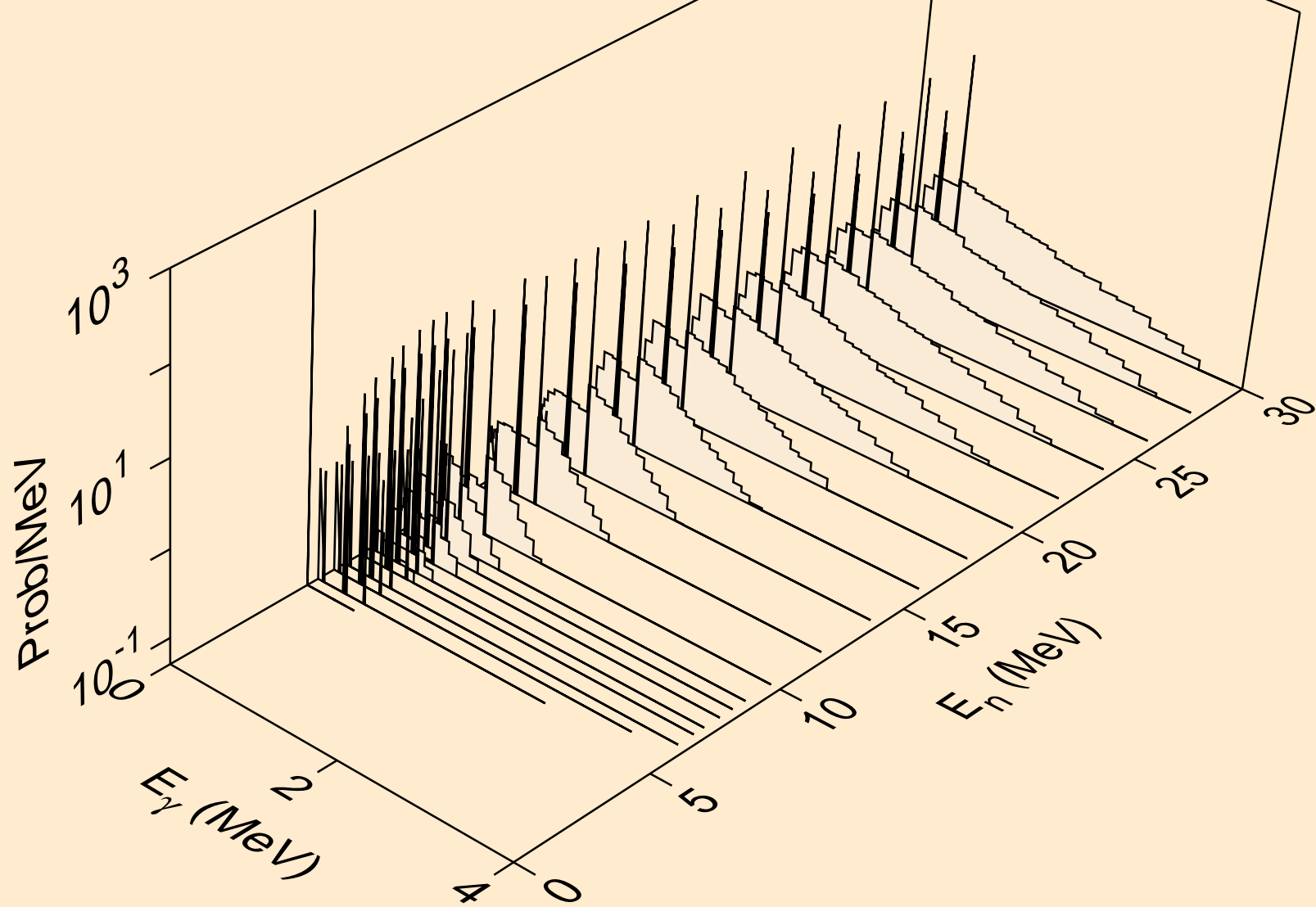

ER147M NEUTRON ACER TENDL-2021 LIBRARY; T=293.6K
Photon emission for (n,pt)

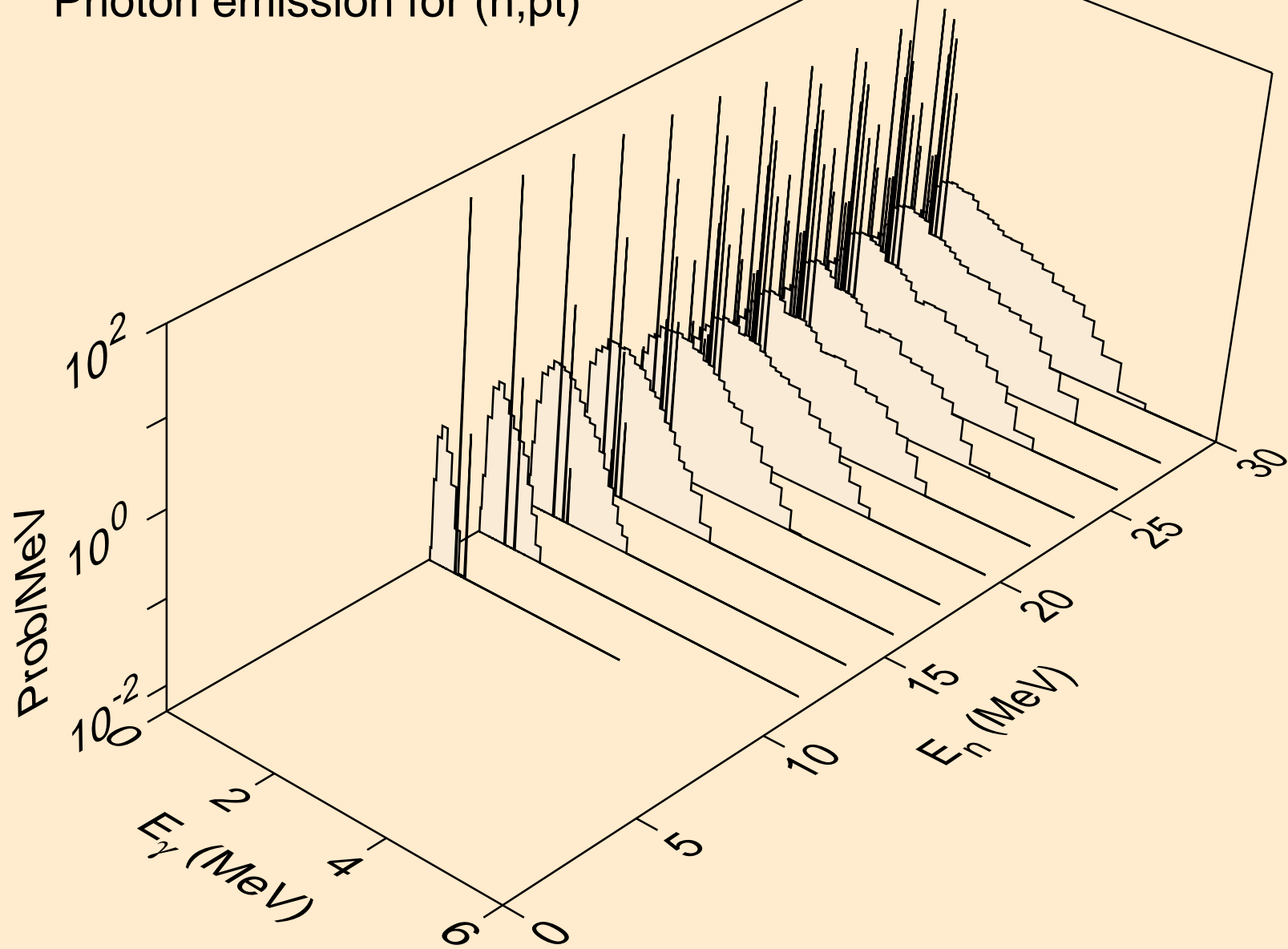

ER147M NEUTRON ACER TENDL-2021 LIBRARY; T=293.6K
Photon emission for (n,da)

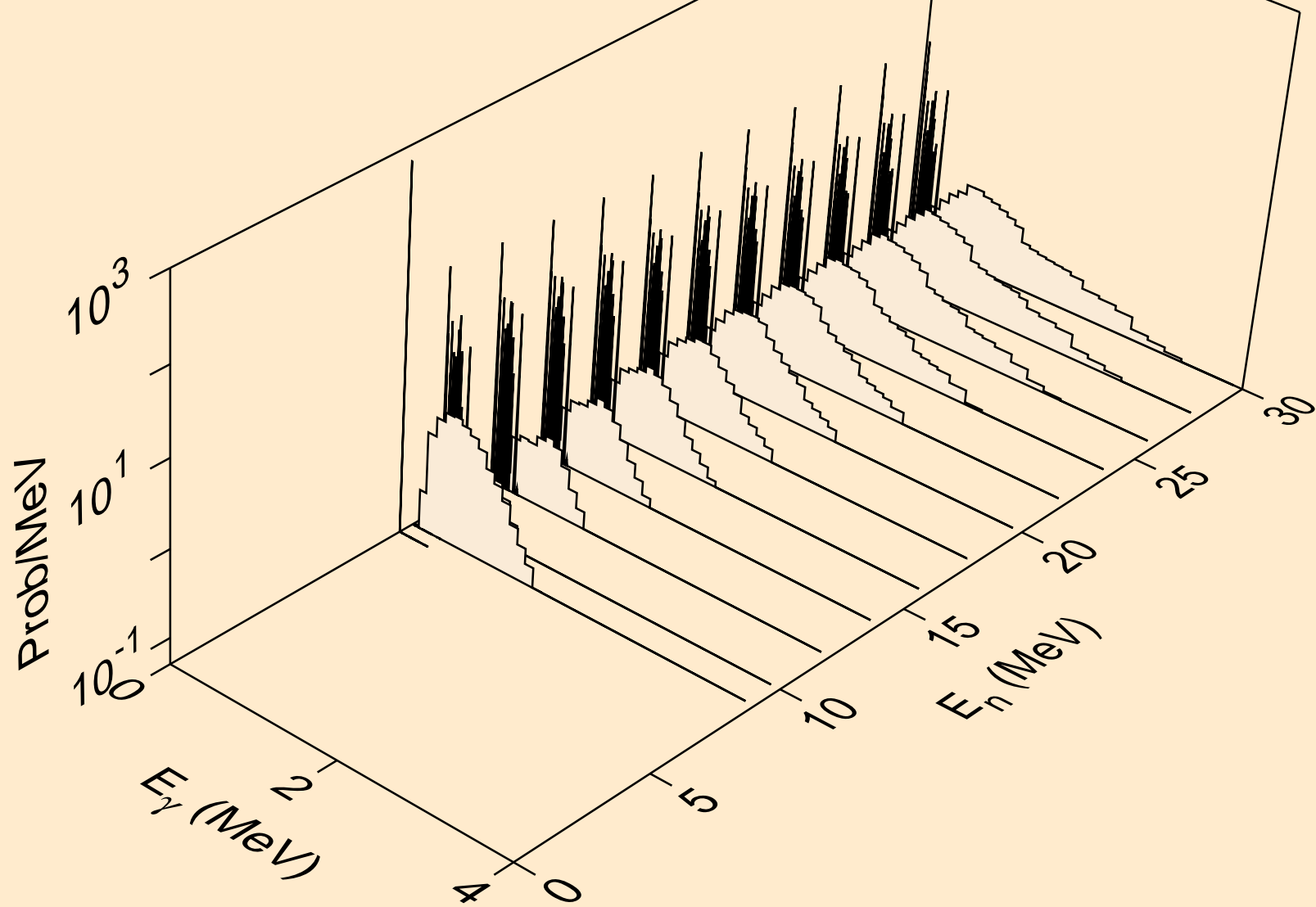

ER147M NEUTRON ACER TENDL-2021 LIBRARY; T=293.6K
thermal capture photon spectrum

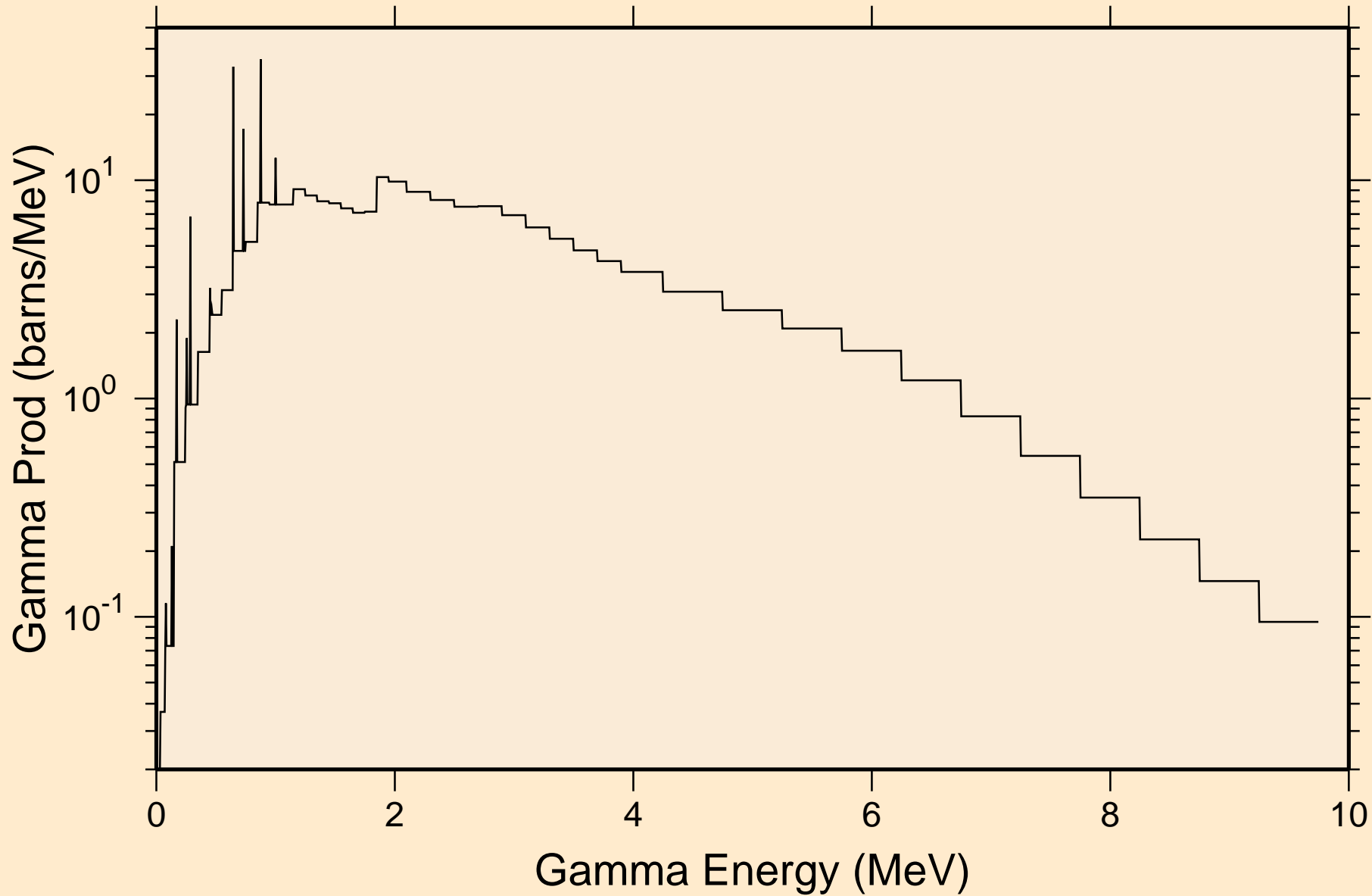

ER147M NEUTRON ACER TENDL-2021 LIBRARY; T=293.6K
14 MeV photon spectrum

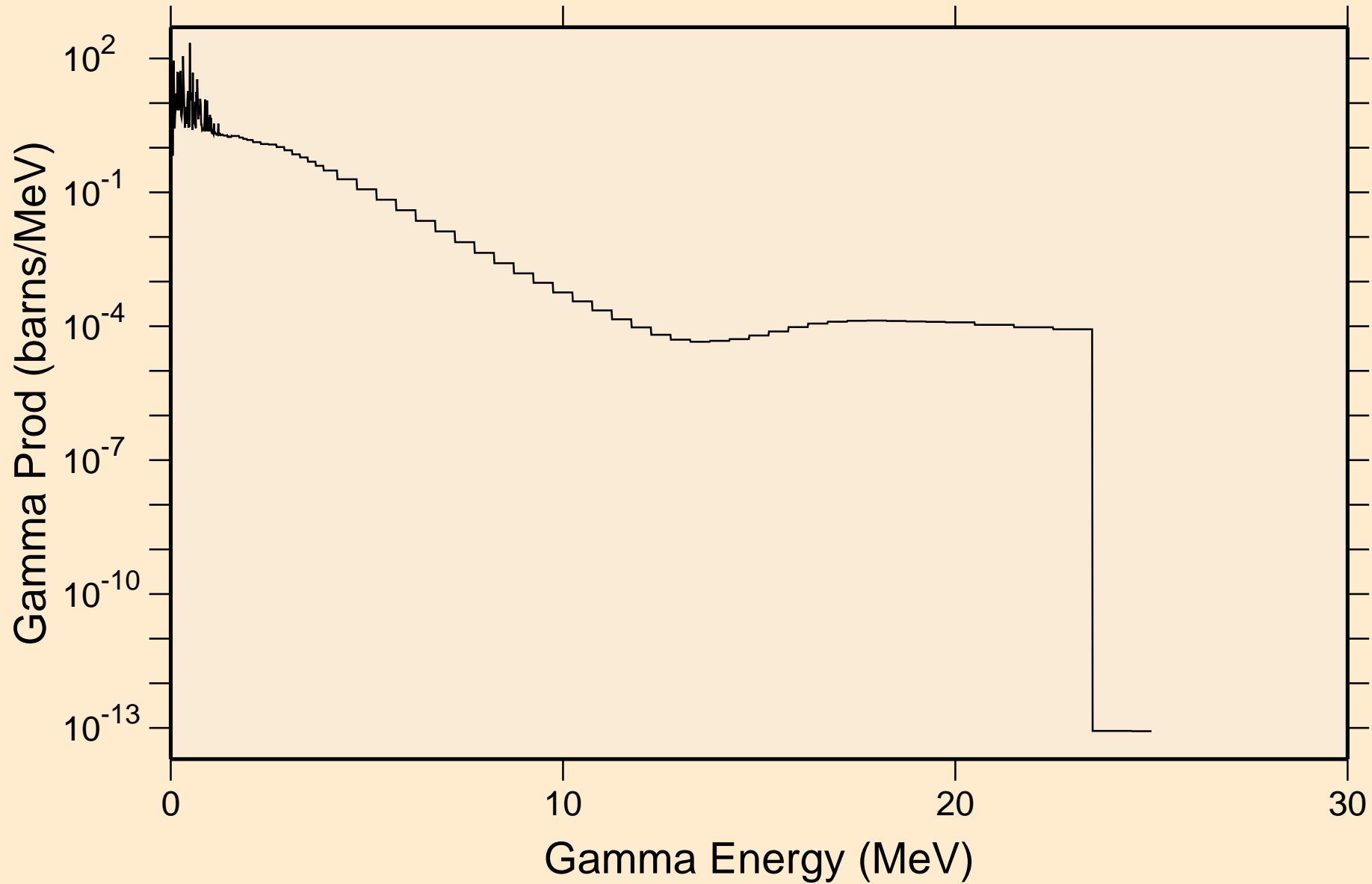

ER147M NEUTRON ACER TENDL-2021 LIBRARY; T=293.6K

Particle heating contributions

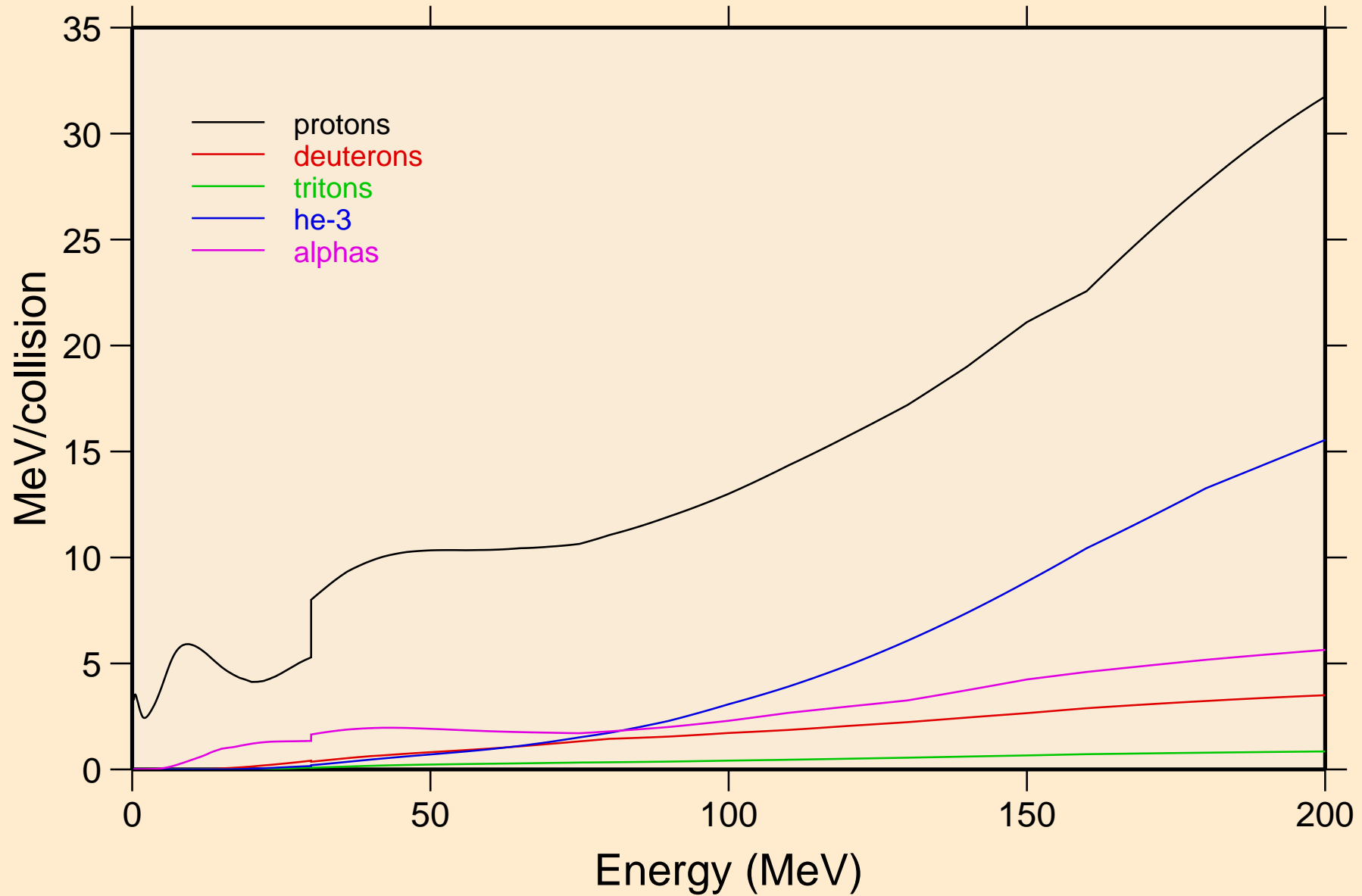

ER147M NEUTRON ACER TENDL-2021 LIBRARY; T=293.6K
Recoil Heating

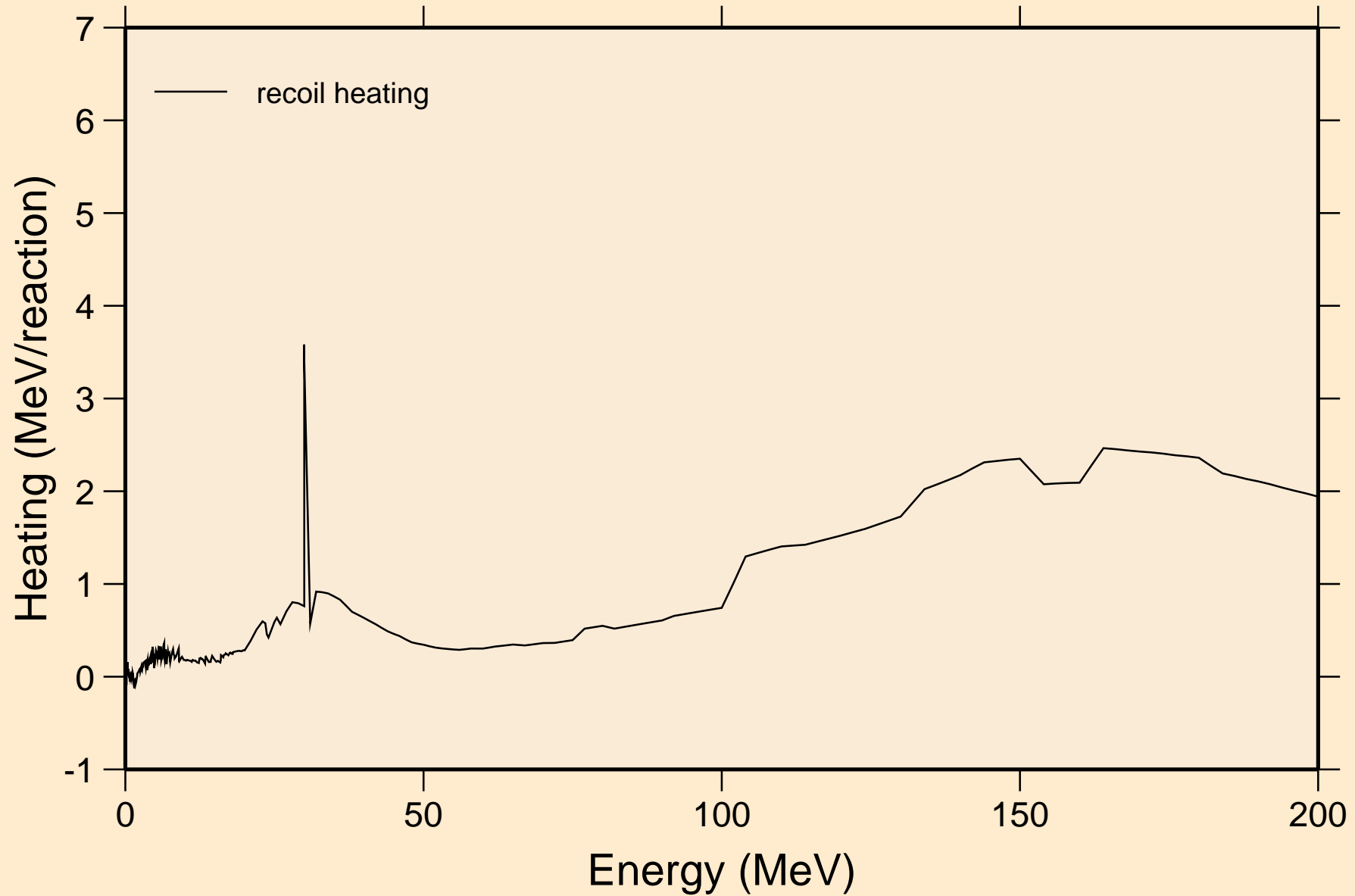

ER147M NEUTRON ACER TENDL-2021 LIBRARY; T=293.6K
Particle production cross sections

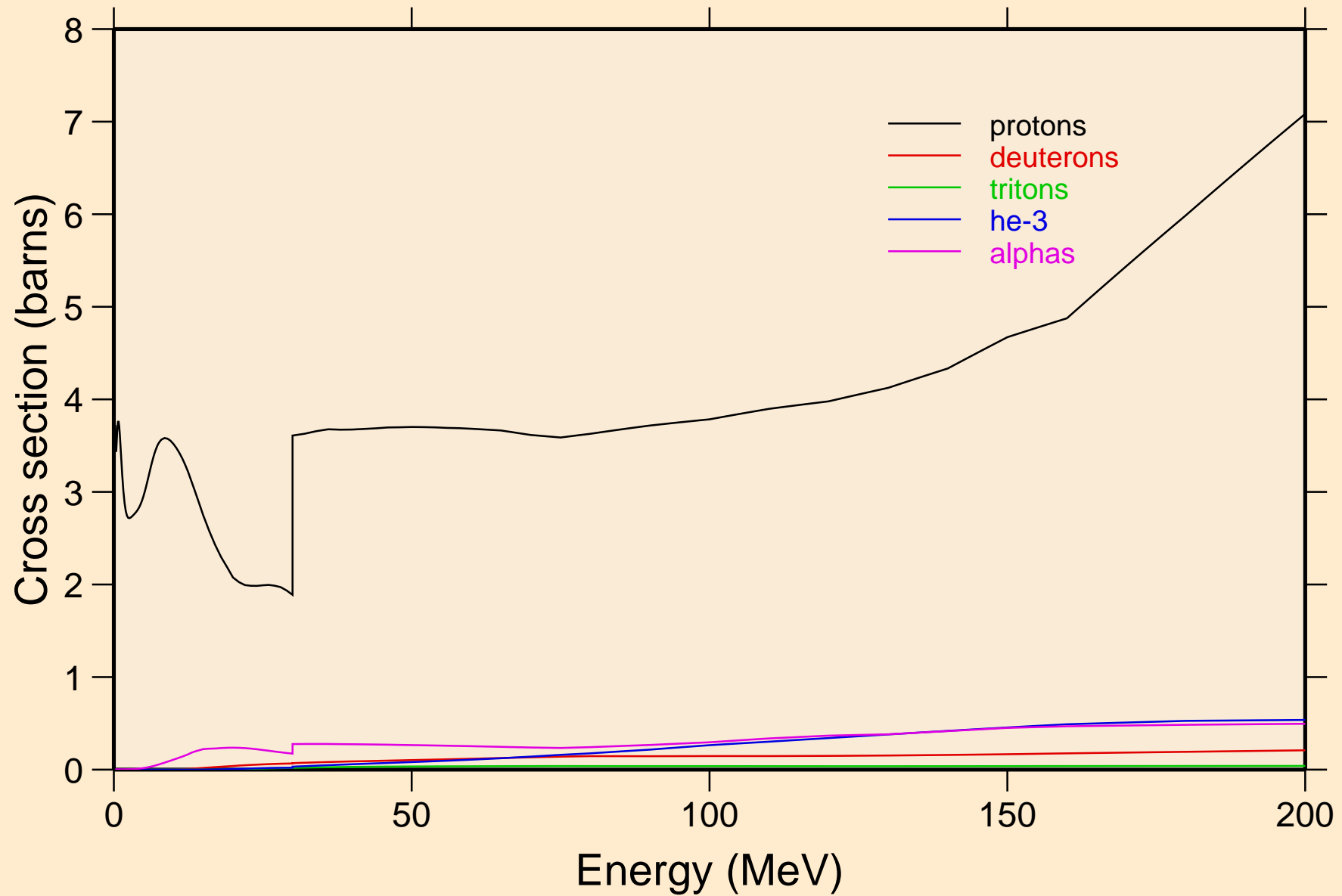

ER147M NEUTRON ACER TENDL-2021 LIBRARY; T=293.6K
protons from (n,x)

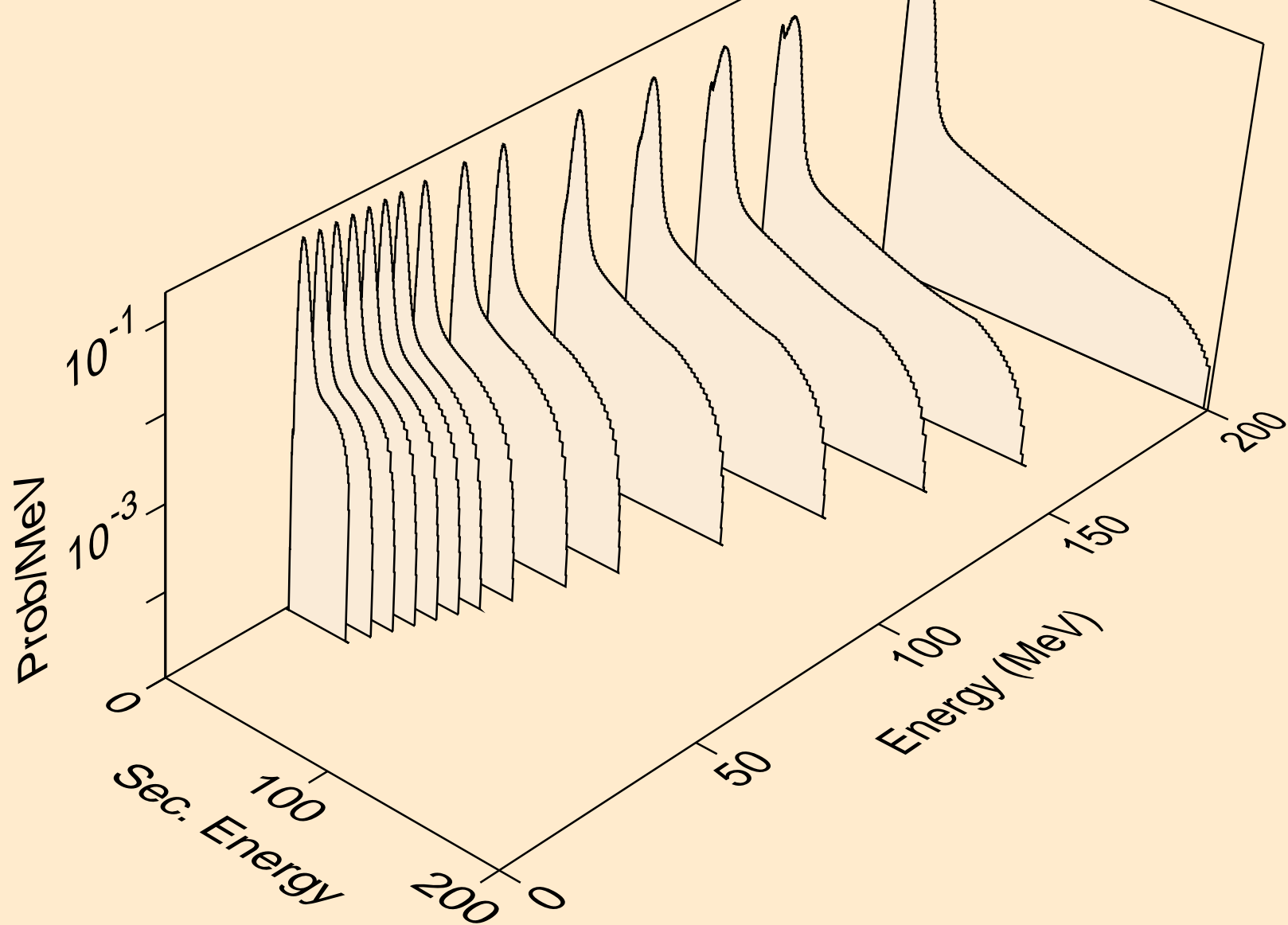

ER147M NEUTRON ACER TENDL-2021 LIBRARY; T=293.6K
protons from (n,n*)p

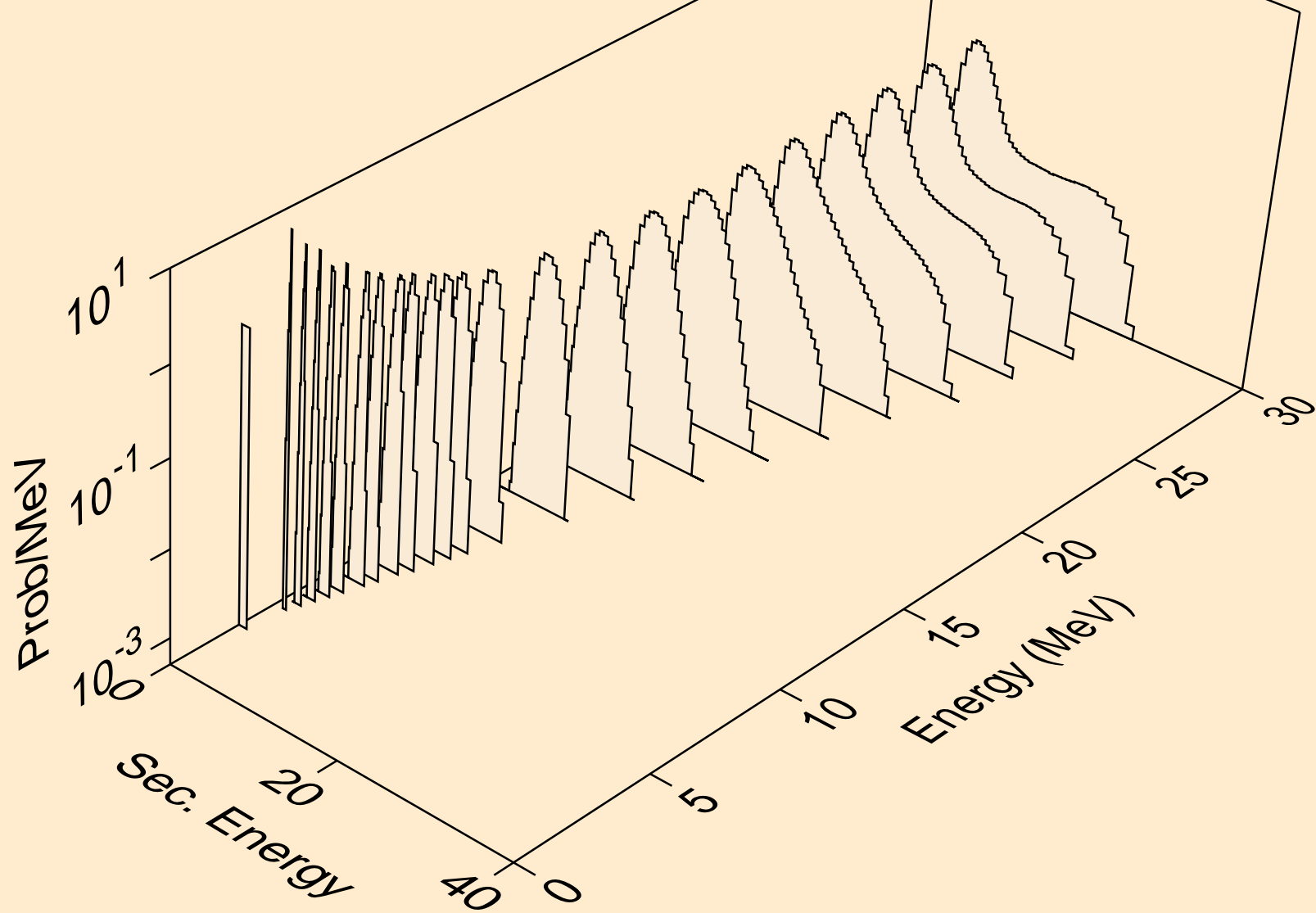

ER147M NEUTRON ACER TENDL-2021 LIBRARY; T=293.6K
protons from (n,2np)

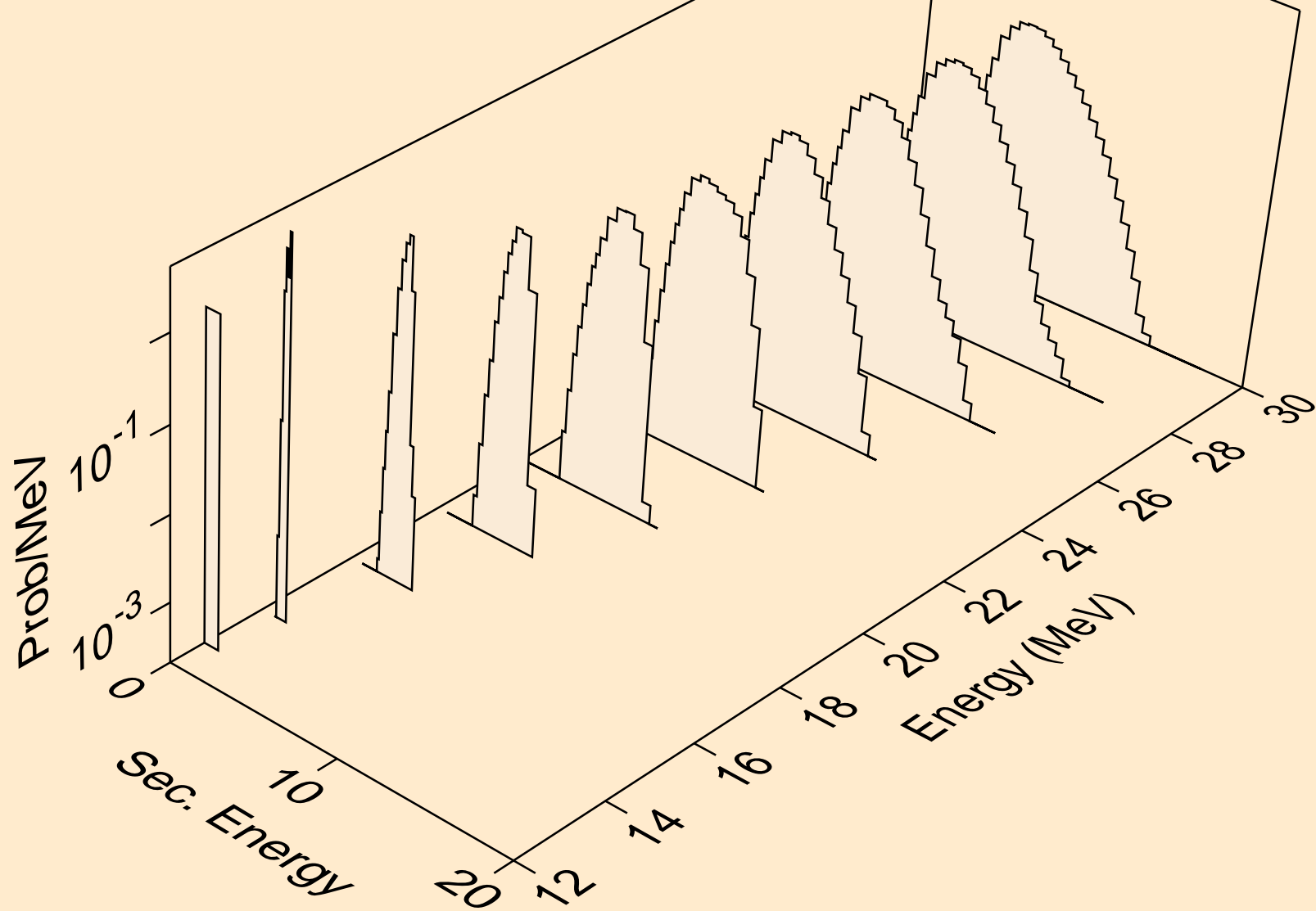

ER147M NEUTRON ACER TENDL-2021 LIBRARY; T=293.6K
protons from (n,3np)

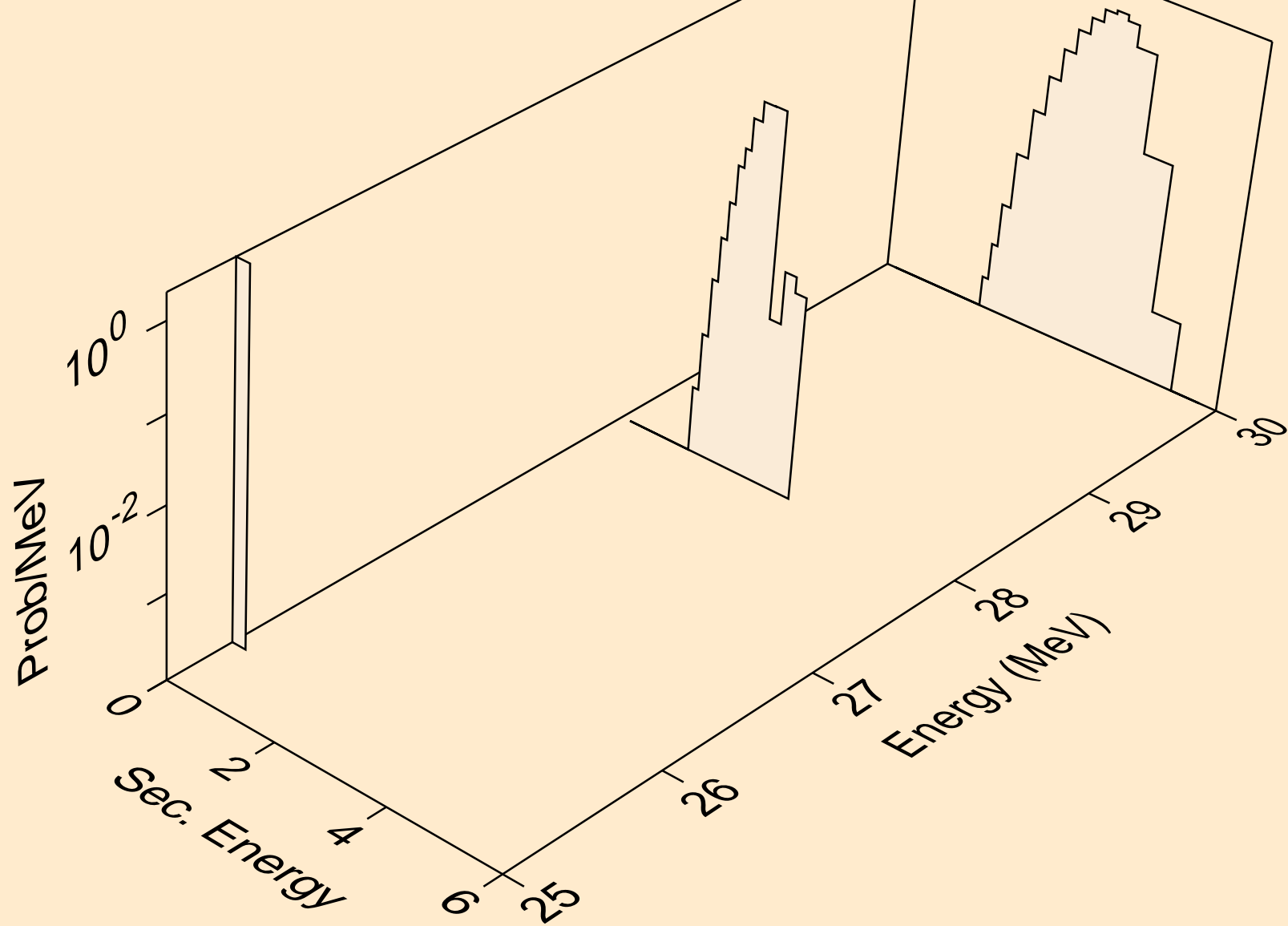

ER147M NEUTRON ACER TENDL-2021 LIBRARY; T=293.6K
protons from (n,2np)

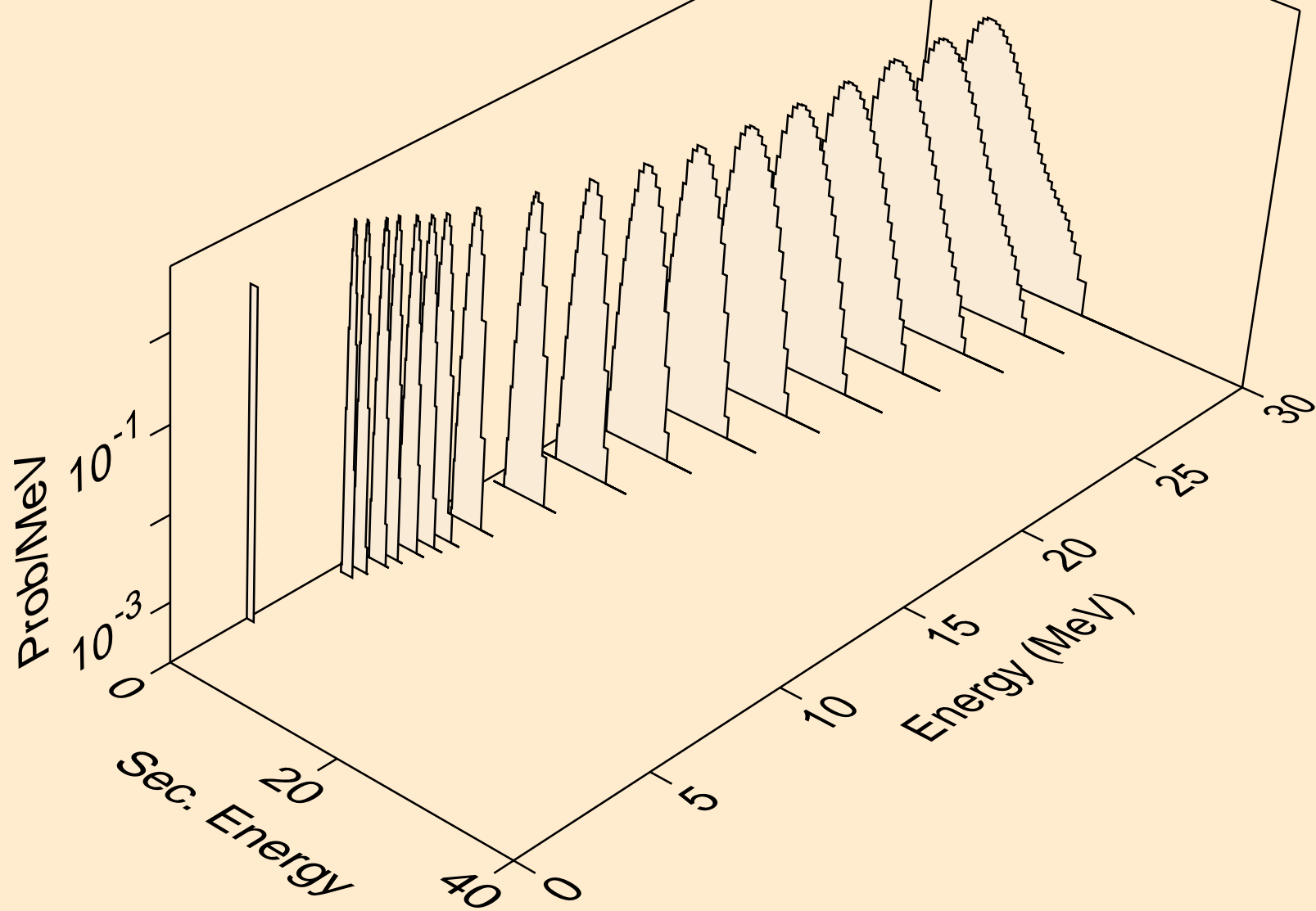

ER147M NEUTRON ACER TENDL-2021 LIBRARY; T=293.6K
protons from (n,npa)

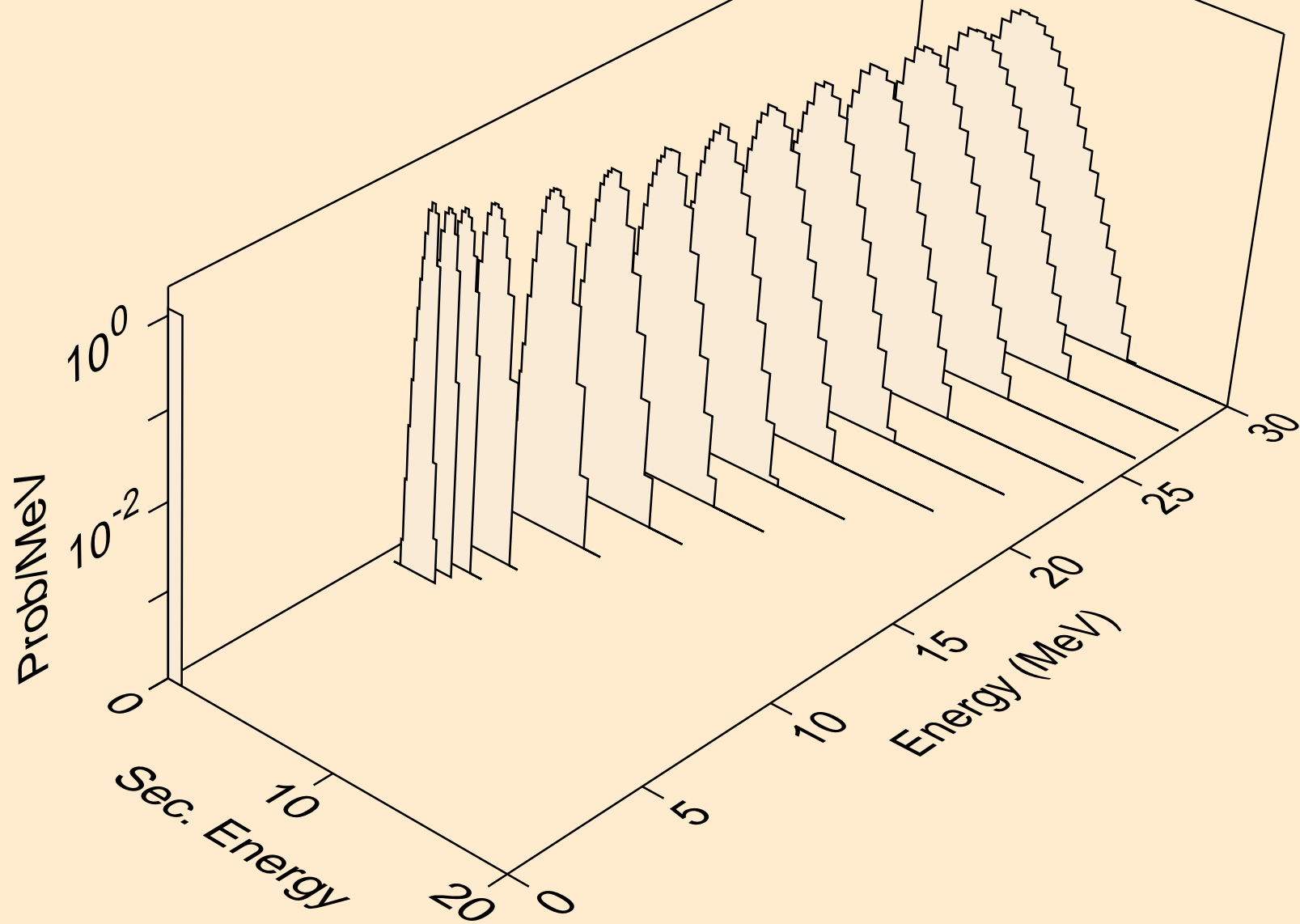

ER147M NEUTRON ACER TENDL-2021 LIBRARY; T=293.6K
protons from (n,p)

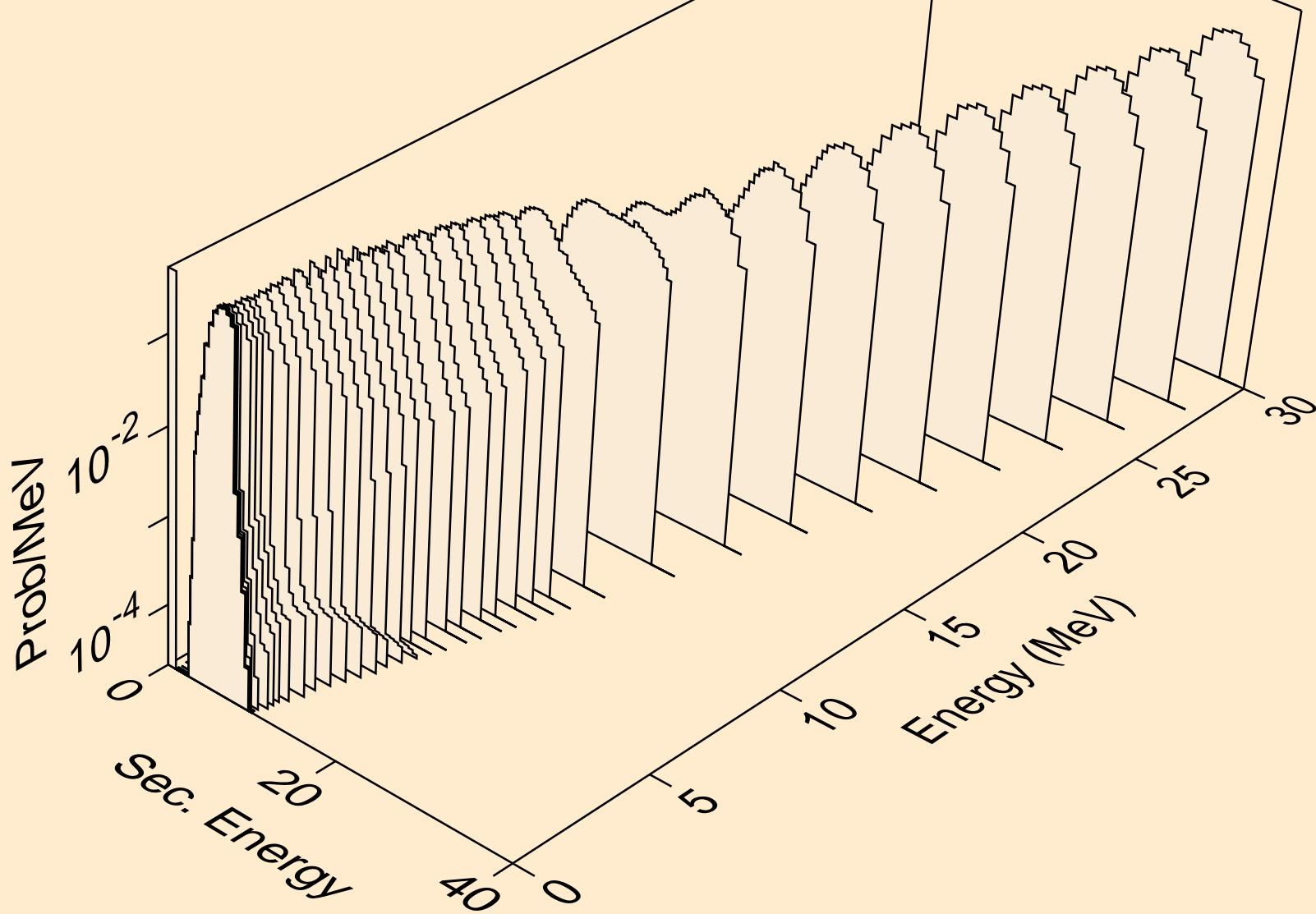

ER147M NEUTRON ACER TENDL-2021 LIBRARY; T=293.6K
protons from (n,2p)

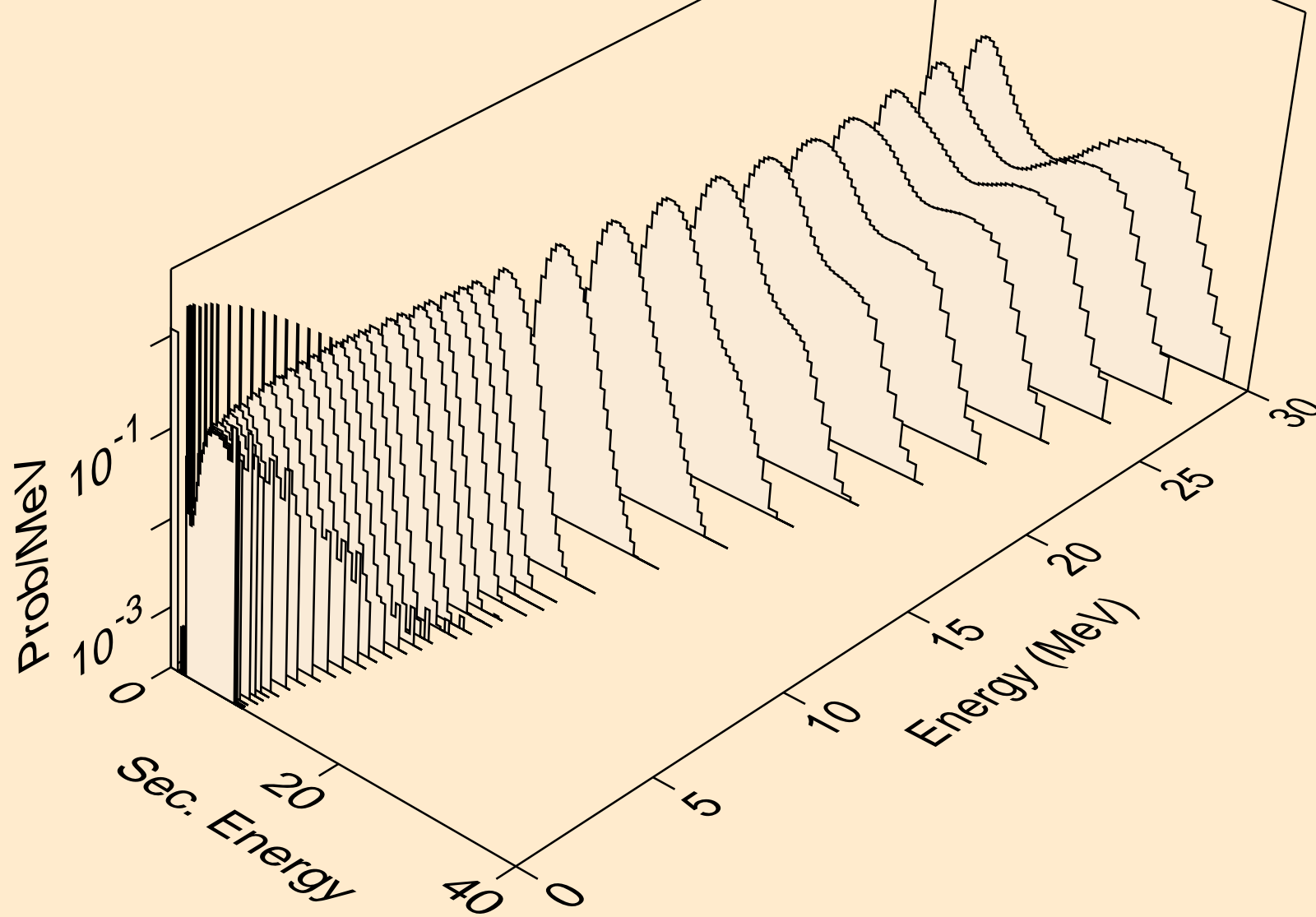

ER147M NEUTRON ACER TENDL-2021 LIBRARY; T=293.6K
protons from (n,p)

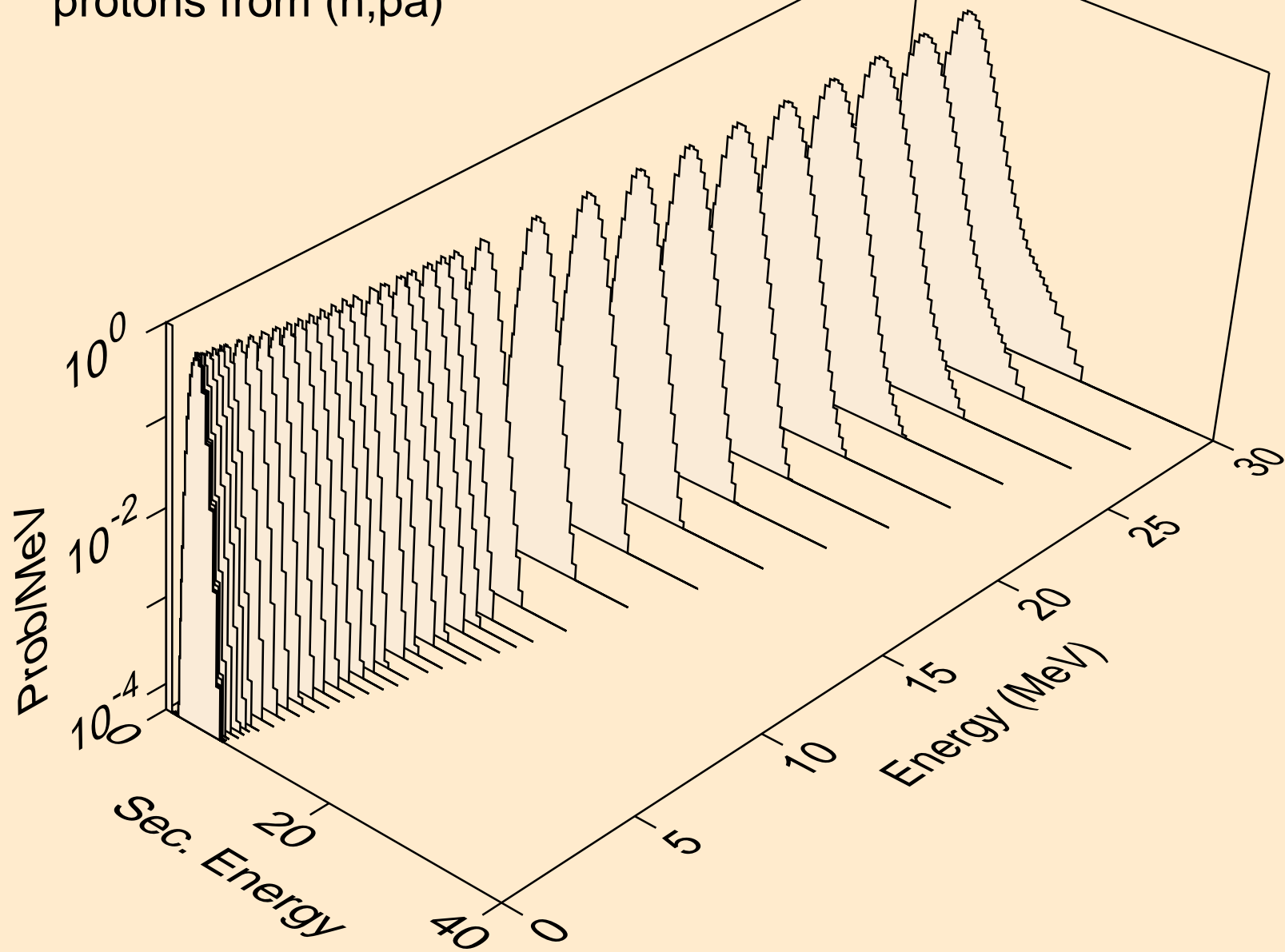

ER147M NEUTRON ACER TENDL-2021 LIBRARY; T=293.6K
protons from (n,pd)

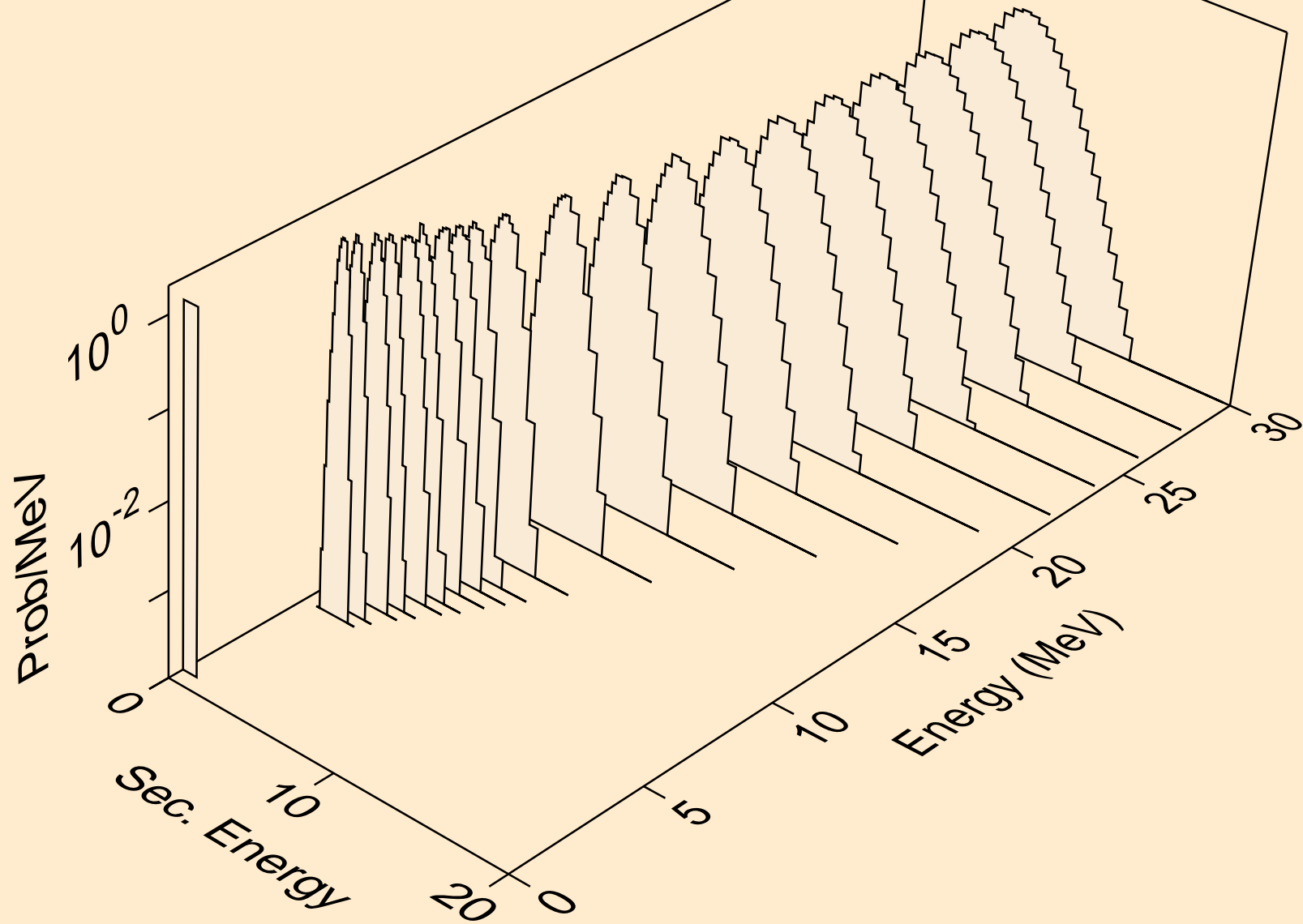

ER147M NEUTRON ACER TENDL-2021 LIBRARY; T=293.6K
protons from (n,pt)

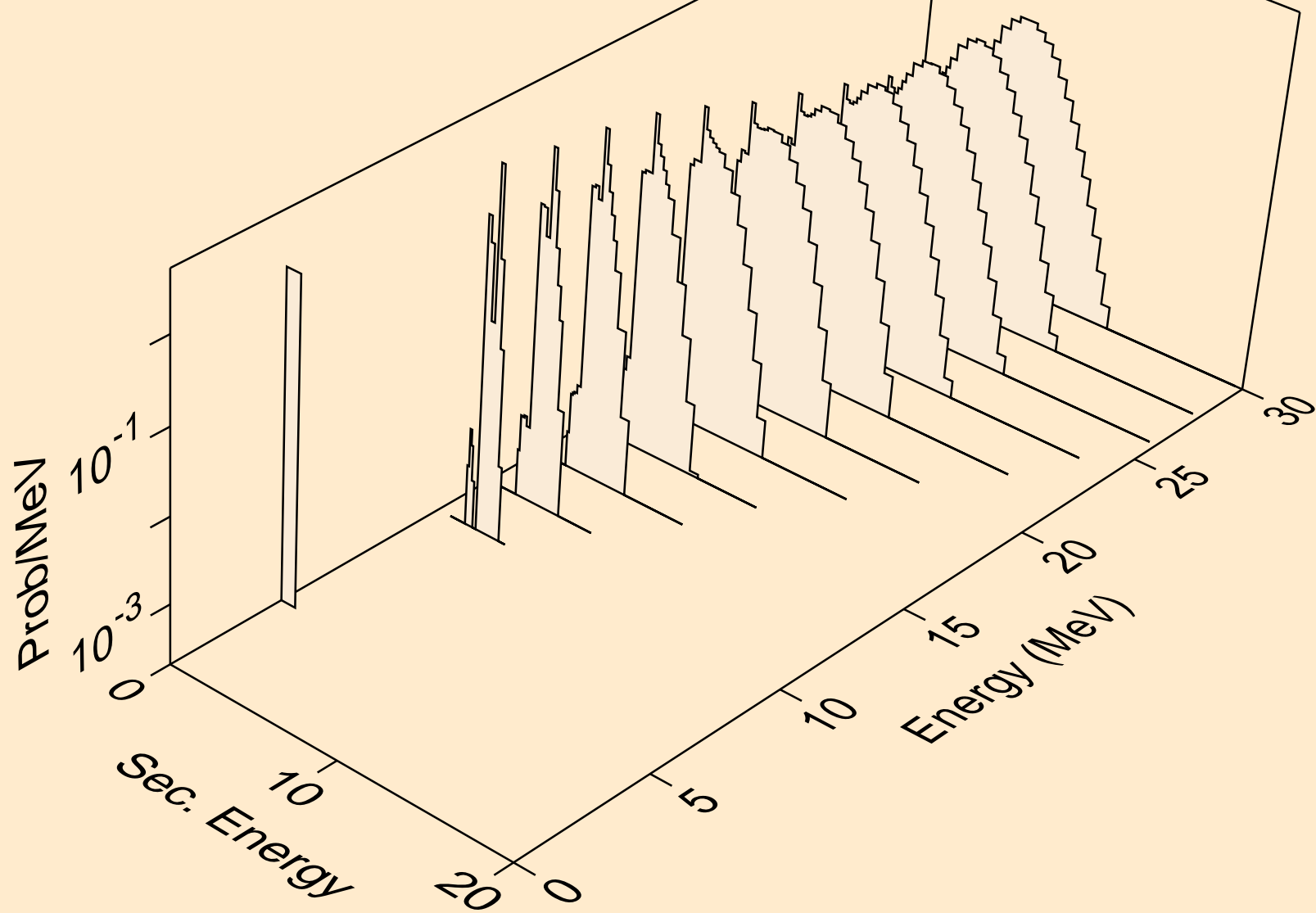

ER147M NEUTRON ACER TENDL-2021 LIBRARY; T=293.6K
deuterons from (n,x)

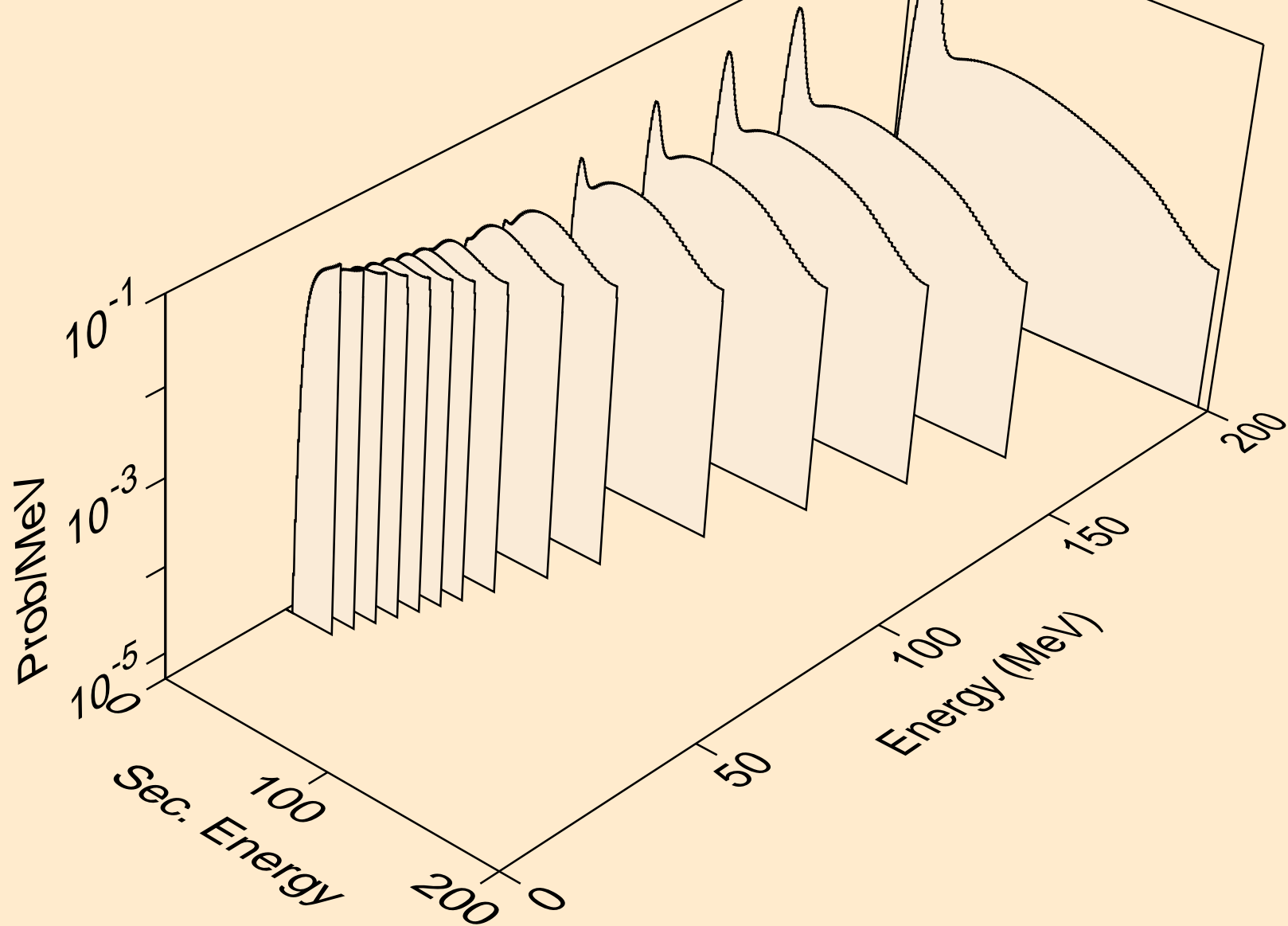

ER147M NEUTRON ACER TENDL-2021 LIBRARY; T=293.6K
deuterons from (n,n*)d

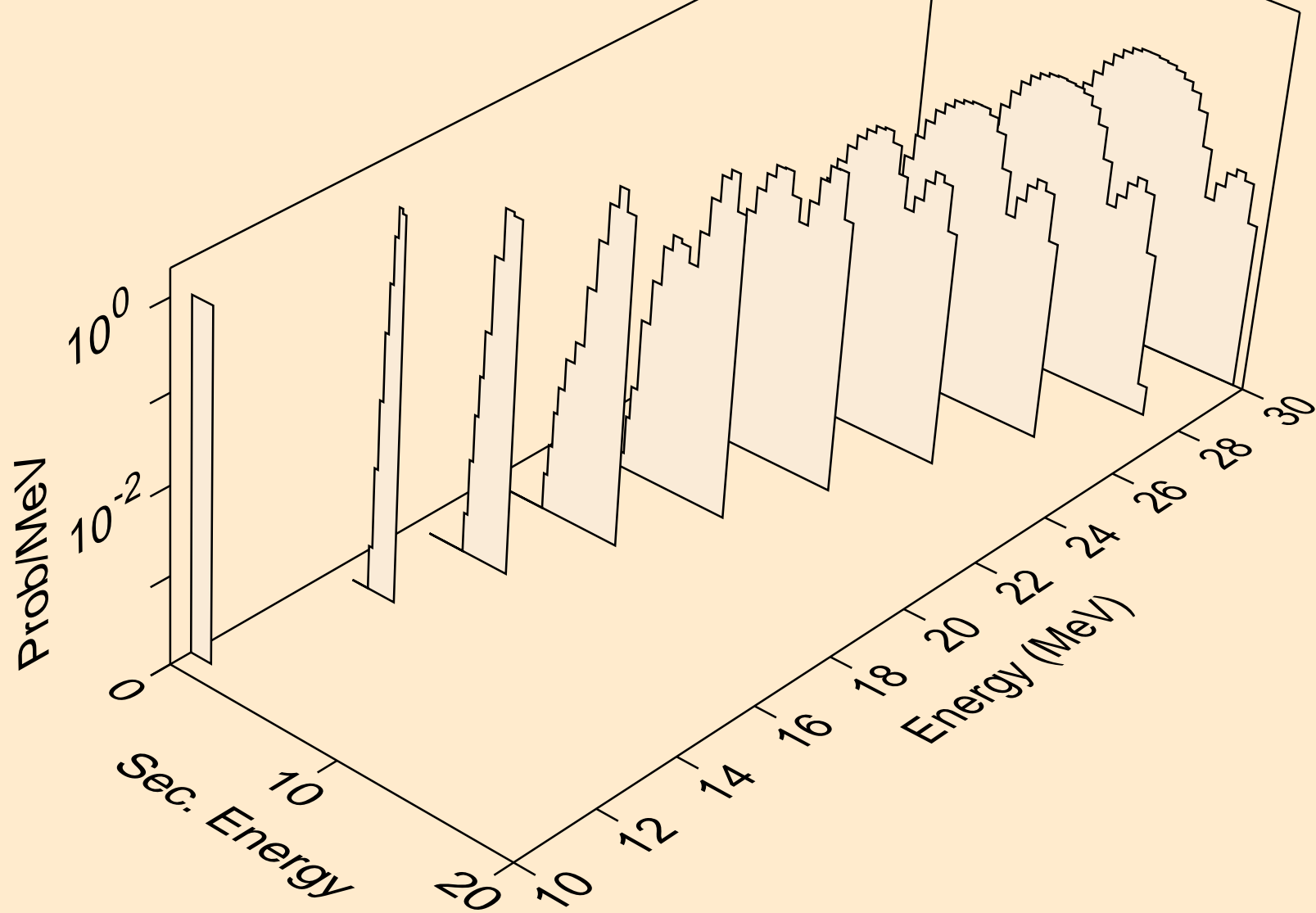

ER147M NEUTRON ACER TENDL-2021 LIBRARY; T=293.6K
deuterons from (n,d)

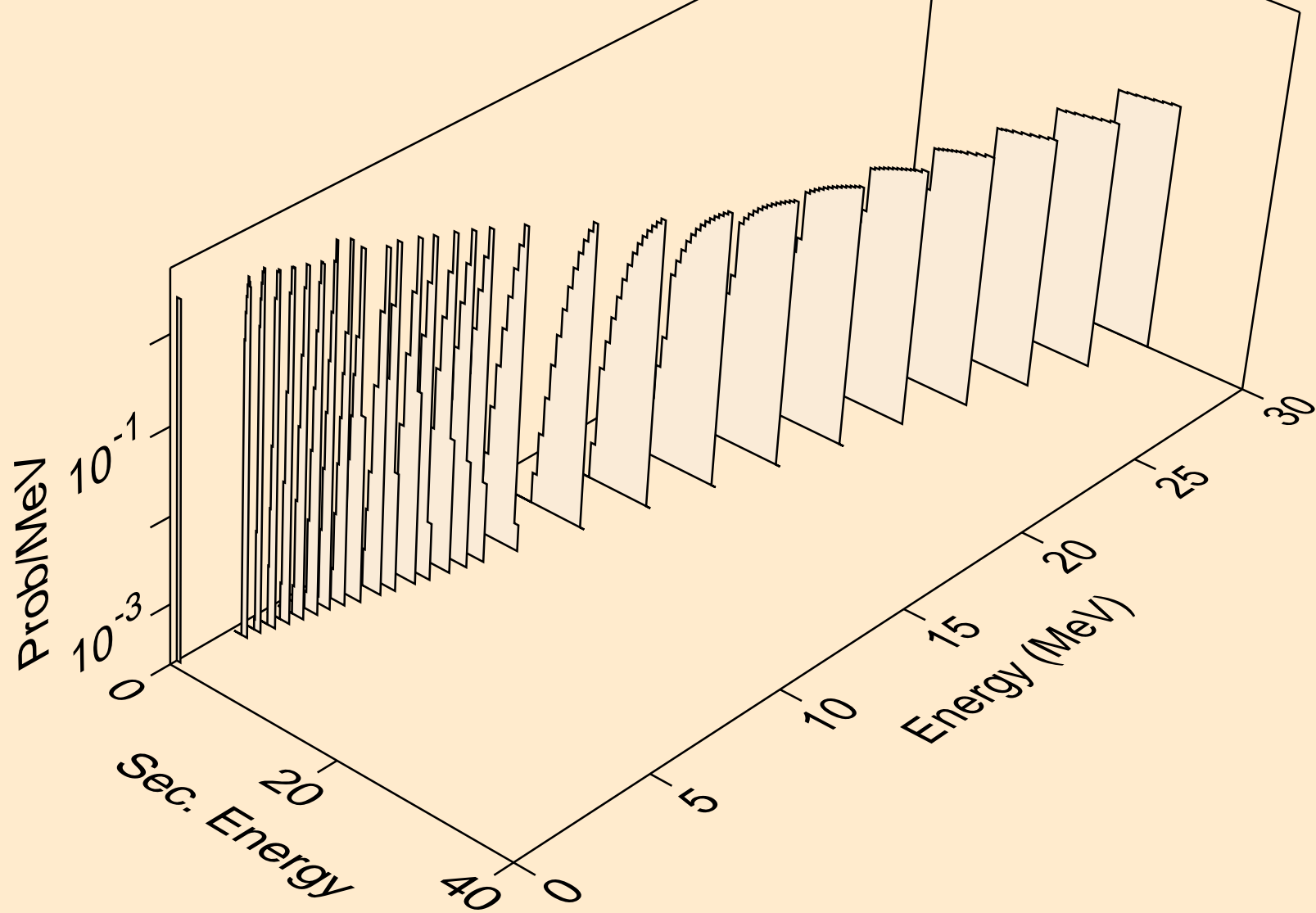

ER147M NEUTRON ACER TENDL-2021 LIBRARY; T=293.6K
deuterons from (n,pd)

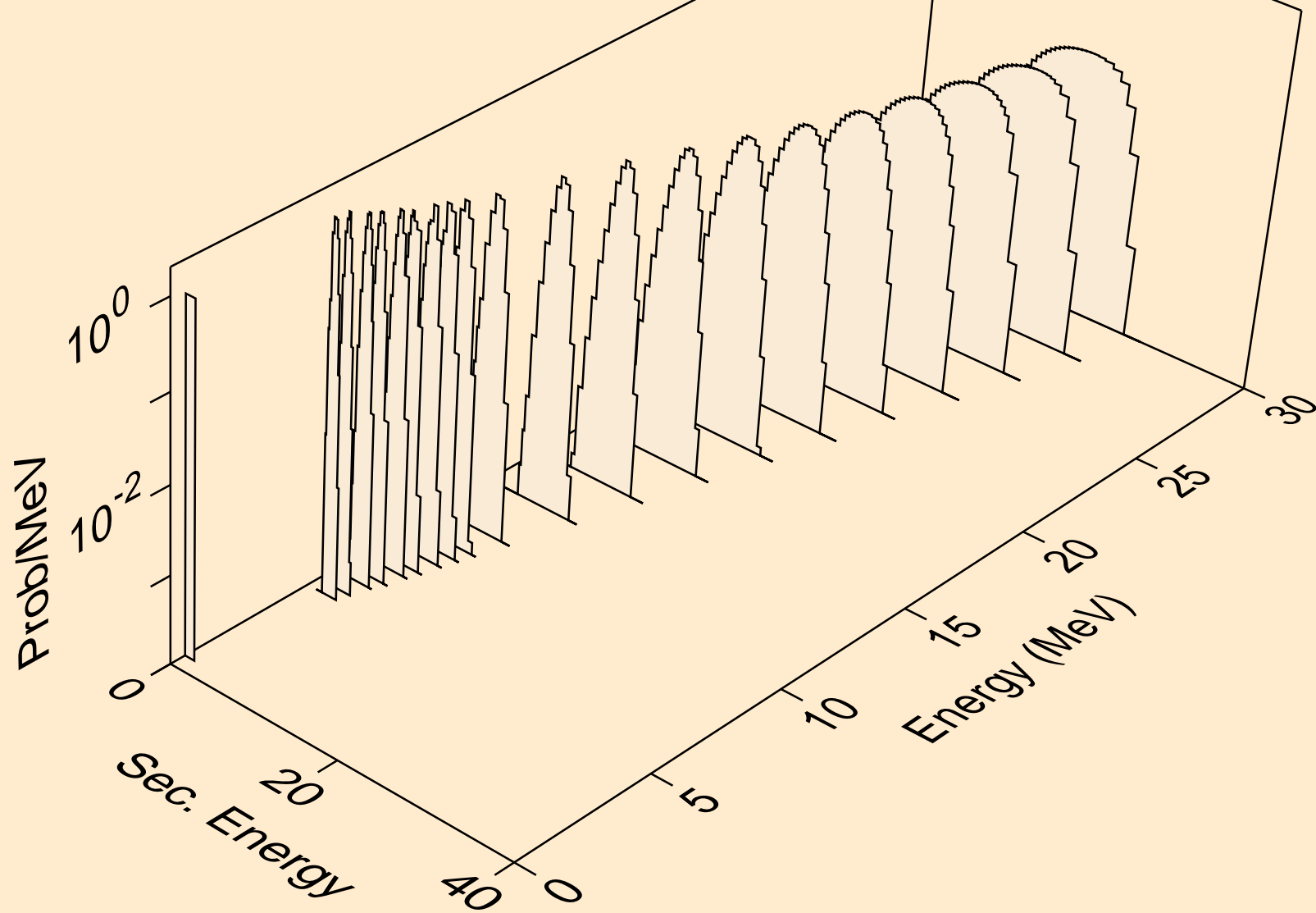

ER147M NEUTRON ACER TENDL-2021 LIBRARY; T=293.6K
deuterons from (n,da)

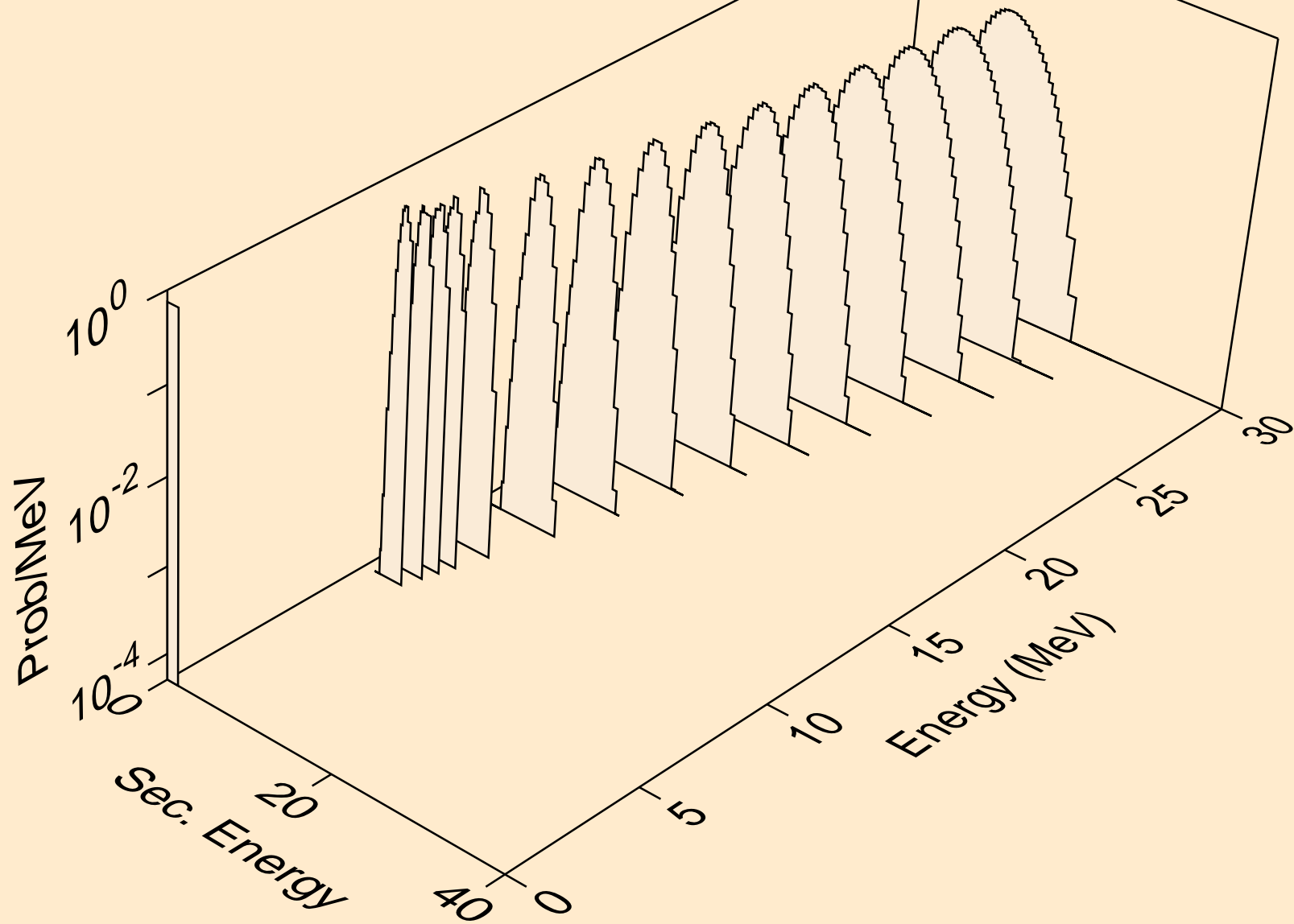

ER147M NEUTRON ACER TENDL-2021 LIBRARY; T=293.6K
tritons from (n,x)

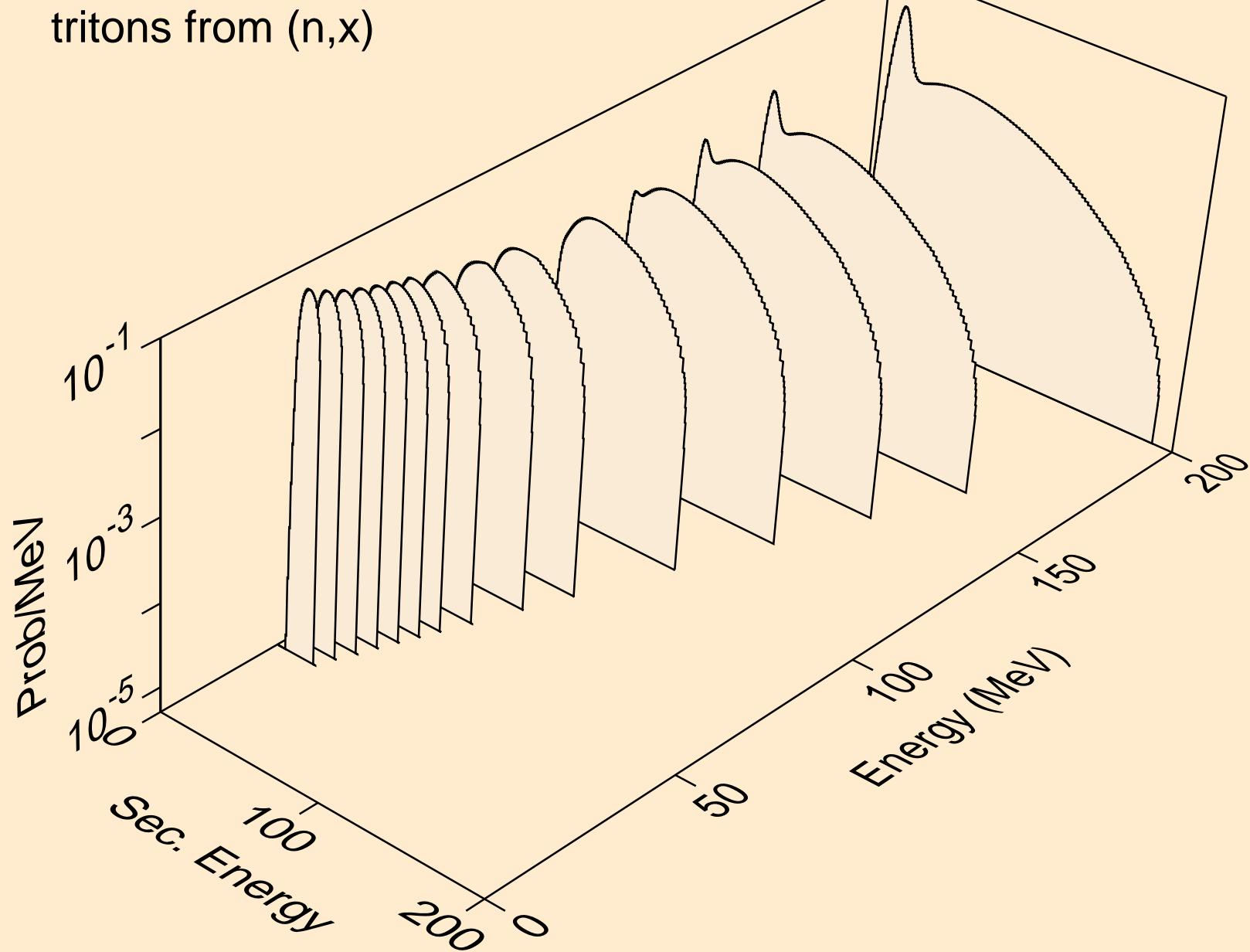

ER147M NEUTRON ACER TENDL-2021 LIBRARY; T=293.6K
tritons from (n,n*)t

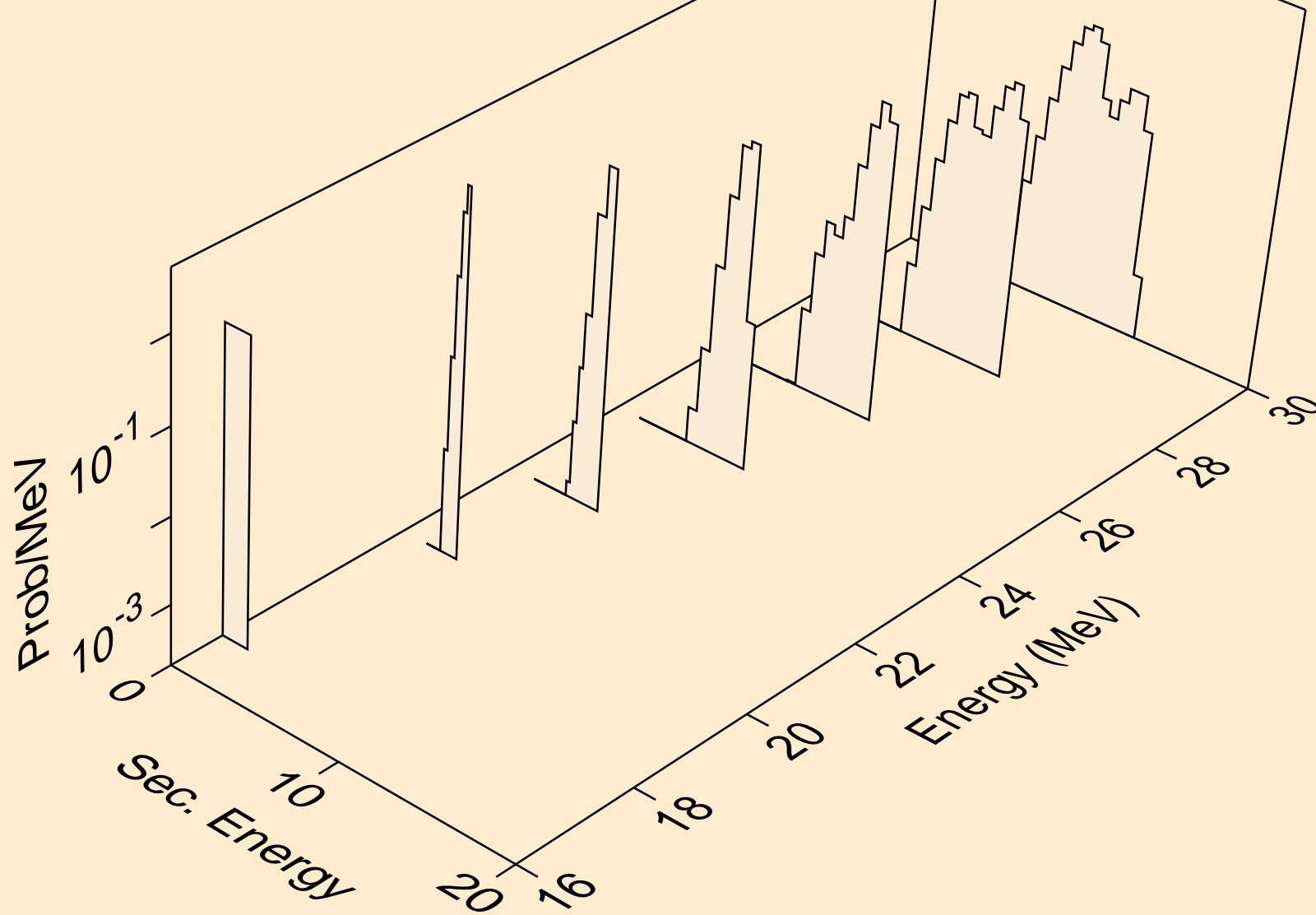

ER147M NEUTRON ACER TENDL-2021 LIBRARY; T=293.6K
tritons from (n,t)

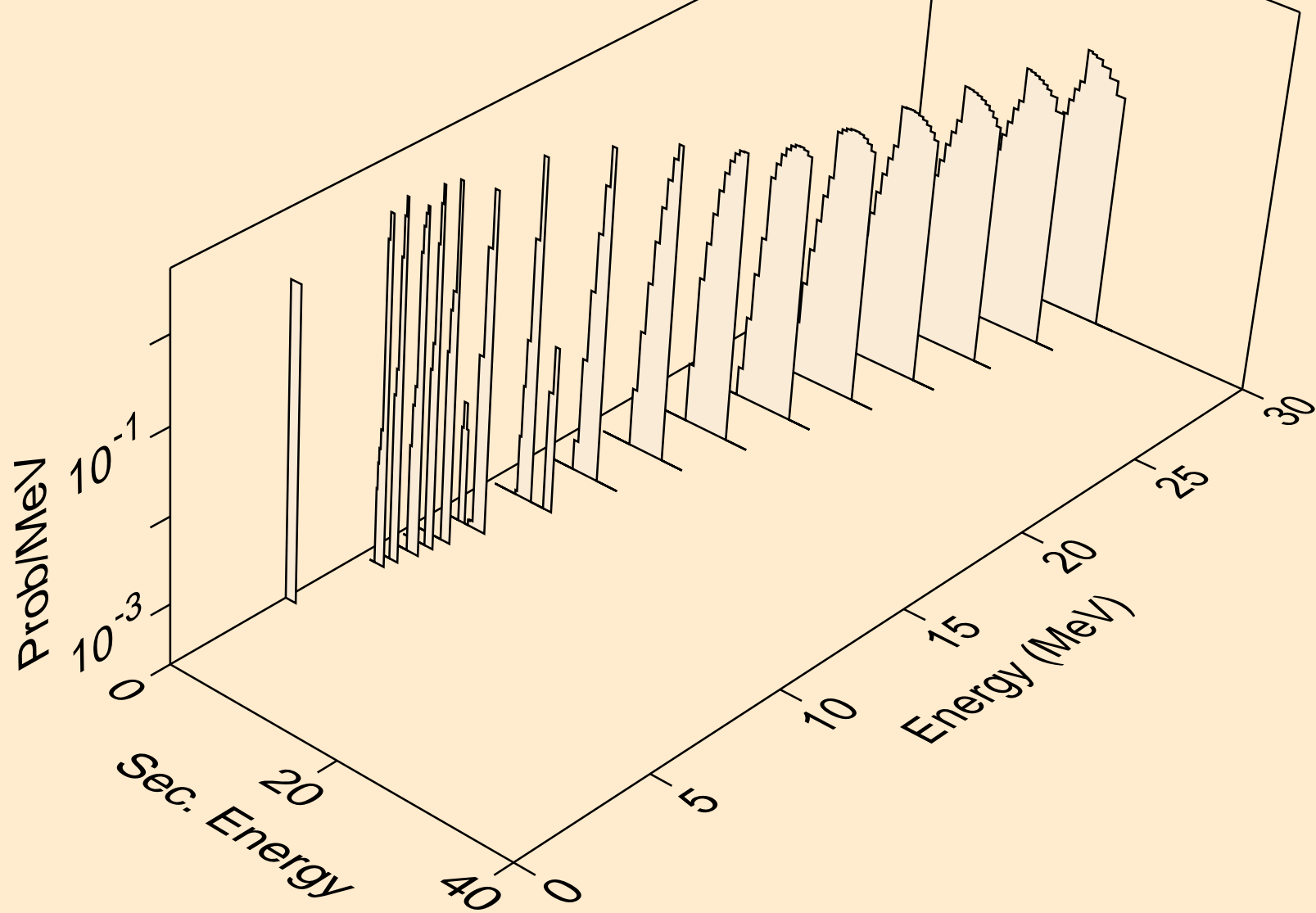

ER147M NEUTRON ACER TENDL-2021 LIBRARY; T=293.6K
tritons from (n,pt)

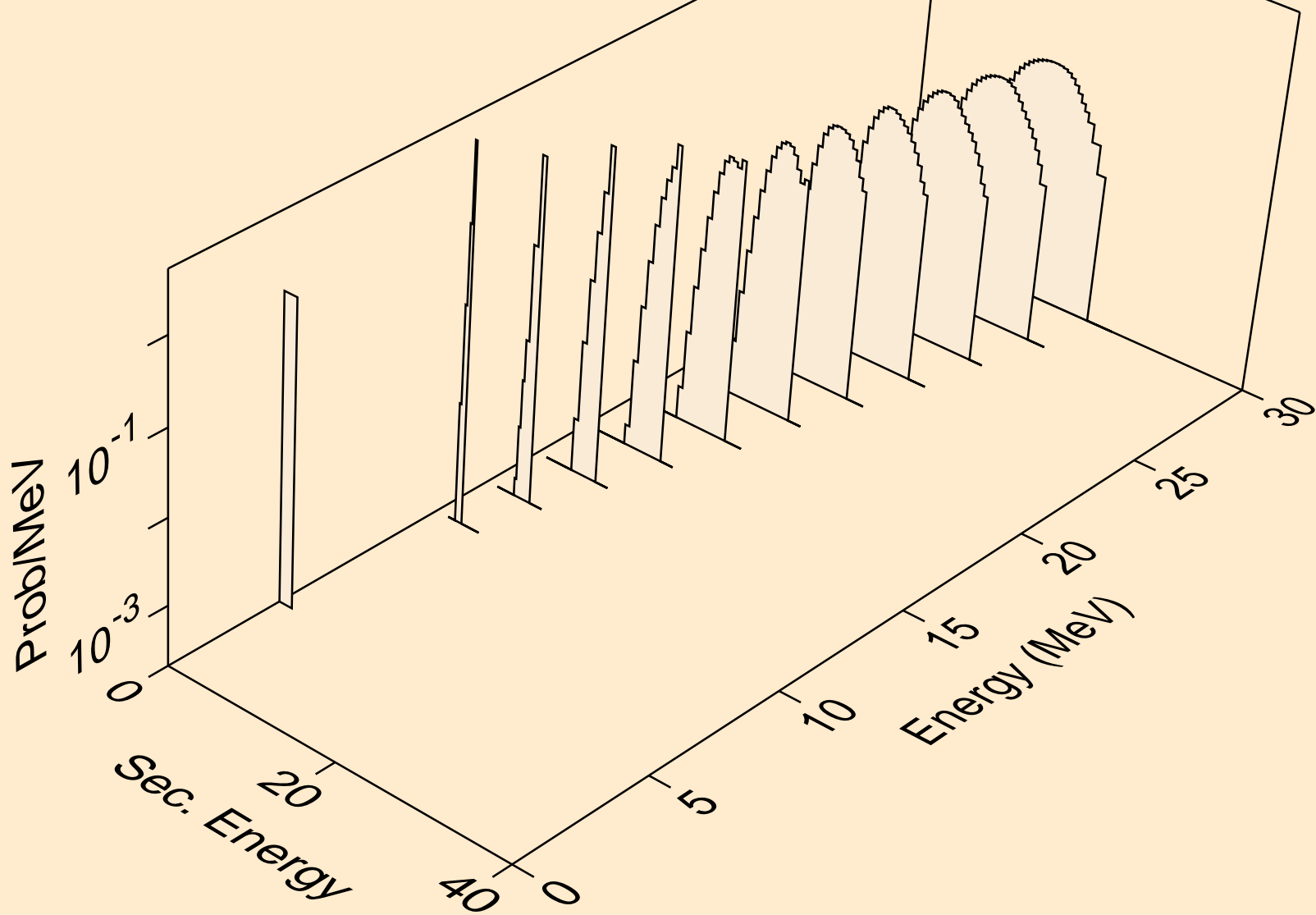

ER147M NEUTRON ACER TENDL-2021 LIBRARY; T=293.6K
he3s from (n,x)

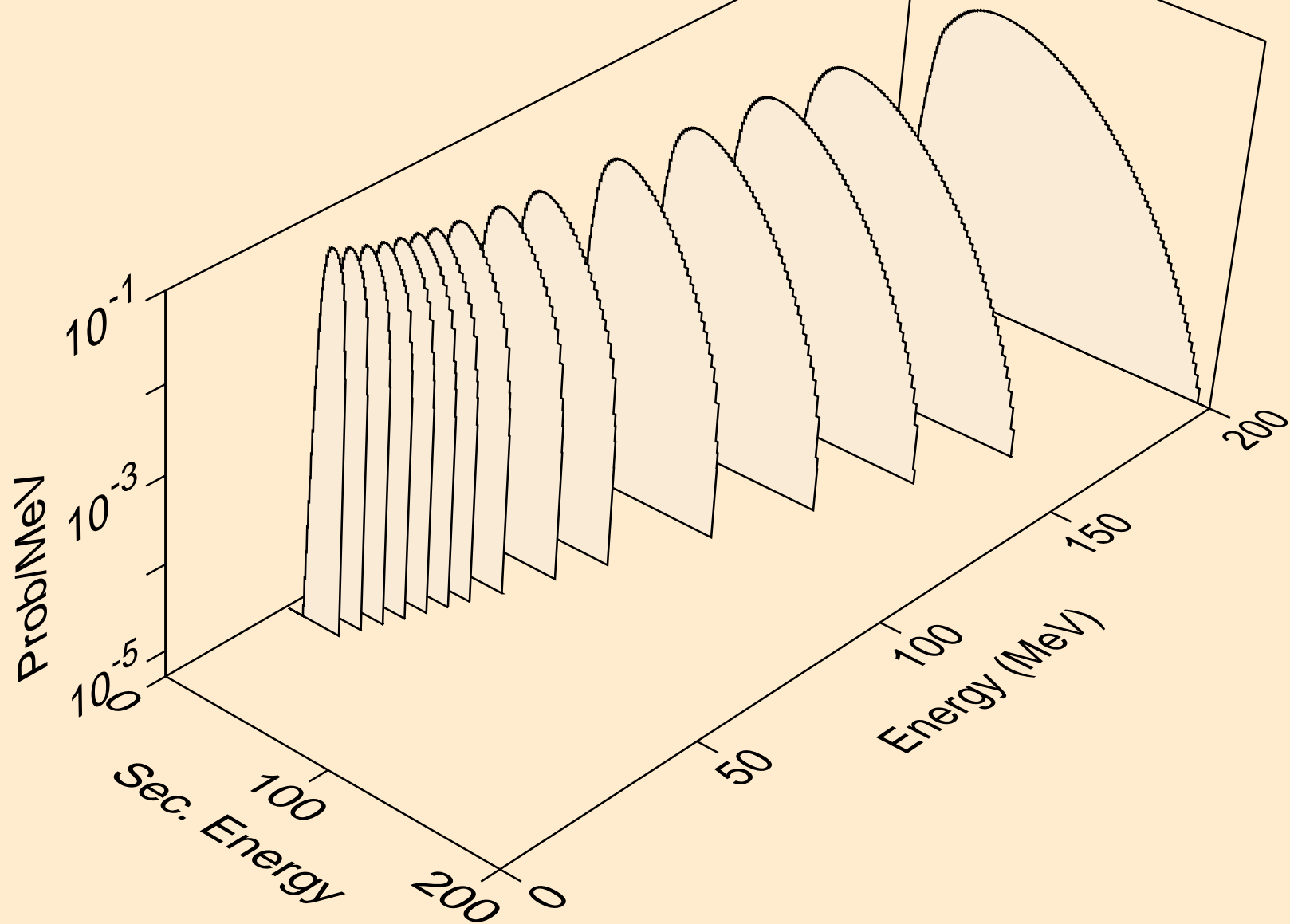

ER147M NEUTRON ACER TENDL-2021 LIBRARY; T=293.6K
he3s from (n,n*)he3

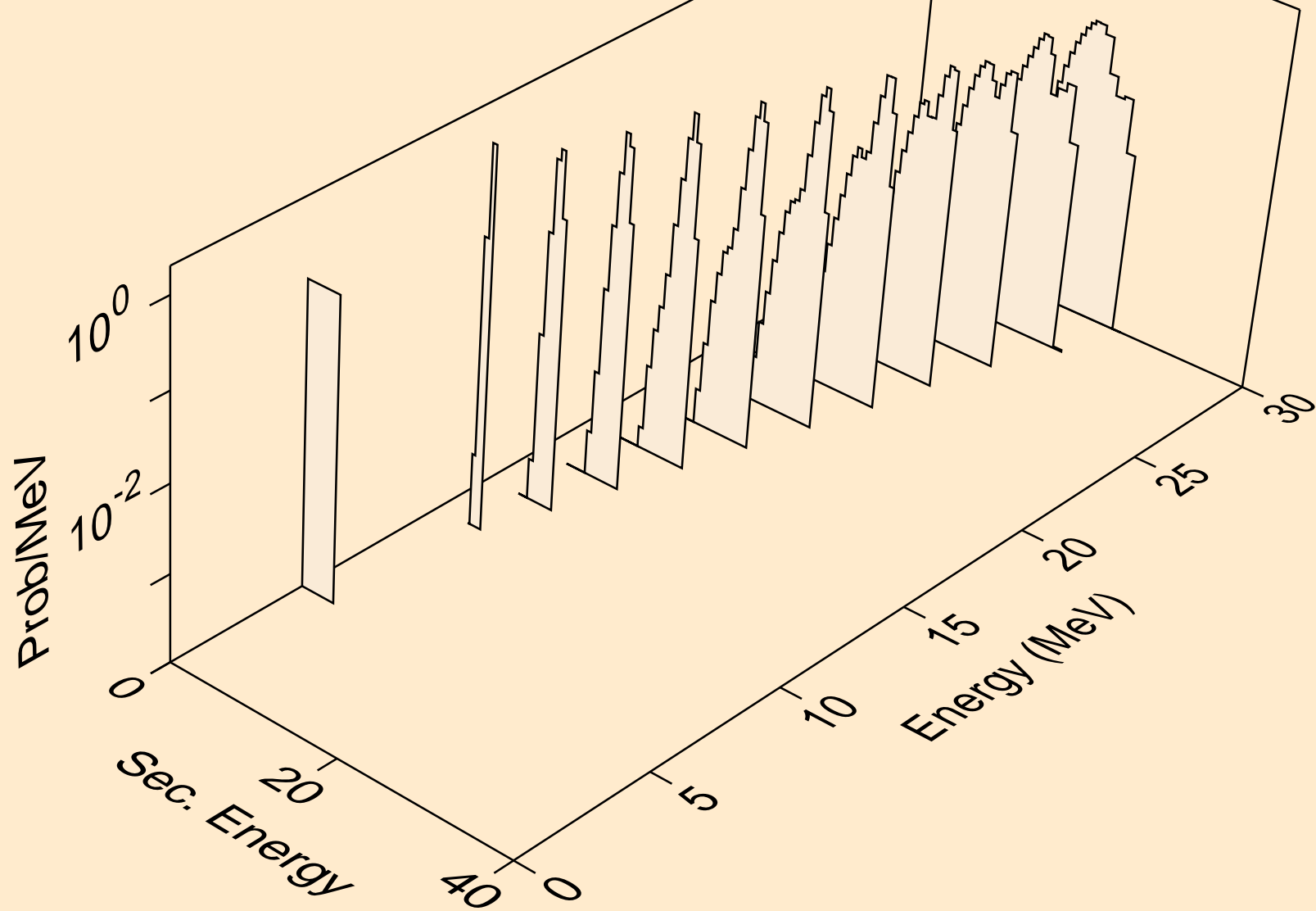

ER147M NEUTRON ACER TENDL-2021 LIBRARY; T=293.6K
he3s from (n,he3)

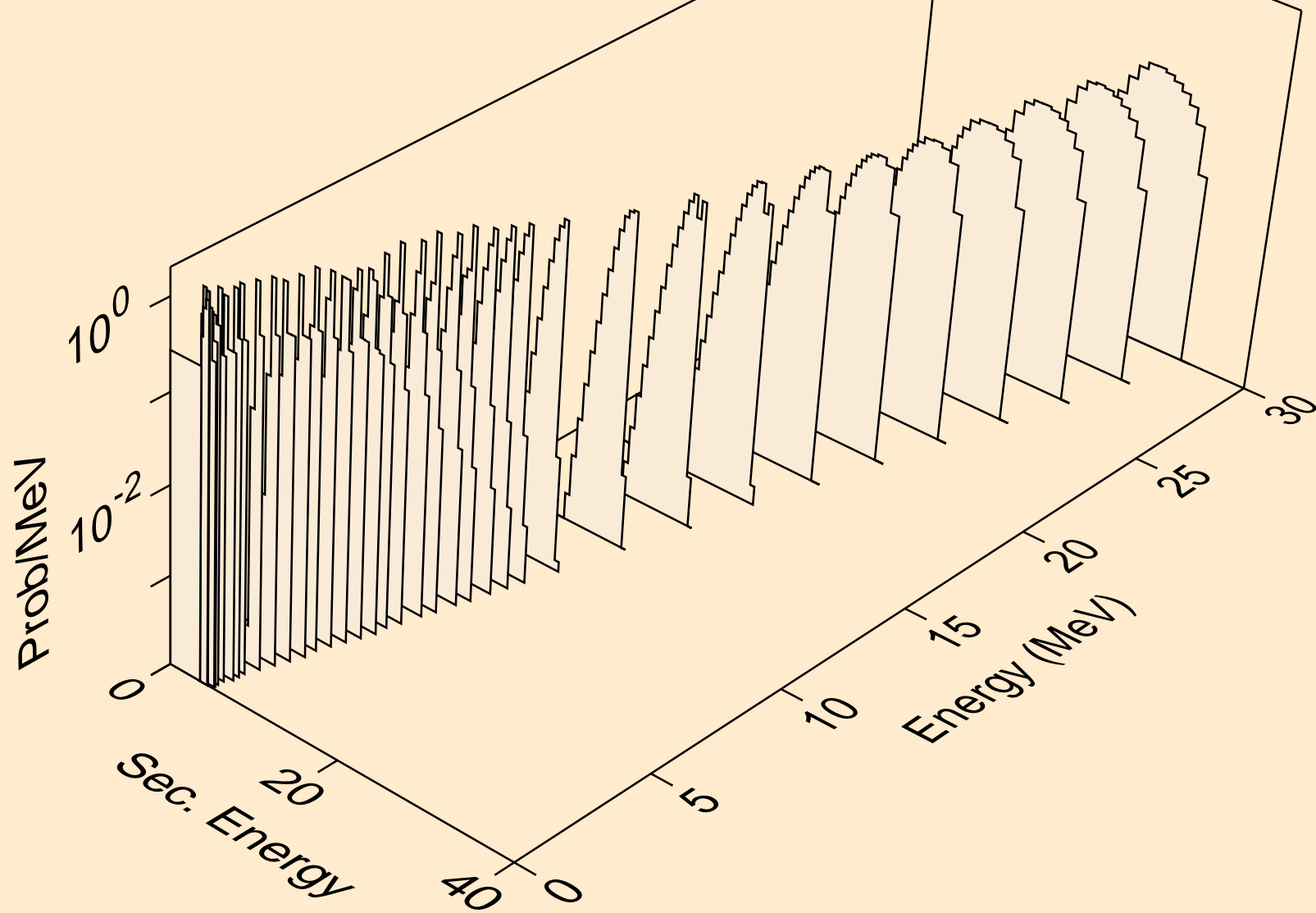

ER147M NEUTRON ACER TENDL-2021 LIBRARY; T=293.6K
alphas from (n,x)

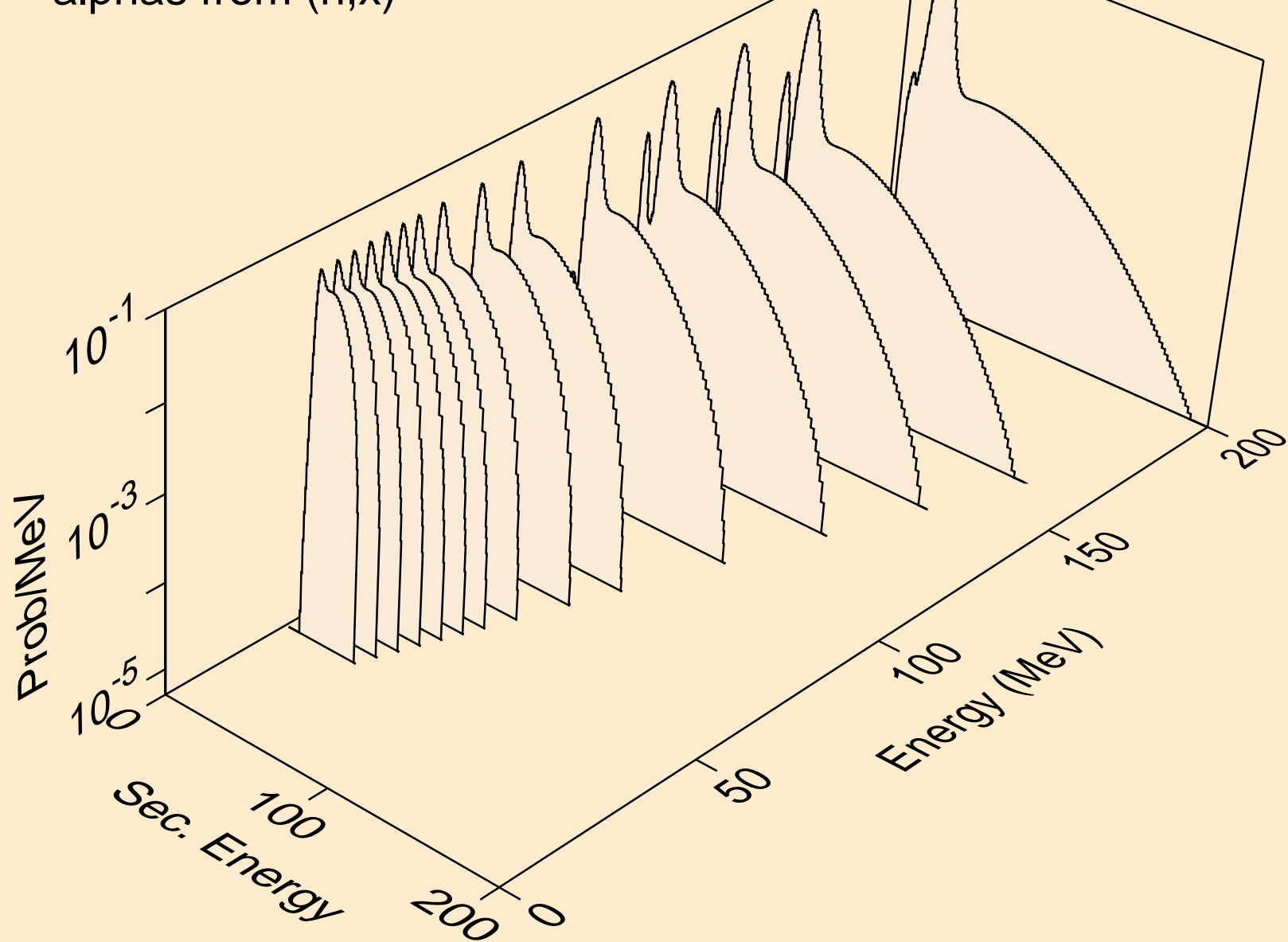

ER147M NEUTRON ACER TENDL-2021 LIBRARY; T=293.6K
alphas from (n,n*)a

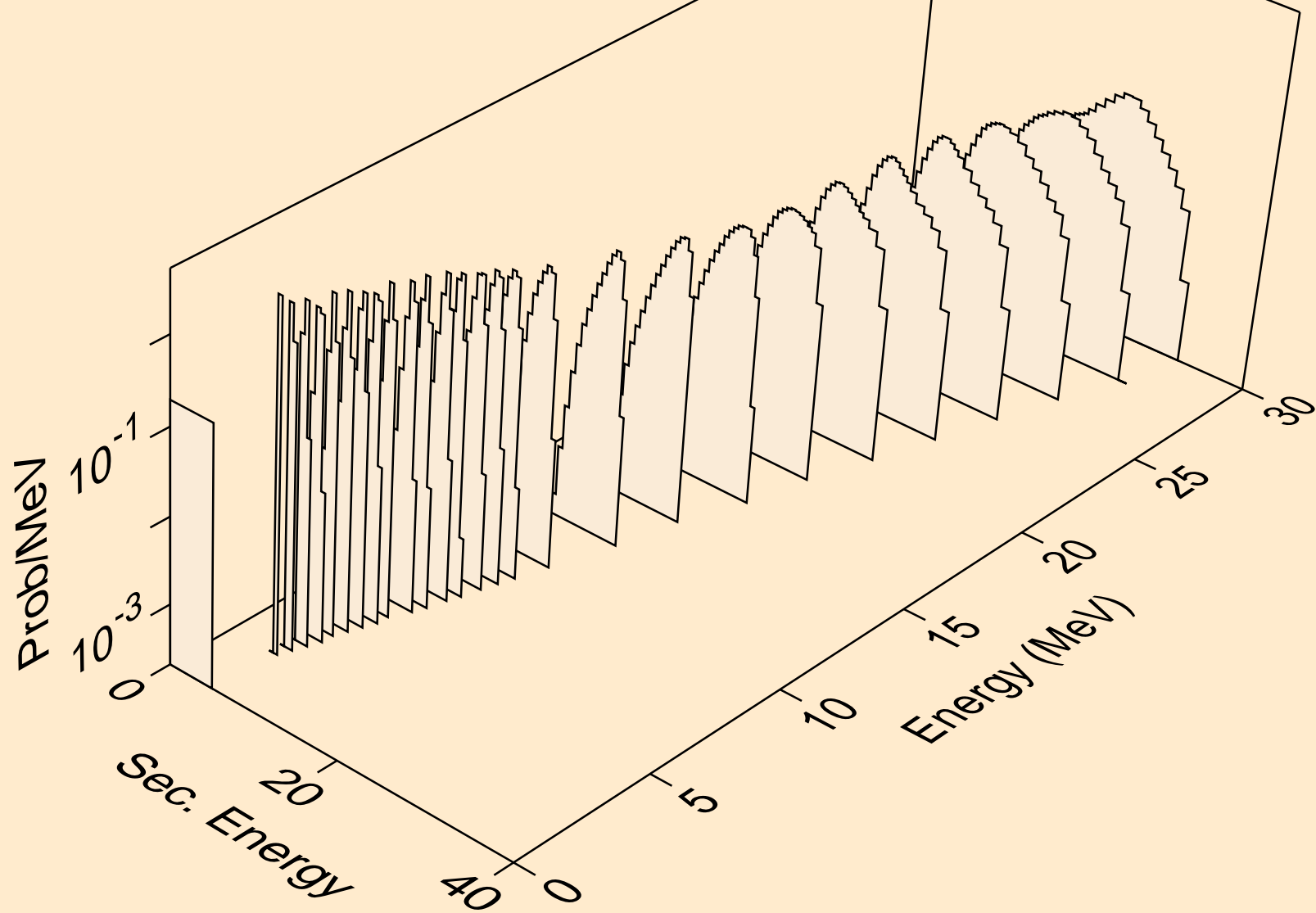

ER147M NEUTRON ACER TENDL-2021 LIBRARY; T=293.6K
alphas from (n,2n)a

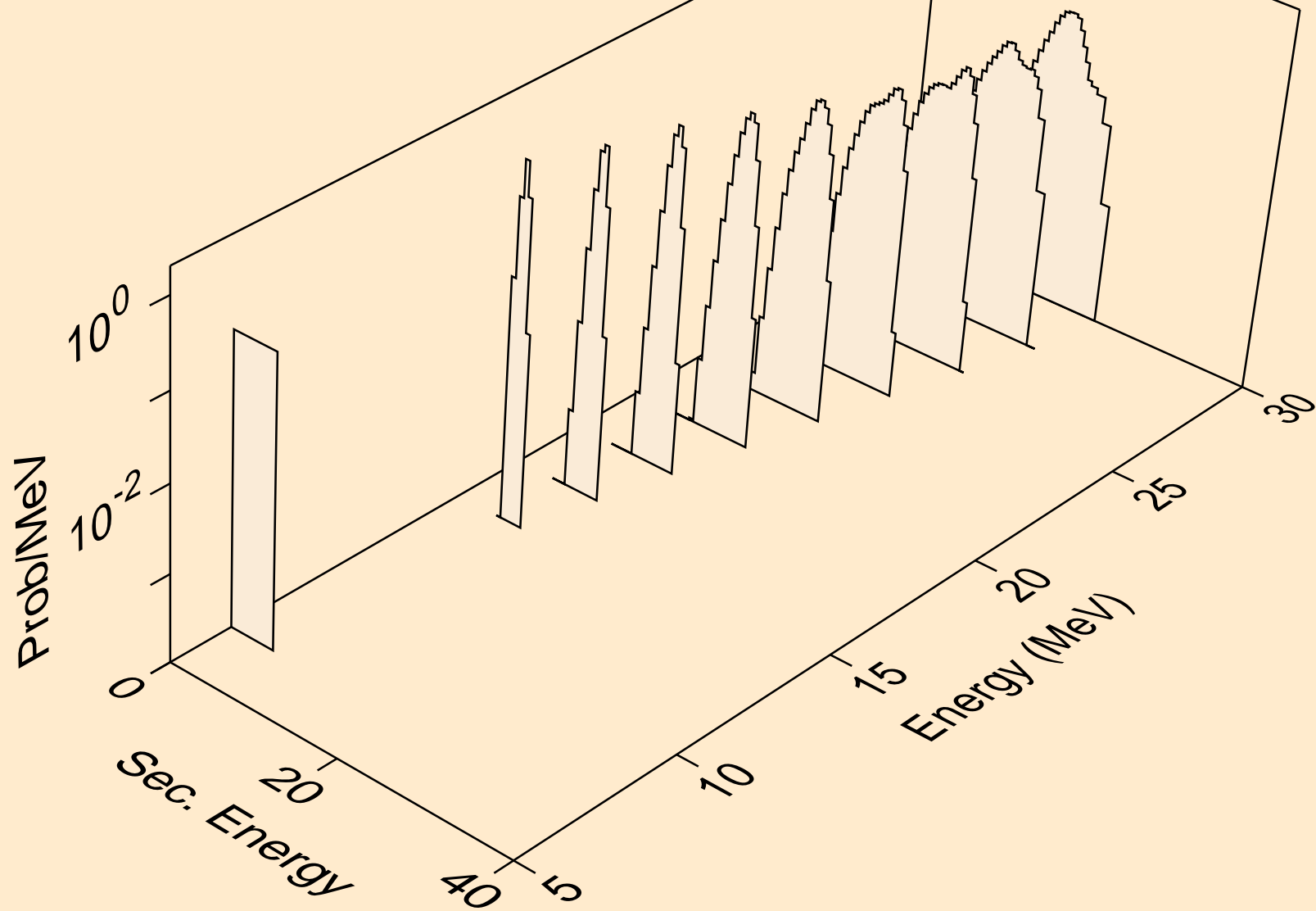

ER147M NEUTRON ACER TENDL-2021 LIBRARY; T=293.6K
alphas from (n,n*)2a

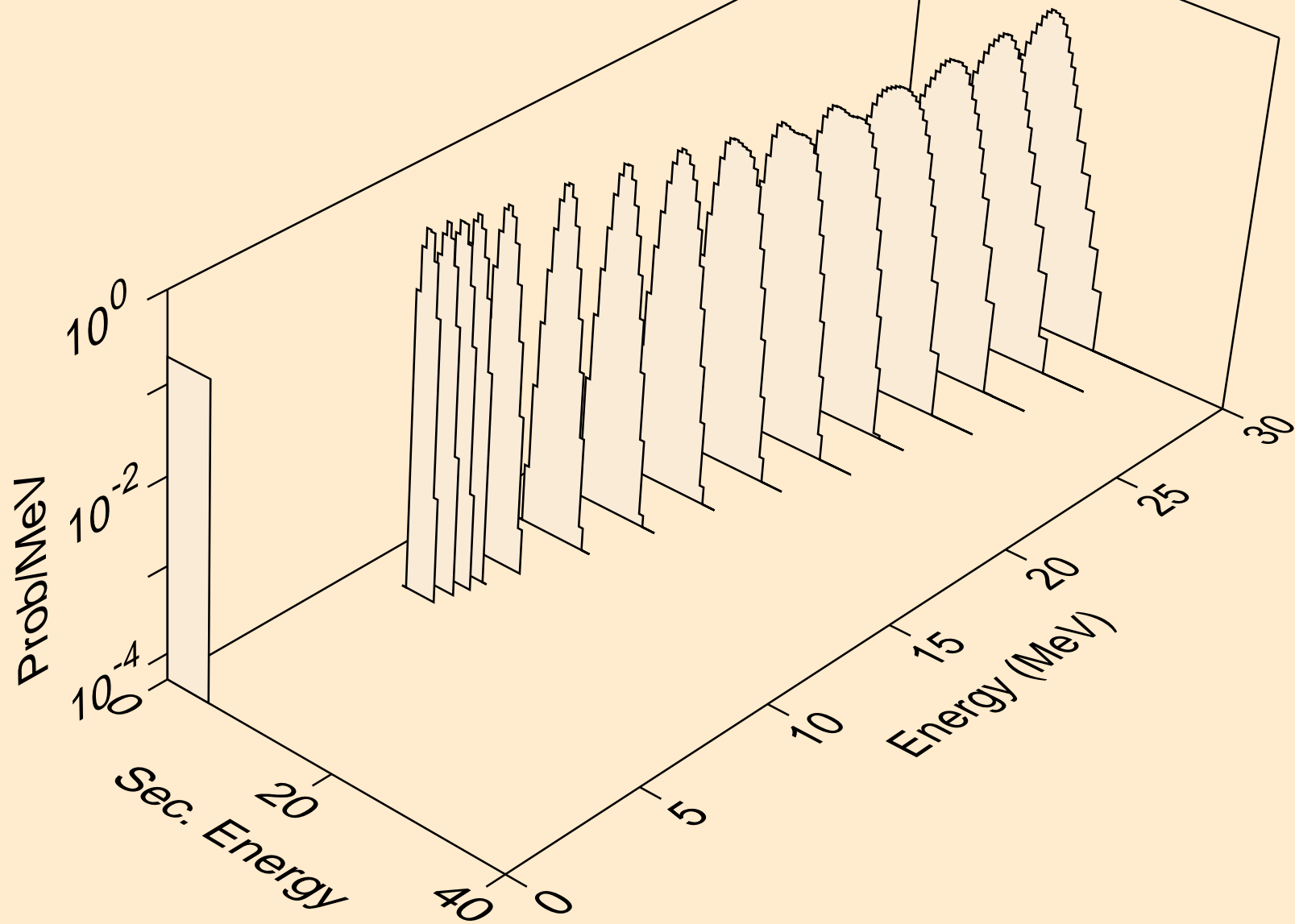

ER147M NEUTRON ACER TENDL-2021 LIBRARY; T=293.6K
alphas from (n,2n)2a

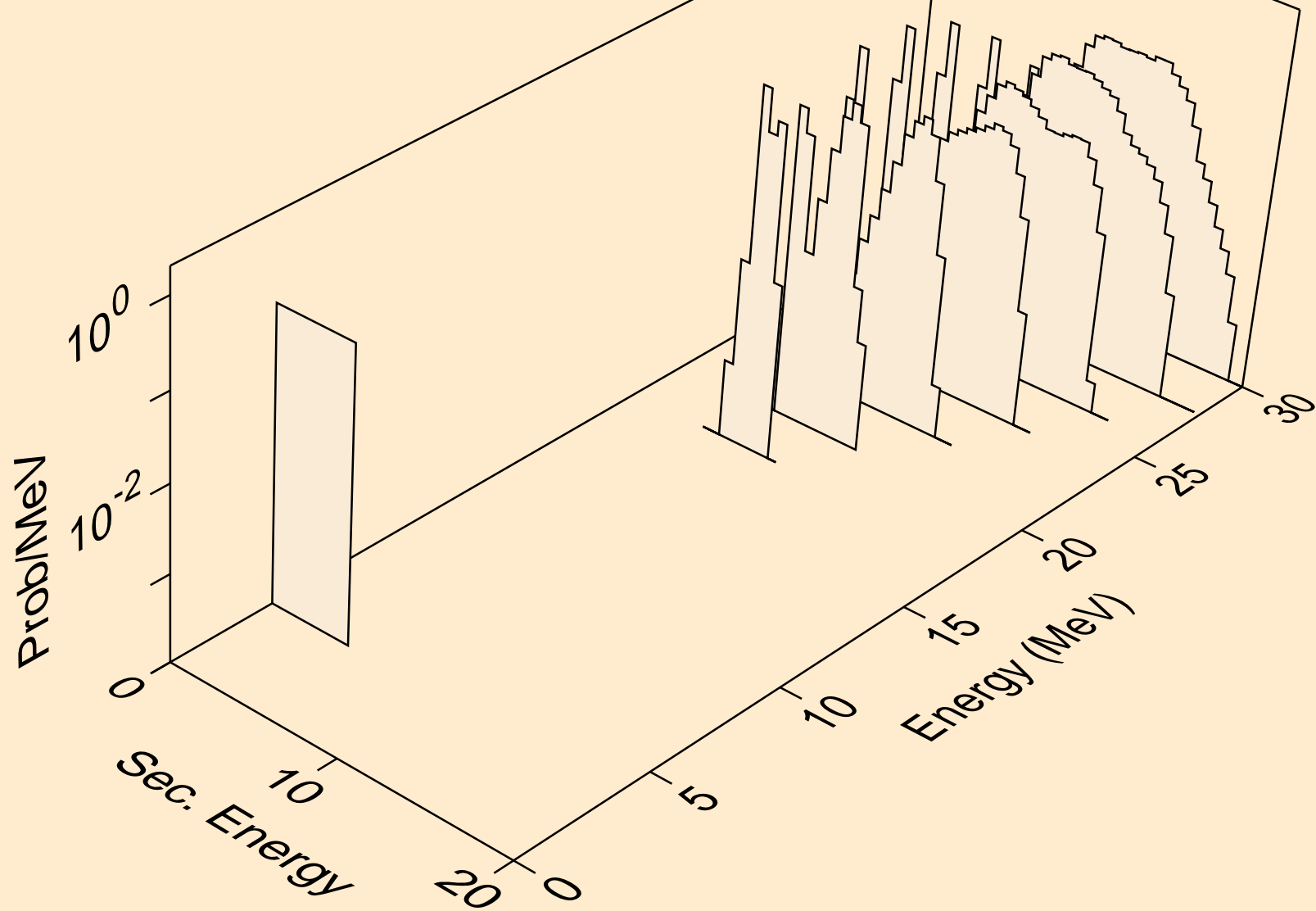

ER147M NEUTRON ACER TENDL-2021 LIBRARY; T=293.6K
alphas from (n,npa)

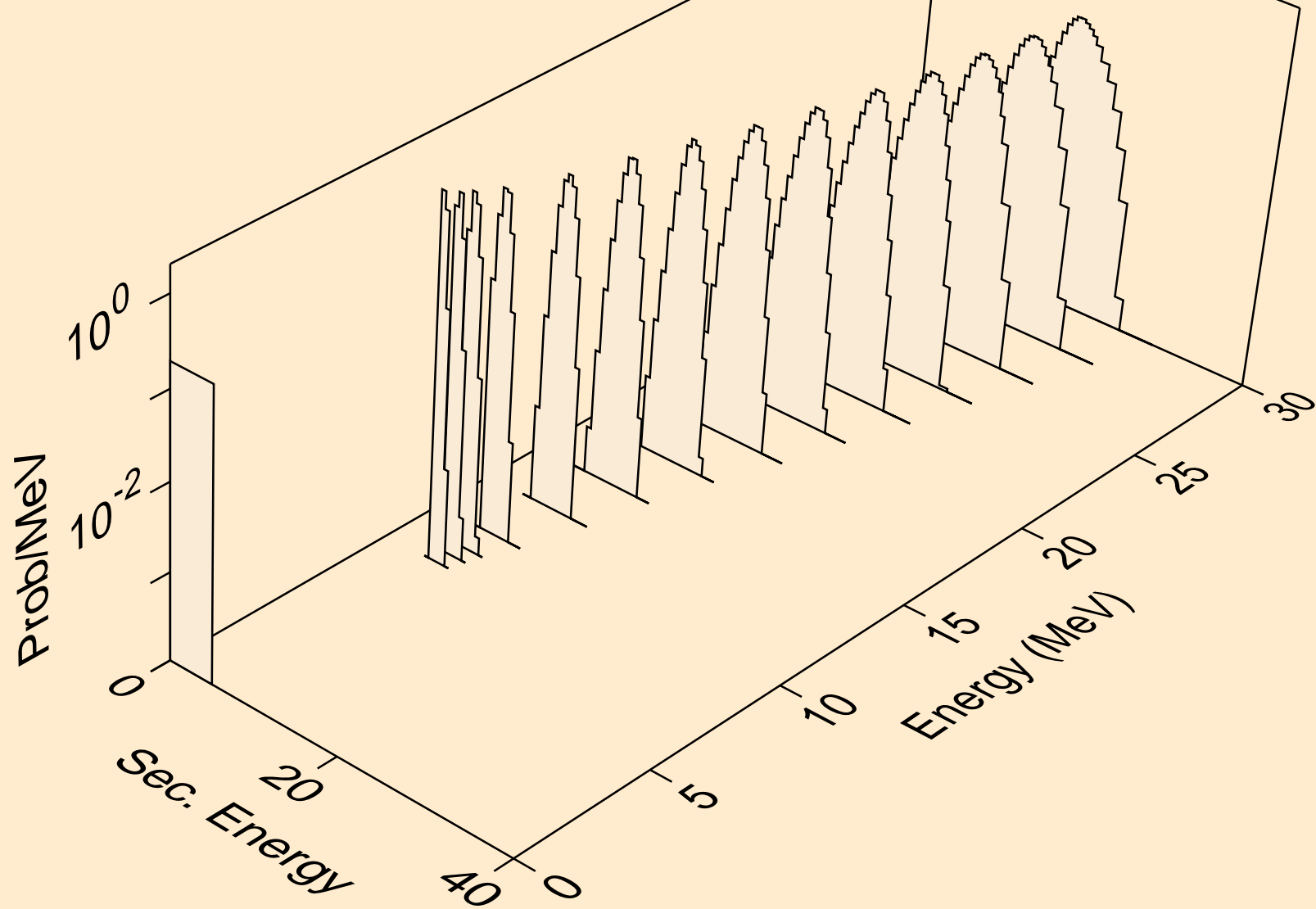

ER147M NEUTRON ACER TENDL-2021 LIBRARY; T=293.6K
alphas from (n,a)

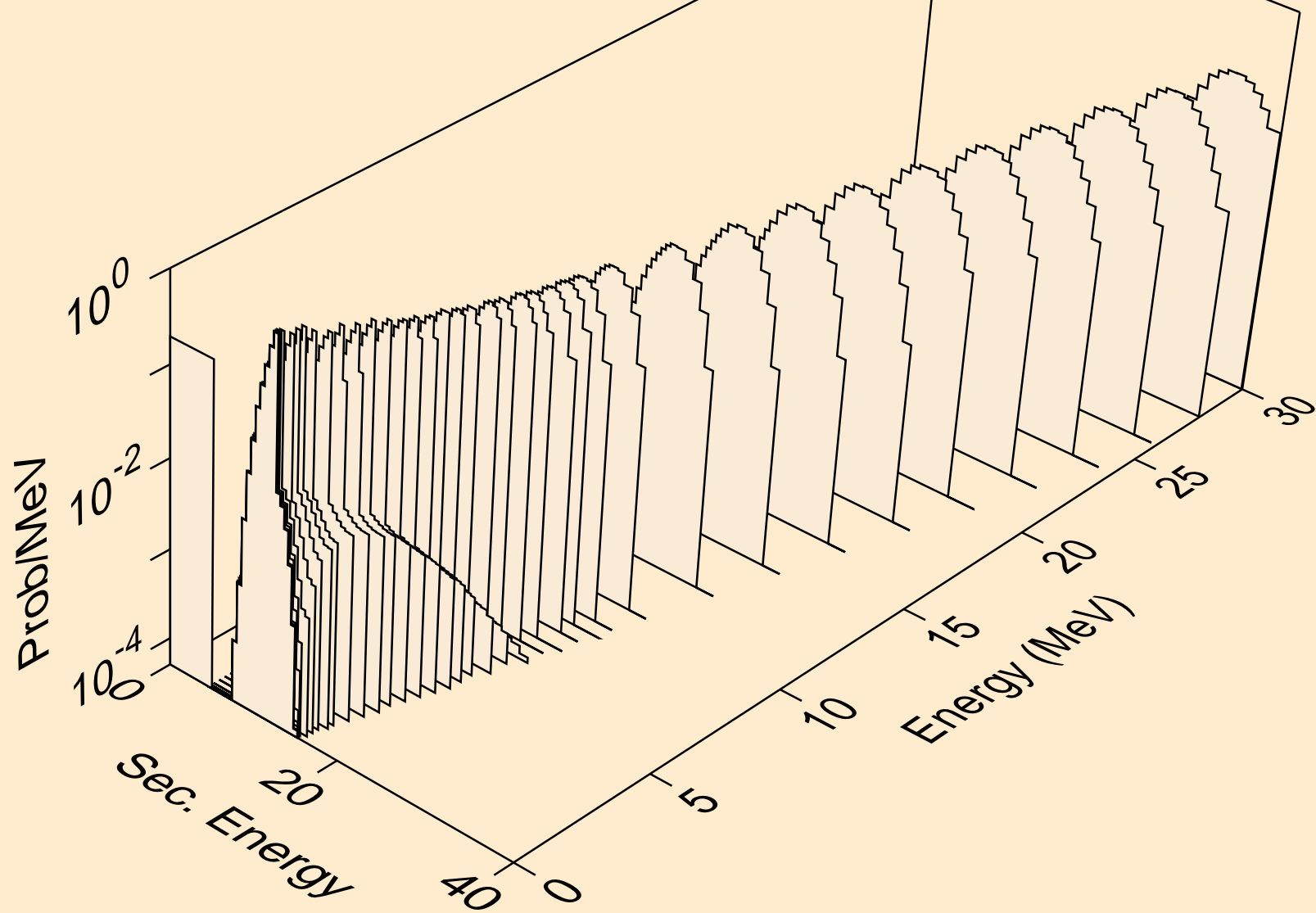

ER147M NEUTRON ACER TENDL-2021 LIBRARY; T=293.6K
alphas from (n,2a)

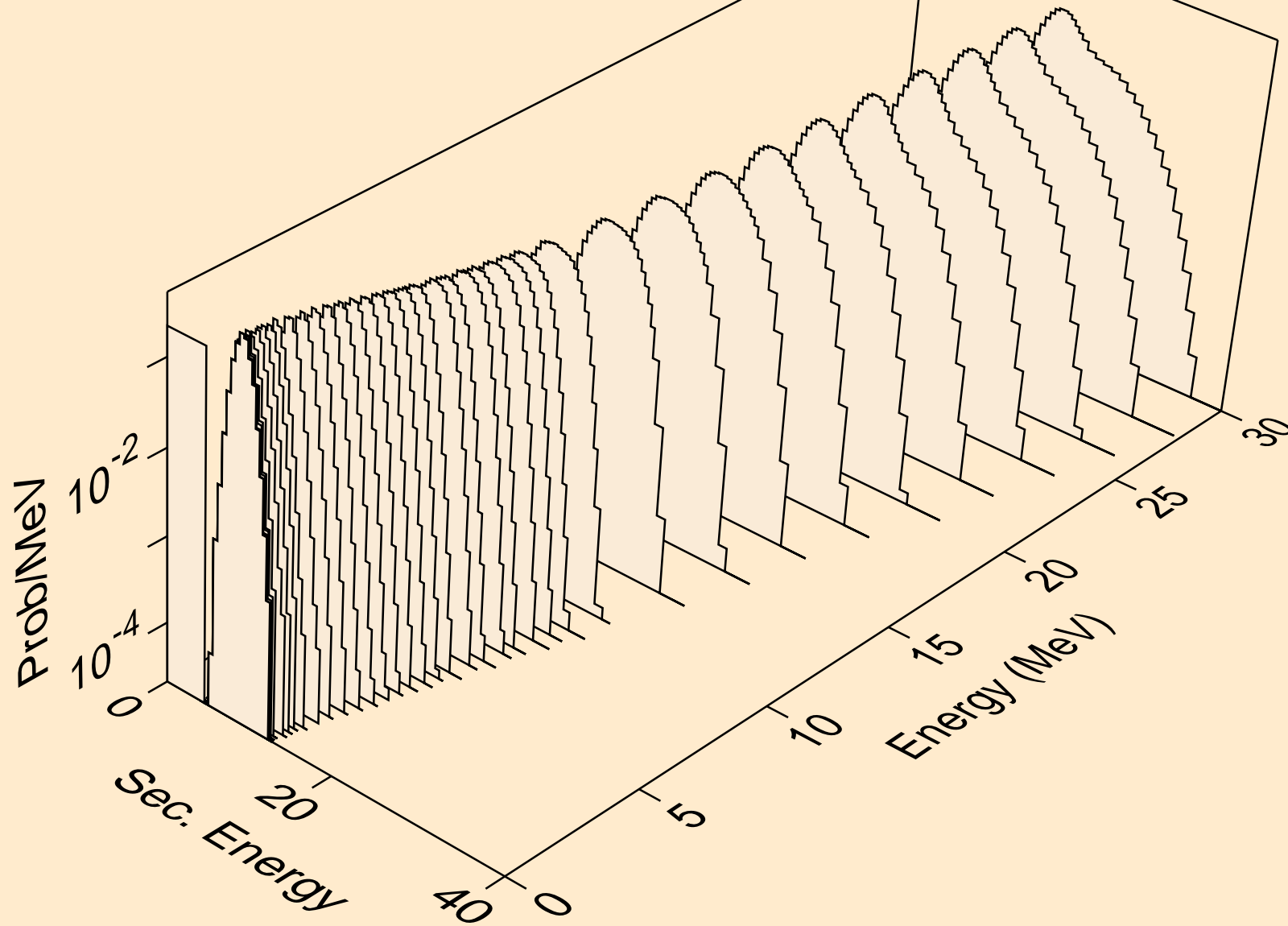

ER147M NEUTRON ACER TENDL-2021 LIBRARY; T=293.6K
alphas from (n,3a)

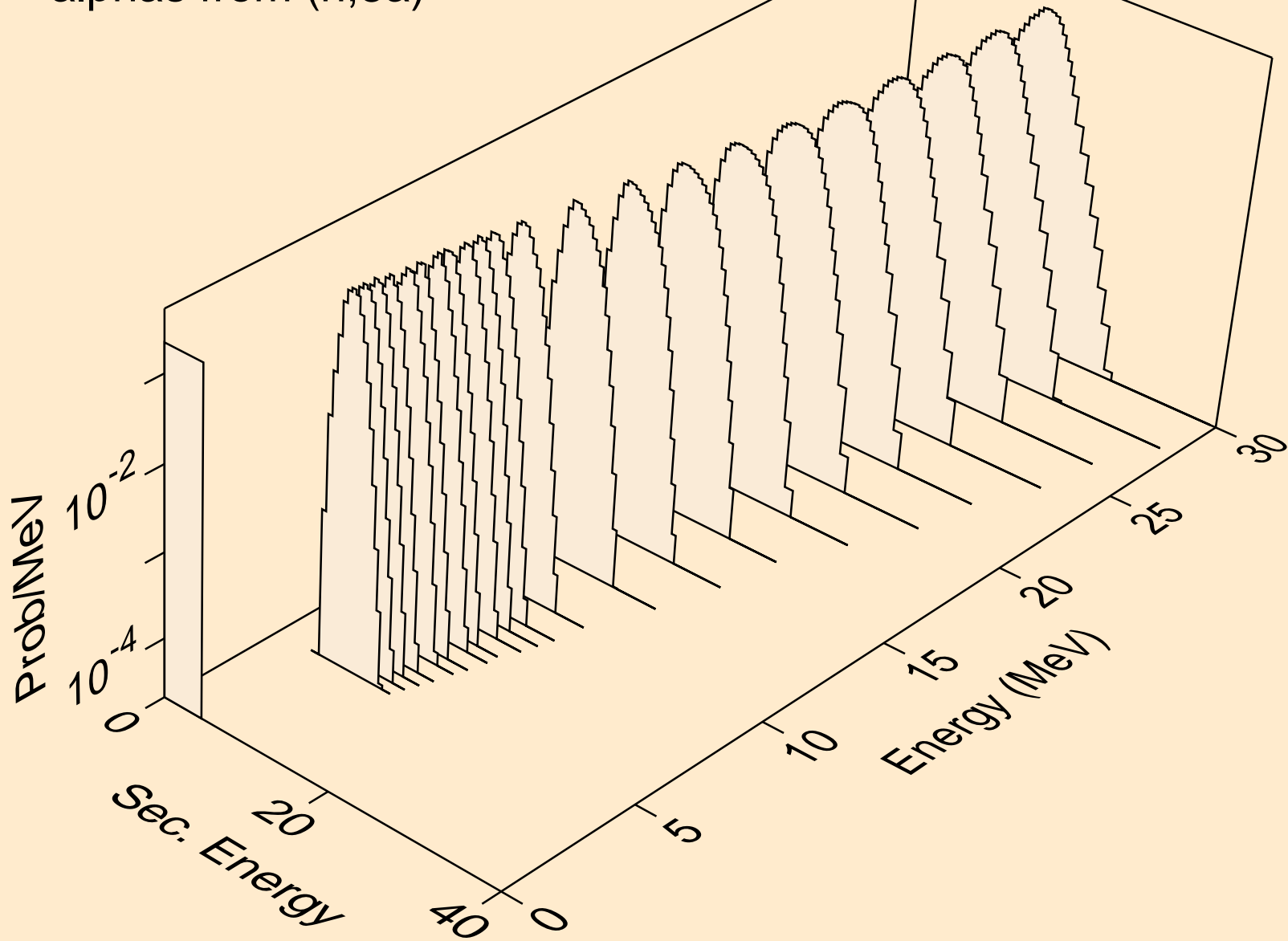

ER147M NEUTRON ACER TENDL-2021 LIBRARY; T=293.6K
alphas from (n,pa)

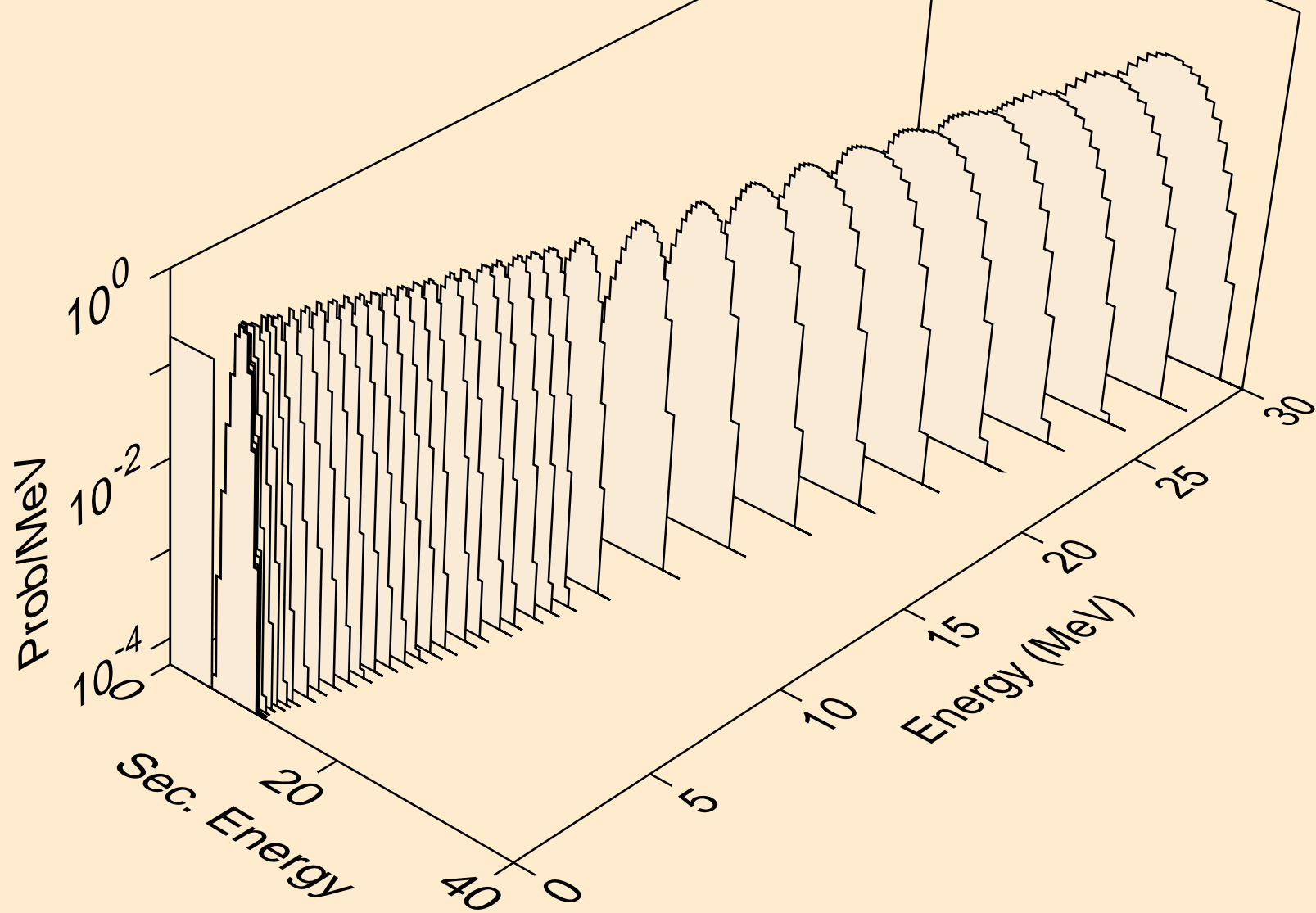

ER147M NEUTRON ACER TENDL-2021 LIBRARY; T=293.6K
alphas from (n,da)

