

ER159 NEUTRON ACER TENDL-2021 LIBRARY; T=293.6K

Principal cross sections

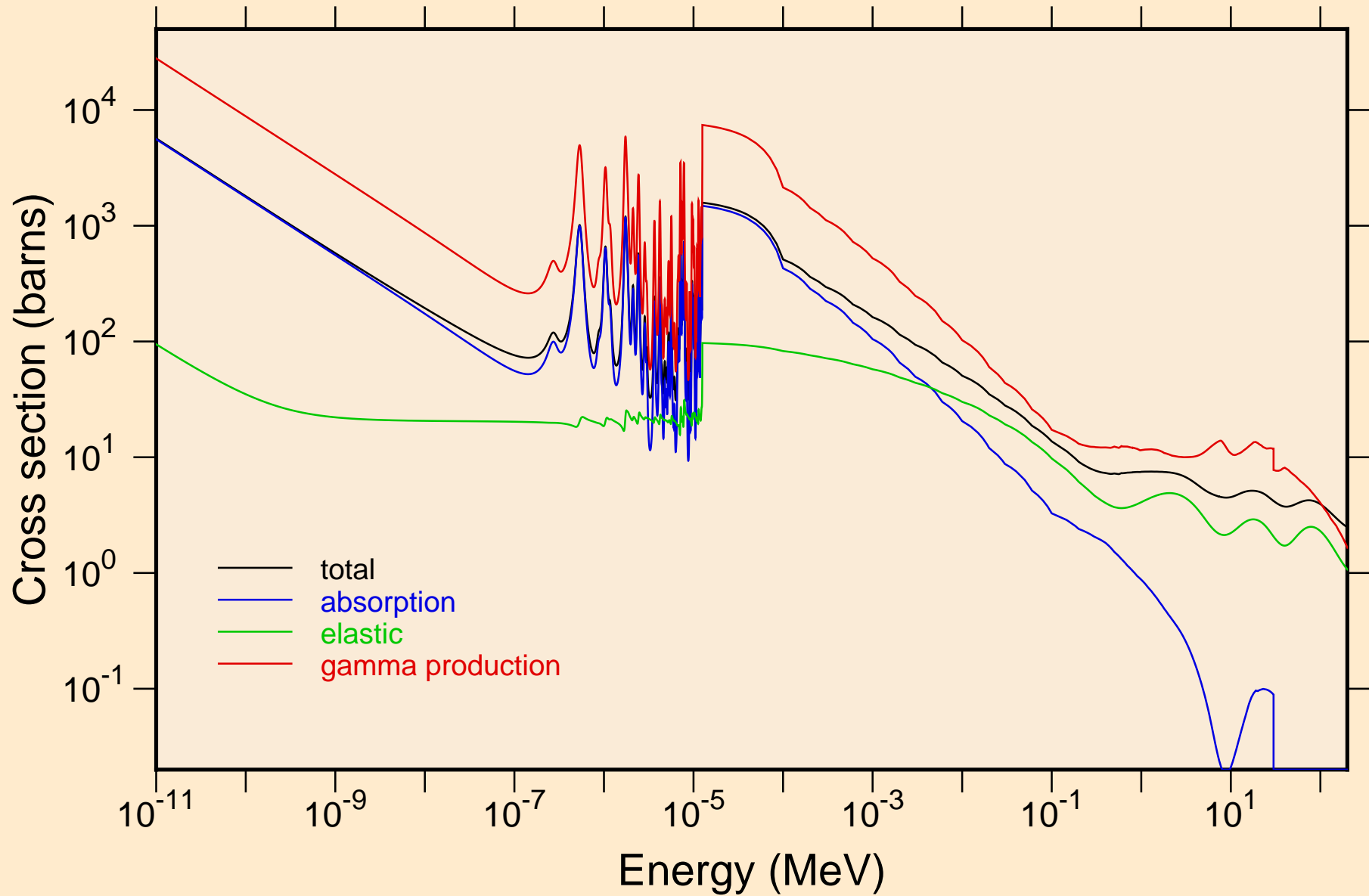

ER159 NEUTRON ACER TENDL-2021 LIBRARY; T=293.6K
resonance total cross section

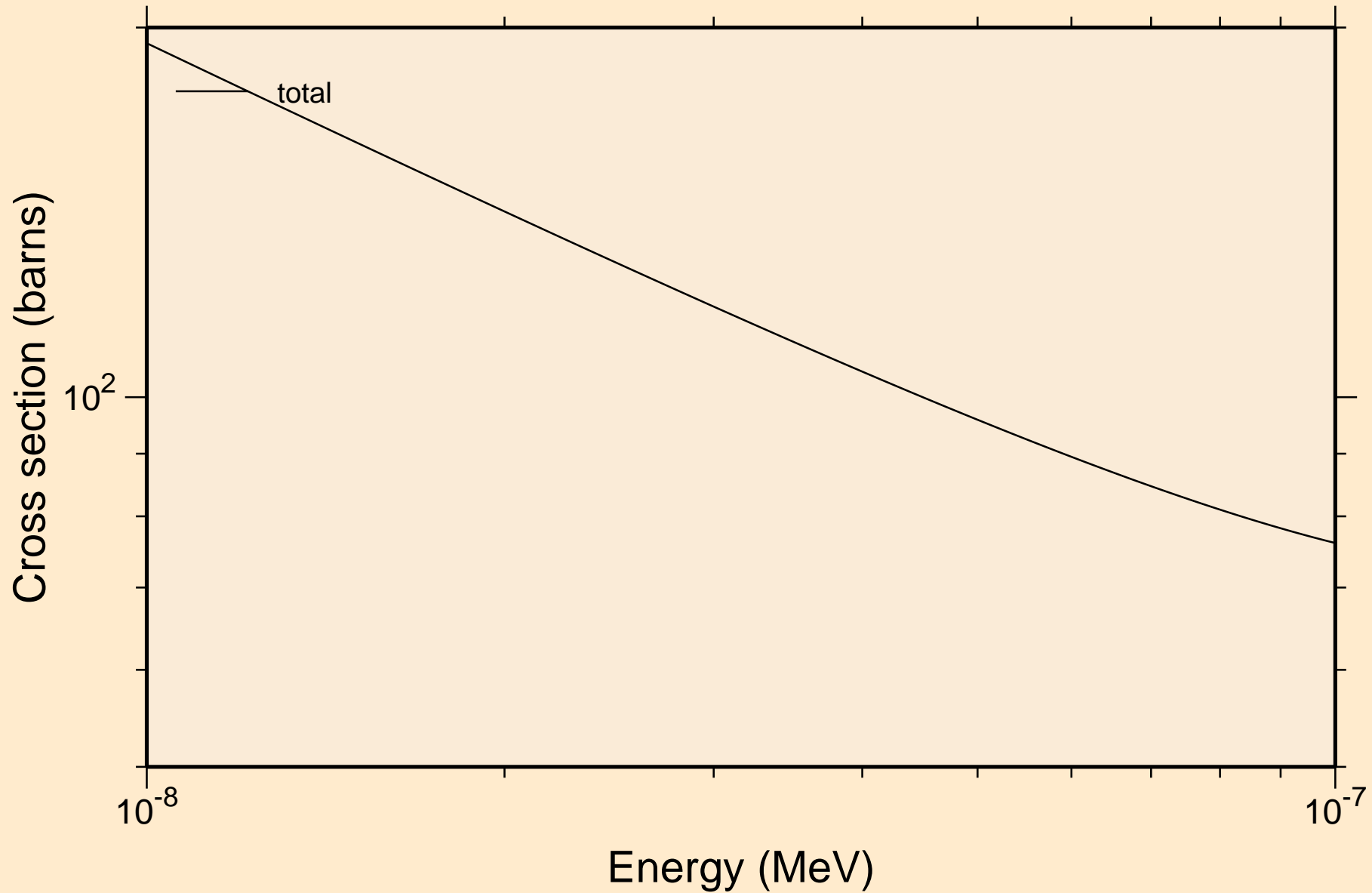

ER159 NEUTRON ACER TENDL-2021 LIBRARY; T=293.6K
resonance total cross section

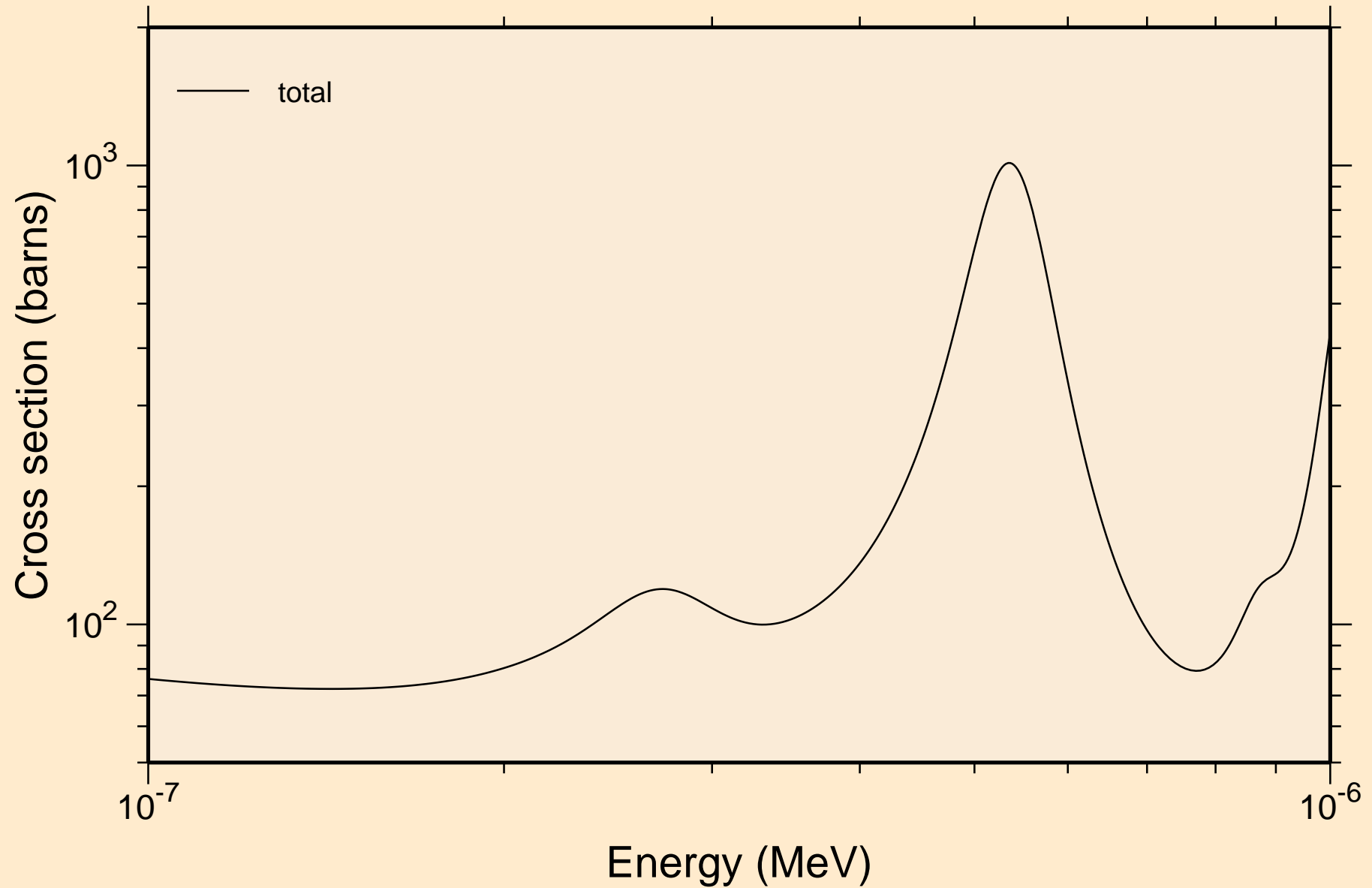

ER159 NEUTRON ACER TENDL-2021 LIBRARY; T=293.6K
resonance total cross section

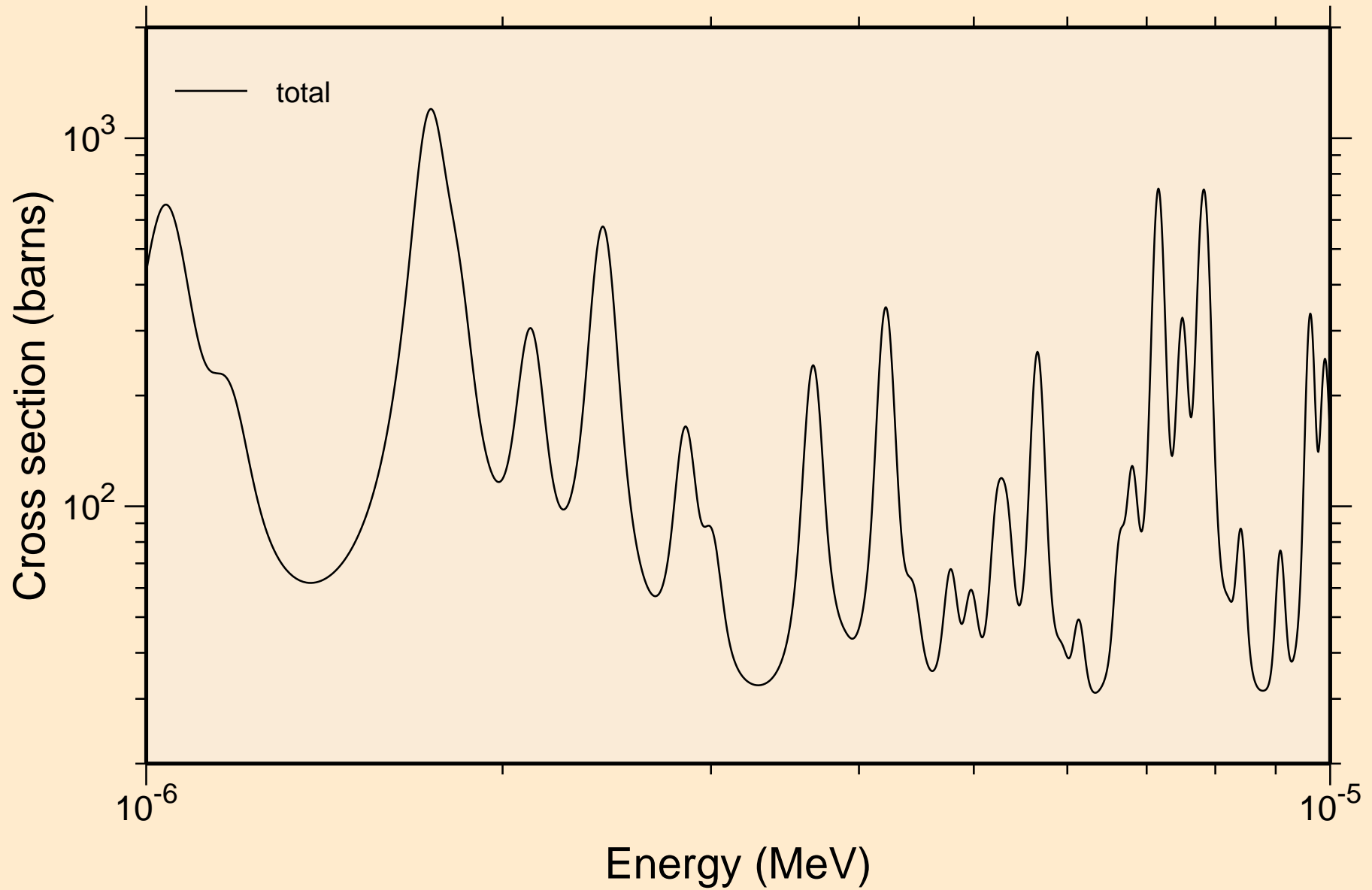

ER159 NEUTRON ACER TENDL-2021 LIBRARY; T=293.6K
resonance total cross section

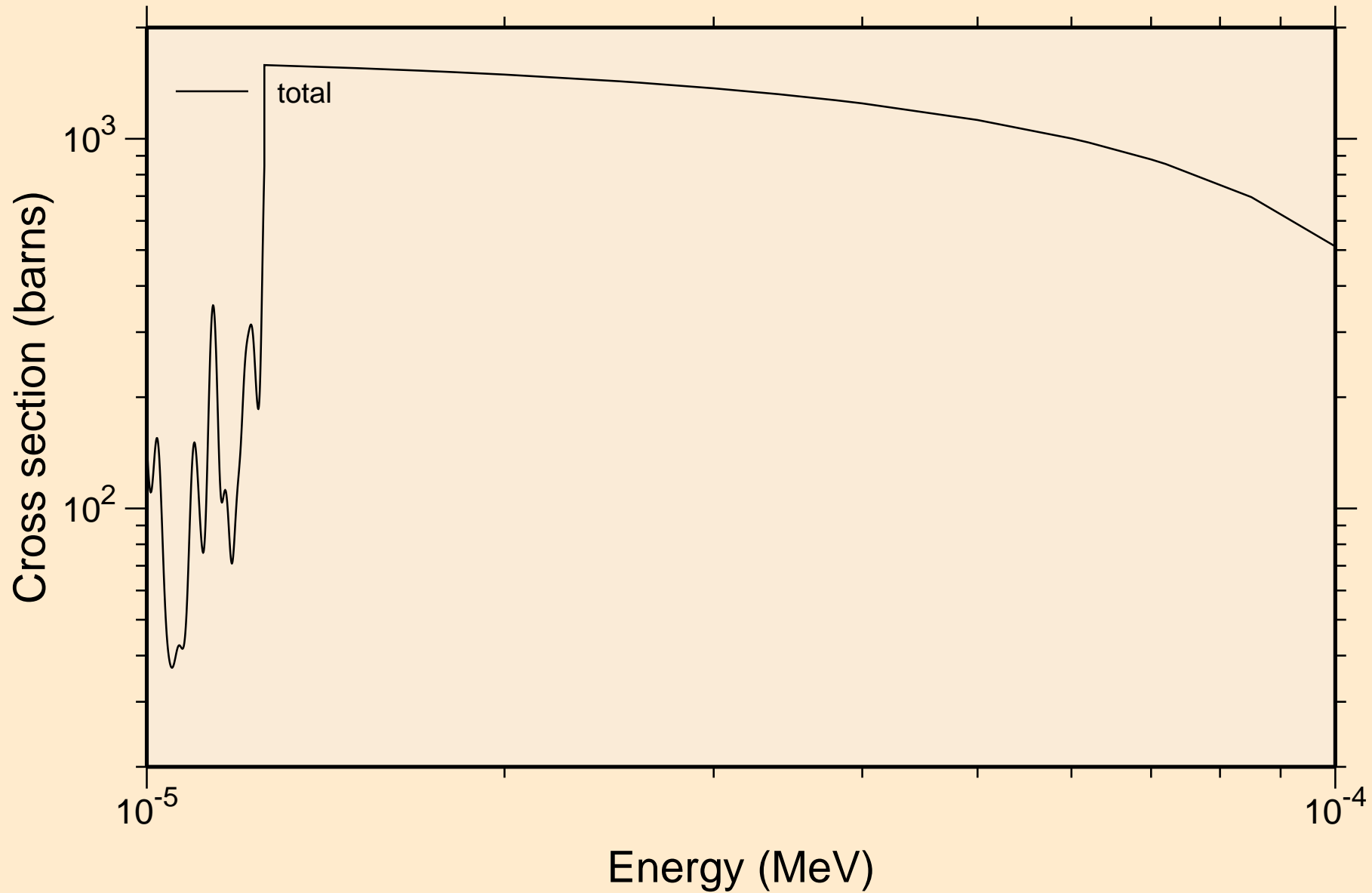

ER159 NEUTRON ACER TENDL-2021 LIBRARY; T=293.6K
resonance total cross section

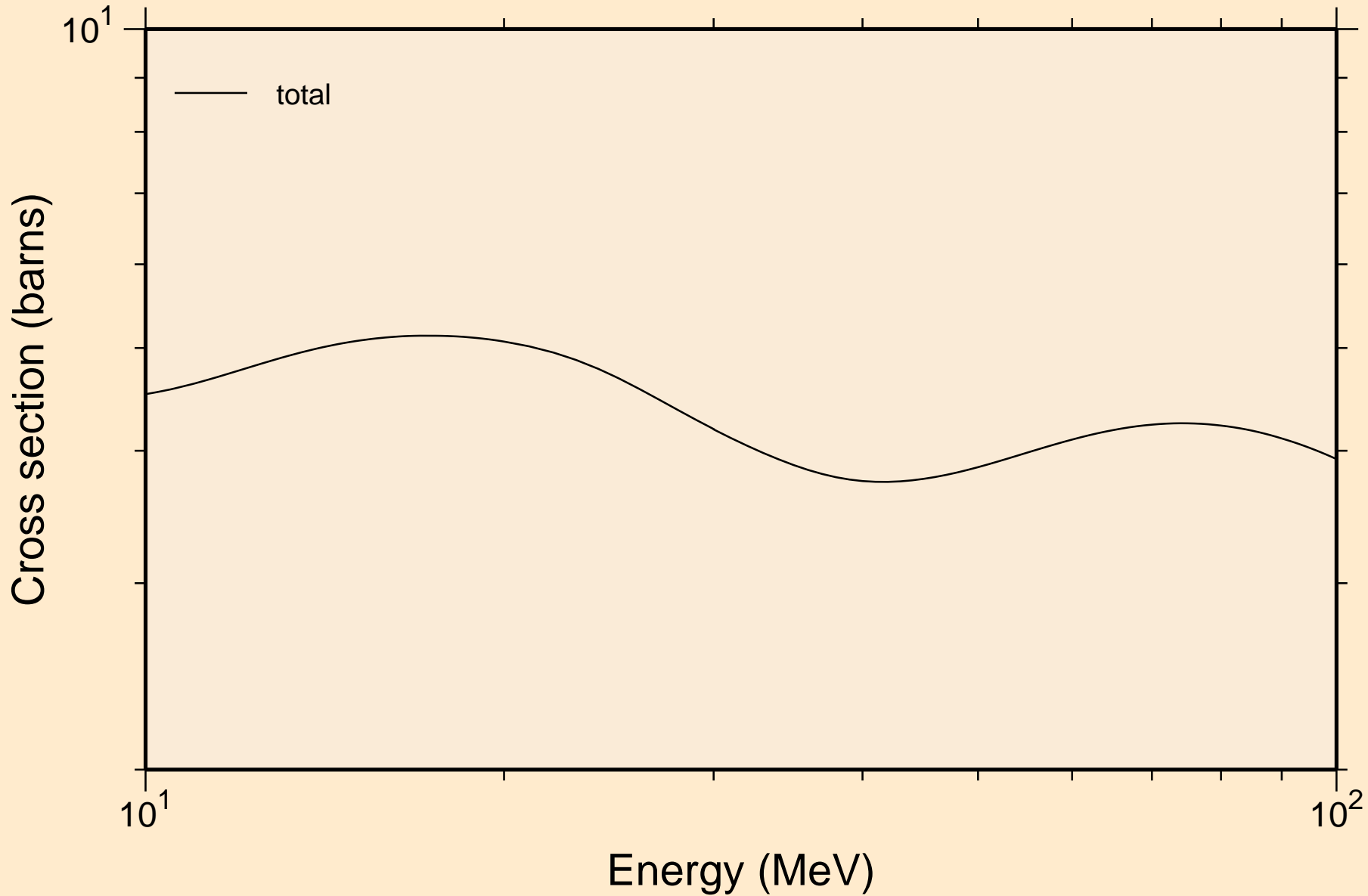

ER159 NEUTRON ACER TENDL-2021 LIBRARY; T=293.6K
resonance absorption cross sections

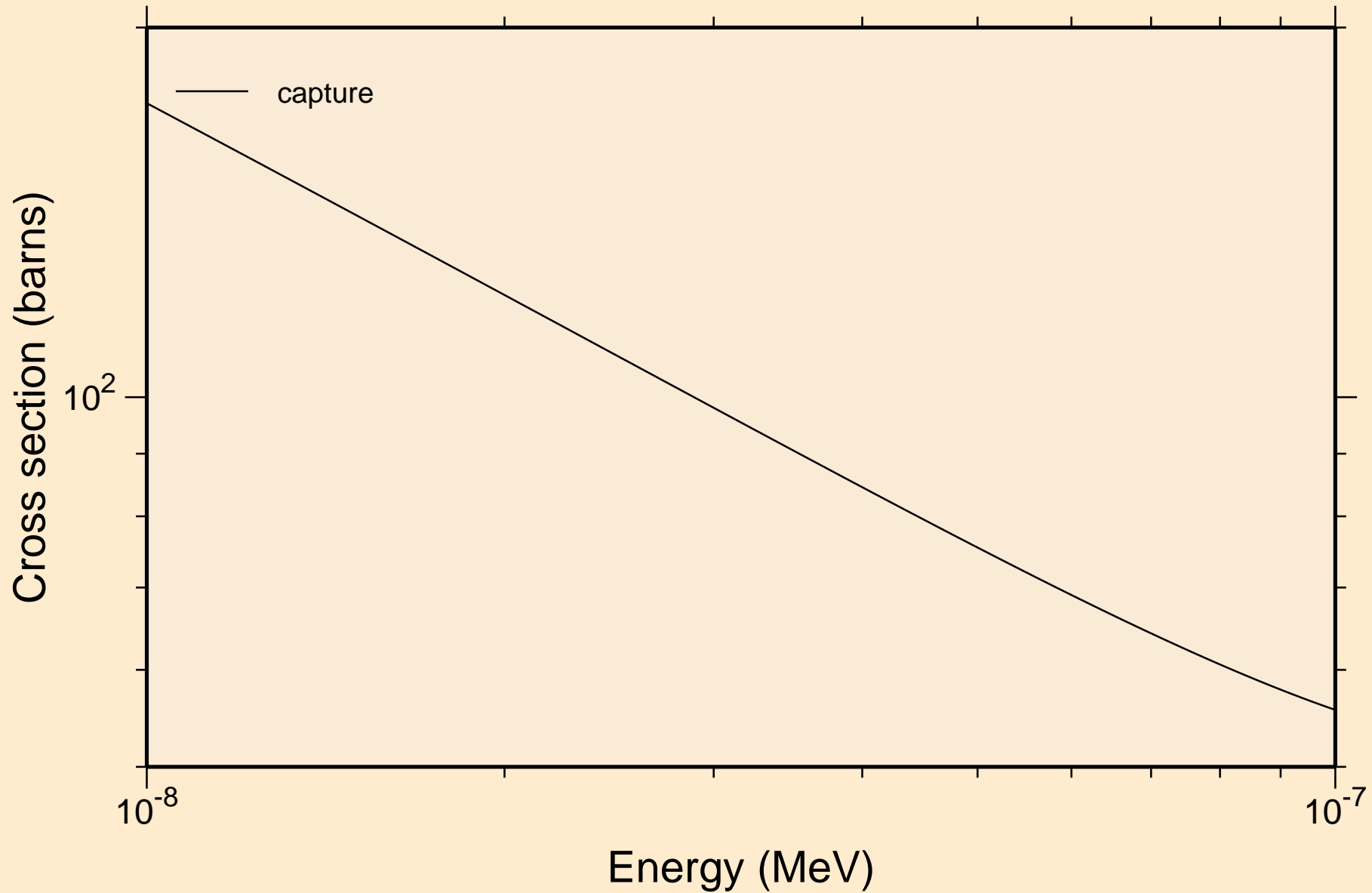

ER159 NEUTRON ACER TENDL-2021 LIBRARY; T=293.6K
resonance absorption cross sections

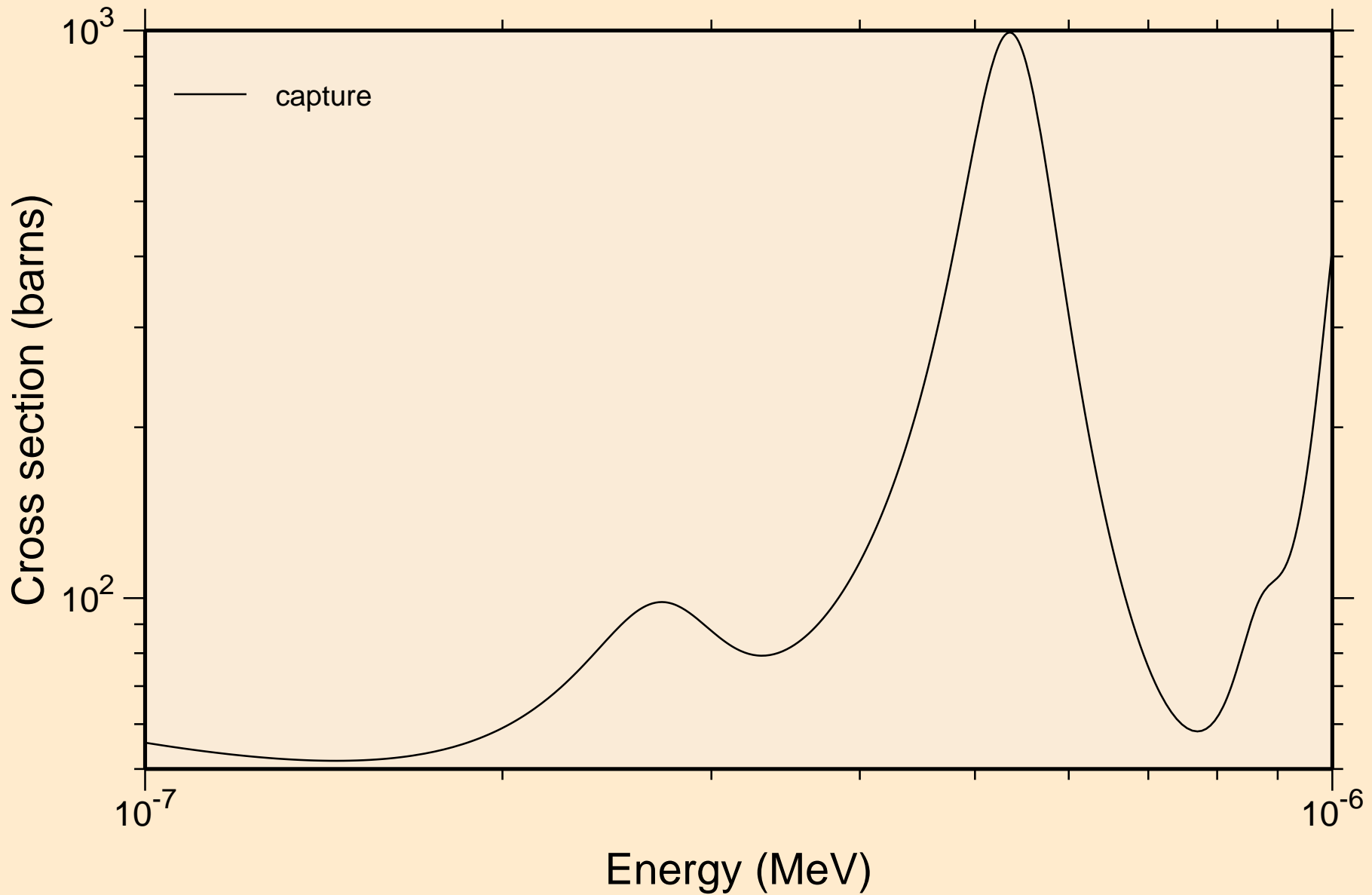

ER159 NEUTRON ACER TENDL-2021 LIBRARY; T=293.6K
resonance absorption cross sections

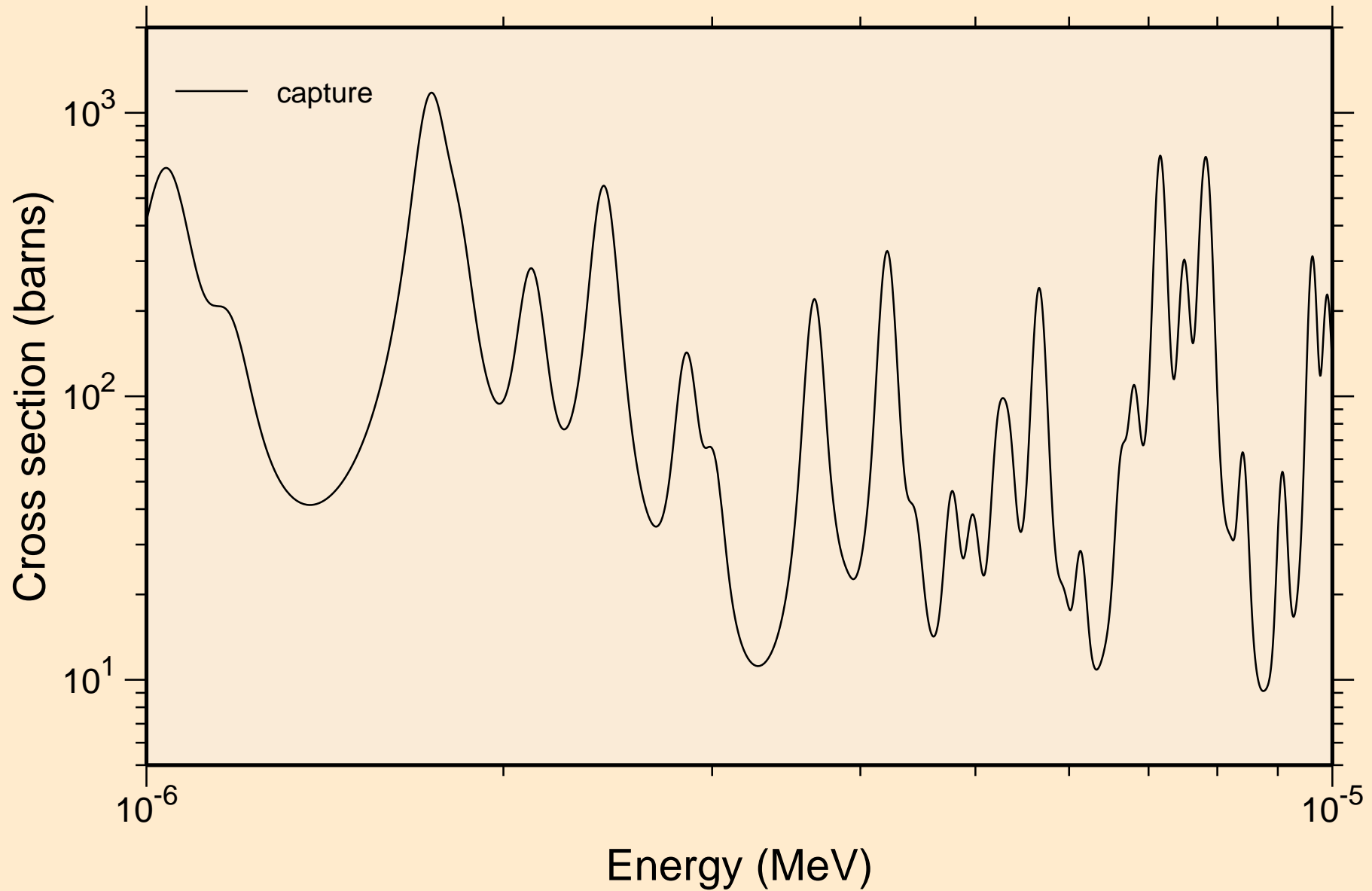

ER159 NEUTRON ACER TENDL-2021 LIBRARY; T=293.6K
resonance absorption cross sections

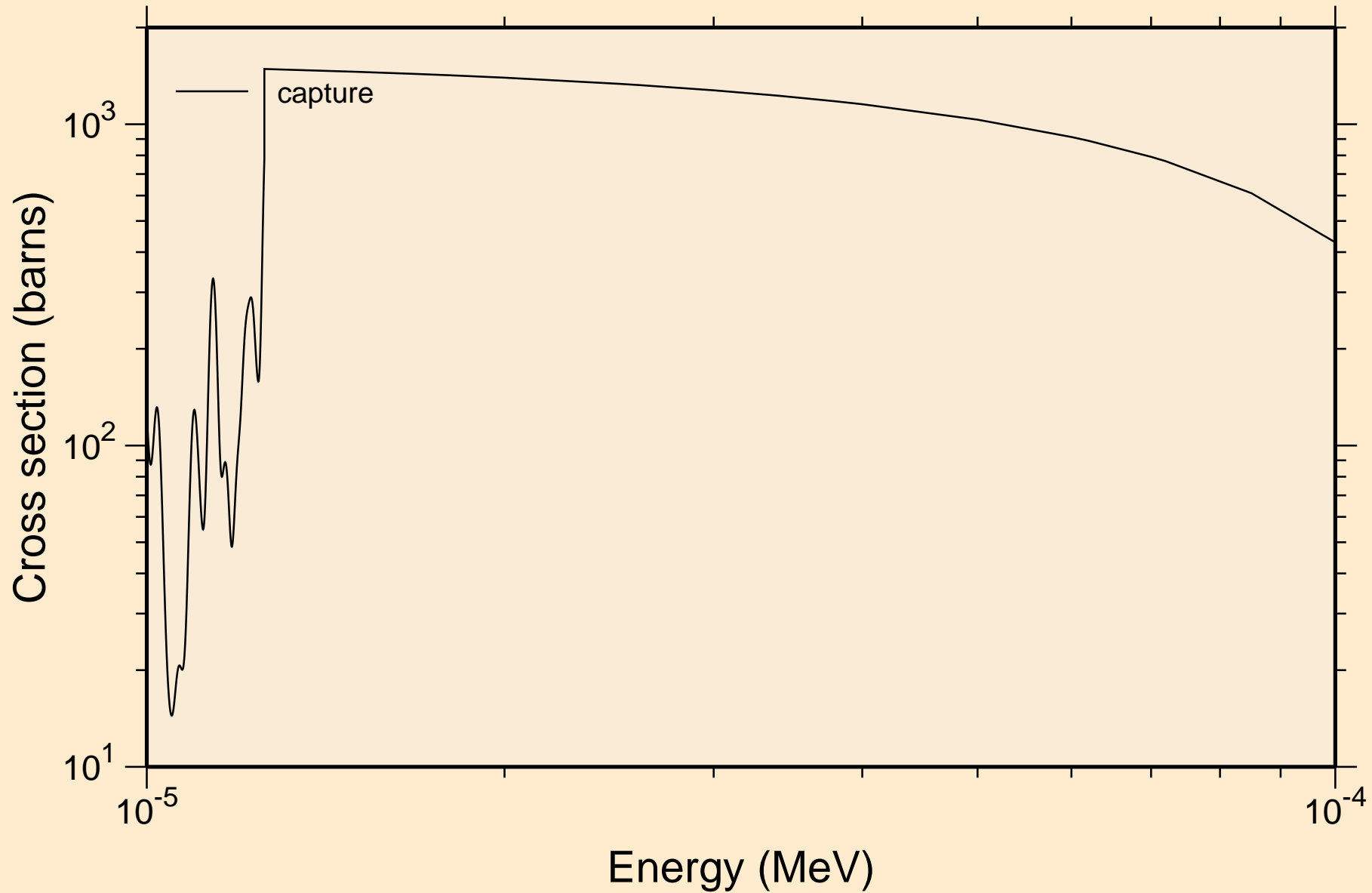

ER159 NEUTRON ACER TENDL-2021 LIBRARY; T=293.6K
resonance absorption cross sections

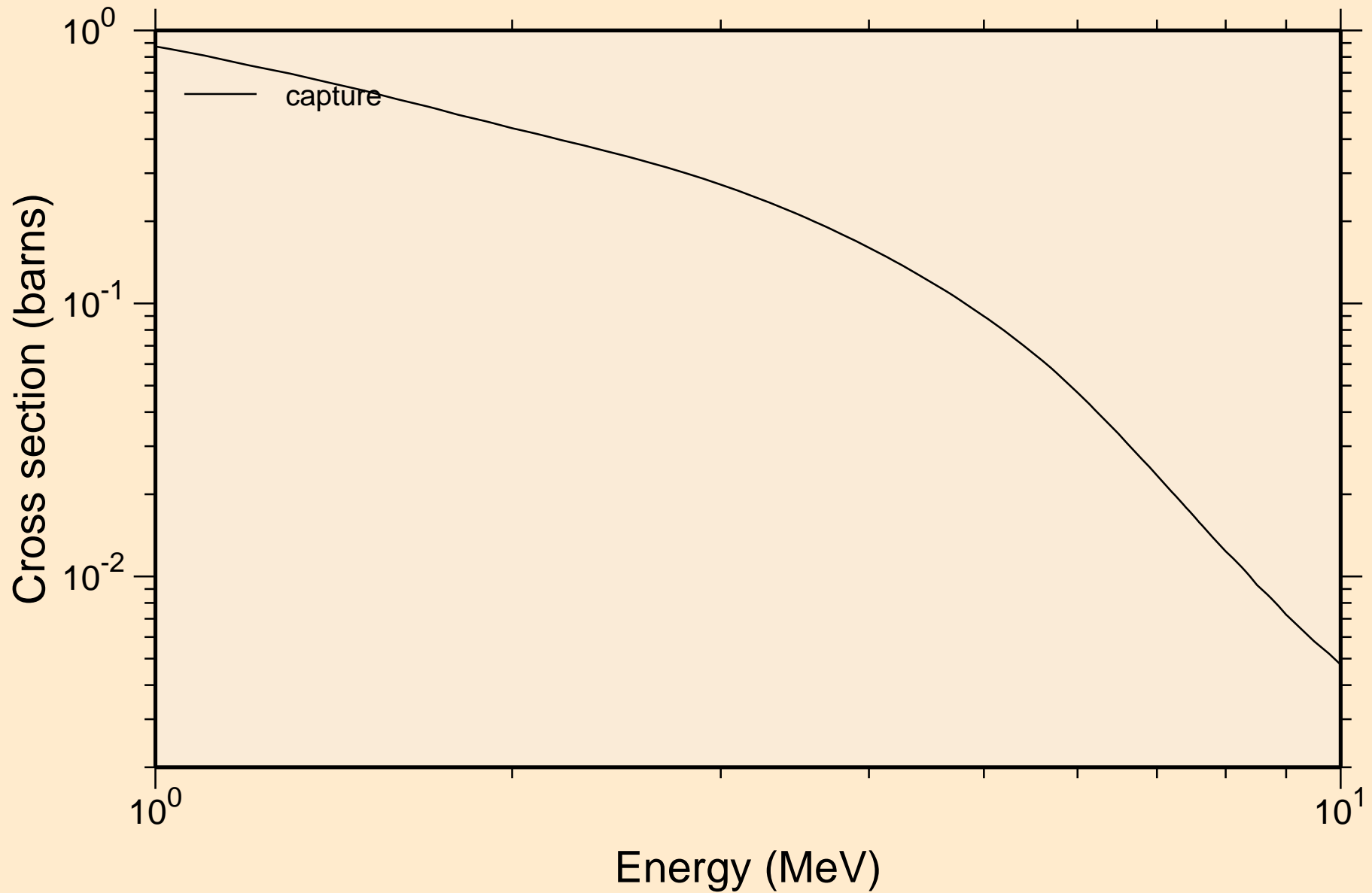

ER159 NEUTRON ACER TENDL-2021 LIBRARY; T=293.6K
Heating

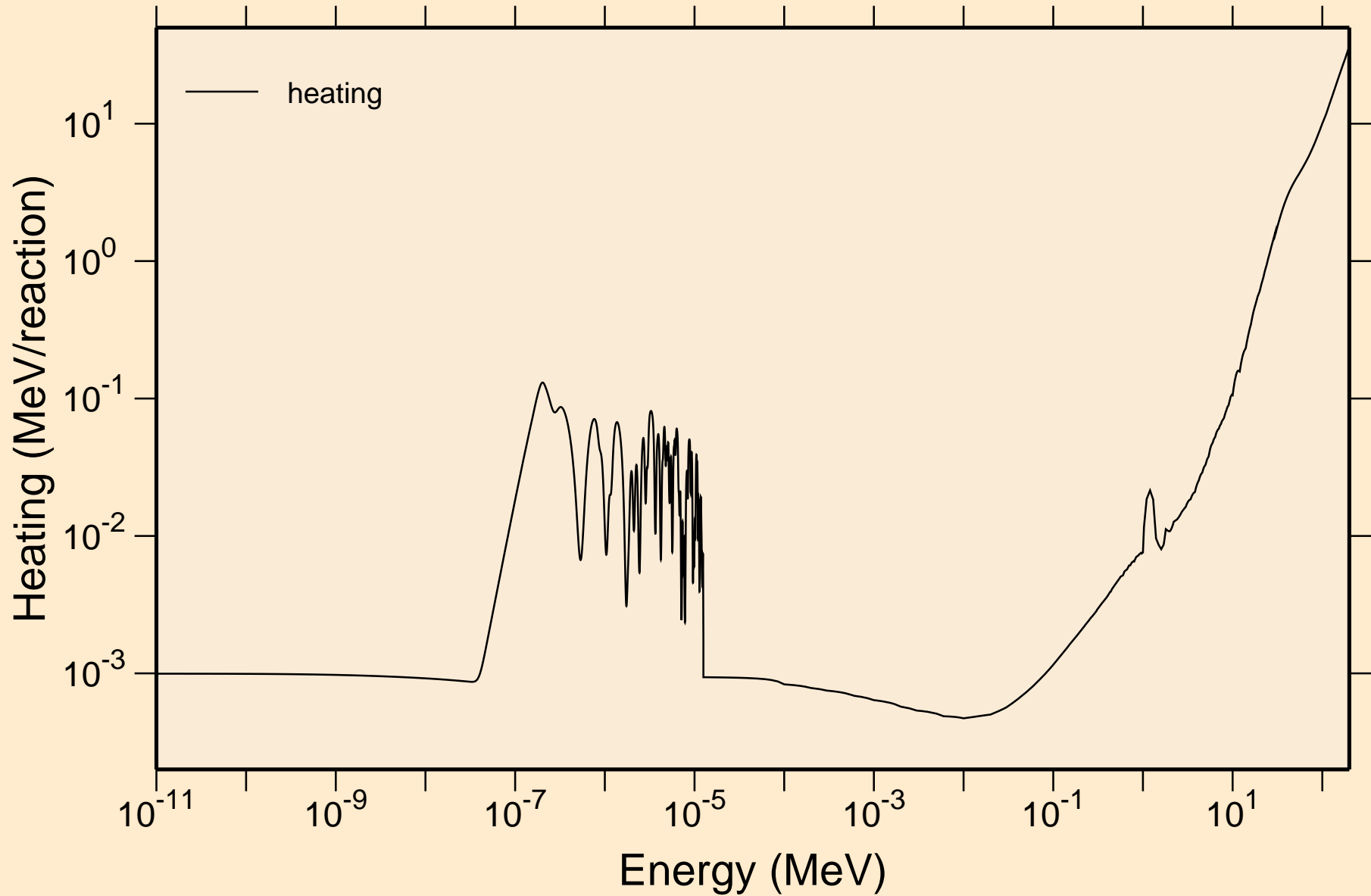

ER159 NEUTRON ACER TENDL-2021 LIBRARY; T=293.6K
Damage

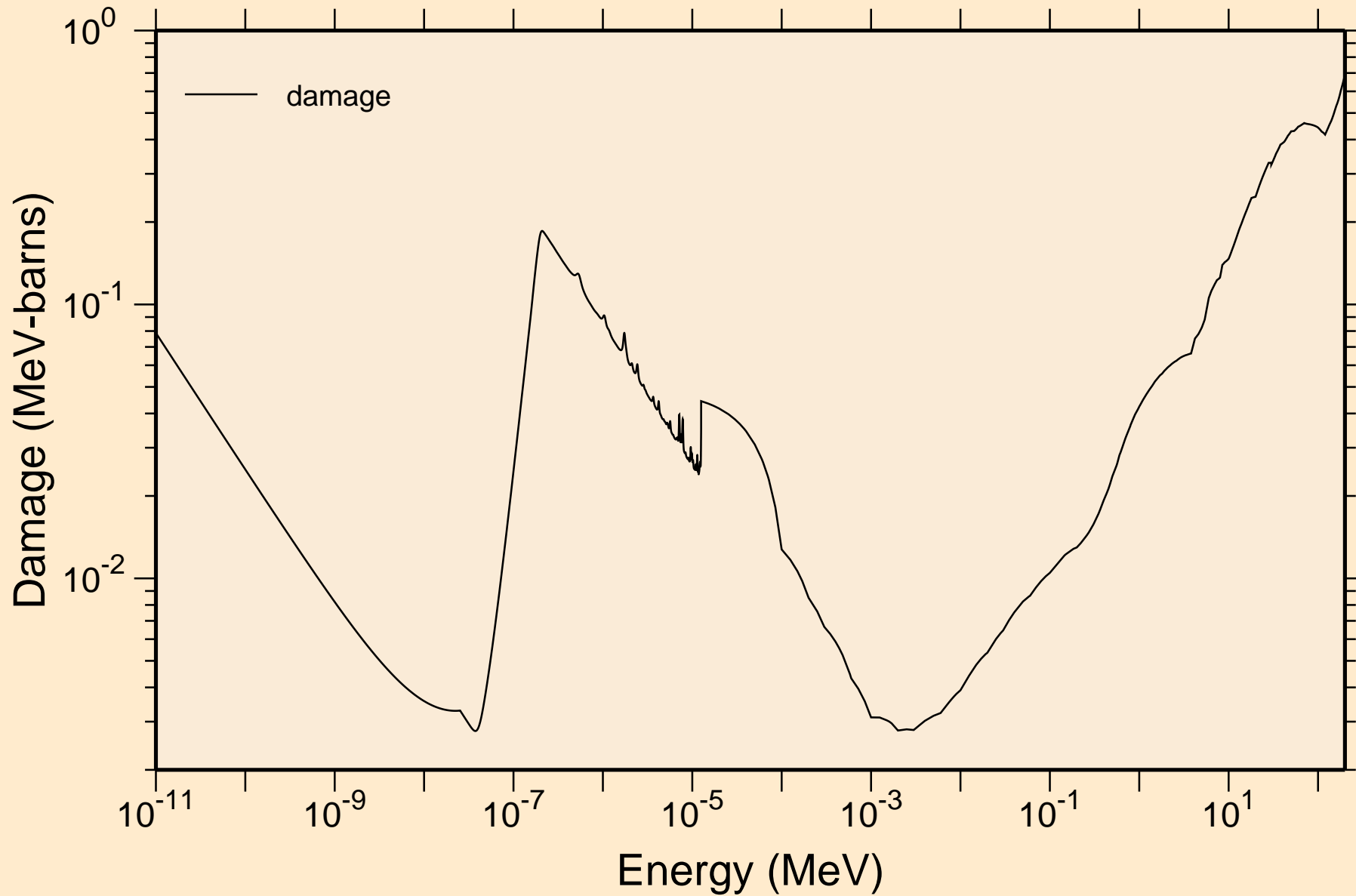

ER159 NEUTRON ACER TENDL-2021 LIBRARY; T=293.6K
Non-threshold reactions

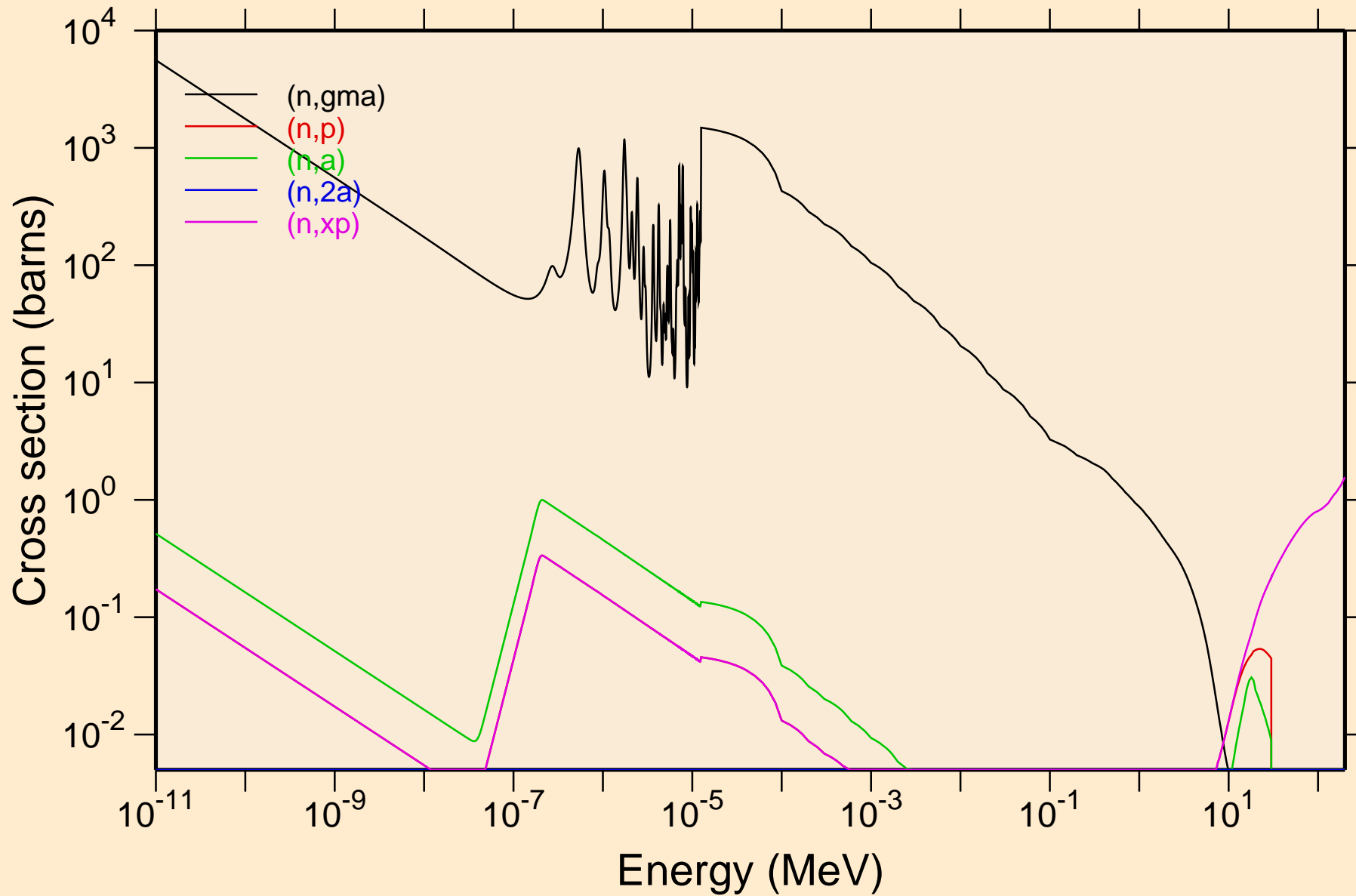

ER159 NEUTRON ACER TENDL-2021 LIBRARY; T=293.6K
Non-threshold reactions

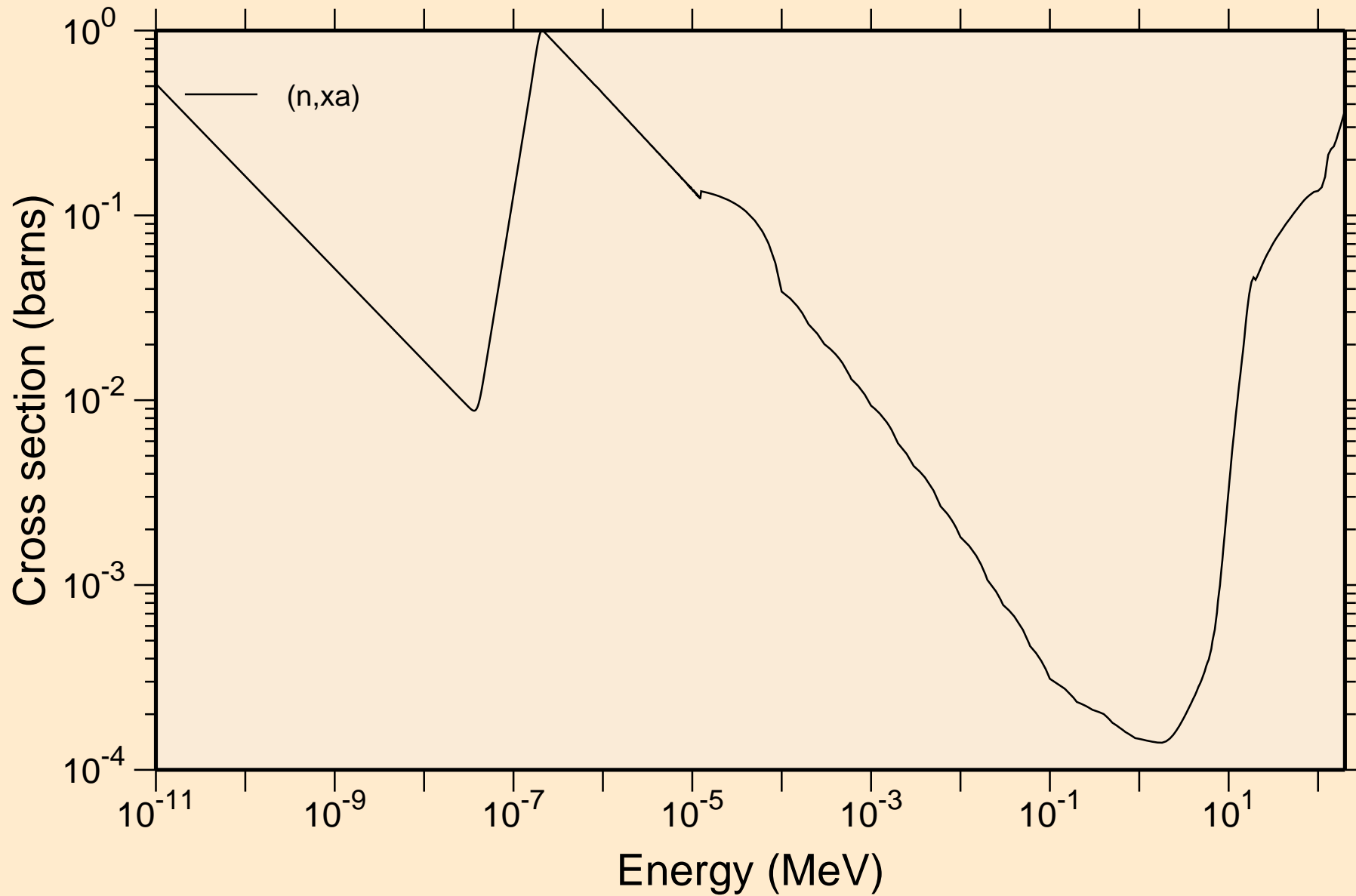

ER159 NEUTRON ACER TENDL-2021 LIBRARY; T=293.6K

Principal cross sections

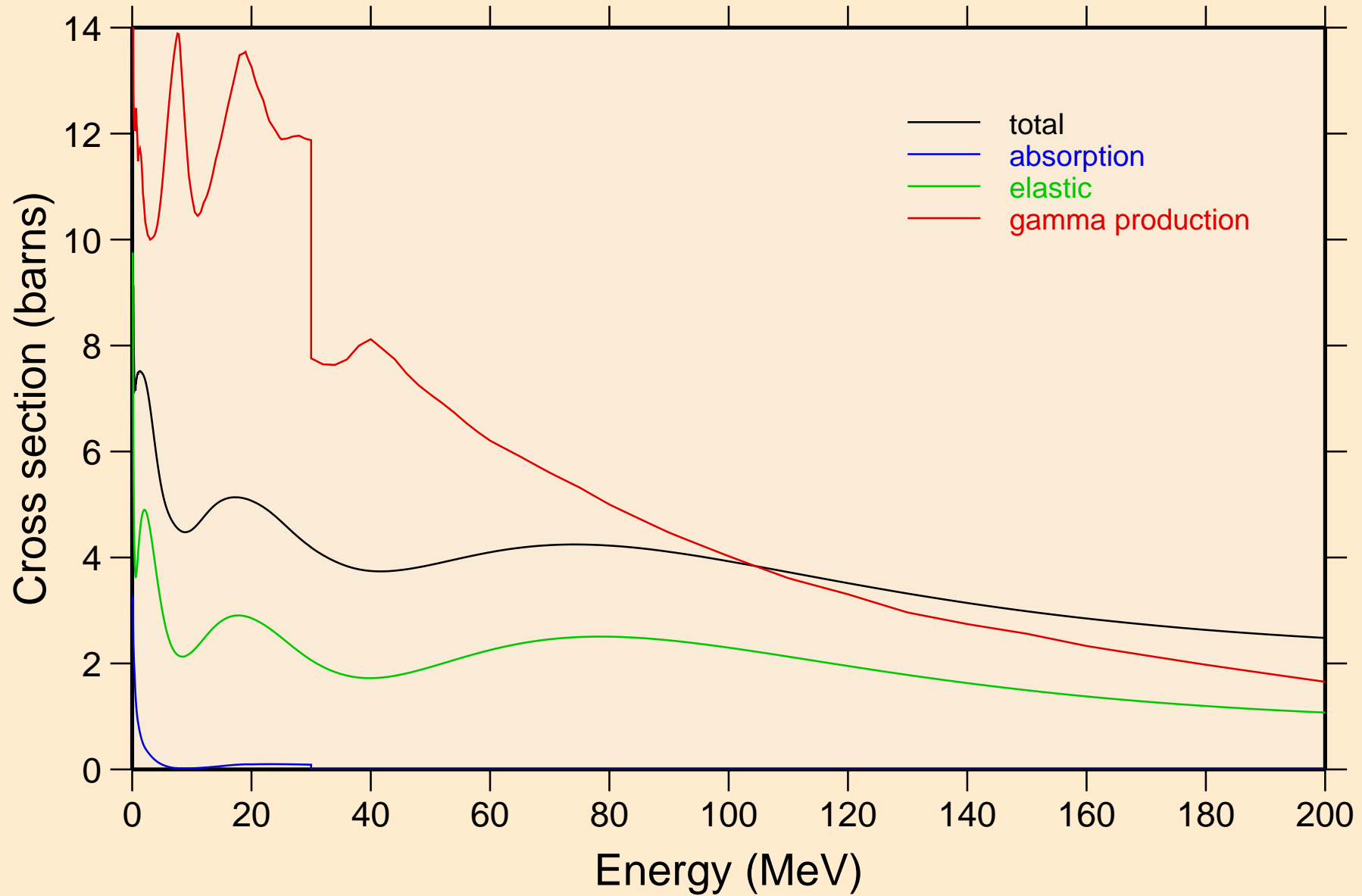

ER159 NEUTRON ACER TENDL-2021 LIBRARY; T=293.6K

Heating

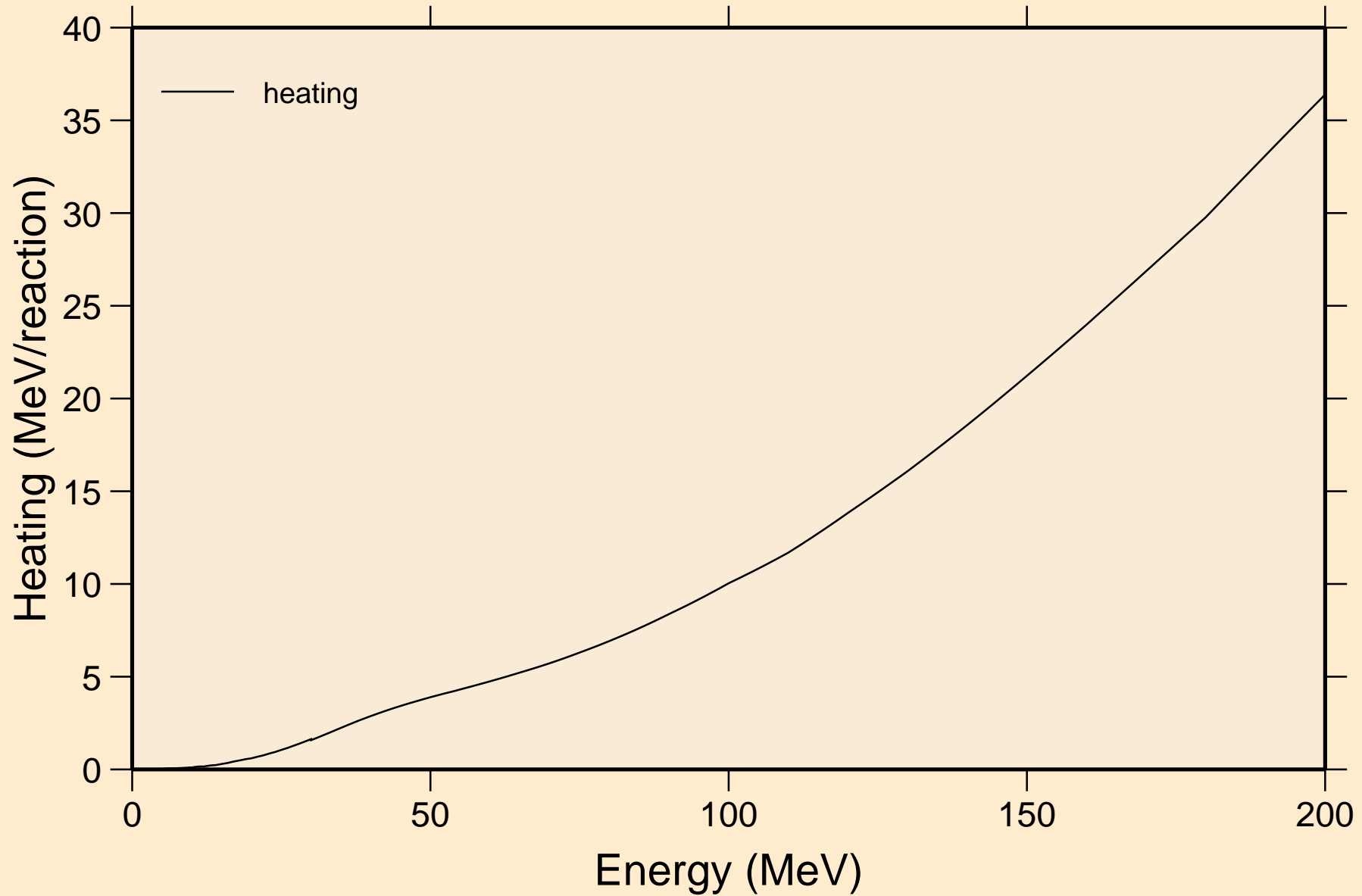

ER159 NEUTRON ACER TENDL-2021 LIBRARY; T=293.6K
Damage

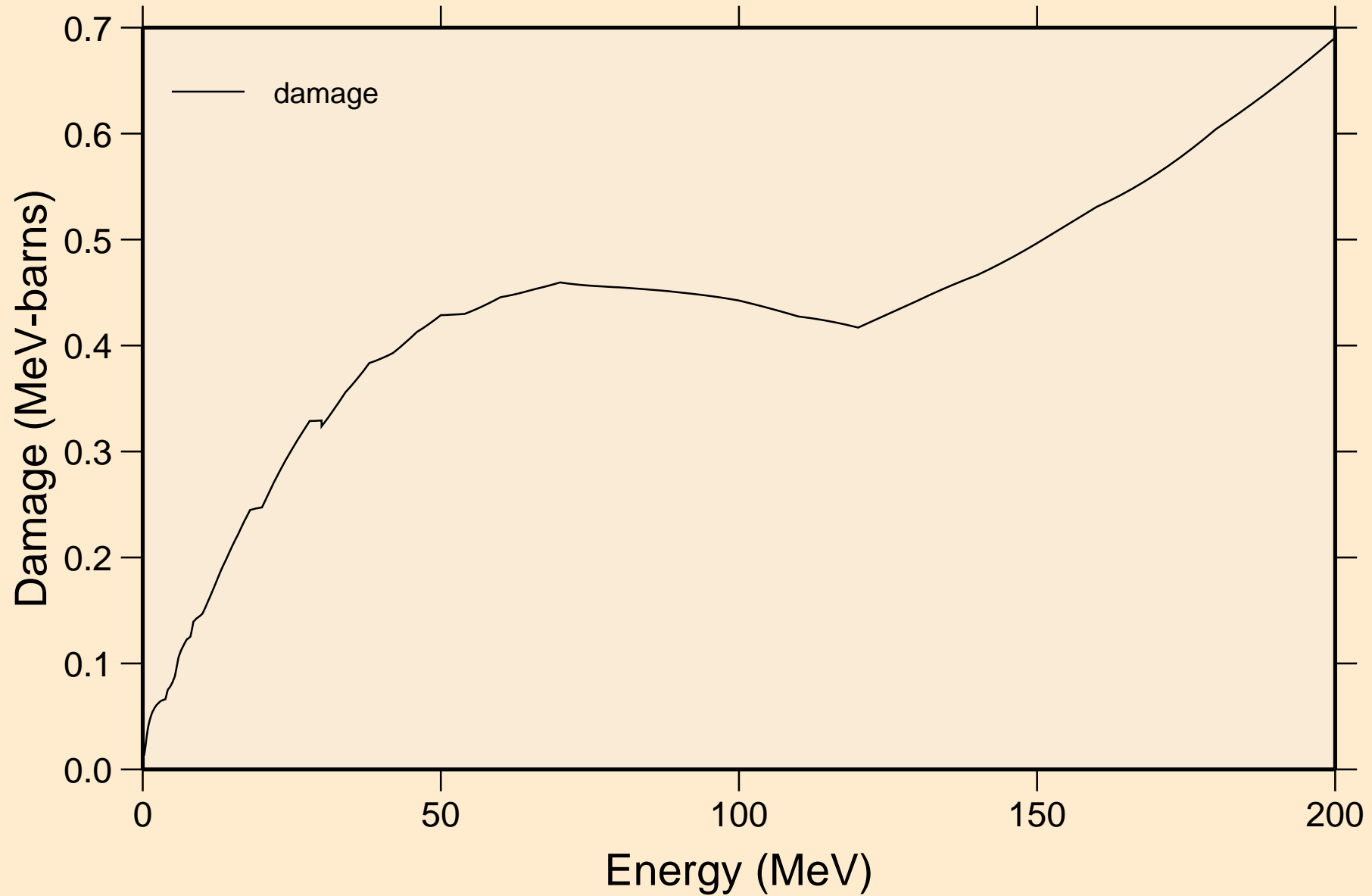

ER159 NEUTRON ACER TENDL-2021 LIBRARY; T=293.6K
Non-threshold reactions

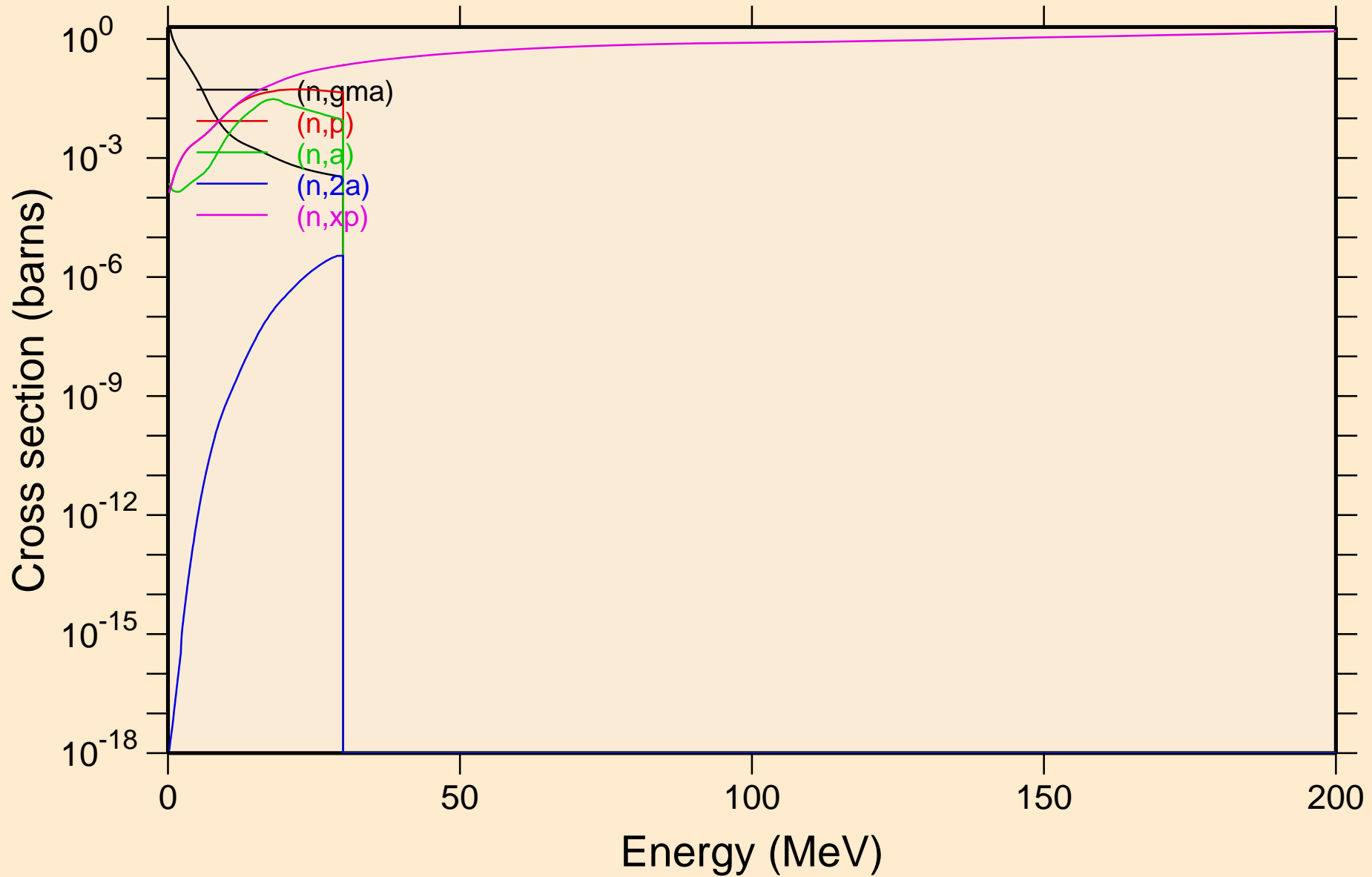

ER159 NEUTRON ACER TENDL-2021 LIBRARY; T=293.6K
Non-threshold reactions

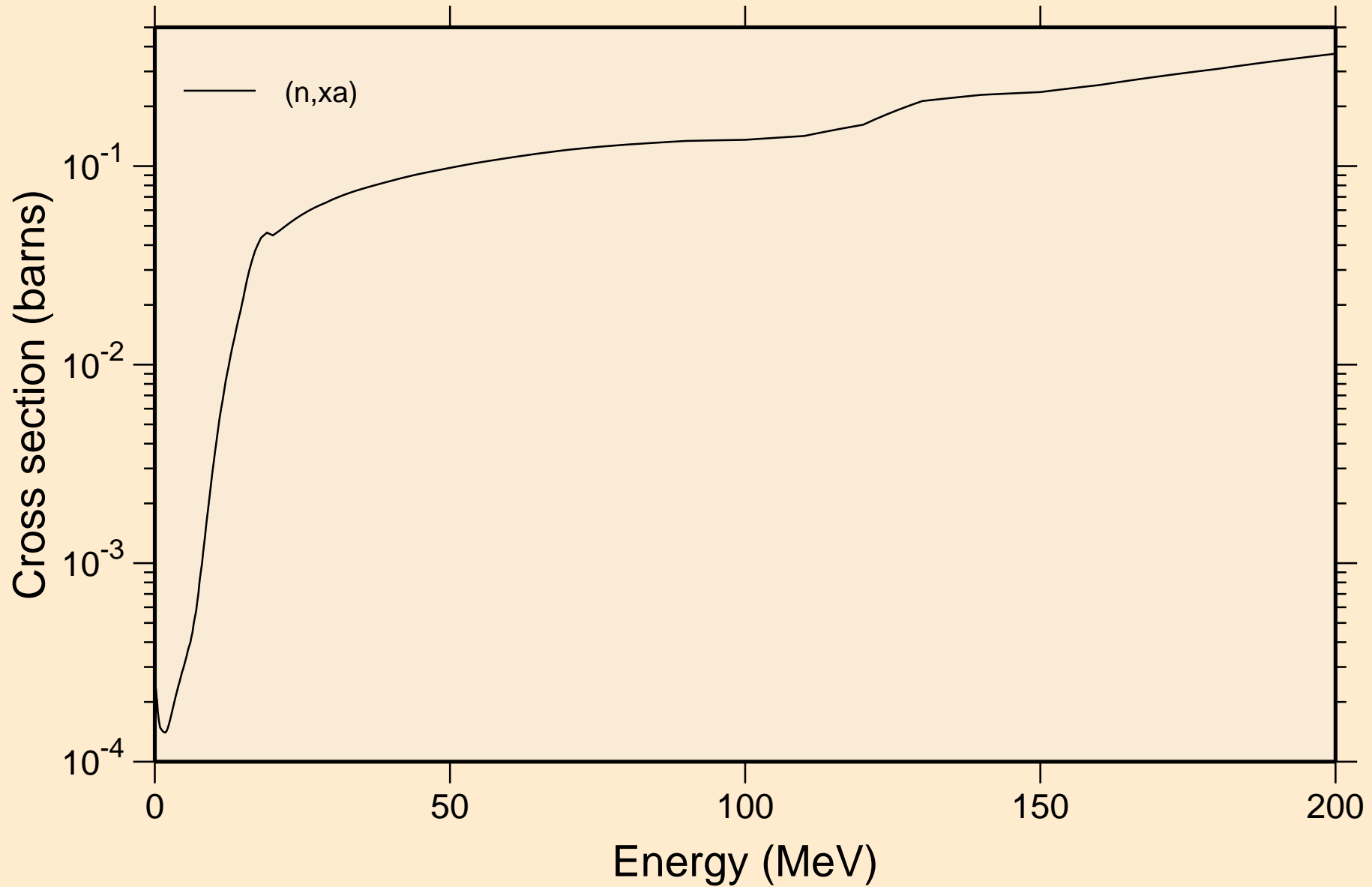

ER159 NEUTRON ACER TENDL-2021 LIBRARY; T=293.6K
Inelastic levels

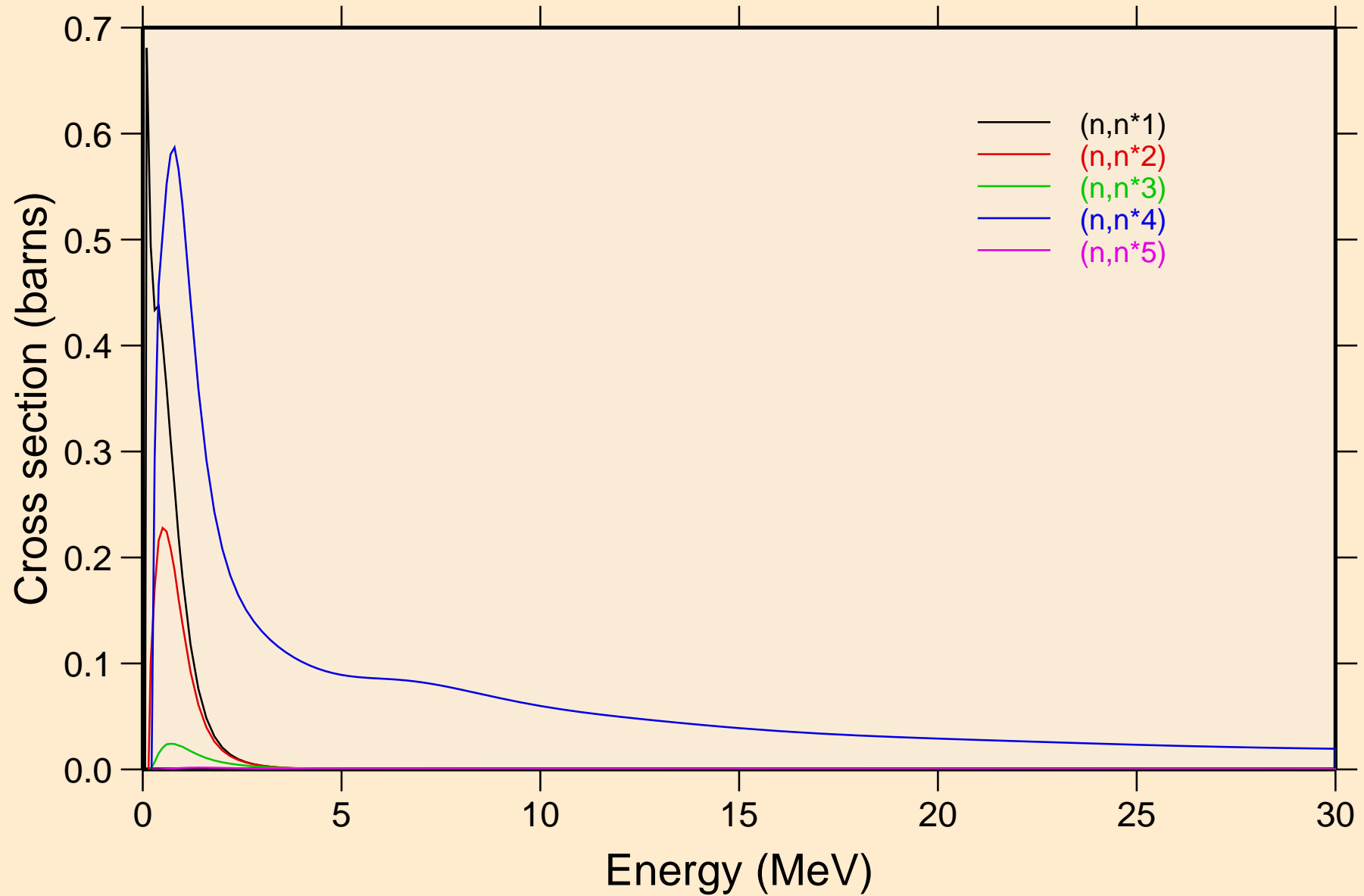

ER159 NEUTRON ACER TENDL-2021 LIBRARY; T=293.6K
Inelastic levels

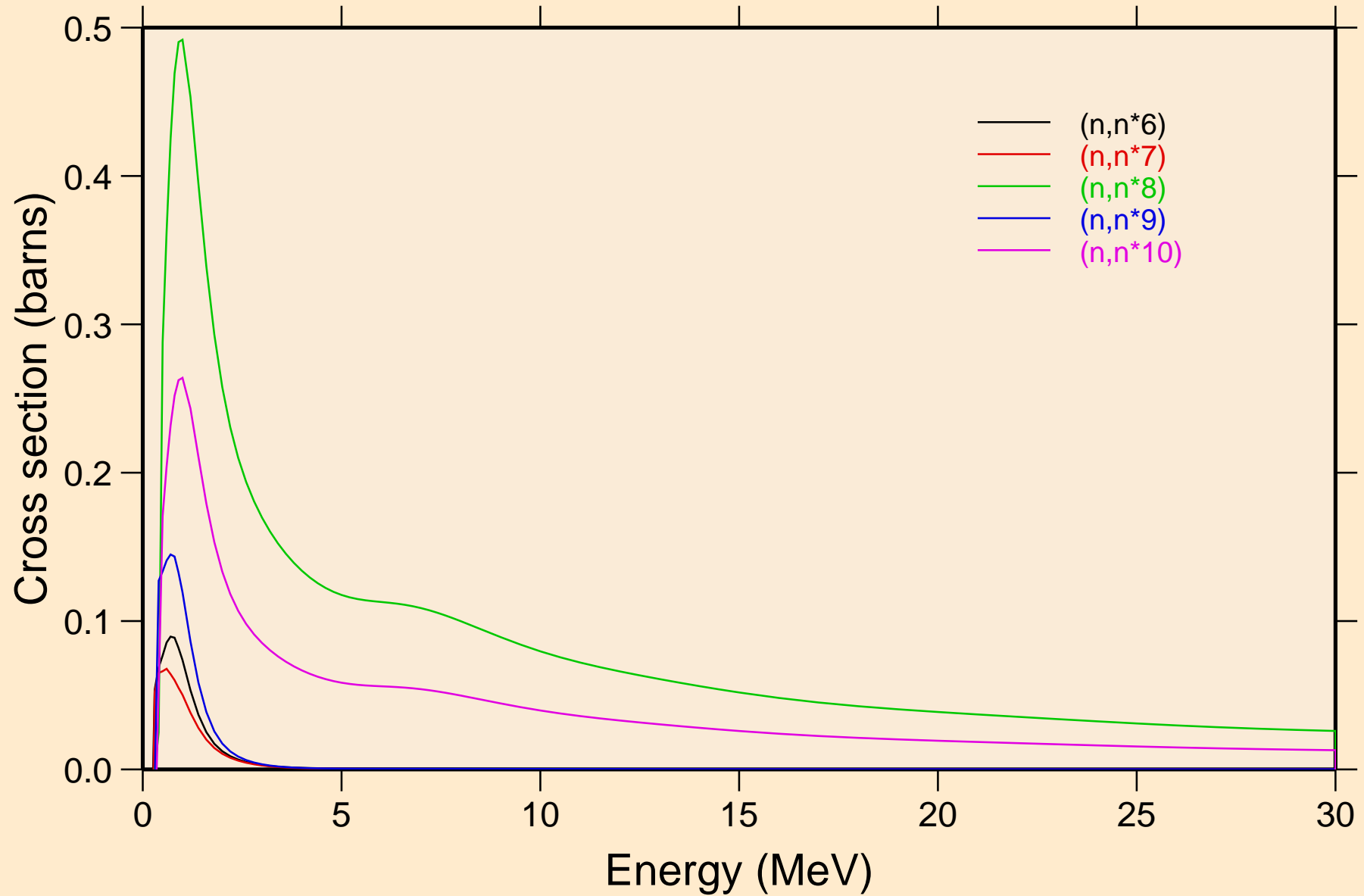

ER159 NEUTRON ACER TENDL-2021 LIBRARY; T=293.6K
Inelastic levels

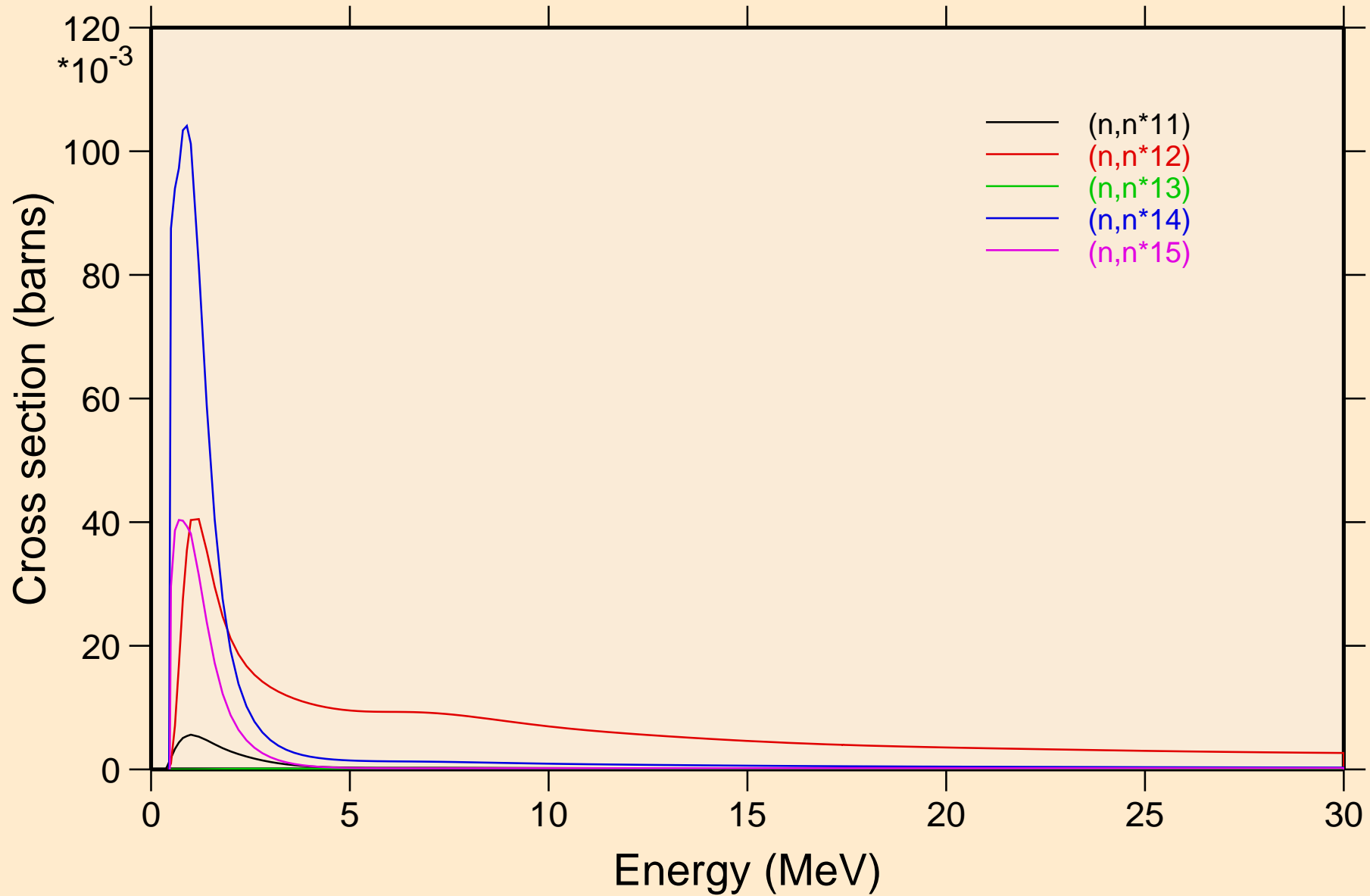

ER159 NEUTRON ACER TENDL-2021 LIBRARY; T=293.6K
Inelastic levels

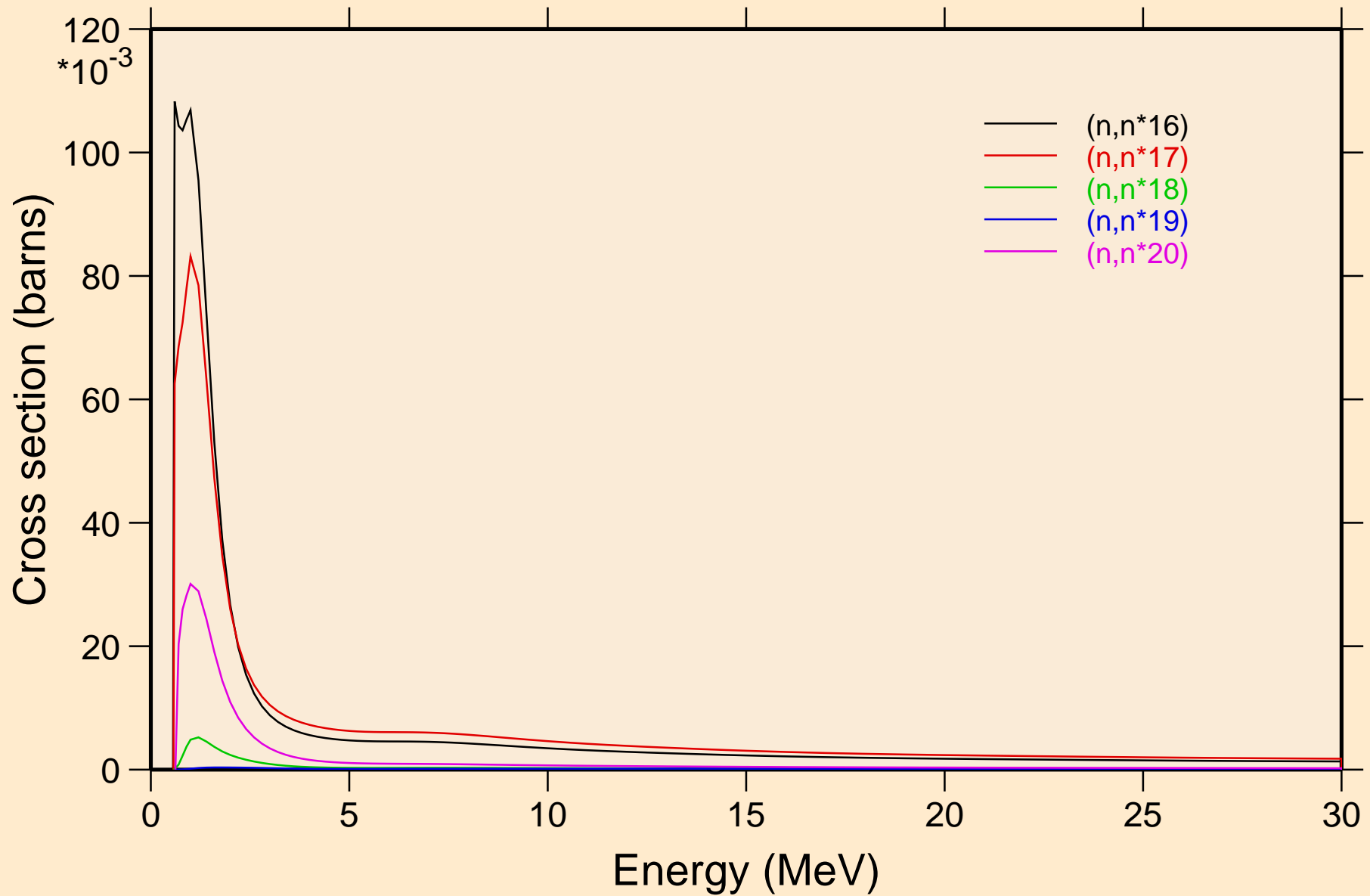

ER159 NEUTRON ACER TENDL-2021 LIBRARY; T=293.6K
Inelastic levels

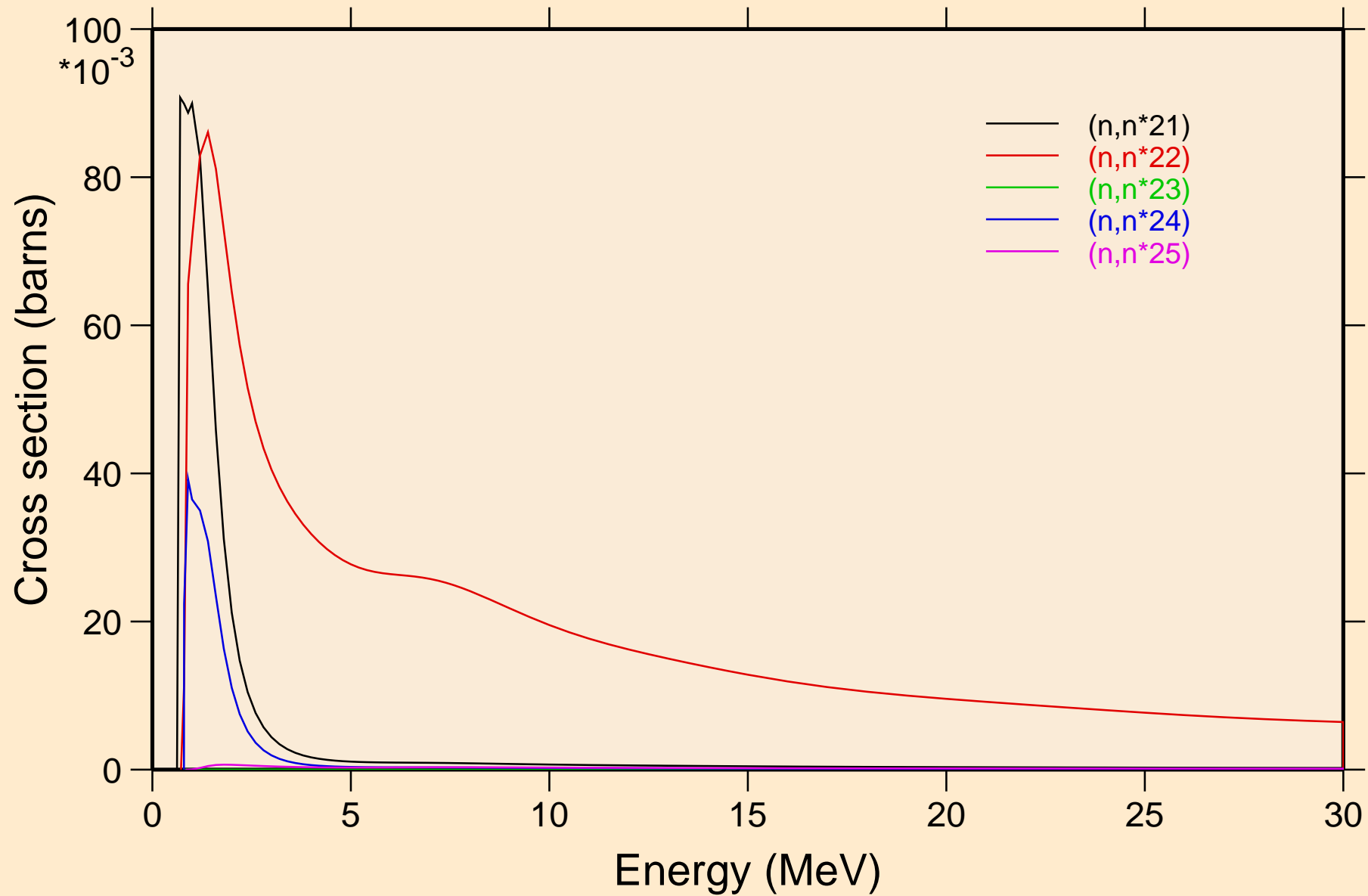

ER159 NEUTRON ACER TENDL-2021 LIBRARY; T=293.6K
Inelastic levels

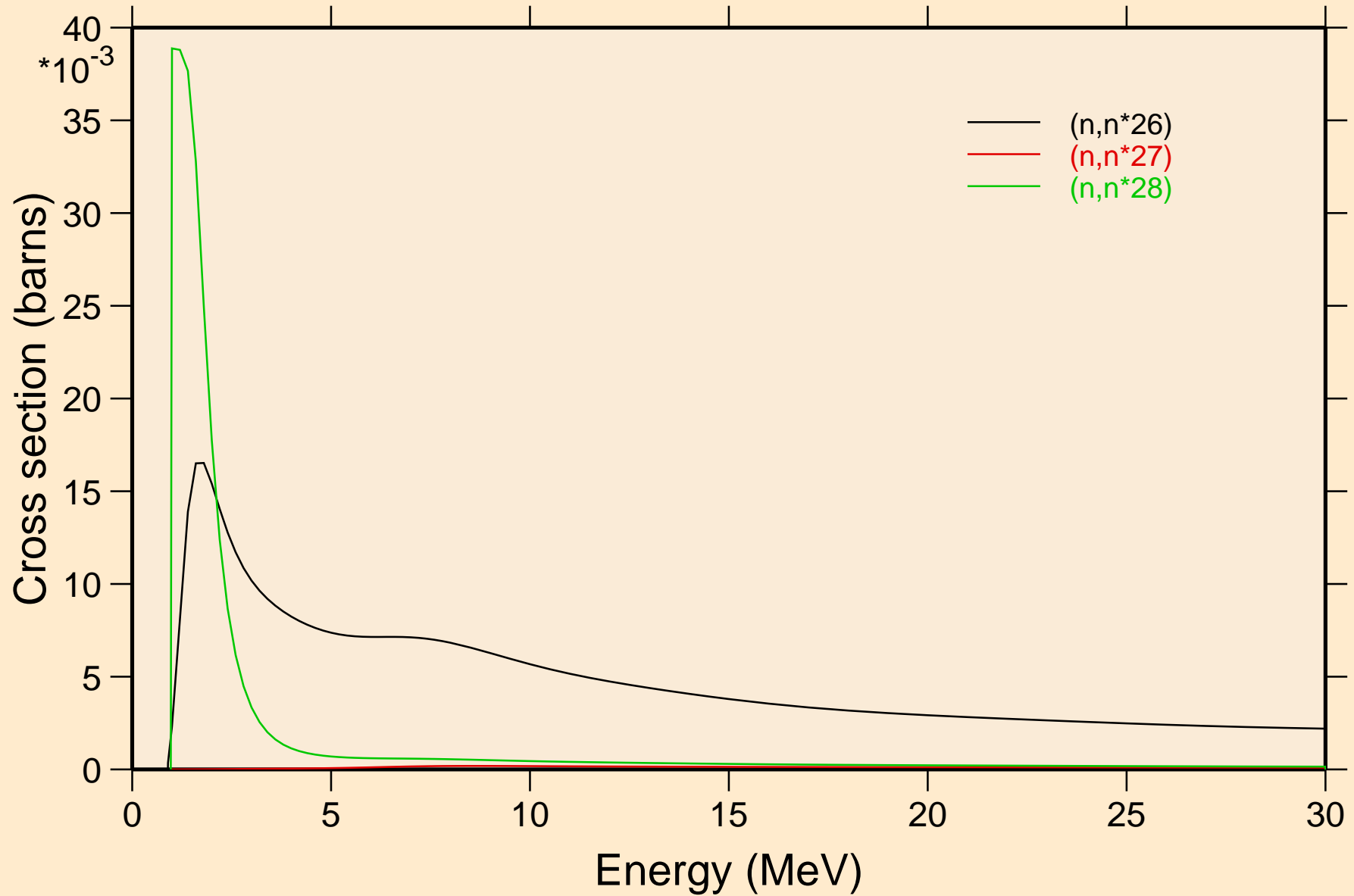

ER159 NEUTRON ACER TENDL-2021 LIBRARY; T=293.6K
Threshold reactions

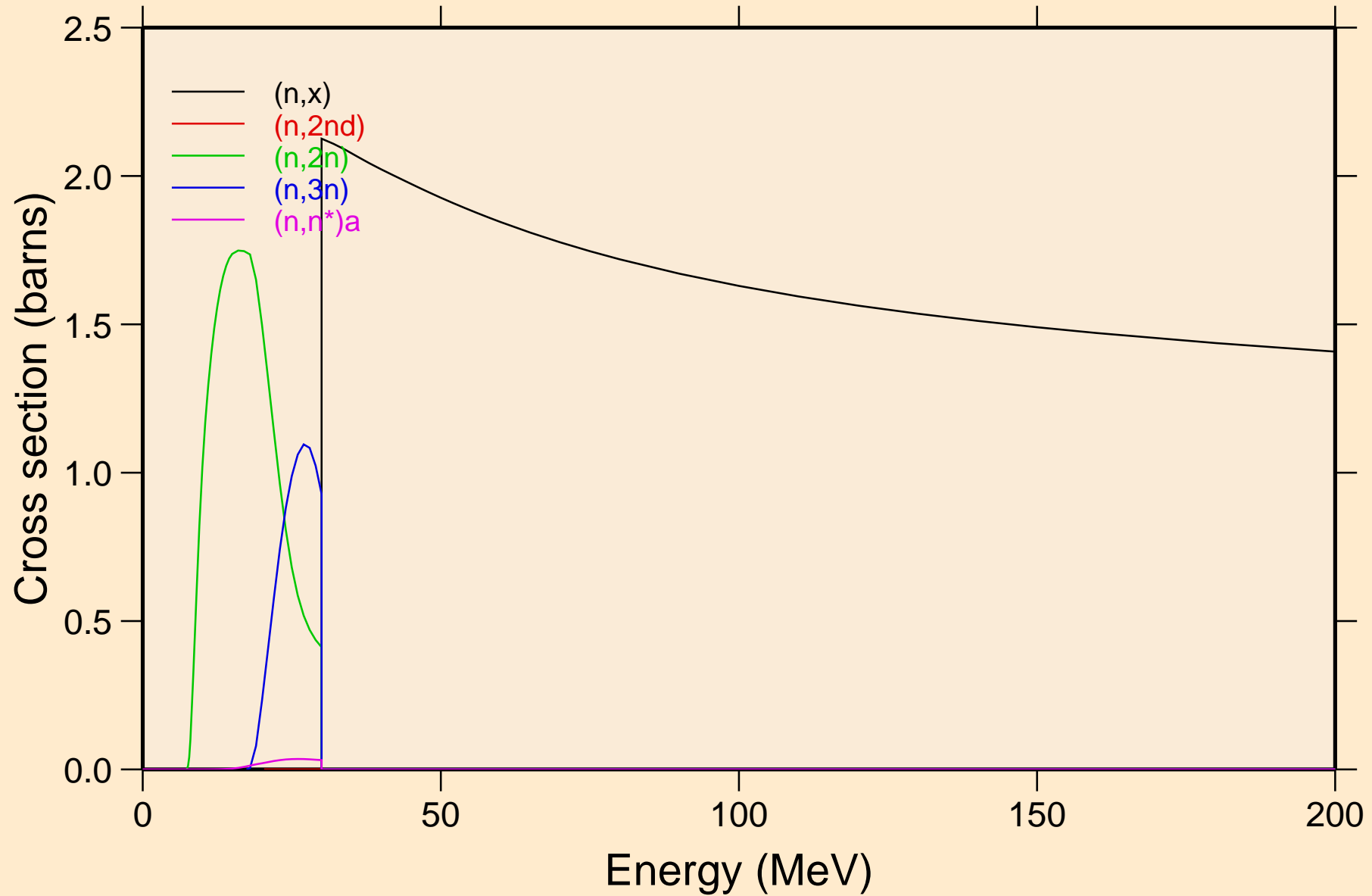

ER159 NEUTRON ACER TENDL-2021 LIBRARY; T=293.6K
Threshold reactions

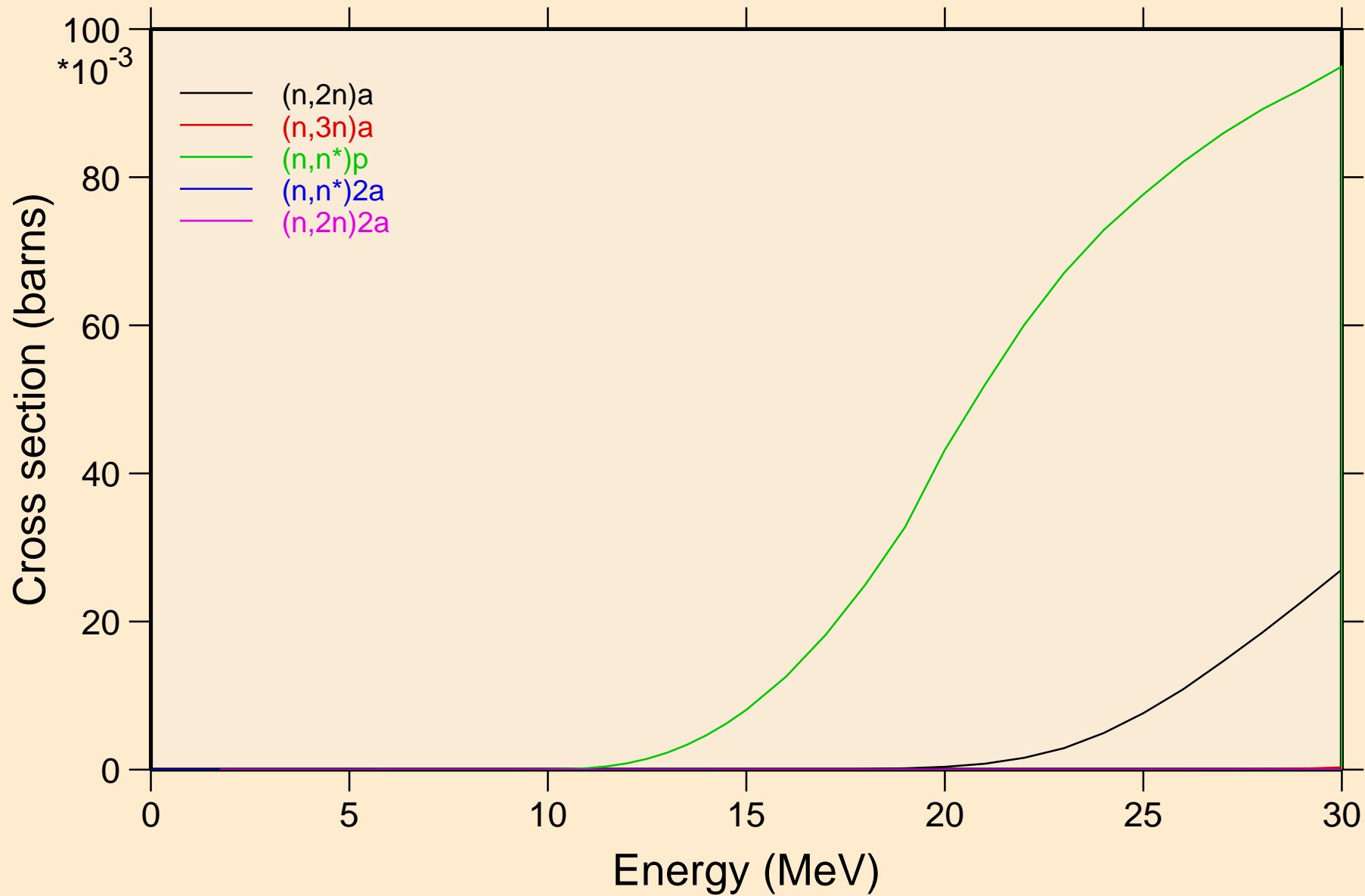

ER159 NEUTRON ACER TENDL-2021 LIBRARY; T=293.6K

Threshold reactions

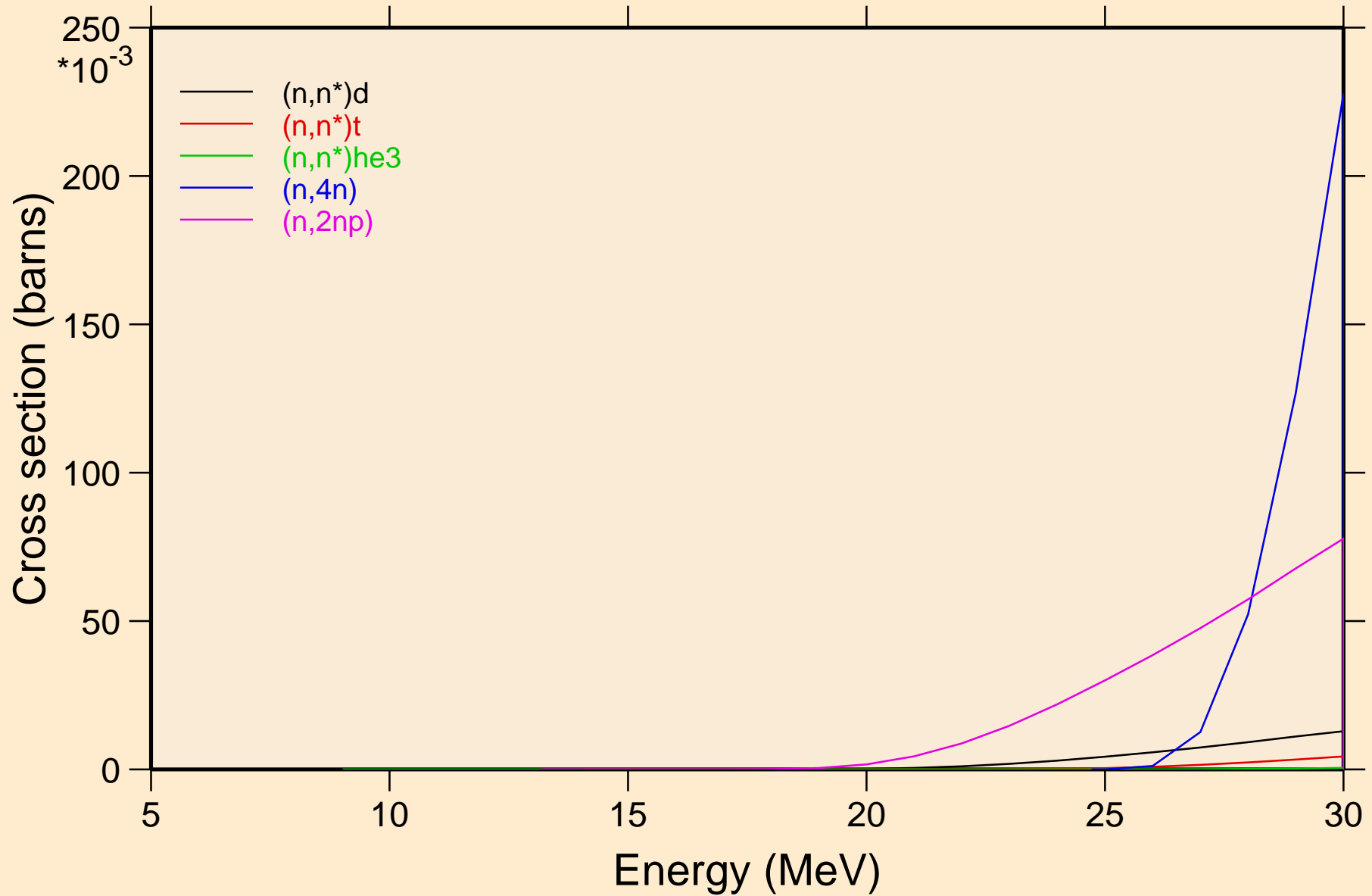

ER159 NEUTRON ACER TENDL-2021 LIBRARY; T=293.6K
Threshold reactions

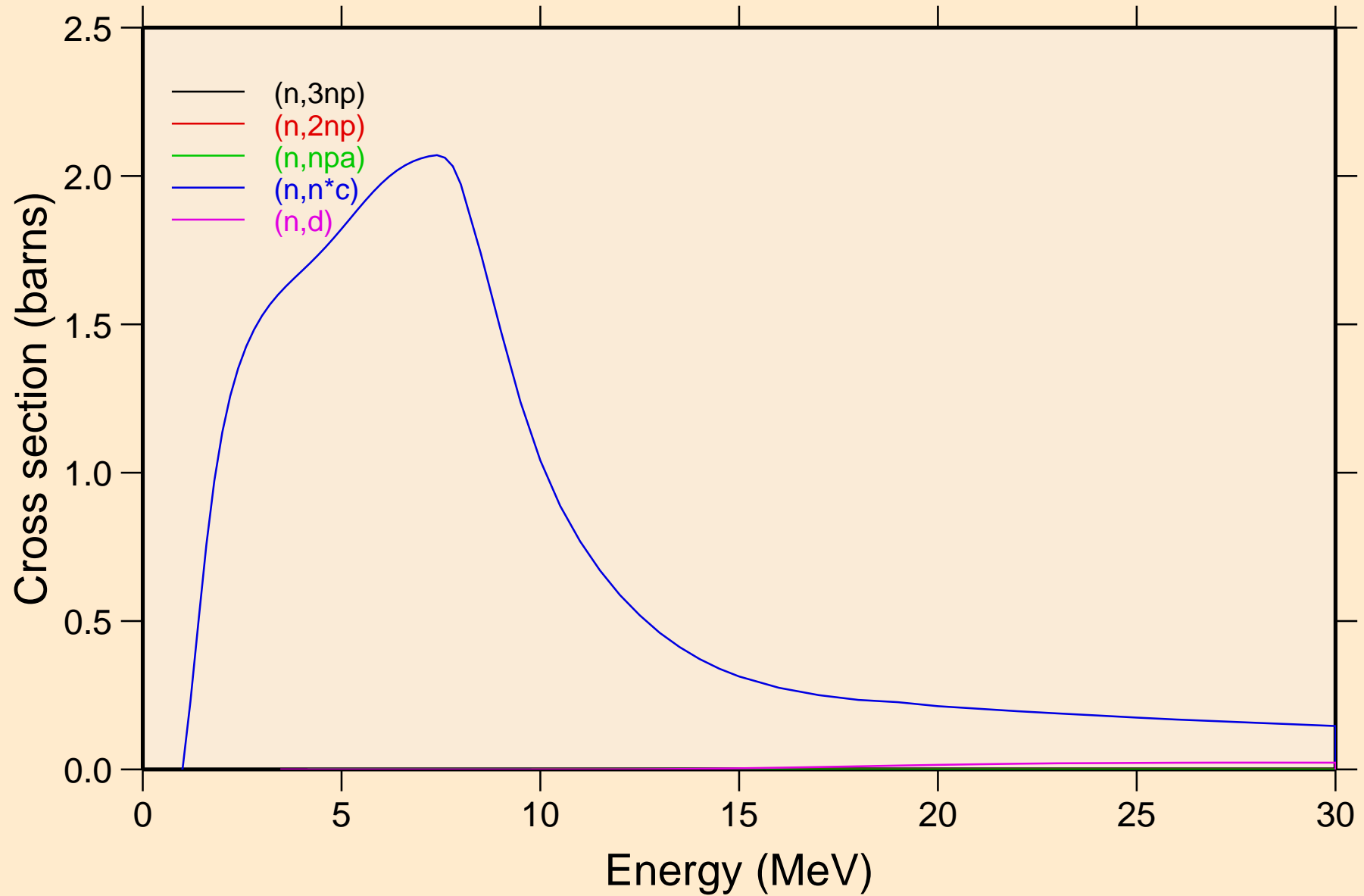

ER159 NEUTRON ACER TENDL-2021 LIBRARY; T=293.6K
Threshold reactions

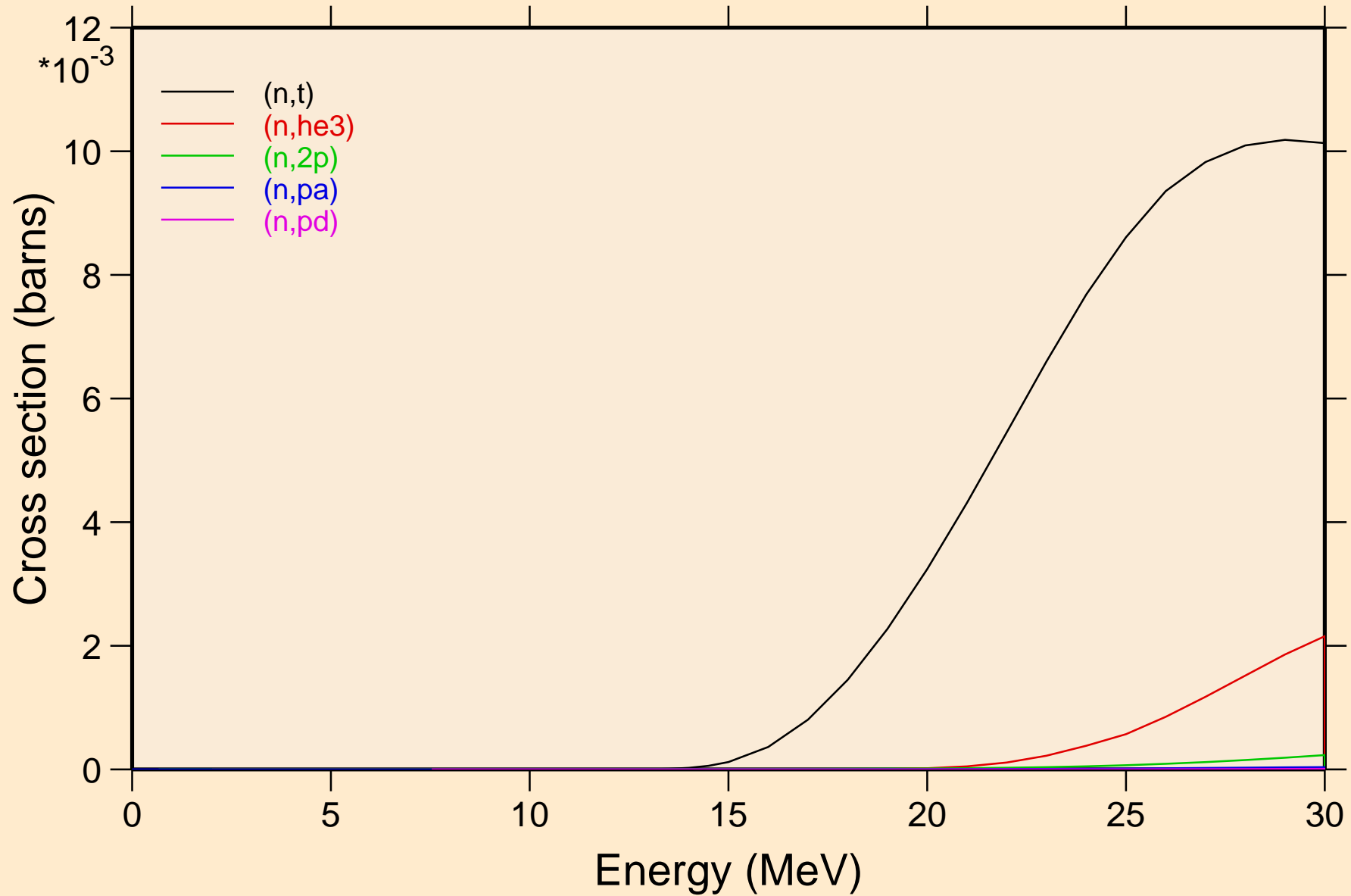

ER159 NEUTRON ACER TENDL-2021 LIBRARY; T=293.6K
Threshold reactions

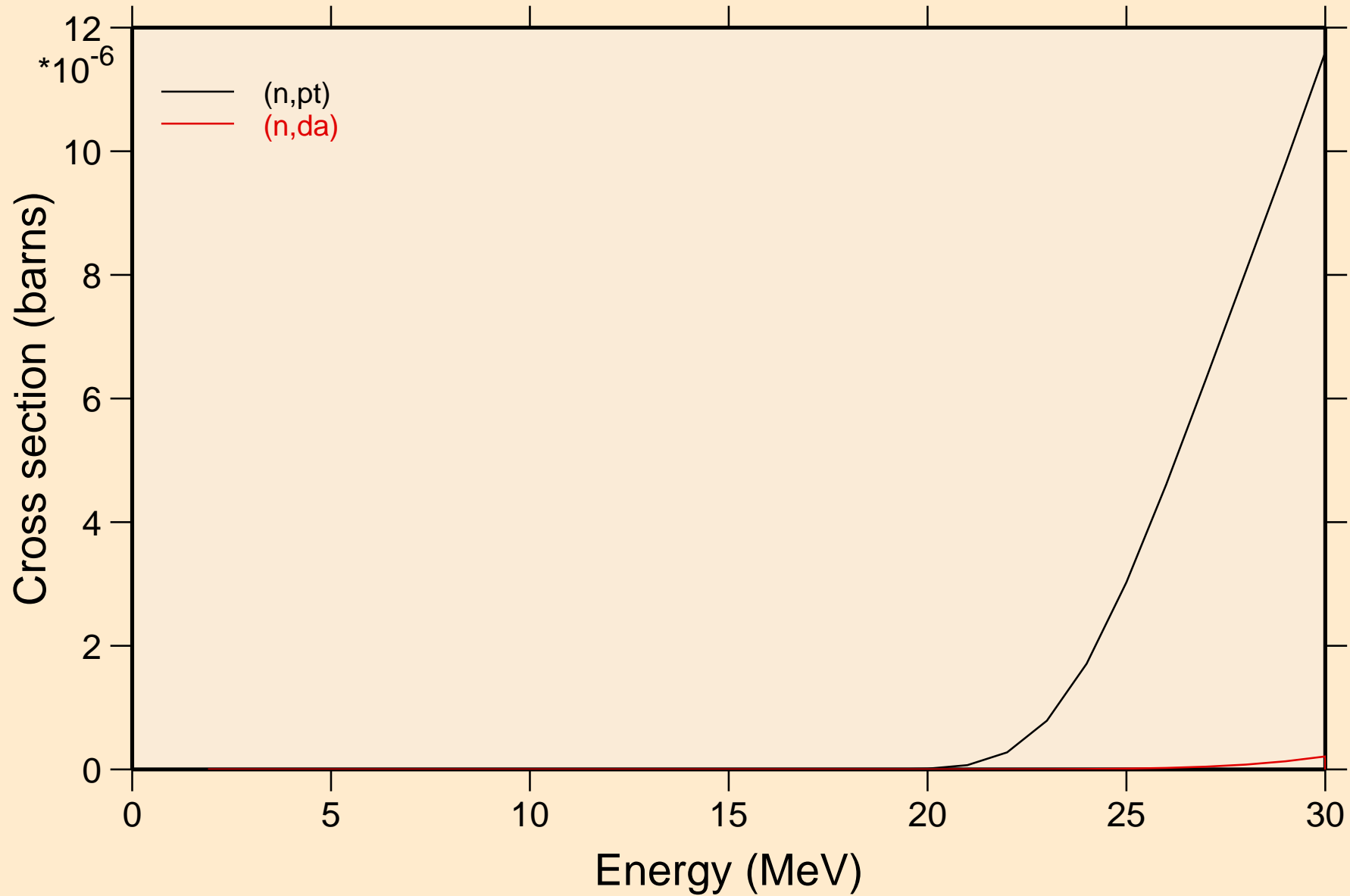

ER159 NEUTRON ACER TENDL-2021 LIBRARY; T=293.6K
Threshold reactions

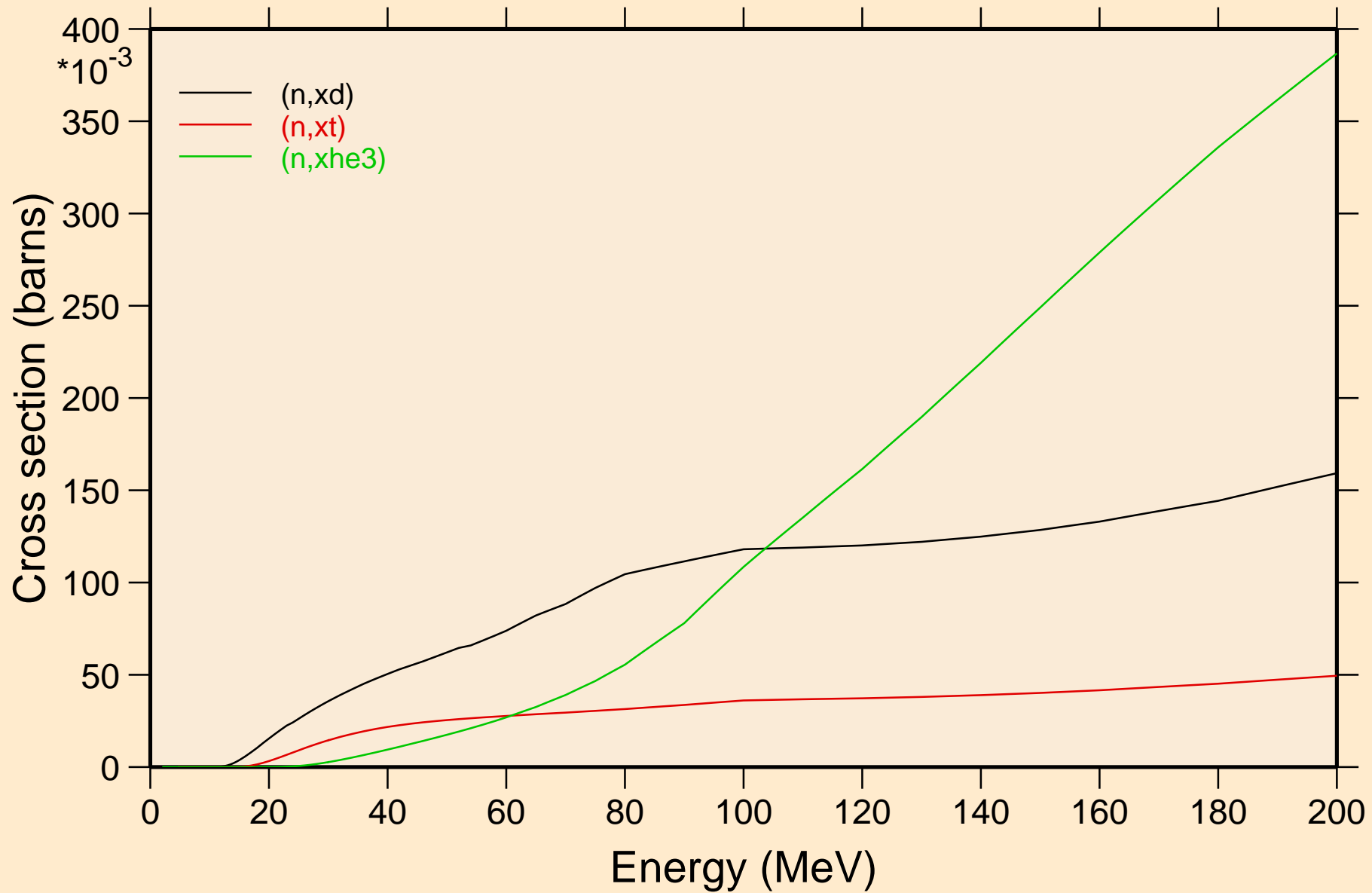

ER159 NEUTRON ACER TENDL-2021 LIBRARY; T=293.6K
angular distribution for elastic

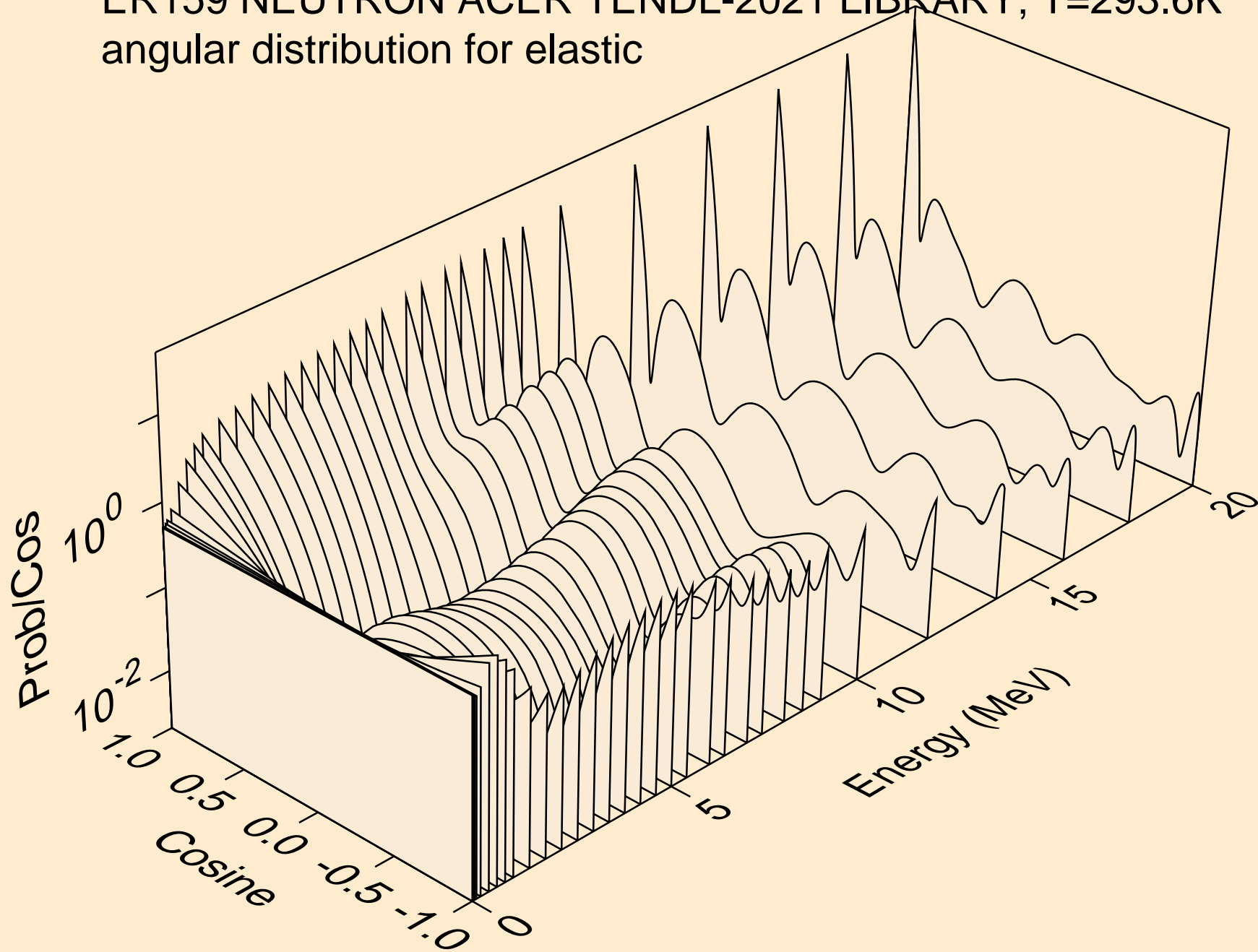

ER159 NEUTRON ACER TENDL-2021 LIBRARY; T=293.6K
angular distribution for elastic

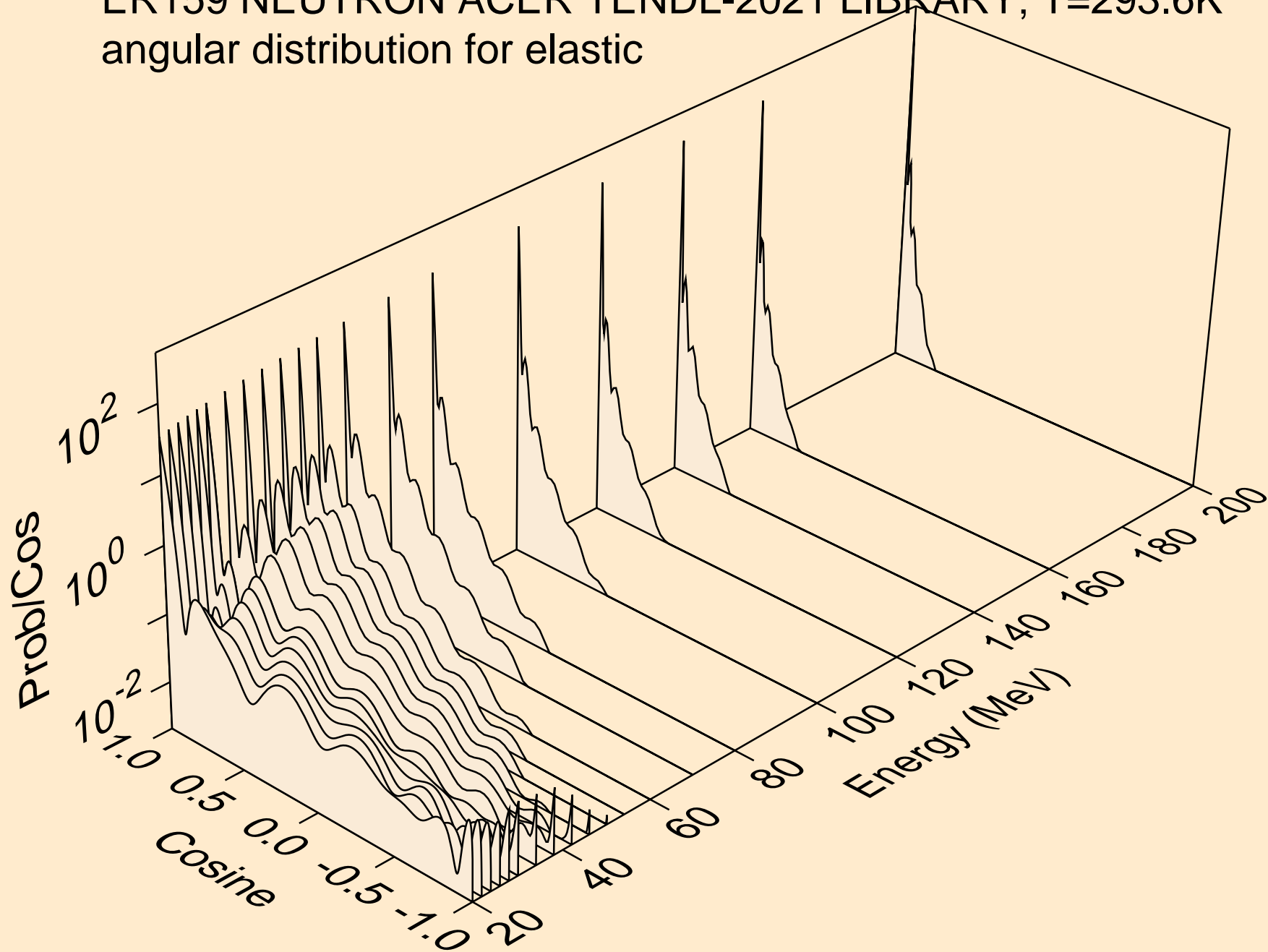

ER159 NEUTRON ACER TENDL-2021 LIBRARY; T=293.6K
angular distribution for (n,n*1)

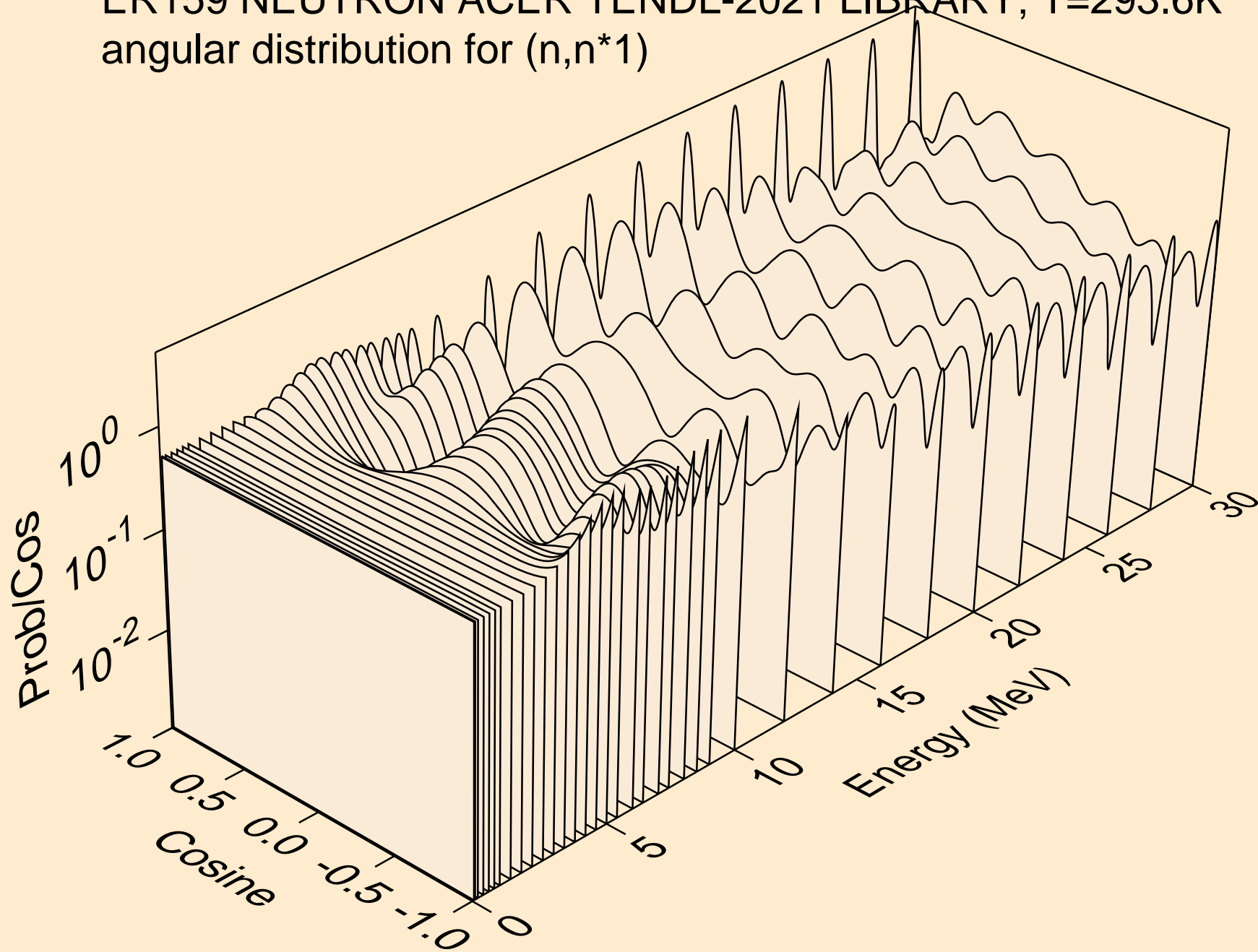

ER159 NEUTRON ACER TENDL-2021 LIBRARY; T=293.6K
angular distribution for (n,n*2)

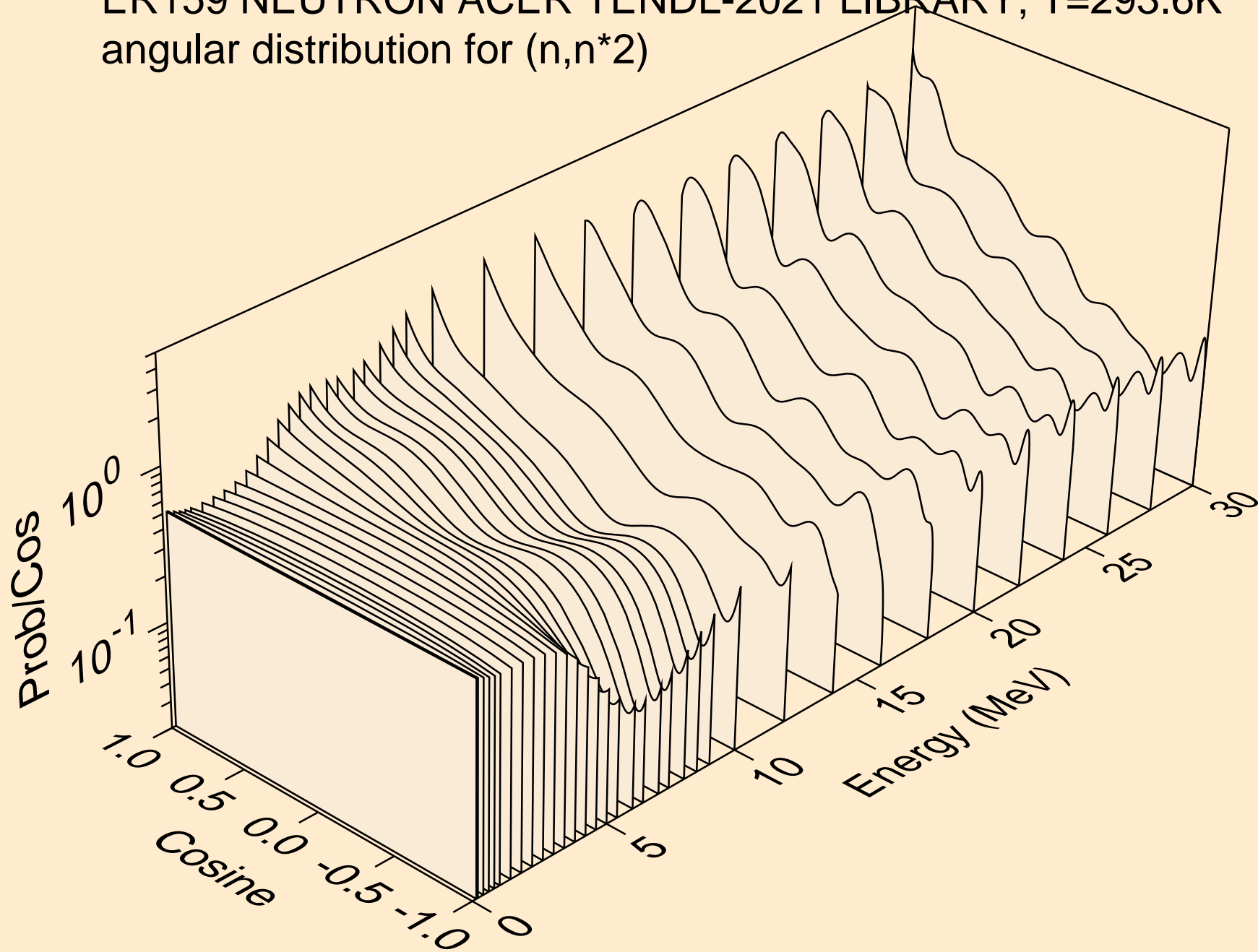

ER159 NEUTRON ACER TENDL-2021 LIBRARY; T=293.6K
angular distribution for (n,n*3)

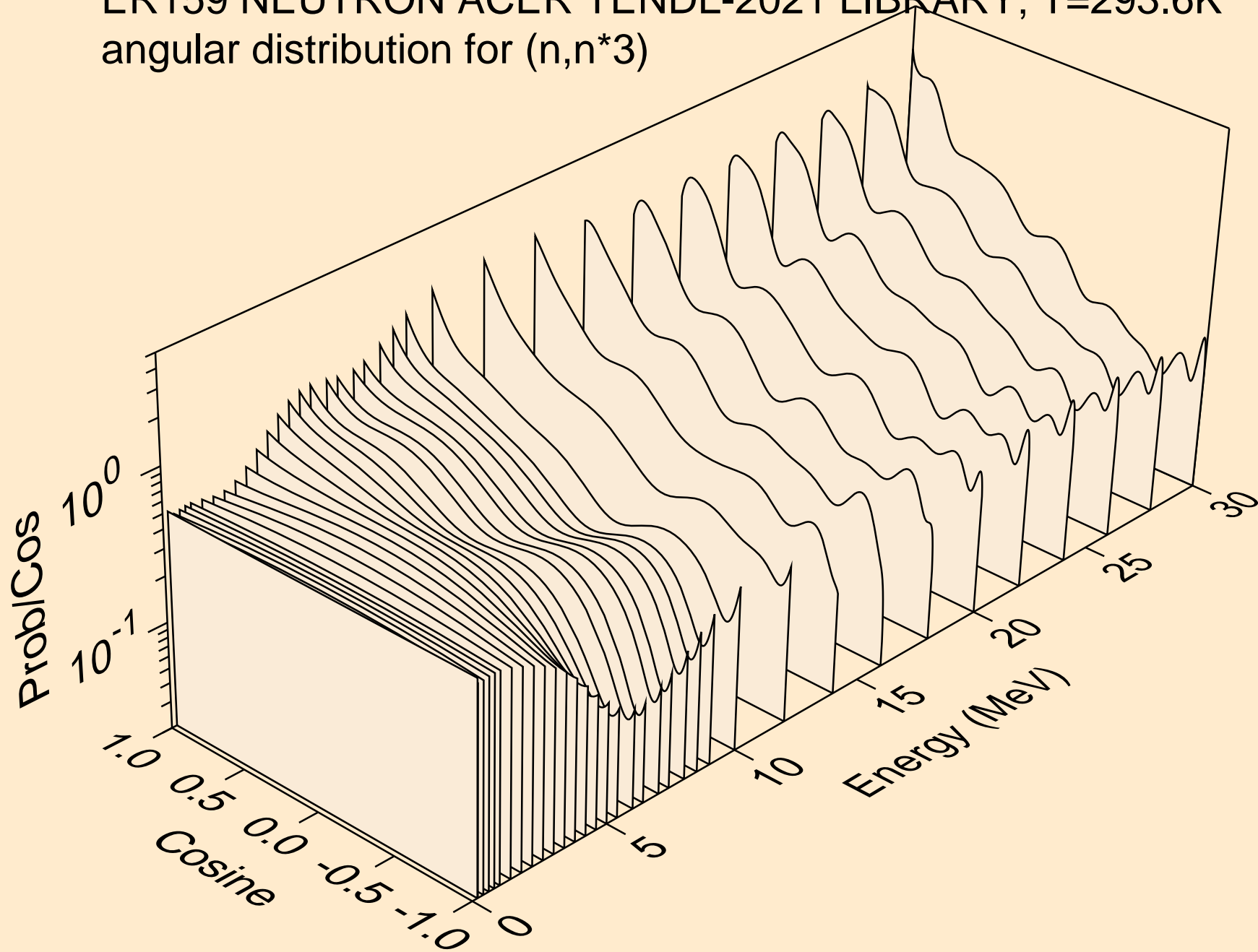

ER159 NEUTRON ACER TENDL-2021 LIBRARY; T=293.6K
angular distribution for (n,n*4)

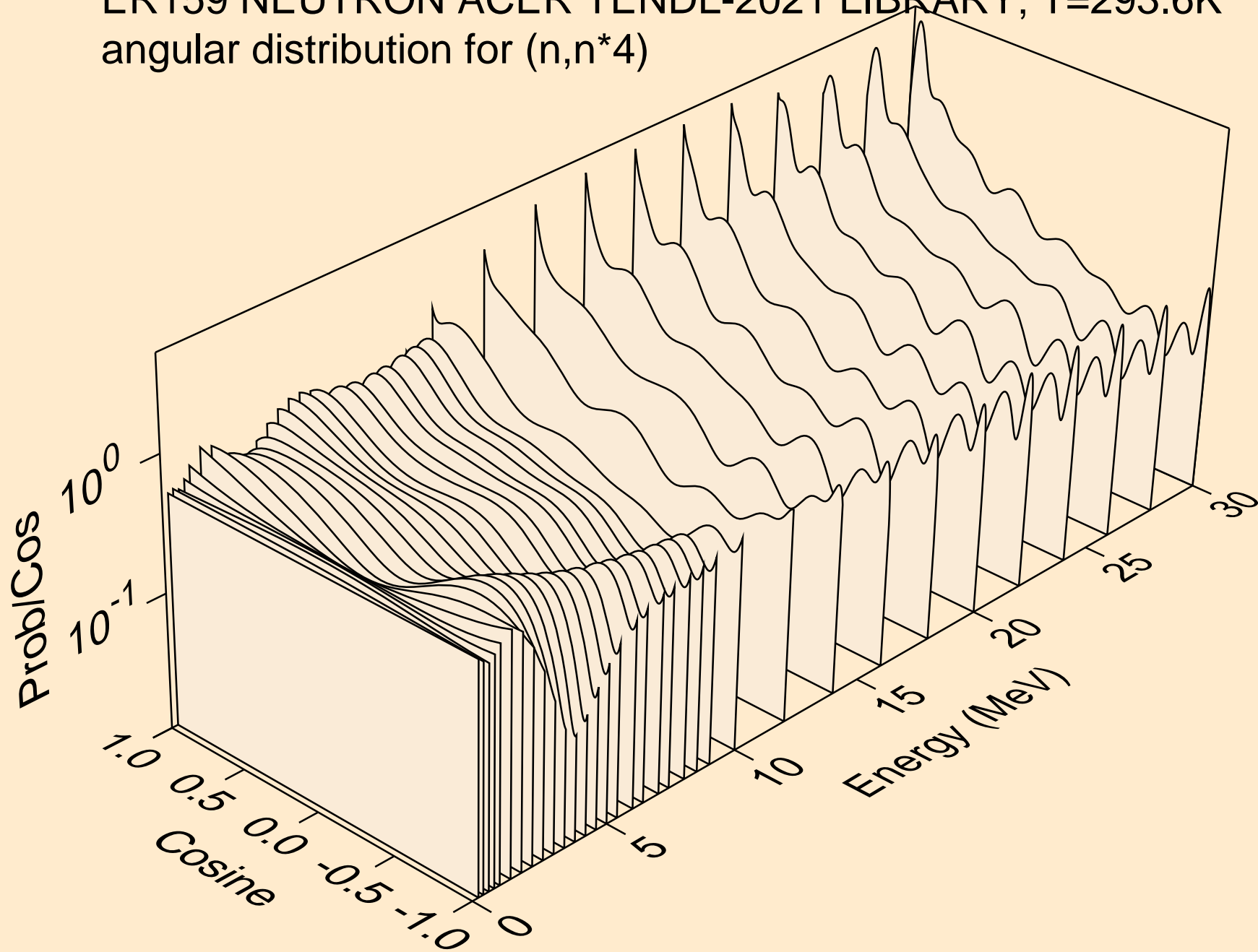

ER159 NEUTRON ACER TENDL-2021 LIBRARY; T=293.6K
angular distribution for (n,n*5)

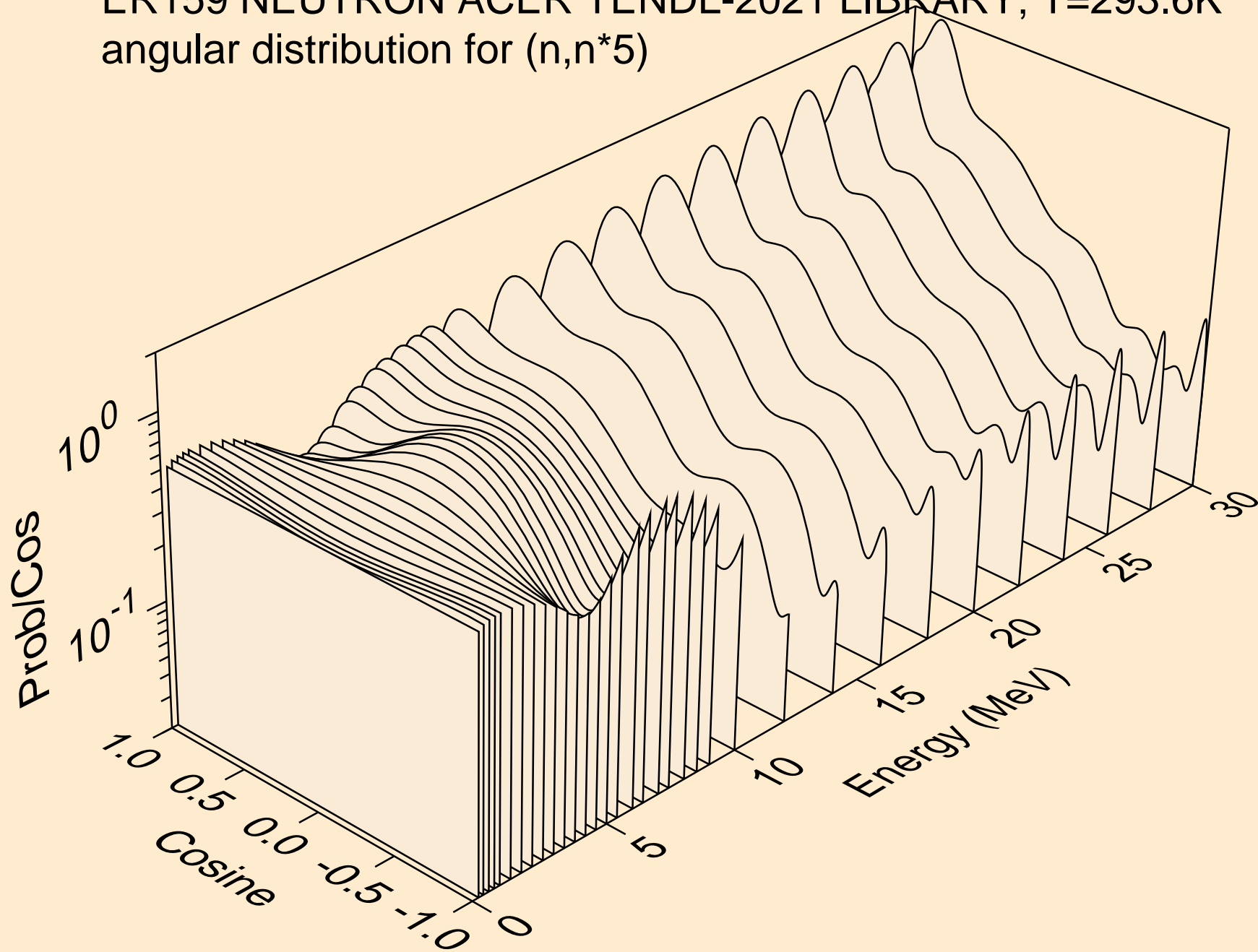

ER159 NEUTRON ACER TENDL-2021 LIBRARY; T=293.6K
angular distribution for (n,n*6)

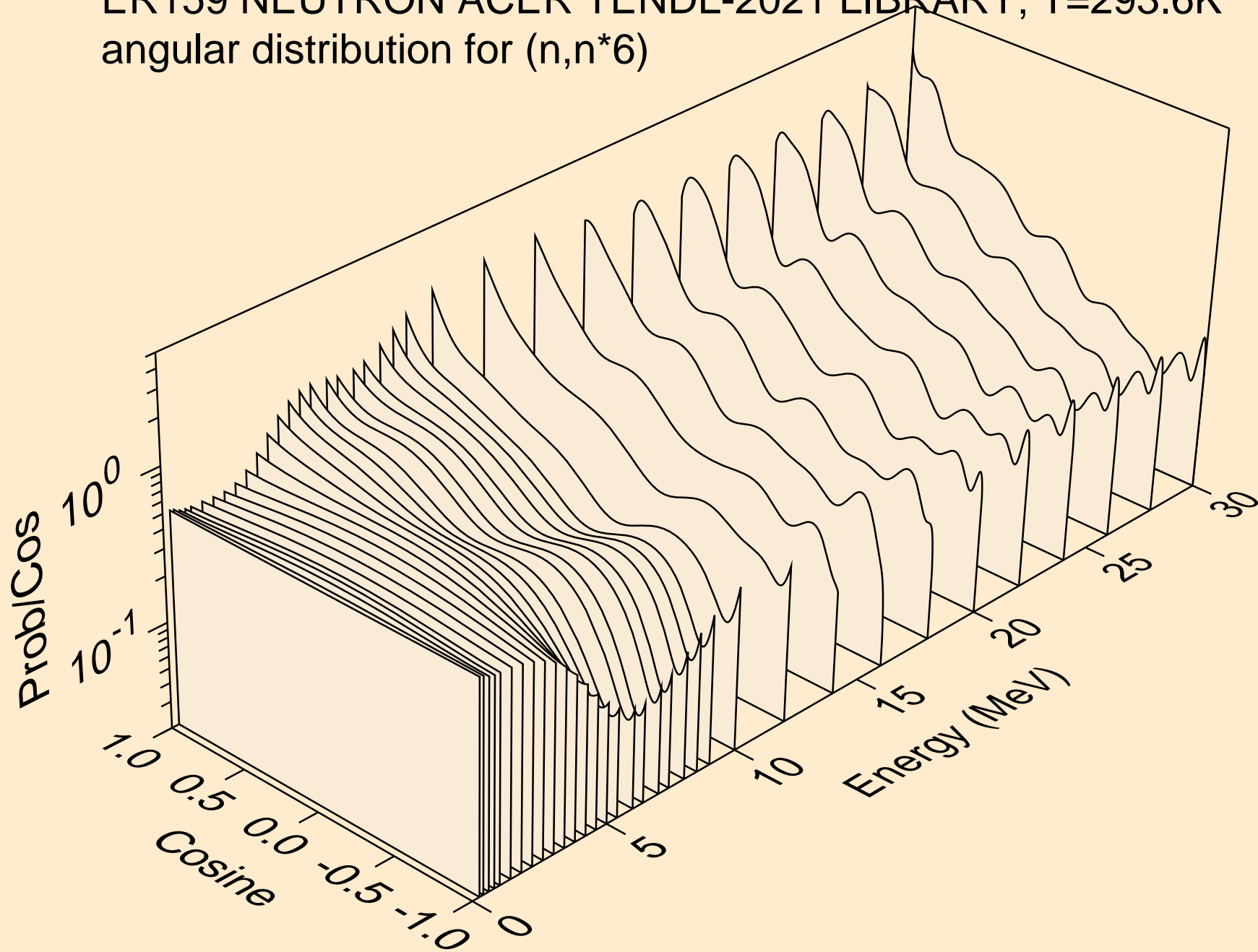

ER159 NEUTRON ACER TENDL-2021 LIBRARY; T=293.6K
angular distribution for (n,n*7)

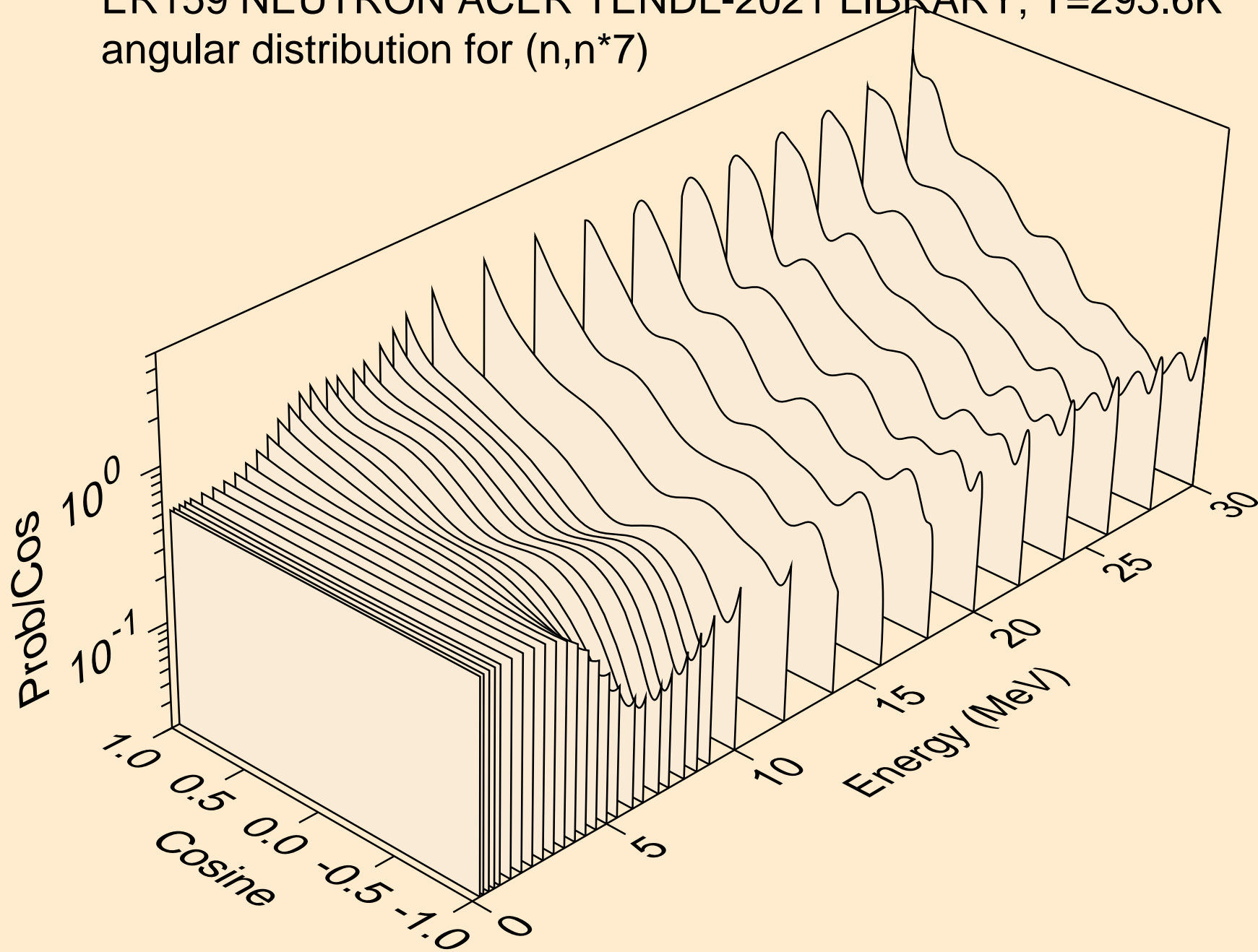

ER159 NEUTRON ACER TENDL-2021 LIBRARY; T=293.6K
angular distribution for (n,n*8)

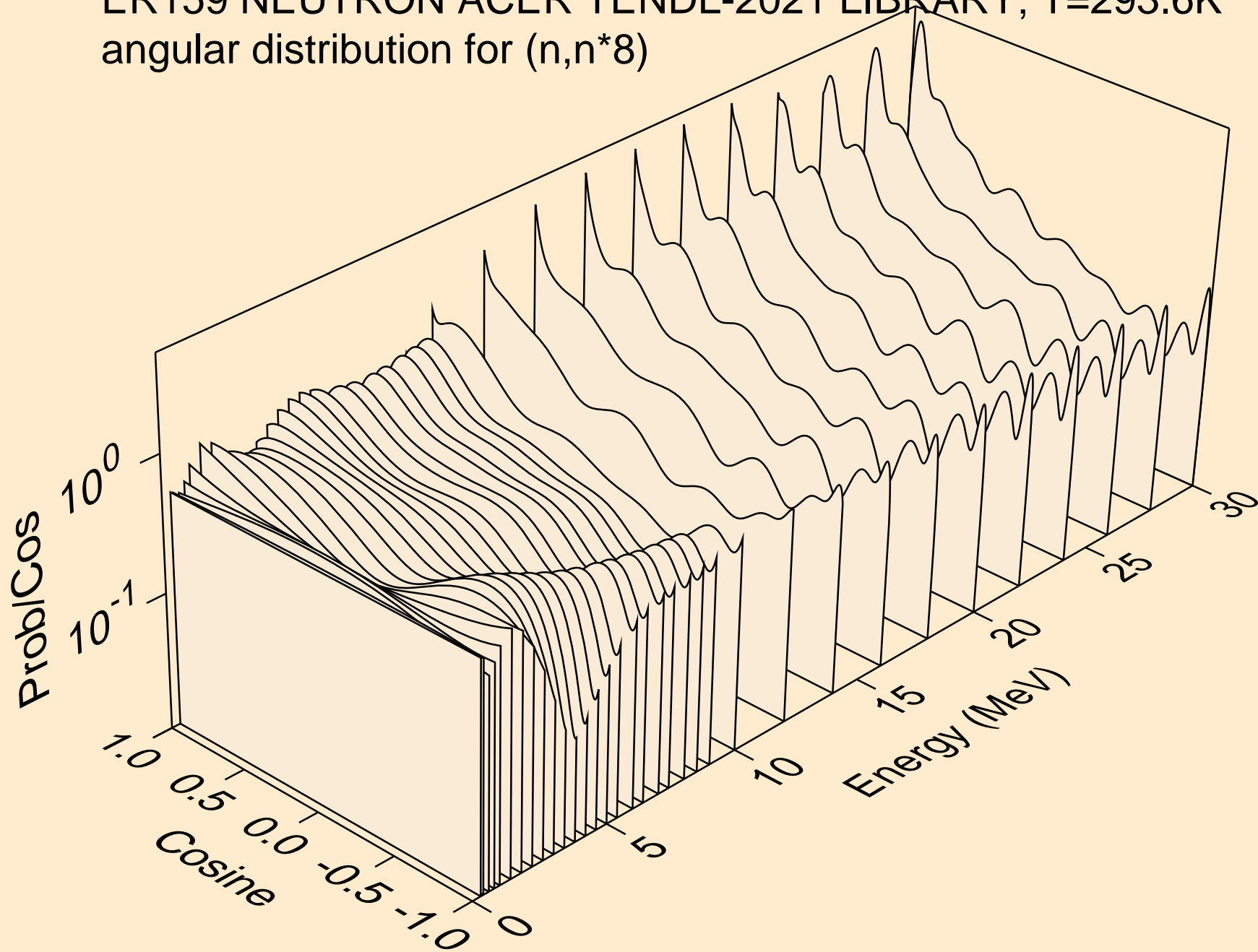

ER159 NEUTRON ACER TENDL-2021 LIBRARY; T=293.6K
angular distribution for (n,n*9)

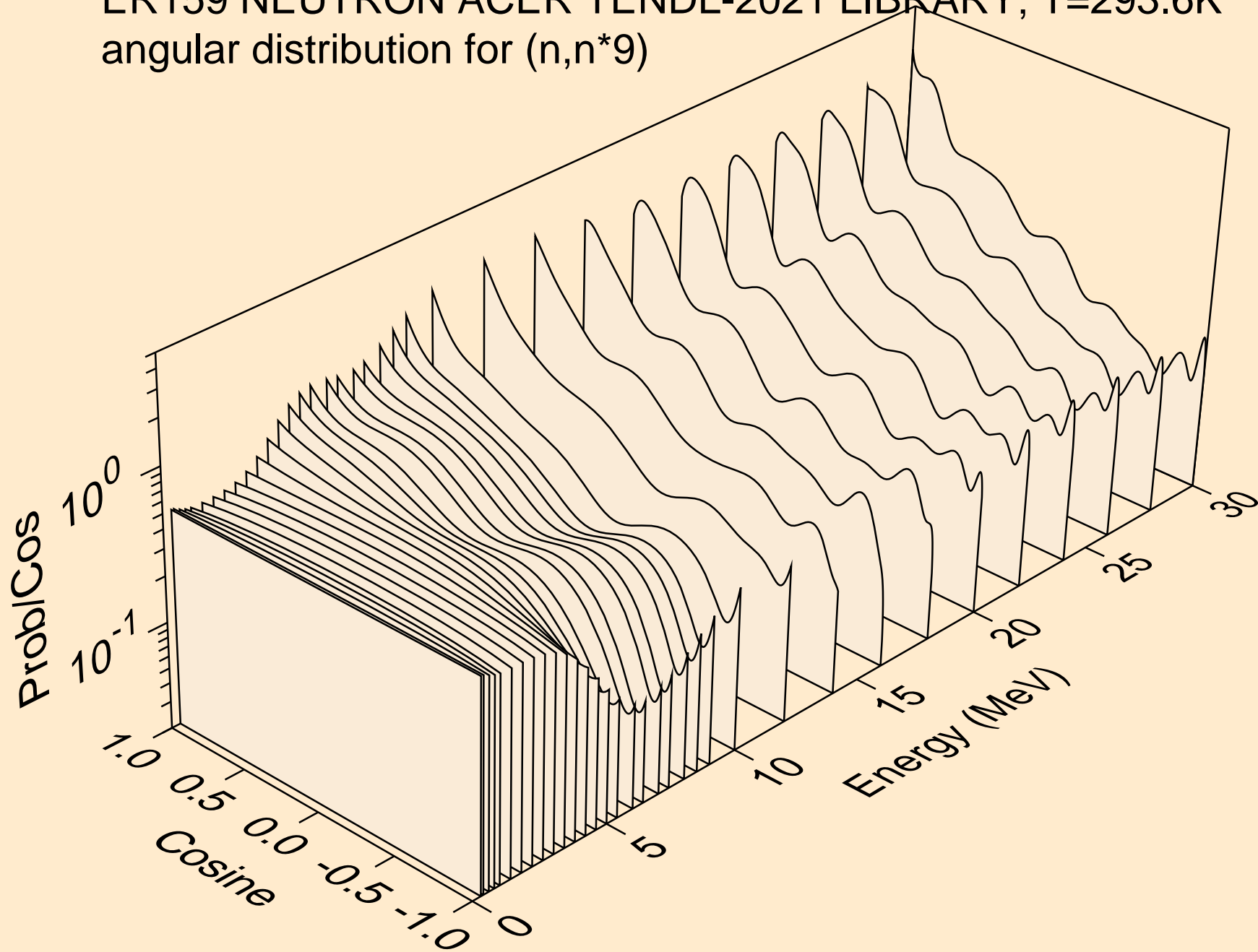

ER159 NEUTRON ACER TENDL-2021 LIBRARY; T=293.6K
angular distribution for (n,n*10)

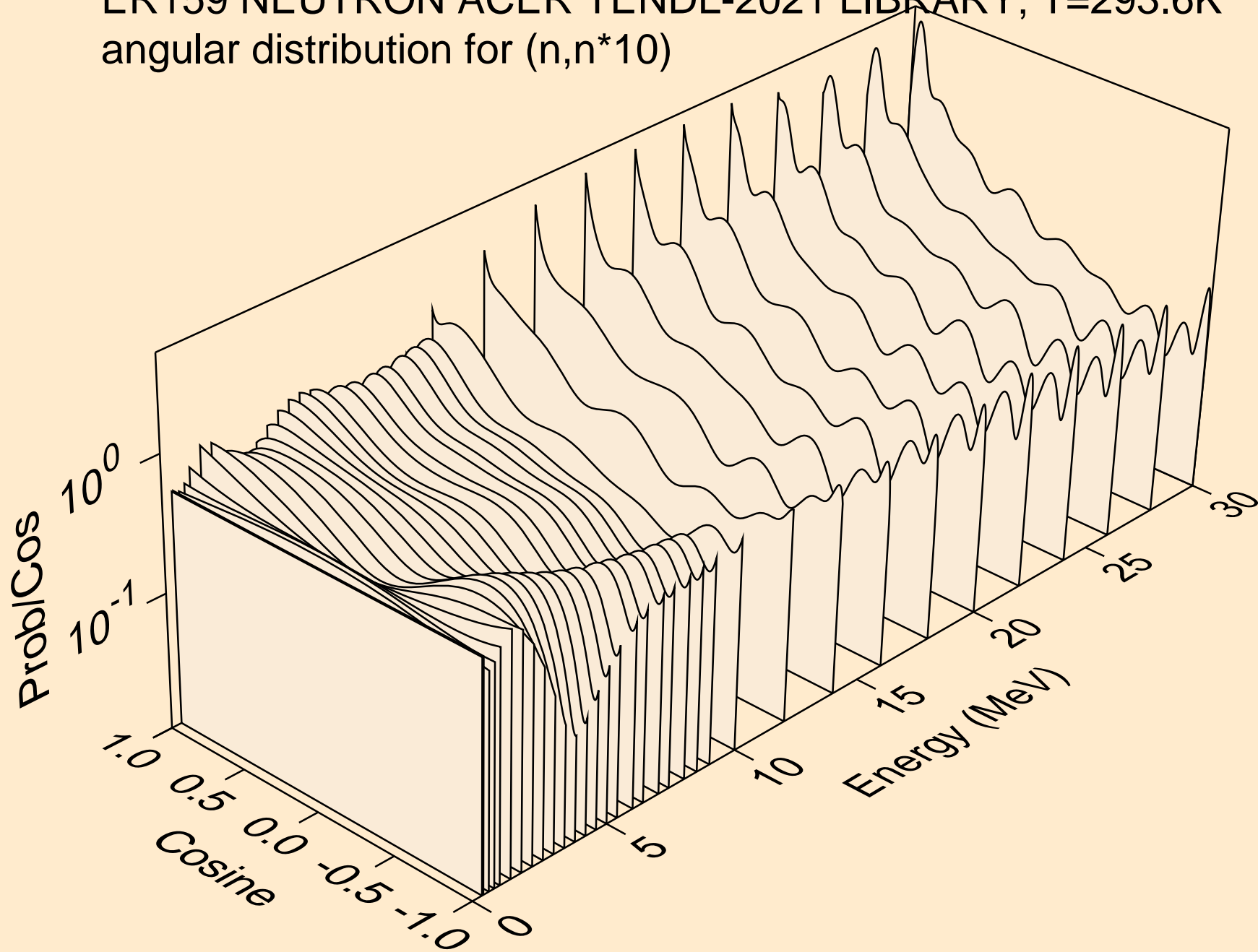

ER159 NEUTRON ACER TENDL-2021 LIBRARY; T=293.6K
angular distribution for (n,n*11)

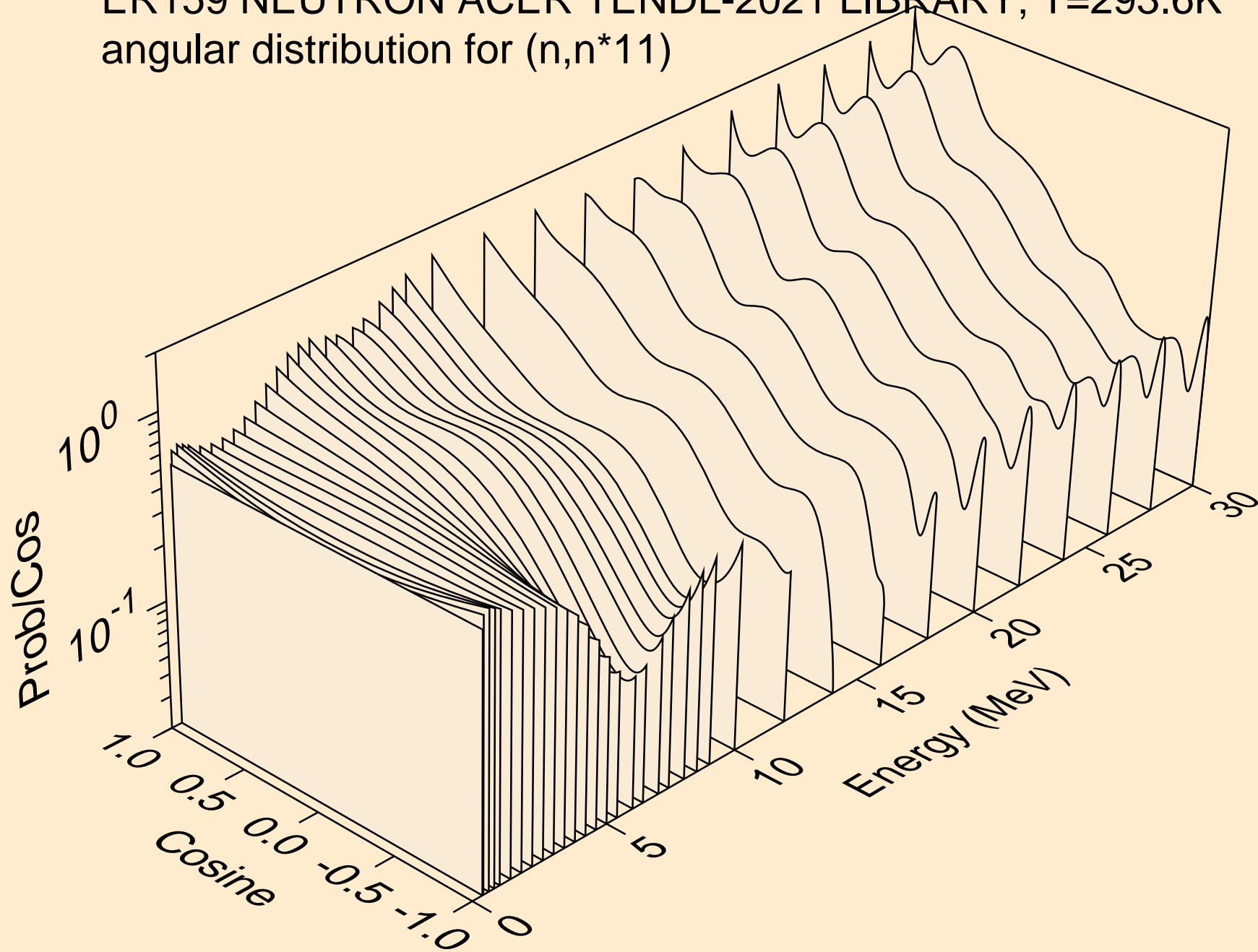

ER159 NEUTRON ACER TENDL-2021 LIBRARY; T=293.6K
angular distribution for (n,n*12)

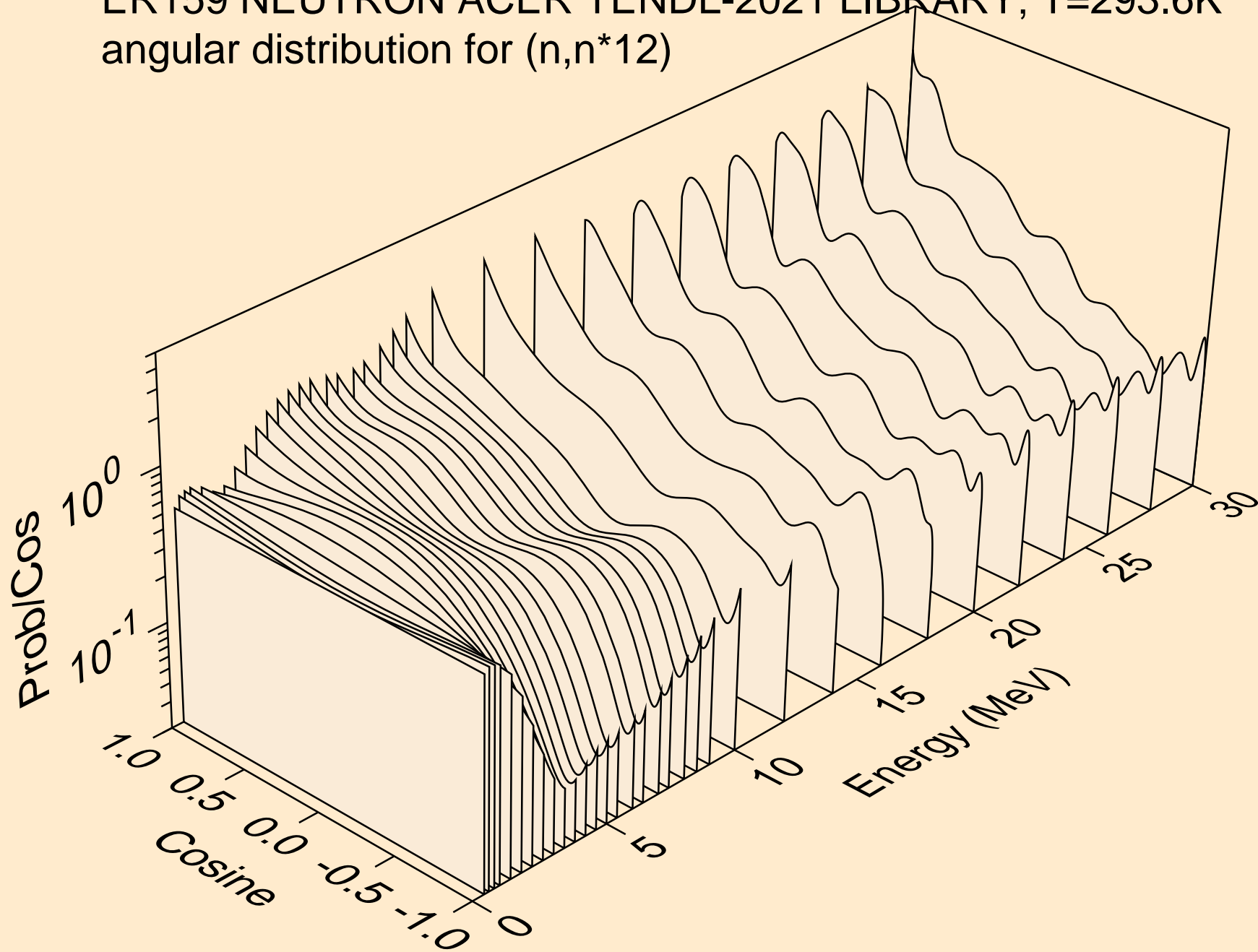

ER159 NEUTRON ACER TENDL-2021 LIBRARY; T=293.6K
angular distribution for (n,n*13)

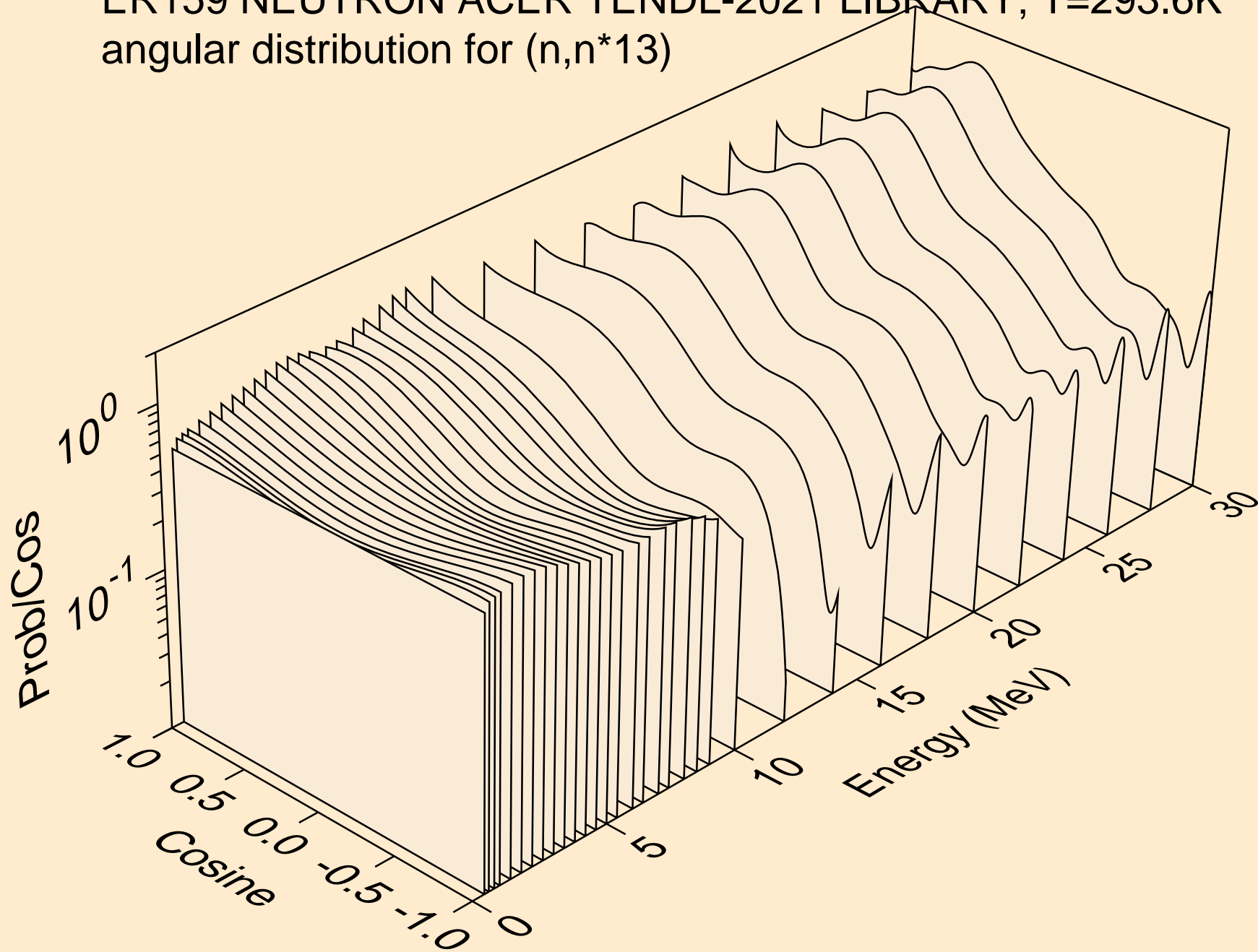

ER159 NEUTRON ACER TENDL-2021 LIBRARY; T=293.6K
angular distribution for (n,n*14)

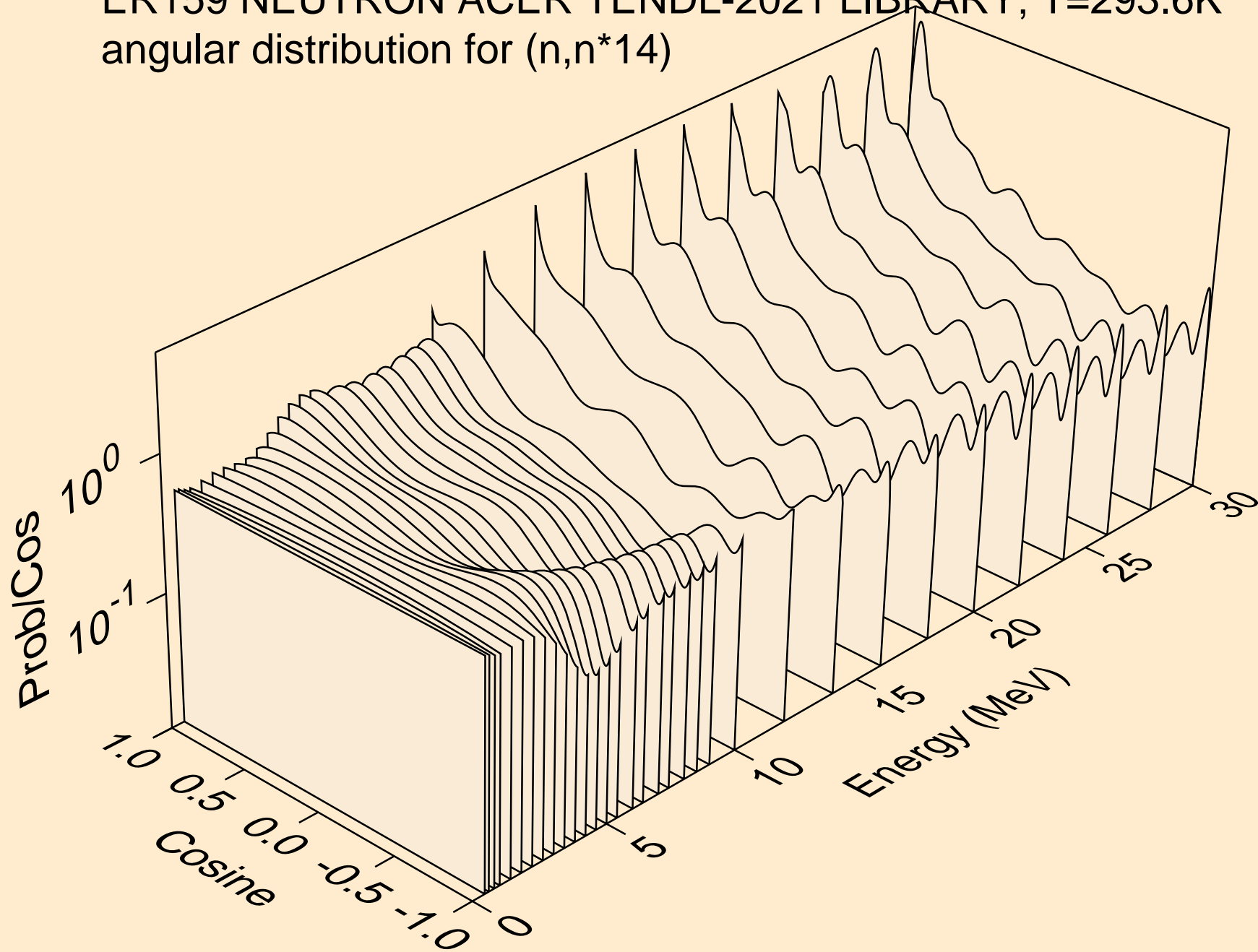

ER159 NEUTRON ACER TENDL-2021 LIBRARY; T=293.6K
angular distribution for (n,n*15)

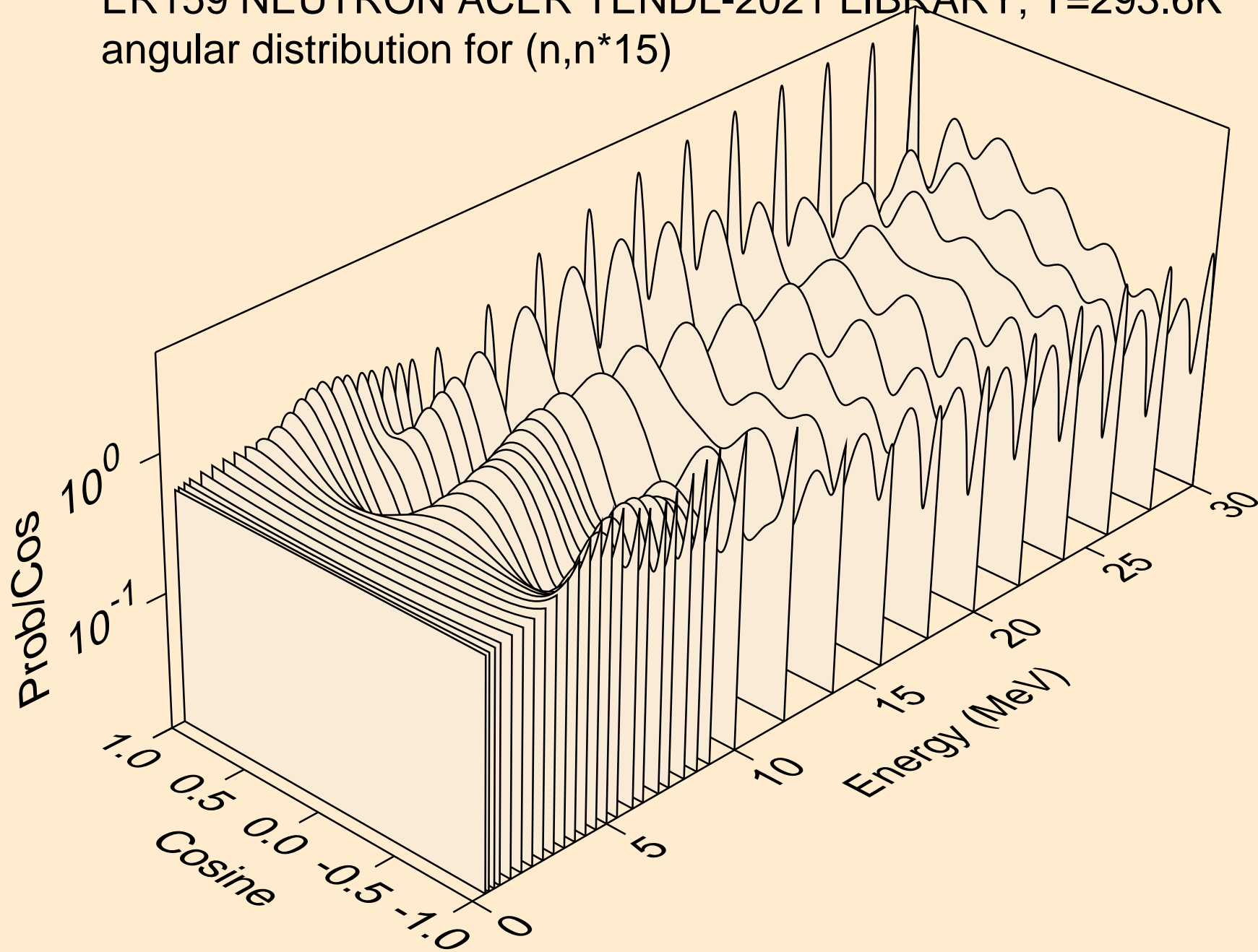

ER159 NEUTRON ACER TENDL-2021 LIBRARY; T=293.6K
angular distribution for (n,n*16)

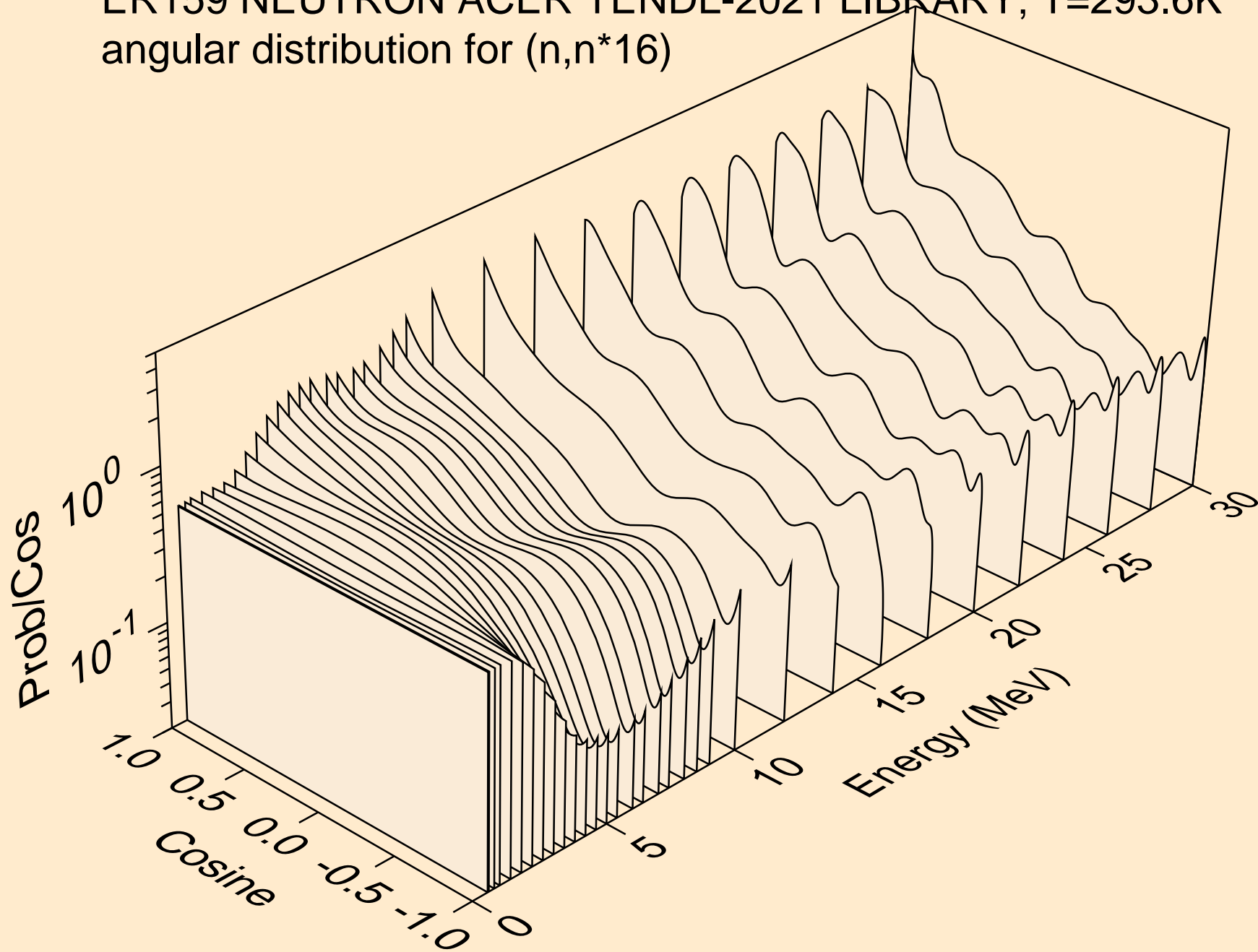

ER159 NEUTRON ACER TENDL-2021 LIBRARY; T=293.6K
angular distribution for (n,n*17)

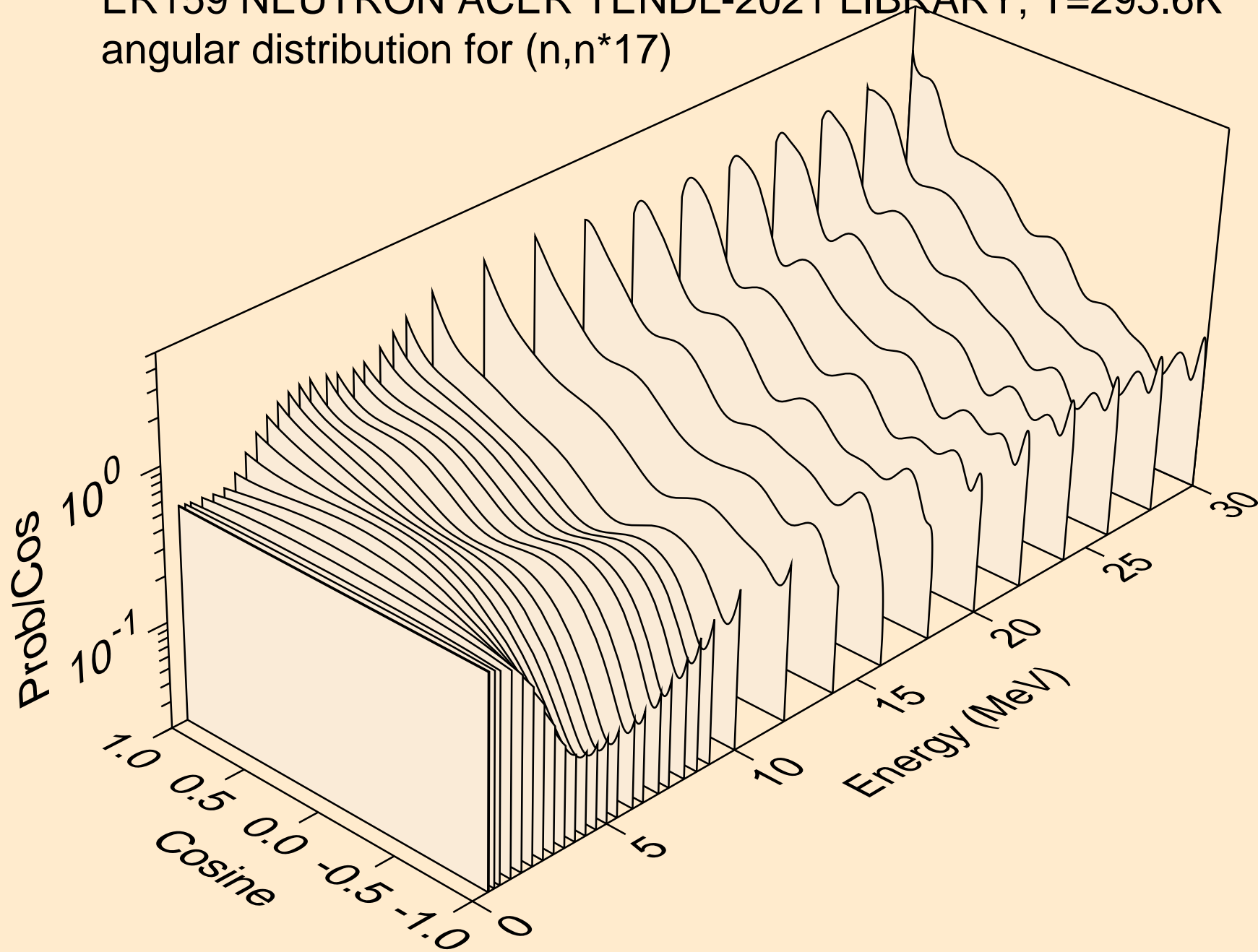

ER159 NEUTRON ACER TENDL-2021 LIBRARY; T=293.6K
angular distribution for (n,n*18)

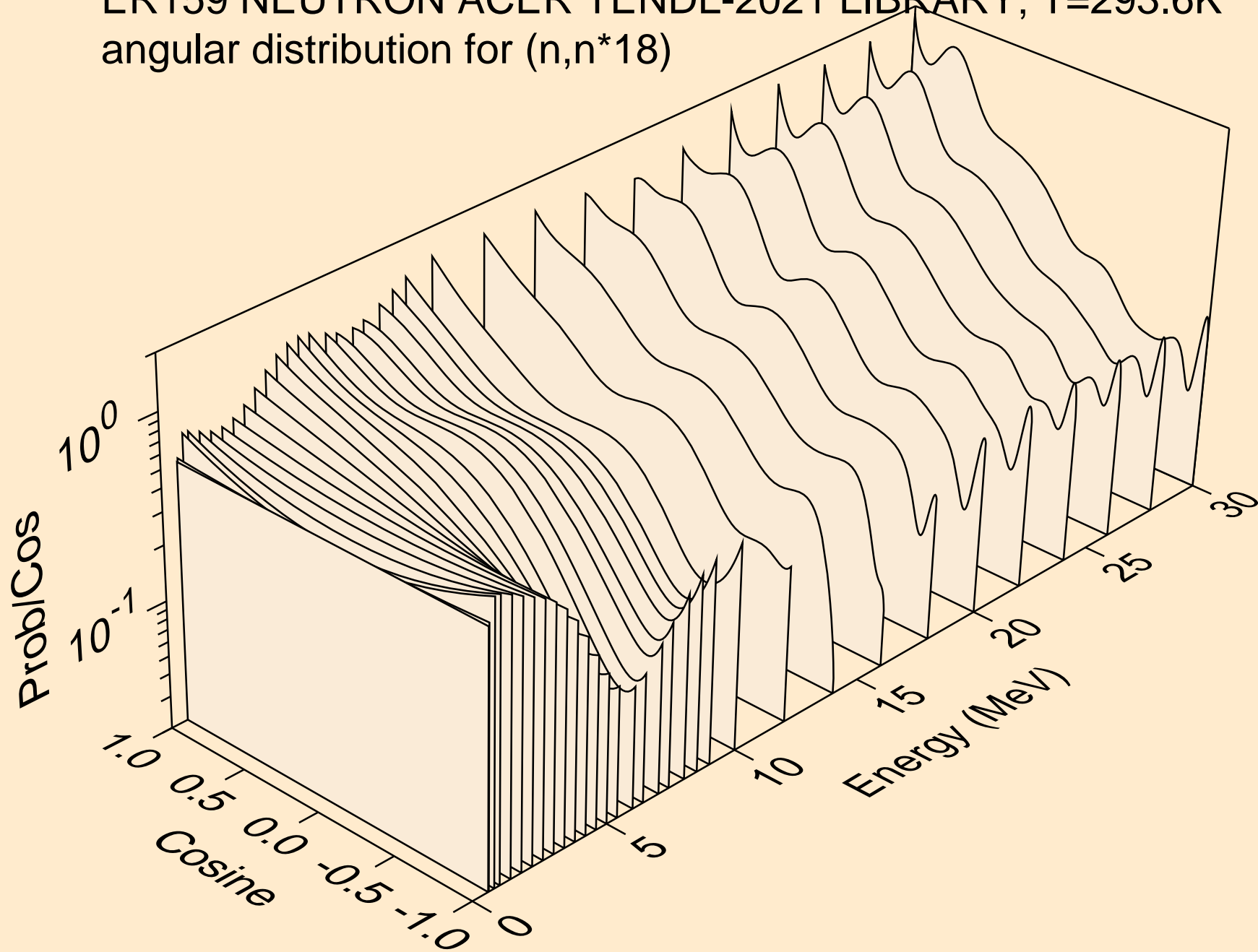

ER159 NEUTRON ACER TENDL-2021 LIBRARY; T=293.6K
angular distribution for (n,n*19)

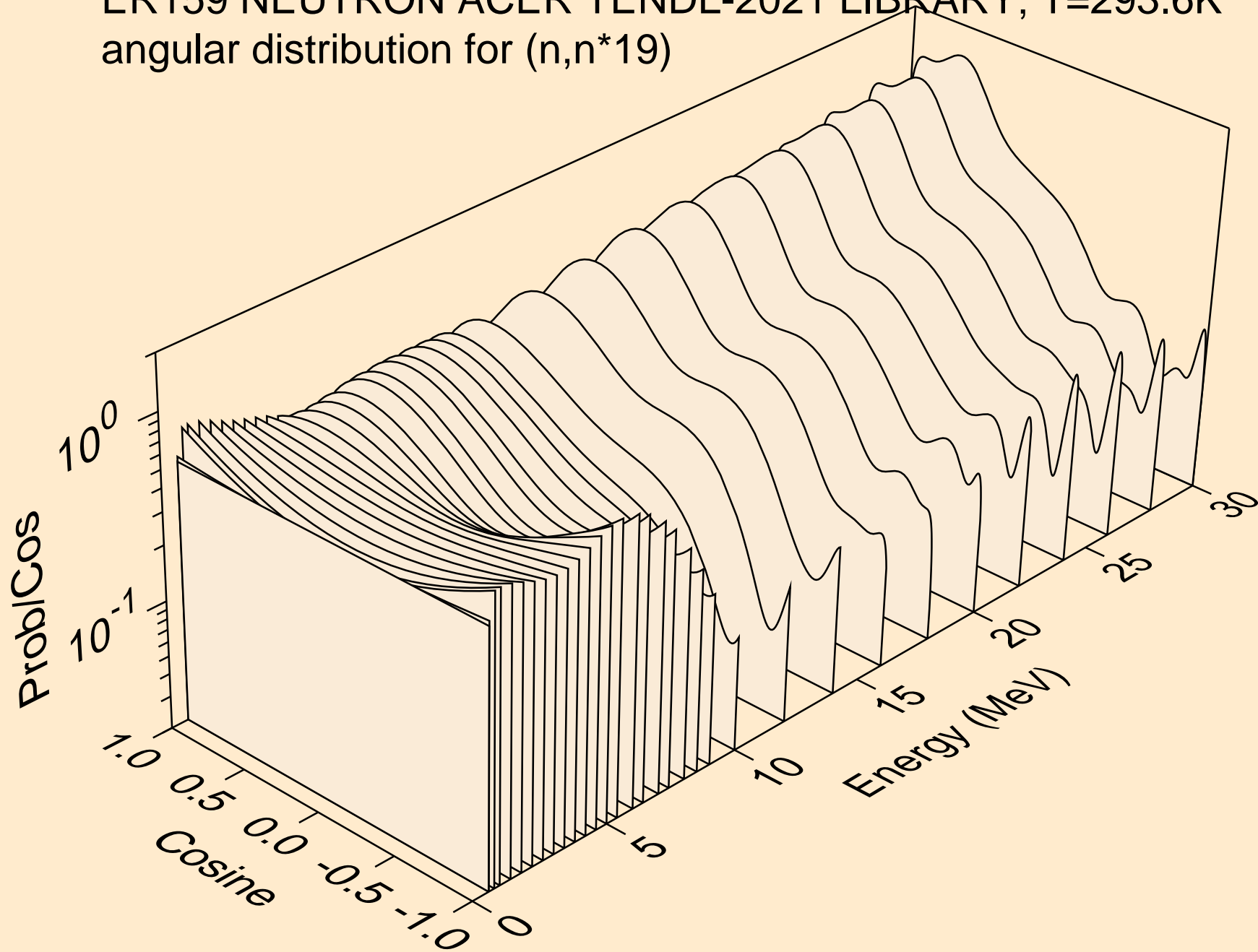

ER159 NEUTRON ACER TENDL-2021 LIBRARY; T=293.6K
angular distribution for (n,n*20)

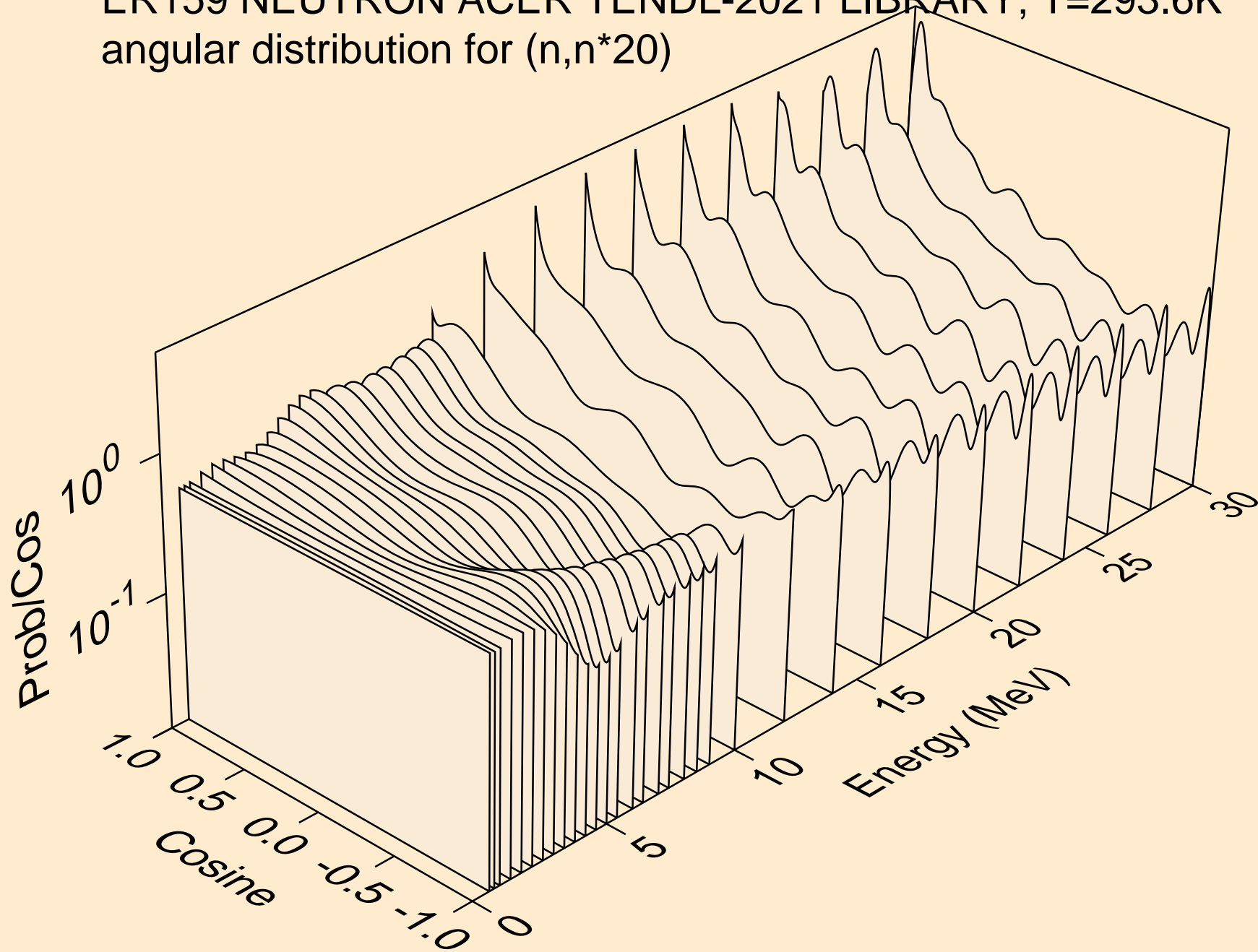

ER159 NEUTRON ACER TENDL-2021 LIBRARY; T=293.6K
angular distribution for (n,n*21)

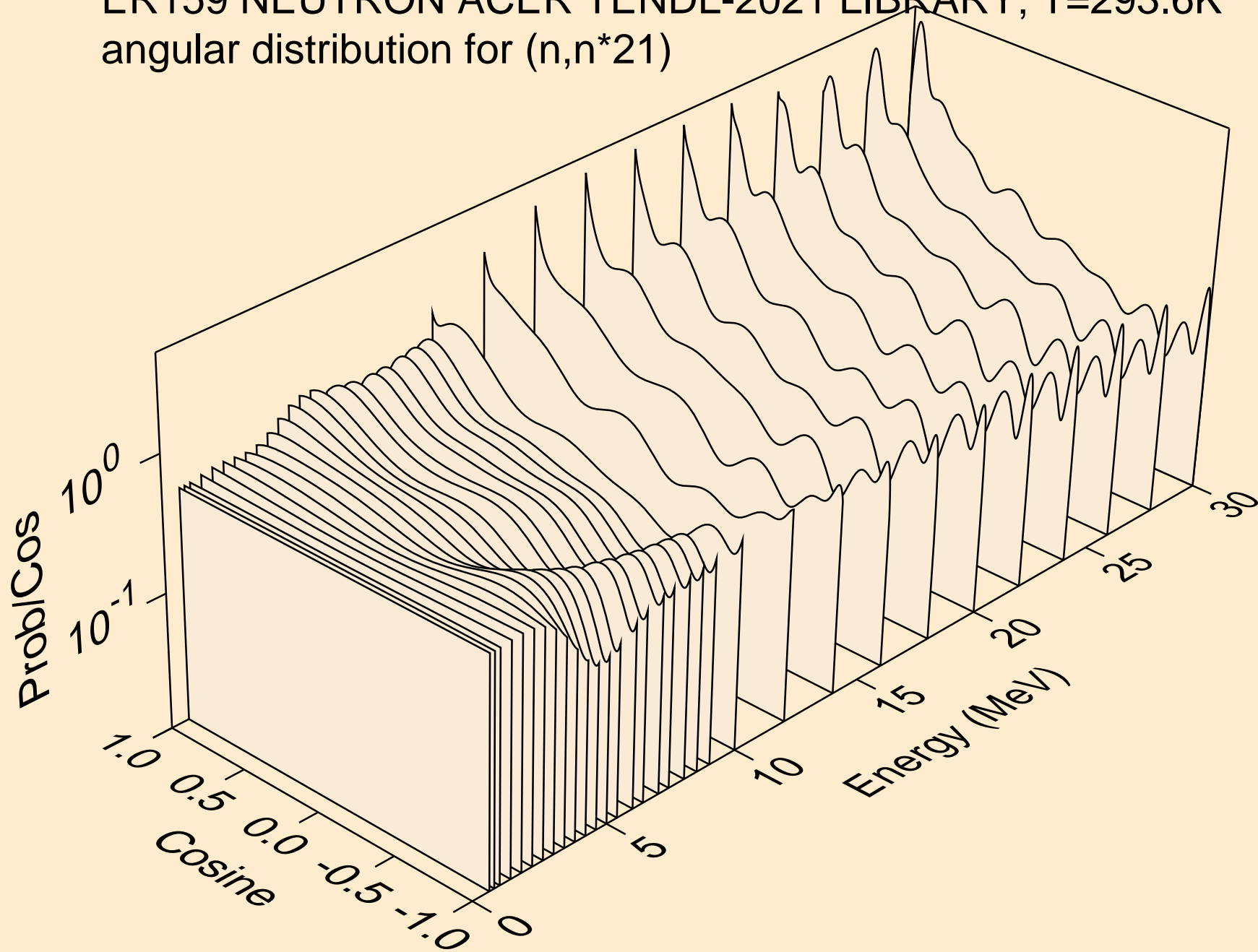

ER159 NEUTRON ACER TENDL-2021 LIBRARY; T=293.6K
angular distribution for (n,n*22)

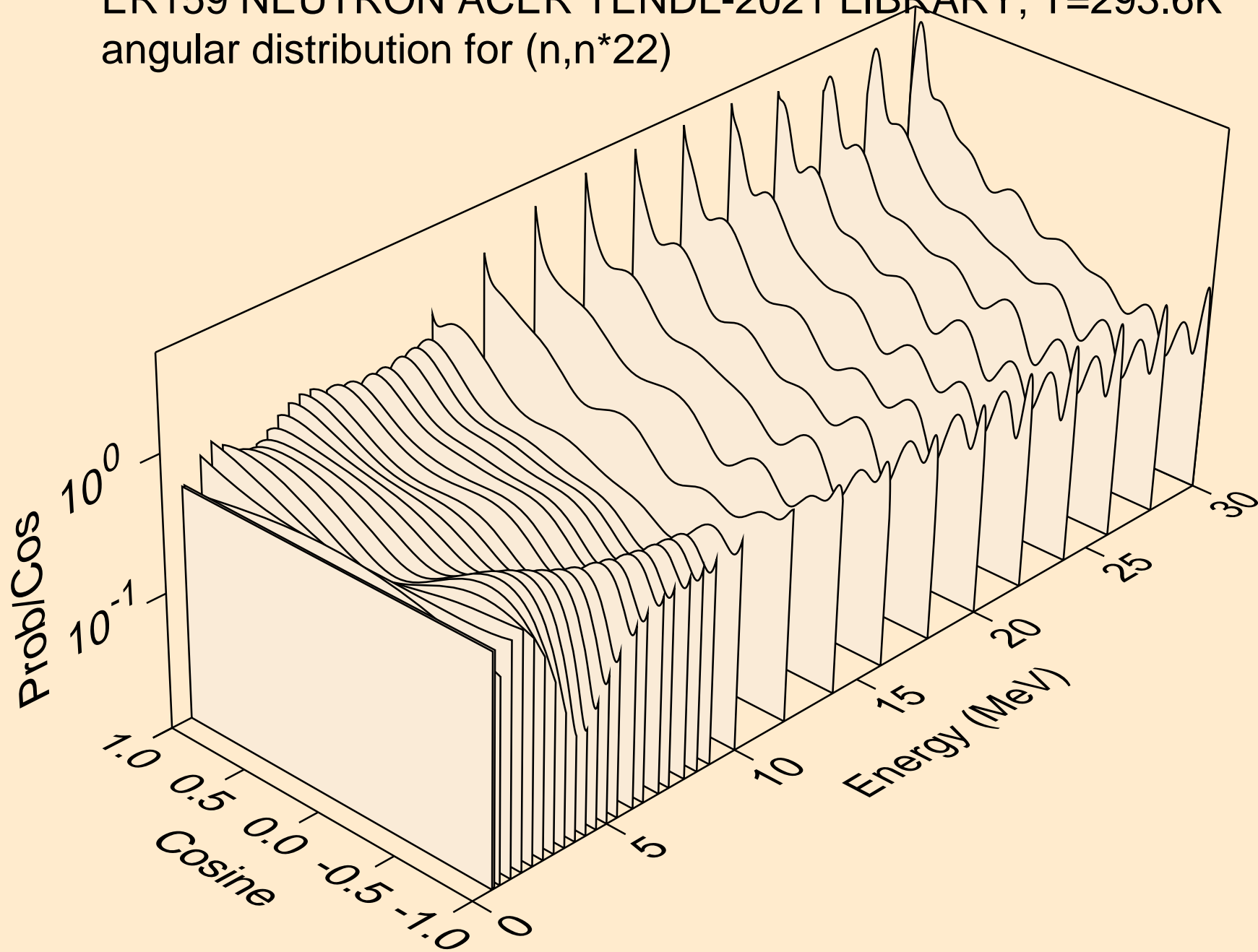

ER159 NEUTRON ACER TENDL-2021 LIBRARY; T=293.6K
angular distribution for (n,n*23)

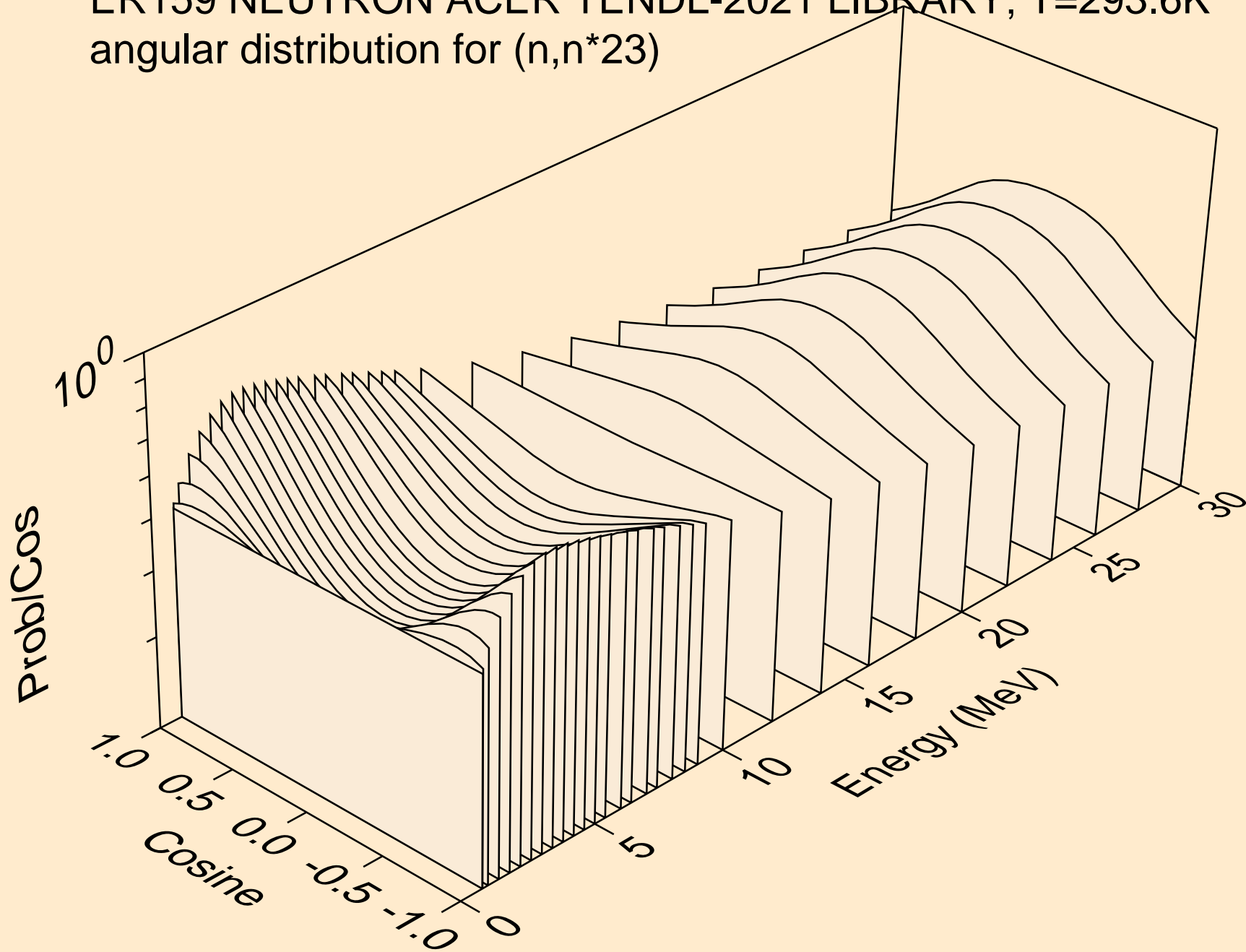

ER159 NEUTRON ACER TENDL-2021 LIBRARY; T=293.6K
angular distribution for (n,n*24)

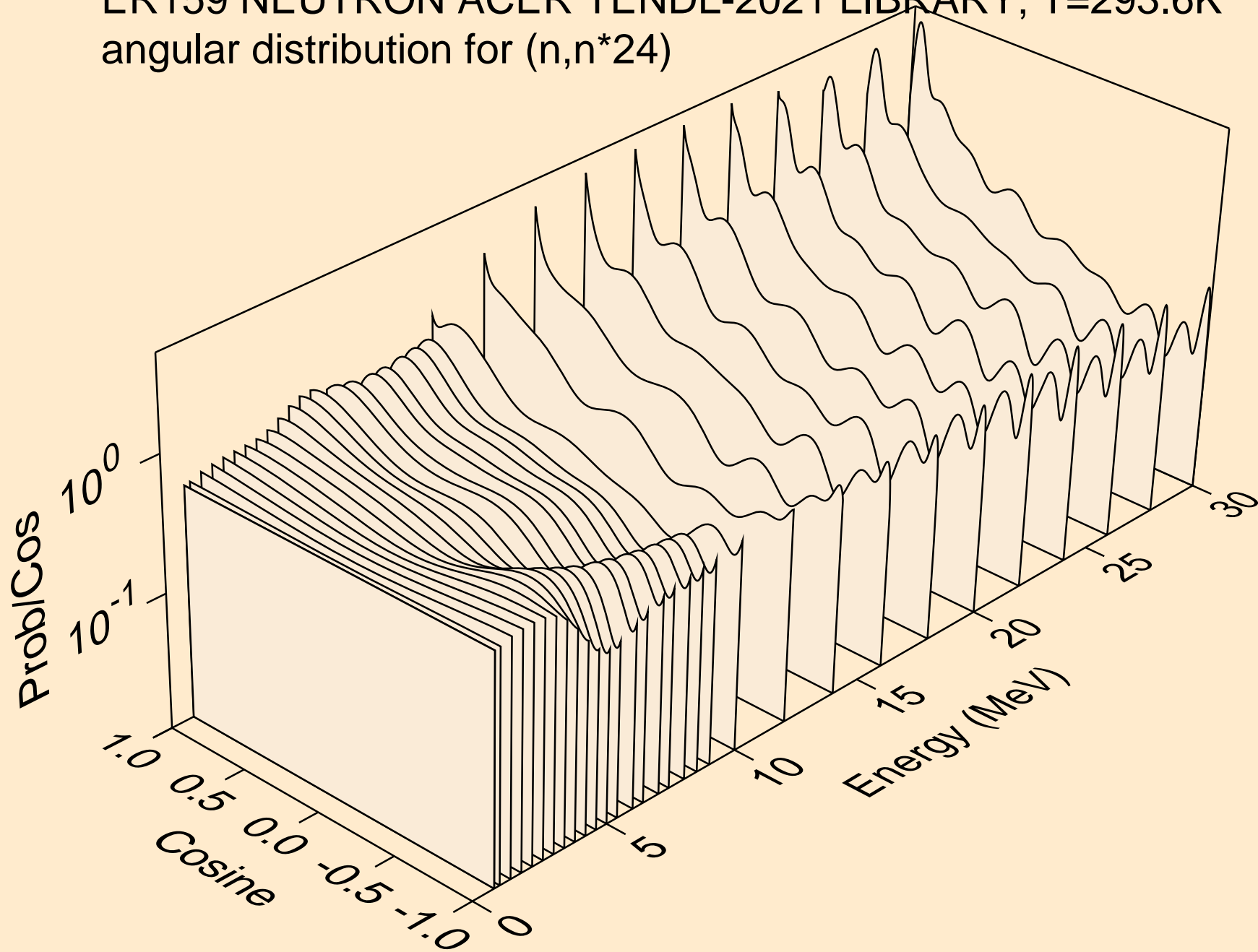

ER159 NEUTRON ACER TENDL-2021 LIBRARY; T=293.6K
angular distribution for (n,n*25)

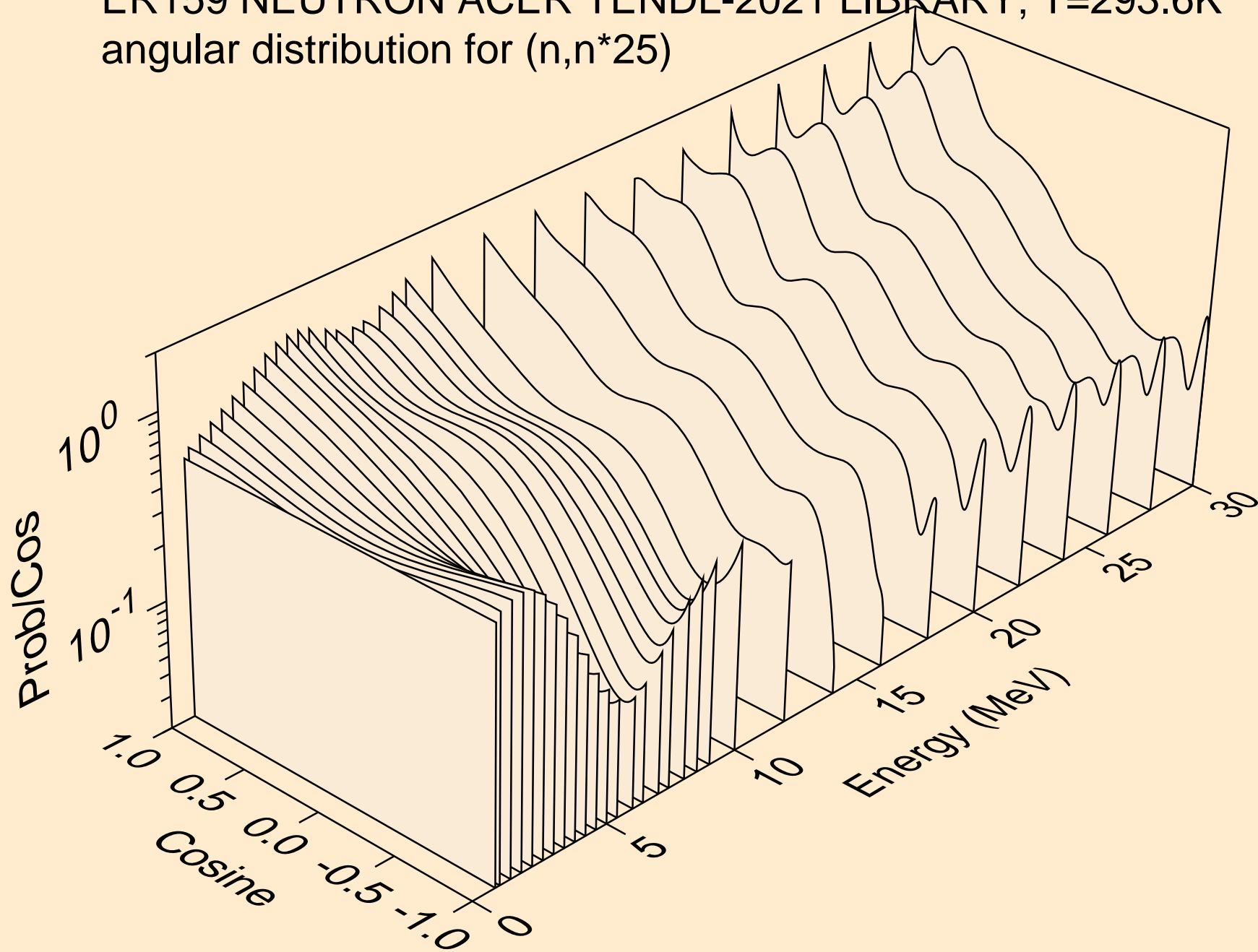

ER159 NEUTRON ACER TENDL-2021 LIBRARY; T=293.6K
angular distribution for (n,n*26)

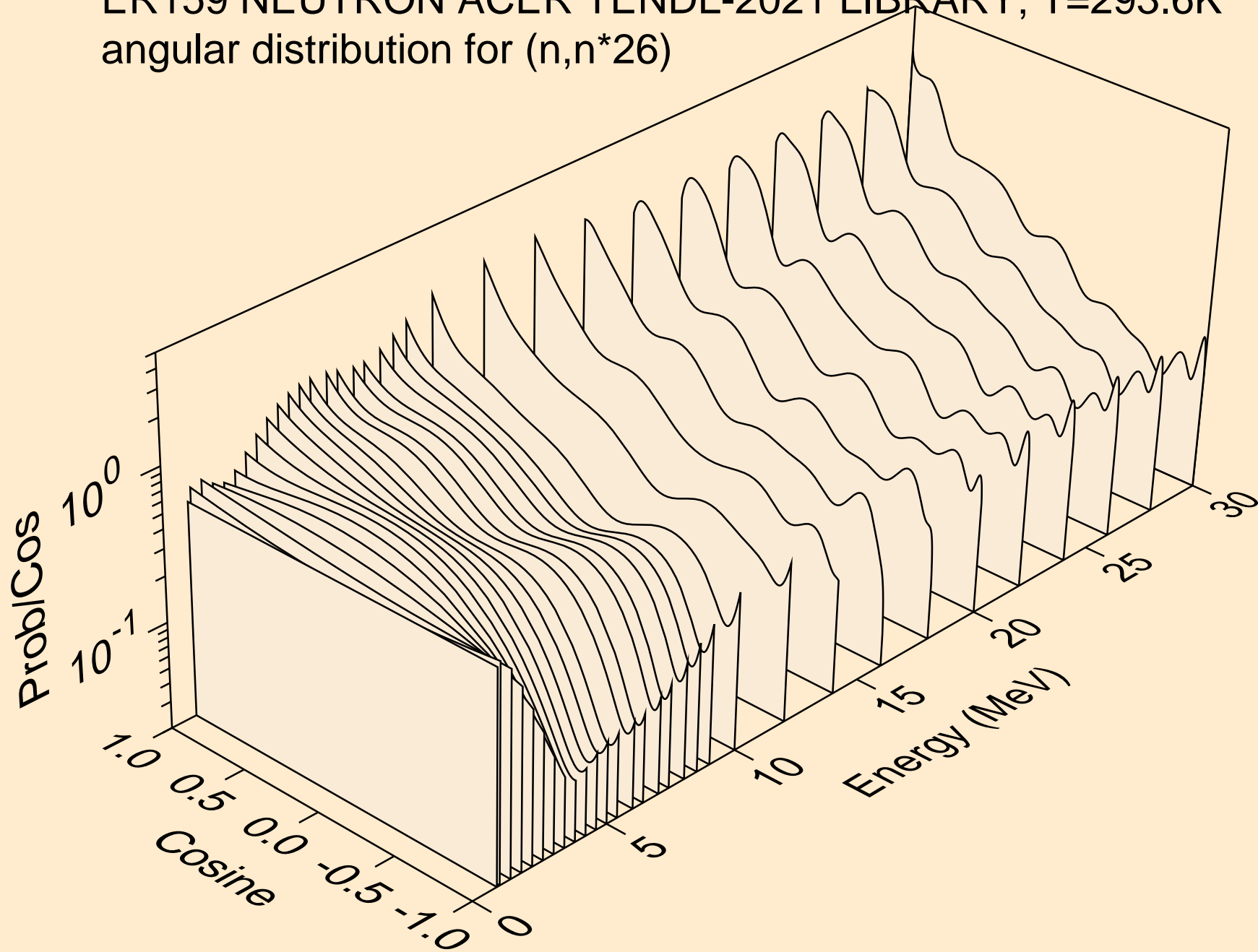

ER159 NEUTRON ACER TENDL-2021 LIBRARY; T=293.6K
angular distribution for (n,n*27)

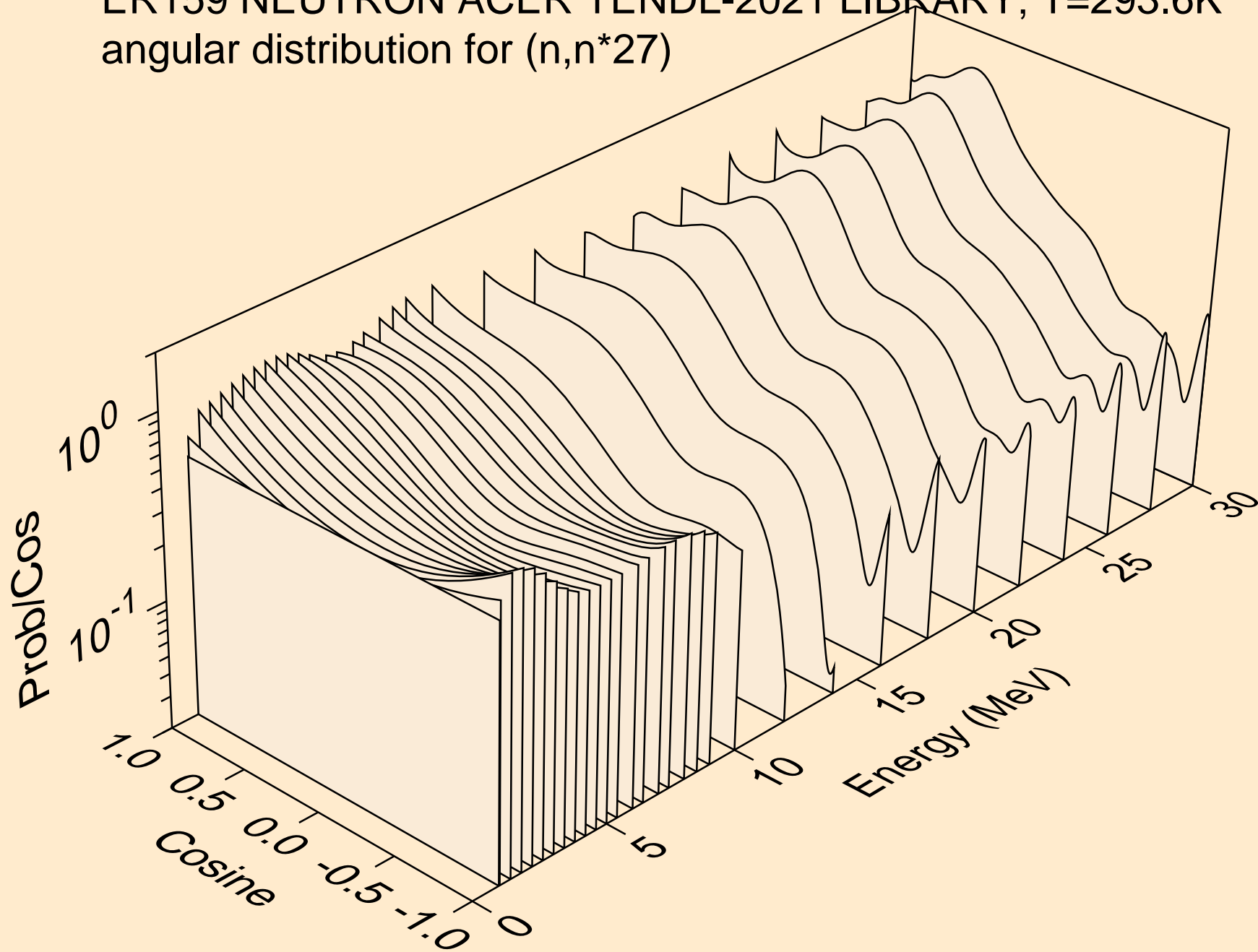

ER159 NEUTRON ACER TENDL-2021 LIBRARY; T=293.6K
angular distribution for (n,n*28)

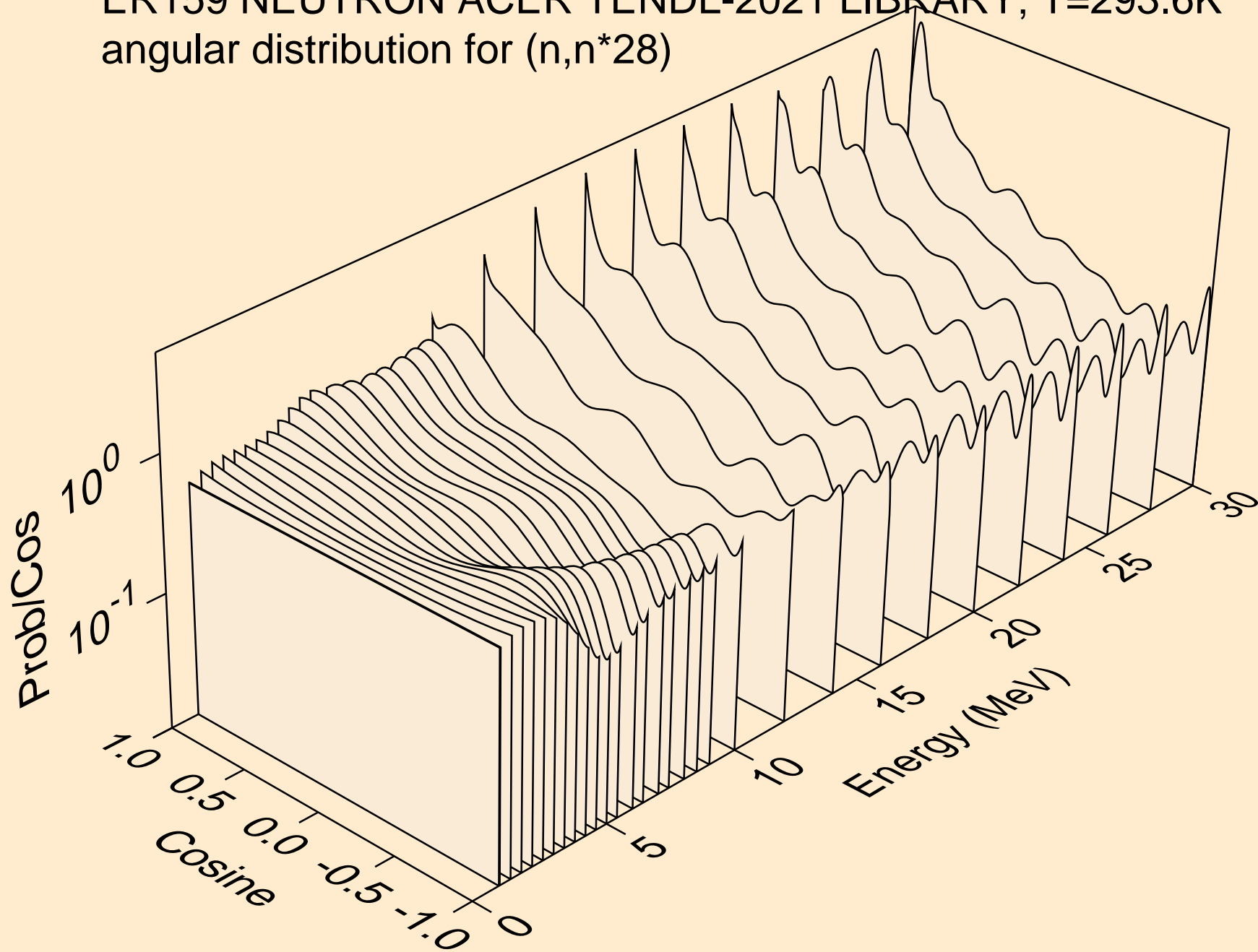

ER159 NEUTRON ACER TENDL-2021 LIBRARY; T=293.6K
Neutron emission for (n,x)

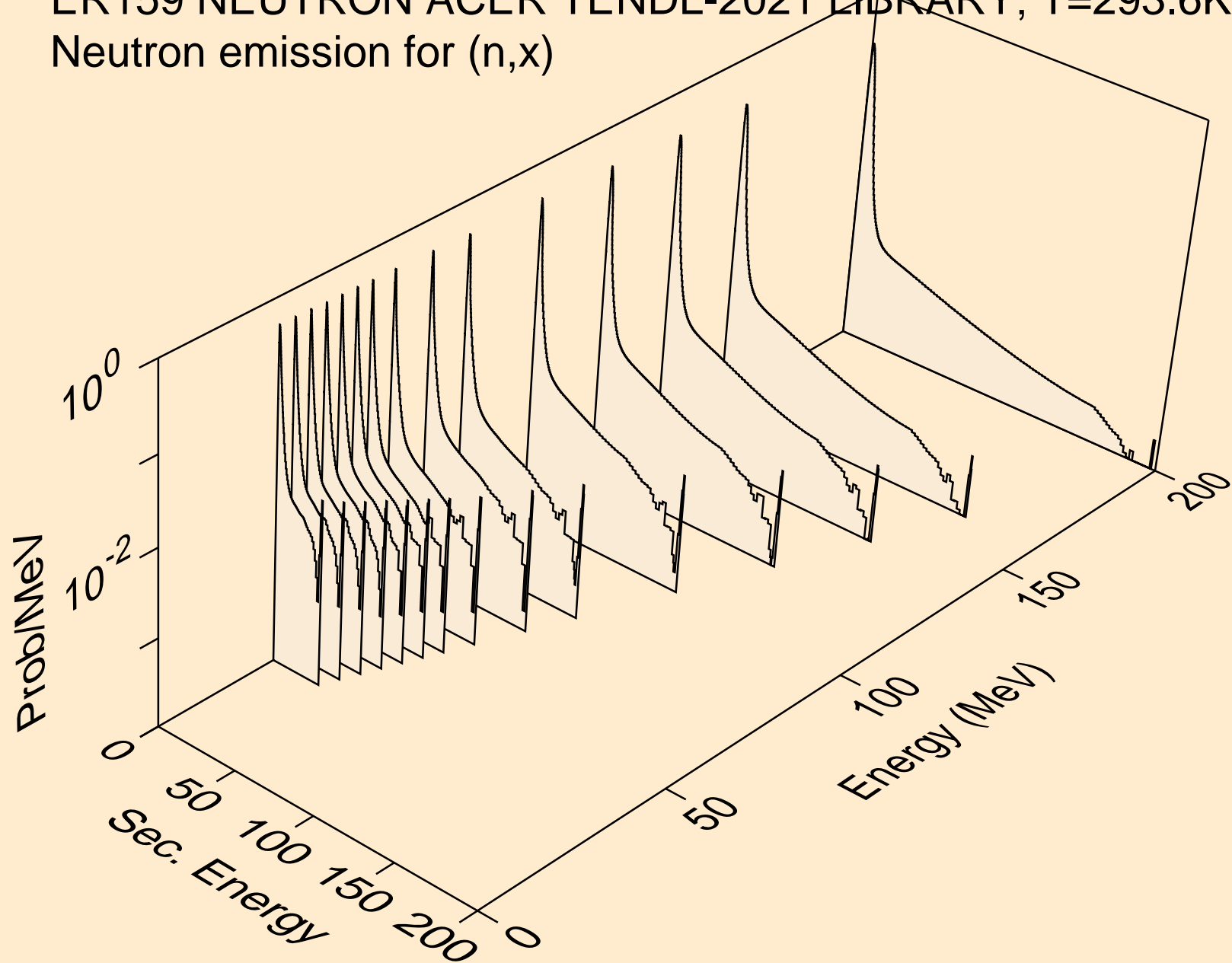

ER159 NEUTRON ACER TENDL-2021 LIBRARY; T=293.6K
Neutron emission for (n,2nd)

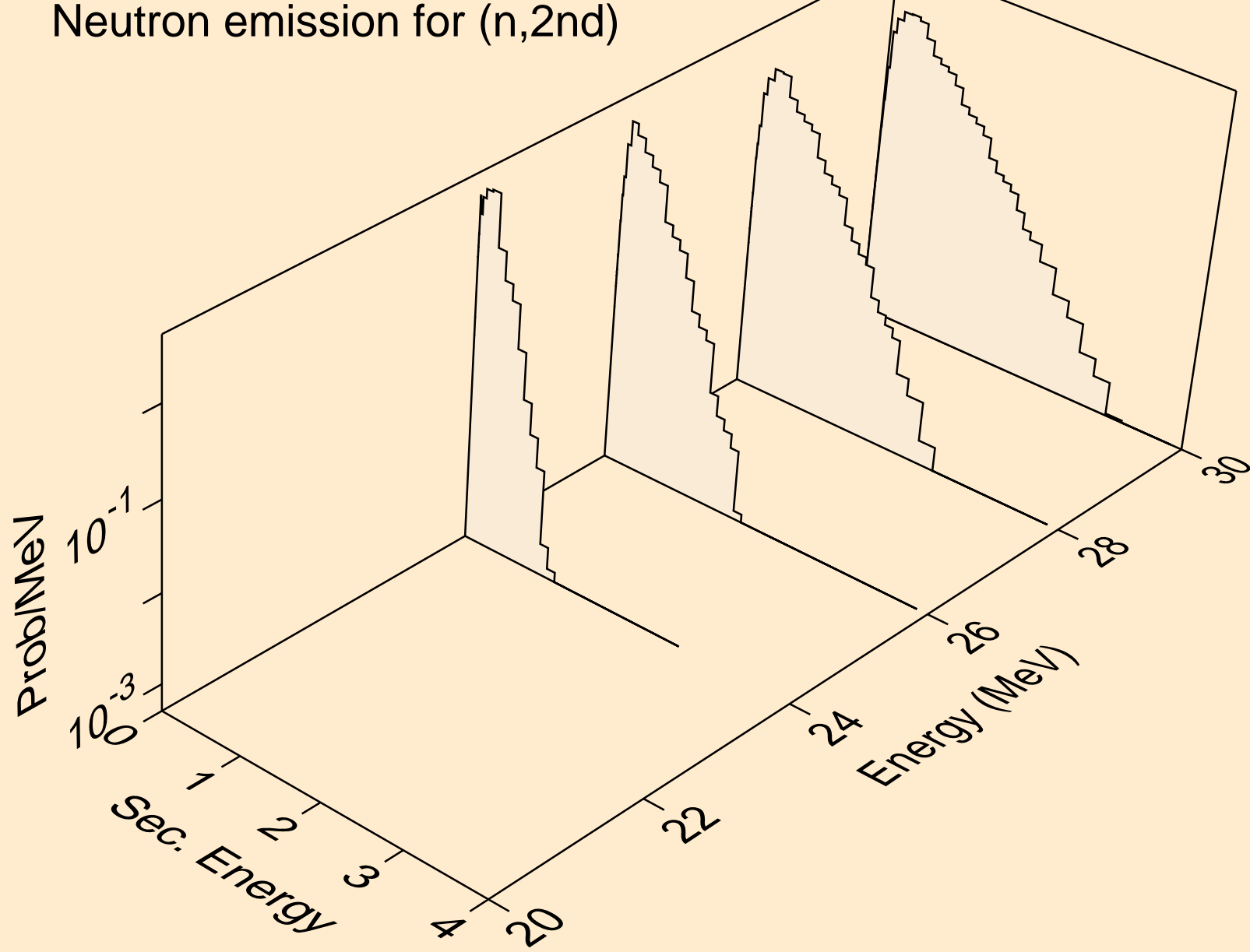

ER159 NEUTRON ACER TENDL-2021 LIBRARY; T=293.6K
Neutron emission for (n,2n)

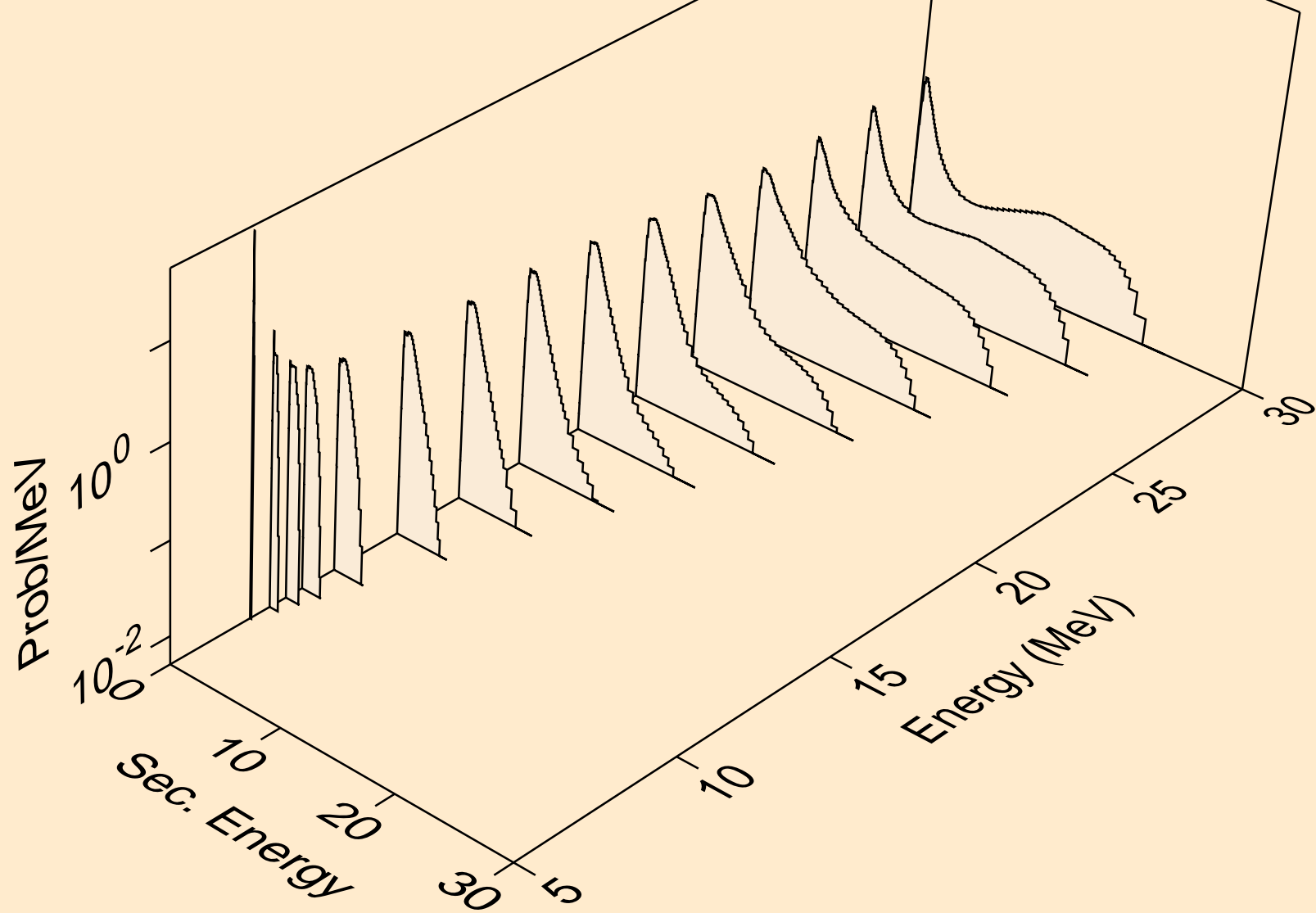

ER159 NEUTRON ACER TENDL-2021 LIBRARY; T=293.6K
Neutron emission for (n,3n)

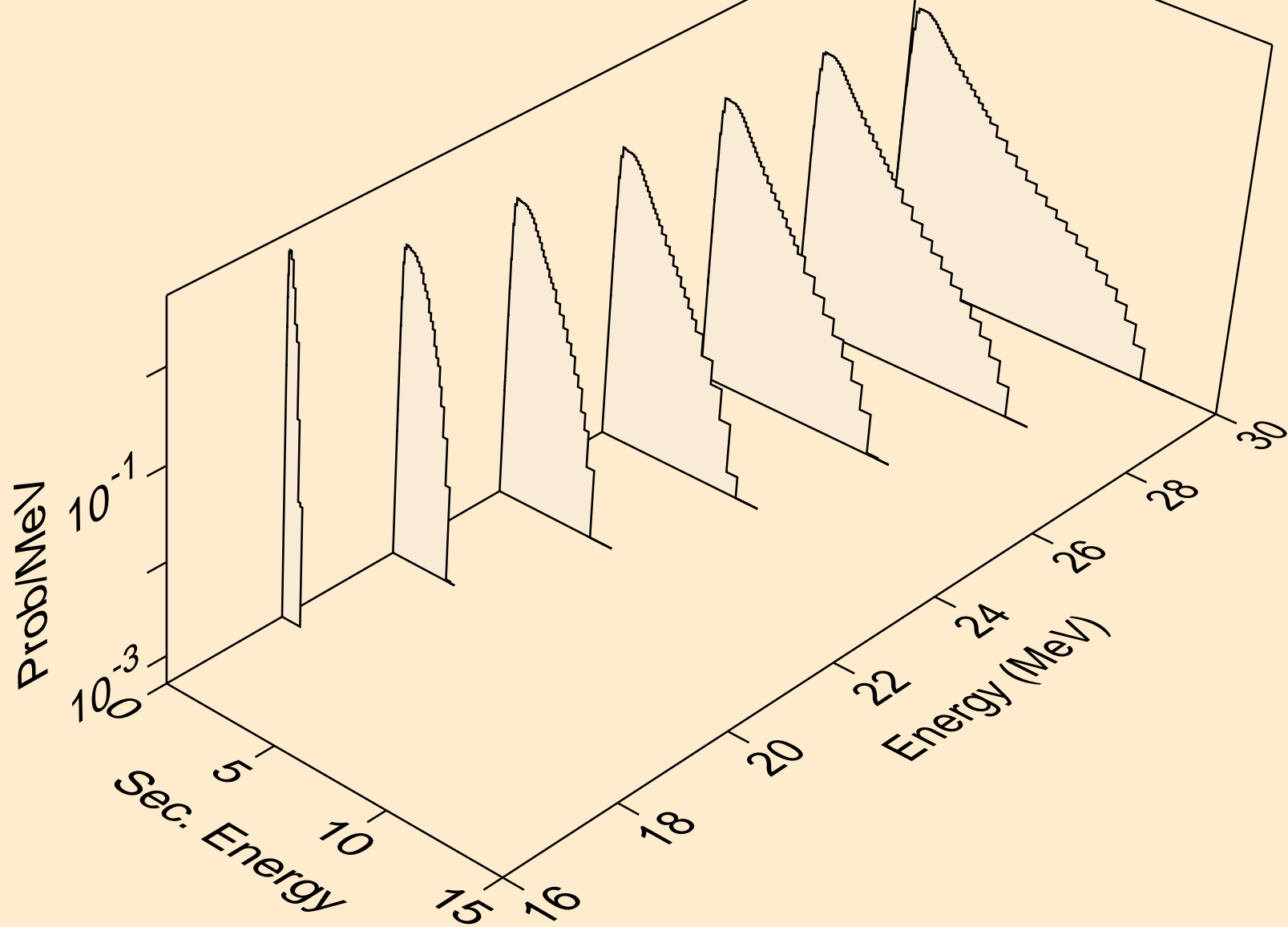

ER159 NEUTRON ACER TENDL-2021 LIBRARY; T=293.6K
Neutron emission for (n,n*)a

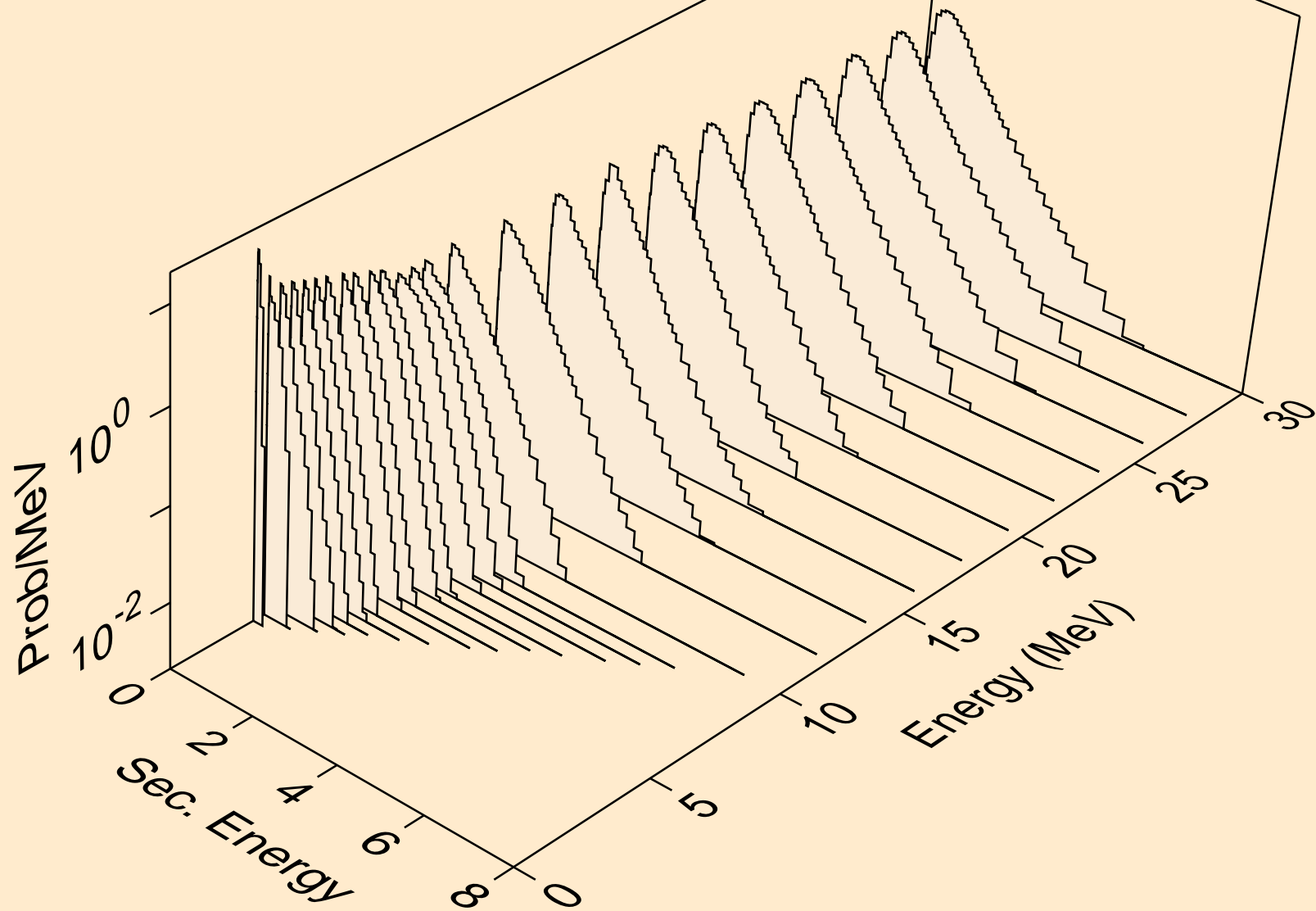

ER159 NEUTRON ACER TENDL-2021 LIBRARY; T=293.6K
Neutron emission for (n,2n)a

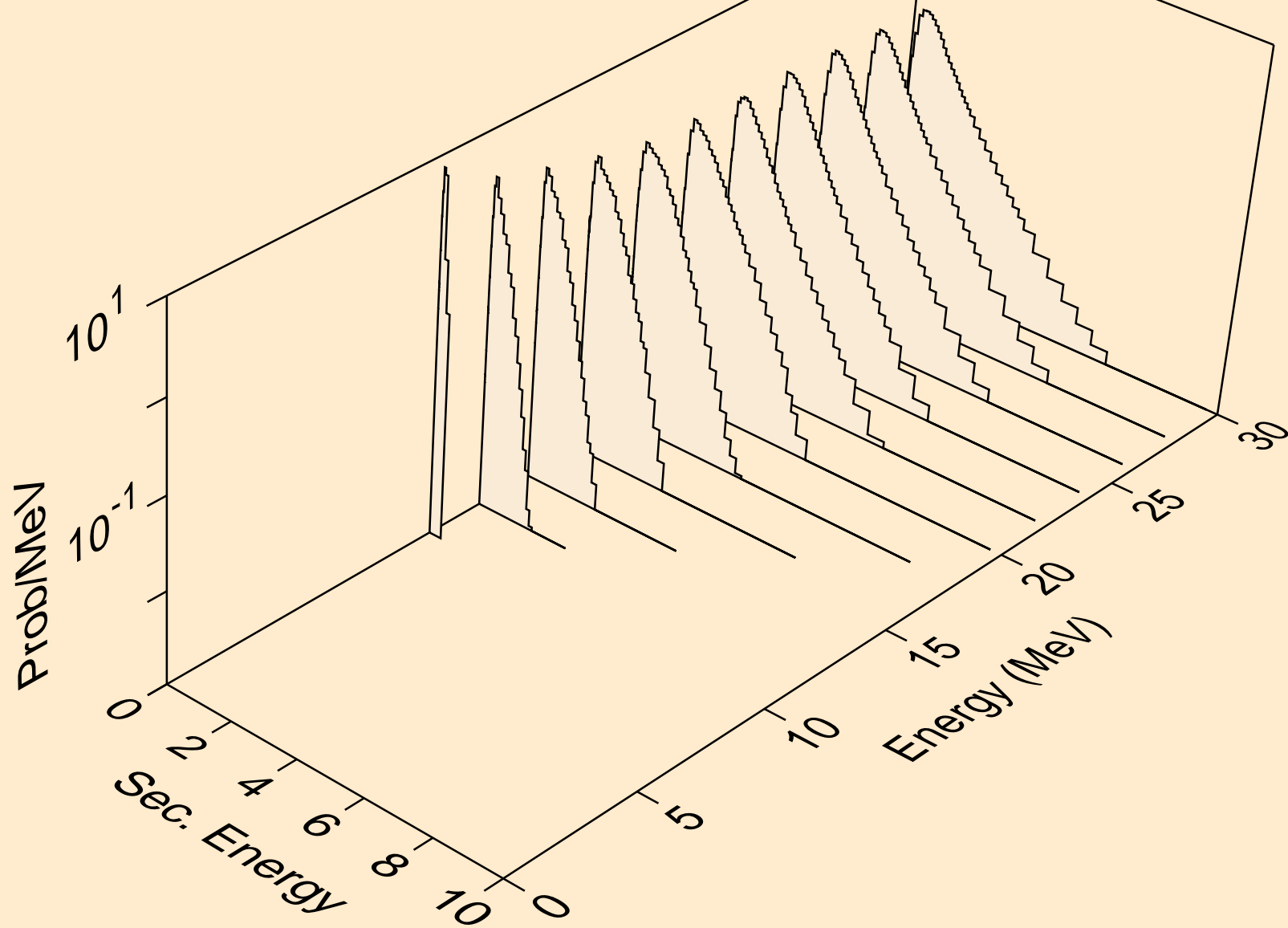

ER159 NEUTRON ACER TENDL-2021 LIBRARY; T=293.6K
Neutron emission for (n,3n)a

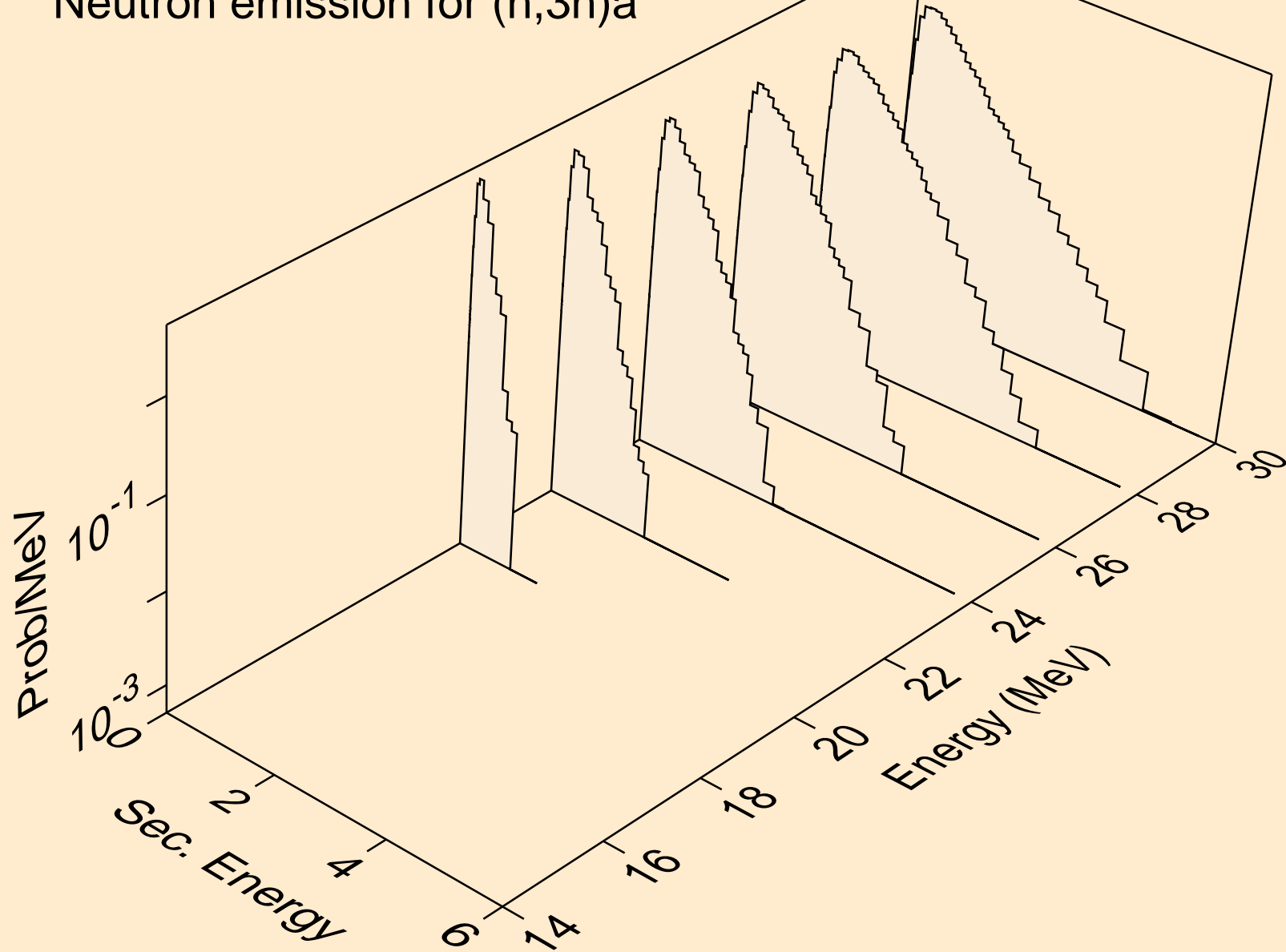

ER159 NEUTRON ACER TENDL-2021 LIBRARY; T=293.6K
Neutron emission for (n,n*)p

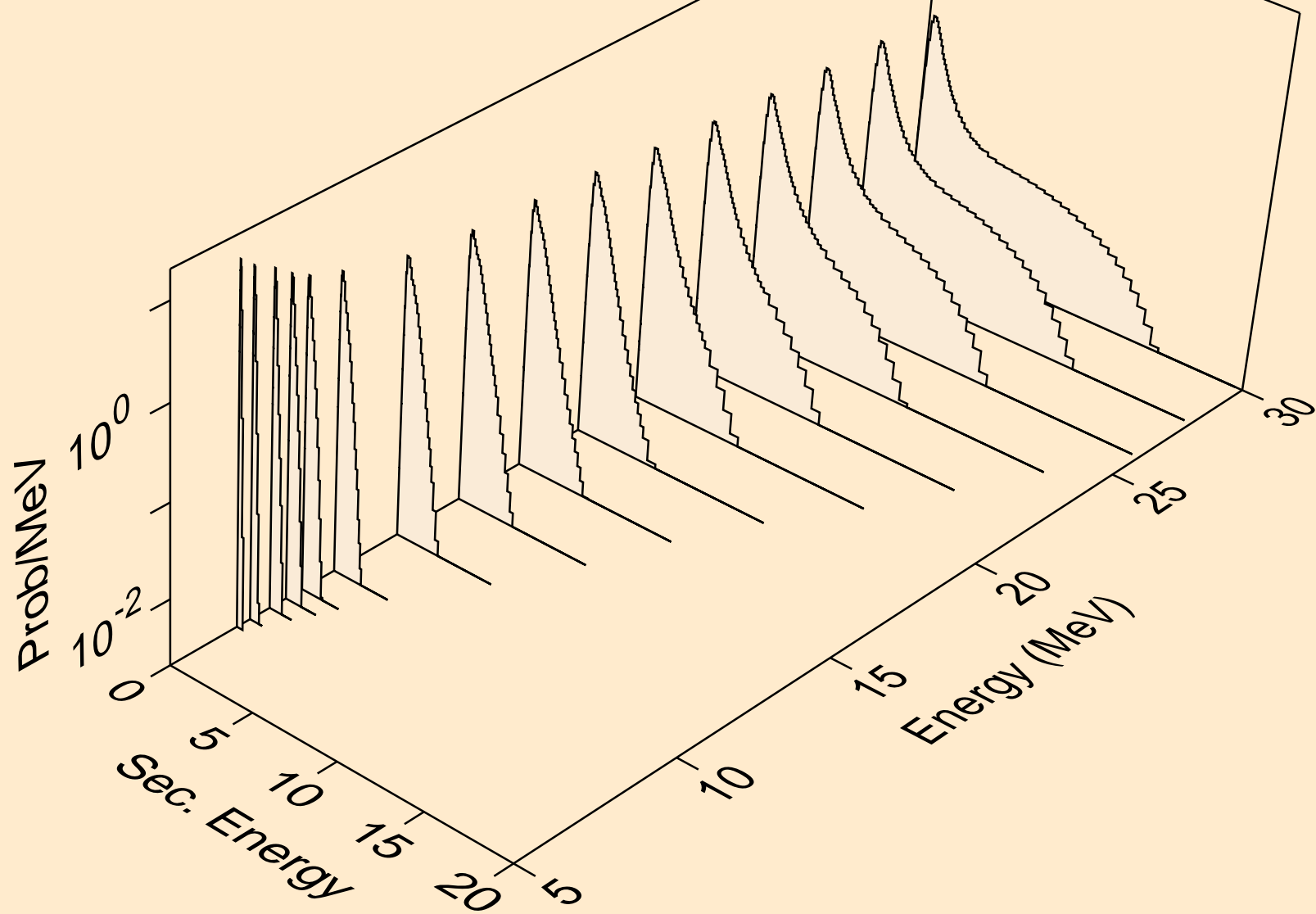

ER159 NEUTRON ACER TENDL-2021 LIBRARY; T=293.6K
Neutron emission for (n,n*)2a

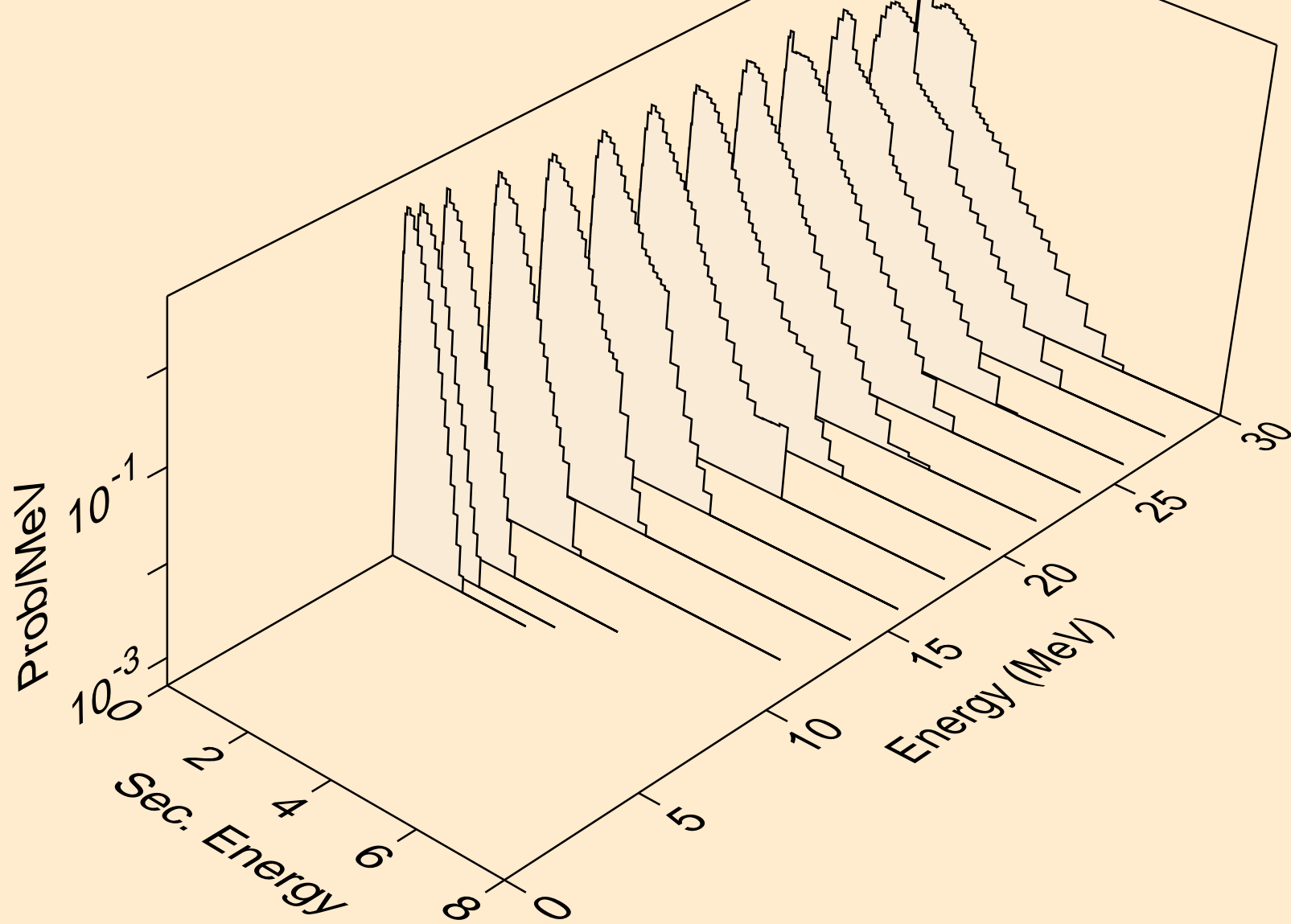

ER159 NEUTRON ACER TENDL-2021 LIBRARY; T=293.6K
Neutron emission for (n,2n)2a

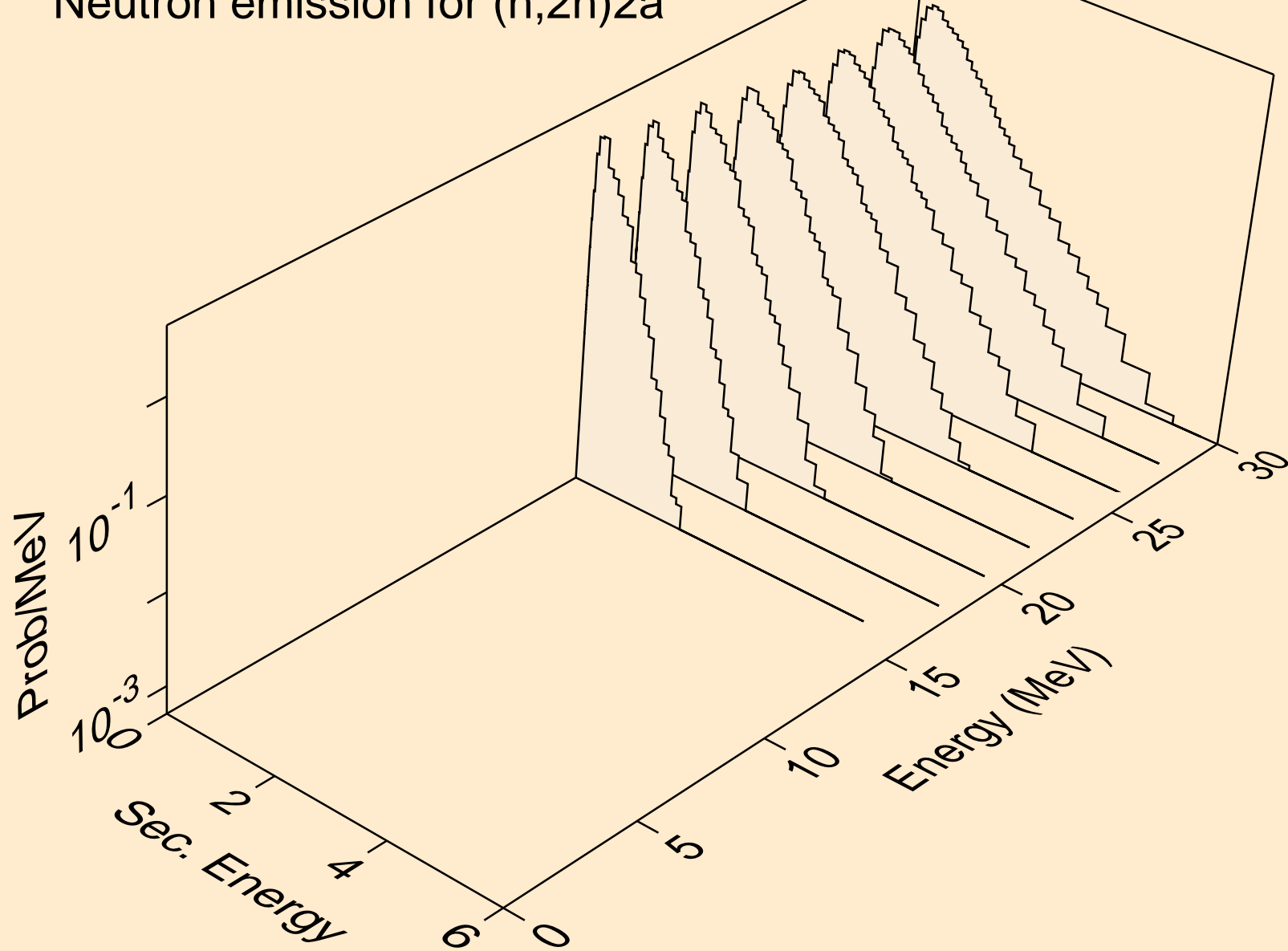

ER159 NEUTRON ACER TENDL-2021 LIBRARY; T=293.6K
Neutron emission for (n,n*)d

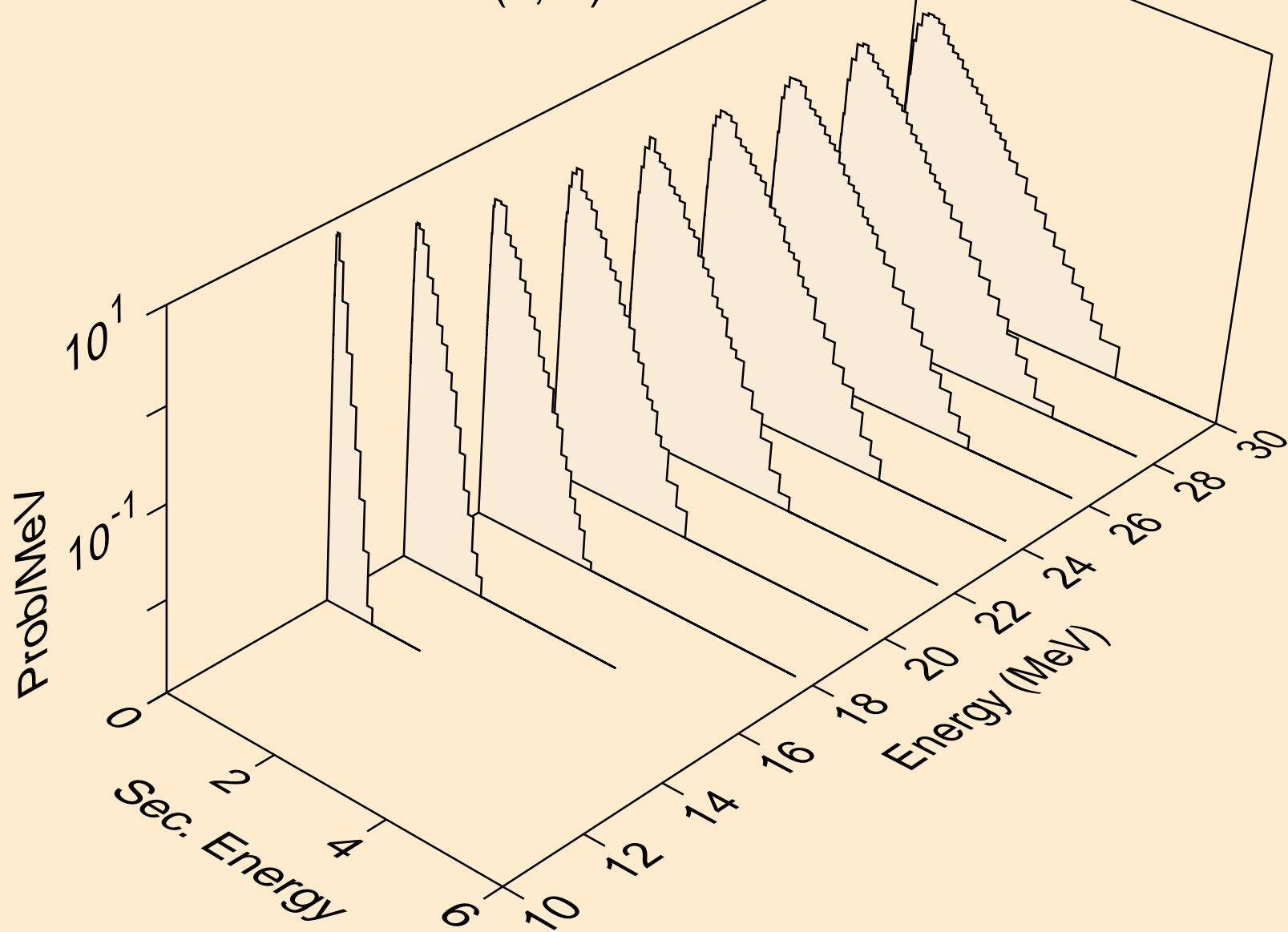

ER159 NEUTRON ACER TENDL-2021 LIBRARY; T=293.6K
Neutron emission for (n,n*)t

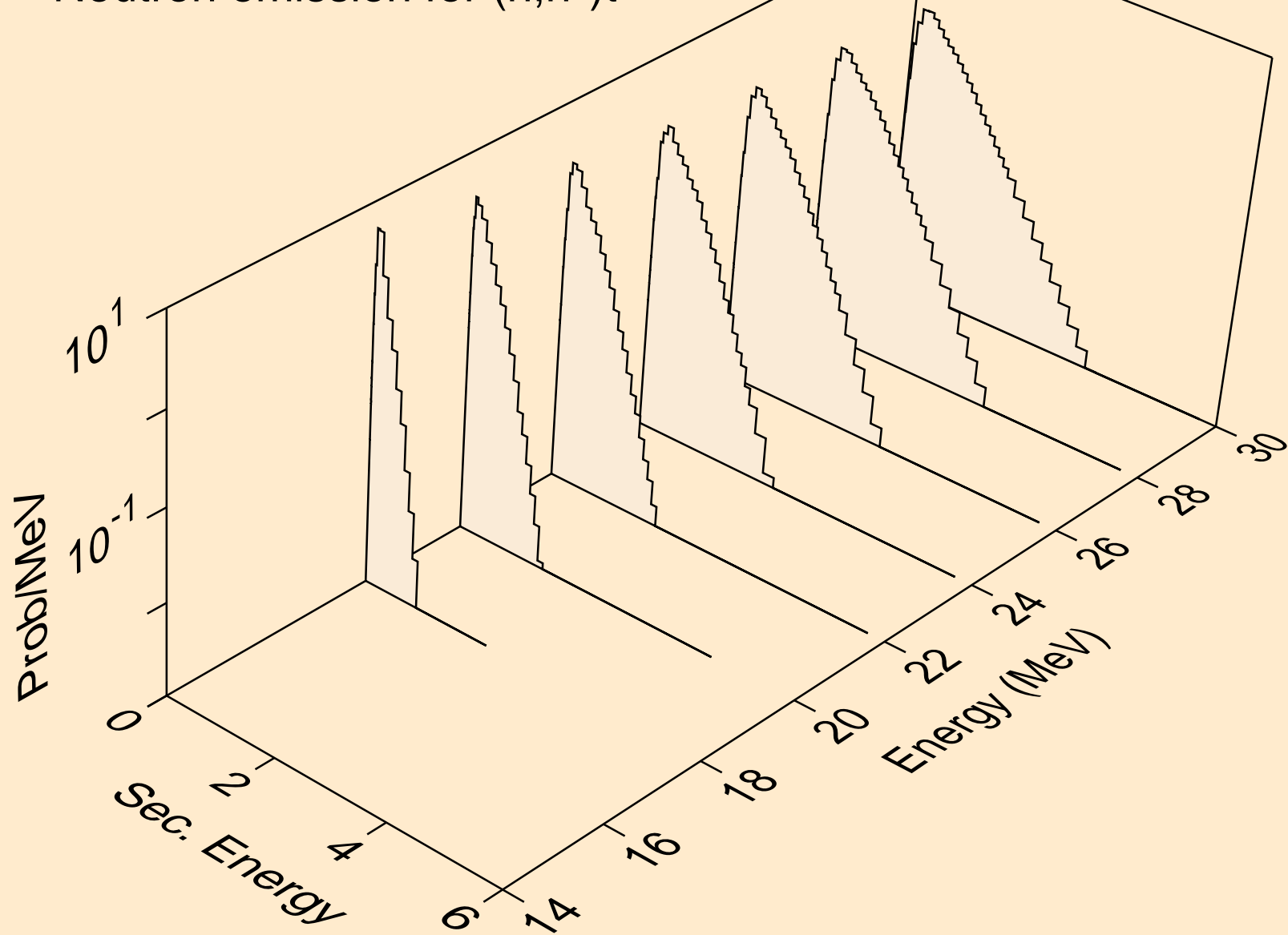

ER159 NEUTRON ACER TENDL-2021 LIBRARY; T=293.6K
Neutron emission for (n,n*)he3

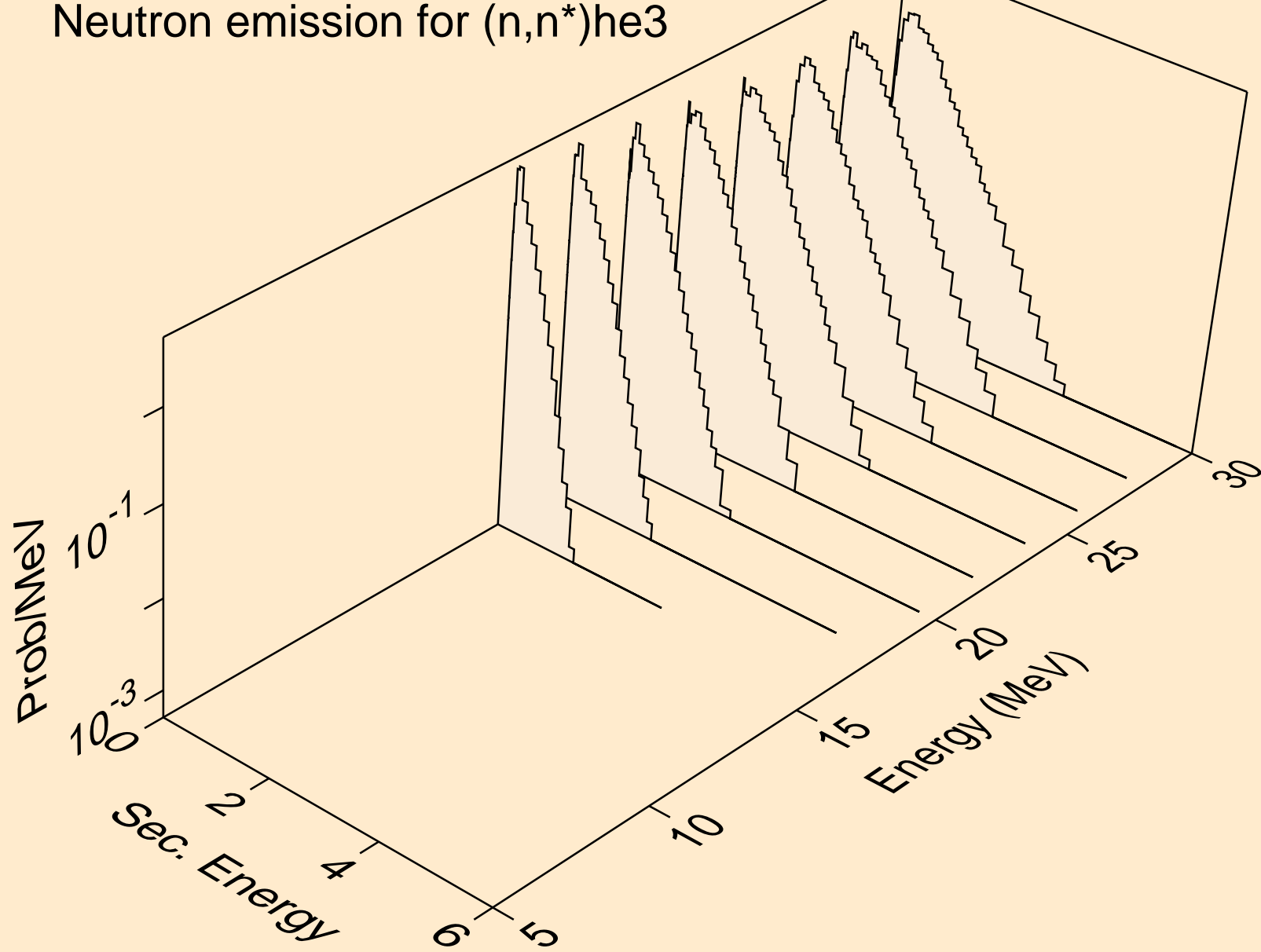

ER159 NEUTRON ACER TENDL-2021 LIBRARY; T=293.6K
Neutron emission for (n,4n)

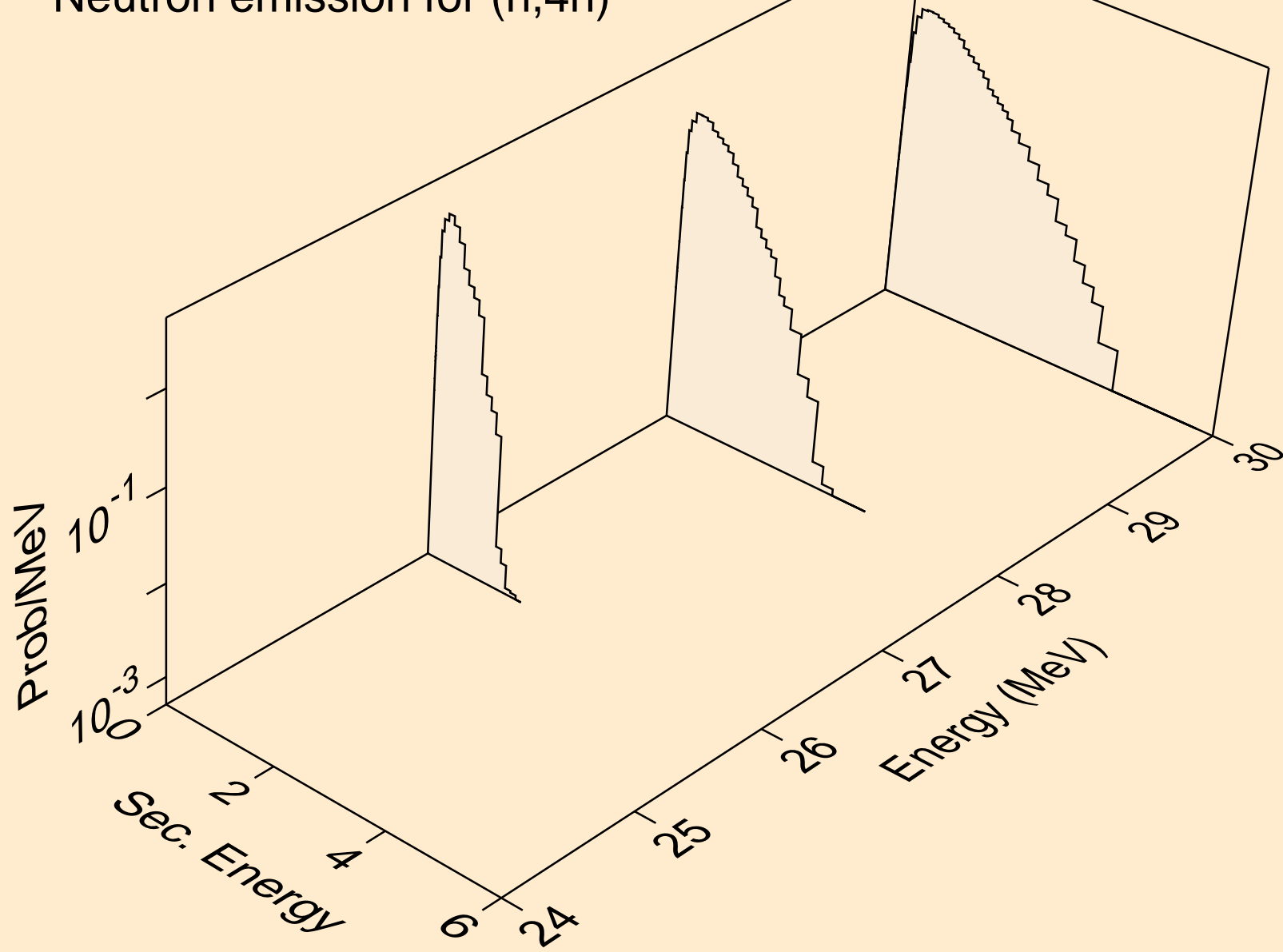

ER159 NEUTRON ACER TENDL-2021 LIBRARY; T=293.6K
Neutron emission for (n,2np)

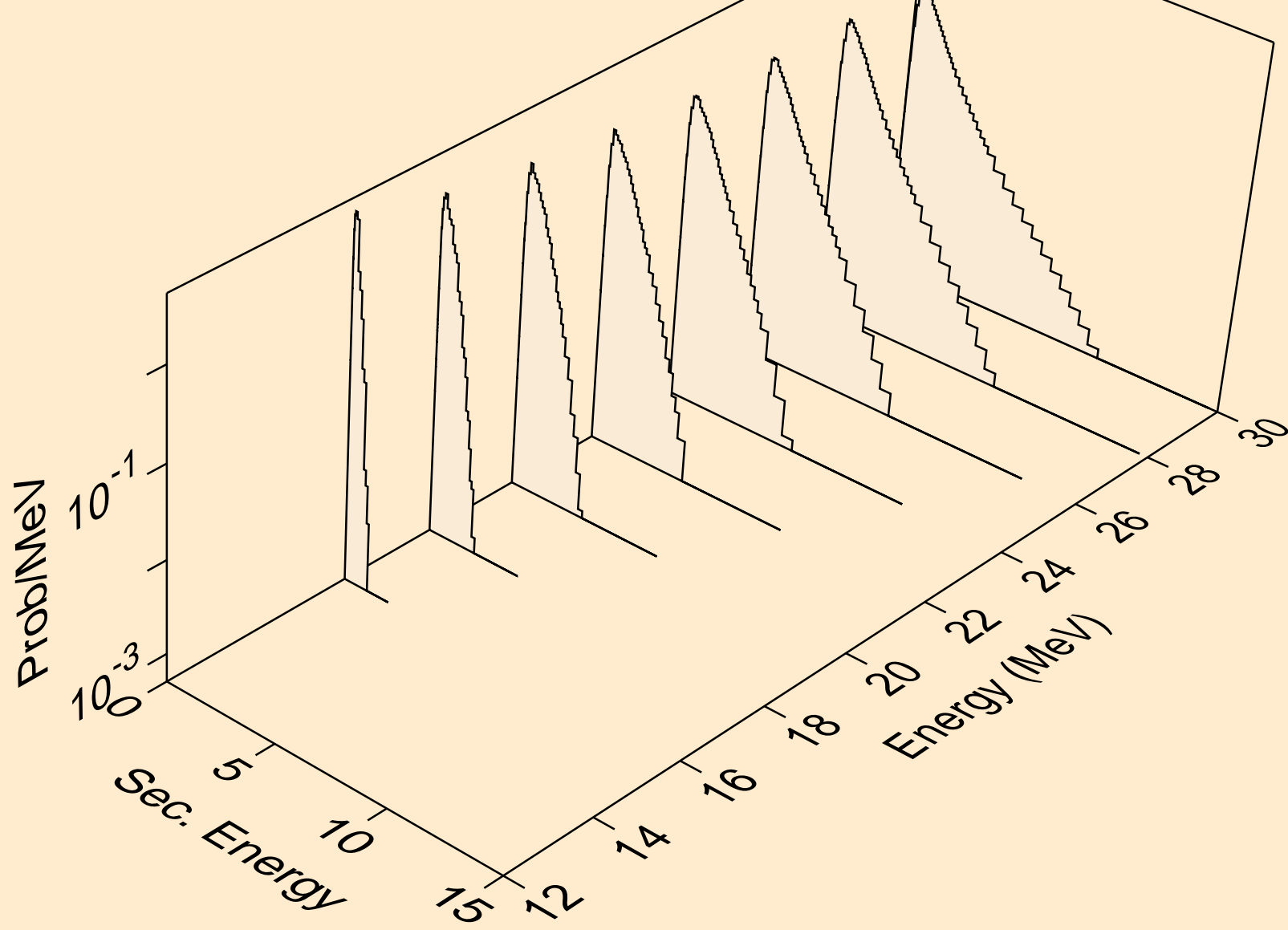

ER159 NEUTRON ACER TENDL-2021 LIBRARY; T=293.6K
Neutron emission for (n,3np)

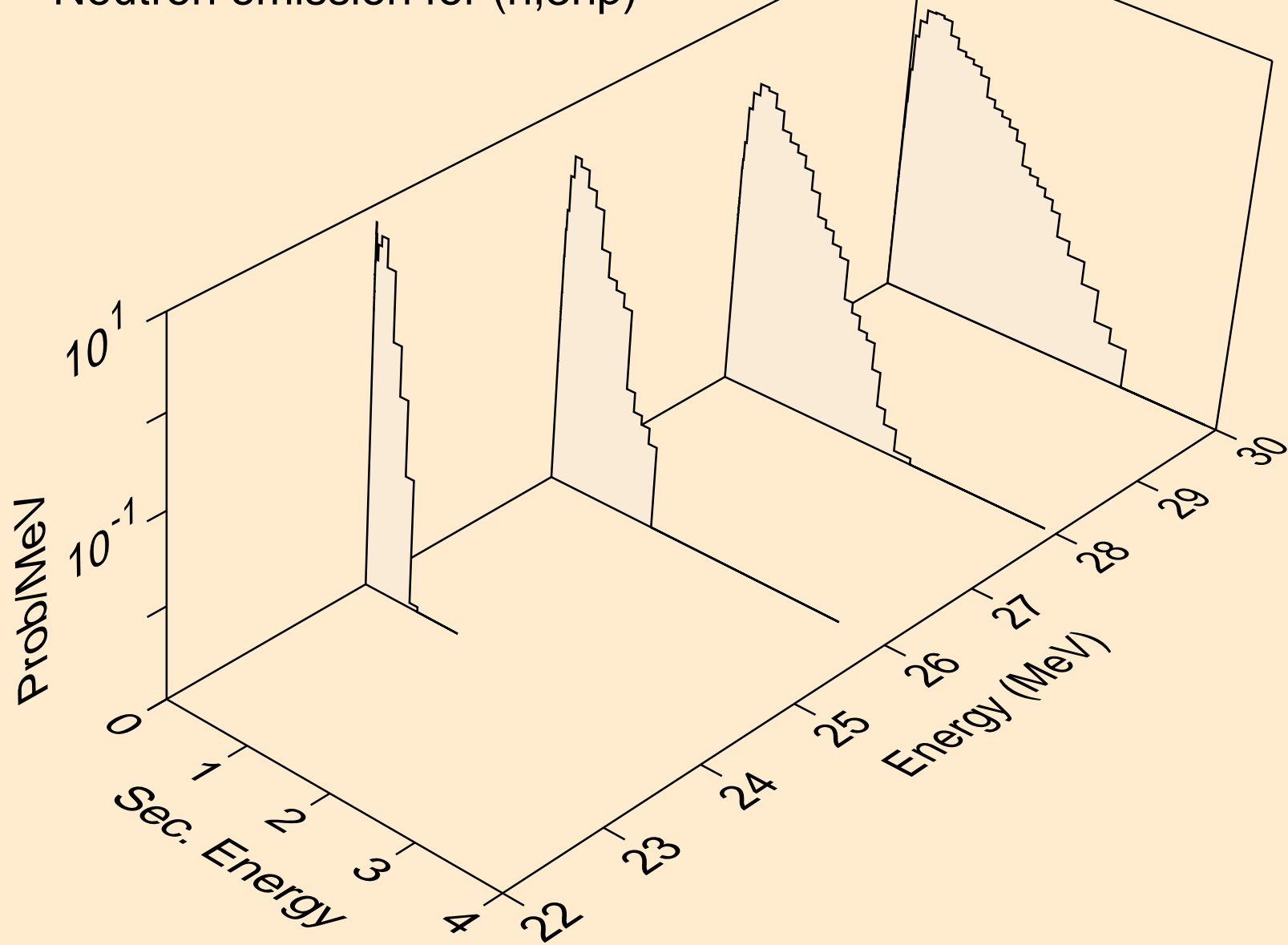

ER159 NEUTRON ACER TENDL-2021 LIBRARY; T=293.6K
Neutron emission for (n,2np)

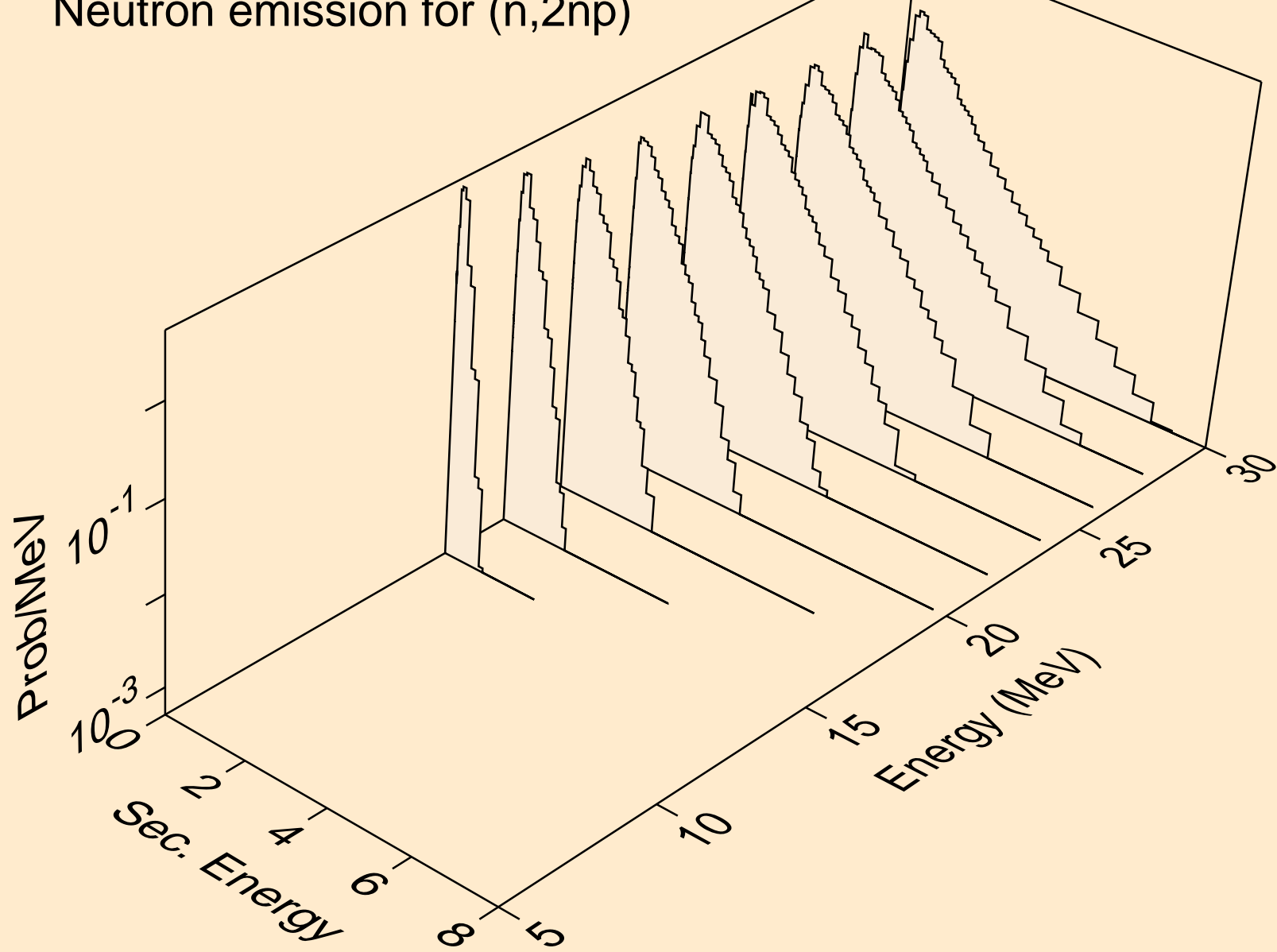

ER159 NEUTRON ACER TENDL-2021 LIBRARY; T=293.6K
Neutron emission for (n,npa)

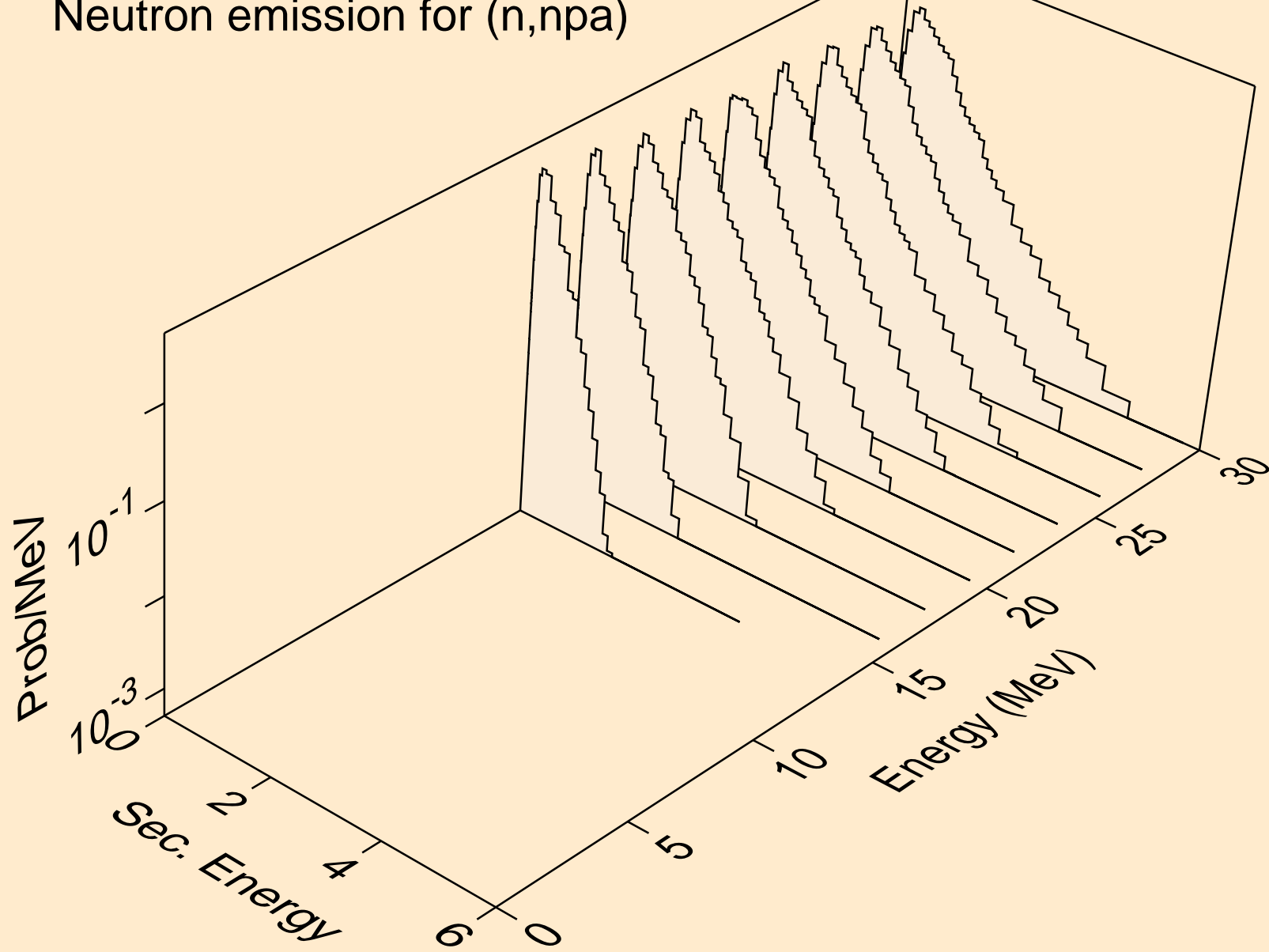

ER159 NEUTRON ACER TENDL-2021 LIBRARY; T=293.6K
Neutron emission for (n,n*c)

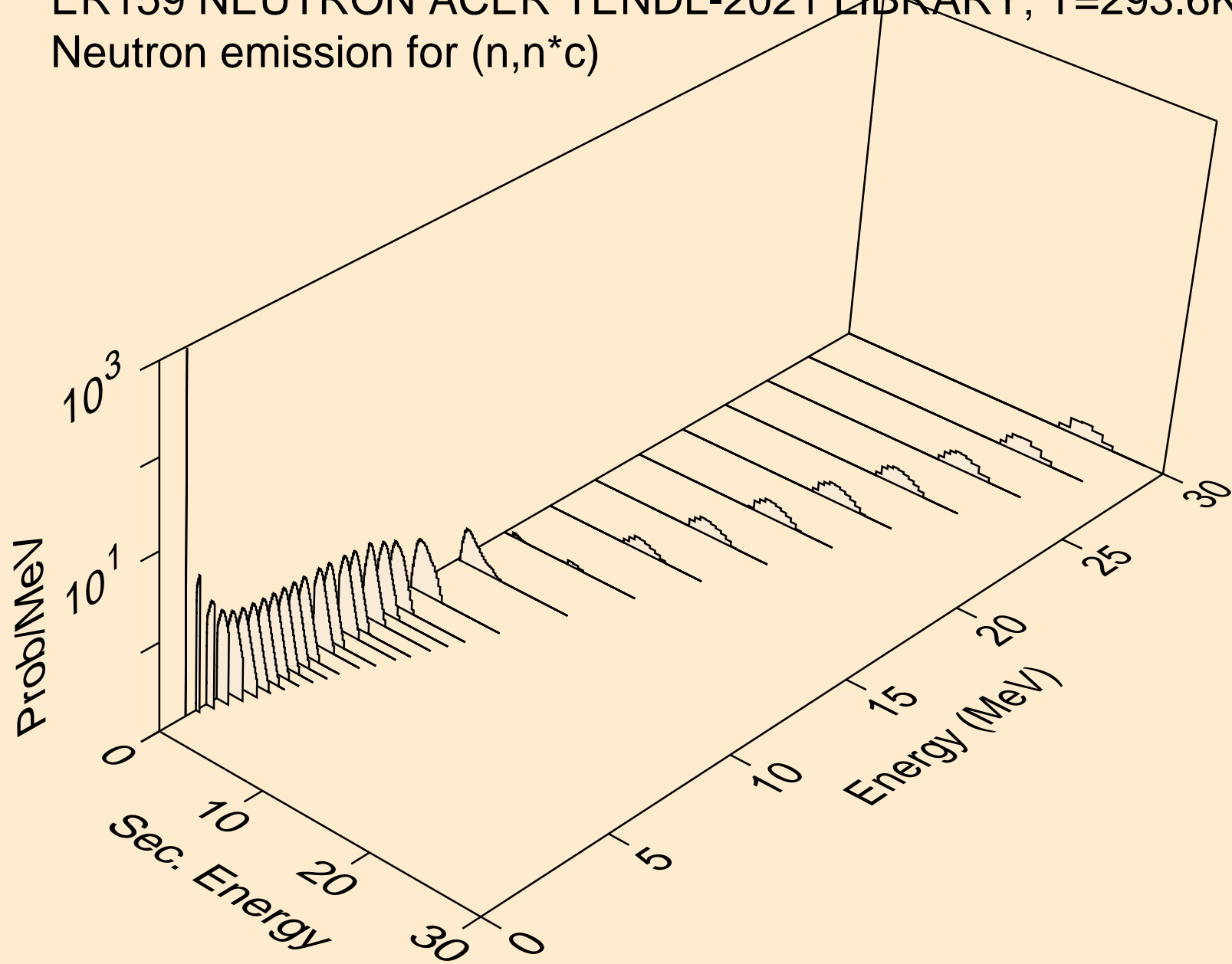

ER159 NEUTRON ACER TENDL-2021 LIBRARY; T=293.6K
Photon emission for (n,x)

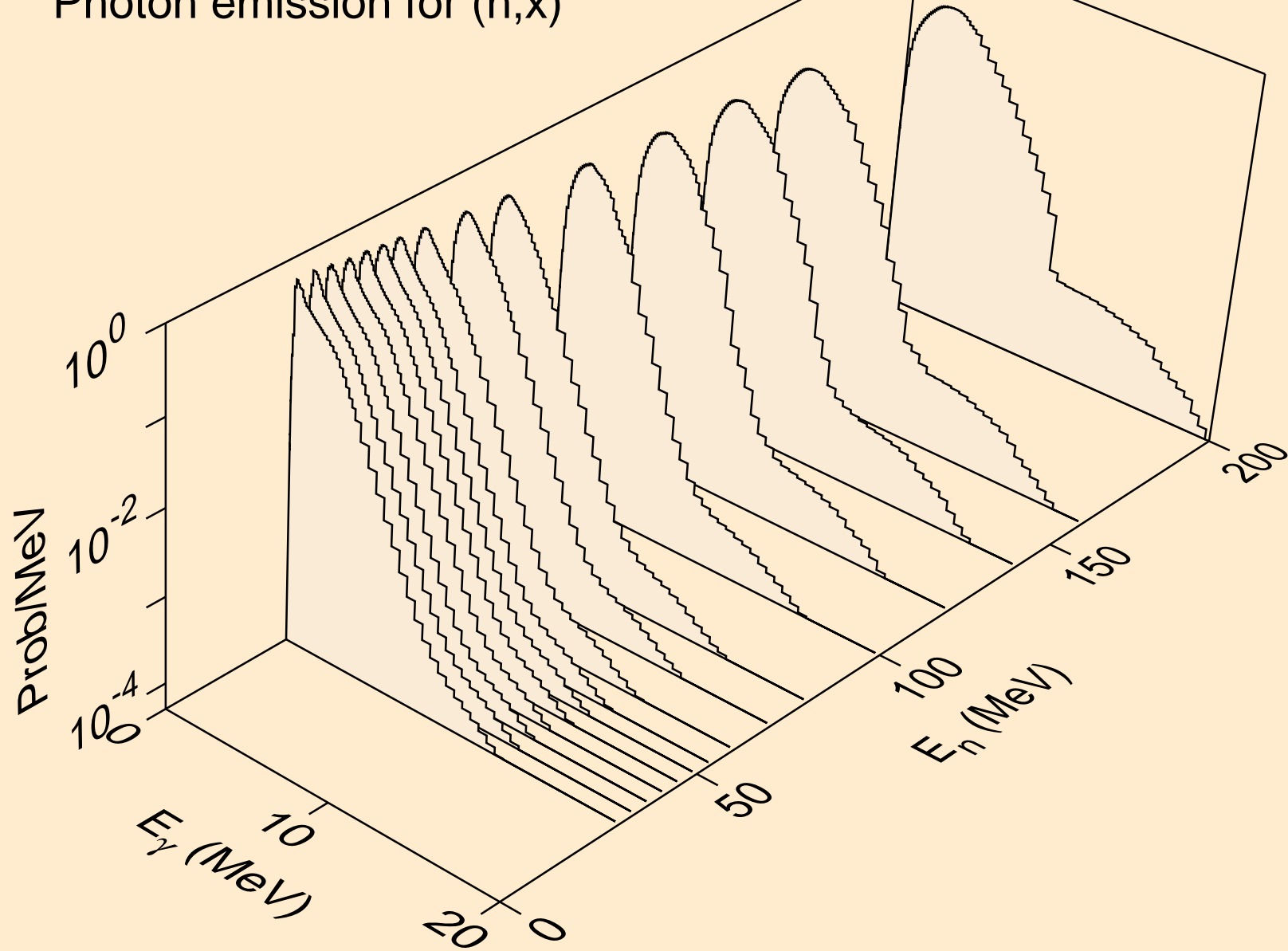

ER159 NEUTRON ACER TENDL-2021 LIBRARY; T=293.6K
Photon emission for (n,2nd)

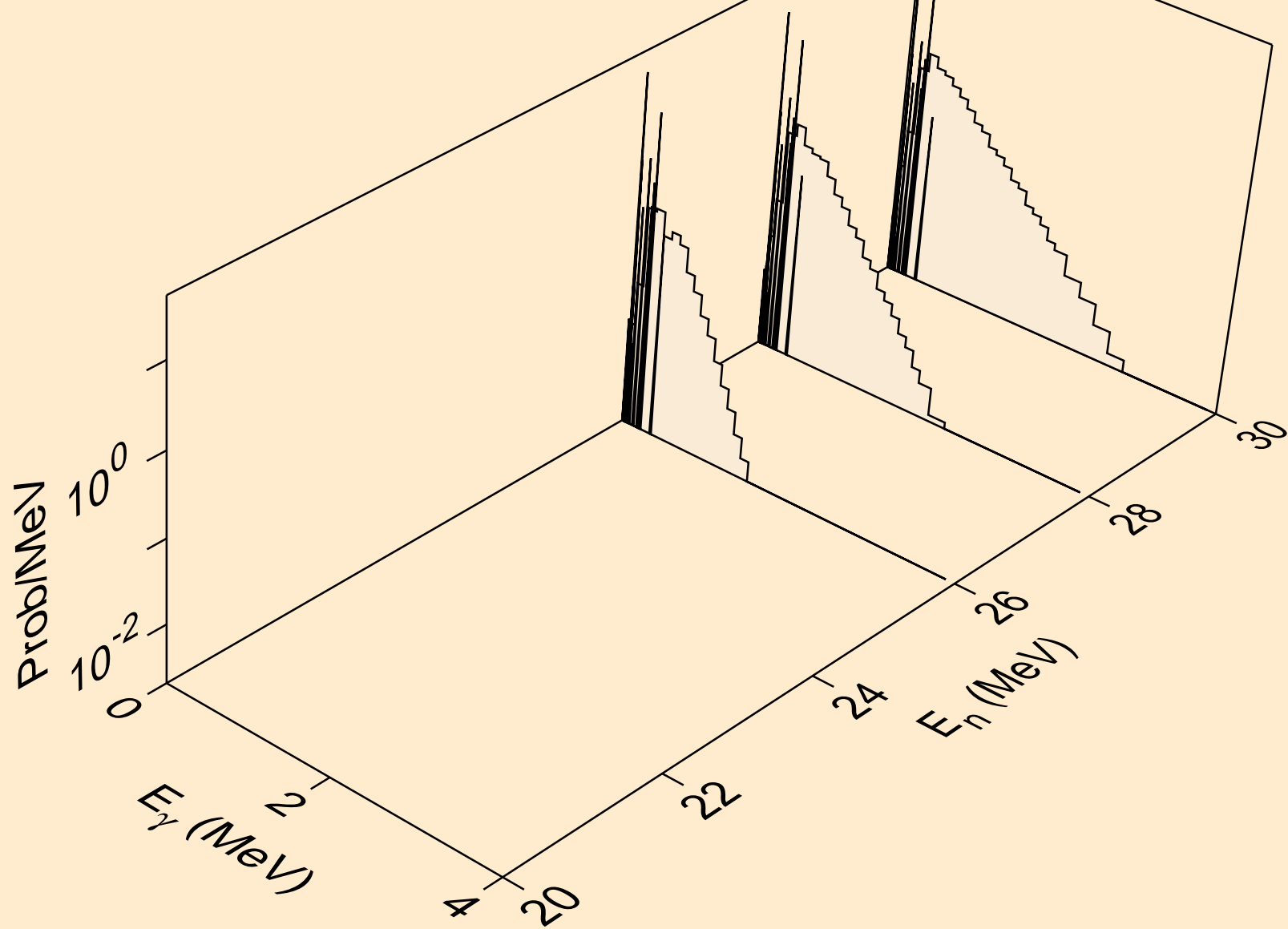

ER159 NEUTRON ACER TENDL-2021 LIBRARY; T=293.6K
Photon emission for (n,2n)

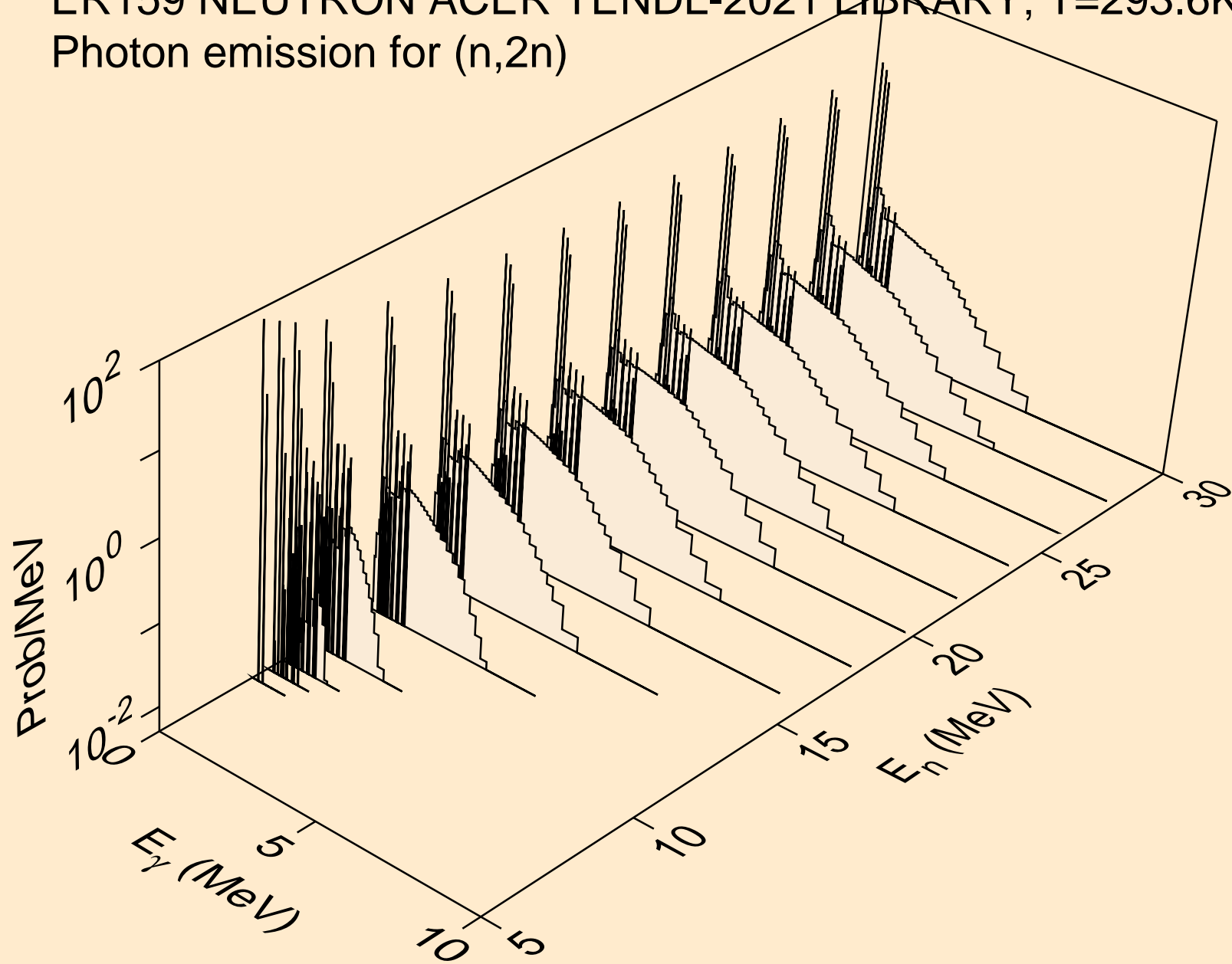

ER159 NEUTRON ACER TENDL-2021 LIBRARY; T=293.6K
Photon emission for (n,3n)

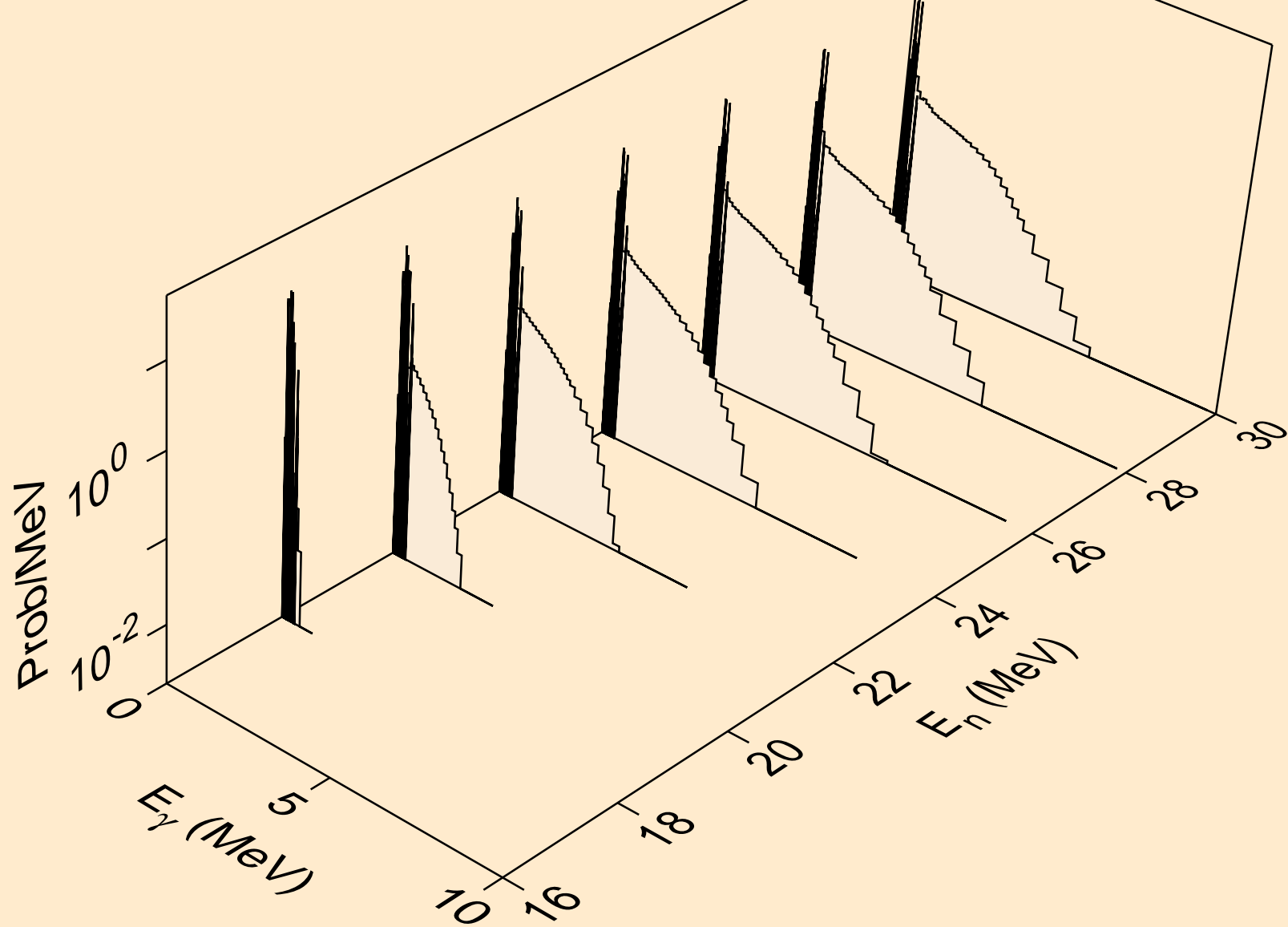

ER159 NEUTRON ACER TENDL-2021 LIBRARY; T=293.6K
Photon emission for (n,n*)a

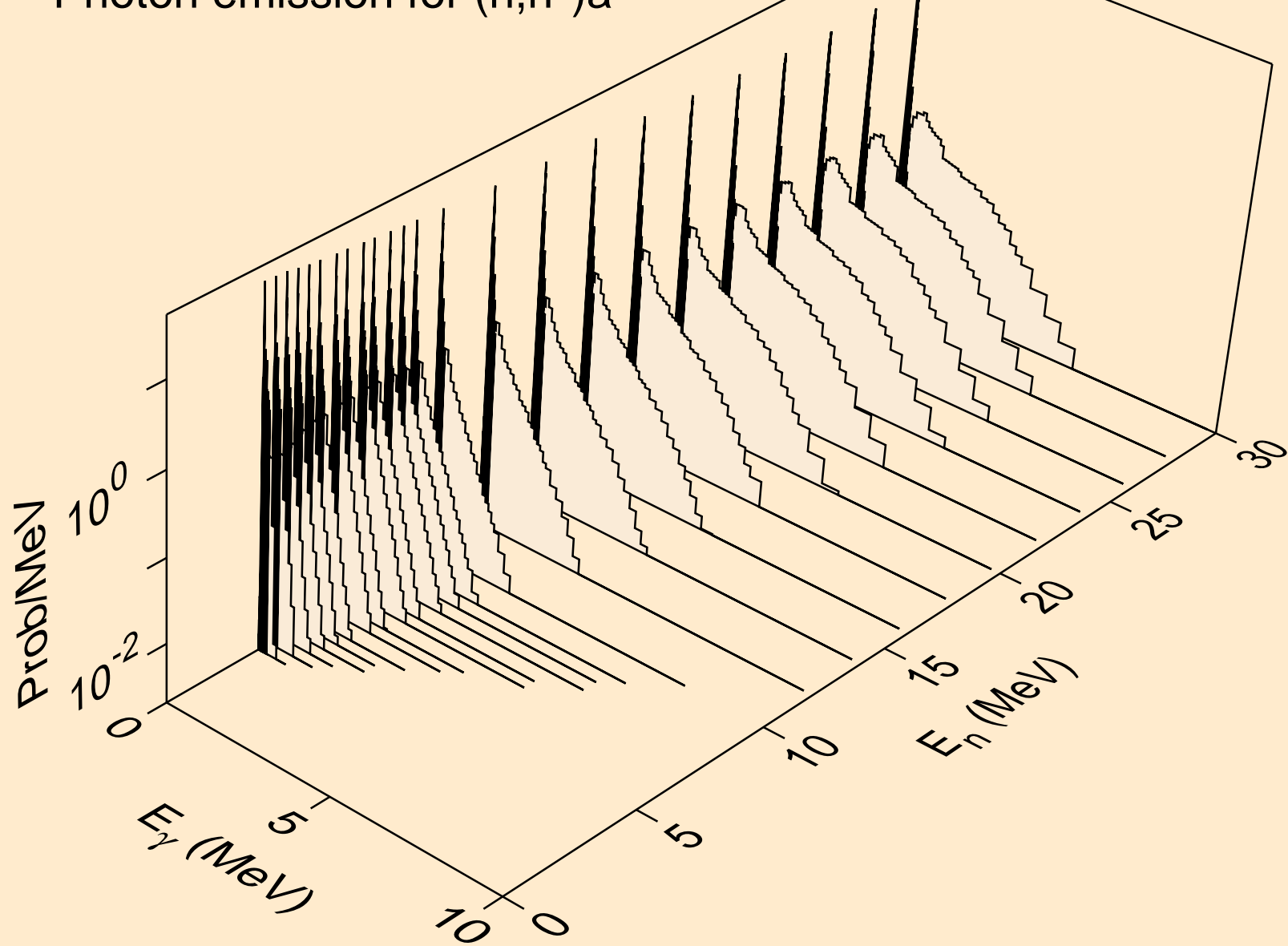

ER159 NEUTRON ACER TENDL-2021 LIBRARY; T=293.6K
Photon emission for (n,2n)a

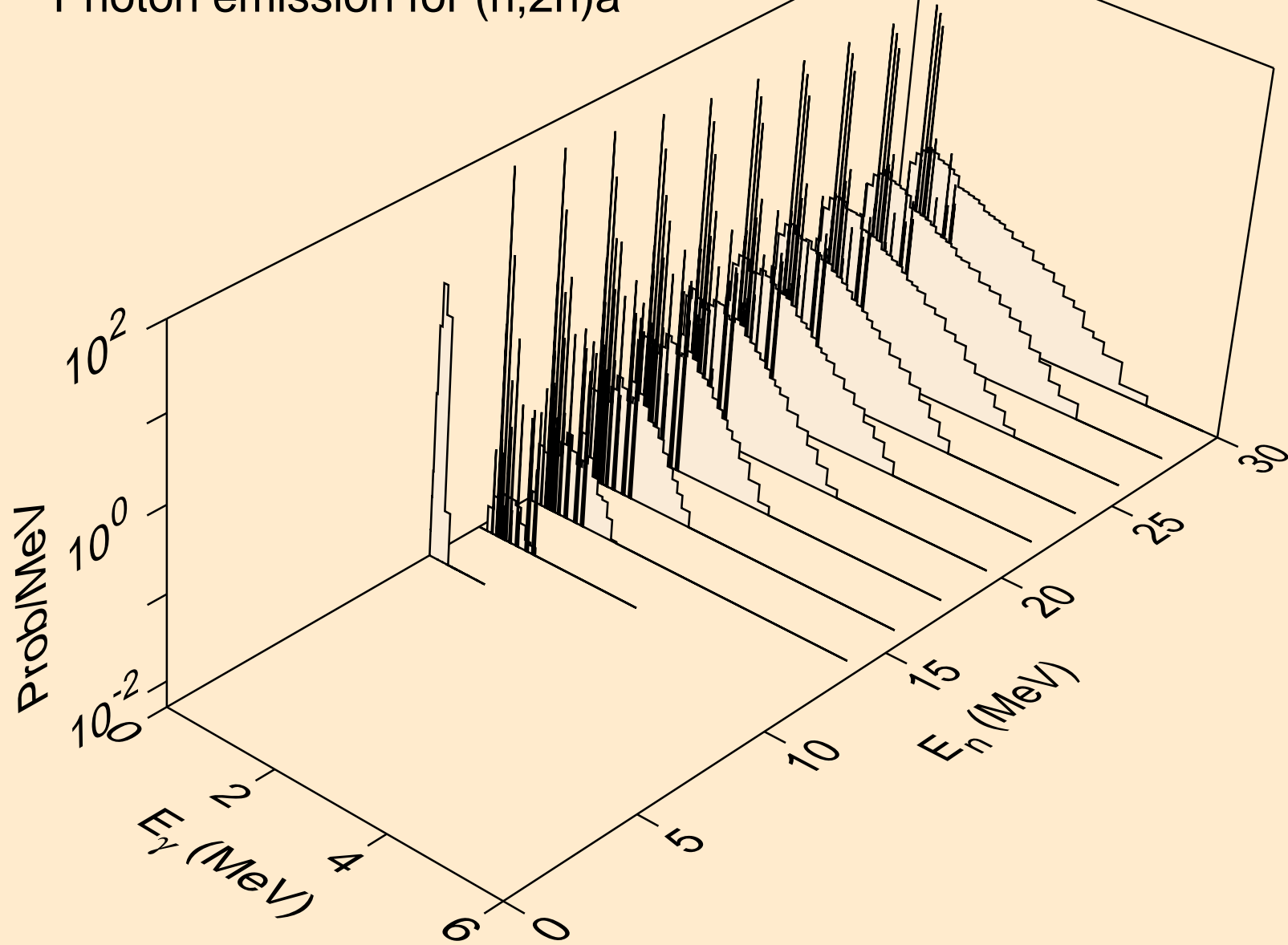

ER159 NEUTRON ACER TENDL-2021 LIBRARY; T=293.6K
Photon emission for (n,3n)a

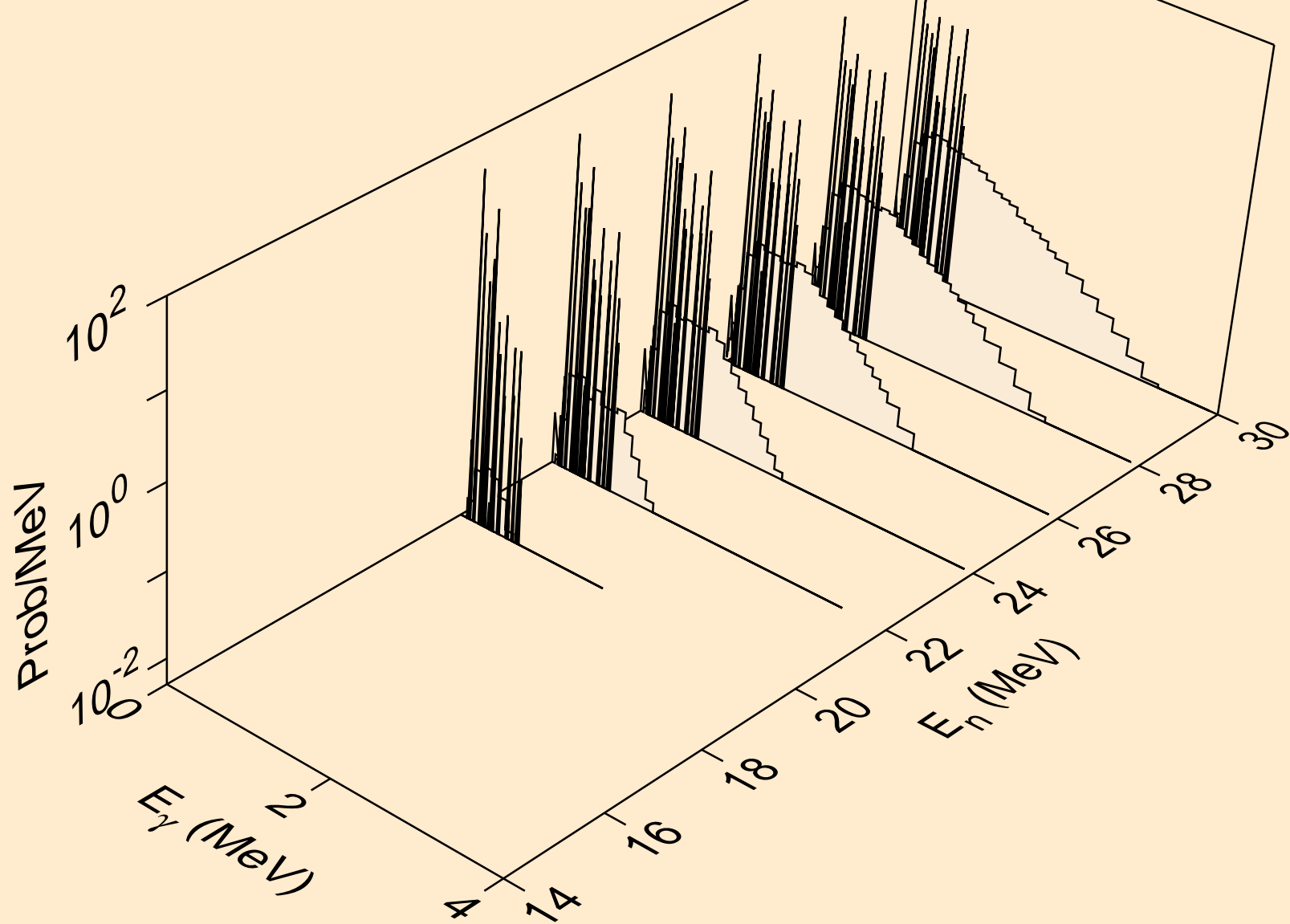

ER159 NEUTRON ACER TENDL-2021 LIBRARY; T=293.6K
Photon emission for (n,n*)p

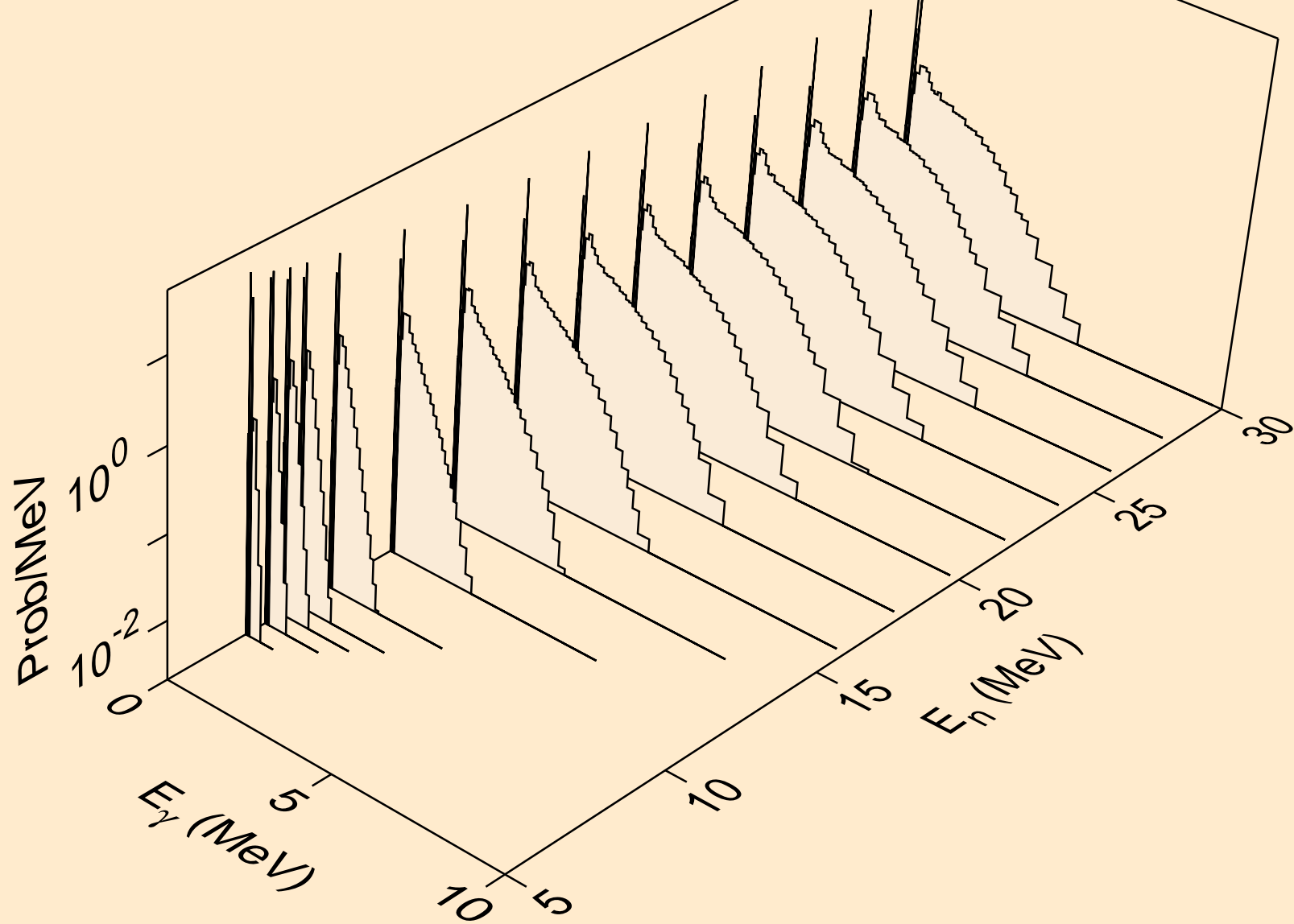

ER159 NEUTRON ACER TENDL-2021 LIBRARY; T=293.6K
Photon emission for (n,n*)2a

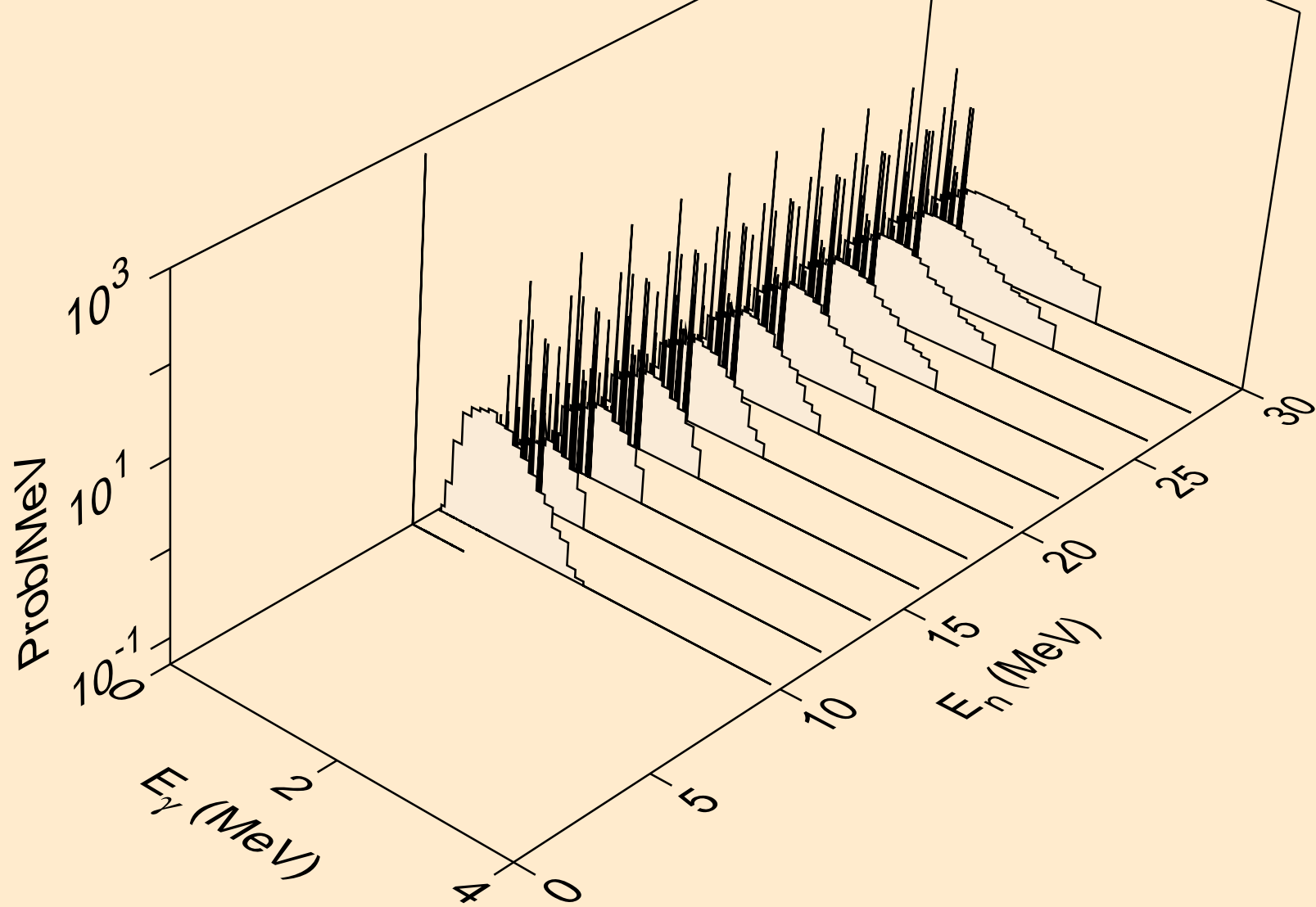

ER159 NEUTRON ACER TENDL-2021 LIBRARY; T=293.6K
Photon emission for (n,2n)2a

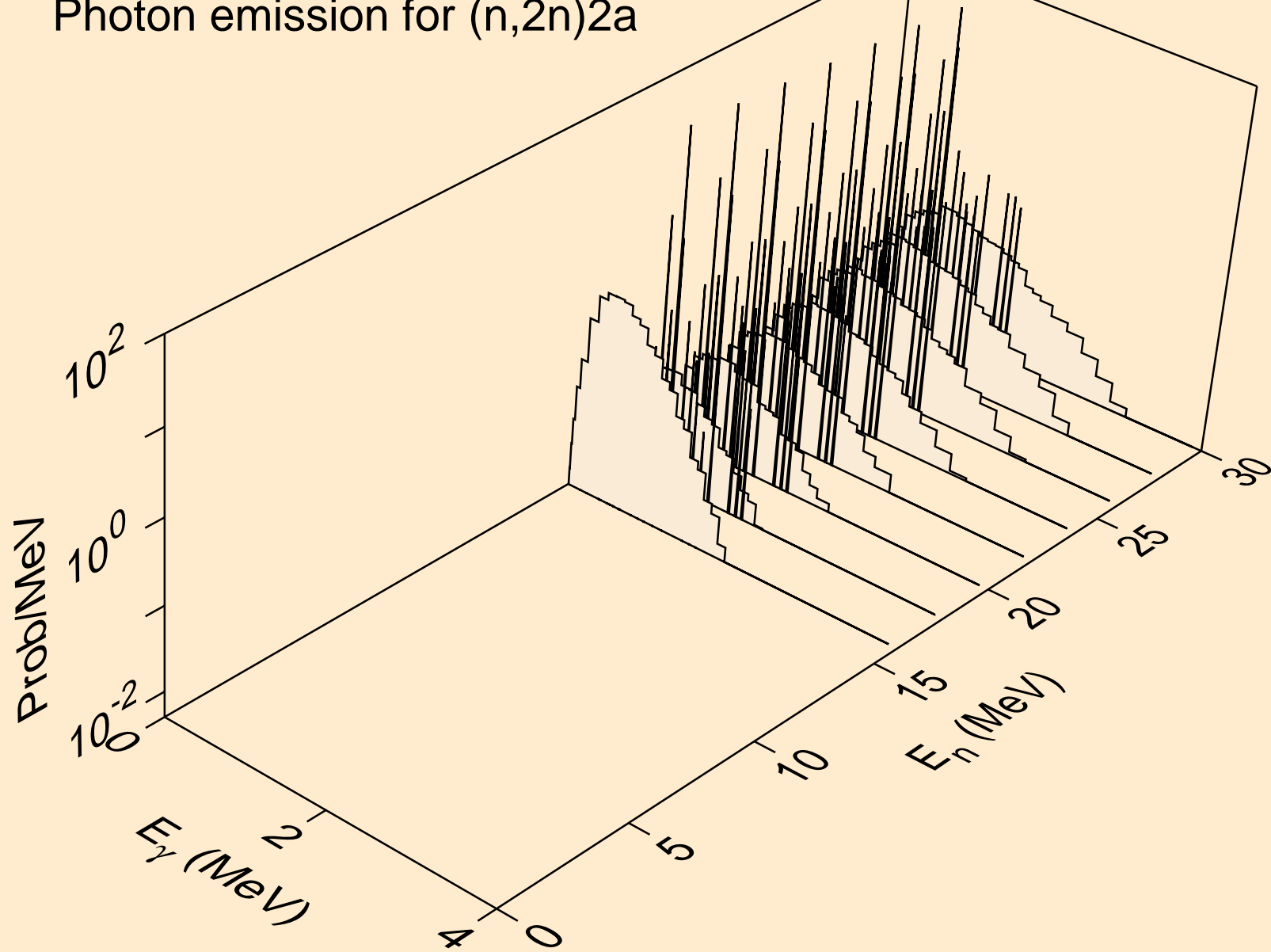

ER159 NEUTRON ACER TENDL-2021 LIBRARY; T=293.6K
Photon emission for (n,n*)d

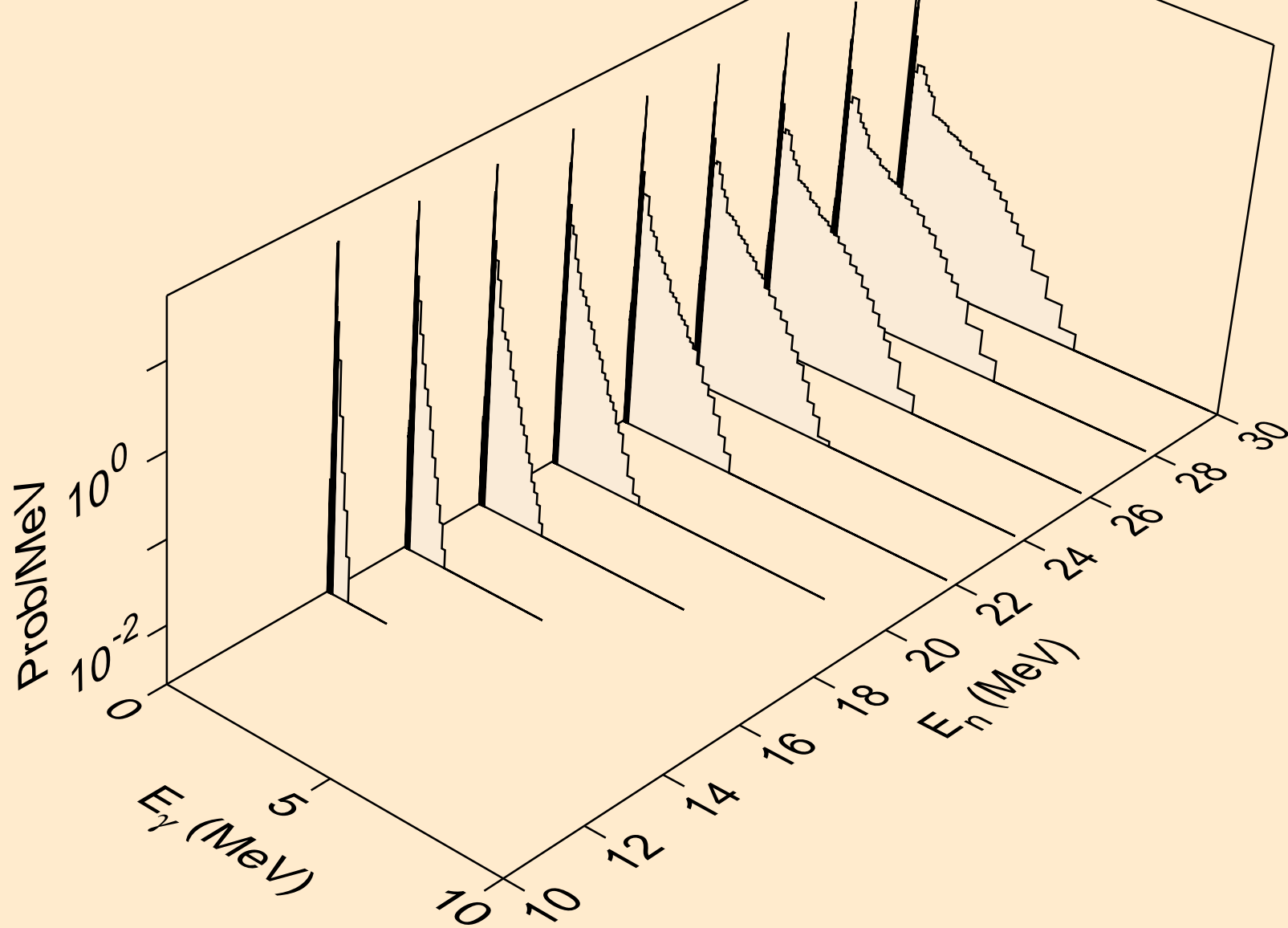

ER159 NEUTRON ACER TENDL-2021 LIBRARY; T=293.6K
Photon emission for (n,n*)t

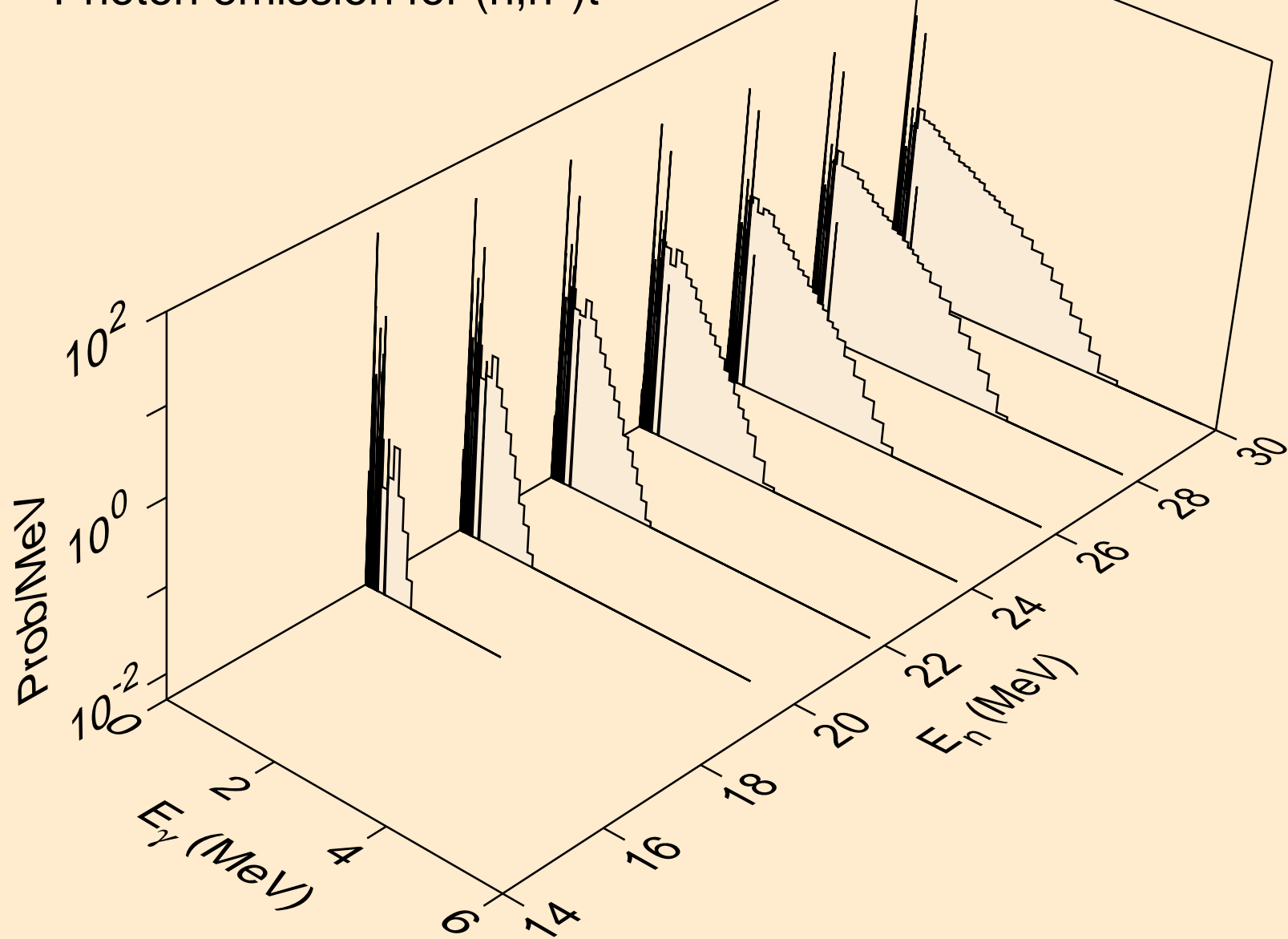

ER159 NEUTRON ACER TENDL-2021 LIBRARY; T=293.6K
Photon emission for (n,n*)he3

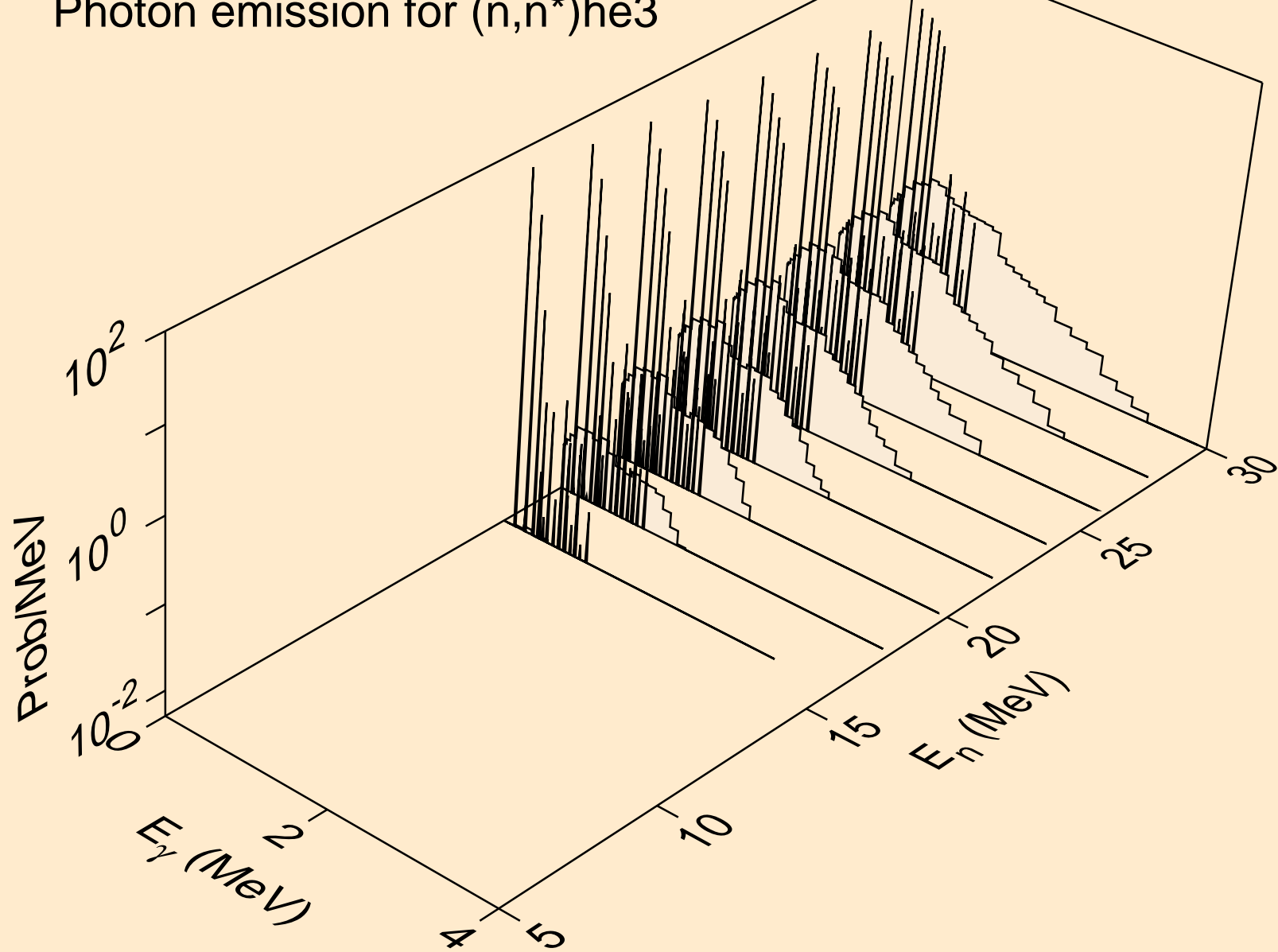

ER159 NEUTRON ACER TENDL-2021 LIBRARY; T=293.6K
Photon emission for (n,4n)

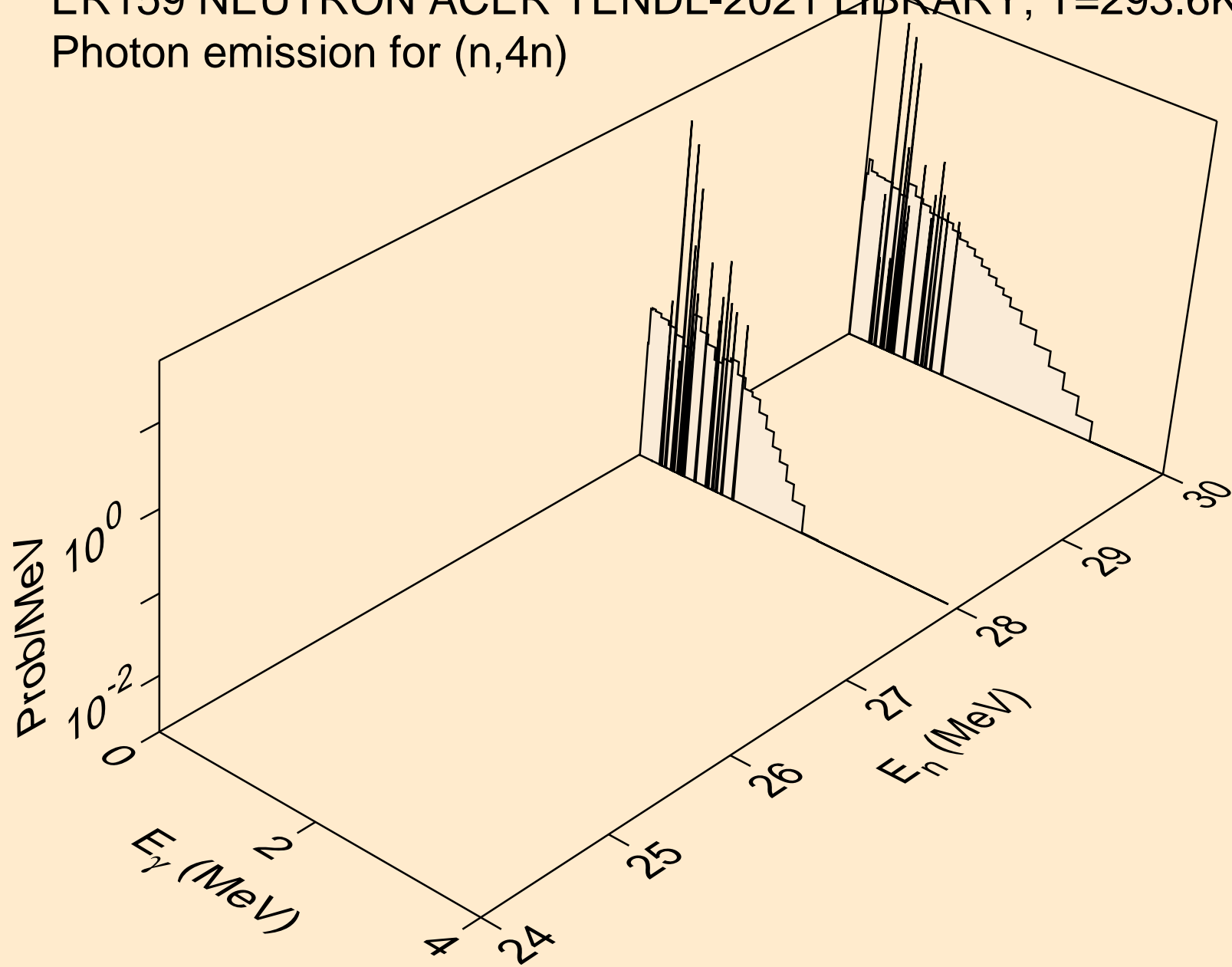

ER159 NEUTRON ACER TENDL-2021 LIBRARY; T=293.6K
Photon emission for (n,2np)

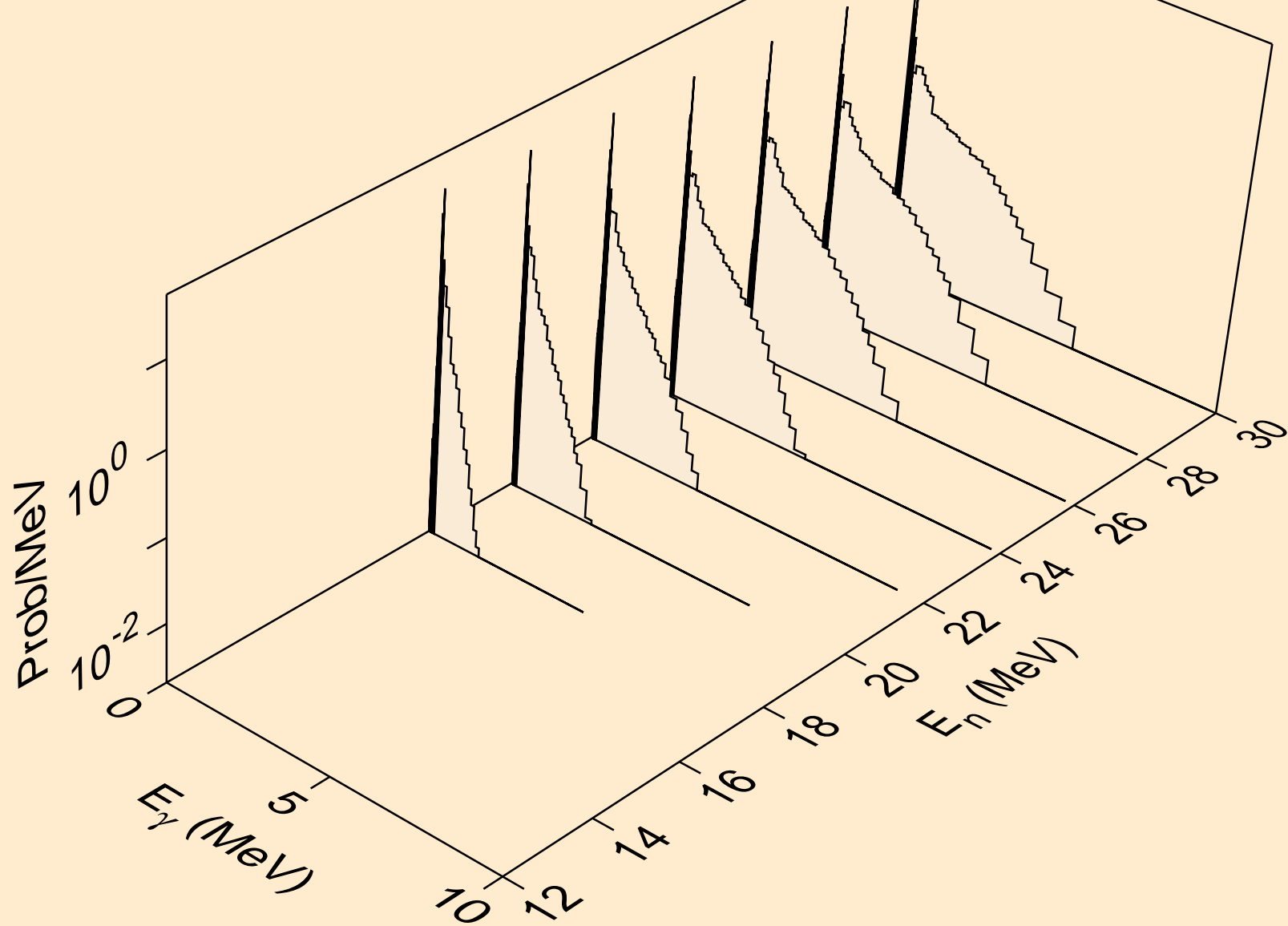

ER159 NEUTRON ACER TENDL-2021 LIBRARY; T=293.6K
Photon emission for (n,3np)

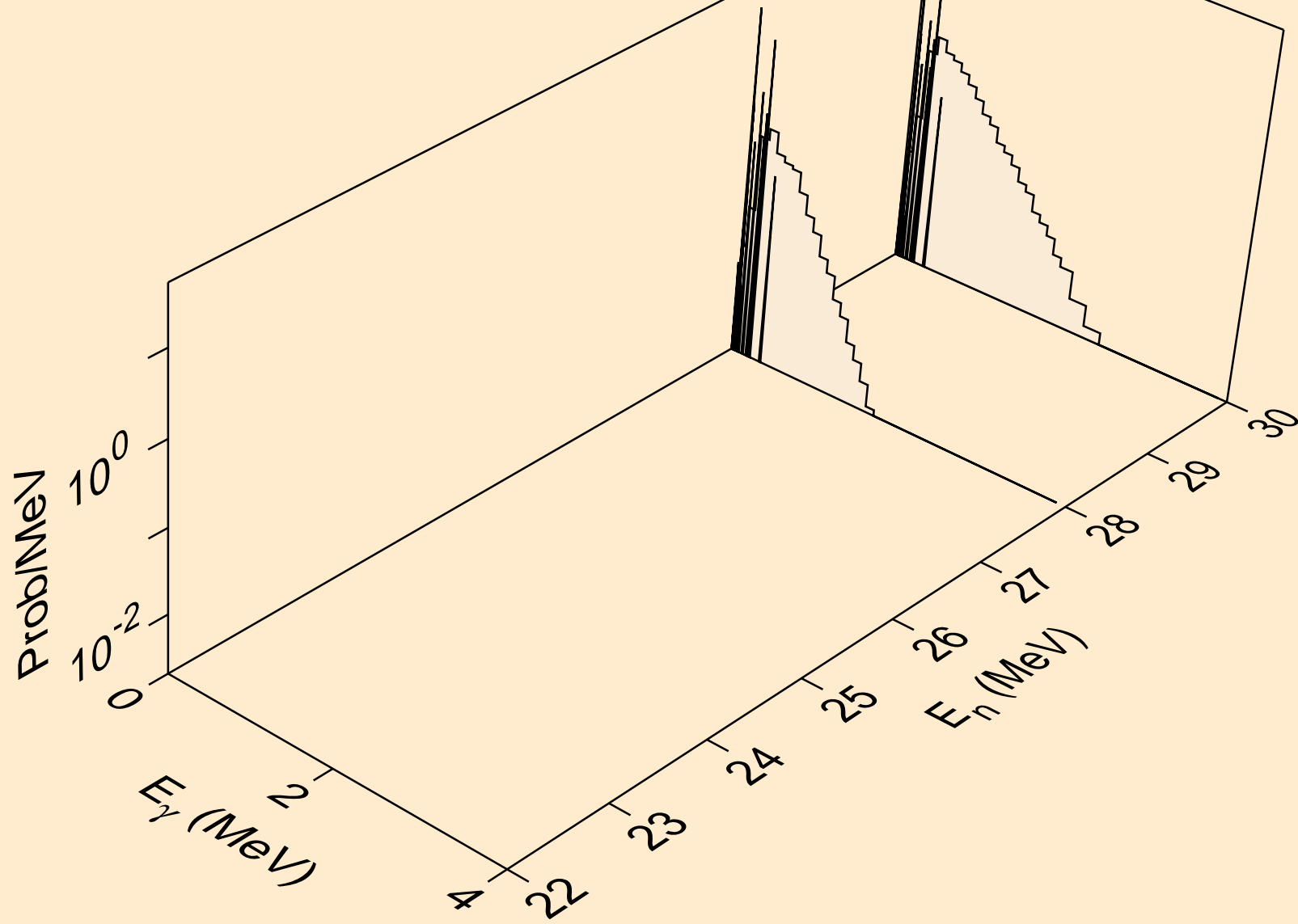

ER159 NEUTRON ACER TENDL-2021 LIBRARY; T=293.6K
Photon emission for (n,2np)

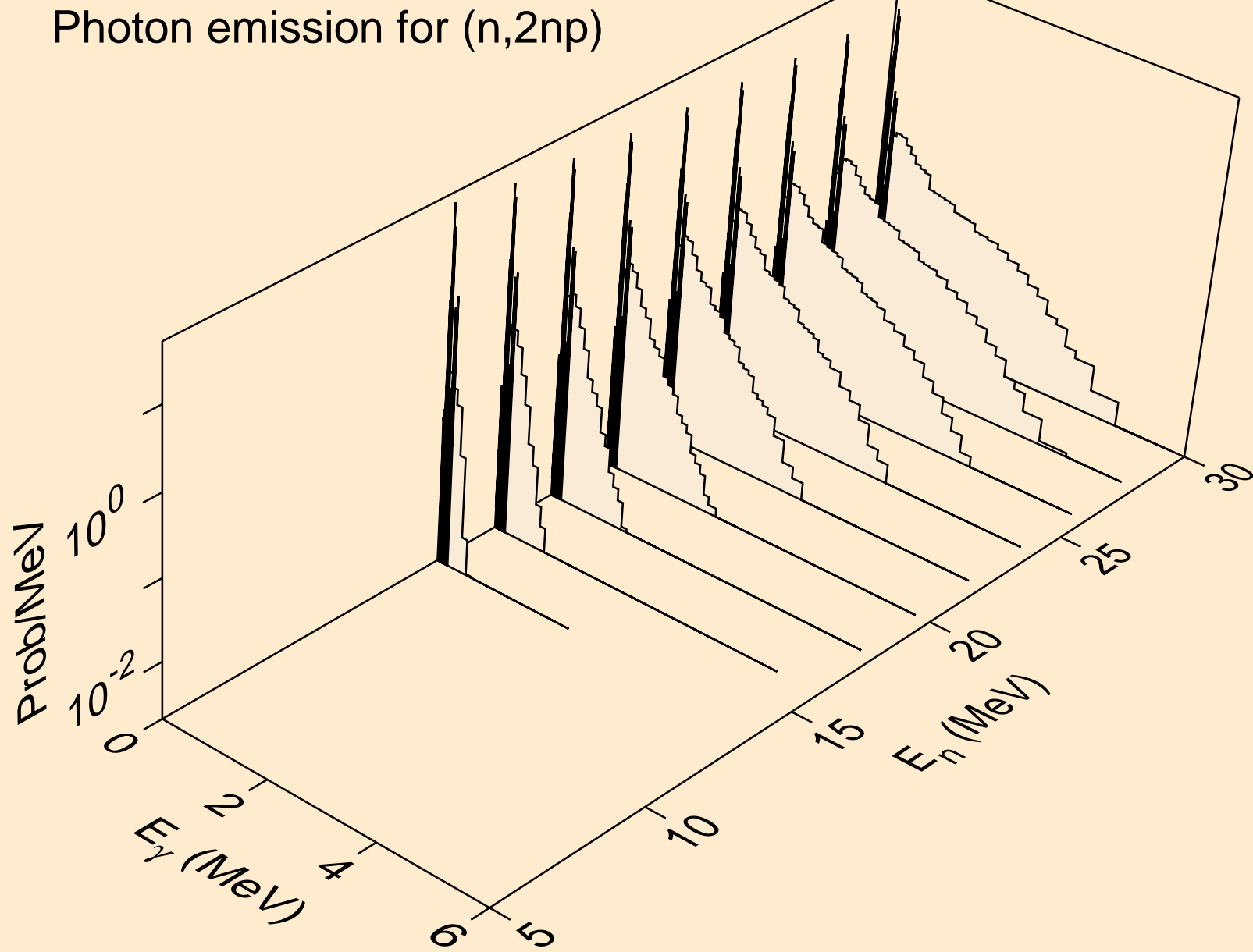

ER159 NEUTRON ACER TENDL-2021 LIBRARY; T=293.6K
Photon emission for (n,npa)

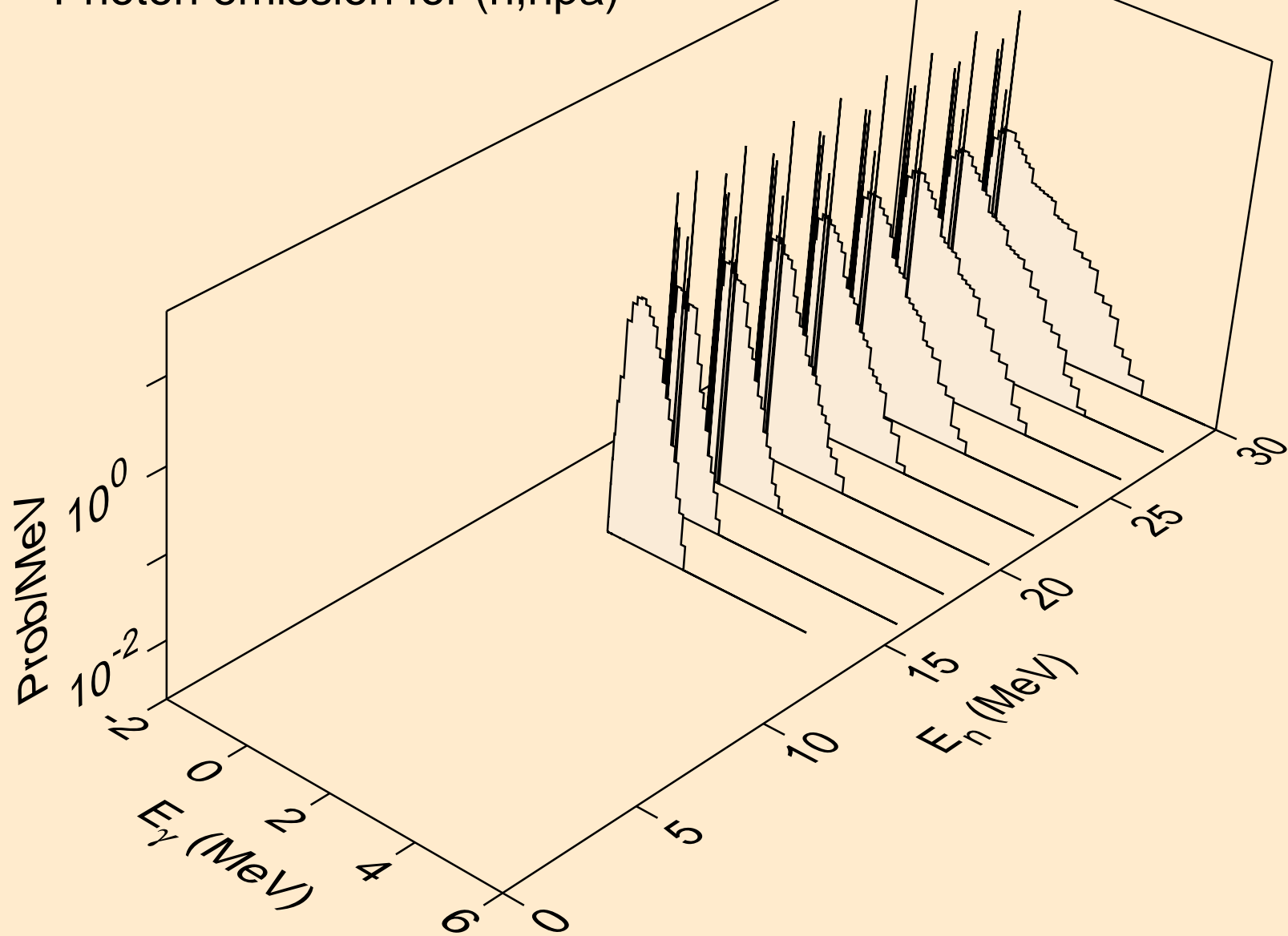

ER159 NEUTRON ACER TENDL-2021 LIBRARY; T=293.6K
Photon emission for (n,n*c)

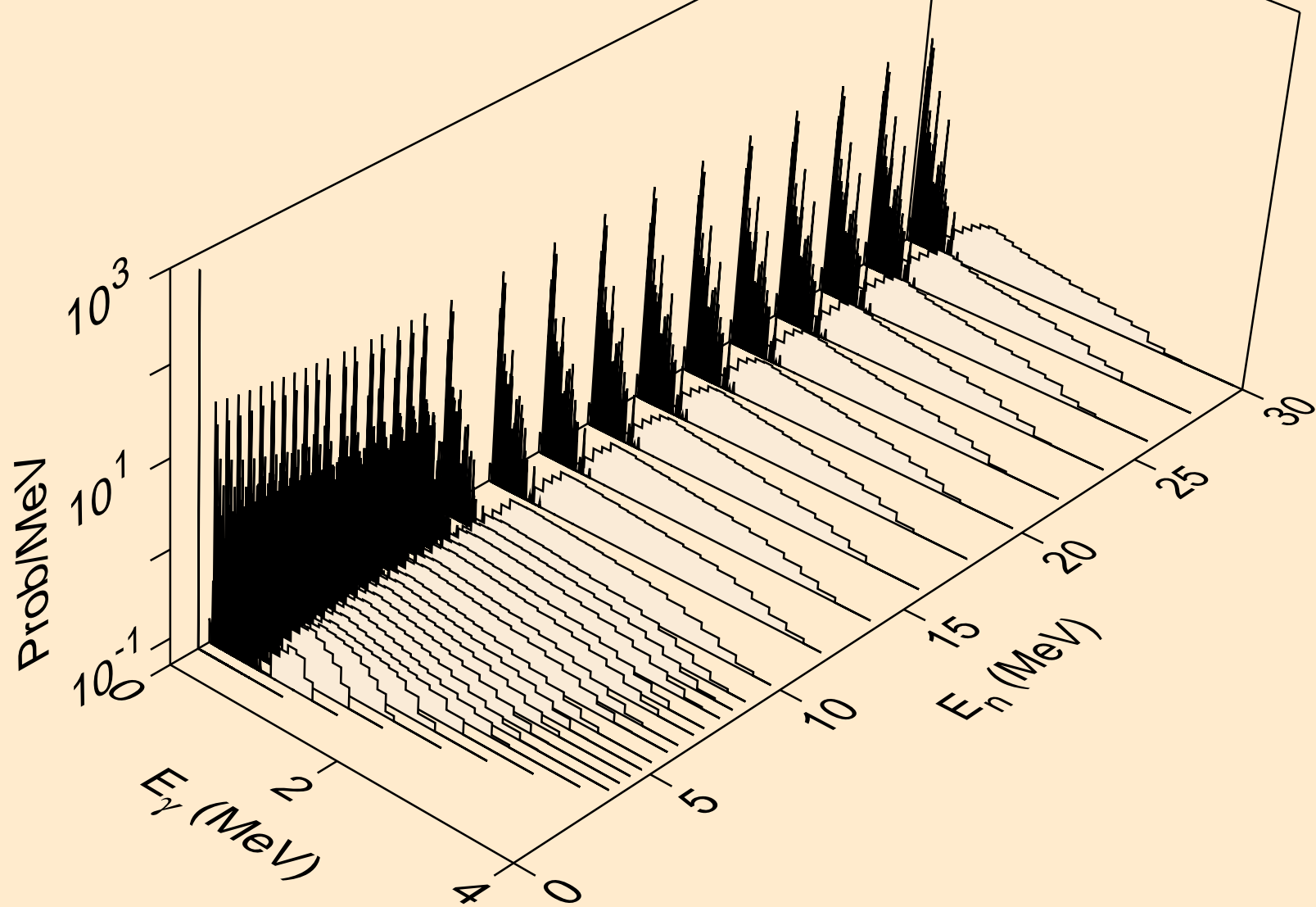

ER159 NEUTRON ACER TENDL-2021 LIBRARY; T=293.6K
Photon emission for (n,gma)

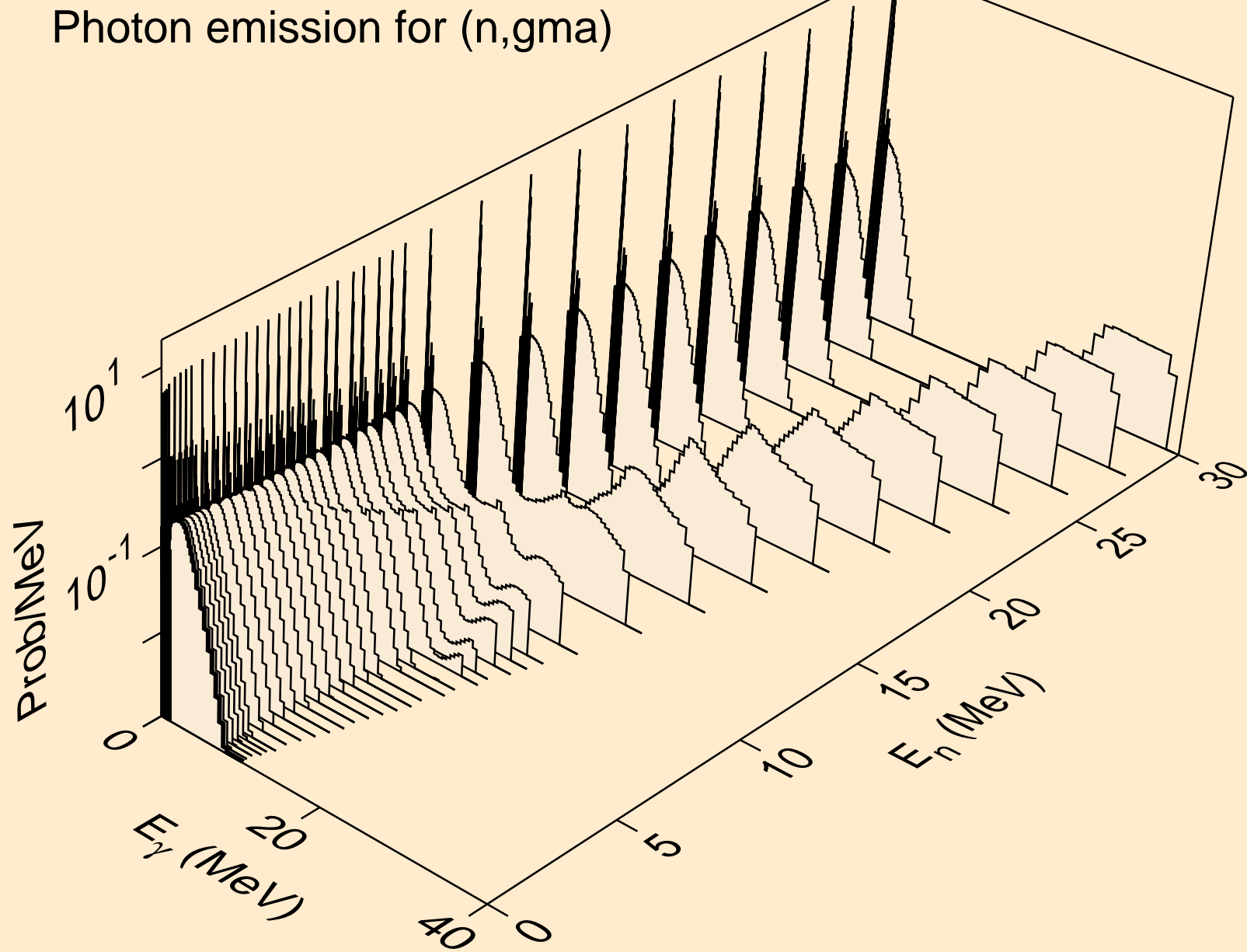

ER159 NEUTRON ACER TENDL-2021 LIBRARY; T=293.6K
Photon emission for (n,p)

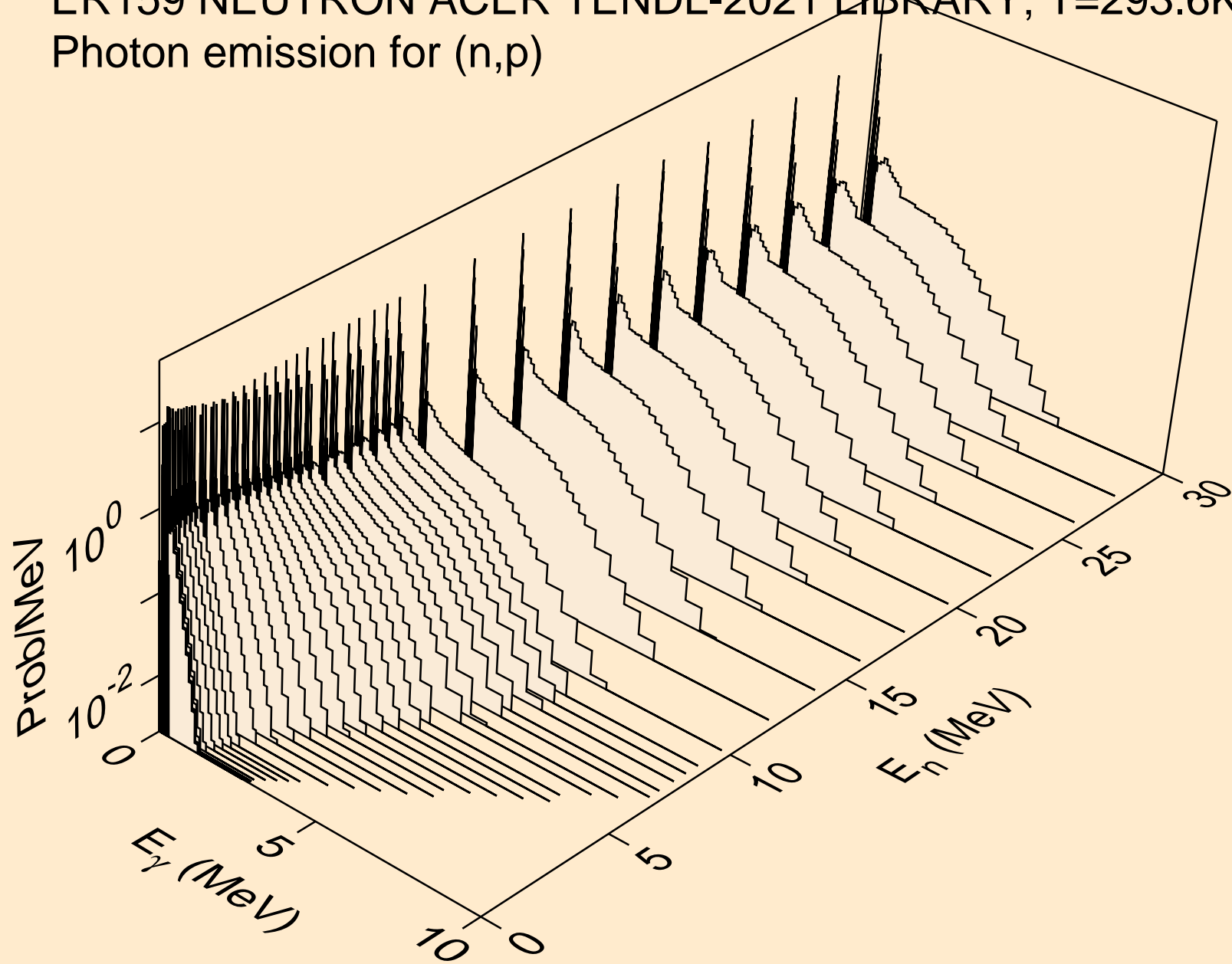

ER159 NEUTRON ACER TENDL-2021 LIBRARY; T=293.6K
Photon emission for (n,d)

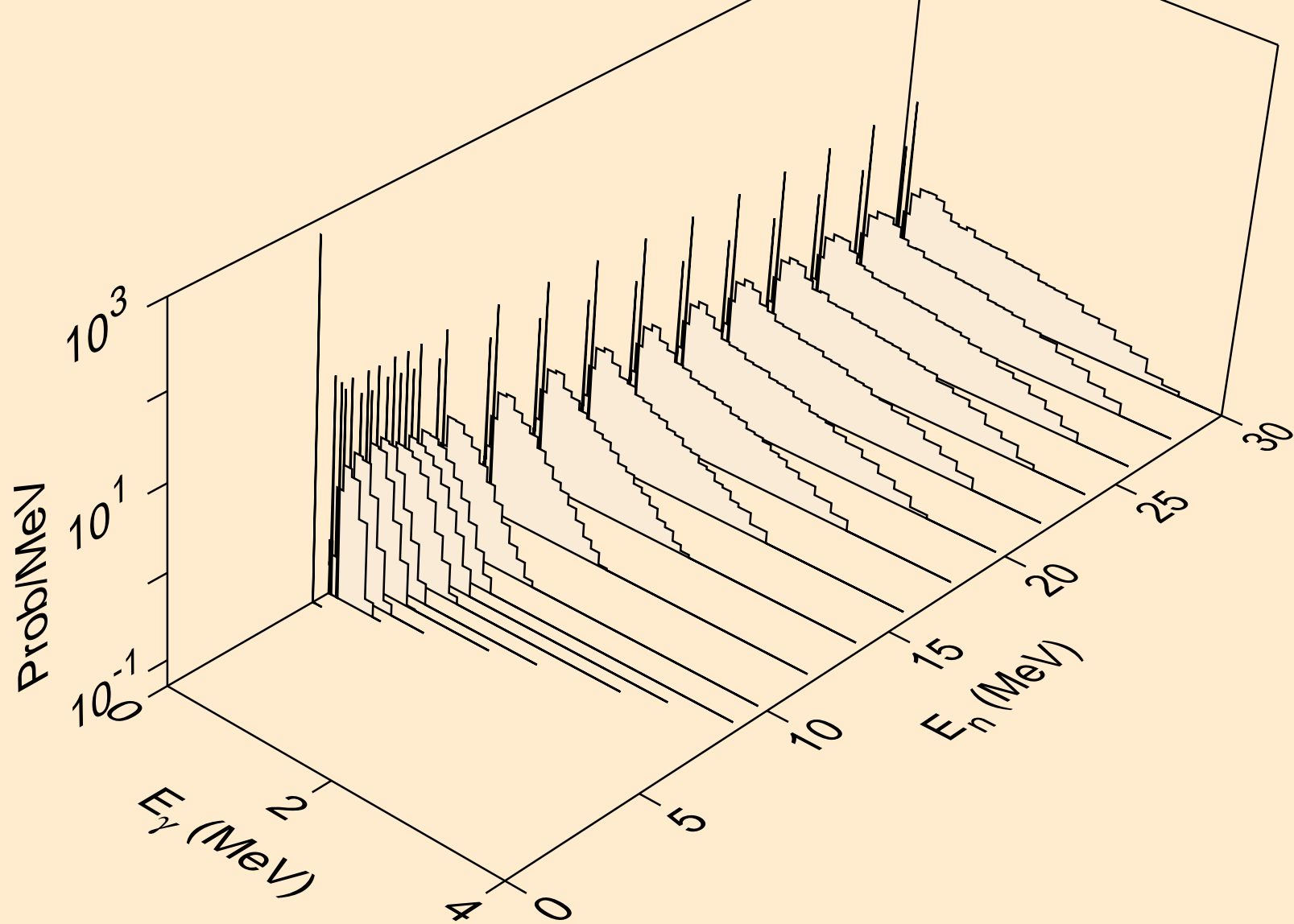

ER159 NEUTRON ACER TENDL-2021 LIBRARY; T=293.6K
Photon emission for (n,t)

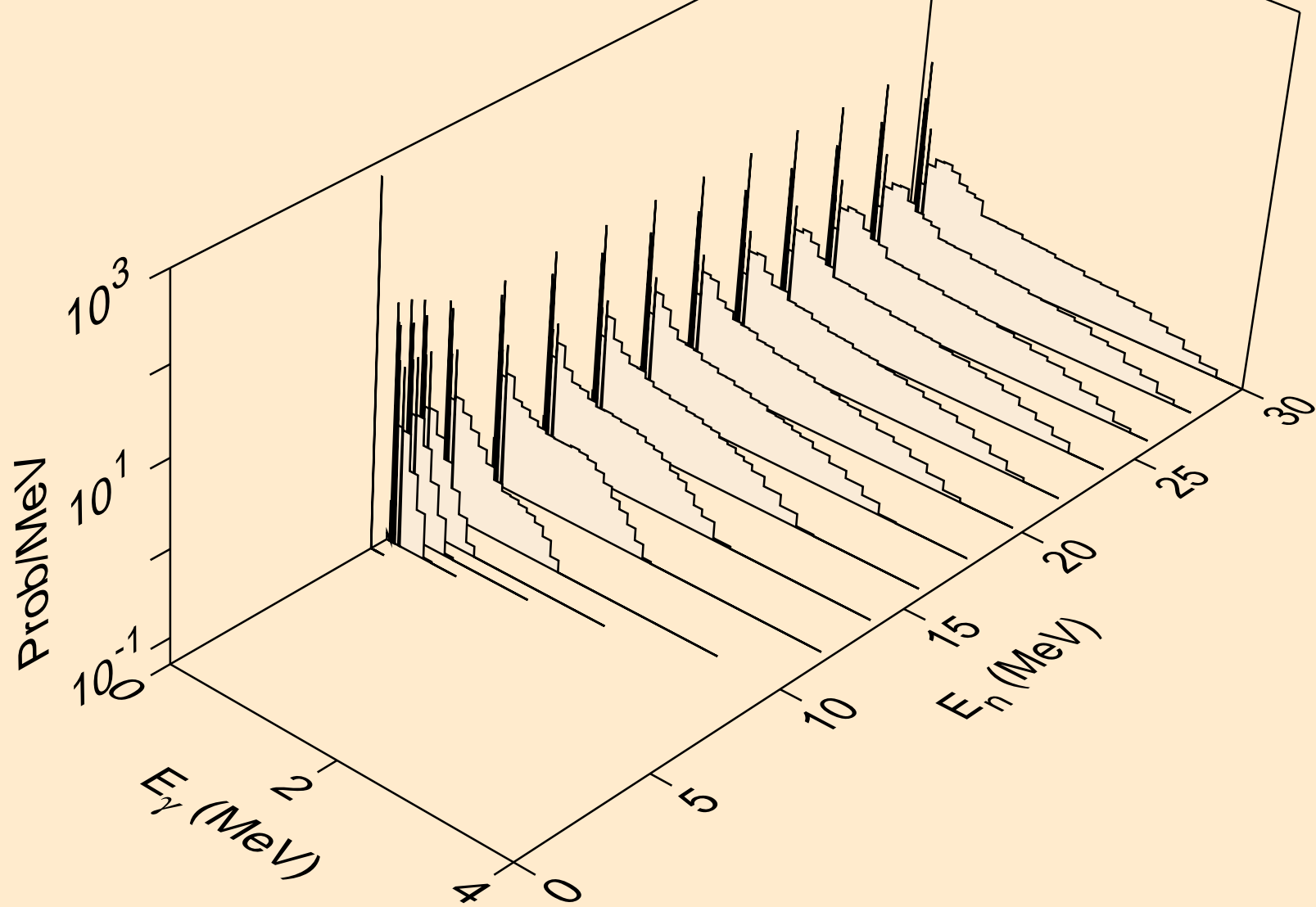

ER159 NEUTRON ACER TENDL-2021 LIBRARY; T=293.6K
Photon emission for (n,he3)

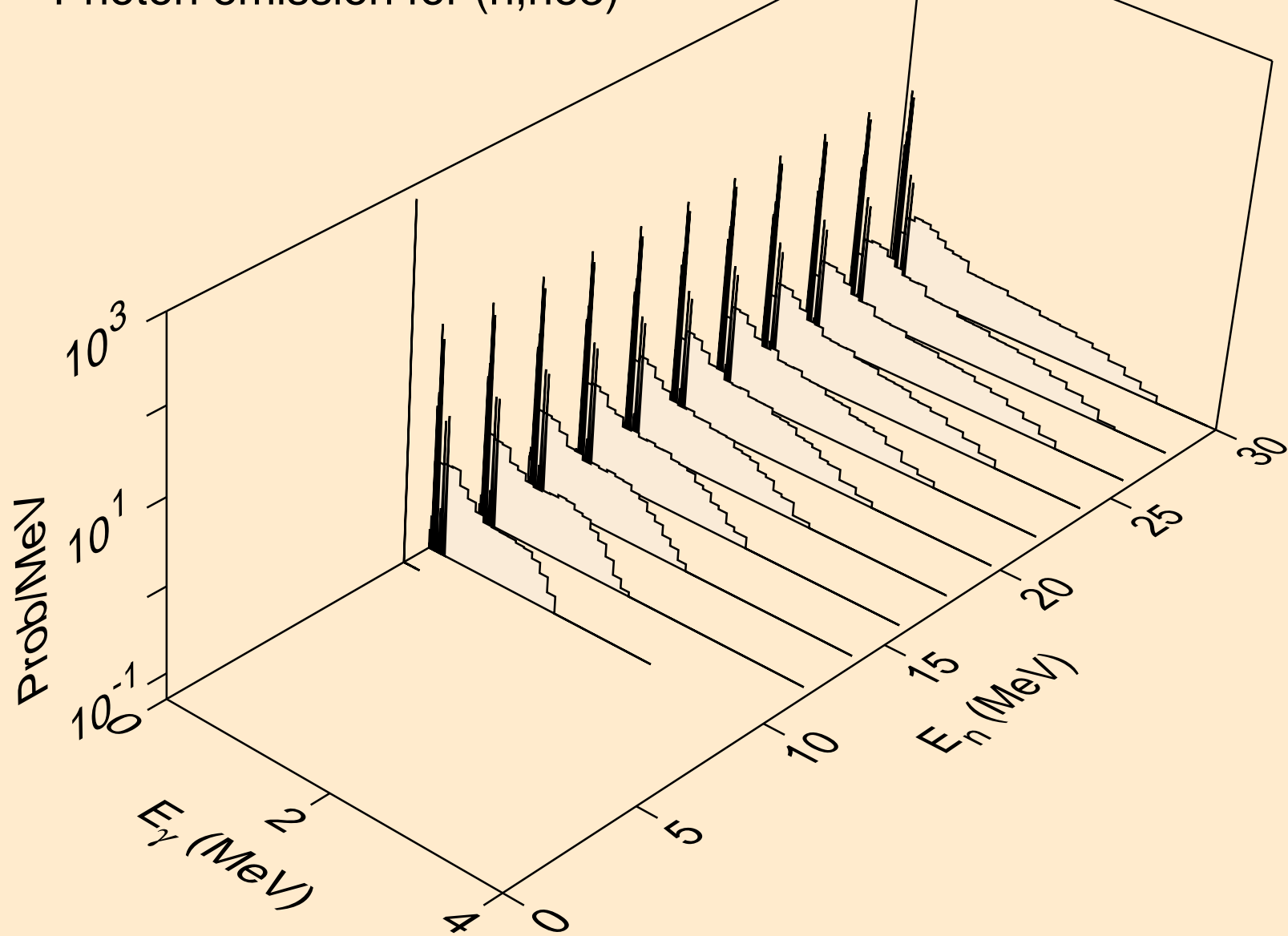

ER159 NEUTRON ACER TENDL-2021 LIBRARY; T=293.6K
Photon emission for (n,a)

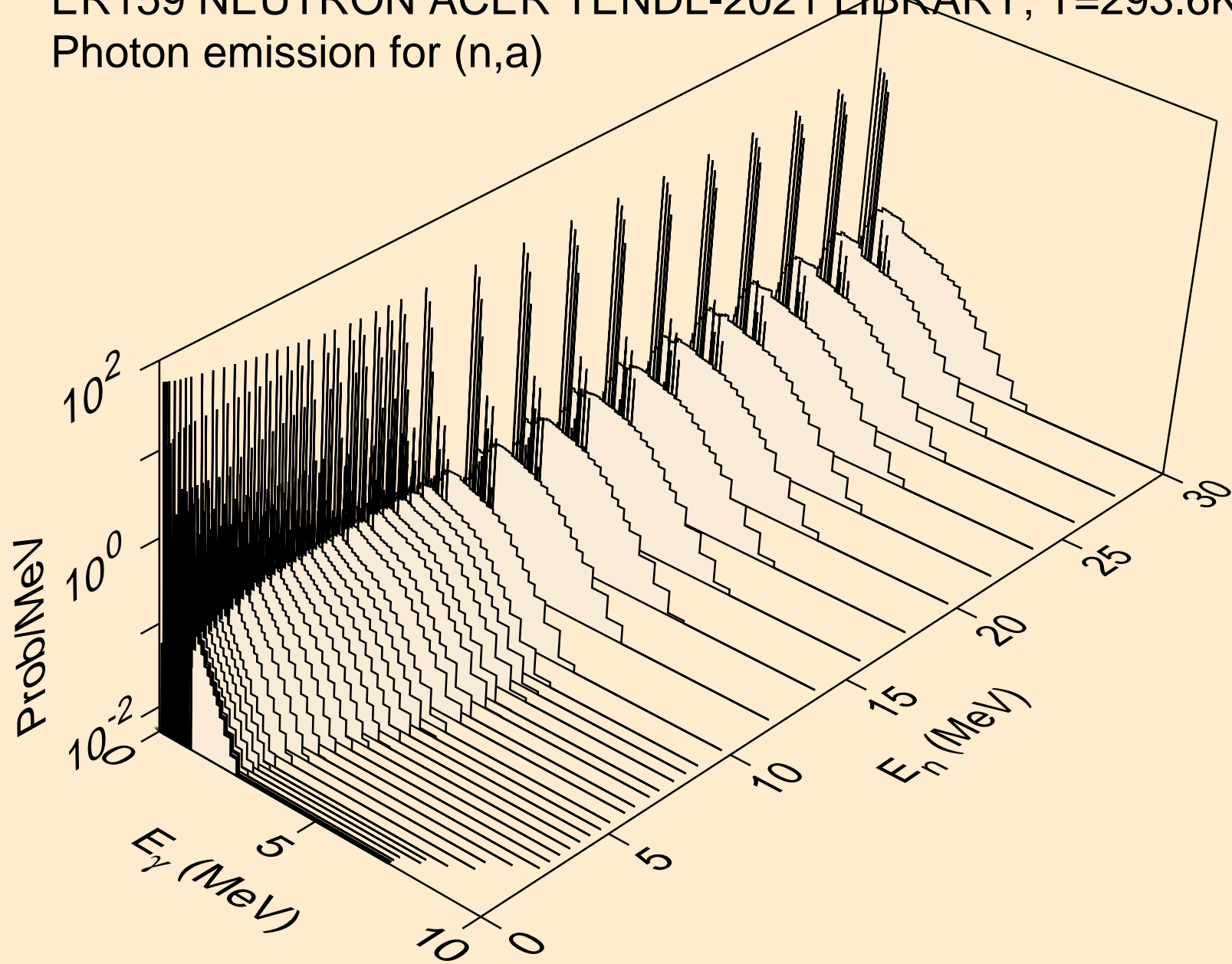

ER159 NEUTRON ACER TENDL-2021 LIBRARY; T=293.6K
Photon emission for (n,2a)

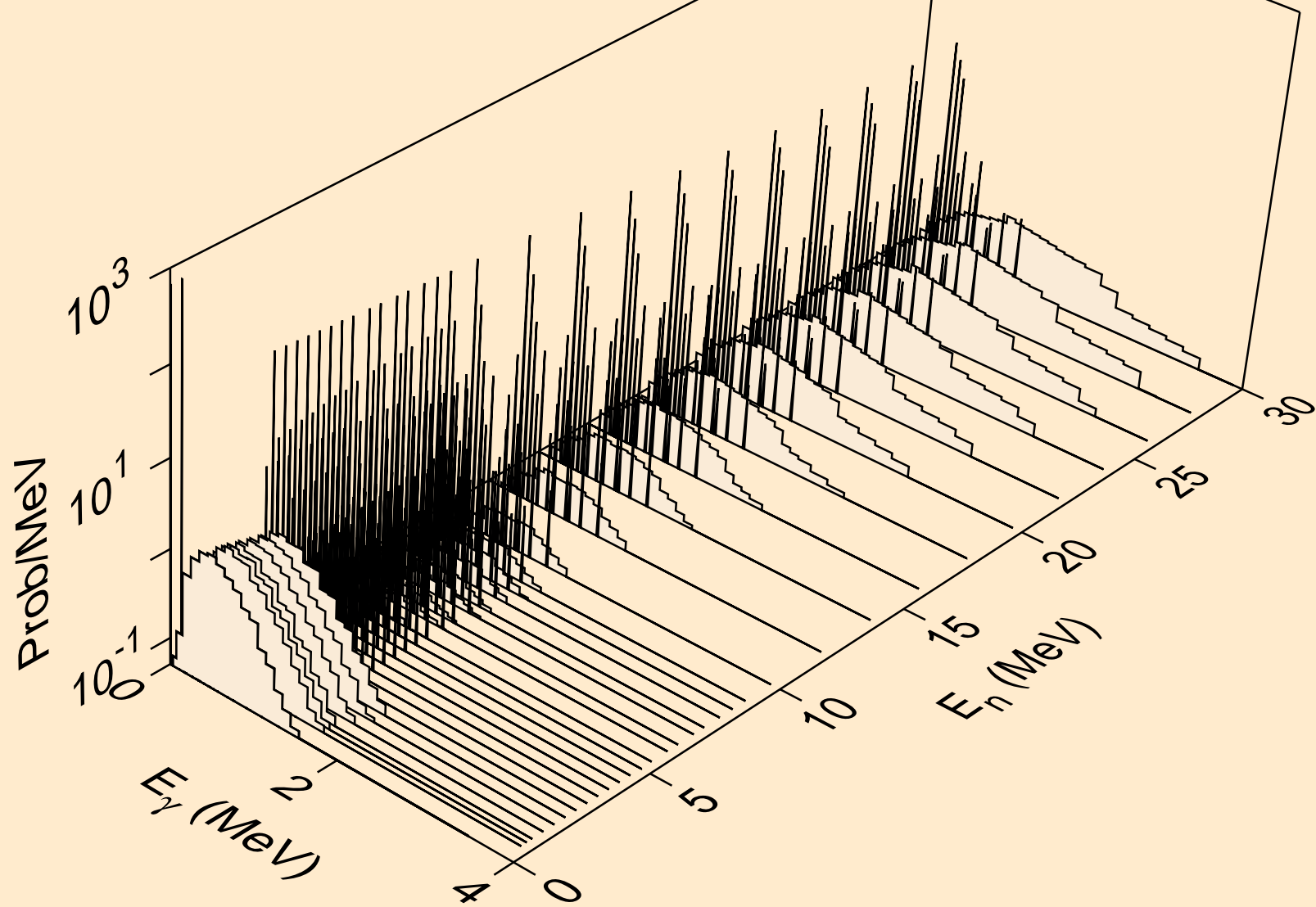

ER159 NEUTRON ACER TENDL-2021 LIBRARY; T=293.6K
Photon emission for (n,2p)

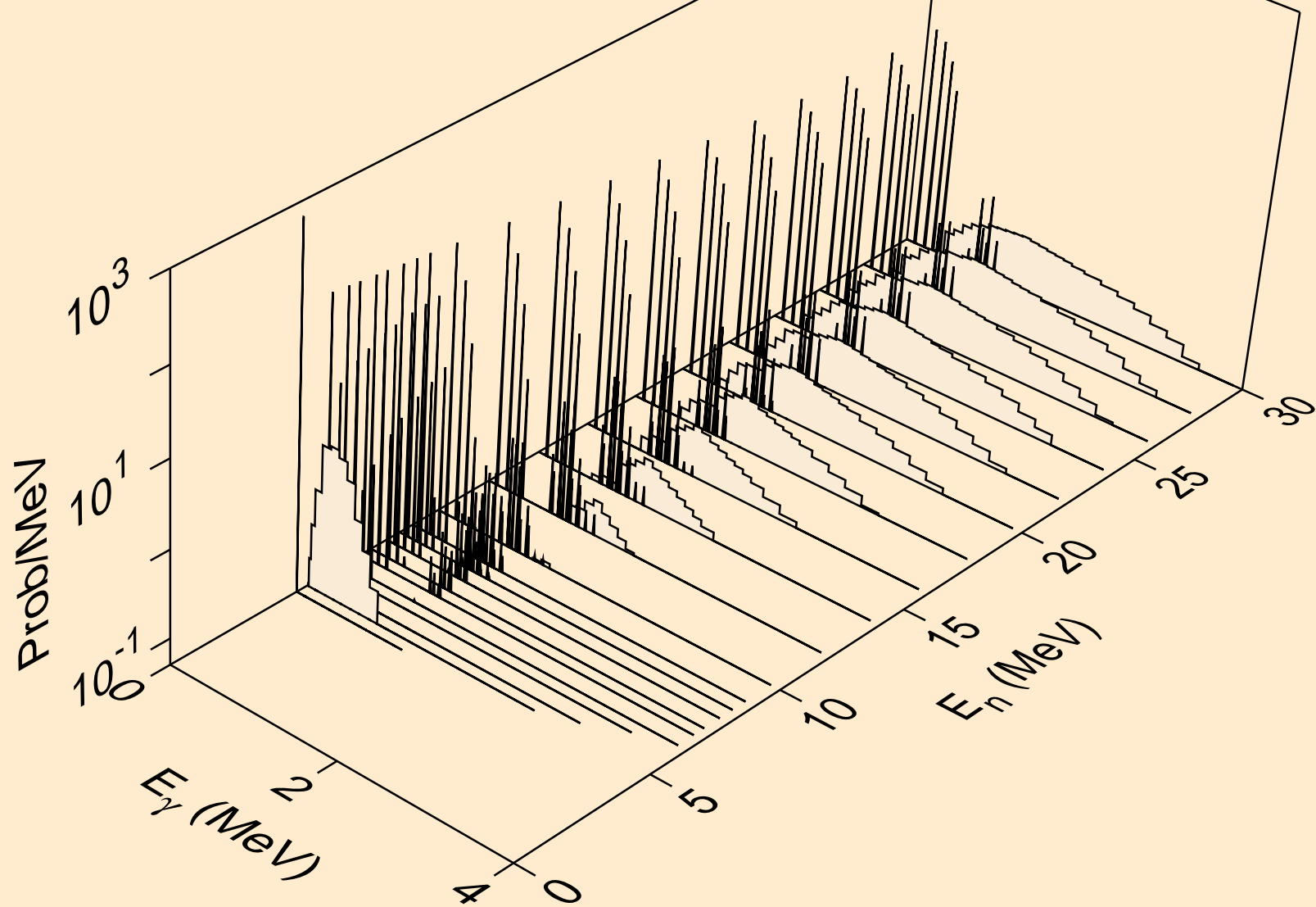

ER159 NEUTRON ACER TENDL-2021 LIBRARY; T=293.6K
Photon emission for (n,p α)

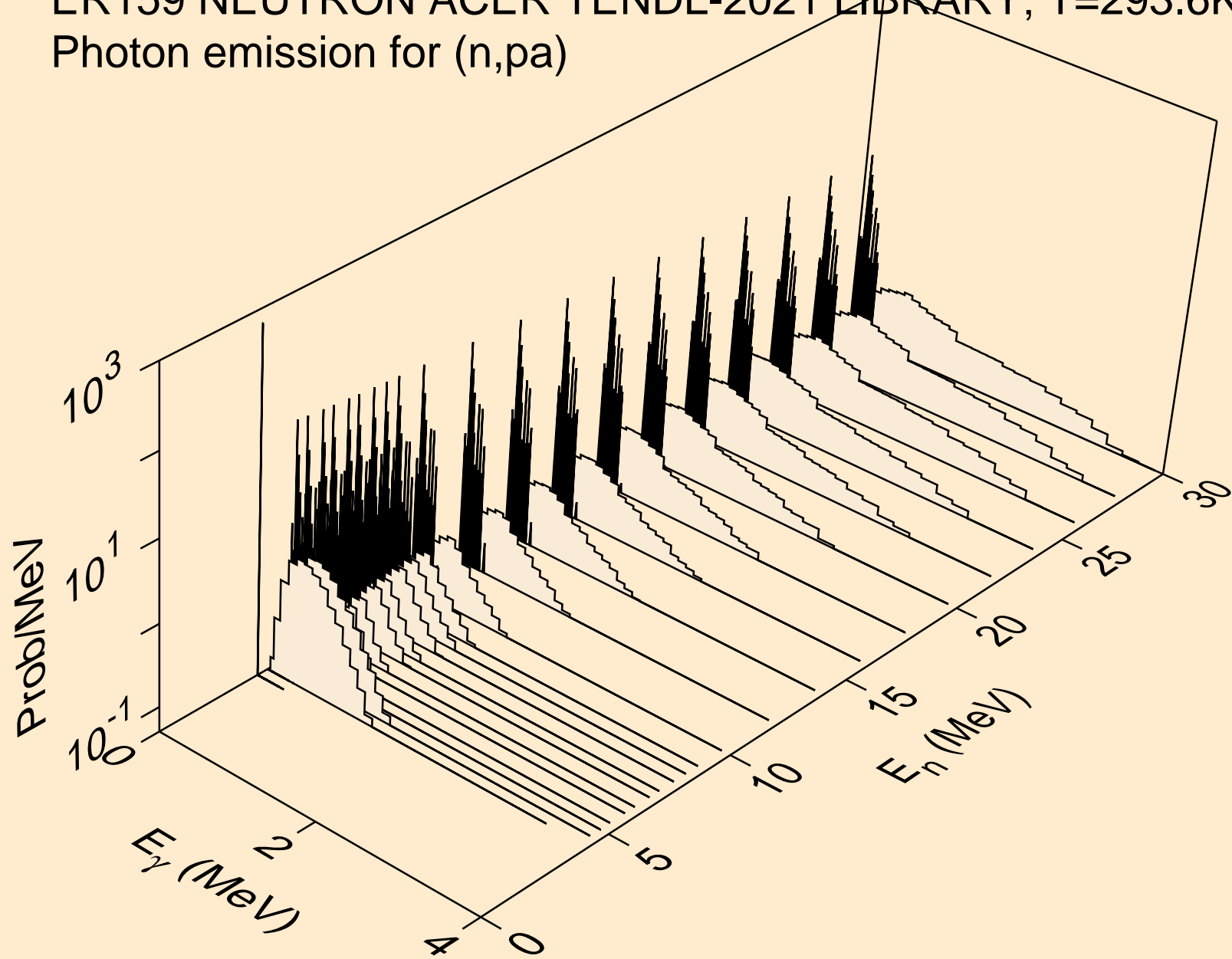

ER159 NEUTRON ACER TENDL-2021 LIBRARY; T=293.6K
Photon emission for (n,pd)

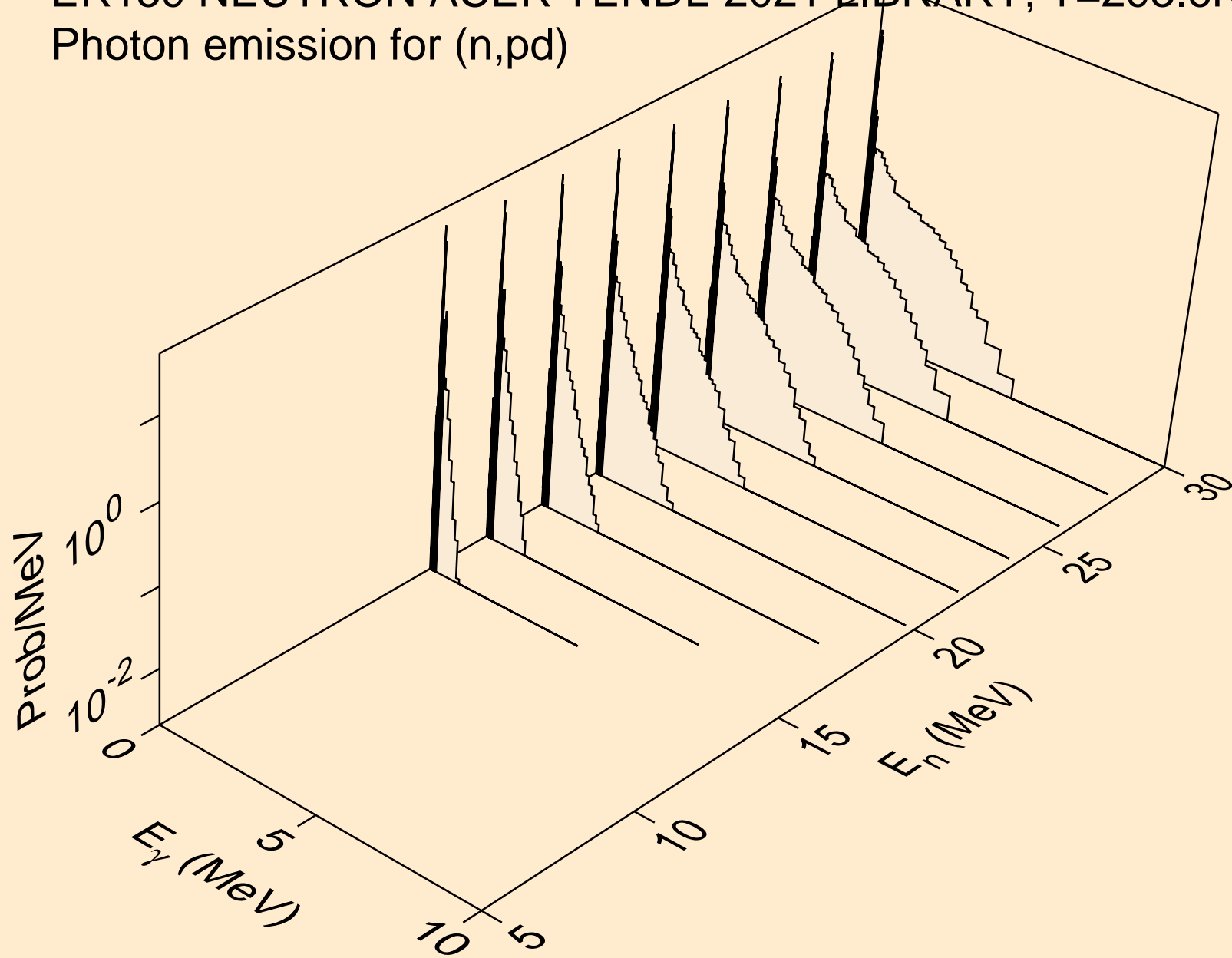

ER159 NEUTRON ACER TENDL-2021 LIBRARY; T=293.6K
Photon emission for (n,pt)

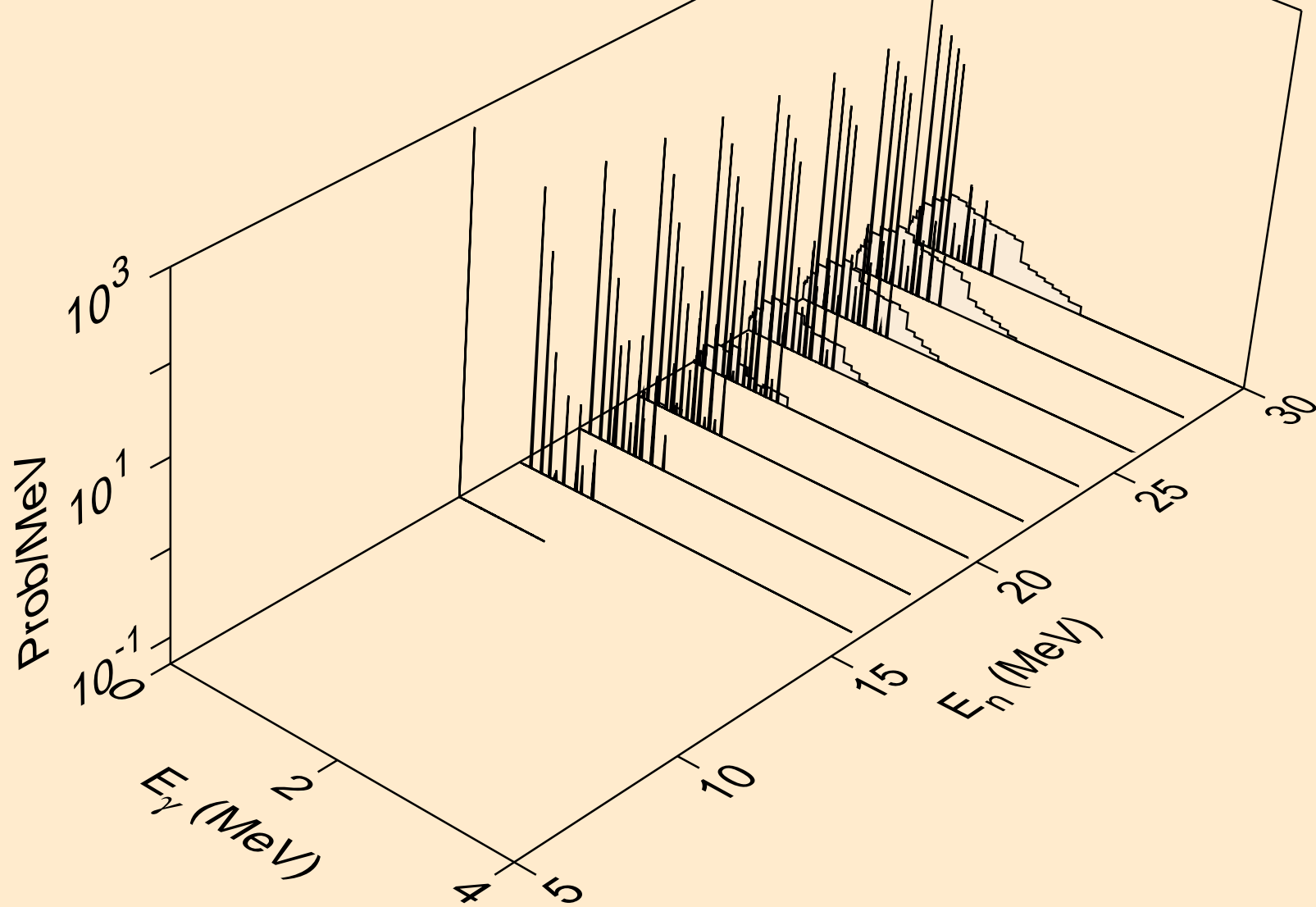

ER159 NEUTRON ACER TENDL-2021 LIBRARY; T=293.6K
Photon emission for (n,da)

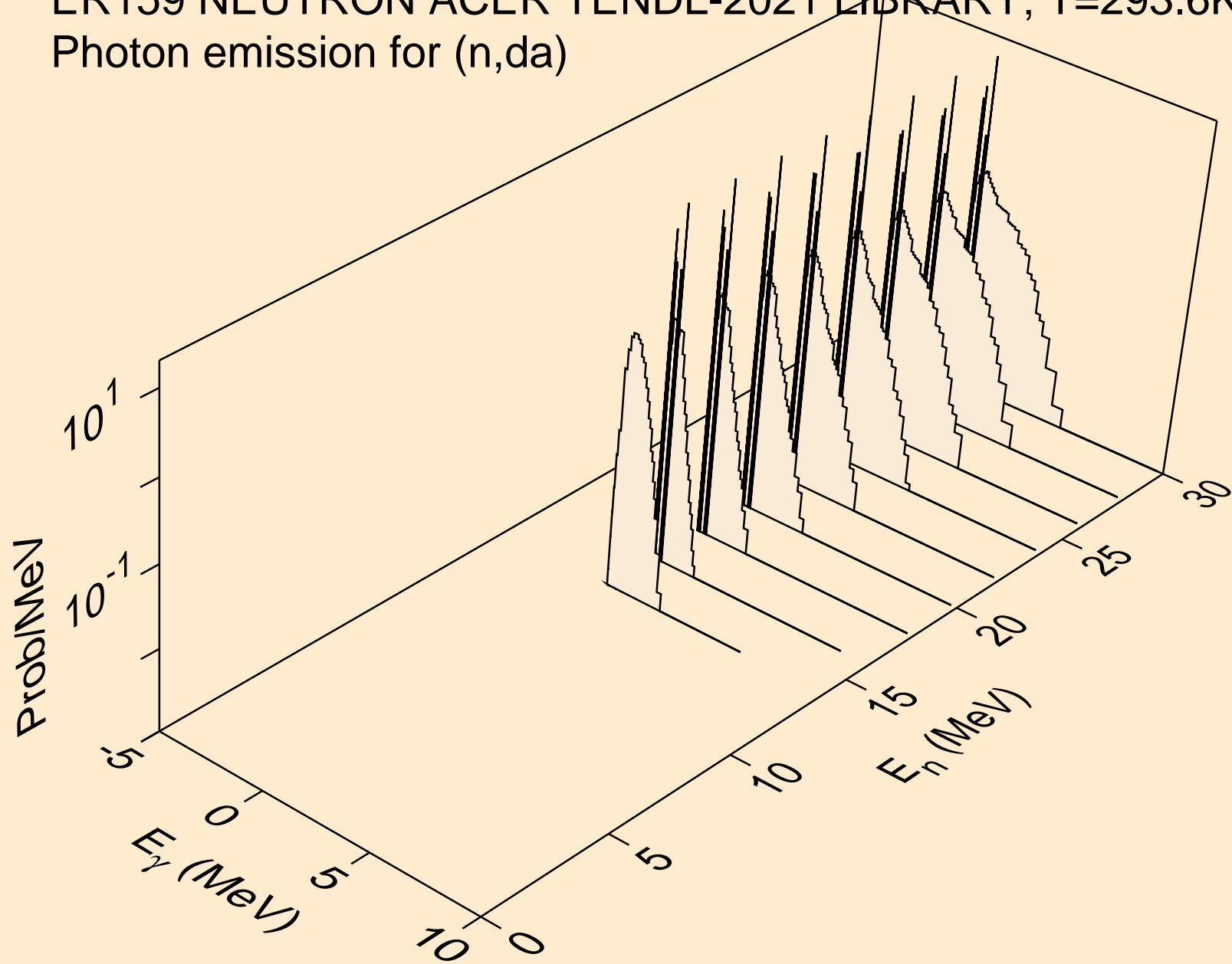

ER159 NEUTRON ACER TENDL-2021 LIBRARY; T=293.6K
thermal capture photon spectrum

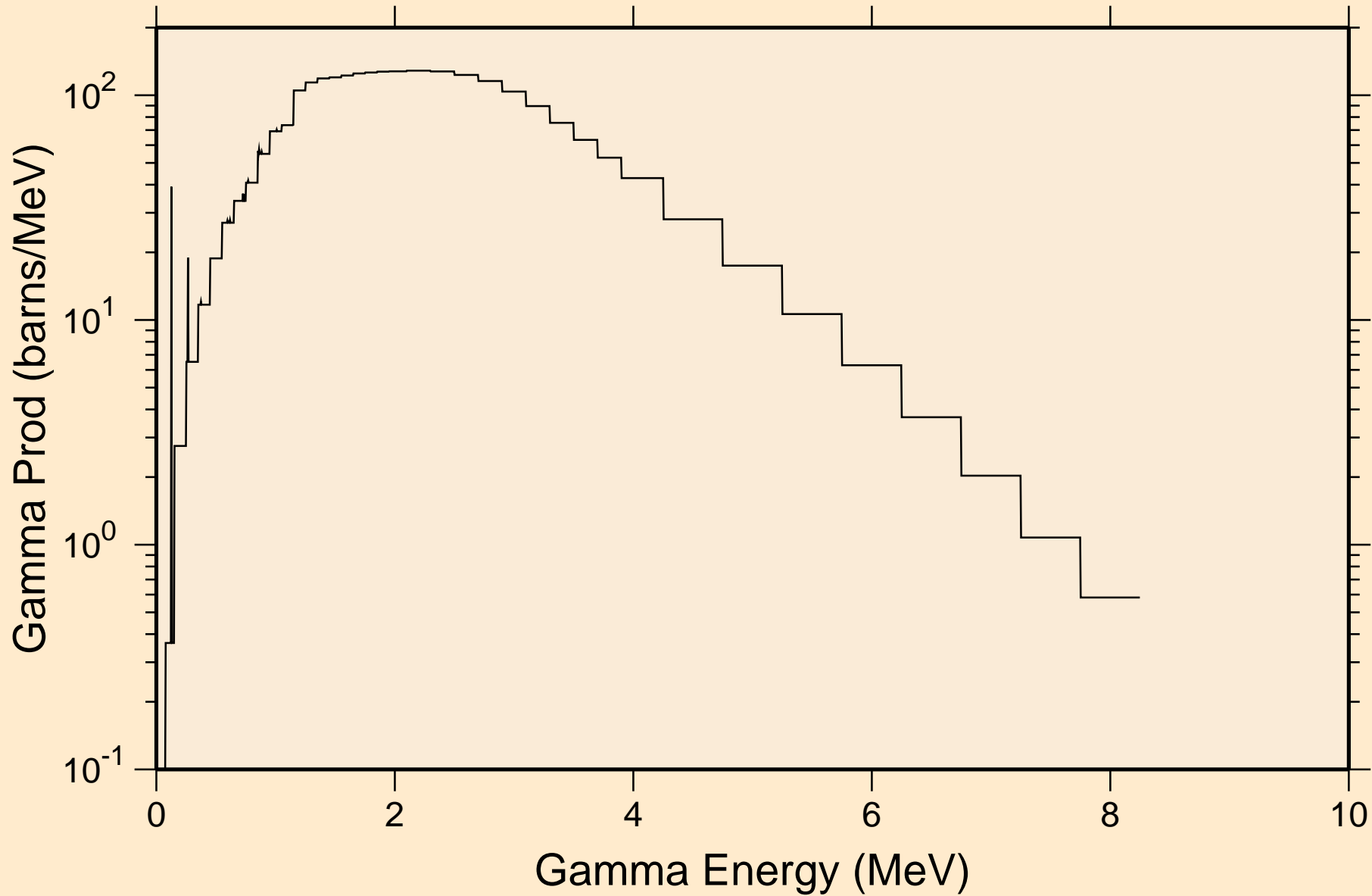

ER159 NEUTRON ACER TENDL-2021 LIBRARY; T=293.6K
14 MeV photon spectrum

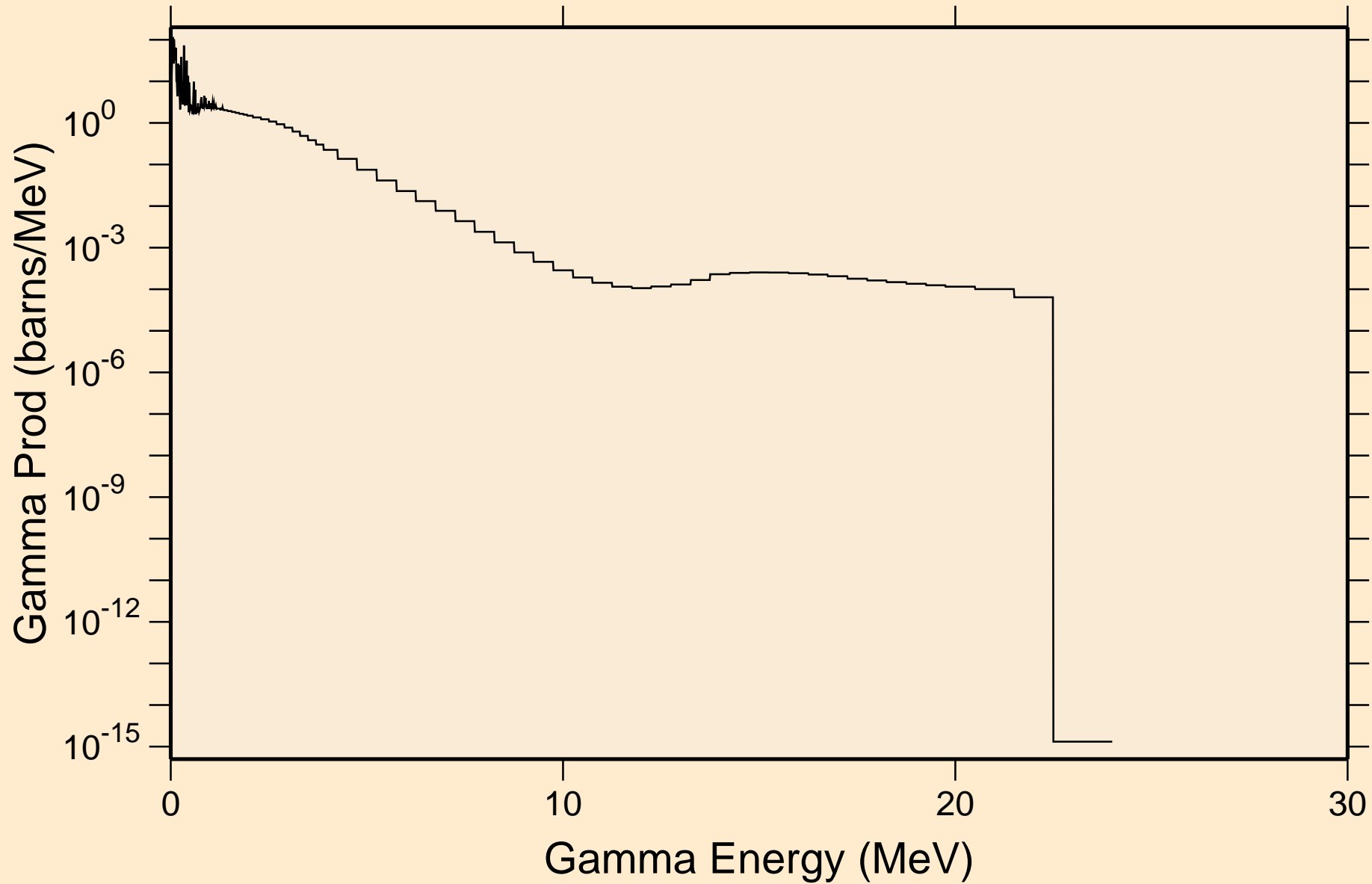

ER159 NEUTRON ACER TENDL-2021 LIBRARY; T=293.6K

Particle heating contributions

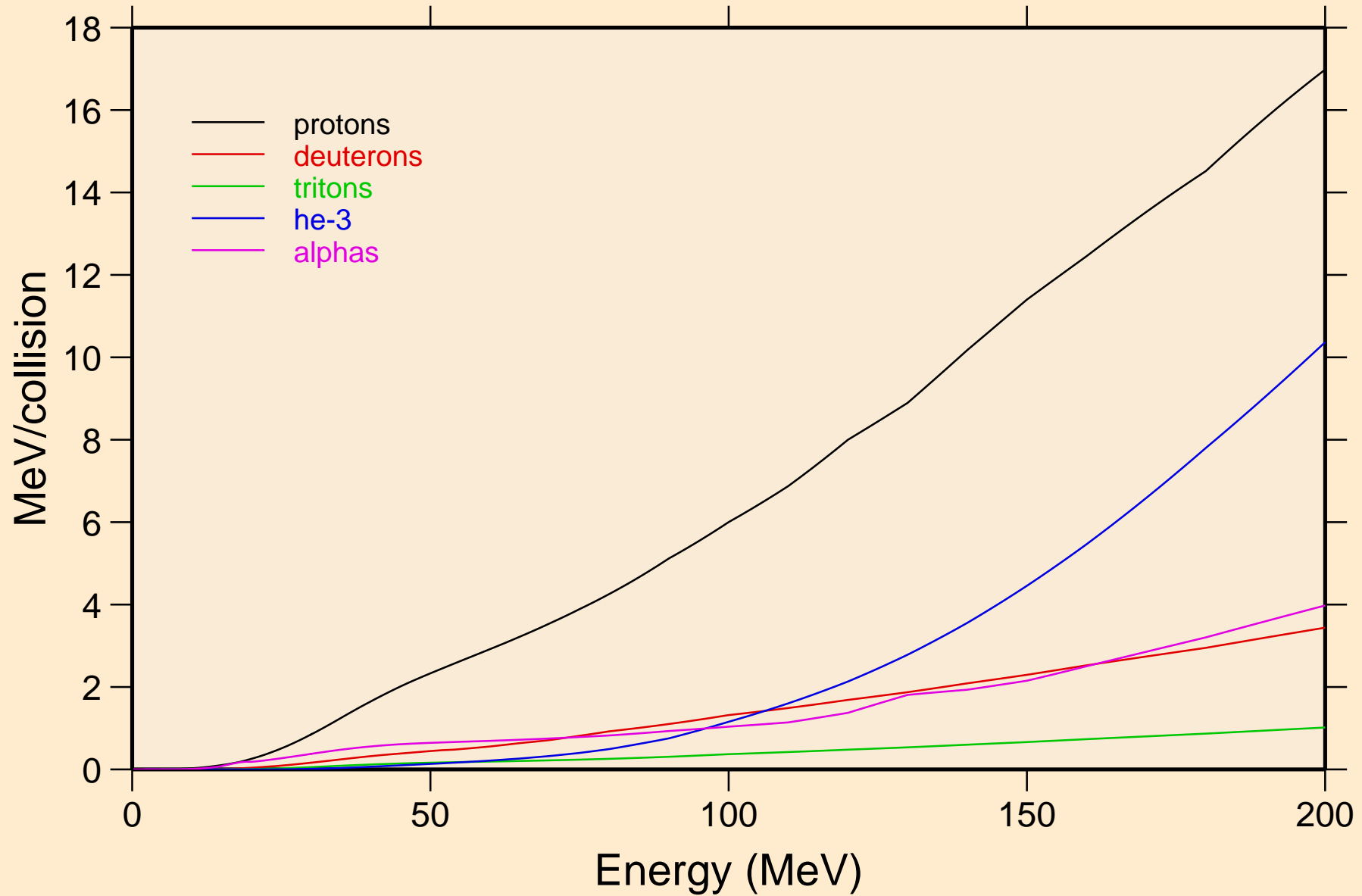

ER159 NEUTRON ACER TENDL-2021 LIBRARY; T=293.6K
Recoil Heating

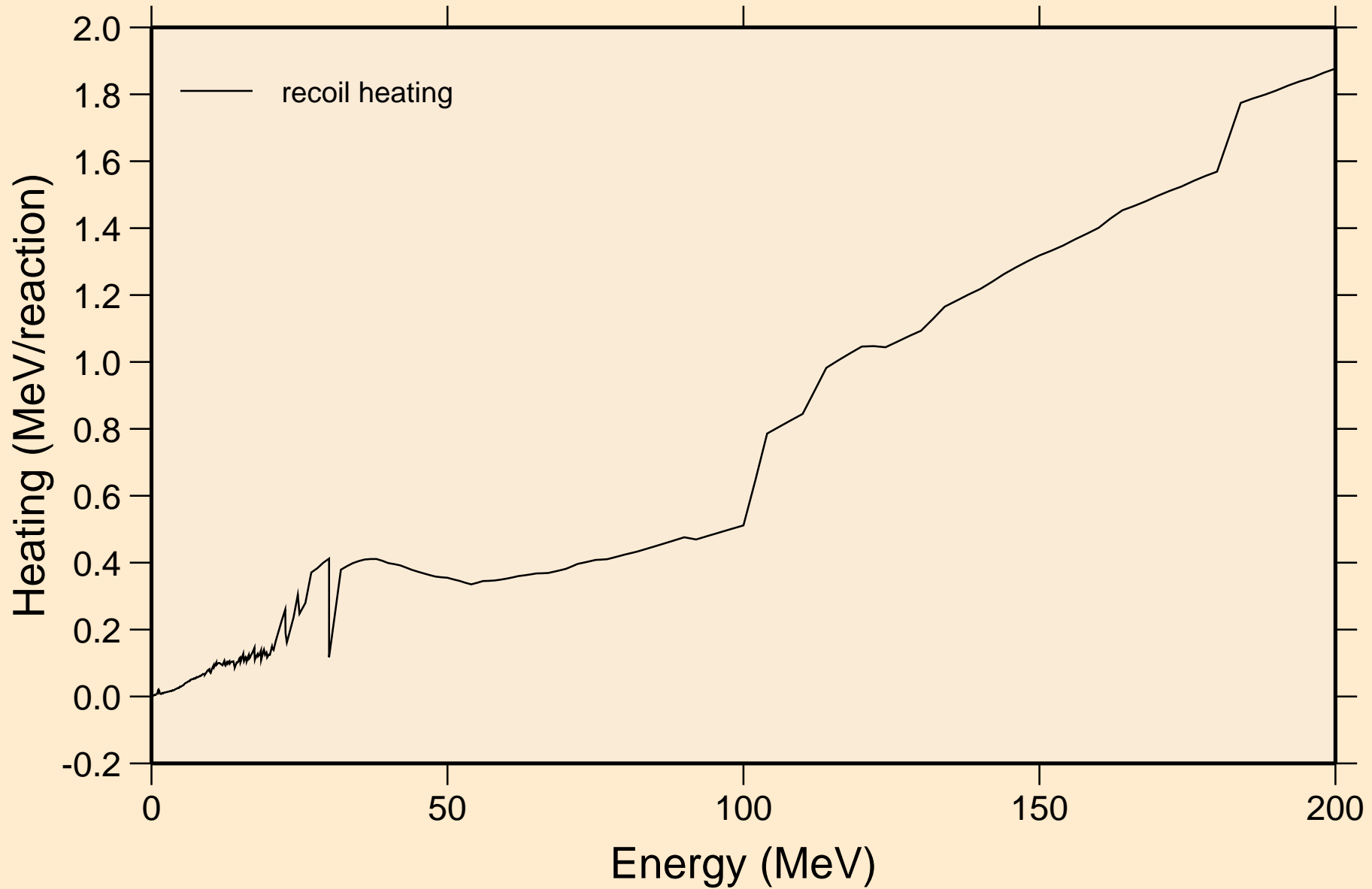

ER159 NEUTRON ACER TENDL-2021 LIBRARY; T=293.6K
Particle production cross sections

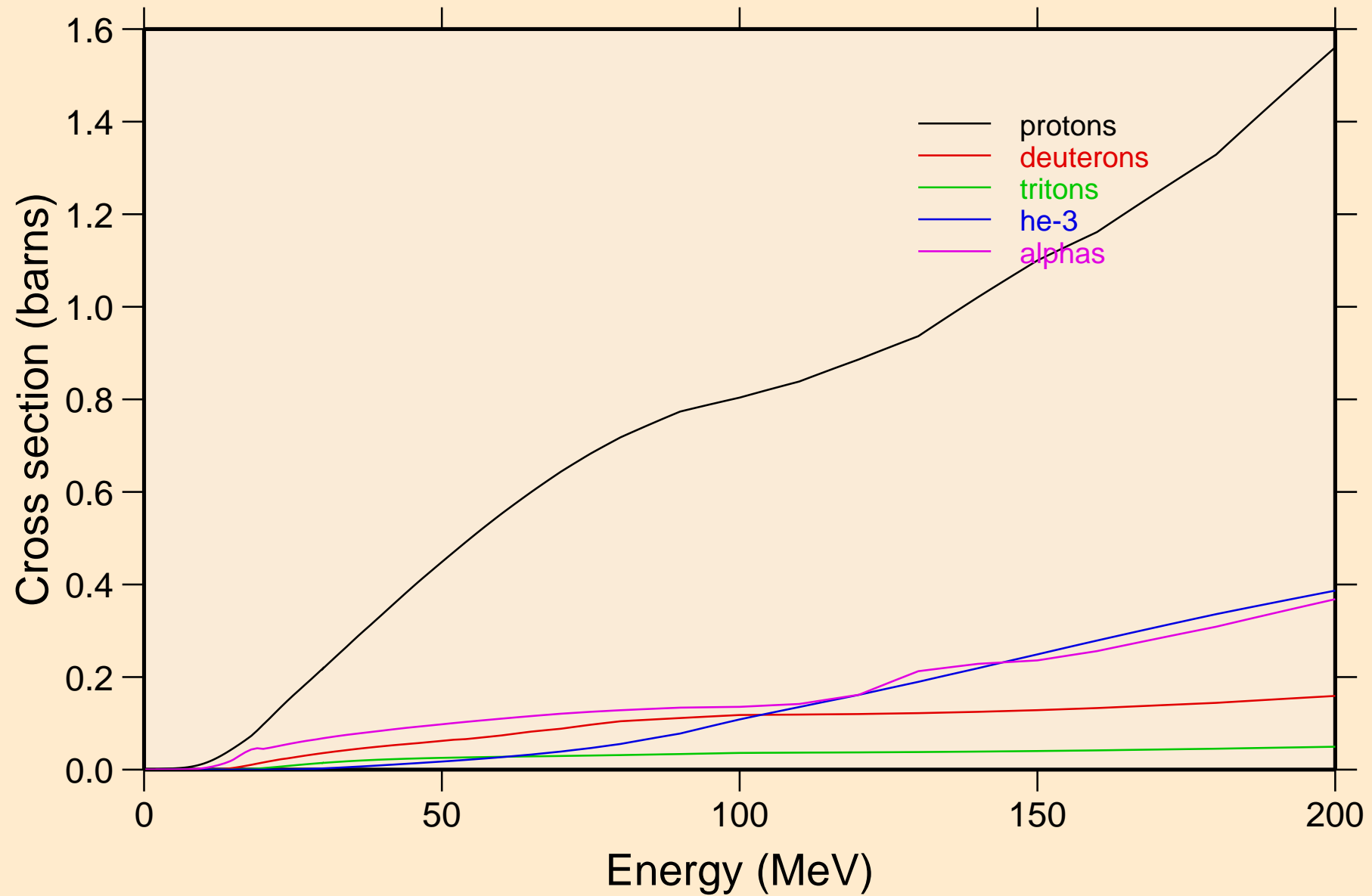

ER159 NEUTRON ACER TENDL-2021 LIBRARY; T=293.6K
protons from (n,x)

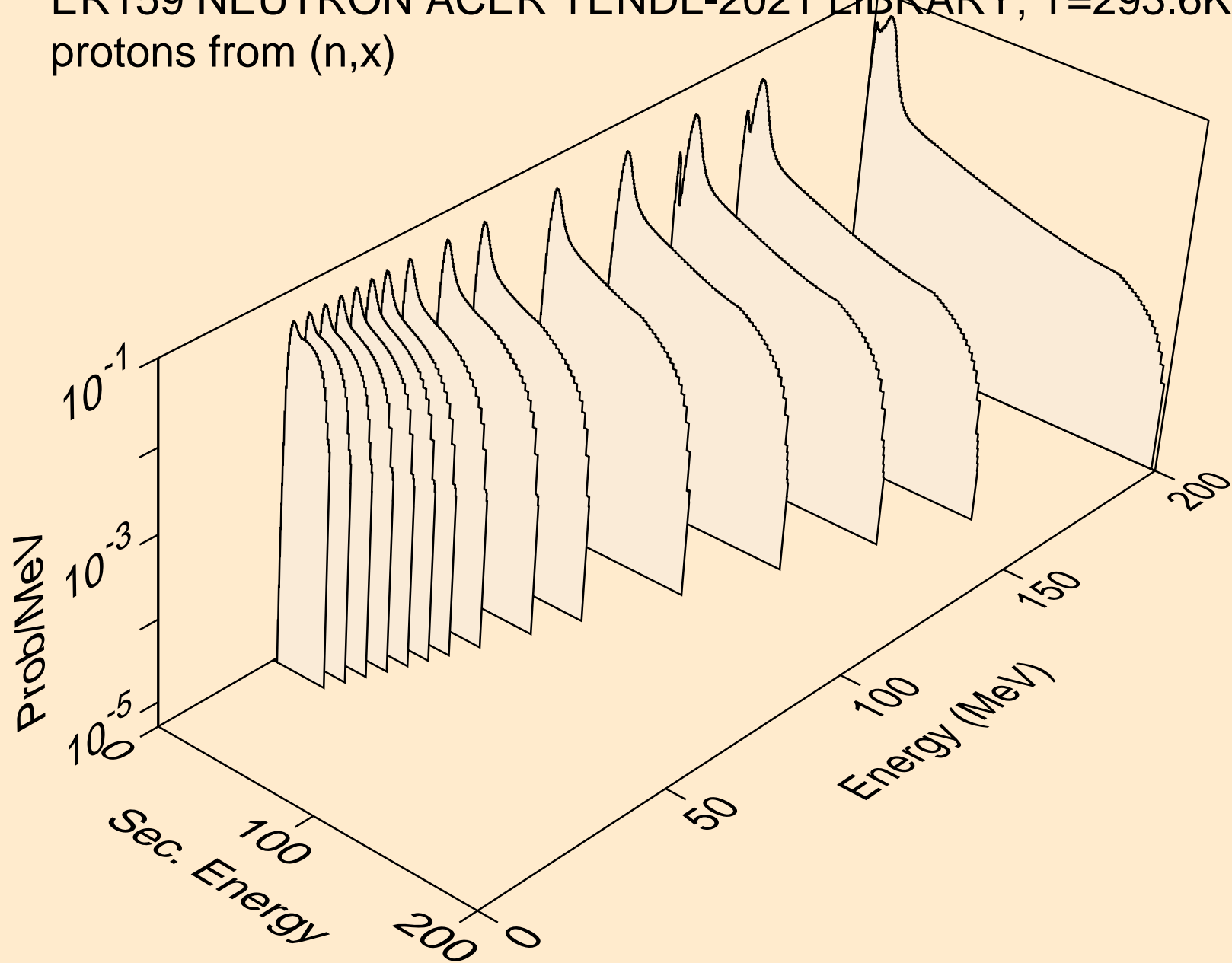

ER159 NEUTRON ACER TENDL-2021 LIBRARY; T=293.6K
protons from (n,n*)p

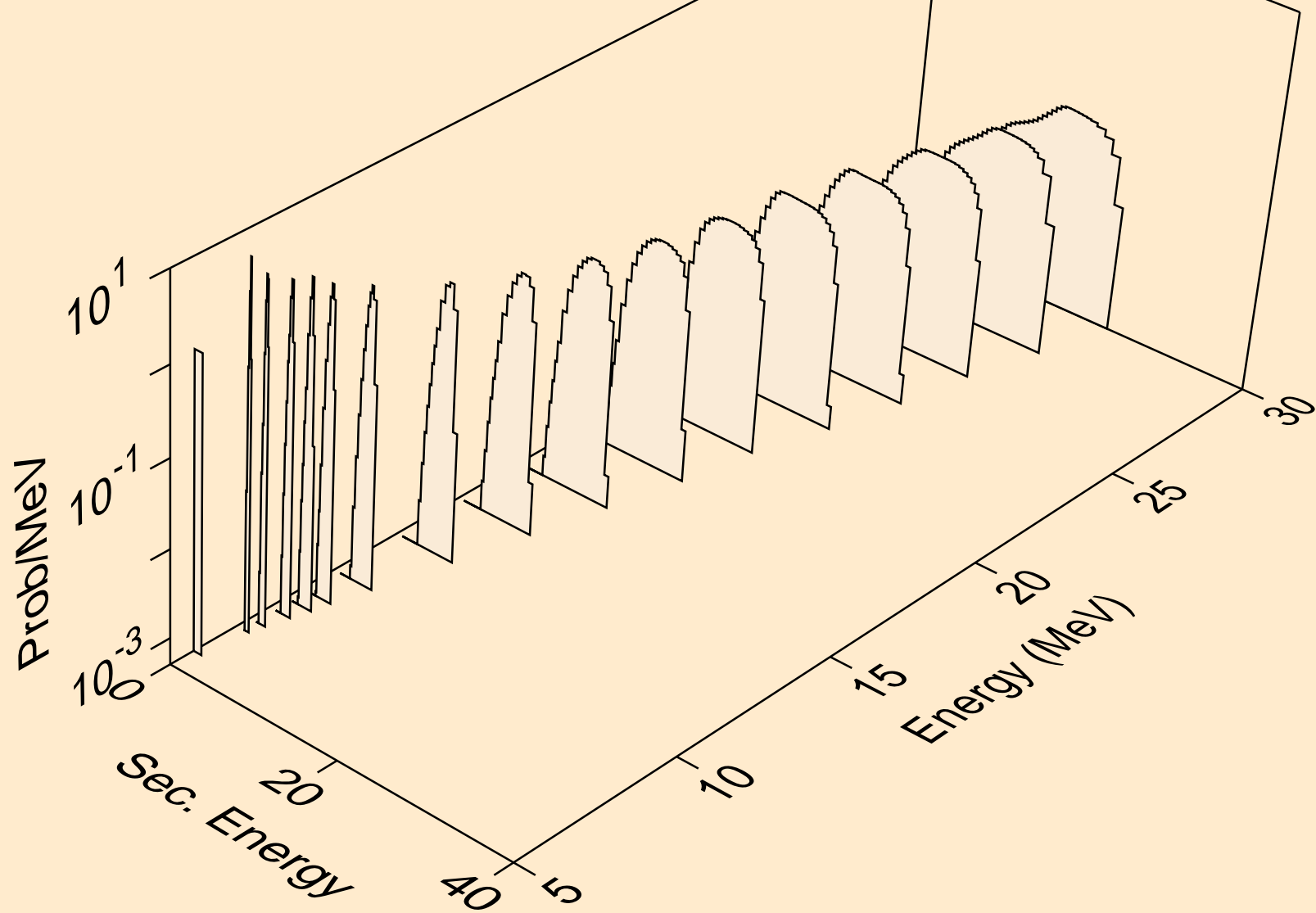

ER159 NEUTRON ACER TENDL-2021 LIBRARY; T=293.6K
protons from (n,2np)

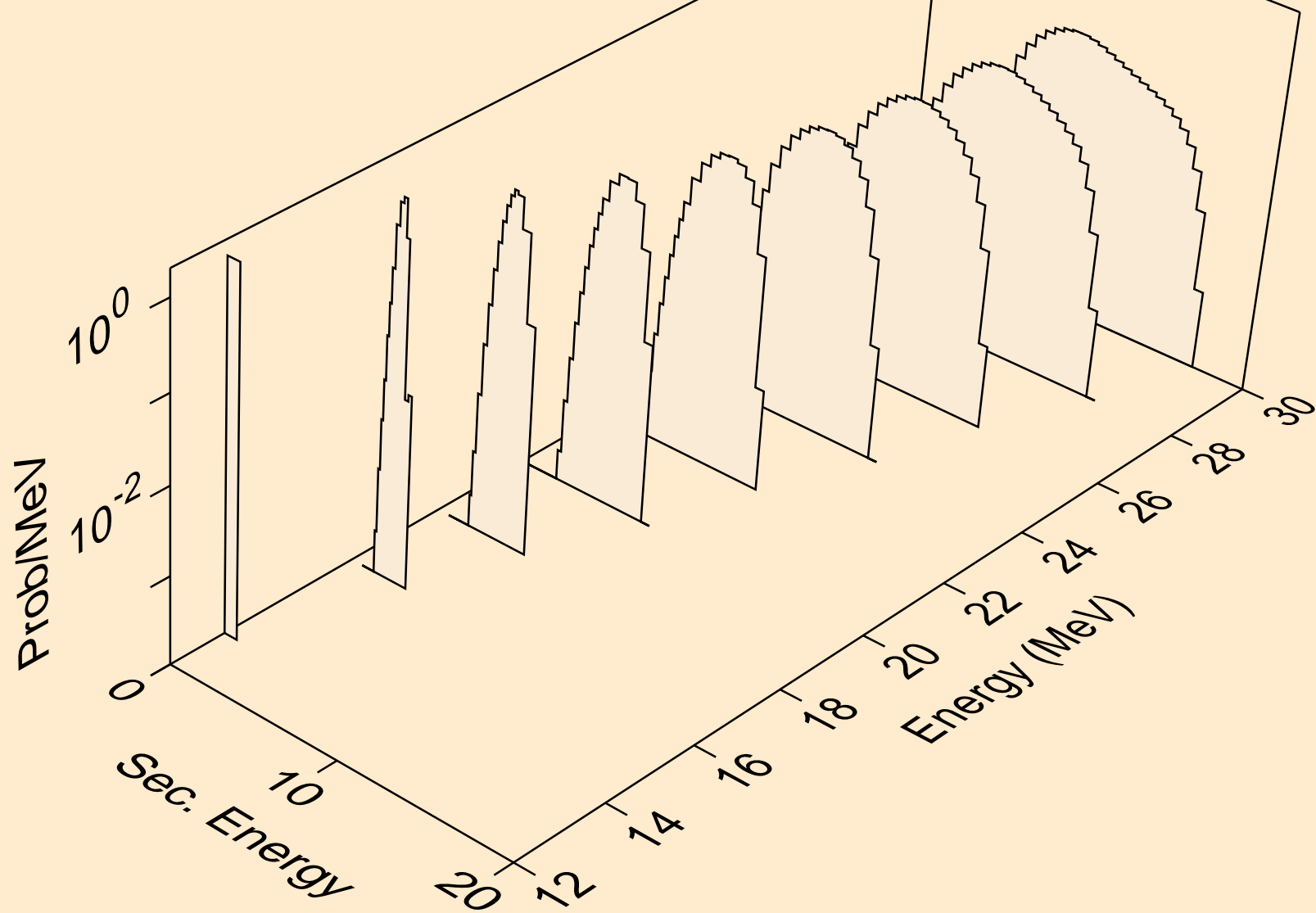

ER159 NEUTRON ACER TENDL-2021 LIBRARY; T=293.6K
protons from (n,3np)

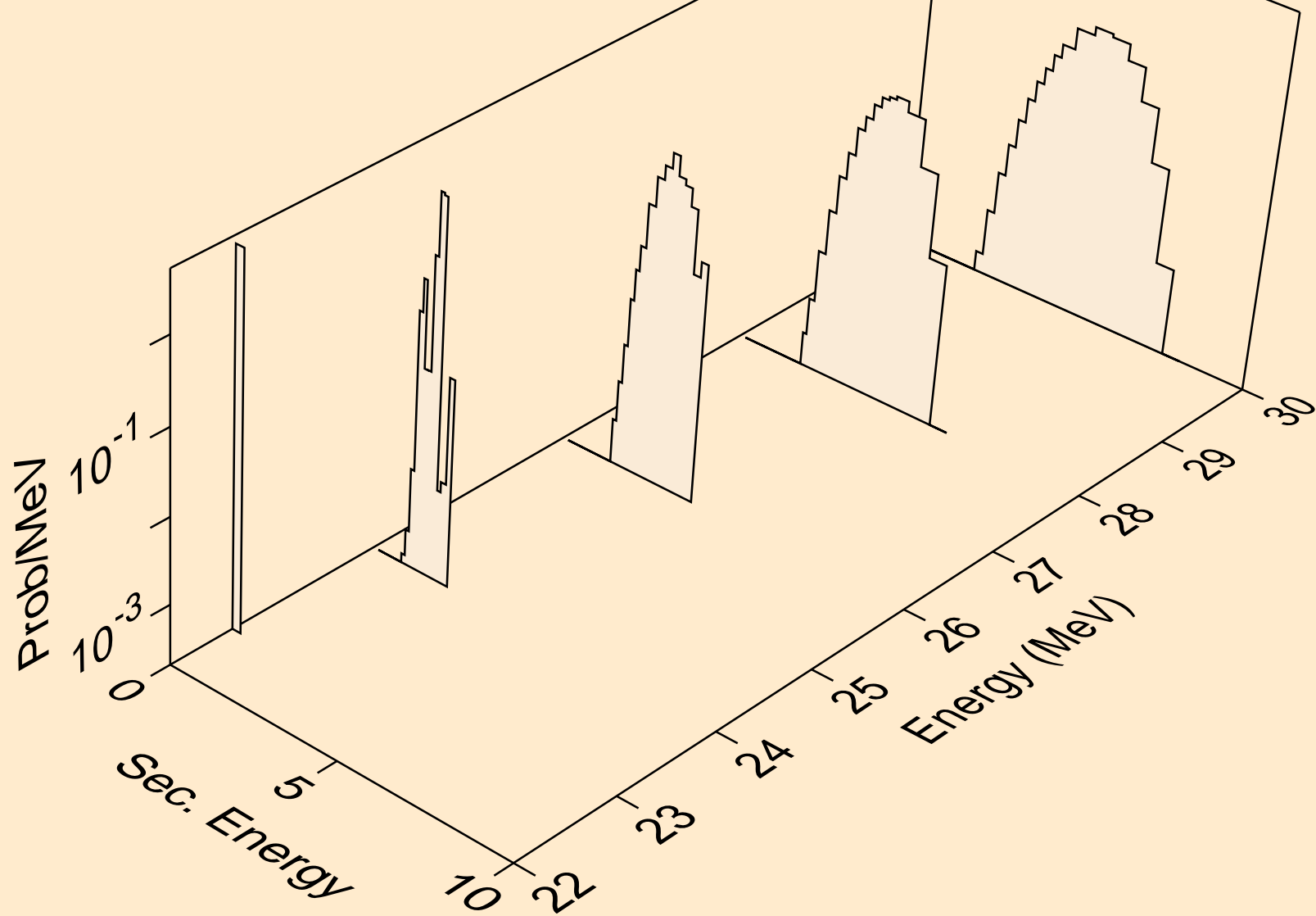

ER159 NEUTRON ACER TENDL-2021 LIBRARY; T=293.6K
protons from (n,2np)

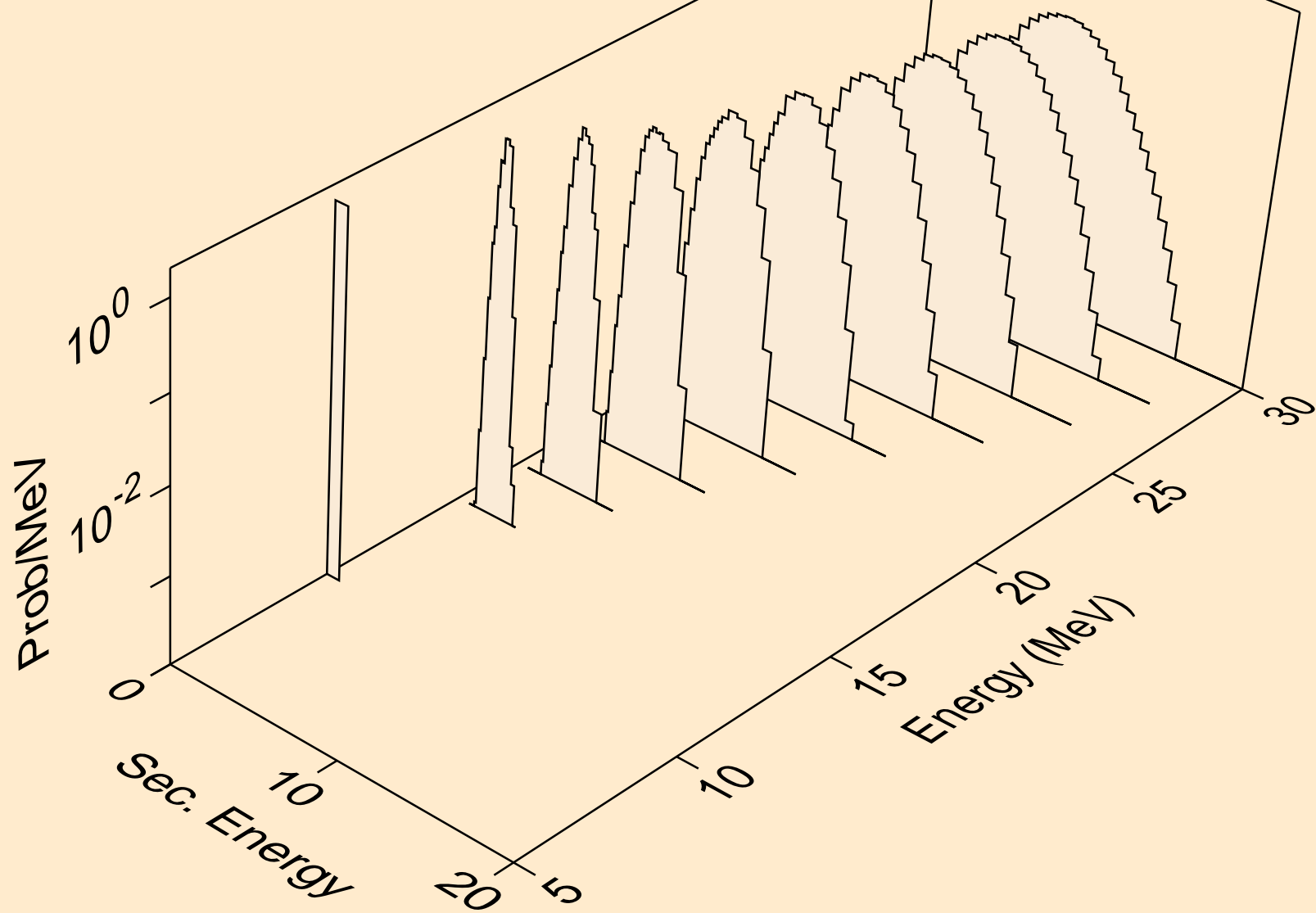

ER159 NEUTRON ACER TENDL-2021 LIBRARY; T=293.6K
protons from (n,npa)

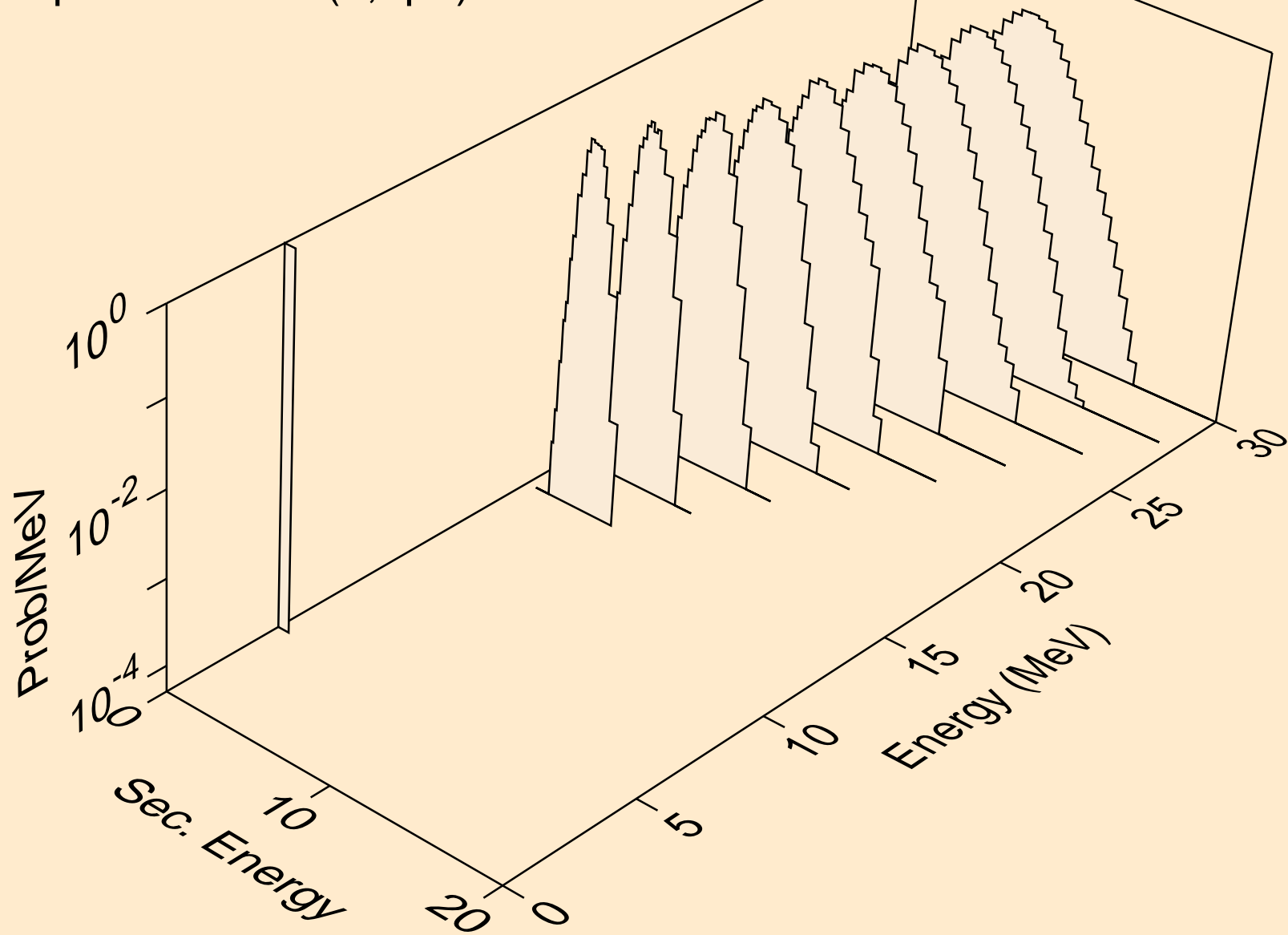

ER159 NEUTRON ACER TENDL-2021 LIBRARY; T=293.6K
protons from (n,p)

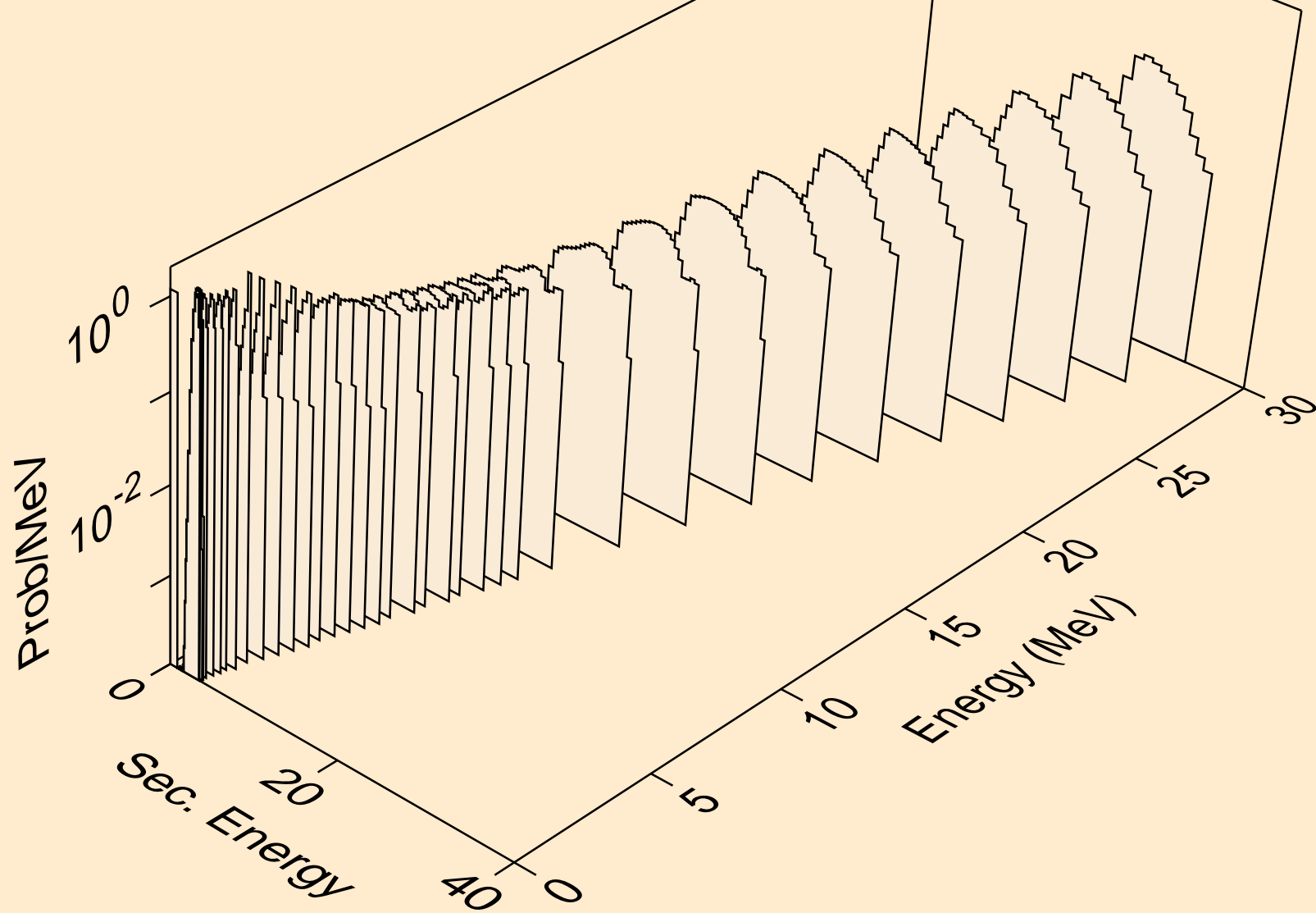

ER159 NEUTRON ACER TENDL-2021 LIBRARY; T=293.6K
protons from (n,2p)

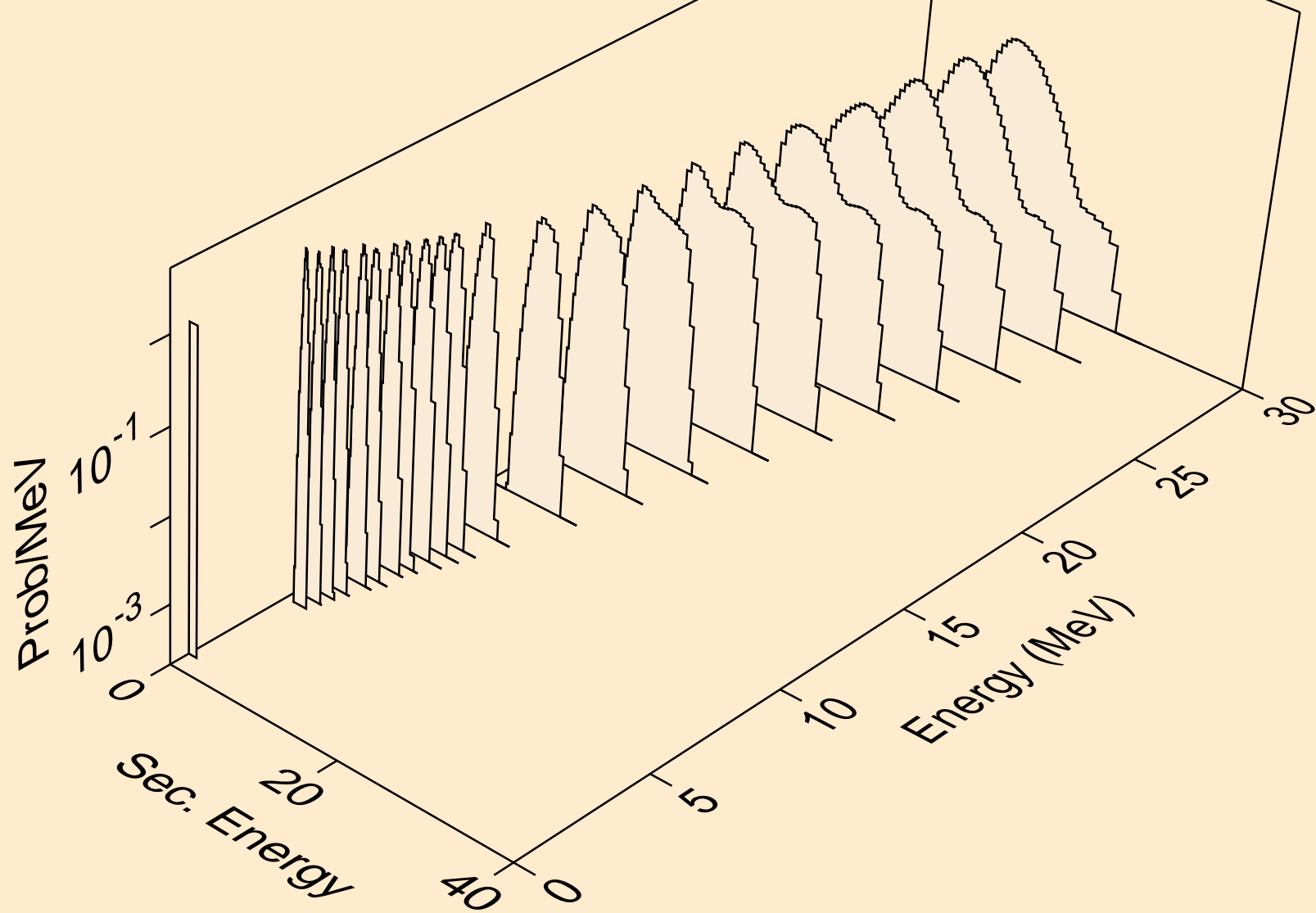

ER159 NEUTRON ACER TENDL-2021 LIBRARY; T=293.6K
protons from (n,p)

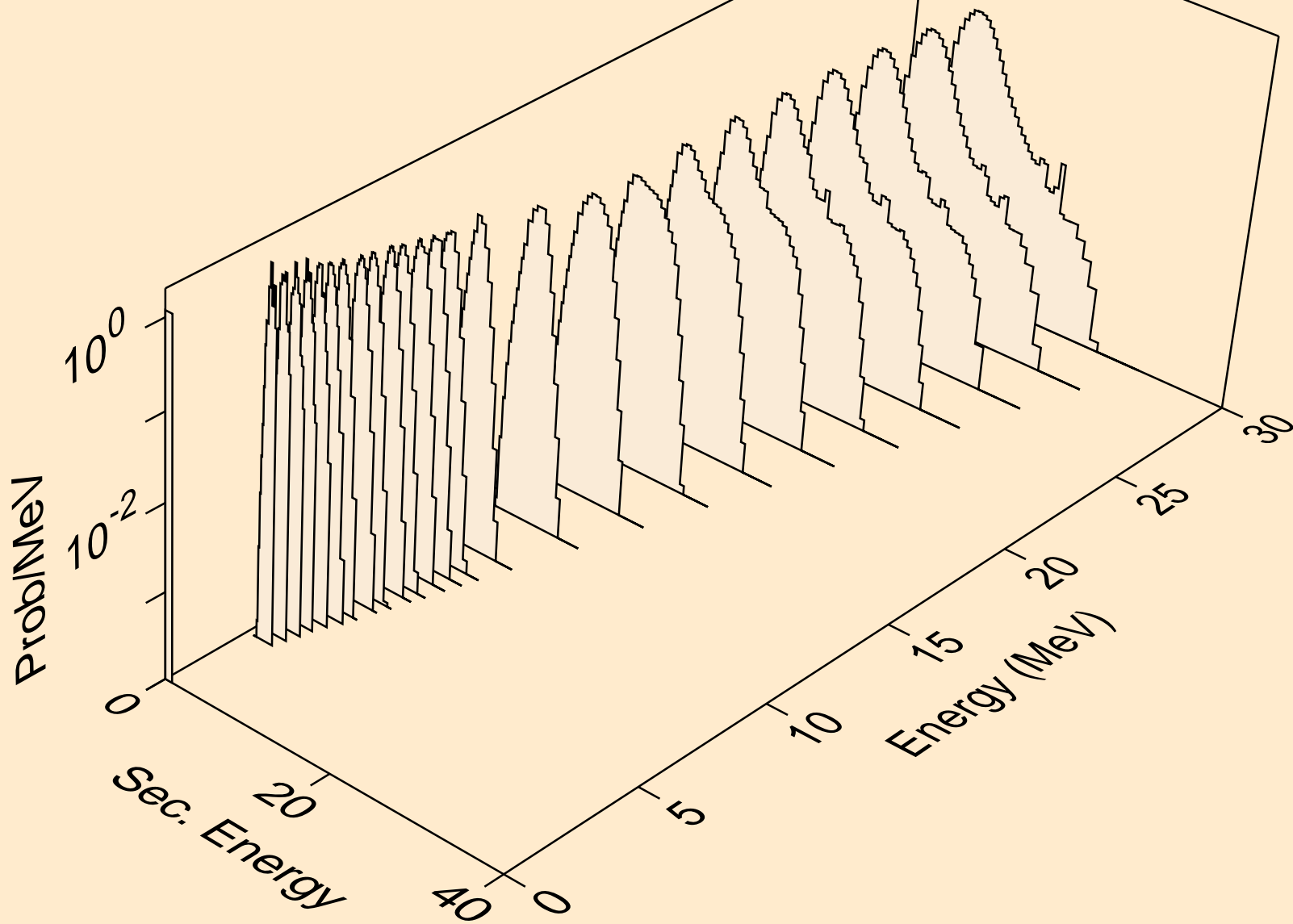

ER159 NEUTRON ACER TENDL-2021 LIBRARY; T=293.6K
protons from (n,pd)

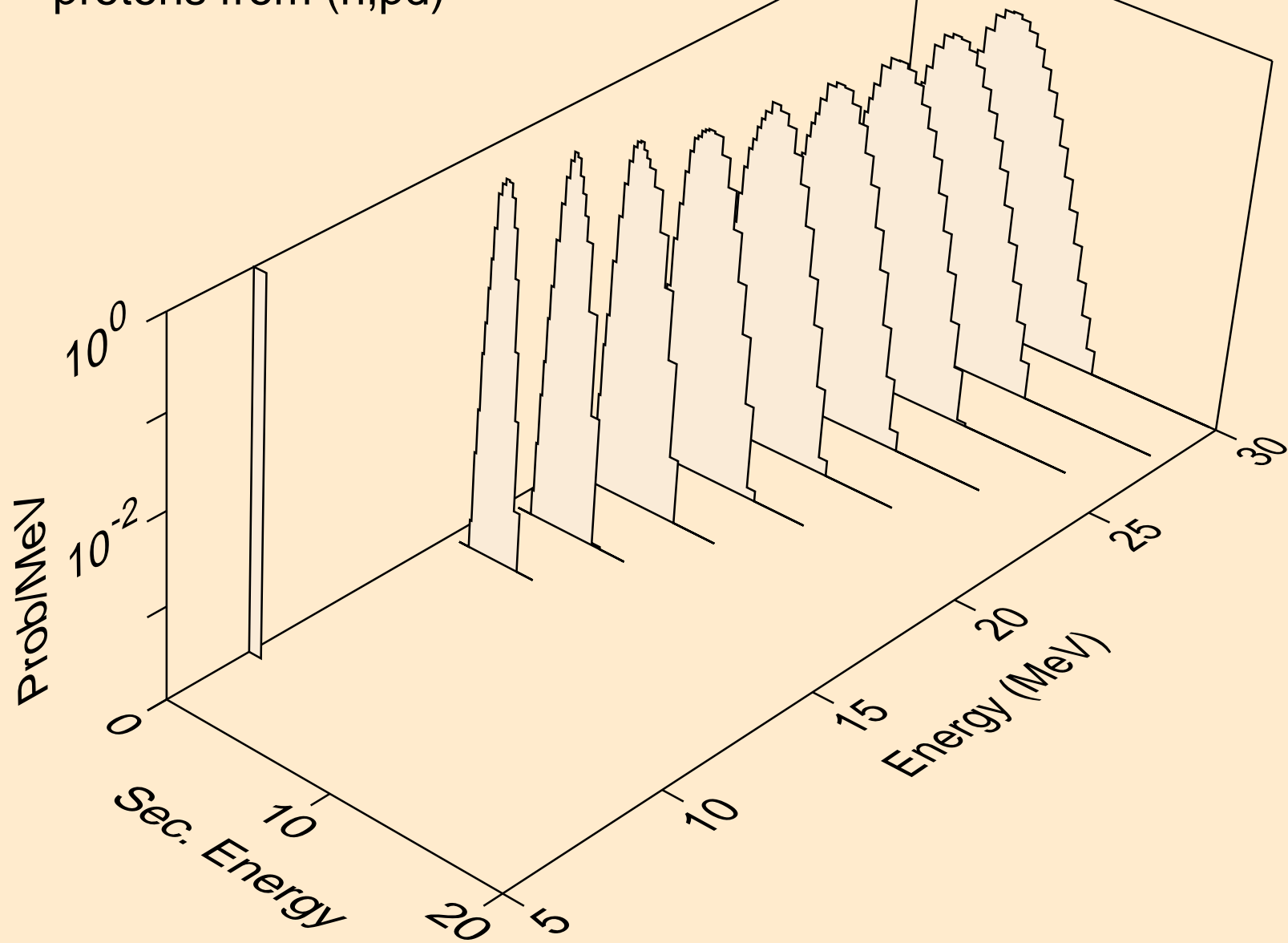

ER159 NEUTRON ACER TENDL-2021 LIBRARY; T=293.6K
protons from (n,pt)

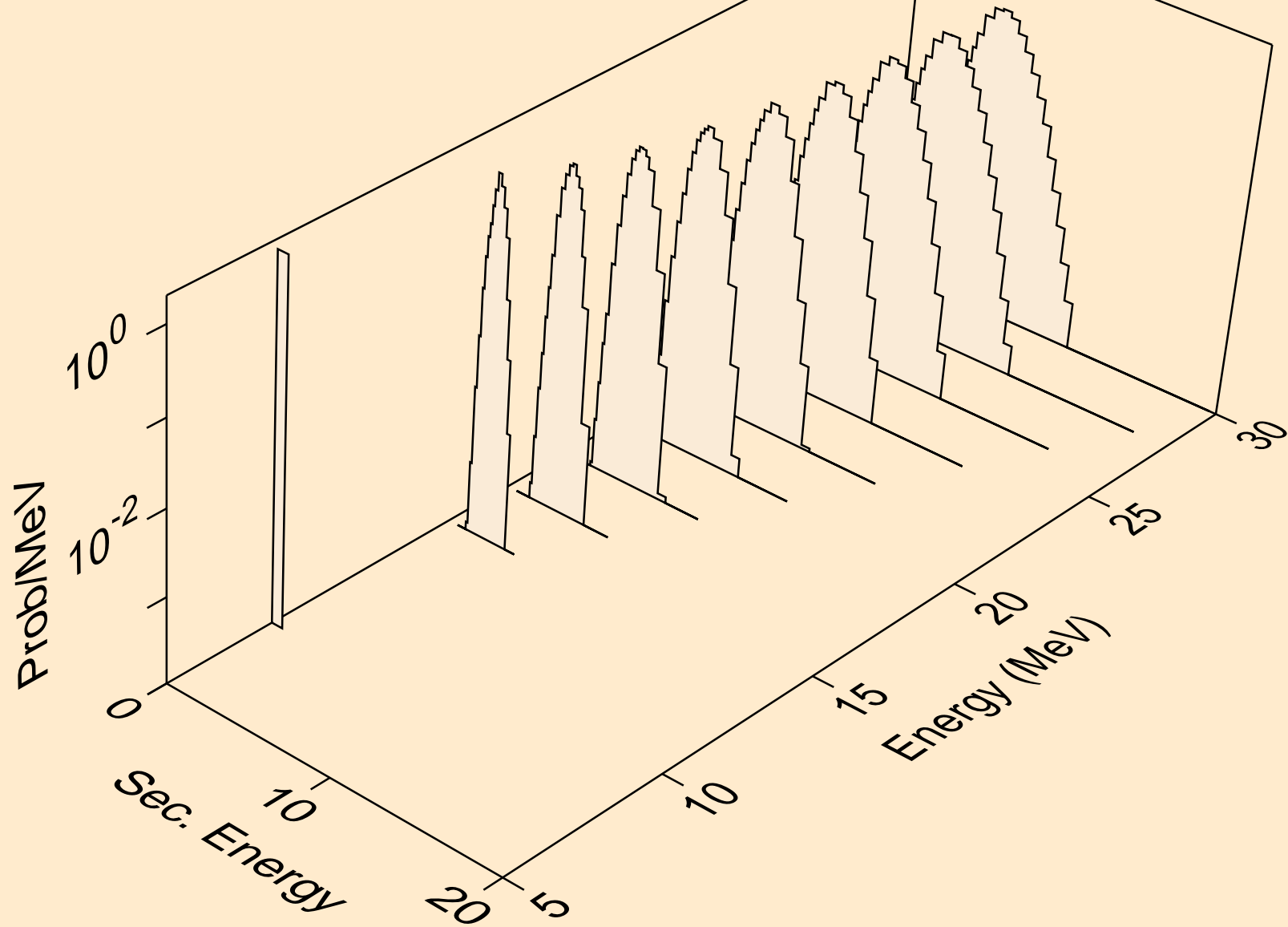

ER159 NEUTRON ACER TENDL-2021 LIBRARY; T=293.6K
deuterons from (n,x)

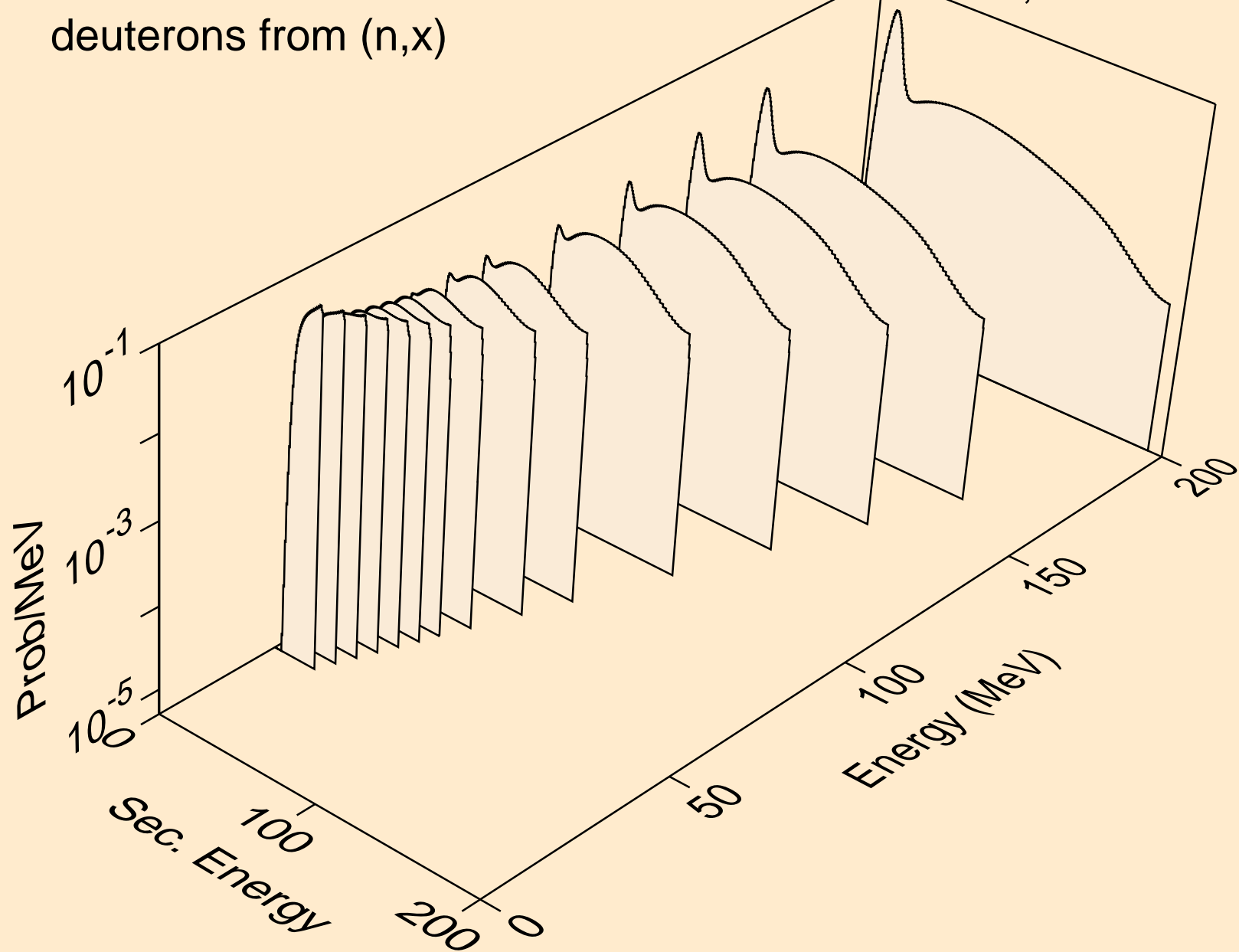

ER159 NEUTRON ACER TENDL-2021 LIBRARY; T=293.6K
deuterons from (n,2nd)

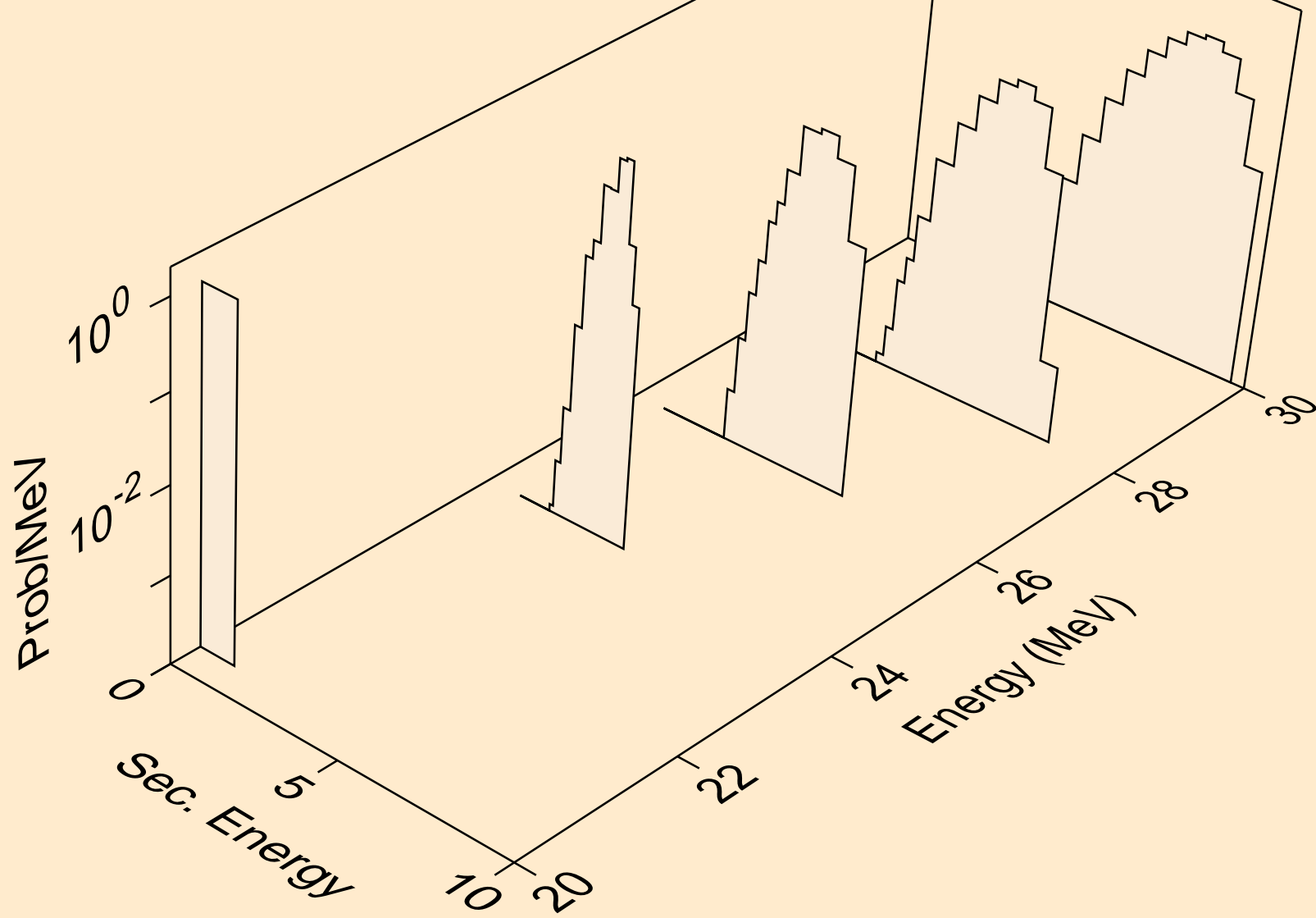

ER159 NEUTRON ACER TENDL-2021 LIBRARY; T=293.6K
deuterons from (n,n*)d

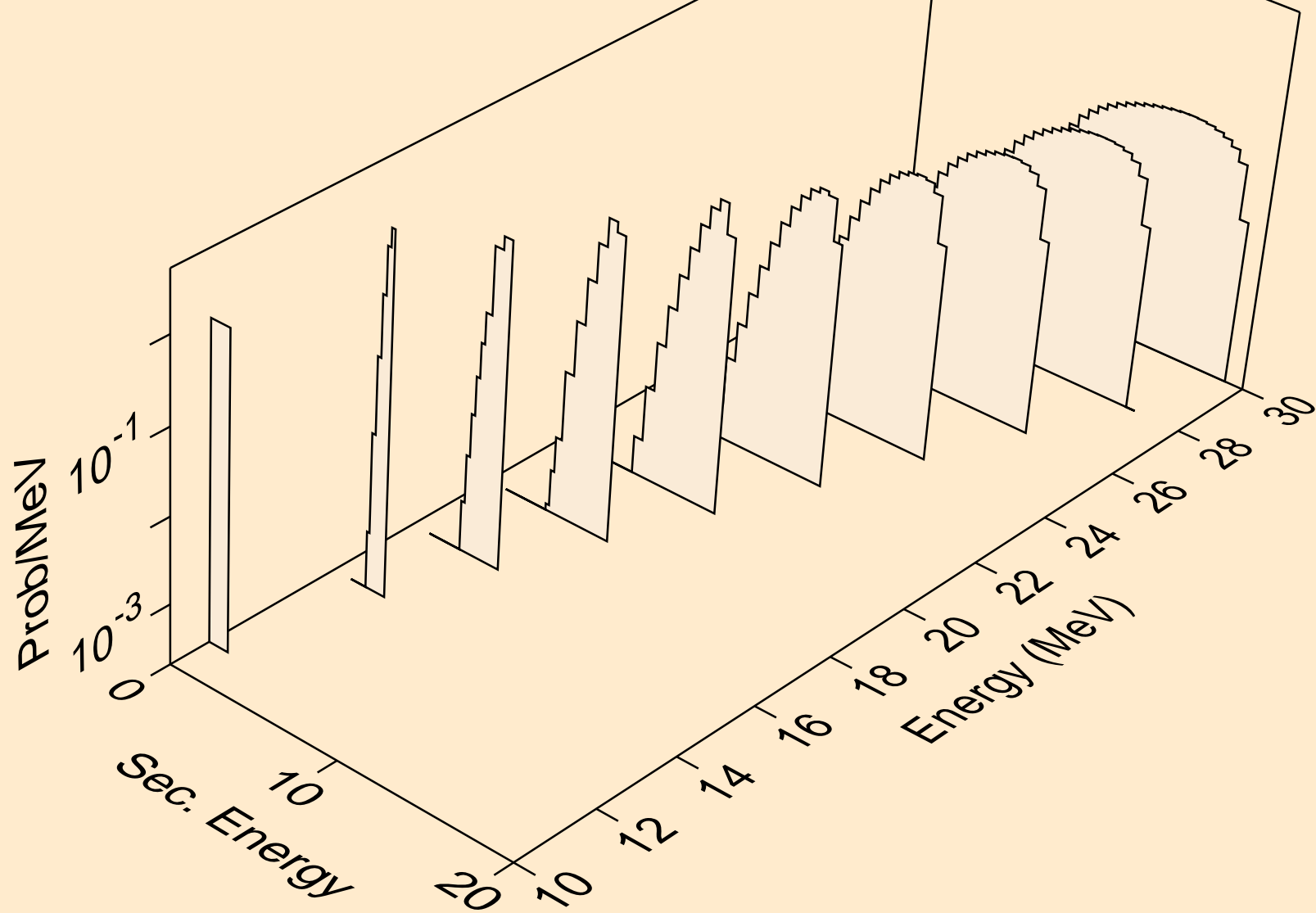

ER159 NEUTRON ACER TENDL-2021 LIBRARY; T=293.6K
deuterons from (n,d)

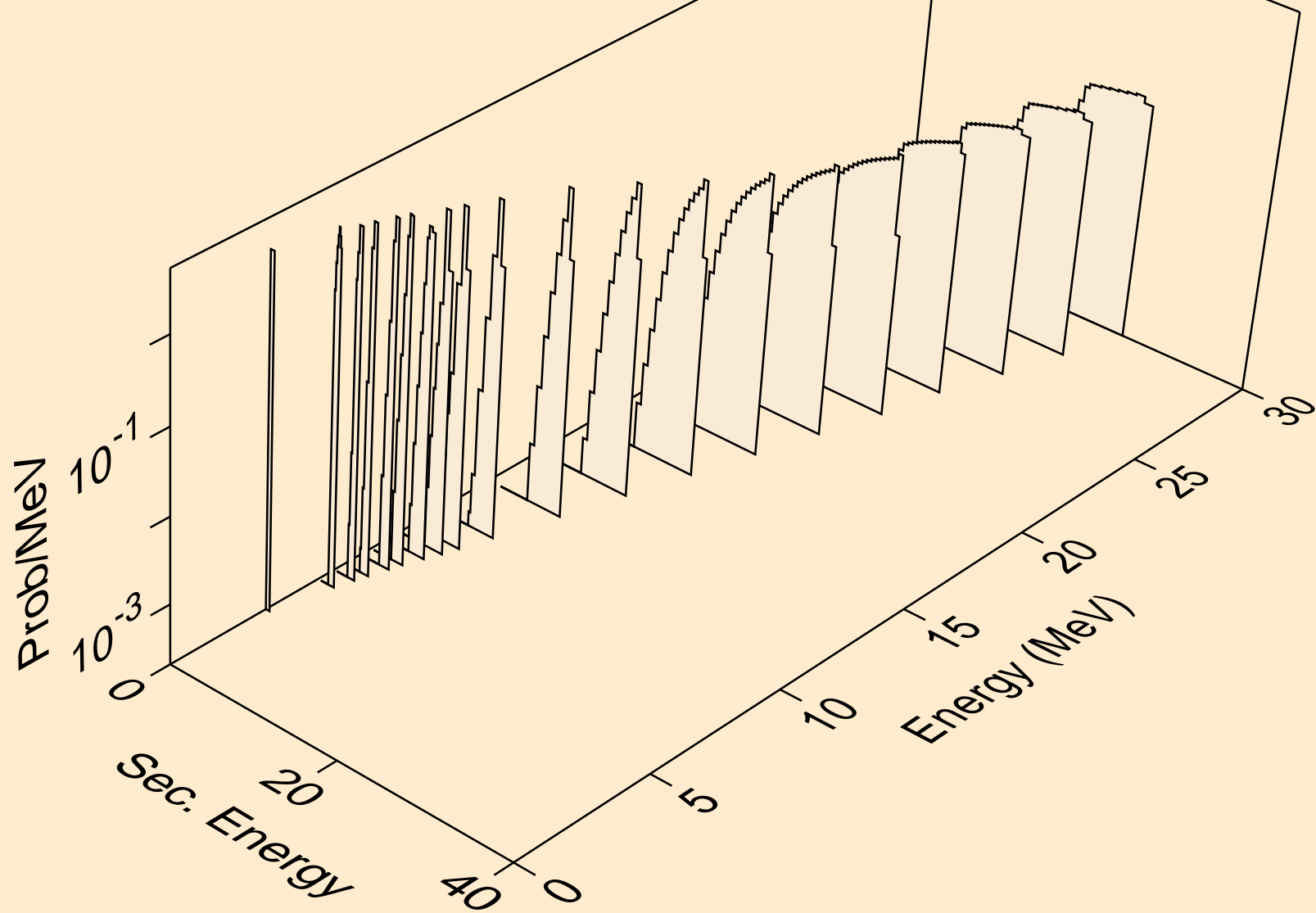

ER159 NEUTRON ACER TENDL-2021 LIBRARY; T=293.6K
deuterons from (n,pd)

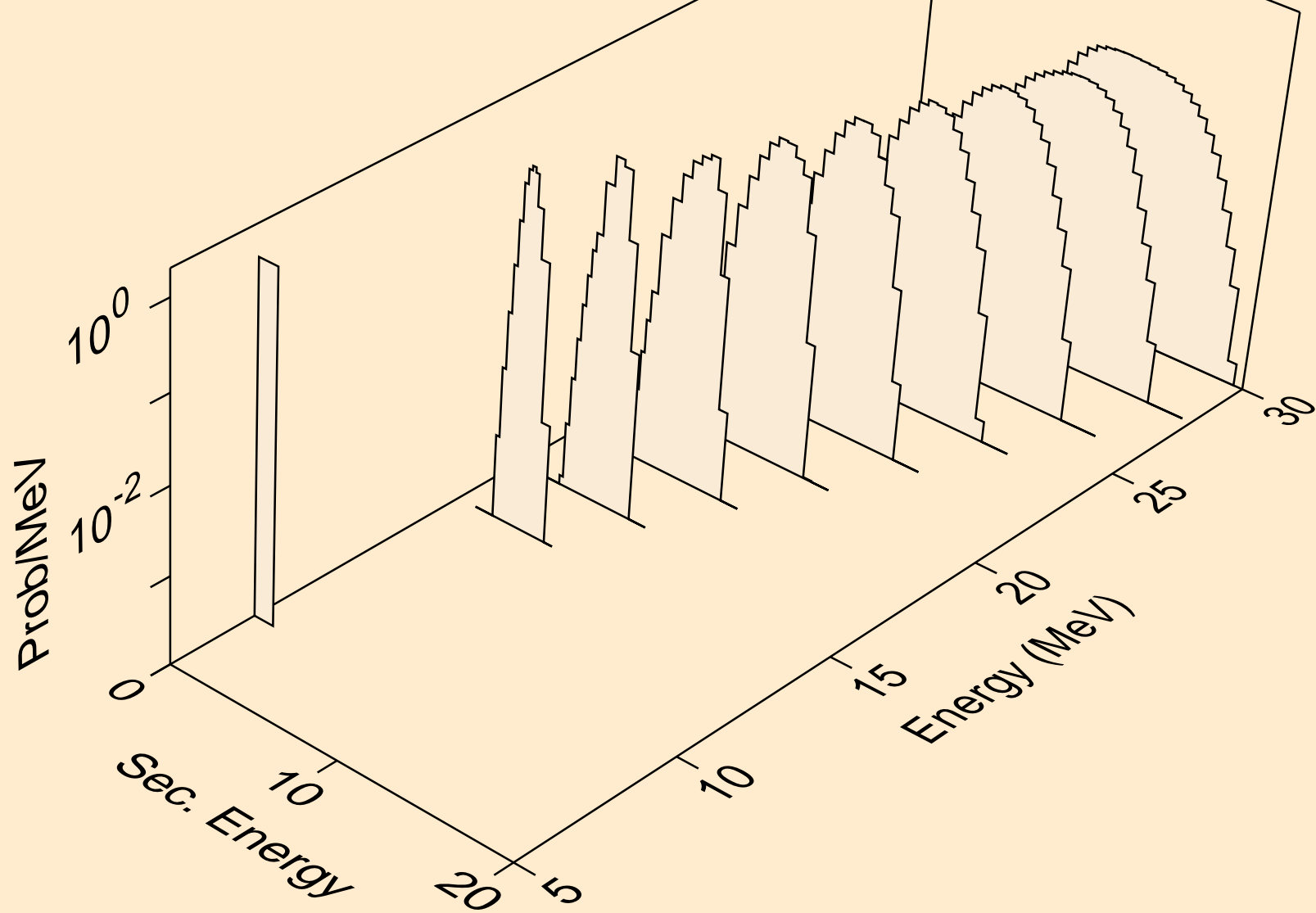

ER159 NEUTRON ACER TENDL-2021 LIBRARY; T=293.6K
deuterons from (n,da)

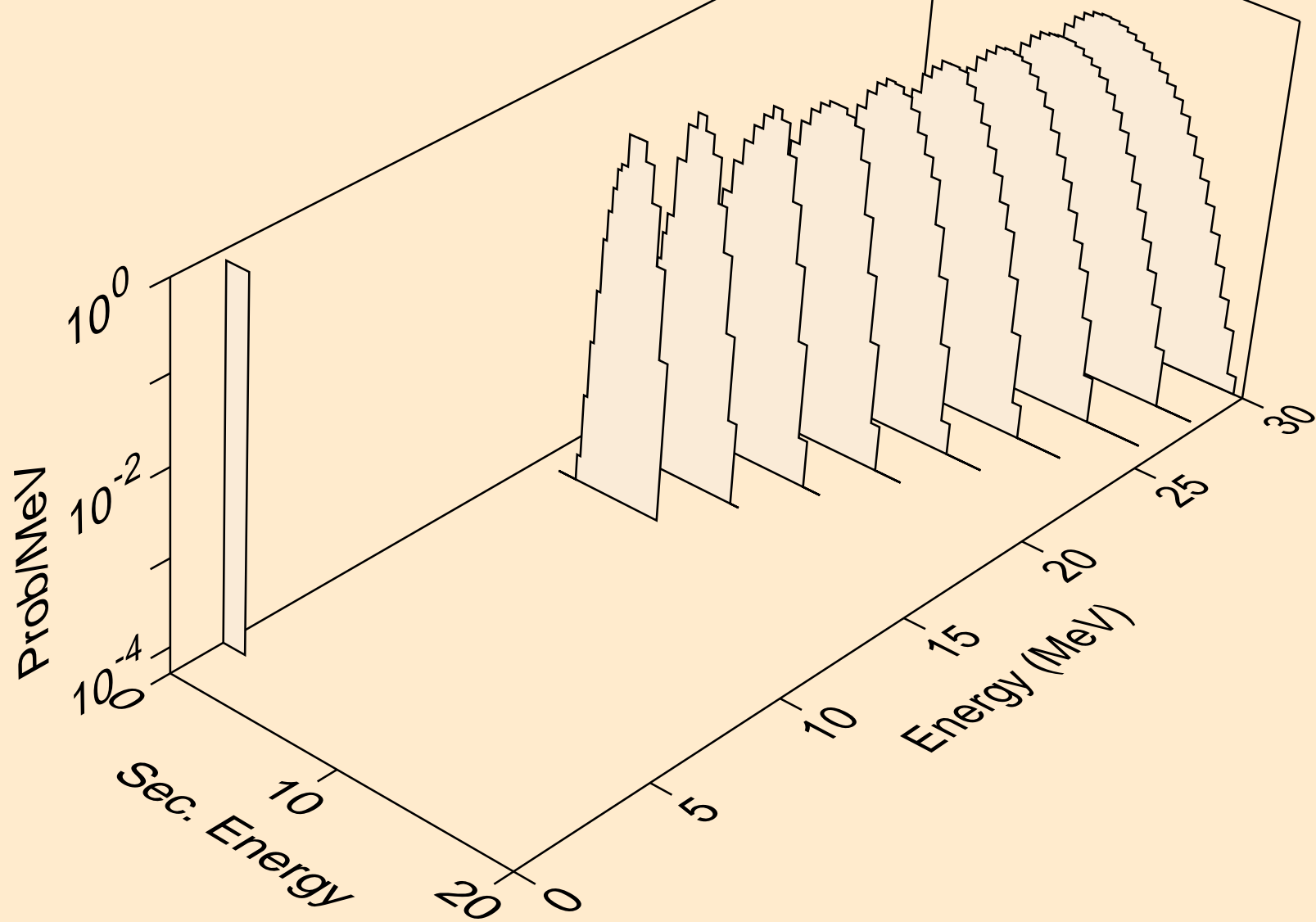

ER159 NEUTRON ACER TENDL-2021 LIBRARY; T=293.6K
tritons from (n,x)

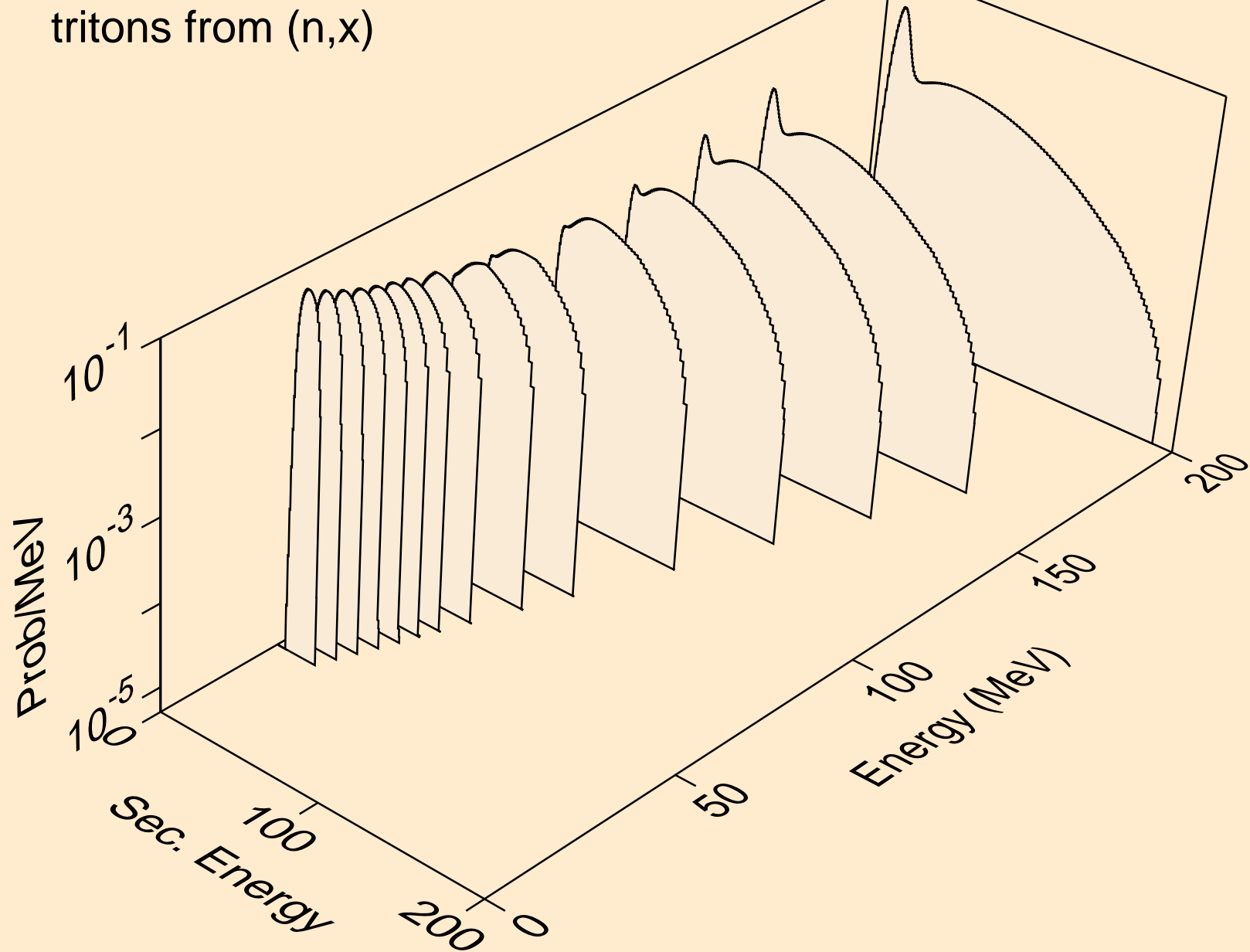

ER159 NEUTRON ACER TENDL-2021 LIBRARY; T=293.6K
tritons from (n,n*)t

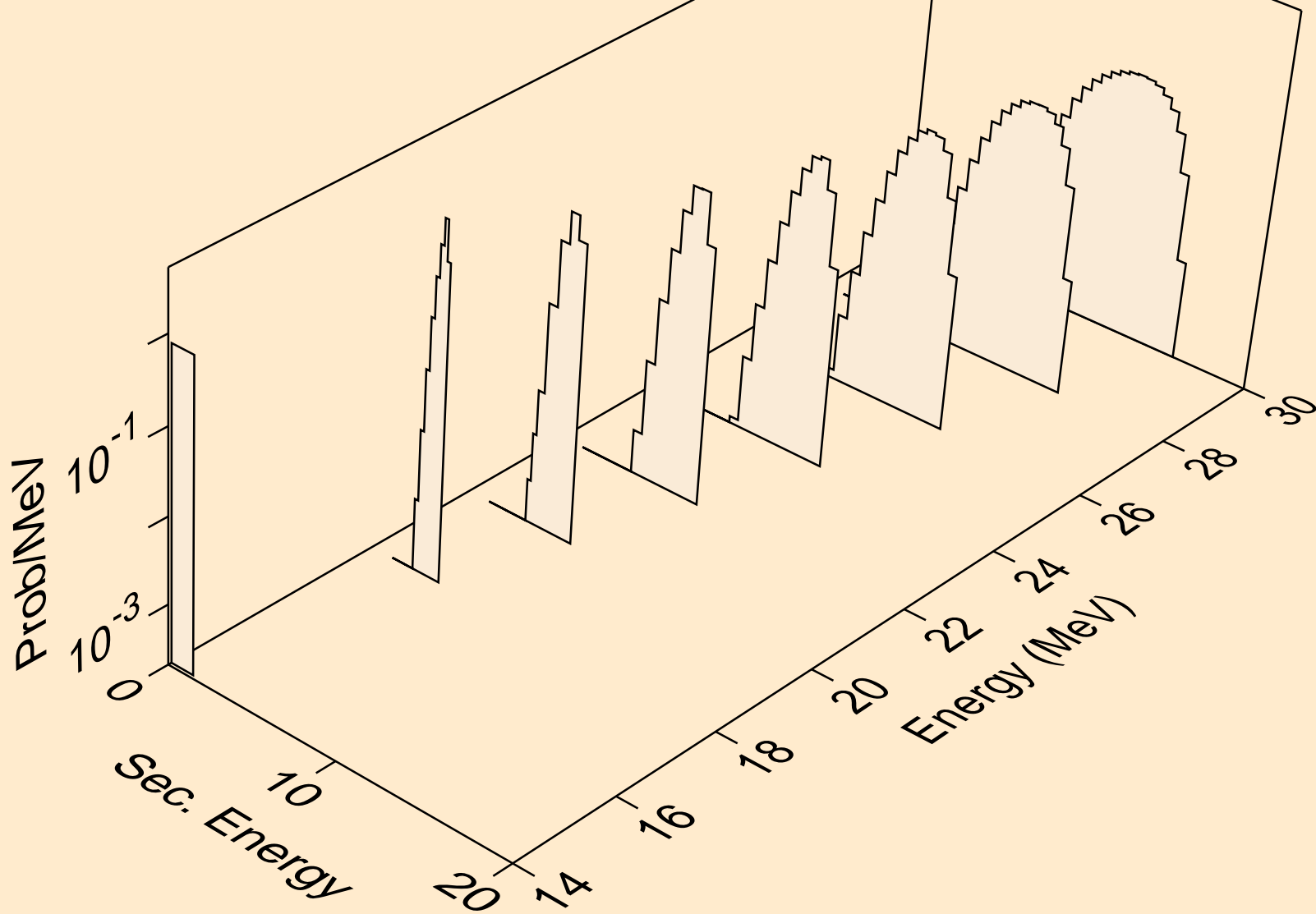

ER159 NEUTRON ACER TENDL-2021 LIBRARY; T=293.6K
tritons from (n,t)

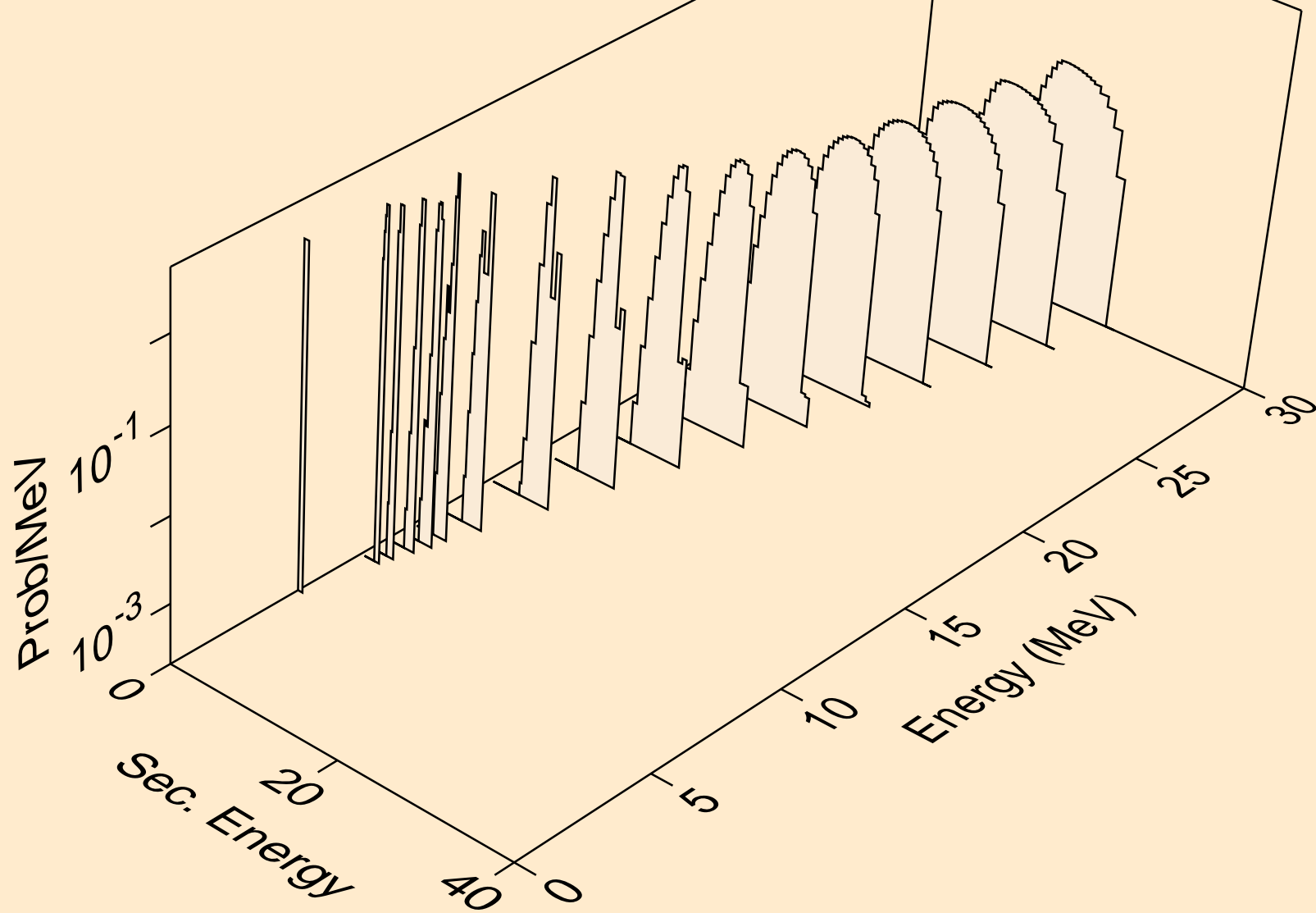

ER159 NEUTRON ACER TENDL-2021 LIBRARY; T=293.6K
tritons from (n,pt)

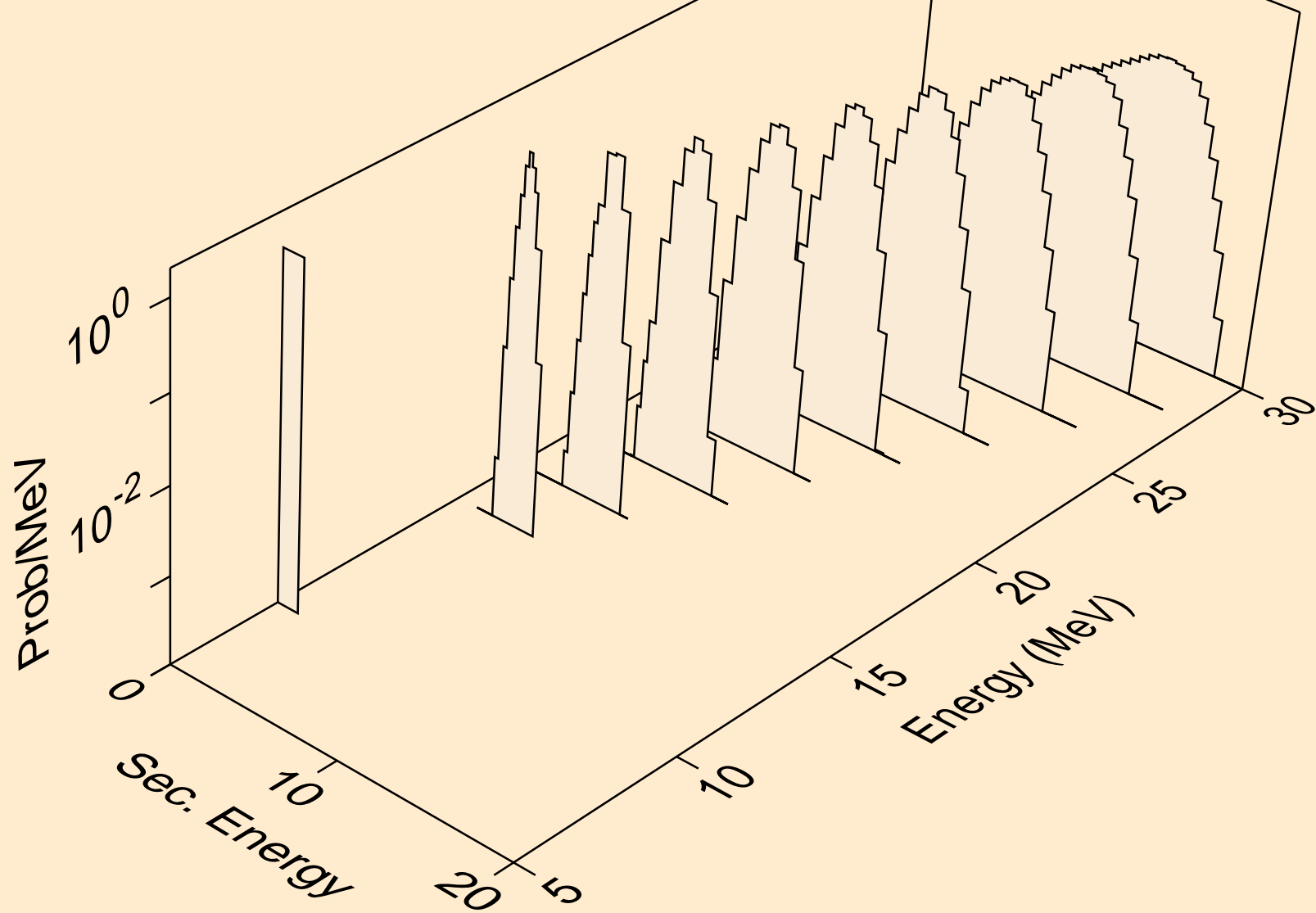

ER159 NEUTRON ACER TENDL-2021 LIBRARY; T=293.6K
he3s from (n,x)

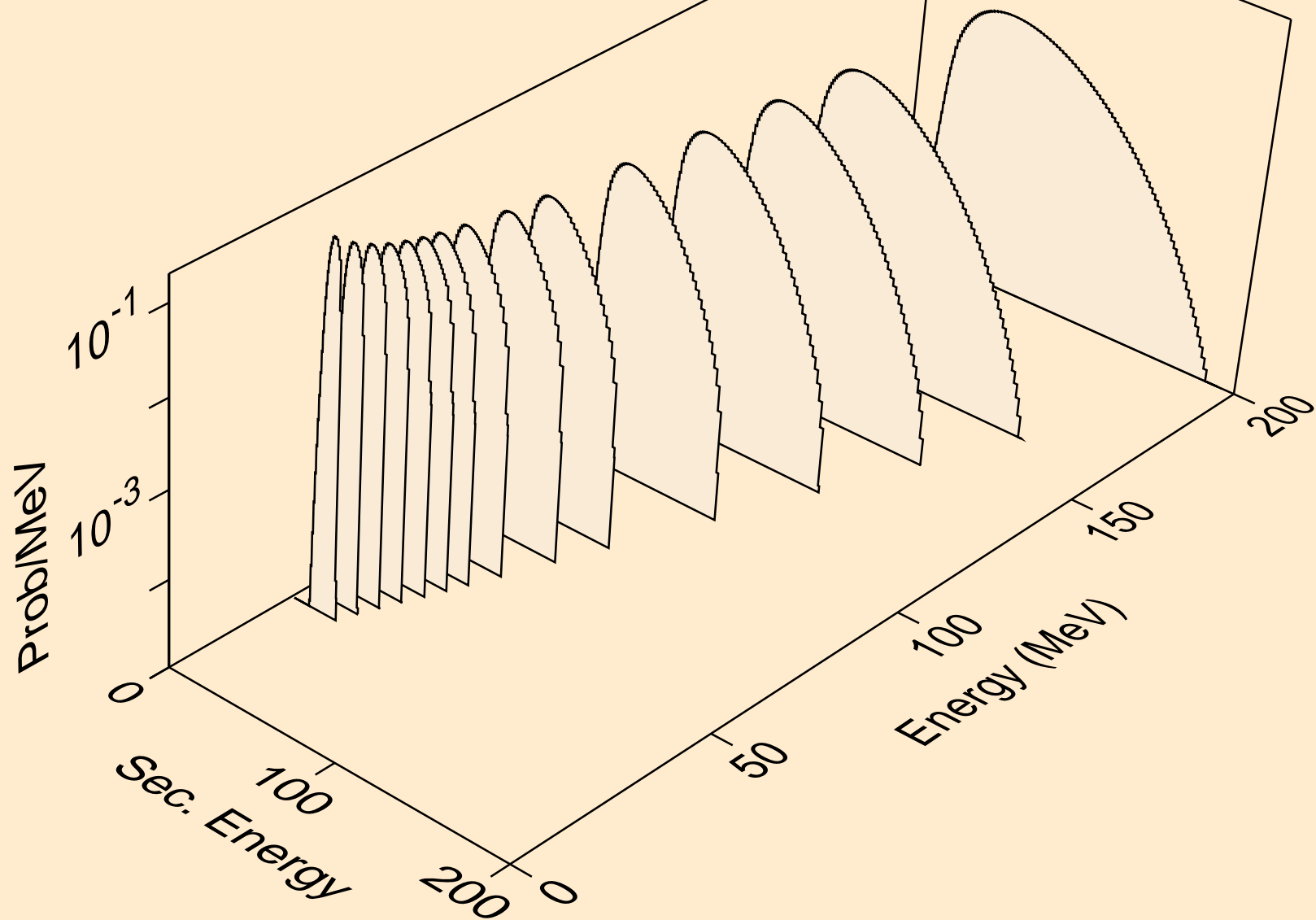

ER159 NEUTRON ACER TENDL-2021 LIBRARY; T=293.6K
he3s from (n,n*)he3

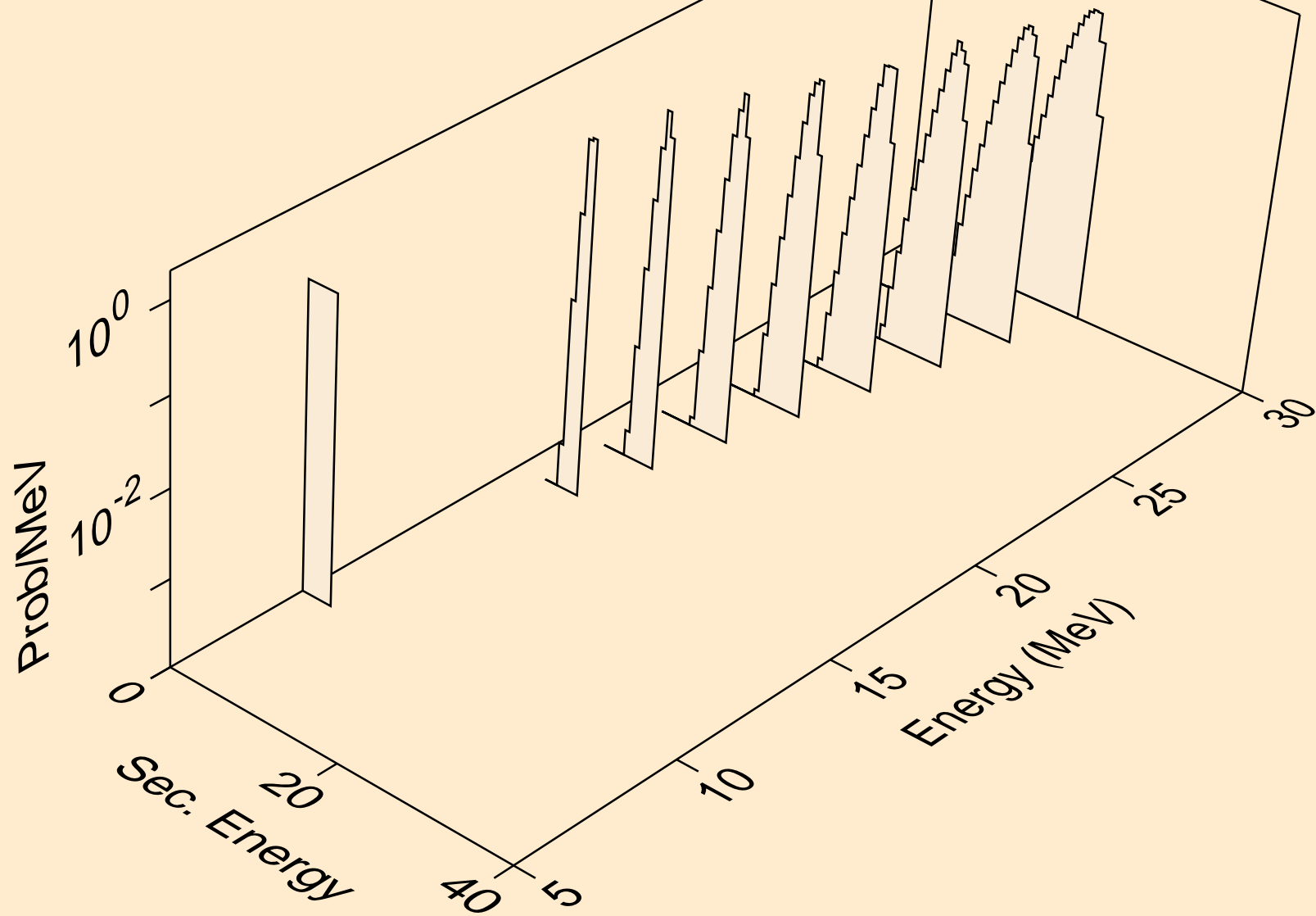

ER159 NEUTRON ACER TENDL-2021 LIBRARY; T=293.6K
he3s from (n,he3)

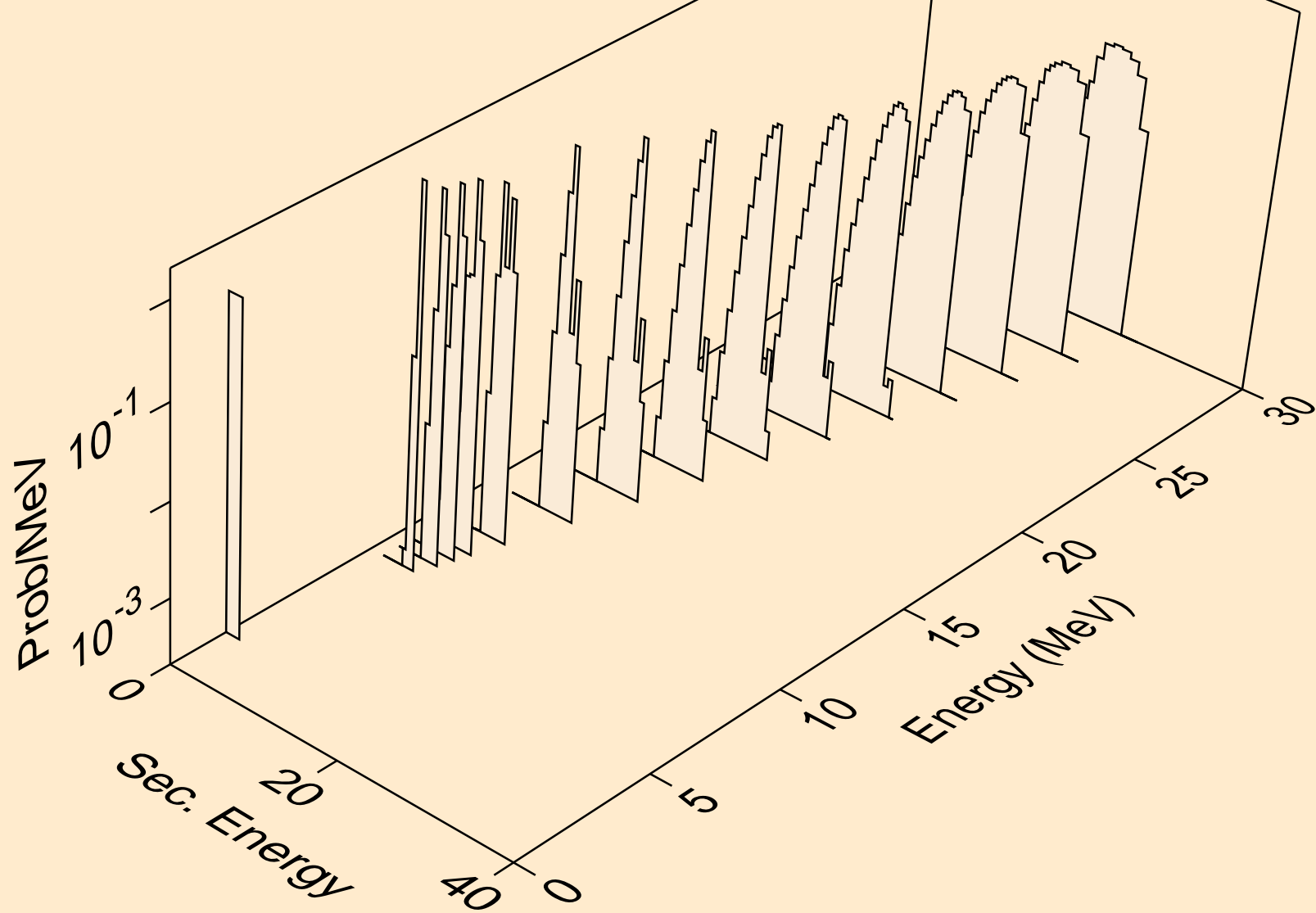

ER159 NEUTRON ACER TENDL-2021 LIBRARY; T=293.6K
alphas from (n,x)

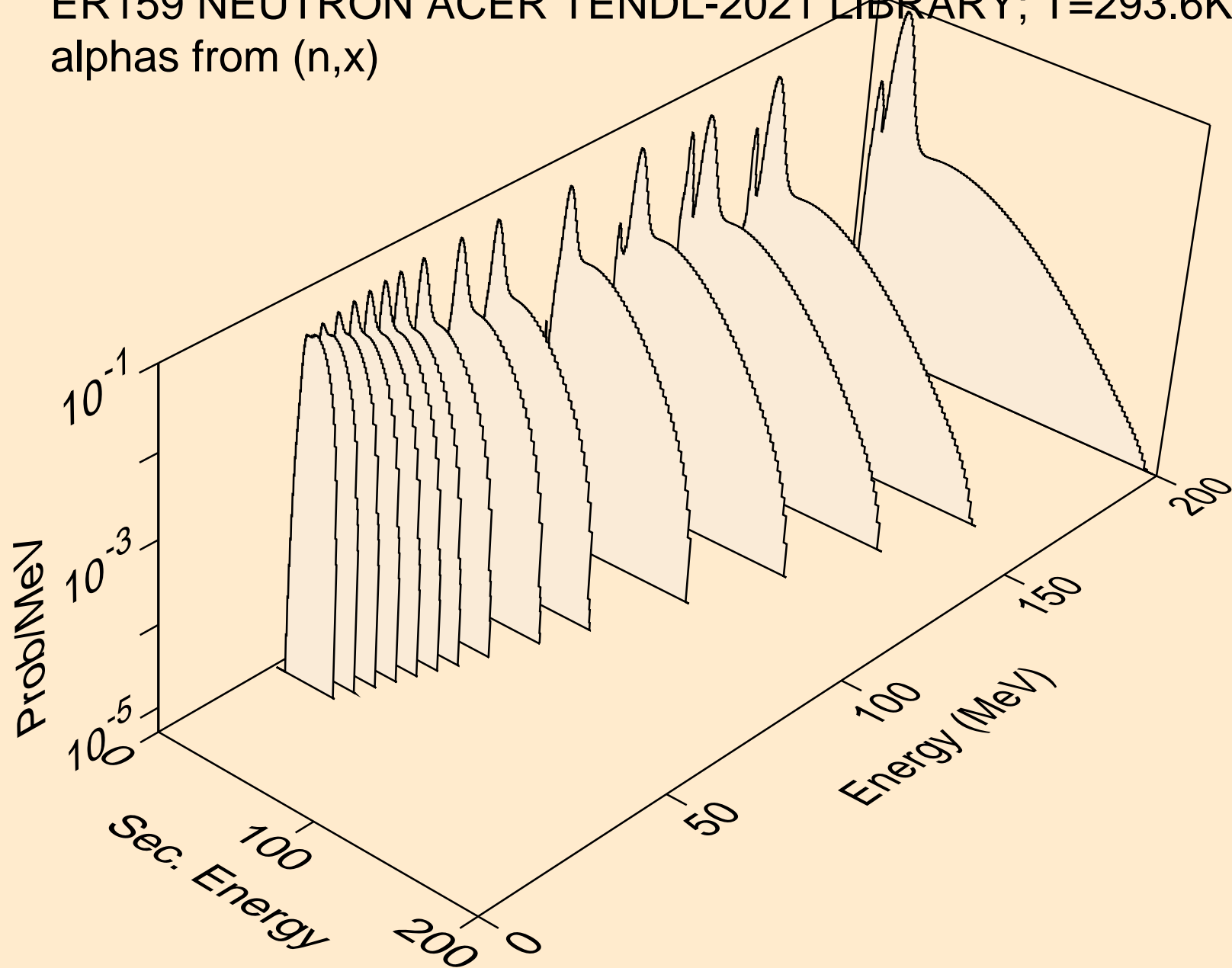

ER159 NEUTRON ACER TENDL-2021 LIBRARY; T=293.6K
alphas from (n,n*)a

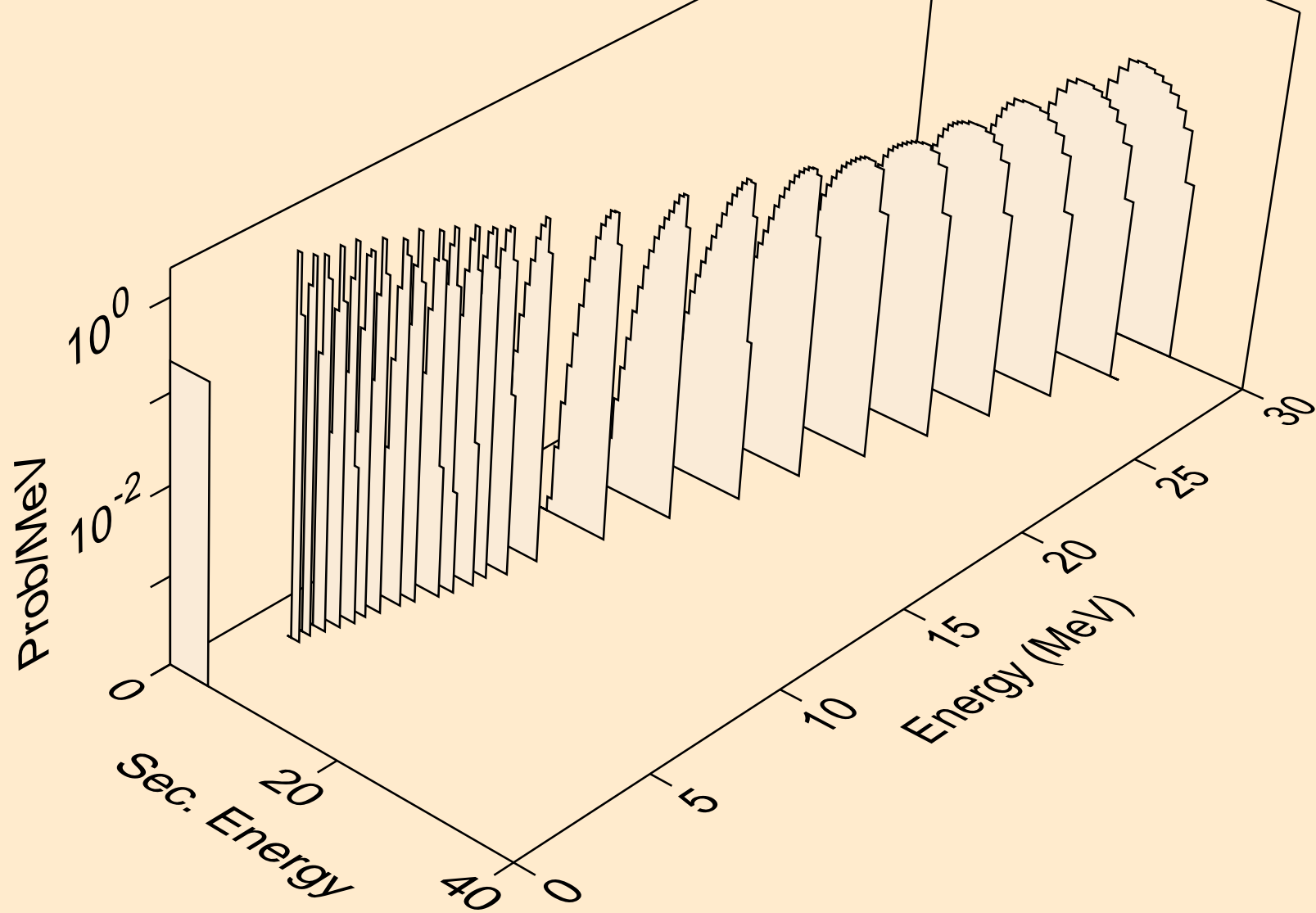

ER159 NEUTRON ACER TENDL-2021 LIBRARY; T=293.6K
alphas from (n,2n)a

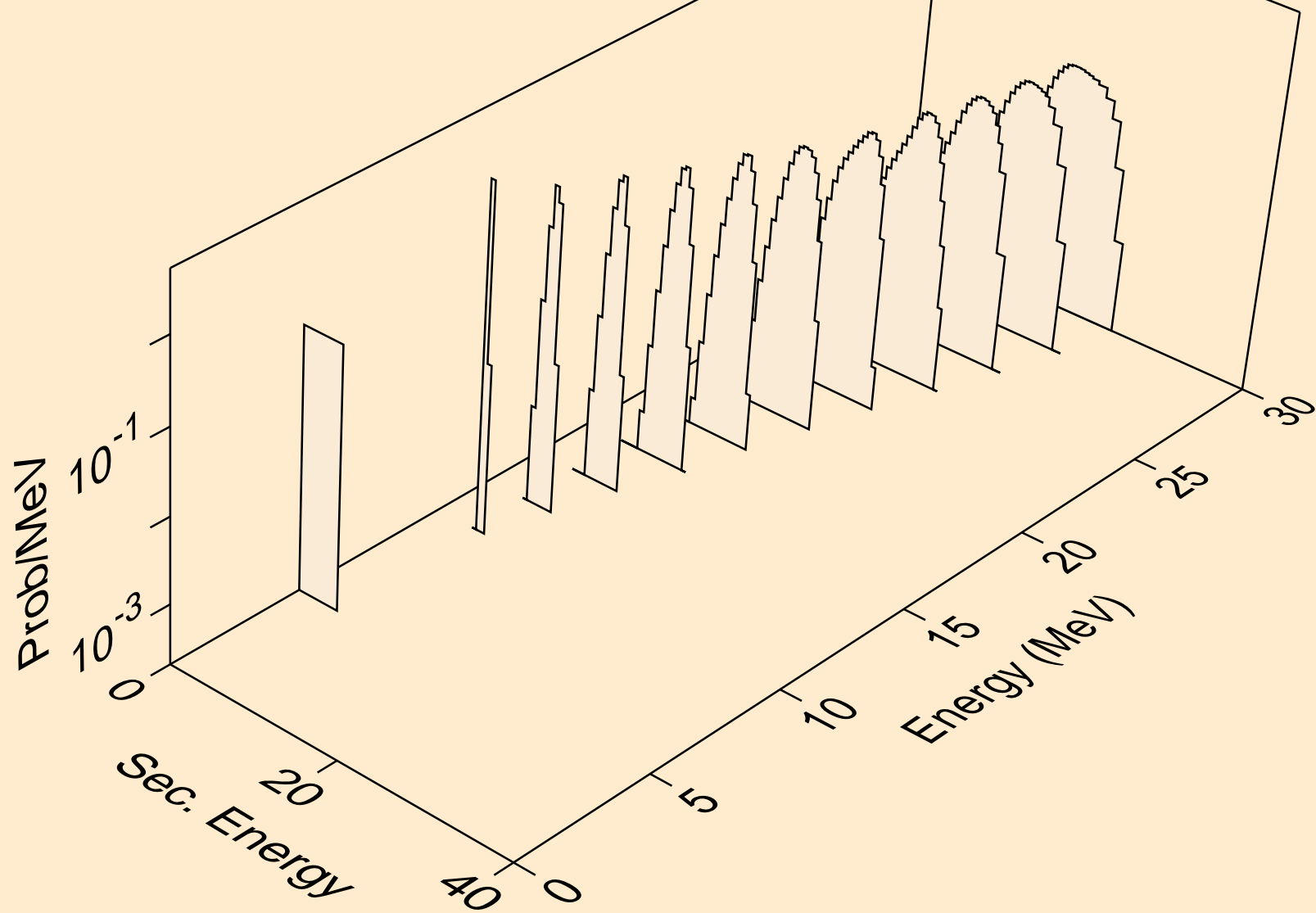

ER159 NEUTRON ACER TENDL-2021 LIBRARY; T=293.6K
alphas from (n,3n)a

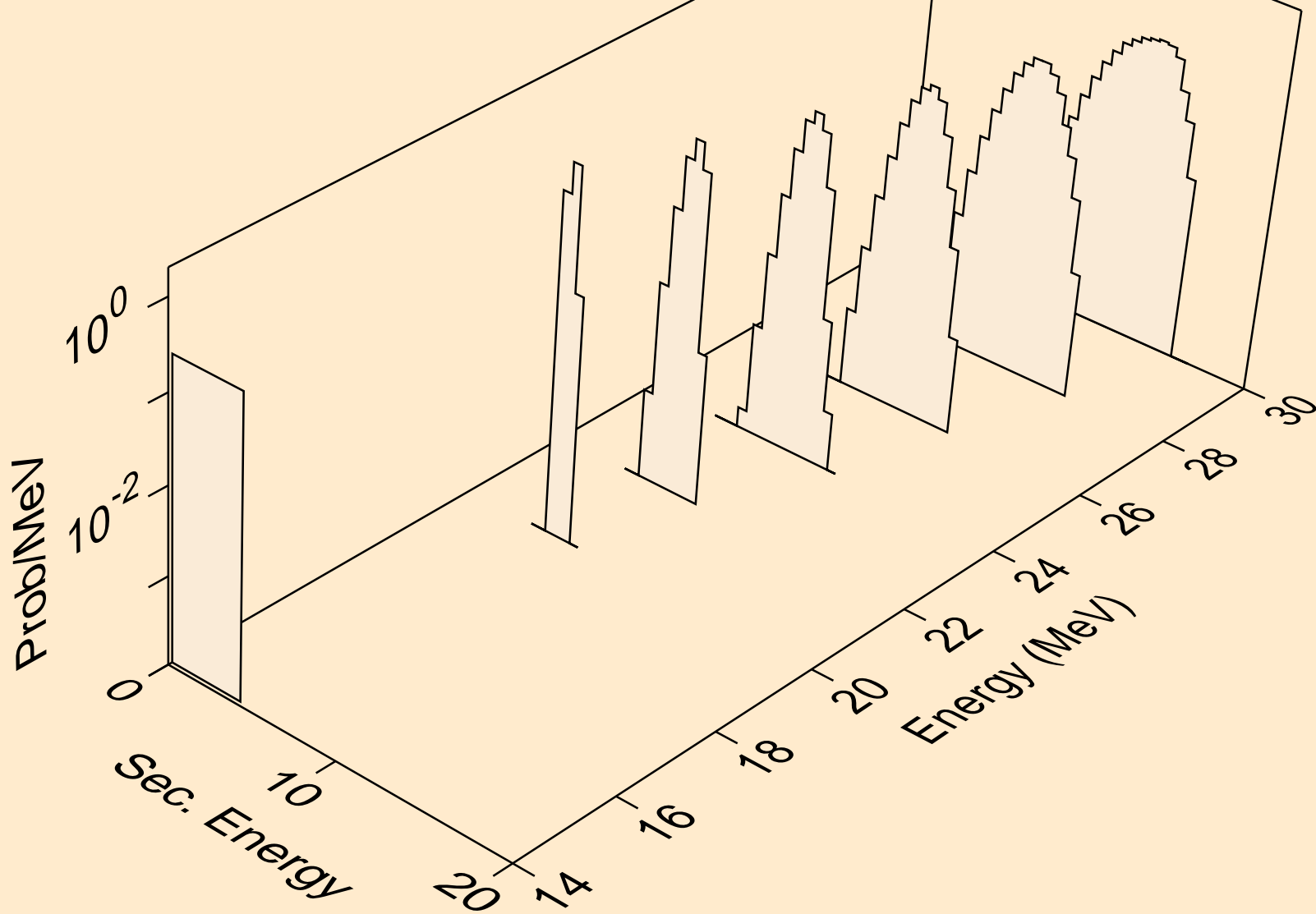

ER159 NEUTRON ACER TENDL-2021 LIBRARY; T=293.6K
alphas from (n,n*)2a

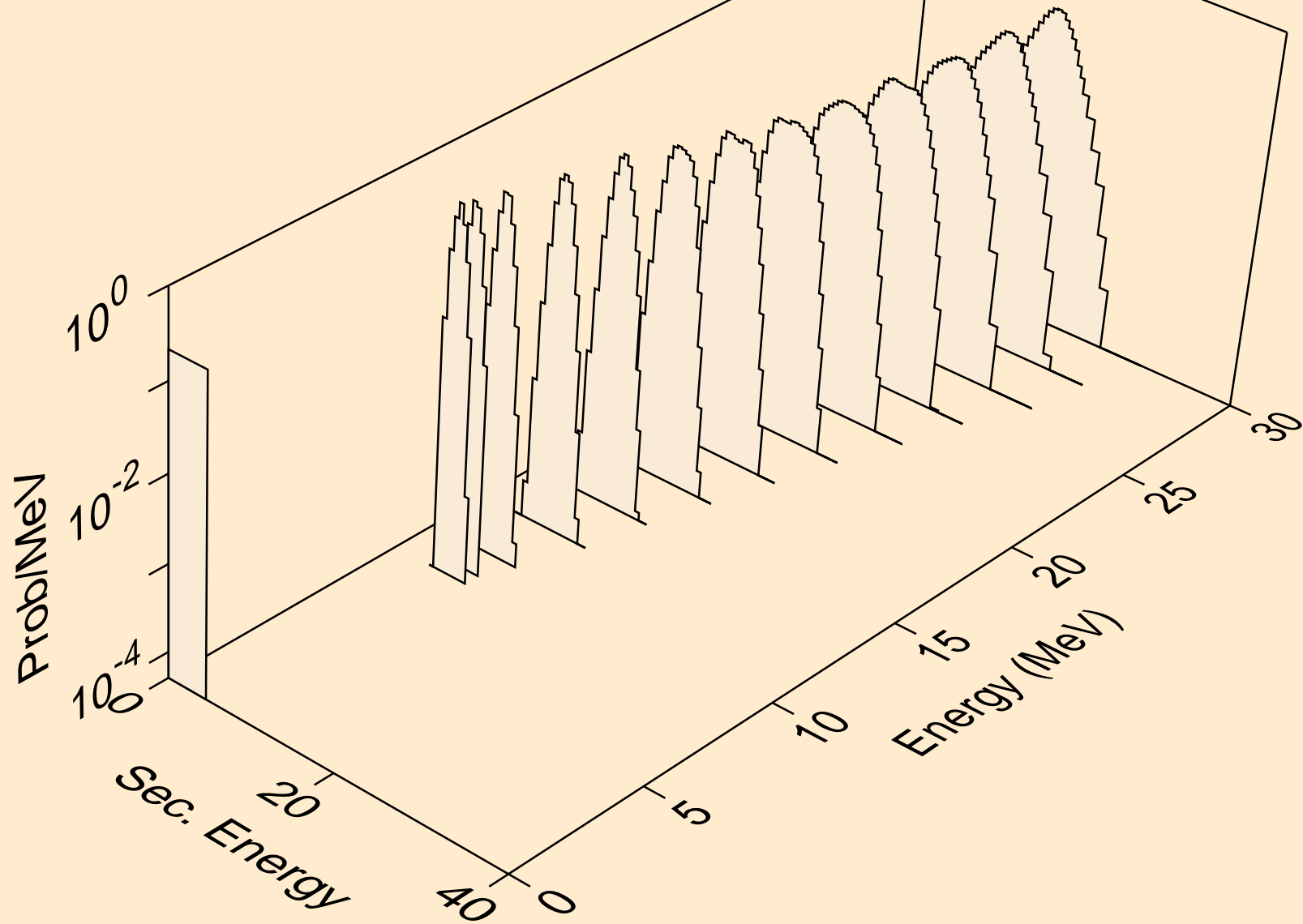

ER159 NEUTRON ACER TENDL-2021 LIBRARY; T=293.6K
alphas from (n,2n)2a

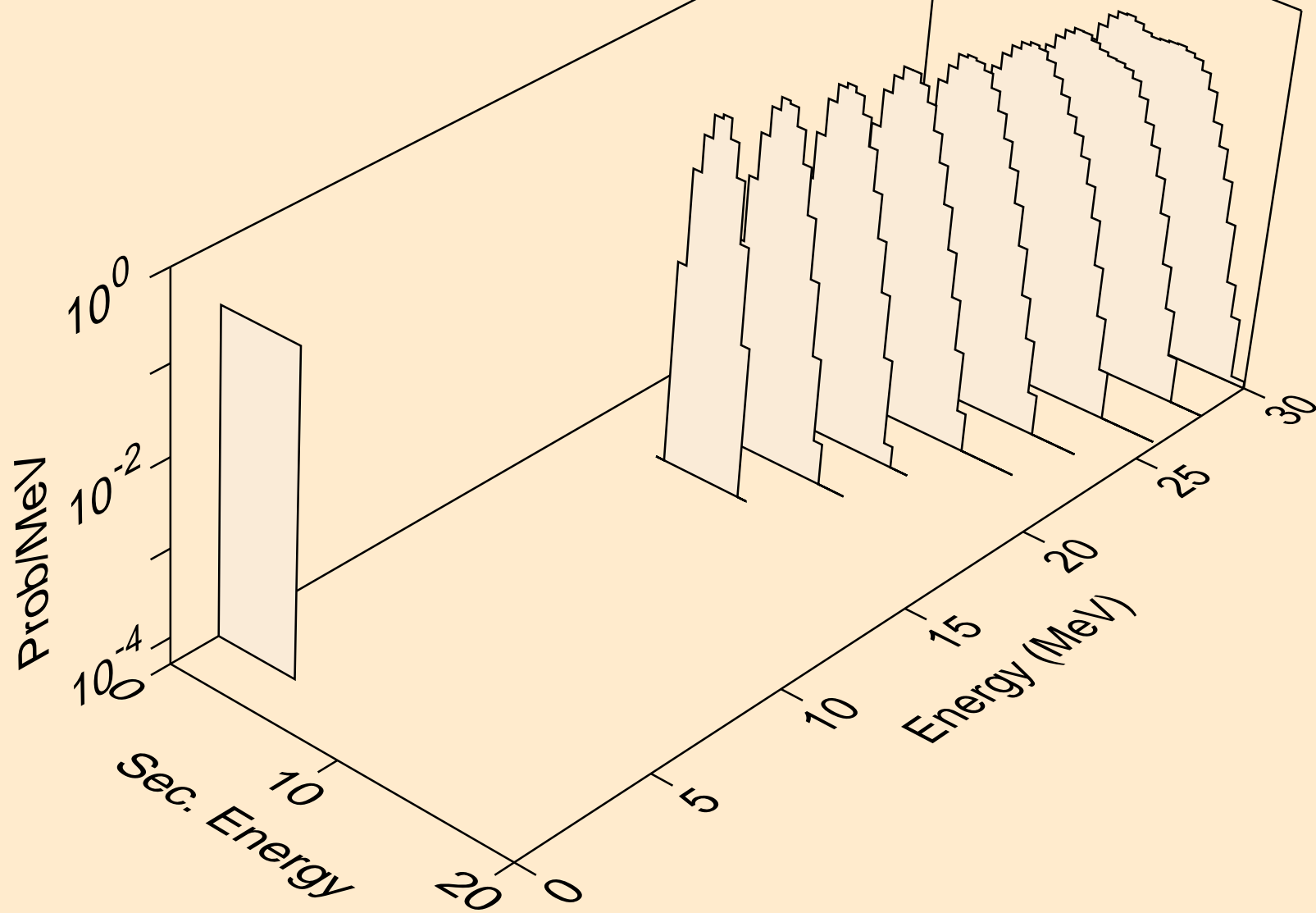

ER159 NEUTRON ACER TENDL-2021 LIBRARY; T=293.6K
alphas from (n,npa)

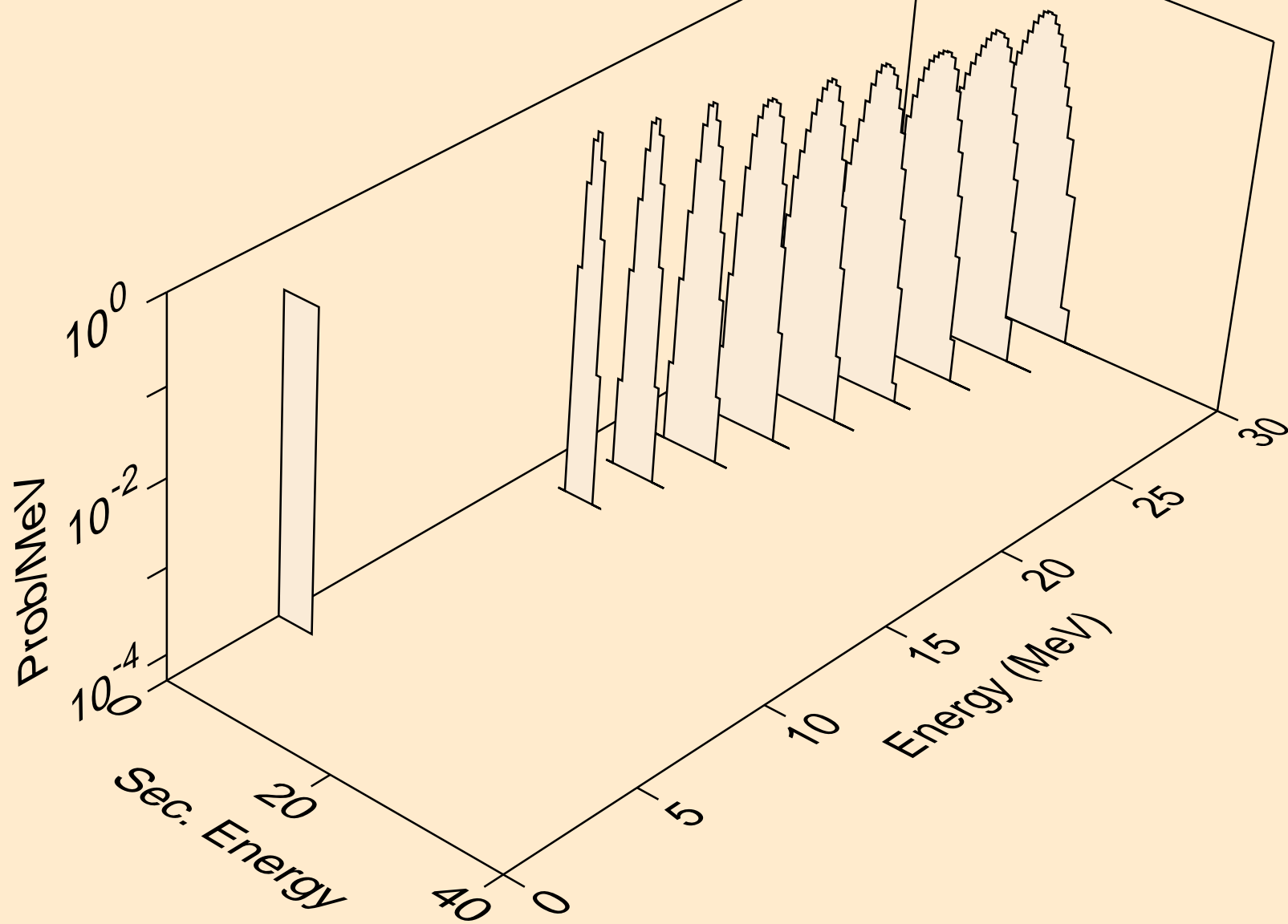

ER159 NEUTRON ACER TENDL-2021 LIBRARY; T=293.6K
alphas from (n,a)

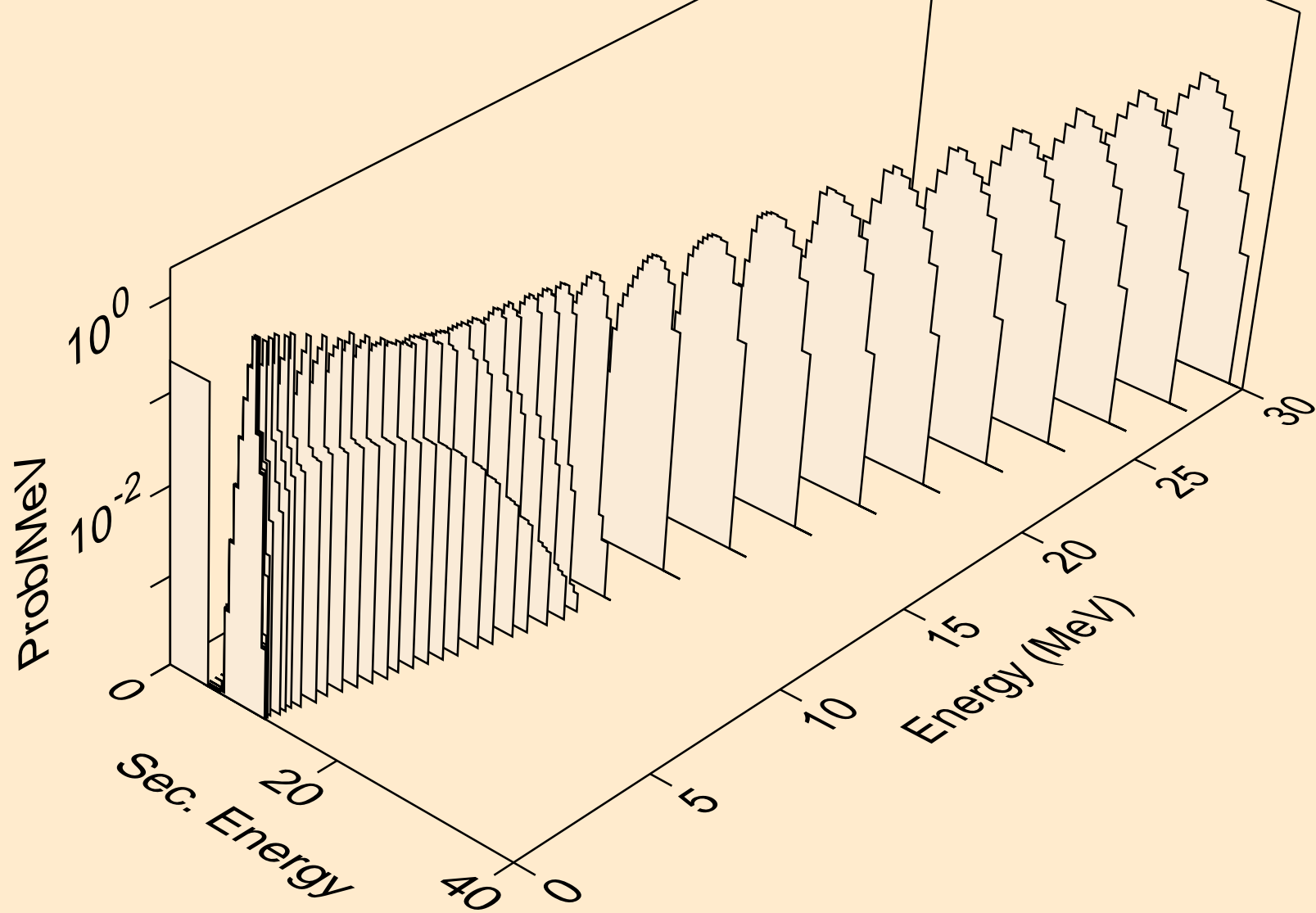

ER159 NEUTRON ACER TENDL-2021 LIBRARY; T=293.6K
alphas from (n,2a)

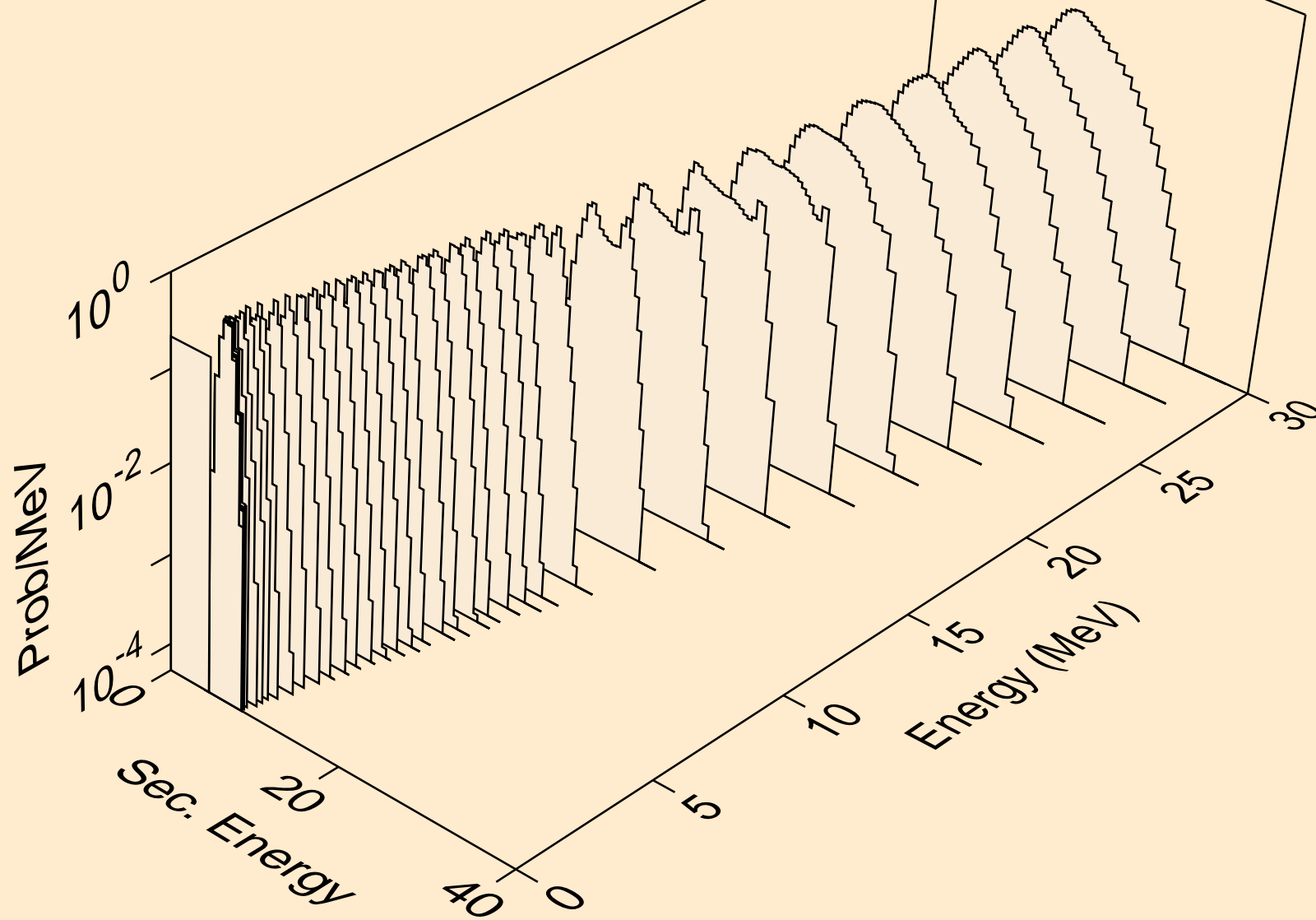

ER159 NEUTRON ACER TENDL-2021 LIBRARY; T=293.6K
alphas from (n,pa)

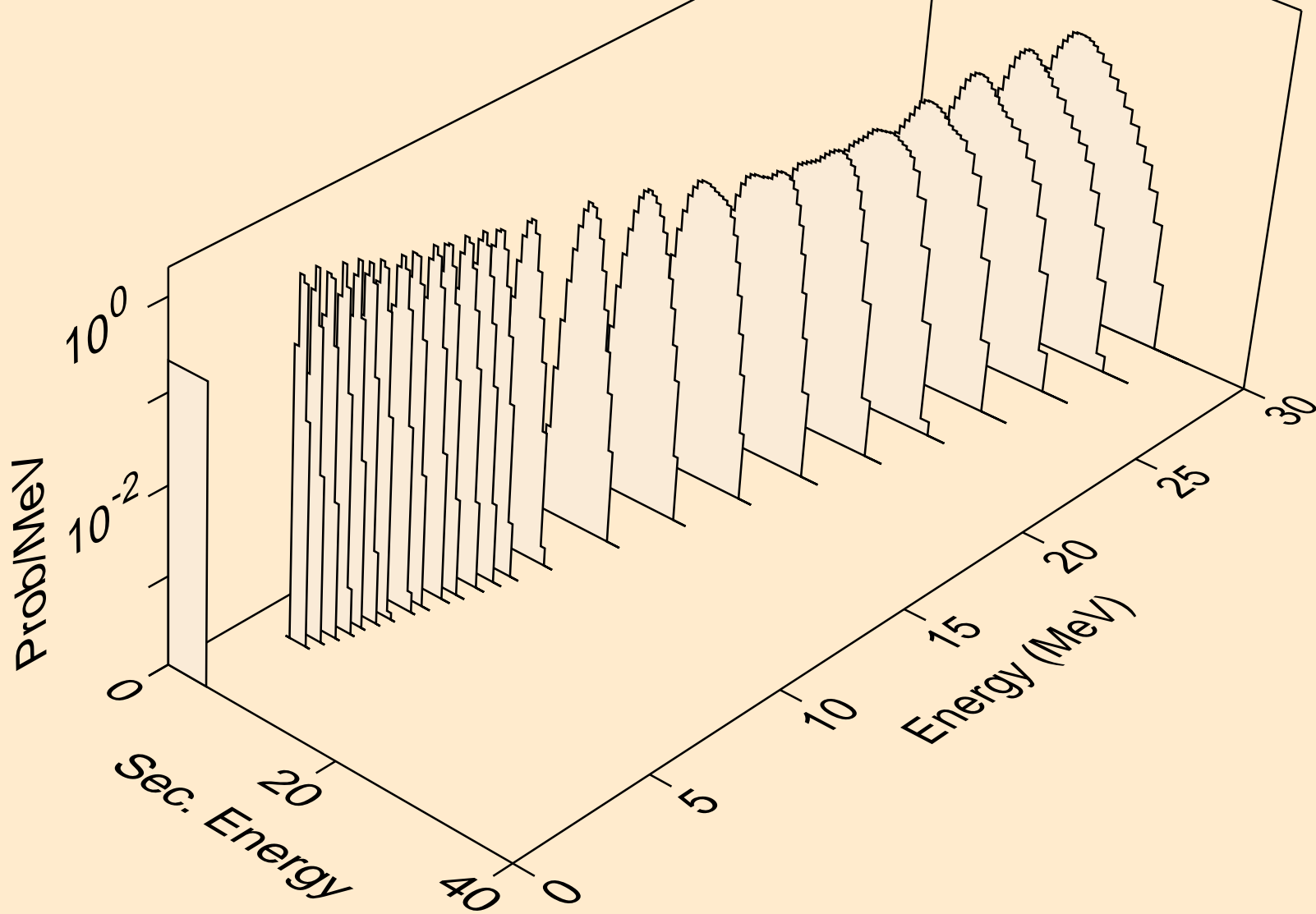

ER159 NEUTRON ACER TENDL-2021 LIBRARY; T=293.6K
alphas from (n,da)

