

ER177 NEUTRON ACER TENDL-2021 LIBRARY; T=293.6K
Principal cross sections

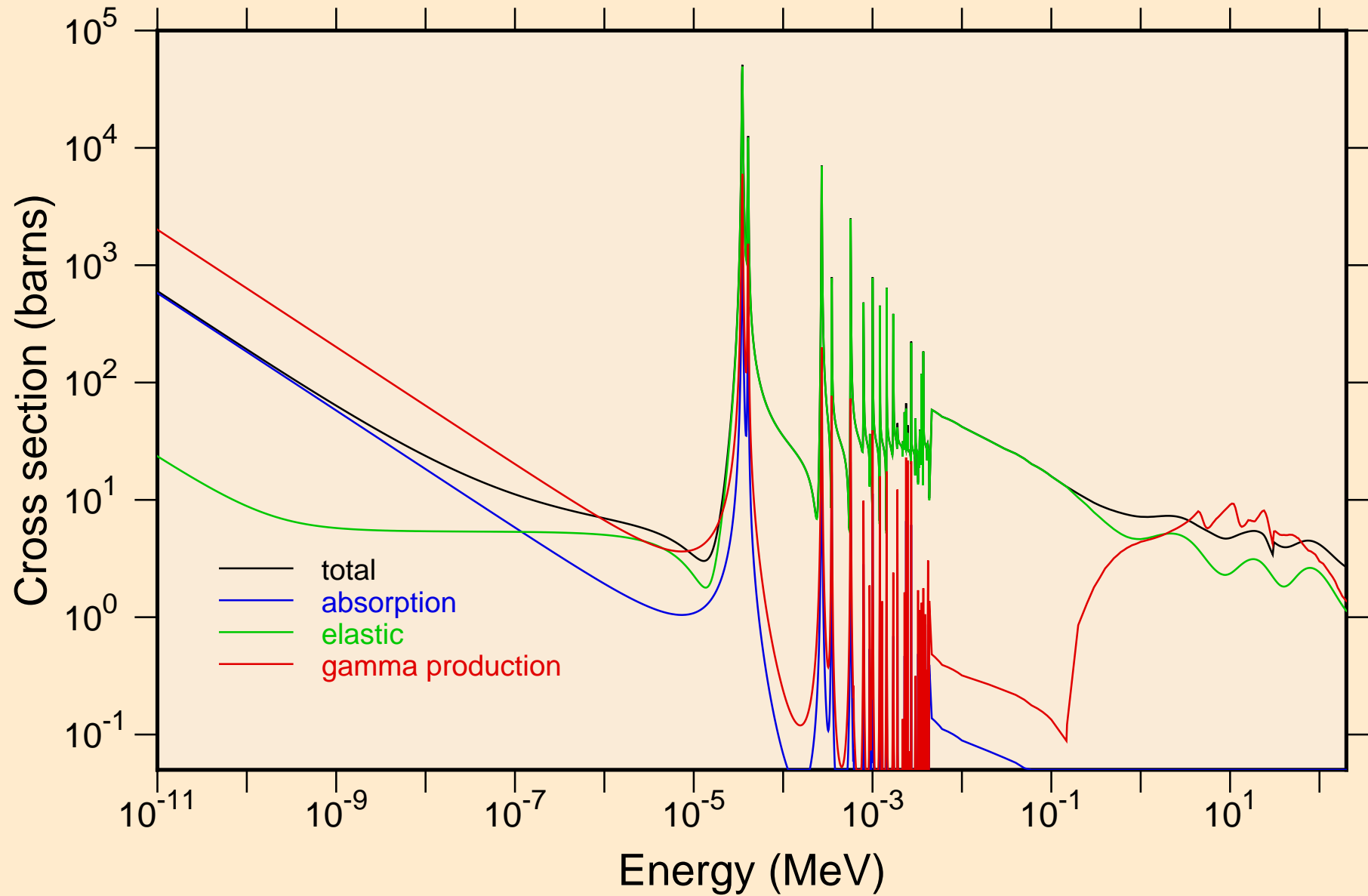

ER177 NEUTRON ACER TENDL-2021 LIBRARY; T=293.6K
resonance total cross section

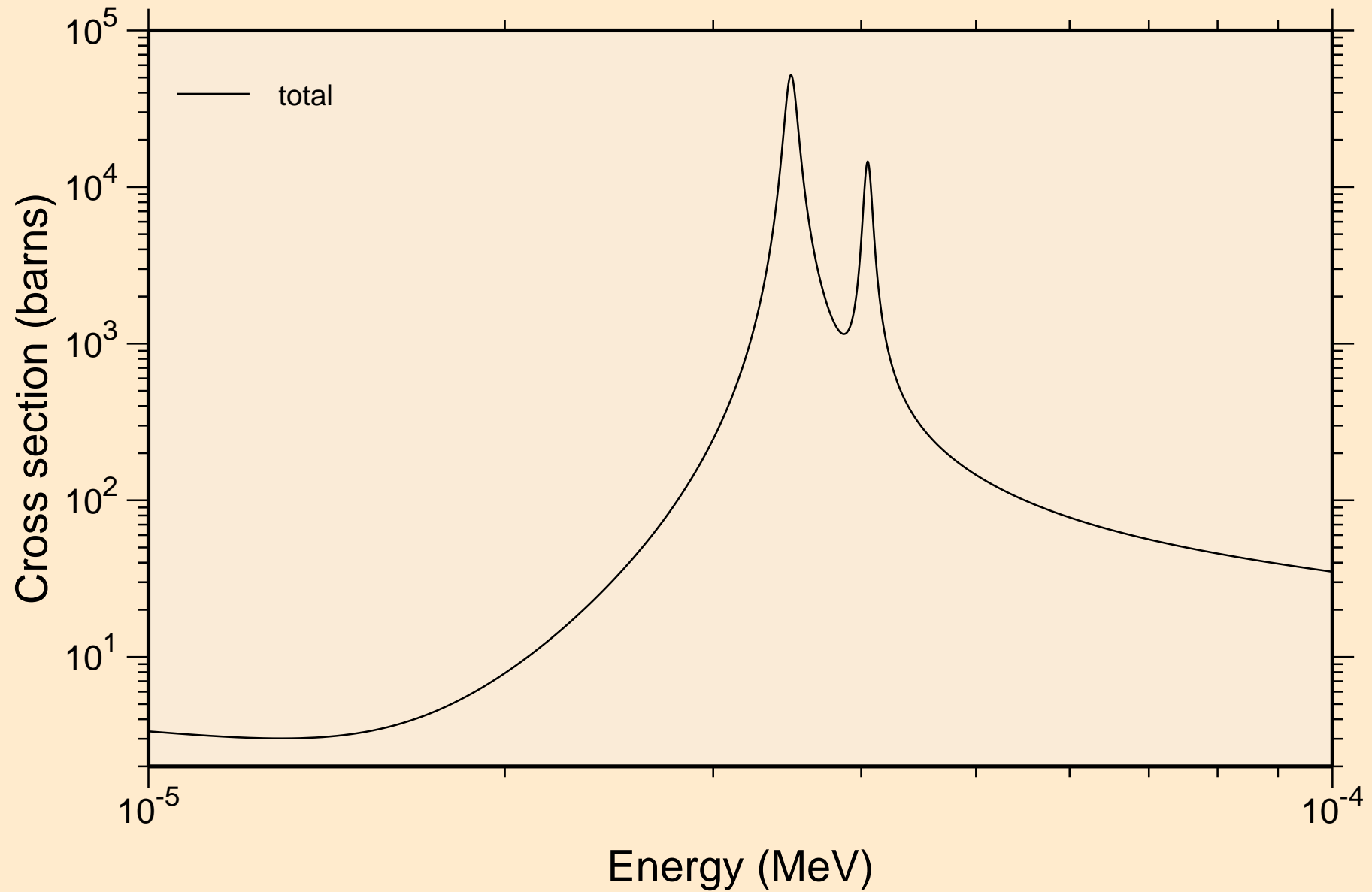

ER177 NEUTRON ACER TENDL-2021 LIBRARY; T=293.6K
resonance total cross section

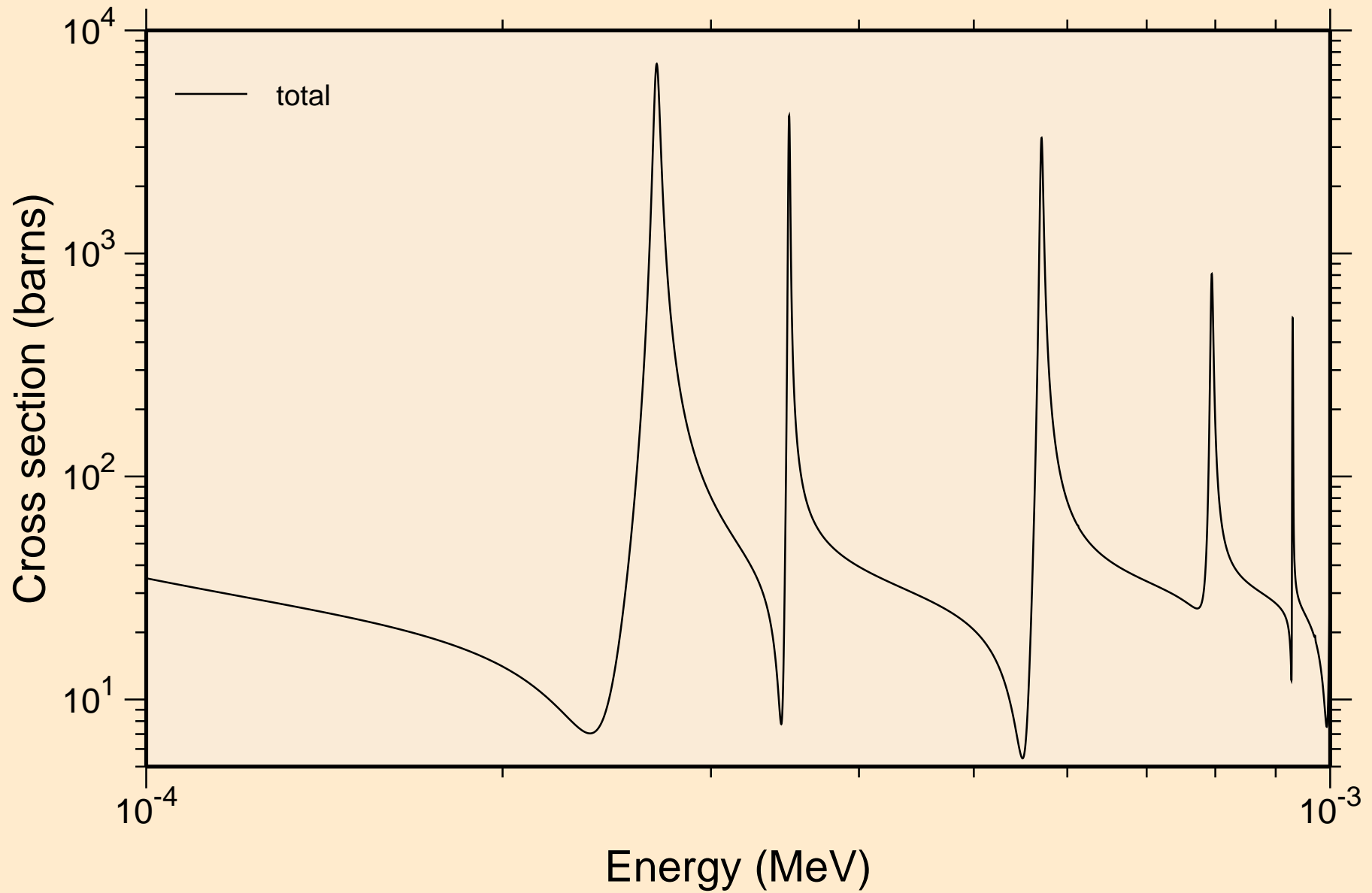

ER177 NEUTRON ACER TENDL-2021 LIBRARY; T=293.6K
resonance total cross section

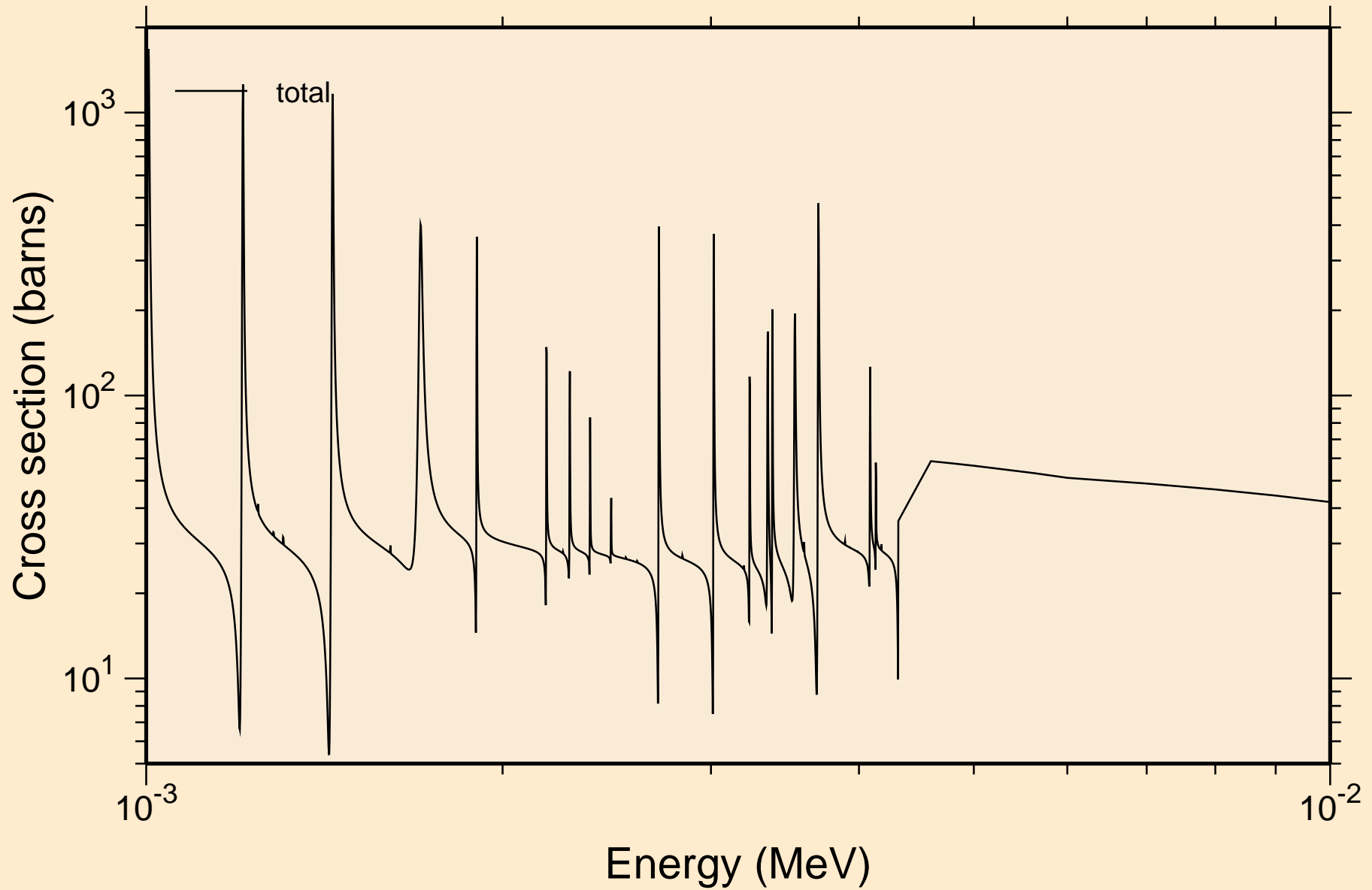

ER177 NEUTRON ACER TENDL-2021 LIBRARY; T=293.6K
resonance total cross section

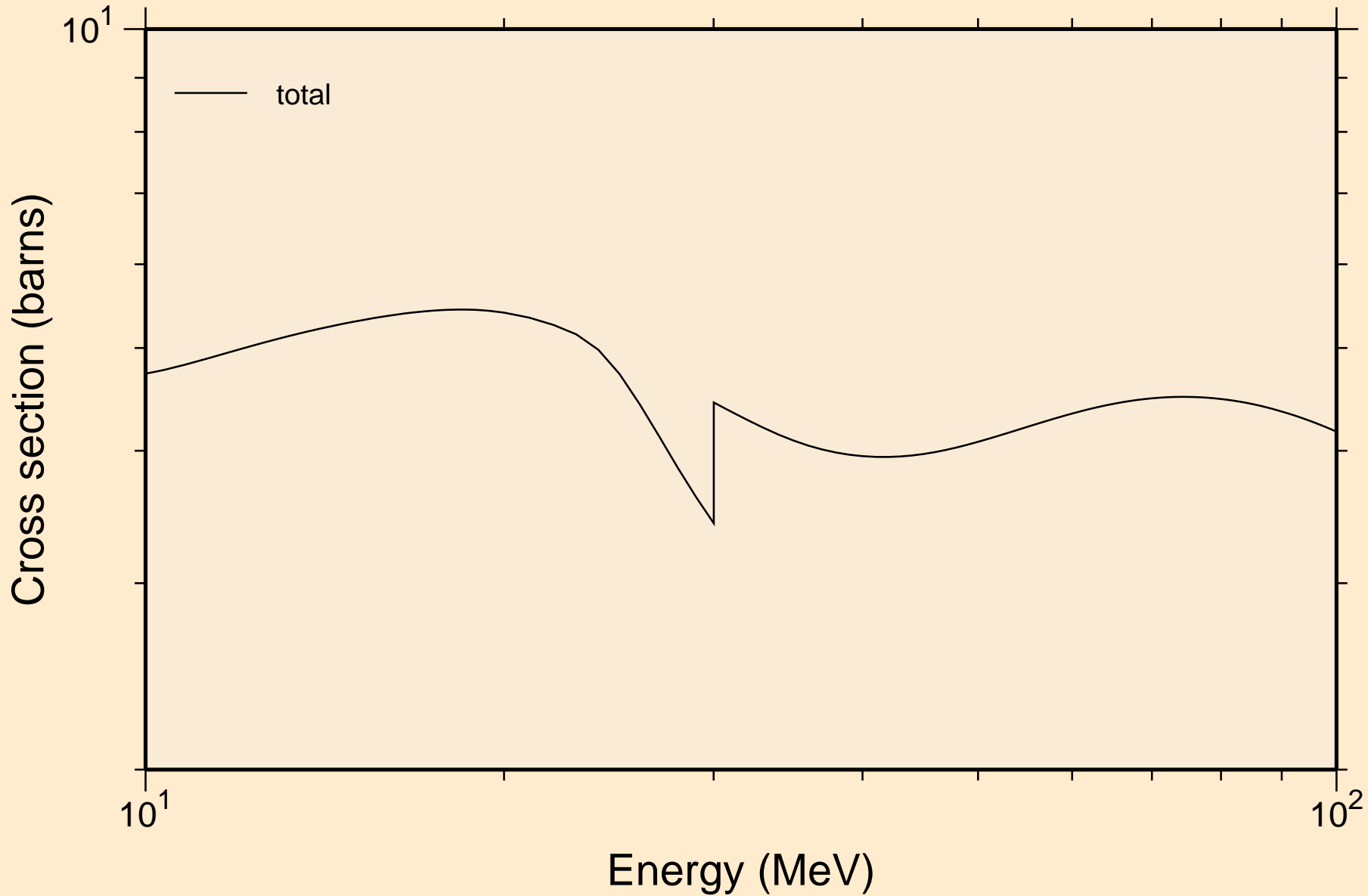

ER177 NEUTRON ACER TENDL-2021 LIBRARY; T=293.6K
resonance absorption cross sections

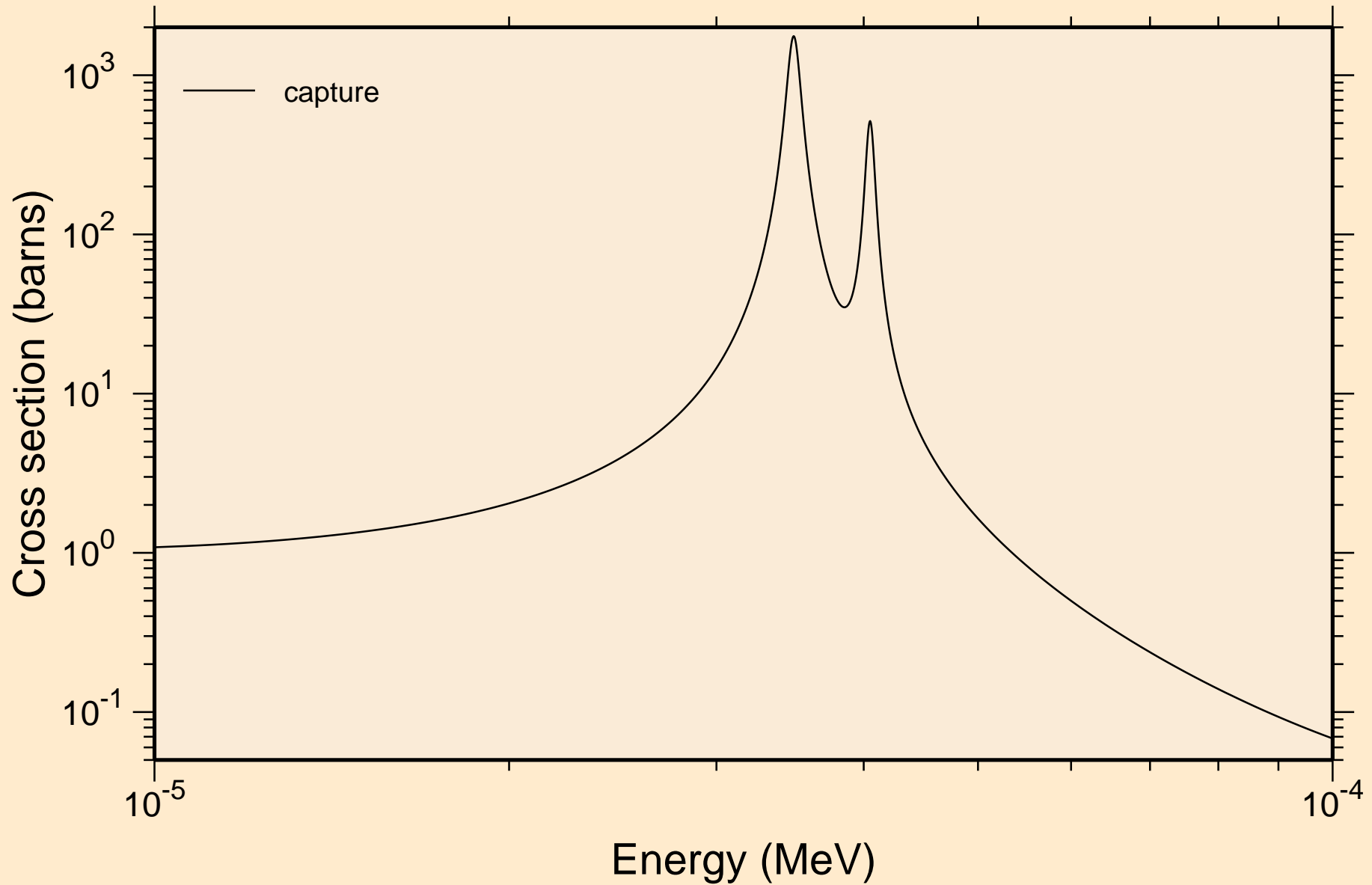

ER177 NEUTRON ACER TENDL-2021 LIBRARY; T=293.6K
resonance absorption cross sections

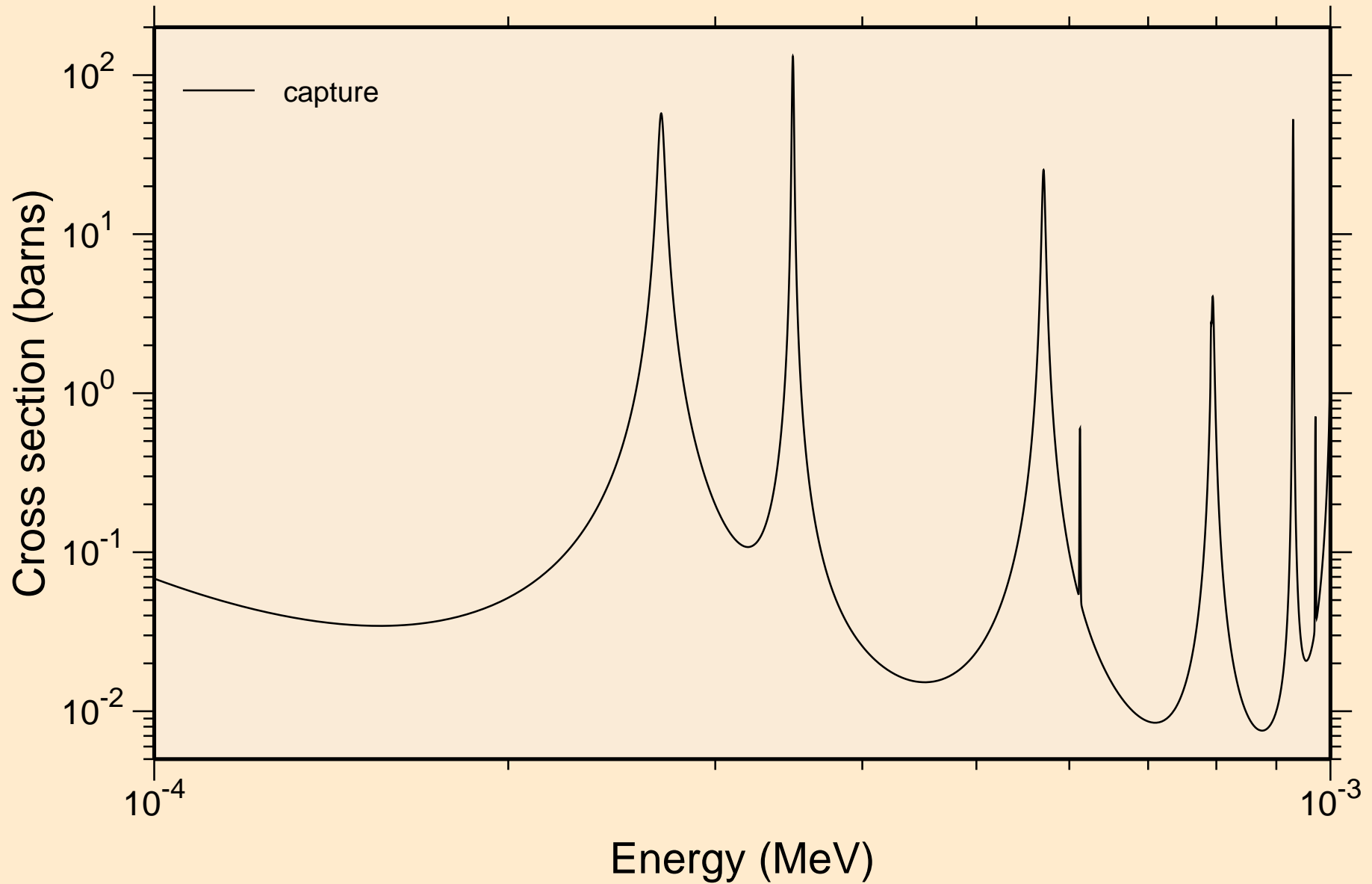

ER177 NEUTRON ACER TENDL-2021 LIBRARY; T=293.6K
resonance absorption cross sections

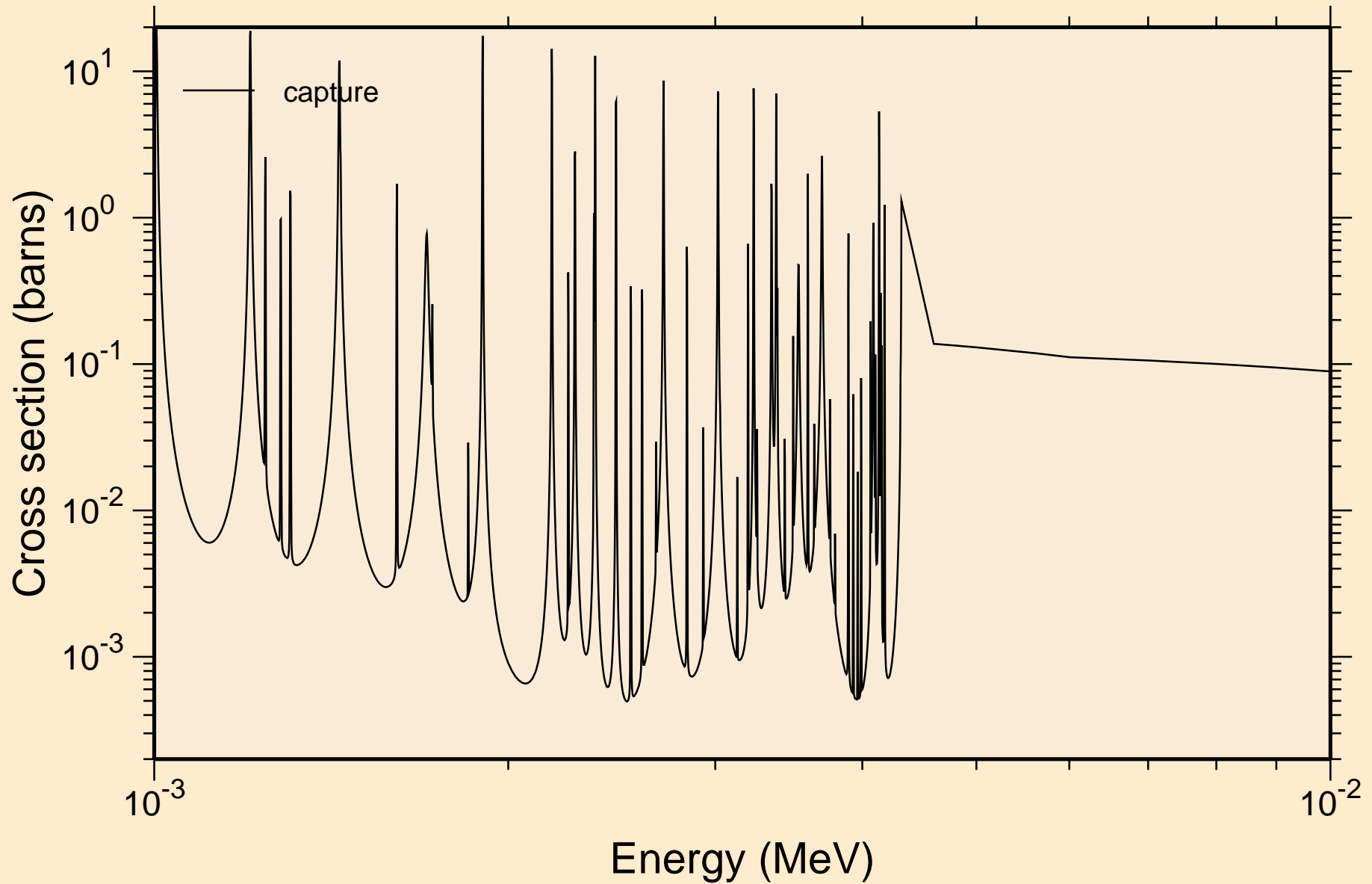

ER177 NEUTRON ACER TENDL-2021 LIBRARY; T=293.6K
resonance absorption cross sections

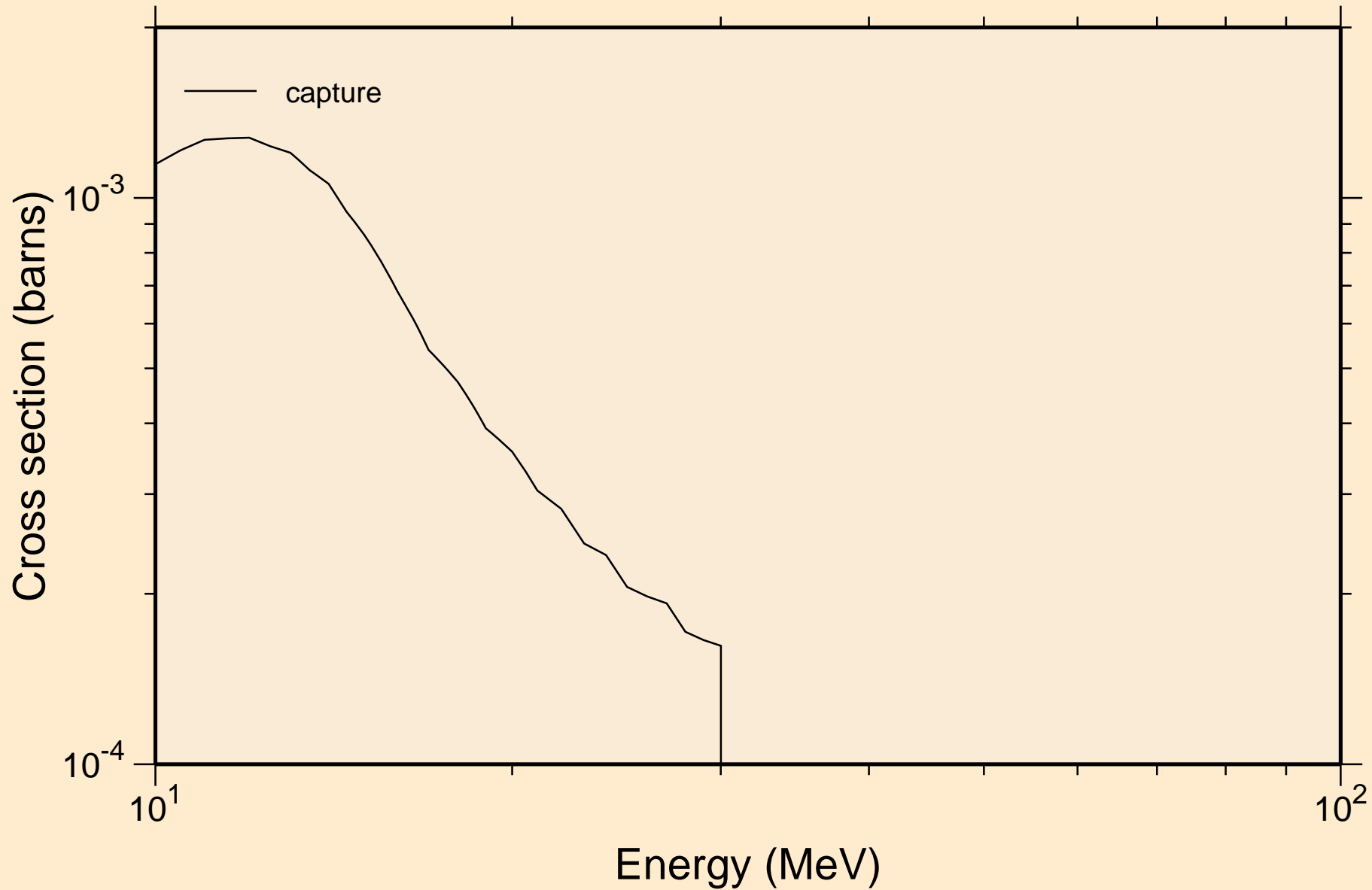

ER177 NEUTRON ACER TENDL-2021 LIBRARY; T=293.6K
Heating

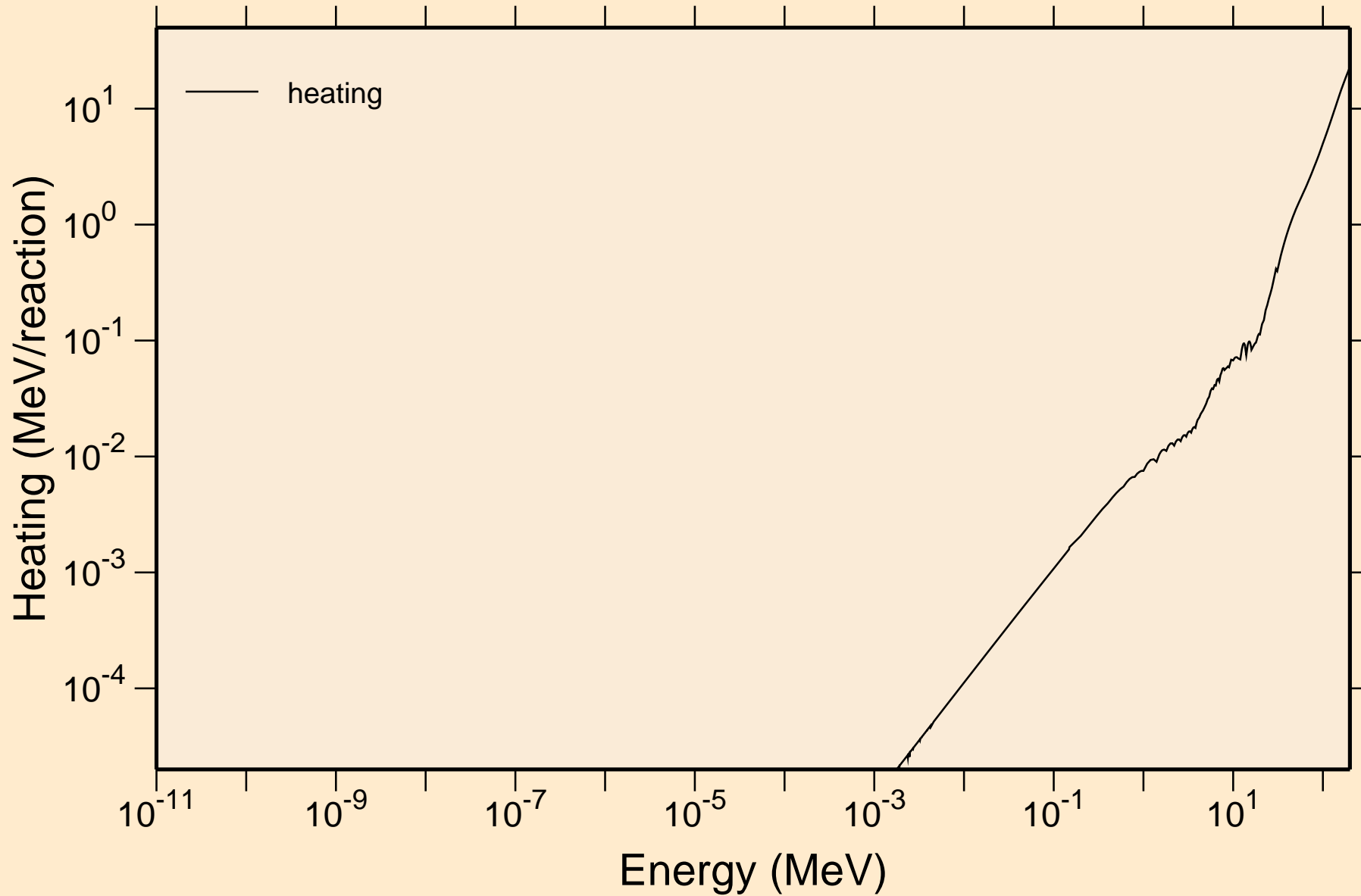

ER177 NEUTRON ACER TENDL-2021 LIBRARY; T=293.6K
Damage

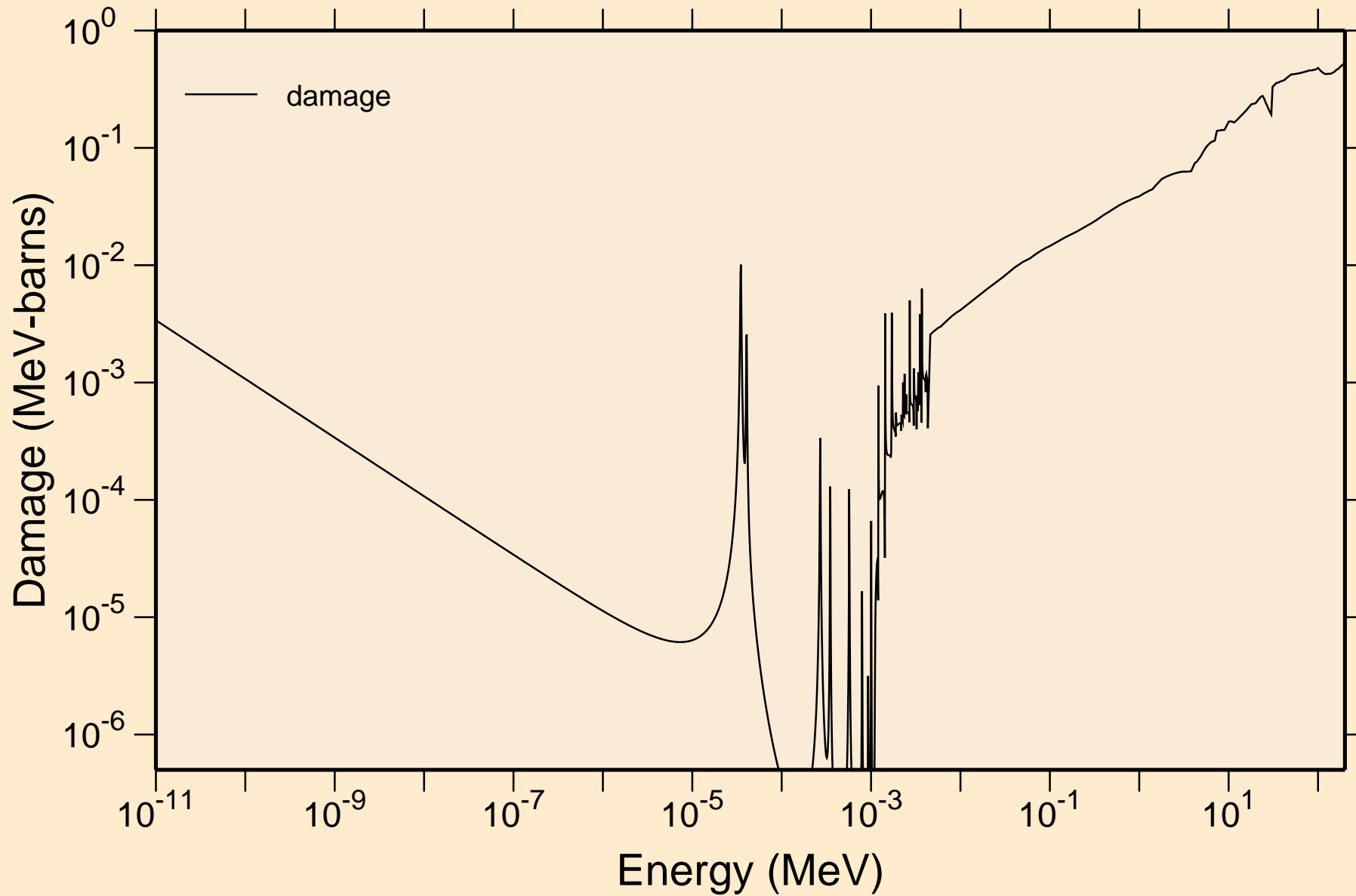

ER177 NEUTRON ACER TENDL-2021 LIBRARY; T=293.6K
Non-threshold reactions

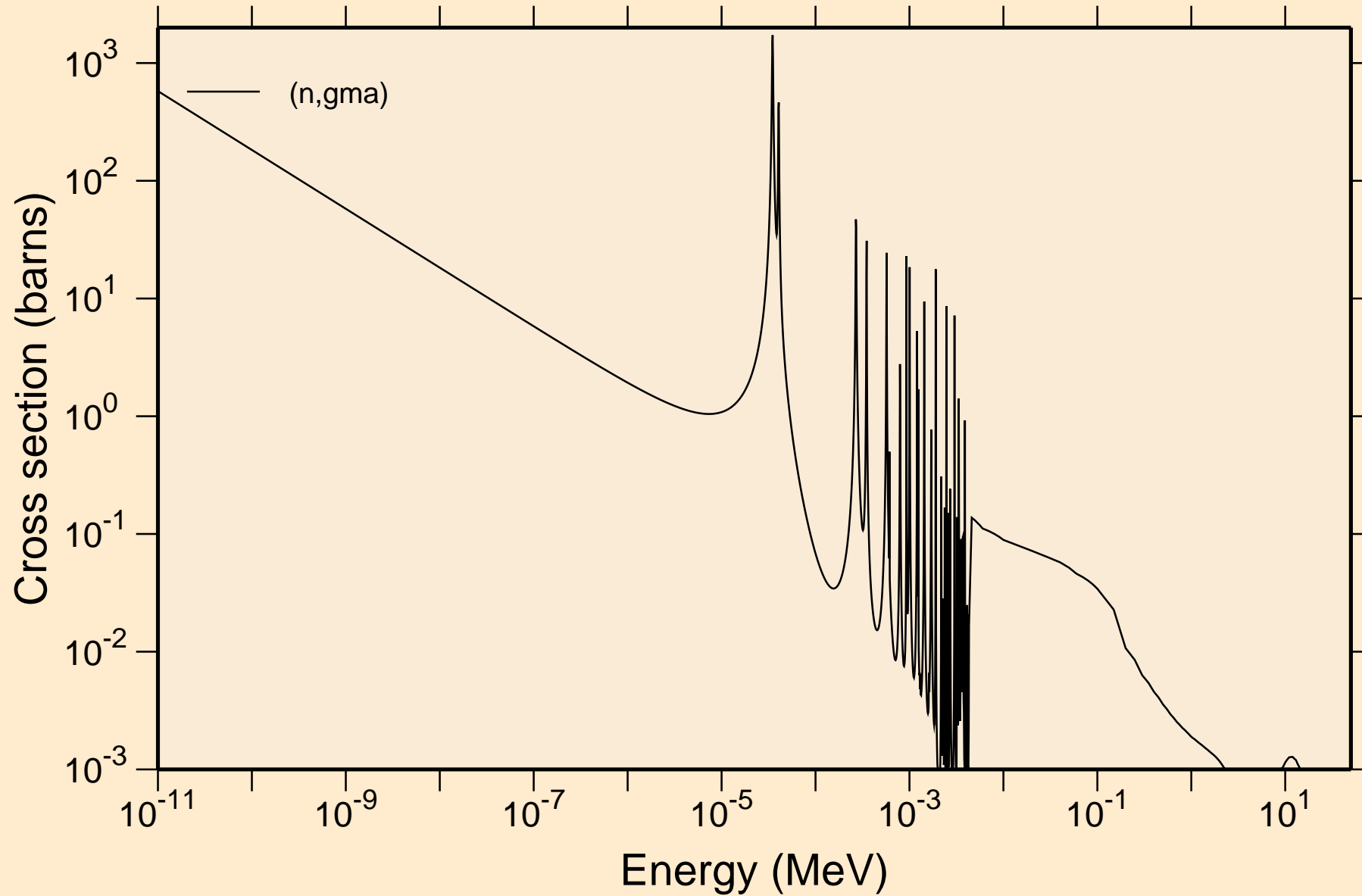

ER177 NEUTRON ACER TENDL-2021 LIBRARY; T=293.6K
Principal cross sections

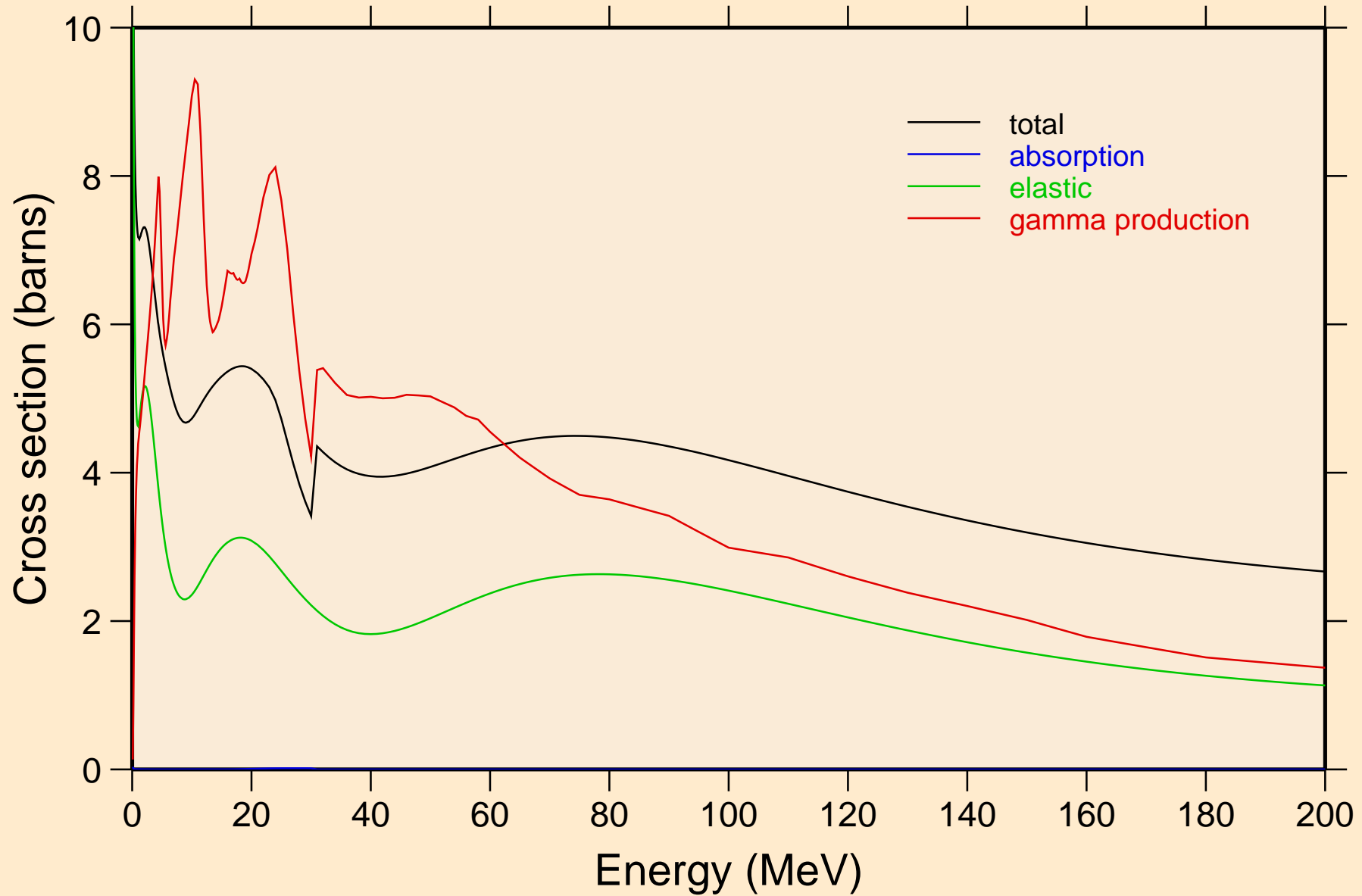

ER177 NEUTRON ACER TENDL-2021 LIBRARY; T=293.6K
Heating

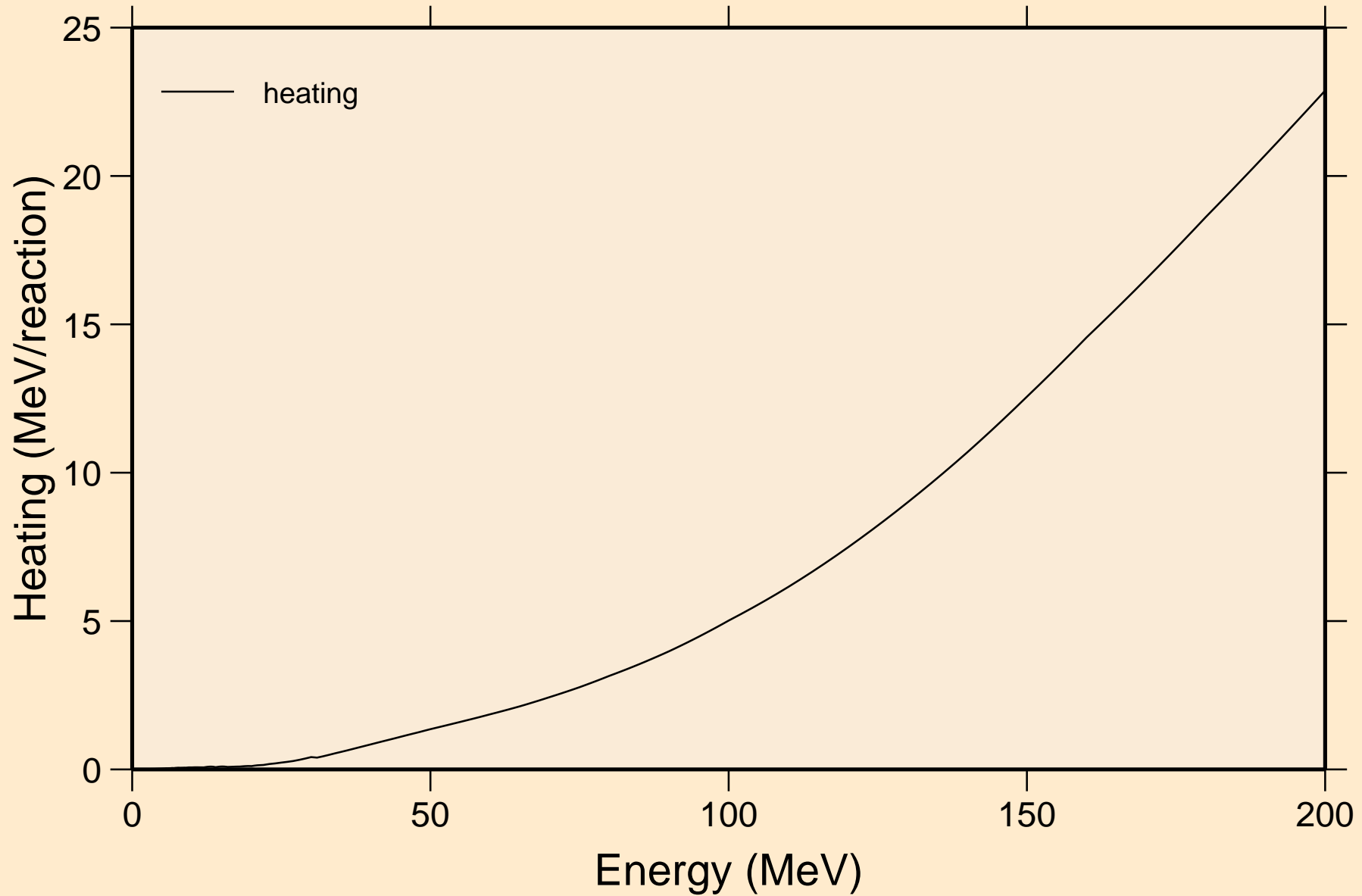

ER177 NEUTRON ACER TENDL-2021 LIBRARY; T=293.6K
Damage

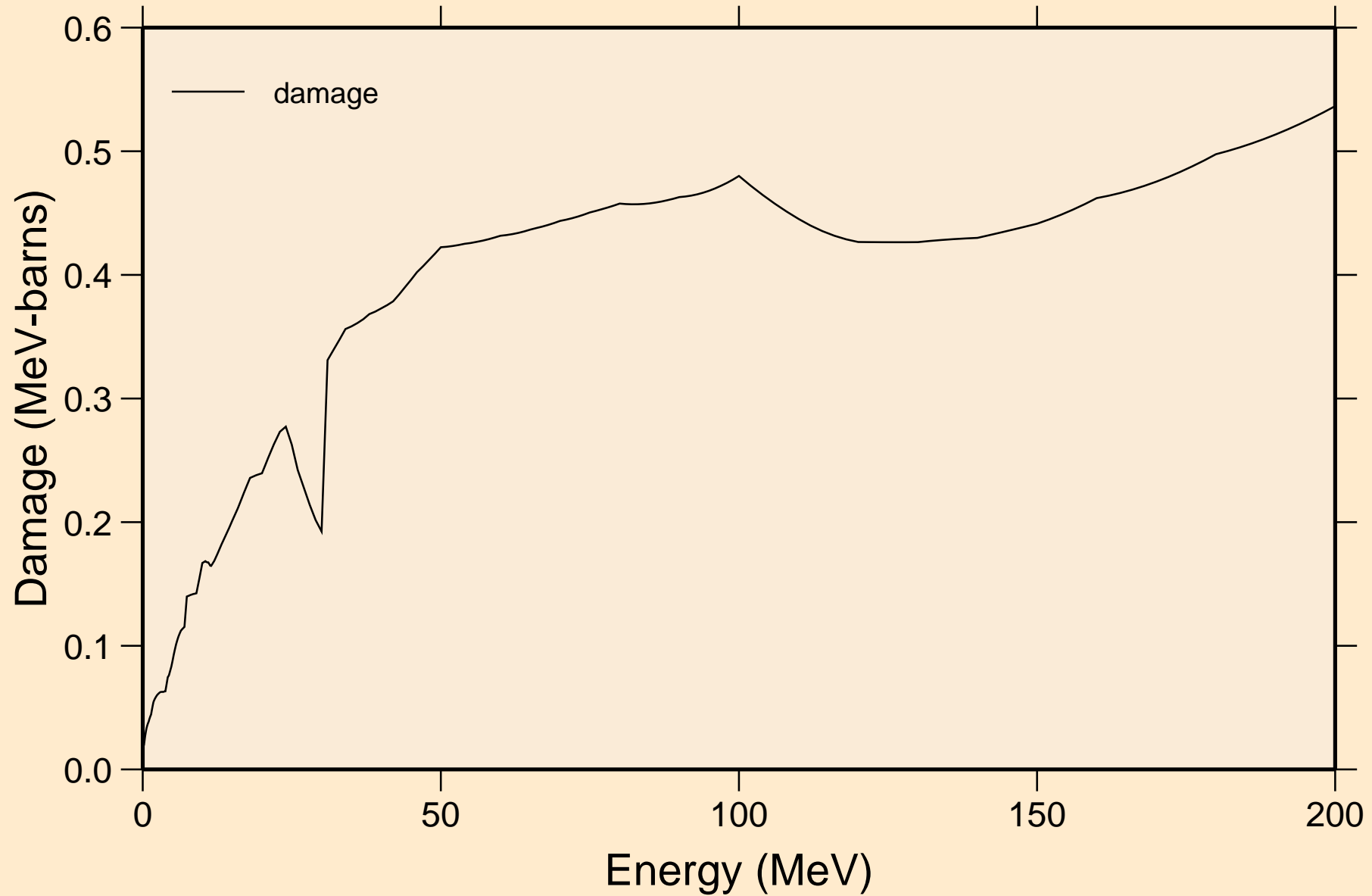

ER177 NEUTRON ACER TENDL-2021 LIBRARY; T=293.6K
Non-threshold reactions

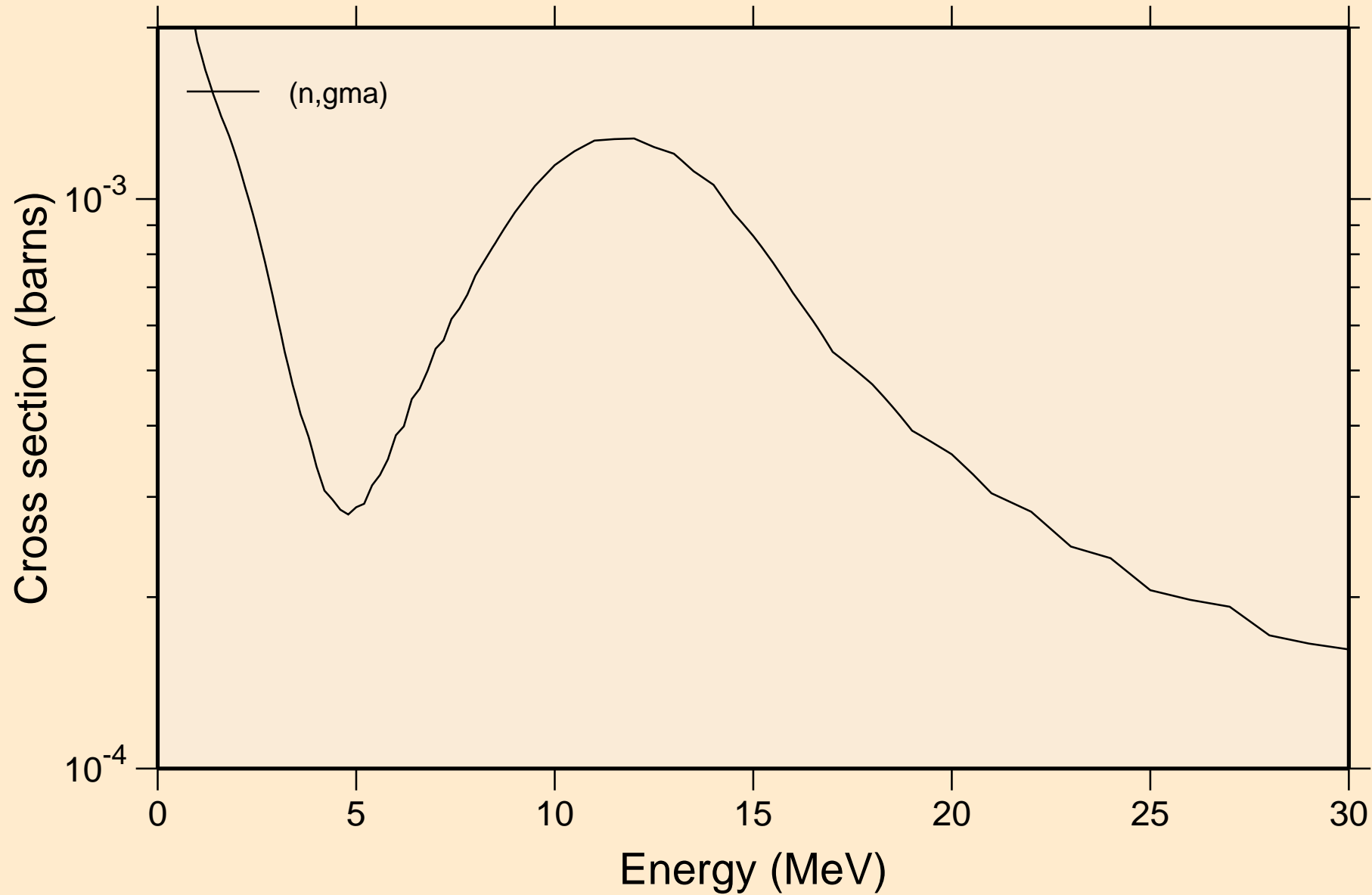

ER177 NEUTRON ACER TENDL-2021 LIBRARY; T=293.6K
Inelastic levels

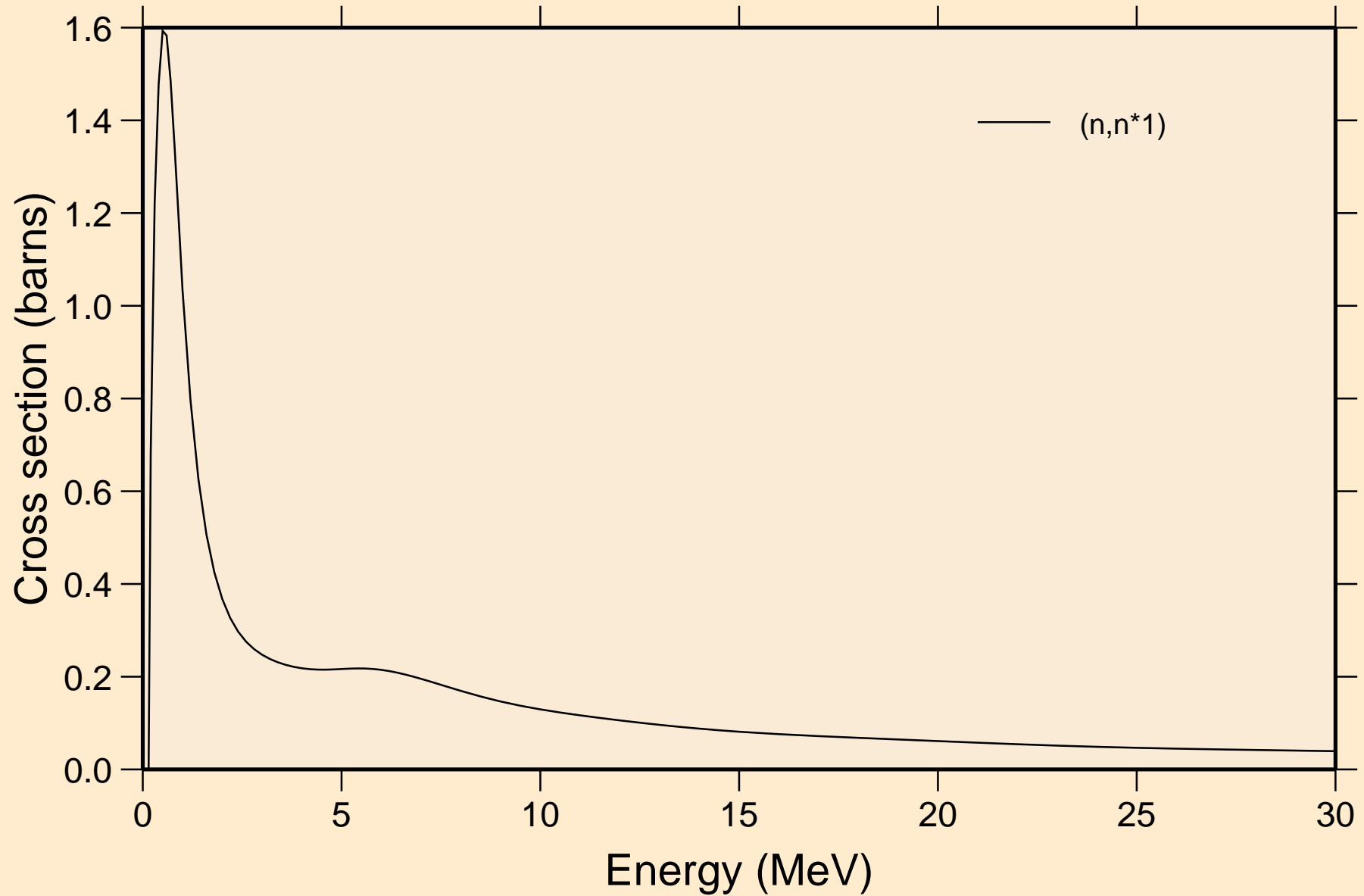

ER177 NEUTRON ACER TENDL-2021 LIBRARY; T=293.6K
Threshold reactions

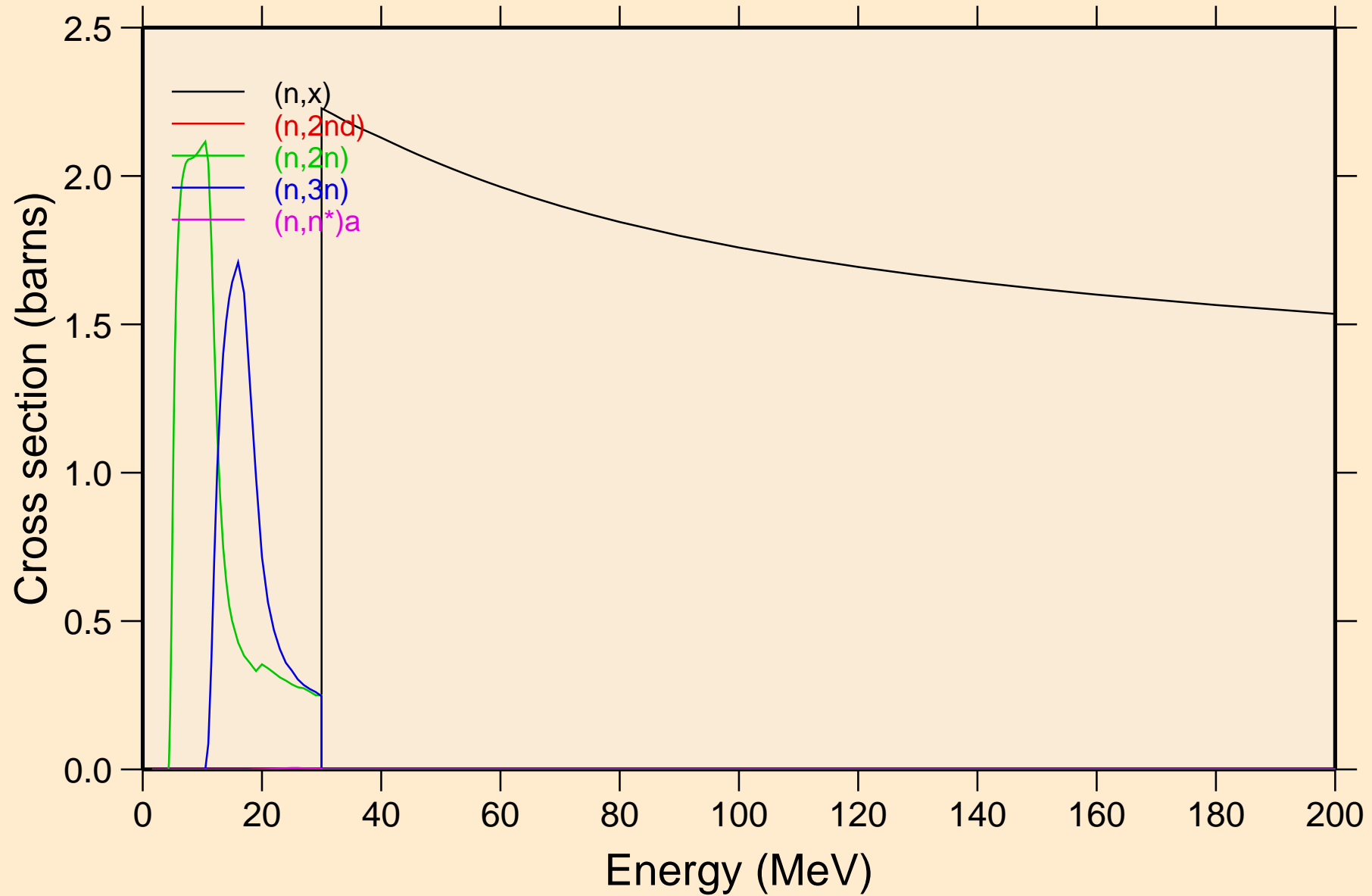

ER177 NEUTRON ACER TENDL-2021 LIBRARY; T=293.6K
Threshold reactions

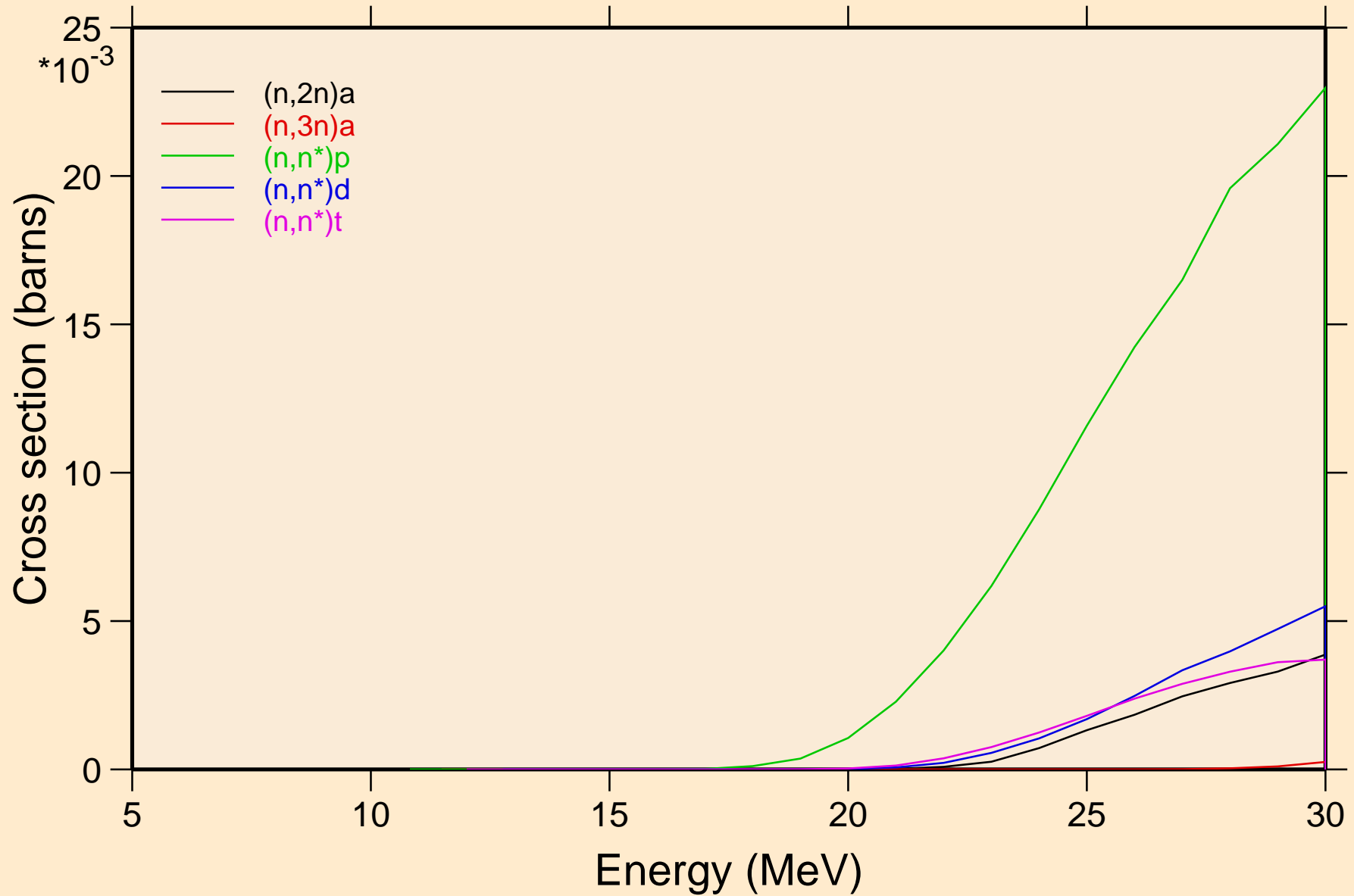

ER177 NEUTRON ACER TENDL-2021 LIBRARY; T=293.6K
Threshold reactions

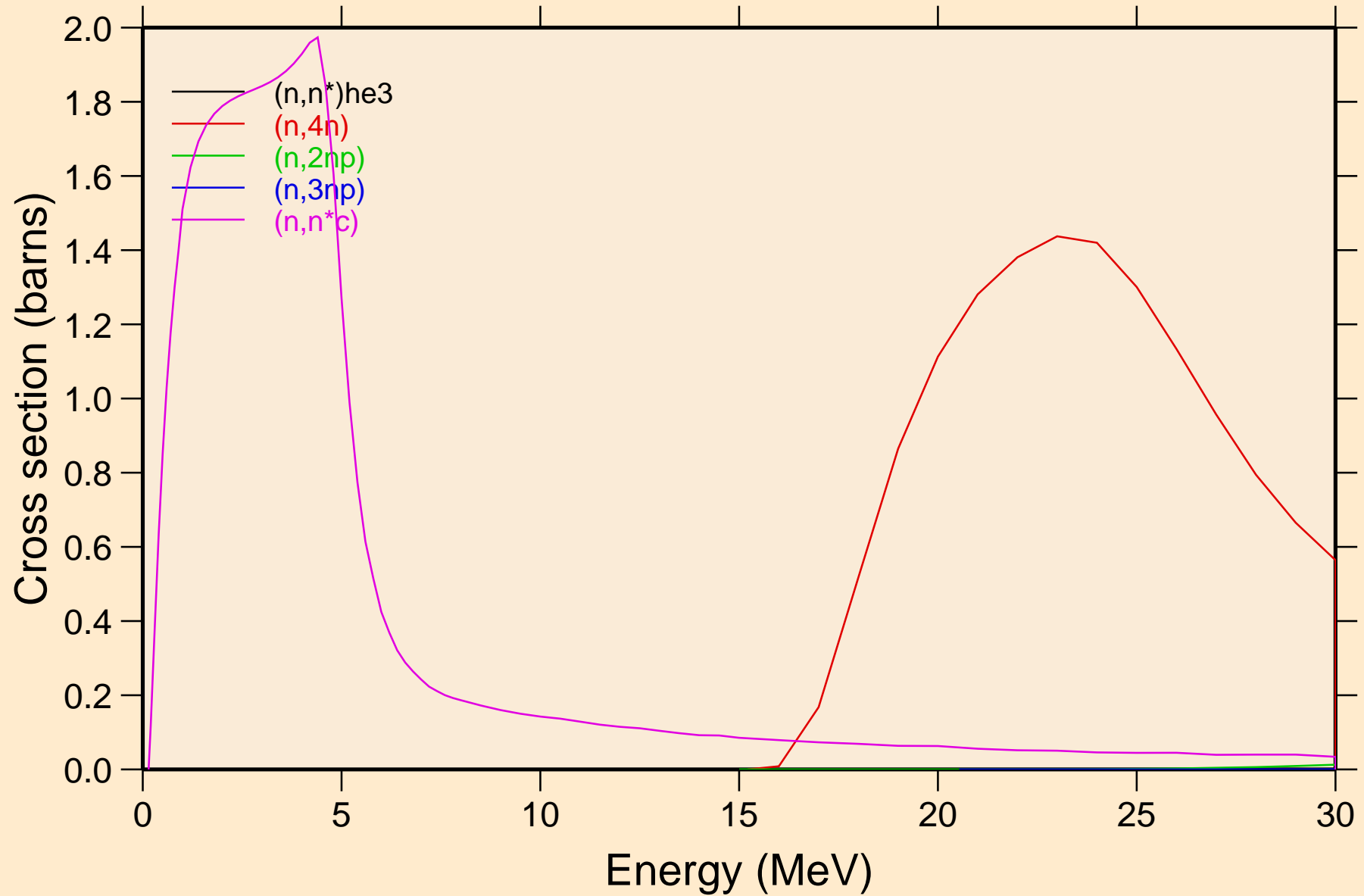

ER177 NEUTRON ACER TENDL-2021 LIBRARY; T=293.6K
Threshold reactions

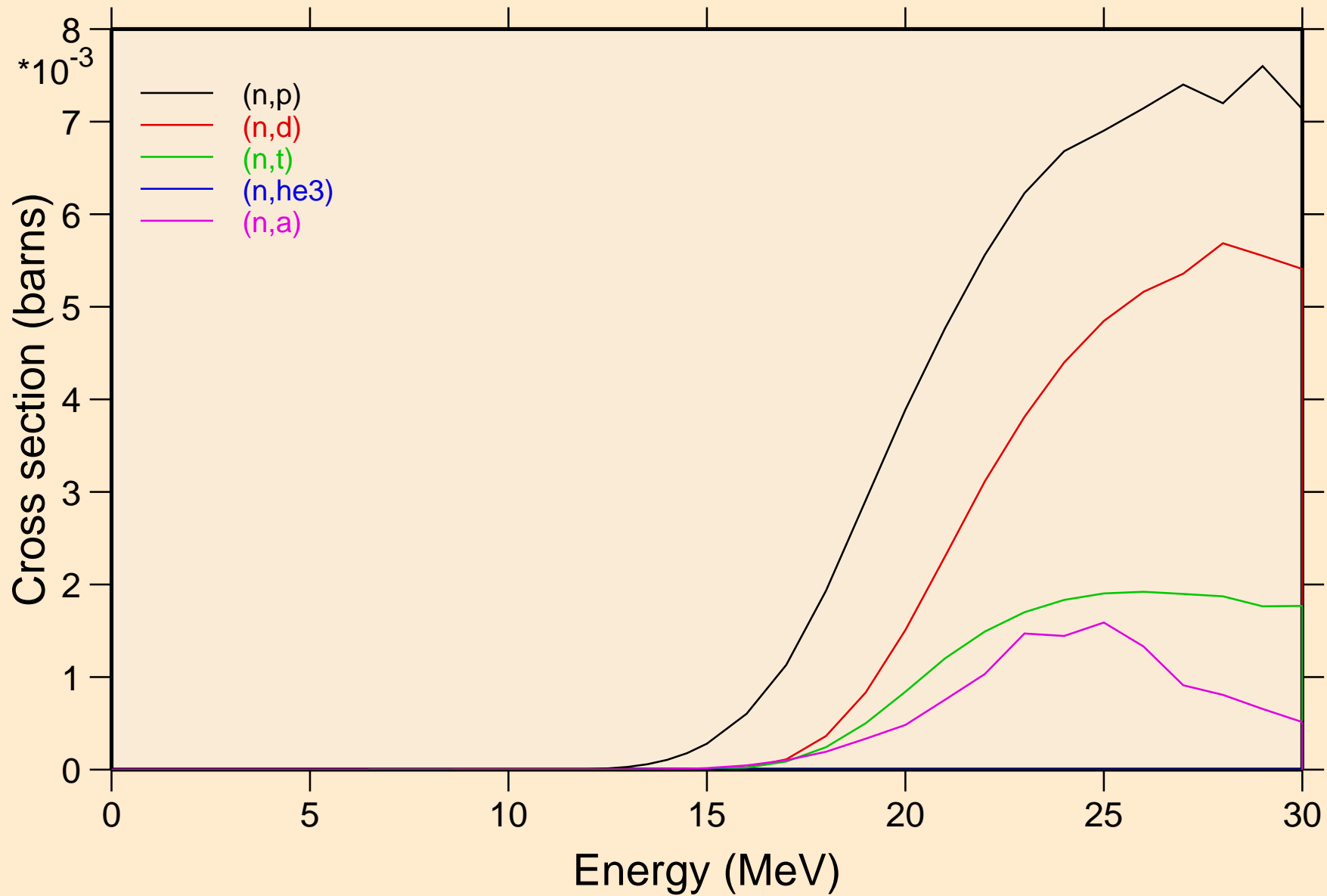

ER177 NEUTRON ACER TENDL-2021 LIBRARY; T=293.6K

Threshold reactions

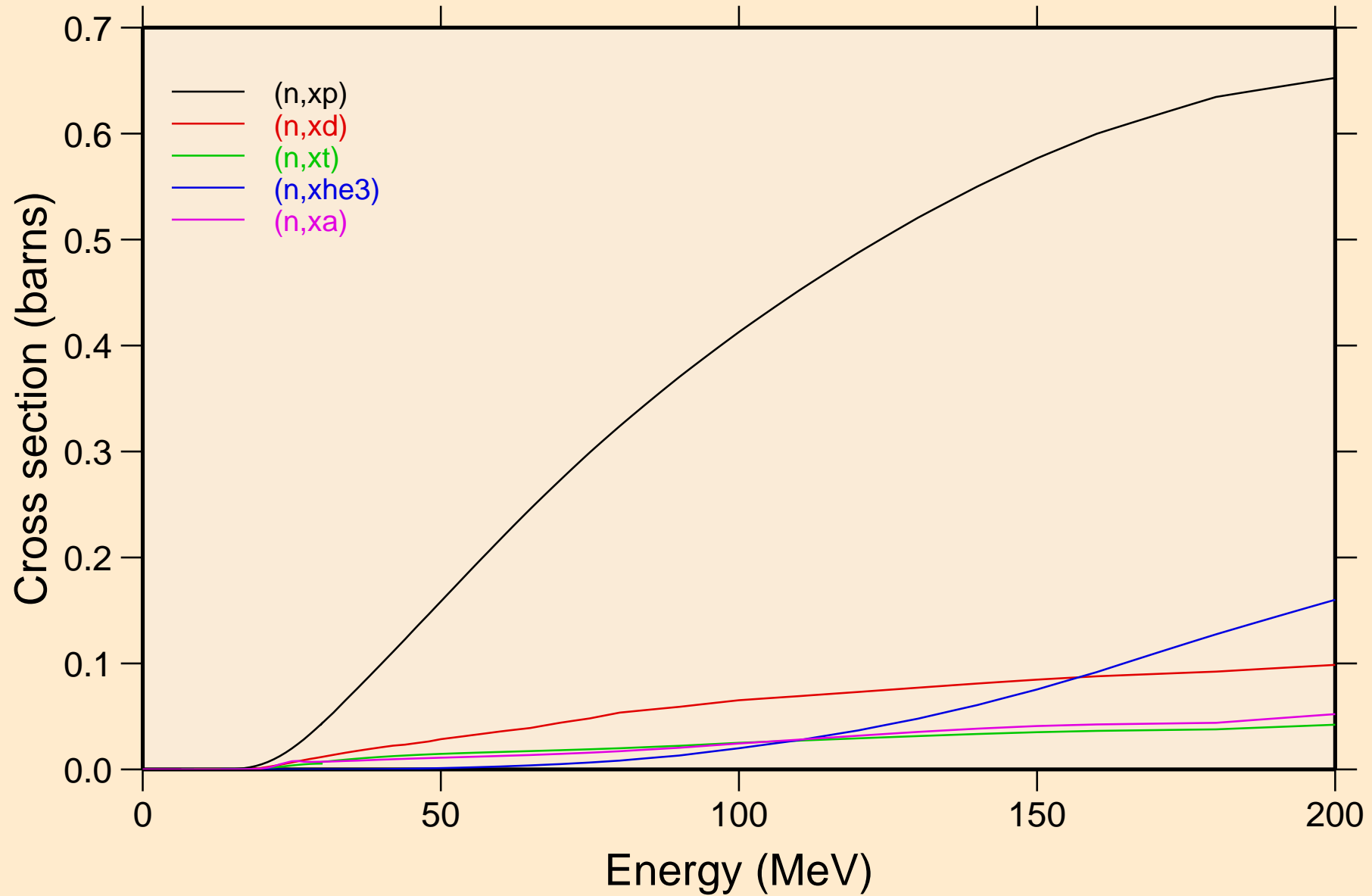

ER177 NEUTRON ACER TENDL-2021 LIBRARY; T=293.6K
angular distribution for elastic

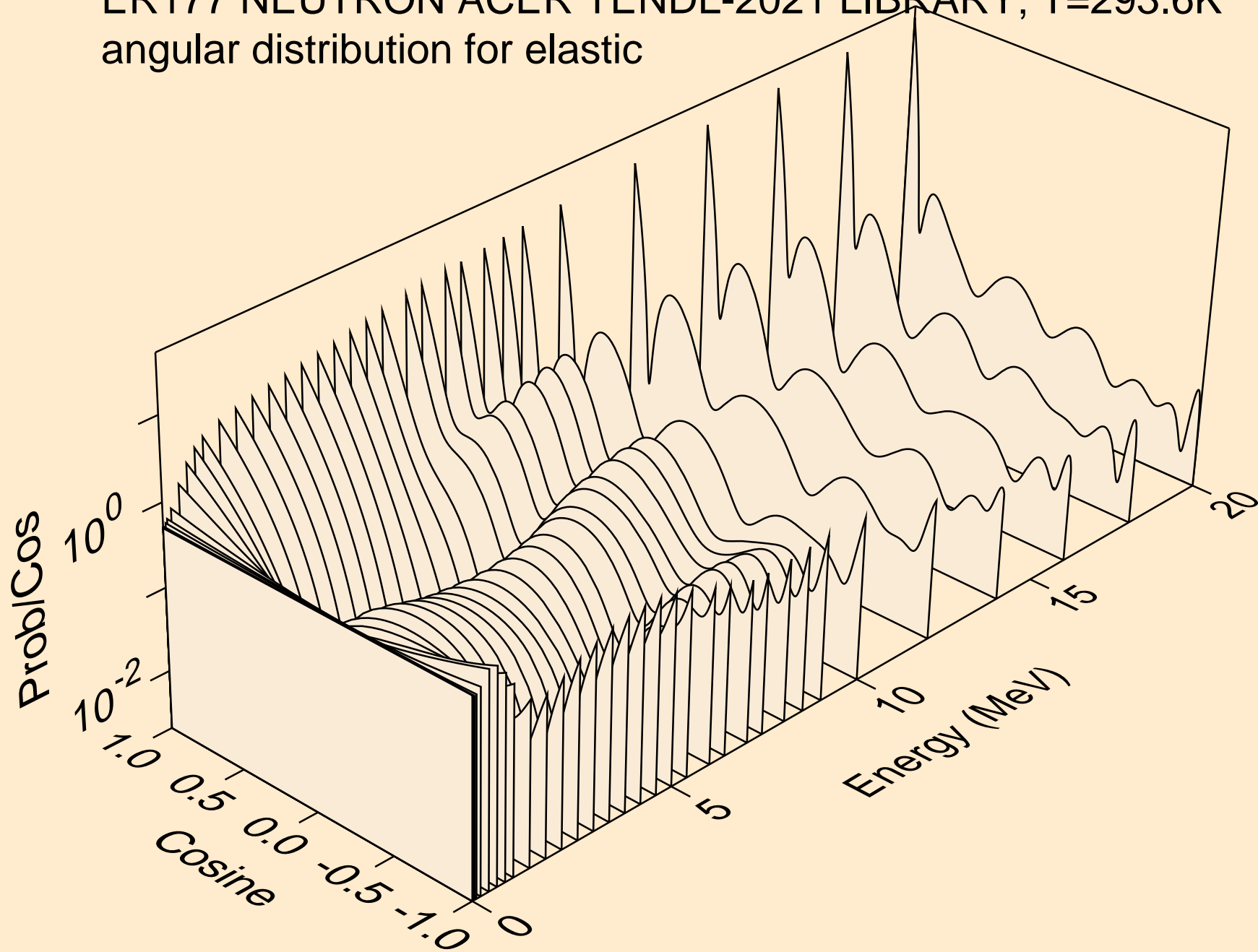

ER177 NEUTRON ACER TENDL-2021 LIBRARY; T=293.6K
angular distribution for elastic

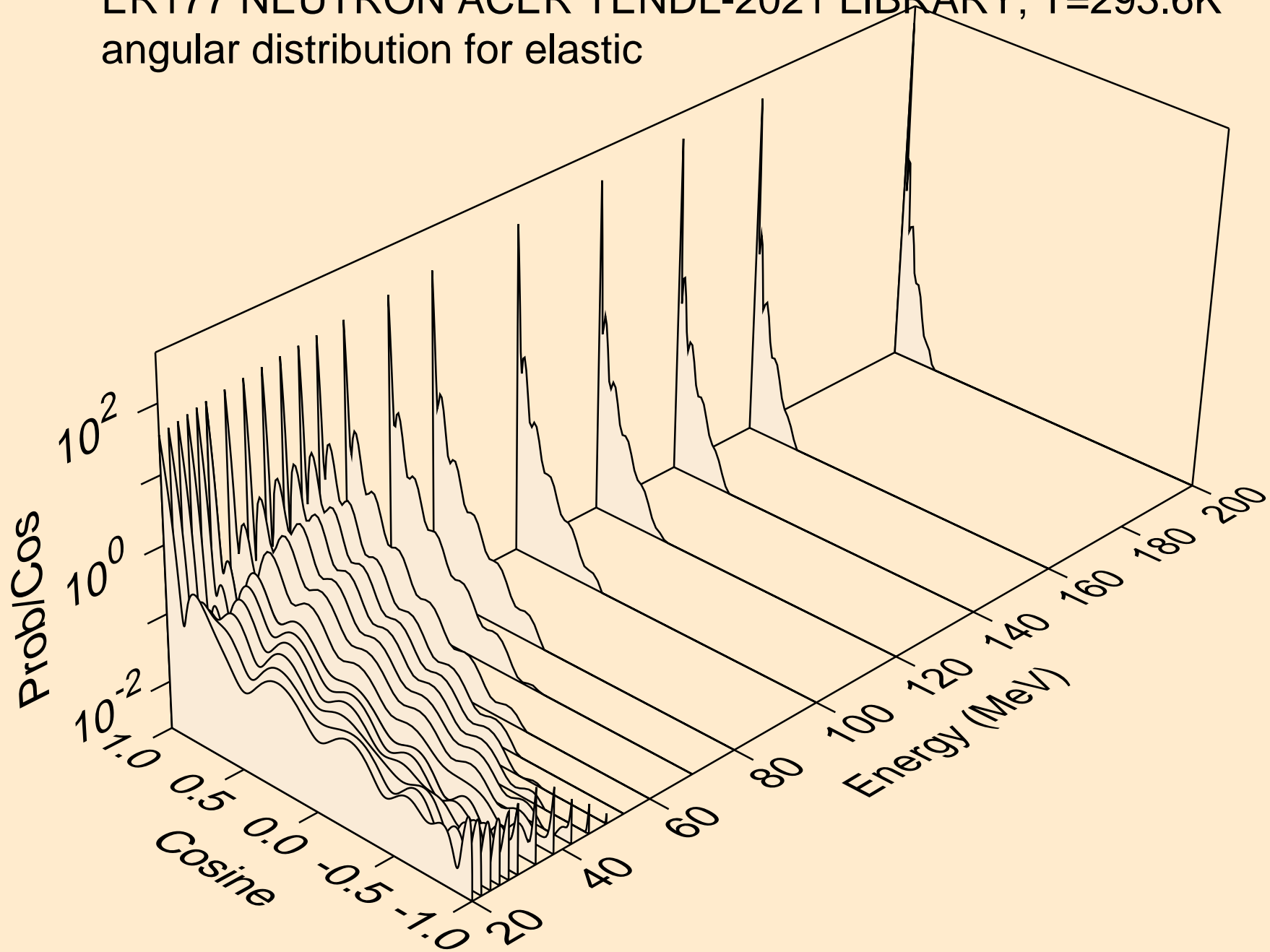

ER177 NEUTRON ACER TENDL-2021 LIBRARY; T=293.6K
angular distribution for (n,n*1)

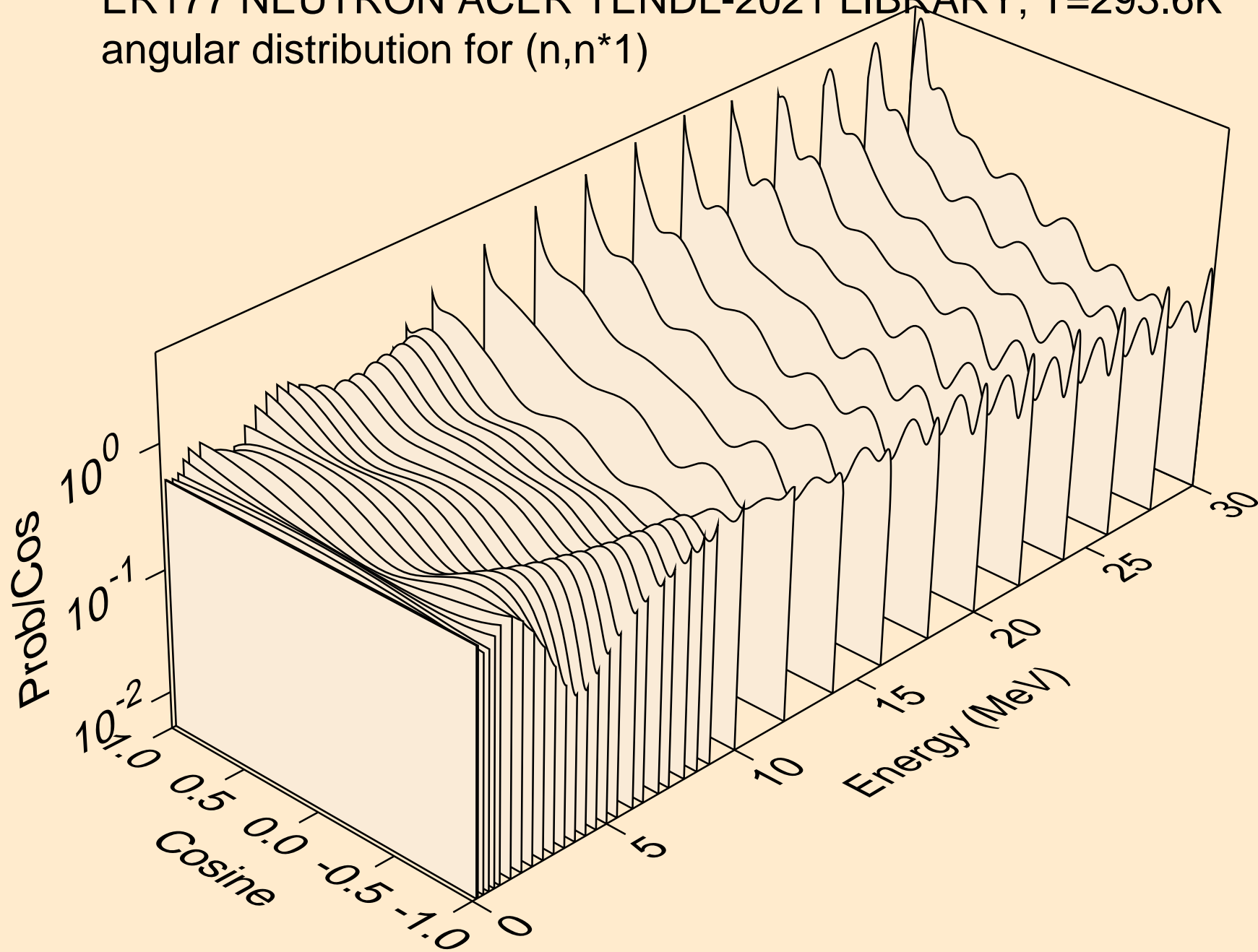

ER177 NEUTRON ACER TENDL-2021 LIBRARY; T=293.6K
Neutron emission for (n,x)

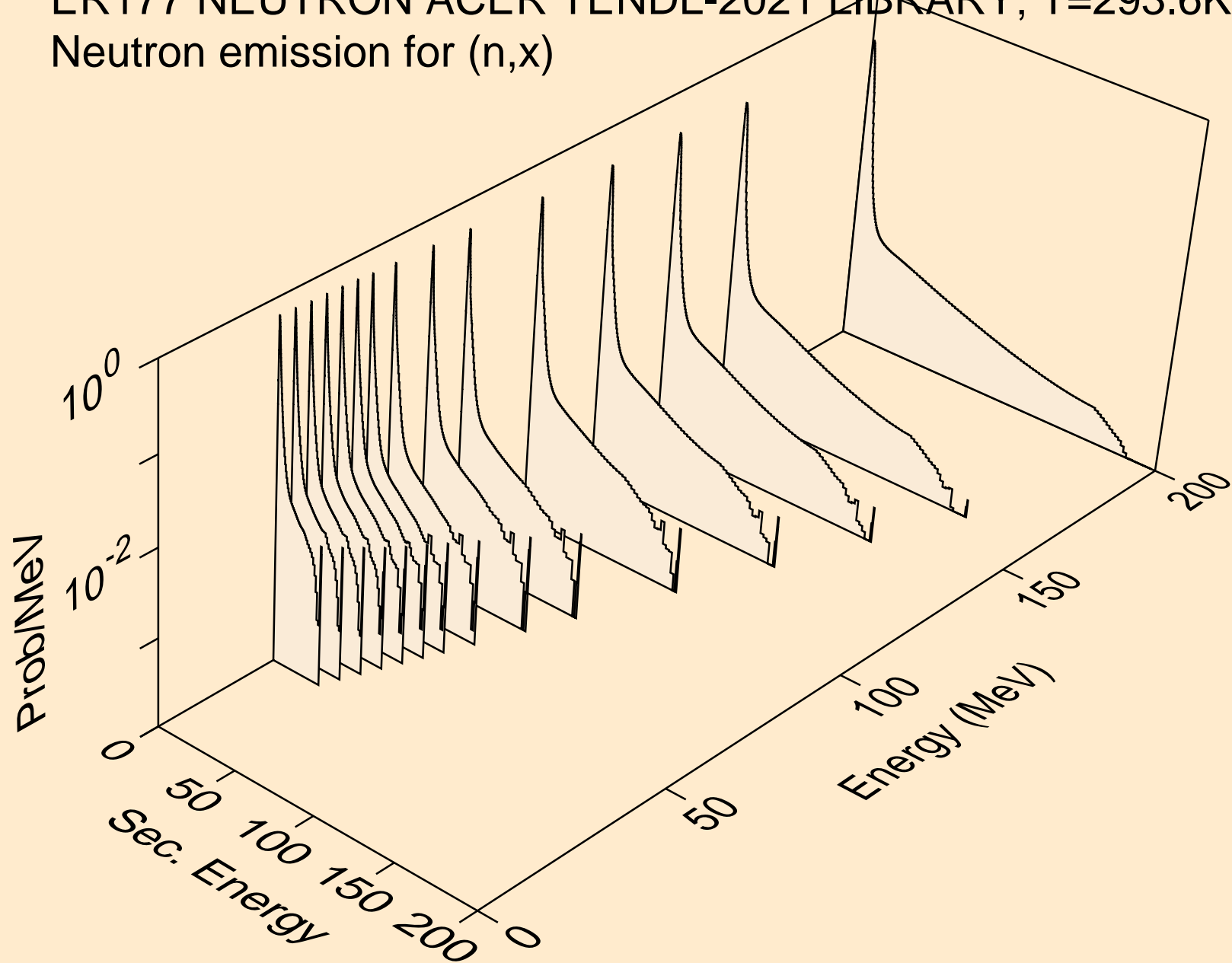

ER177 NEUTRON ACER TENDL-2021 LIBRARY; T=293.6K
Neutron emission for (n,2nd)

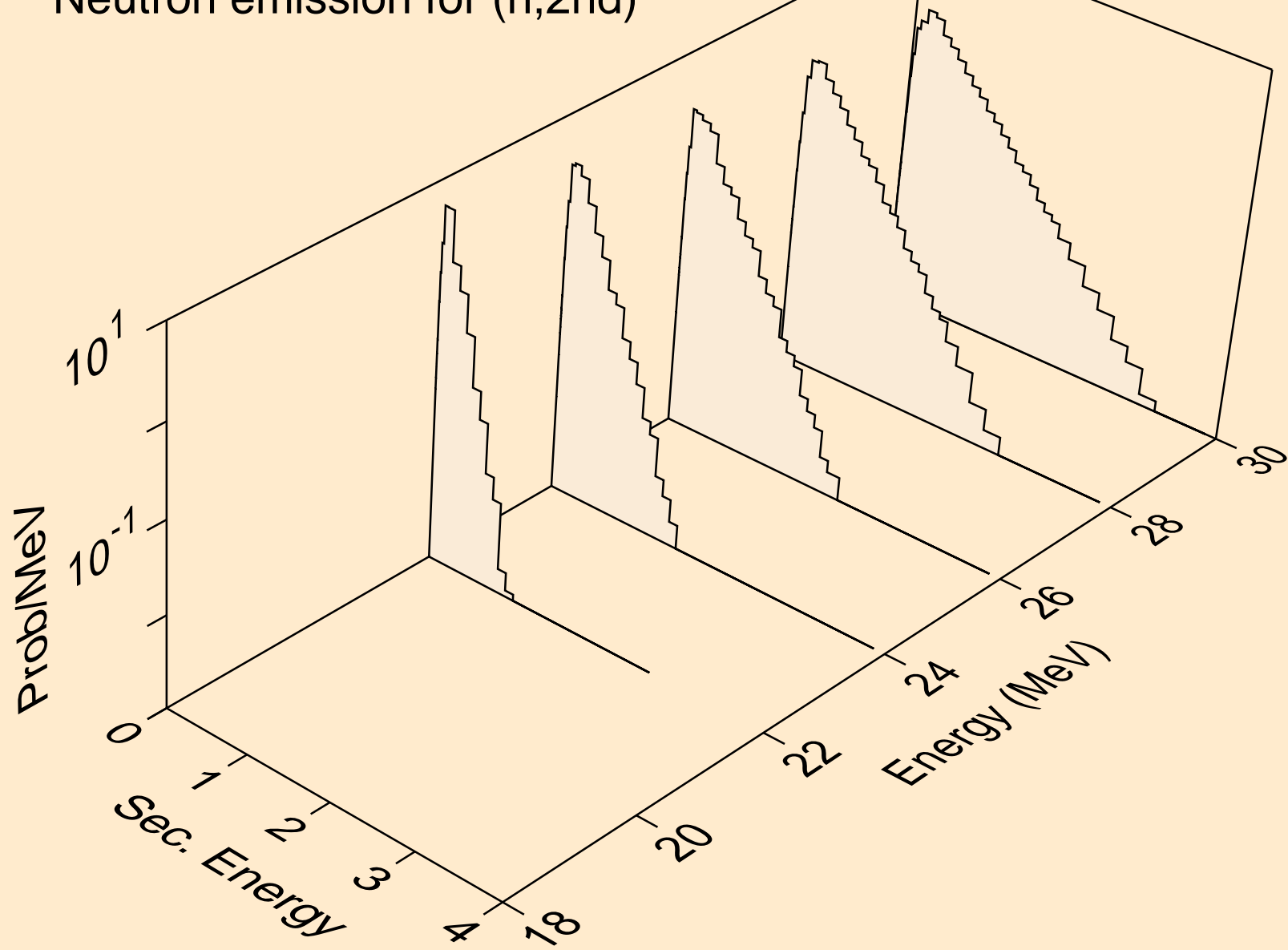

ER177 NEUTRON ACER TENDL-2021 LIBRARY; T=293.6K
Neutron emission for (n,2n)

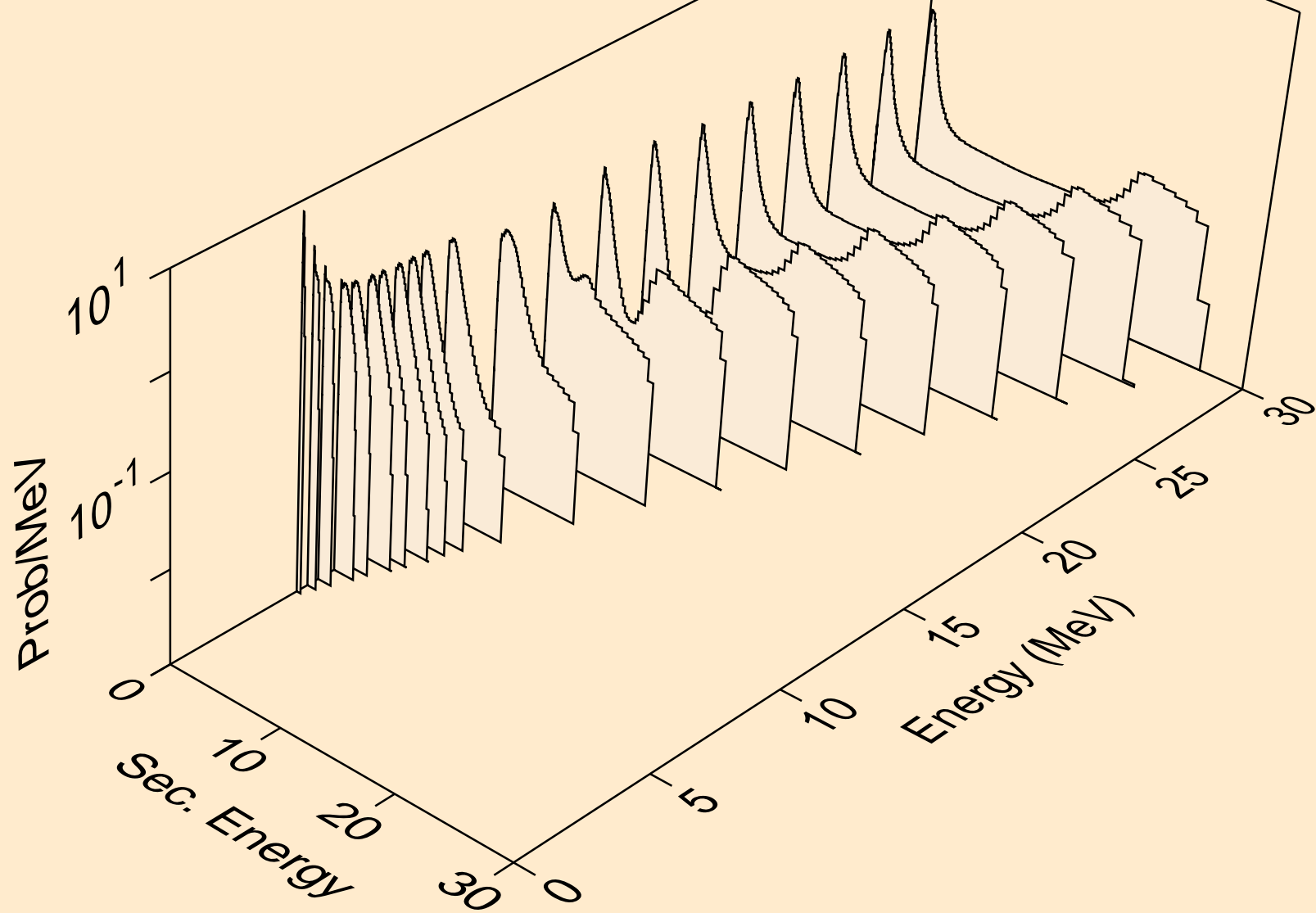

ER177 NEUTRON ACER TENDL-2021 LIBRARY; T=293.6K
Neutron emission for (n,3n)

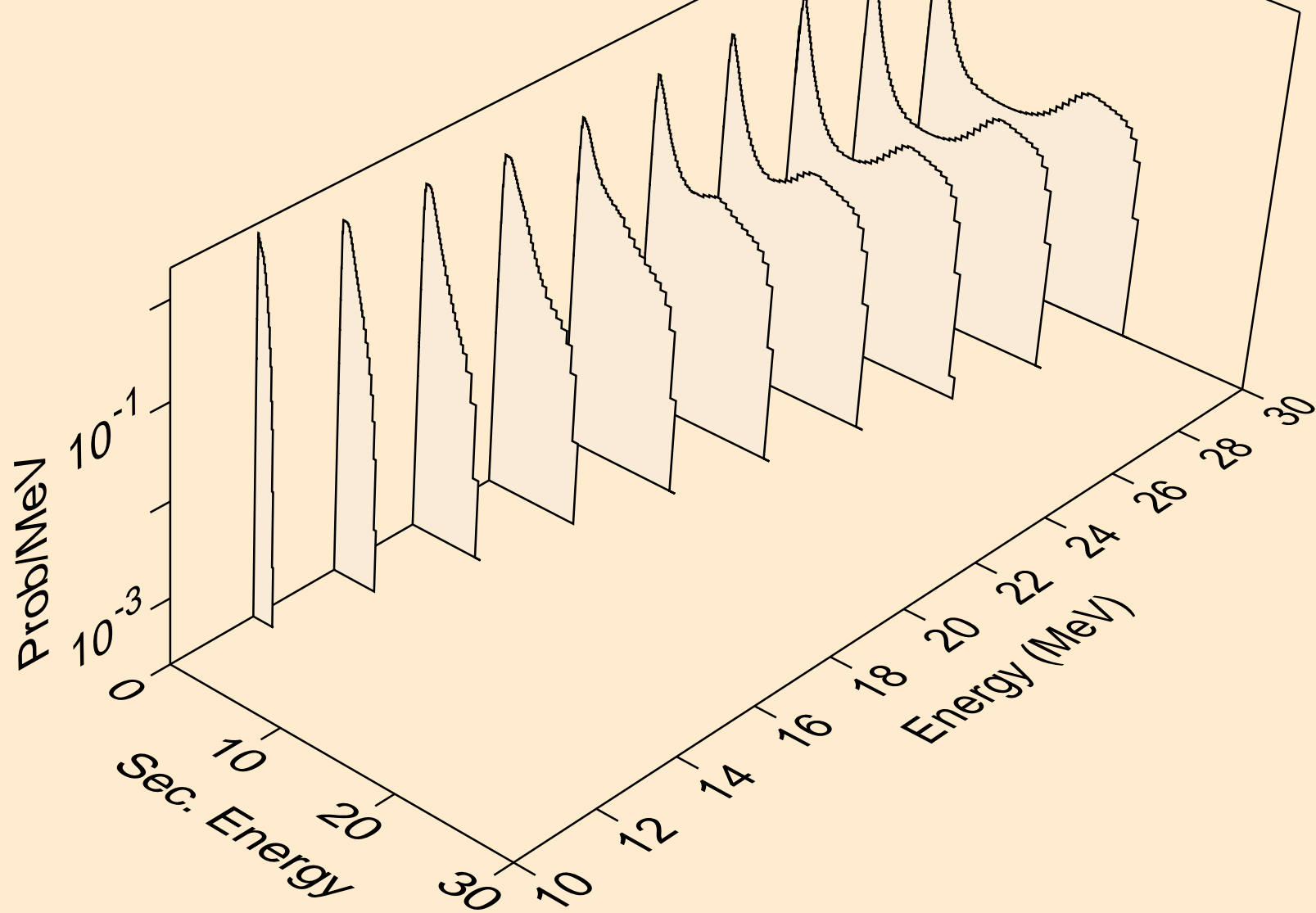

ER177 NEUTRON ACER TENDL-2021 LIBRARY; T=293.6K
Neutron emission for (n,n*)a

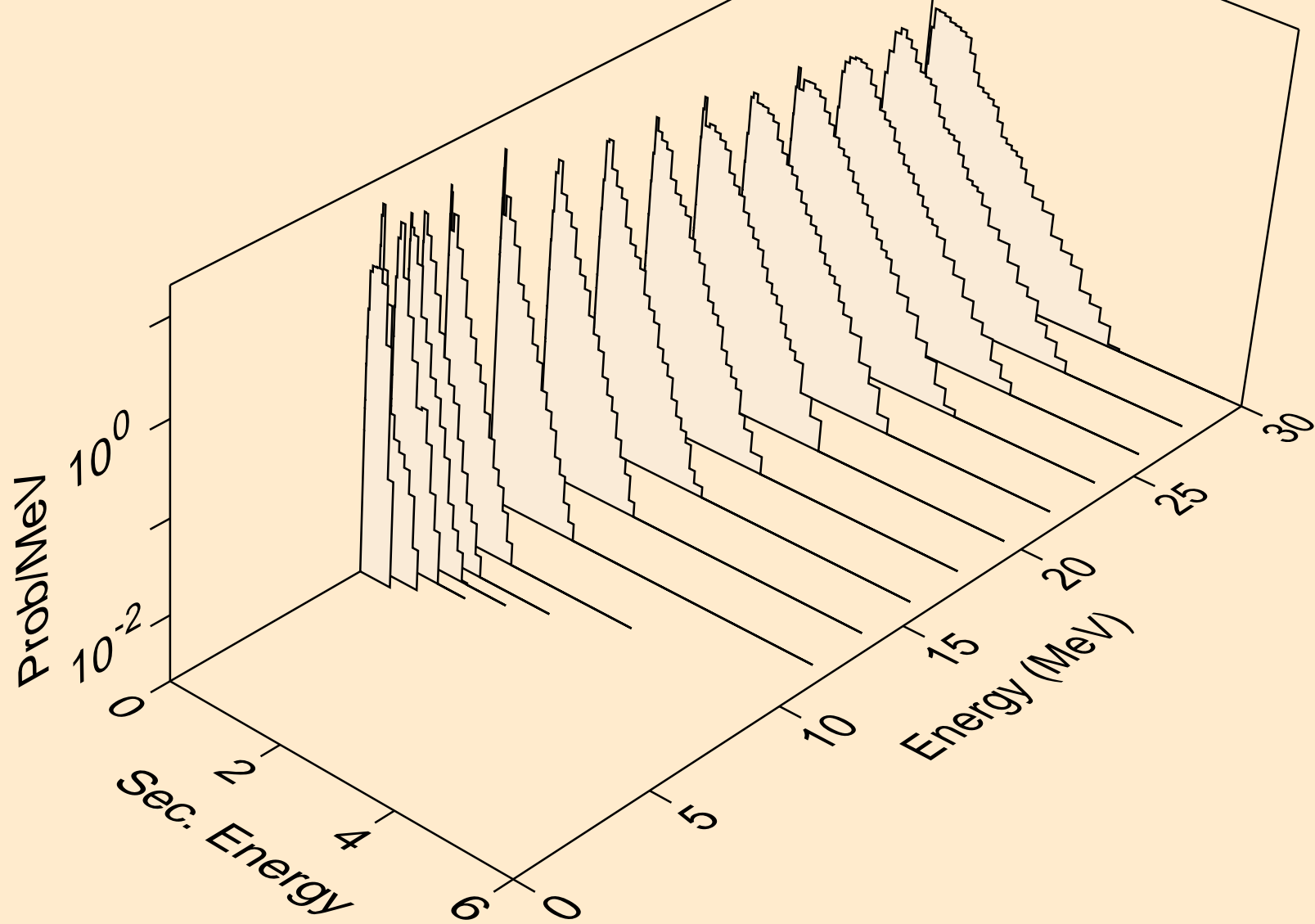

ER177 NEUTRON ACER TENDL-2021 LIBRARY; T=293.6K
Neutron emission for (n,2n)_a

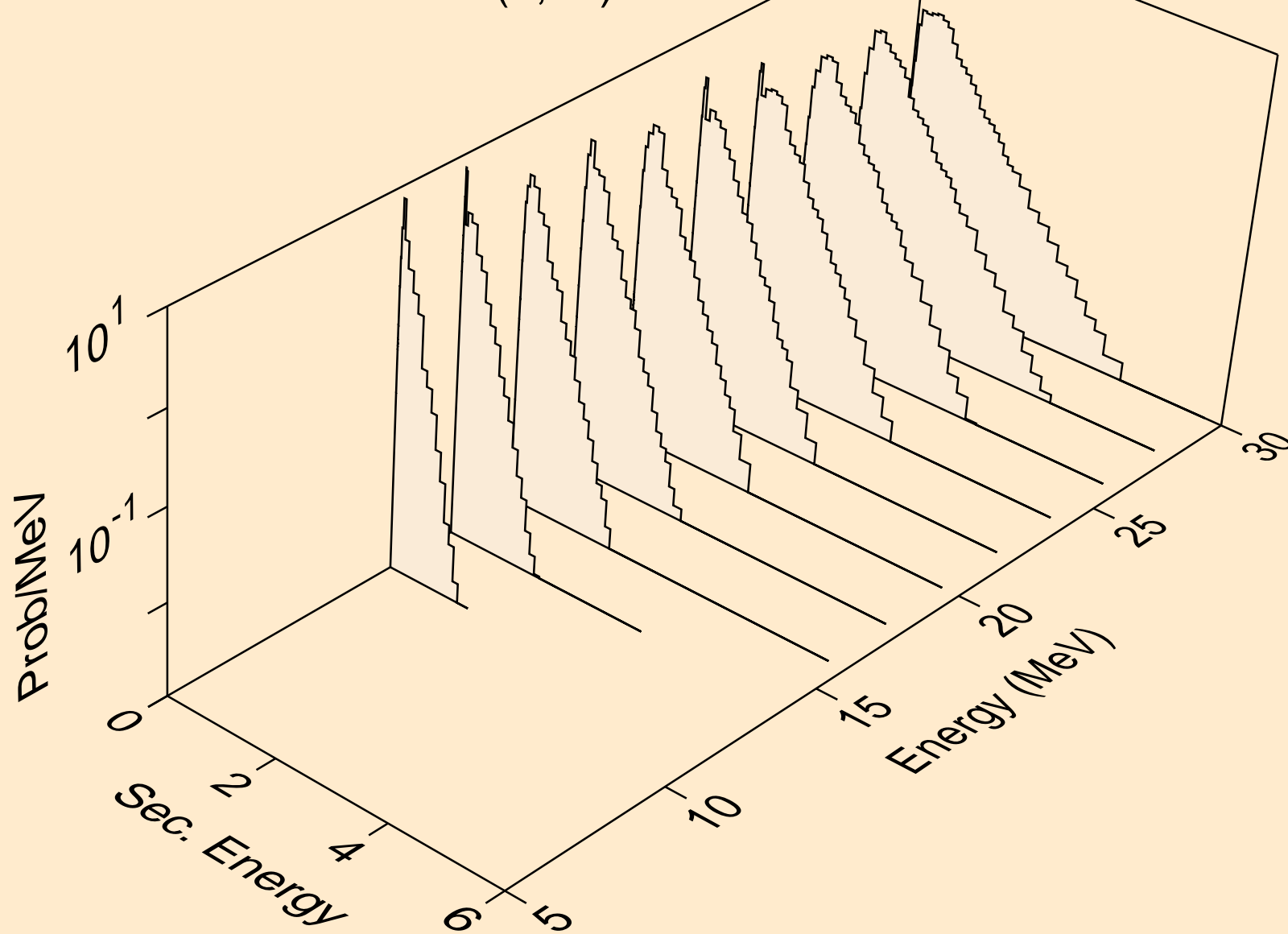

ER177 NEUTRON ACER TENDL-2021 LIBRARY; T=293.6K
Neutron emission for (n,3n)a

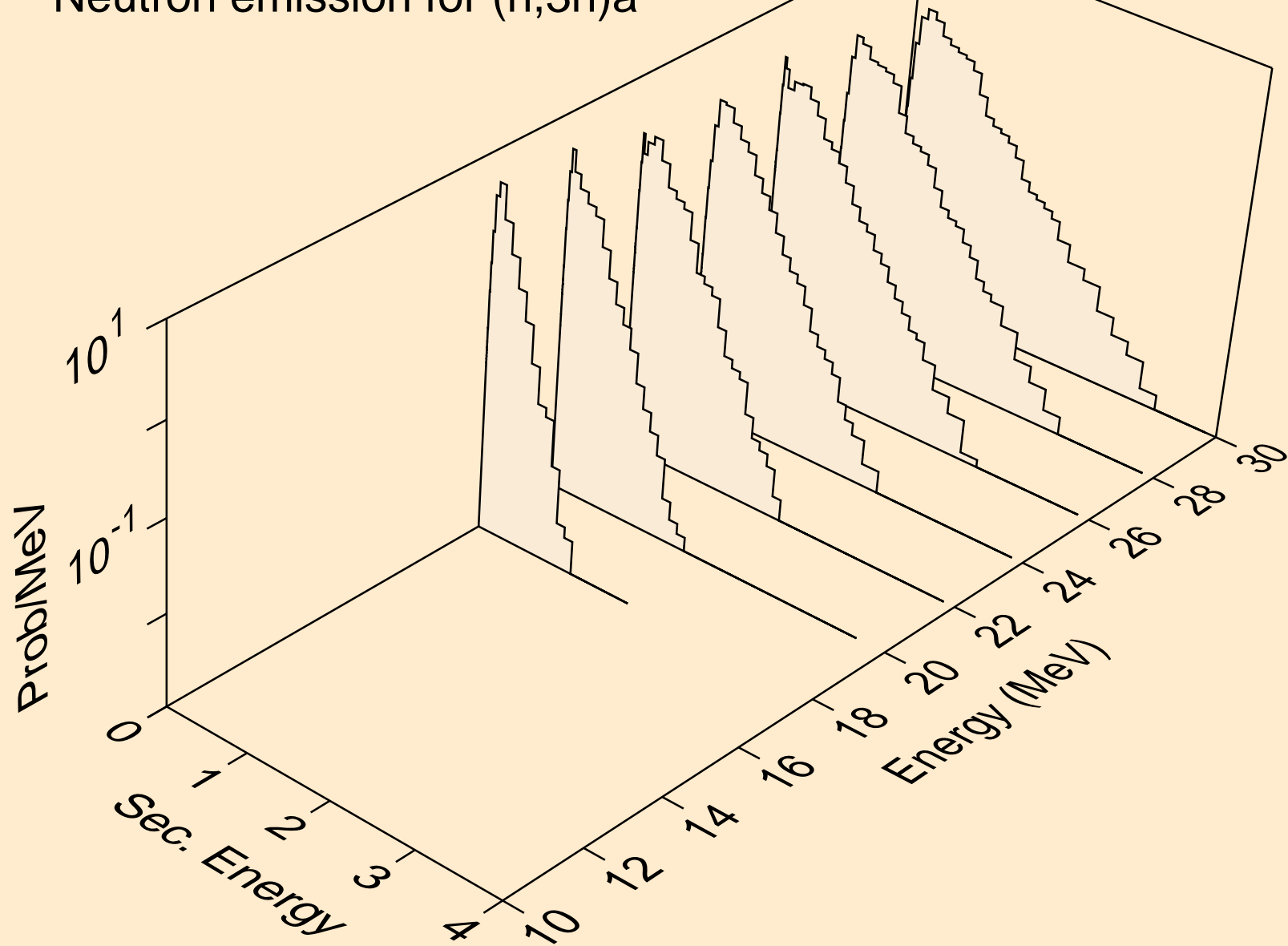

ER177 NEUTRON ACER TENDL-2021 LIBRARY; T=293.6K
Neutron emission for (n,n*)p

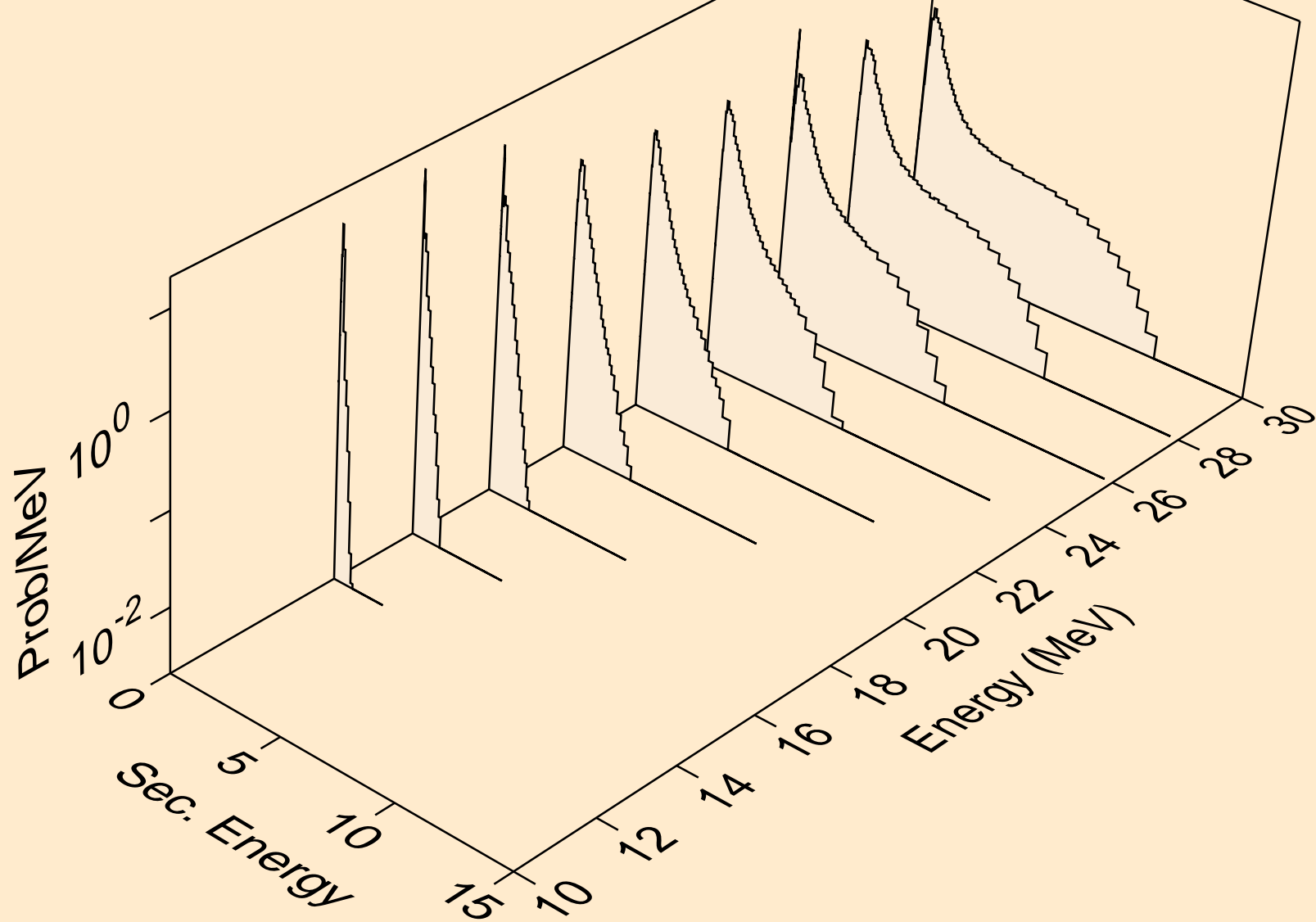

ER177 NEUTRON ACER TENDL-2021 LIBRARY; T=293.6K
Neutron emission for (n,n*)d

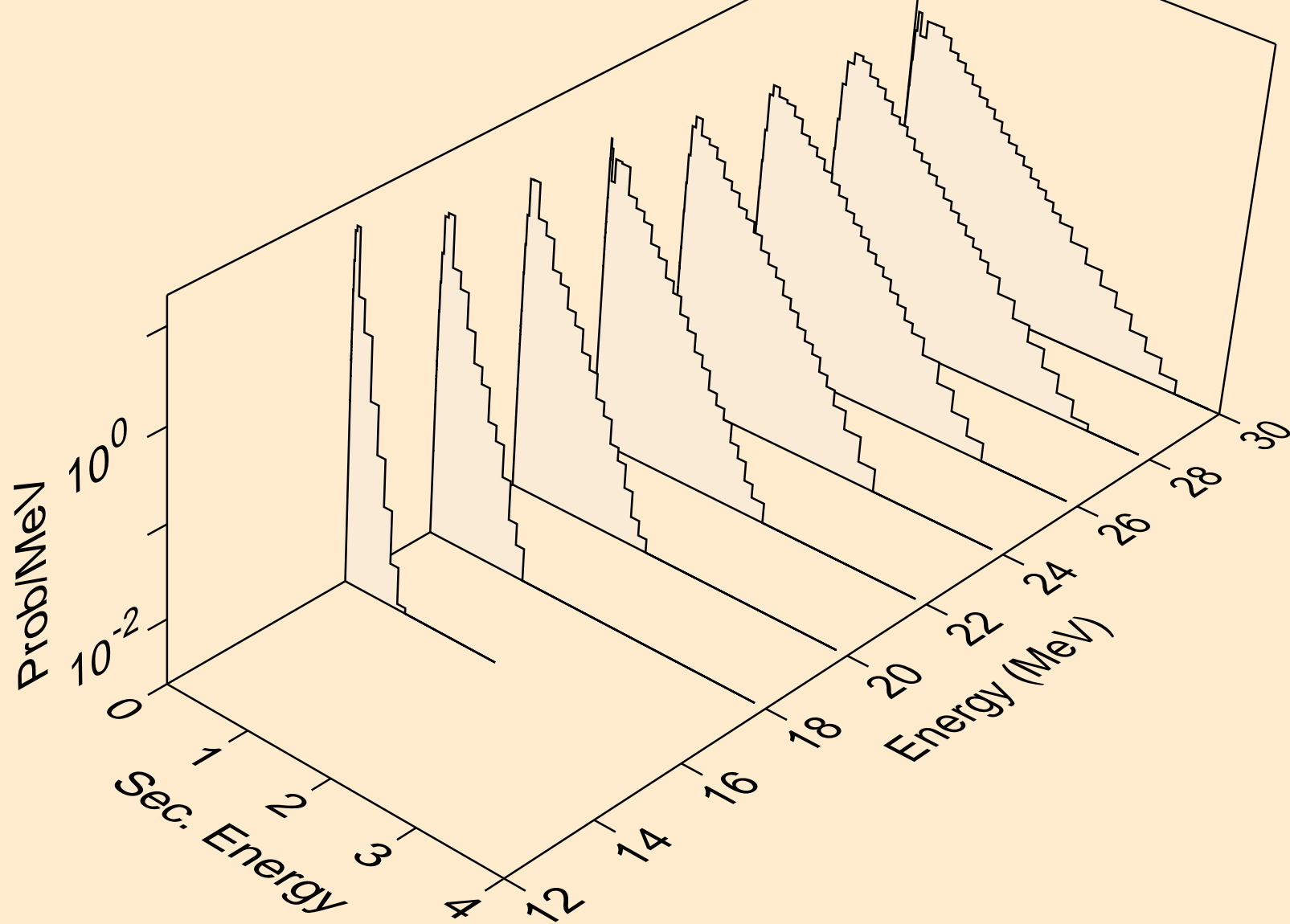

ER177 NEUTRON ACER TENDL-2021 LIBRARY; T=293.6K
Neutron emission for (n,n*)t

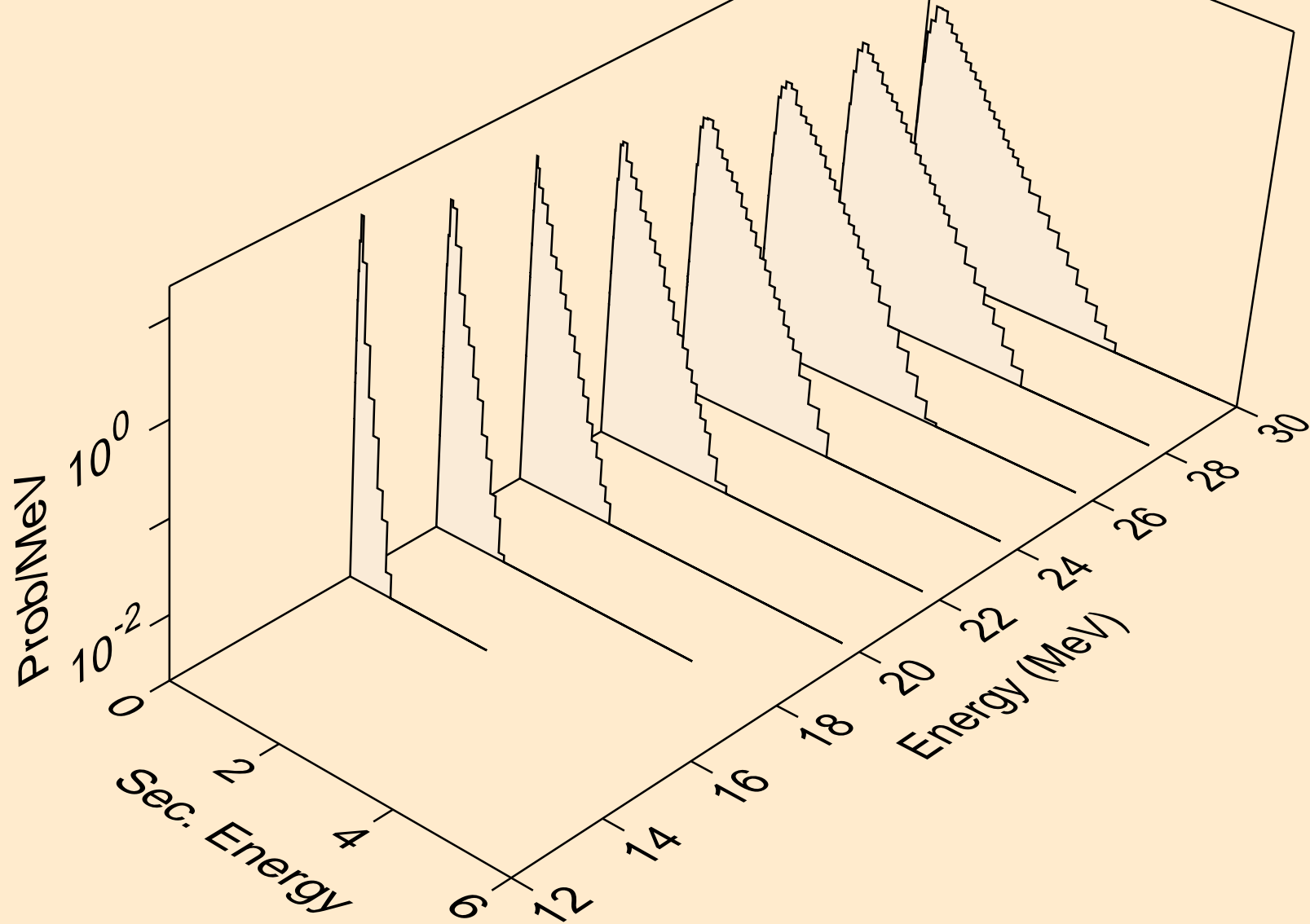

ER177 NEUTRON ACER TENDL-2021 LIBRARY; T=293.6K
Neutron emission for (n,n*)he3

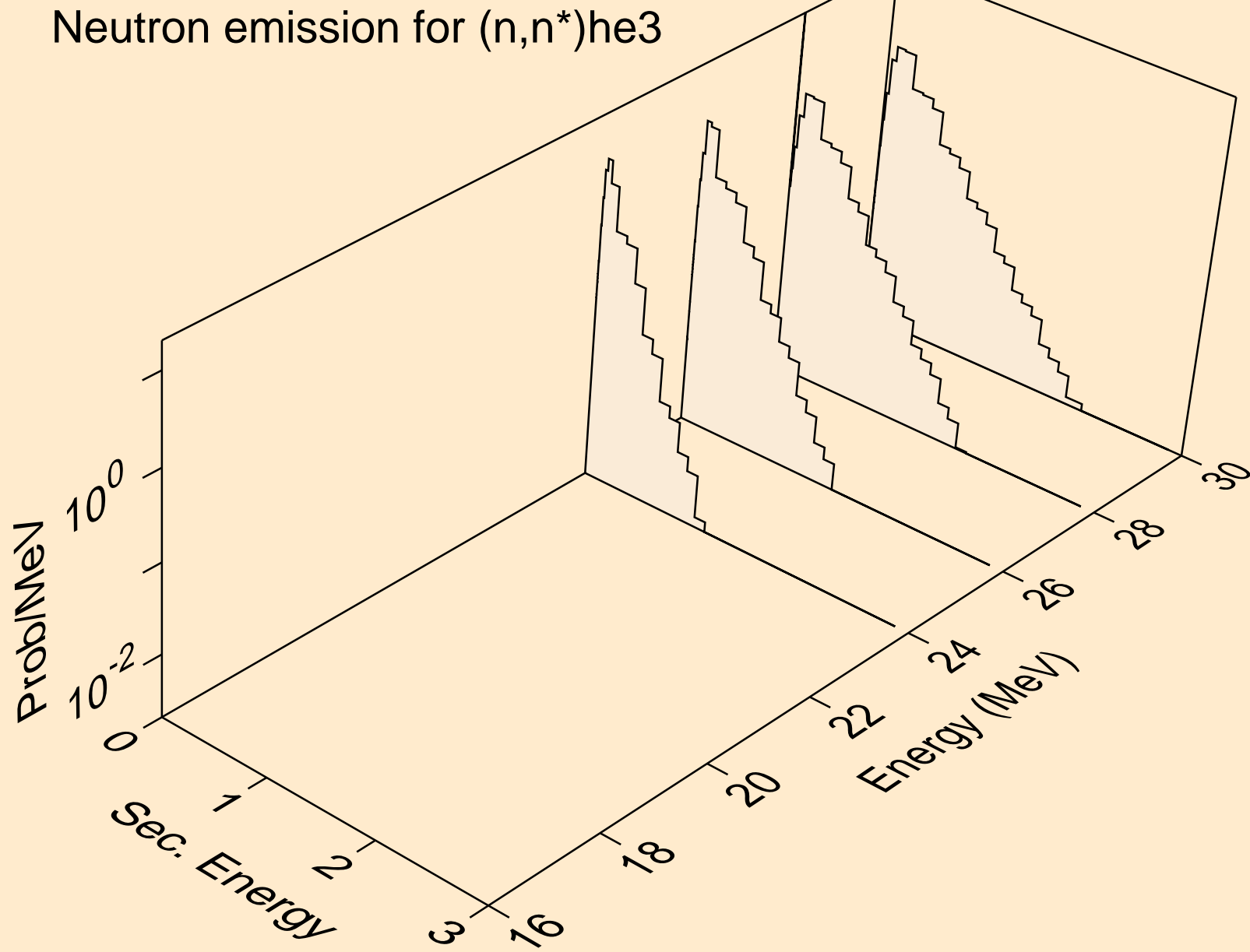

ER177 NEUTRON ACER TENDL-2021 LIBRARY; T=293.6K
Neutron emission for (n,4n)

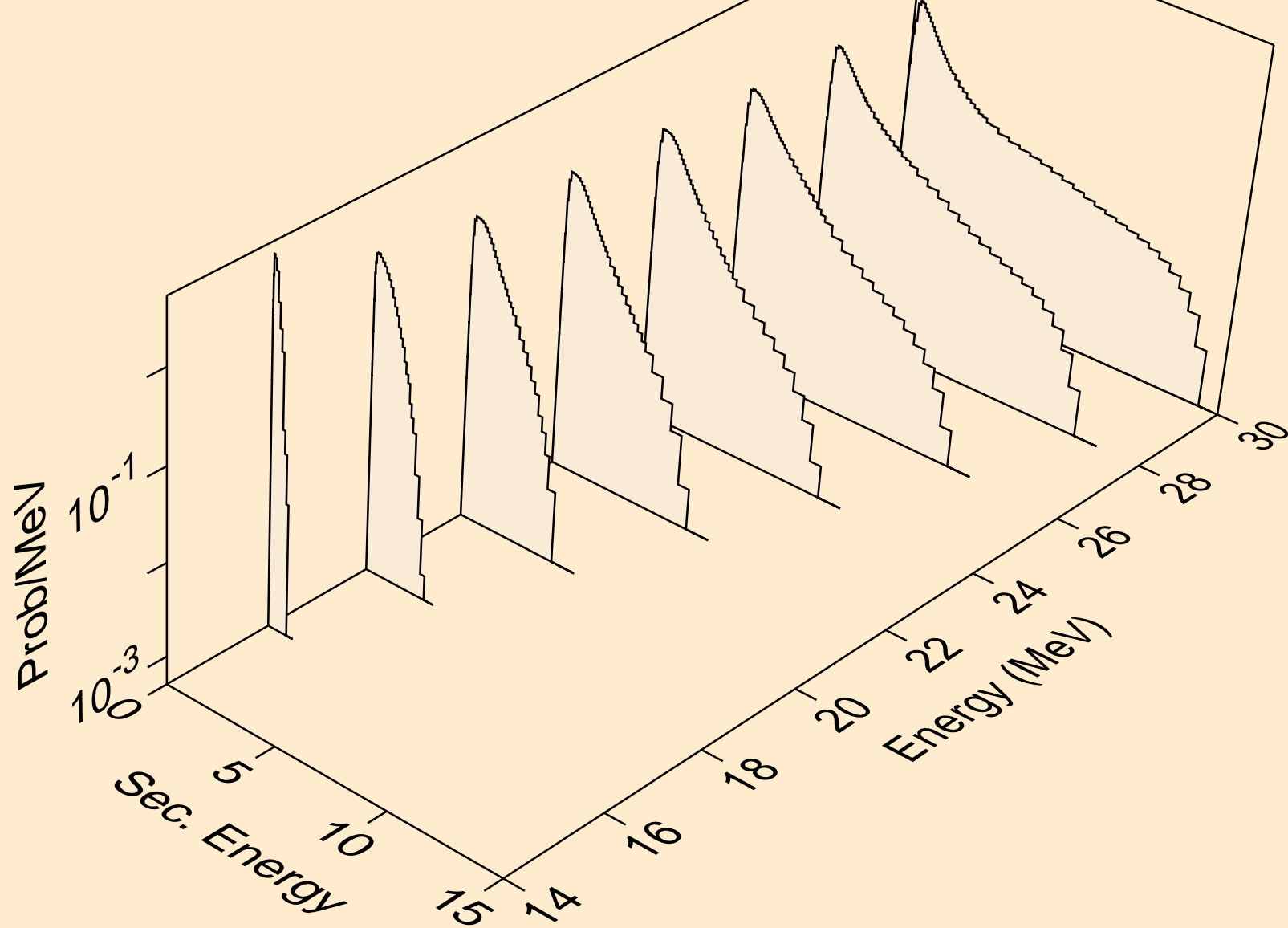

ER177 NEUTRON ACER TENDL-2021 LIBRARY; T=293.6K
Neutron emission for (n,2np)

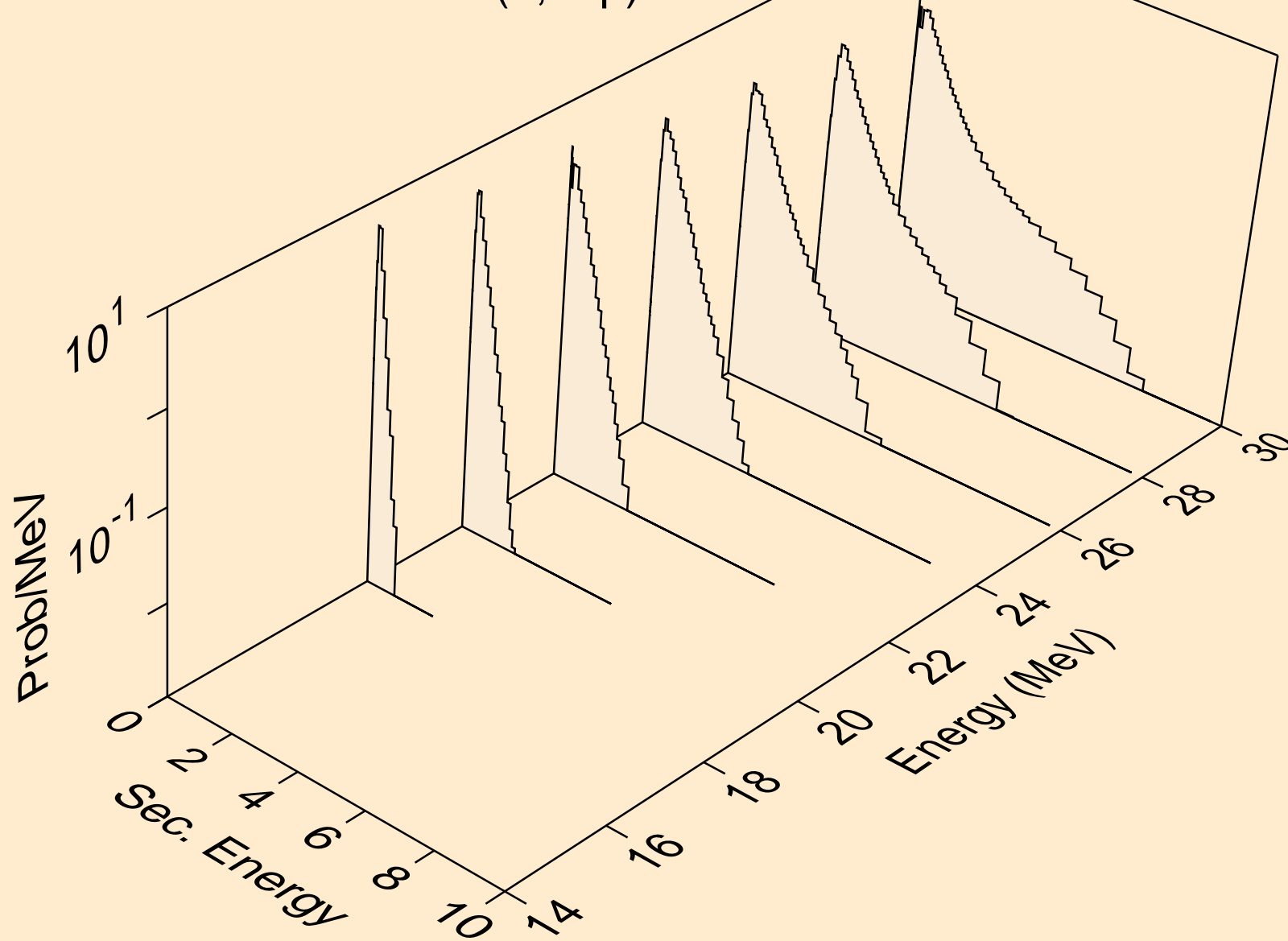

ER177 NEUTRON ACER TENDL-2021 LIBRARY; T=293.6K
Neutron emission for (n,3np)

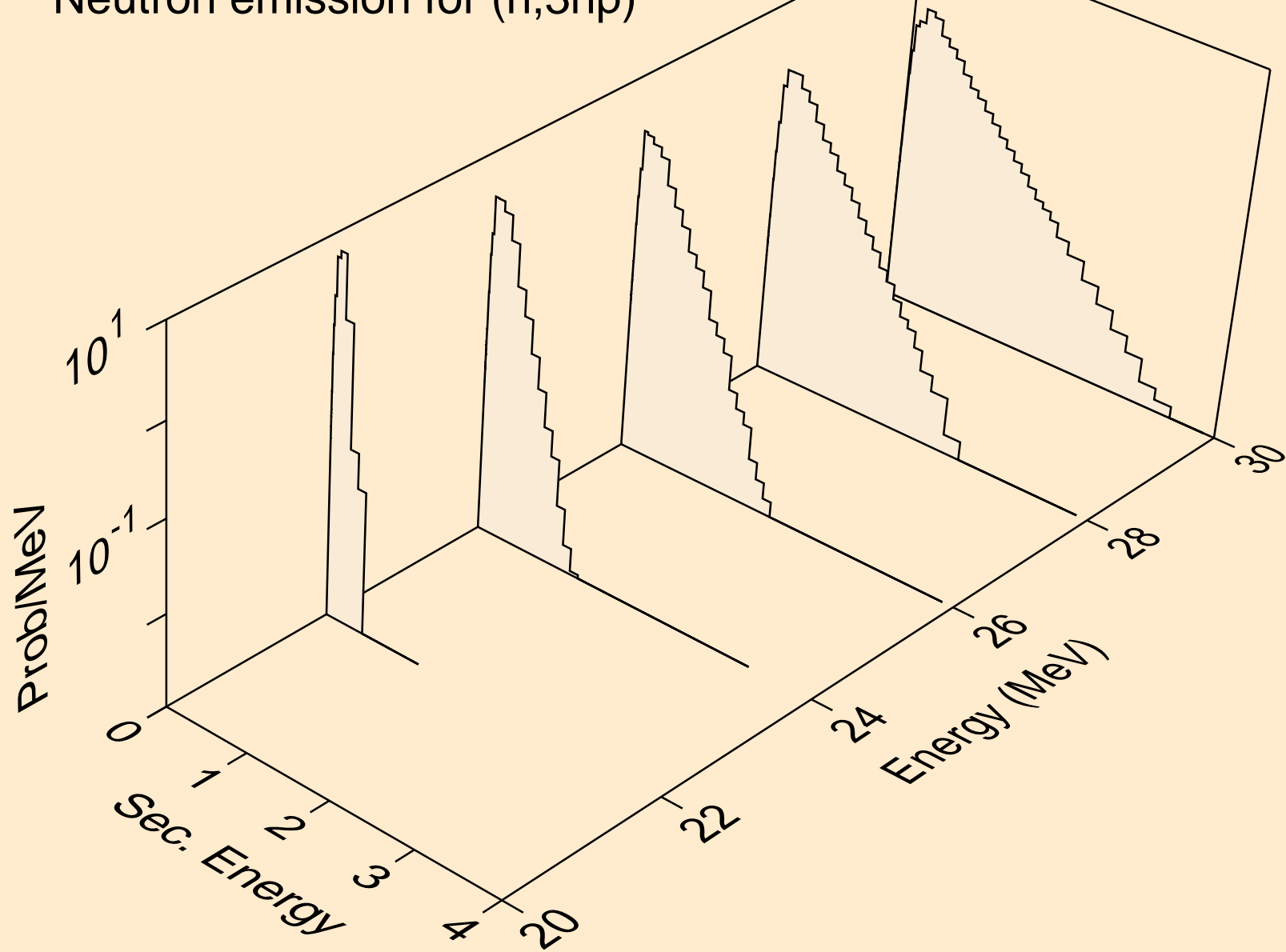

ER177 NEUTRON ACER TENDL-2021 LIBRARY; T=293.6K
Neutron emission for (n,n*c)

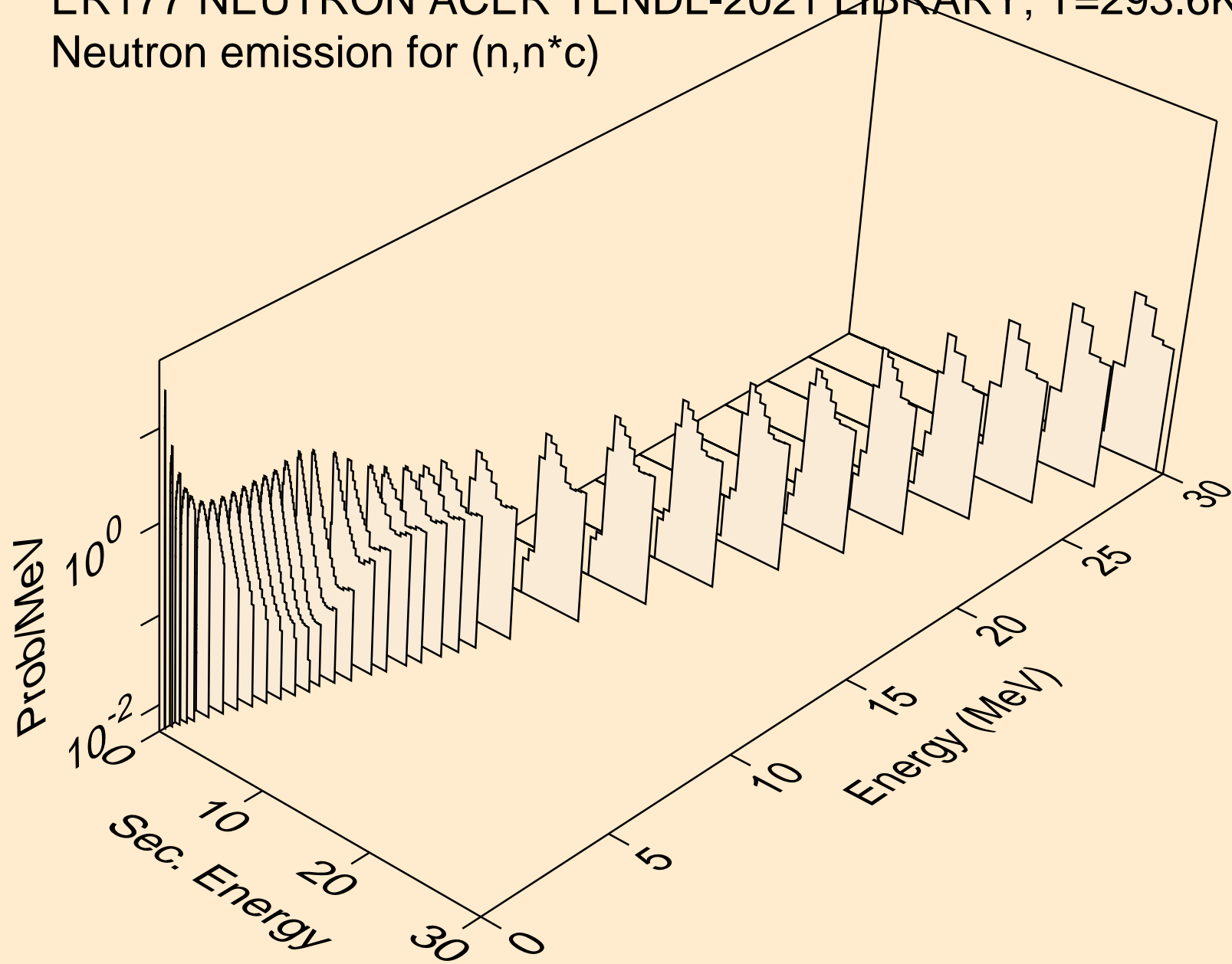

ER177 NEUTRON ACER TENDL-2021 LIBRARY; T=293.6K
Photon emission for (n,x)

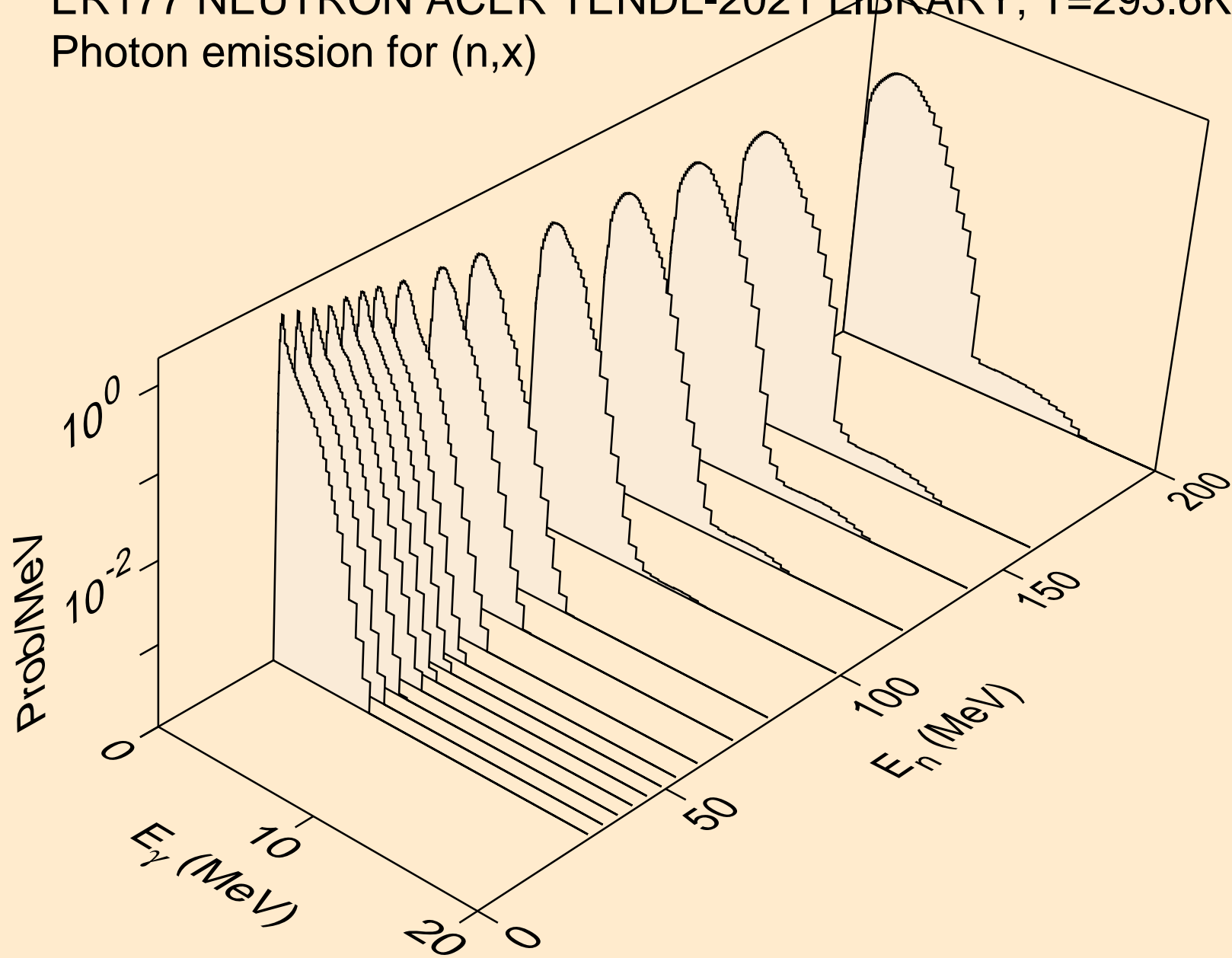

ER177 NEUTRON ACER TENDL-2021 LIBRARY; T=293.6K
Photon emission for (n,2nd)

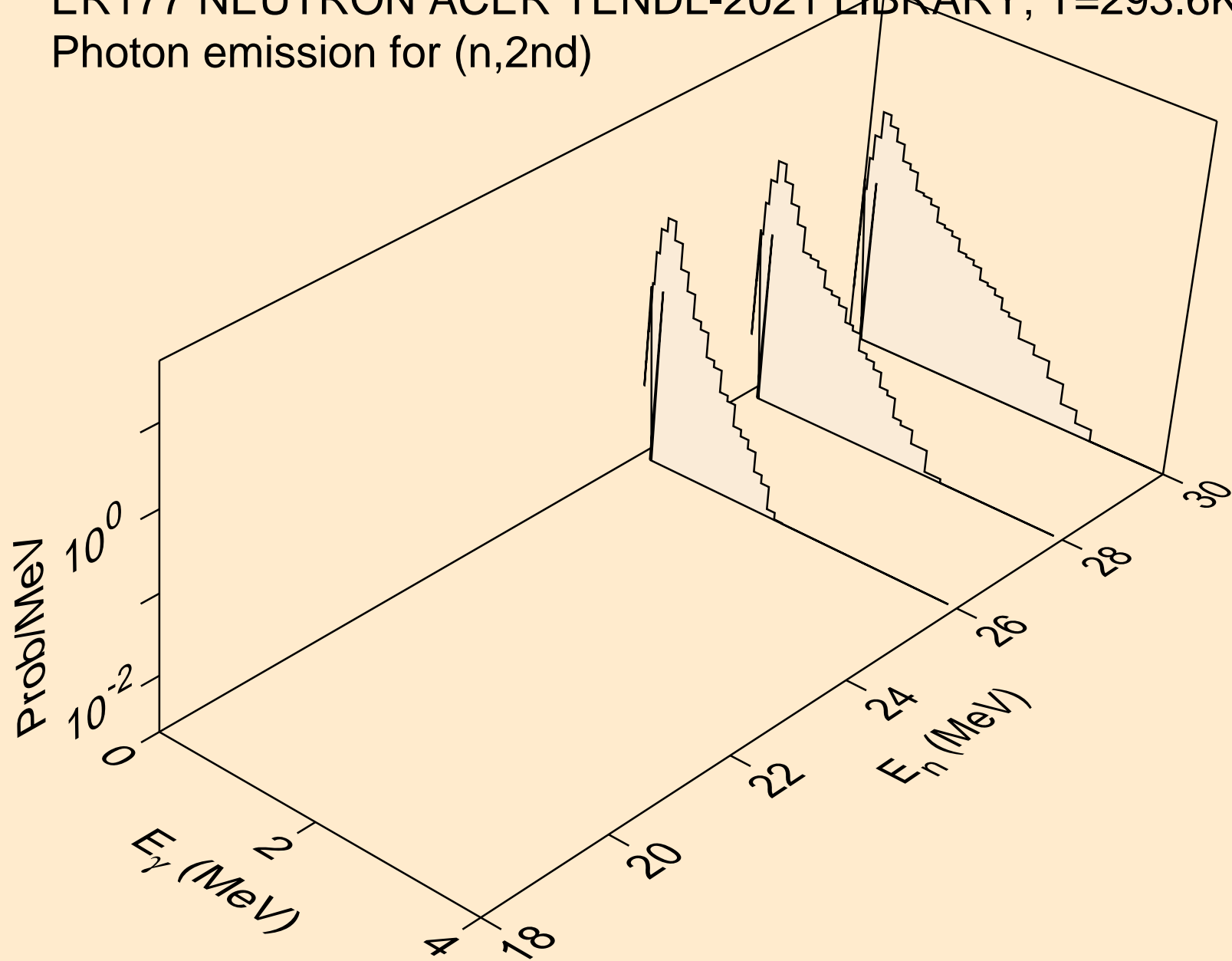

ER177 NEUTRON ACER TENDL-2021 LIBRARY; T=293.6K
Photon emission for (n,2n)

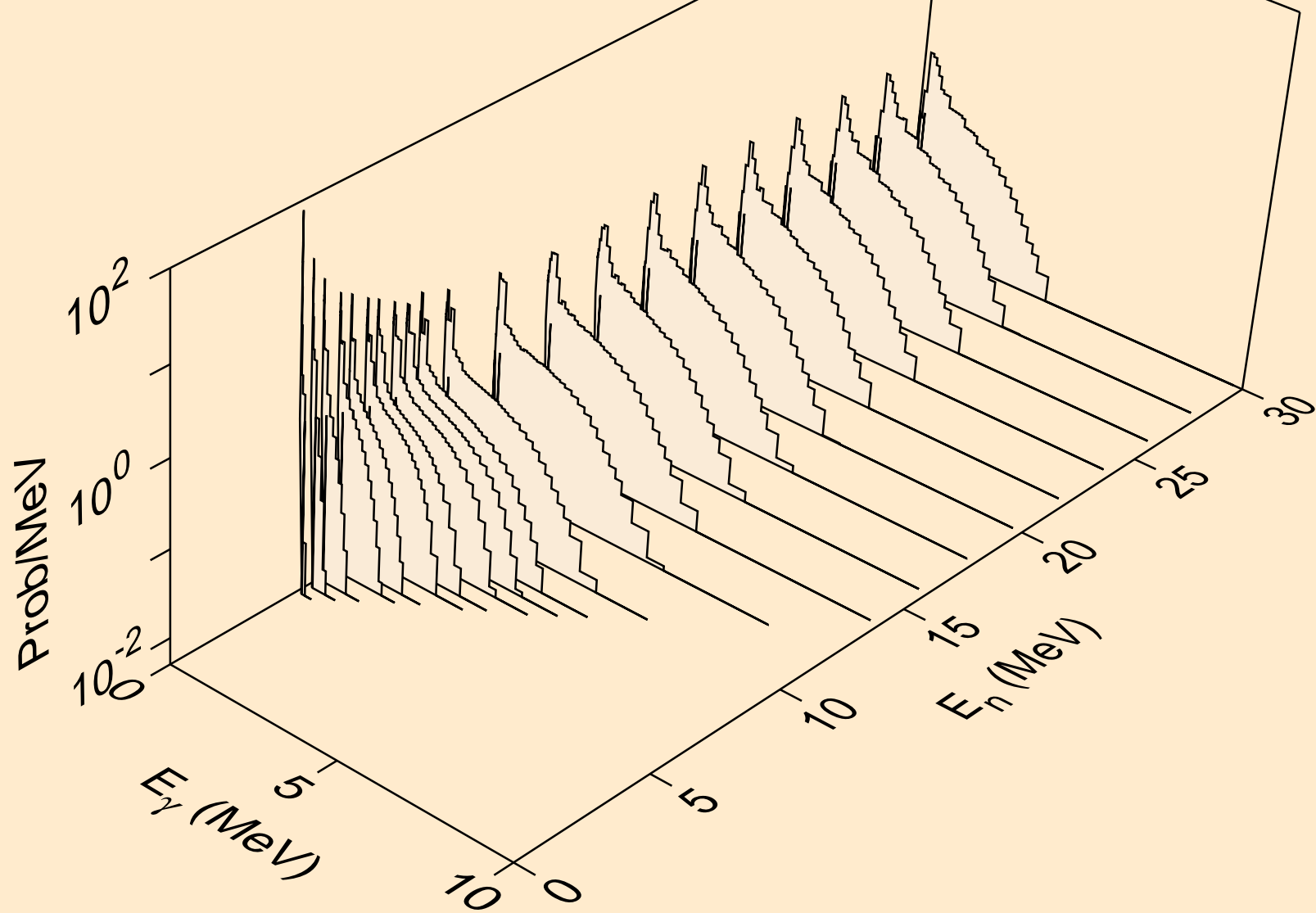

ER177 NEUTRON ACER TENDL-2021 LIBRARY; T=293.6K
Photon emission for (n,3n)

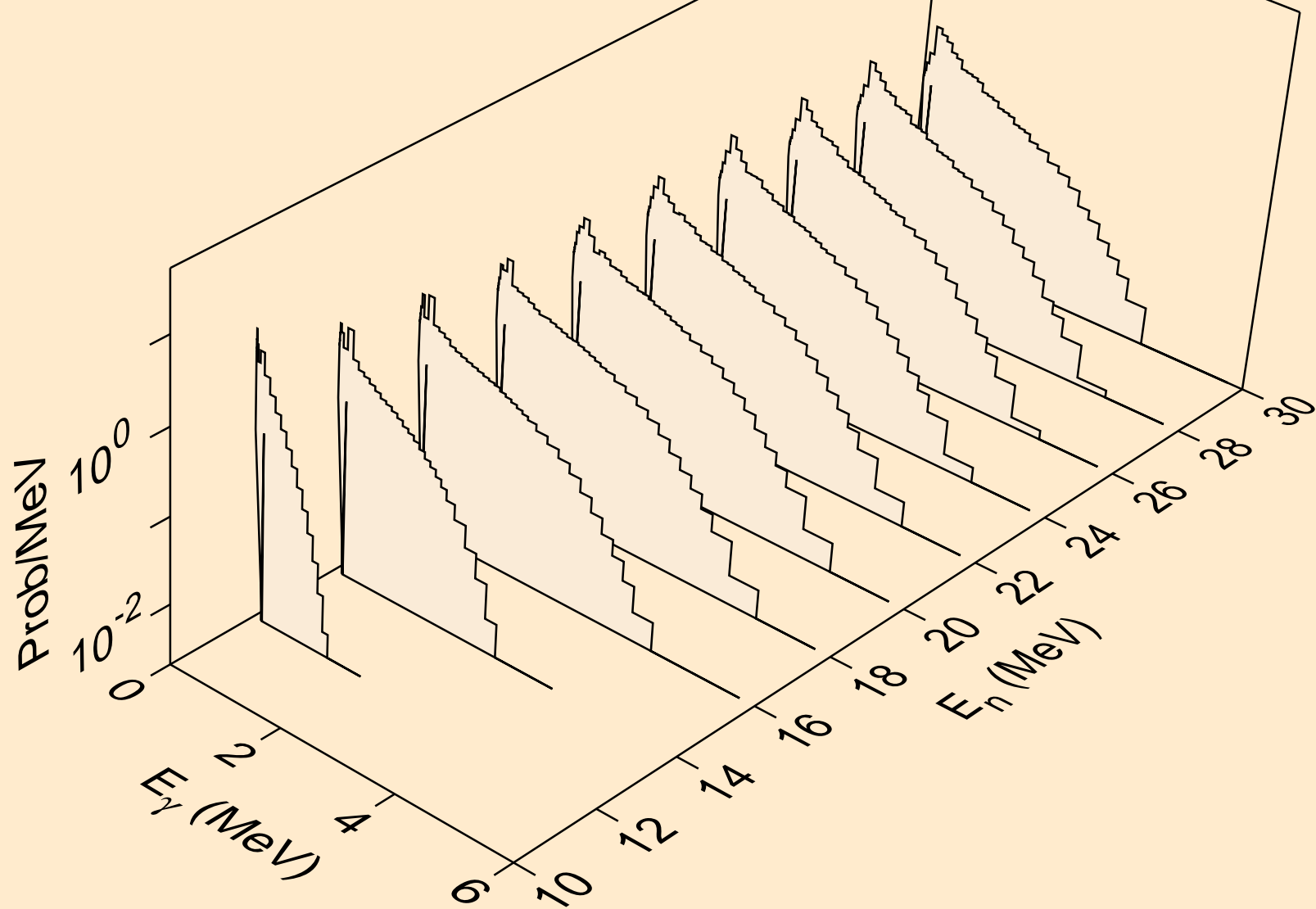

ER177 NEUTRON ACER TENDL-2021 LIBRARY; T=293.6K
Photon emission for (n,n*)a

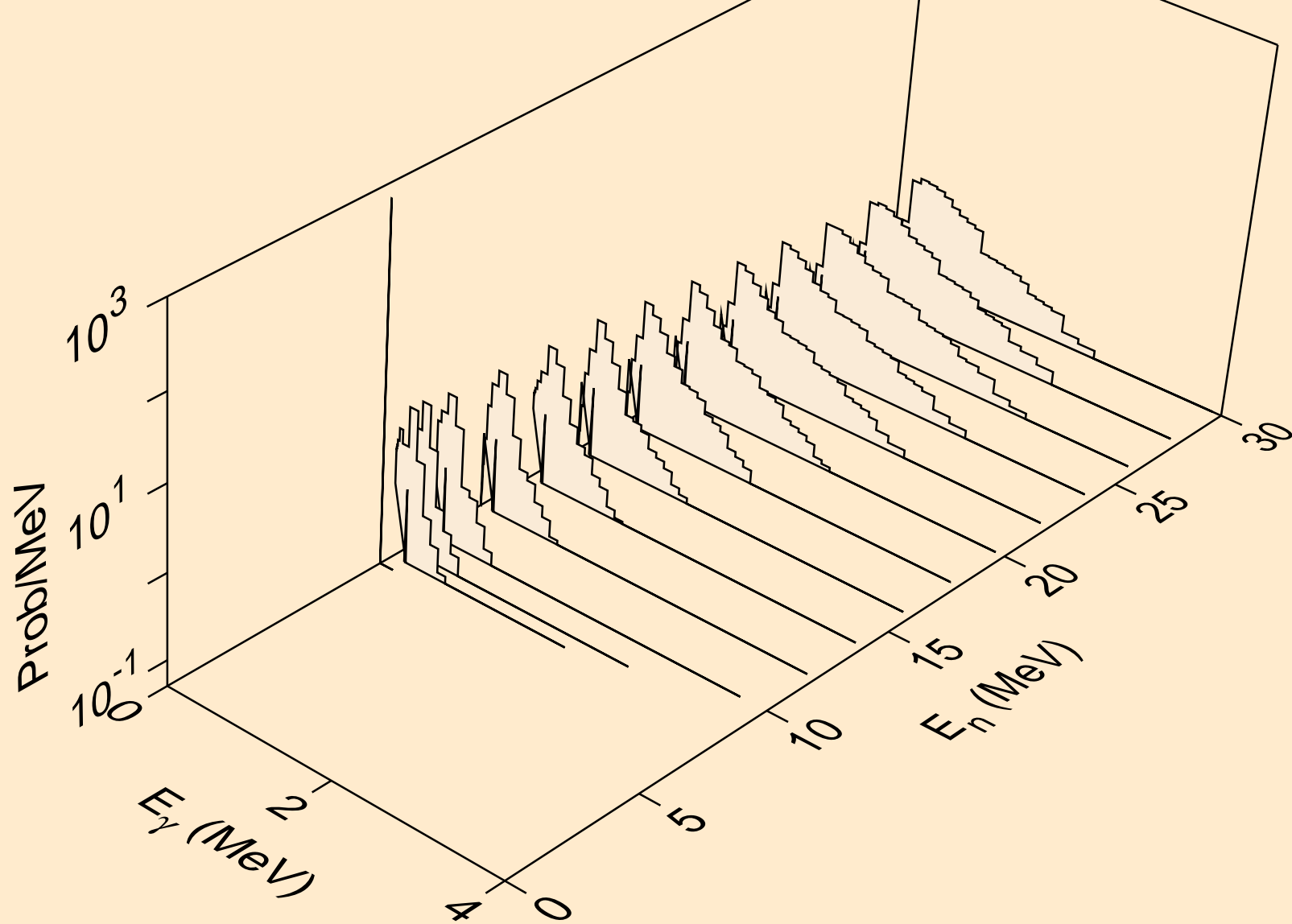

ER177 NEUTRON ACER TENDL-2021 LIBRARY; T=293.6K
Photon emission for (n,2n)a

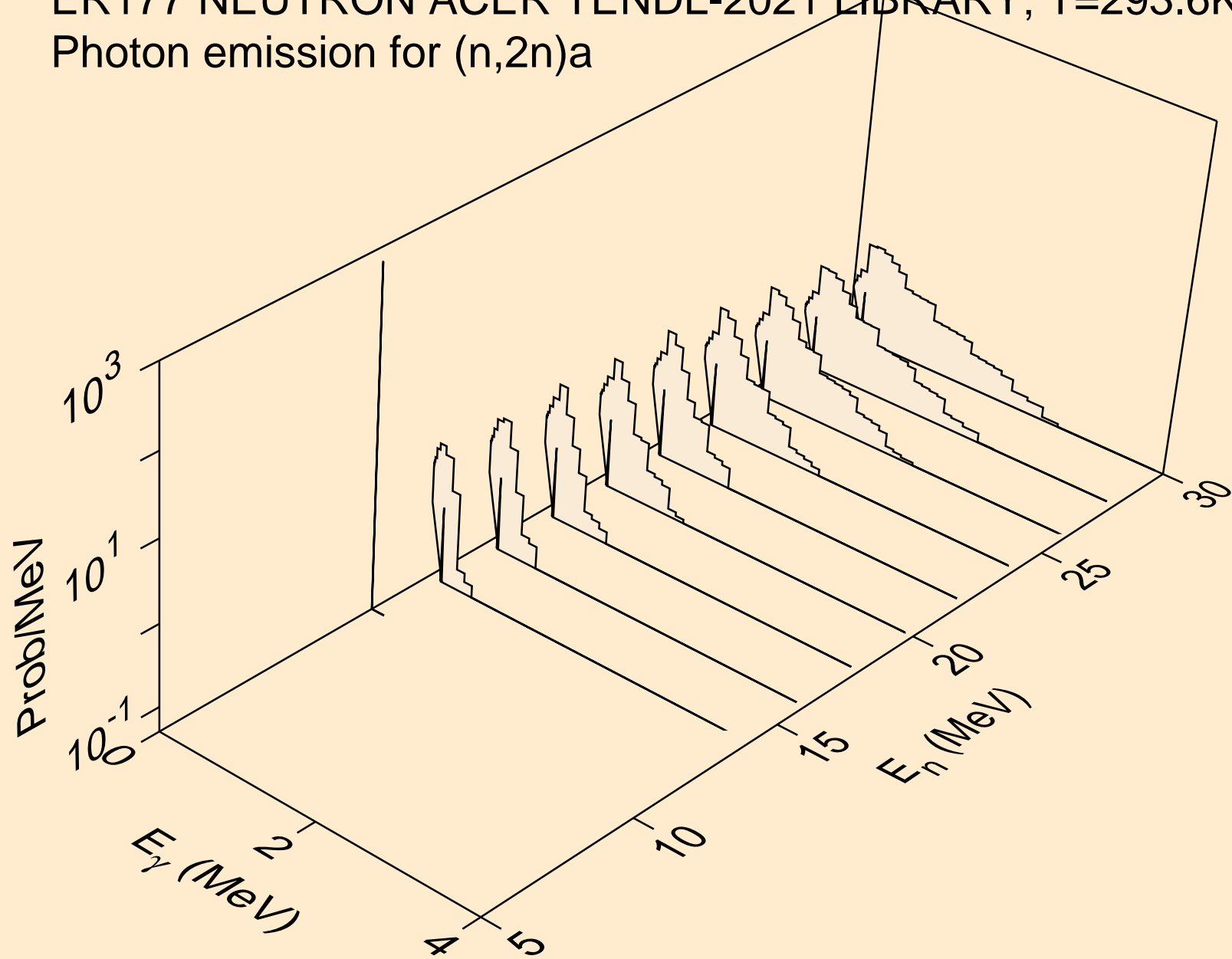

ER177 NEUTRON ACER TENDL-2021 LIBRARY; T=293.6K
Photon emission for (n,3n)a

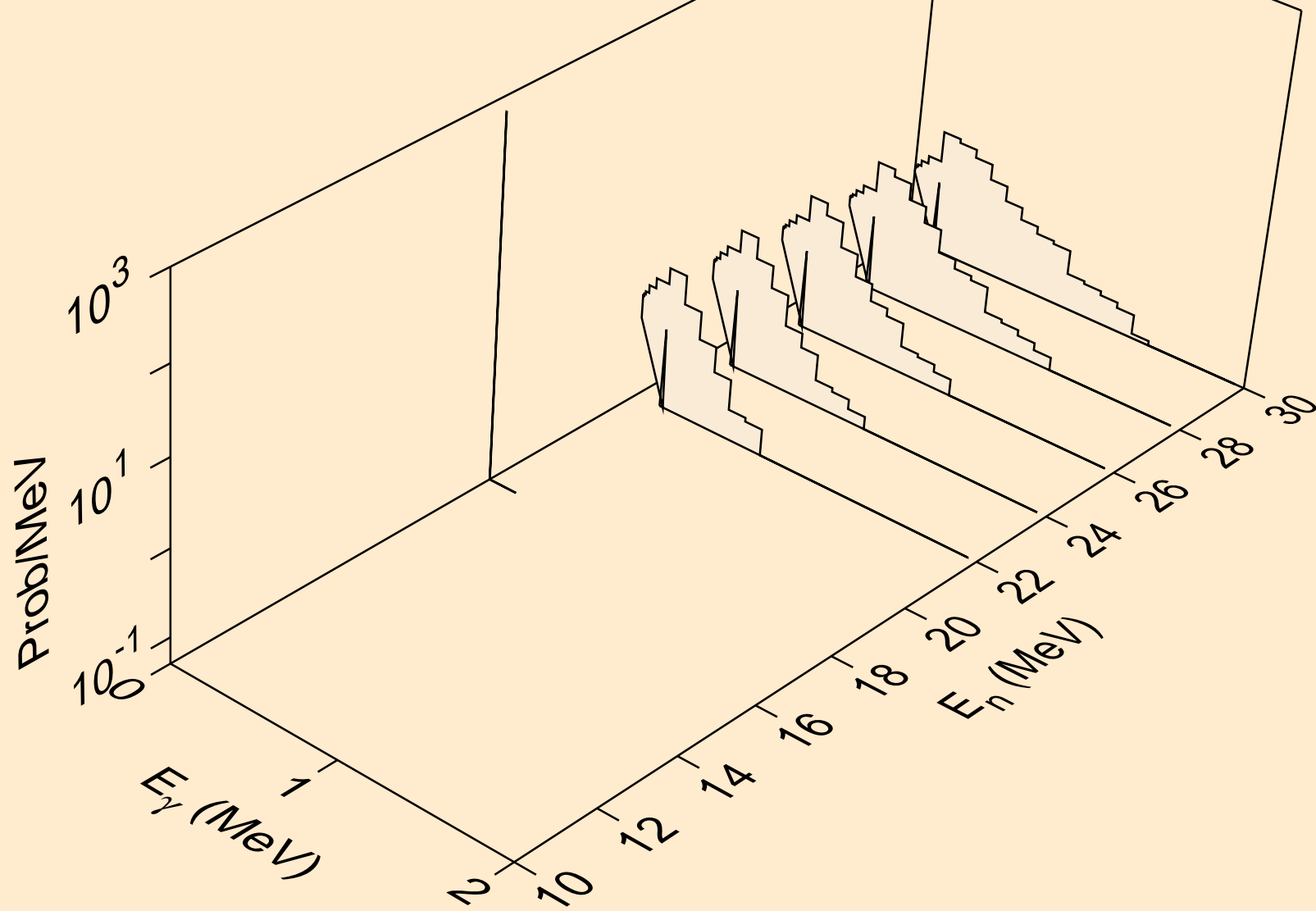

ER177 NEUTRON ACER TENDL-2021 LIBRARY; T=293.6K
Photon emission for (n,n*)p

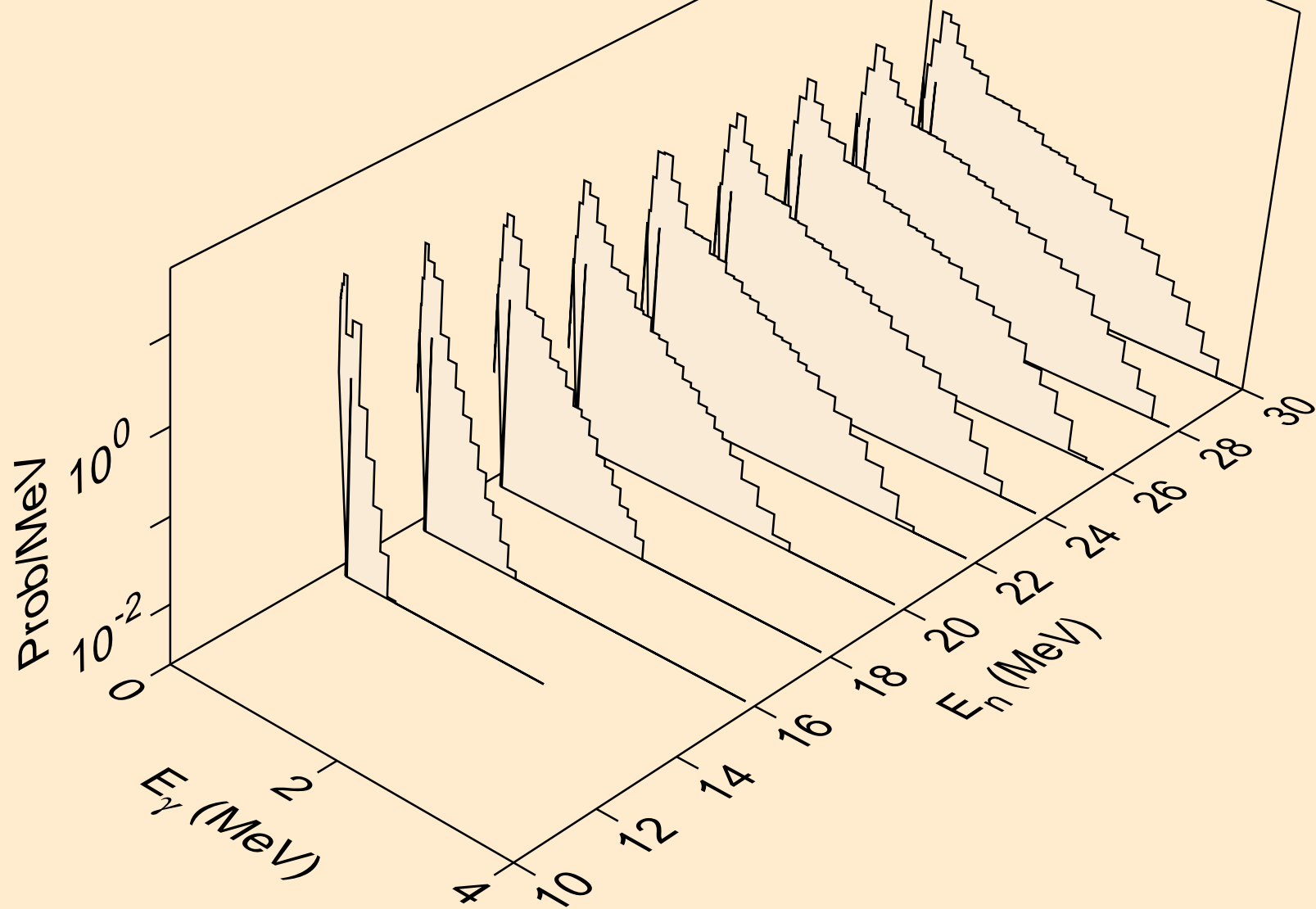

ER177 NEUTRON ACER TENDL-2021 LIBRARY; T=293.6K
Photon emission for (n,n*)d

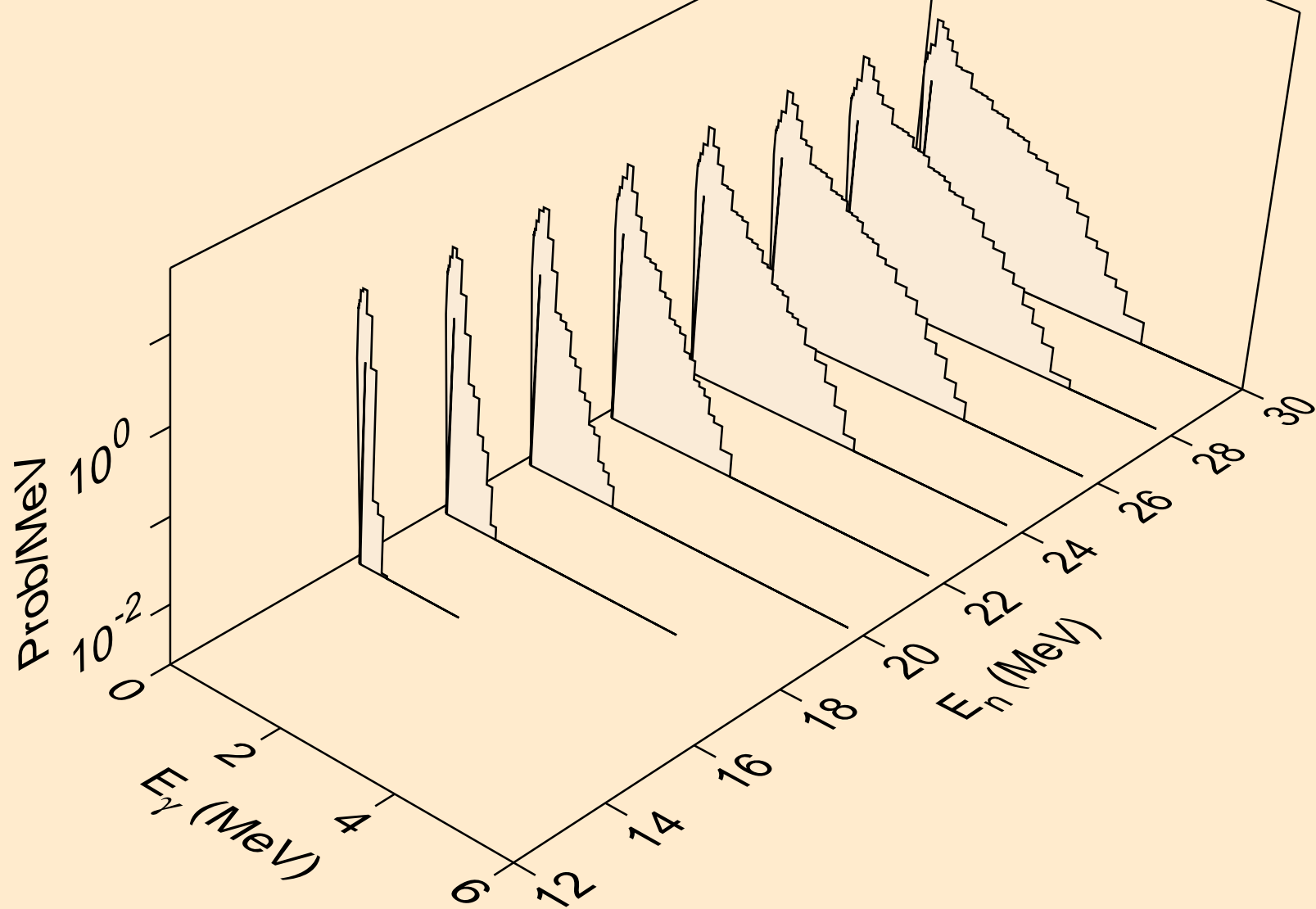

ER177 NEUTRON ACER TENDL-2021 LIBRARY; T=293.6K
Photon emission for (n,n*)t

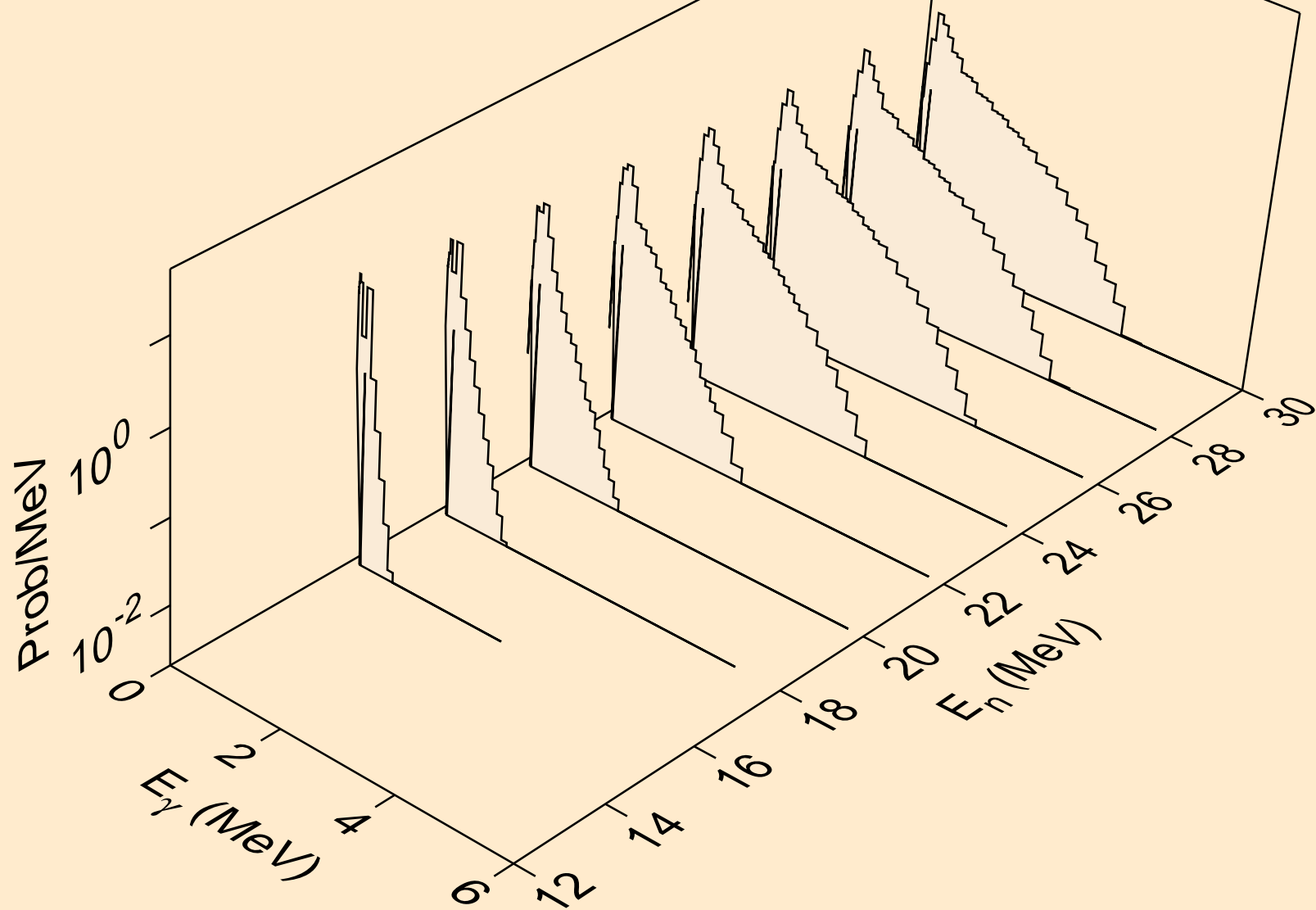

ER177 NEUTRON ACER TENDL-2021 LIBRARY; T=293.6K
Photon emission for (n,n*)he3

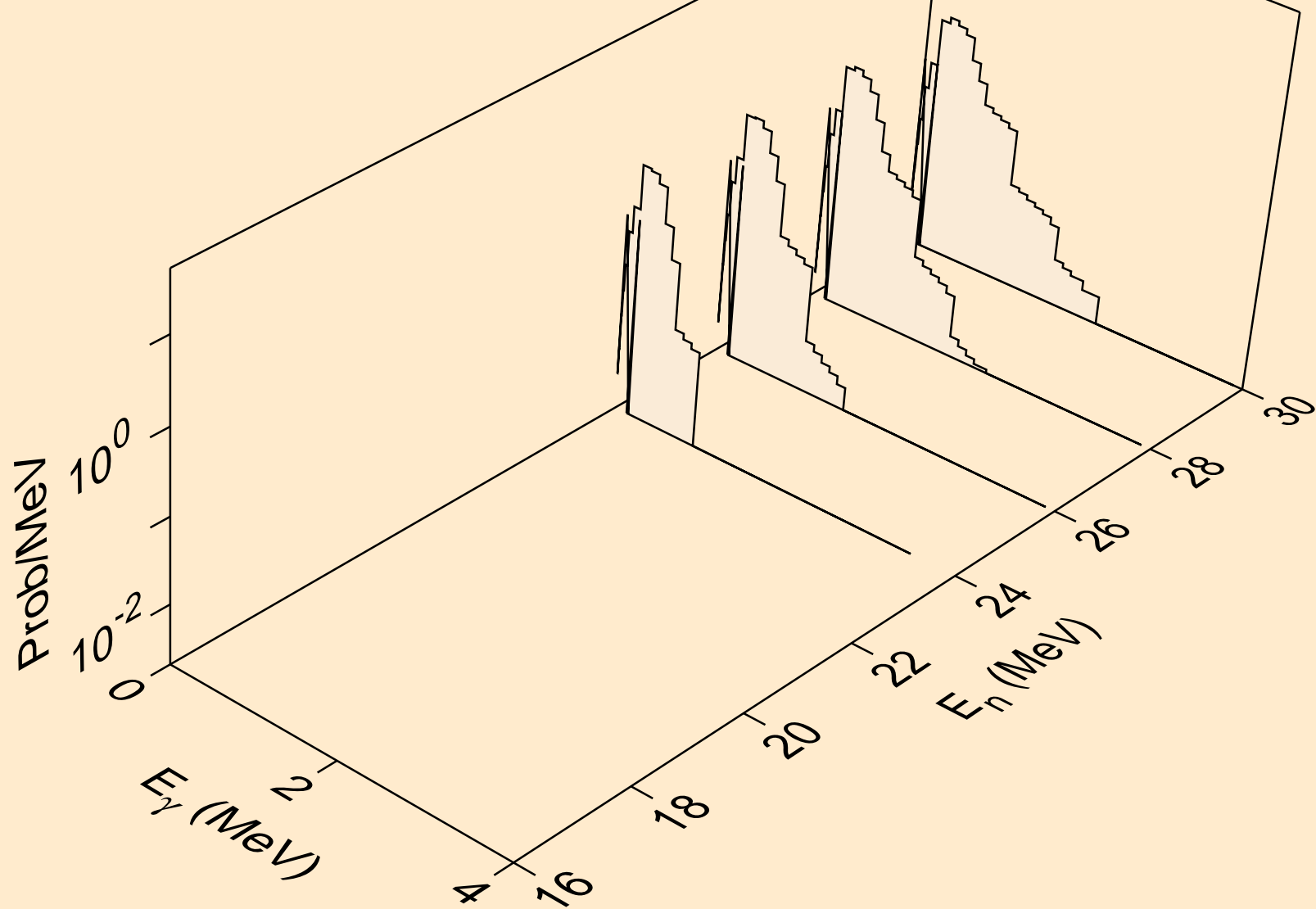

ER177 NEUTRON ACER TENDL-2021 LIBRARY; T=293.6K
Photon emission for (n,4n)

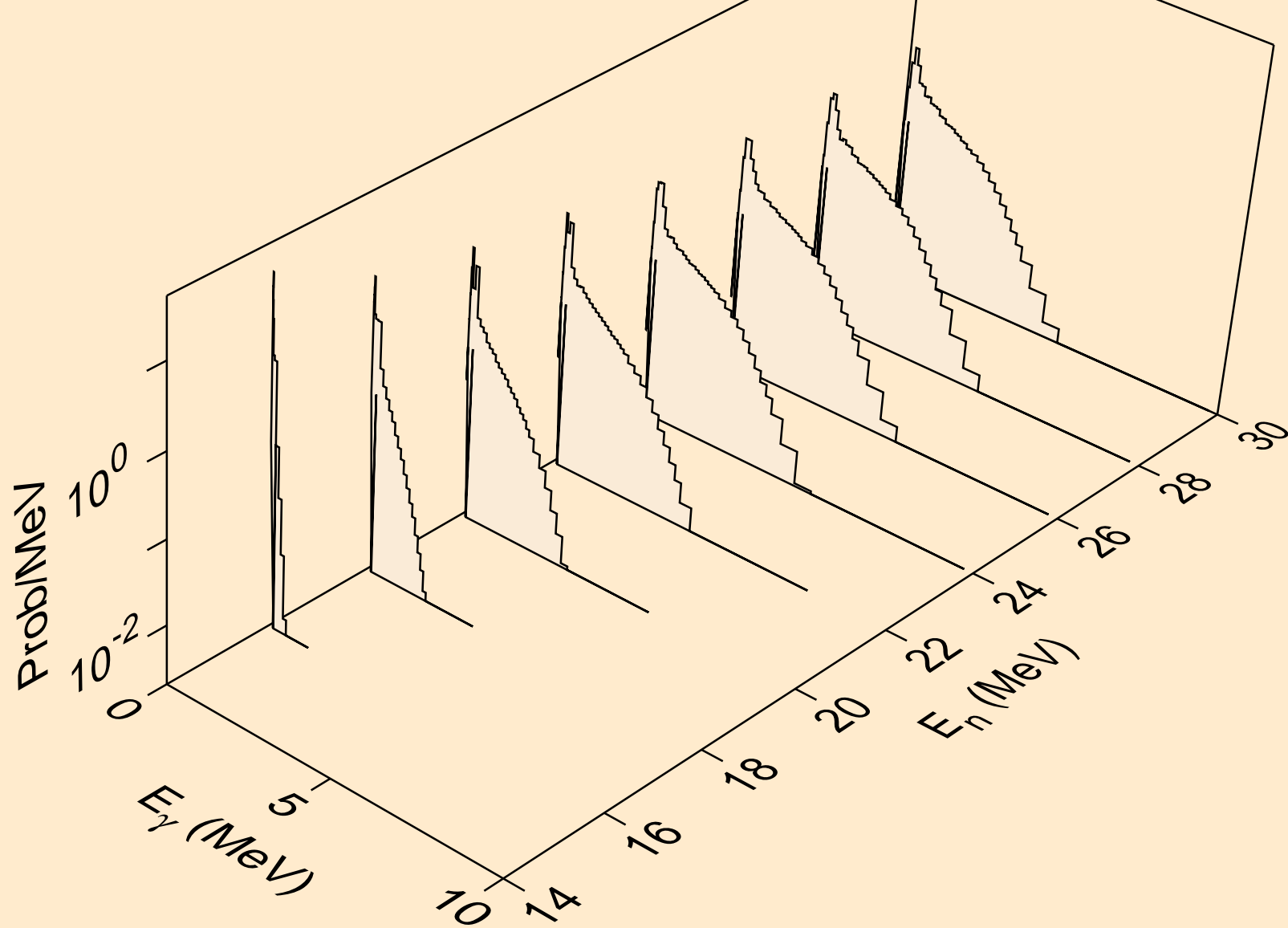

ER177 NEUTRON ACER TENDL-2021 LIBRARY; T=293.6K
Photon emission for (n,2np)

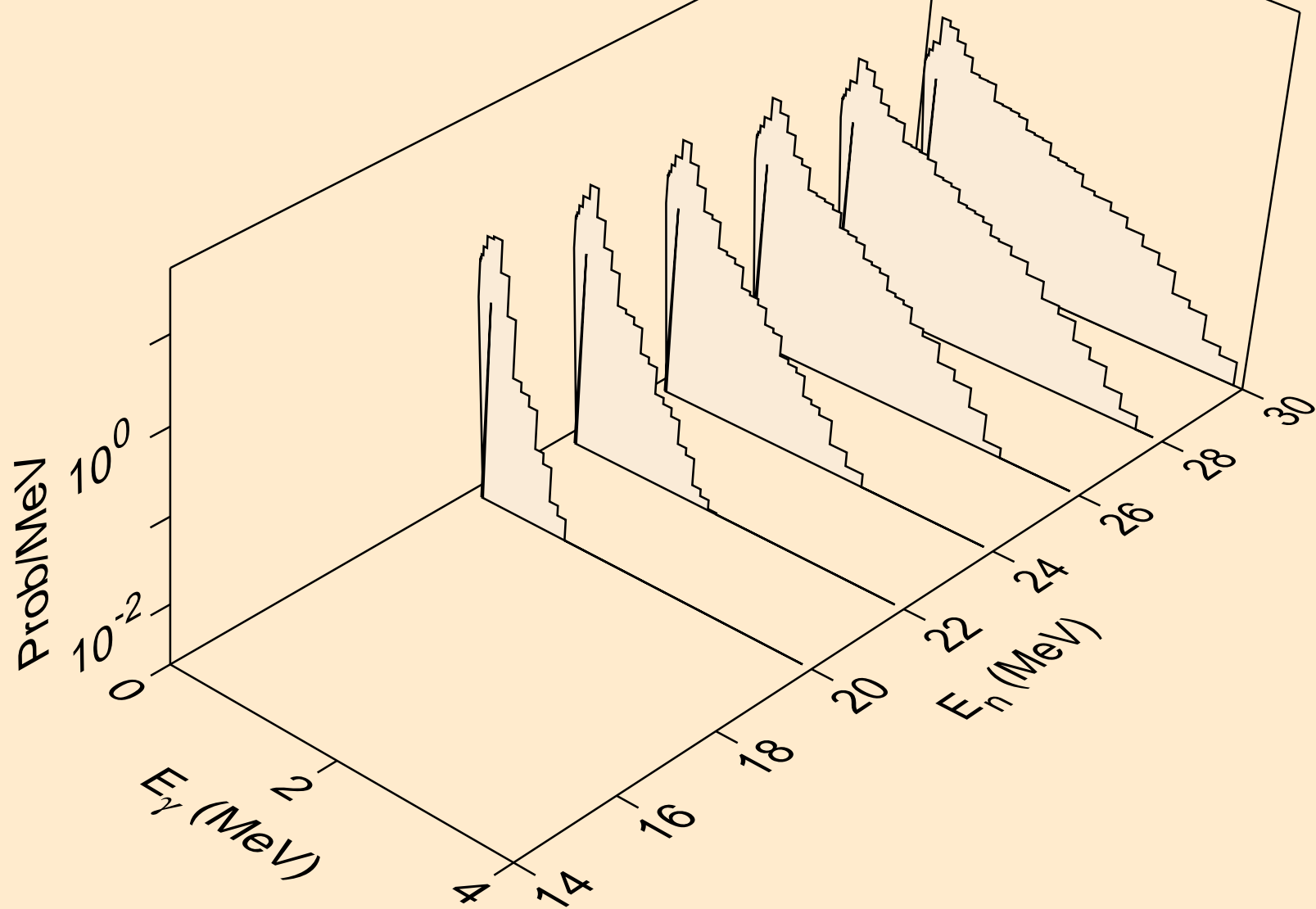

ER177 NEUTRON ACER TENDL-2021 LIBRARY; T=293.6K
Photon emission for (n,3np)

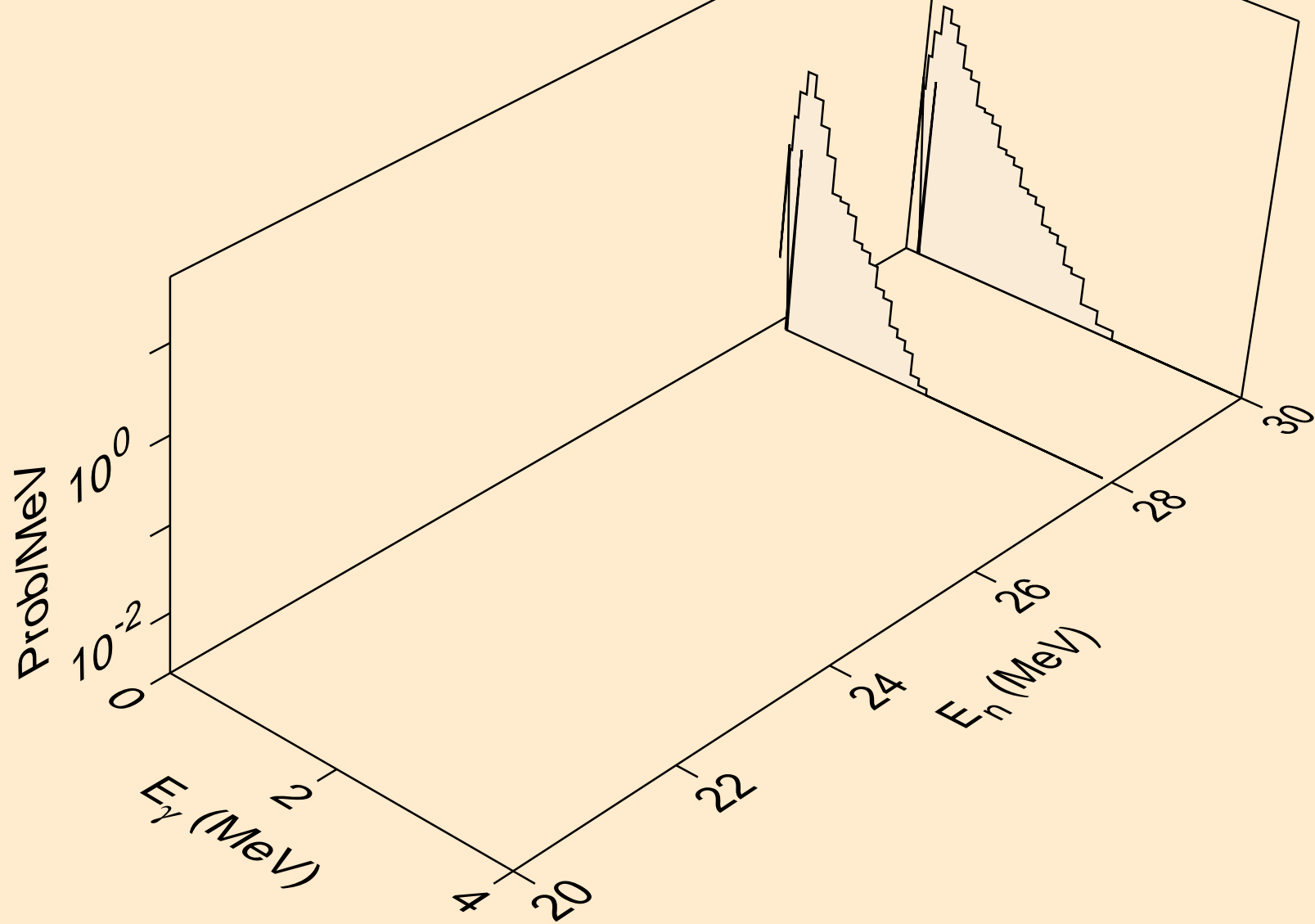

ER177 NEUTRON ACER TENDL-2021 LIBRARY; T=293.6K
Photon emission for (n,n*c)

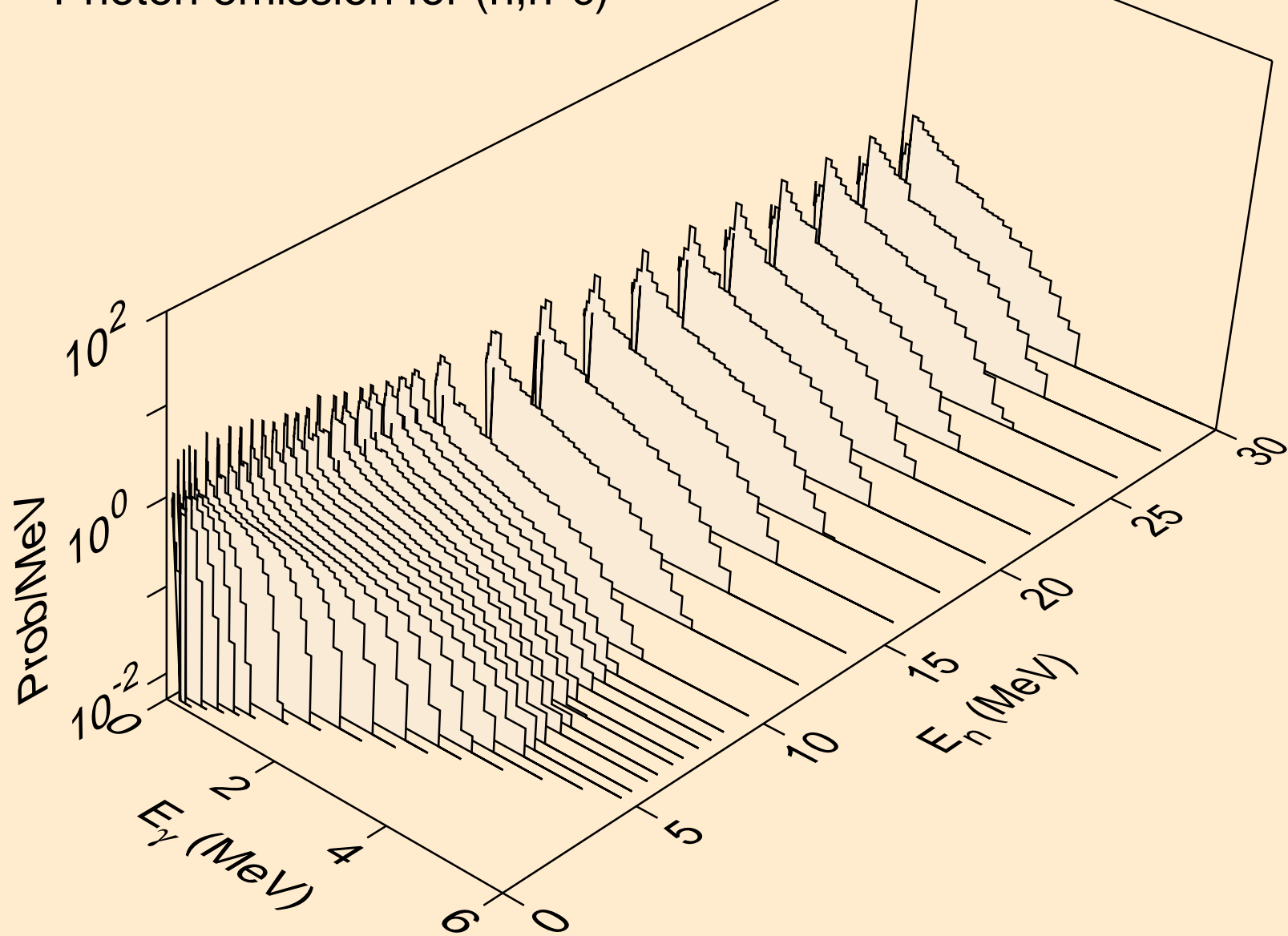

ER177 NEUTRON ACER TENDL-2021 LIBRARY; T=293.6K
Photon emission for (n,gma)

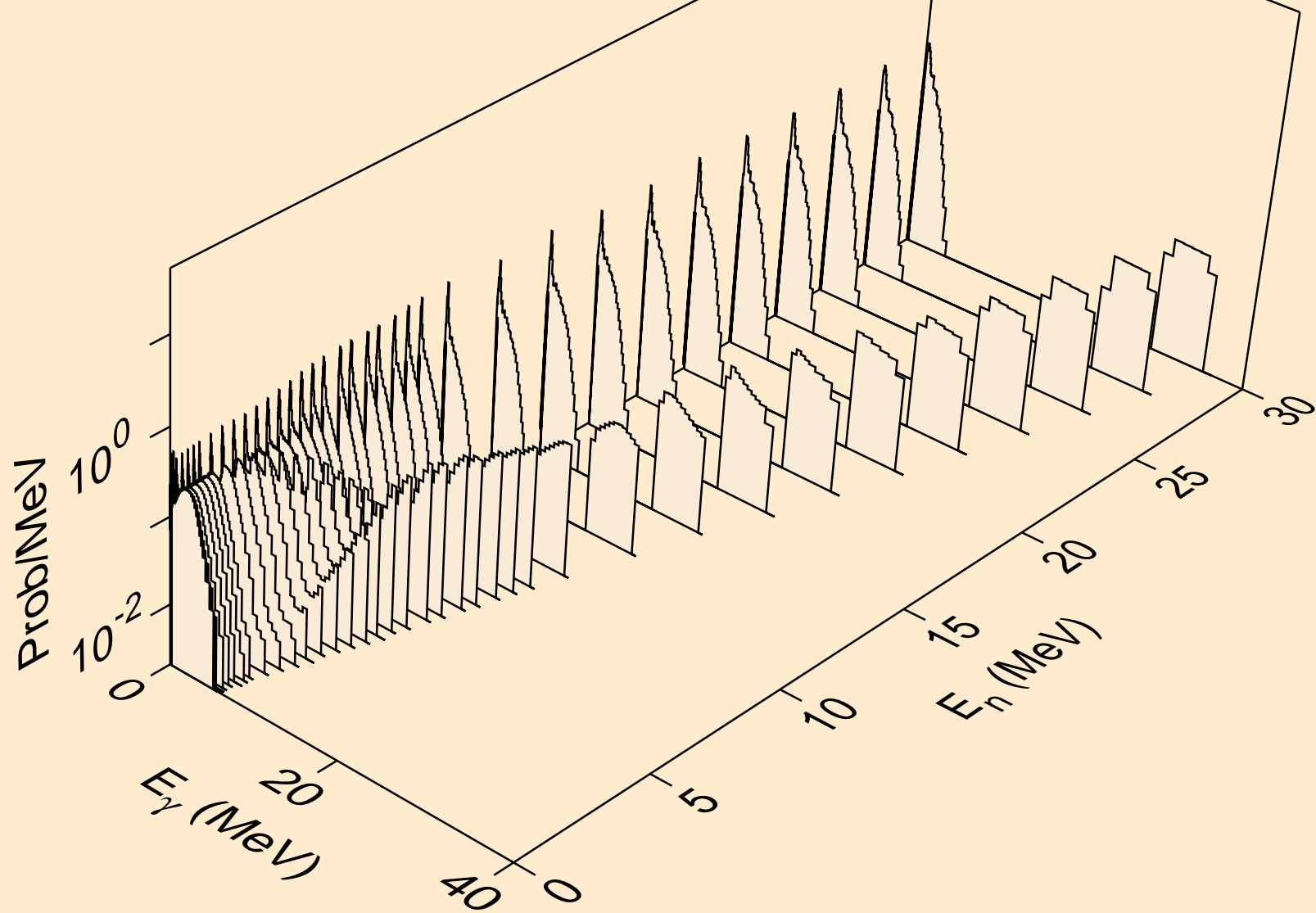

ER177 NEUTRON ACER TENDL-2021 LIBRARY; T=293.6K
Photon emission for (n,p)

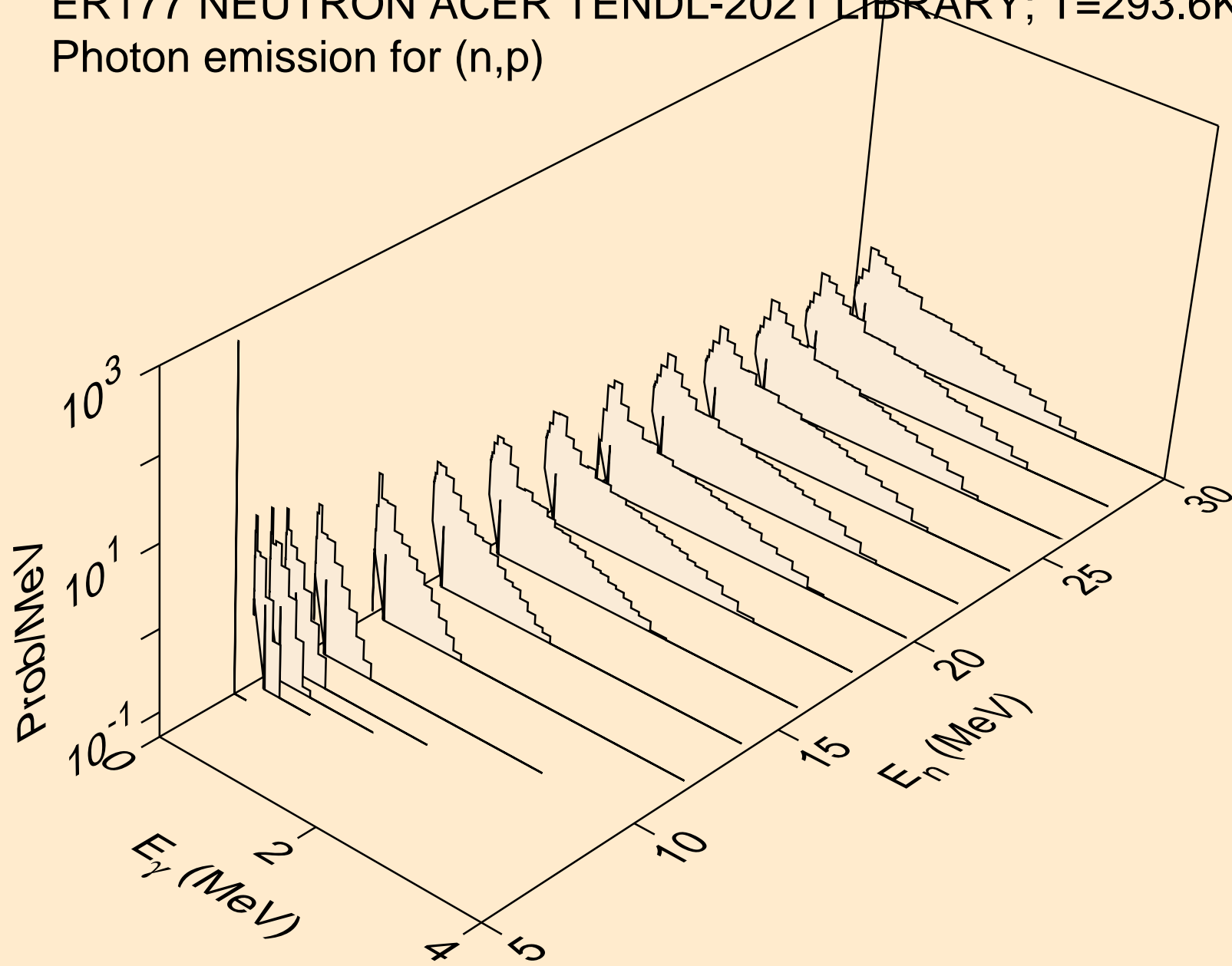

ER177 NEUTRON ACER TENDL-2021 LIBRARY; T=293.6K
Photon emission for (n,d)

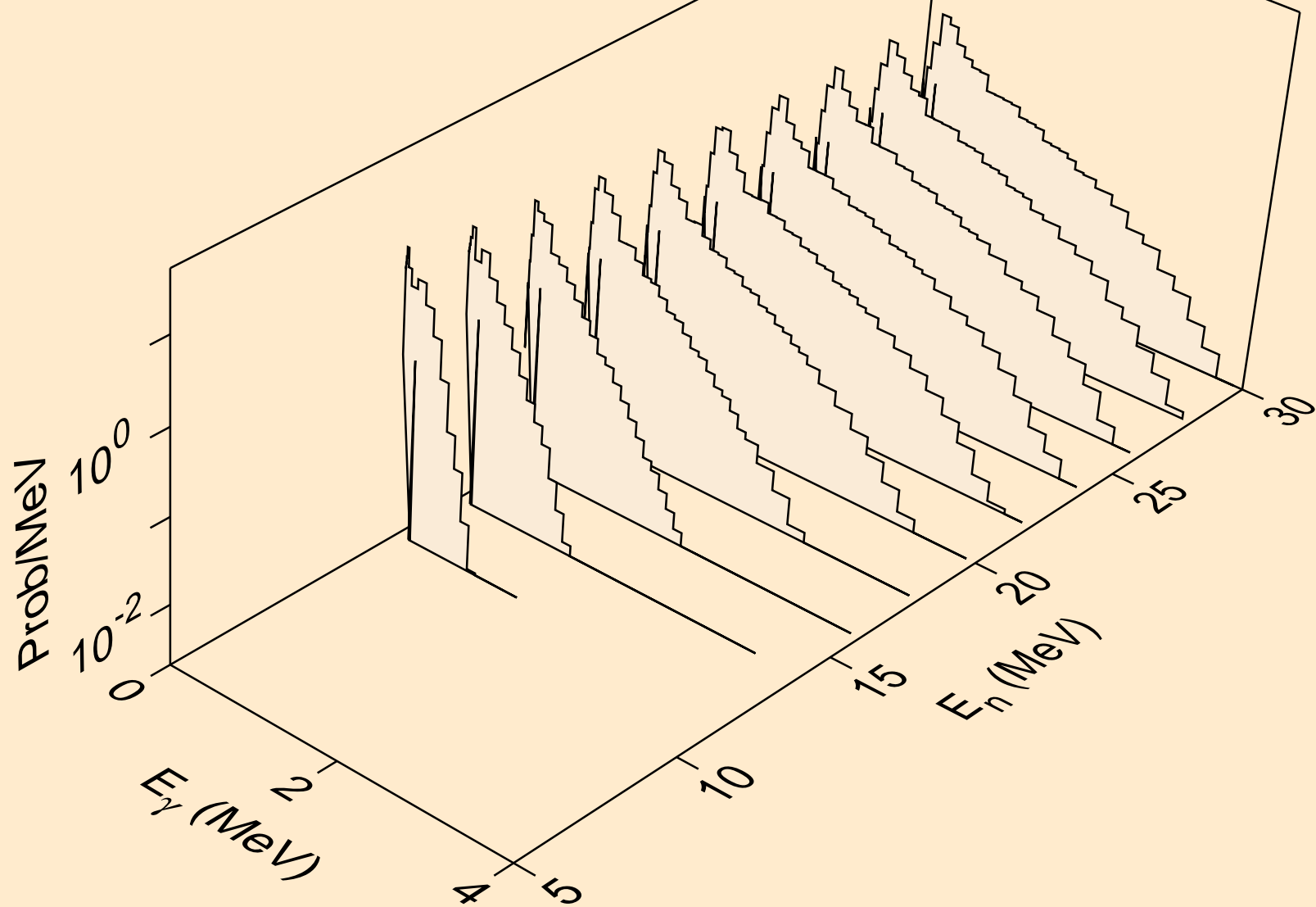

ER177 NEUTRON ACER TENDL-2021 LIBRARY; T=293.6K
Photon emission for (n,t)

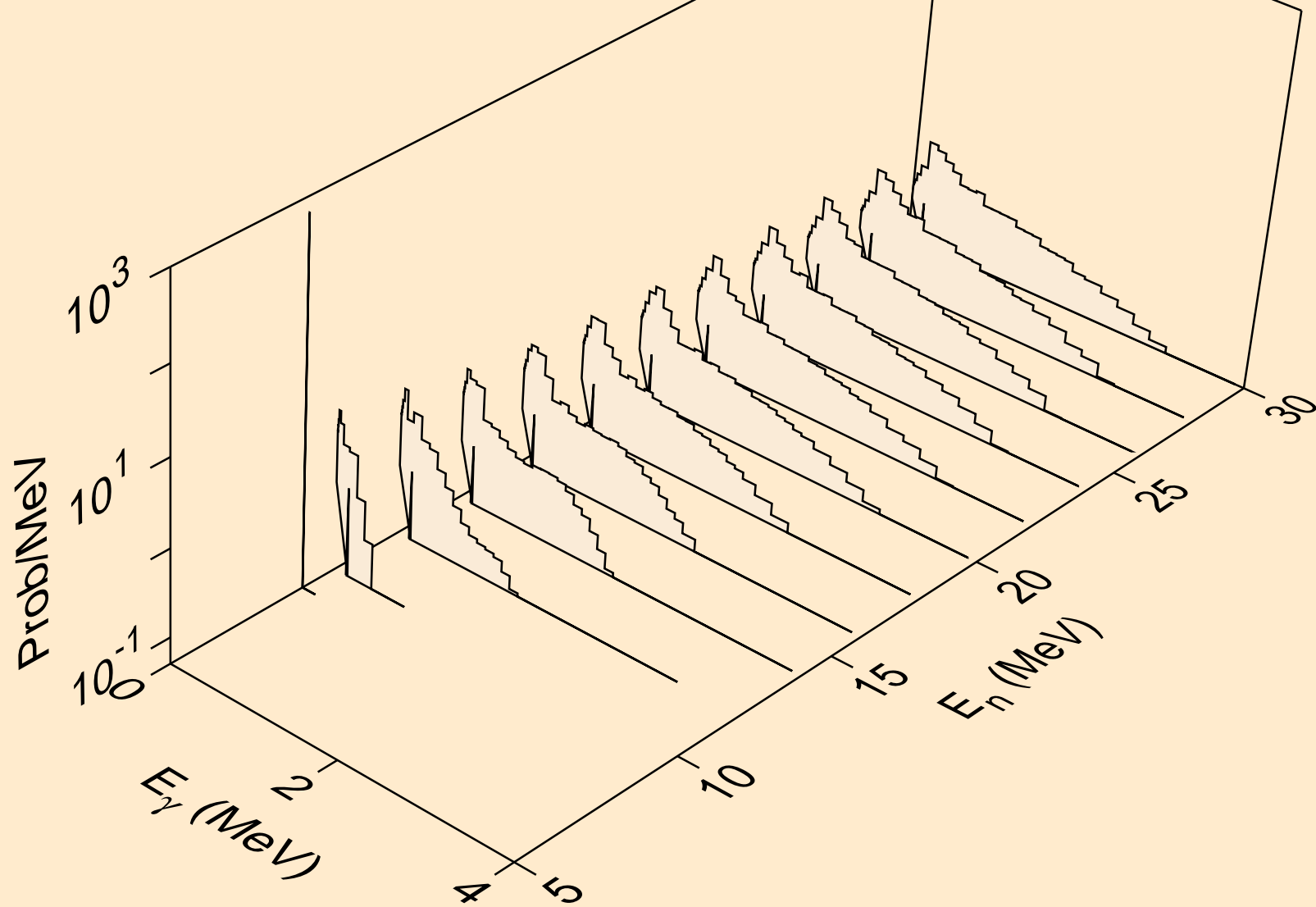

ER177 NEUTRON ACER TENDL-2021 LIBRARY; T=293.6K
Photon emission for (n,he3)

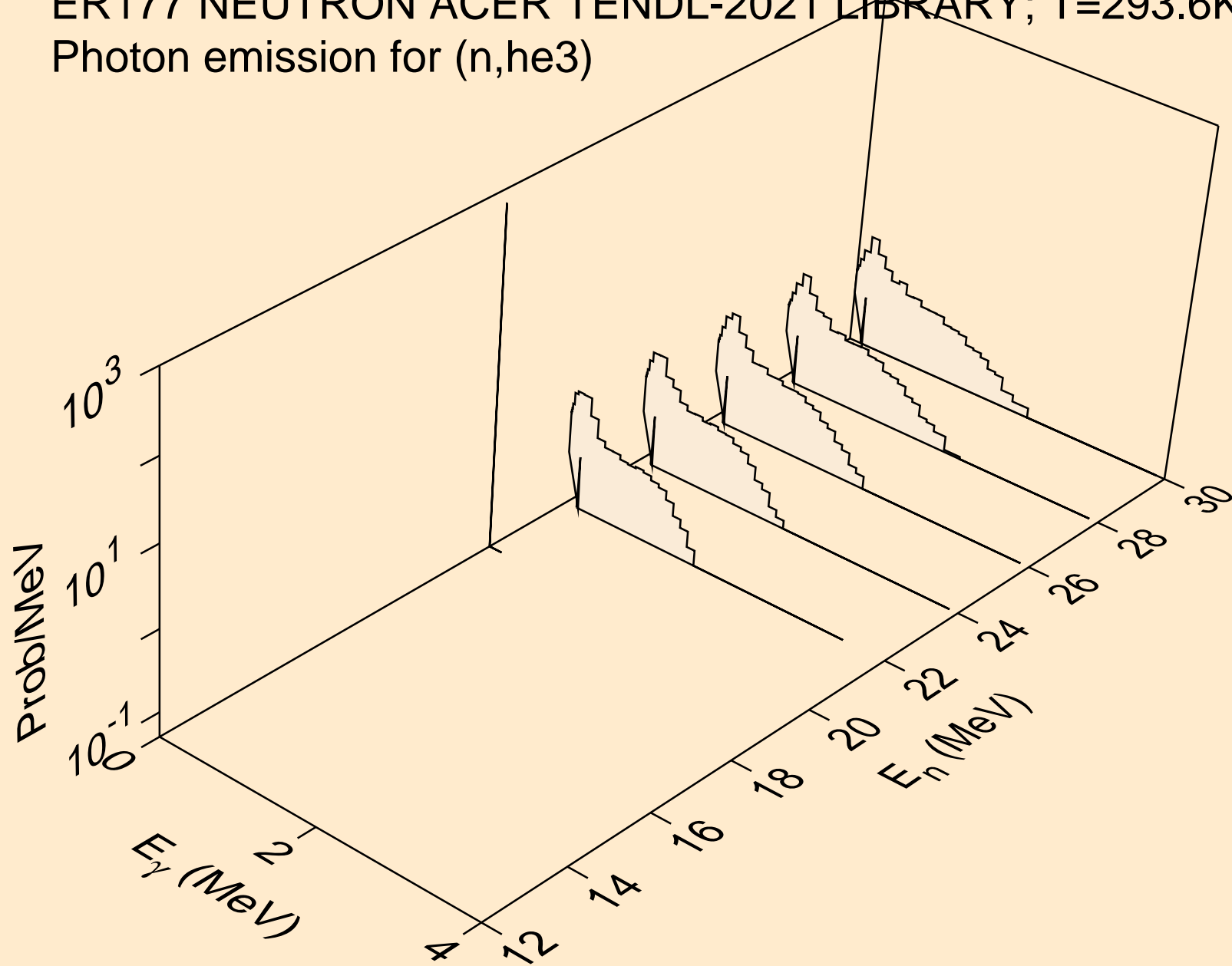

ER177 NEUTRON ACER TENDL-2021 LIBRARY; T=293.6K
Photon emission for (n,a)

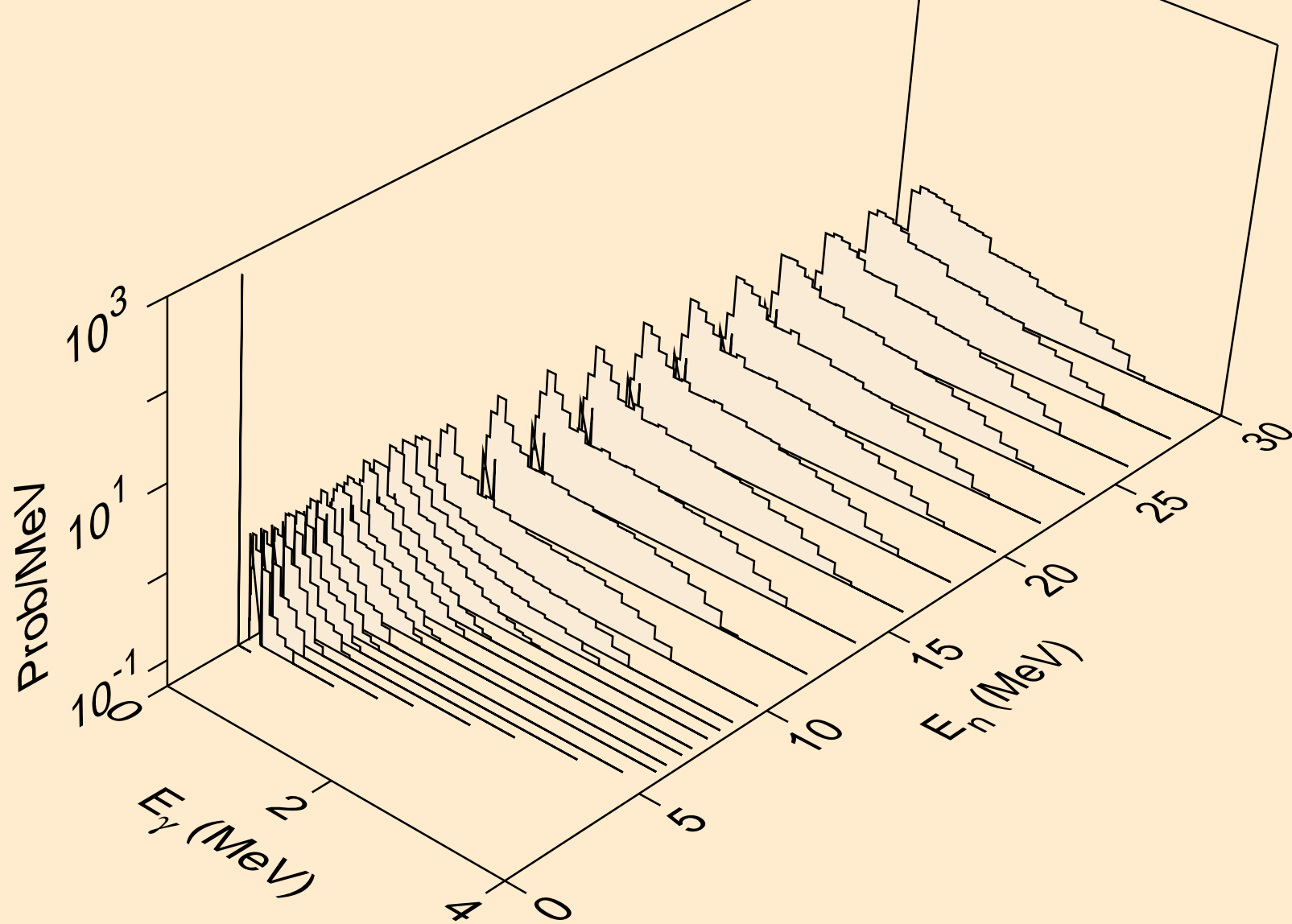

ER177 NEUTRON ACER TENDL-2021 LIBRARY; T=293.6K
thermal capture photon spectrum

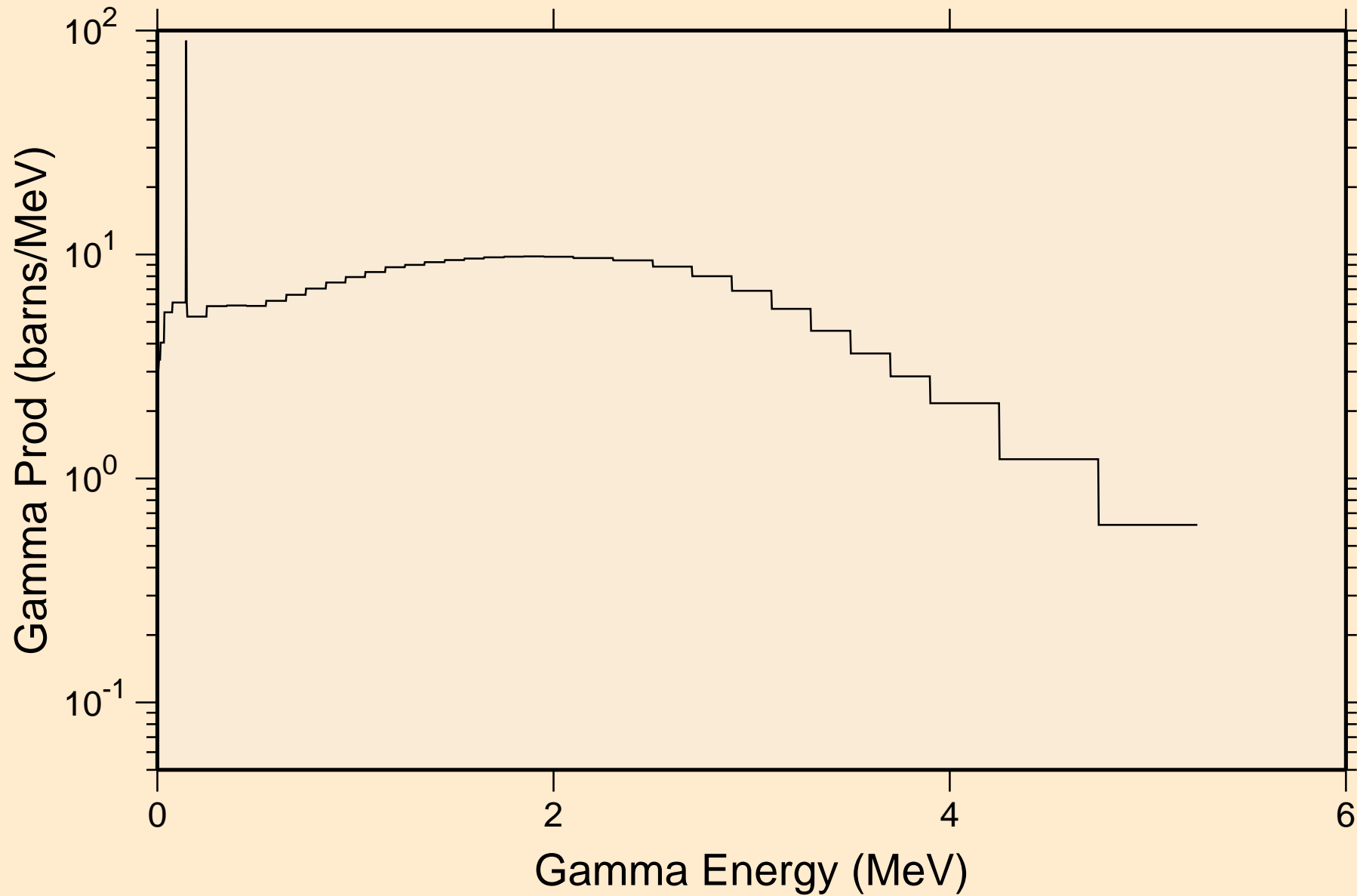

ER177 NEUTRON ACER TENDL-2021 LIBRARY; T=293.6K
14 MeV photon spectrum

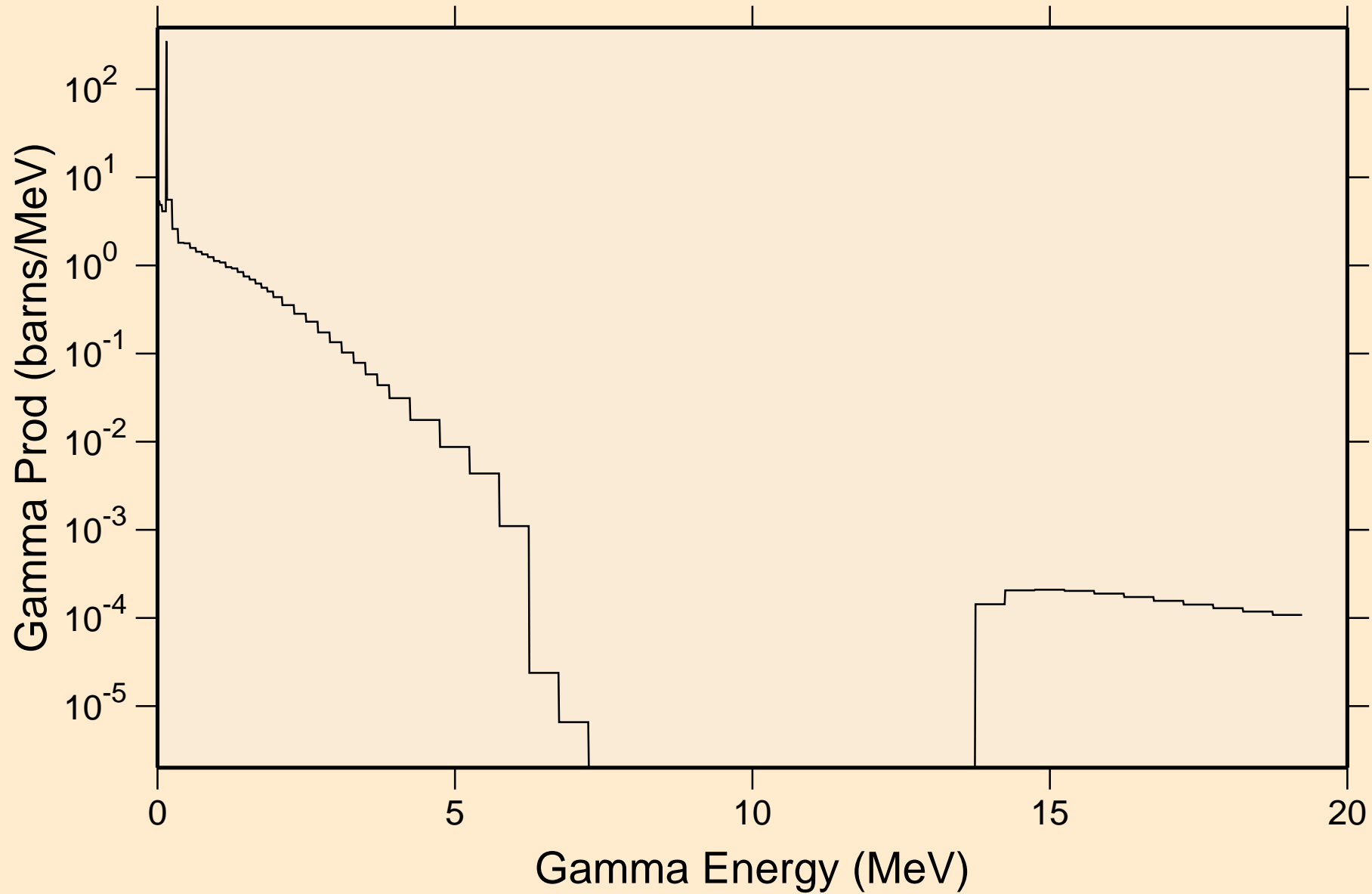

ER177 NEUTRON ACER TENDL-2021 LIBRARY; T=293.6K
Particle heating contributions

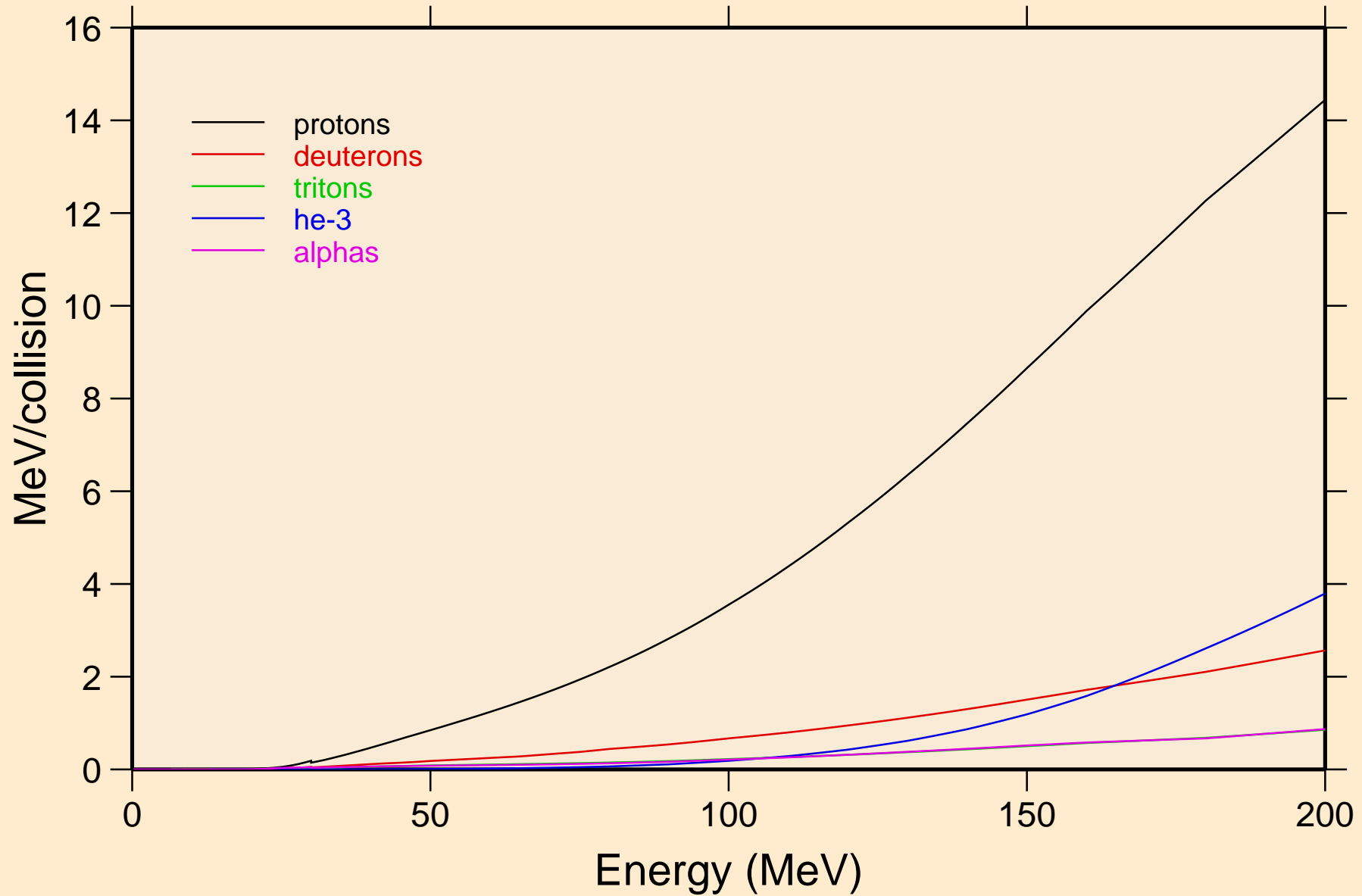

ER177 NEUTRON ACER TENDL-2021 LIBRARY; T=293.6K
Recoil Heating

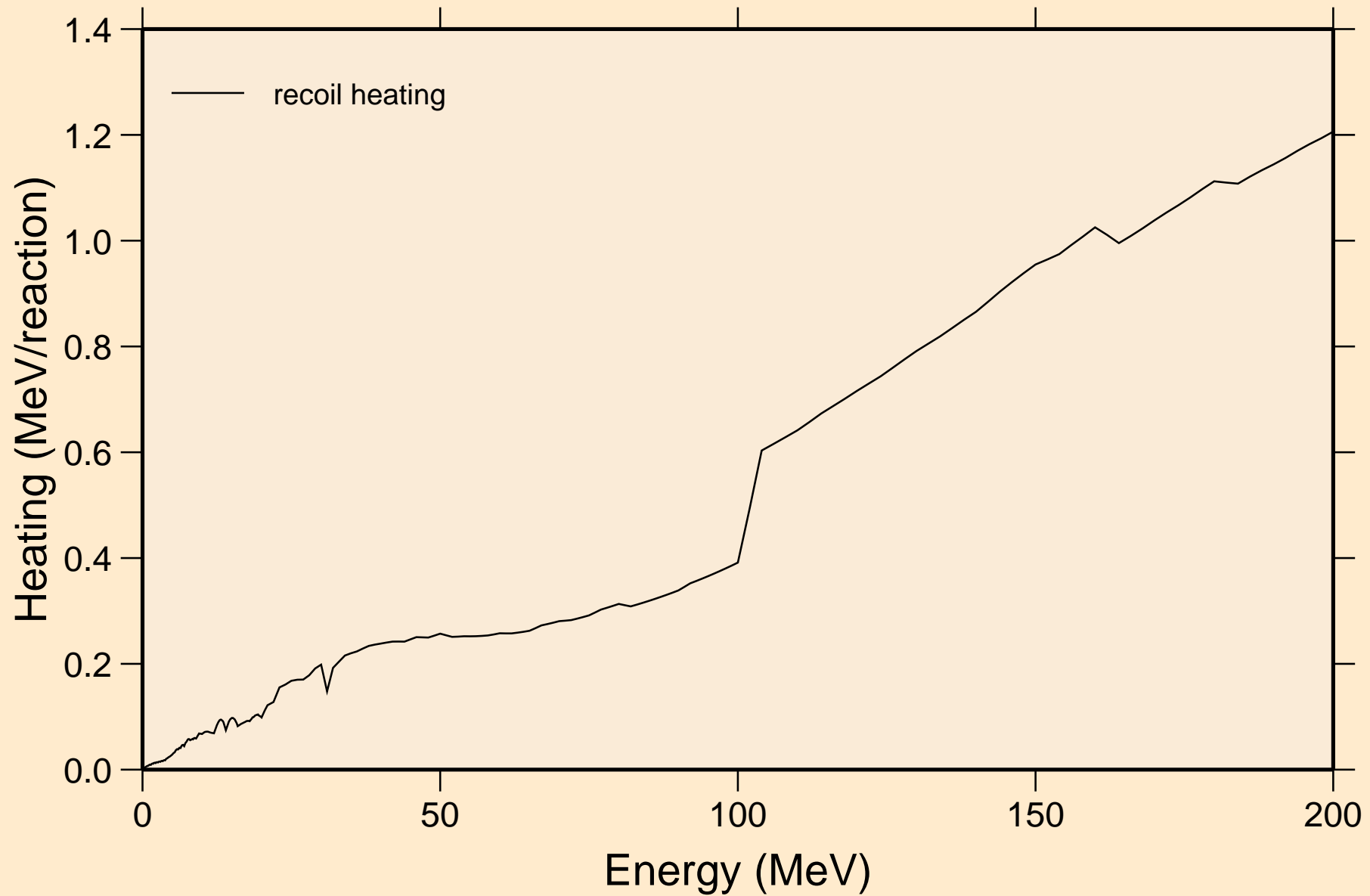

ER177 NEUTRON ACER TENDL-2021 LIBRARY; T=293.6K
Particle production cross sections

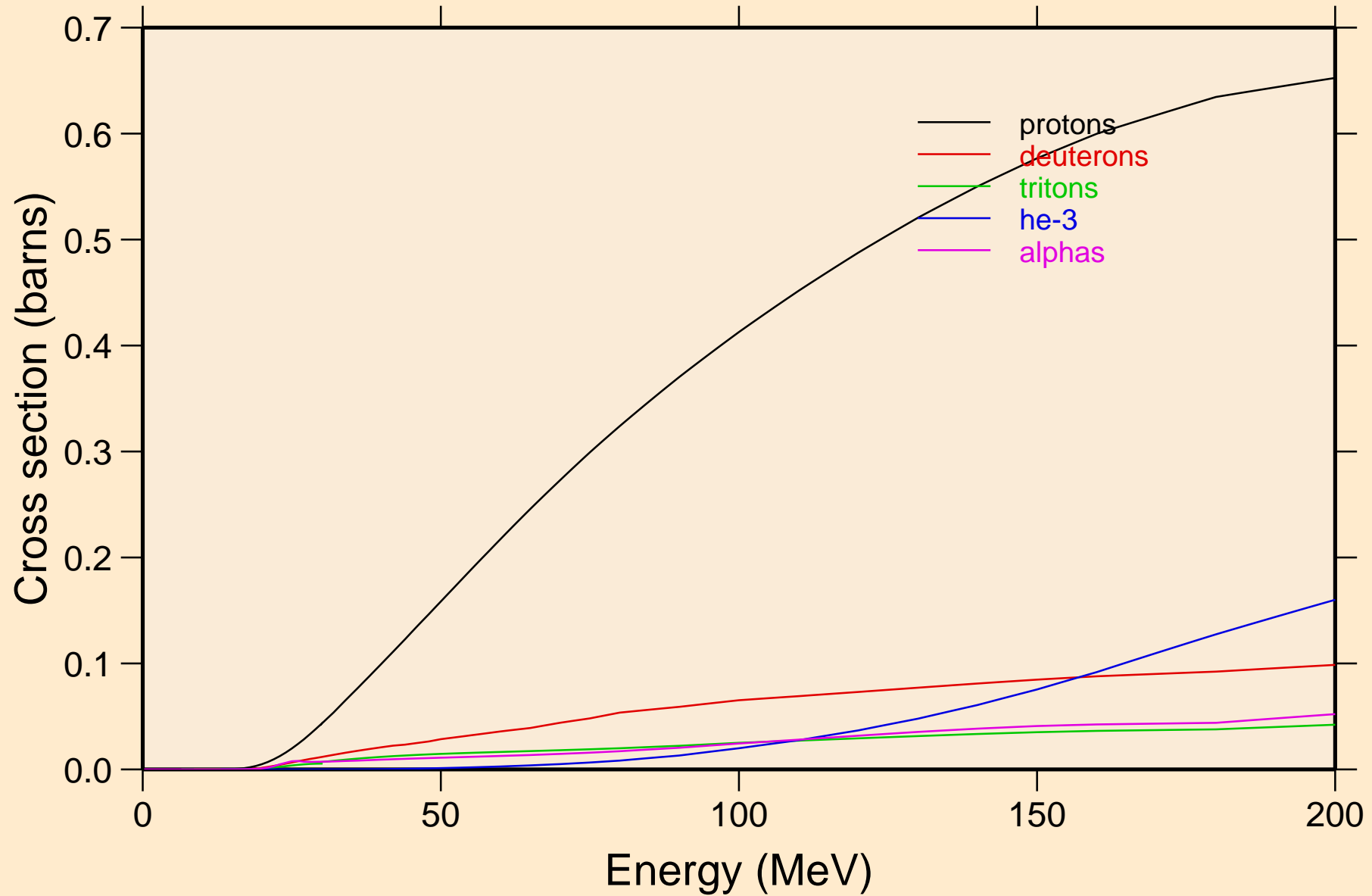

ER177 NEUTRON ACER TENDL-2021 LIBRARY; T=293.6K
protons from (n,x)

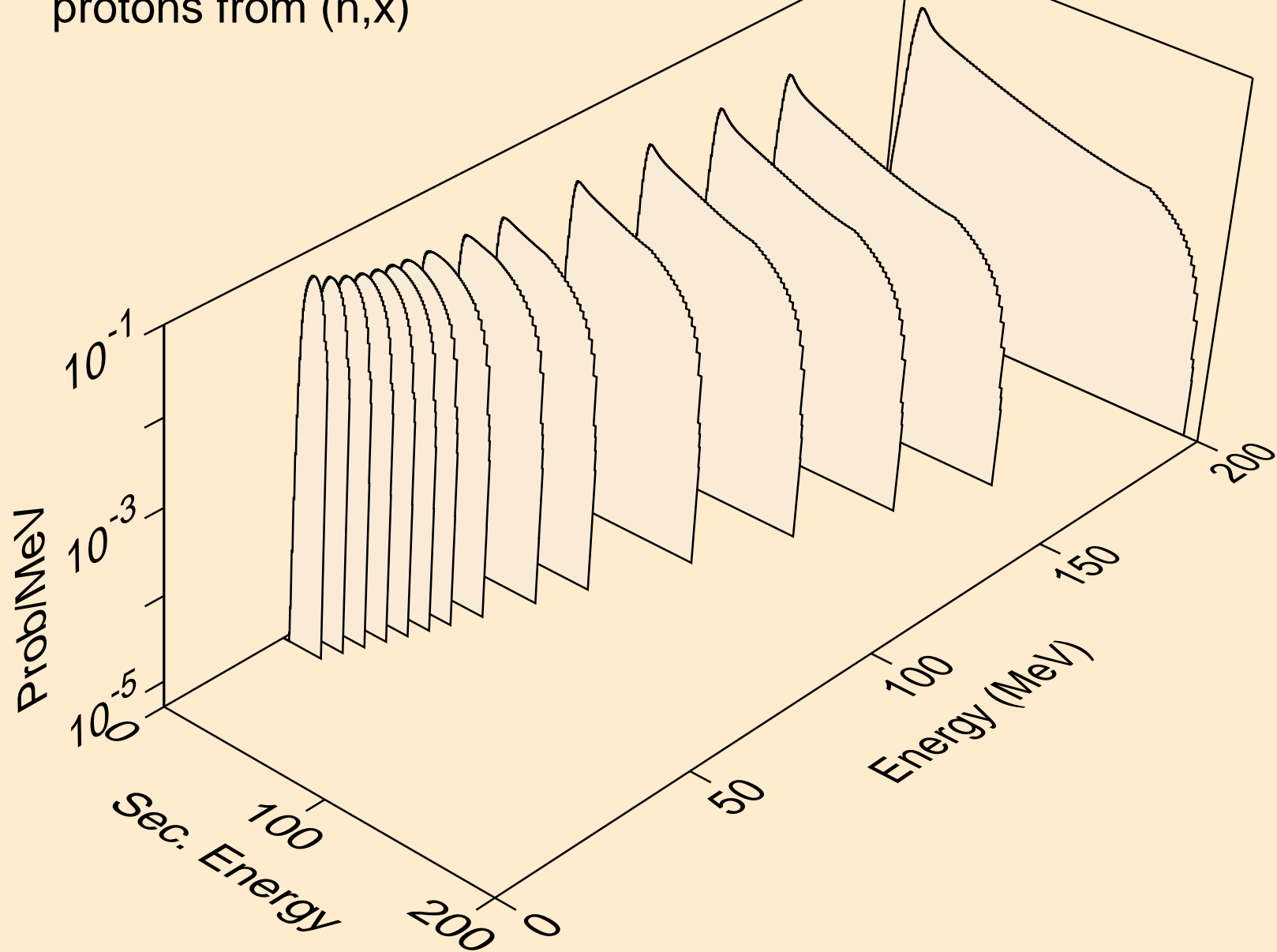

ER177 NEUTRON ACER TENDL-2021 LIBRARY; T=293.6K
protons from (n,n*)p

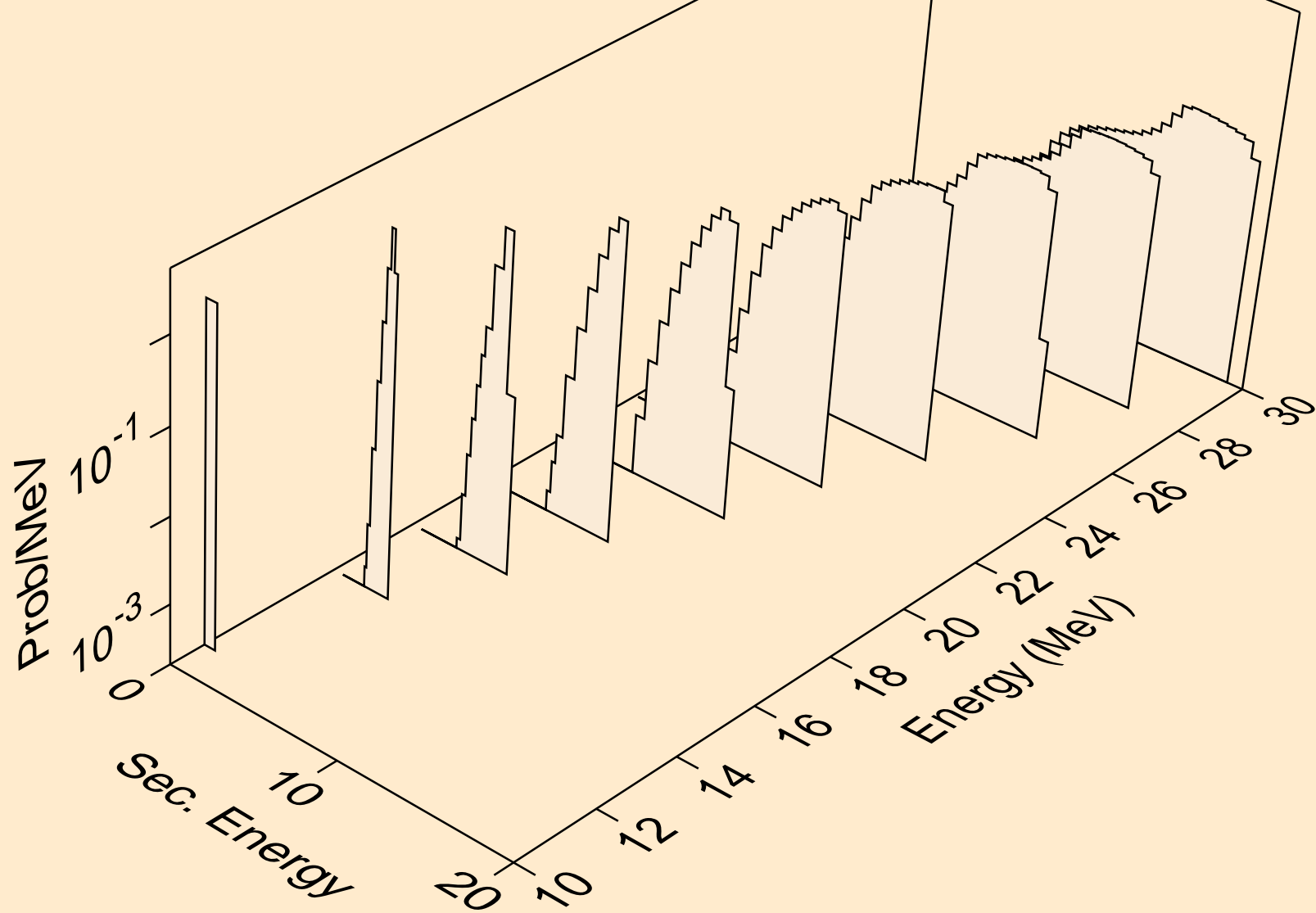

ER177 NEUTRON ACER TENDL-2021 LIBRARY; T=293.6K
protons from (n,2np)

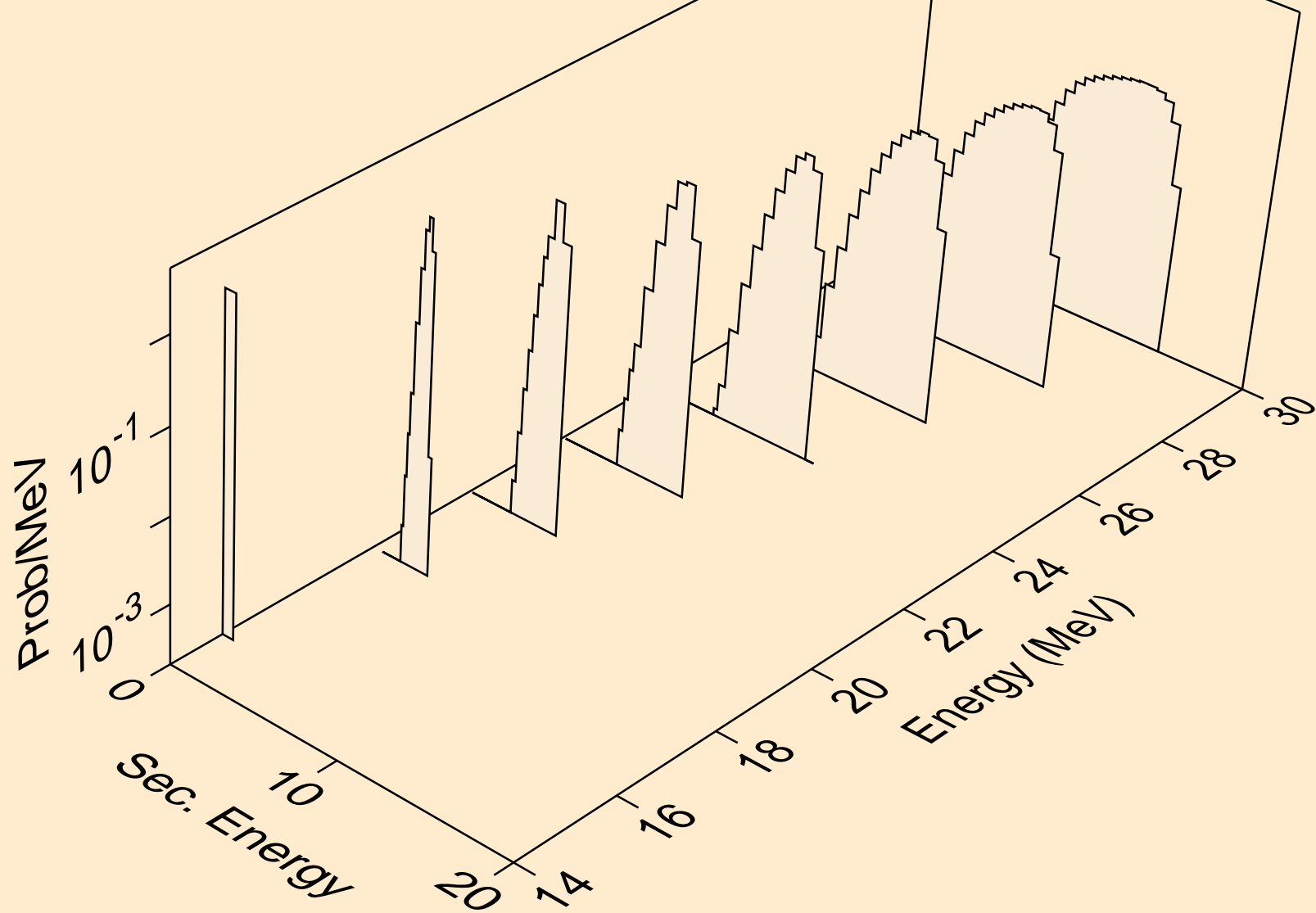

ER177 NEUTRON ACER TENDL-2021 LIBRARY; T=293.6K
protons from (n,3np)

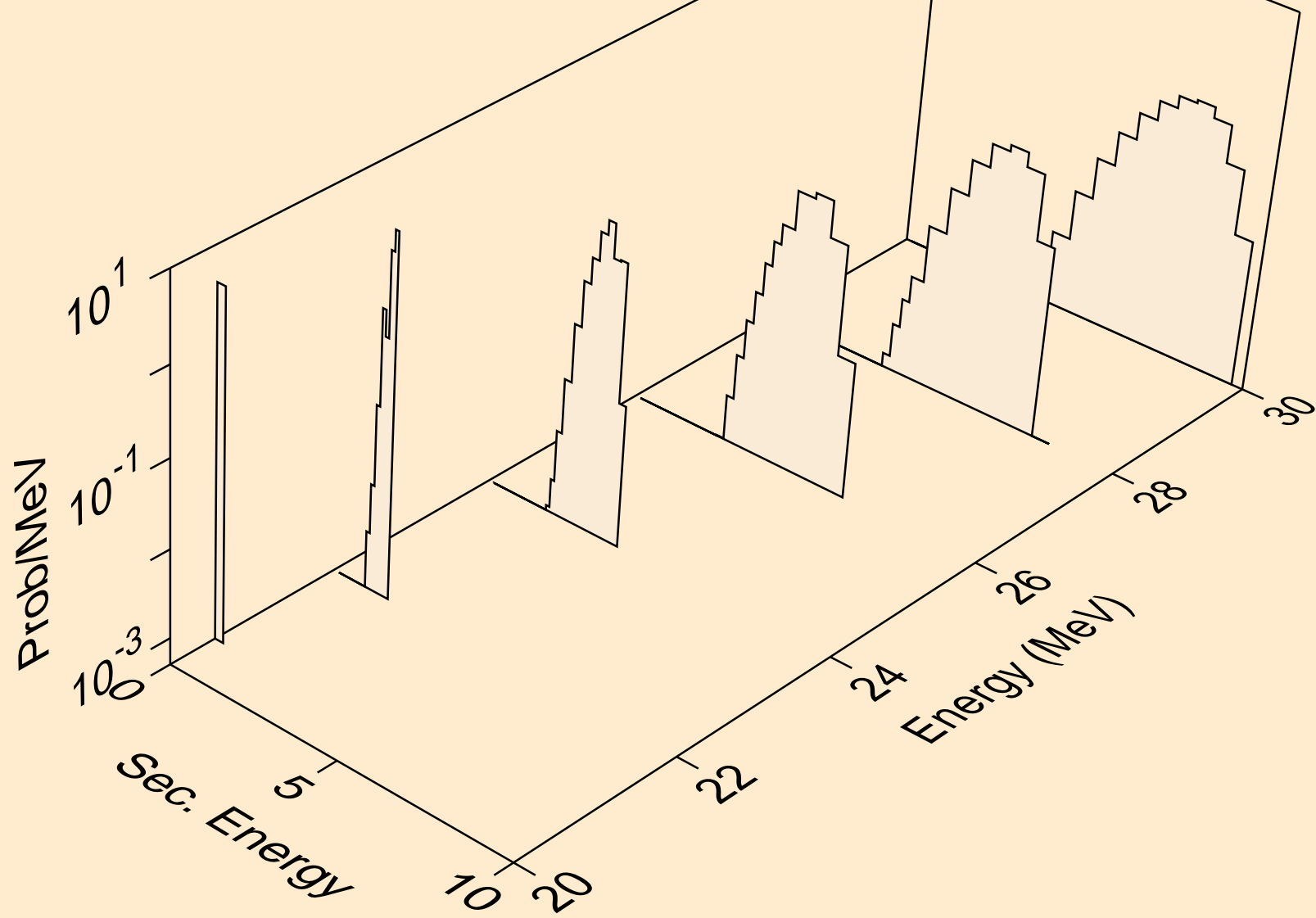

ER177 NEUTRON ACER TENDL-2021 LIBRARY; T=293.6K
protons from (n,p)

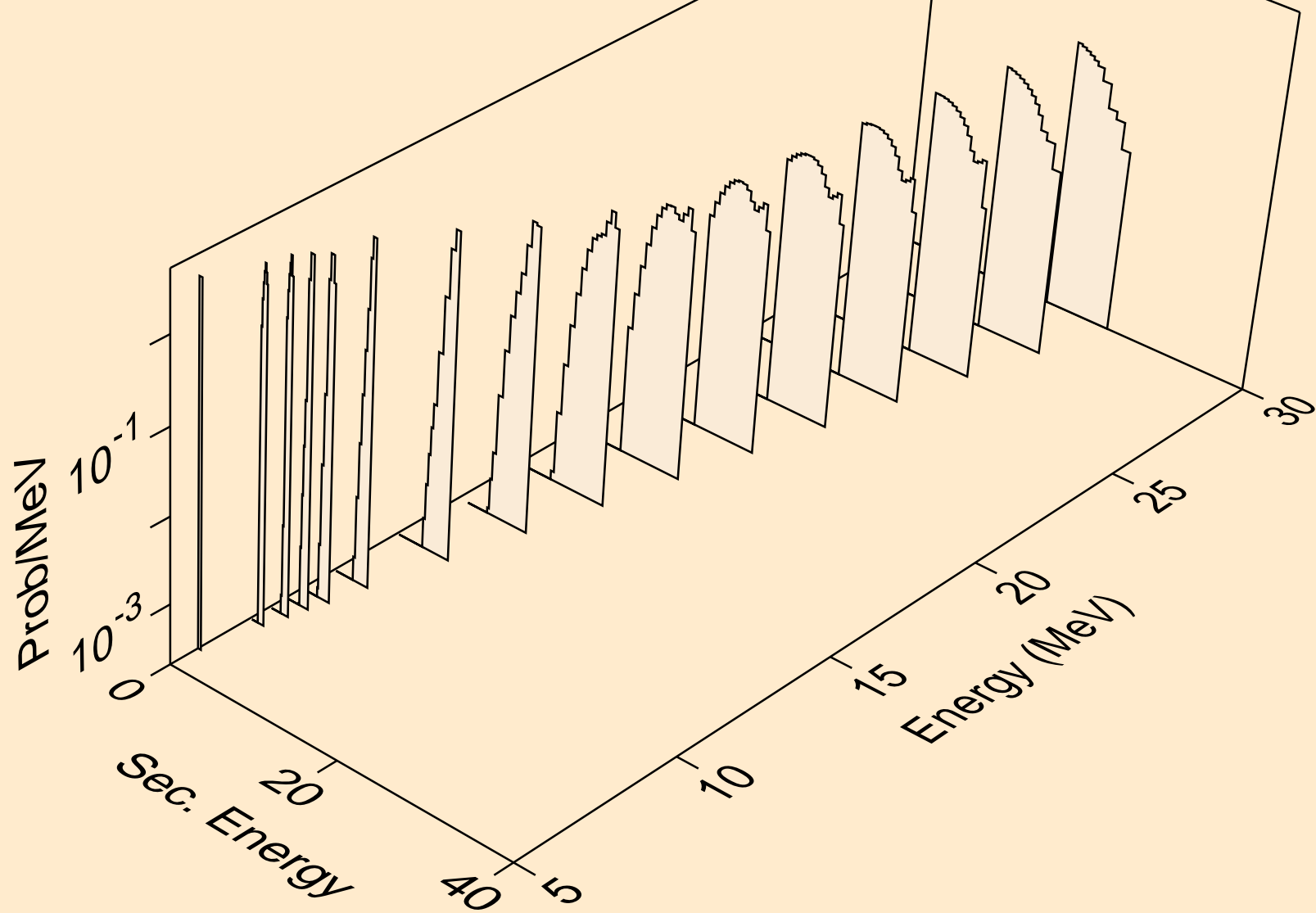

ER177 NEUTRON ACER TENDL-2021 LIBRARY; T=293.6K
deuterons from (n,x)

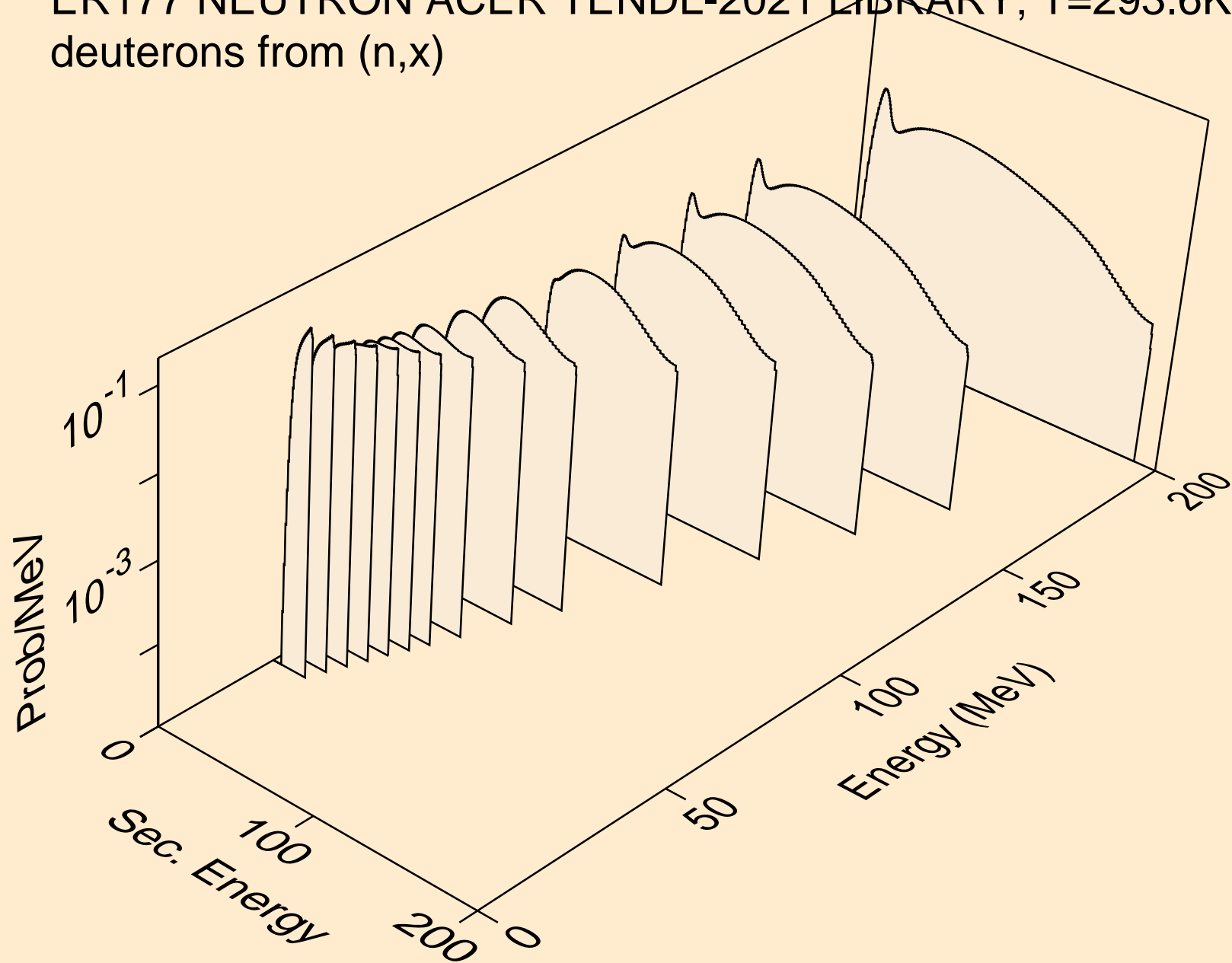

ER177 NEUTRON ACER TENDL-2021 LIBRARY; T=293.6K
deuterons from (n,2nd)

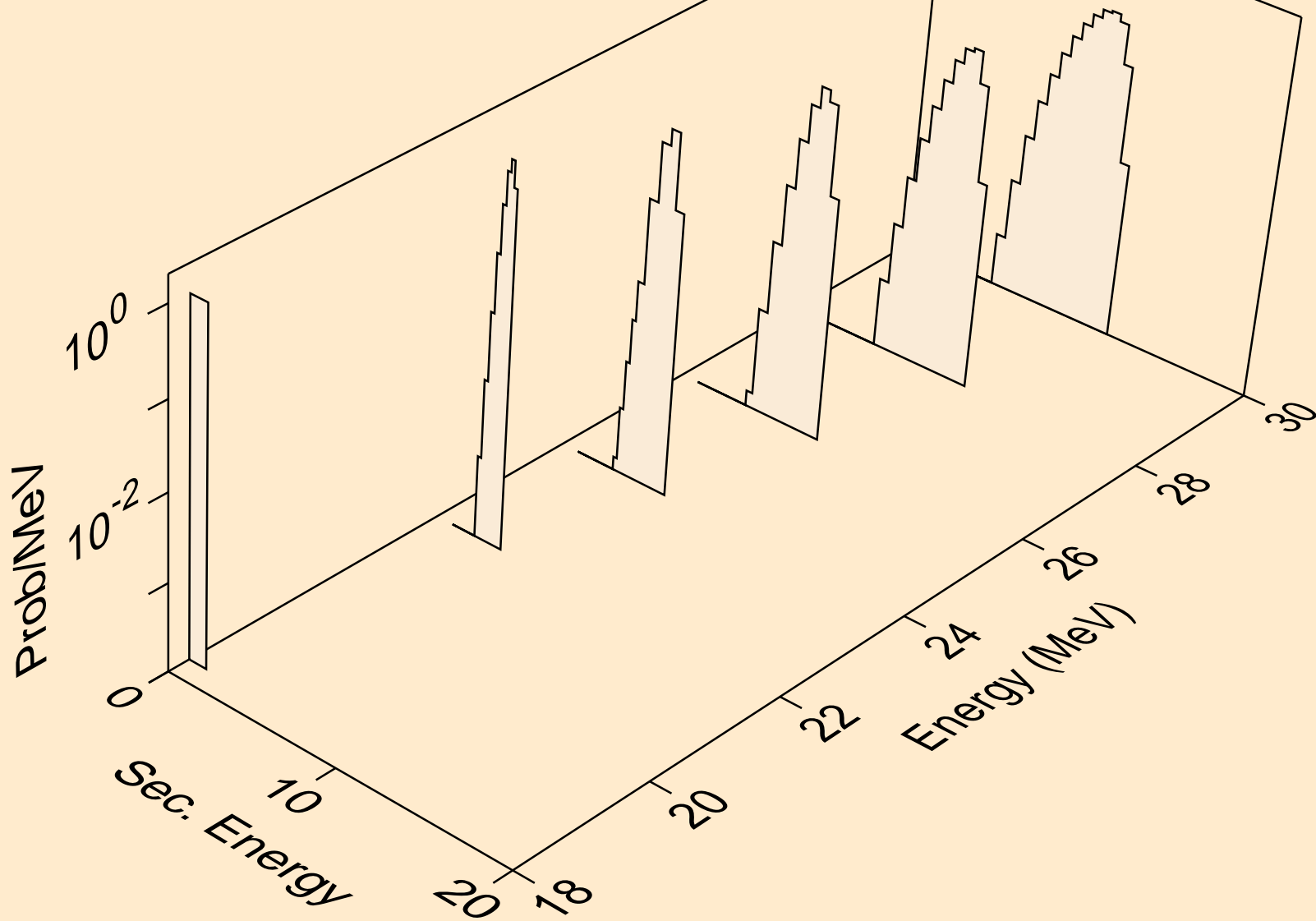

ER177 NEUTRON ACER TENDL-2021 LIBRARY; T=293.6K
deuterons from (n,n*)d

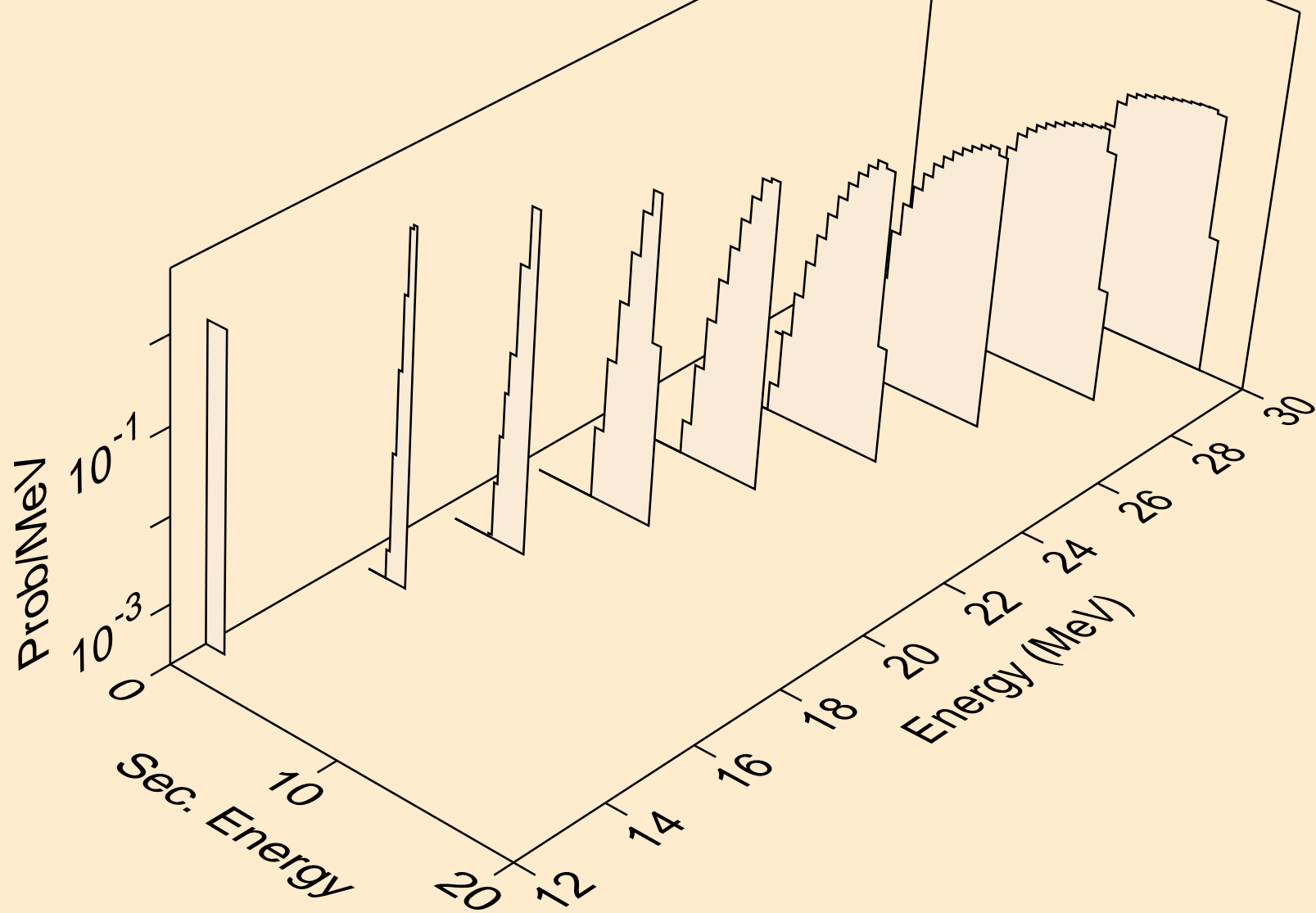

ER177 NEUTRON ACER TENDL-2021 LIBRARY; T=293.6K
deuterons from (n,d)

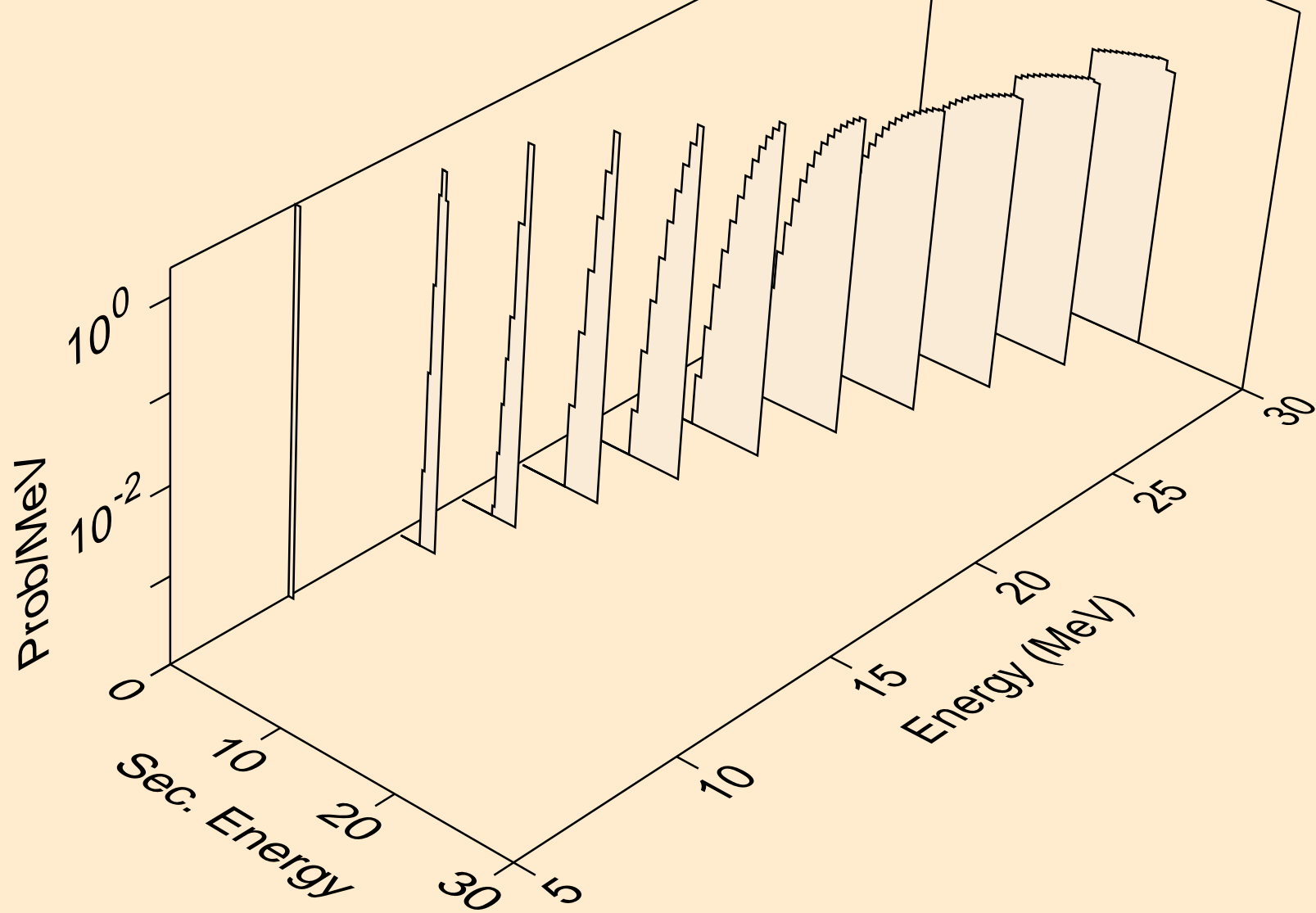

ER177 NEUTRON ACER TENDL-2021 LIBRARY; T=293.6K
tritons from (n,x)

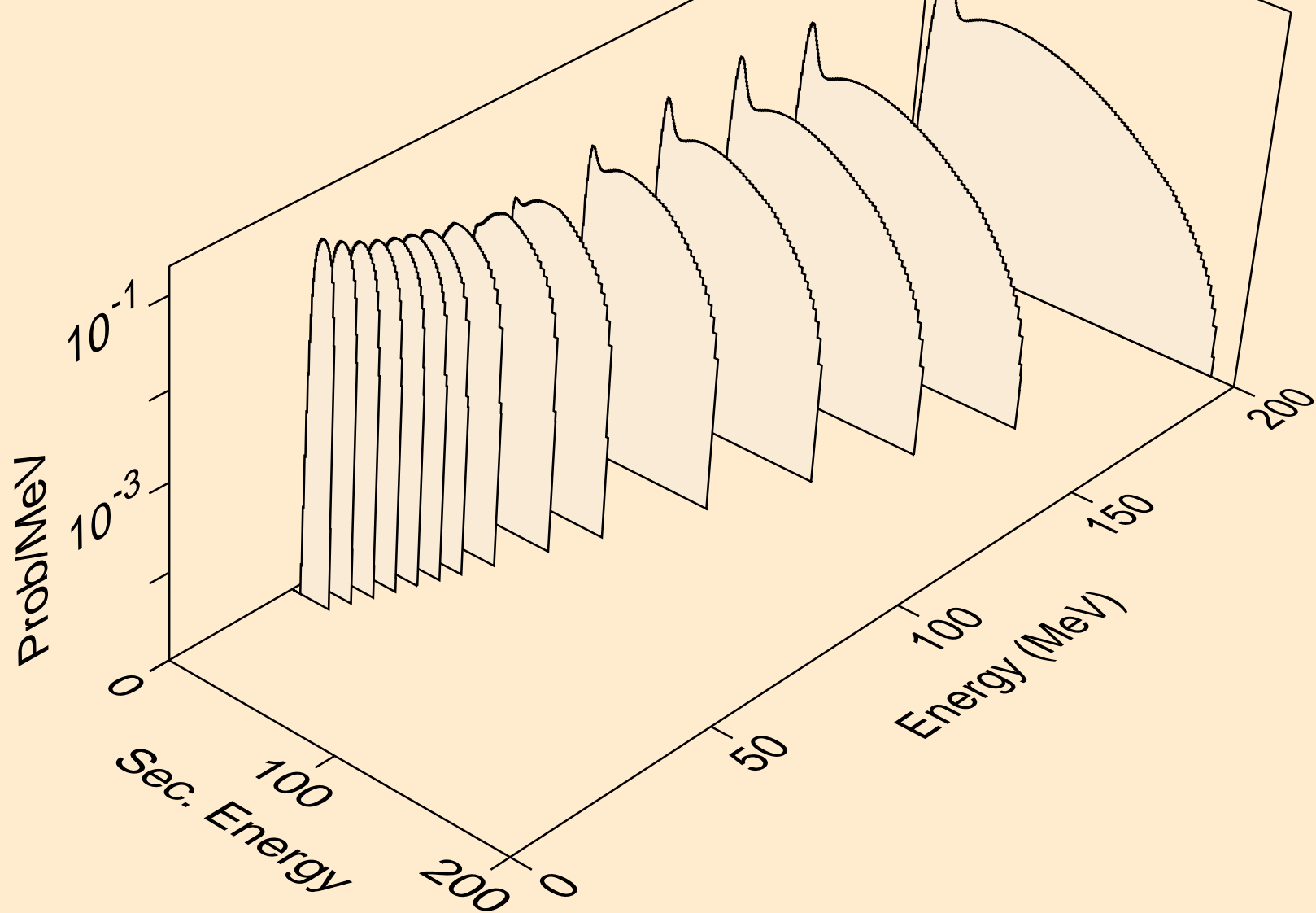

ER177 NEUTRON ACER TENDL-2021 LIBRARY; T=293.6K
tritons from (n,n*)t

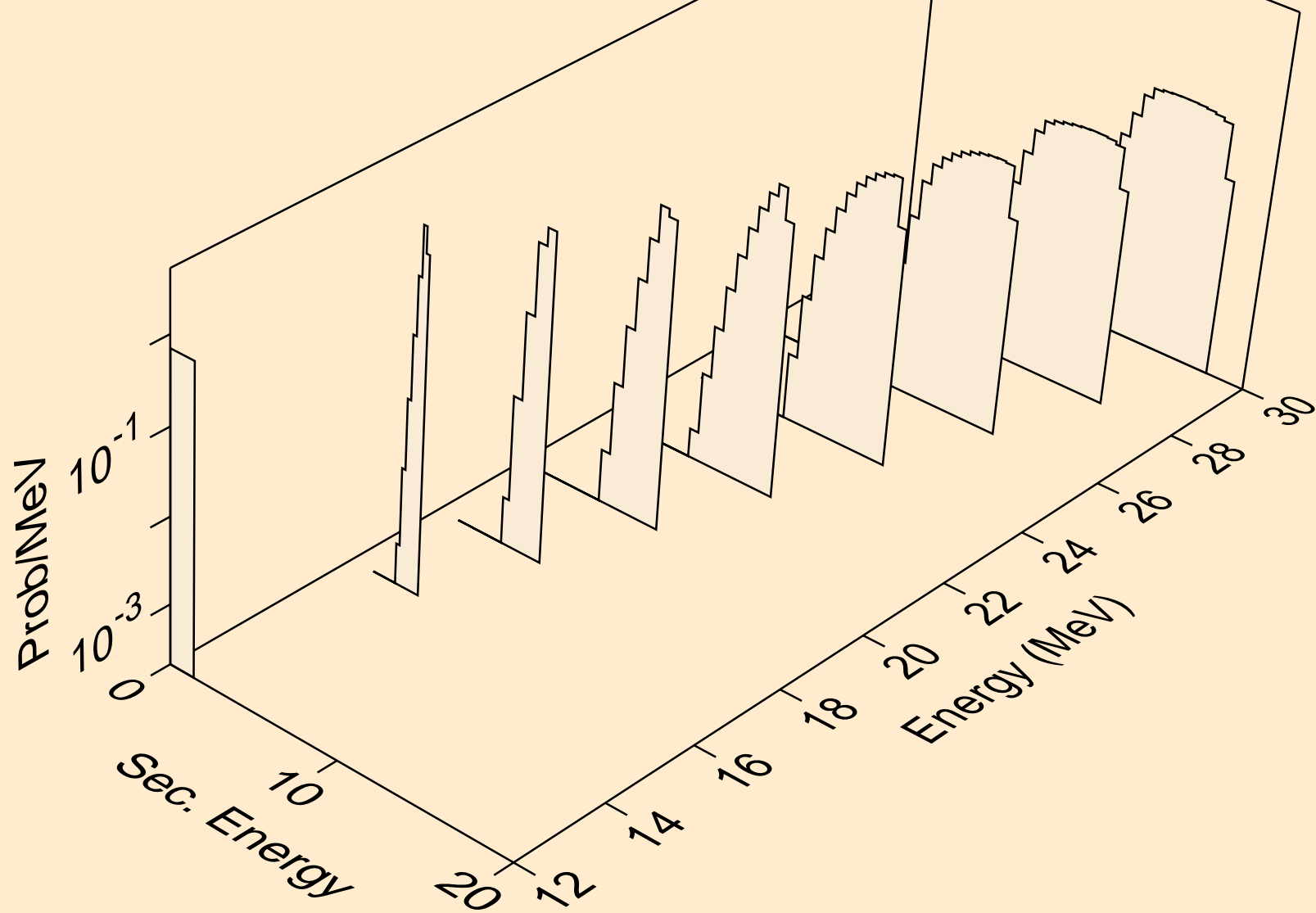

ER177 NEUTRON ACER TENDL-2021 LIBRARY; T=293.6K
tritons from (n,t)

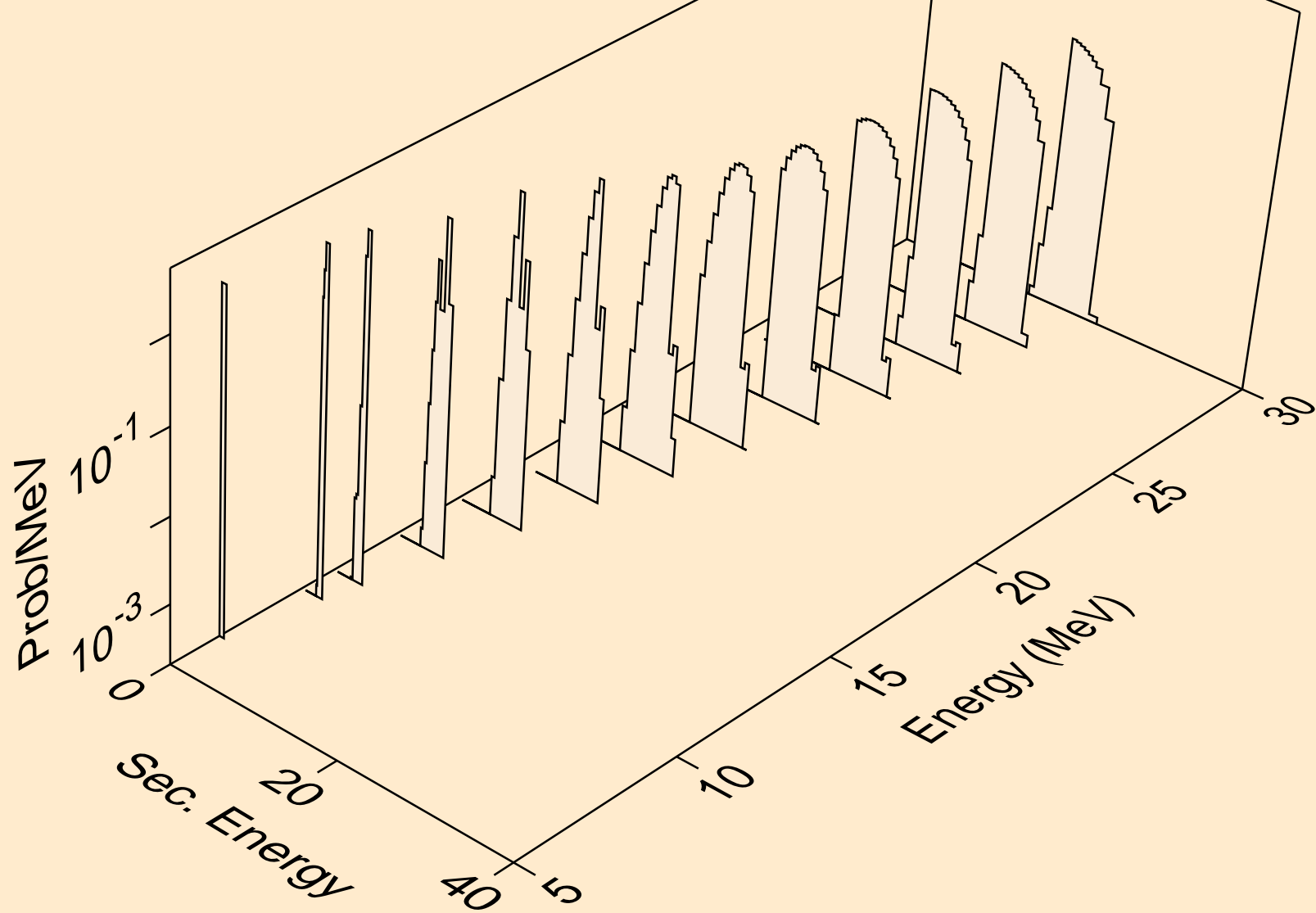

ER177 NEUTRON ACER TENDL-2021 LIBRARY; T=293.6K
he3s from (n,x)

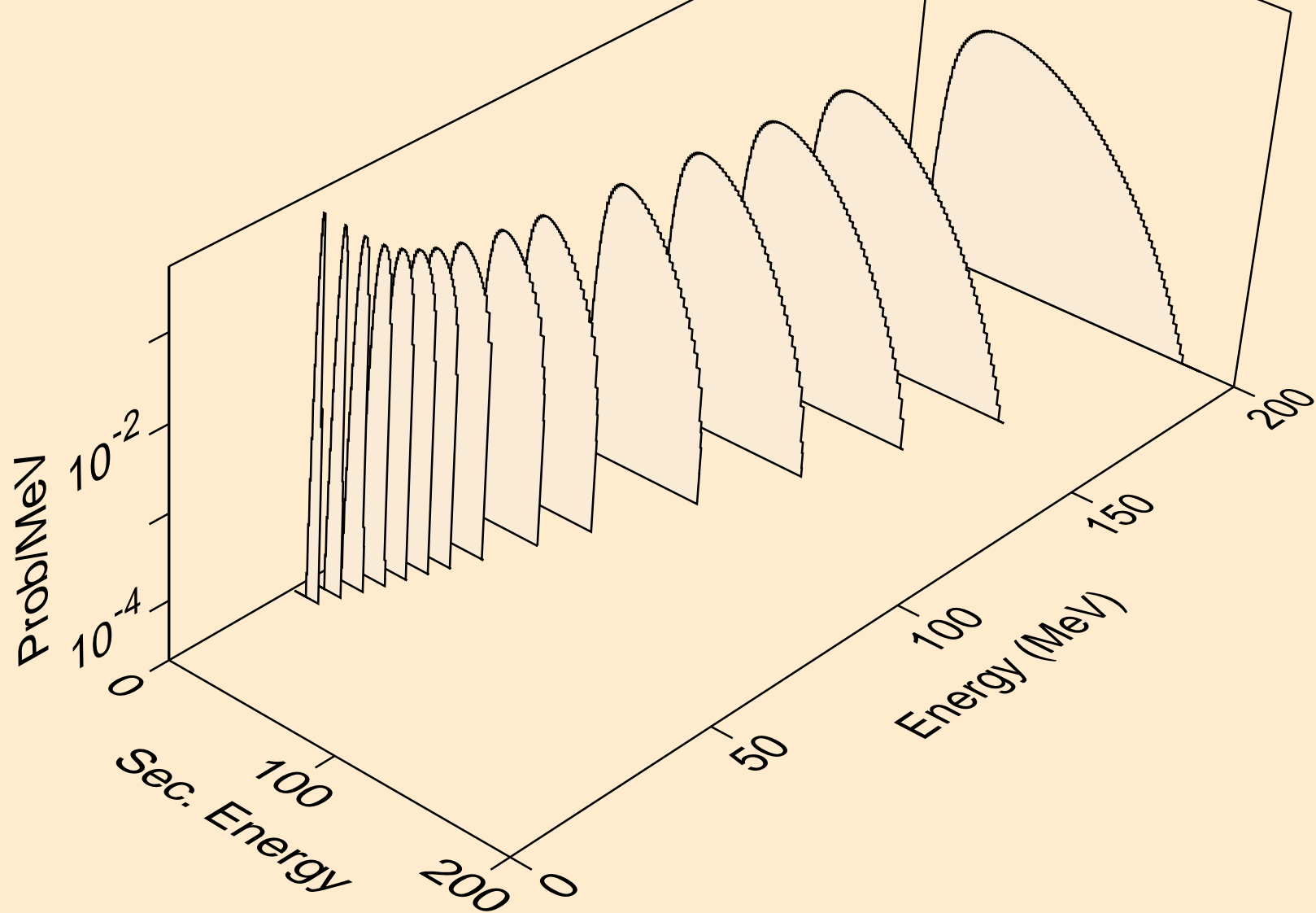

ER177 NEUTRON ACER TENDL-2021 LIBRARY; T=293.6K
he3s from (n,n*)he3

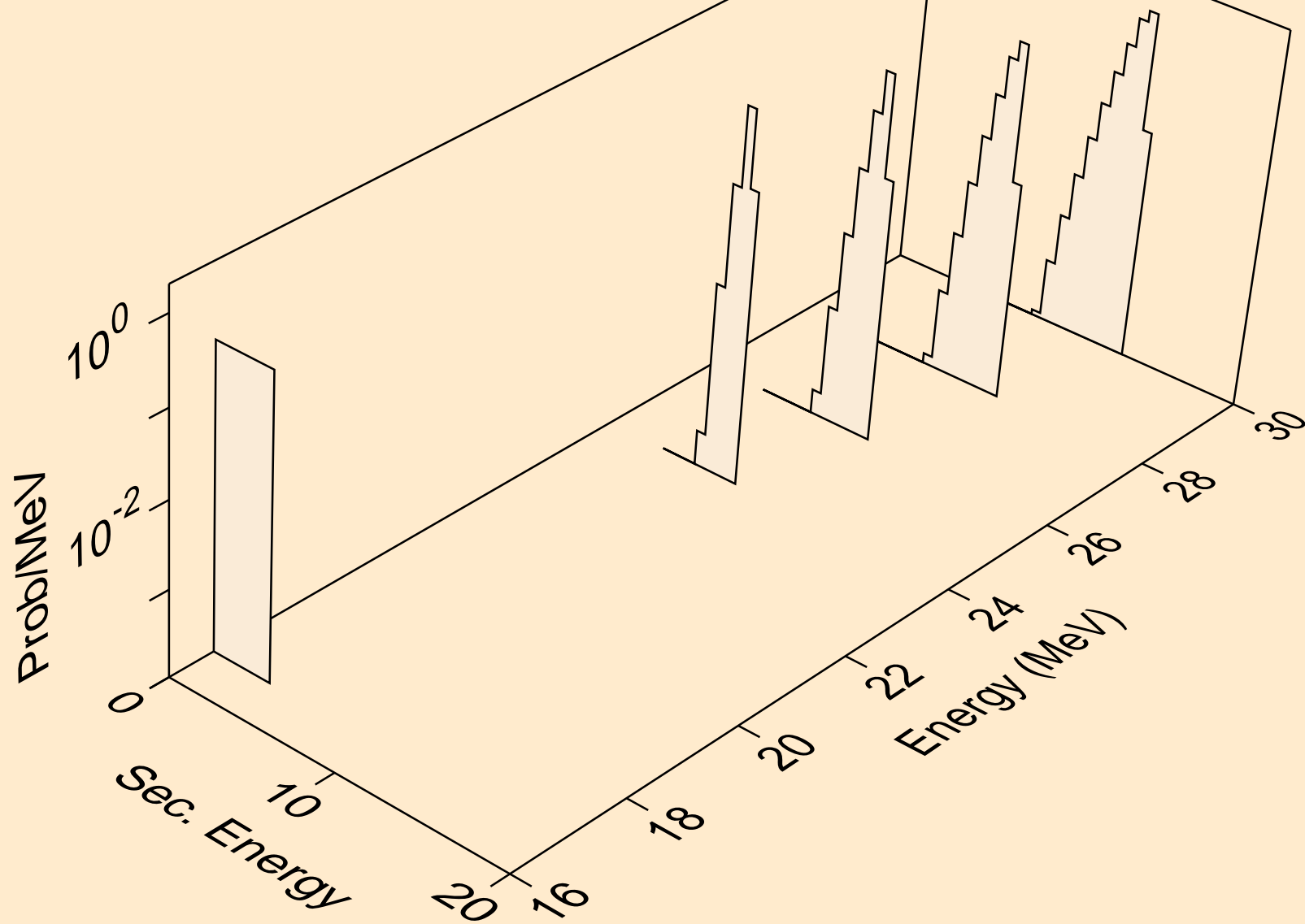

ER177 NEUTRON ACER TENDL-2021 LIBRARY; T=293.6K
he3s from (n,he3)

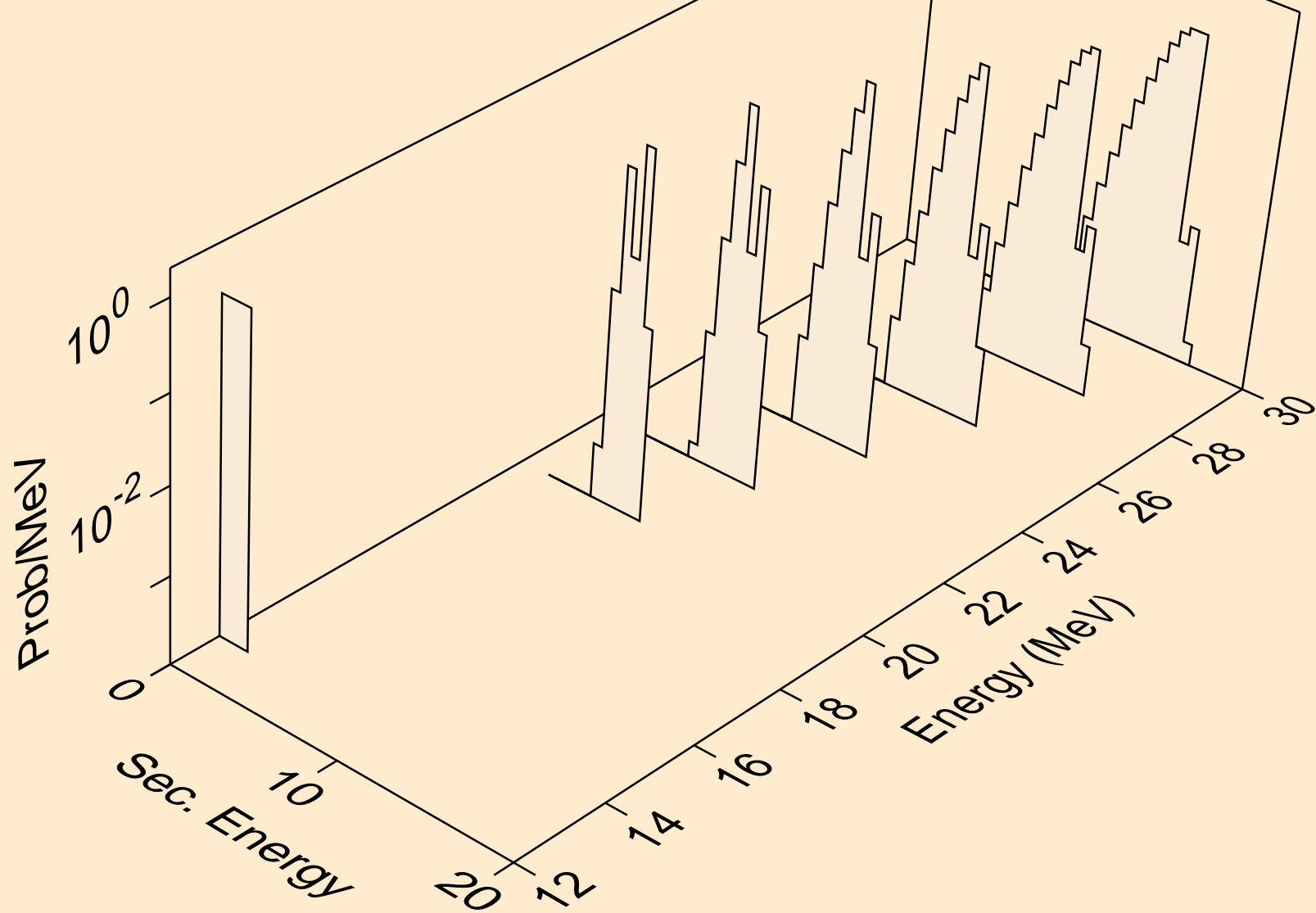

ER177 NEUTRON ACER TENDL-2021 LIBRARY; T=293.6K
alphas from (n,x)

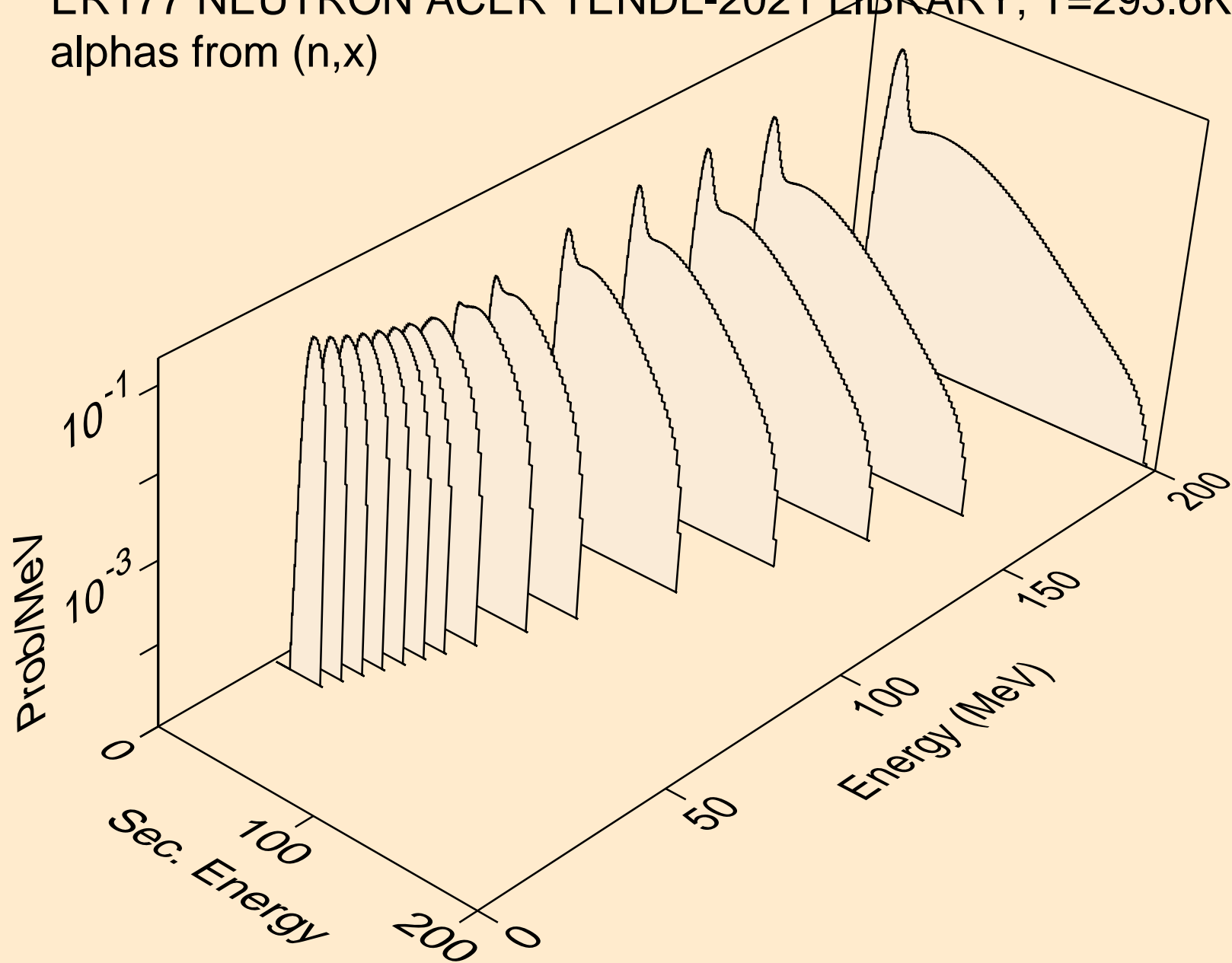

ER177 NEUTRON ACER TENDL-2021 LIBRARY; T=293.6K
alphas from (n,n*)a

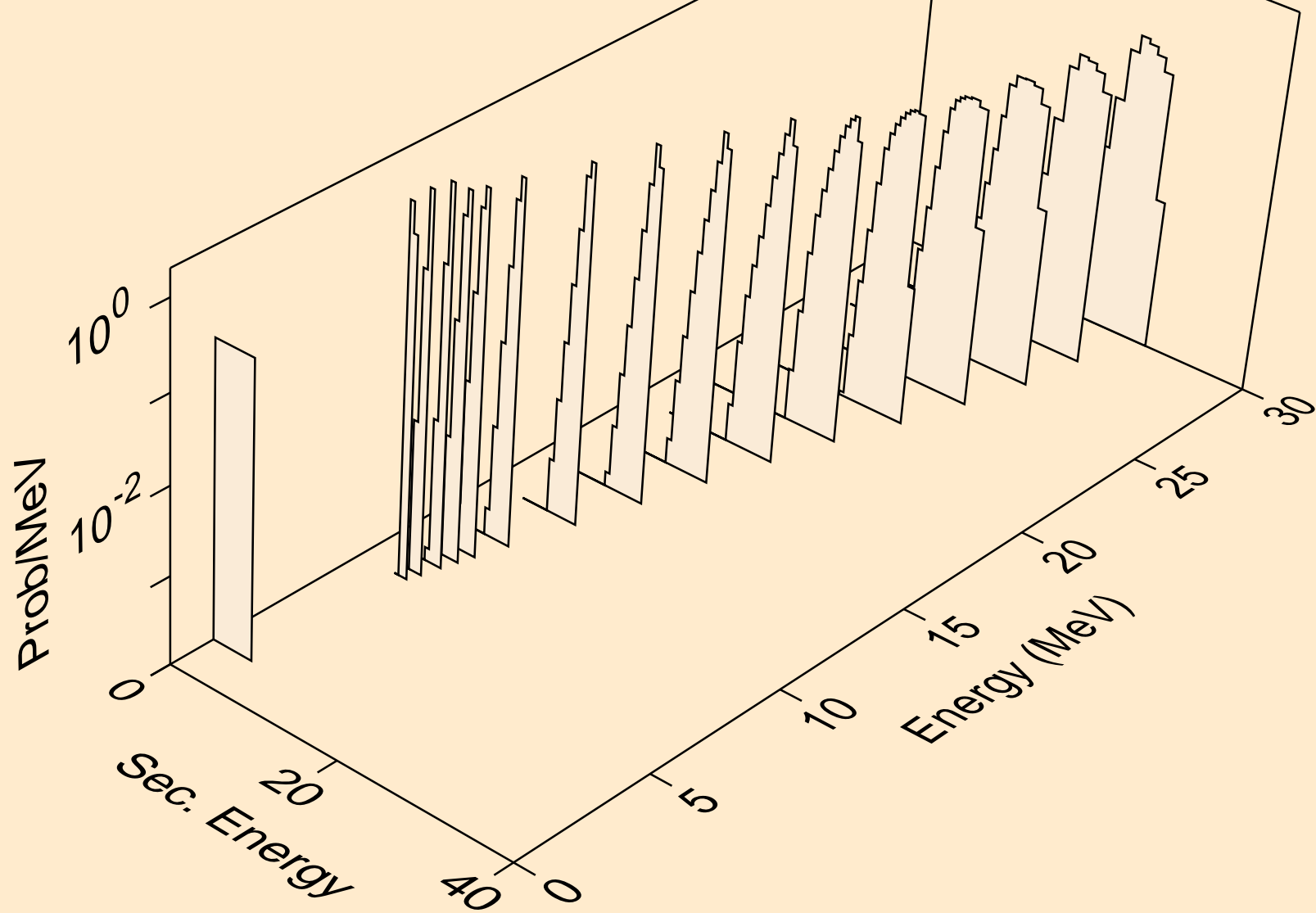

ER177 NEUTRON ACER TENDL-2021 LIBRARY; T=293.6K
alphas from (n,2n)a

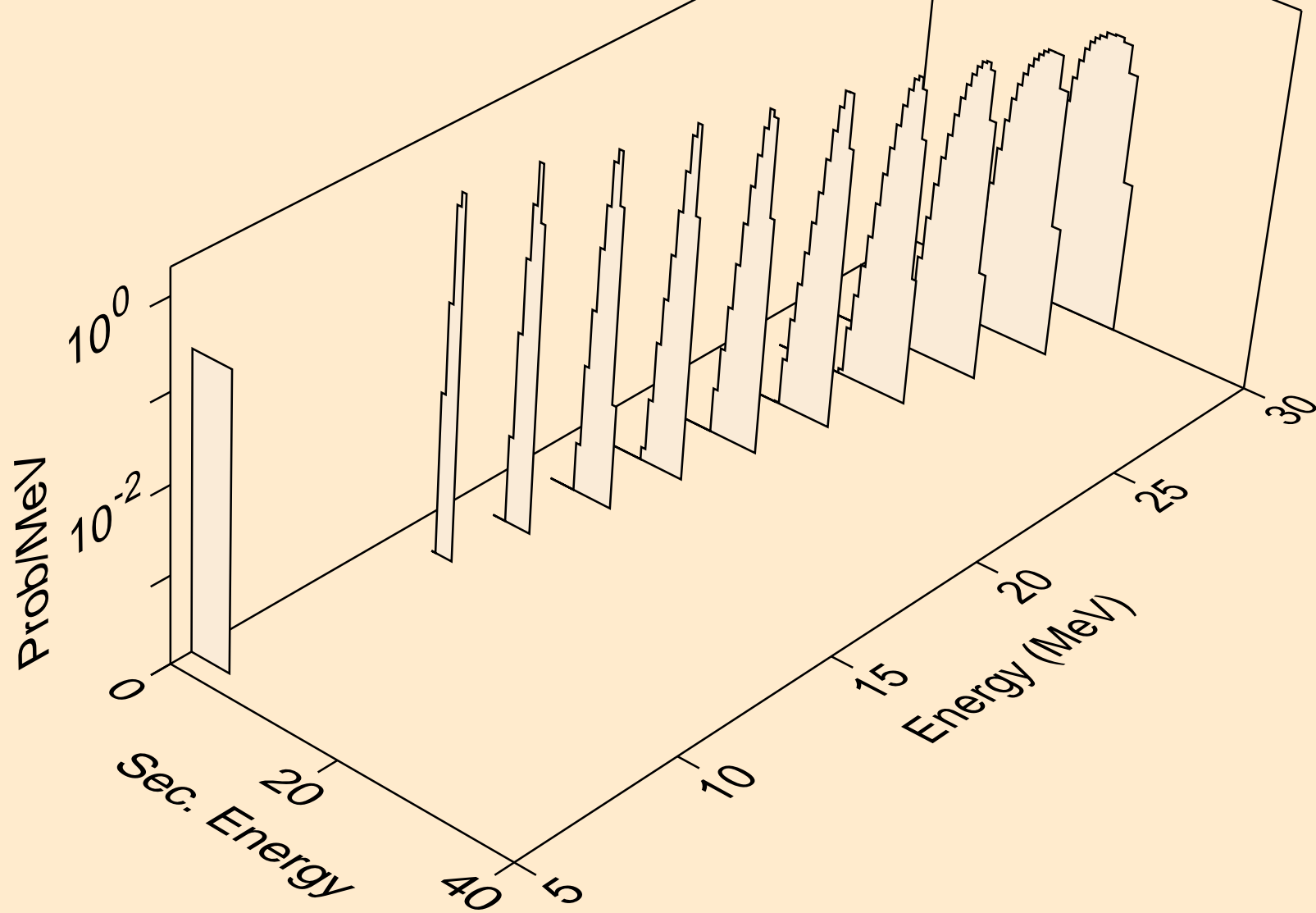

ER177 NEUTRON ACER TENDL-2021 LIBRARY; T=293.6K
alphas from (n,3n)a

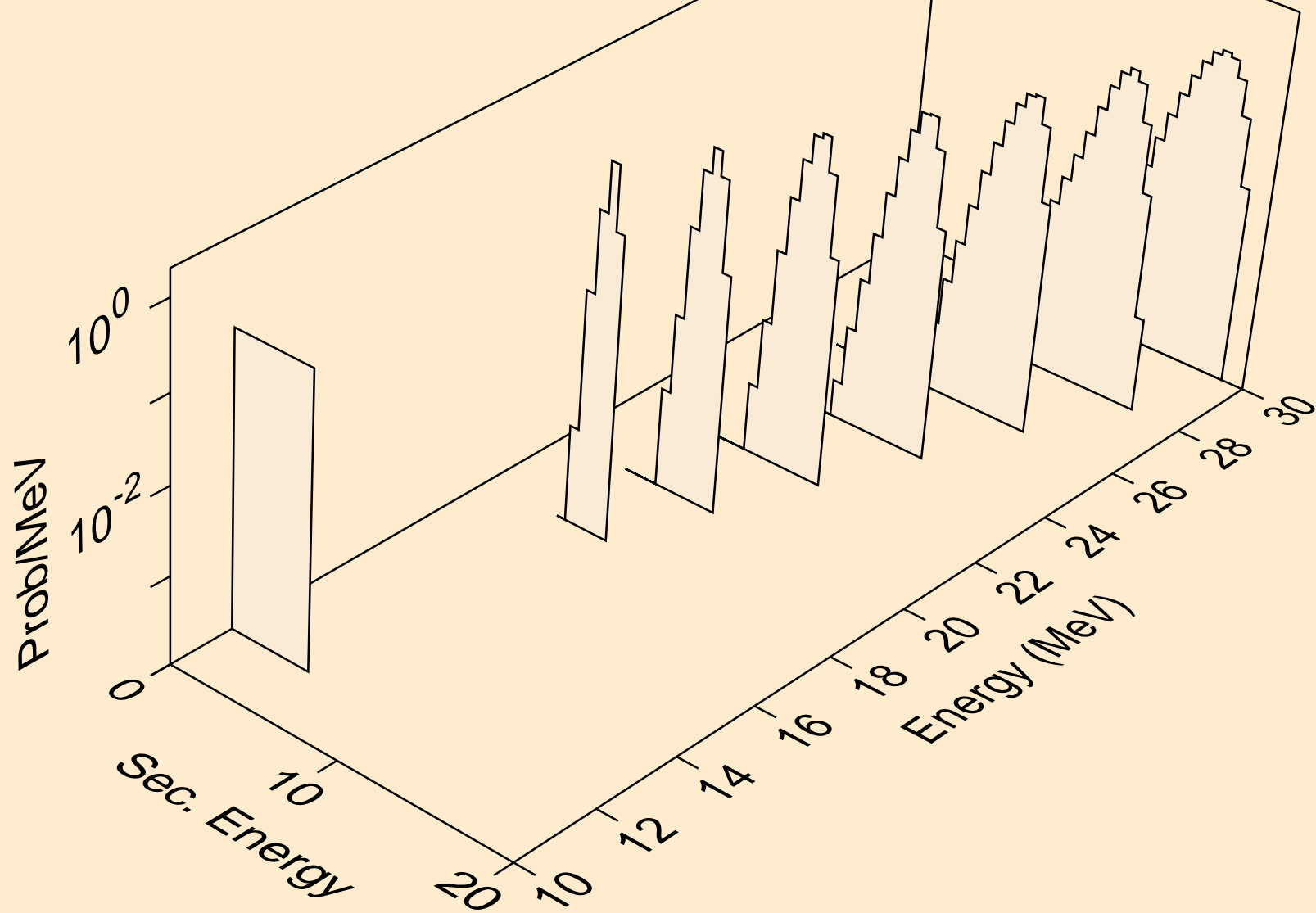

ER177 NEUTRON ACER TENDL-2021 LIBRARY; T=293.6K
alphas from (n,a)

