

# ES239 NEUTRON ACER TENDL-2021 LIBRARY; T=293.6K

## Principal cross sections

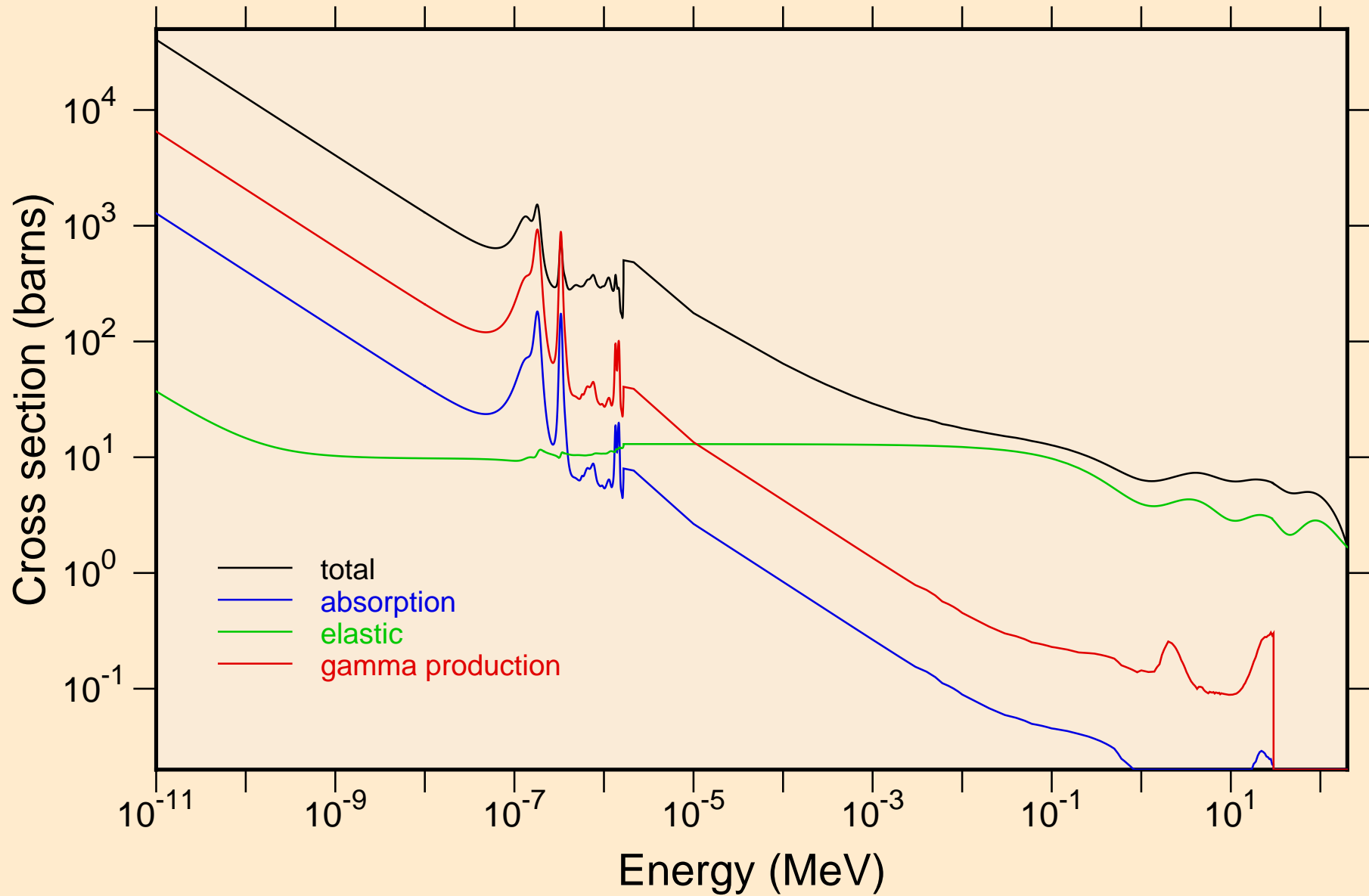

ES239 NEUTRON ACER TENDL-2021 LIBRARY; T=293.6K  
resonance total cross section

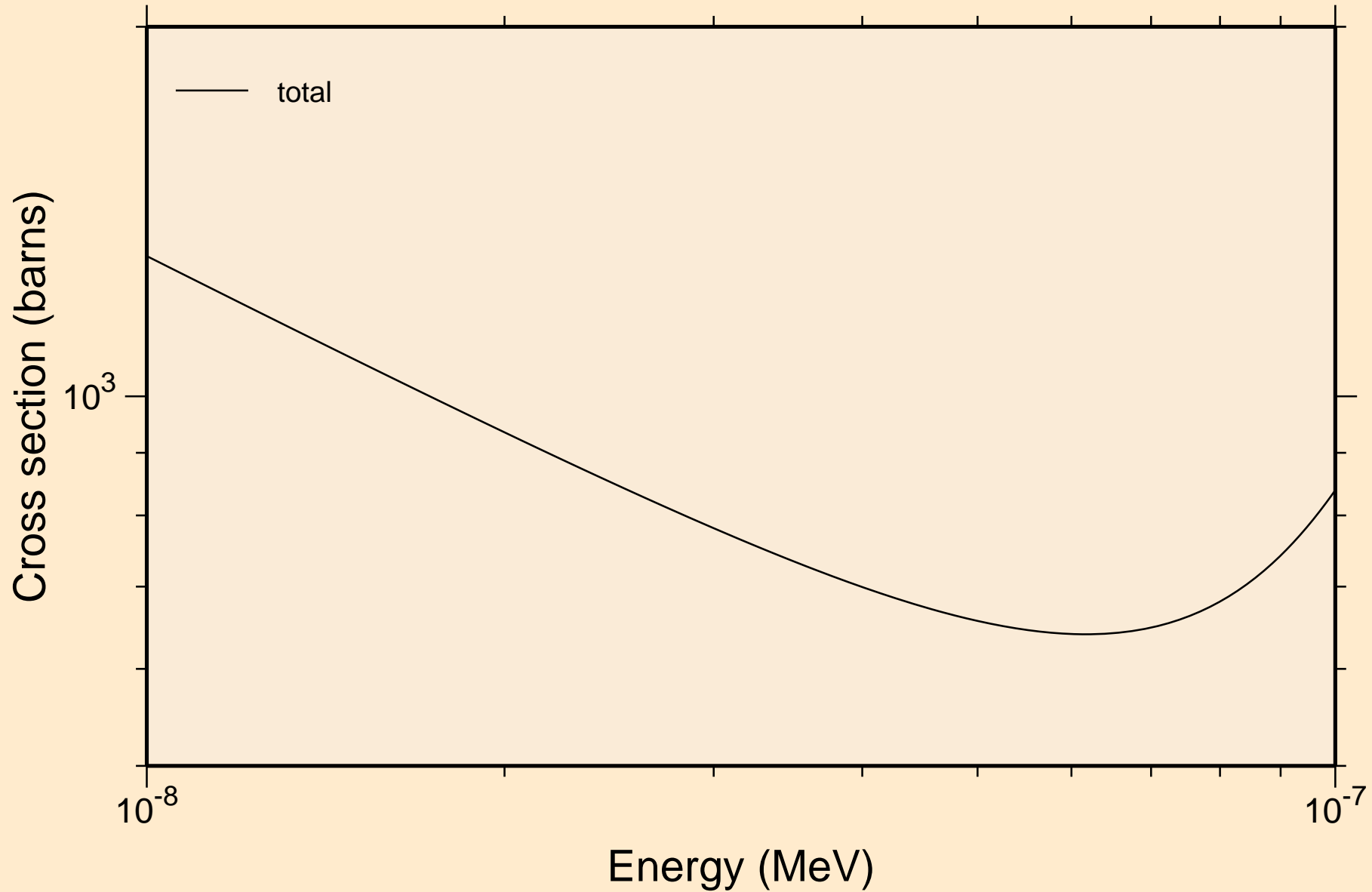

ES239 NEUTRON ACER TENDL-2021 LIBRARY; T=293.6K  
resonance total cross section

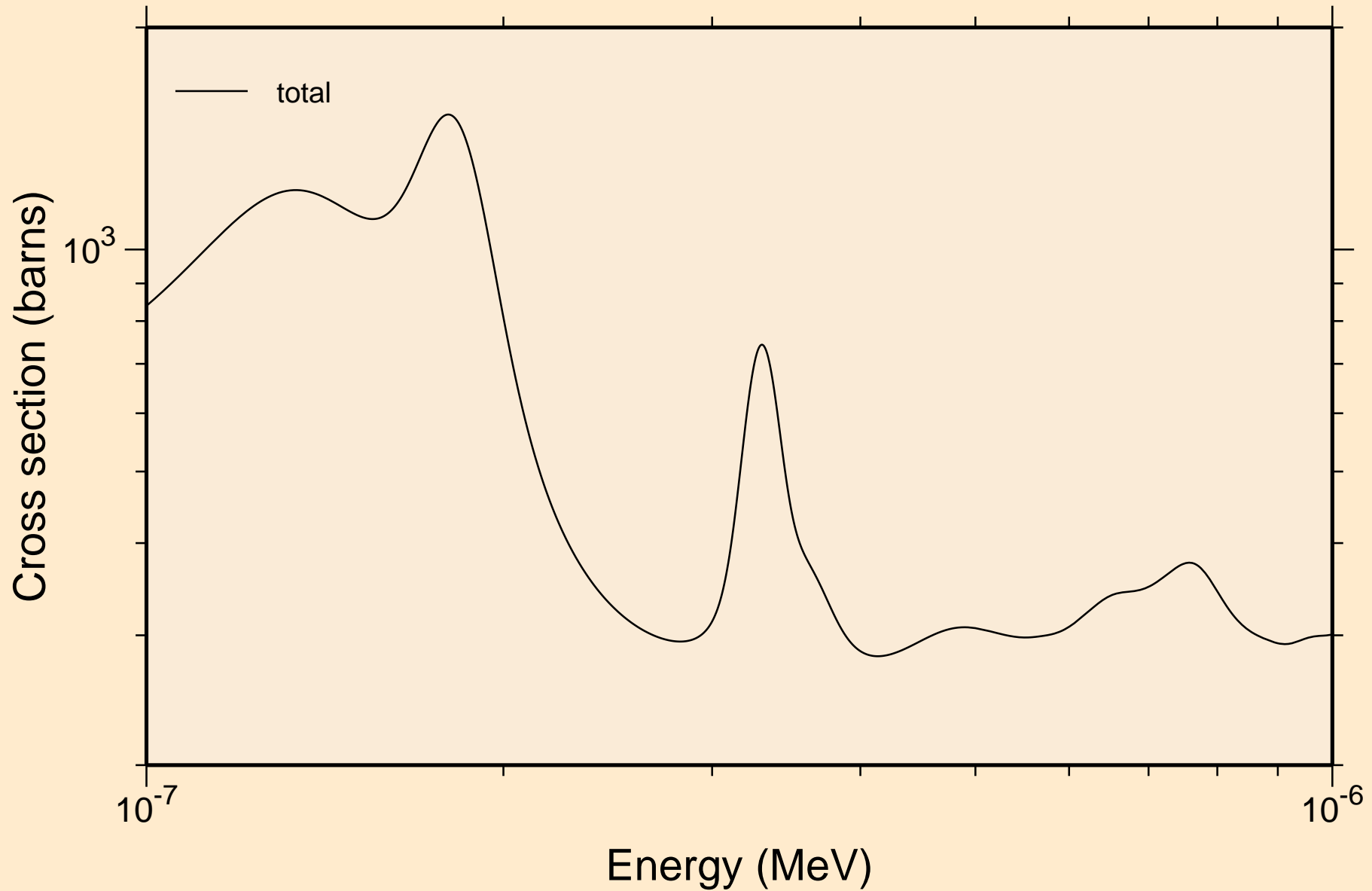

ES239 NEUTRON ACER TENDL-2021 LIBRARY; T=293.6K  
resonance total cross section

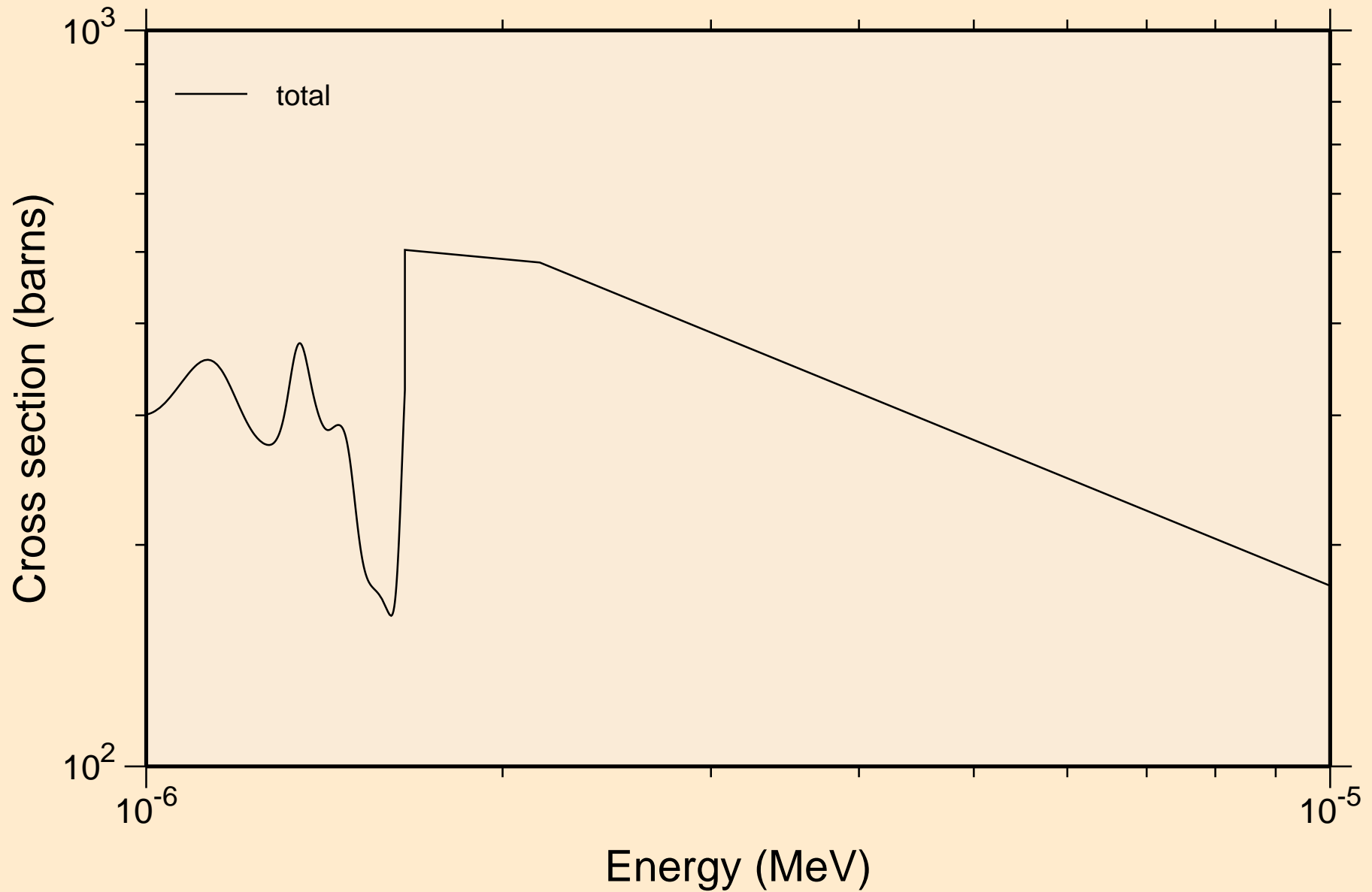

ES239 NEUTRON ACER TENDL-2021 LIBRARY; T=293.6K  
resonance total cross section

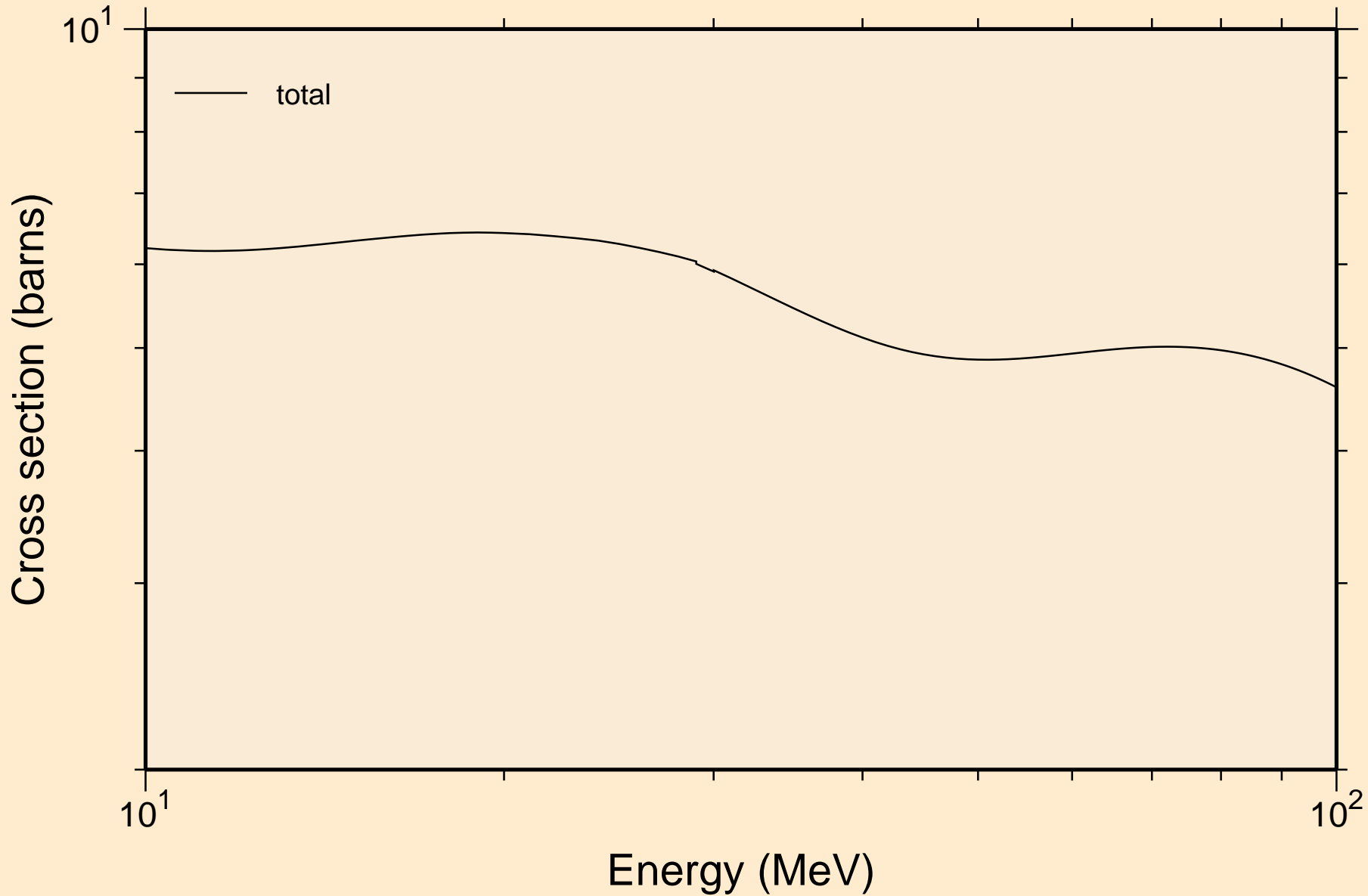

ES239 NEUTRON ACER TENDL-2021 LIBRARY; T=293.6K  
resonance absorption cross sections

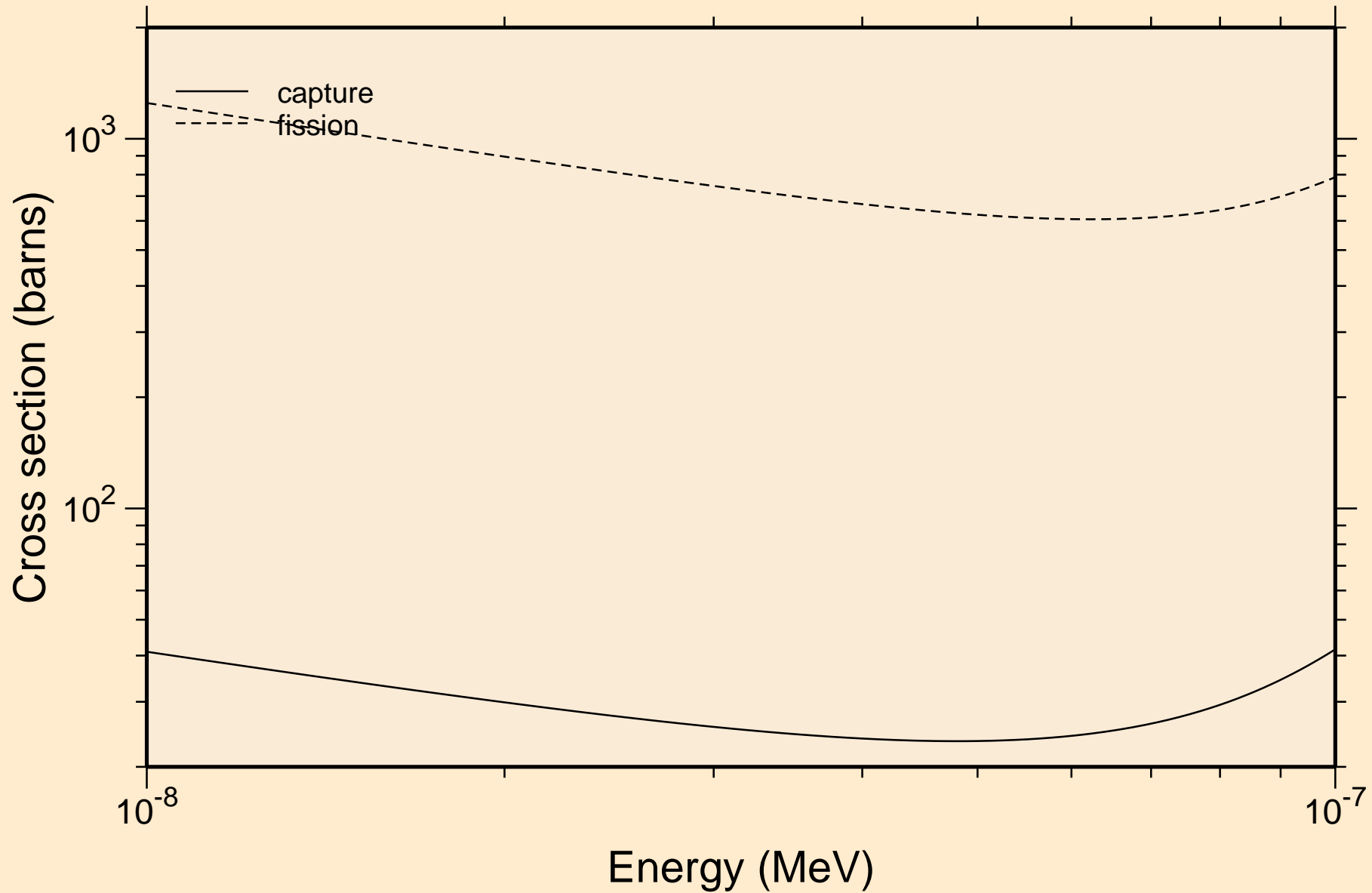

ES239 NEUTRON ACER TENDL-2021 LIBRARY; T=293.6K  
resonance absorption cross sections

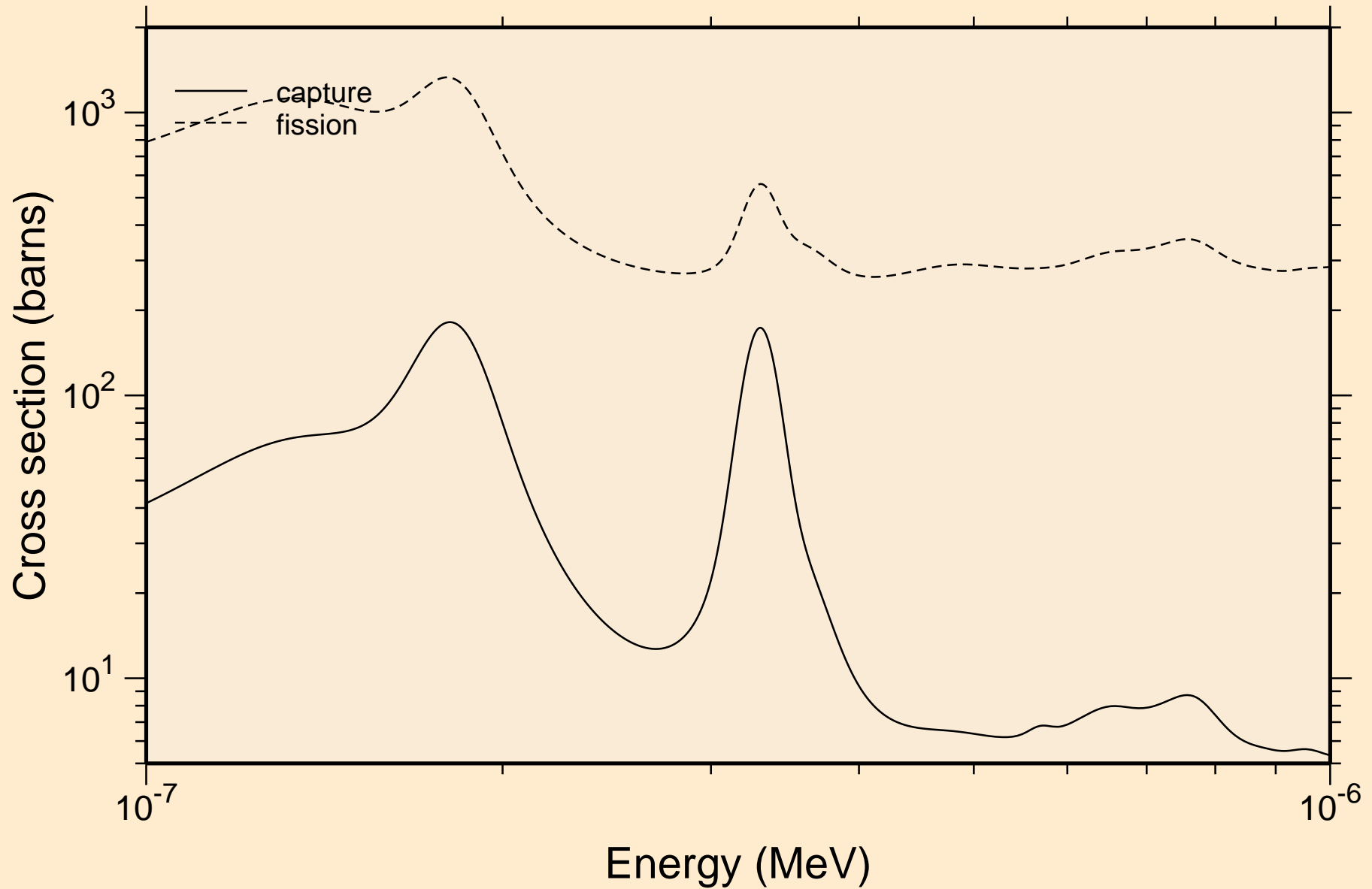

ES239 NEUTRON ACER TENDL-2021 LIBRARY; T=293.6K  
resonance absorption cross sections

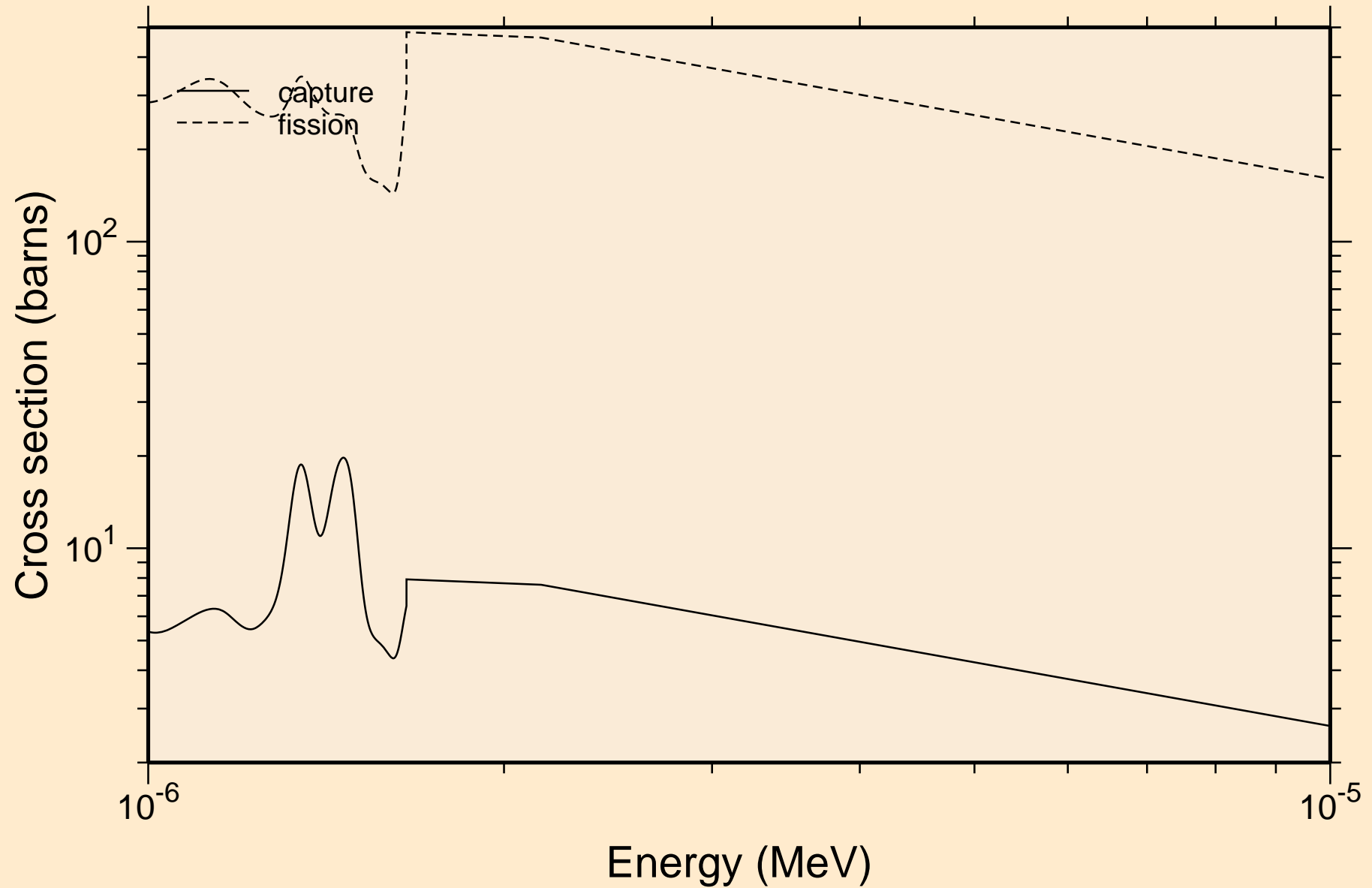



ES239 NEUTRON ACER TENDL-2021 LIBRARY; T=293.6K  
resonance absorption cross sections

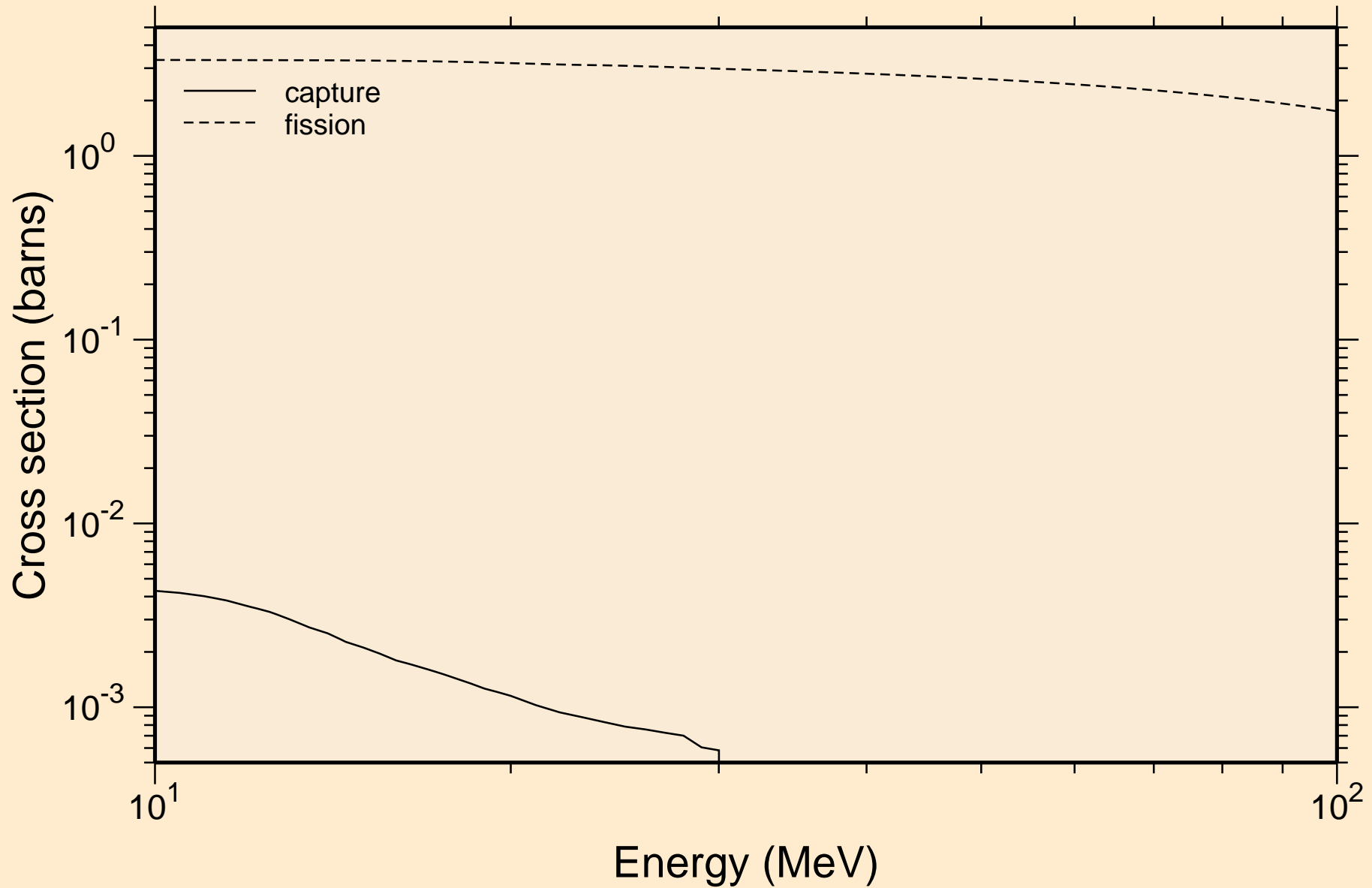

ES239 NEUTRON ACER TENDL-2021 LIBRARY; T=293.6K  
Heating

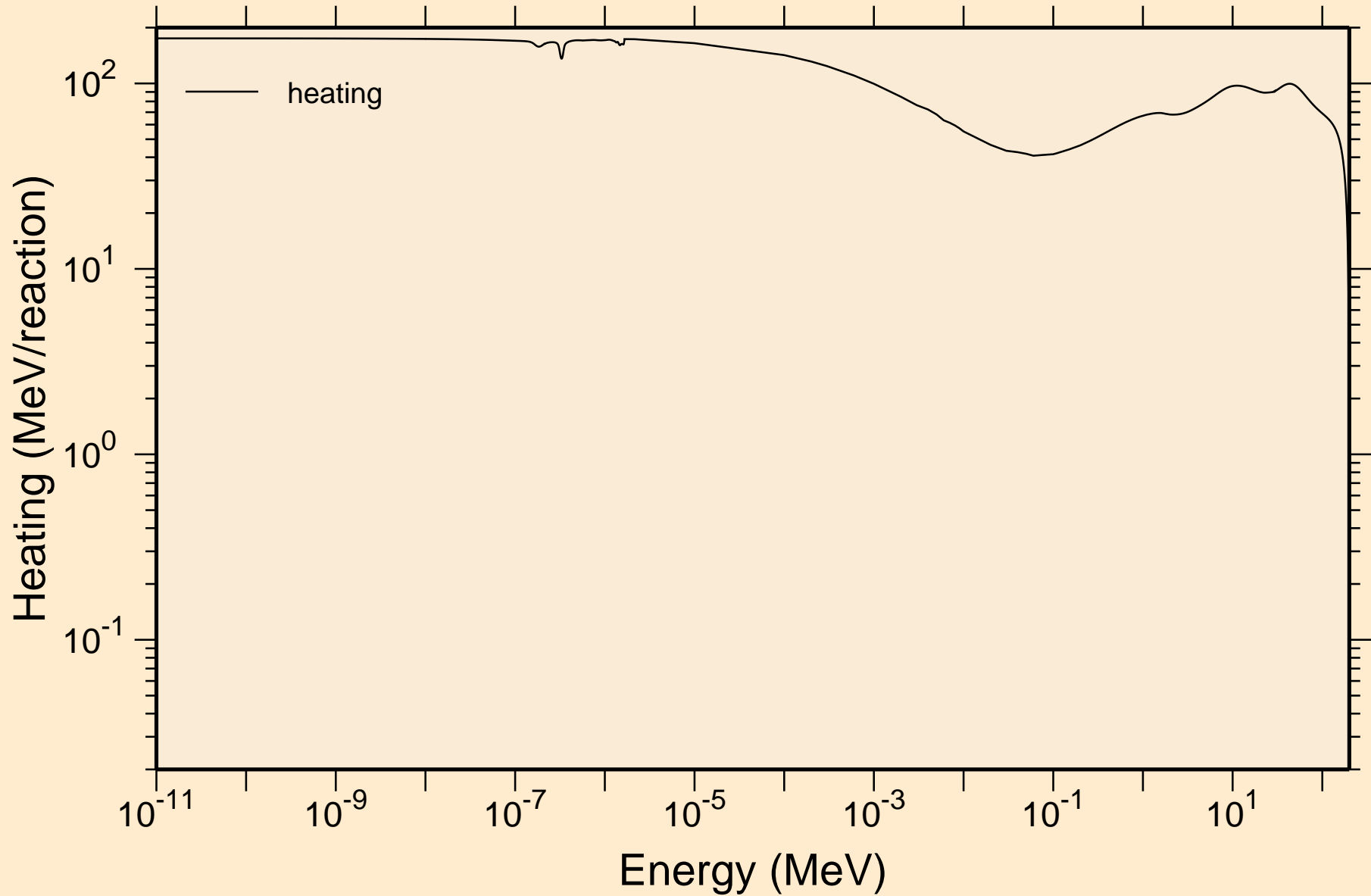

ES239 NEUTRON ACER TENDL-2021 LIBRARY; T=293.6K  
Damage

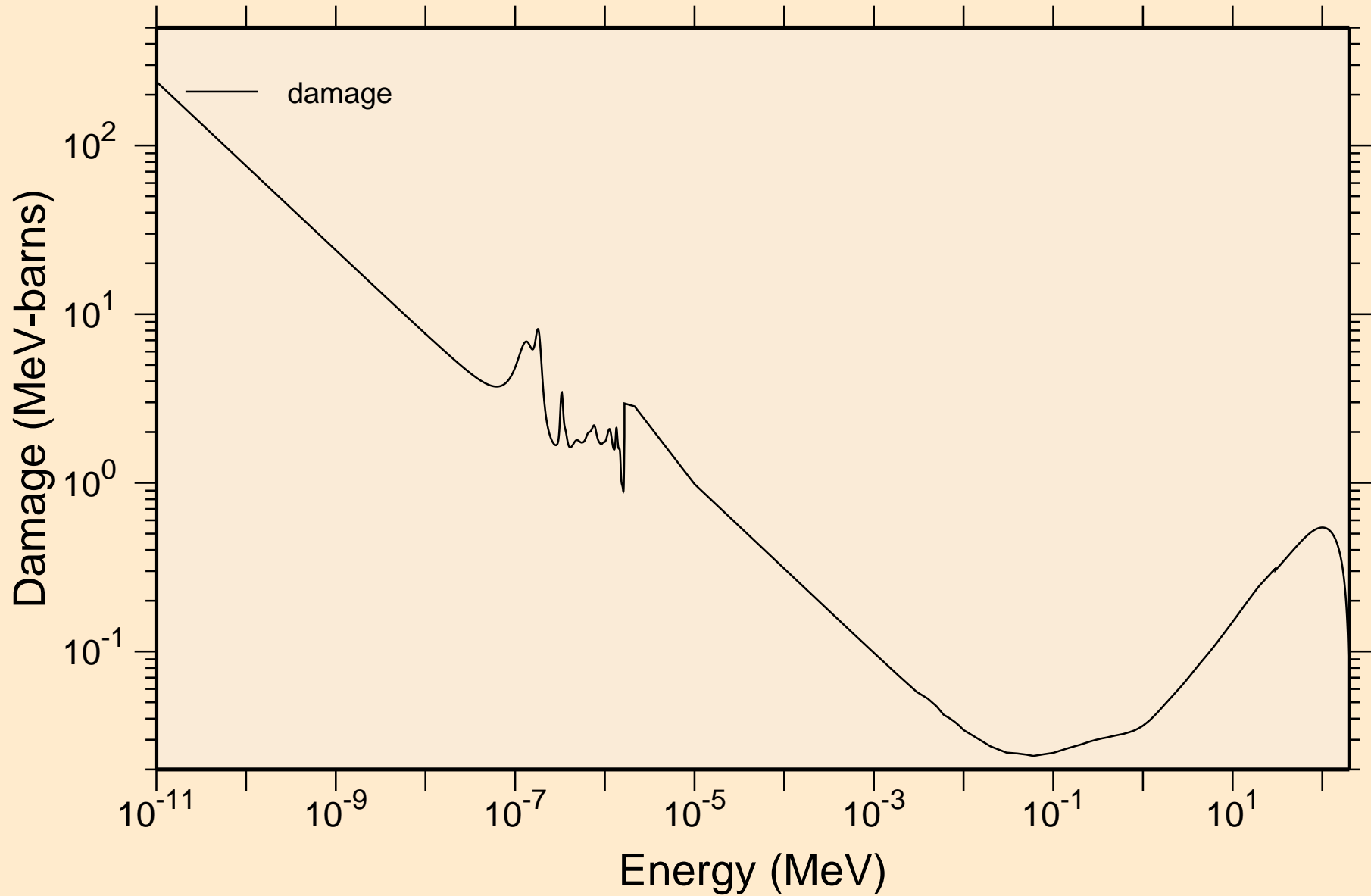

# ES239 NEUTRON ACER TENDL-2021 LIBRARY; T=293.6K

## Non-threshold reactions

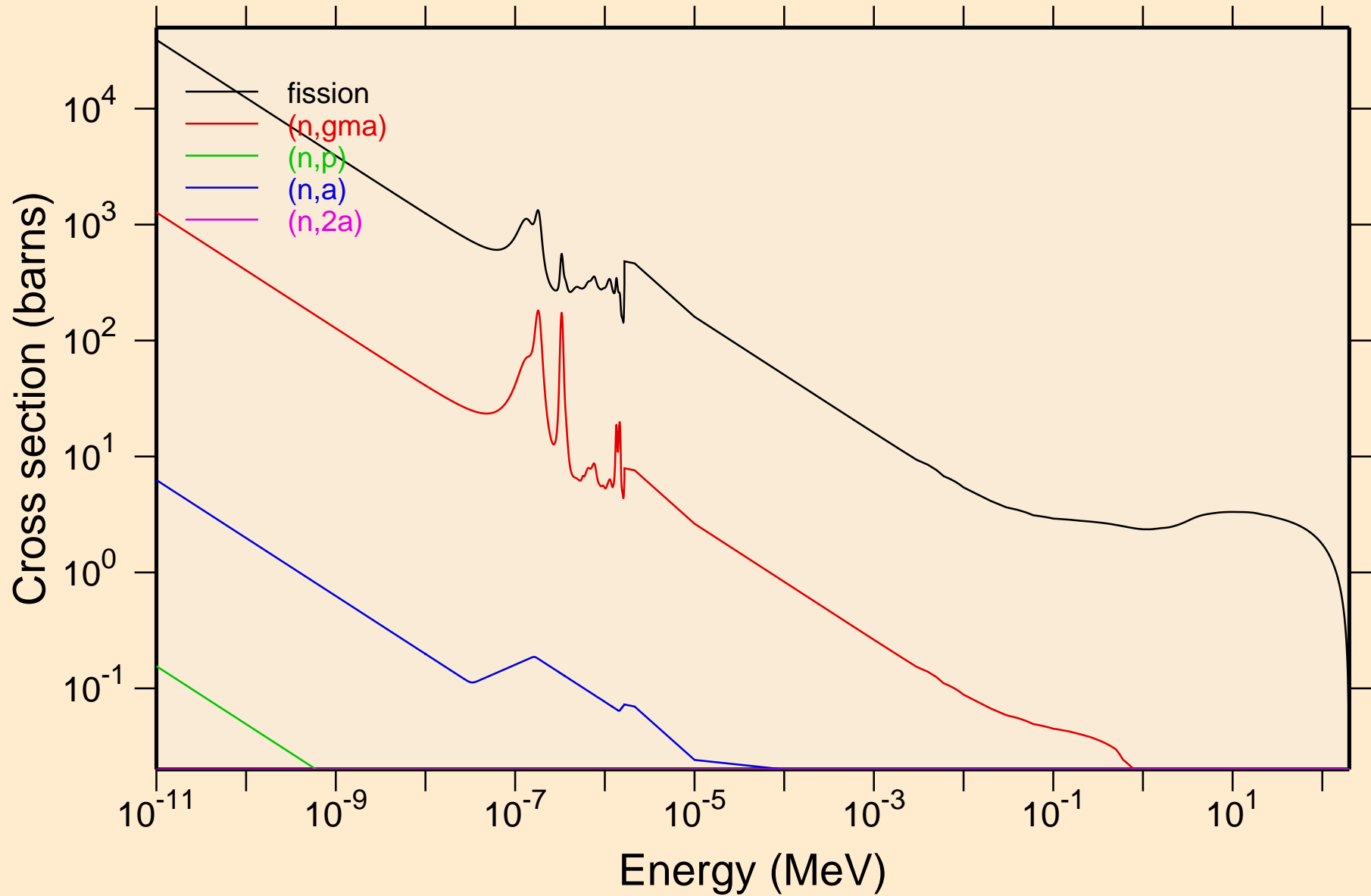

ES239 NEUTRON ACER TENDL-2021 LIBRARY; T=293.6K  
Non-threshold reactions

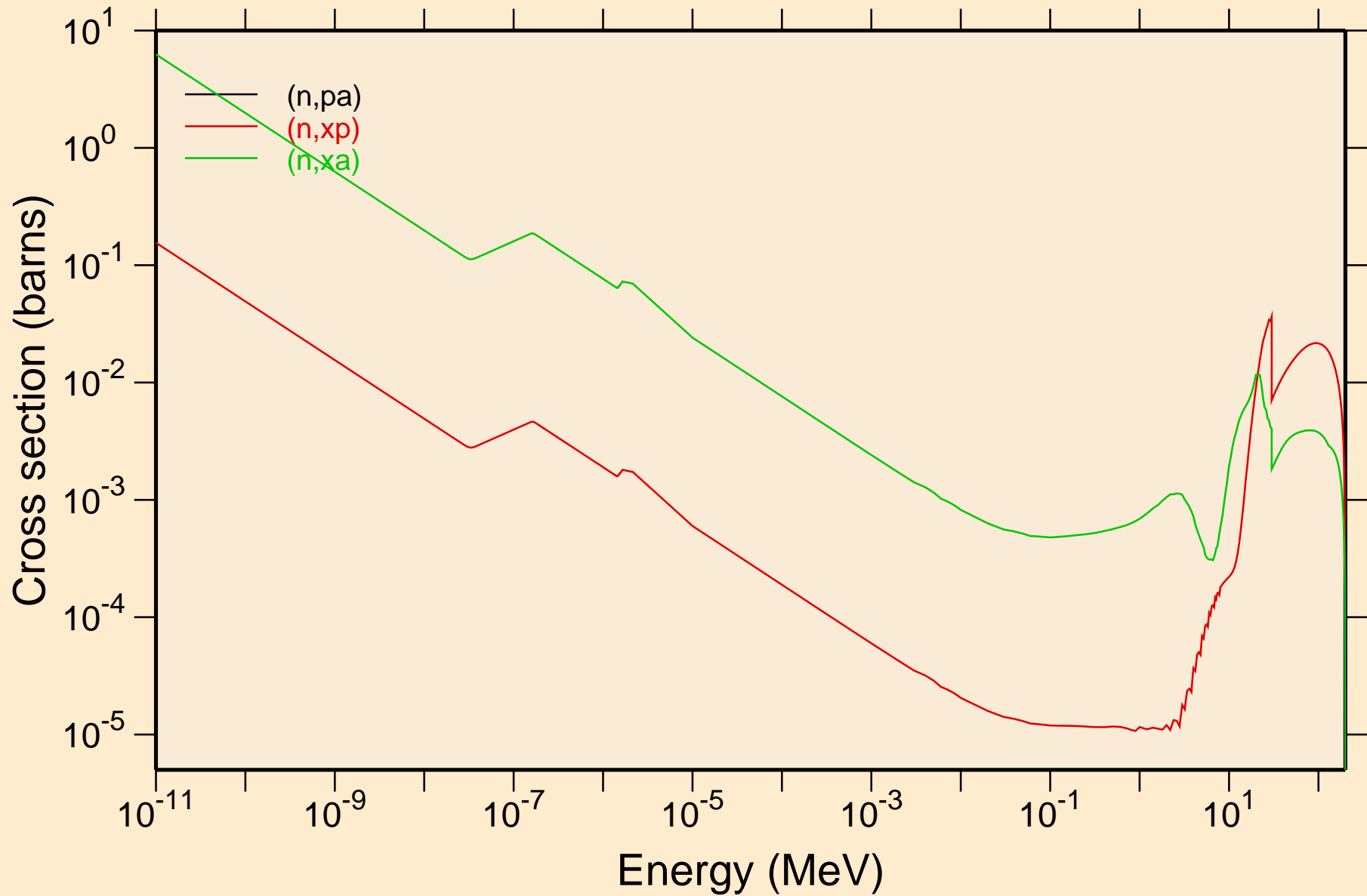

# ES239 NEUTRON ACER TENDL-2021 LIBRARY; T=293.6K

## Principal cross sections

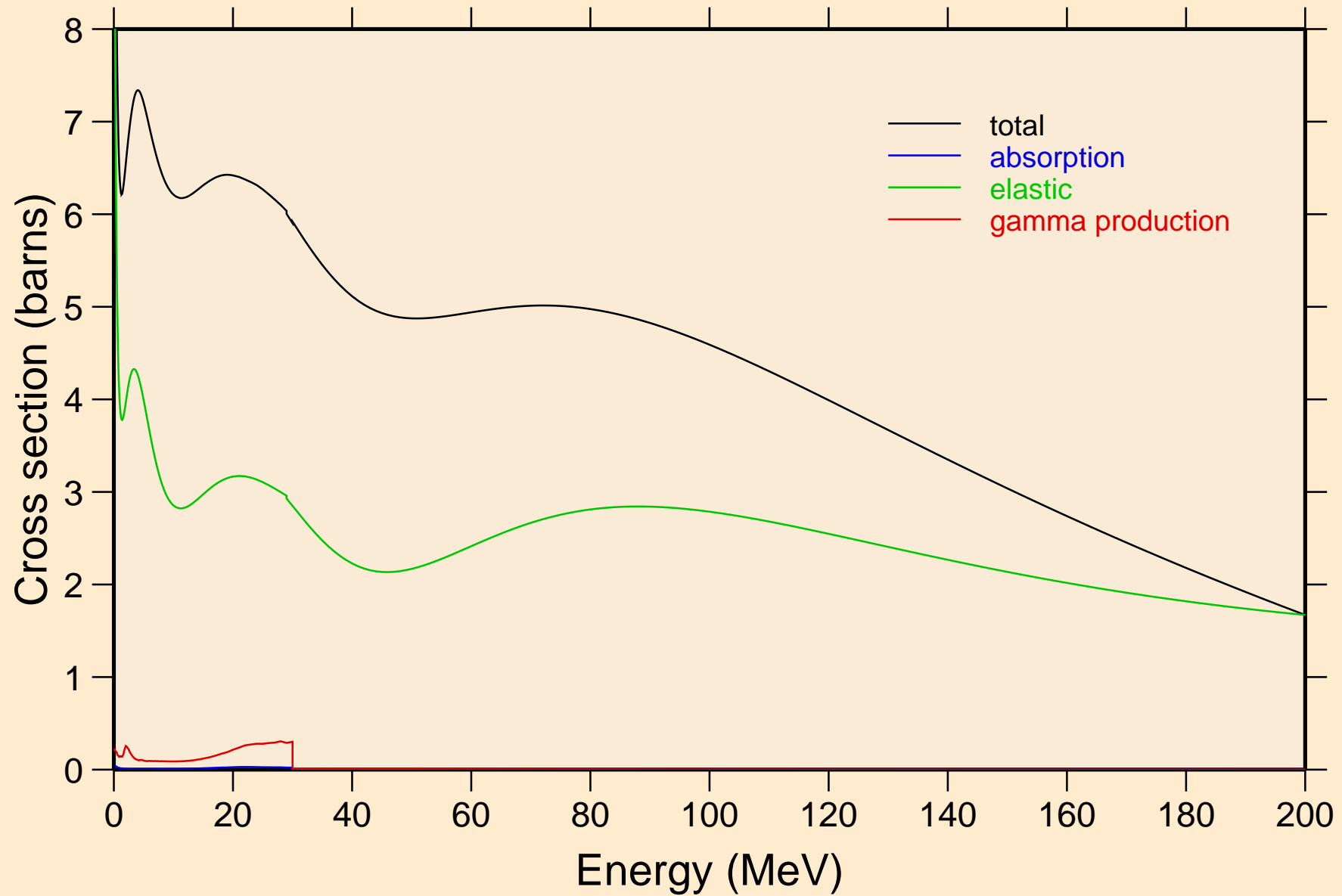

ES239 NEUTRON ACER TENDL-2021 LIBRARY; T=293.6K

Heating

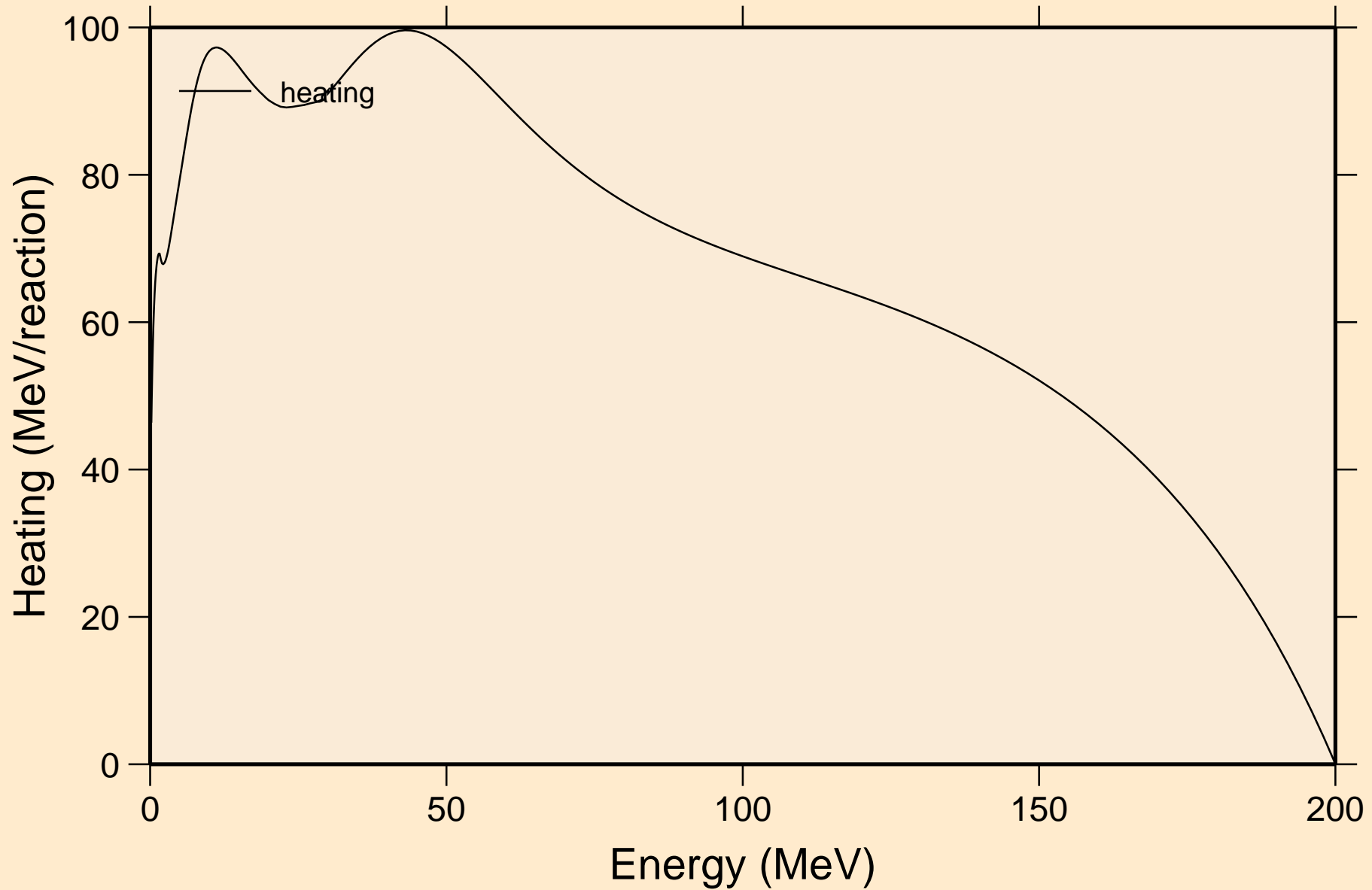

ES239 NEUTRON ACER TENDL-2021 LIBRARY; T=293.6K  
Damage

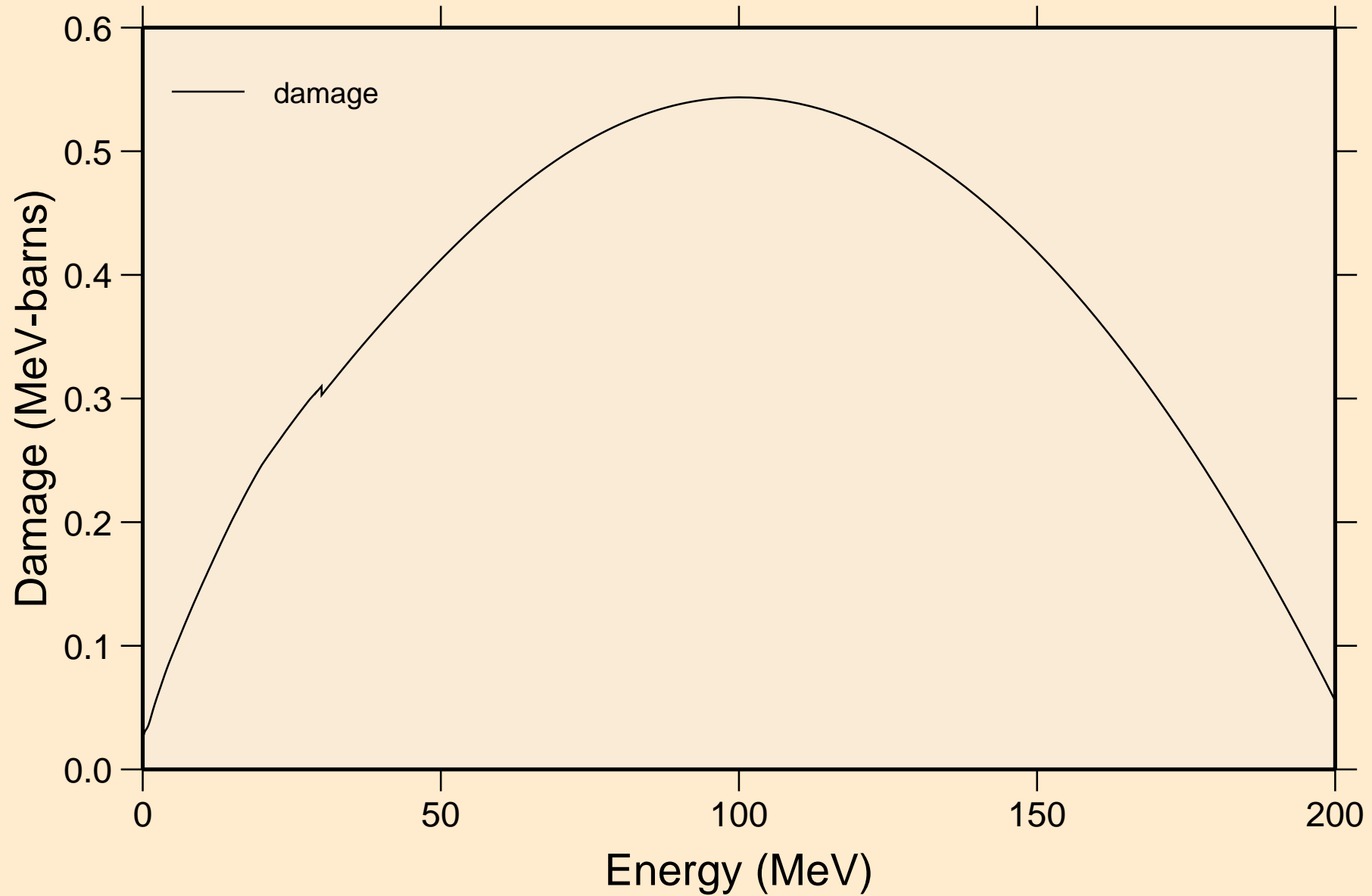



# ES239 NEUTRON ACER TENDL-2021 LIBRARY; T=293.6K

## Non-threshold reactions

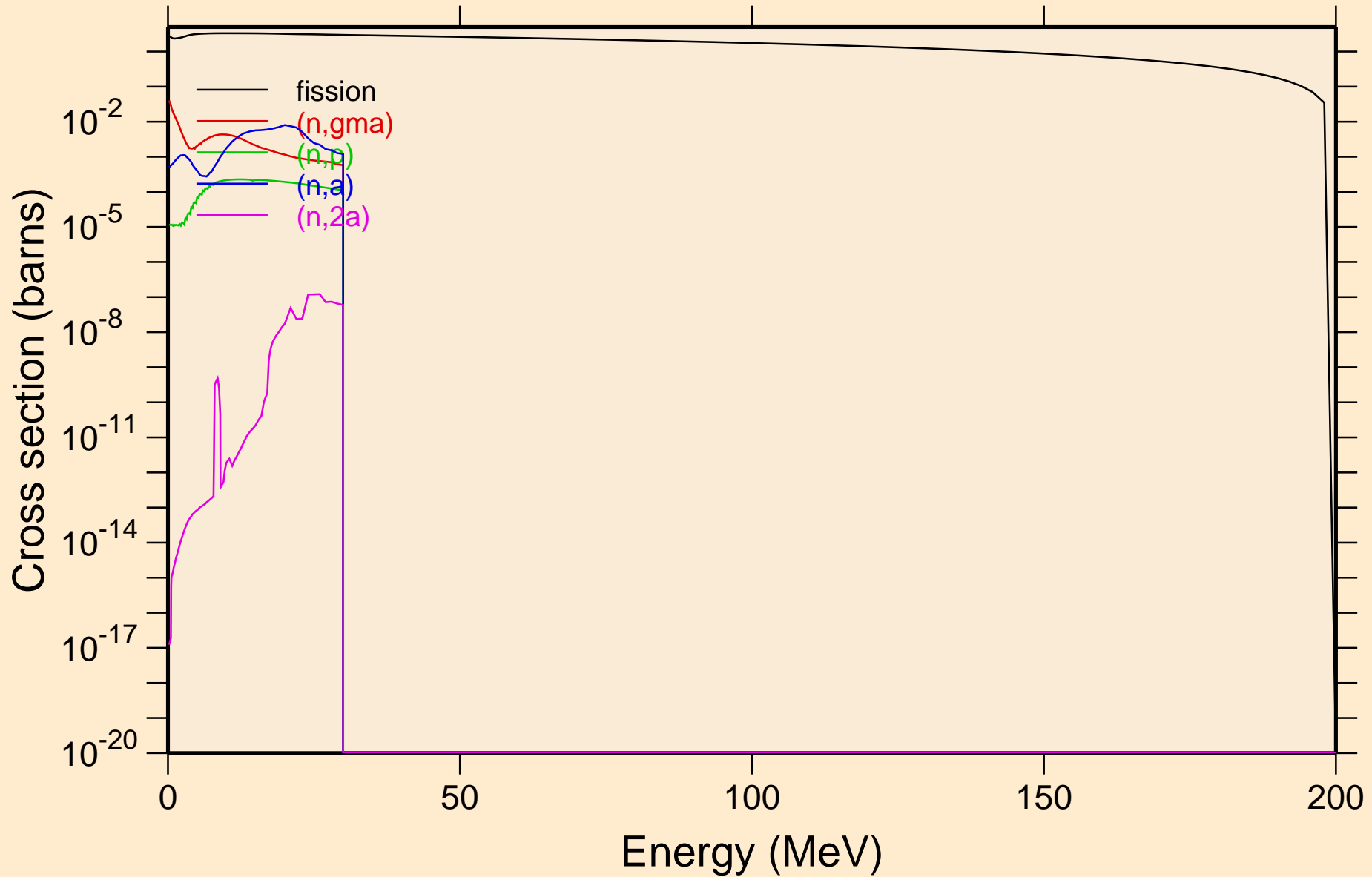

ES239 NEUTRON ACER TENDL-2021 LIBRARY; T=293.6K  
Non-threshold reactions

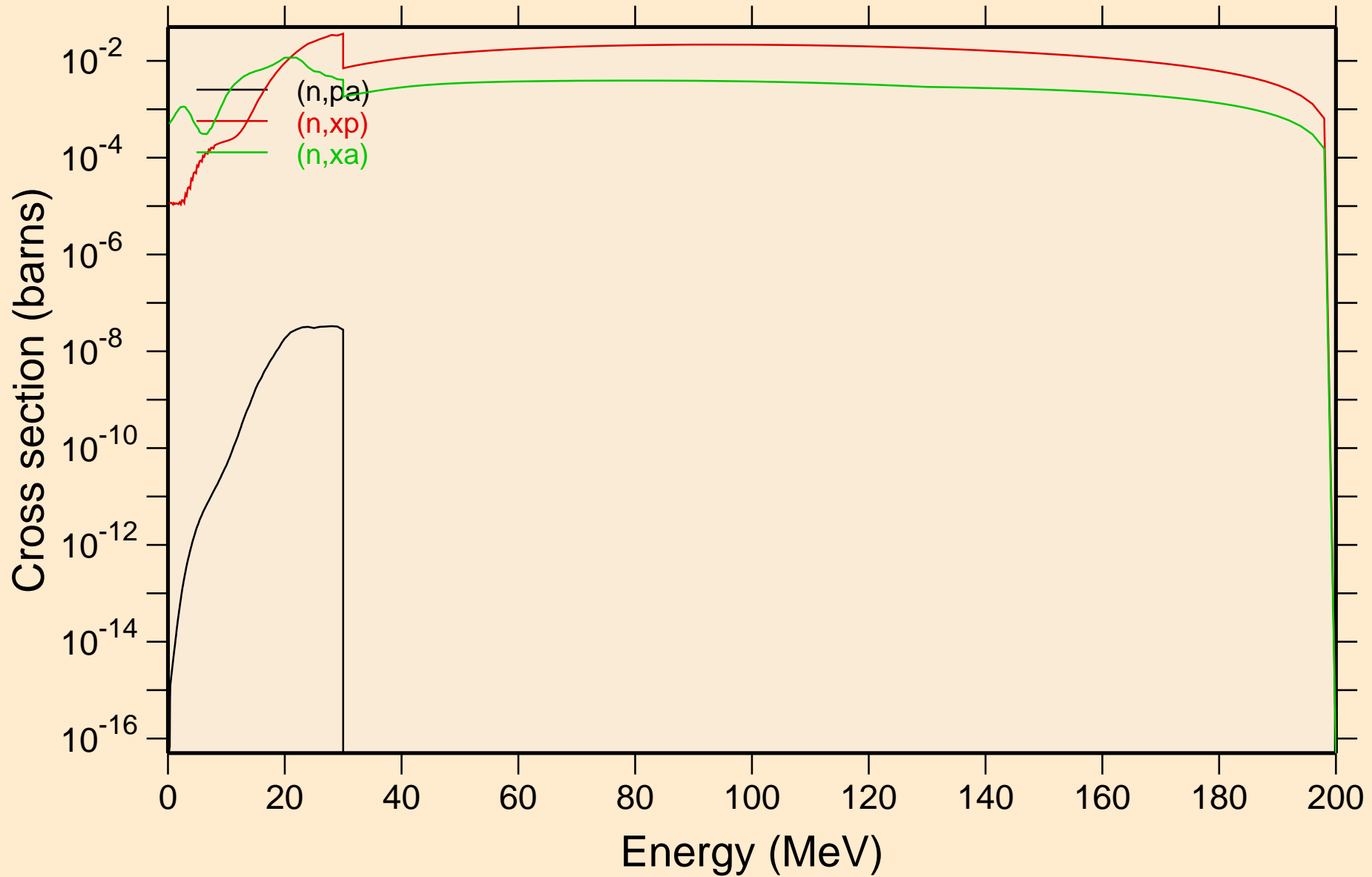

ES239 NEUTRON ACER TENDL-2021 LIBRARY; T=293.6K  
Inelastic levels

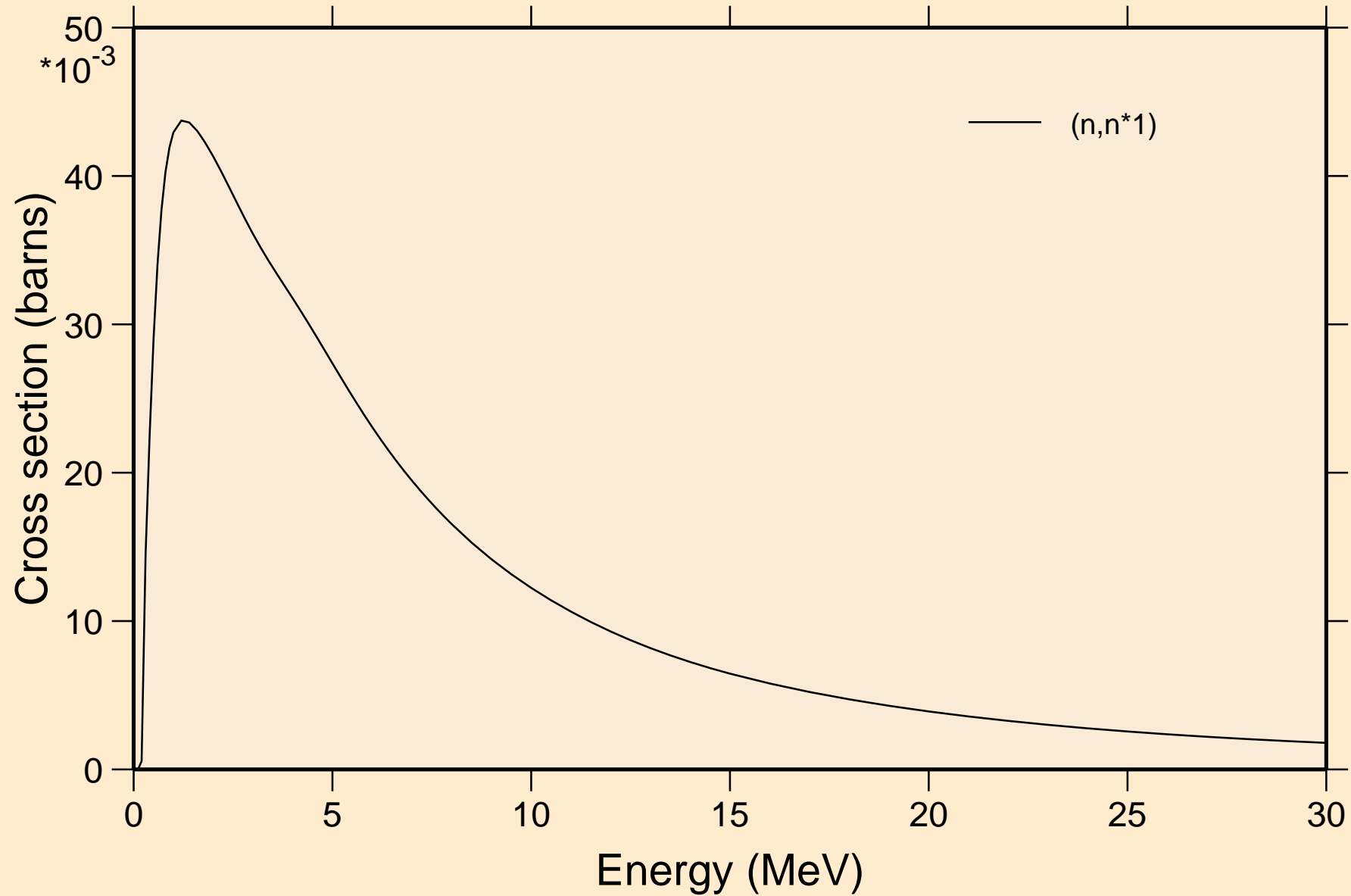

# ES239 NEUTRON ACER TENDL-2021 LIBRARY; T=293.6K

## Threshold reactions

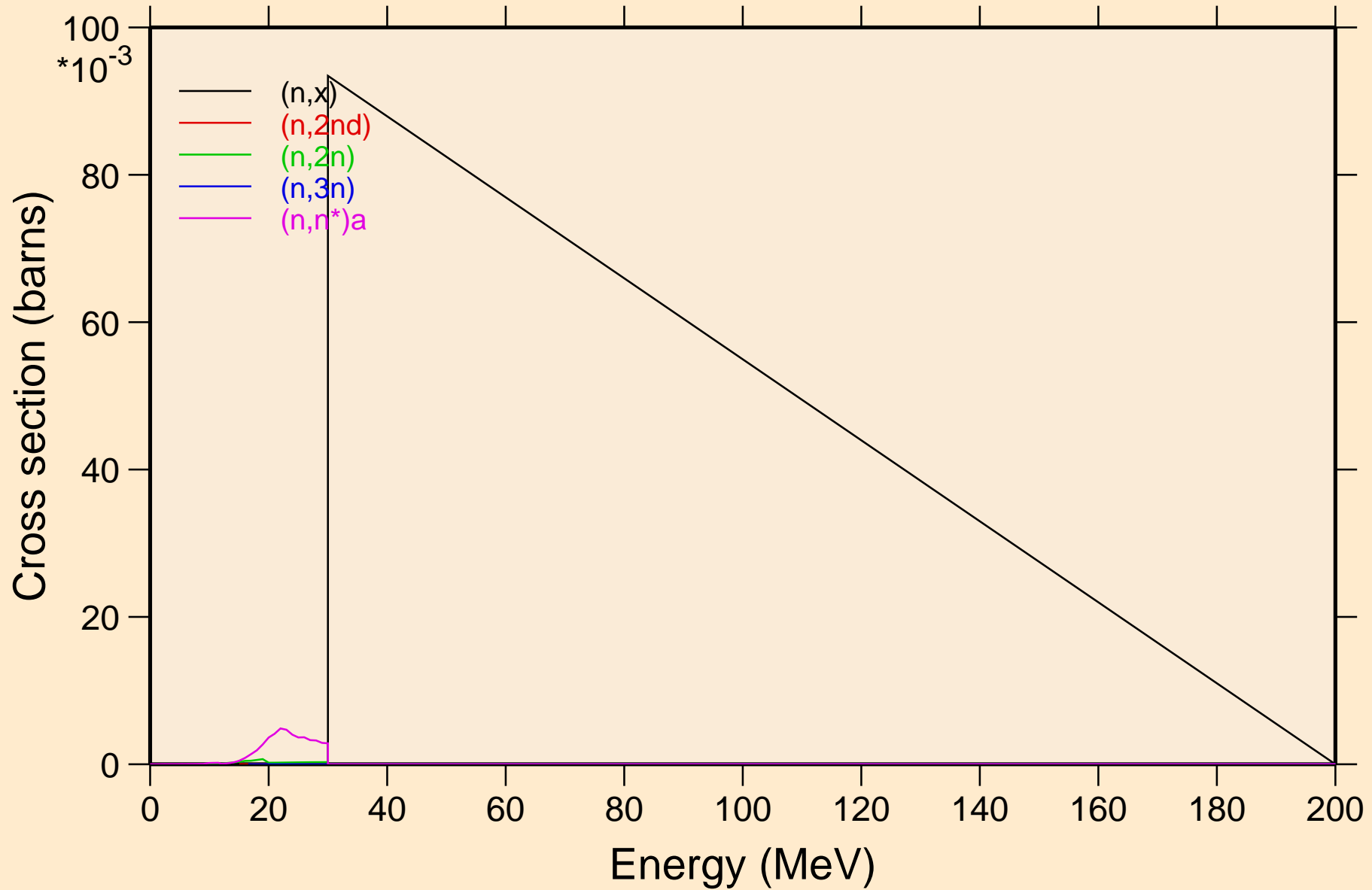

ES239 NEUTRON ACER TENDL-2021 LIBRARY; T=293.6K  
Threshold reactions

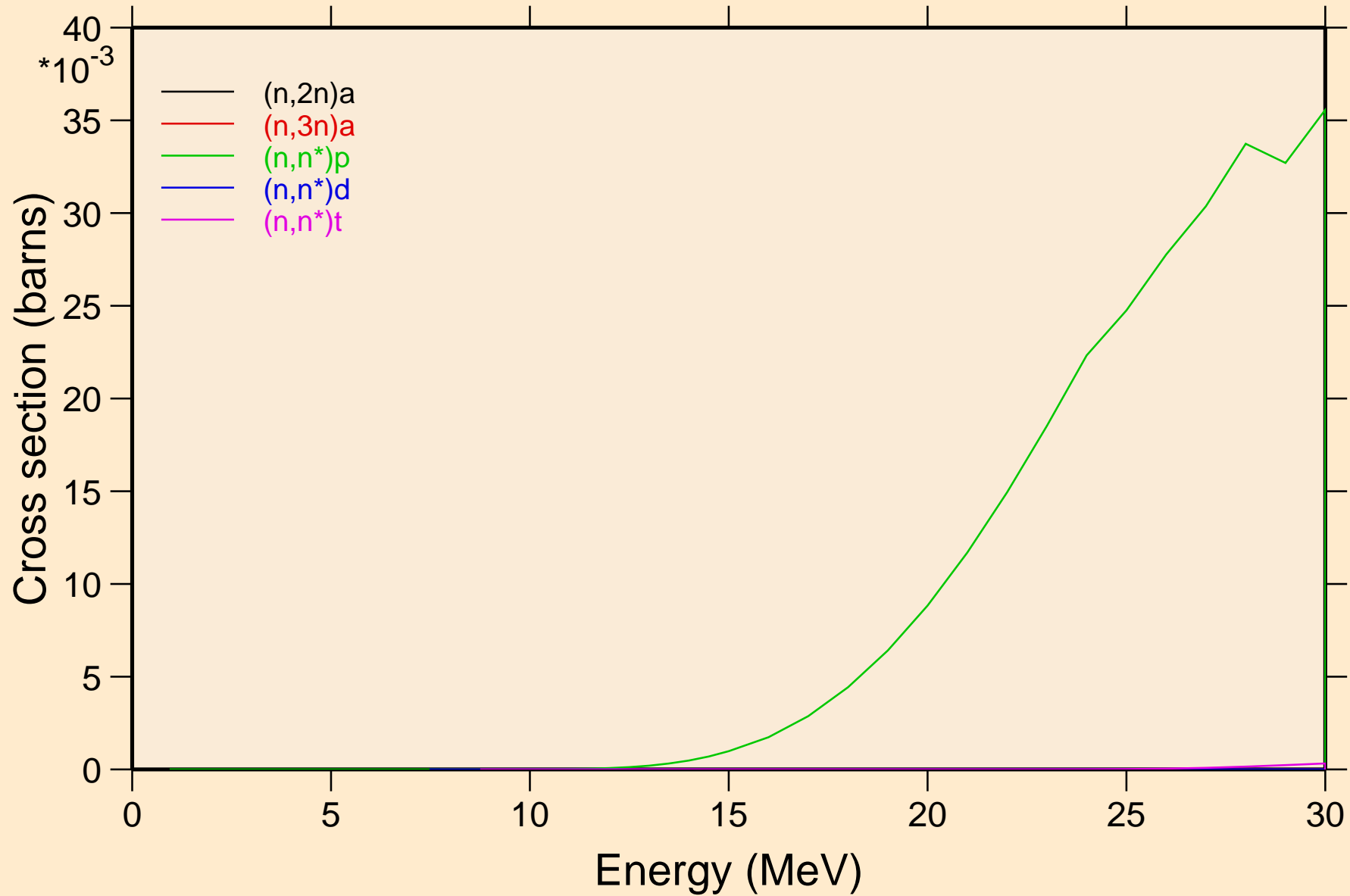

# ES239 NEUTRON ACER TENDL-2021 LIBRARY; T=293.6K

## Threshold reactions

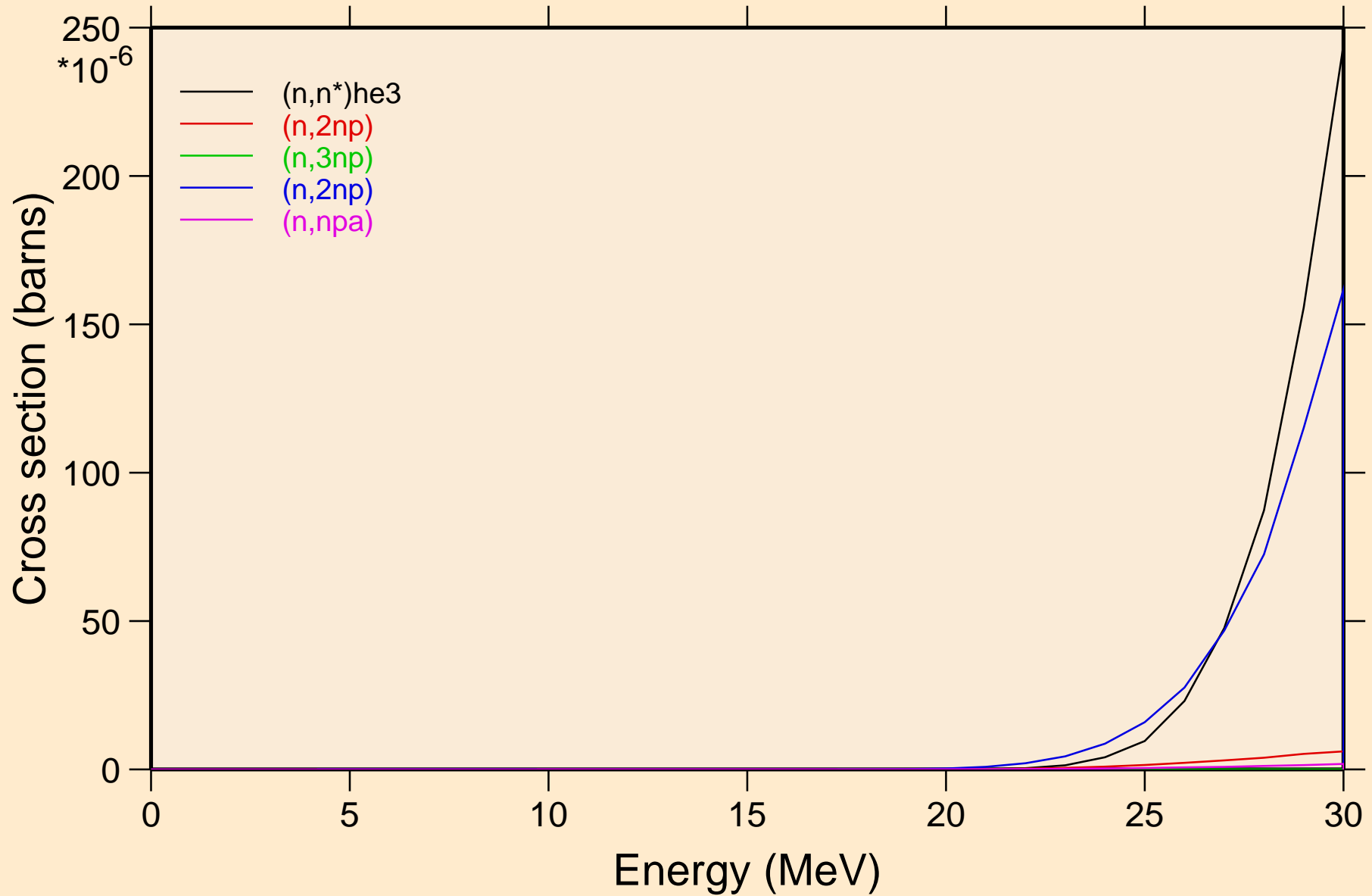

# ES239 NEUTRON ACER TENDL-2021 LIBRARY; T=293.6K

## Threshold reactions

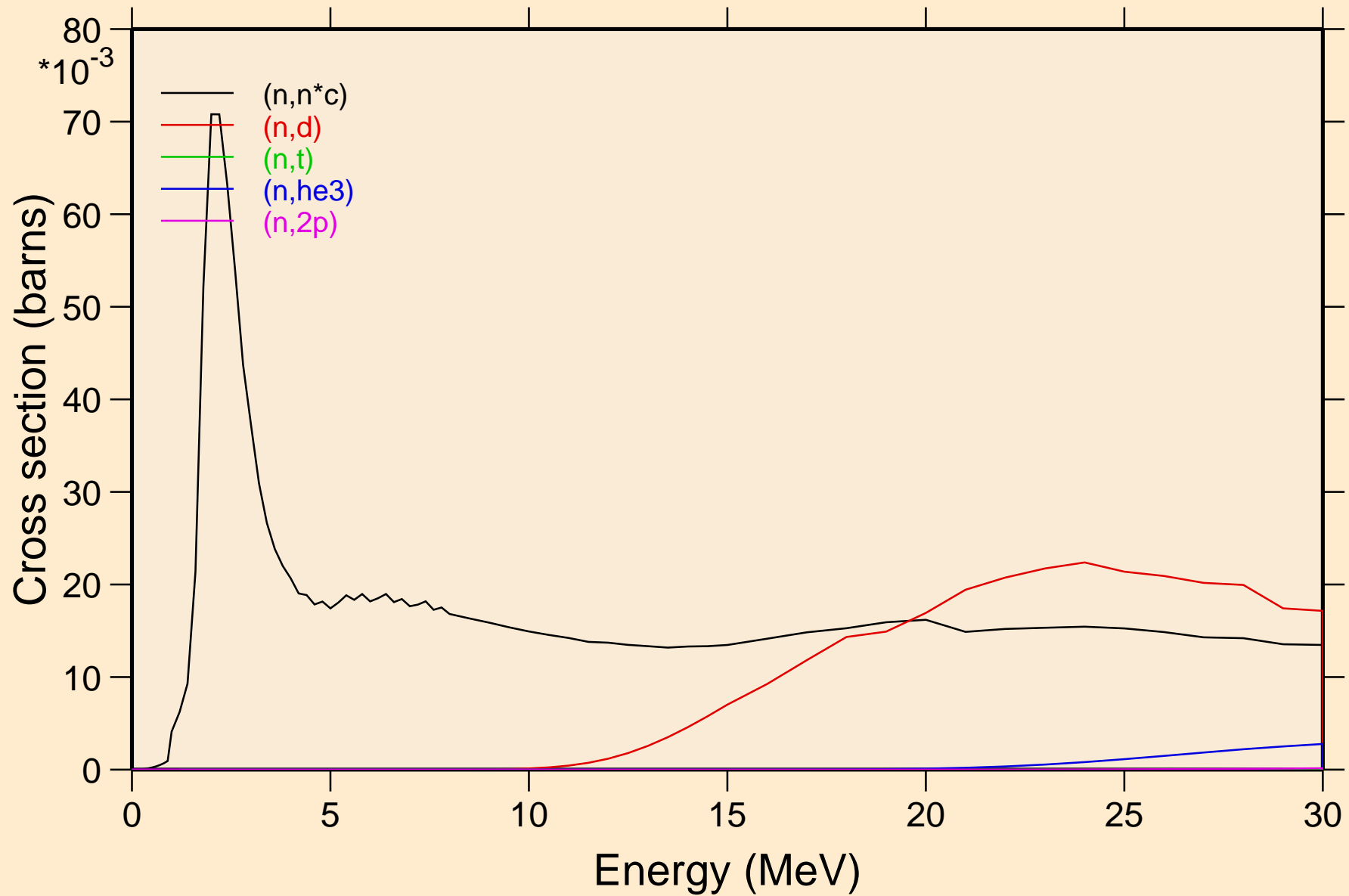

ES239 NEUTRON ACER TENDL-2021 LIBRARY; T=293.6K  
Threshold reactions

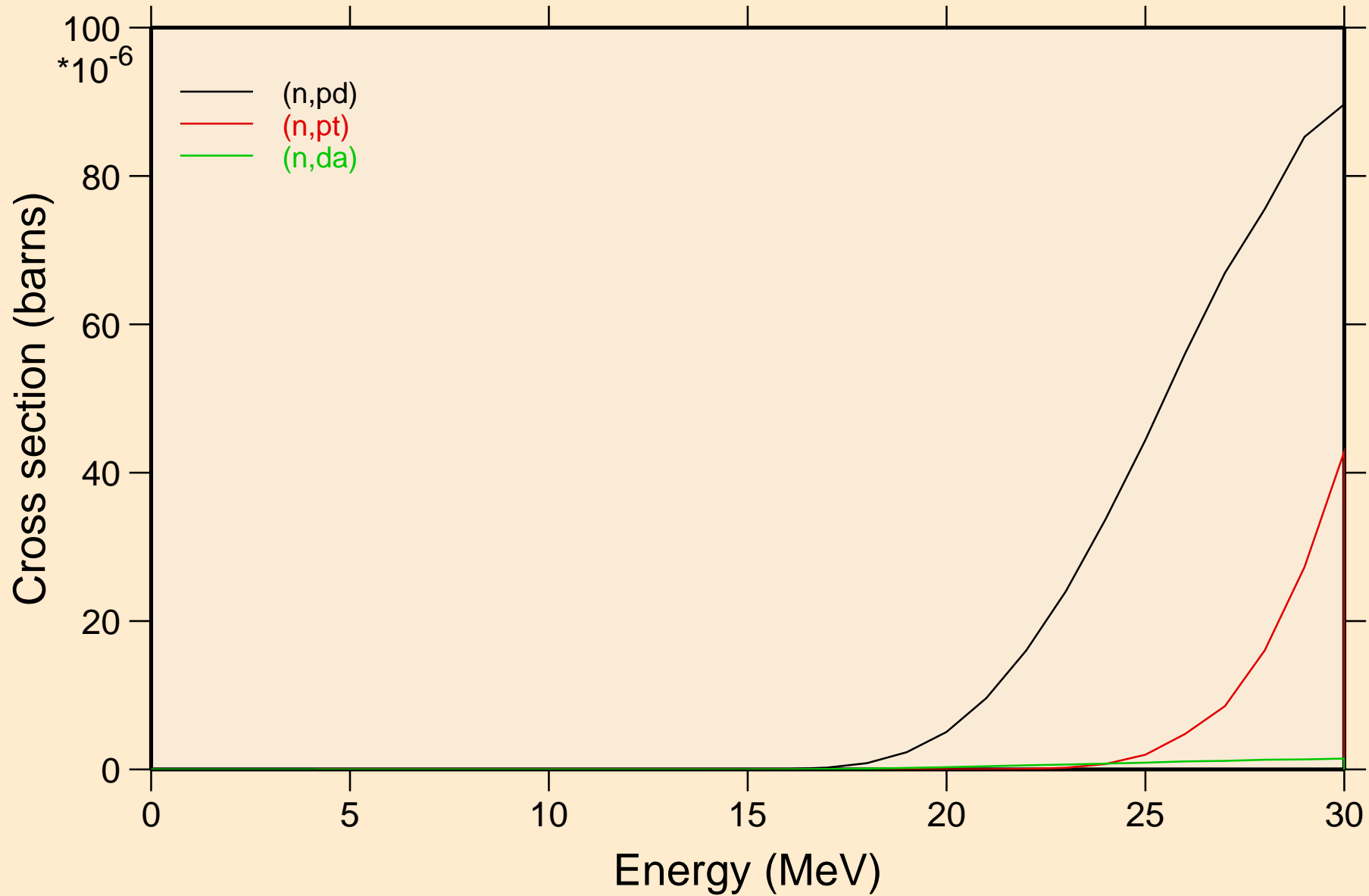



ES239 NEUTRON ACER TENDL-2021 LIBRARY; T=293.6K  
Threshold reactions

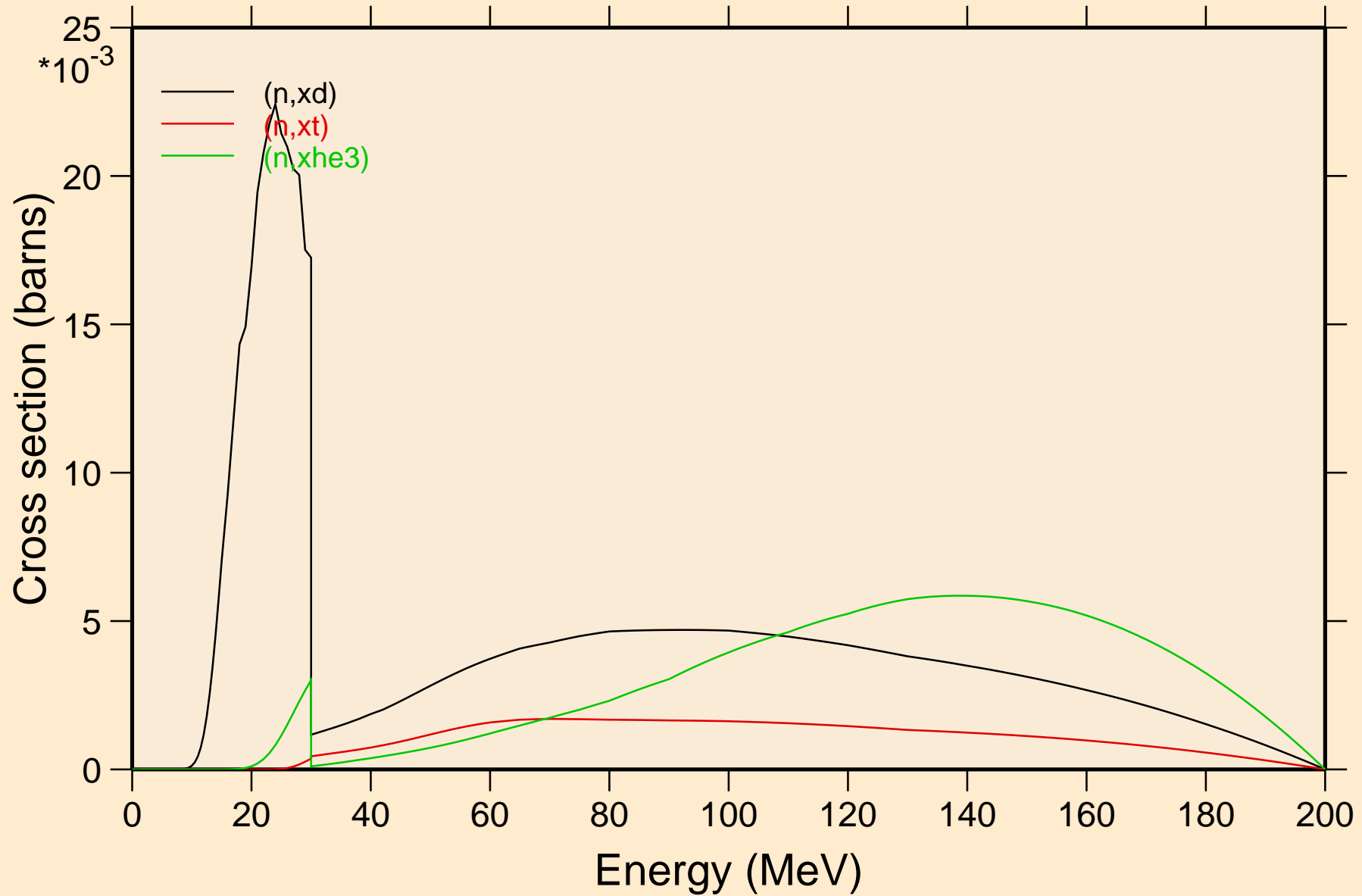

ES239 NEUTRON ACER TENDL-2021 LIBRARY; T=293.6K  
angular distribution for elastic

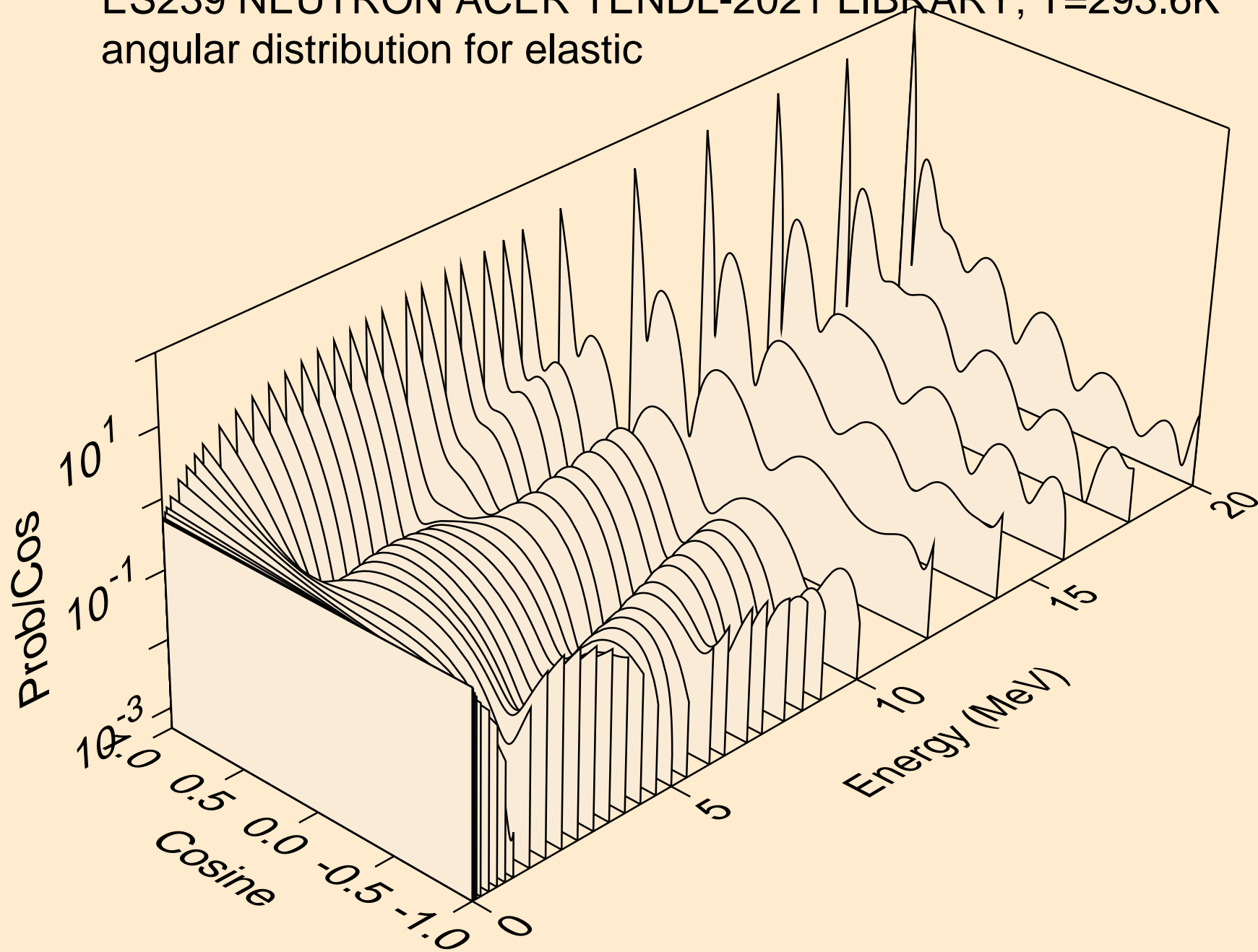

ES239 NEUTRON ACER TENDL-2021 LIBRARY; T=293.6K  
angular distribution for elastic

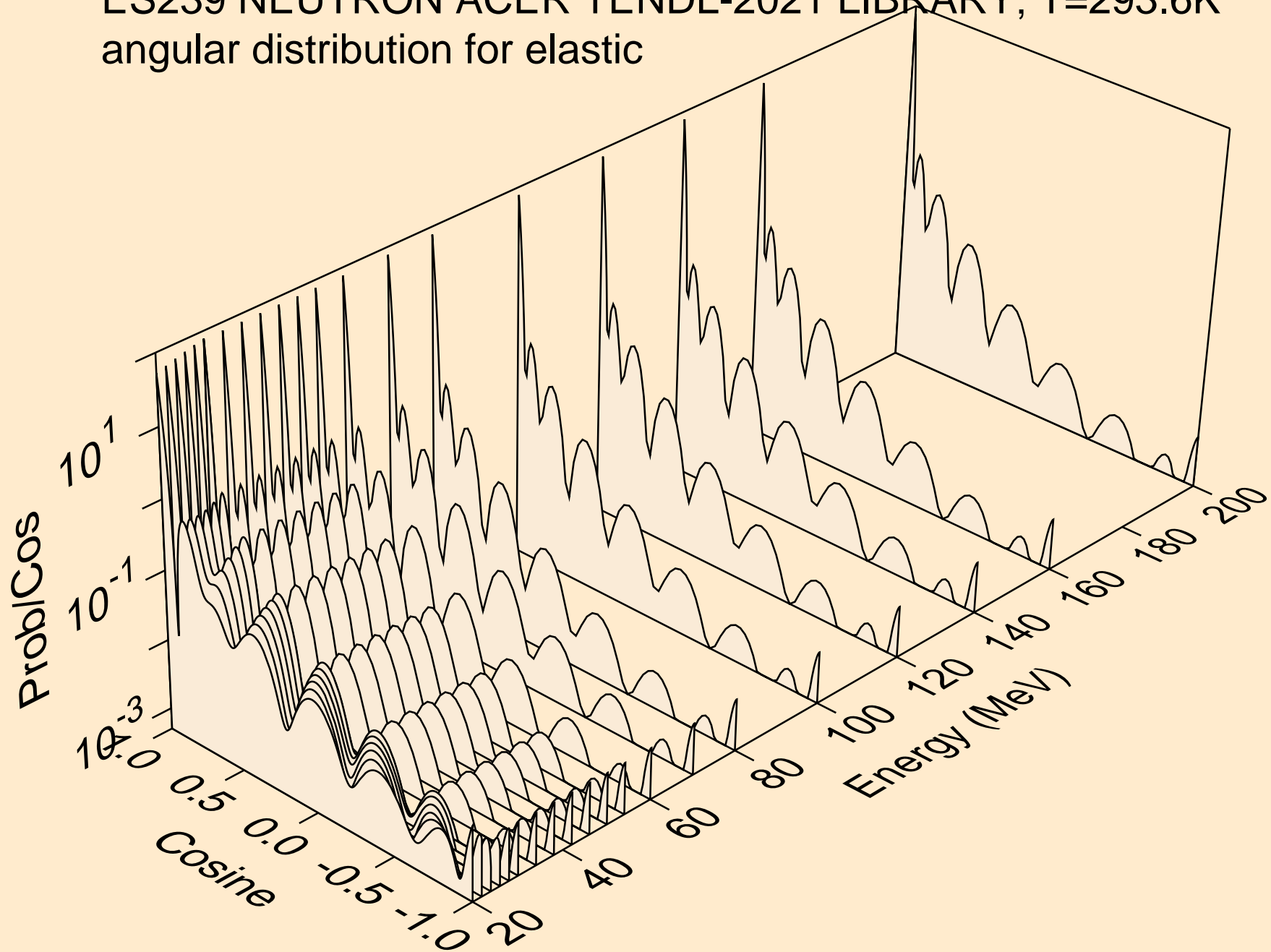

ES239 NEUTRON ACER TENDL-2021 LIBRARY; T=293.6K  
angular distribution for (n,n\*1)

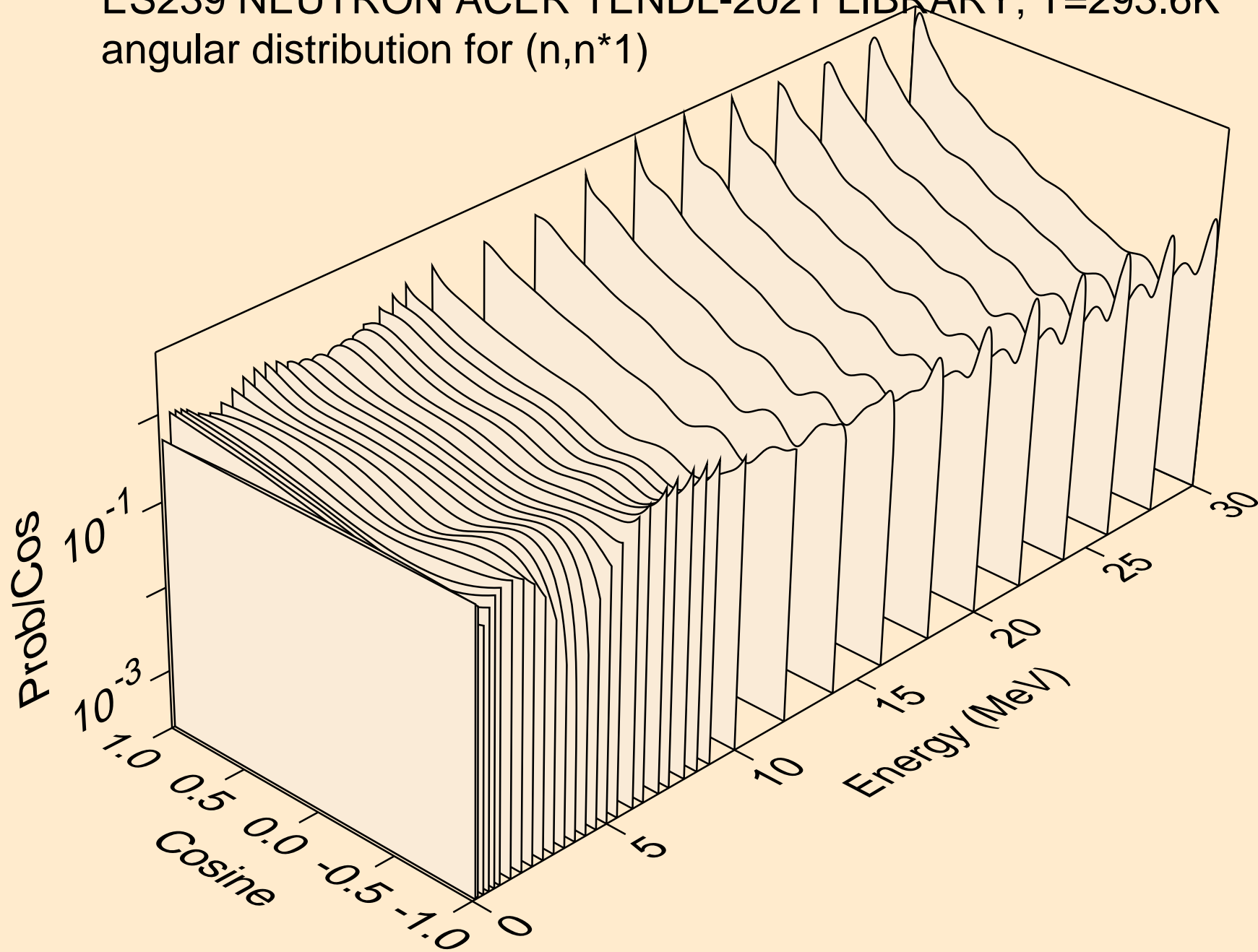

ES239 NEUTRON ACER TENDL-2021 LIBRARY; T=293.6K  
Total fission nubar

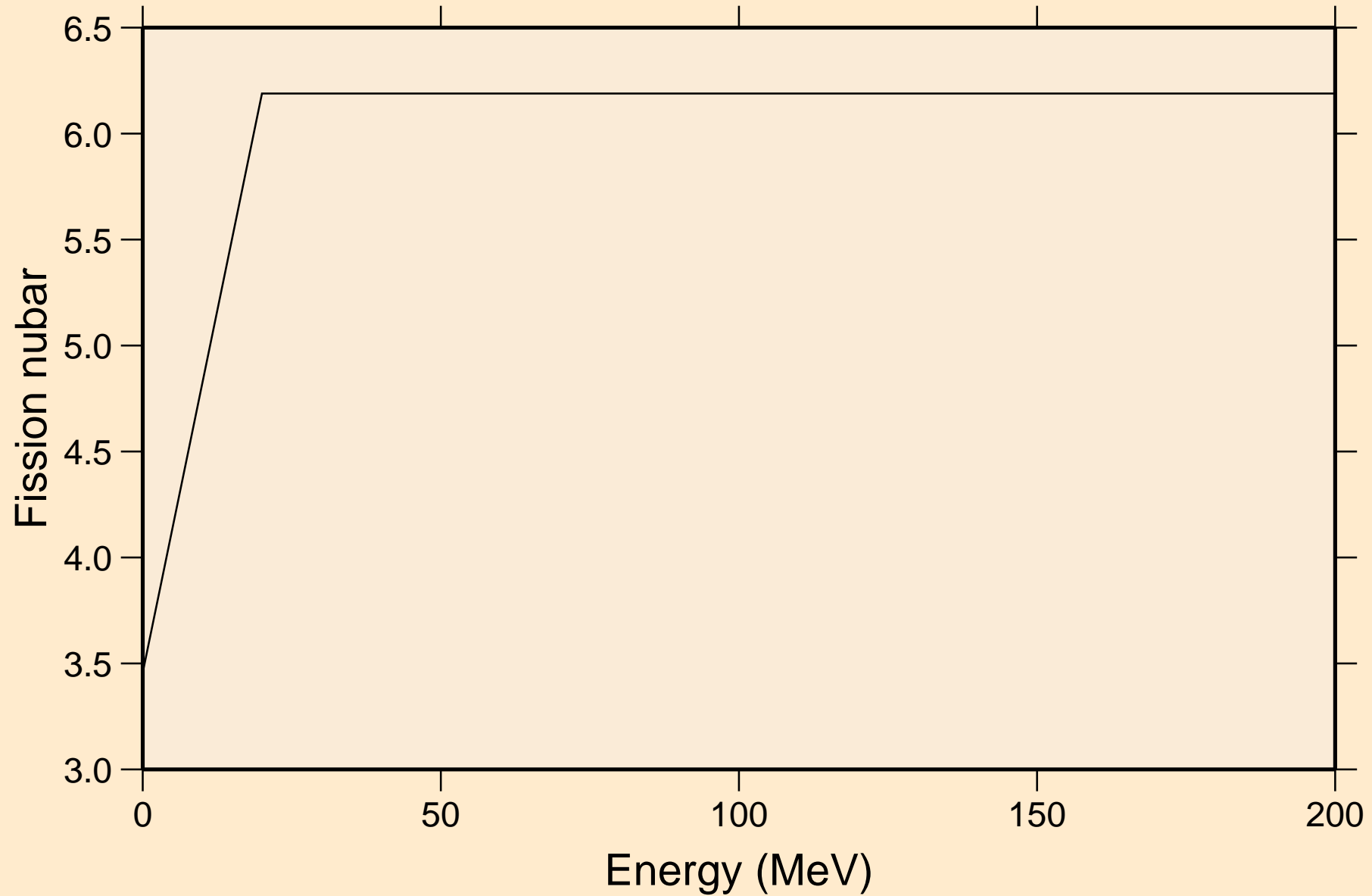

ES239 NEUTRON ACER TENDL-2021 LIBRARY; T=293.6K  
Neutron emission for (n,x)

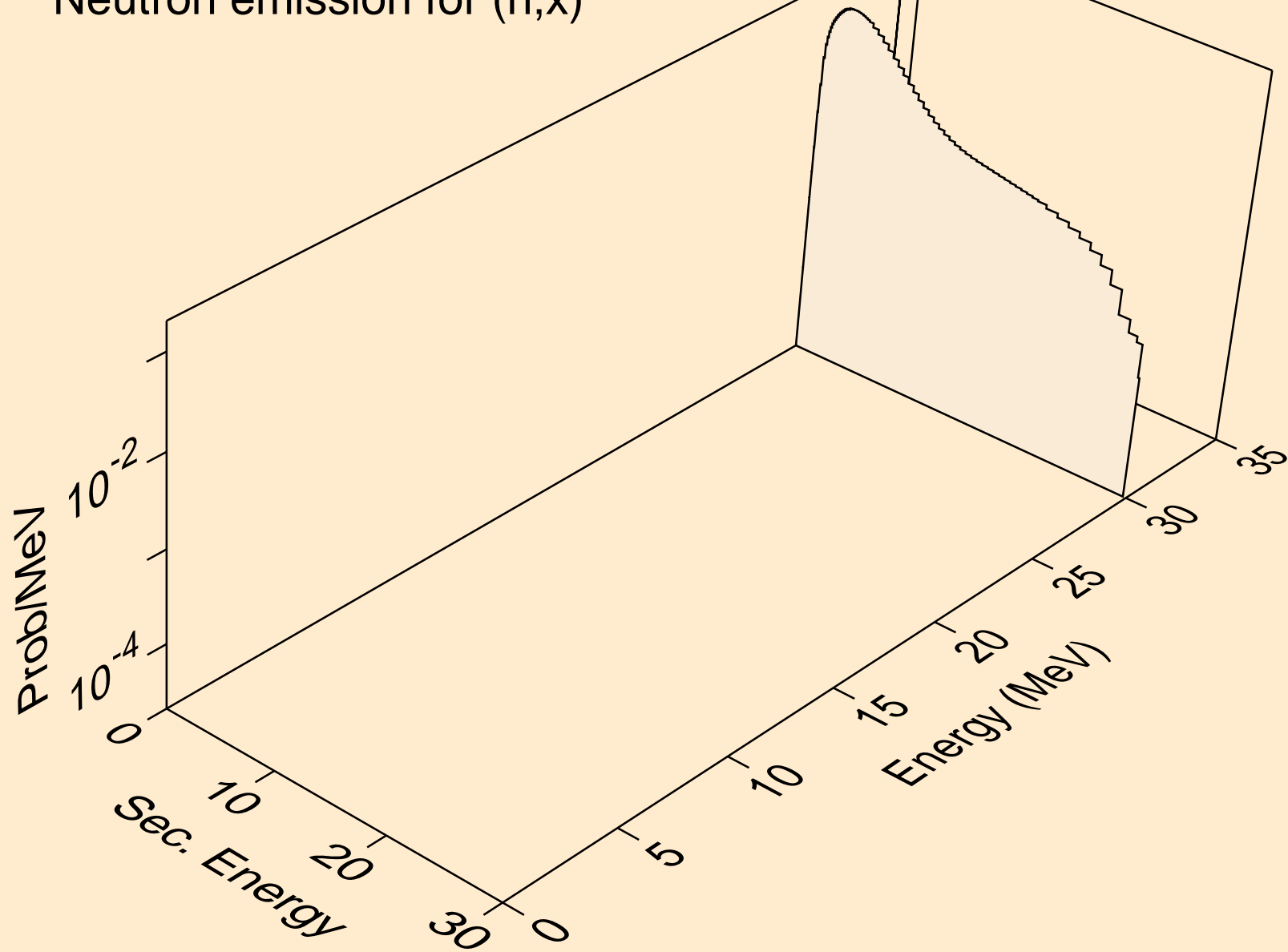

ES239 NEUTRON ACER TENDL-2021 LIBRARY; T=293.6K  
Neutron emission for (n,2nd)

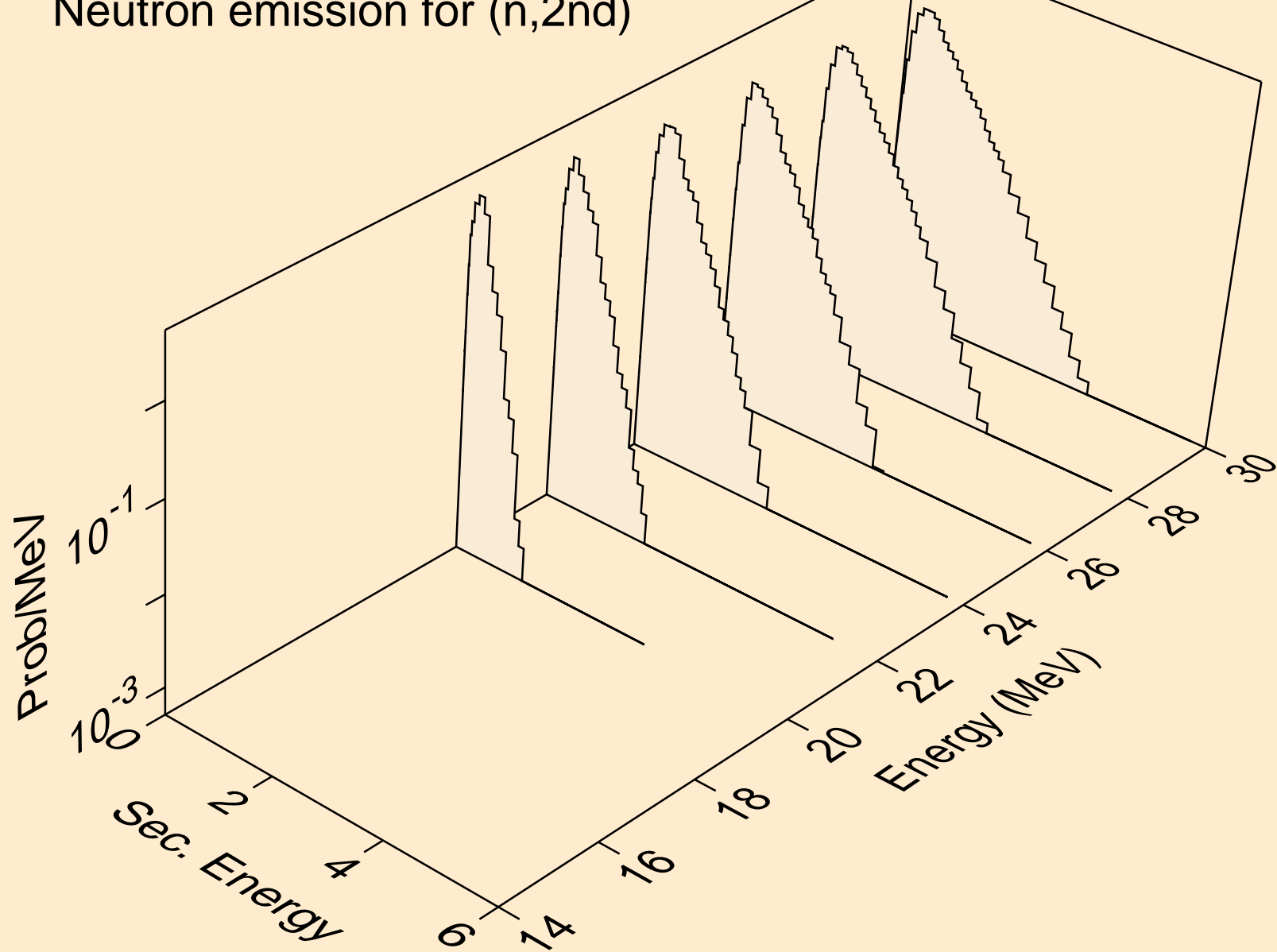

ES239 NEUTRON ACER TENDL-2021 LIBRARY; T=293.6K  
Neutron emission for (n,2n)

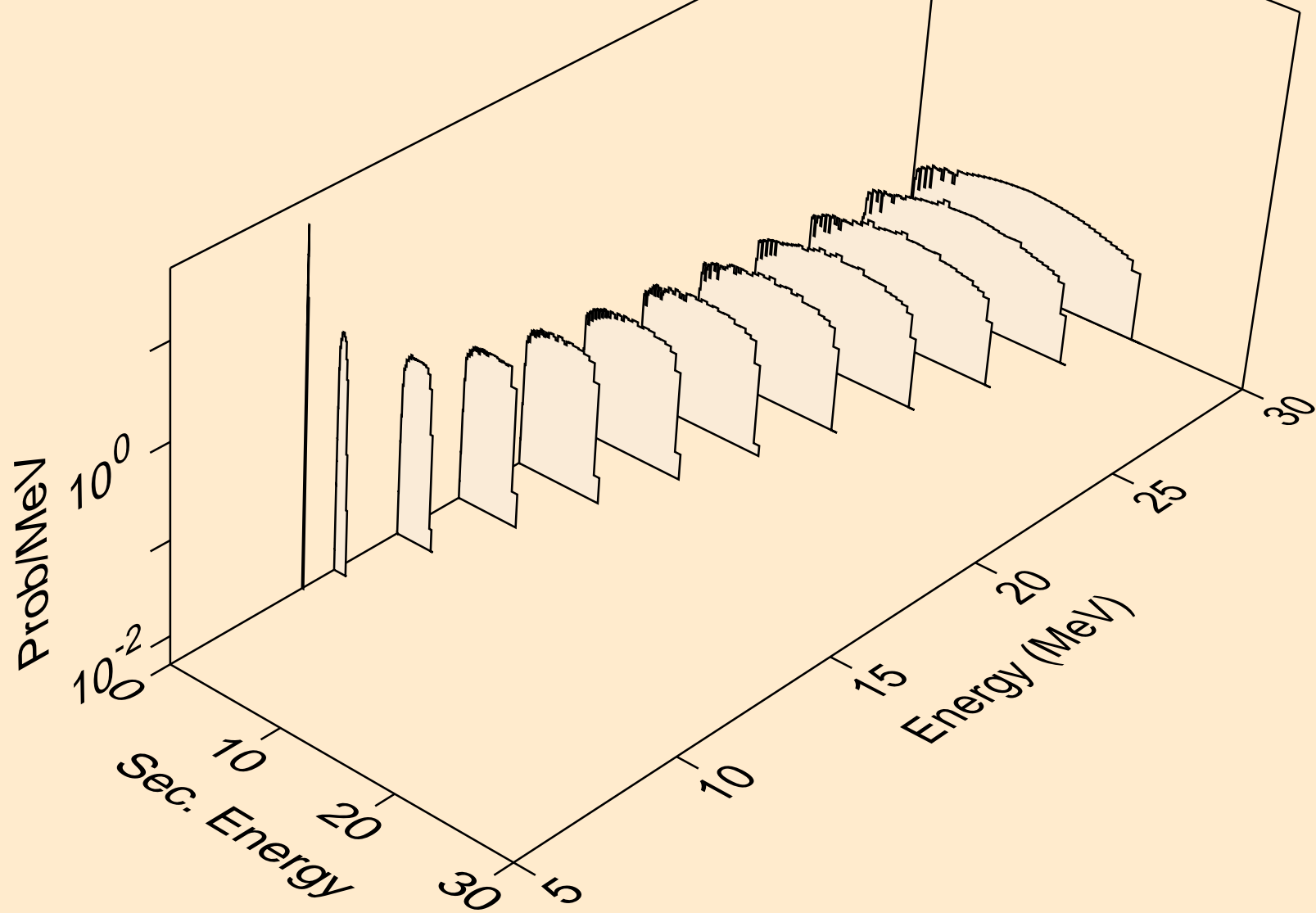



ES239 NEUTRON ACER TENDL-2021 LIBRARY; T=293.6K  
Neutron emission for (n,3n)

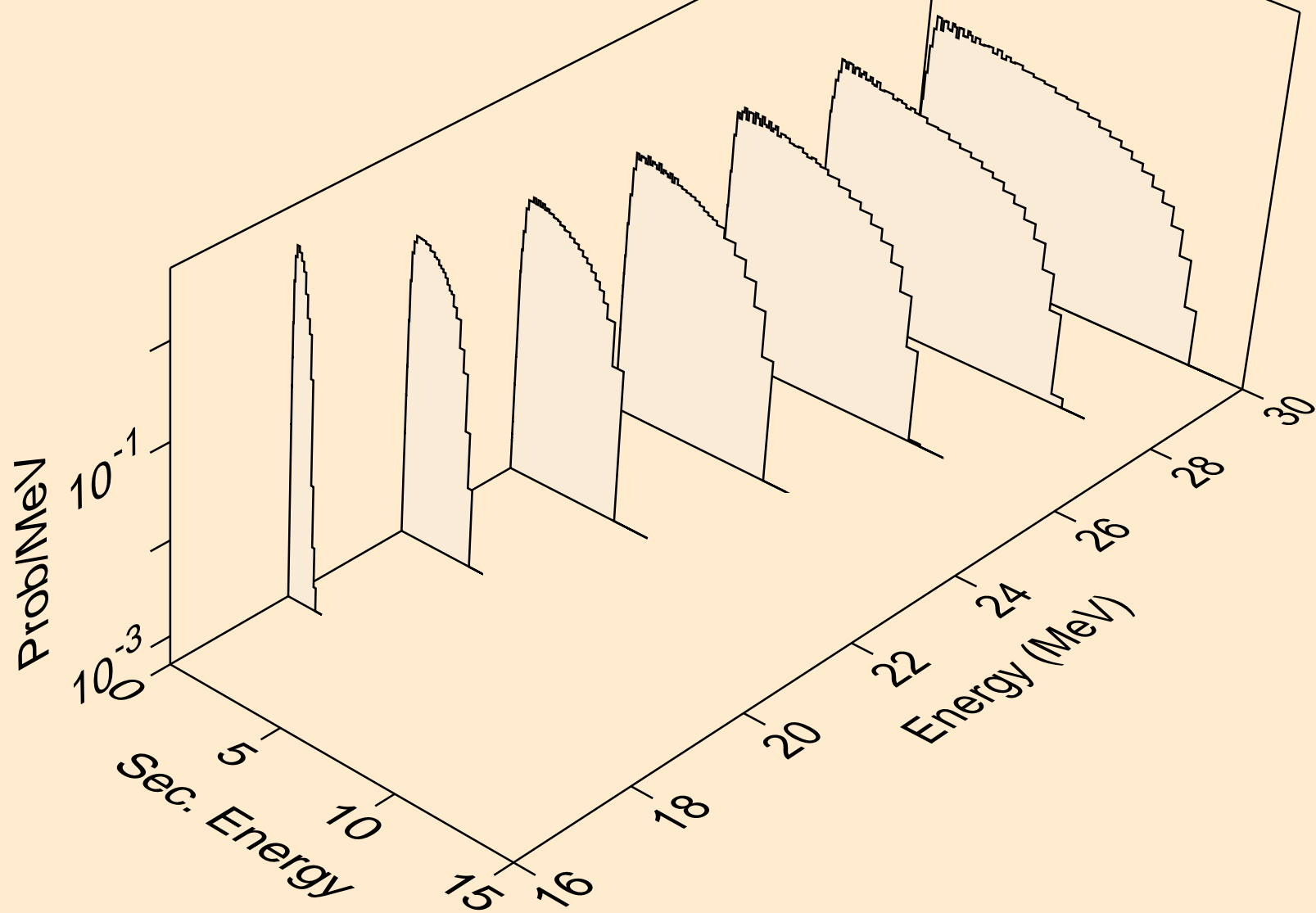

ES239 NEUTRON ACER TENDL-2021 LIBRARY; T=293.6K  
Neutron emission for fission

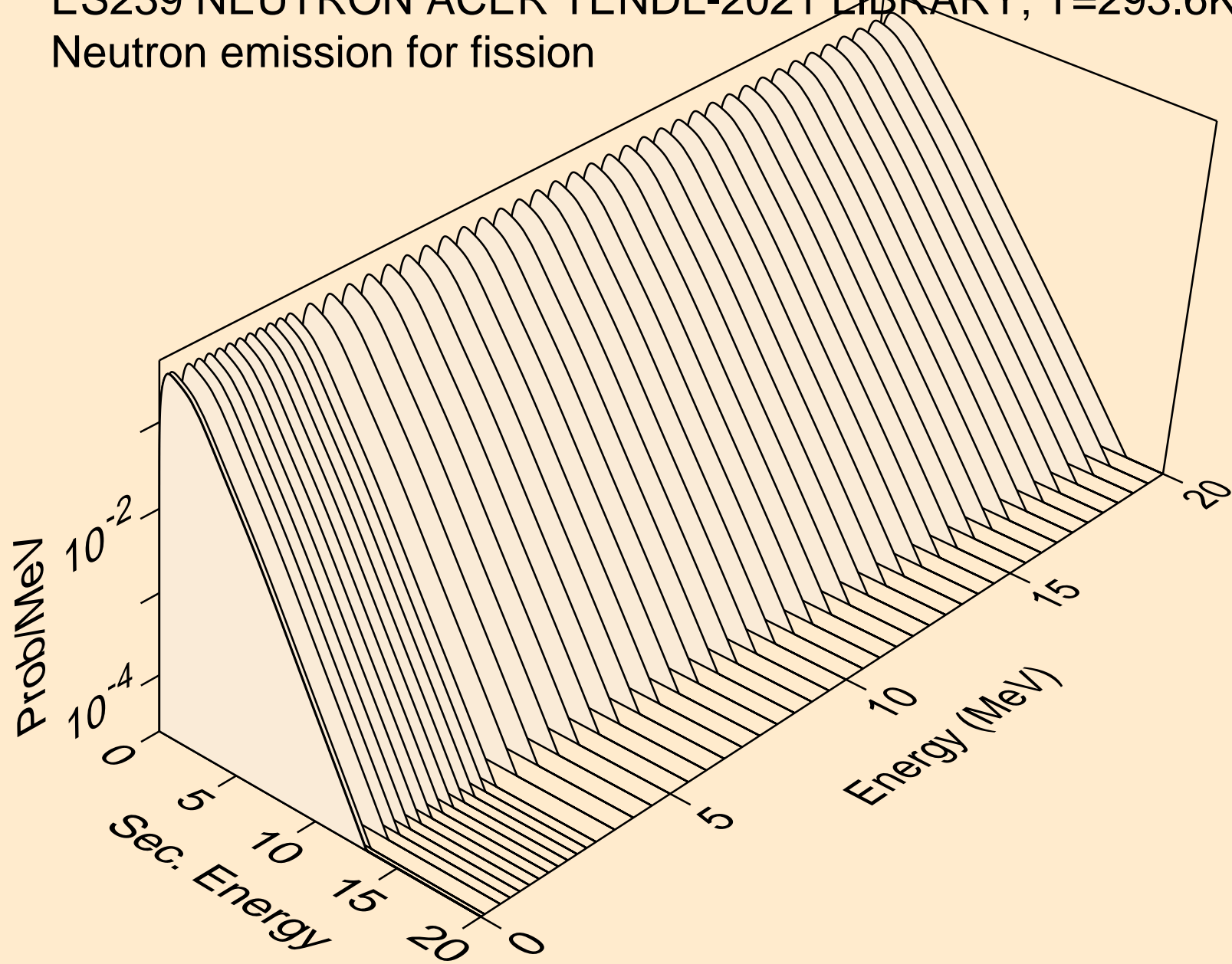

ES239 NEUTRON ACER TENDL-2021 LIBRARY; T=293.6K  
Neutron emission for (n,n\*)a

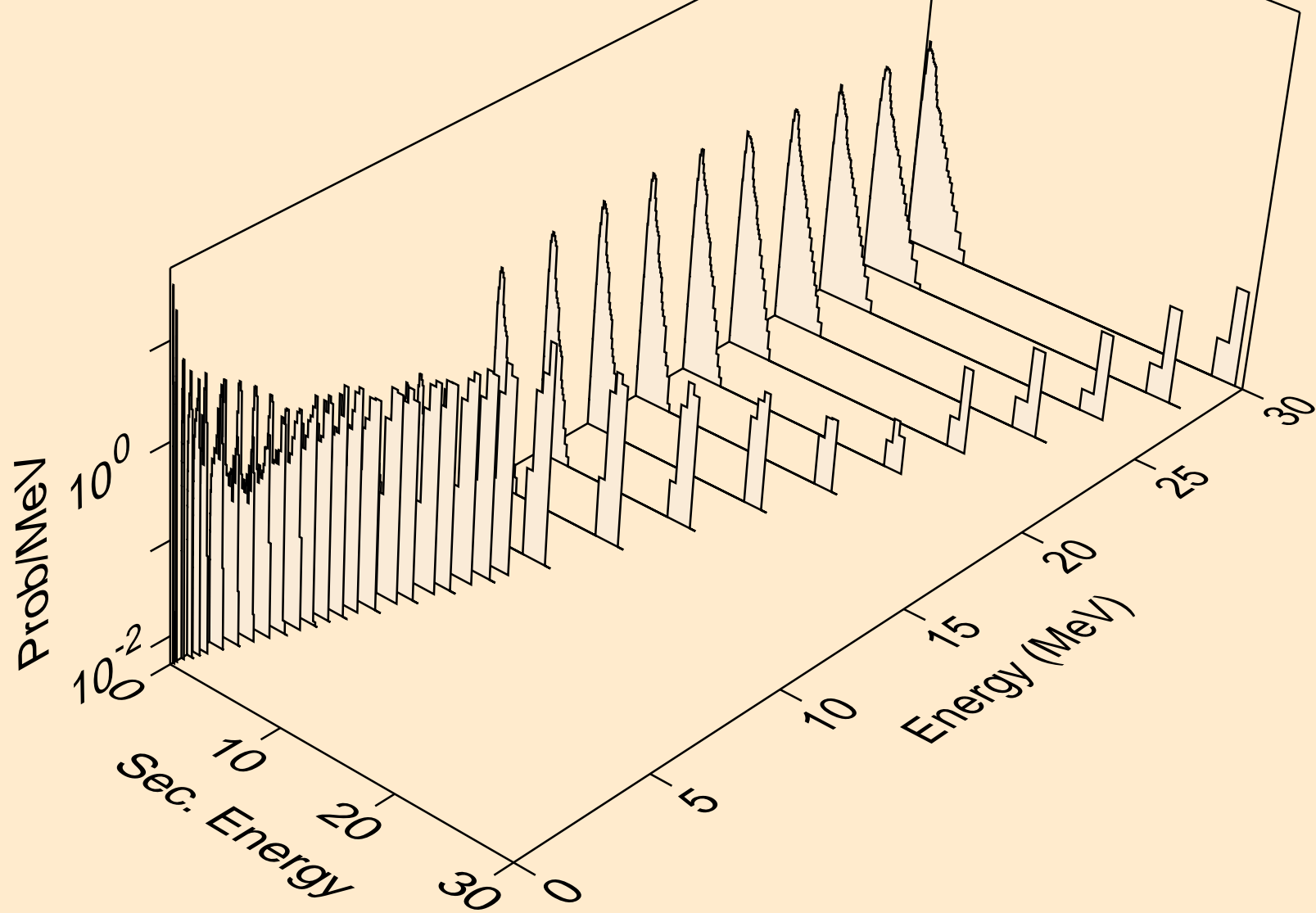

ES239 NEUTRON ACER TENDL-2021 LIBRARY; T=293.6K  
Neutron emission for (n,2n)a

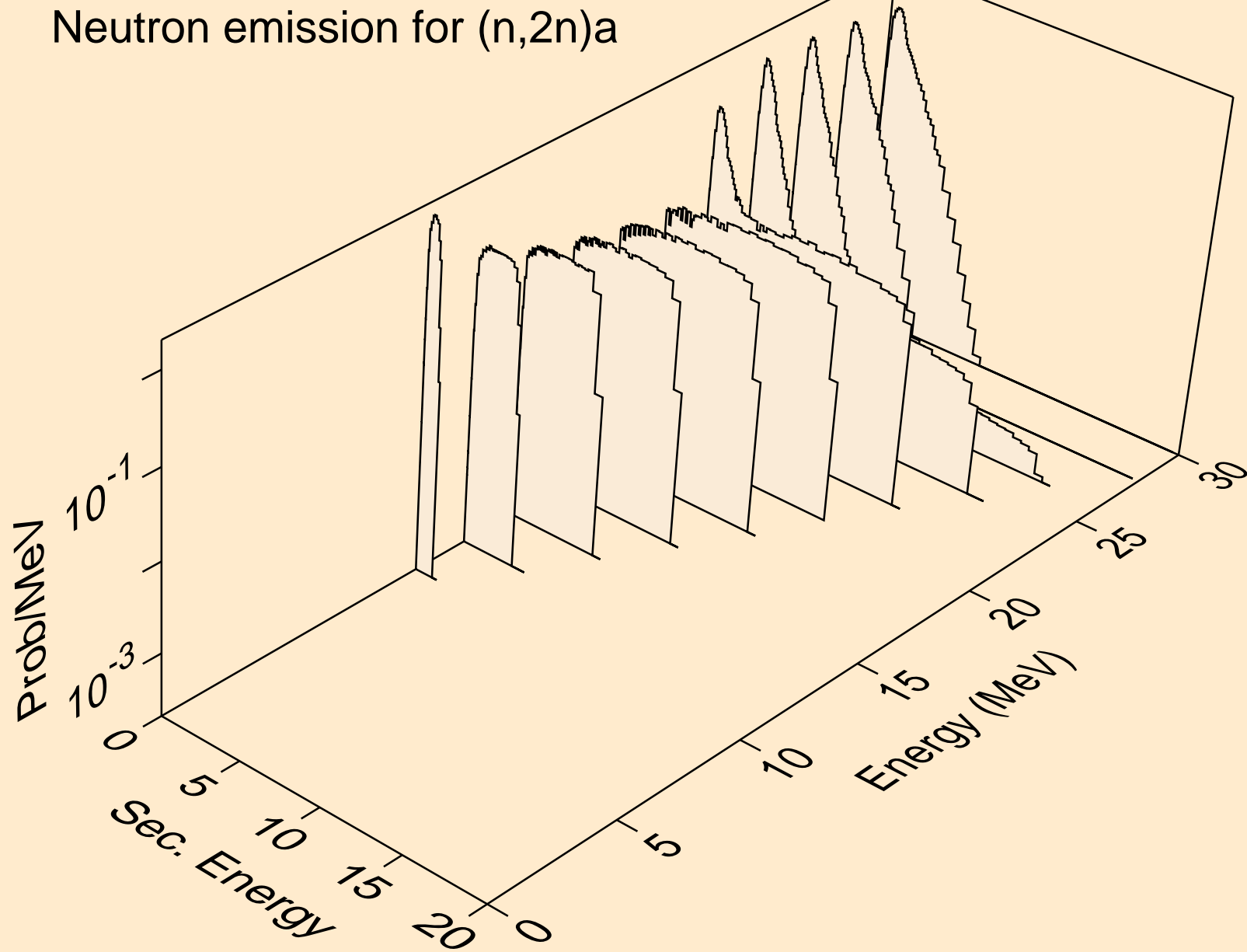

ES239 NEUTRON ACER TENDL-2021 LIBRARY; T=293.6K  
Neutron emission for (n,3n)a

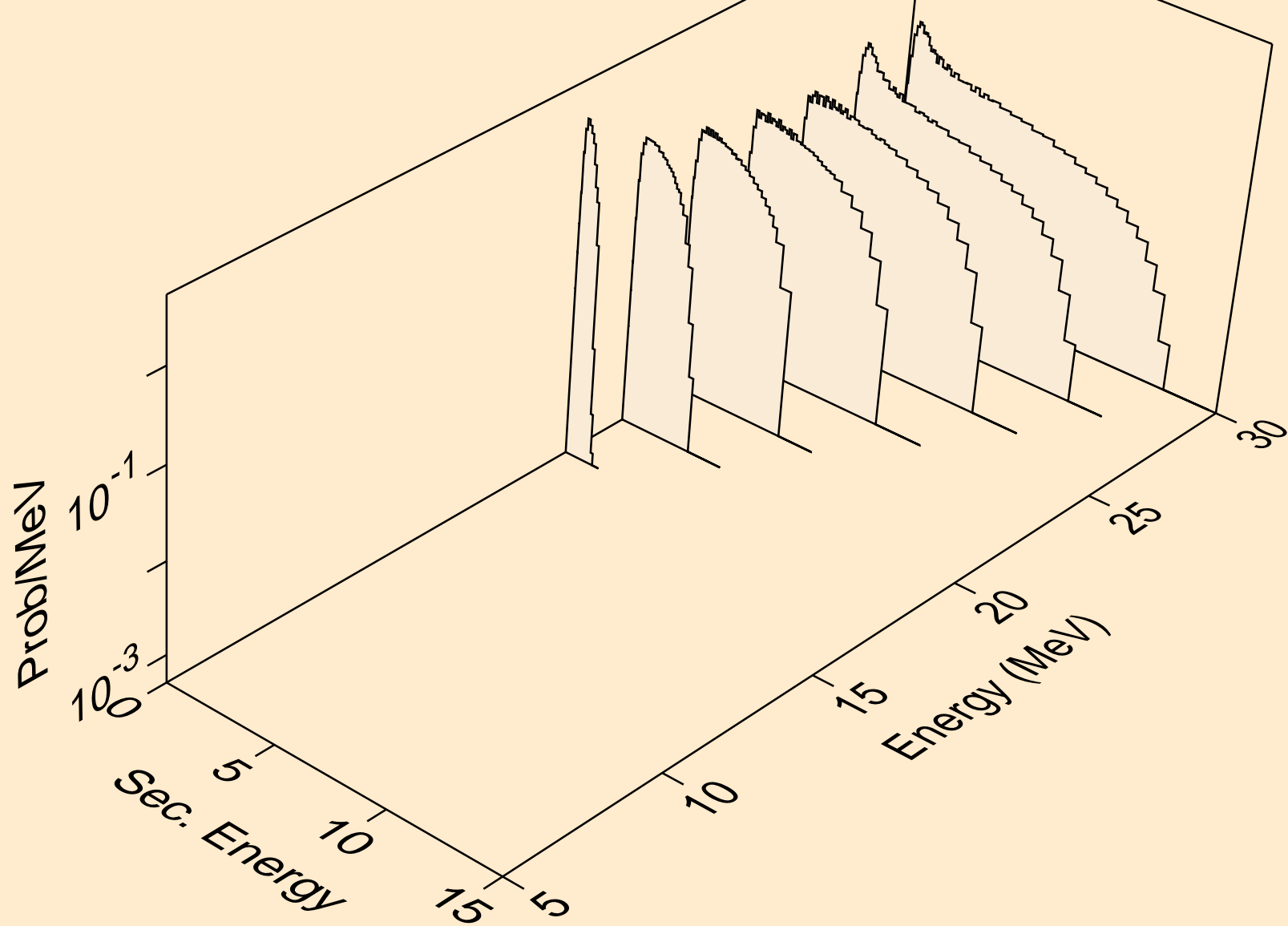

ES239 NEUTRON ACER TENDL-2021 LIBRARY; T=293.6K  
Neutron emission for (n,n\*)p

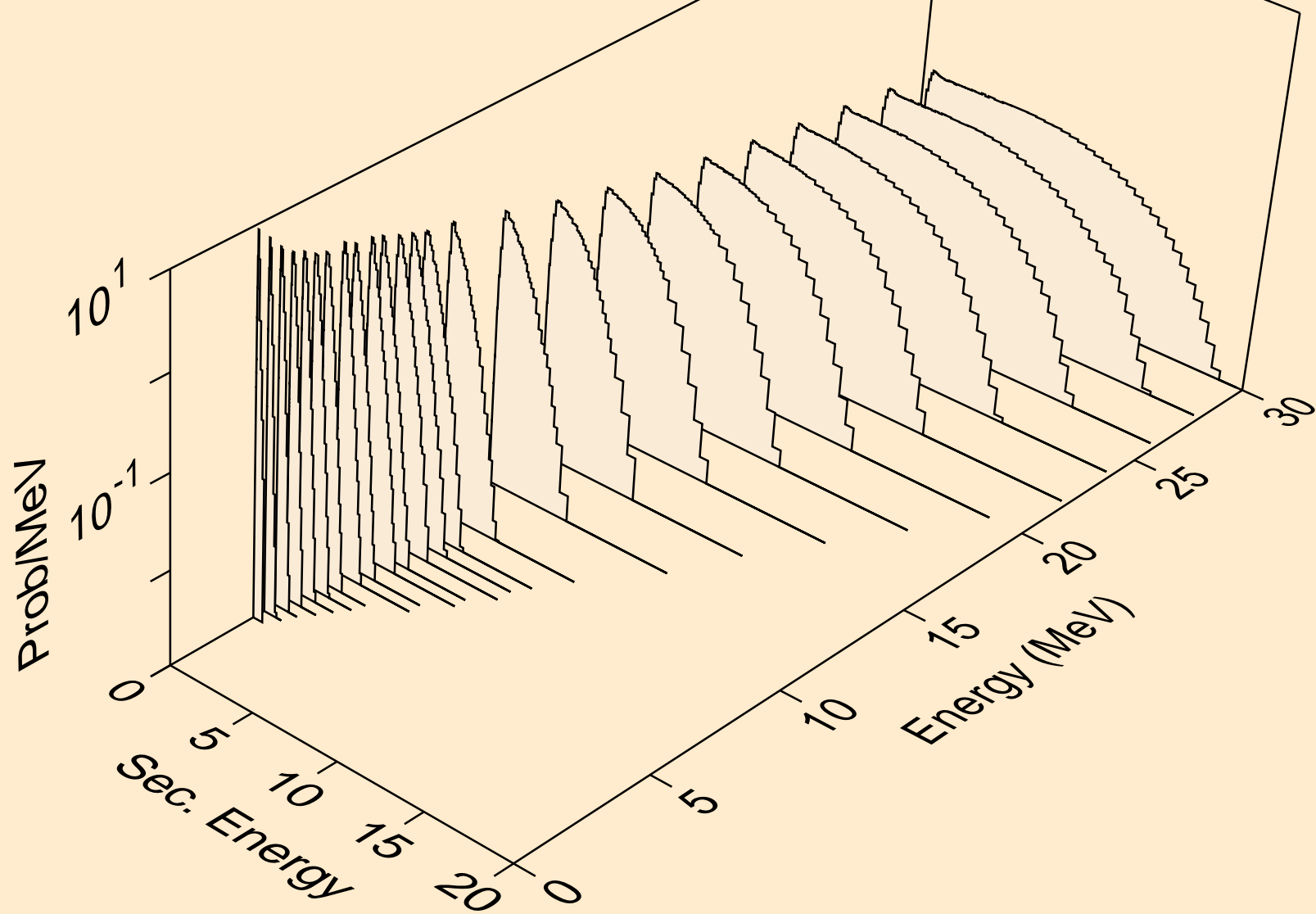

ES239 NEUTRON ACER TENDL-2021 LIBRARY; T=293.6K  
Neutron emission for (n,n\*)d

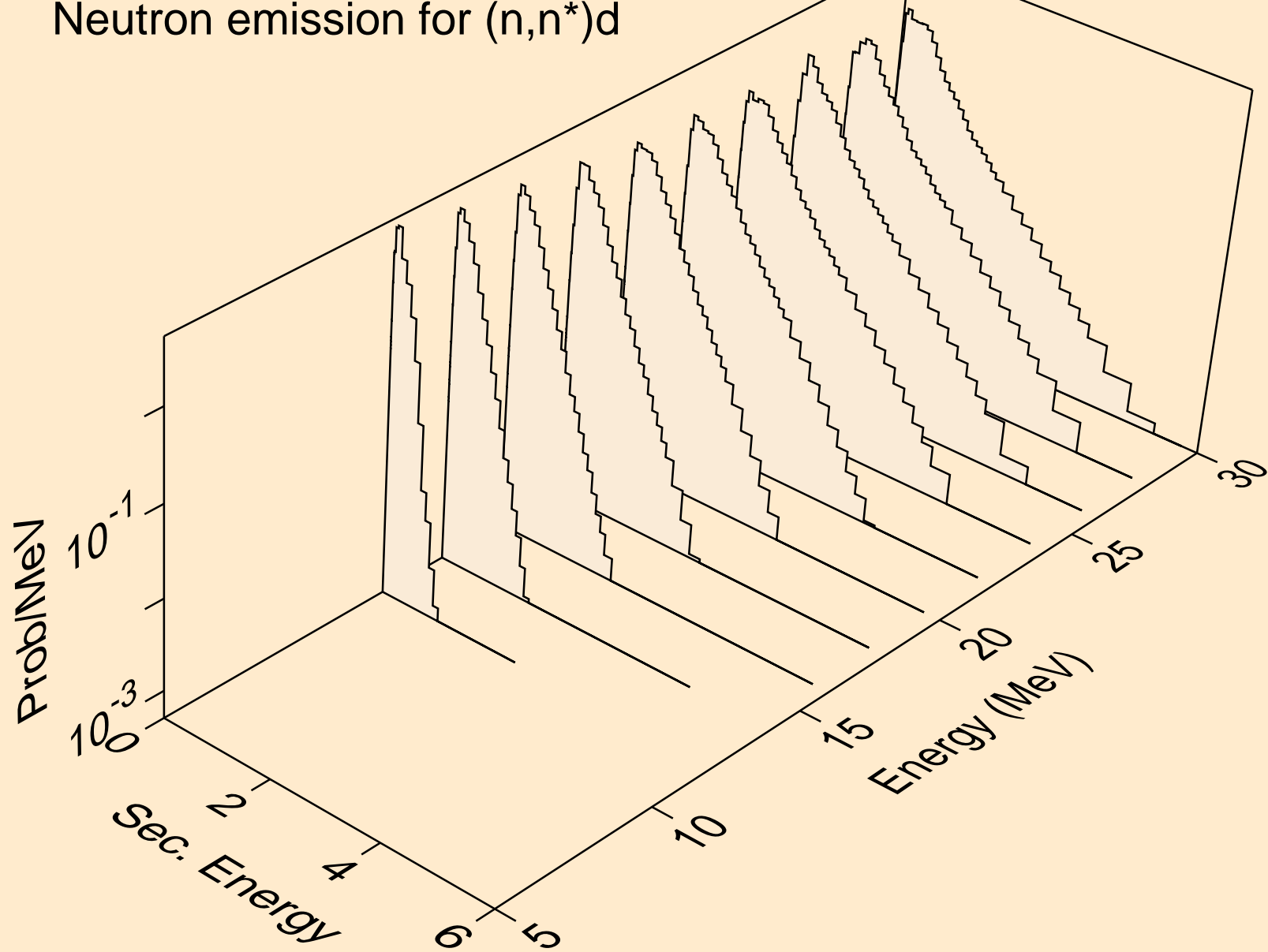

ES239 NEUTRON ACER TENDL-2021 LIBRARY; T=293.6K  
Neutron emission for (n,n\*)t

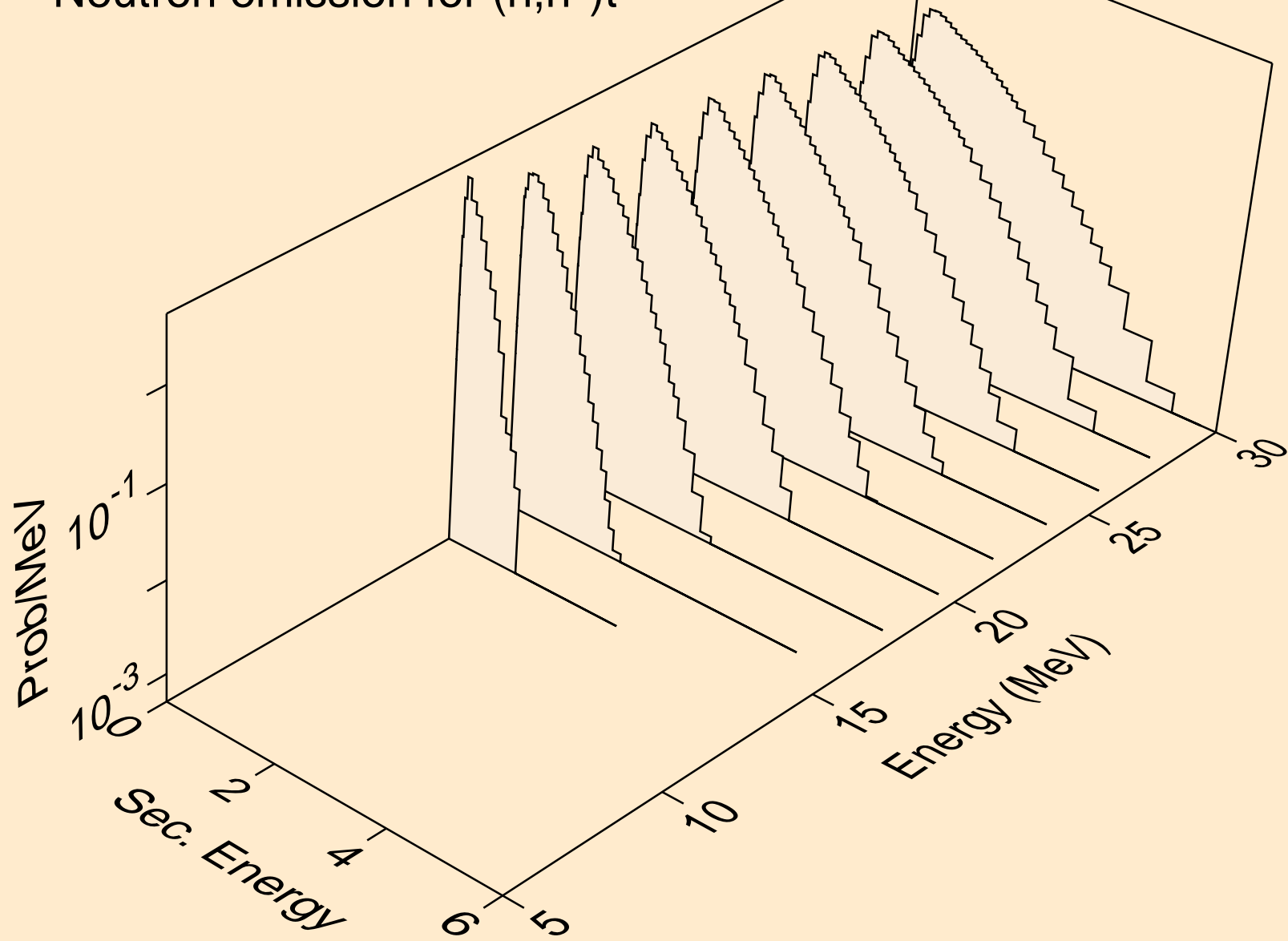



ES239 NEUTRON ACER TENDL-2021 LIBRARY; T=293.6K  
Neutron emission for (n,n\*)he3

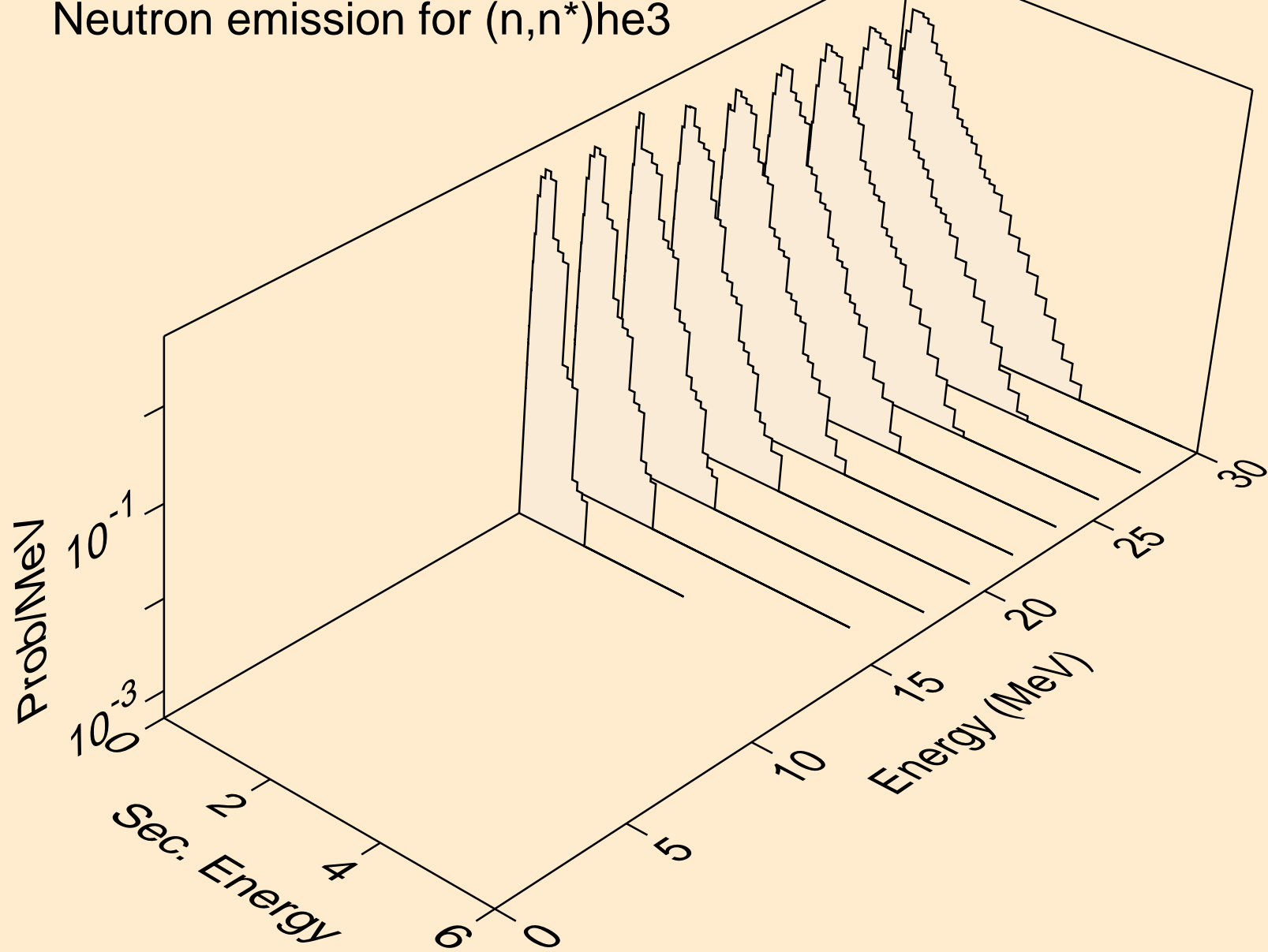

ES239 NEUTRON ACER TENDL-2021 LIBRARY; T=293.6K  
Neutron emission for (n,2np)

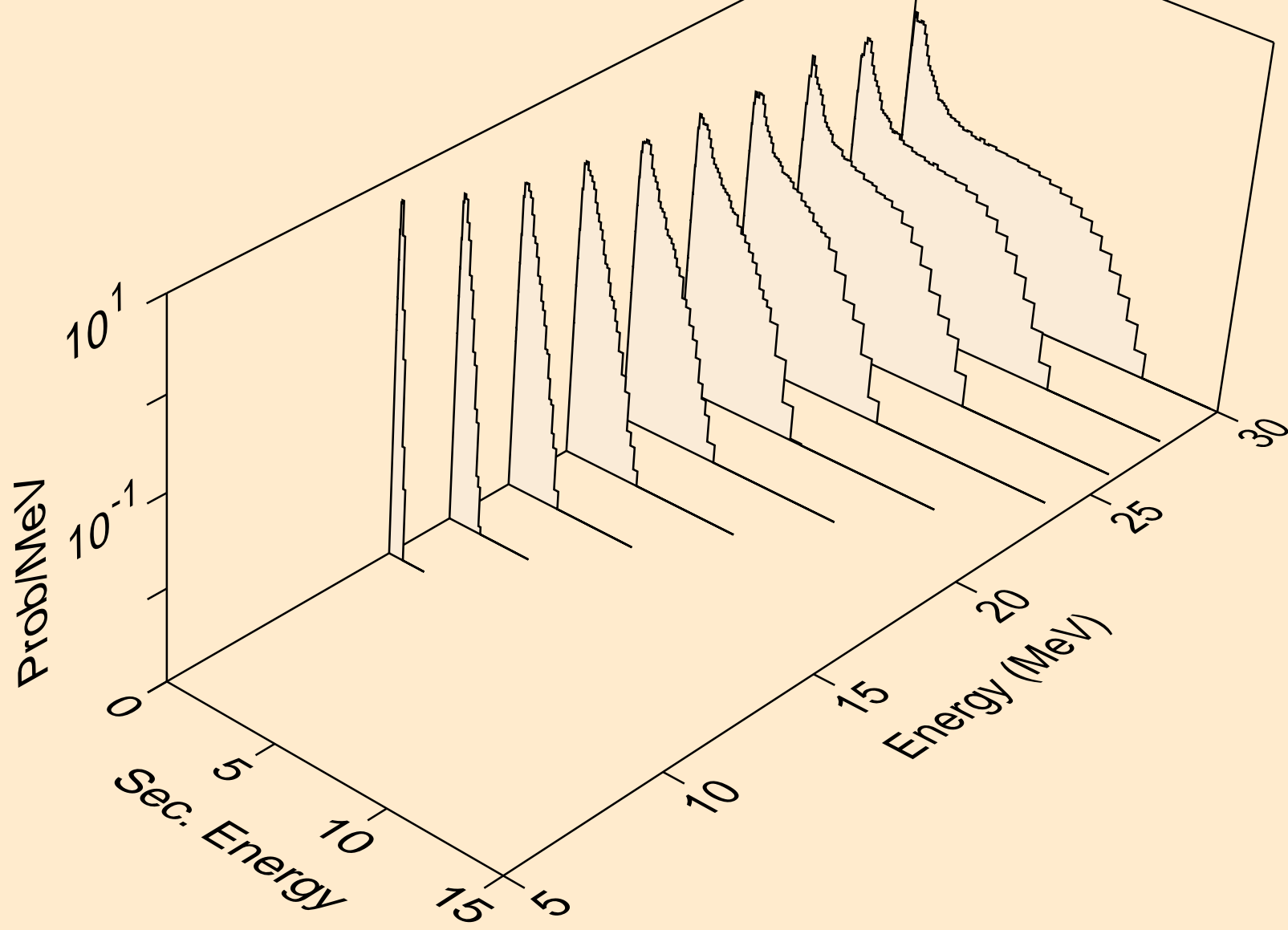

ES239 NEUTRON ACER TENDL-2021 LIBRARY; T=293.6K  
Neutron emission for (n,3np)

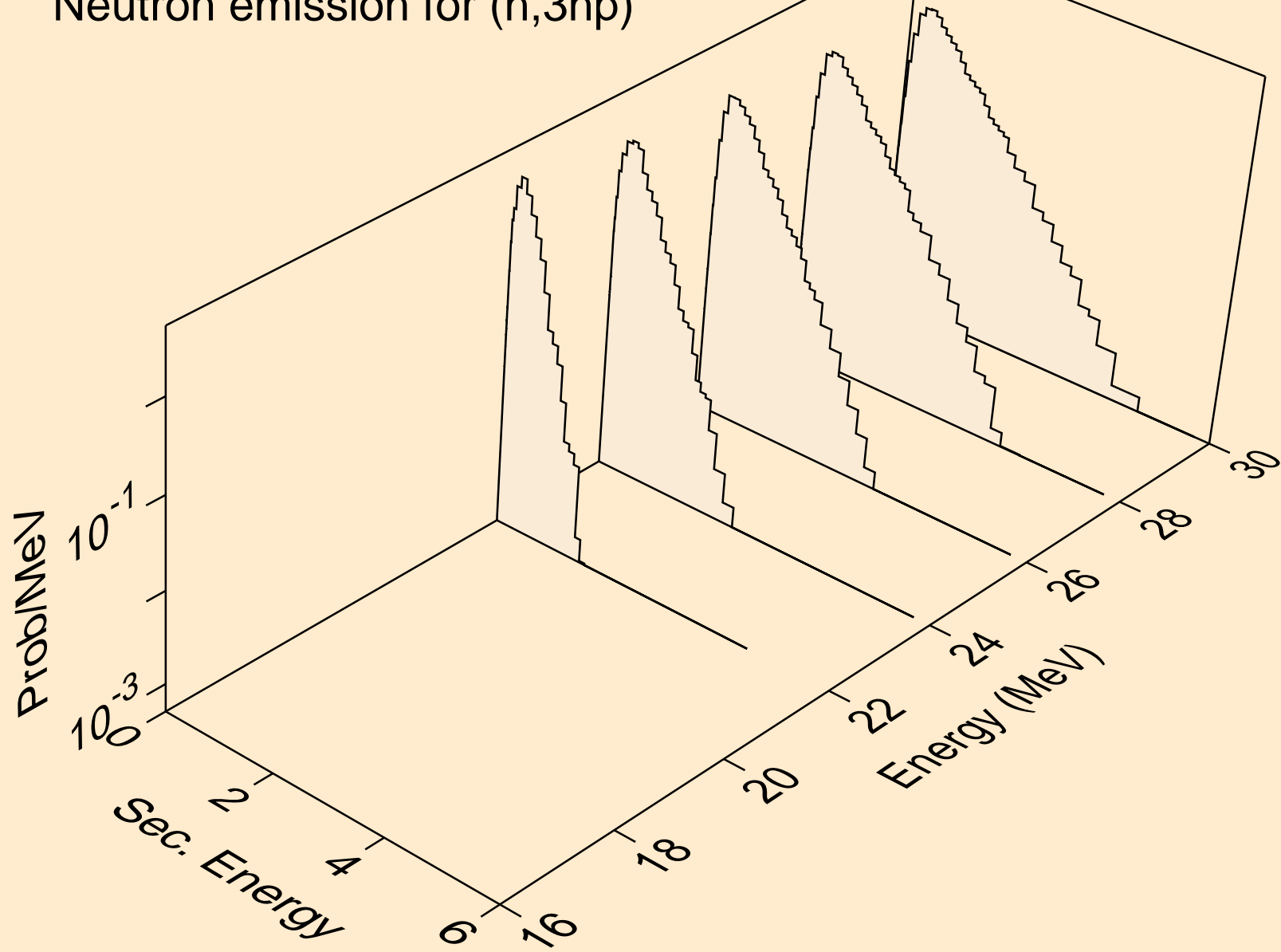

ES239 NEUTRON ACER TENDL-2021 LIBRARY; T=293.6K  
Neutron emission for (n,2np)

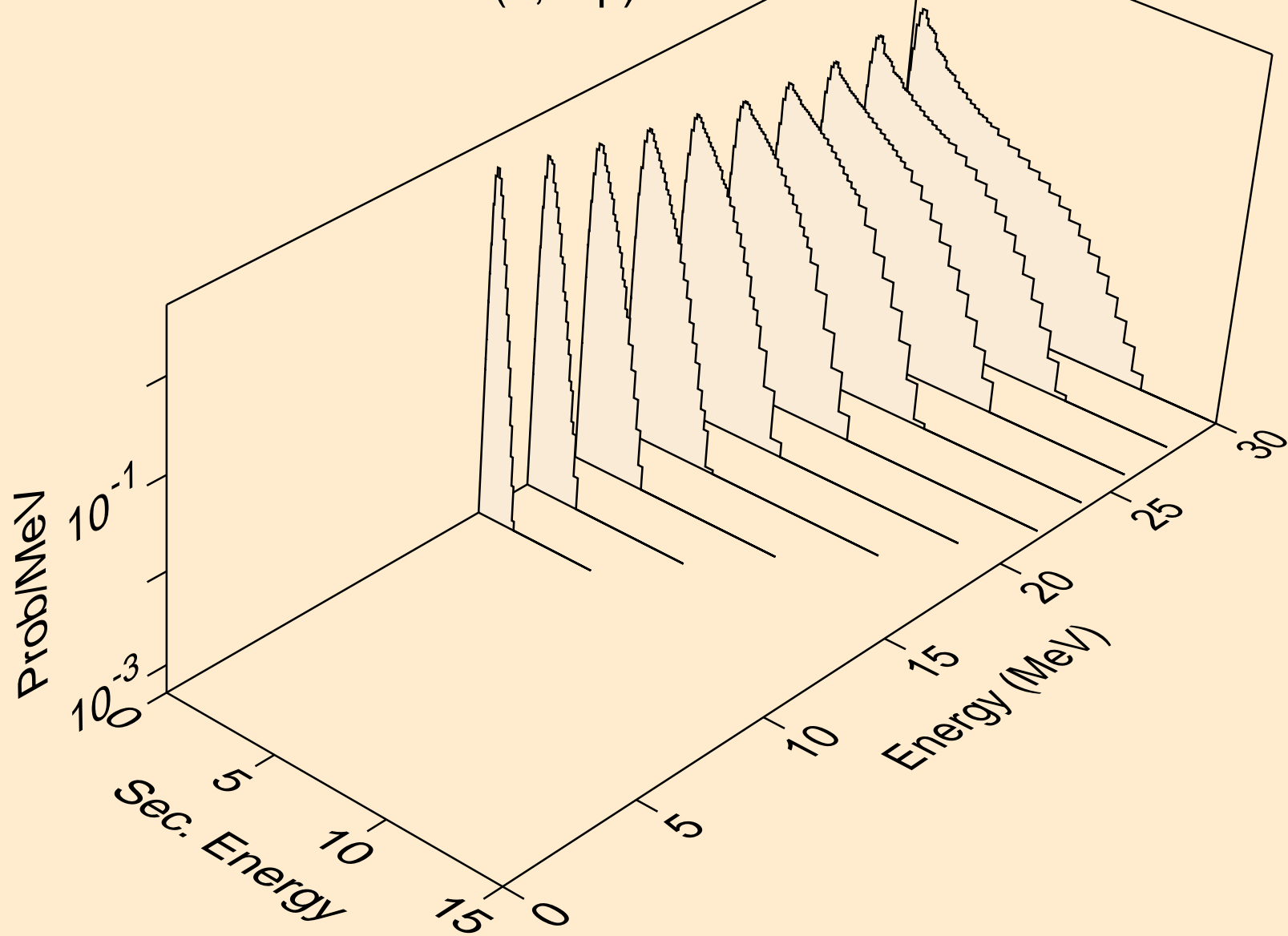

ES239 NEUTRON ACER TENDL-2021 LIBRARY; T=293.6K  
Neutron emission for (n,npa)

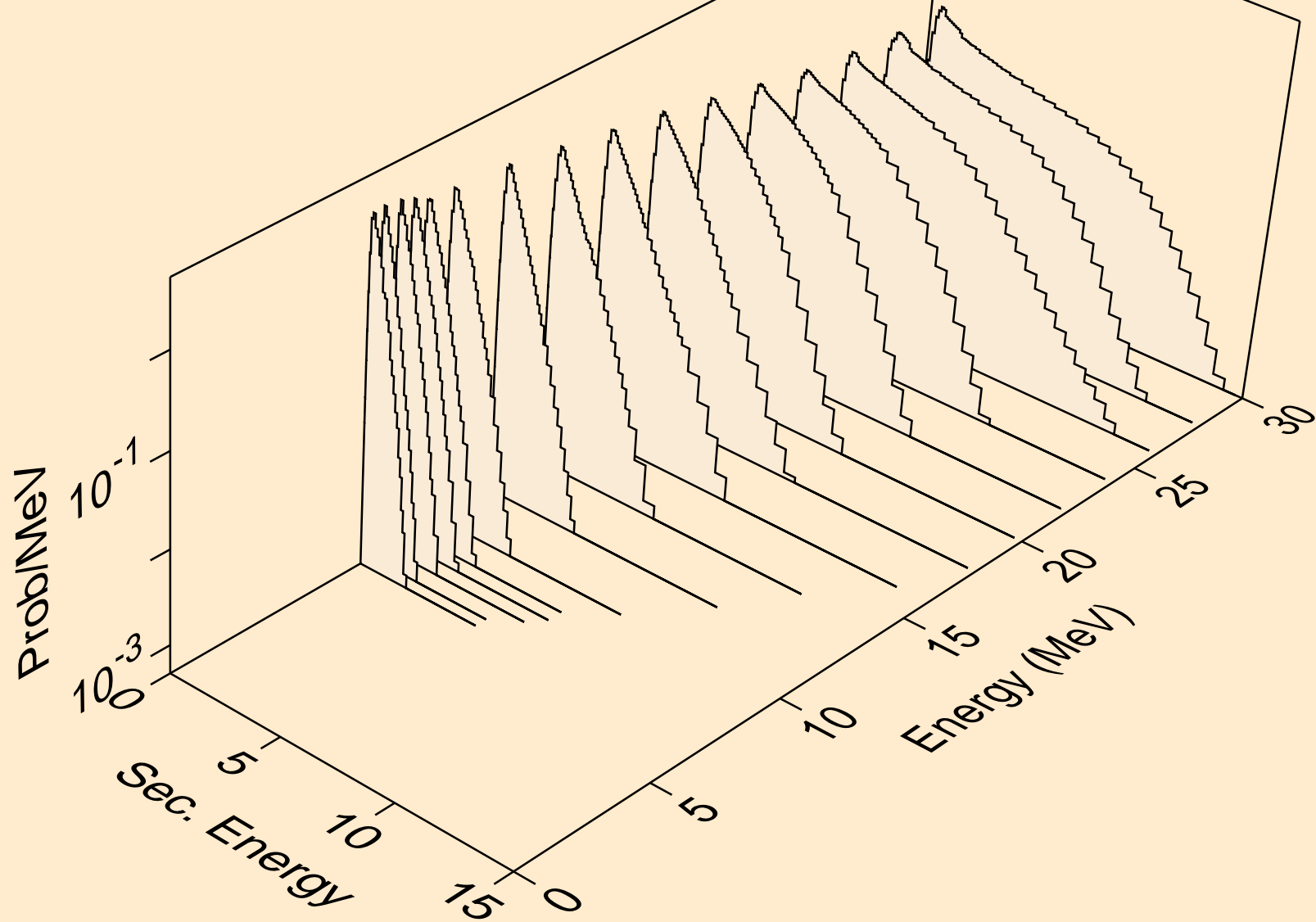

ES239 NEUTRON ACER TENDL-2021 LIBRARY; T=293.6K  
Neutron emission for (n,n\*c)

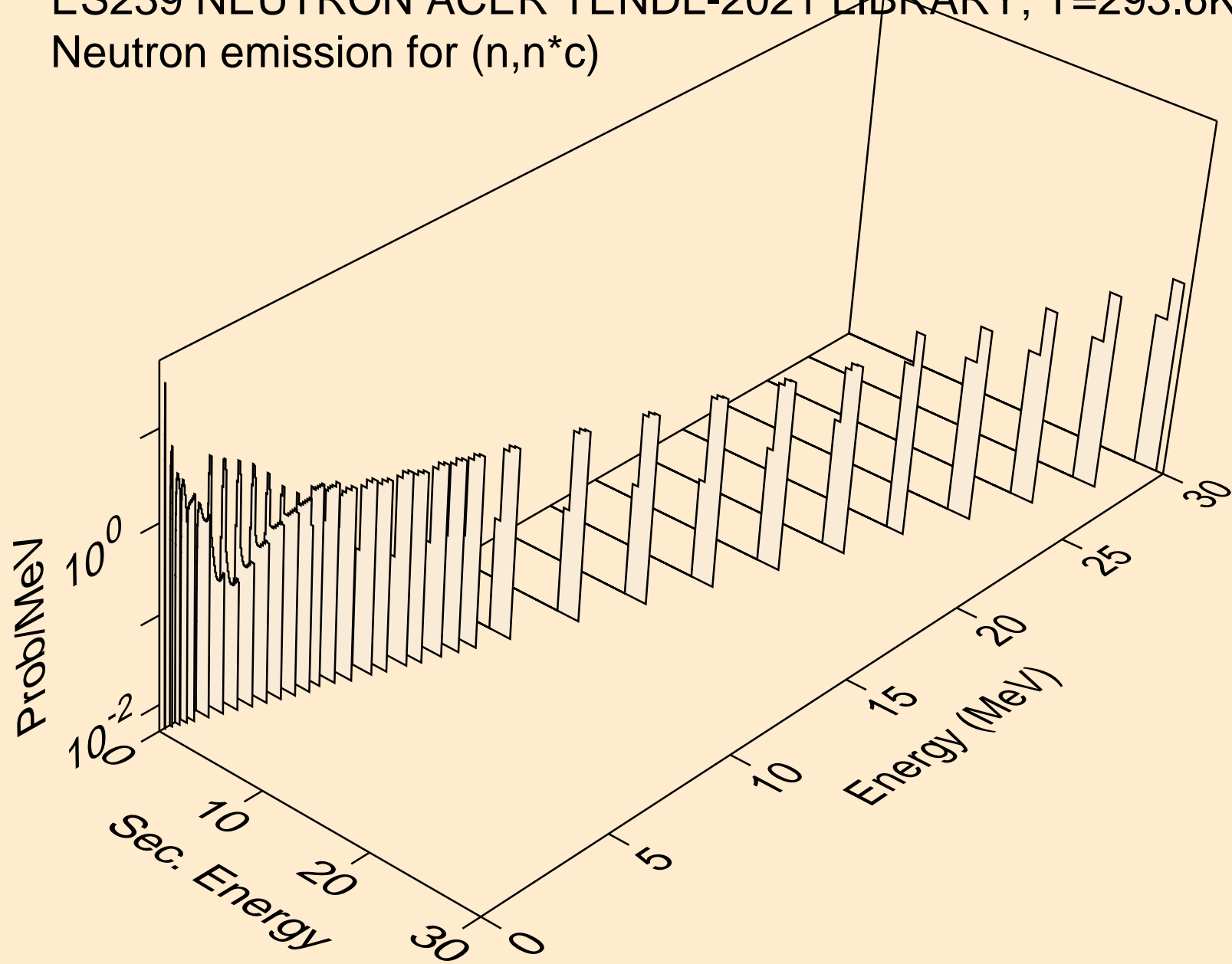

# ES239 NEUTRON ACER TENDL-2021 LIBRARY; T=293.6K

## Delayed nubar

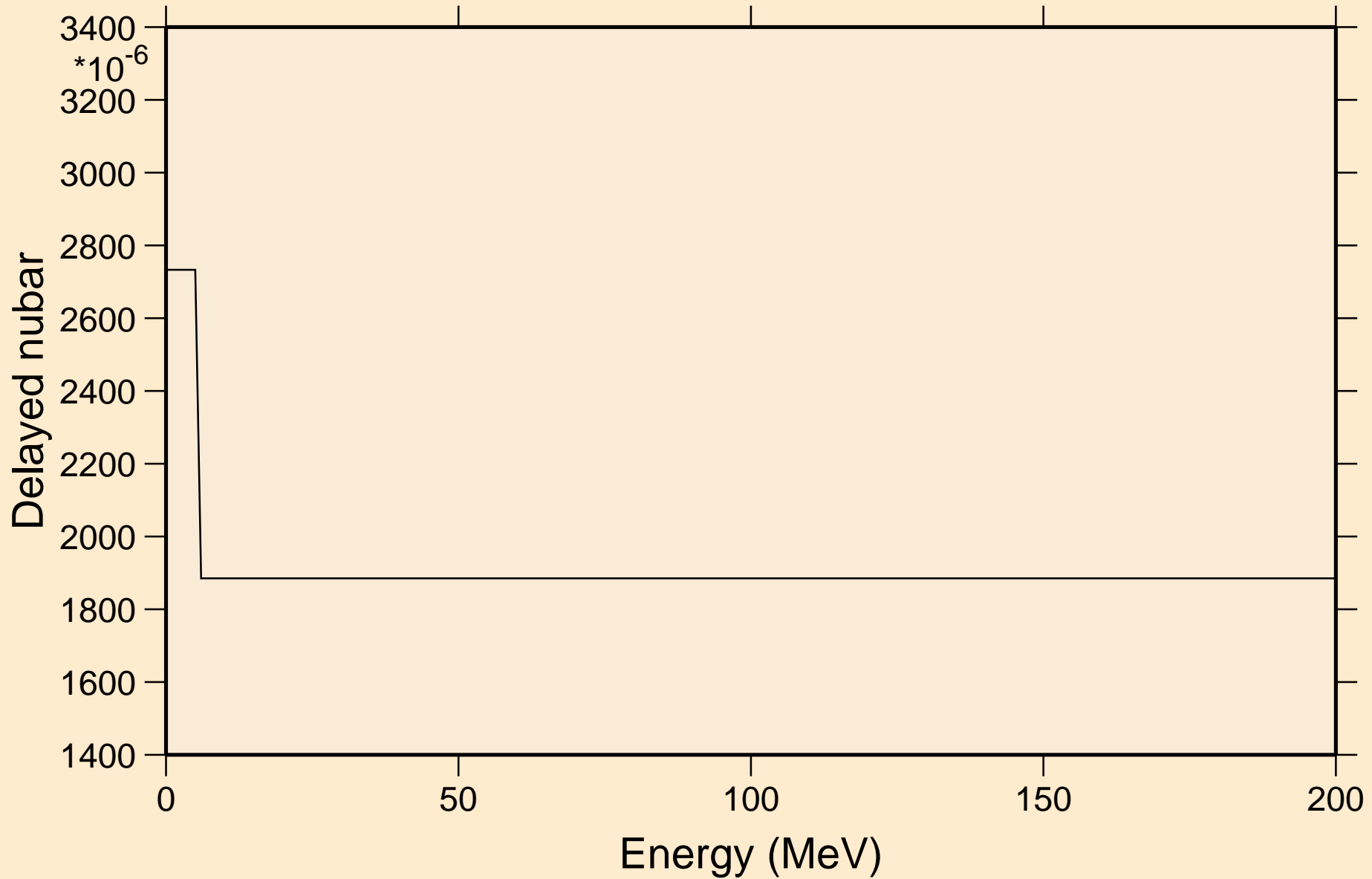

# ES239 NEUTRON ACER TENDL-2021 LIBRARY; T=293.6K

## Delayed neutron spectra

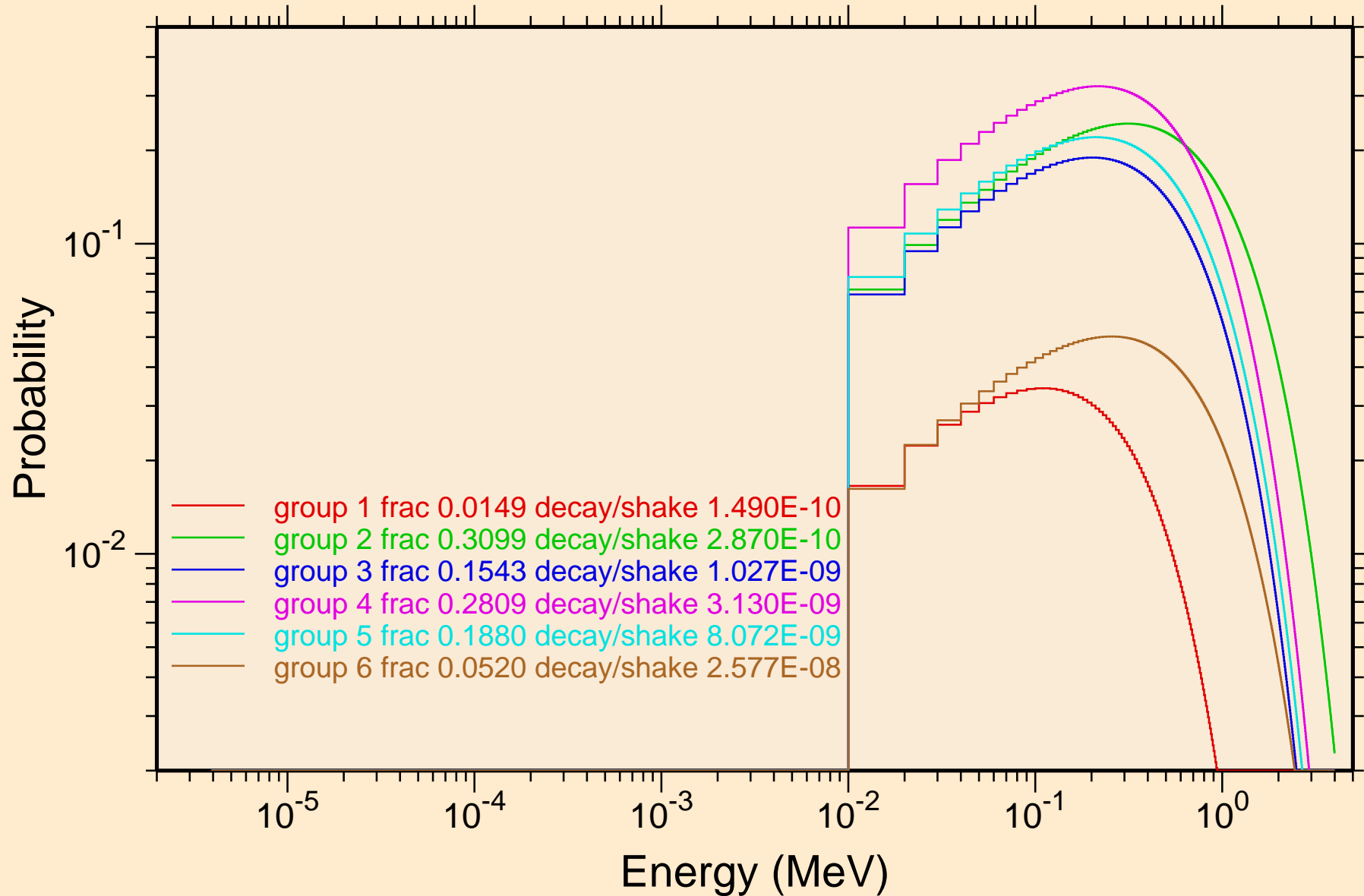



ES239 NEUTRON ACER TENDL-2021 LIBRARY; T=293.6K  
Photon emission for (n,x)

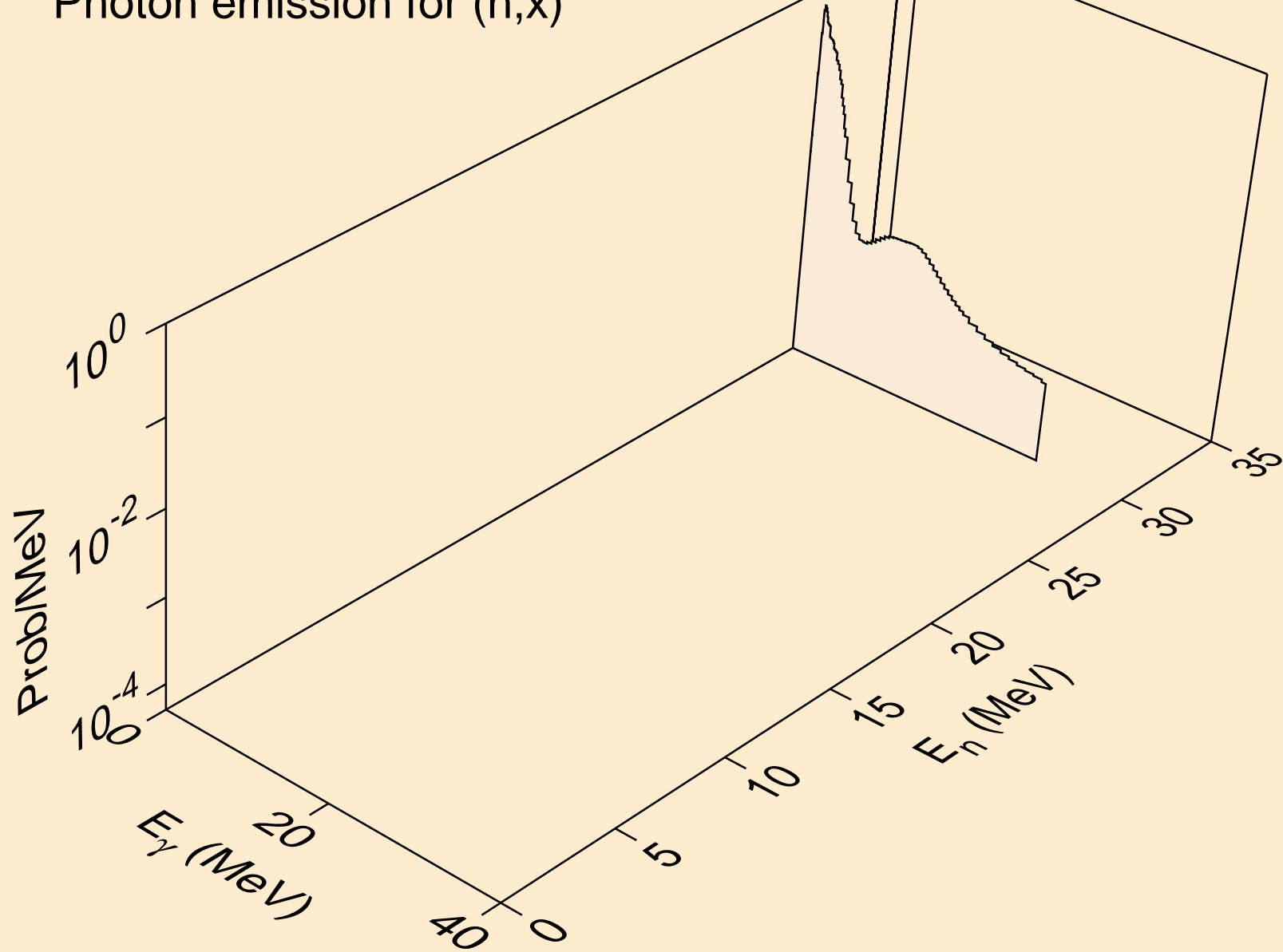

ES239 NEUTRON ACER TENDL-2021 LIBRARY; T=293.6K  
Photon emission for (n,2nd)

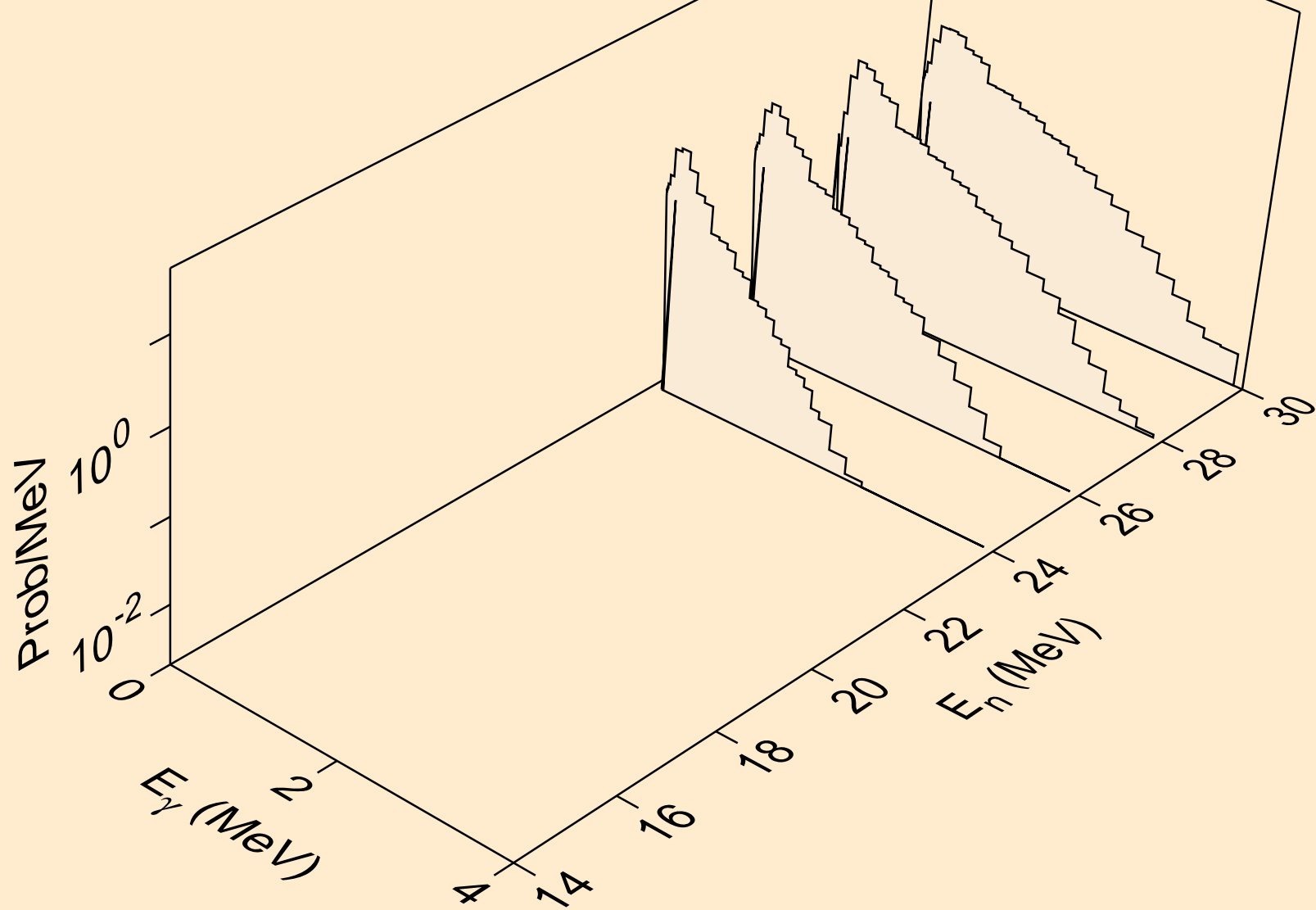

ES239 NEUTRON ACER TENDL-2021 LIBRARY; T=293.6K  
Photon emission for (n,2n)

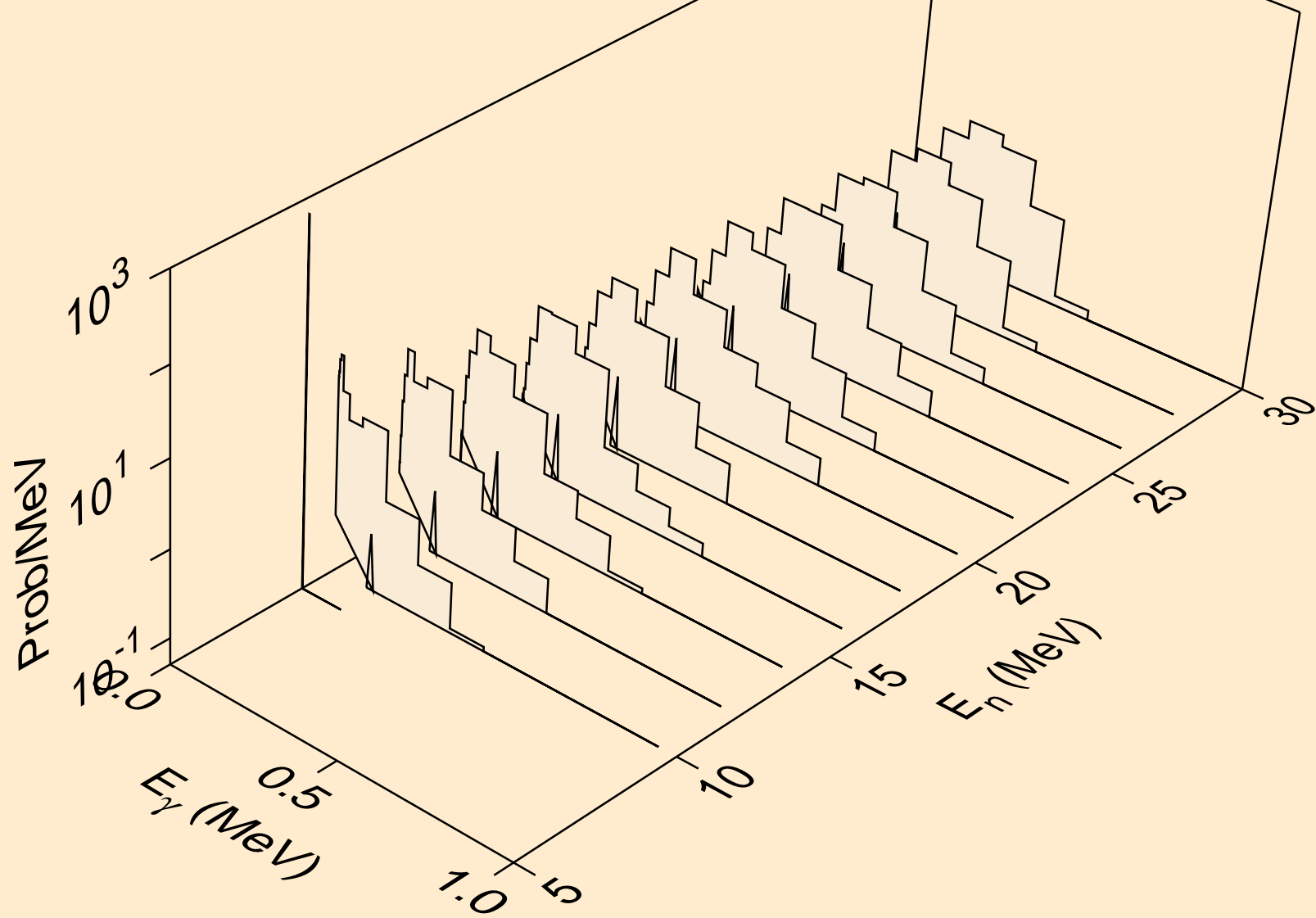

ES239 NEUTRON ACER TENDL-2021 LIBRARY; T=293.6K  
Photon emission for (n,3n)

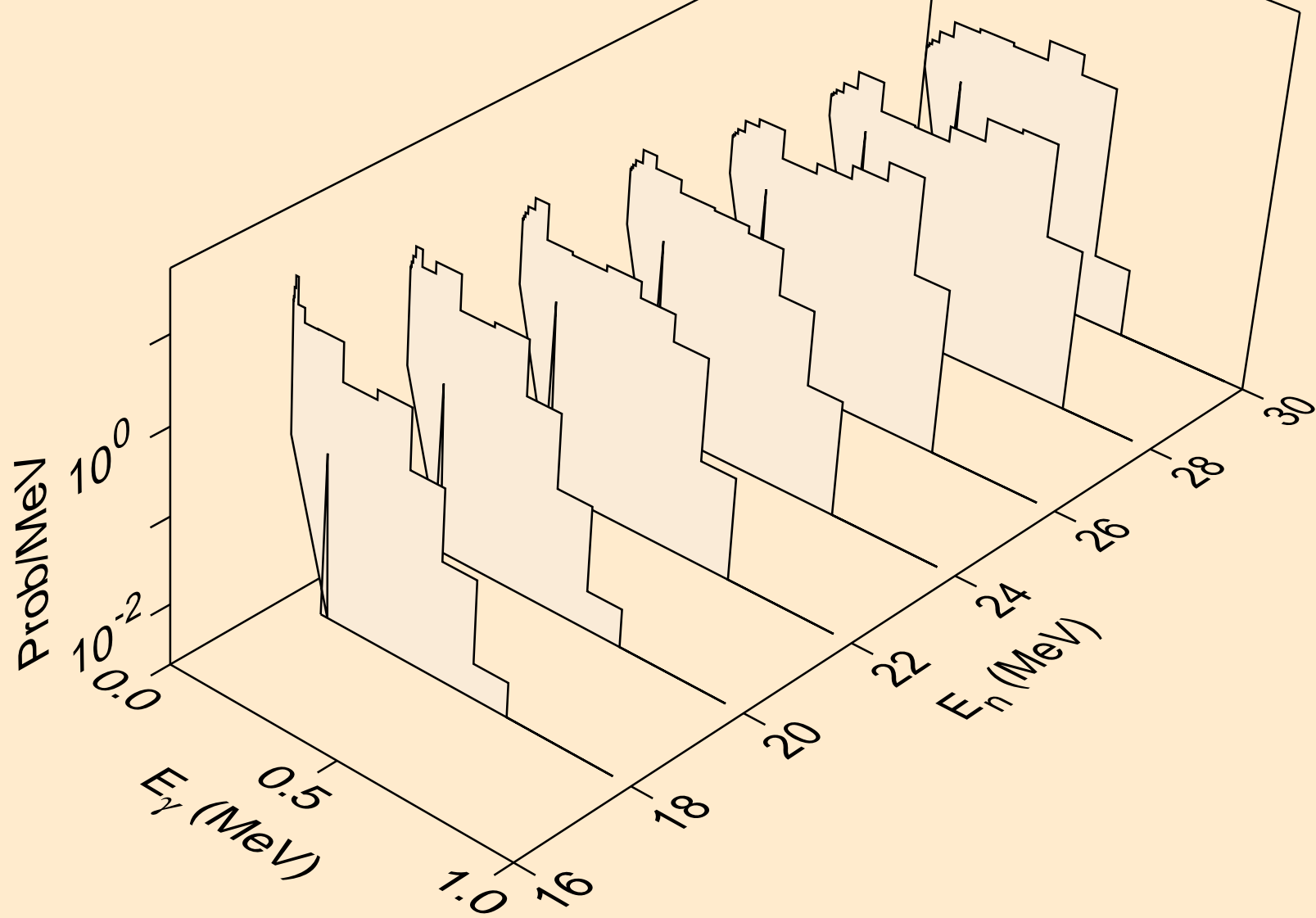

ES239 NEUTRON ACER TENDL-2021 LIBRARY; T=293.6K  
Photon emission for (n,n\*)a

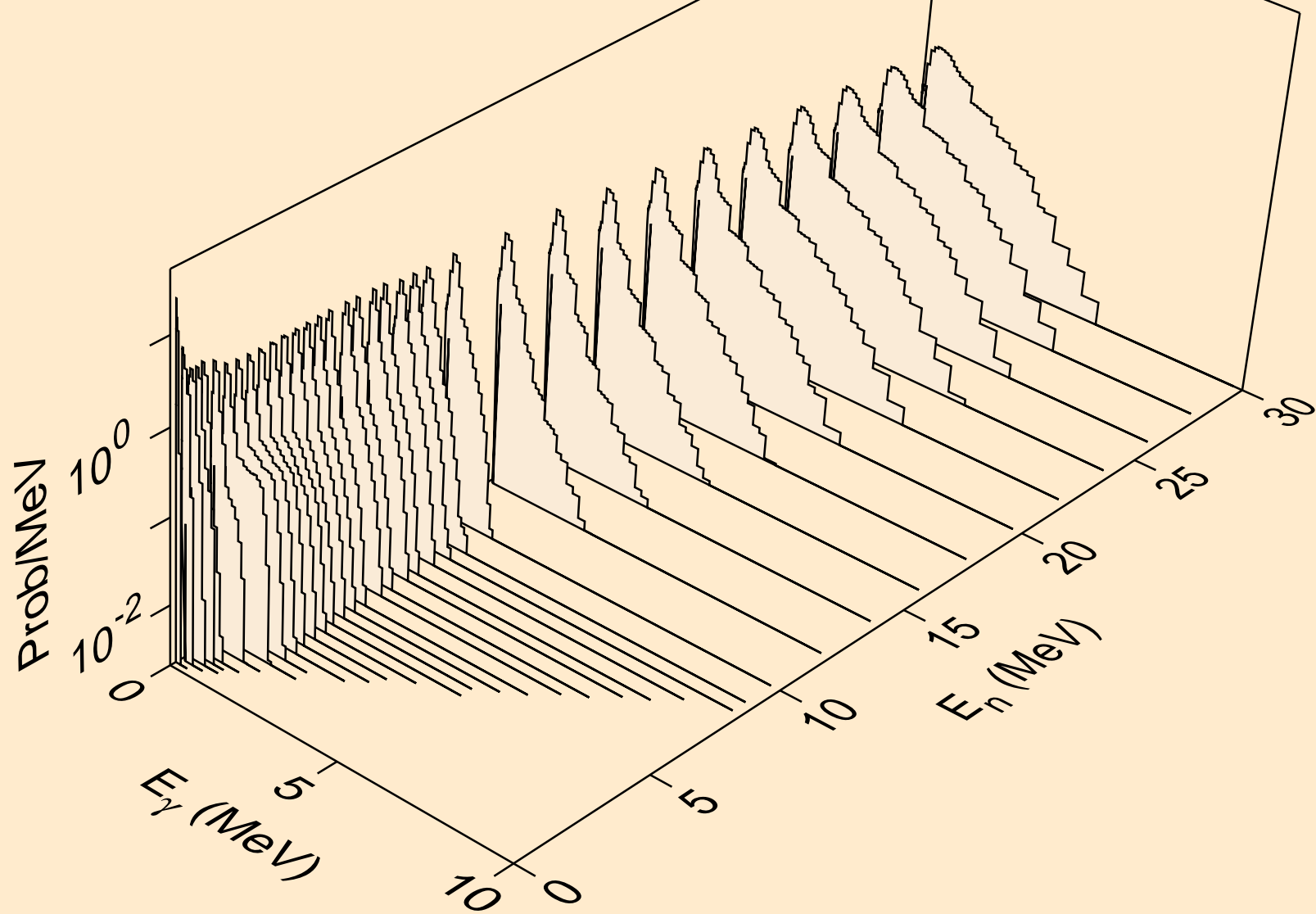

ES239 NEUTRON ACER TENDL-2021 LIBRARY; T=293.6K  
Photon emission for (n,2n)a

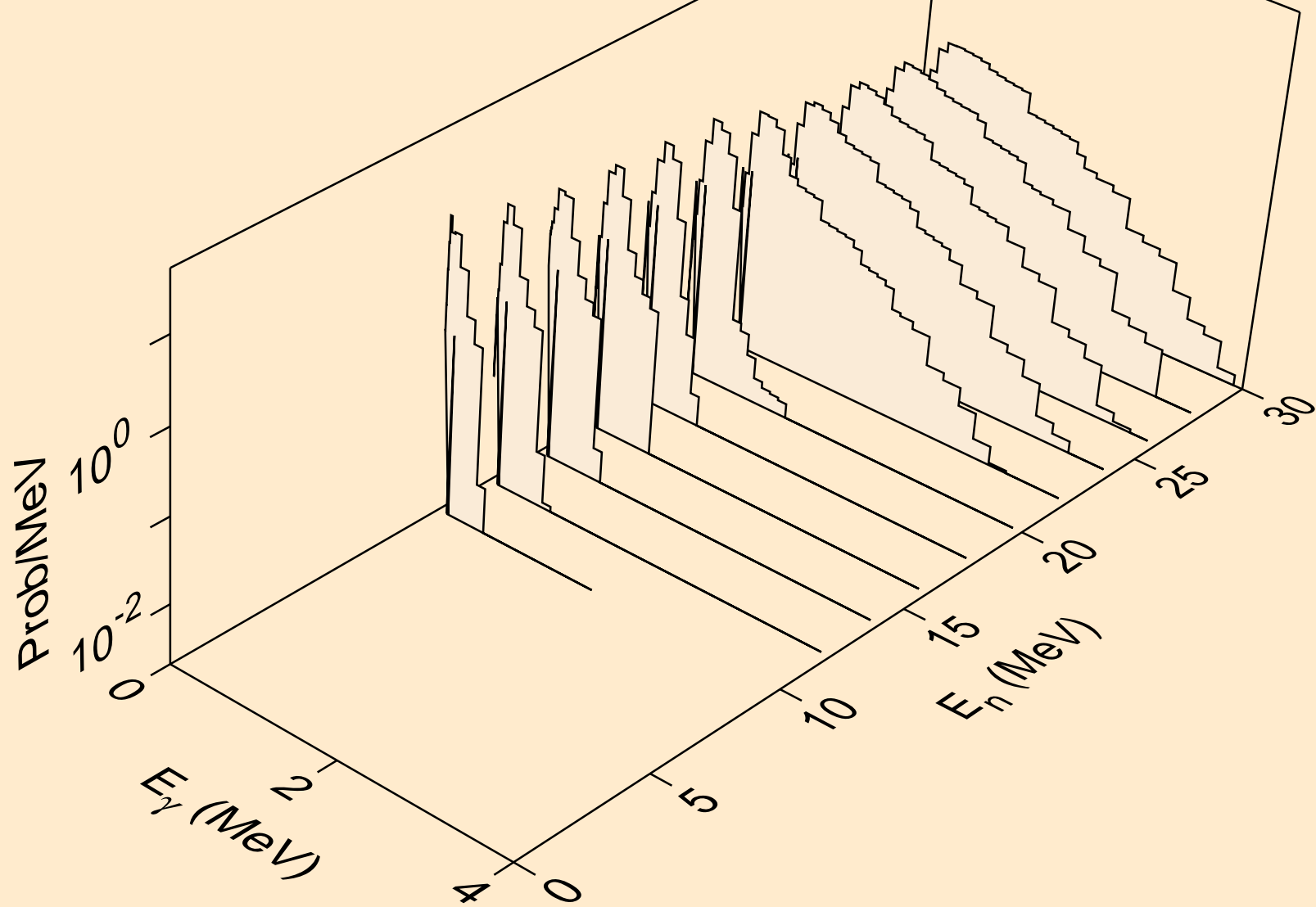

ES239 NEUTRON ACER TENDL-2021 LIBRARY; T=293.6K  
Photon emission for (n,3n)a

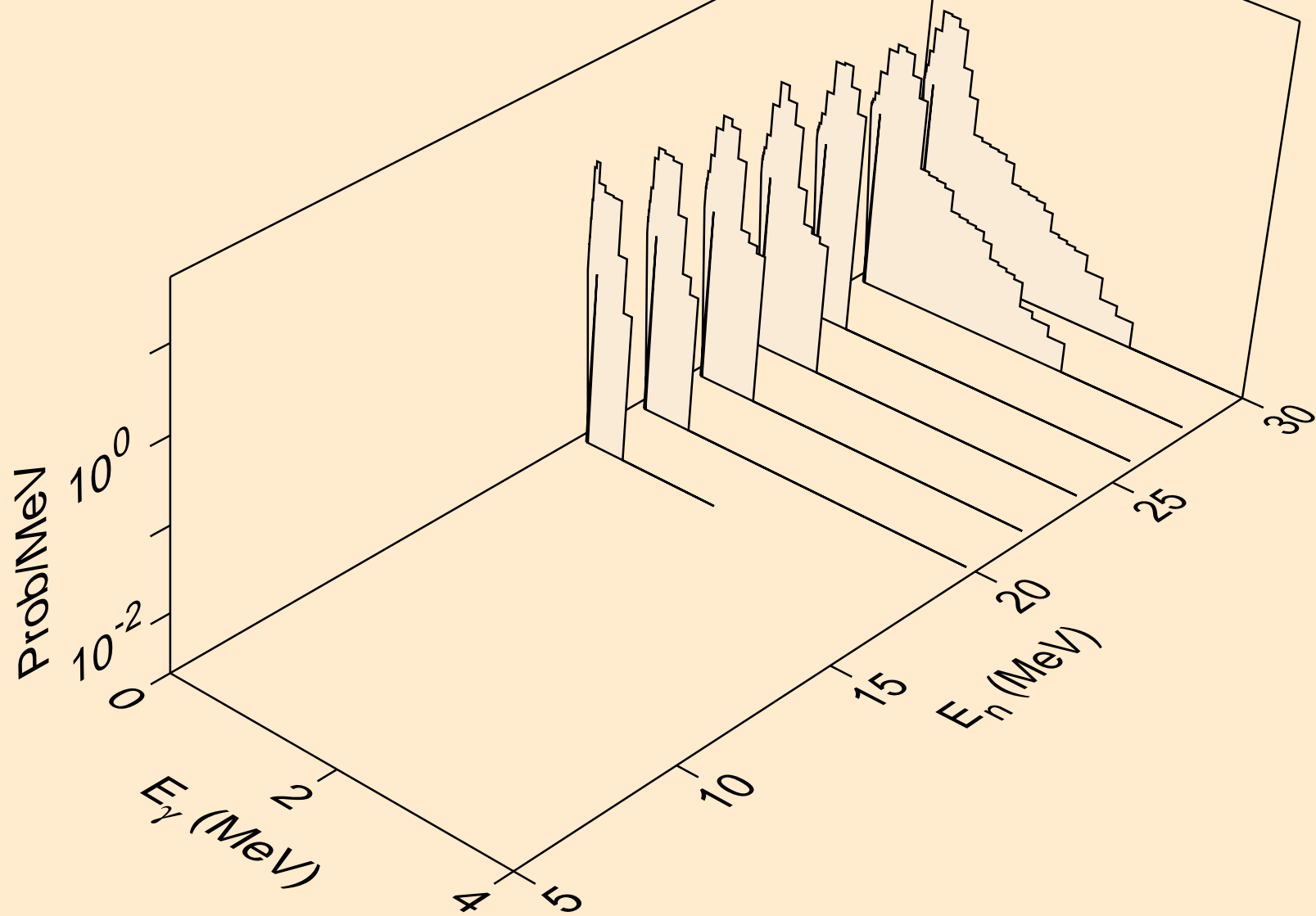

ES239 NEUTRON ACER TENDL-2021 LIBRARY; T=293.6K  
Photon emission for (n,n\*)p

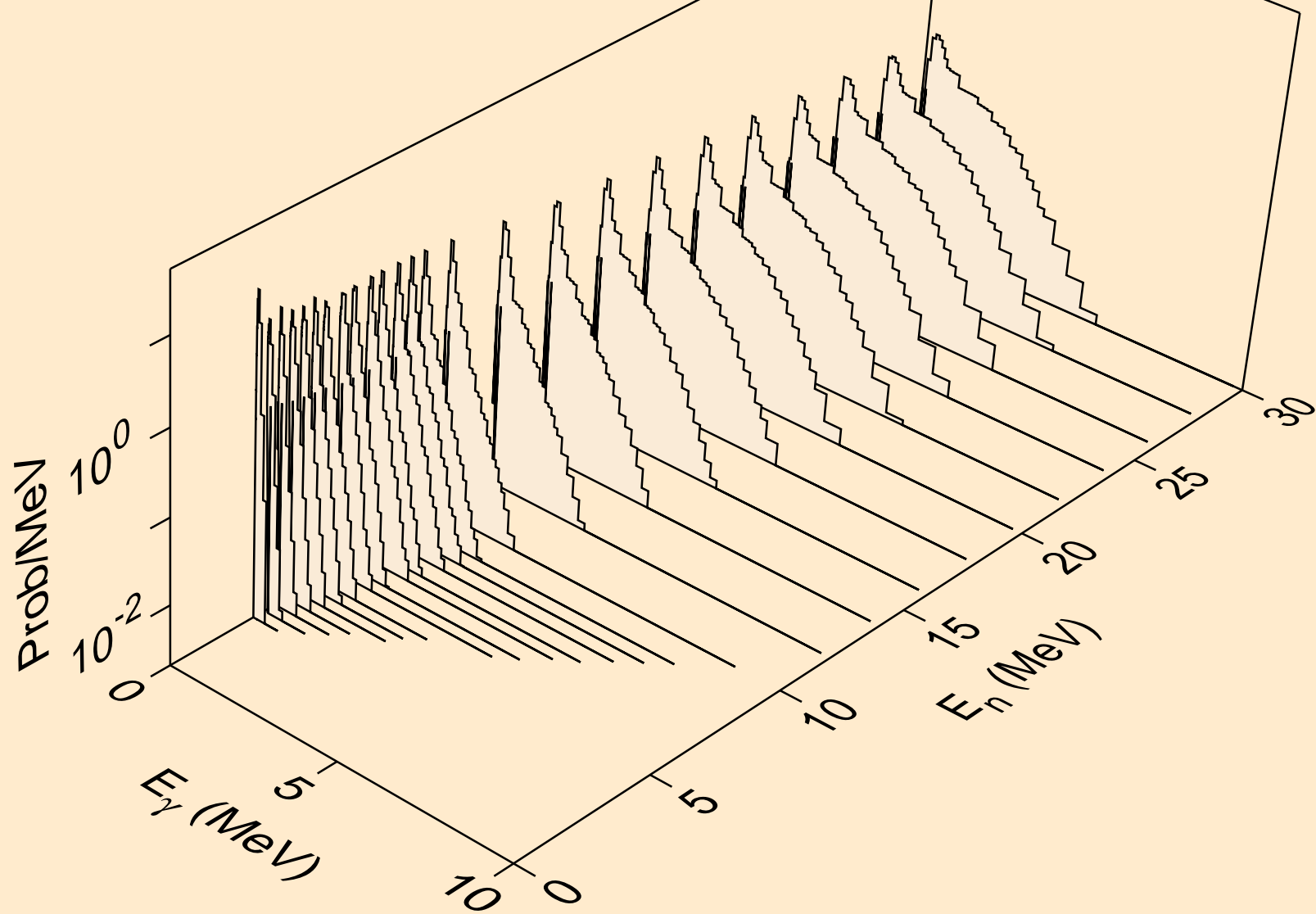



ES239 NEUTRON ACER TENDL-2021 LIBRARY; T=293.6K  
Photon emission for (n,n\*)d

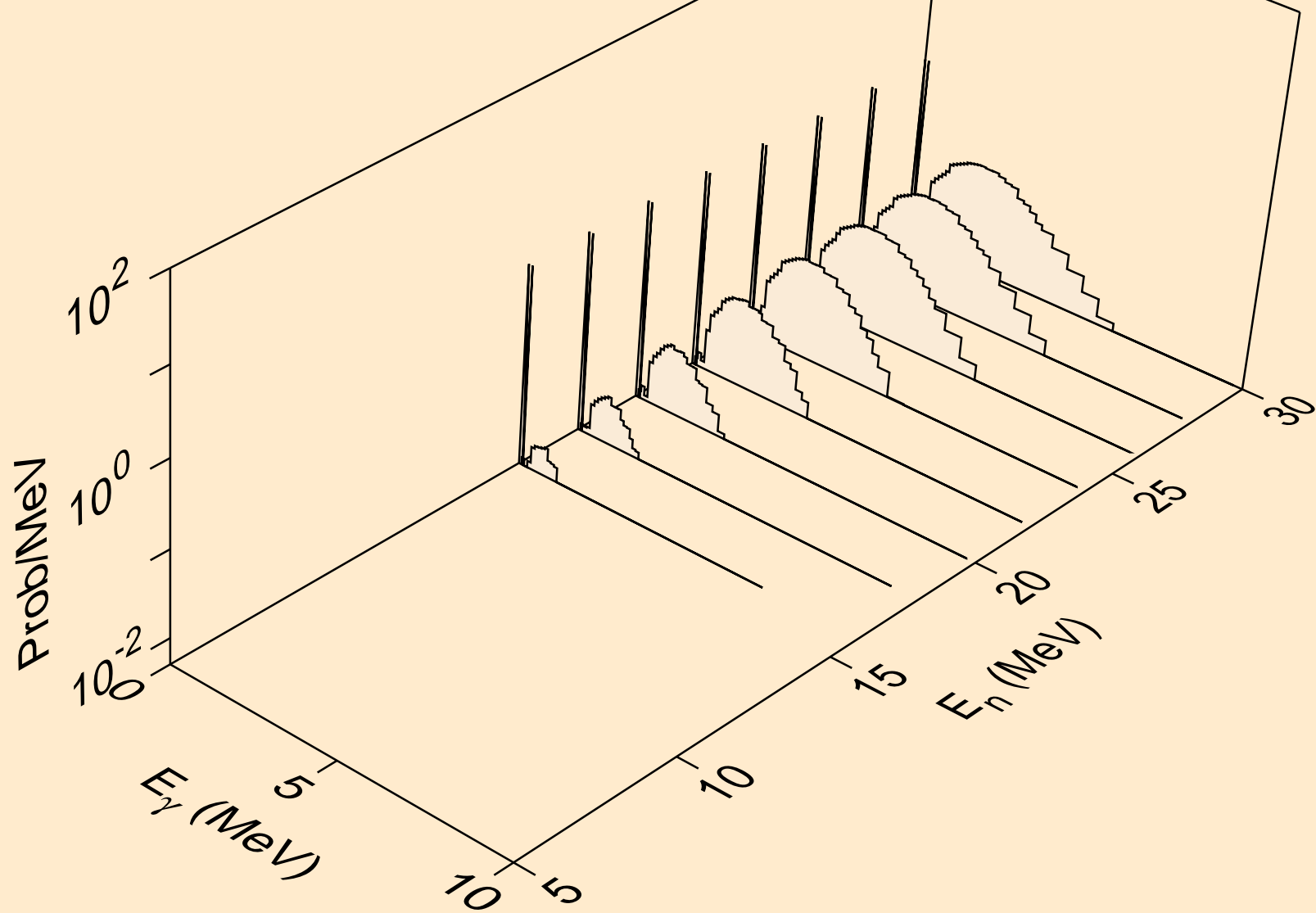

ES239 NEUTRON ACER TENDL-2021 LIBRARY; T=293.6K  
Photon emission for (n,n\*)t

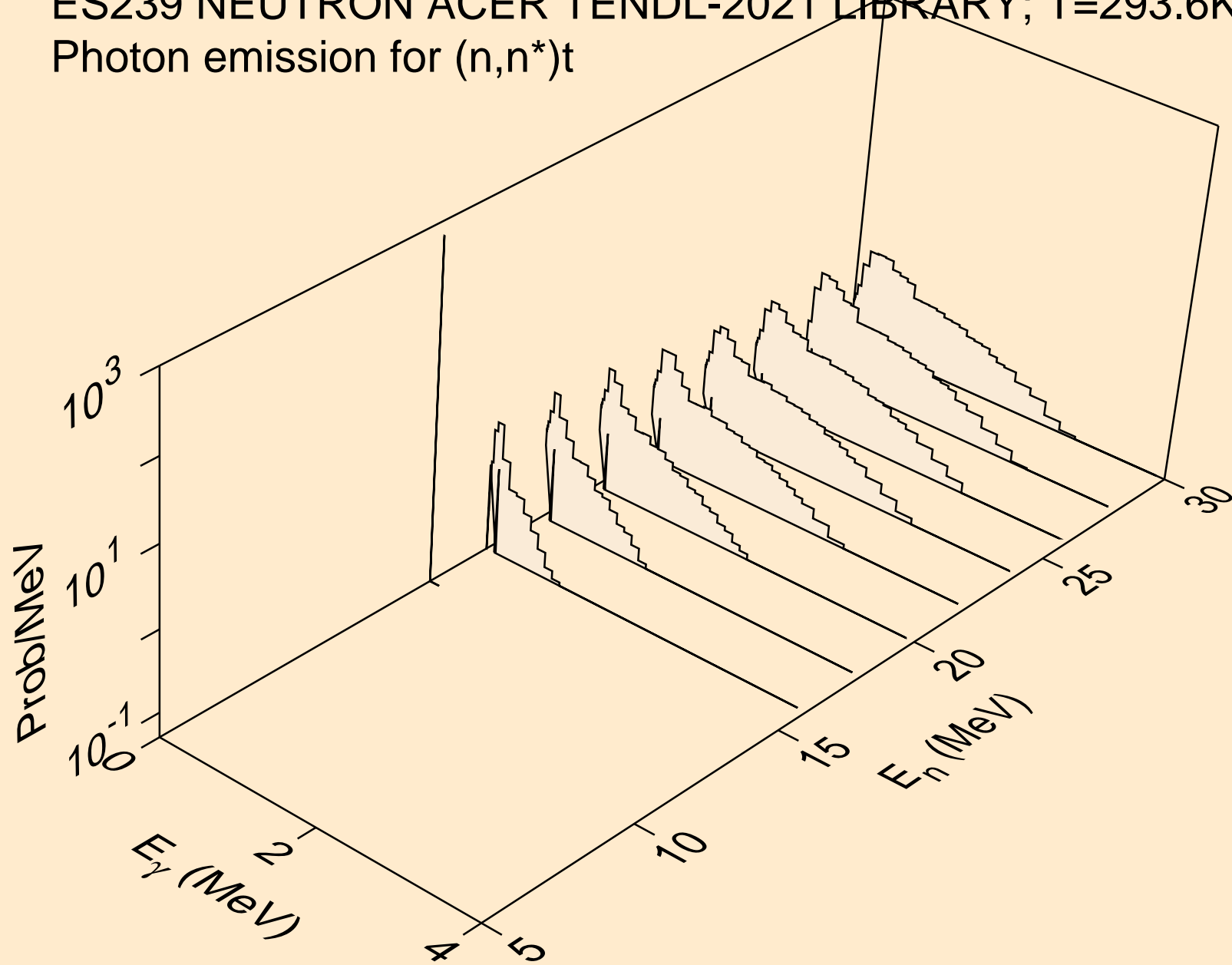

ES239 NEUTRON ACER TENDL-2021 LIBRARY; T=293.6K  
Photon emission for (n,n\*)he3

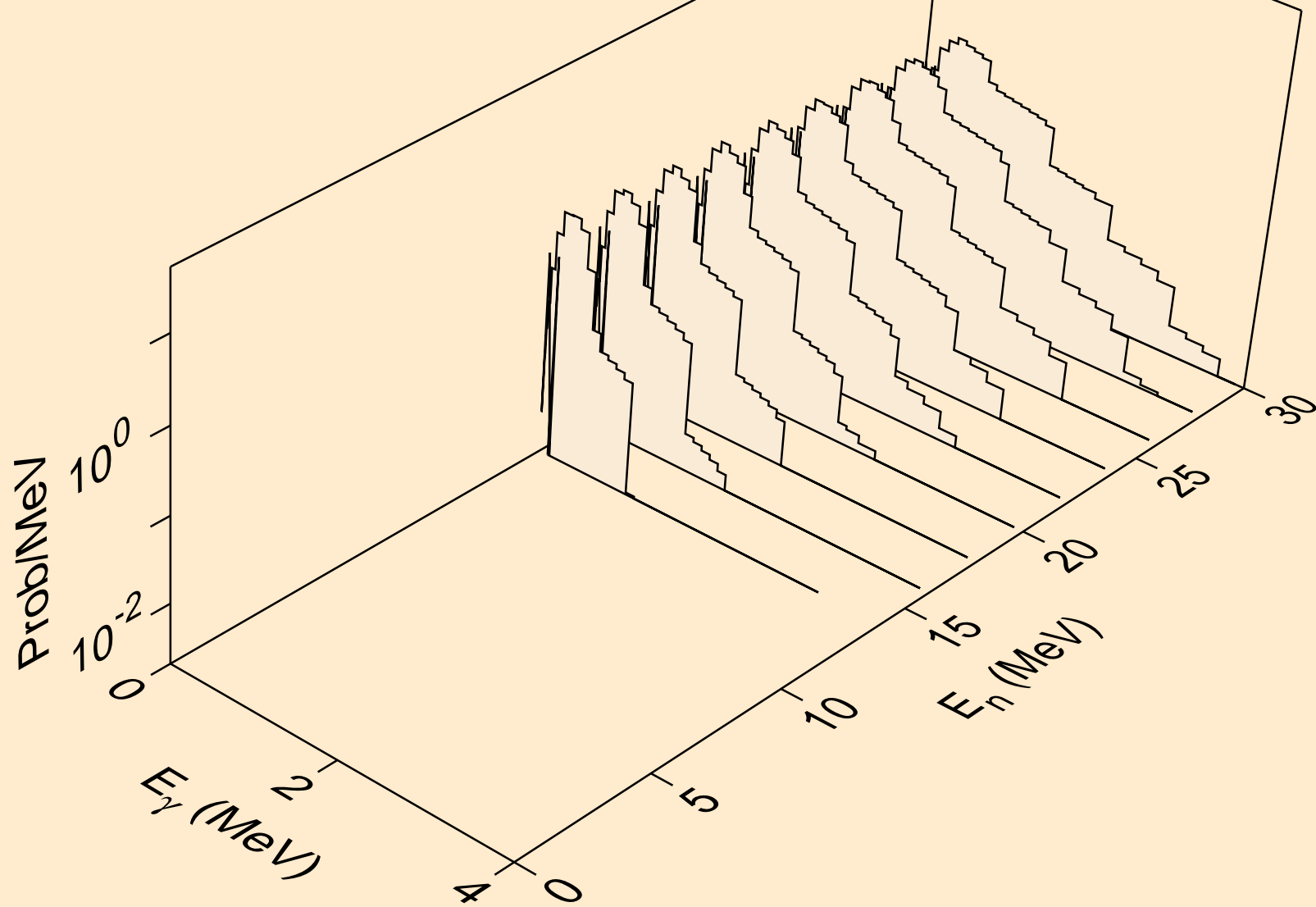

ES239 NEUTRON ACER TENDL-2021 LIBRARY; T=293.6K  
Photon emission for (n,2np)

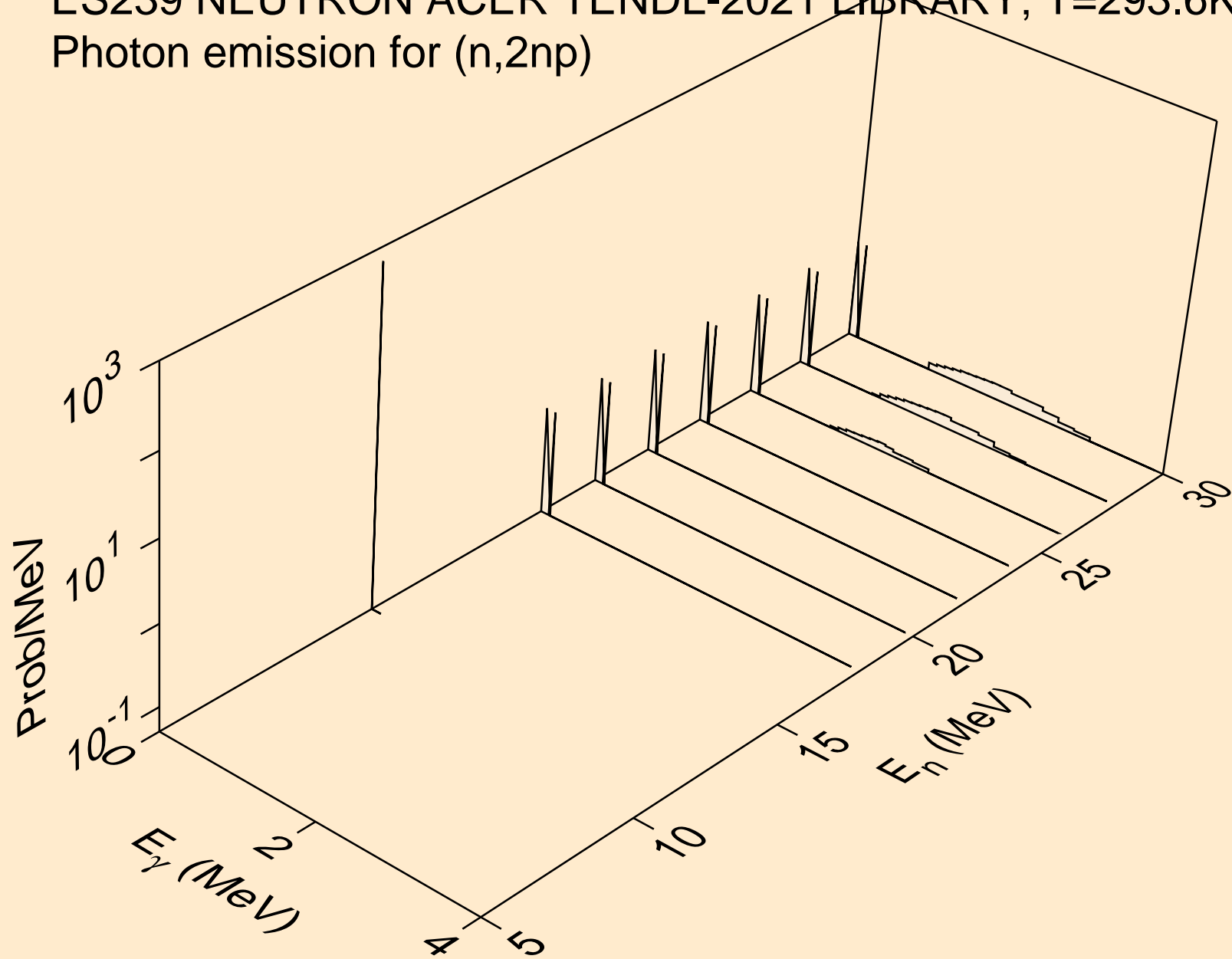

ES239 NEUTRON ACER TENDL-2021 LIBRARY; T=293.6K  
Photon emission for (n,3np)

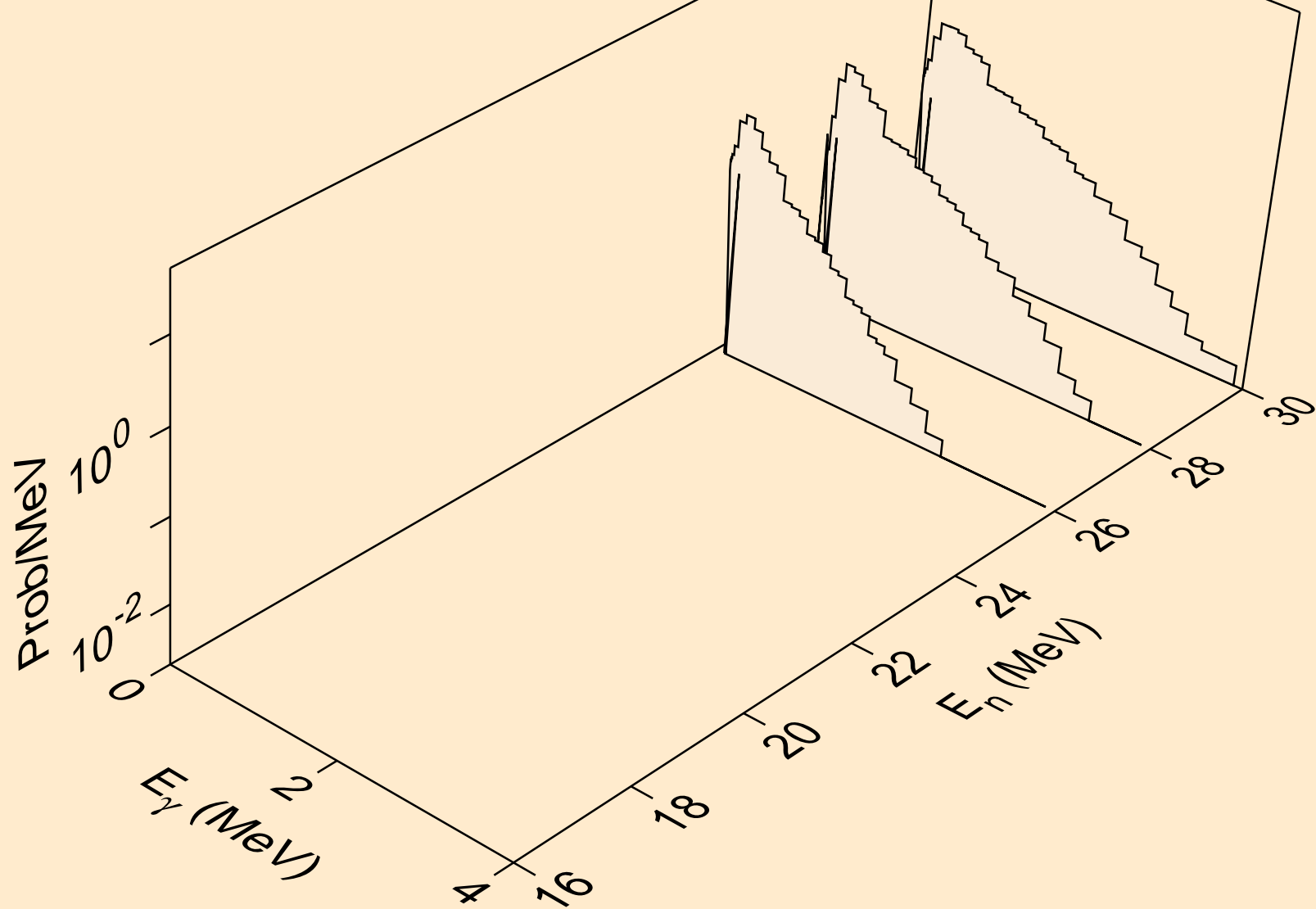

ES239 NEUTRON ACER TENDL-2021 LIBRARY; T=293.6K  
Photon emission for (n,2np)

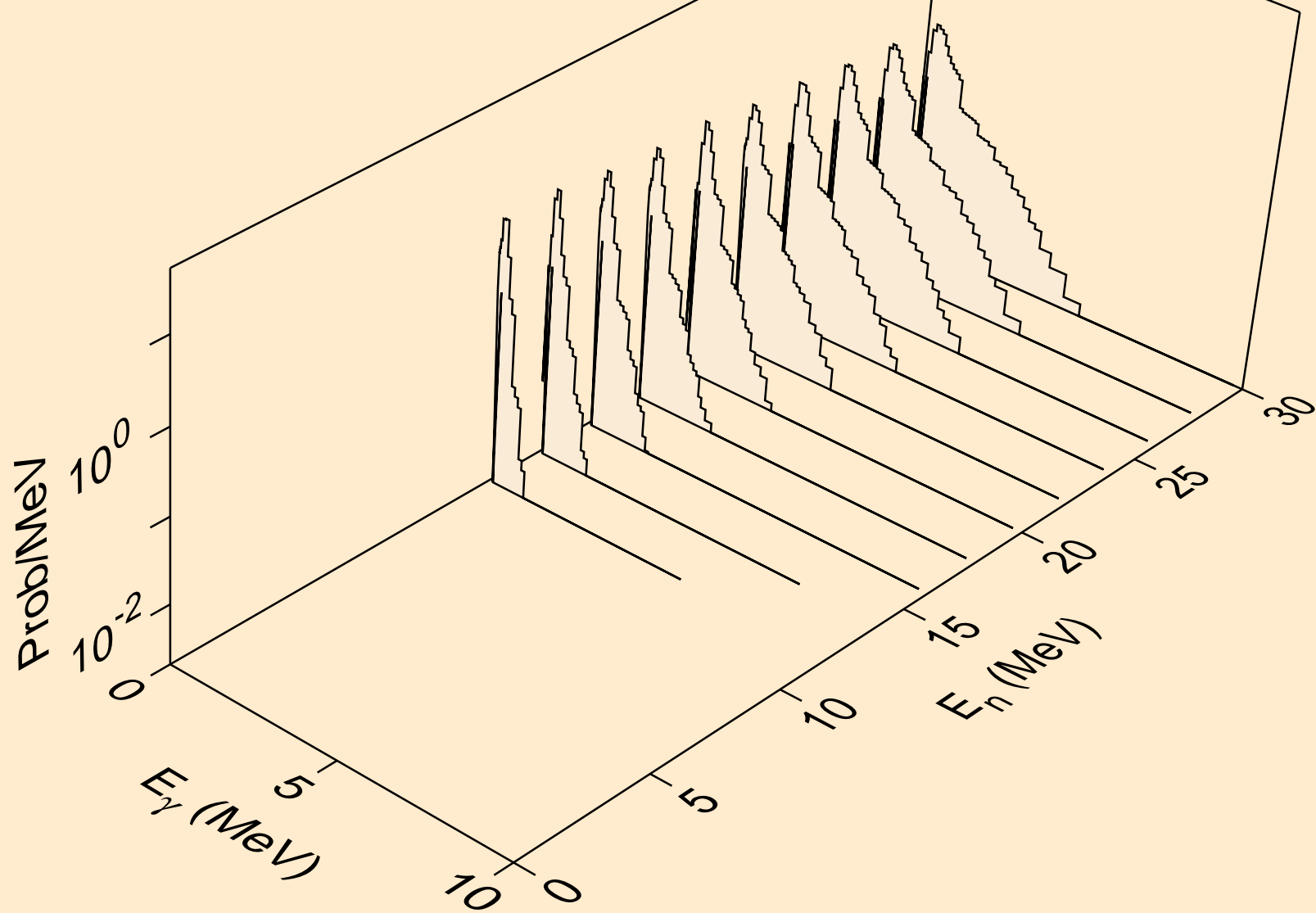

ES239 NEUTRON ACER TENDL-2021 LIBRARY; T=293.6K  
Photon emission for (n,npa)

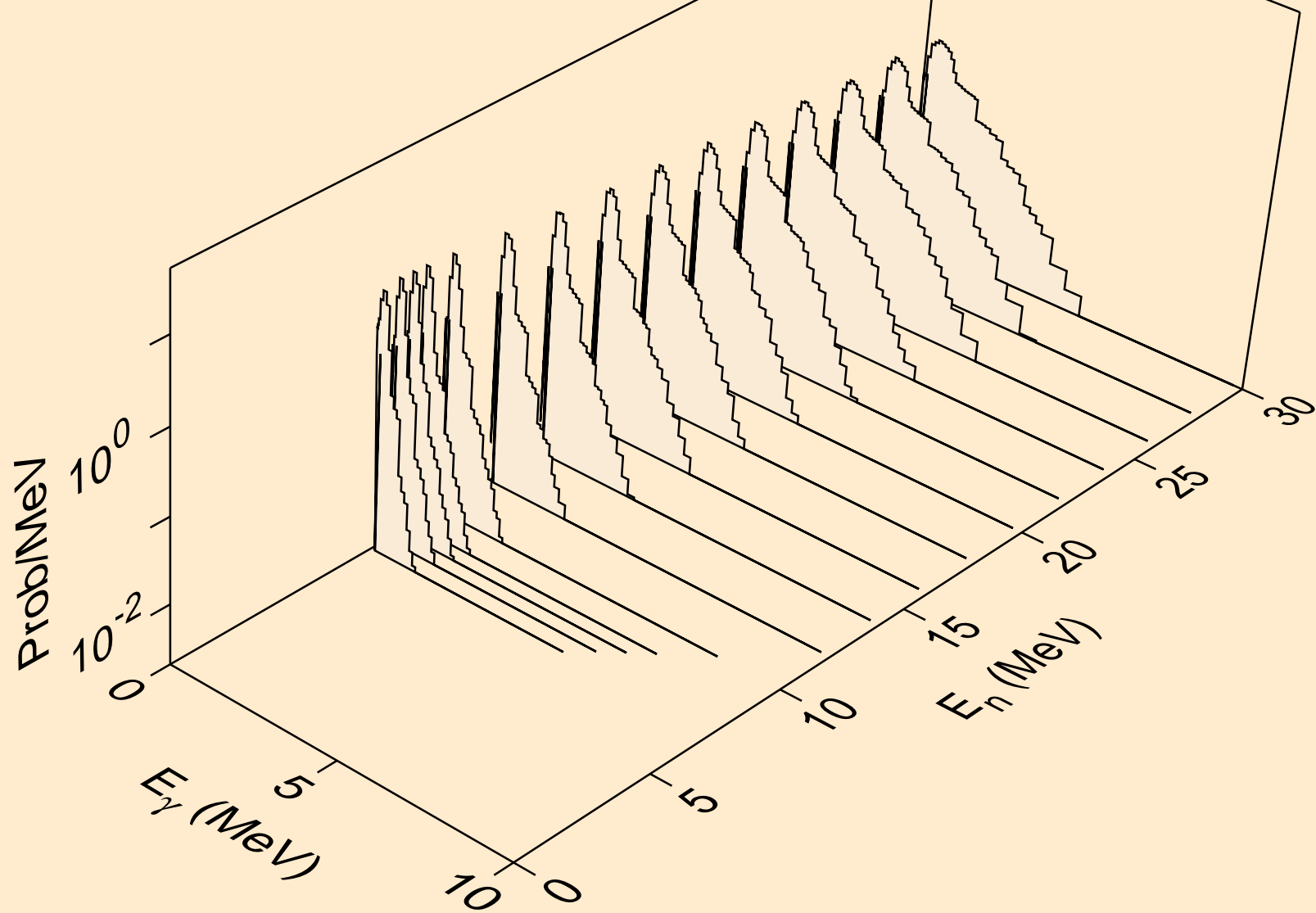

ES239 NEUTRON ACER TENDL-2021 LIBRARY; T=293.6K  
Photon emission for (n,n\*c)

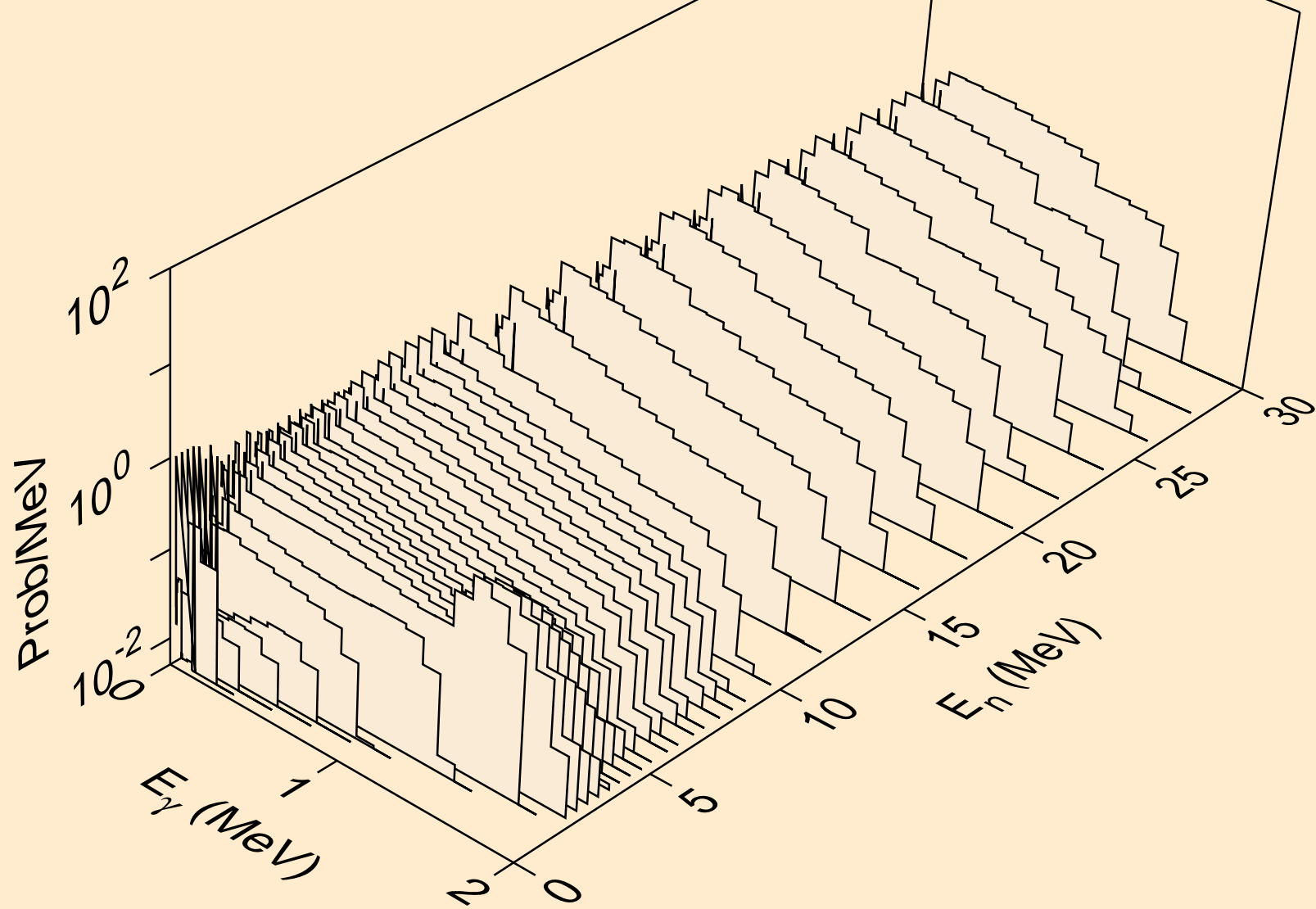



ES239 NEUTRON ACER TENDL-2021 LIBRARY; T=293.6K  
Photon emission for (n,gma)

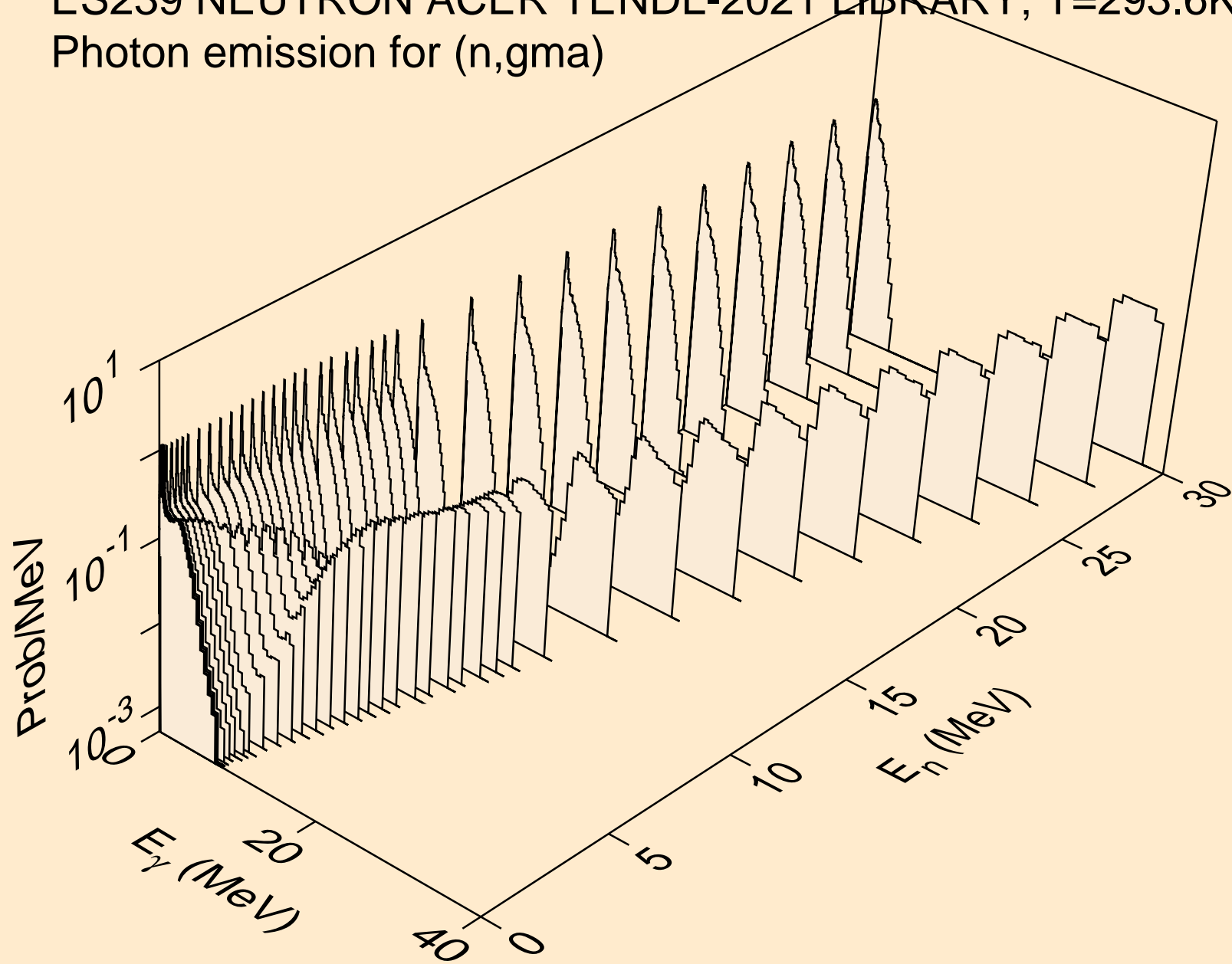

ES239 NEUTRON ACER TENDL-2021 LIBRARY; T=293.6K  
Photon emission for (n,p)

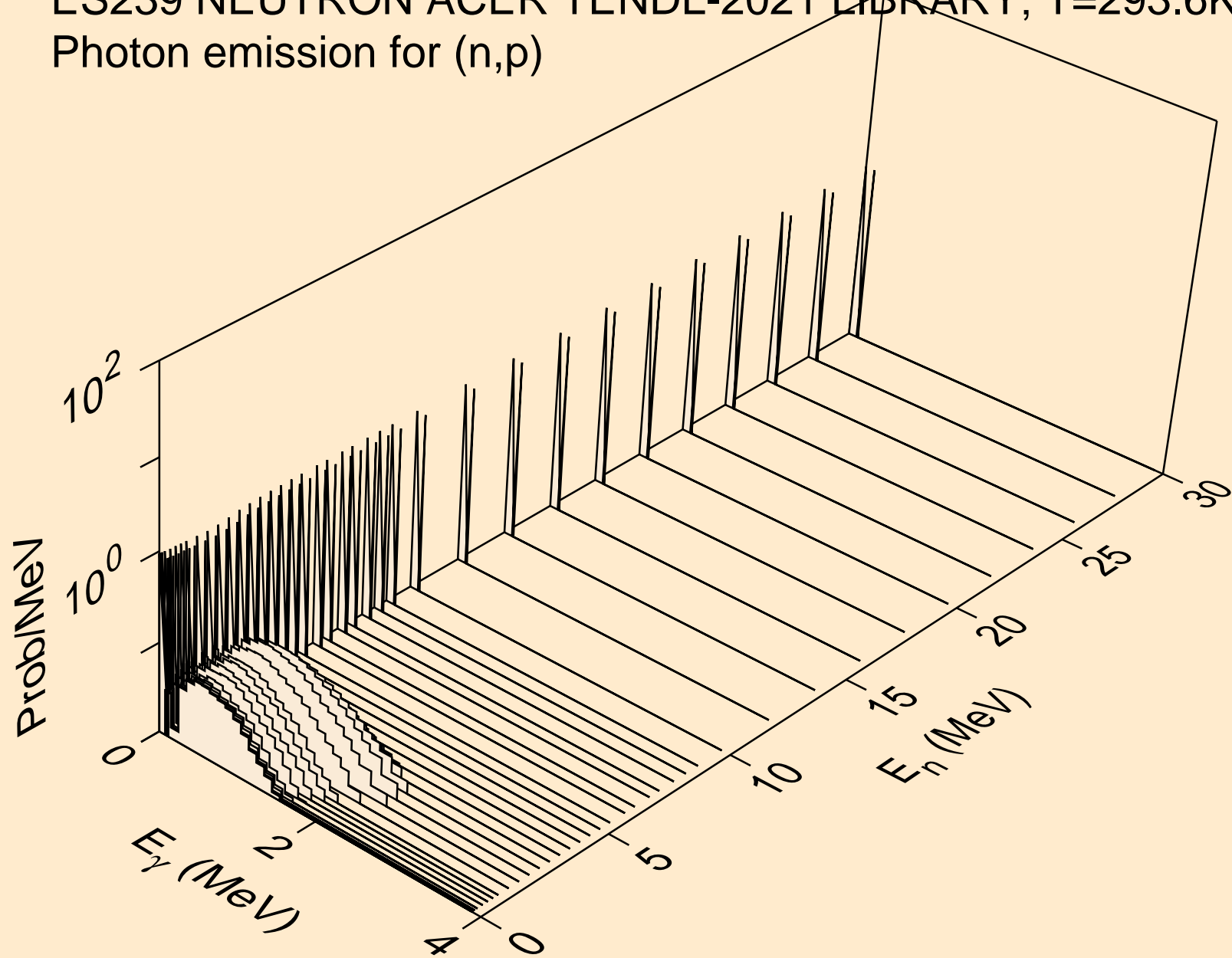

ES239 NEUTRON ACER TENDL-2021 LIBRARY; T=293.6K  
Photon emission for (n,d)

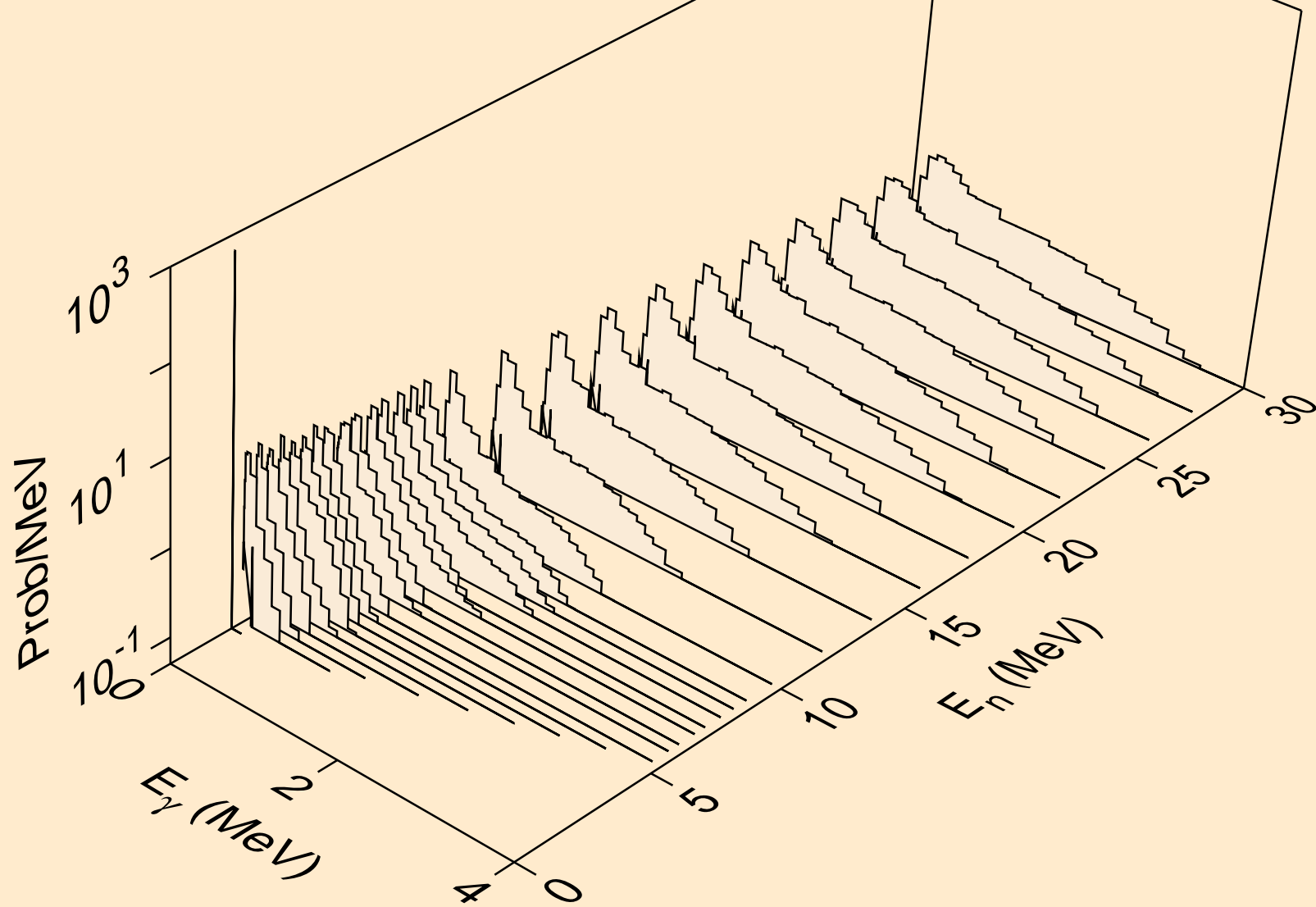

ES239 NEUTRON ACER TENDL-2021 LIBRARY; T=293.6K  
Photon emission for (n,t)

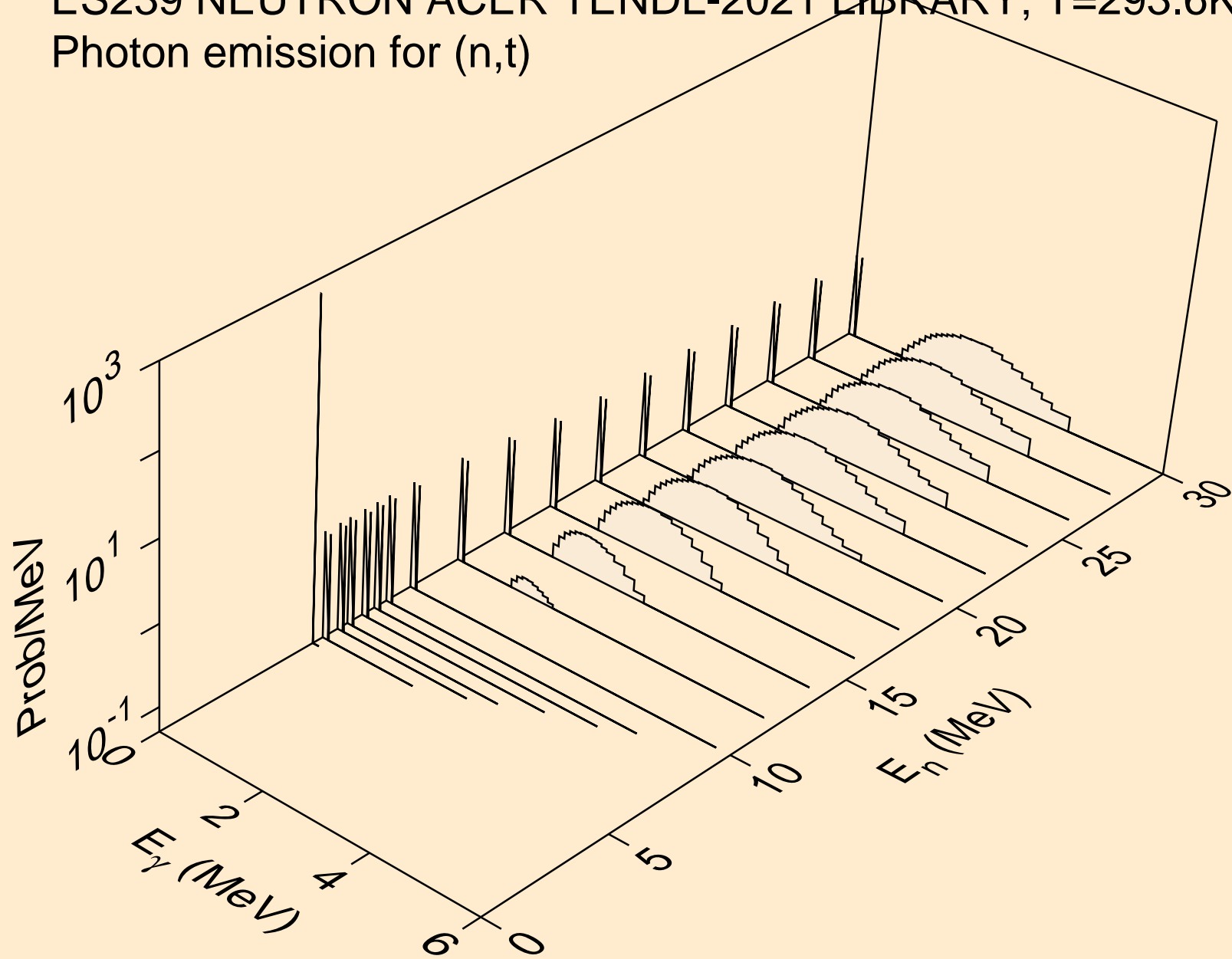

ES239 NEUTRON ACER TENDL-2021 LIBRARY; T=293.6K  
Photon emission for (n,he3)

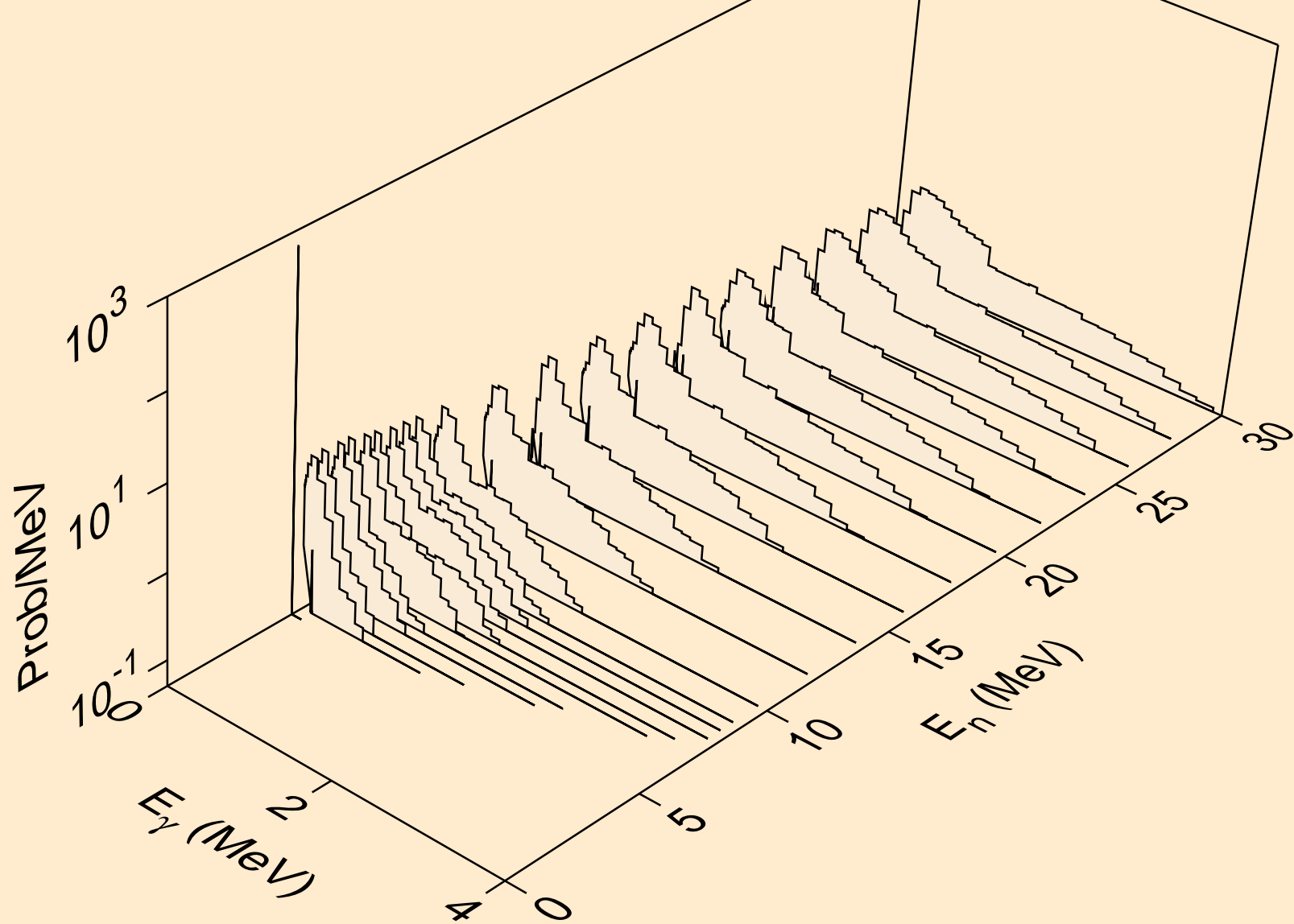

ES239 NEUTRON ACER TENDL-2021 LIBRARY; T=293.6K  
Photon emission for (n,a)

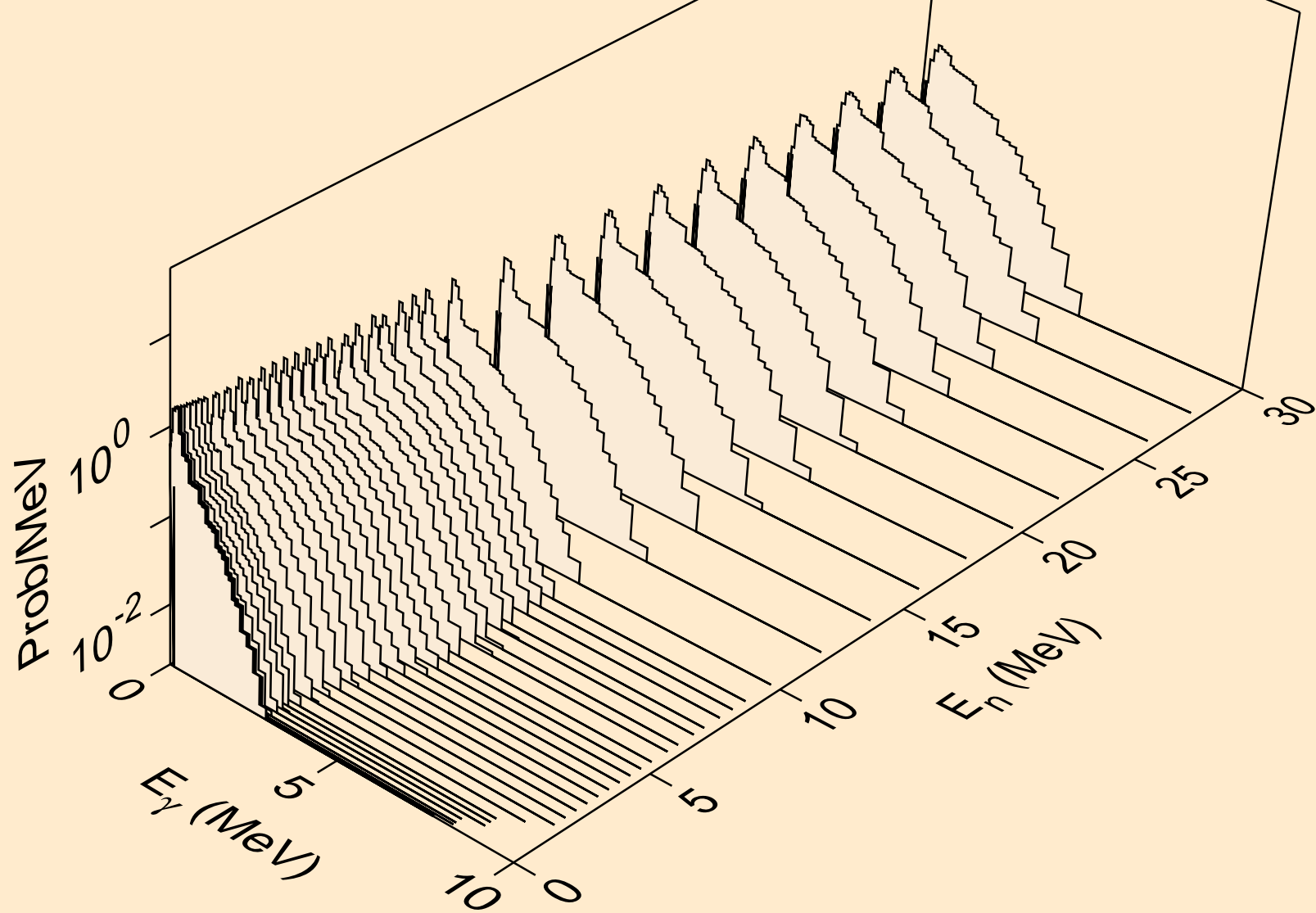

ES239 NEUTRON ACER TENDL-2021 LIBRARY; T=293.6K  
Photon emission for (n,2a)

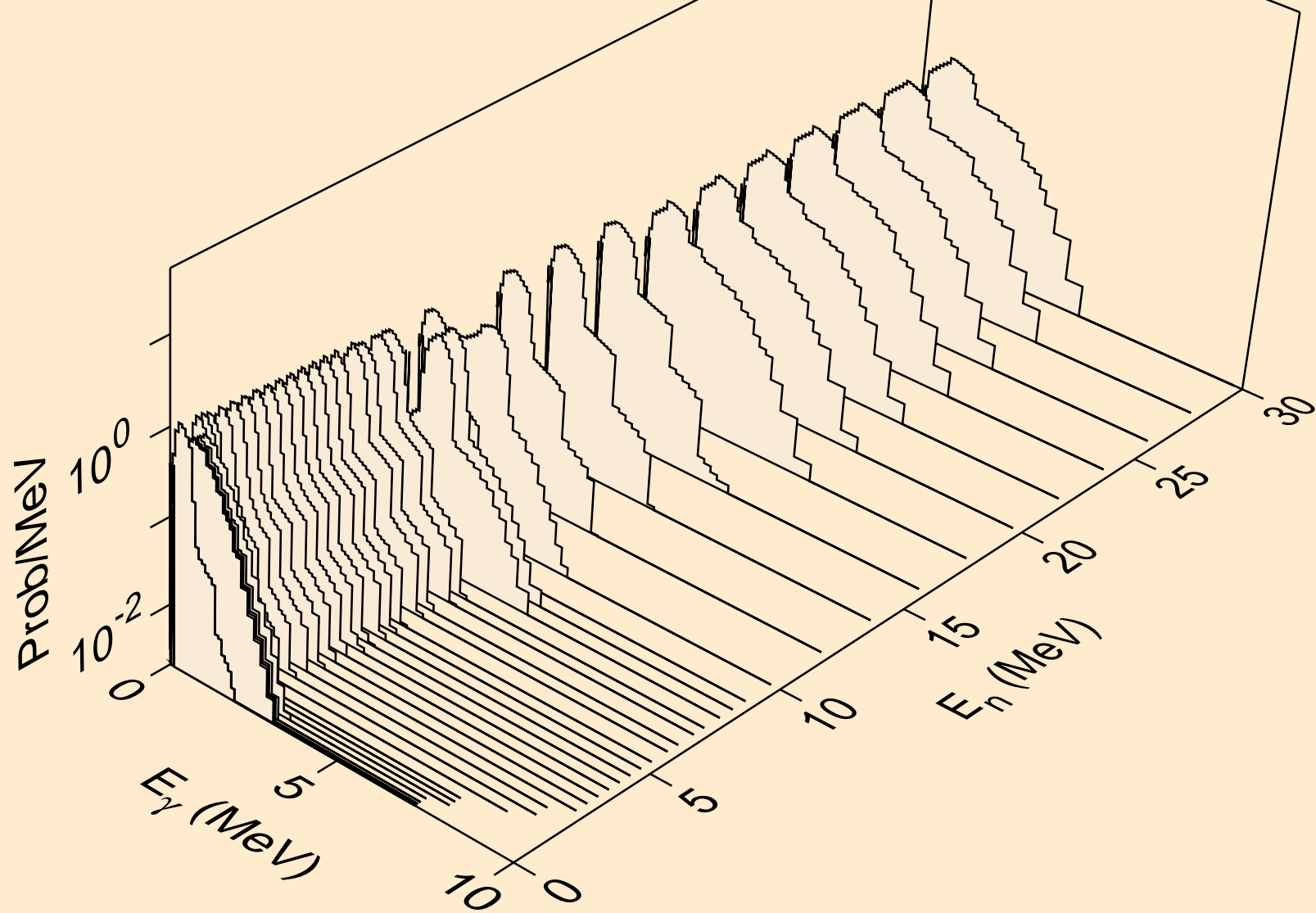

ES239 NEUTRON ACER TENDL-2021 LIBRARY; T=293.6K  
Photon emission for (n,2p)

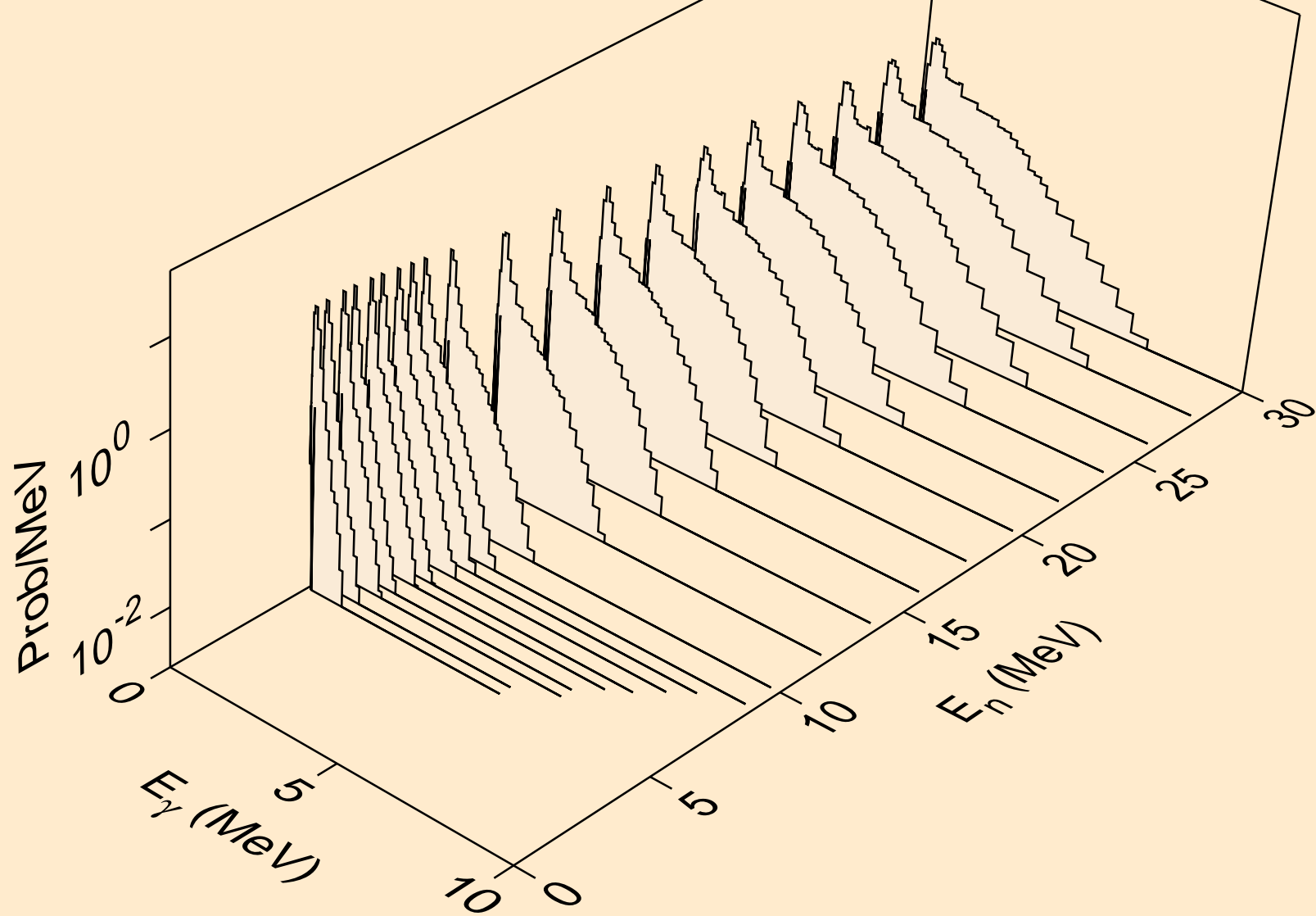



ES239 NEUTRON ACER TENDL-2021 LIBRARY; T=293.6K  
Photon emission for (n,p)

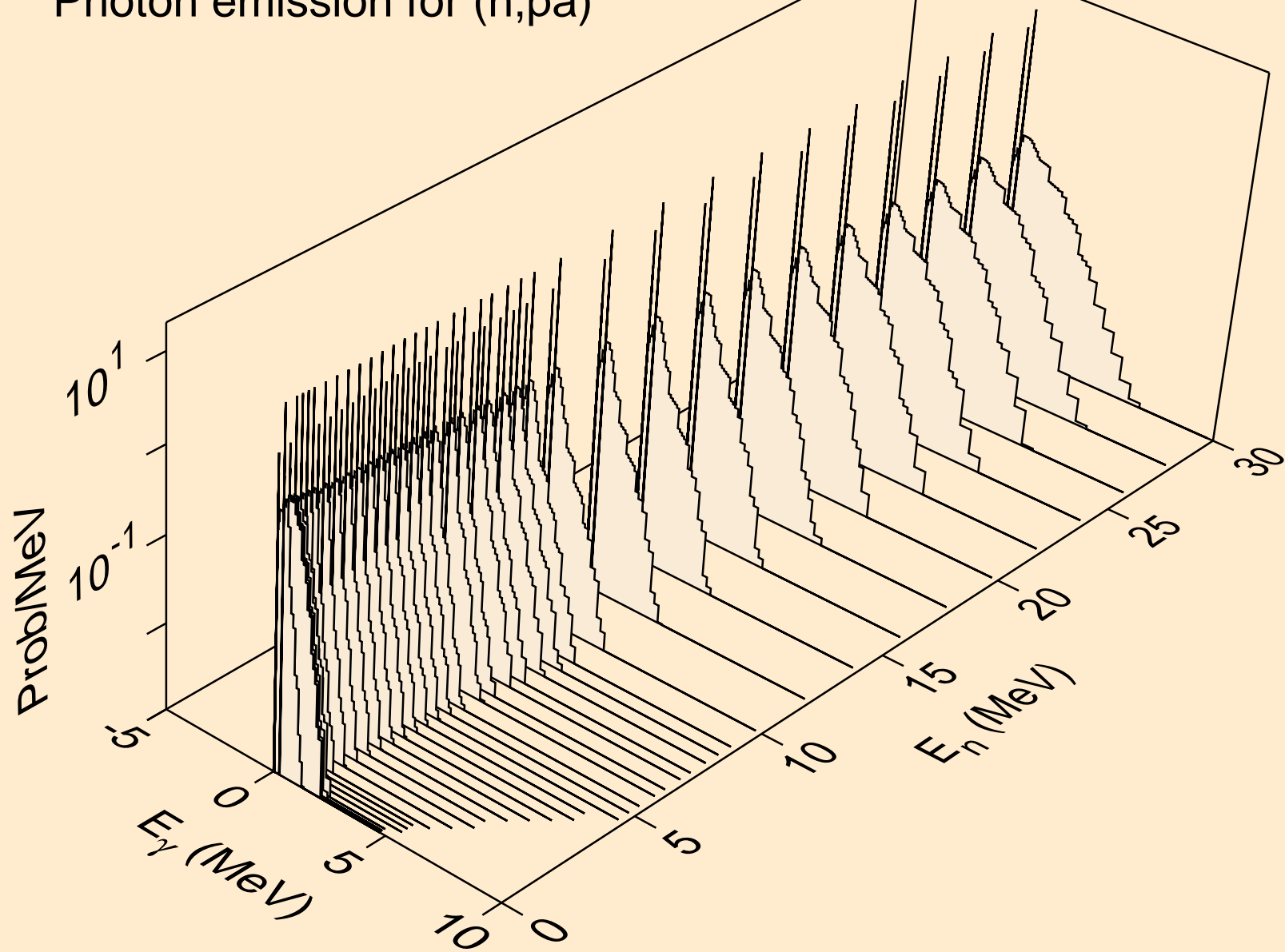

ES239 NEUTRON ACER TENDL-2021 LIBRARY; T=293.6K  
Photon emission for (n,pd)

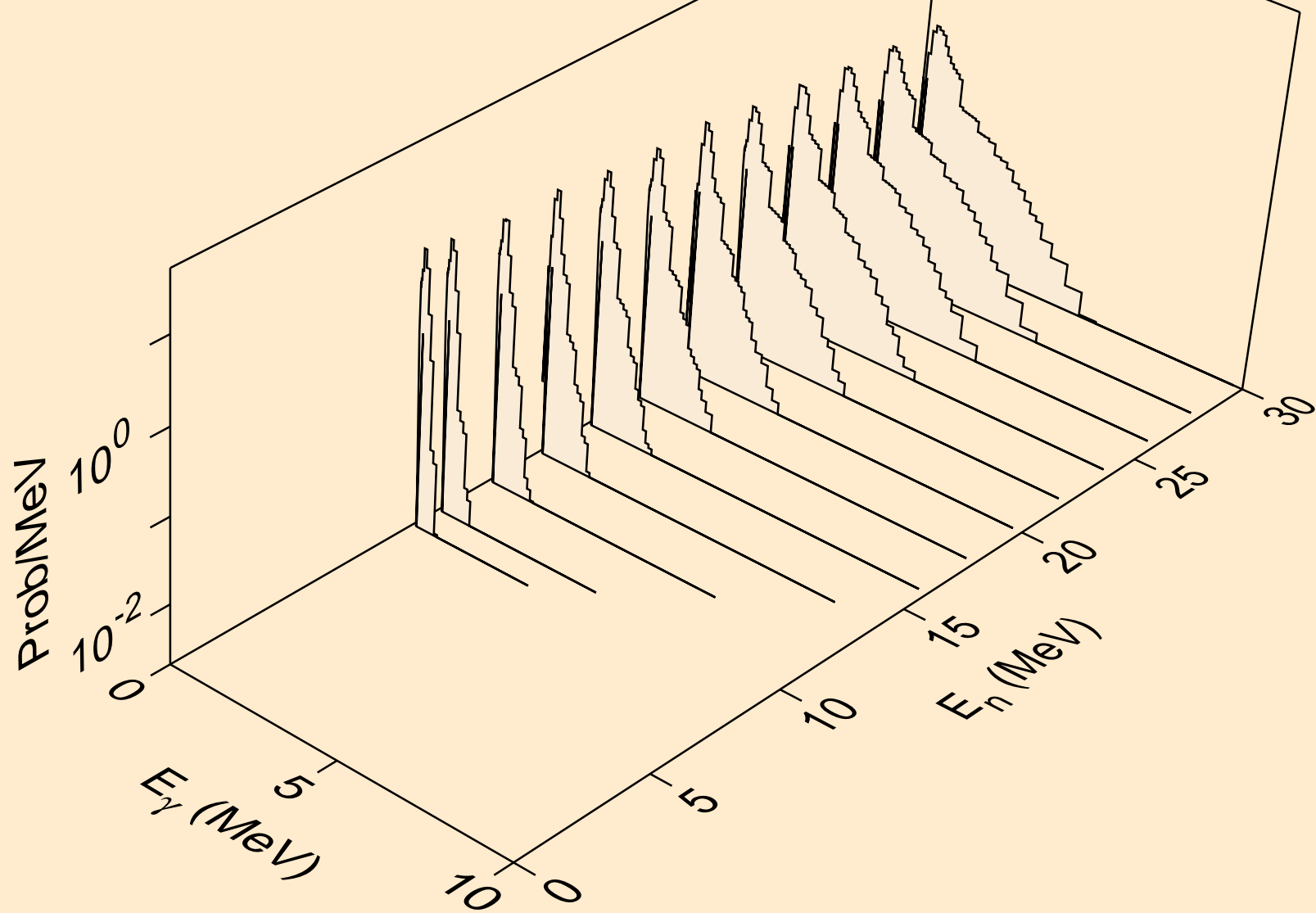

ES239 NEUTRON ACER TENDL-2021 LIBRARY; T=293.6K  
Photon emission for (n,pt)

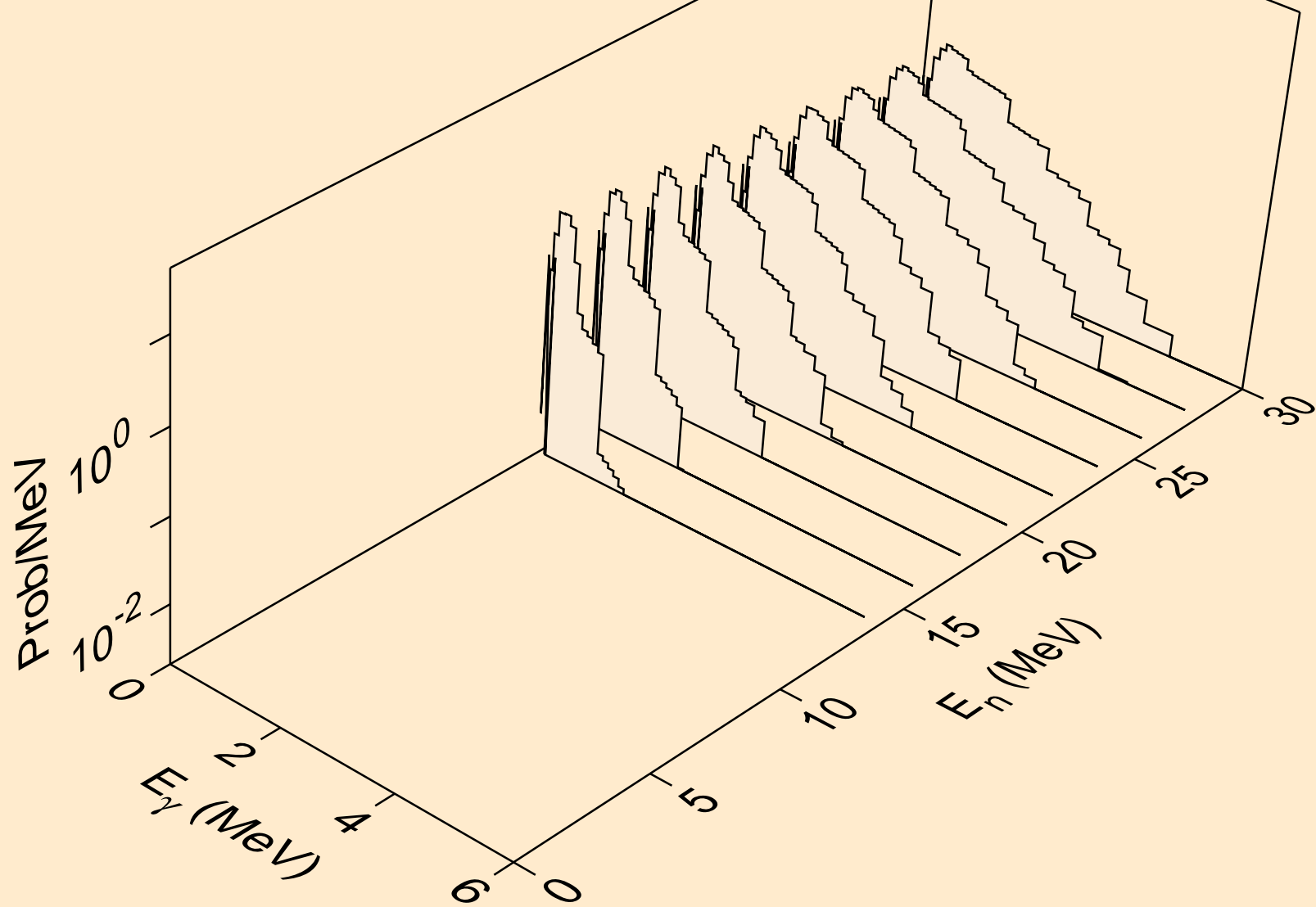

ES239 NEUTRON ACER TENDL-2021 LIBRARY; T=293.6K  
Photon emission for (n,da)

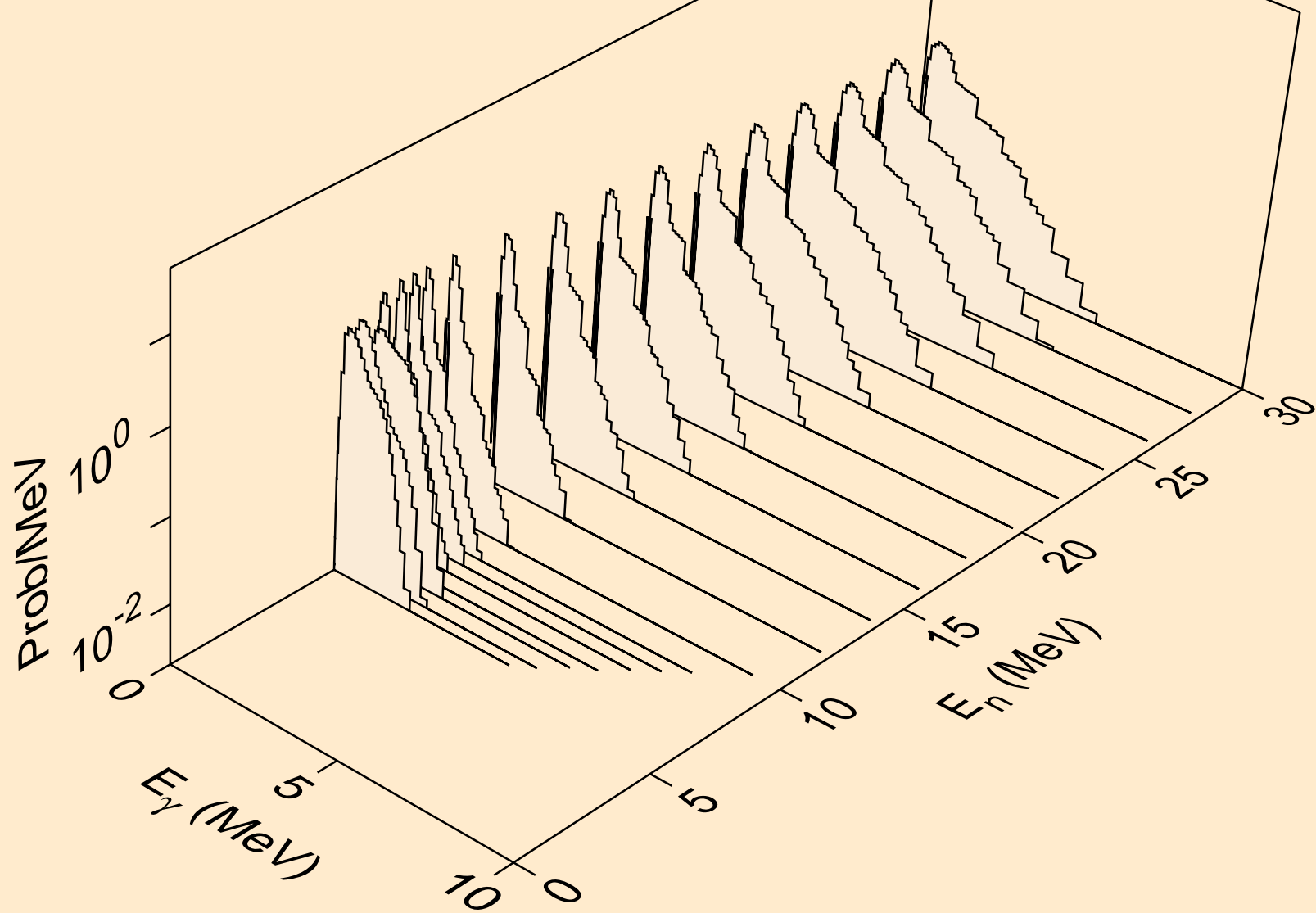

ES239 NEUTRON ACER TENDL-2021 LIBRARY; T=293.6K  
thermal capture photon spectrum

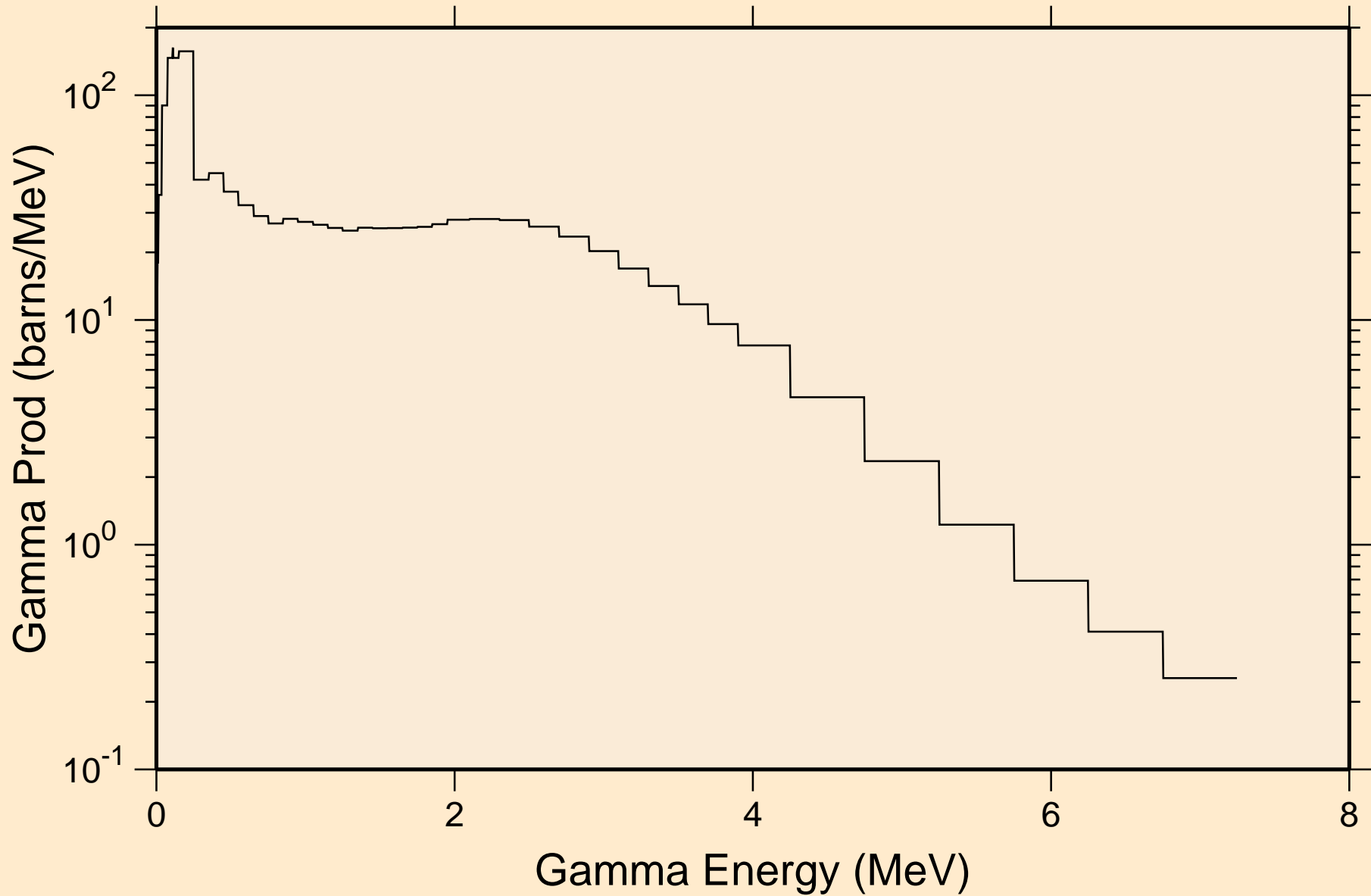

ES239 NEUTRON ACER TENDL-2021 LIBRARY; T=293.6K  
14 MeV photon spectrum

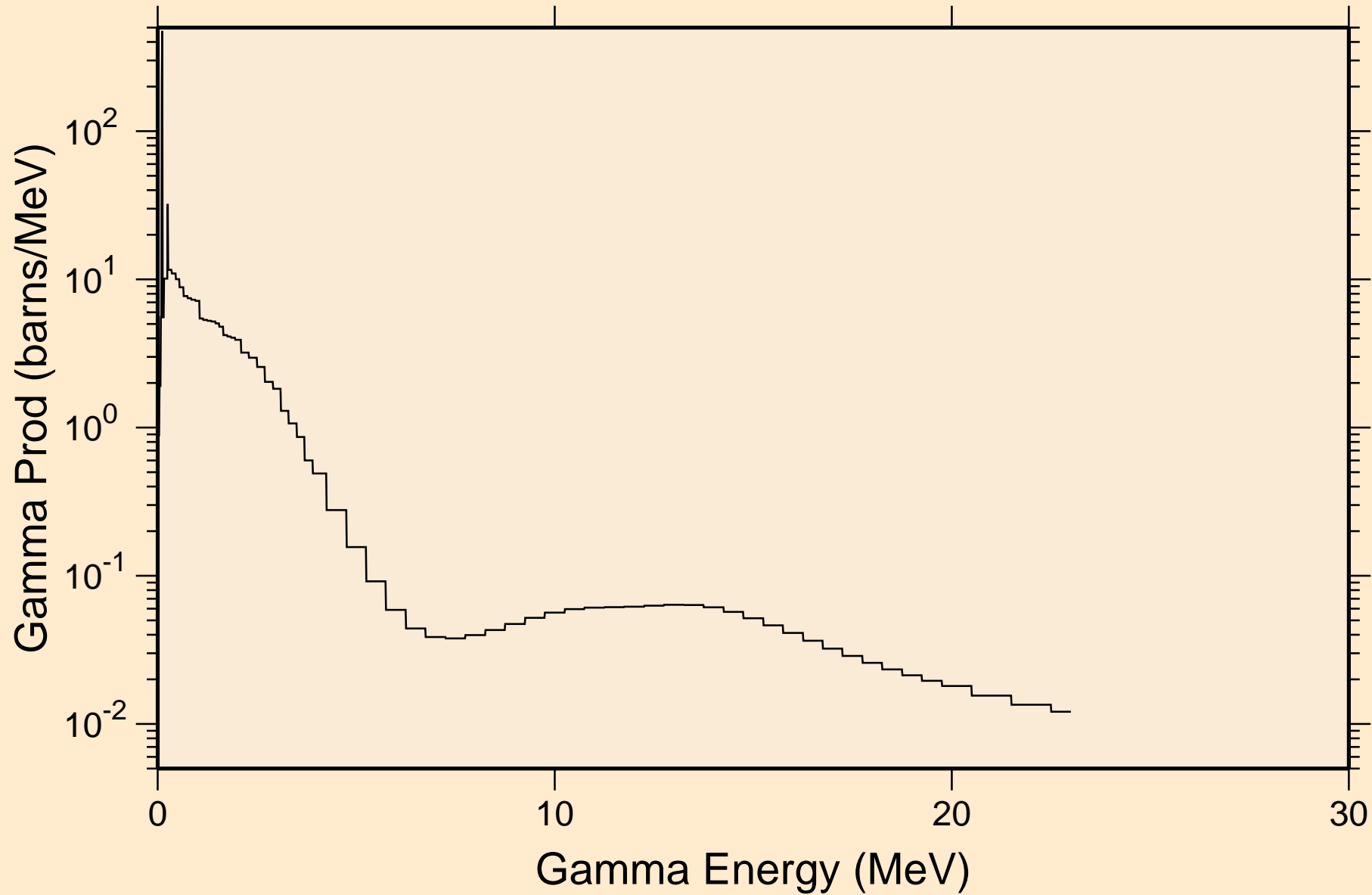

# ES239 NEUTRON ACER TENDL-2021 LIBRARY; T=293.6K

## Particle heating contributions

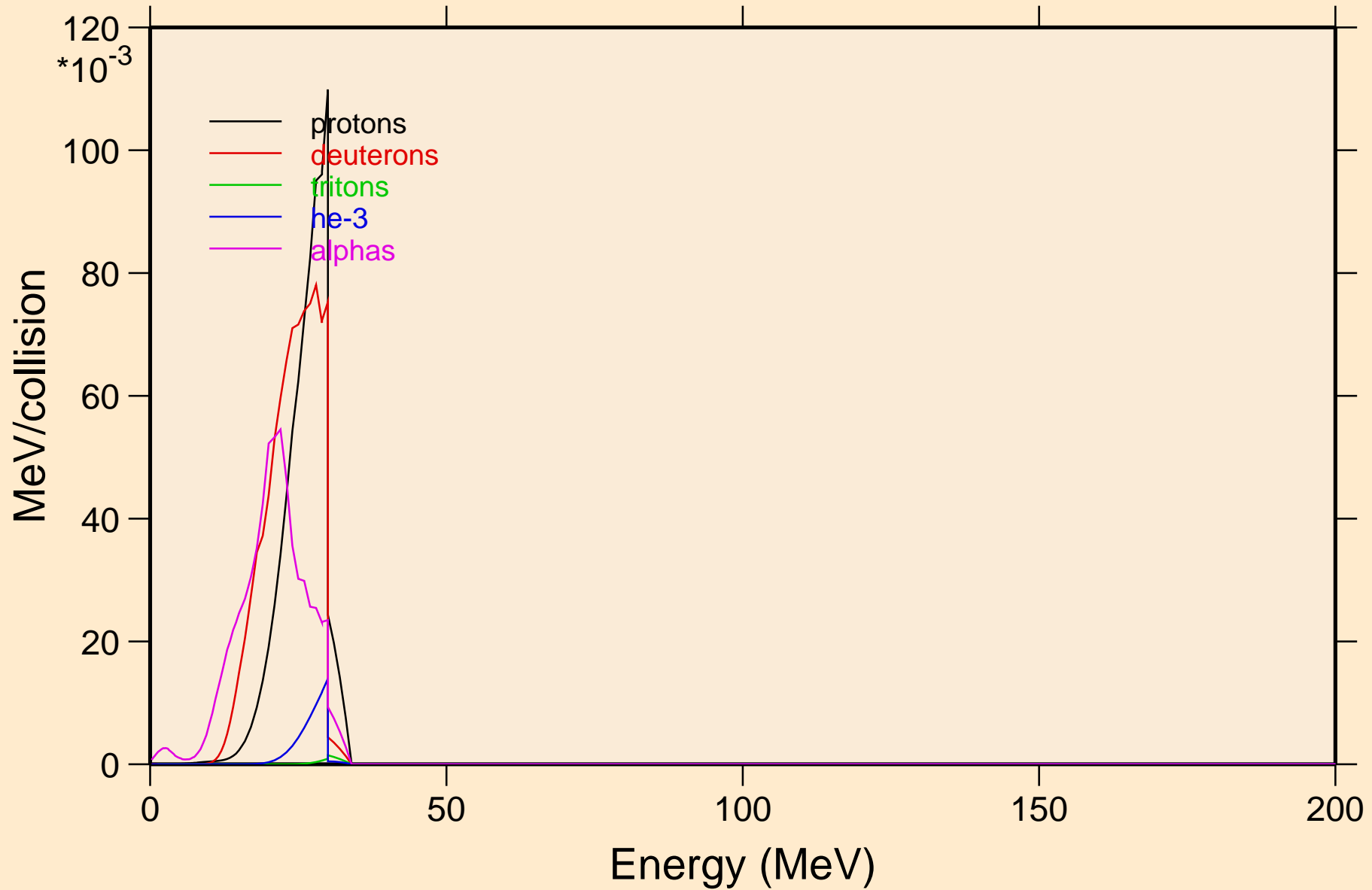

ES239 NEUTRON ACER TENDL-2021 LIBRARY; T=293.6K  
Recoil Heating

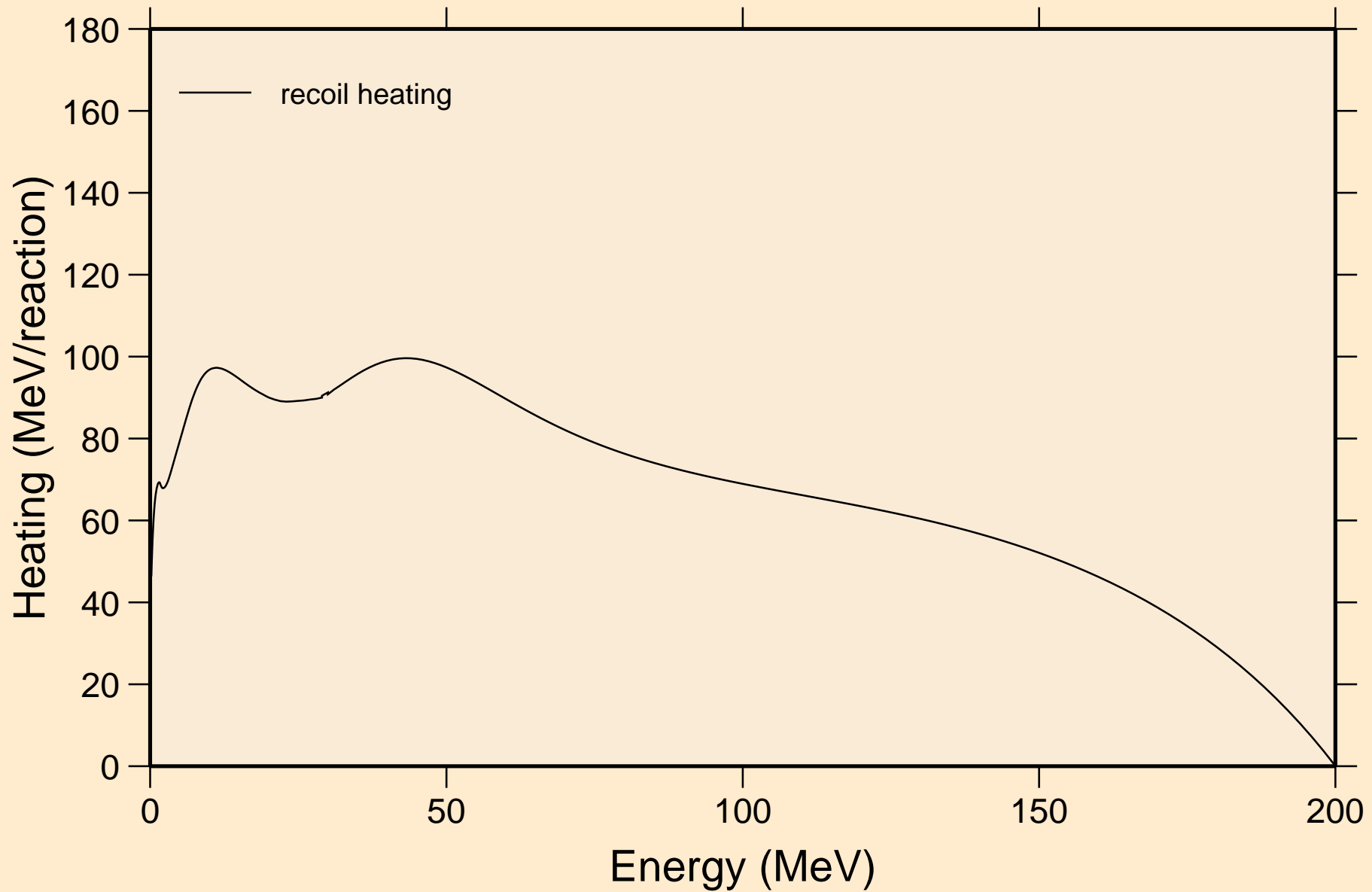



# ES239 NEUTRON ACER TENDL-2021 LIBRARY; T=293.6K

## Particle production cross sections

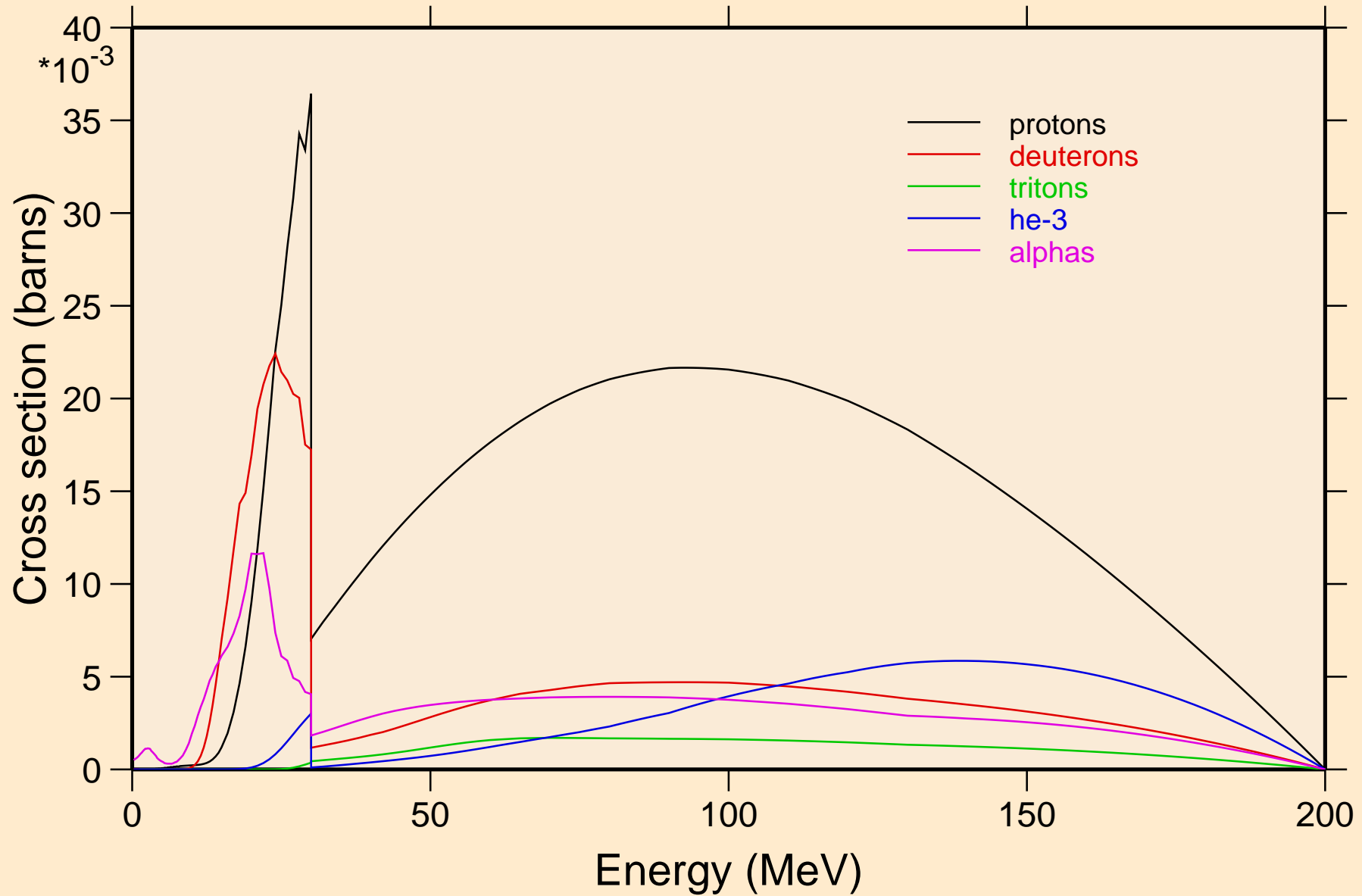

ES239 NEUTRON ACER TENDL-2021 LIBRARY; T=293.6K  
protons from (n,x)

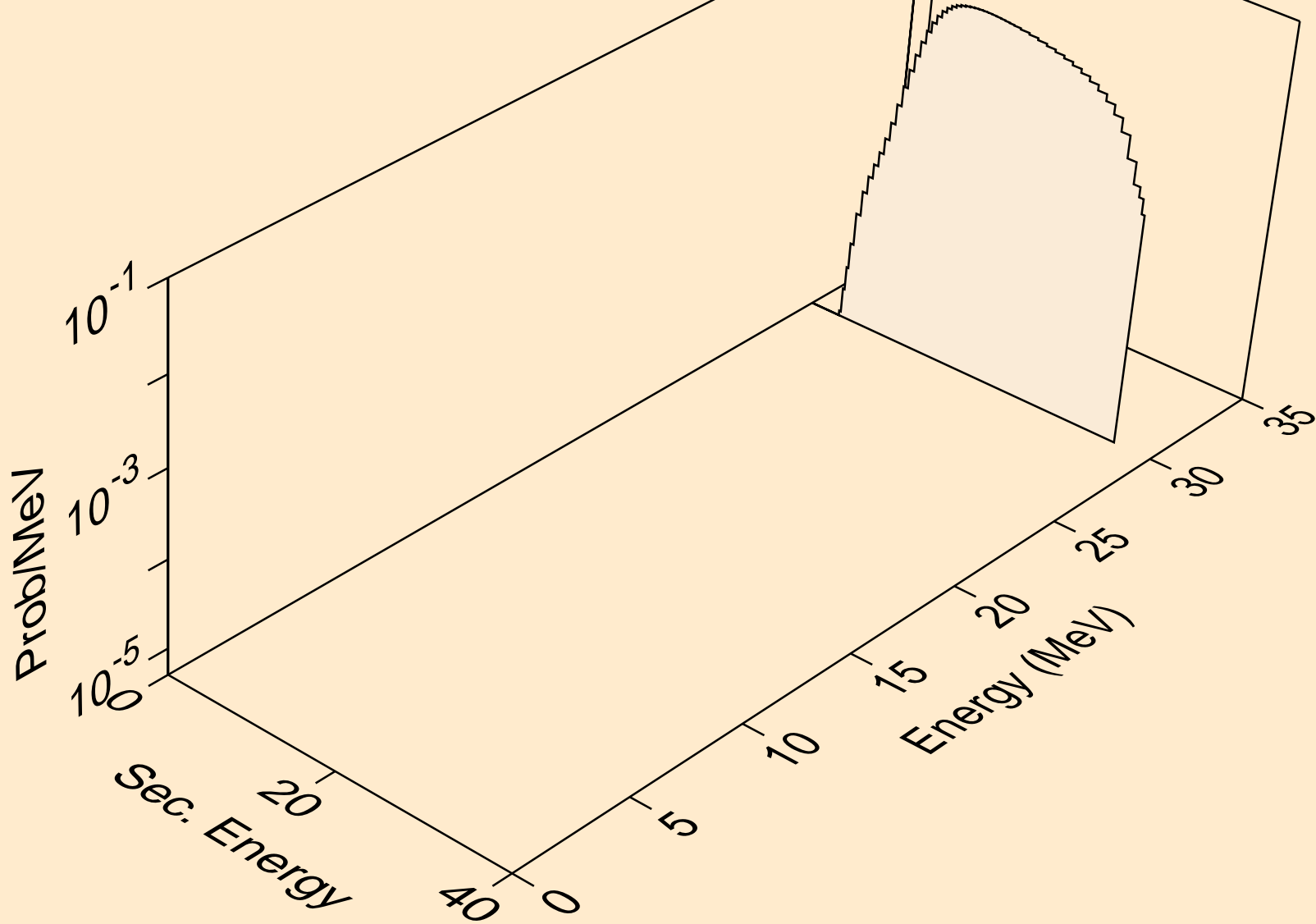

ES239 NEUTRON ACER TENDL-2021 LIBRARY; T=293.6K  
protons from (n,n\*)p

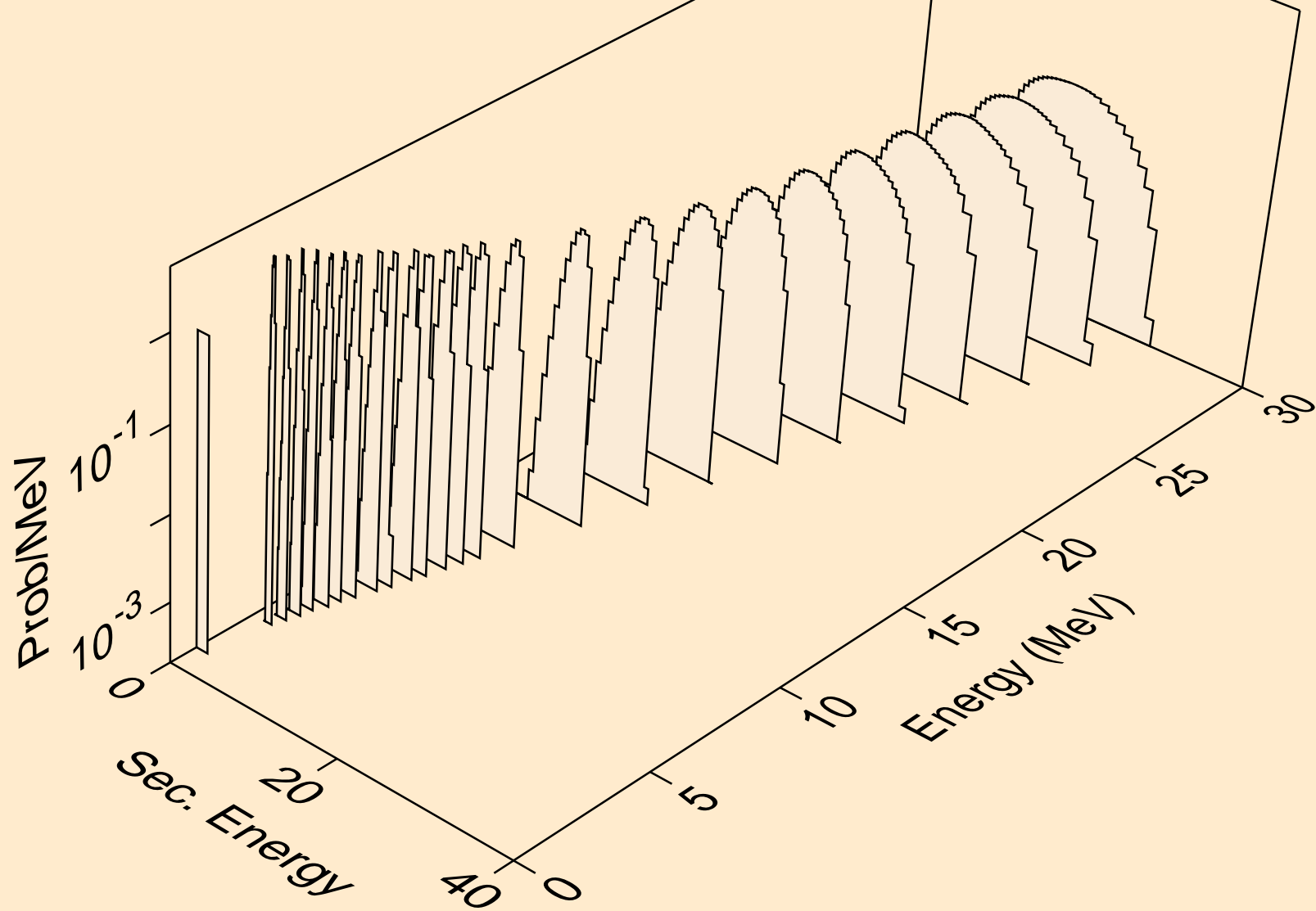

ES239 NEUTRON ACER TENDL-2021 LIBRARY; T=293.6K  
protons from (n,2np)

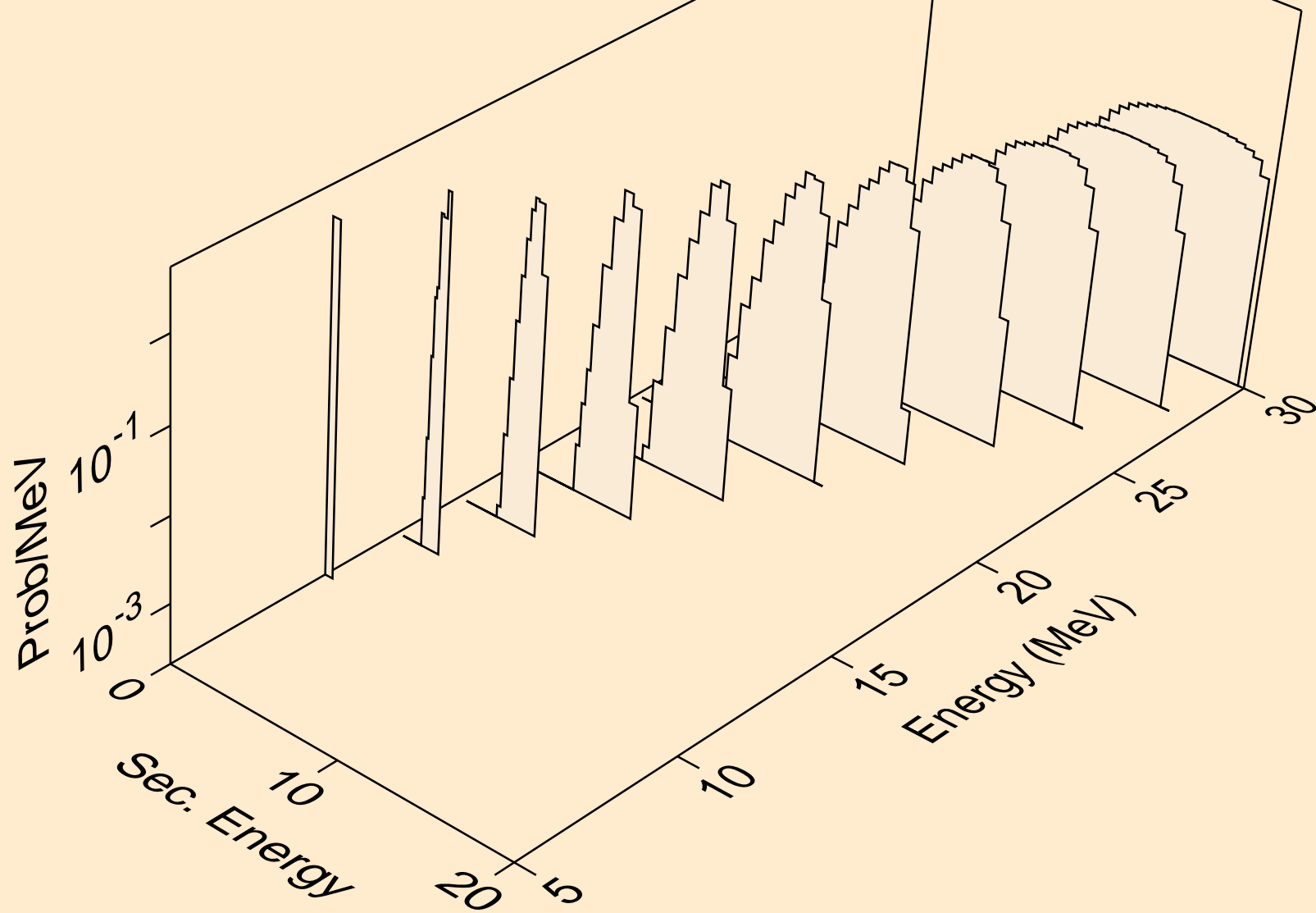

ES239 NEUTRON ACER TENDL-2021 LIBRARY; T=293.6K  
protons from (n,3np)

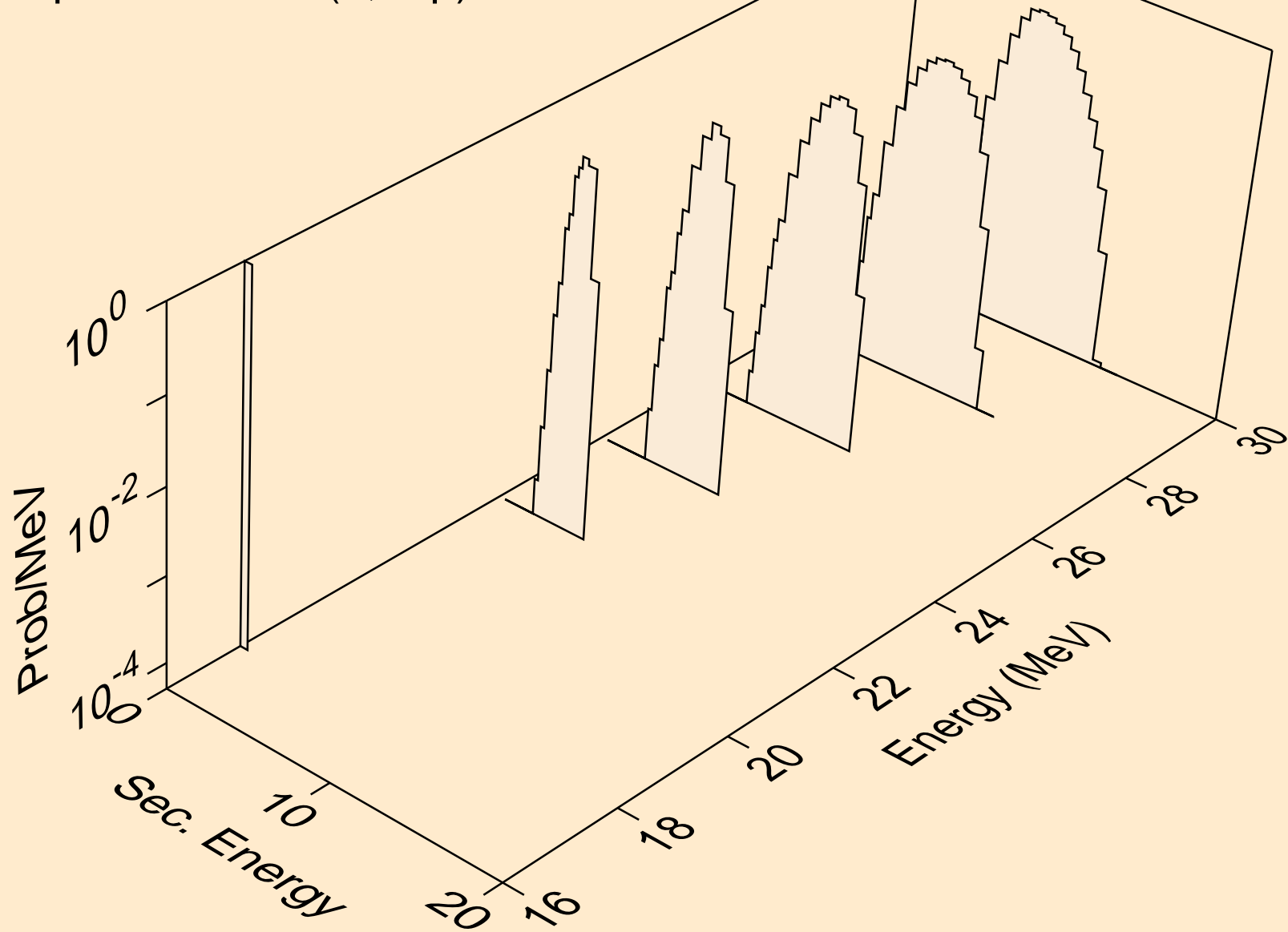

ES239 NEUTRON ACER TENDL-2021 LIBRARY; T=293.6K  
protons from (n,2np)

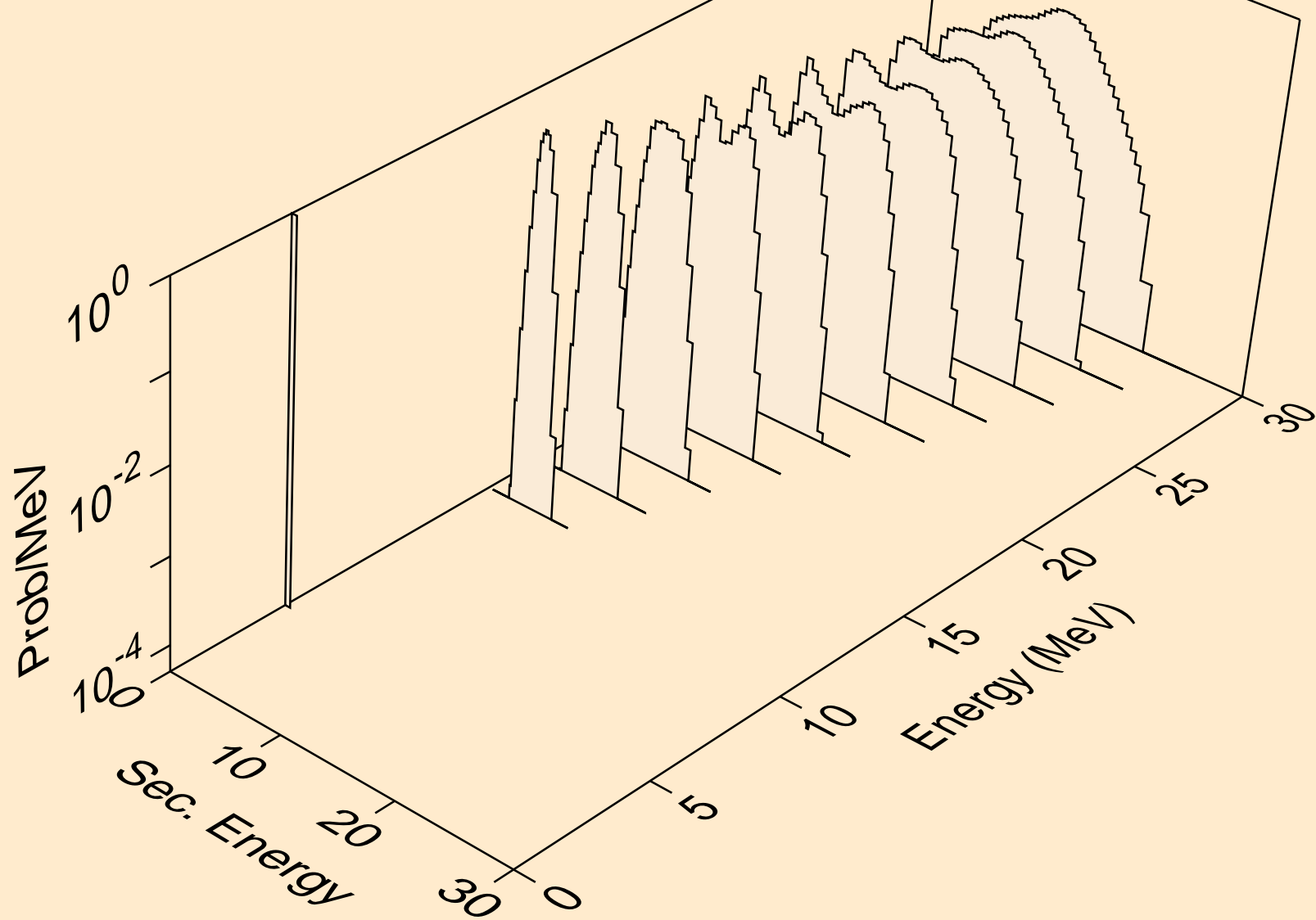

ES239 NEUTRON ACER TENDL-2021 LIBRARY; T=293.6K  
protons from (n,npa)

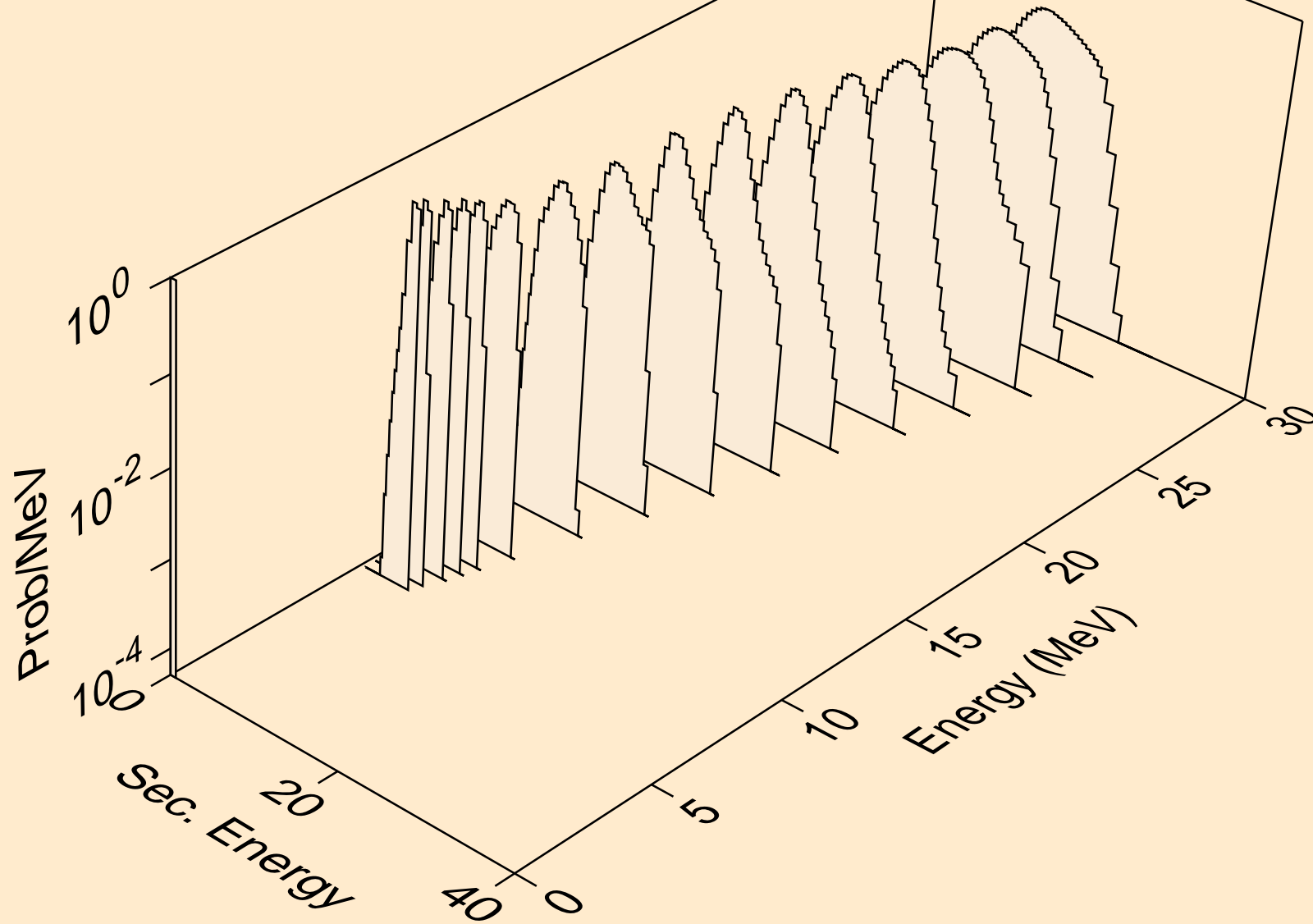

ES239 NEUTRON ACER TENDL-2021 LIBRARY; T=293.6K  
protons from (n,p)

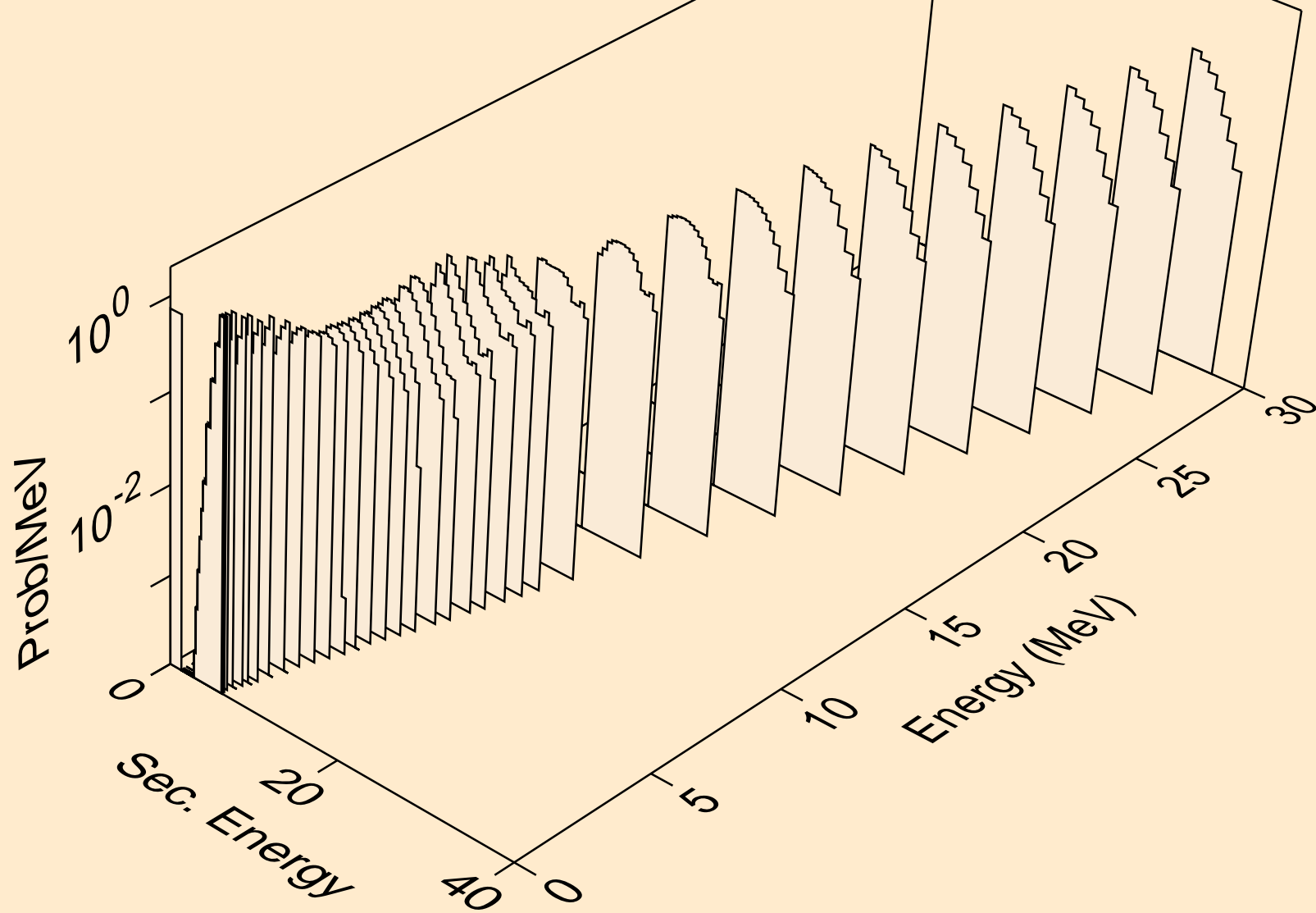



ES239 NEUTRON ACER TENDL-2021 LIBRARY; T=293.6K  
protons from (n,2p)

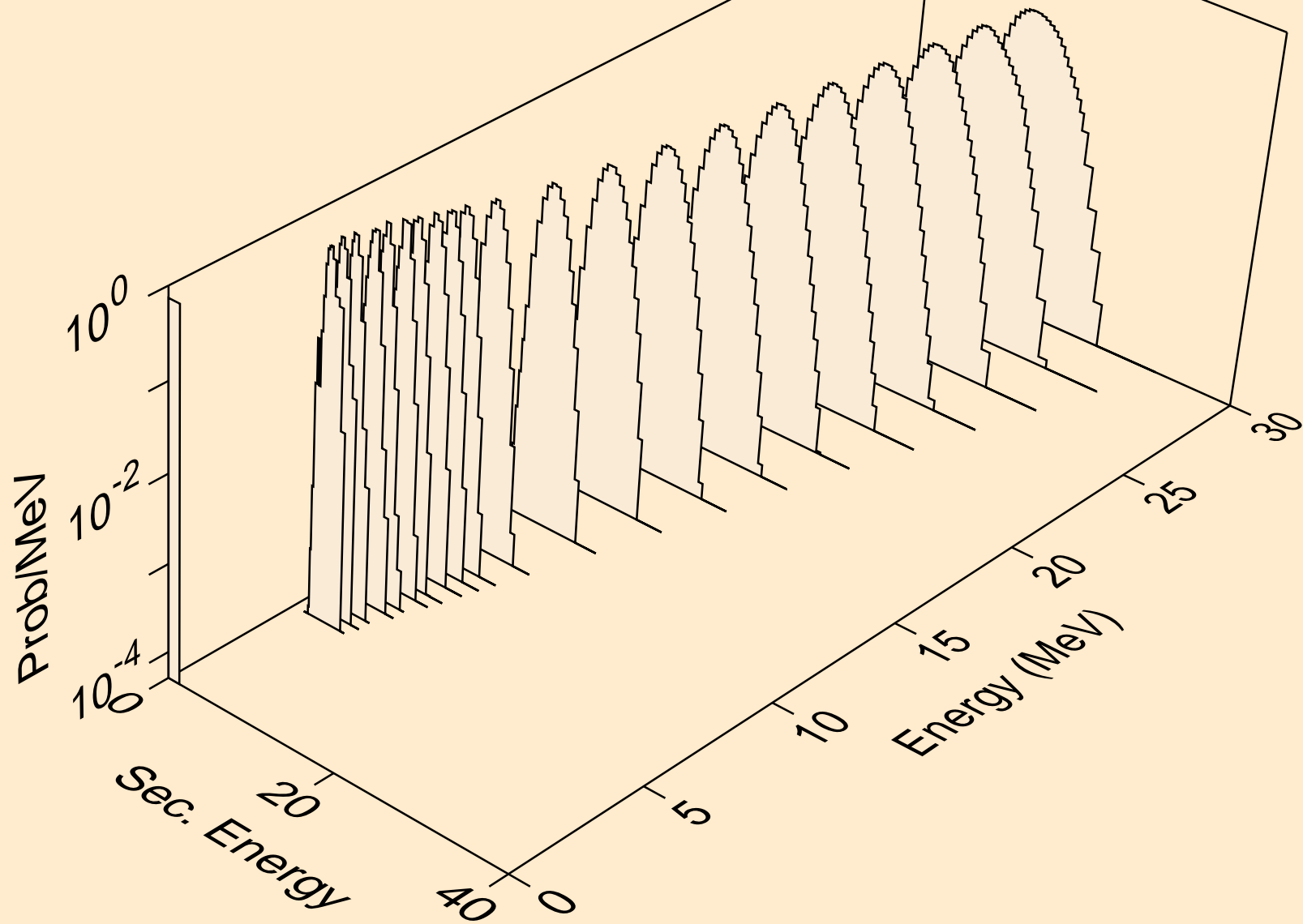

ES239 NEUTRON ACER TENDL-2021 LIBRARY; T=293.6K  
protons from (n,p)

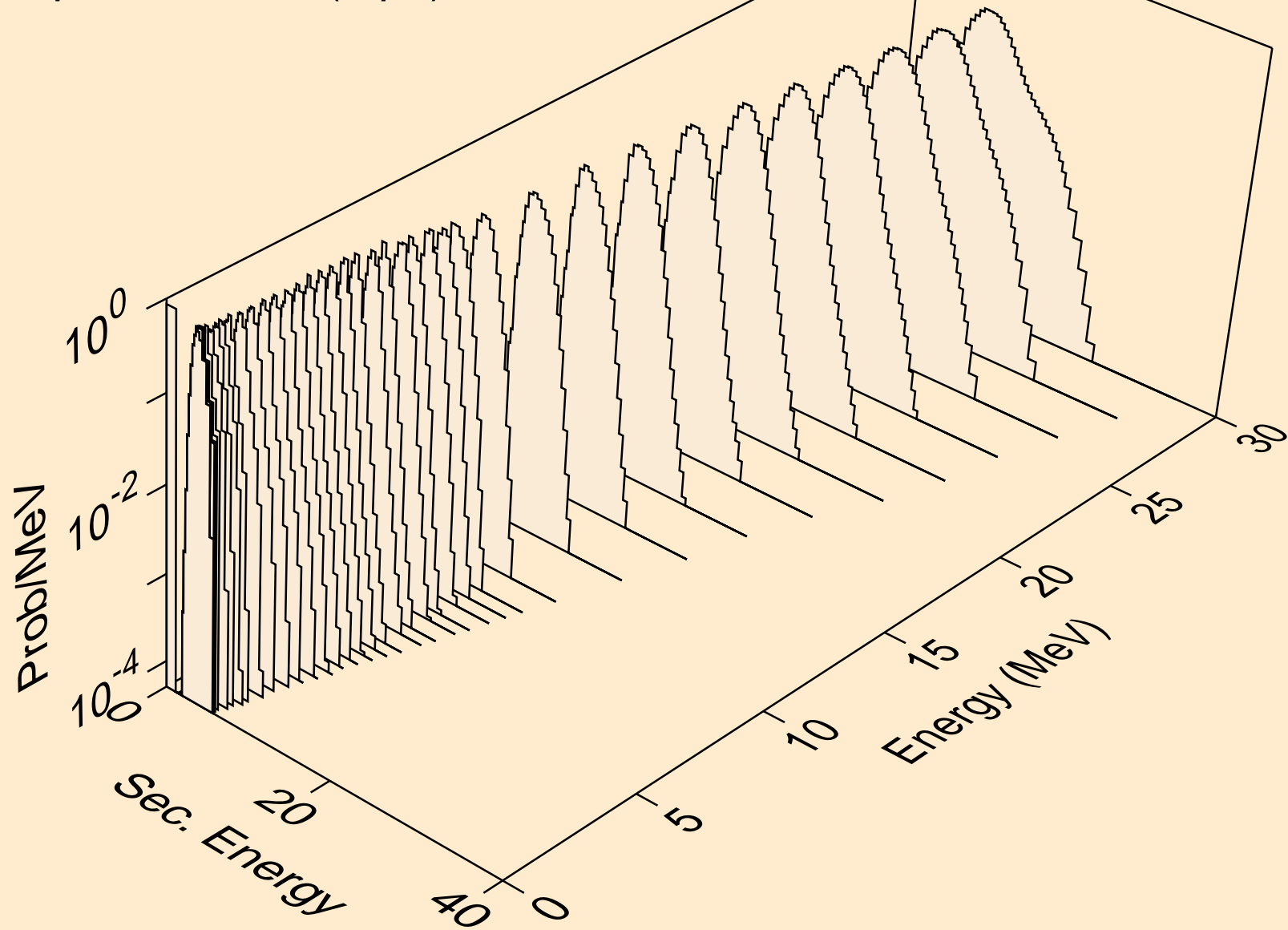

ES239 NEUTRON ACER TENDL-2021 LIBRARY; T=293.6K  
protons from (n,pd)

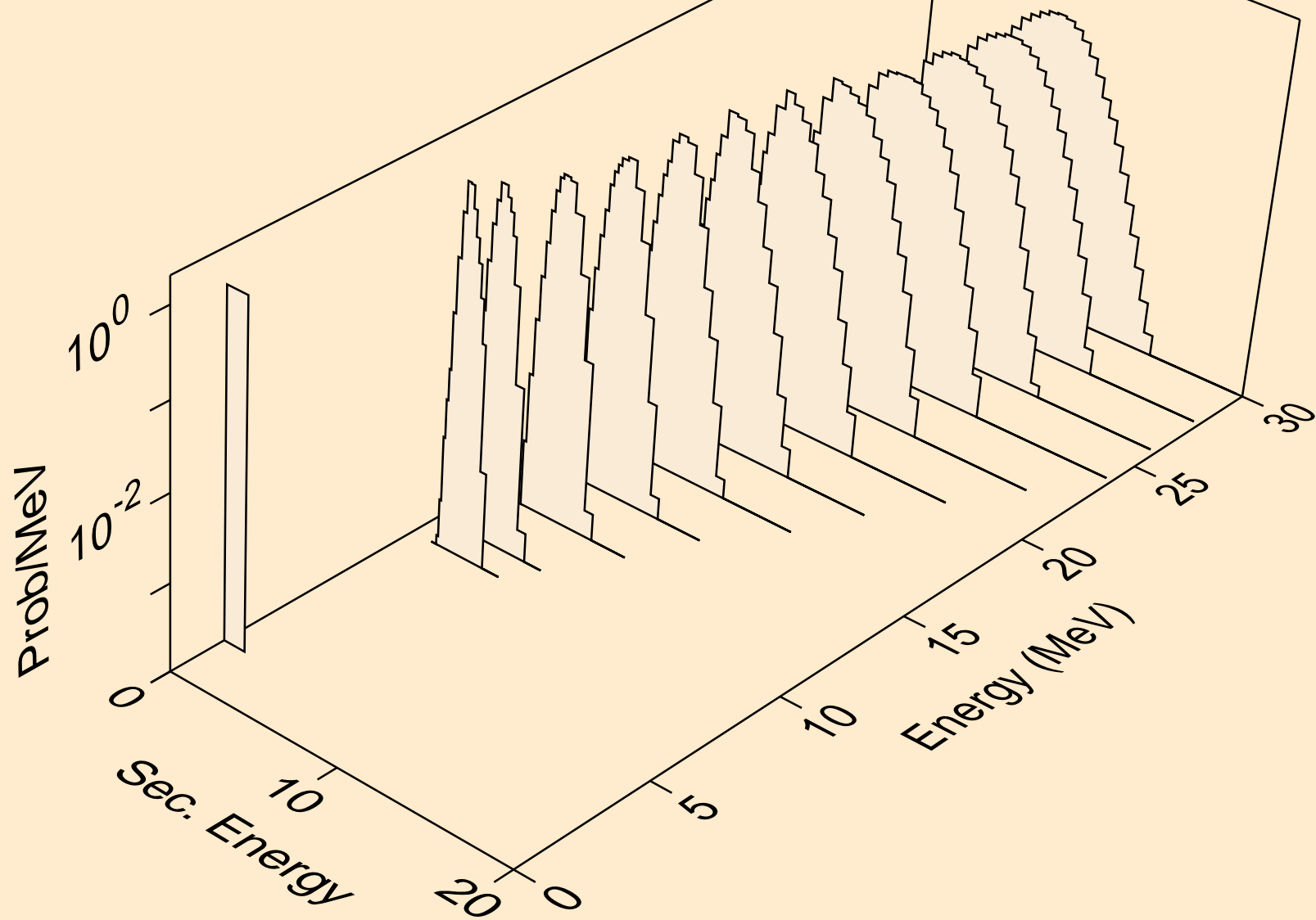

ES239 NEUTRON ACER TENDL-2021 LIBRARY; T=293.6K  
protons from (n,pt)

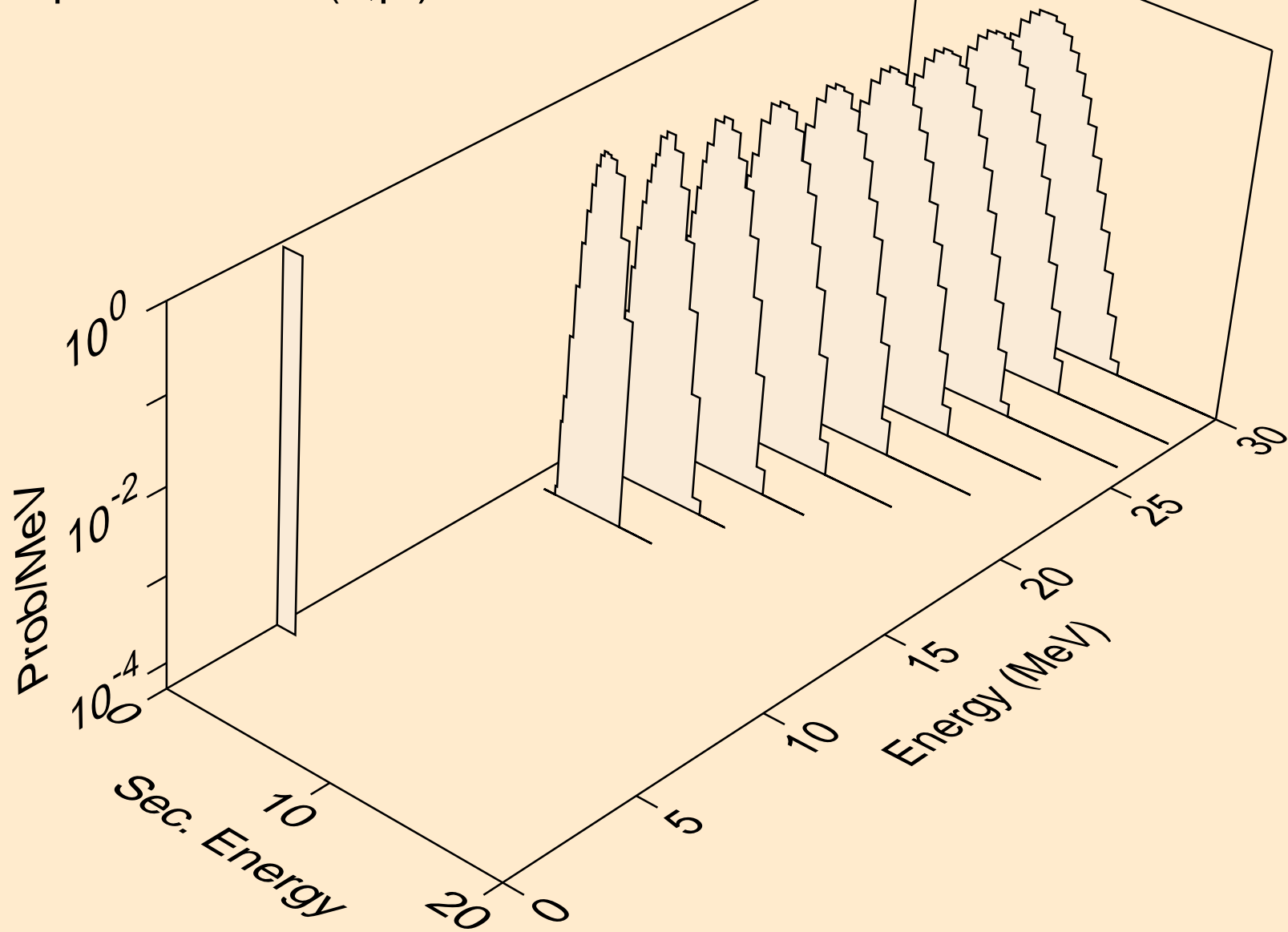

ES239 NEUTRON ACER TENDL-2021 LIBRARY; T=293.6K  
deuterons from (n,x)

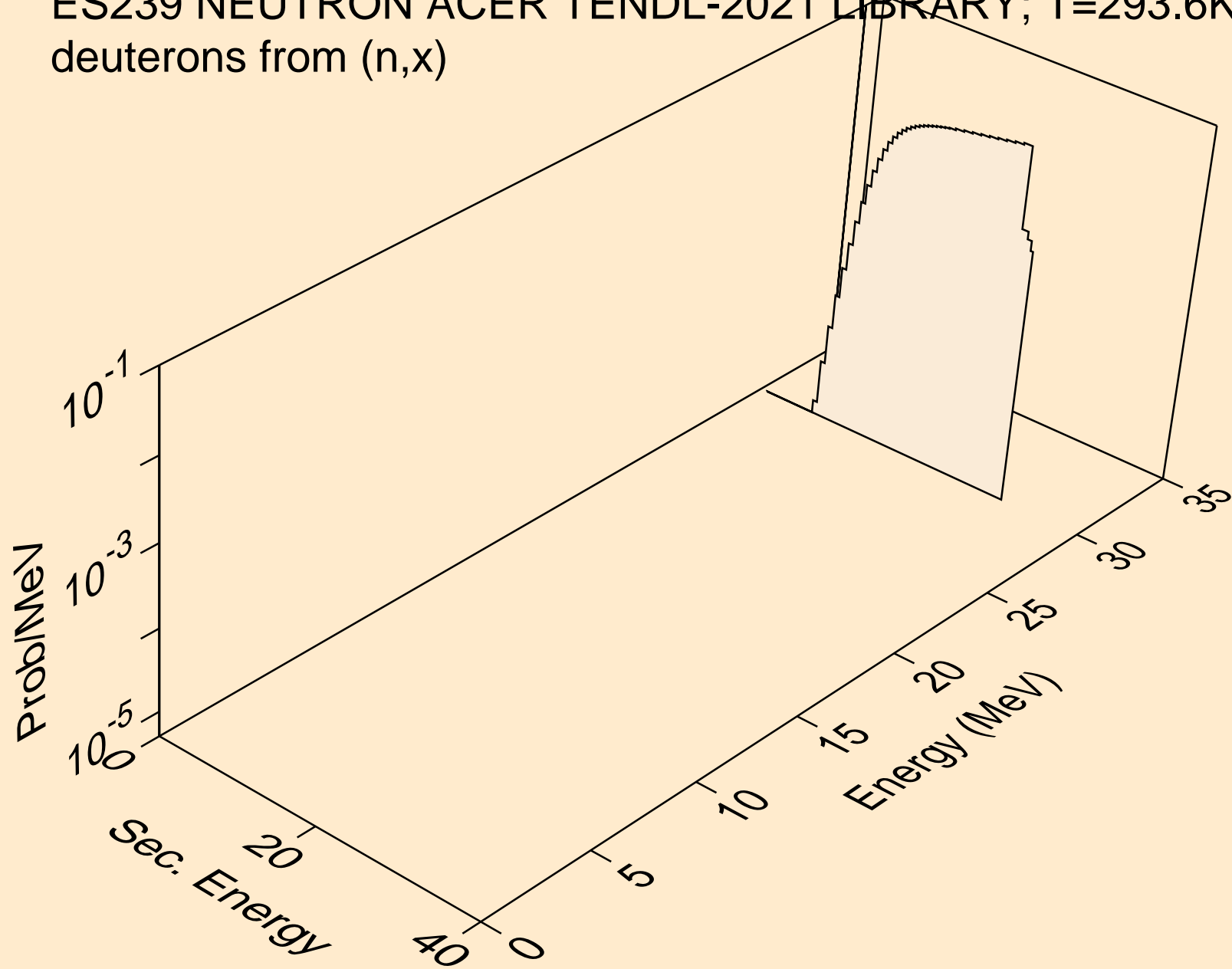

ES239 NEUTRON ACER TENDL-2021 LIBRARY; T=293.6K  
deuterons from (n,2nd)

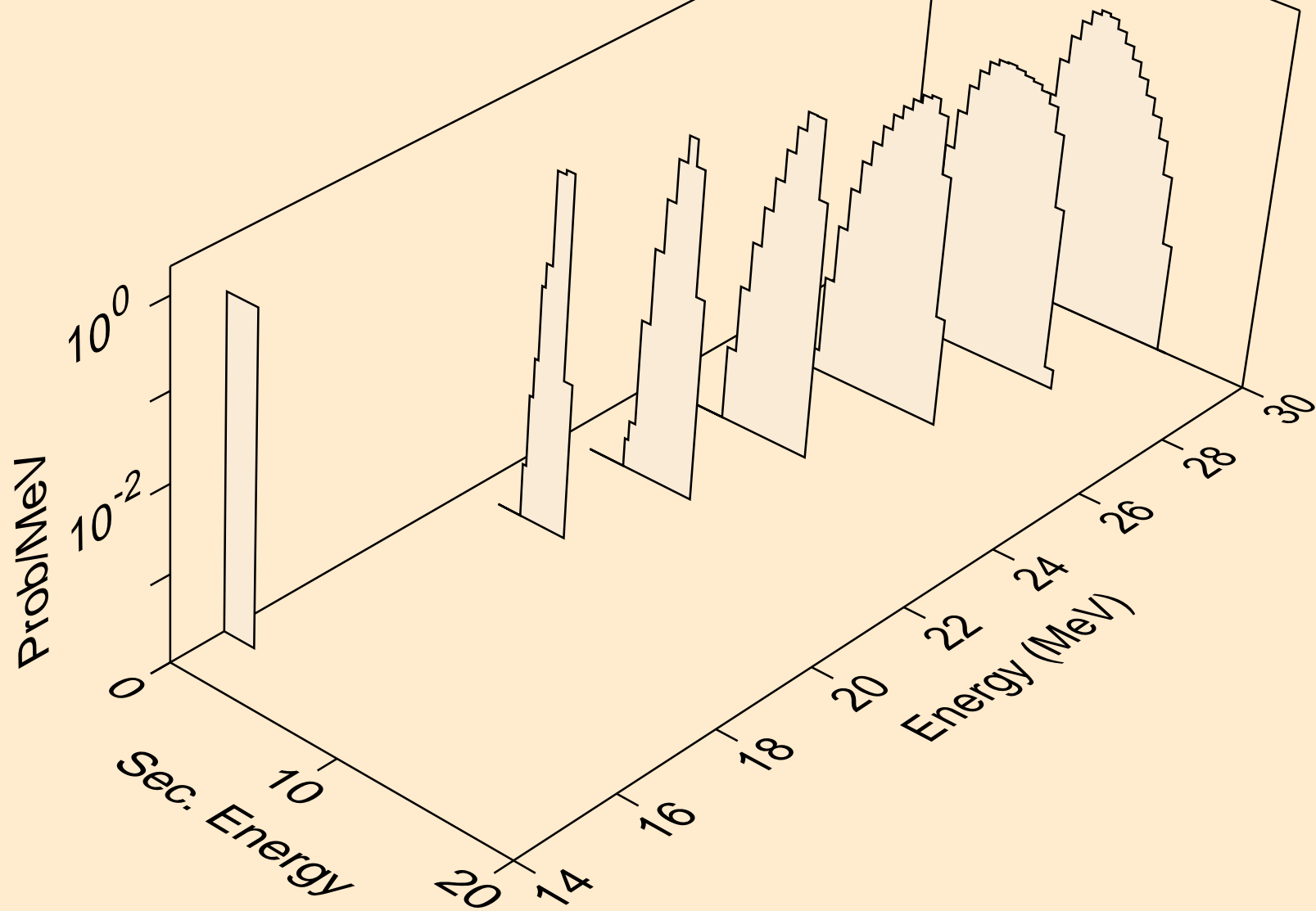

ES239 NEUTRON ACER TENDL-2021 LIBRARY; T=293.6K  
deuterons from (n,n\*)d

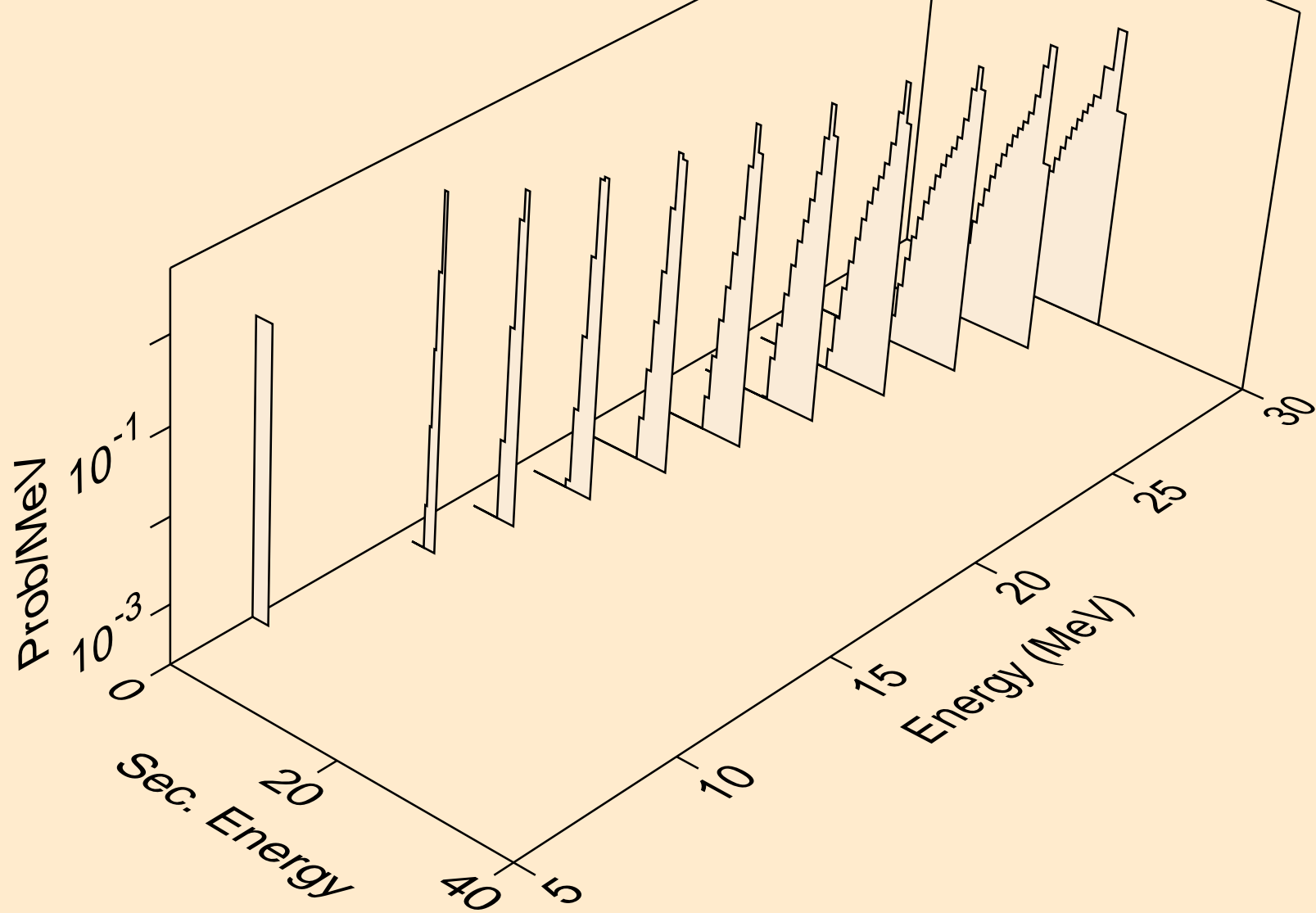

ES239 NEUTRON ACER TENDL-2021 LIBRARY; T=293.6K  
deuterons from (n,d)

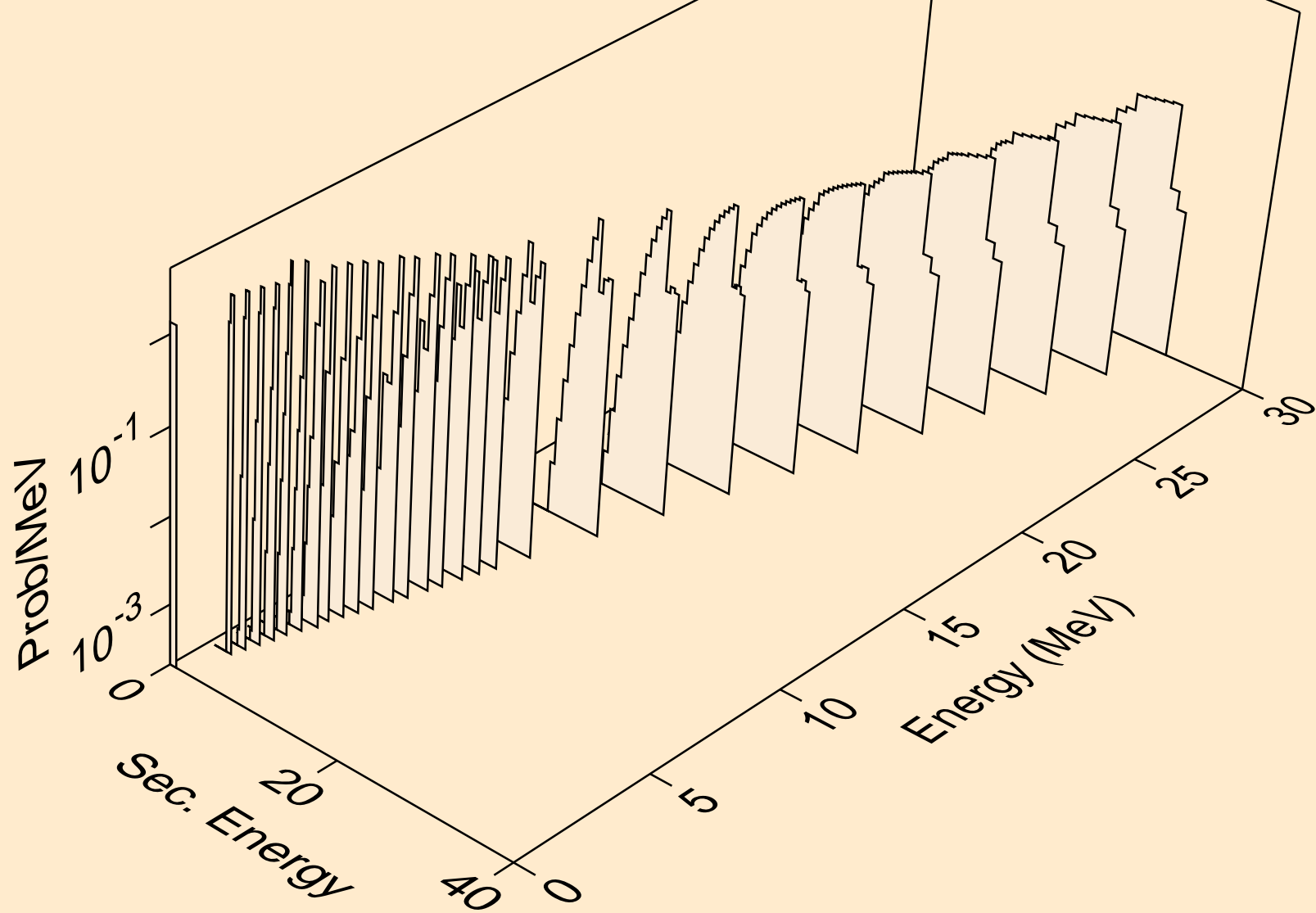



ES239 NEUTRON ACER TENDL-2021 LIBRARY; T=293.6K  
deuterons from (n,pd)

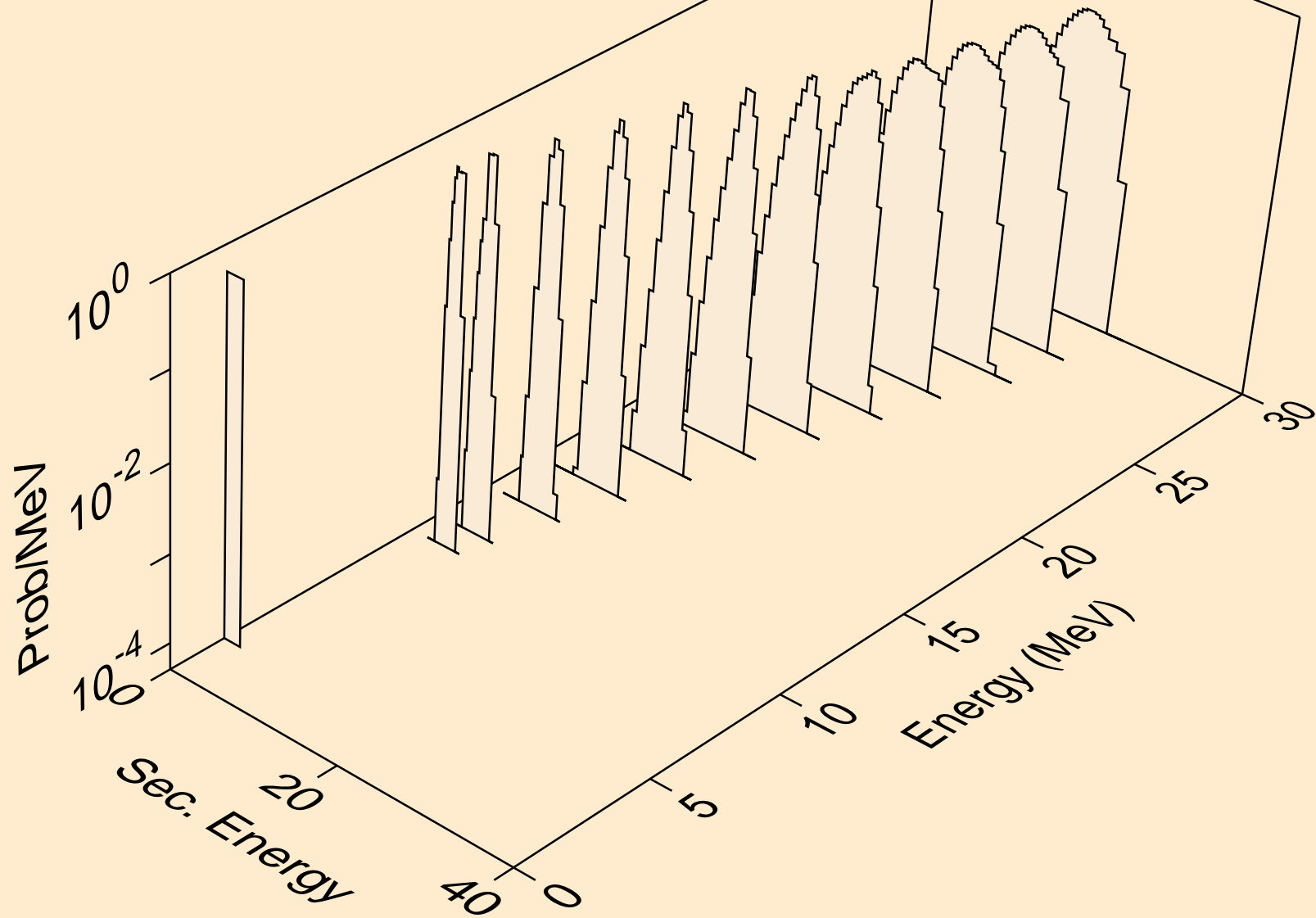

ES239 NEUTRON ACER TENDL-2021 LIBRARY; T=293.6K  
deuterons from (n,da)

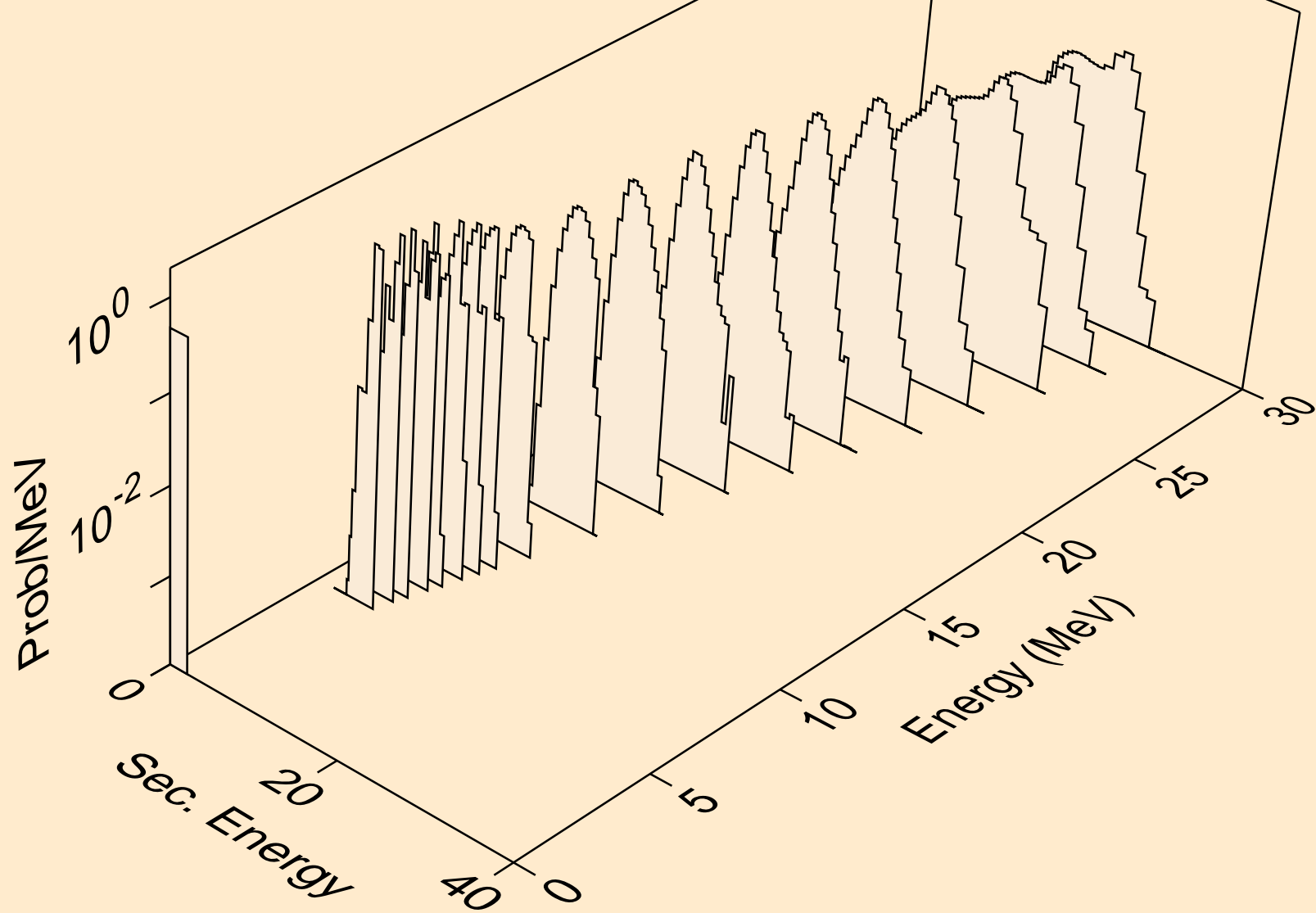

ES239 NEUTRON ACER TENDL-2021 LIBRARY; T=293.6K  
tritons from (n,x)

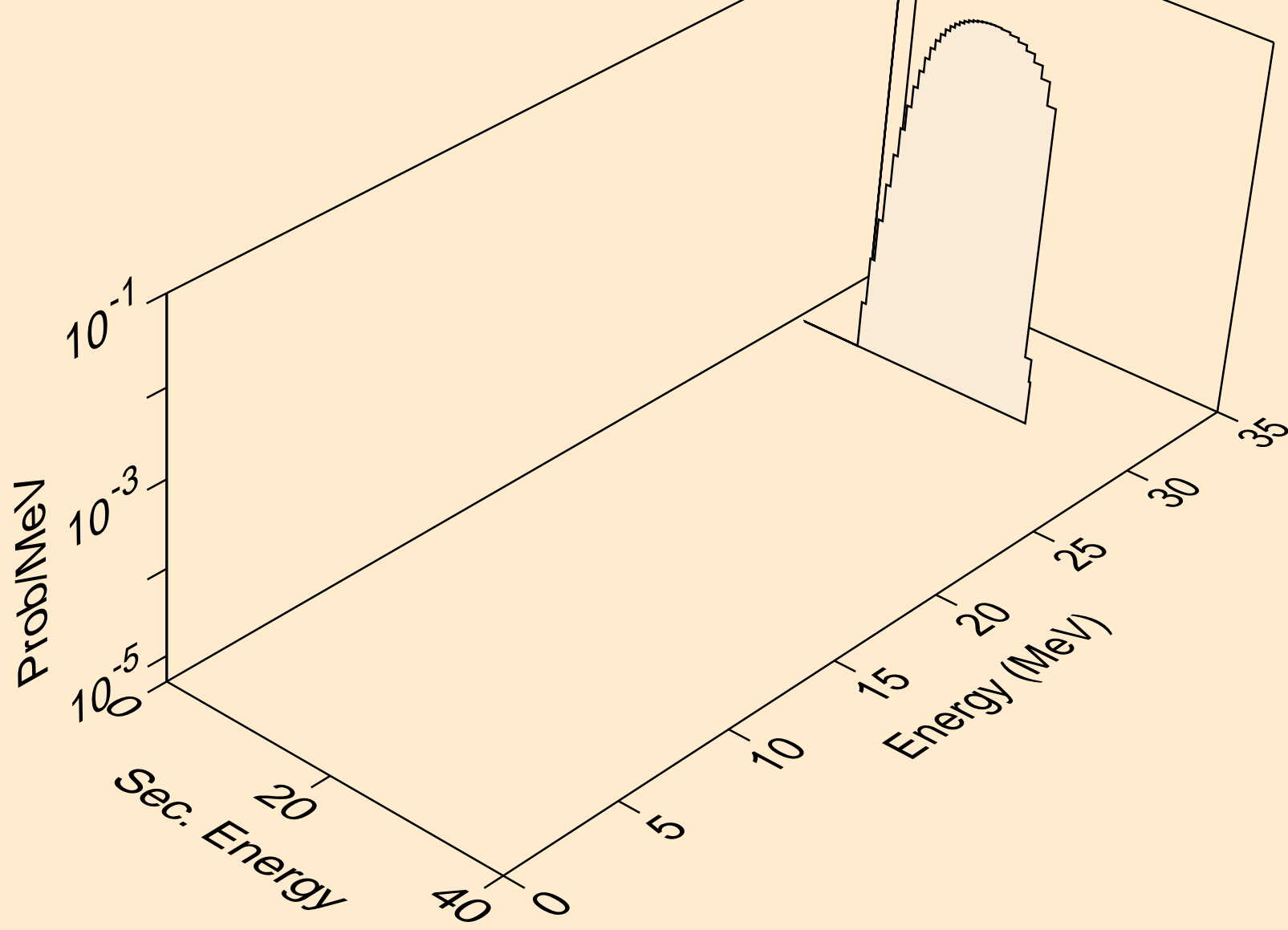

ES239 NEUTRON ACER TENDL-2021 LIBRARY; T=293.6K  
tritons from (n,n\*)t

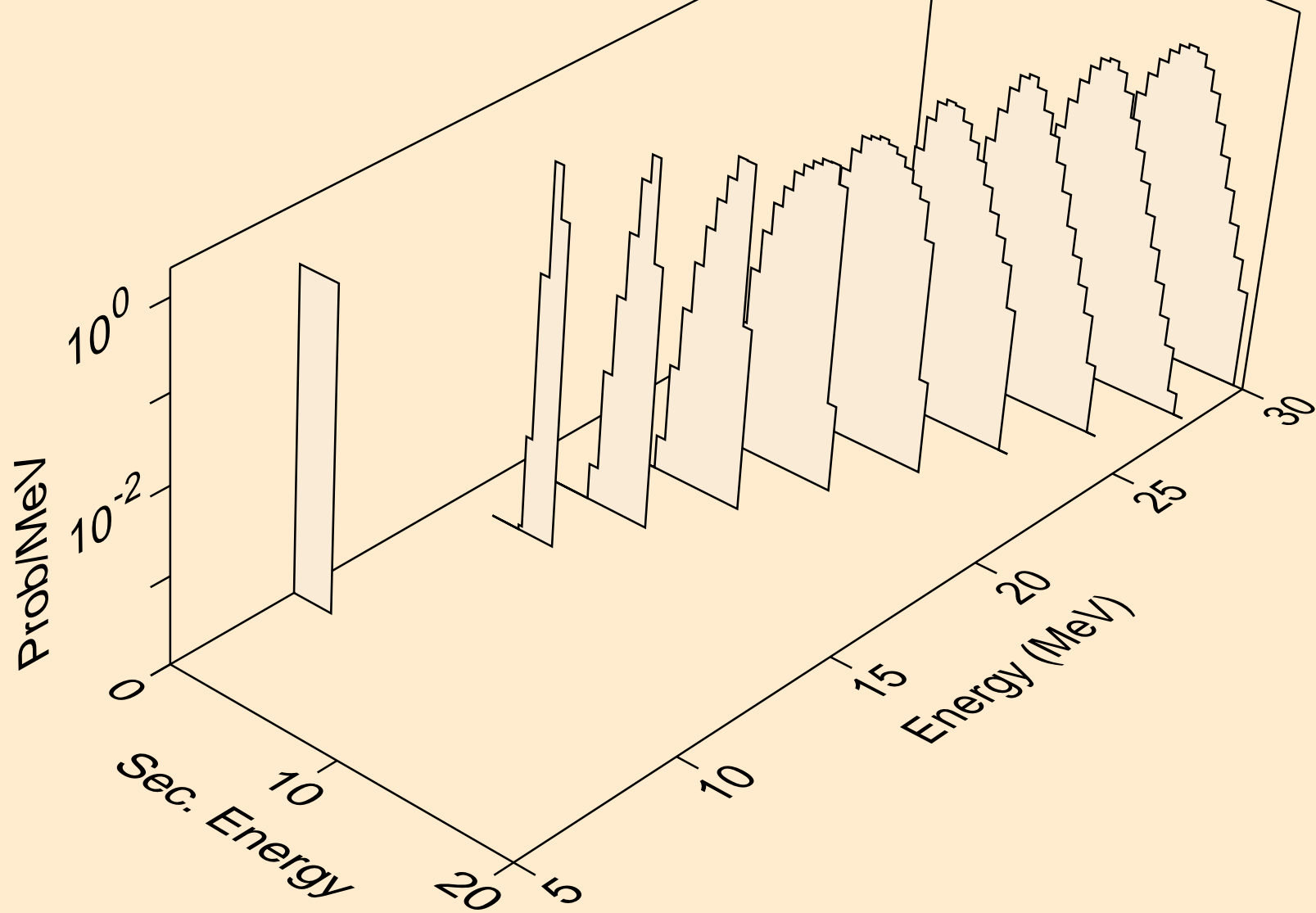

ES239 NEUTRON ACER TENDL-2021 LIBRARY; T=293.6K  
tritons from (n,t)

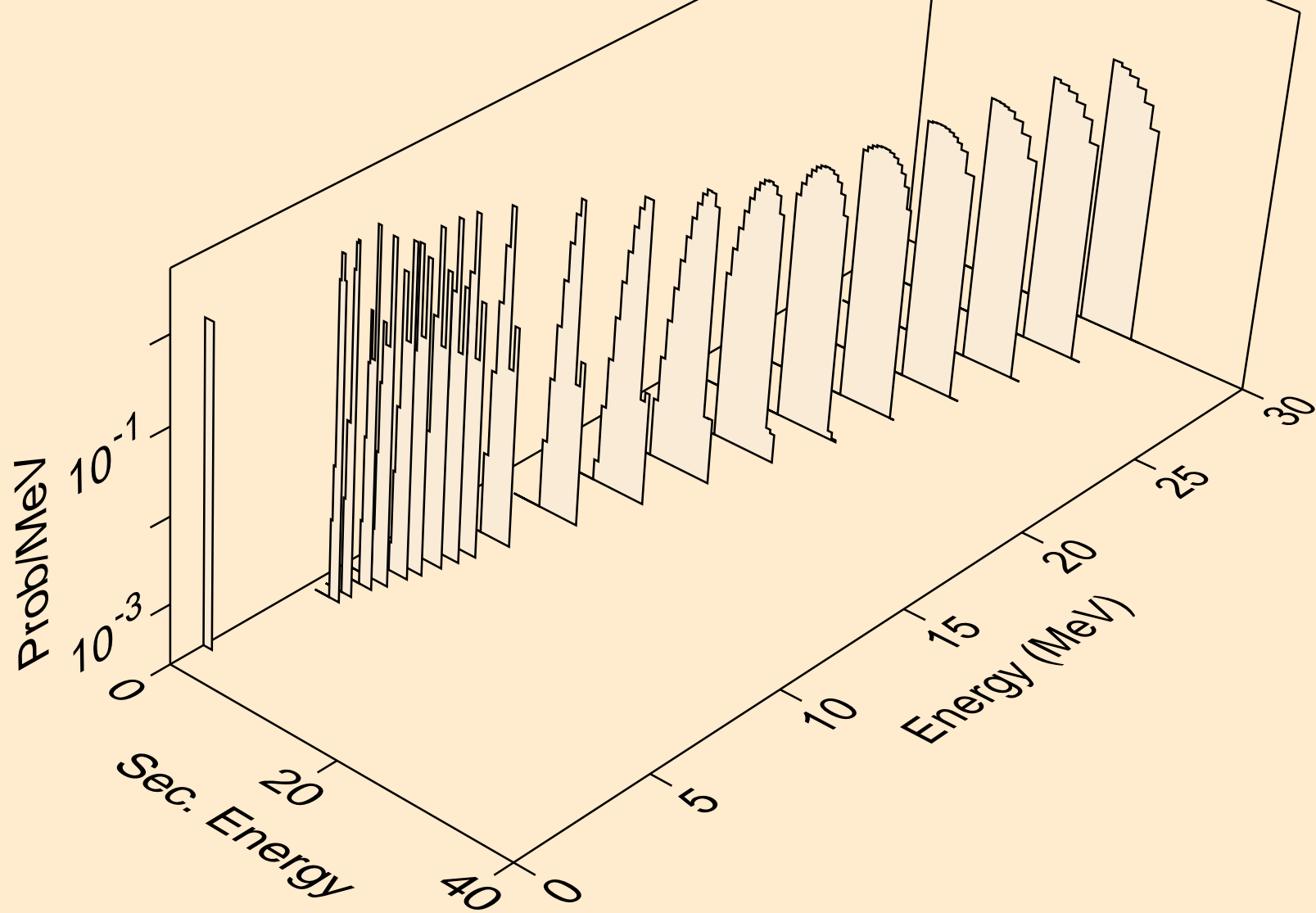

ES239 NEUTRON ACER TENDL-2021 LIBRARY; T=293.6K  
tritons from (n,pt)

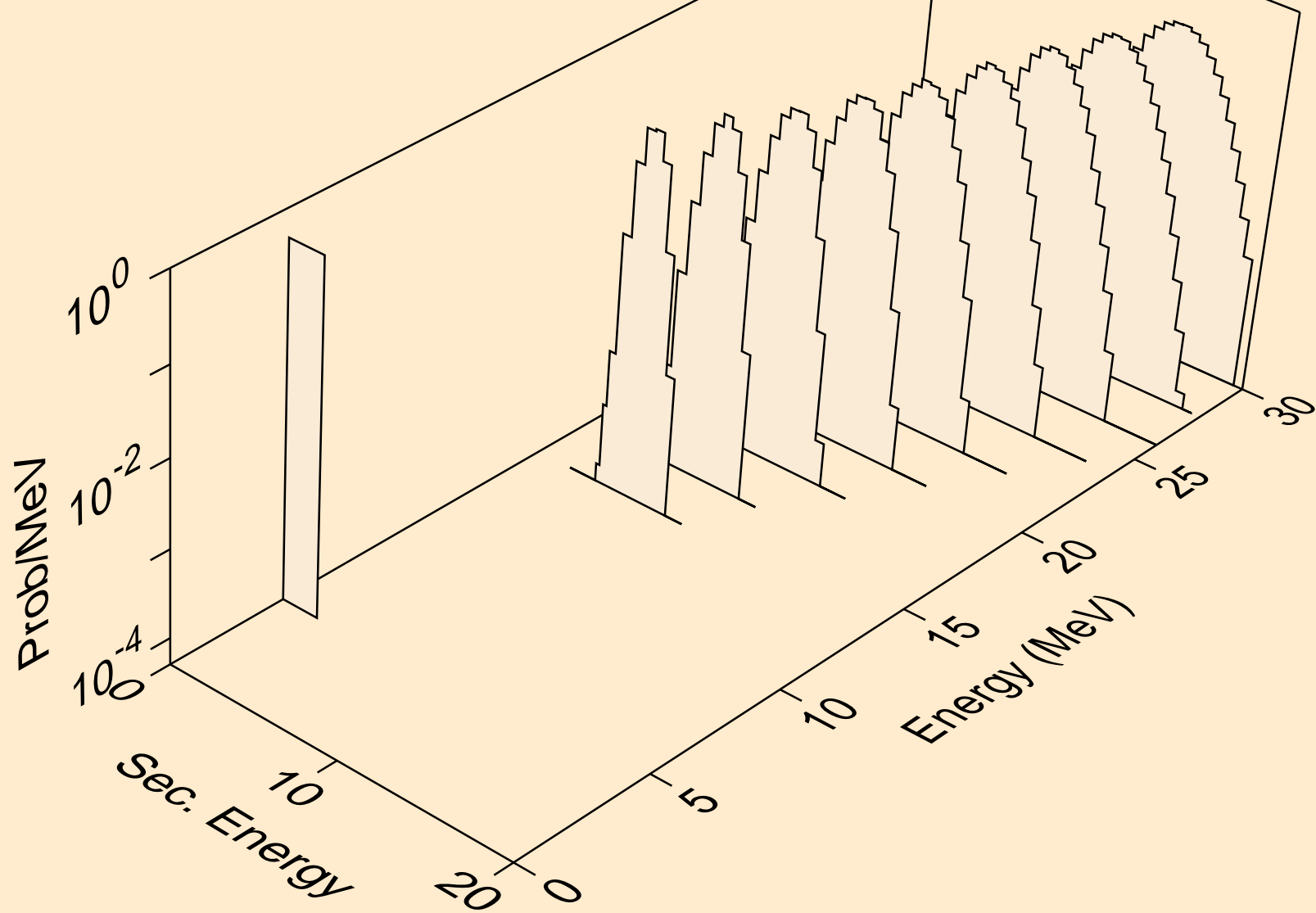

ES239 NEUTRON ACER TENDL-2021 LIBRARY; T=293.6K  
he3s from (n,x)

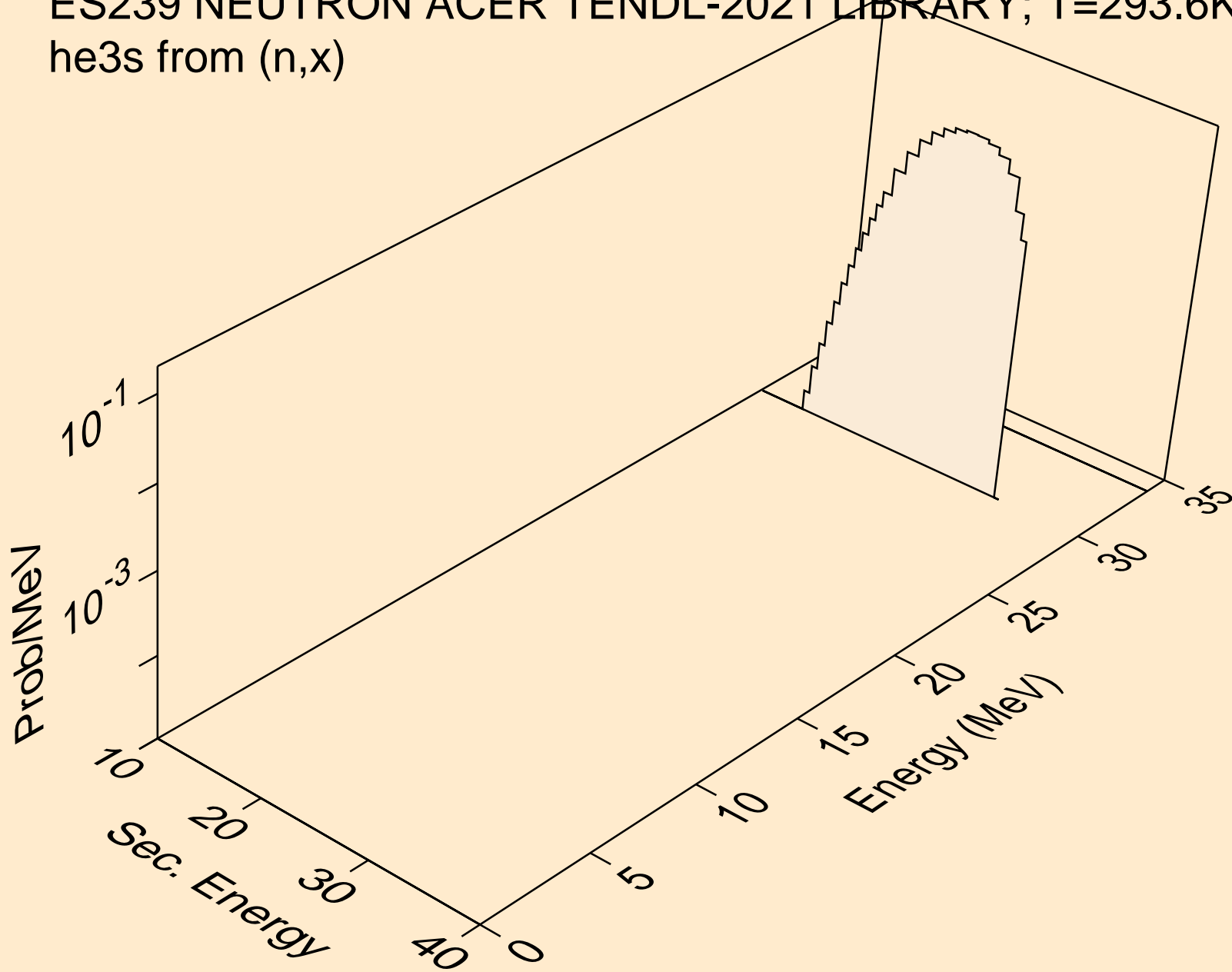

ES239 NEUTRON ACER TENDL-2021 LIBRARY; T=293.6K  
he3s from (n,n\*)he3

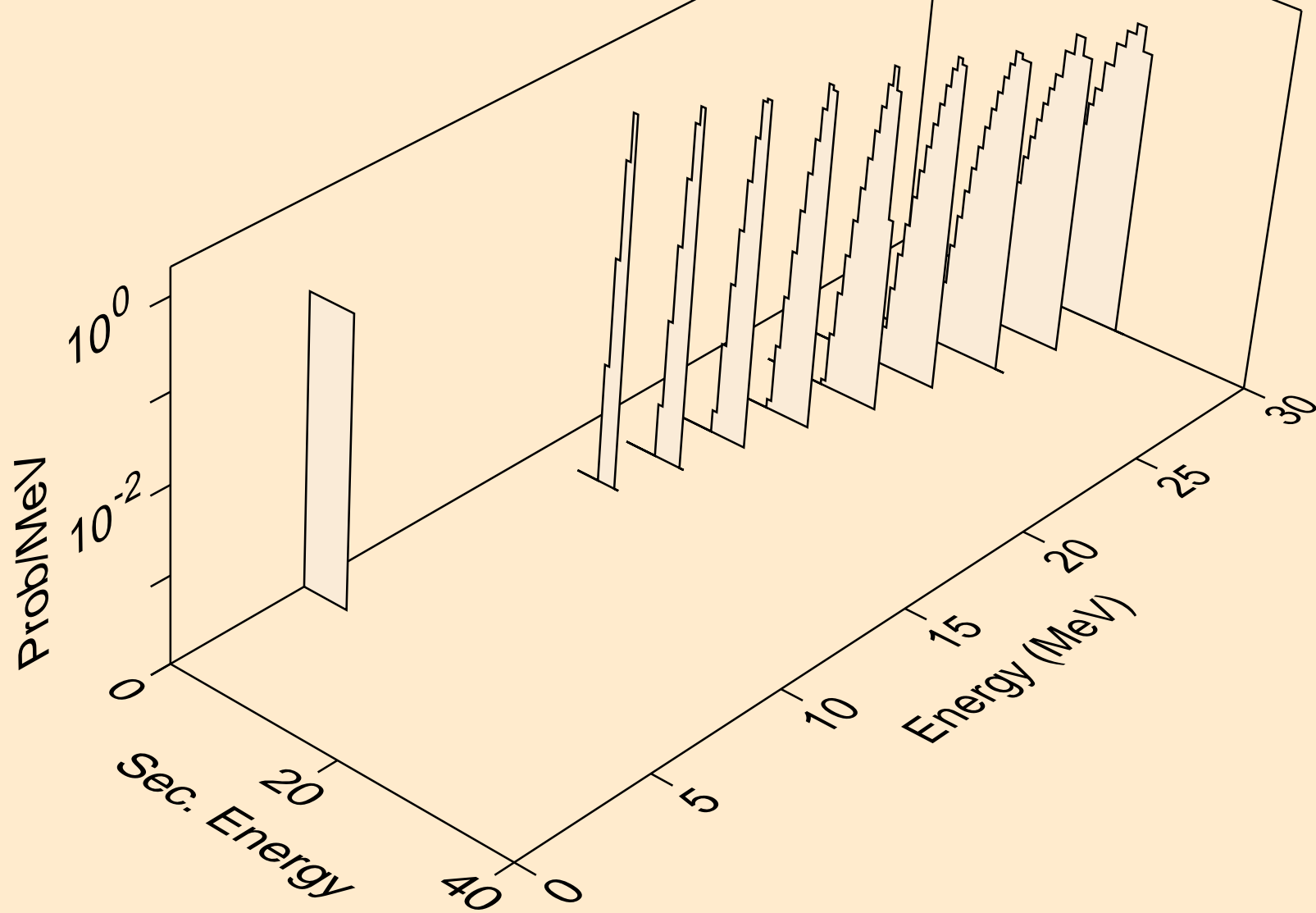



ES239 NEUTRON ACER TENDL-2021 LIBRARY; T=293.6K  
he3s from (n,he3)

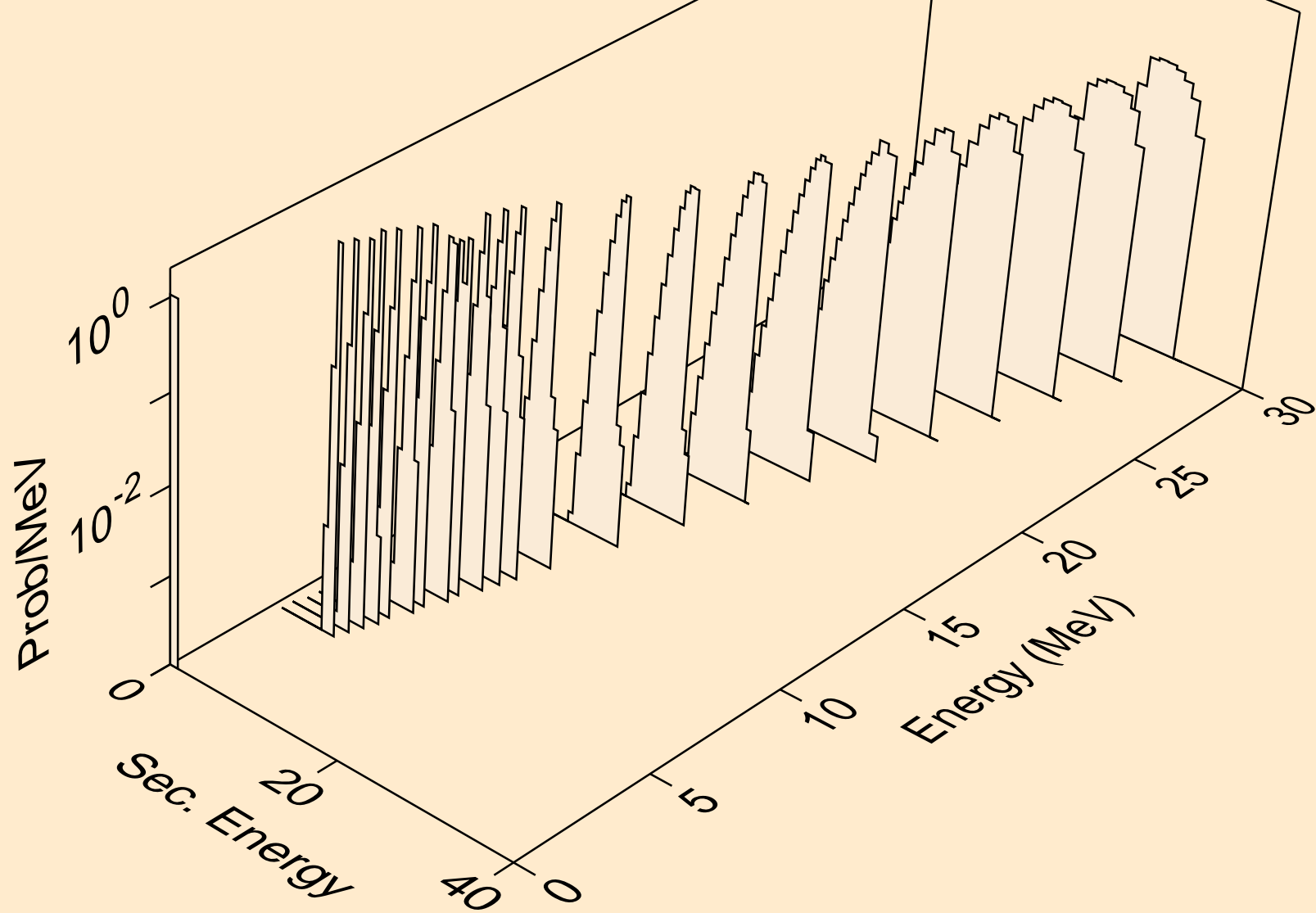

ES239 NEUTRON ACER TENDL-2021 LIBRARY; T=293.6K  
alphas from (n,x)

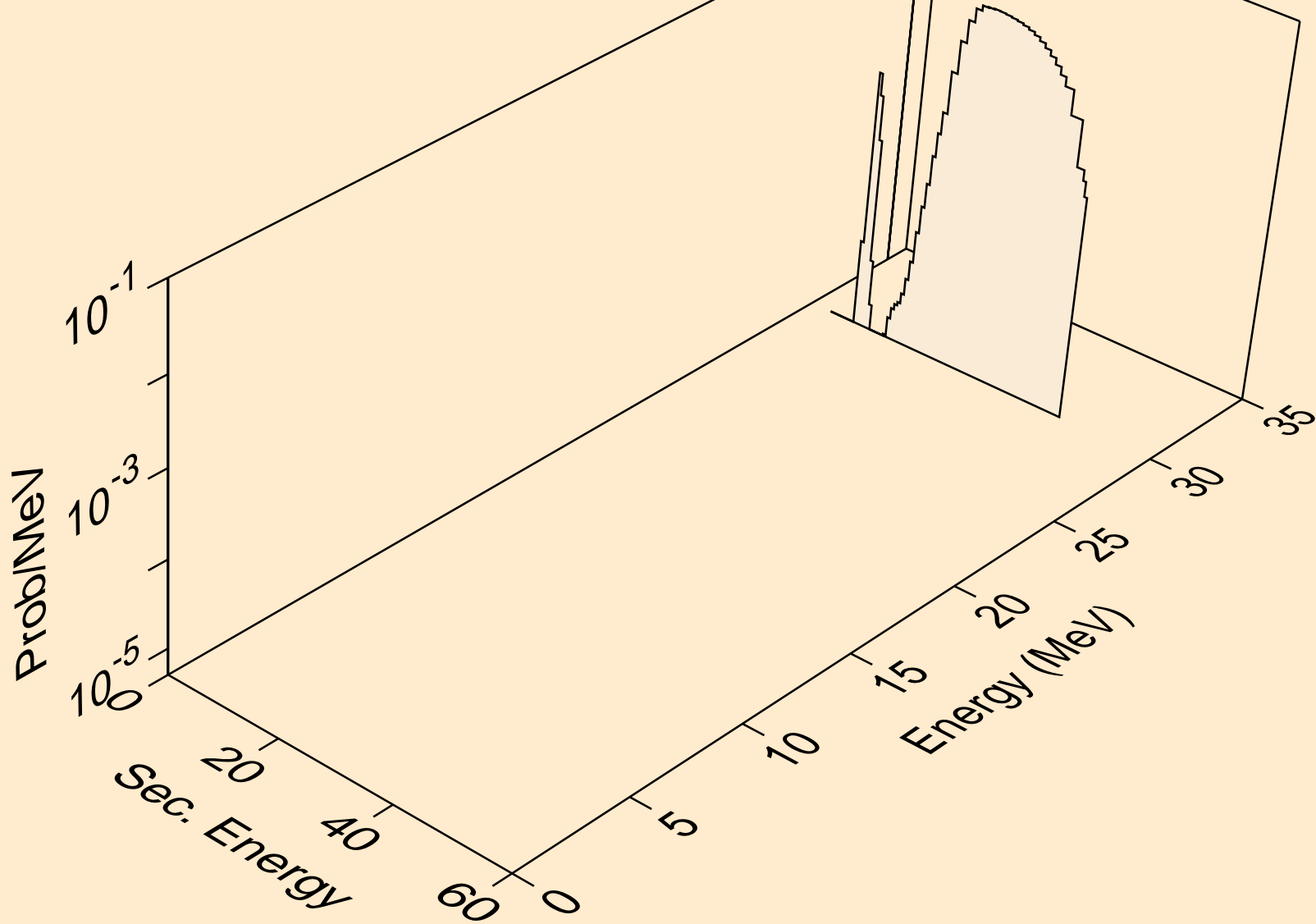

ES239 NEUTRON ACER TENDL-2021 LIBRARY; T=293.6K  
alphas from (n,n\*)a

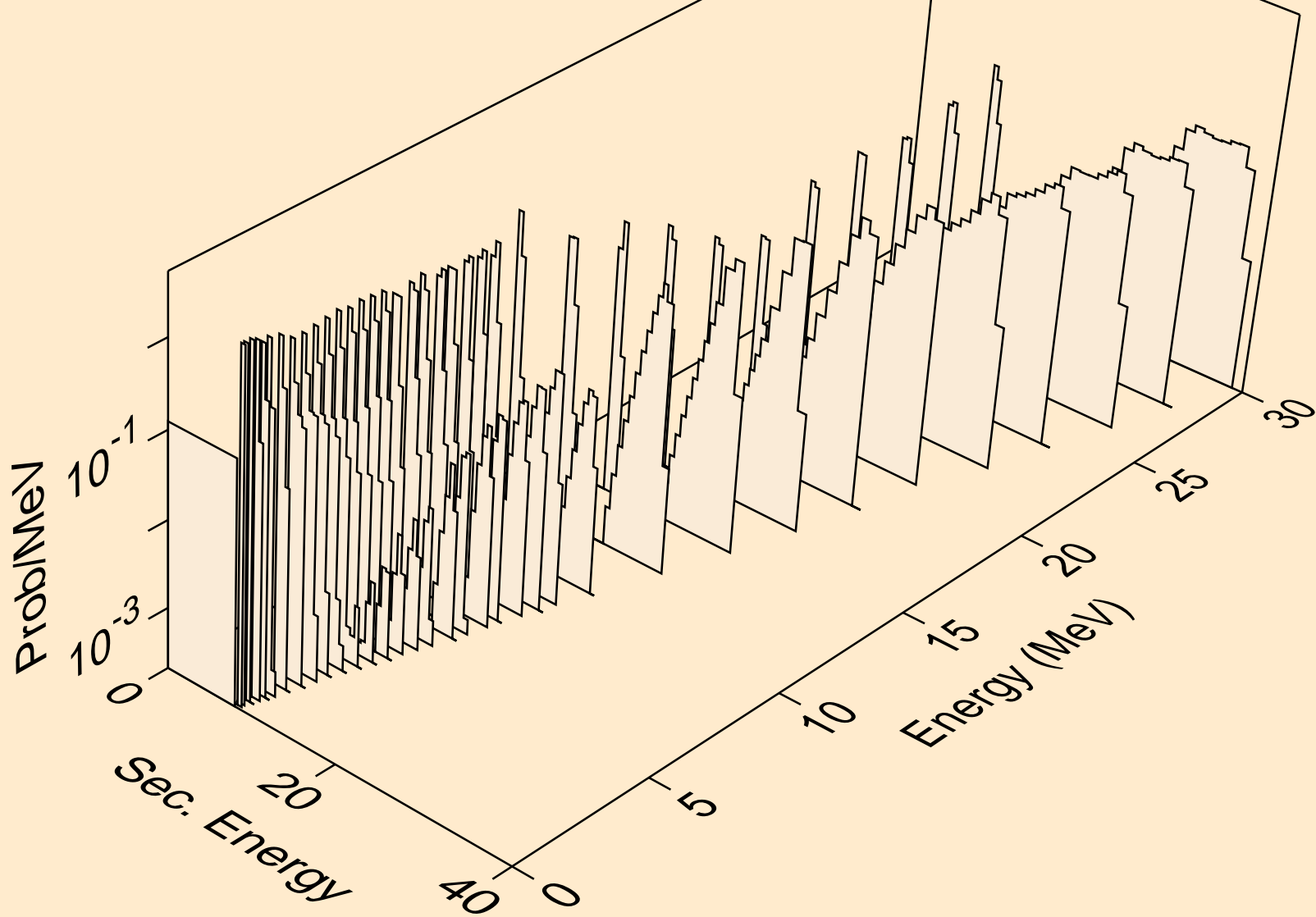

ES239 NEUTRON ACER TENDL-2021 LIBRARY; T=293.6K  
alphas from (n,2n)a

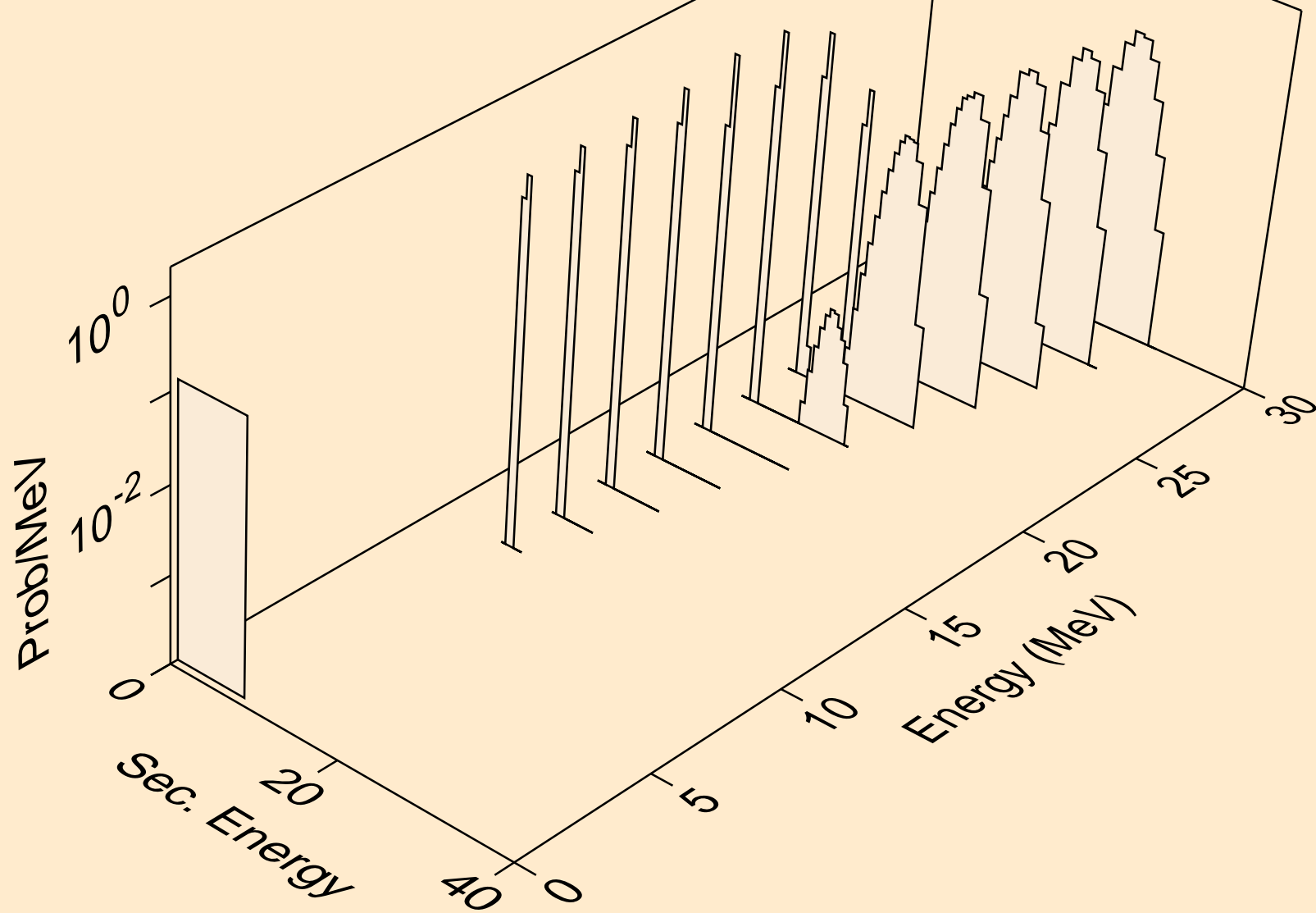

ES239 NEUTRON ACER TENDL-2021 LIBRARY; T=293.6K  
alphas from (n,3n)a

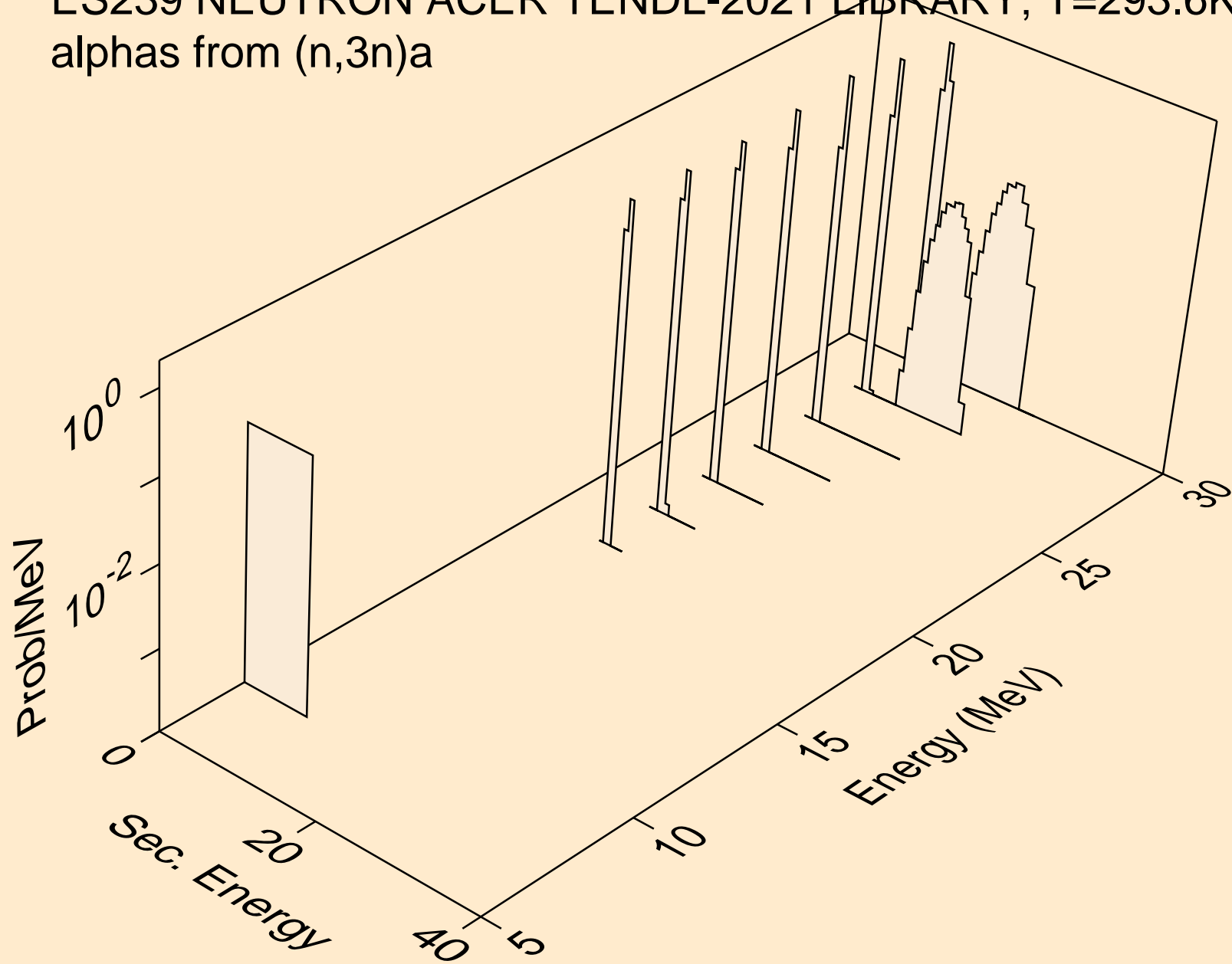

ES239 NEUTRON ACER TENDL-2021 LIBRARY; T=293.6K  
alphas from (n,npa)

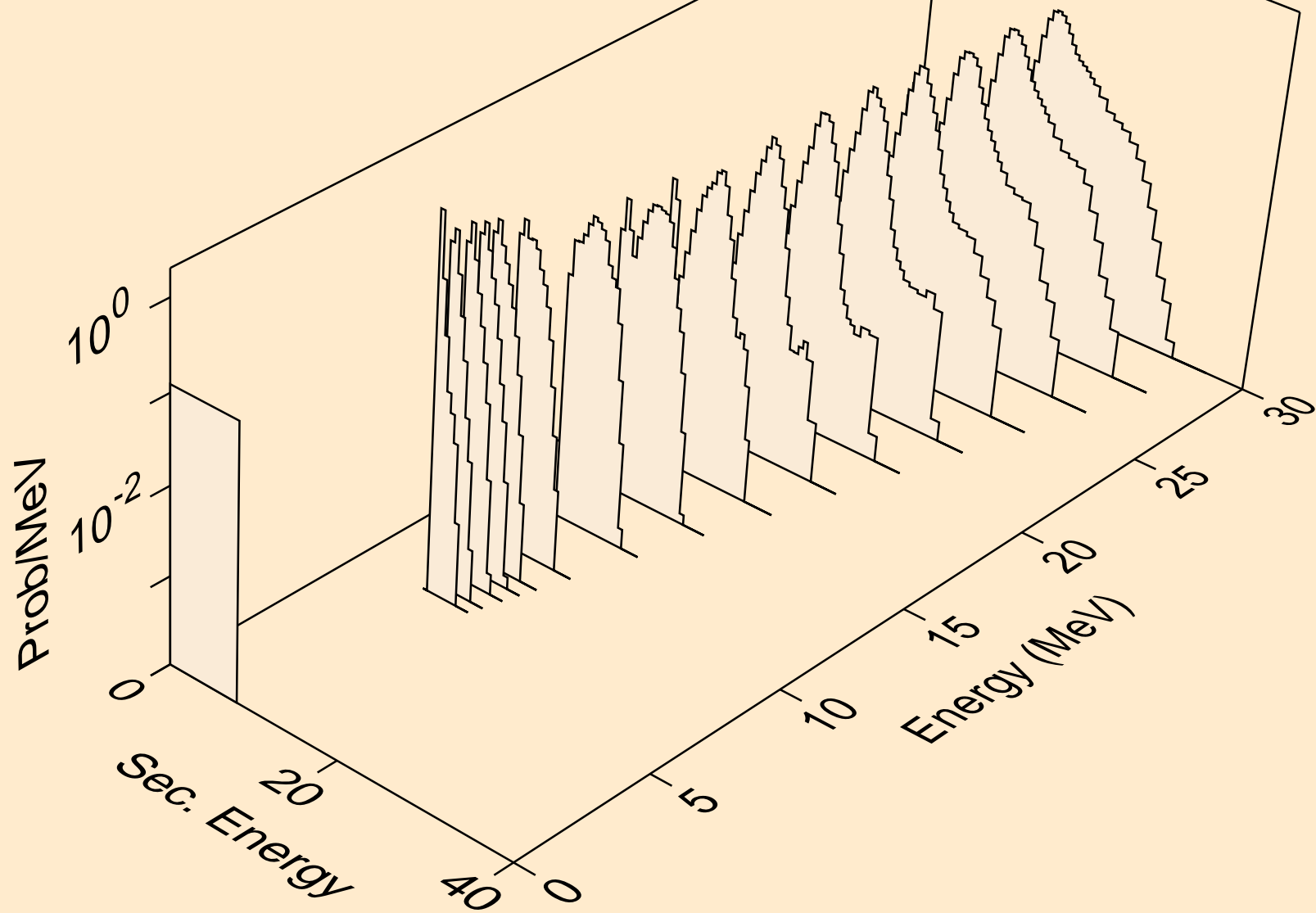

ES239 NEUTRON ACER TENDL-2021 LIBRARY; T=293.6K  
alphas from (n,a)

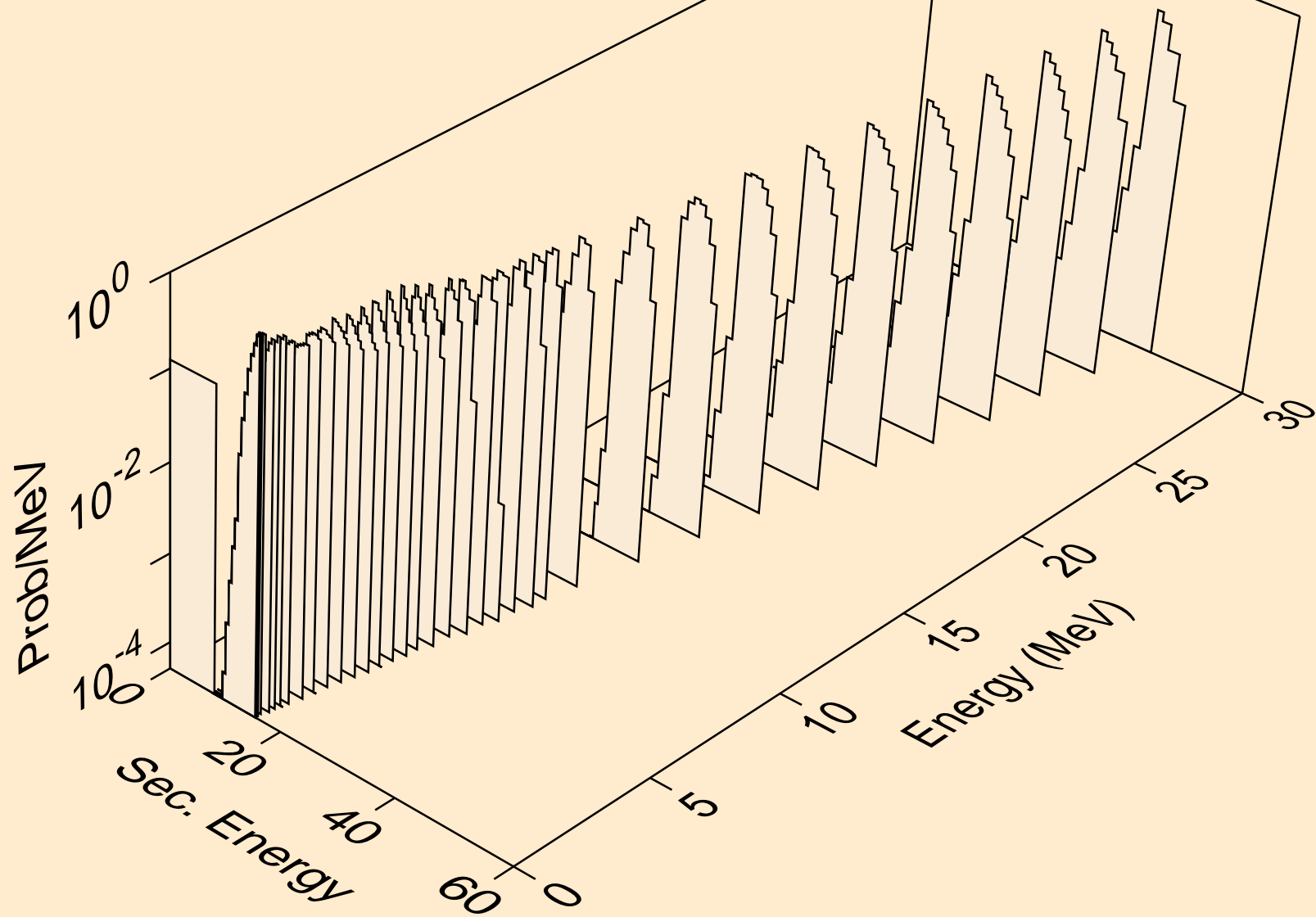

ES239 NEUTRON ACER TENDL-2021 LIBRARY; T=293.6K  
alphas from (n,2a)

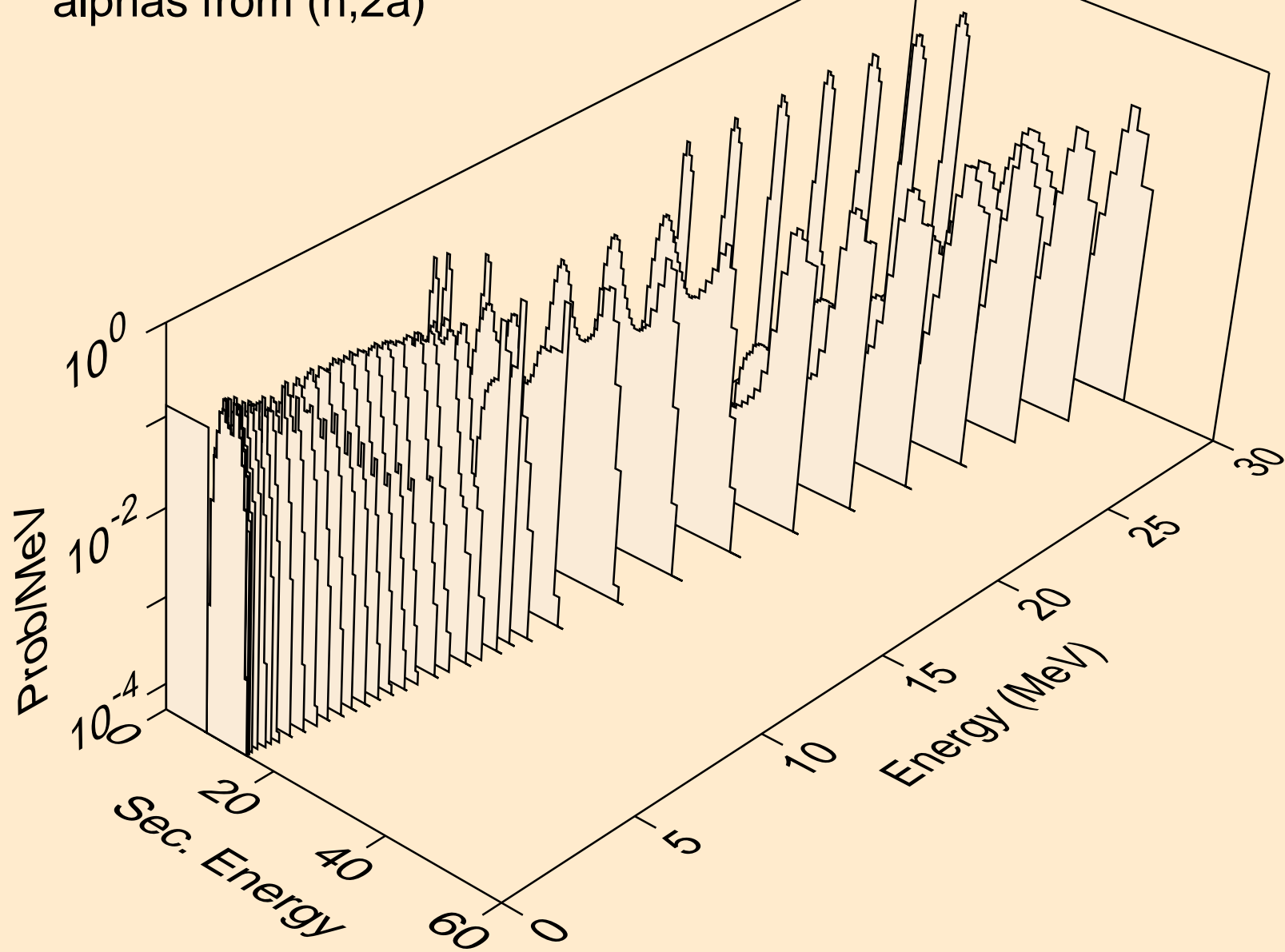



ES239 NEUTRON ACER TENDL-2021 LIBRARY; T=293.6K  
alphas from (n,p)

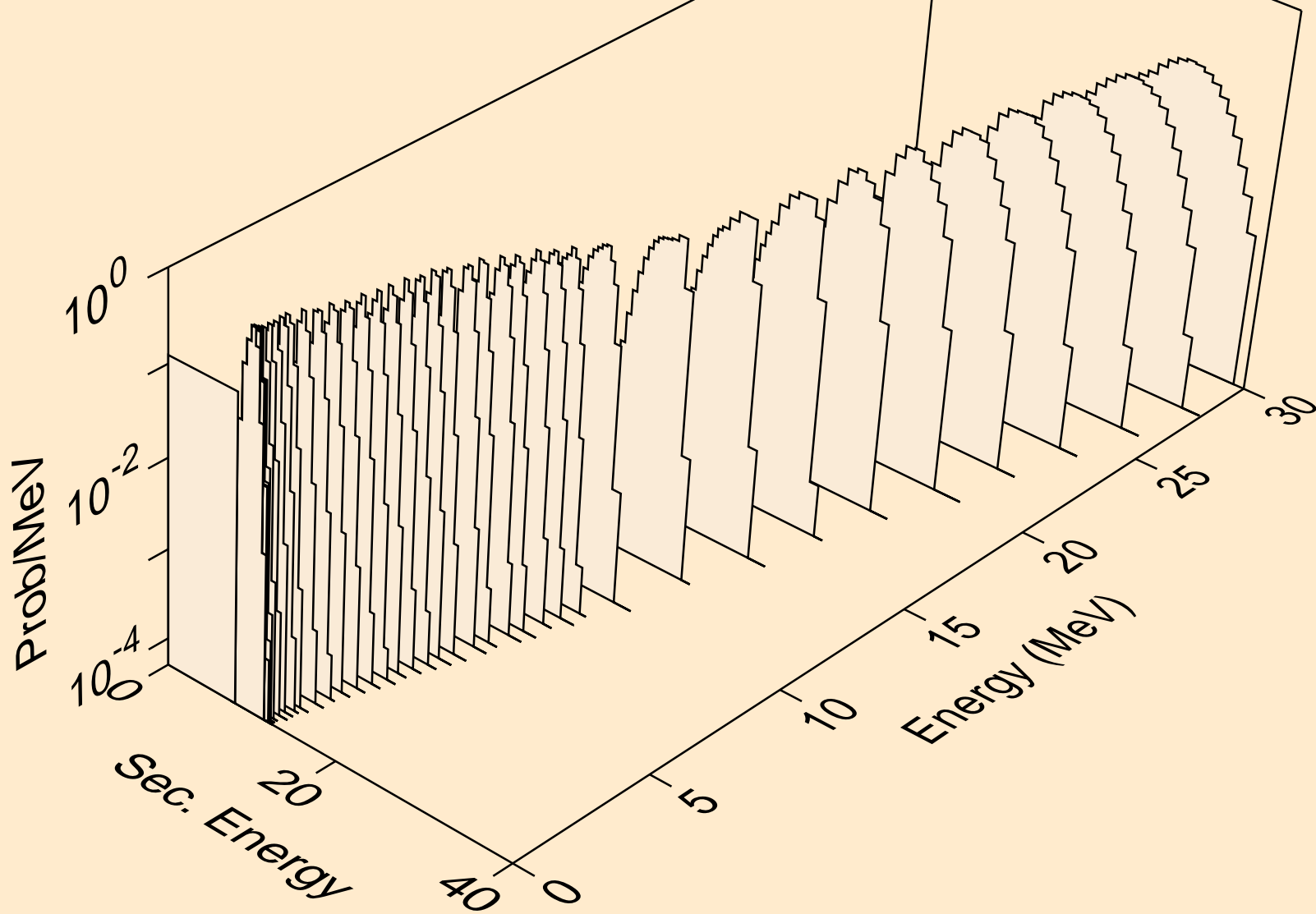

ES239 NEUTRON ACER TENDL-2021 LIBRARY; T=293.6K  
alphas from (n,da)

