

ES240 NEUTRON ACER TENDL-2021 LIBRARY; T=293.6K

Principal cross sections

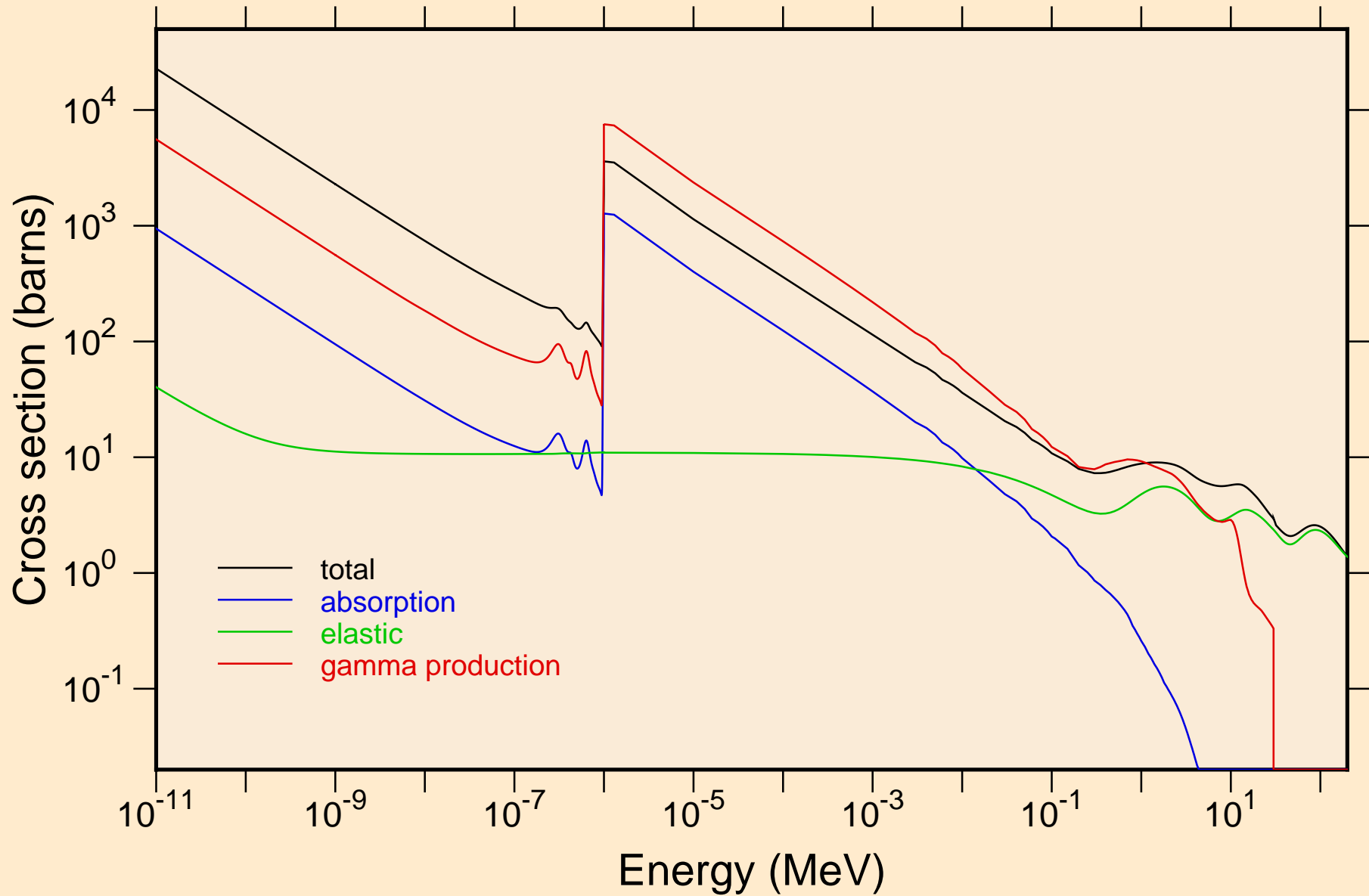

ES240 NEUTRON ACER TENDL-2021 LIBRARY; T=293.6K
Heating

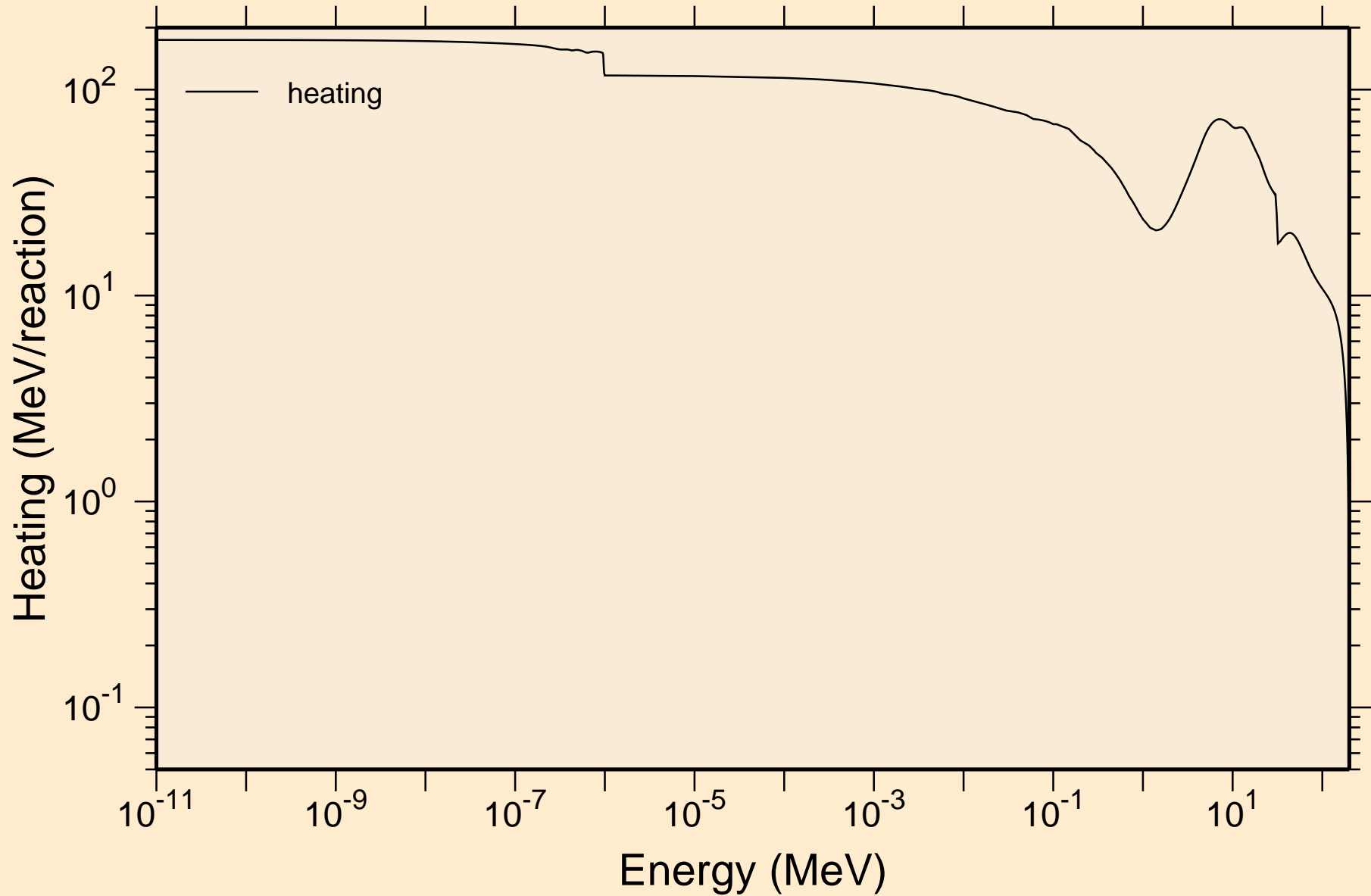

ES240 NEUTRON ACER TENDL-2021 LIBRARY; T=293.6K
Damage

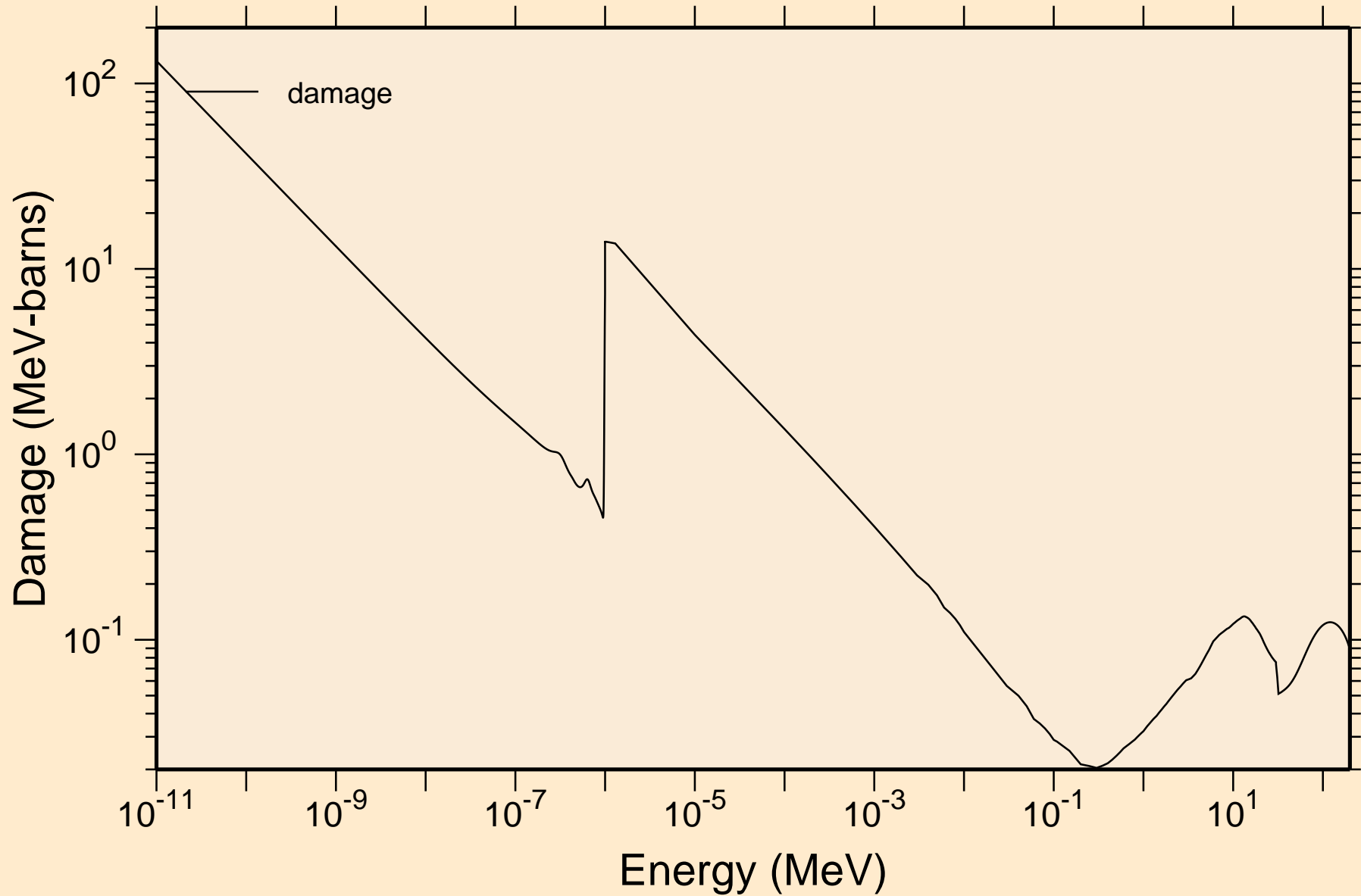

ES240 NEUTRON ACER TENDL-2021 LIBRARY; T=293.6K

Non-threshold reactions

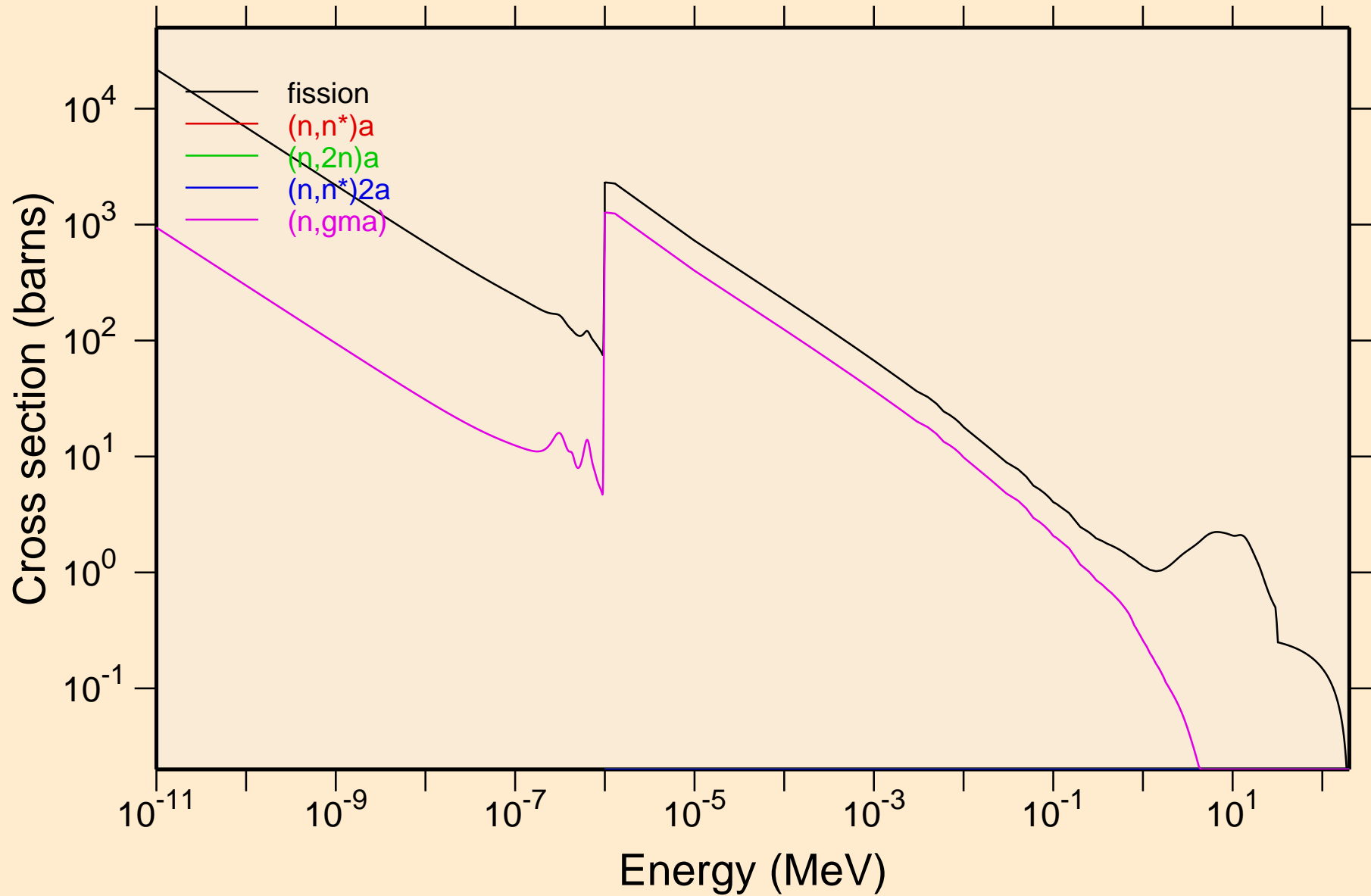

ES240 NEUTRON ACER TENDL-2021 LIBRARY; T=293.6K

Non-threshold reactions

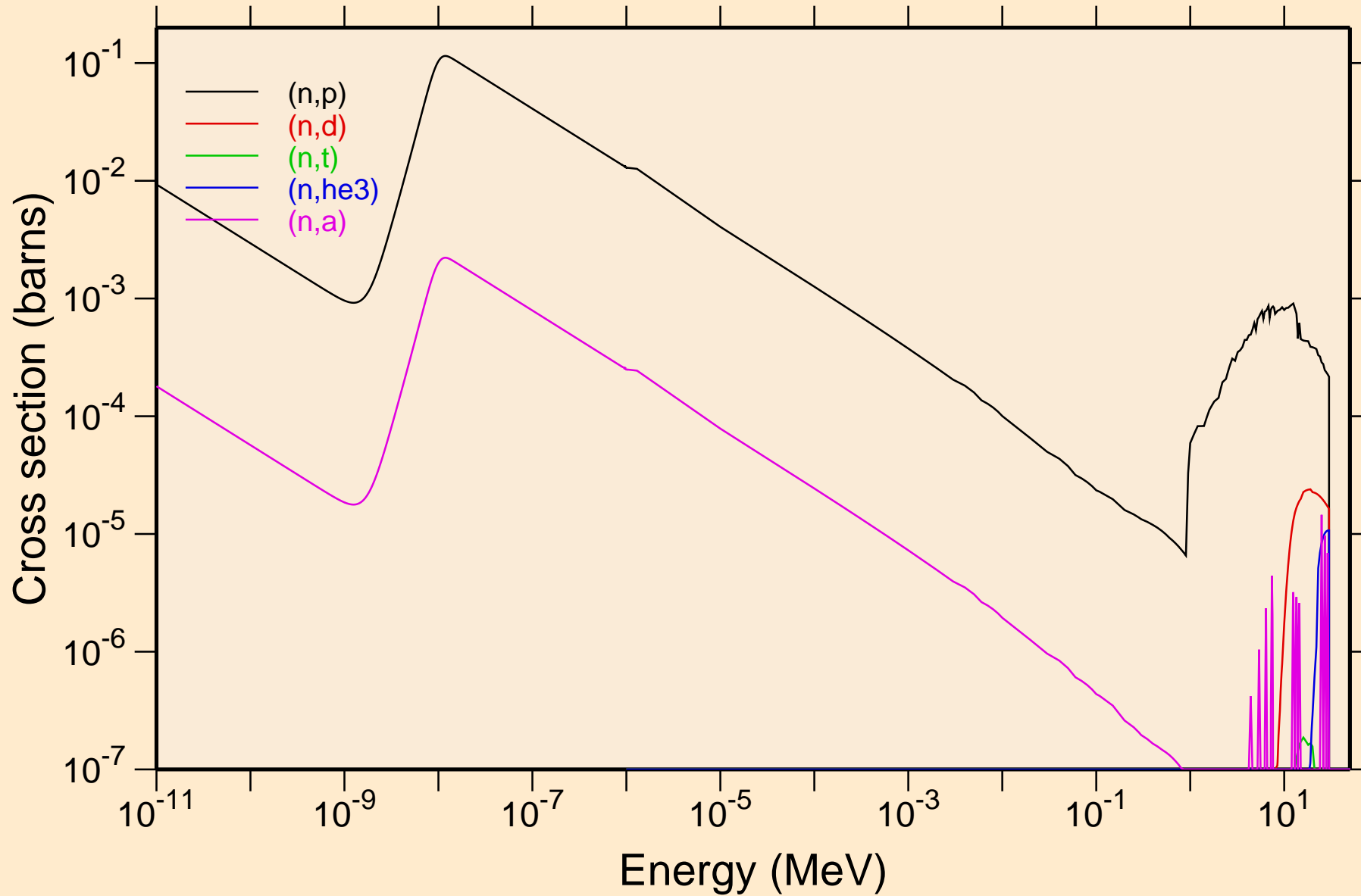

ES240 NEUTRON ACER TENDL-2021 LIBRARY; T=293.6K

Non-threshold reactions

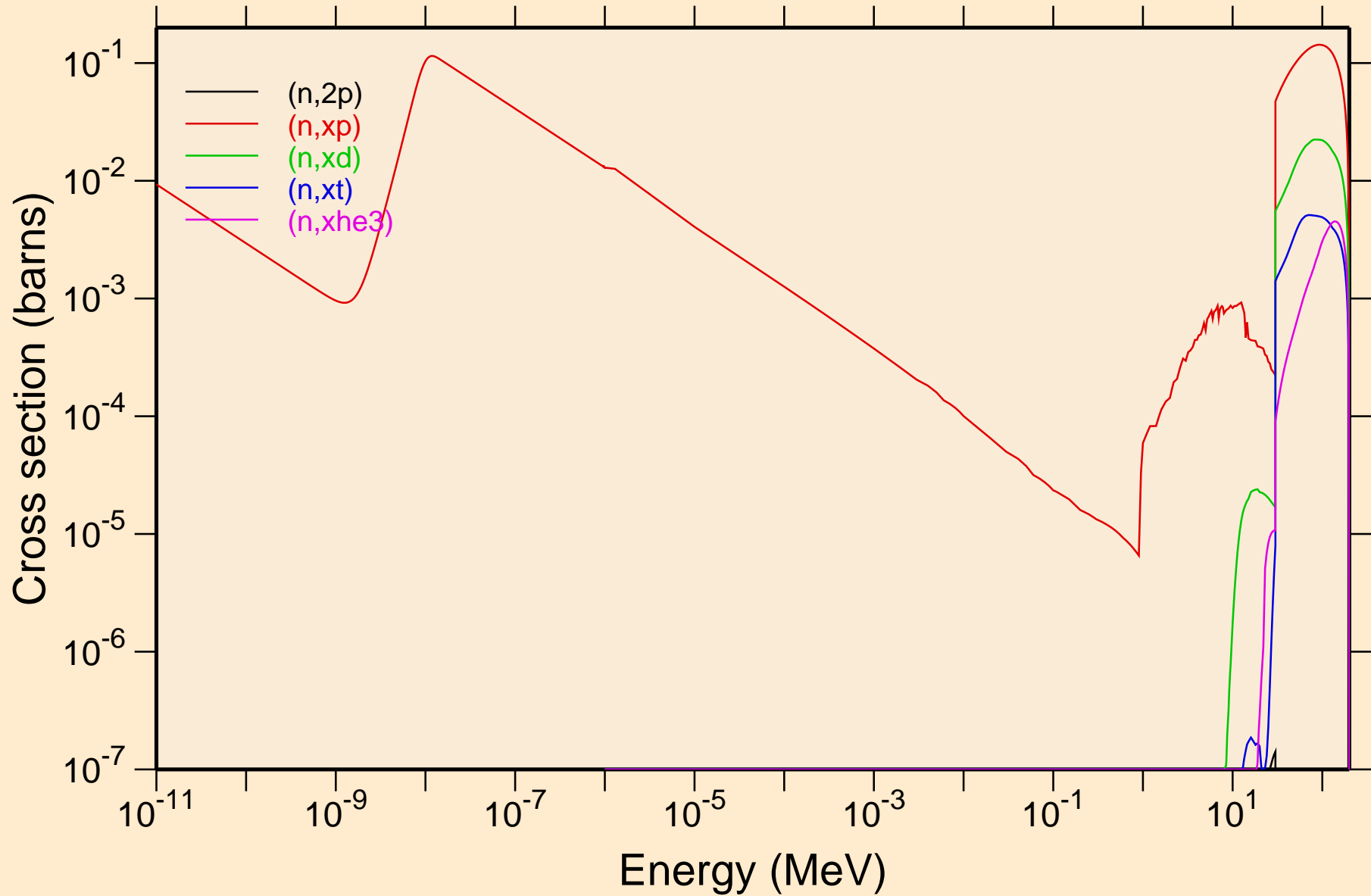

ES240 NEUTRON ACER TENDL-2021 LIBRARY; T=293.6K
Non-threshold reactions

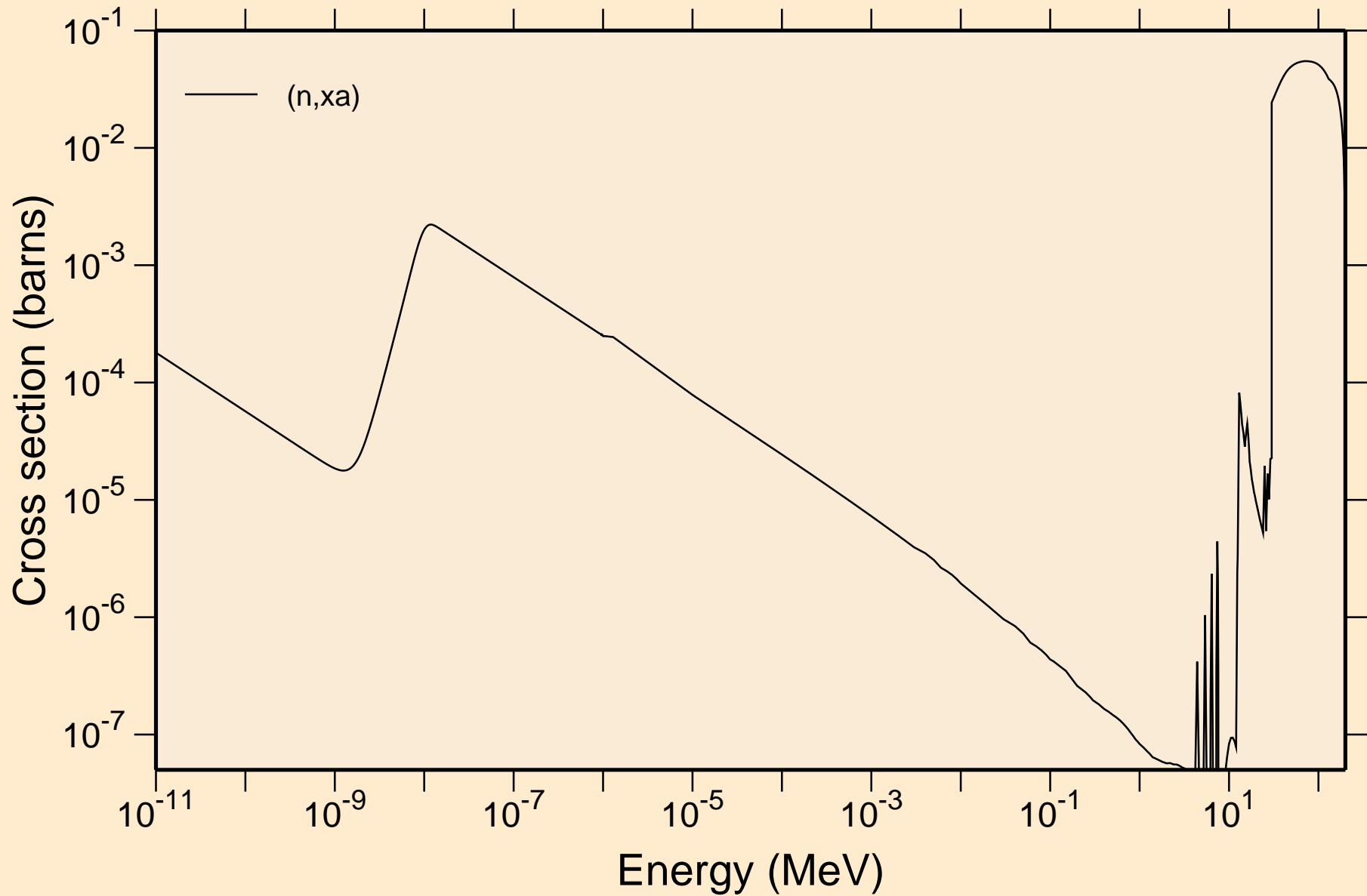

ES240 NEUTRON ACER TENDL-2021 LIBRARY; T=293.6K

Principal cross sections

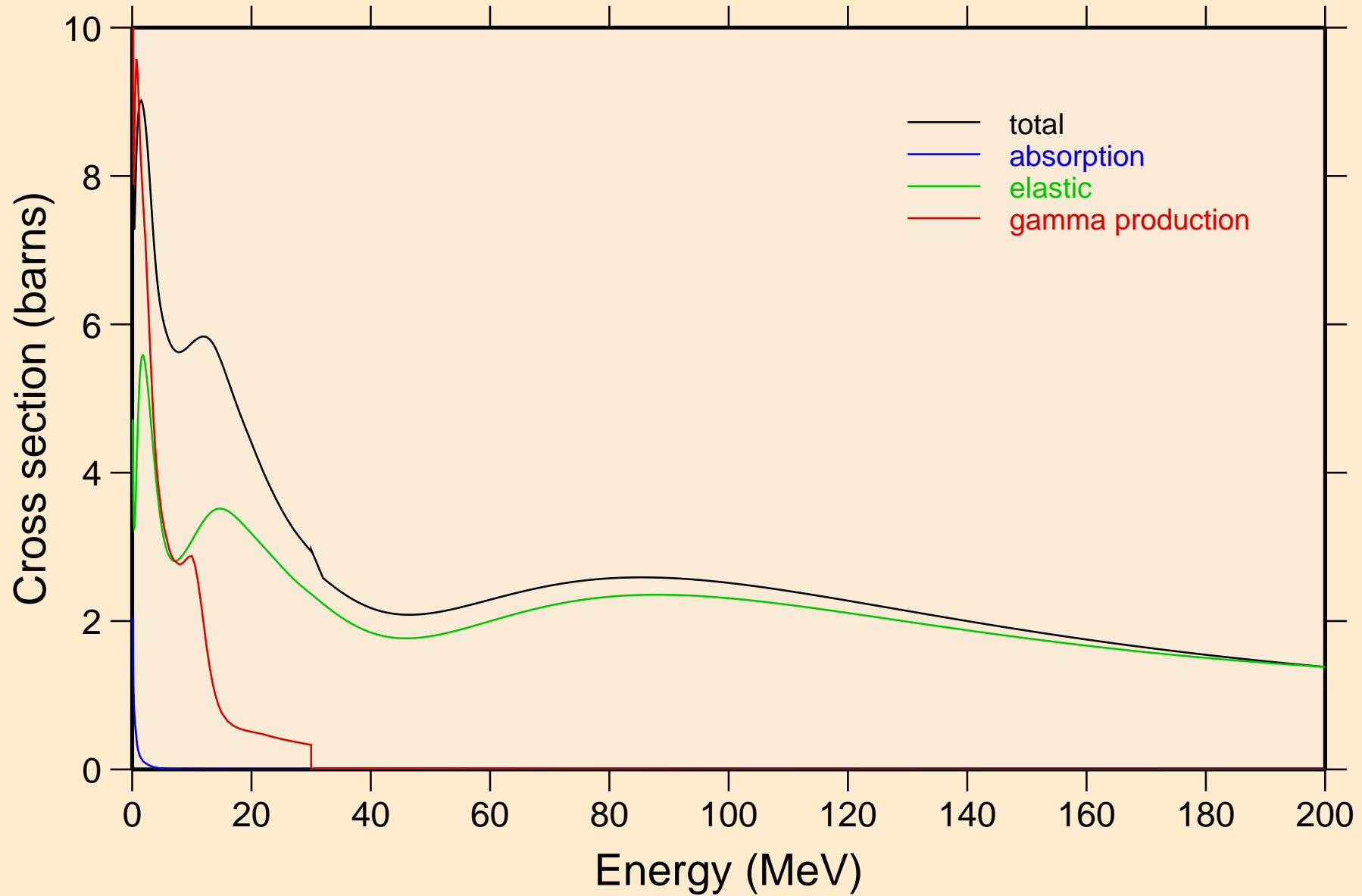

ES240 NEUTRON ACER TENDL-2021 LIBRARY; T=293.6K

Heating

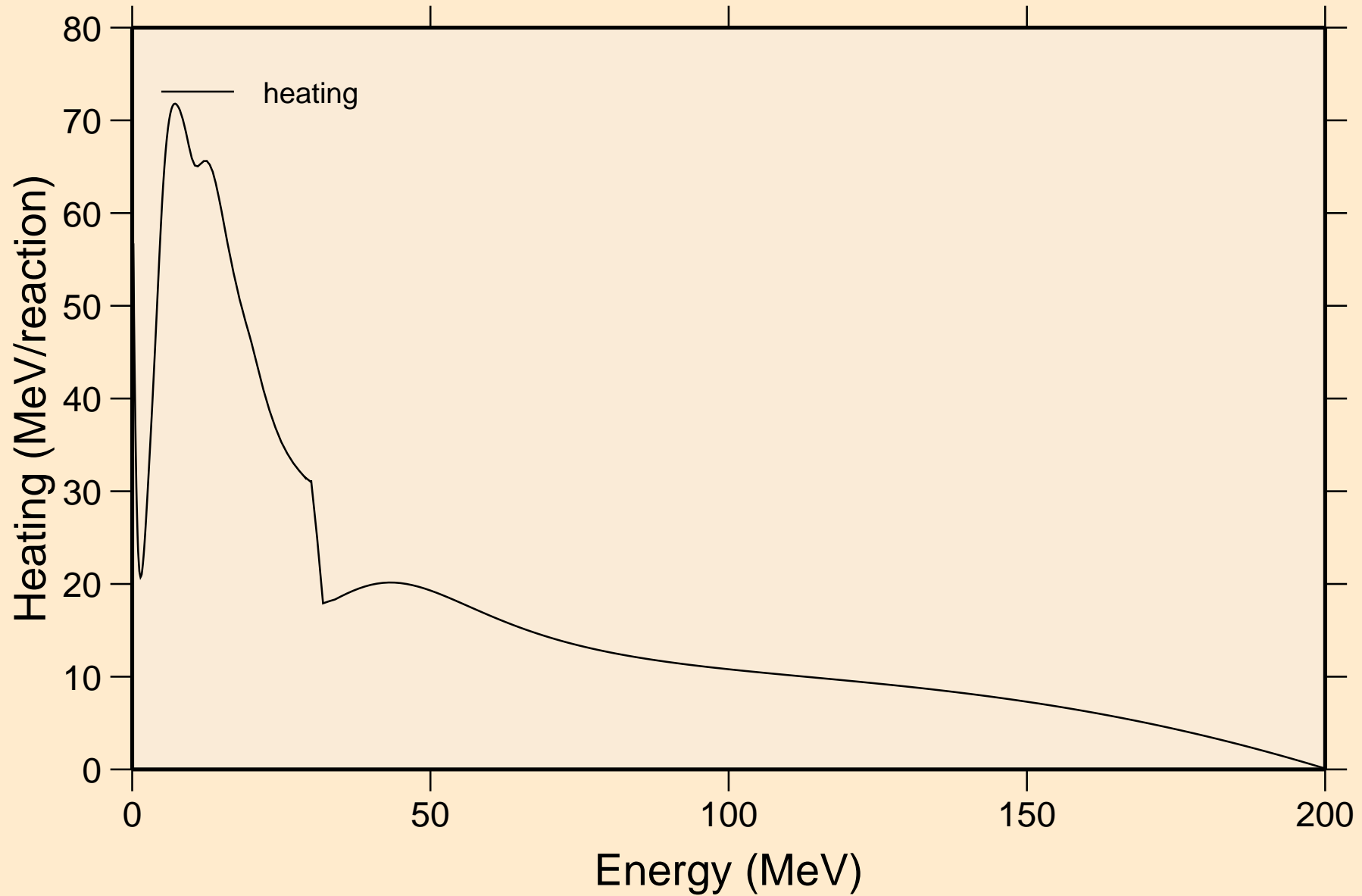

ES240 NEUTRON ACER TENDL-2021 LIBRARY; T=293.6K
Damage

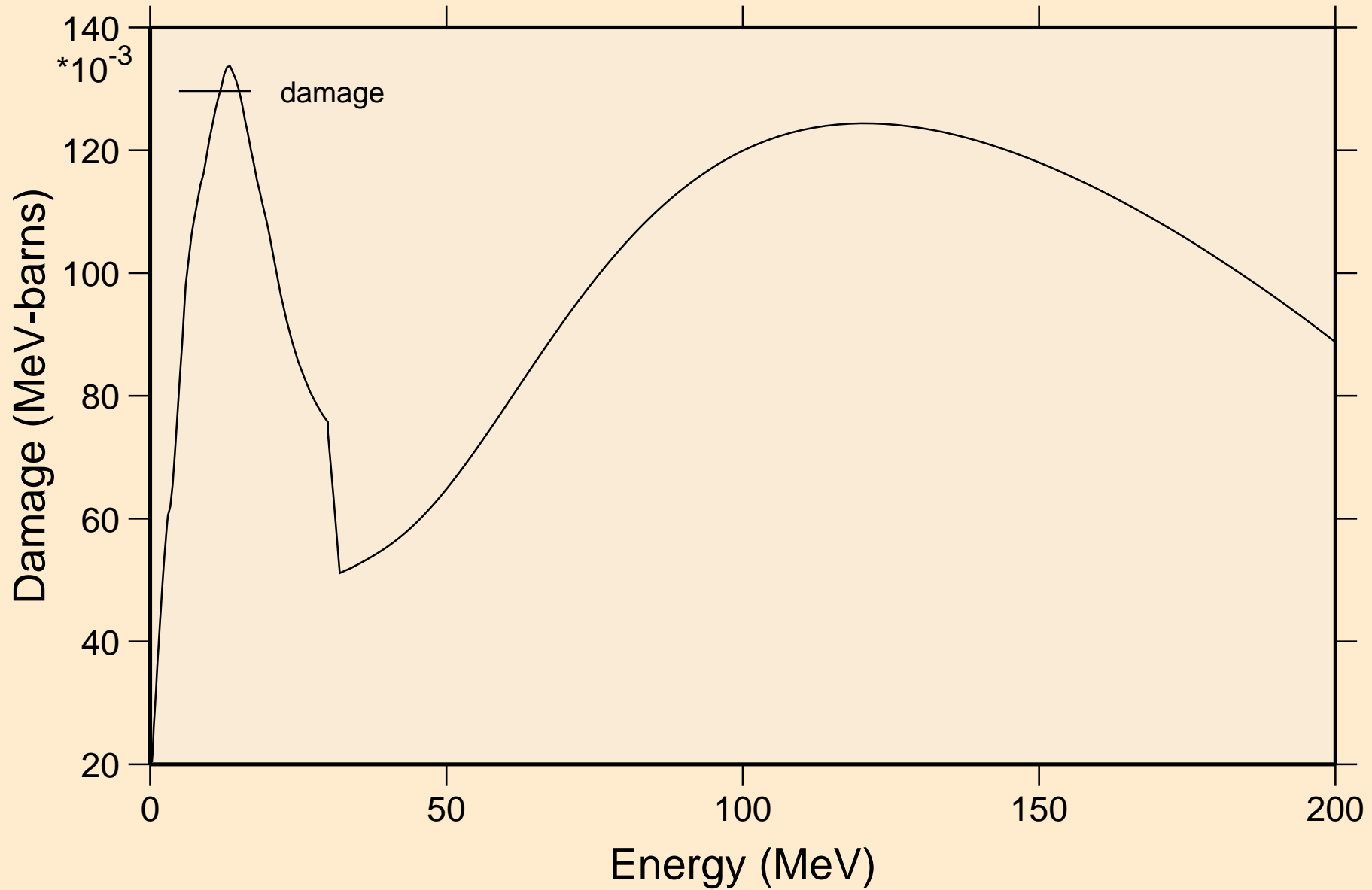

ES240 NEUTRON ACER TENDL-2021 LIBRARY; T=293.6K

Non-threshold reactions

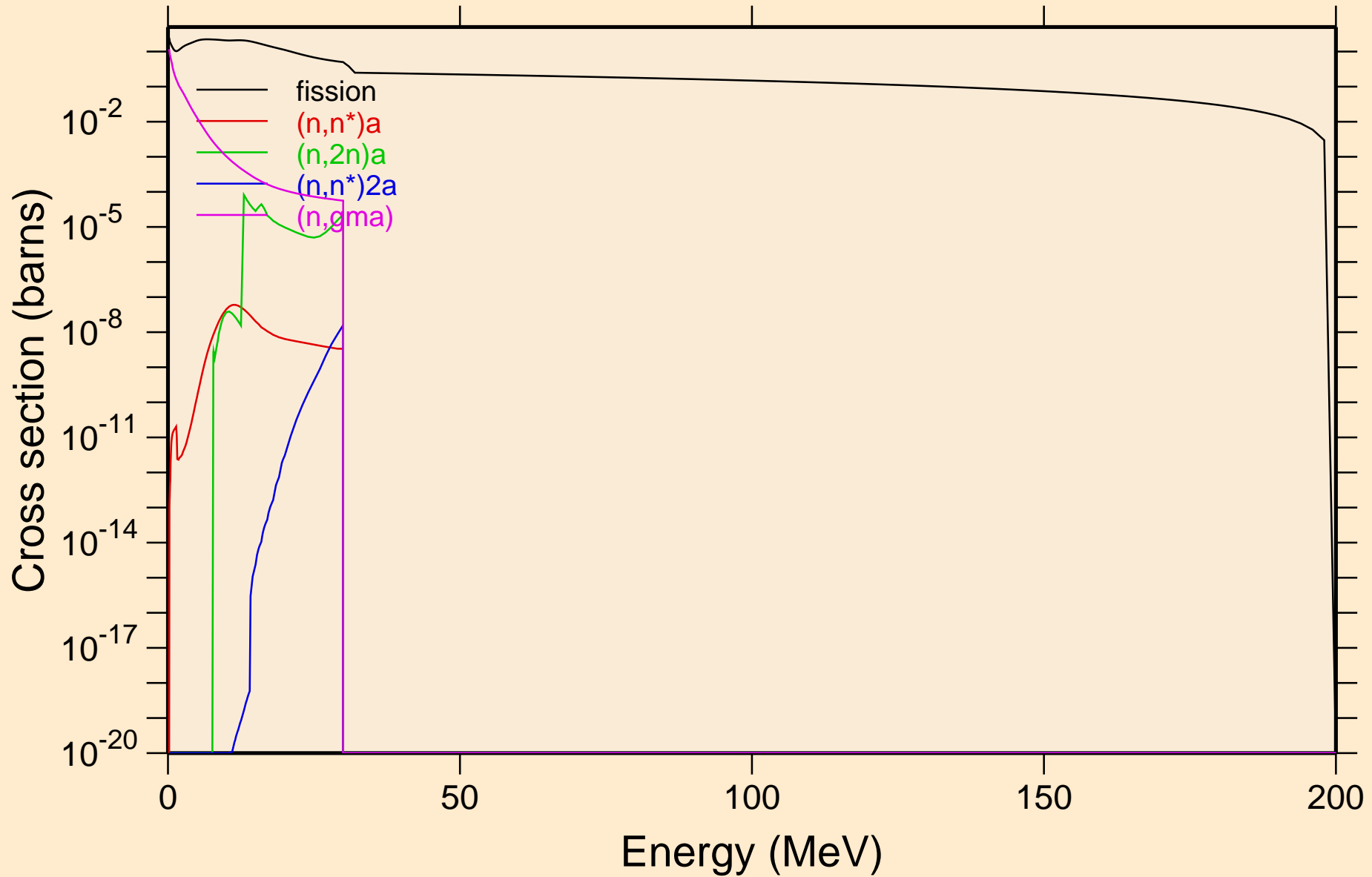

ES240 NEUTRON ACER TENDL-2021 LIBRARY; T=293.6K

Non-threshold reactions

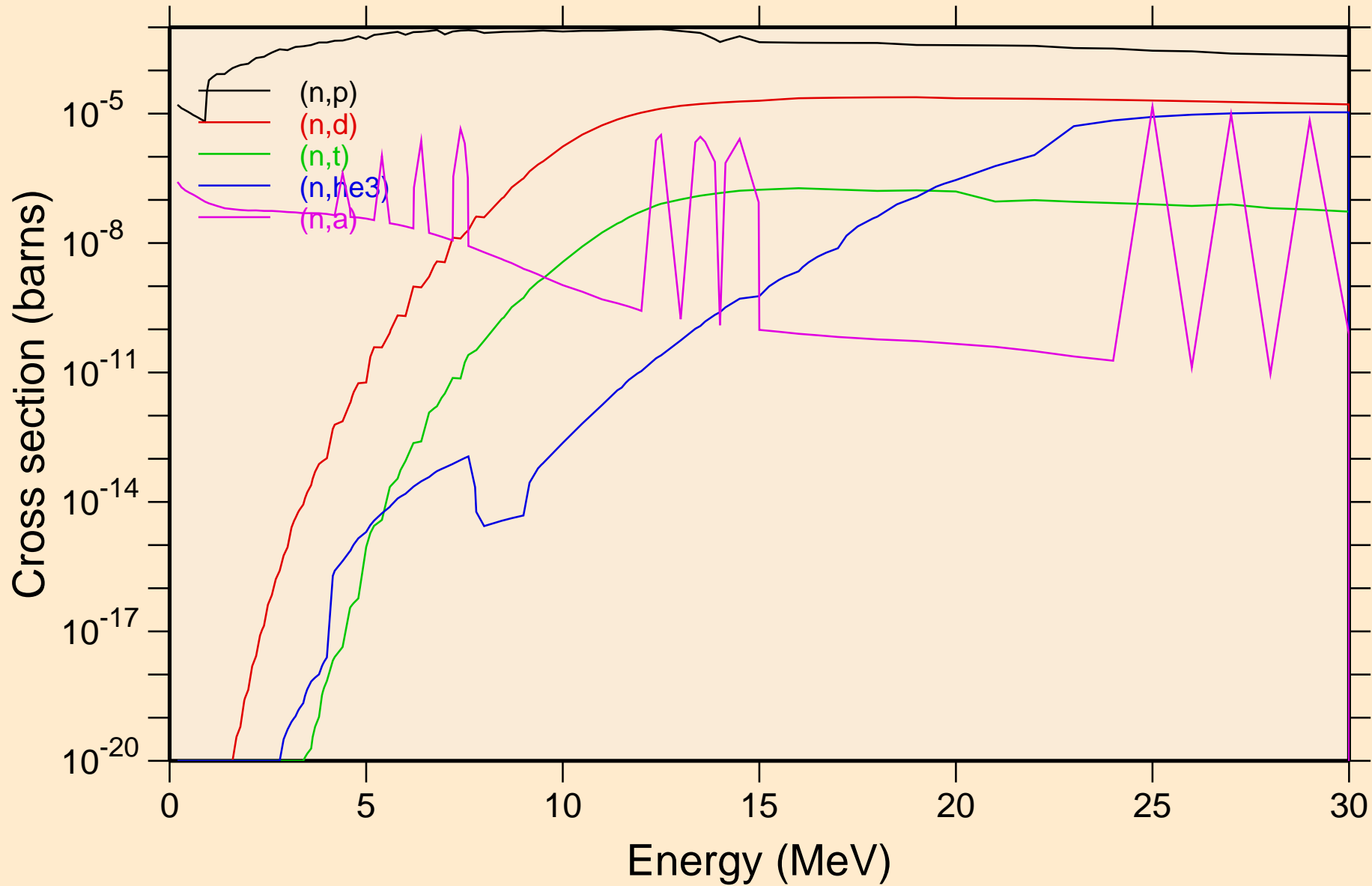

ES240 NEUTRON ACER TENDL-2021 LIBRARY; T=293.6K
Non-threshold reactions

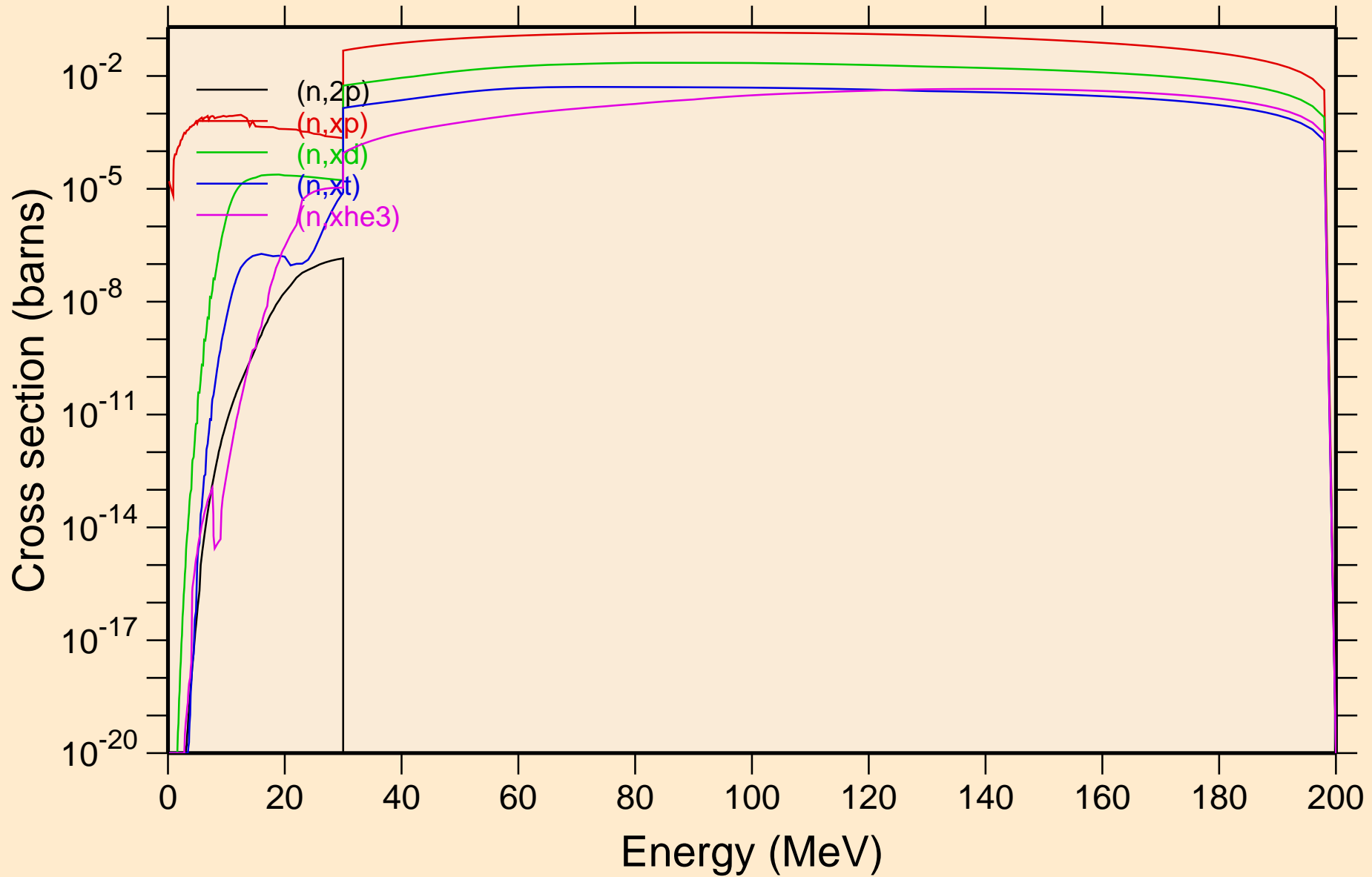

ES240 NEUTRON ACER TENDL-2021 LIBRARY; T=293.6K
Non-threshold reactions

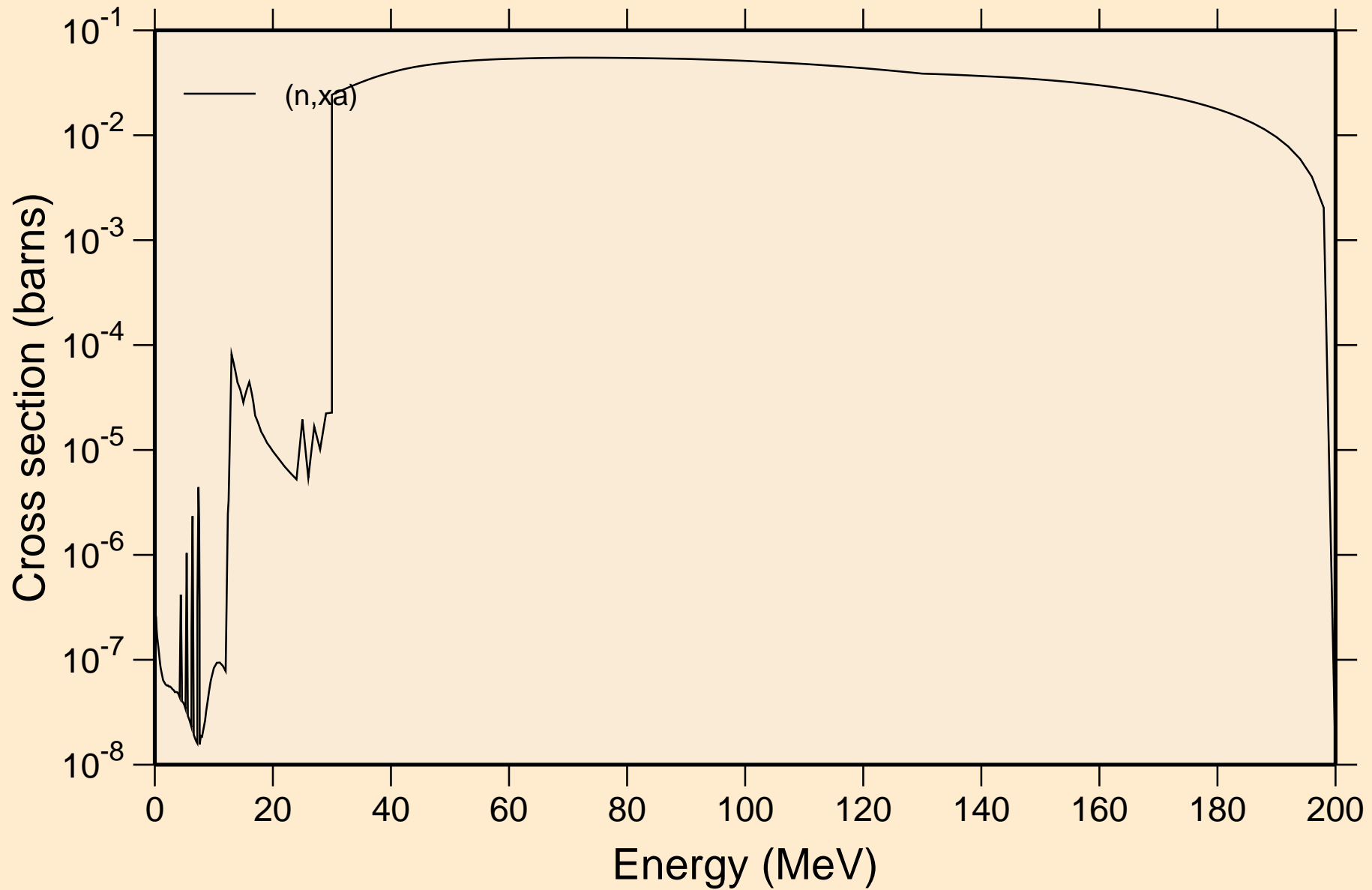

ES240 NEUTRON ACER TENDL-2021 LIBRARY; T=293.6K
Inelastic levels

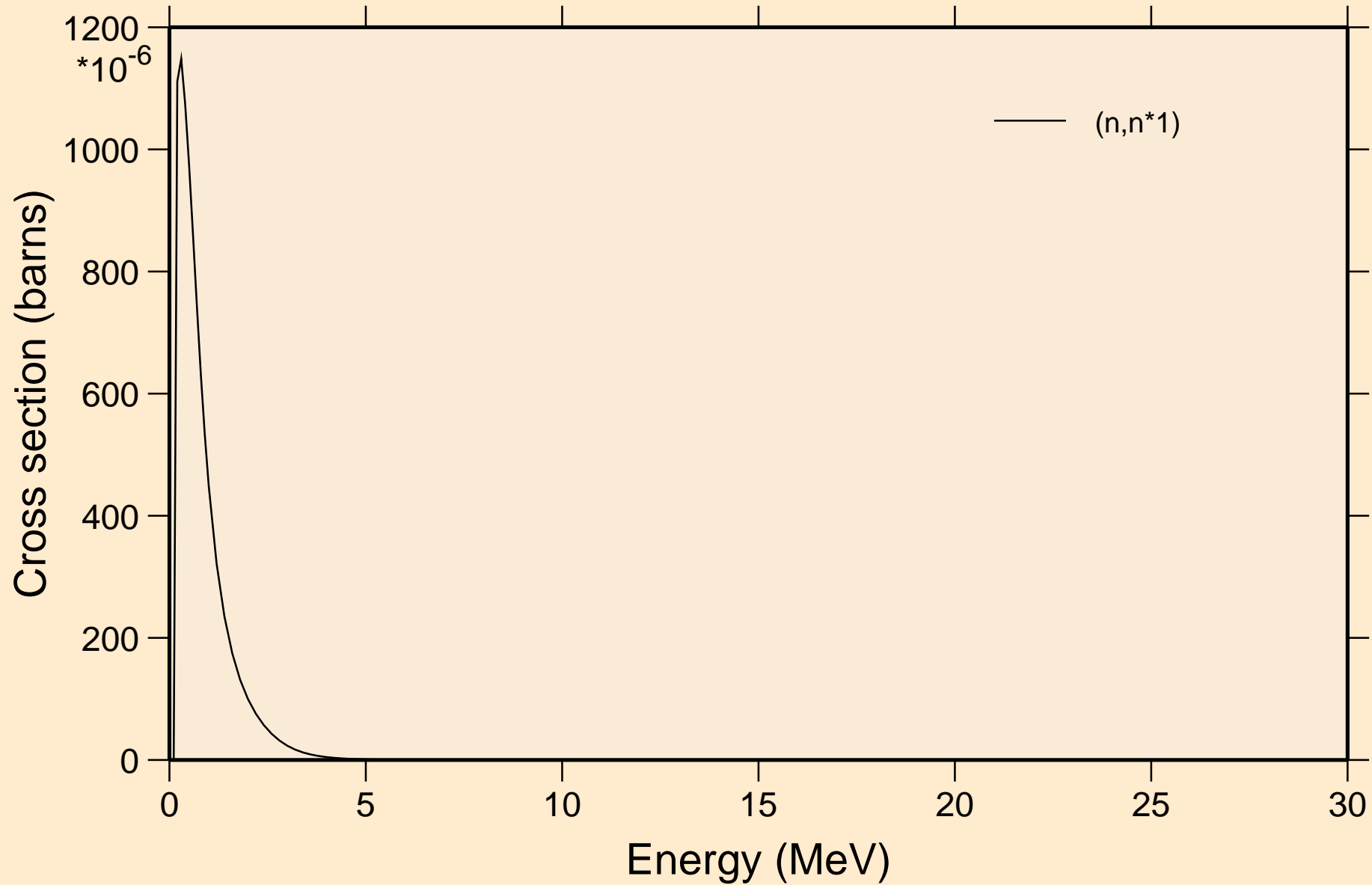

ES240 NEUTRON ACER TENDL-2021 LIBRARY; T=293.6K
Threshold reactions

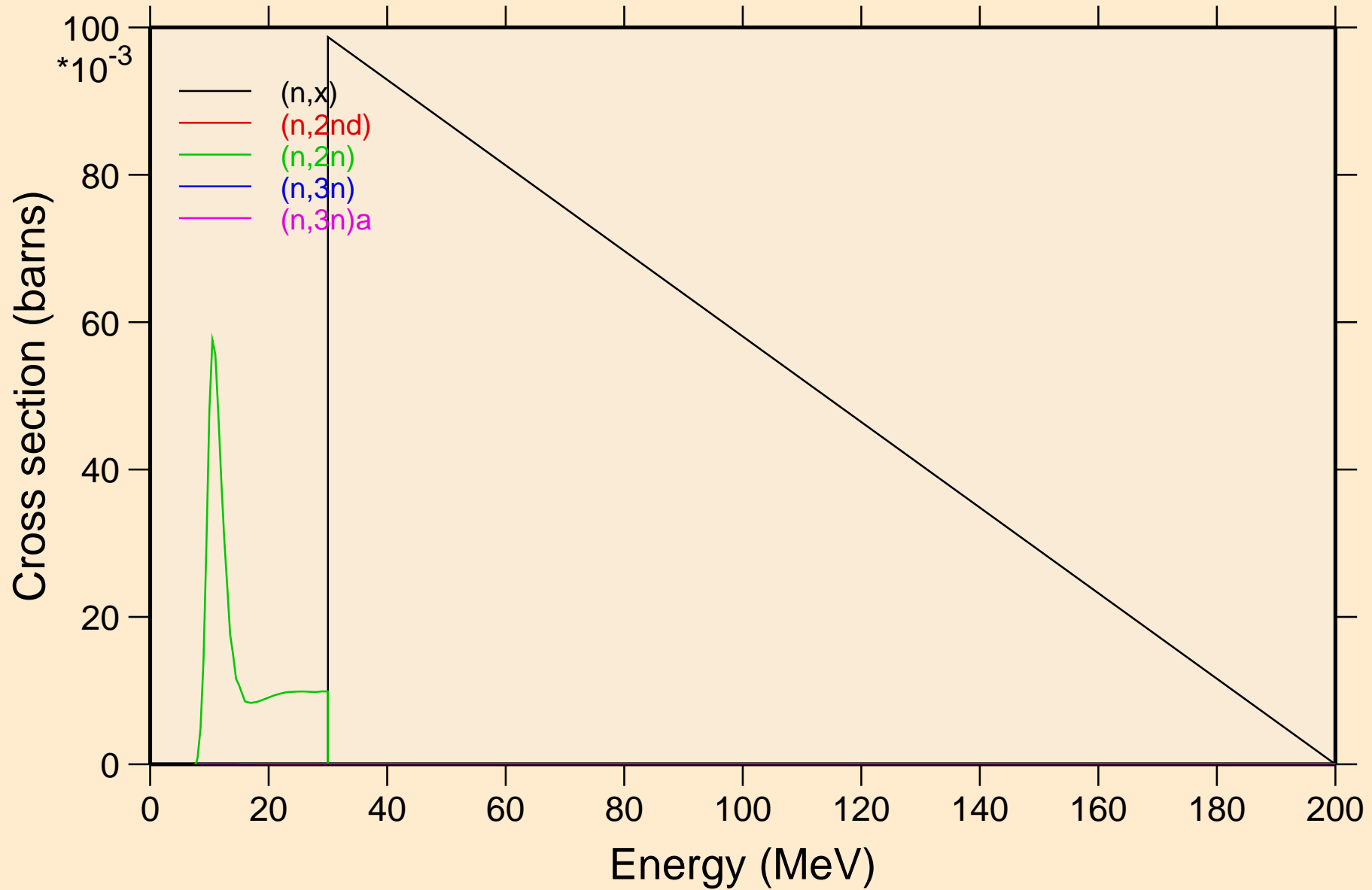

ES240 NEUTRON ACER TENDL-2021 LIBRARY; T=293.6K
Threshold reactions

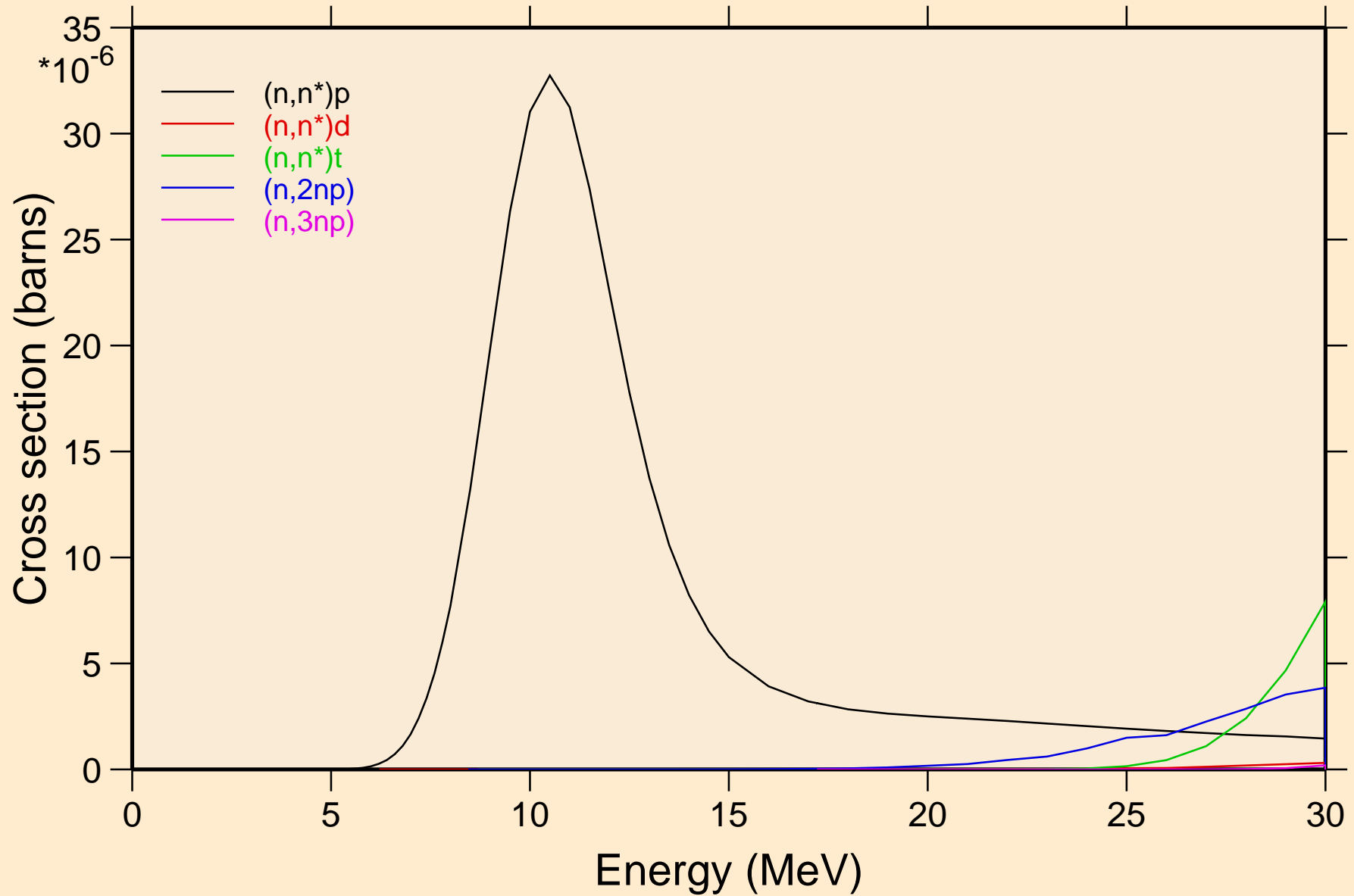

ES240 NEUTRON ACER TENDL-2021 LIBRARY; T=293.6K
Threshold reactions

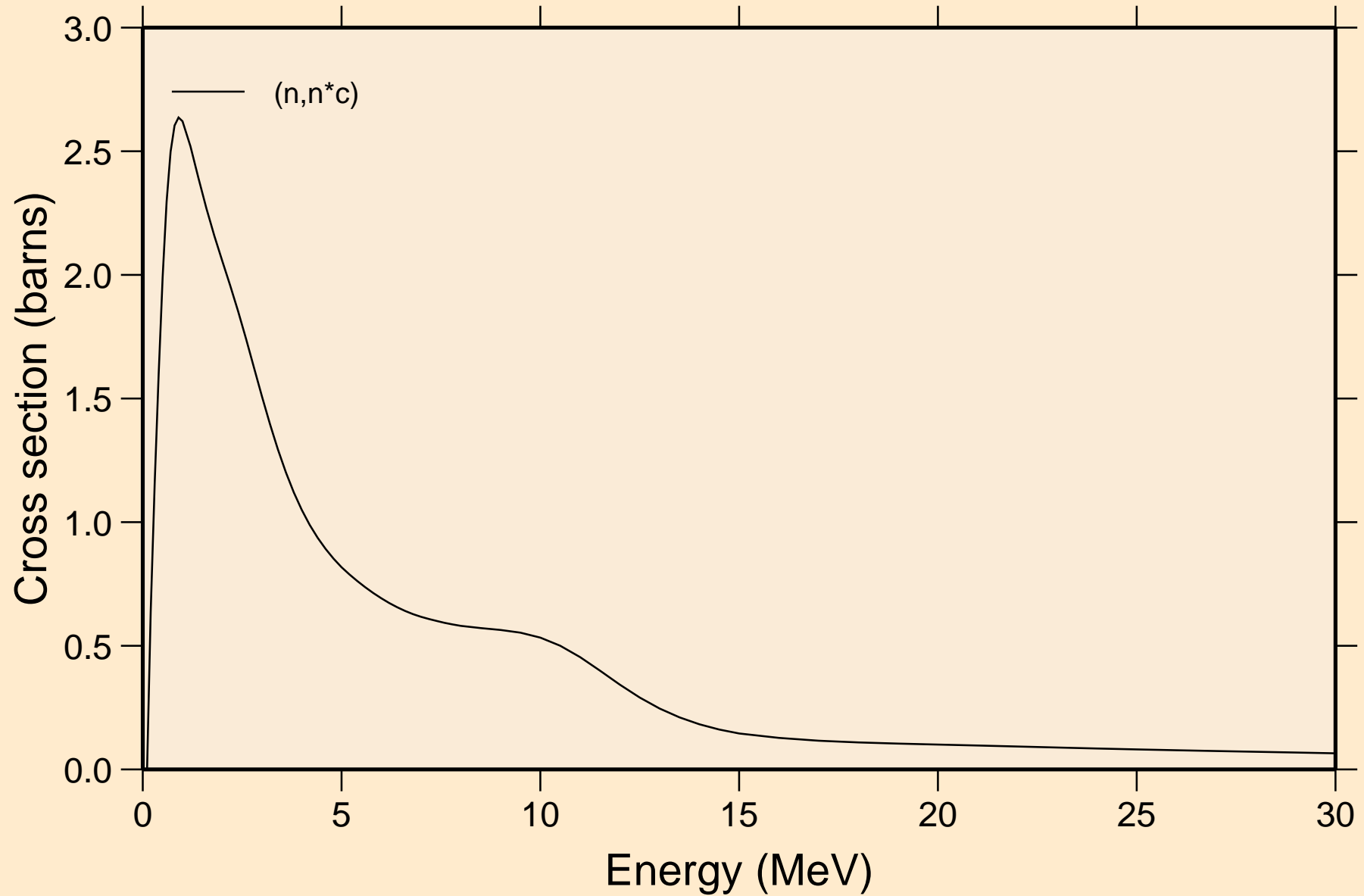

ES240 NEUTRON ACER TENDL-2021 LIBRARY; T=293.6K
angular distribution for elastic

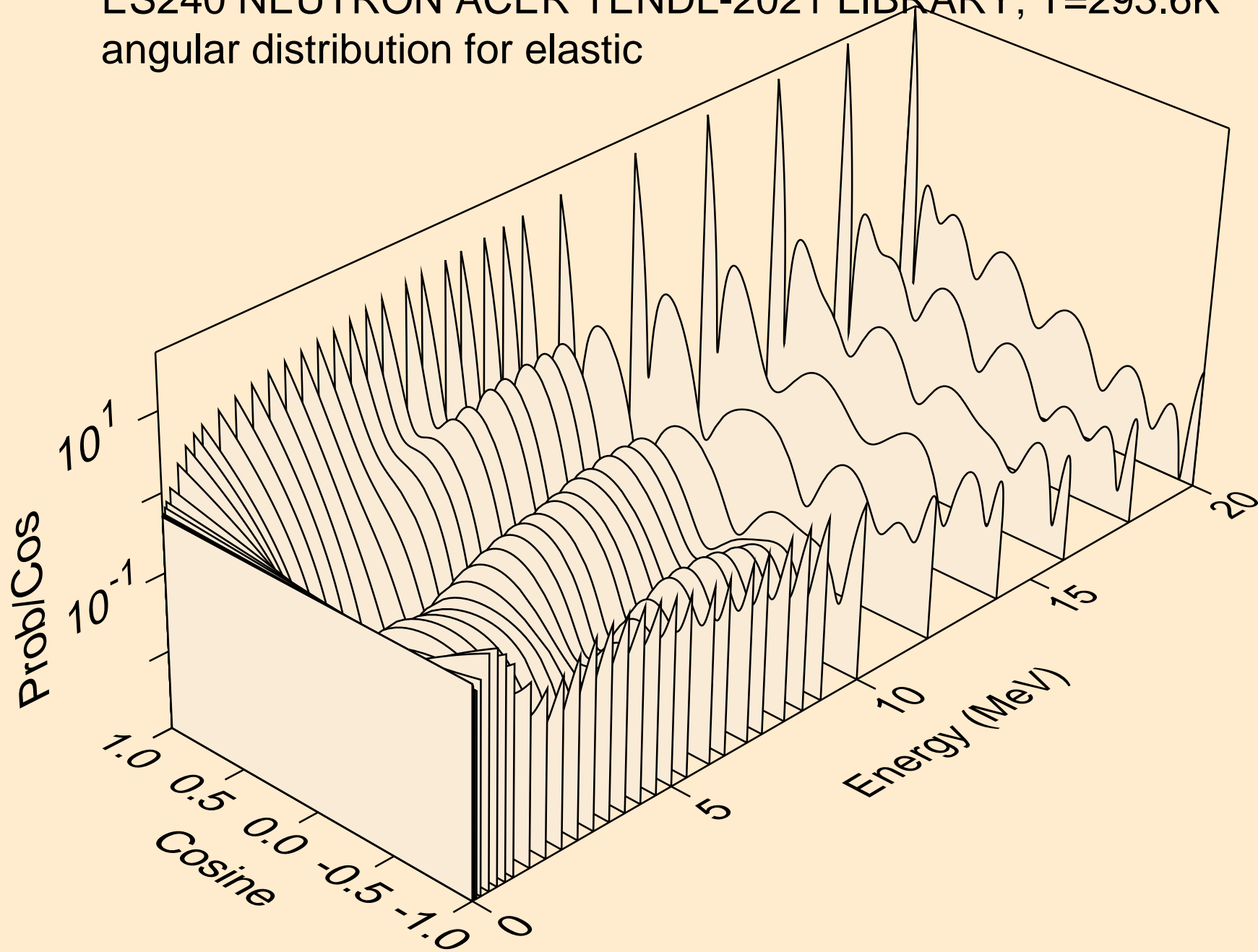

ES240 NEUTRON ACER TENDL-2021 LIBRARY; T=293.6K
angular distribution for elastic

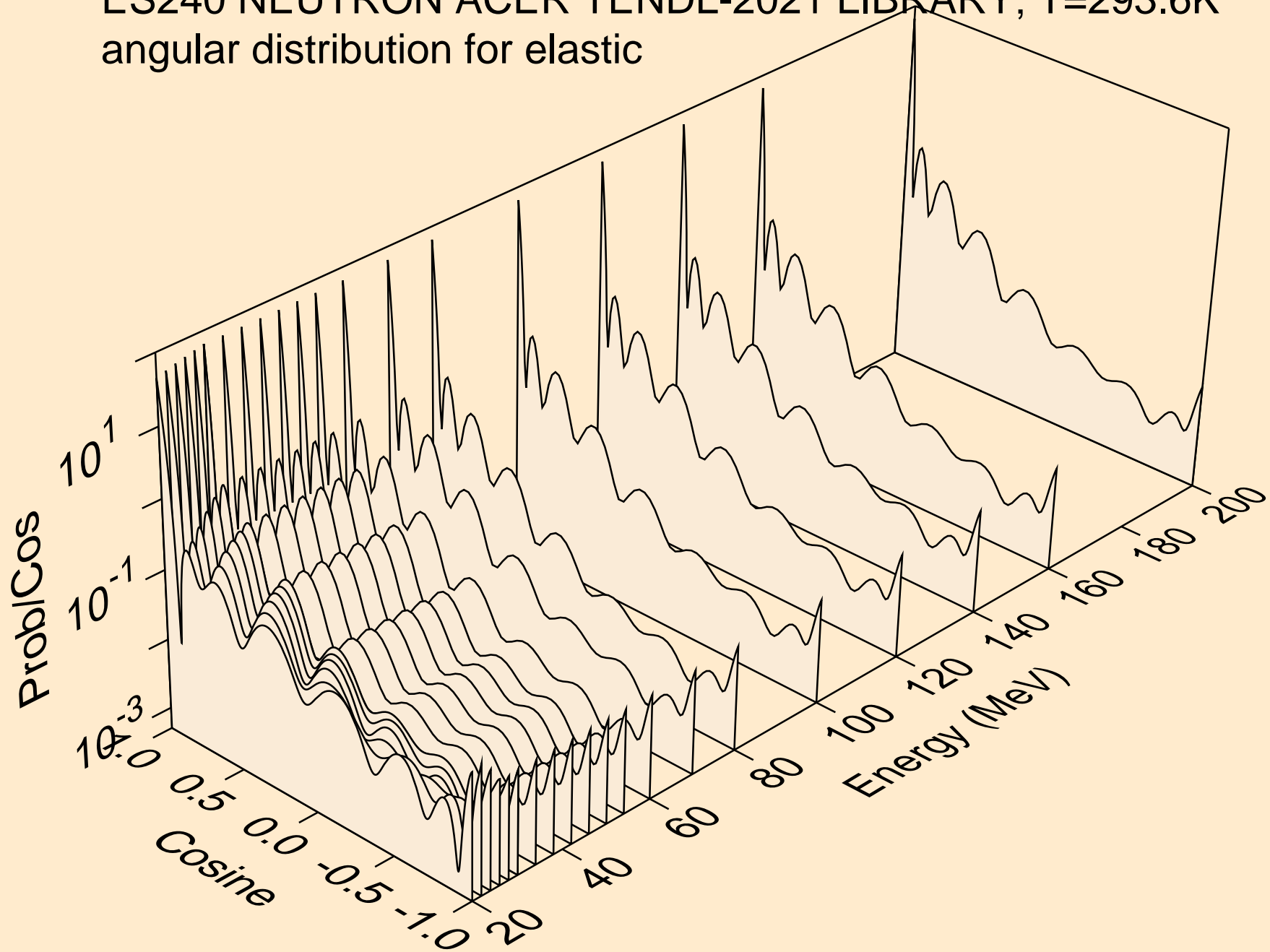

ES240 NEUTRON ACER TENDL-2021 LIBRARY; T=293.6K
angular distribution for (n,n*1)

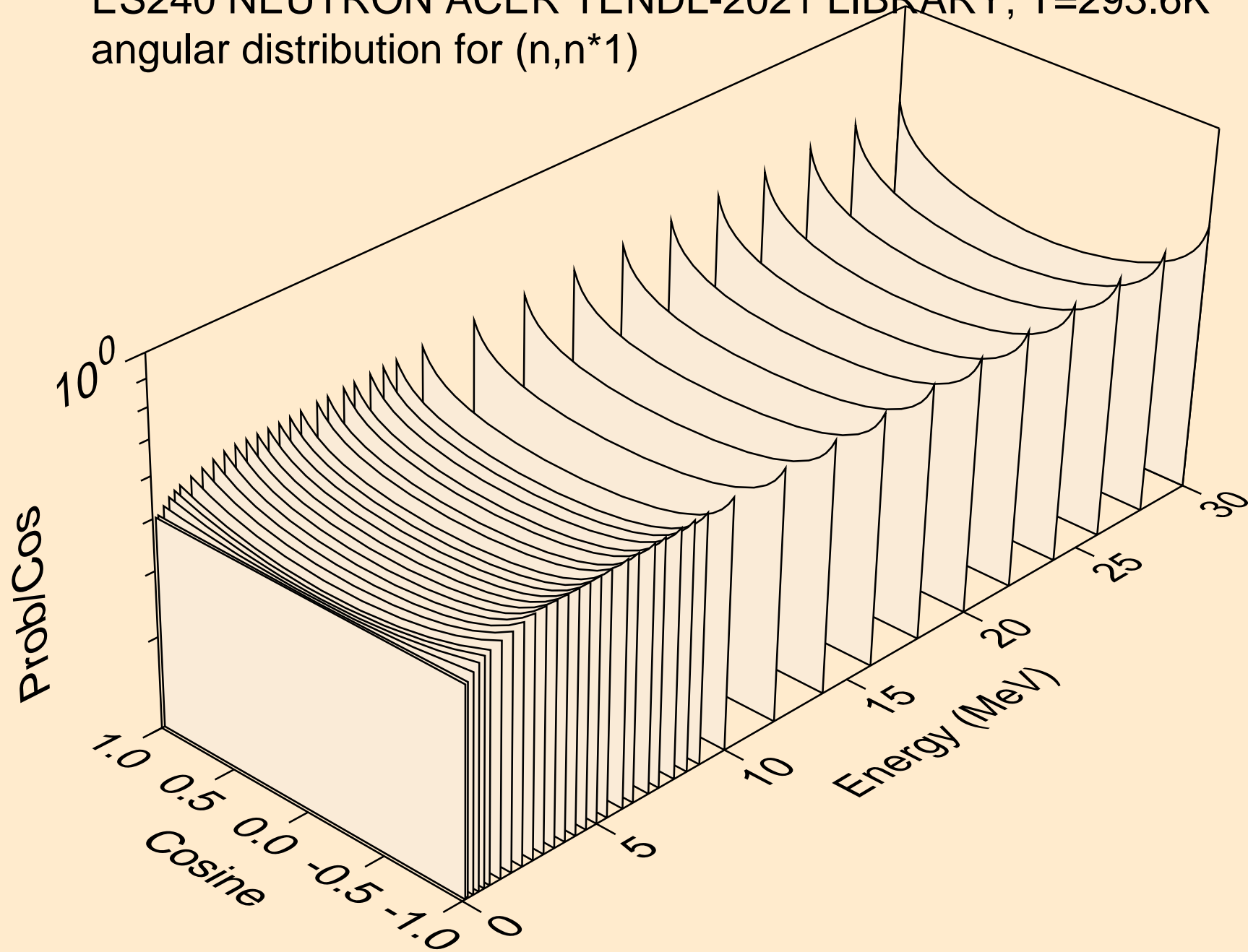

ES240 NEUTRON ACER TENDL-2021 LIBRARY; T=293.6K
Total fission nubar

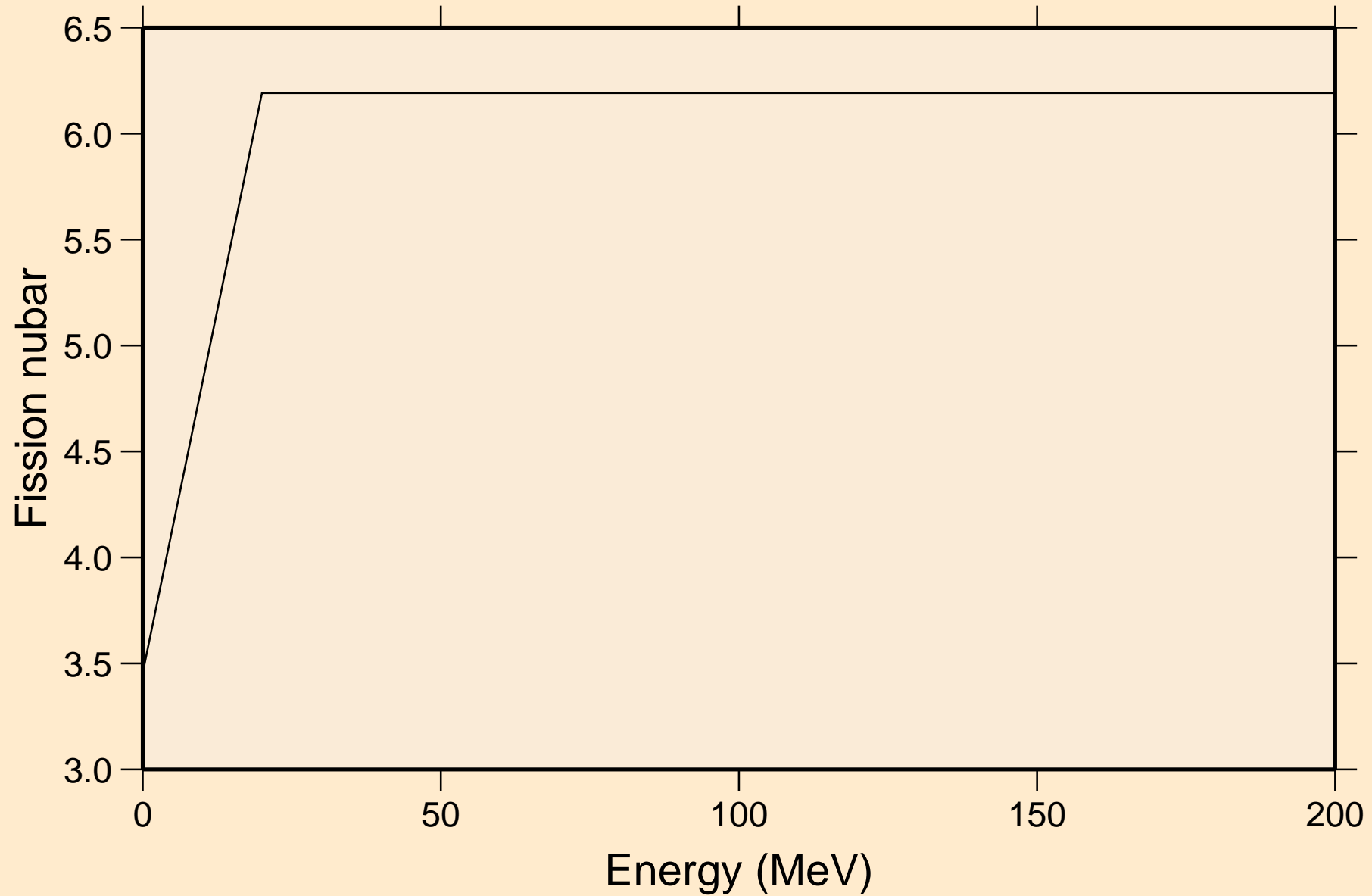

ES240 NEUTRON ACER TENDL-2021 LIBRARY; T=293.6K
Neutron emission for (n,x)

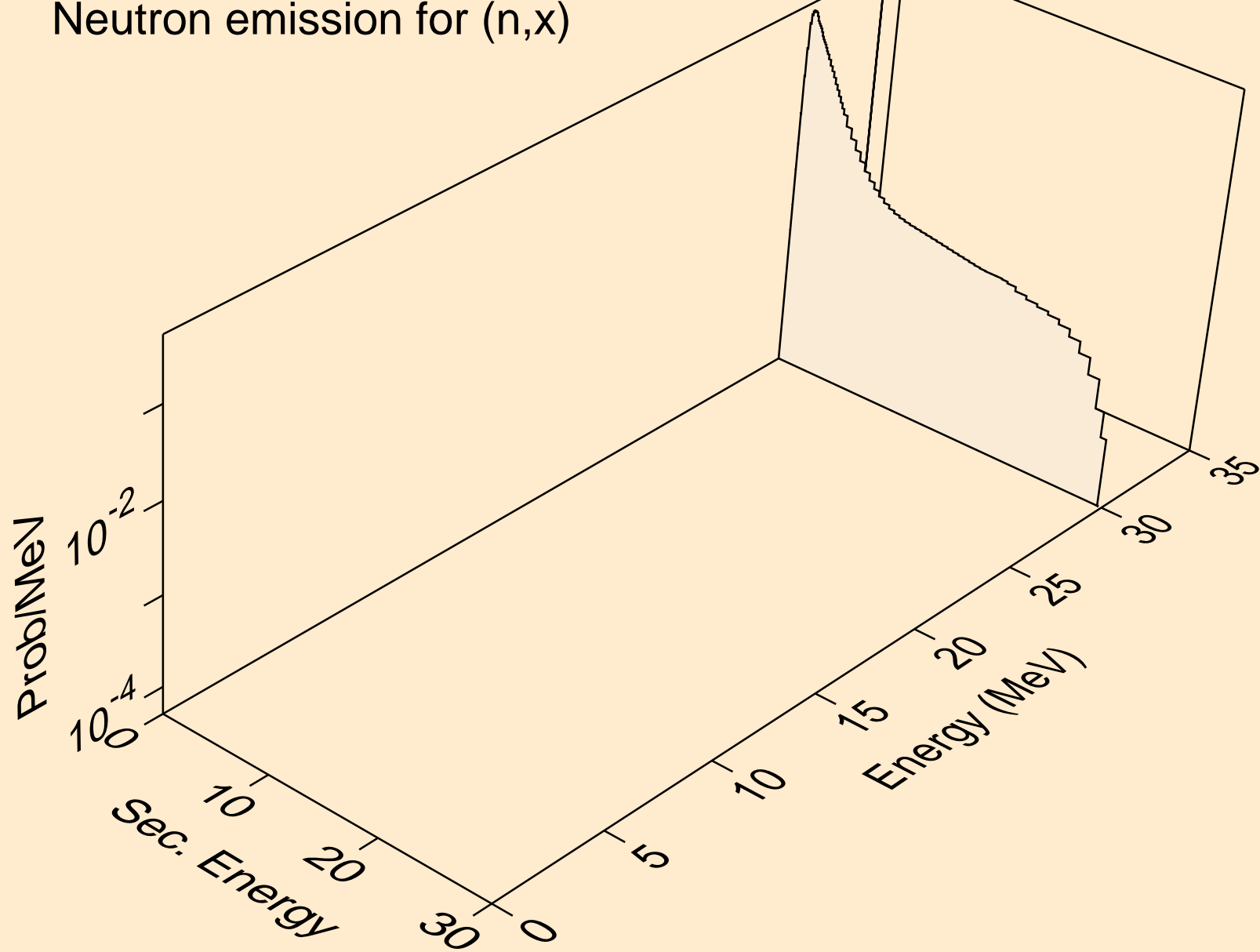

ES240 NEUTRON ACER TENDL-2021 LIBRARY; T=293.6K
Neutron emission for (n,2nd)

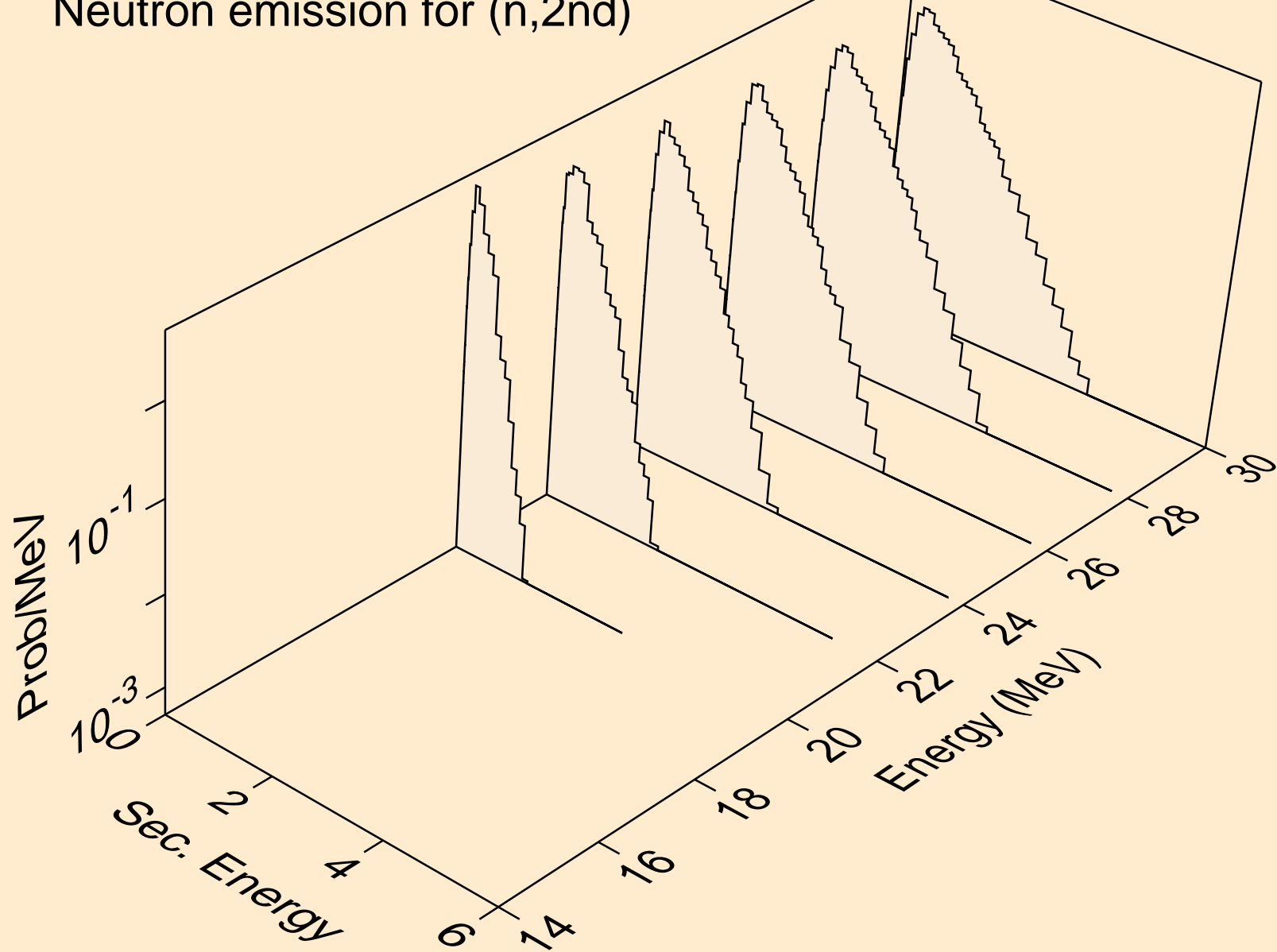

ES240 NEUTRON ACER TENDL-2021 LIBRARY; T=293.6K
Neutron emission for (n,2n)

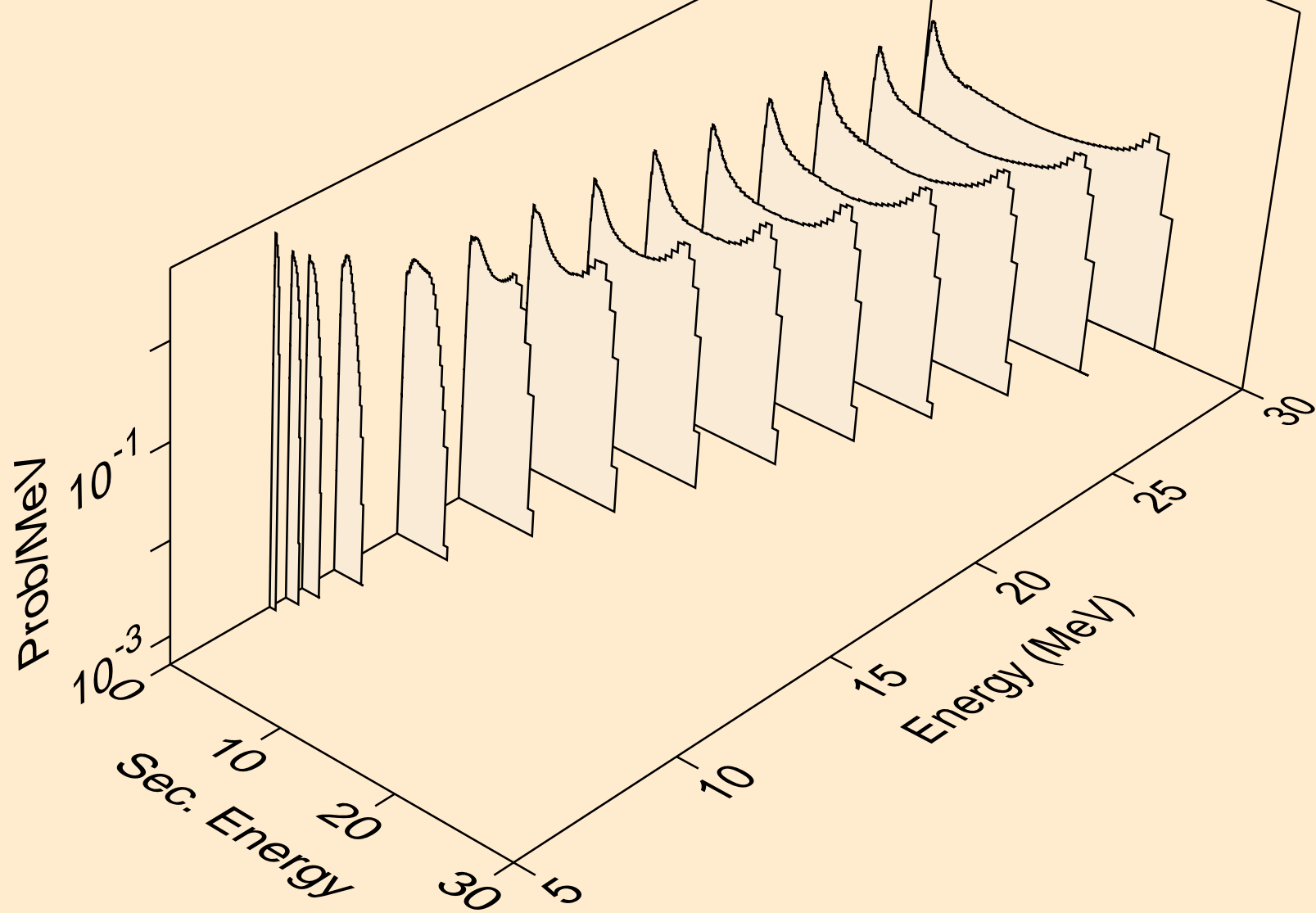

ES240 NEUTRON ACER TENDL-2021 LIBRARY; T=293.6K
Neutron emission for (n,3n)

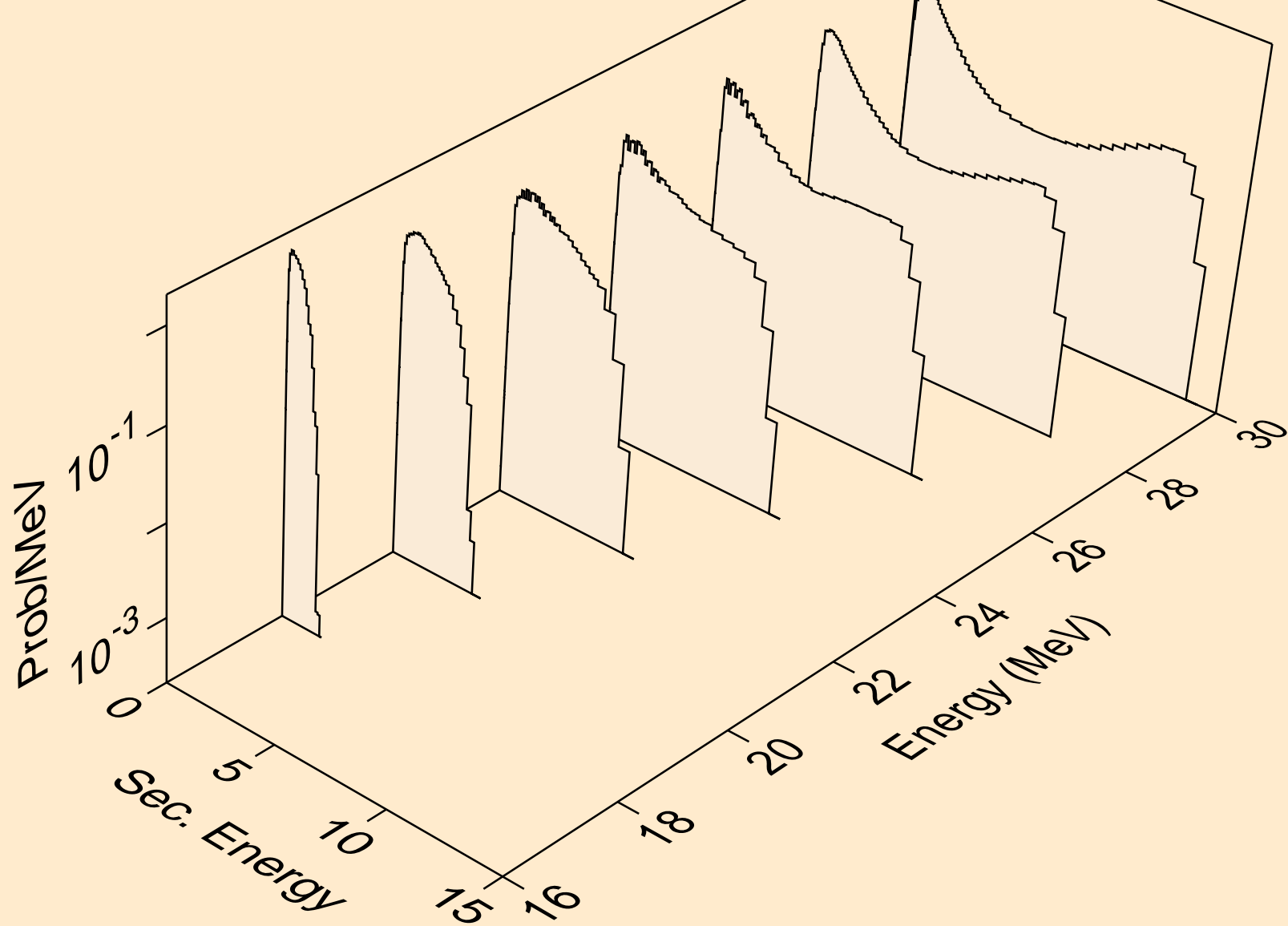

ES240 NEUTRON ACER TENDL-2021 LIBRARY; T=293.6K
Neutron emission for fission

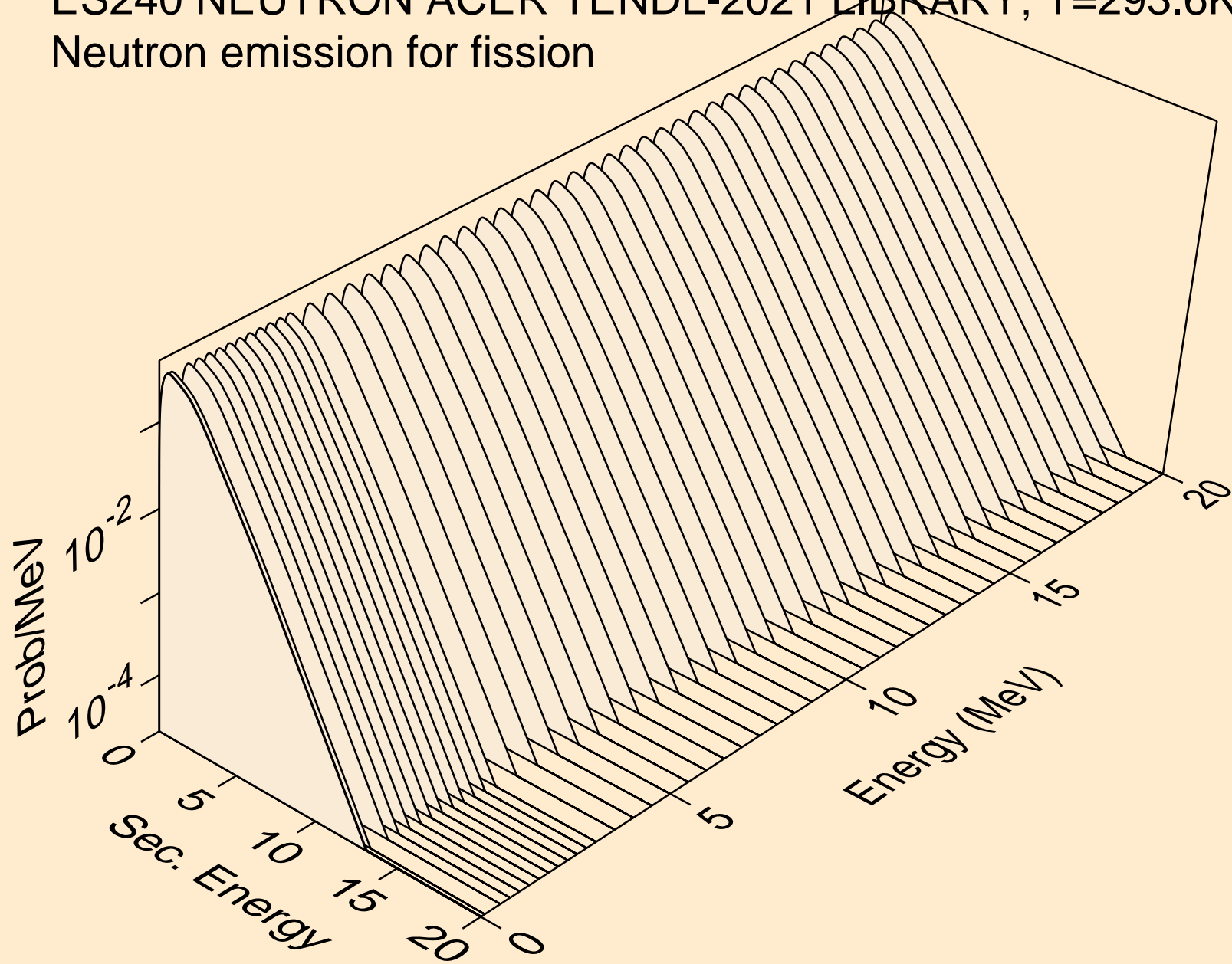

ES240 NEUTRON ACER TENDL-2021 LIBRARY; T=293.6K
Neutron emission for (n,n*)a

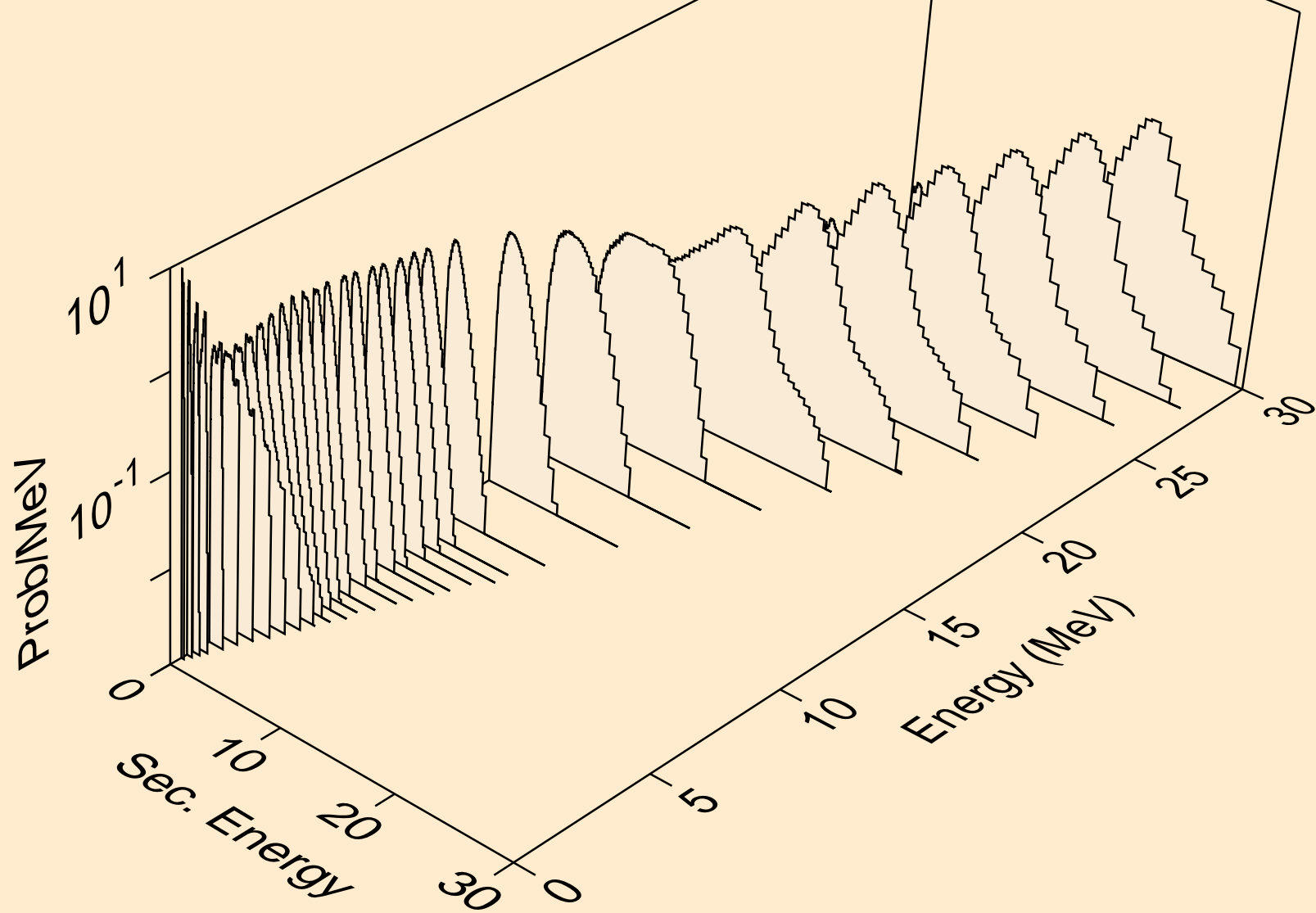

ES240 NEUTRON ACER TENDL-2021 LIBRARY; T=293.6K
Neutron emission for (n,2n)a

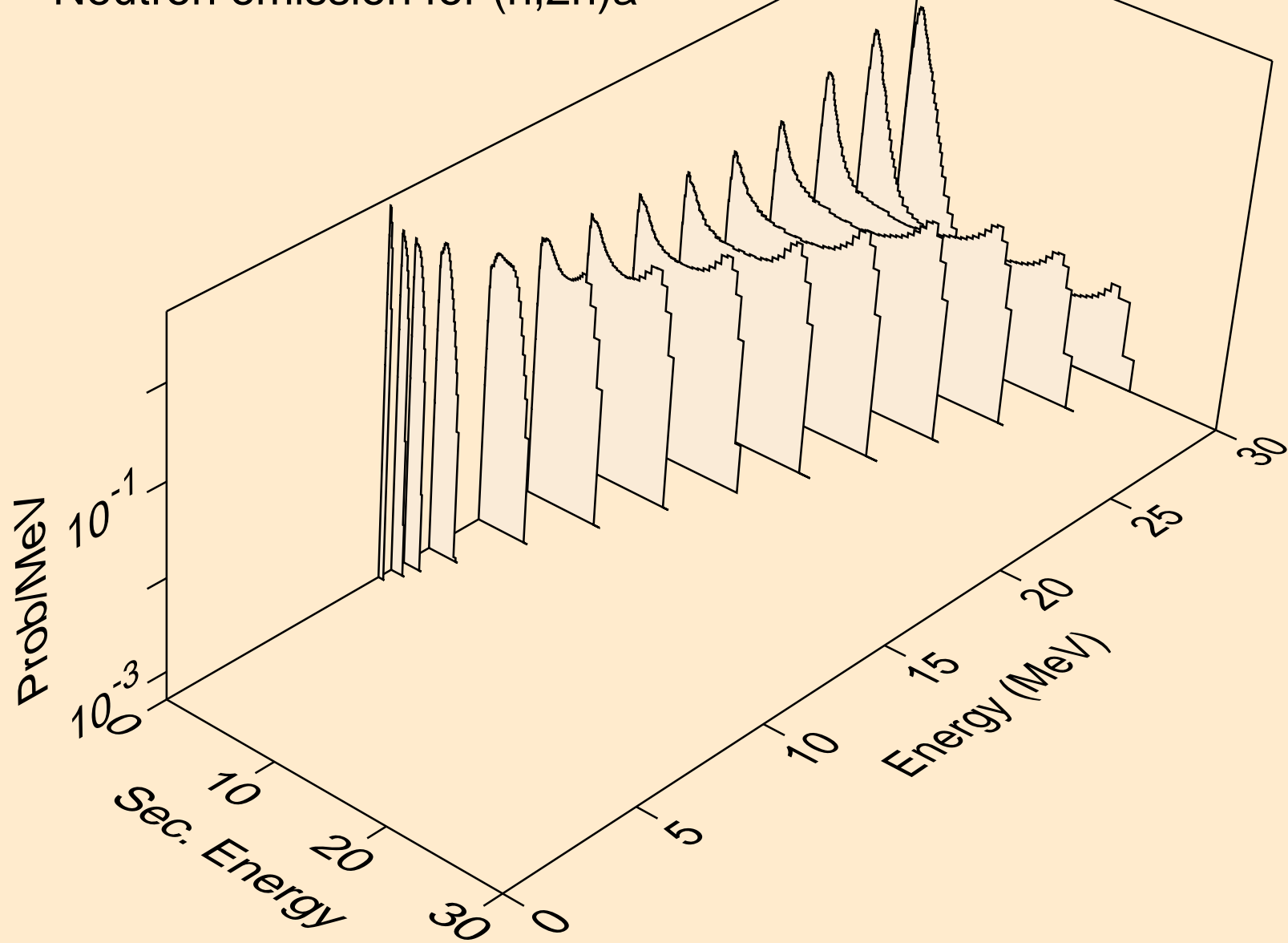

ES240 NEUTRON ACER TENDL-2021 LIBRARY; T=293.6K
Neutron emission for (n,3n)a

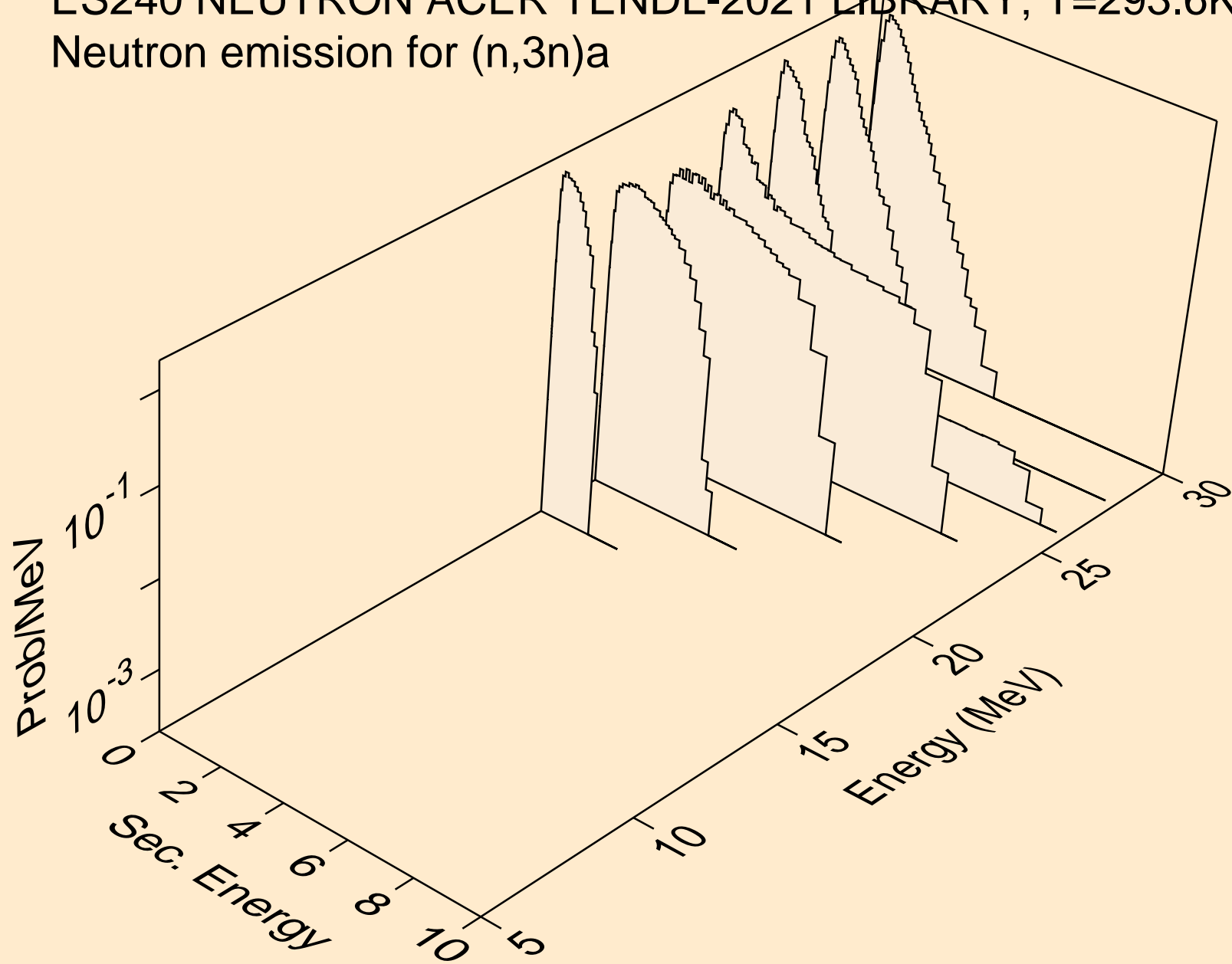

ES240 NEUTRON ACER TENDL-2021 LIBRARY; T=293.6K
Neutron emission for (n,n*)p

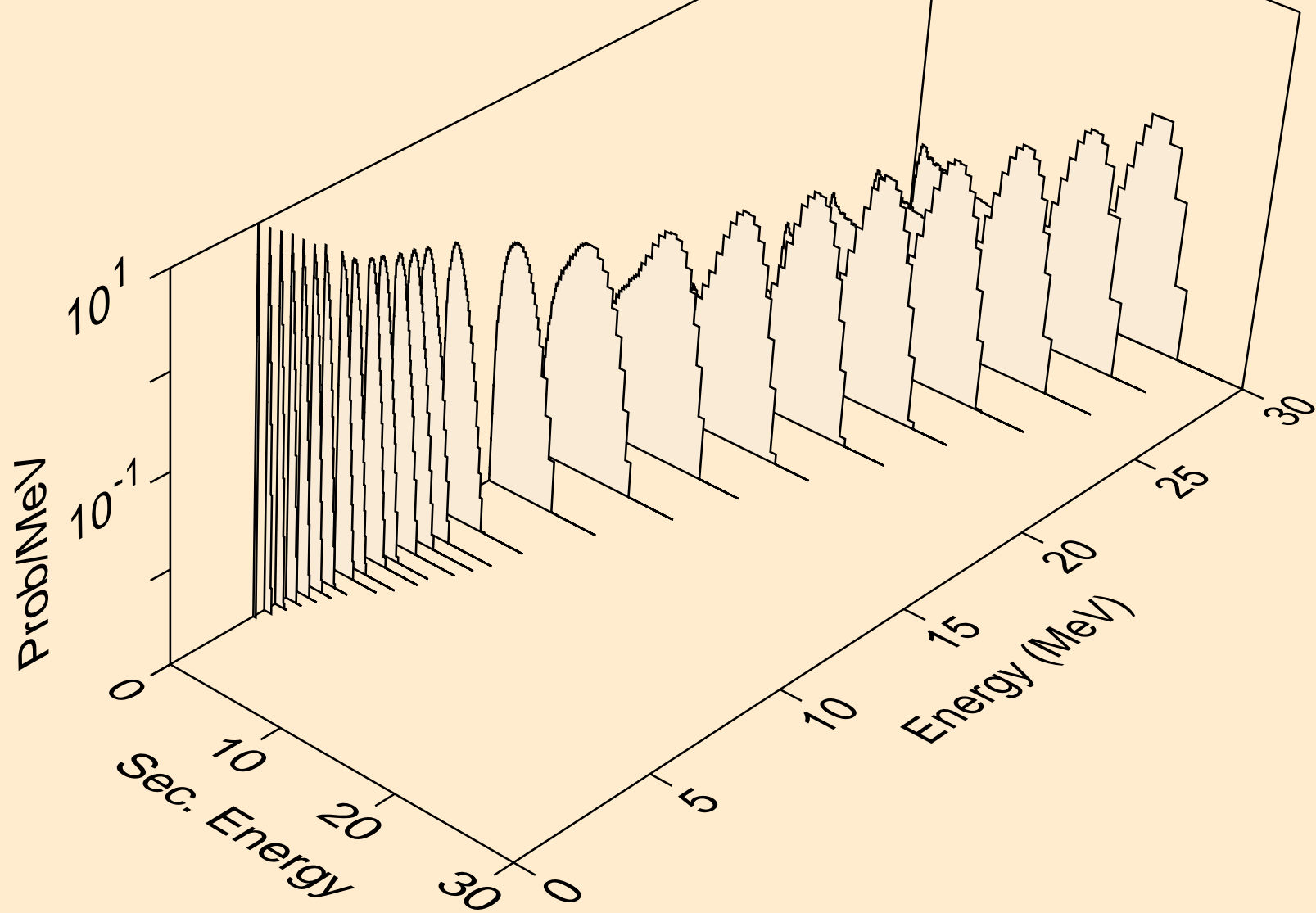

ES240 NEUTRON ACER TENDL-2021 LIBRARY; T=293.6K
Neutron emission for (n,n*)2a

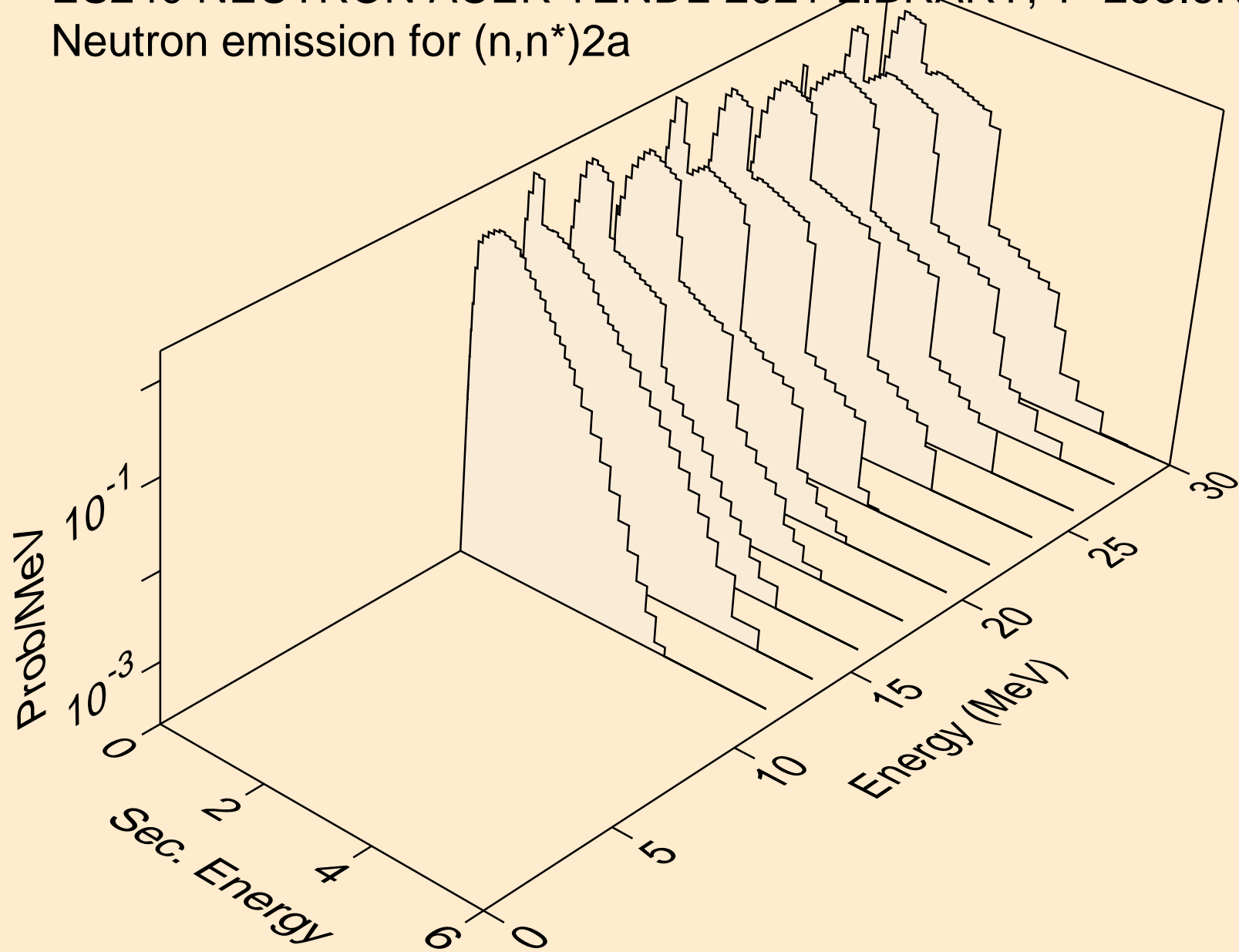

ES240 NEUTRON ACER TENDL-2021 LIBRARY; T=293.6K
Neutron emission for (n,n*)d

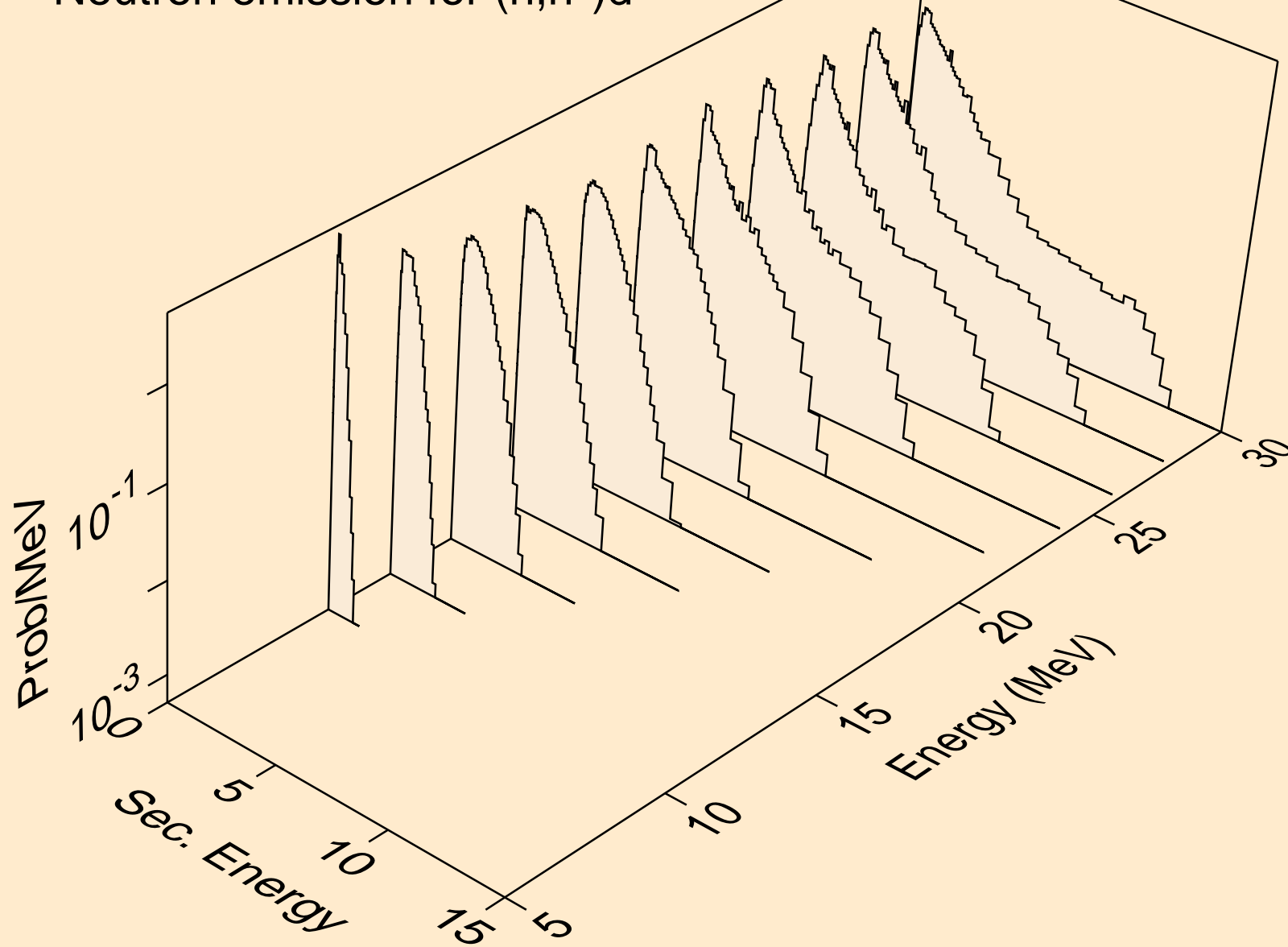

ES240 NEUTRON ACER TENDL-2021 LIBRARY; T=293.6K
Neutron emission for (n,n*)t

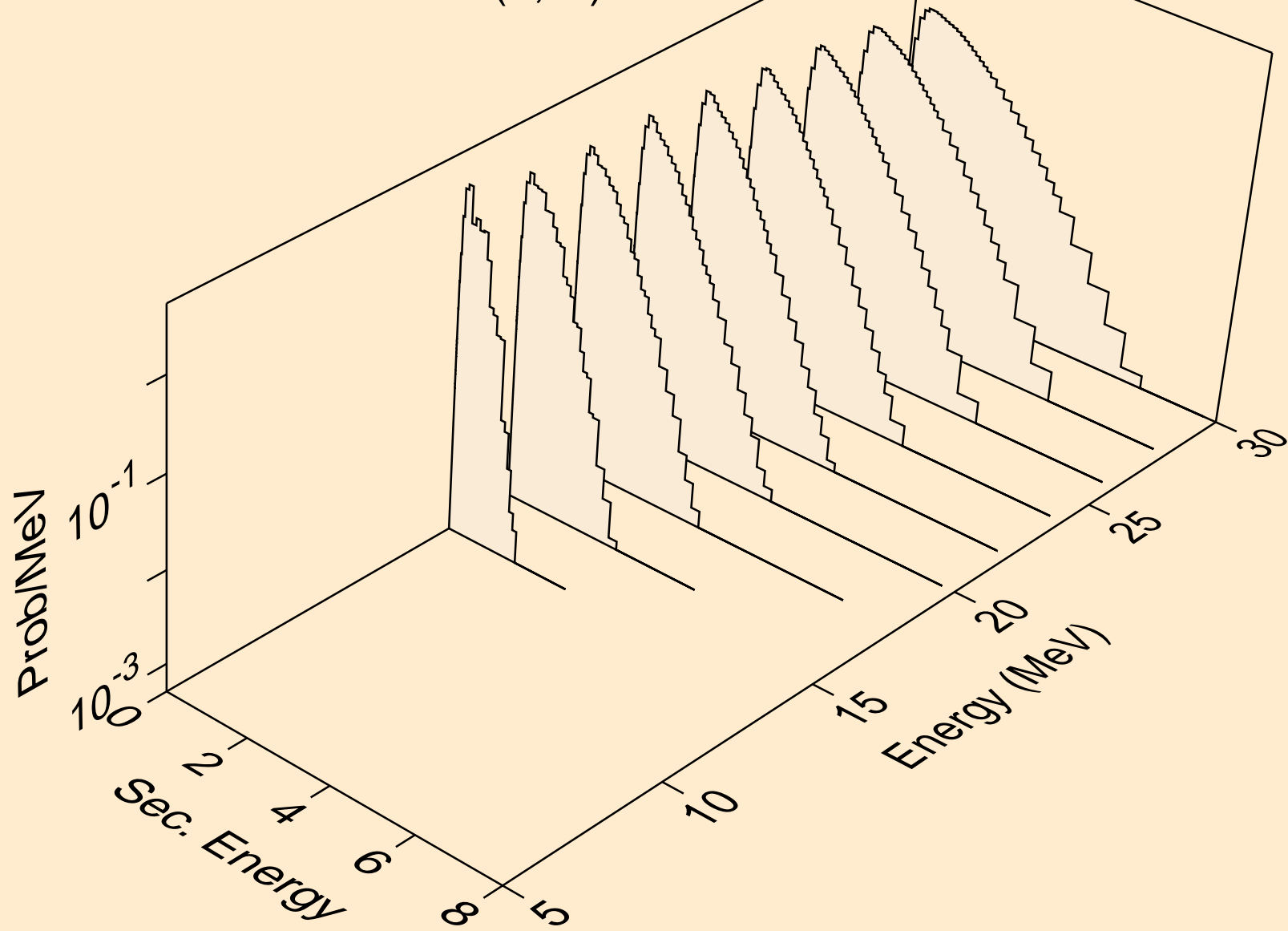

ES240 NEUTRON ACER TENDL-2021 LIBRARY; T=293.6K
Neutron emission for (n,2np)

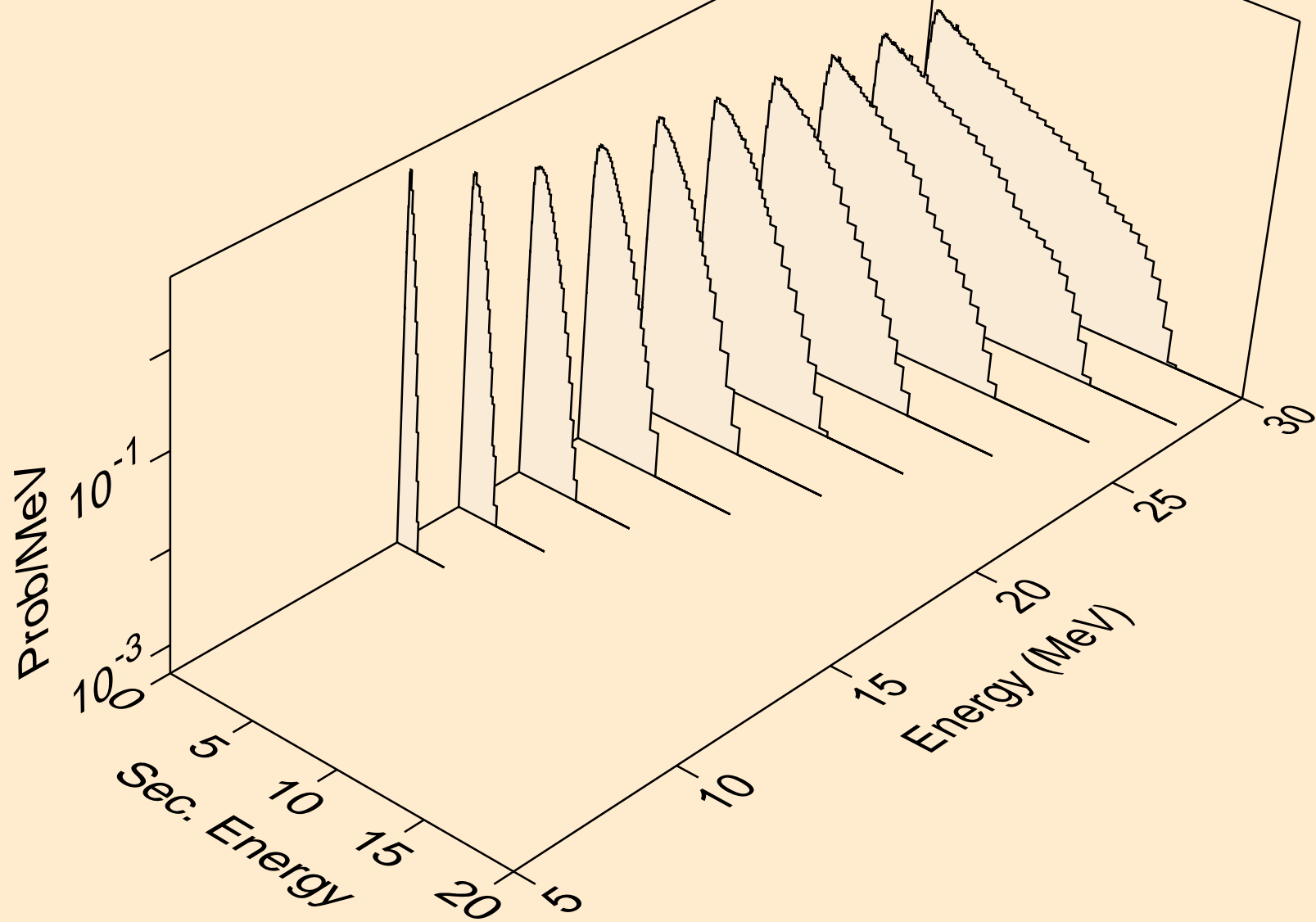

ES240 NEUTRON ACER TENDL-2021 LIBRARY; T=293.6K
Neutron emission for (n,3np)

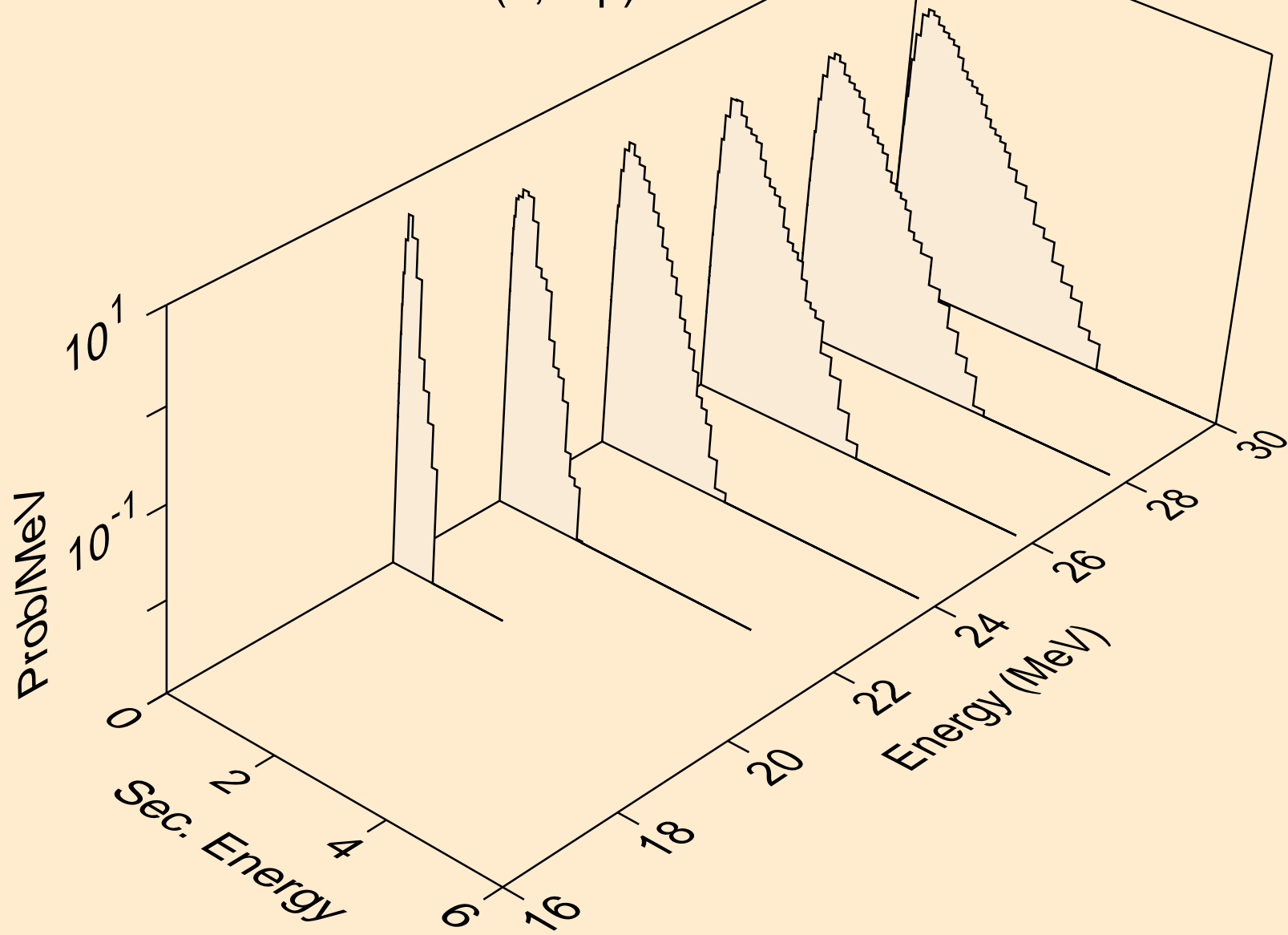

ES240 NEUTRON ACER TENDL-2021 LIBRARY; T=293.6K
Neutron emission for (n,n*c)

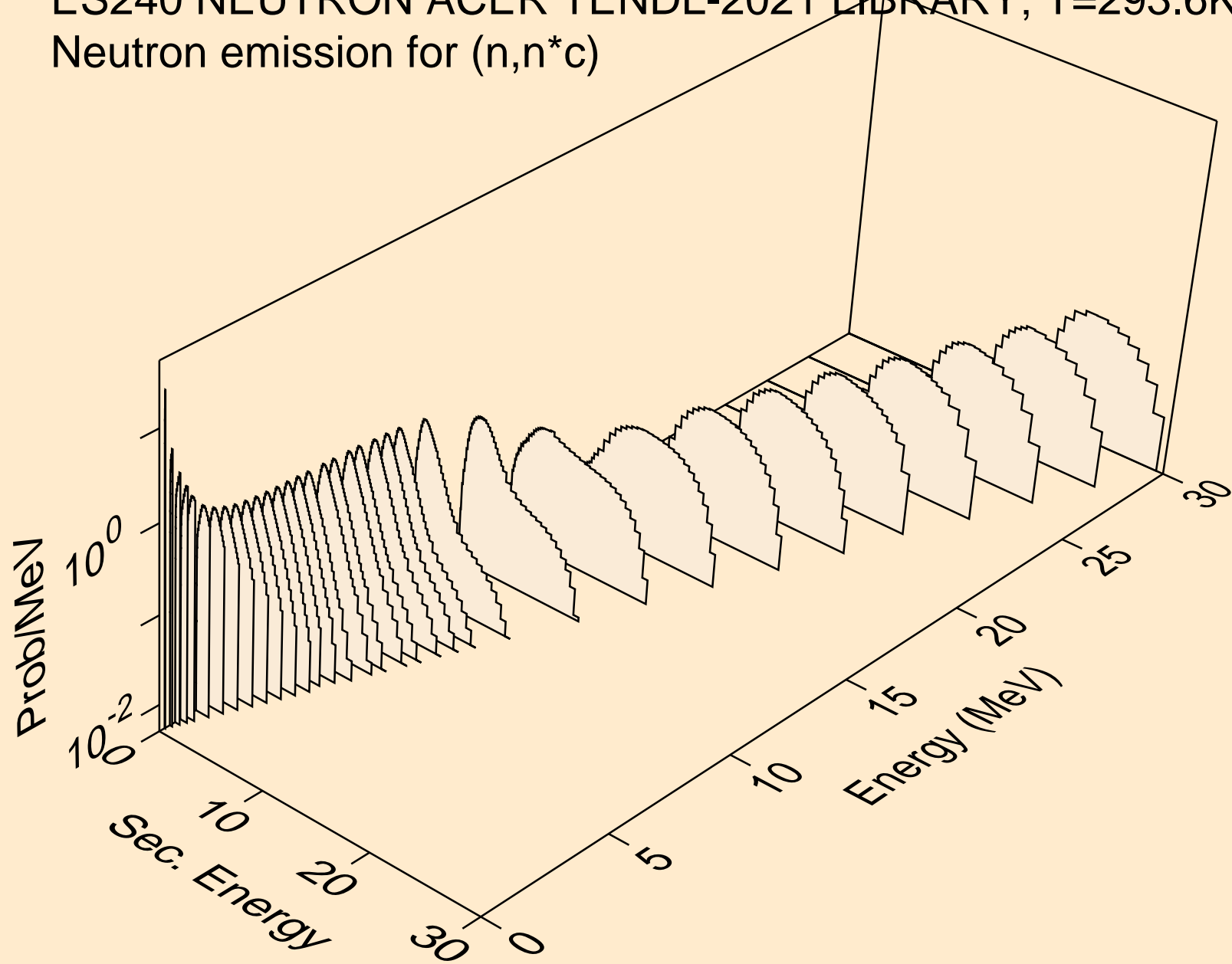

ES240 NEUTRON ACER TENDL-2021 LIBRARY; T=293.6K

Delayed nubar

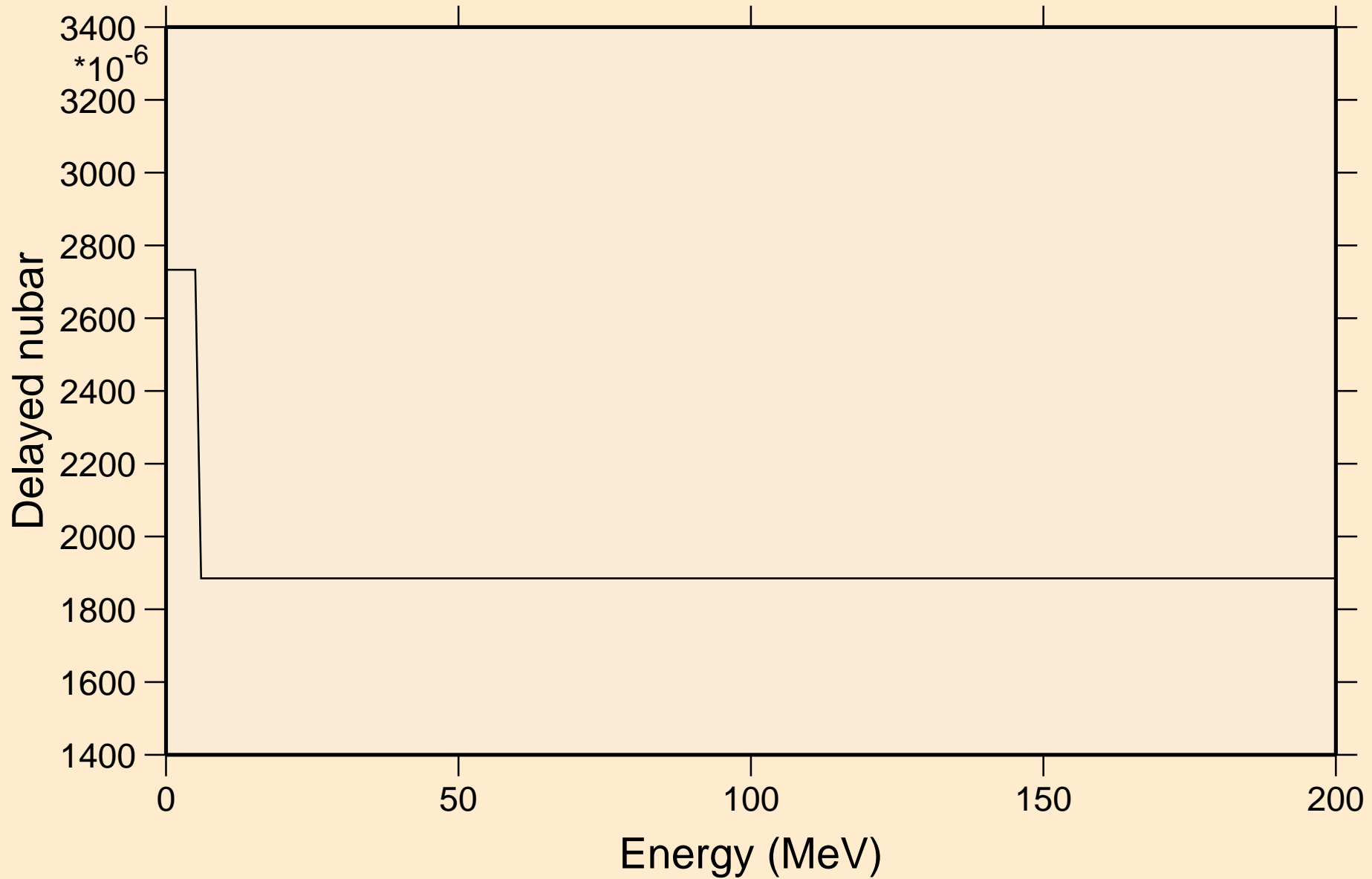

ES240 NEUTRON ACER TENDL-2021 LIBRARY; T=293.6K

Delayed neutron spectra

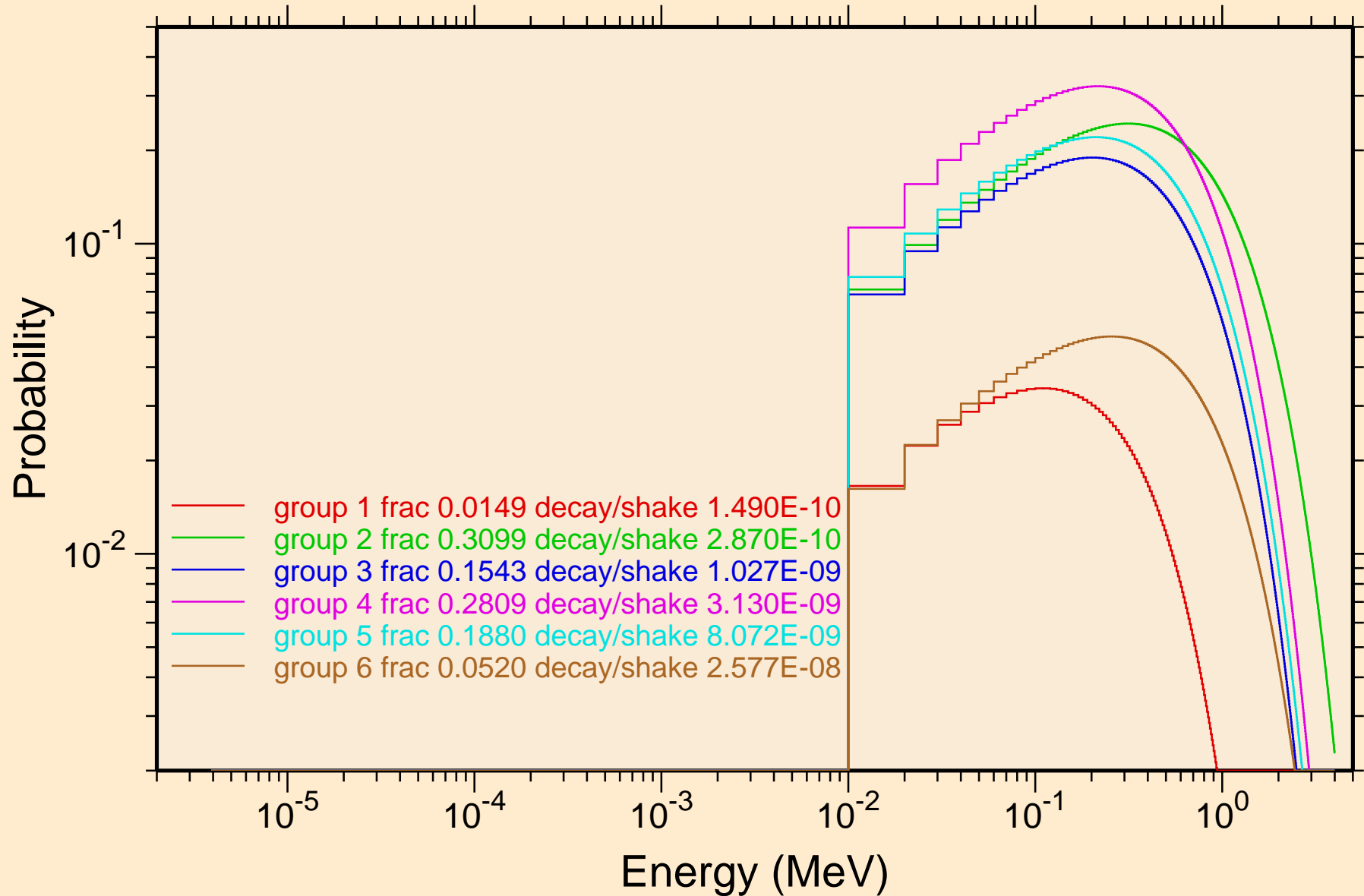

ES240 NEUTRON ACER TENDL-2021 LIBRARY; T=293.6K
Photon emission for (n,x)

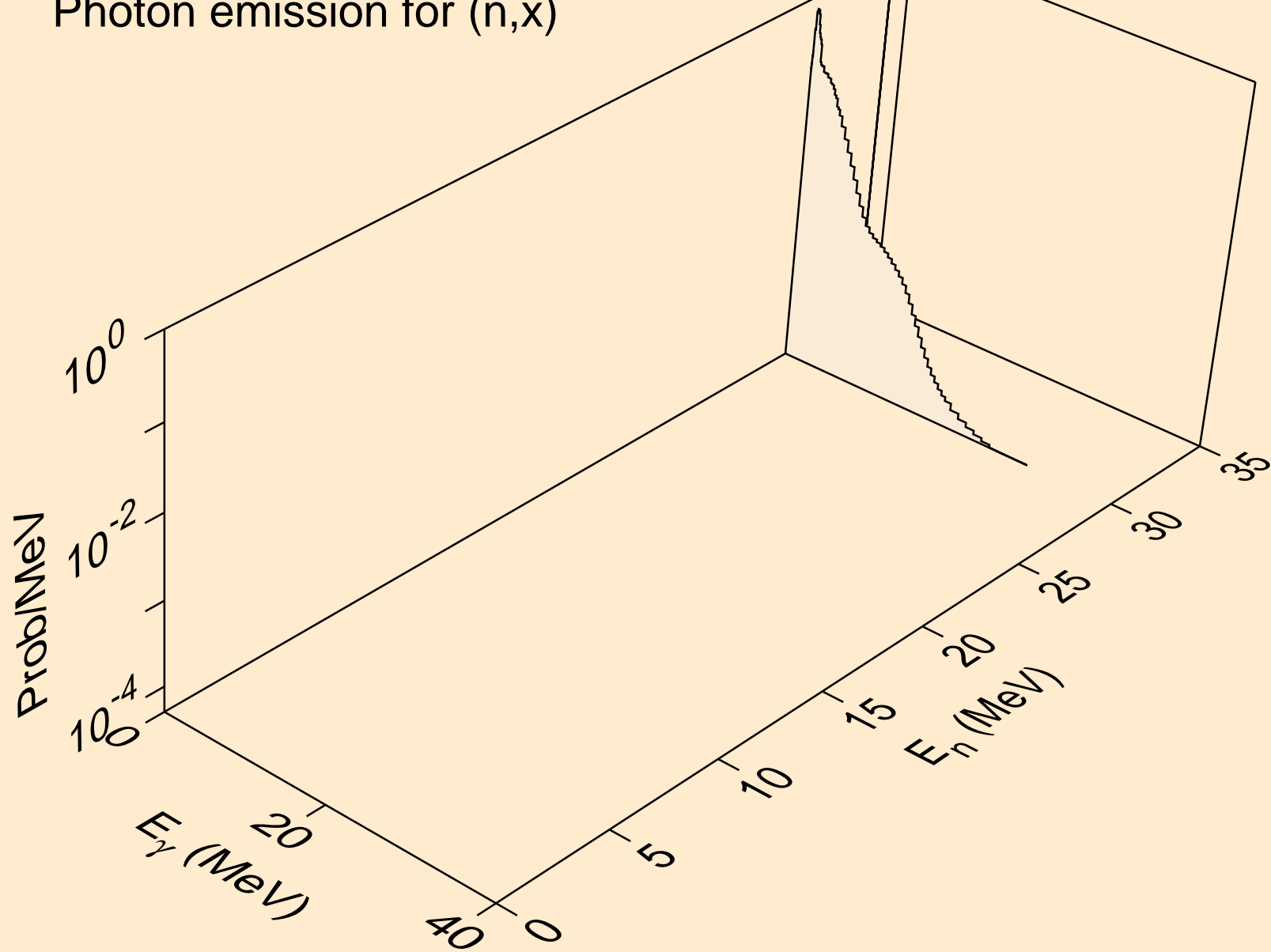

ES240 NEUTRON ACER TENDL-2021 LIBRARY; T=293.6K
Photon emission for (n,2nd)

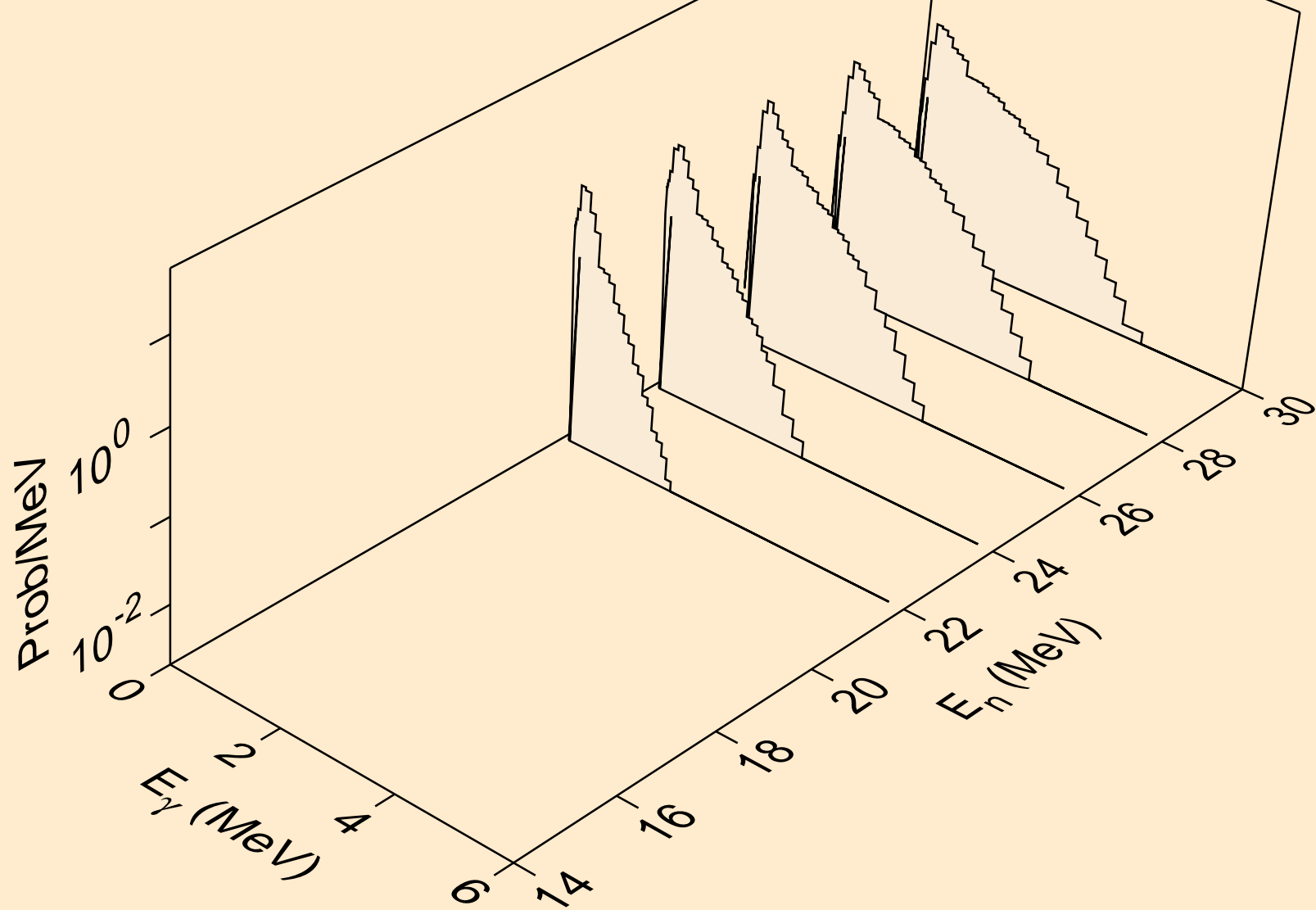

ES240 NEUTRON ACER TENDL-2021 LIBRARY; T=293.6K
Photon emission for (n,2n)

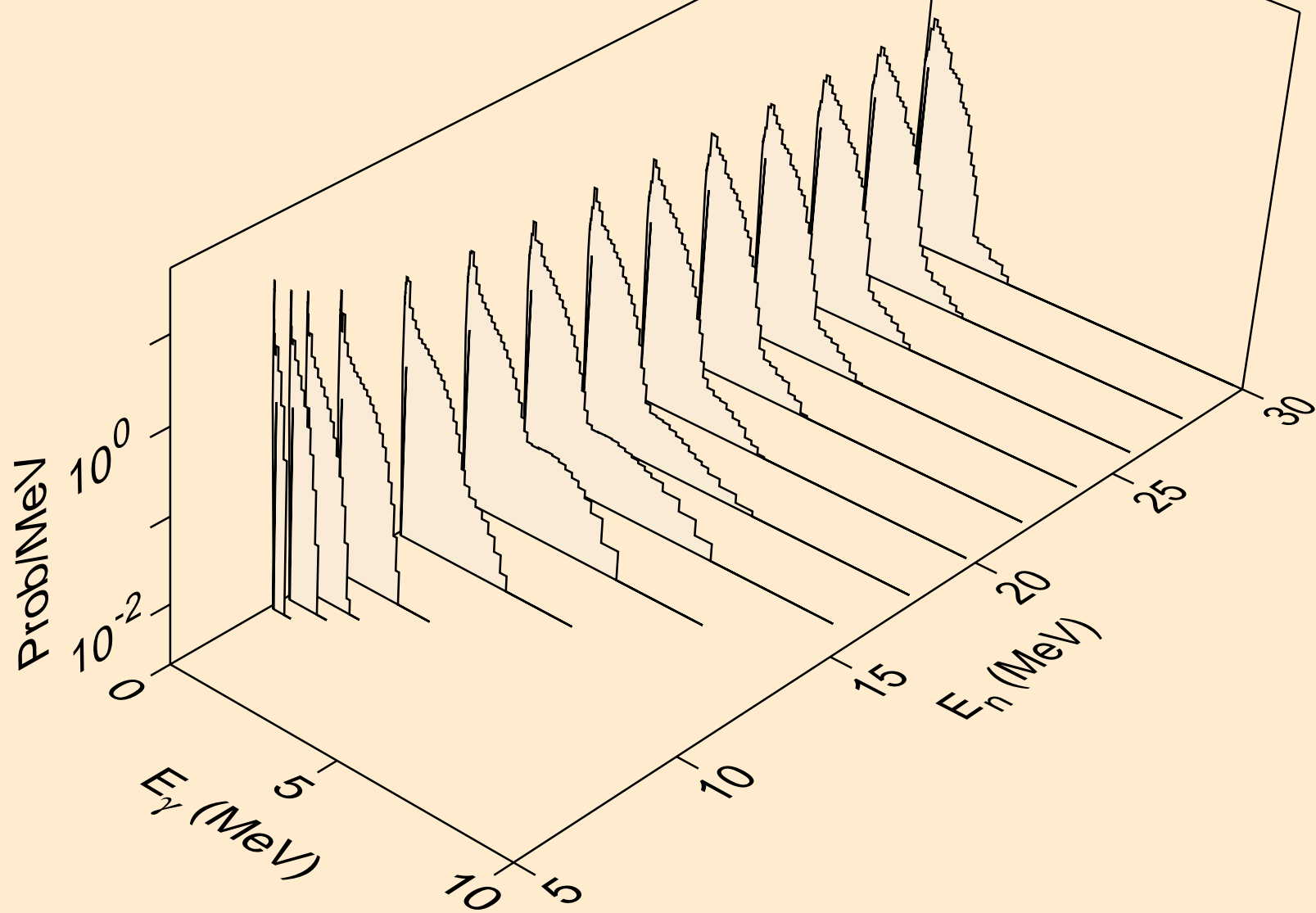

ES240 NEUTRON ACER TENDL-2021 LIBRARY; T=293.6K
Photon emission for (n,3n)

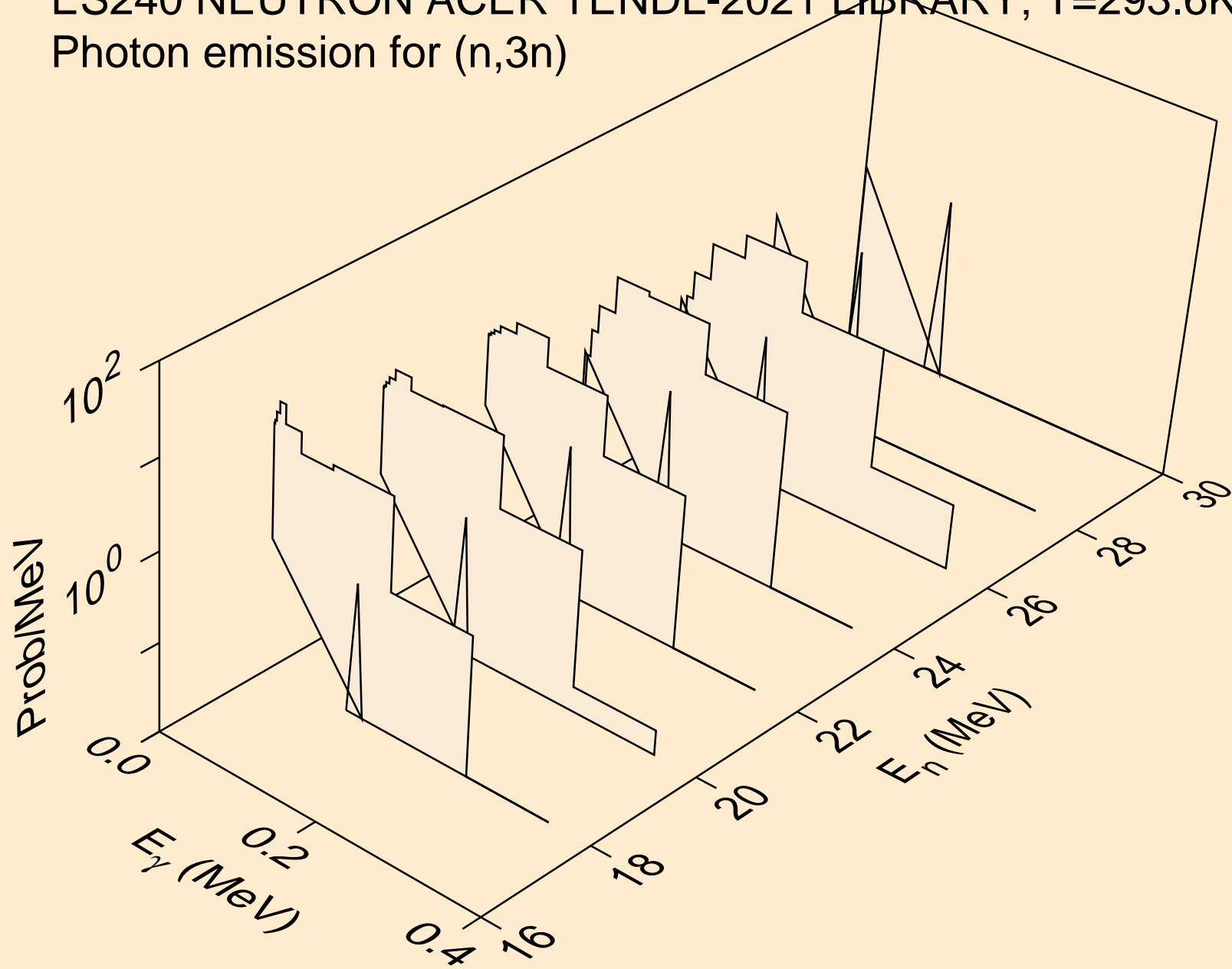

ES240 NEUTRON ACER TENDL-2021 LIBRARY; T=293.6K
Photon emission for (n,n*)a

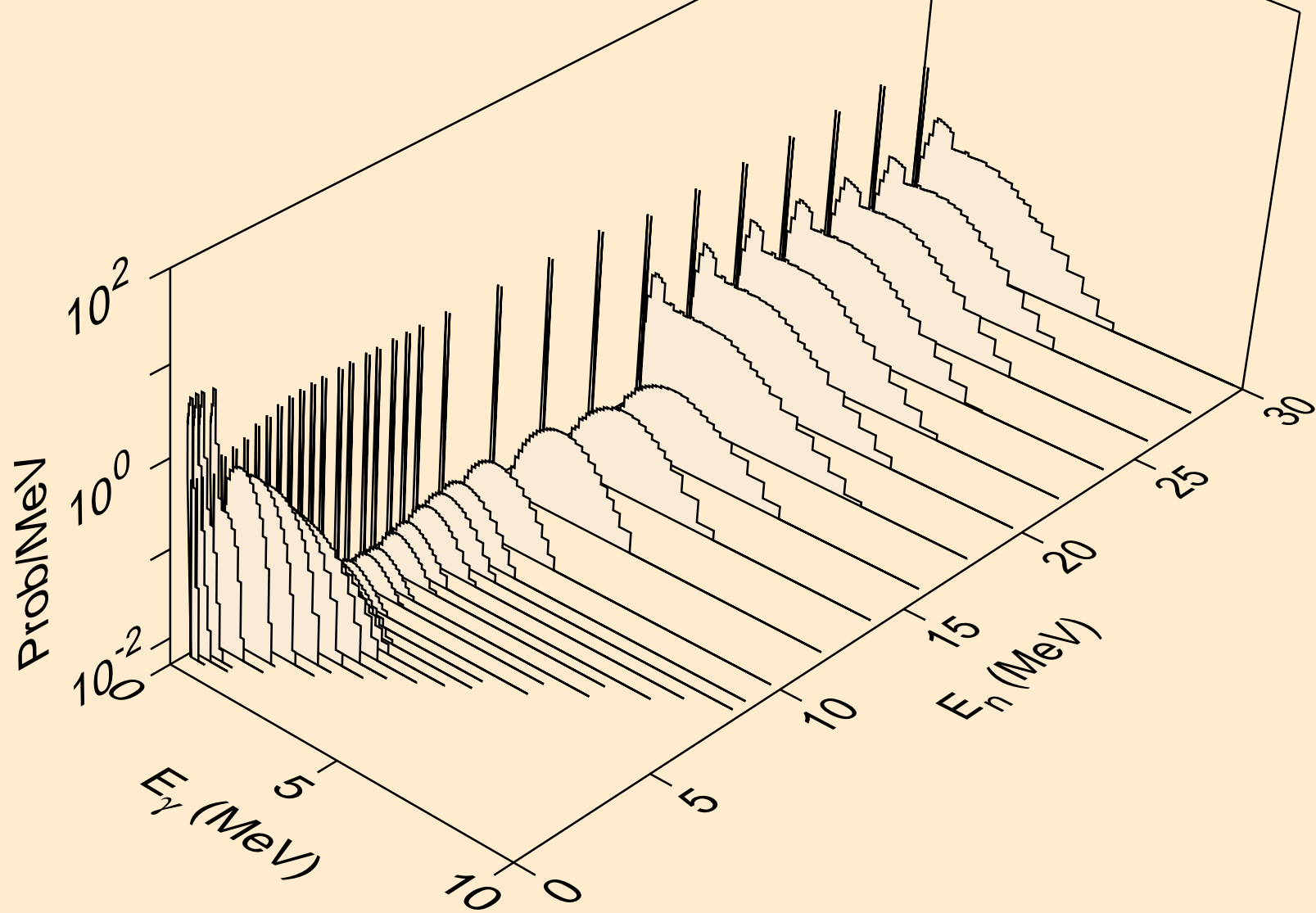

ES240 NEUTRON ACER TENDL-2021 LIBRARY; T=293.6K
Photon emission for (n,2n)a

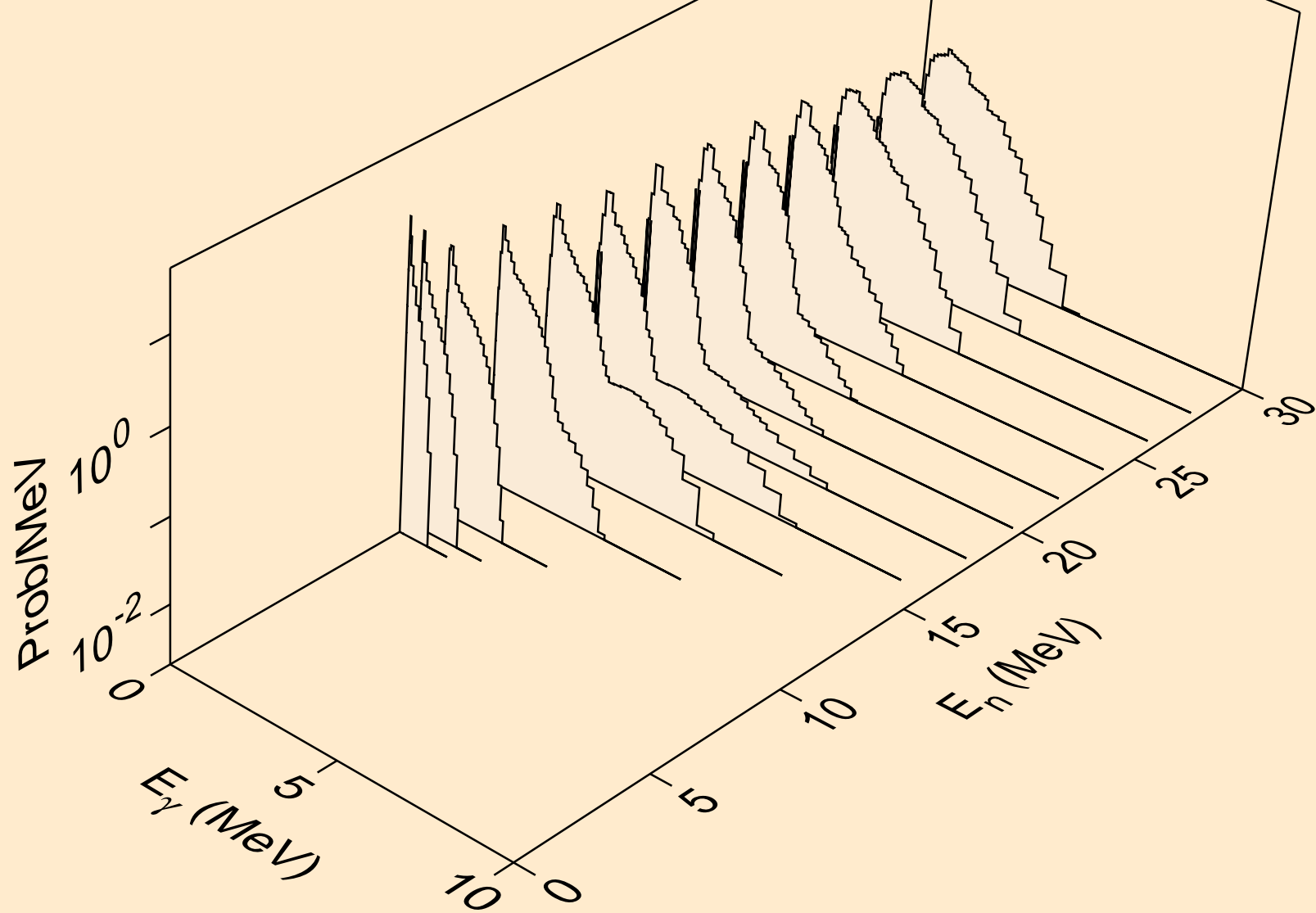

ES240 NEUTRON ACER TENDL-2021 LIBRARY; T=293.6K
Photon emission for (n,3n)a

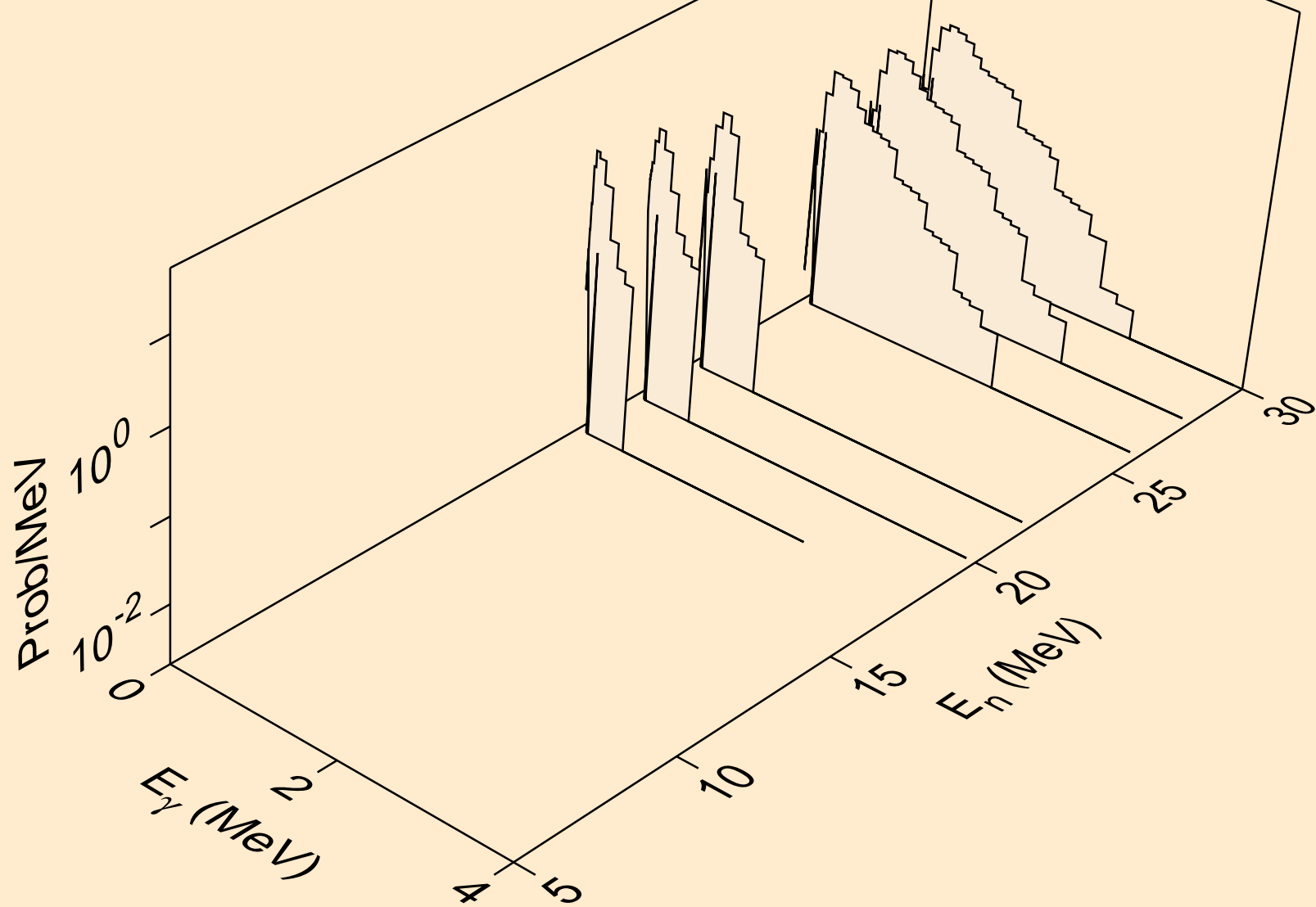

ES240 NEUTRON ACER TENDL-2021 LIBRARY; T=293.6K
Photon emission for (n,n*)p

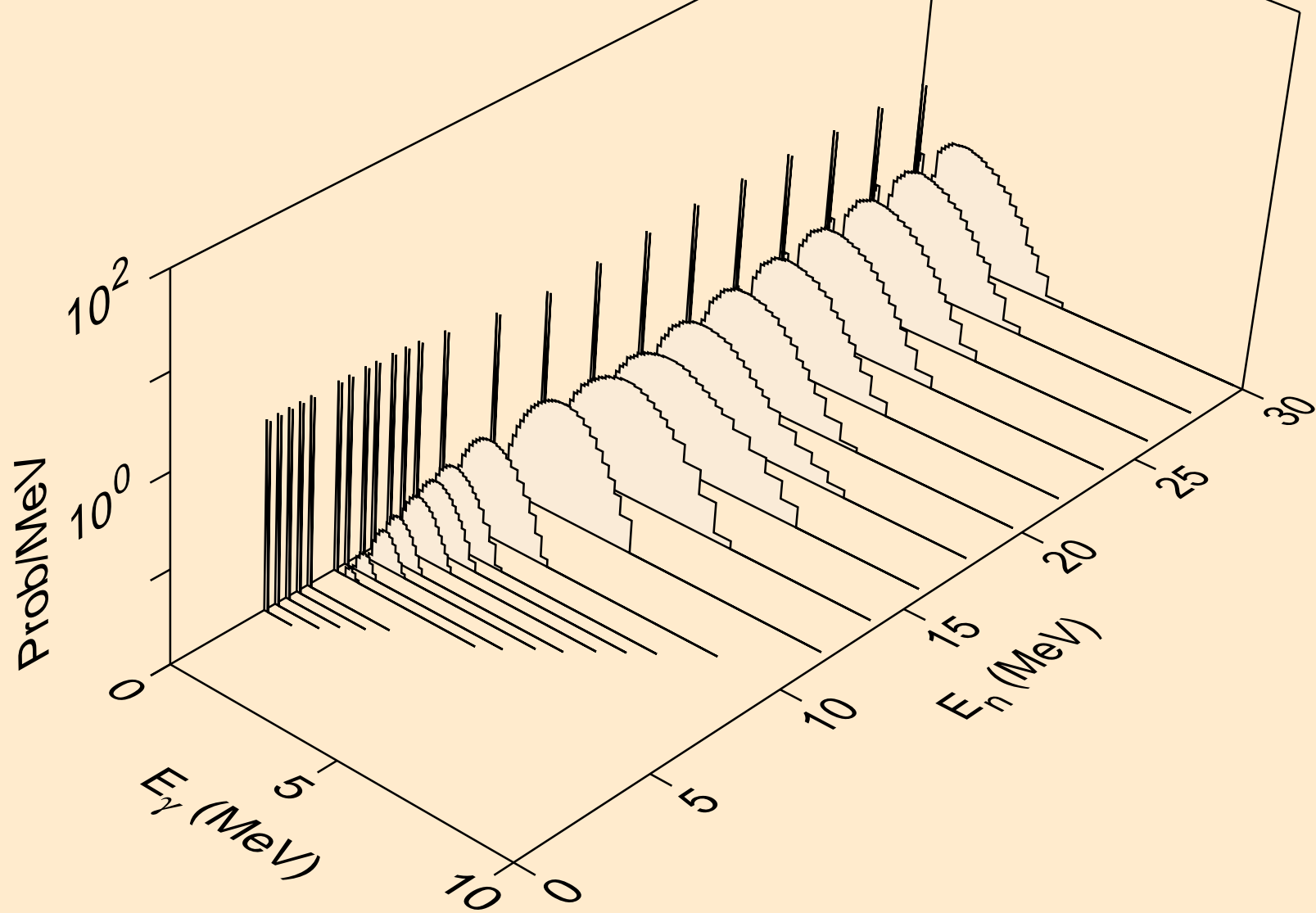

ES240 NEUTRON ACER TENDL-2021 LIBRARY; T=293.6K
Photon emission for (n,n*)2a

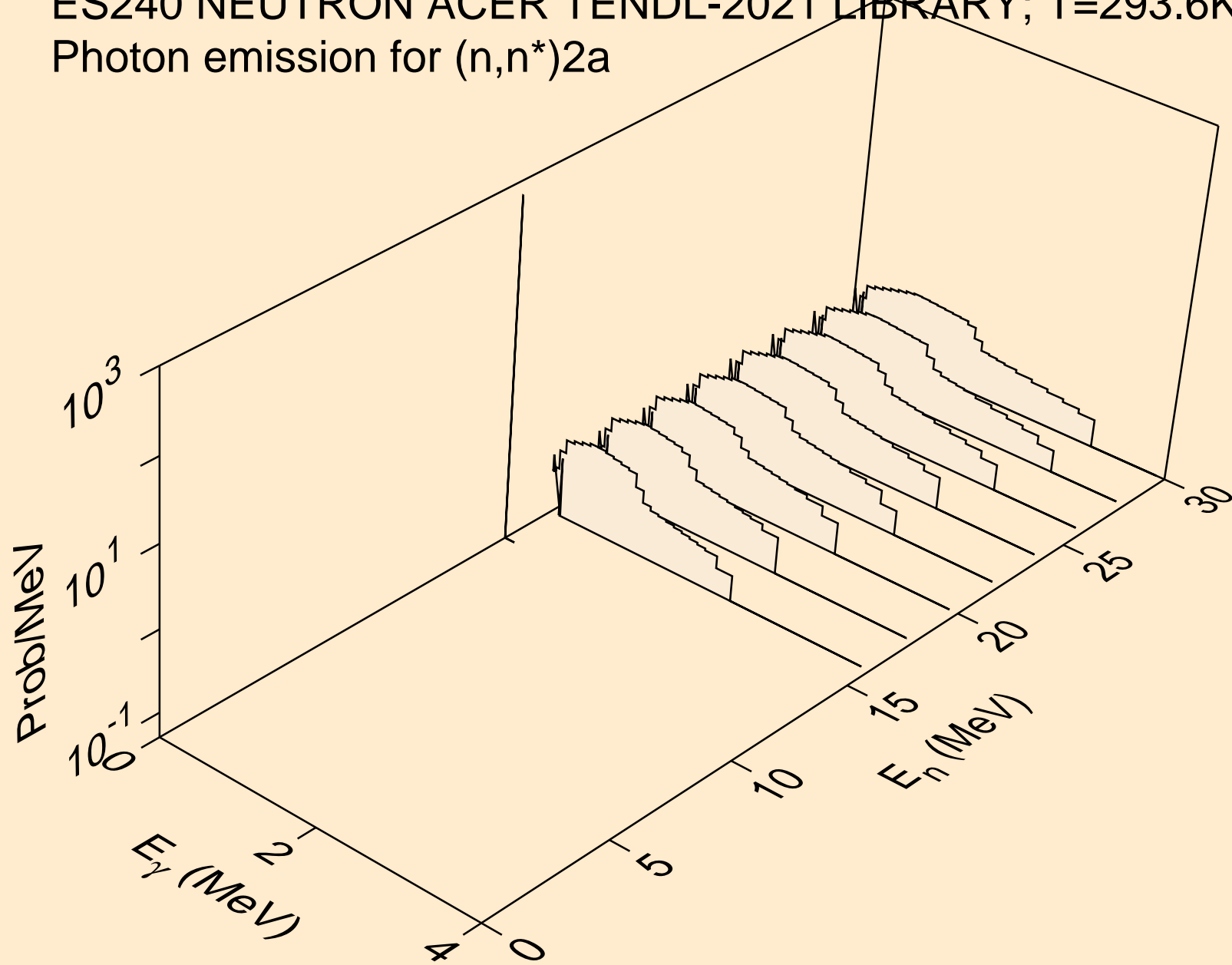

ES240 NEUTRON ACER TENDL-2021 LIBRARY; T=293.6K
Photon emission for (n,n*)d

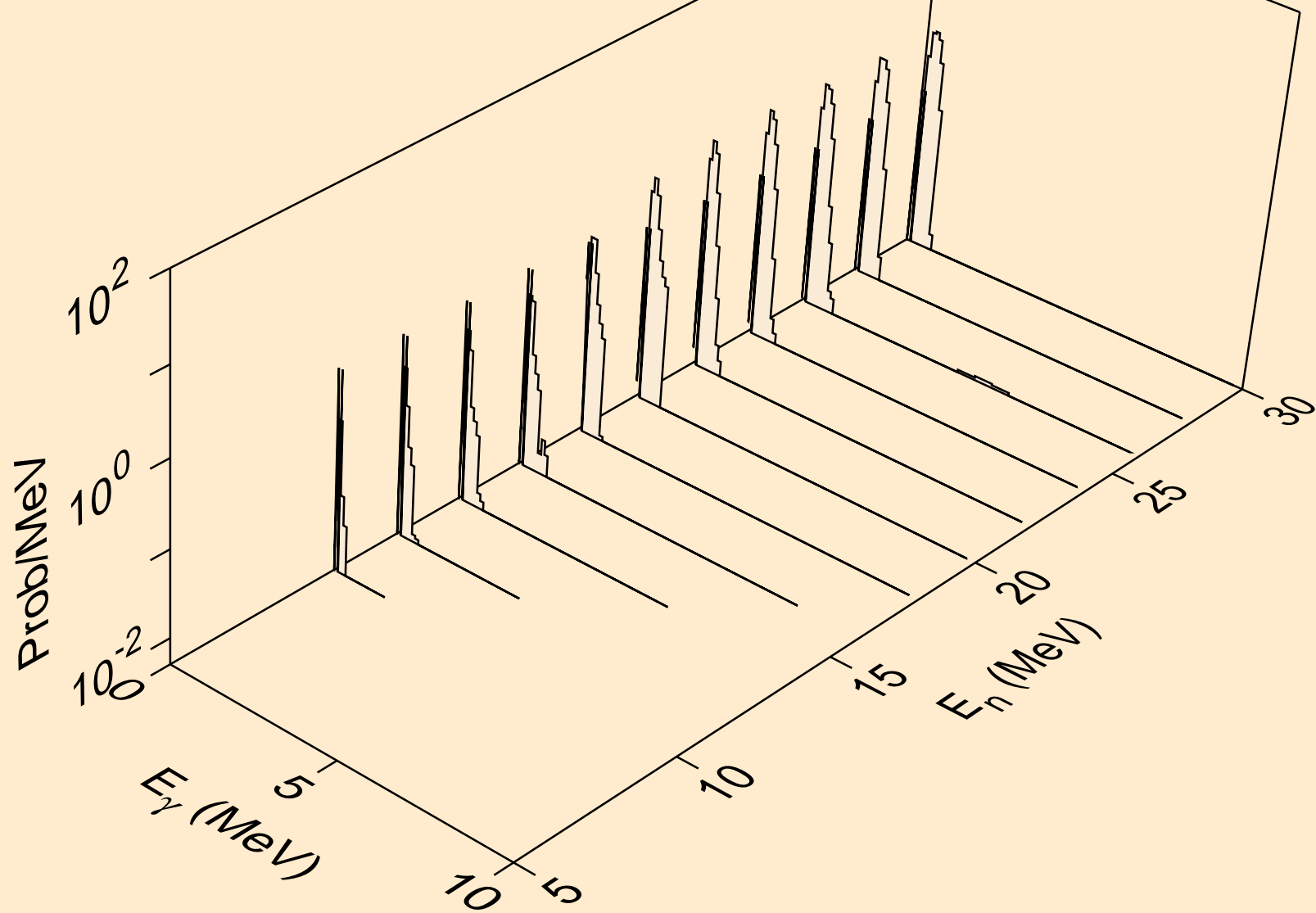

ES240 NEUTRON ACER TENDL-2021 LIBRARY; T=293.6K
Photon emission for (n,n*)t

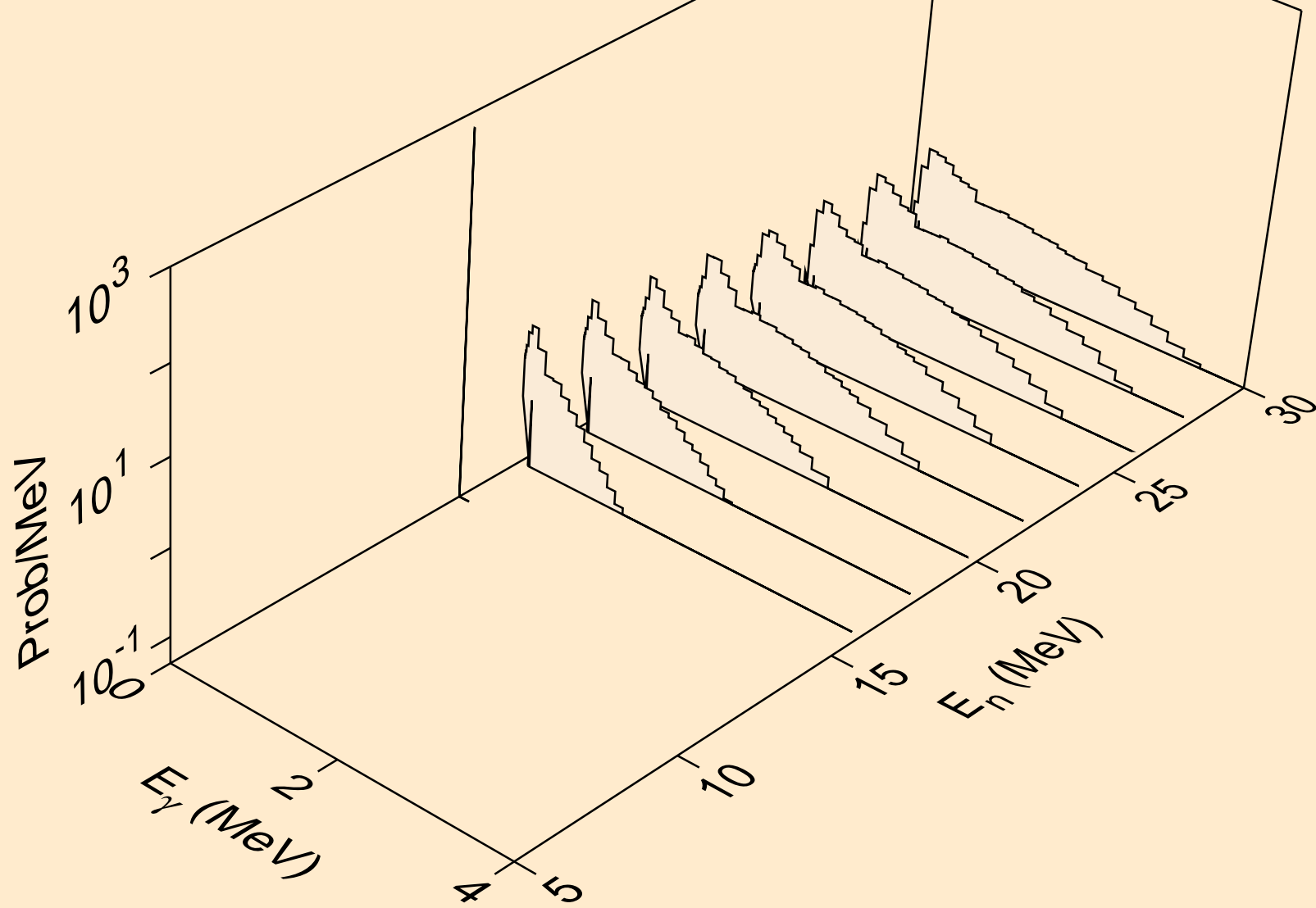

ES240 NEUTRON ACER TENDL-2021 LIBRARY; T=293.6K
Photon emission for (n,2np)

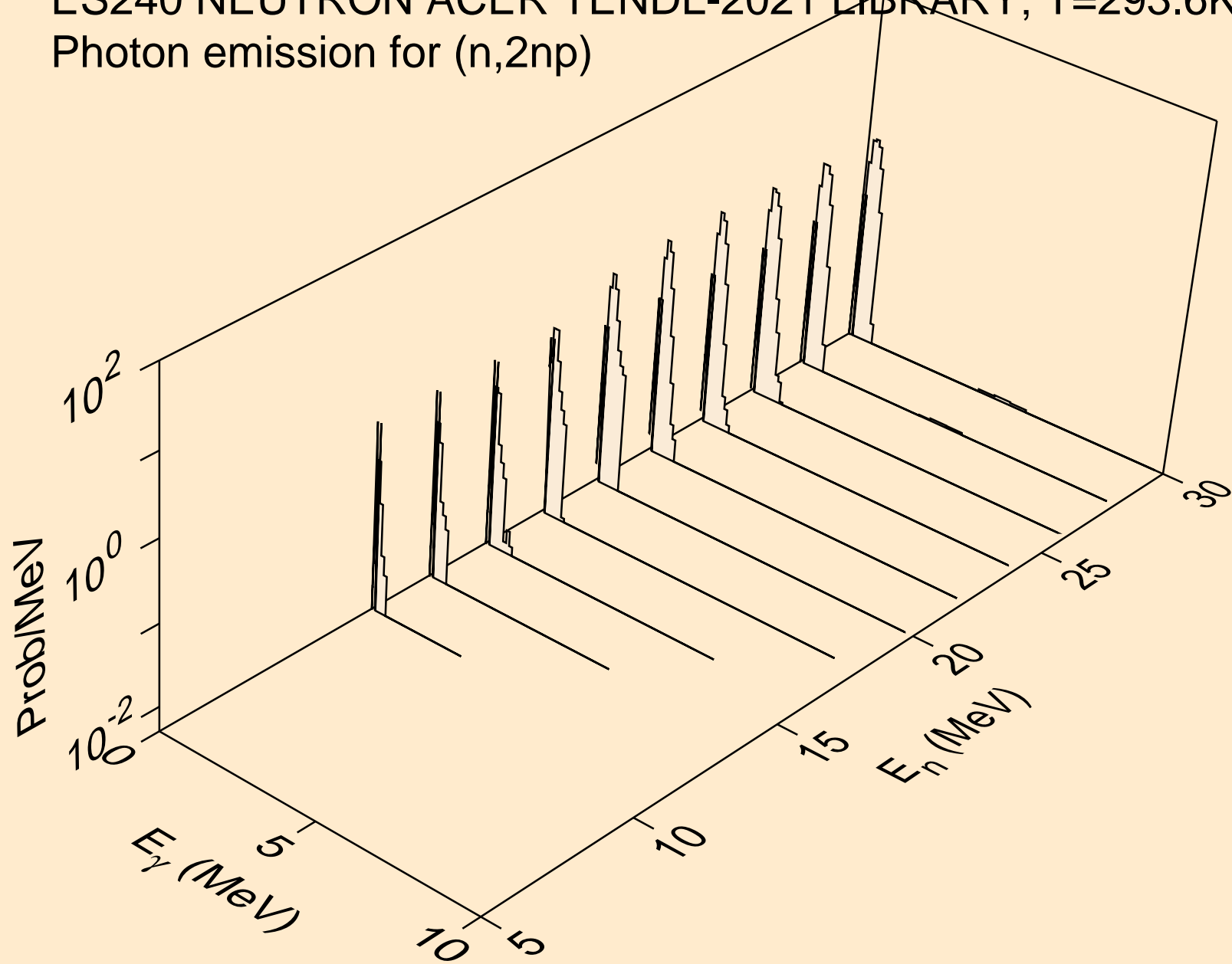

ES240 NEUTRON ACER TENDL-2021 LIBRARY; T=293.6K
Photon emission for (n,3np)

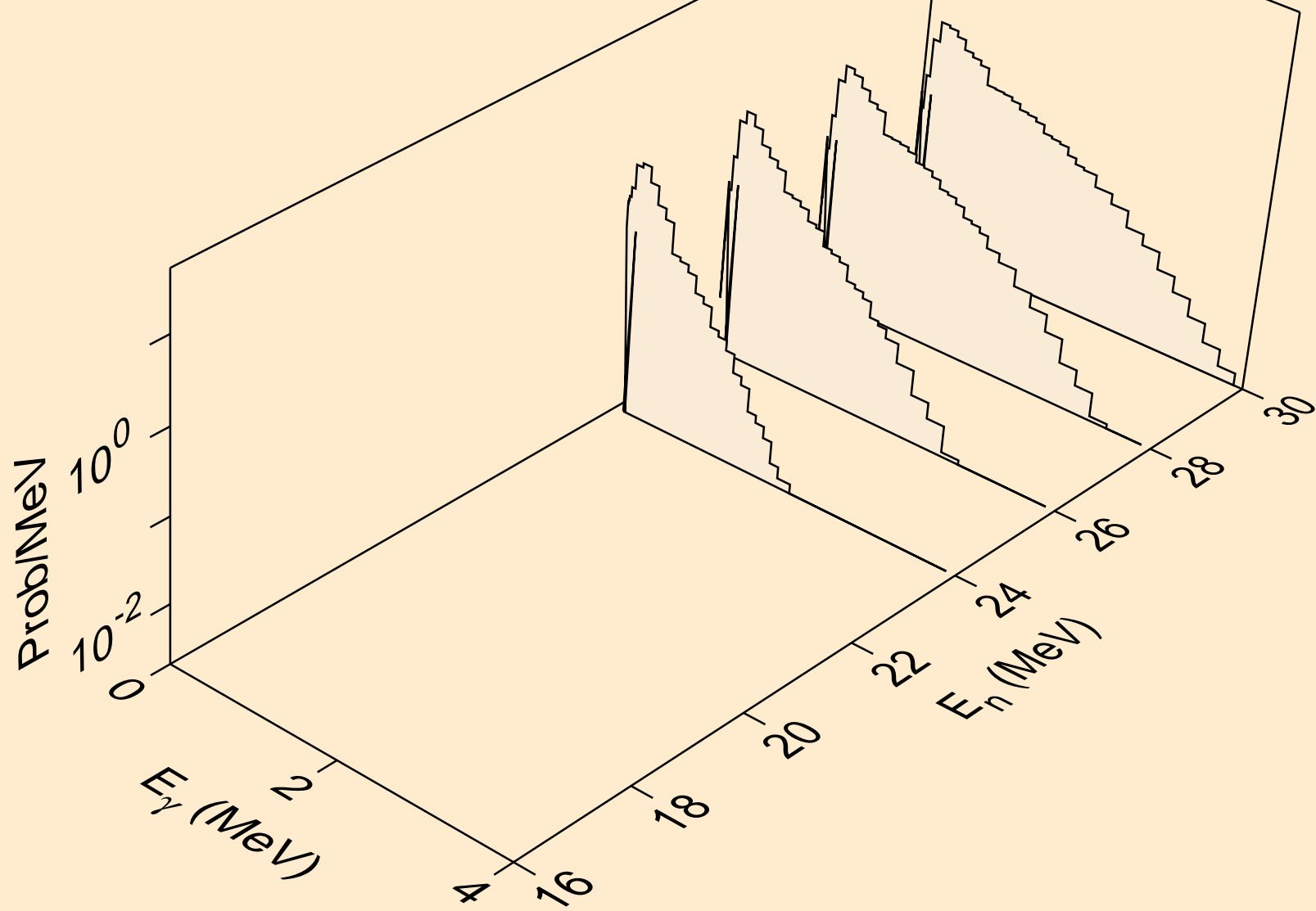

ES240 NEUTRON ACER TENDL-2021 LIBRARY; T=293.6K
Photon emission for (n,n*c)

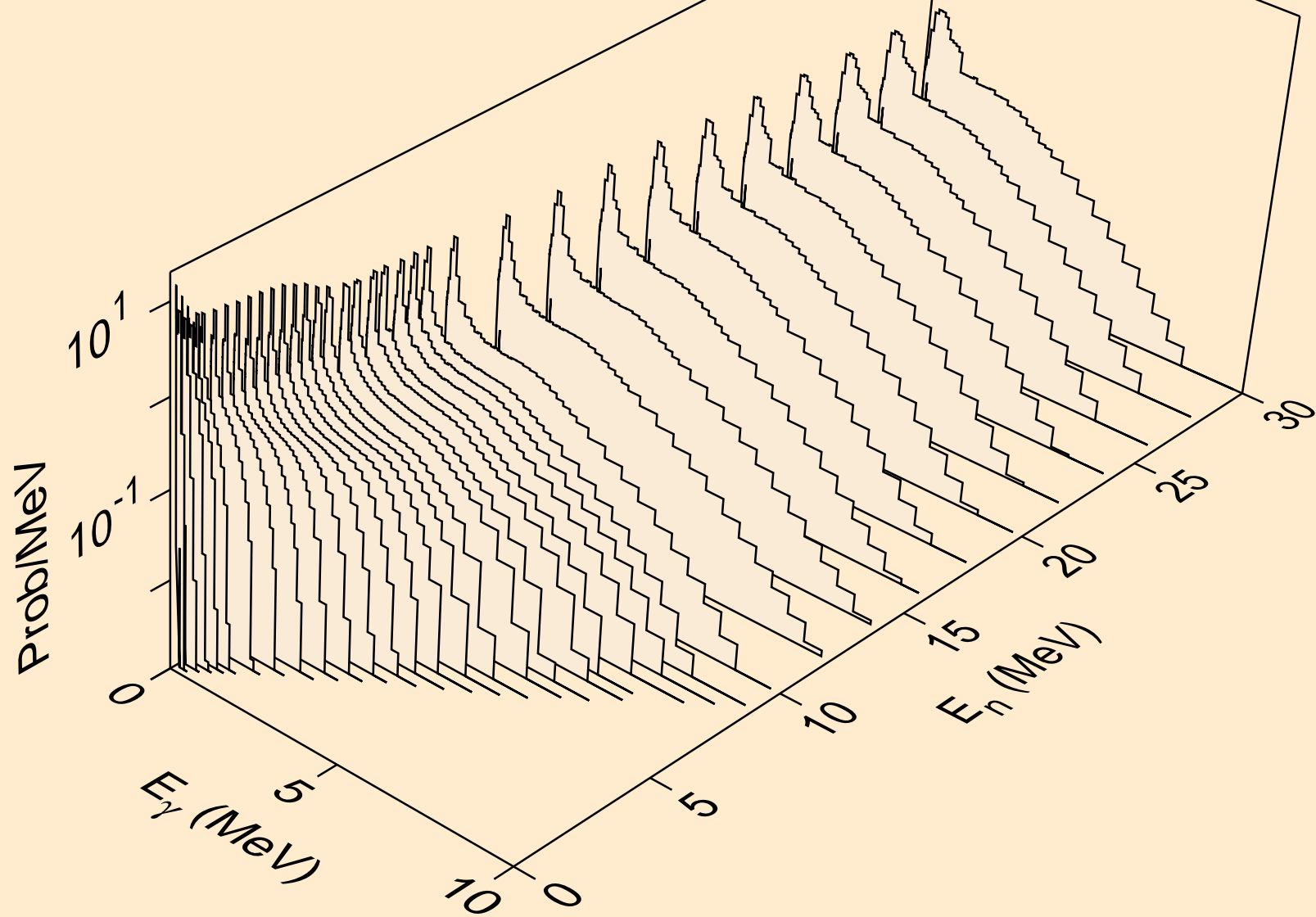

ES240 NEUTRON ACER TENDL-2021 LIBRARY; T=293.6K
Photon emission for (n,gma)

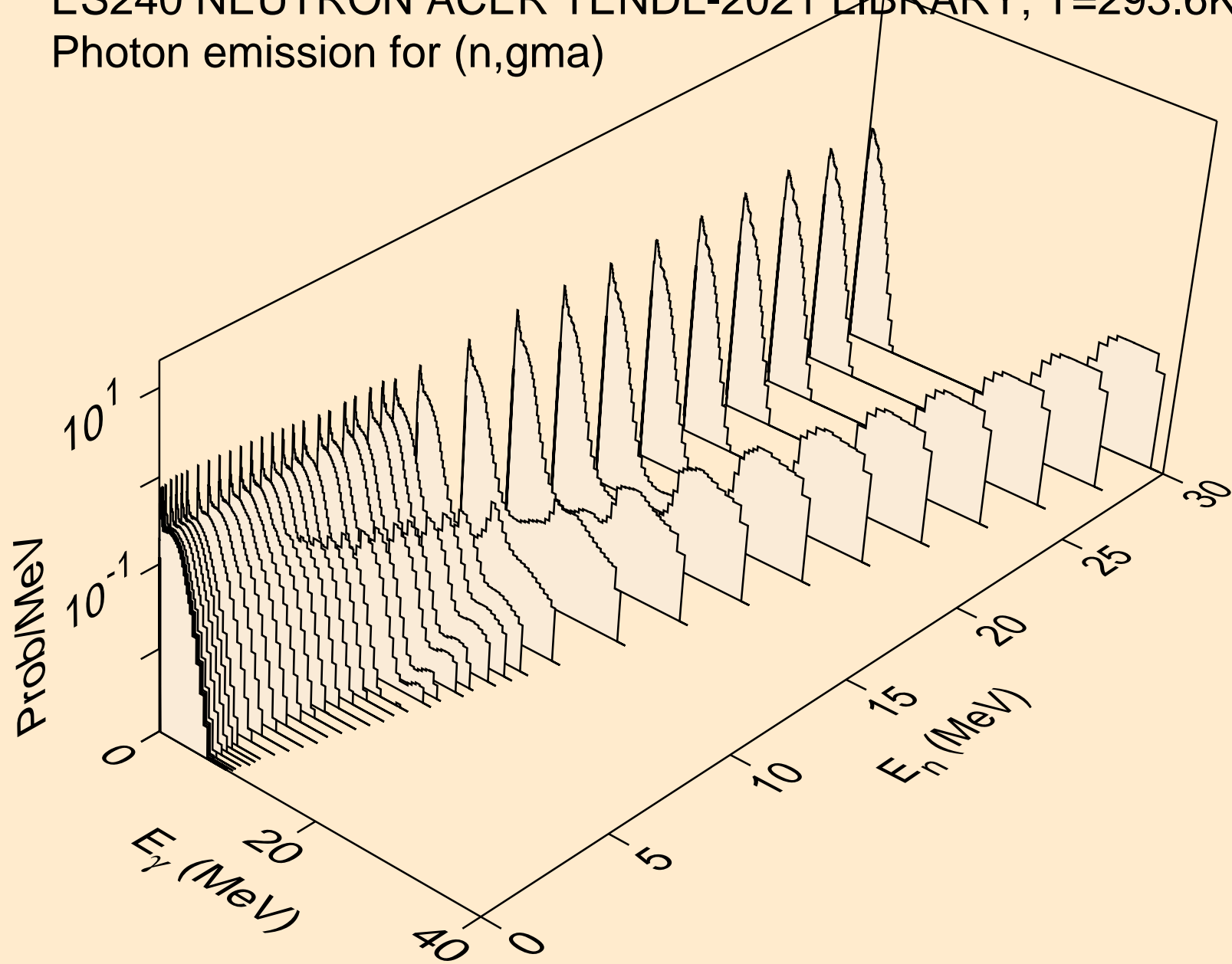

ES240 NEUTRON ACER TENDL-2021 LIBRARY; T=293.6K
Photon emission for (n,p)

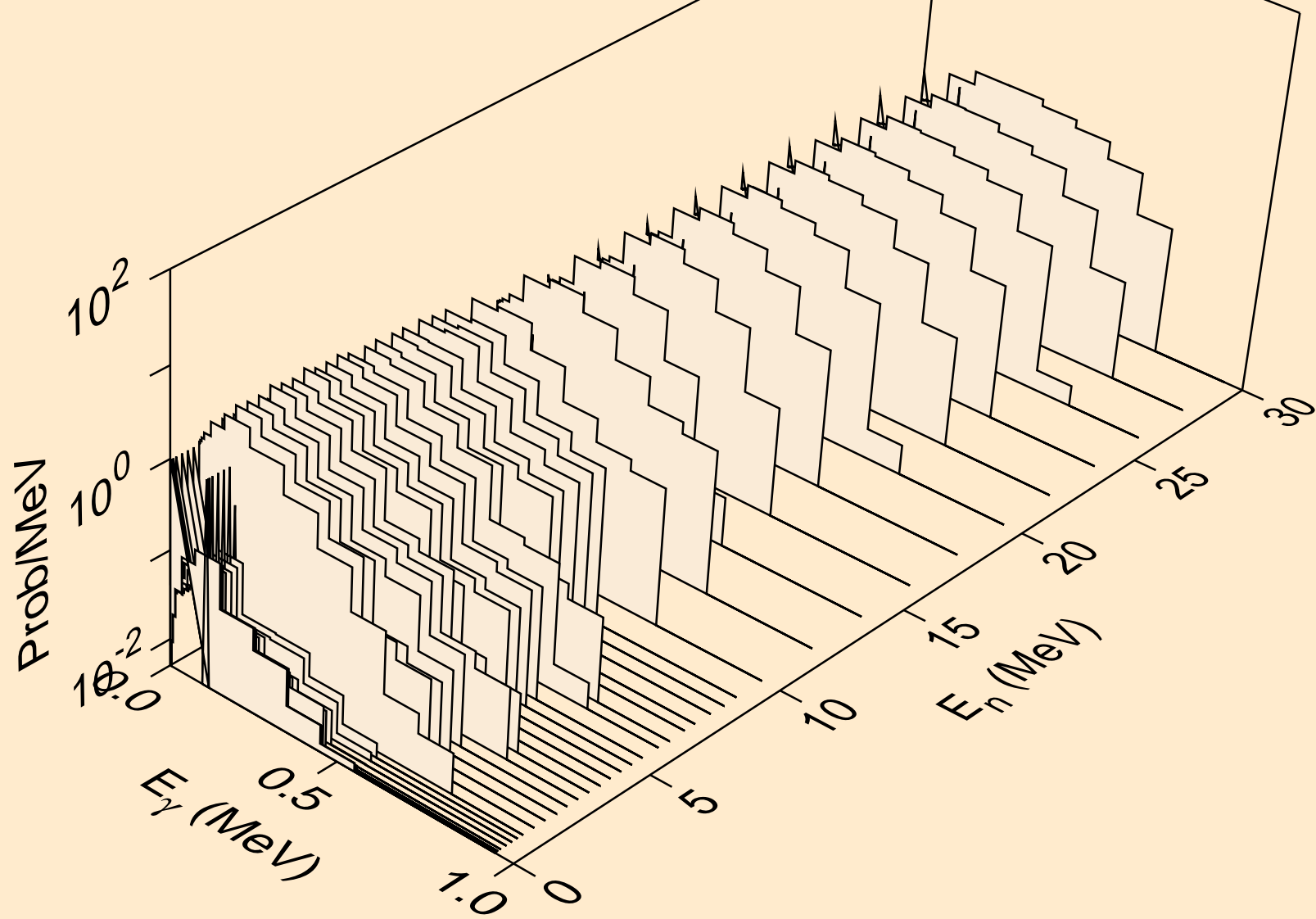

ES240 NEUTRON ACER TENDL-2021 LIBRARY; T=293.6K
Photon emission for (n,d)

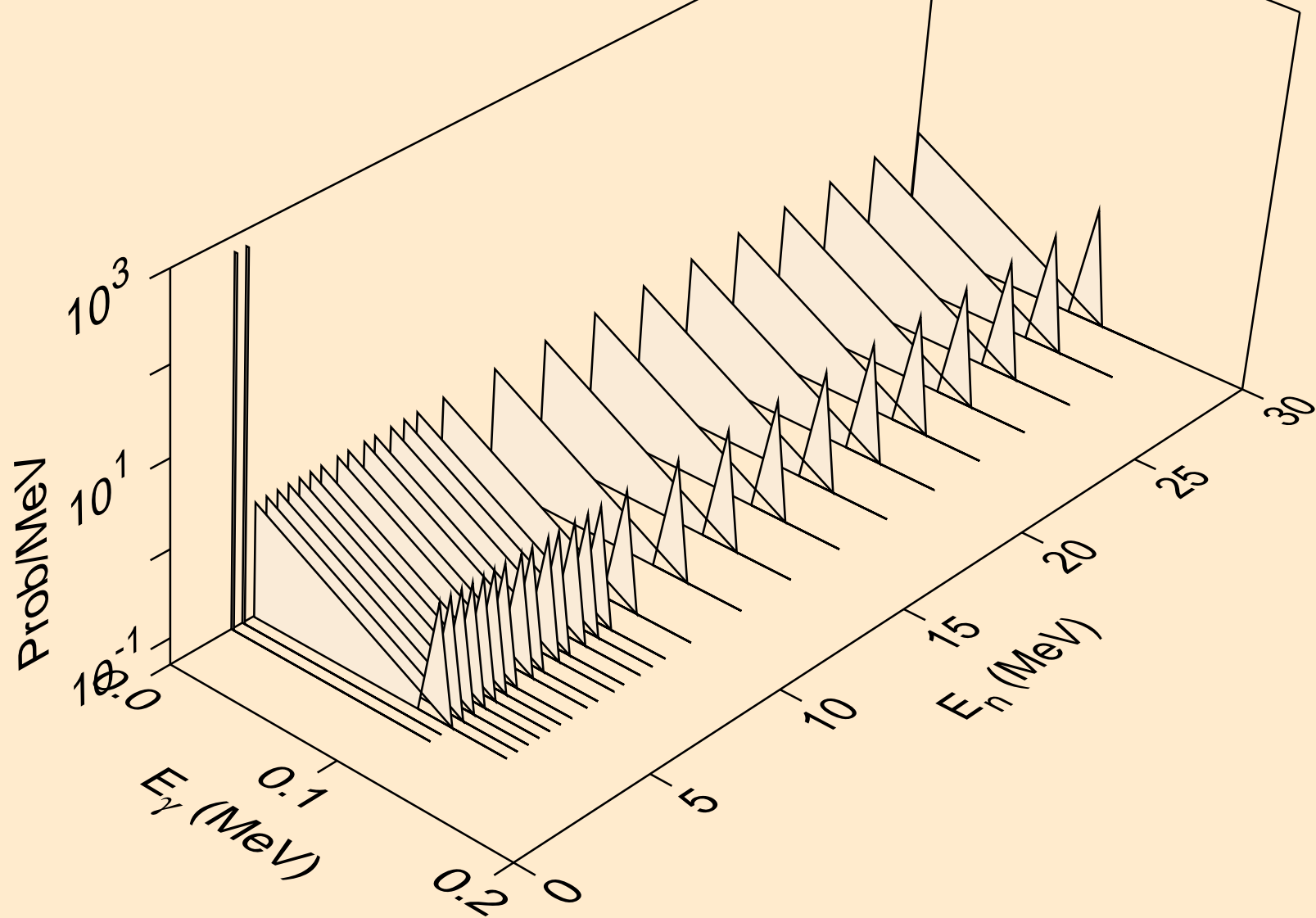

ES240 NEUTRON ACER TENDL-2021 LIBRARY; T=293.6K
Photon emission for (n,t)

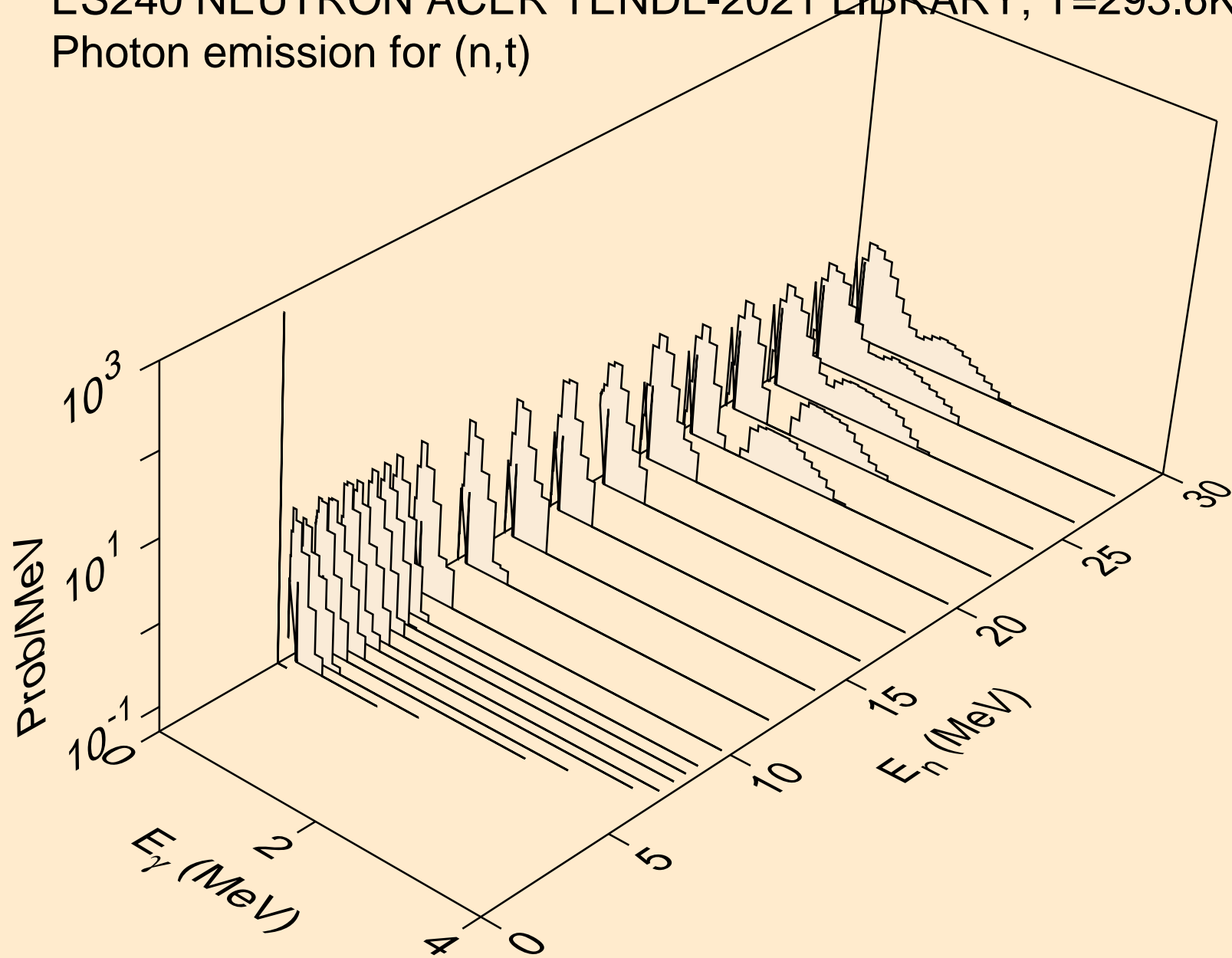

ES240 NEUTRON ACER TENDL-2021 LIBRARY; T=293.6K
Photon emission for (n,he3)

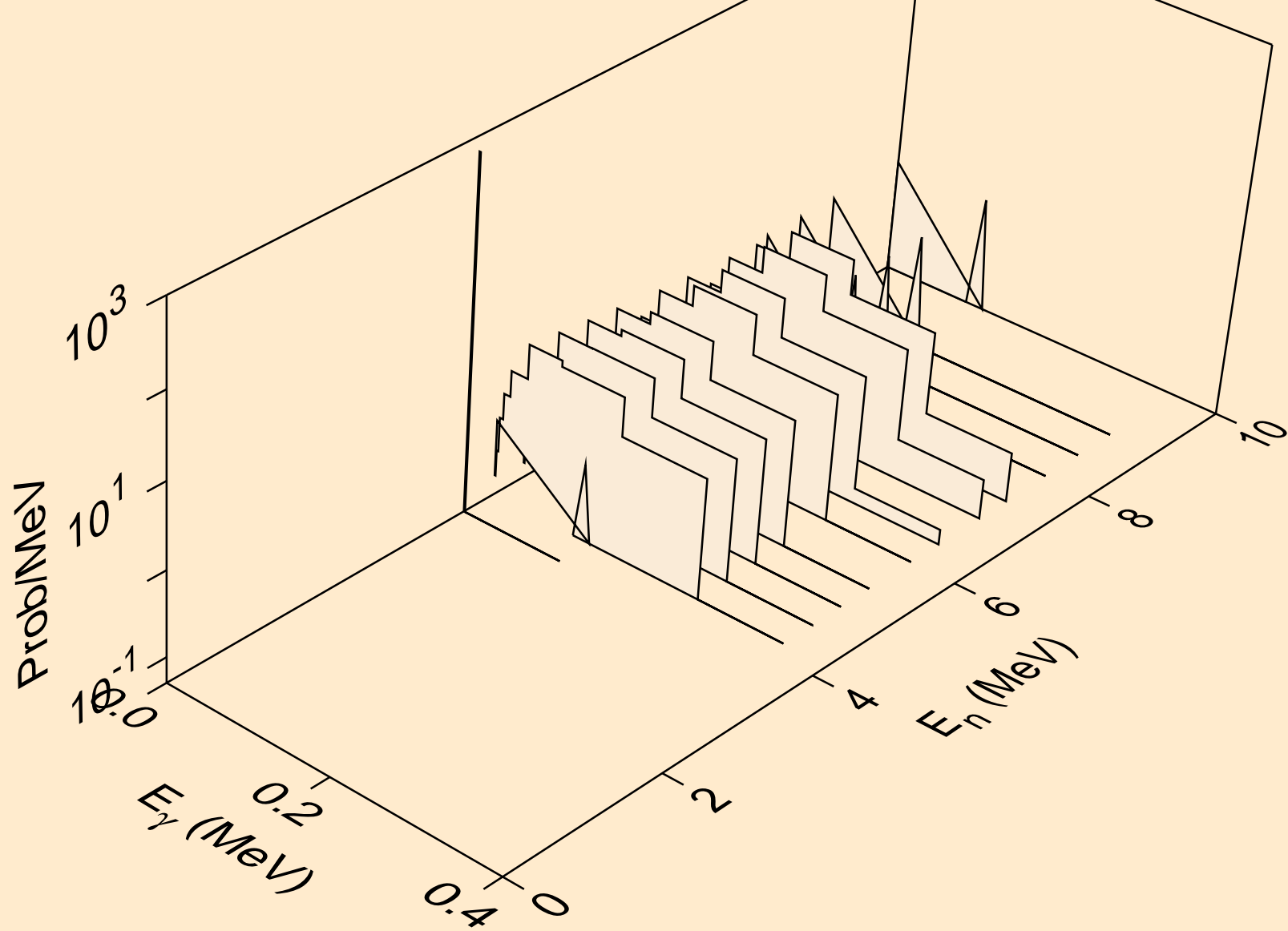

ES240 NEUTRON ACER TENDL-2021 LIBRARY; T=293.6K
Photon emission for (n,a)

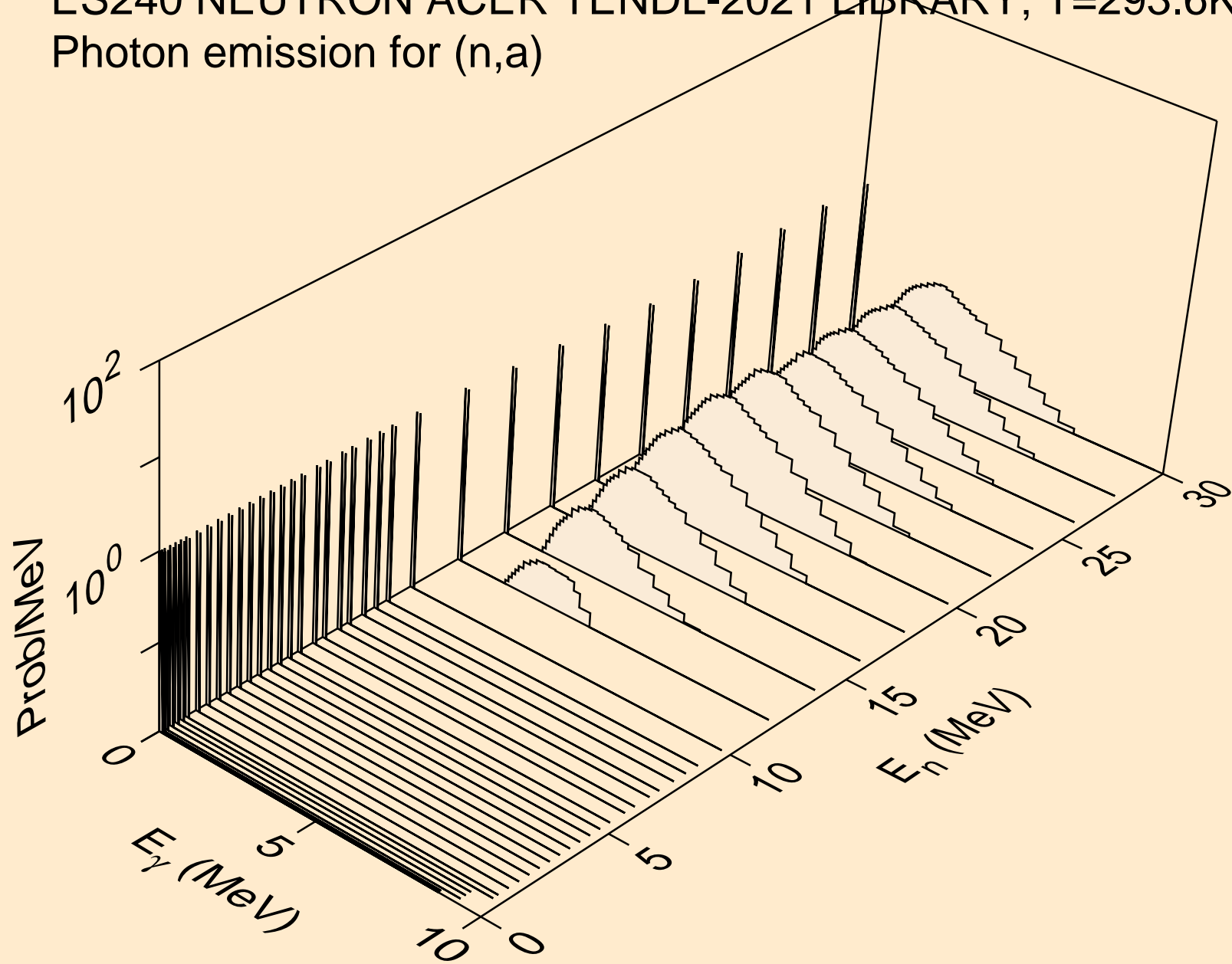

ES240 NEUTRON ACER TENDL-2021 LIBRARY; T=293.6K
Photon emission for (n,2p)

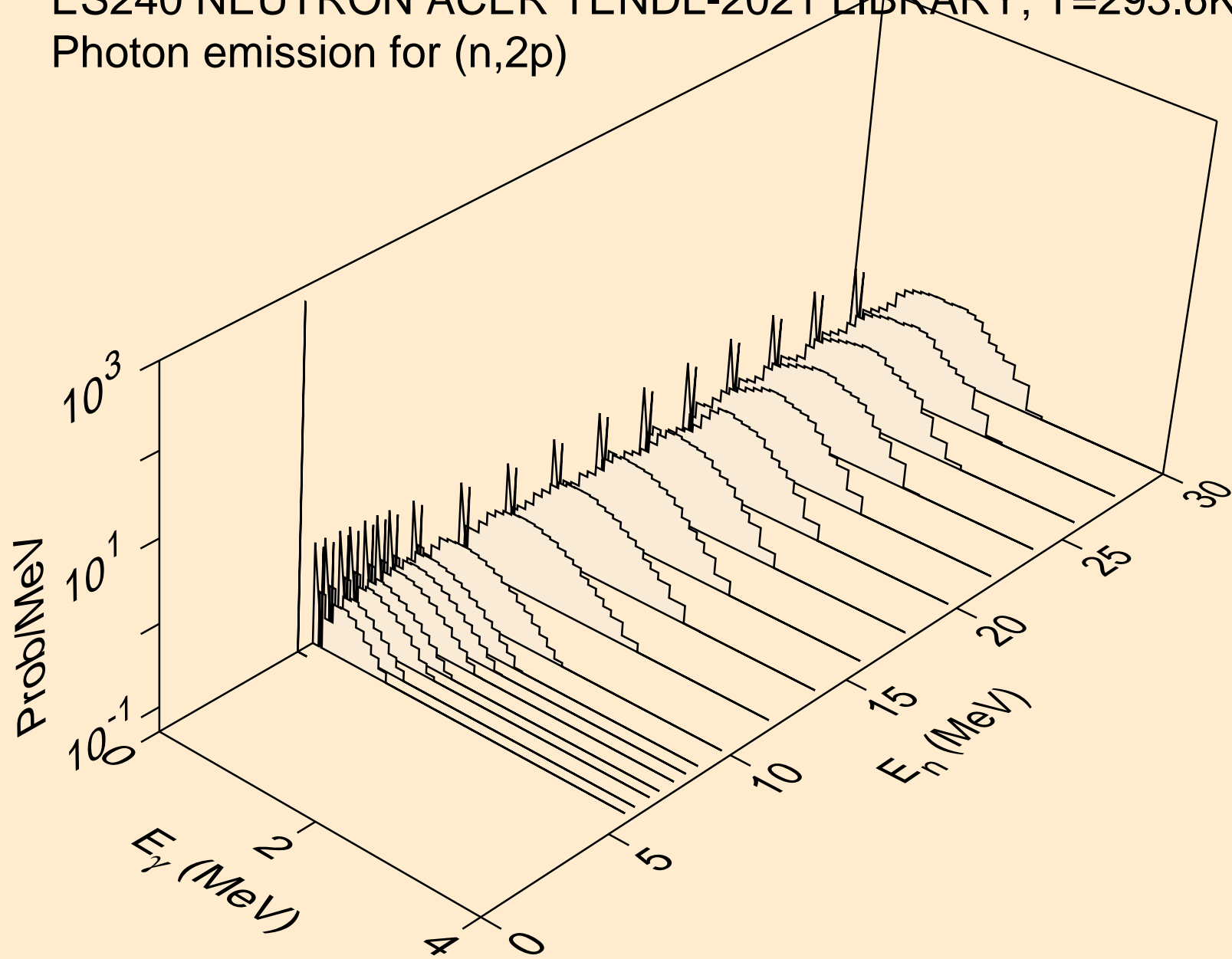

ES240 NEUTRON ACER TENDL-2021 LIBRARY; T=293.6K
thermal capture photon spectrum

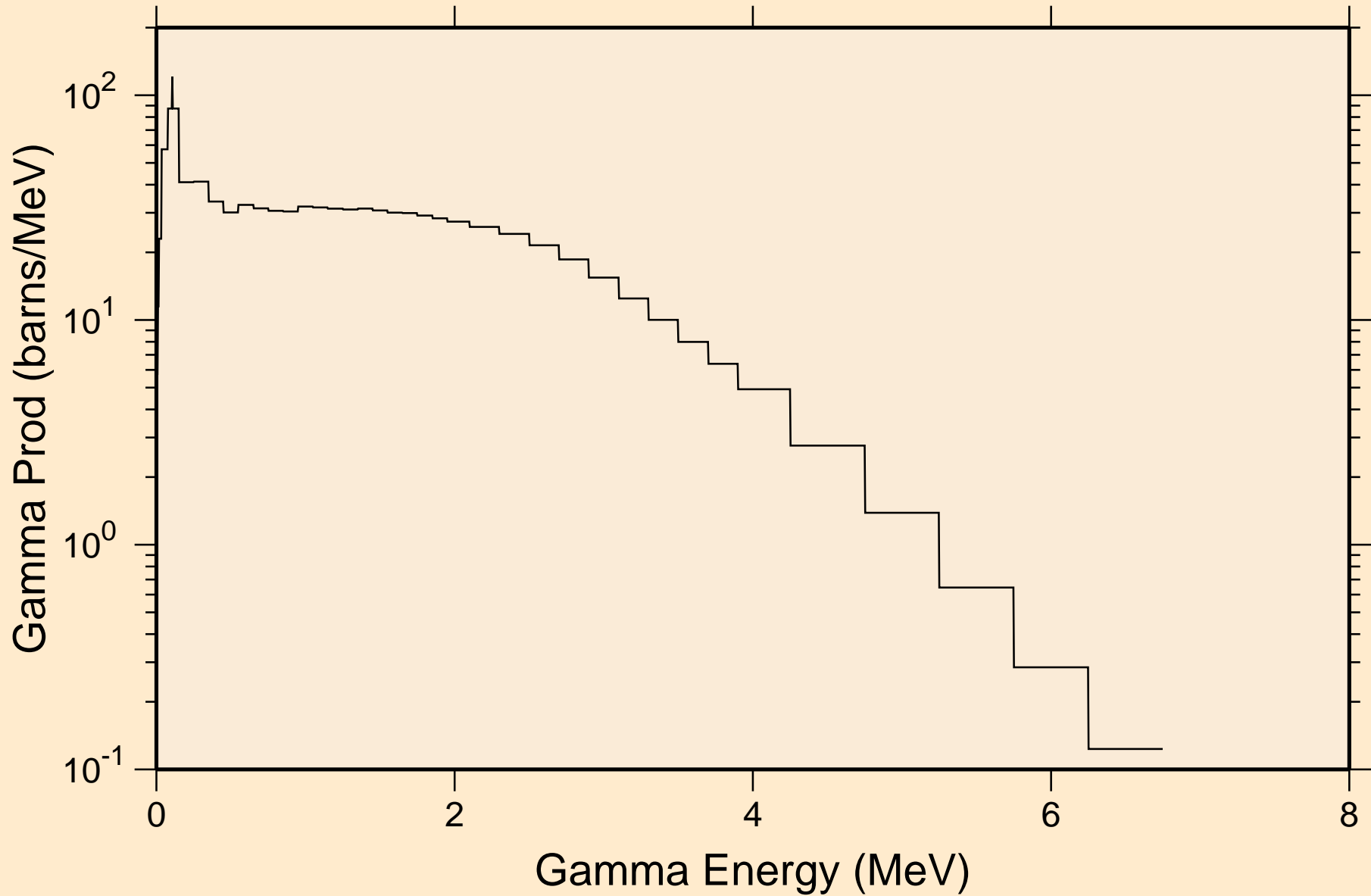

ES240 NEUTRON ACER TENDL-2021 LIBRARY; T=293.6K
14 MeV photon spectrum

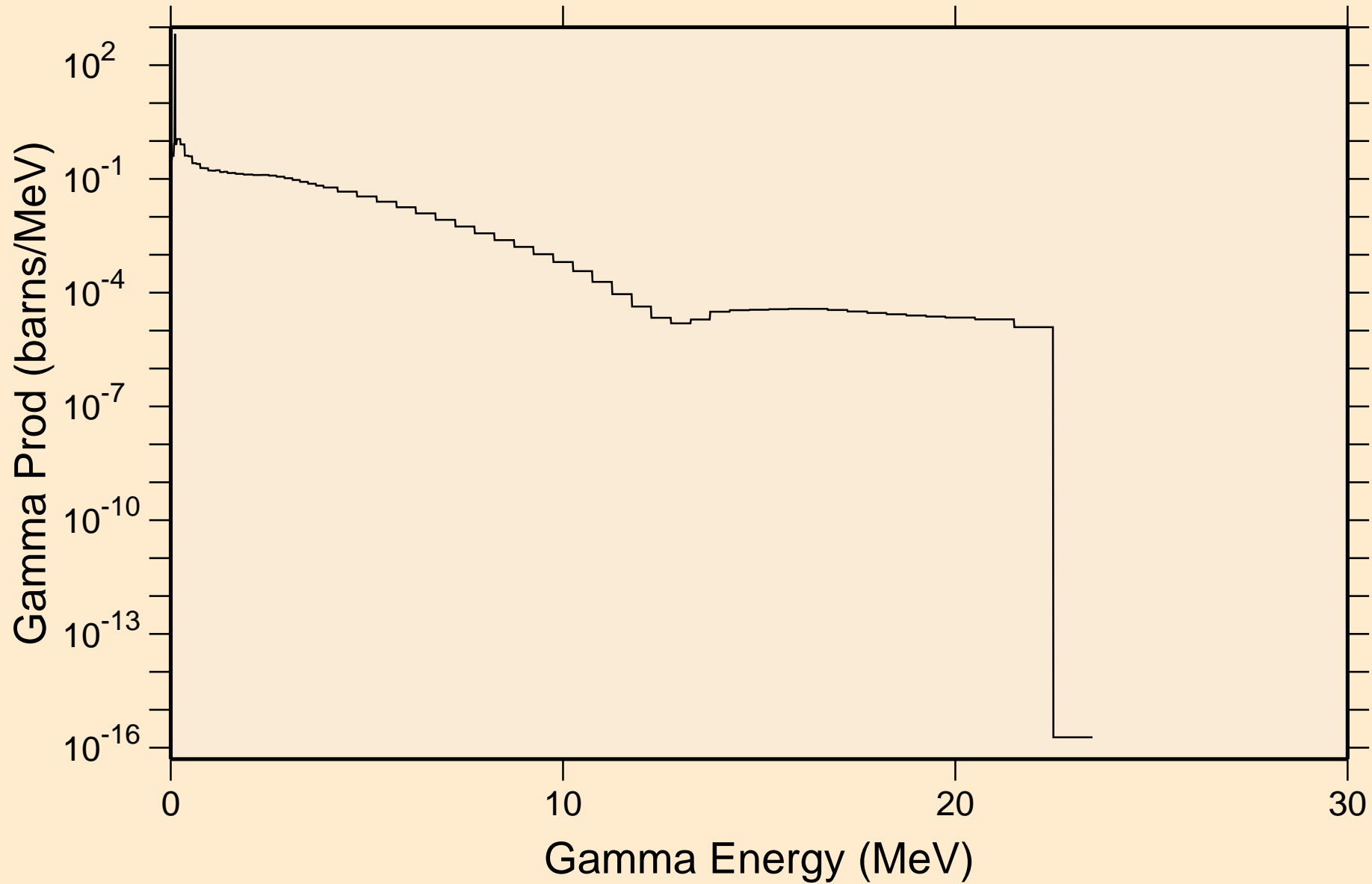

ES240 NEUTRON ACER TENDL-2021 LIBRARY; T=293.6K

Particle heating contributions

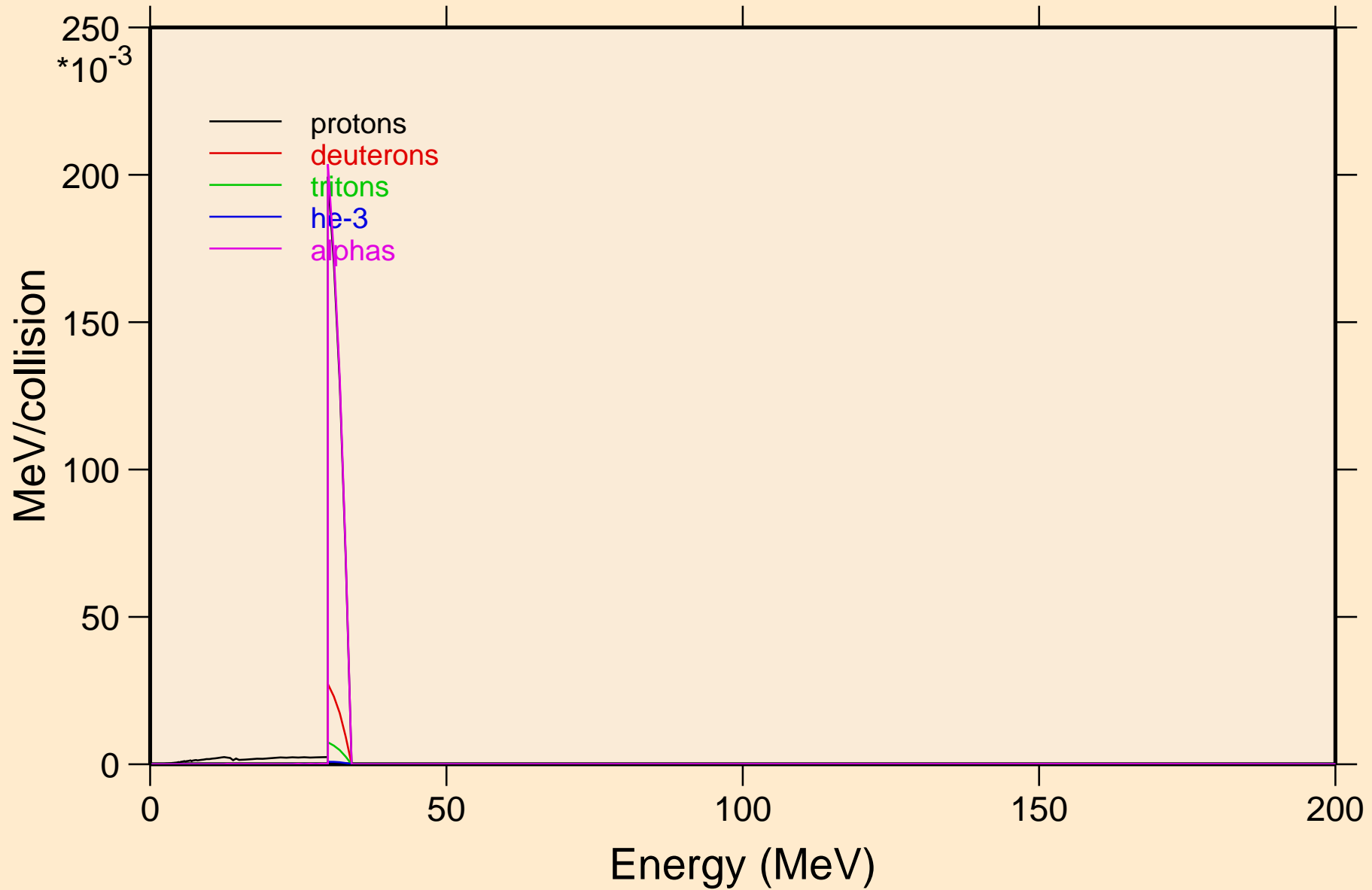

ES240 NEUTRON ACER TENDL-2021 LIBRARY; T=293.6K
Recoil Heating

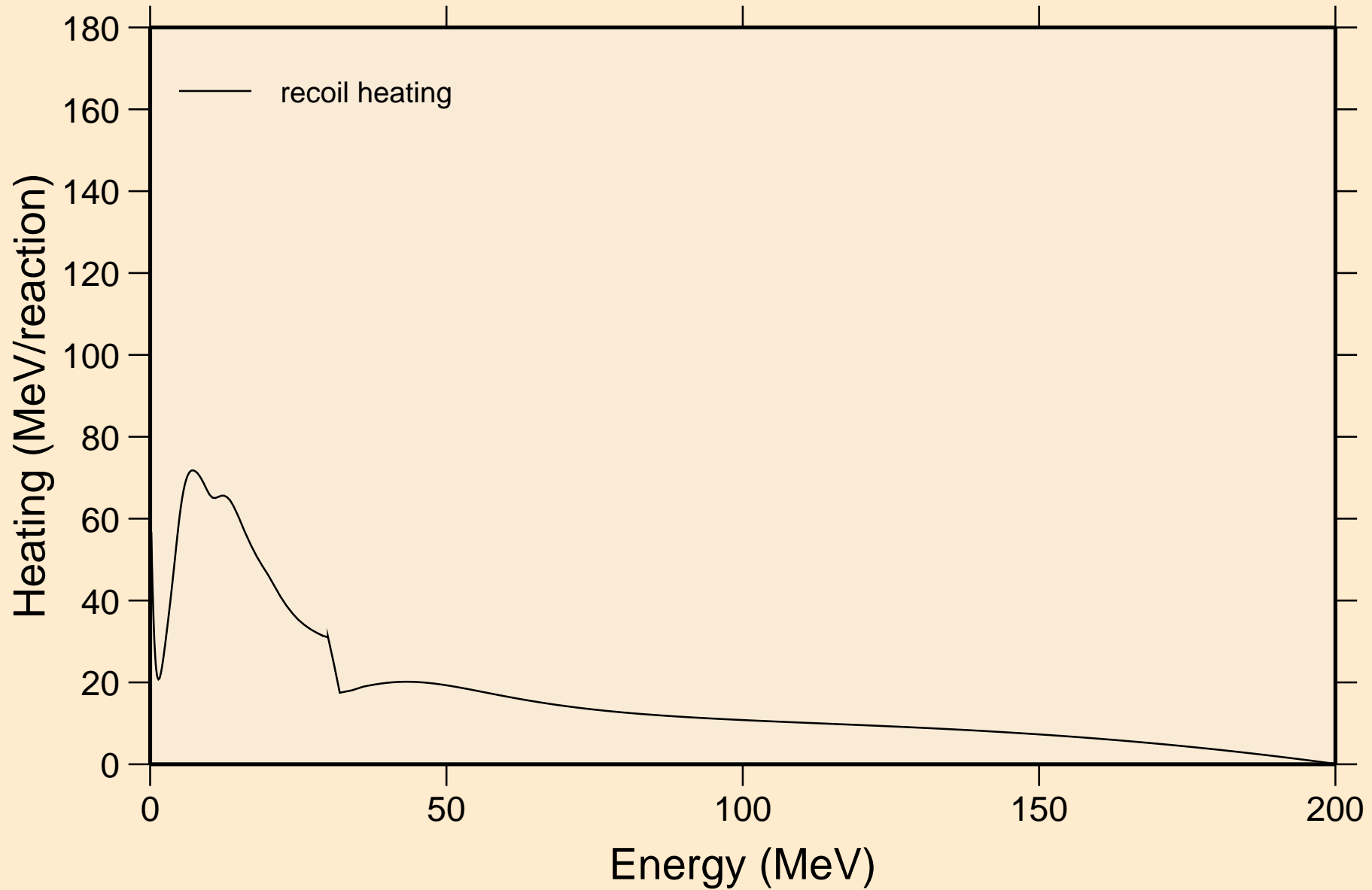

ES240 NEUTRON ACER TENDL-2021 LIBRARY; T=293.6K

Particle production cross sections

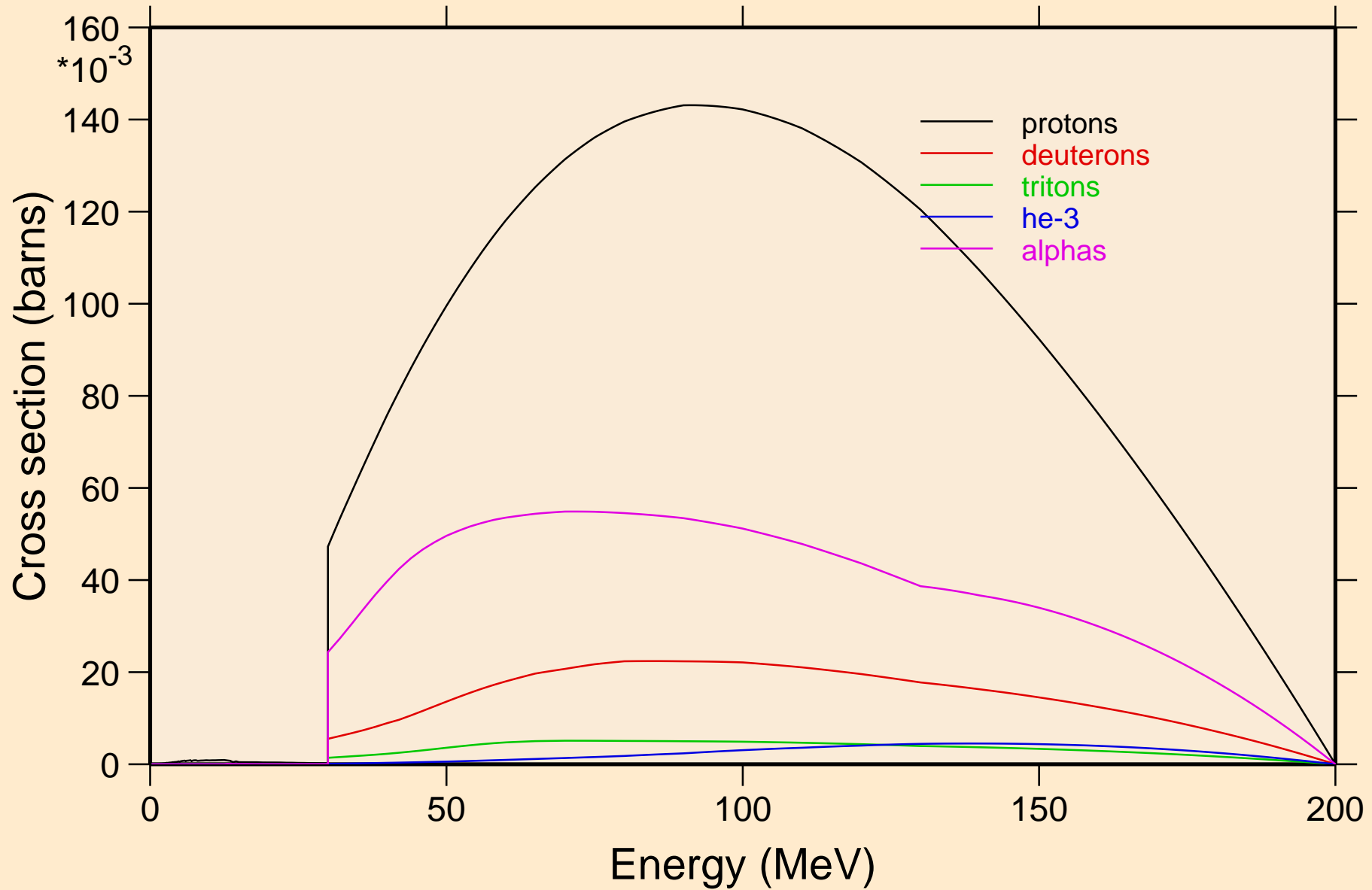

ES240 NEUTRON ACER TENDL-2021 LIBRARY; T=293.6K
protons from (n,x)

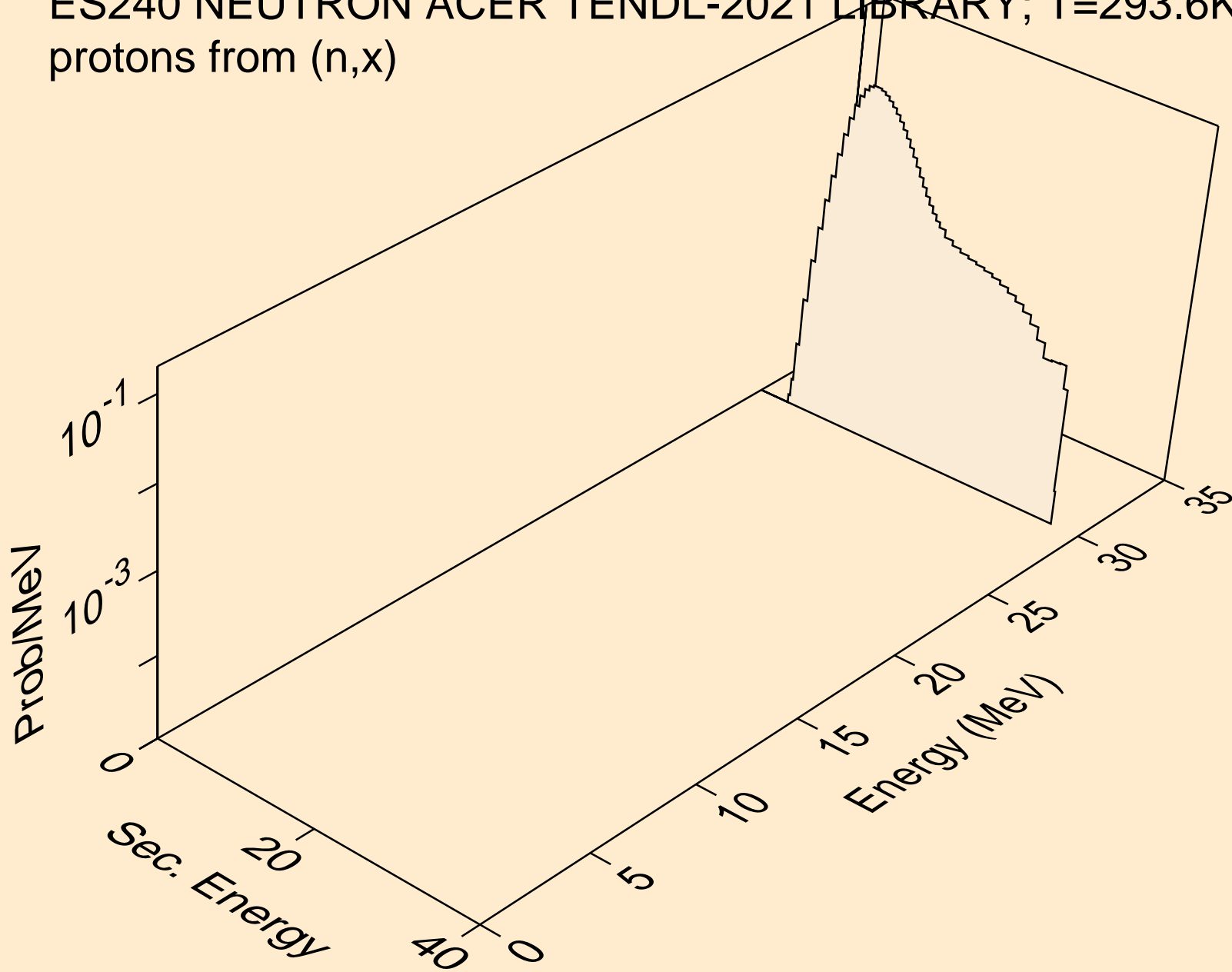

ES240 NEUTRON ACER TENDL-2021 LIBRARY; T=293.6K
protons from (n,n*)p

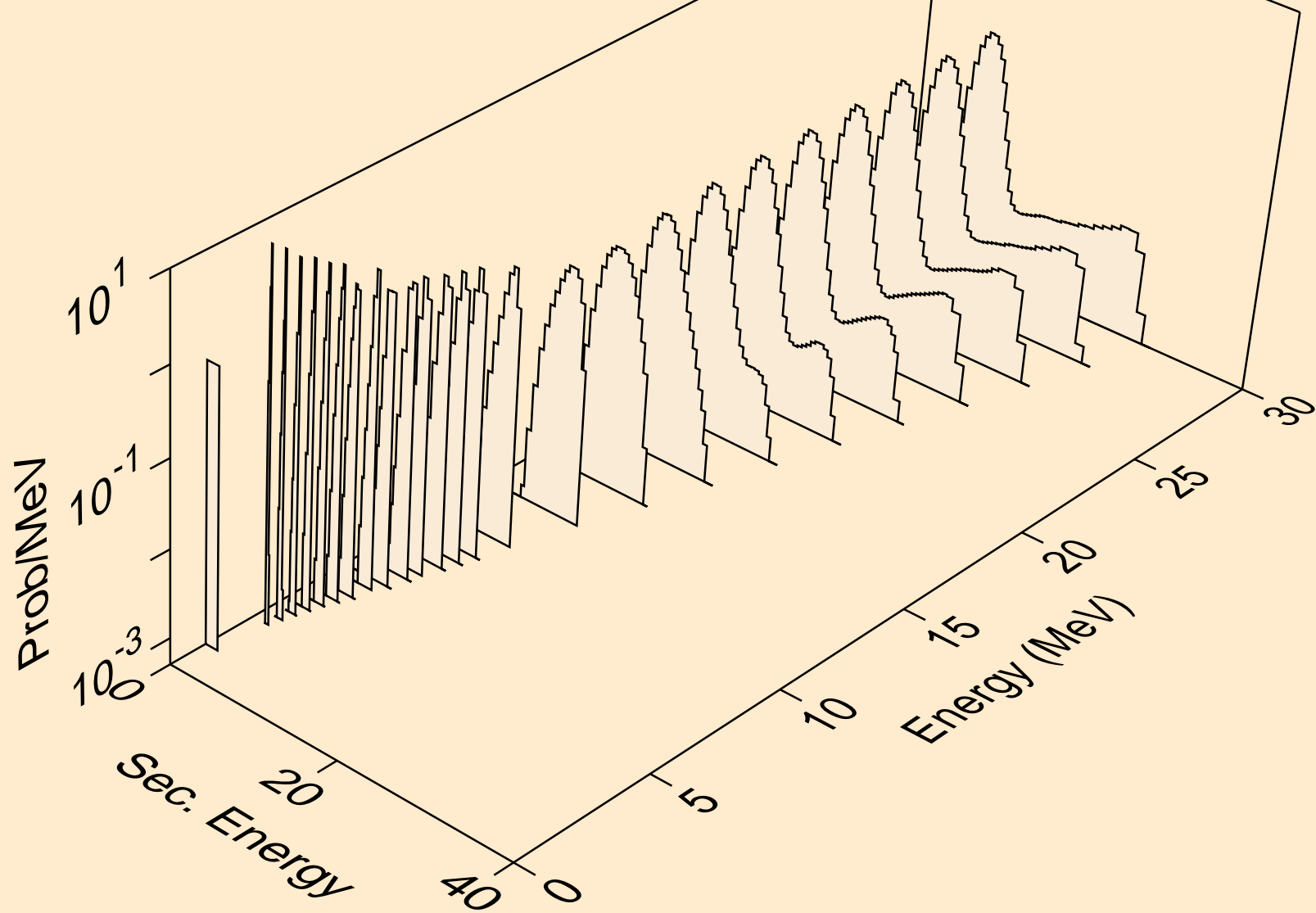

ES240 NEUTRON ACER TENDL-2021 LIBRARY; T=293.6K
protons from (n,2np)

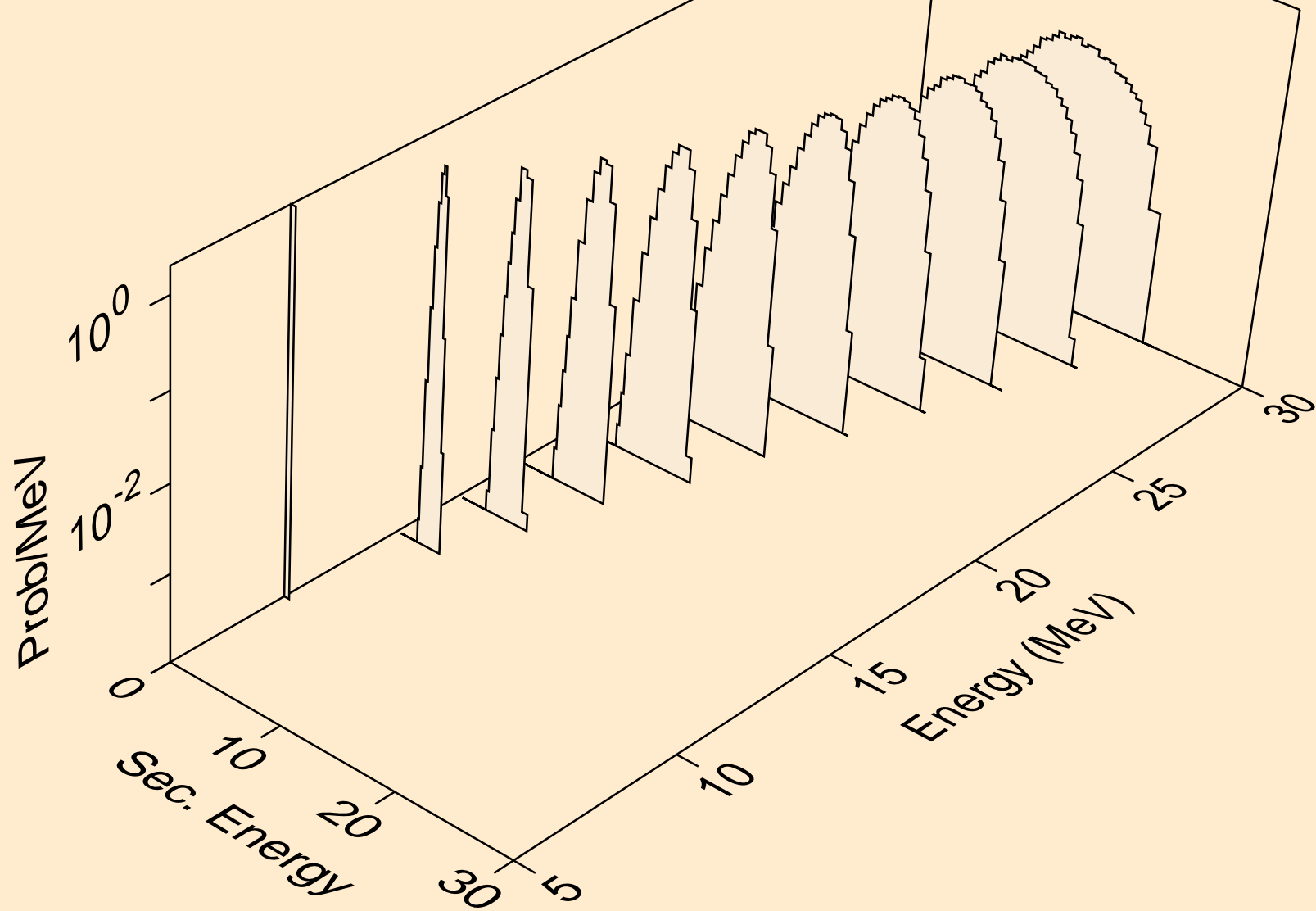

ES240 NEUTRON ACER TENDL-2021 LIBRARY; T=293.6K
protons from (n,3np)

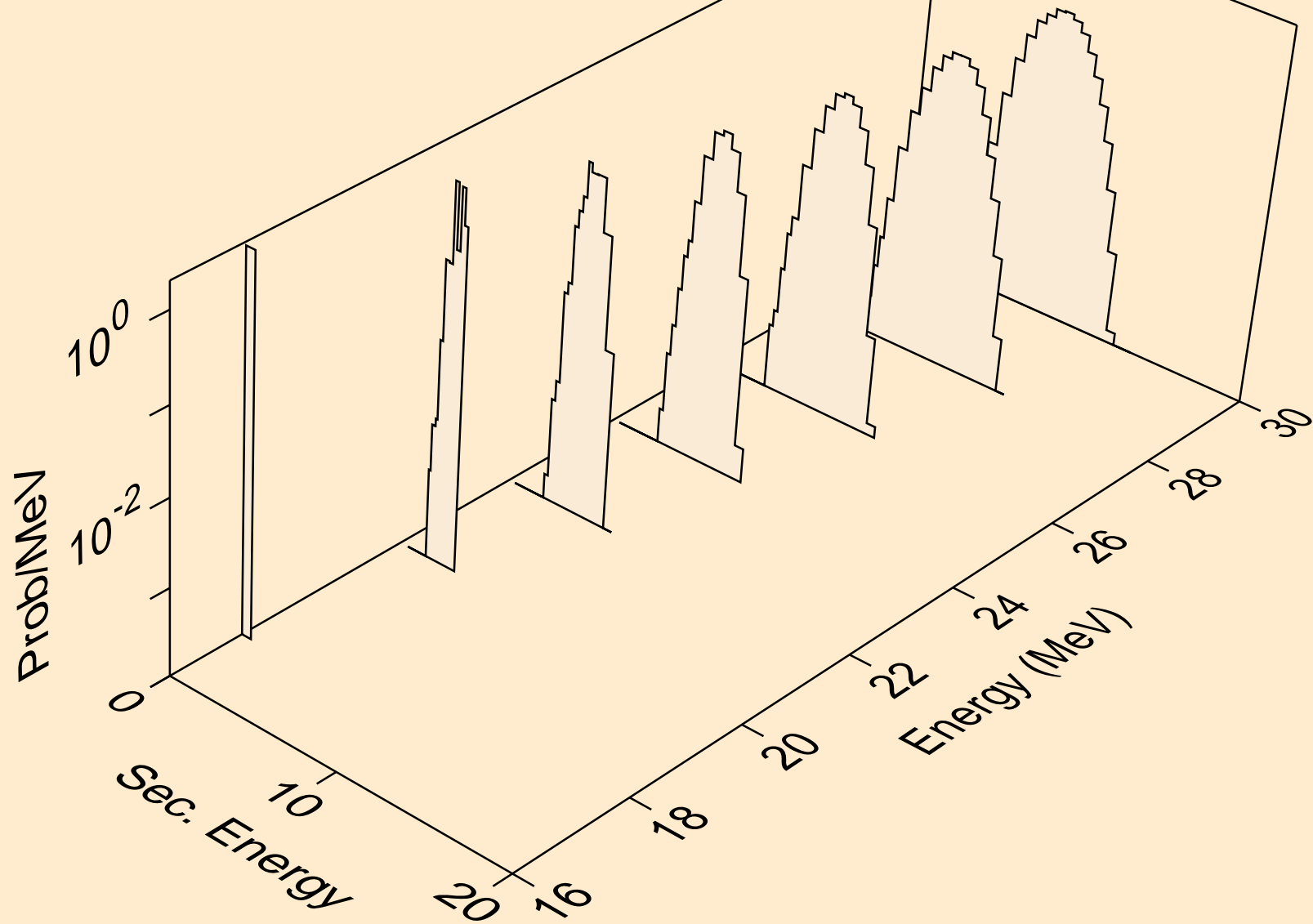

ES240 NEUTRON ACER TENDL-2021 LIBRARY; T=293.6K
protons from (n,p)

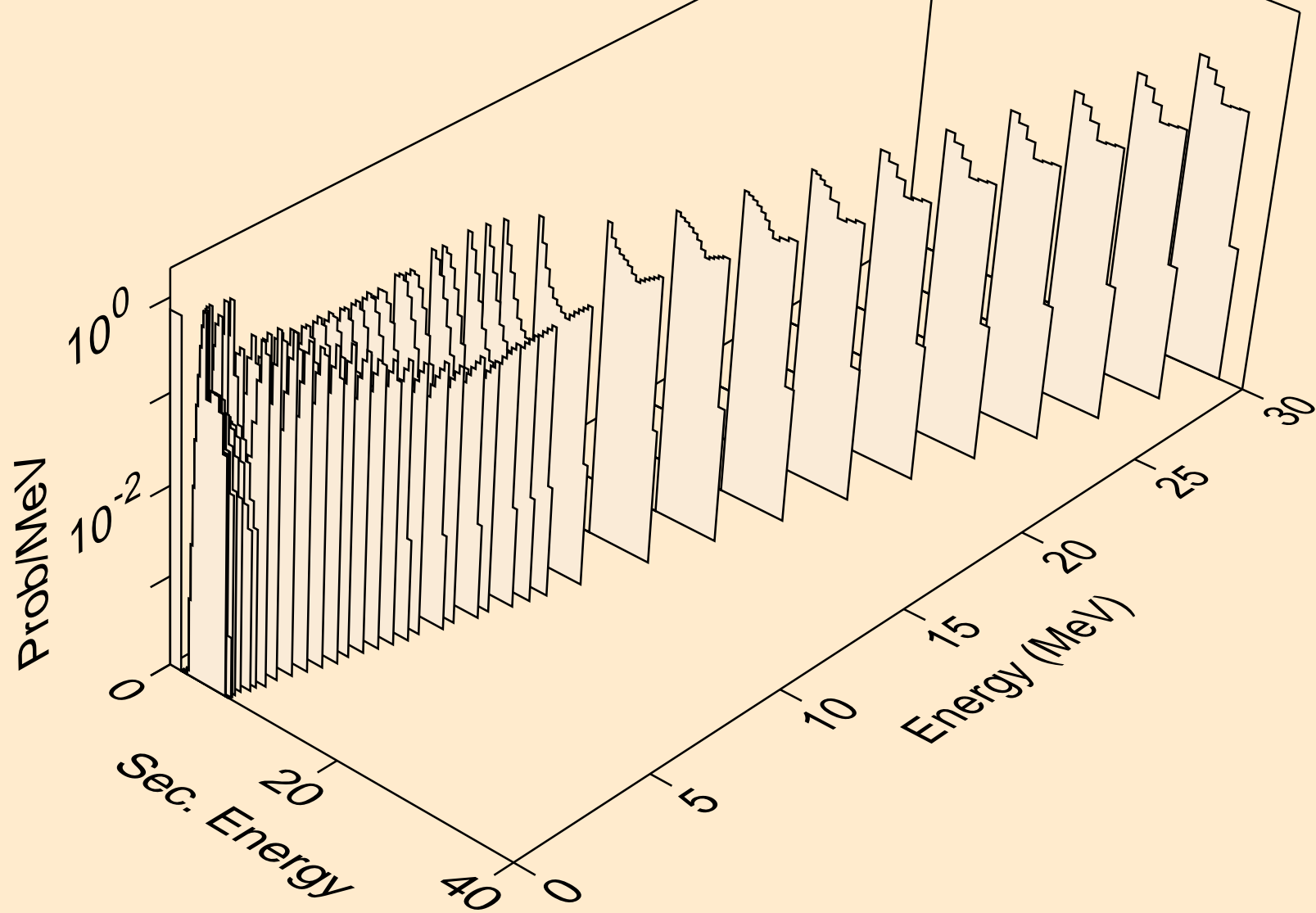

ES240 NEUTRON ACER TENDL-2021 LIBRARY; T=293.6K
protons from (n,2p)

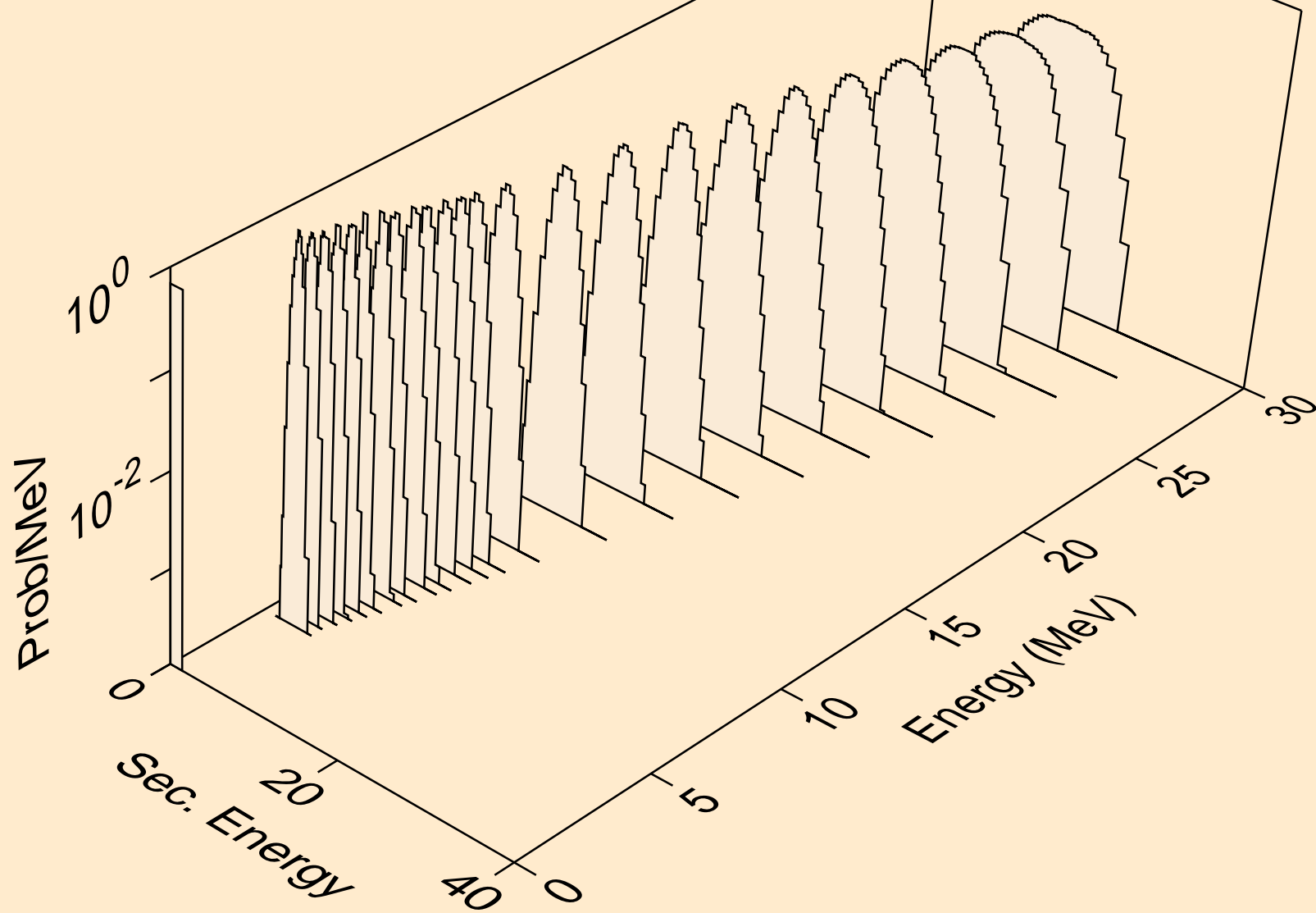

ES240 NEUTRON ACER TENDL-2021 LIBRARY; T=293.6K
deuterons from (n,x)

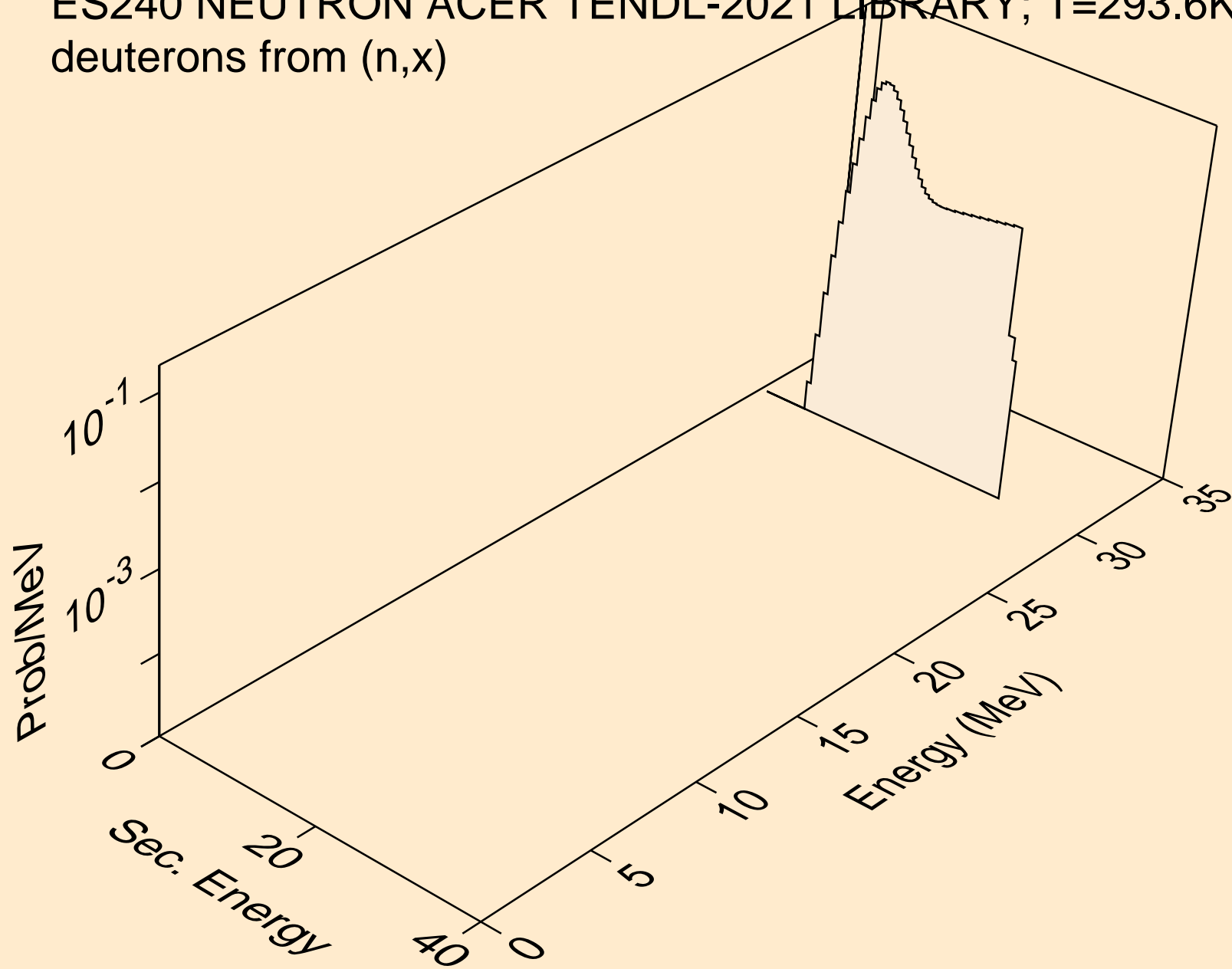

ES240 NEUTRON ACER TENDL-2021 LIBRARY; T=293.6K
deuterons from (n,2nd)

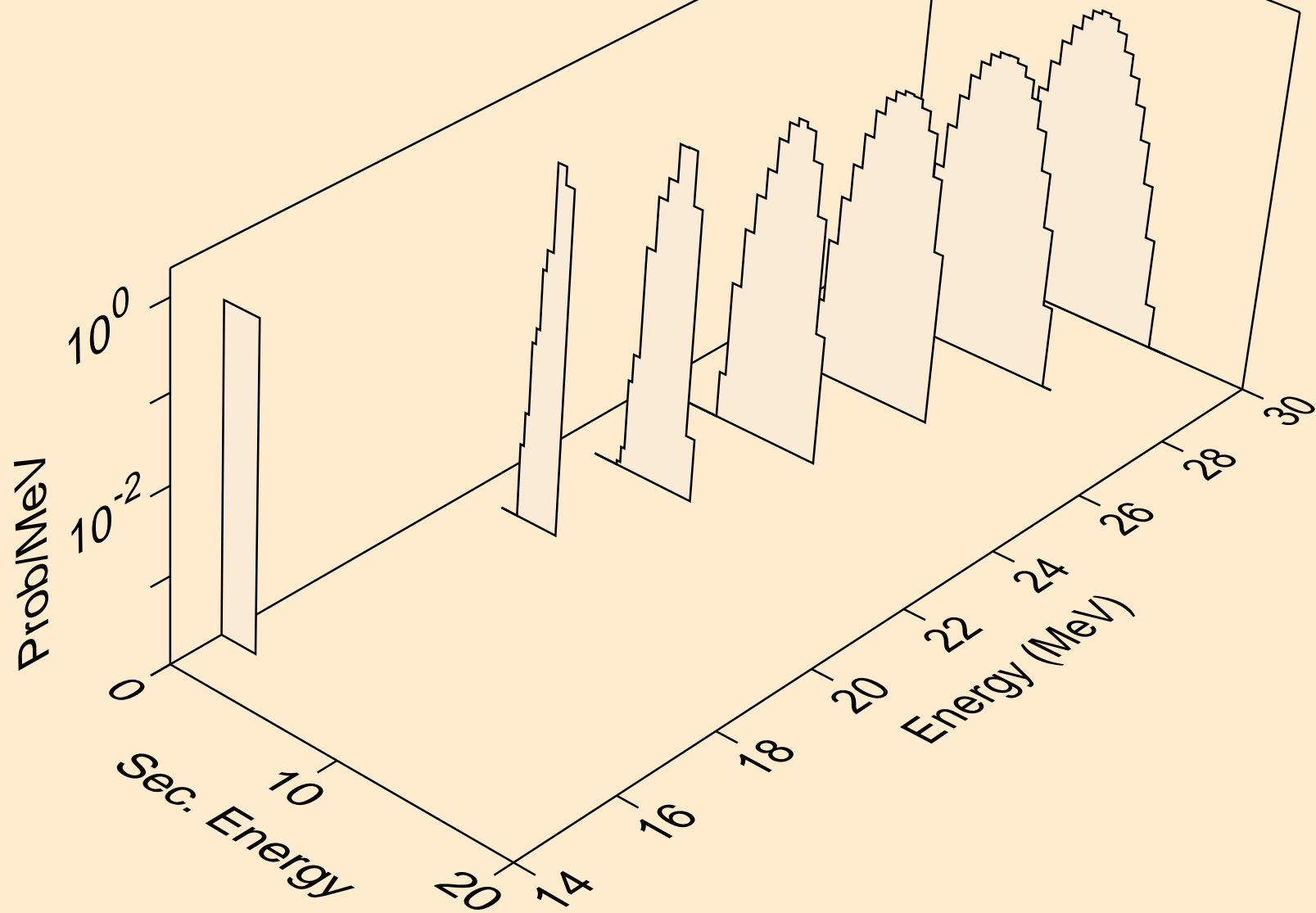

ES240 NEUTRON ACER TENDL-2021 LIBRARY; T=293.6K
deuterons from (n,n*)d

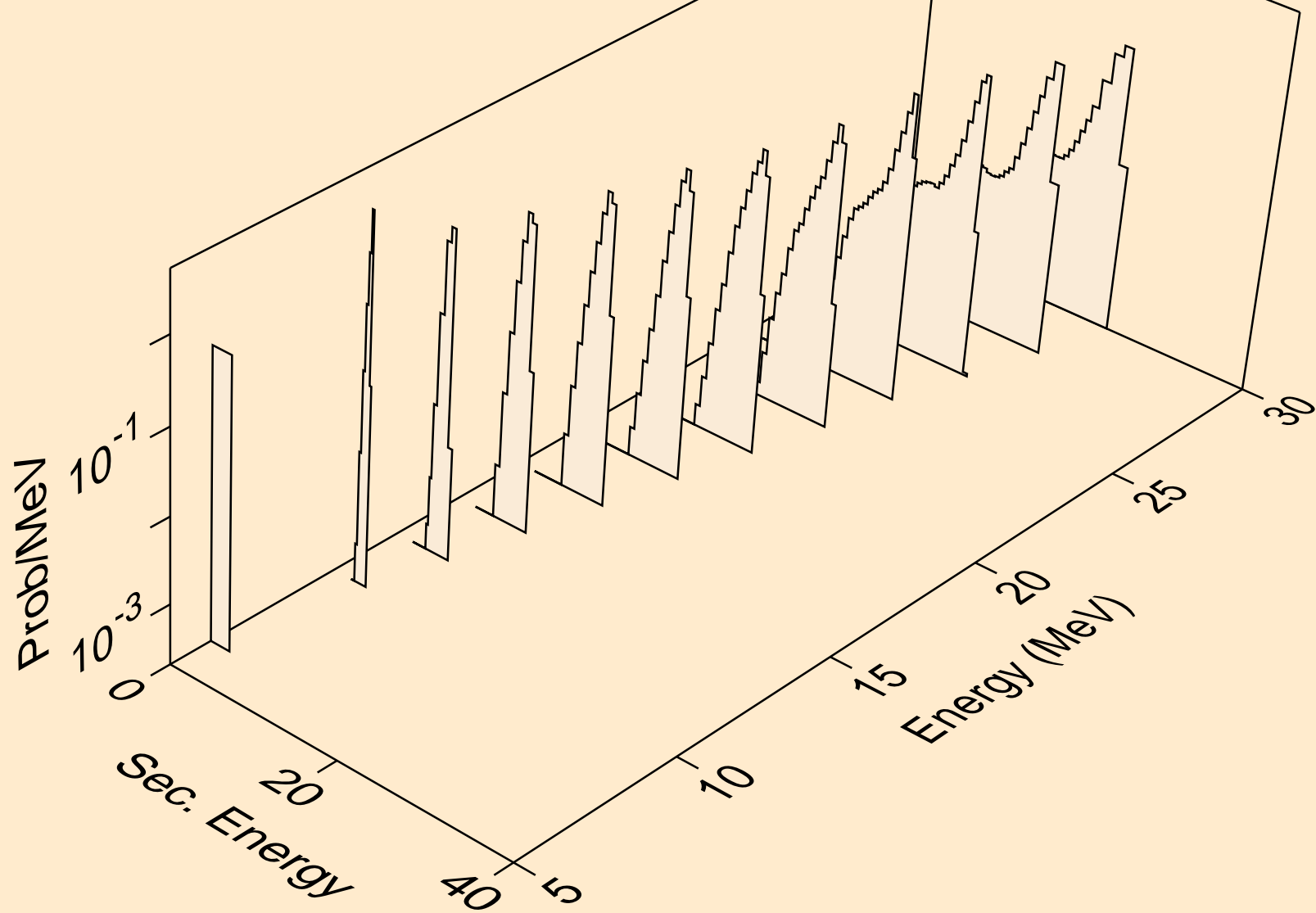

ES240 NEUTRON ACER TENDL-2021 LIBRARY; T=293.6K
deuterons from (n,d)

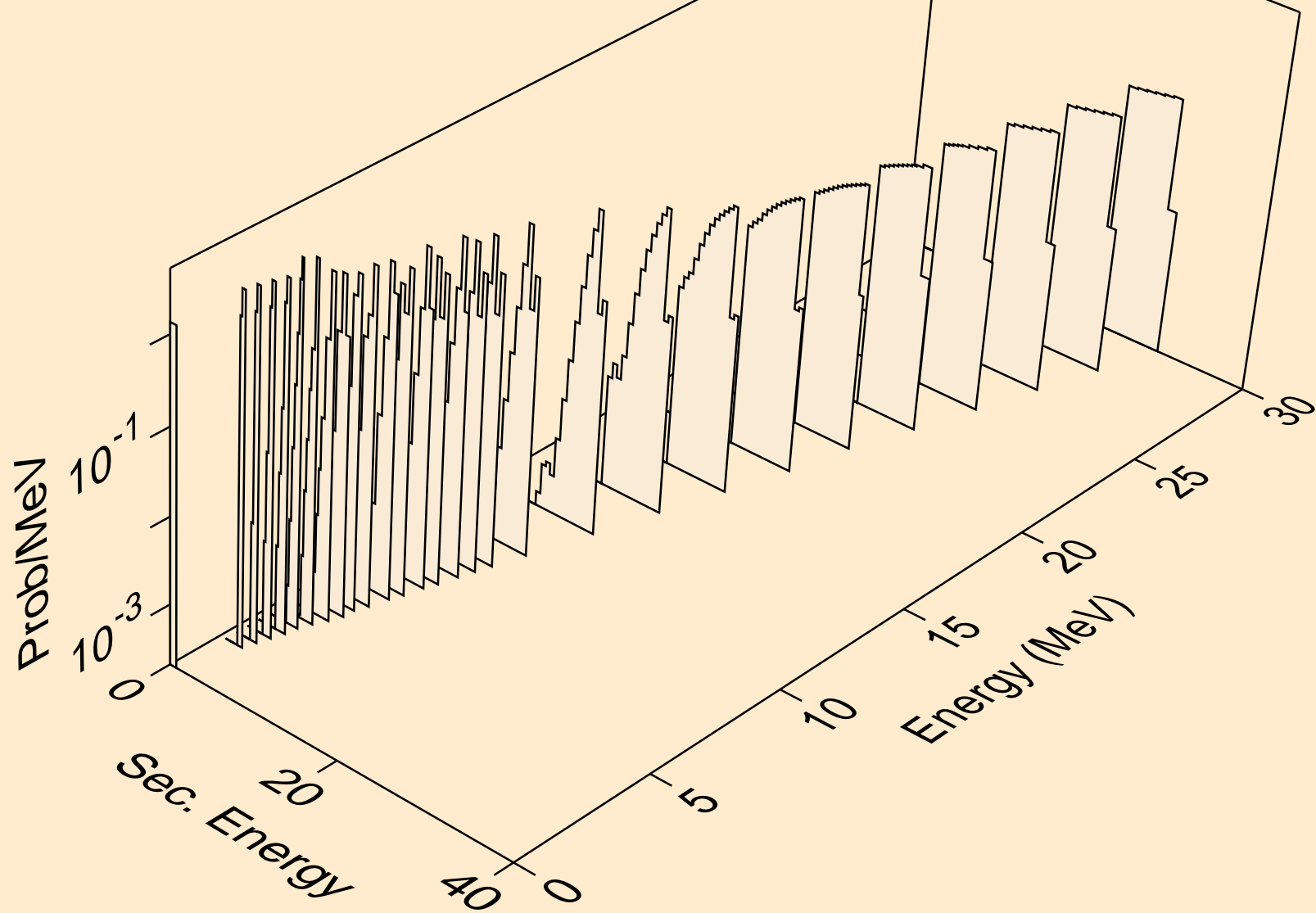

ES240 NEUTRON ACER TENDL-2021 LIBRARY; T=293.6K
tritons from (n,x)

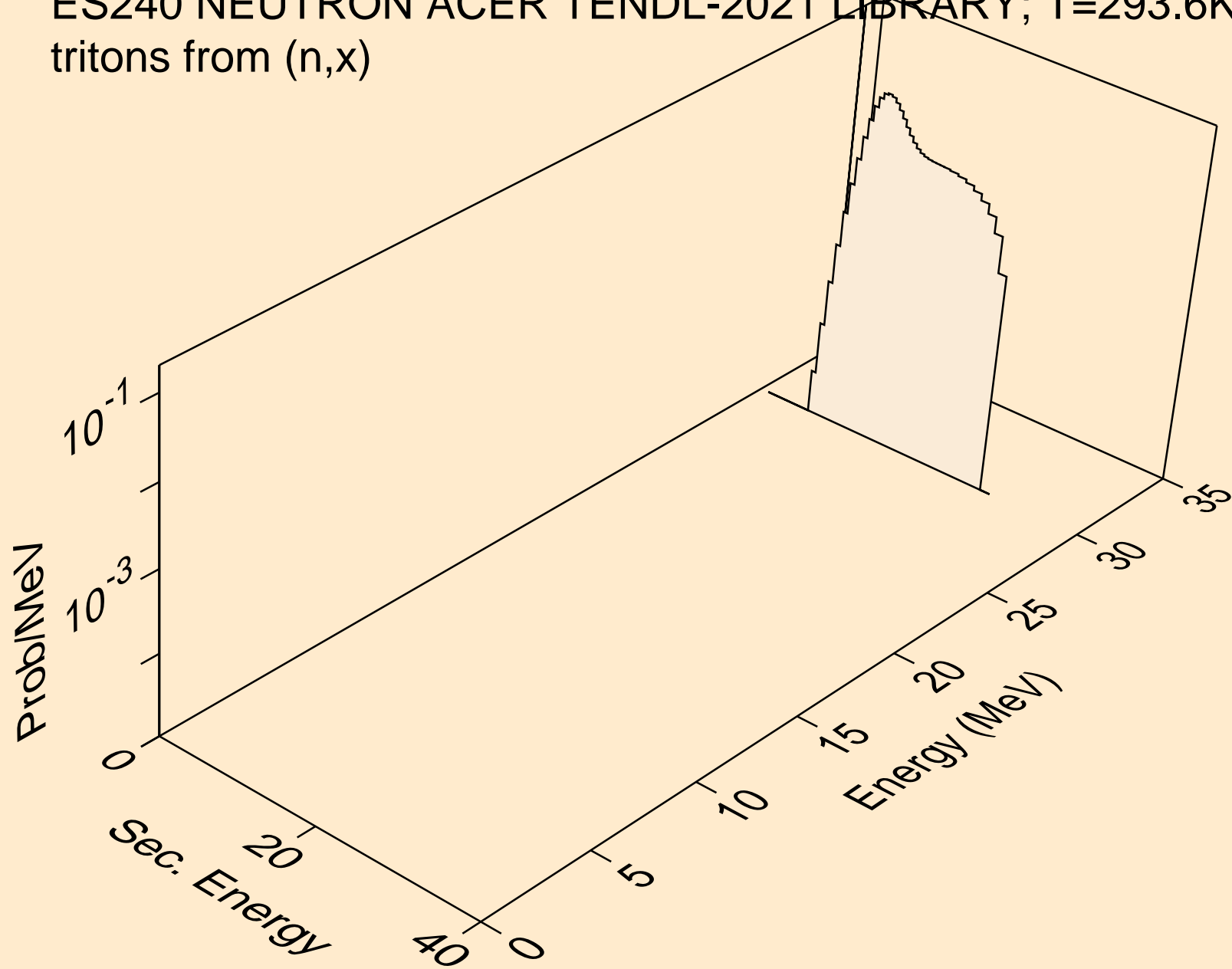

ES240 NEUTRON ACER TENDL-2021 LIBRARY; T=293.6K
tritons from (n,n*)t

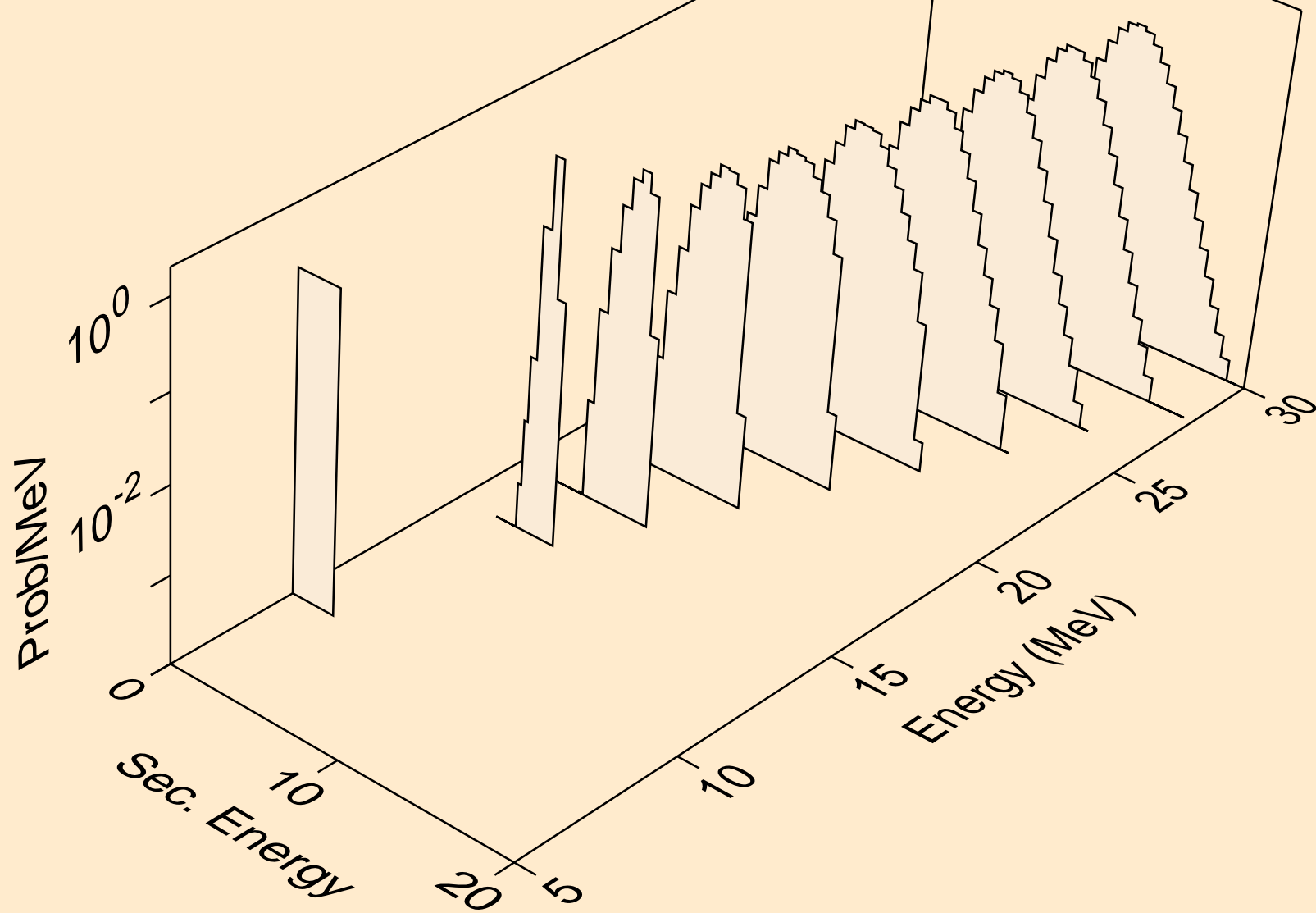

ES240 NEUTRON ACER TENDL-2021 LIBRARY; T=293.6K
tritons from (n,t)

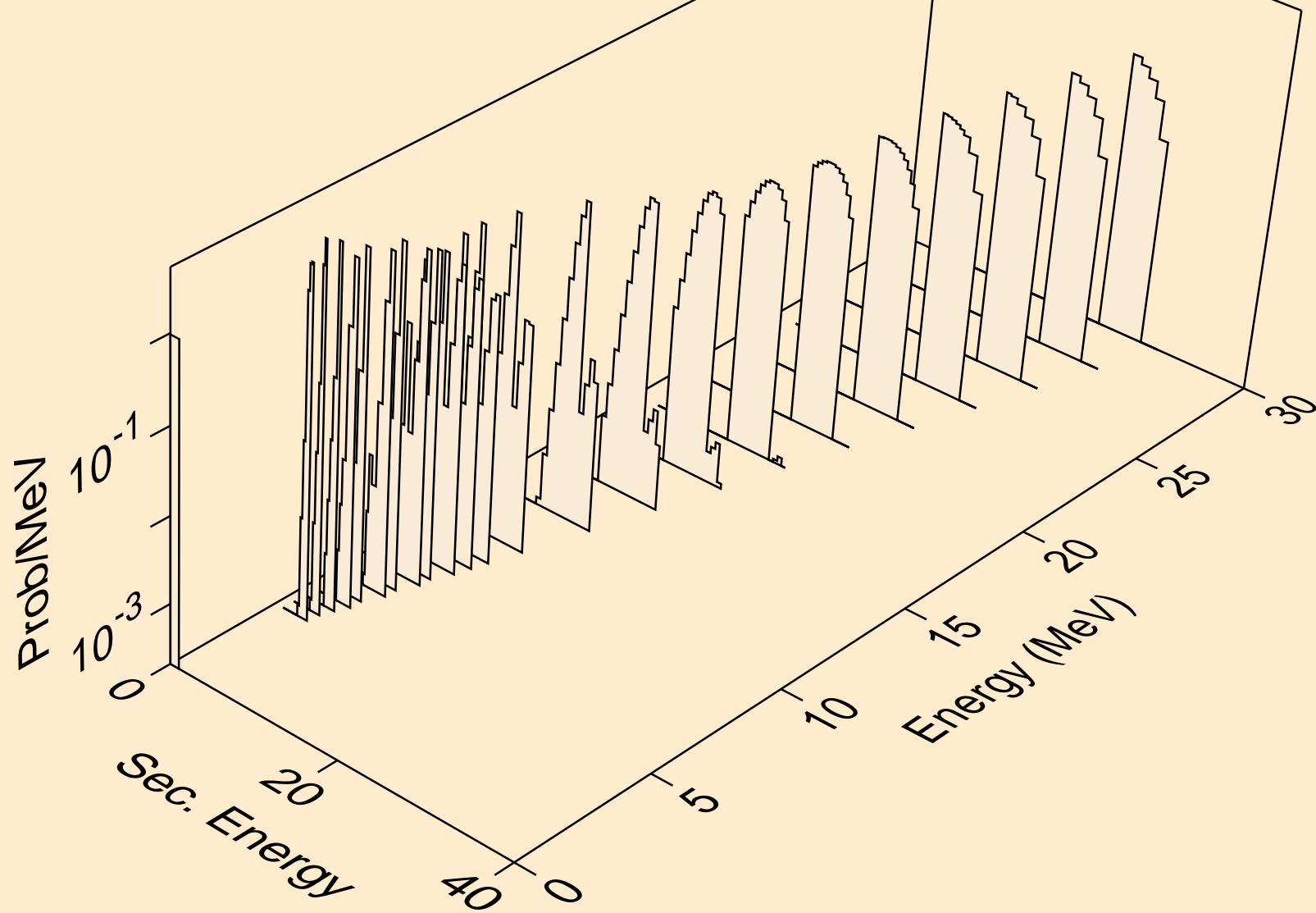

ES240 NEUTRON ACER TENDL-2021 LIBRARY; T=293.6K
he3s from (n,x)

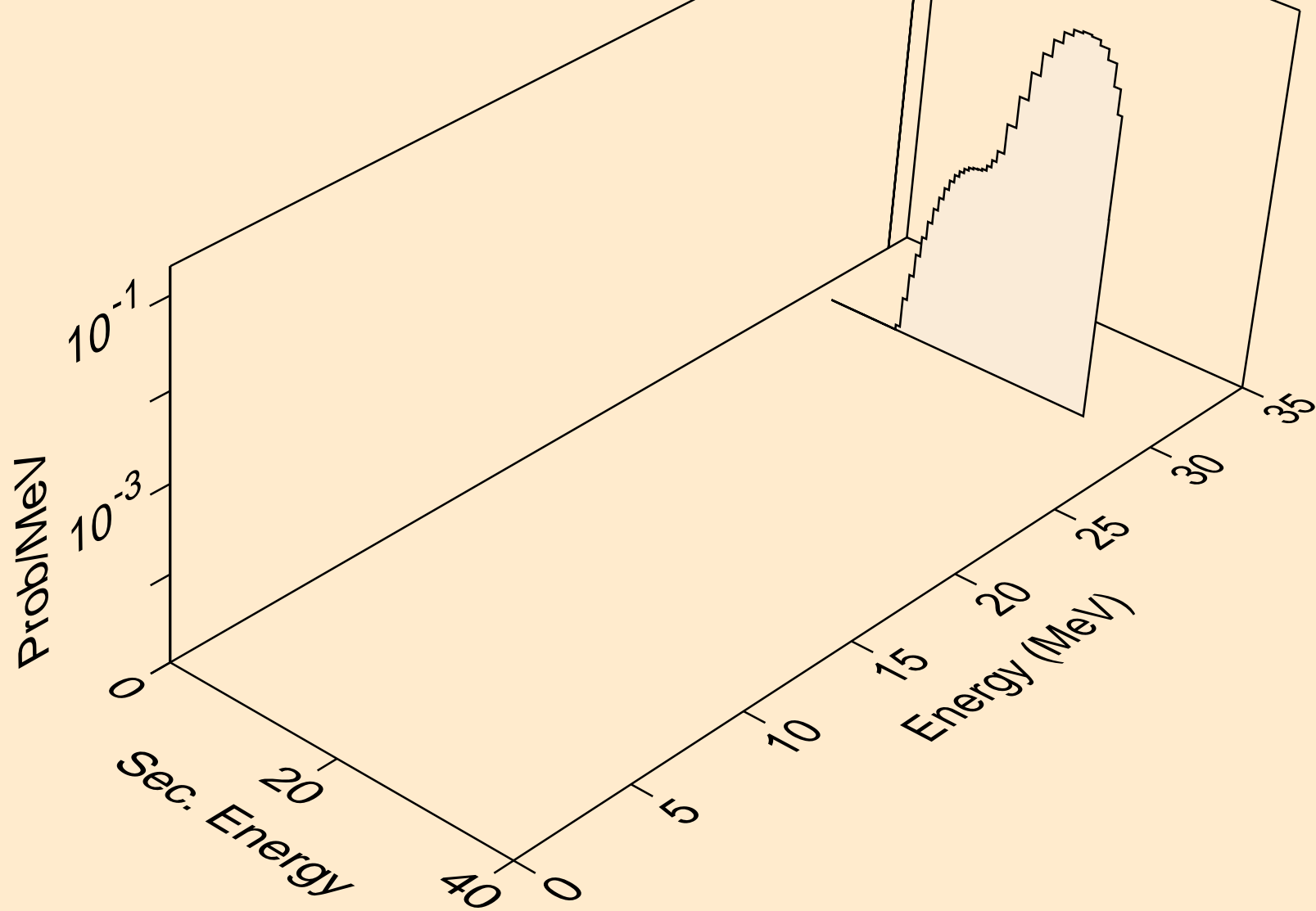

ES240 NEUTRON ACER TENDL-2021 LIBRARY; T=293.6K
he3s from (n,he3)

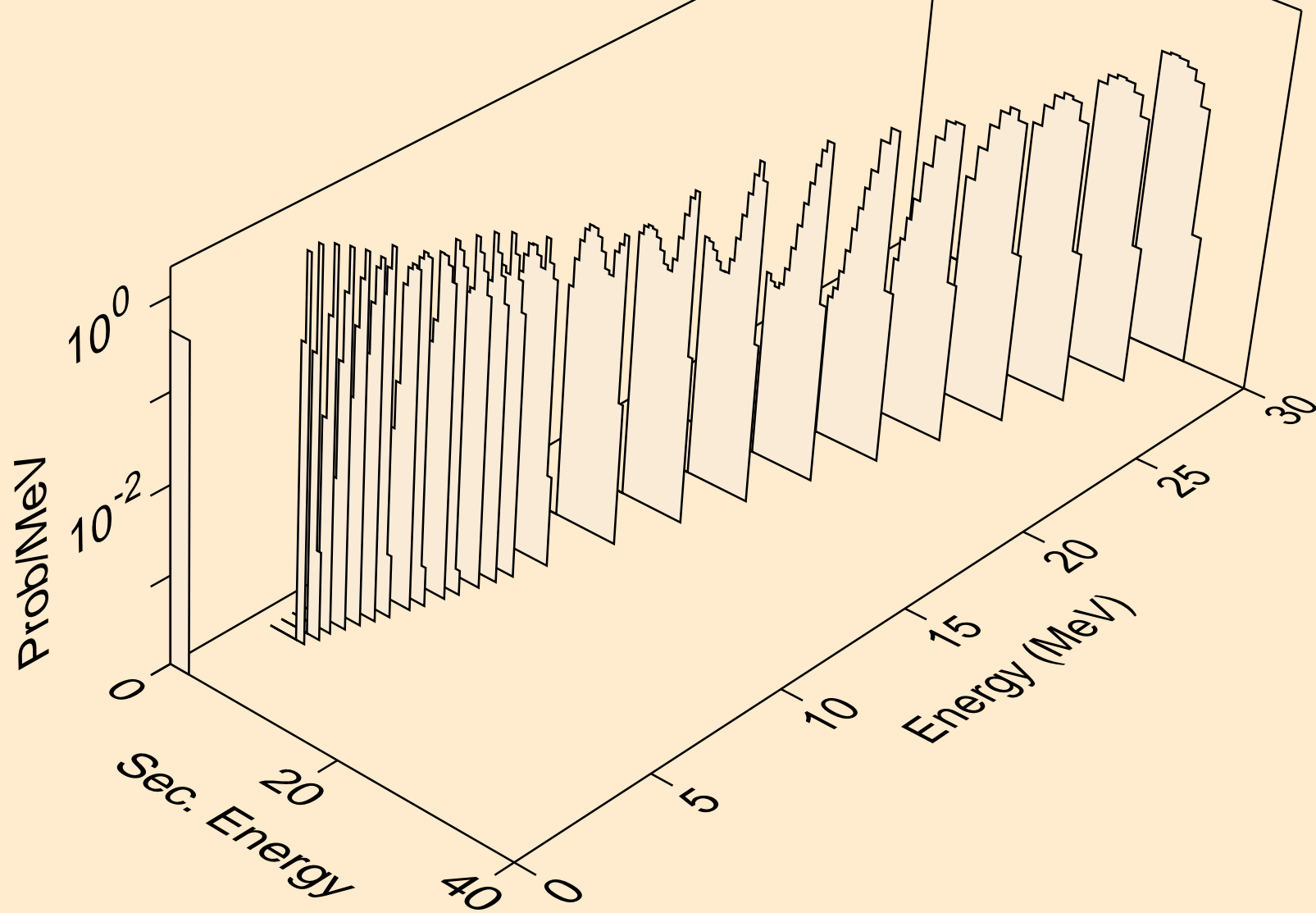

ES240 NEUTRON ACER TENDL-2021 LIBRARY; T=293.6K
alphas from (n,x)

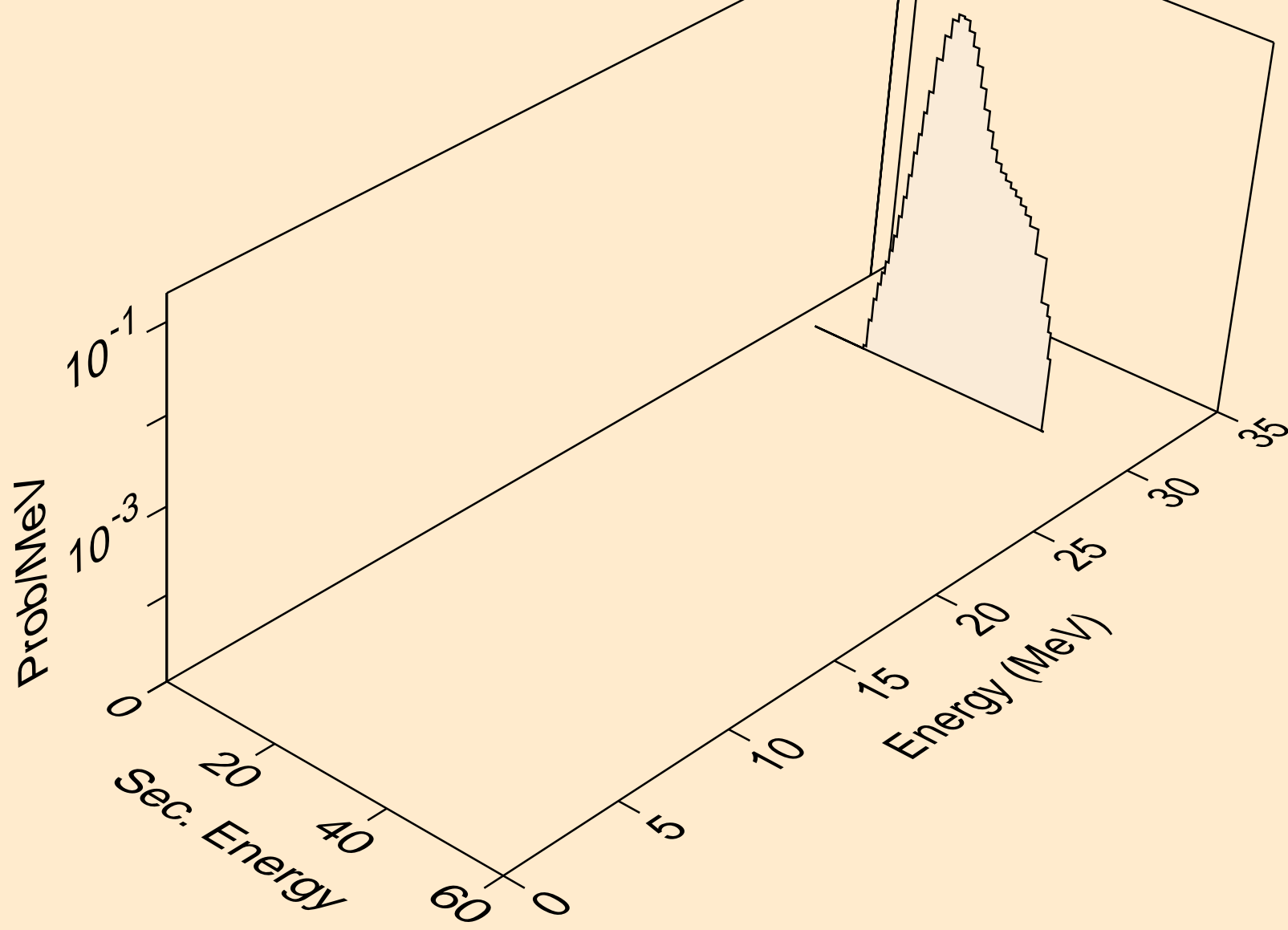

ES240 NEUTRON ACER TENDL-2021 LIBRARY; T=293.6K
alphas from (n,n*)a

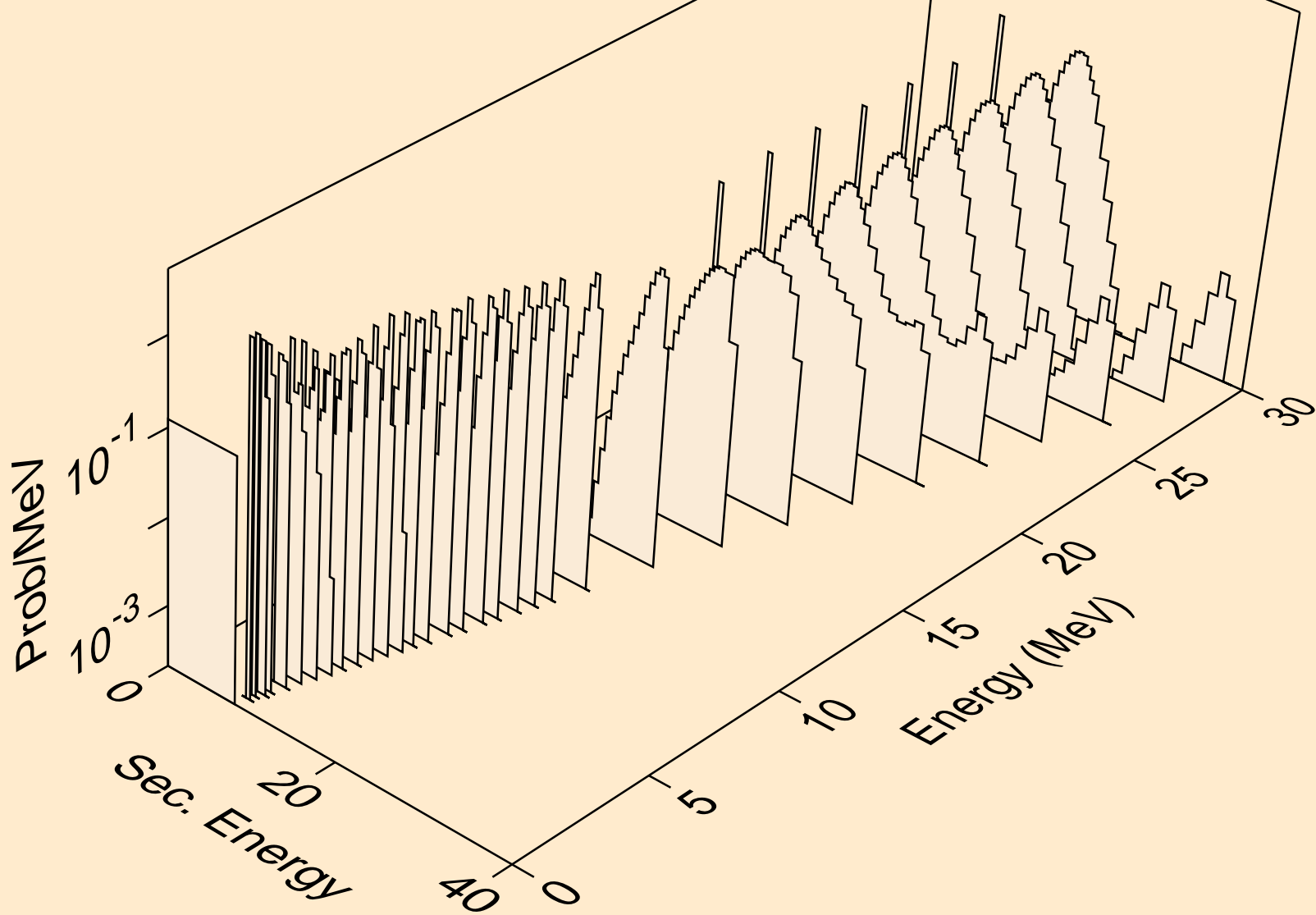

ES240 NEUTRON ACER TENDL-2021 LIBRARY; T=293.6K
alphas from (n,2n)a

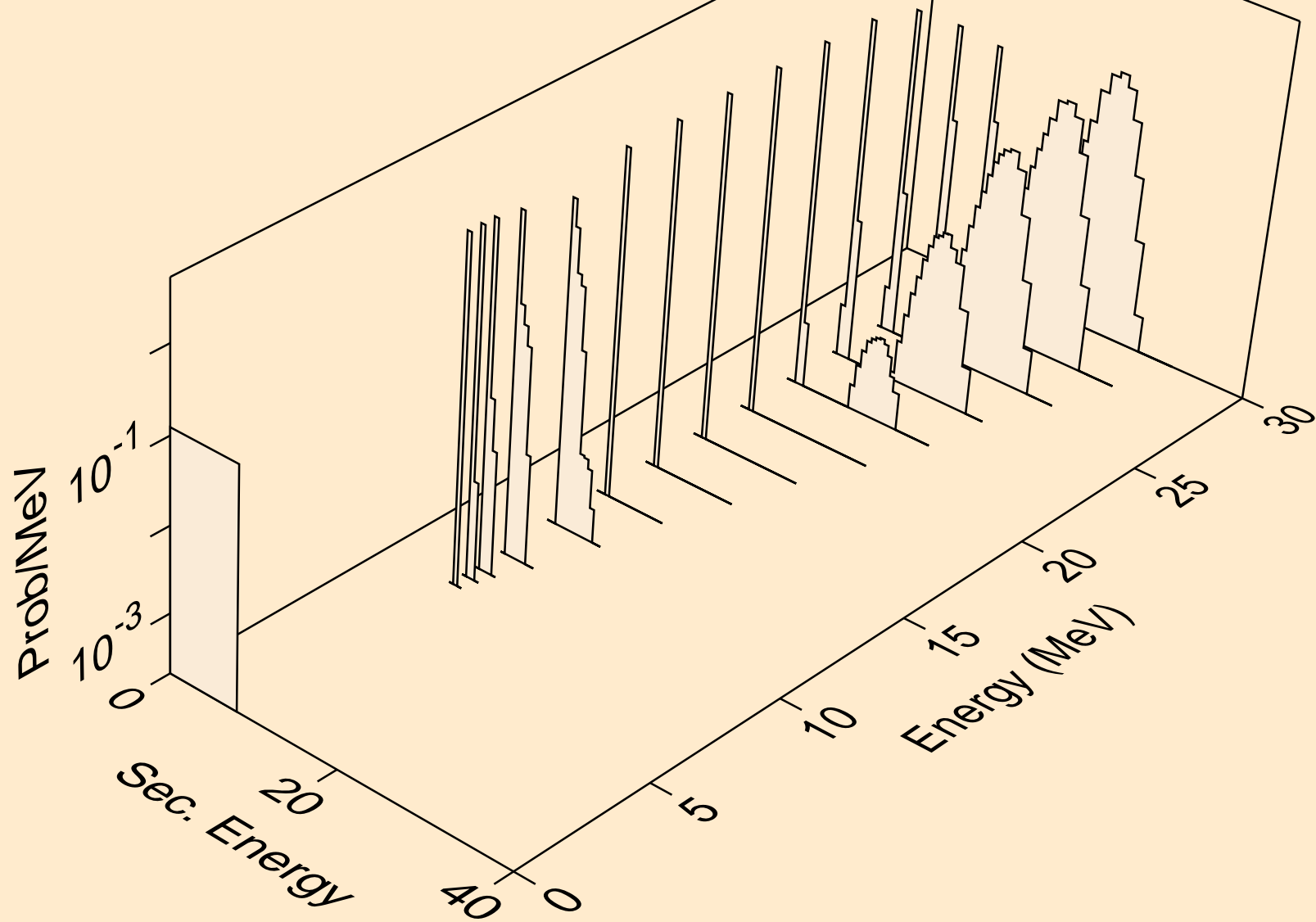

ES240 NEUTRON ACER TENDL-2021 LIBRARY; T=293.6K
alphas from (n,3n)a

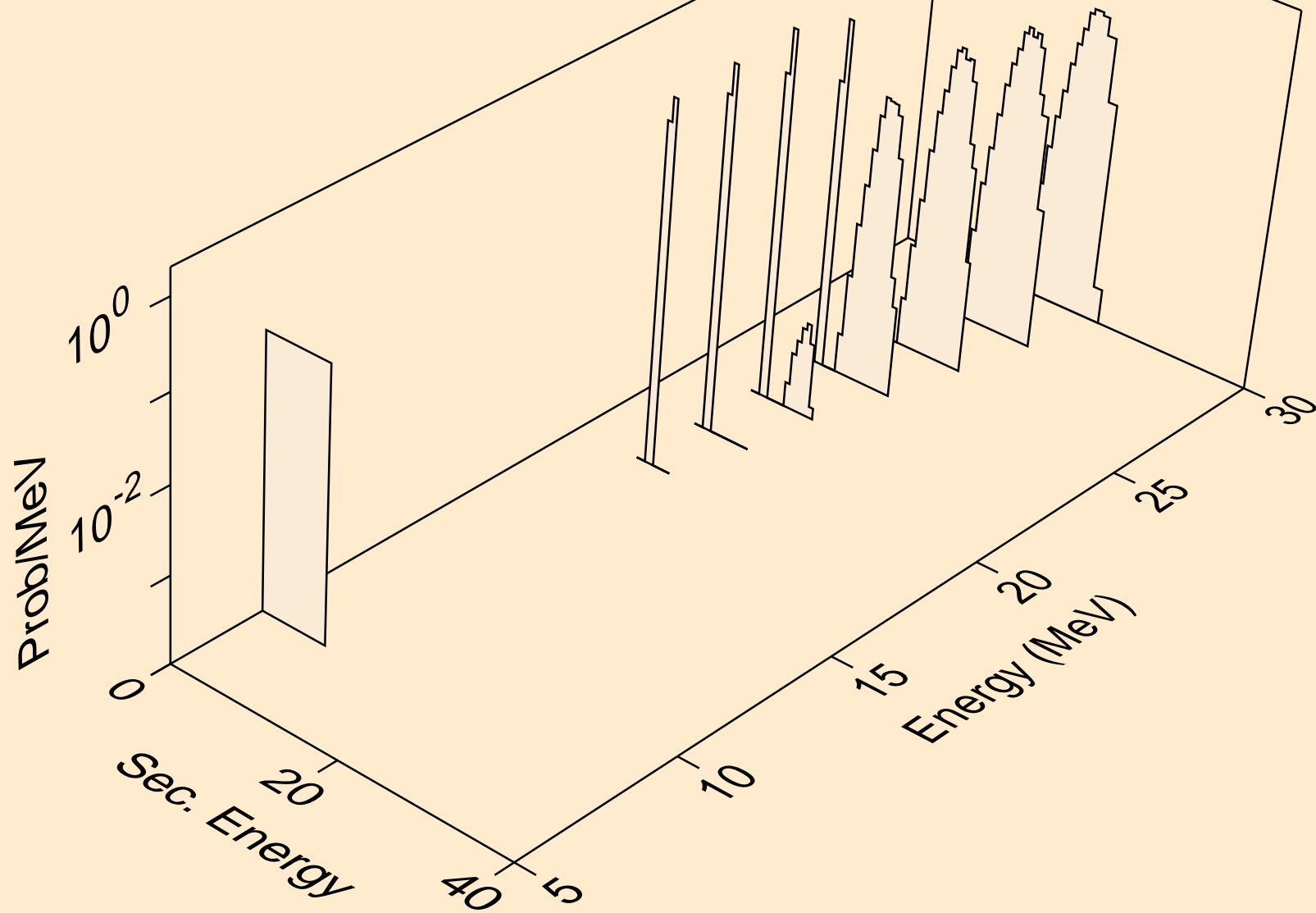

ES240 NEUTRON ACER TENDL-2021 LIBRARY; T=293.6K
alphas from (n,n*)2a

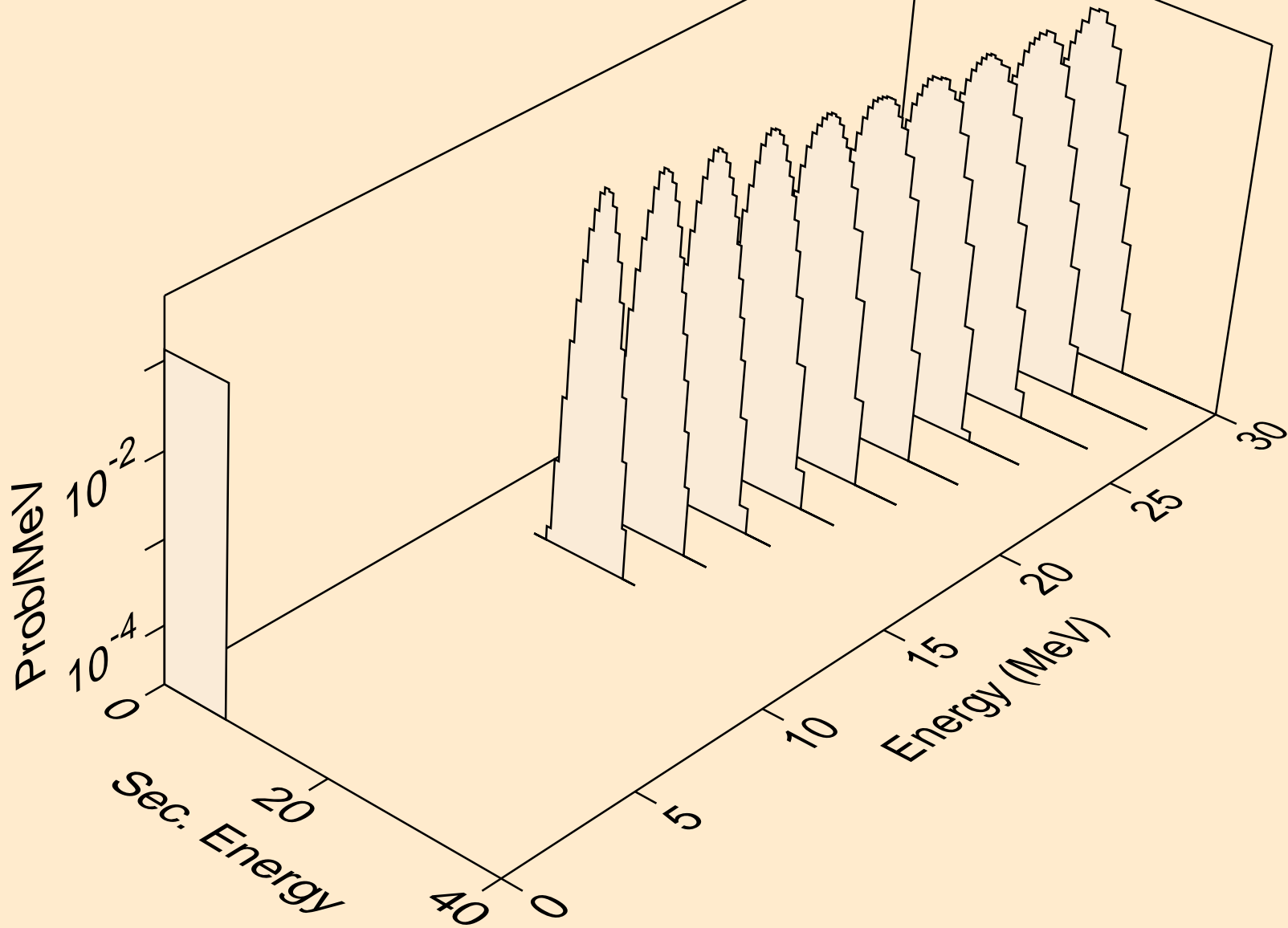

ES240 NEUTRON ACER TENDL-2021 LIBRARY; T=293.6K
alphas from (n,a)

