

# ES254 NEUTRON ACER TENDL-2021 LIBRARY; T=293.6K

## Principal cross sections

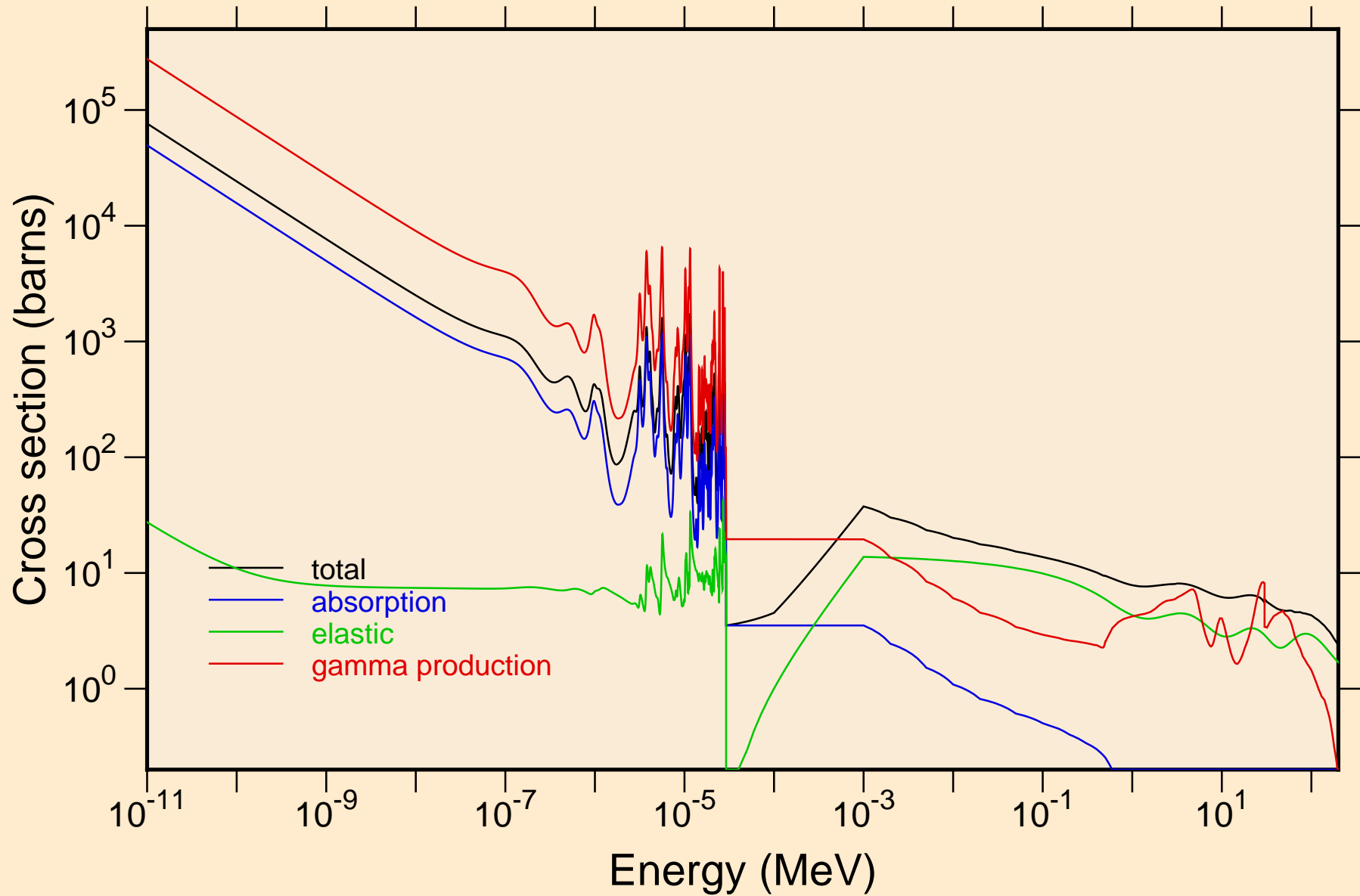

ES254 NEUTRON ACER TENDL-2021 LIBRARY; T=293.6K  
resonance total cross section

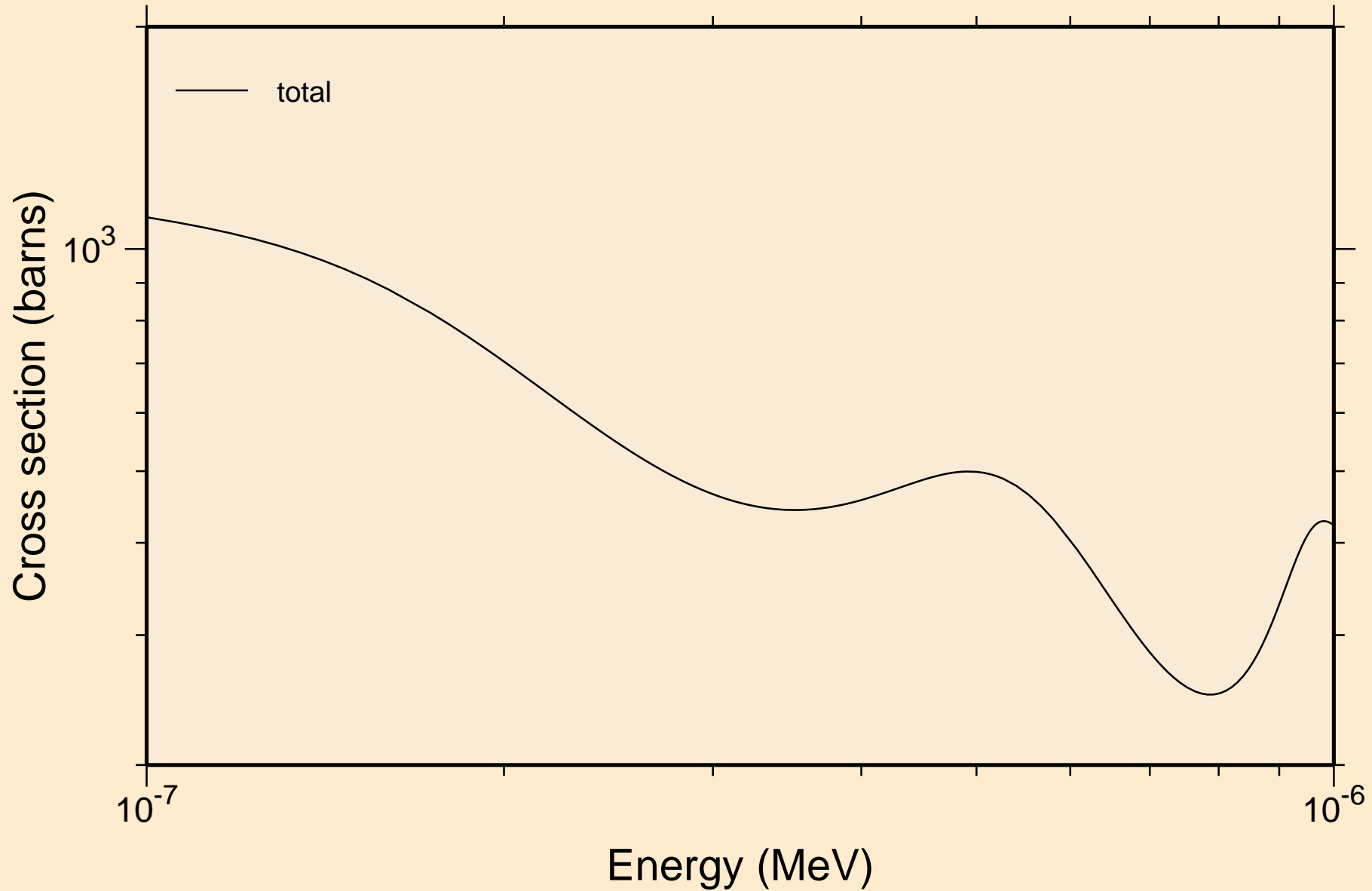

ES254 NEUTRON ACER TENDL-2021 LIBRARY; T=293.6K  
resonance total cross section

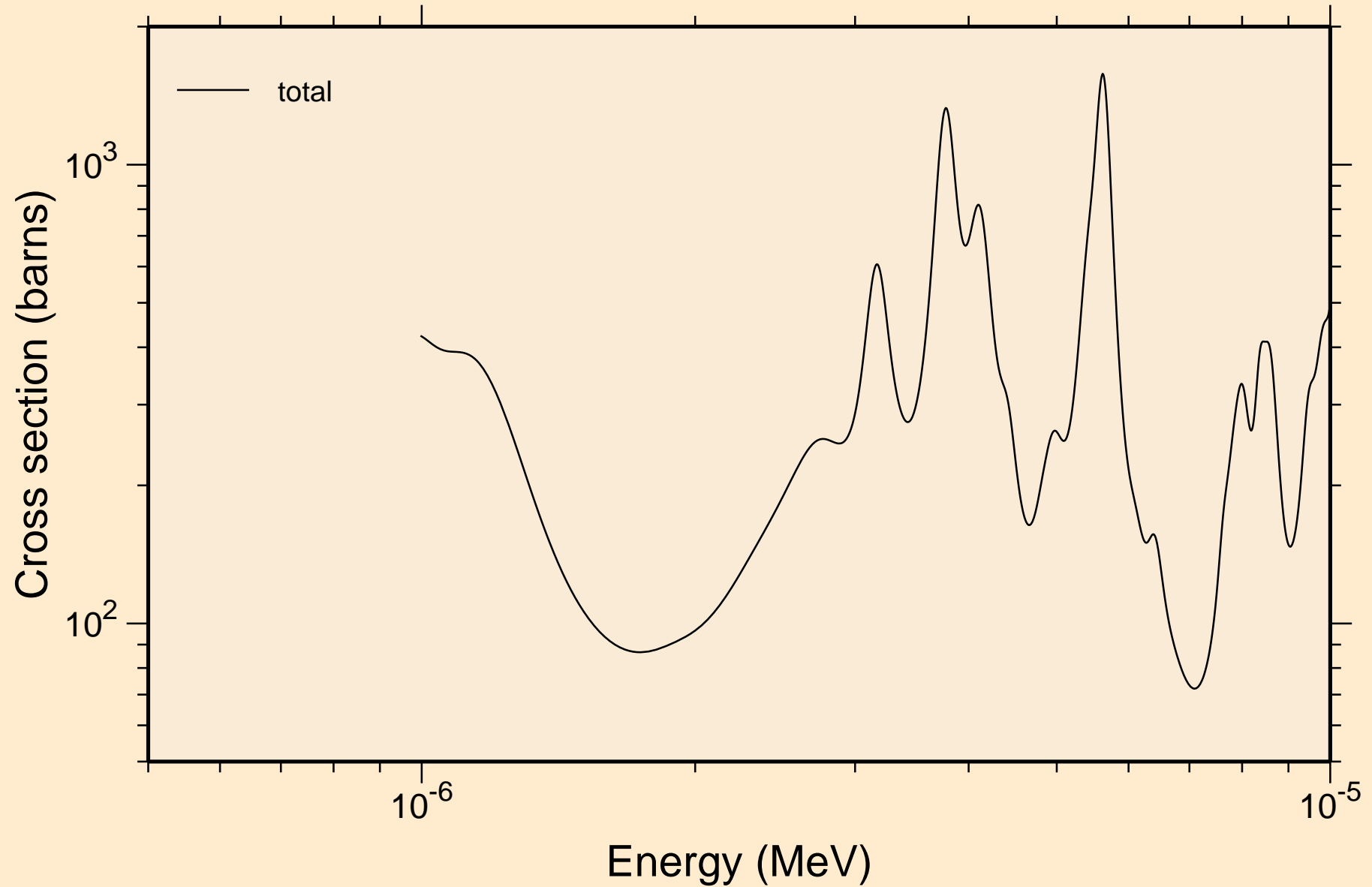

ES254 NEUTRON ACER TENDL-2021 LIBRARY; T=293.6K  
resonance total cross section

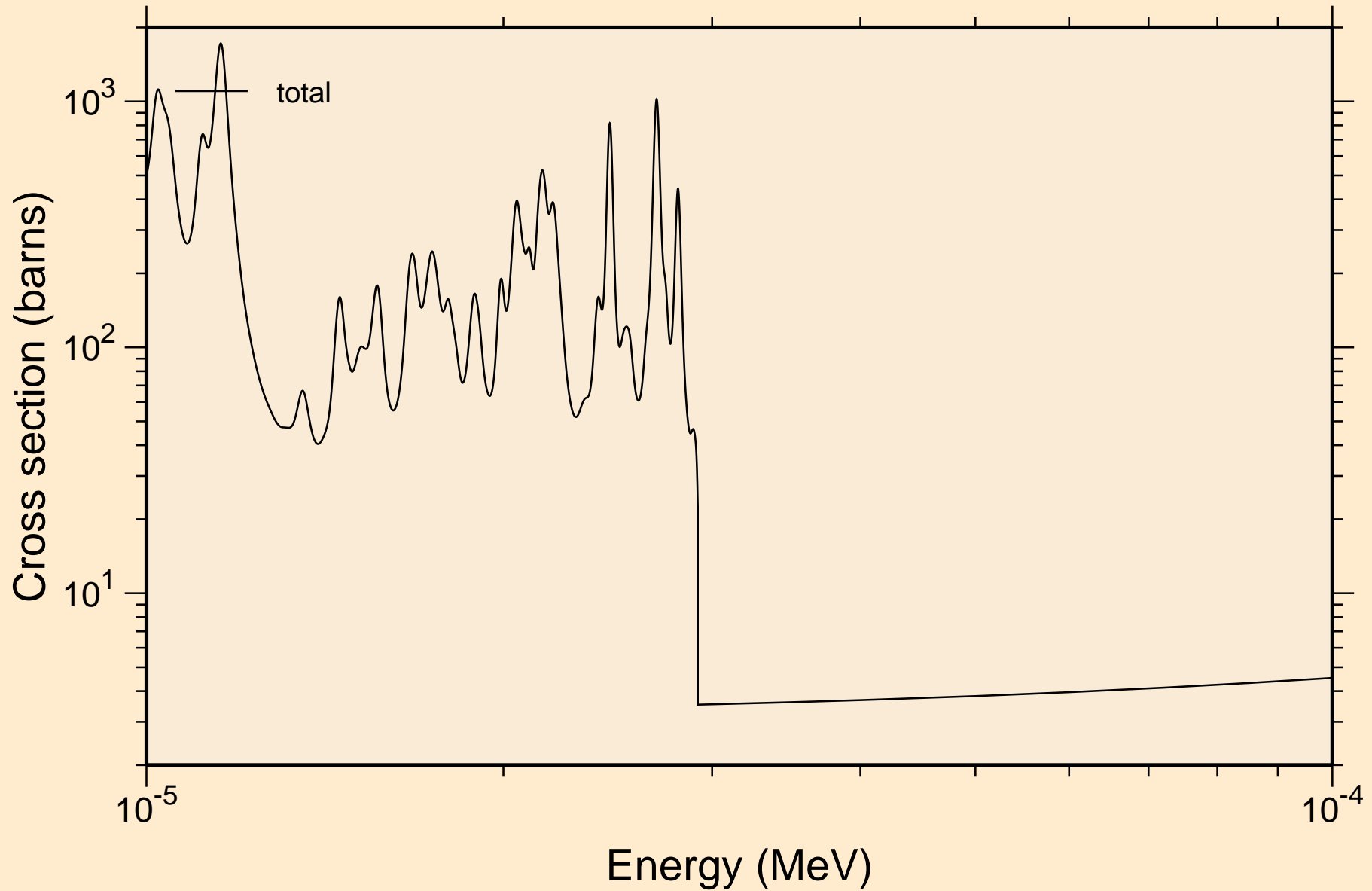

ES254 NEUTRON ACER TENDL-2021 LIBRARY; T=293.6K  
resonance total cross section

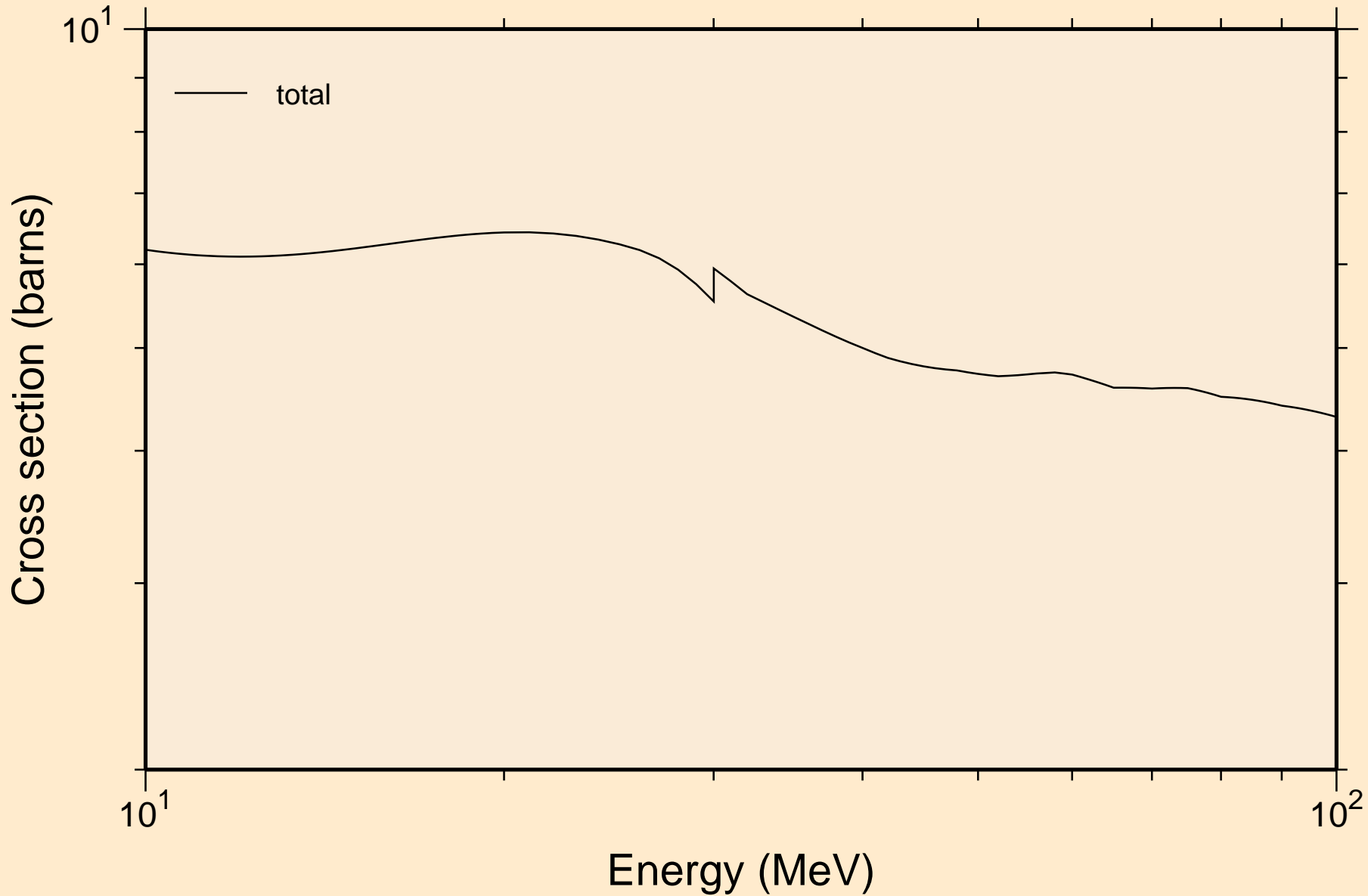

ES254 NEUTRON ACER TENDL-2021 LIBRARY; T=293.6K  
resonance absorption cross sections

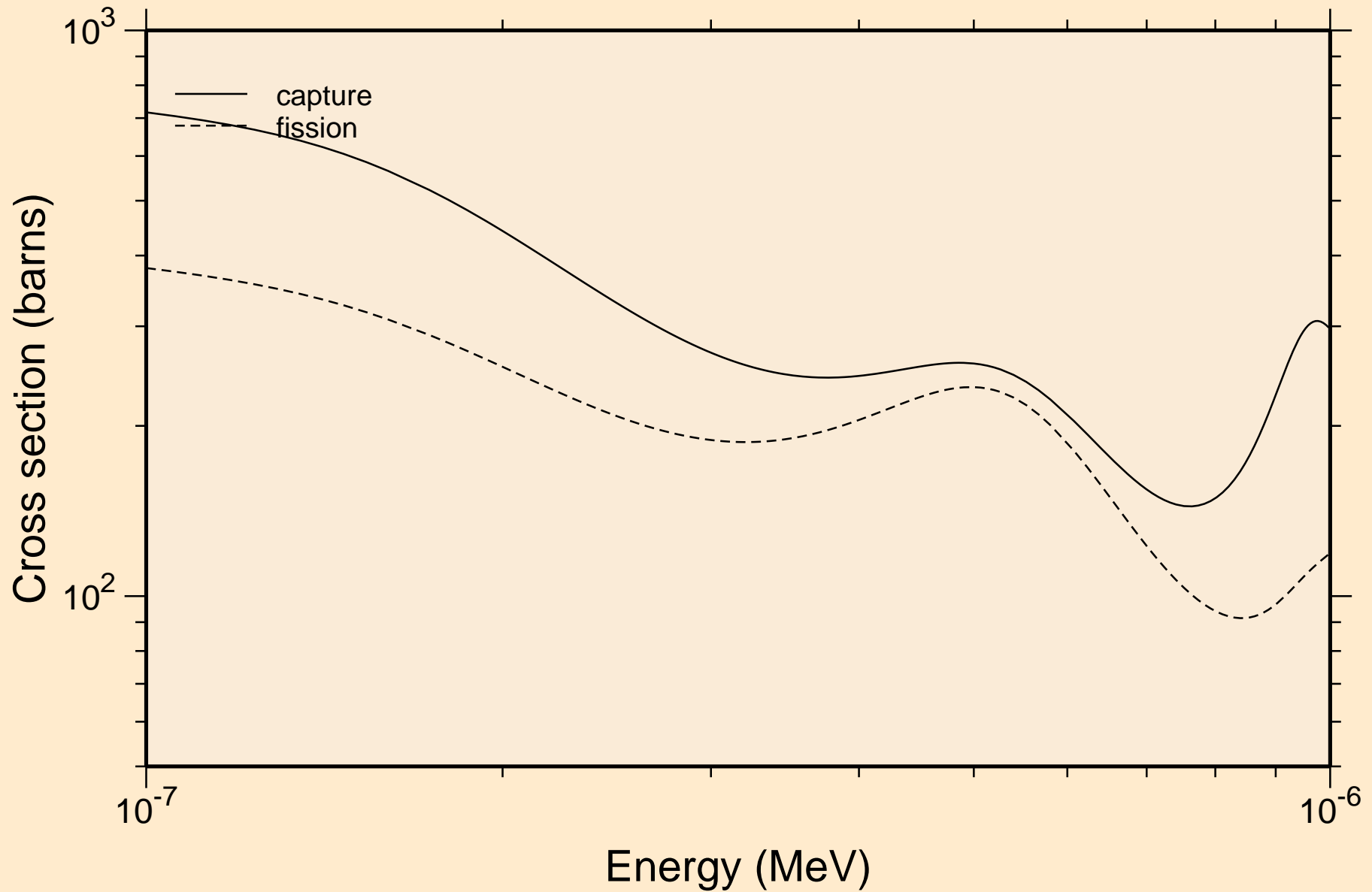

ES254 NEUTRON ACER TENDL-2021 LIBRARY; T=293.6K  
resonance absorption cross sections

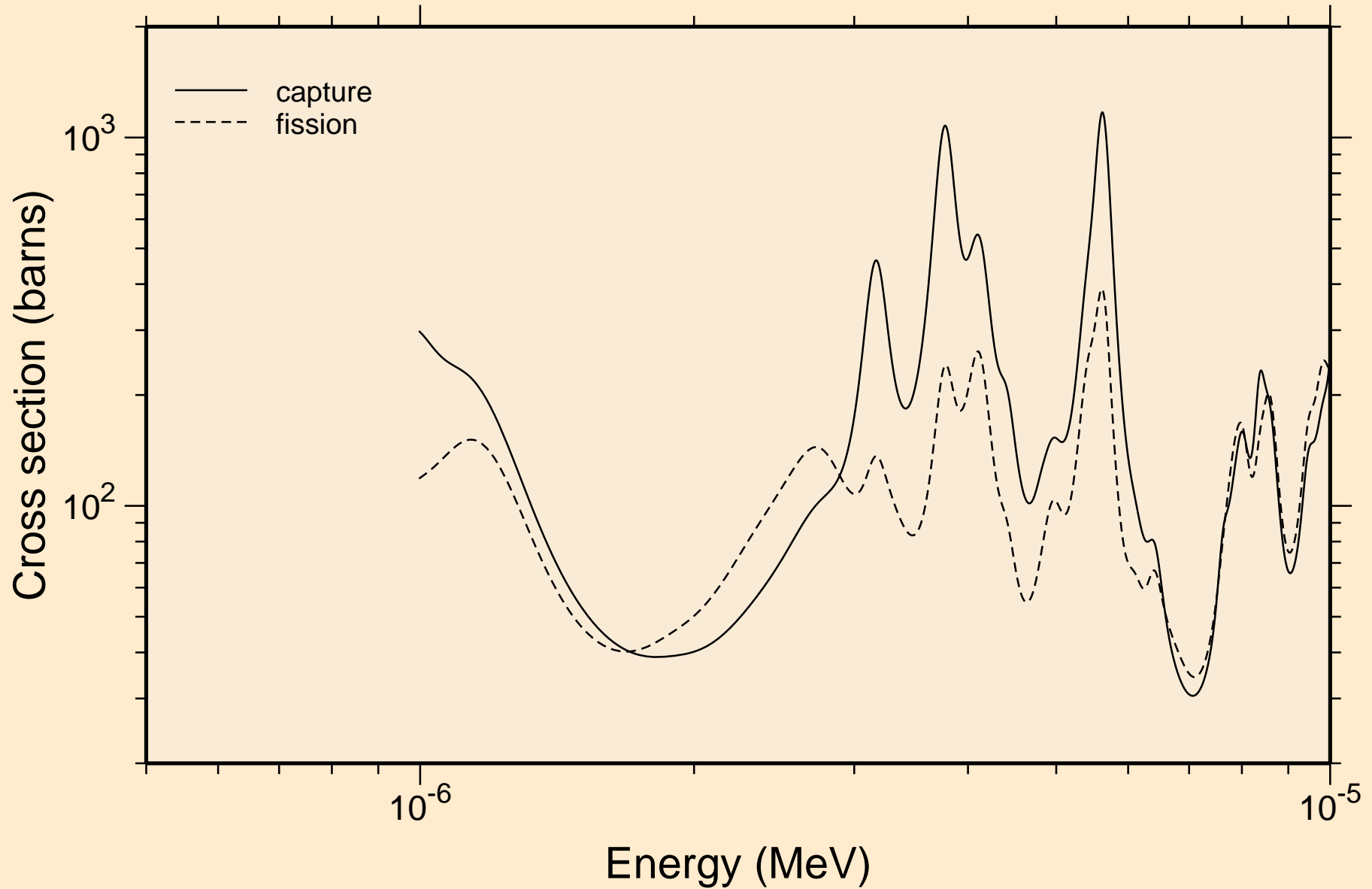

ES254 NEUTRON ACER TENDL-2021 LIBRARY; T=293.6K  
resonance absorption cross sections

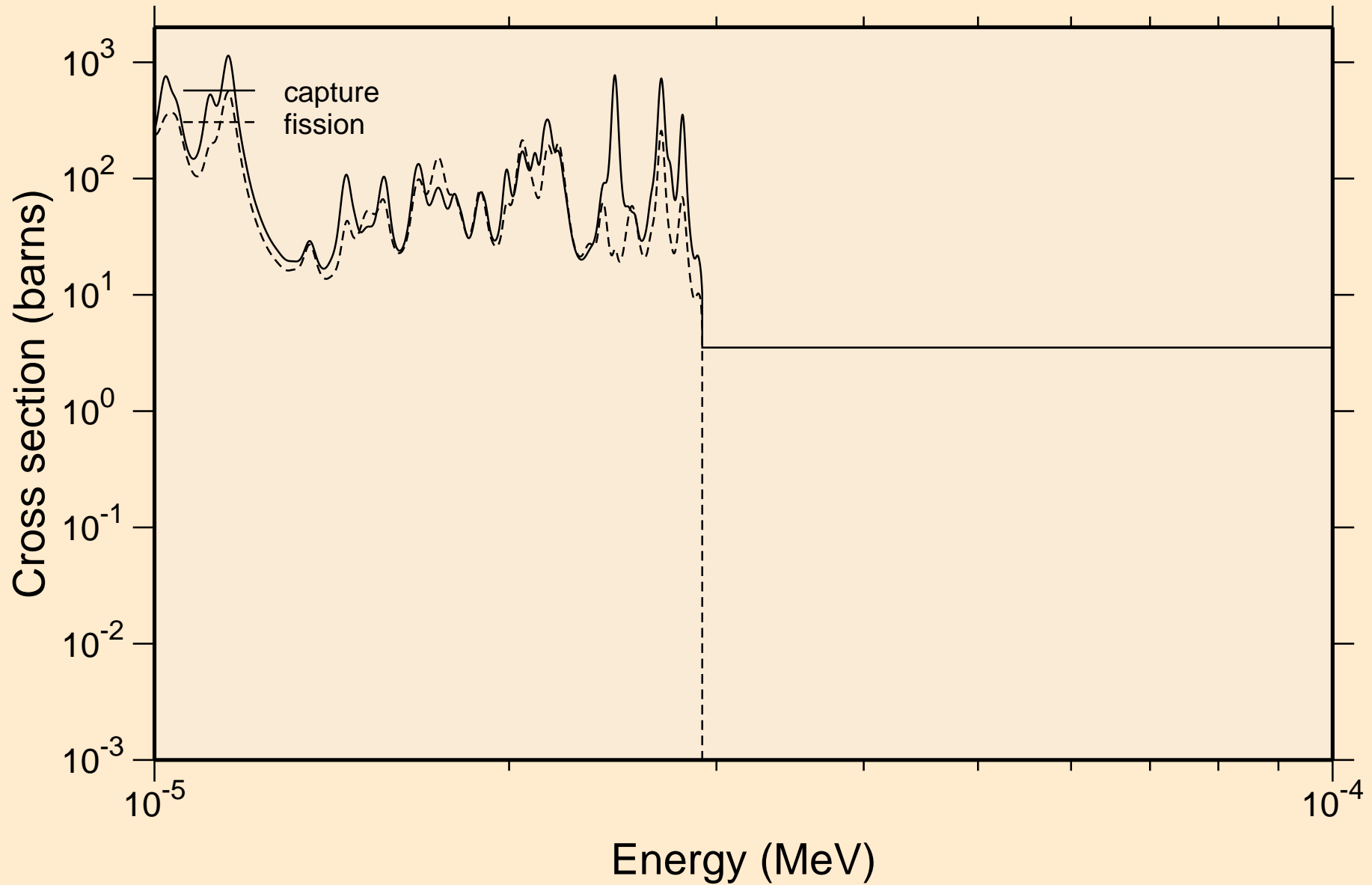



ES254 NEUTRON ACER TENDL-2021 LIBRARY; T=293.6K  
resonance absorption cross sections

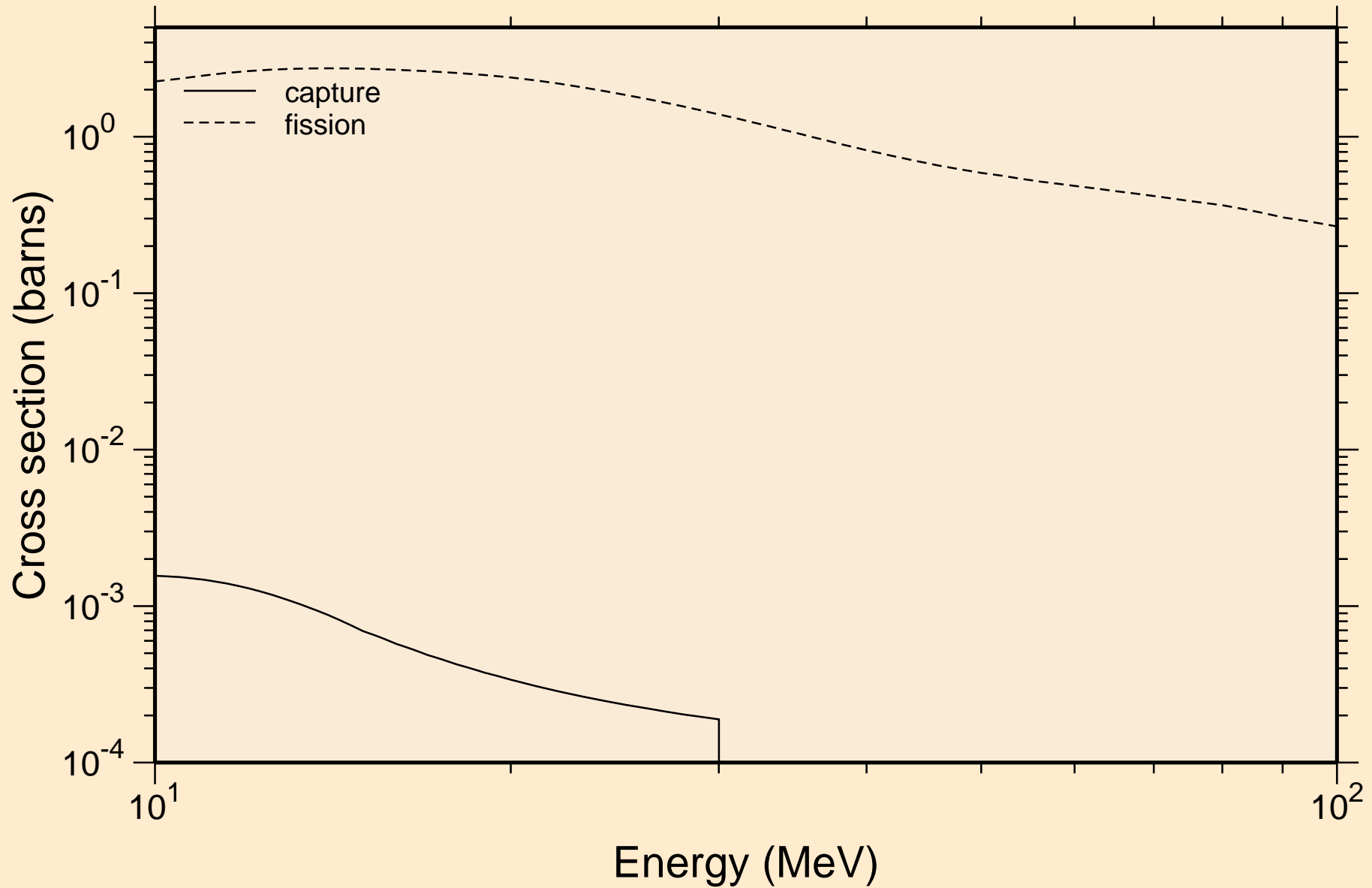

ES254 NEUTRON ACER TENDL-2021 LIBRARY; T=293.6K  
Heating

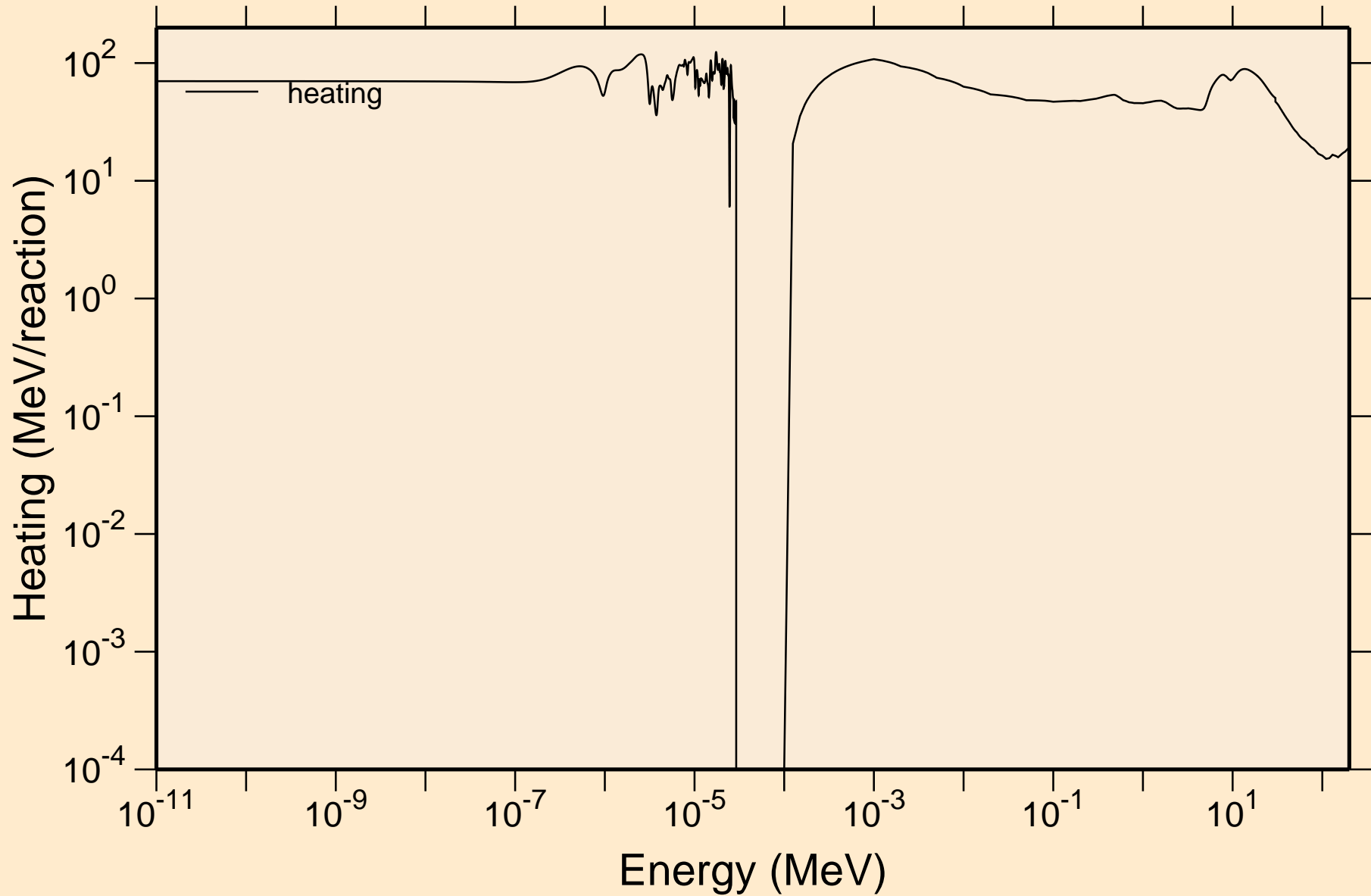

ES254 NEUTRON ACER TENDL-2021 LIBRARY; T=293.6K  
Damage

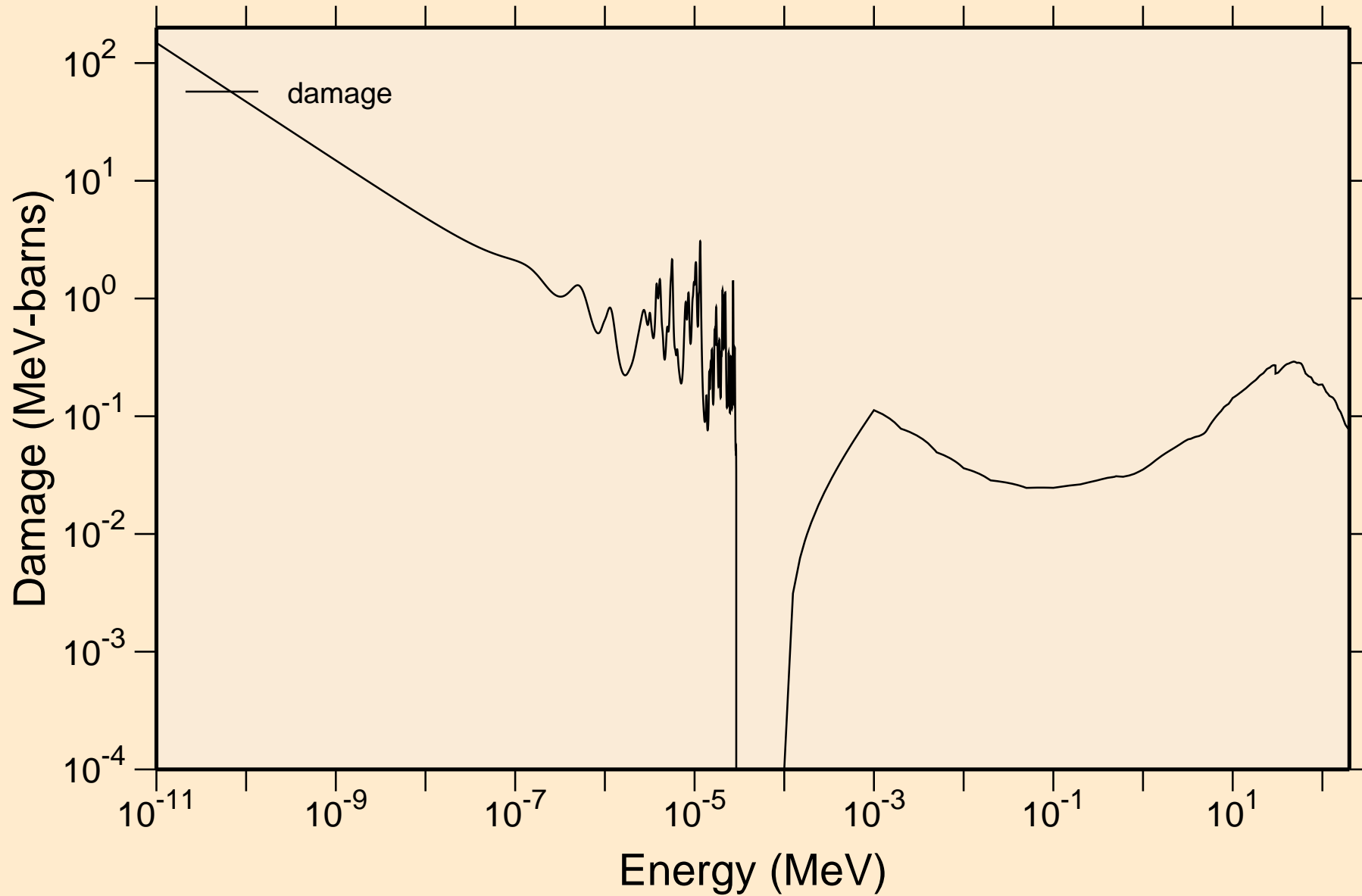

# ES254 NEUTRON ACER TENDL-2021 LIBRARY; T=293.6K

## Non-threshold reactions

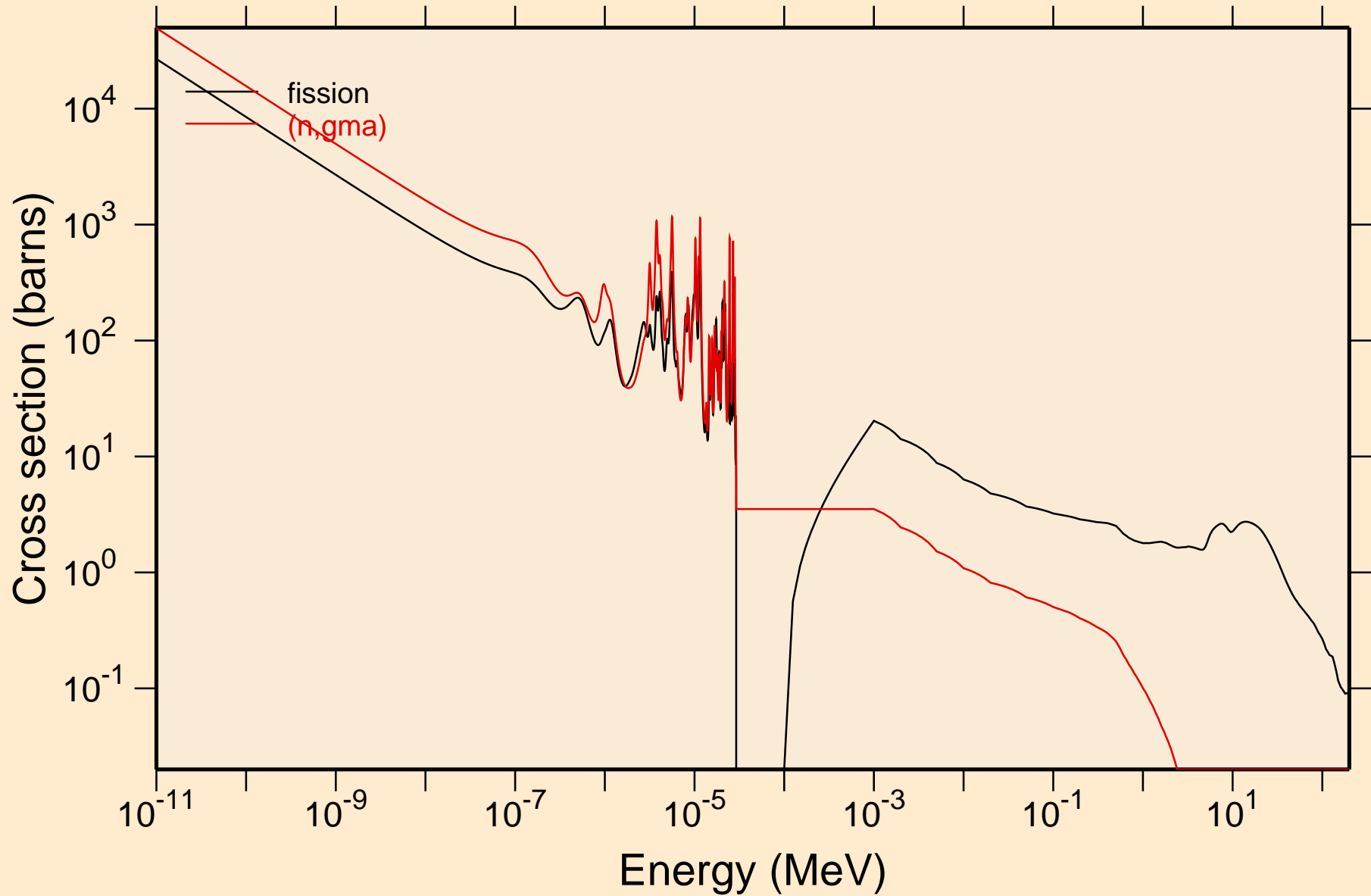

ES254 NEUTRON ACER TENDL-2021 LIBRARY; T=293.6K  
Principal cross sections

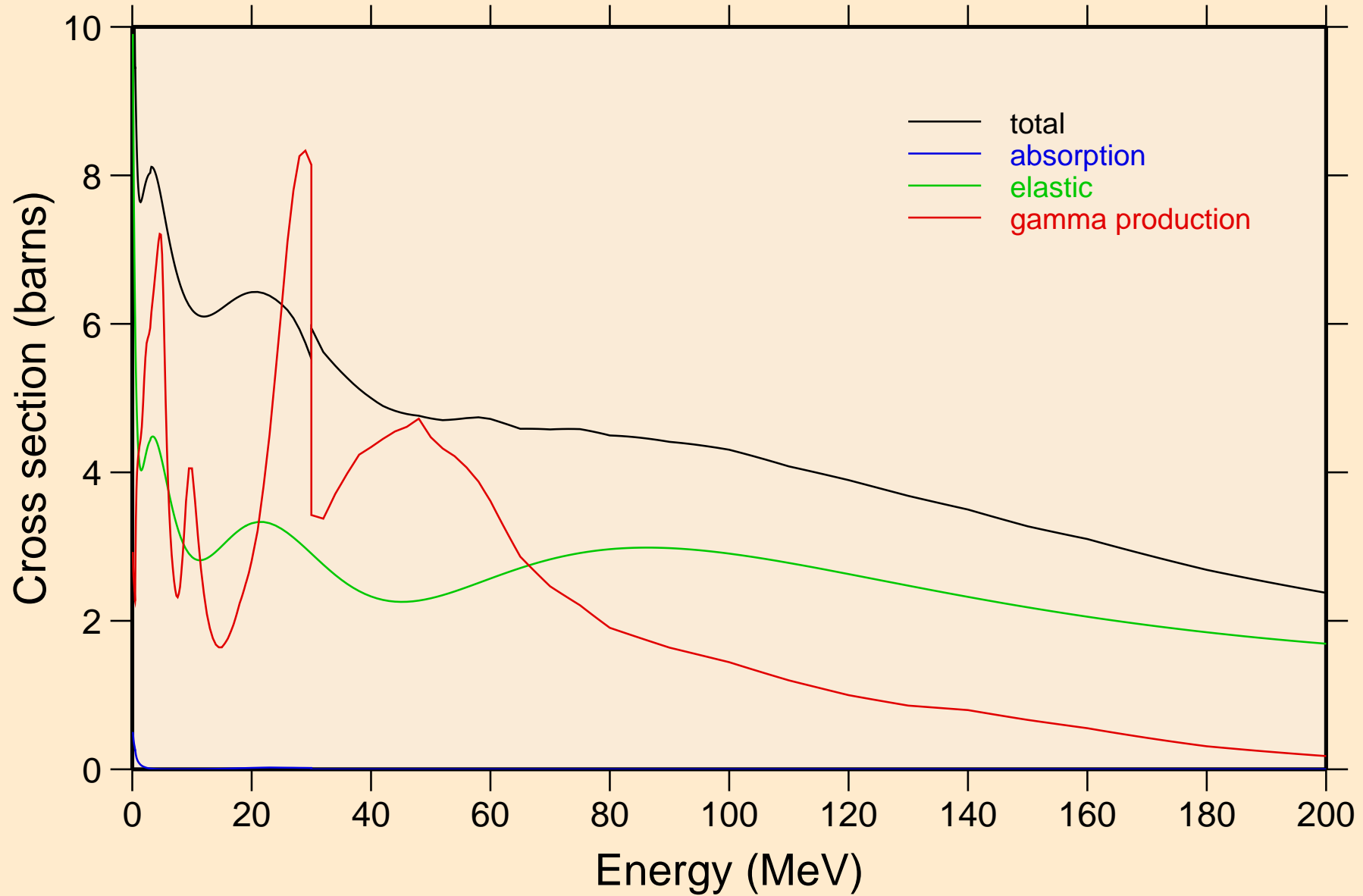

# ES254 NEUTRON ACER TENDL-2021 LIBRARY; T=293.6K

## Heating

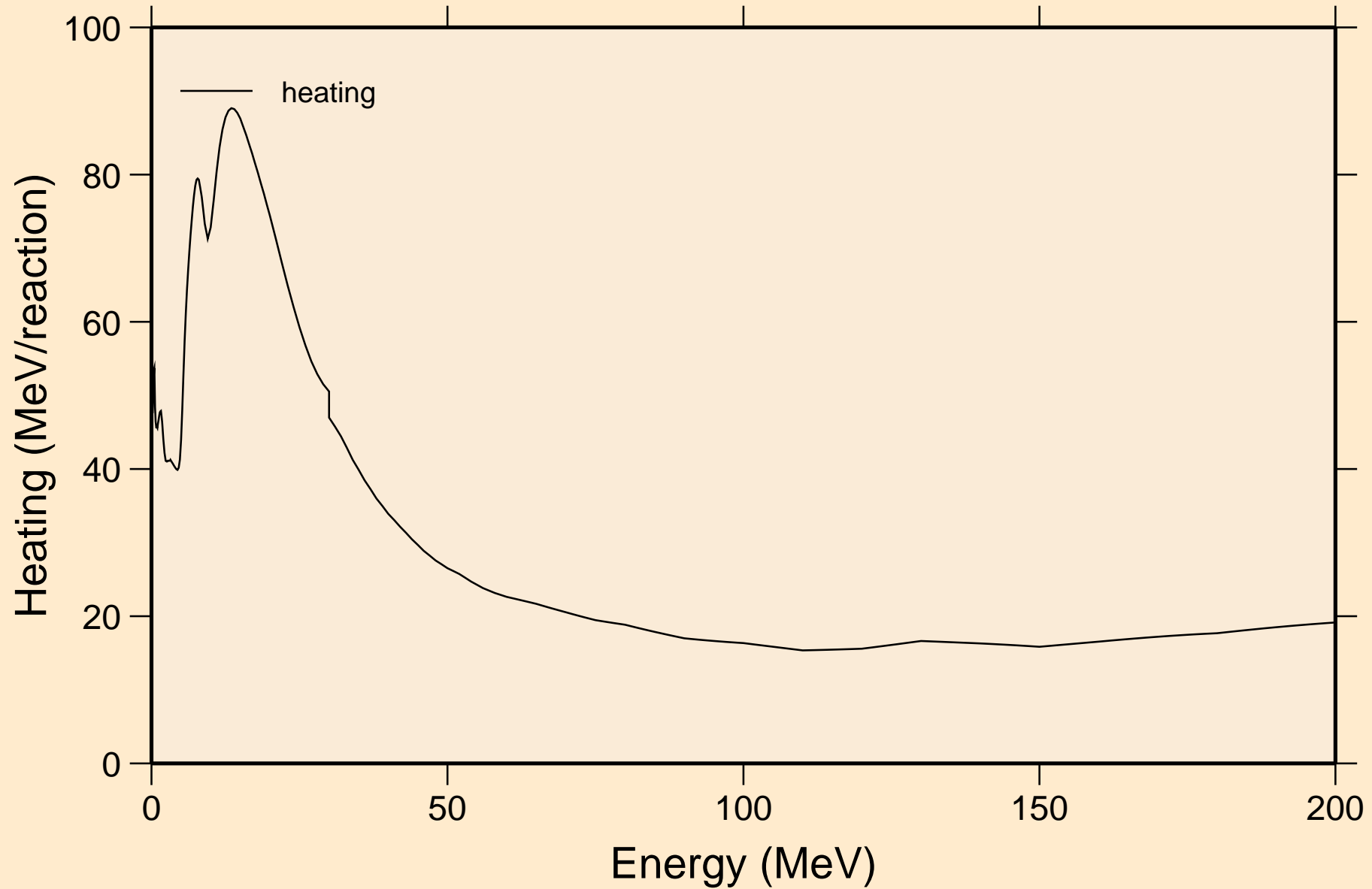

# ES254 NEUTRON ACER TENDL-2021 LIBRARY; T=293.6K

## Damage

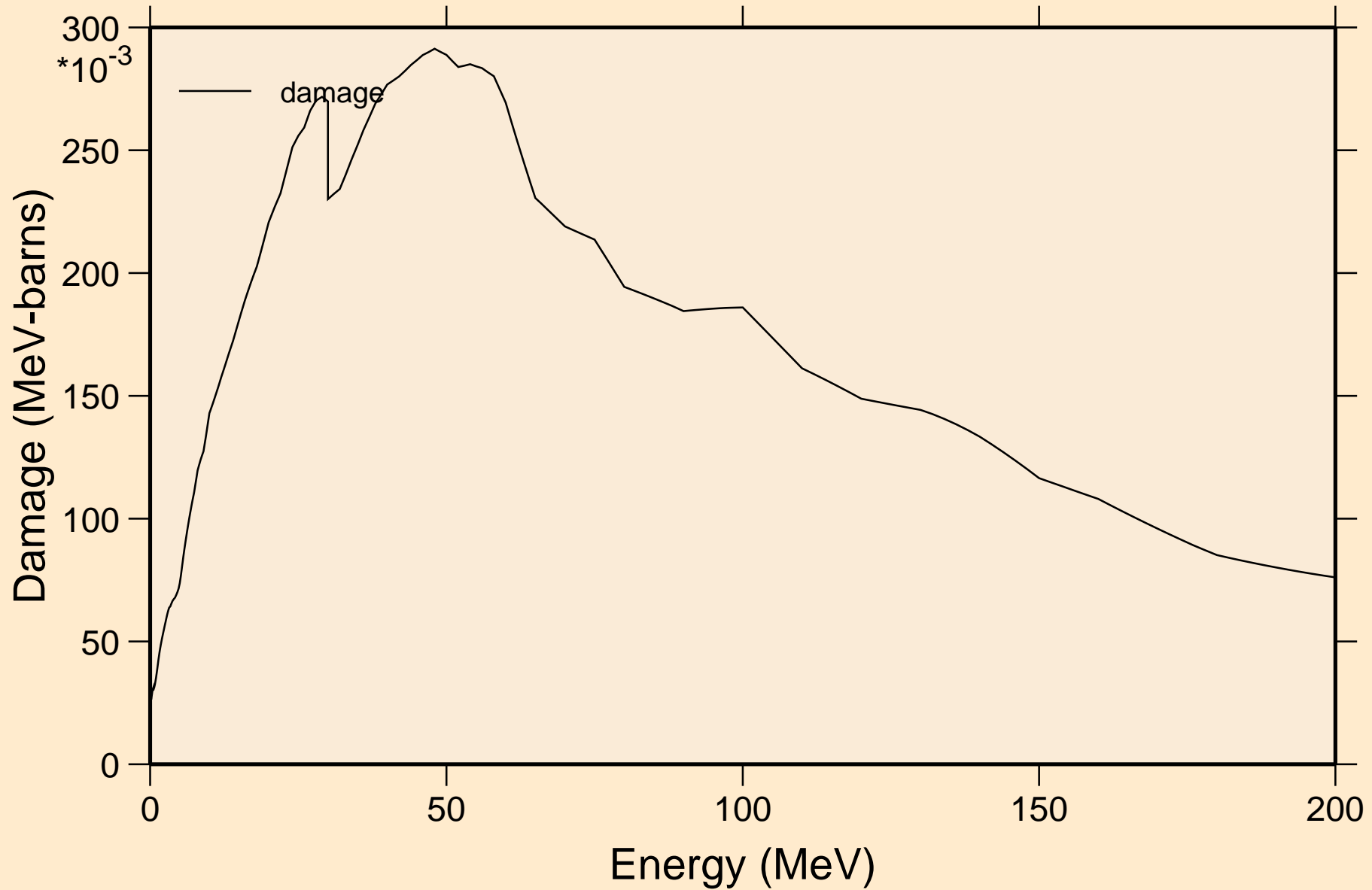

ES254 NEUTRON ACER TENDL-2021 LIBRARY; T=293.6K  
Non-threshold reactions

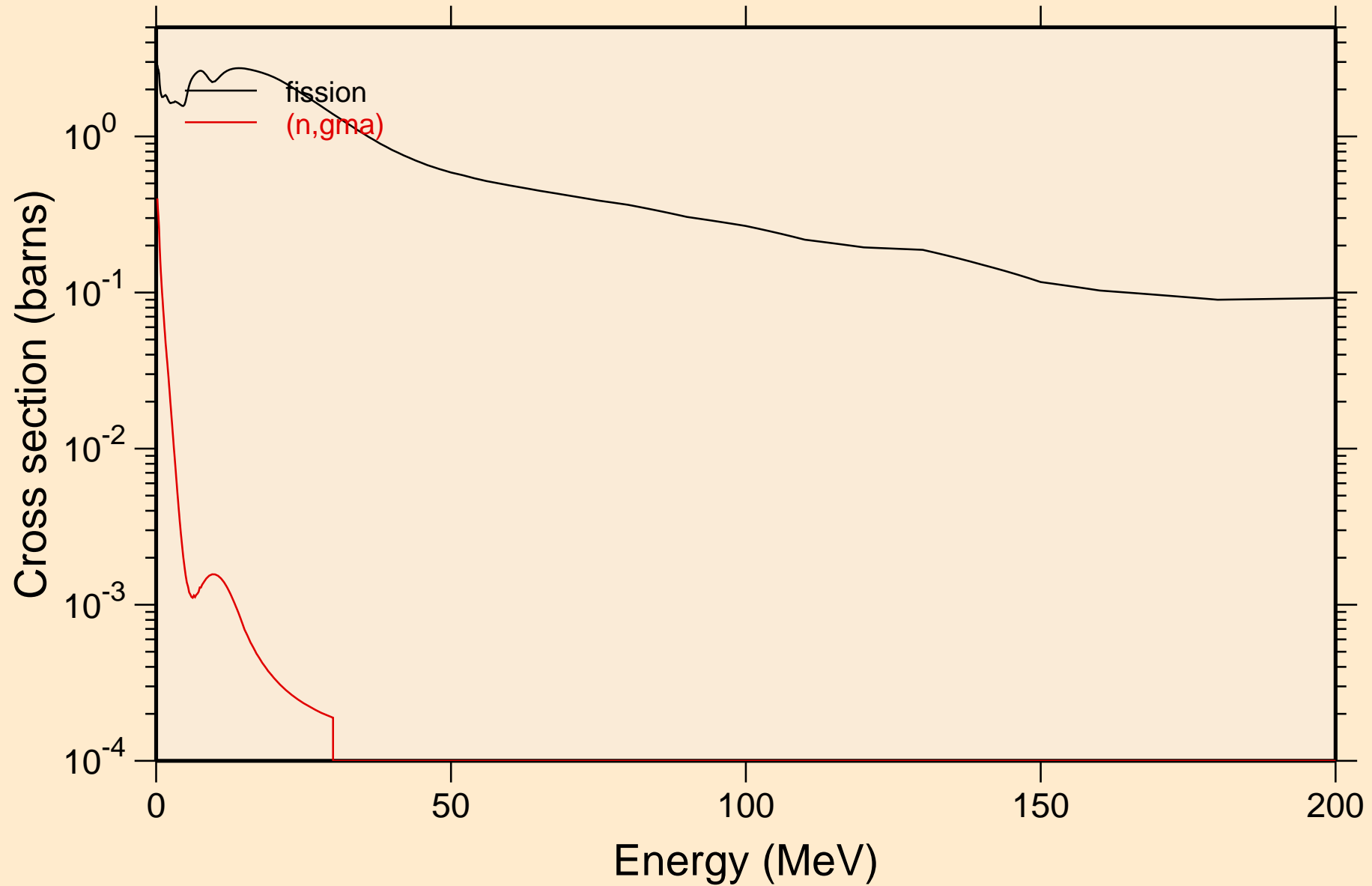



# ES254 NEUTRON ACER TENDL-2021 LIBRARY; T=293.6K

## Inelastic levels

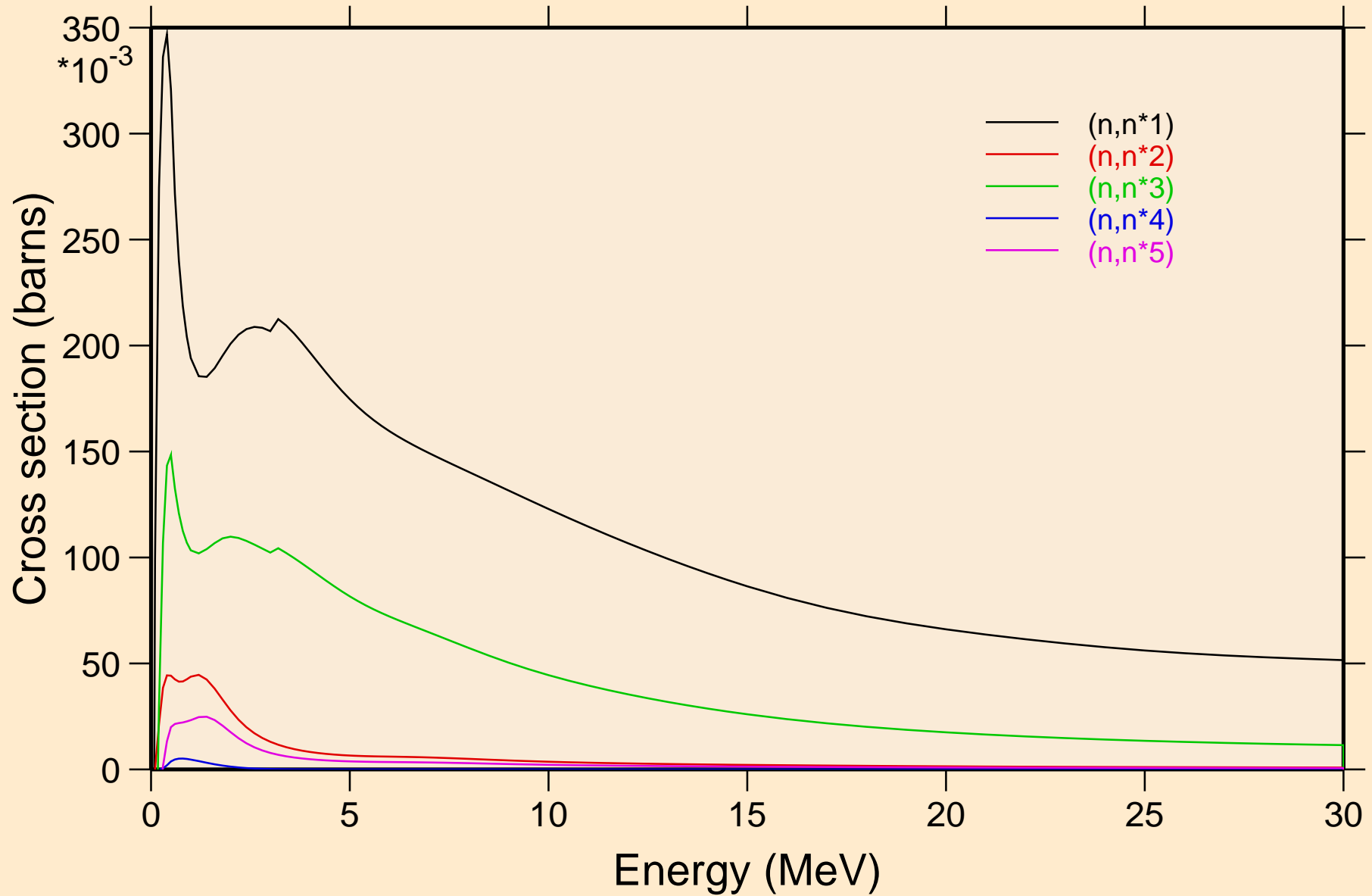

ES254 NEUTRON ACER TENDL-2021 LIBRARY; T=293.6K  
Inelastic levels

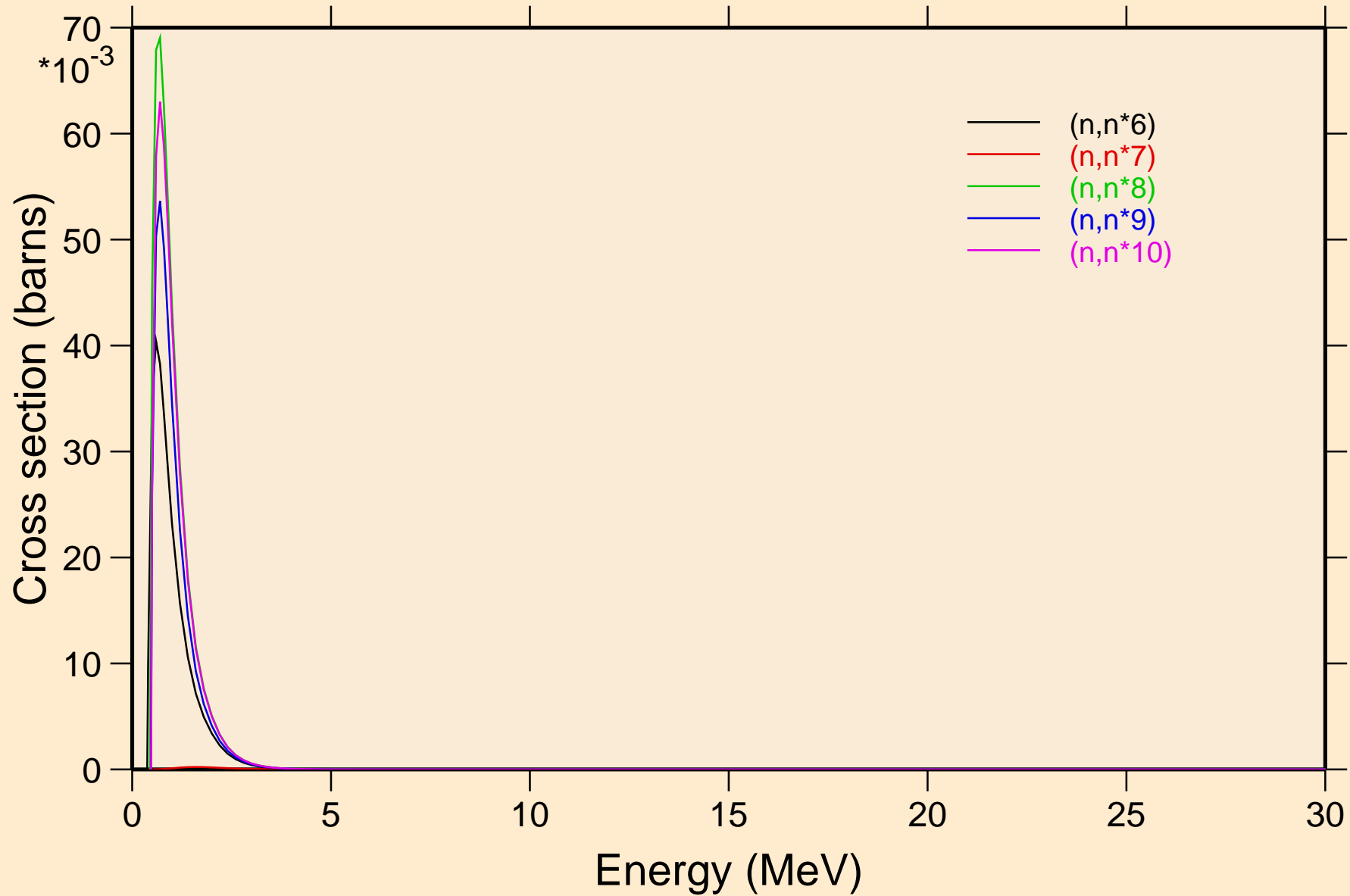

ES254 NEUTRON ACER TENDL-2021 LIBRARY; T=293.6K  
Inelastic levels

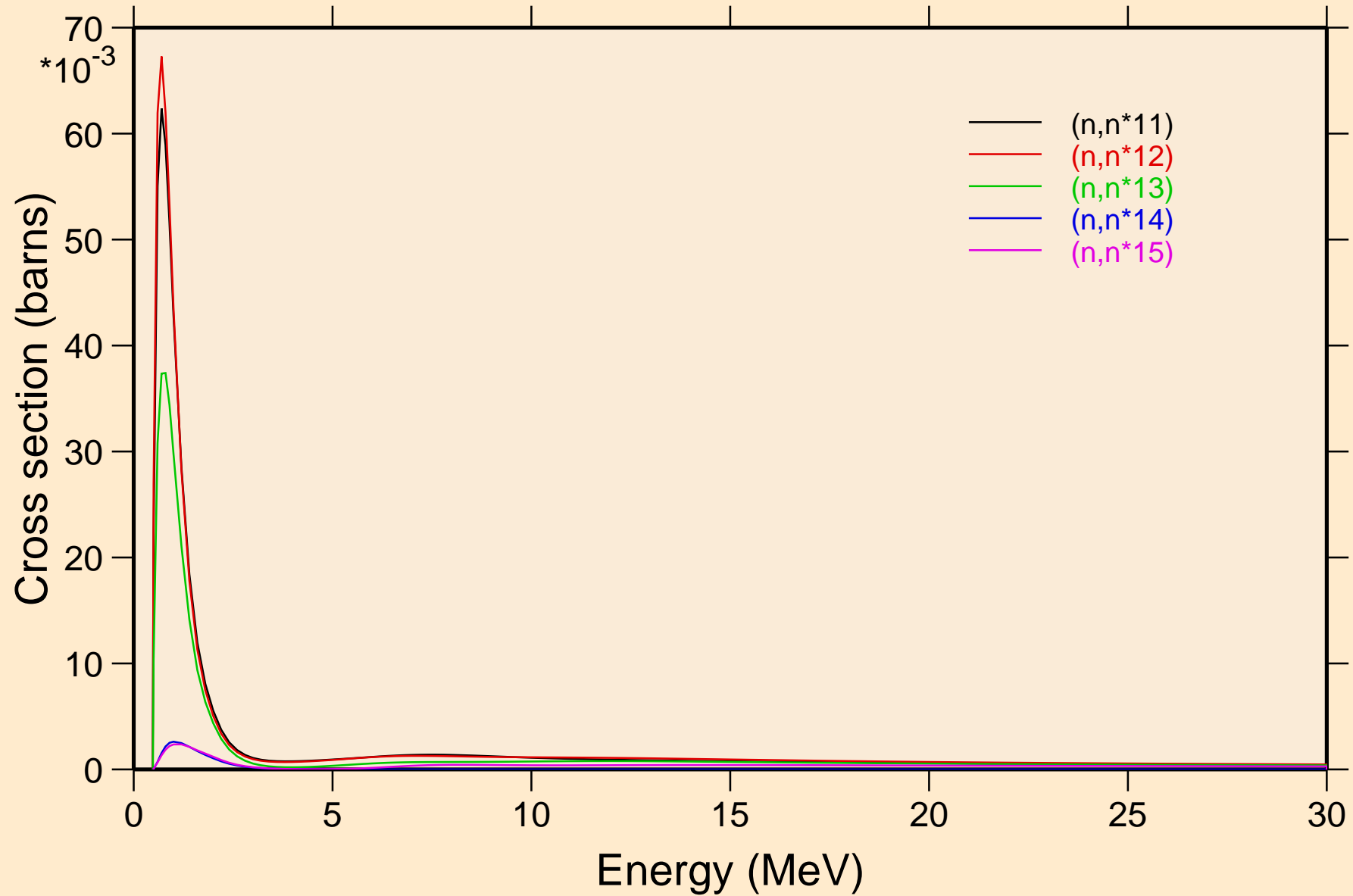

ES254 NEUTRON ACER TENDL-2021 LIBRARY; T=293.6K  
Inelastic levels

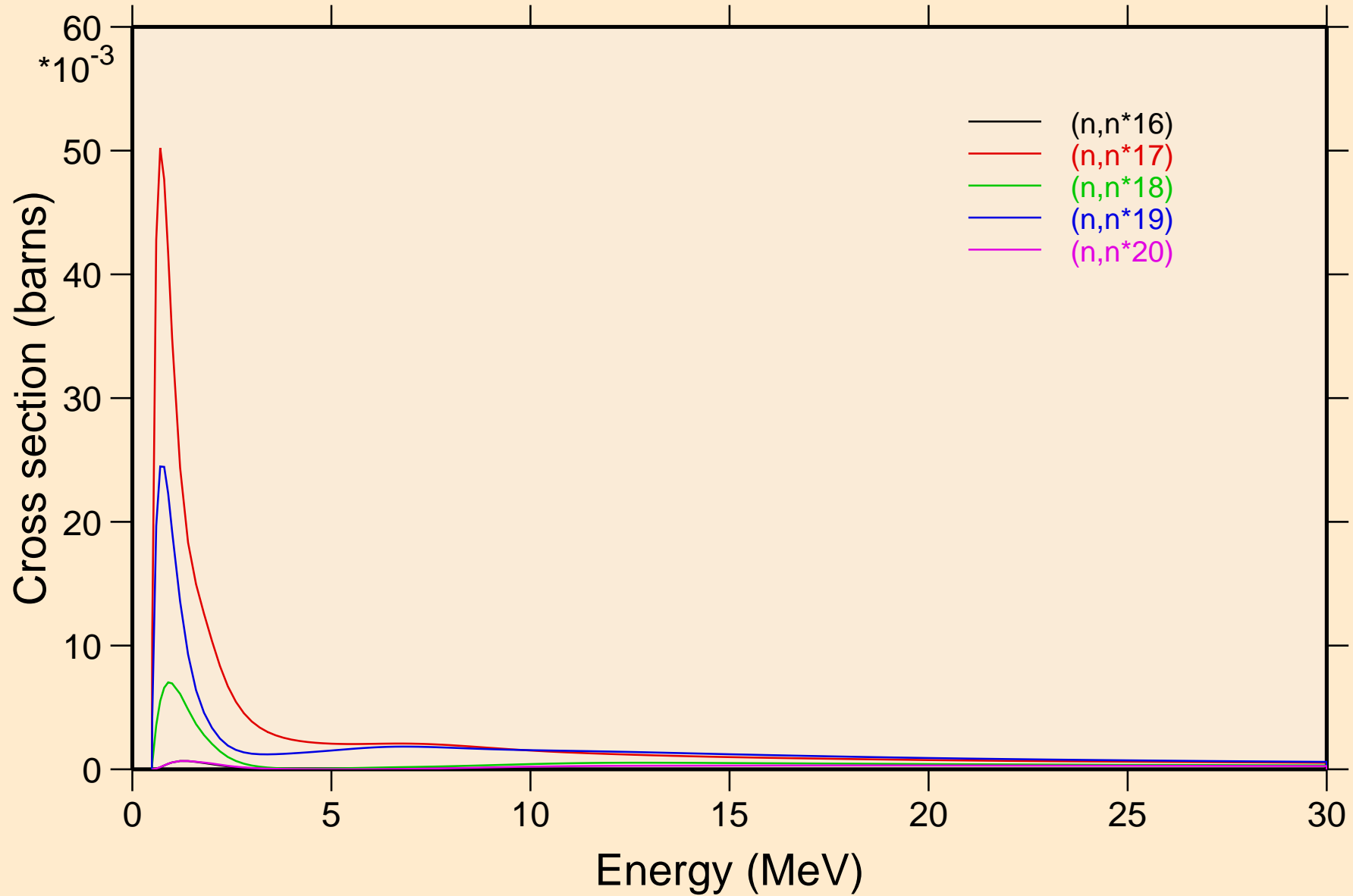

# ES254 NEUTRON ACER TENDL-2021 LIBRARY; T=293.6K

## Inelastic levels

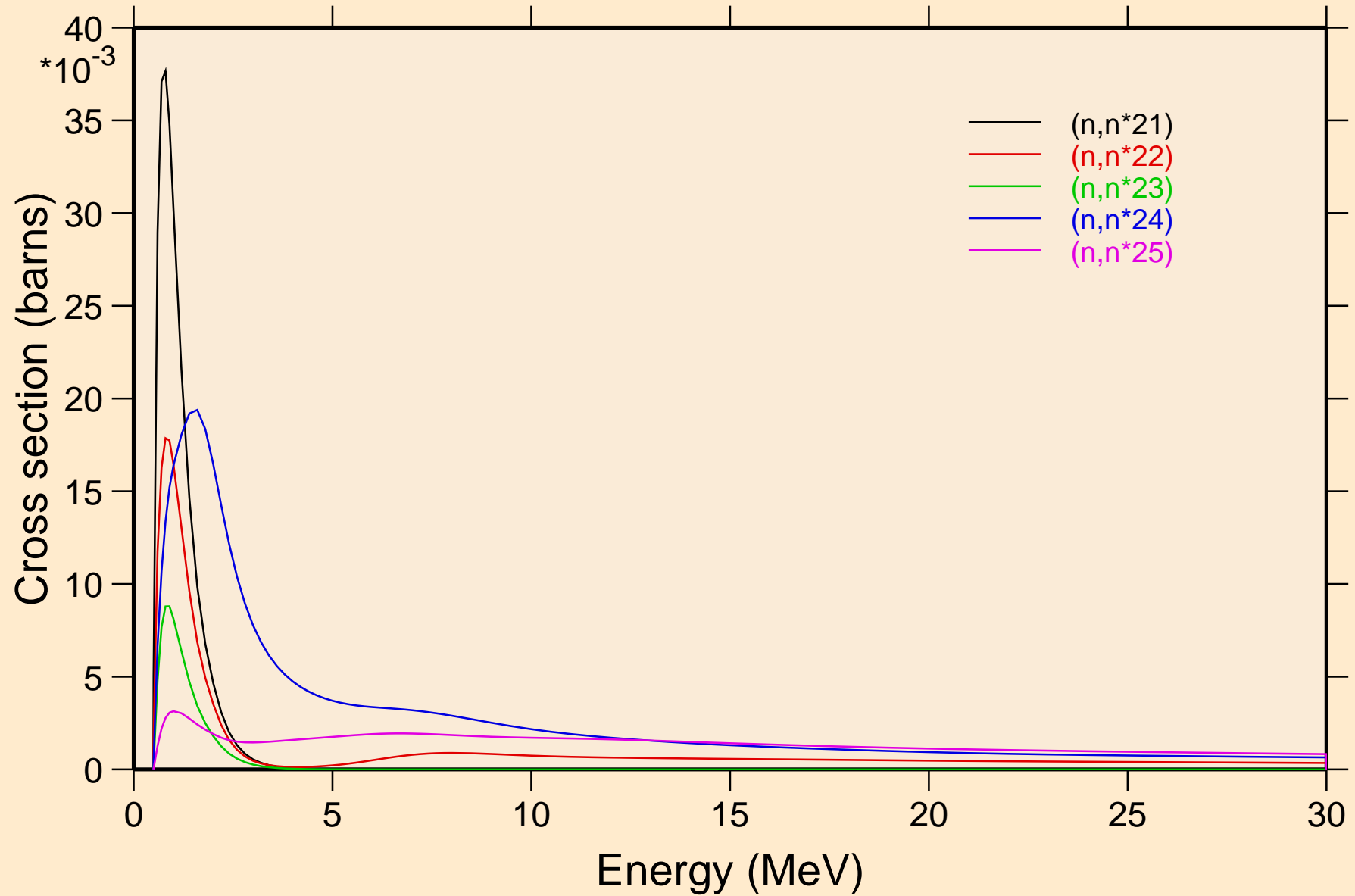

ES254 NEUTRON ACER TENDL-2021 LIBRARY; T=293.6K  
Inelastic levels

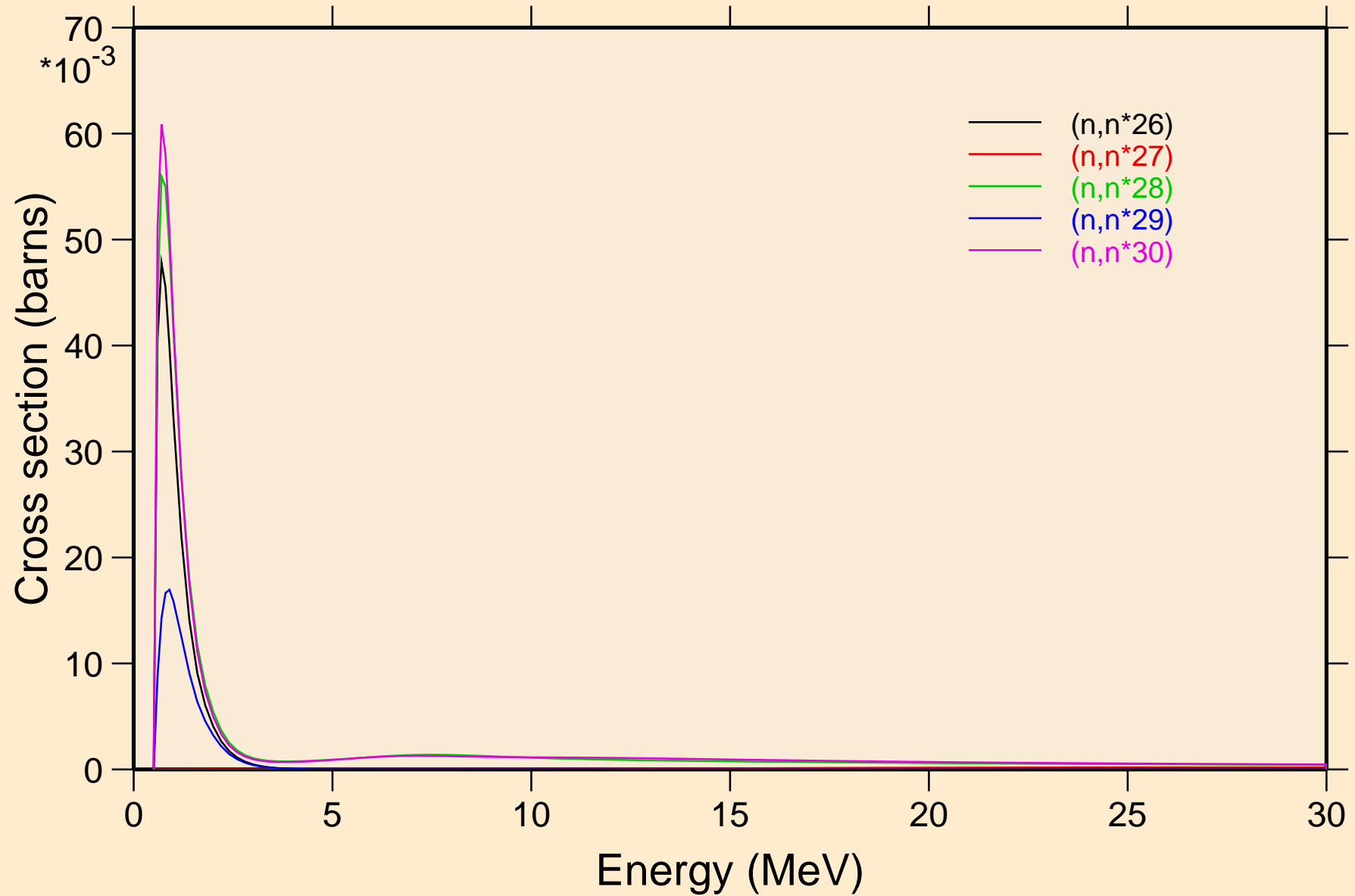

# ES254 NEUTRON ACER TENDL-2021 LIBRARY; T=293.6K

## Threshold reactions

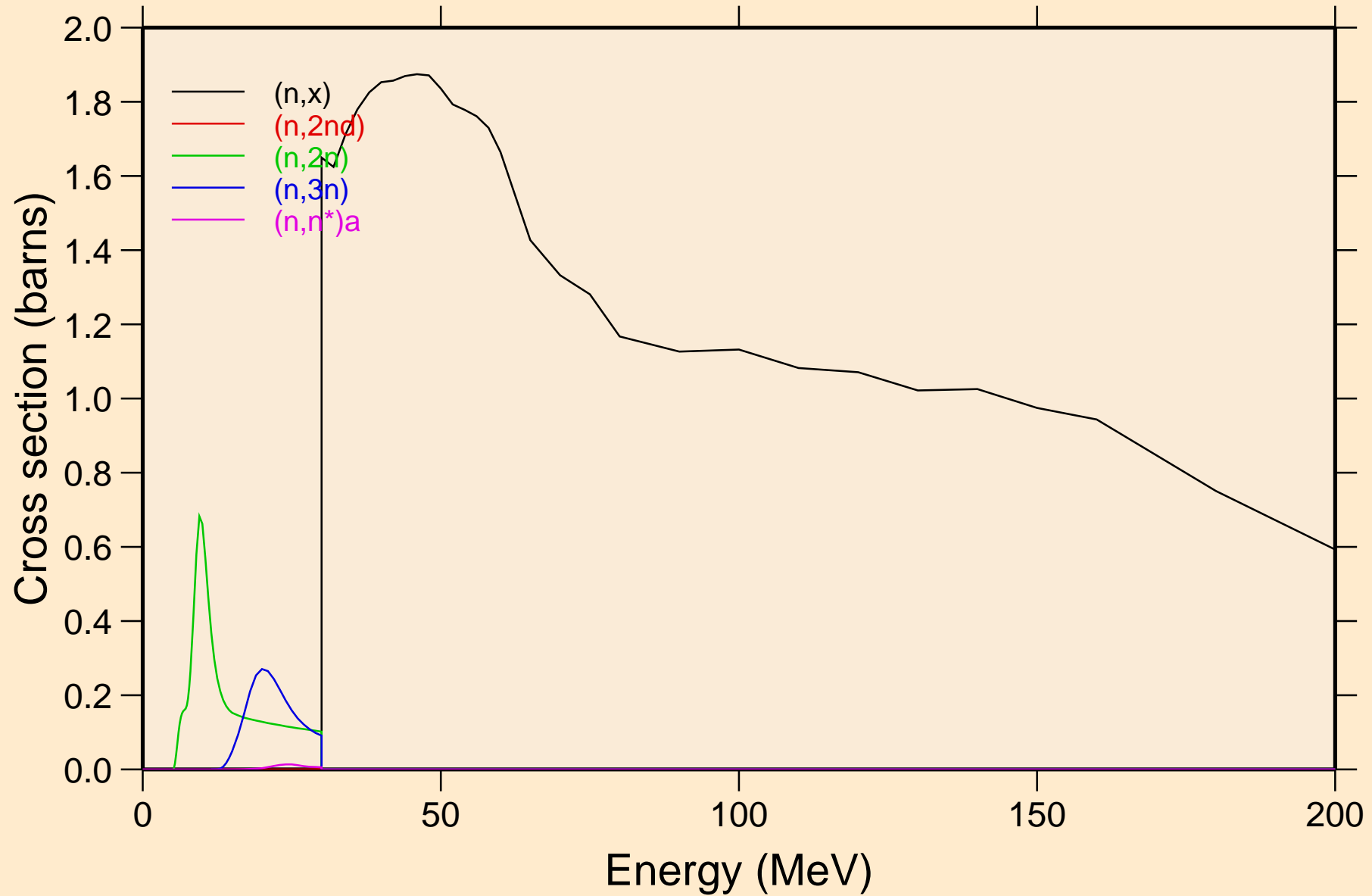

ES254 NEUTRON ACER TENDL-2021 LIBRARY; T=293.6K  
Threshold reactions

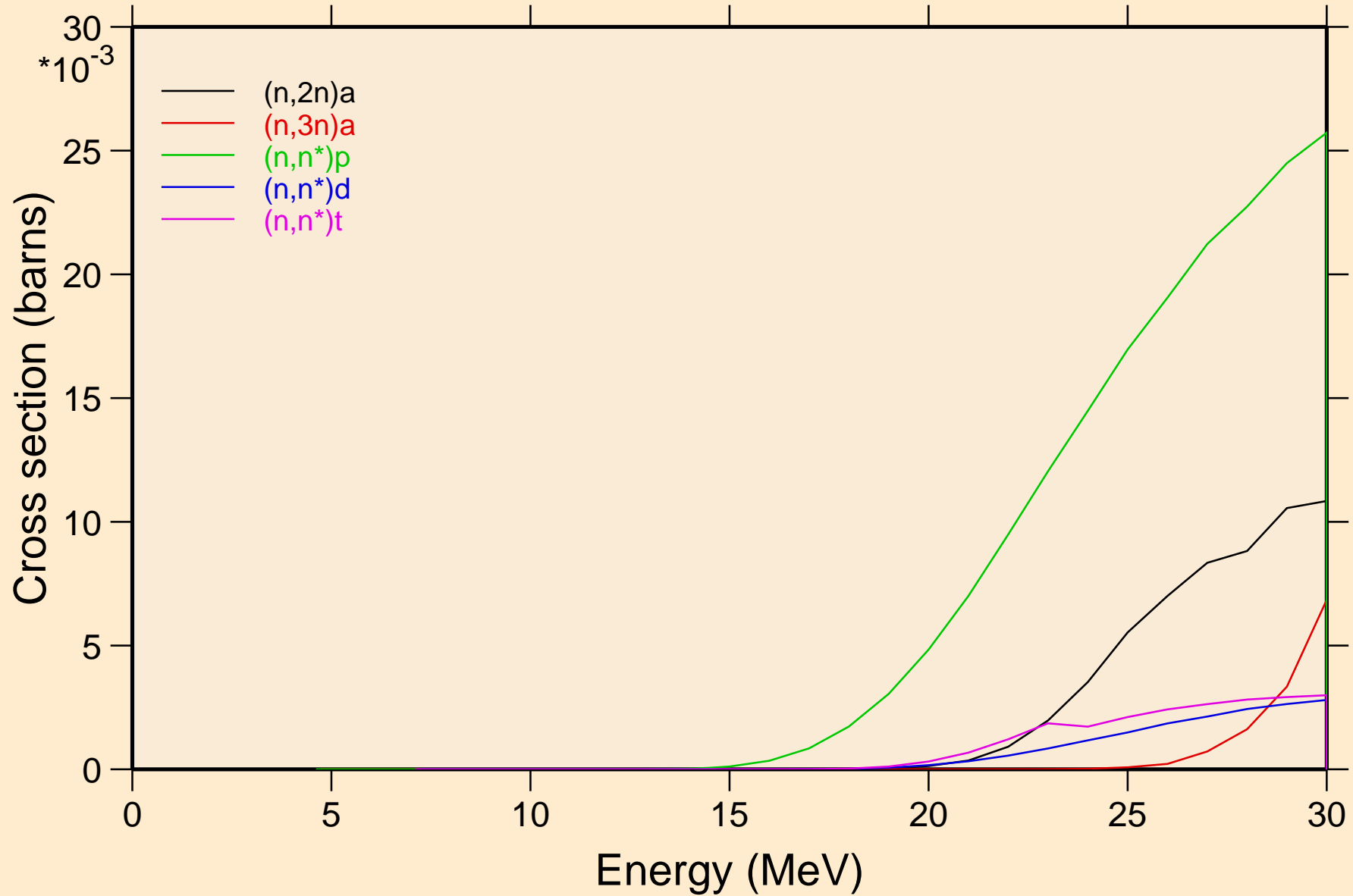



ES254 NEUTRON ACER TENDL-2021 LIBRARY; T=293.6K  
Threshold reactions

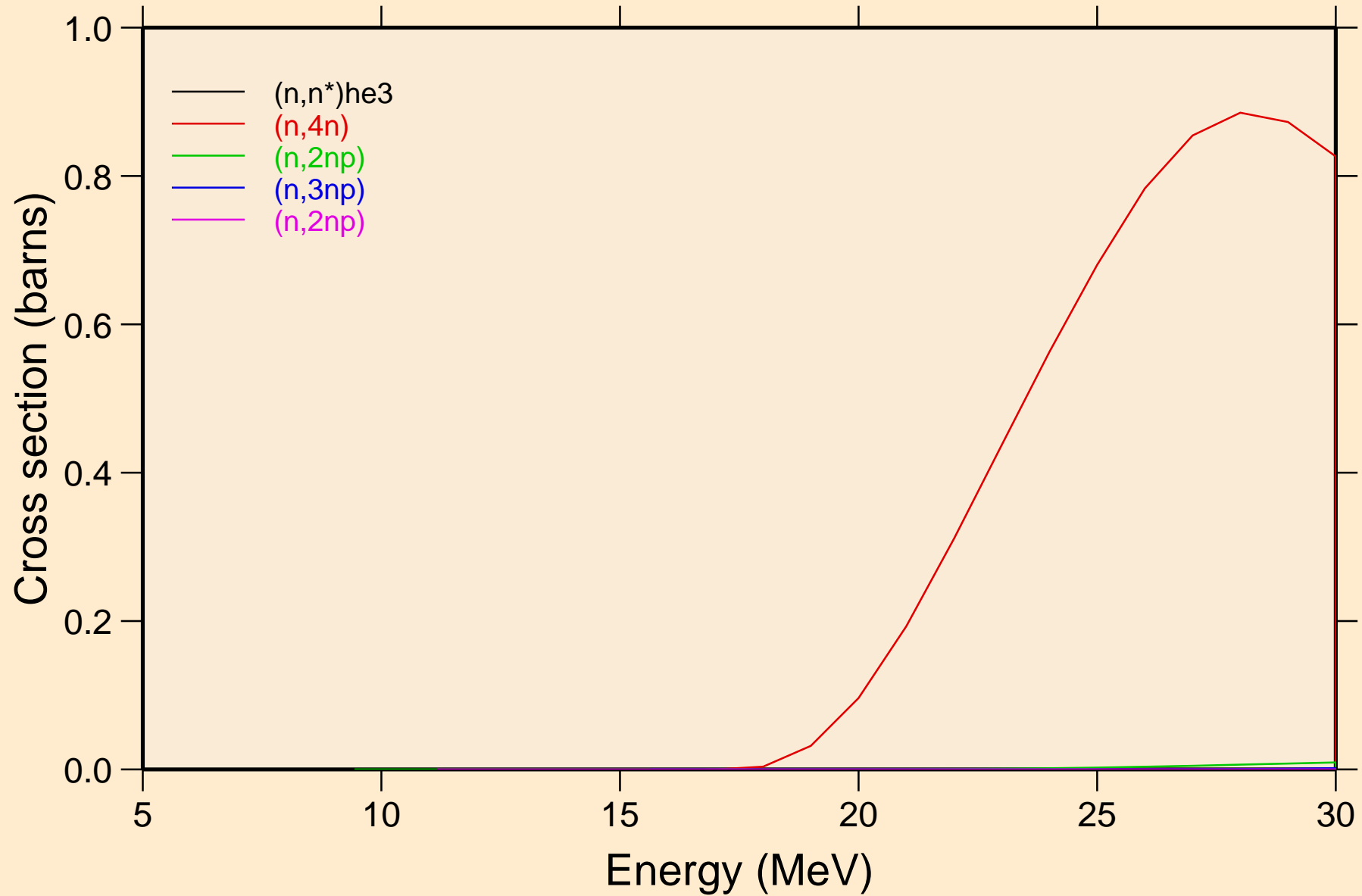

ES254 NEUTRON ACER TENDL-2021 LIBRARY; T=293.6K  
Threshold reactions

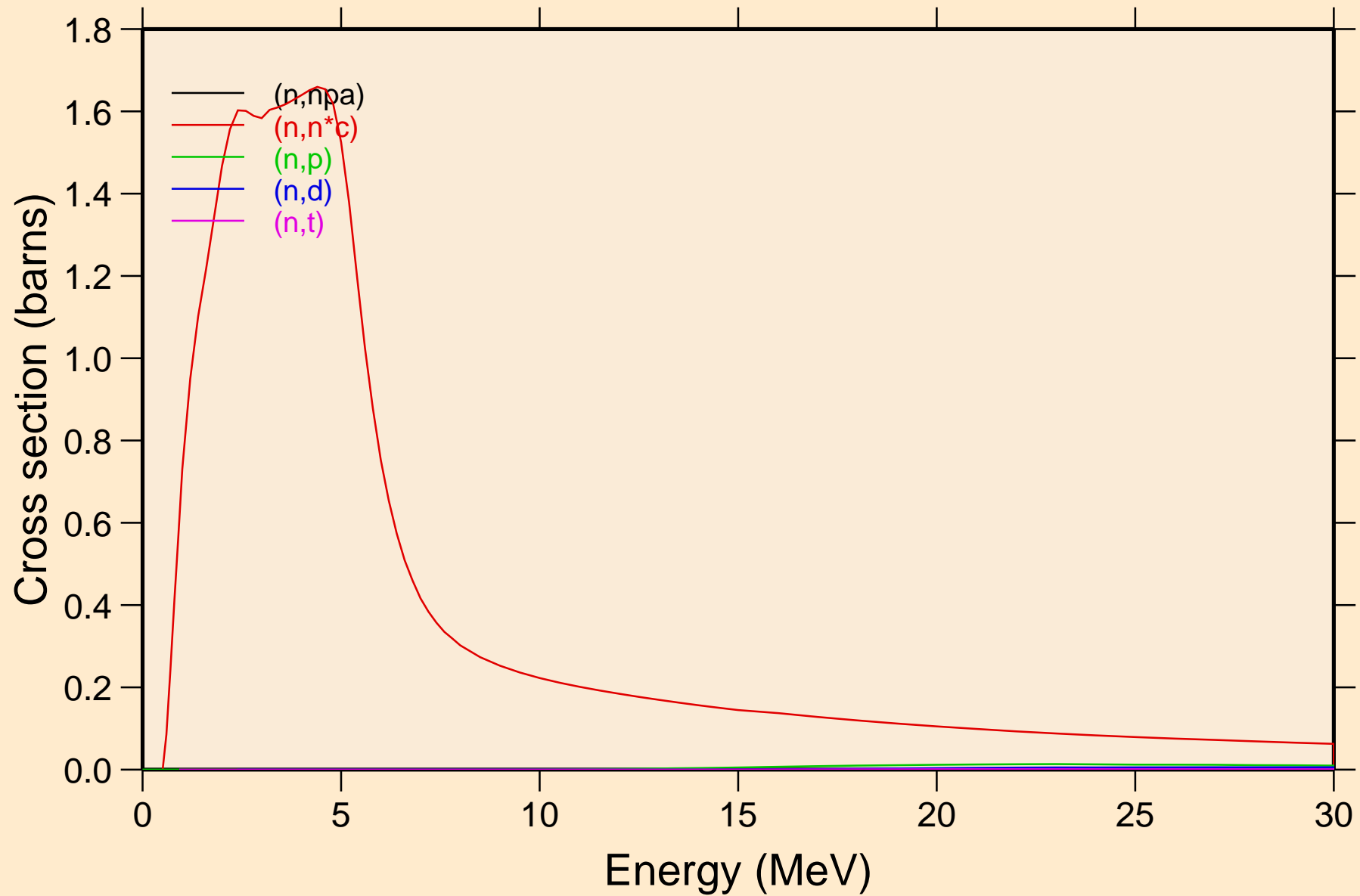

ES254 NEUTRON ACER TENDL-2021 LIBRARY; T=293.6K  
Threshold reactions

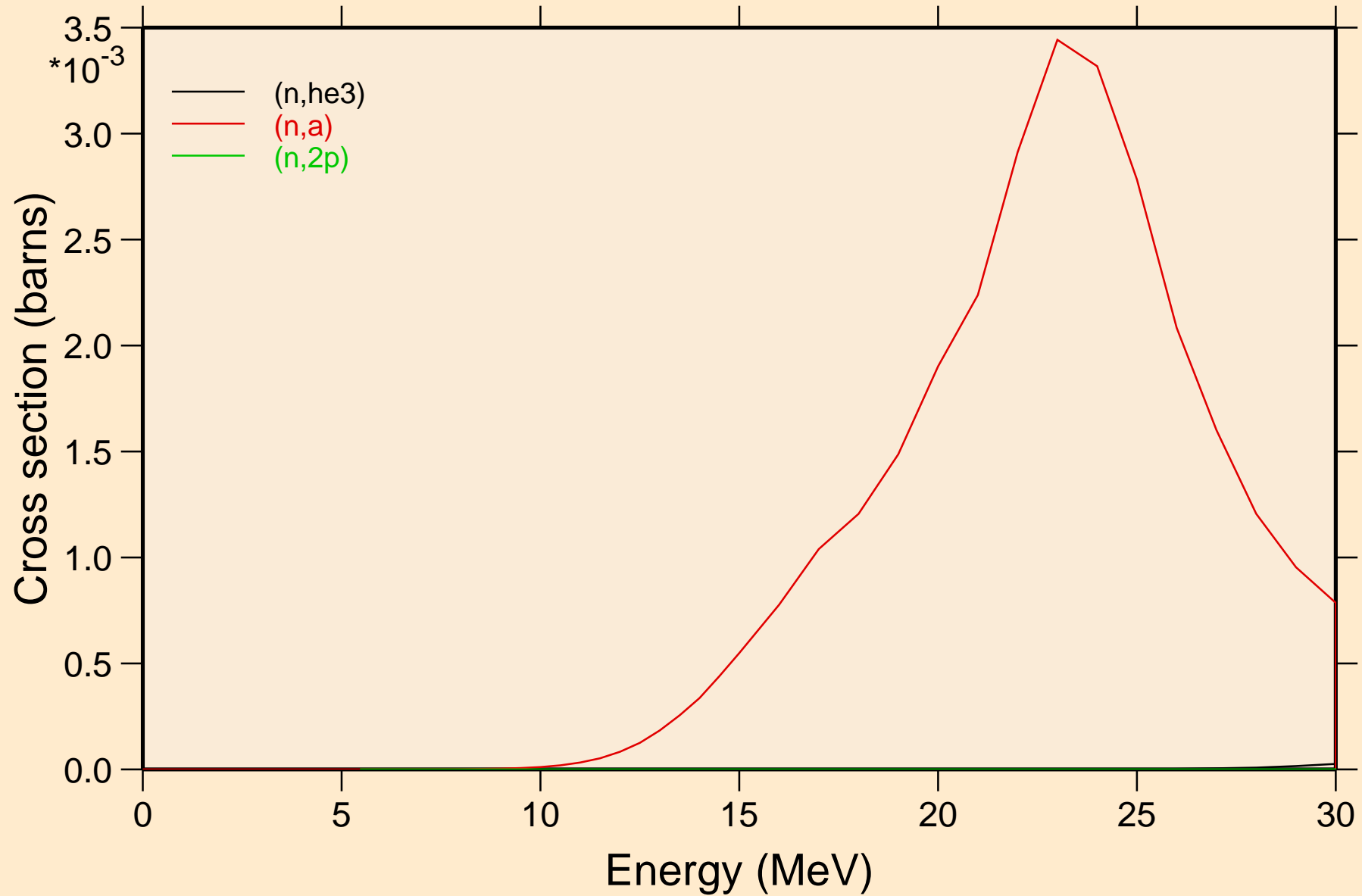

# ES254 NEUTRON ACER TENDL-2021 LIBRARY; T=293.6K

## Threshold reactions

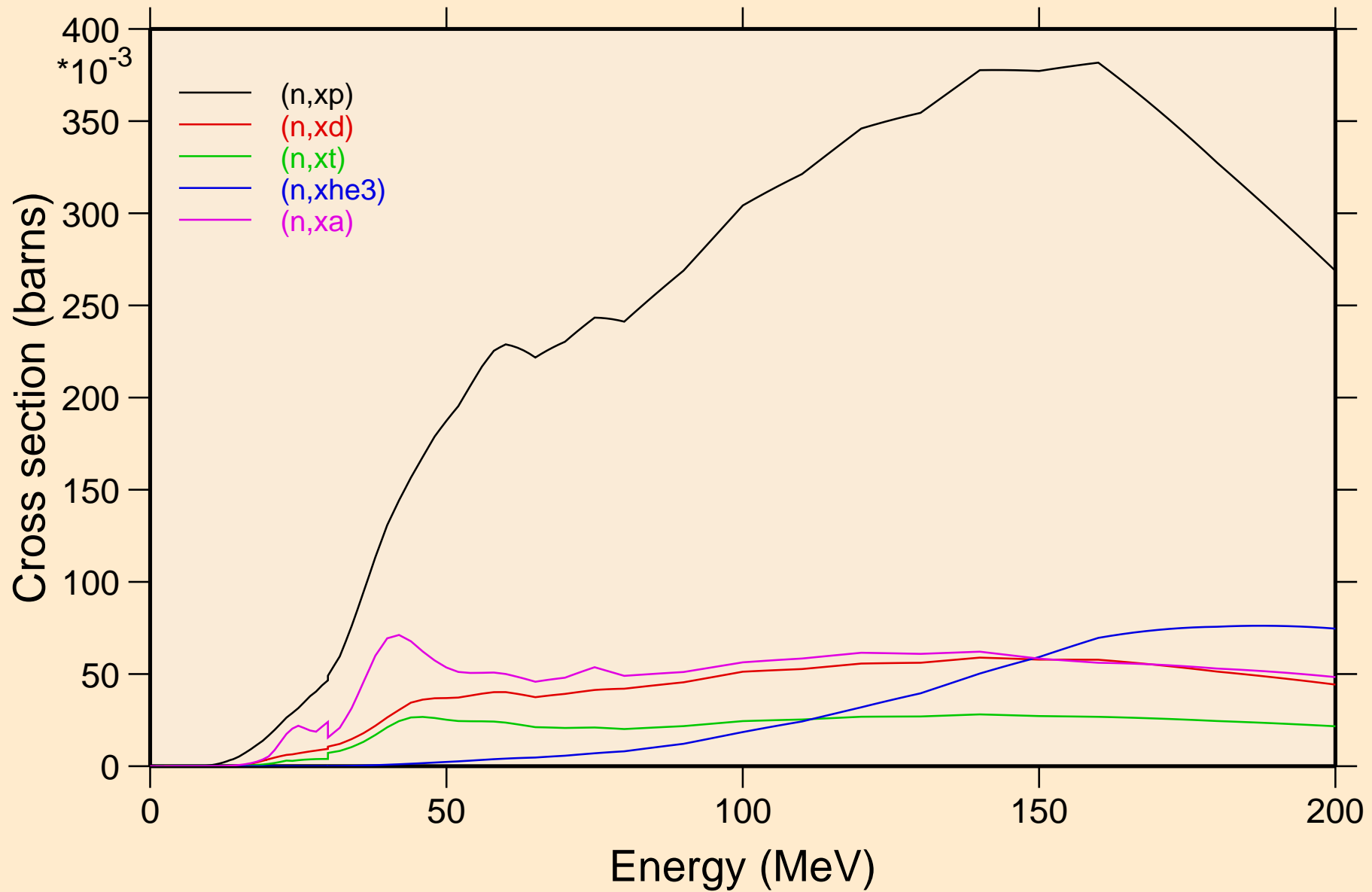

ES254 NEUTRON ACER TENDL-2021 LIBRARY; T=293.6K  
angular distribution for elastic

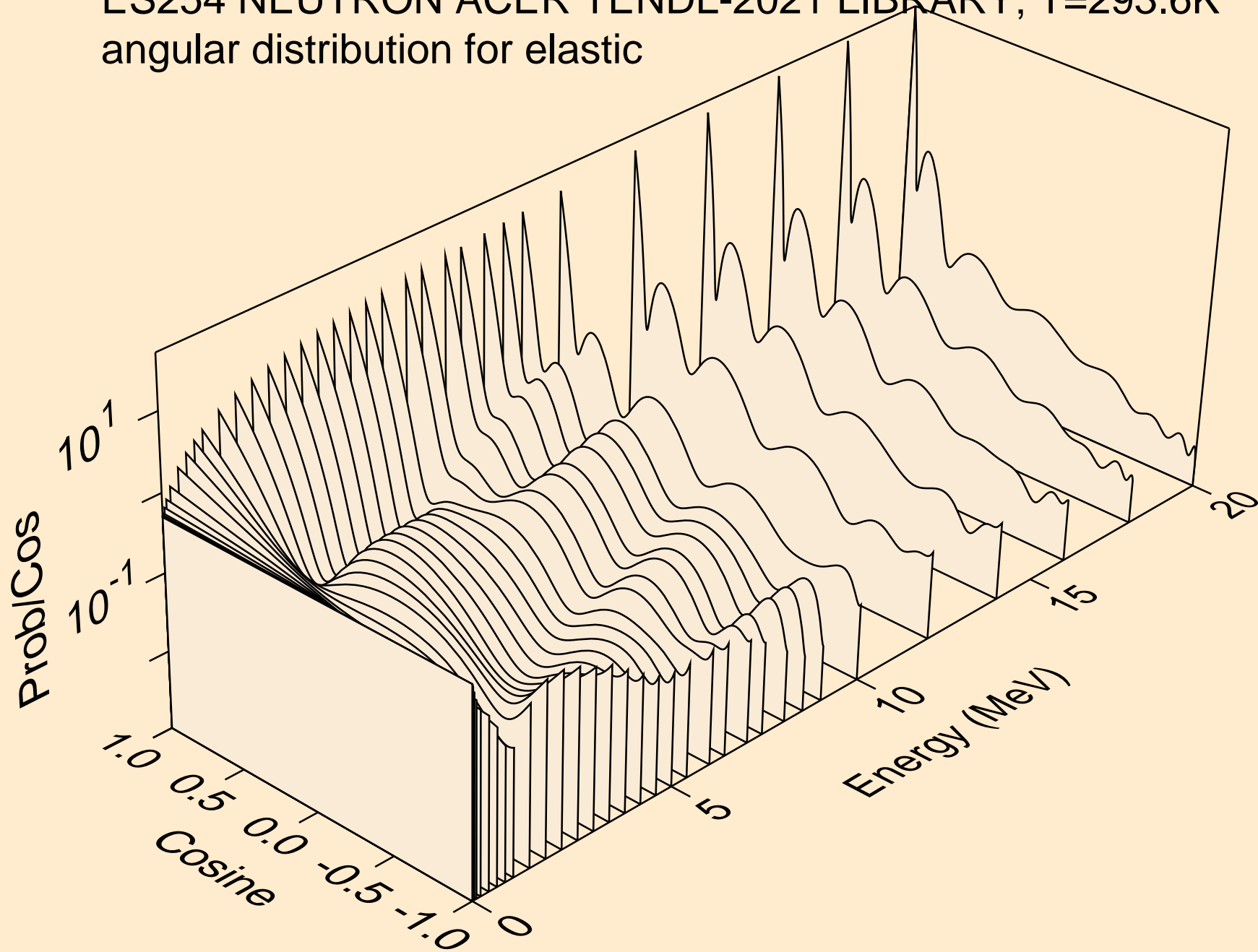

ES254 NEUTRON ACER TENDL-2021 LIBRARY; T=293.6K  
angular distribution for elastic

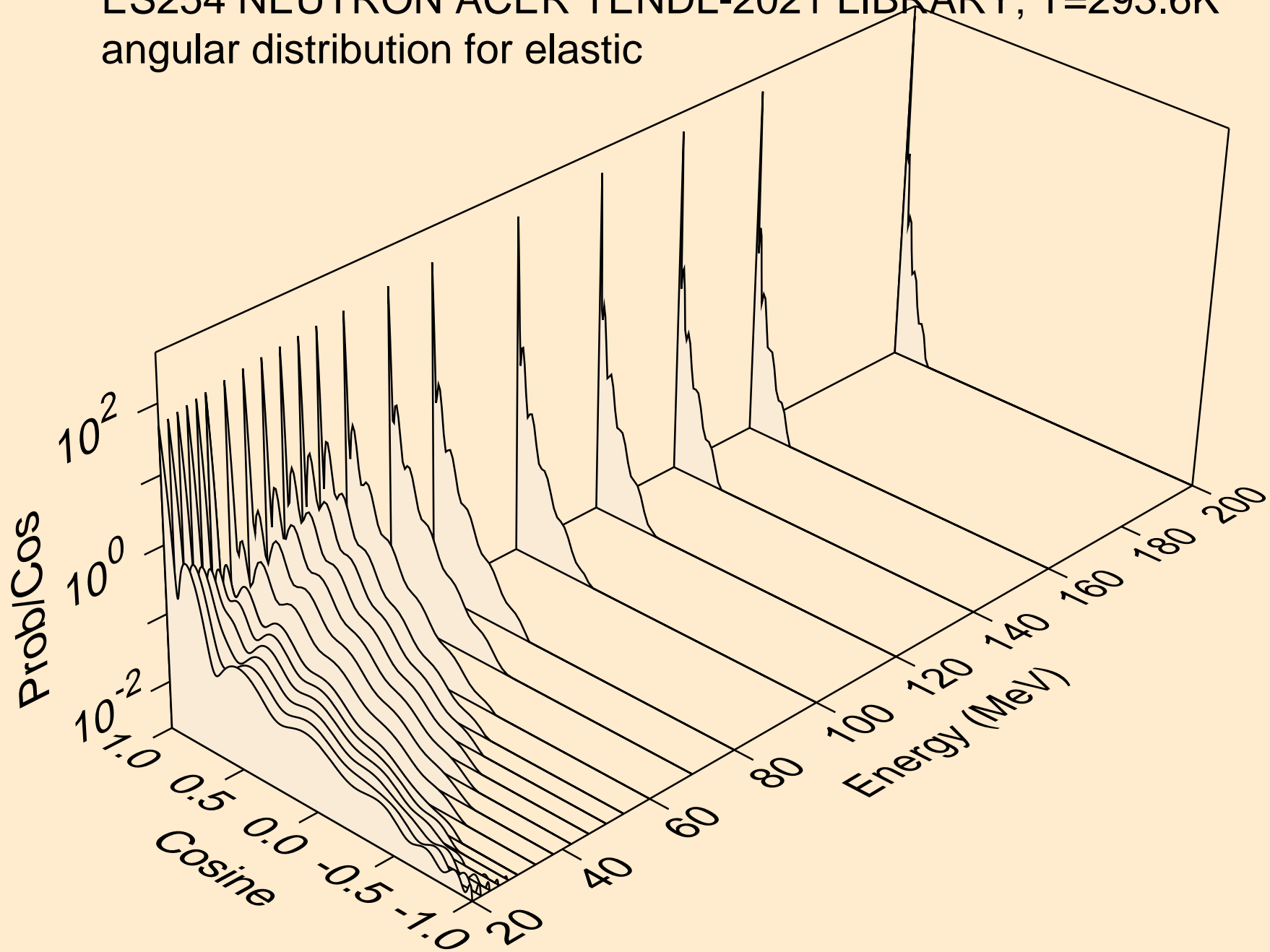

ES254 NEUTRON ACER TENDL-2021 LIBRARY; T=293.6K  
angular distribution for (n,n\*1)

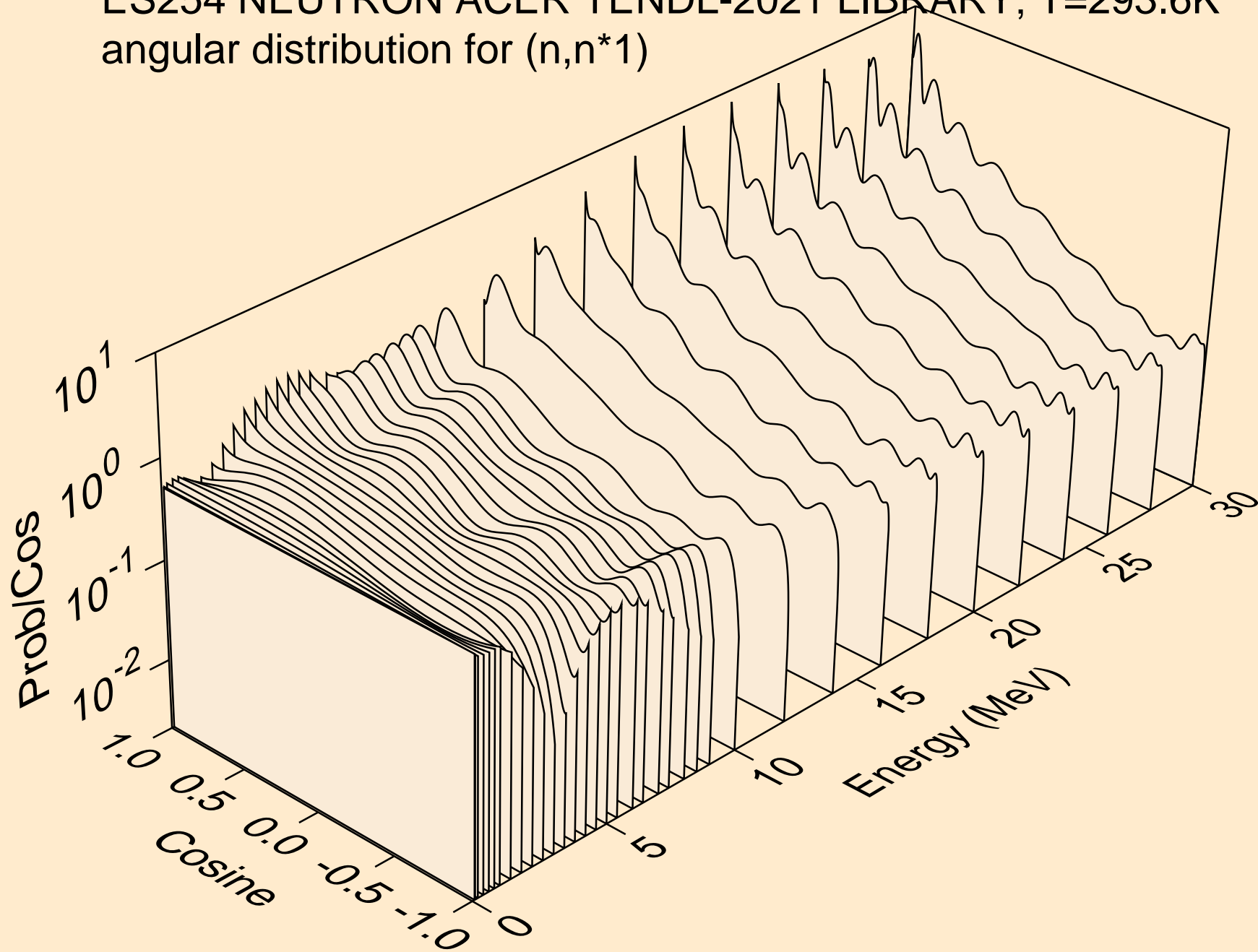

ES254 NEUTRON ACER TENDL-2021 LIBRARY; T=293.6K  
angular distribution for (n,n\*2)

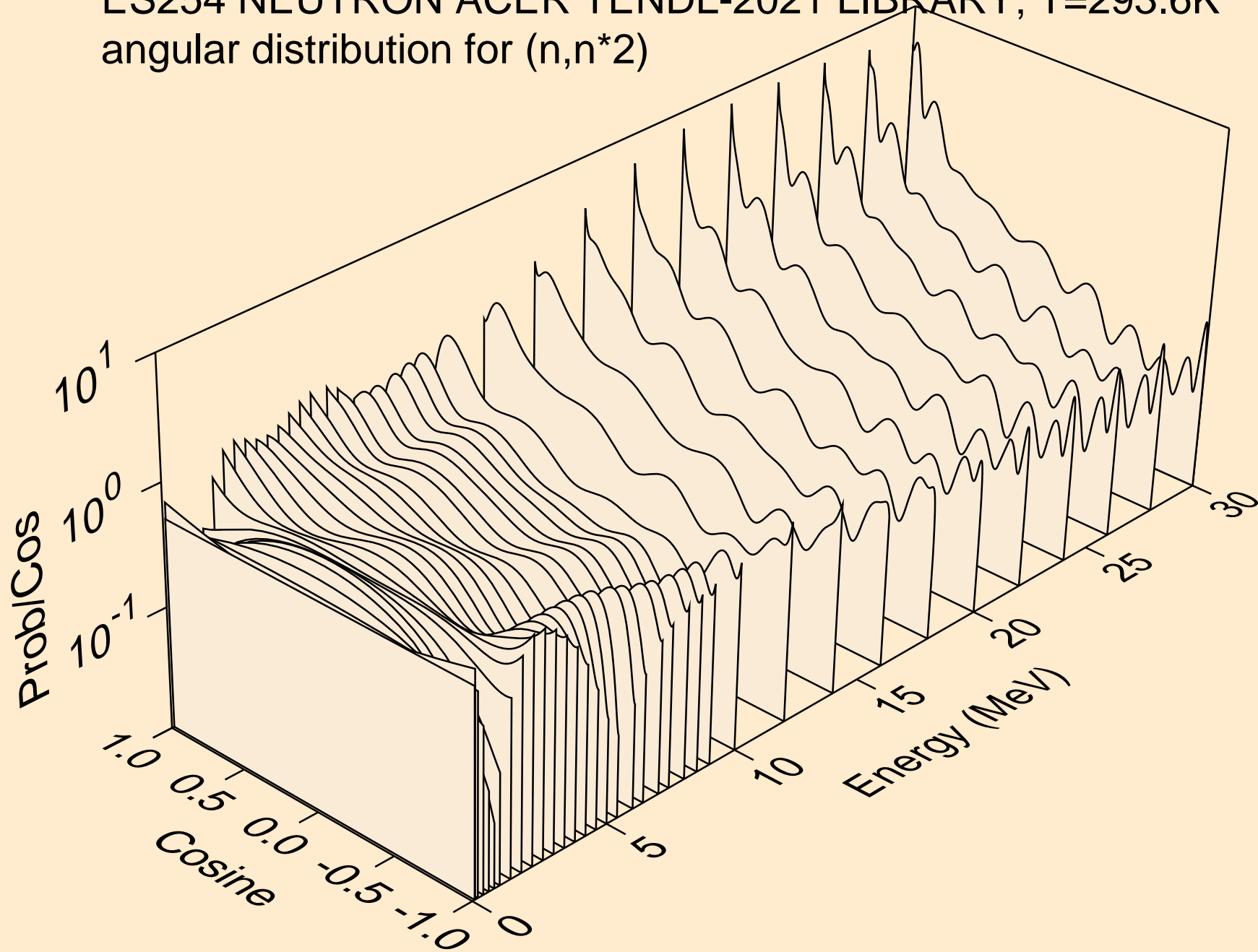



ES254 NEUTRON ACER TENDL-2021 LIBRARY; T=293.6K  
angular distribution for (n,n\*3)

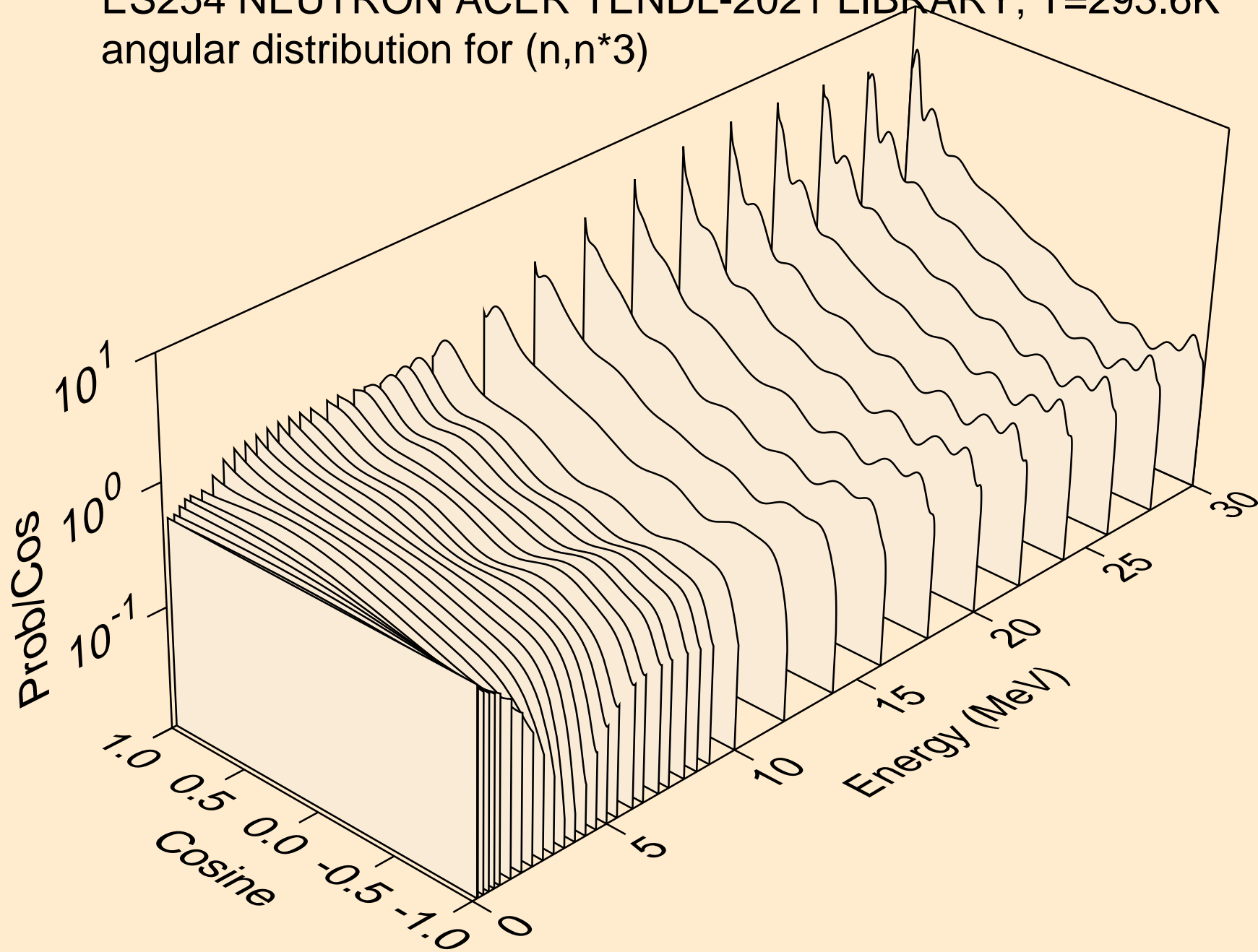

ES254 NEUTRON ACER TENDL-2021 LIBRARY; T=293.6K  
angular distribution for (n,n\*4)

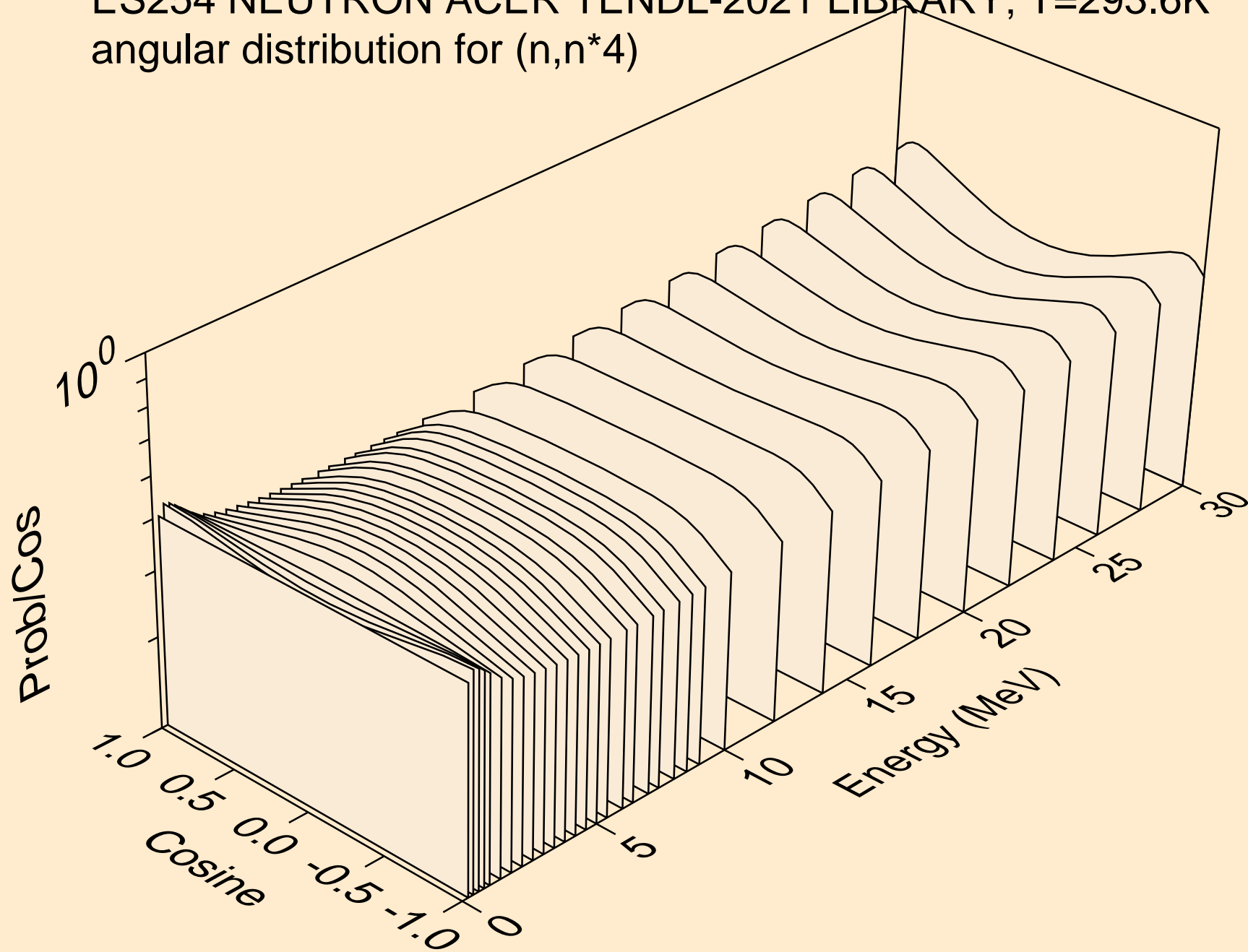

ES254 NEUTRON ACER TENDL-2021 LIBRARY; T=293.6K  
angular distribution for (n,n\*5)

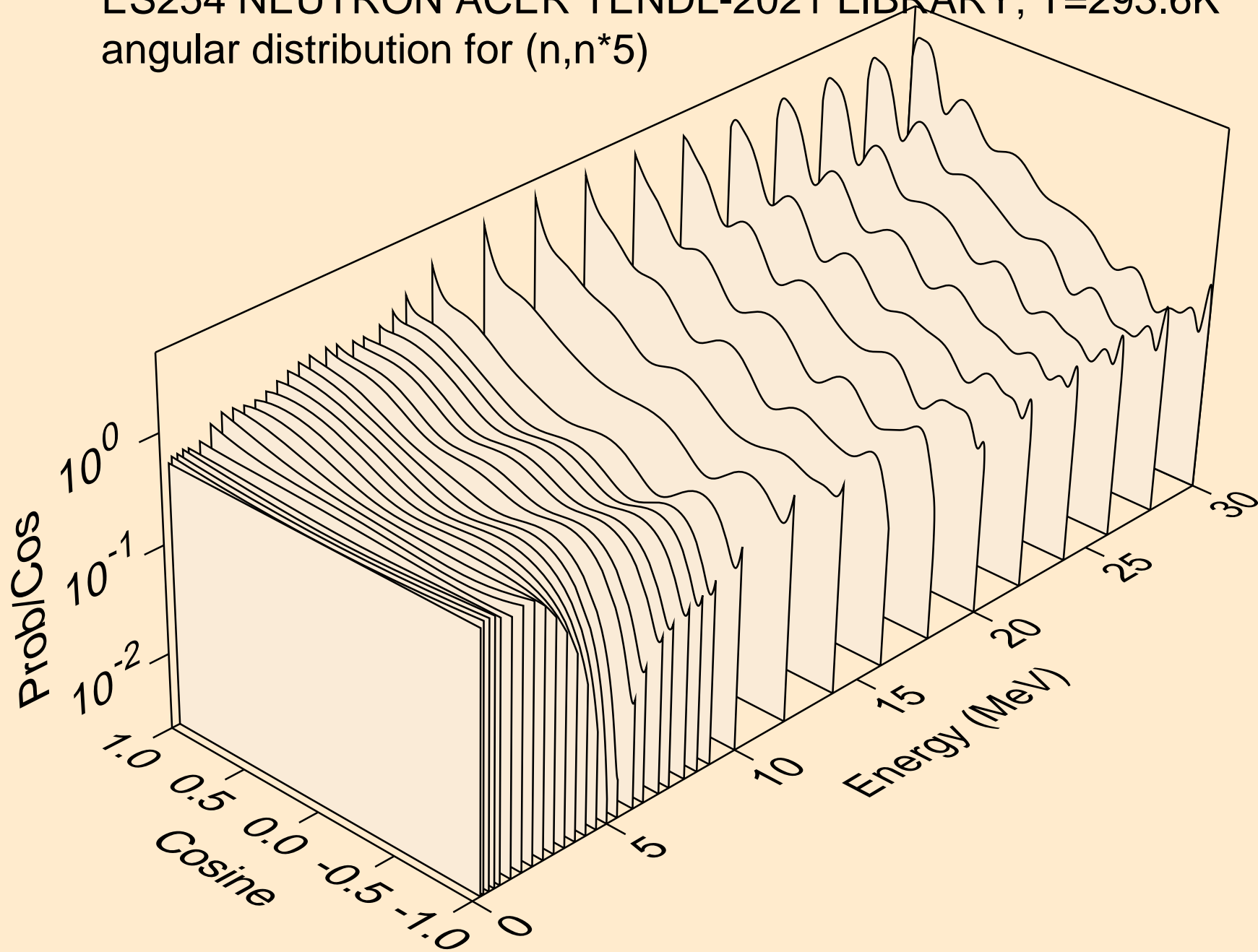

ES254 NEUTRON ACER TENDL-2021 LIBRARY; T=293.6K  
angular distribution for (n,n\*6)

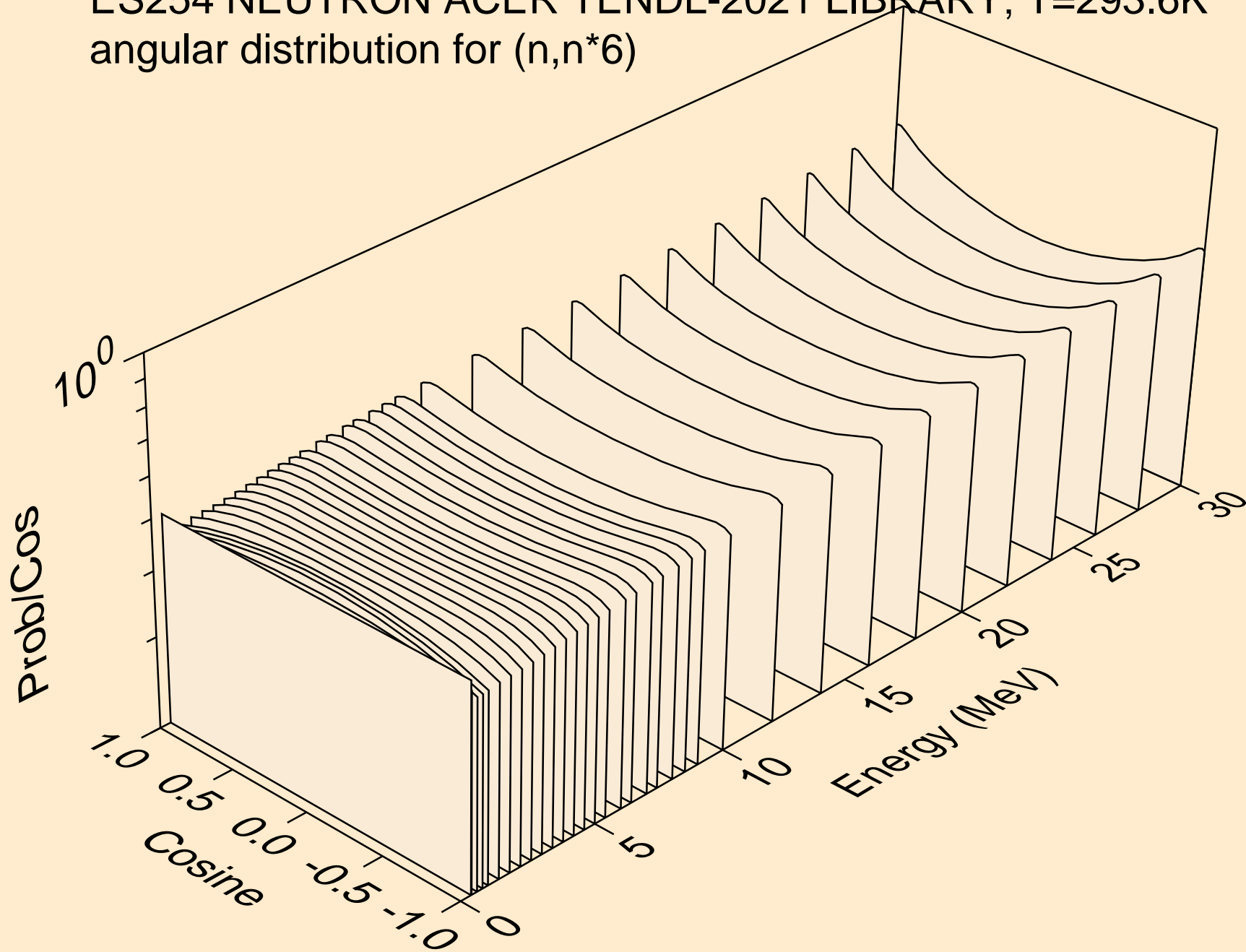

ES254 NEUTRON ACER TENDL-2021 LIBRARY; T=293.6K  
angular distribution for (n,n\*7)

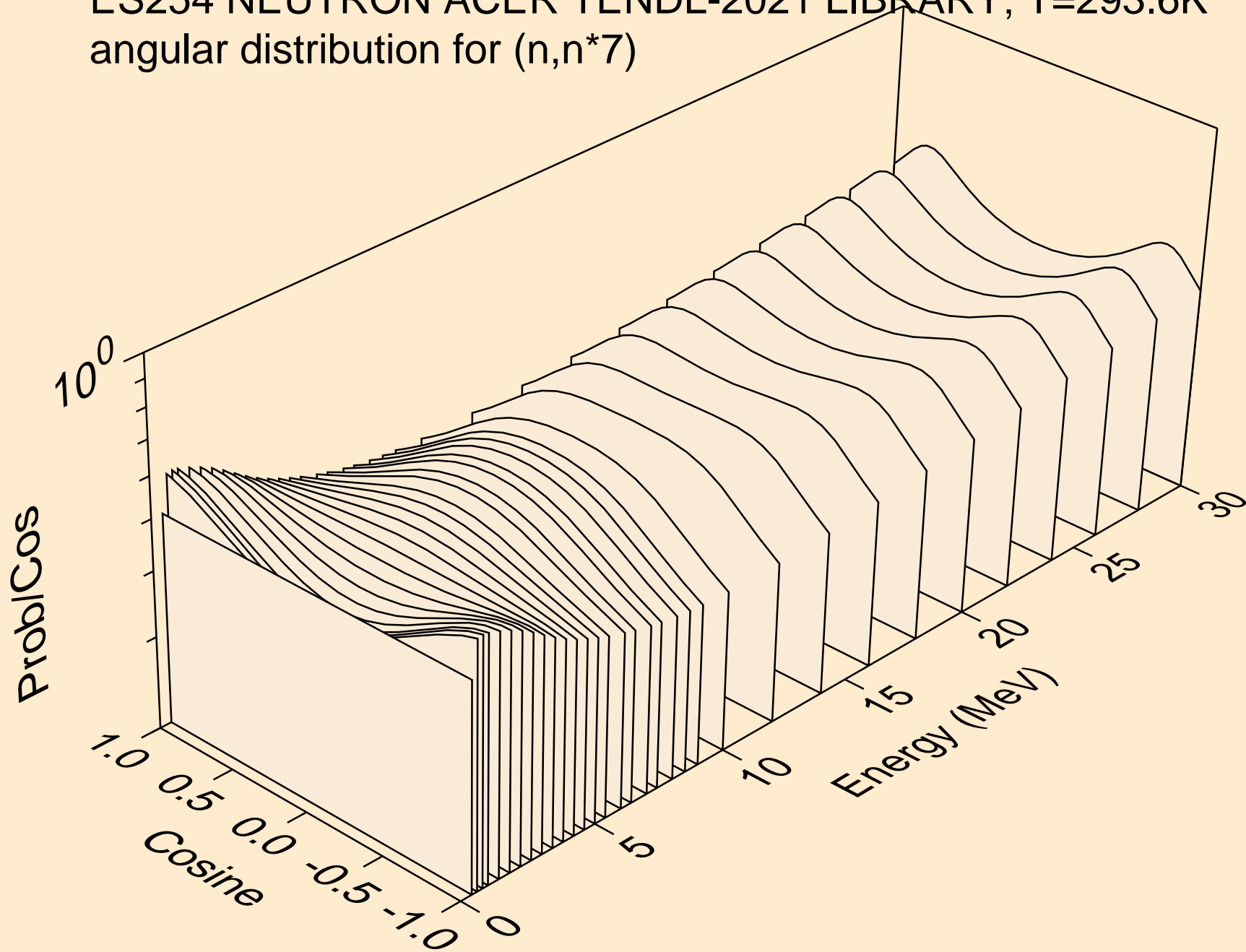

ES254 NEUTRON ACER TENDL-2021 LIBRARY; T=293.6K  
angular distribution for (n,n\*8)

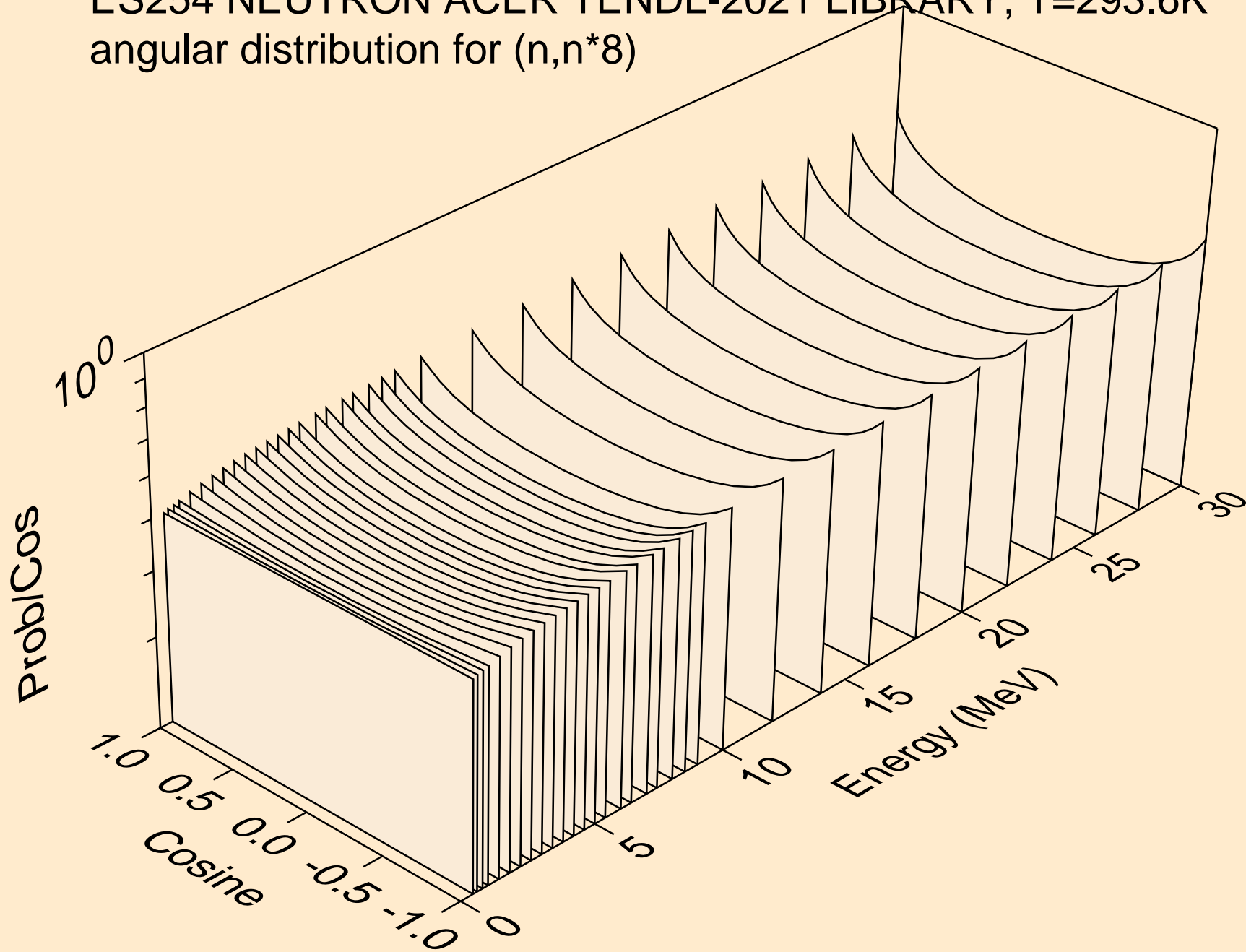

ES254 NEUTRON ACER TENDL-2021 LIBRARY; T=293.6K  
angular distribution for (n,n\*9)

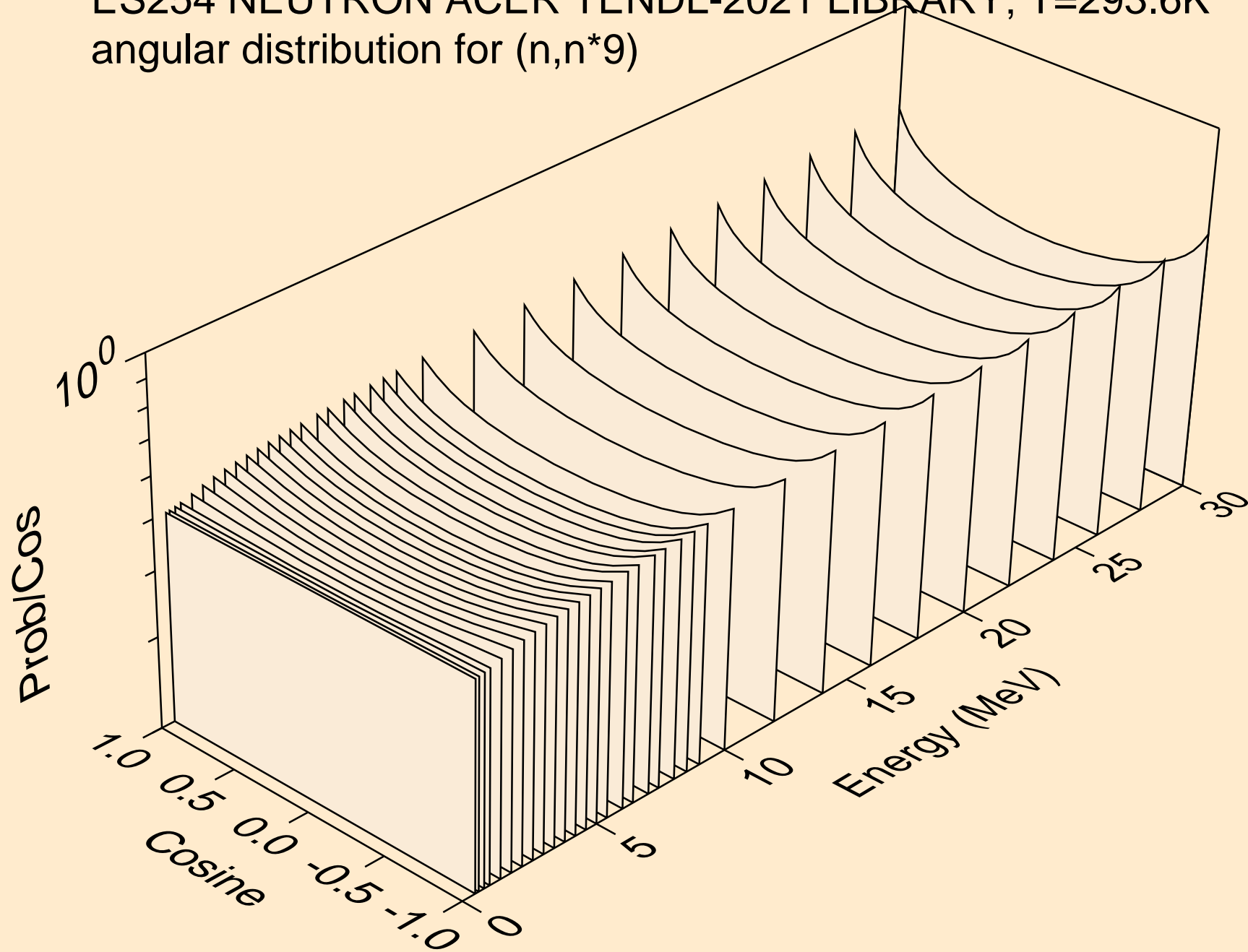

ES254 NEUTRON ACER TENDL-2021 LIBRARY; T=293.6K  
angular distribution for (n,n\*10)

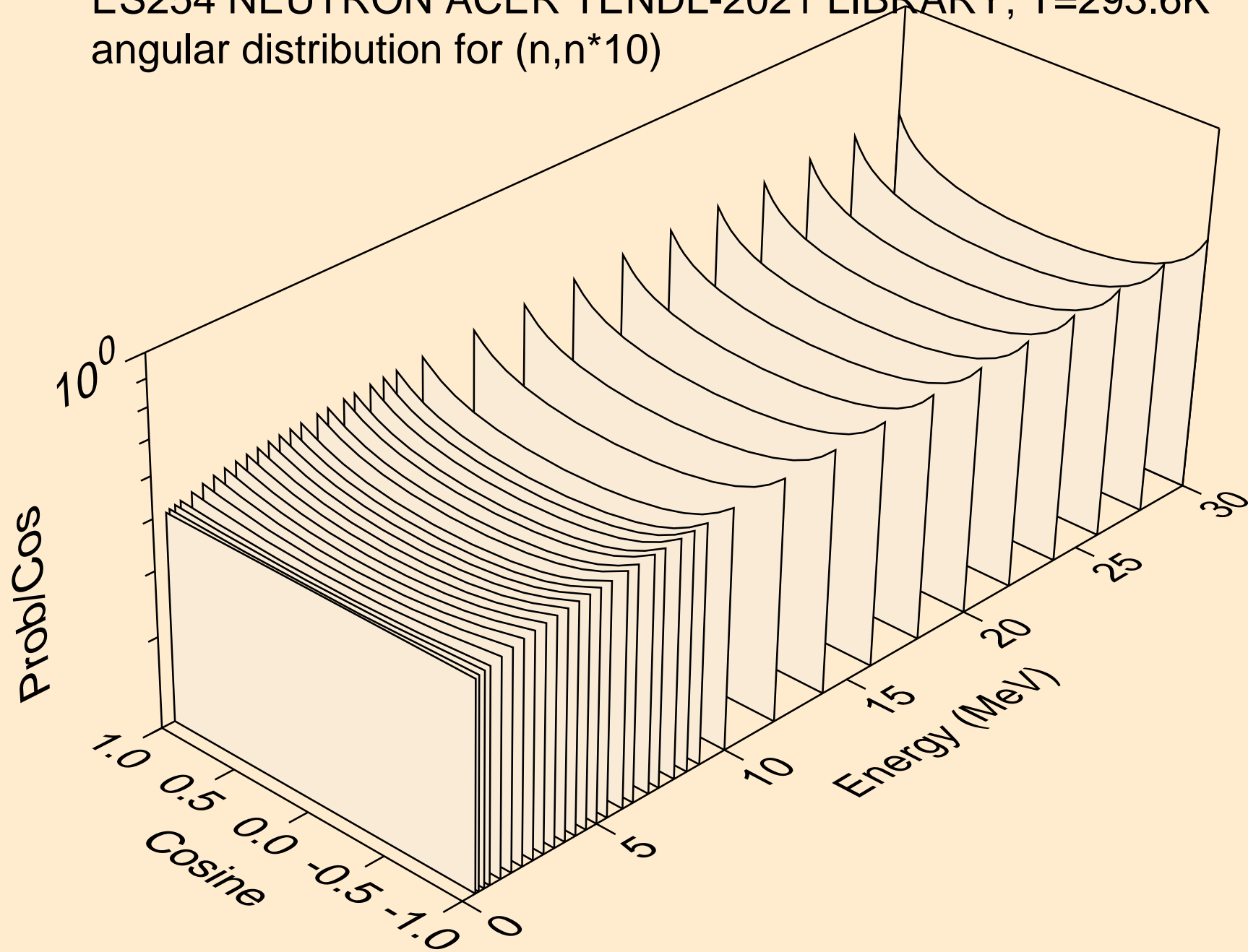



ES254 NEUTRON ACER TENDL-2021 LIBRARY; T=293.6K  
angular distribution for (n,n\*11)

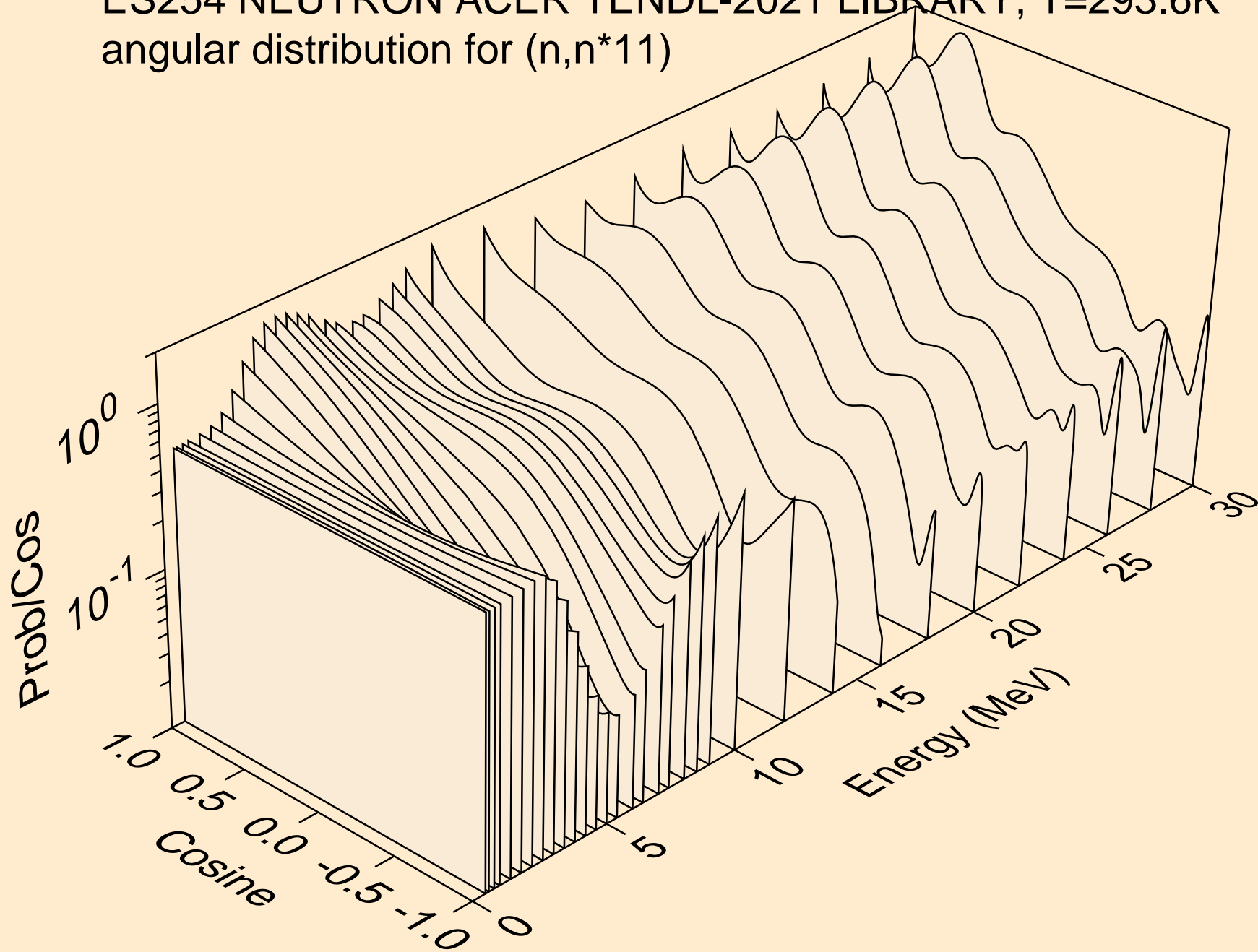

ES254 NEUTRON ACER TENDL-2021 LIBRARY; T=293.6K  
angular distribution for (n,n\*12)

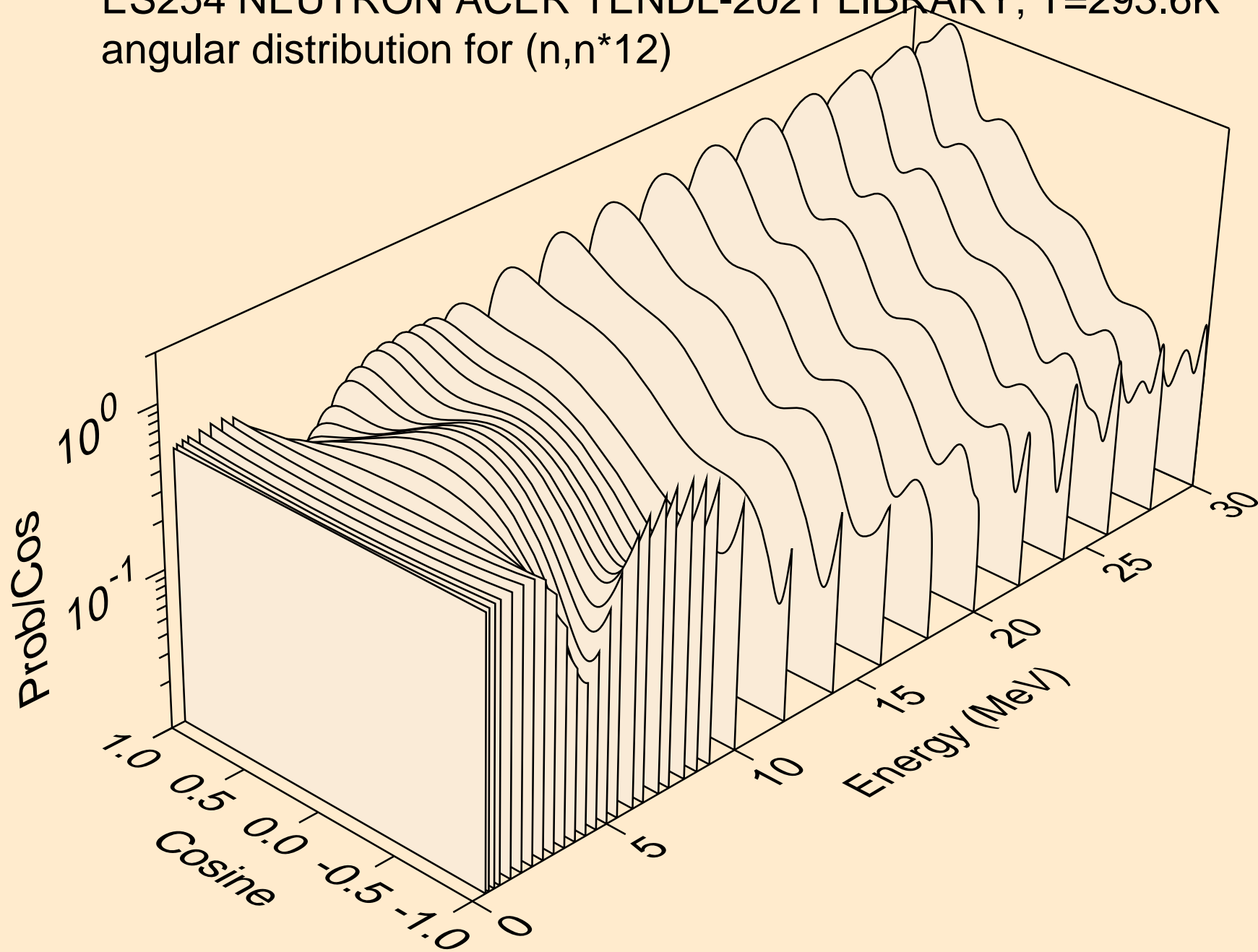

ES254 NEUTRON ACER TENDL-2021 LIBRARY; T=293.6K  
angular distribution for (n,n\*13)

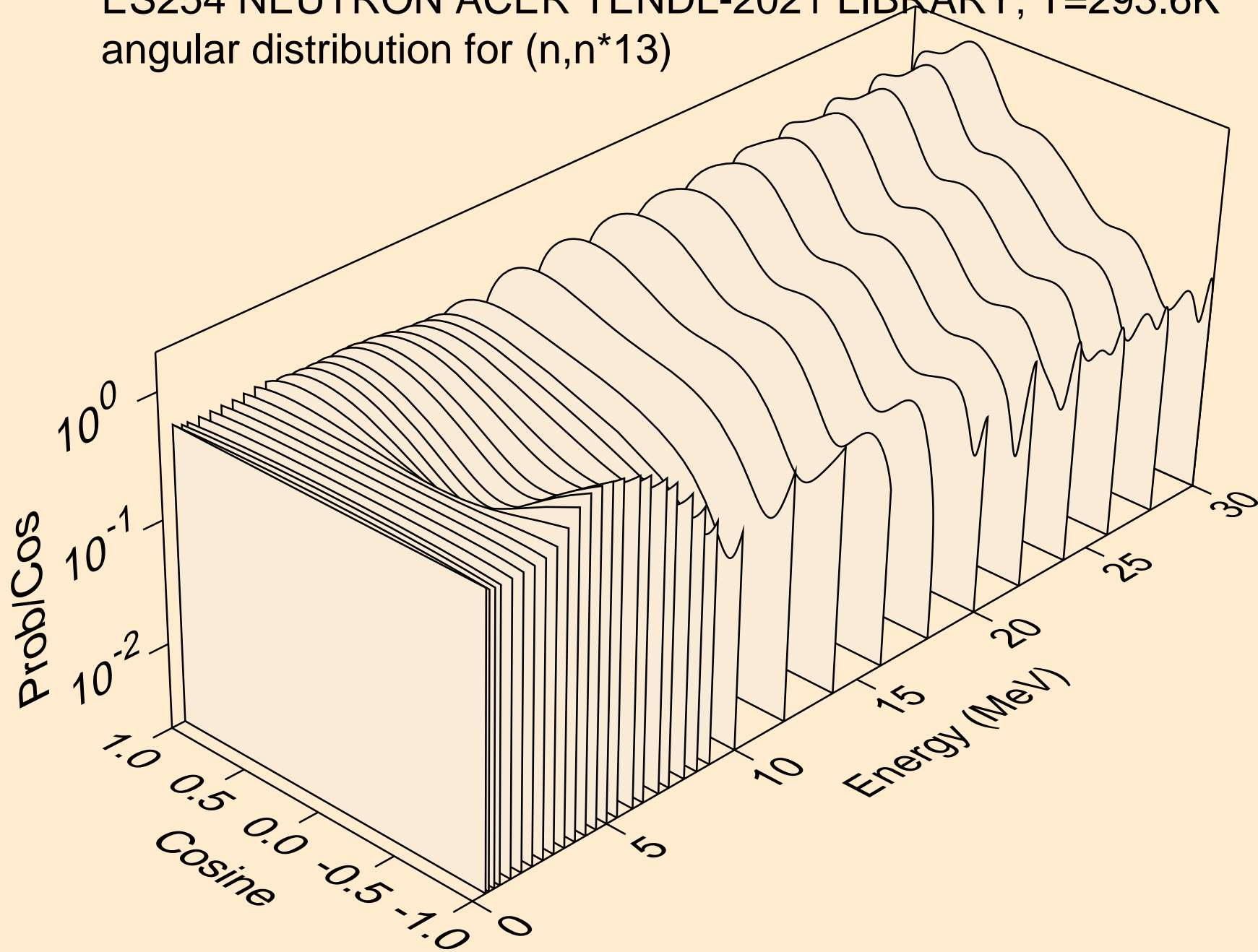

ES254 NEUTRON ACER TENDL-2021 LIBRARY; T=293.6K  
angular distribution for (n,n\*14)

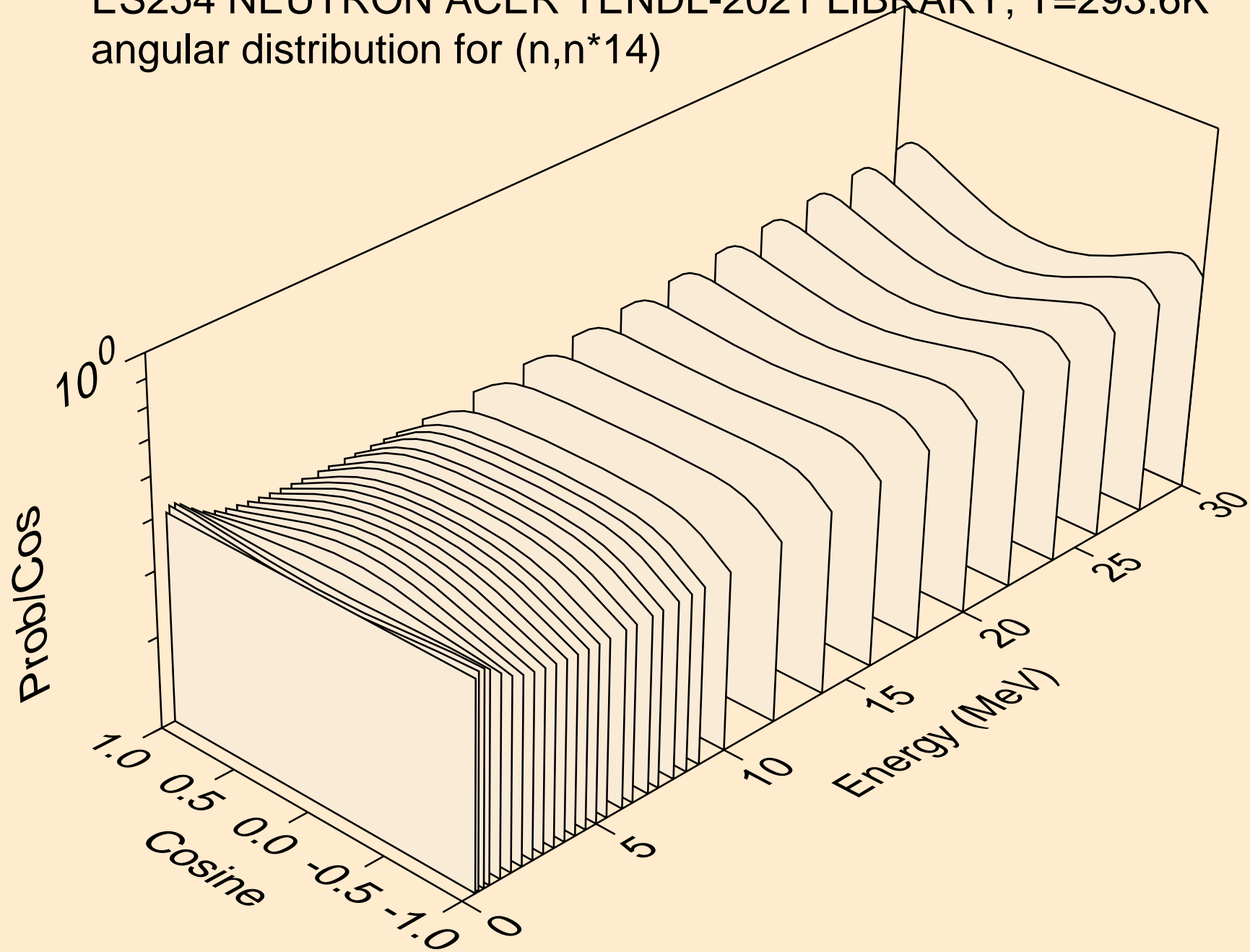

ES254 NEUTRON ACER TENDL-2021 LIBRARY; T=293.6K  
angular distribution for (n,n\*15)

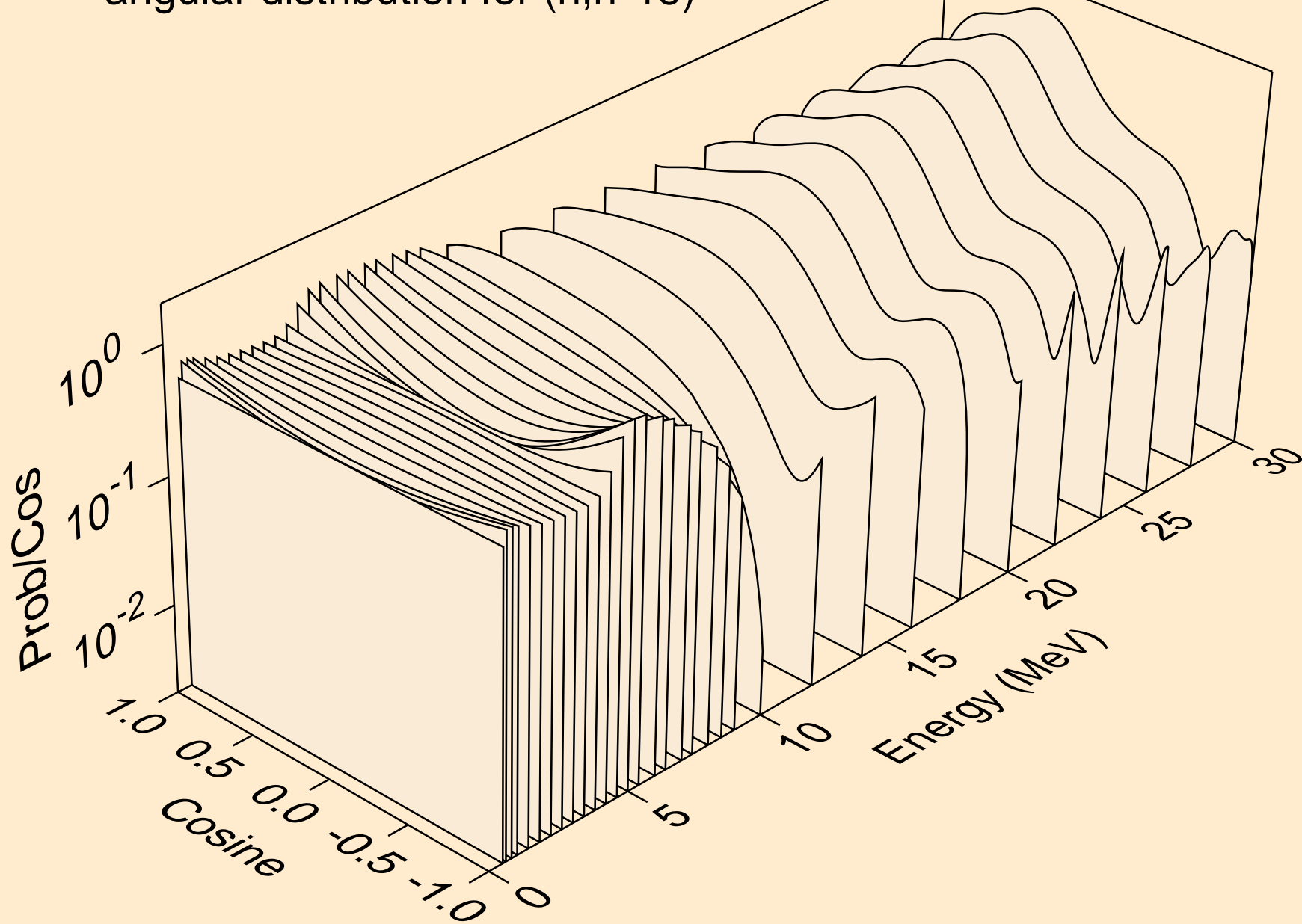

ES254 NEUTRON ACER TENDL-2021 LIBRARY; T=293.6K  
angular distribution for (n,n\*16)

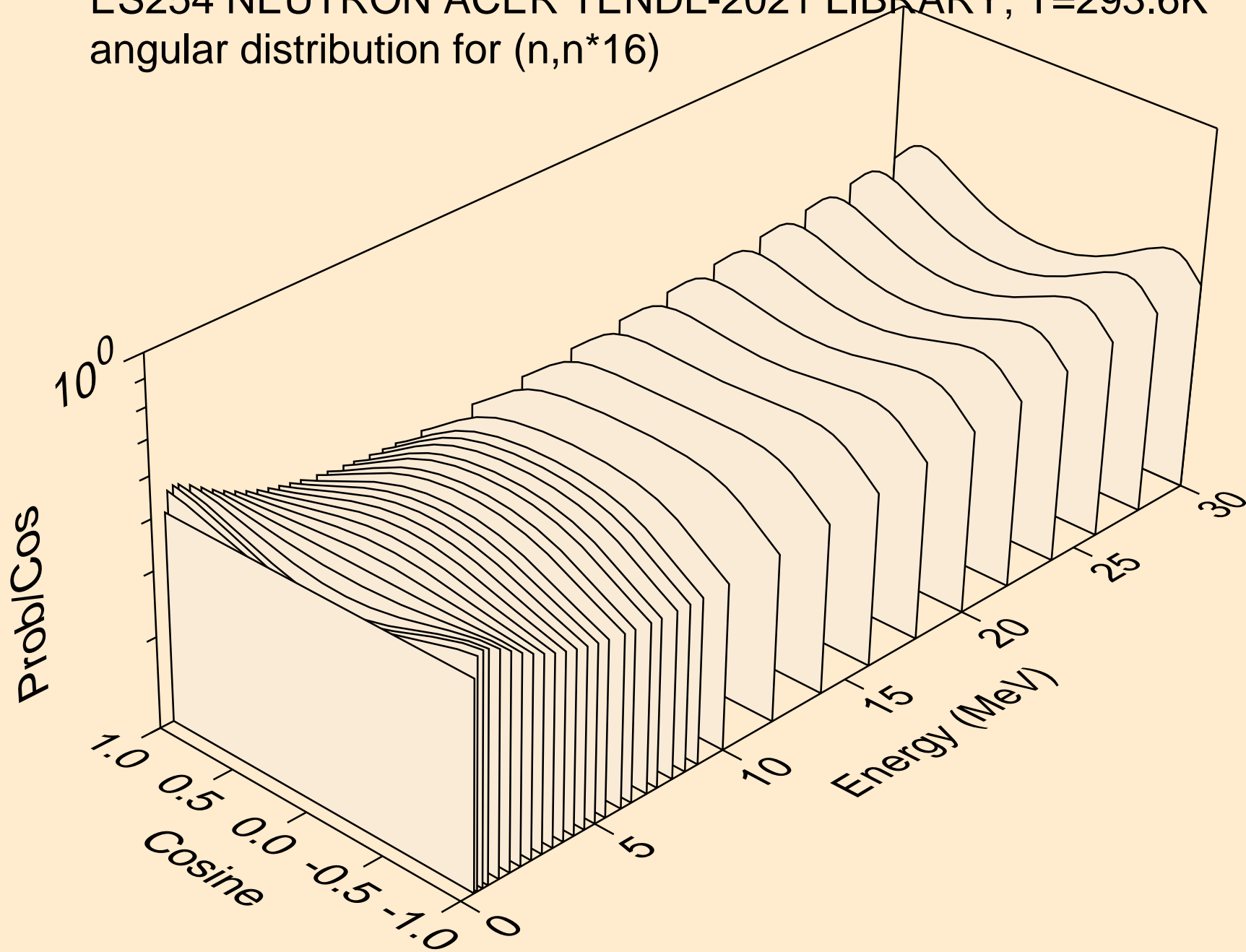

ES254 NEUTRON ACER TENDL-2021 LIBRARY; T=293.6K  
angular distribution for (n,n\*17)

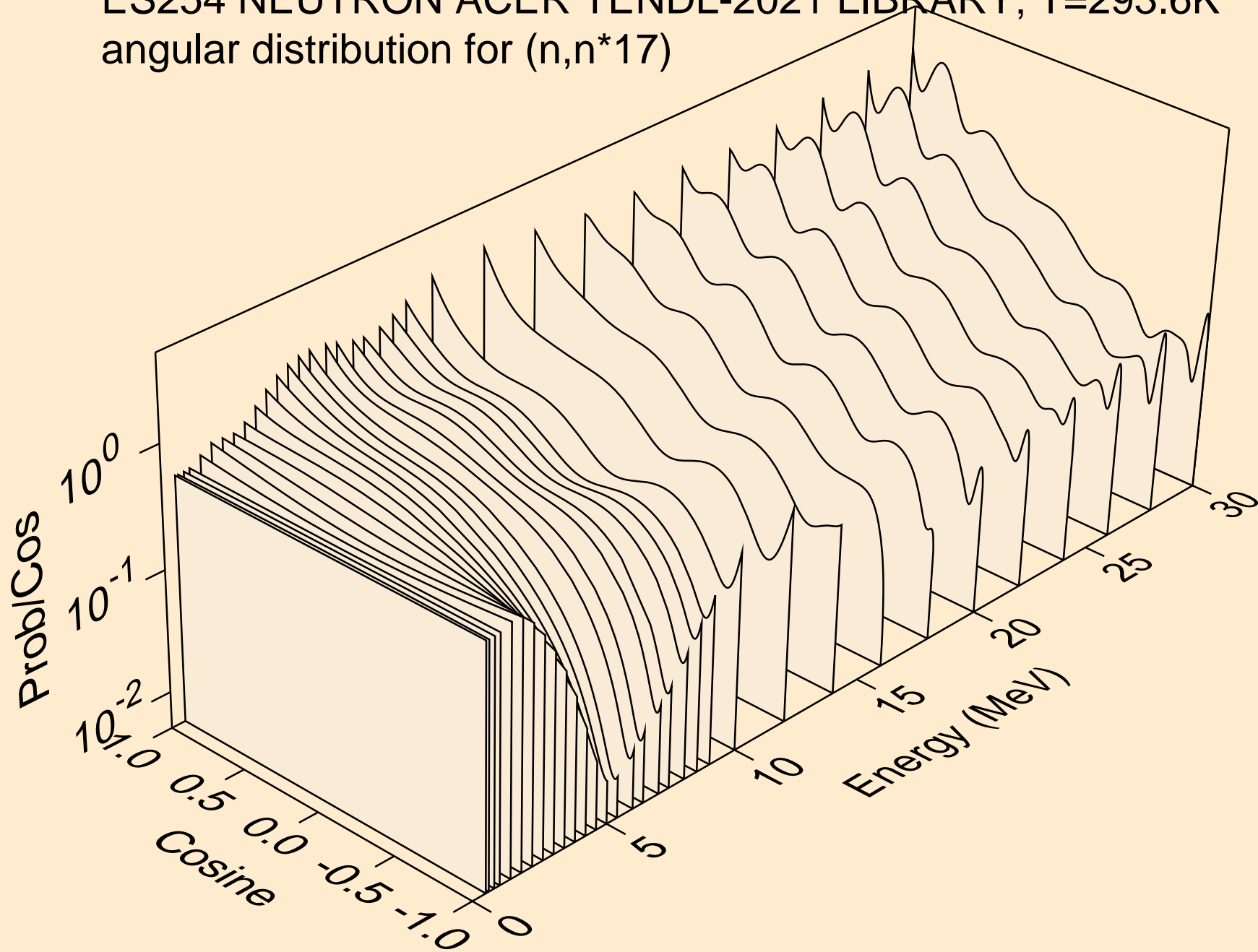

ES254 NEUTRON ACER TENDL-2021 LIBRARY; T=293.6K  
angular distribution for (n,n\*18)

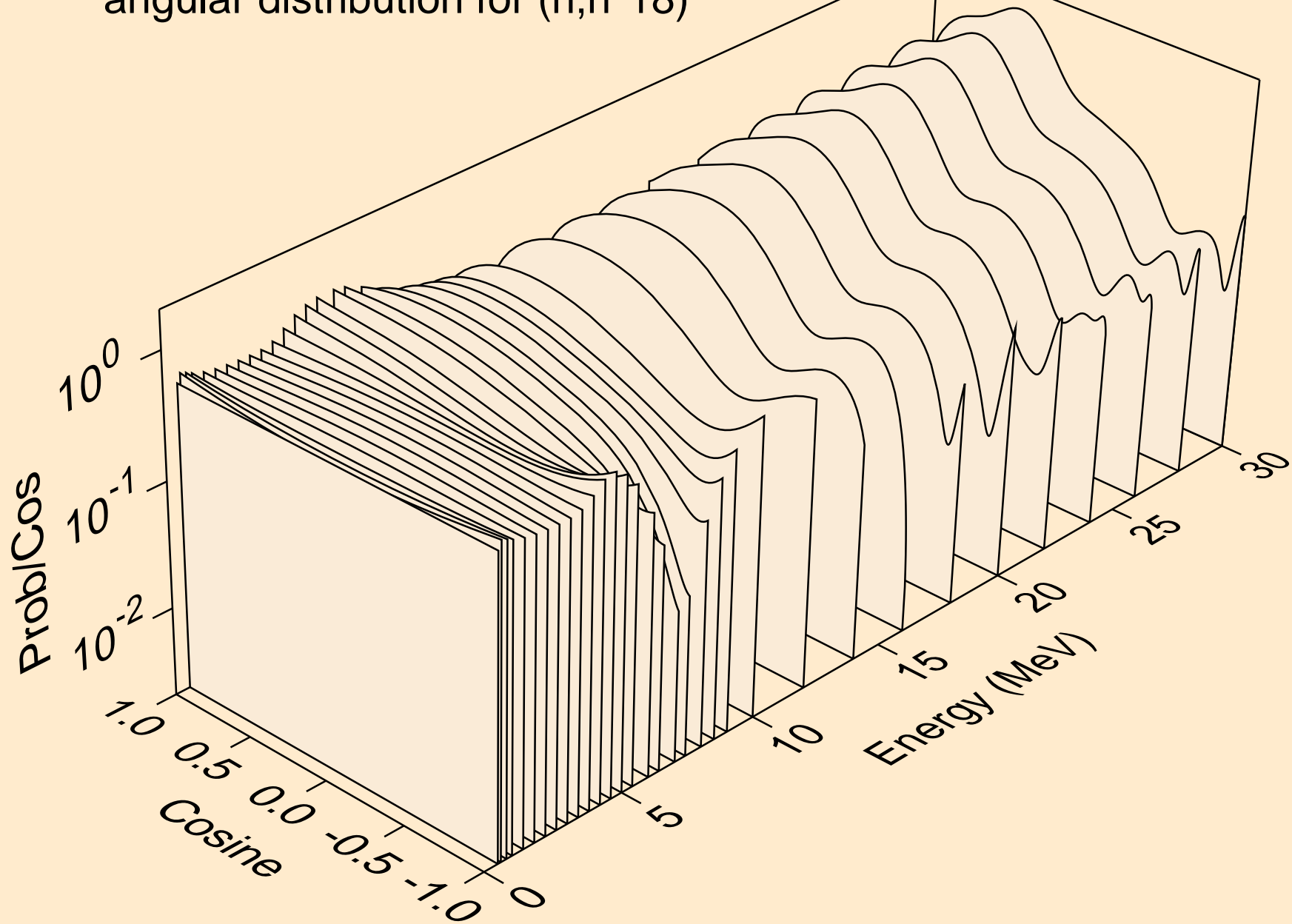



ES254 NEUTRON ACER TENDL-2021 LIBRARY; T=293.6K  
angular distribution for (n,n\*19)

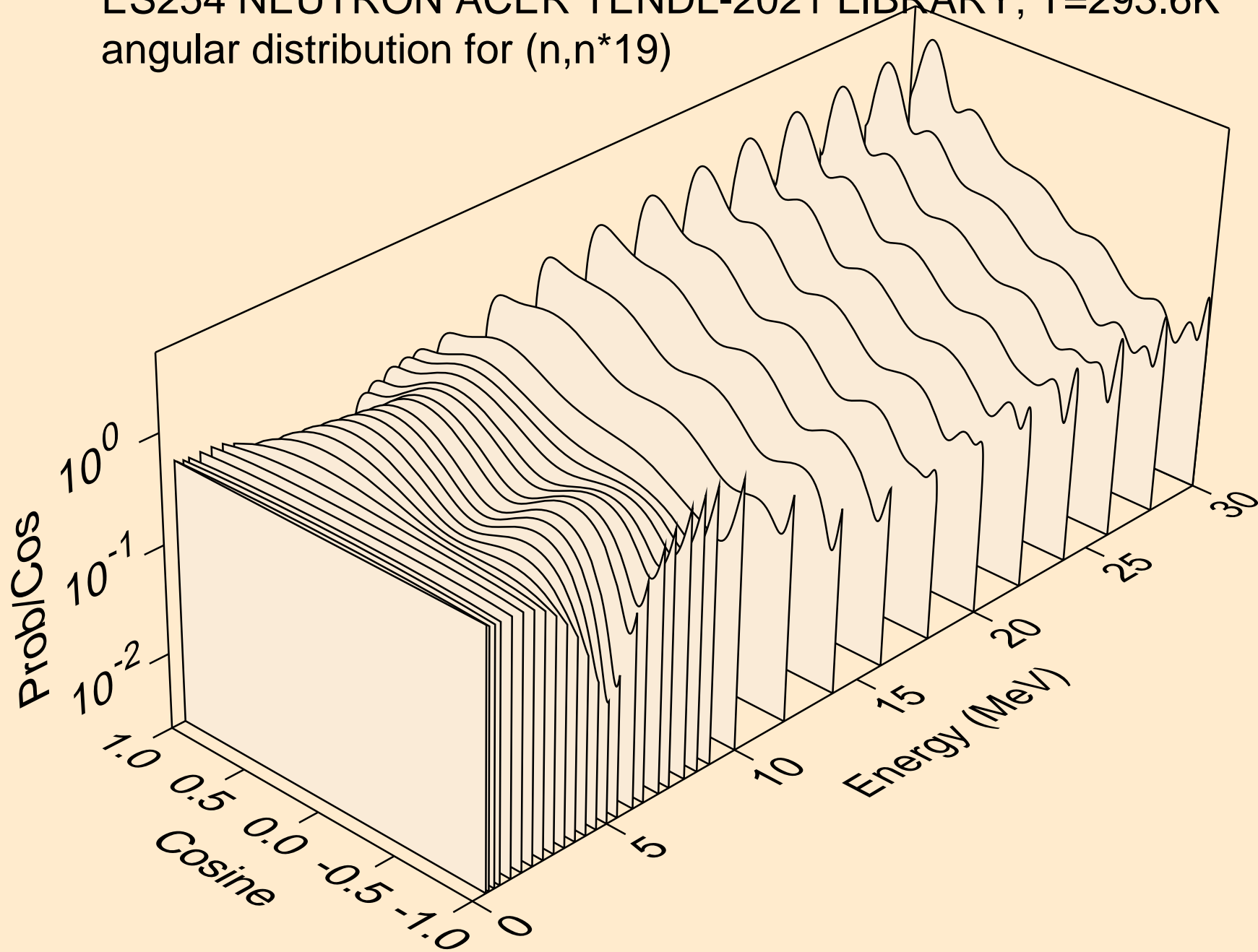

ES254 NEUTRON ACER TENDL-2021 LIBRARY; T=293.6K  
angular distribution for (n,n\*20)

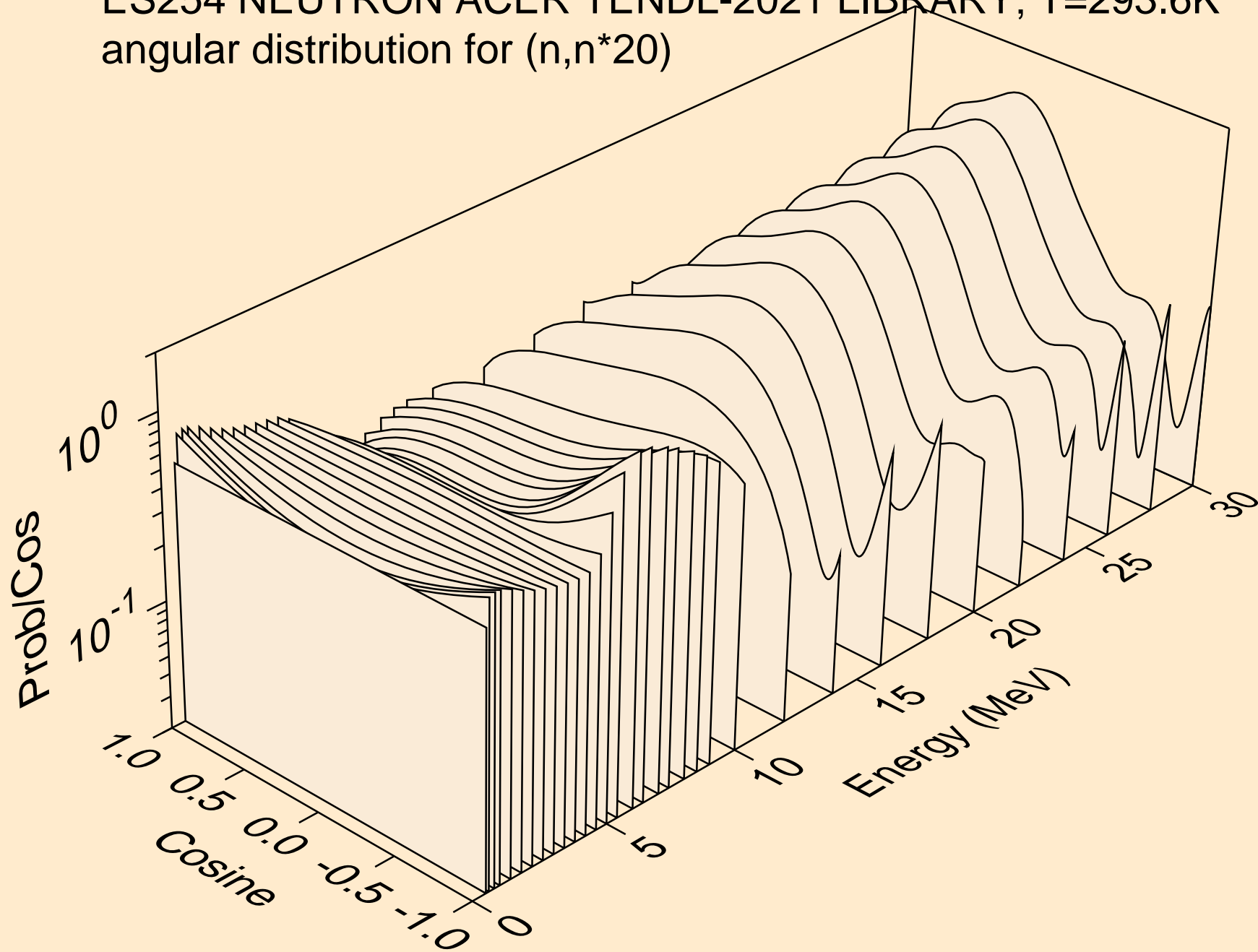

ES254 NEUTRON ACER TENDL-2021 LIBRARY; T=293.6K  
angular distribution for (n,n\*21)

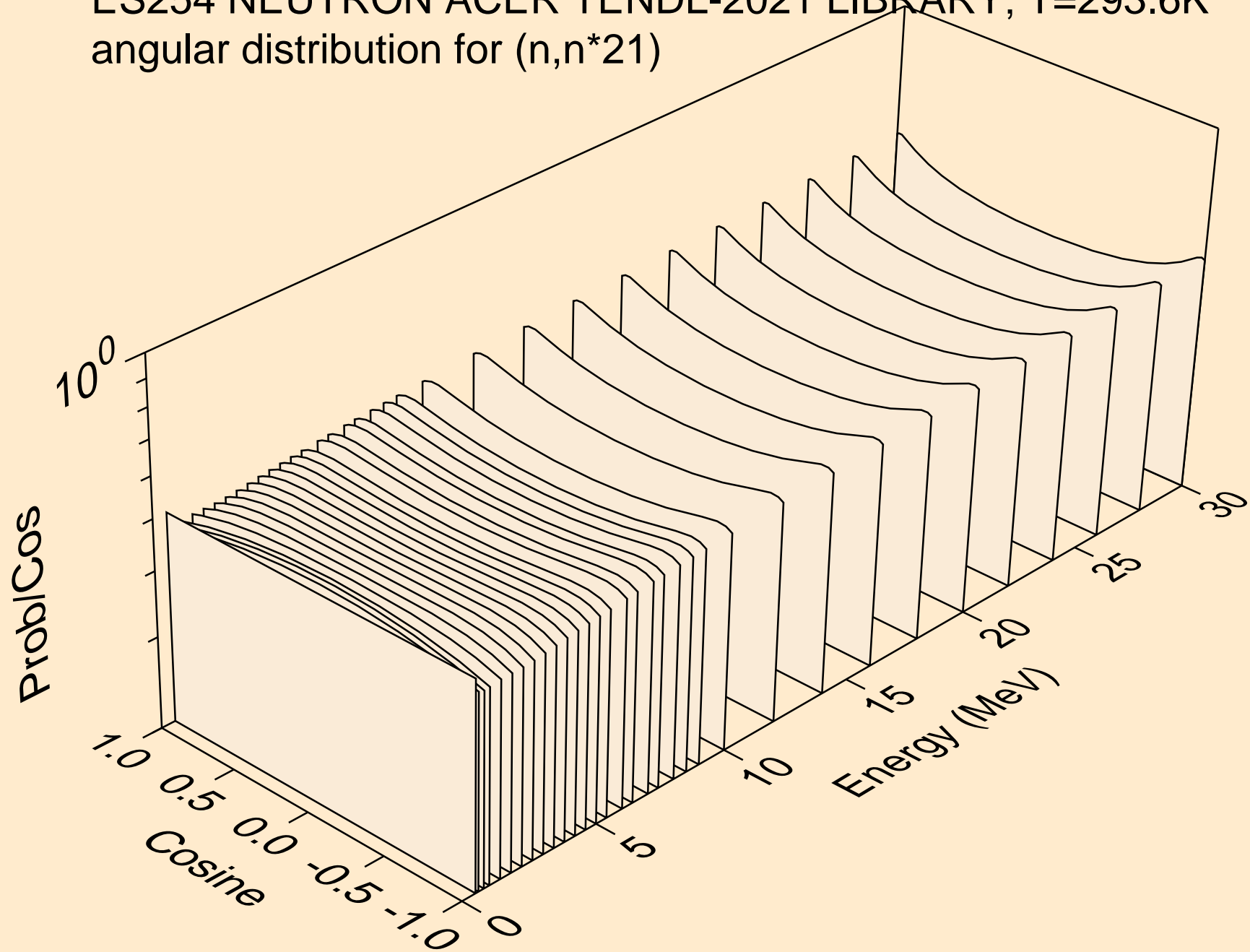

ES254 NEUTRON ACER TENDL-2021 LIBRARY; T=293.6K  
angular distribution for (n,n\*22)

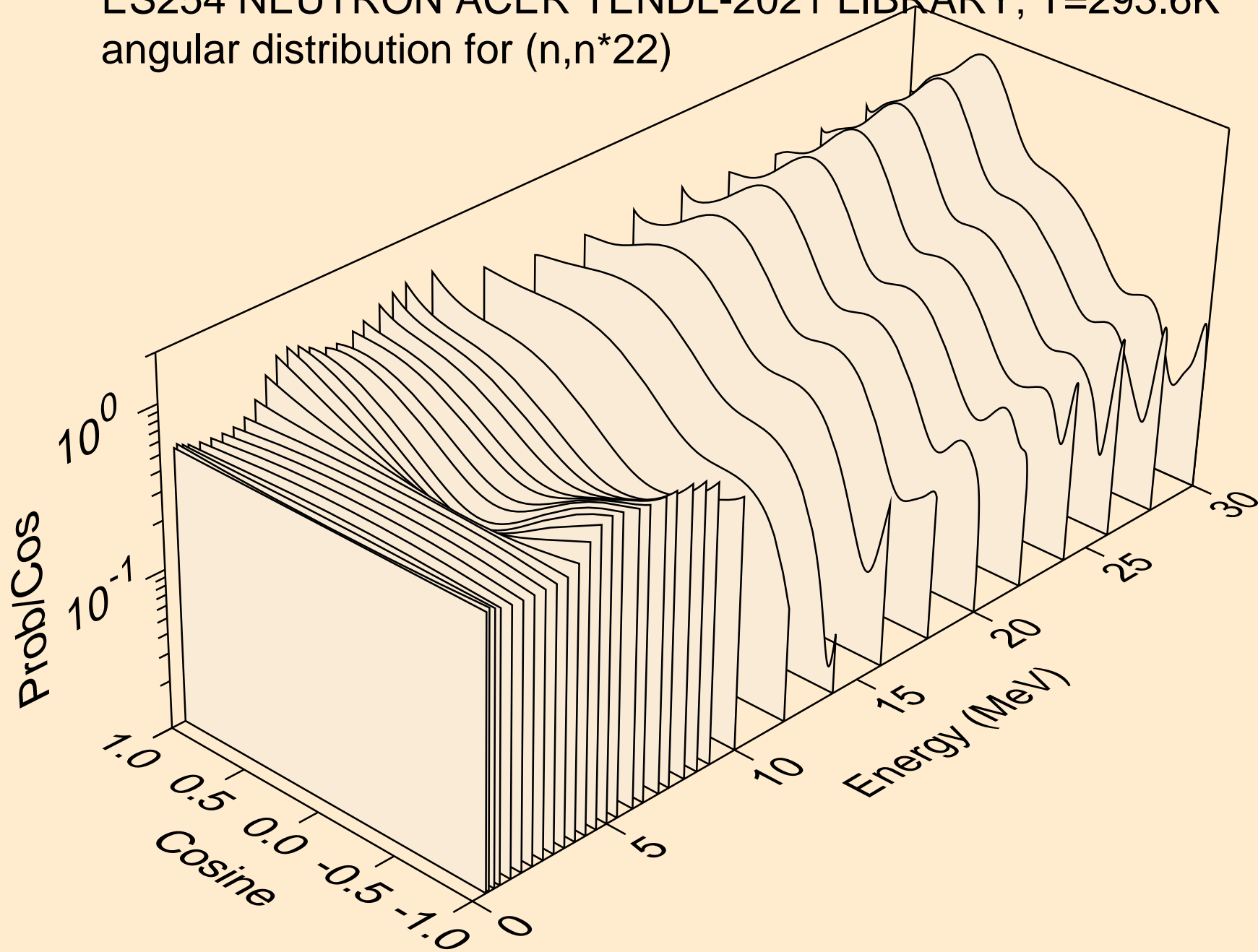

ES254 NEUTRON ACER TENDL-2021 LIBRARY; T=293.6K  
angular distribution for (n,n\*23)

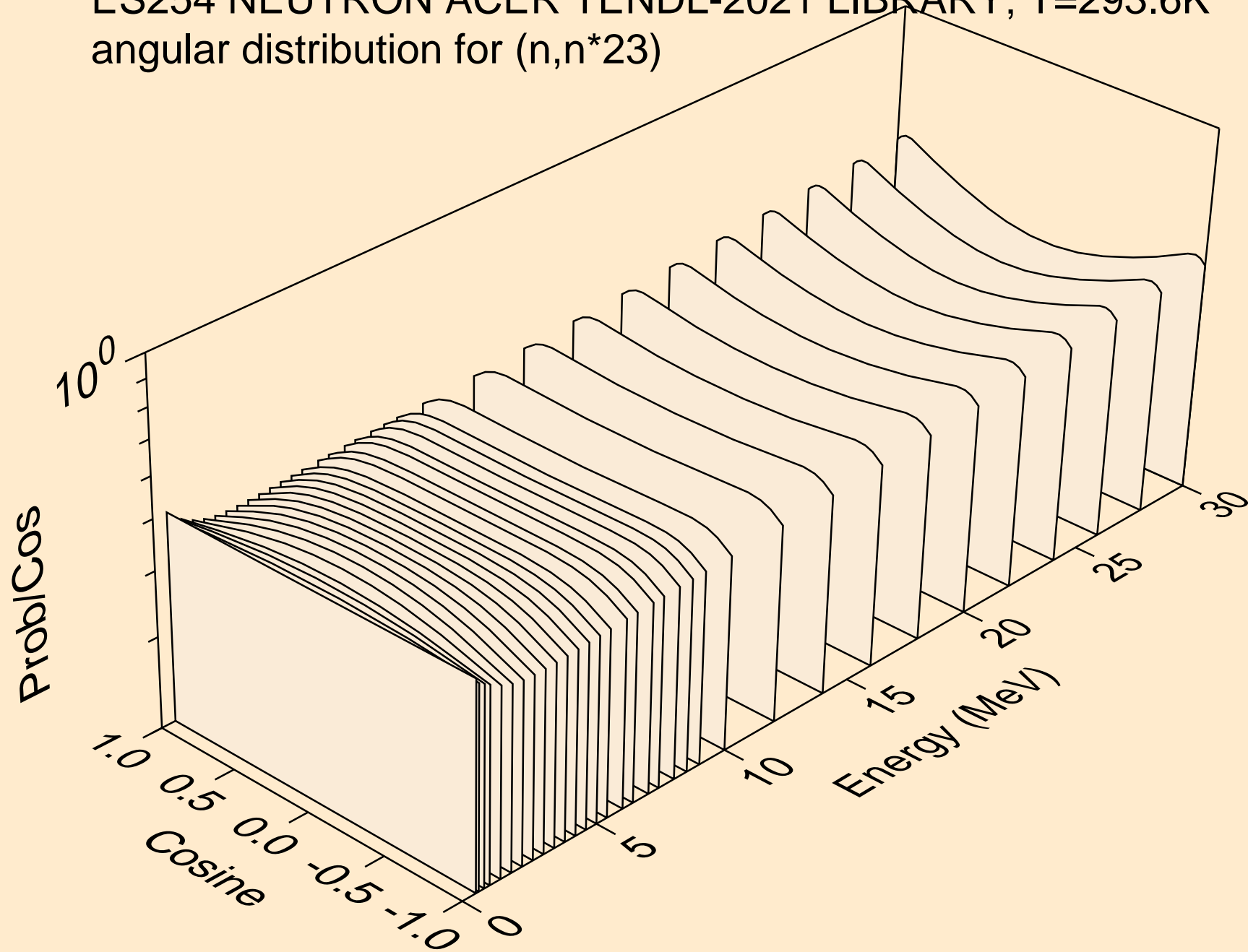

ES254 NEUTRON ACER TENDL-2021 LIBRARY; T=293.6K  
angular distribution for (n,n\*24)

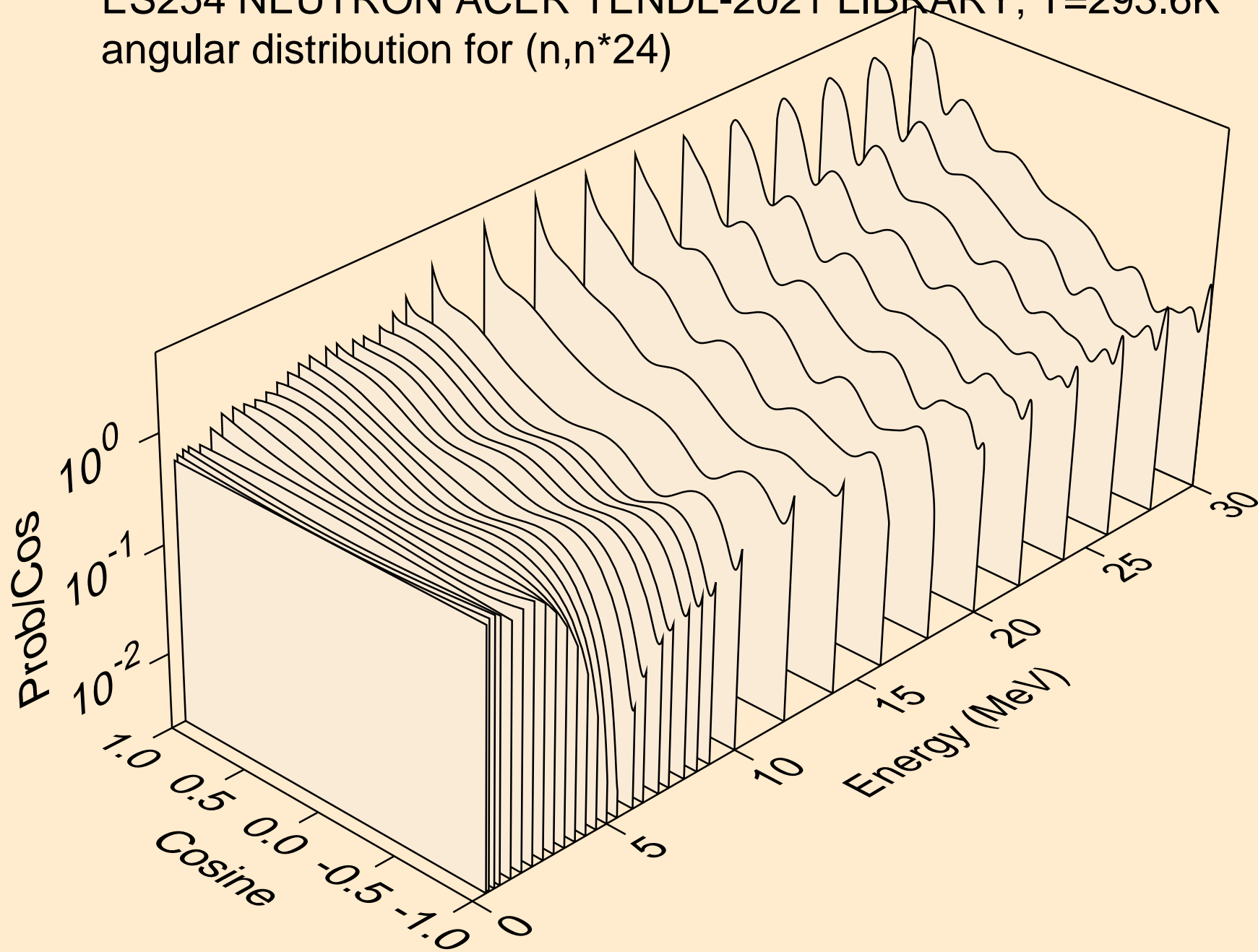

ES254 NEUTRON ACER TENDL-2021 LIBRARY; T=293.6K  
angular distribution for (n,n\*25)

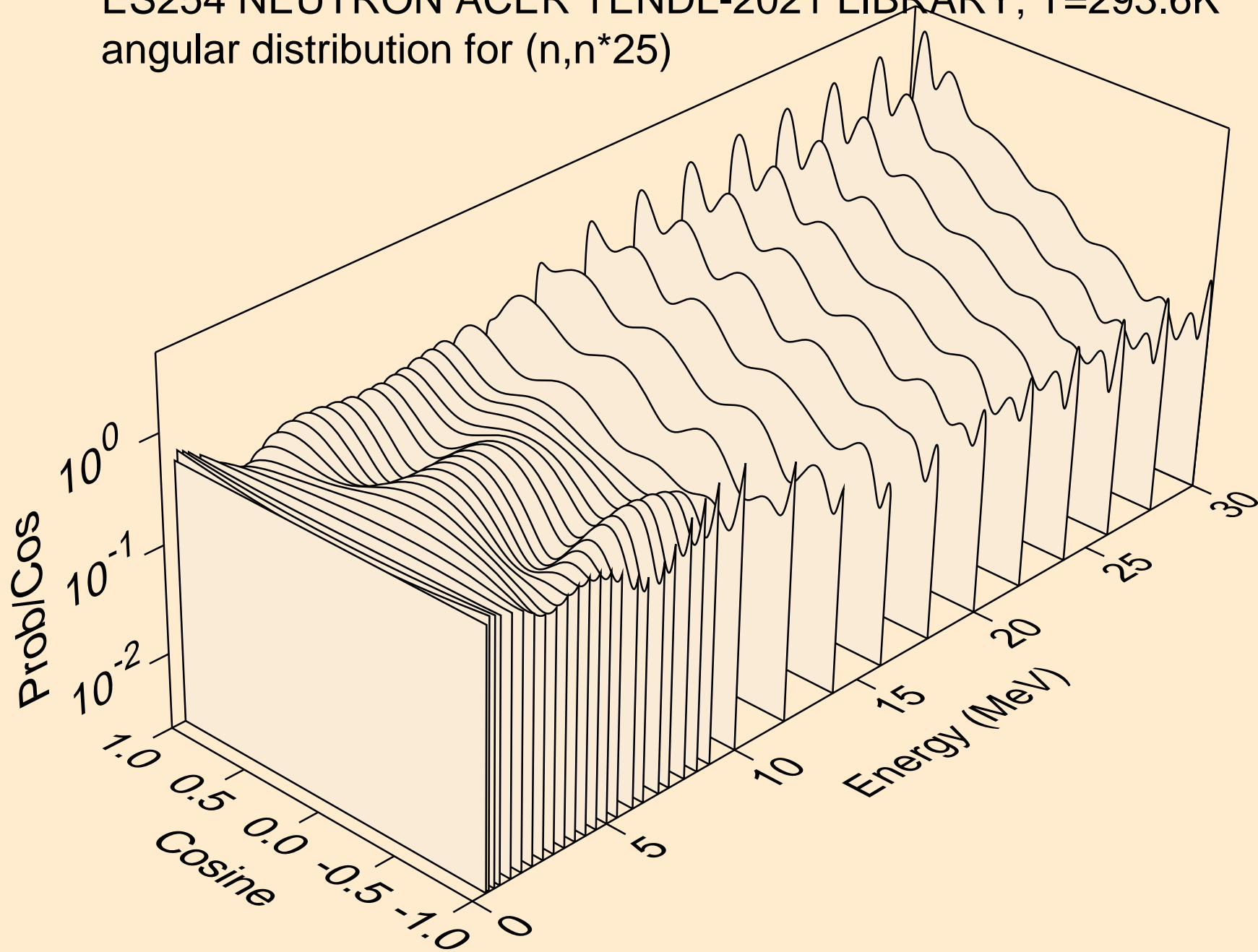

ES254 NEUTRON ACER TENDL-2021 LIBRARY; T=293.6K  
angular distribution for (n,n\*26)

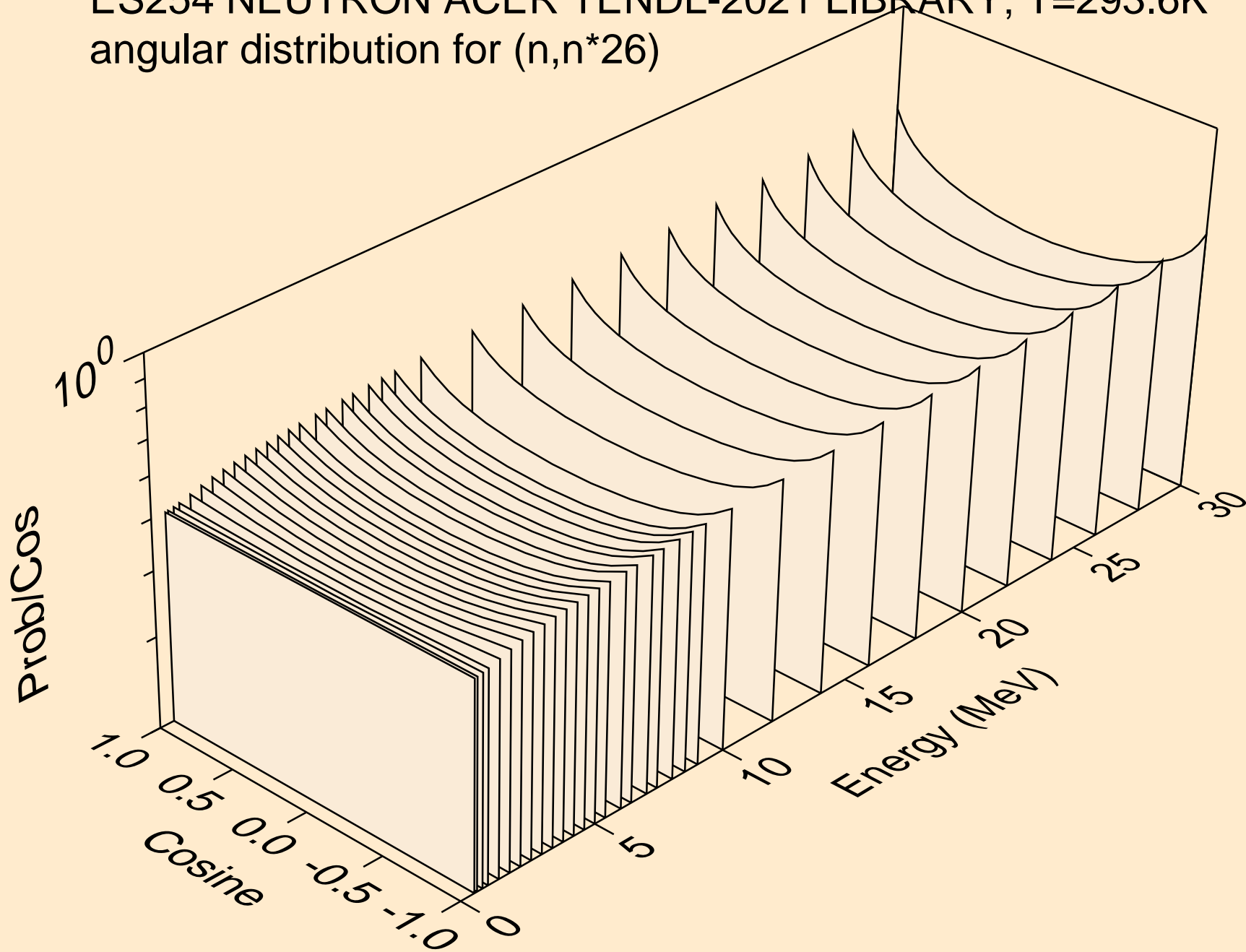



ES254 NEUTRON ACER TENDL-2021 LIBRARY; T=293.6K  
angular distribution for (n,n\*27)

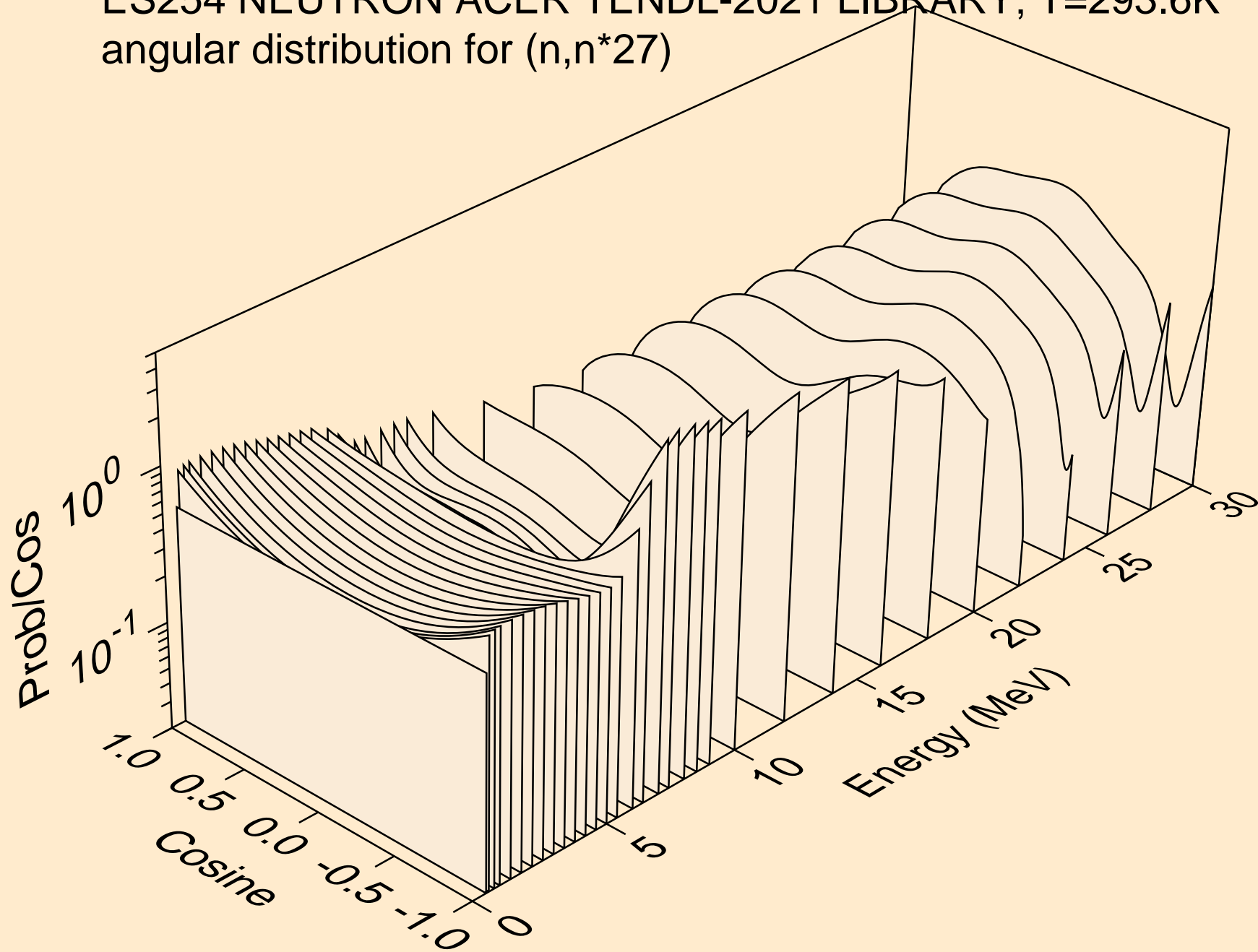

ES254 NEUTRON ACER TENDL-2021 LIBRARY; T=293.6K  
angular distribution for (n,n\*28)

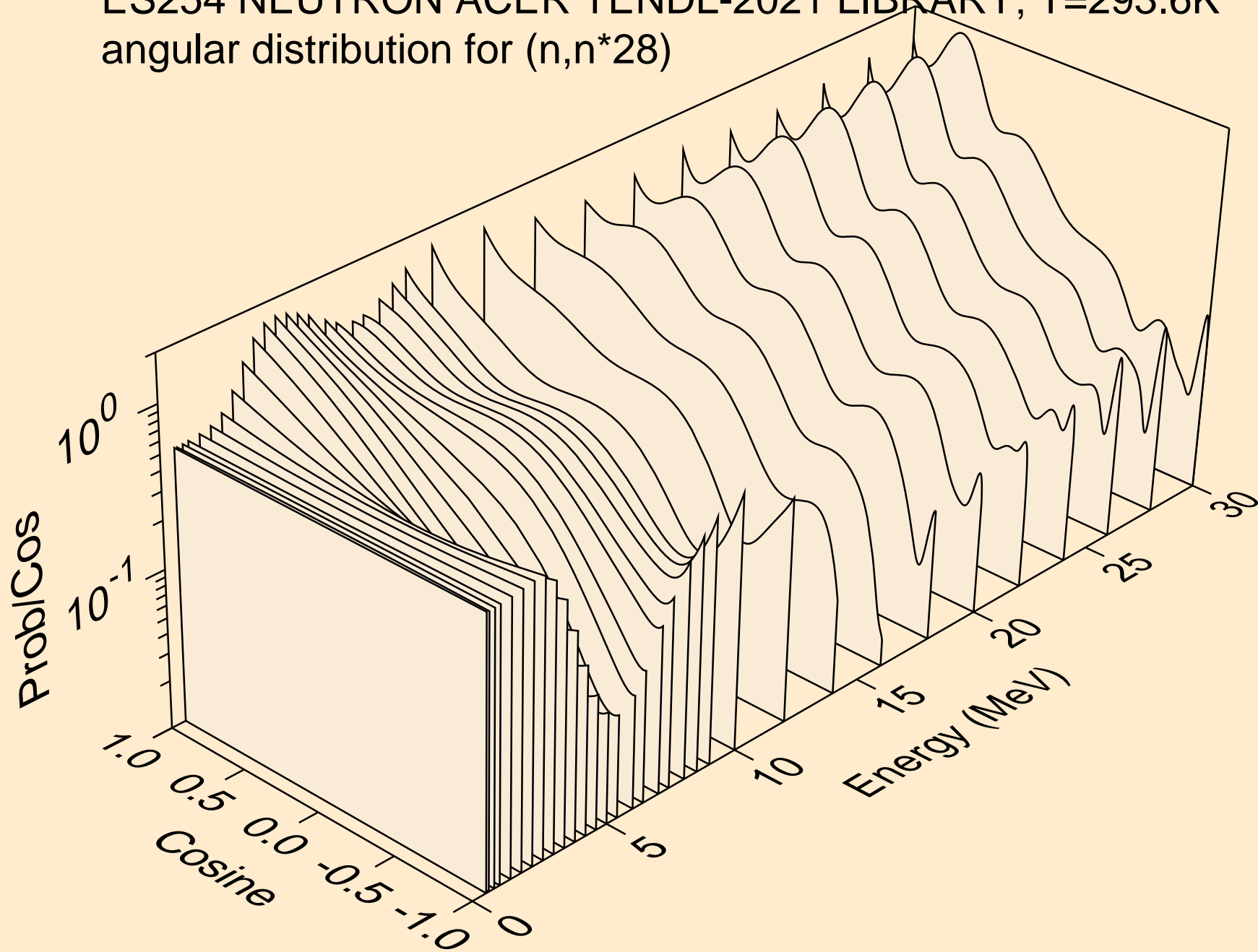

ES254 NEUTRON ACER TENDL-2021 LIBRARY; T=293.6K  
angular distribution for (n,n\*29)

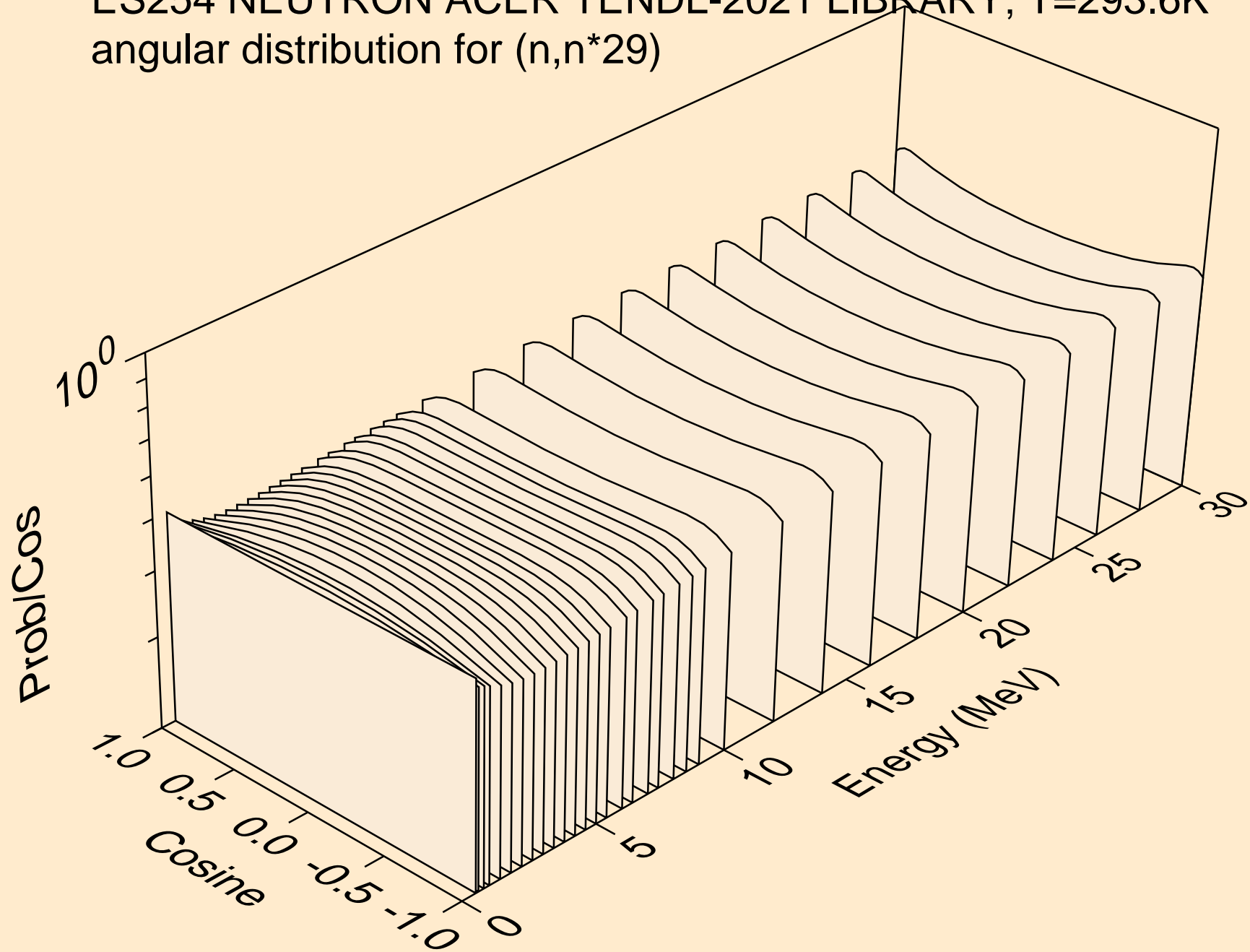

ES254 NEUTRON ACER TENDL-2021 LIBRARY; T=293.6K  
angular distribution for (n,n\*30)

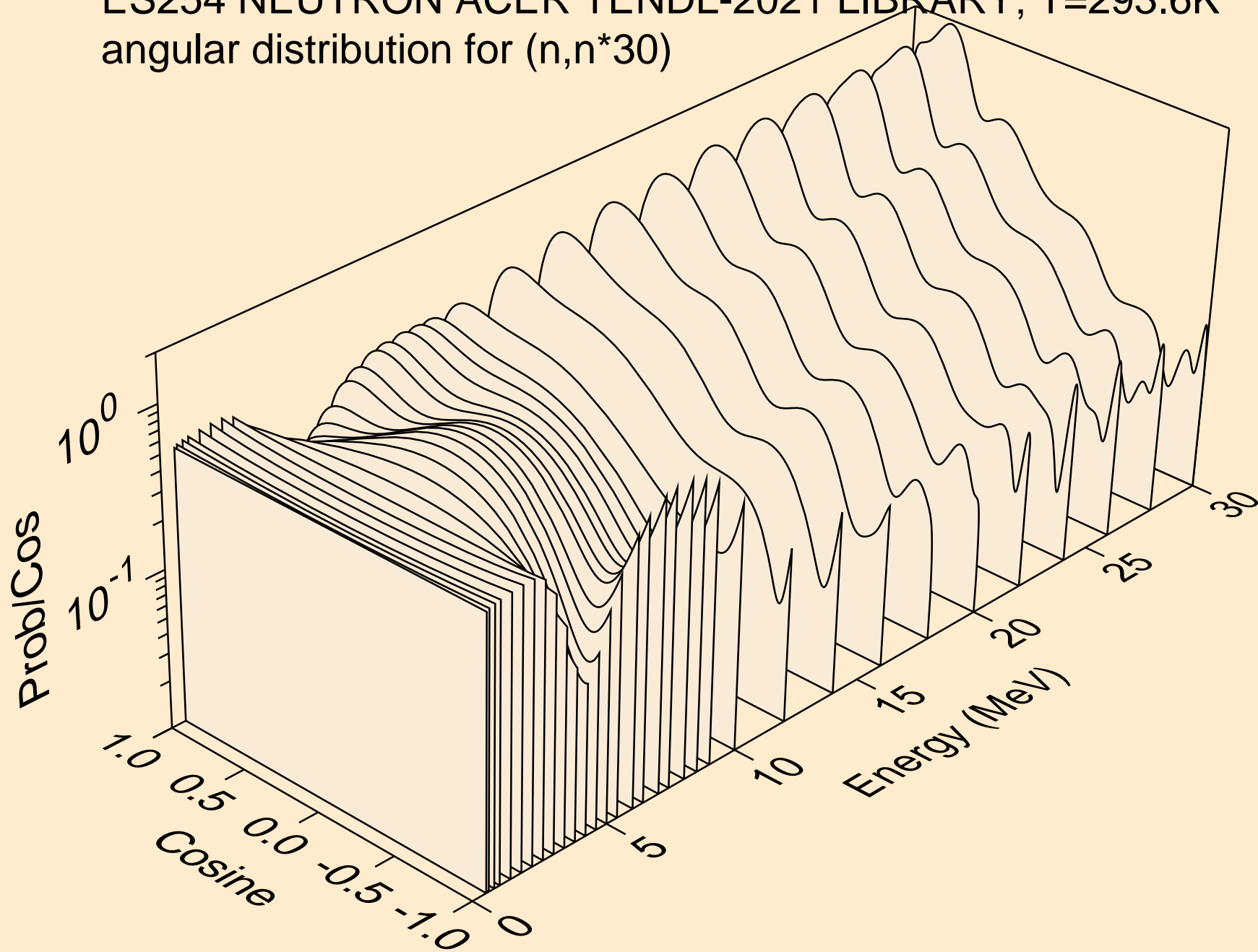

ES254 NEUTRON ACER TENDL-2021 LIBRARY; T=293.6K  
Total fission nubar

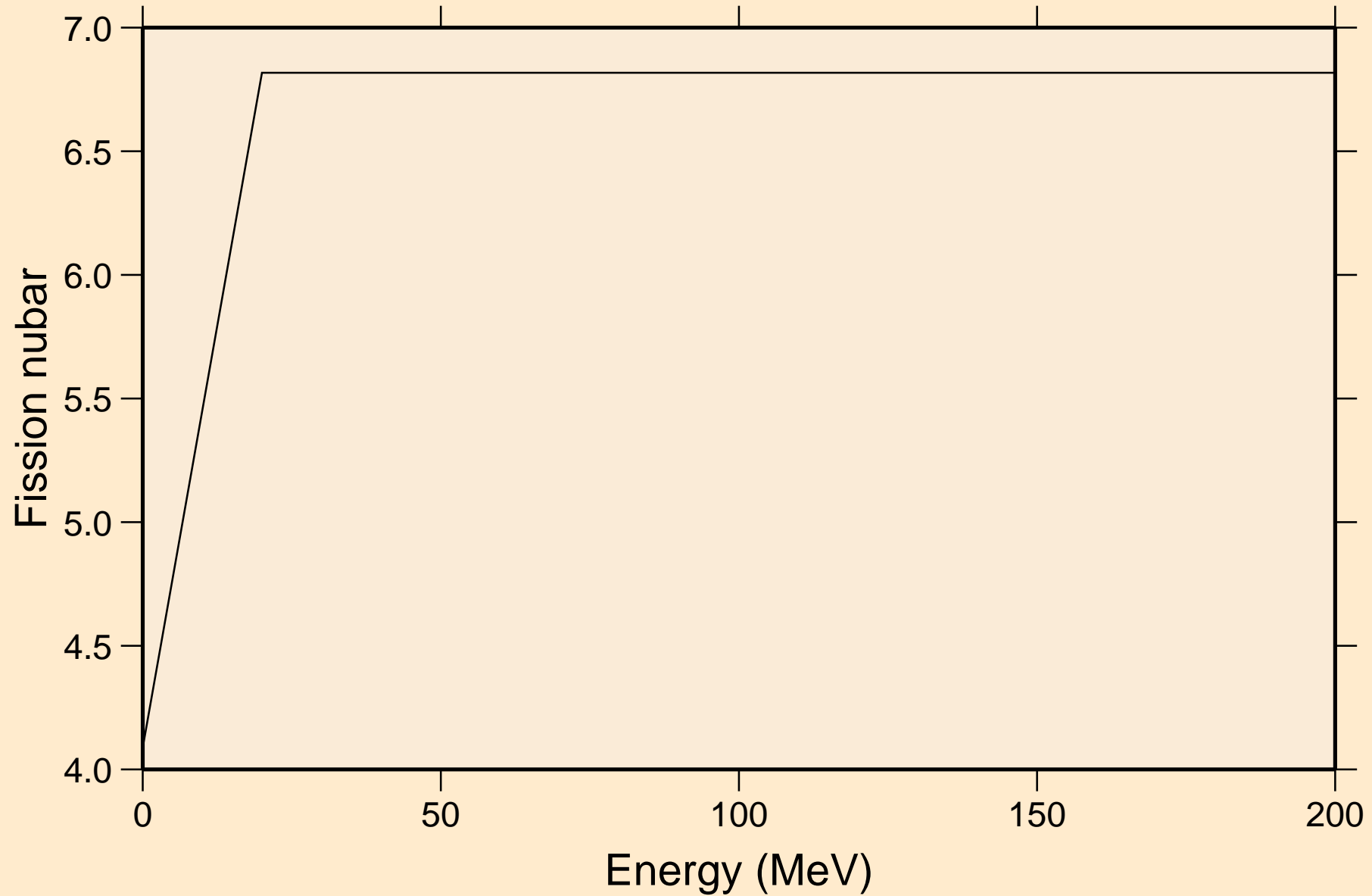

ES254 NEUTRON ACER TENDL-2021 LIBRARY; T=293.6K  
Neutron emission for (n,x)

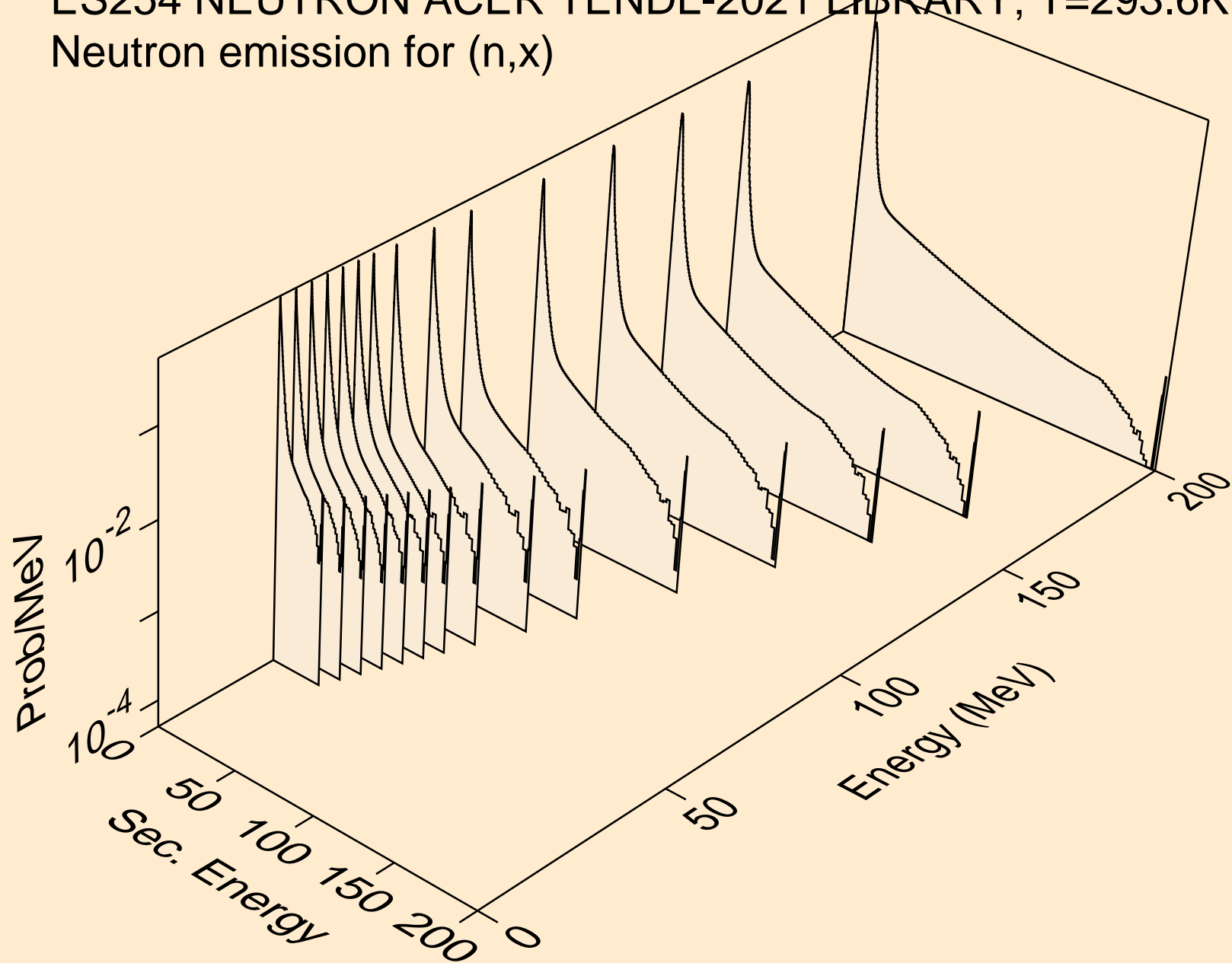

ES254 NEUTRON ACER TENDL-2021 LIBRARY; T=293.6K  
Neutron emission for (n,2nd)

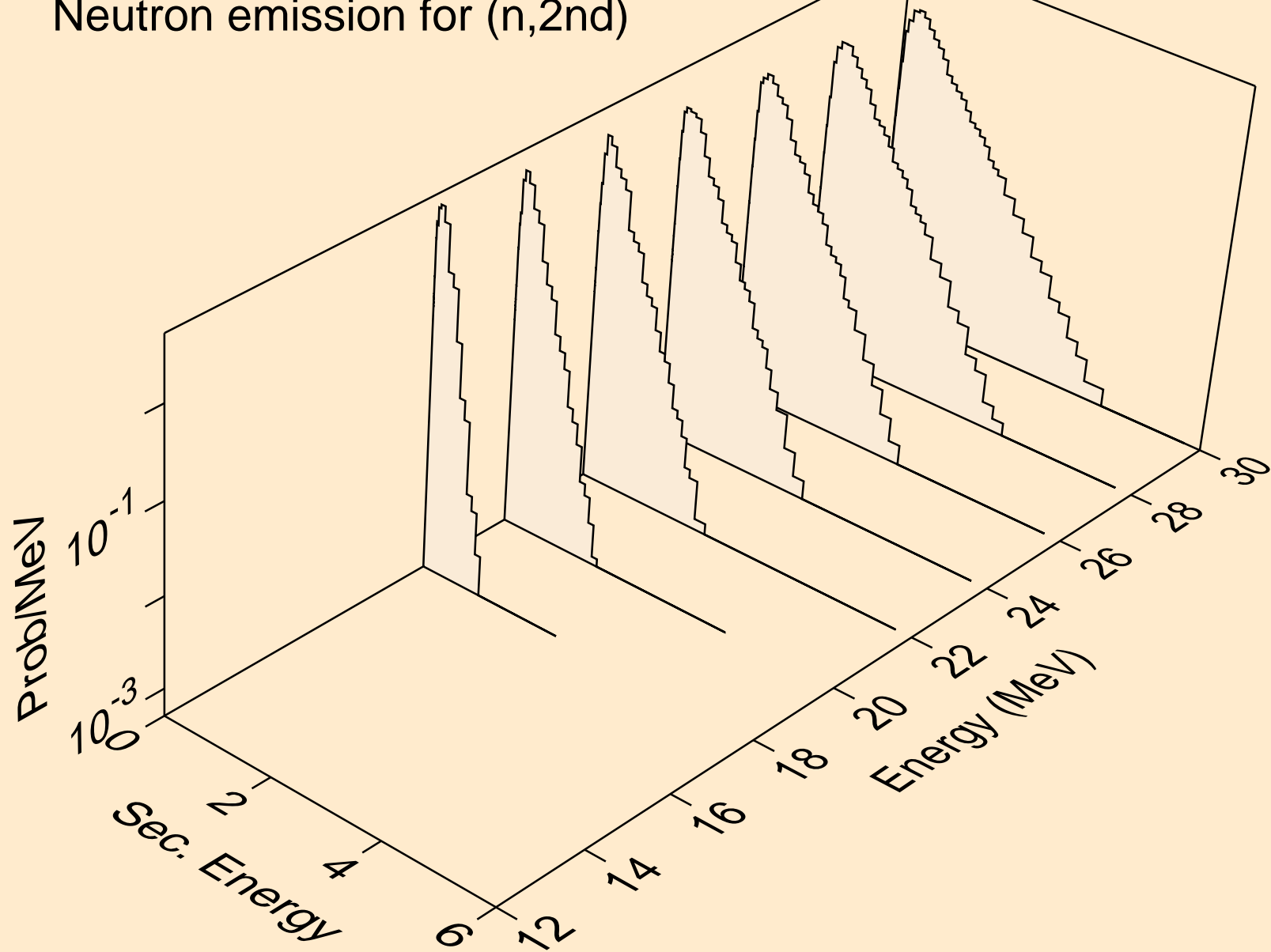

ES254 NEUTRON ACER TENDL-2021 LIBRARY; T=293.6K  
Neutron emission for (n,2n)

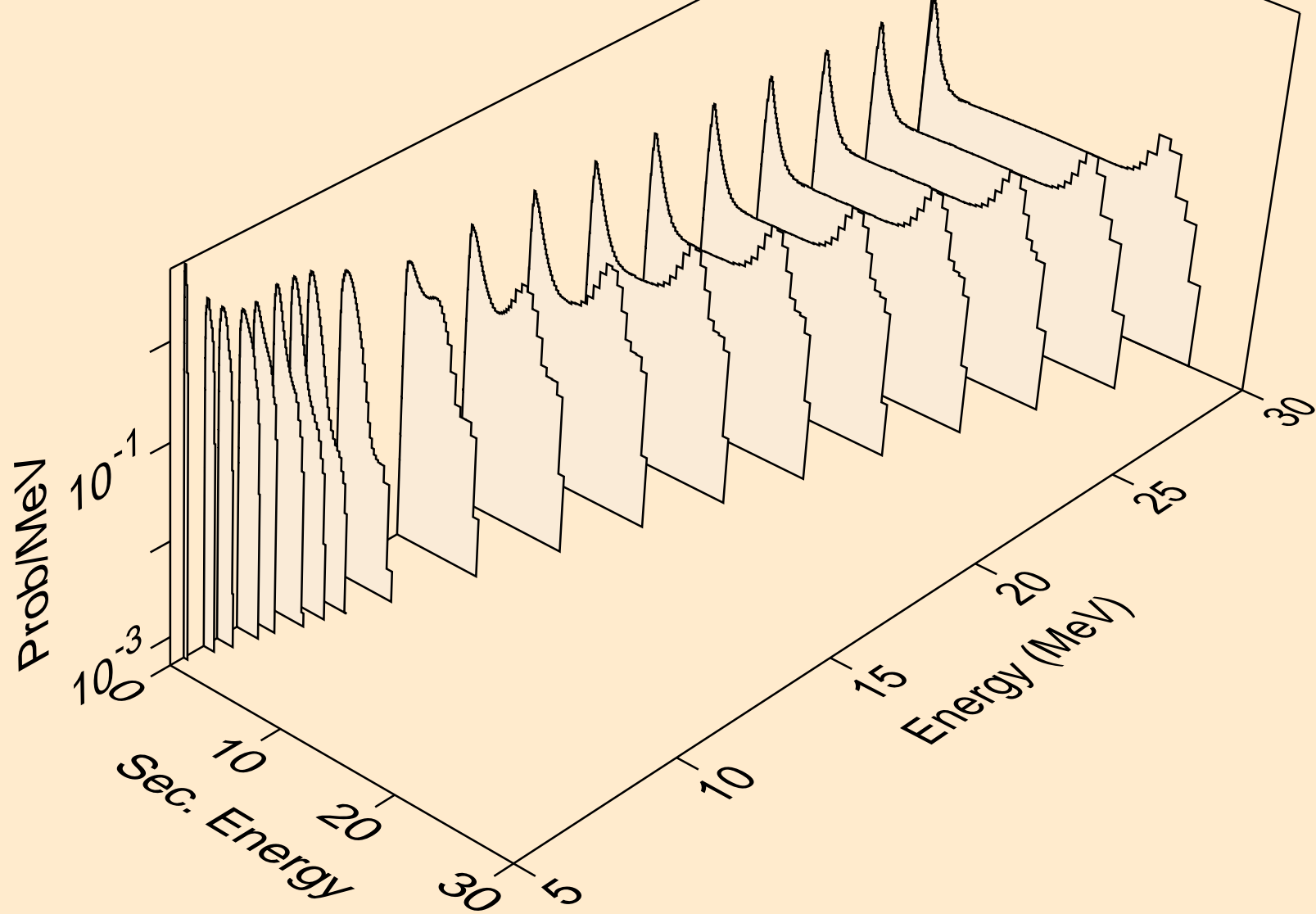



ES254 NEUTRON ACER TENDL-2021 LIBRARY; T=293.6K  
Neutron emission for (n,3n)

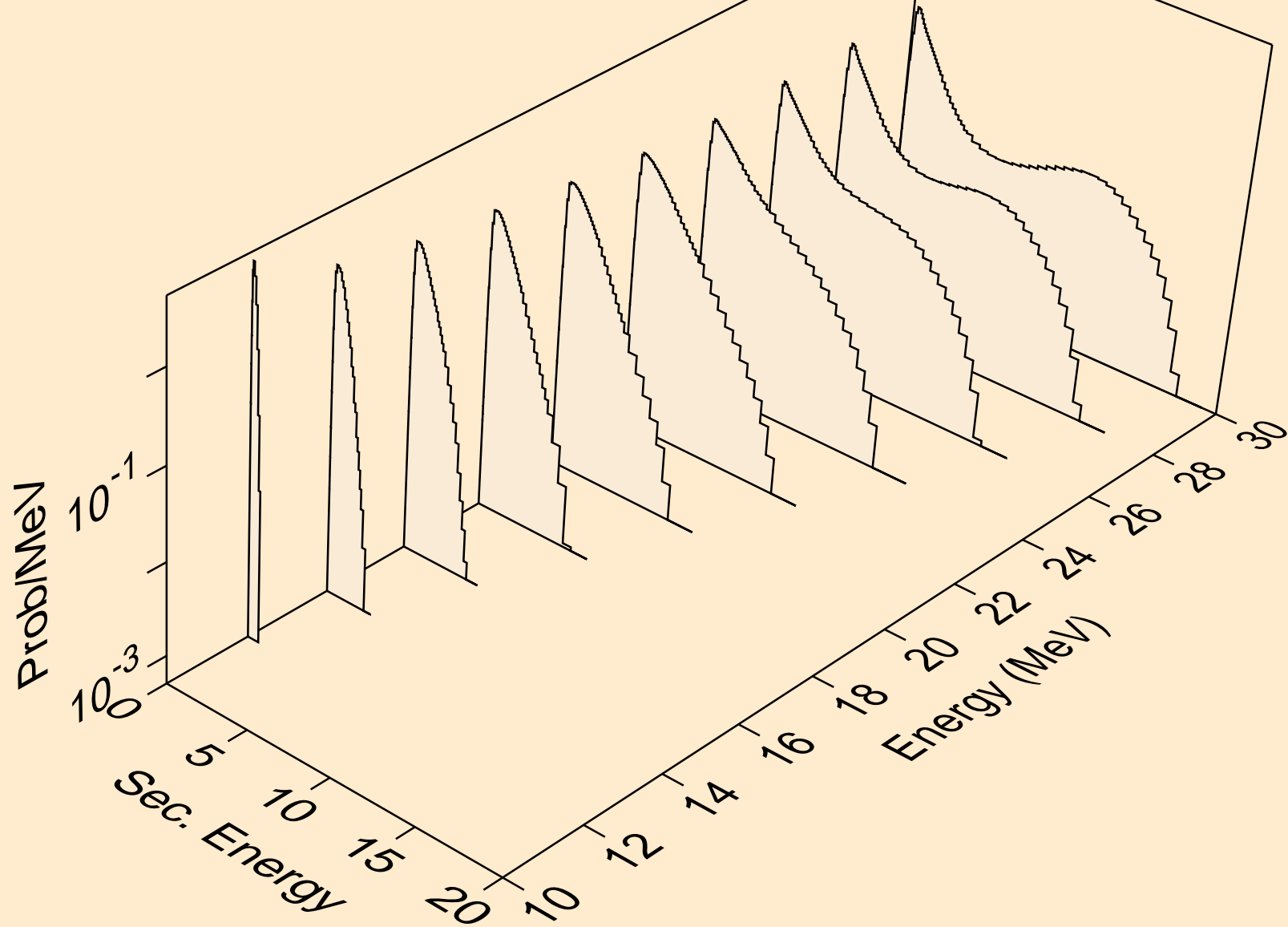

ES254 NEUTRON ACER TENDL-2021 LIBRARY; T=293.6K  
Neutron emission for fission

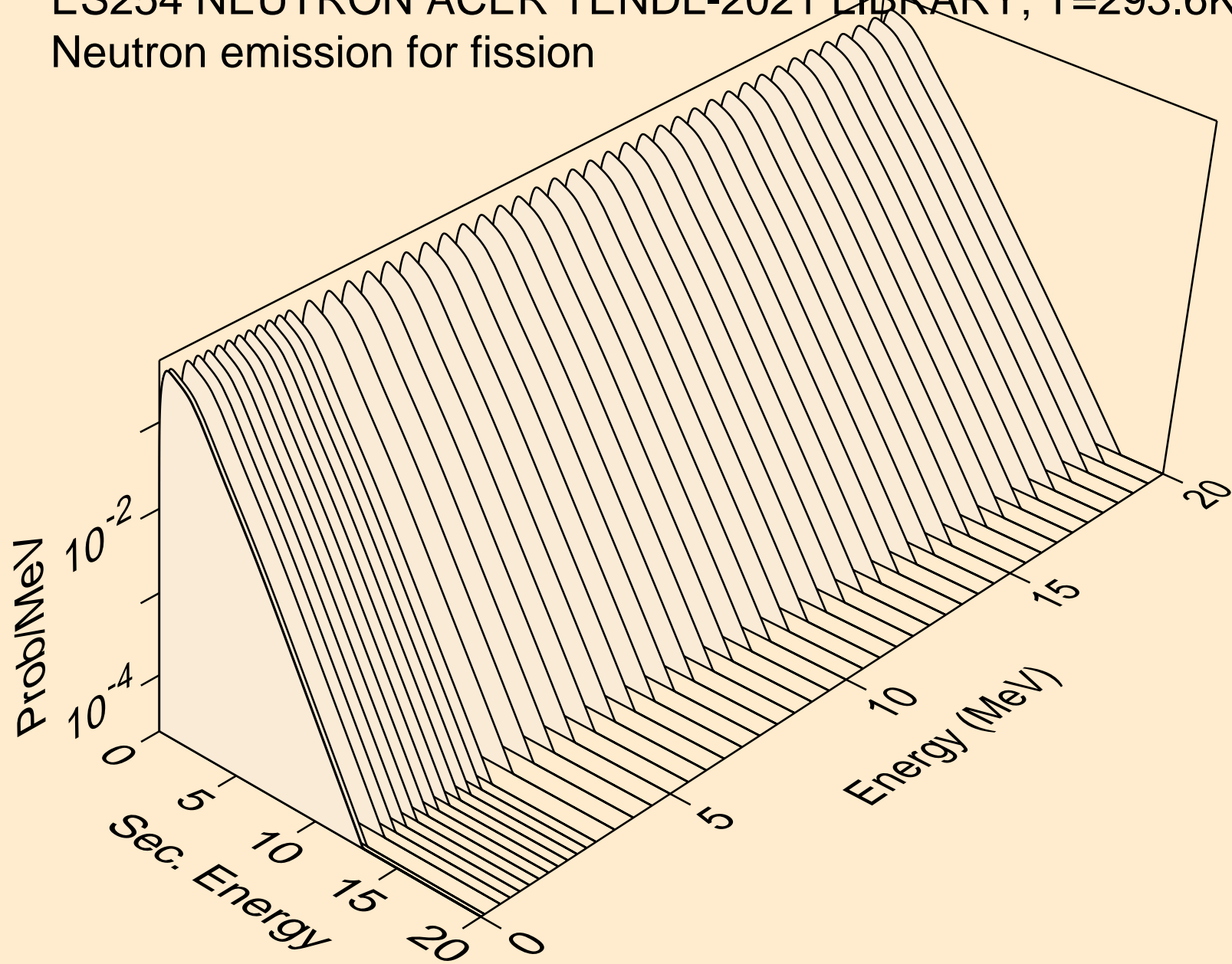

ES254 NEUTRON ACER TENDL-2021 LIBRARY; T=293.6K  
Neutron emission for (n,n\*)a

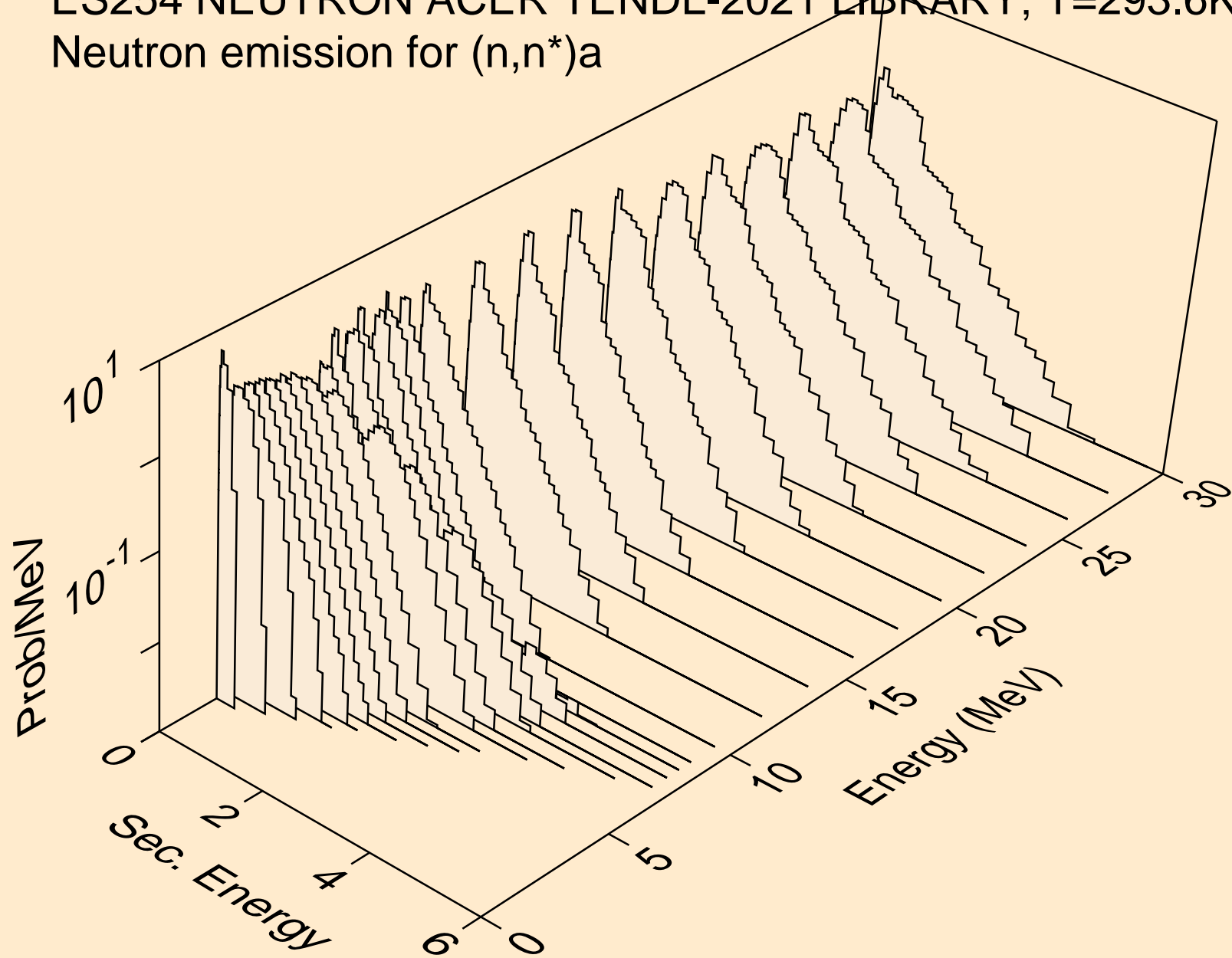

ES254 NEUTRON ACER TENDL-2021 LIBRARY; T=293.6K  
Neutron emission for (n,2n)a

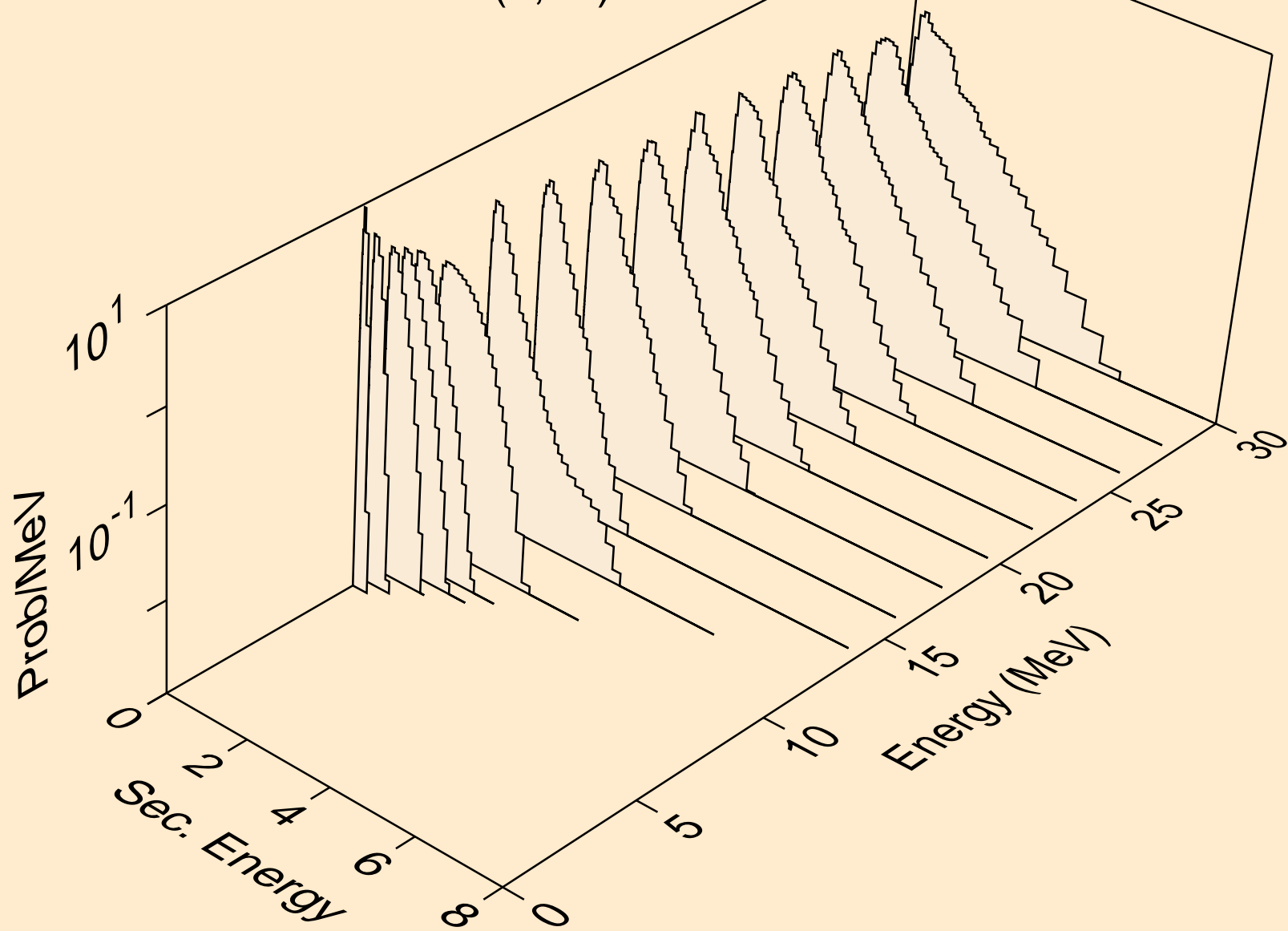

ES254 NEUTRON ACER TENDL-2021 LIBRARY; T=293.6K  
Neutron emission for (n,3n)a

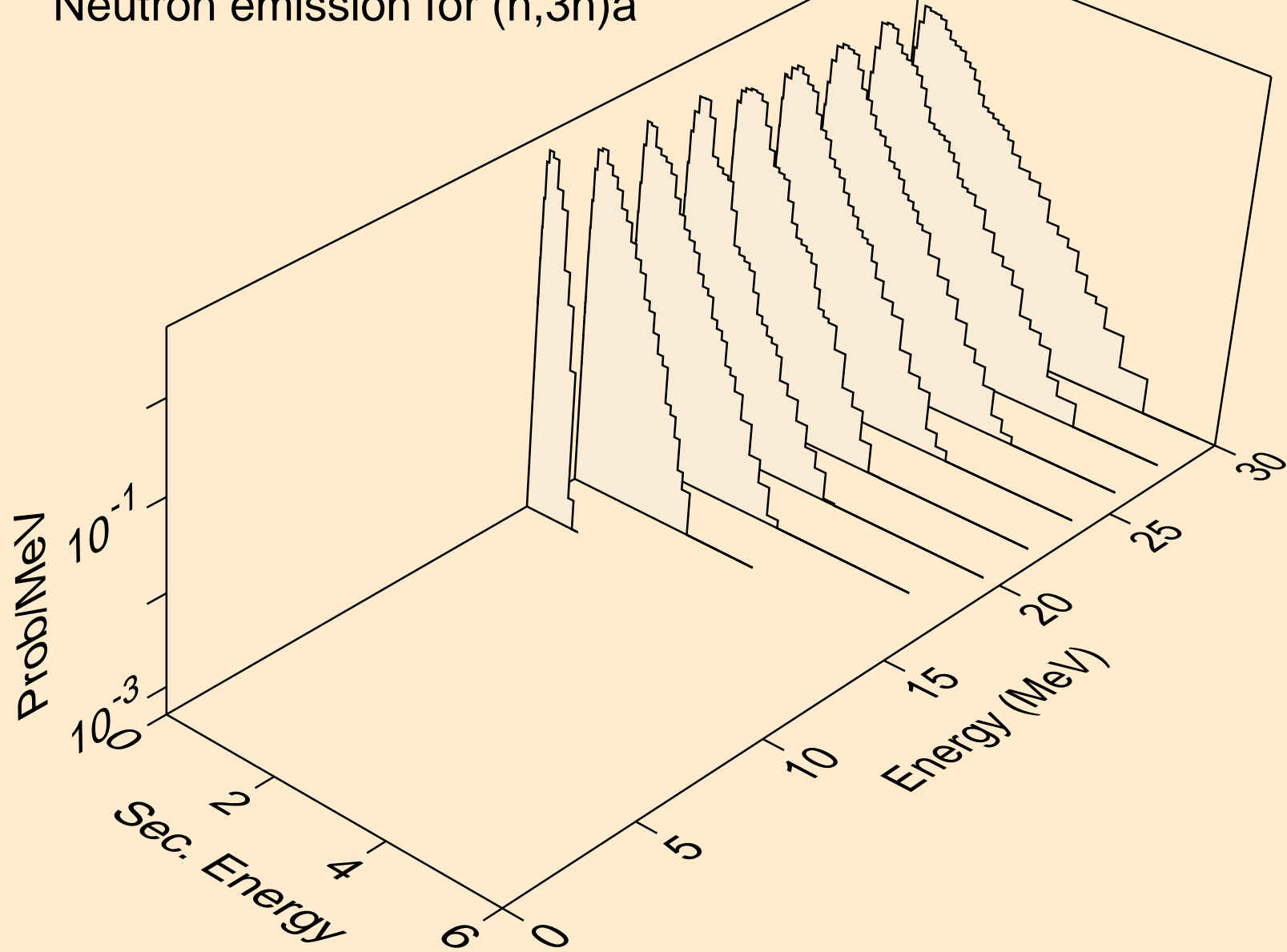

ES254 NEUTRON ACER TENDL-2021 LIBRARY; T=293.6K  
Neutron emission for (n,n\*)p

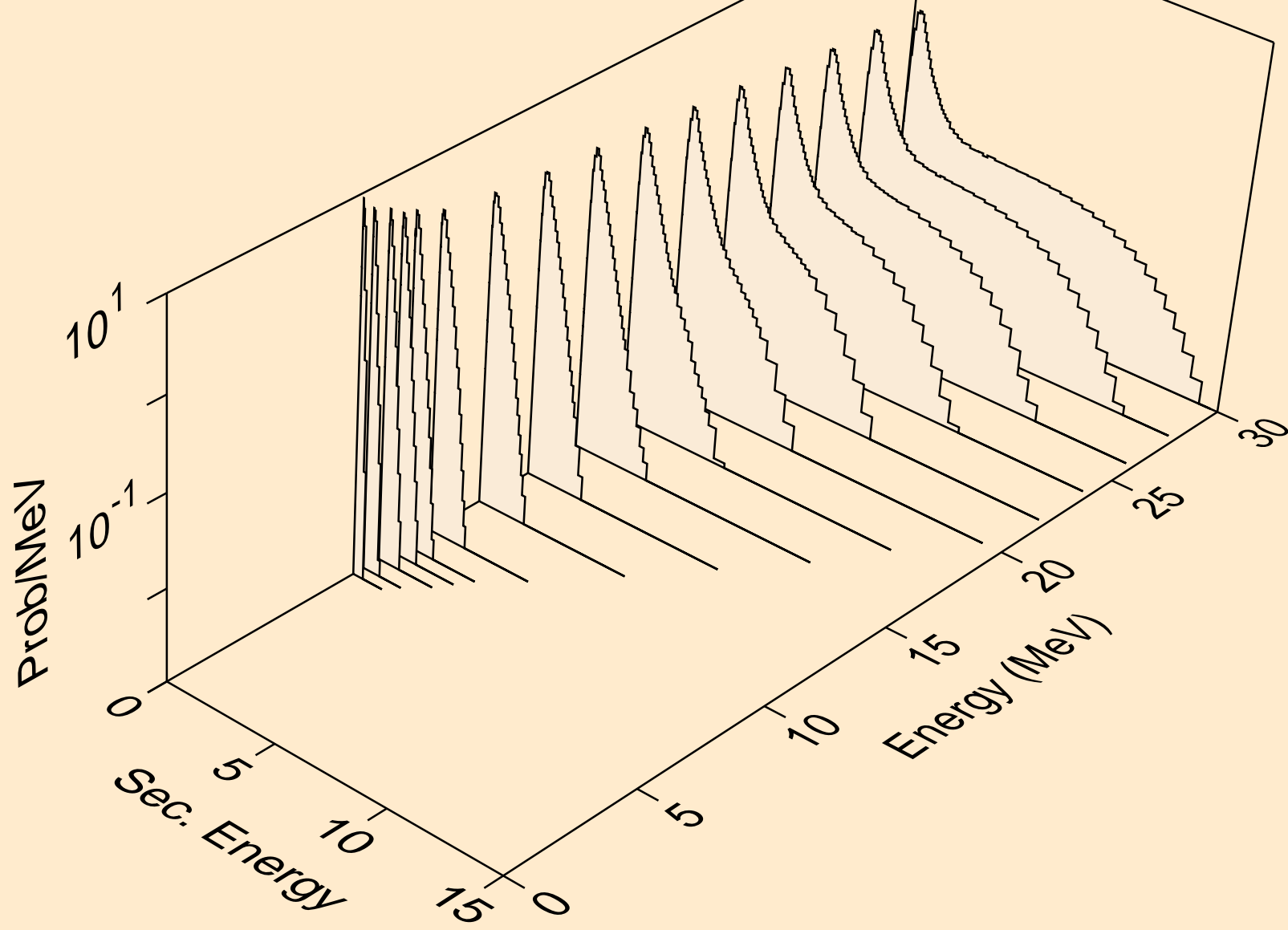

ES254 NEUTRON ACER TENDL-2021 LIBRARY; T=293.6K  
Neutron emission for (n,n\*)d

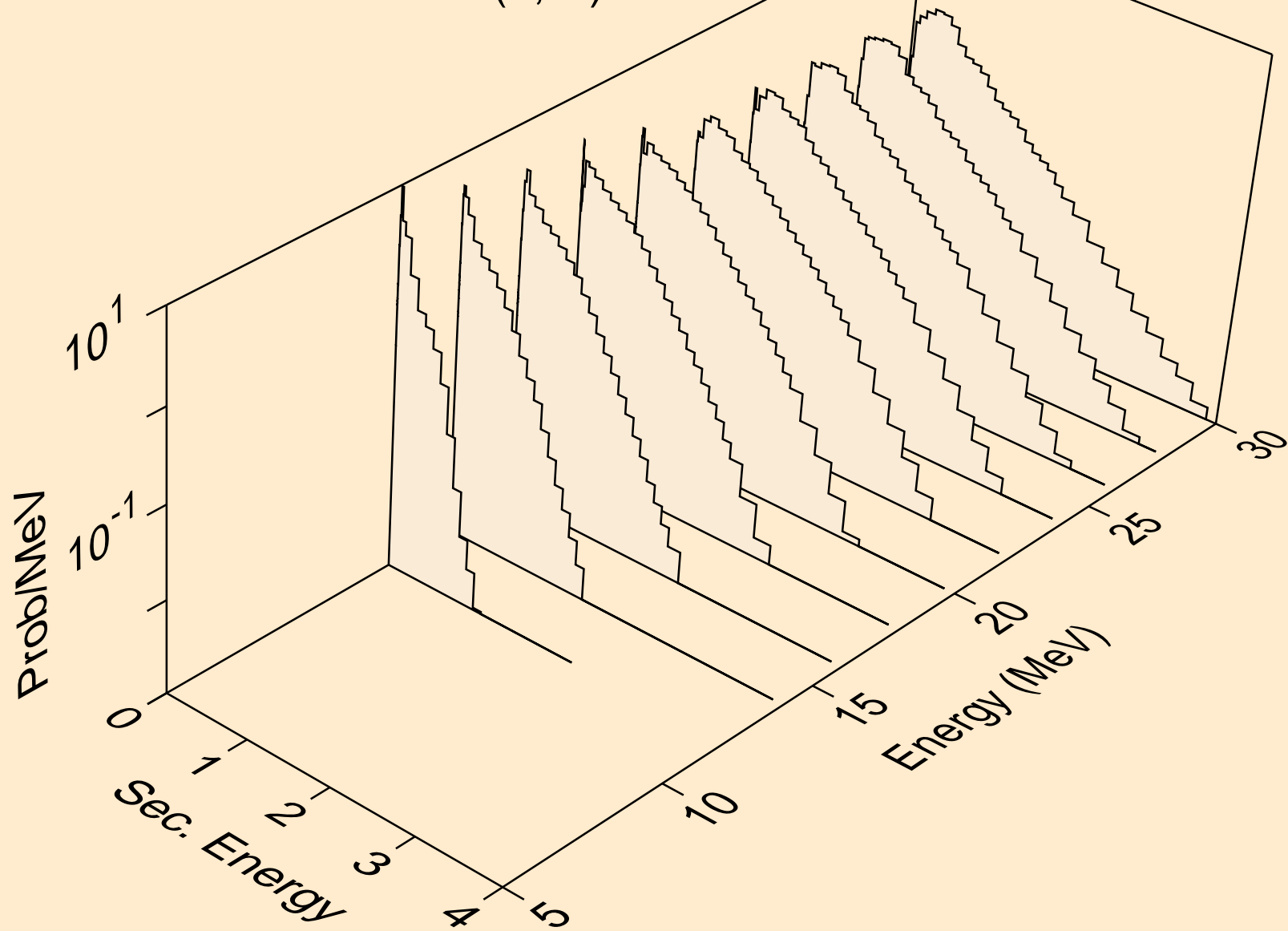

ES254 NEUTRON ACER TENDL-2021 LIBRARY; T=293.6K  
Neutron emission for (n,n\*)t

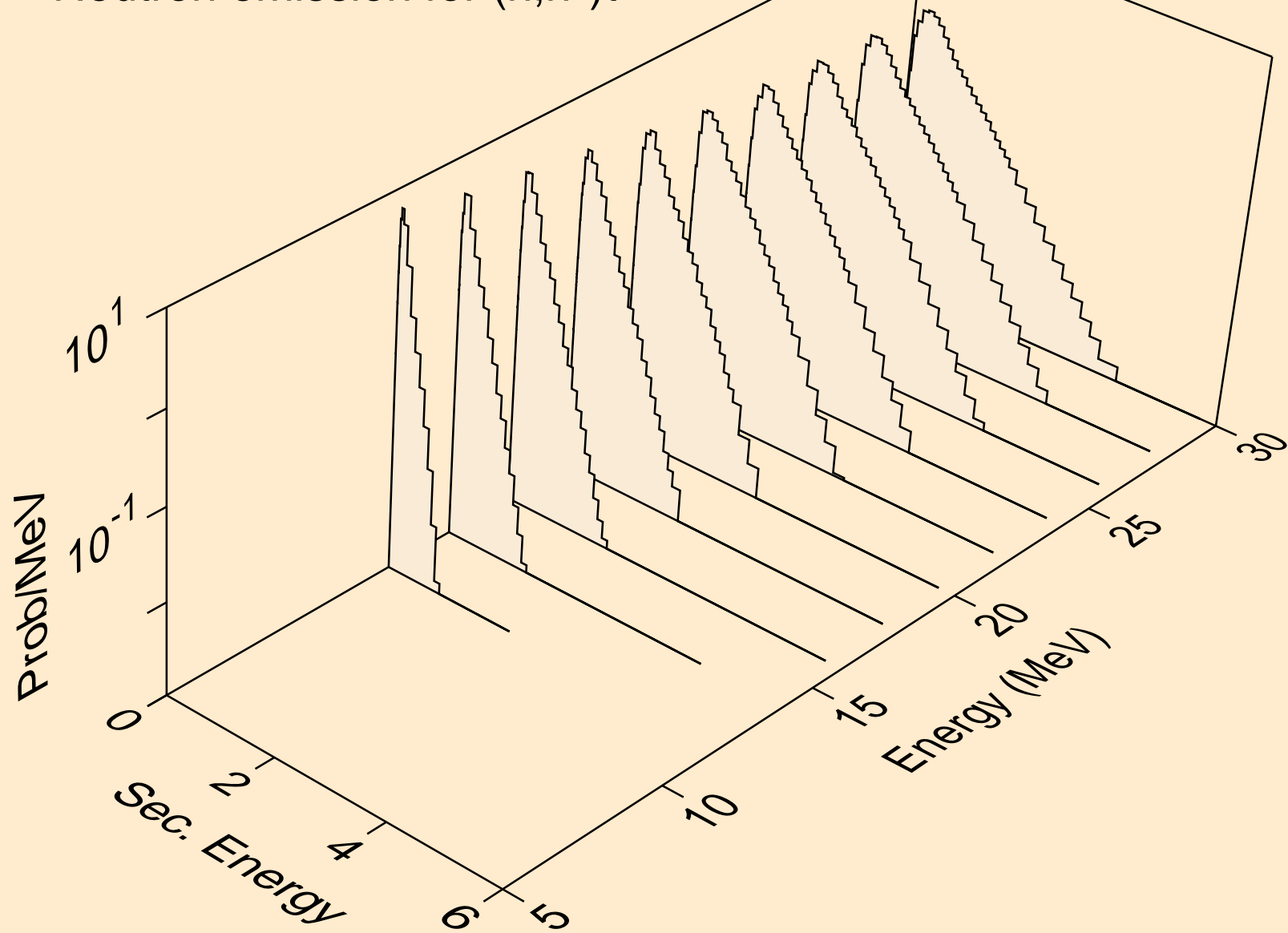



ES254 NEUTRON ACER TENDL-2021 LIBRARY; T=293.6K  
Neutron emission for (n,n\*)he3

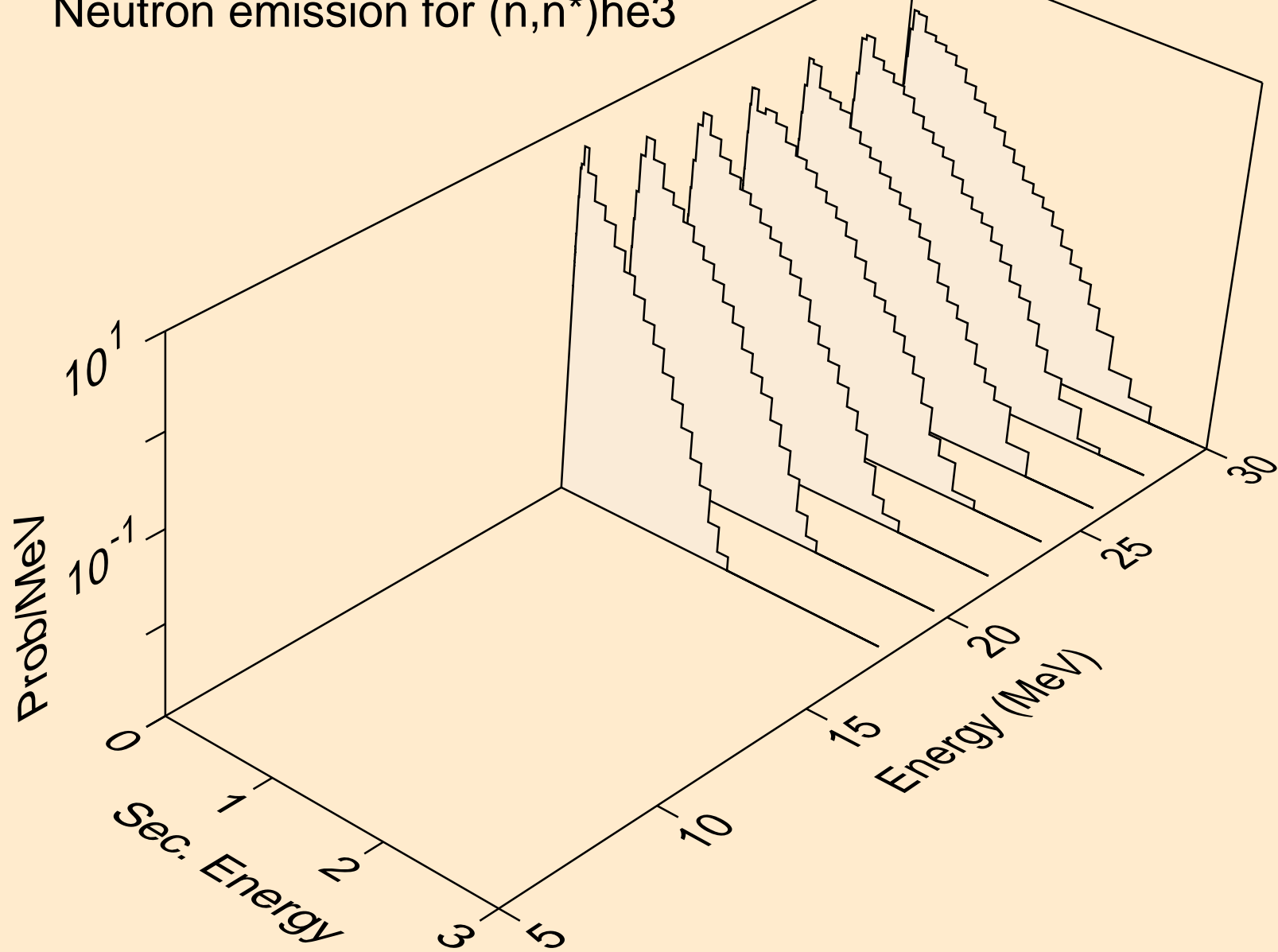

ES254 NEUTRON ACER TENDL-2021 LIBRARY; T=293.6K  
Neutron emission for (n,4n)

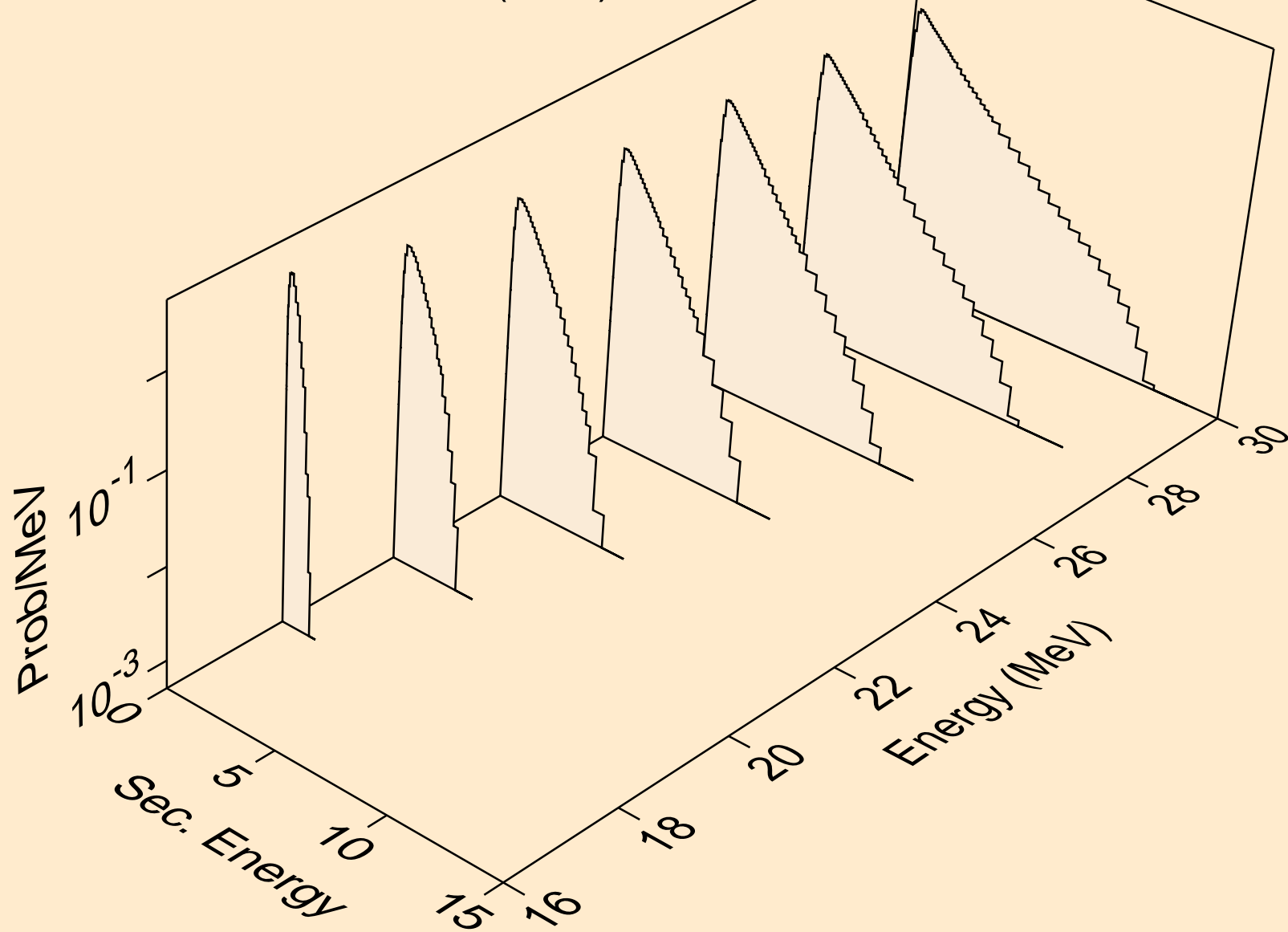

ES254 NEUTRON ACER TENDL-2021 LIBRARY; T=293.6K  
Neutron emission for (n,2np)

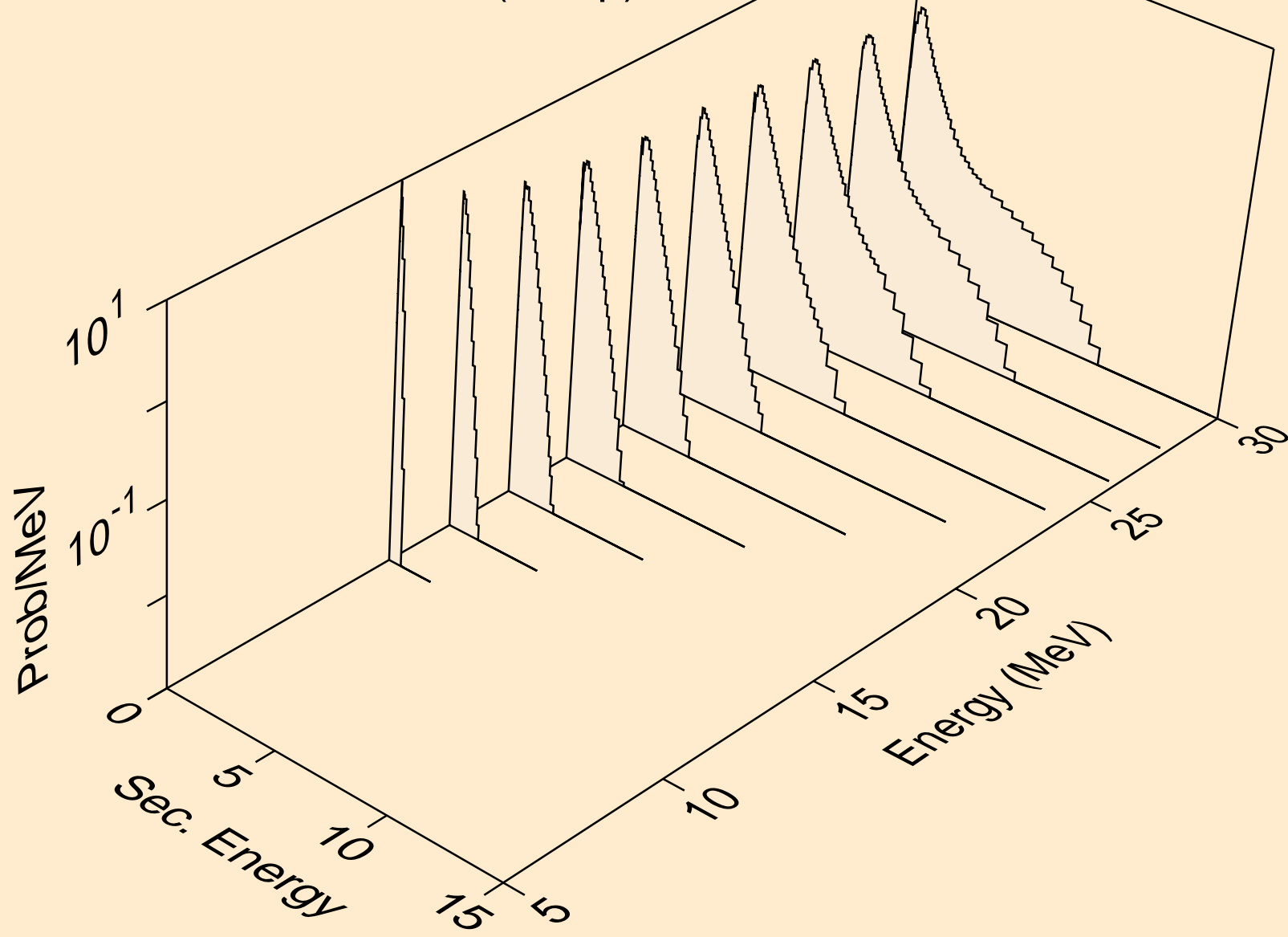

ES254 NEUTRON ACER TENDL-2021 LIBRARY; T=293.6K  
Neutron emission for (n,3np)

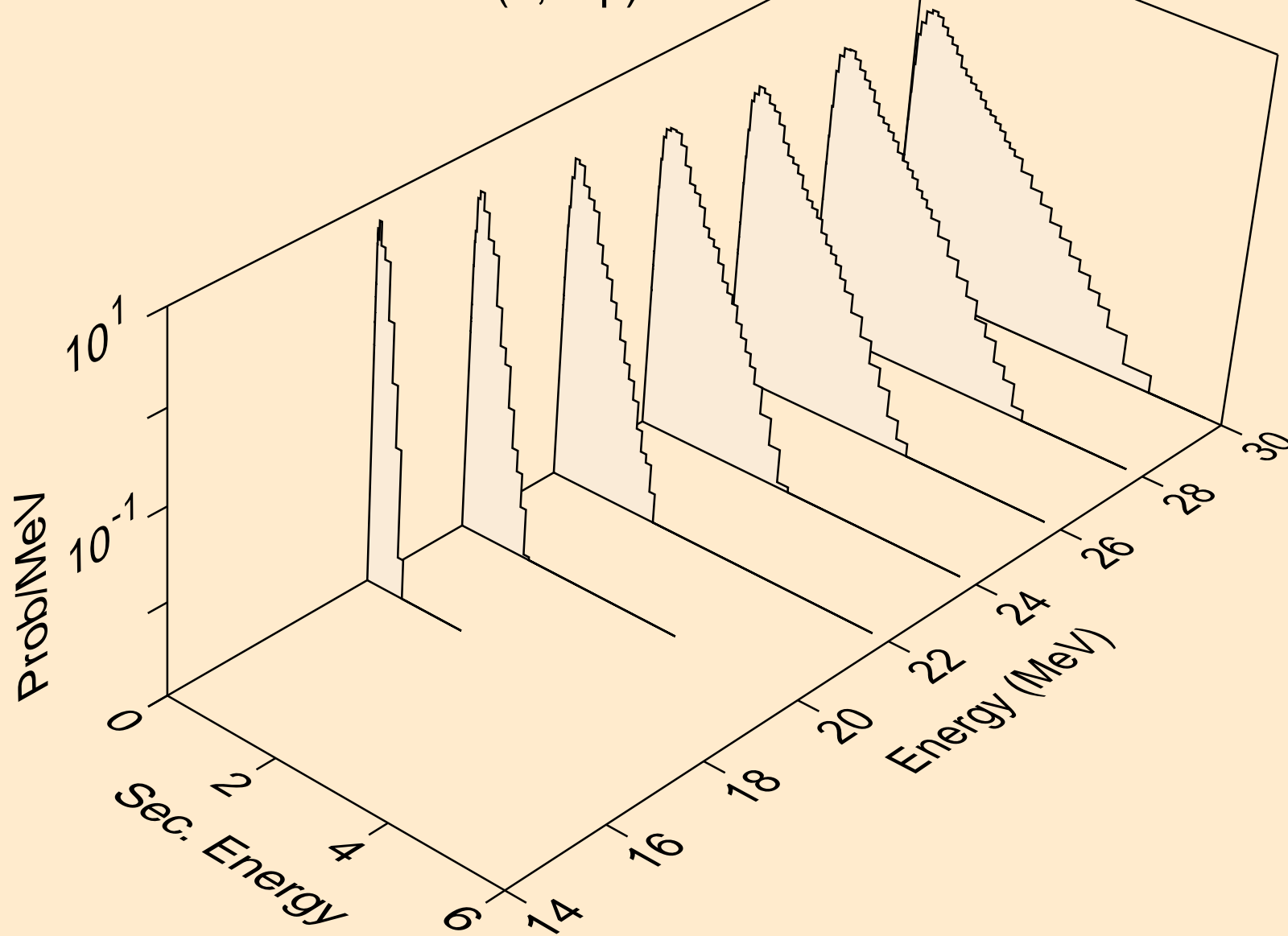

ES254 NEUTRON ACER TENDL-2021 LIBRARY; T=293.6K  
Neutron emission for (n,2np)

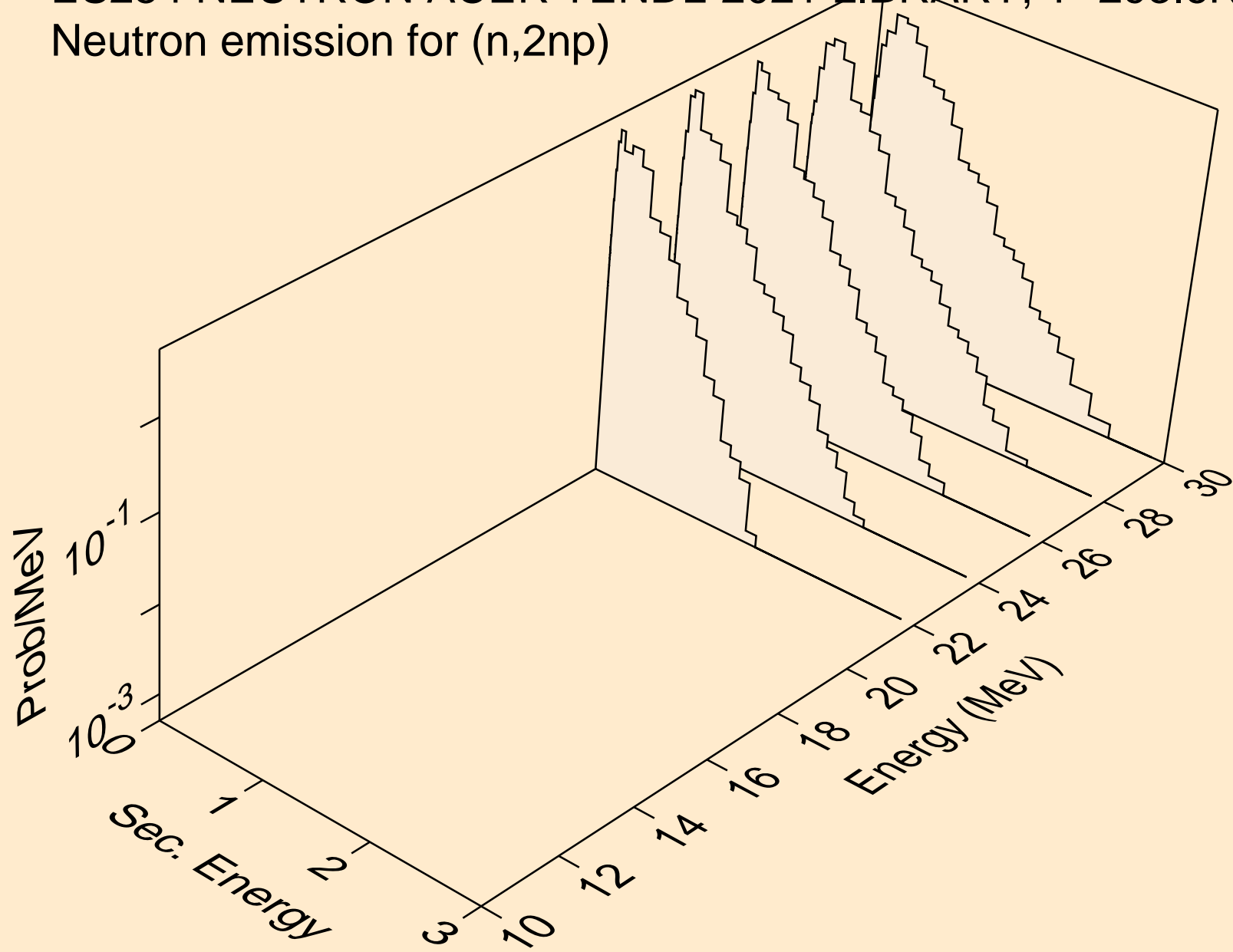

ES254 NEUTRON ACER TENDL-2021 LIBRARY; T=293.6K  
Neutron emission for (n,npa)

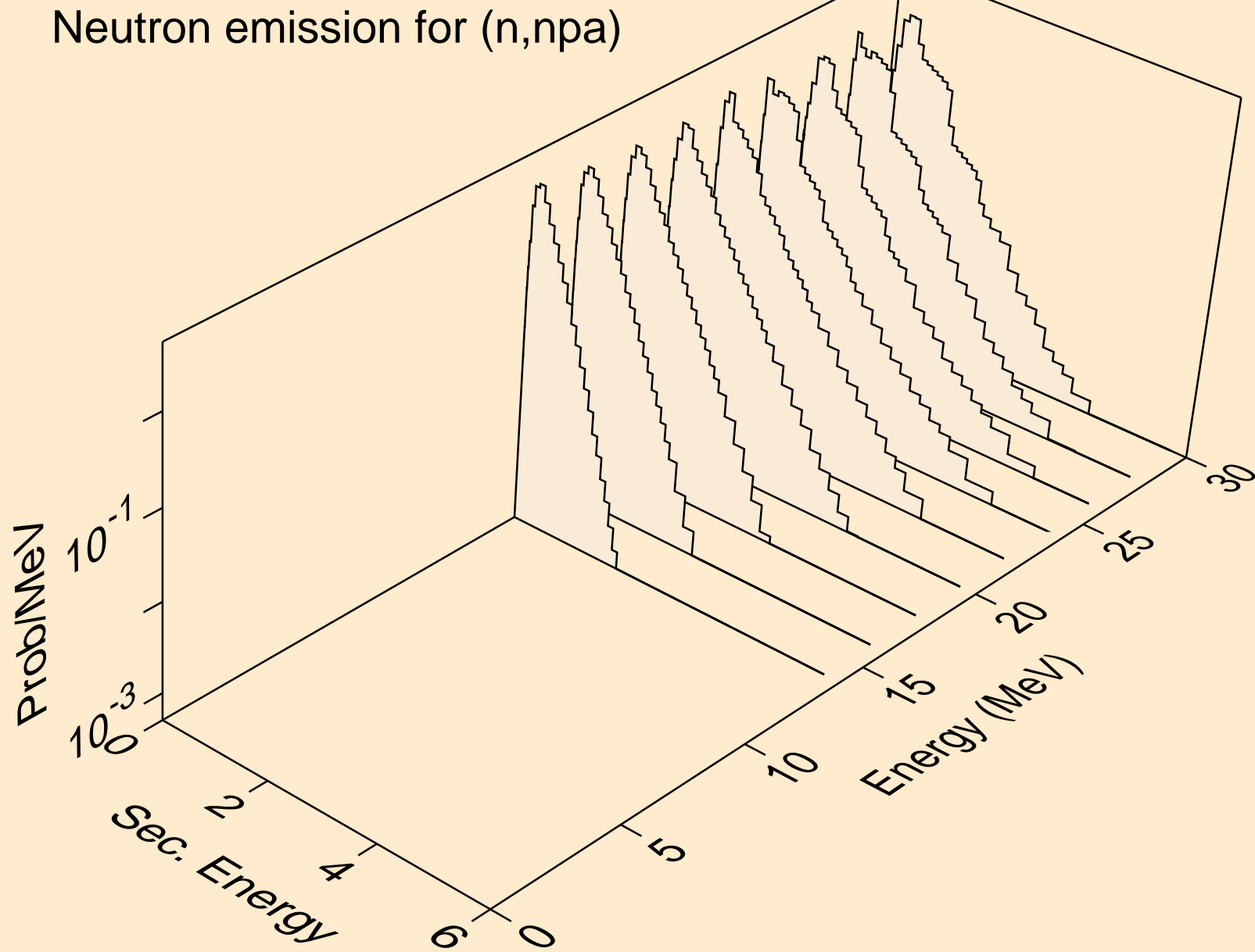

ES254 NEUTRON ACER TENDL-2021 LIBRARY; T=293.6K  
Neutron emission for (n,n\*c)

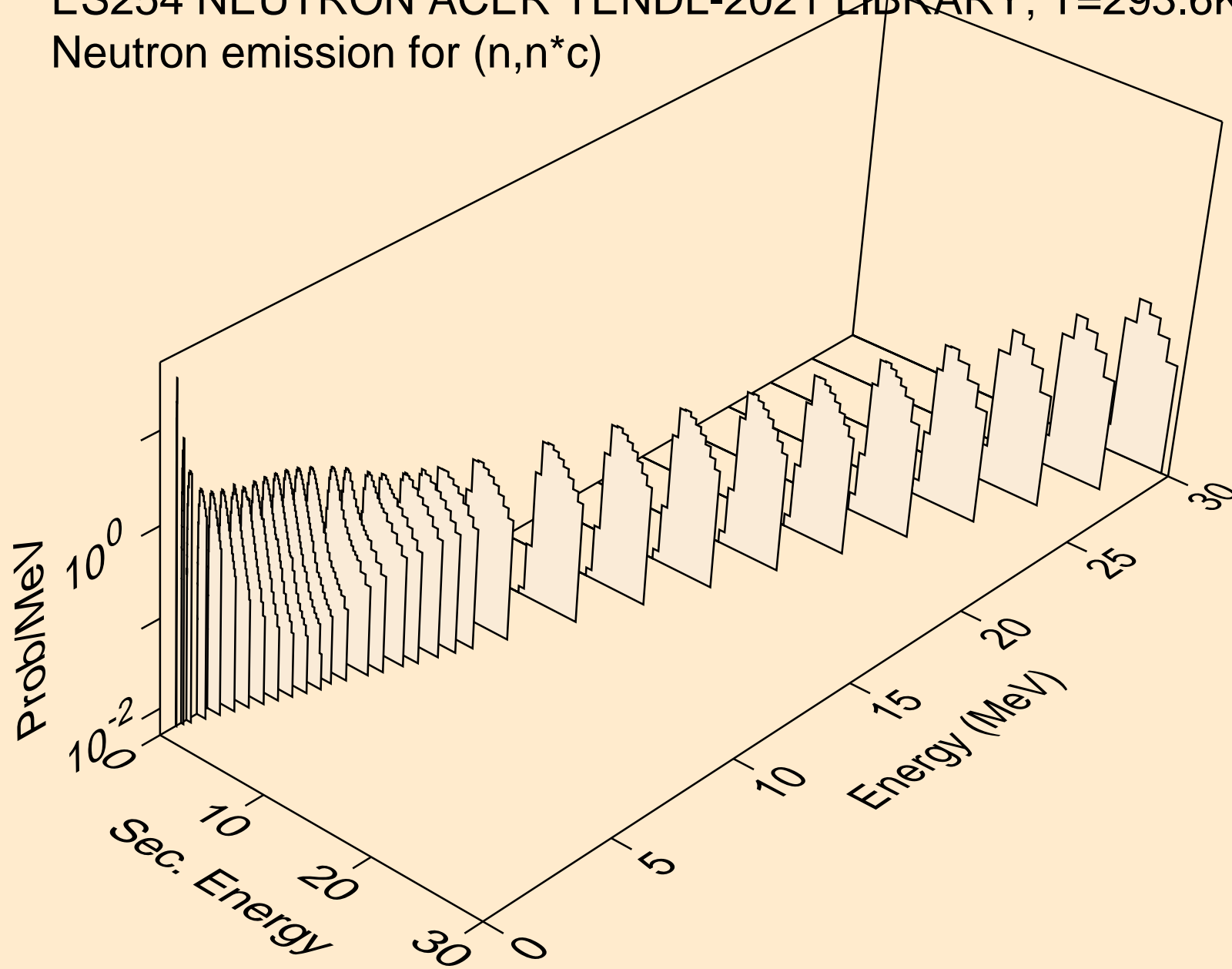

# ES254 NEUTRON ACER TENDL-2021 LIBRARY; T=293.6K

## Delayed nubar

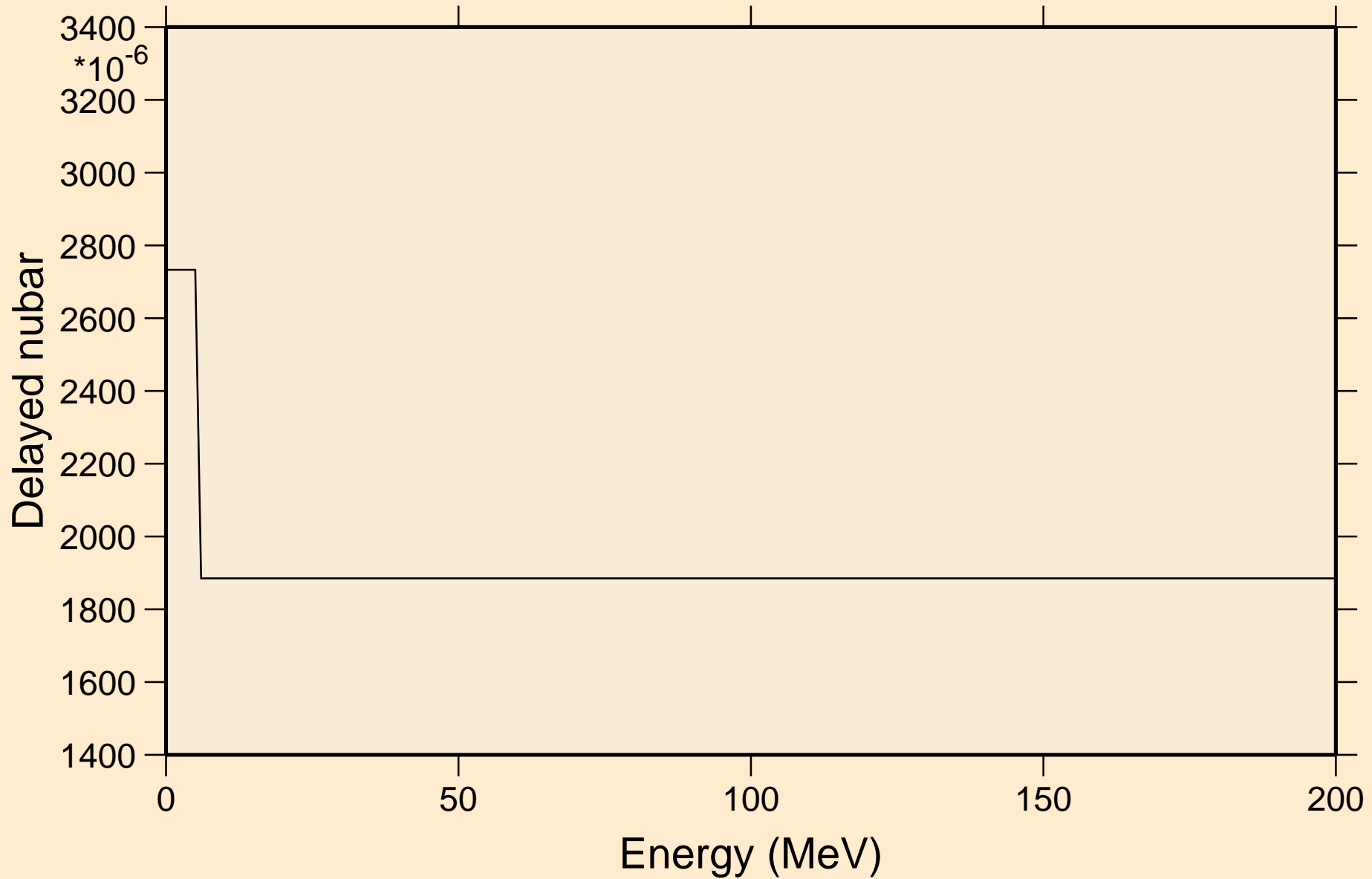



# ES254 NEUTRON ACER TENDL-2021 LIBRARY; T=293.6K

## Delayed neutron spectra

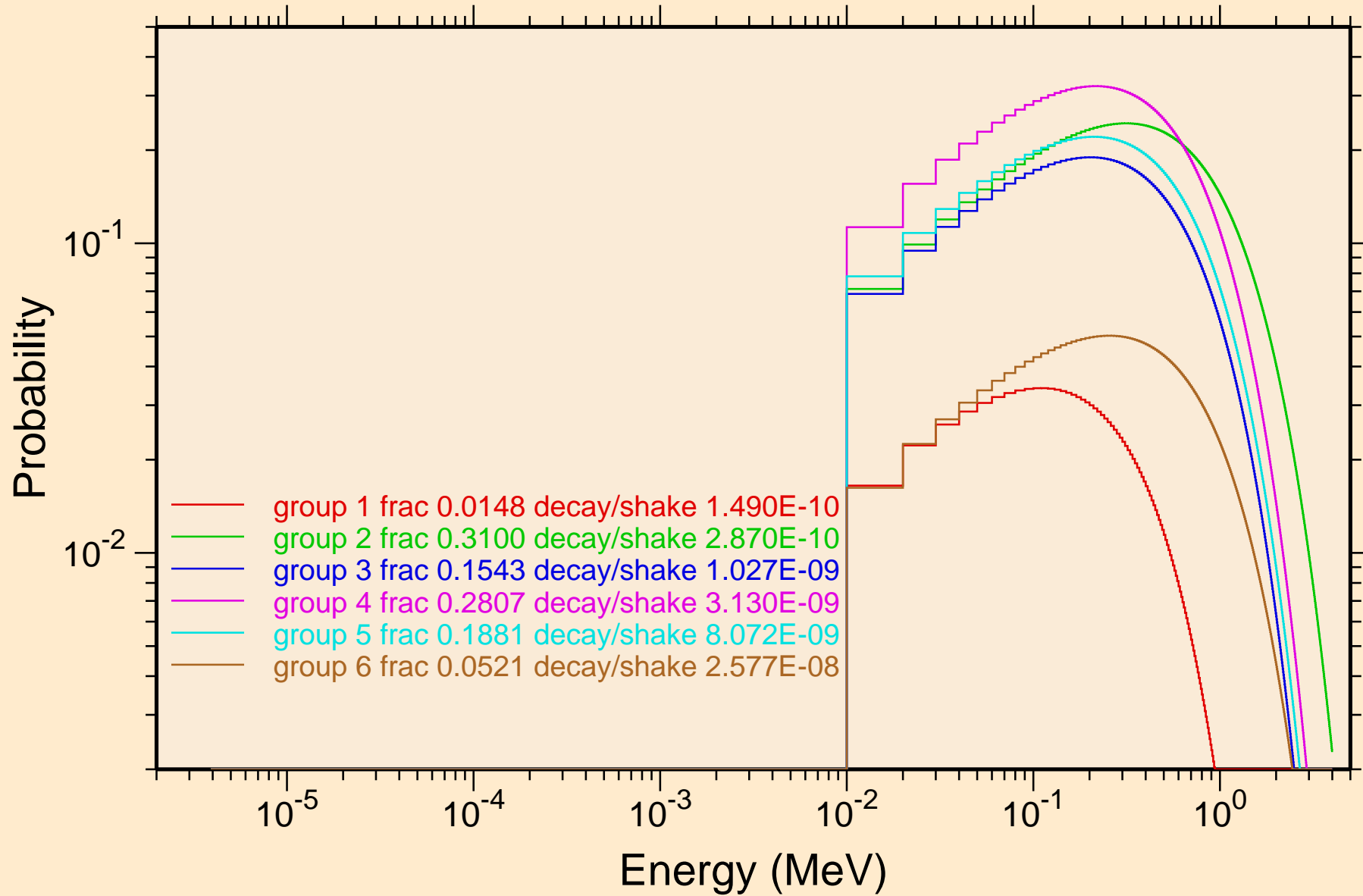

ES254 NEUTRON ACER TENDL-2021 LIBRARY; T=293.6K  
Photon emission for (n,x)

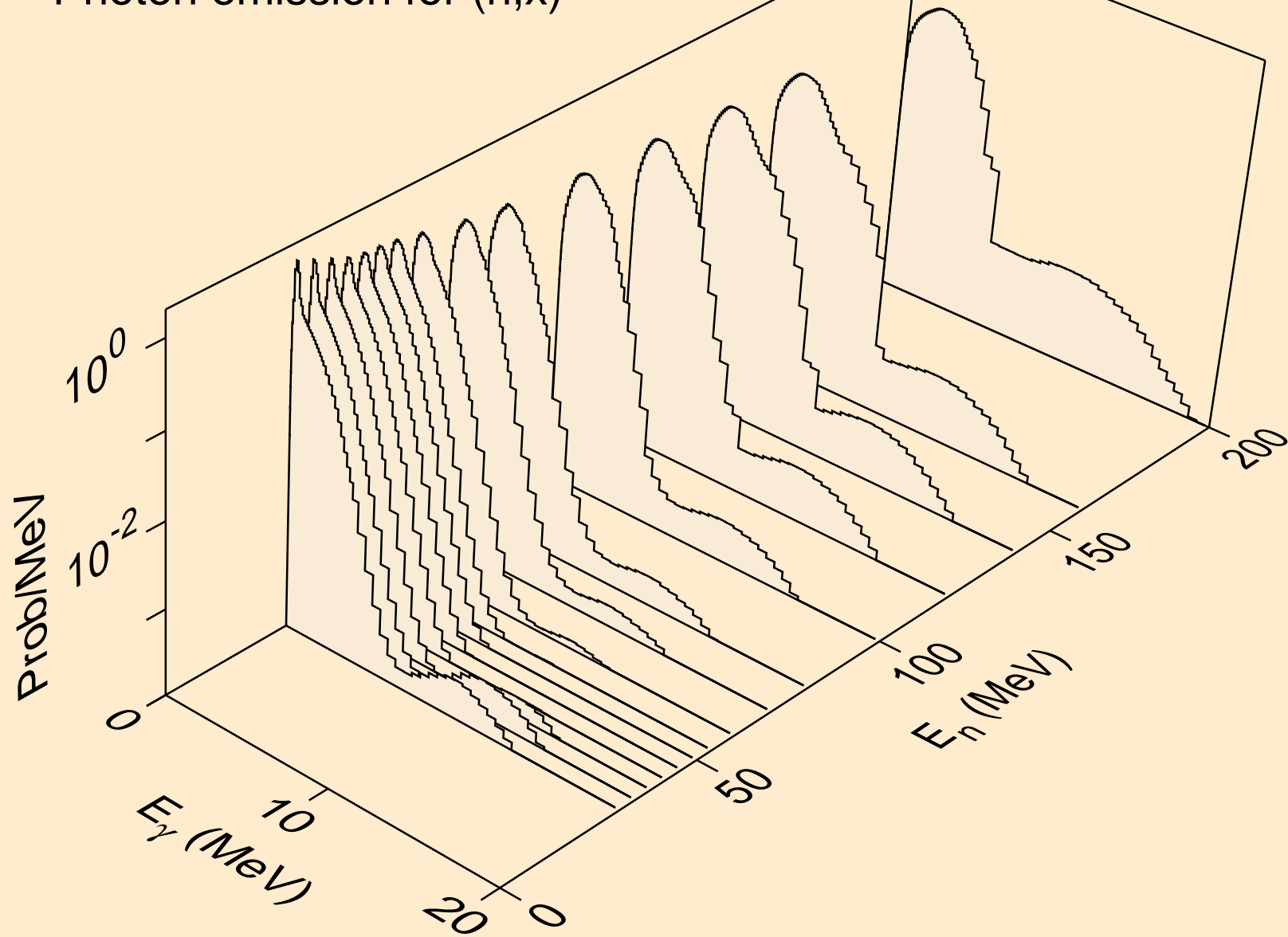

ES254 NEUTRON ACER TENDL-2021 LIBRARY; T=293.6K  
Photon emission for (n,2nd)

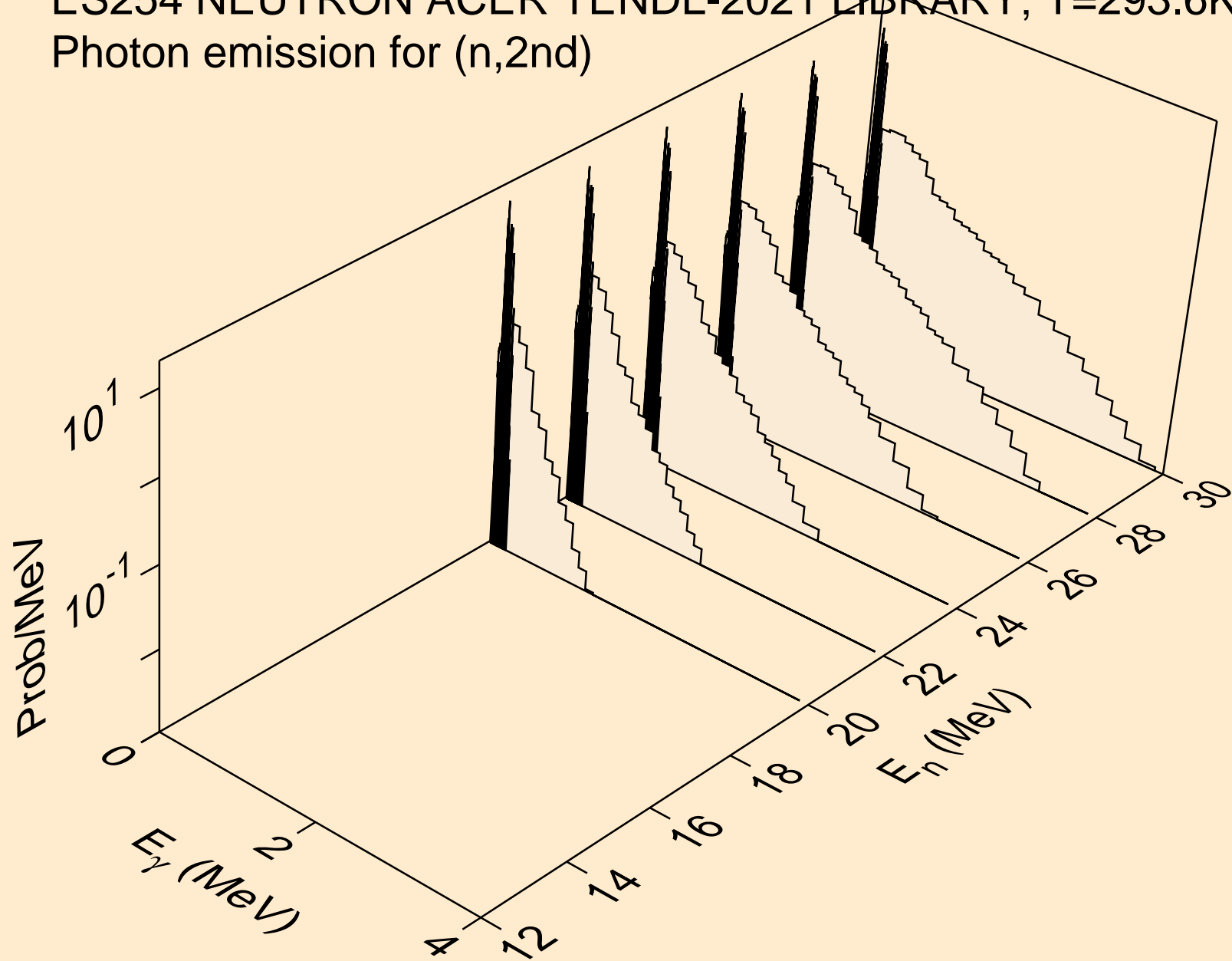

ES254 NEUTRON ACER TENDL-2021 LIBRARY; T=293.6K  
Photon emission for (n,2n)

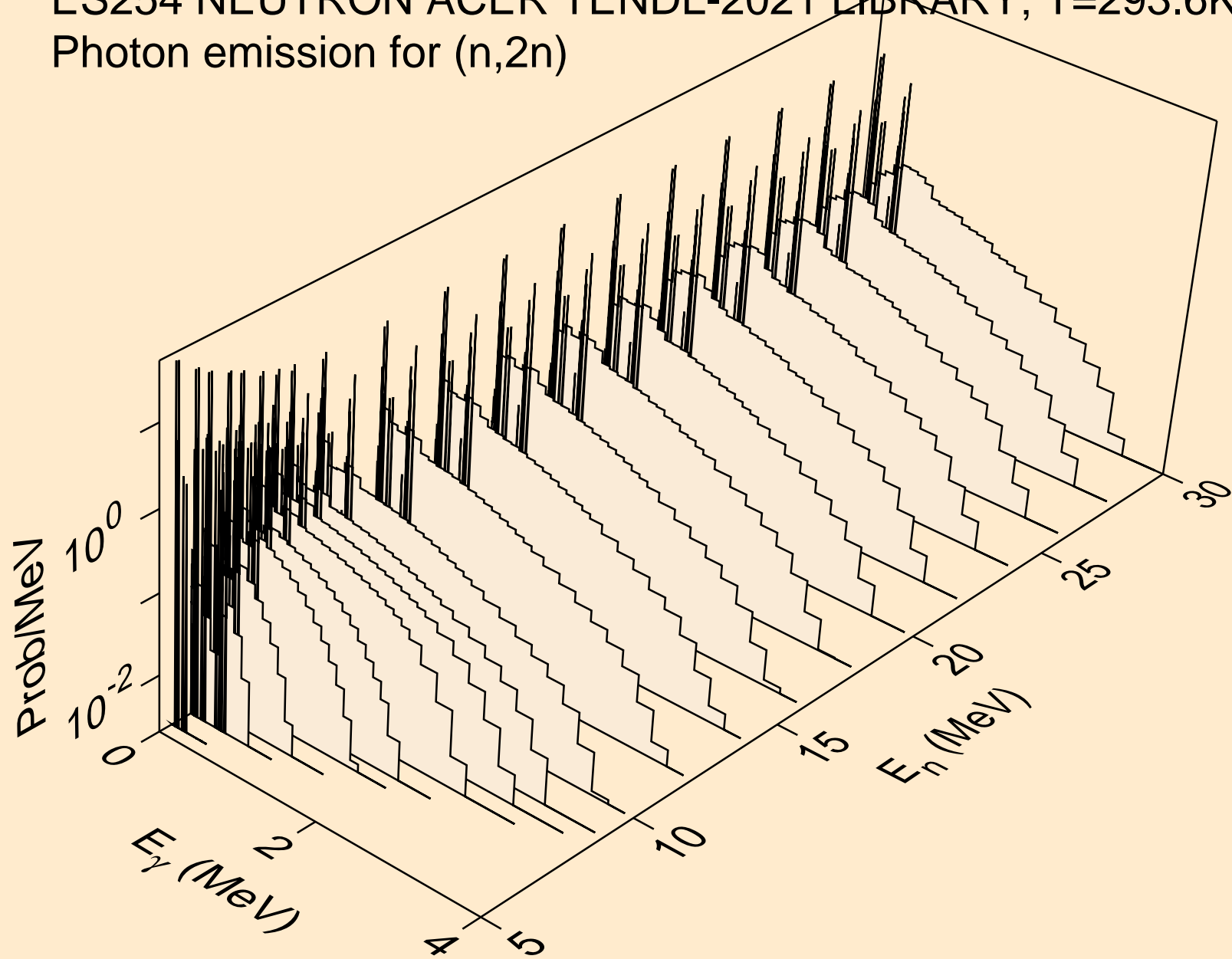

ES254 NEUTRON ACER TENDL-2021 LIBRARY; T=293.6K  
Photon emission for (n,3n)

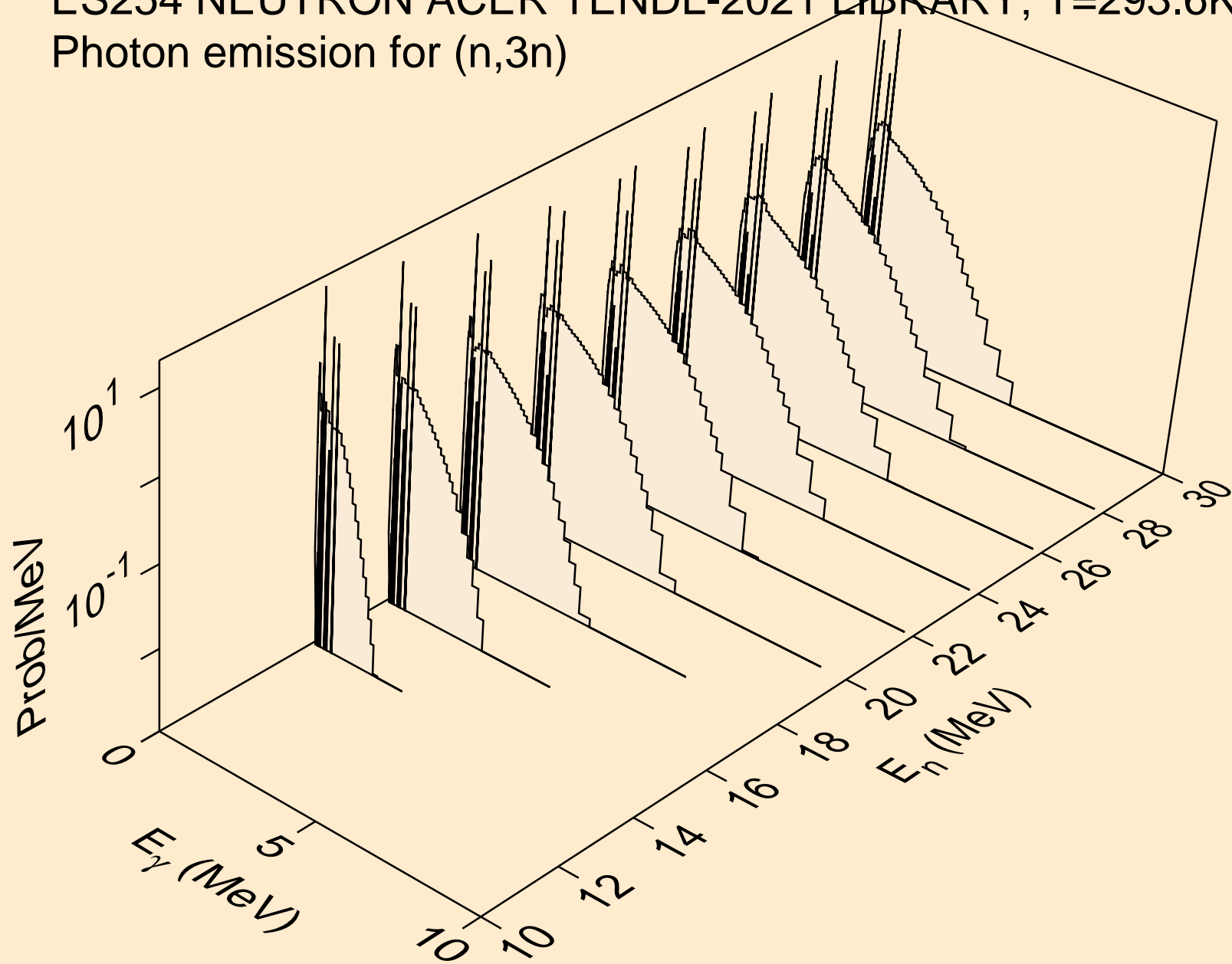

ES254 NEUTRON ACER TENDL-2021 LIBRARY; T=293.6K  
Photon emission for (n,n\*)a

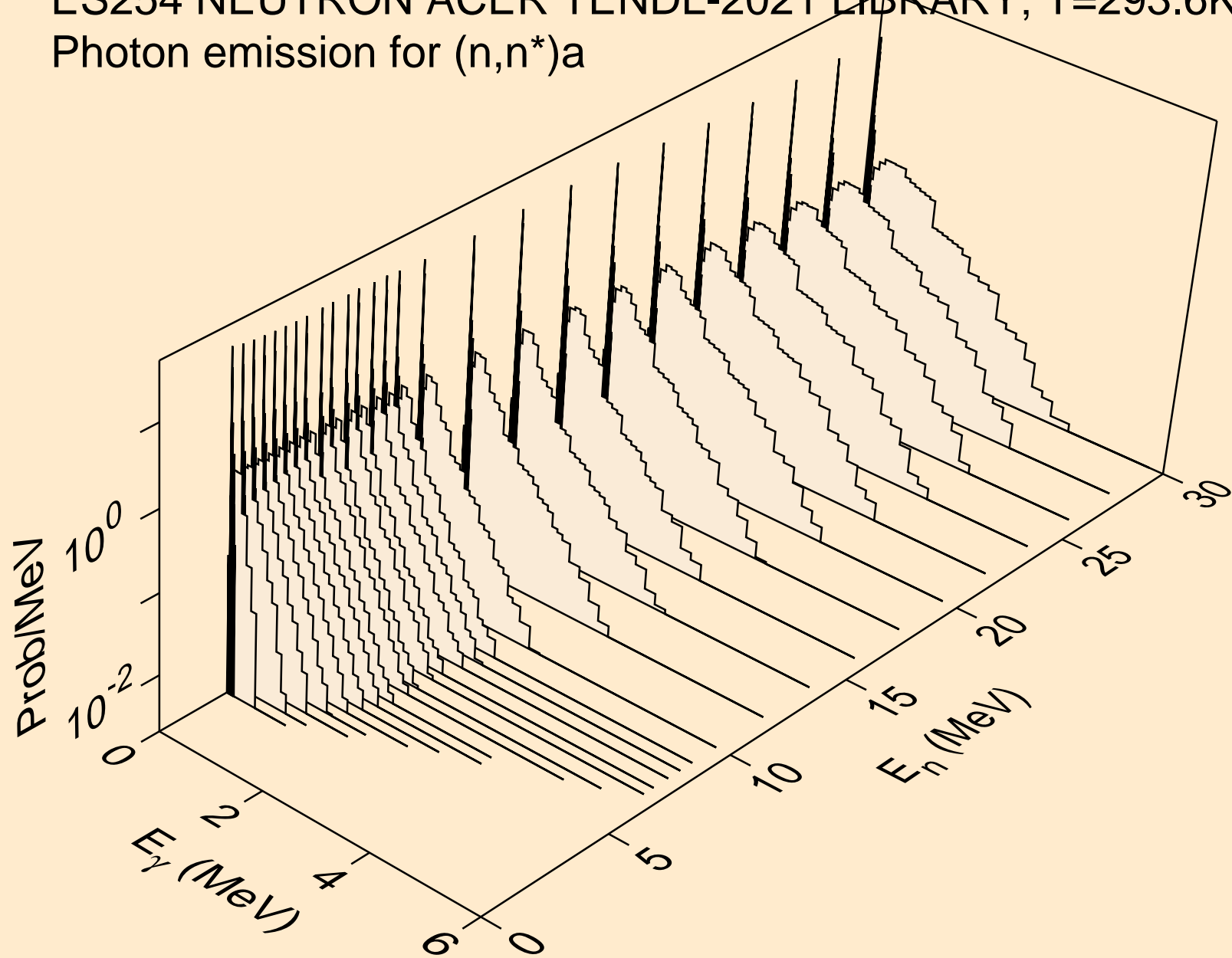

ES254 NEUTRON ACER TENDL-2021 LIBRARY; T=293.6K  
Photon emission for (n,2n)a

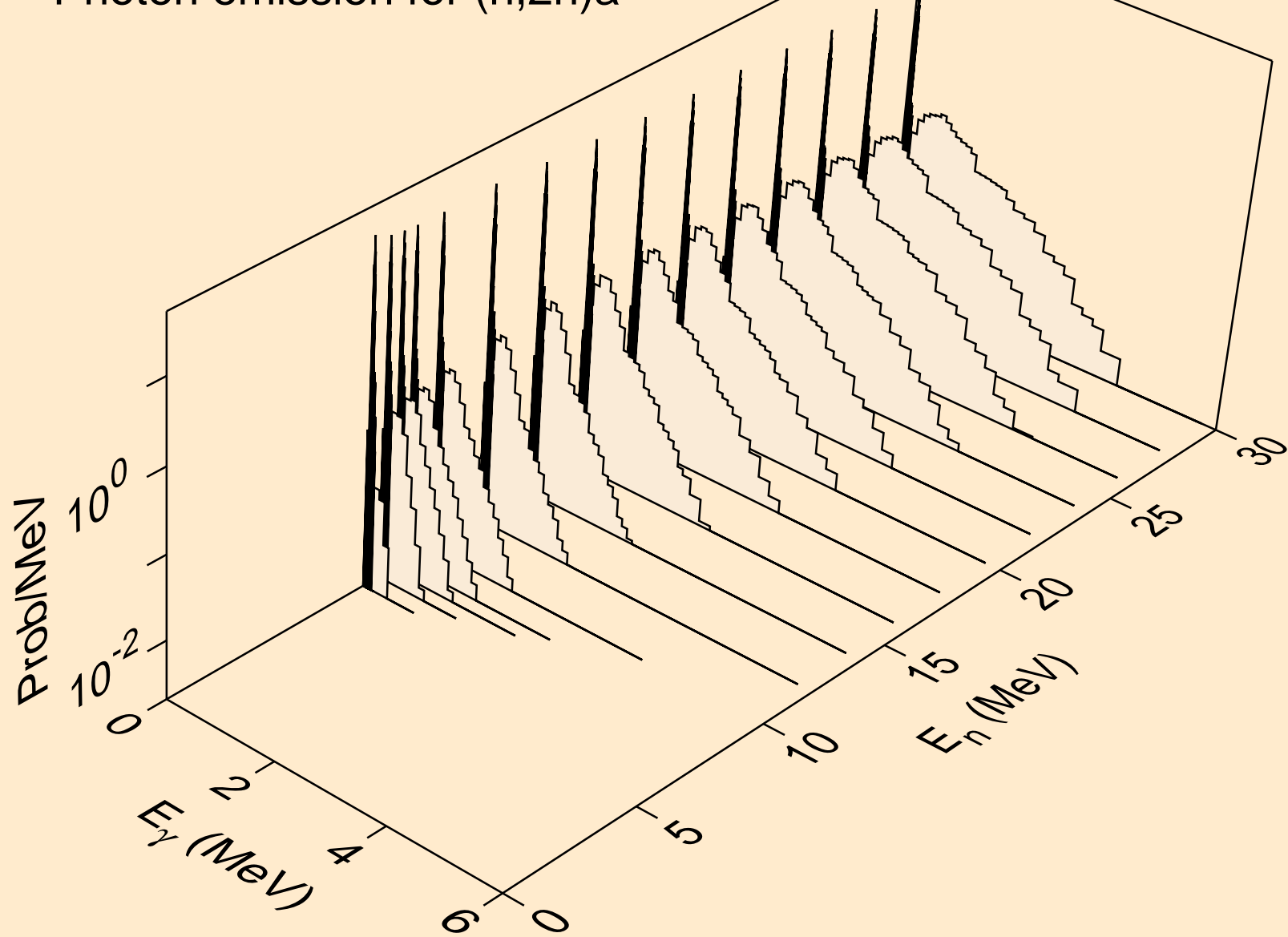

ES254 NEUTRON ACER TENDL-2021 LIBRARY; T=293.6K  
Photon emission for (n,3n)a

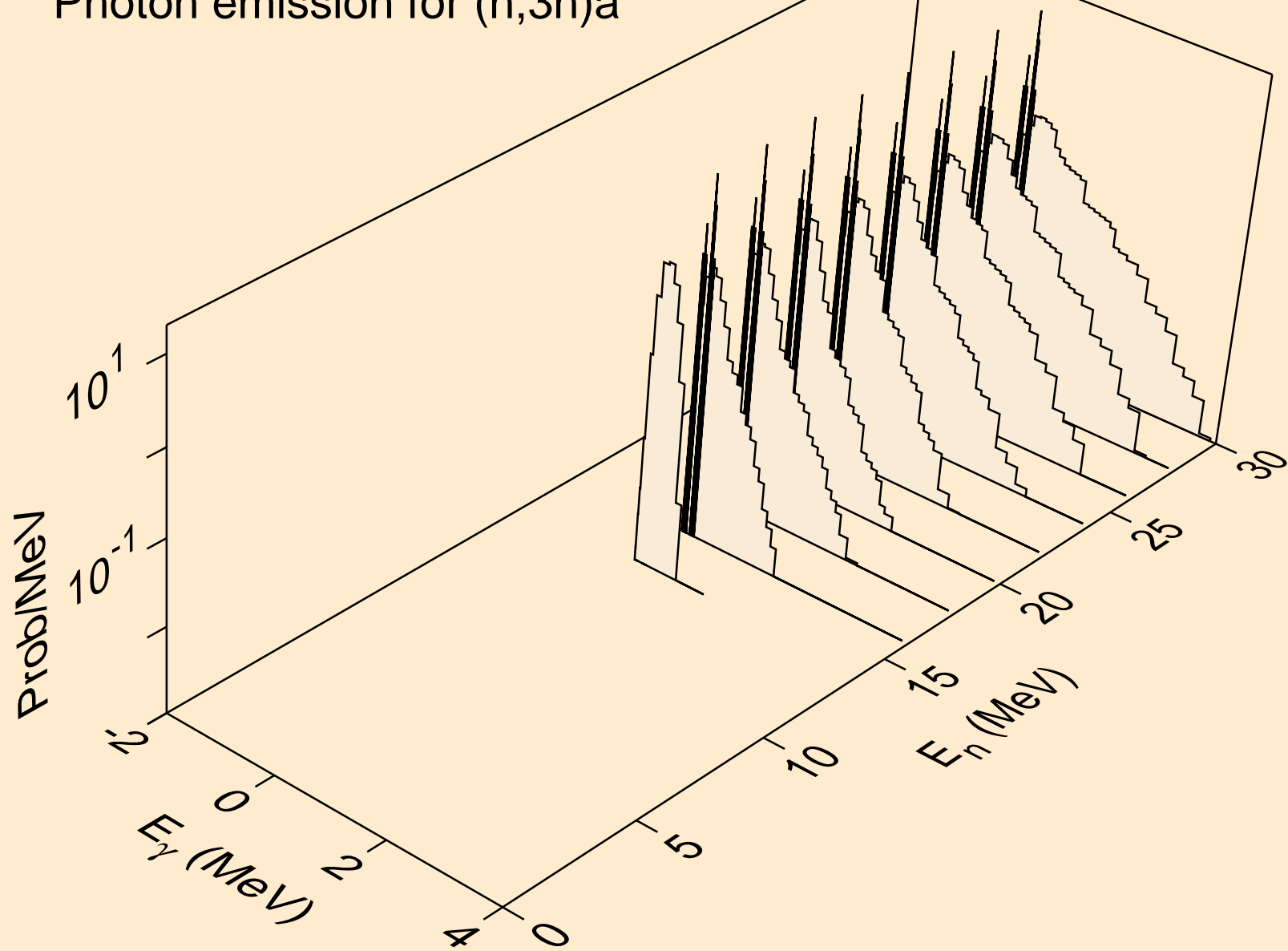



ES254 NEUTRON ACER TENDL-2021 LIBRARY; T=293.6K  
Photon emission for (n,n\*)p

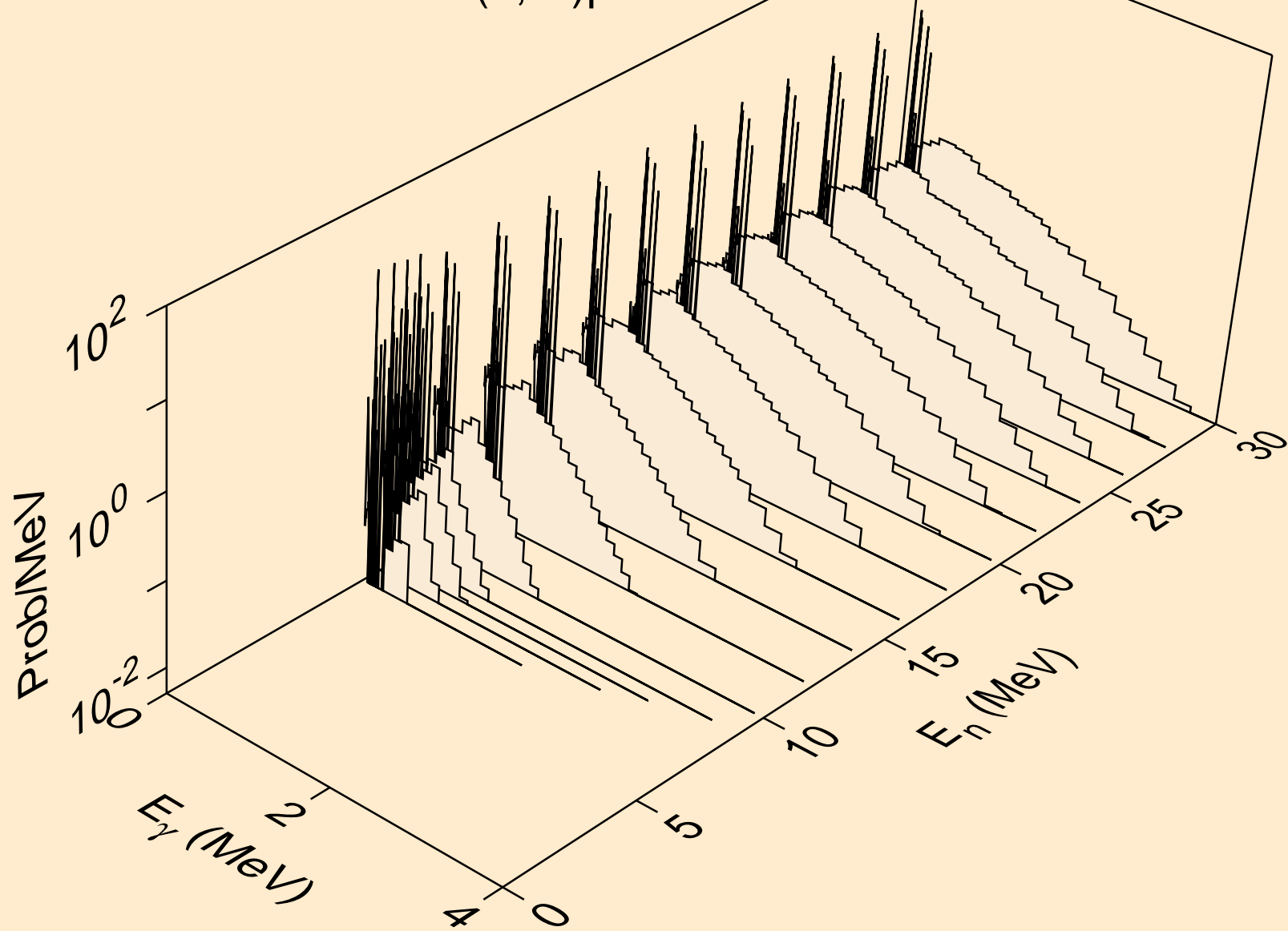

ES254 NEUTRON ACER TENDL-2021 LIBRARY; T=293.6K  
Photon emission for (n,n\*)d

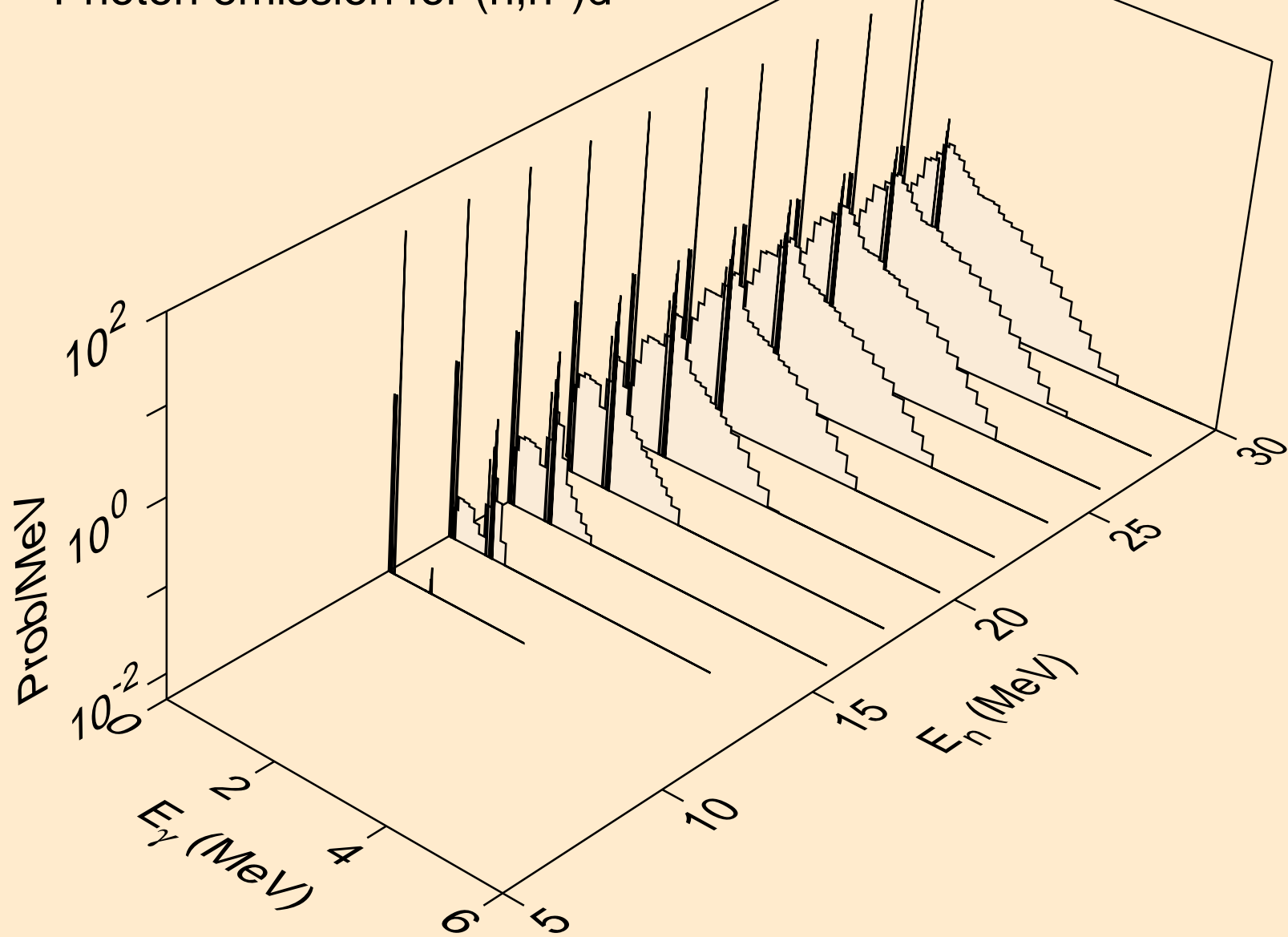

ES254 NEUTRON ACER TENDL-2021 LIBRARY; T=293.6K  
Photon emission for (n,n\*)t

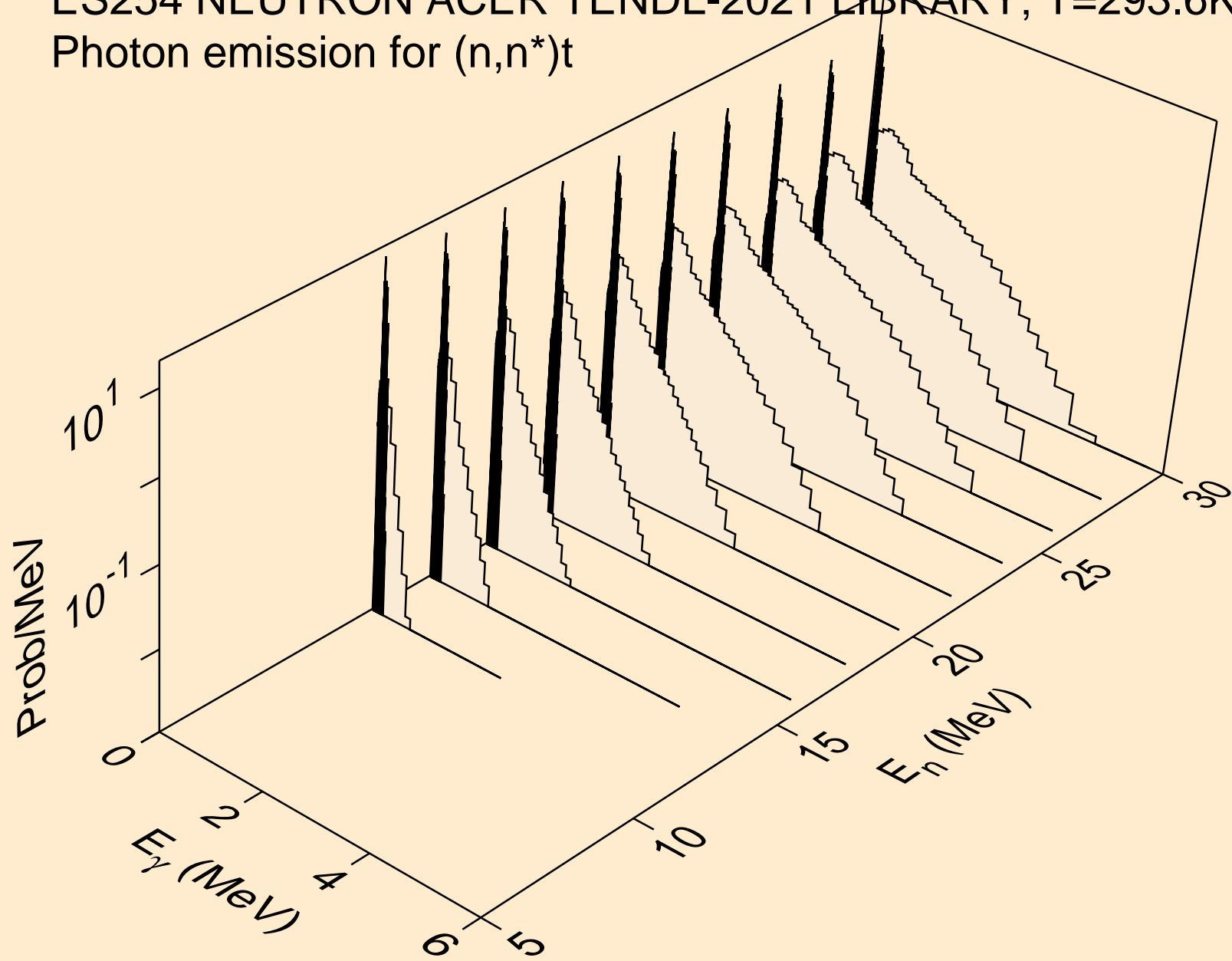

ES254 NEUTRON ACER TENDL-2021 LIBRARY; T=293.6K  
Photon emission for (n,n\*)he3

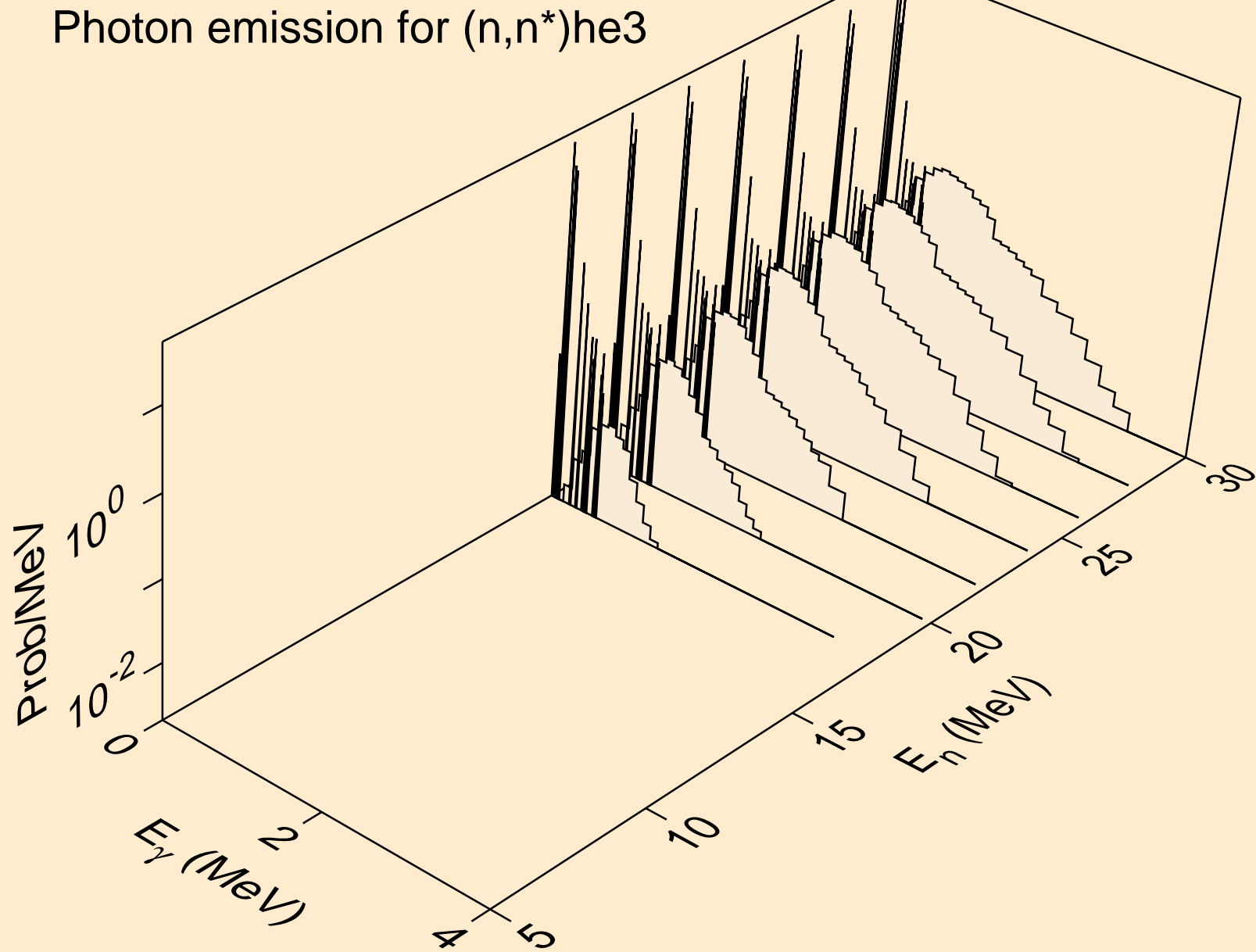

ES254 NEUTRON ACER TENDL-2021 LIBRARY; T=293.6K  
Photon emission for (n,4n)

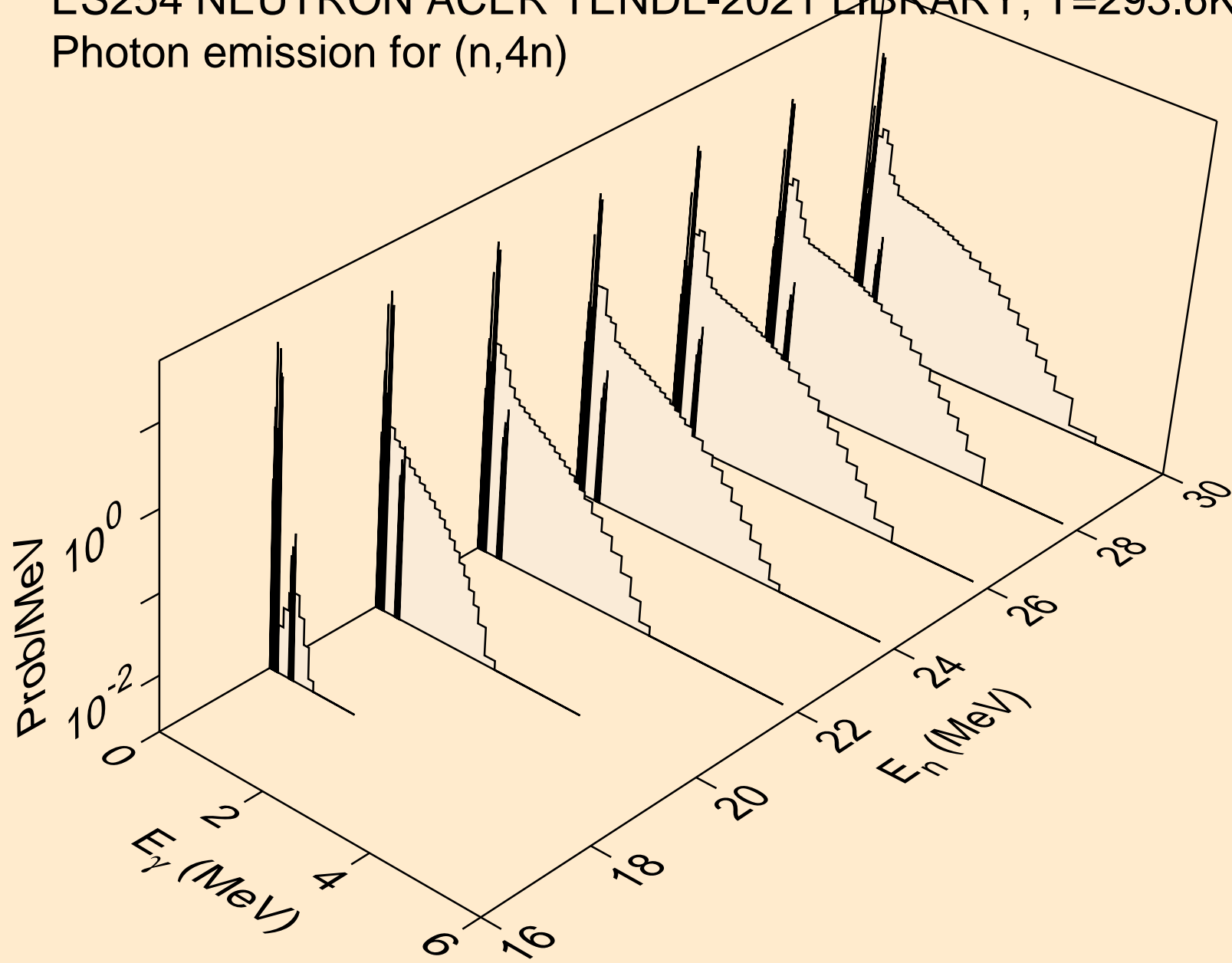

ES254 NEUTRON ACER TENDL-2021 LIBRARY; T=293.6K  
Photon emission for (n,2np)

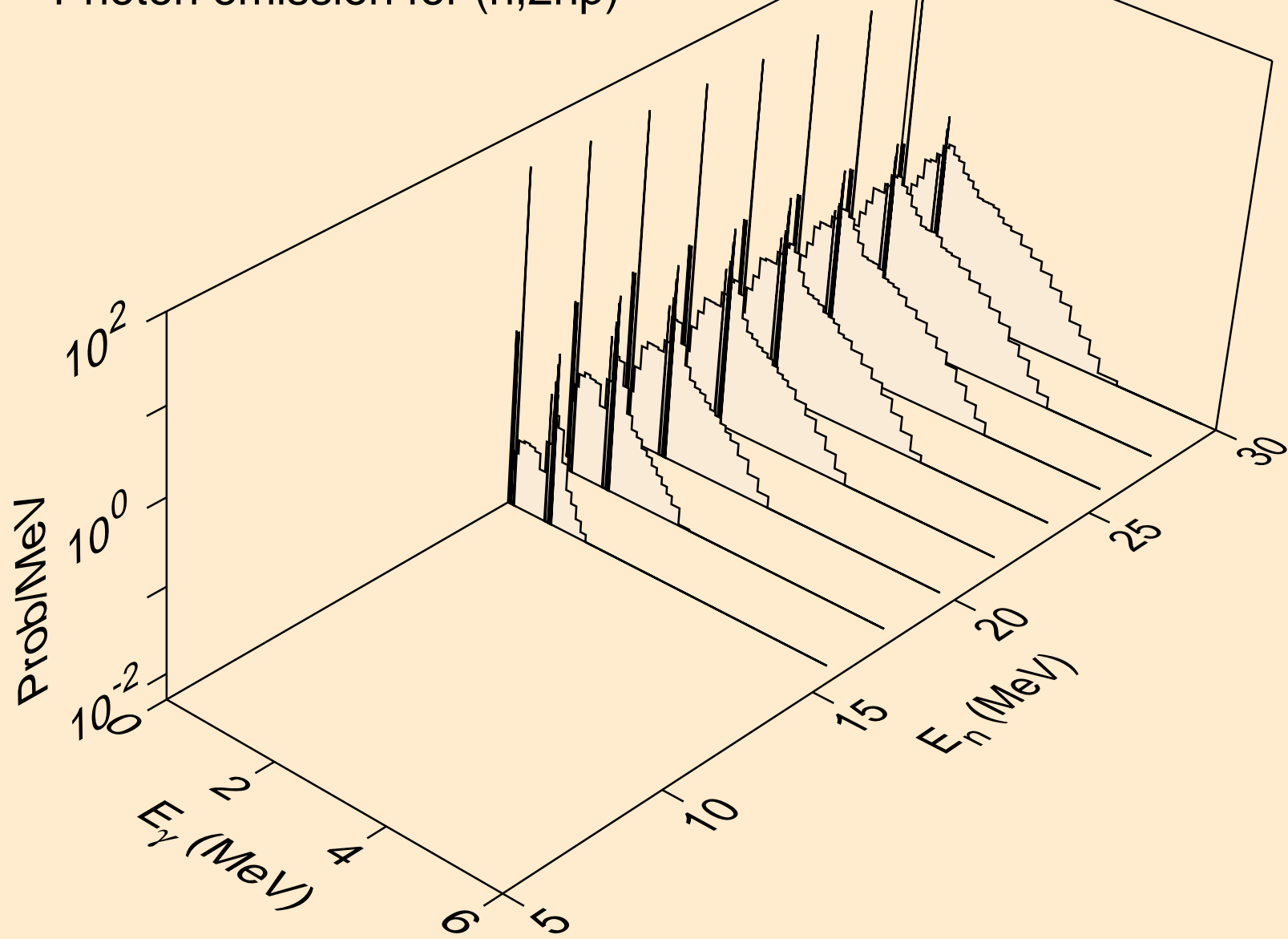

ES254 NEUTRON ACER TENDL-2021 LIBRARY; T=293.6K  
Photon emission for (n,3np)

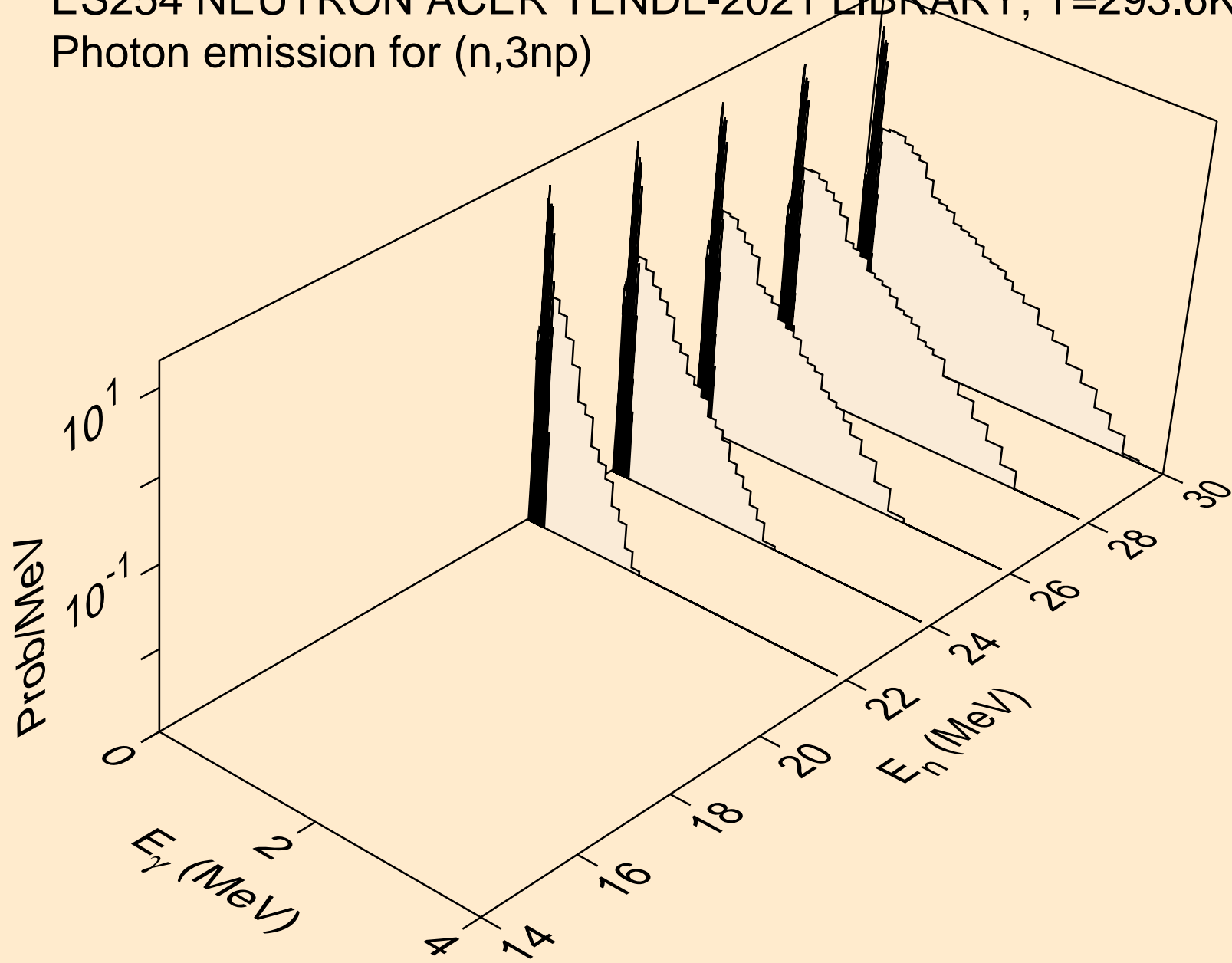

ES254 NEUTRON ACER TENDL-2021 LIBRARY; T=293.6K  
Photon emission for (n,2np)

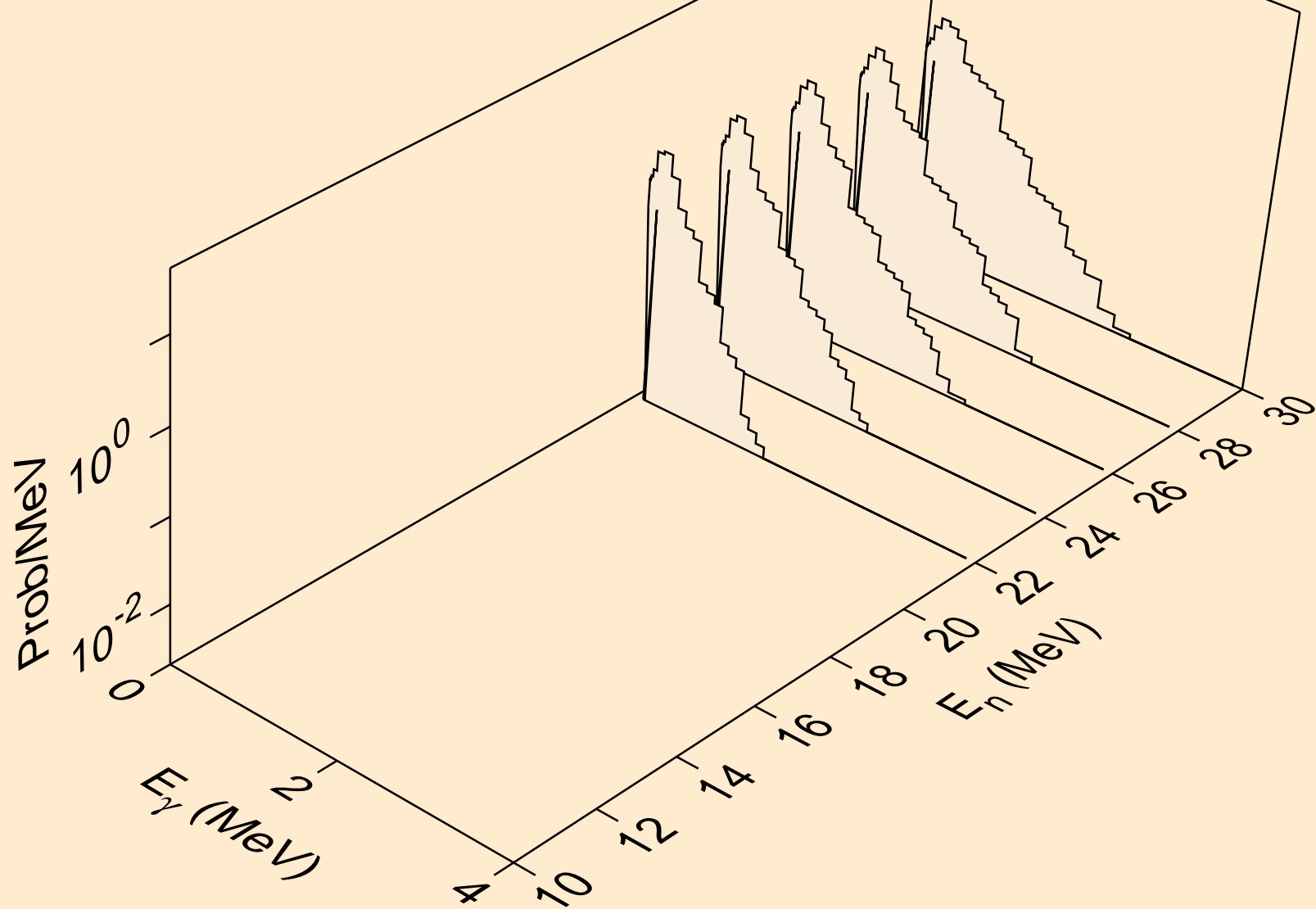



ES254 NEUTRON ACER TENDL-2021 LIBRARY; T=293.6K  
Photon emission for (n,npa)

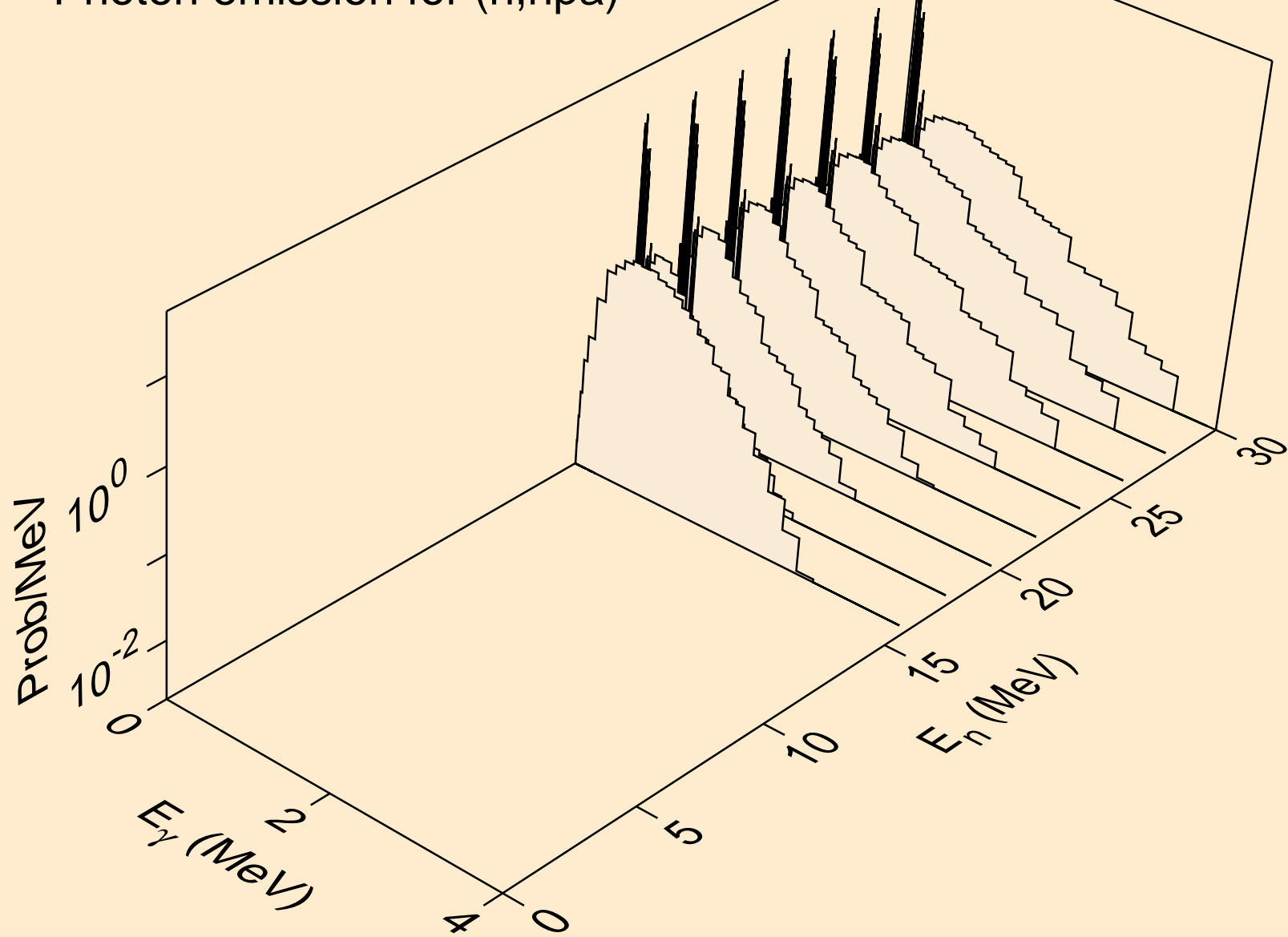

ES254 NEUTRON ACER TENDL-2021 LIBRARY; T=293.6K  
Photon emission for (n,n\*c)

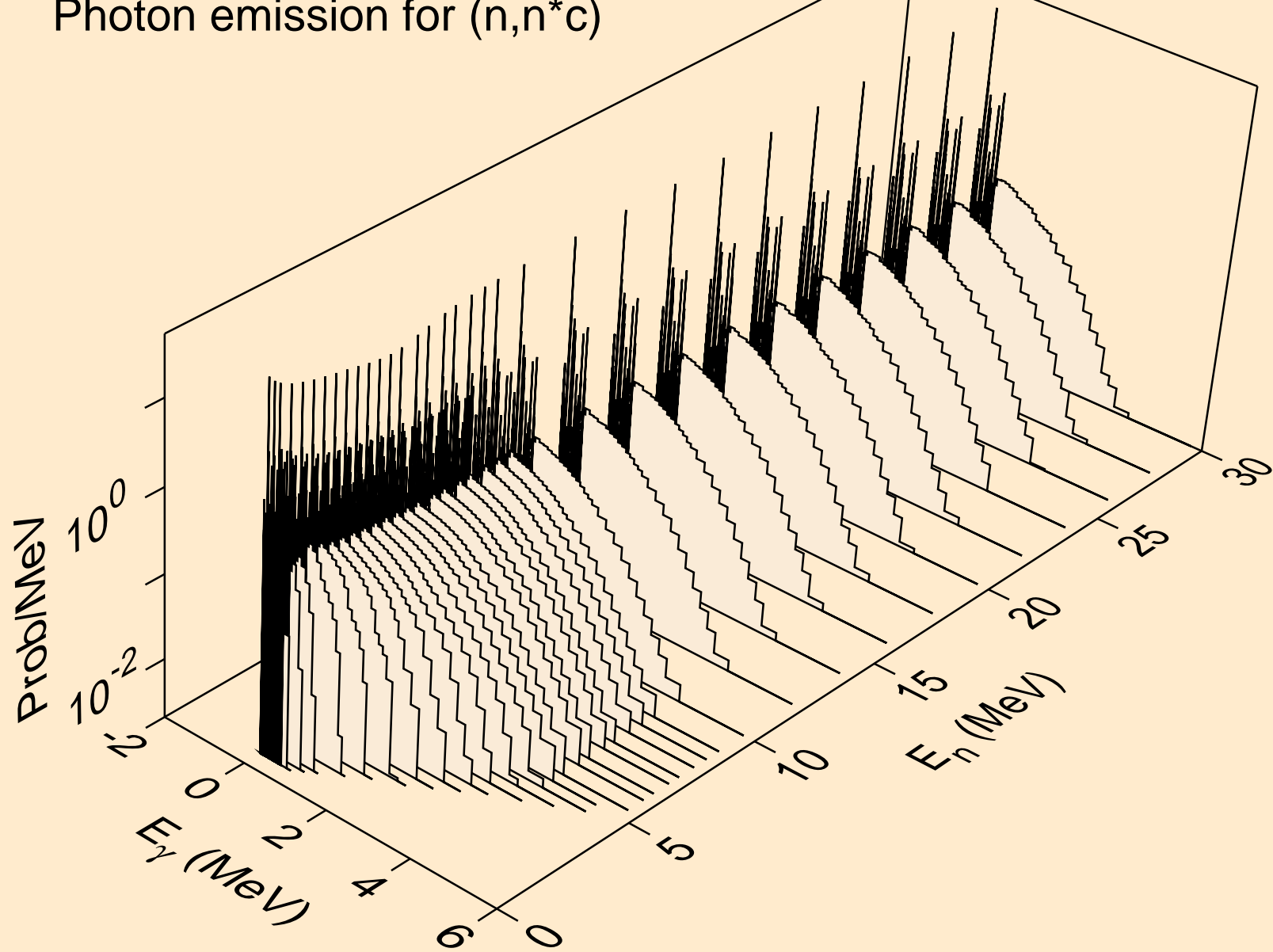

ES254 NEUTRON ACER TENDL-2021 LIBRARY; T=293.6K  
Photon emission for (n,gma)

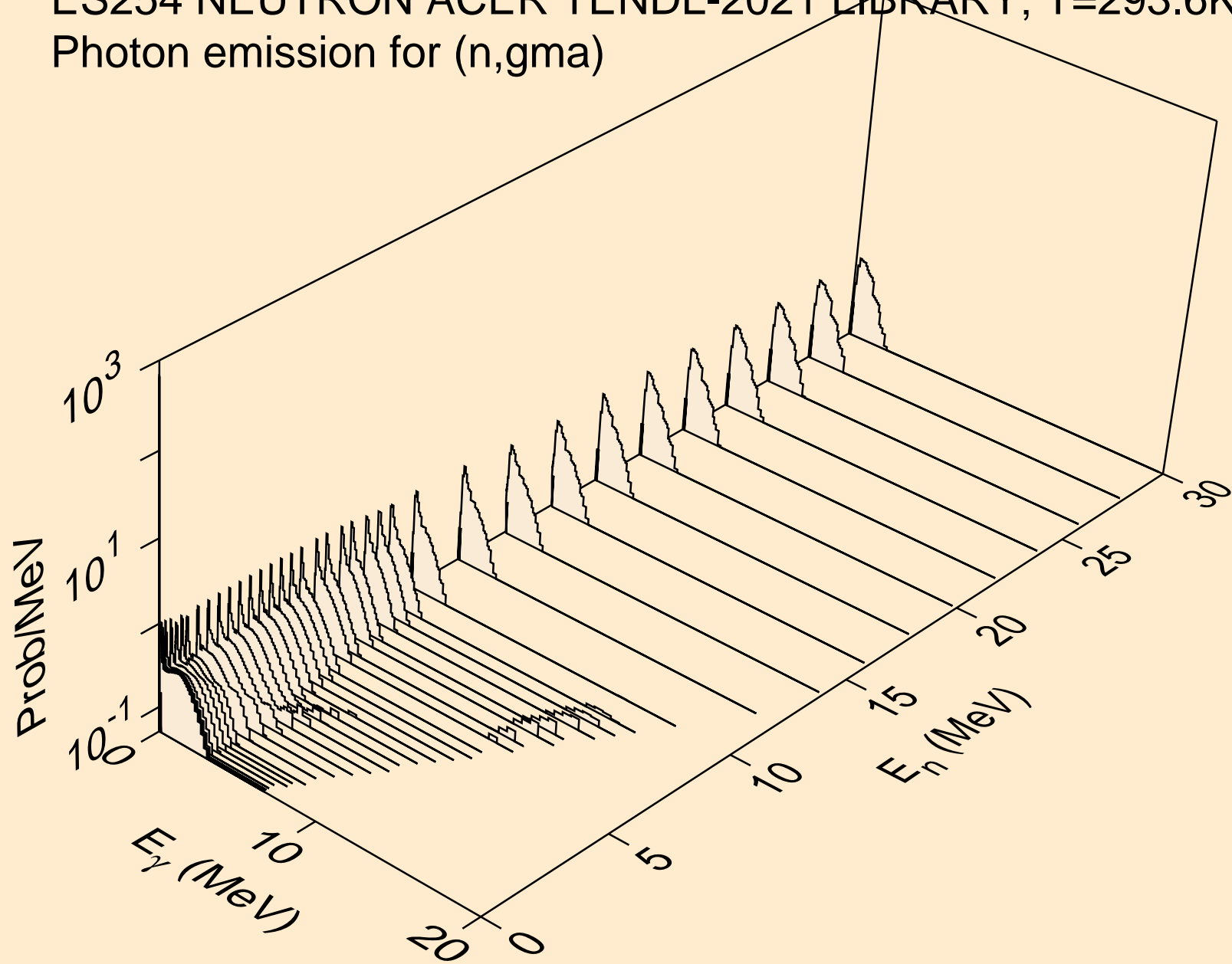

ES254 NEUTRON ACER TENDL-2021 LIBRARY; T=293.6K  
Photon emission for (n,p)

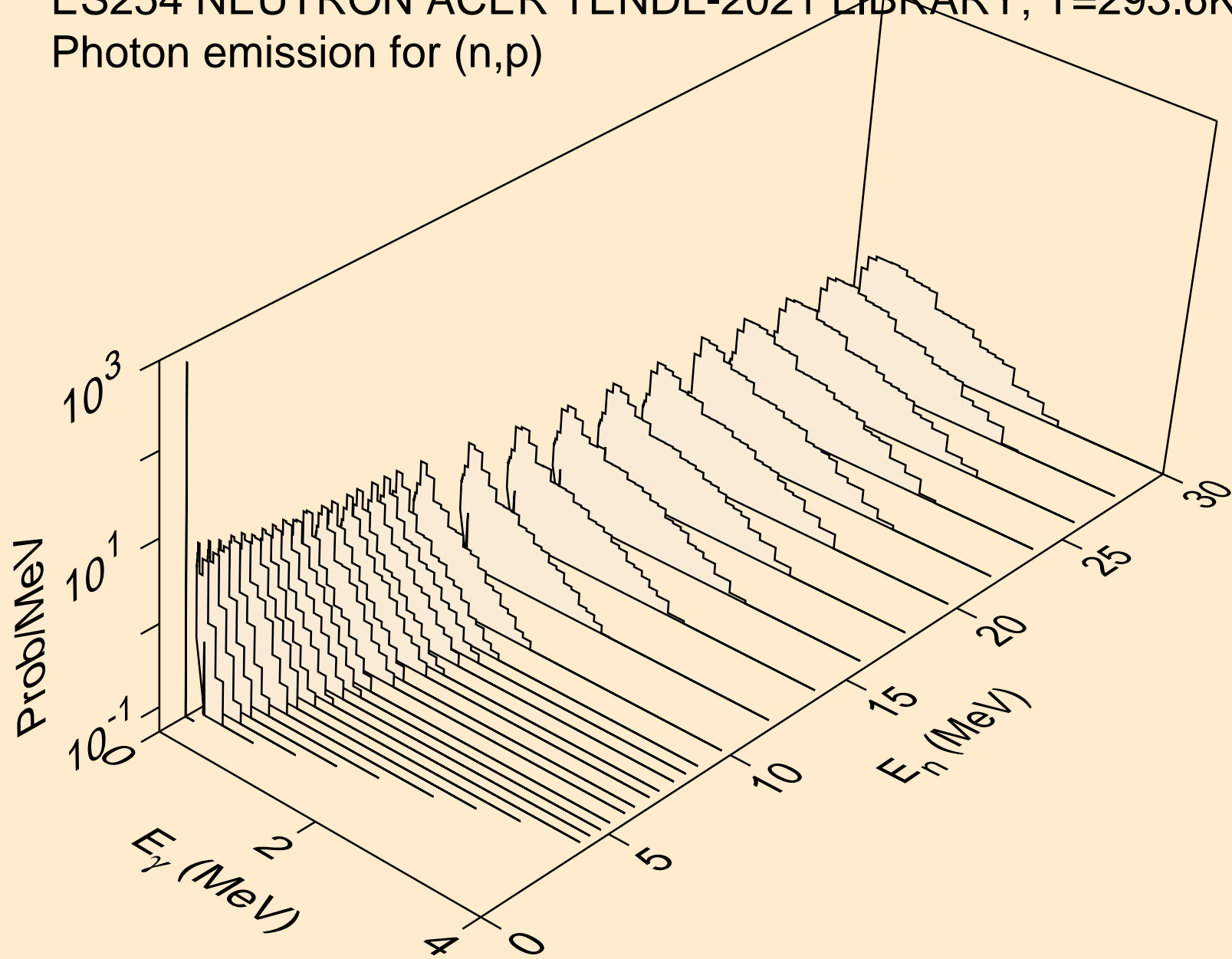

ES254 NEUTRON ACER TENDL-2021 LIBRARY; T=293.6K  
Photon emission for (n,d)

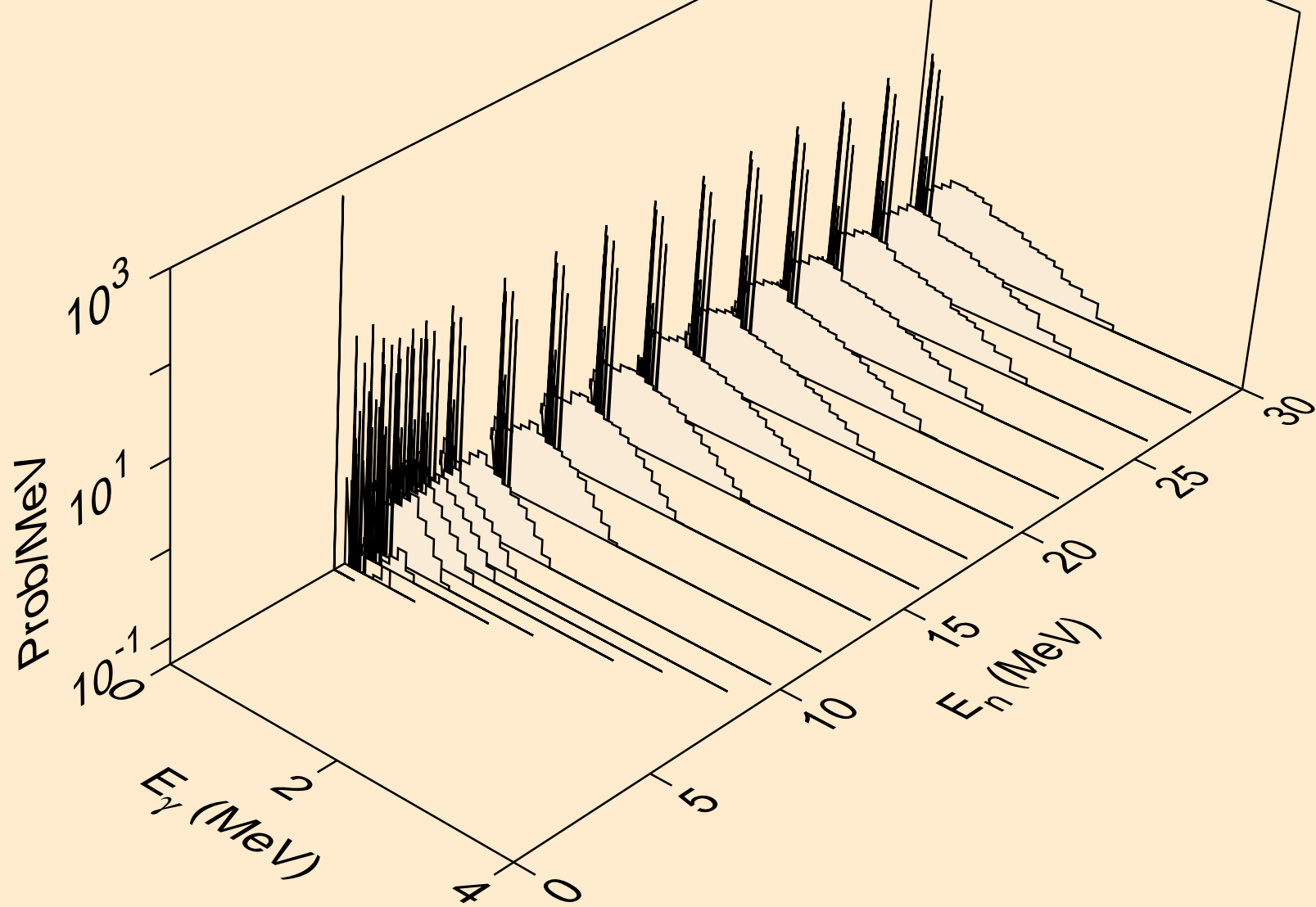

ES254 NEUTRON ACER TENDL-2021 LIBRARY; T=293.6K  
Photon emission for (n,t)

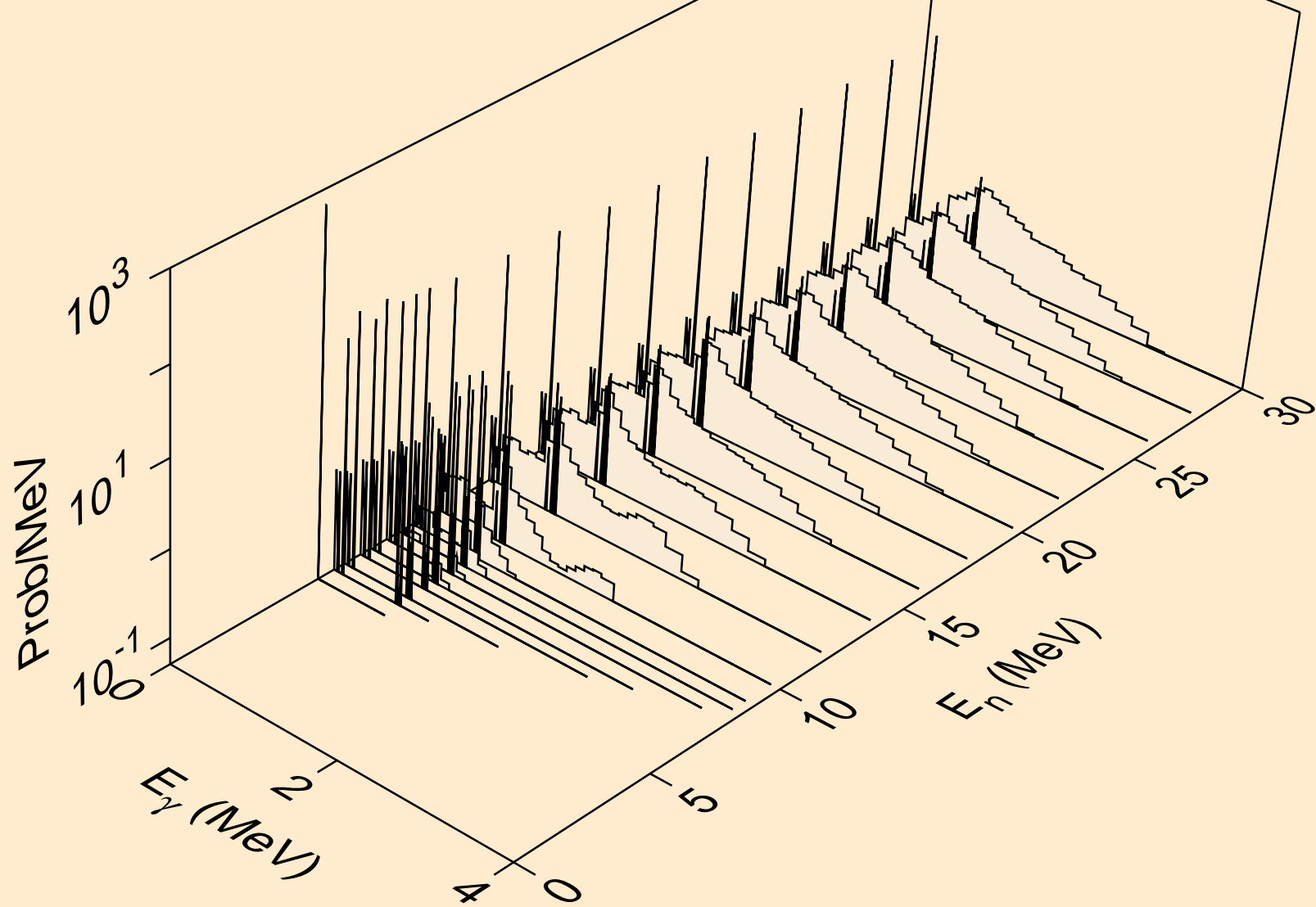

ES254 NEUTRON ACER TENDL-2021 LIBRARY; T=293.6K  
Photon emission for (n,he3)

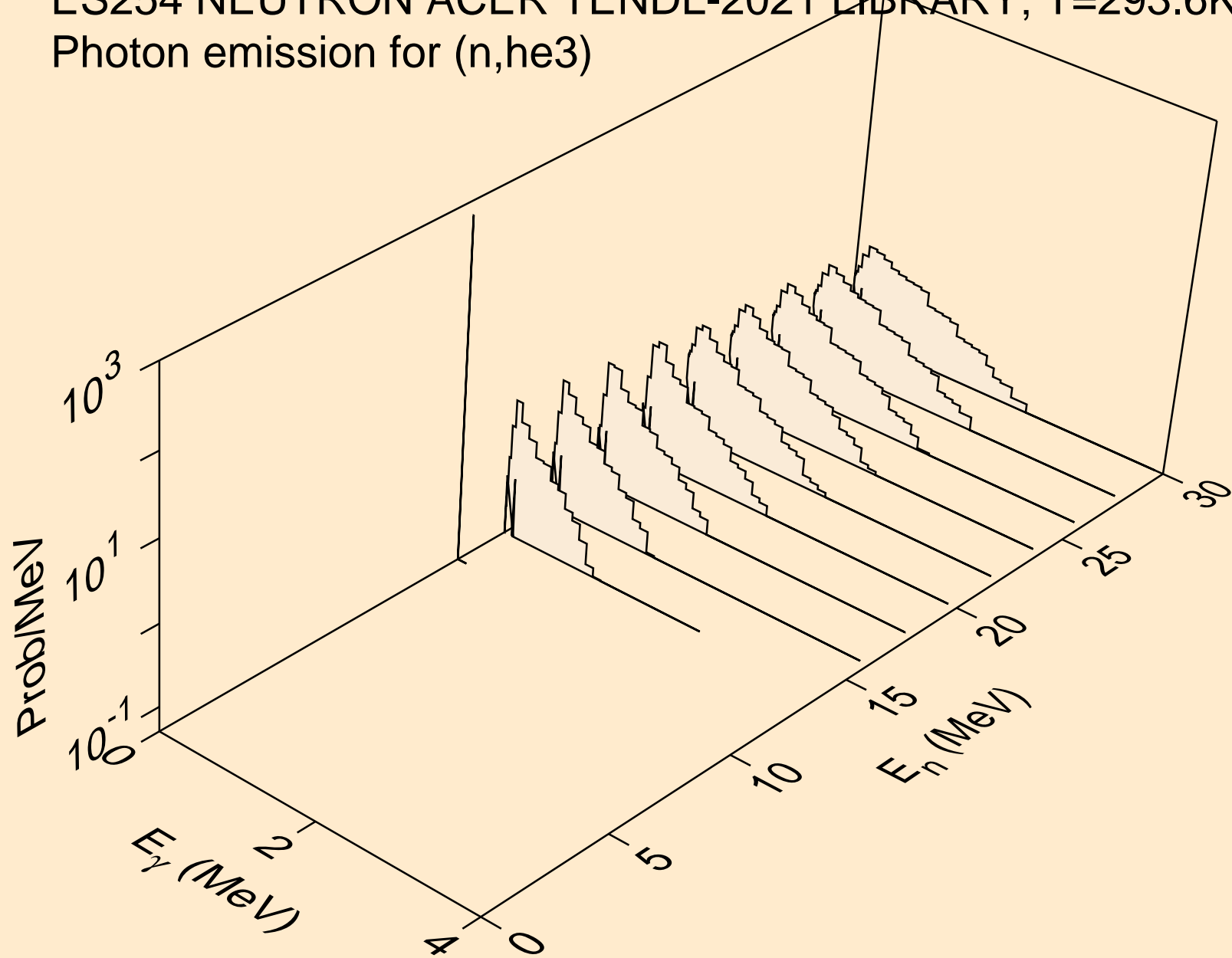

ES254 NEUTRON ACER TENDL-2021 LIBRARY; T=293.6K  
Photon emission for (n,a)

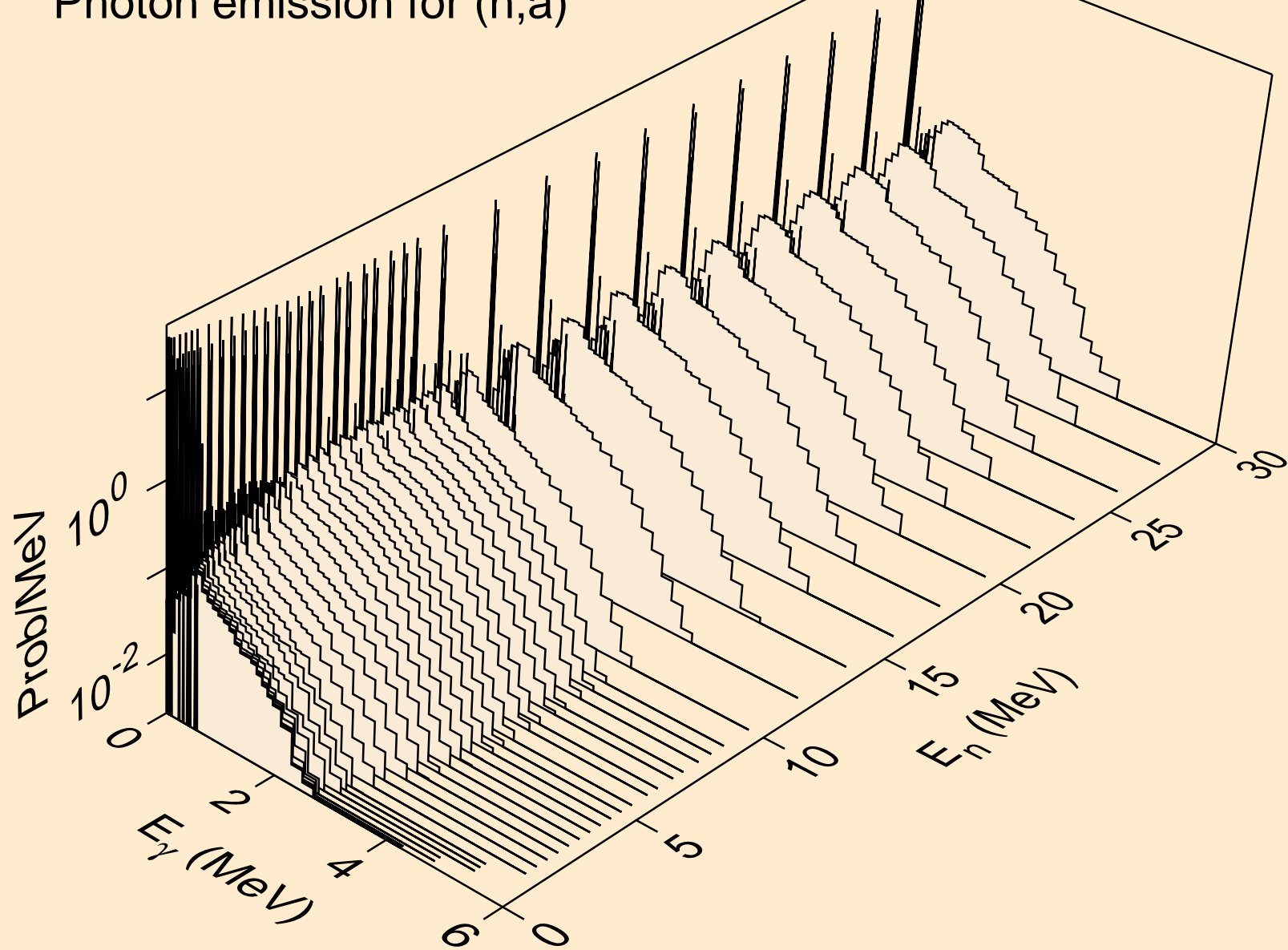



ES254 NEUTRON ACER TENDL-2021 LIBRARY; T=293.6K  
Photon emission for (n,2p)

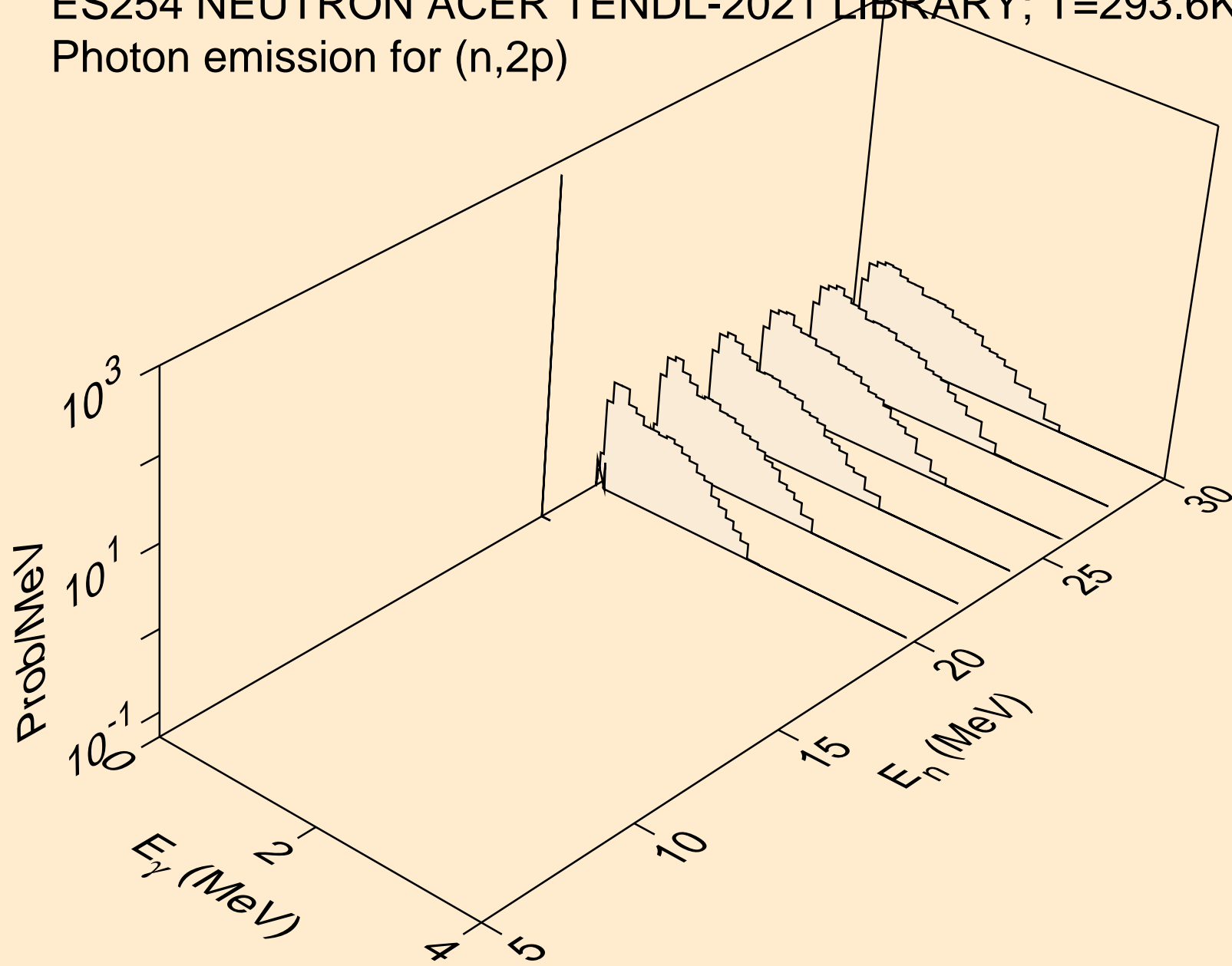

ES254 NEUTRON ACER TENDL-2021 LIBRARY; T=293.6K  
thermal capture photon spectrum

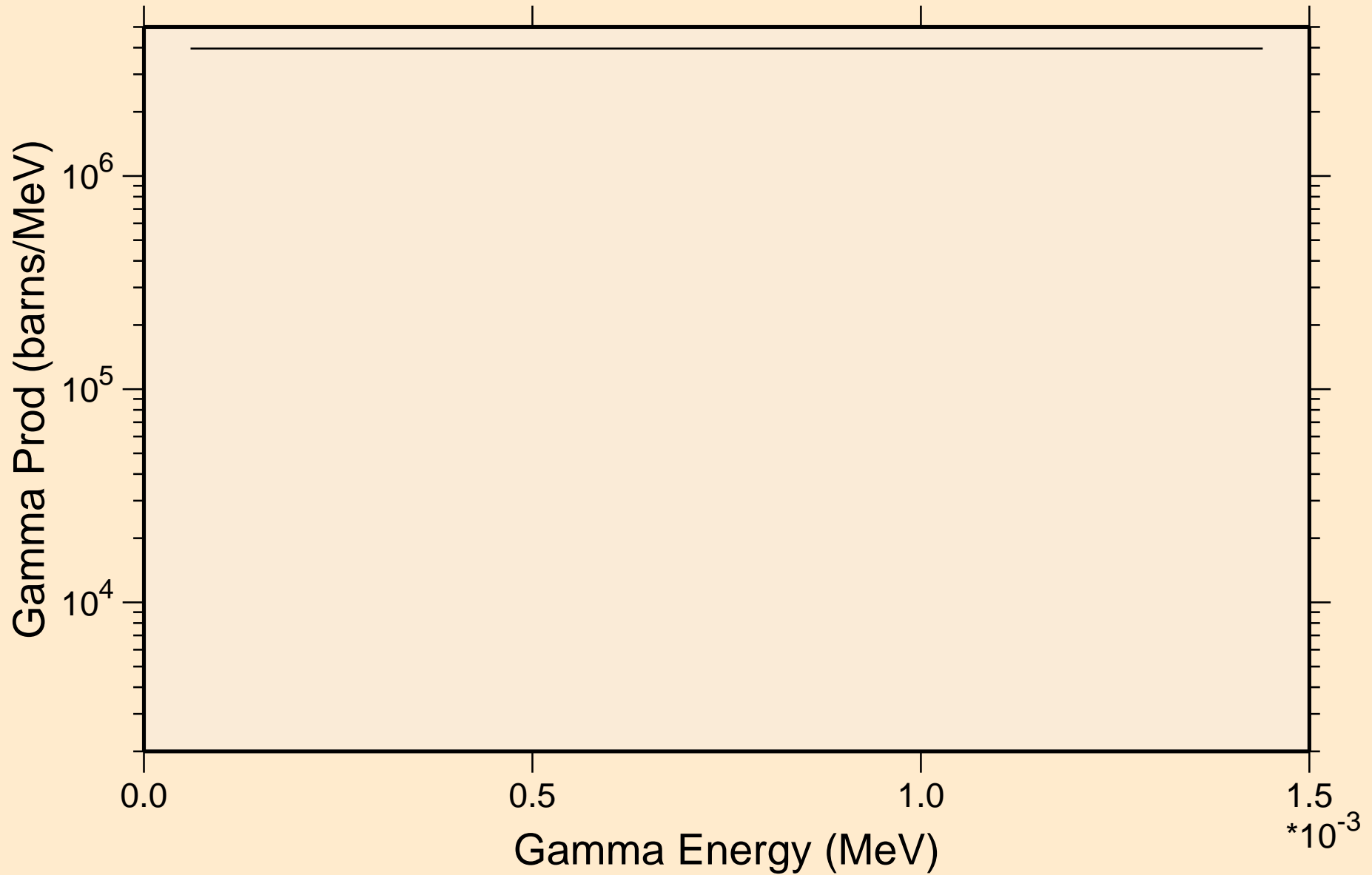

ES254 NEUTRON ACER TENDL-2021 LIBRARY; T=293.6K  
14 MeV photon spectrum

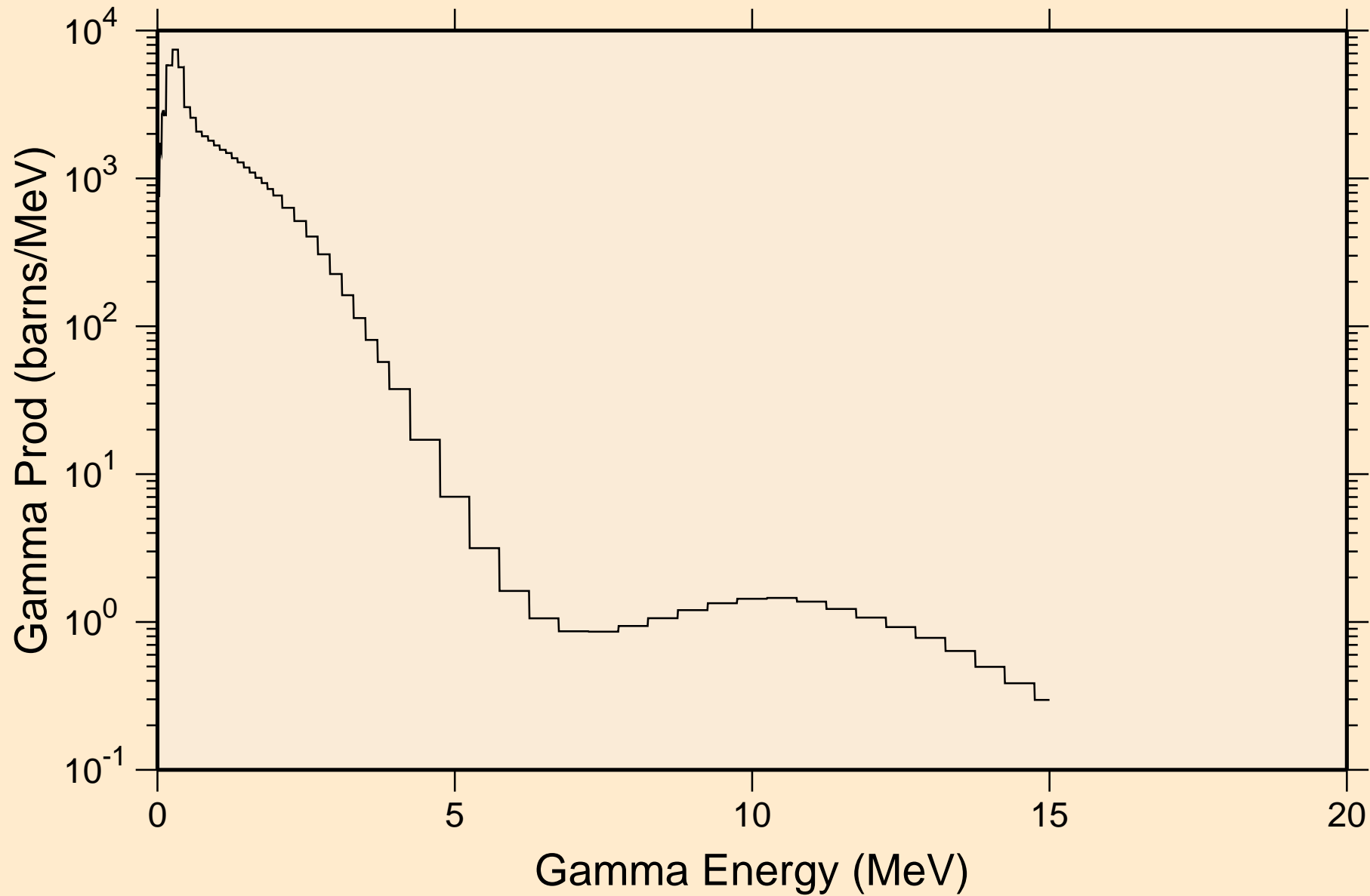

ES254 NEUTRON ACER TENDL-2021 LIBRARY; T=293.6K  
Particle heating contributions

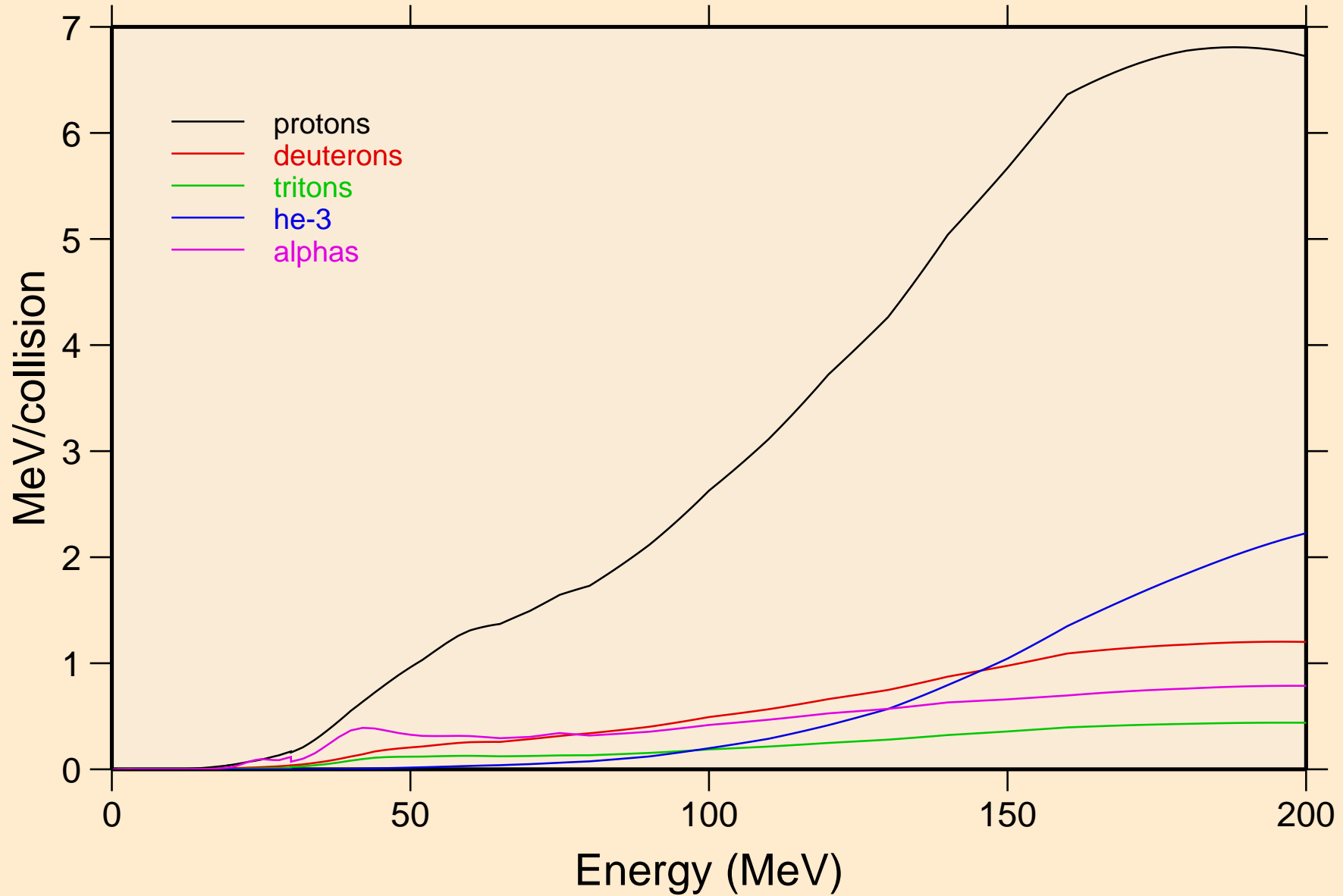

ES254 NEUTRON ACER TENDL-2021 LIBRARY; T=293.6K  
Recoil Heating

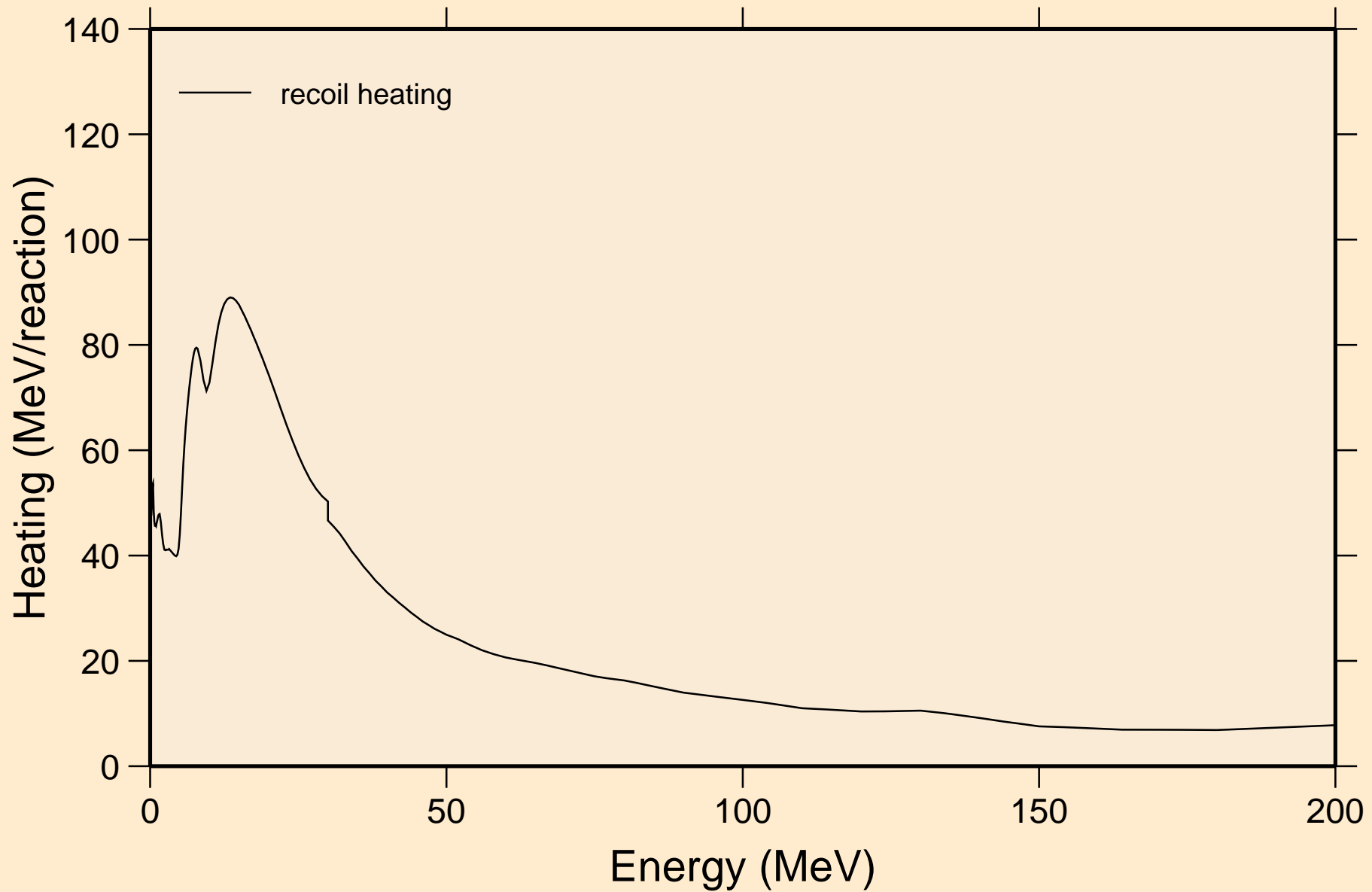

# ES254 NEUTRON ACER TENDL-2021 LIBRARY; T=293.6K

## Particle production cross sections

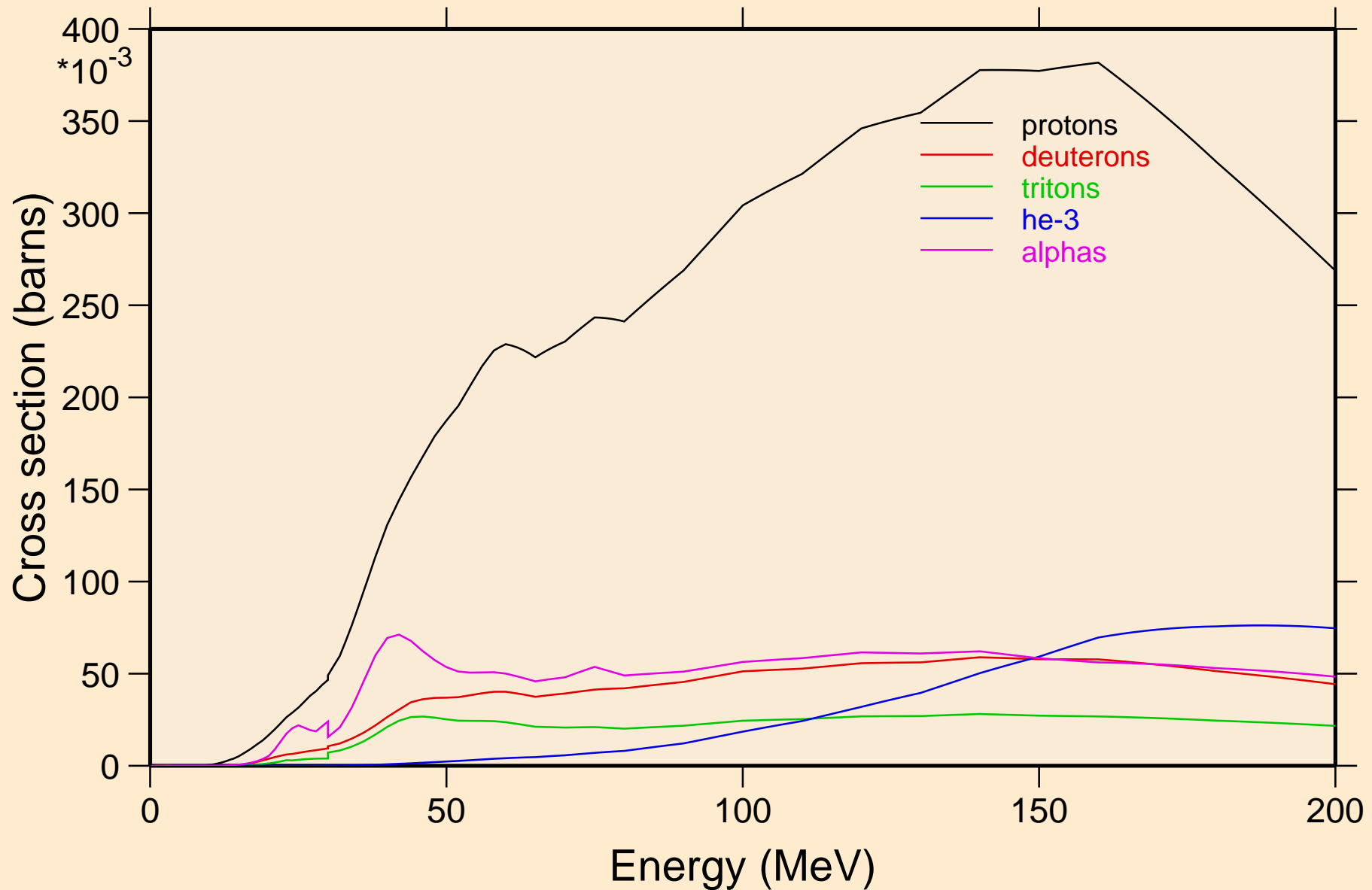

ES254 NEUTRON ACER TENDL-2021 LIBRARY; T=293.6K  
protons from (n,x)

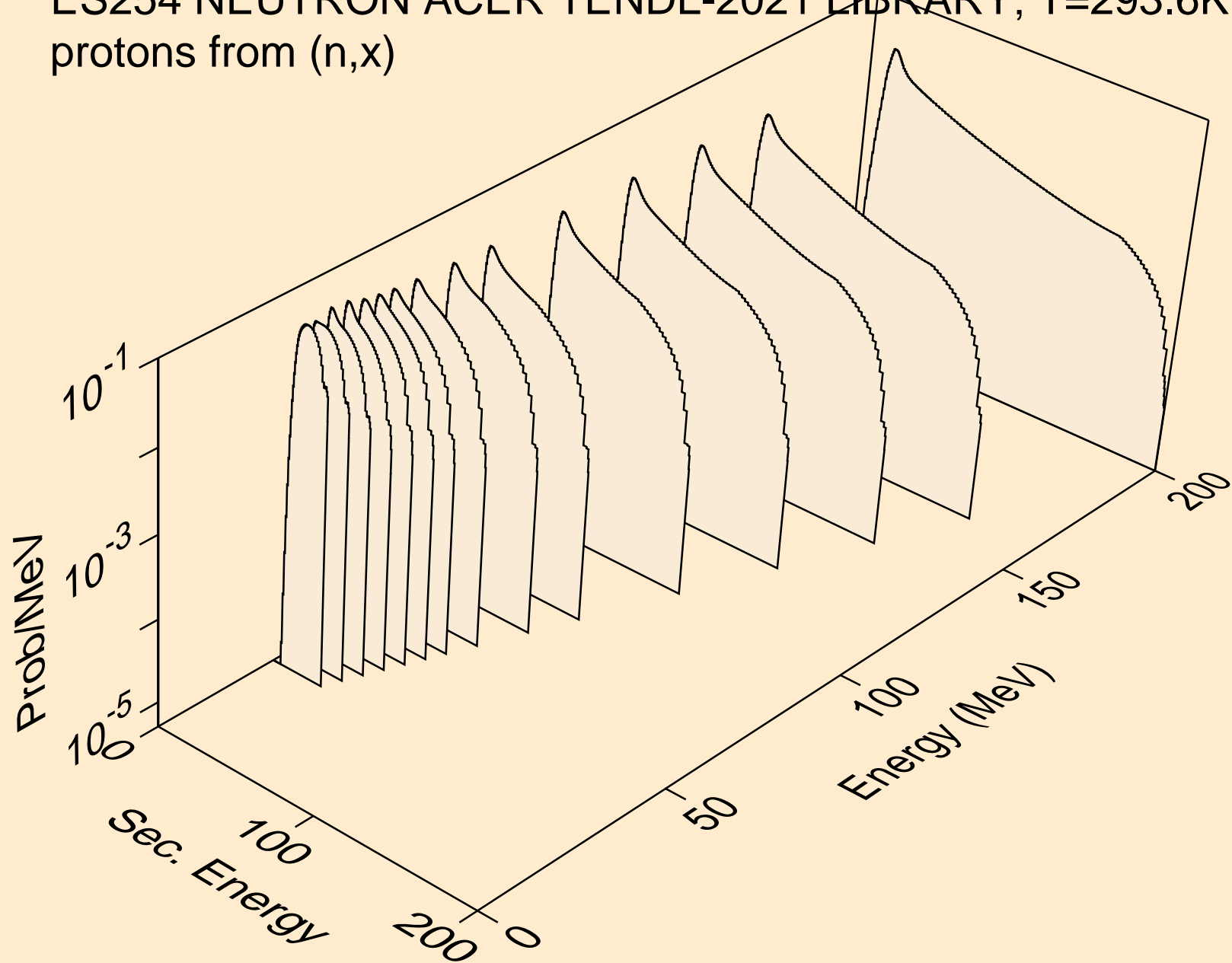

ES254 NEUTRON ACER TENDL-2021 LIBRARY; T=293.6K  
protons from (n,n\*)p

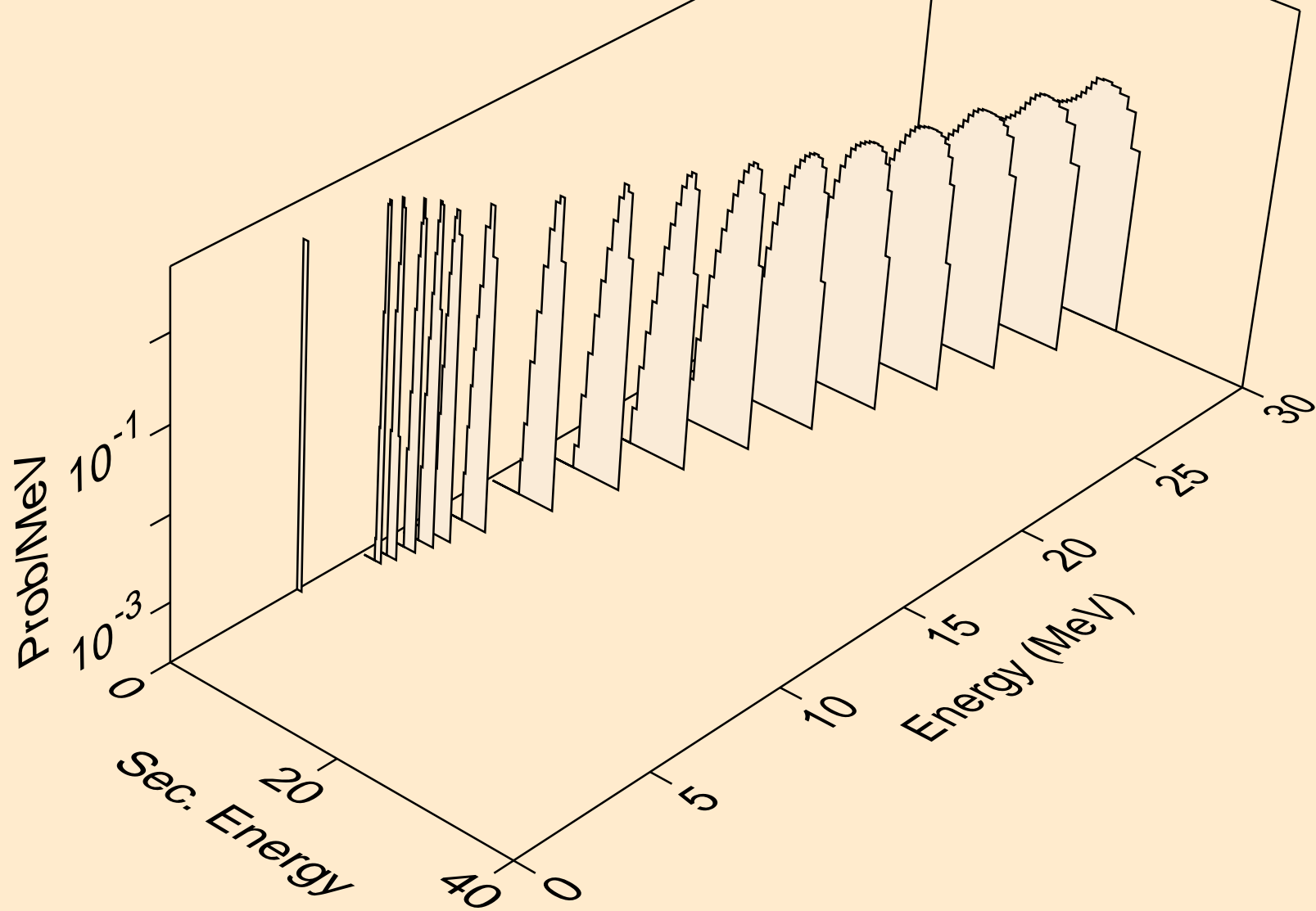



ES254 NEUTRON ACER TENDL-2021 LIBRARY; T=293.6K  
protons from (n,2np)

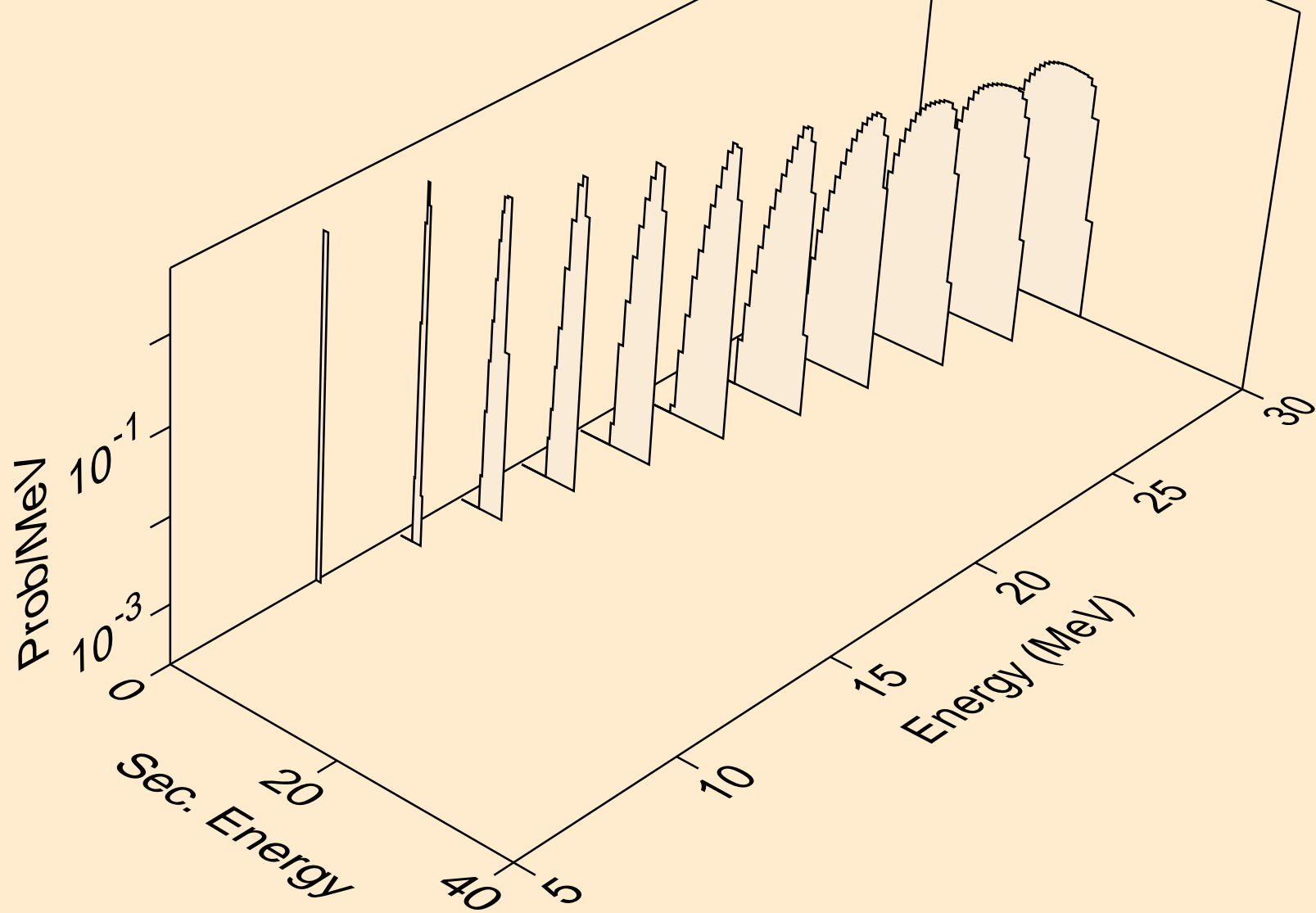

ES254 NEUTRON ACER TENDL-2021 LIBRARY; T=293.6K  
protons from (n,3np)

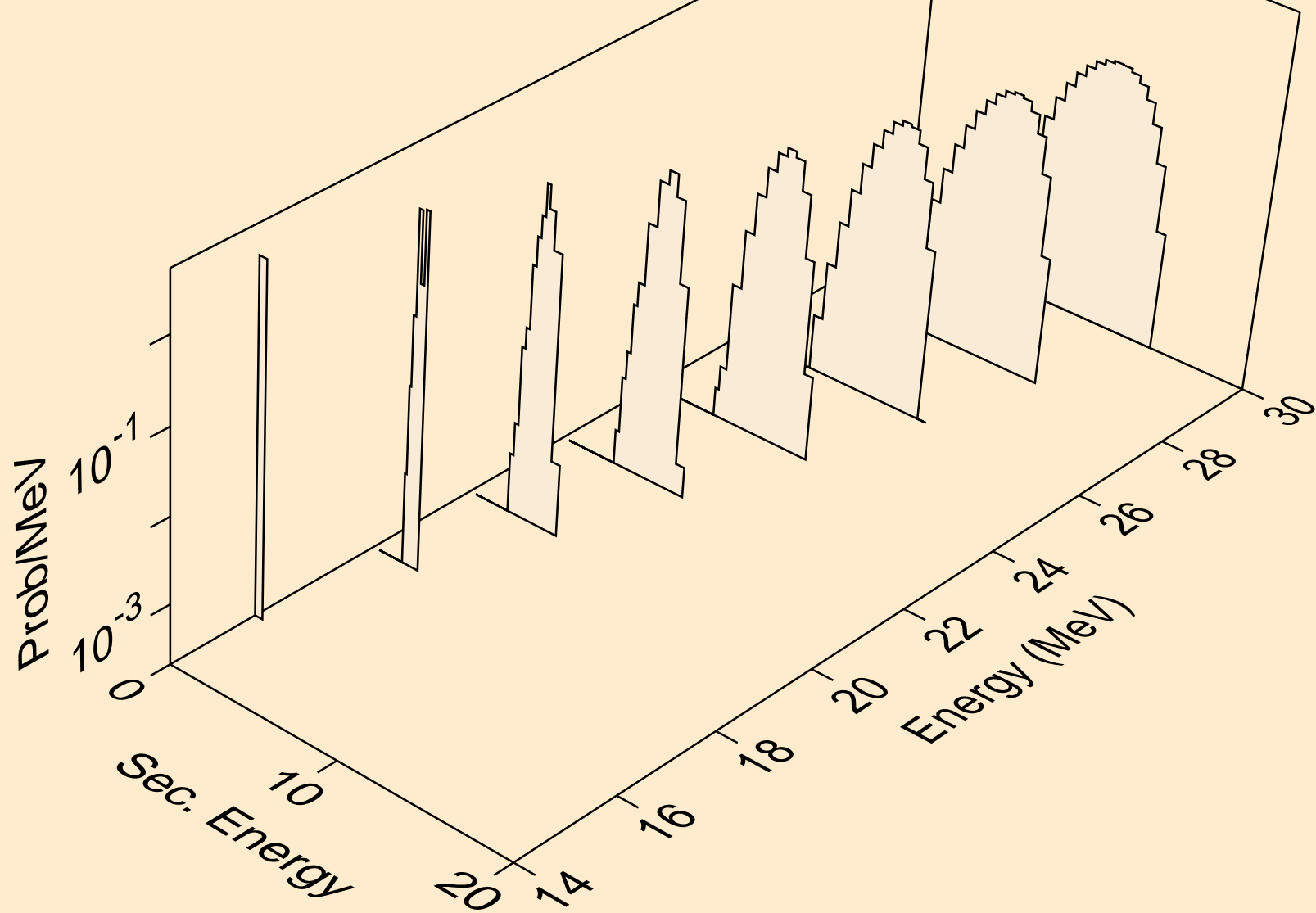

ES254 NEUTRON ACER TENDL-2021 LIBRARY; T=293.6K  
protons from (n,2np)

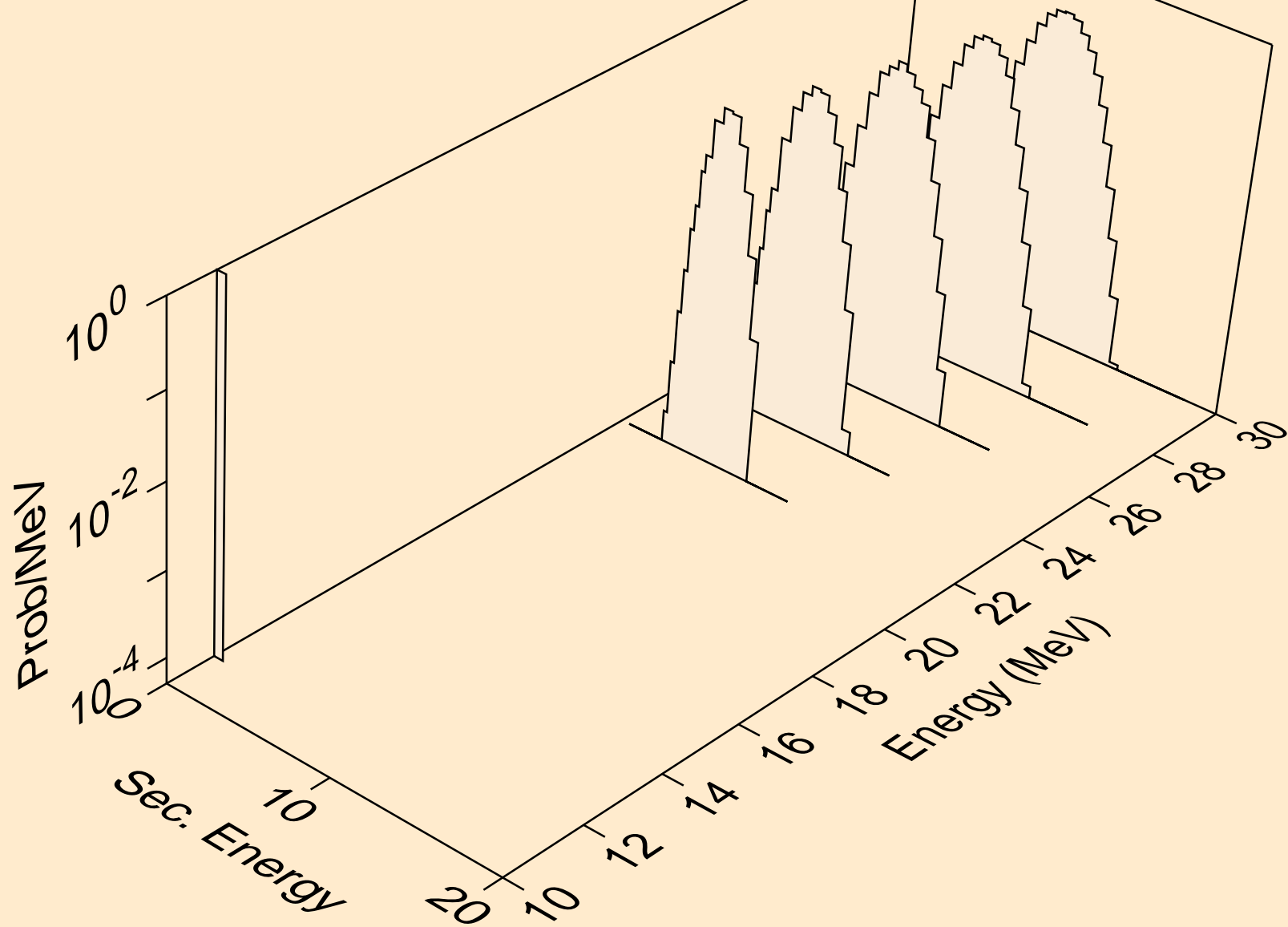

ES254 NEUTRON ACER TENDL-2021 LIBRARY; T=293.6K  
protons from (n,npa)

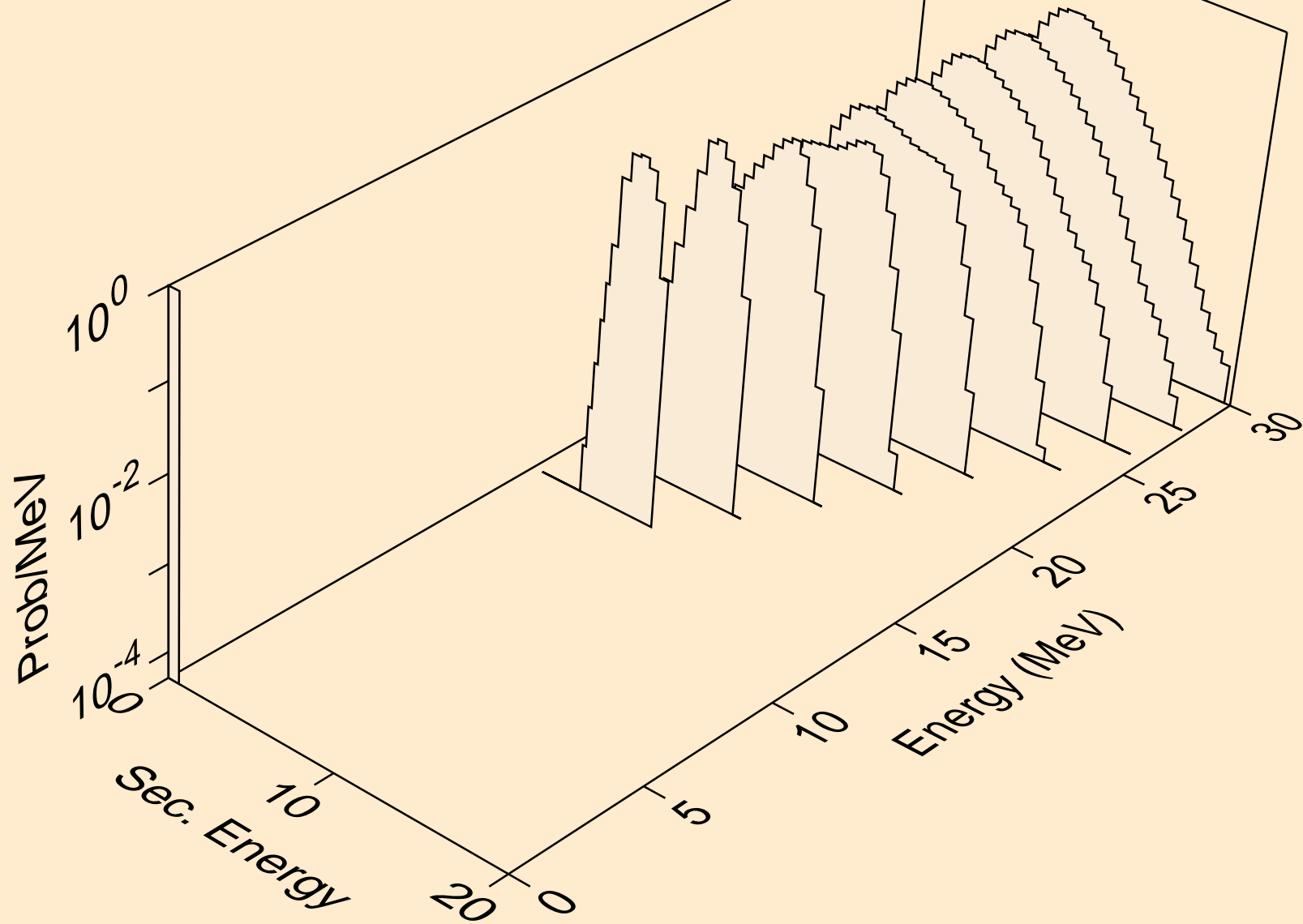

ES254 NEUTRON ACER TENDL-2021 LIBRARY; T=293.6K  
protons from (n,p)

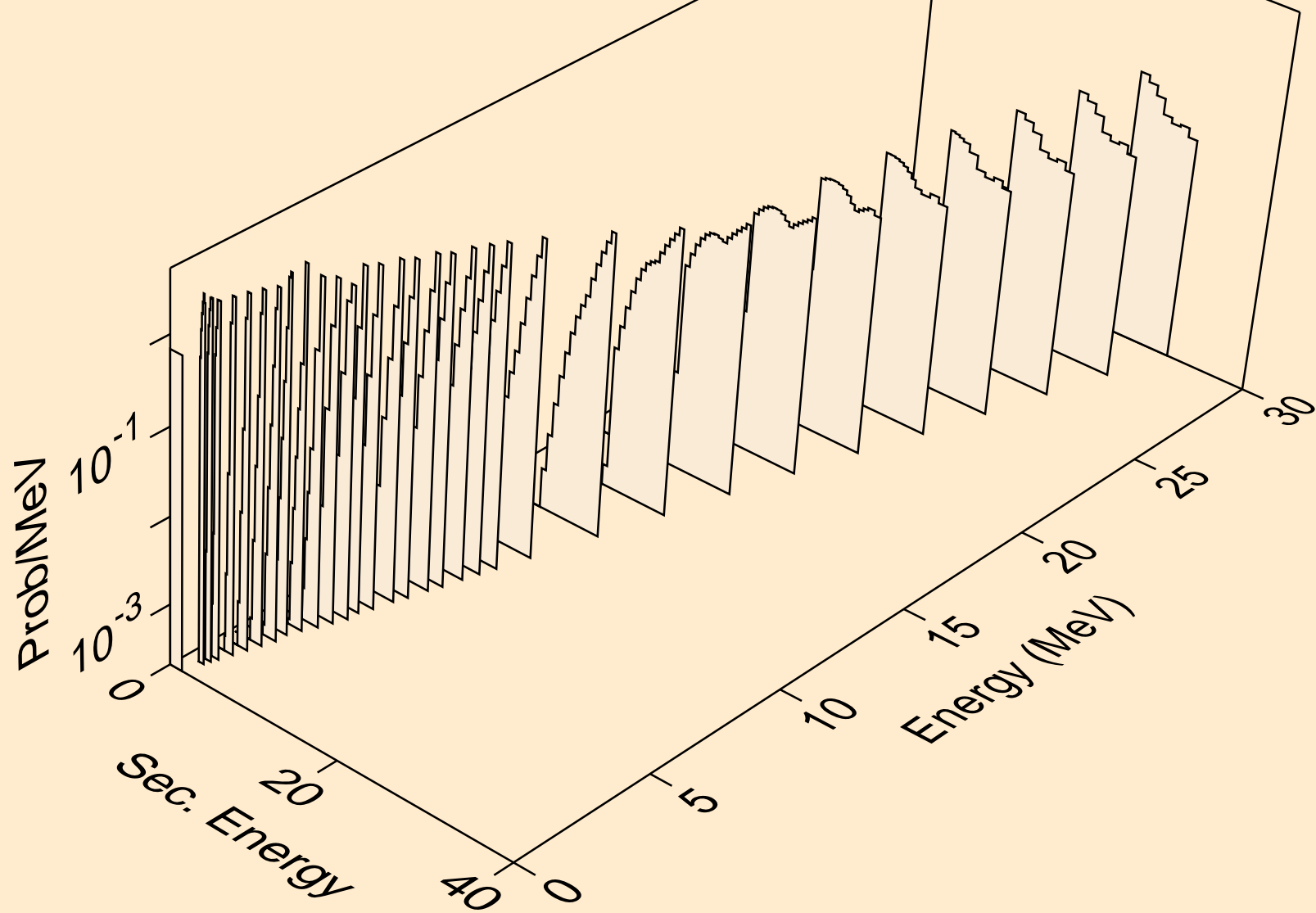

ES254 NEUTRON ACER TENDL-2021 LIBRARY; T=293.6K  
protons from (n,2p)

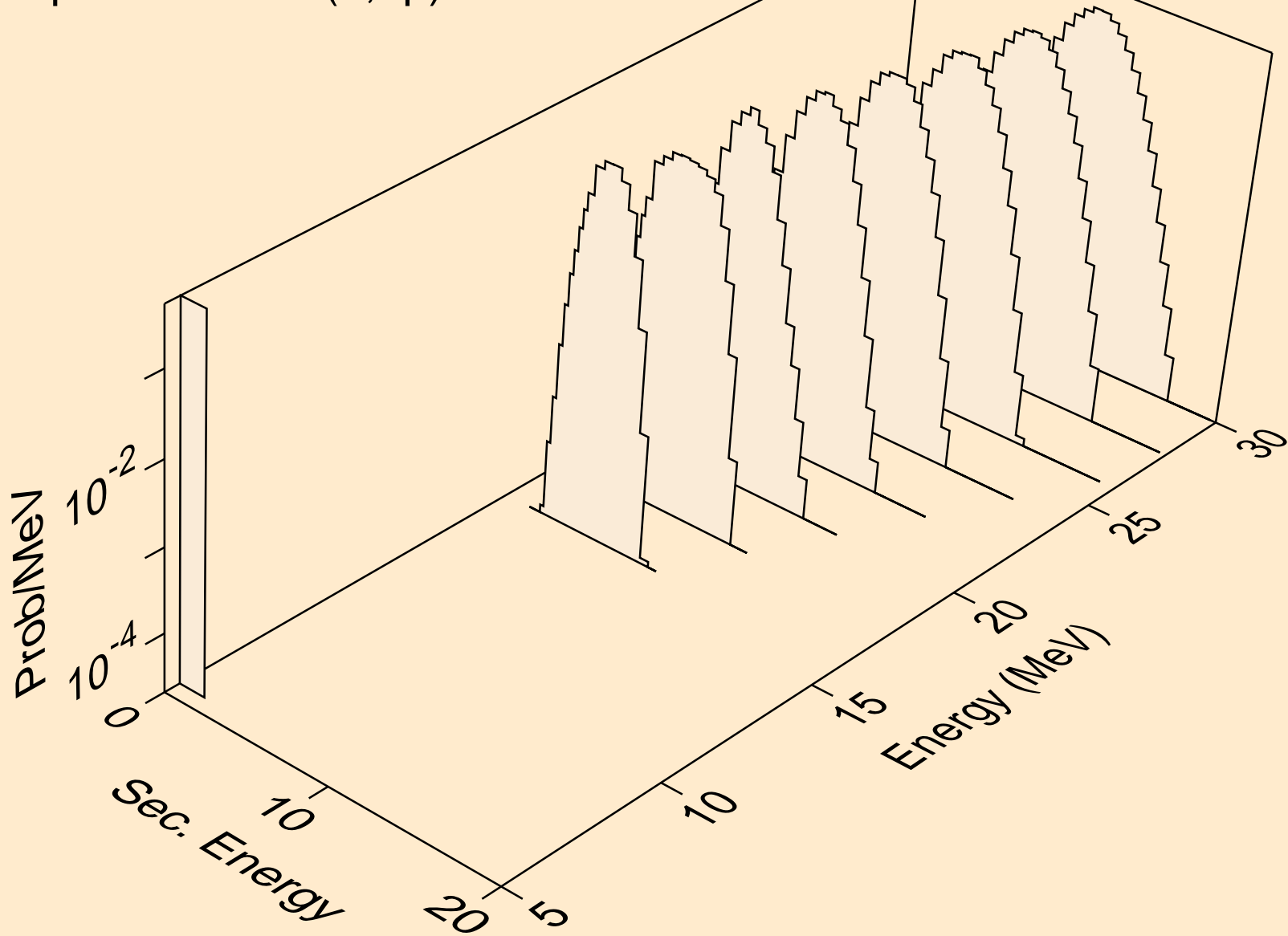

ES254 NEUTRON ACER TENDL-2021 LIBRARY; T=293.6K  
deuterons from (n,x)

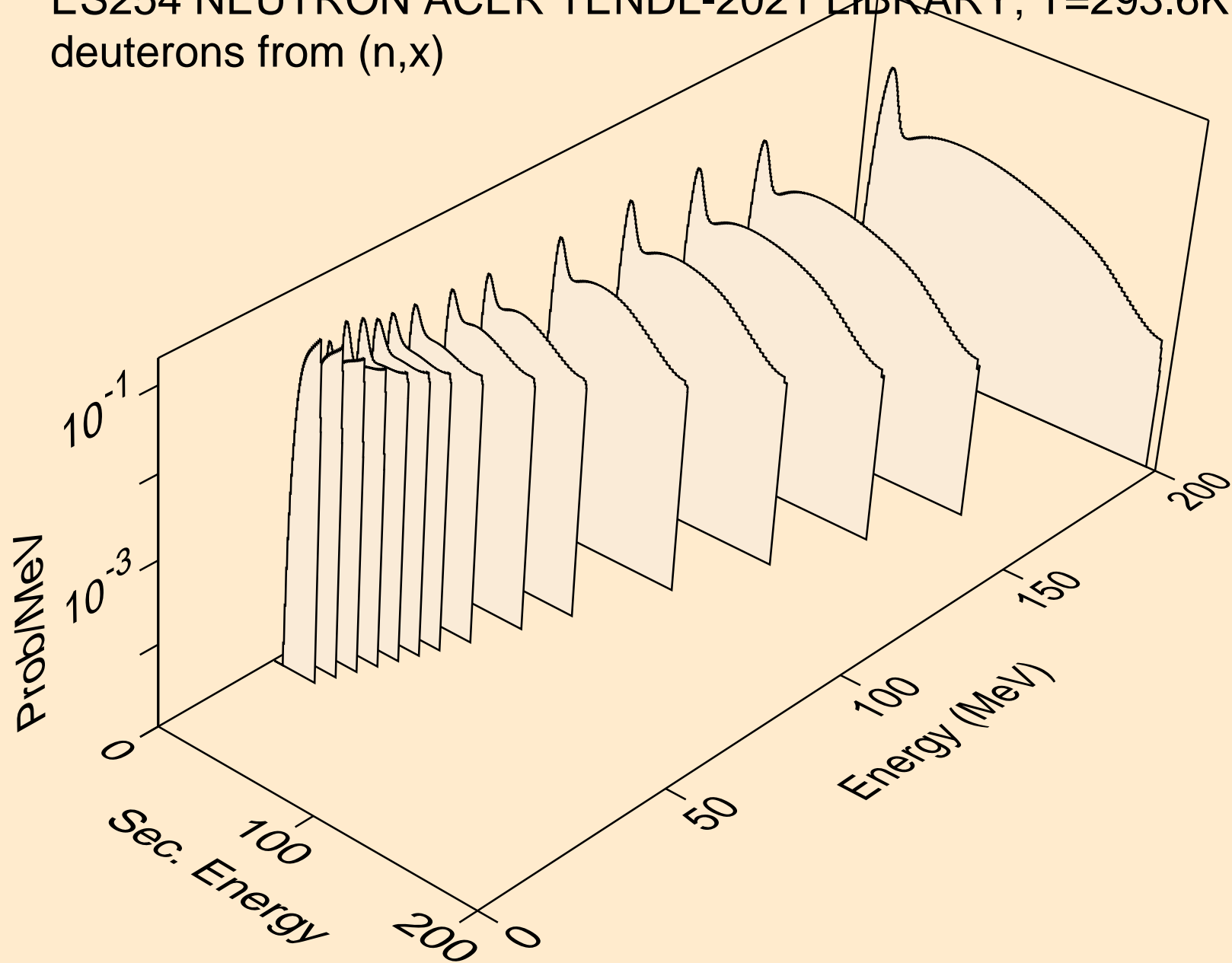

ES254 NEUTRON ACER TENDL-2021 LIBRARY; T=293.6K  
deuterons from (n,2nd)

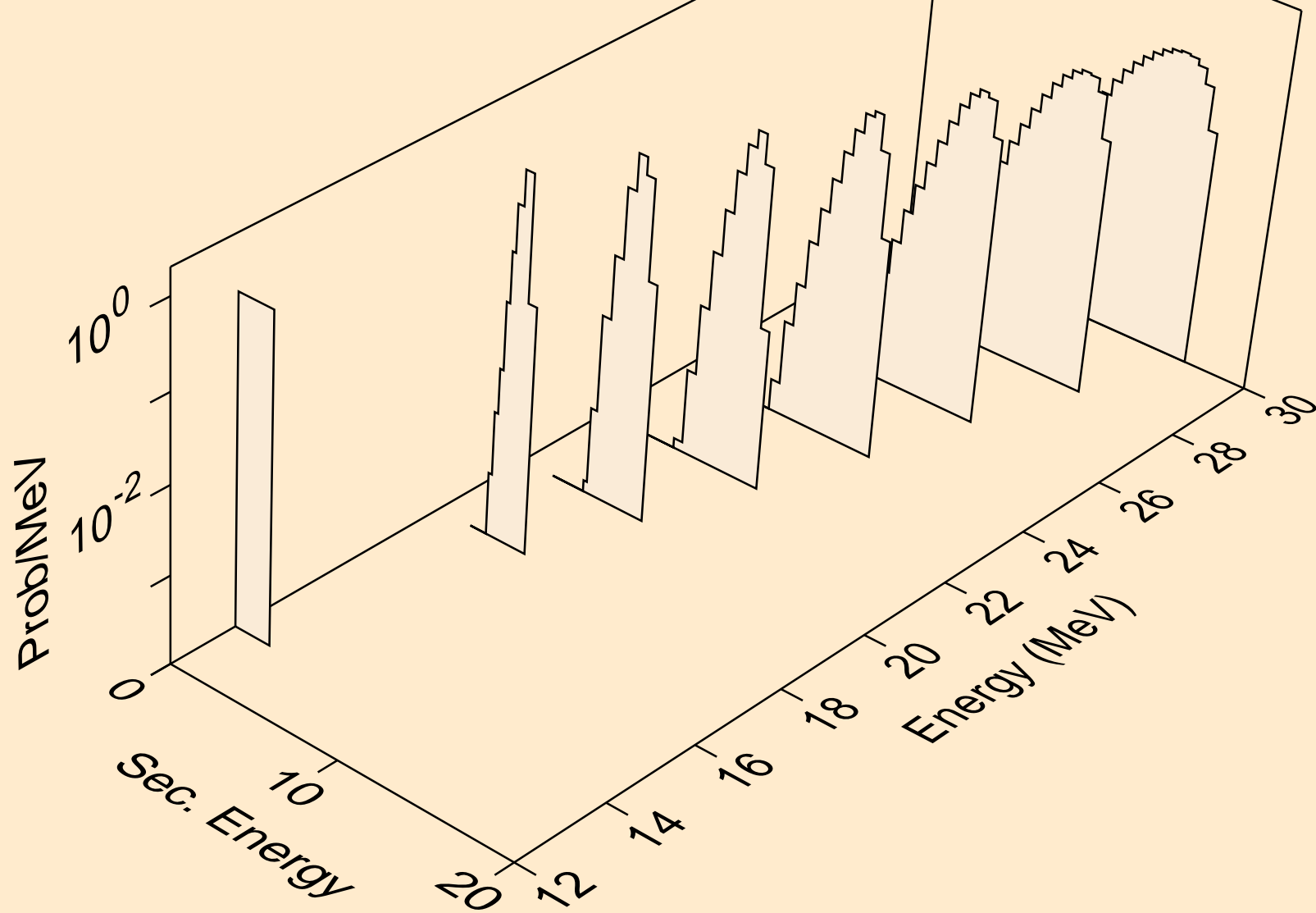



ES254 NEUTRON ACER TENDL-2021 LIBRARY; T=293.6K  
deuterons from (n,n\*)d

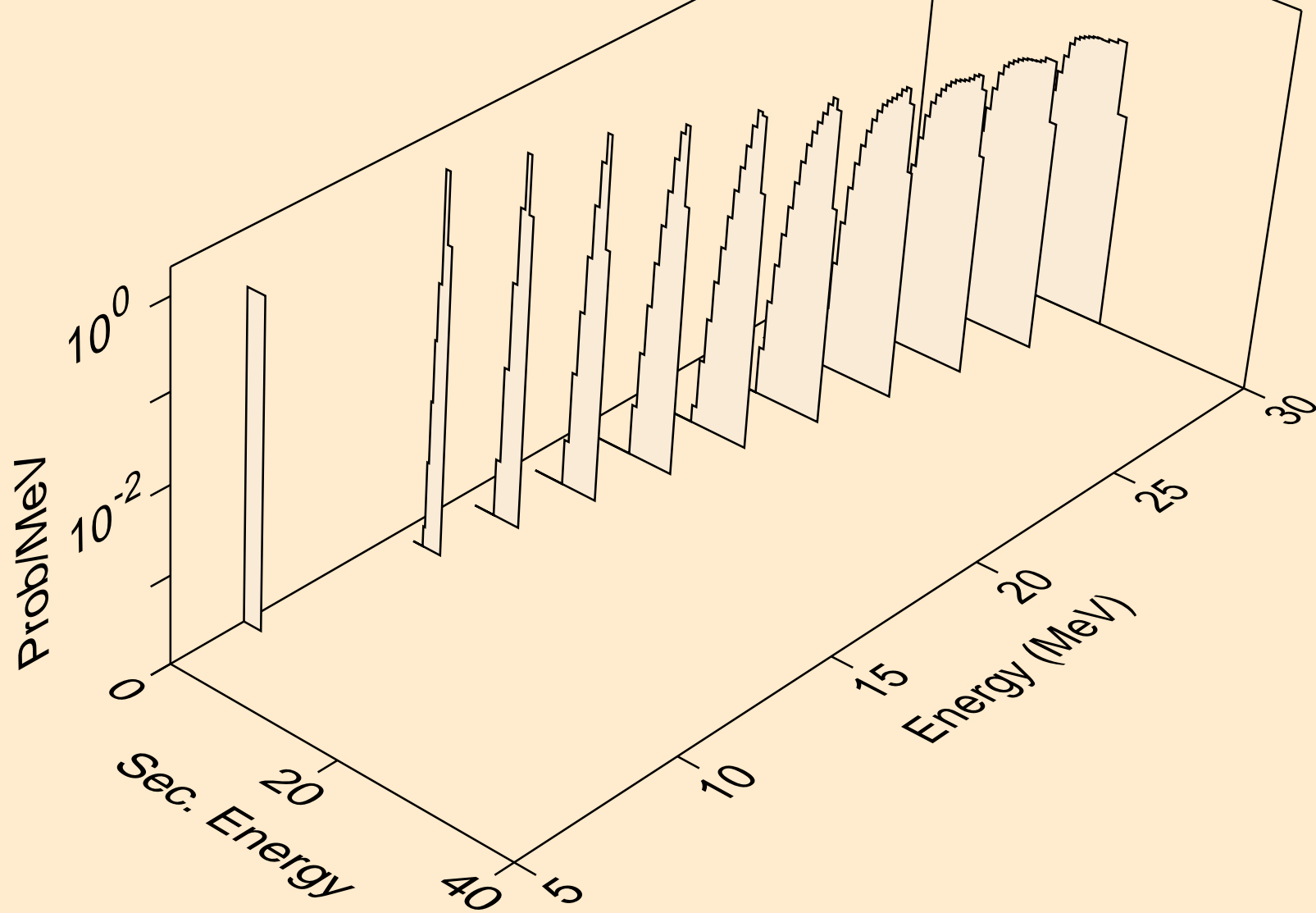

ES254 NEUTRON ACER TENDL-2021 LIBRARY; T=293.6K  
deuterons from (n,d)

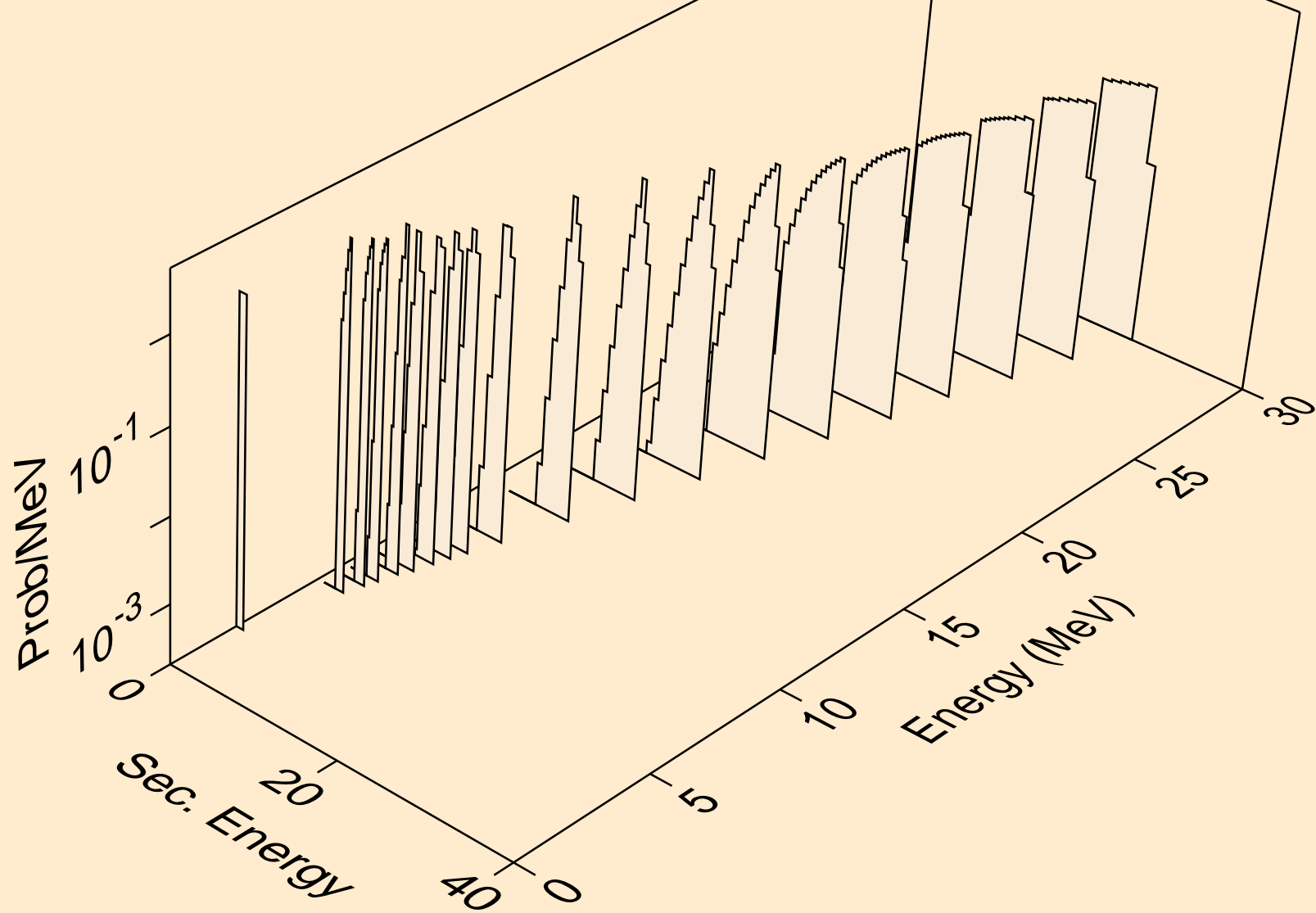

ES254 NEUTRON ACER TENDL-2021 LIBRARY; T=293.6K  
tritons from (n,x)

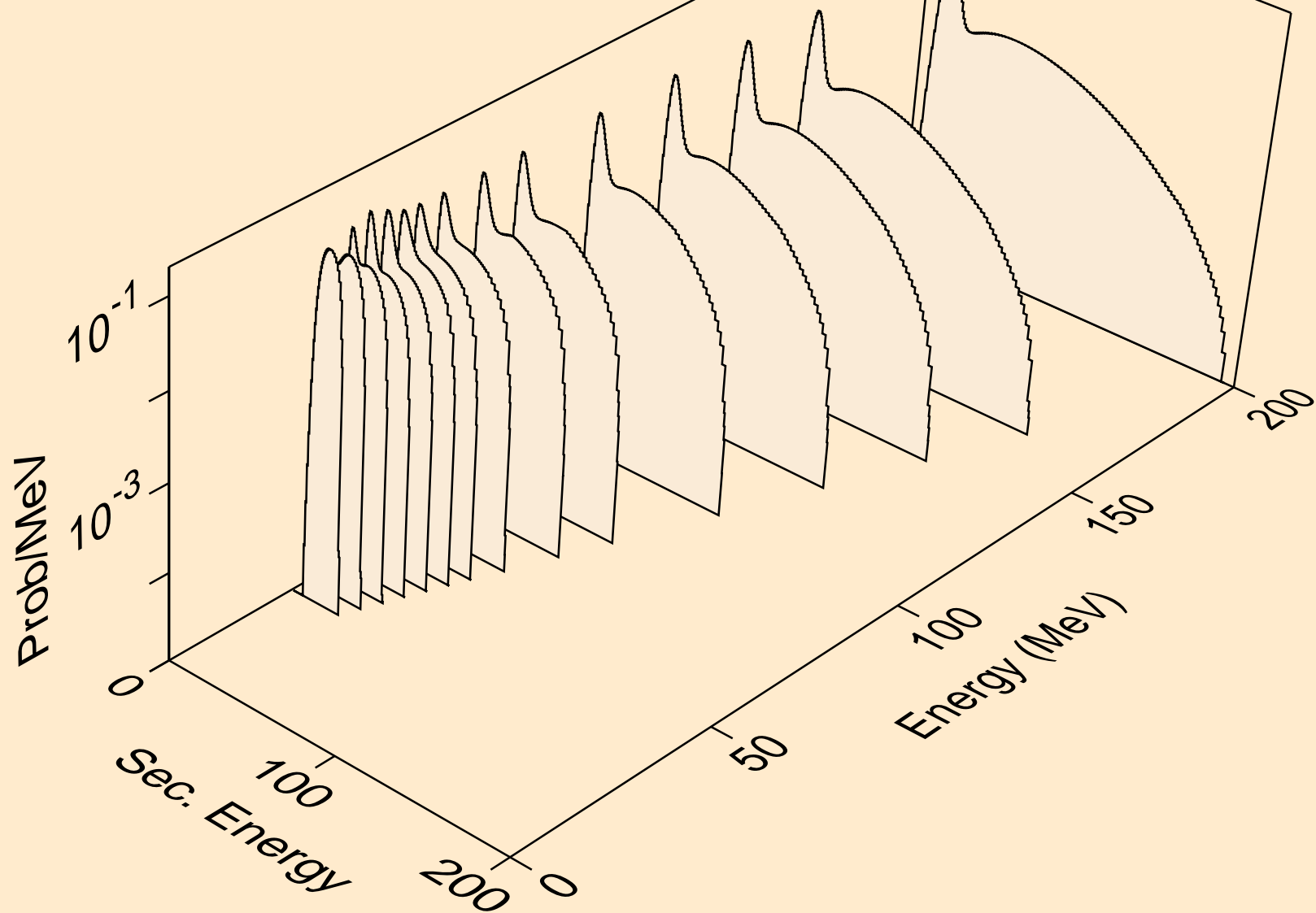

ES254 NEUTRON ACER TENDL-2021 LIBRARY; T=293.6K  
tritons from (n,n\*)t

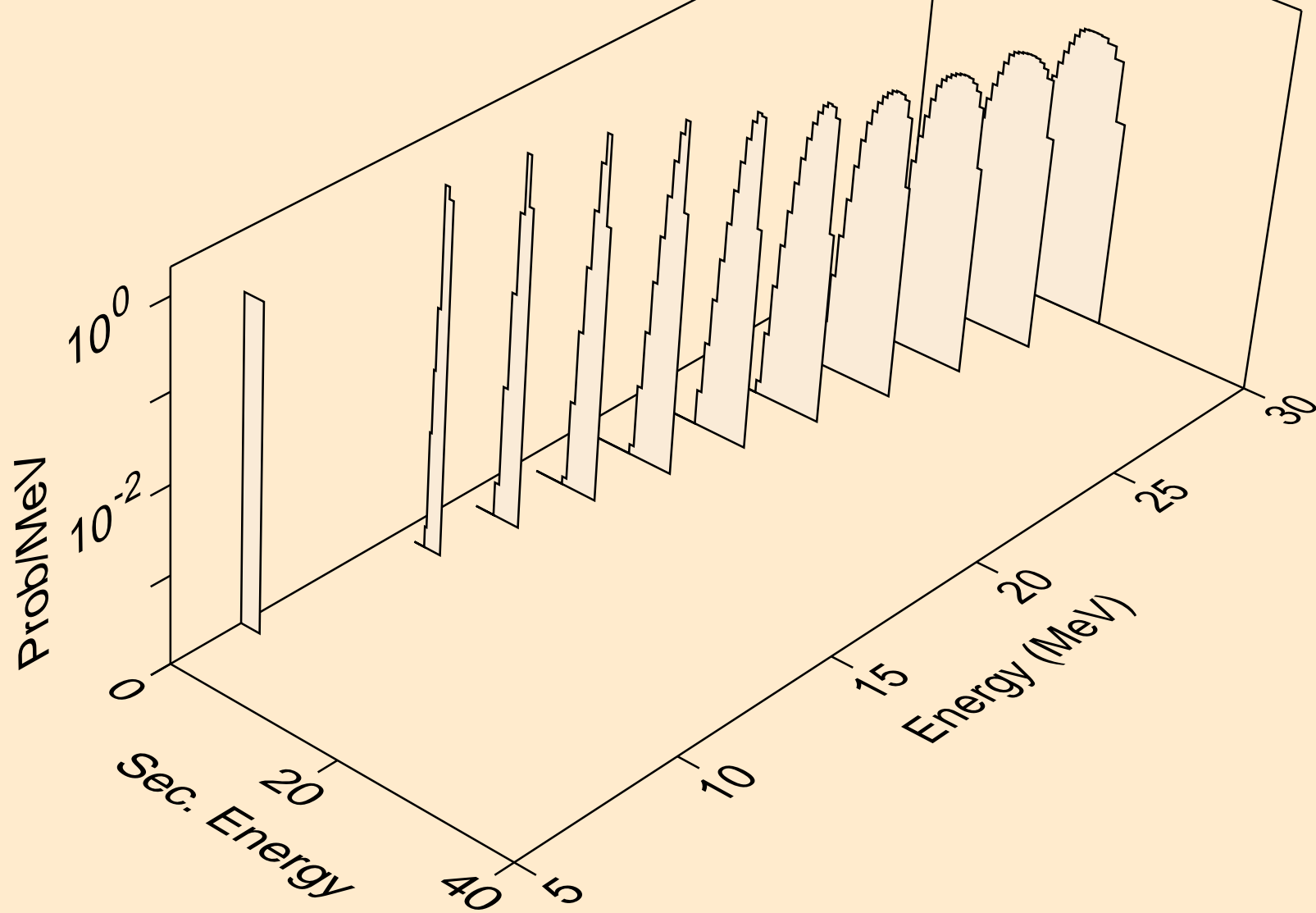

ES254 NEUTRON ACER TENDL-2021 LIBRARY; T=293.6K  
tritons from (n,t)

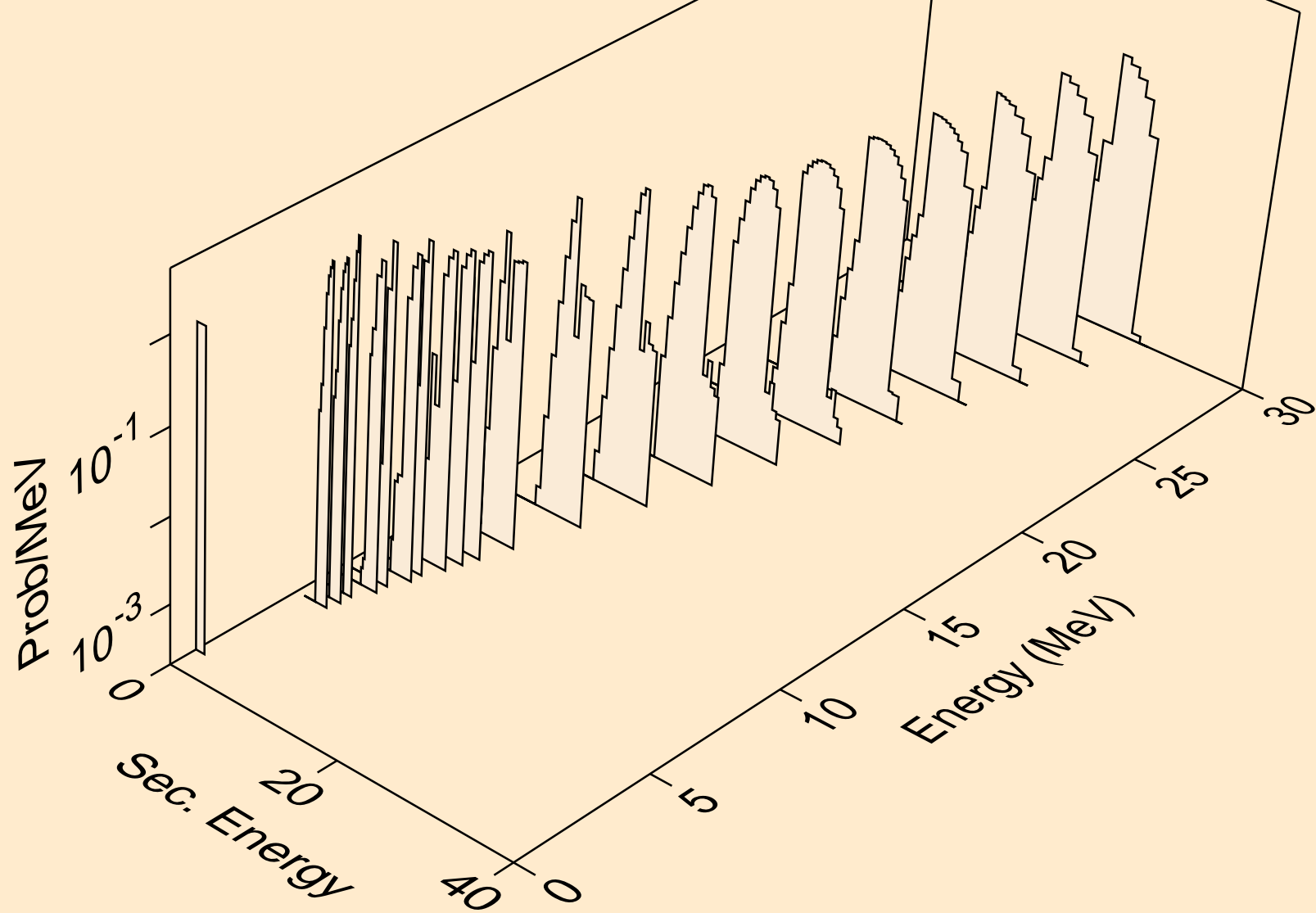

ES254 NEUTRON ACER TENDL-2021 LIBRARY; T=293.6K  
he3s from (n,x)

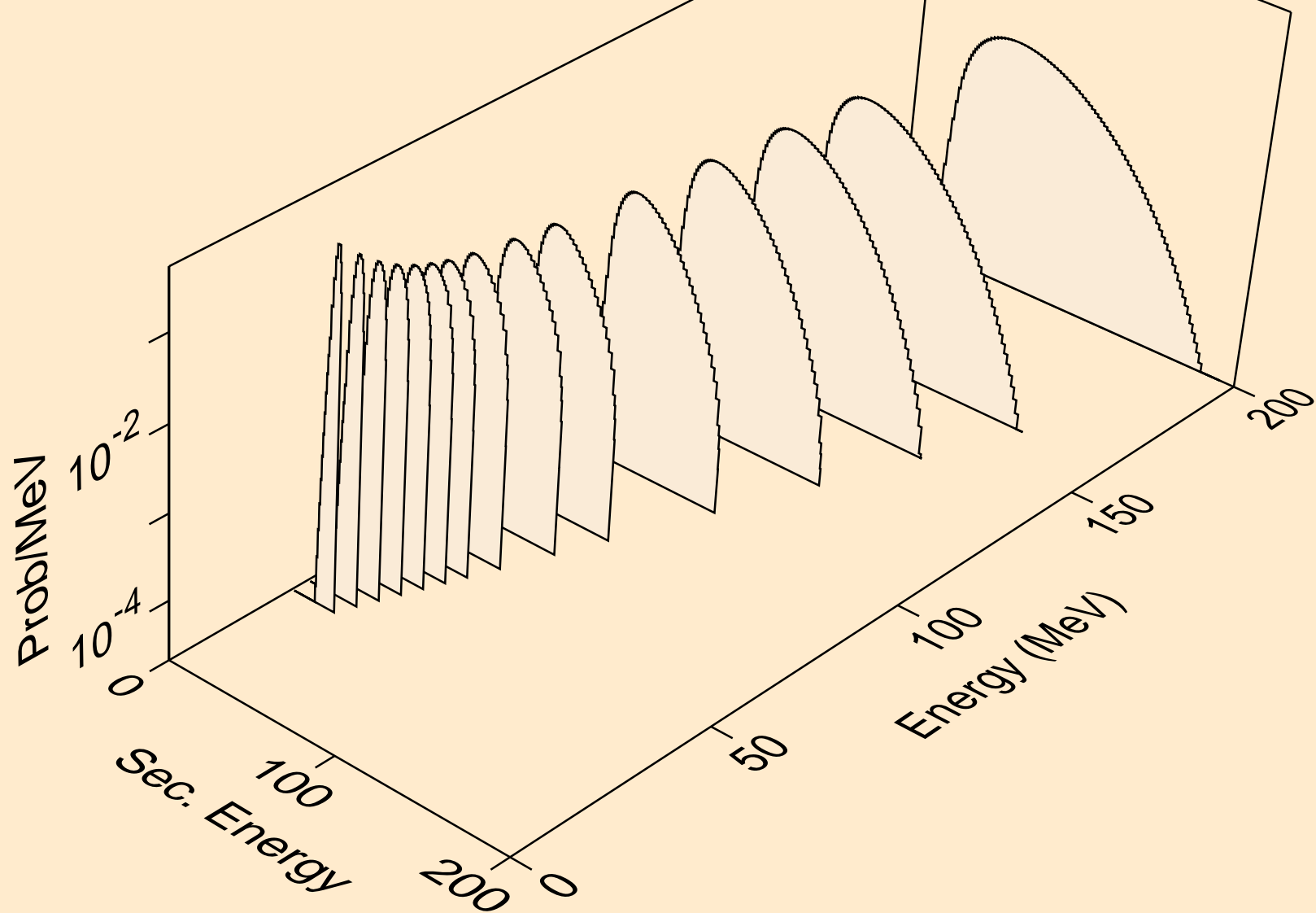

ES254 NEUTRON ACER TENDL-2021 LIBRARY; T=293.6K  
he3s from (n,n\*)he3

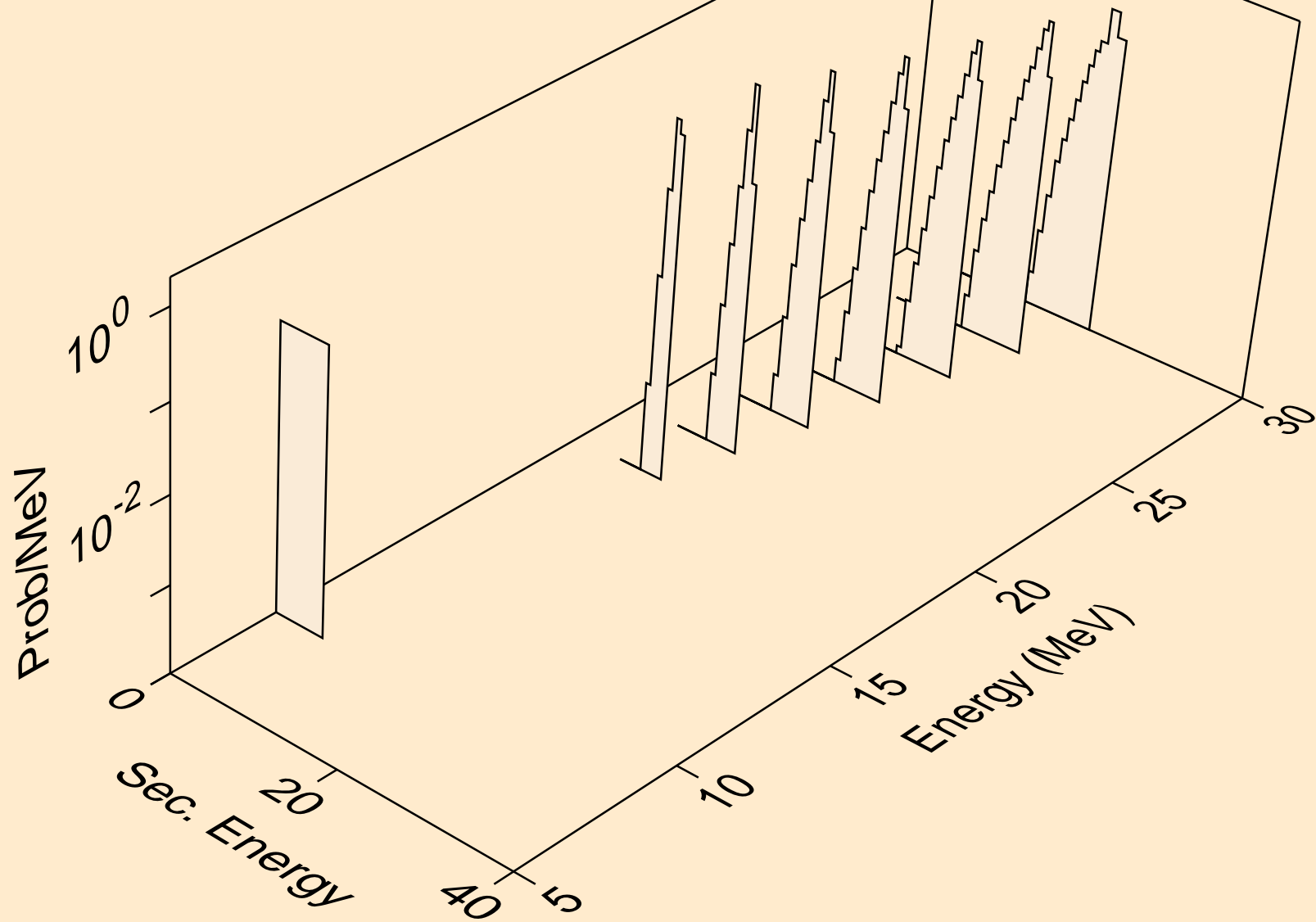

ES254 NEUTRON ACER TENDL-2021 LIBRARY; T=293.6K  
he3s from (n,he3)

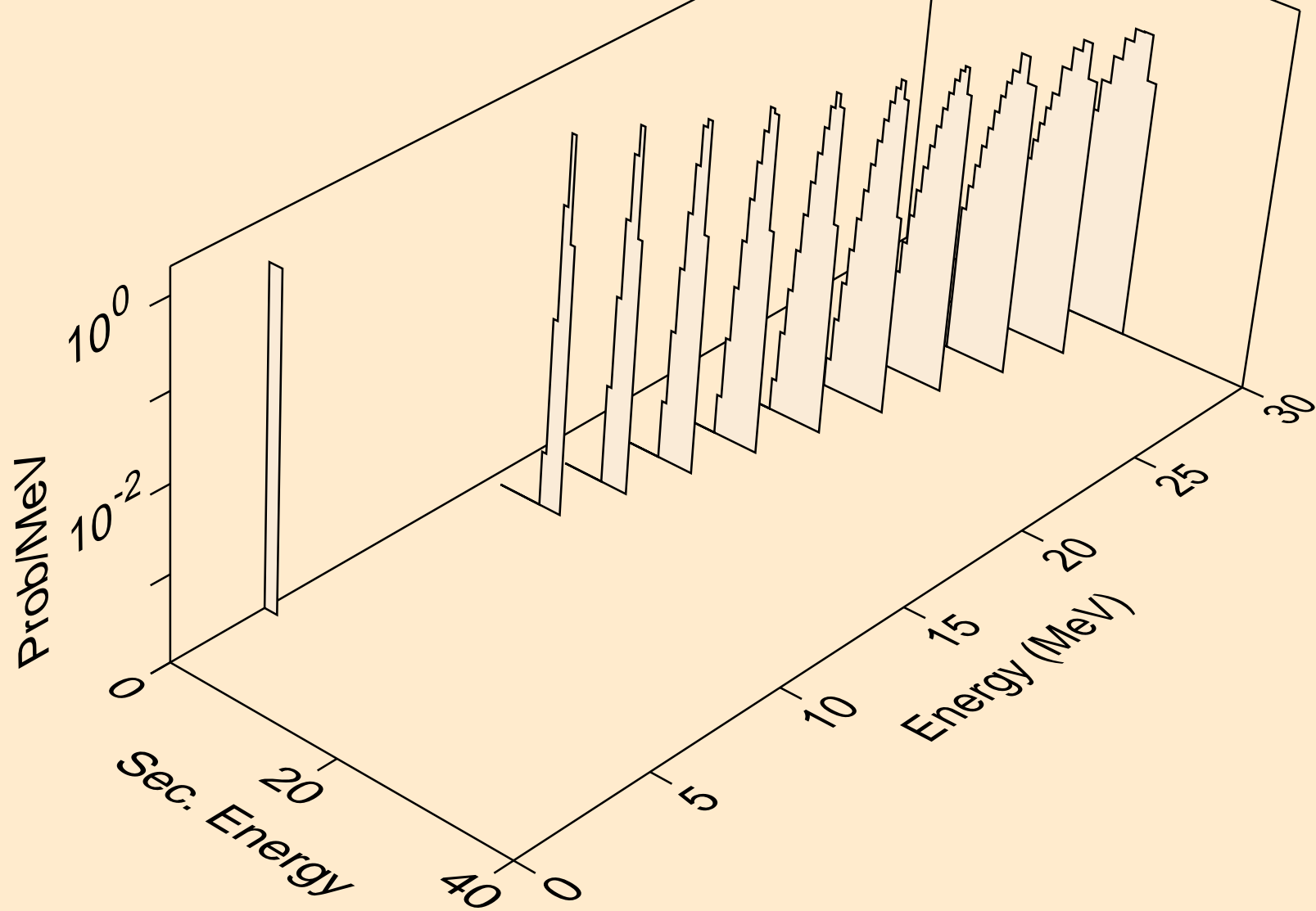



ES254 NEUTRON ACER TENDL-2021 LIBRARY; T=293.6K  
alphas from (n,x)

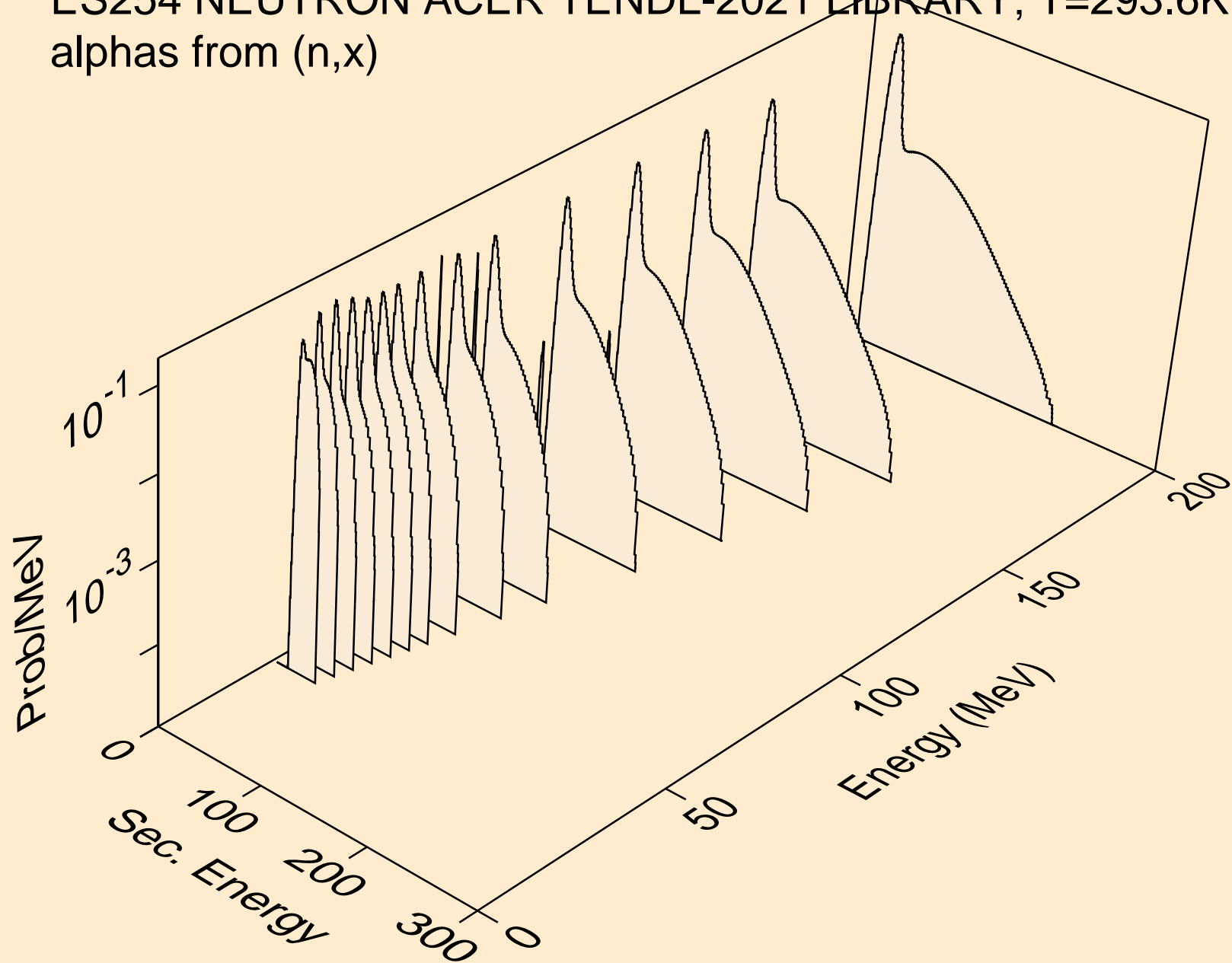

ES254 NEUTRON ACER TENDL-2021 LIBRARY; T=293.6K  
alphas from (n,n\*)a

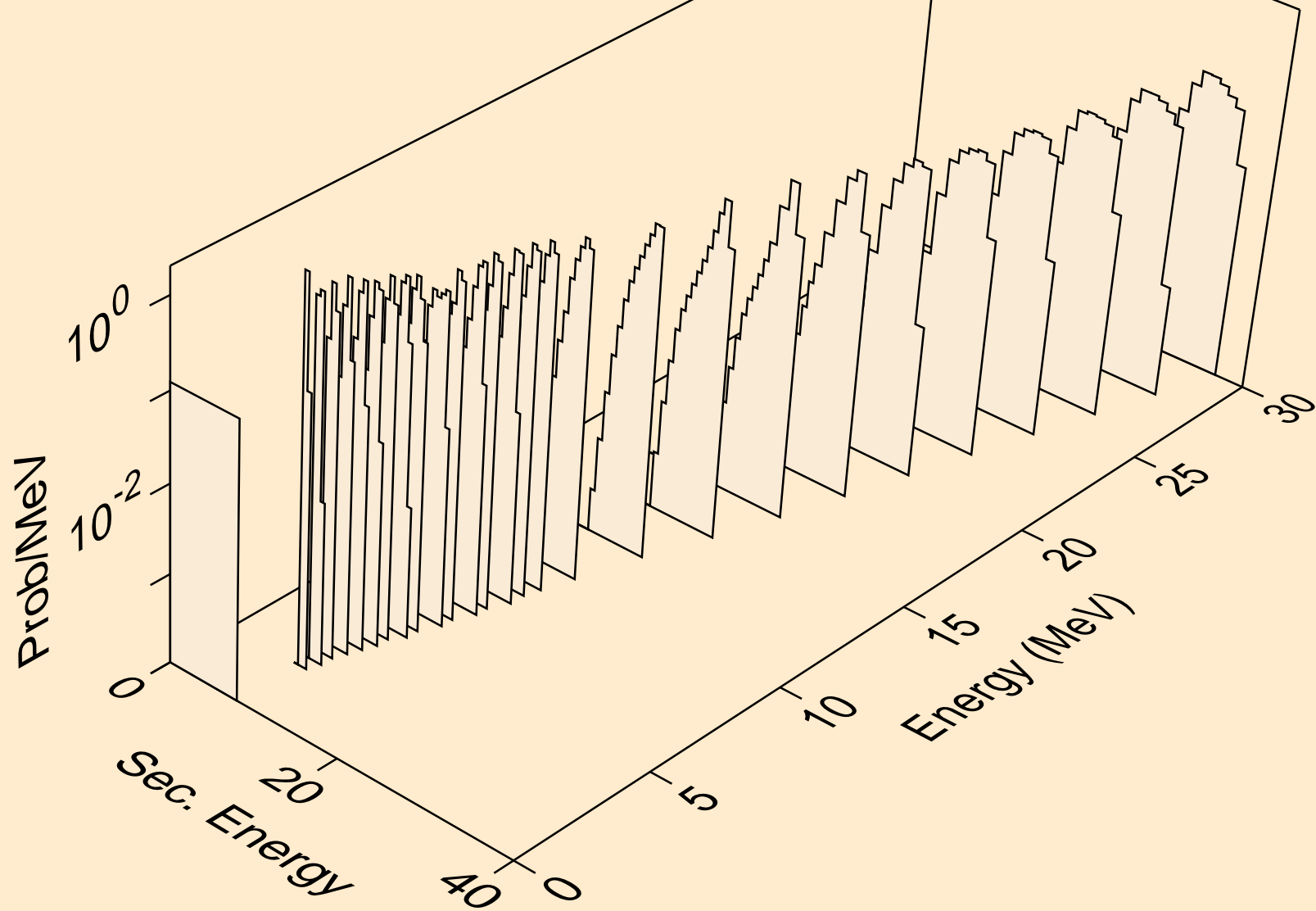

ES254 NEUTRON ACER TENDL-2021 LIBRARY; T=293.6K  
alphas from (n,2n)a

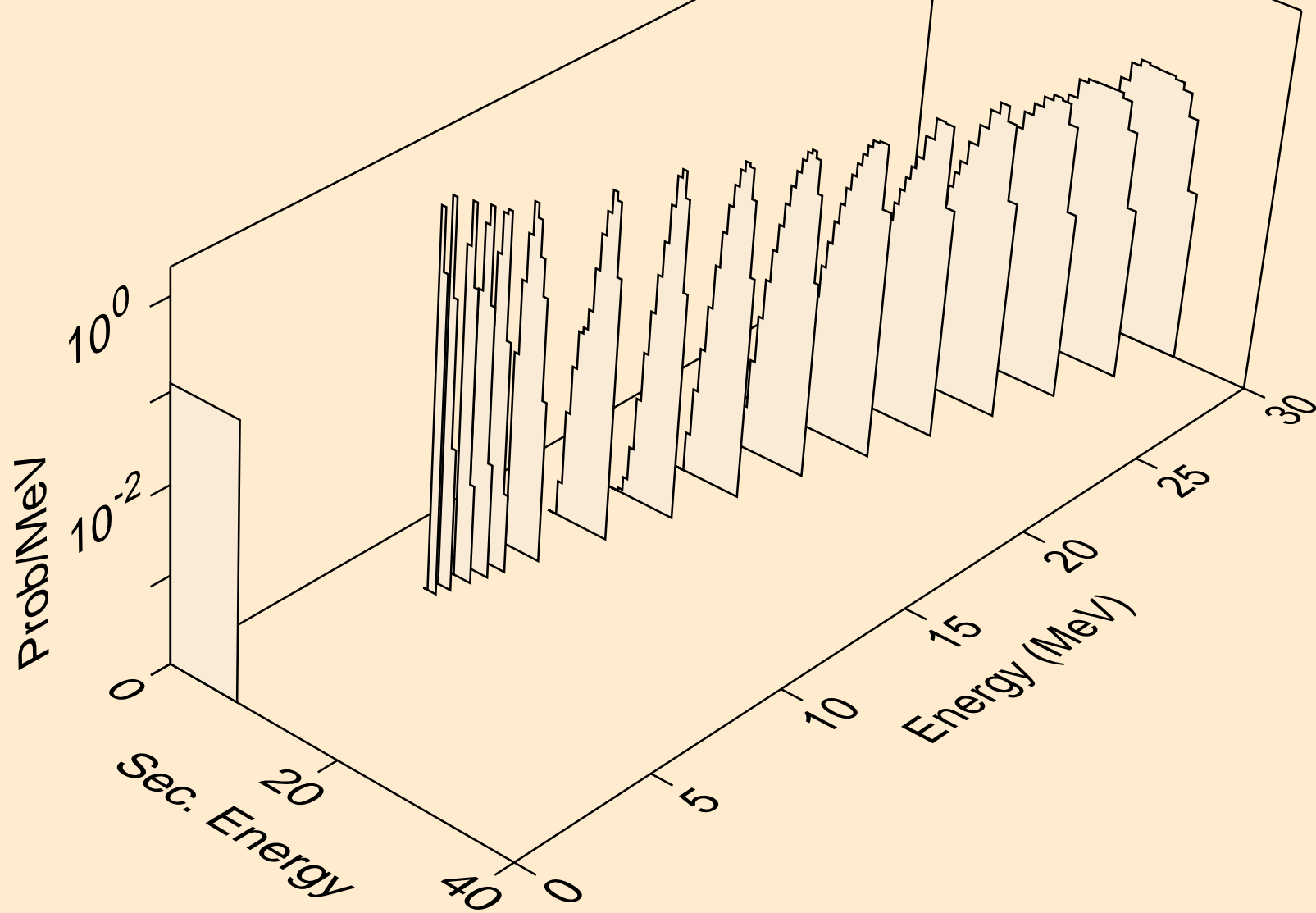

ES254 NEUTRON ACER TENDL-2021 LIBRARY; T=293.6K  
alphas from (n,3n)a

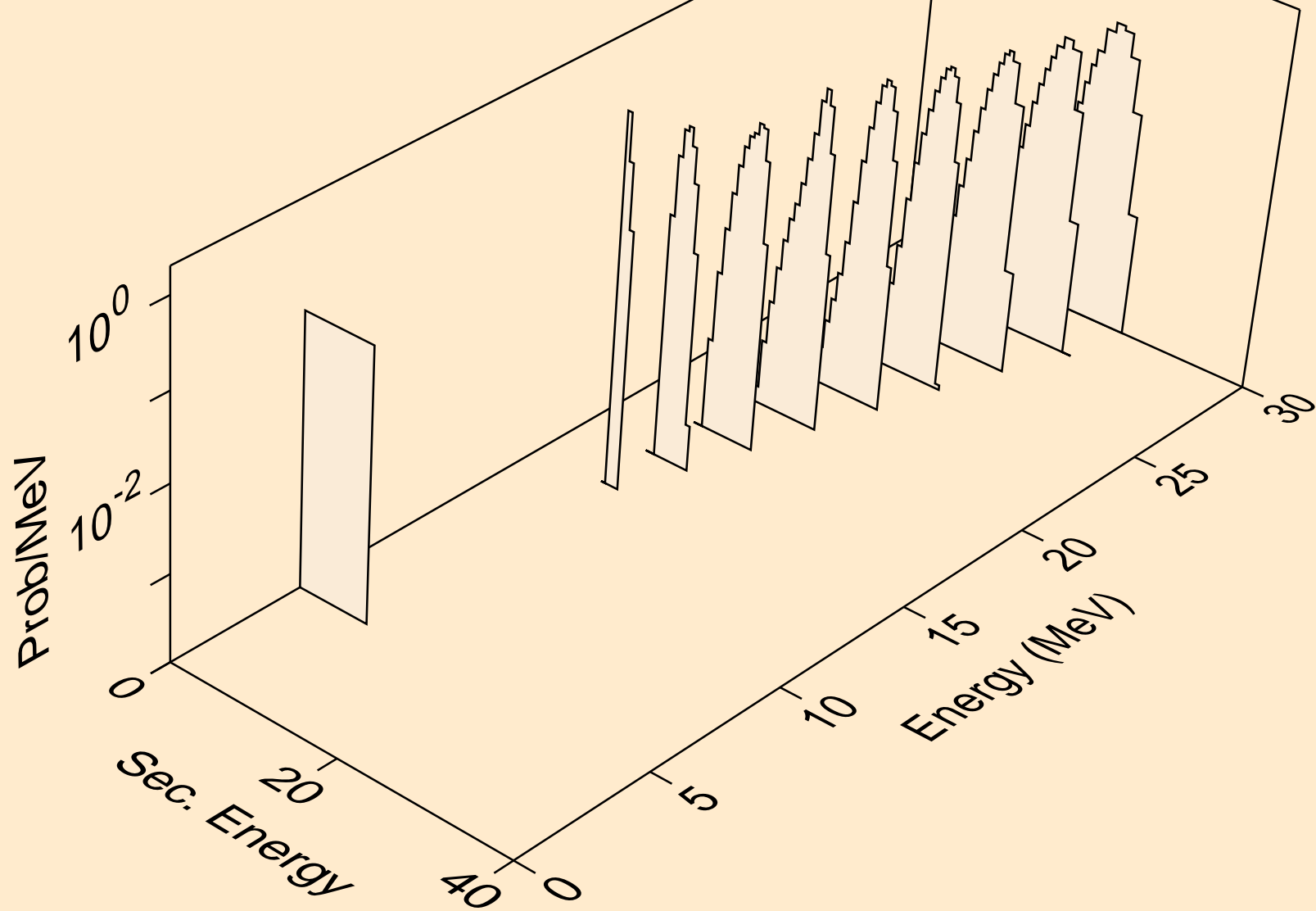

ES254 NEUTRON ACER TENDL-2021 LIBRARY; T=293.6K  
alphas from (n,npa)

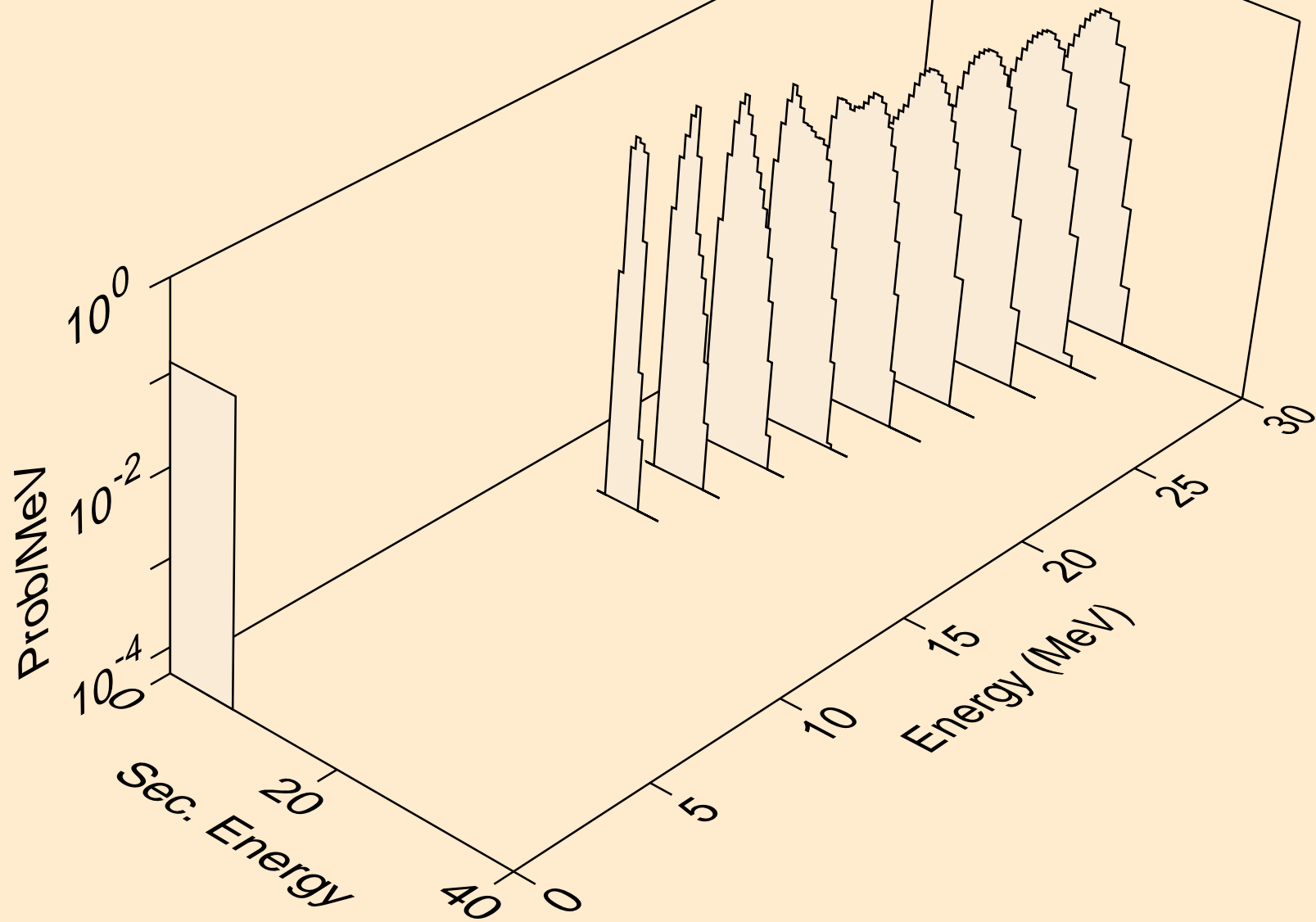

ES254 NEUTRON ACER TENDL-2021 LIBRARY; T=293.6K  
alphas from (n,a)

