

EU136M NEUTRON ACER TENDL-2021 LIBRARY; T=293.6K

Principal cross sections

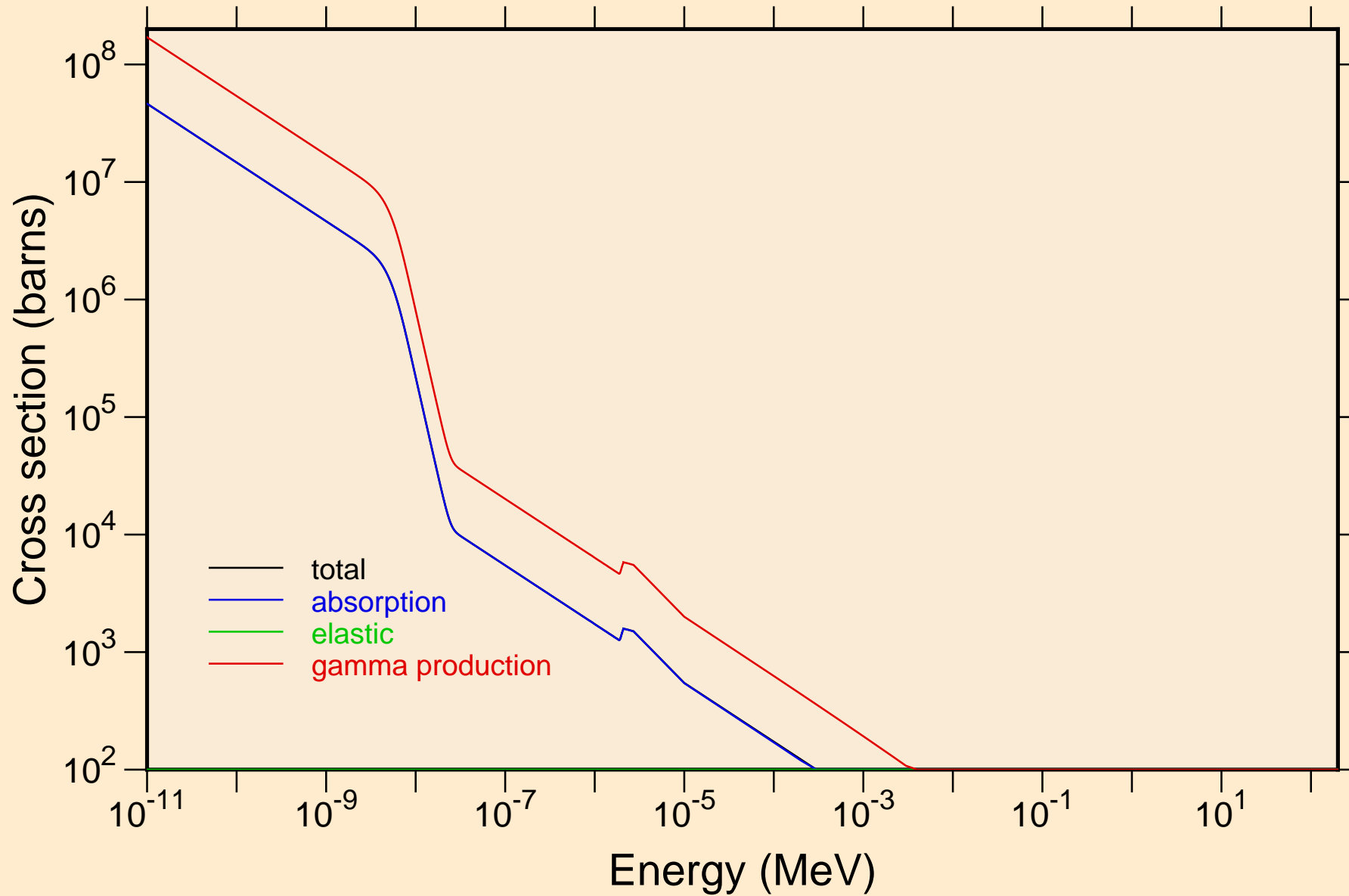

EU136M NEUTRON ACER TENDL-2021 LIBRARY; T=293.6K
Heating

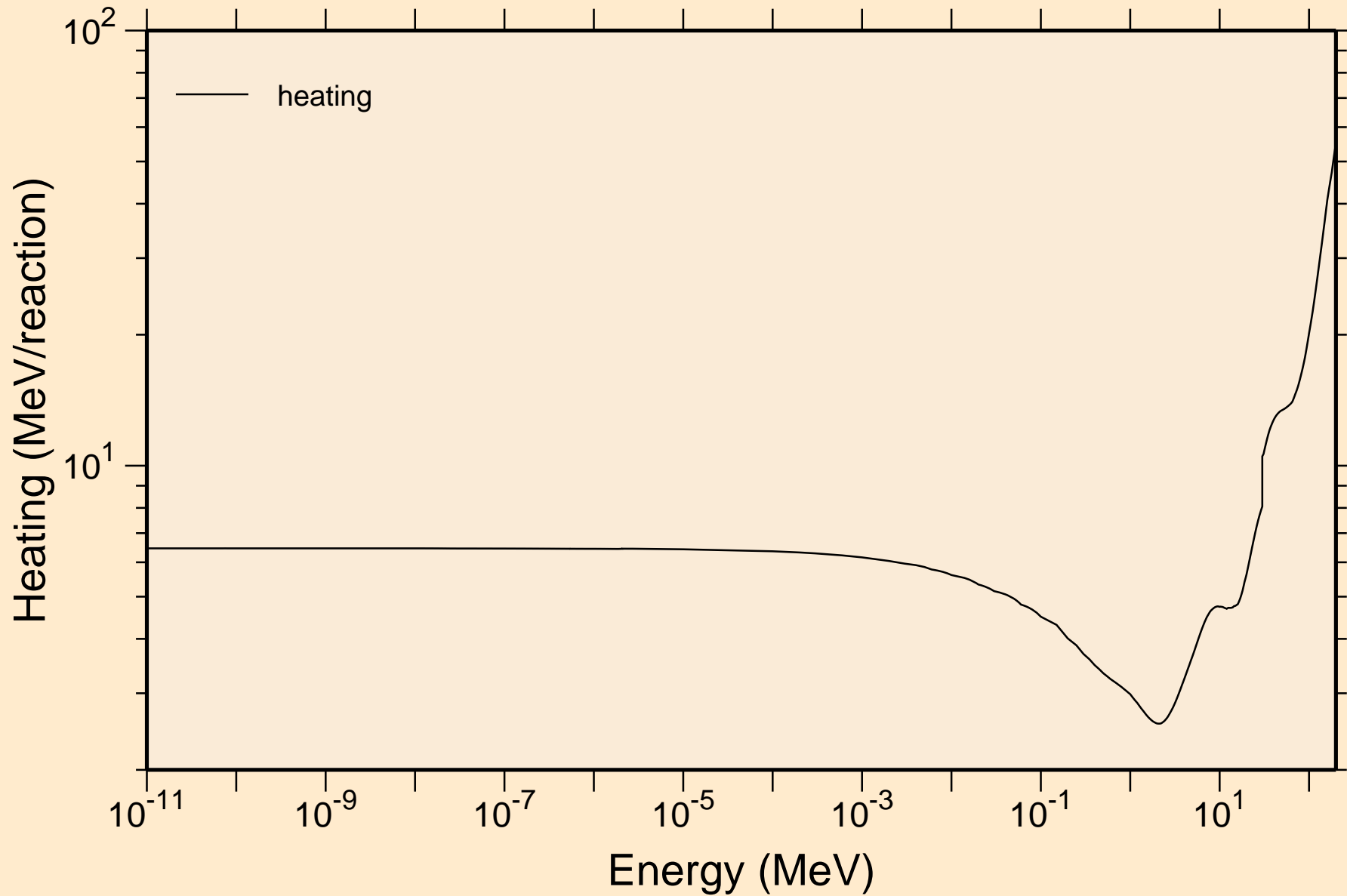

EU136M NEUTRON ACER TENDL-2021 LIBRARY; T=293.6K Damage

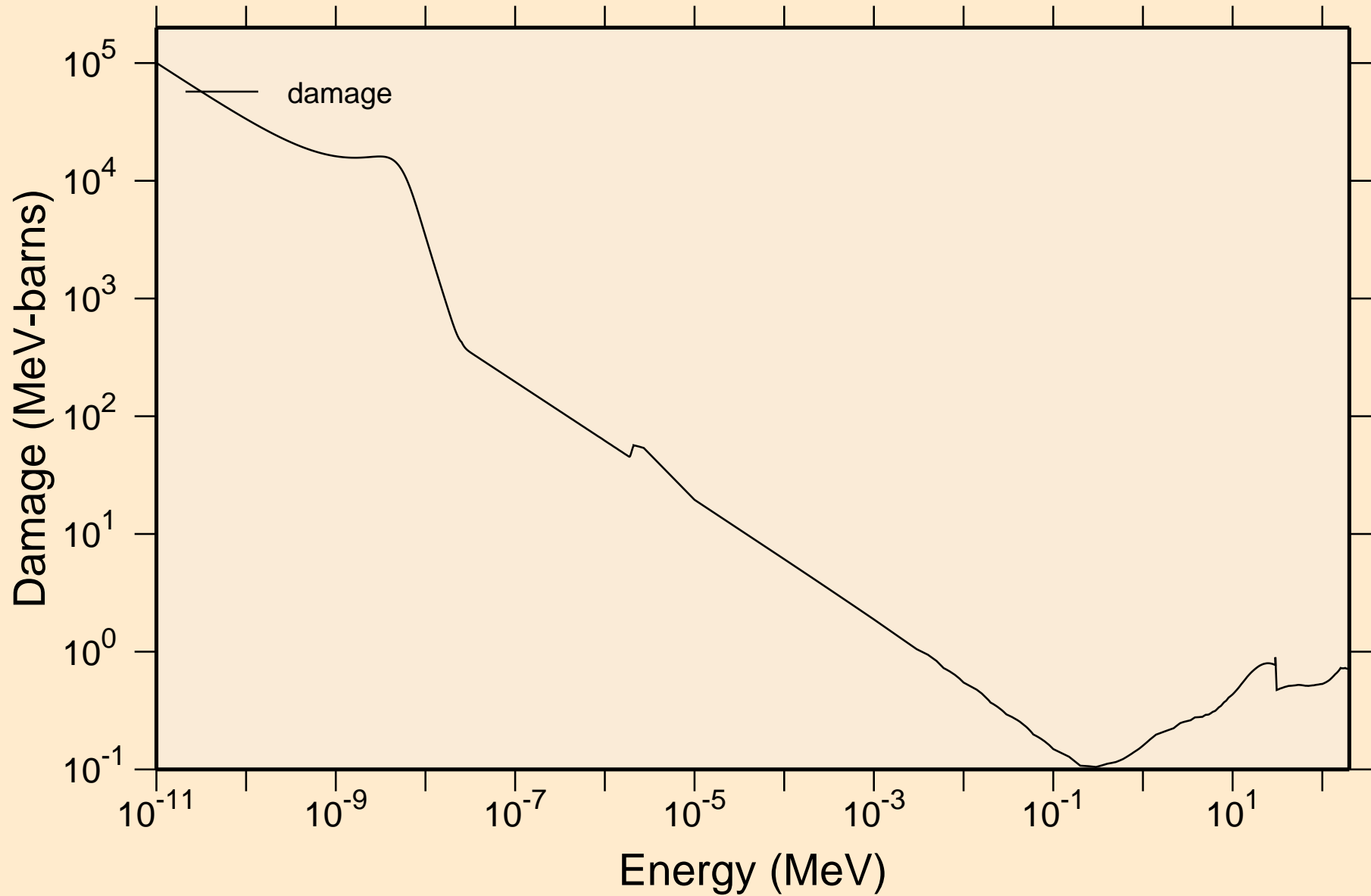

EU136M NEUTRON ACER TENDL-2021 LIBRARY; T=293.6K
Non-threshold reactions

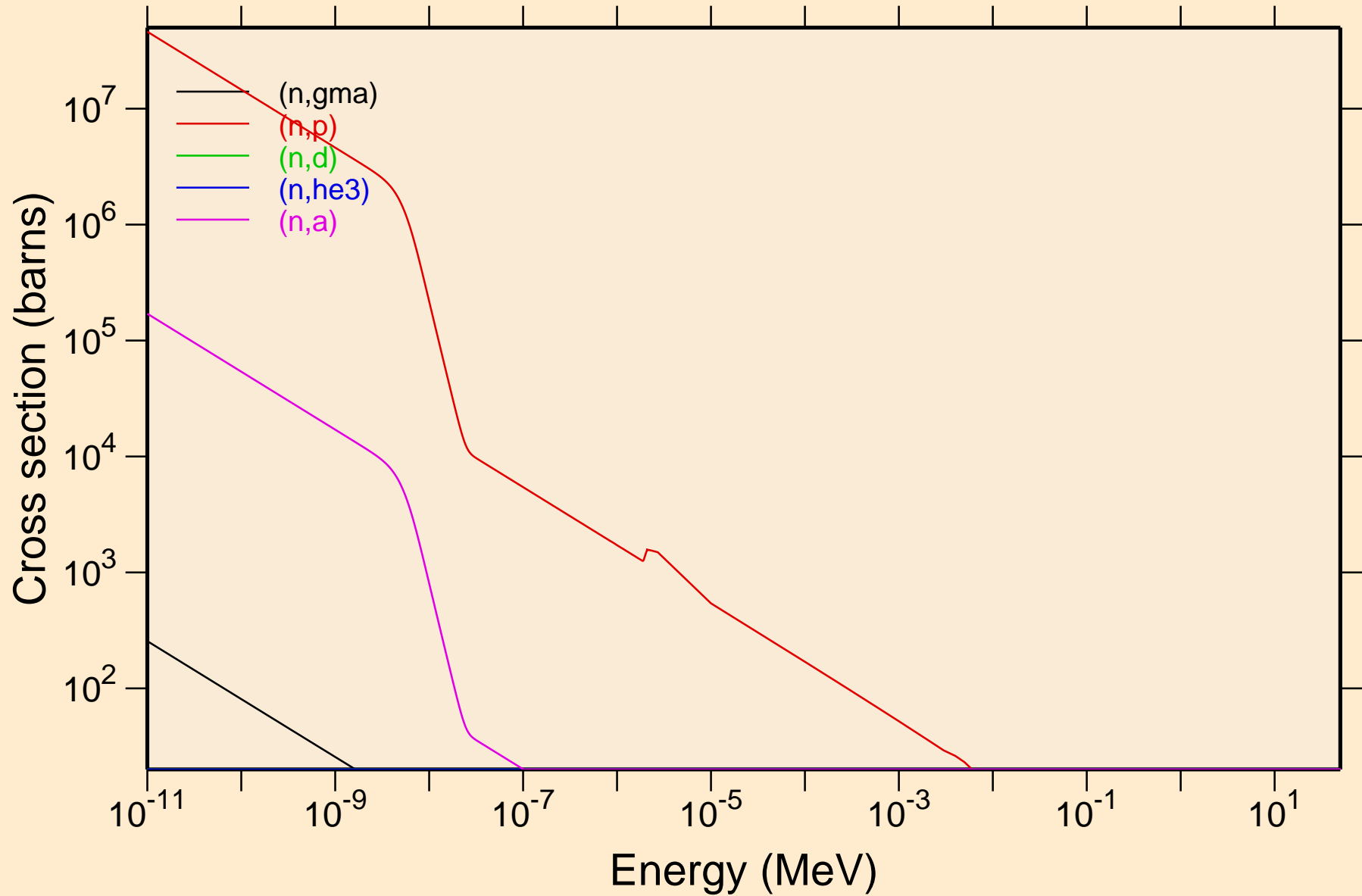

EU136M NEUTRON ACER TENDL-2021 LIBRARY; T=293.6K
Non-threshold reactions

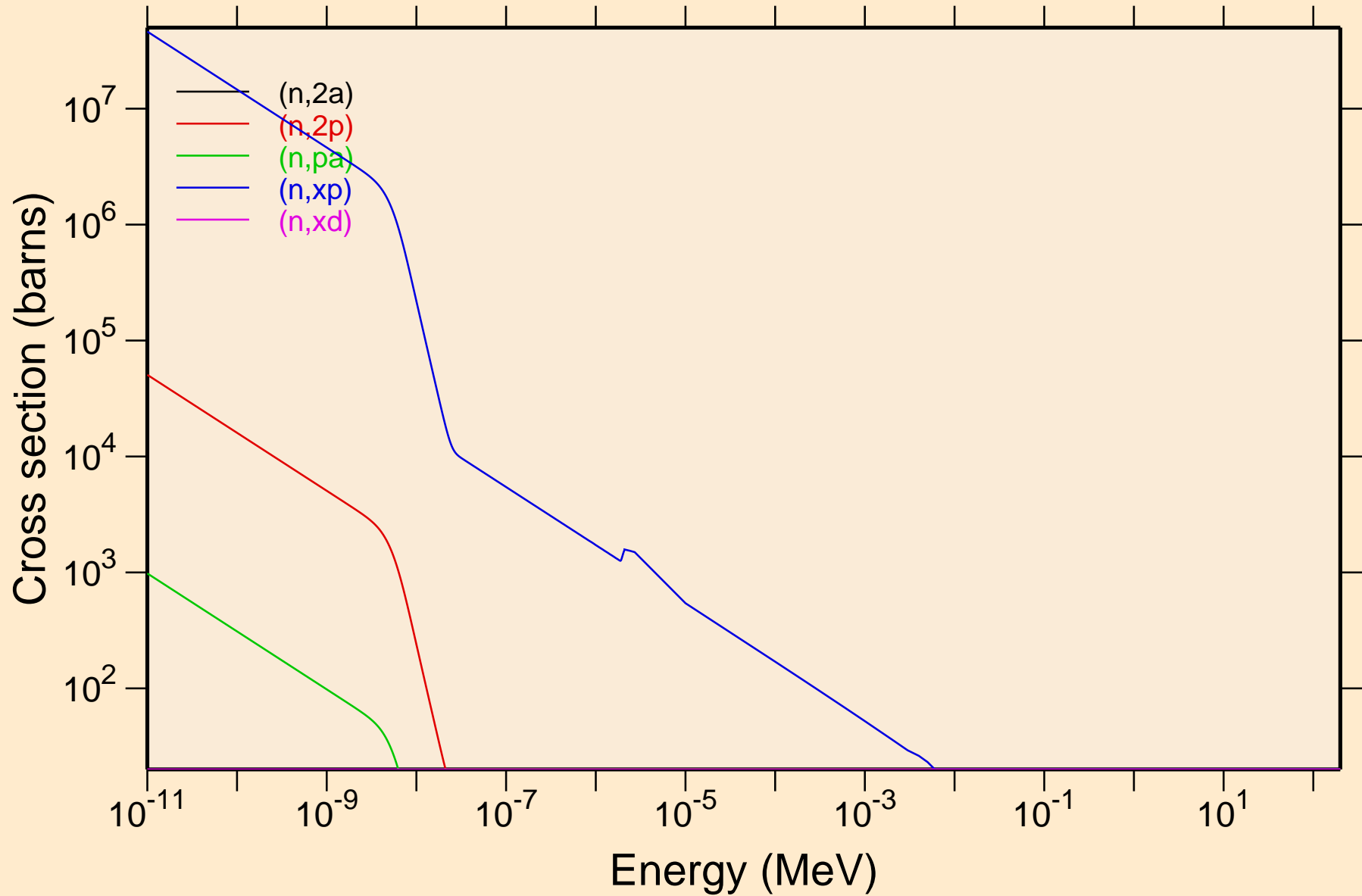

EU136M NEUTRON ACER TENDL-2021 LIBRARY; T=293.6K
Non-threshold reactions

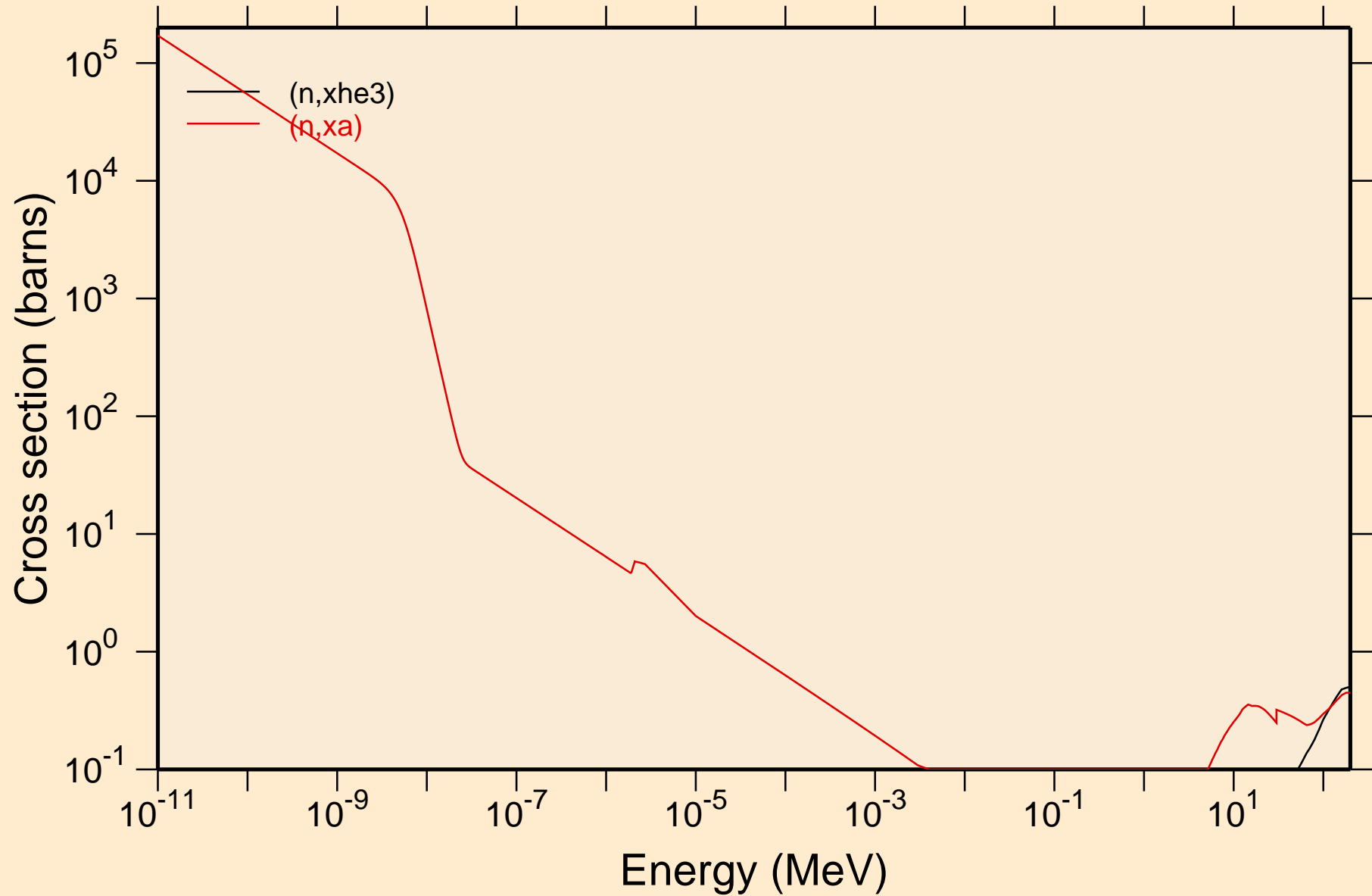

EU136M NEUTRON ACER TENDL-2021 LIBRARY; T=293.6K
Principal cross sections

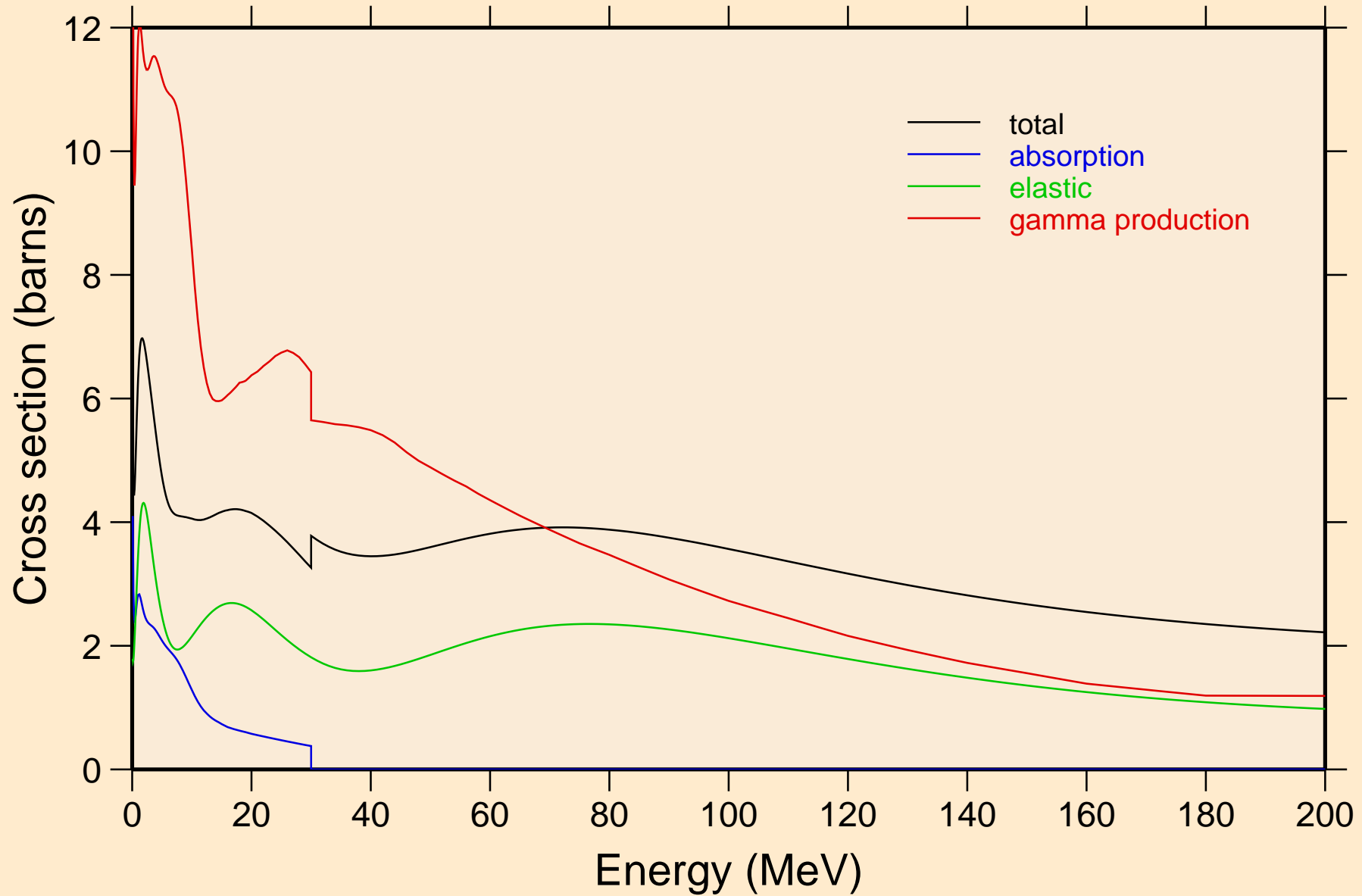

EU136M NEUTRON ACER TENDL-2021 LIBRARY; T=293.6K
Heating

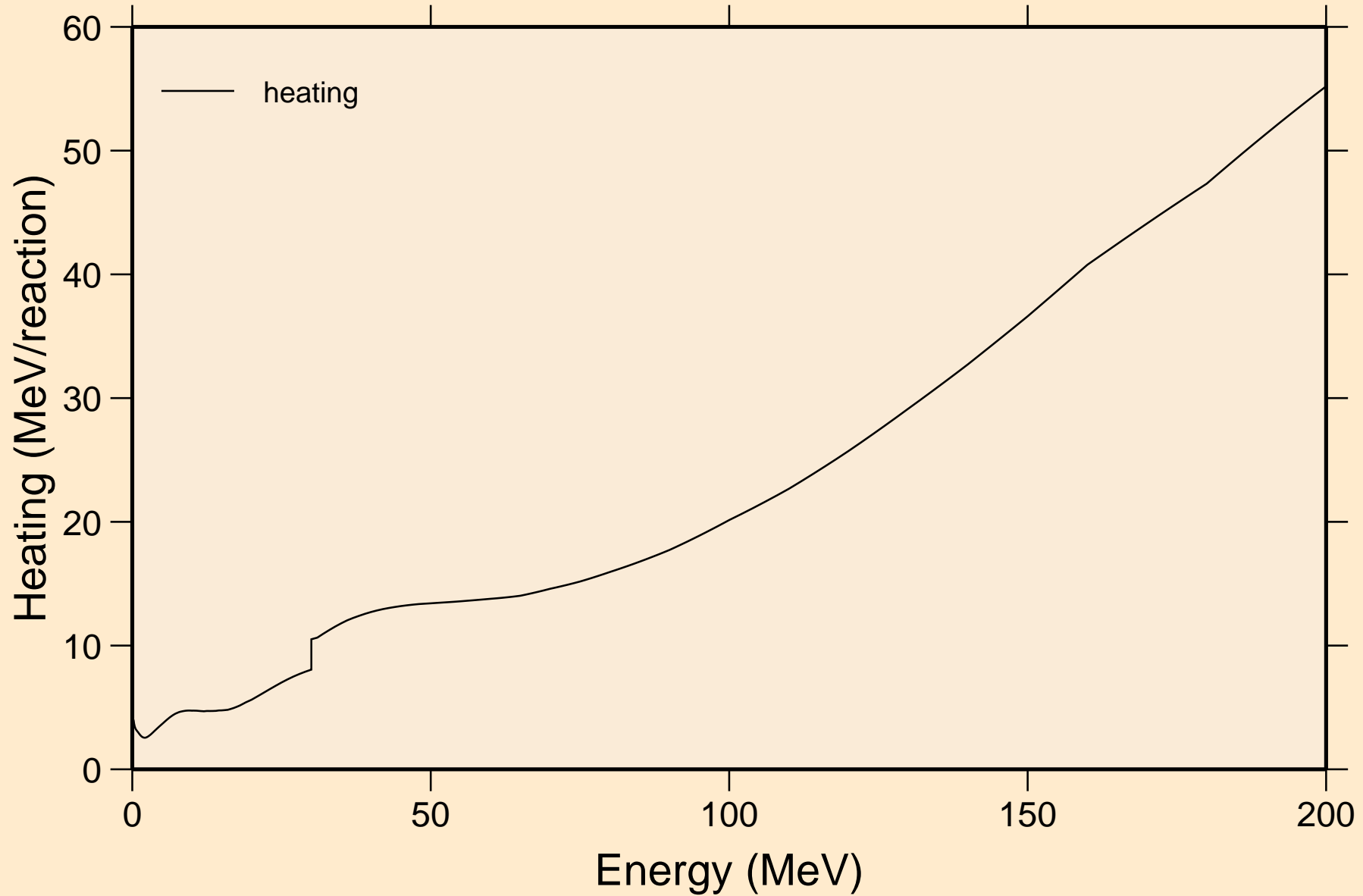

EU136M NEUTRON ACER TENDL-2021 LIBRARY; T=293.6K
Damage

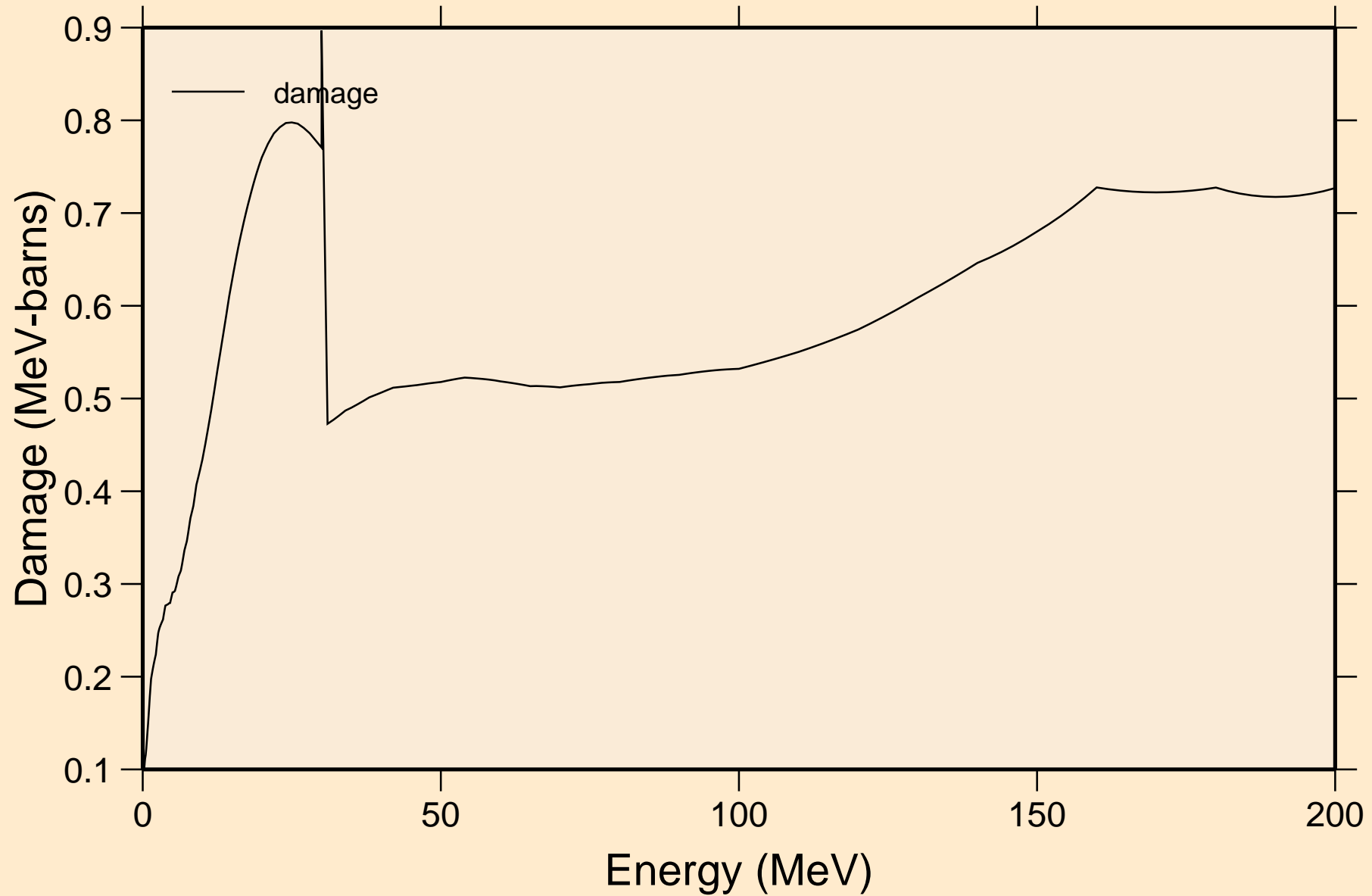

EU136M NEUTRON ACER TENDL-2021 LIBRARY; T=293.6K
Non-threshold reactions

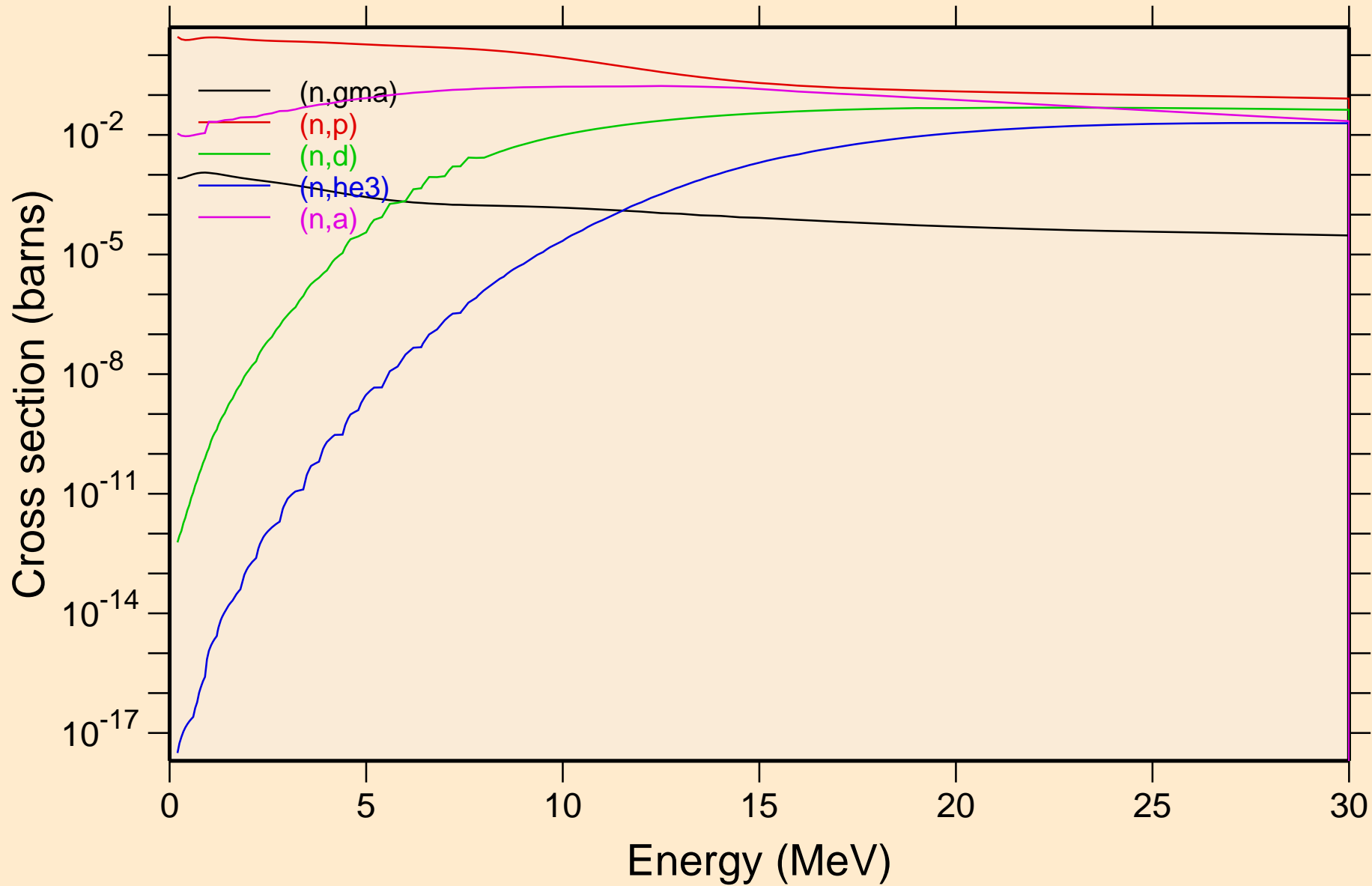

EU136M NEUTRON ACER TENDL-2021 LIBRARY; T=293.6K
Non-threshold reactions

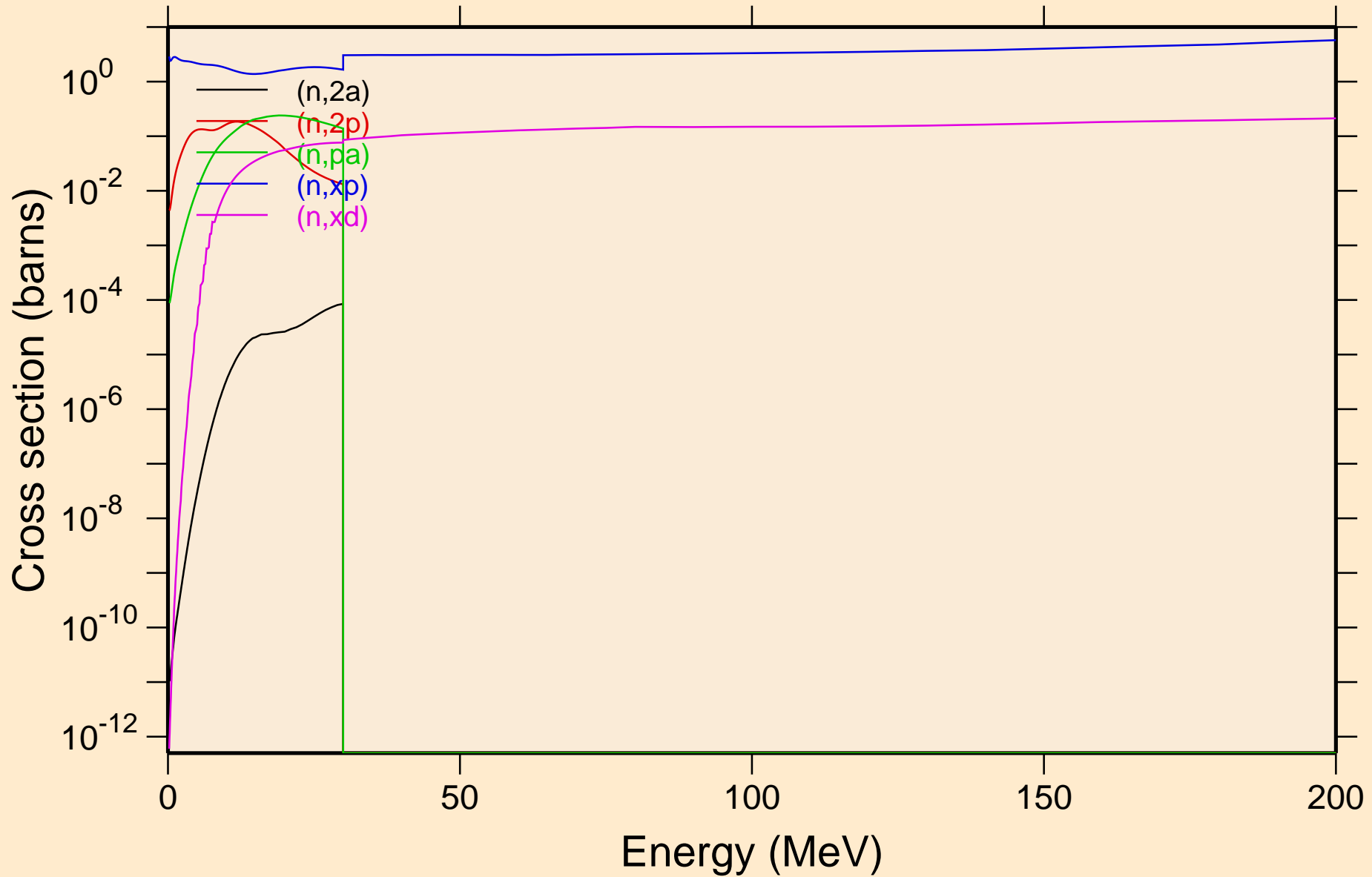

EU136M NEUTRON ACER TENDL-2021 LIBRARY; T=293.6K
Non-threshold reactions

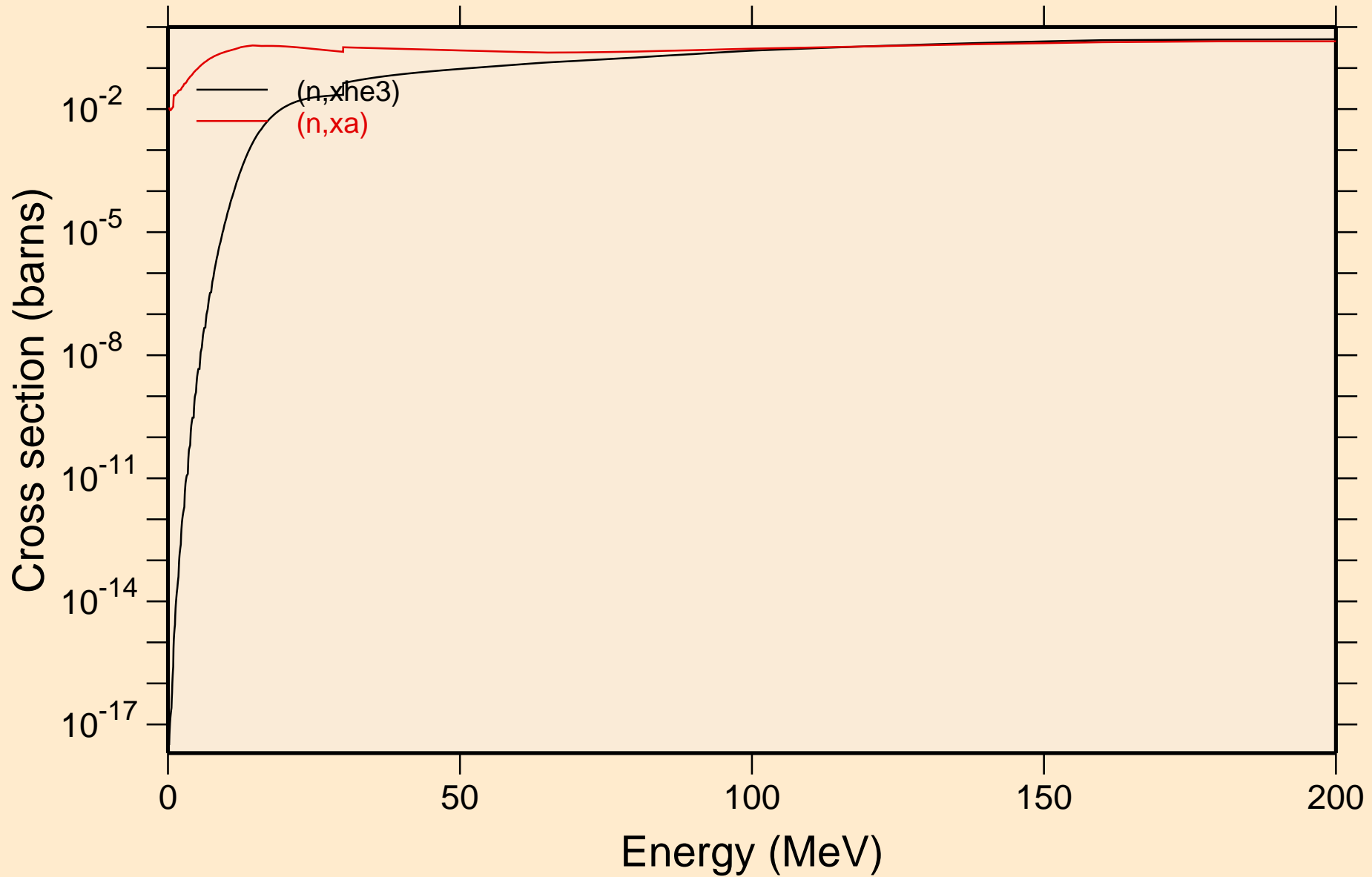

EU136M NEUTRON ACER TENDL-2021 LIBRARY; T=293.6K
Inelastic levels

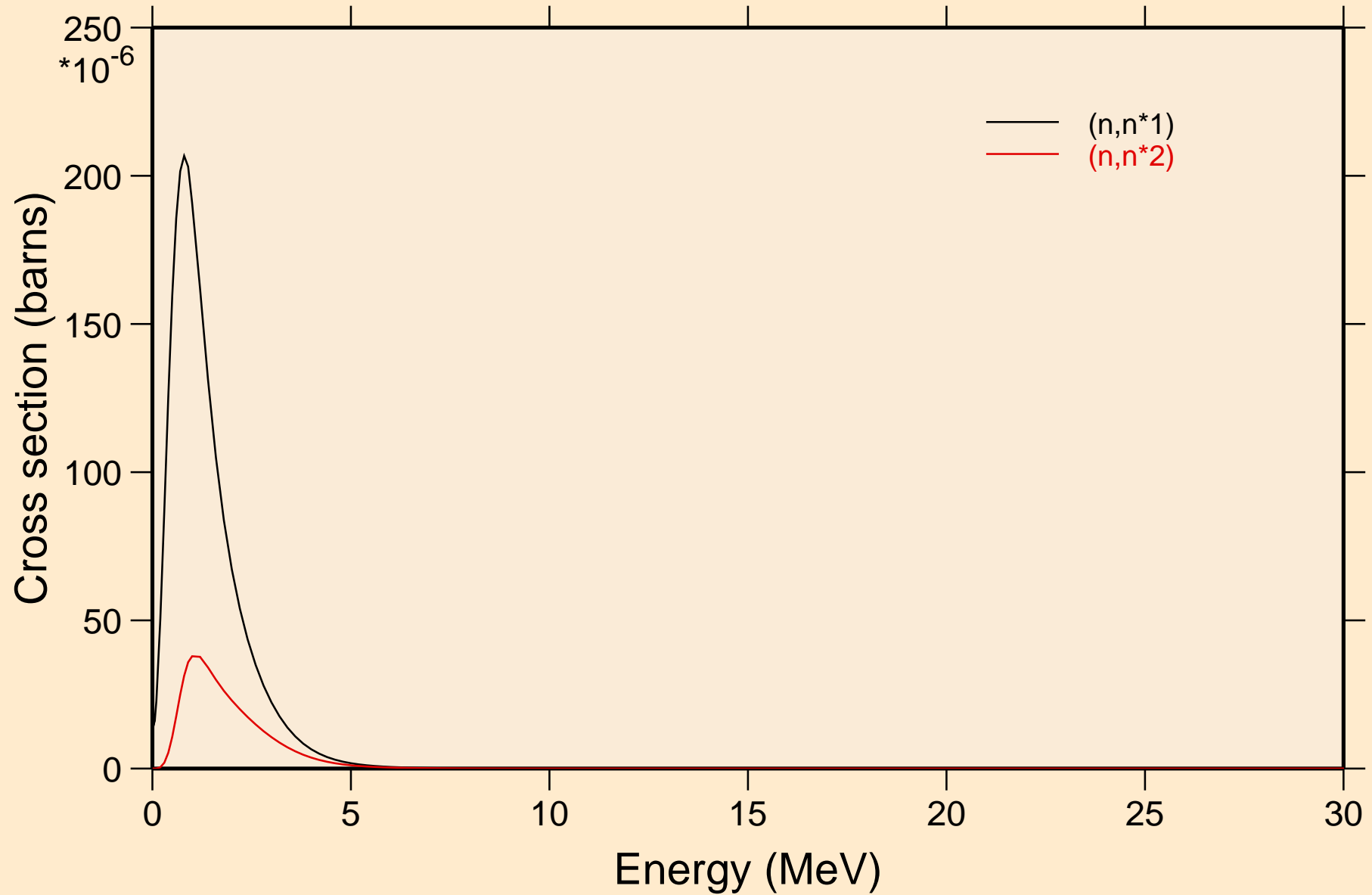

EU136M NEUTRON ACER TENDL-2021 LIBRARY; T=293.6K
Threshold reactions

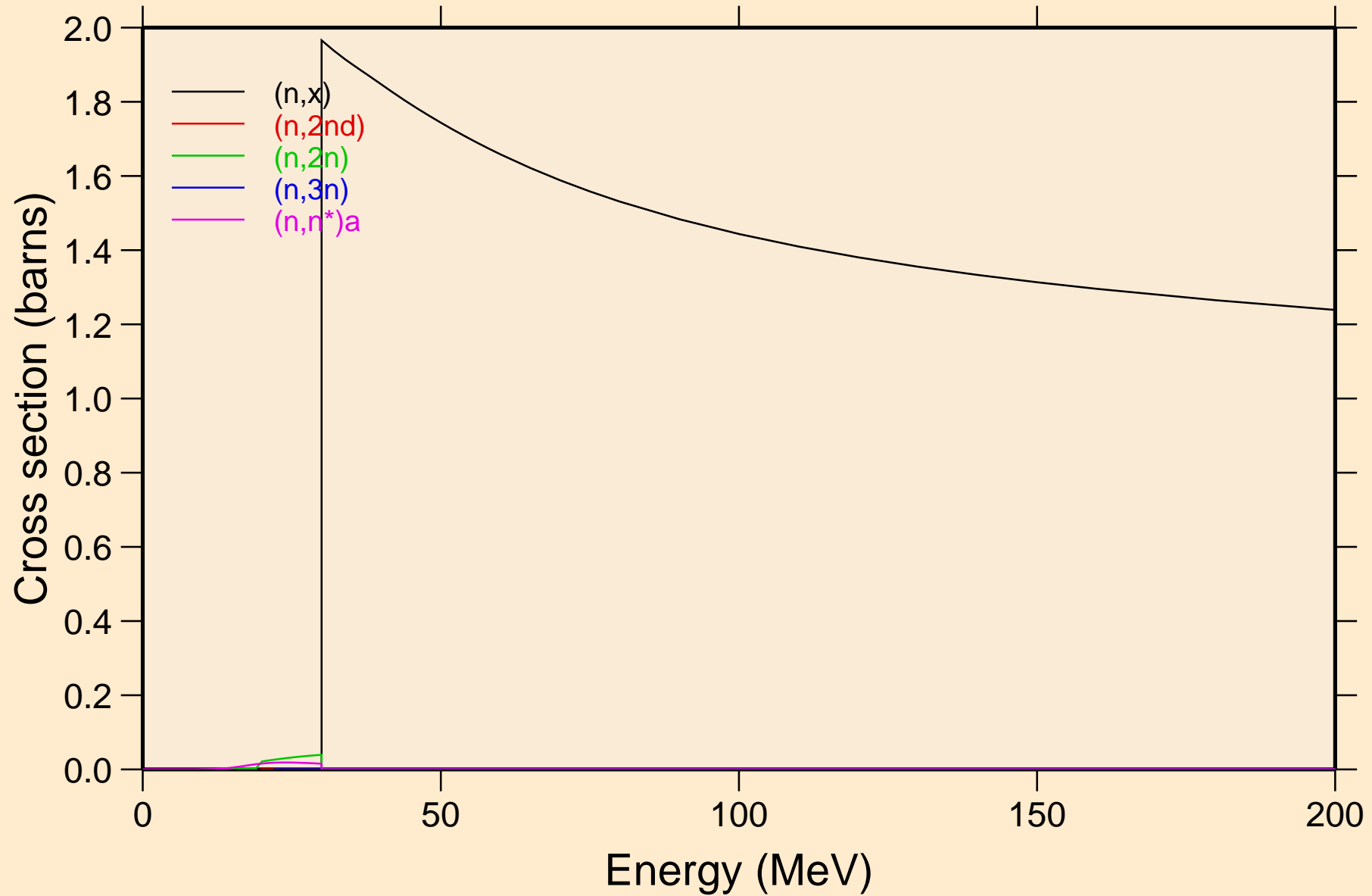

EU136M NEUTRON ACER TENDL-2021 LIBRARY; T=293.6K
Threshold reactions

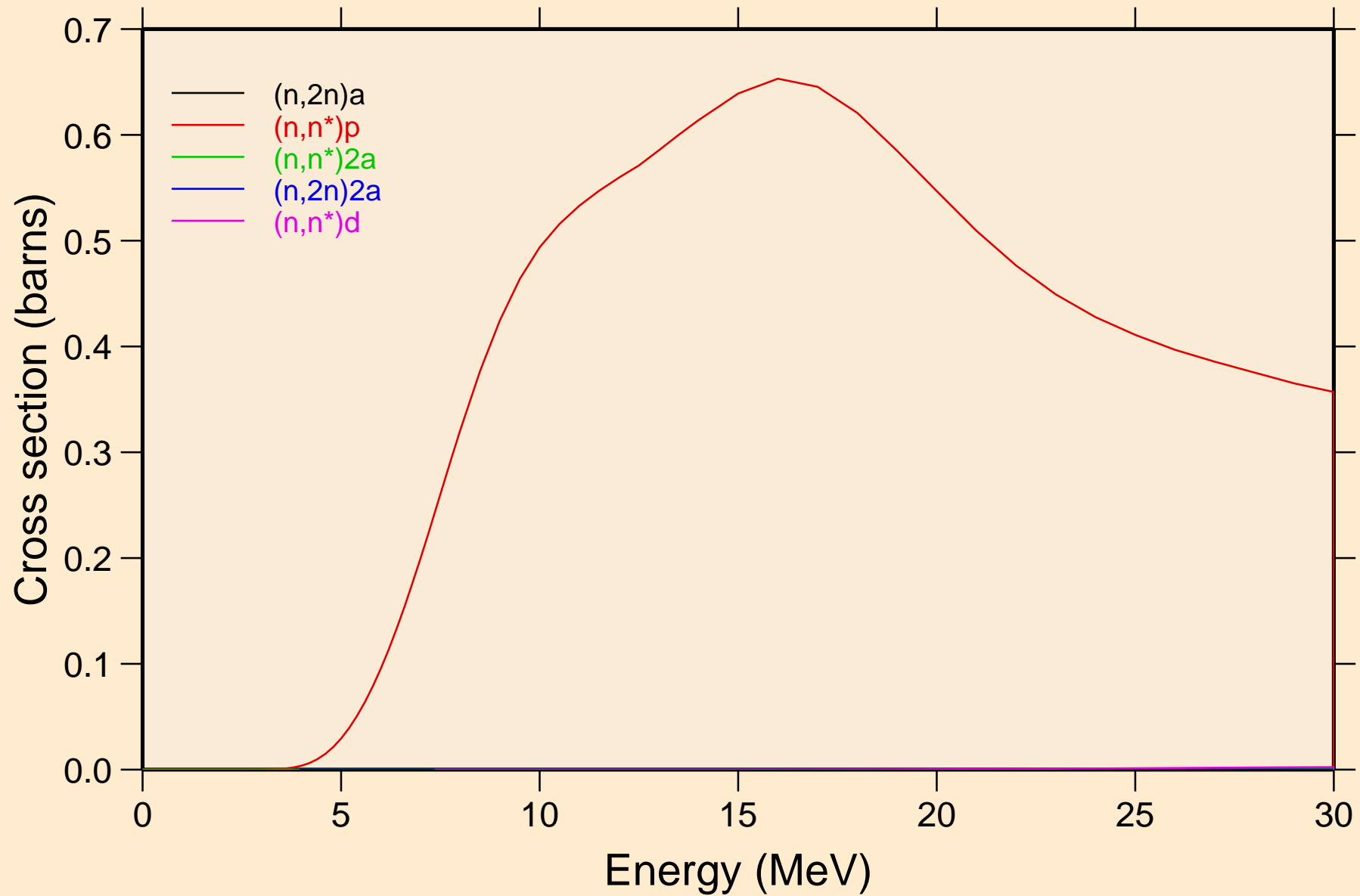

EU136M NEUTRON ACER TENDL-2021 LIBRARY; T=293.6K
Threshold reactions

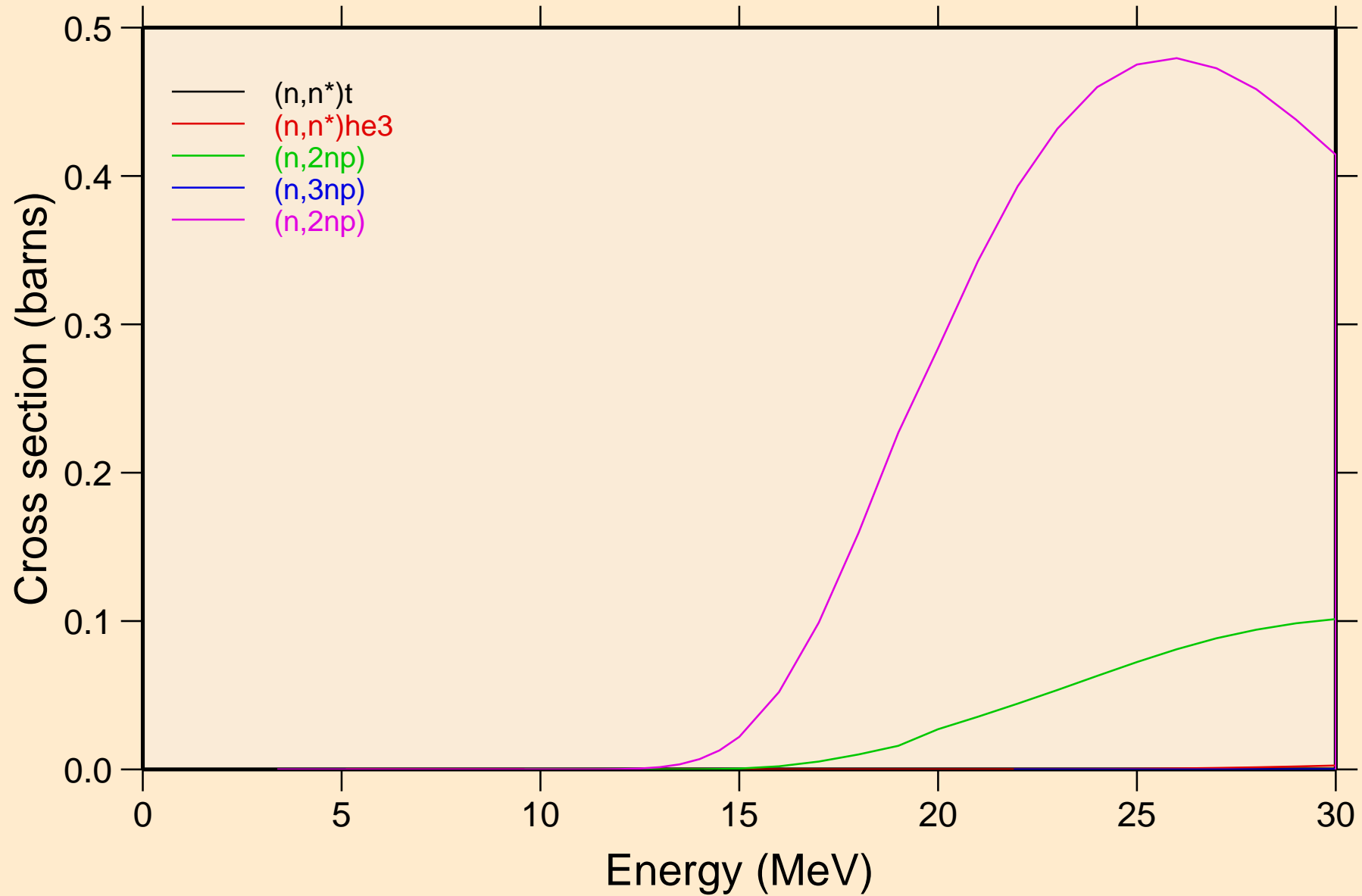

EU136M NEUTRON ACER TENDL-2021 LIBRARY; T=293.6K

Threshold reactions

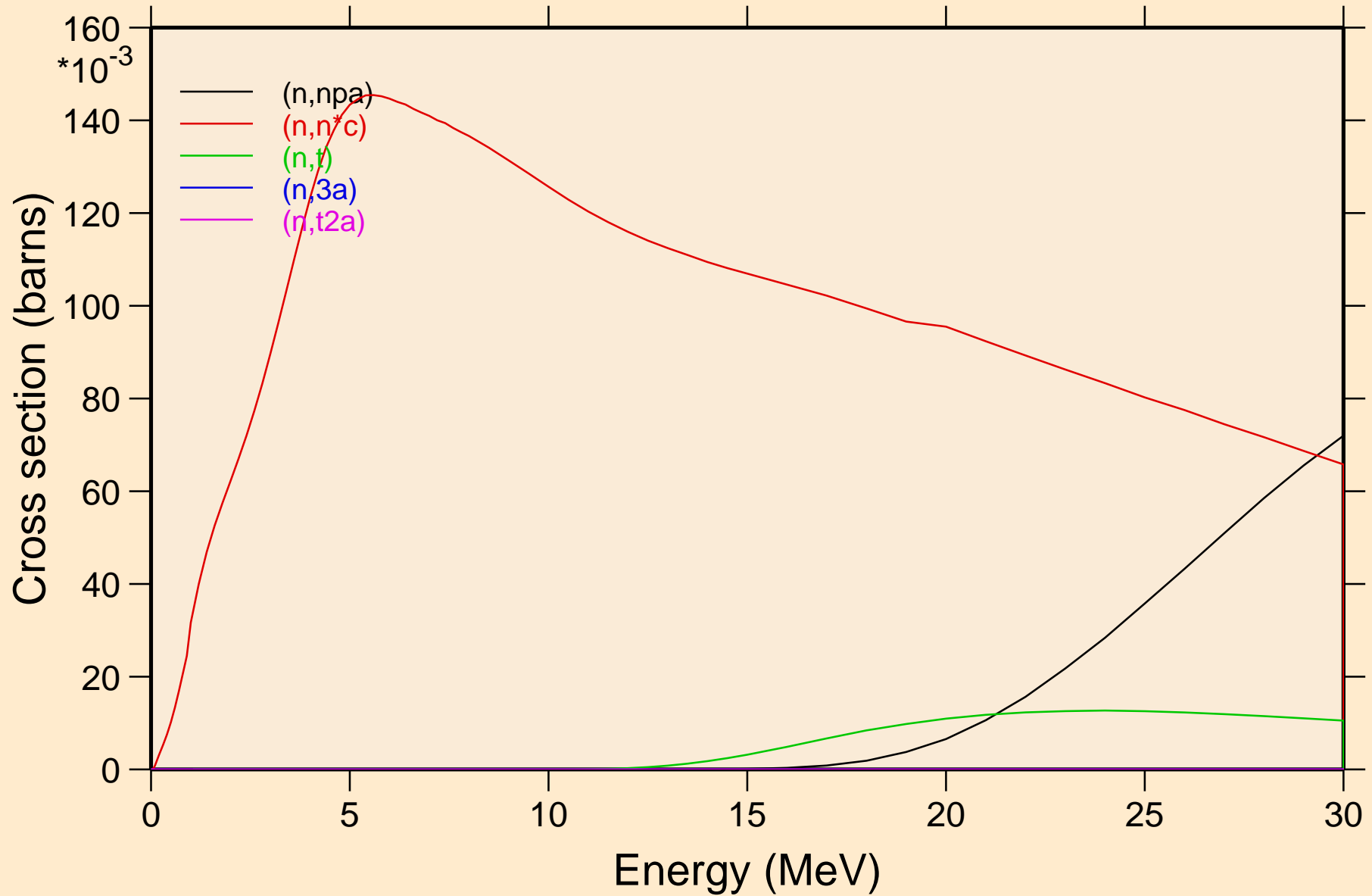

EU136M NEUTRON ACER TENDL-2021 LIBRARY; T=293.6K
Threshold reactions

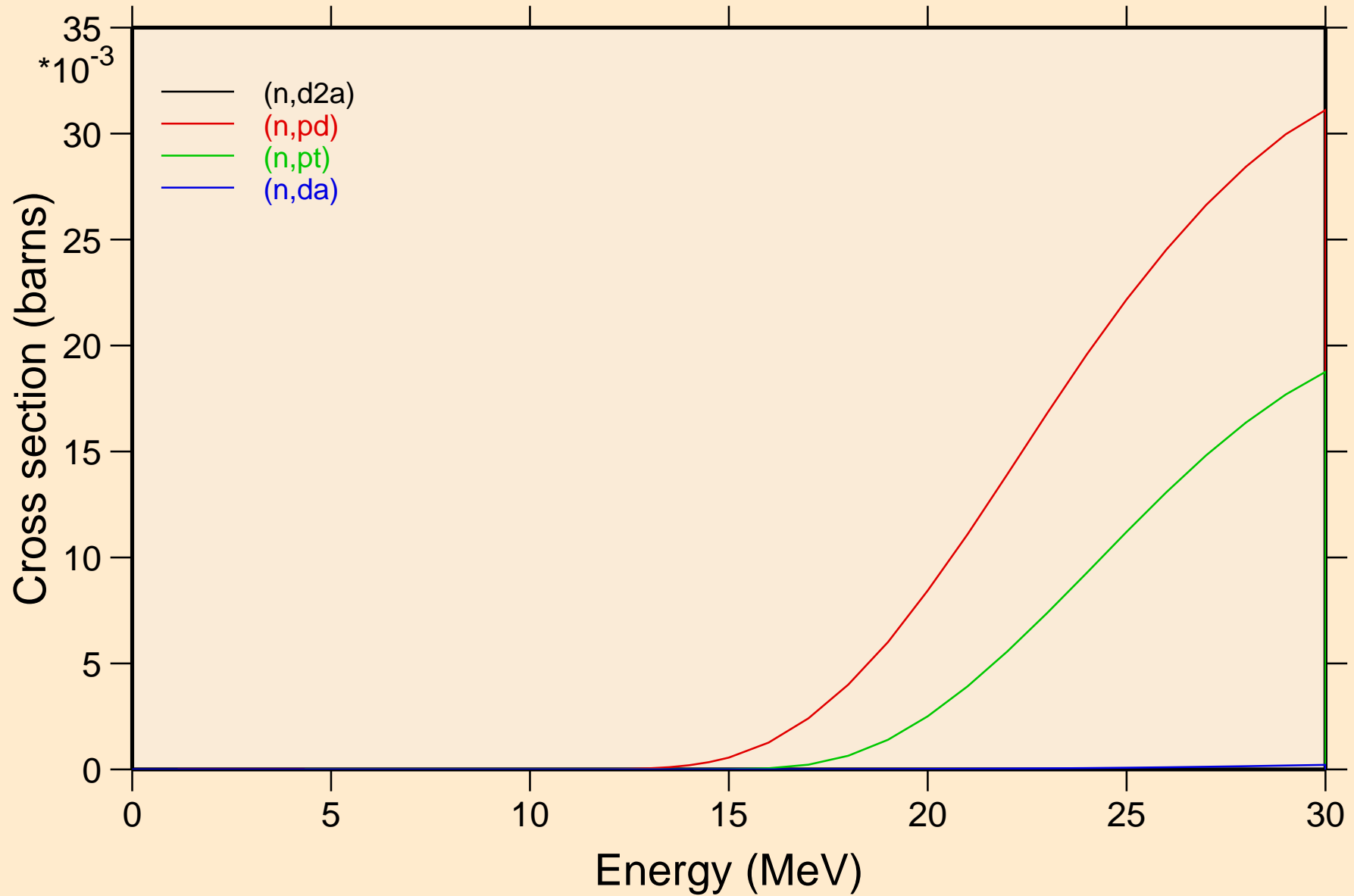

EU136M NEUTRON ACER TENDL-2021 LIBRARY; T=293.6K
Threshold reactions

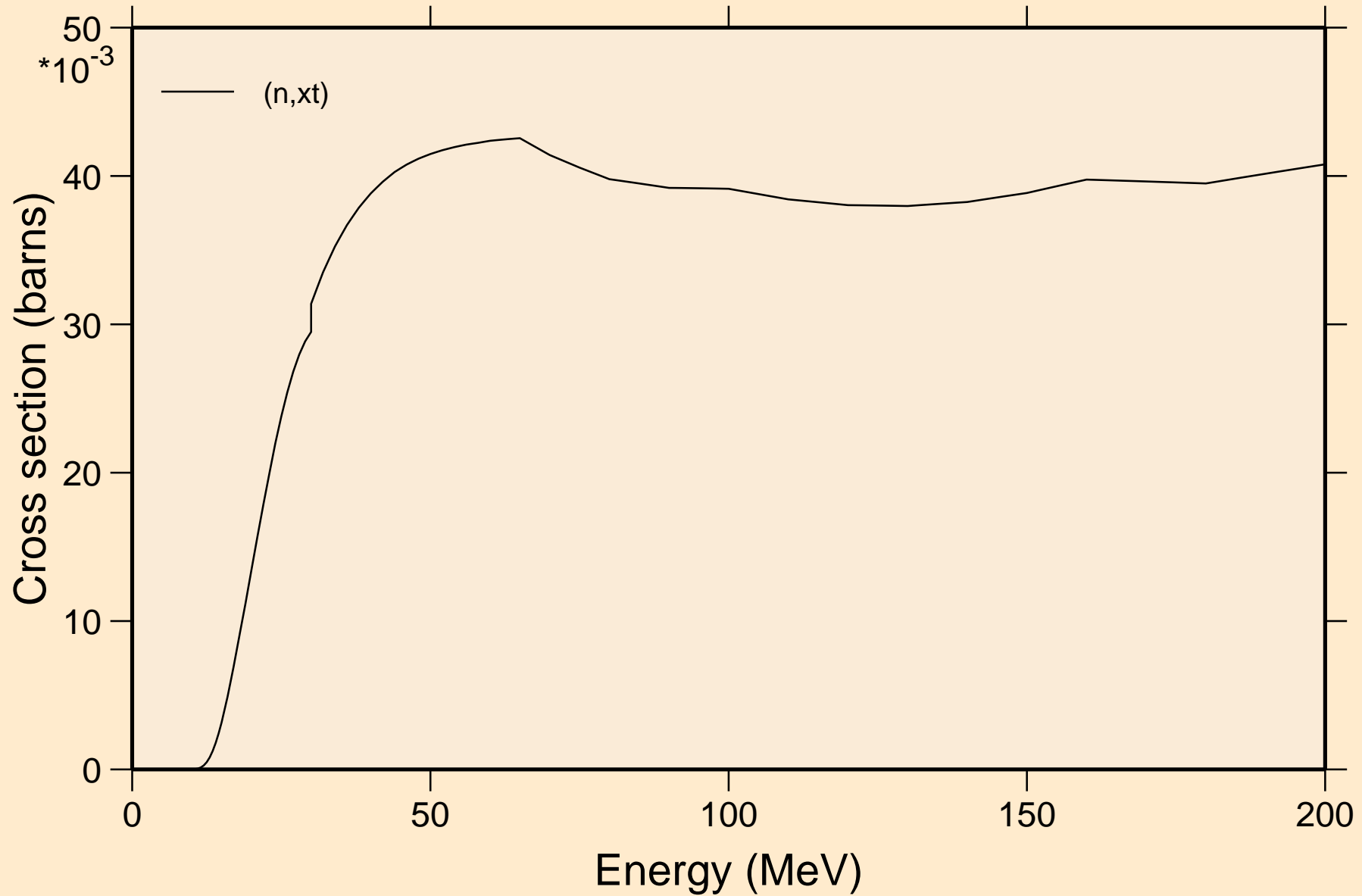

EU136M NEUTRON ACER TENDL-2021 LIBRARY; T=293.6K
angular distribution for elastic

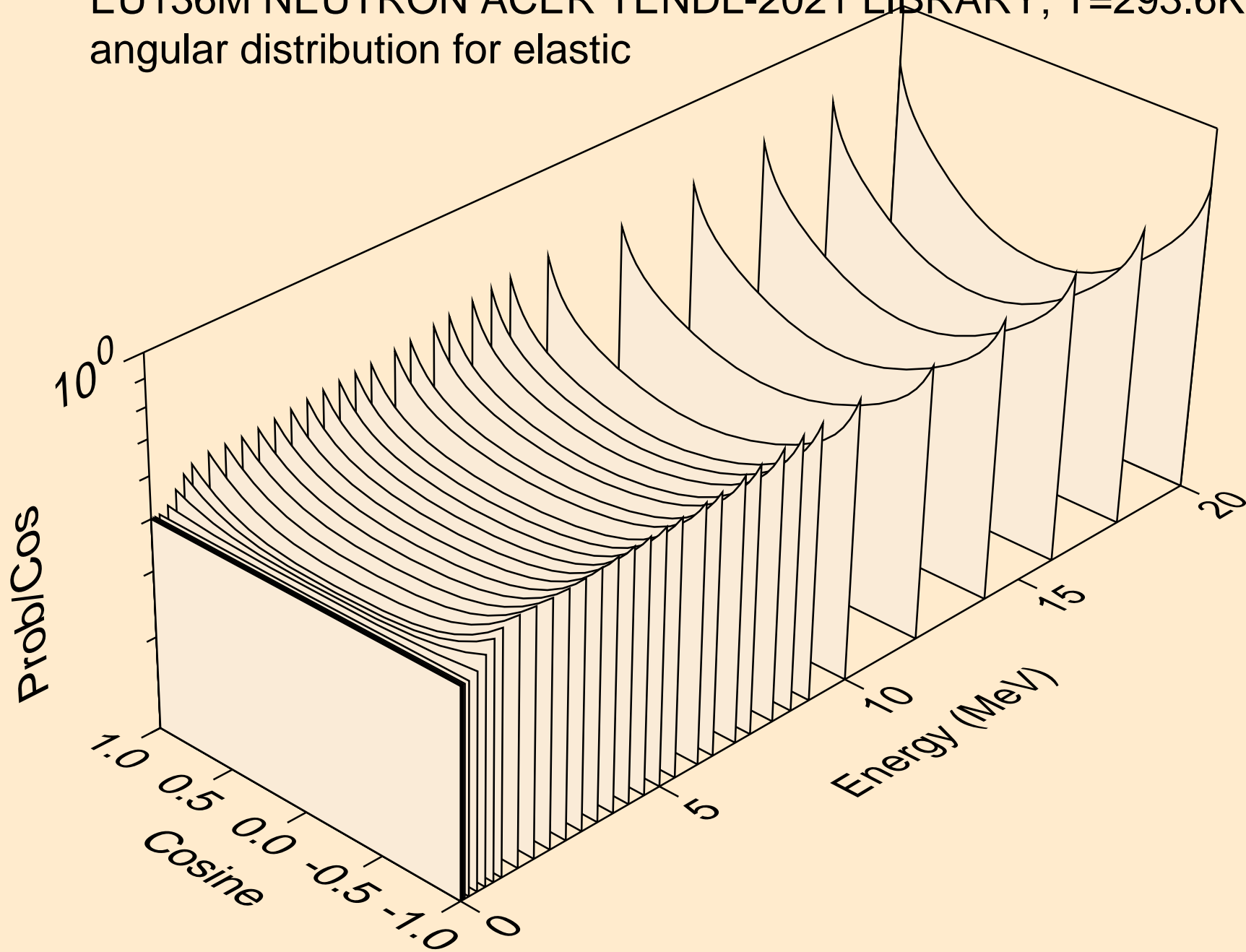

EU136M NEUTRON ACER TENDL-2021 LIBRARY; T=293.6K
angular distribution for elastic

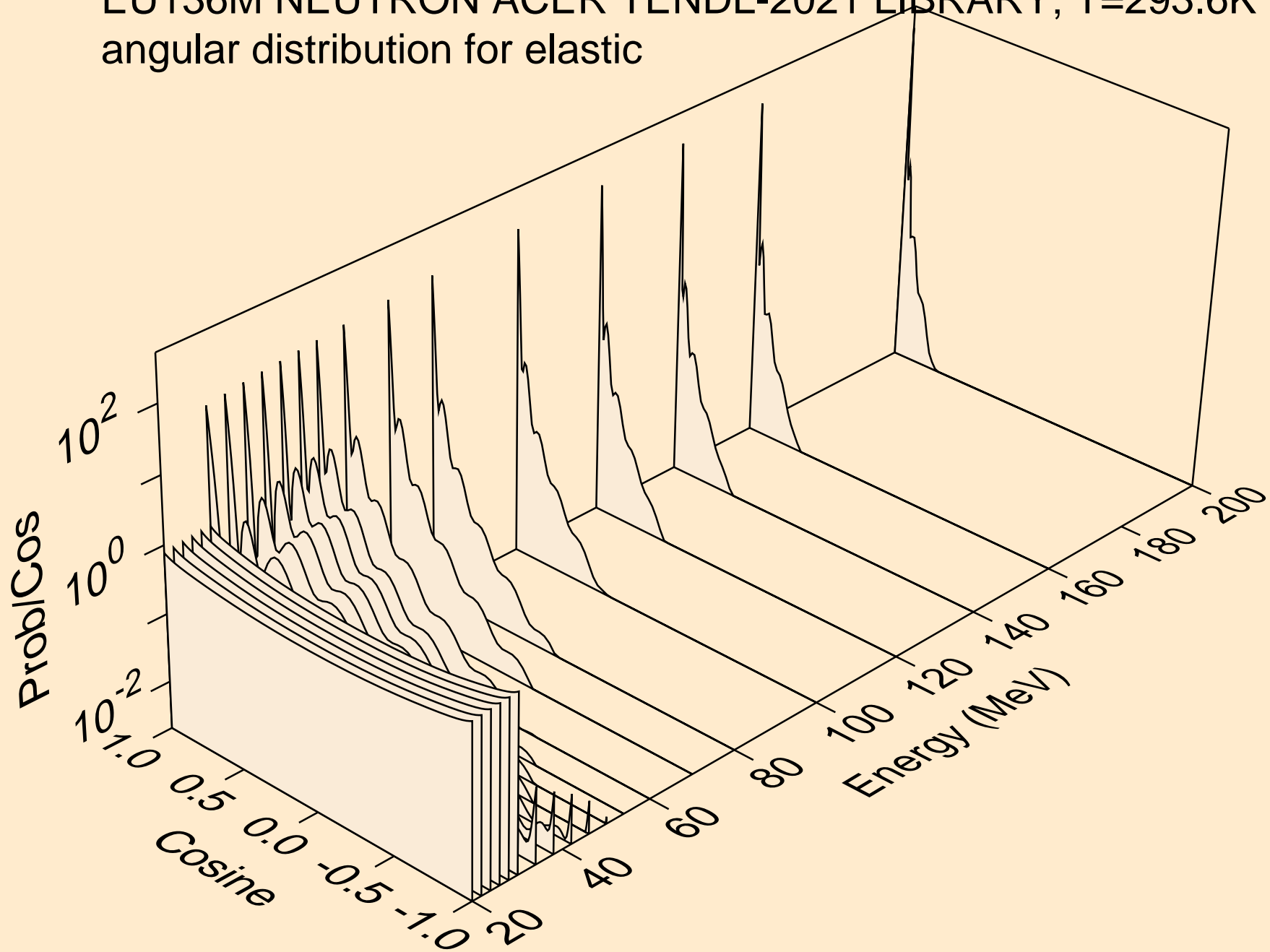

EU136M NEUTRON ACER TENDL-2021 LIBRARY; T=293.6K
angular distribution for (n,n*1)

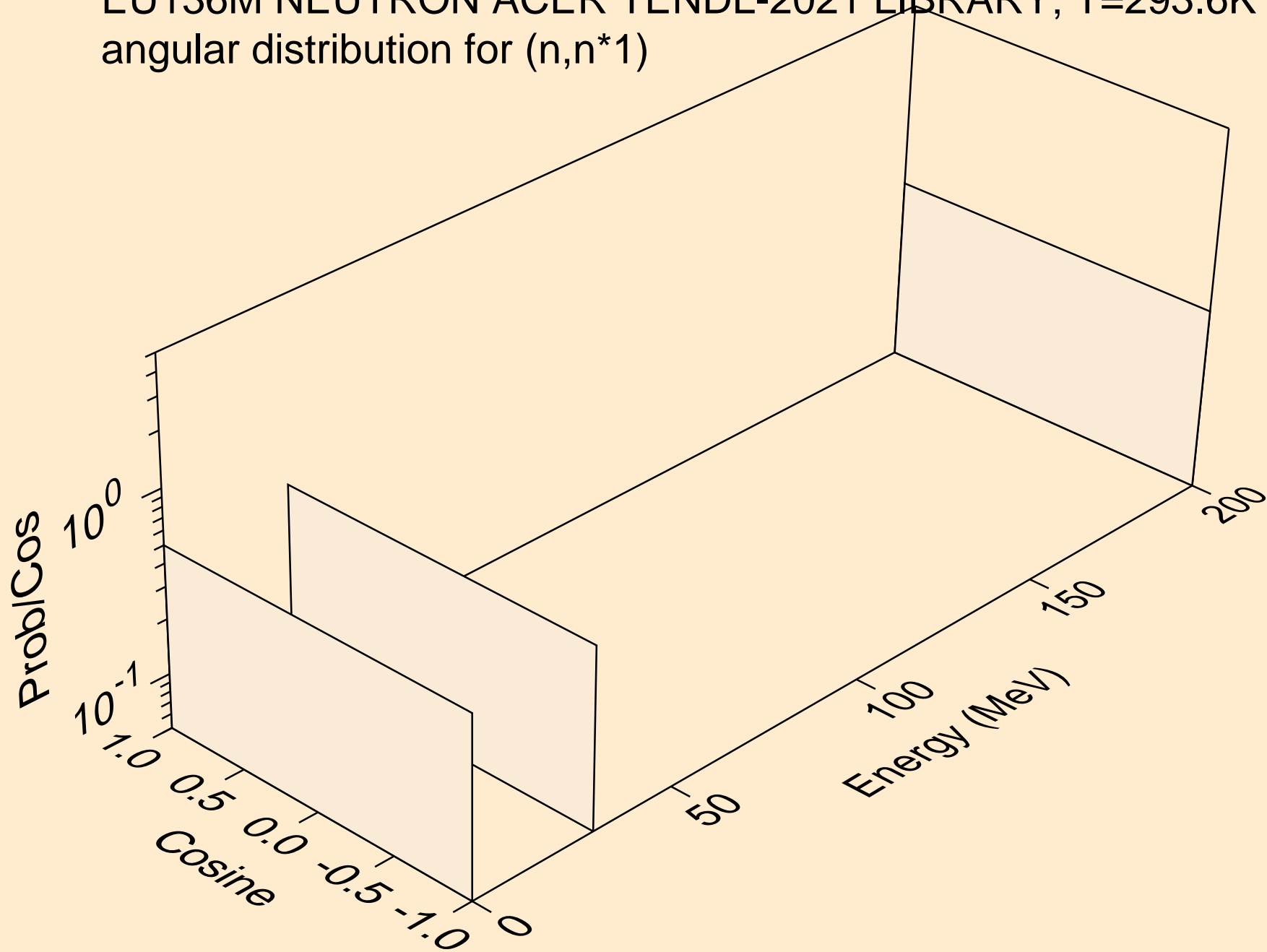

EU136M NEUTRON ACER TENDL-2021 LIBRARY; T=293.6K
angular distribution for (n,n*2)

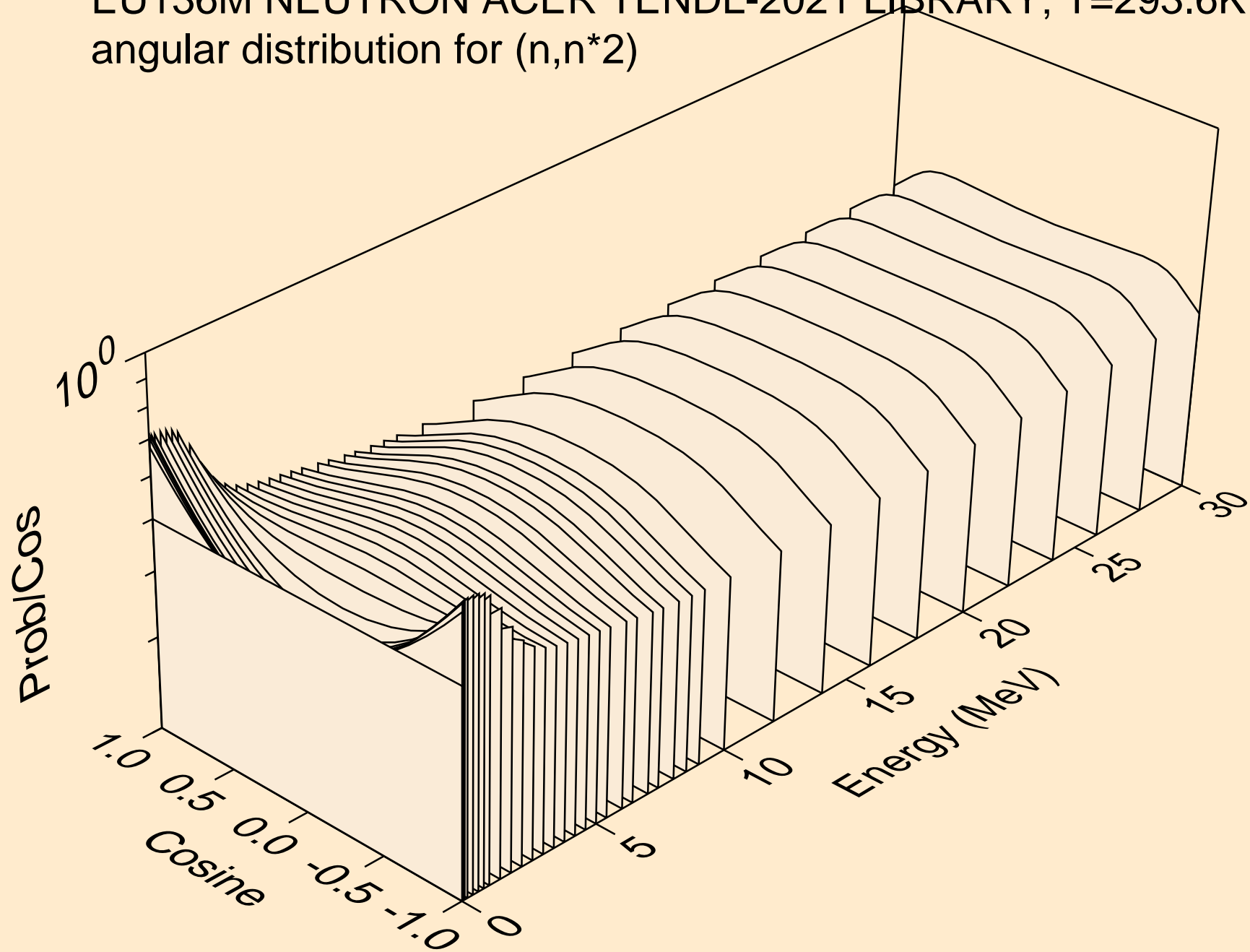

EU136M NEUTRON ACER TENDL-2021 LIBRARY; T=293.6K
Neutron emission for (n,x)

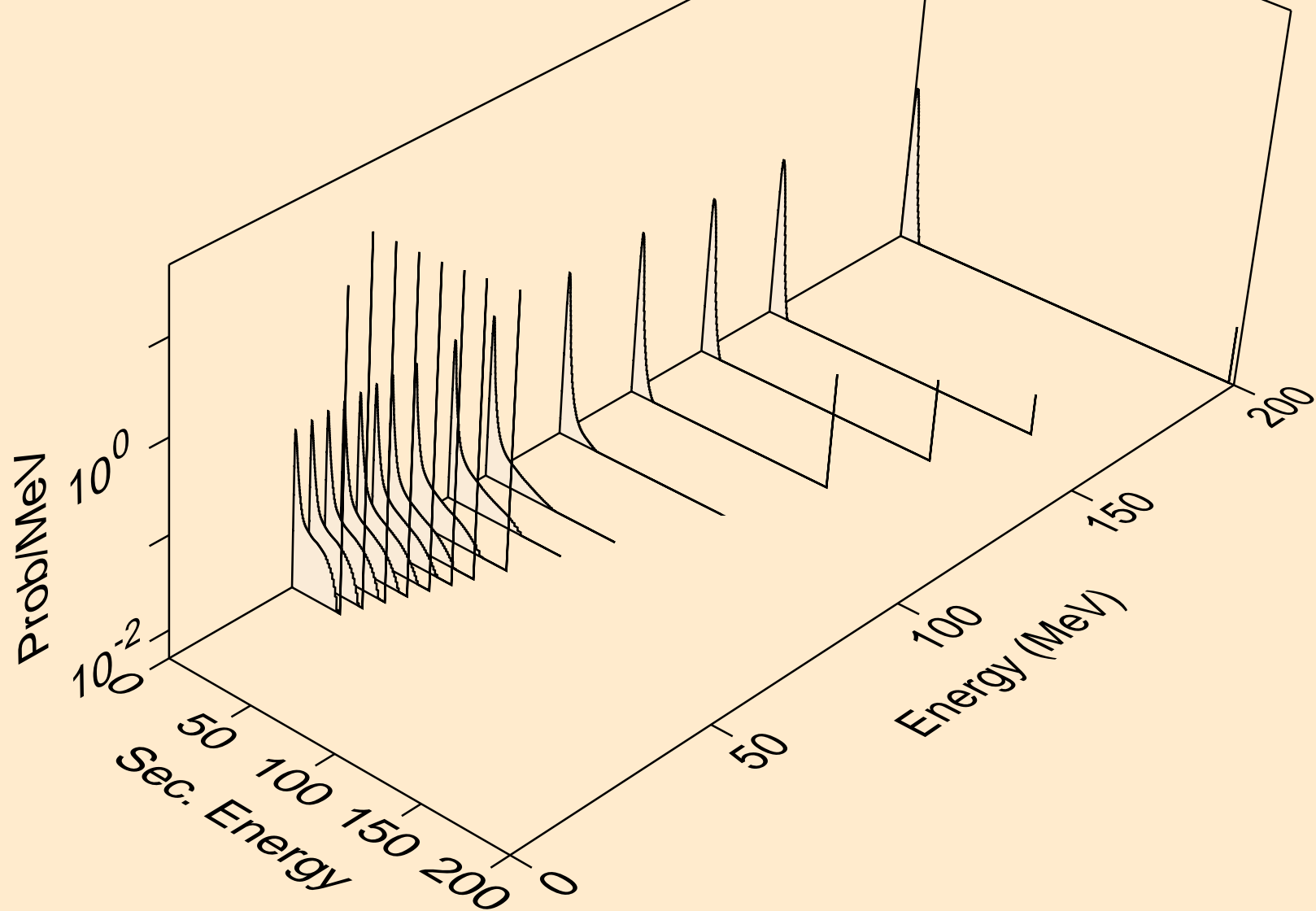

EU136M NEUTRON ACER TENDL-2021 LIBRARY; T=293.6K
Neutron emission for (n,2nd)

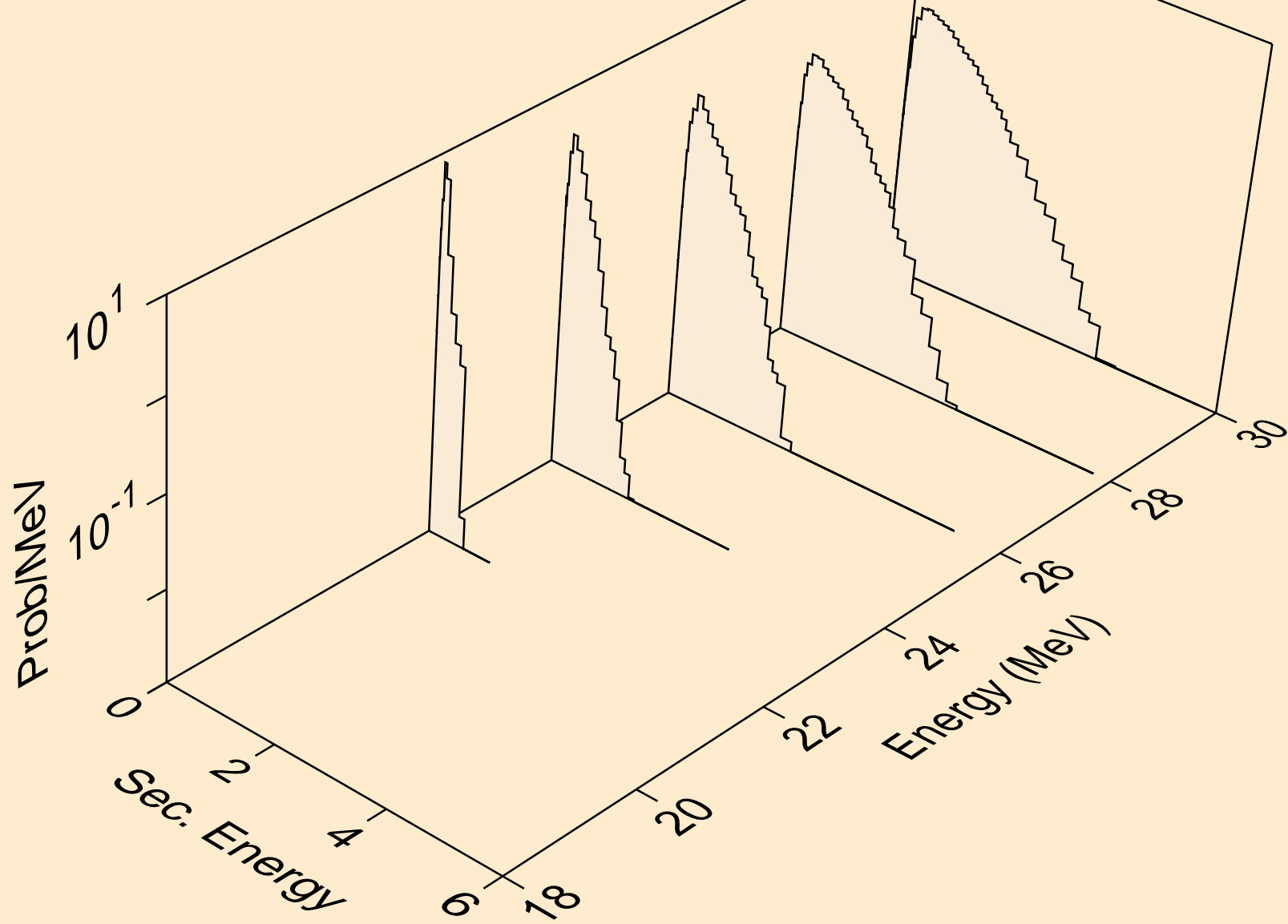

EU136M NEUTRON ACER TENDL-2021 LIBRARY; T=293.6K
Neutron emission for (n,2n)

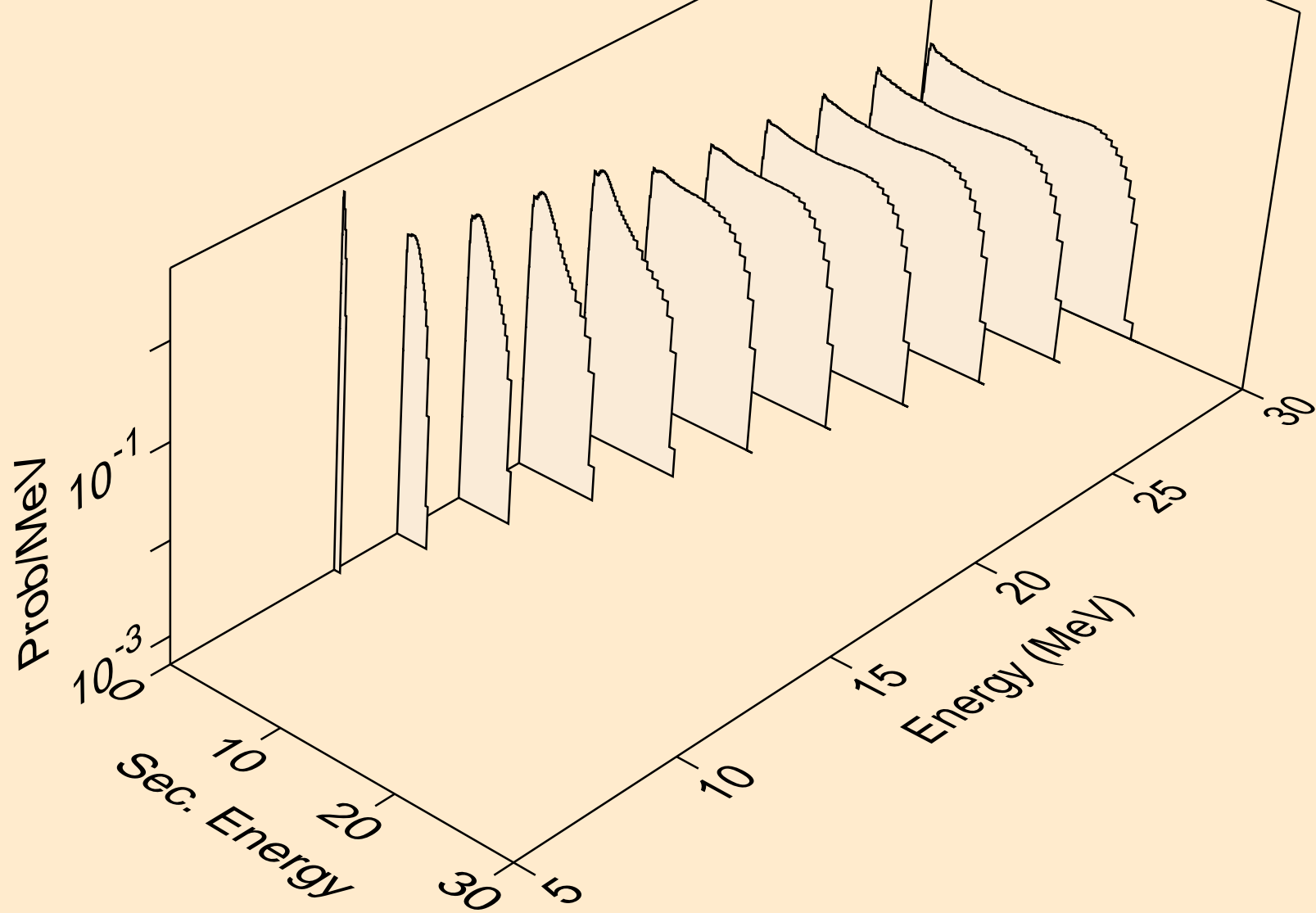

EU136M NEUTRON ACER TENDL-2021 LIBRARY; T=293.6K
Neutron emission for (n,3n)

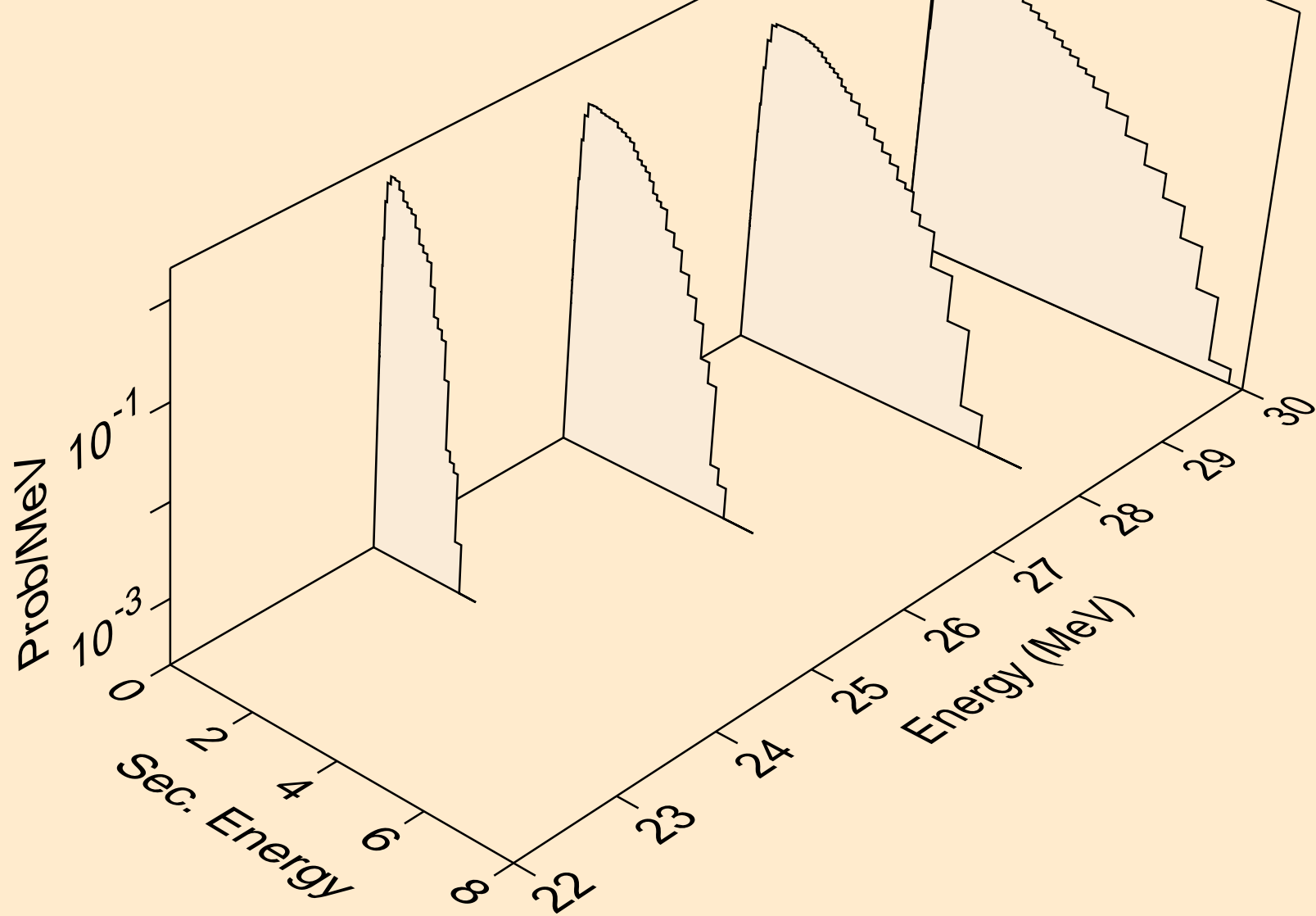

EU136M NEUTRON ACER TENDL-2021 LIBRARY; T=293.6K
Neutron emission for (n,n*)a

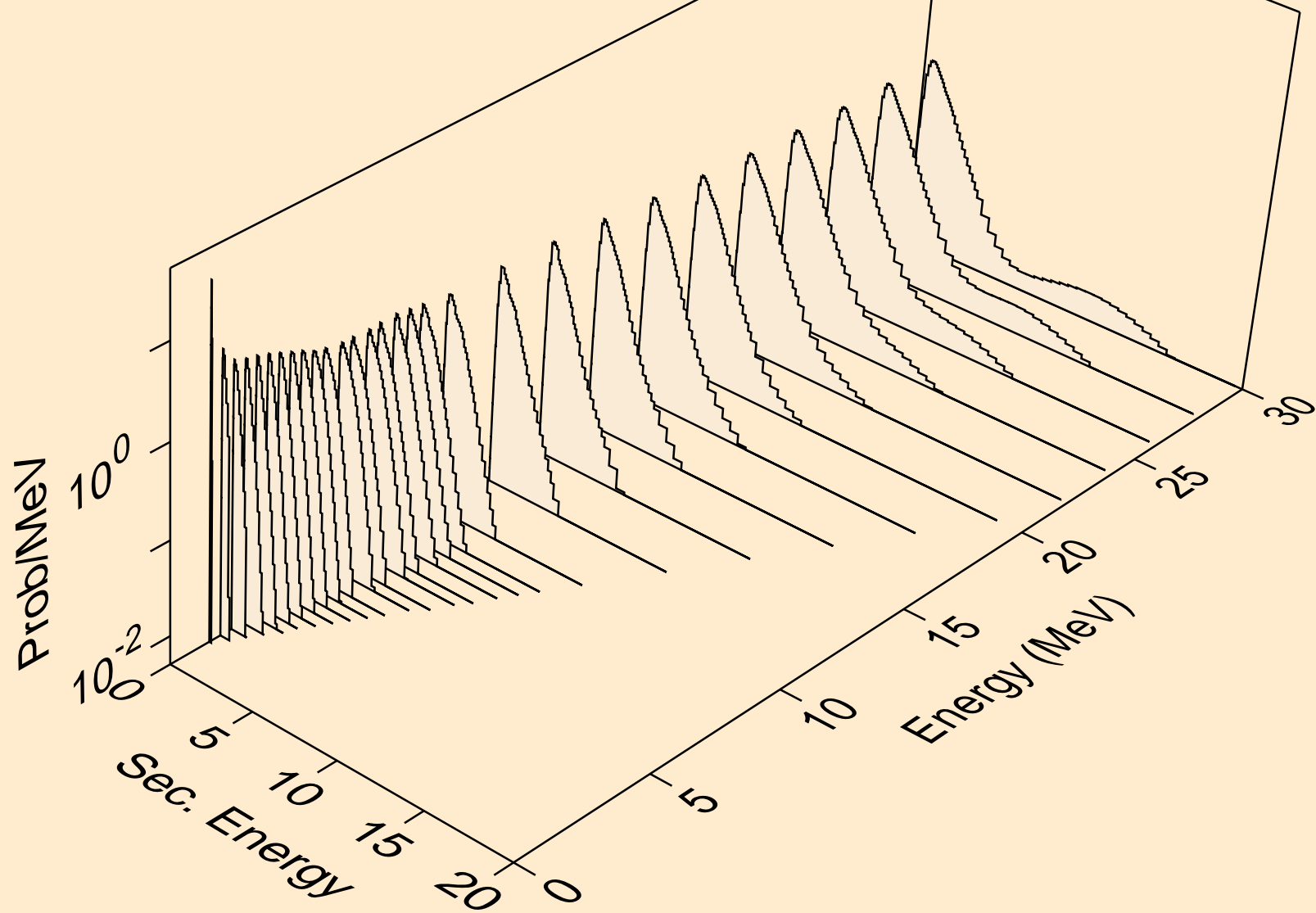

EU136M NEUTRON ACER TENDL-2021 LIBRARY; T=293.6K
Neutron emission for (n,2n)_a

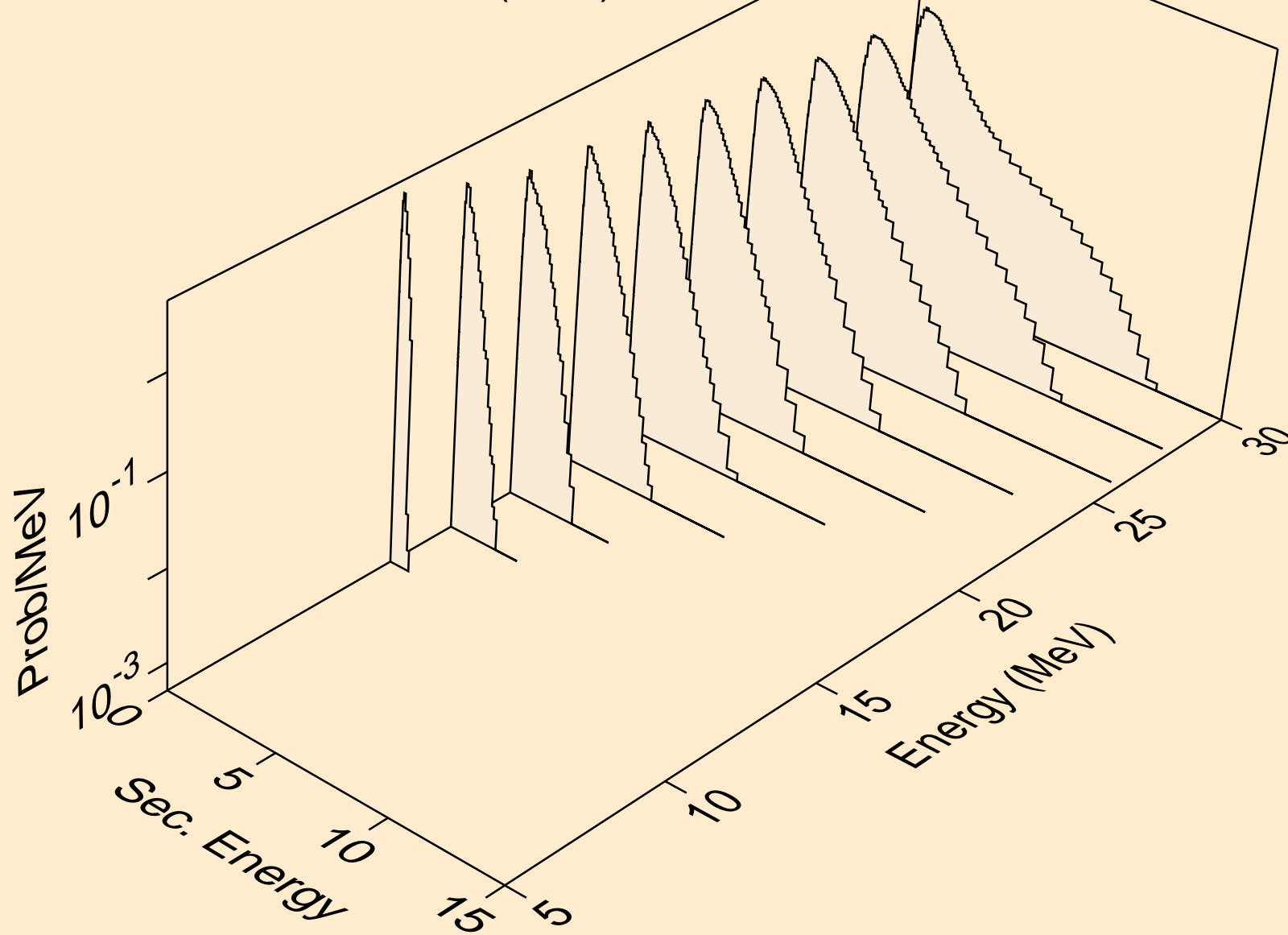

EU136M NEUTRON ACER TENDL-2021 LIBRARY; T=293.6K
Neutron emission for (n,n*)p

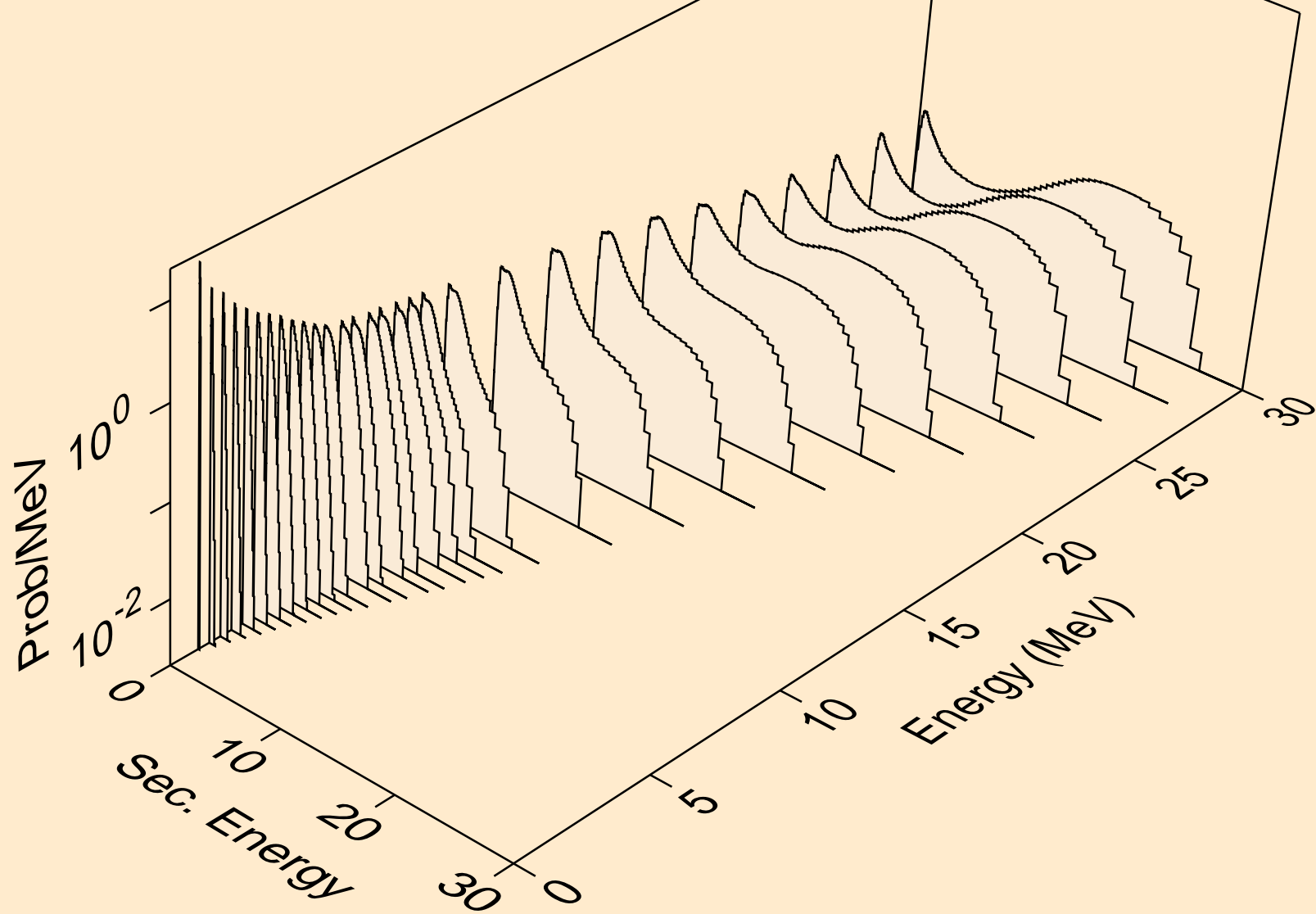

EU136M NEUTRON ACER TENDL-2021 LIBRARY; T=293.6K
Neutron emission for (n,n*)2a

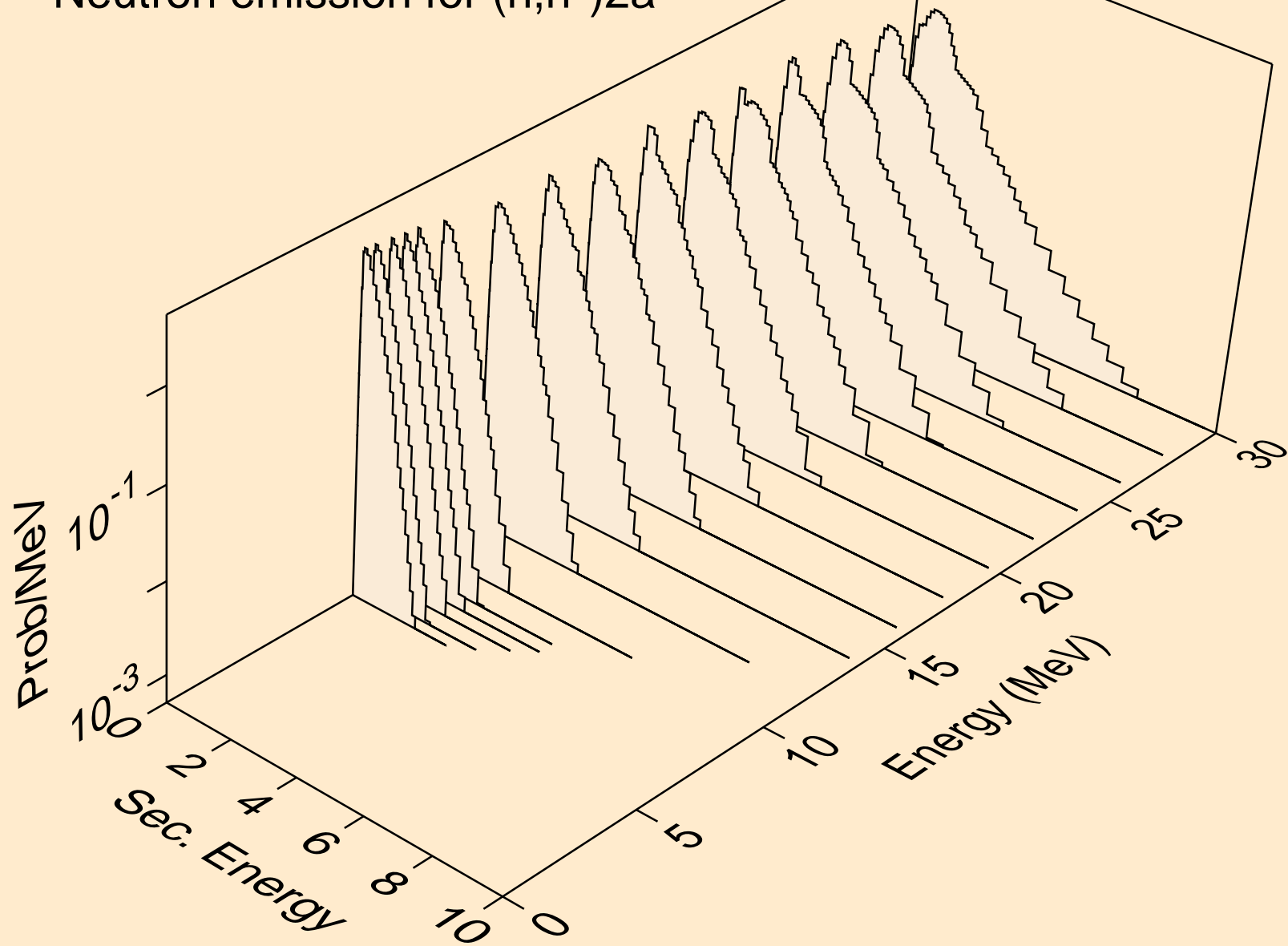

EU136M NEUTRON ACER TENDL-2021 LIBRARY; T=293.6K
Neutron emission for (n,2n)2a

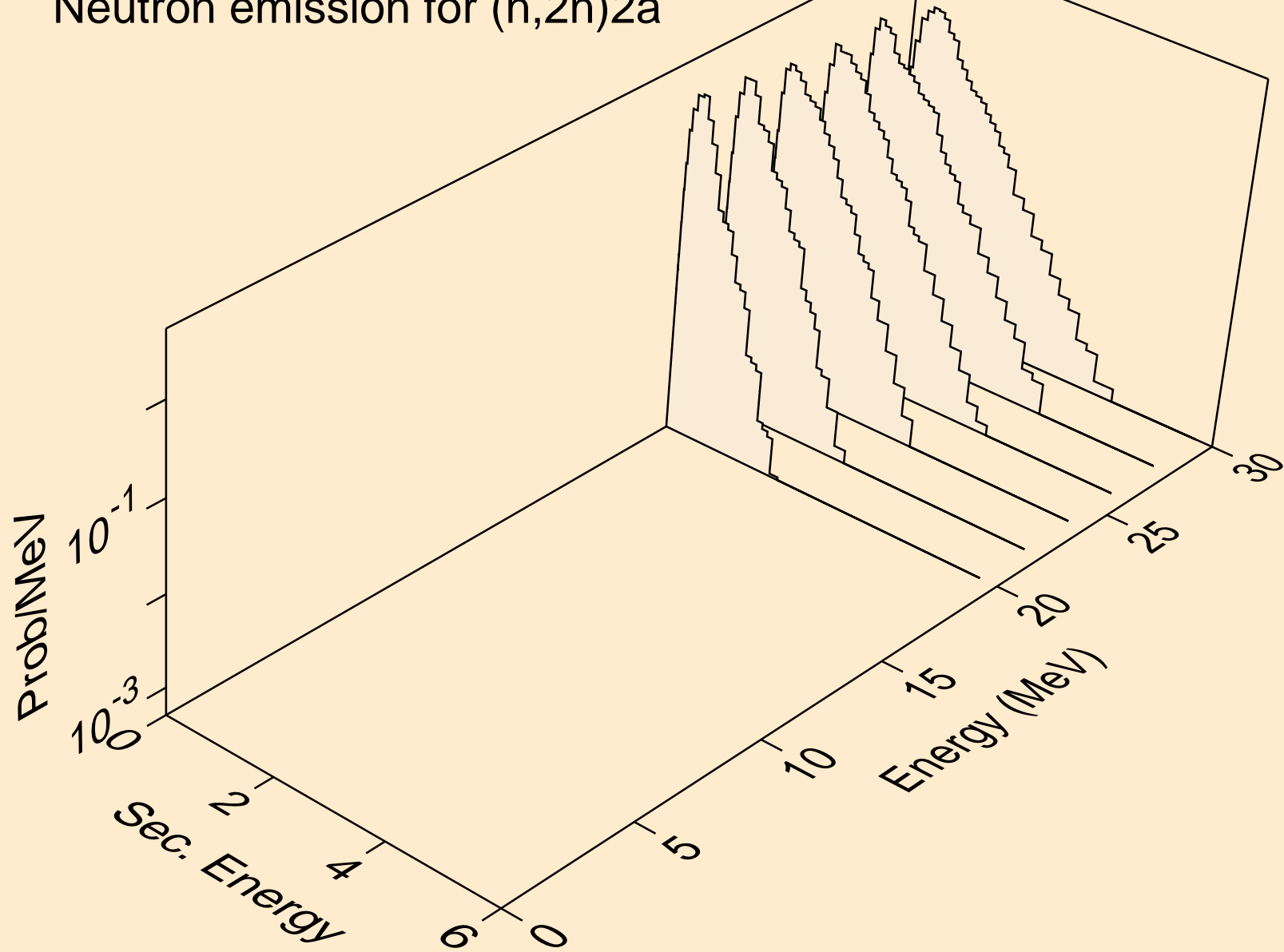

EU136M NEUTRON ACER TENDL-2021 LIBRARY; T=293.6K
Neutron emission for (n,n*)d

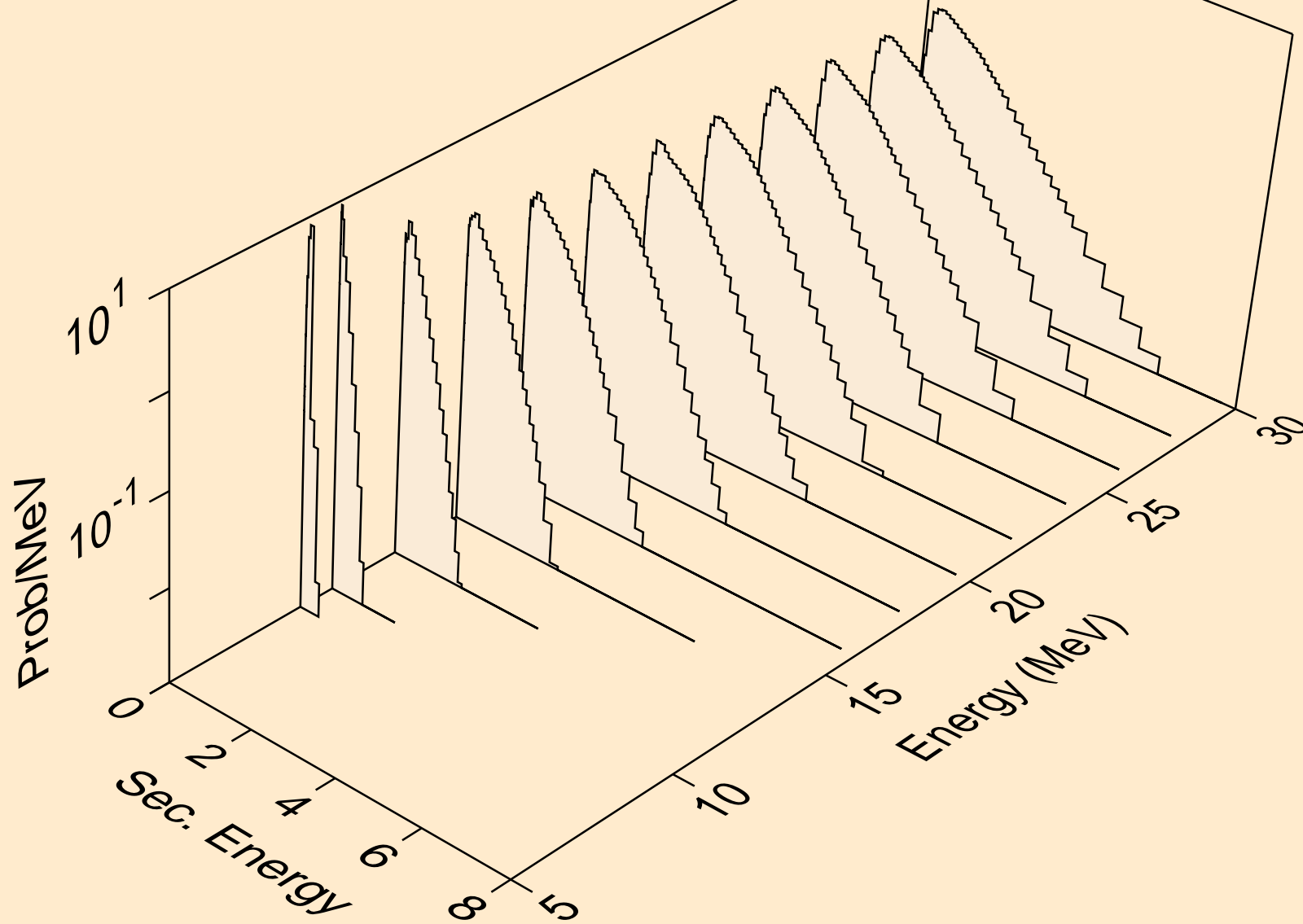

EU136M NEUTRON ACER TENDL-2021 LIBRARY; T=293.6K
Neutron emission for (n,n*)t

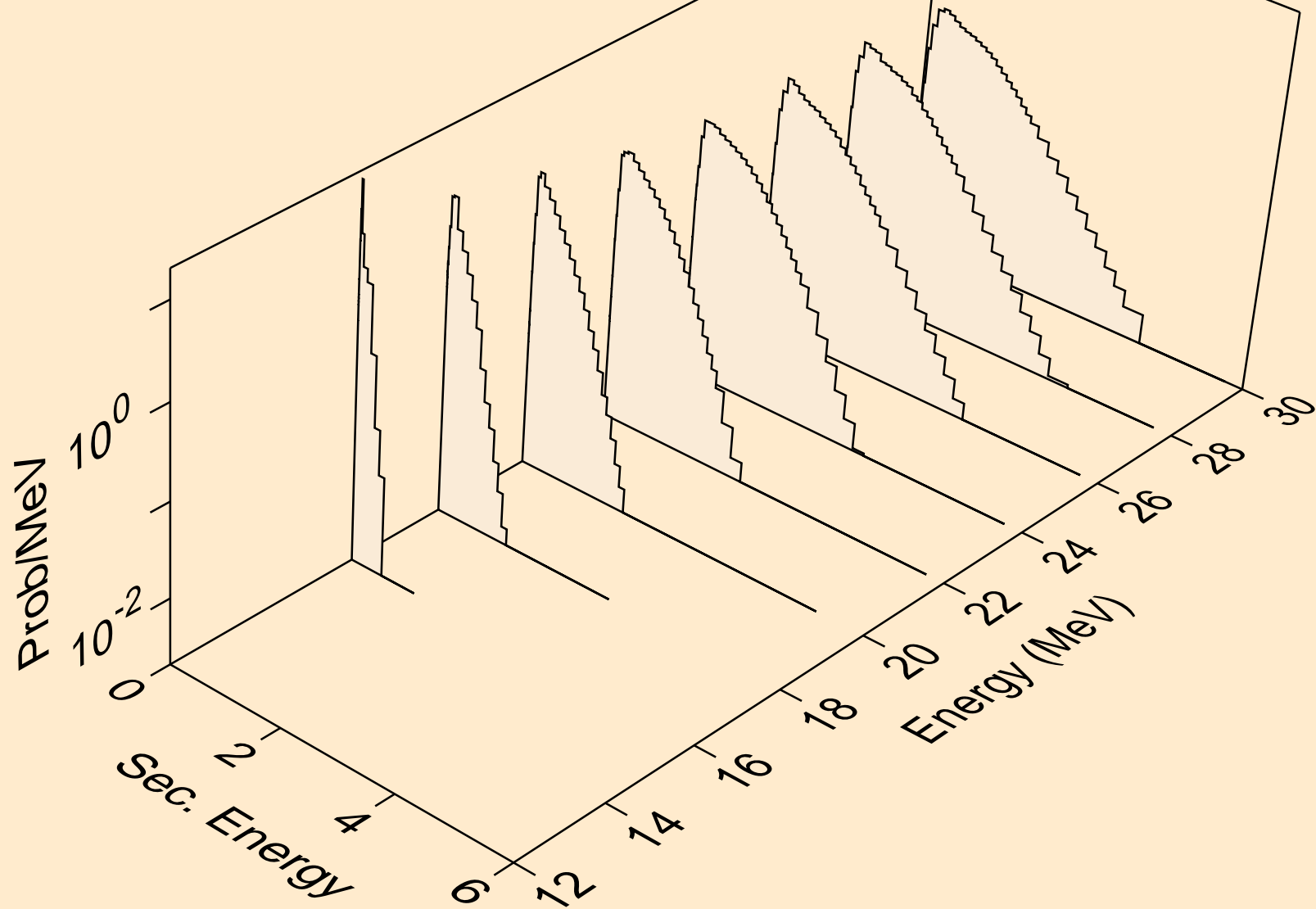

EU136M NEUTRON ACER TENDL-2021 LIBRARY; T=293.6K
Neutron emission for (n,n*)he3

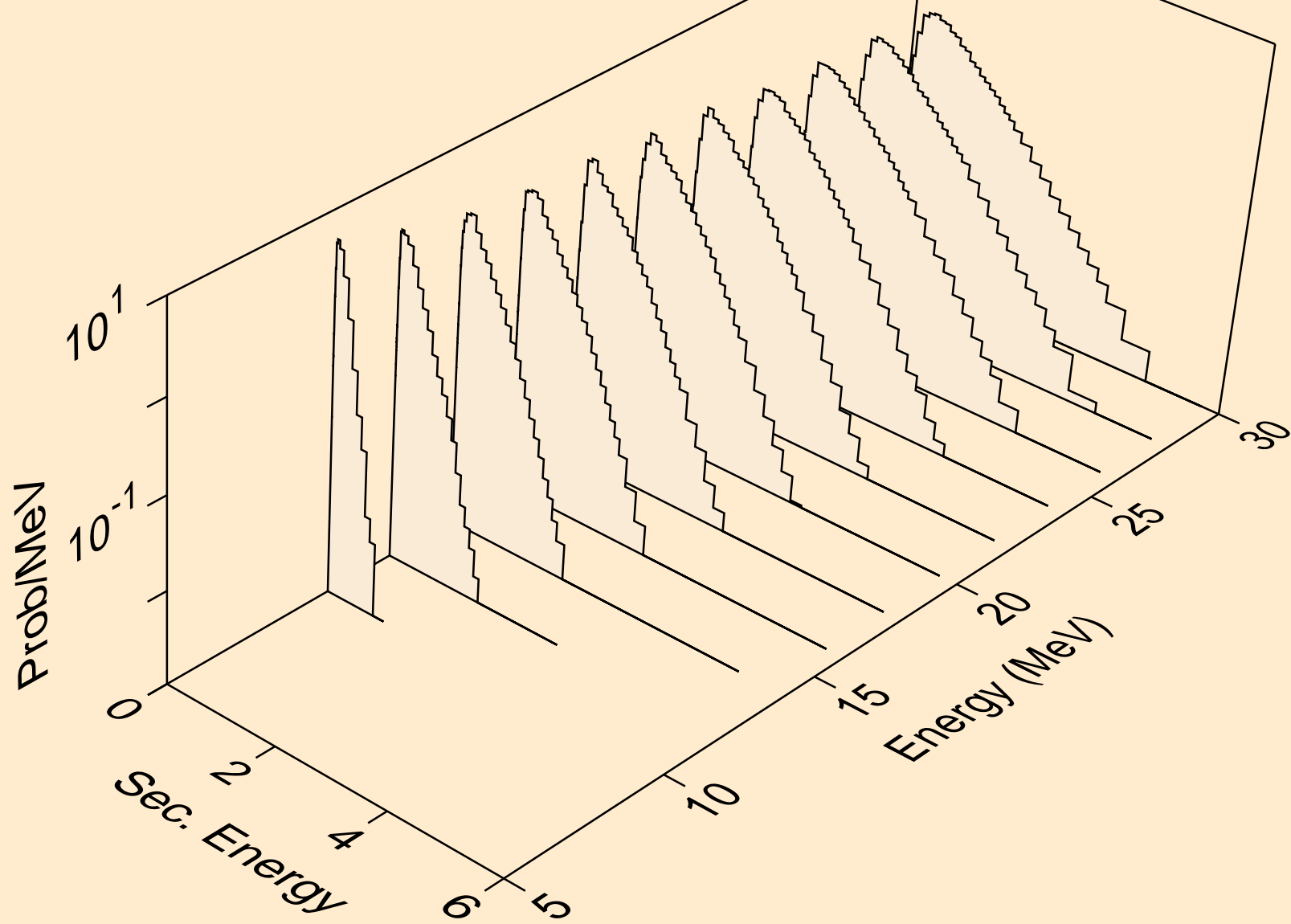

EU136M NEUTRON ACER TENDL-2021 LIBRARY; T=293.6K
Neutron emission for (n,2np)

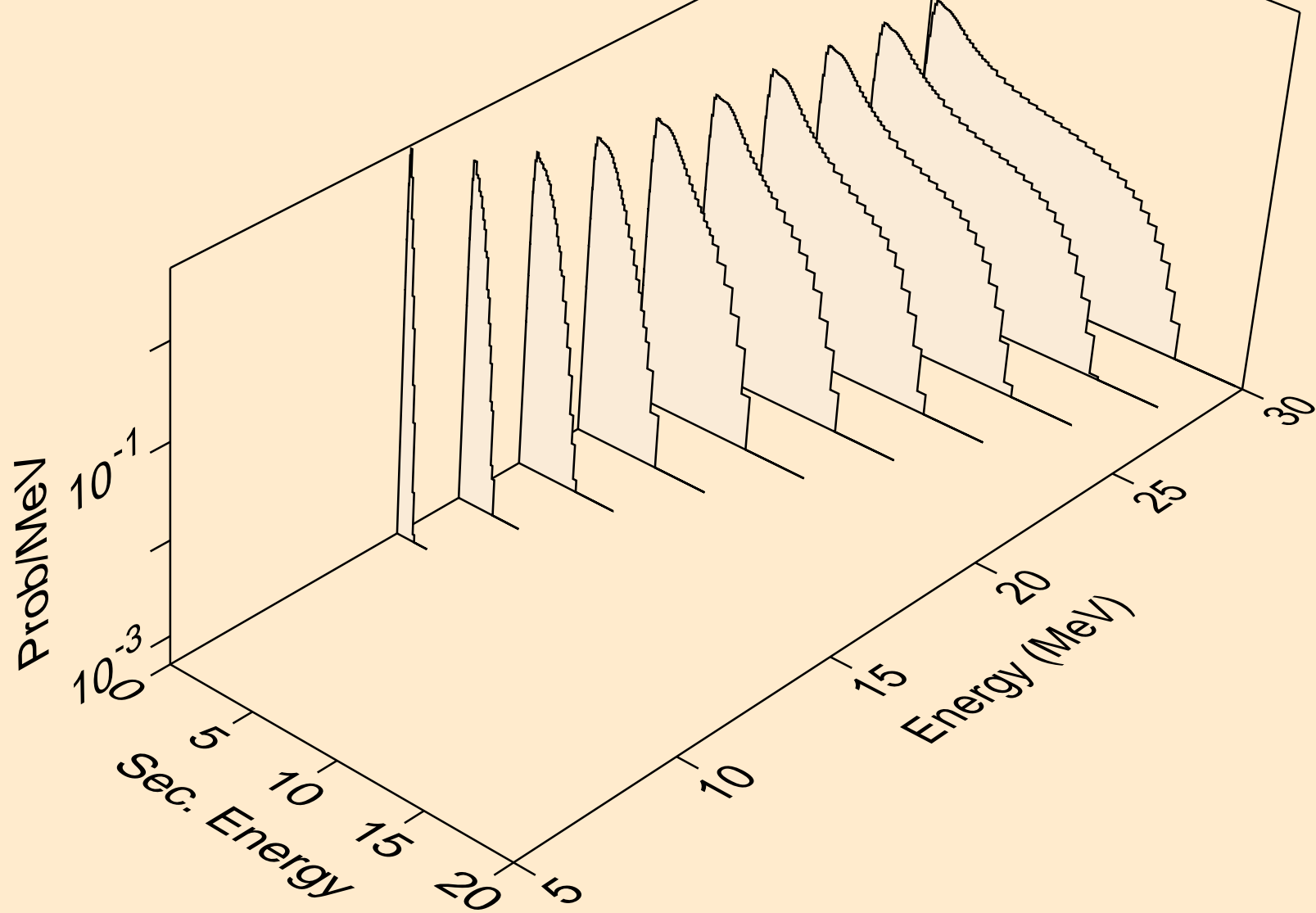

EU136M NEUTRON ACER TENDL-2021 LIBRARY; T=293.6K
Neutron emission for (n,3np)

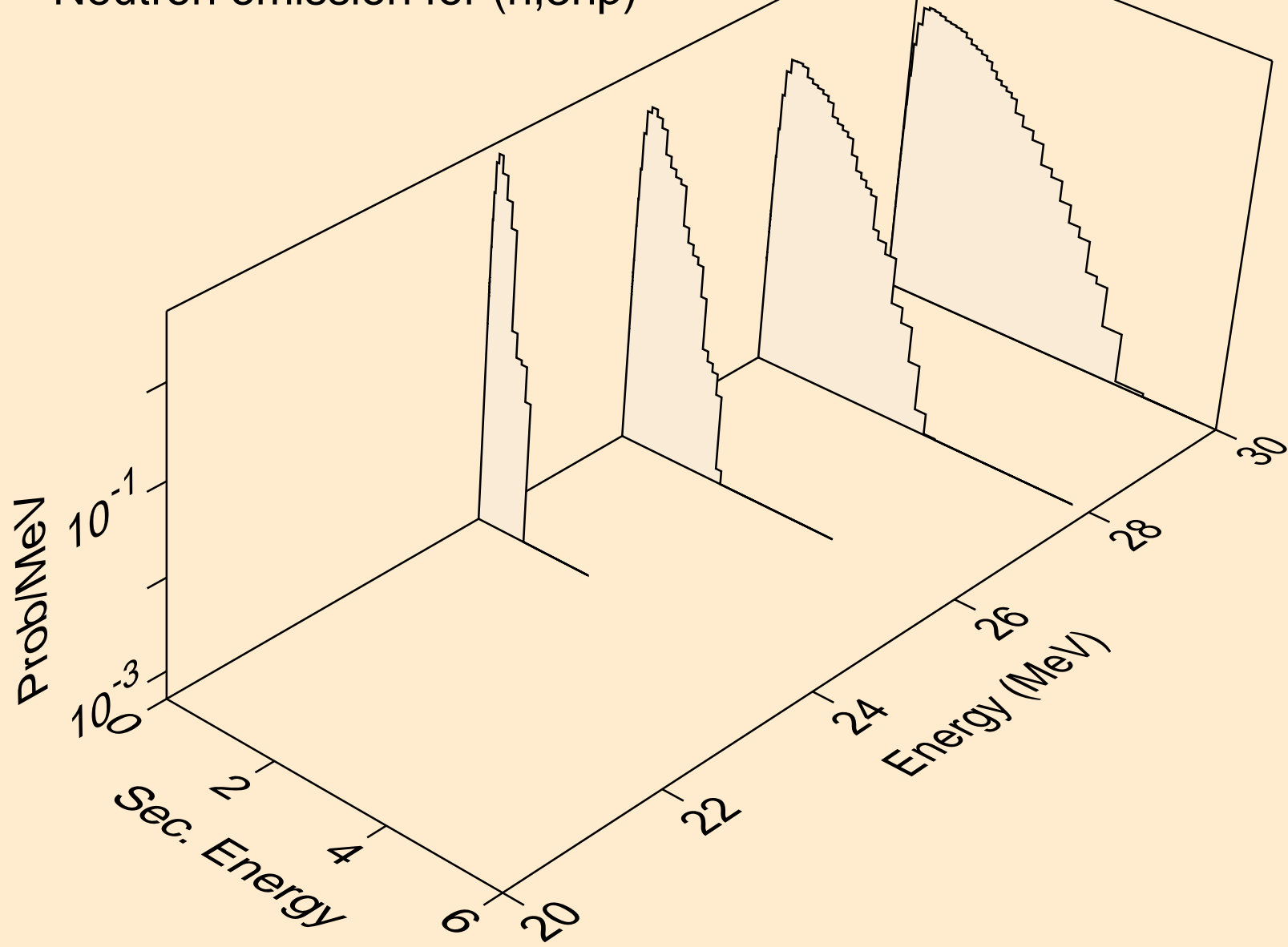

EU136M NEUTRON ACER TENDL-2021 LIBRARY; T=293.6K
Neutron emission for (n,2np)

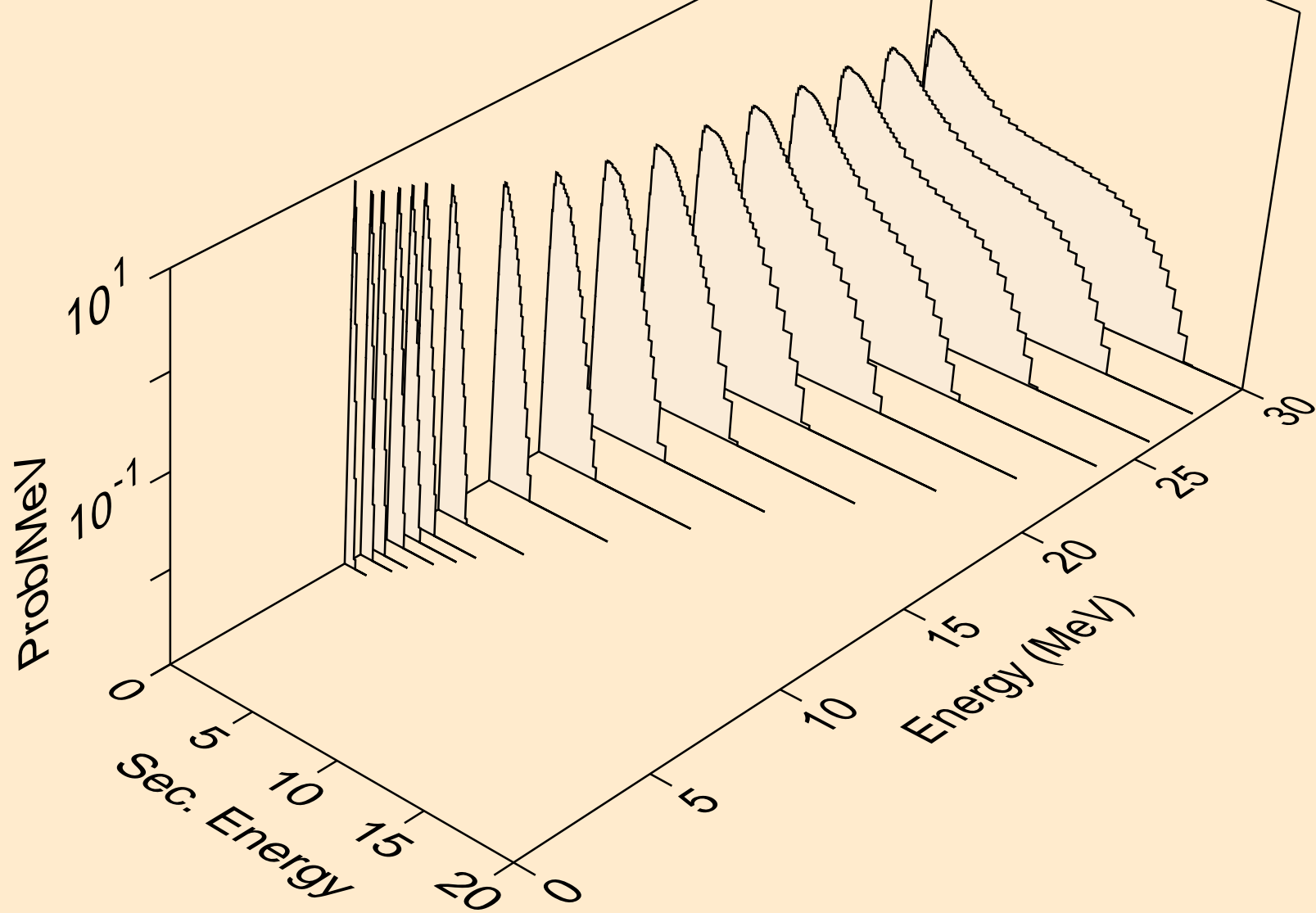

EU136M NEUTRON ACER TENDL-2021 LIBRARY; T=293.6K
Neutron emission for (n,npa)

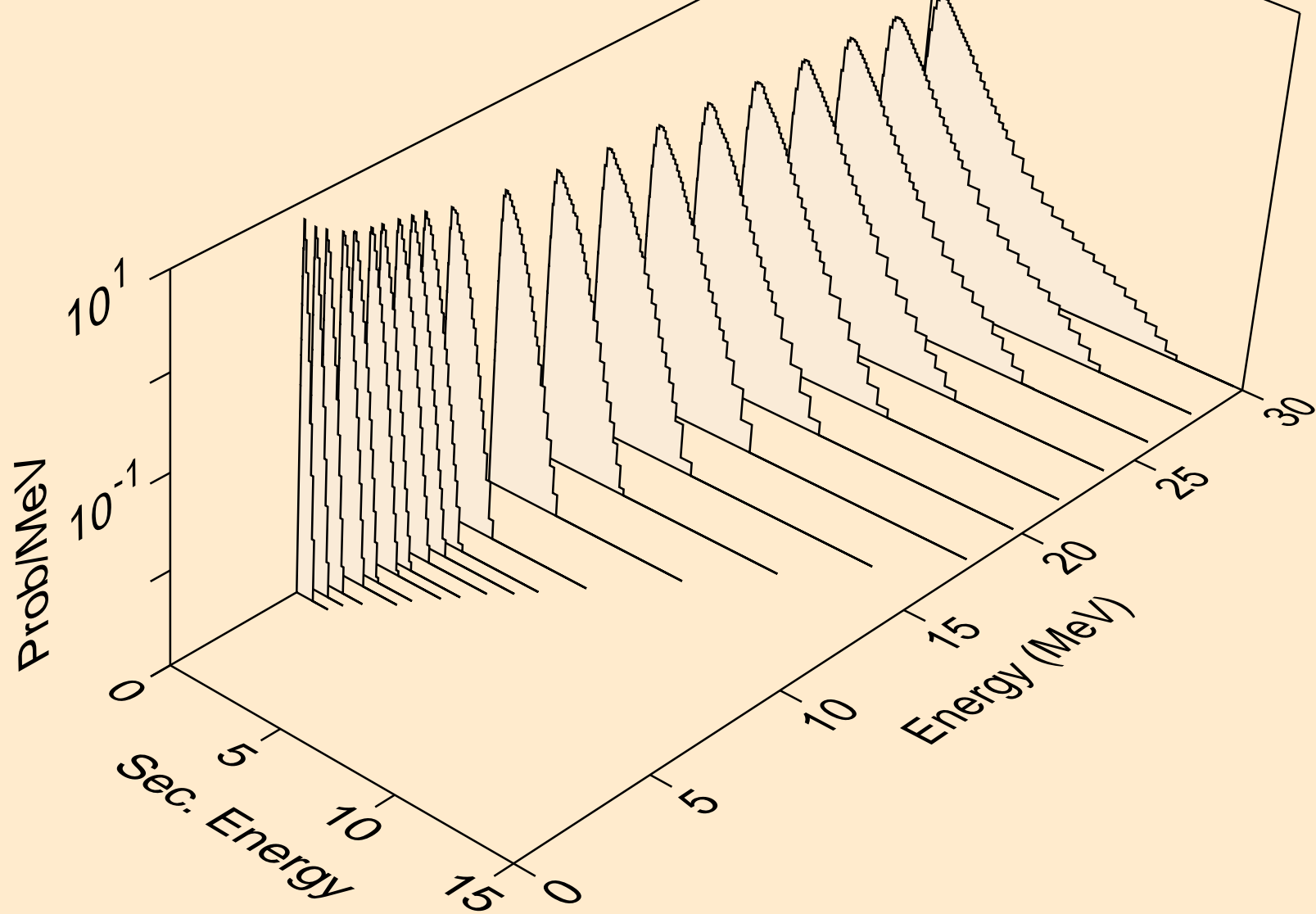

EU136M NEUTRON ACER TENDL-2021 LIBRARY; T=293.6K
Neutron emission for (n,n*c)

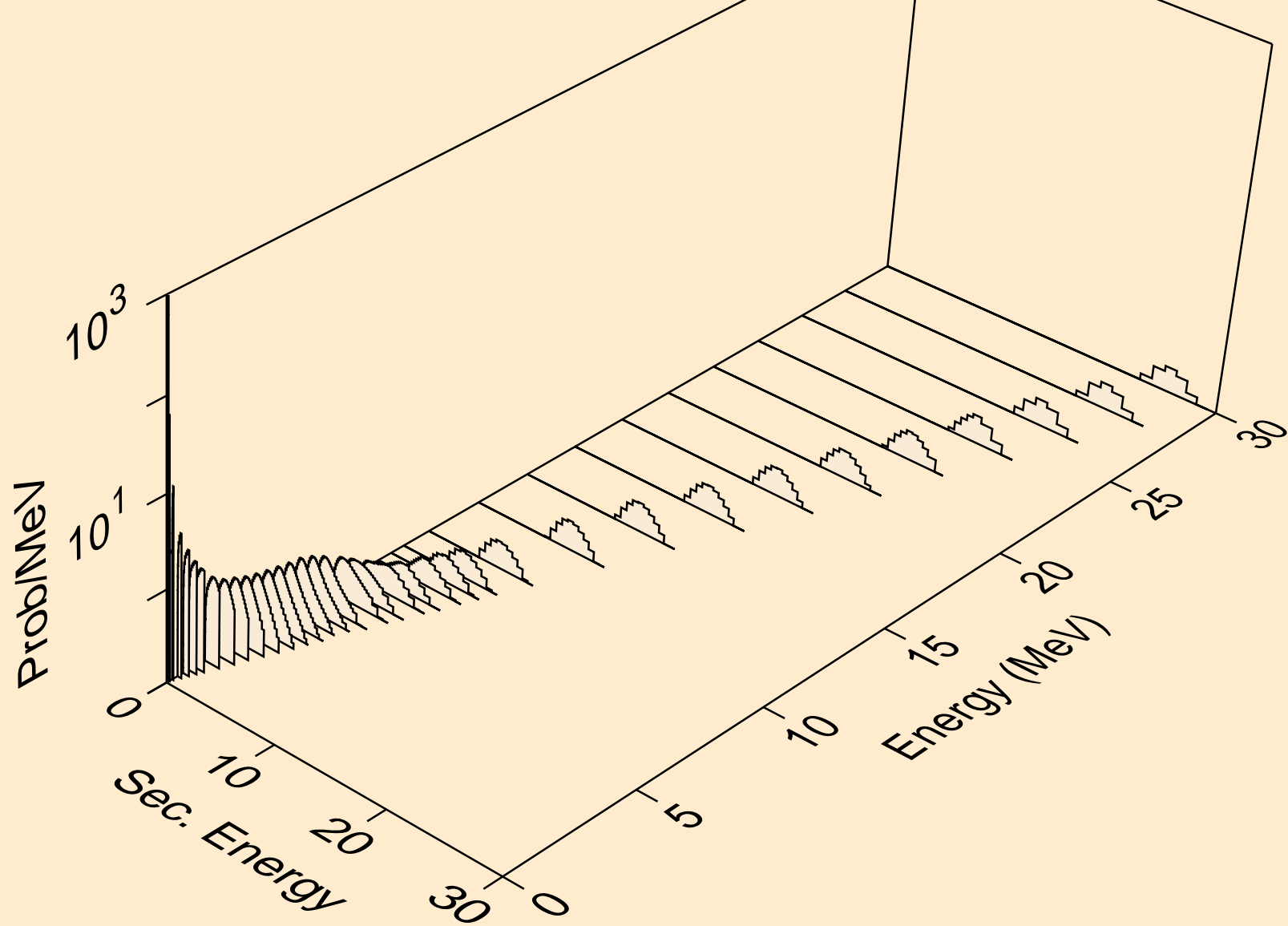

EU136M NEUTRON ACER TENDL-2021 LIBRARY; T=293.6K
Photon emission for (n,x)

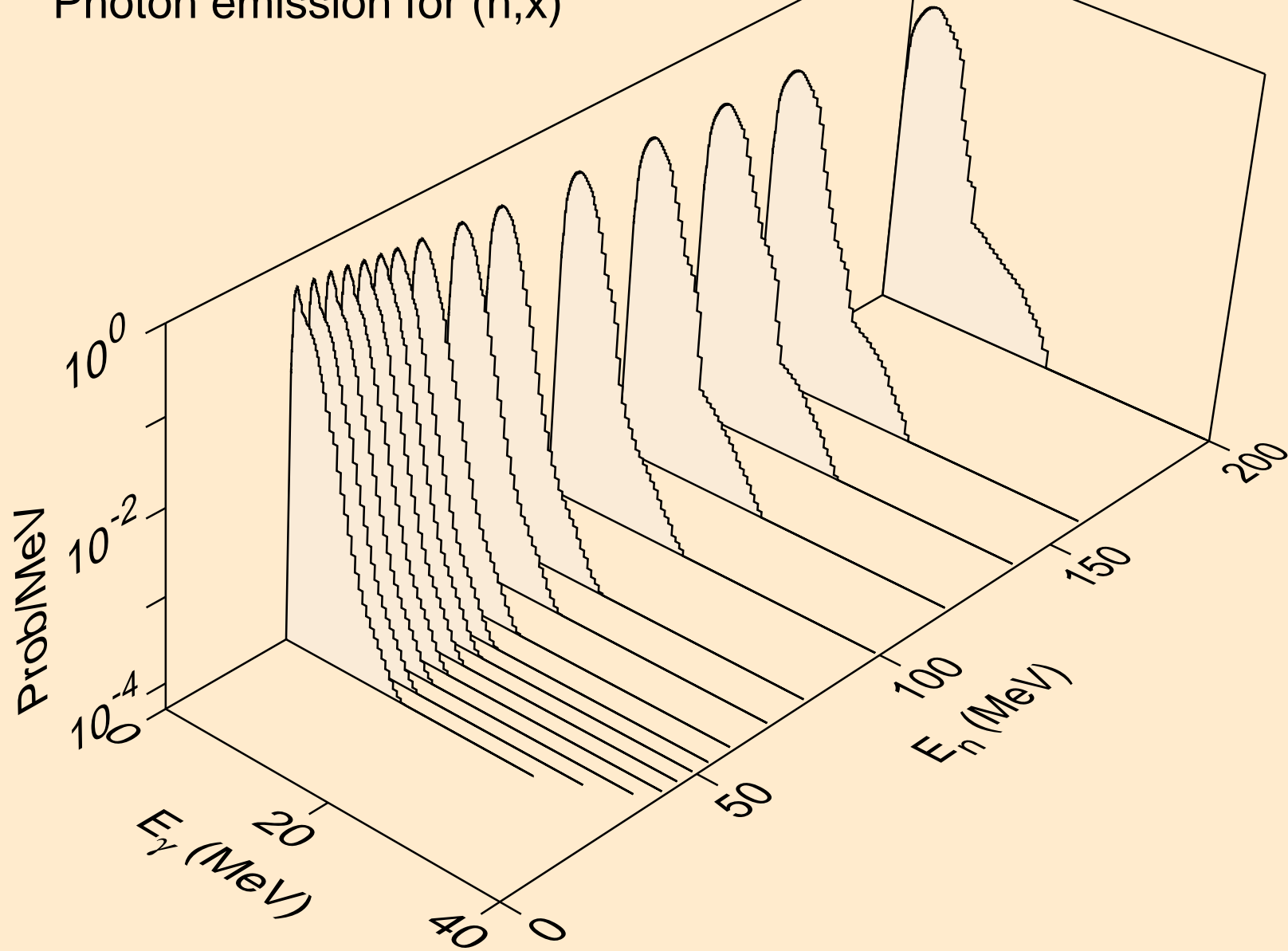

EU136M NEUTRON ACER TENDL-2021 LIBRARY; T=293.6K
Photon emission for (n,2nd)

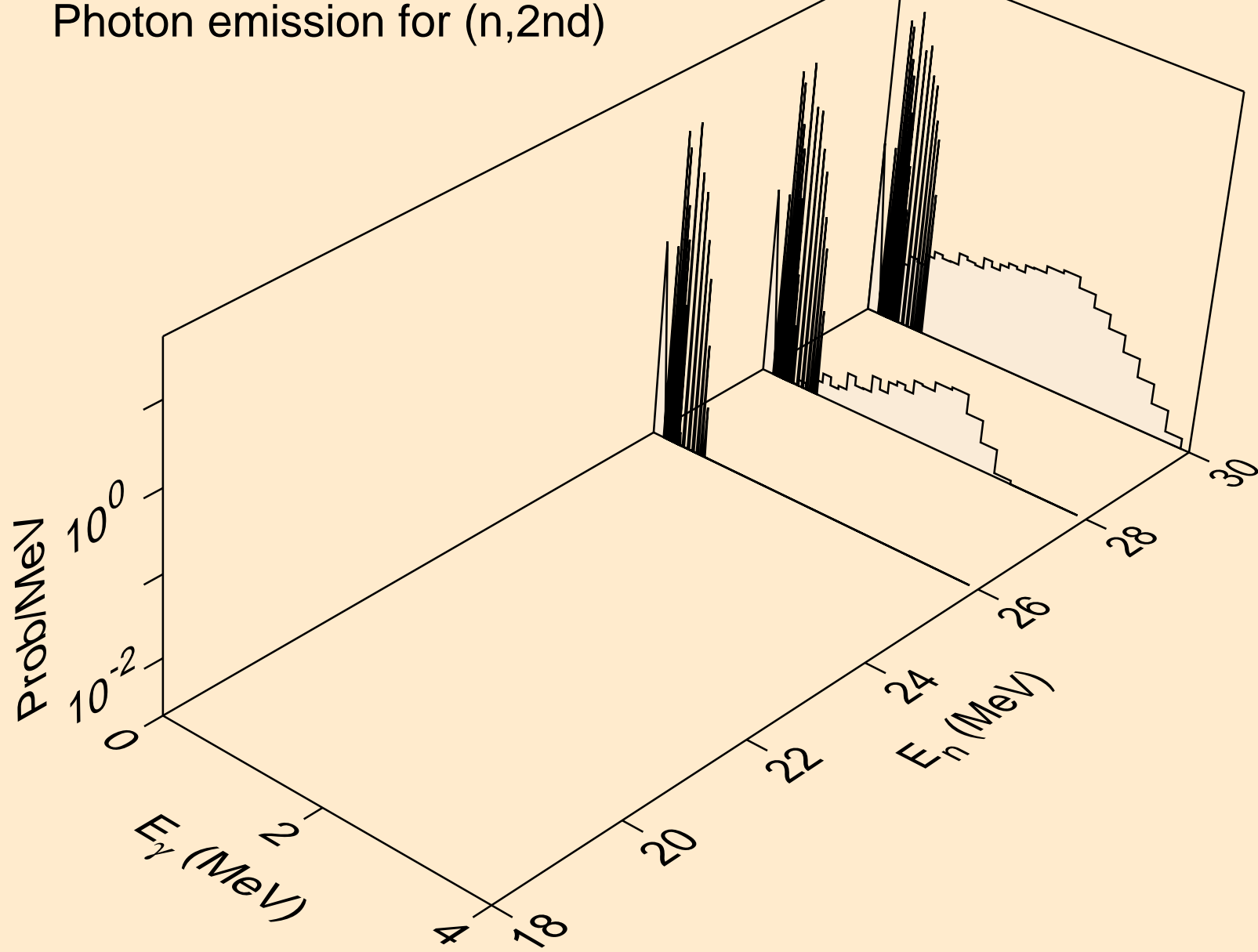

EU136M NEUTRON ACER TENDL-2021 LIBRARY; T=293.6K
Photon emission for (n,2n)

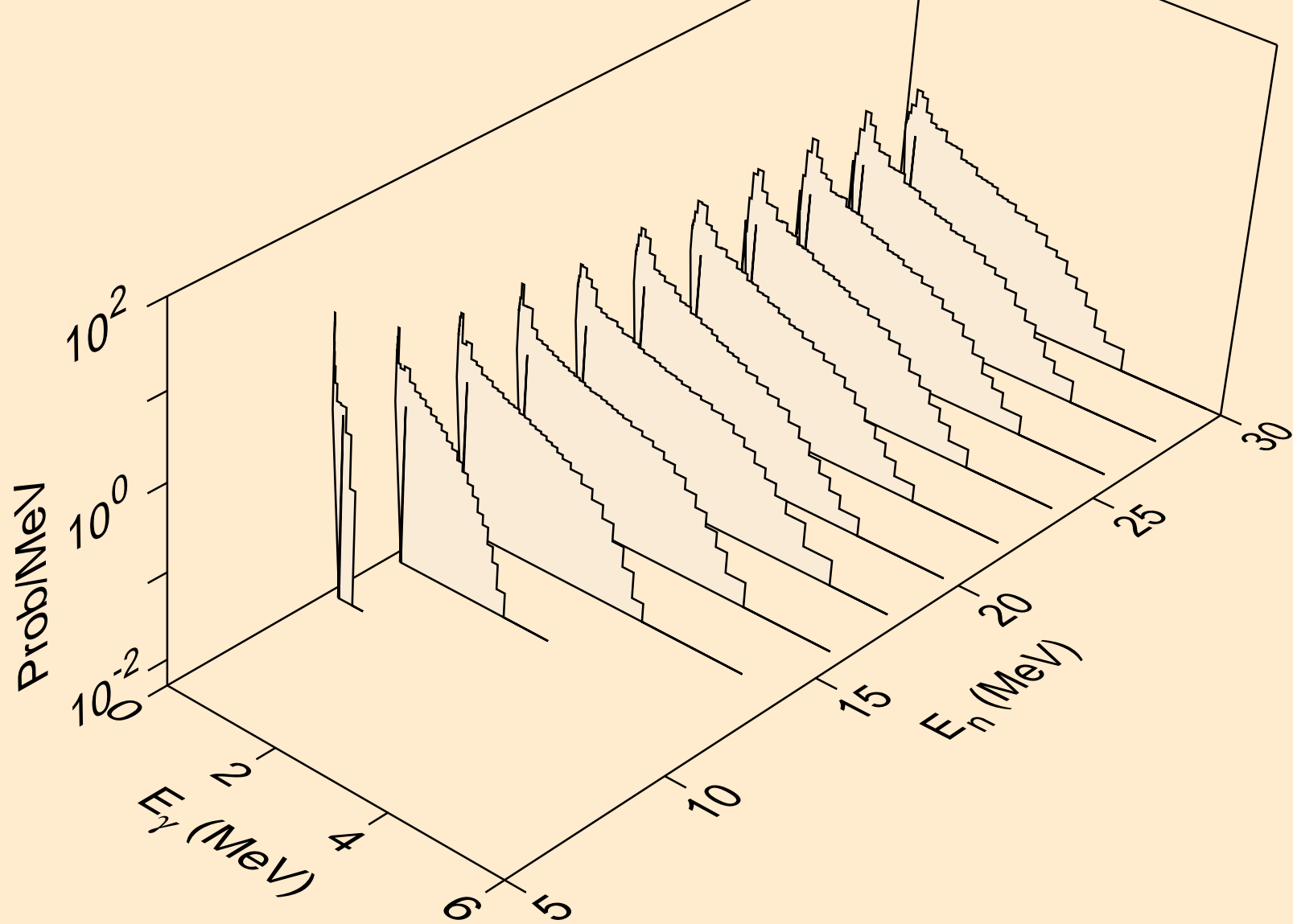

EU136M NEUTRON ACER TENDL-2021 LIBRARY; T=293.6K
Photon emission for (n,3n)

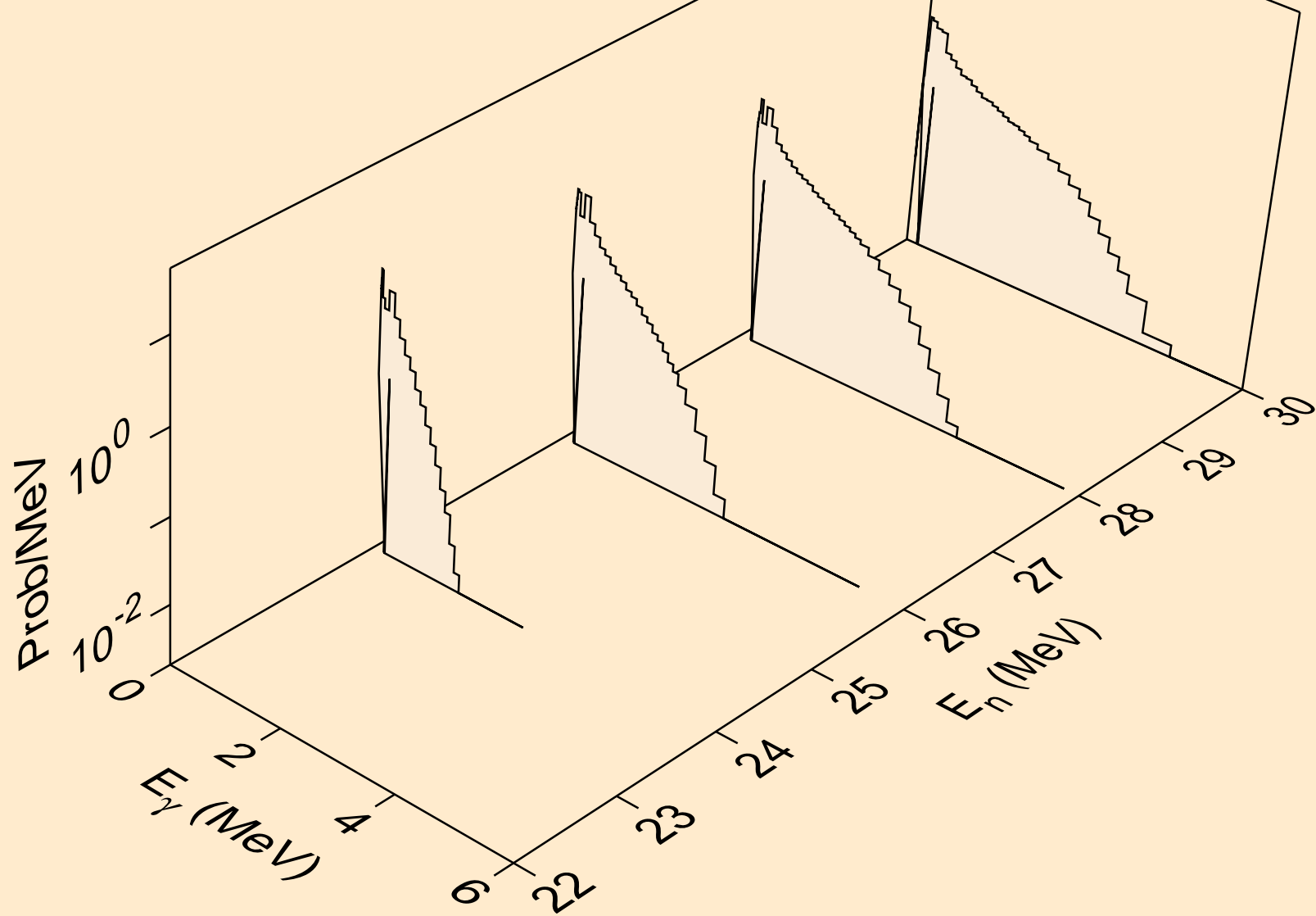

EU136M NEUTRON ACER TENDL-2021 LIBRARY; T=293.6K
Photon emission for (n,n*)a

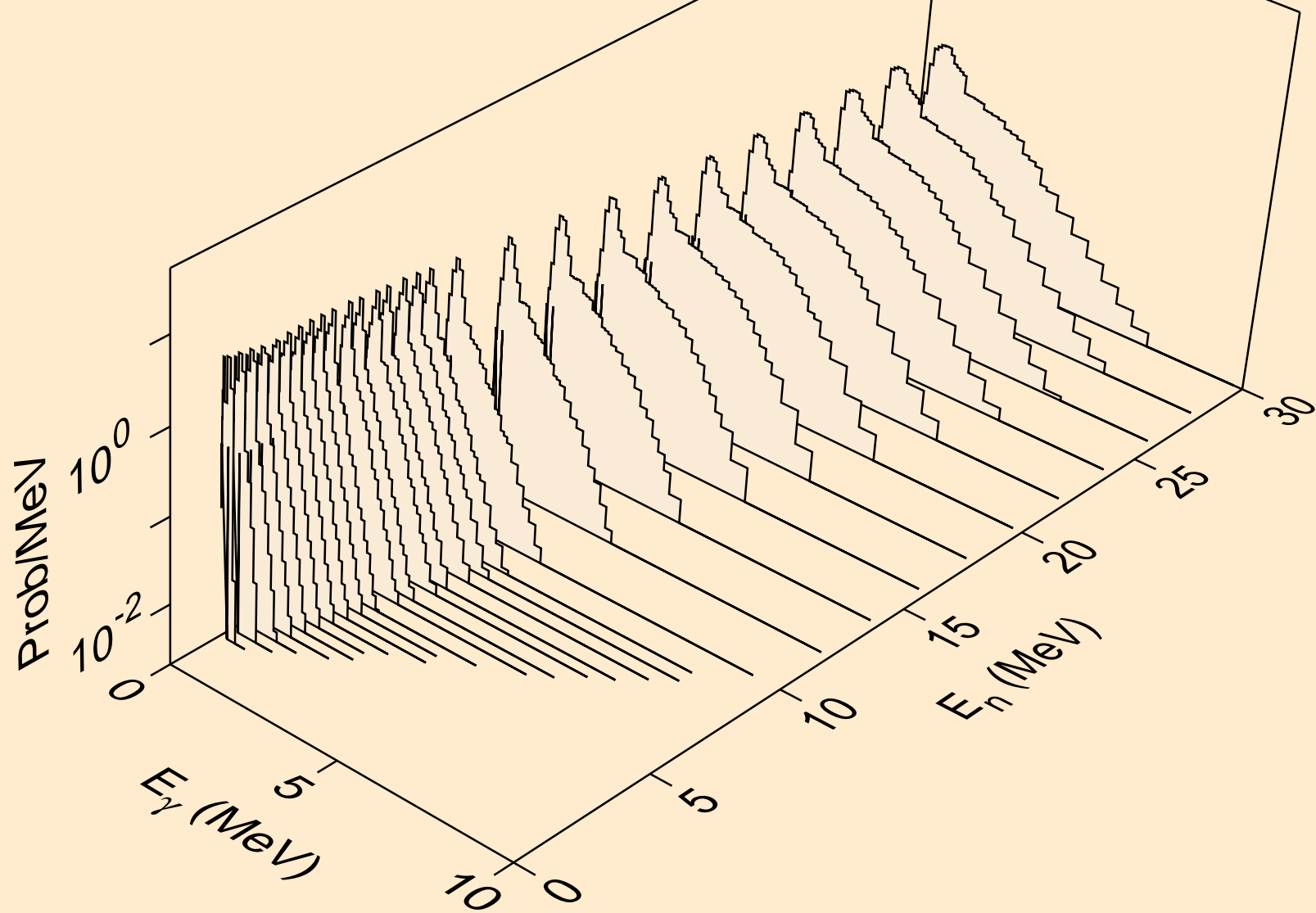

EU136M NEUTRON ACER TENDL-2021 LIBRARY; T=293.6K
Photon emission for (n,2n)a

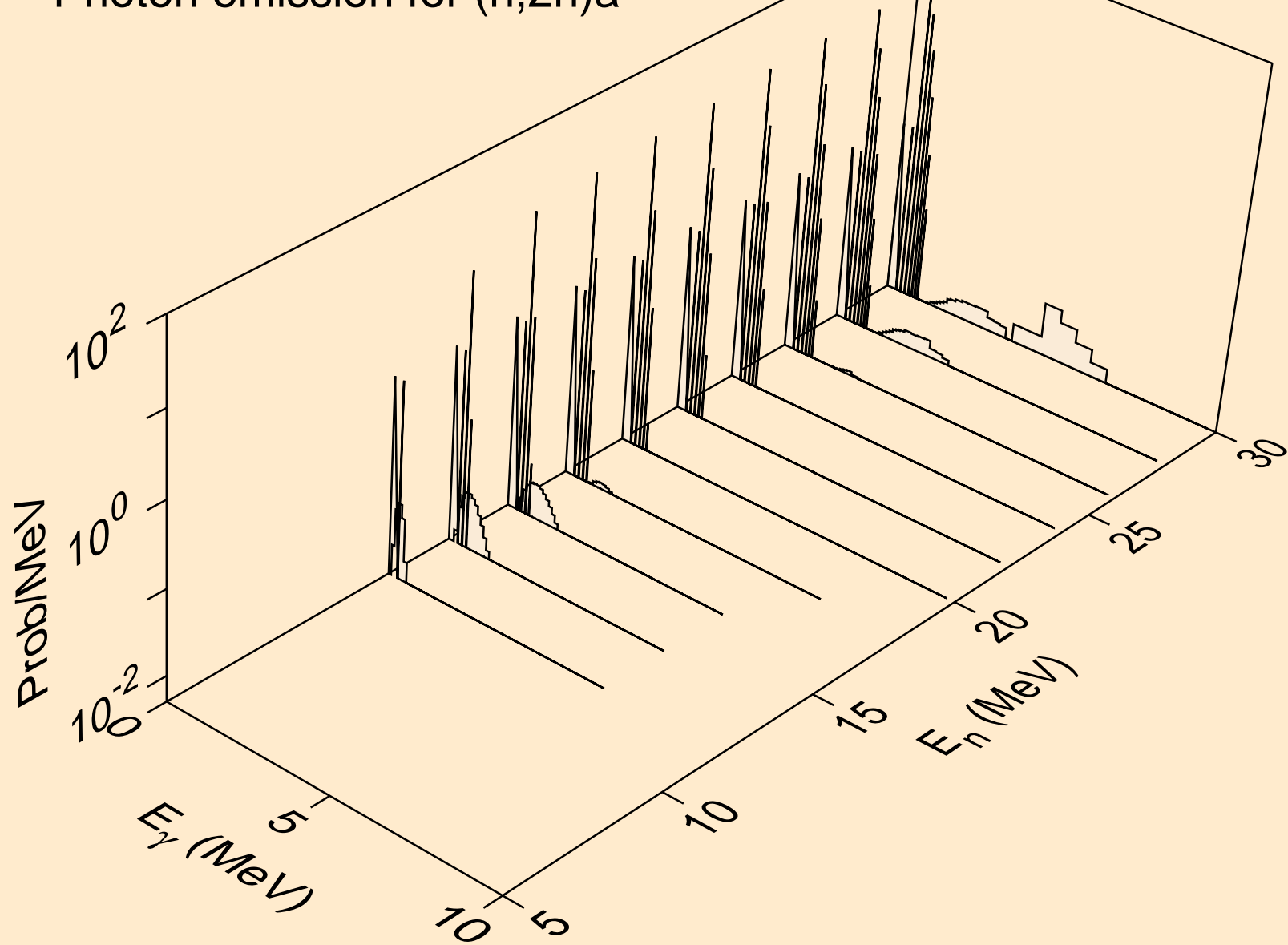

EU136M NEUTRON ACER TENDL-2021 LIBRARY; T=293.6K
Photon emission for (n,n*)p

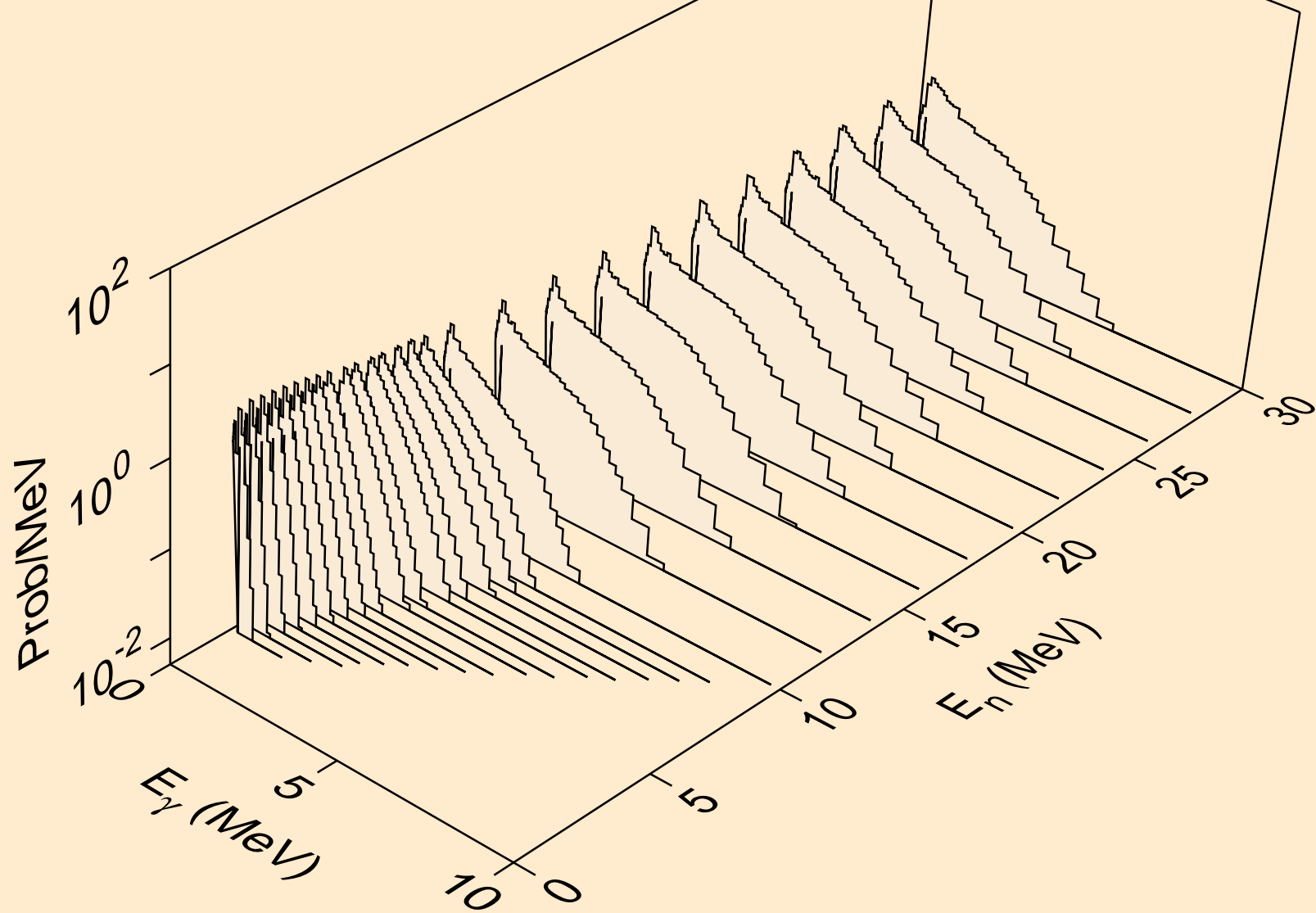

EU136M NEUTRON ACER TENDL-2021 LIBRARY; T=293.6K
Photon emission for (n,n*)2a

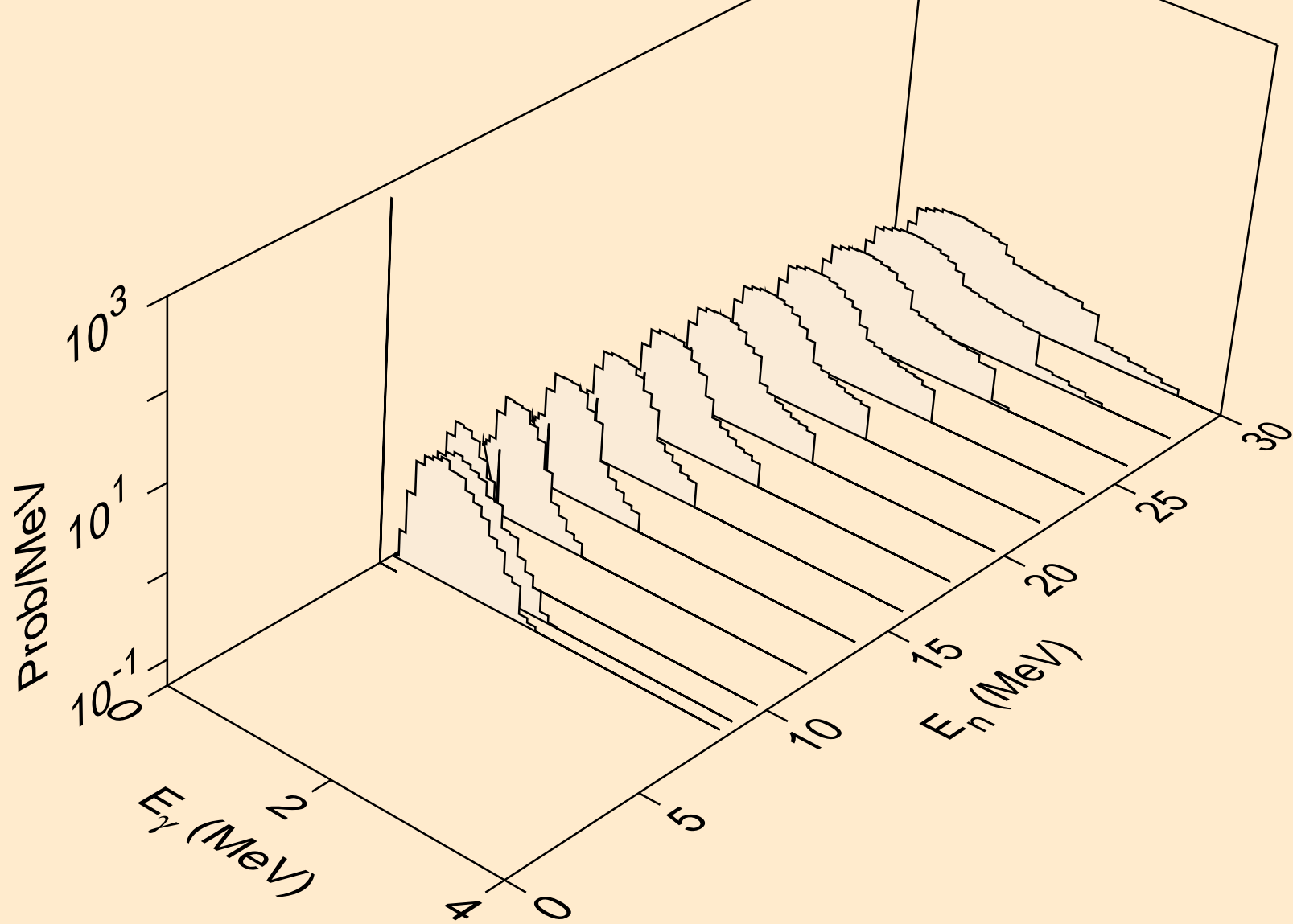

EU136M NEUTRON ACER TENDL-2021 LIBRARY; T=293.6K
Photon emission for (n,2n)2a

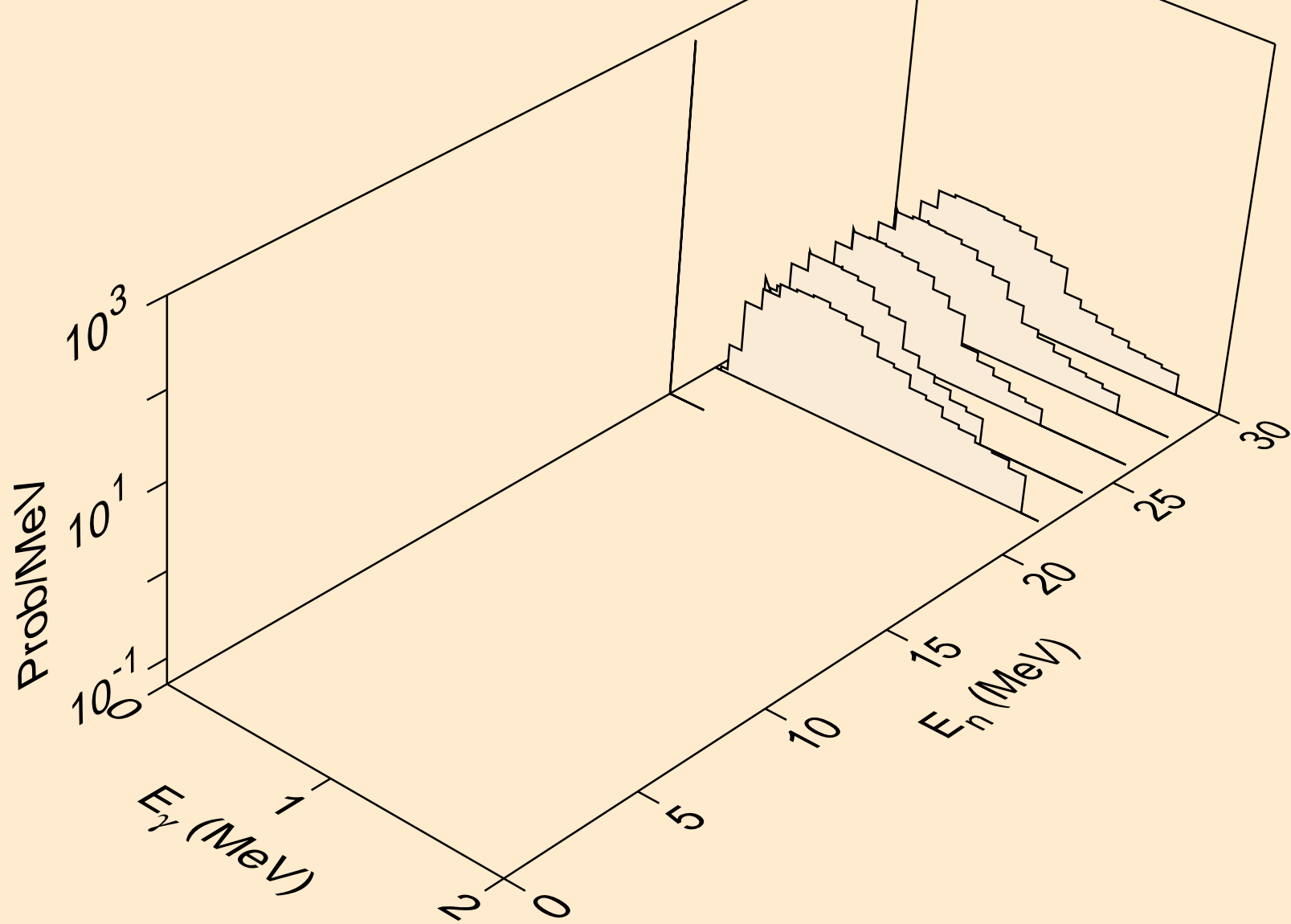

EU136M NEUTRON ACER TENDL-2021 LIBRARY; T=293.6K
Photon emission for (n,n*)d

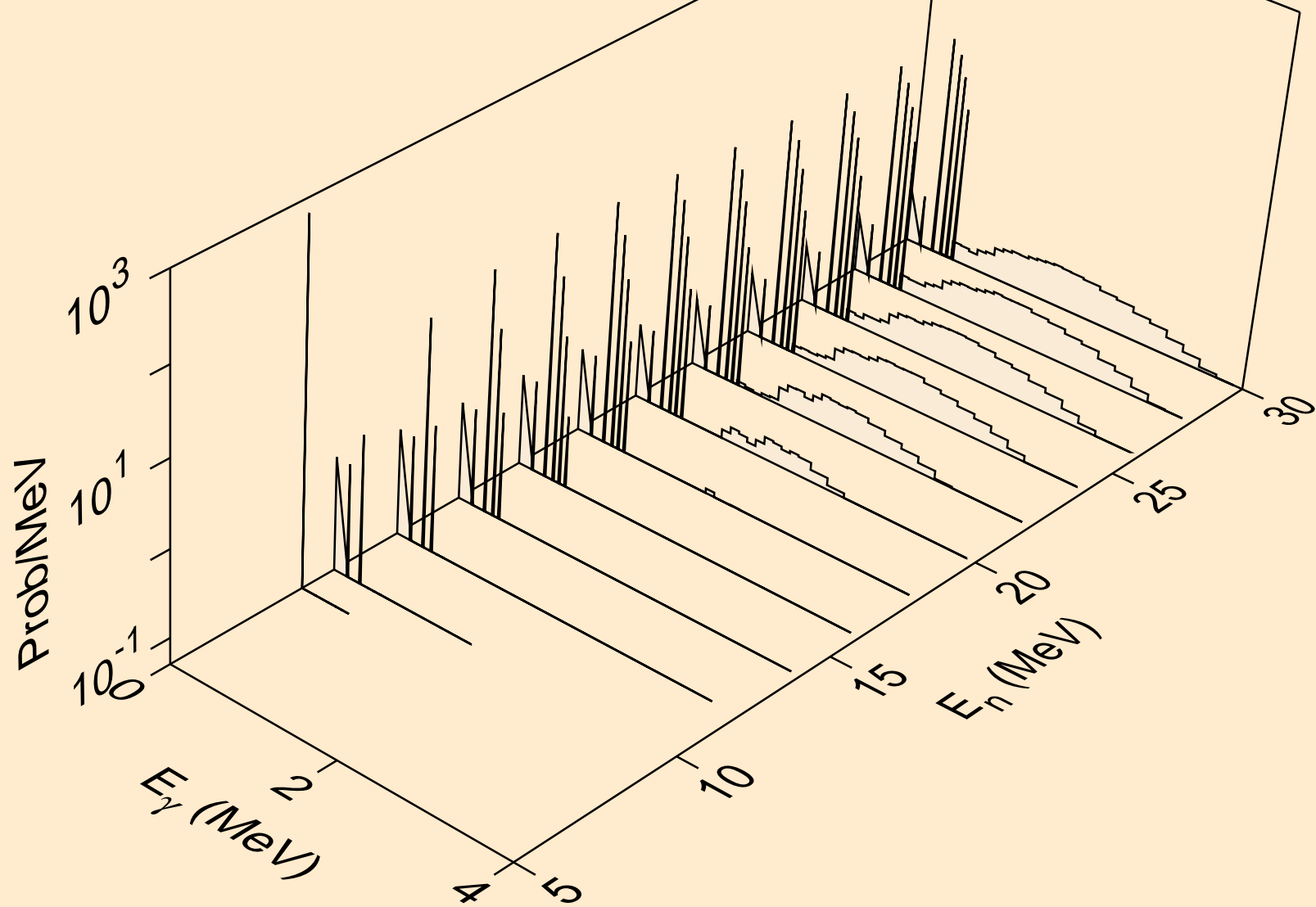

EU136M NEUTRON ACER TENDL-2021 LIBRARY; T=293.6K
Photon emission for (n,n*)t

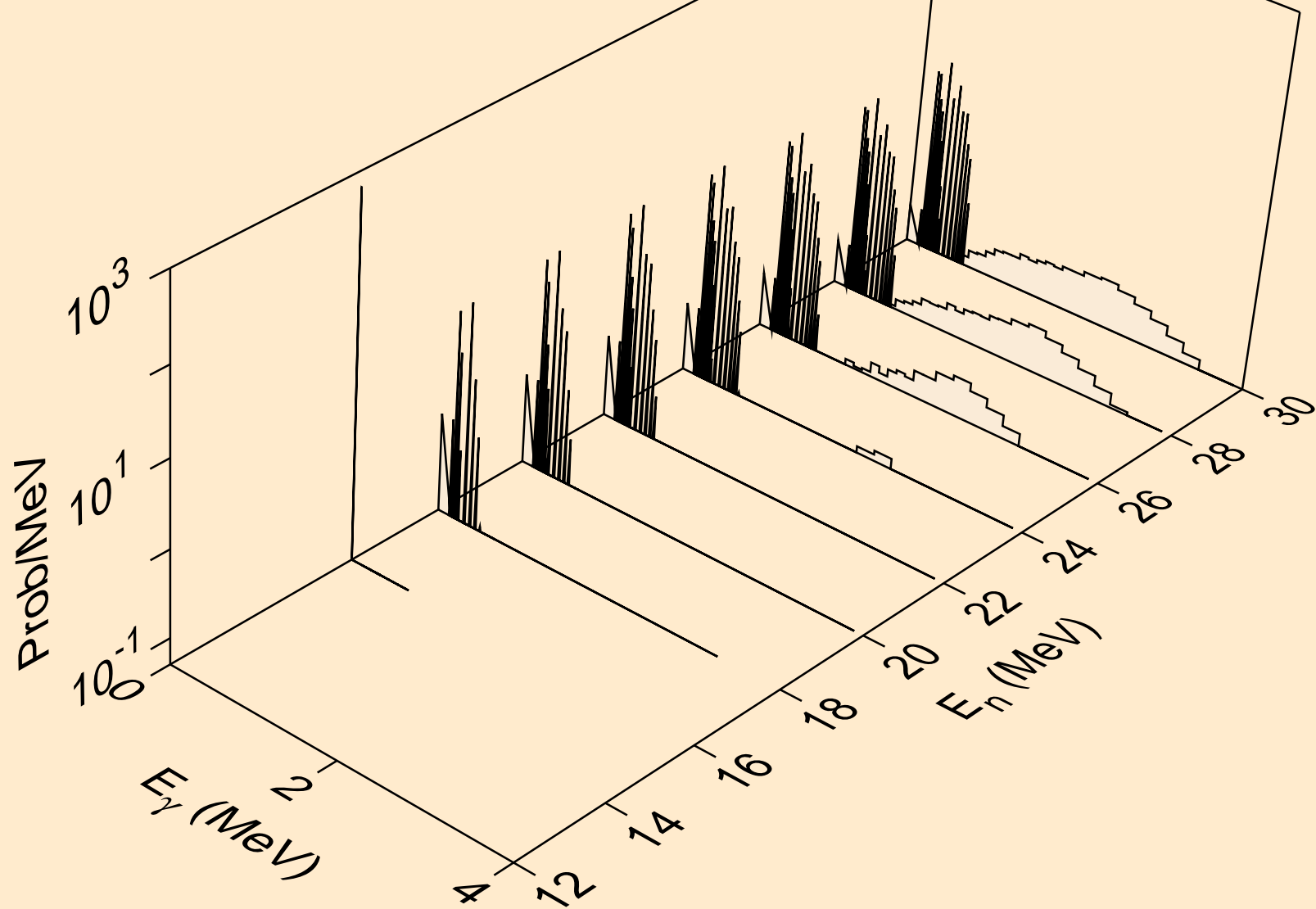

EU136M NEUTRON ACER TENDL-2021 LIBRARY; T=293.6K
Photon emission for (n,n*)he3

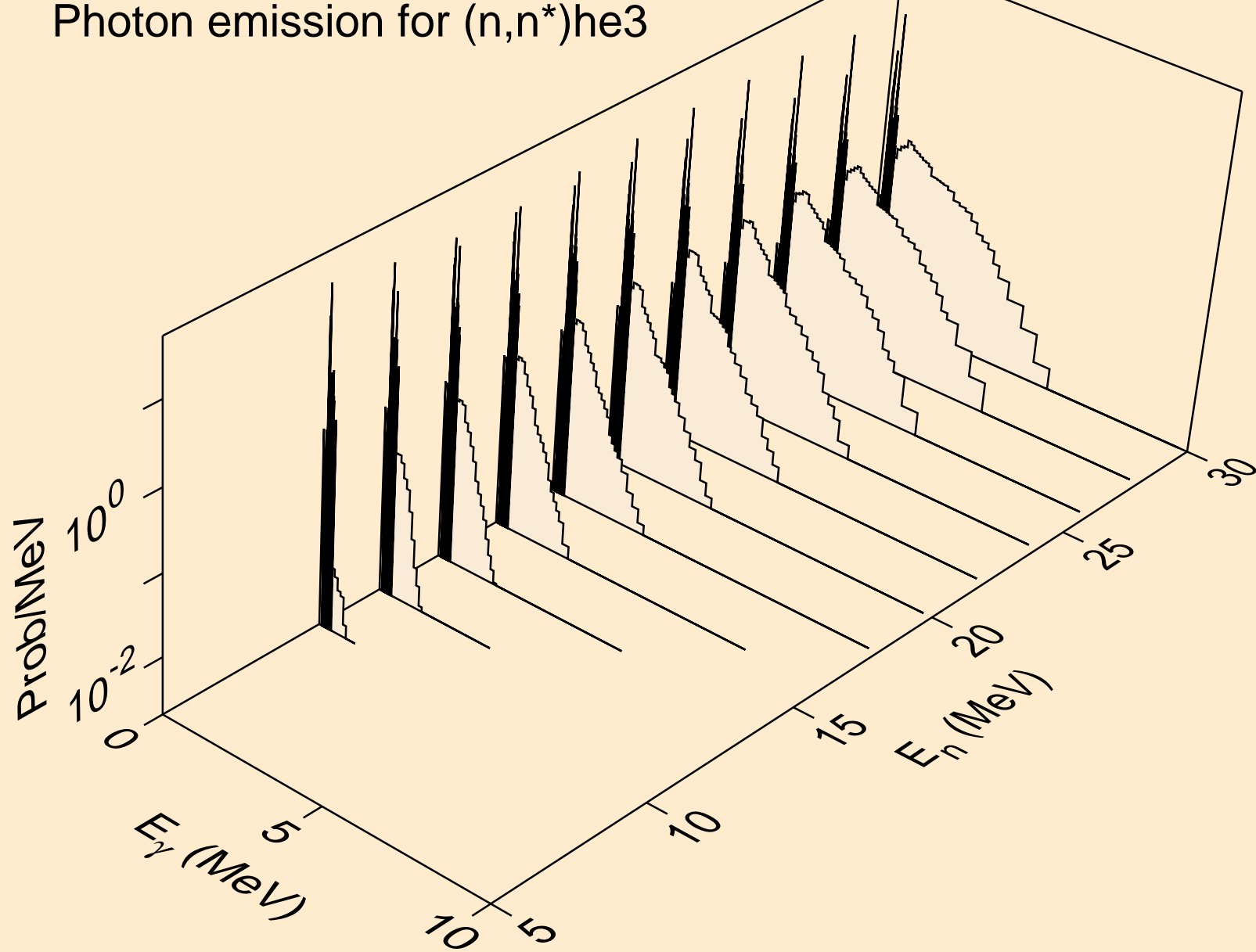

EU136M NEUTRON ACER TENDL-2021 LIBRARY; T=293.6K
Photon emission for (n,2np)

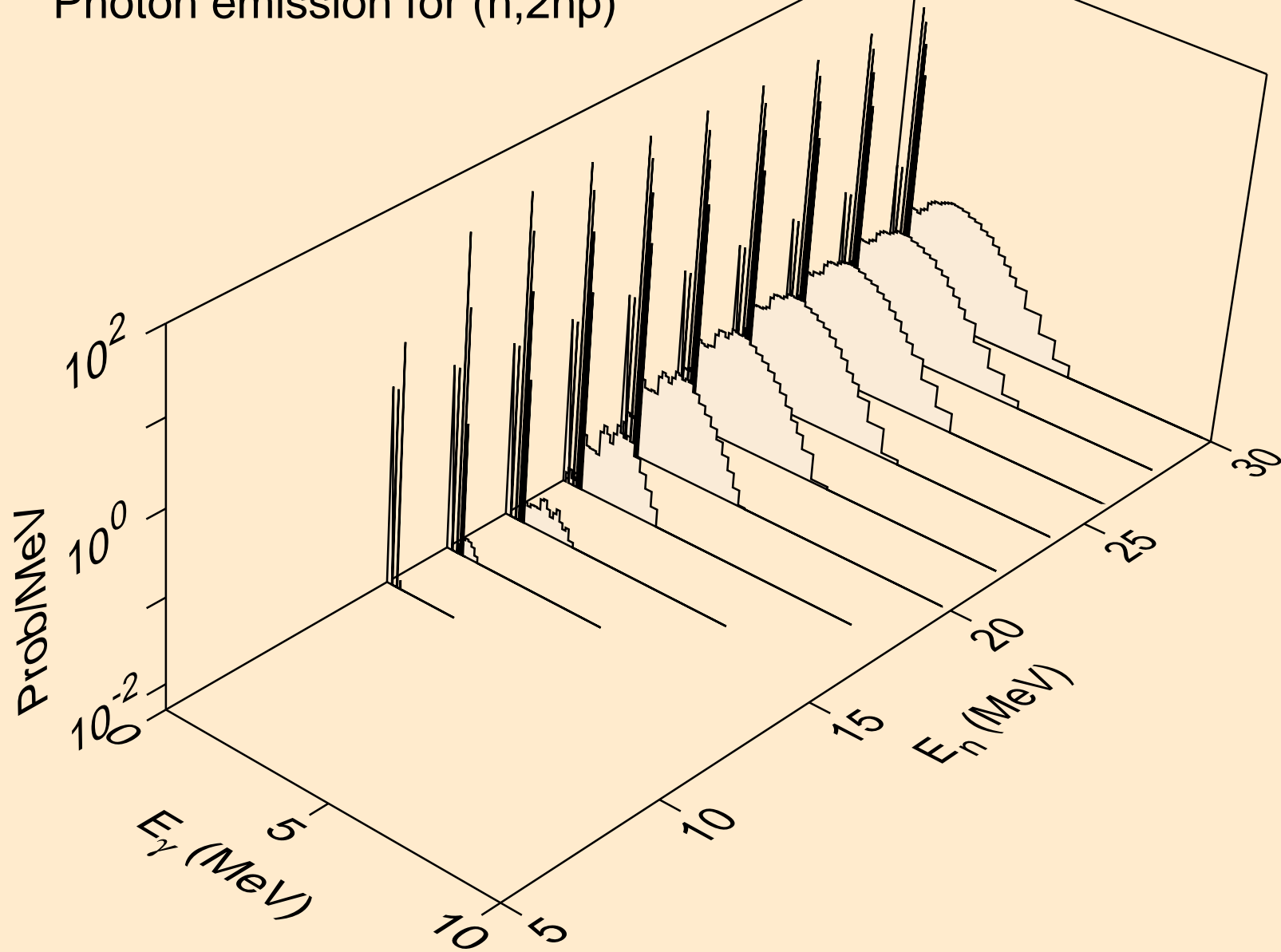

EU136M NEUTRON ACER TENDL-2021 LIBRARY; T=293.6K
Photon emission for (n,3np)

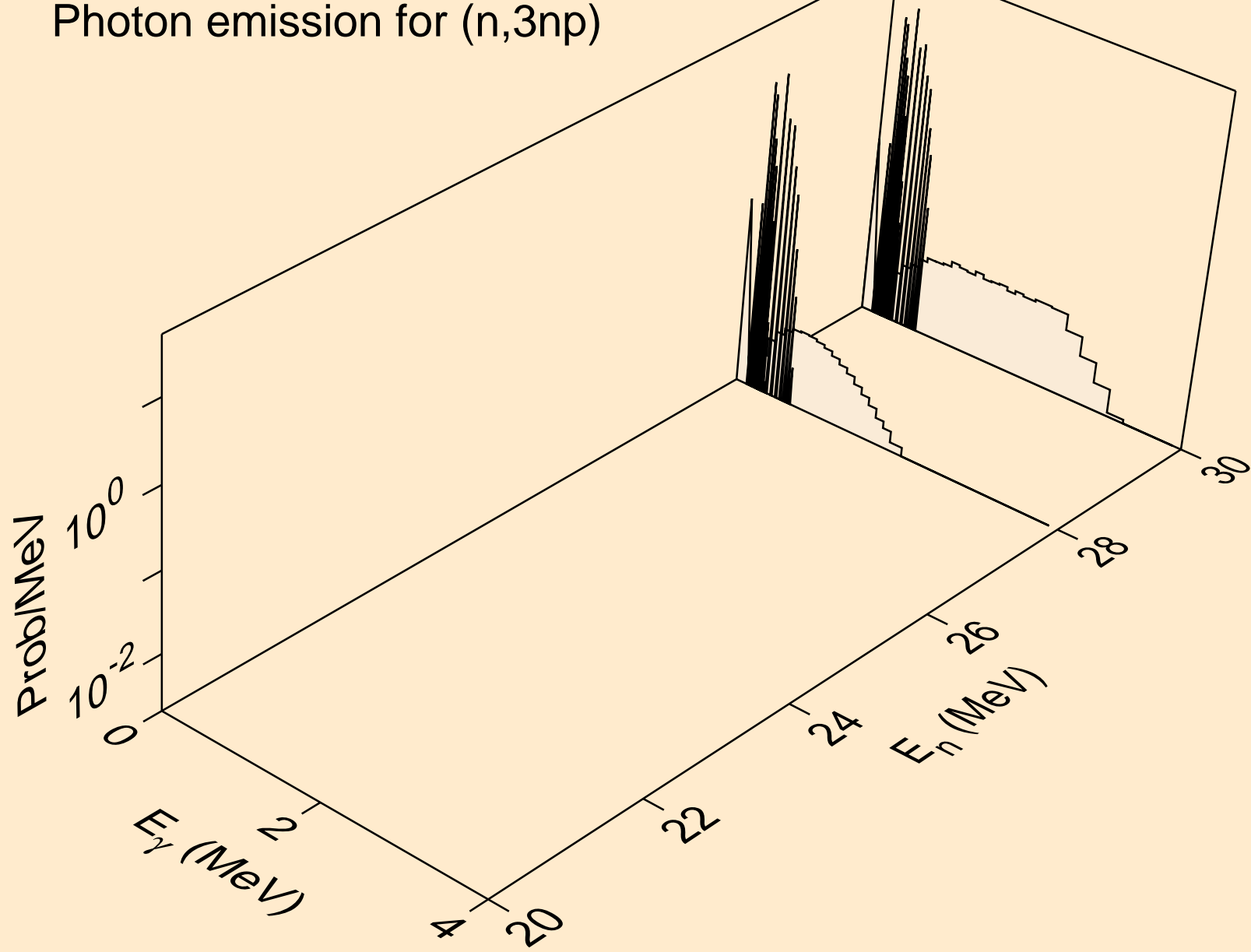

EU136M NEUTRON ACER TENDL-2021 LIBRARY; T=293.6K
Photon emission for (n,2np)

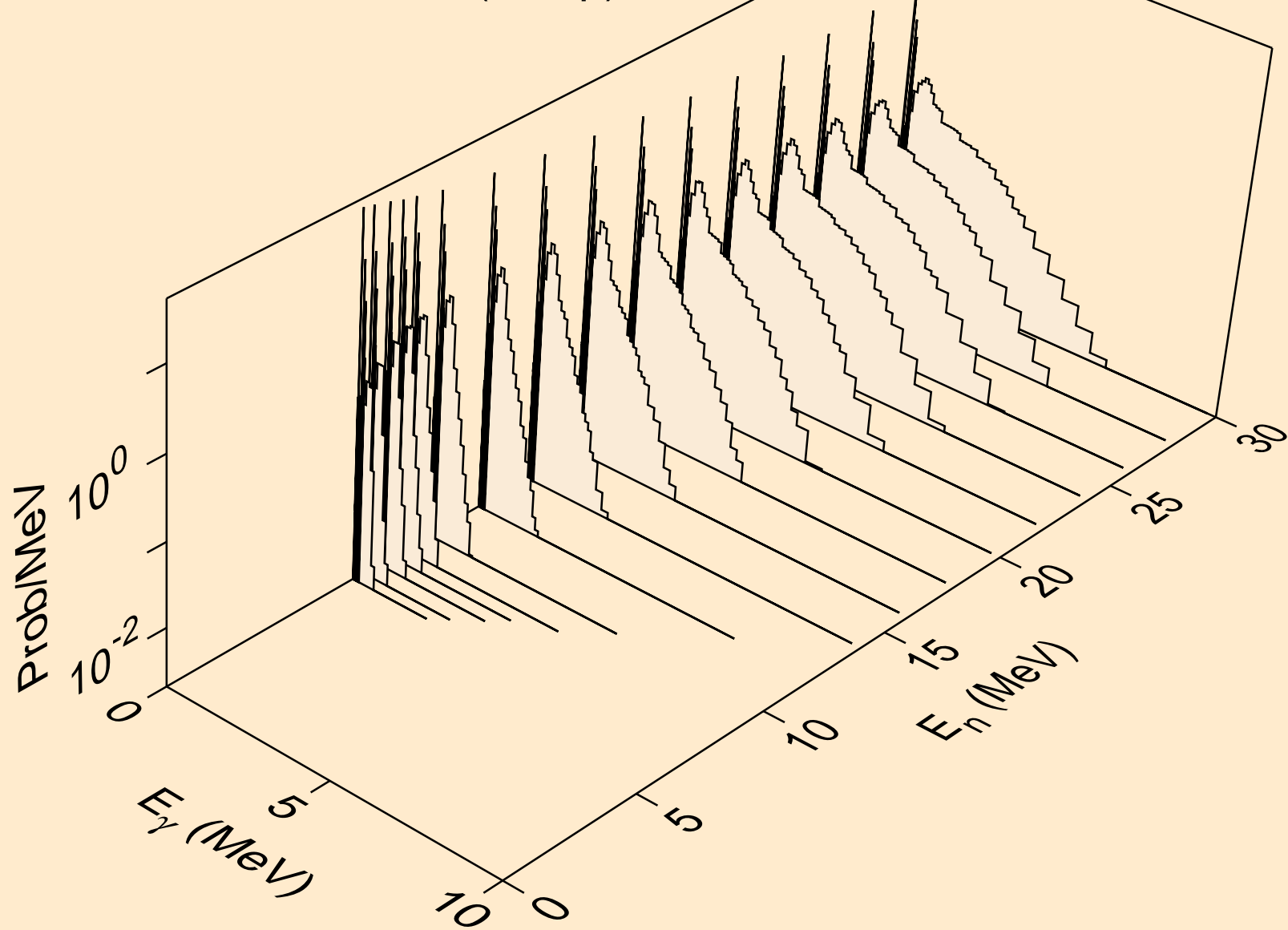

EU136M NEUTRON ACER TENDL-2021 LIBRARY; T=293.6K
Photon emission for (n,npa)

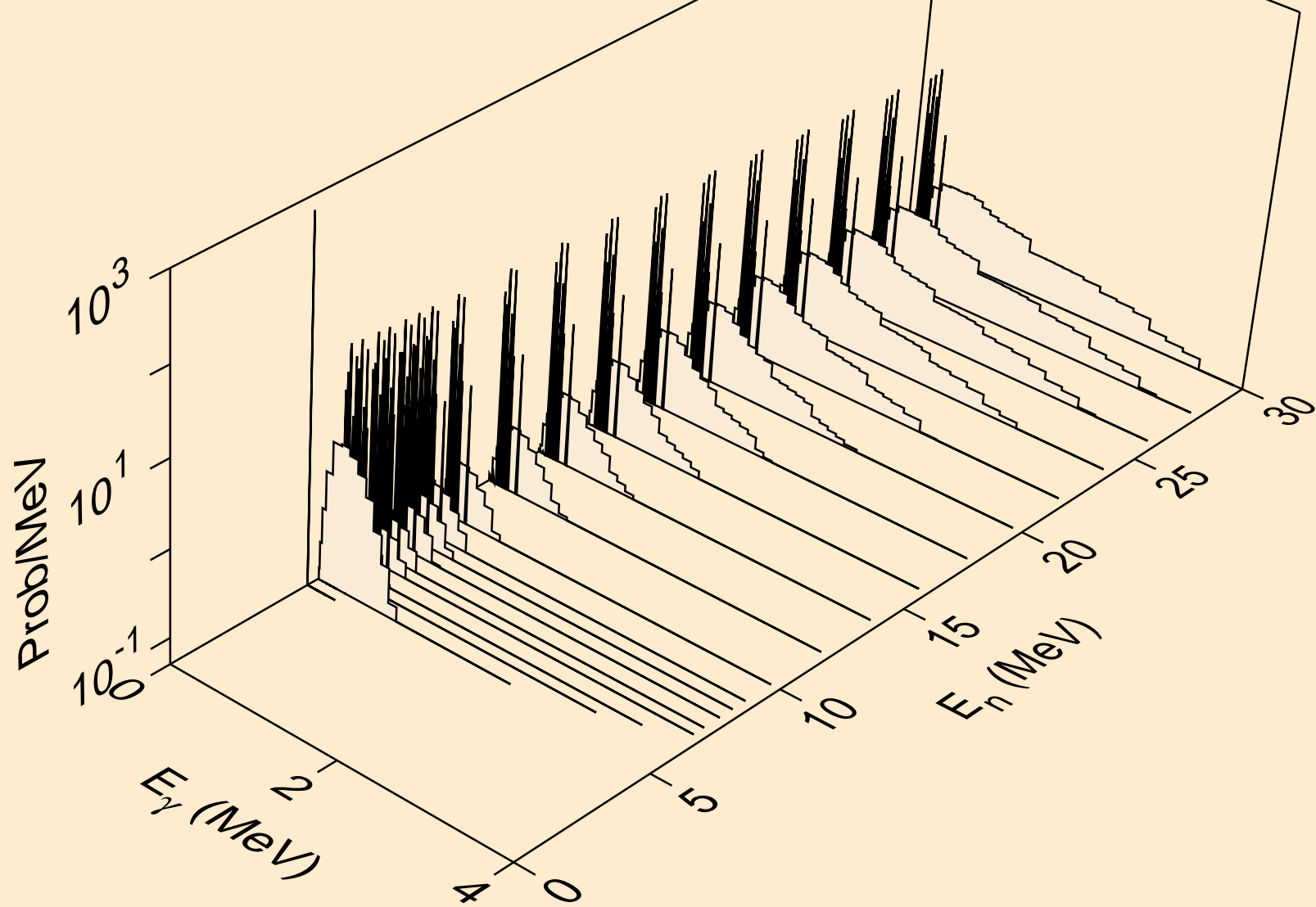

EU136M NEUTRON ACER TENDL-2021 LIBRARY; T=293.6K
Photon emission for (n,n*2)

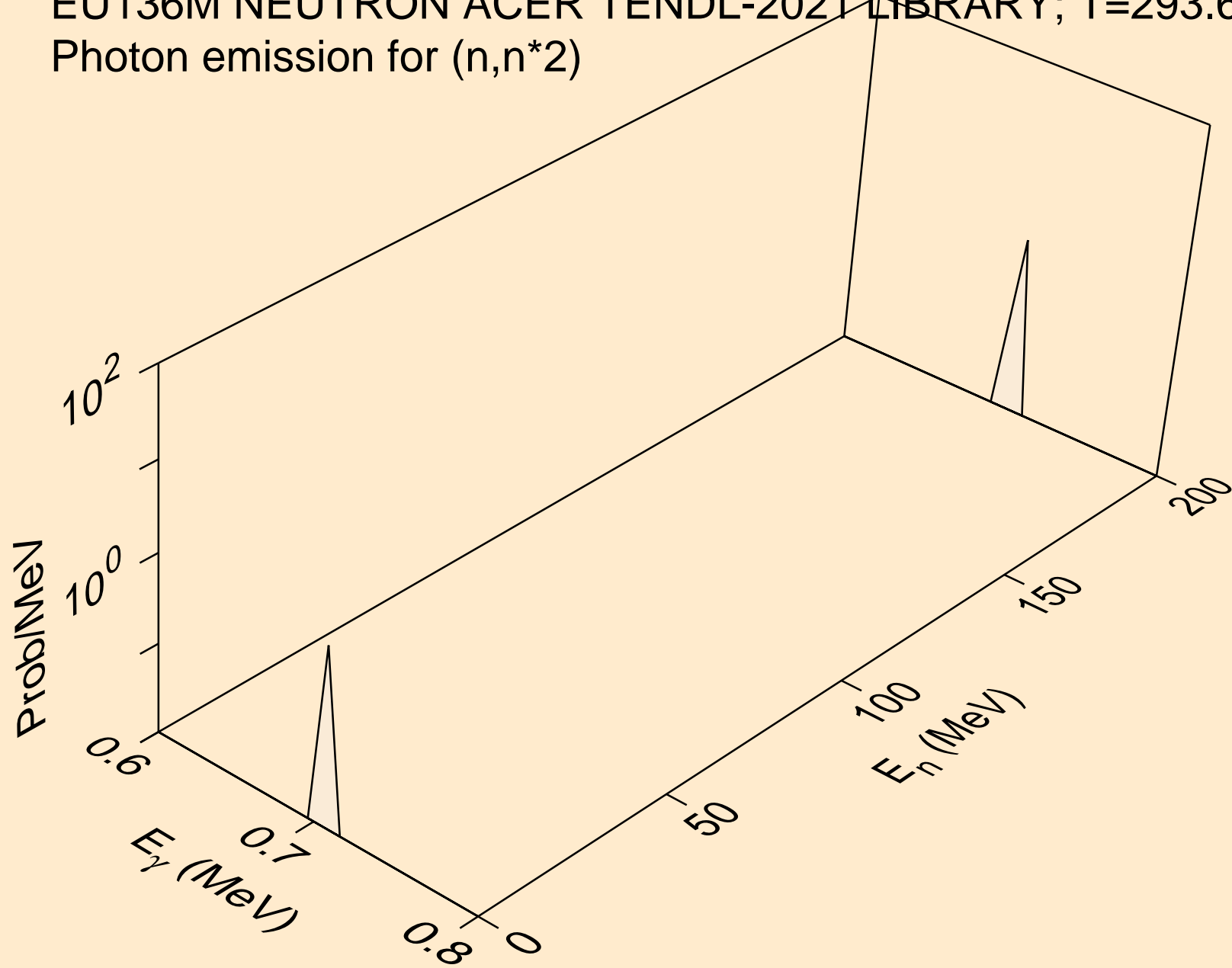

EU136M NEUTRON ACER TENDL-2021 LIBRARY; T=293.6K
Photon emission for (n,n*c)

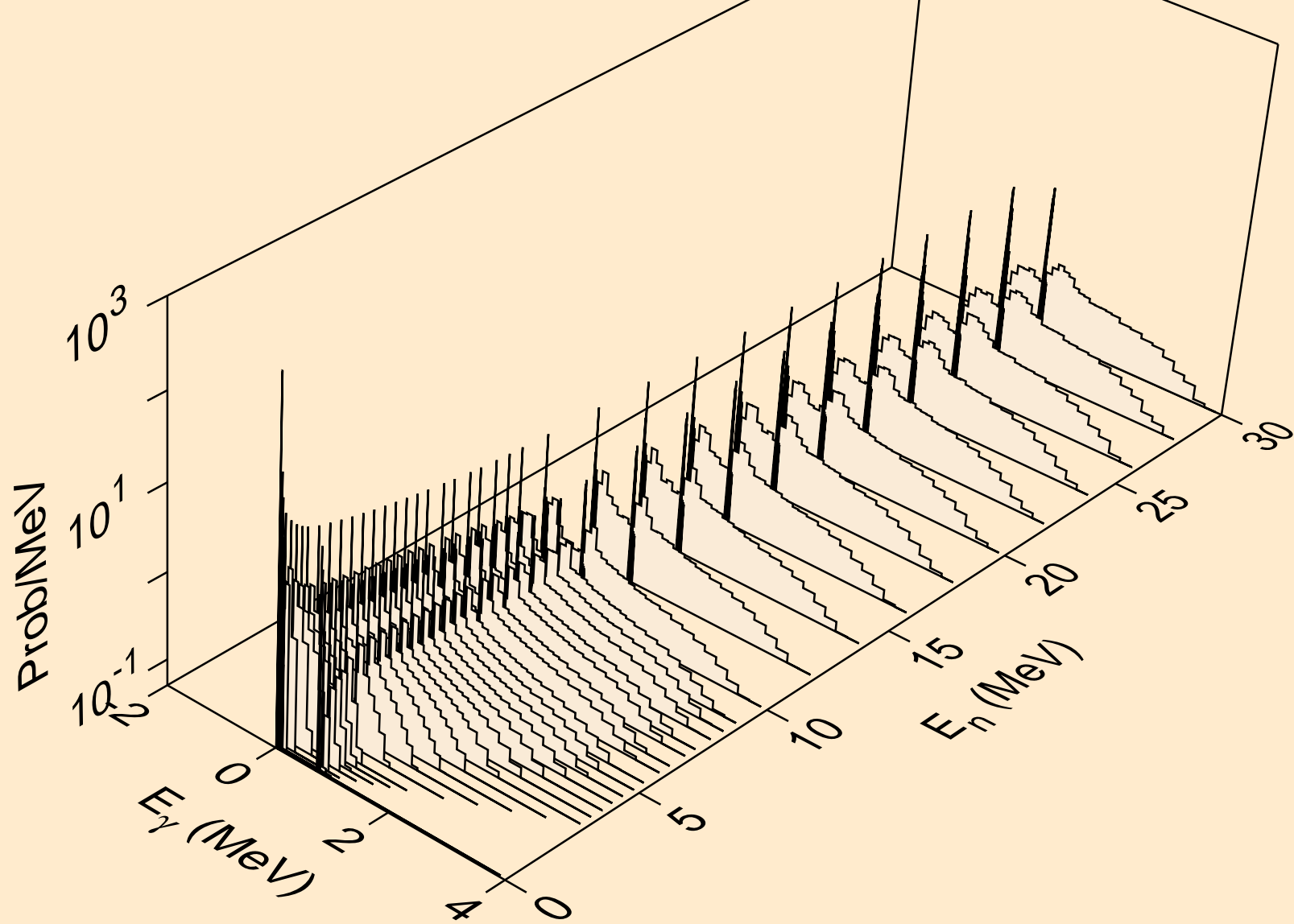

EU136M NEUTRON ACER TENDL-2021 LIBRARY; T=293.6K
Photon emission for (n,gma)

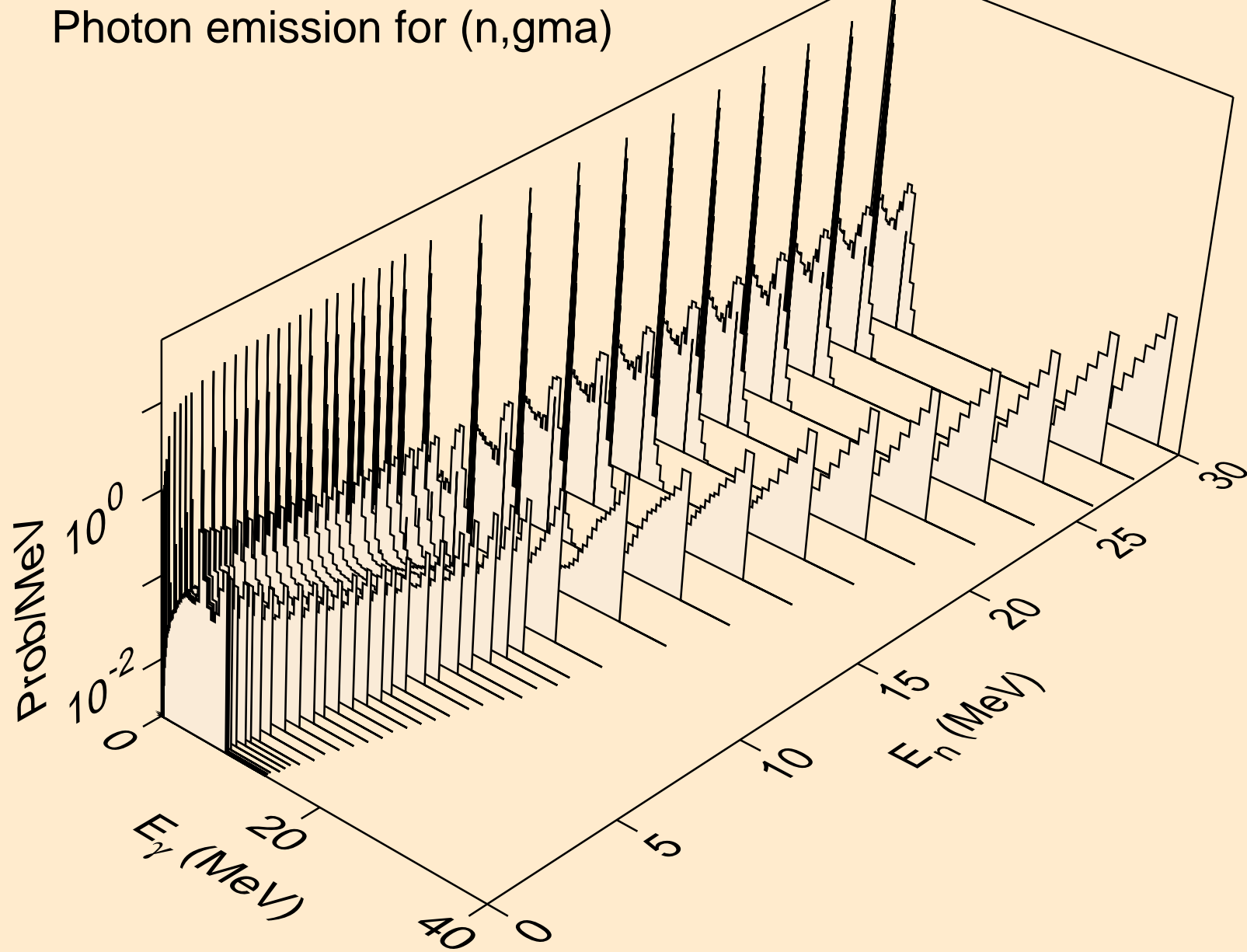

EU136M NEUTRON ACER TENDL-2021 LIBRARY; T=293.6K
Photon emission for (n,p)

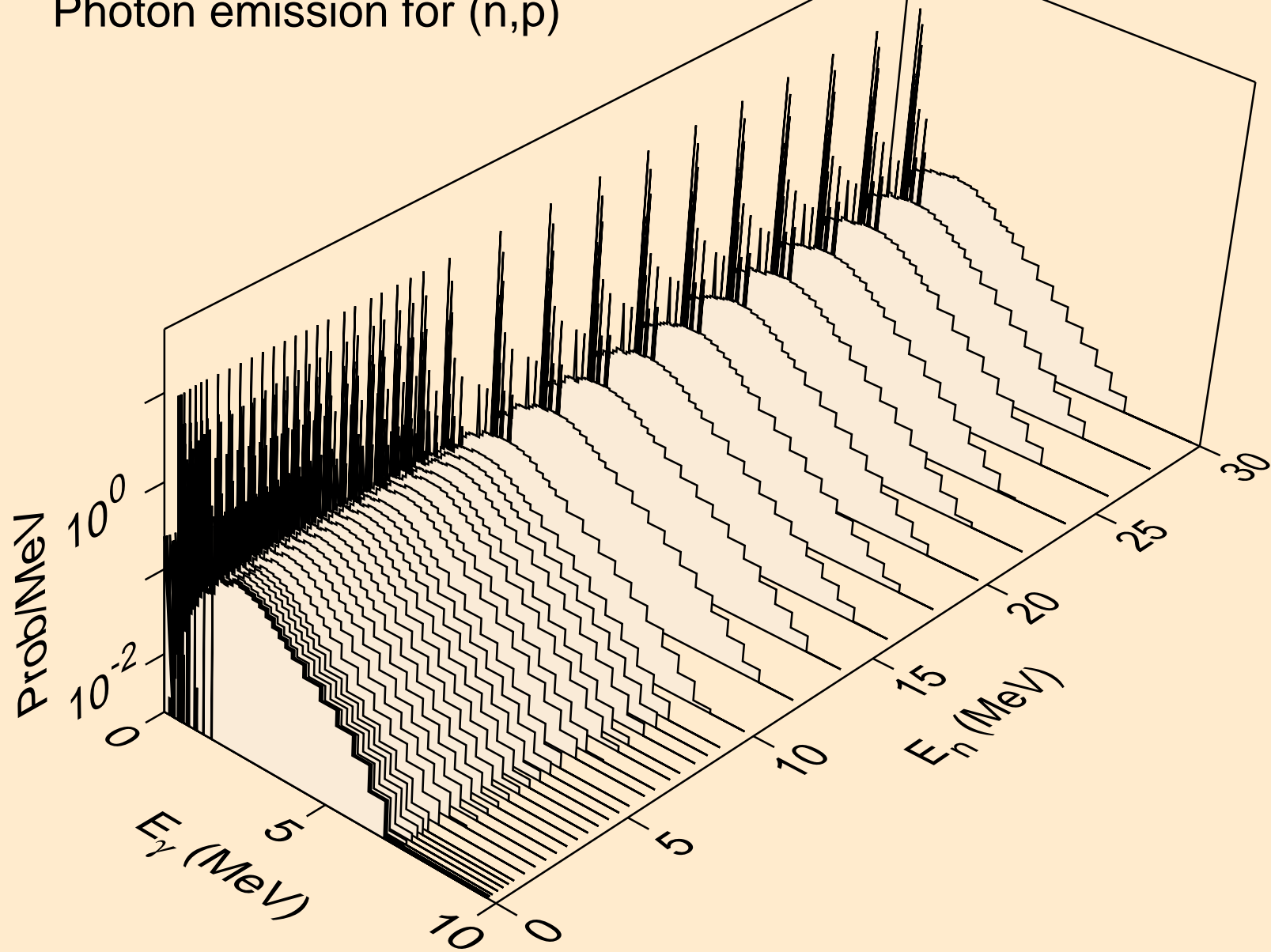

EU136M NEUTRON ACER TENDL-2021 LIBRARY; T=293.6K
Photon emission for (n,d)

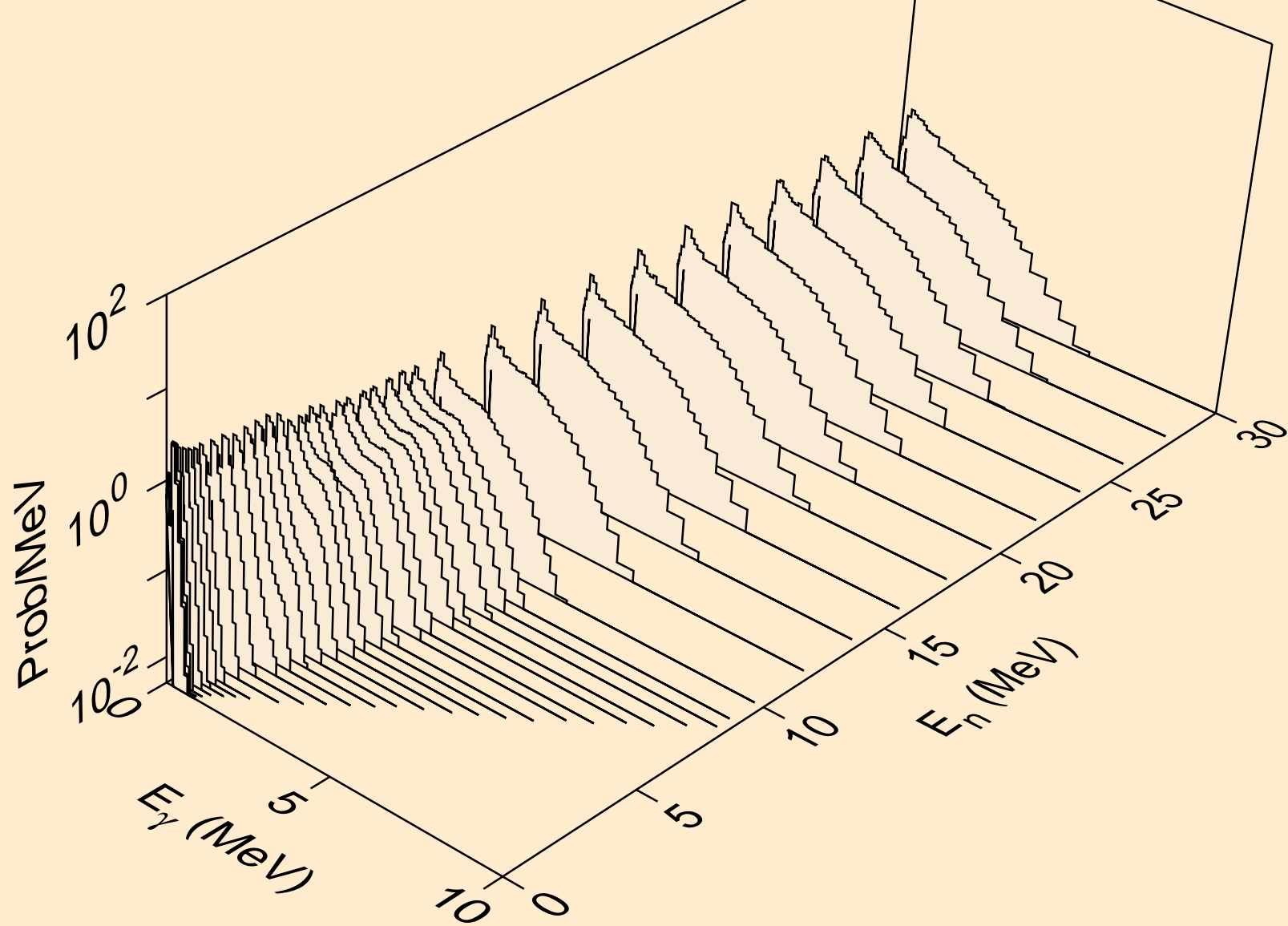

EU136M NEUTRON ACER TENDL-2021 LIBRARY; T=293.6K
Photon emission for (n,t)

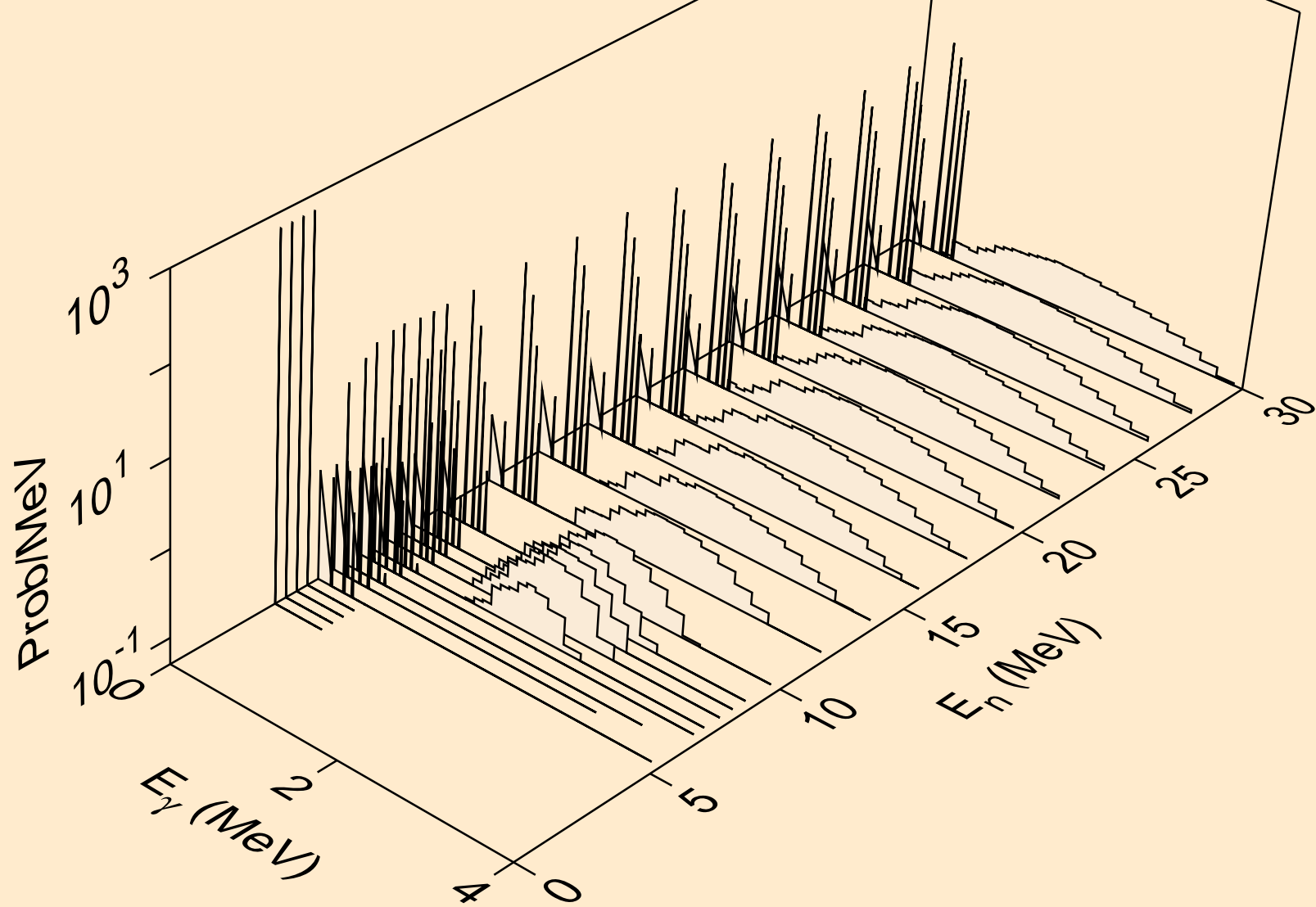

EU136M NEUTRON ACER TENDL-2021 LIBRARY; T=293.6K
Photon emission for (n,he3)

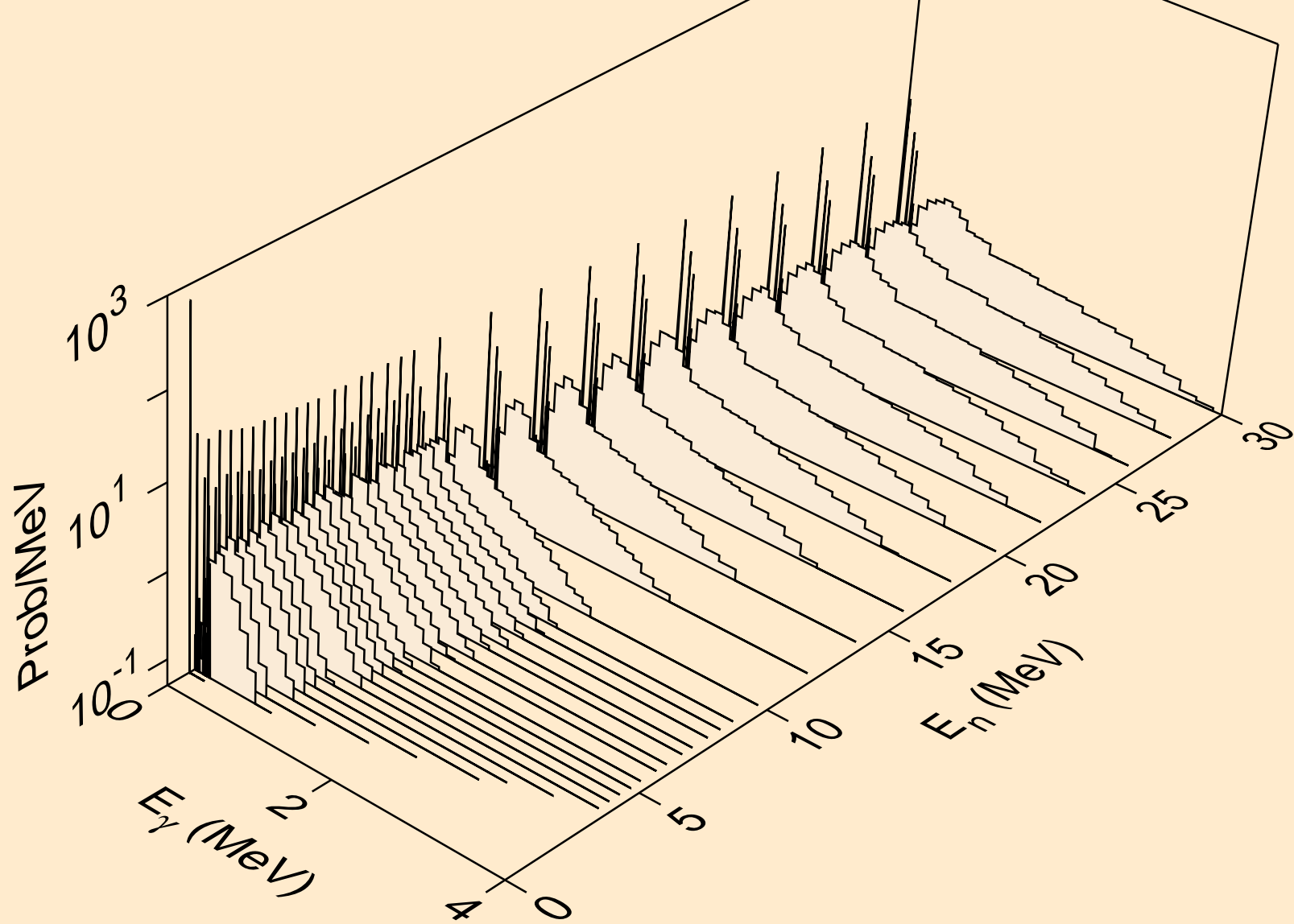

EU136M NEUTRON ACER TENDL-2021 LIBRARY; T=293.6K
Photon emission for (n,a)

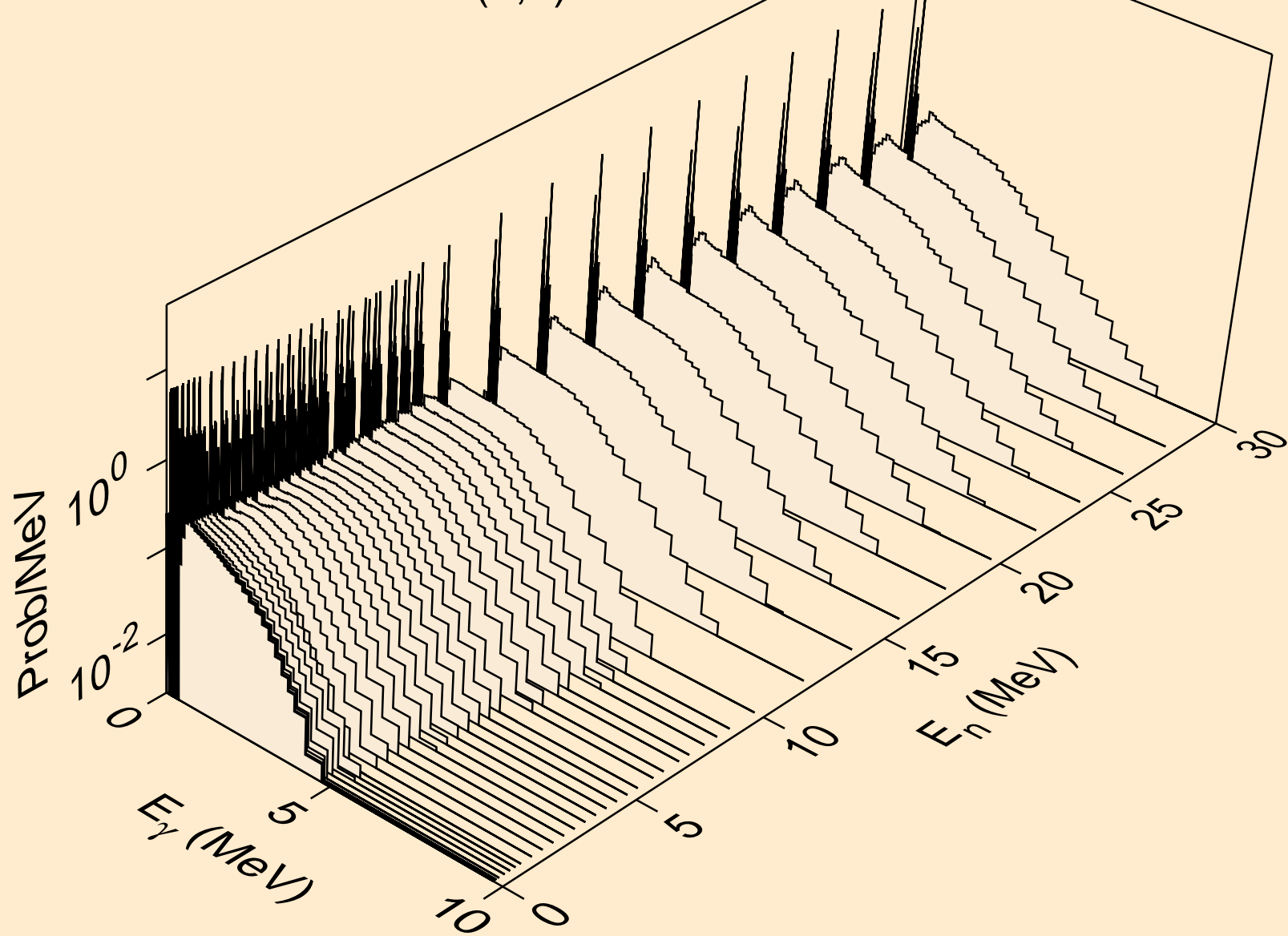

EU136M NEUTRON ACER TENDL-2021 LIBRARY; T=293.6K
Photon emission for (n,2a)

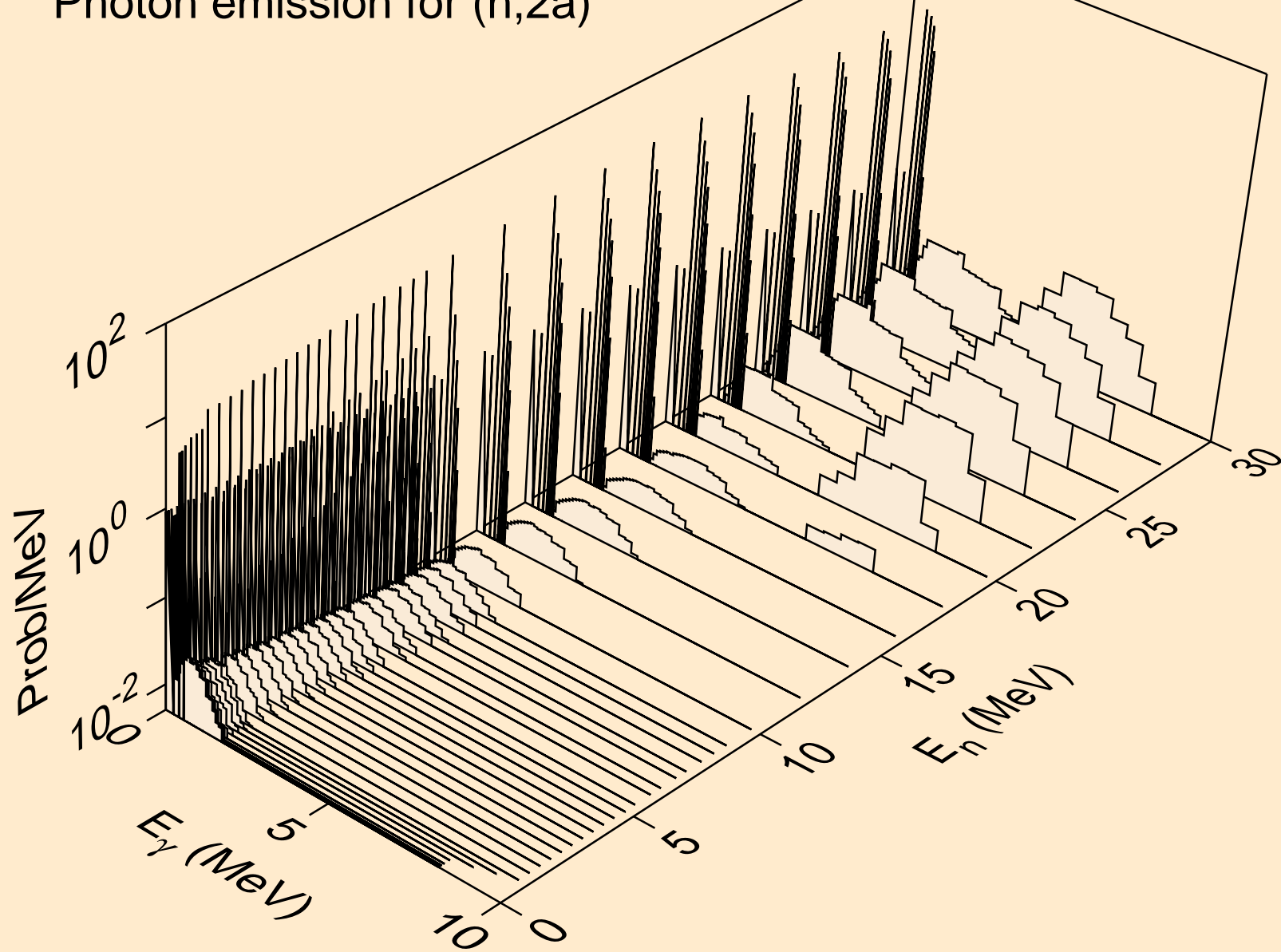

EU136M NEUTRON ACER TENDL-2021 LIBRARY; T=293.6K
Photon emission for (n,3a)

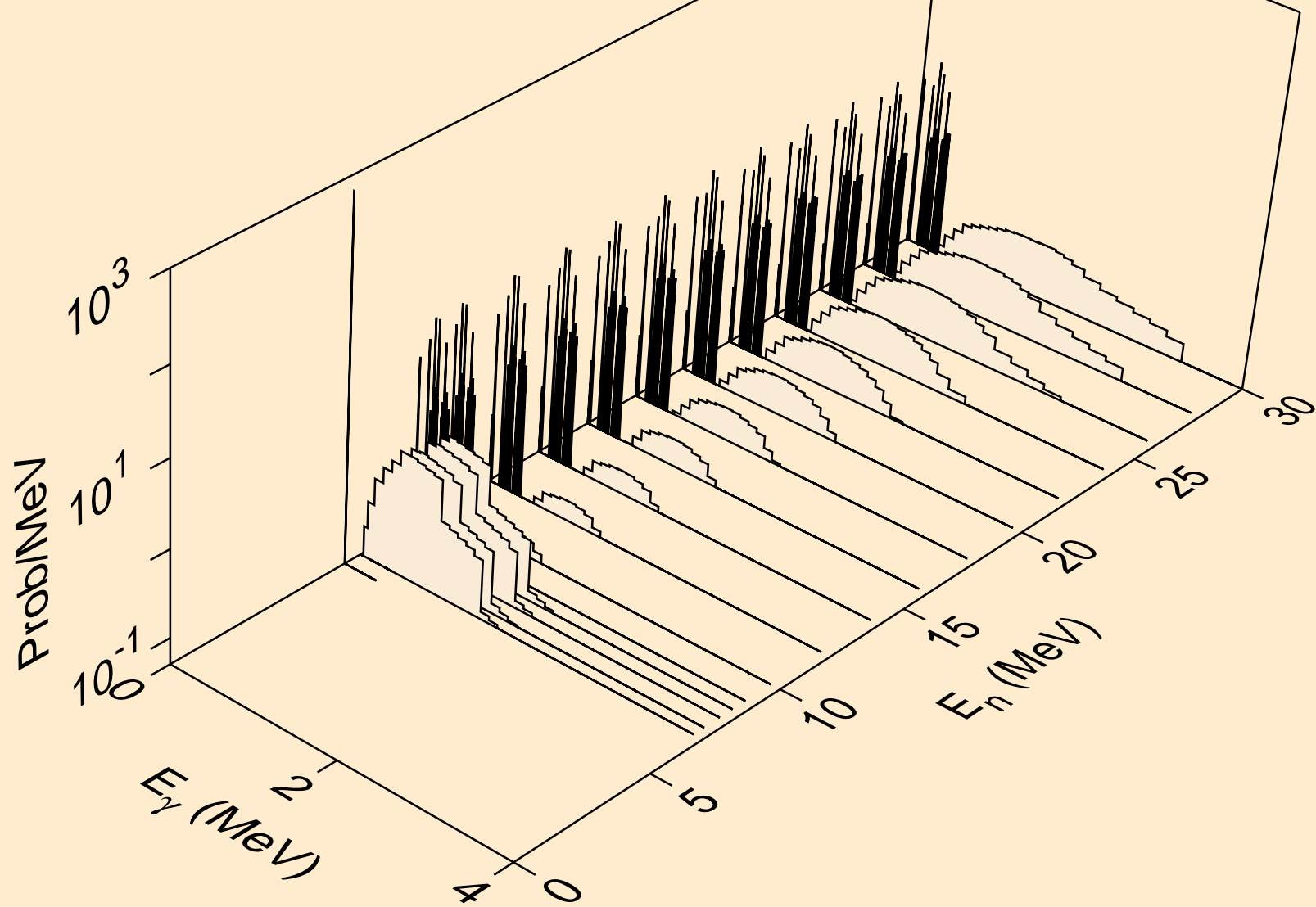

EU136M NEUTRON ACER TENDL-2021 LIBRARY; T=293.6K
Photon emission for (n,2p)

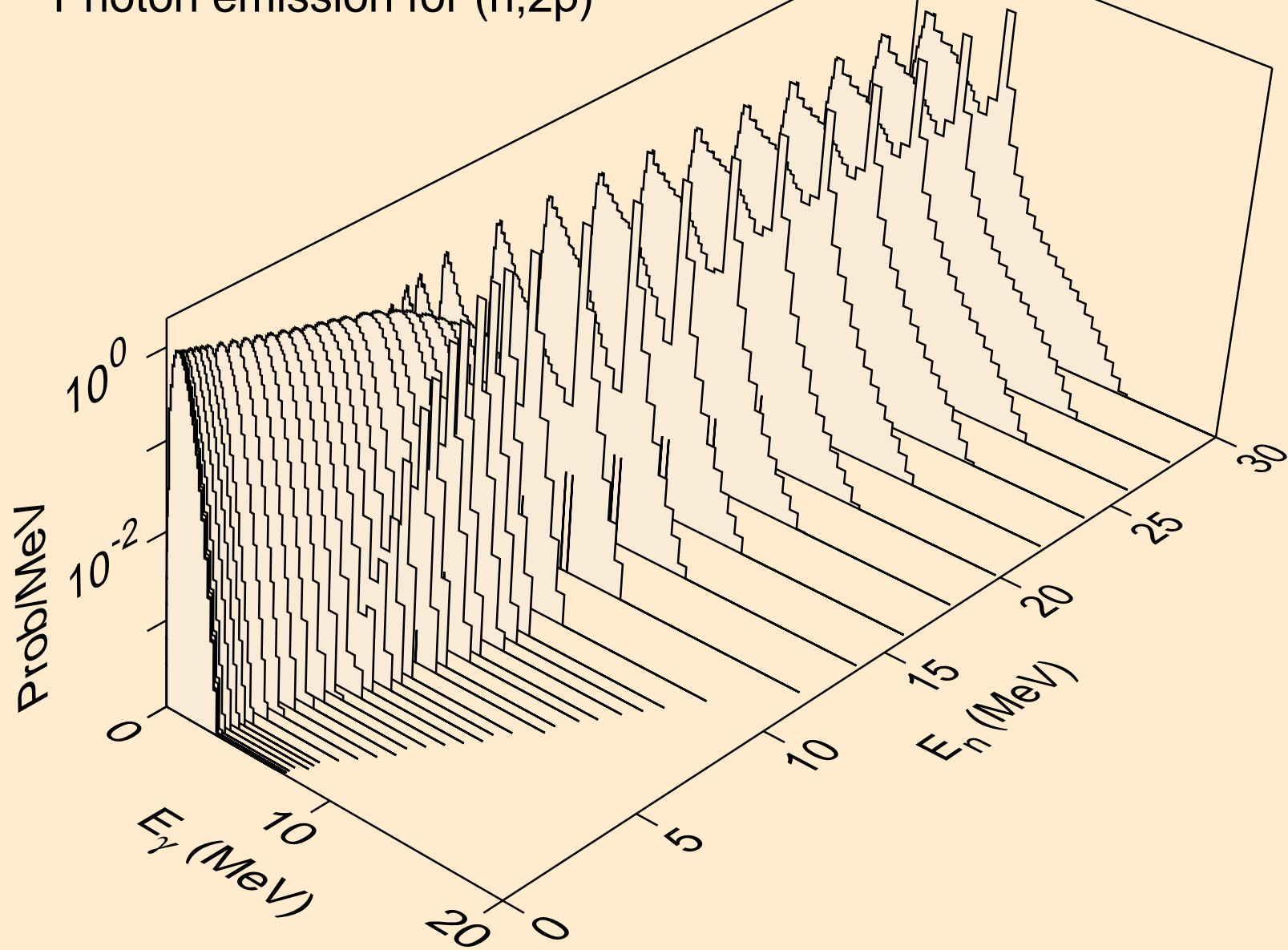

EU136M NEUTRON ACER TENDL-2021 LIBRARY; T=293.6K
Photon emission for (n,p)

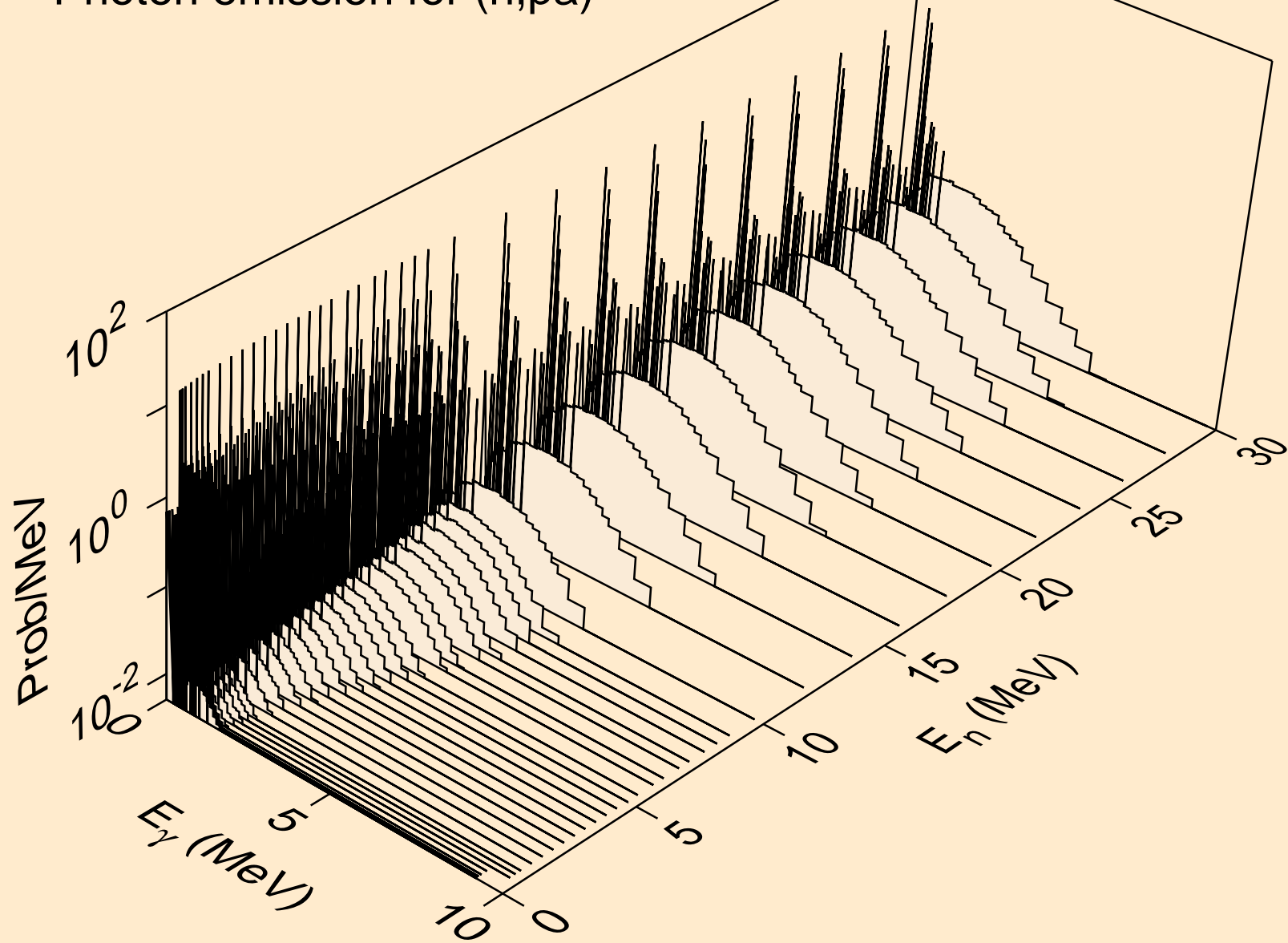

EU136M NEUTRON ACER TENDL-2021 LIBRARY; T=293.6K
Photon emission for (n,t2a)

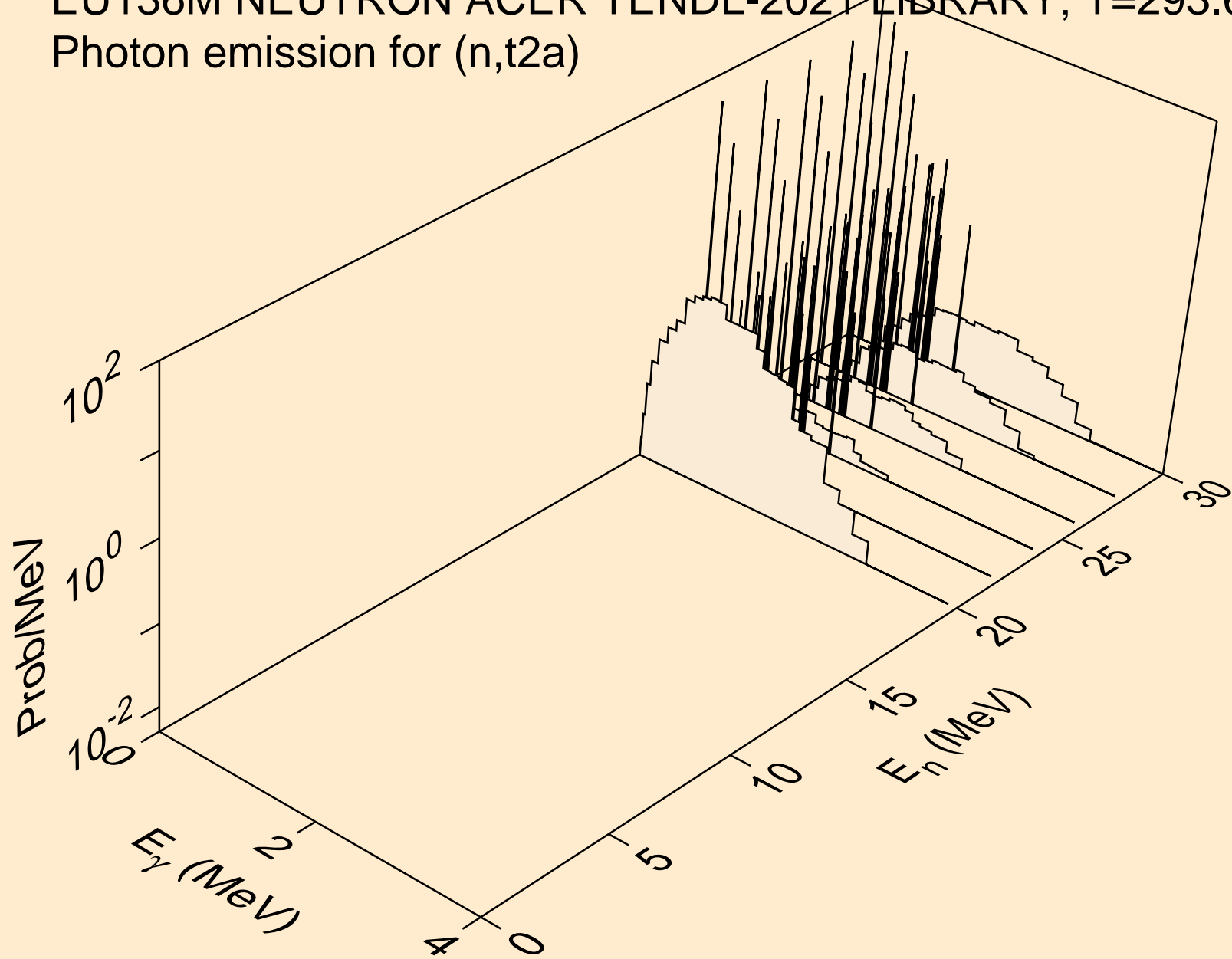

EU136M NEUTRON ACER TENDL-2021 LIBRARY; T=293.6K
Photon emission for (n,d2a)

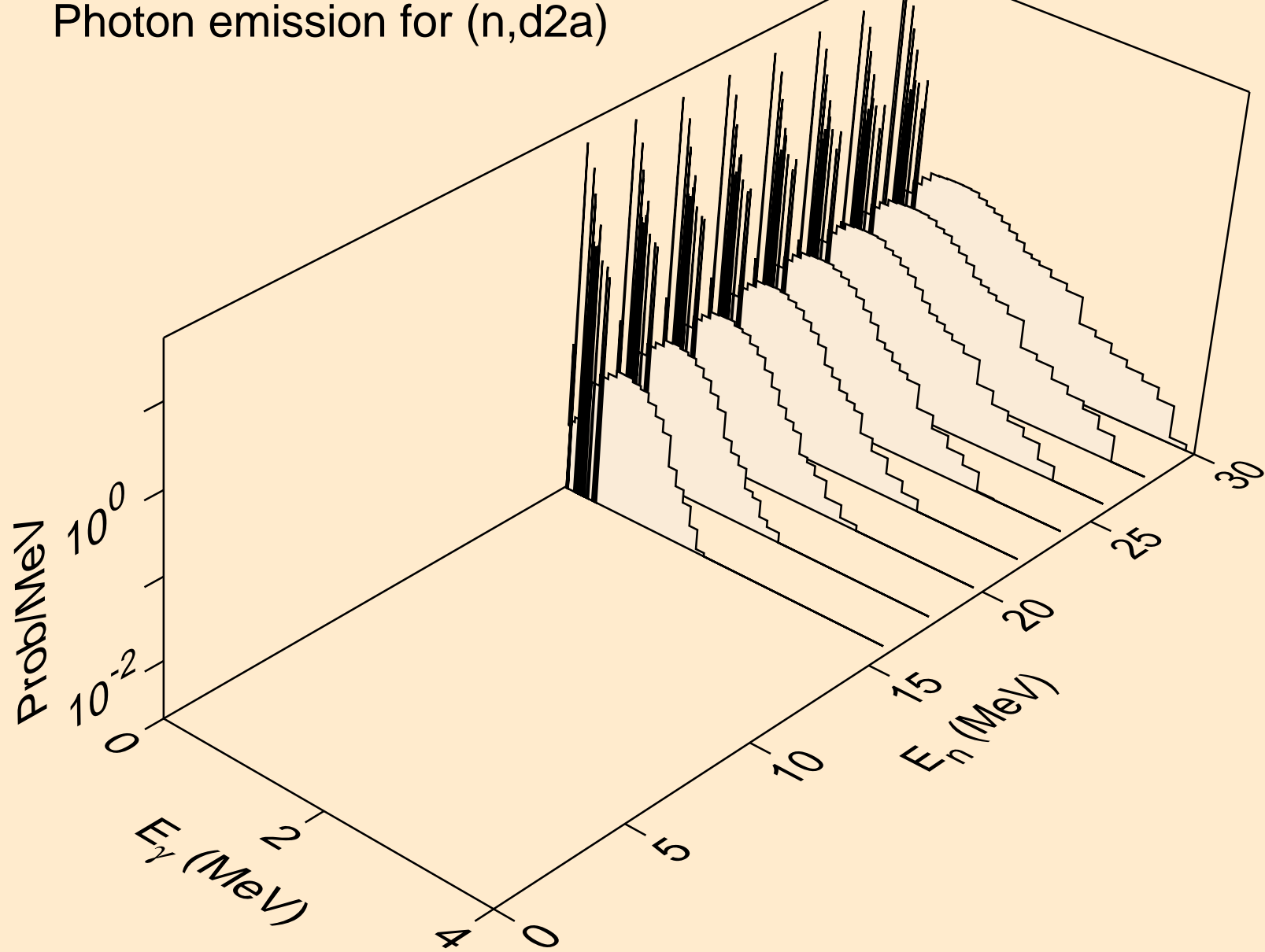

EU136M NEUTRON ACER TENDL-2021 LIBRARY; T=293.6K
Photon emission for (n,pd)

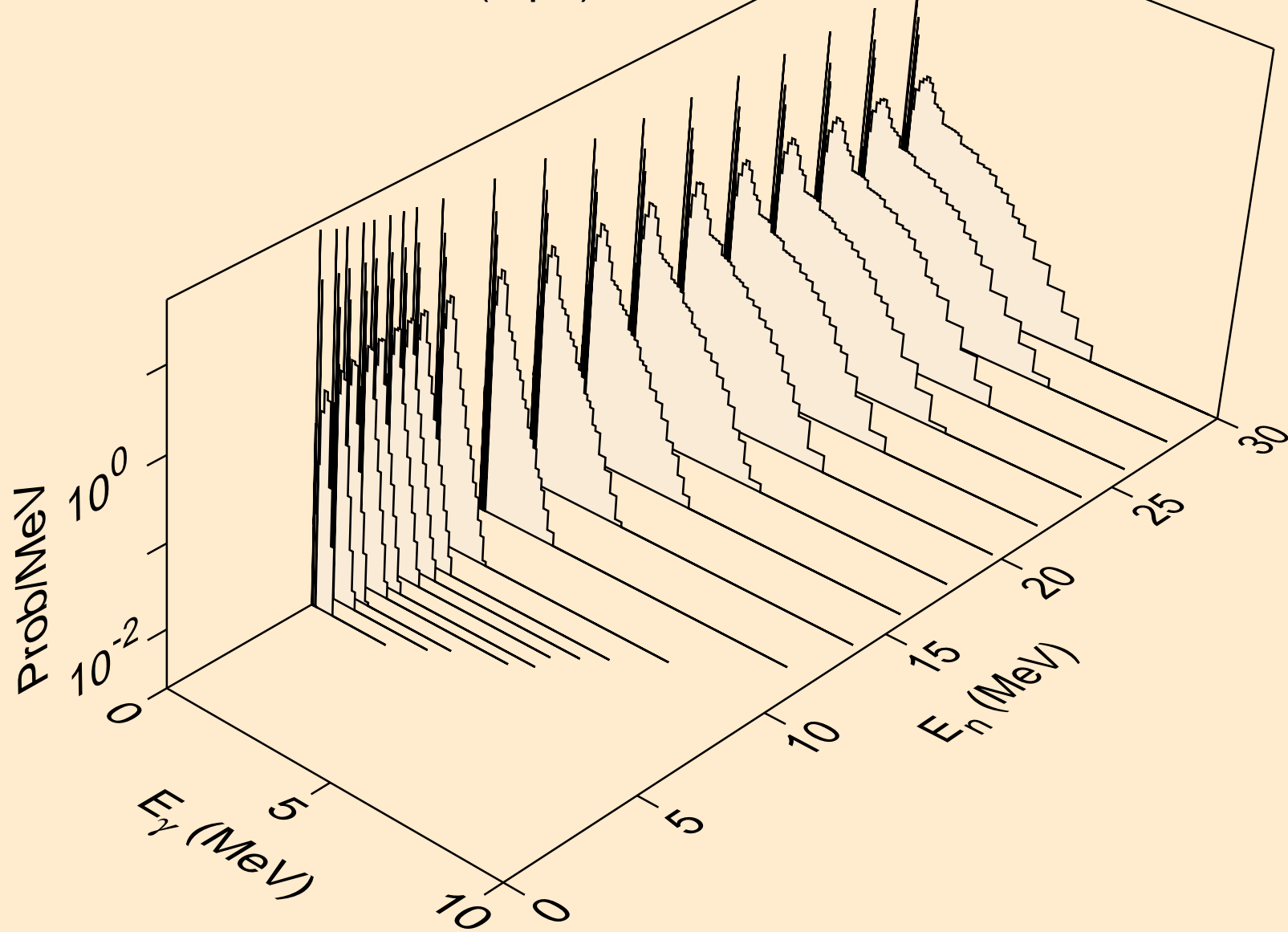

EU136M NEUTRON ACER TENDL-2021 LIBRARY; T=293.6K
Photon emission for (n,pt)

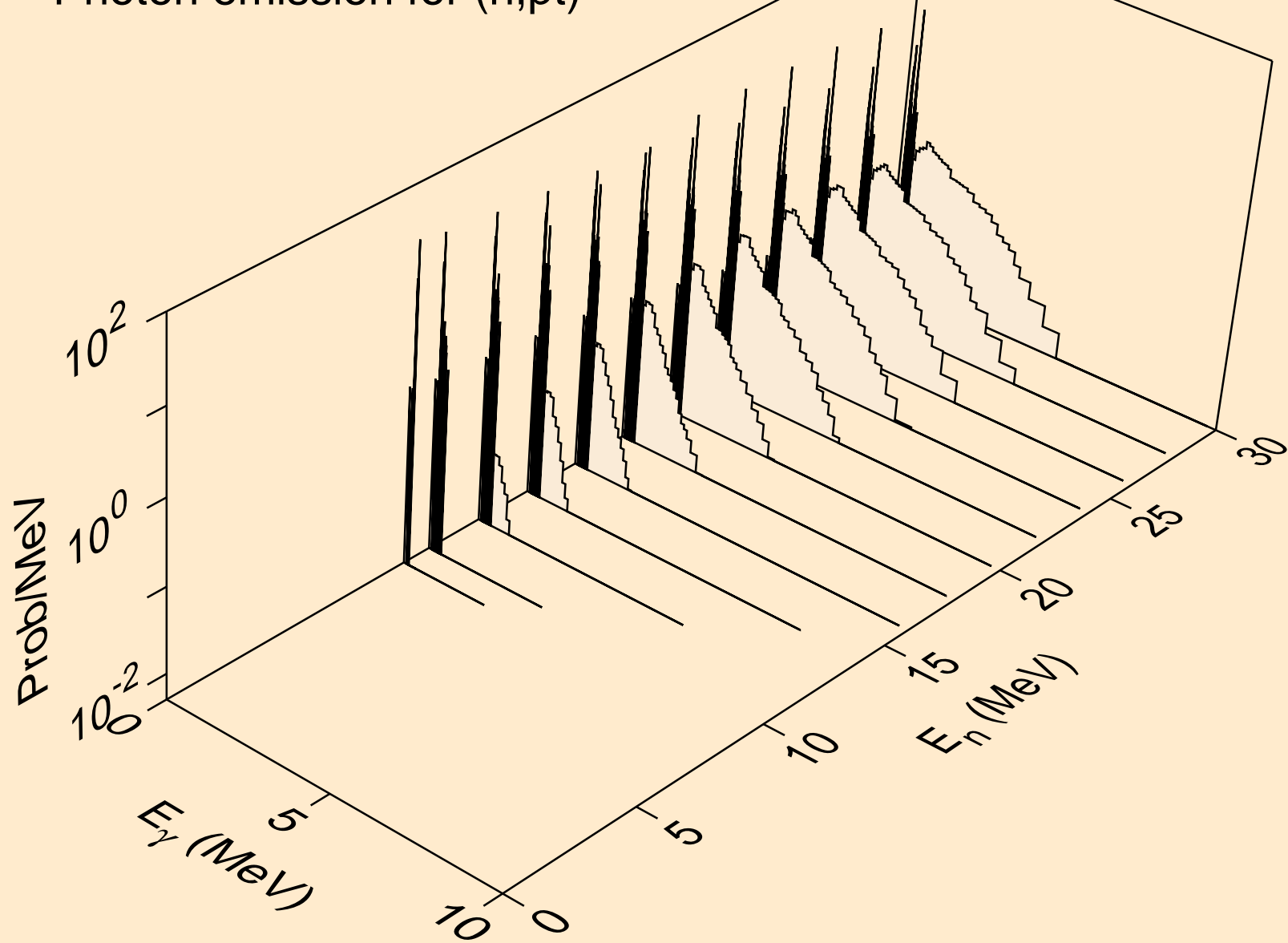

EU136M NEUTRON ACER TENDL-2021 LIBRARY; T=293.6K
Photon emission for (n,da)

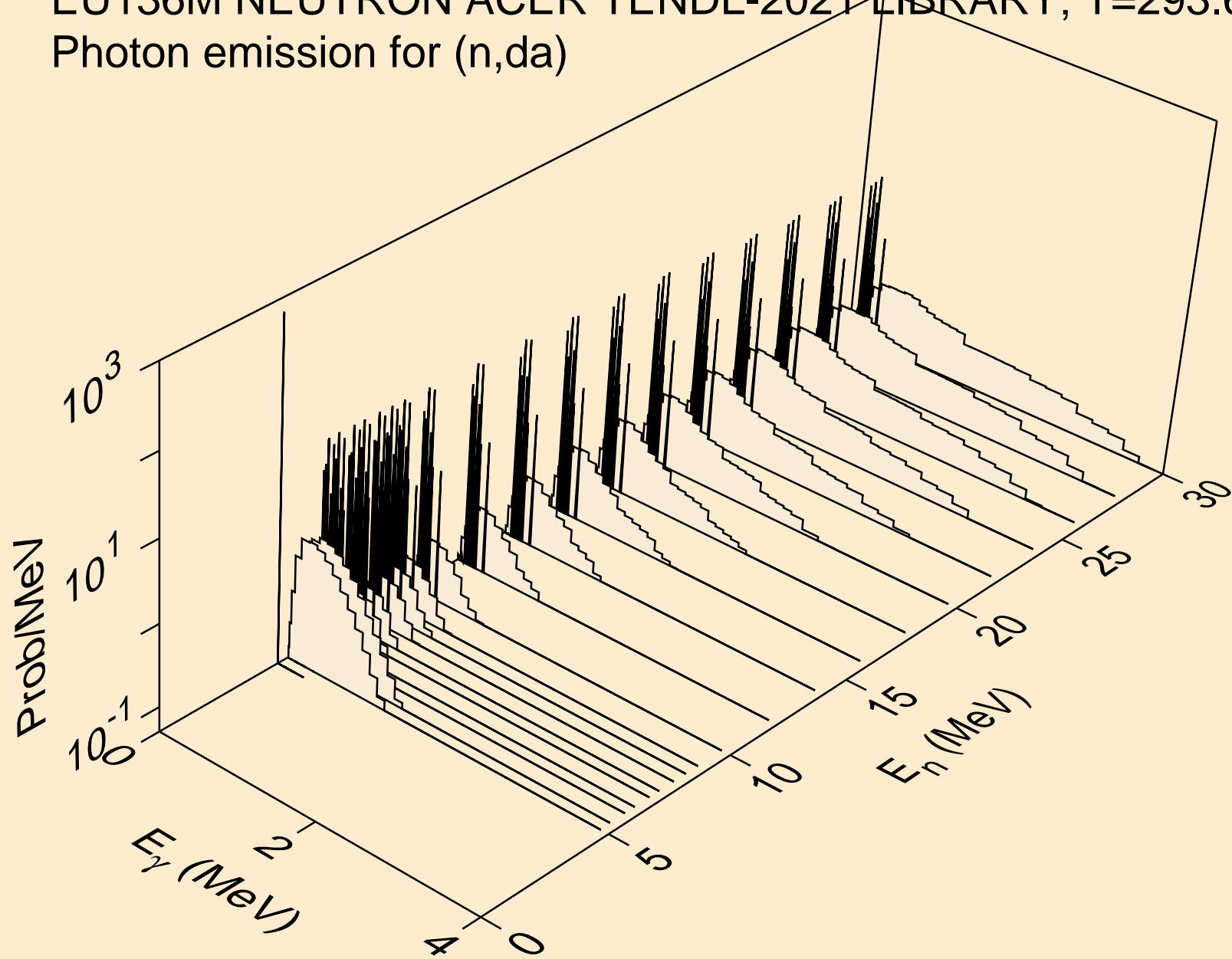

EU136M NEUTRON ACER TENDL-2021 LIBRARY; T=293.6K
thermal capture photon spectrum

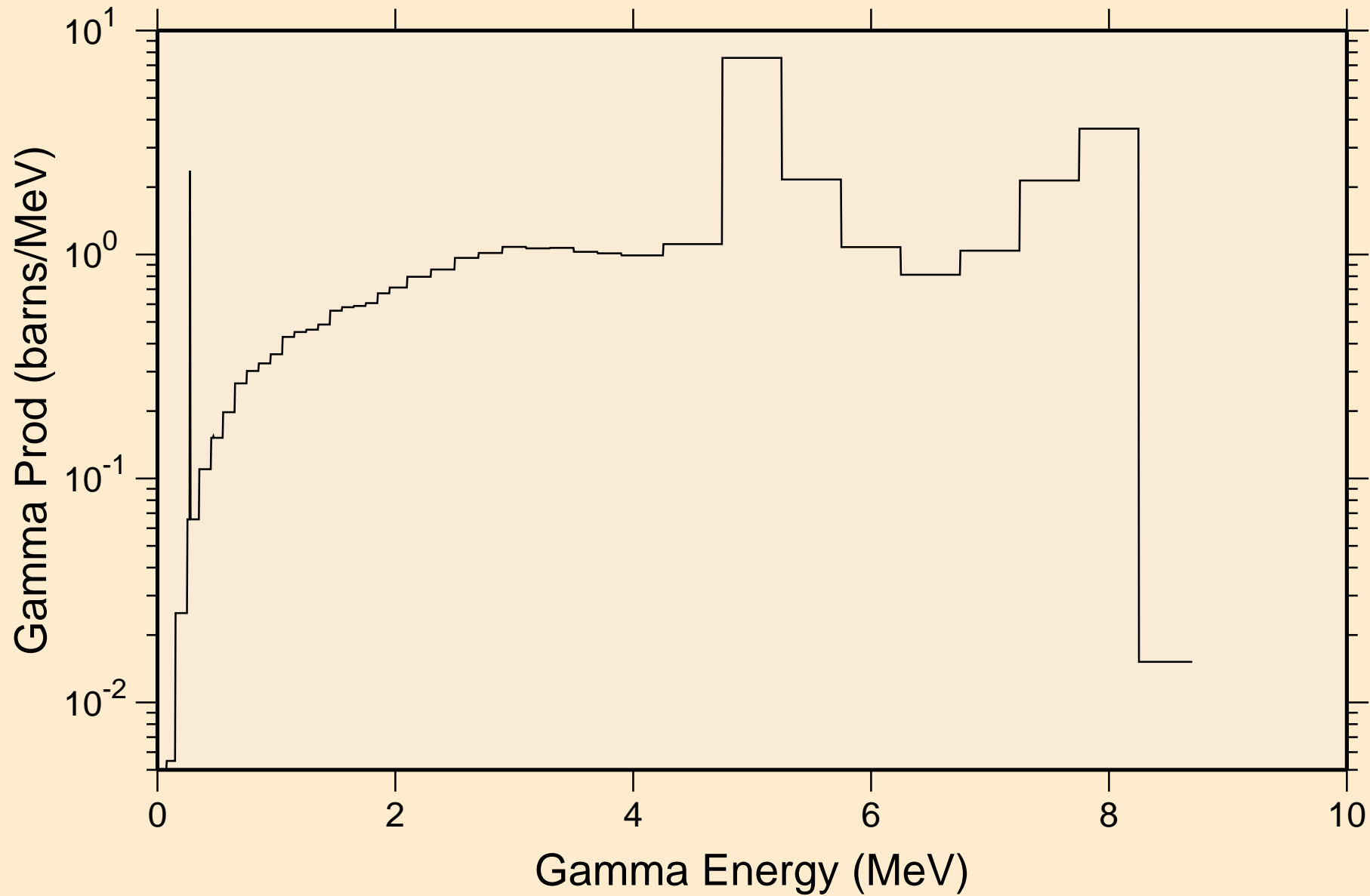

EU136M NEUTRON ACER TENDL-2021 LIBRARY; T=293.6K
14 MeV photon spectrum

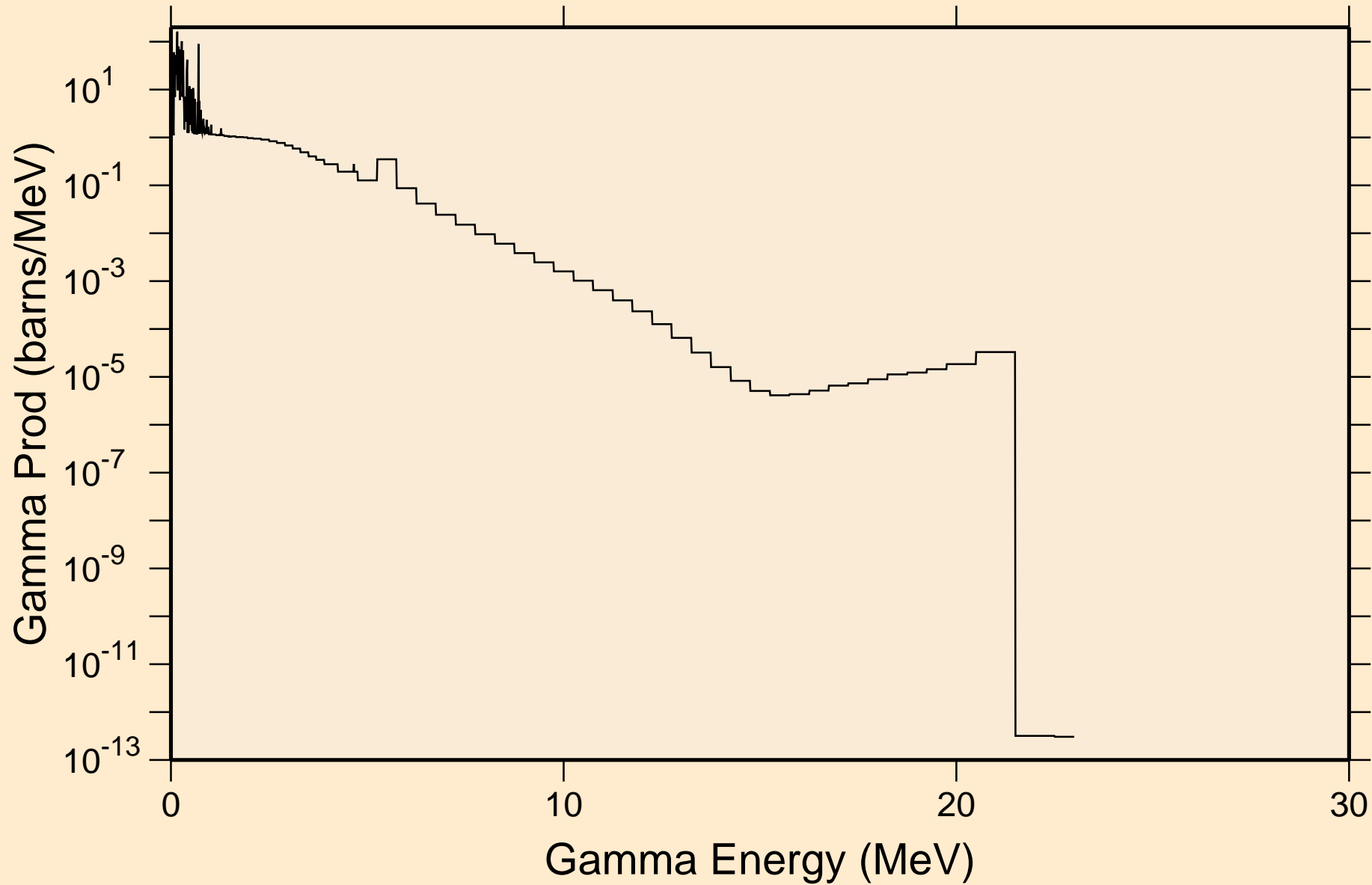

EU136M NEUTRON ACER TENDL-2021 LIBRARY; T=293.6K

Particle heating contributions

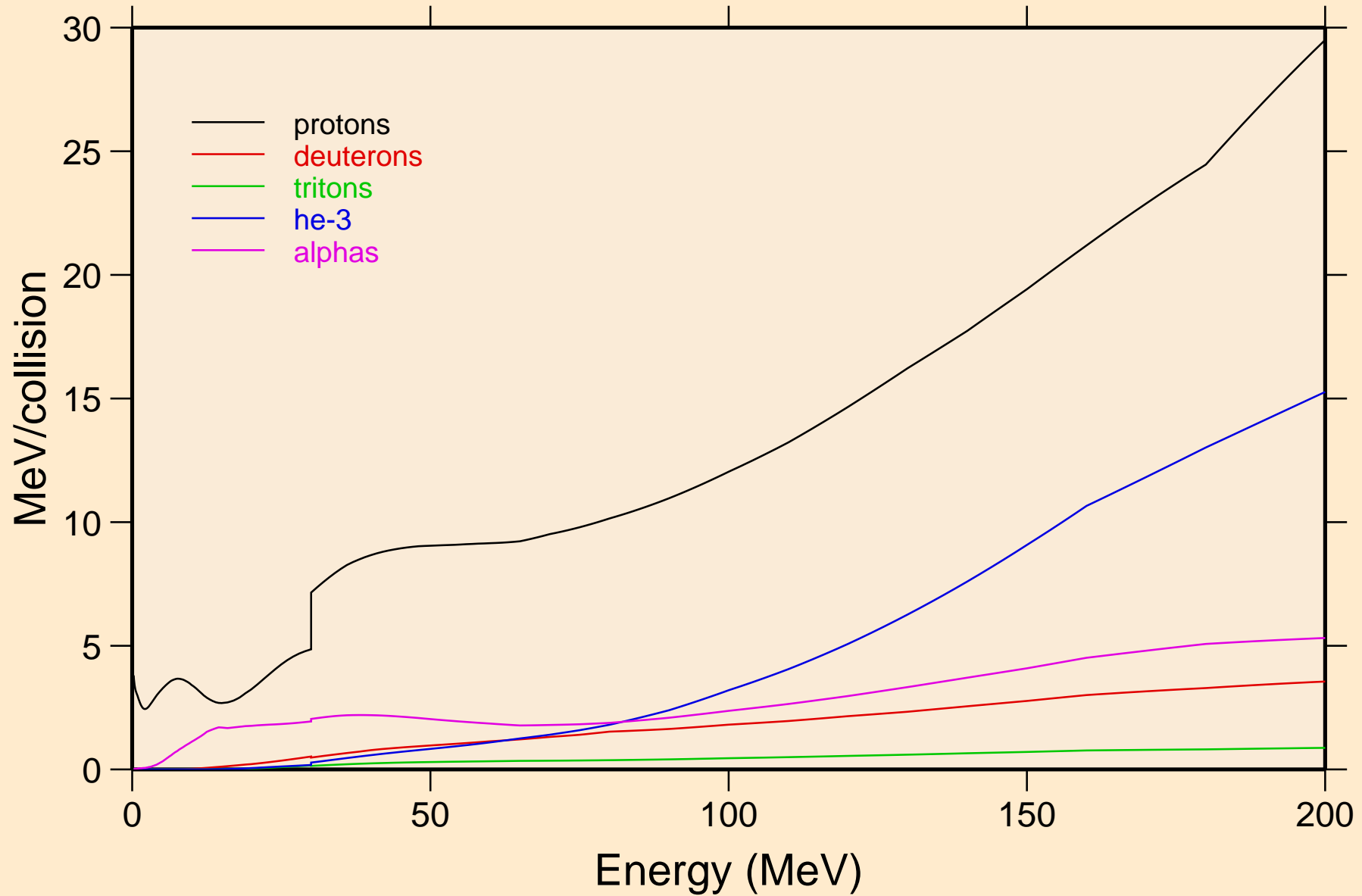

EU136M NEUTRON ACER TENDL-2021 LIBRARY; T=293.6K
Recoil Heating

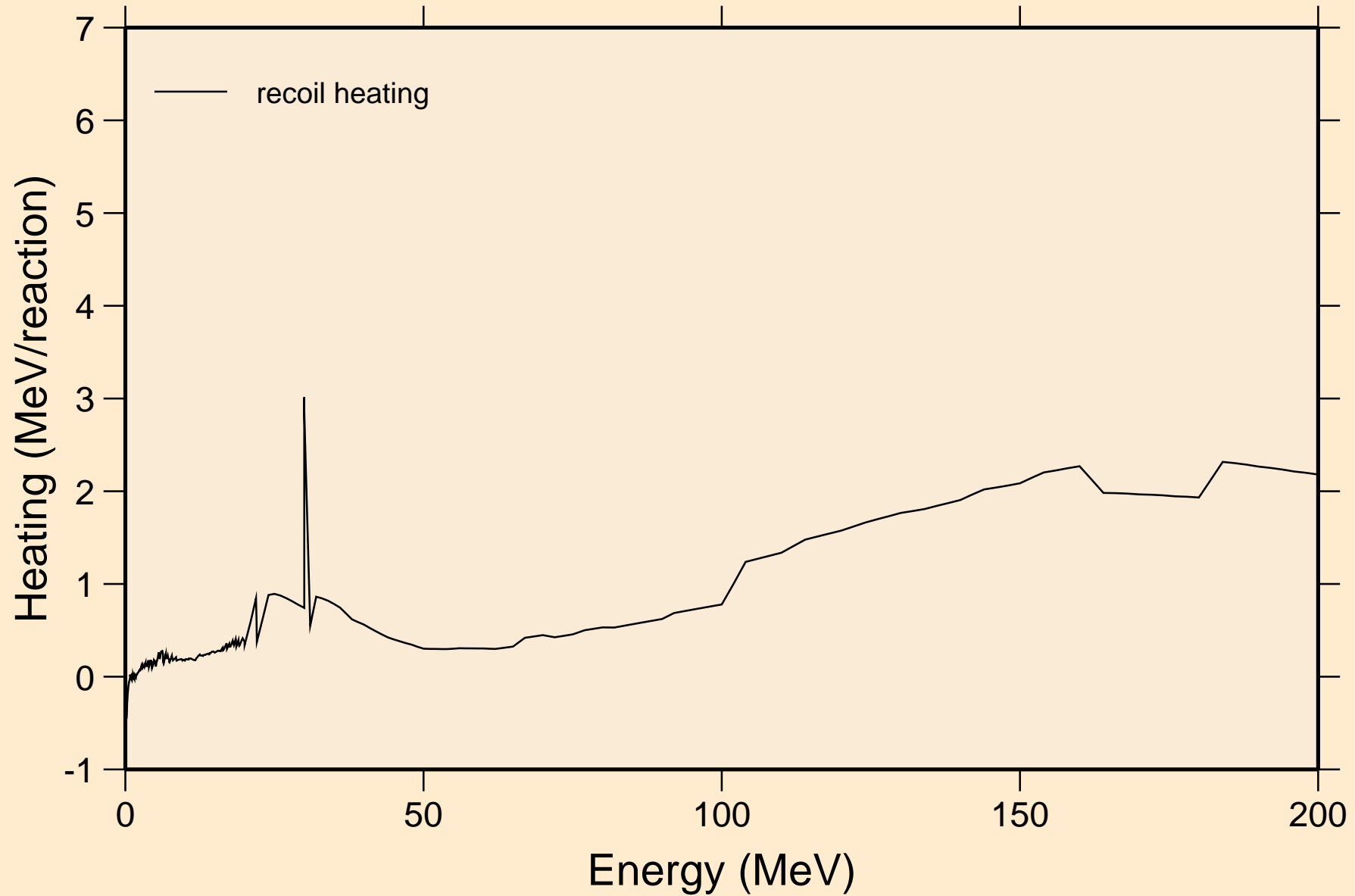

EU136M NEUTRON ACER TENDL-2021 LIBRARY; T=293.6K
Particle production cross sections

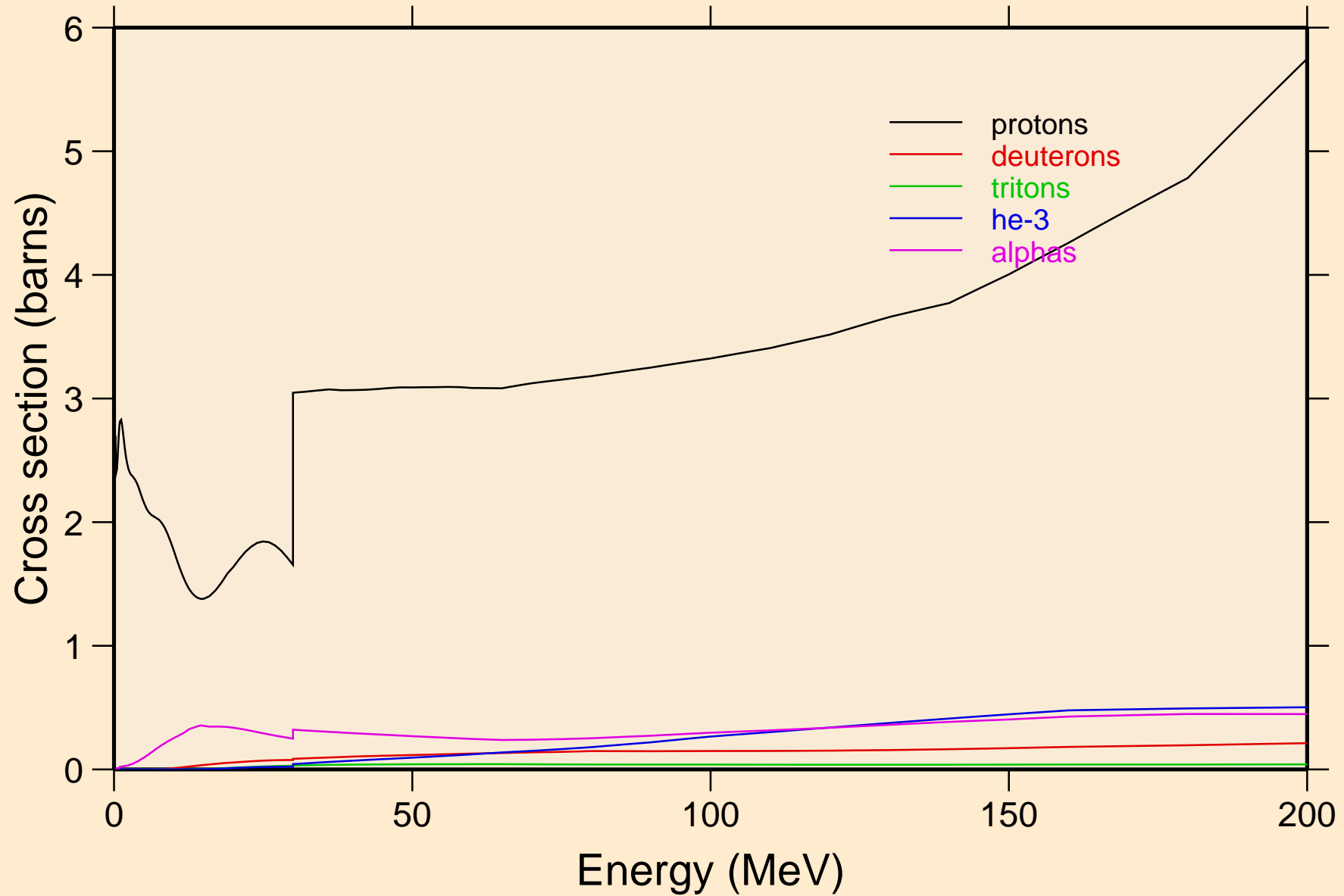

EU136M NEUTRON ACER TENDL-2021 LIBRARY; T=293.6K
protons from (n,x)

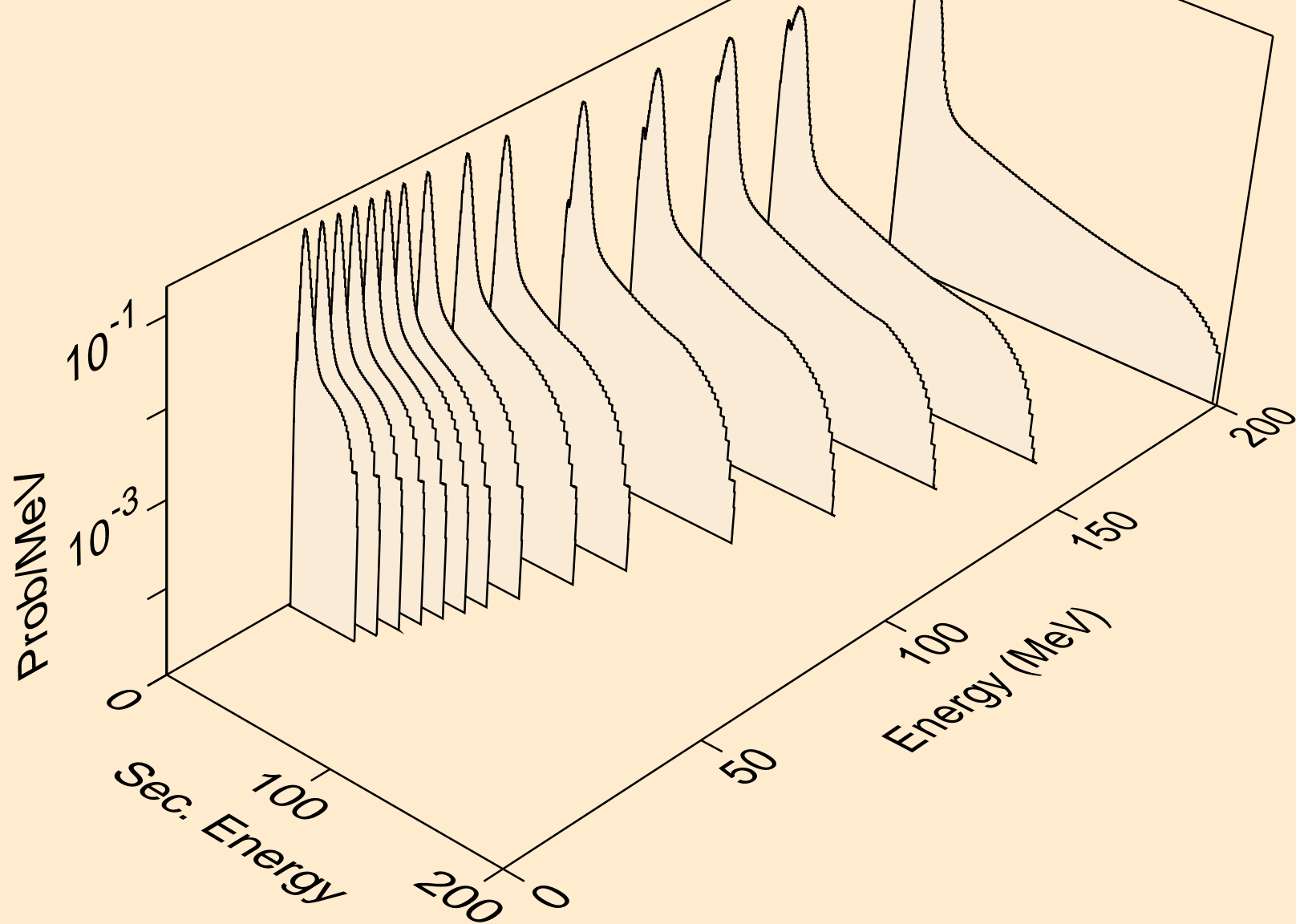

EU136M NEUTRON ACER TENDL-2021 LIBRARY; T=293.6K
protons from (n,n*)p

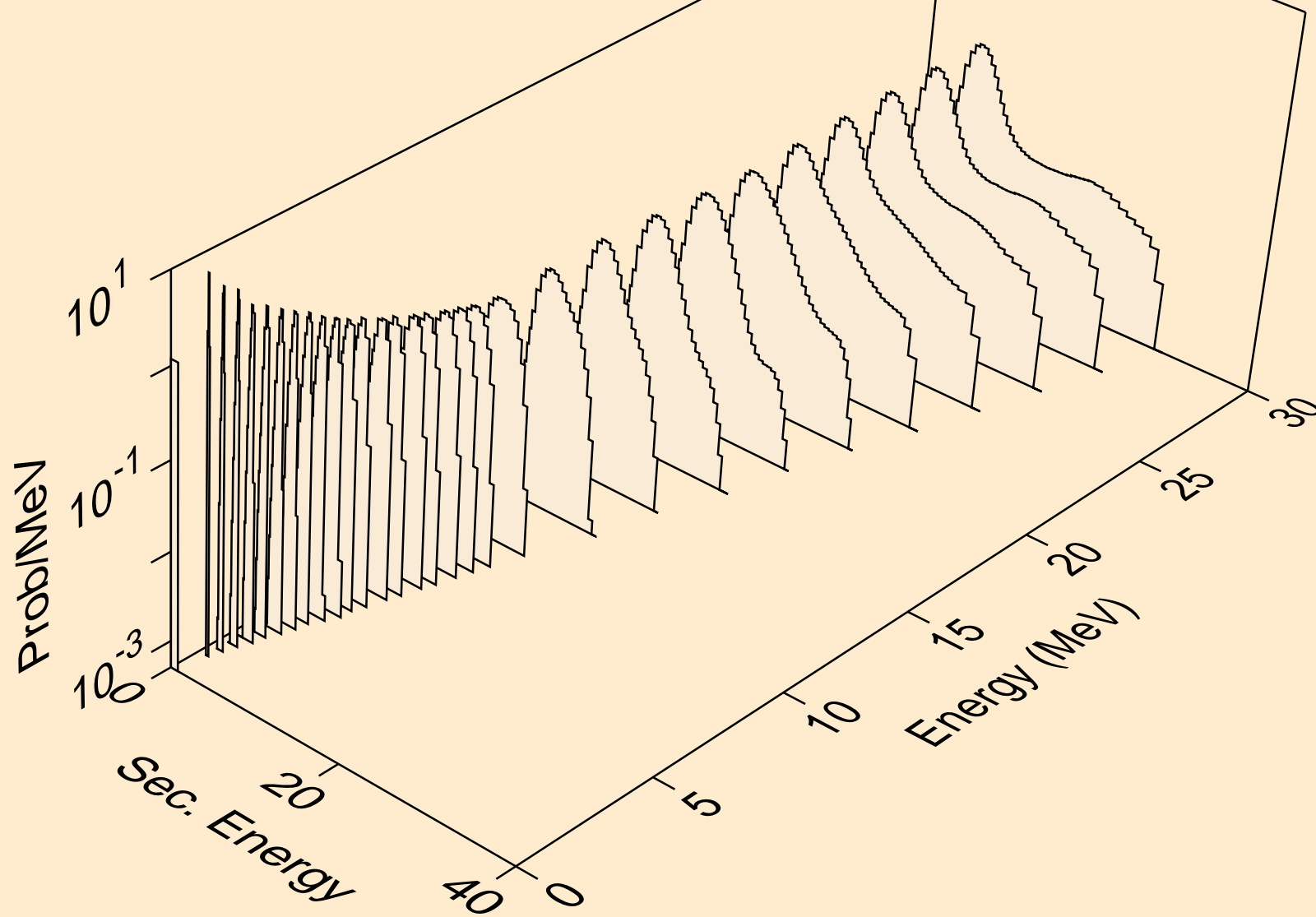

EU136M NEUTRON ACER TENDL-2021 LIBRARY; T=293.6K
protons from (n,2np)

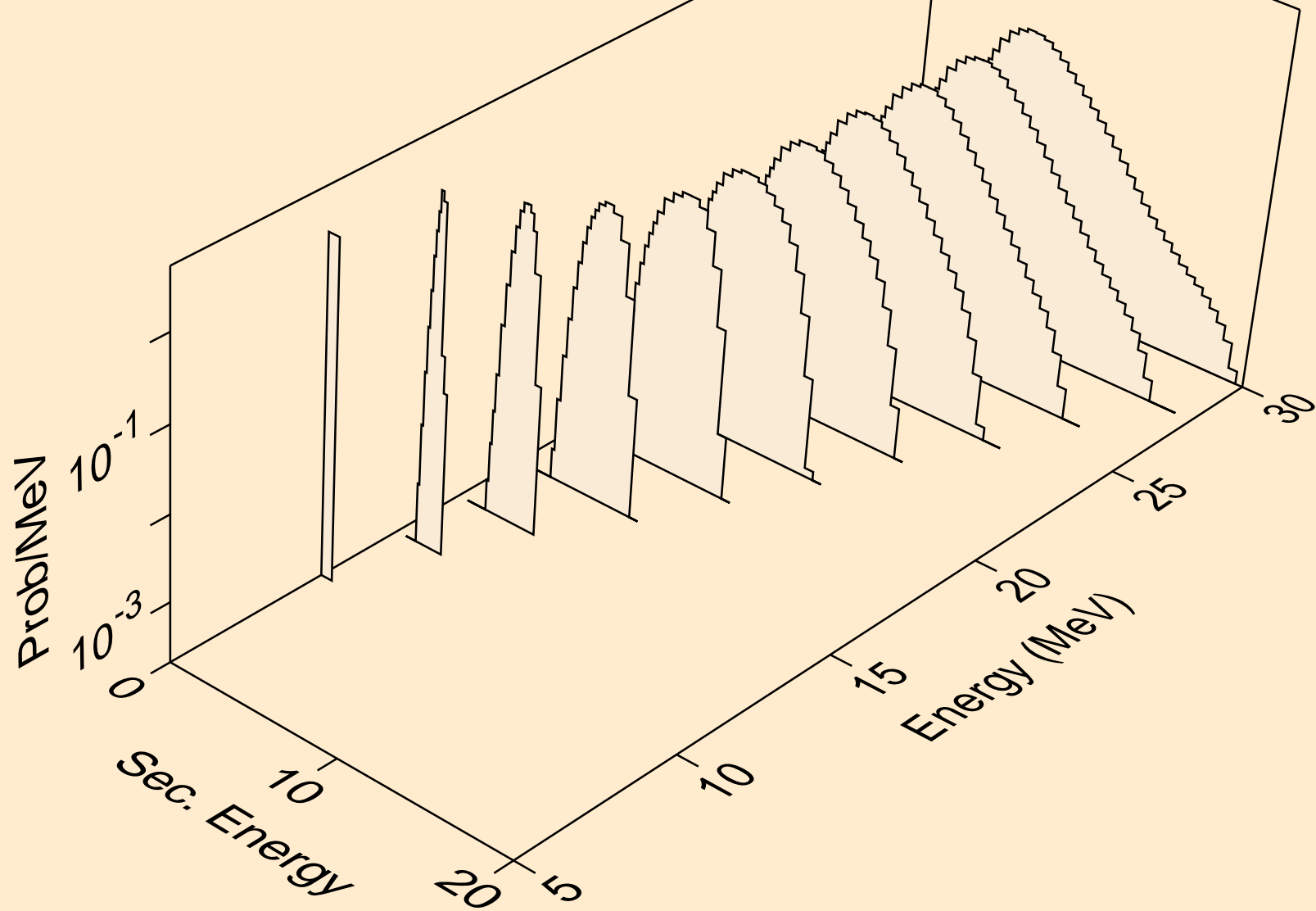

EU136M NEUTRON ACER TENDL-2021 LIBRARY; T=293.6K
protons from (n,3np)

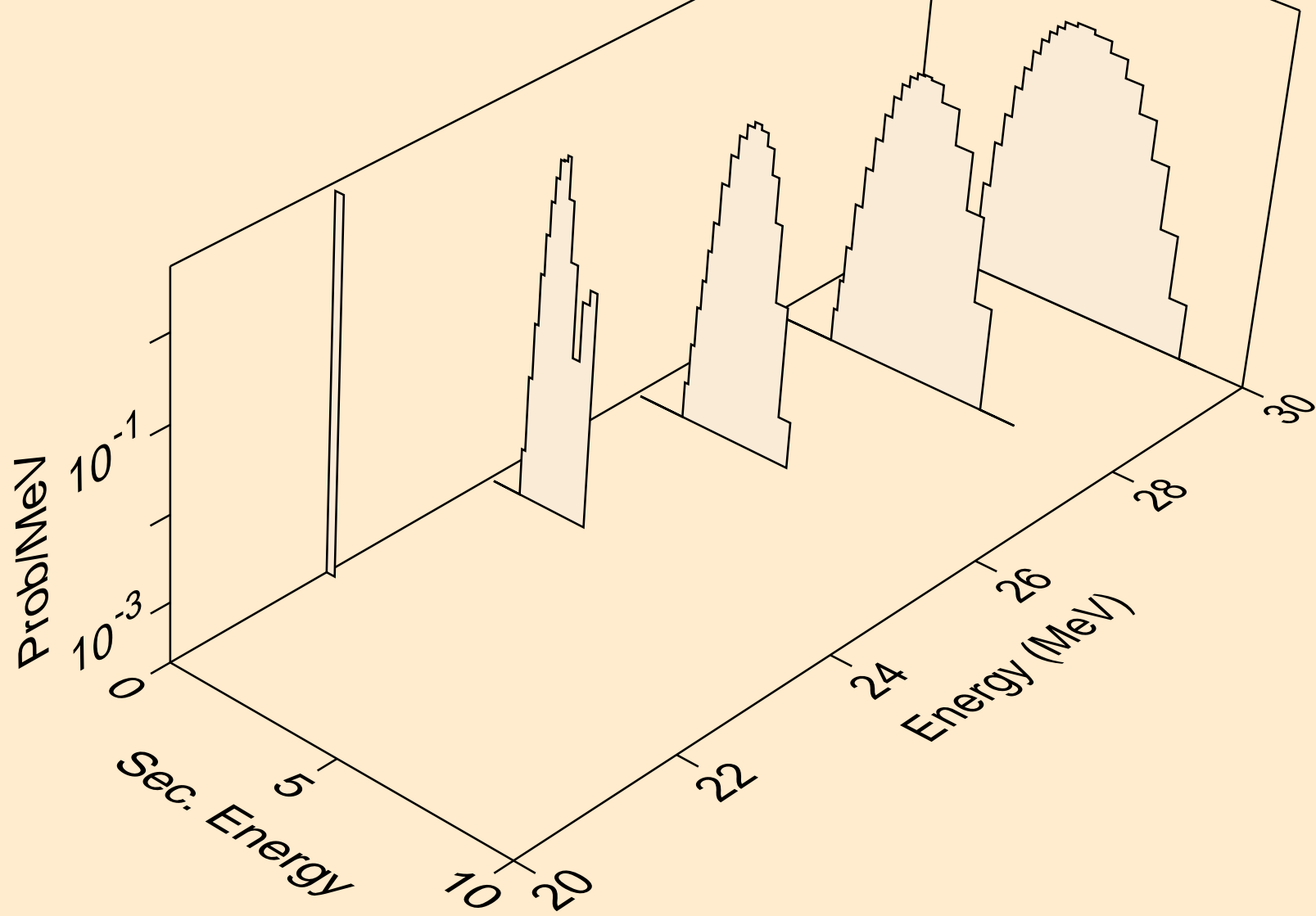

EU136M NEUTRON ACER TENDL-2021 LIBRARY; T=293.6K
protons from (n,2np)

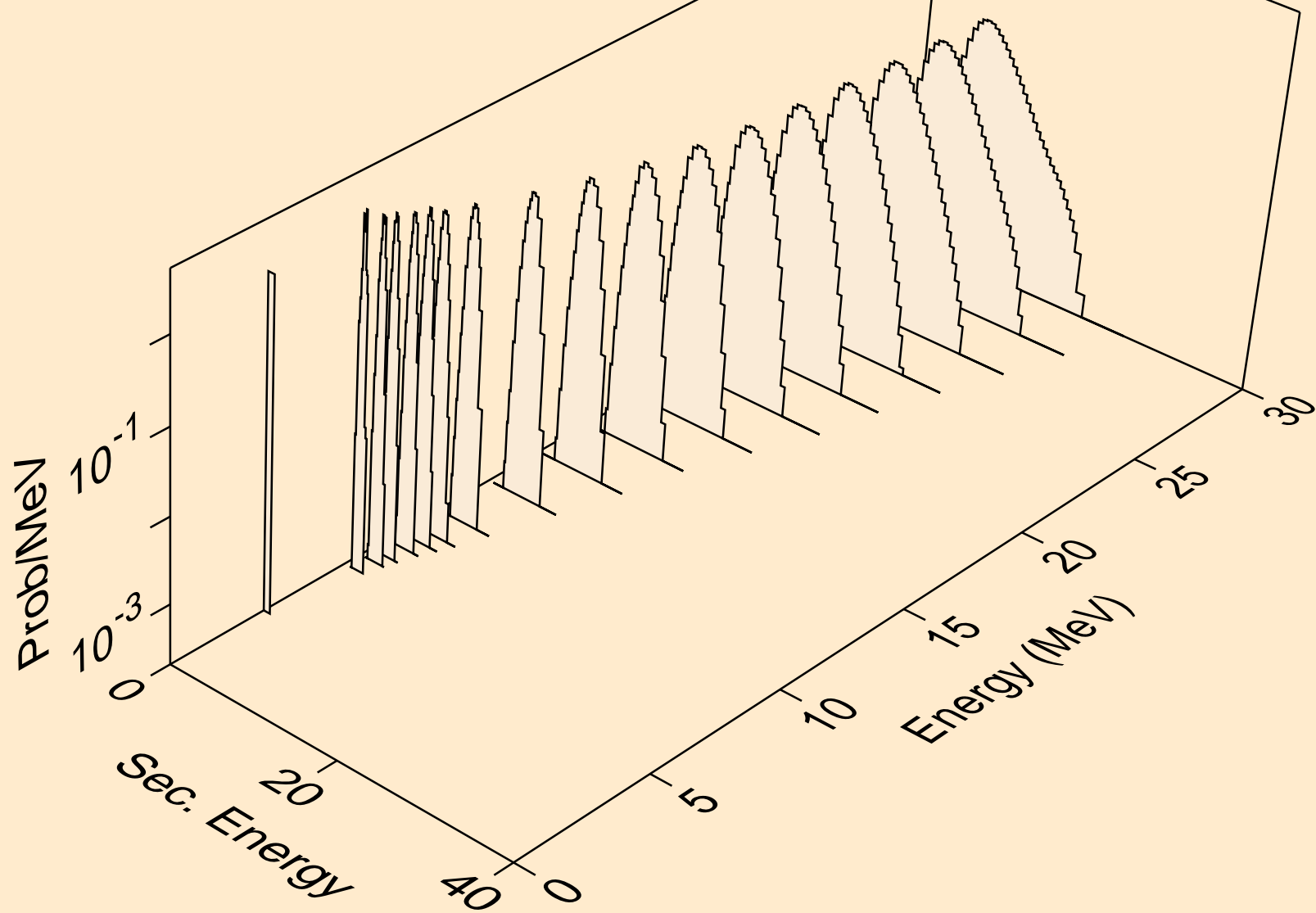

EU136M NEUTRON ACER TENDL-2021 LIBRARY; T=293.6K
protons from (n,npa)

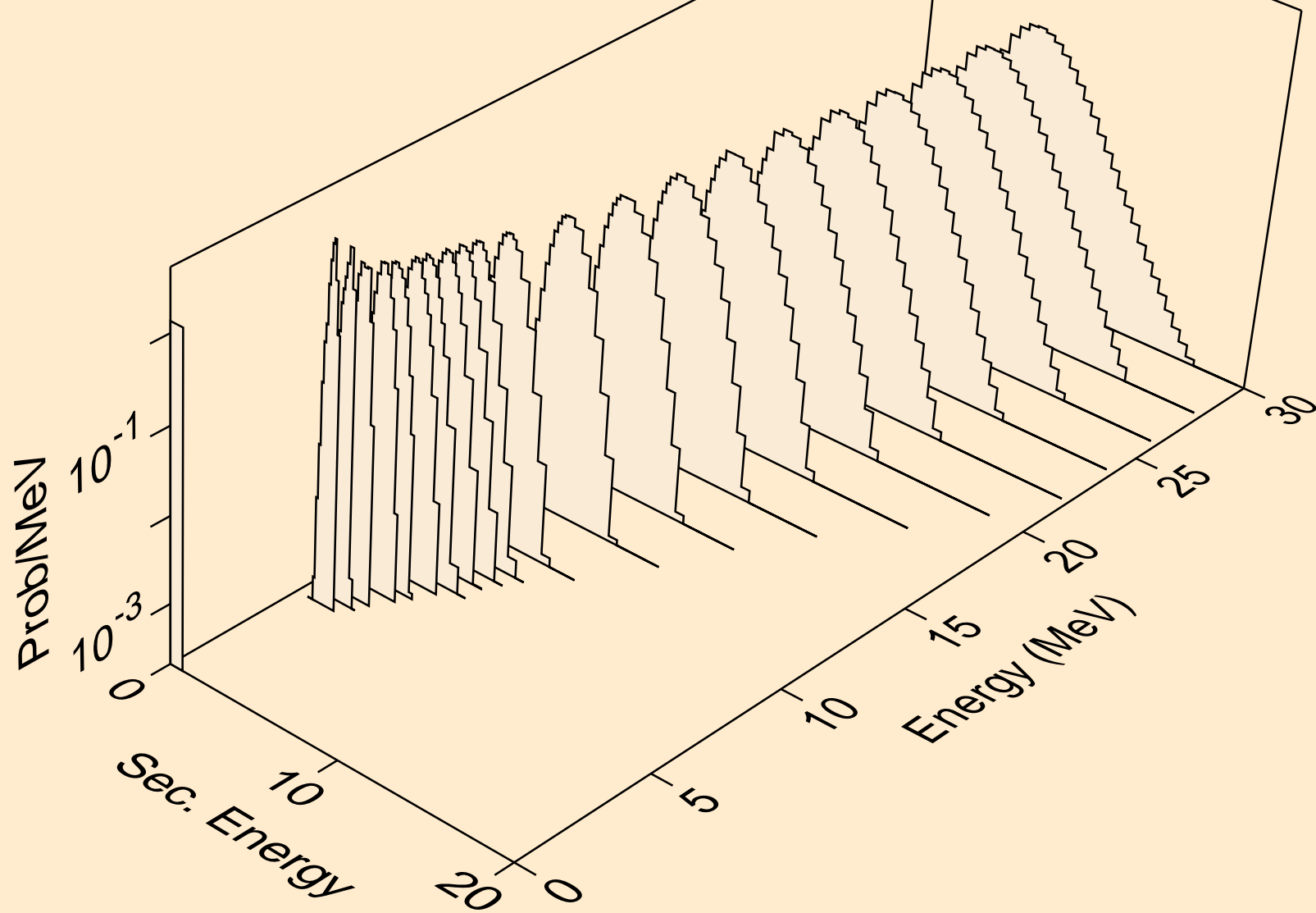

EU136M NEUTRON ACER TENDL-2021 LIBRARY; T=293.6K
protons from (n,p)

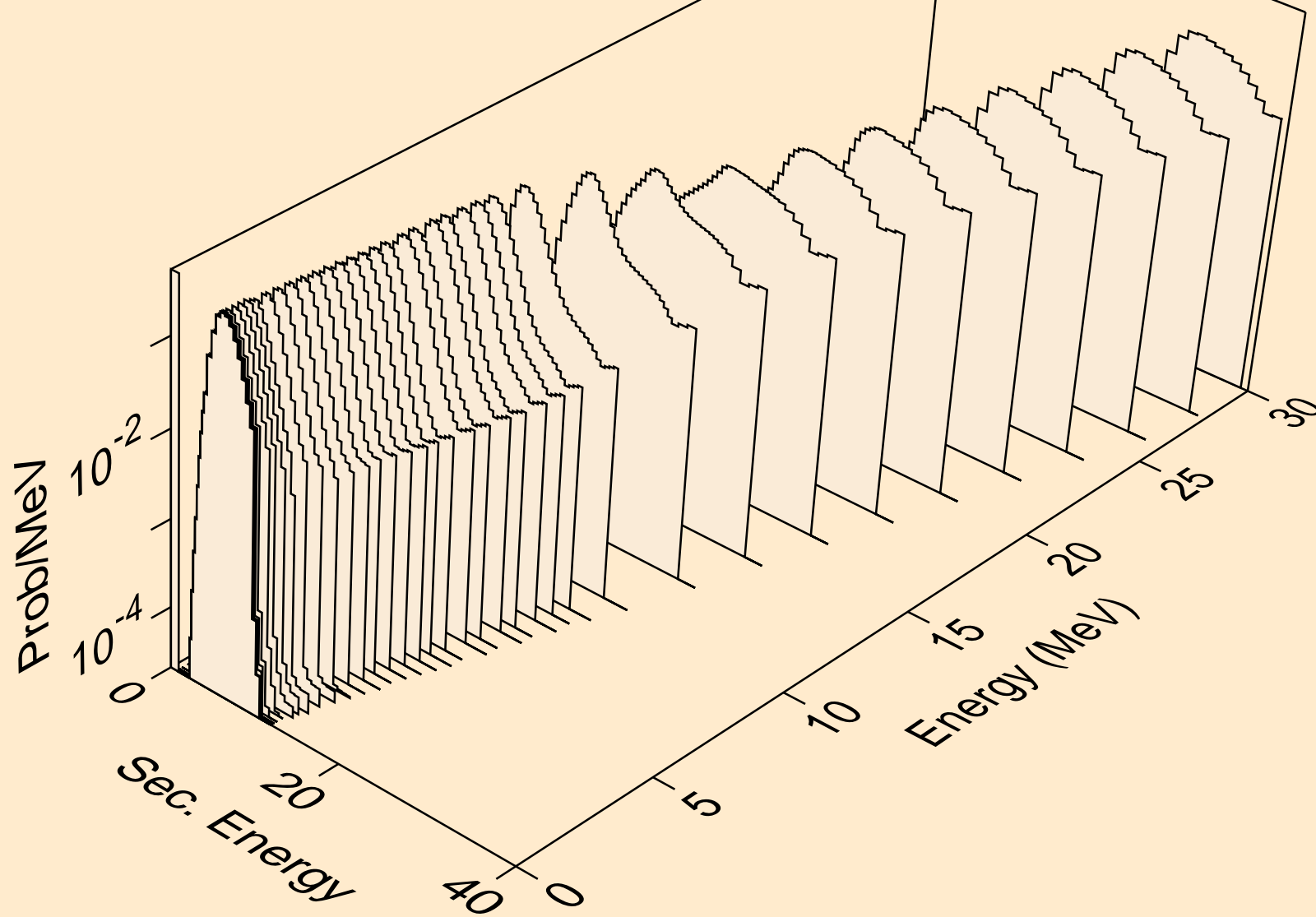

EU136M NEUTRON ACER TENDL-2021 LIBRARY; T=293.6K
protons from (n,2p)

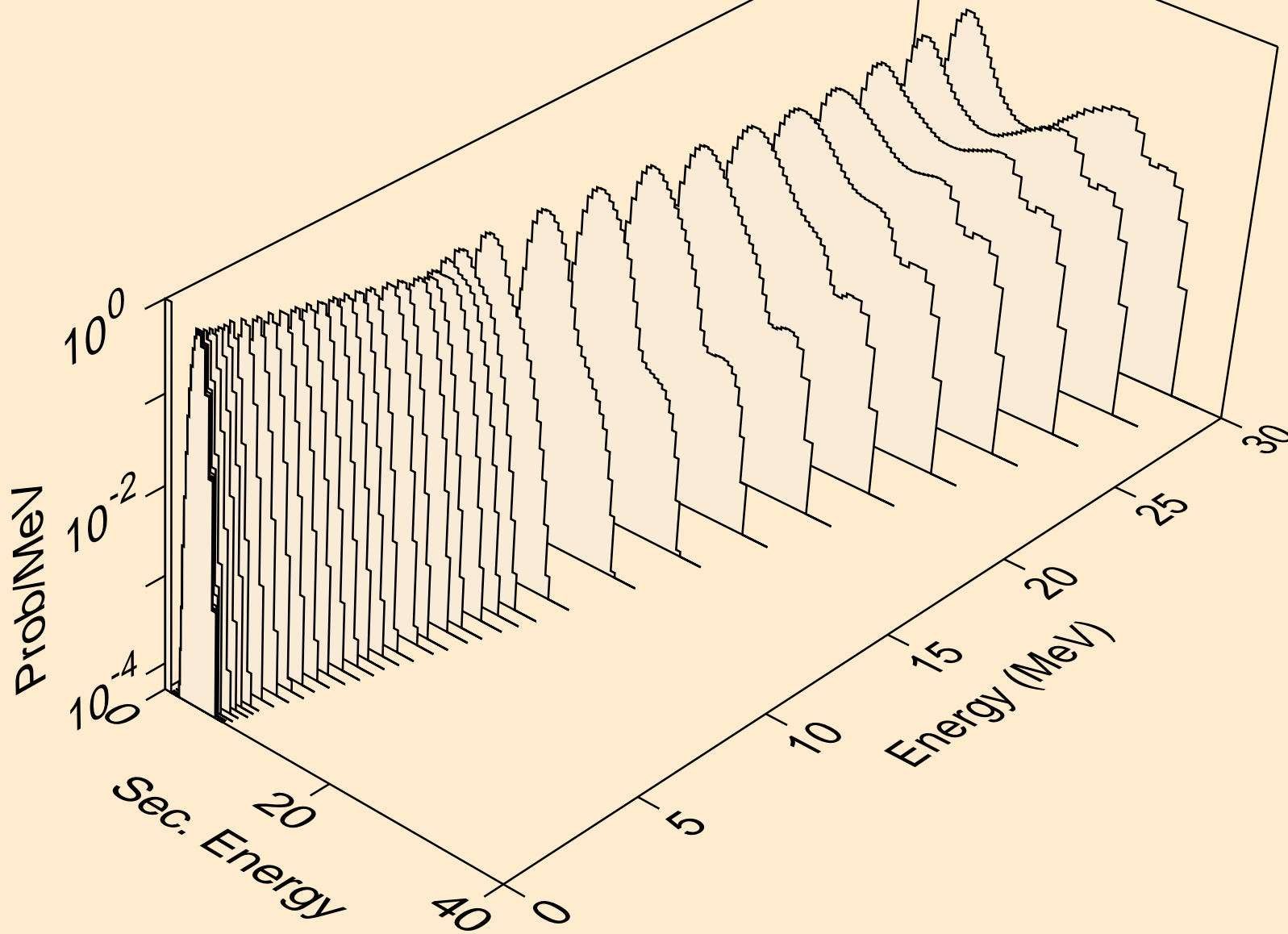

EU136M NEUTRON ACER TENDL-2021 LIBRARY; T=293.6K
protons from (n,p)

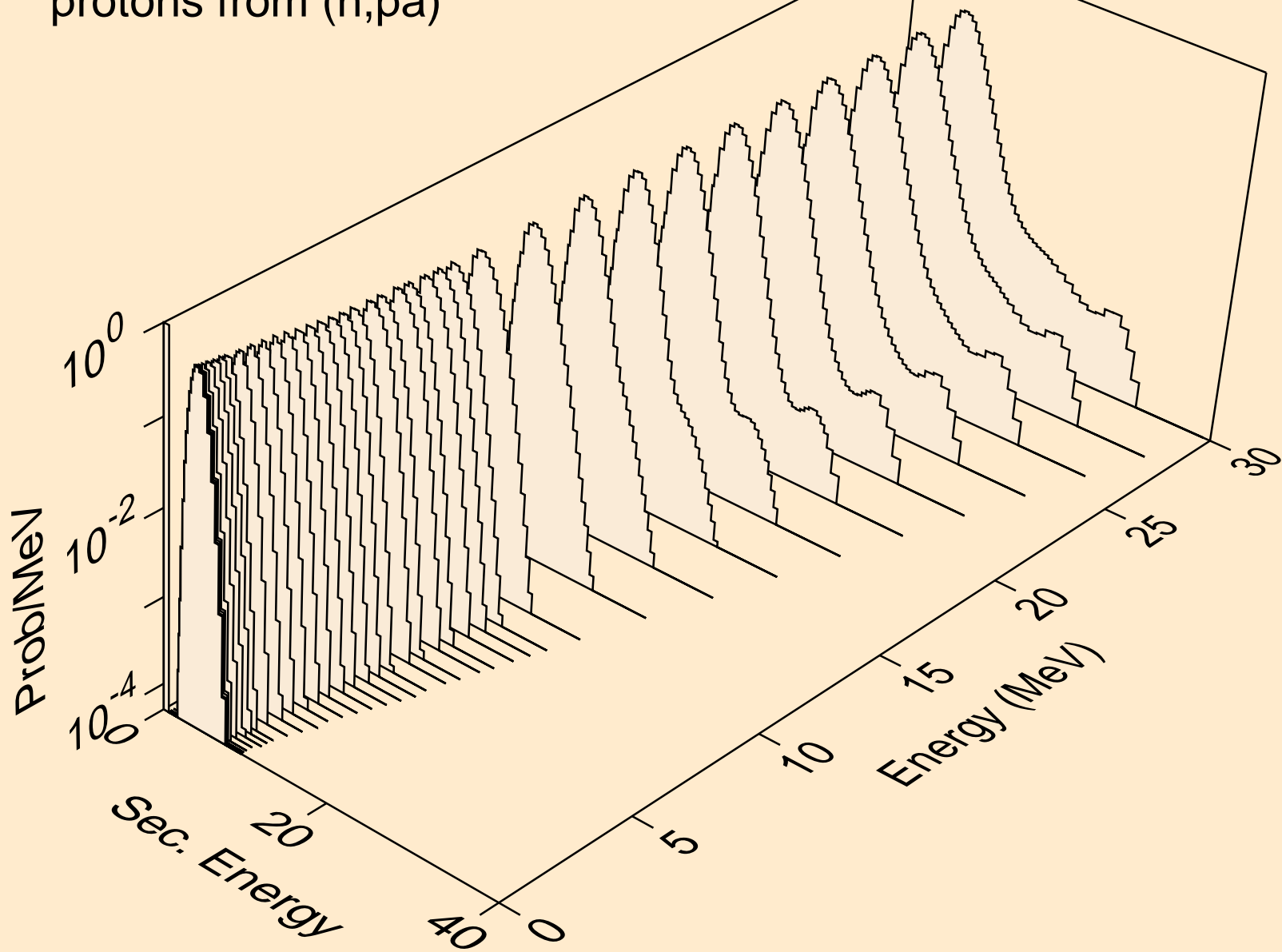

EU136M NEUTRON ACER TENDL-2021 LIBRARY; T=293.6K
protons from (n,pd)

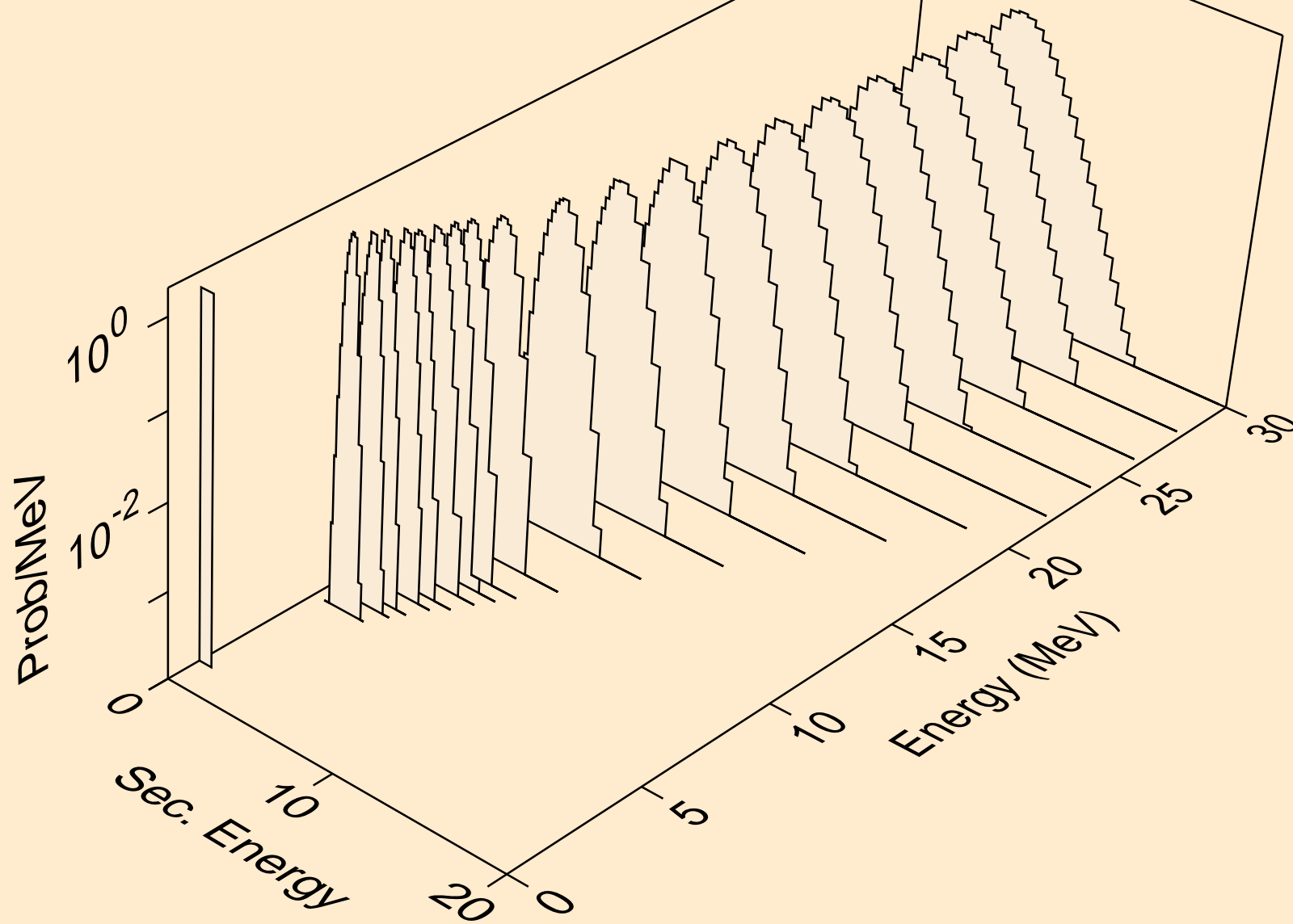

EU136M NEUTRON ACER TENDL-2021 LIBRARY; T=293.6K
protons from (n,pt)

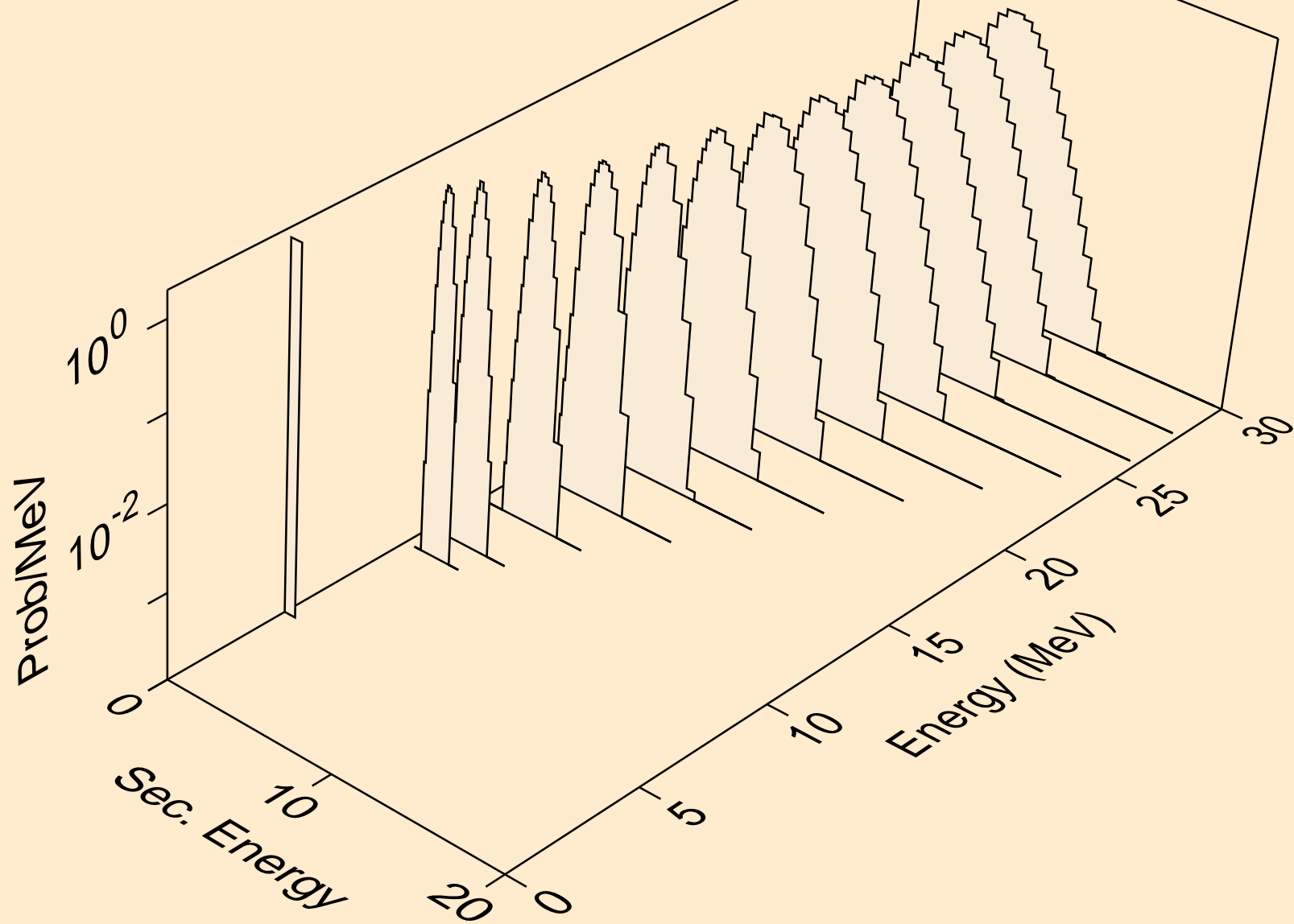

EU136M NEUTRON ACER TENDL-2021 LIBRARY; T=293.6K
deuterons from (n,x)

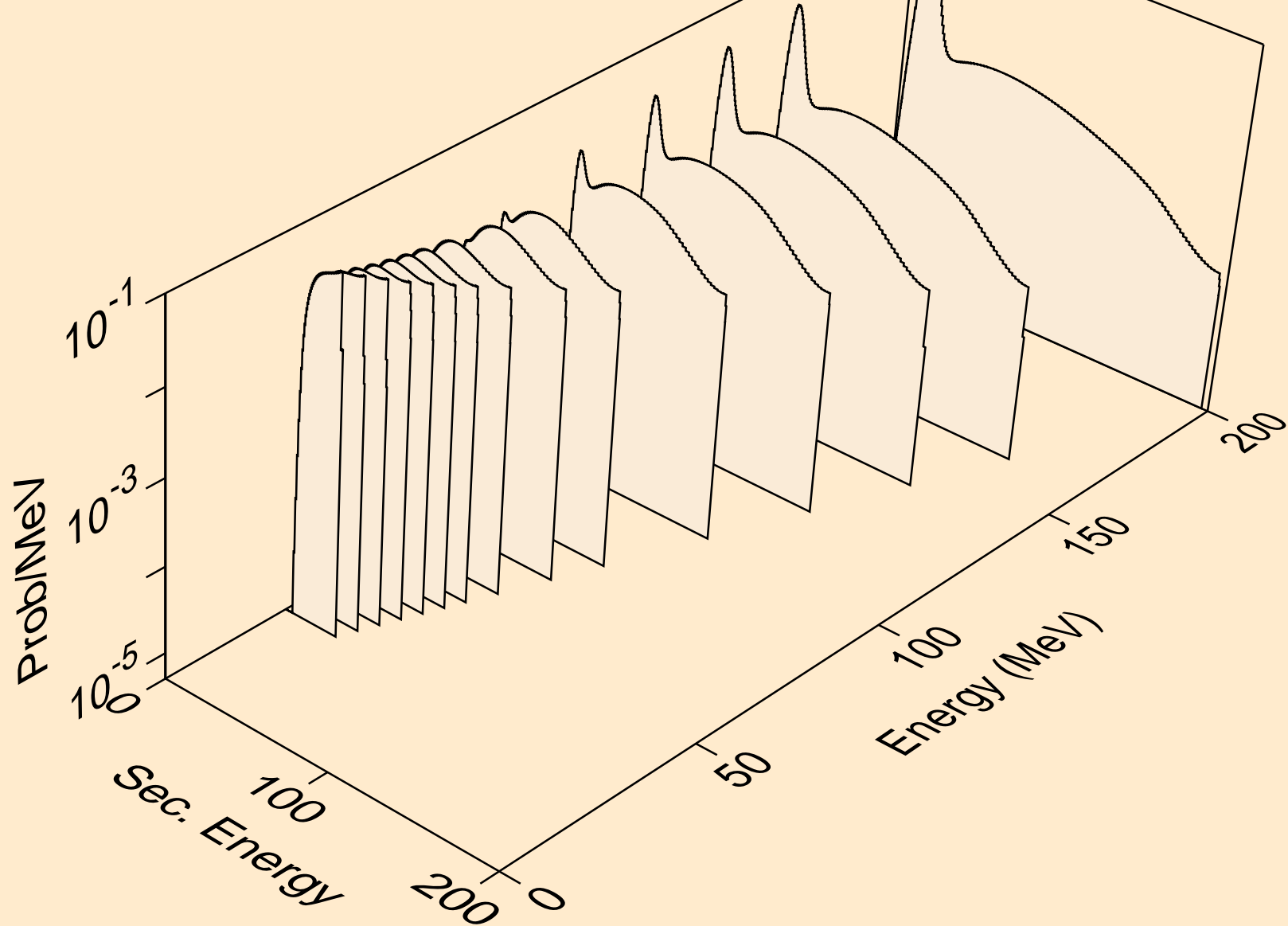

EU136M NEUTRON ACER TENDL-2021 LIBRARY; T=293.6K
deuterons from (n,2nd)

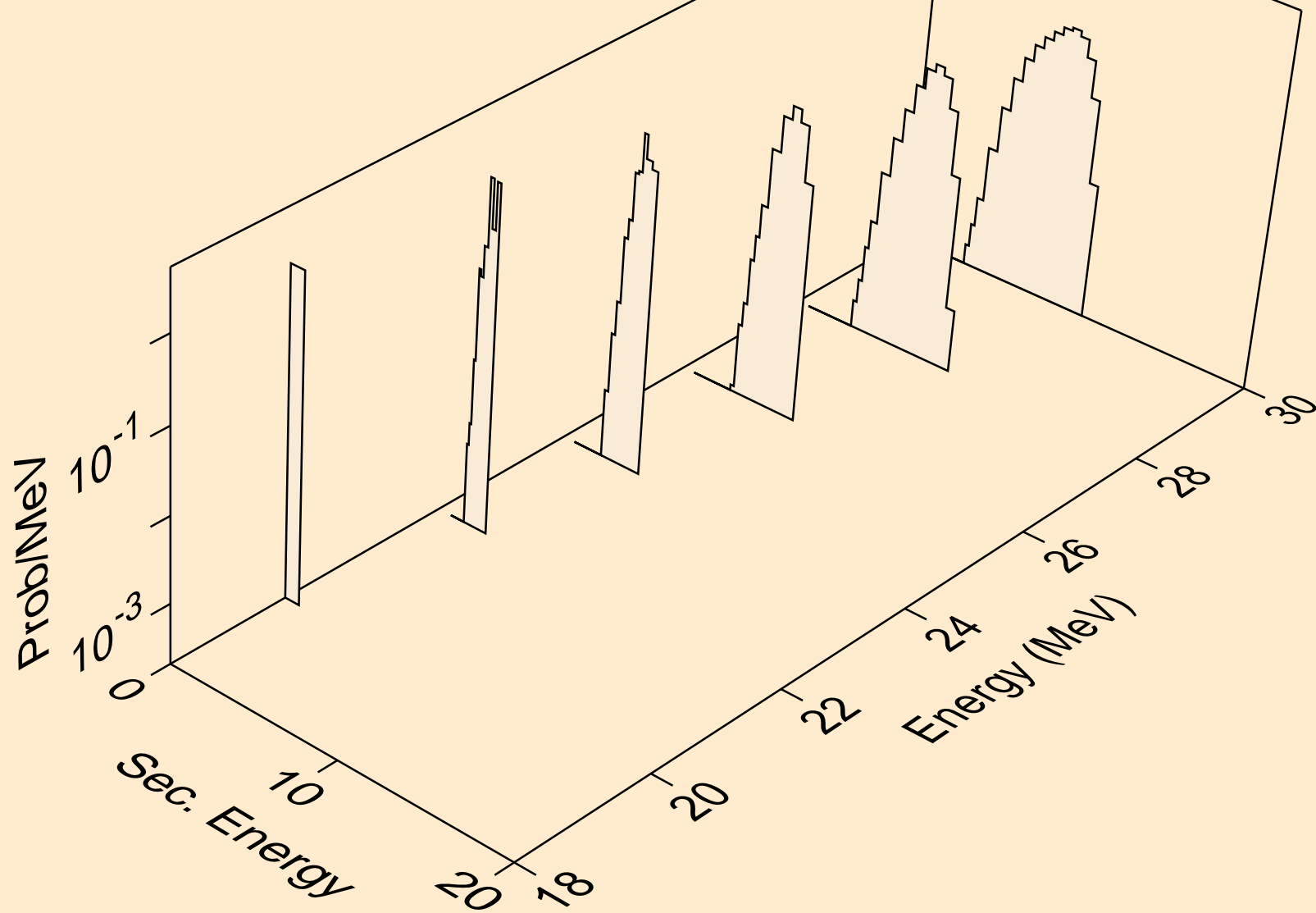

EU136M NEUTRON ACER TENDL-2021 LIBRARY; T=293.6K
deuterons from (n,n*)d

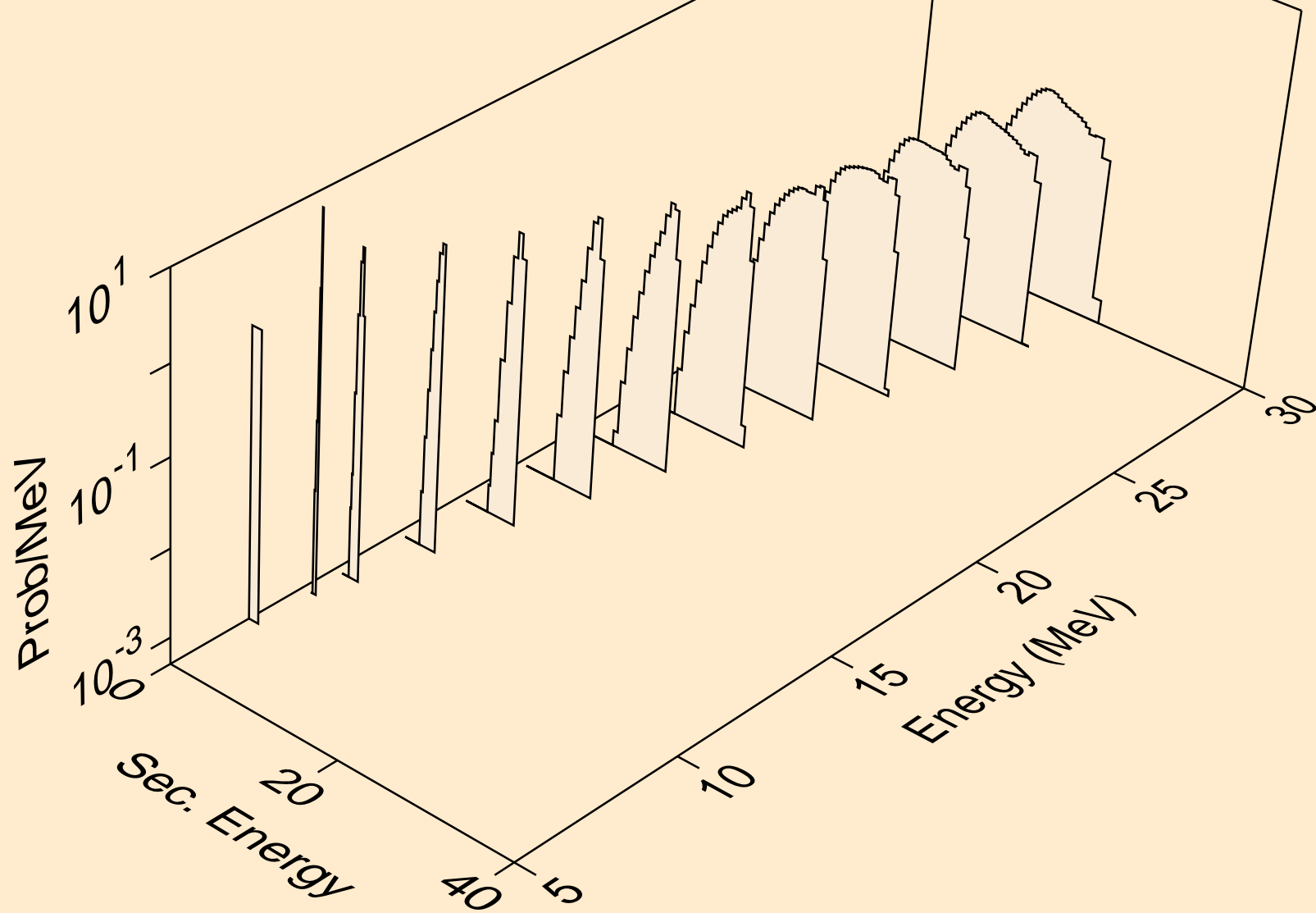

EU136M NEUTRON ACER TENDL-2021 LIBRARY; T=293.6K
deuterons from (n,d)

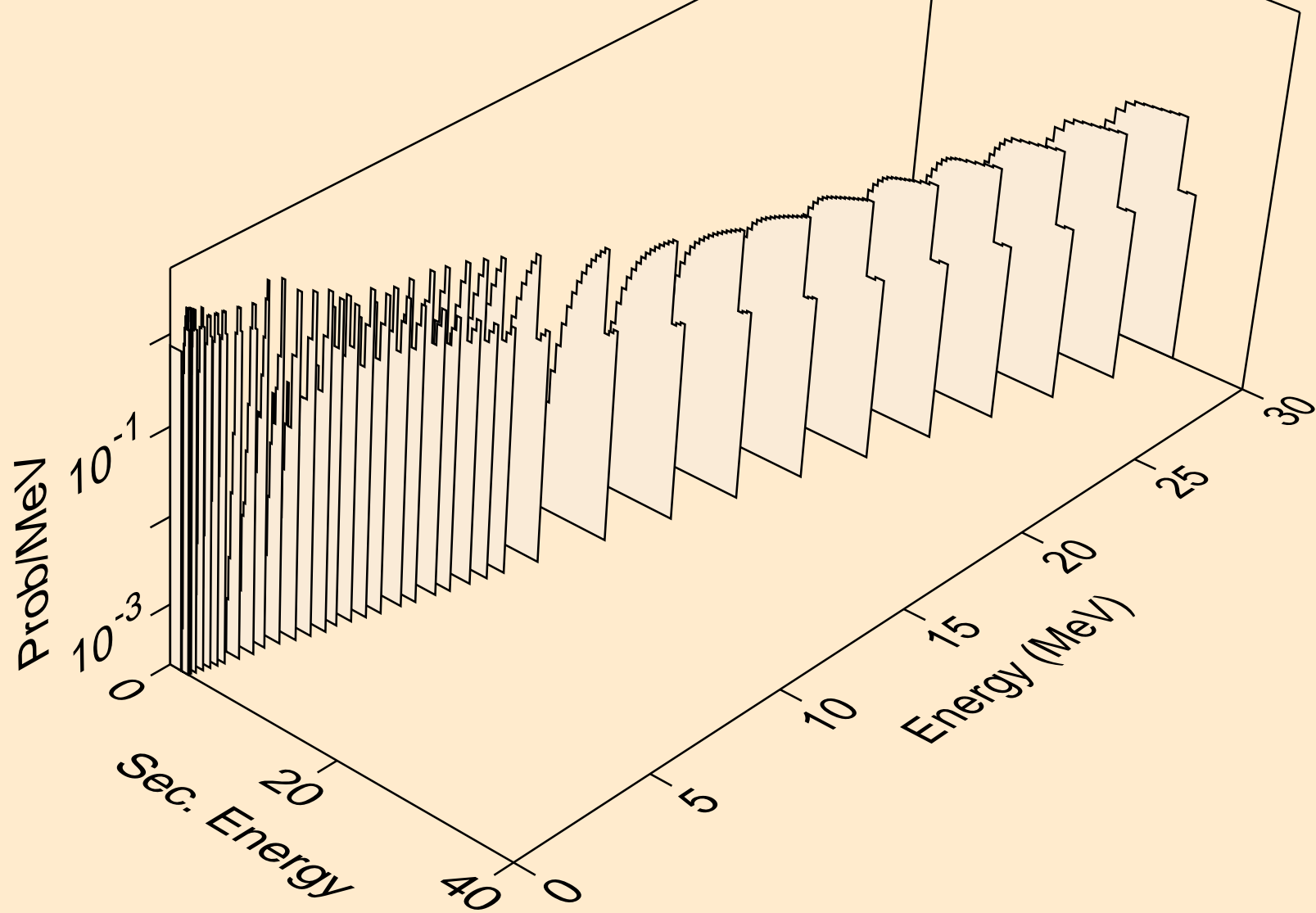

EU136M NEUTRON ACER TENDL-2021 LIBRARY; T=293.6K
deuterons from (n,d2a)

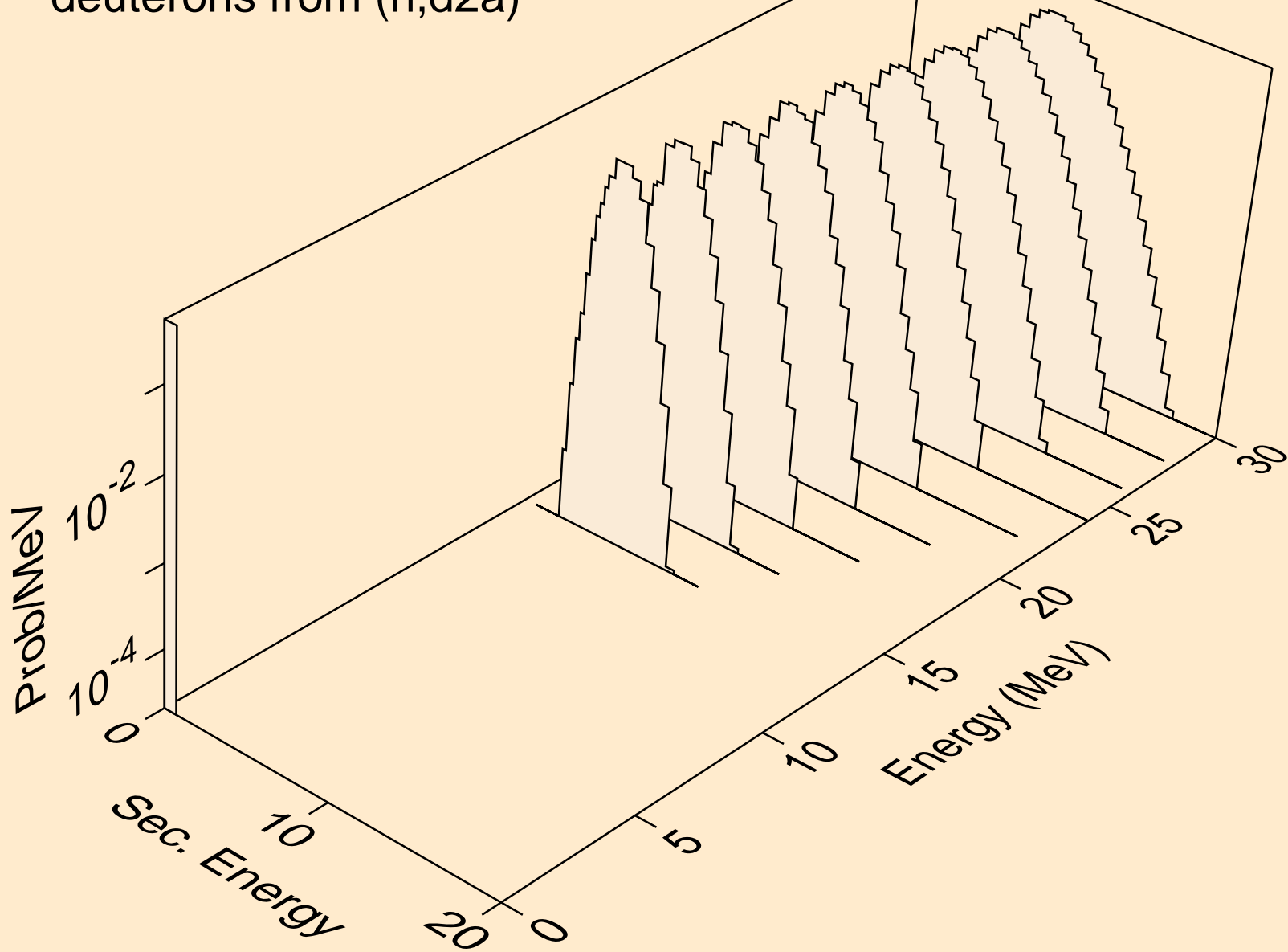

EU136M NEUTRON ACER TENDL-2021 LIBRARY; T=293.6K
deuterons from (n,pd)

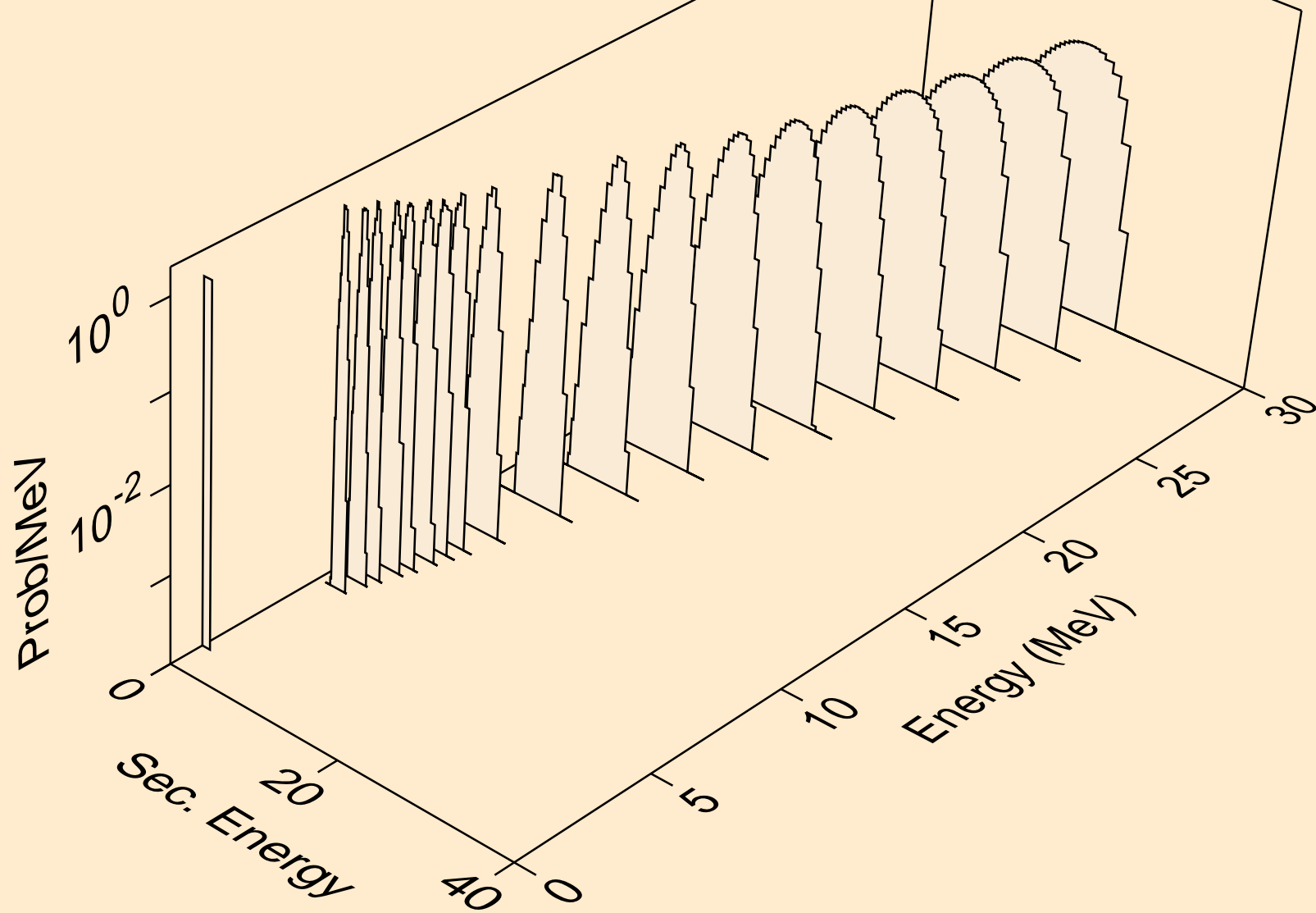

EU136M NEUTRON ACER TENDL-2021 LIBRARY; T=293.6K
deuterons from (n,da)

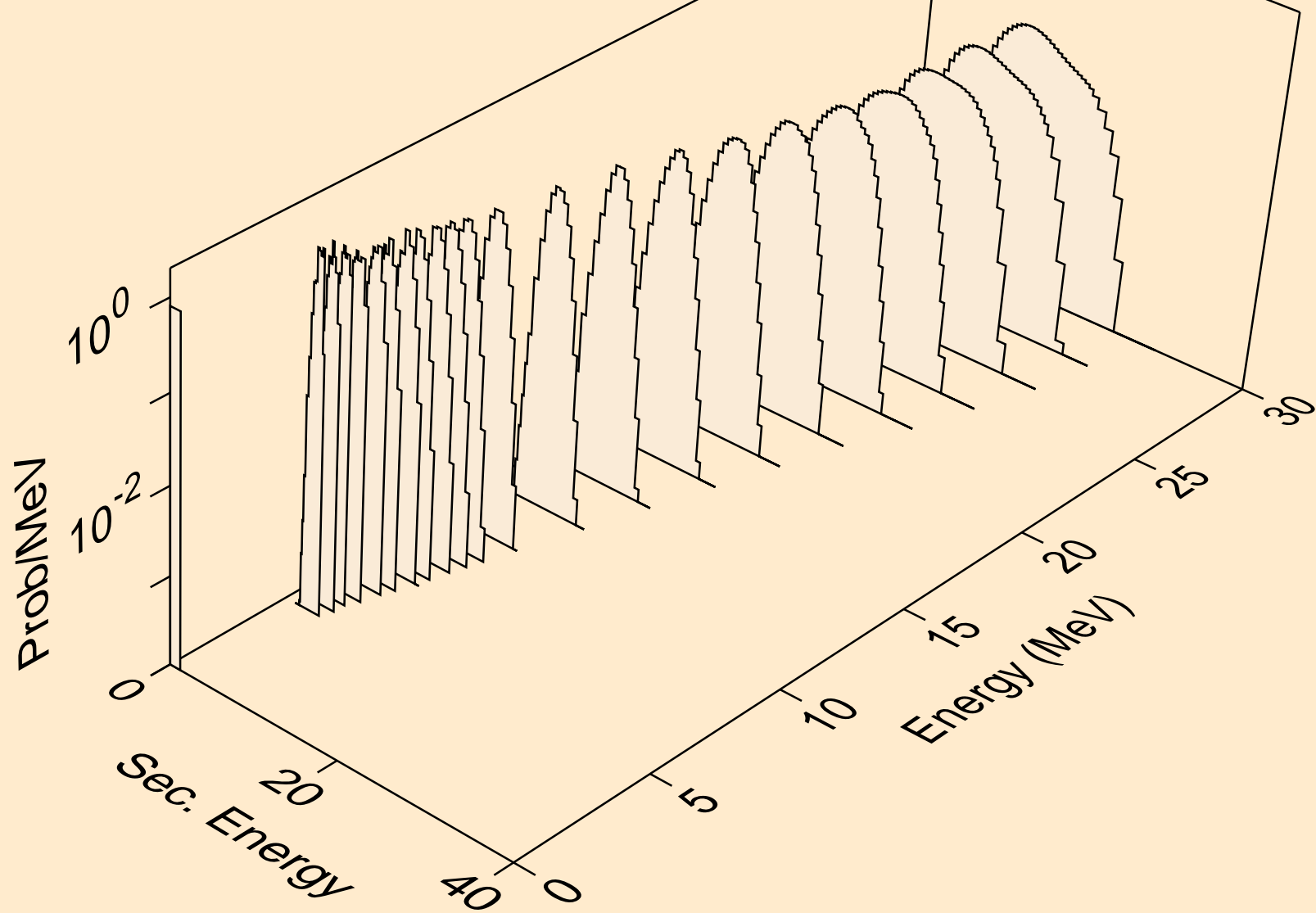

EU136M NEUTRON ACER TENDL-2021 LIBRARY; T=293.6K
tritons from (n,x)

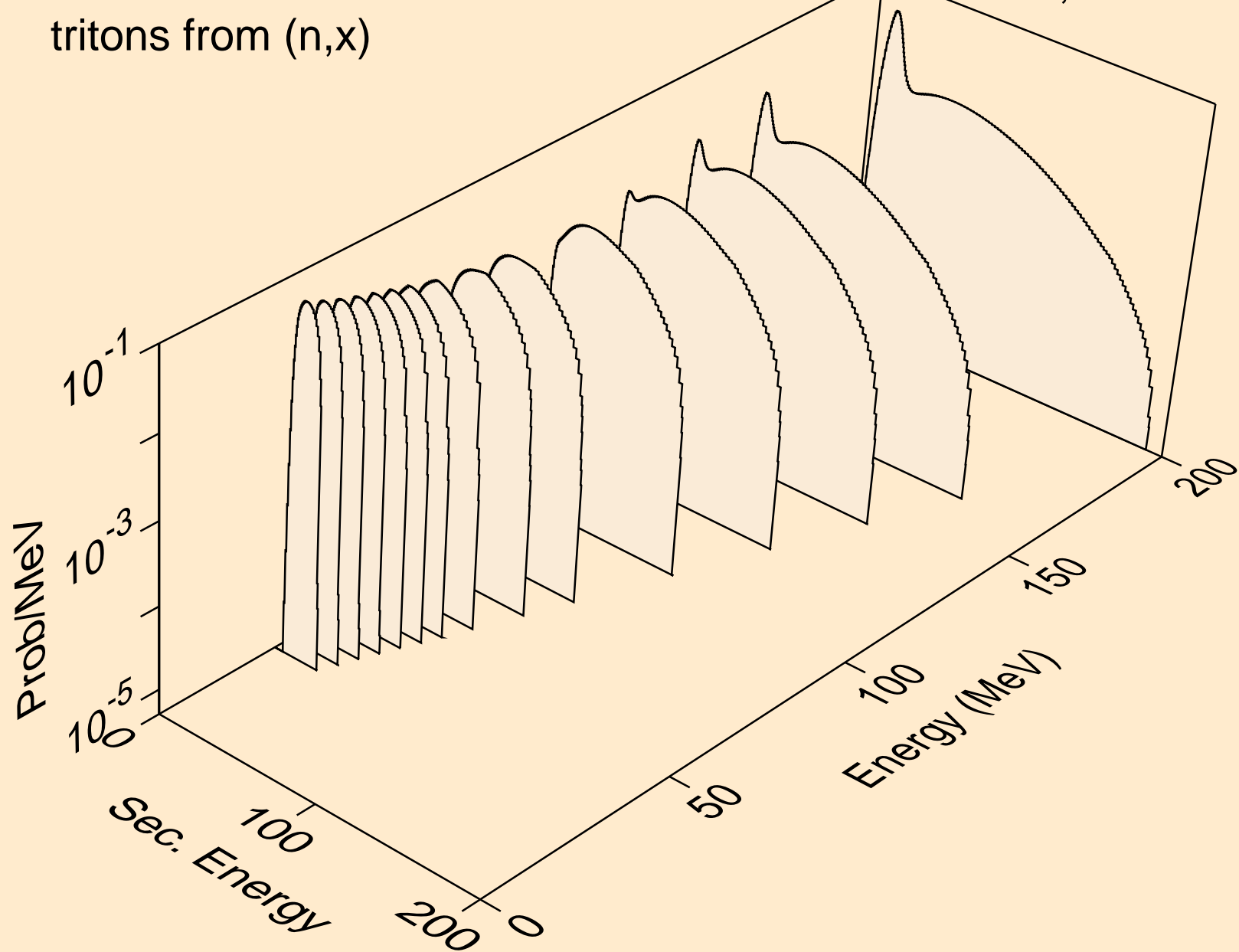

EU136M NEUTRON ACER TENDL-2021 LIBRARY; T=293.6K
tritons from (n,n*)t

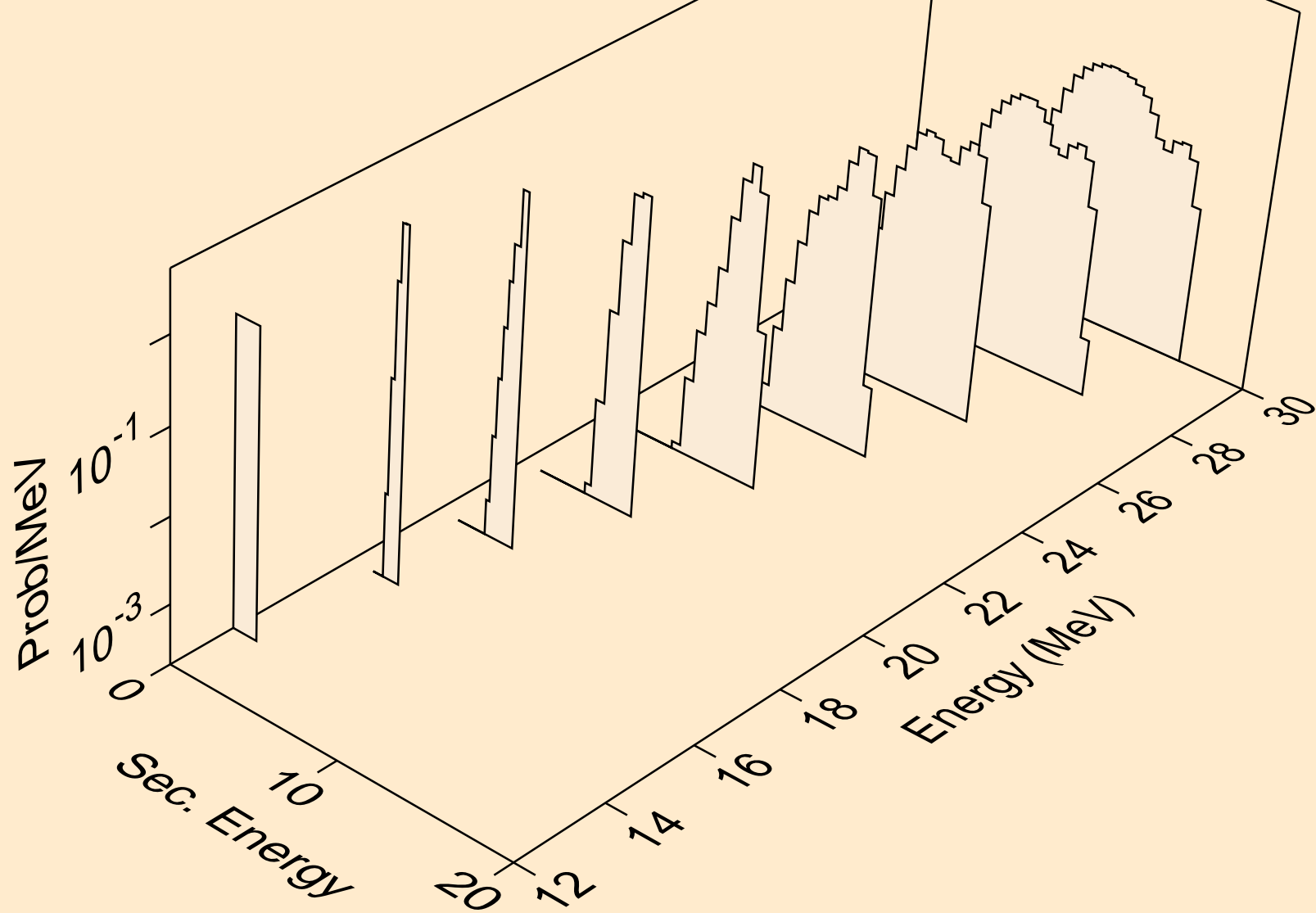

EU136M NEUTRON ACER TENDL-2021 LIBRARY; T=293.6K
tritons from (n,t)

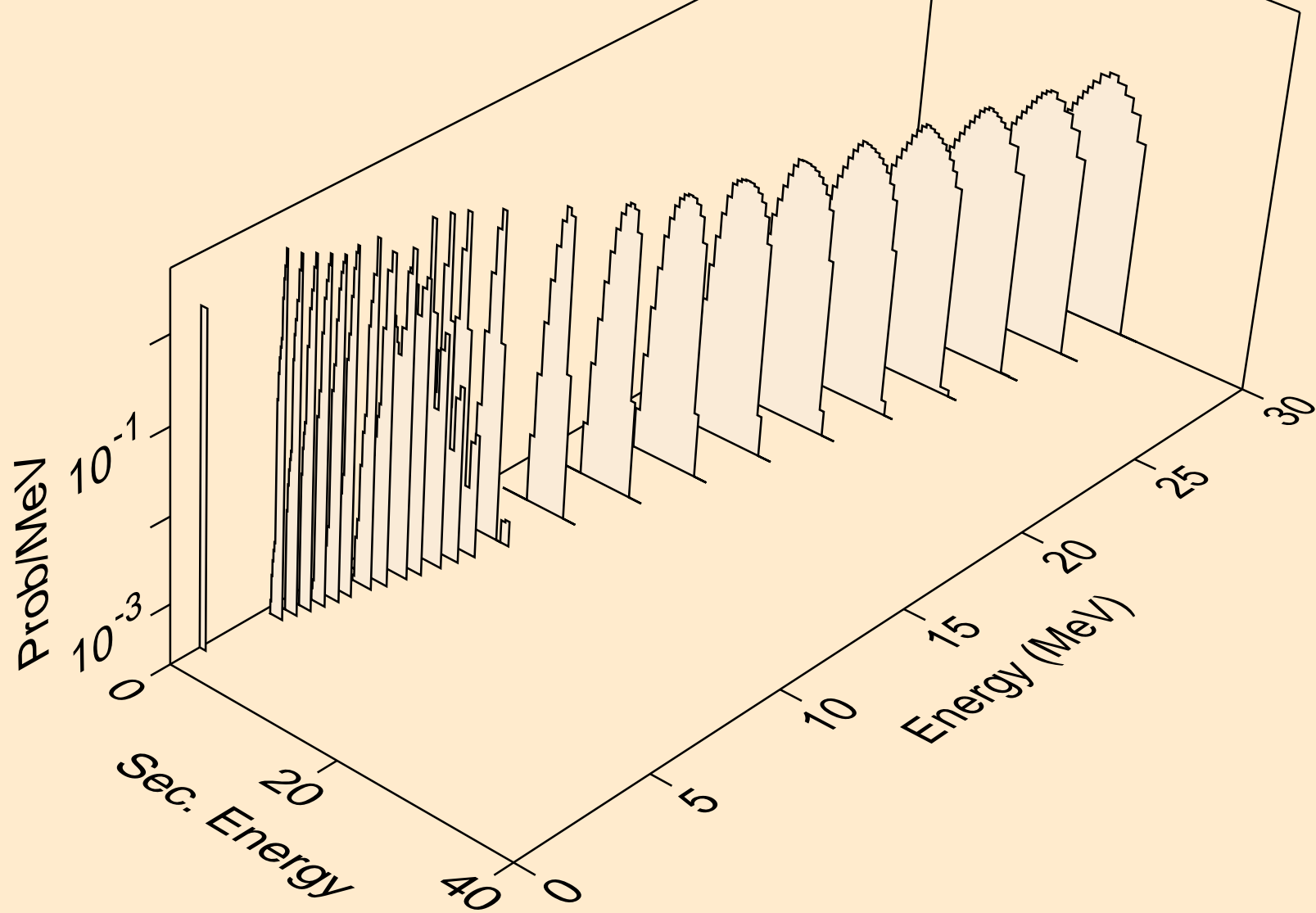

EU136M NEUTRON ACER TENDL-2021 LIBRARY; T=293.6K
tritons from (n,t2a)

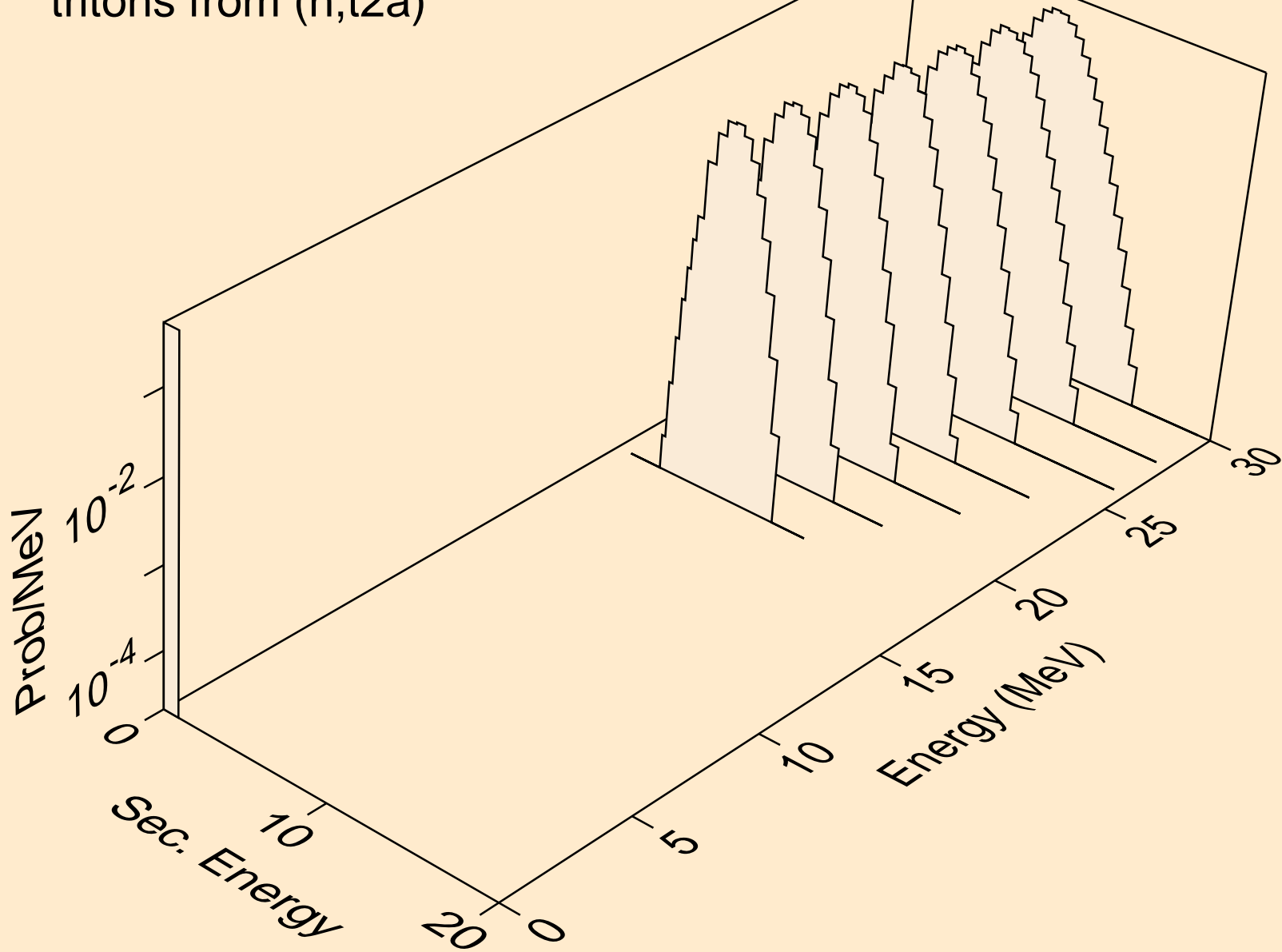

EU136M NEUTRON ACER TENDL-2021 LIBRARY; T=293.6K
tritons from (n,pt)

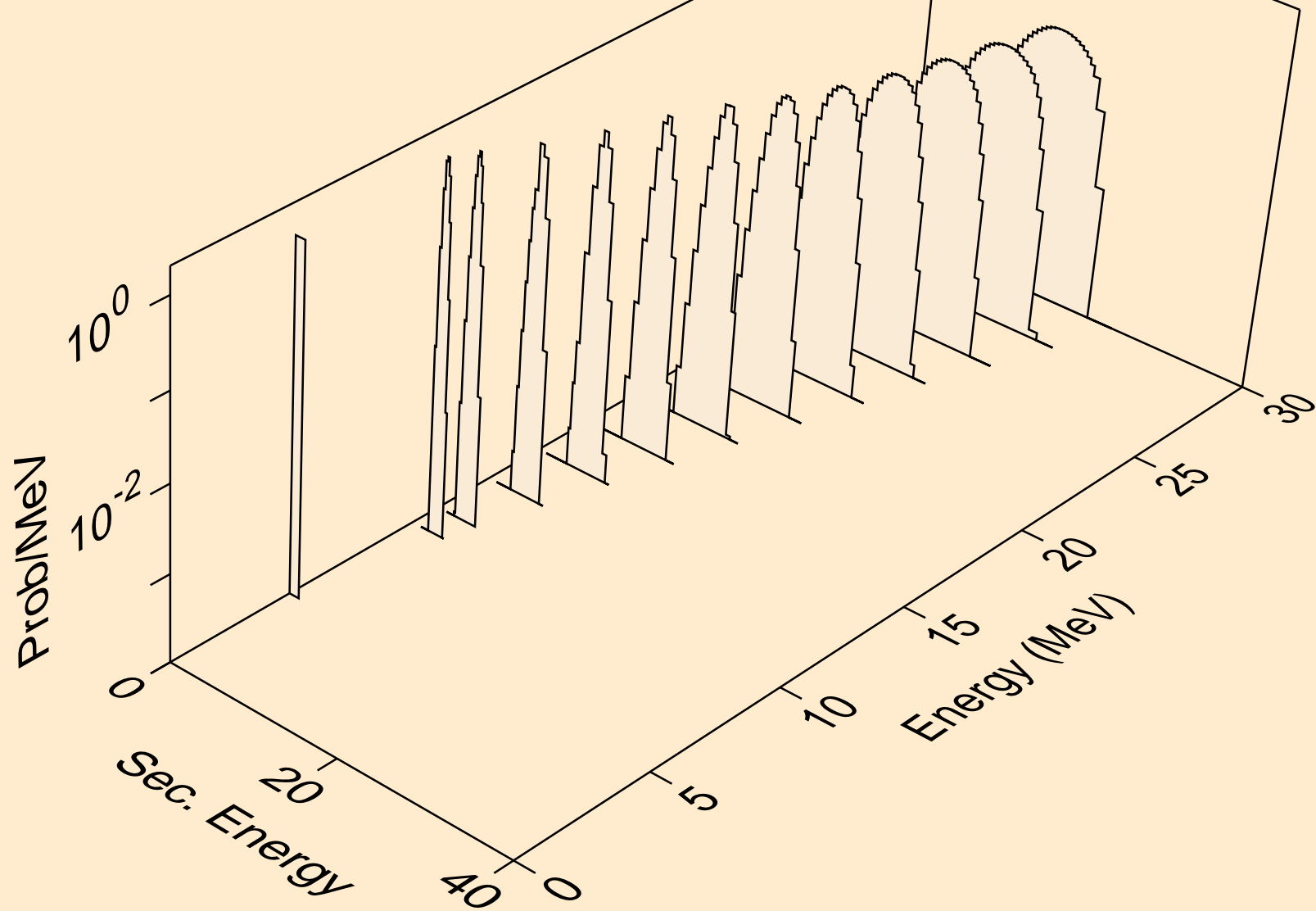

EU136M NEUTRON ACER TENDL-2021 LIBRARY; T=293.6K
he3s from (n,x)

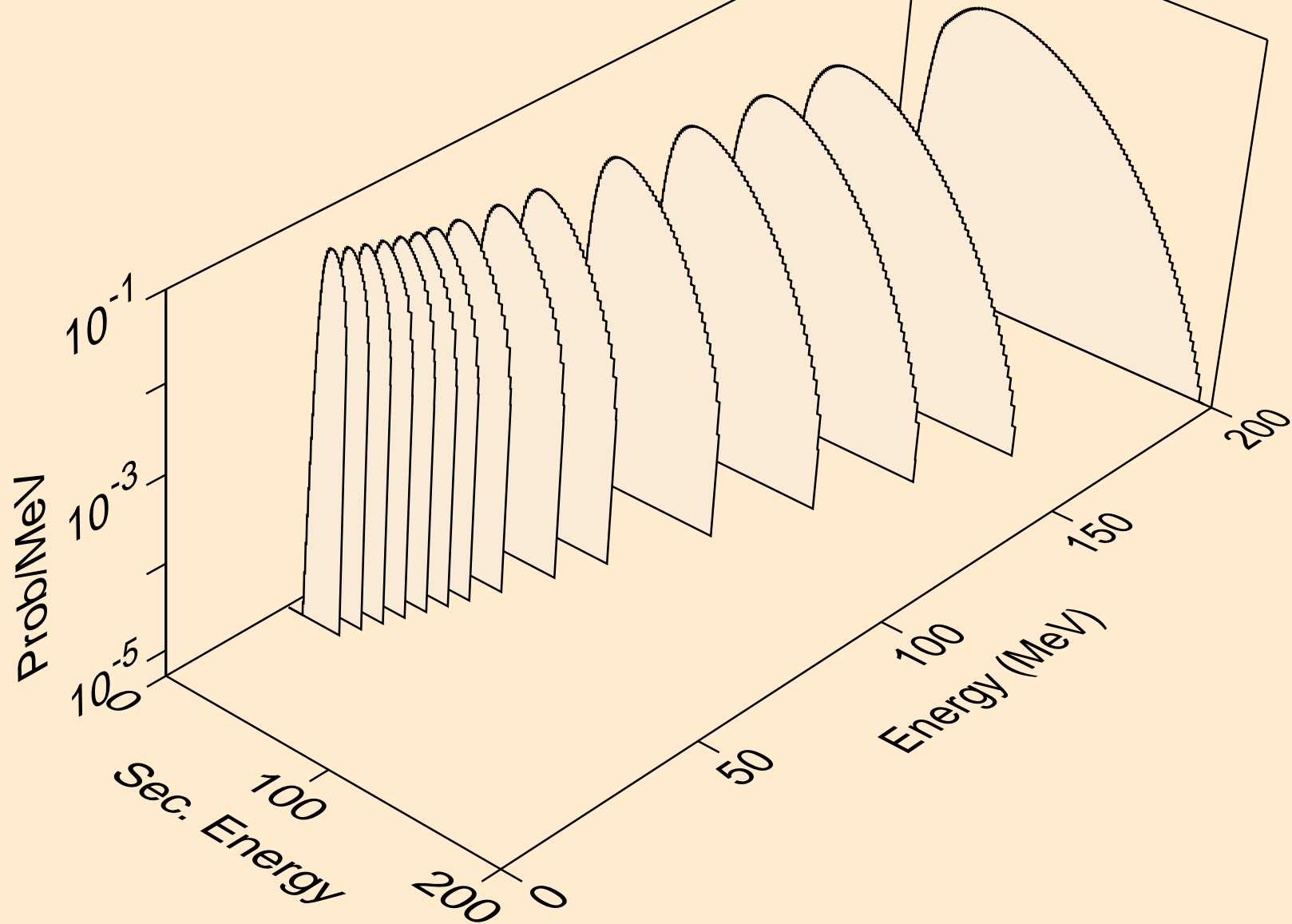

EU136M NEUTRON ACER TENDL-2021 LIBRARY; T=293.6K
he3s from (n,n*)he3

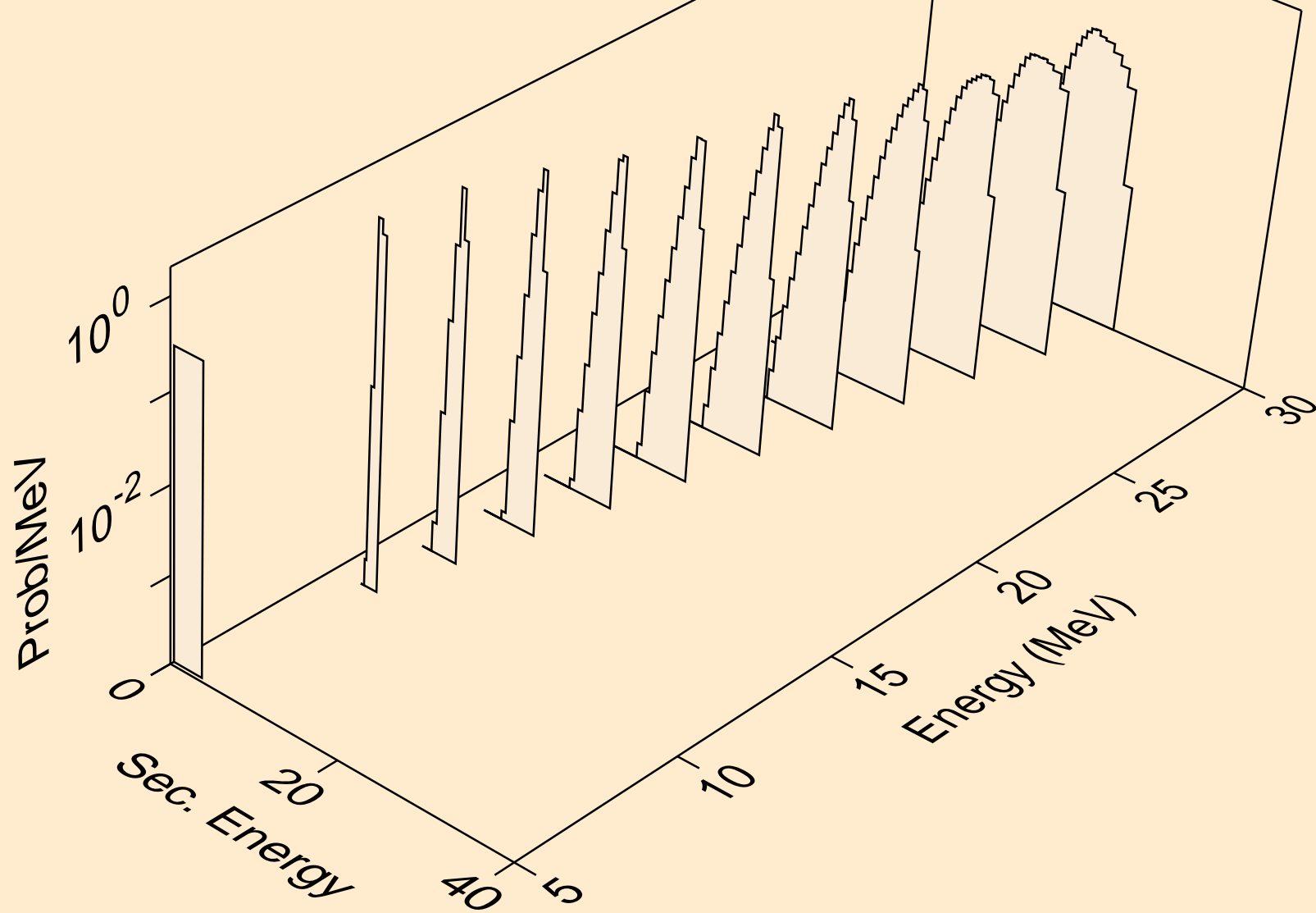

EU136M NEUTRON ACER TENDL-2021 LIBRARY; T=293.6K
he3s from (n,he3)

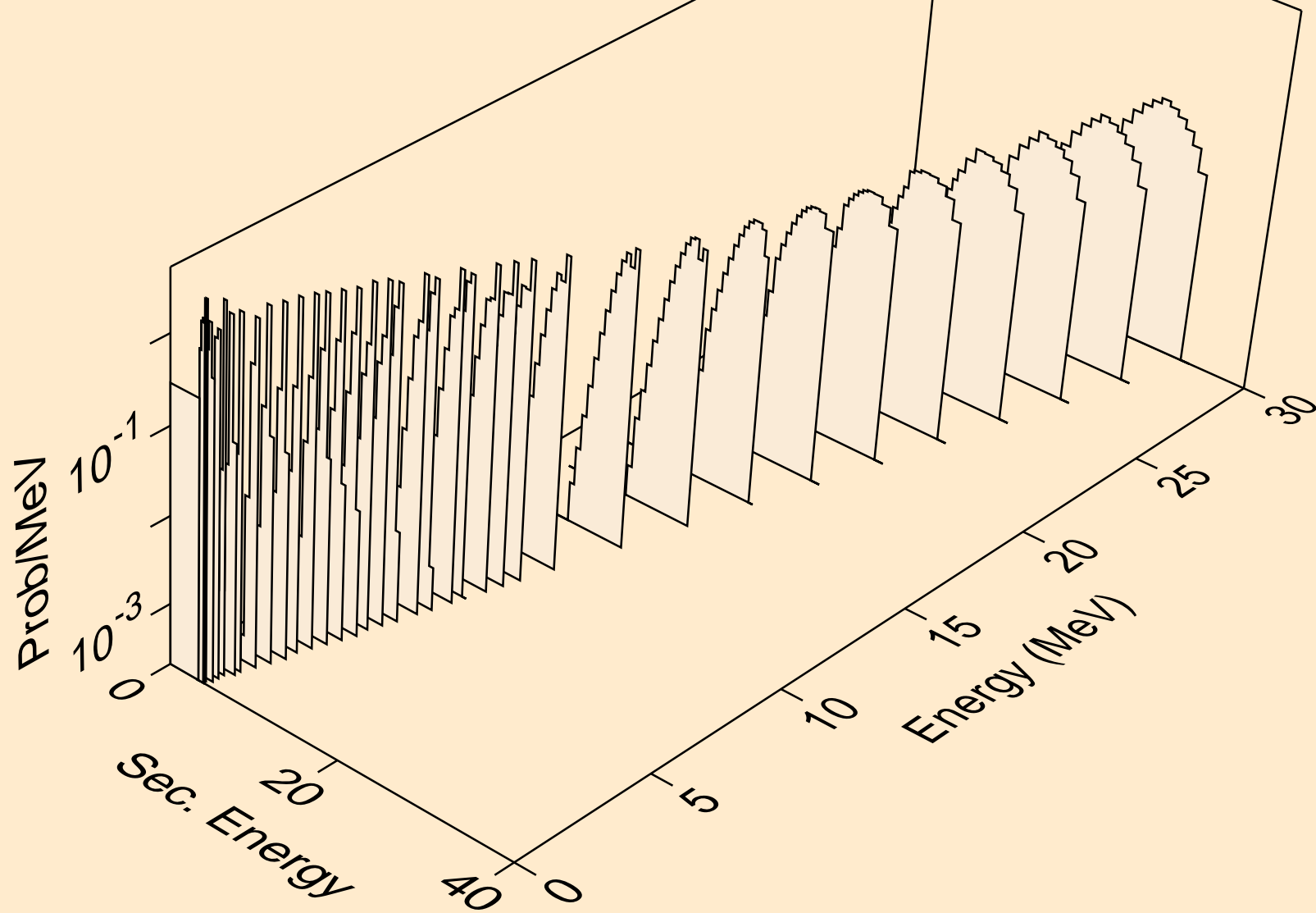

EU136M NEUTRON ACER TENDL-2021 LIBRARY; T=293.6K
alphas from (n,x)

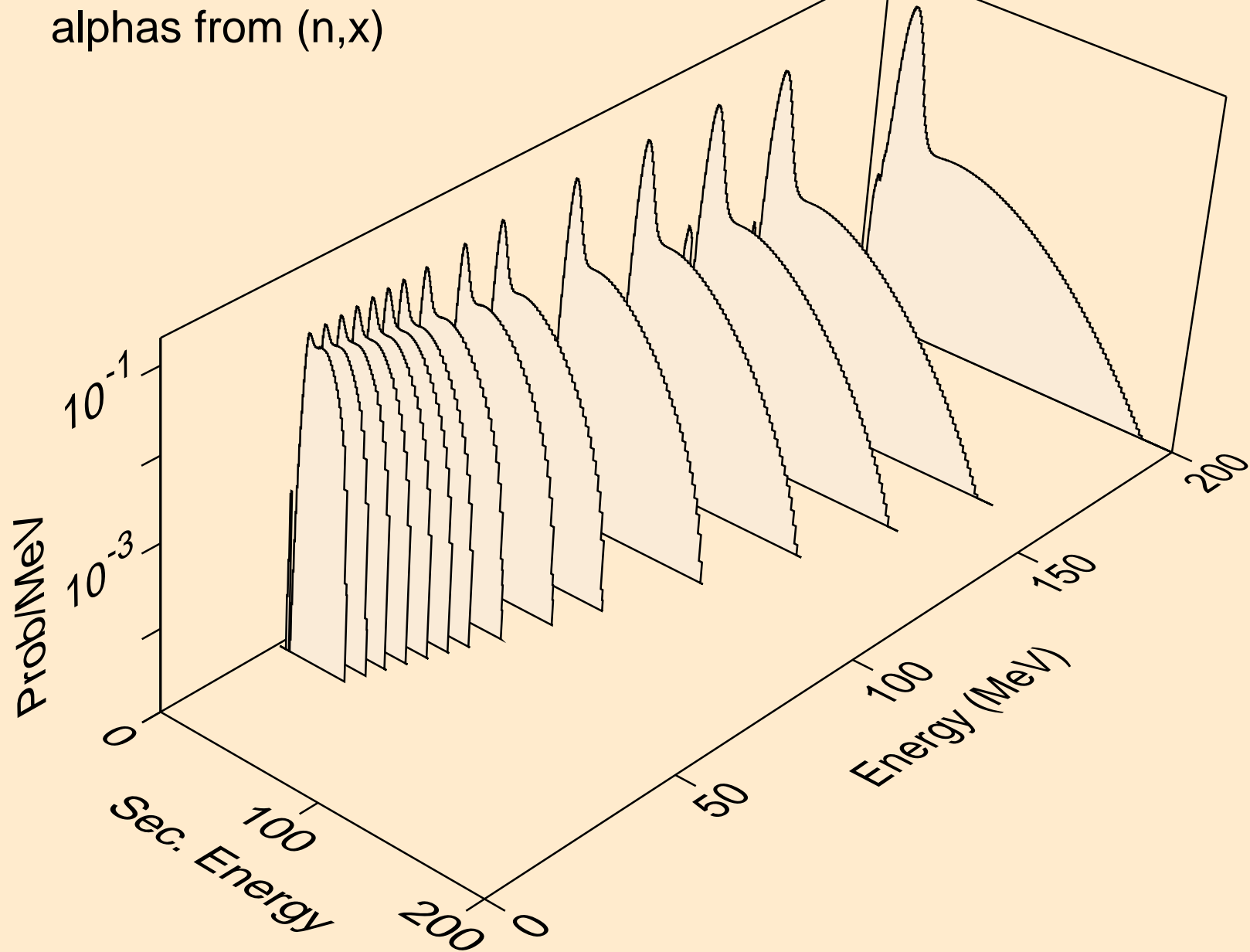

EU136M NEUTRON ACER TENDL-2021 LIBRARY; T=293.6K
alphas from (n,n*)a

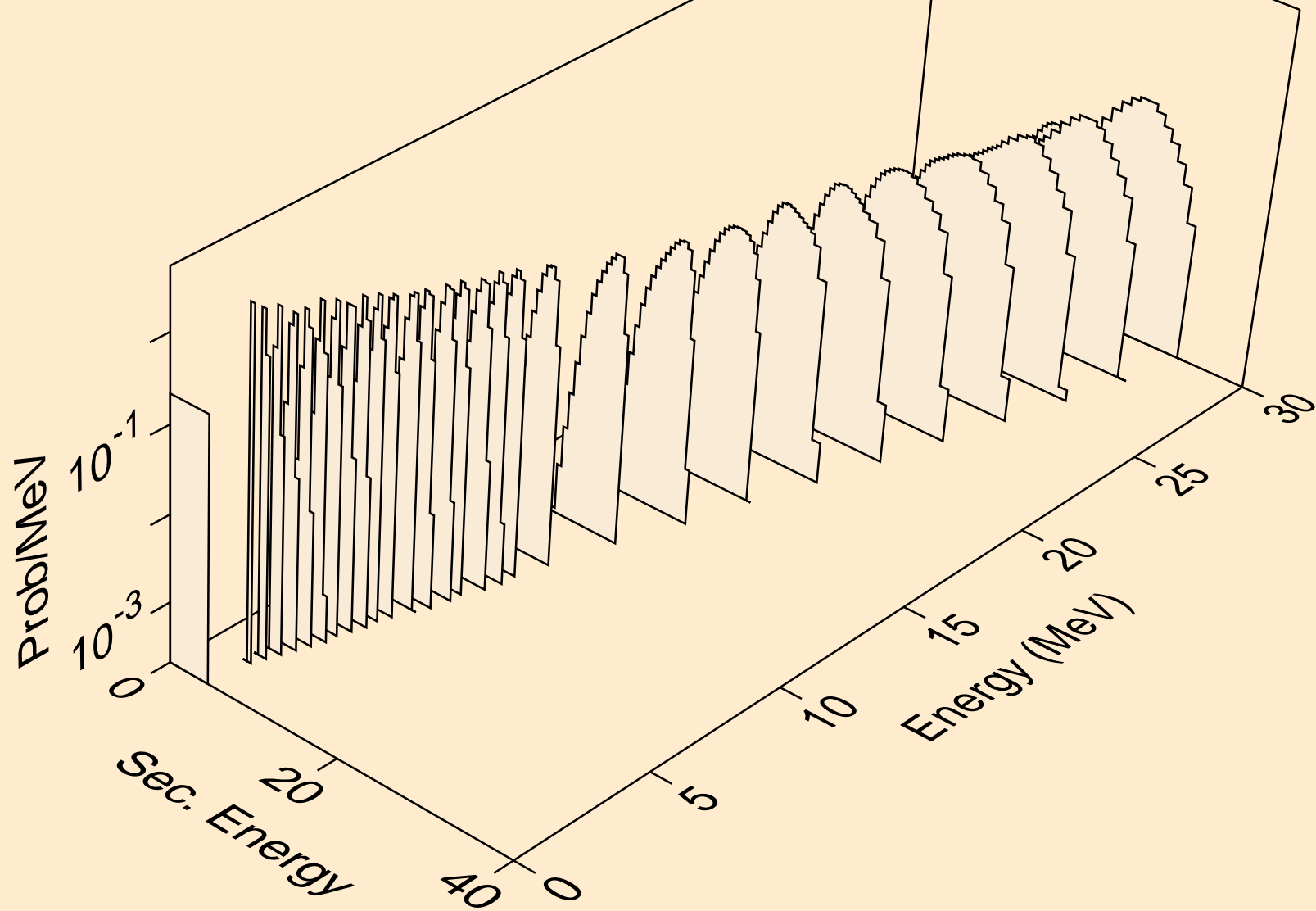

EU136M NEUTRON ACER TENDL-2021 LIBRARY; T=293.6K
alphas from (n,2n)a

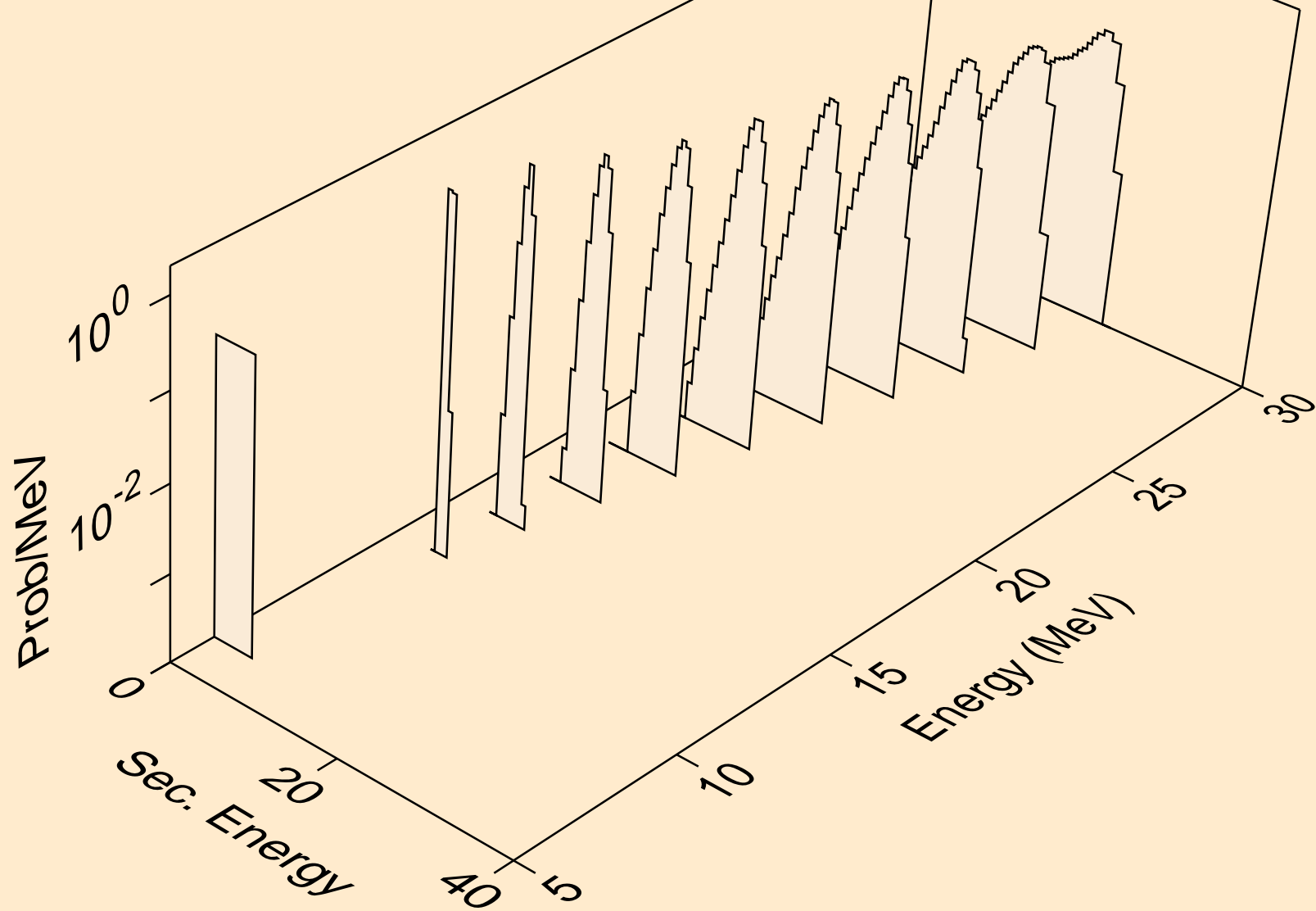

EU136M NEUTRON ACER TENDL-2021 LIBRARY; T=293.6K
alphas from (n,n*)2a

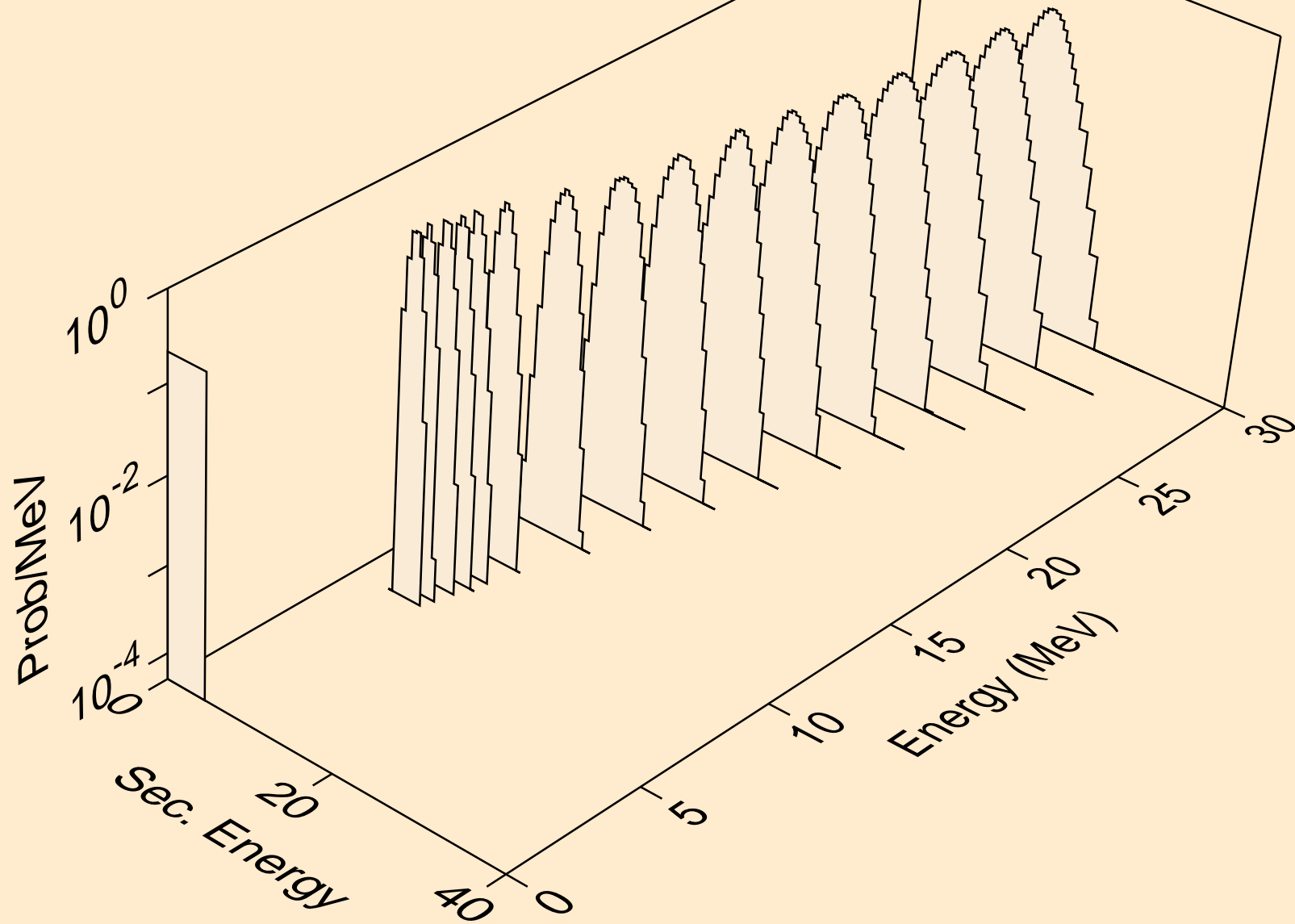

EU136M NEUTRON ACER TENDL-2021 LIBRARY; T=293.6K
alphas from (n,2n)2a

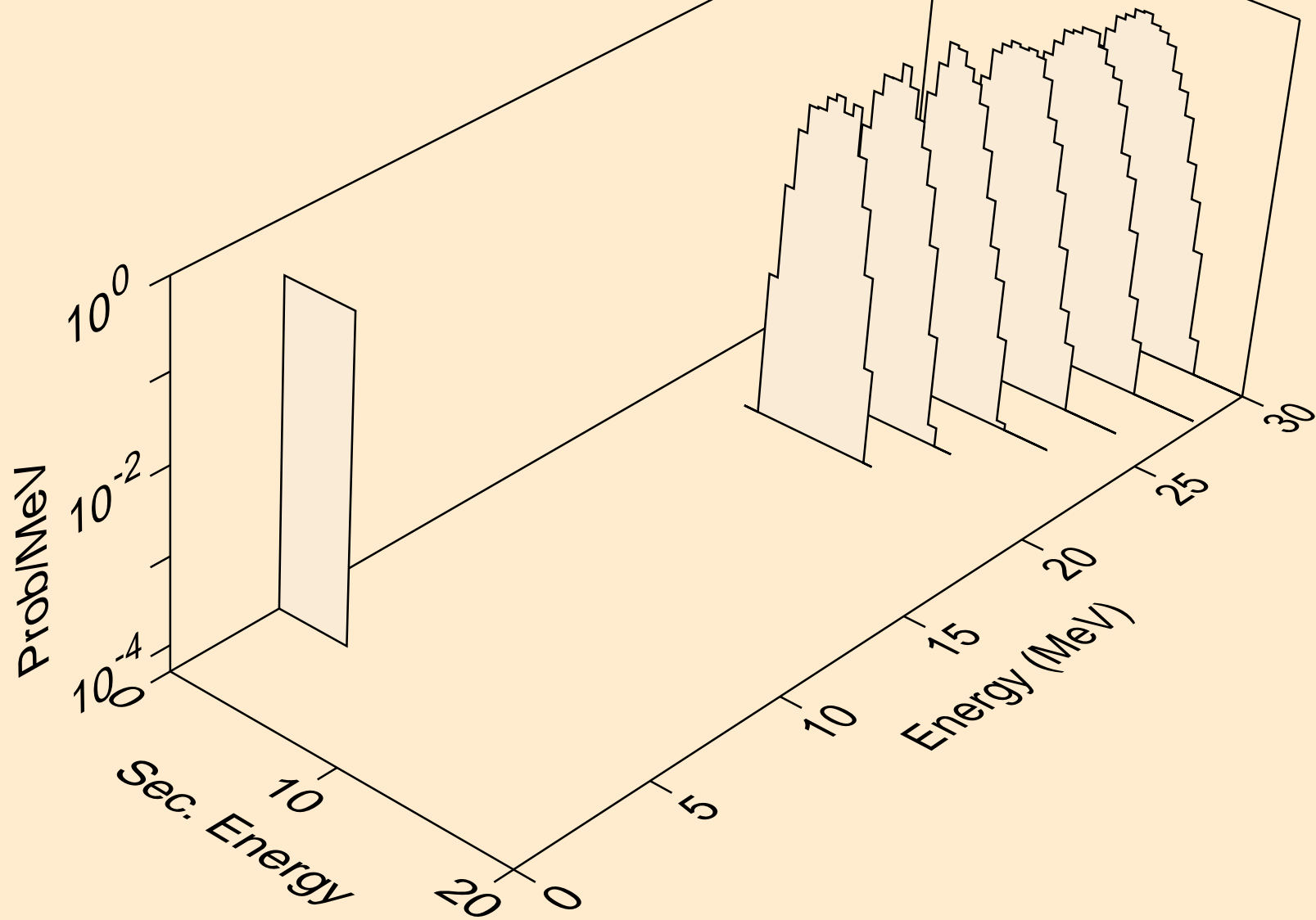

EU136M NEUTRON ACER TENDL-2021 LIBRARY; T=293.6K
alphas from (n,npa)

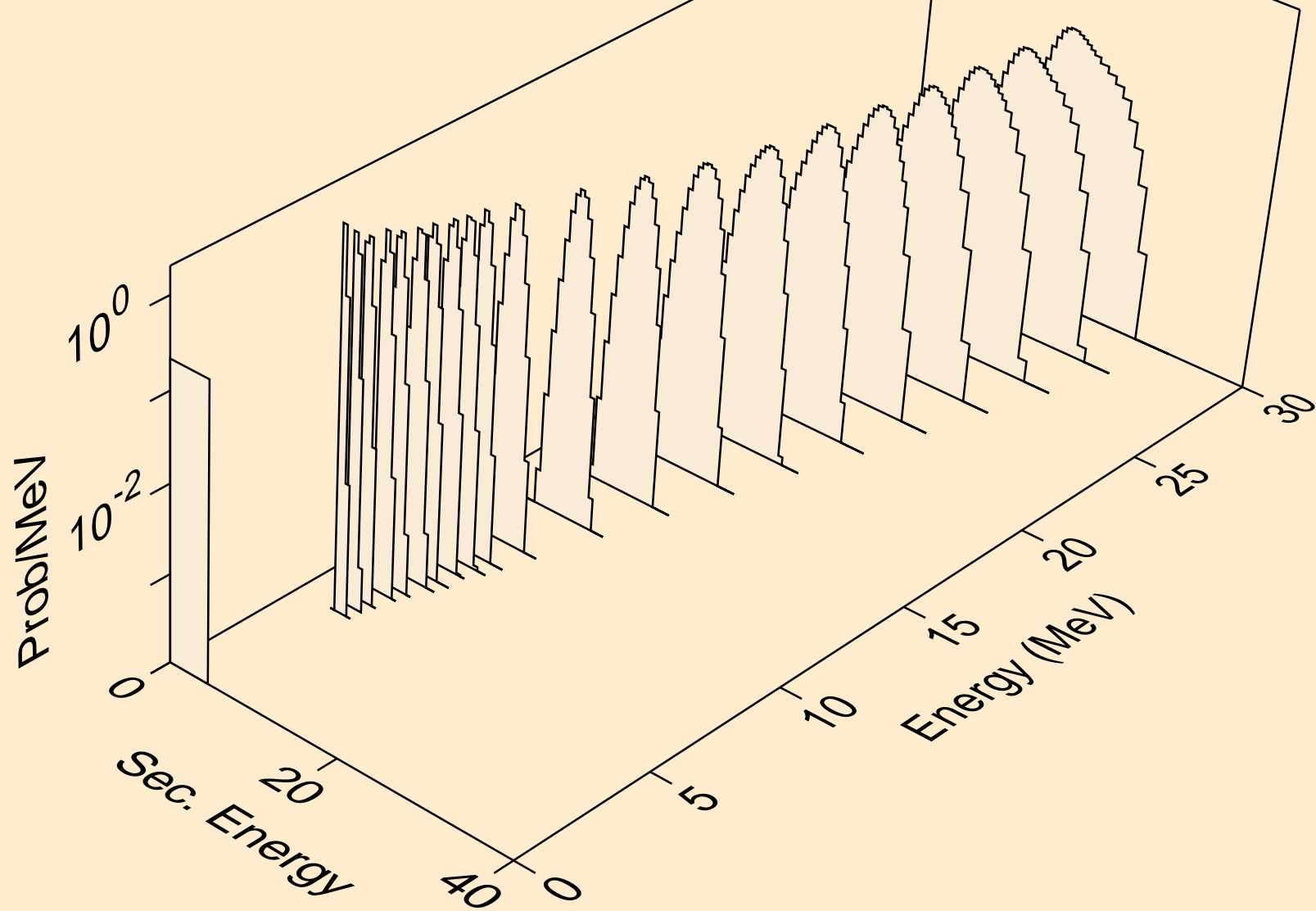

EU136M NEUTRON ACER TENDL-2021 LIBRARY; T=293.6K
alphas from (n,a)

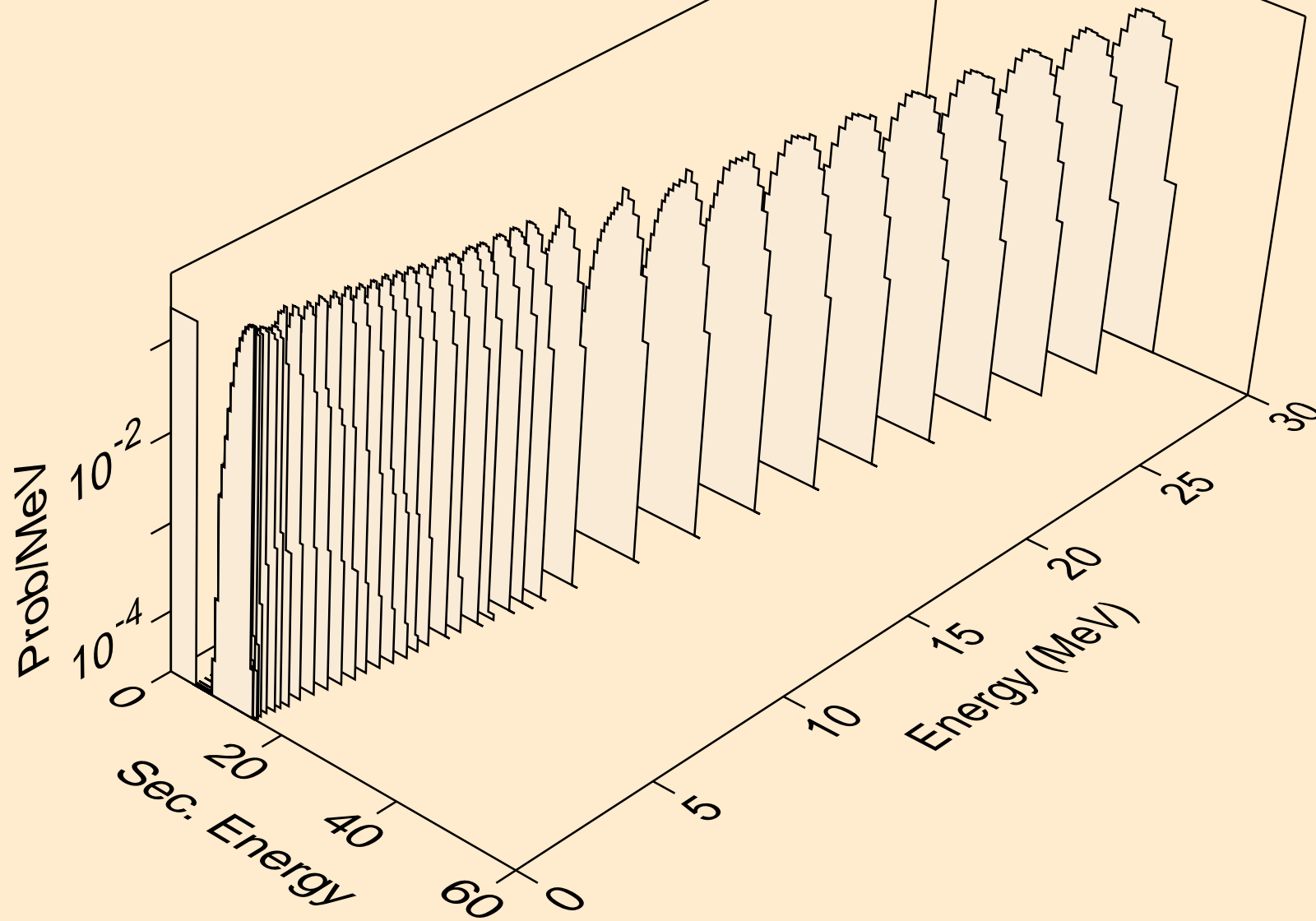

EU136M NEUTRON ACER TENDL-2021 LIBRARY; T=293.6K
alphas from (n,2a)

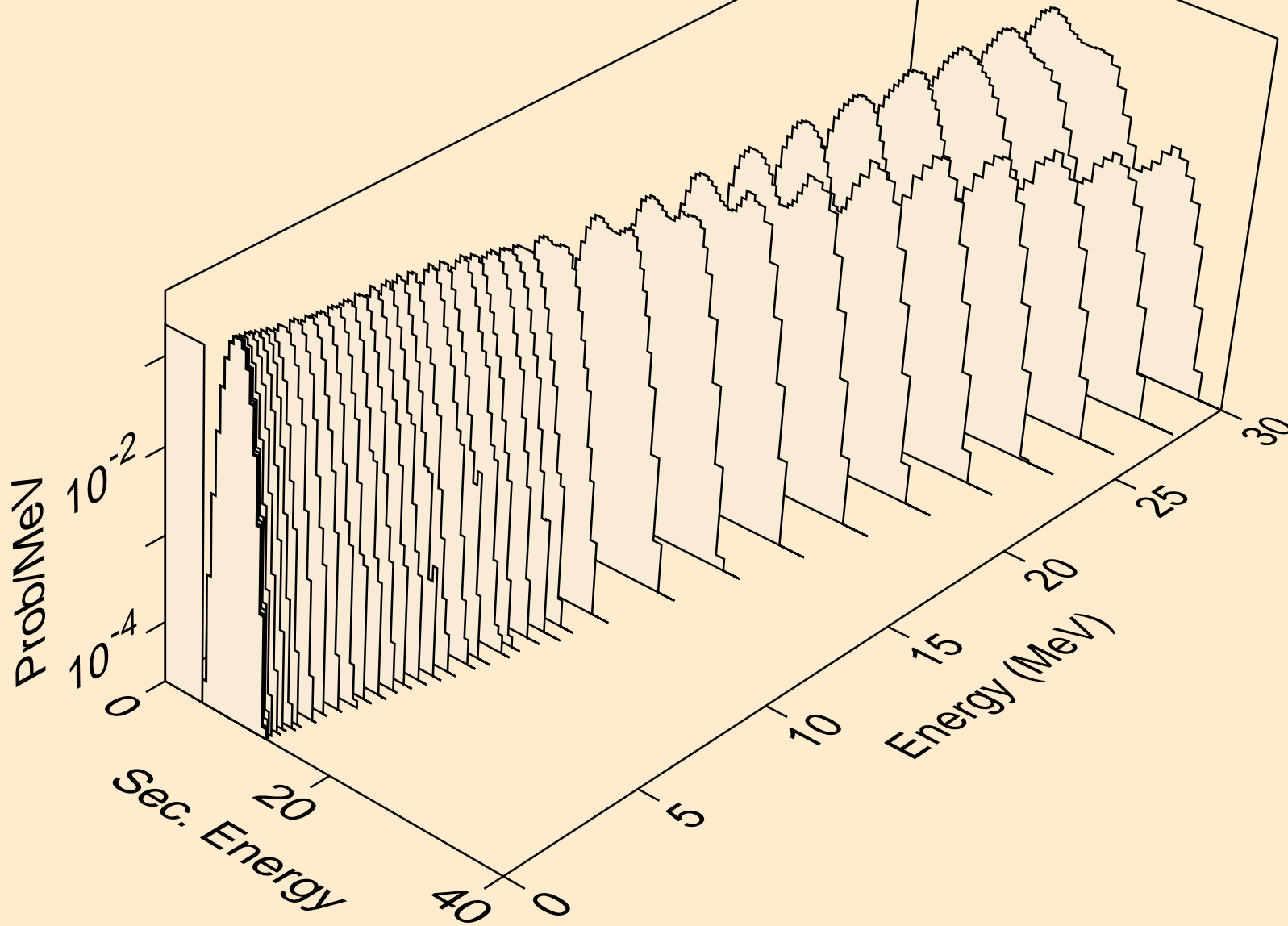

EU136M NEUTRON ACER TENDL-2021 LIBRARY; T=293.6K
alphas from (n,3a)

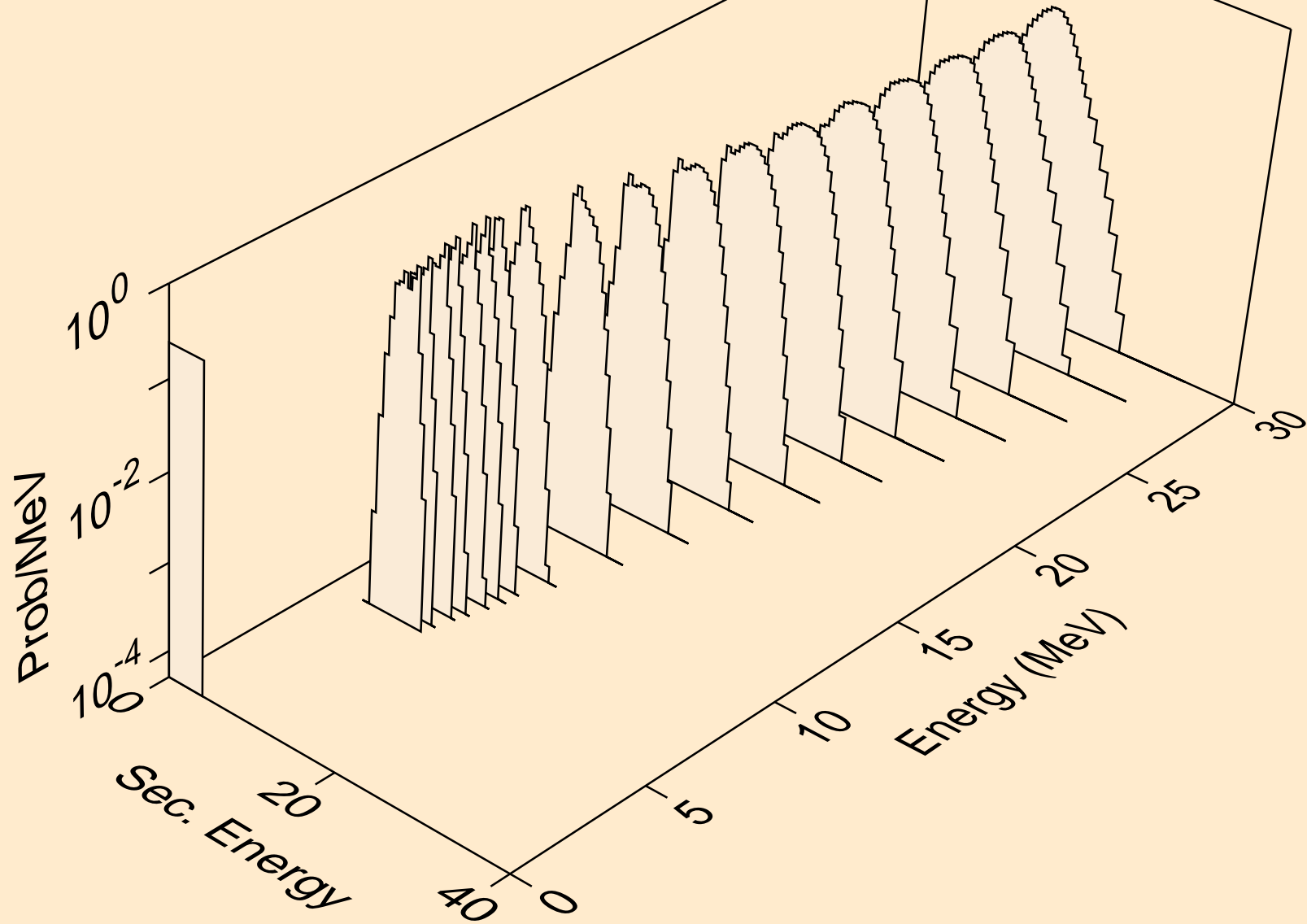

EU136M NEUTRON ACER TENDL-2021 LIBRARY; T=293.6K
alphas from (n,pa)

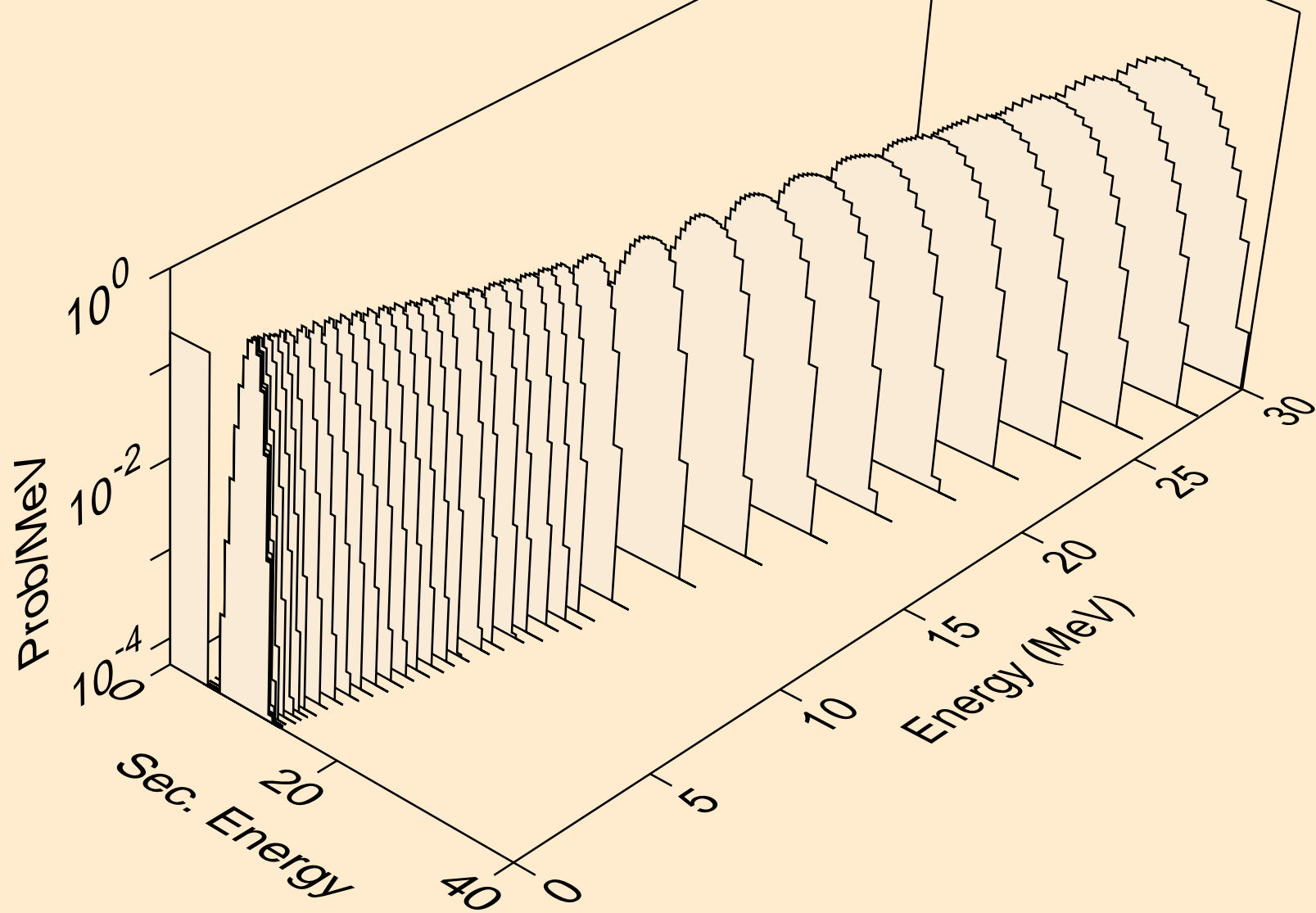

EU136M NEUTRON ACER TENDL-2021 LIBRARY; T=293.6K
alphas from (n,t2a)

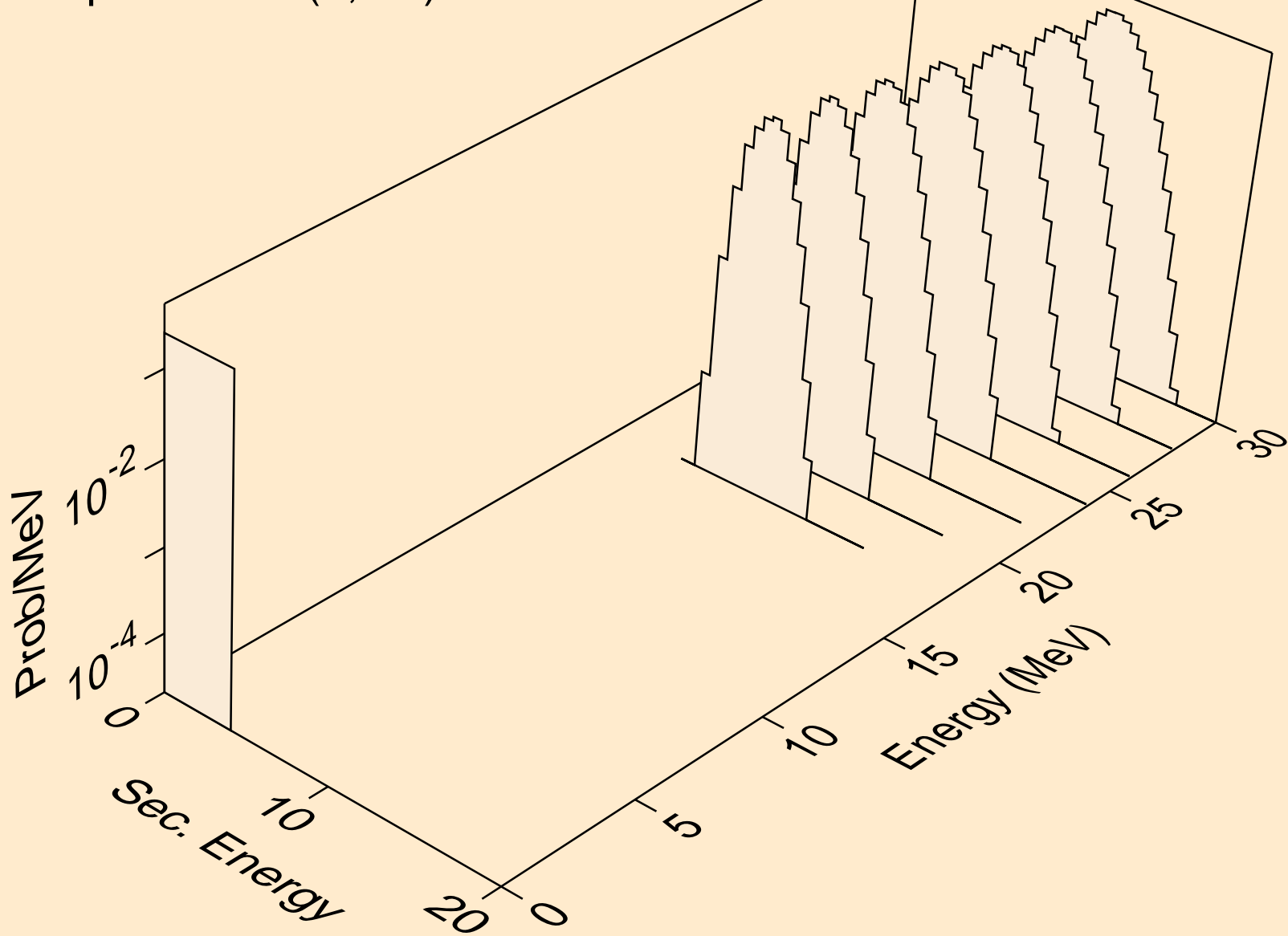

EU136M NEUTRON ACER TENDL-2021 LIBRARY; T=293.6K
alphas from (n,d2a)

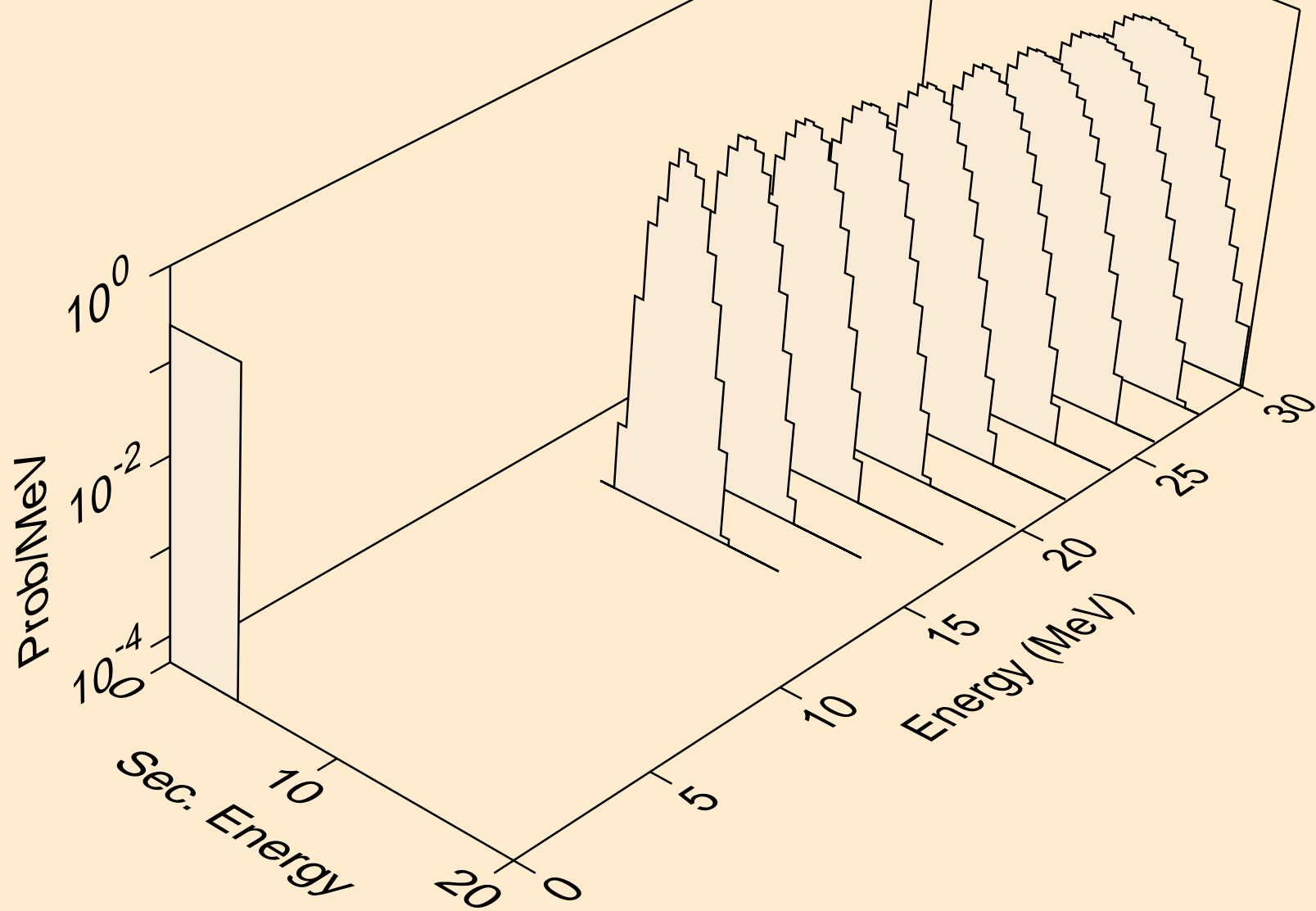

EU136M NEUTRON ACER TENDL-2021 LIBRARY; T=293.6K
alphas from (n,da)

