

EU146 NEUTRON ACER TENDL-2021 LIBRARY; T=293.6K

Principal cross sections

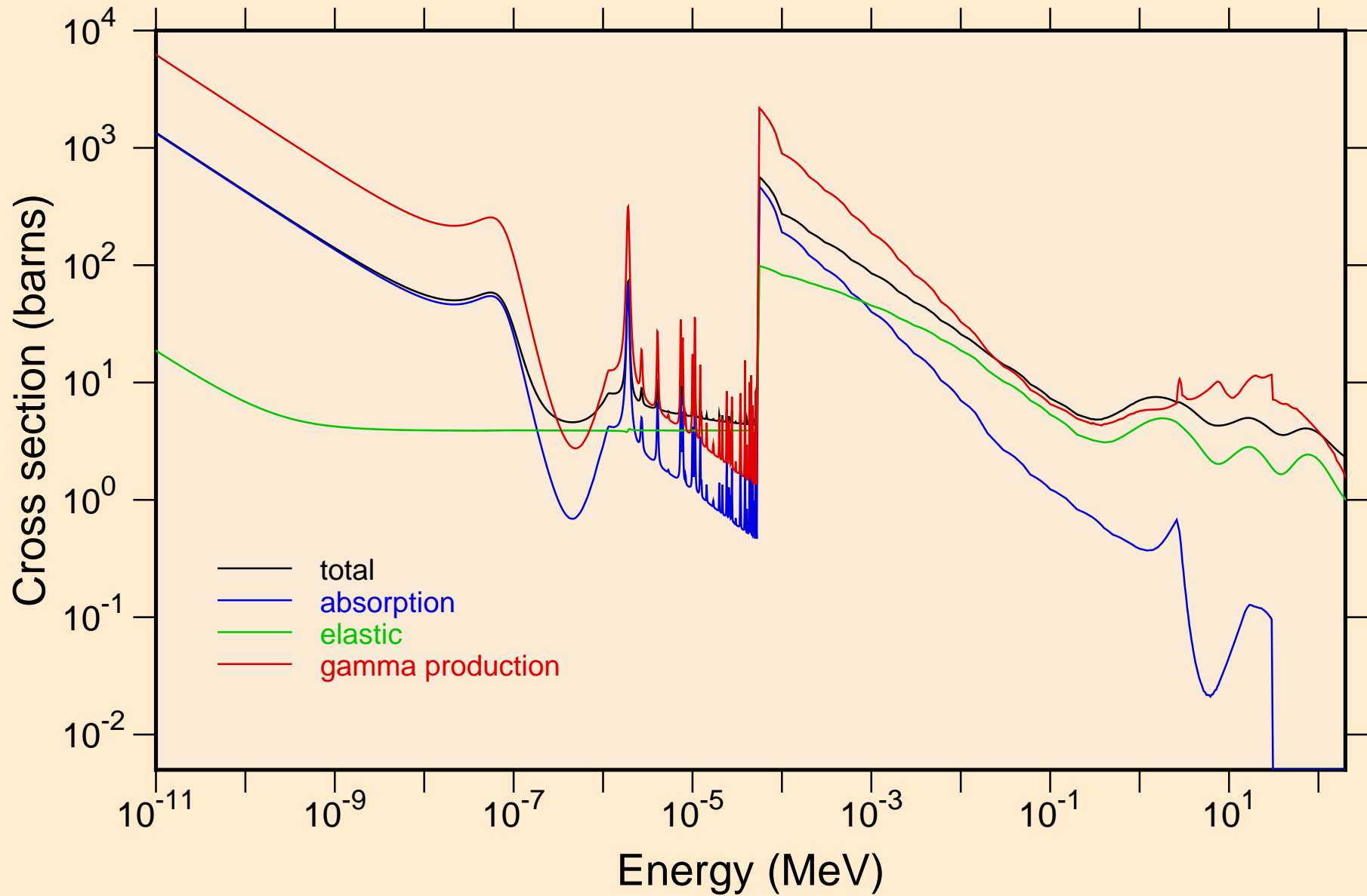

EU146 NEUTRON ACER TENDL-2021 LIBRARY; T=293.6K
resonance total cross section

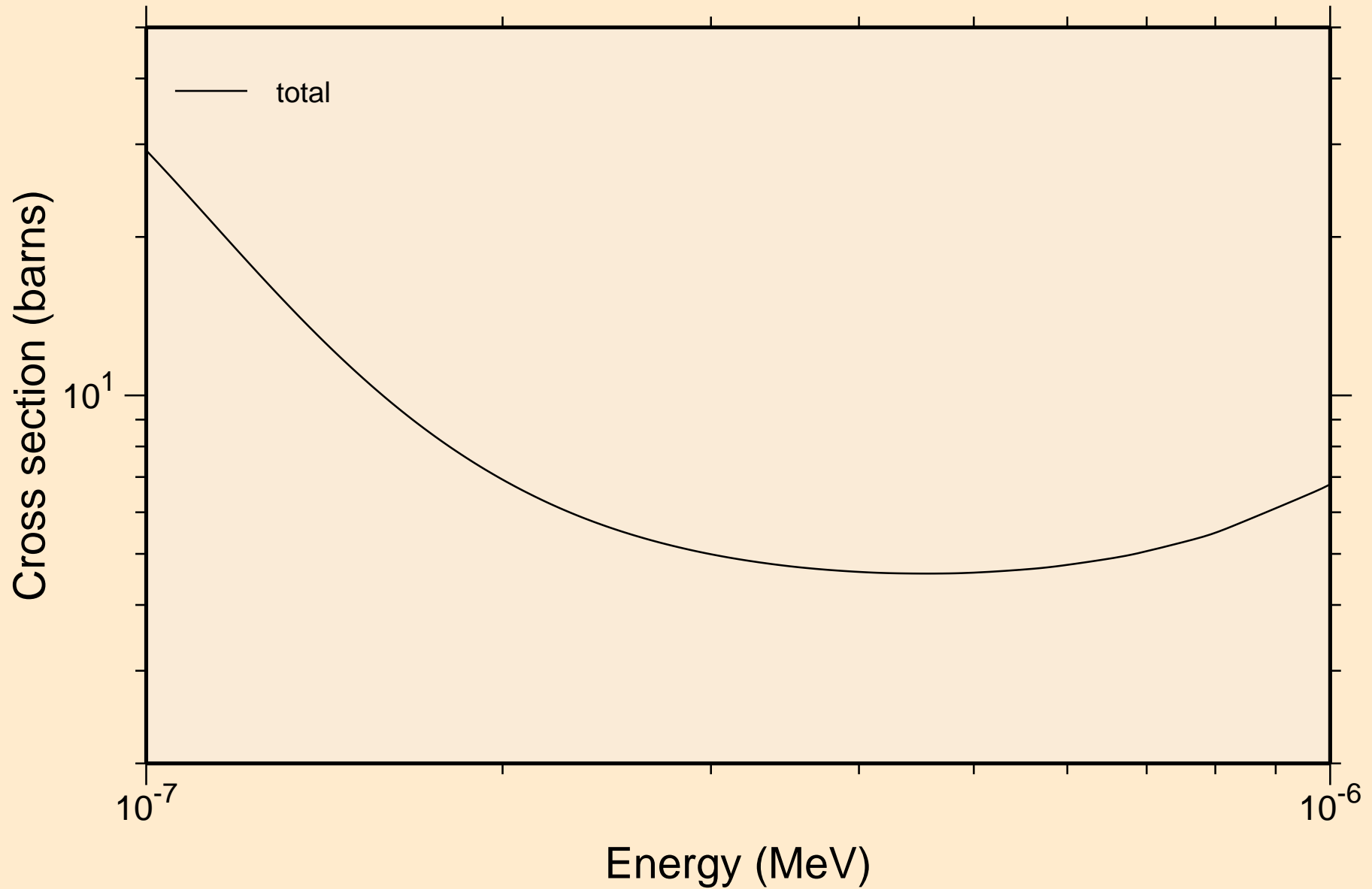

EU146 NEUTRON ACER TENDL-2021 LIBRARY; T=293.6K
resonance total cross section

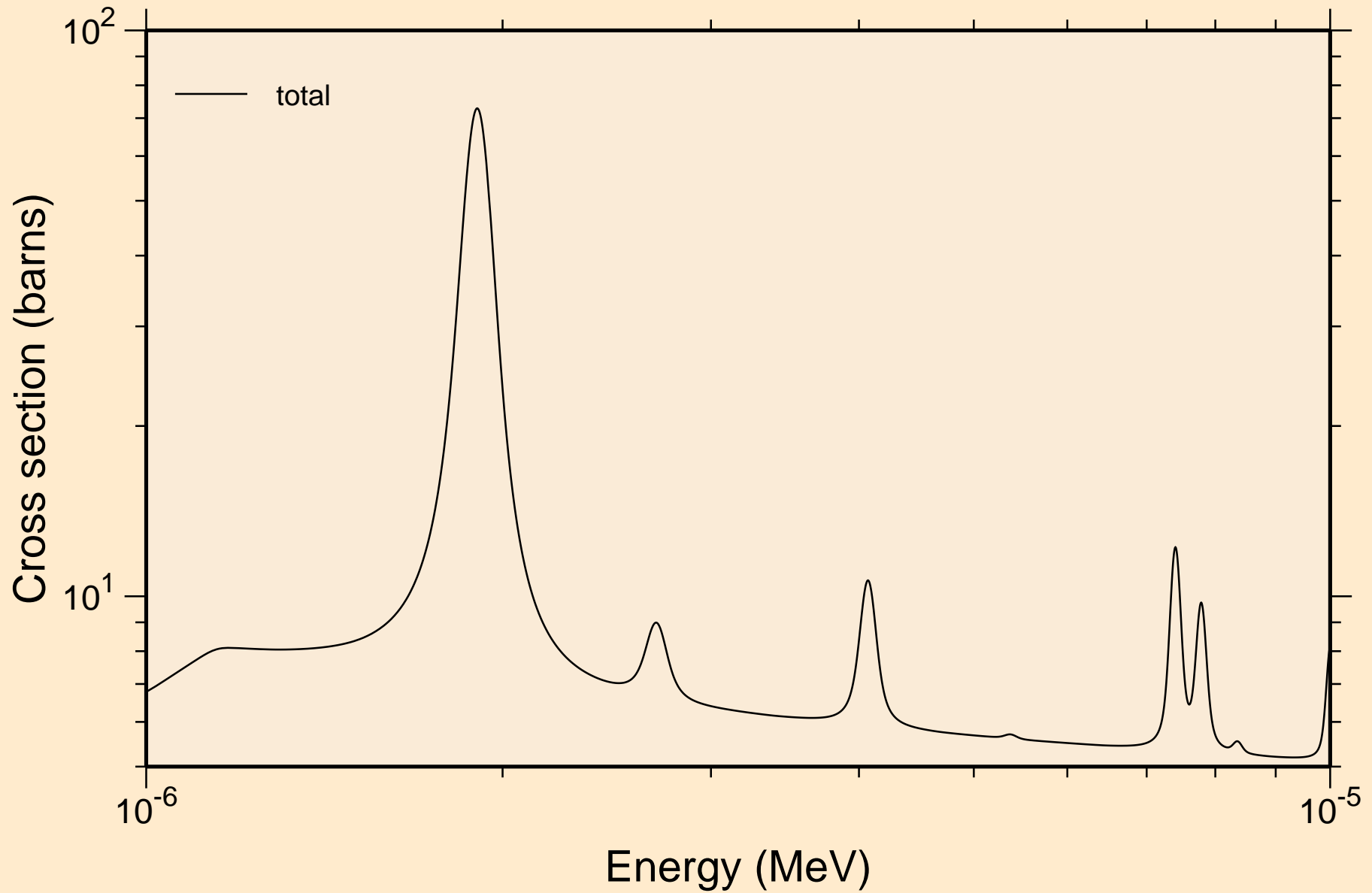

EU146 NEUTRON ACER TENDL-2021 LIBRARY; T=293.6K
resonance total cross section

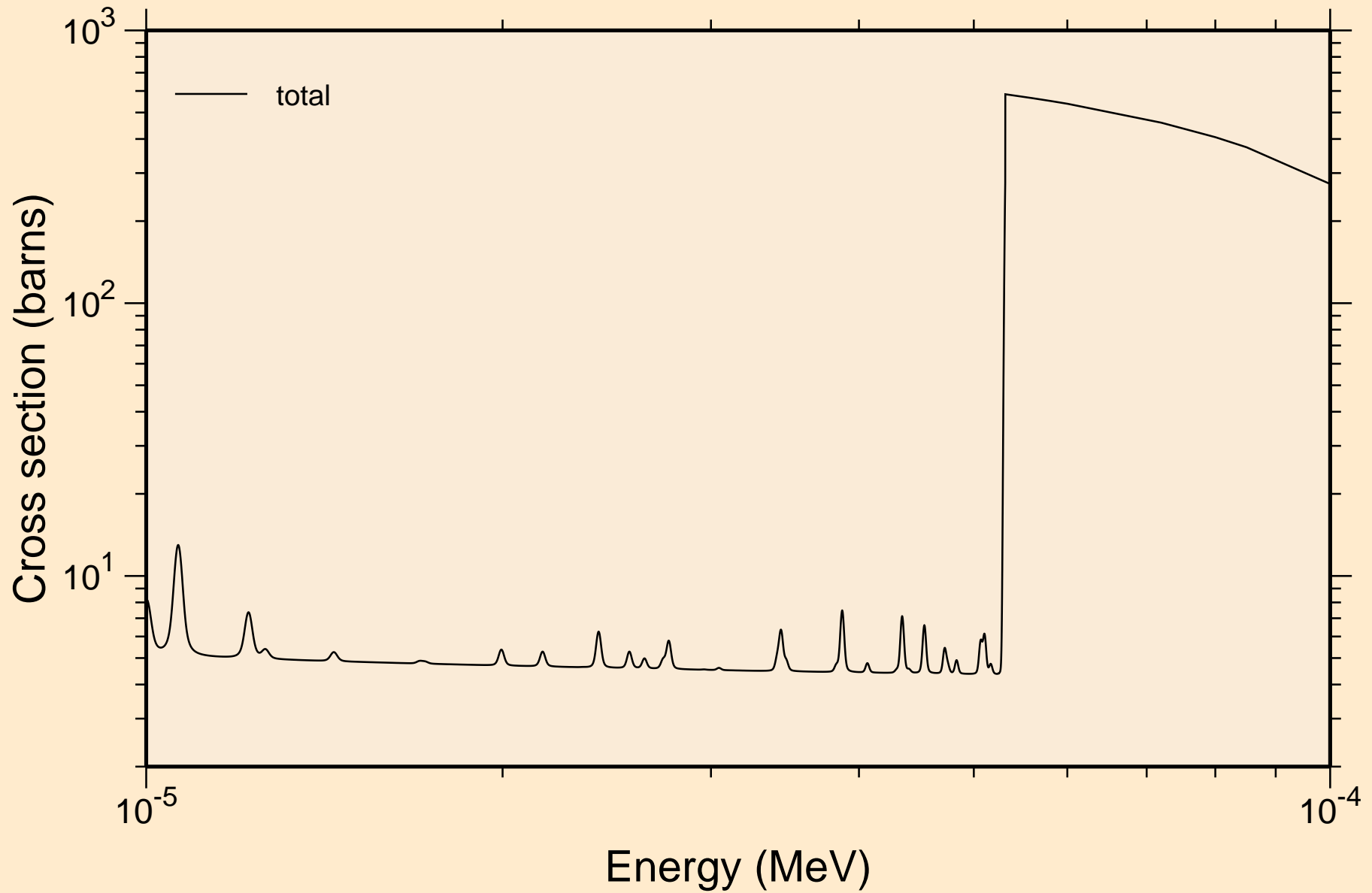

EU146 NEUTRON ACER TENDL-2021 LIBRARY; T=293.6K
resonance total cross section

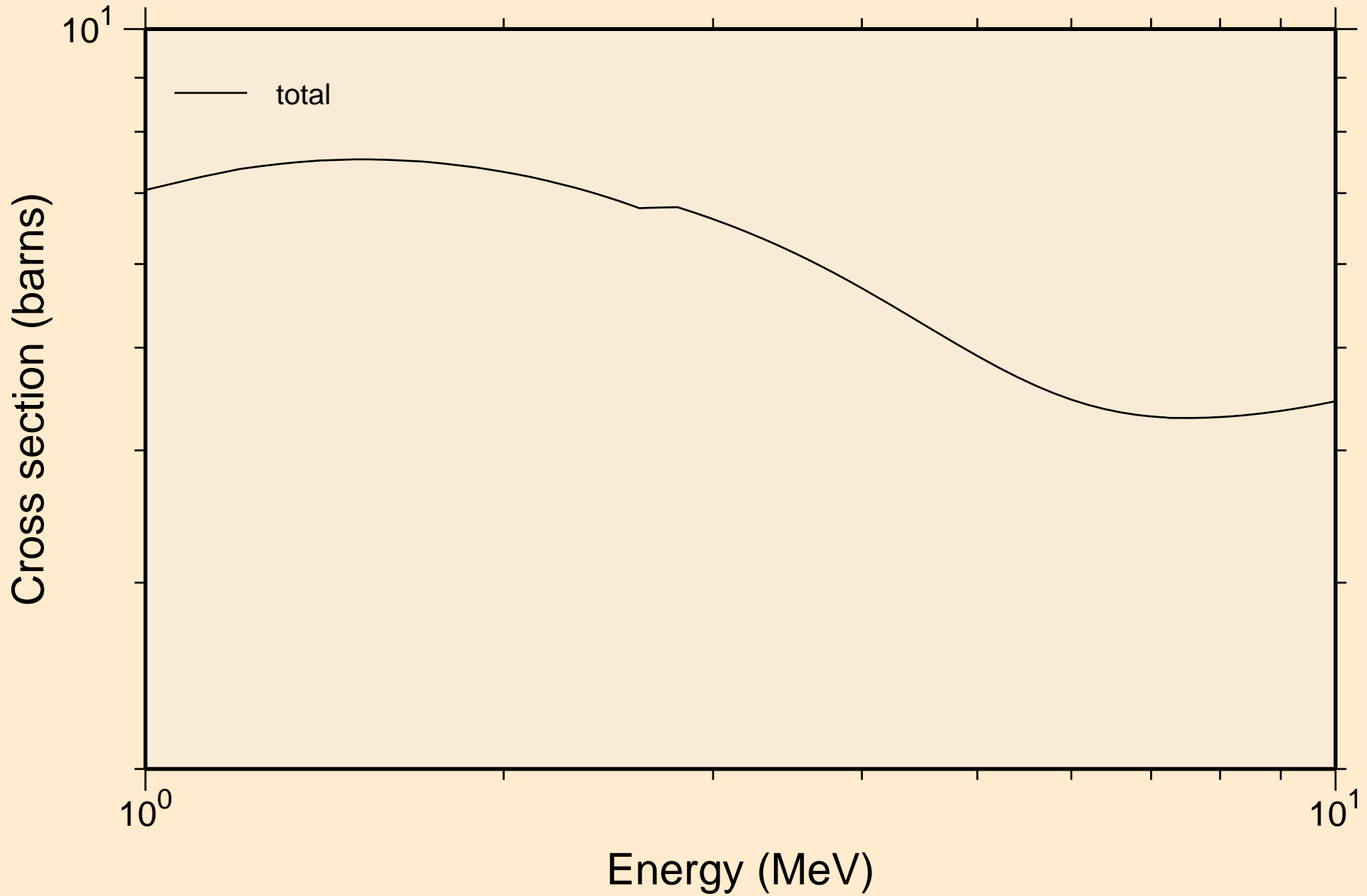

EU146 NEUTRON ACER TENDL-2021 LIBRARY; T=293.6K
resonance absorption cross sections

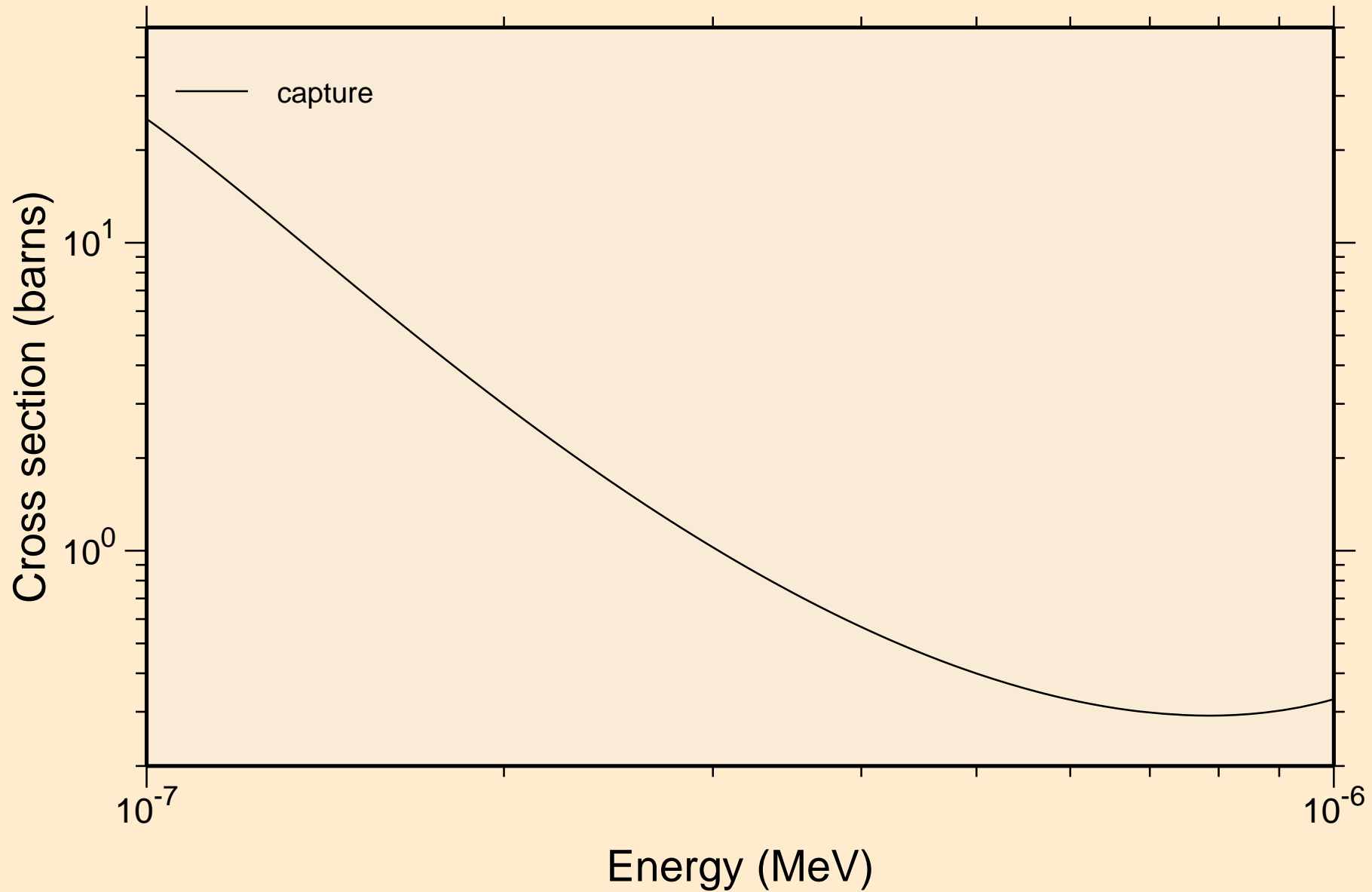

EU146 NEUTRON ACER TENDL-2021 LIBRARY; T=293.6K
resonance absorption cross sections

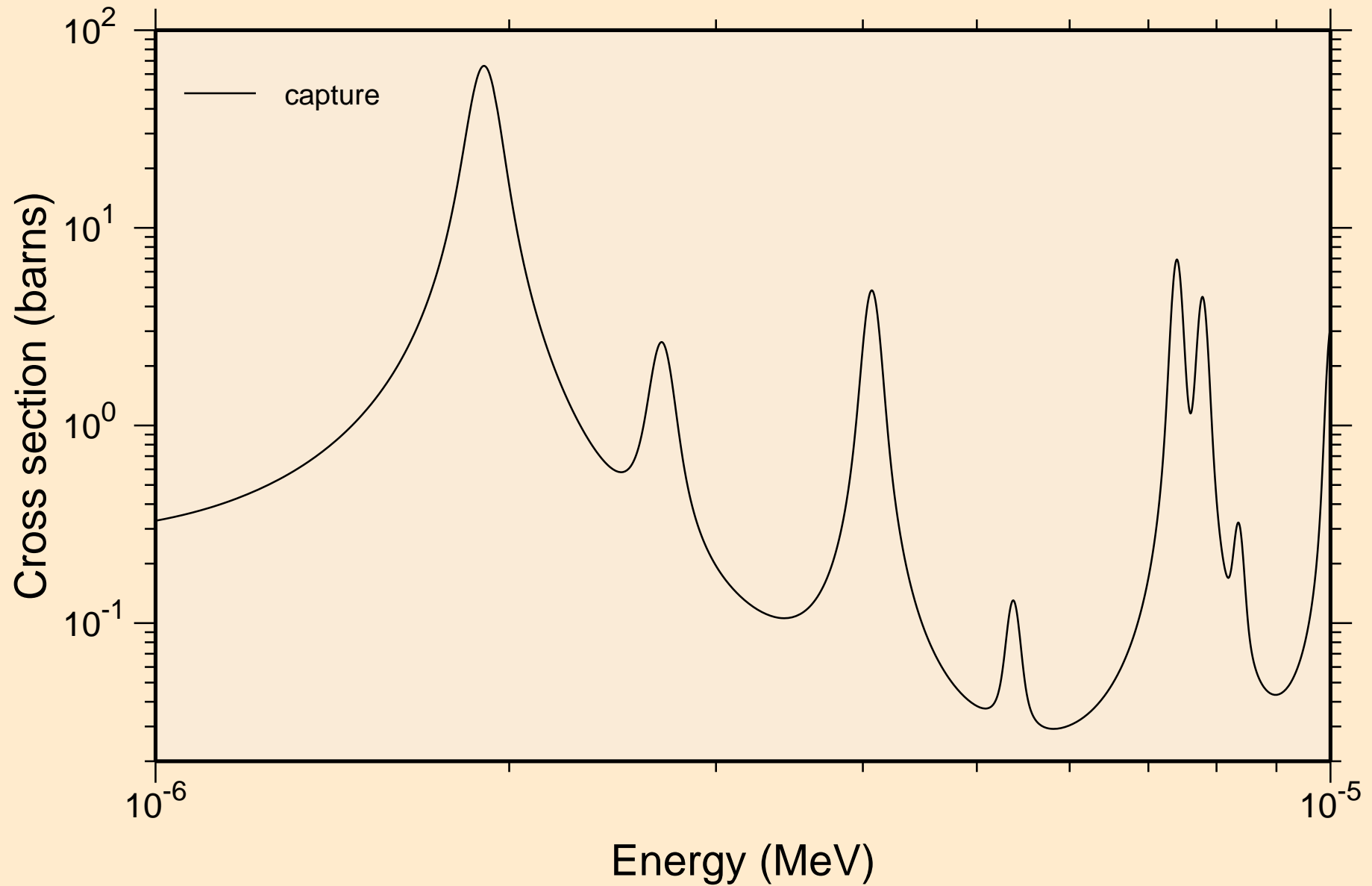

EU146 NEUTRON ACER TENDL-2021 LIBRARY; T=293.6K
resonance absorption cross sections

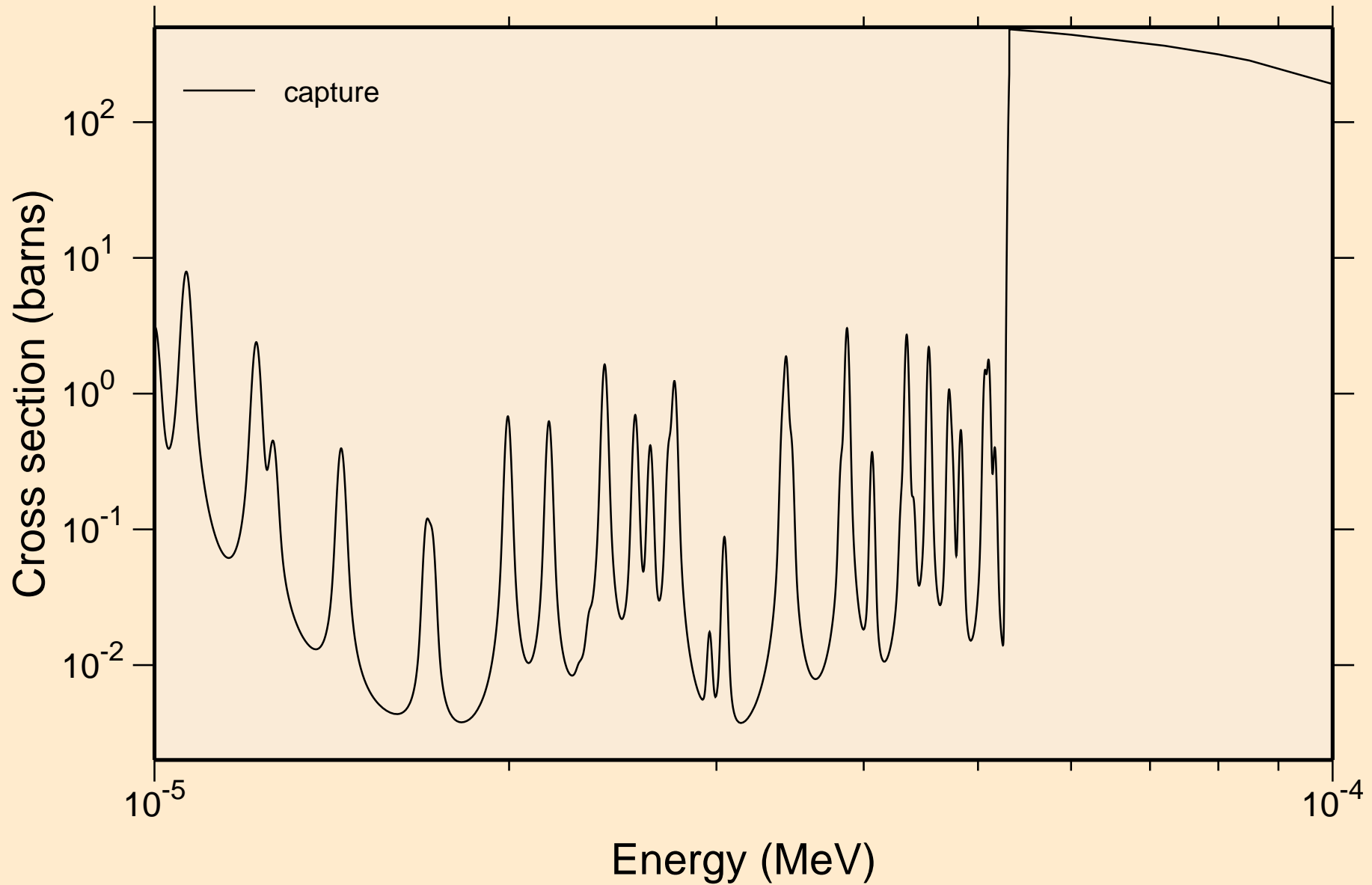

EU146 NEUTRON ACER TENDL-2021 LIBRARY; T=293.6K
resonance absorption cross sections

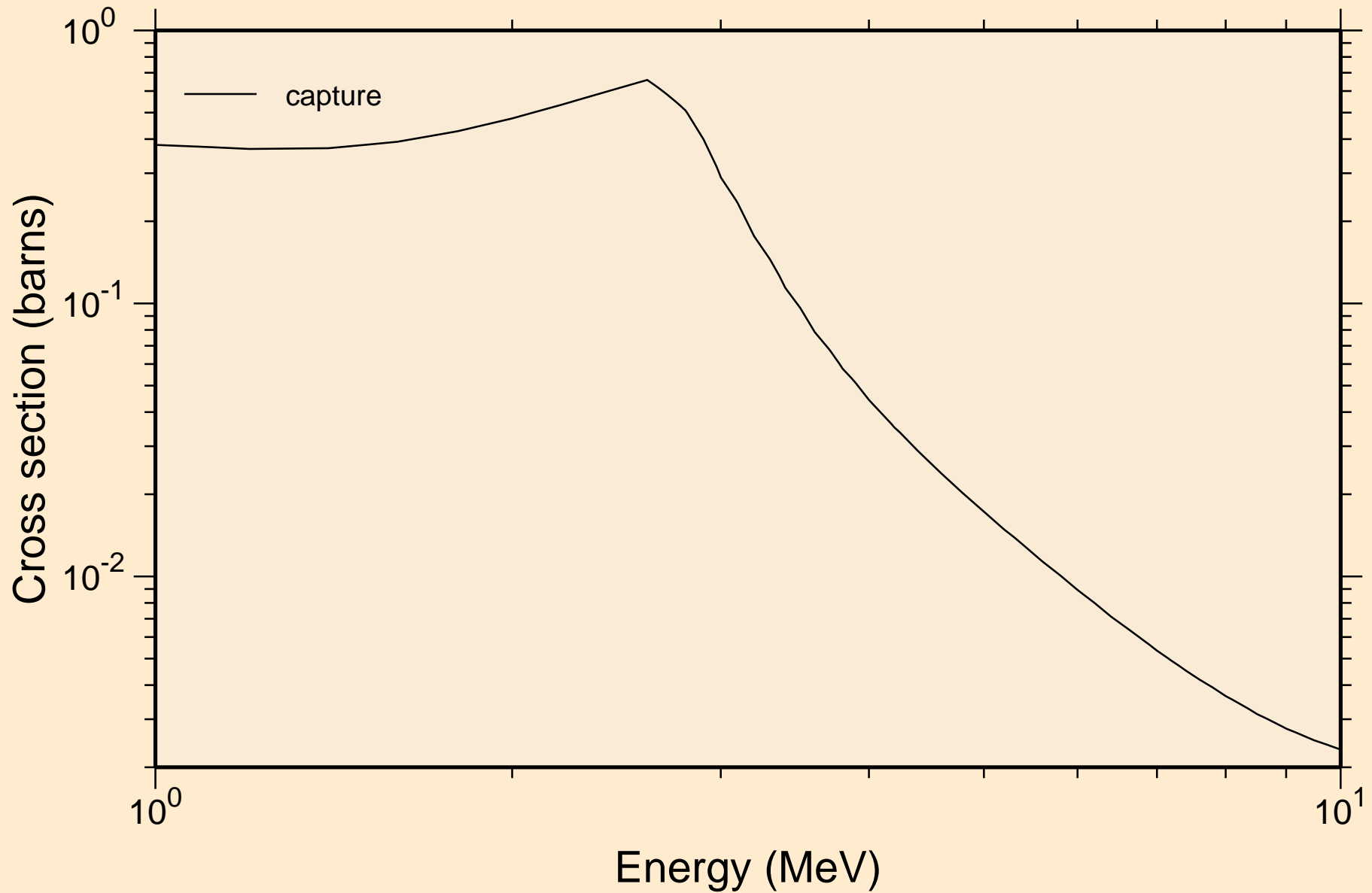

EU146 NEUTRON ACER TENDL-2021 LIBRARY; T=293.6K
Heating

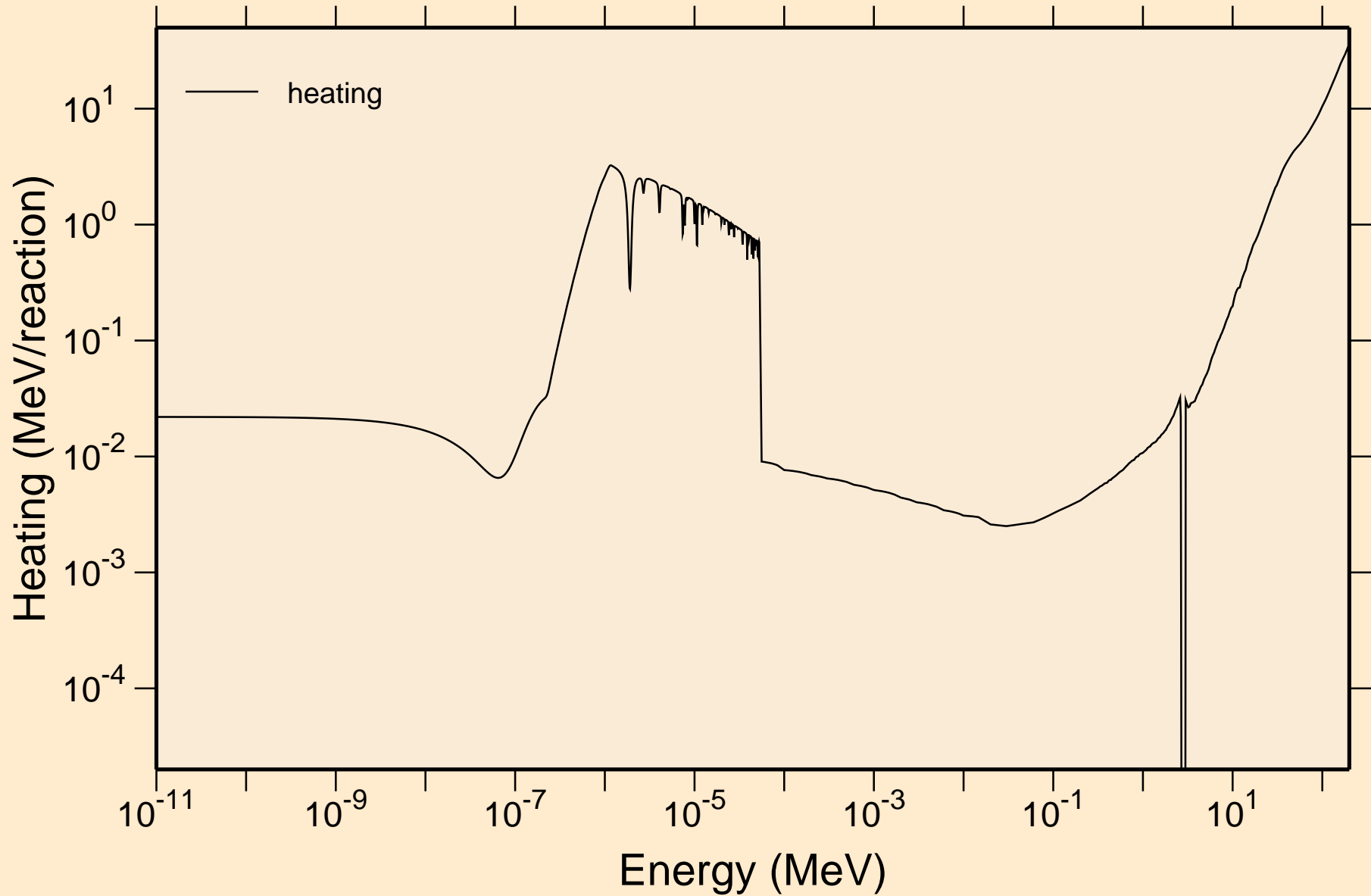

EU146 NEUTRON ACER TENDL-2021 LIBRARY; T=293.6K
Damage

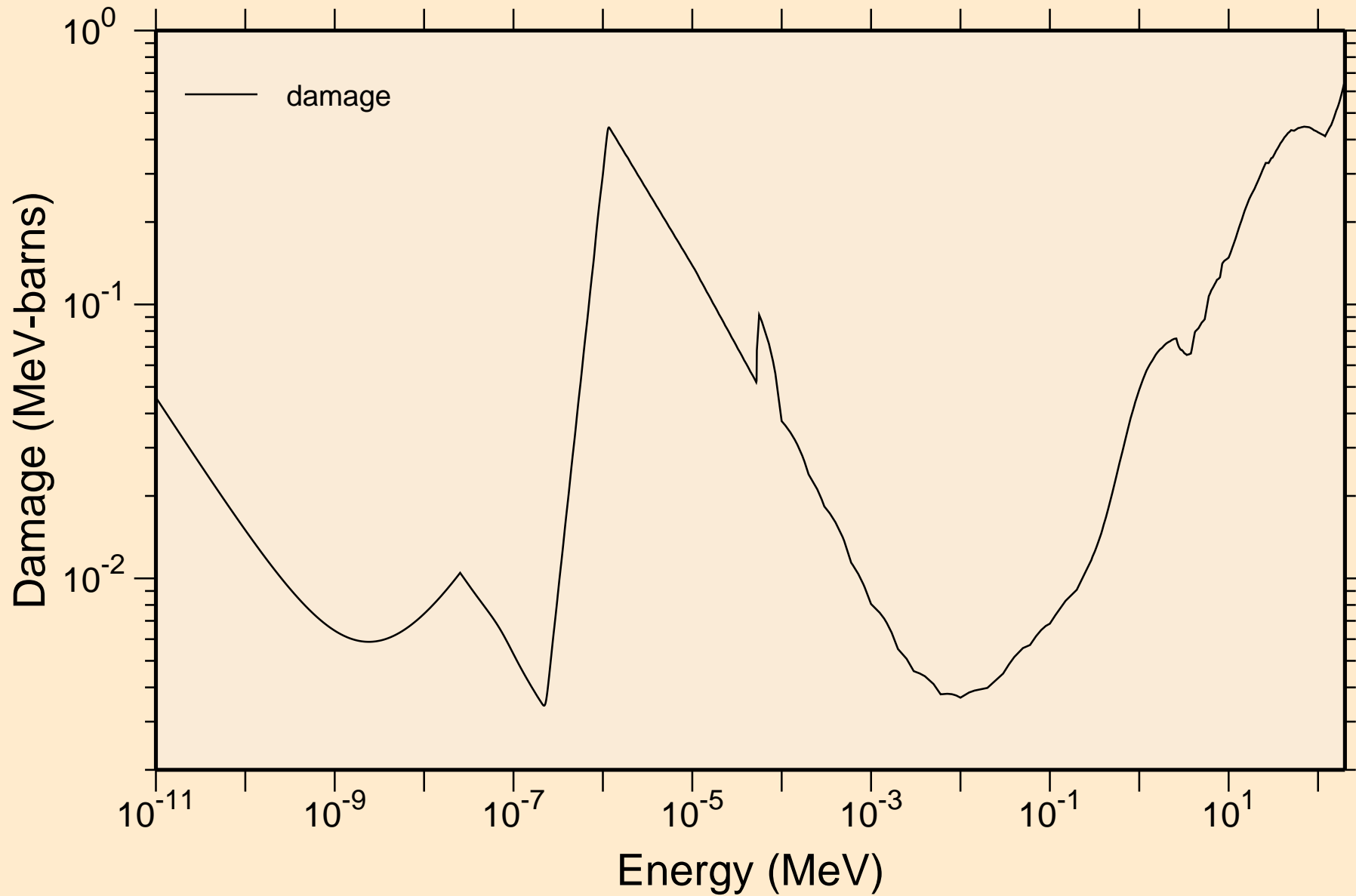

EU146 NEUTRON ACER TENDL-2021 LIBRARY; T=293.6K
Non-threshold reactions

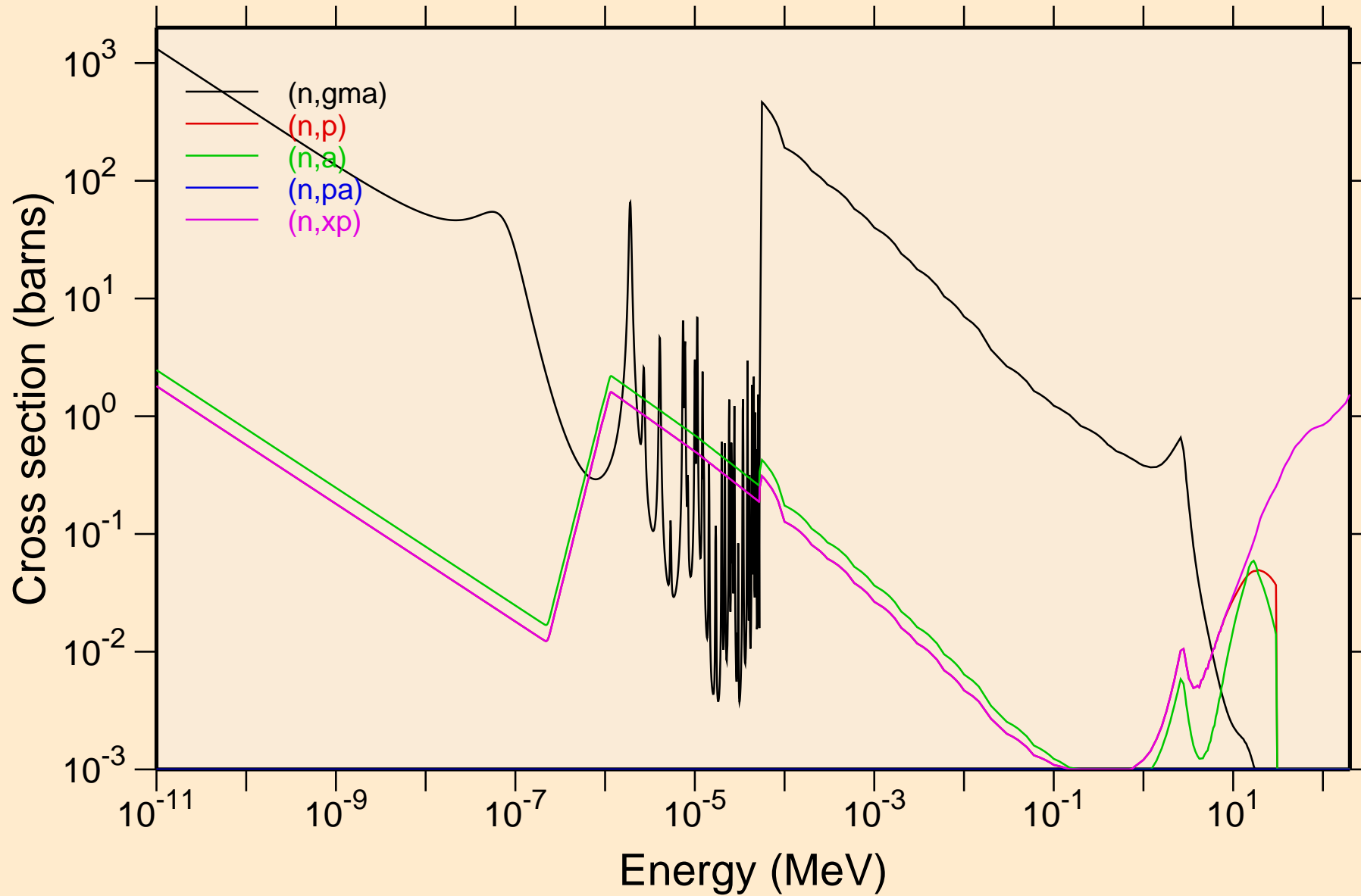

EU146 NEUTRON ACER TENDL-2021 LIBRARY; T=293.6K
Non-threshold reactions

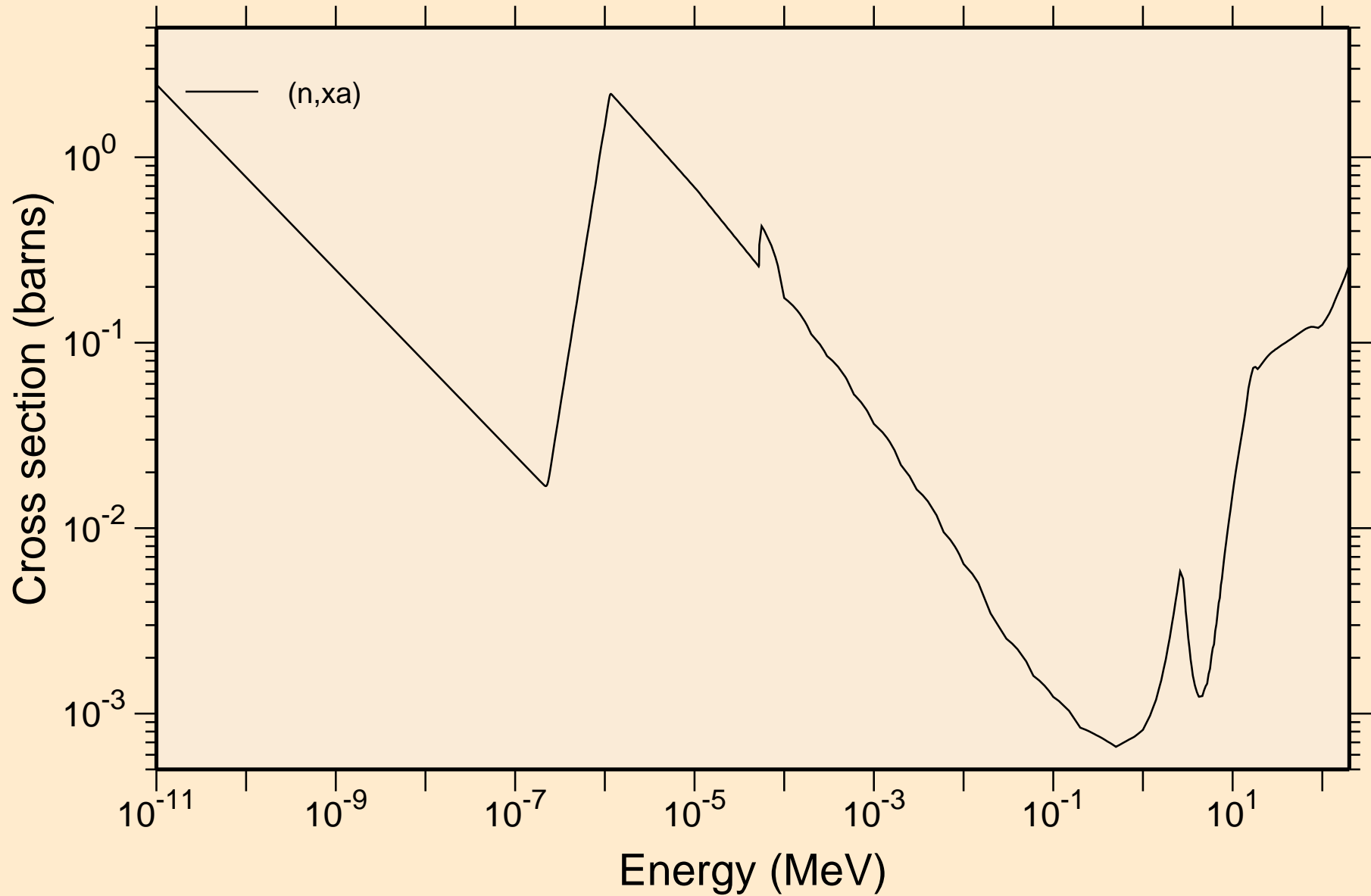

EU146 NEUTRON ACER TENDL-2021 LIBRARY; T=293.6K
Principal cross sections

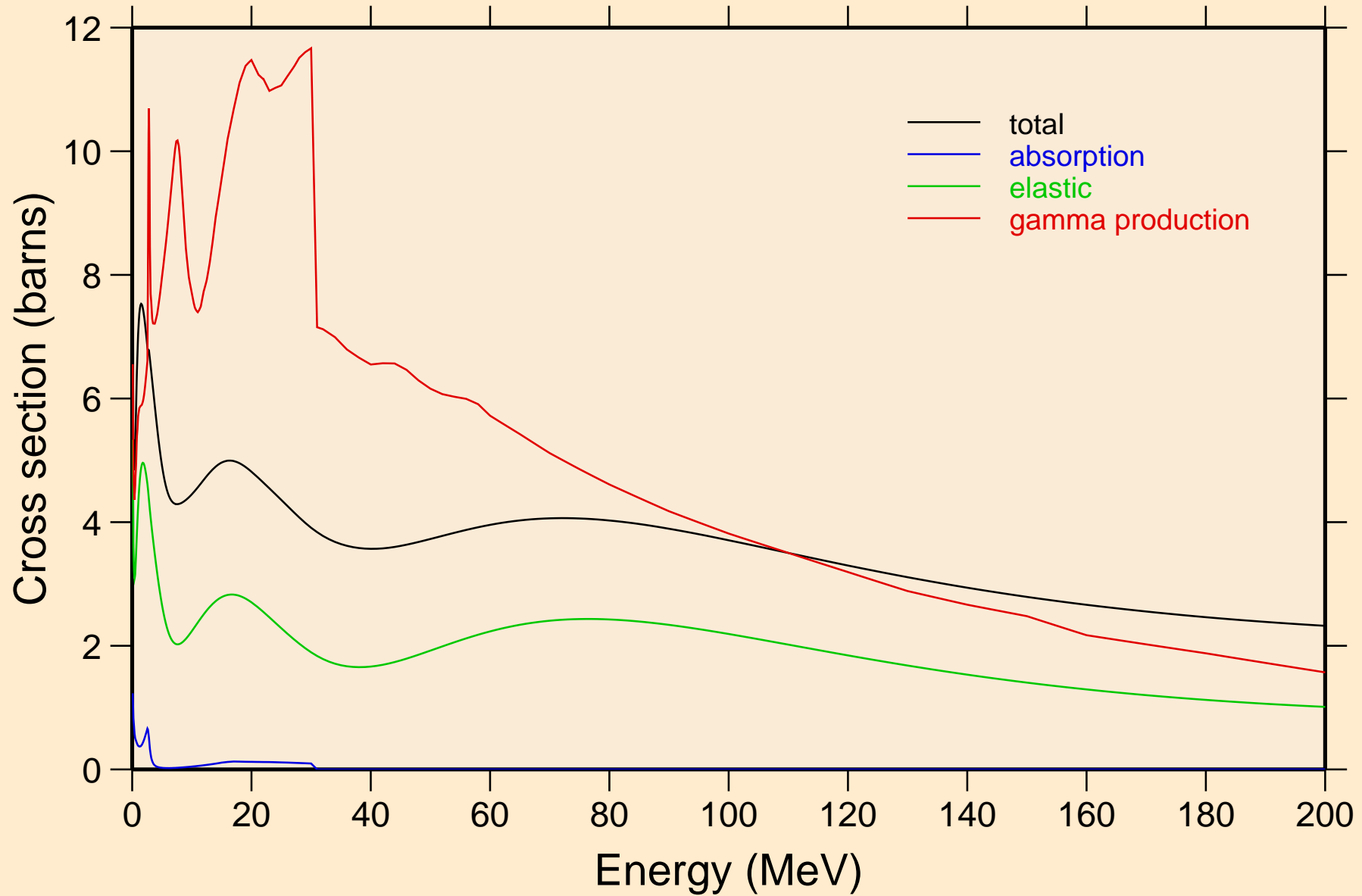

EU146 NEUTRON ACER TENDL-2021 LIBRARY; T=293.6K
Heating

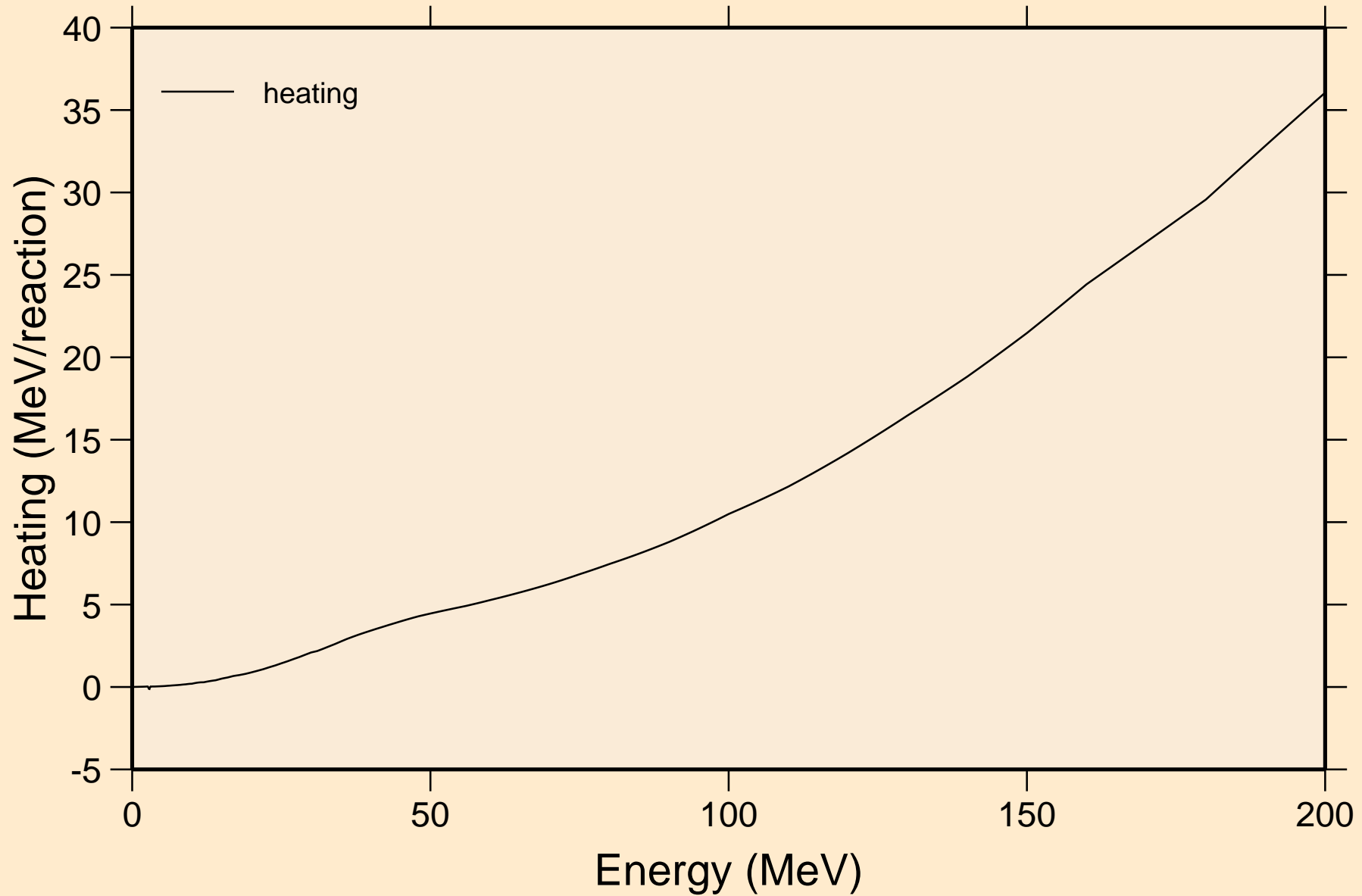

EU146 NEUTRON ACER TENDL-2021 LIBRARY; T=293.6K
Damage

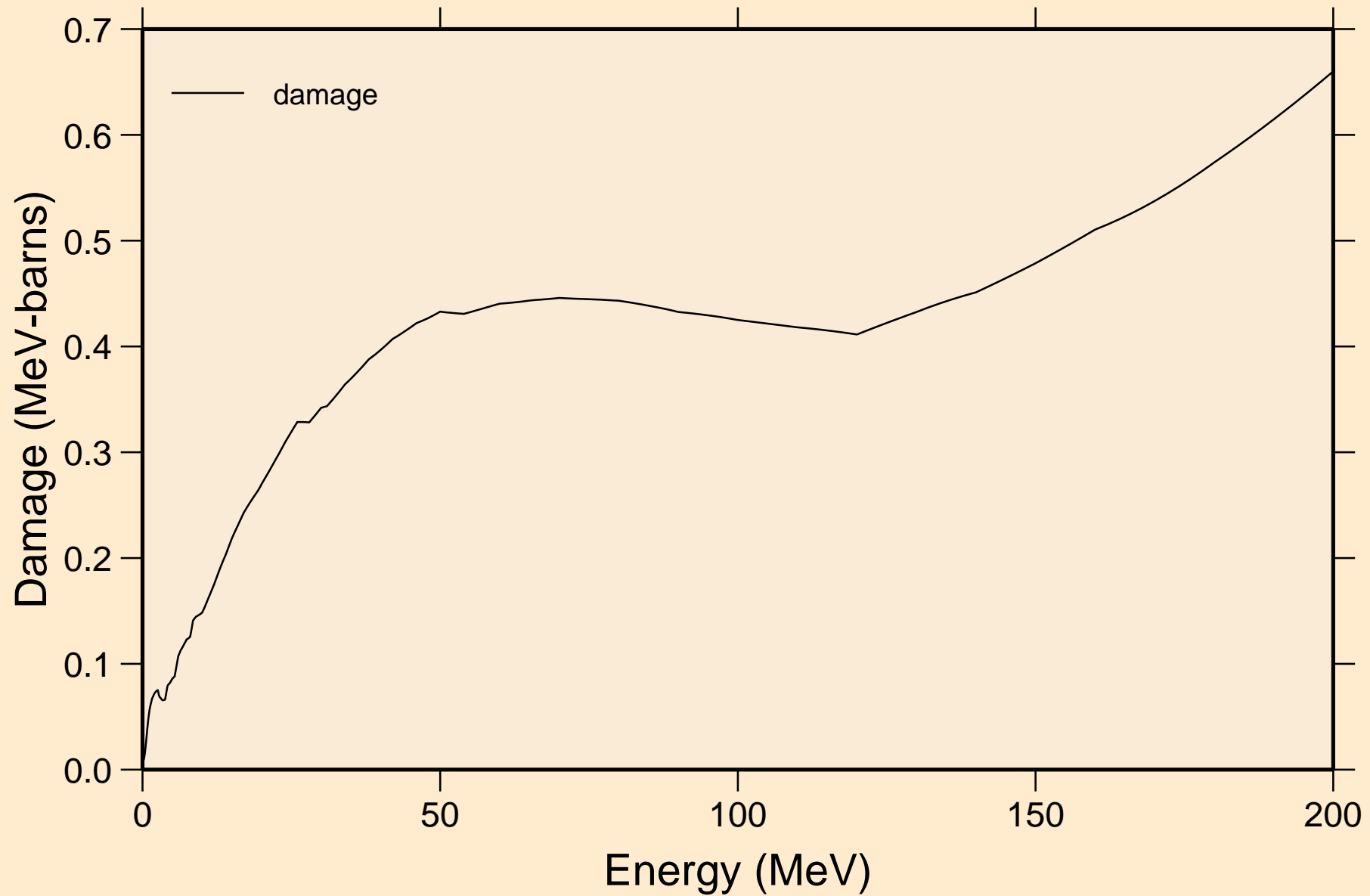

EU146 NEUTRON ACER TENDL-2021 LIBRARY; T=293.6K
Non-threshold reactions

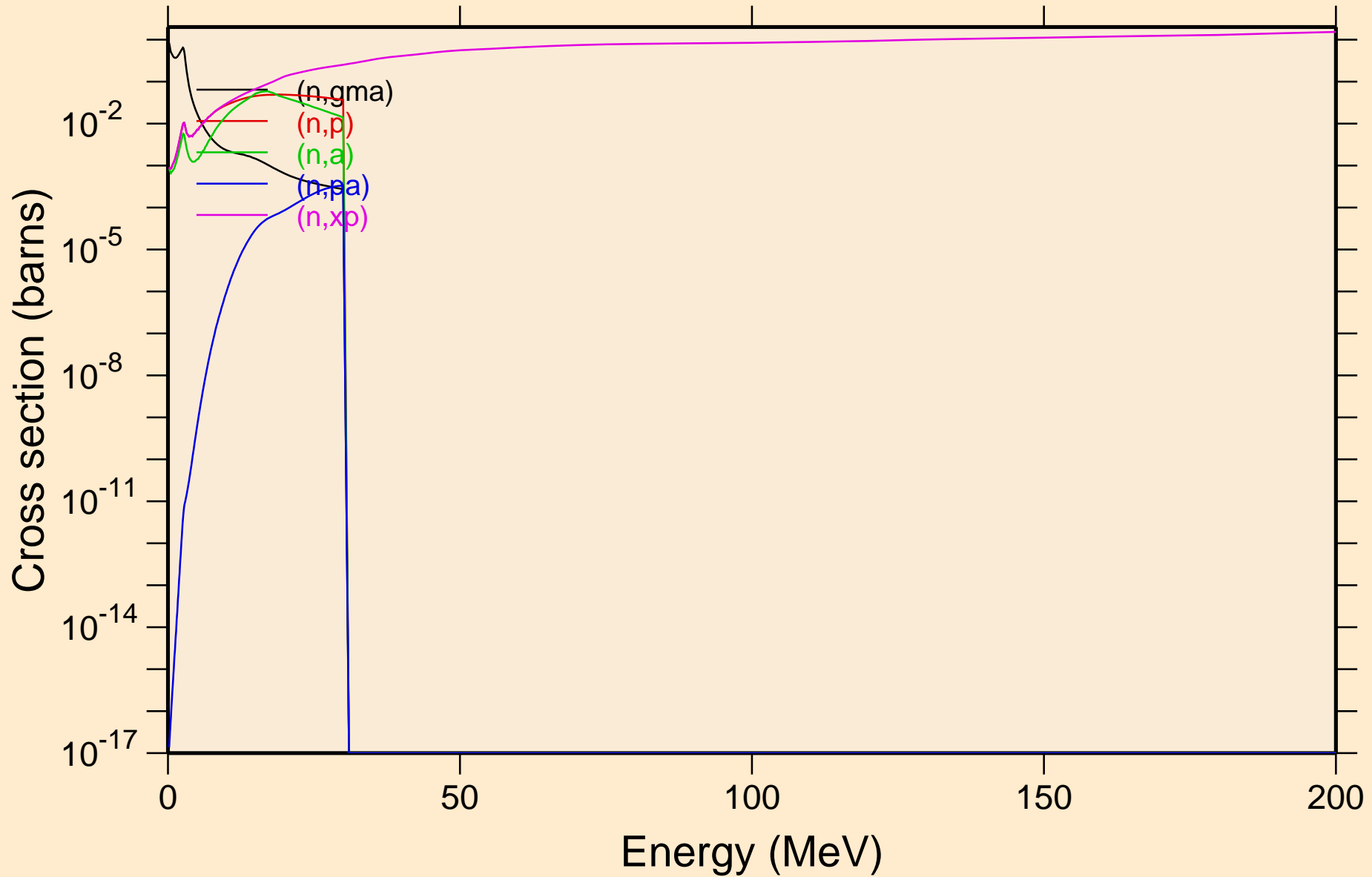

EU146 NEUTRON ACER TENDL-2021 LIBRARY; T=293.6K
Non-threshold reactions

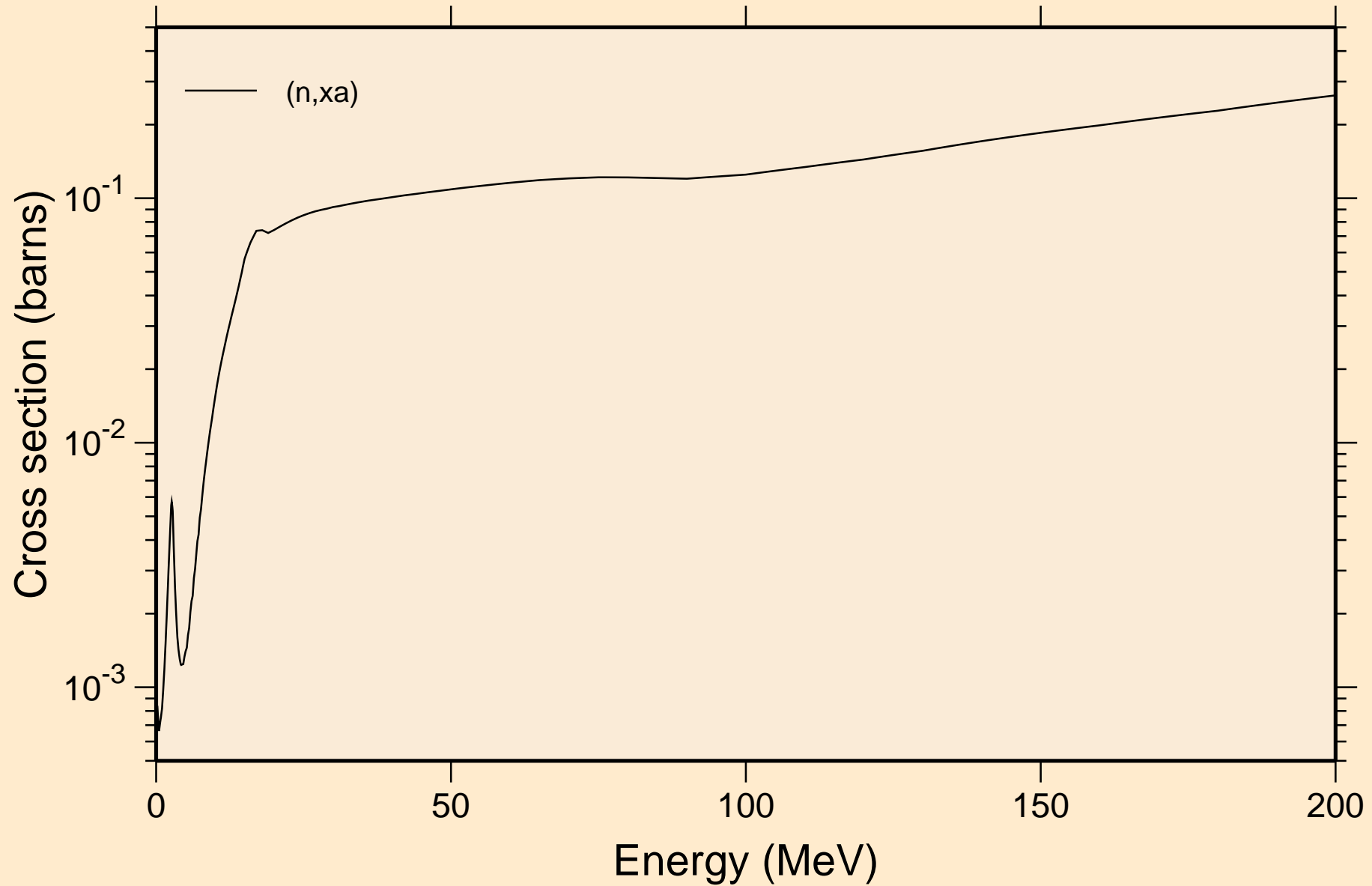

EU146 NEUTRON ACER TENDL-2021 LIBRARY; T=293.6K
Inelastic levels

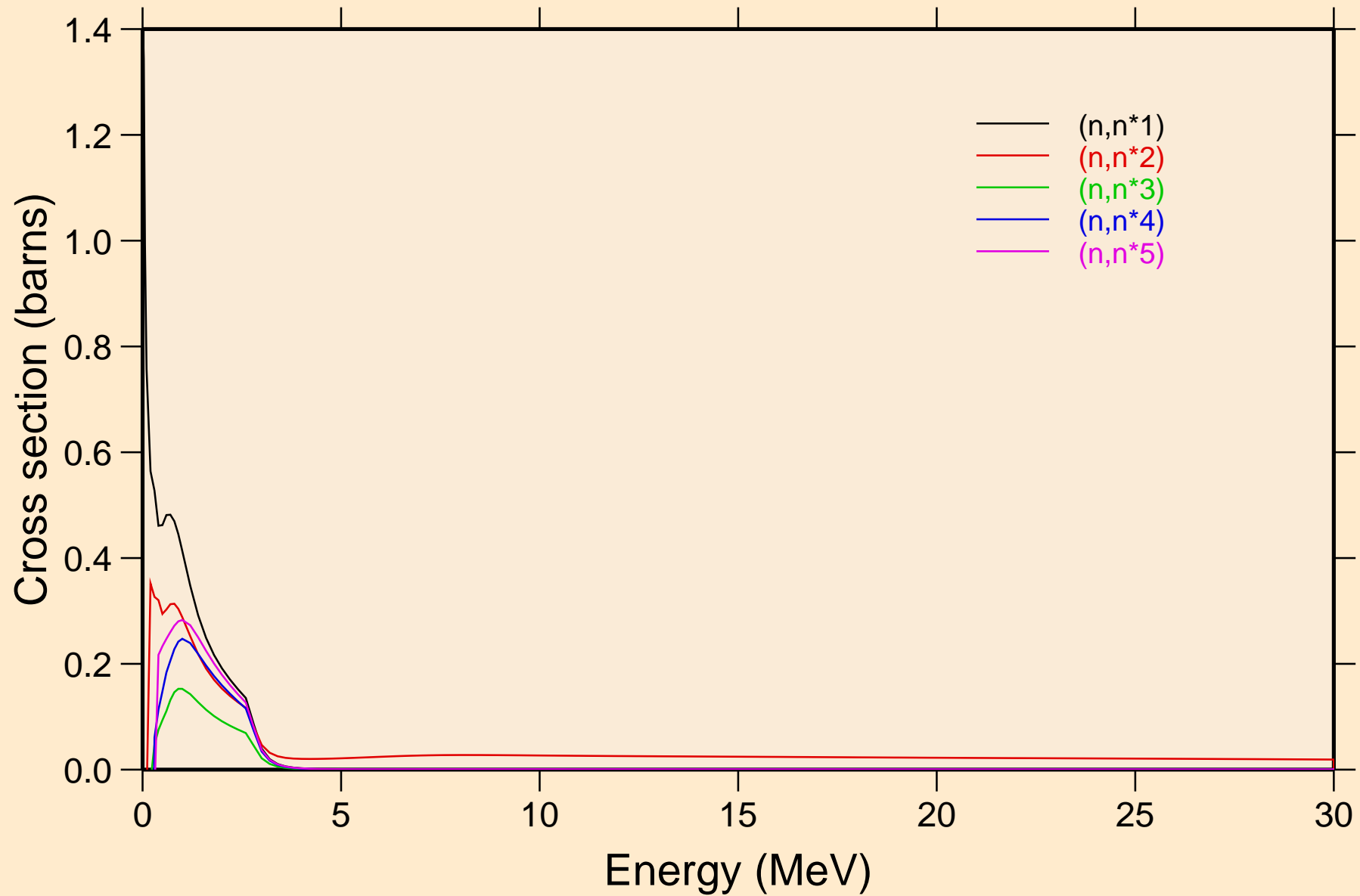

EU146 NEUTRON ACER TENDL-2021 LIBRARY; T=293.6K
Inelastic levels

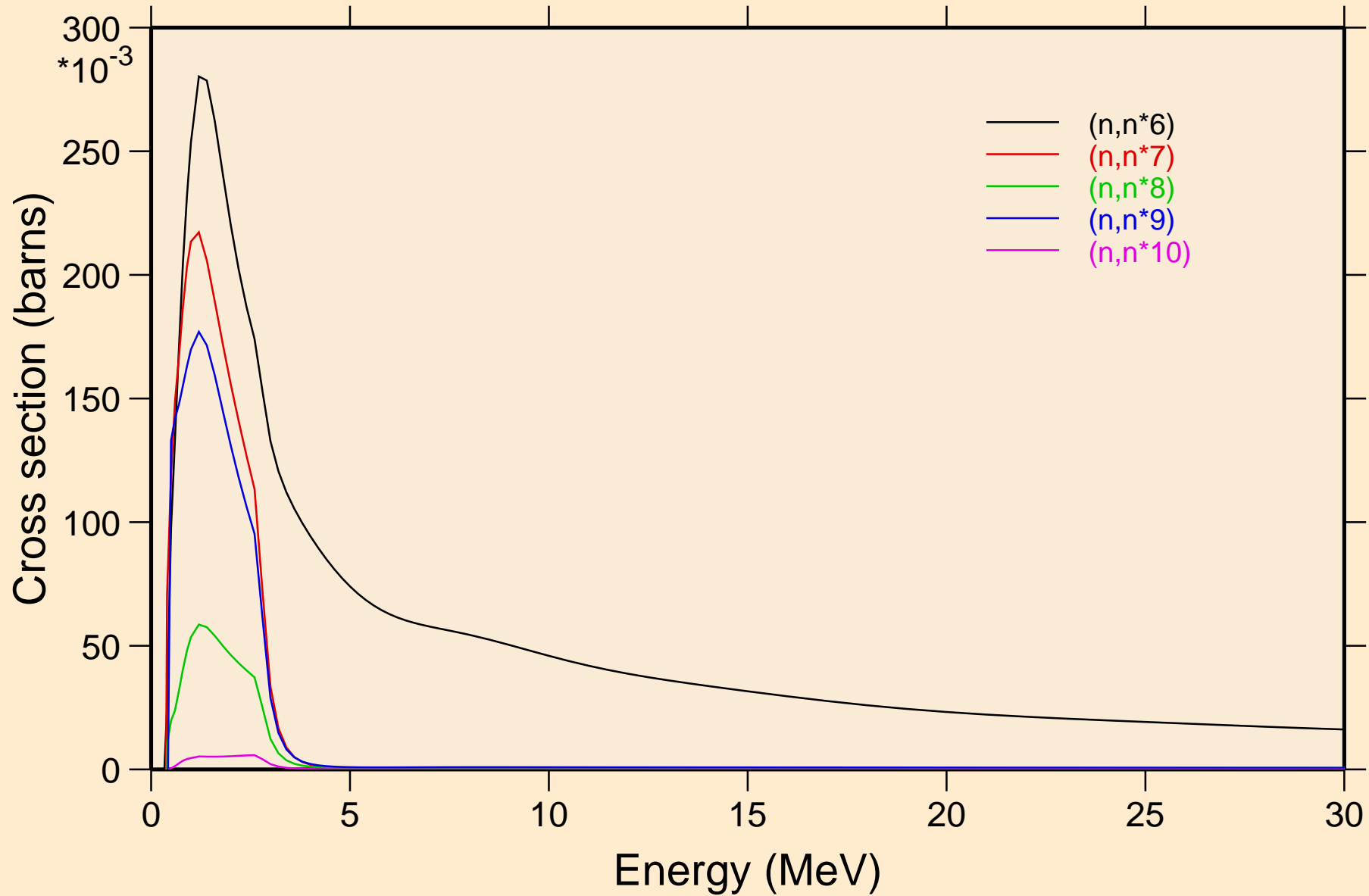

EU146 NEUTRON ACER TENDL-2021 LIBRARY; T=293.6K
Inelastic levels

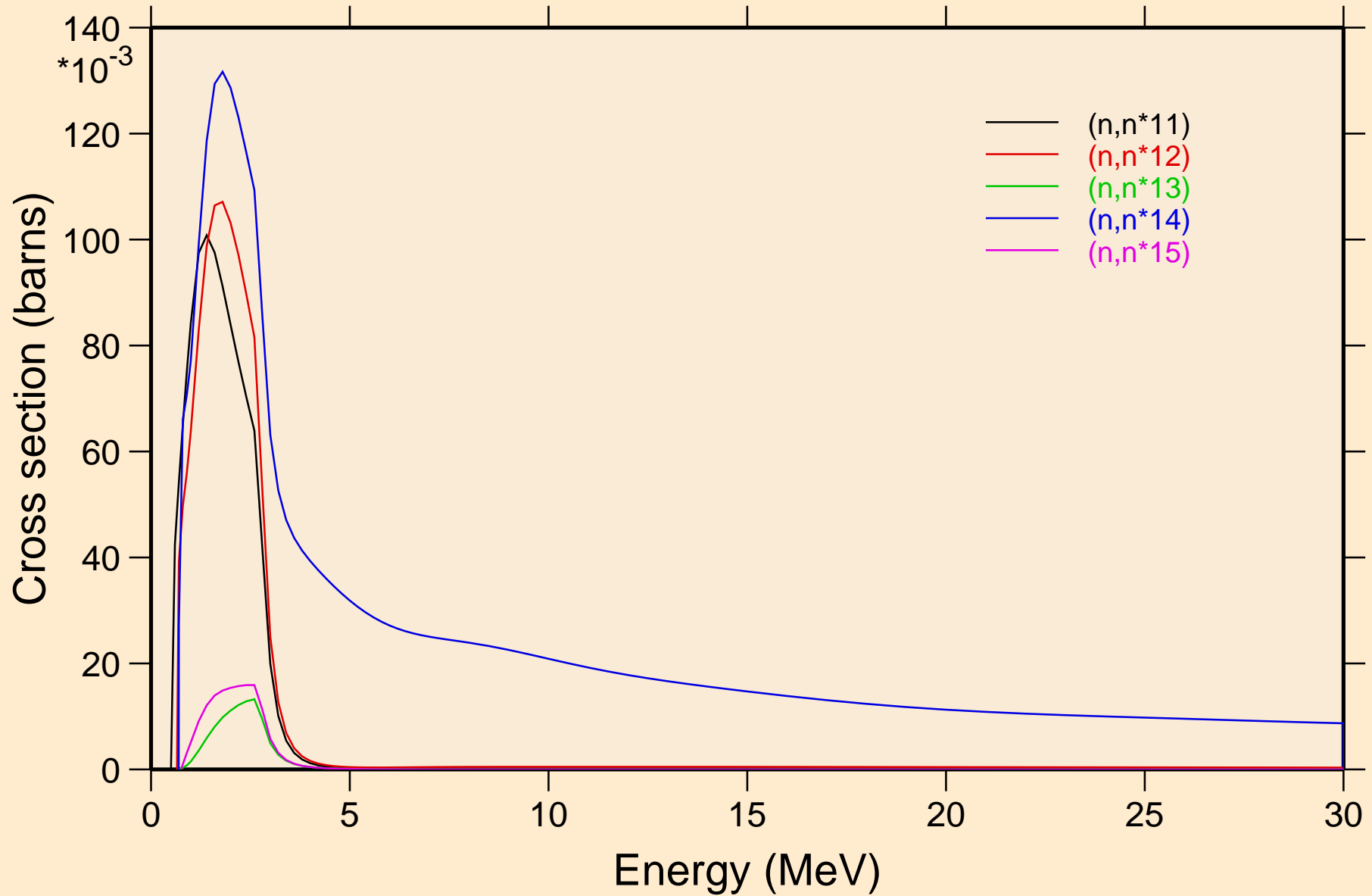

EU146 NEUTRON ACER TENDL-2021 LIBRARY; T=293.6K
Inelastic levels

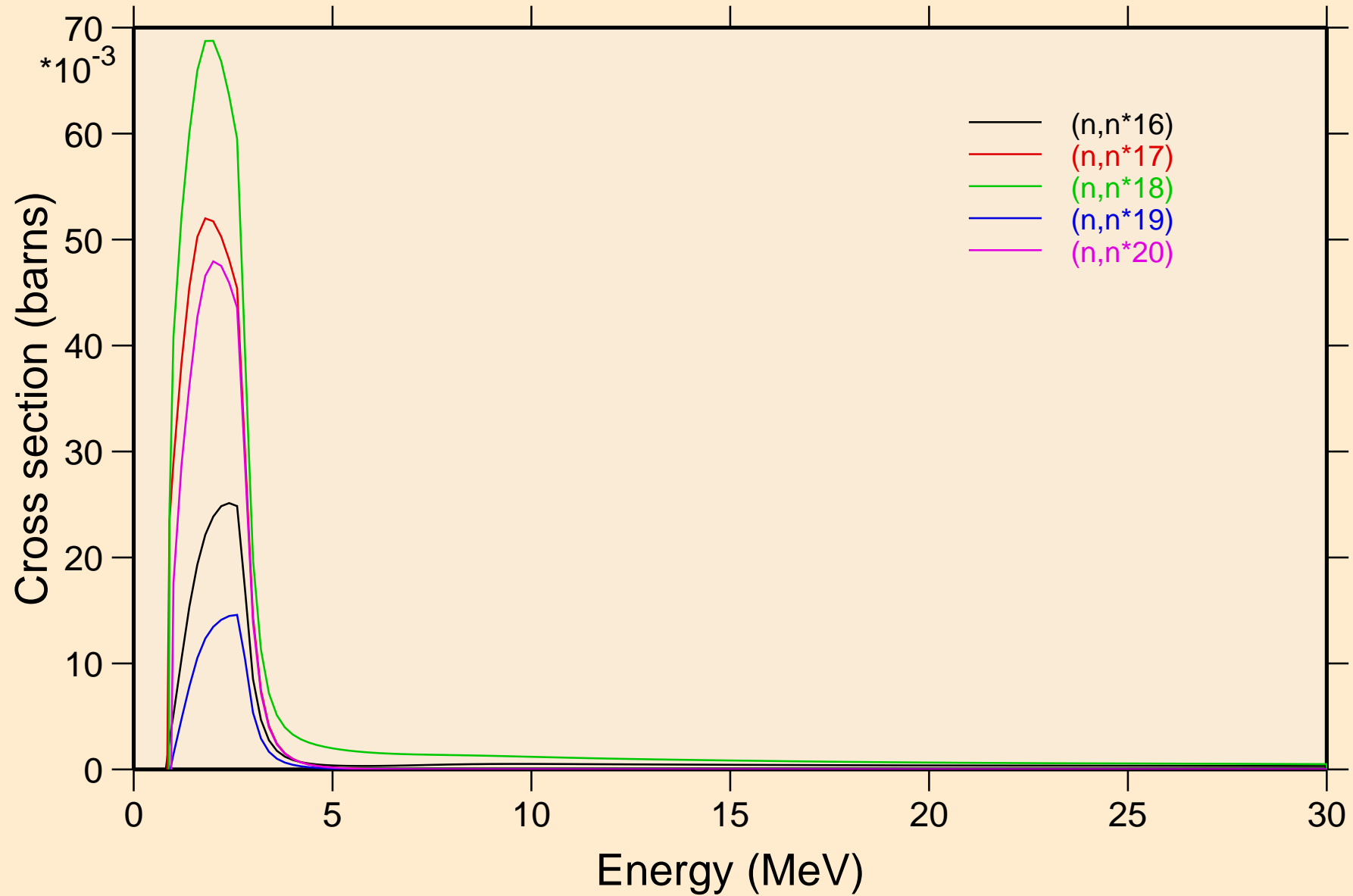

EU146 NEUTRON ACER TENDL-2021 LIBRARY; T=293.6K
Inelastic levels

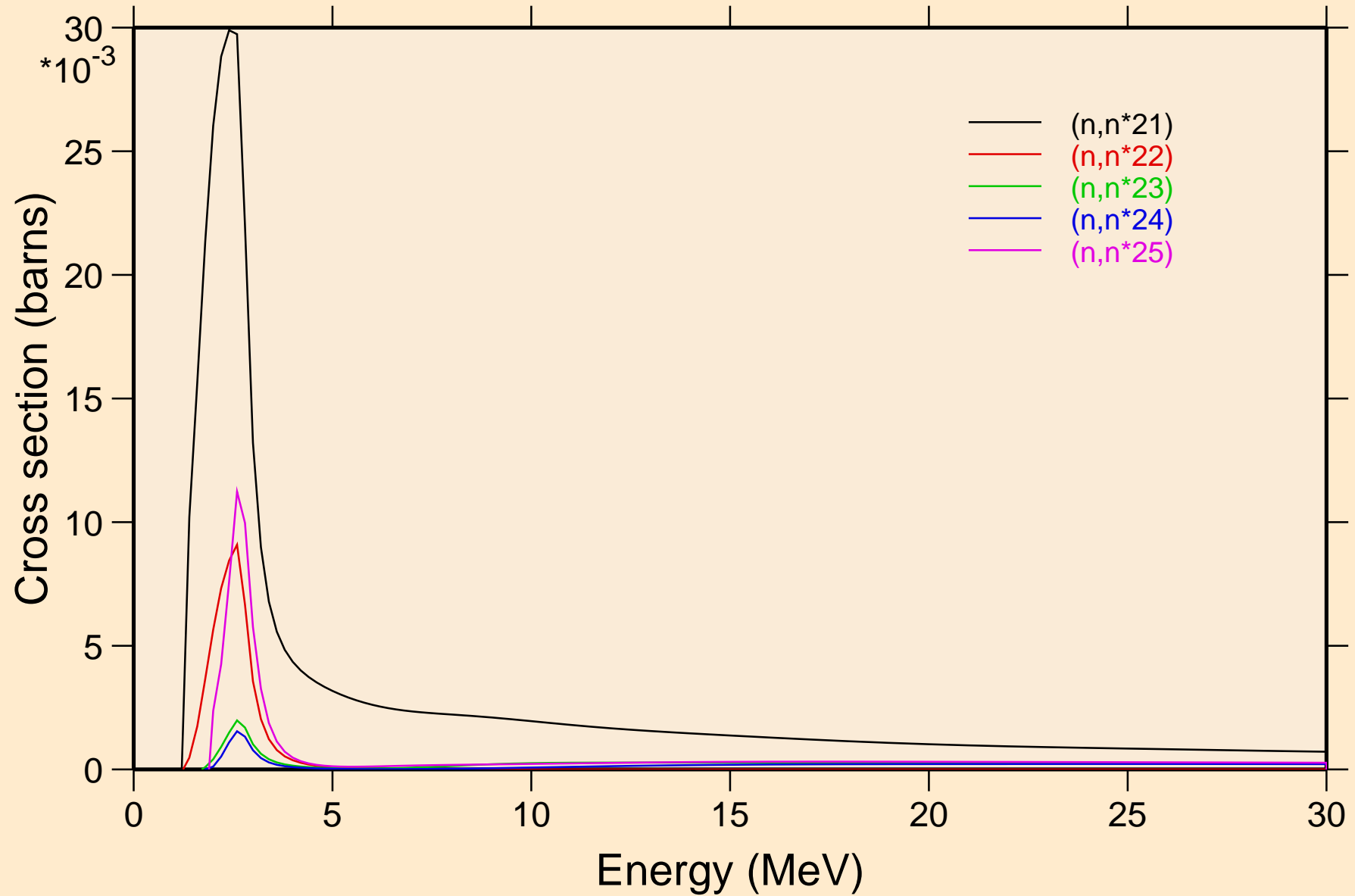

EU146 NEUTRON ACER TENDL-2021 LIBRARY; T=293.6K
Threshold reactions

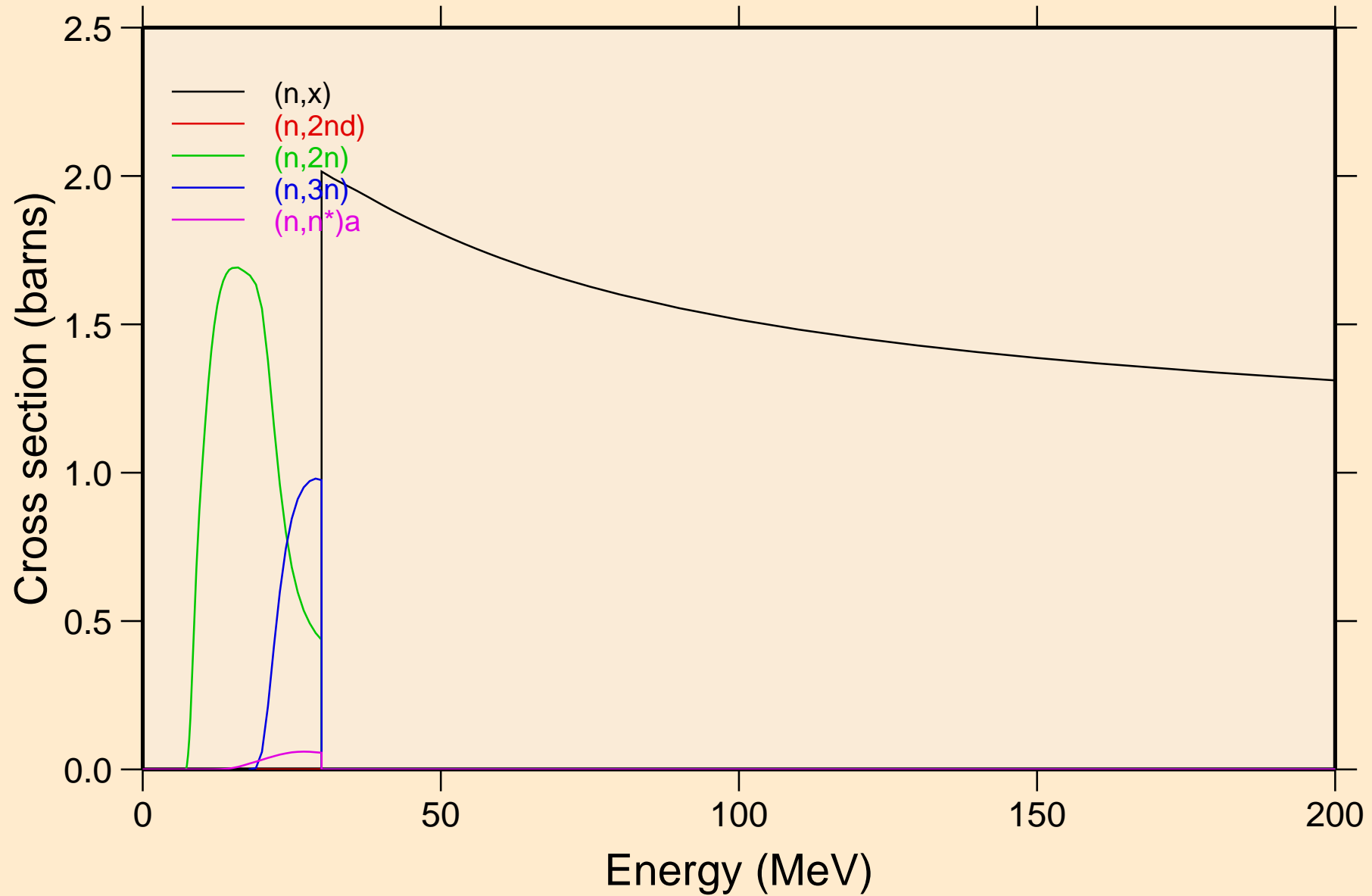

EU146 NEUTRON ACER TENDL-2021 LIBRARY; T=293.6K

Threshold reactions

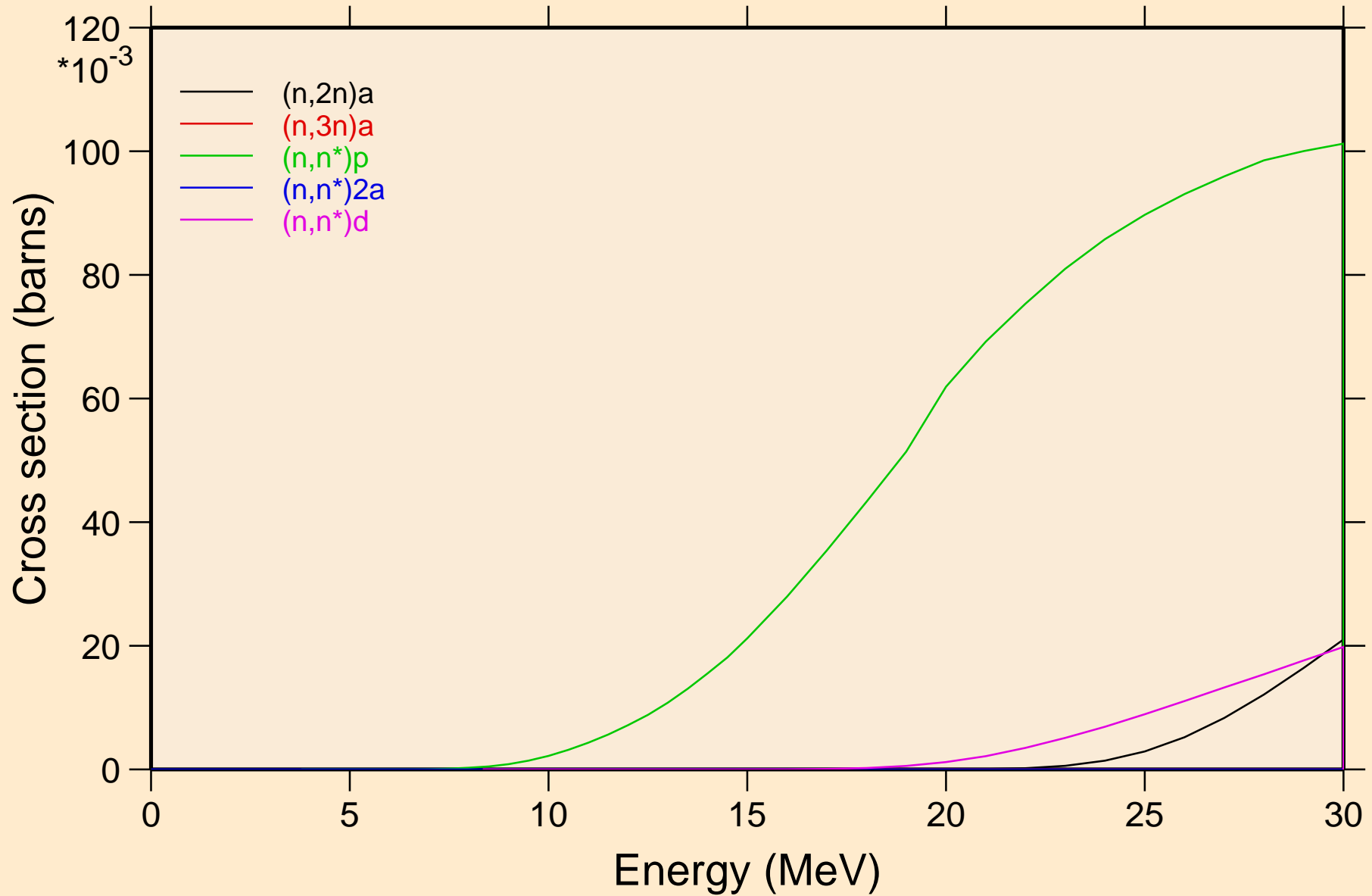

EU146 NEUTRON ACER TENDL-2021 LIBRARY; T=293.6K
Threshold reactions

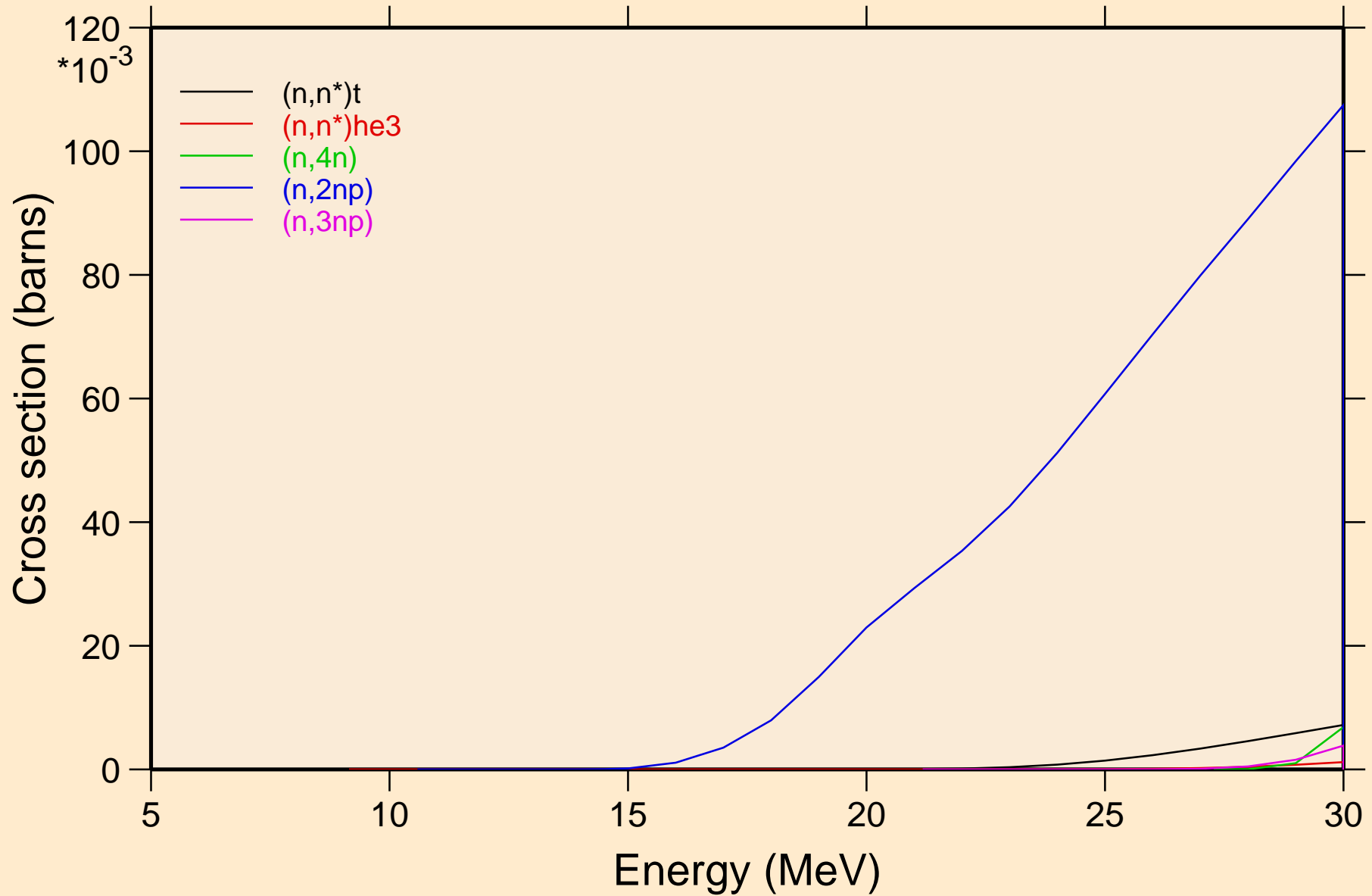

EU146 NEUTRON ACER TENDL-2021 LIBRARY; T=293.6K

Threshold reactions

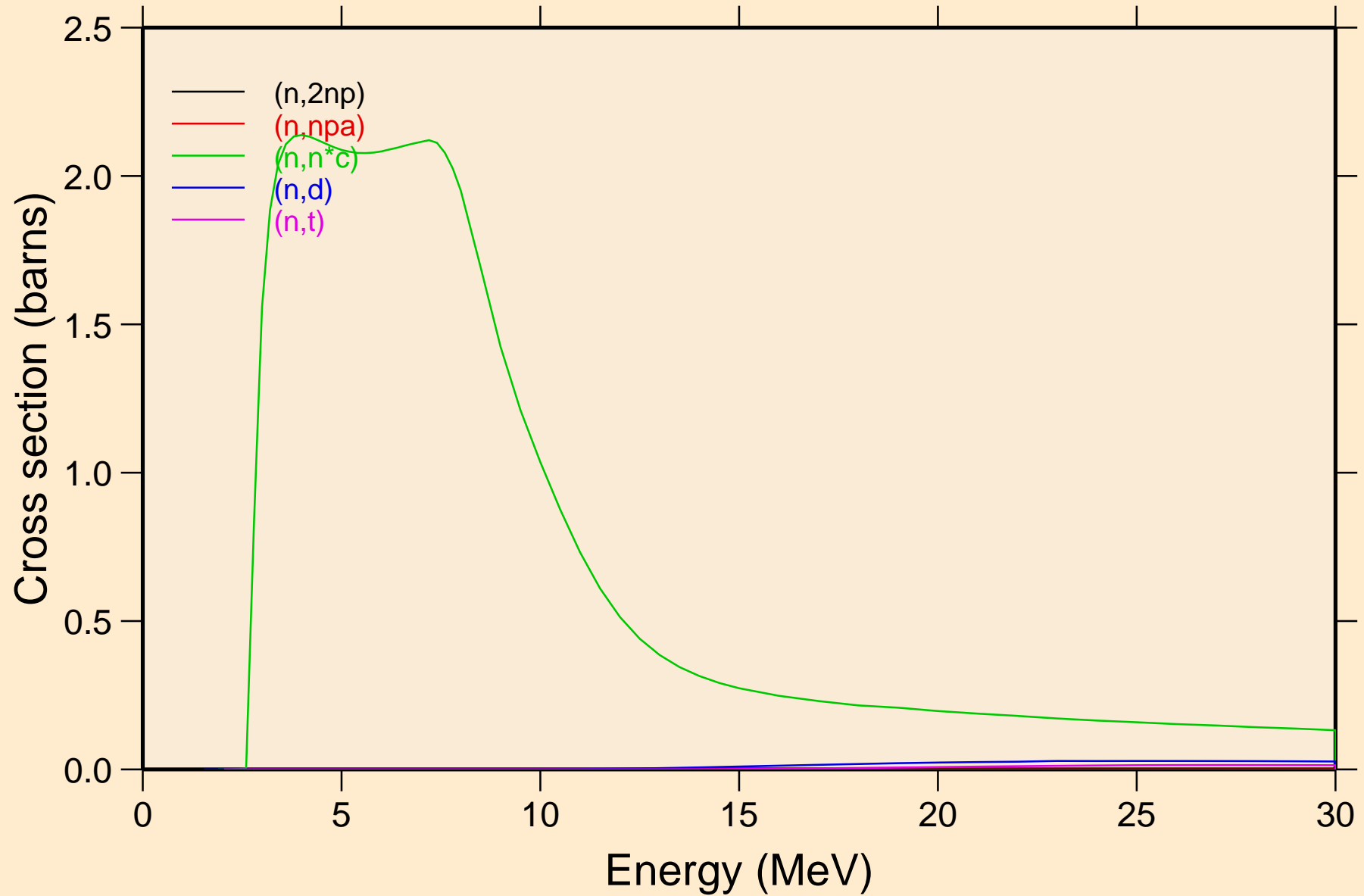

EU146 NEUTRON ACER TENDL-2021 LIBRARY; T=293.6K

Threshold reactions

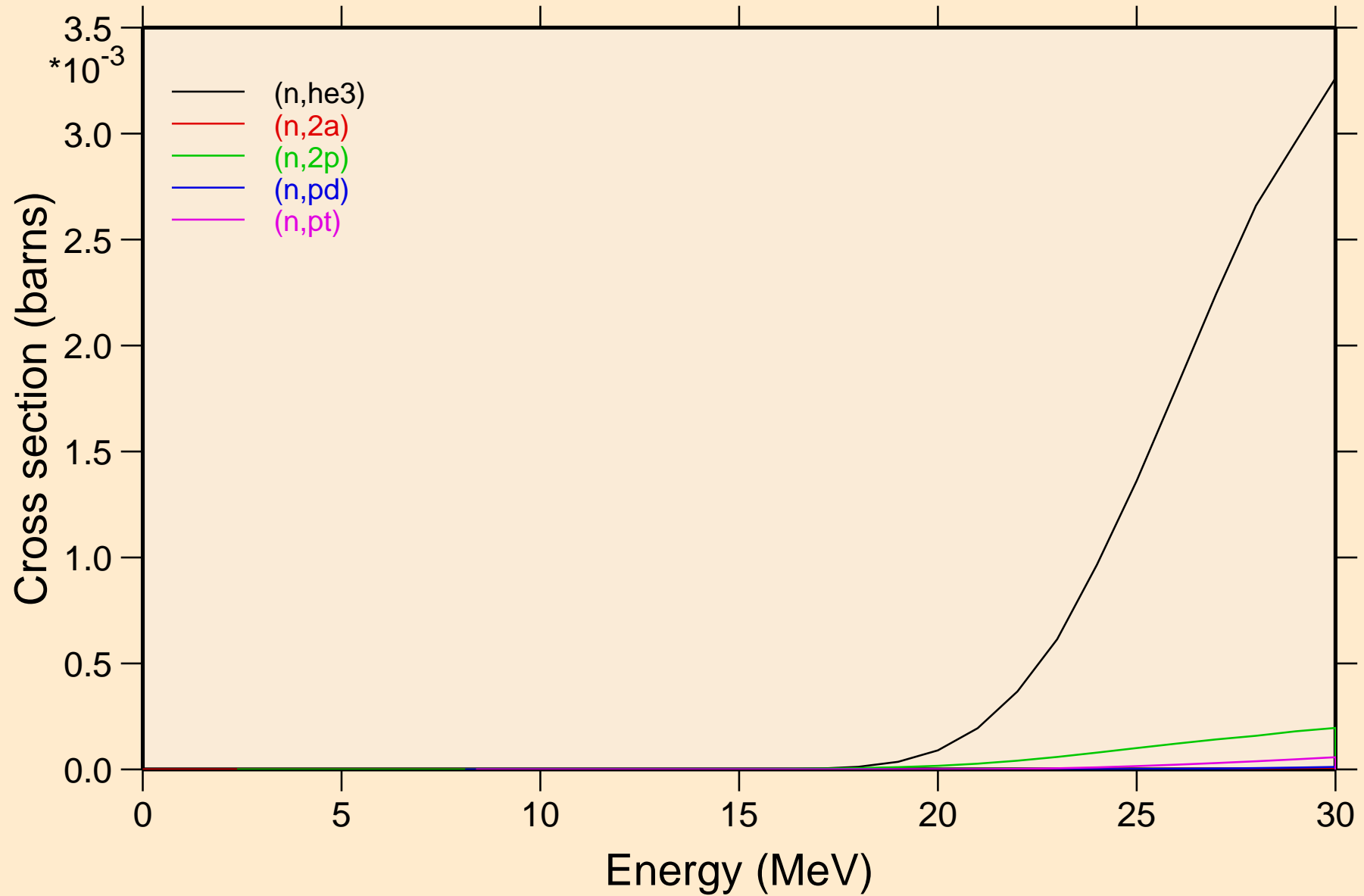

EU146 NEUTRON ACER TENDL-2021 LIBRARY; T=293.6K
Threshold reactions

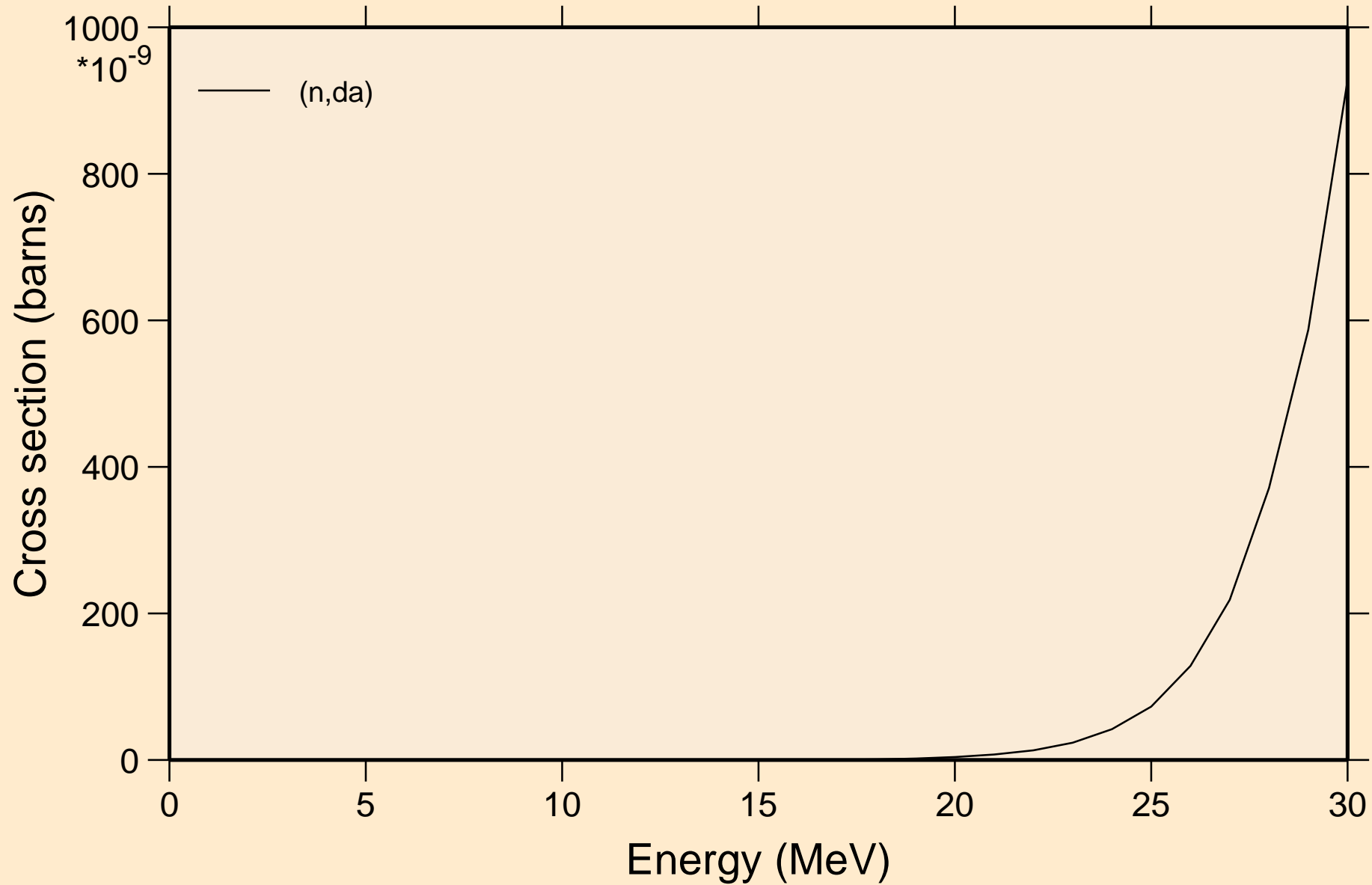

EU146 NEUTRON ACER TENDL-2021 LIBRARY; T=293.6K
Threshold reactions

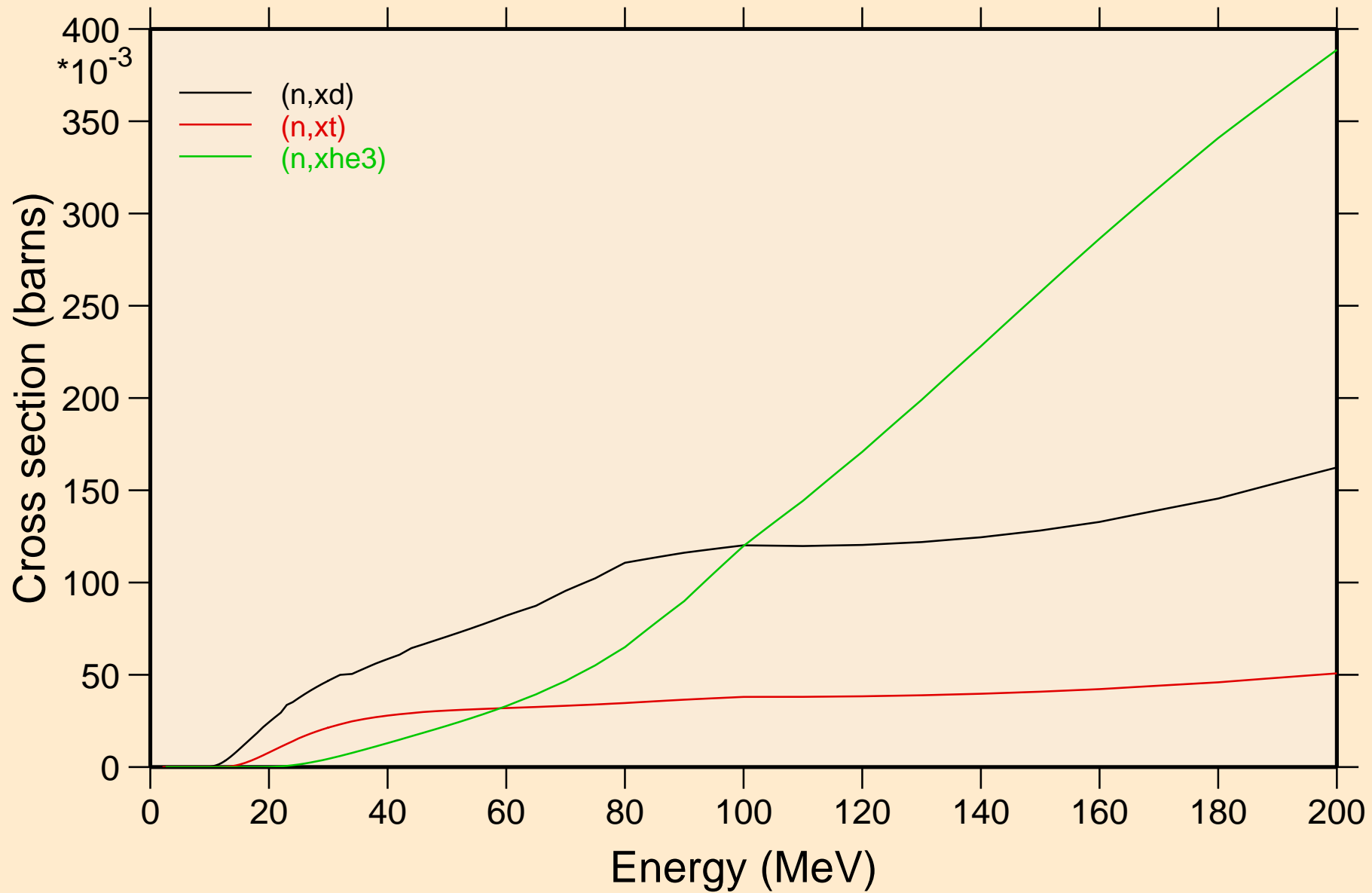

EU146 NEUTRON ACER TENDL-2021 LIBRARY; T=293.6K
angular distribution for elastic

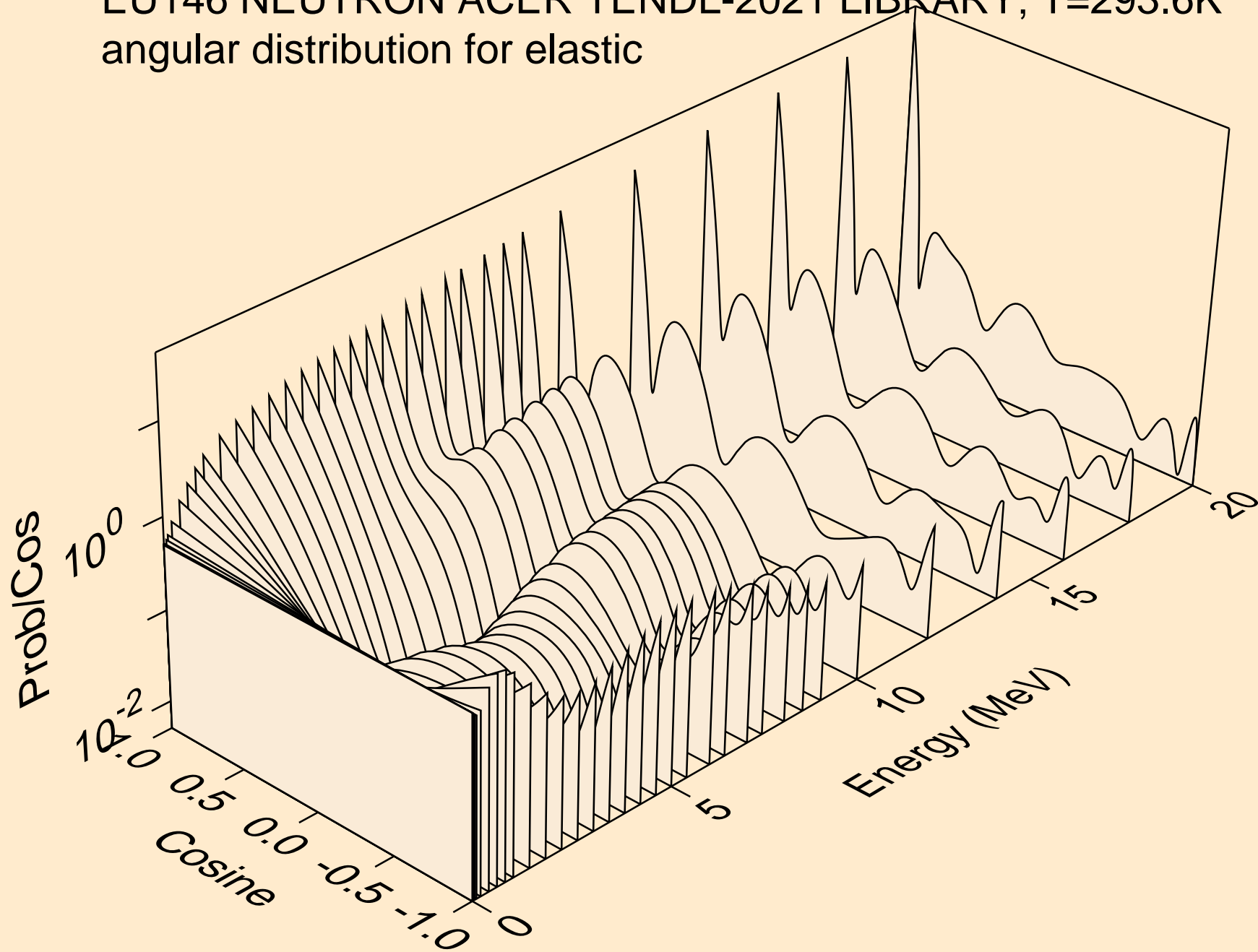

EU146 NEUTRON ACER TENDL-2021 LIBRARY; T=293.6K
angular distribution for elastic

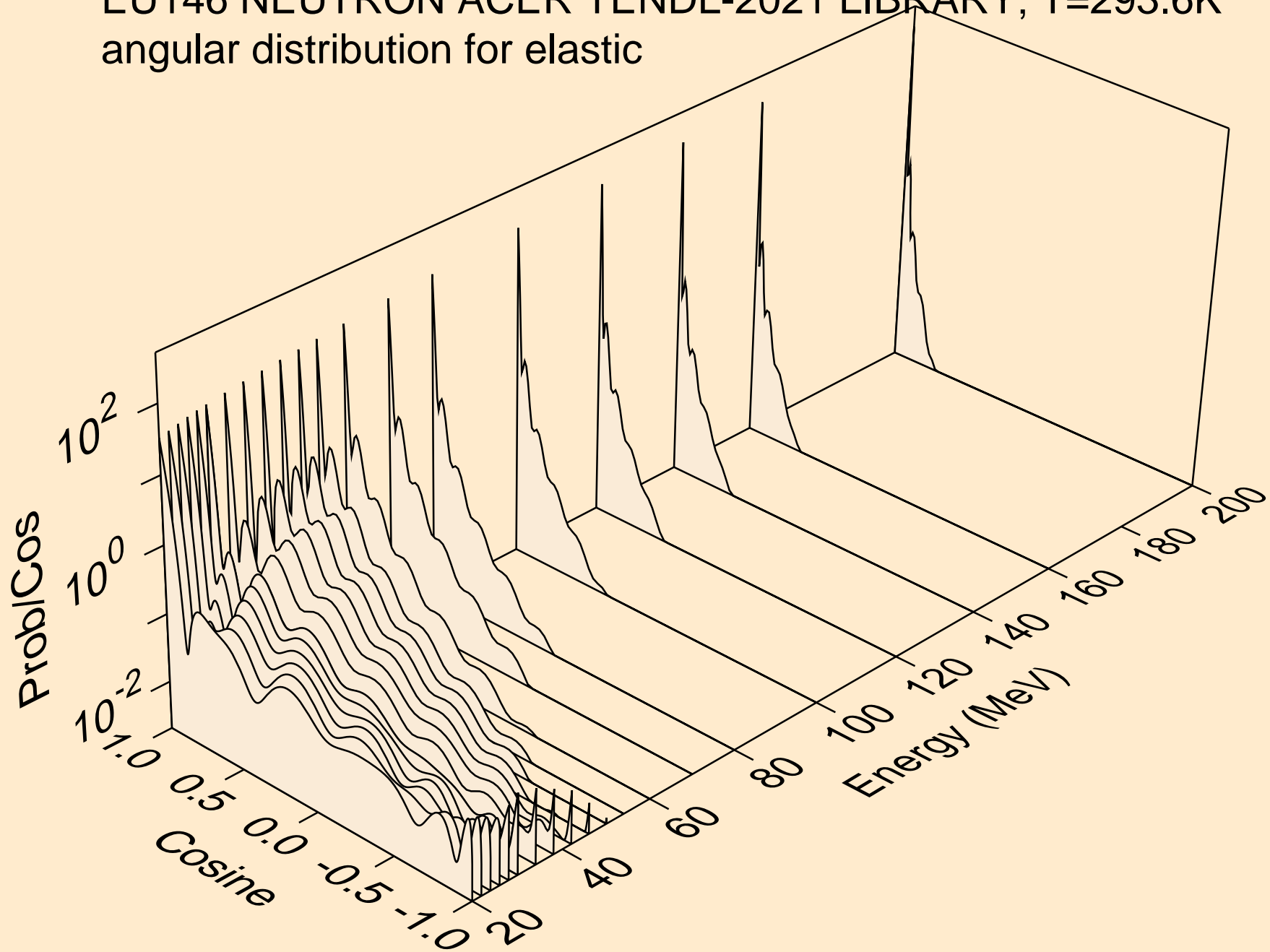

EU146 NEUTRON ACER TENDL-2021 LIBRARY; T=293.6K
angular distribution for (n,n*1)

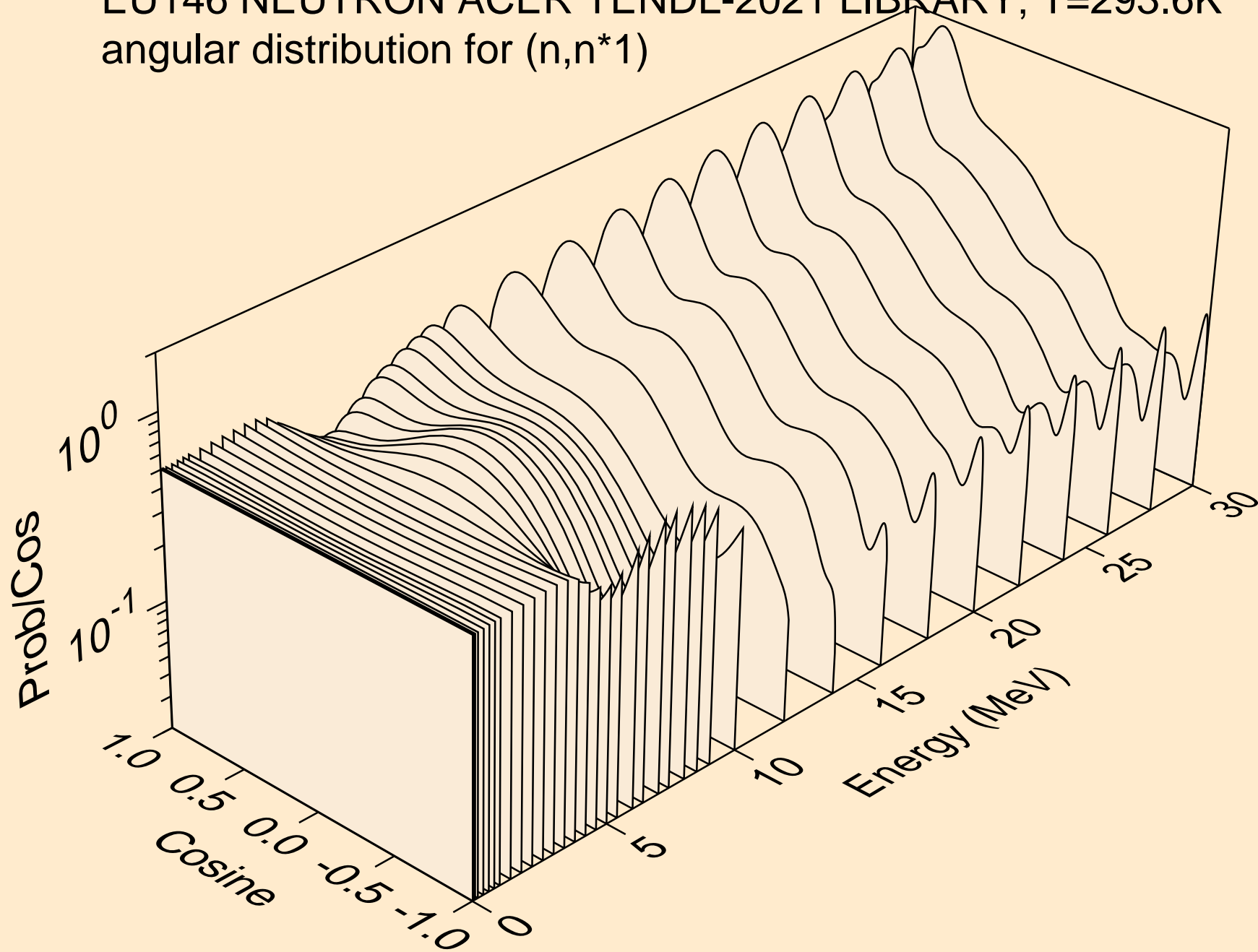

EU146 NEUTRON ACER TENDL-2021 LIBRARY; T=293.6K
angular distribution for (n,n*2)

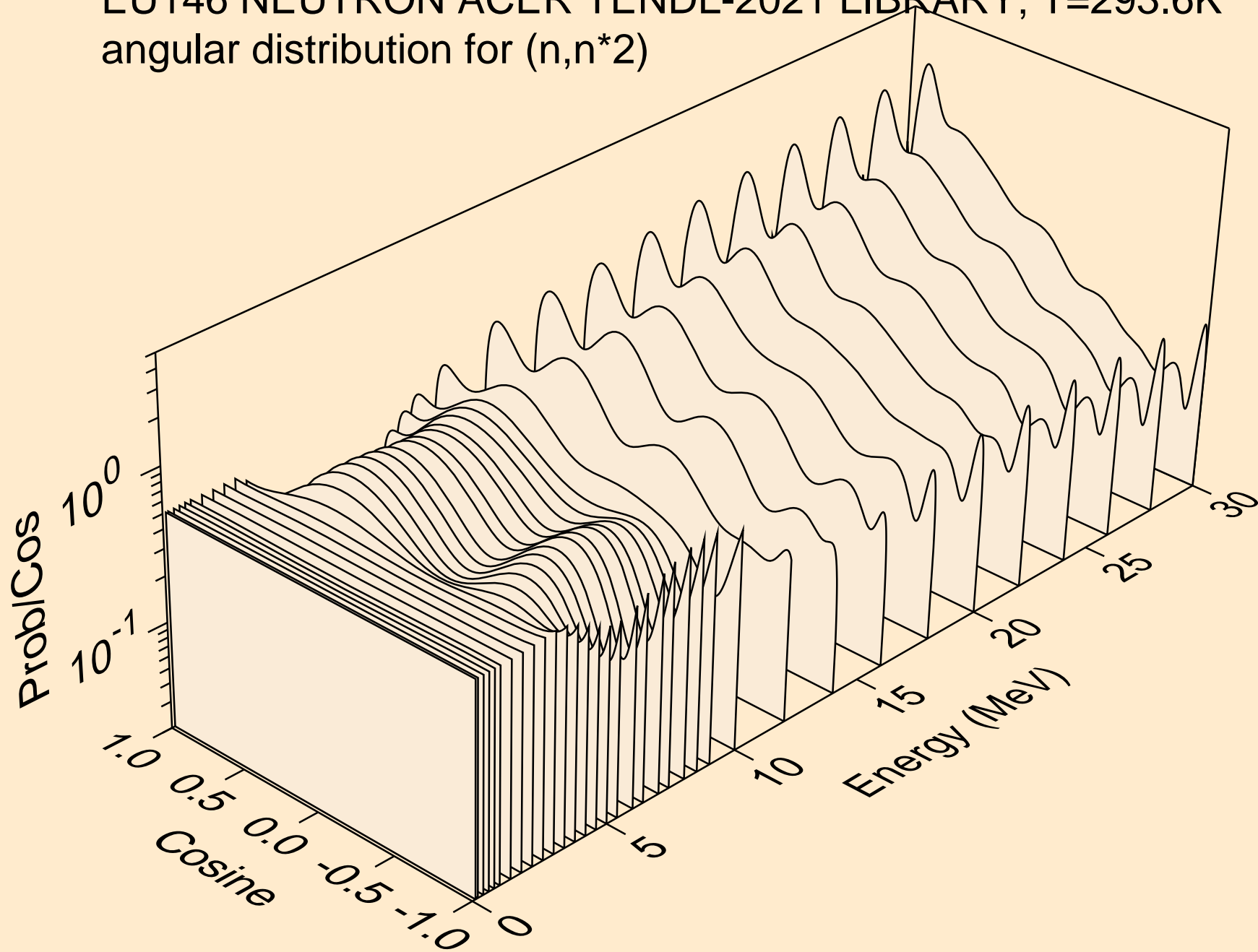

EU146 NEUTRON ACER TENDL-2021 LIBRARY; T=293.6K
angular distribution for (n,n*3)

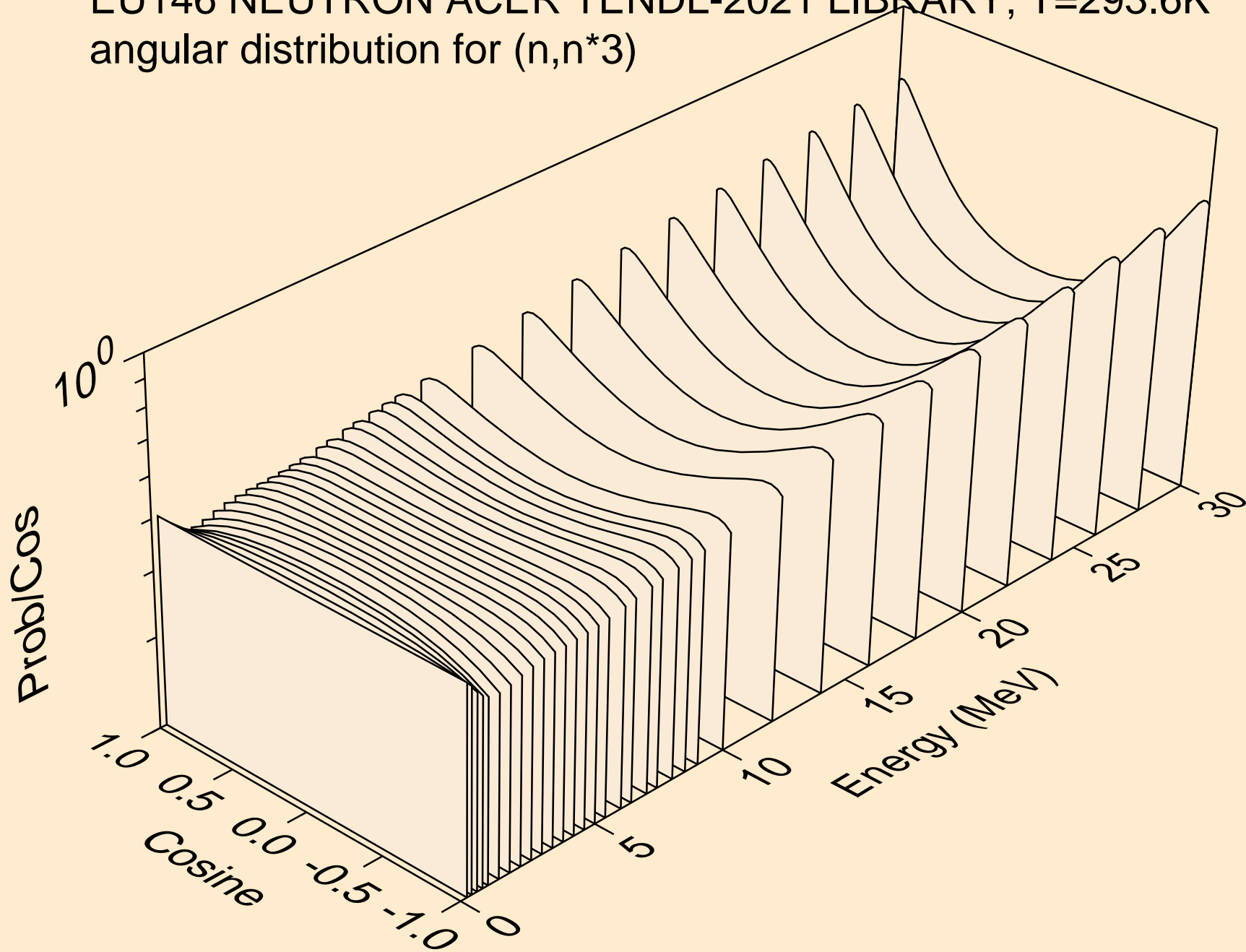

EU146 NEUTRON ACER TENDL-2021 LIBRARY; T=293.6K
angular distribution for (n,n*4)

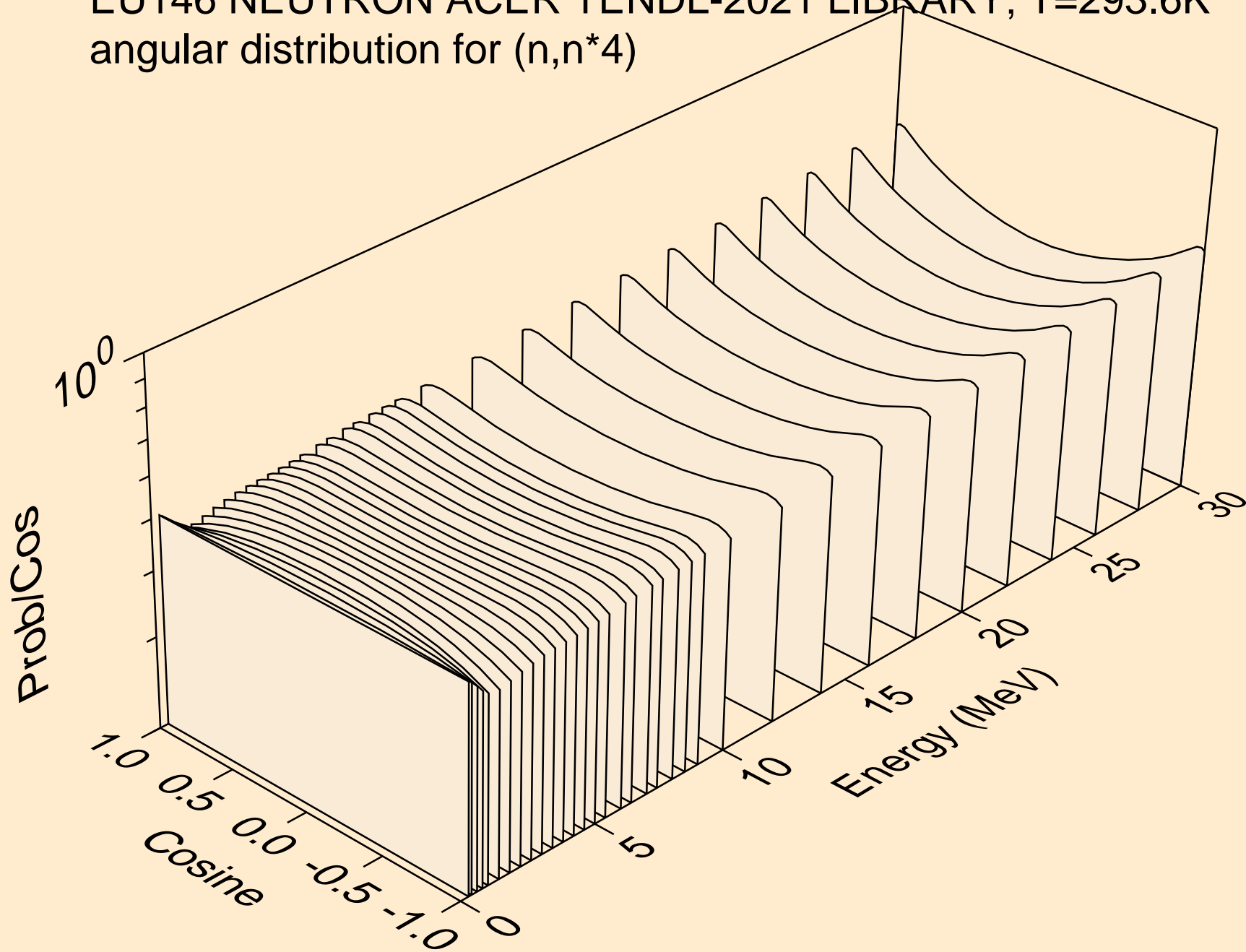

EU146 NEUTRON ACER TENDL-2021 LIBRARY; T=293.6K
angular distribution for (n,n*5)

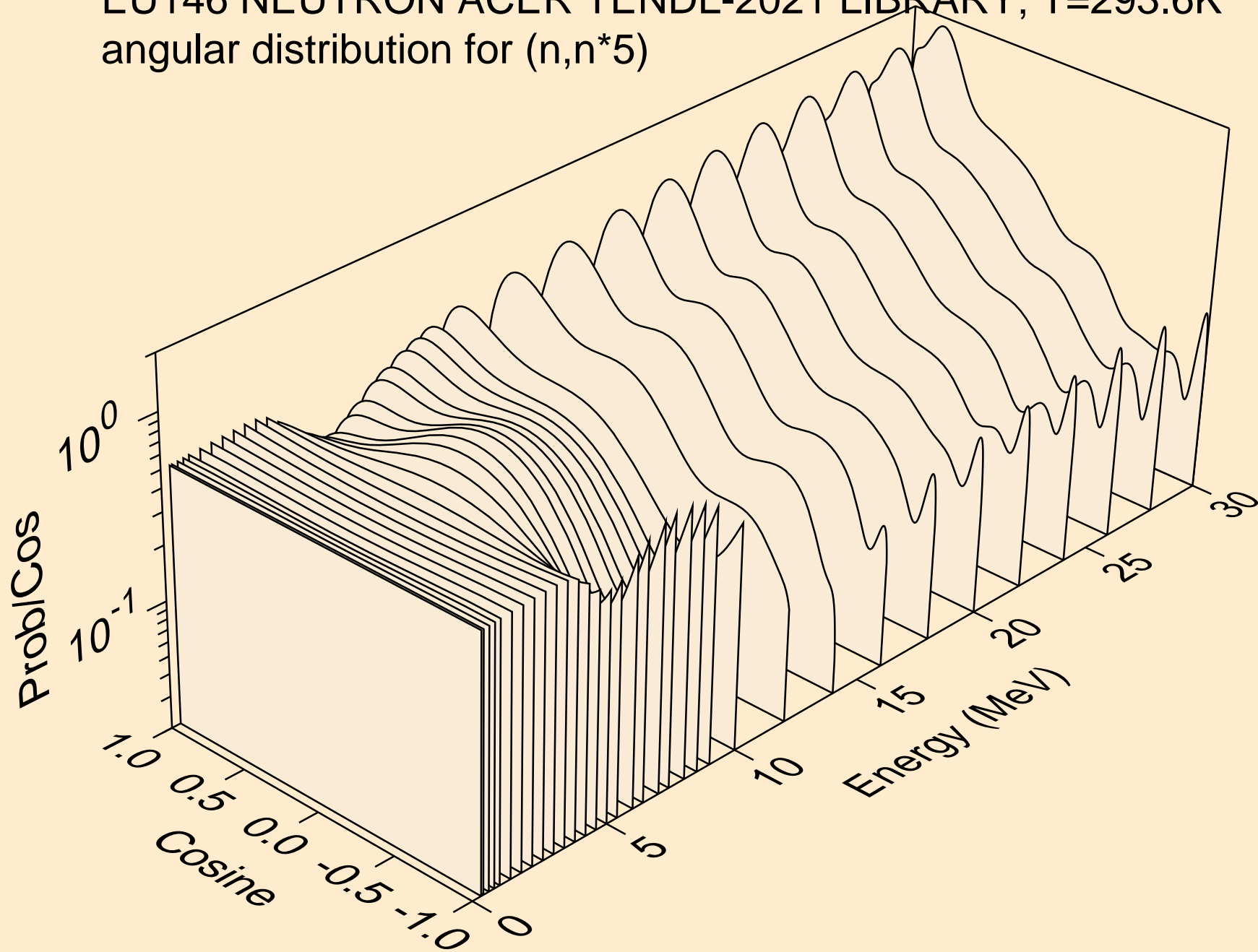

EU146 NEUTRON ACER TENDL-2021 LIBRARY; T=293.6K
angular distribution for (n,n*6)

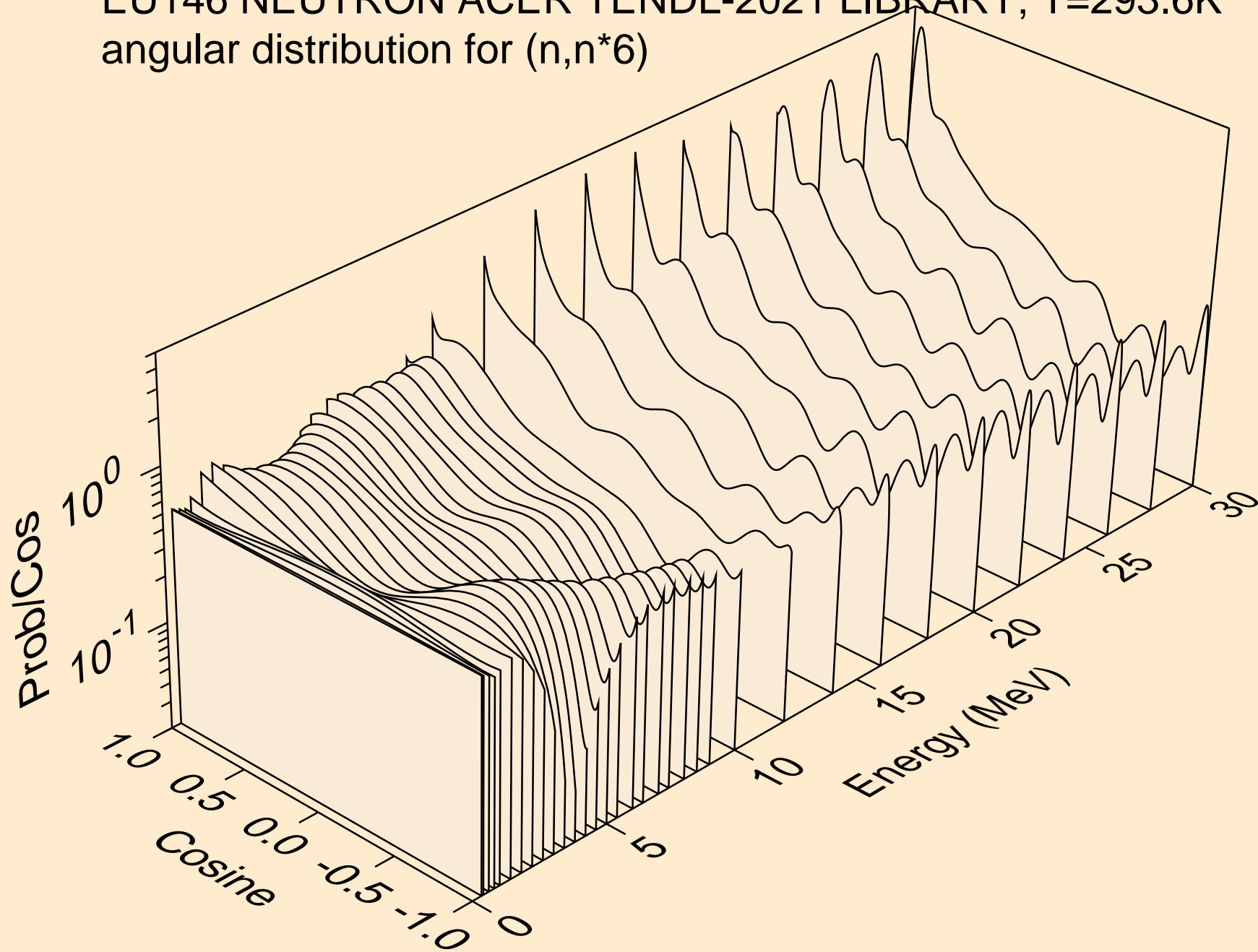

EU146 NEUTRON ACER TENDL-2021 LIBRARY; T=293.6K
angular distribution for (n,n*7)

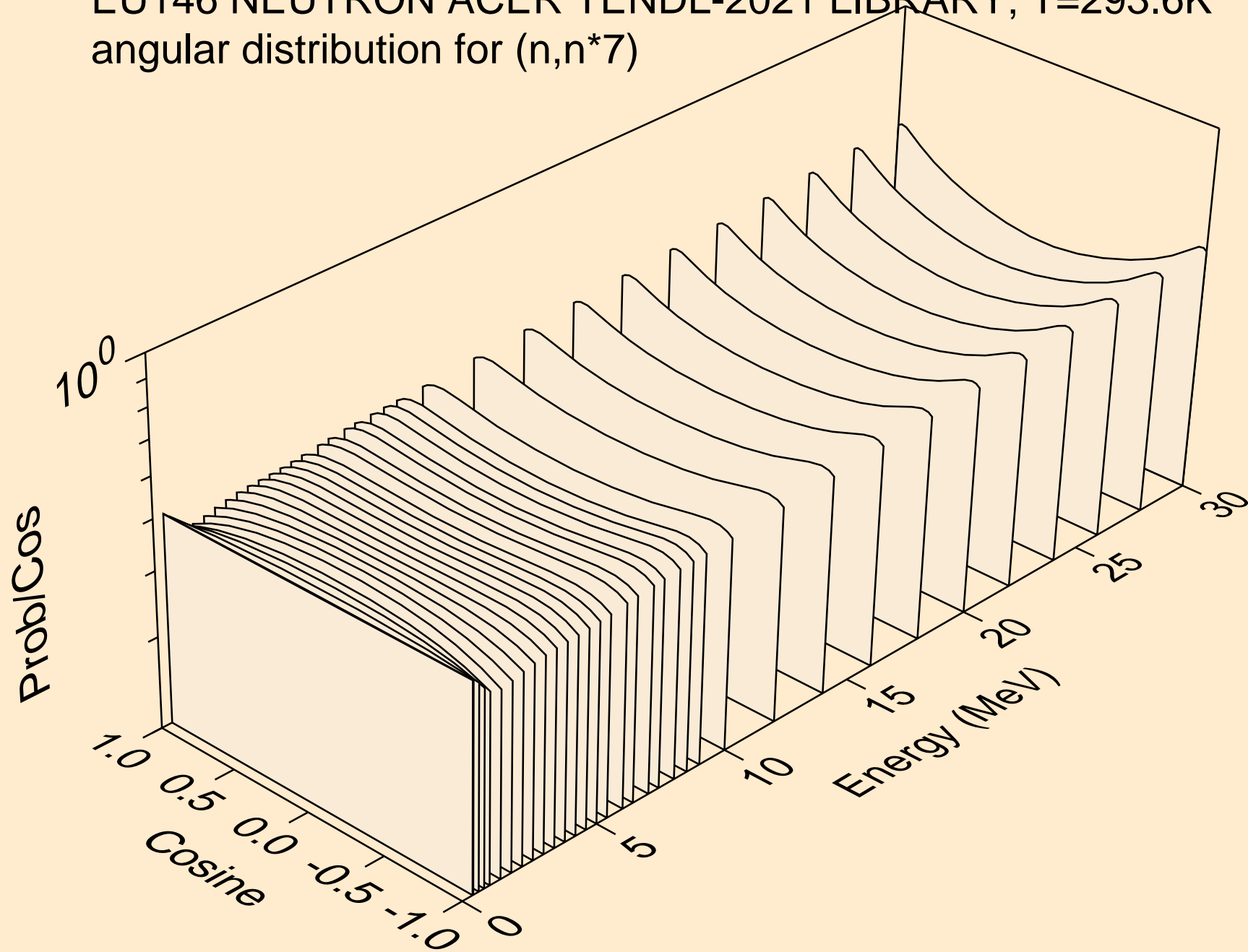

EU146 NEUTRON ACER TENDL-2021 LIBRARY; T=293.6K
angular distribution for (n,n*8)

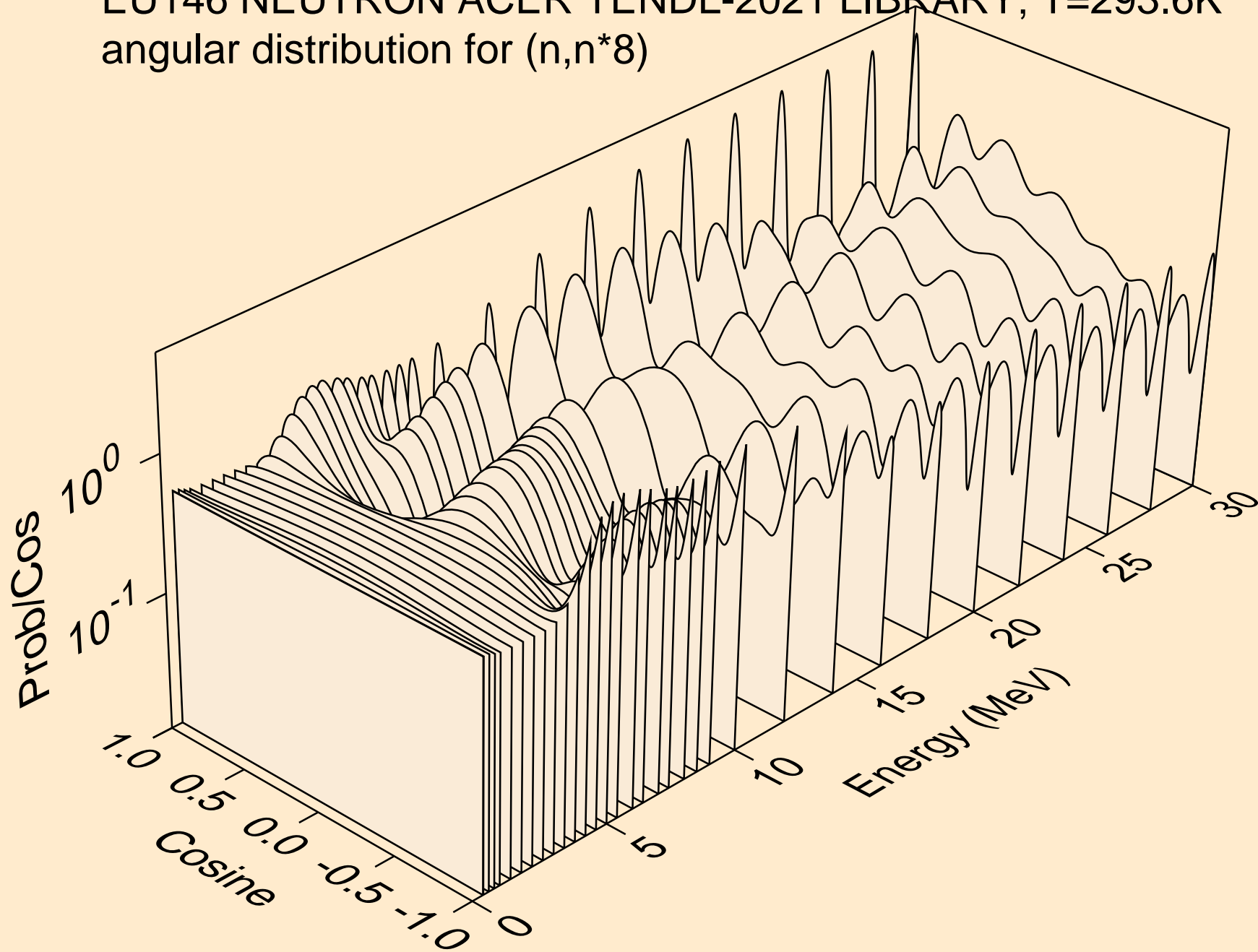

EU146 NEUTRON ACER TENDL-2021 LIBRARY; T=293.6K
angular distribution for (n,n*9)

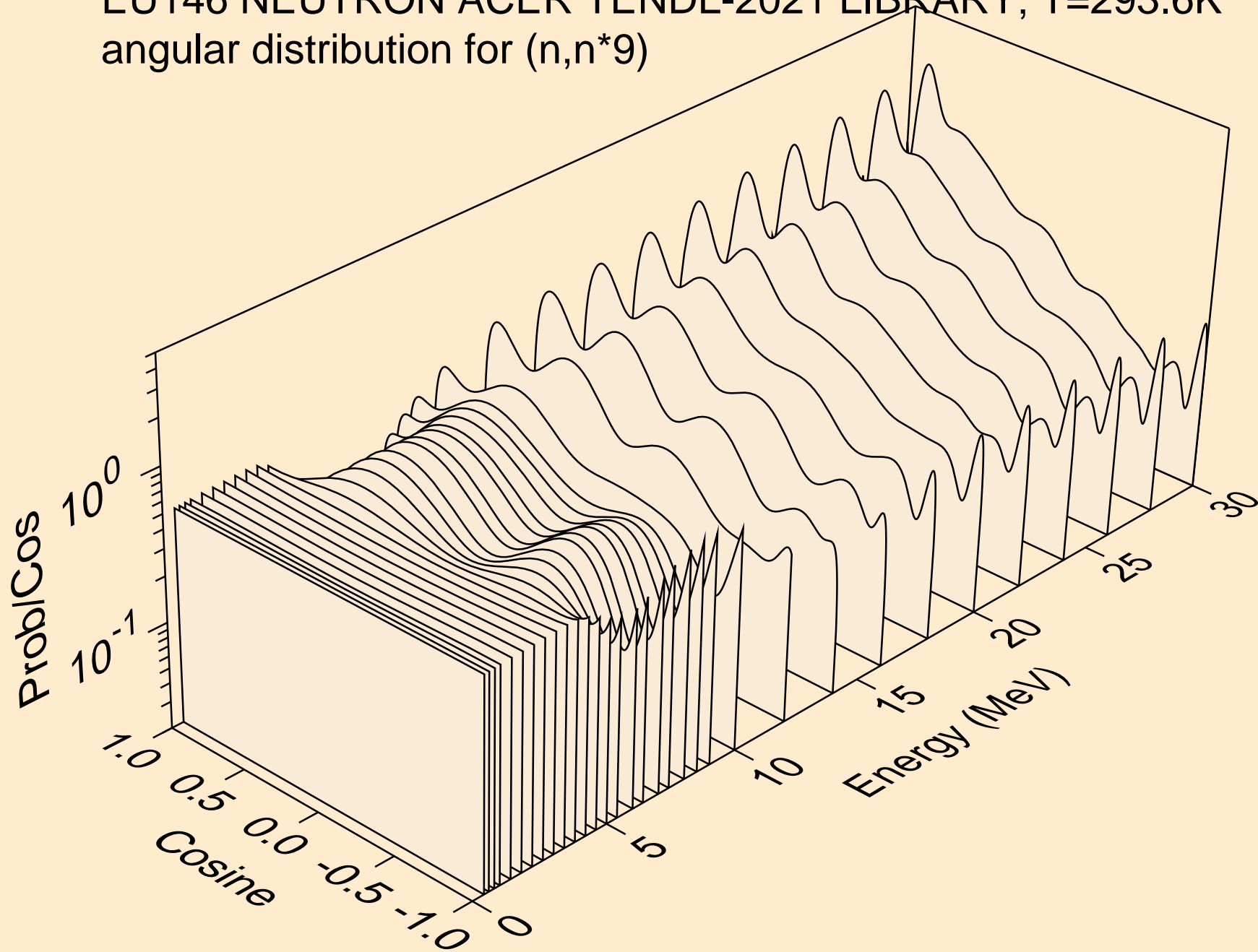

EU146 NEUTRON ACER TENDL-2021 LIBRARY; T=293.6K
angular distribution for (n,n*10)

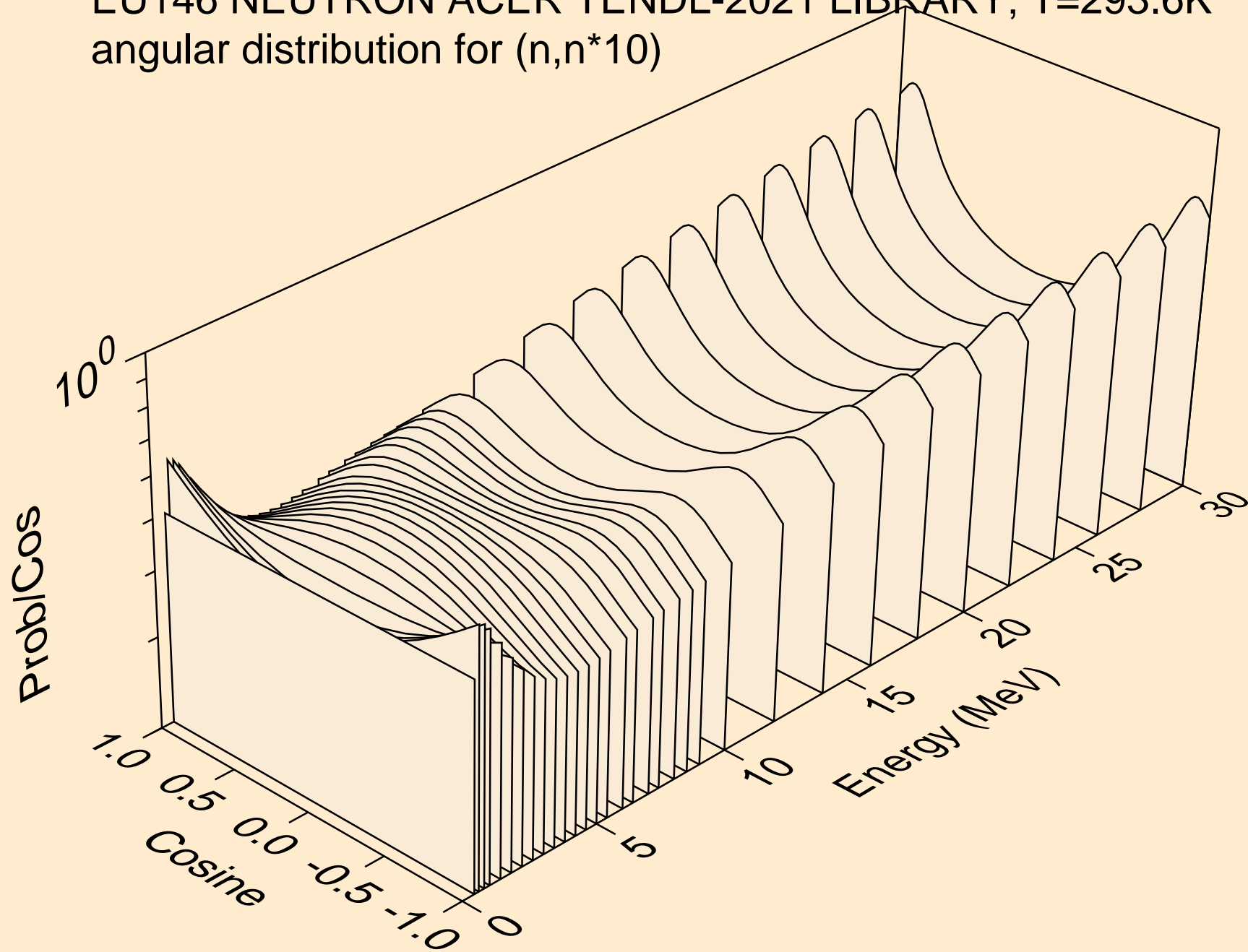

EU146 NEUTRON ACER TENDL-2021 LIBRARY; T=293.6K
angular distribution for (n,n*11)

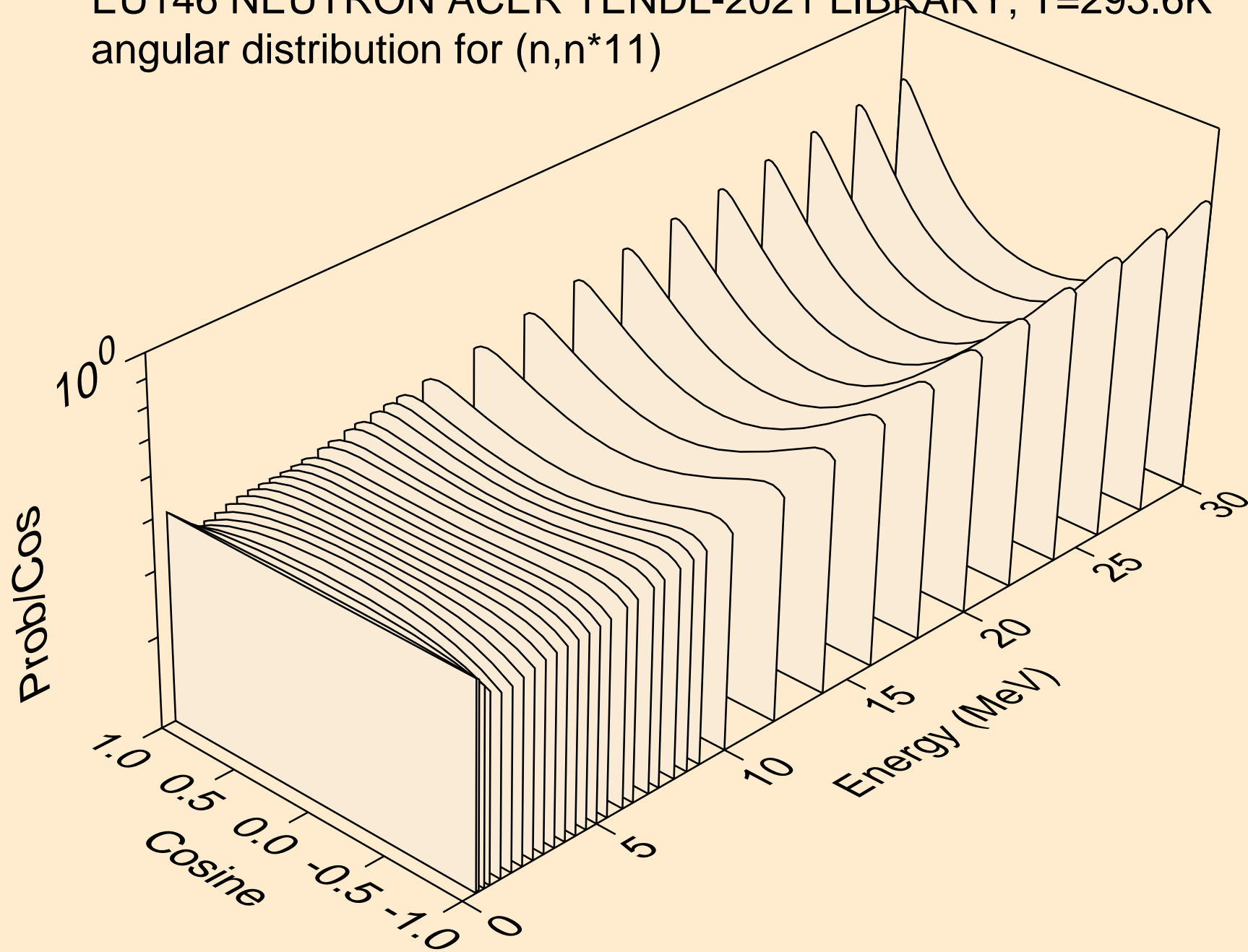

EU146 NEUTRON ACER TENDL-2021 LIBRARY; T=293.6K
angular distribution for (n,n*12)

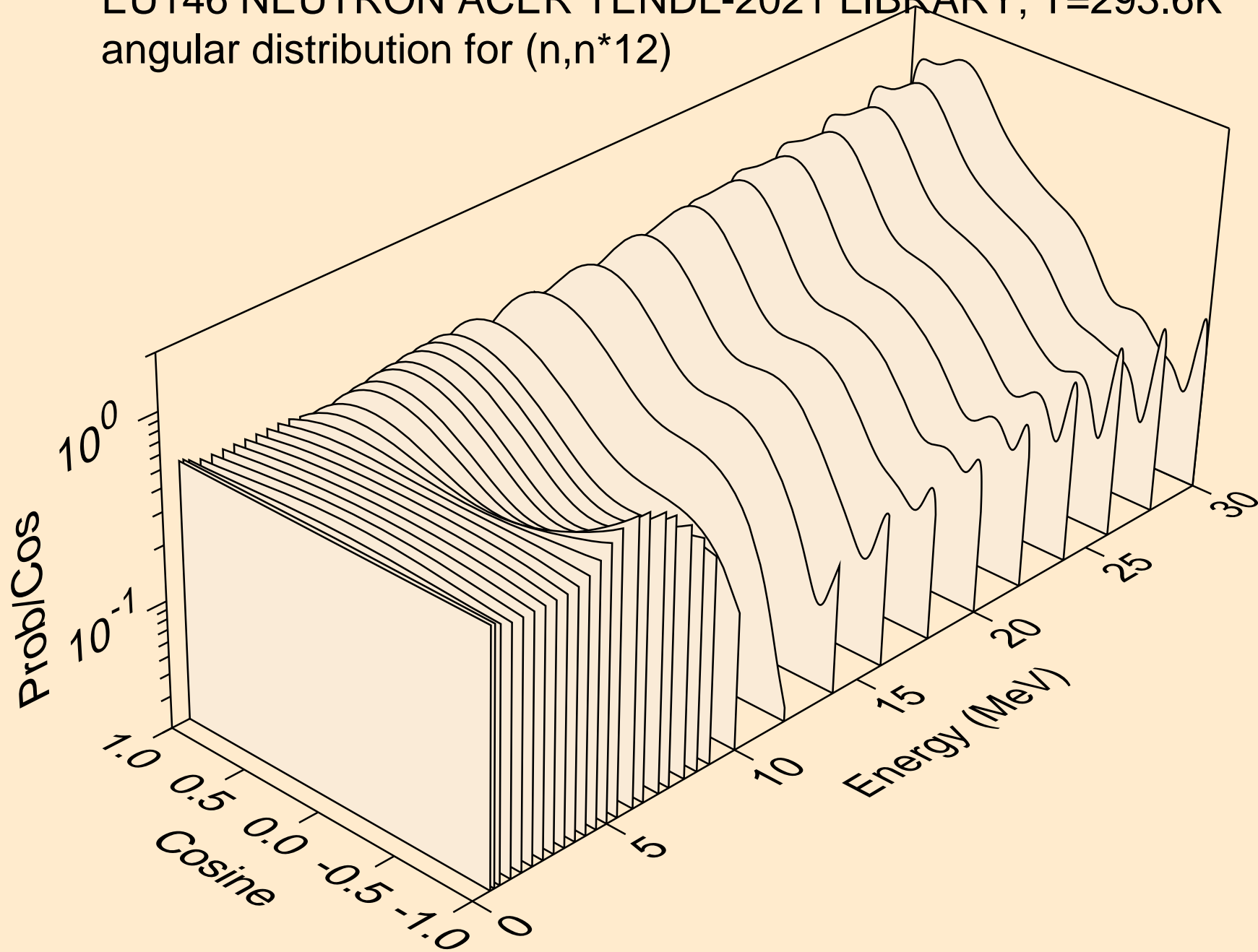

EU146 NEUTRON ACER TENDL-2021 LIBRARY; T=293.6K
angular distribution for (n,n*13)

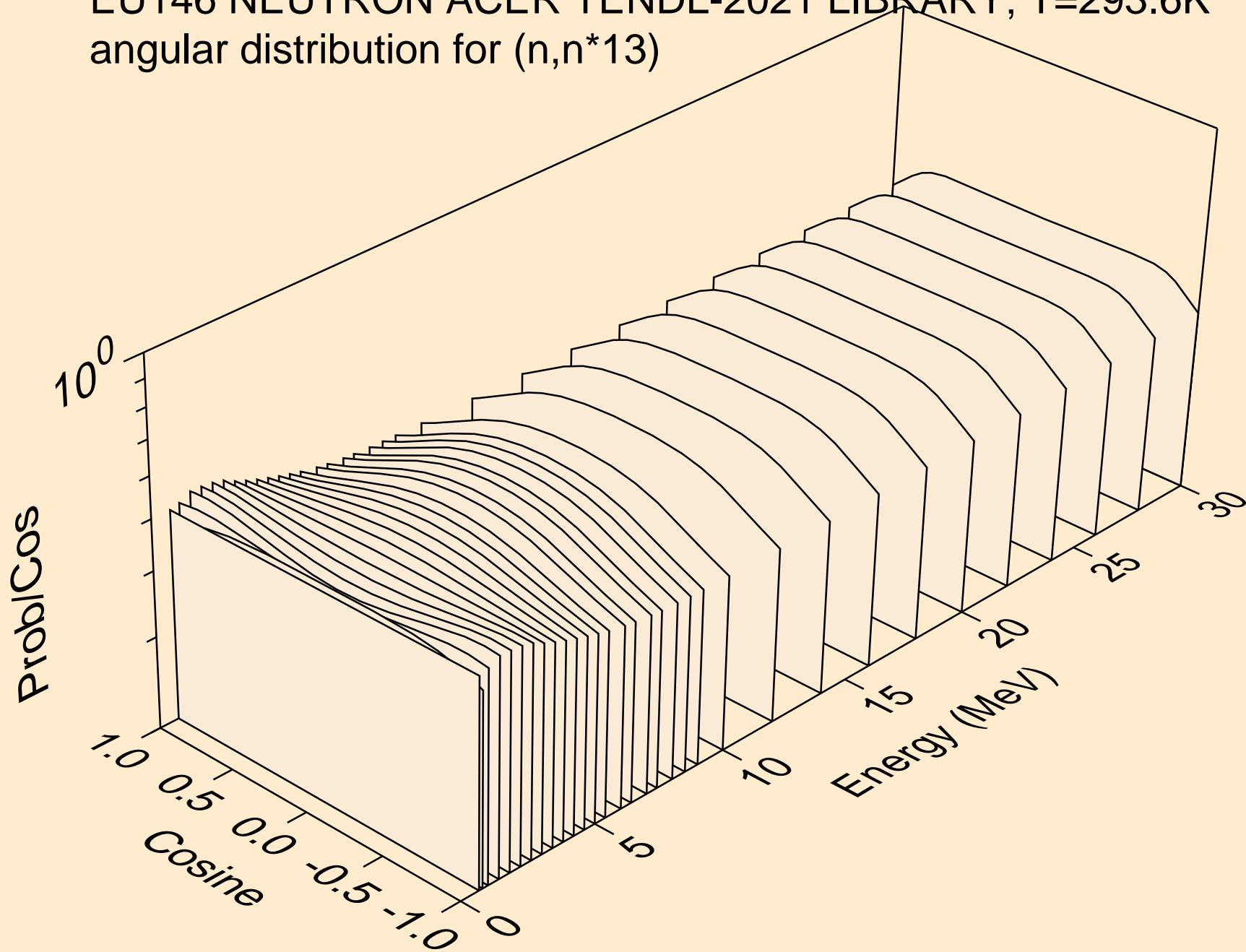

EU146 NEUTRON ACER TENDL-2021 LIBRARY; T=293.6K
angular distribution for (n,n*14)

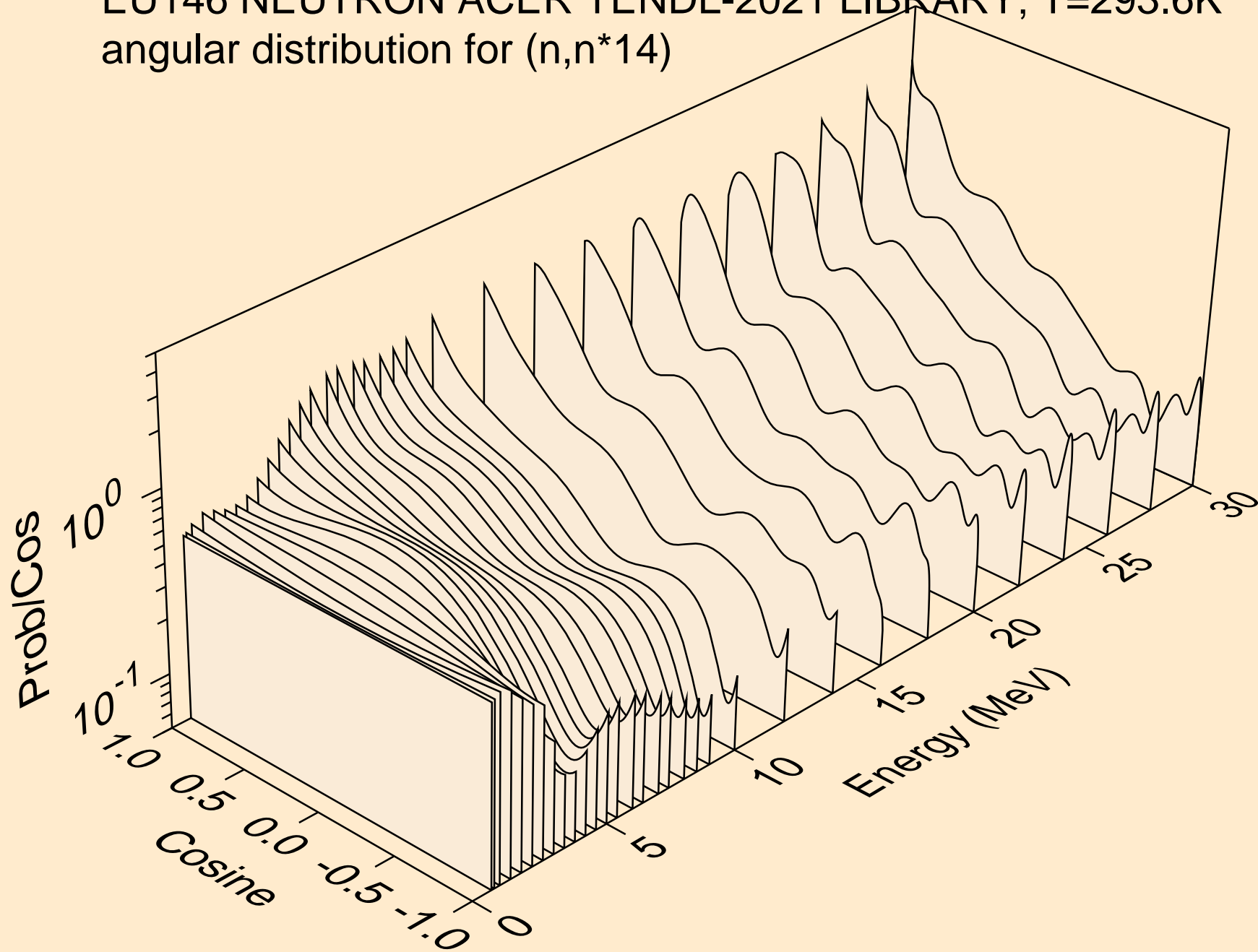

EU146 NEUTRON ACER TENDL-2021 LIBRARY; T=293.6K
angular distribution for (n,n*15)

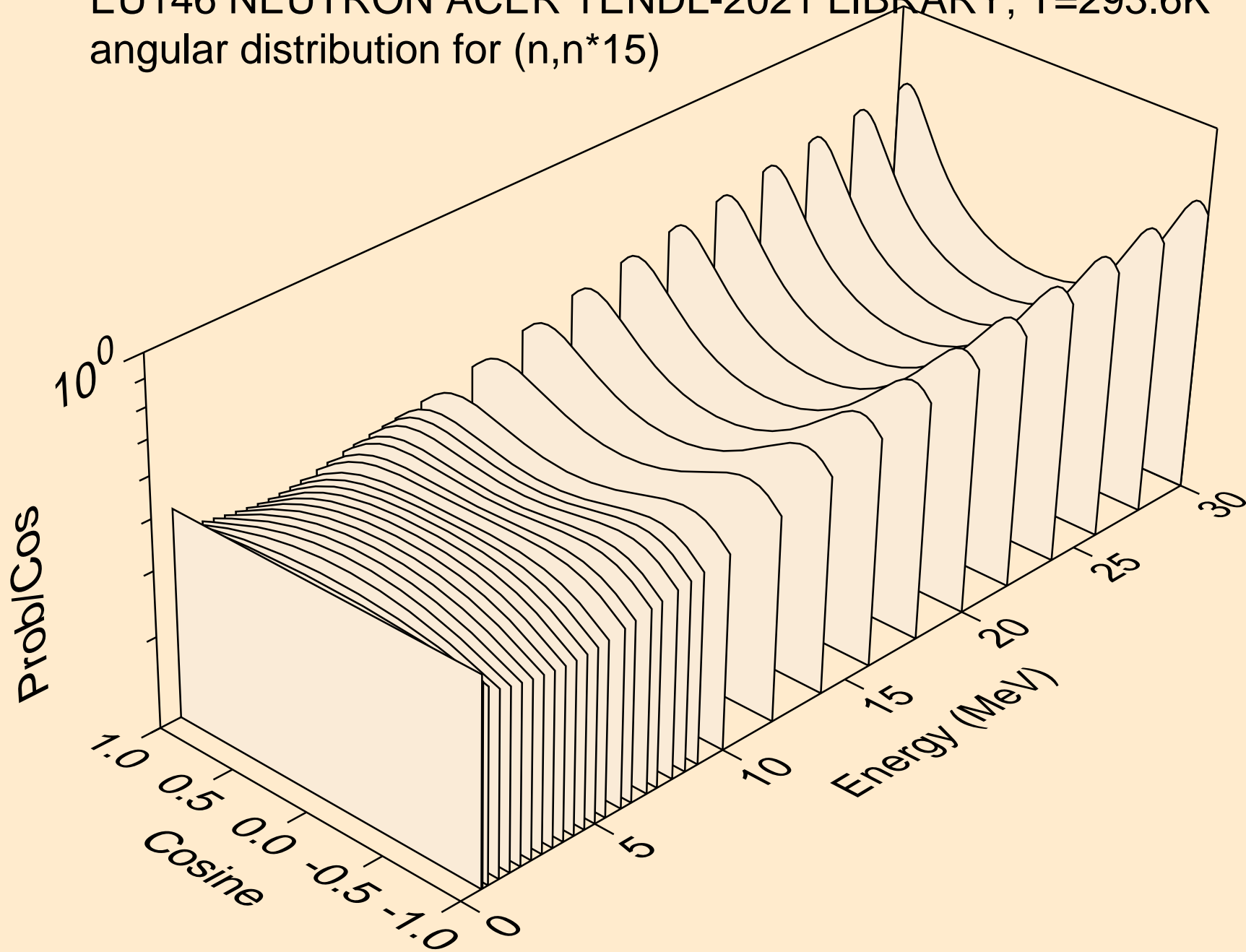

EU146 NEUTRON ACER TENDL-2021 LIBRARY; T=293.6K
angular distribution for (n,n*16)

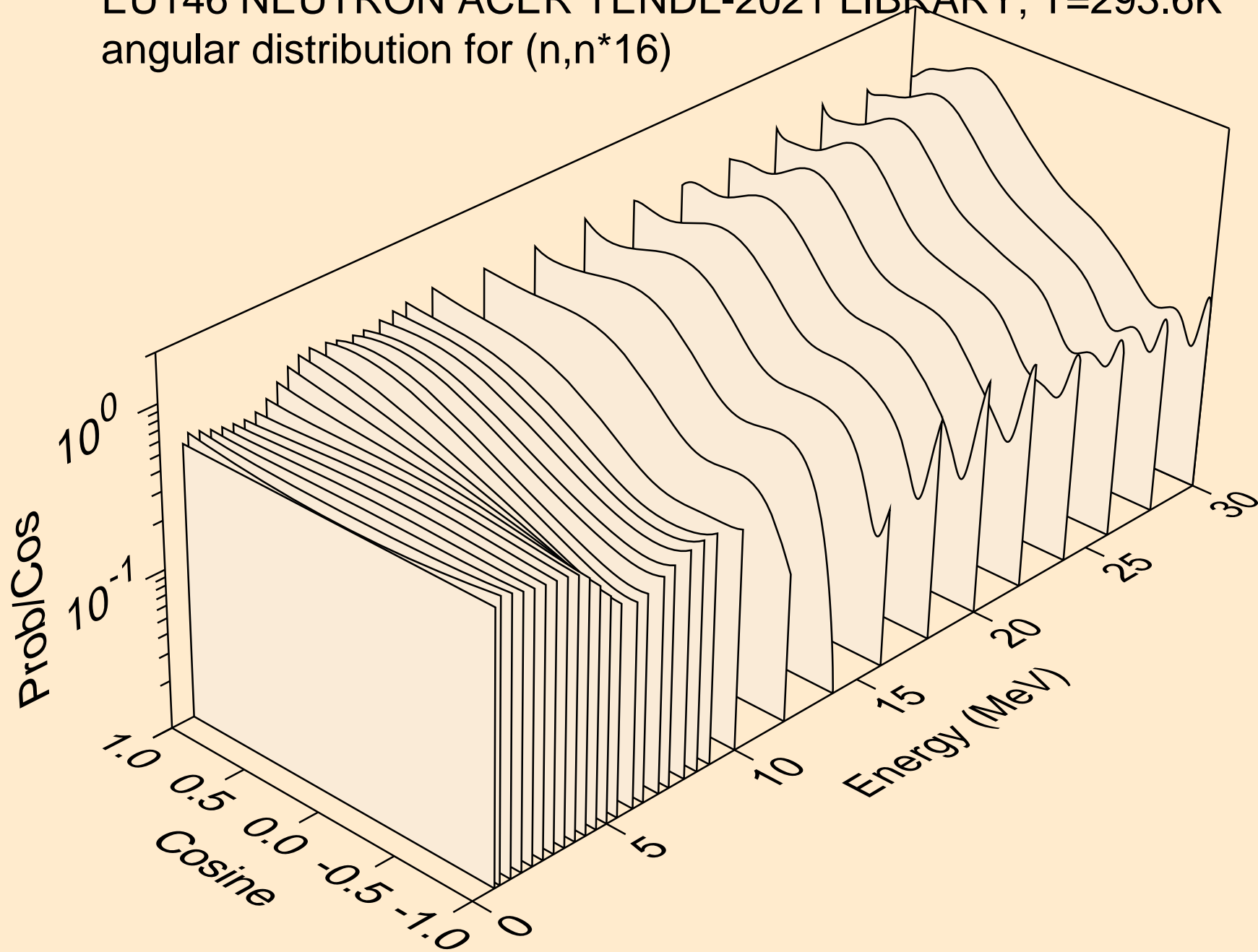

EU146 NEUTRON ACER TENDL-2021 LIBRARY; T=293.6K
angular distribution for (n,n*17)

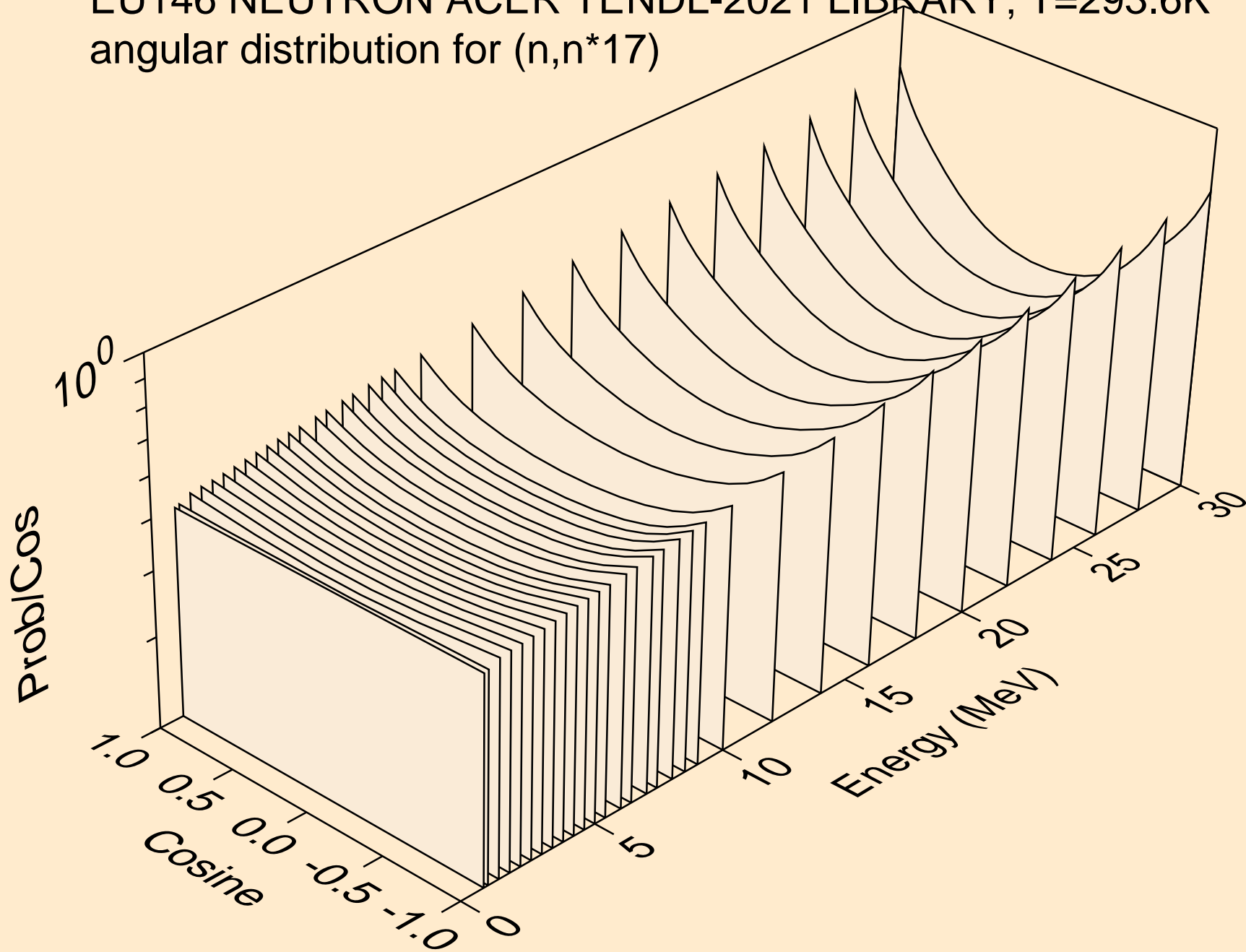

EU146 NEUTRON ACER TENDL-2021 LIBRARY; T=293.6K
angular distribution for (n,n*18)

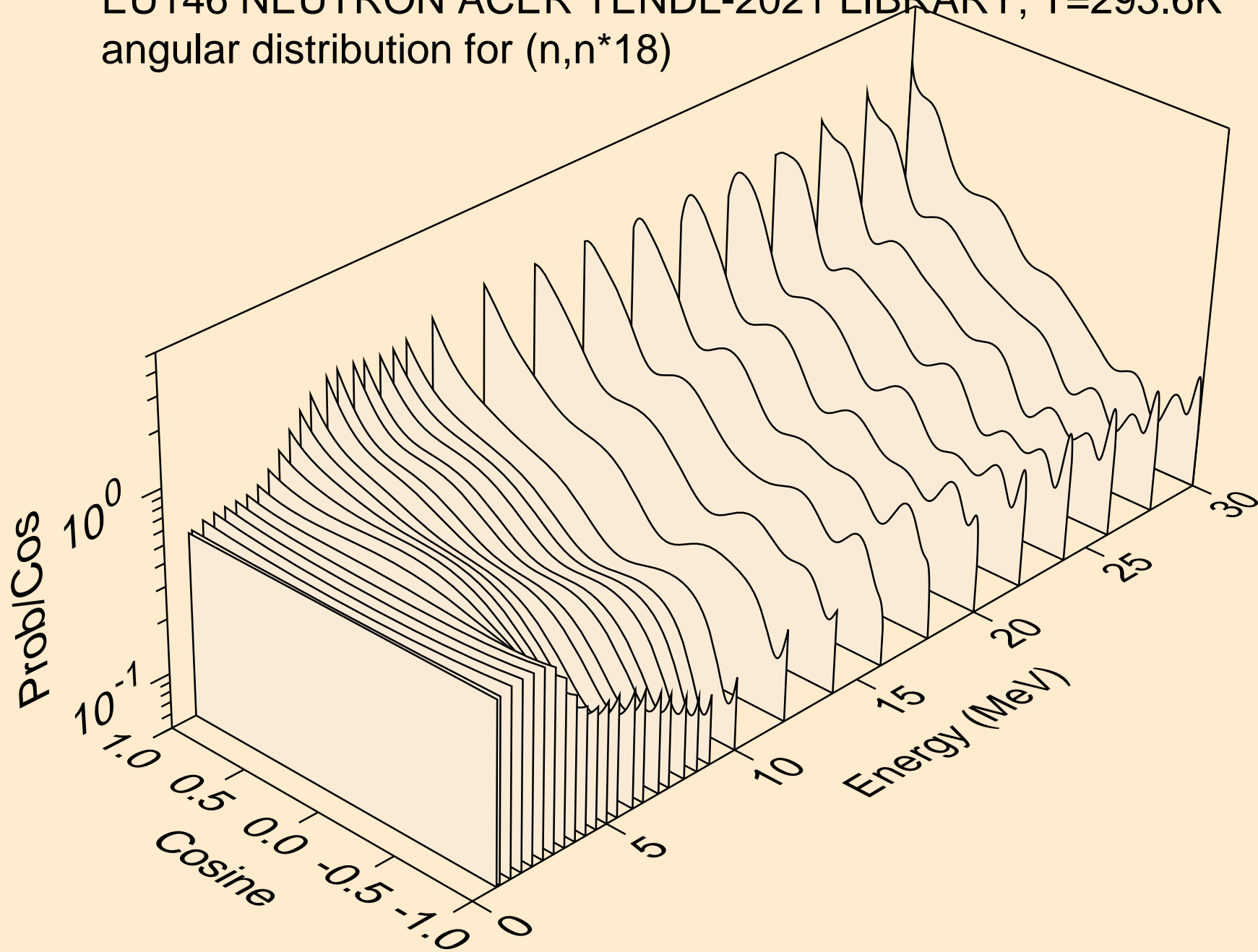

EU146 NEUTRON ACER TENDL-2021 LIBRARY; T=293.6K
angular distribution for (n,n*19)

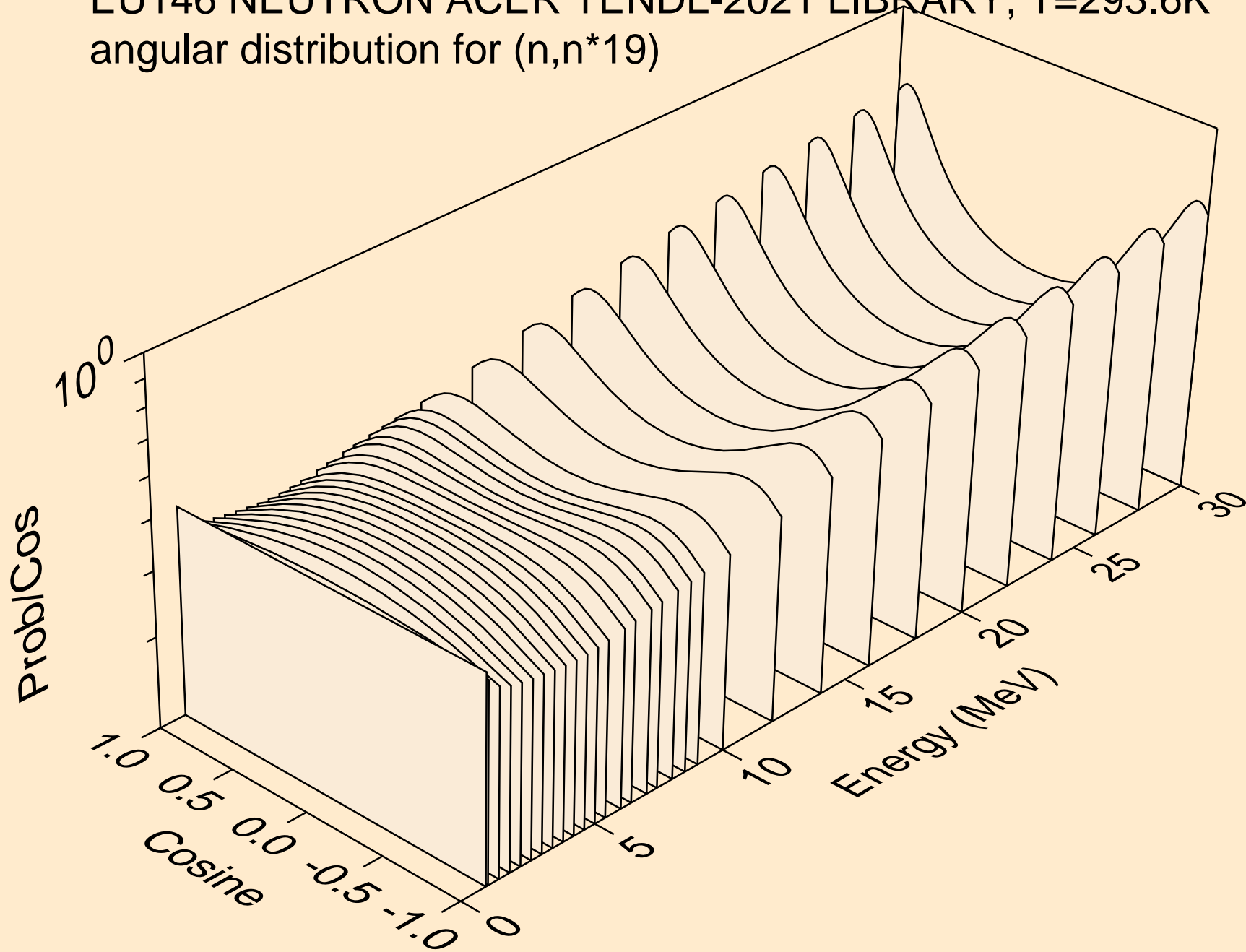

EU146 NEUTRON ACER TENDL-2021 LIBRARY; T=293.6K
angular distribution for (n,n*20)

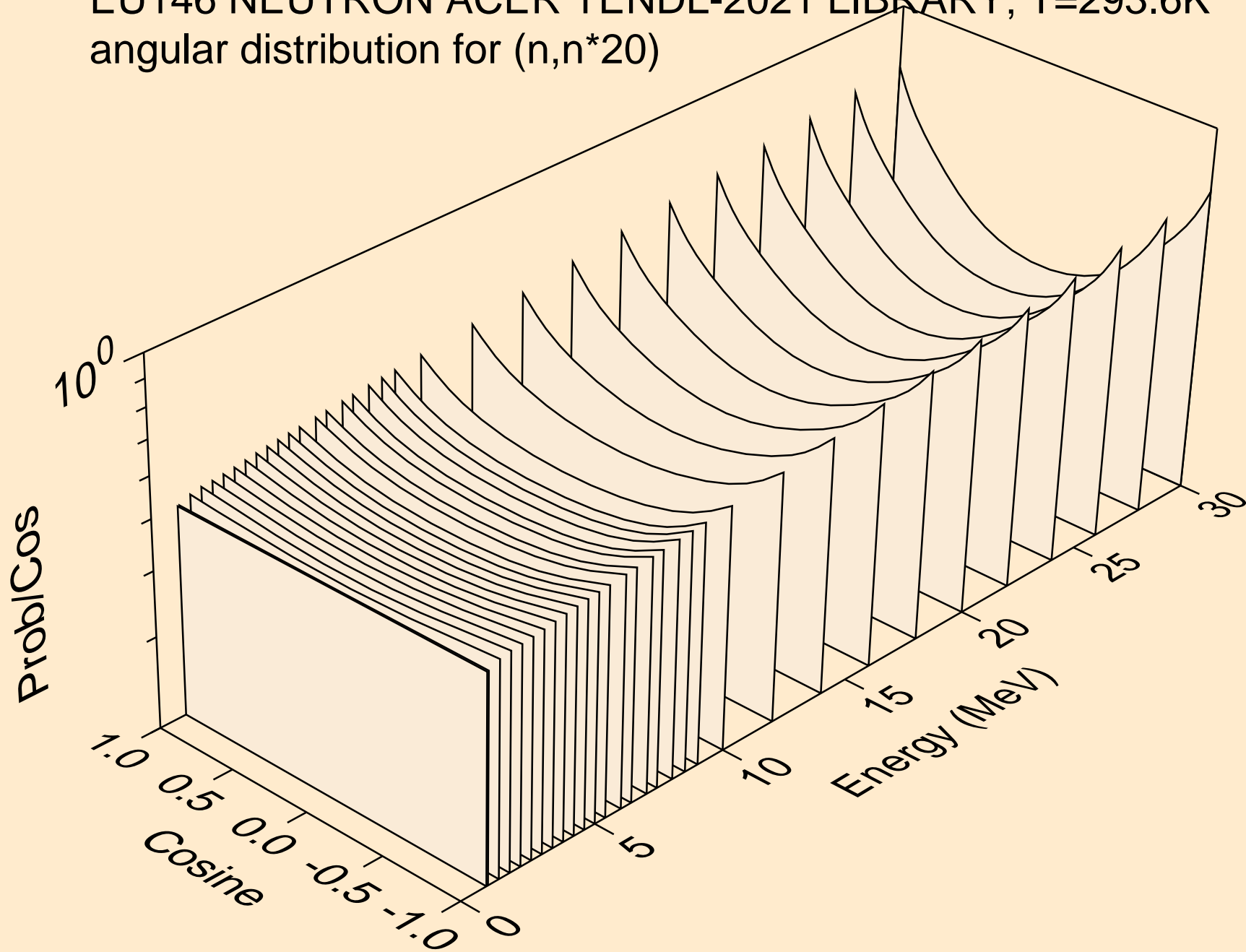

EU146 NEUTRON ACER TENDL-2021 LIBRARY; T=293.6K
angular distribution for (n,n*21)

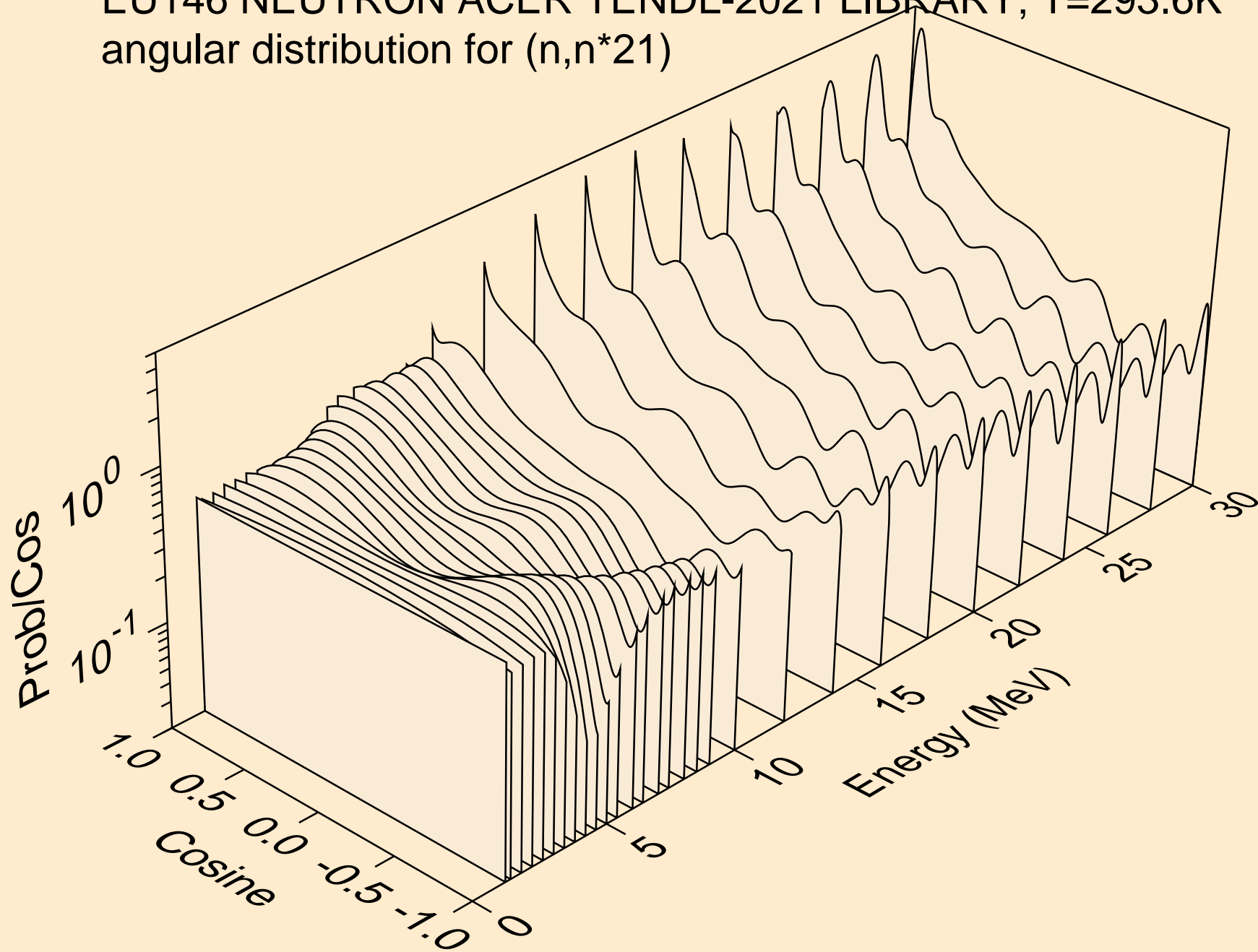

EU146 NEUTRON ACER TENDL-2021 LIBRARY; T=293.6K
angular distribution for (n,n*22)

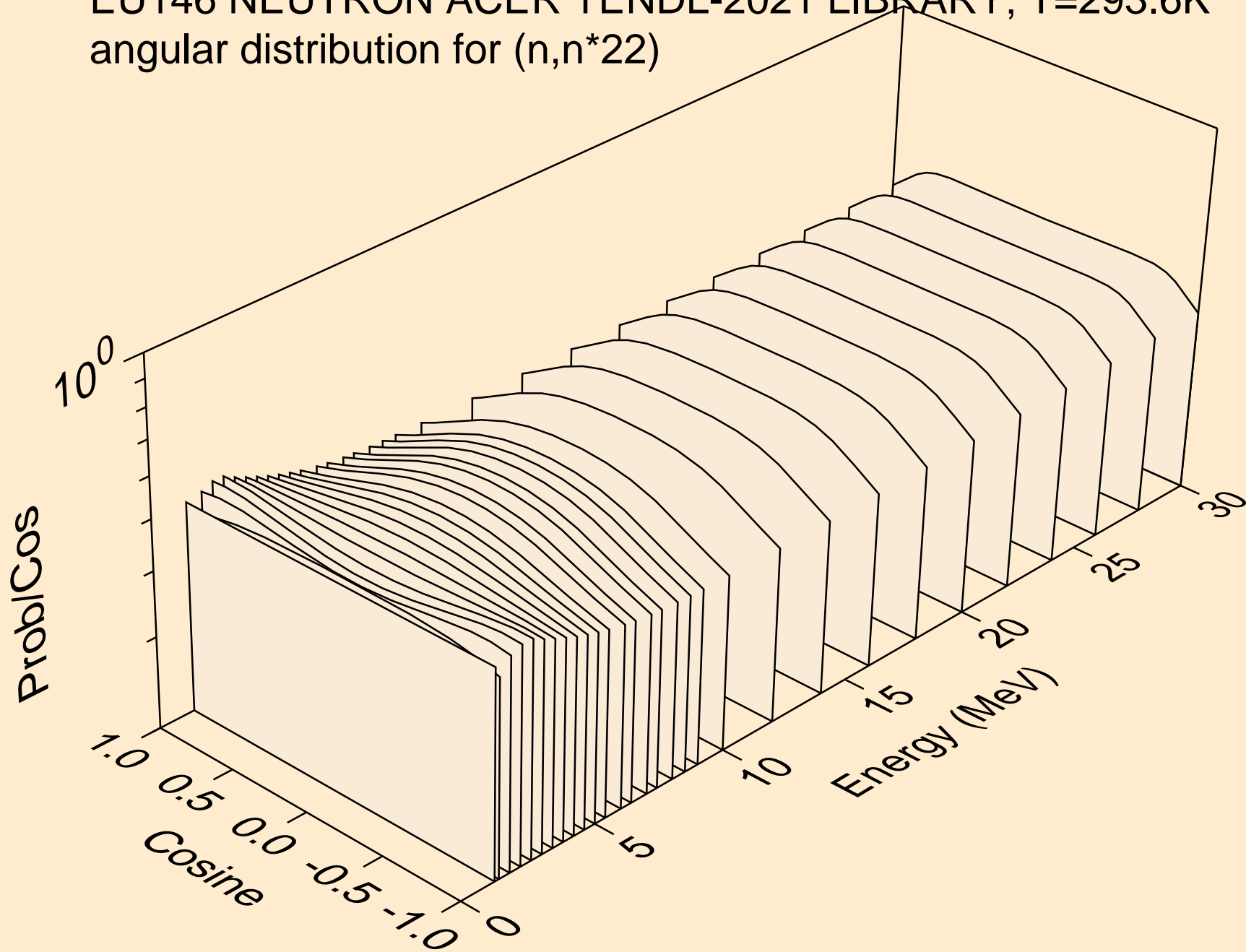

EU146 NEUTRON ACER TENDL-2021 LIBRARY; T=293.6K
angular distribution for (n,n*23)

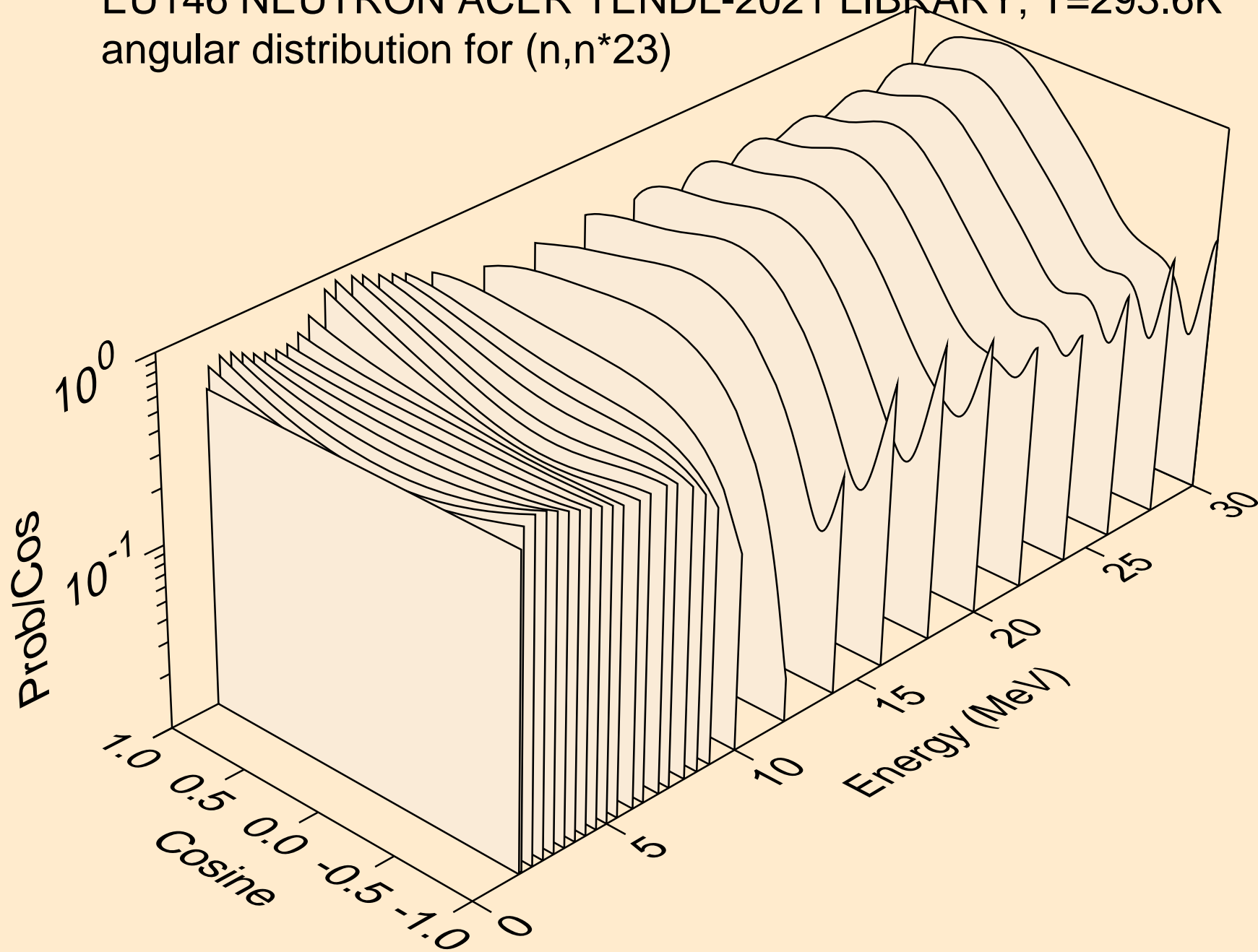

EU146 NEUTRON ACER TENDL-2021 LIBRARY; T=293.6K
angular distribution for (n,n*24)

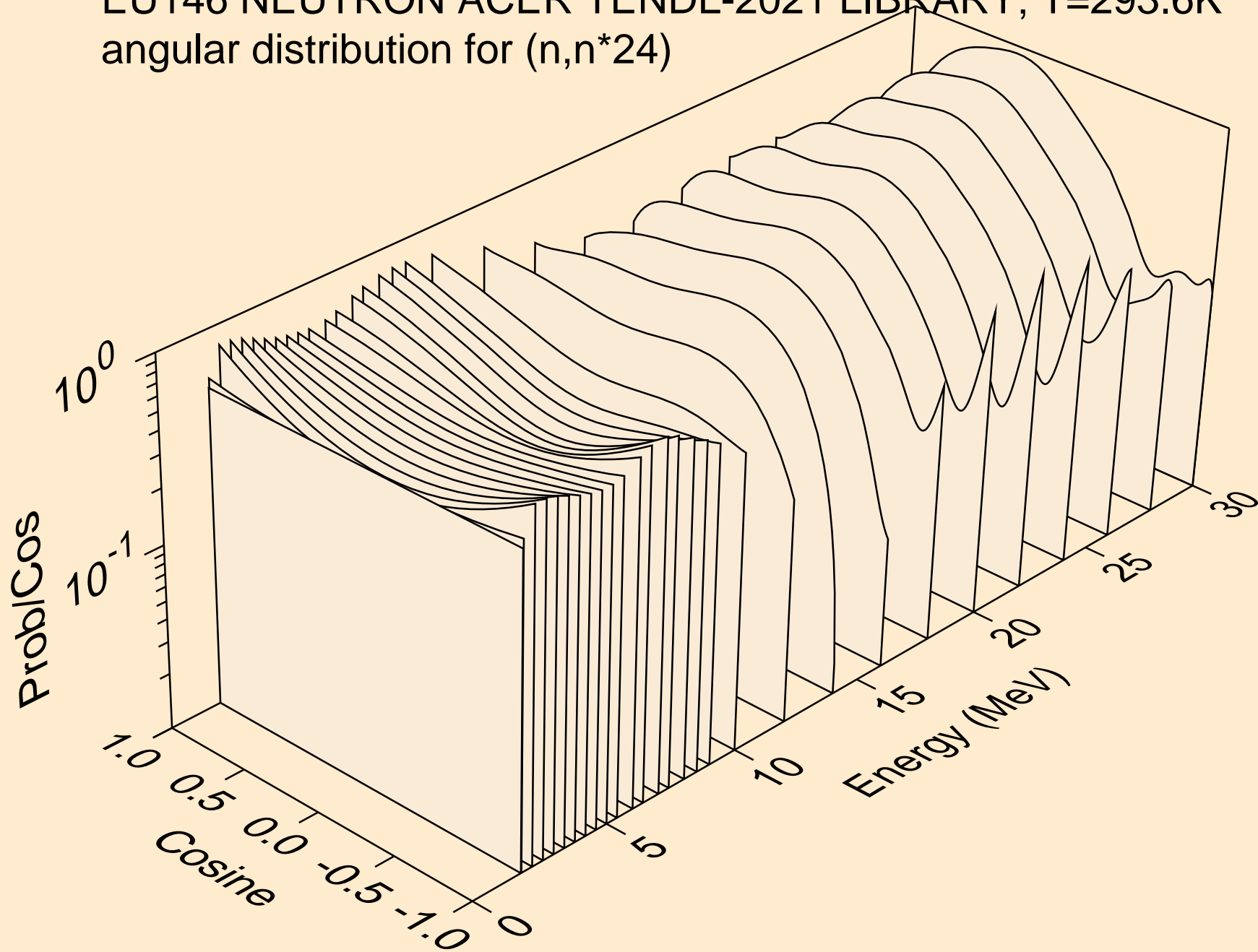

EU146 NEUTRON ACER TENDL-2021 LIBRARY; T=293.6K
angular distribution for (n,n*25)

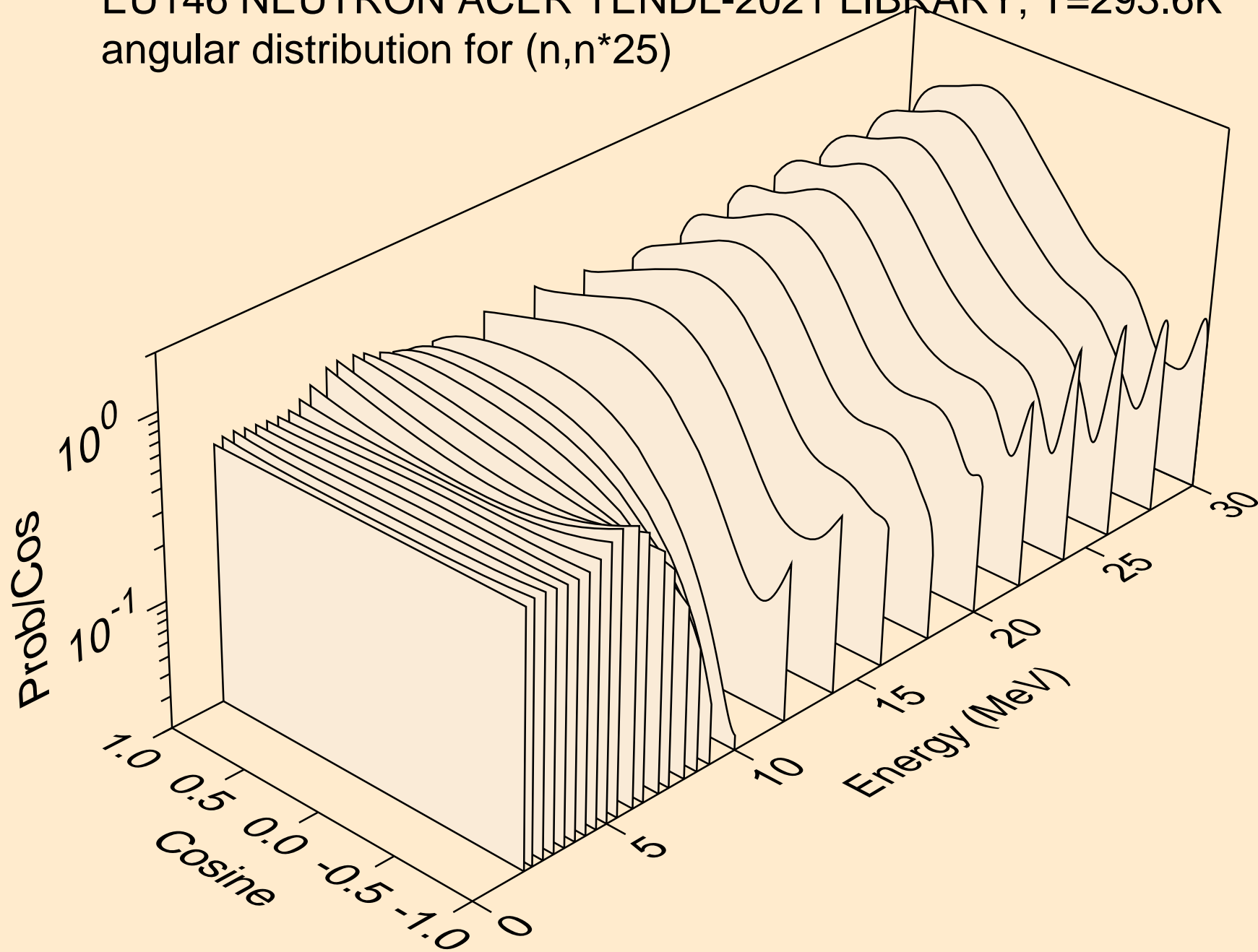

EU146 NEUTRON ACER TENDL-2021 LIBRARY; T=293.6K
Neutron emission for (n,x)

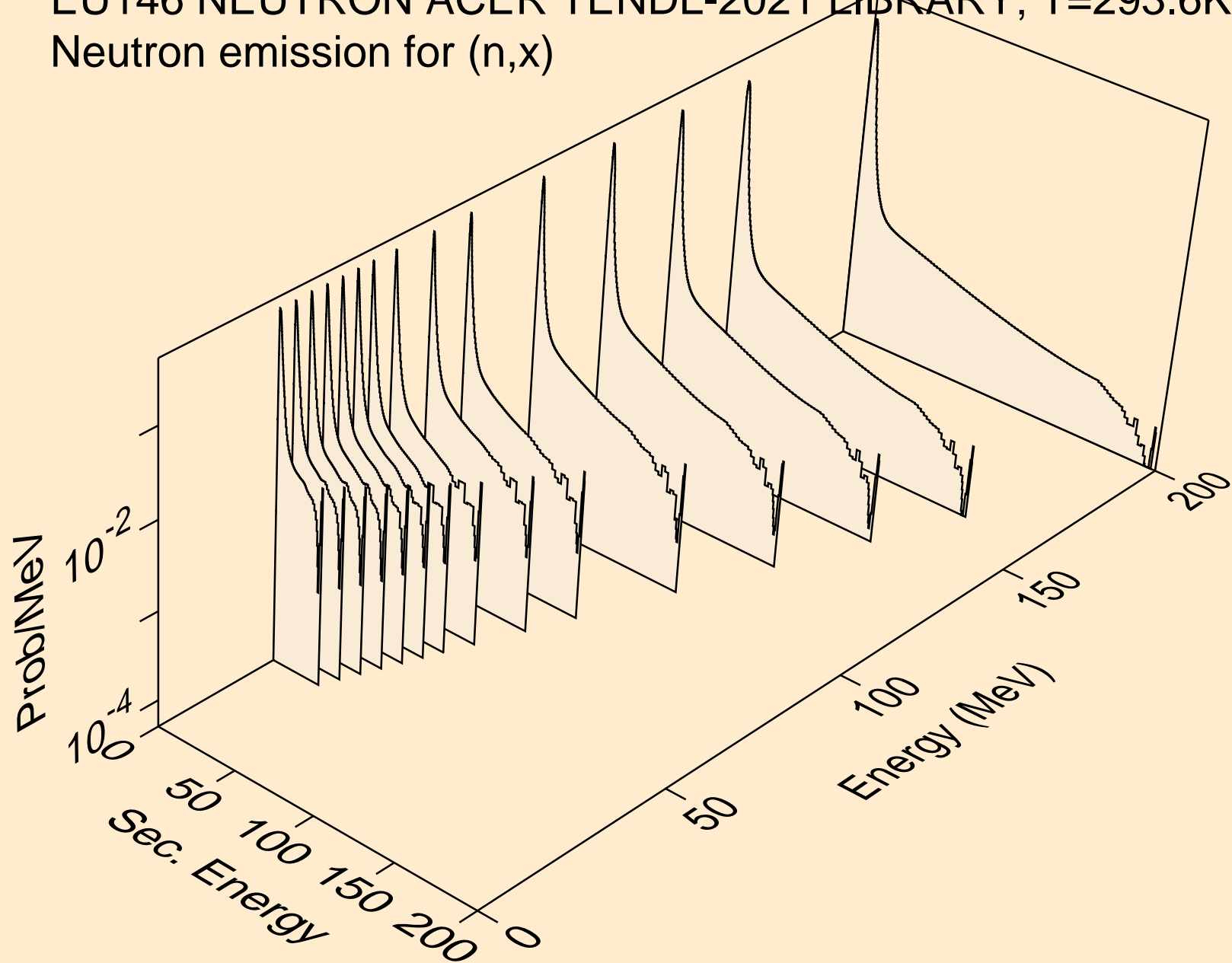

EU146 NEUTRON ACER TENDL-2021 LIBRARY; T=293.6K
Neutron emission for (n,2nd)

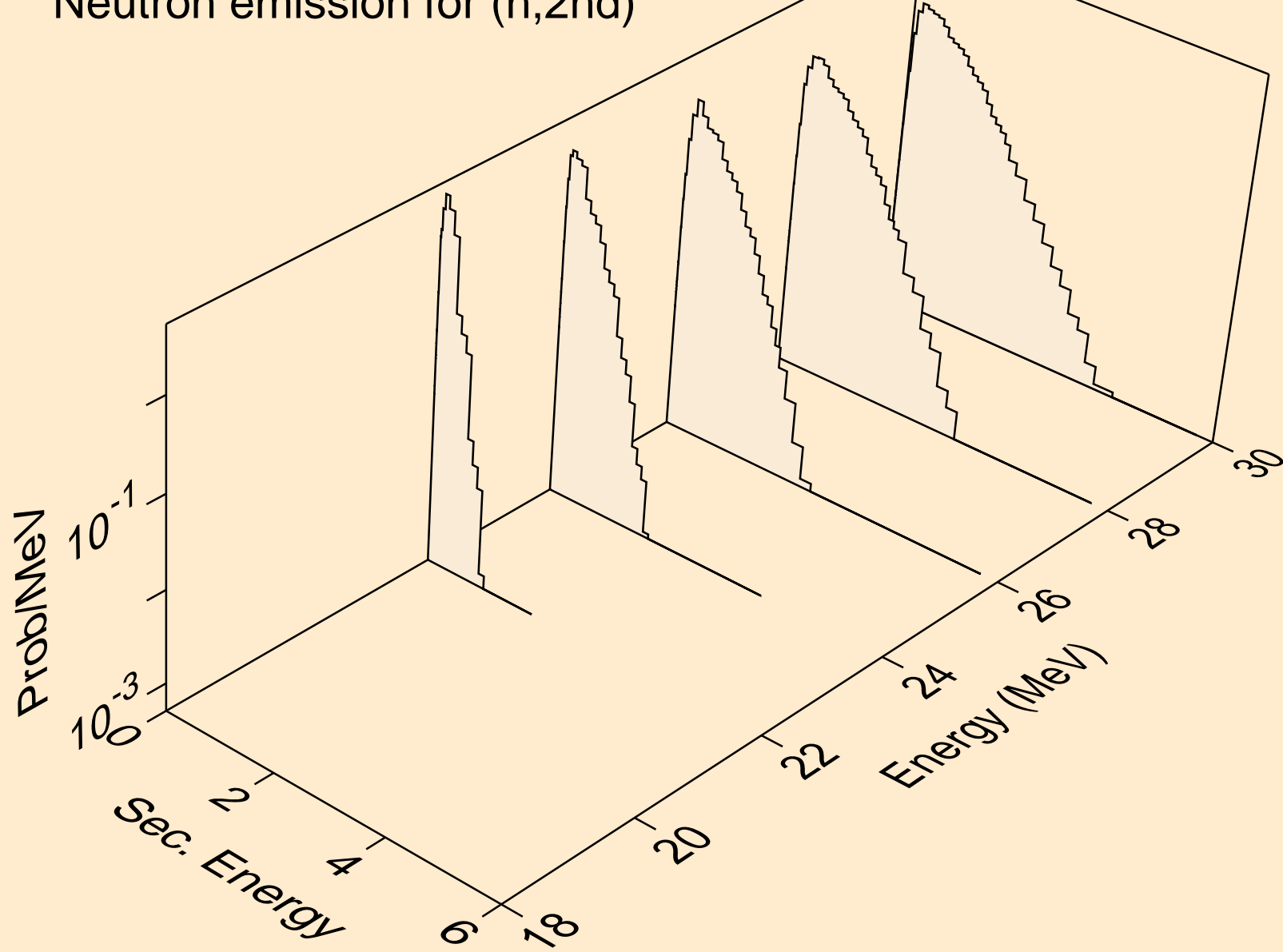

EU146 NEUTRON ACER TENDL-2021 LIBRARY; T=293.6K
Neutron emission for (n,2n)

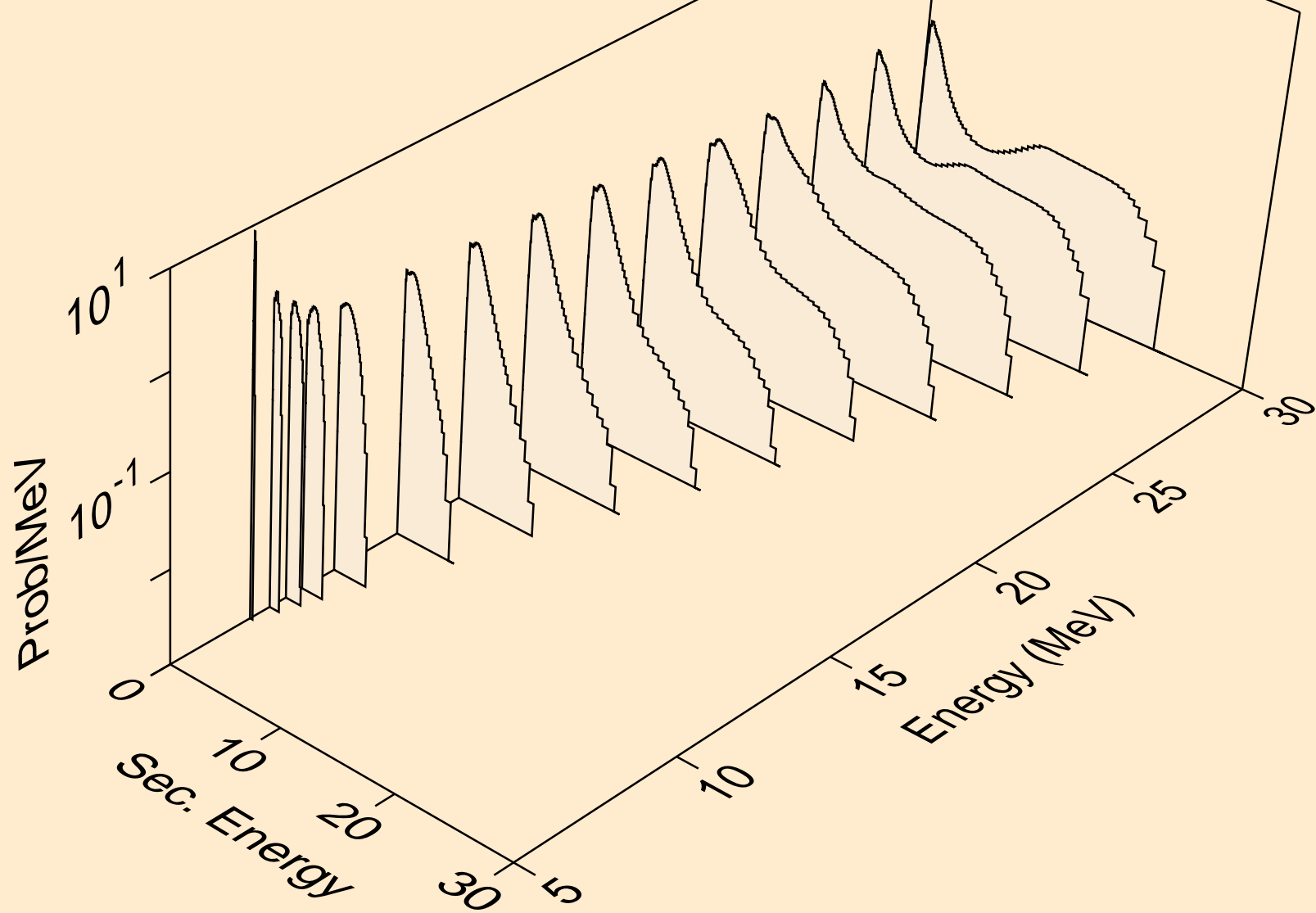

EU146 NEUTRON ACER TENDL-2021 LIBRARY; T=293.6K
Neutron emission for (n,3n)

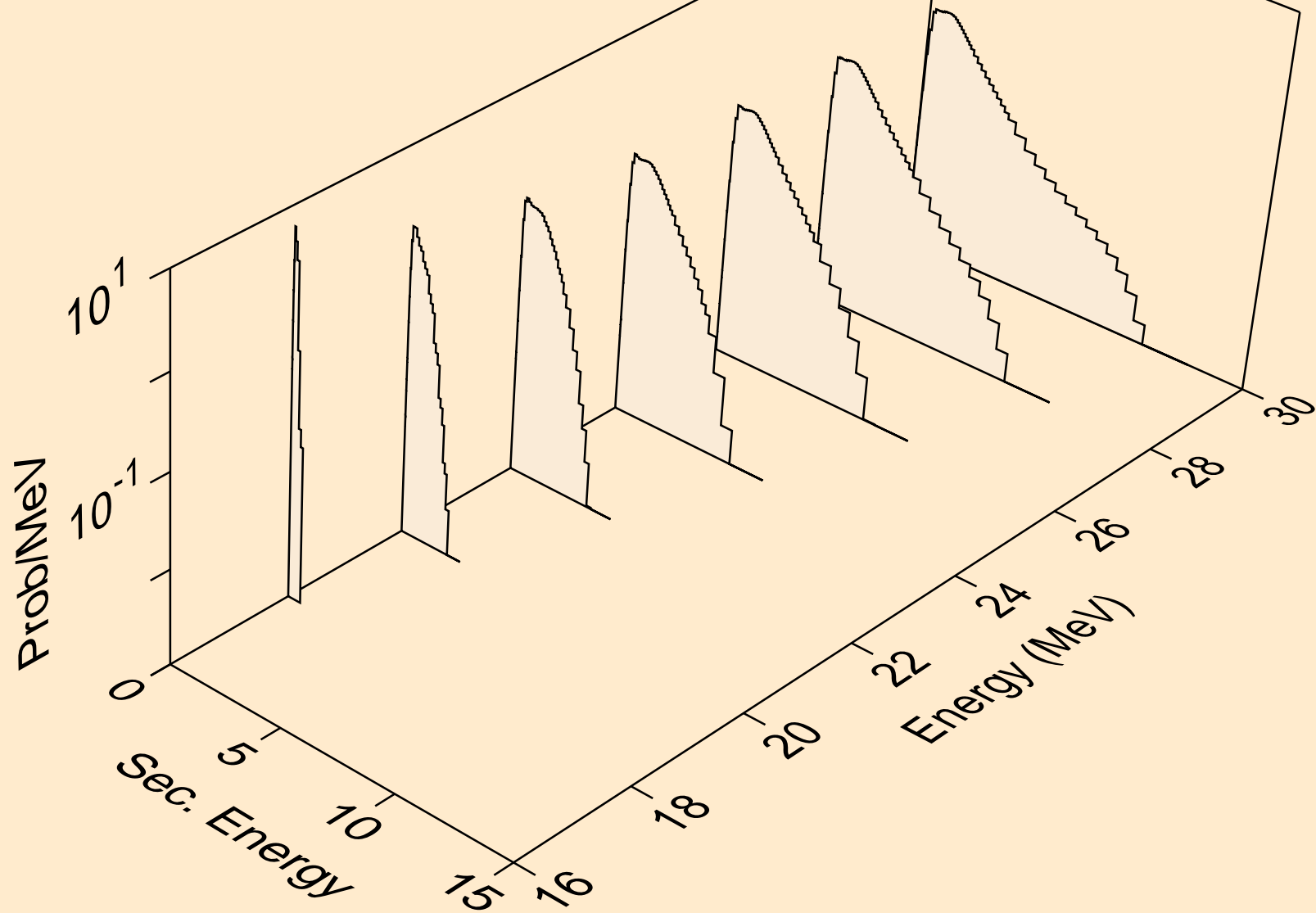

EU146 NEUTRON ACER TENDL-2021 LIBRARY; T=293.6K
Neutron emission for (n,n*)a

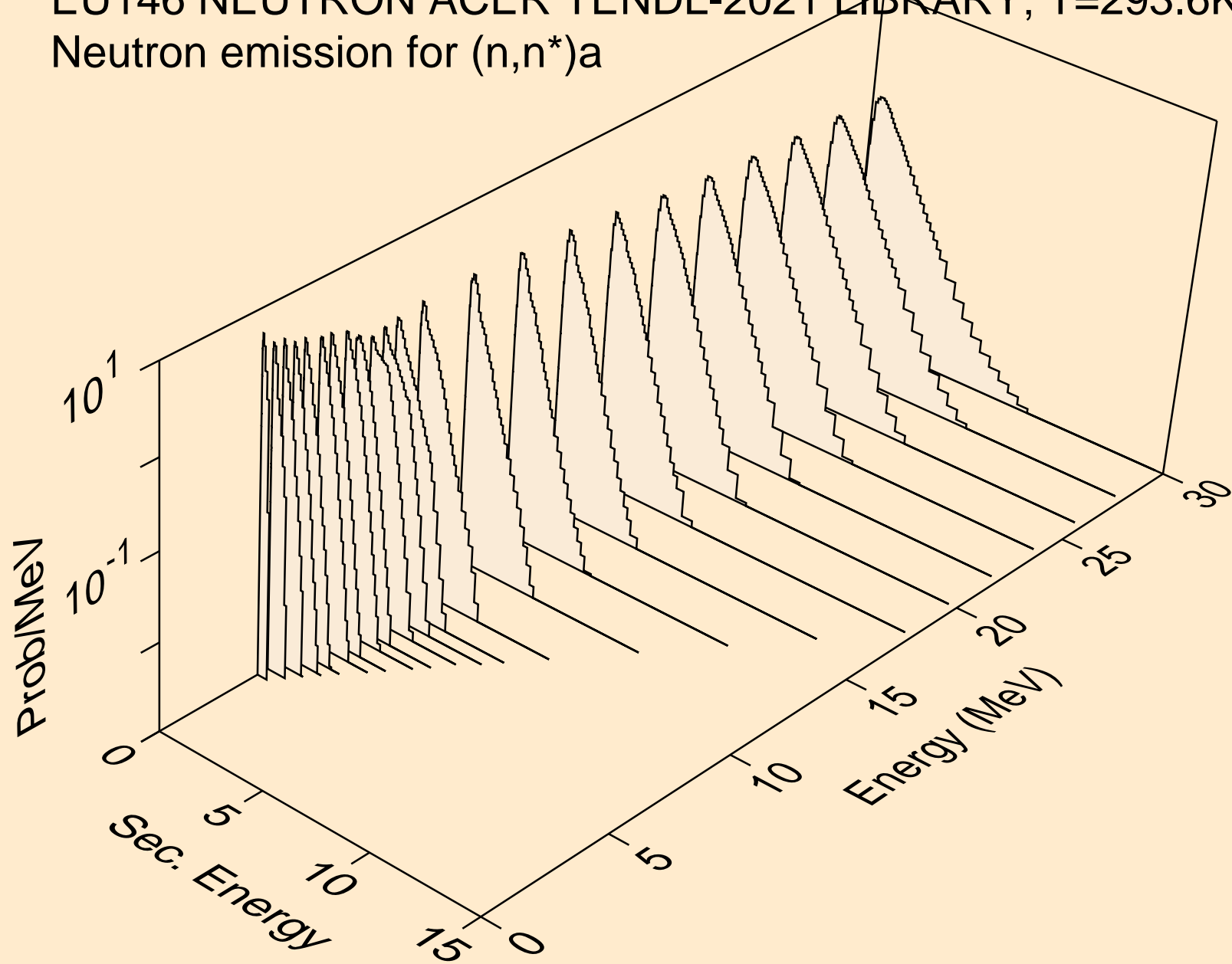

EU146 NEUTRON ACER TENDL-2021 LIBRARY; T=293.6K
Neutron emission for (n,2n)_a

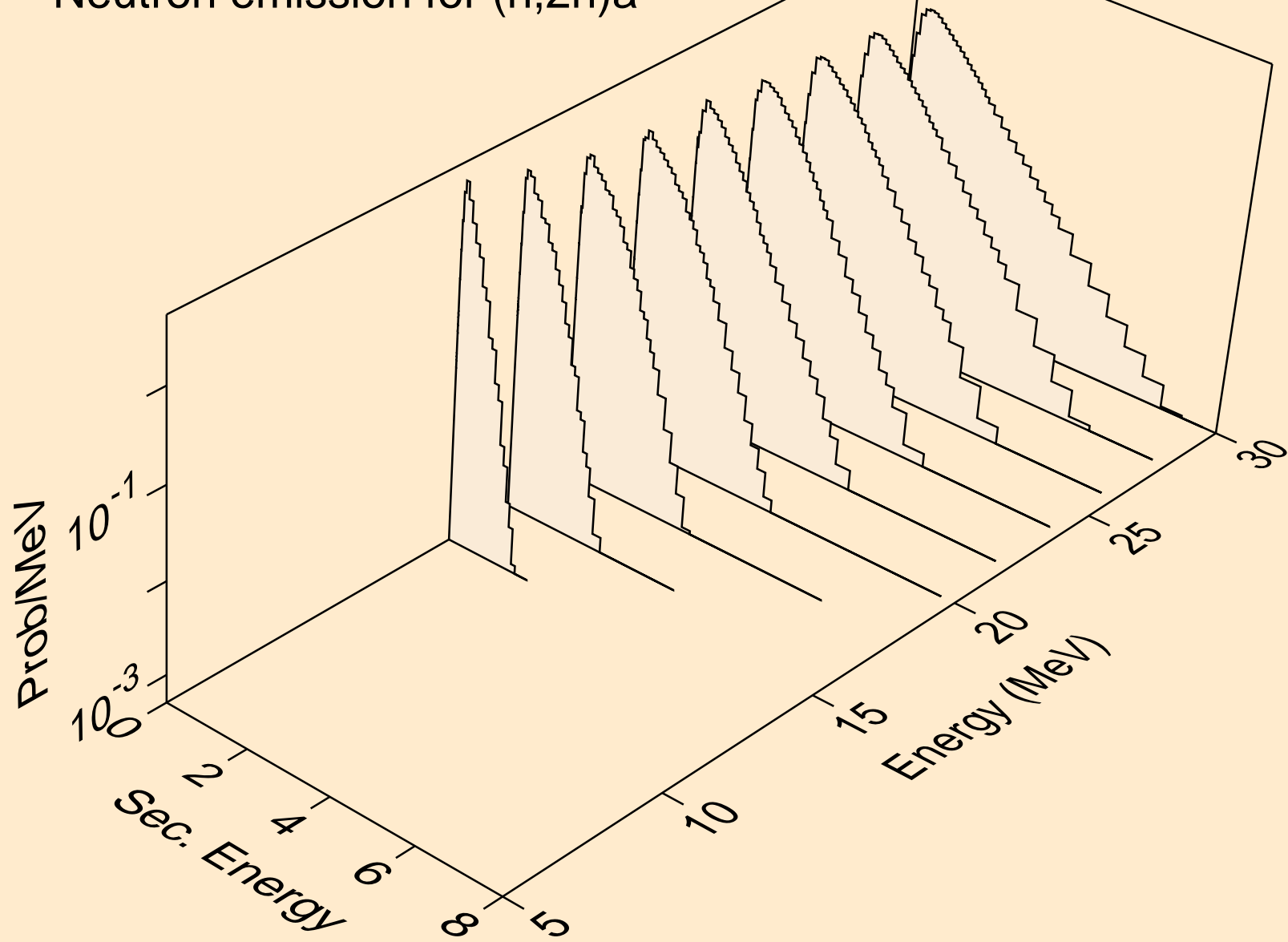

EU146 NEUTRON ACER TENDL-2021 LIBRARY; T=293.6K
Neutron emission for (n,3n)a

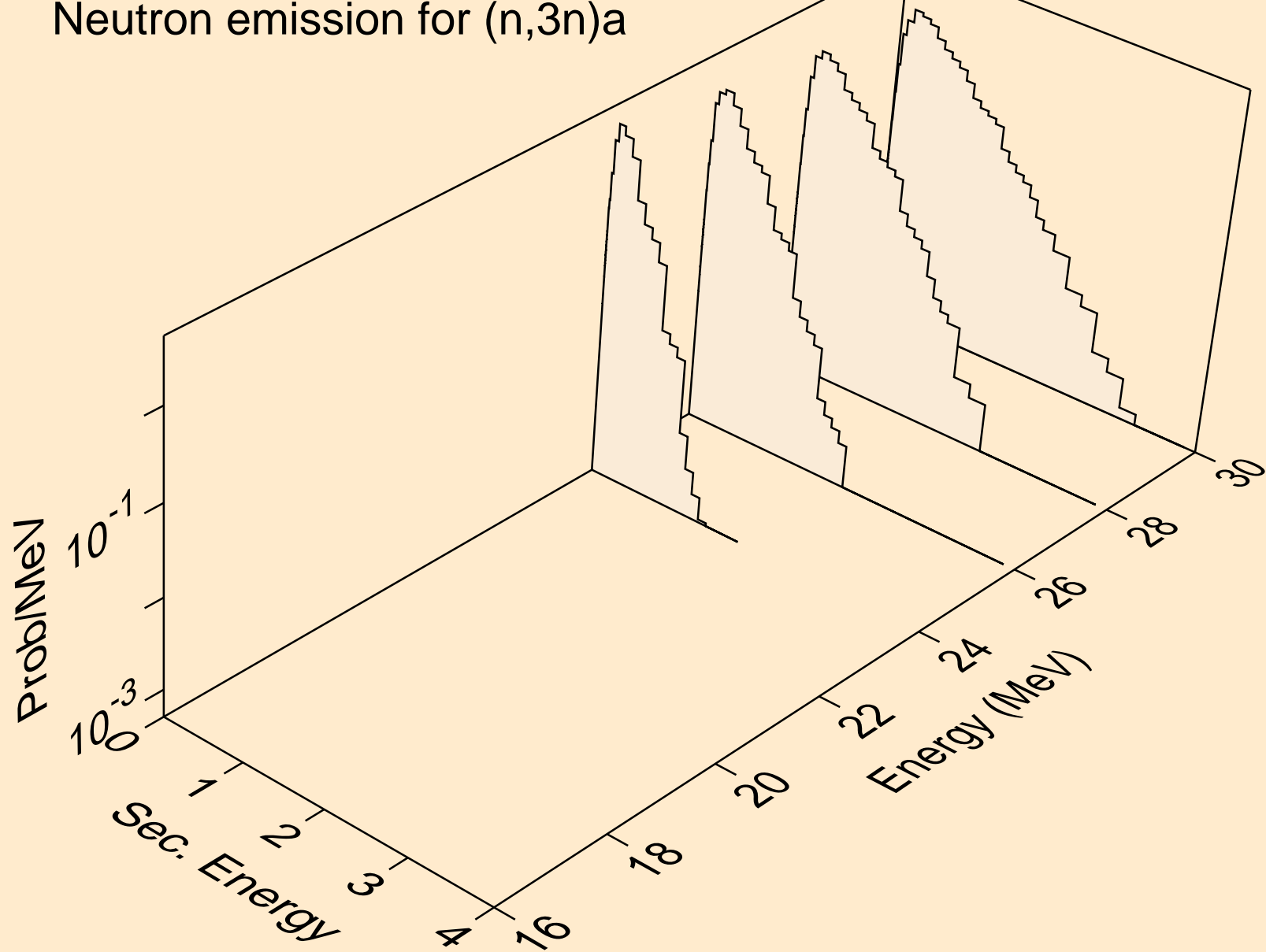

EU146 NEUTRON ACER TENDL-2021 LIBRARY; T=293.6K
Neutron emission for (n,n*)p

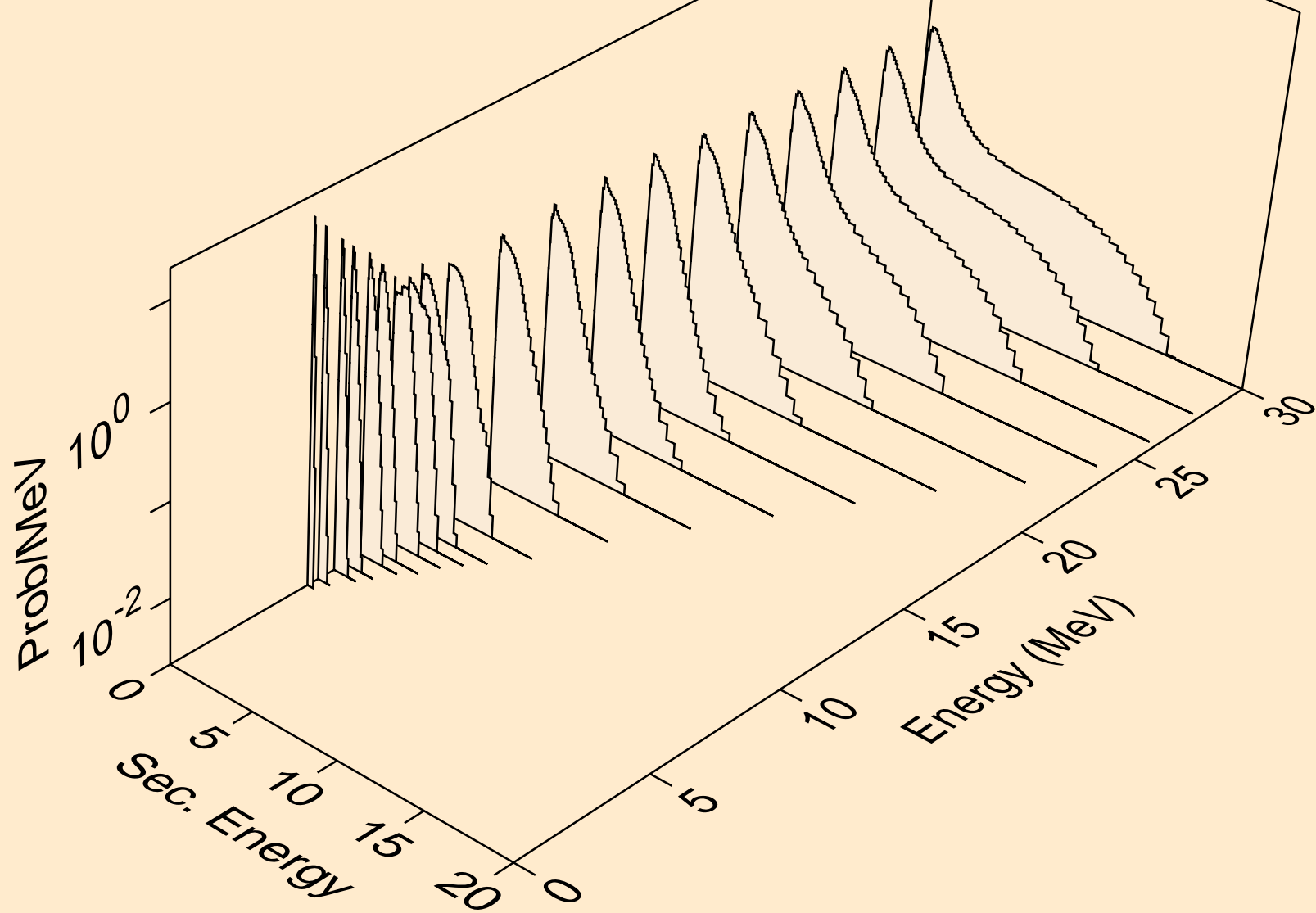

EU146 NEUTRON ACER TENDL-2021 LIBRARY; T=293.6K
Neutron emission for (n,n*)2a

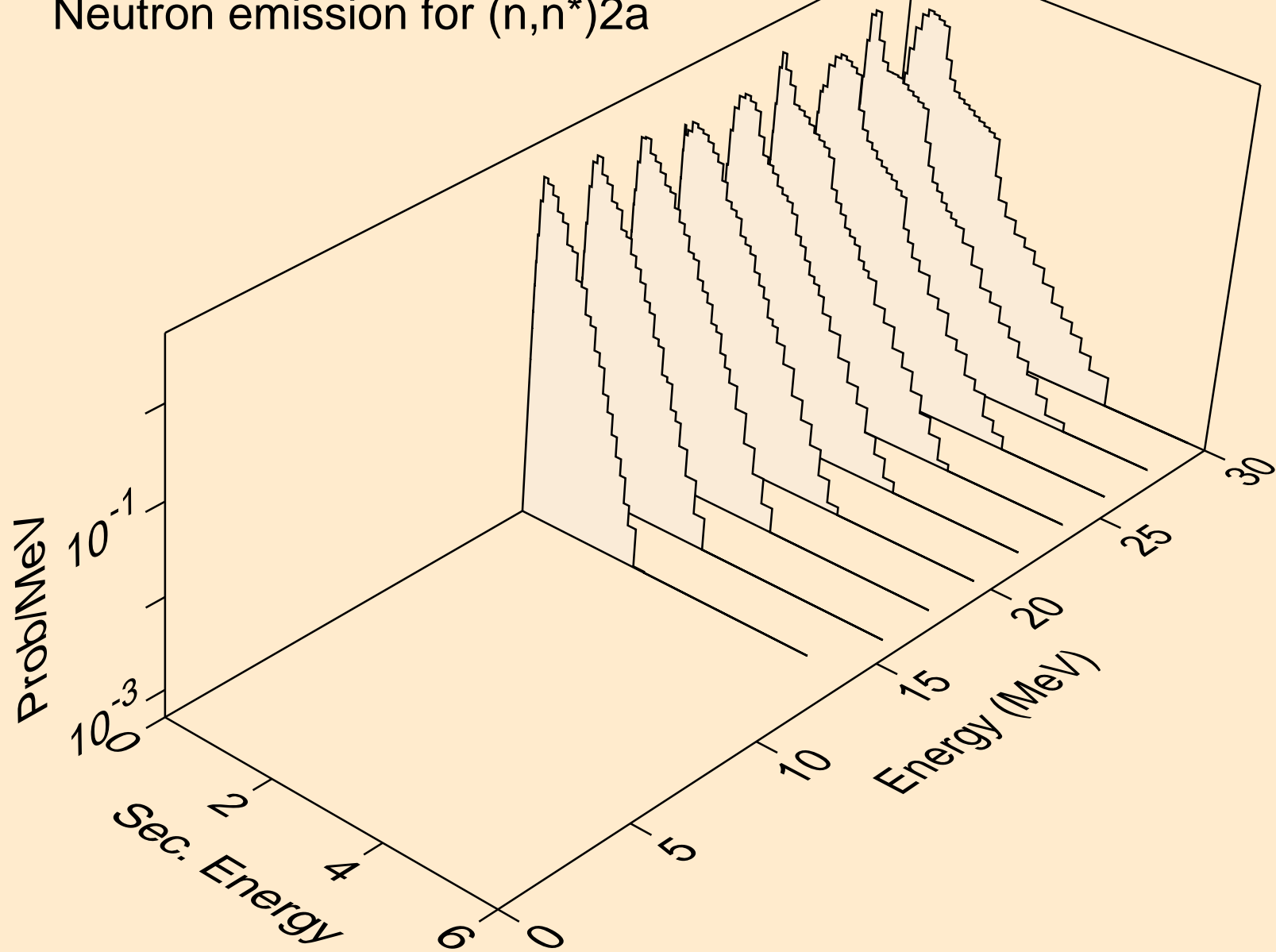

EU146 NEUTRON ACER TENDL-2021 LIBRARY; T=293.6K
Neutron emission for (n,n*)d

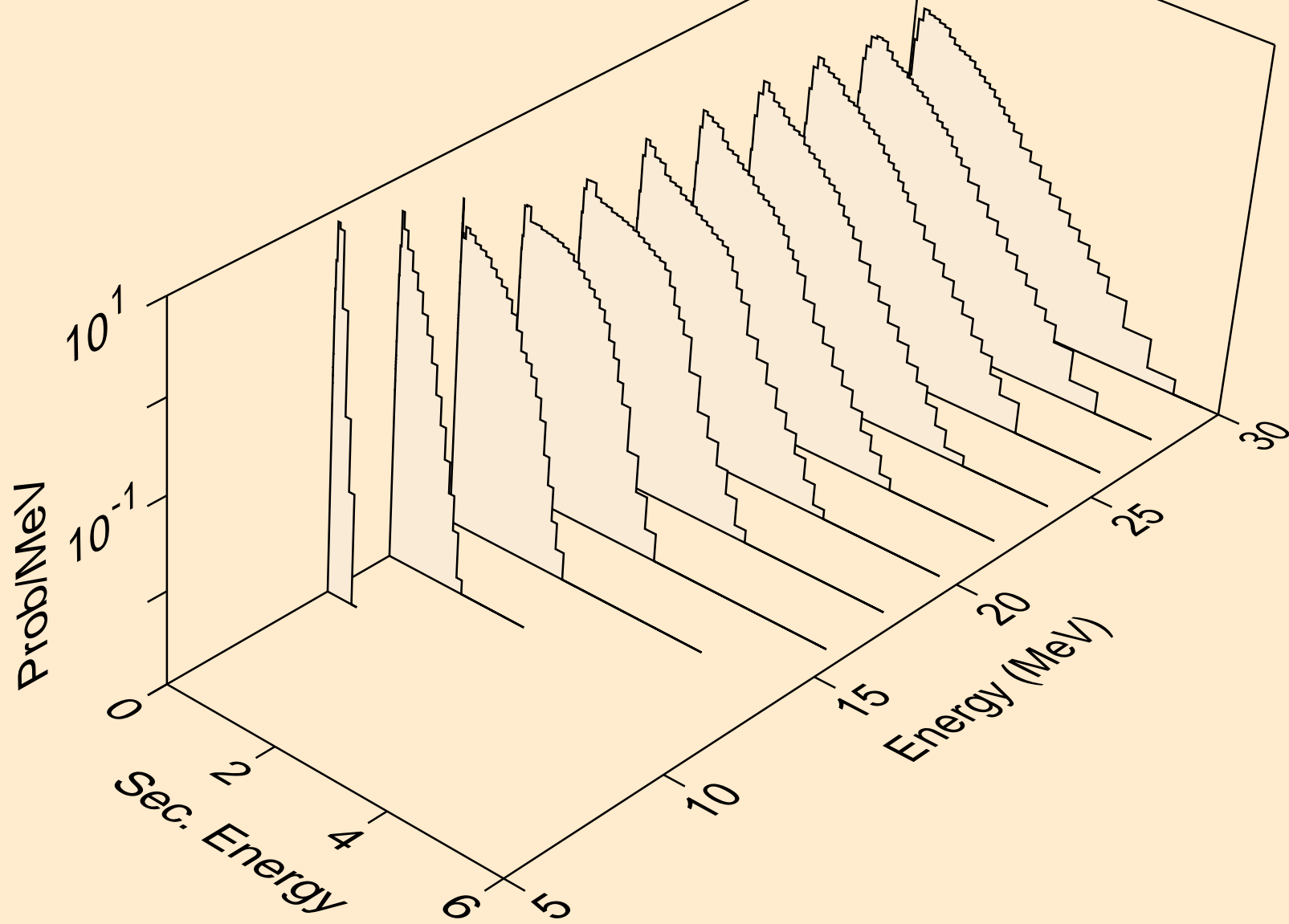

EU146 NEUTRON ACER TENDL-2021 LIBRARY; T=293.6K
Neutron emission for (n,n*)t

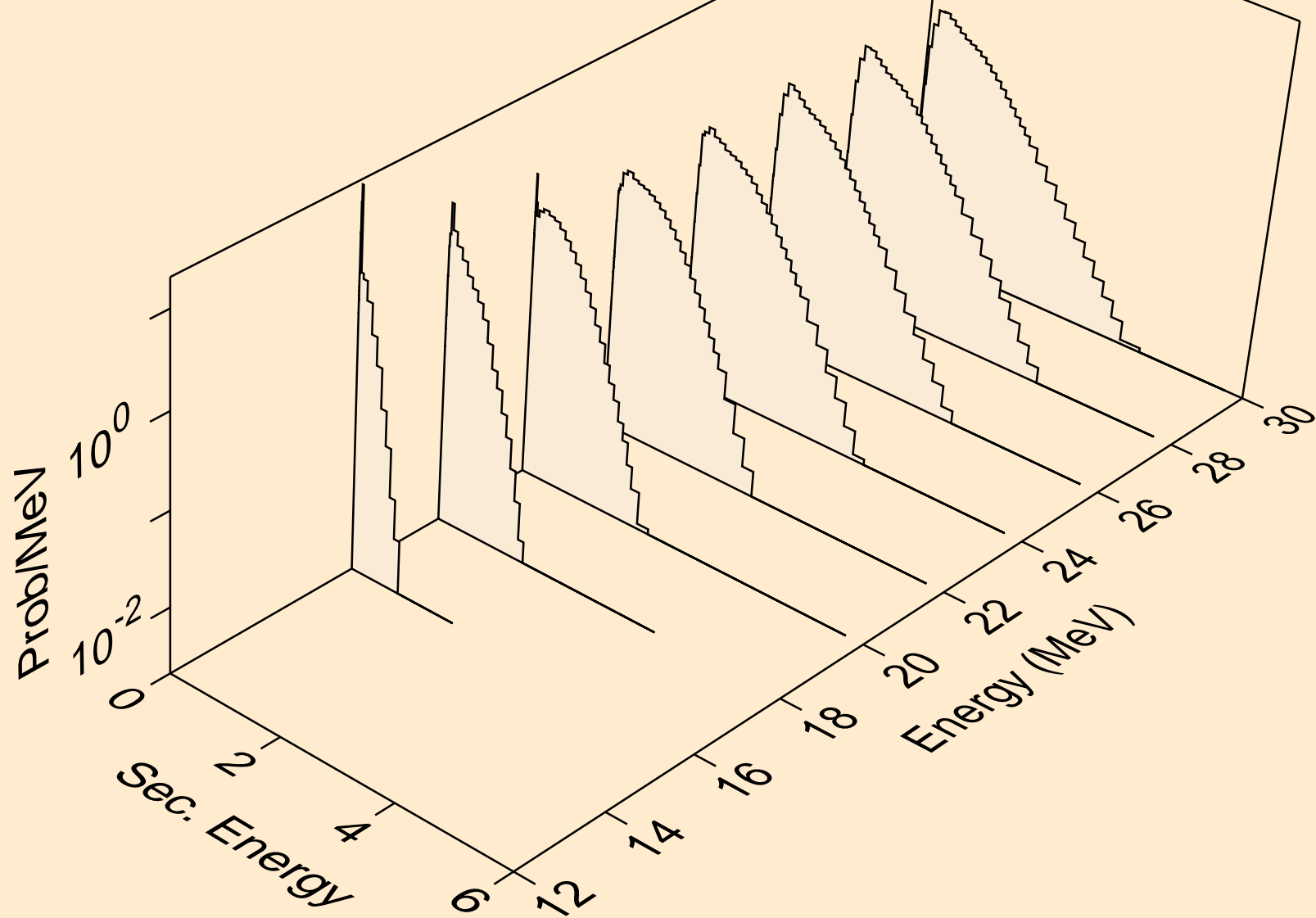

EU146 NEUTRON ACER TENDL-2021 LIBRARY; T=293.6K
Neutron emission for (n,n*)he3

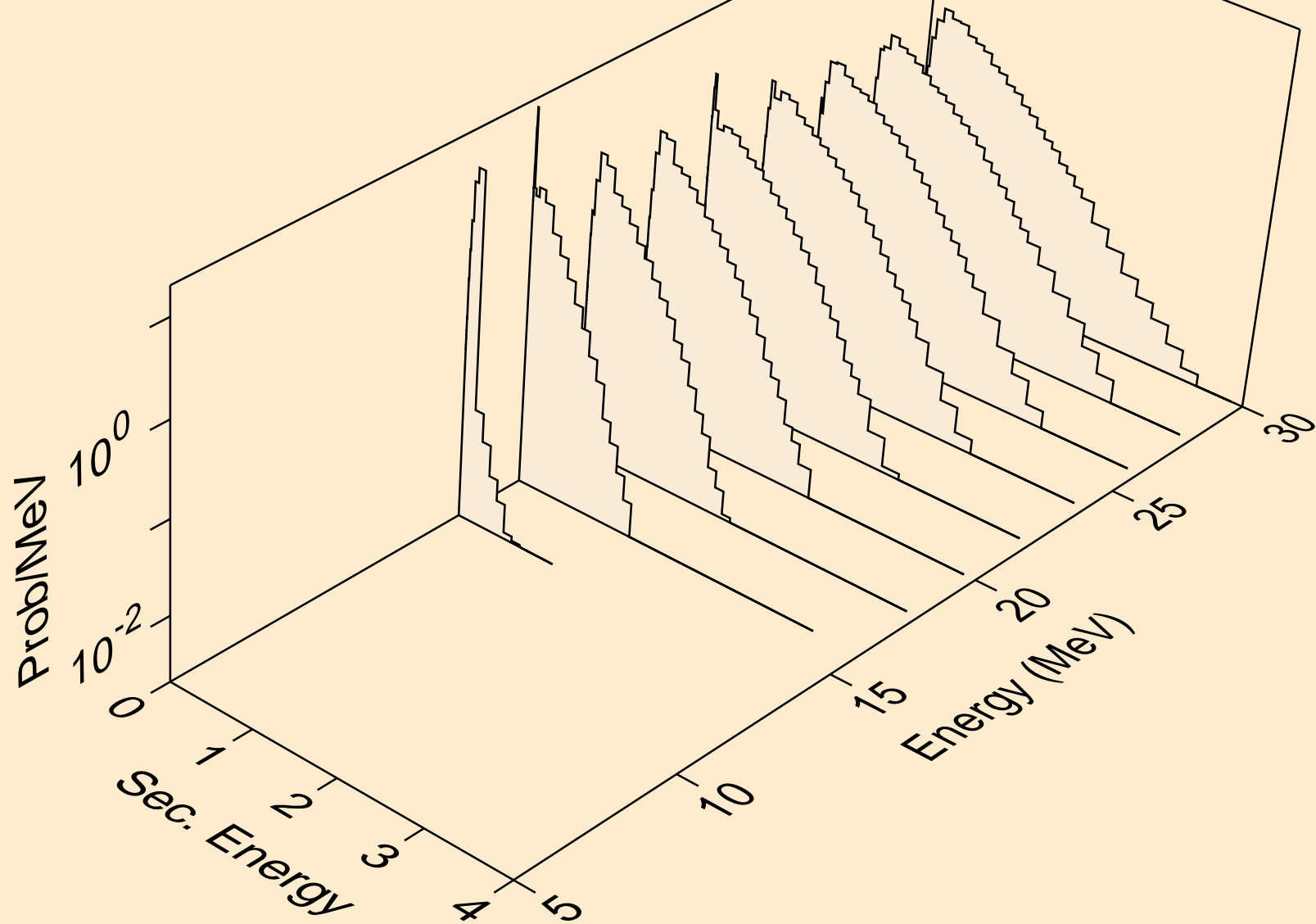

EU146 NEUTRON ACER TENDL-2021 LIBRARY; T=293.6K
Neutron emission for (n,4n)

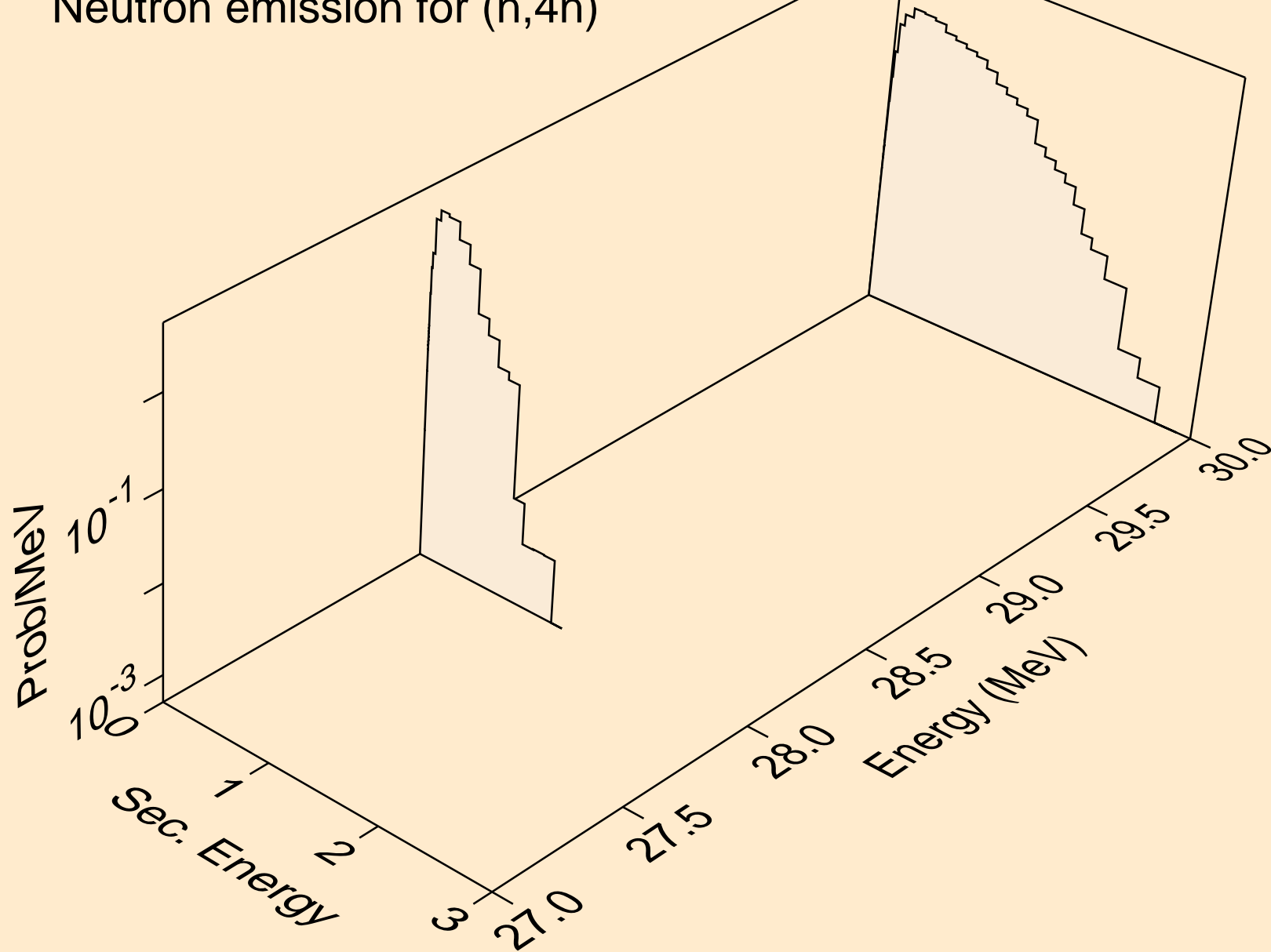

EU146 NEUTRON ACER TENDL-2021 LIBRARY; T=293.6K
Neutron emission for (n,2np)

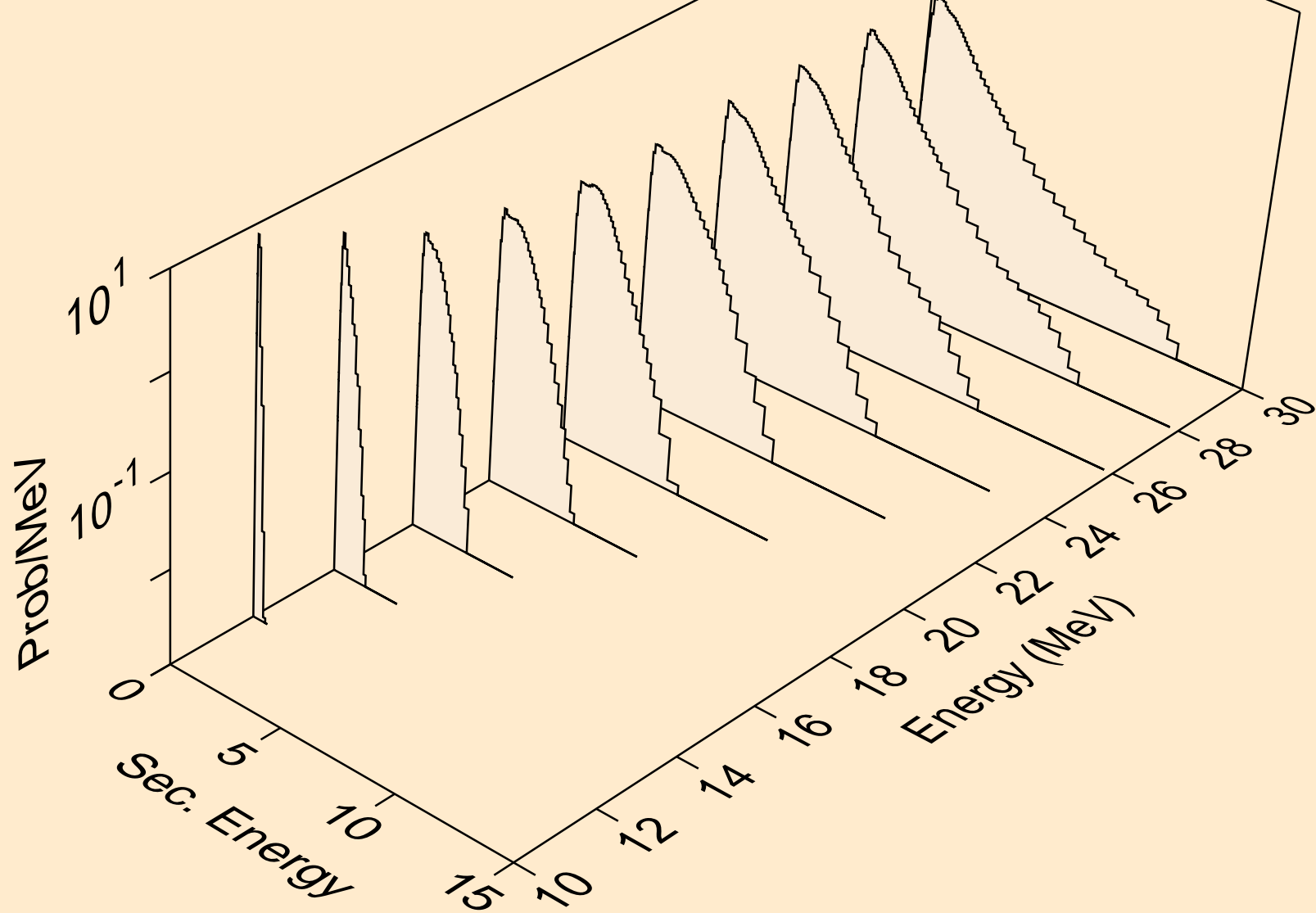

EU146 NEUTRON ACER TENDL-2021 LIBRARY; T=293.6K
Neutron emission for (n,3np)

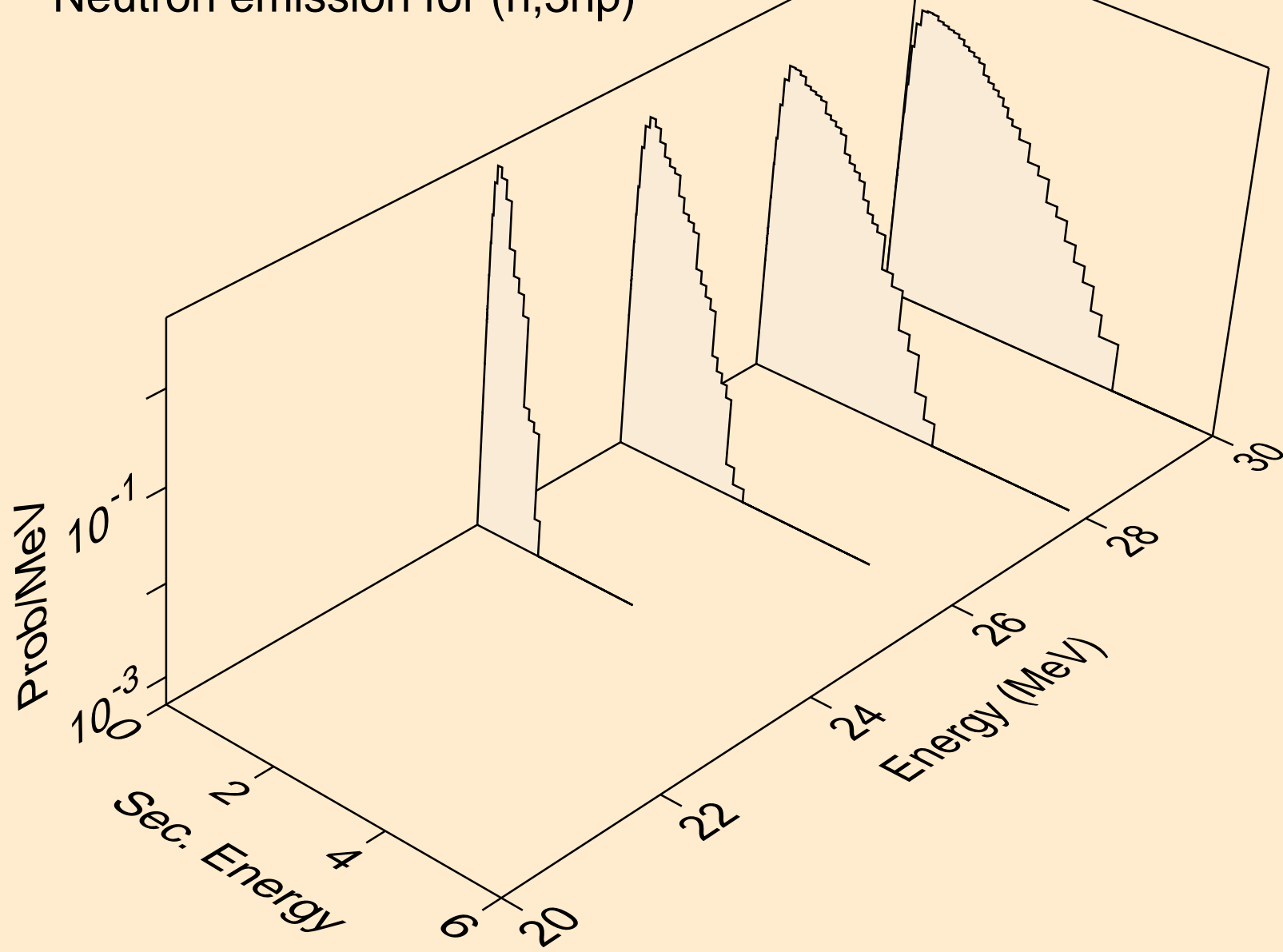

EU146 NEUTRON ACER TENDL-2021 LIBRARY; T=293.6K
Neutron emission for (n,2np)

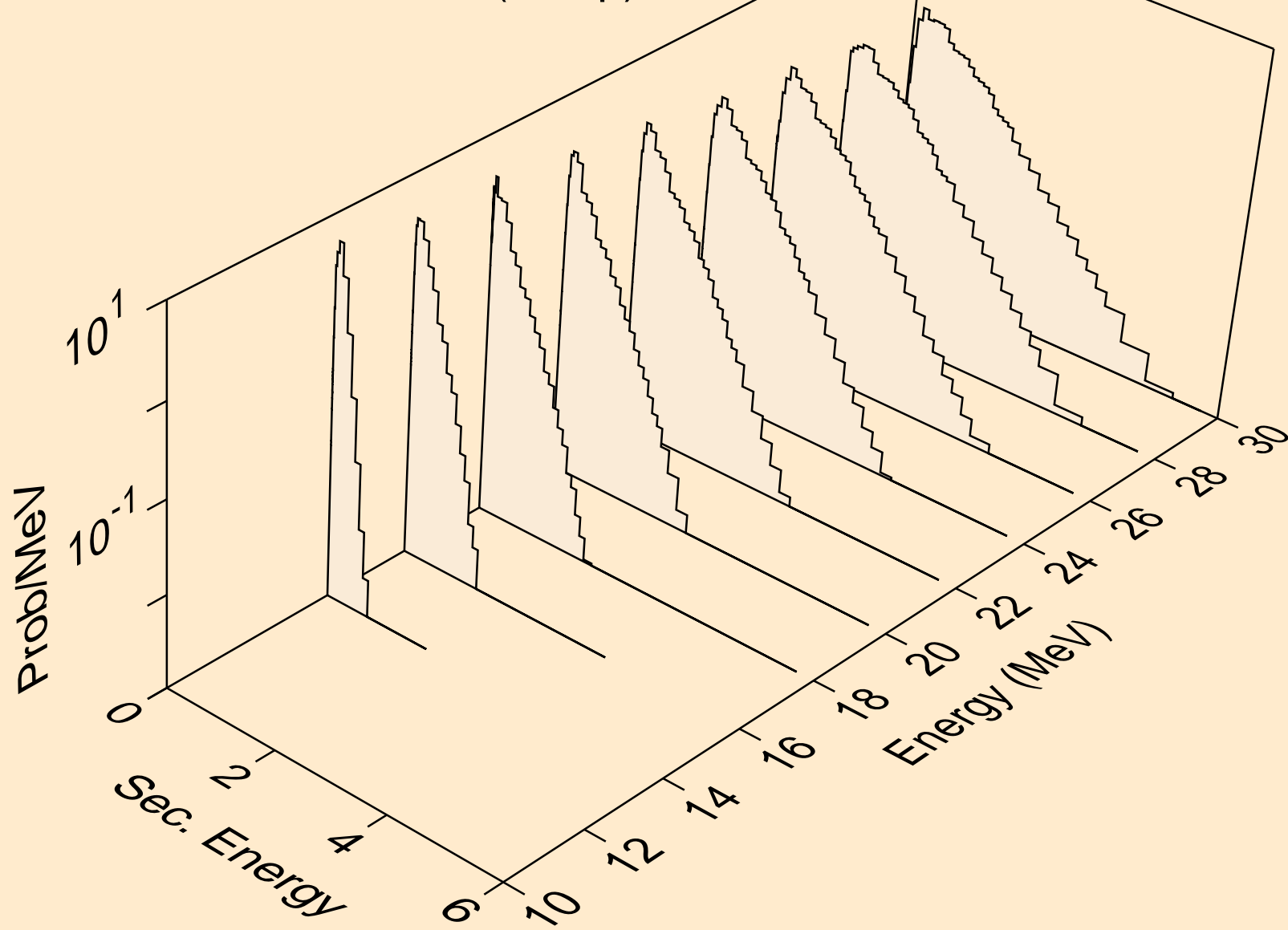

EU146 NEUTRON ACER TENDL-2021 LIBRARY; T=293.6K
Neutron emission for (n,npa)

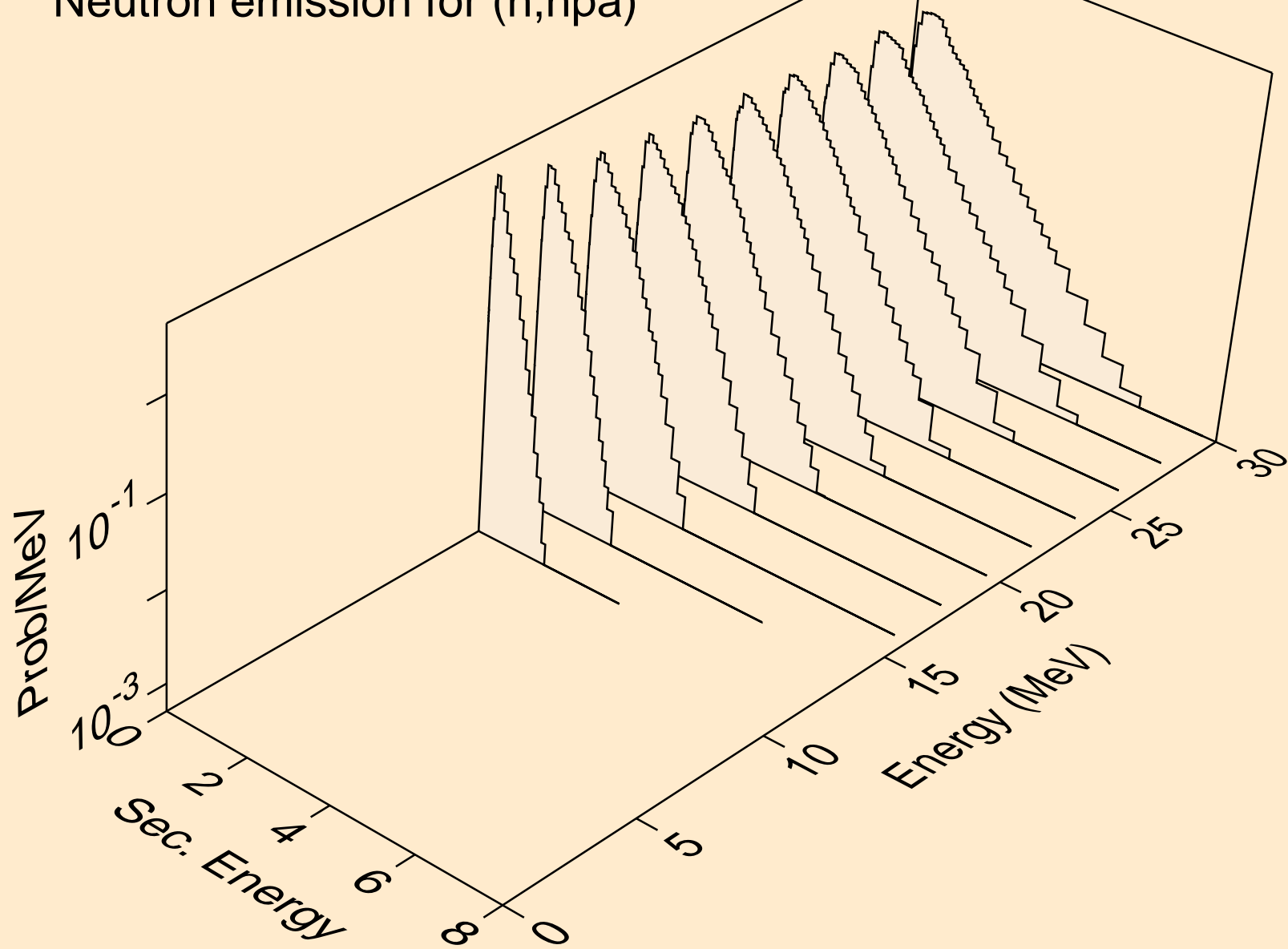

EU146 NEUTRON ACER TENDL-2021 LIBRARY; T=293.6K
Neutron emission for (n,n*c)

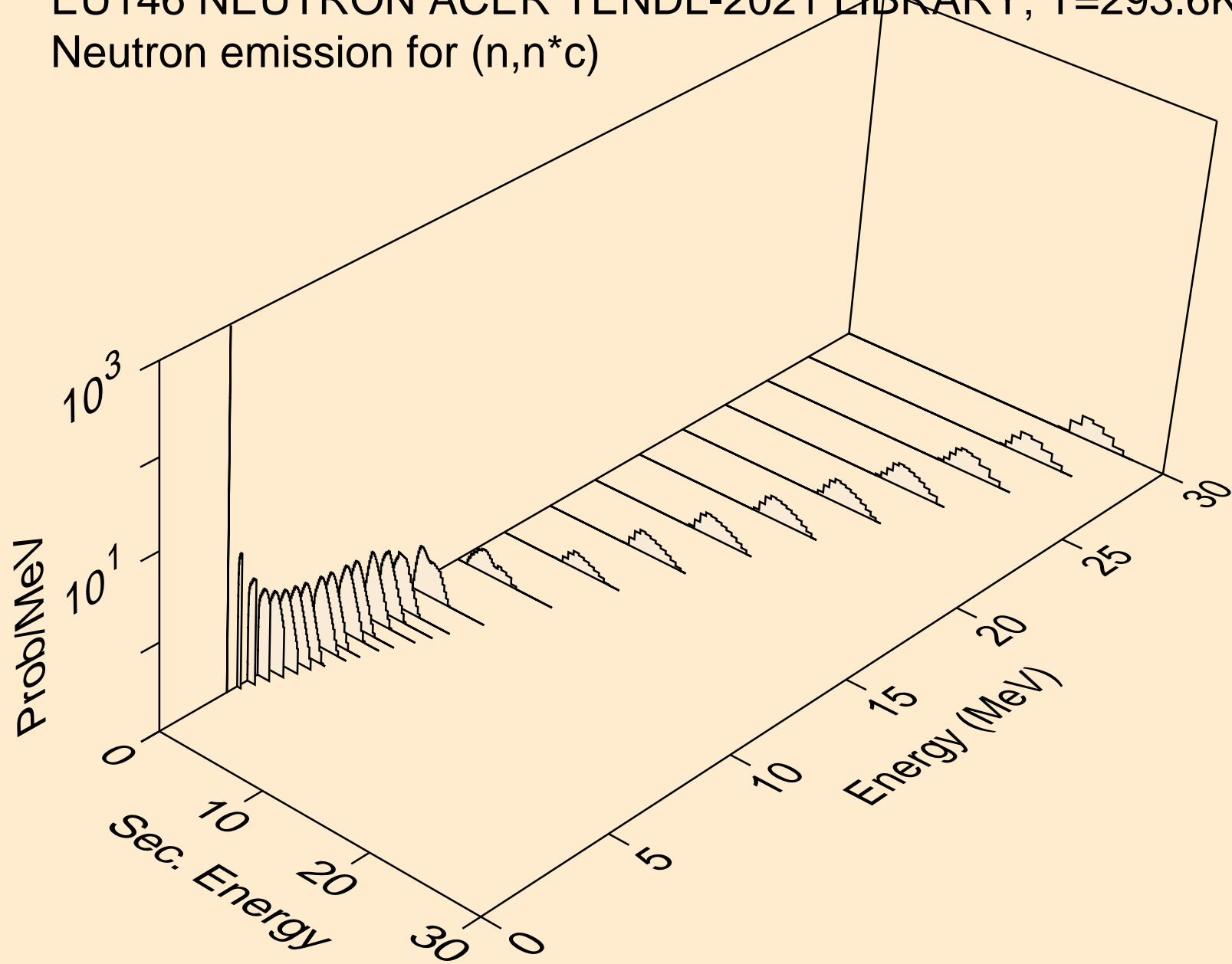

EU146 NEUTRON ACER TENDL-2021 LIBRARY; T=293.6K
Photon emission for (n,x)

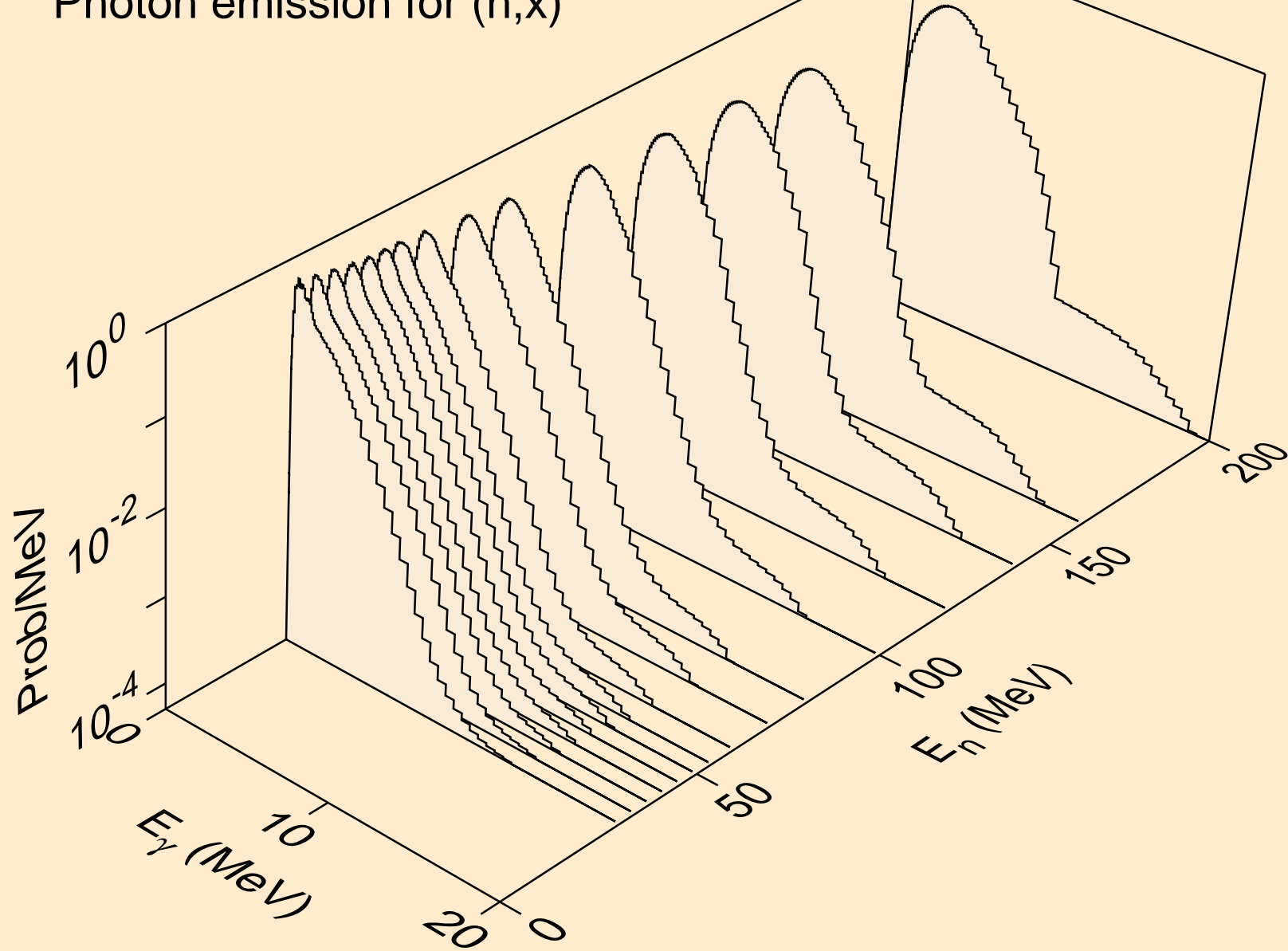

EU146 NEUTRON ACER TENDL-2021 LIBRARY; T=293.6K
Photon emission for (n,2nd)

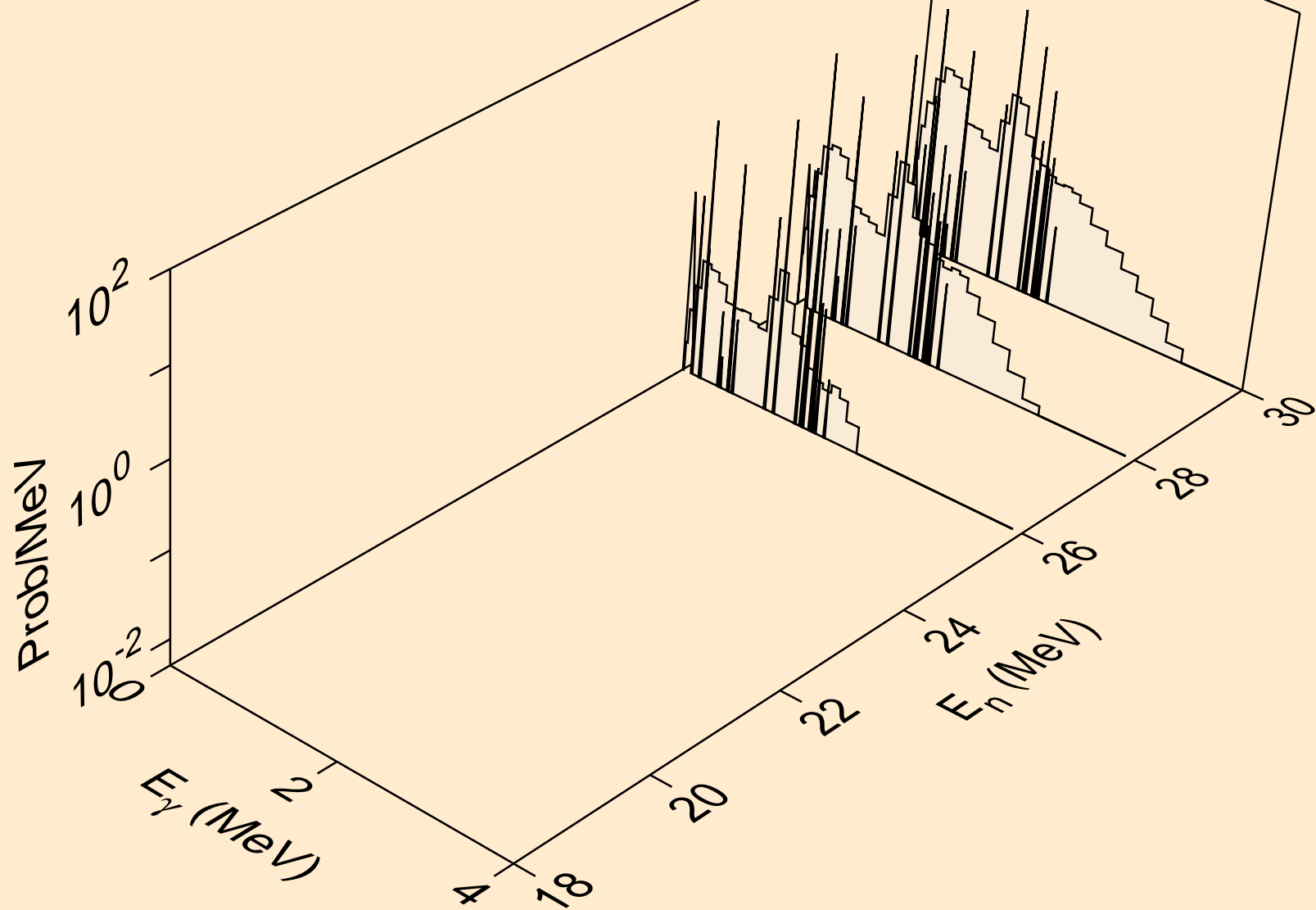

EU146 NEUTRON ACER TENDL-2021 LIBRARY; T=293.6K
Photon emission for (n,2n)

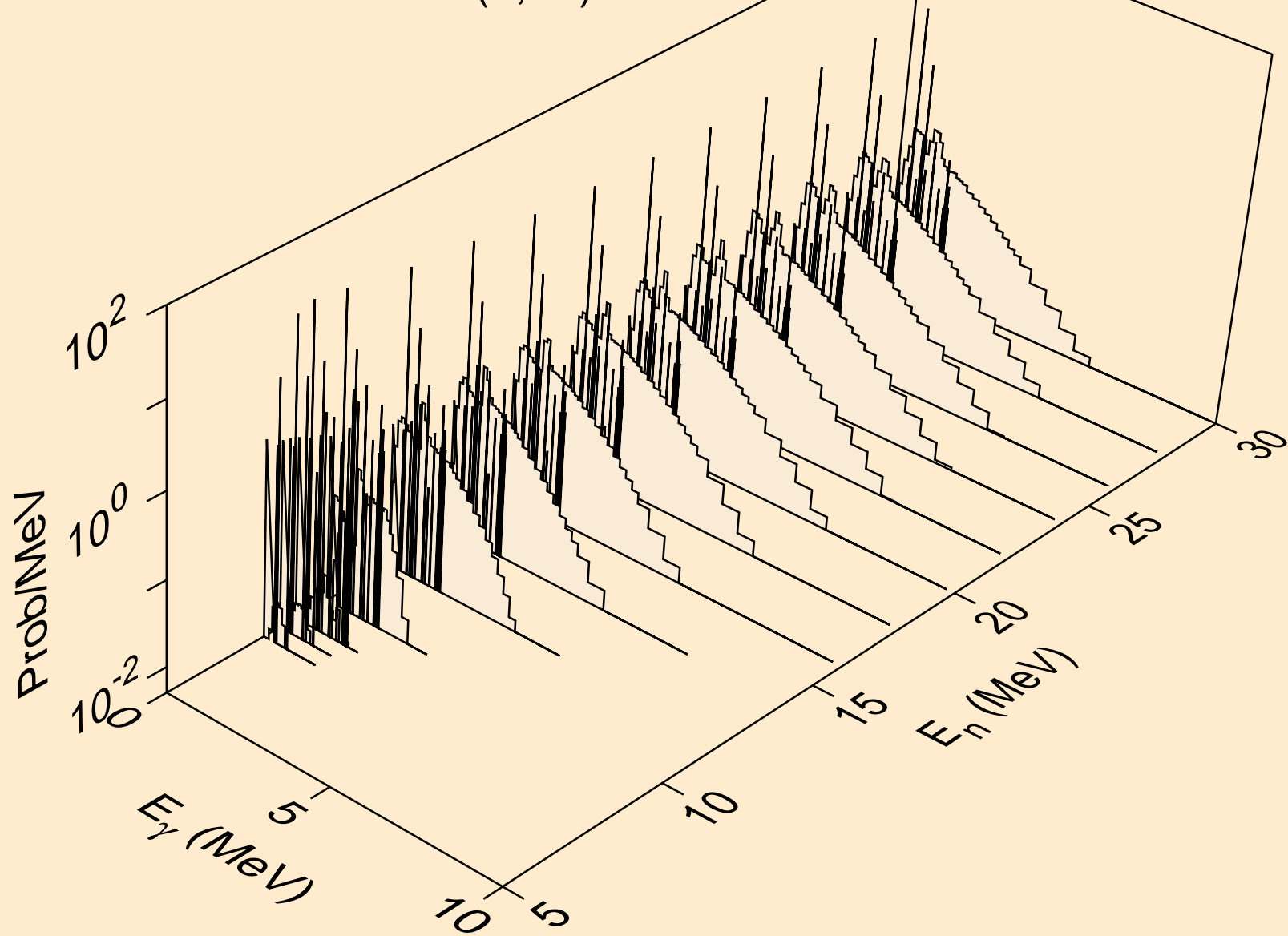

EU146 NEUTRON ACER TENDL-2021 LIBRARY; T=293.6K
Photon emission for (n,3n)

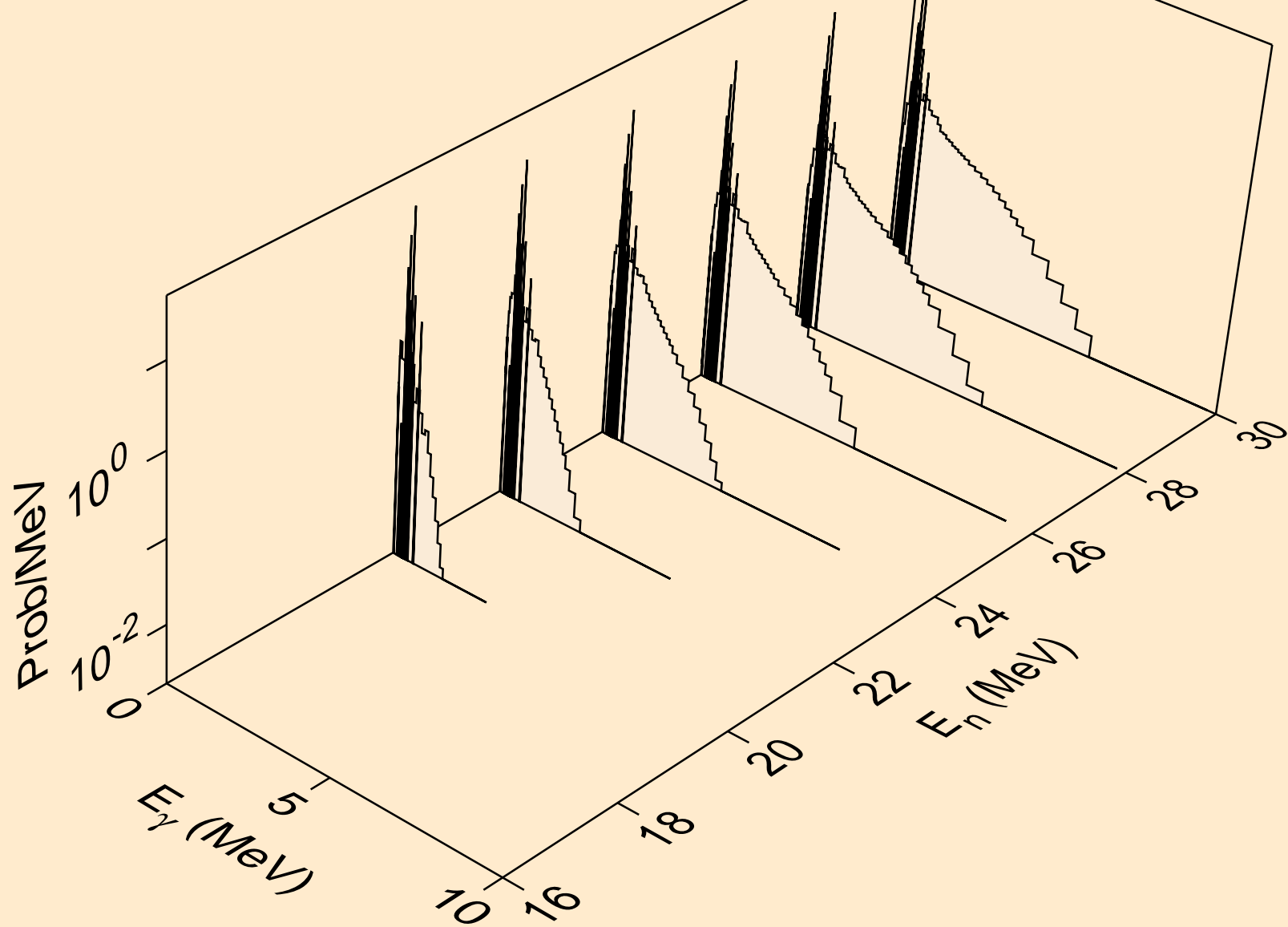

EU146 NEUTRON ACER TENDL-2021 LIBRARY; T=293.6K
Photon emission for (n,n*)a

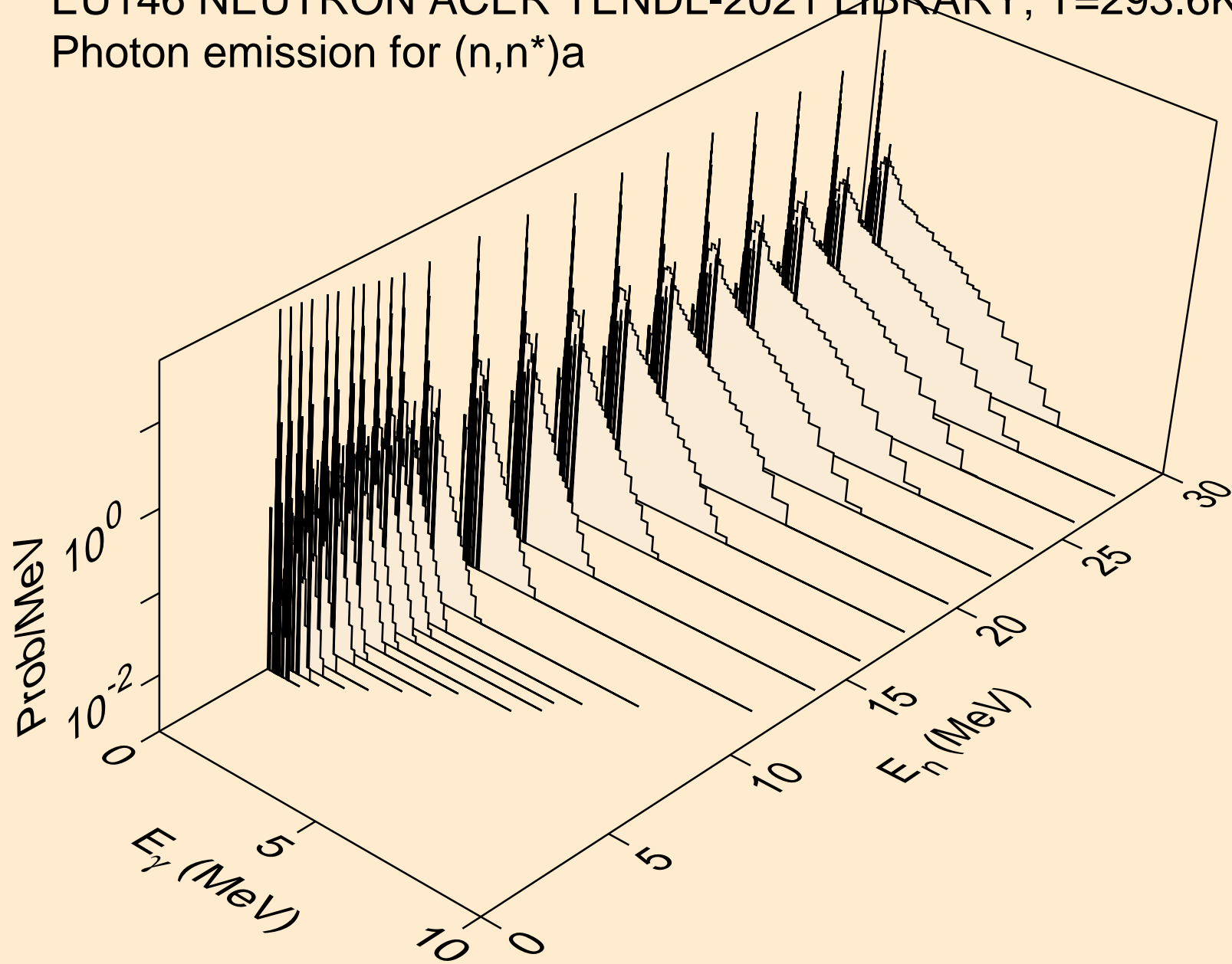

EU146 NEUTRON ACER TENDL-2021 LIBRARY; T=293.6K
Photon emission for (n,2n) α

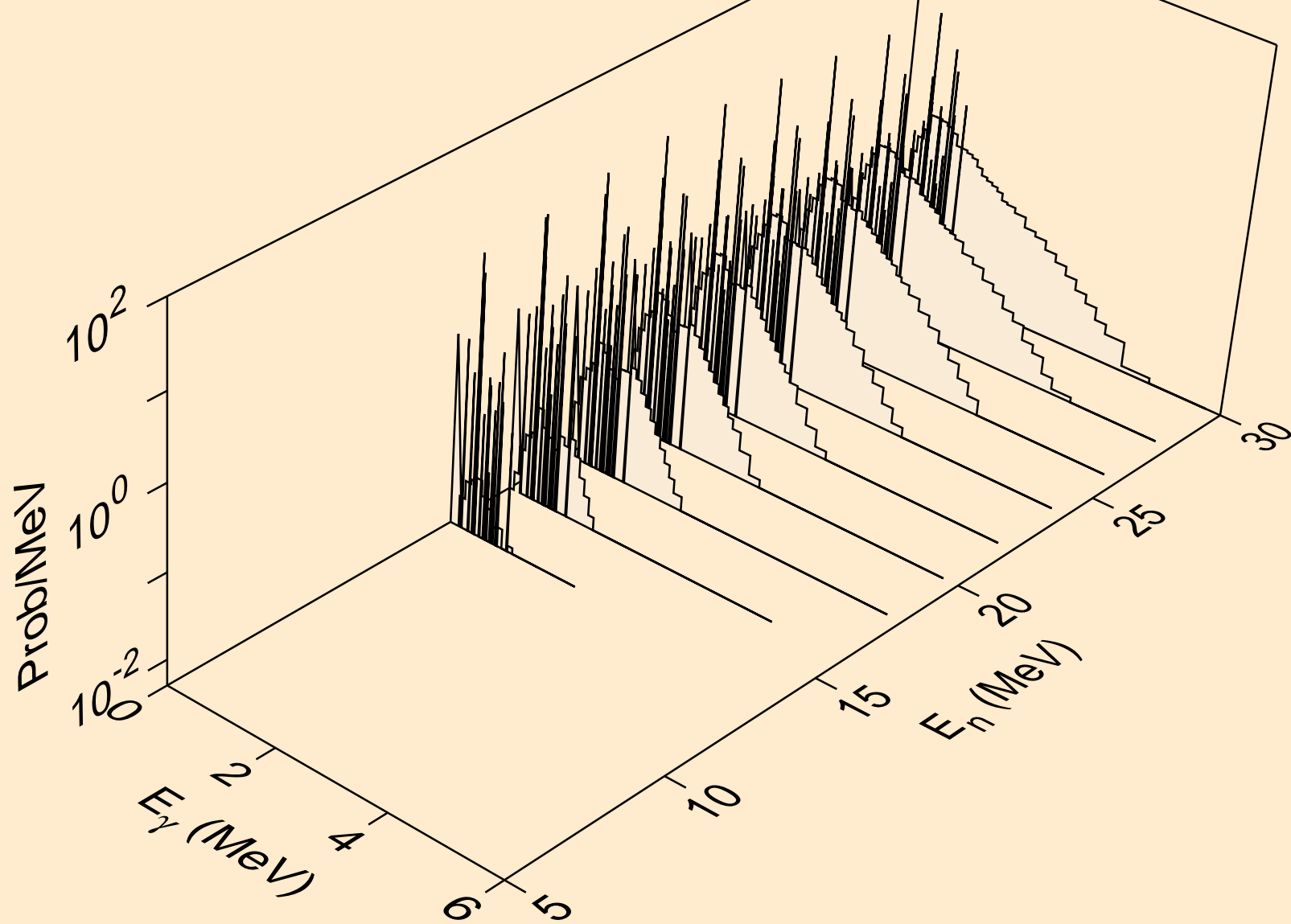

EU146 NEUTRON ACER TENDL-2021 LIBRARY; T=293.6K
Photon emission for (n,3n)a

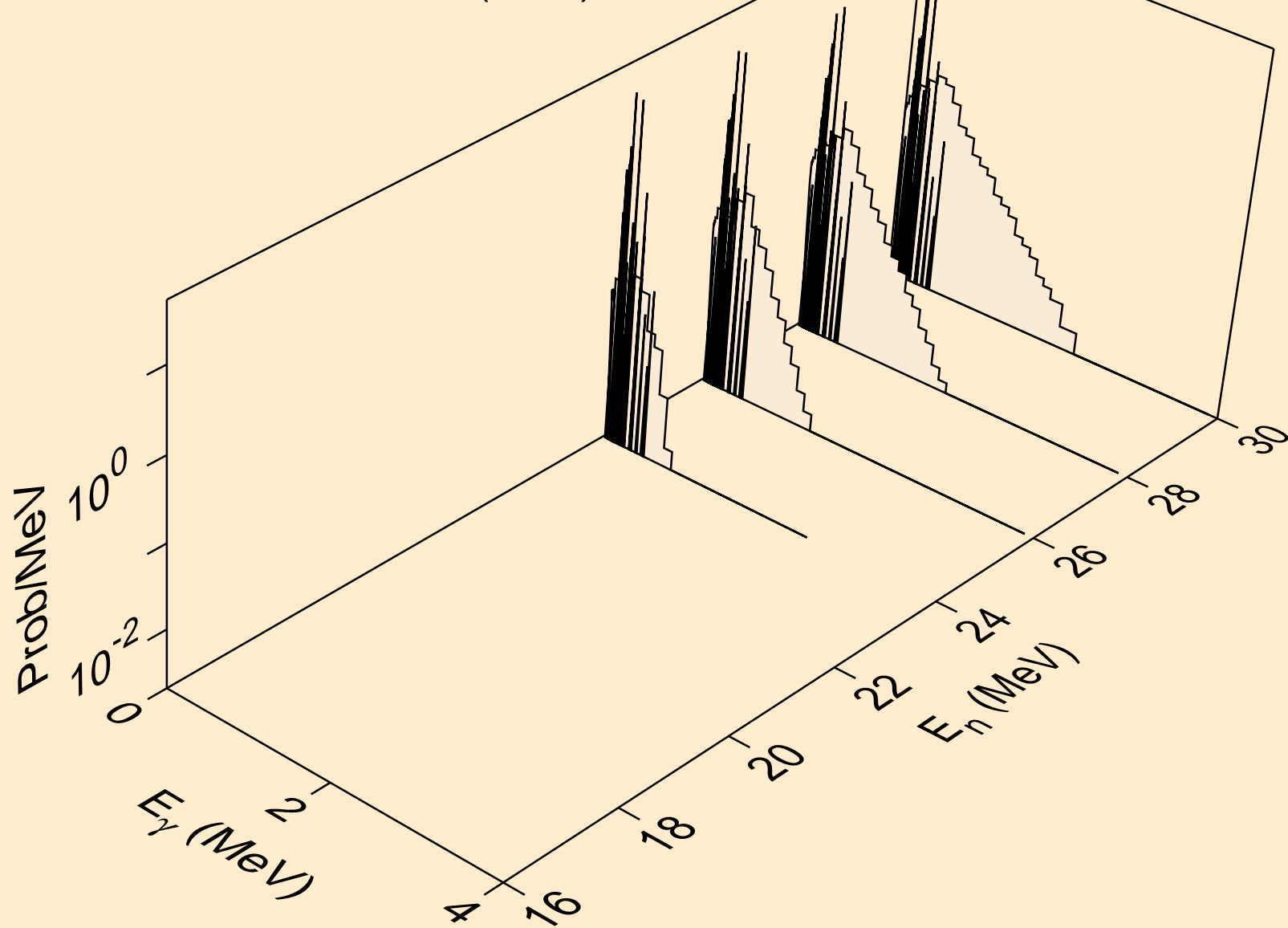

EU146 NEUTRON ACER TENDL-2021 LIBRARY; T=293.6K
Photon emission for (n,n*)p

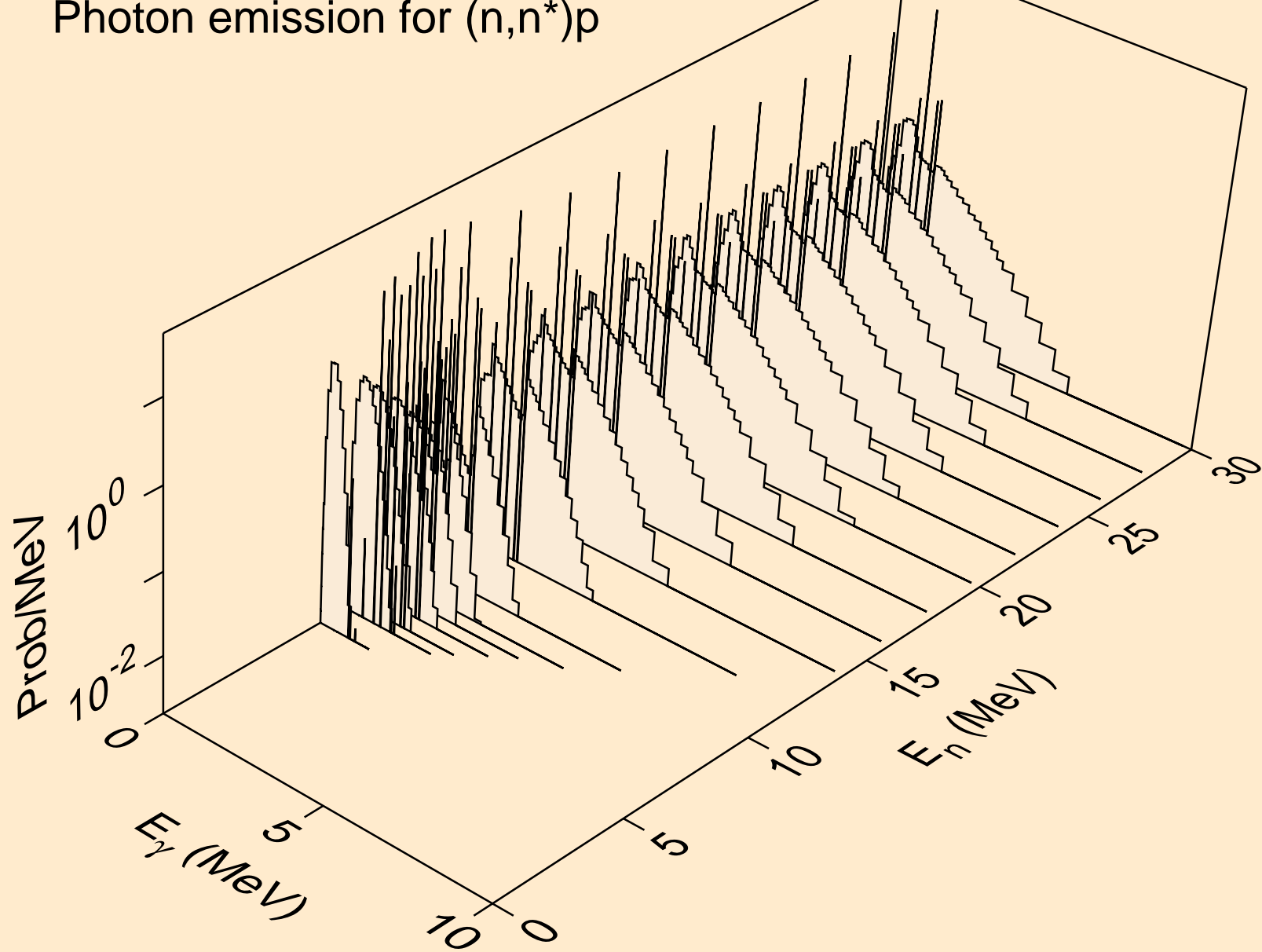

EU146 NEUTRON ACER TENDL-2021 LIBRARY; T=293.6K
Photon emission for (n,n*)2a

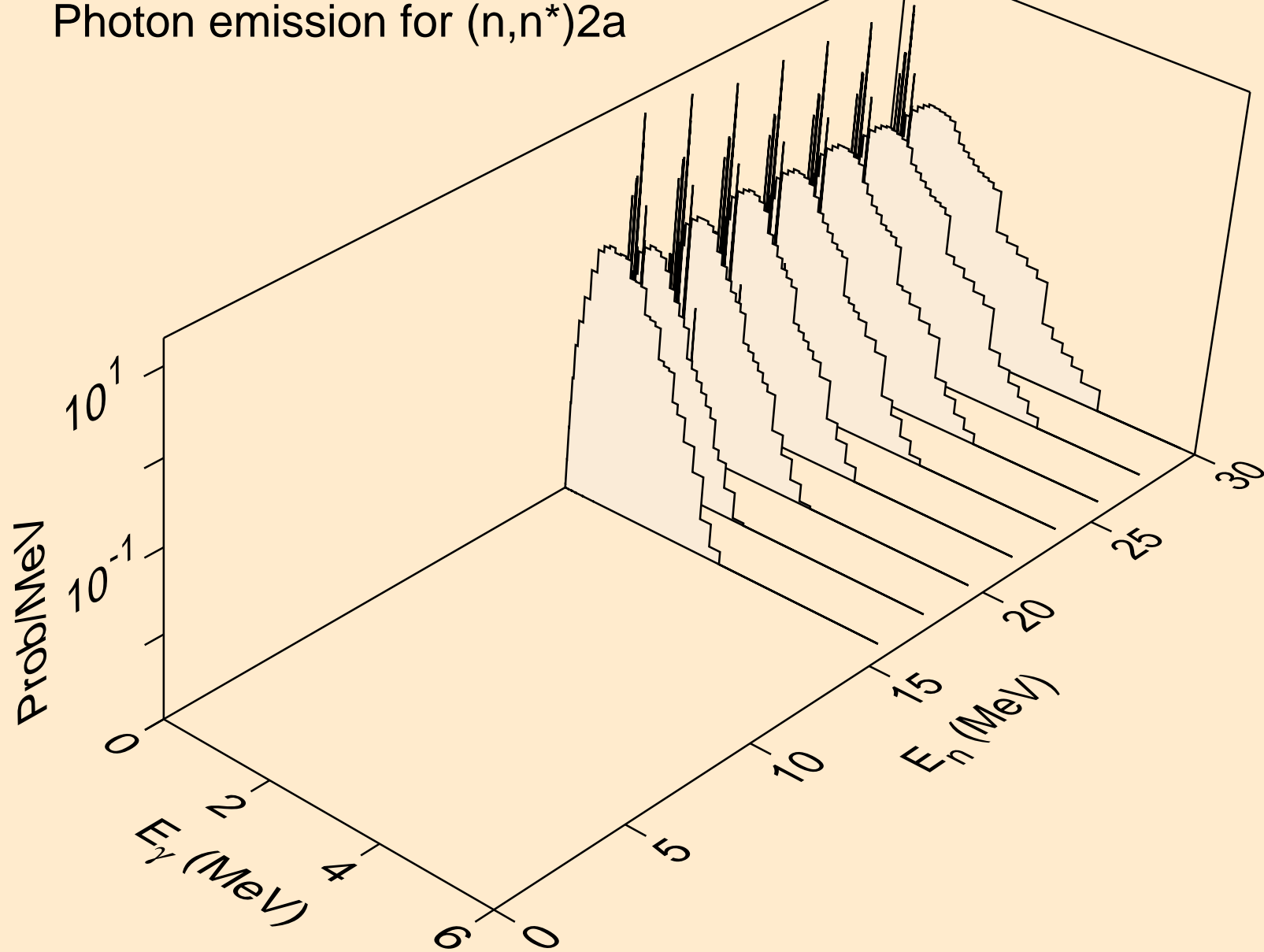

EU146 NEUTRON ACER TENDL-2021 LIBRARY; T=293.6K
Photon emission for (n,n*)d

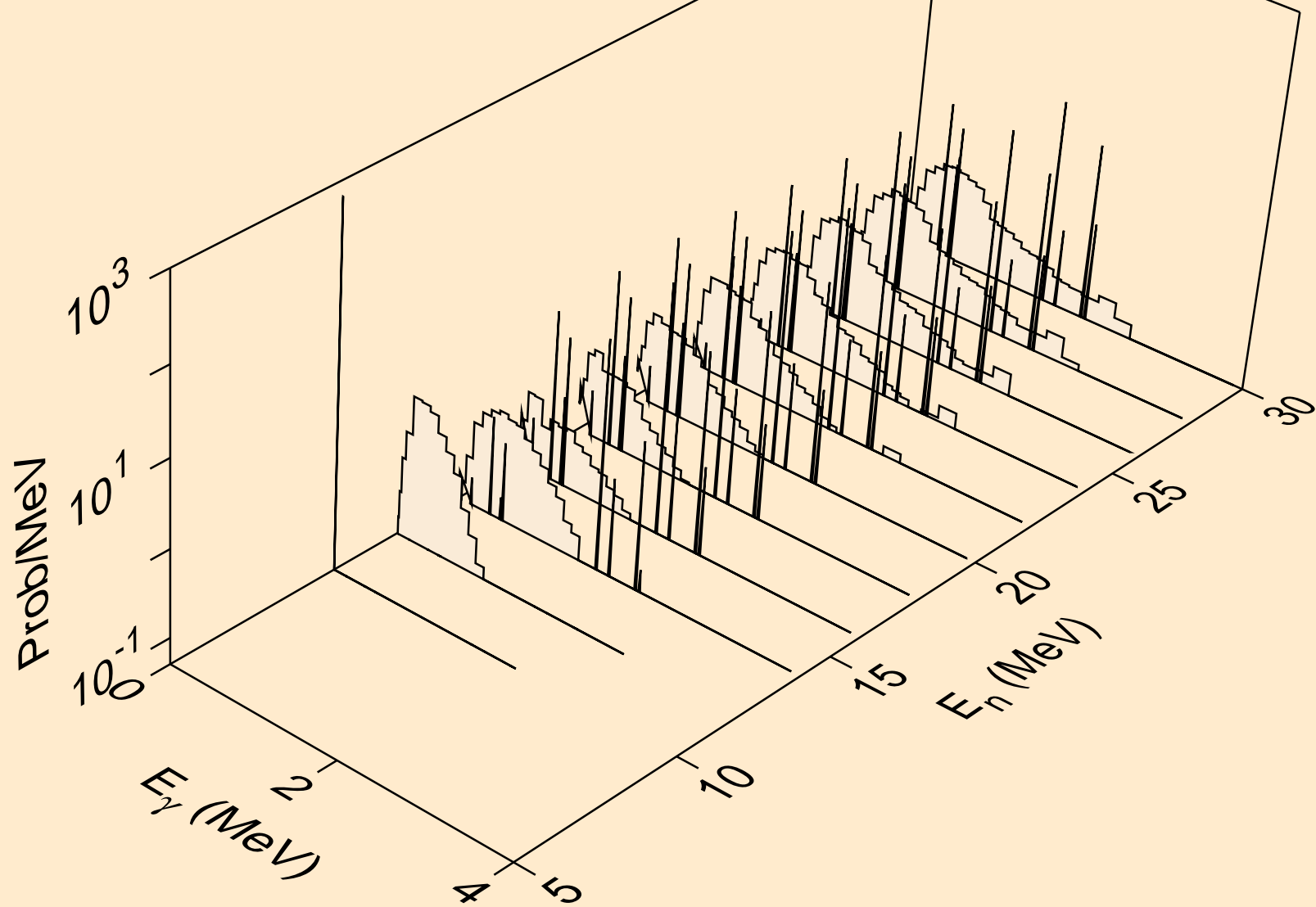

EU146 NEUTRON ACER TENDL-2021 LIBRARY; T=293.6K
Photon emission for (n,n*)t

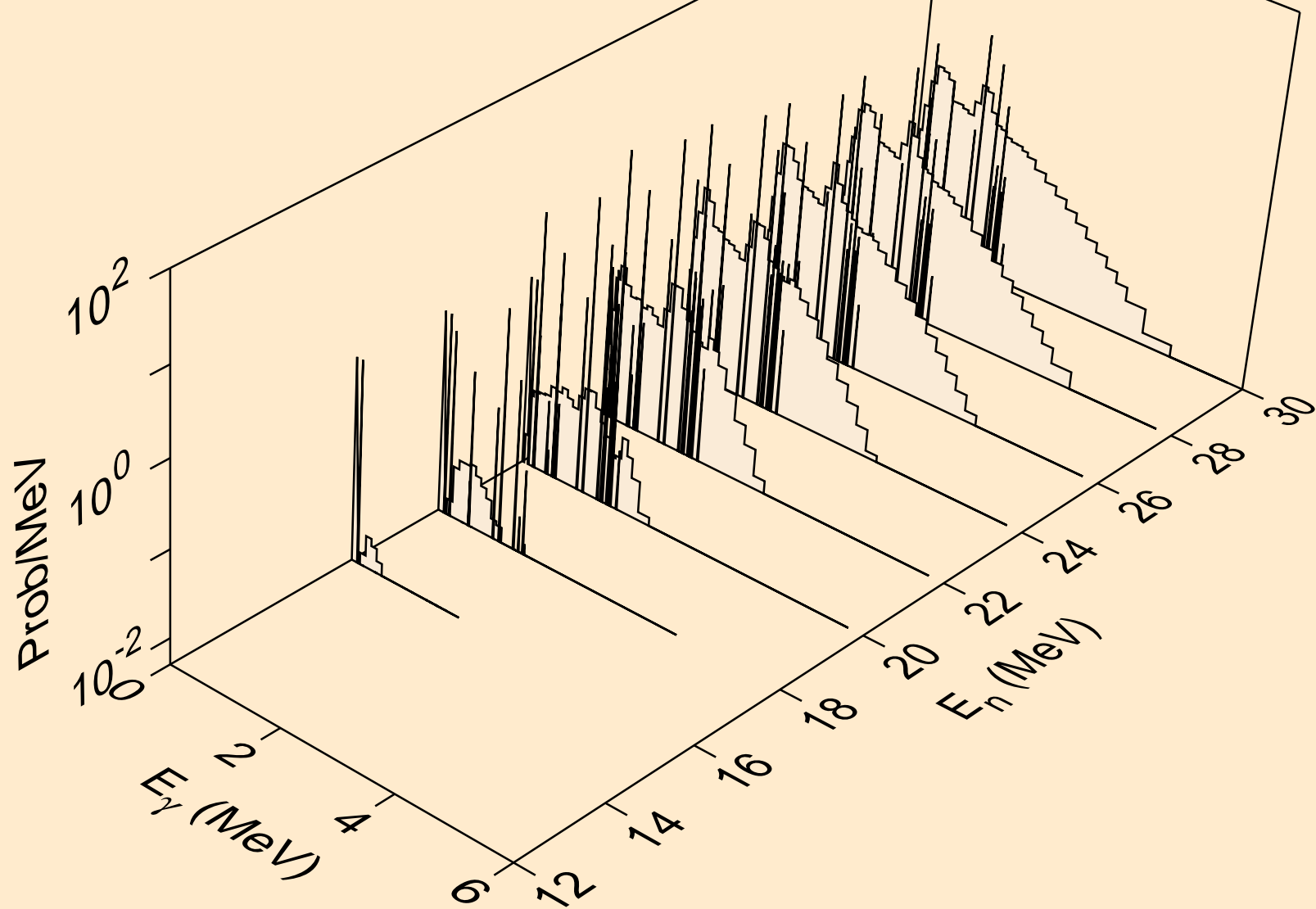

EU146 NEUTRON ACER TENDL-2021 LIBRARY; T=293.6K
Photon emission for (n,n*)he3

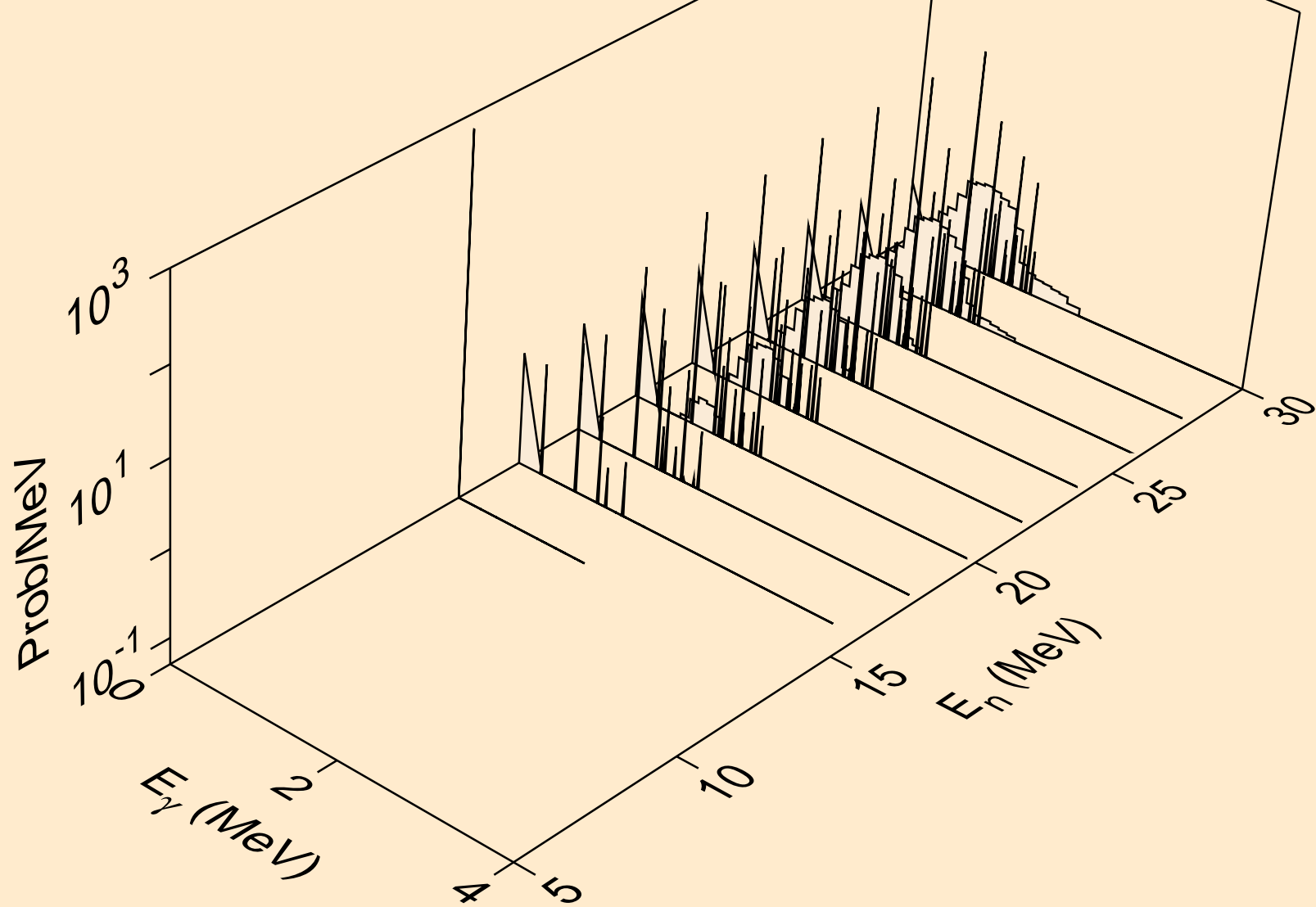

EU146 NEUTRON ACER TENDL-2021 LIBRARY; T=293.6K
Photon emission for (n,4n)

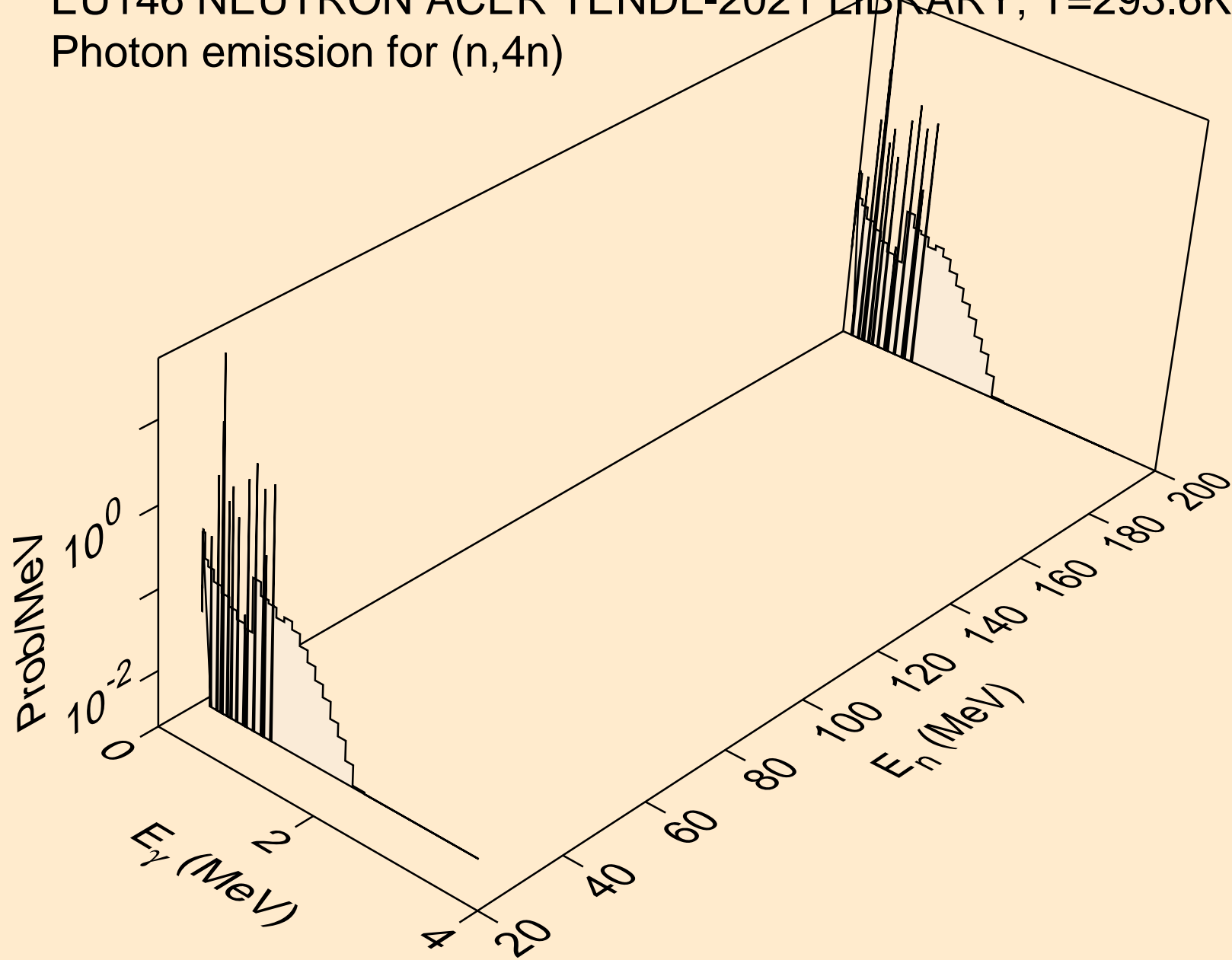

EU146 NEUTRON ACER TENDL-2021 LIBRARY; T=293.6K
Photon emission for (n,2np)

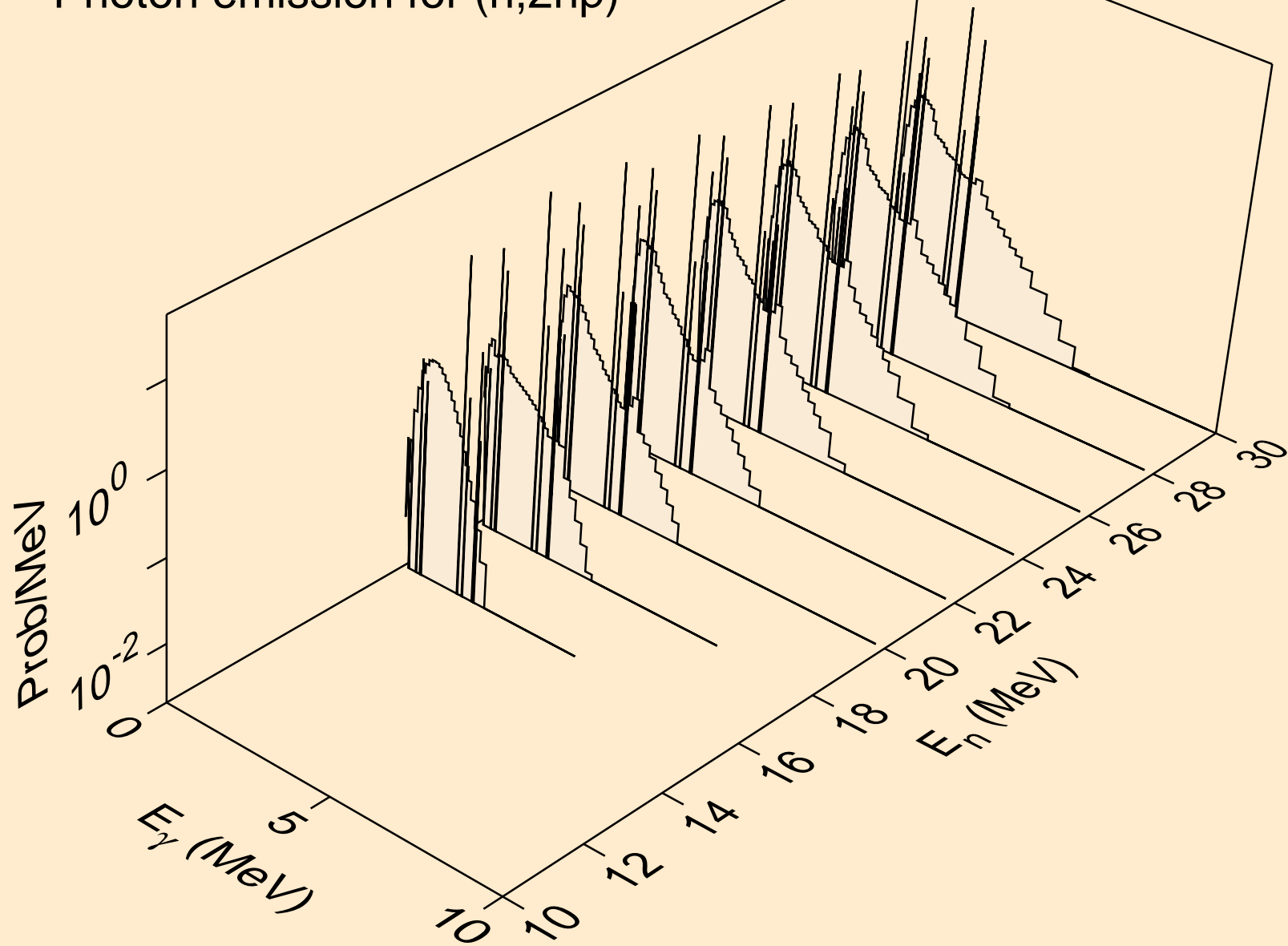

EU146 NEUTRON ACER TENDL-2021 LIBRARY; T=293.6K
Photon emission for (n,3np)

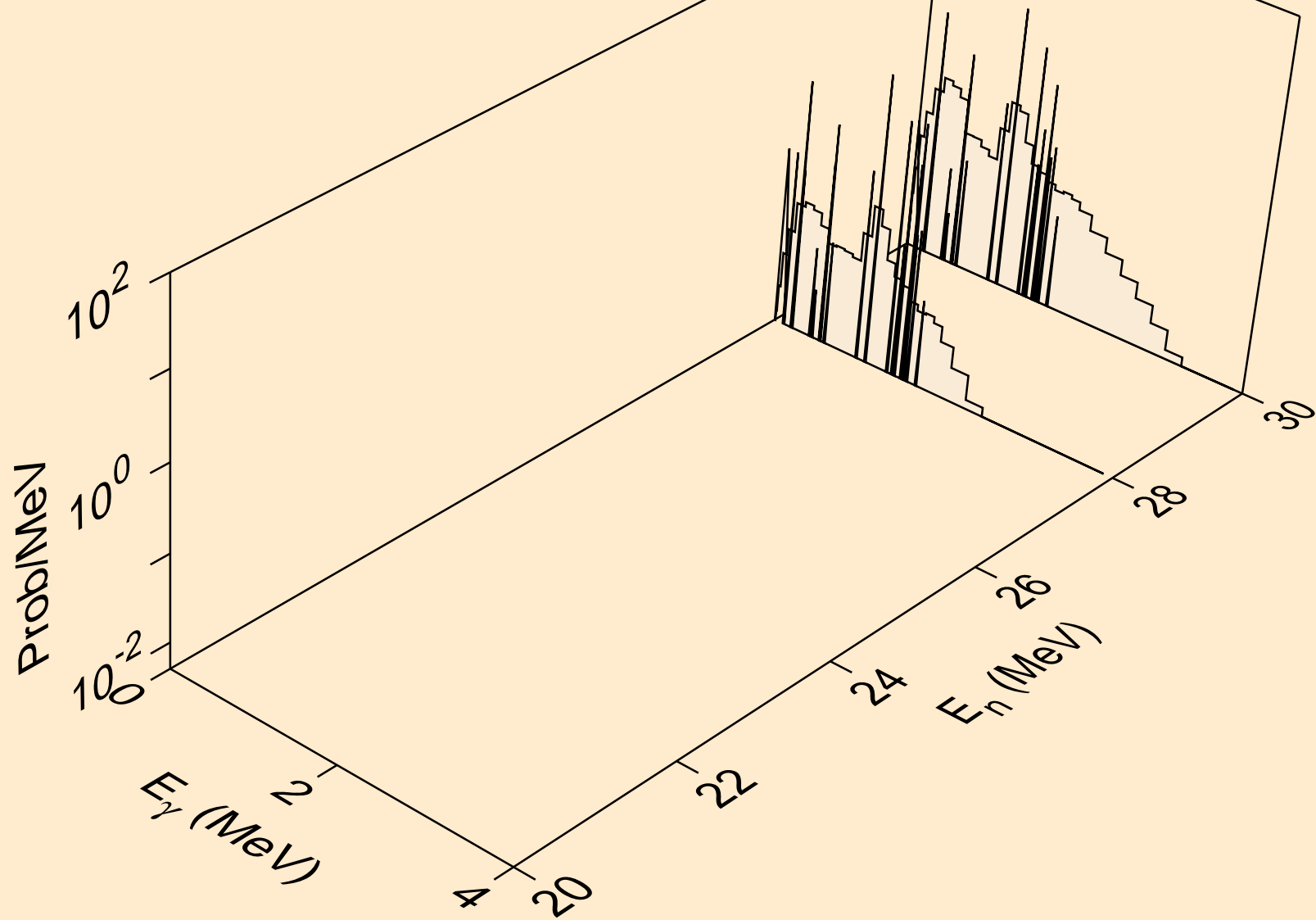

EU146 NEUTRON ACER TENDL-2021 LIBRARY; T=293.6K
Photon emission for (n,2np)

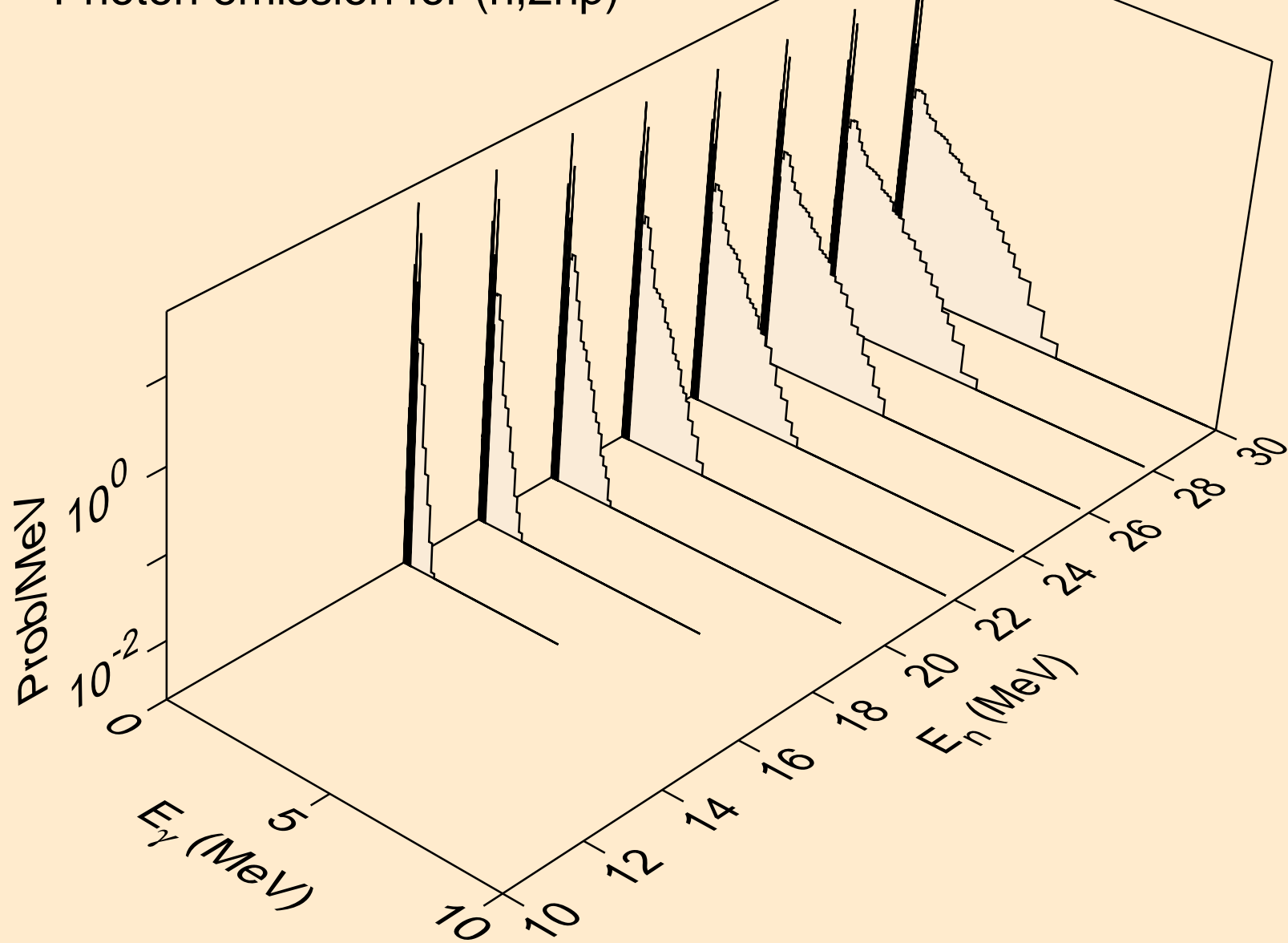

EU146 NEUTRON ACER TENDL-2021 LIBRARY; T=293.6K
Photon emission for (n,npa)

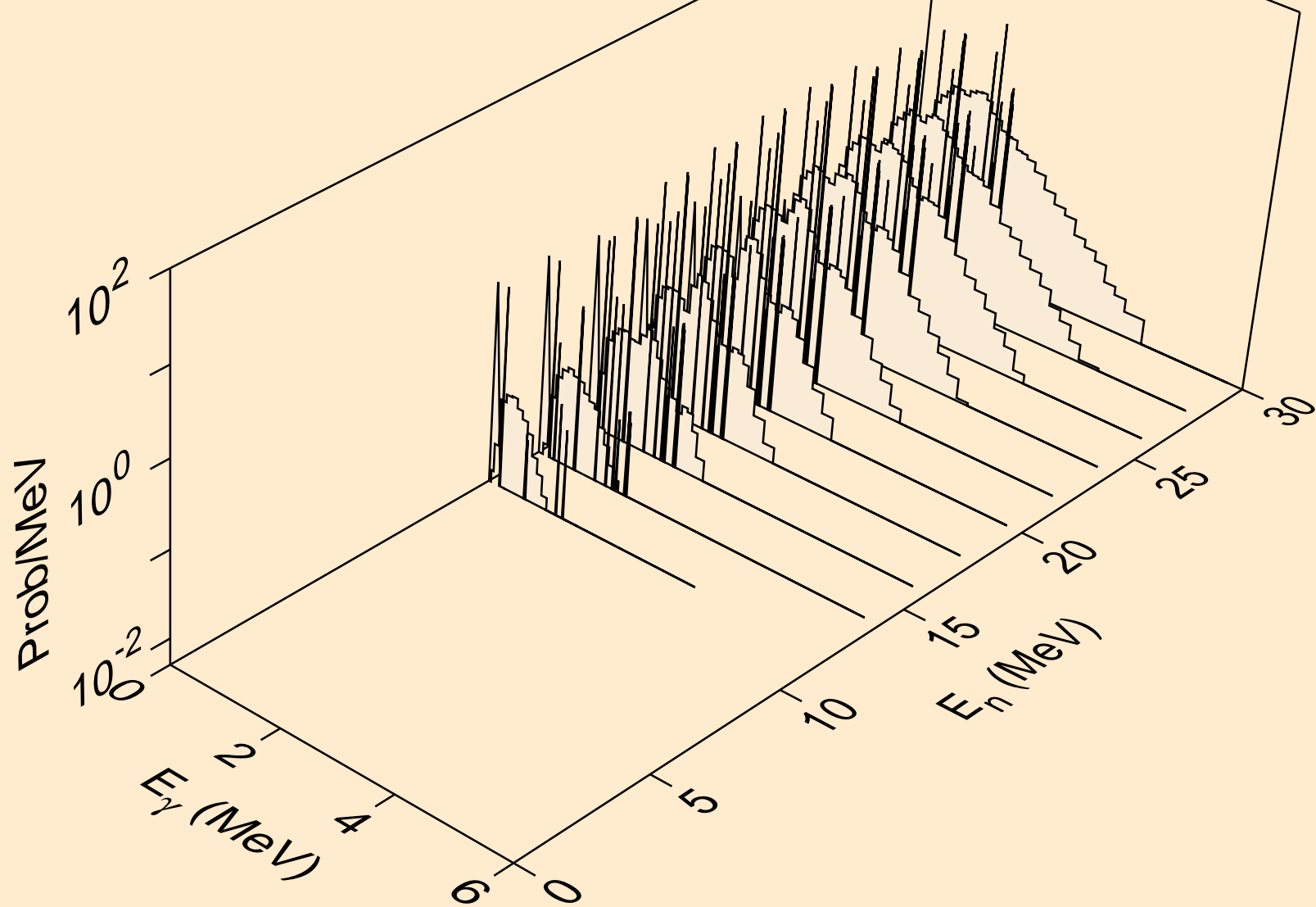

EU146 NEUTRON ACER TENDL-2021 LIBRARY; T=293.6K
Photon emission for (n,n*c)

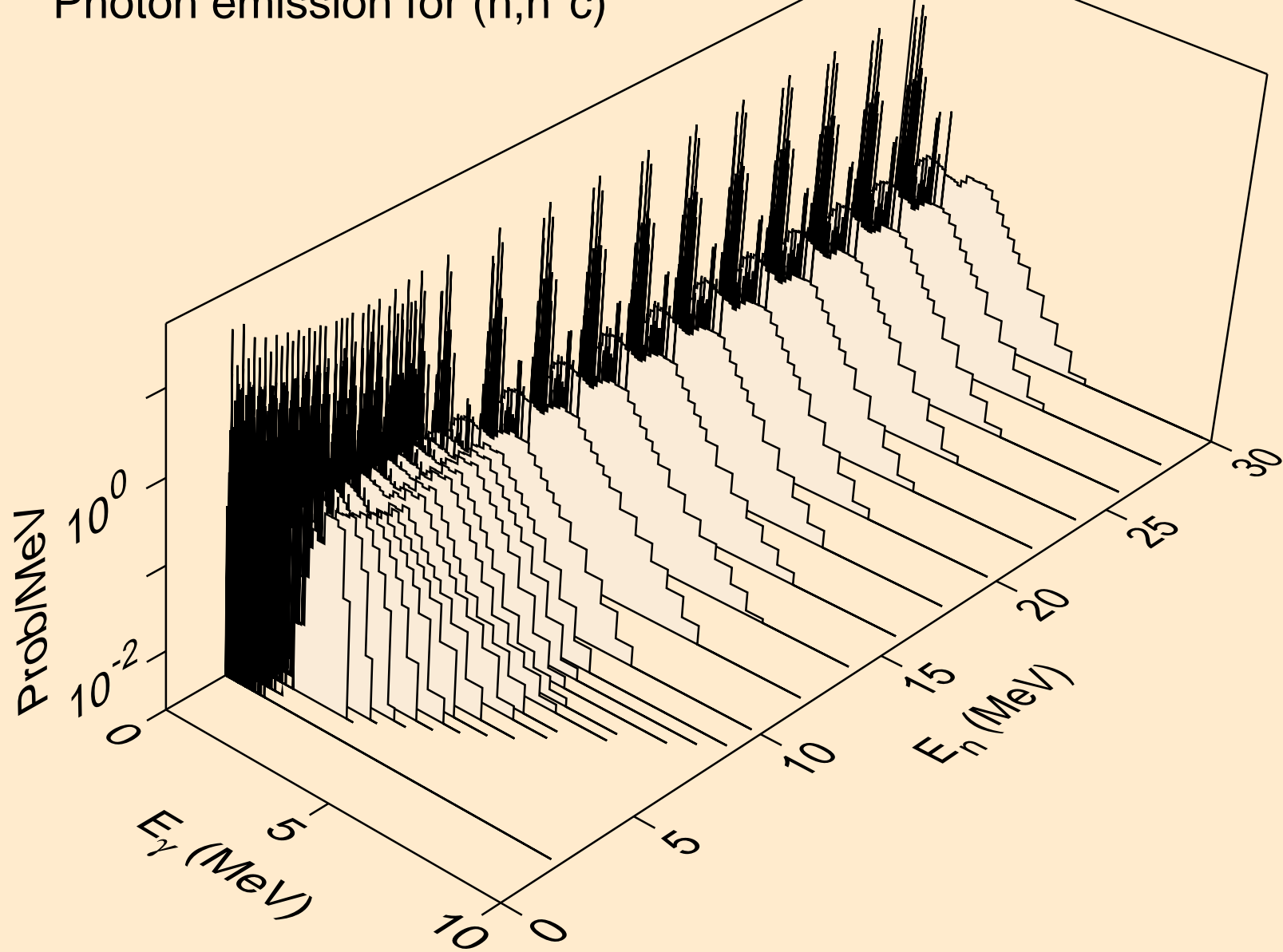

EU146 NEUTRON ACER TENDL-2021 LIBRARY; T=293.6K
Photon emission for (n,gma)

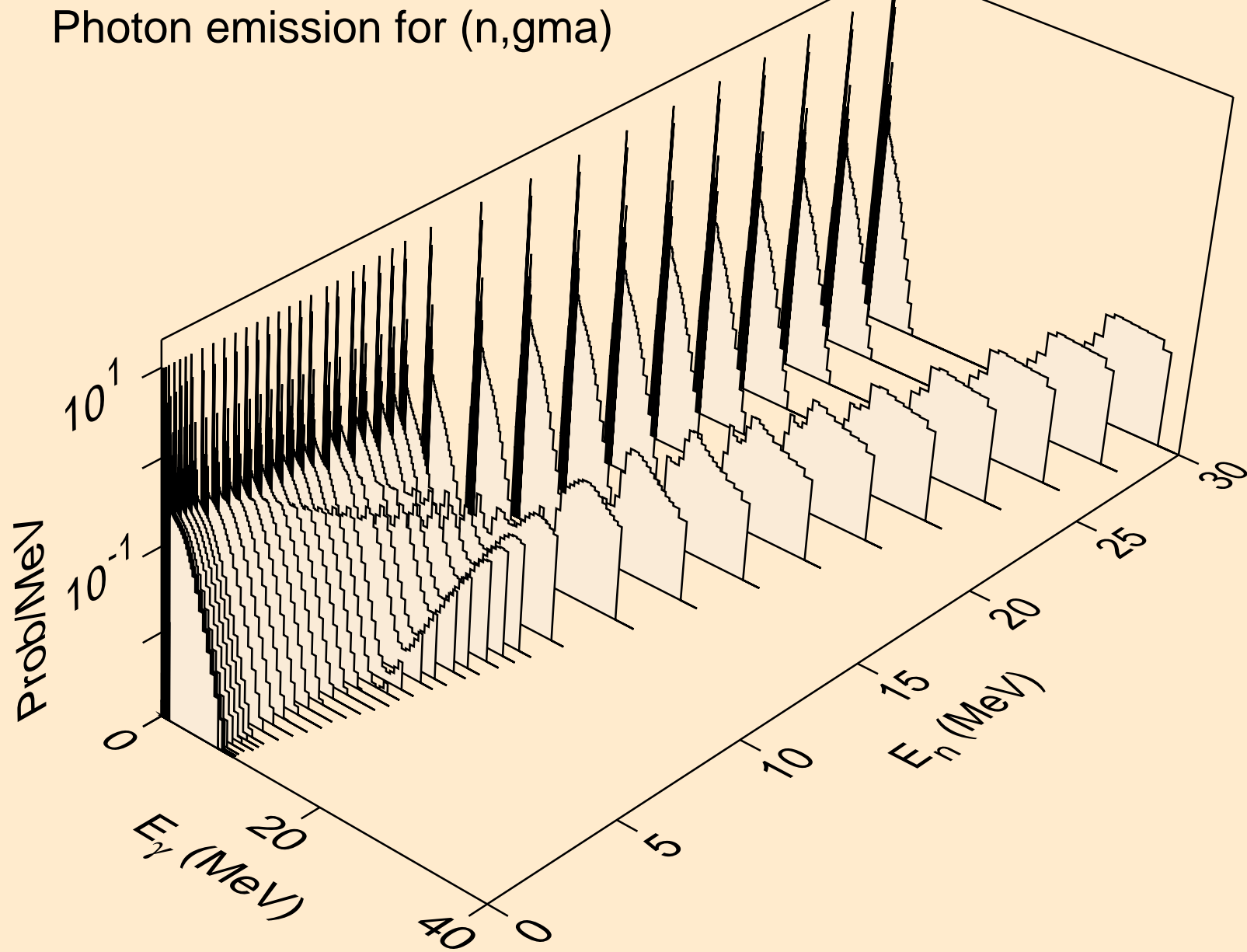

EU146 NEUTRON ACER TENDL-2021 LIBRARY; T=293.6K
Photon emission for (n,p)

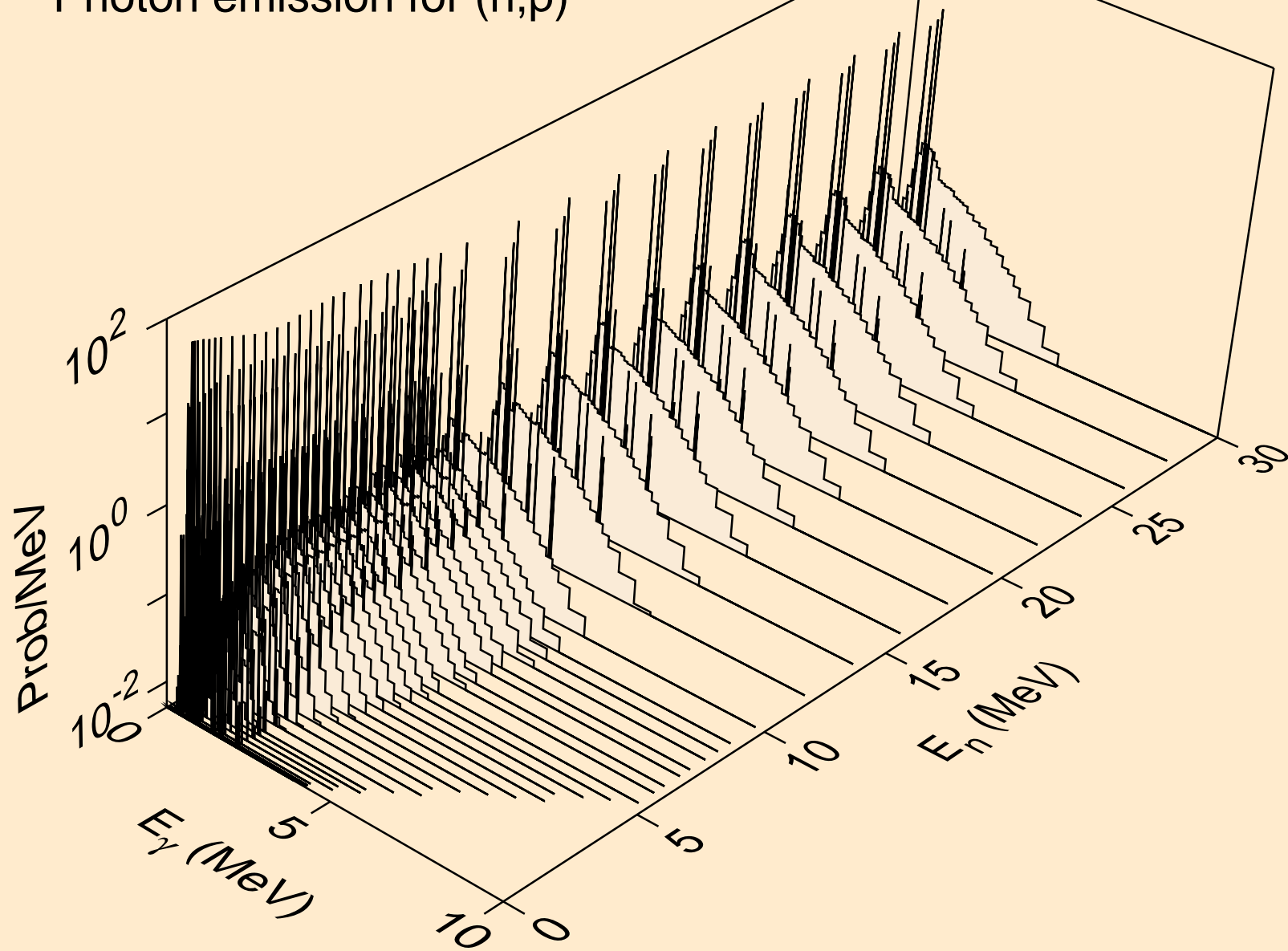

EU146 NEUTRON ACER TENDL-2021 LIBRARY; T=293.6K
Photon emission for (n,d)

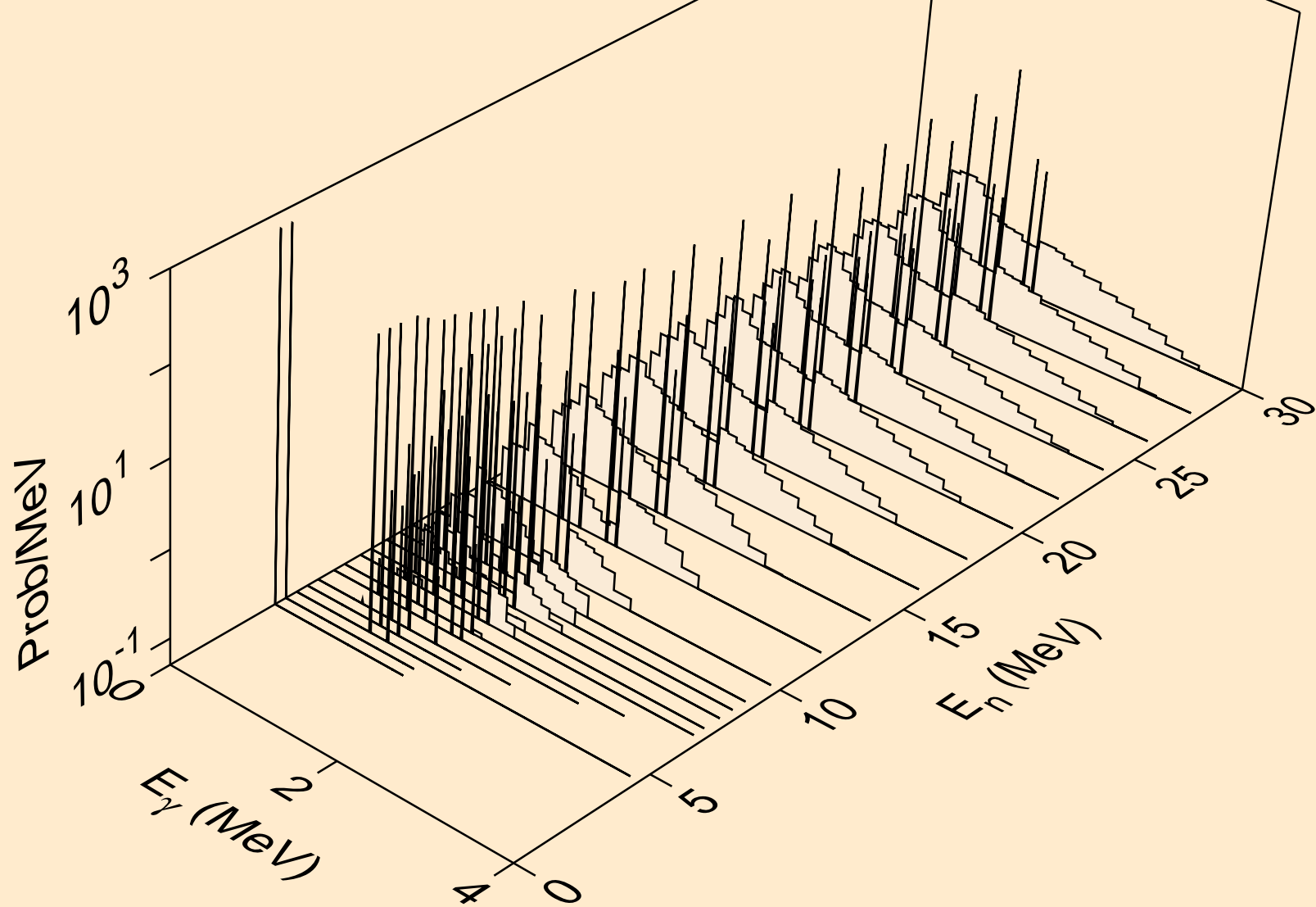

EU146 NEUTRON ACER TENDL-2021 LIBRARY; T=293.6K
Photon emission for (n,t)

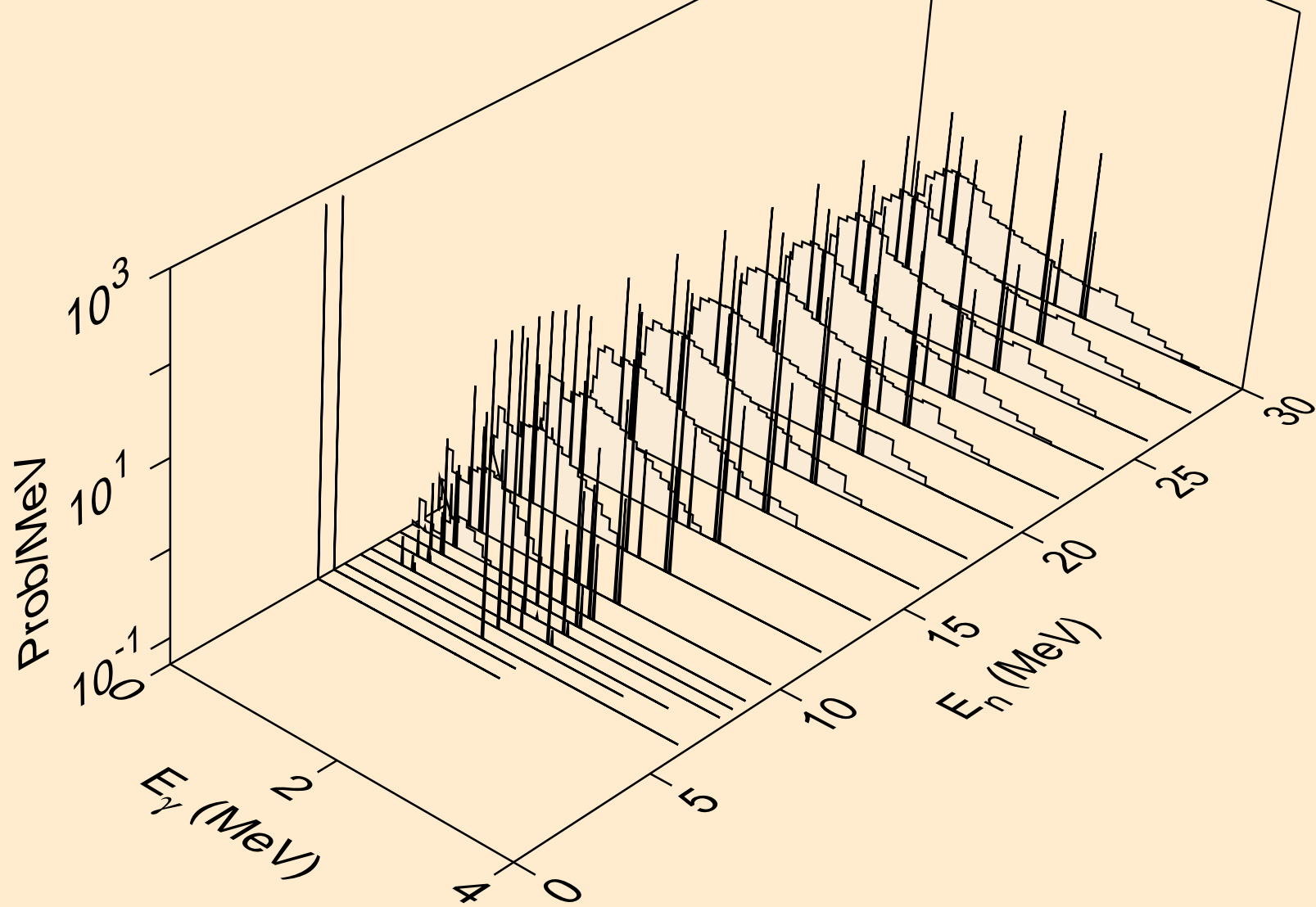

EU146 NEUTRON ACER TENDL-2021 LIBRARY; T=293.6K
Photon emission for (n,he3)

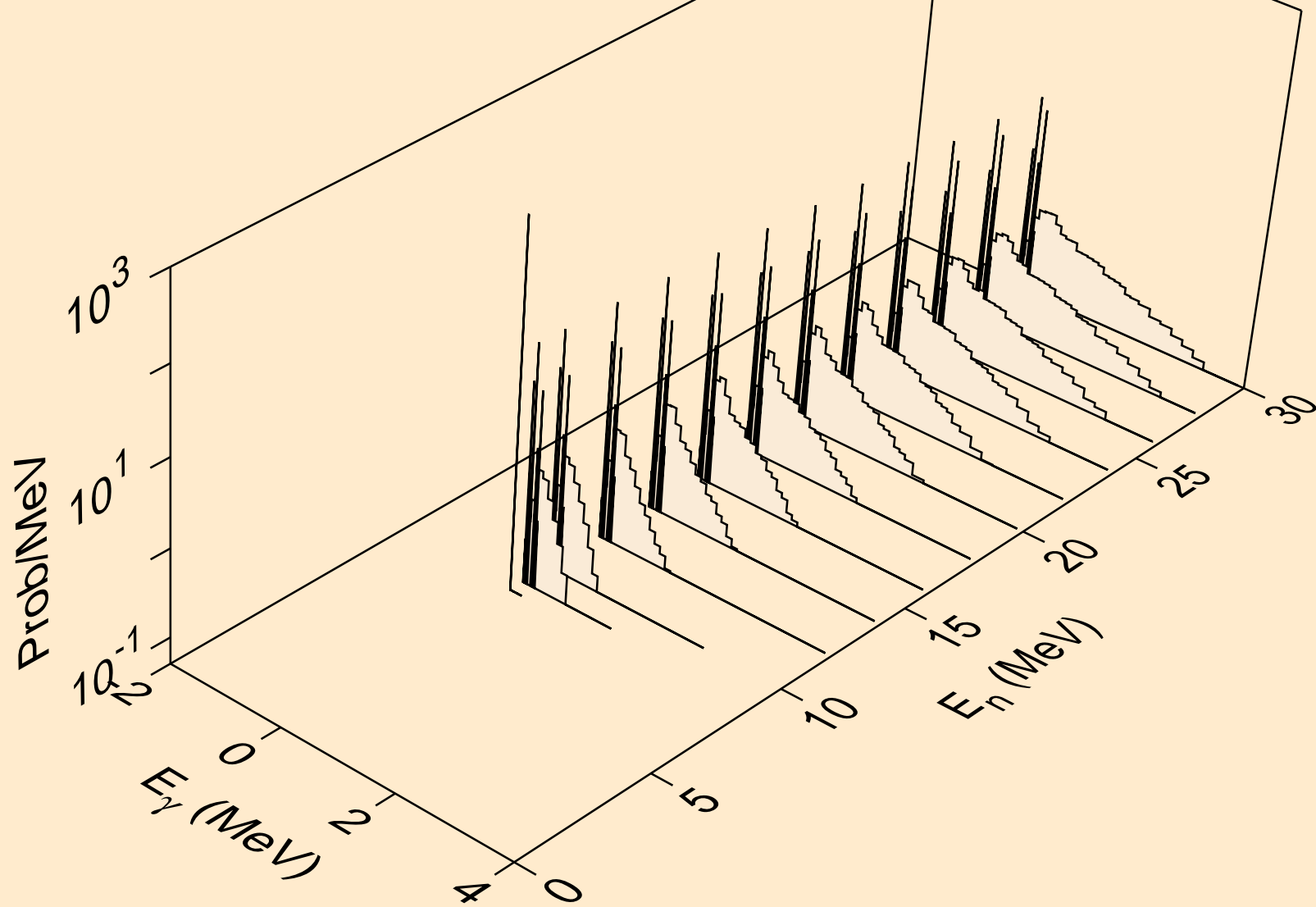

EU146 NEUTRON ACER TENDL-2021 LIBRARY; T=293.6K
Photon emission for (n,a)

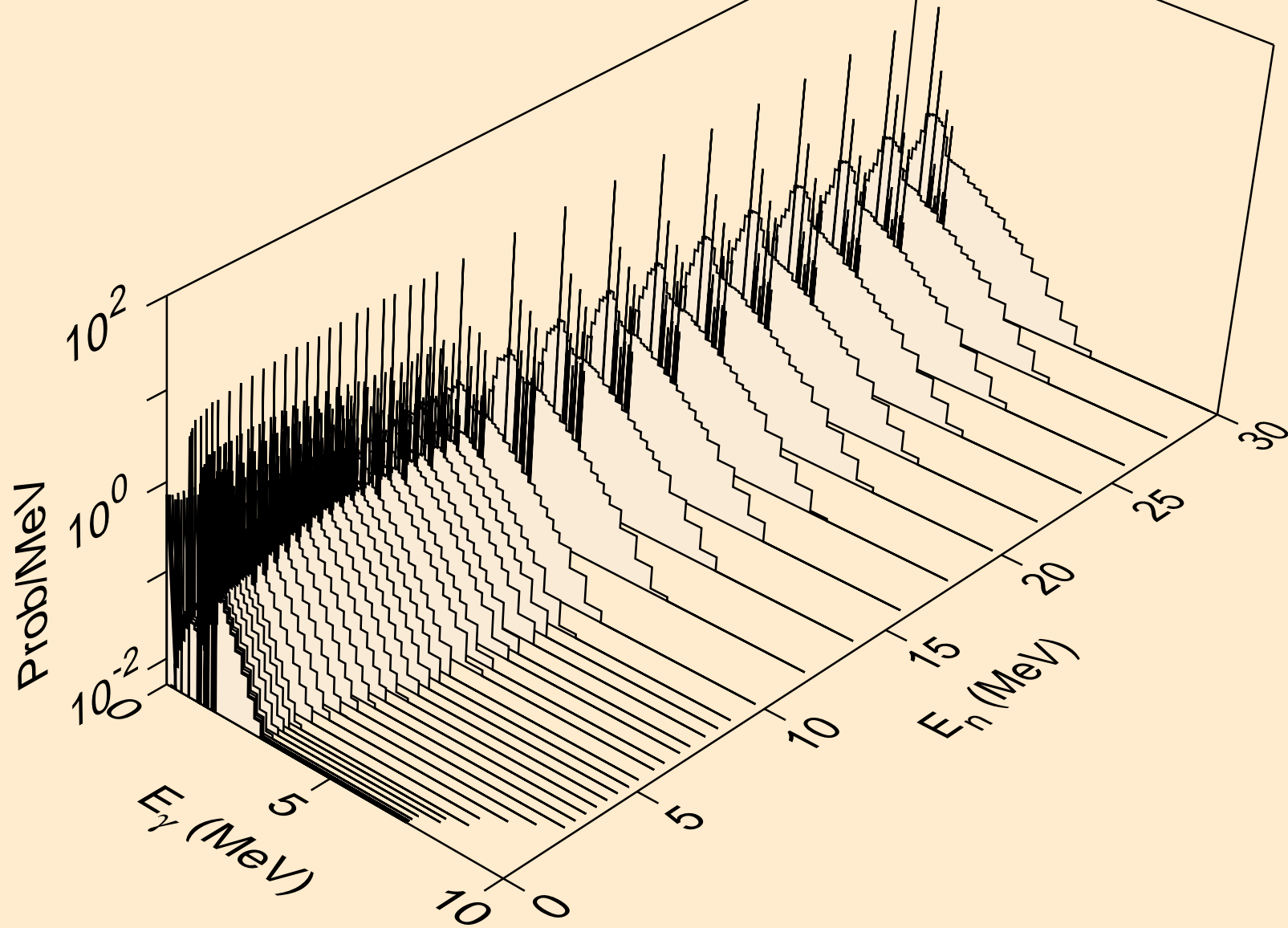

EU146 NEUTRON ACER TENDL-2021 LIBRARY; T=293.6K
Photon emission for (n,2a)

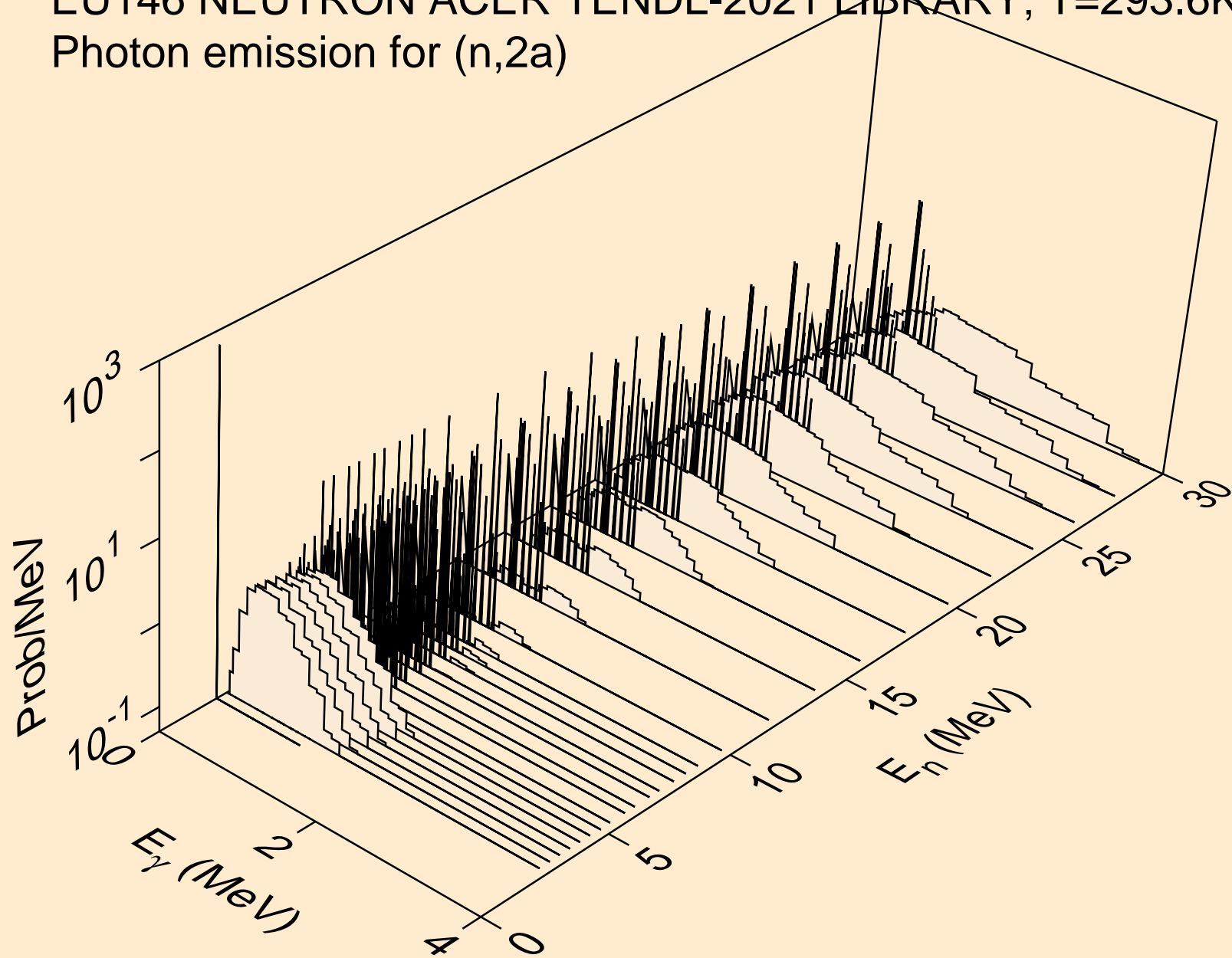

EU146 NEUTRON ACER TENDL-2021 LIBRARY; T=293.6K
Photon emission for (n,2p)

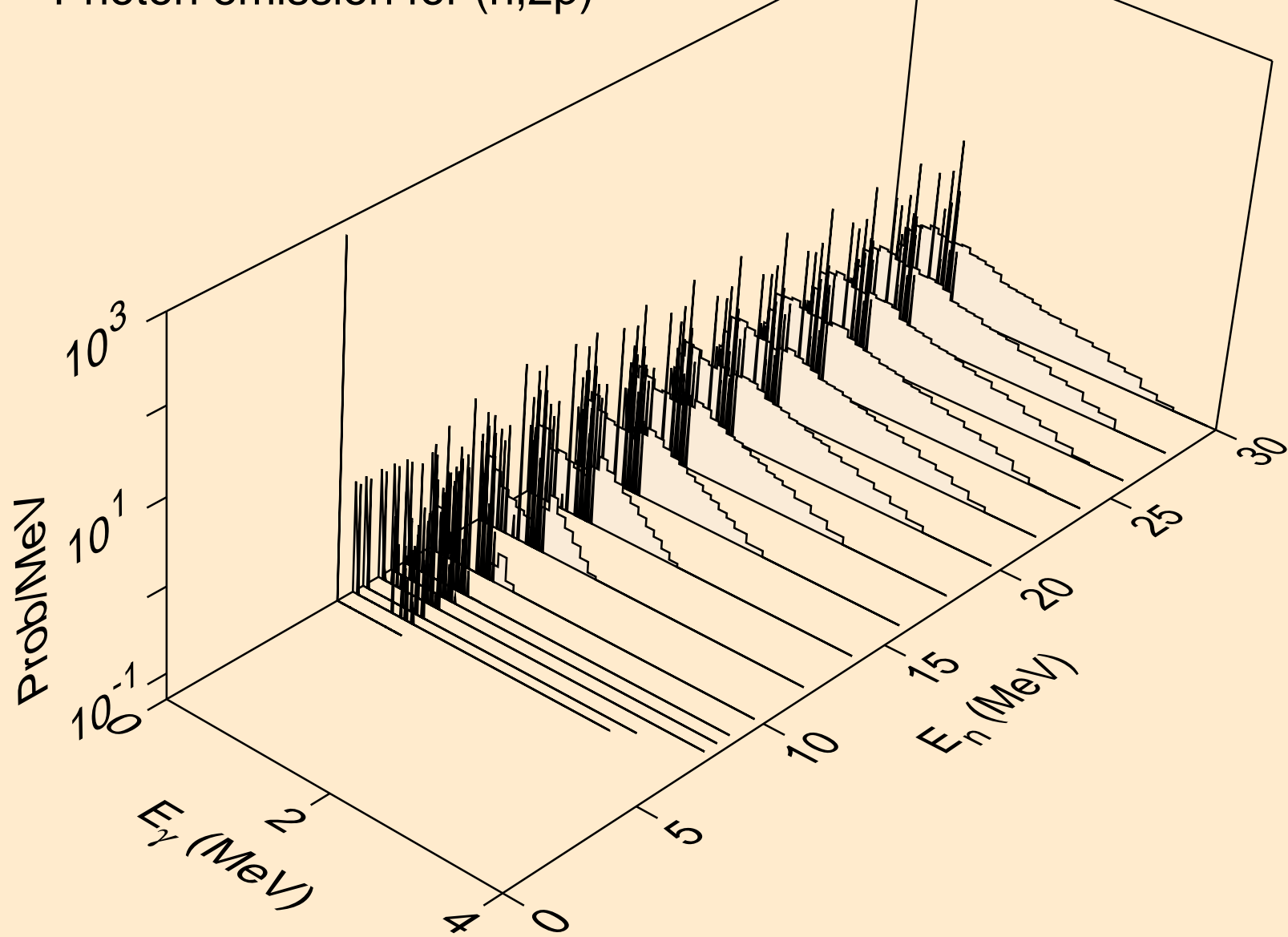

EU146 NEUTRON ACER TENDL-2021 LIBRARY; T=293.6K
Photon emission for (n,p α)

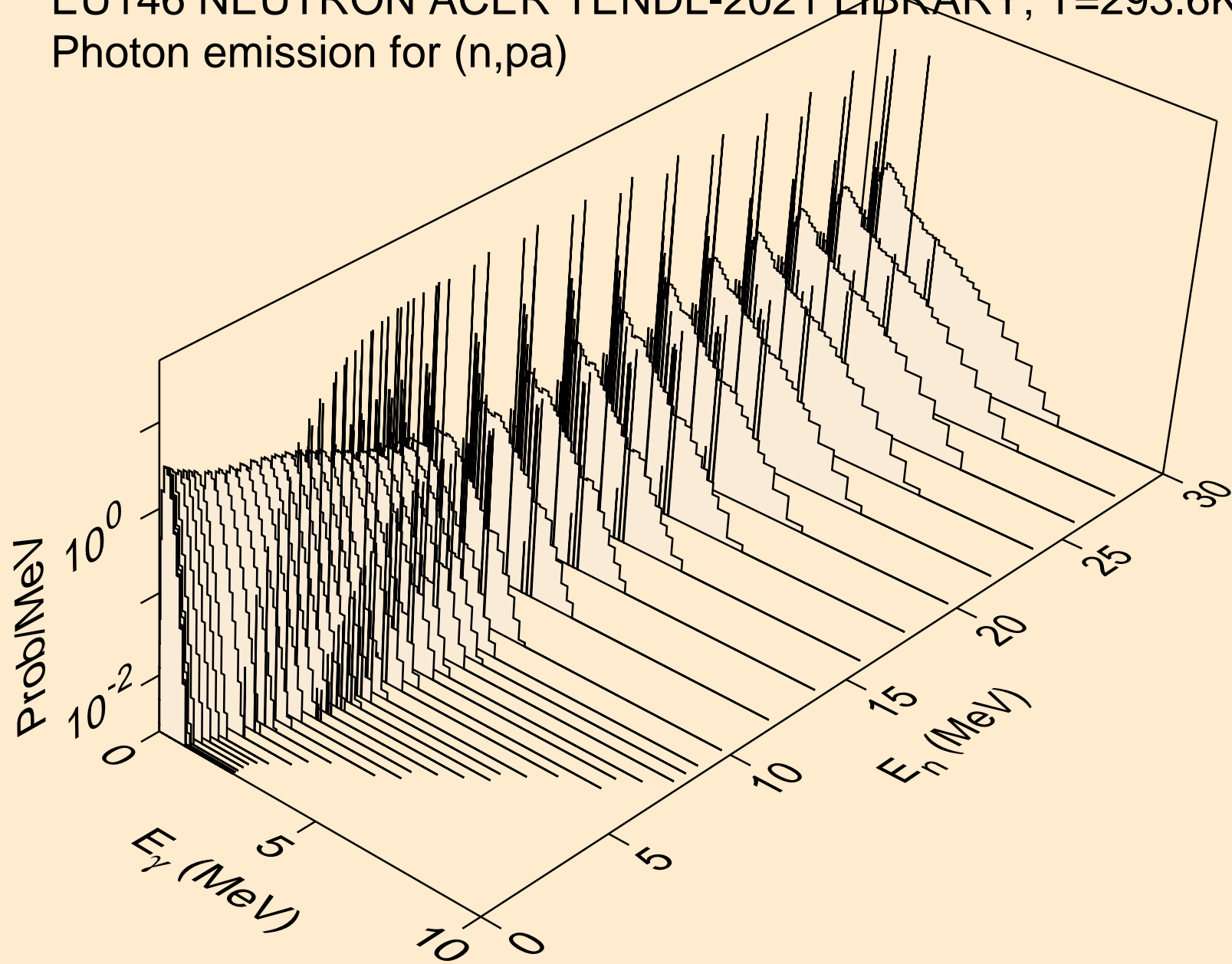

EU146 NEUTRON ACER TENDL-2021 LIBRARY; T=293.6K
Photon emission for (n,pd)

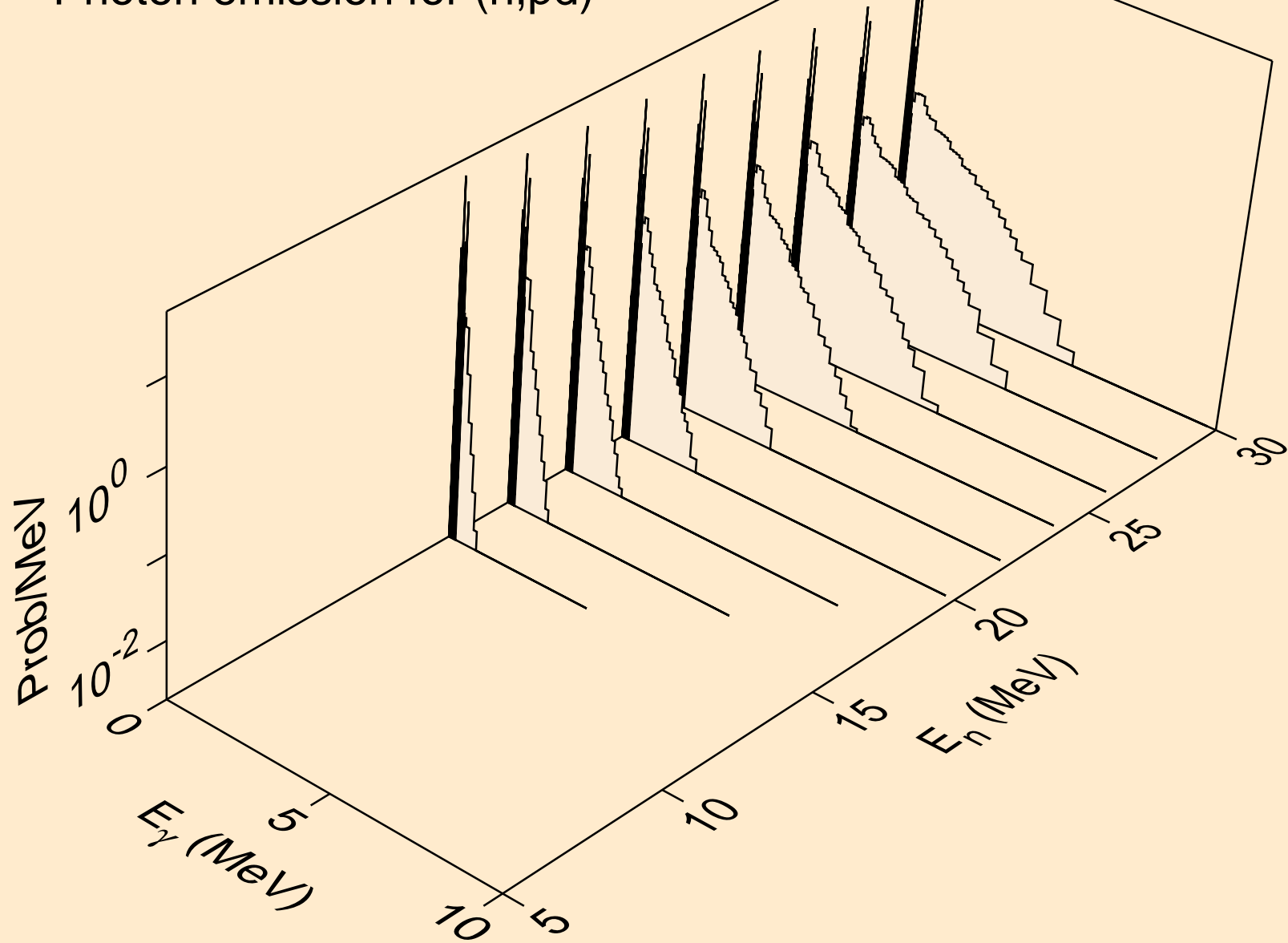

EU146 NEUTRON ACER TENDL-2021 LIBRARY; T=293.6K
Photon emission for (n,pt)

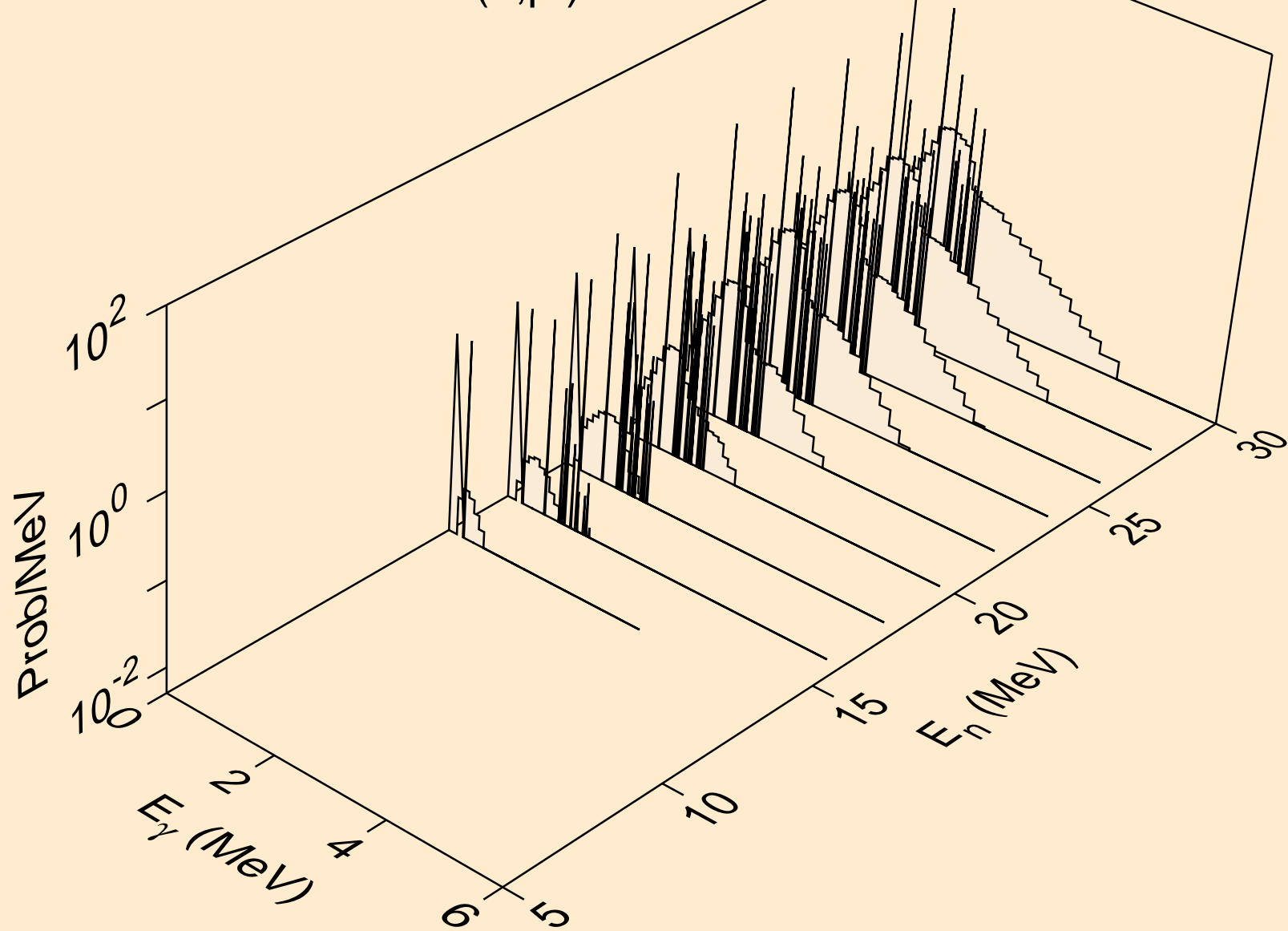

EU146 NEUTRON ACER TENDL-2021 LIBRARY; T=293.6K
Photon emission for (n,da)

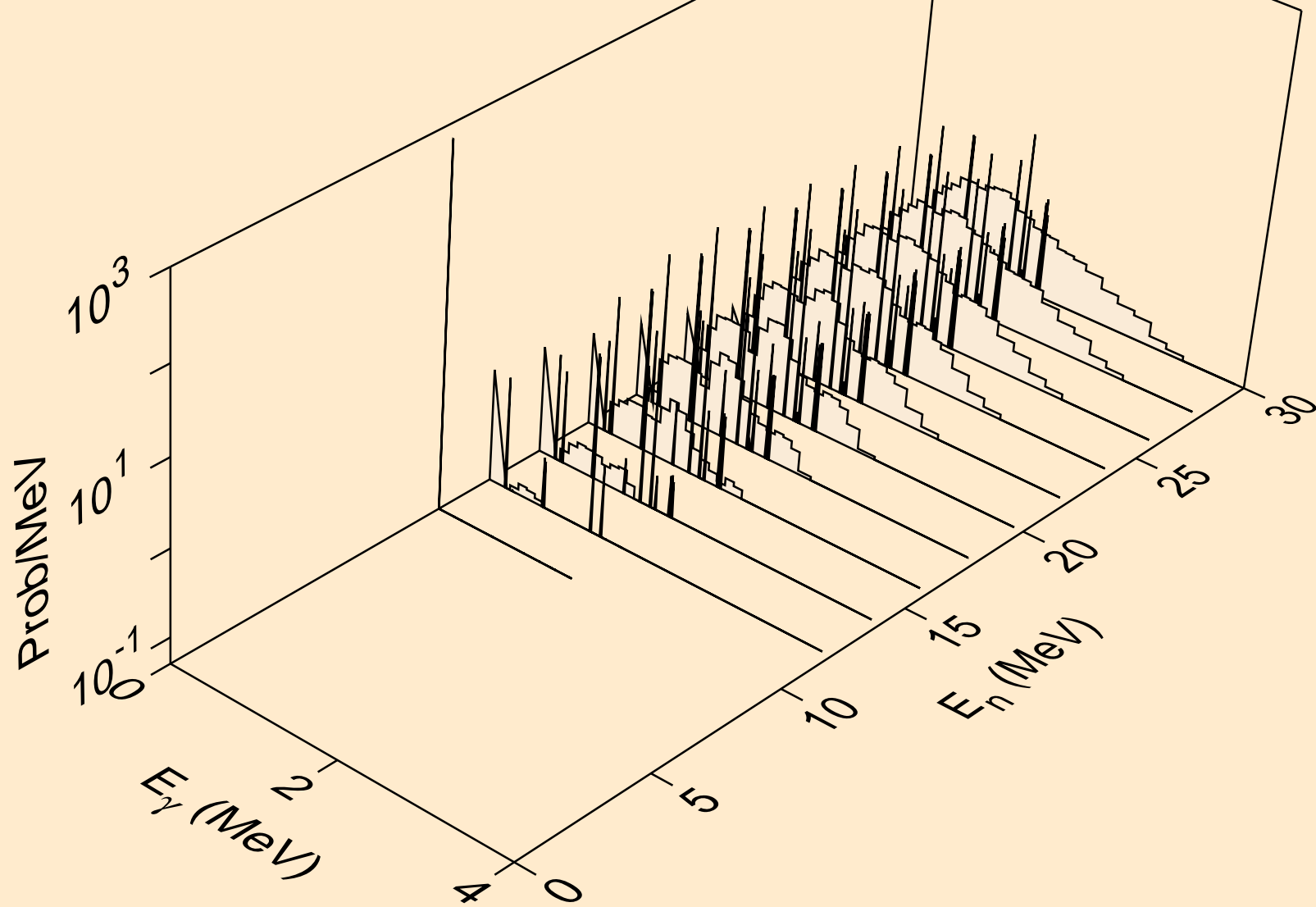

EU146 NEUTRON ACER TENDL-2021 LIBRARY; T=293.6K
thermal capture photon spectrum

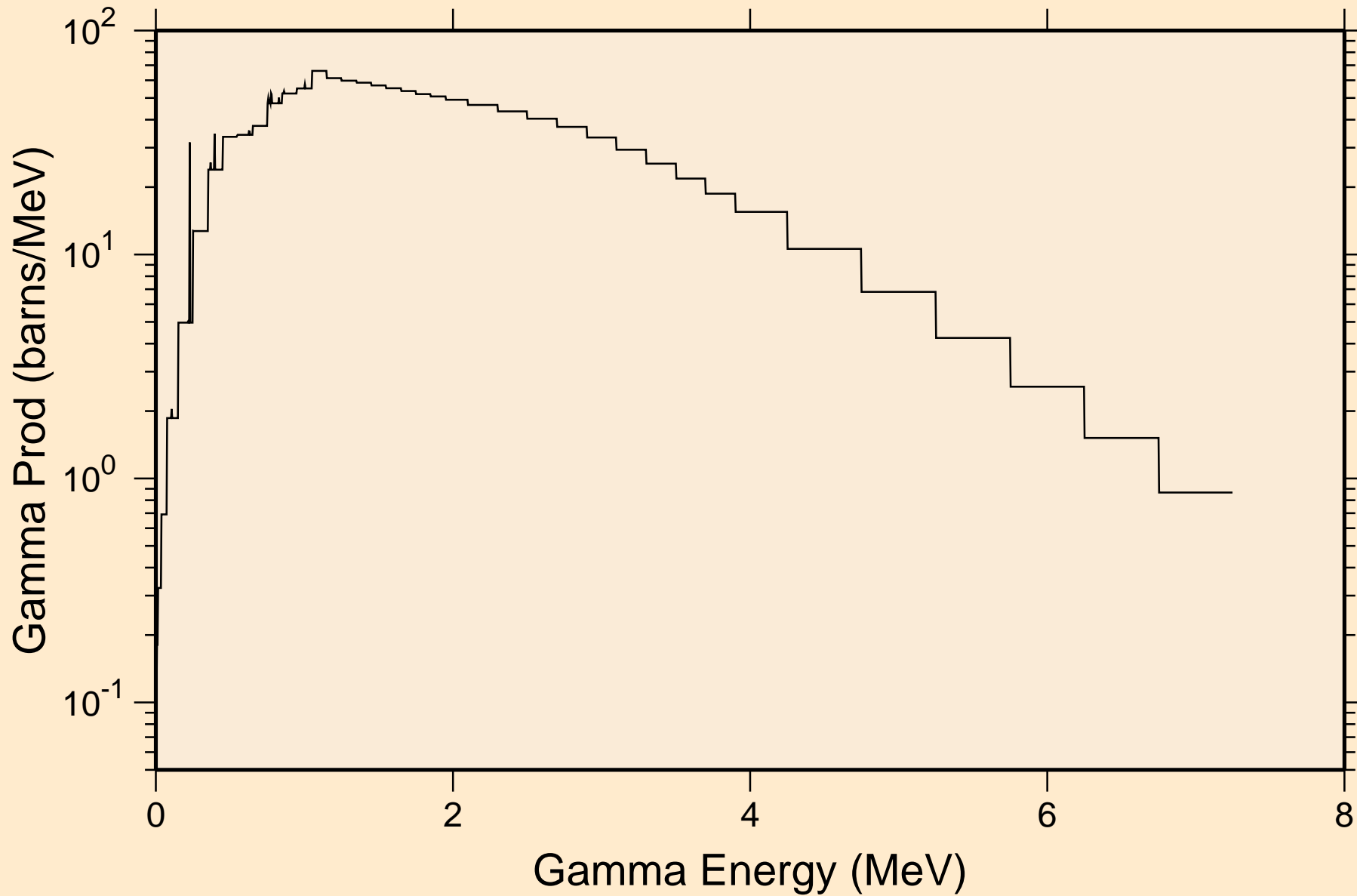

EU146 NEUTRON ACER TENDL-2021 LIBRARY; T=293.6K
14 MeV photon spectrum

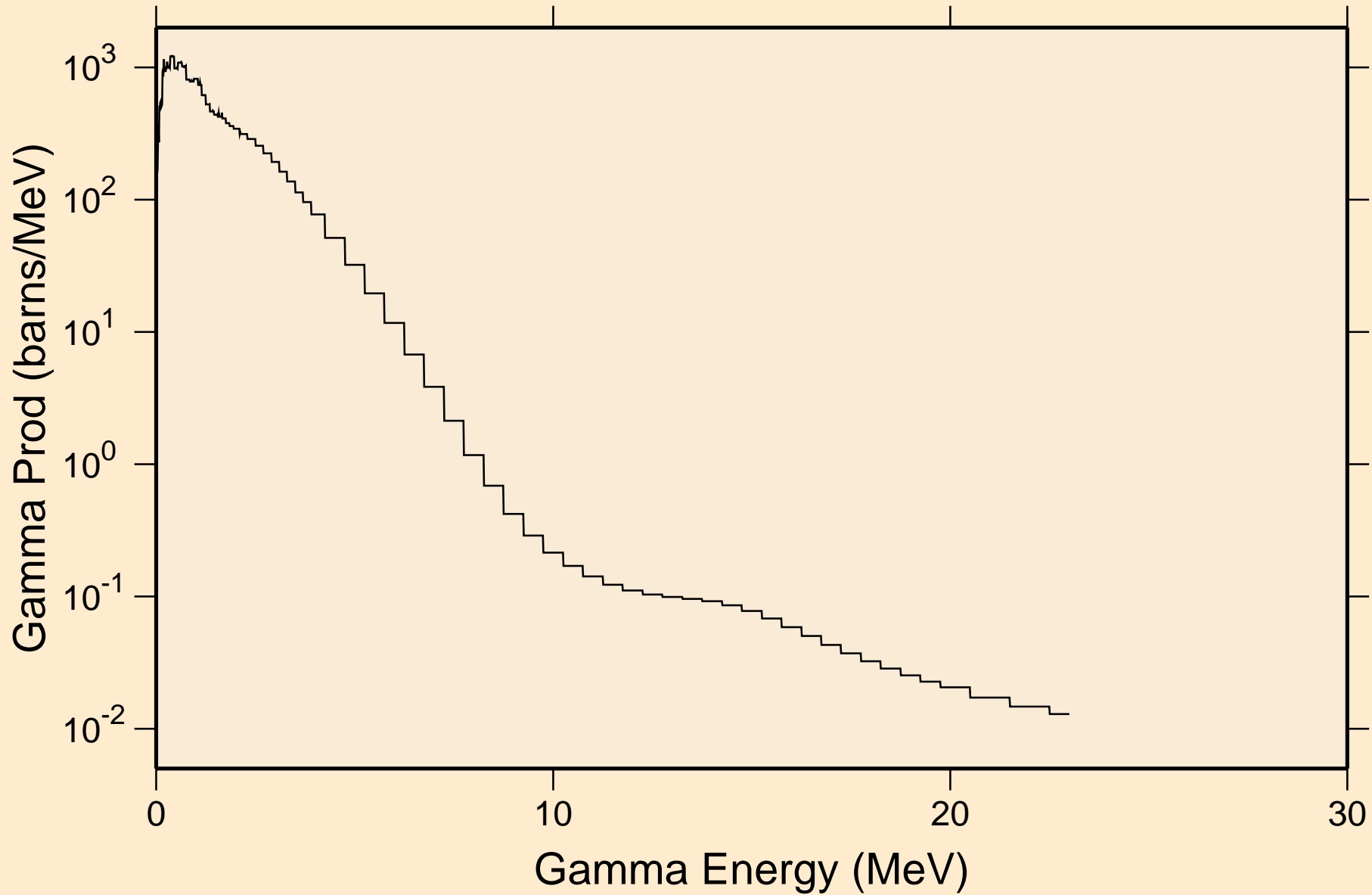

EU146 NEUTRON ACER TENDL-2021 LIBRARY; T=293.6K

Particle heating contributions

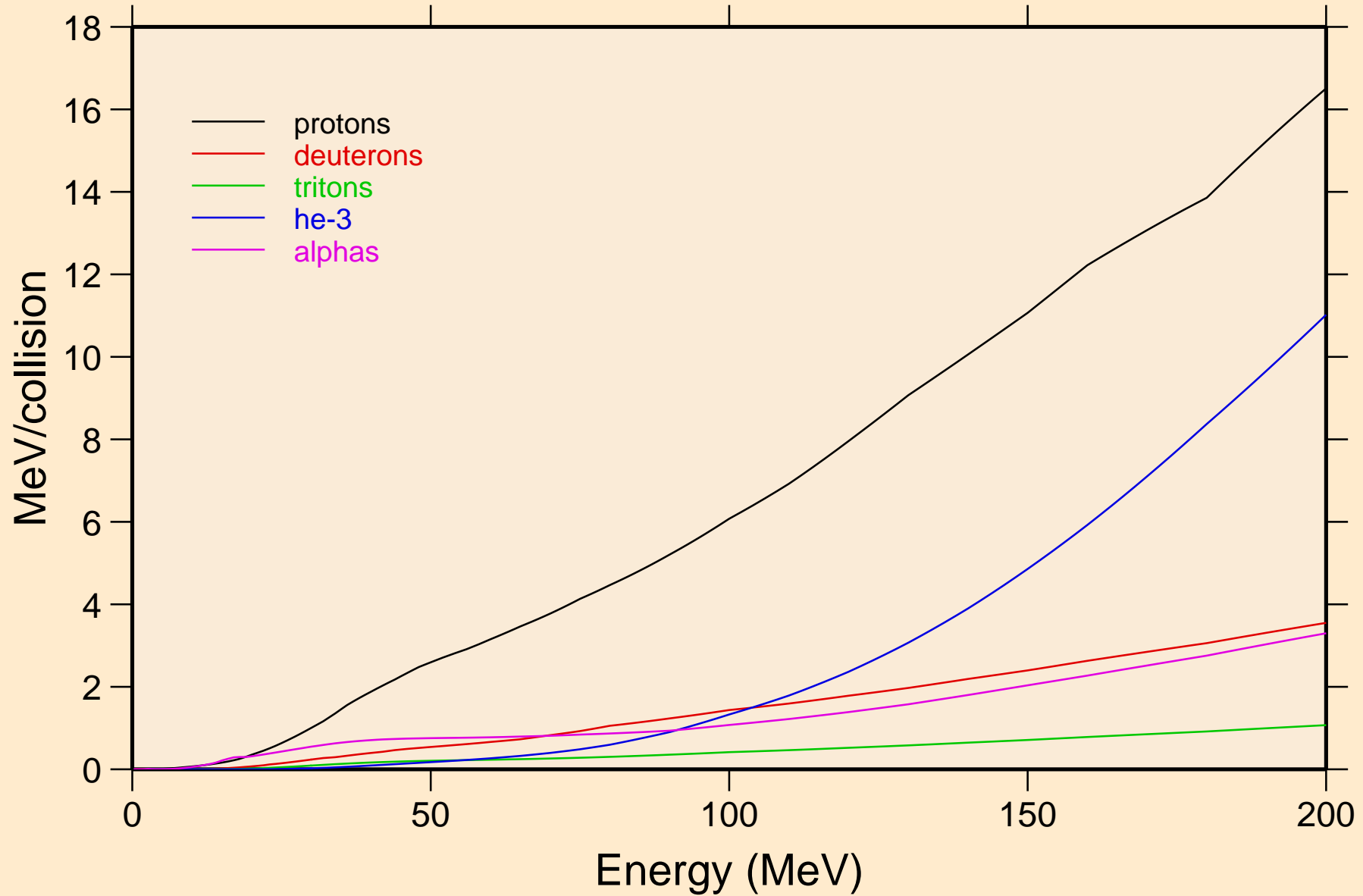

EU146 NEUTRON ACER TENDL-2021 LIBRARY; T=293.6K
Recoil Heating

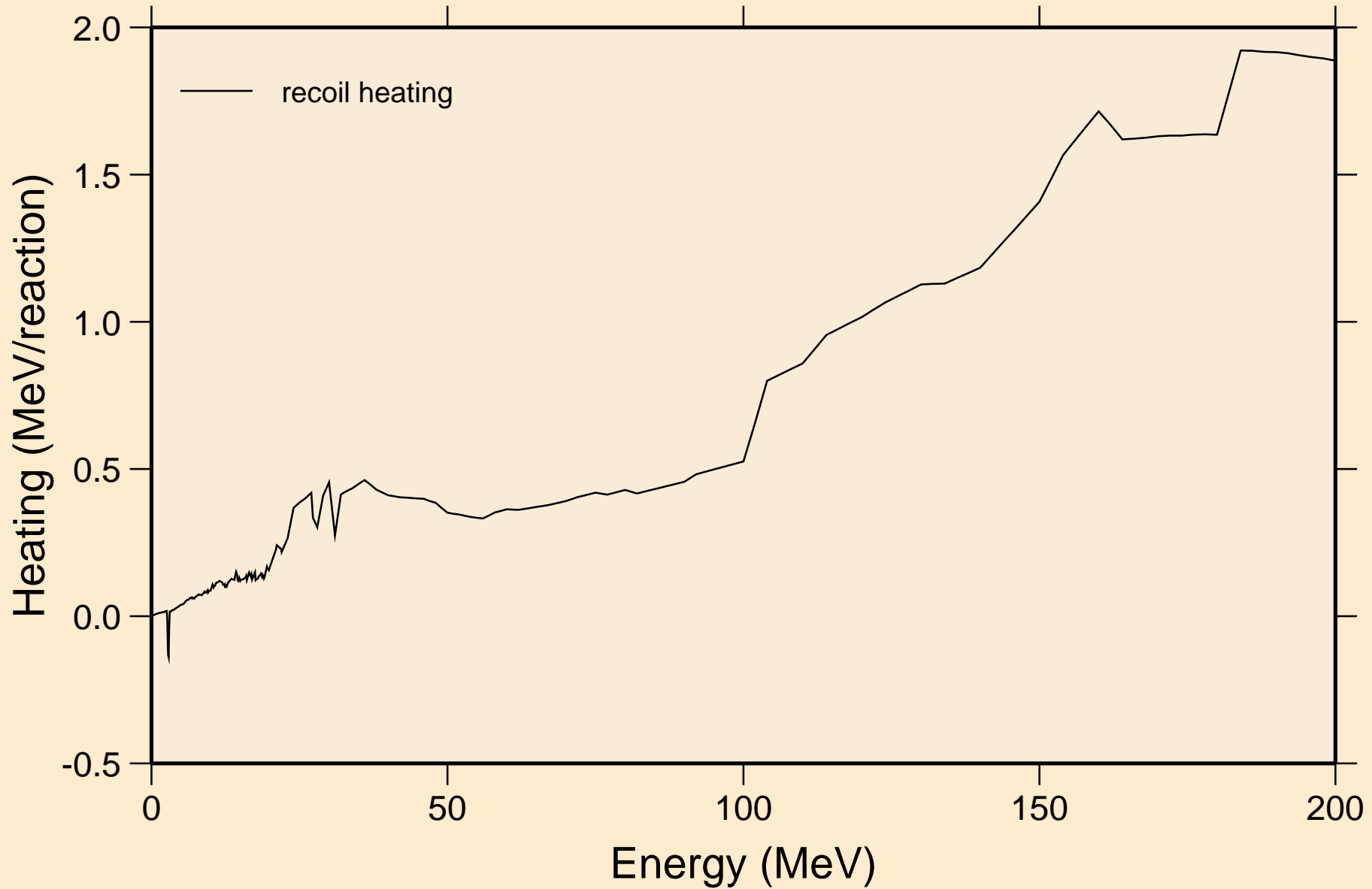

EU146 NEUTRON ACER TENDL-2021 LIBRARY; T=293.6K
Particle production cross sections

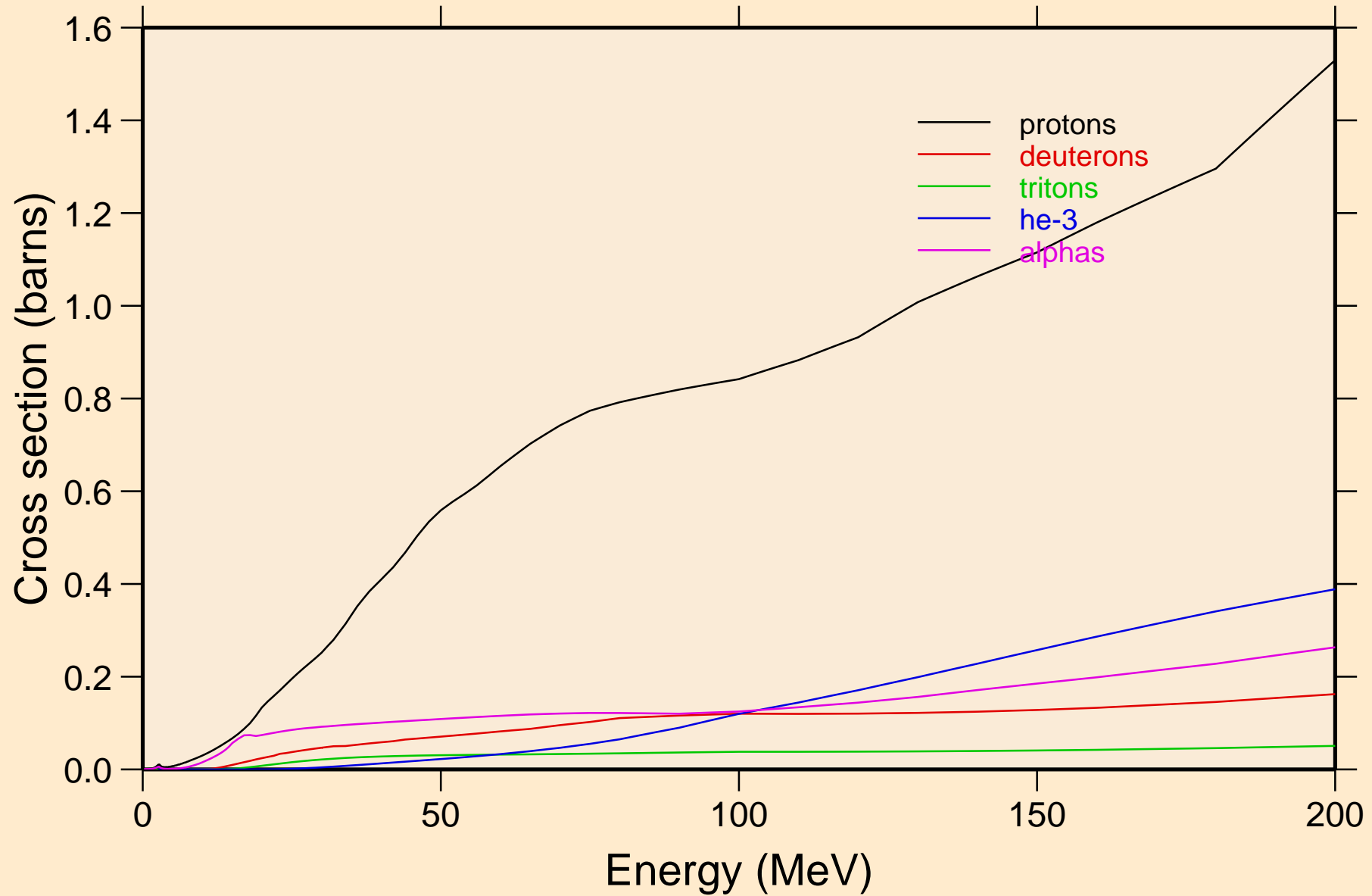

EU146 NEUTRON ACER TENDL-2021 LIBRARY; T=293.6K
protons from (n,x)

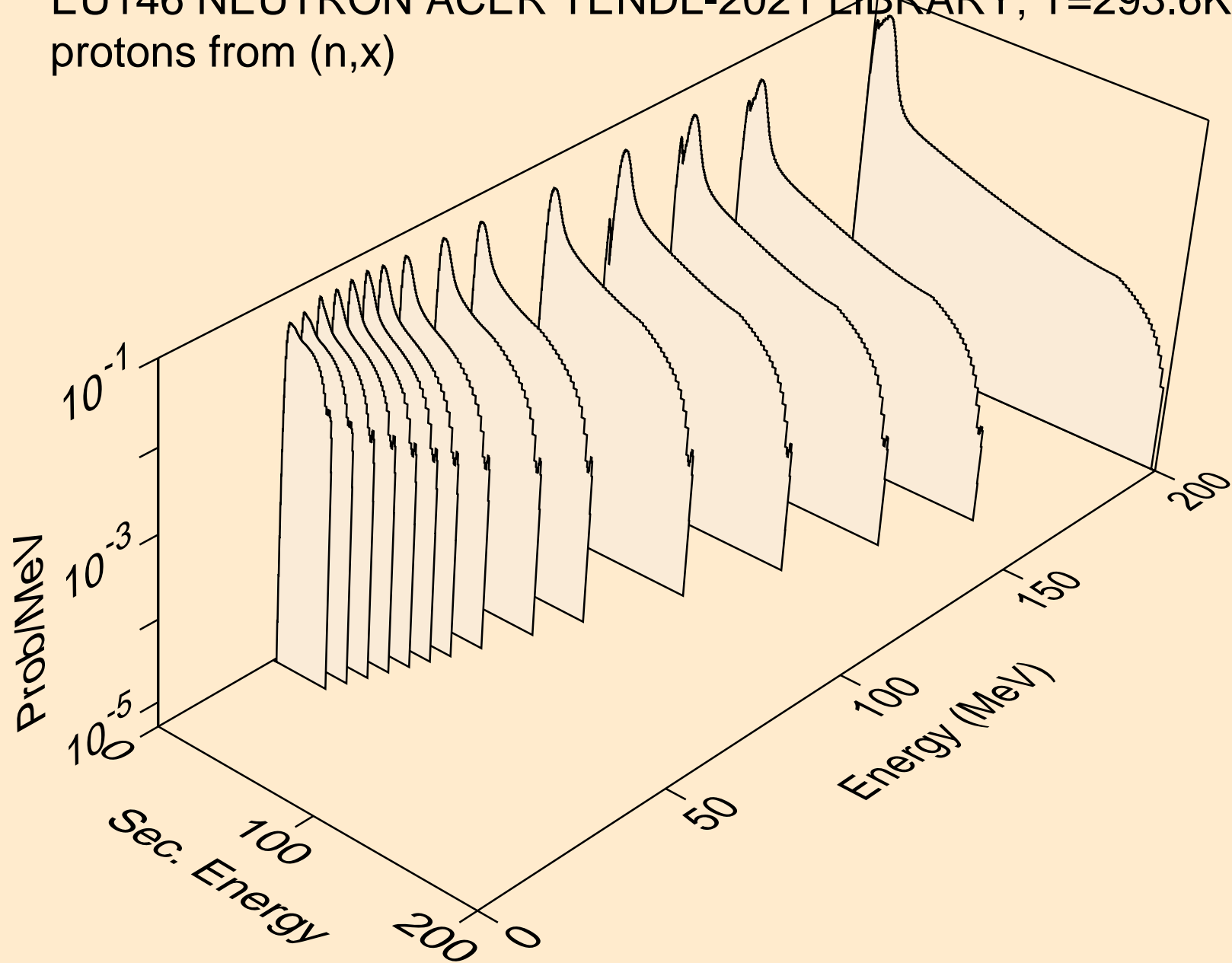

EU146 NEUTRON ACER TENDL-2021 LIBRARY; T=293.6K
protons from (n,n*)p

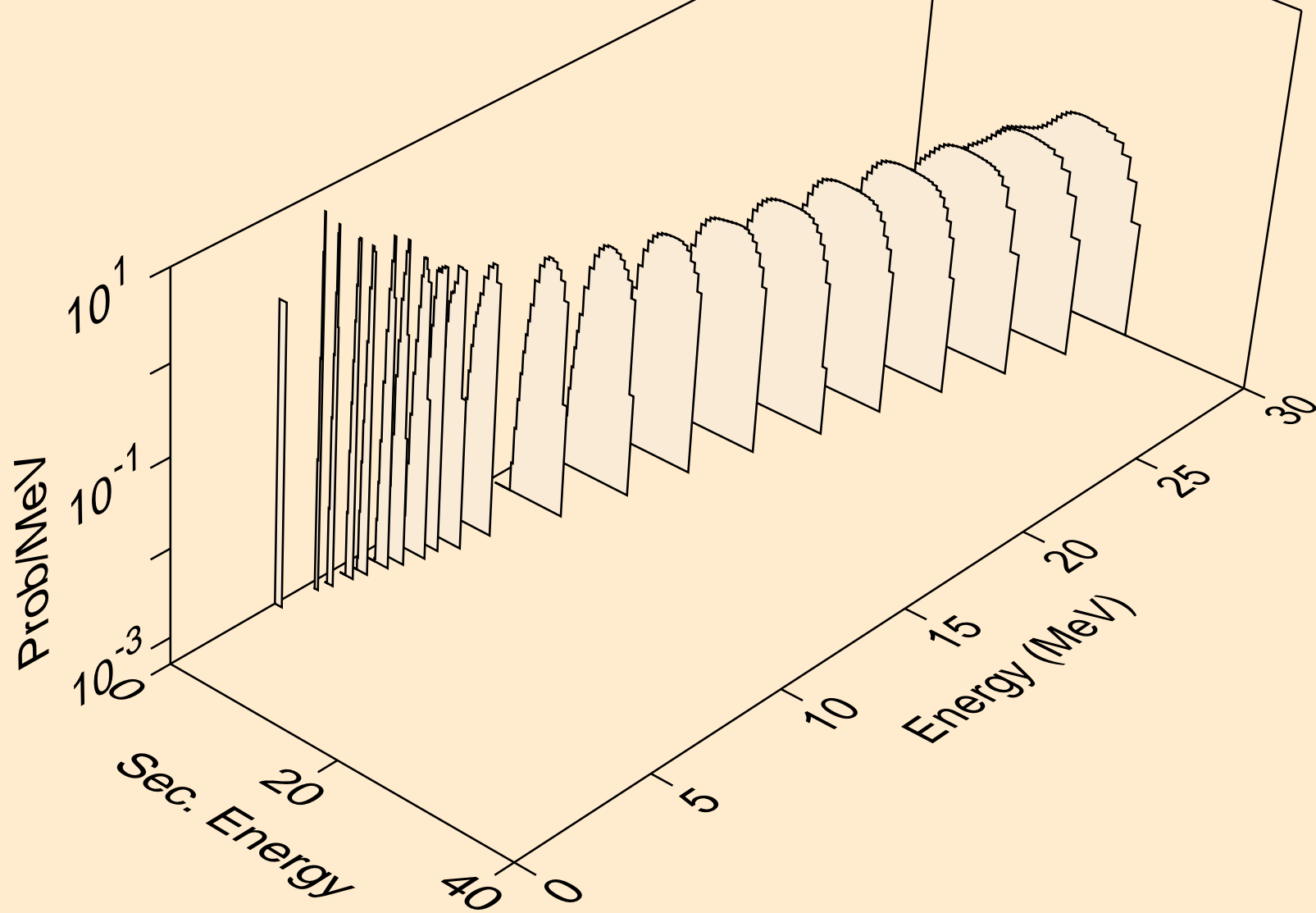

EU146 NEUTRON ACER TENDL-2021 LIBRARY; T=293.6K
protons from (n,2np)

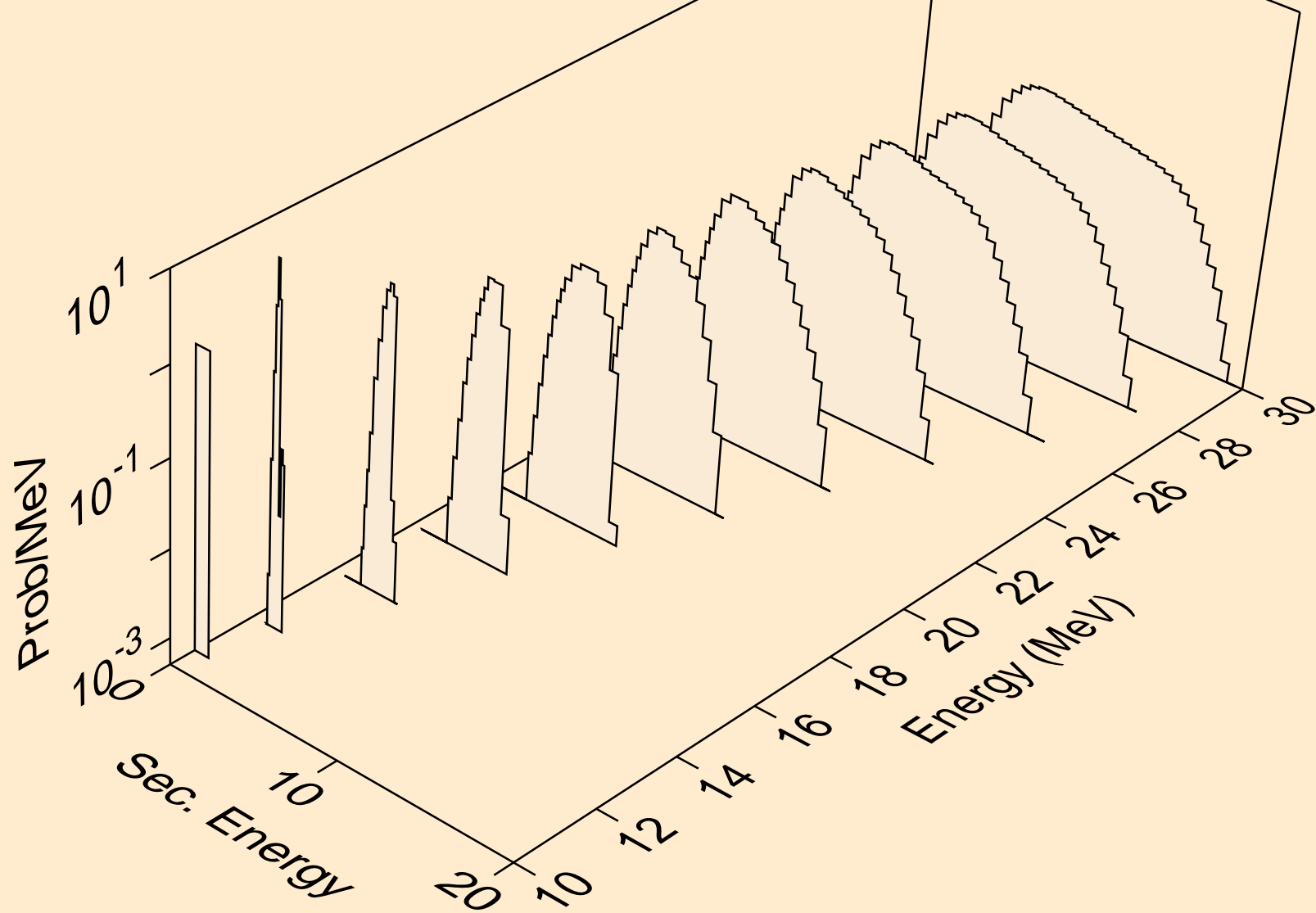

EU146 NEUTRON ACER TENDL-2021 LIBRARY; T=293.6K
protons from (n,3np)

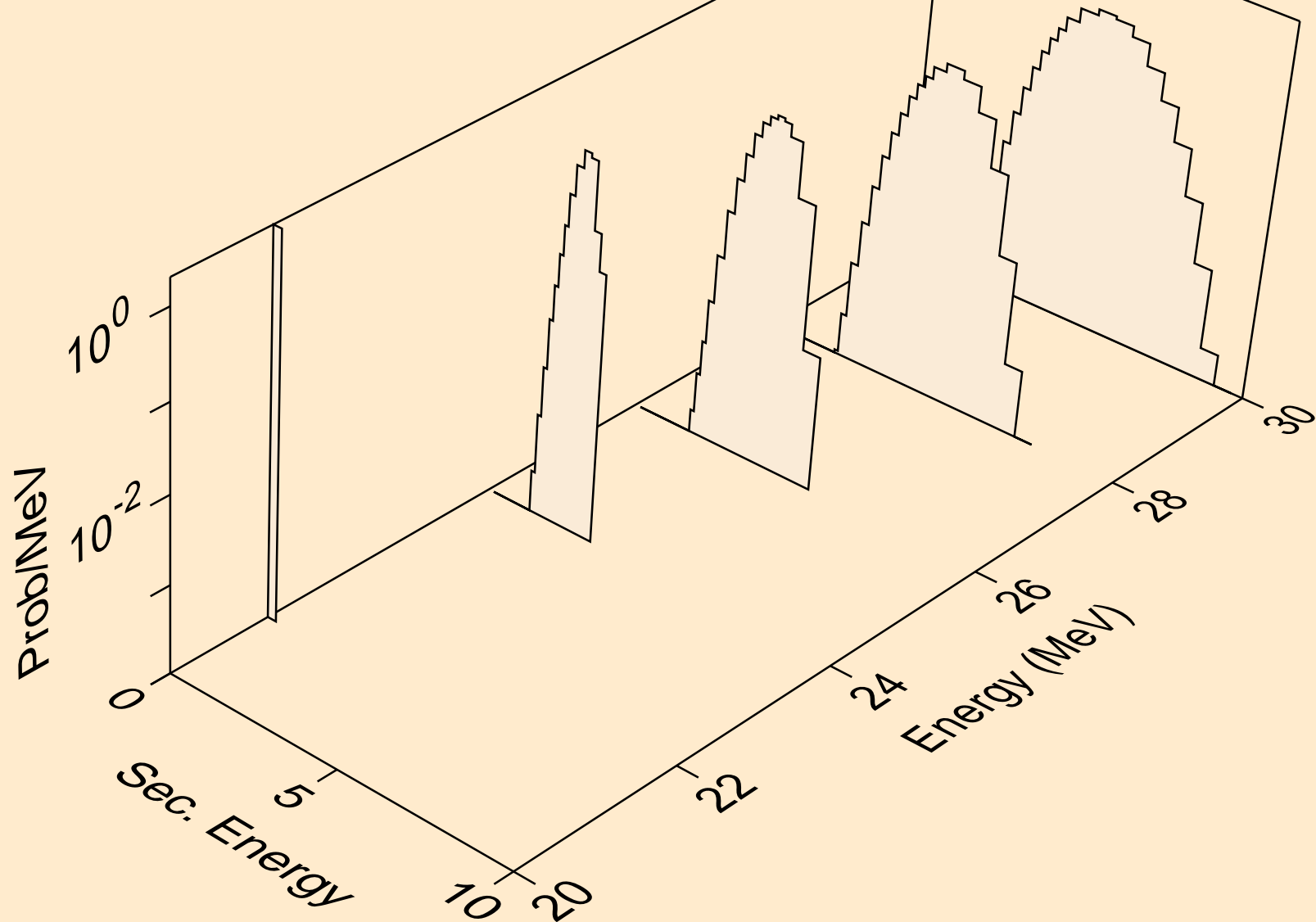

EU146 NEUTRON ACER TENDL-2021 LIBRARY; T=293.6K
protons from (n,2np)

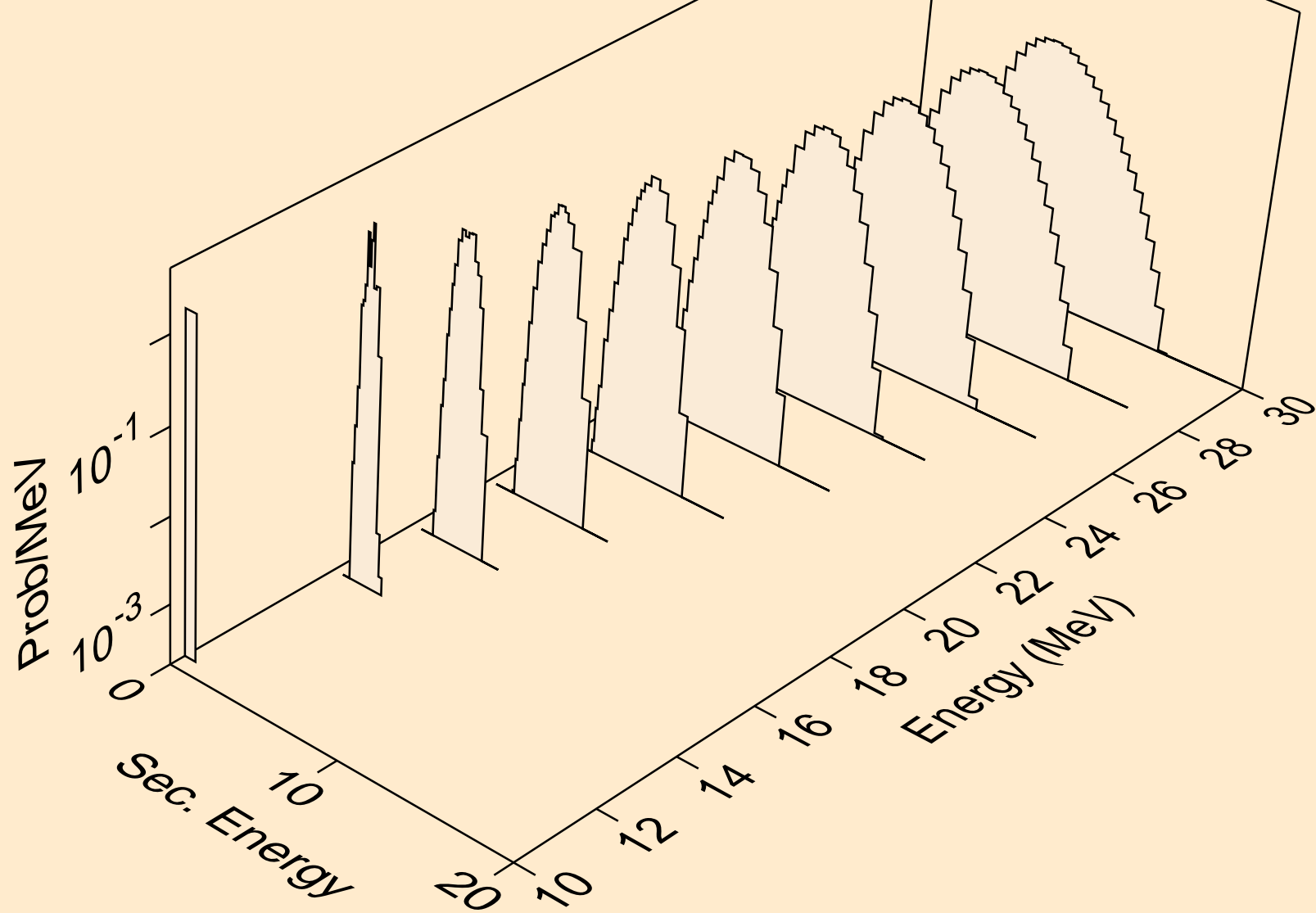

EU146 NEUTRON ACER TENDL-2021 LIBRARY; T=293.6K
protons from (n,npa)

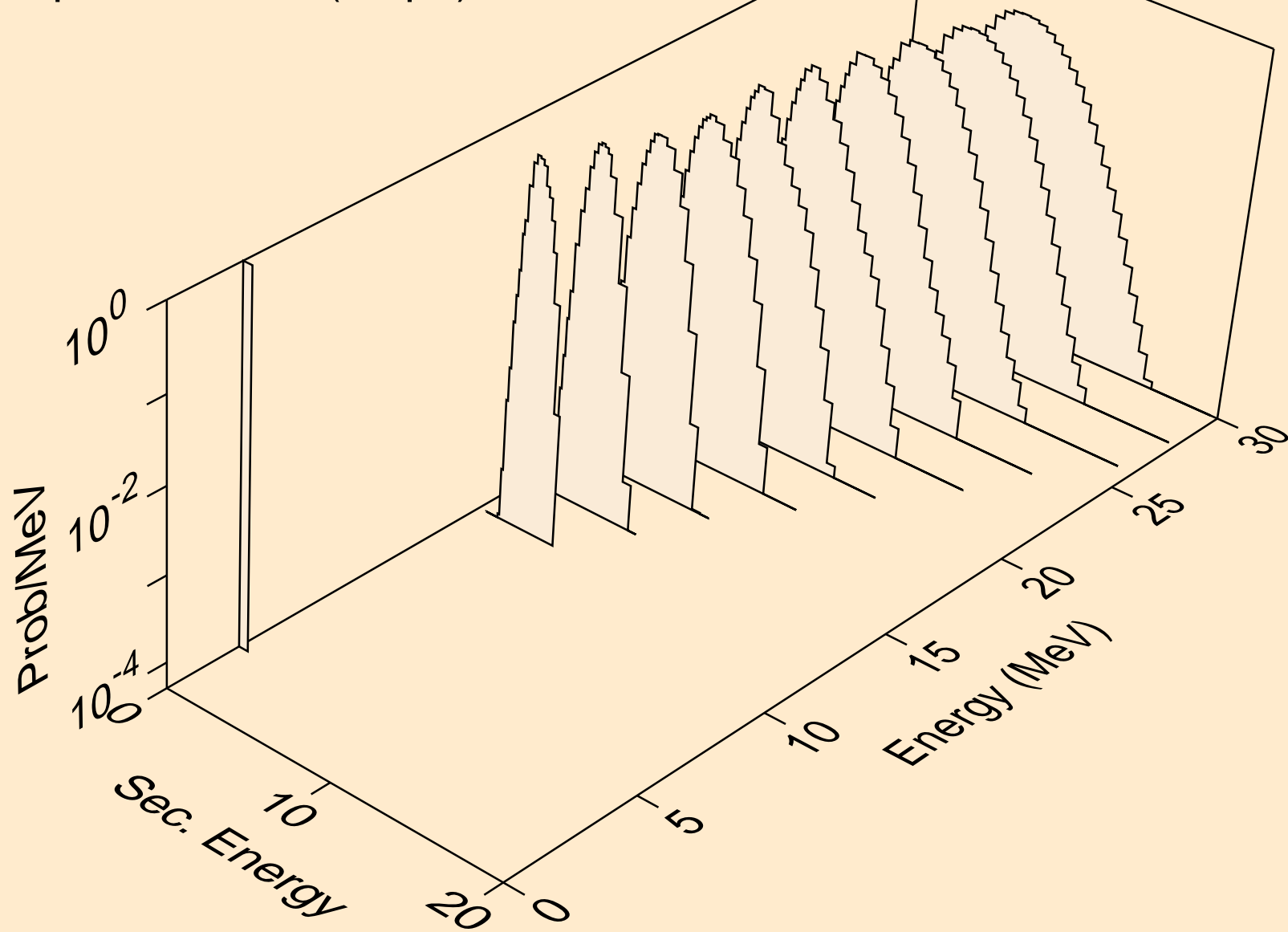

EU146 NEUTRON ACER TENDL-2021 LIBRARY; T=293.6K
protons from (n,p)

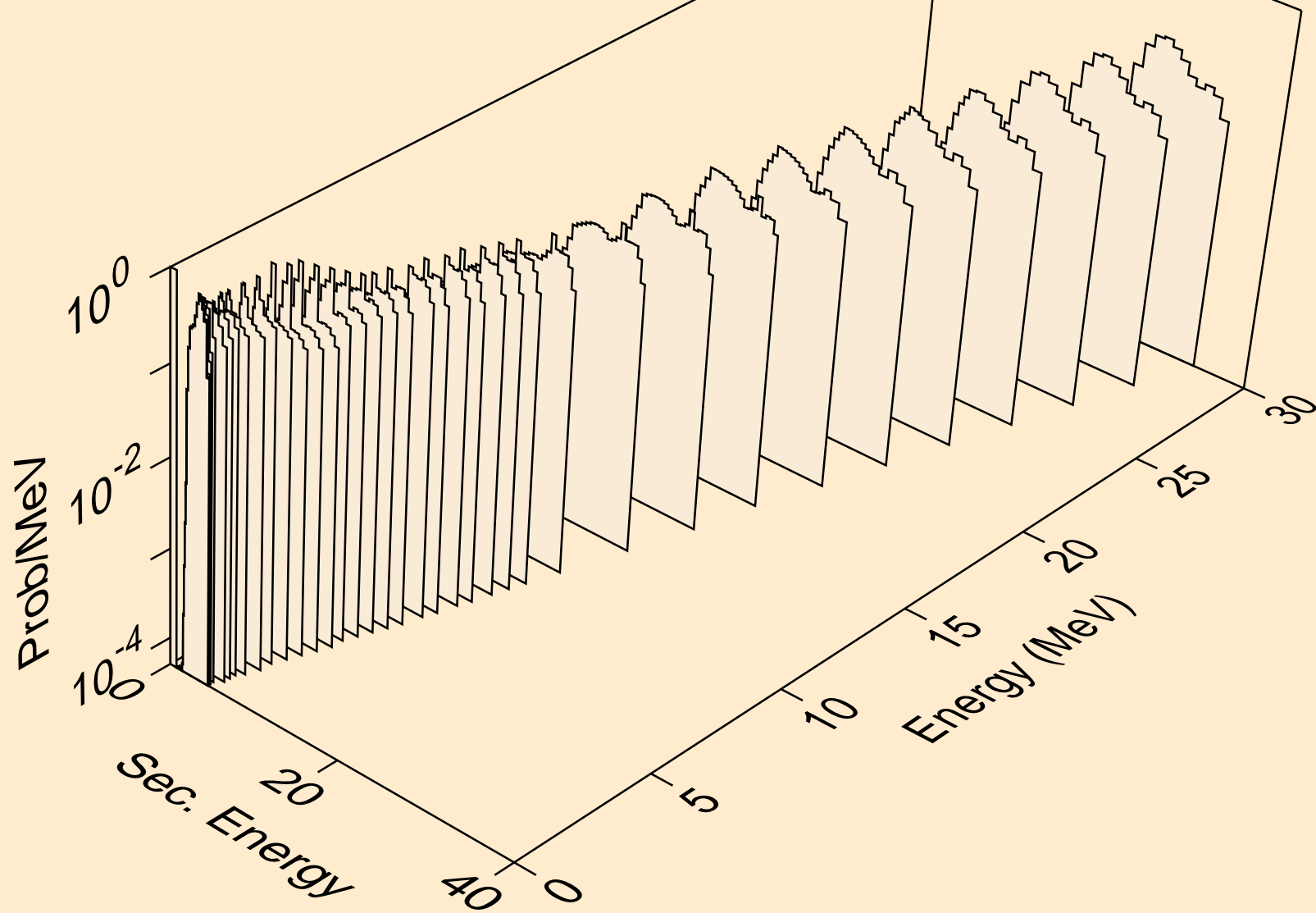

EU146 NEUTRON ACER TENDL-2021 LIBRARY; T=293.6K
protons from (n,2p)

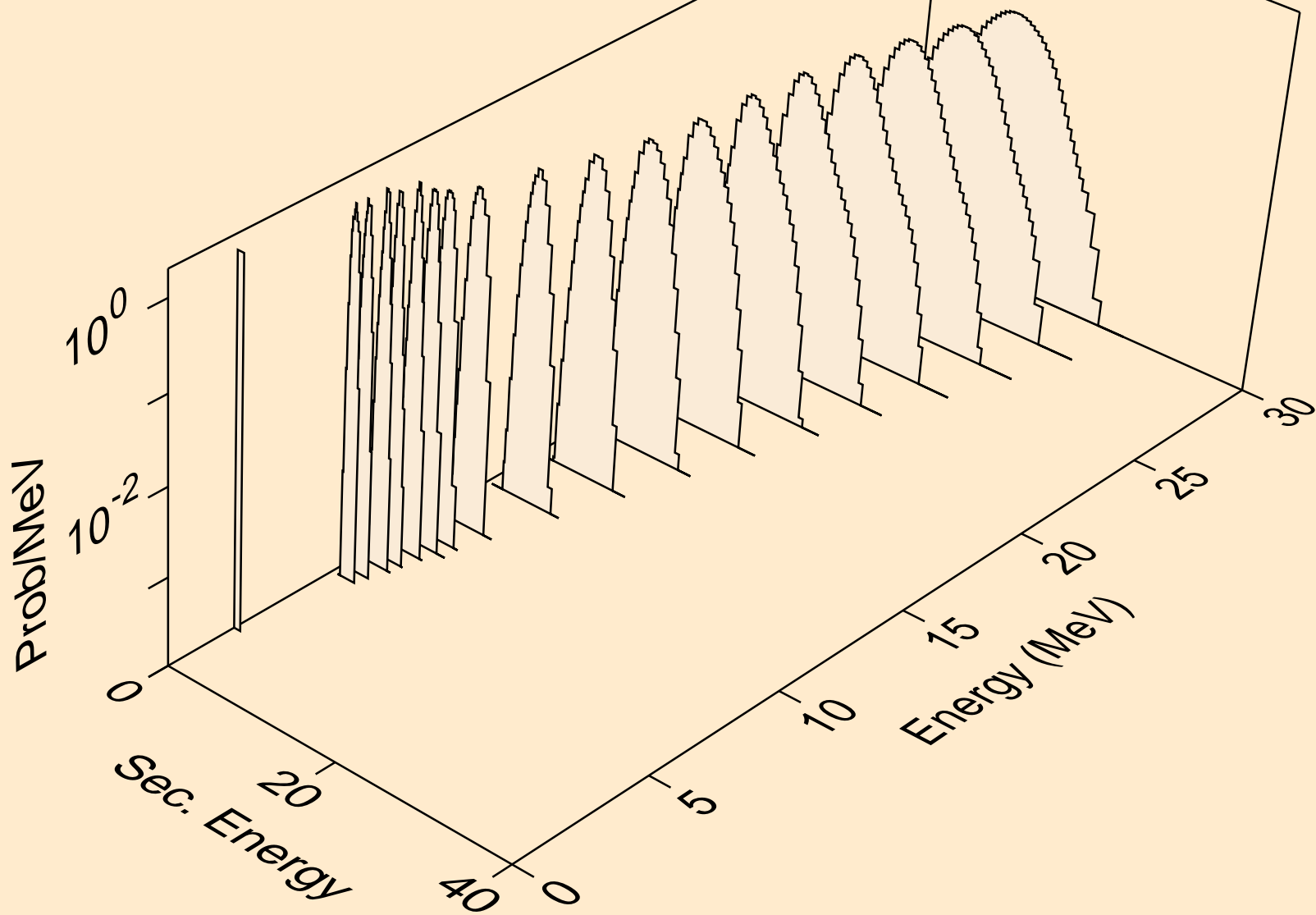

EU146 NEUTRON ACER TENDL-2021 LIBRARY; T=293.6K
protons from (n,p)

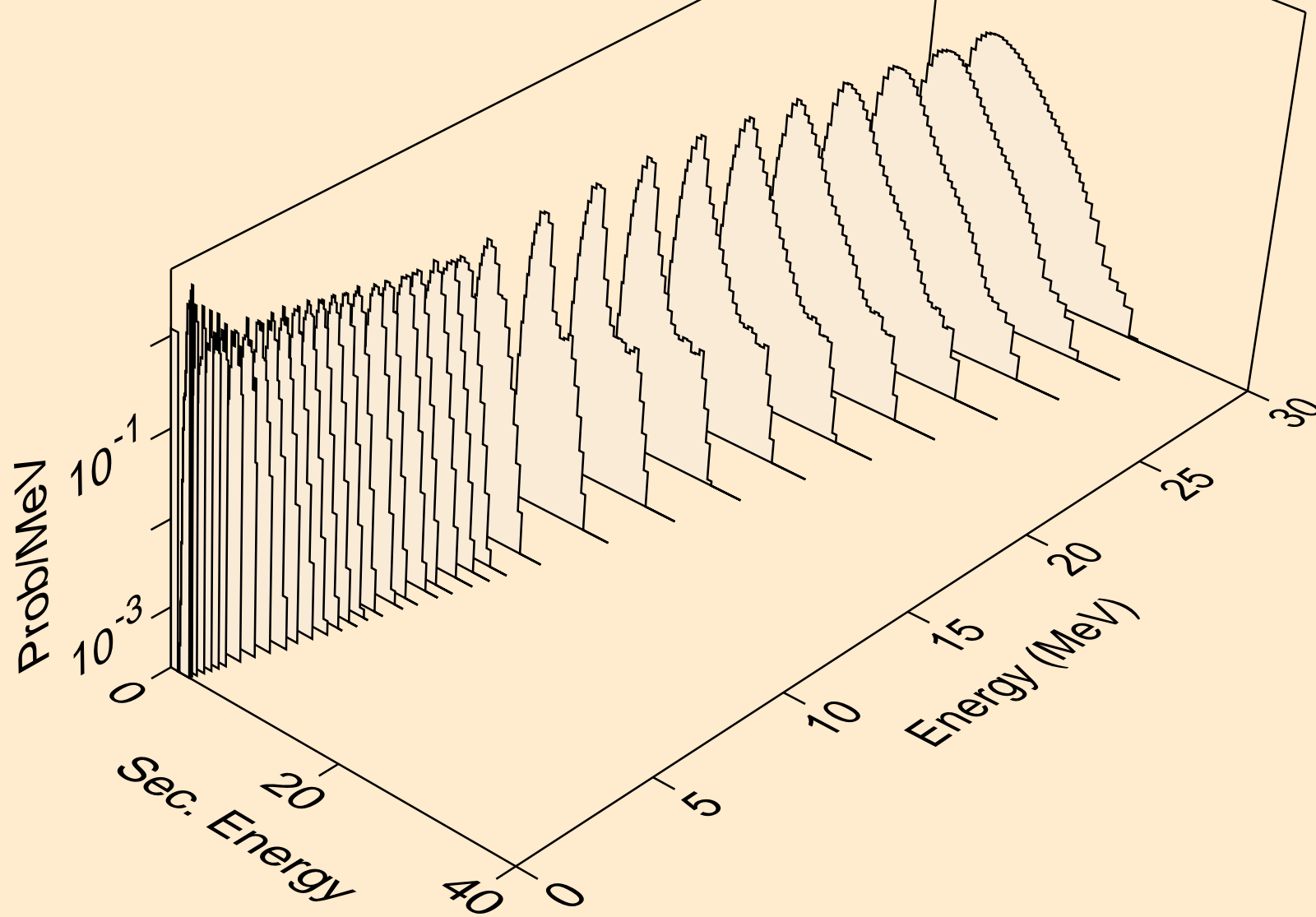

EU146 NEUTRON ACER TENDL-2021 LIBRARY; T=293.6K
protons from (n,pd)

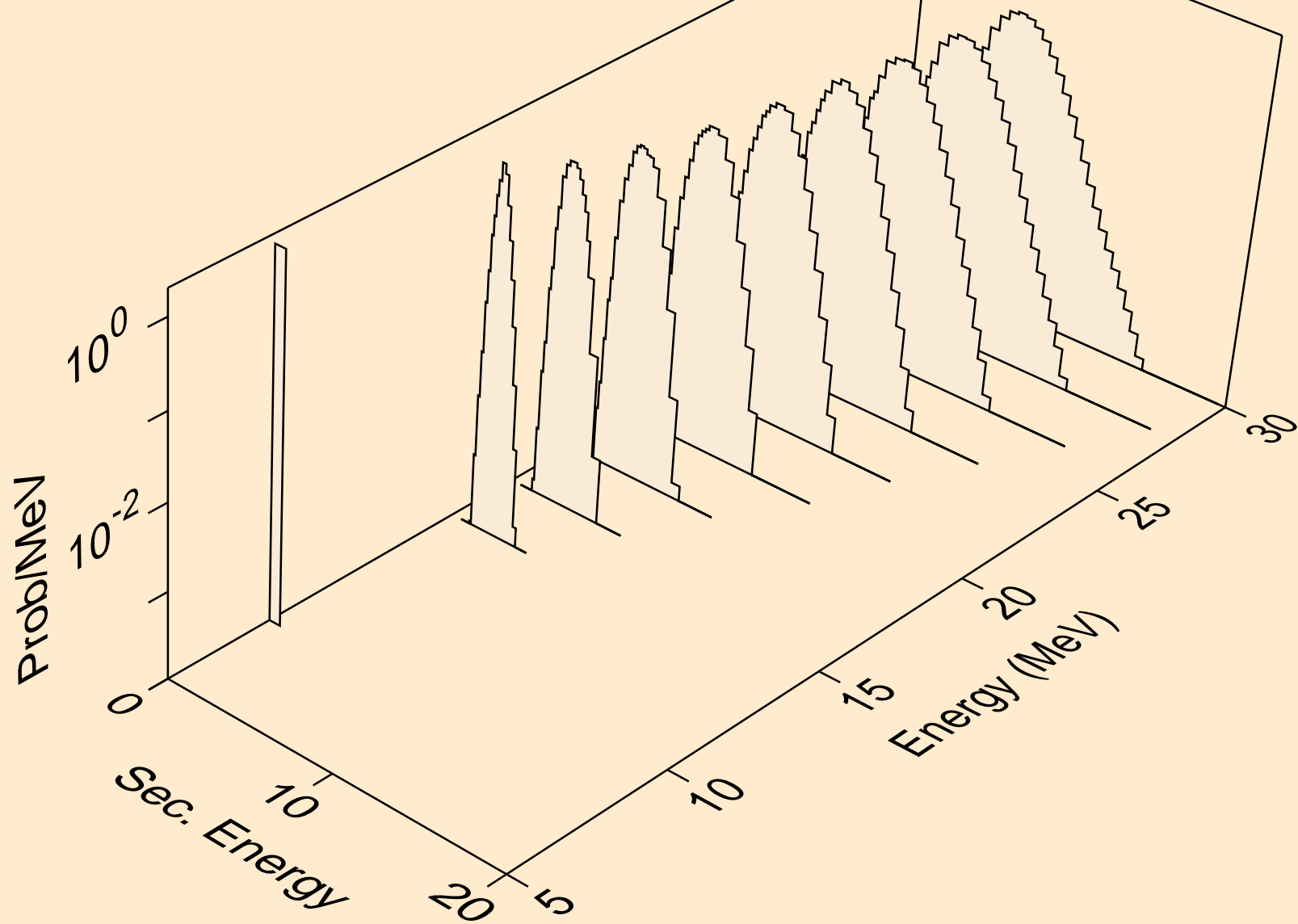

EU146 NEUTRON ACER TENDL-2021 LIBRARY; T=293.6K
protons from (n,pt)

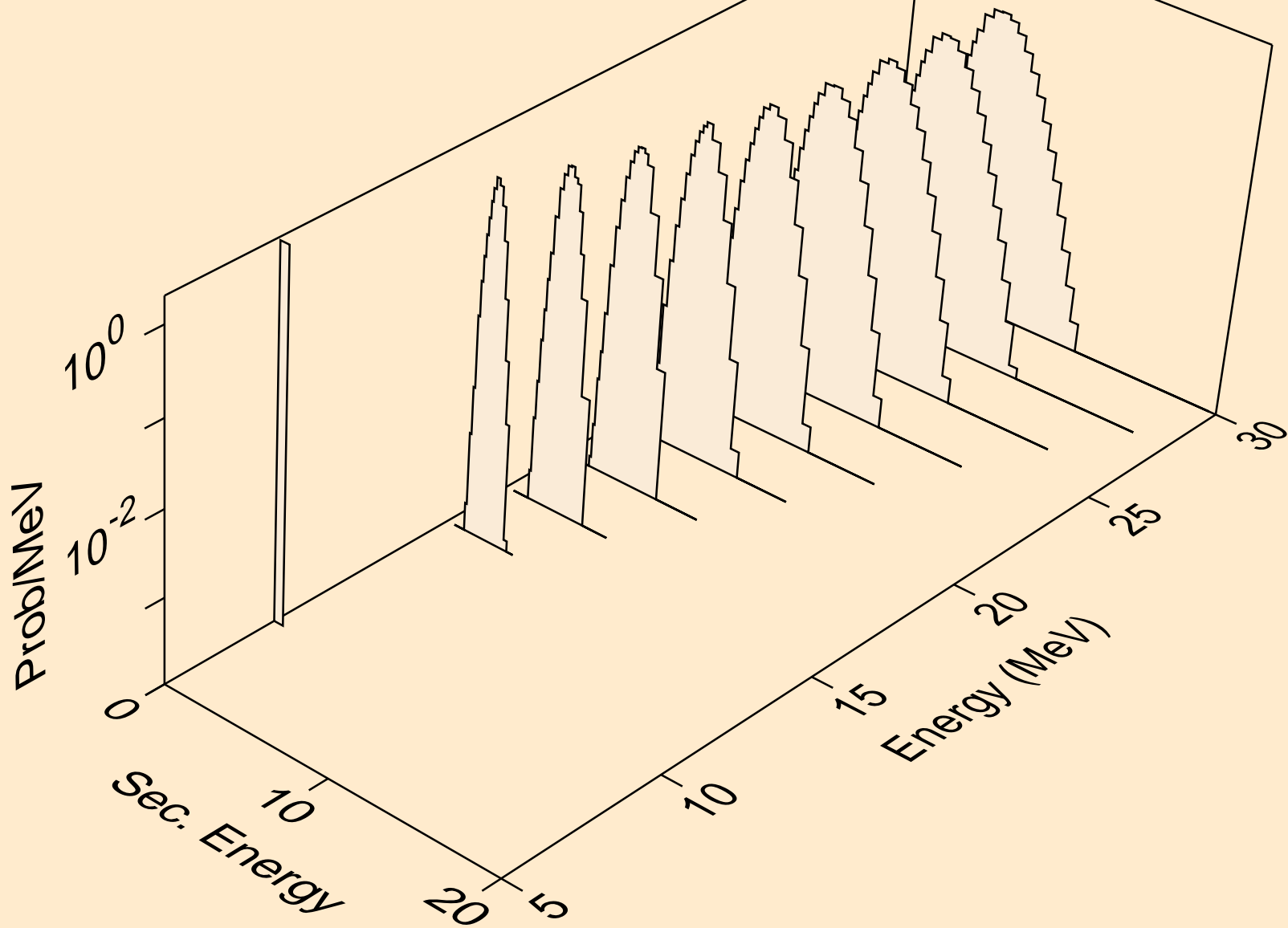

EU146 NEUTRON ACER TENDL-2021 LIBRARY; T=293.6K
deuterons from (n,x)

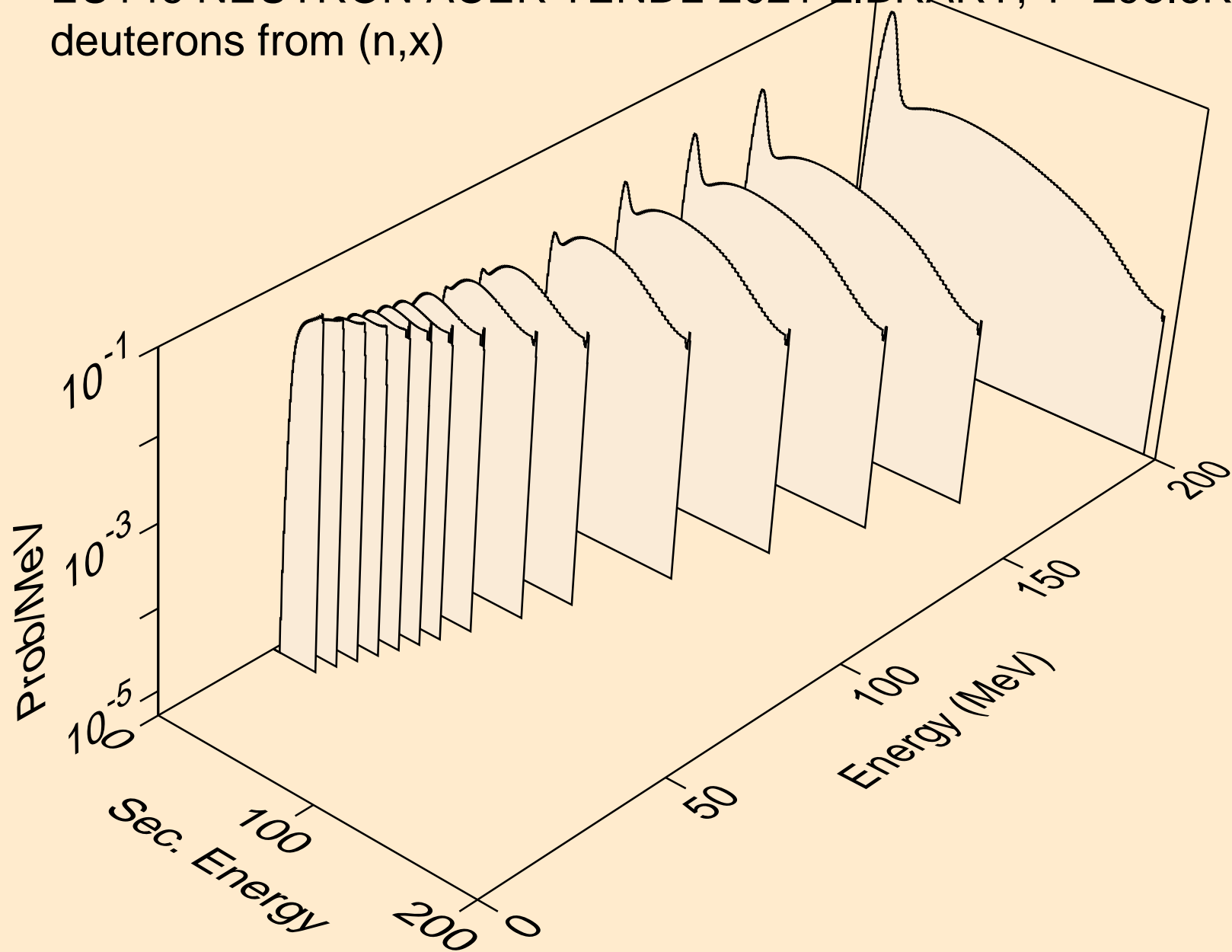

EU146 NEUTRON ACER TENDL-2021 LIBRARY; T=293.6K
deuterons from (n,2nd)

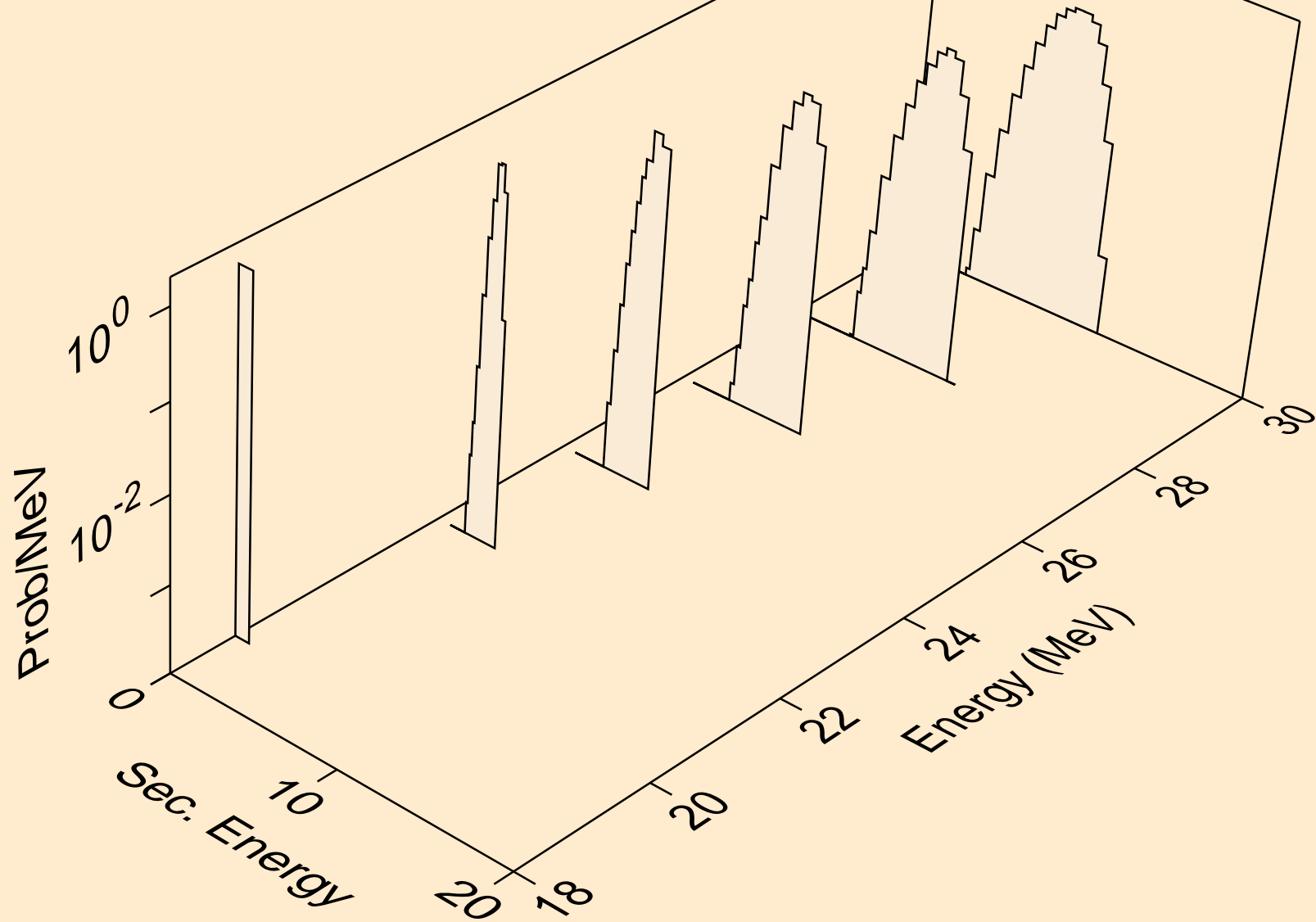

EU146 NEUTRON ACER TENDL-2021 LIBRARY; T=293.6K
deuterons from (n,n*)d

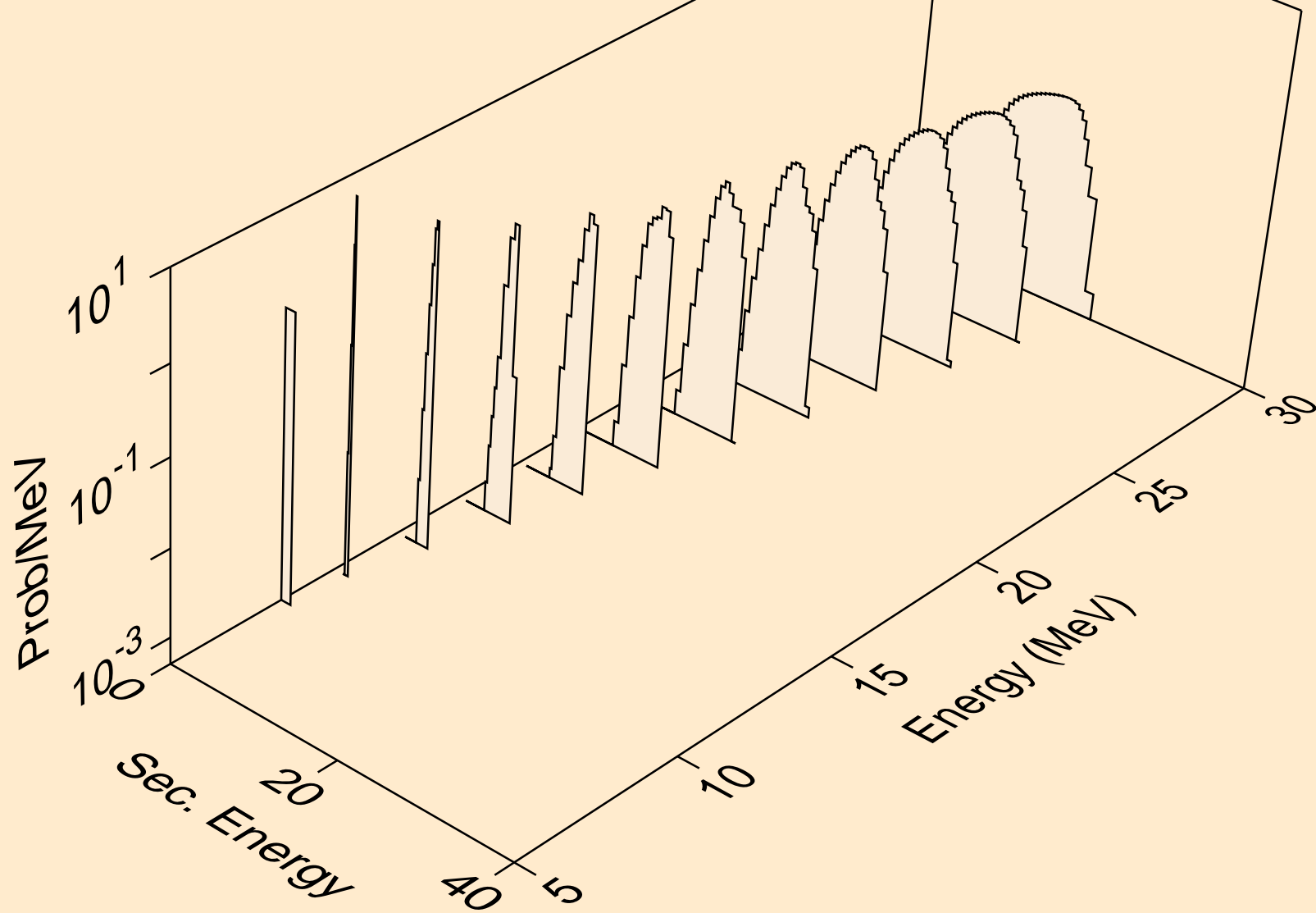

EU146 NEUTRON ACER TENDL-2021 LIBRARY; T=293.6K
deuterons from (n,d)

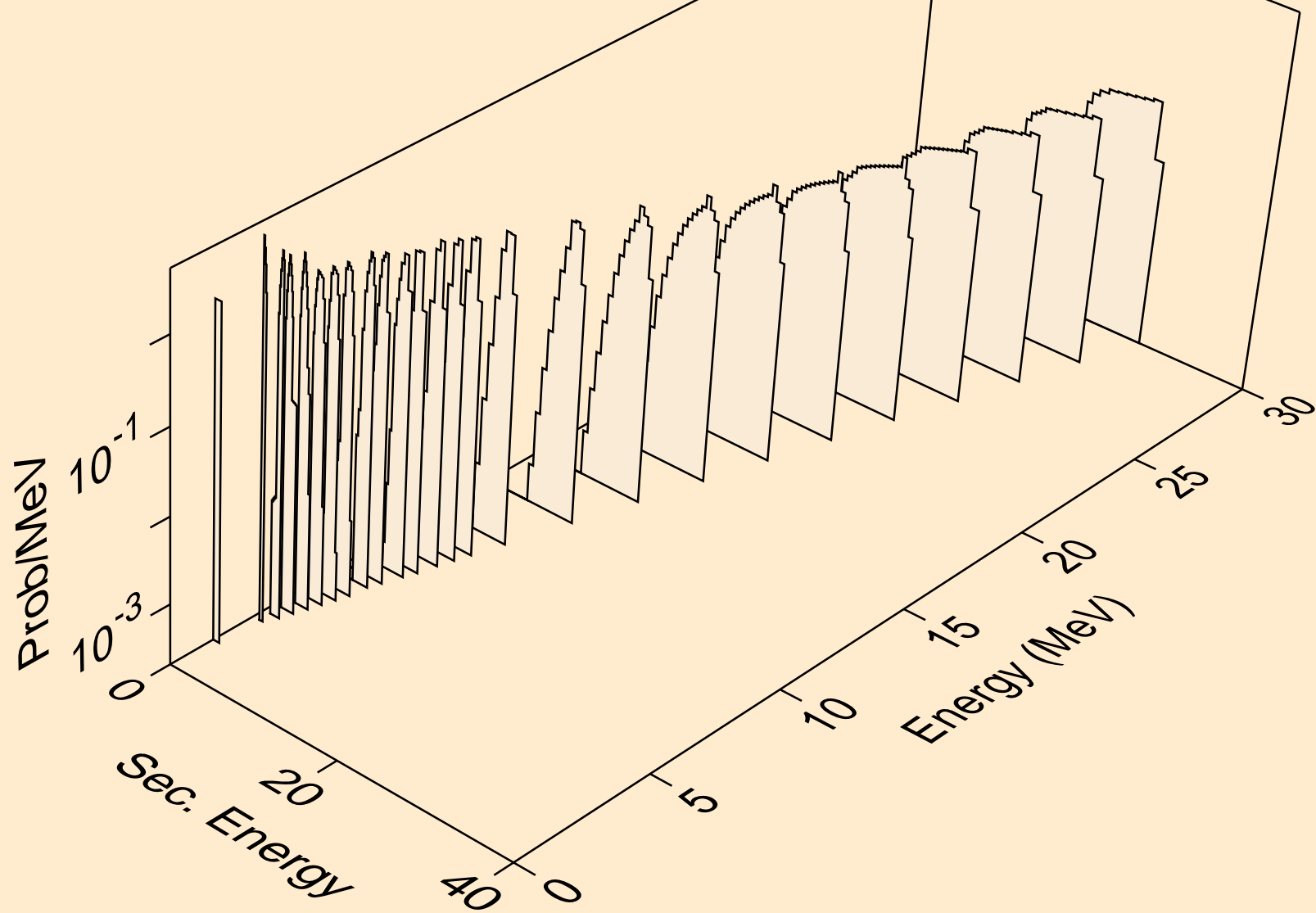

EU146 NEUTRON ACER TENDL-2021 LIBRARY; T=293.6K
deuterons from (n,pd)

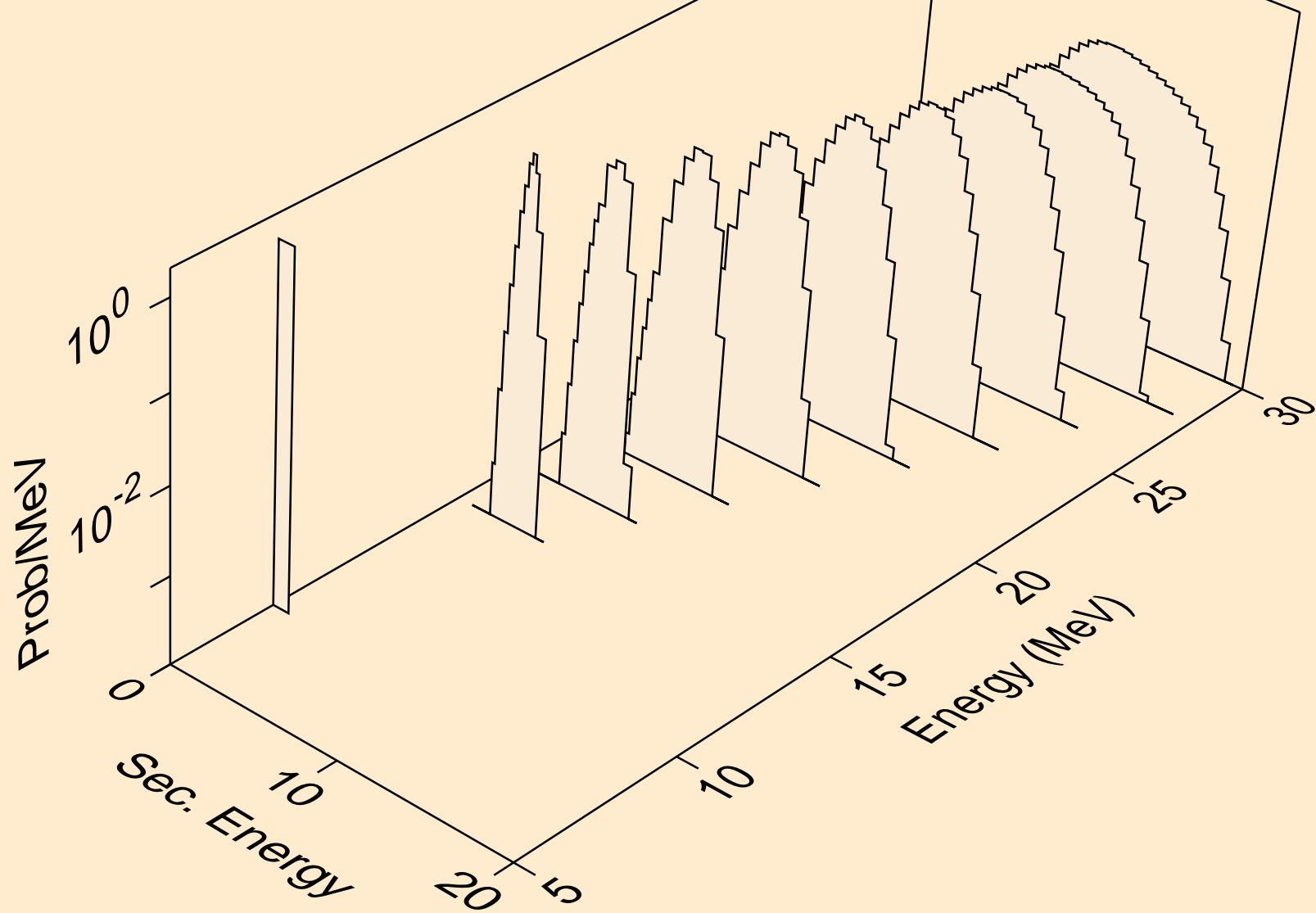

EU146 NEUTRON ACER TENDL-2021 LIBRARY; T=293.6K
deuterons from (n,da)

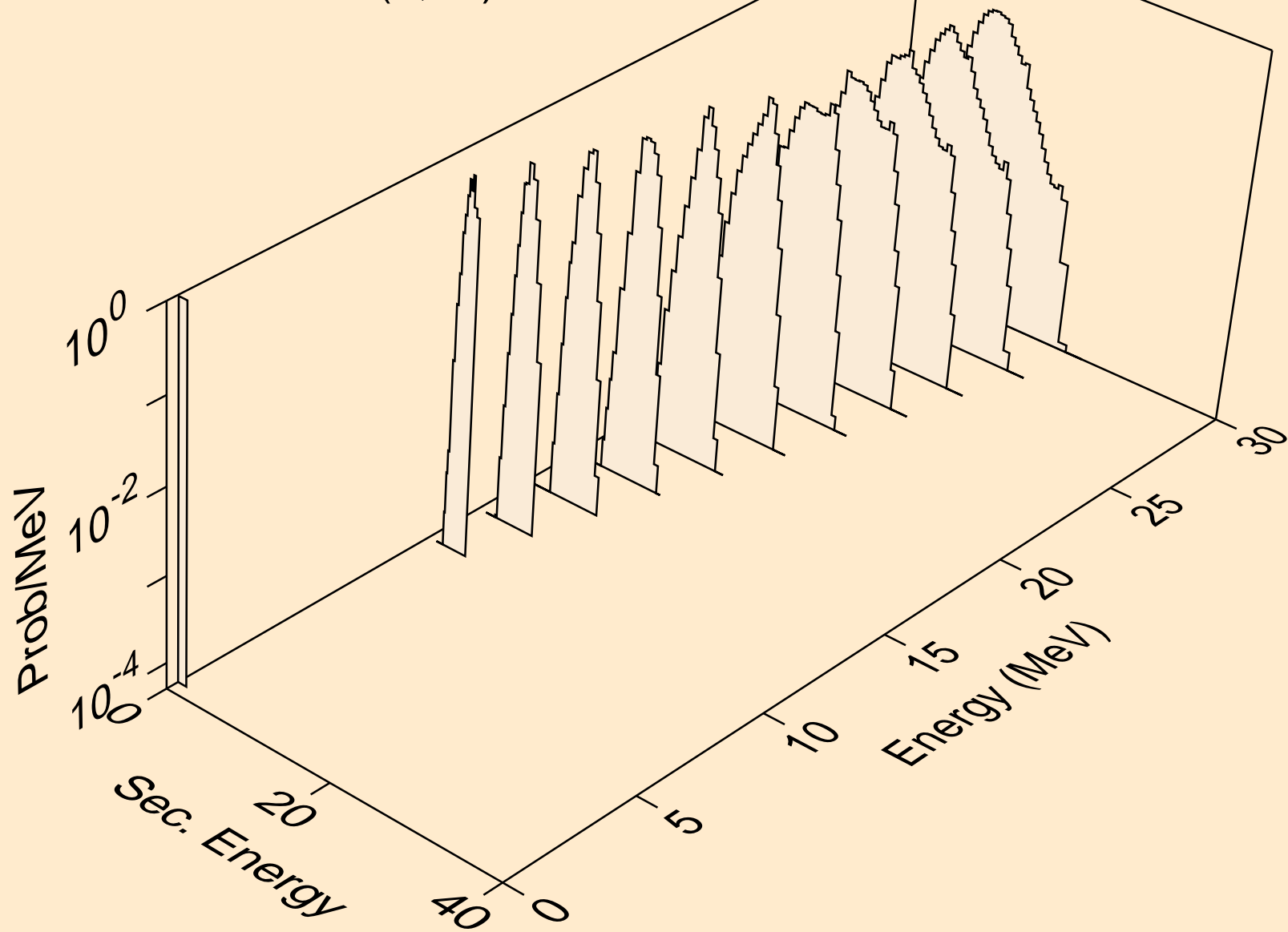

EU146 NEUTRON ACER TENDL-2021 LIBRARY; T=293.6K
tritons from (n,x)

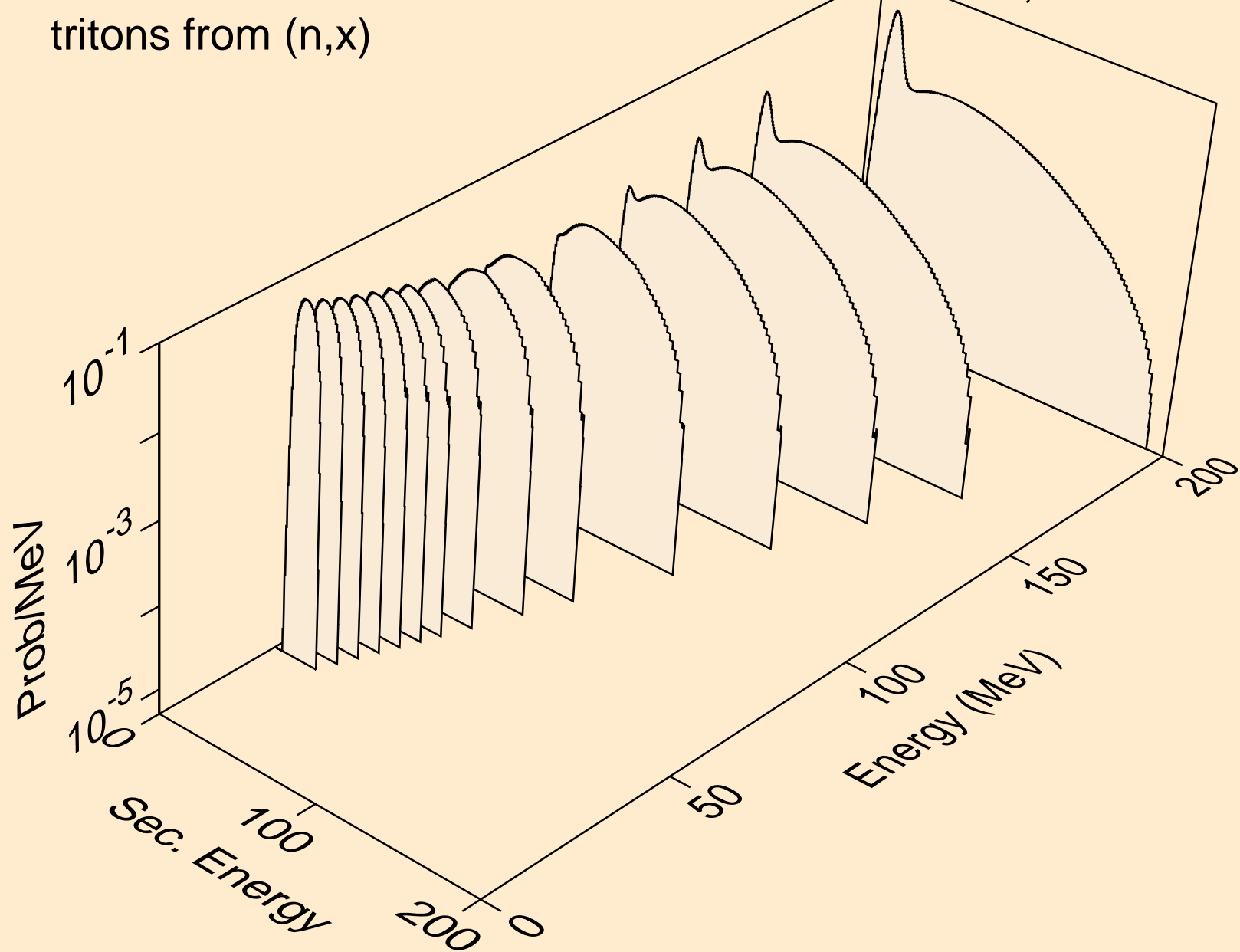

EU146 NEUTRON ACER TENDL-2021 LIBRARY; T=293.6K
tritons from (n,n*)t

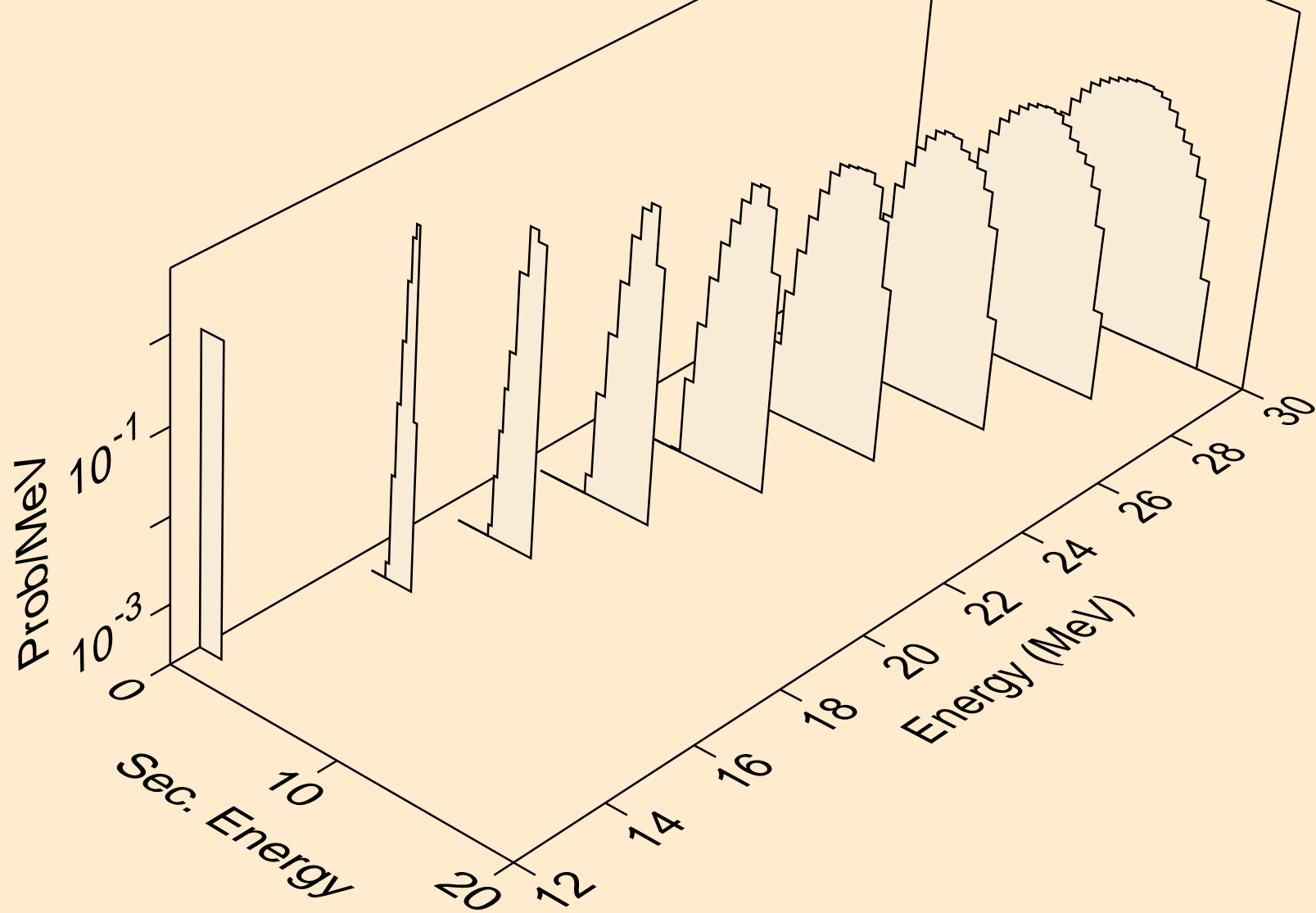

EU146 NEUTRON ACER TENDL-2021 LIBRARY; T=293.6K
tritons from (n,t)

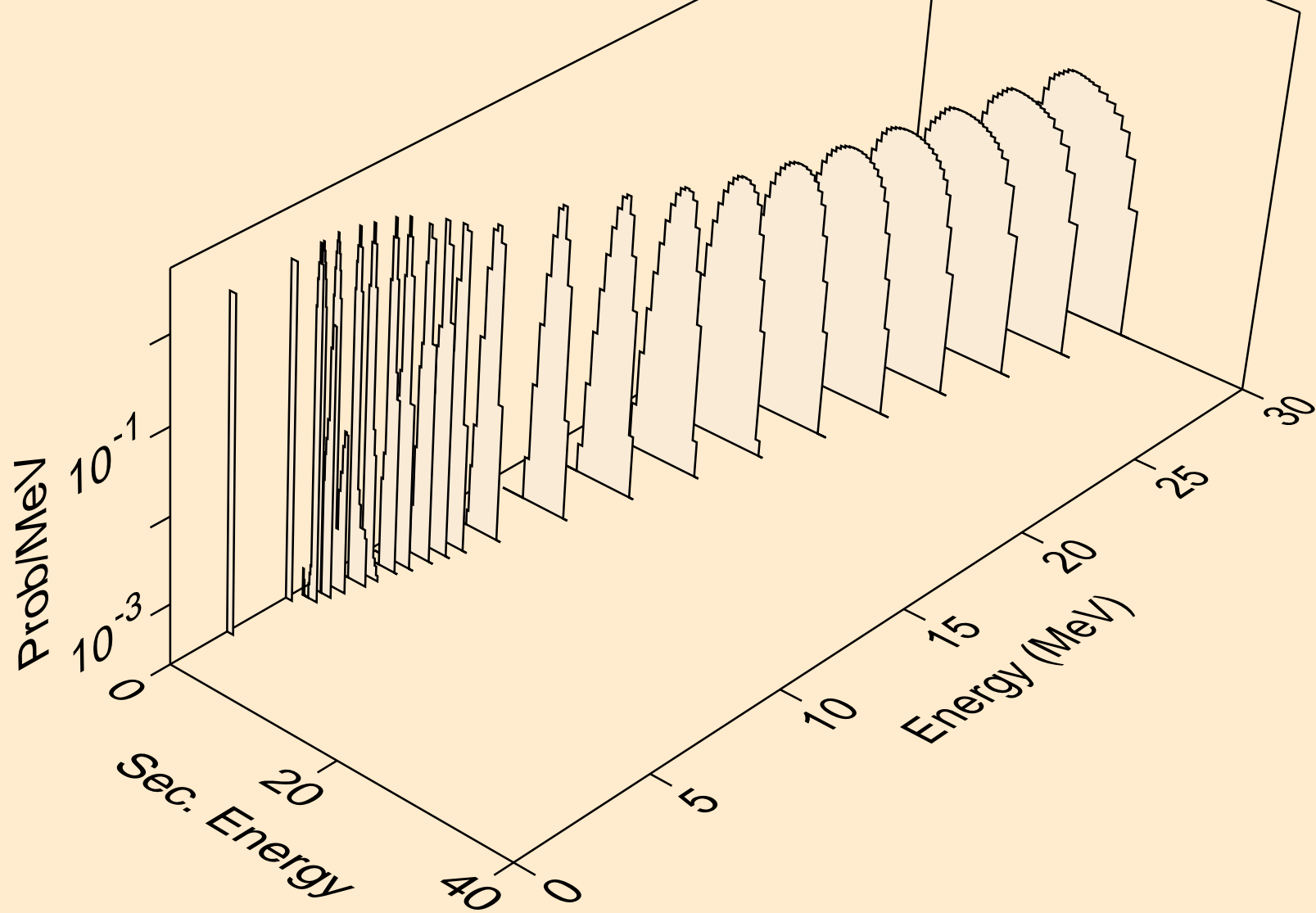

EU146 NEUTRON ACER TENDL-2021 LIBRARY; T=293.6K
tritons from (n,pt)

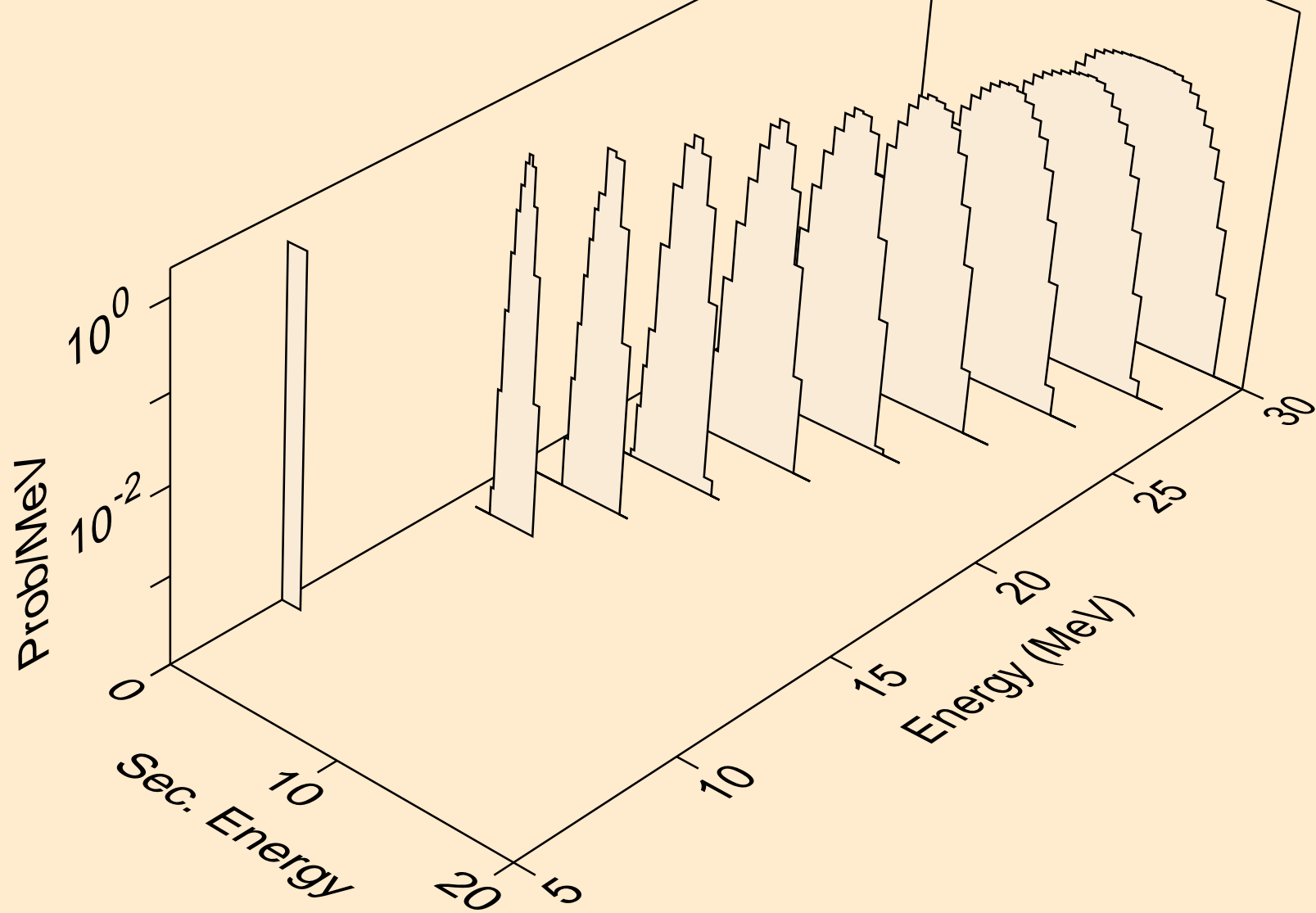

EU146 NEUTRON ACER TENDL-2021 LIBRARY; T=293.6K
he3s from (n,x)

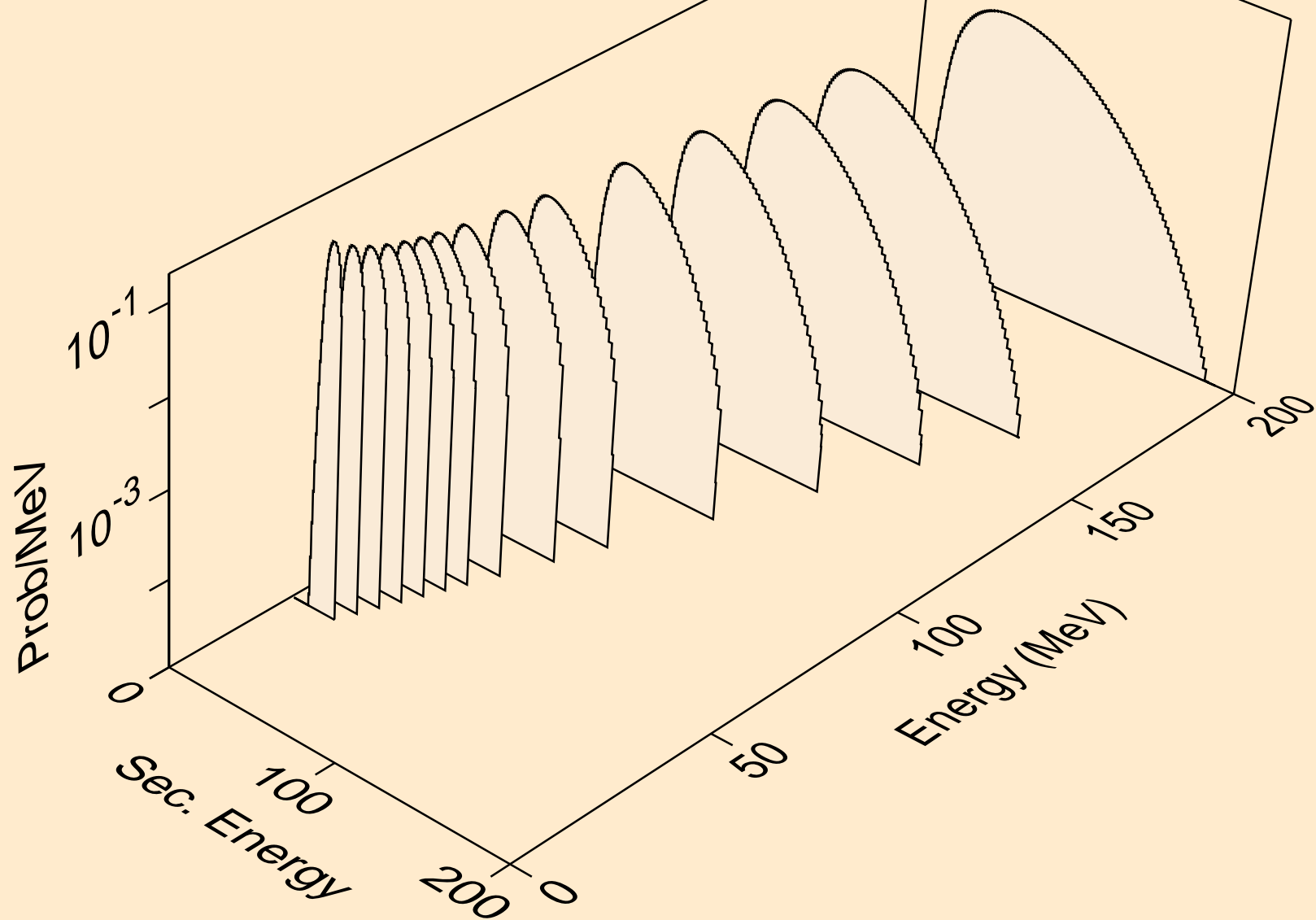

EU146 NEUTRON ACER TENDL-2021 LIBRARY; T=293.6K
he3s from (n,n*)he3

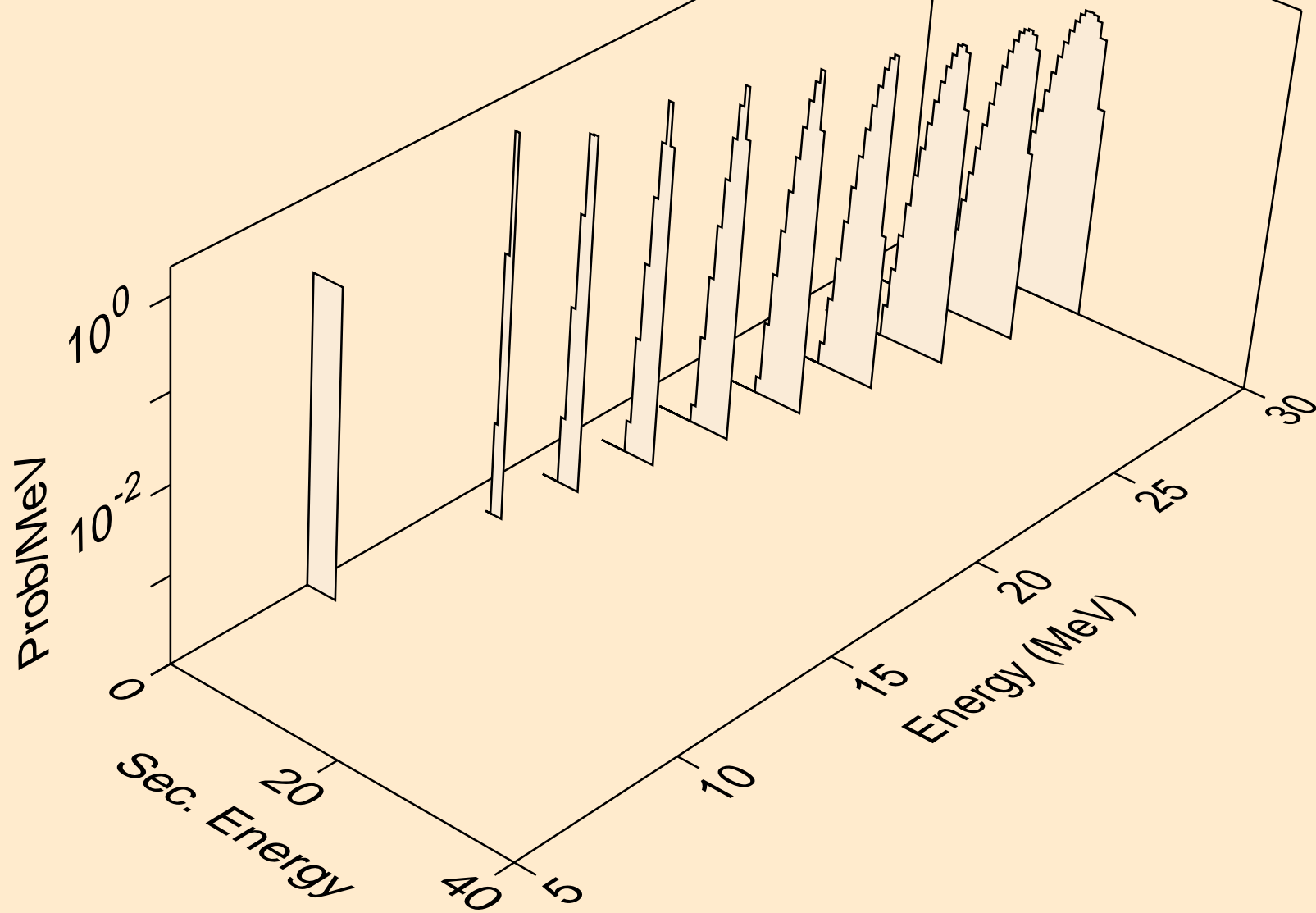

EU146 NEUTRON ACER TENDL-2021 LIBRARY; T=293.6K
he3s from (n,he3)

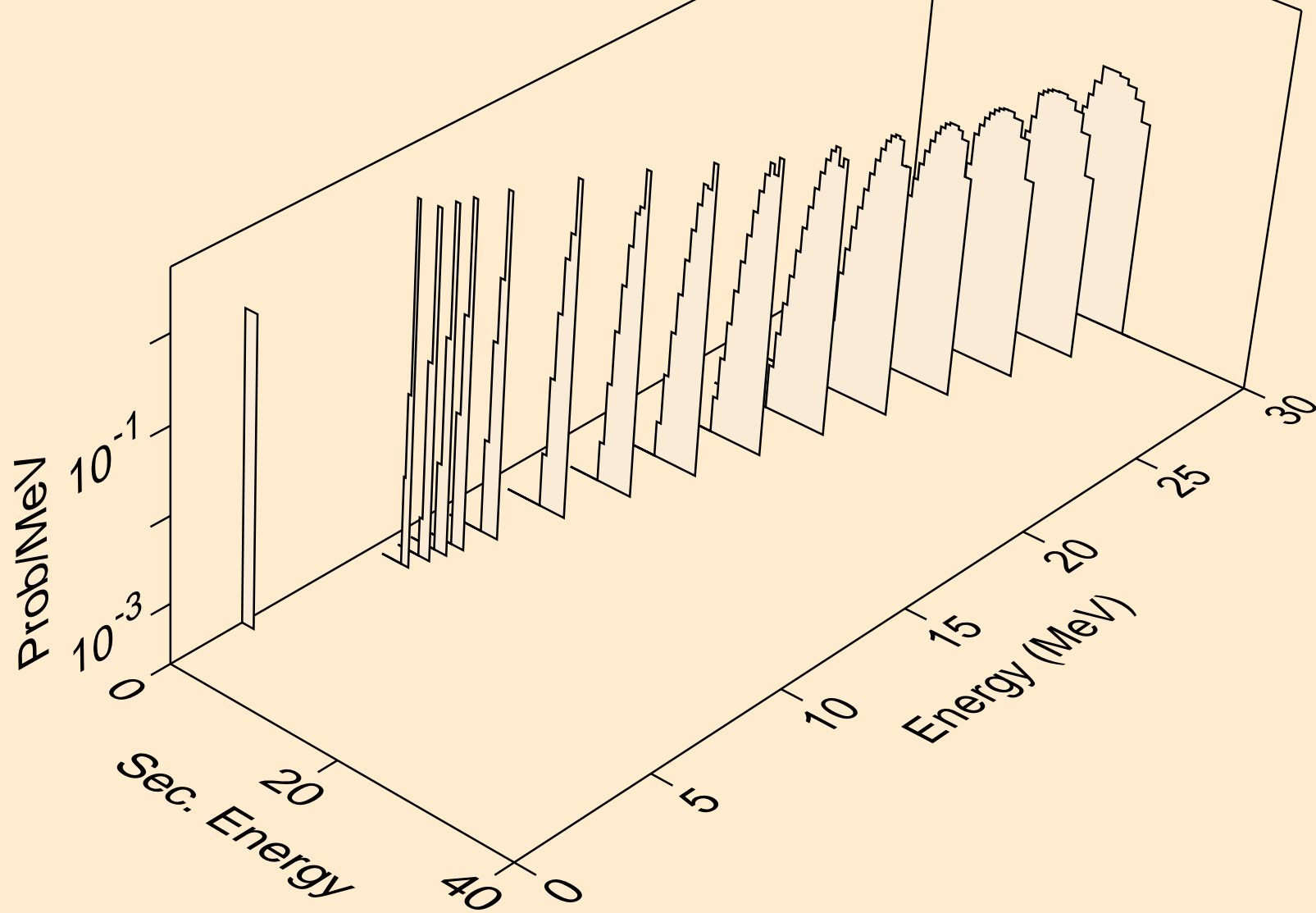

EU146 NEUTRON ACER TENDL-2021 LIBRARY; T=293.6K
alphas from (n,x)

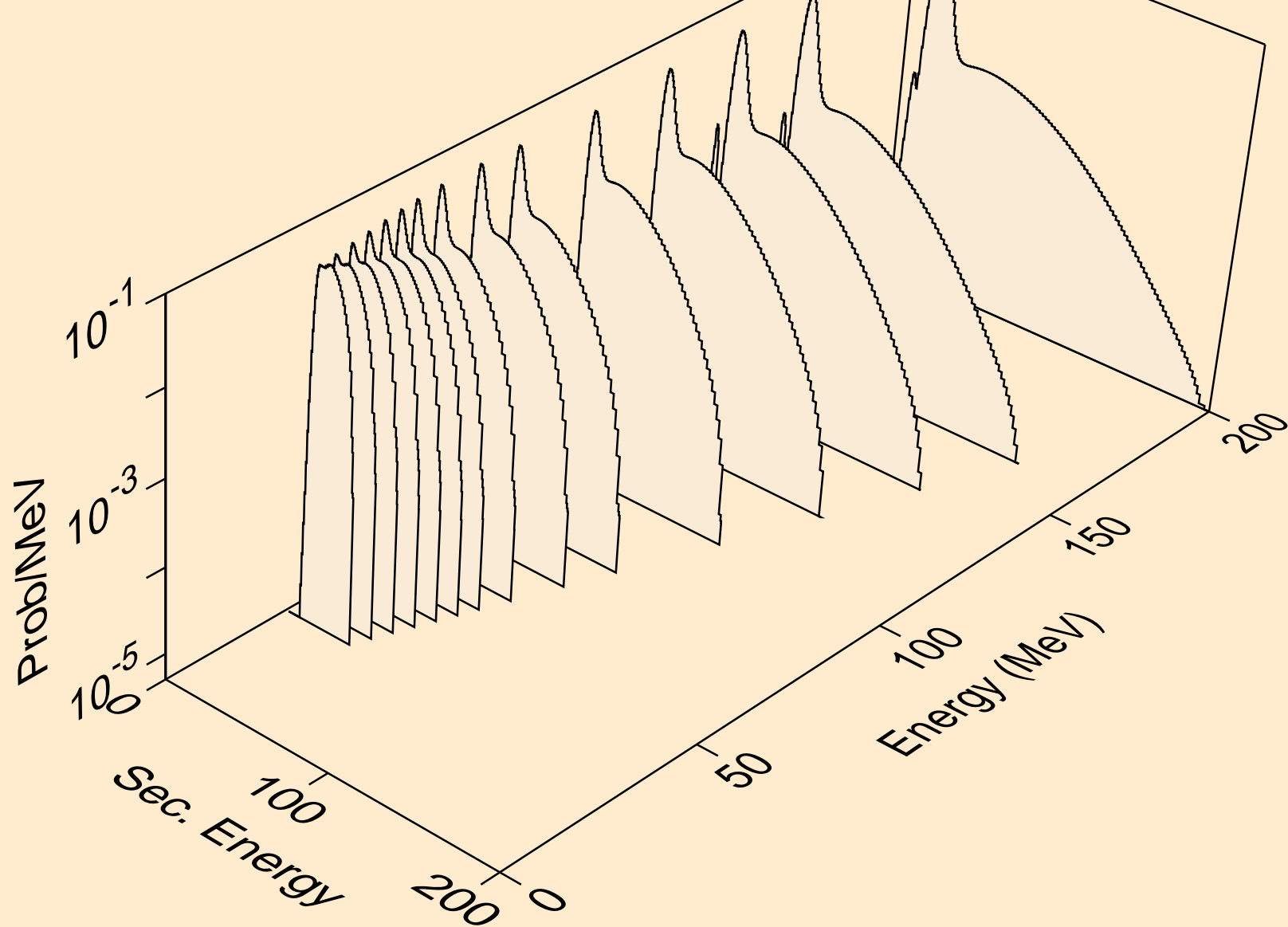

EU146 NEUTRON ACER TENDL-2021 LIBRARY; T=293.6K
alphas from (n,n*)a

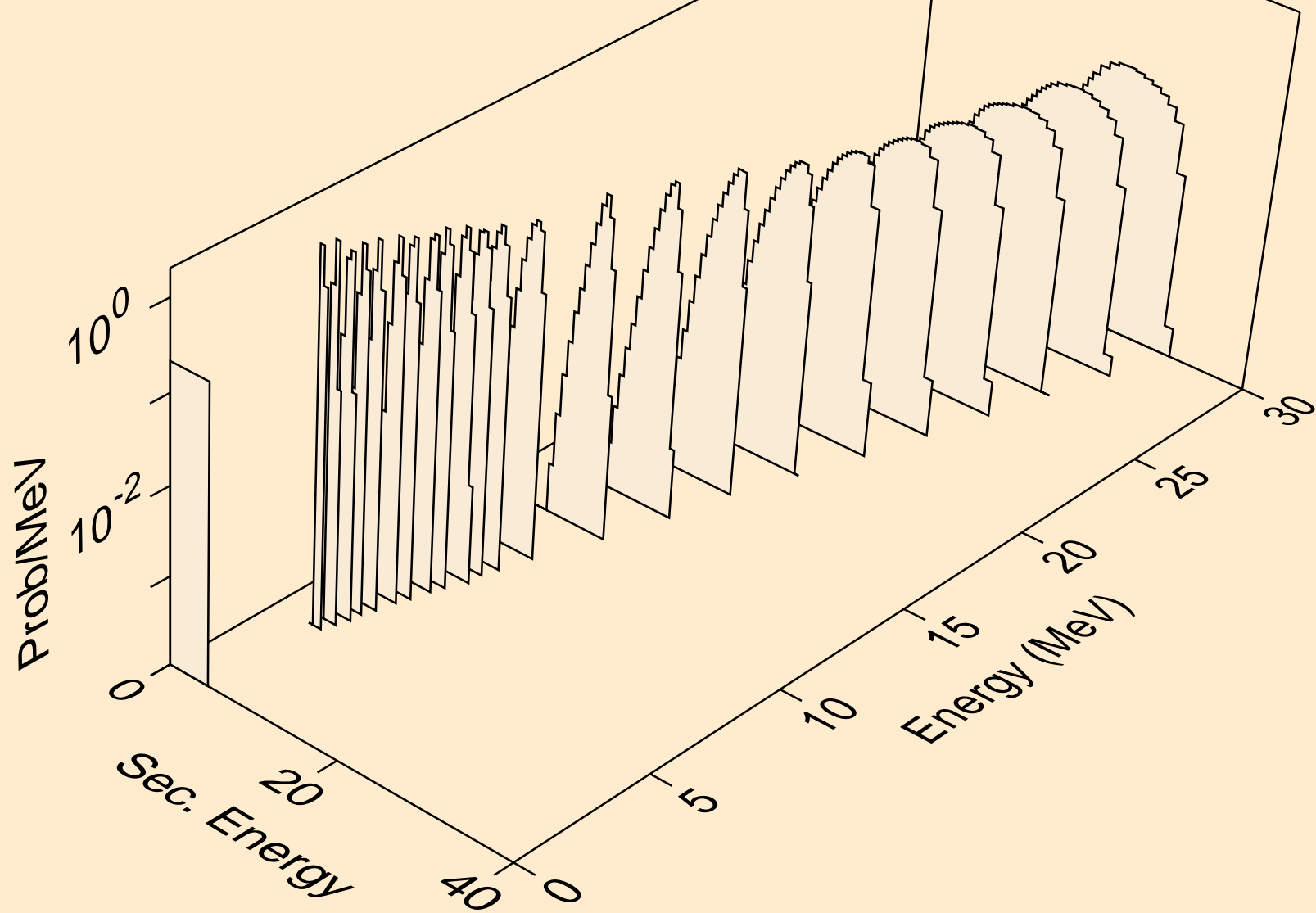

EU146 NEUTRON ACER TENDL-2021 LIBRARY; T=293.6K
alphas from (n,2n)a

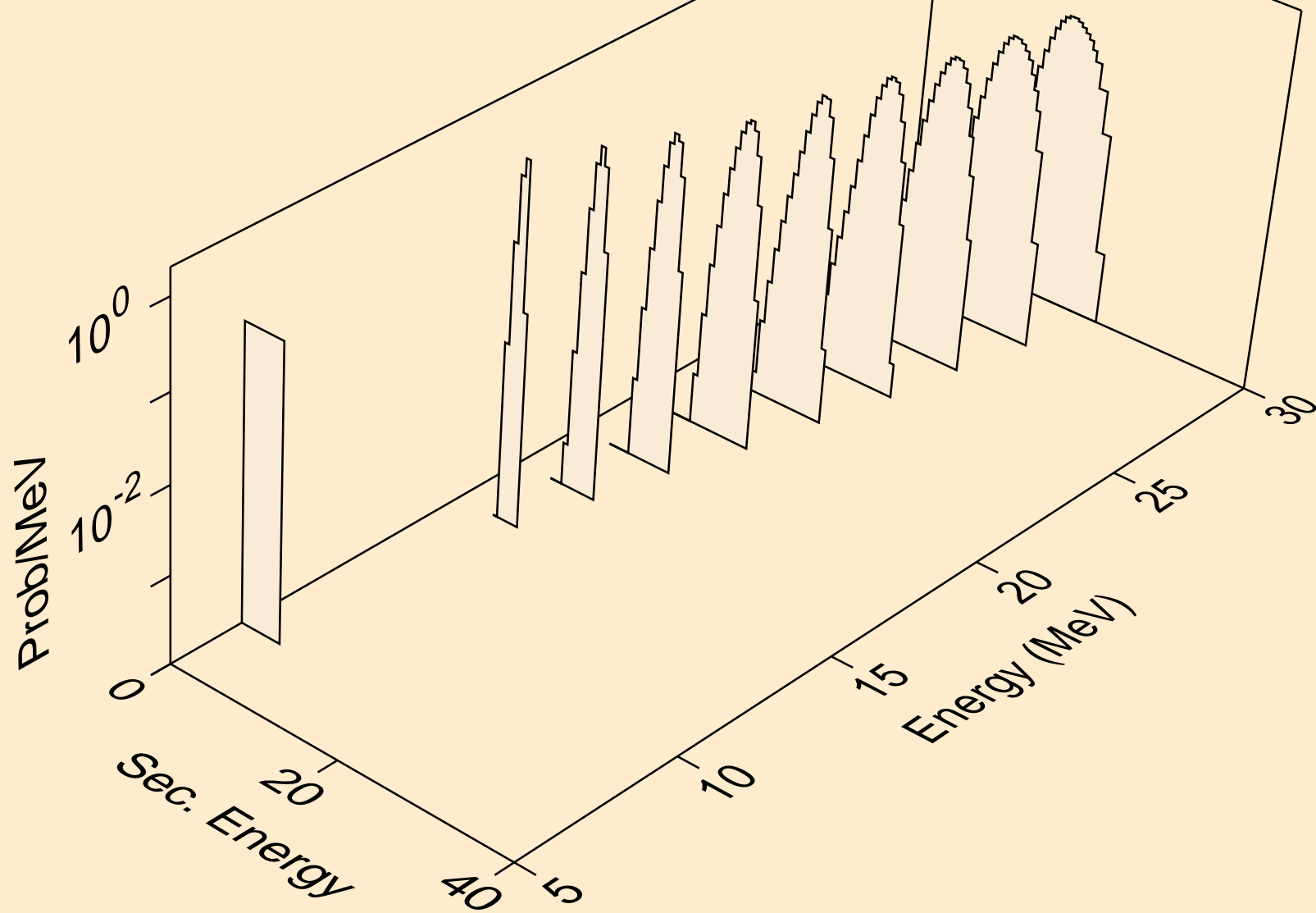

EU146 NEUTRON ACER TENDL-2021 LIBRARY; T=293.6K
alphas from (n,3n)a

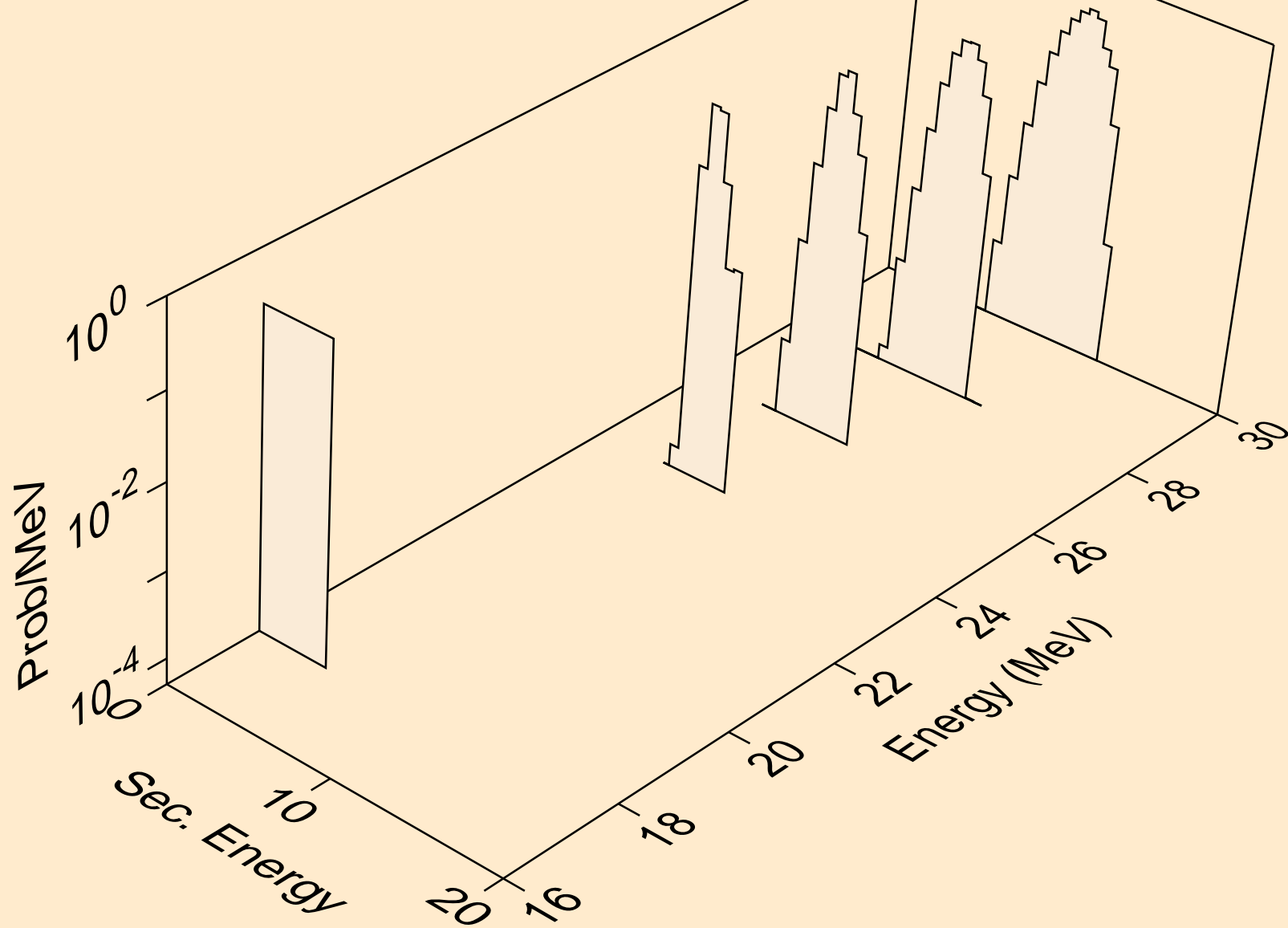

EU146 NEUTRON ACER TENDL-2021 LIBRARY; T=293.6K
alphas from (n,n*)2a

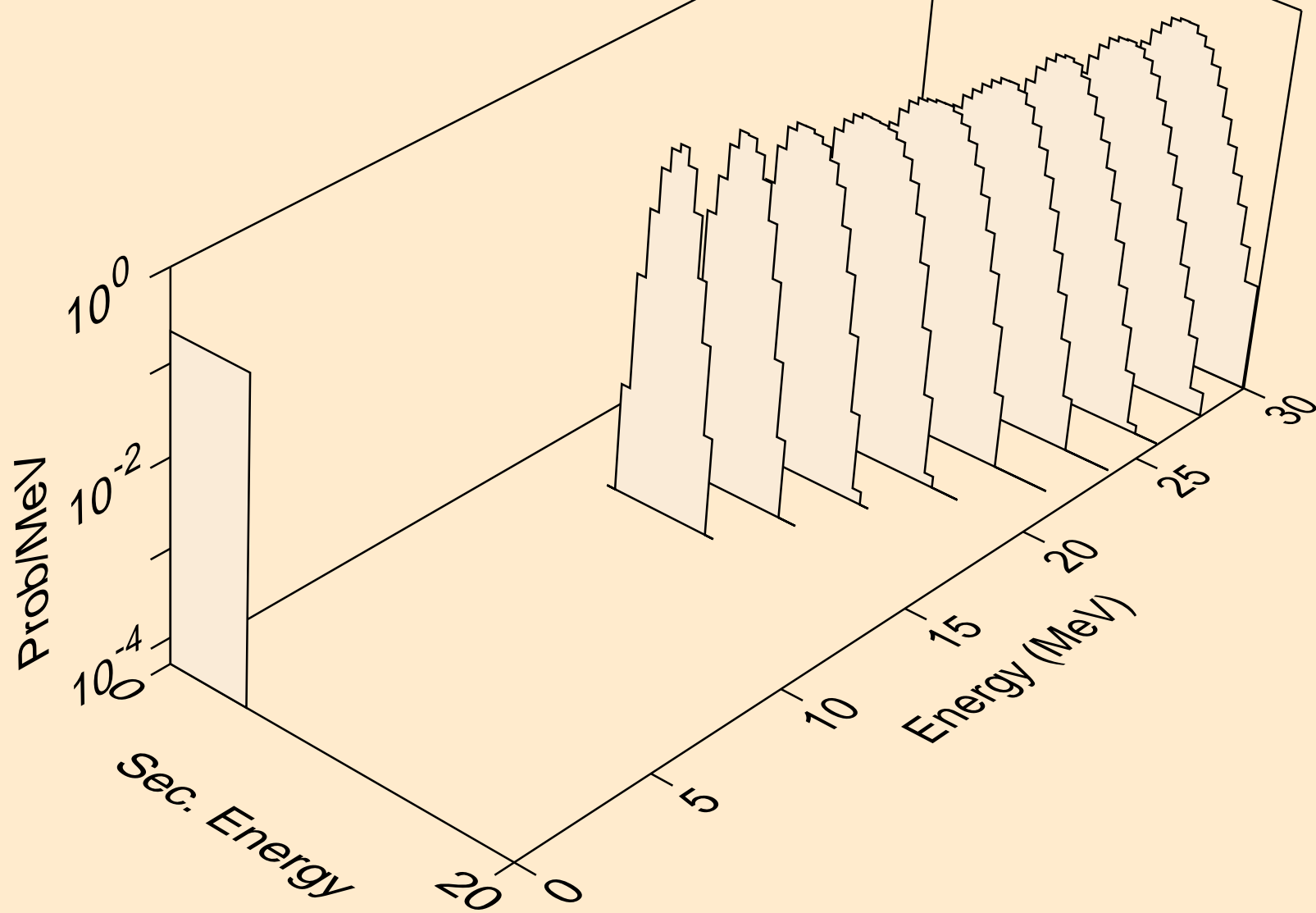

EU146 NEUTRON ACER TENDL-2021 LIBRARY; T=293.6K
alphas from (n,npa)

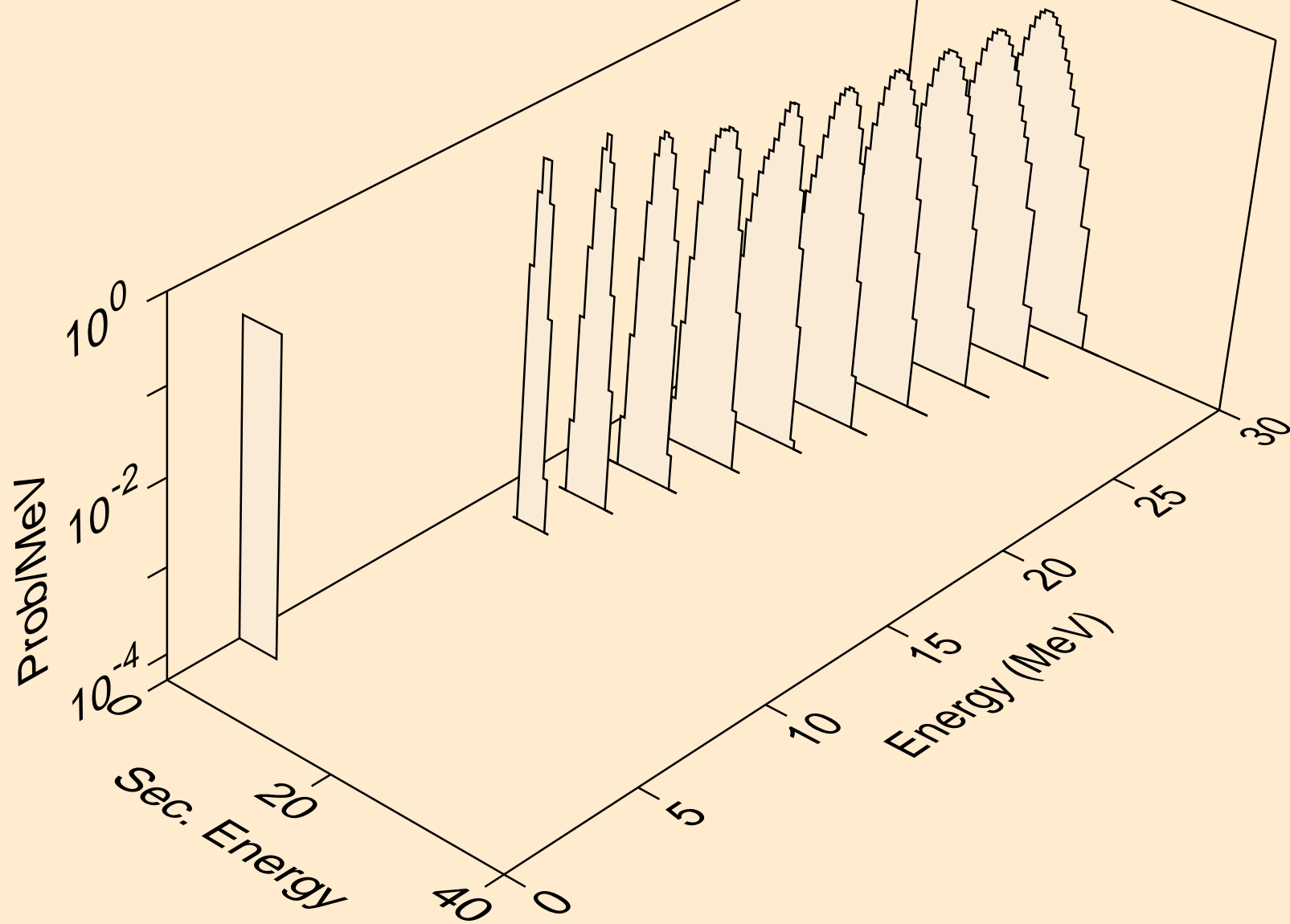

EU146 NEUTRON ACER TENDL-2021 LIBRARY; T=293.6K
alphas from (n,a)

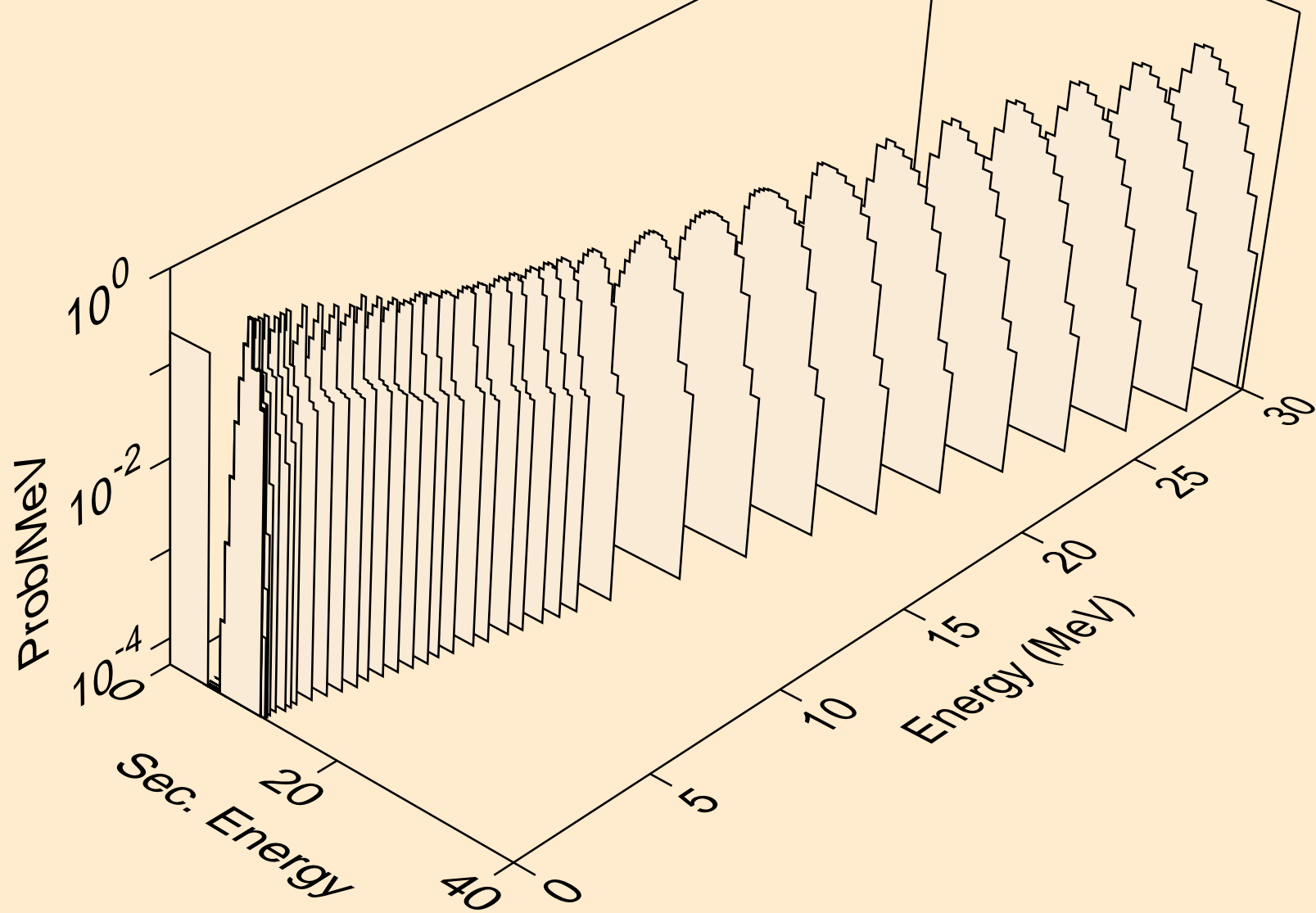

EU146 NEUTRON ACER TENDL-2021 LIBRARY; T=293.6K
alphas from (n,2a)

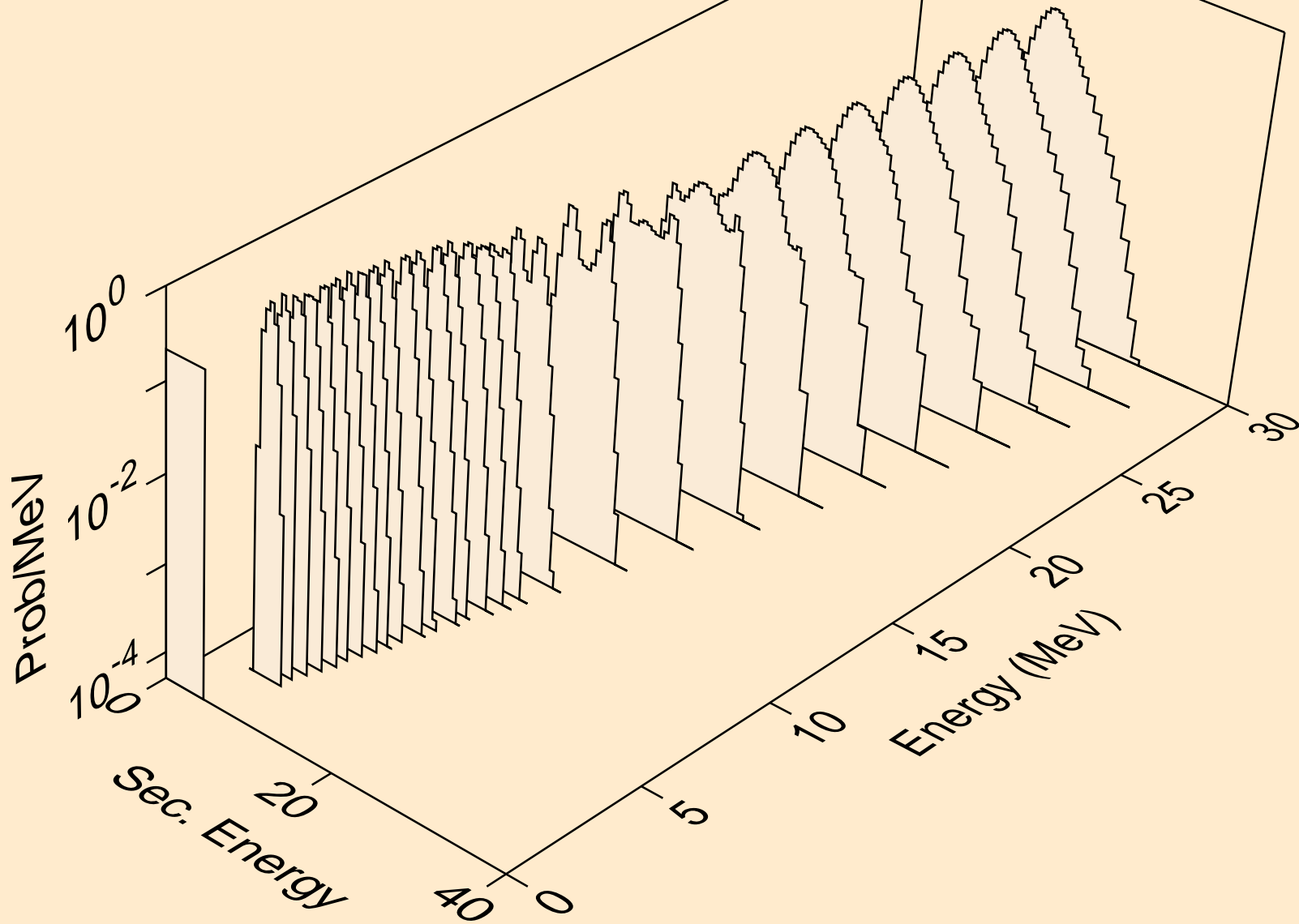

EU146 NEUTRON ACER TENDL-2021 LIBRARY; T=293.6K
alphas from (n,pa)

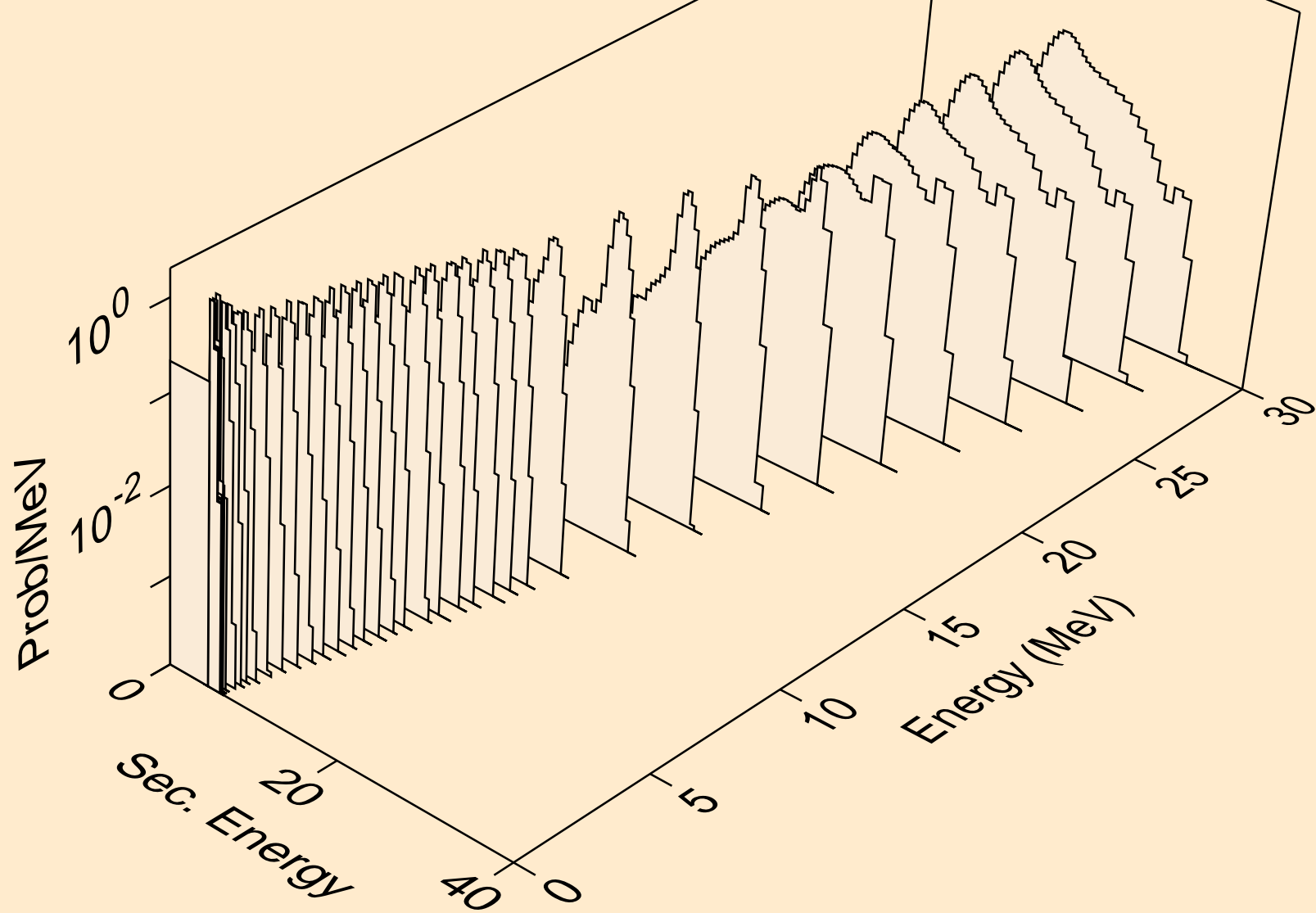

EU146 NEUTRON ACER TENDL-2021 LIBRARY; T=293.6K
alphas from (n,da)

