

FE053M NEUTRON ACER TENDL-2021 LIBRARY; T=293.6K

Principal cross sections

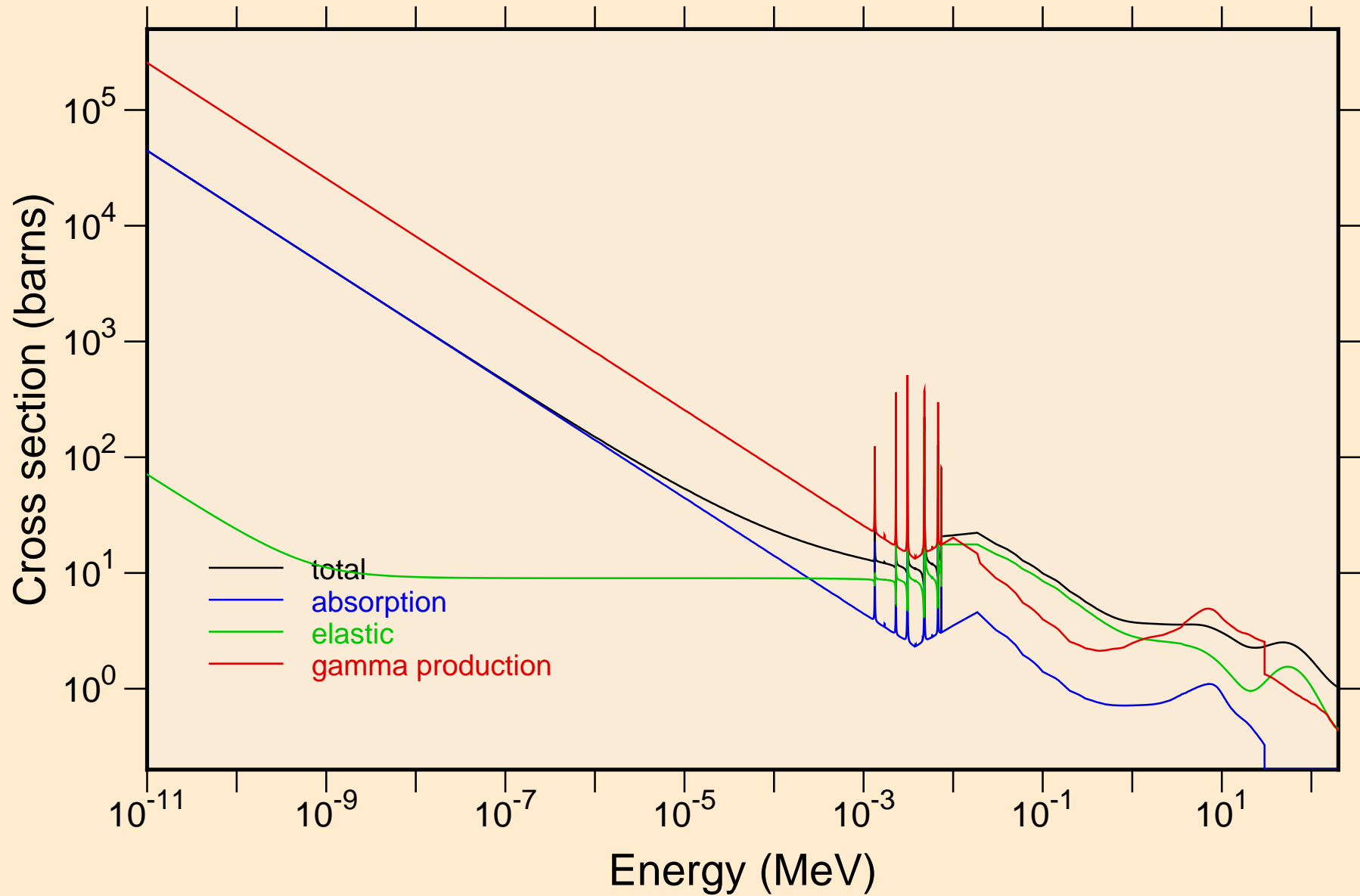

FE053M NEUTRON ACER TENDL-2021 LIBRARY; T=293.6K
resonance total cross section

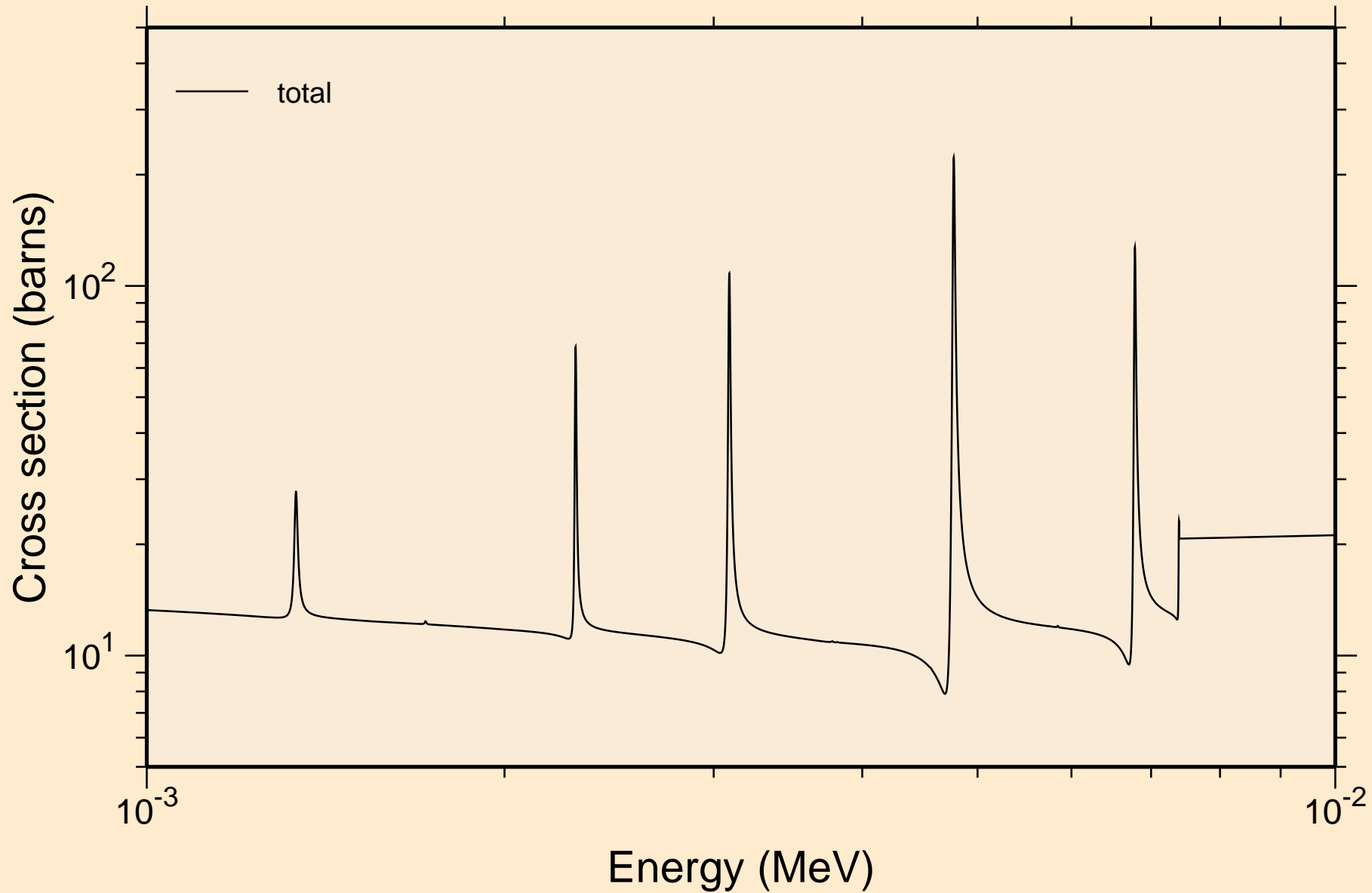

FE053M NEUTRON ACER TENDL-2021 LIBRARY; T=293.6K
resonance total cross section

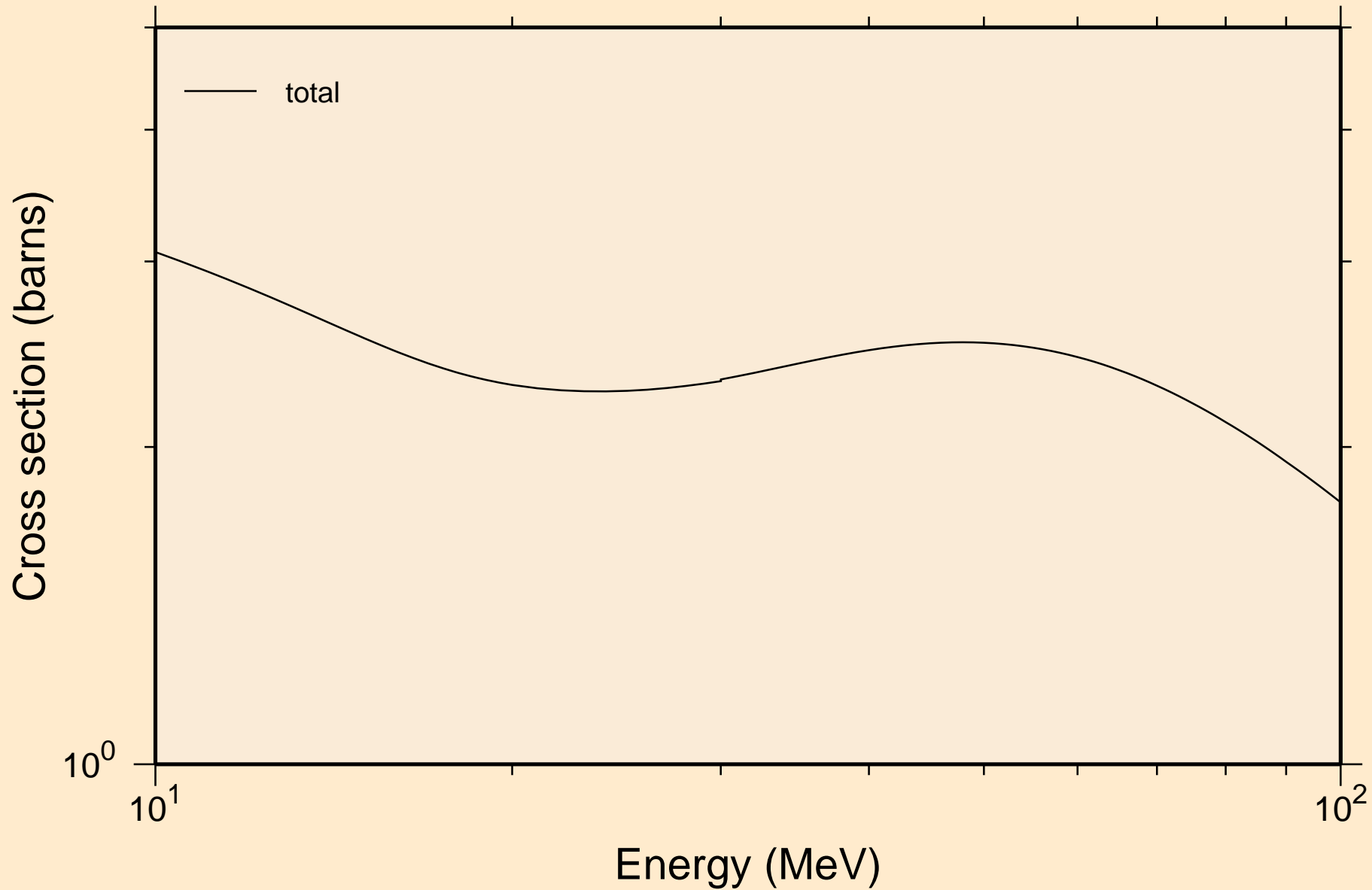

FE053M NEUTRON ACER TENDL-2021 LIBRARY; T=293.6K
resonance absorption cross sections

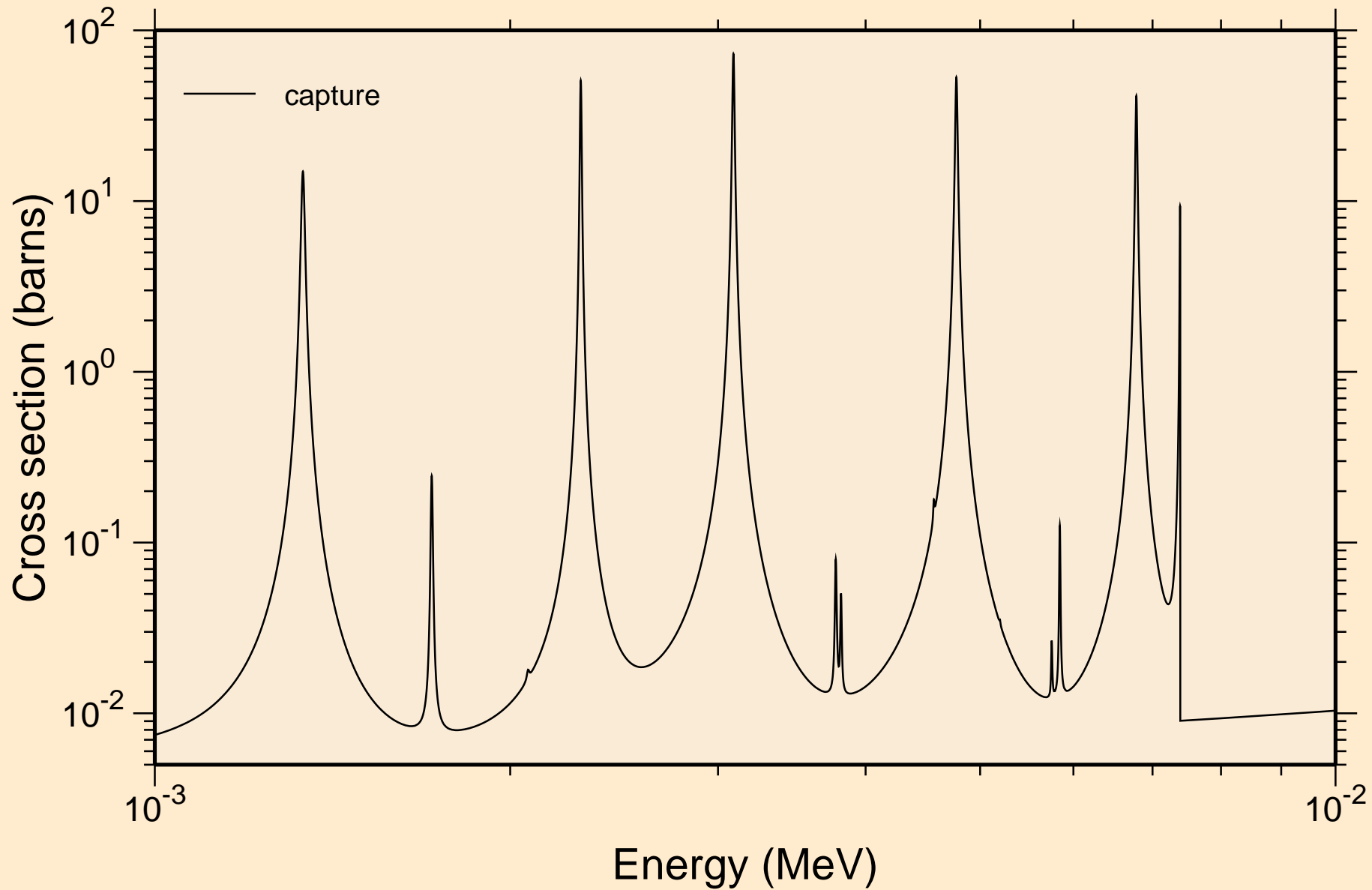

FE053M NEUTRON ACER TENDL-2021 LIBRARY; T=293.6K
resonance absorption cross sections

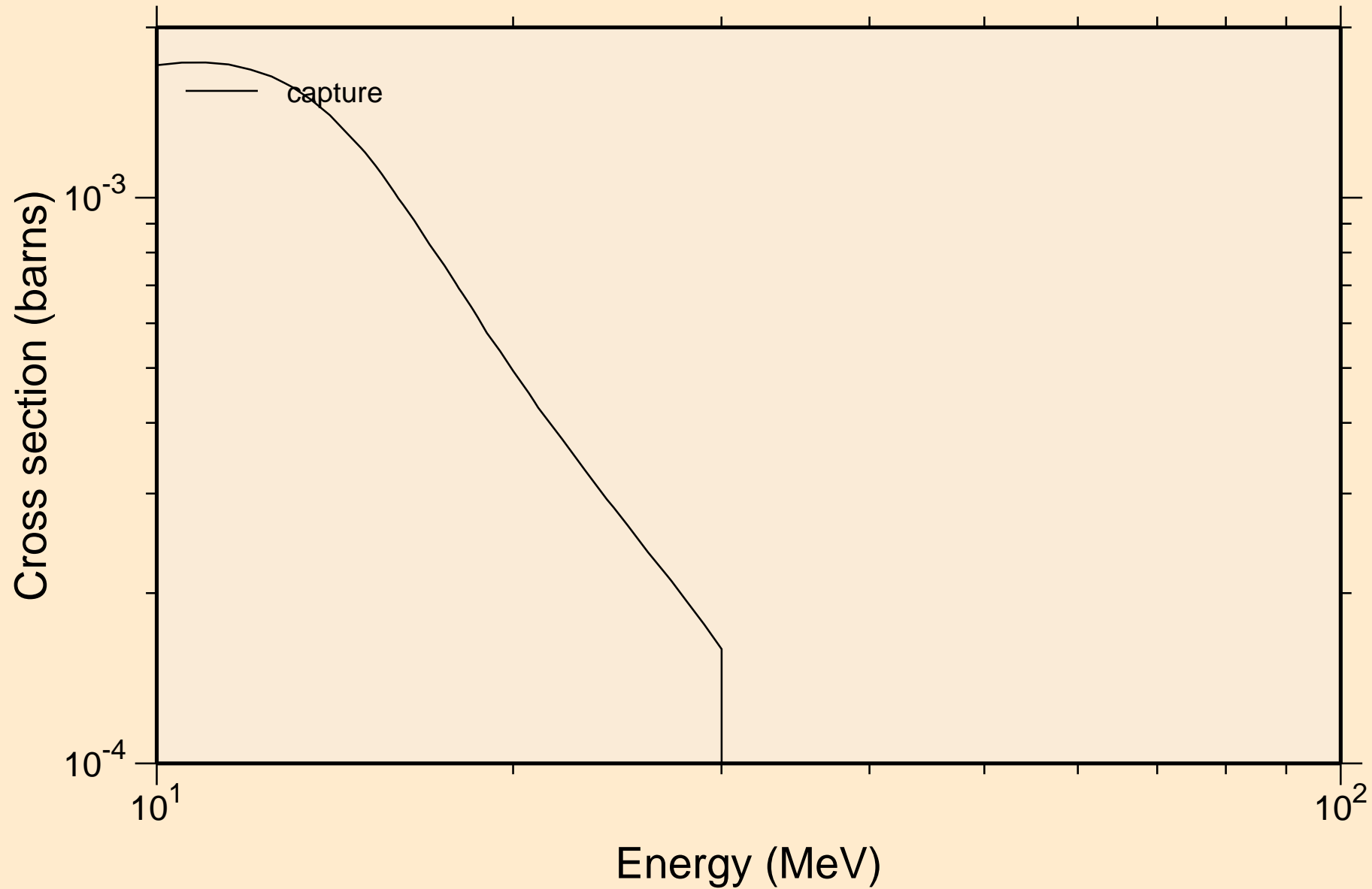

FE053M NEUTRON ACER TENDL-2021 LIBRARY; T=293.6K
Heating

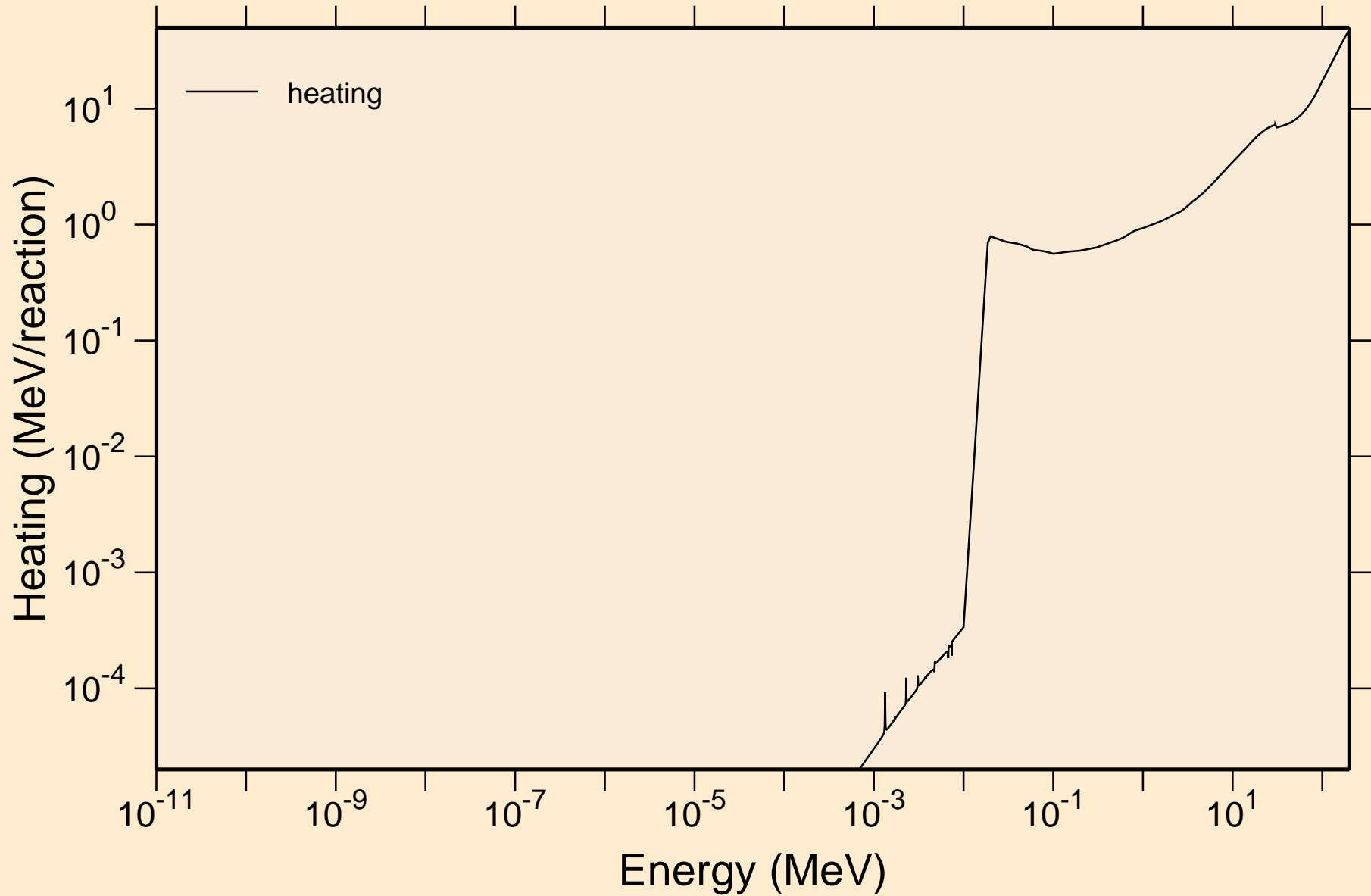

FE053M NEUTRON ACER TENDL-2021 LIBRARY; T=293.6K
Damage

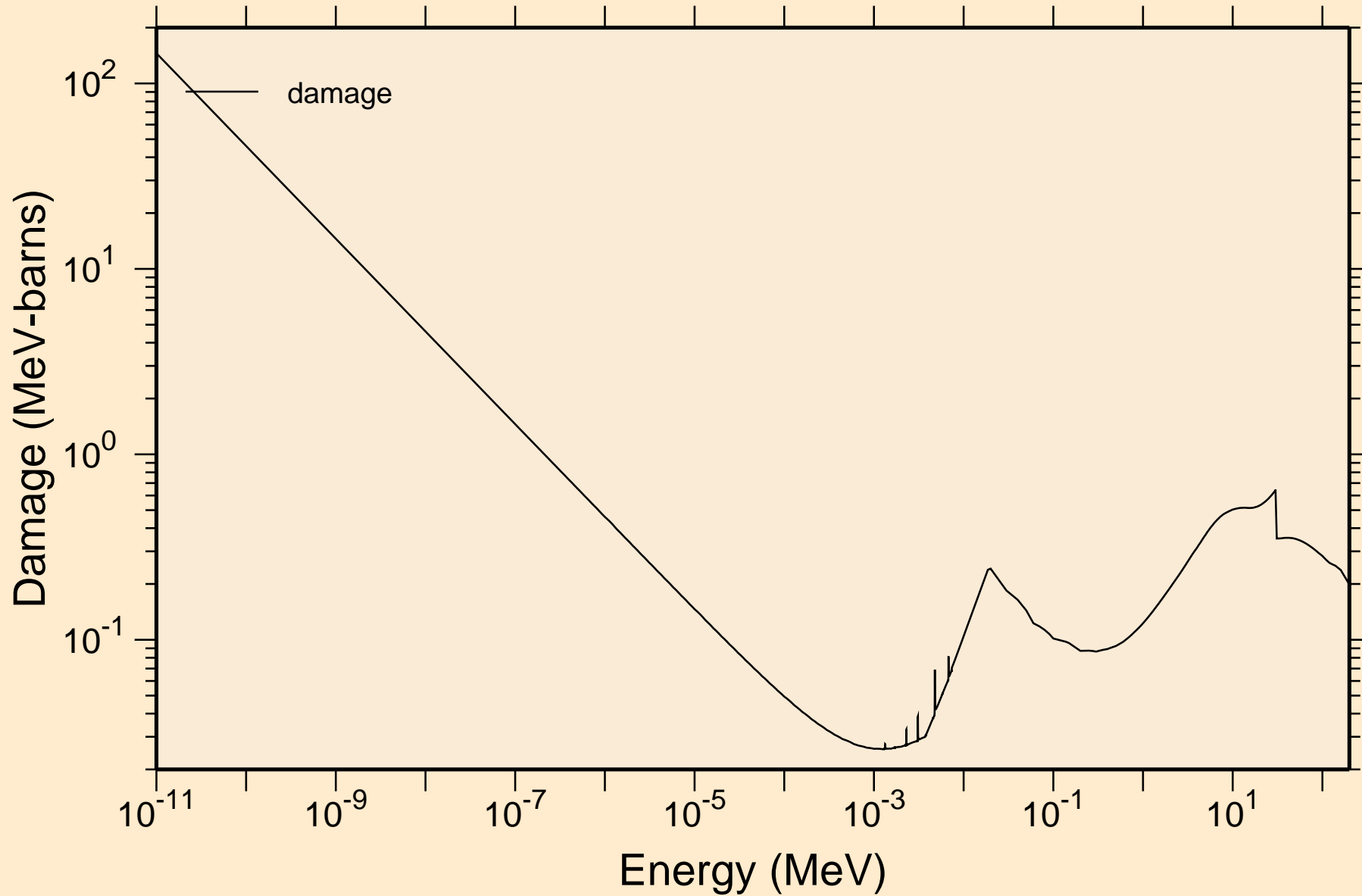

FE053M NEUTRON ACER TENDL-2021 LIBRARY; T=293.6K
Non-threshold reactions

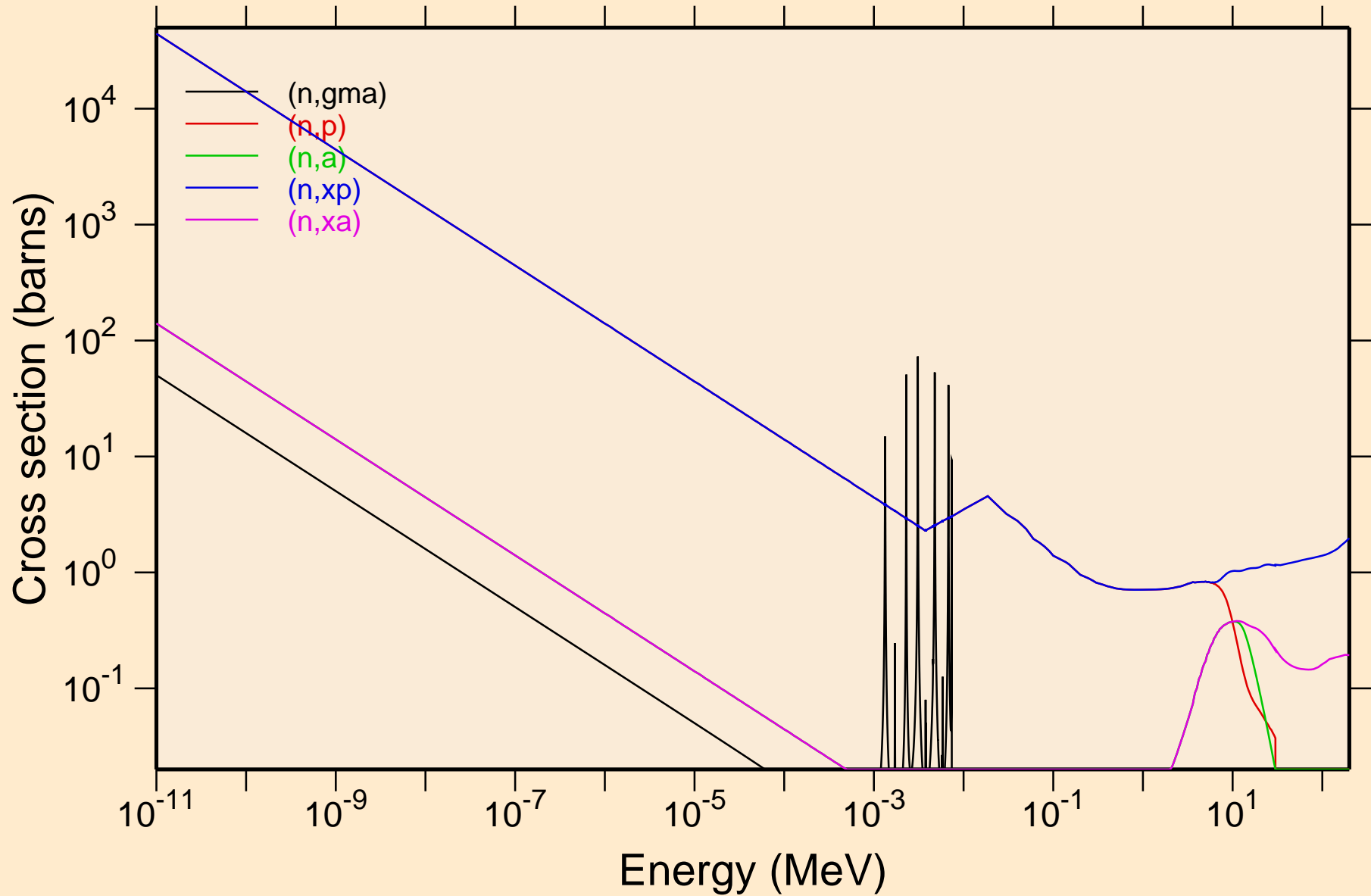

FE053M NEUTRON ACER TENDL-2021 LIBRARY; T=293.6K
Principal cross sections

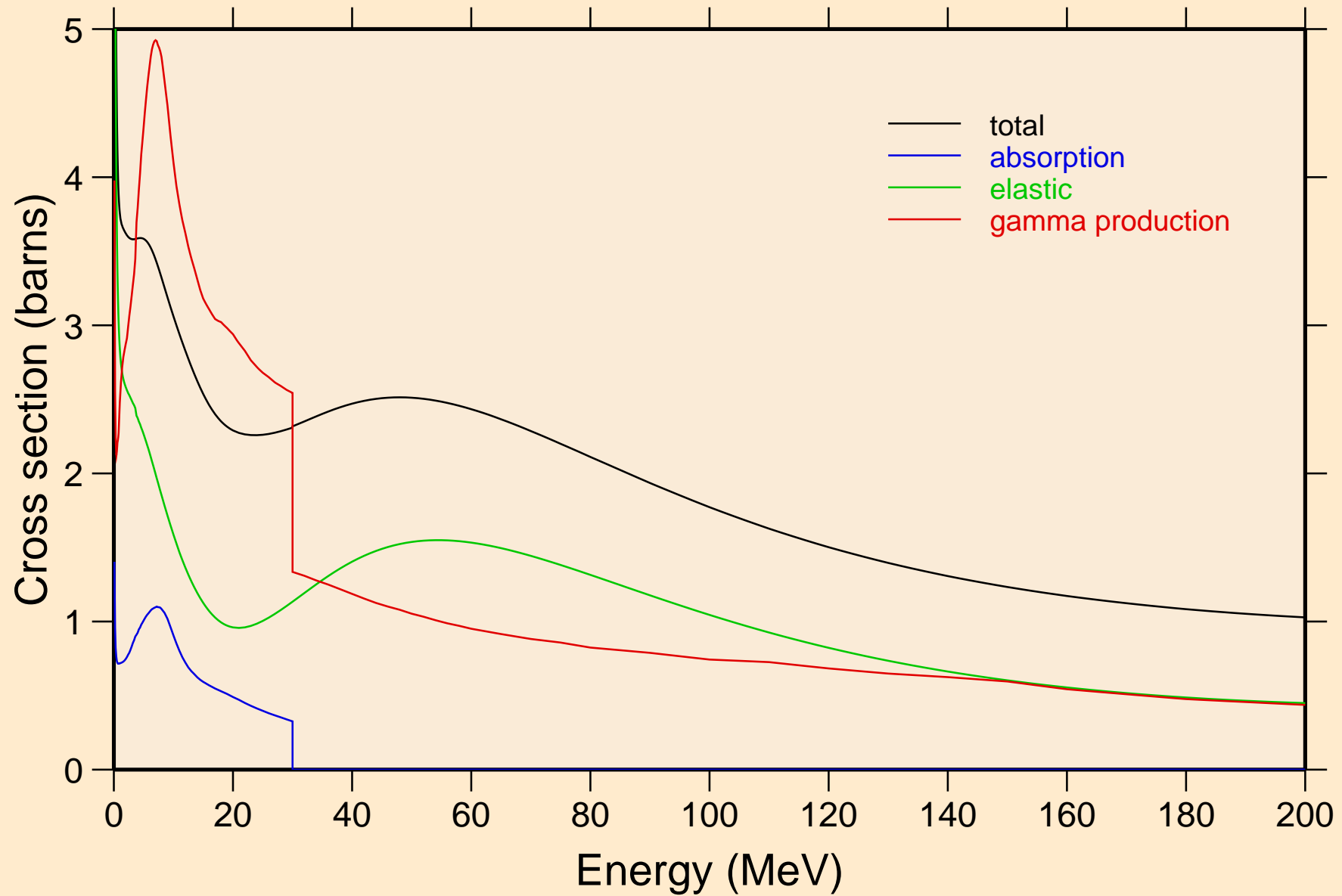

FE053M NEUTRON ACER TENDL-2021 LIBRARY; T=293.6K
Heating

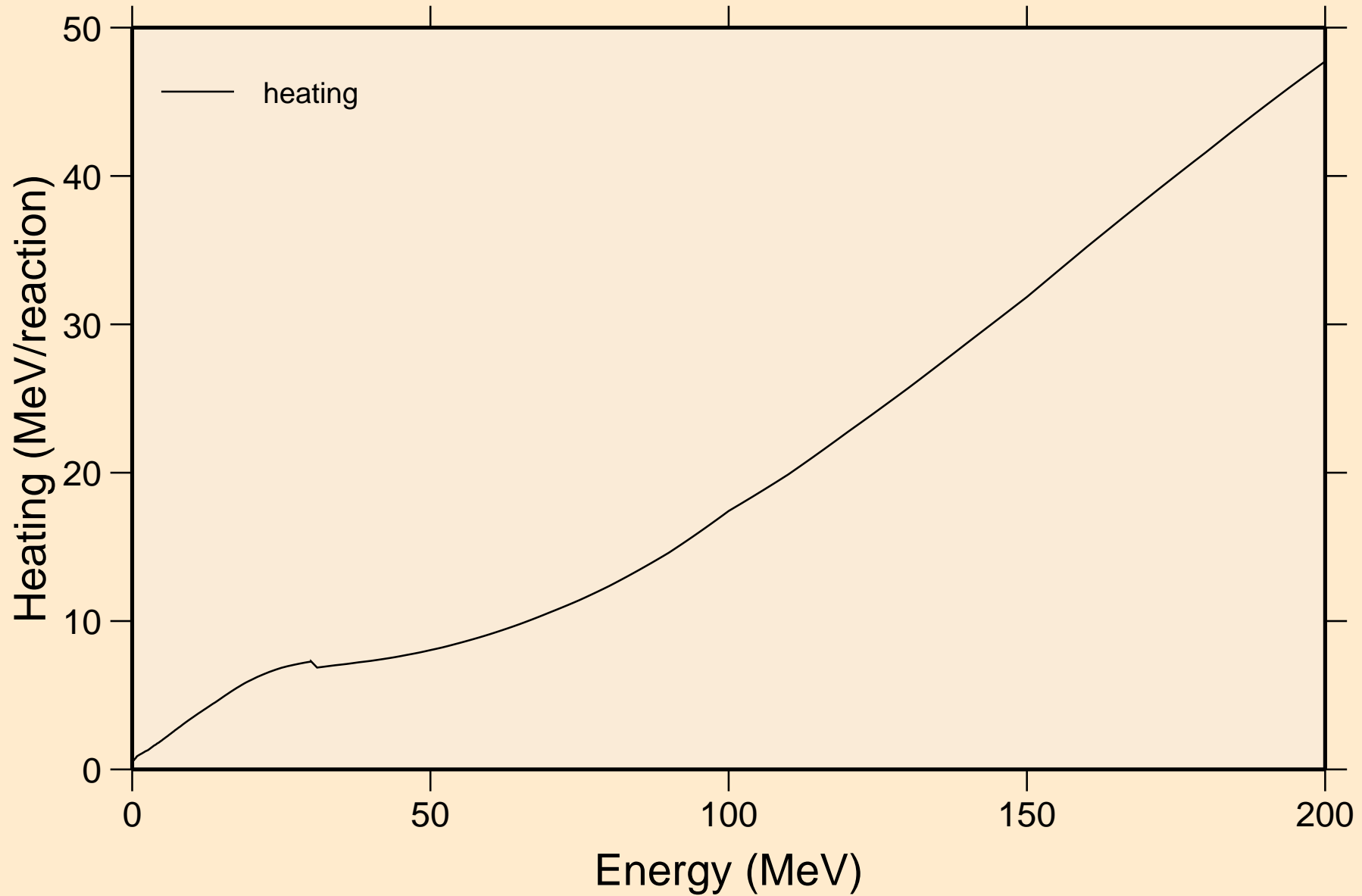

FE053M NEUTRON ACER TENDL-2021 LIBRARY; T=293.6K
Damage

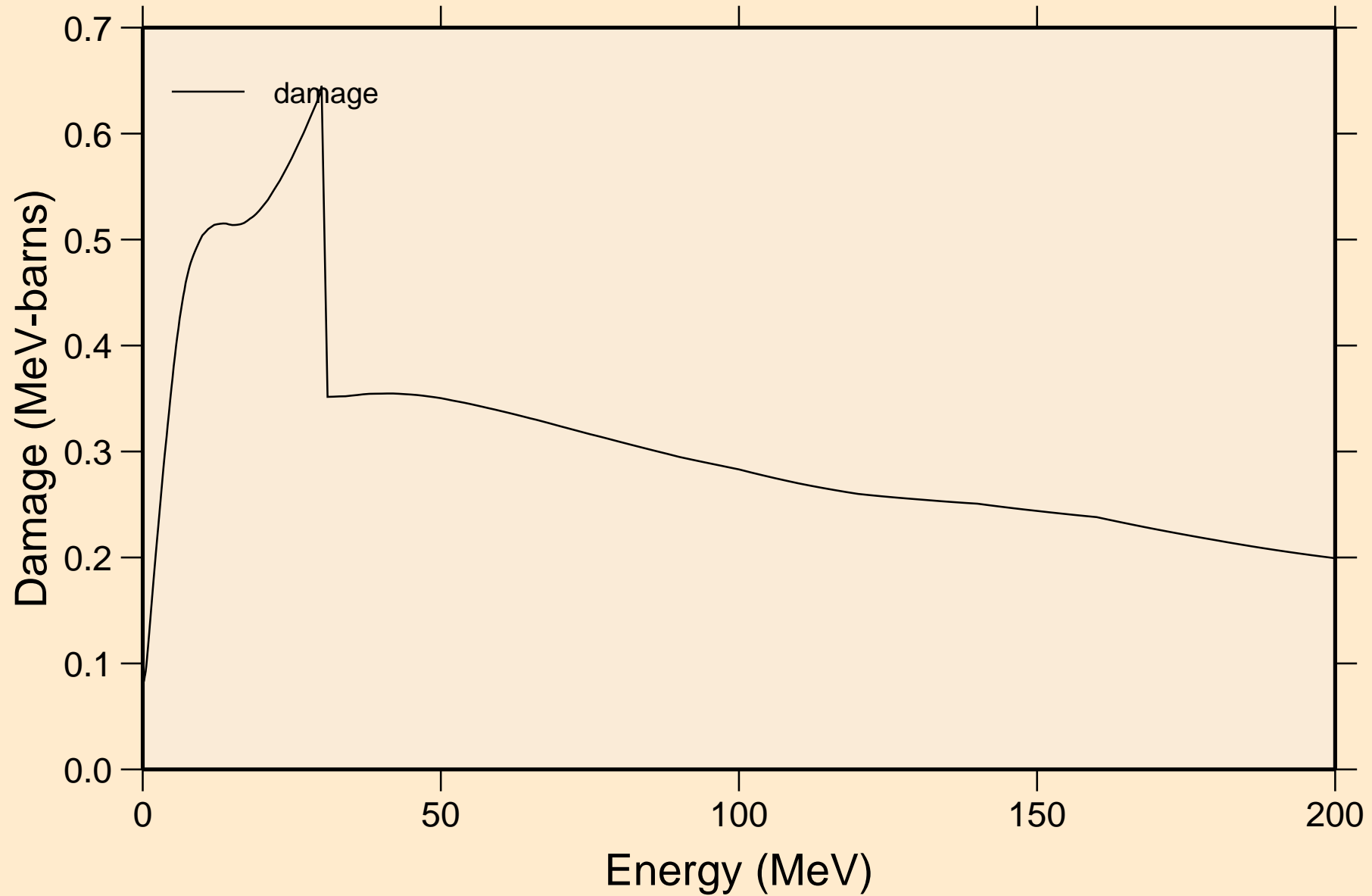

FE053M NEUTRON ACER TENDL-2021 LIBRARY; T=293.6K
Non-threshold reactions

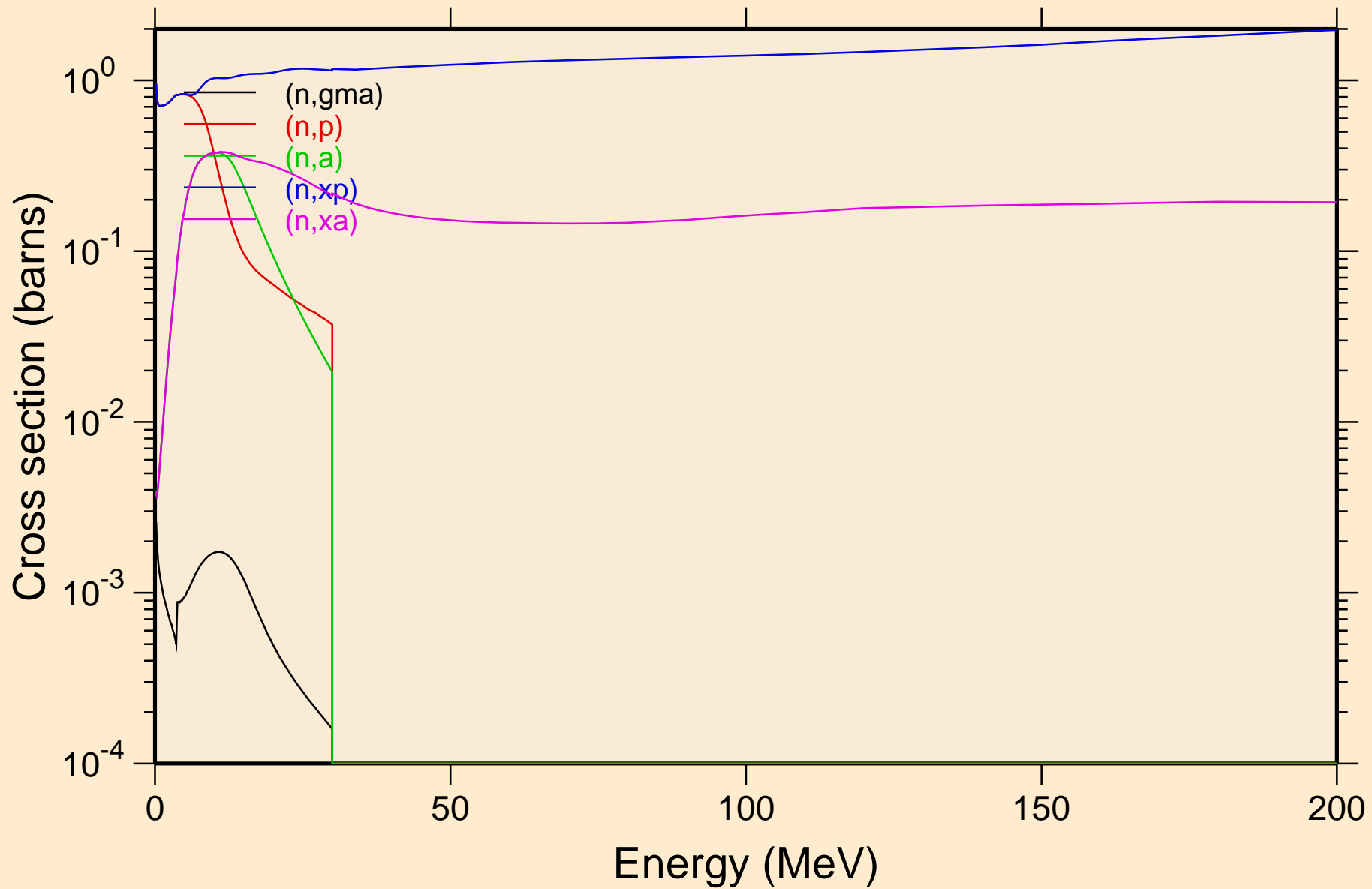

FE053M NEUTRON ACER TENDL-2021 LIBRARY; T=293.6K
Inelastic levels

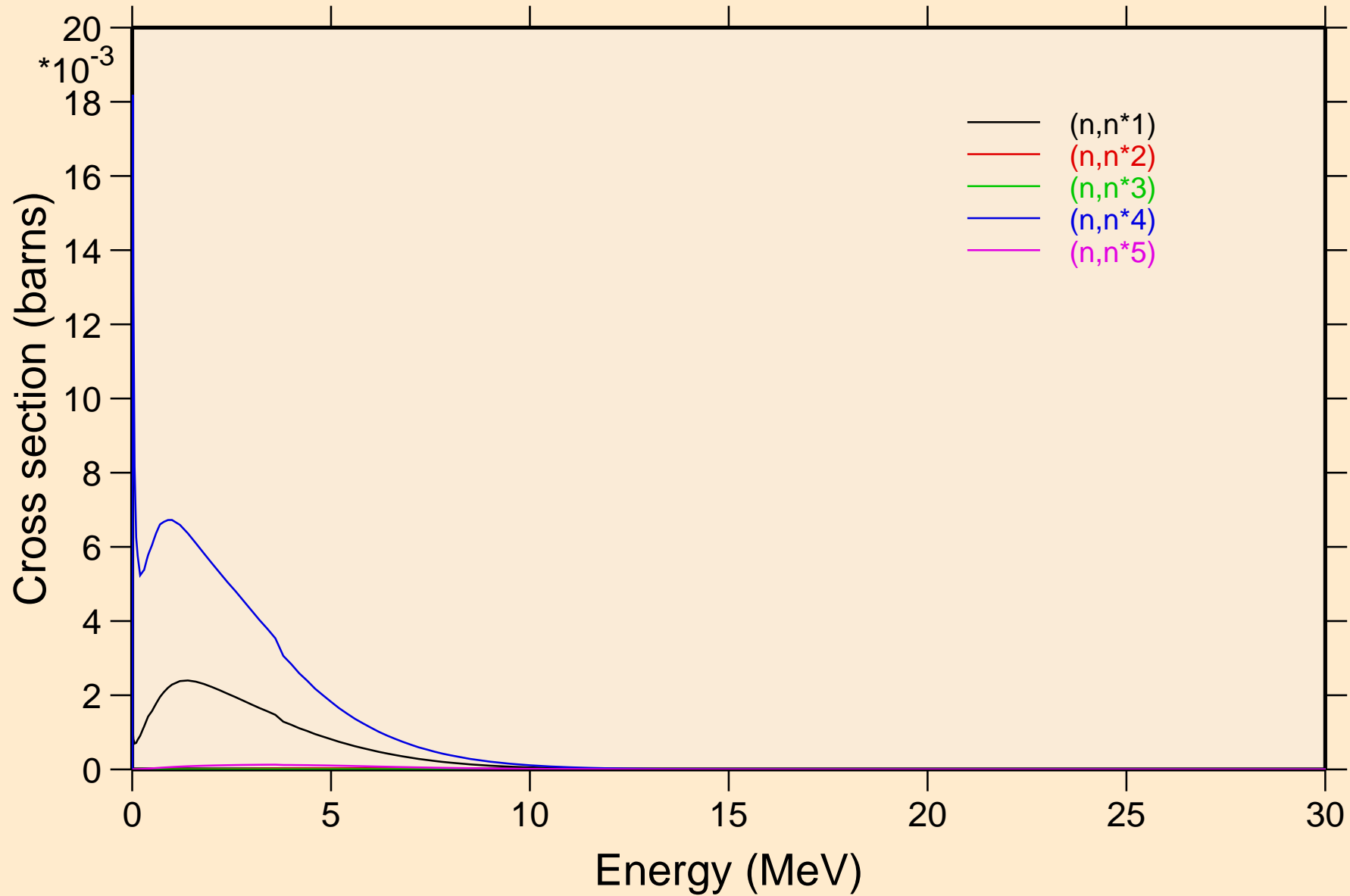

FE053M NEUTRON ACER TENDL-2021 LIBRARY; T=293.6K
Inelastic levels

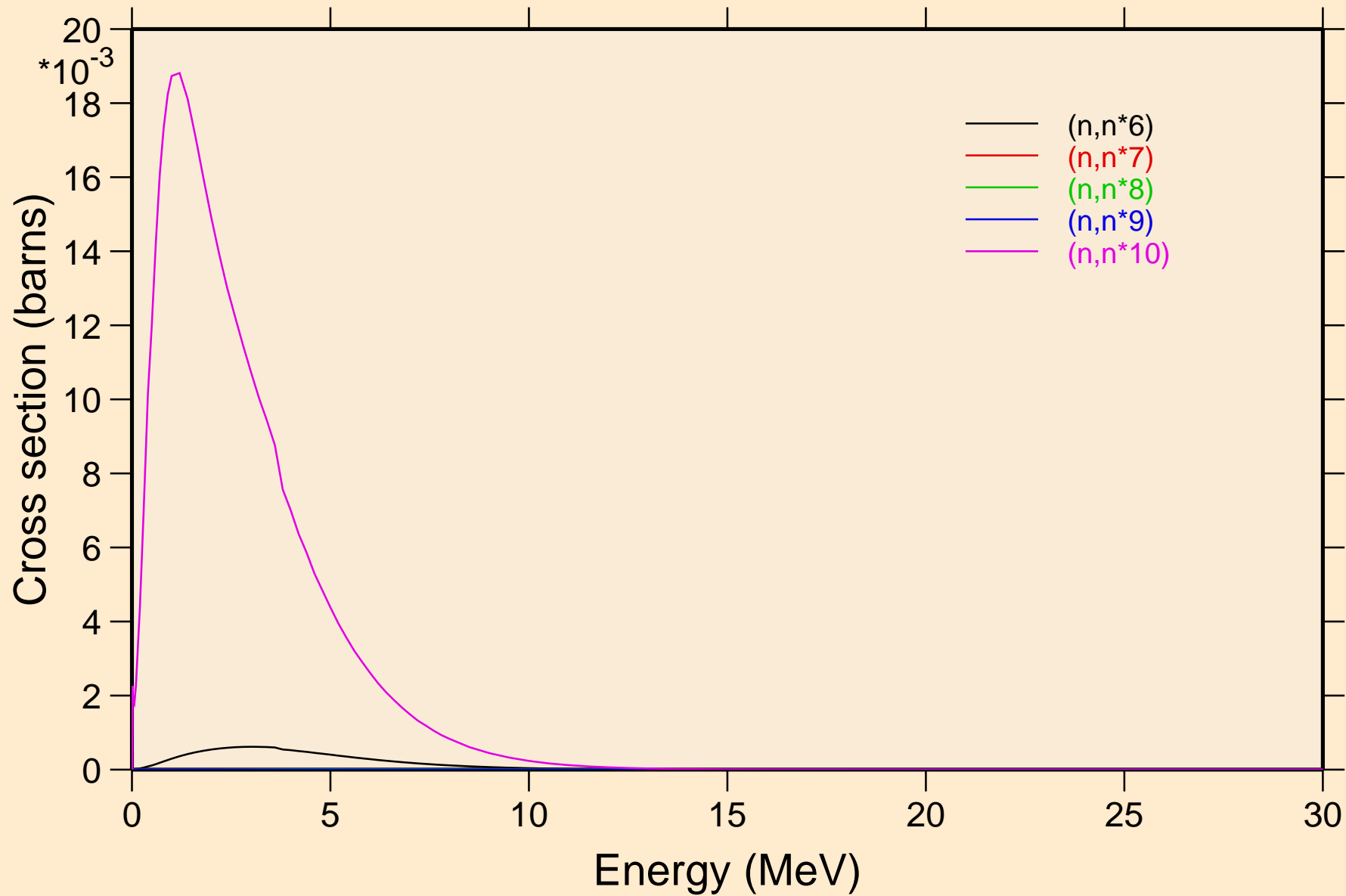

FE053M NEUTRON ACER TENDL-2021 LIBRARY; T=293.6K
Inelastic levels

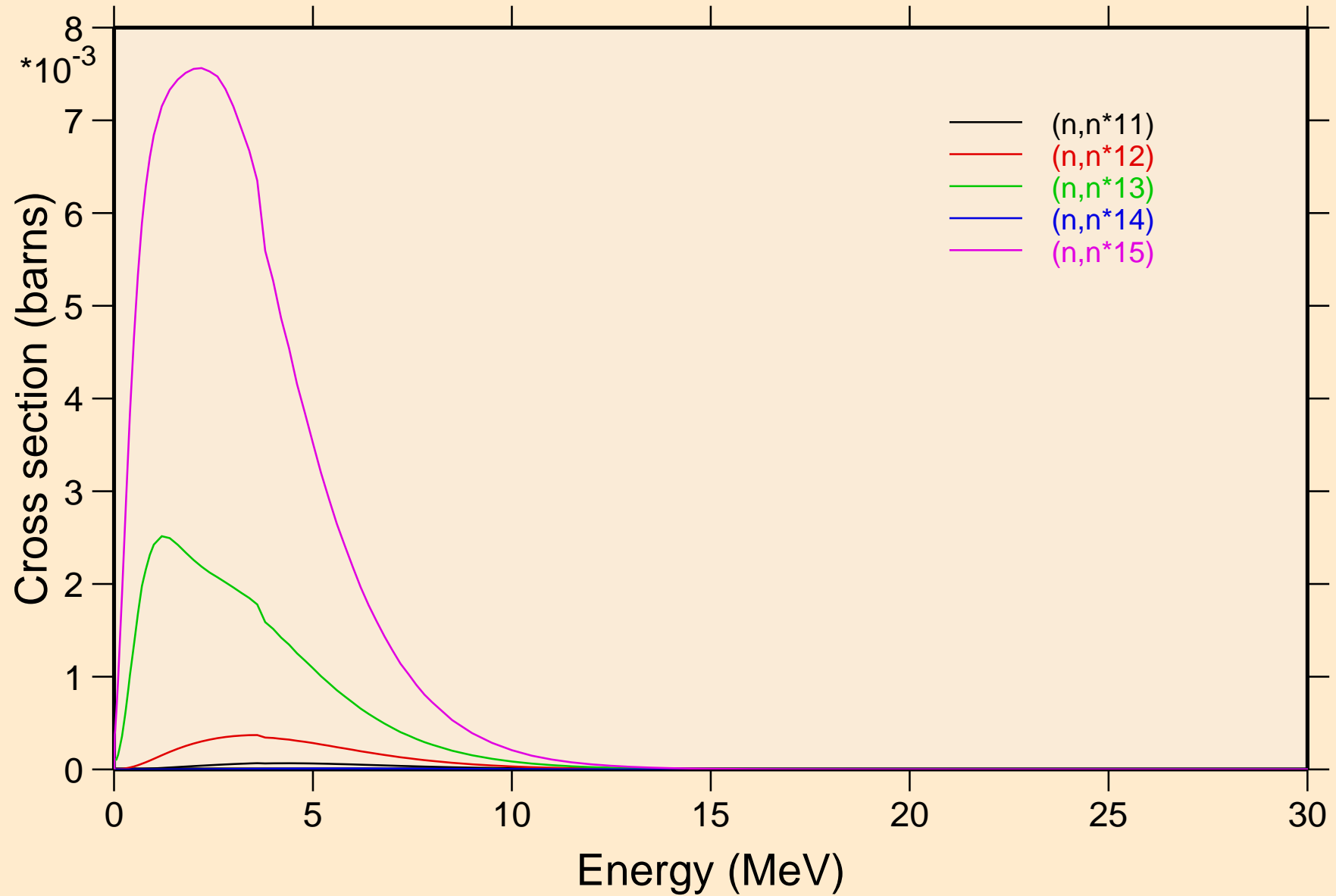

FE053M NEUTRON ACER TENDL-2021 LIBRARY; T=293.6K
Inelastic levels

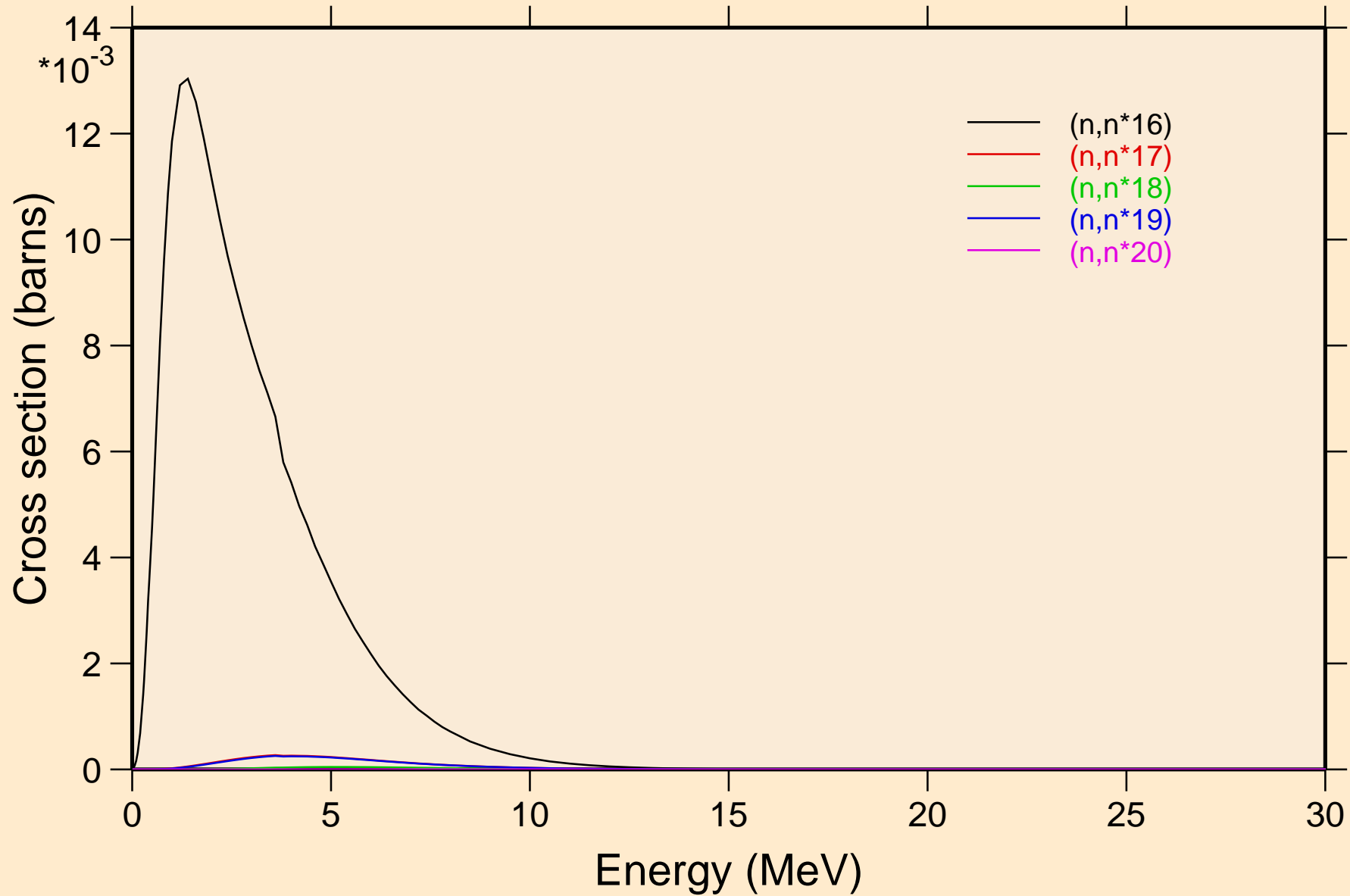

FE053M NEUTRON ACER TENDL-2021 LIBRARY; T=293.6K
Inelastic levels

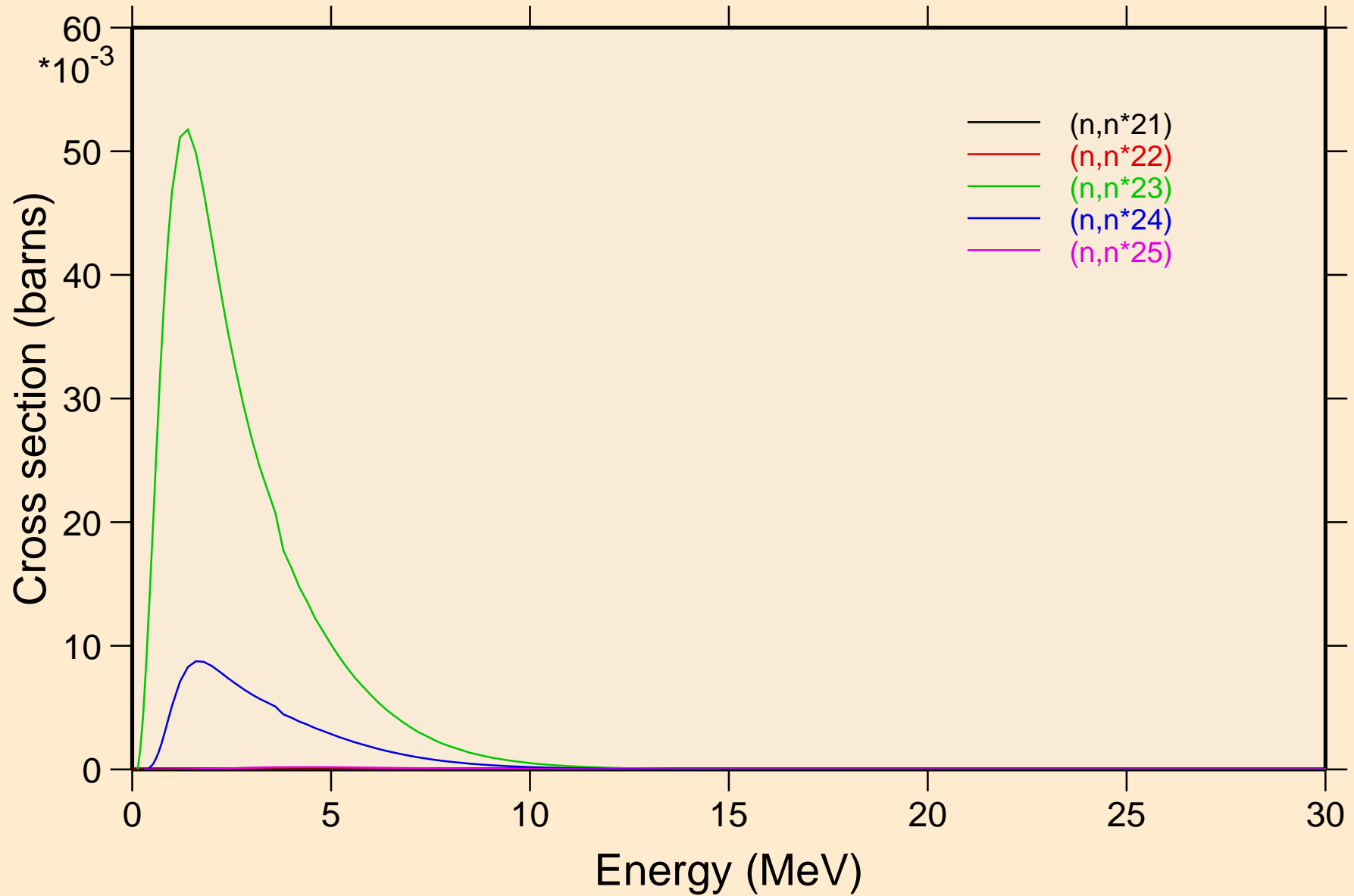

FE053M NEUTRON ACER TENDL-2021 LIBRARY; T=293.6K
Inelastic levels

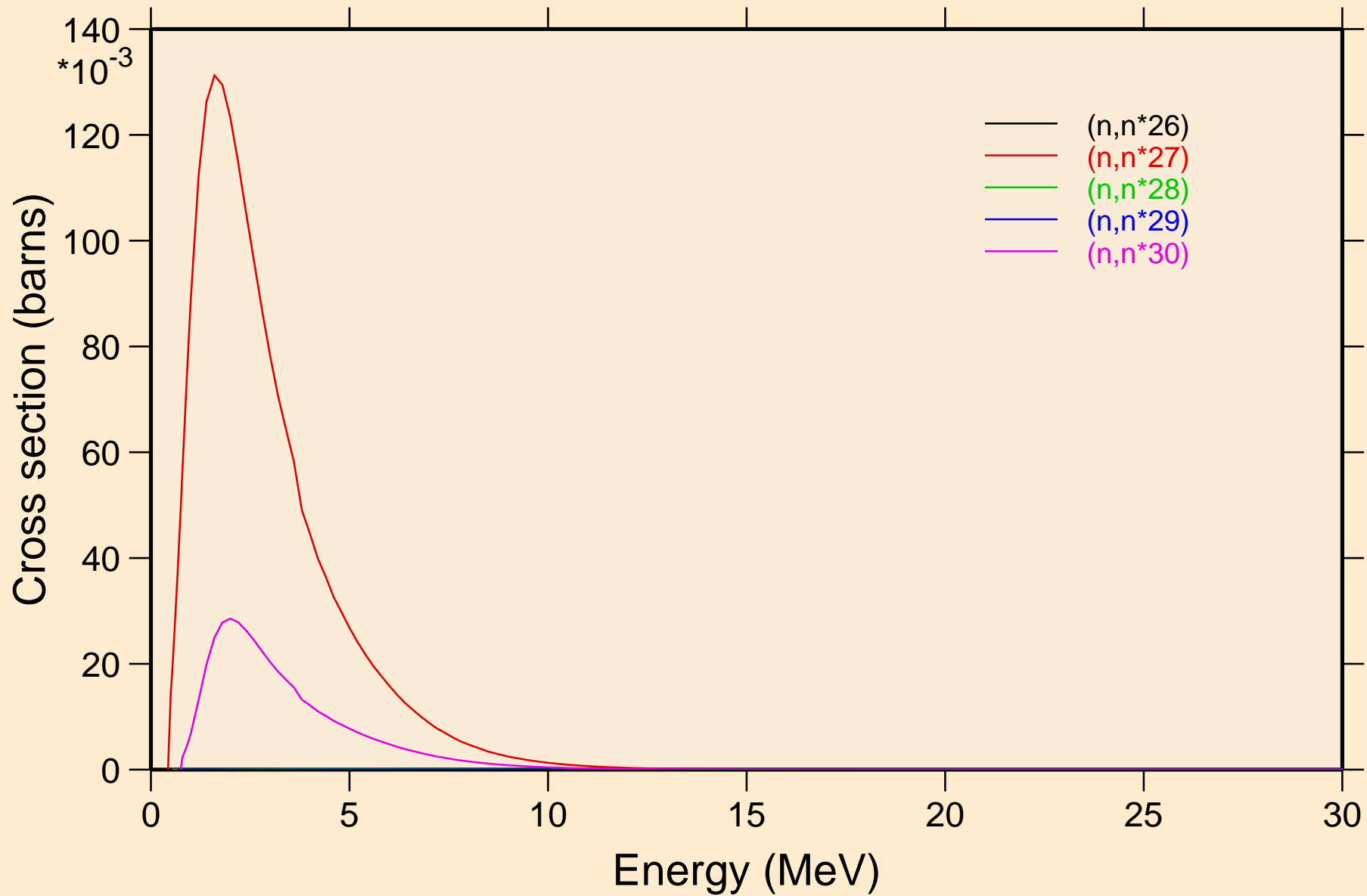

FE053M NEUTRON ACER TENDL-2021 LIBRARY; T=293.6K
Threshold reactions

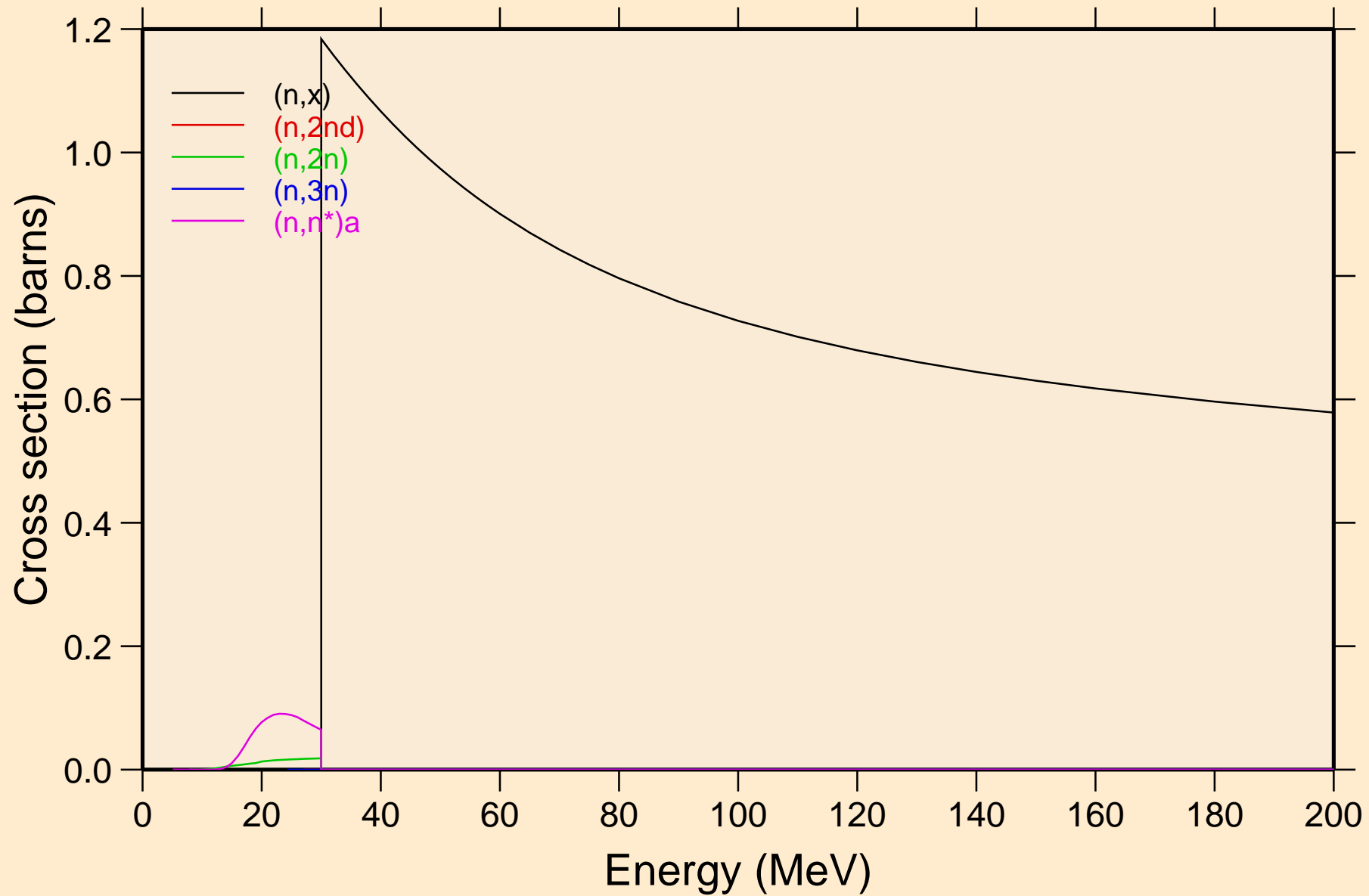

FE053M NEUTRON ACER TENDL-2021 LIBRARY; T=293.6K
Threshold reactions

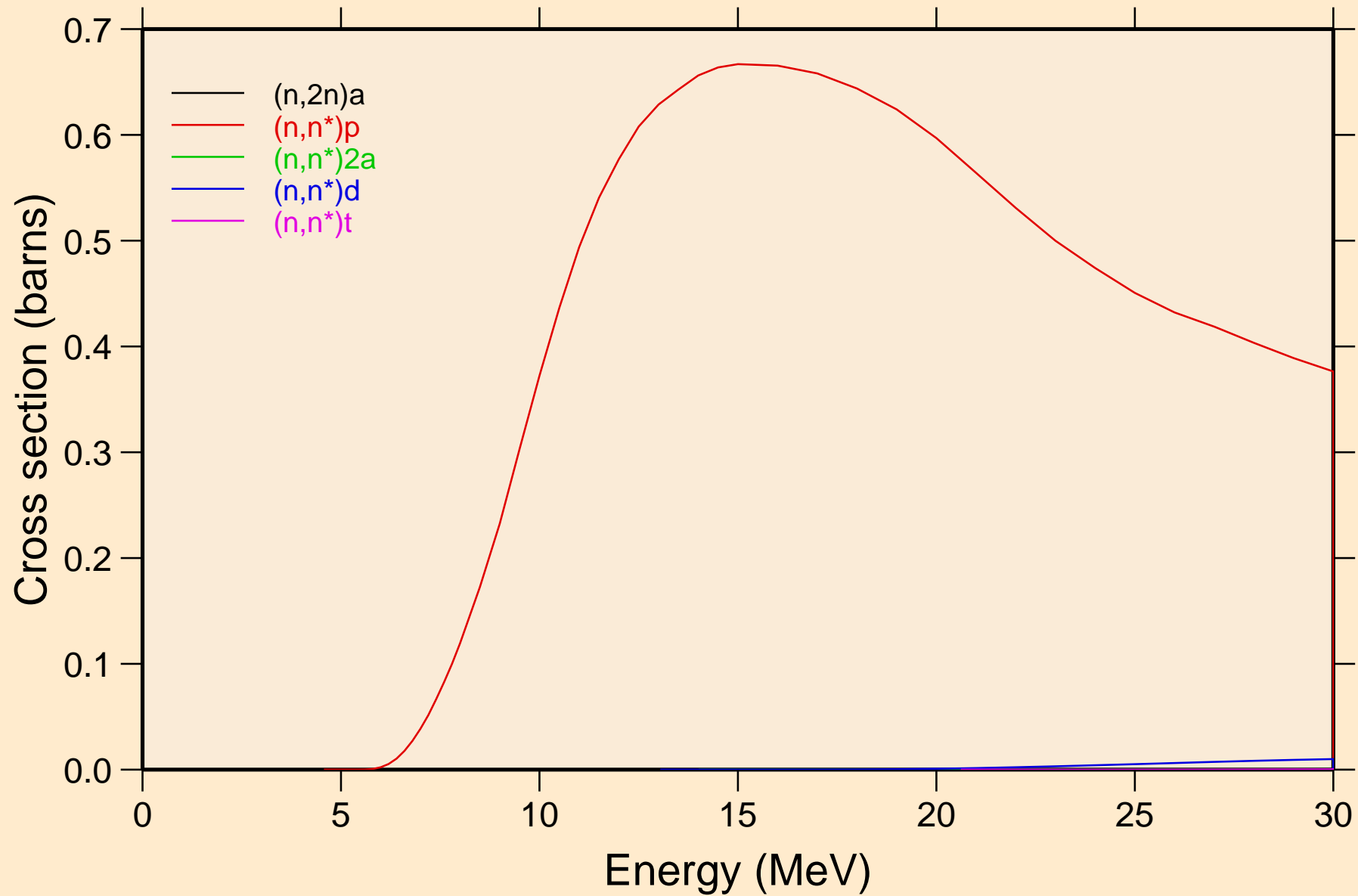

FE053M NEUTRON ACER TENDL-2021 LIBRARY; T=293.6K
Threshold reactions

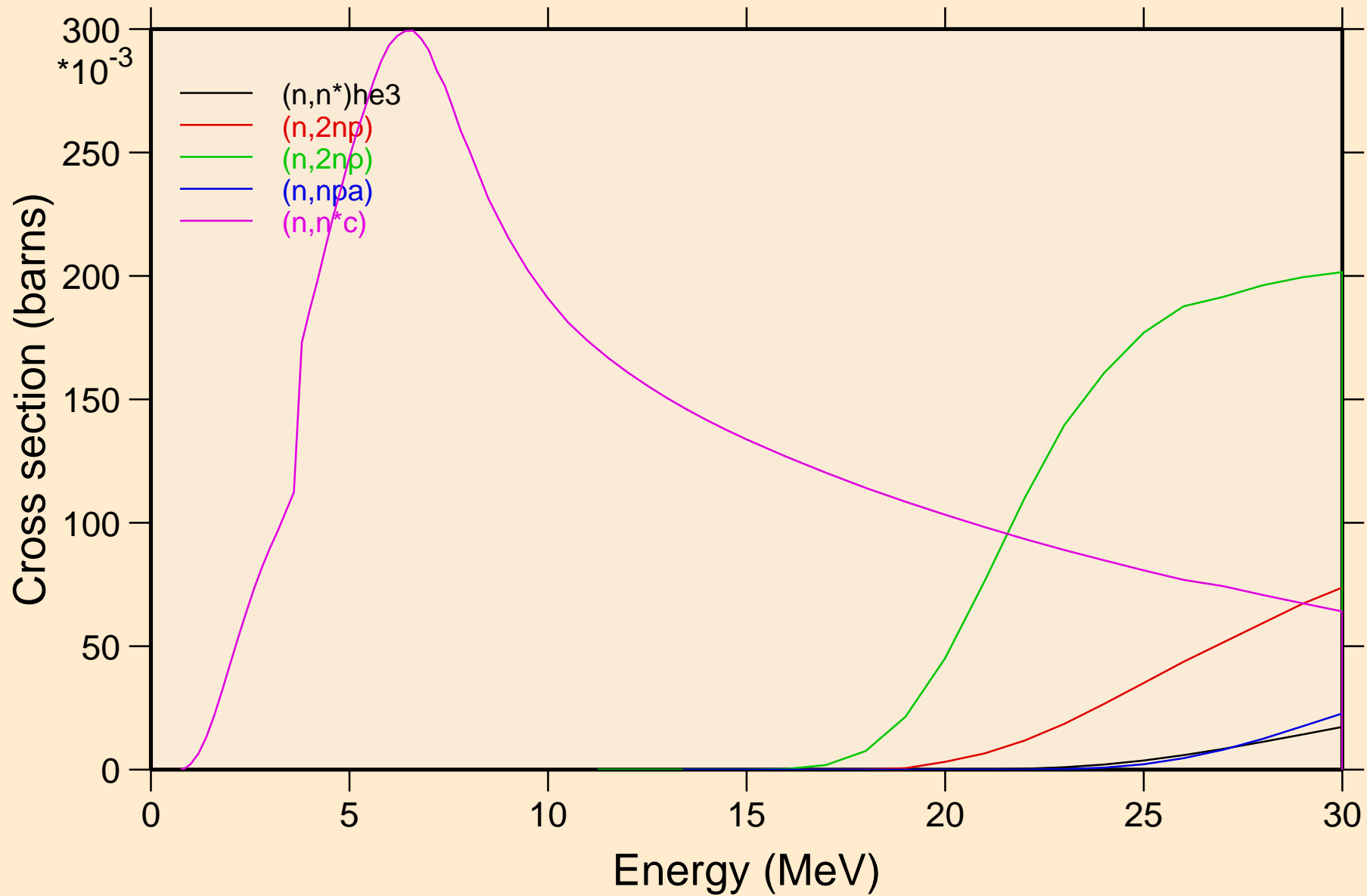

FE053M NEUTRON ACER TENDL-2021 LIBRARY; T=293.6K
Threshold reactions

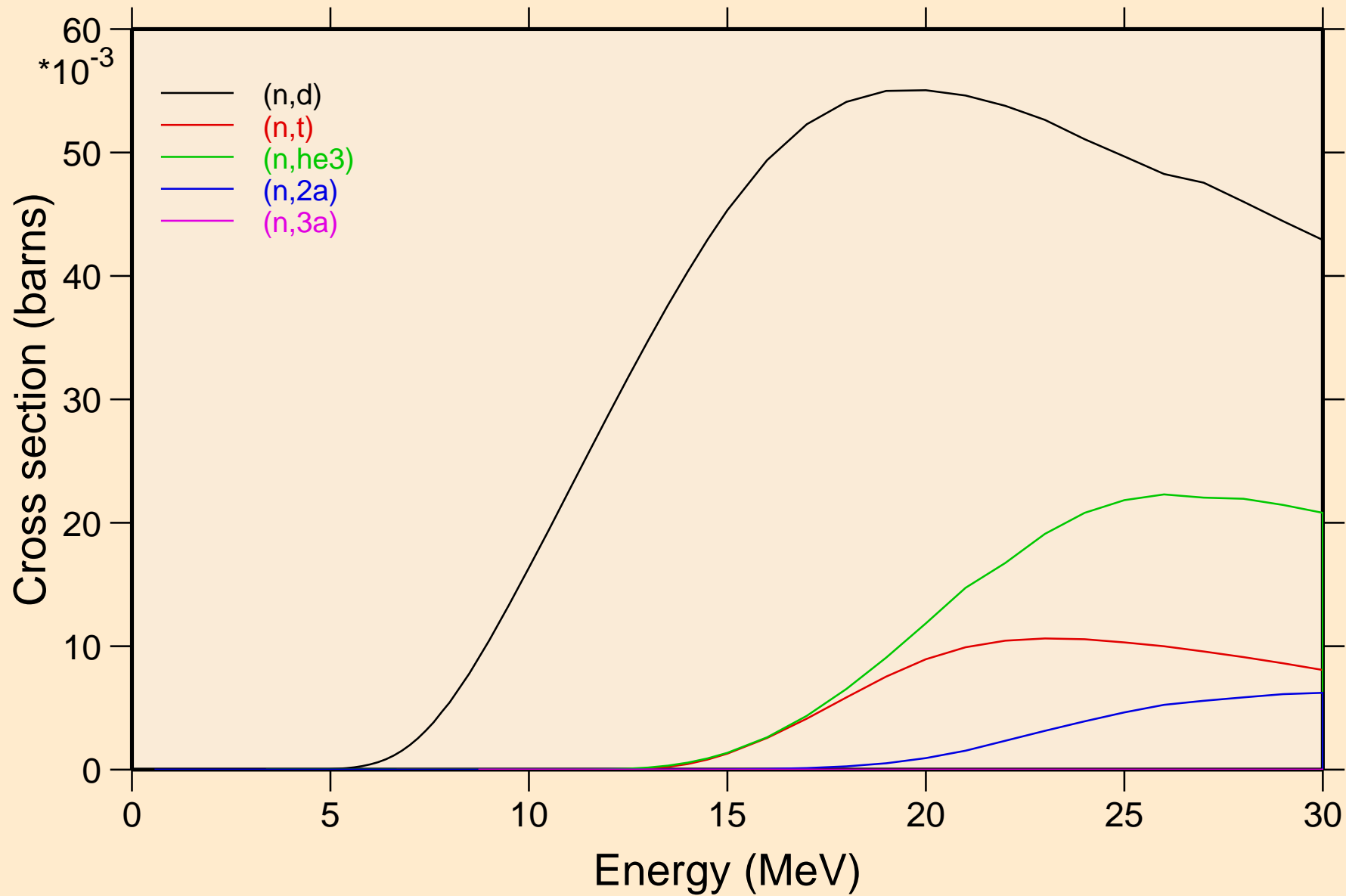

FE053M NEUTRON ACER TENDL-2021 LIBRARY; T=293.6K
Threshold reactions

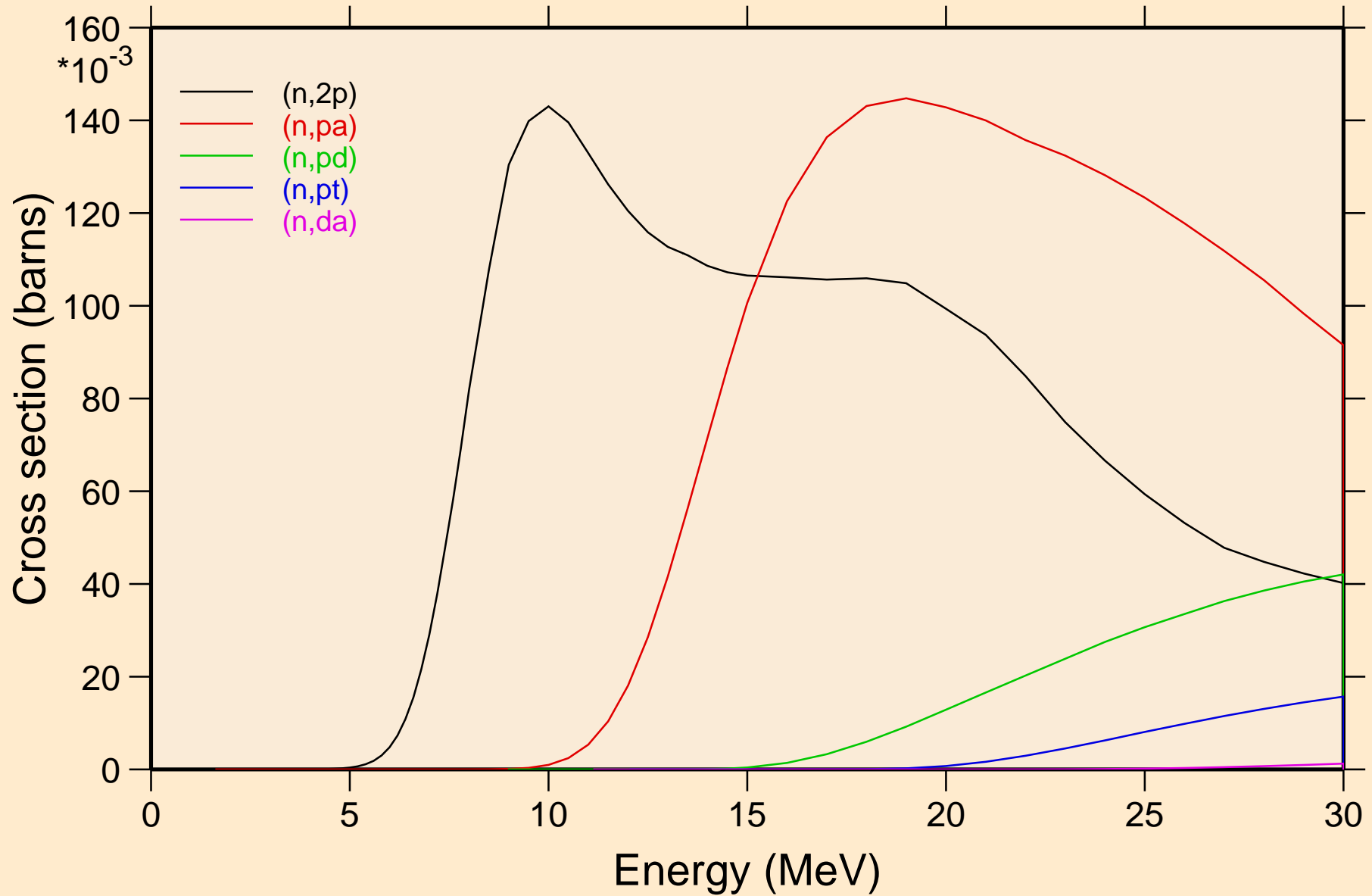

FE053M NEUTRON ACER TENDL-2021 LIBRARY; T=293.6K
Threshold reactions

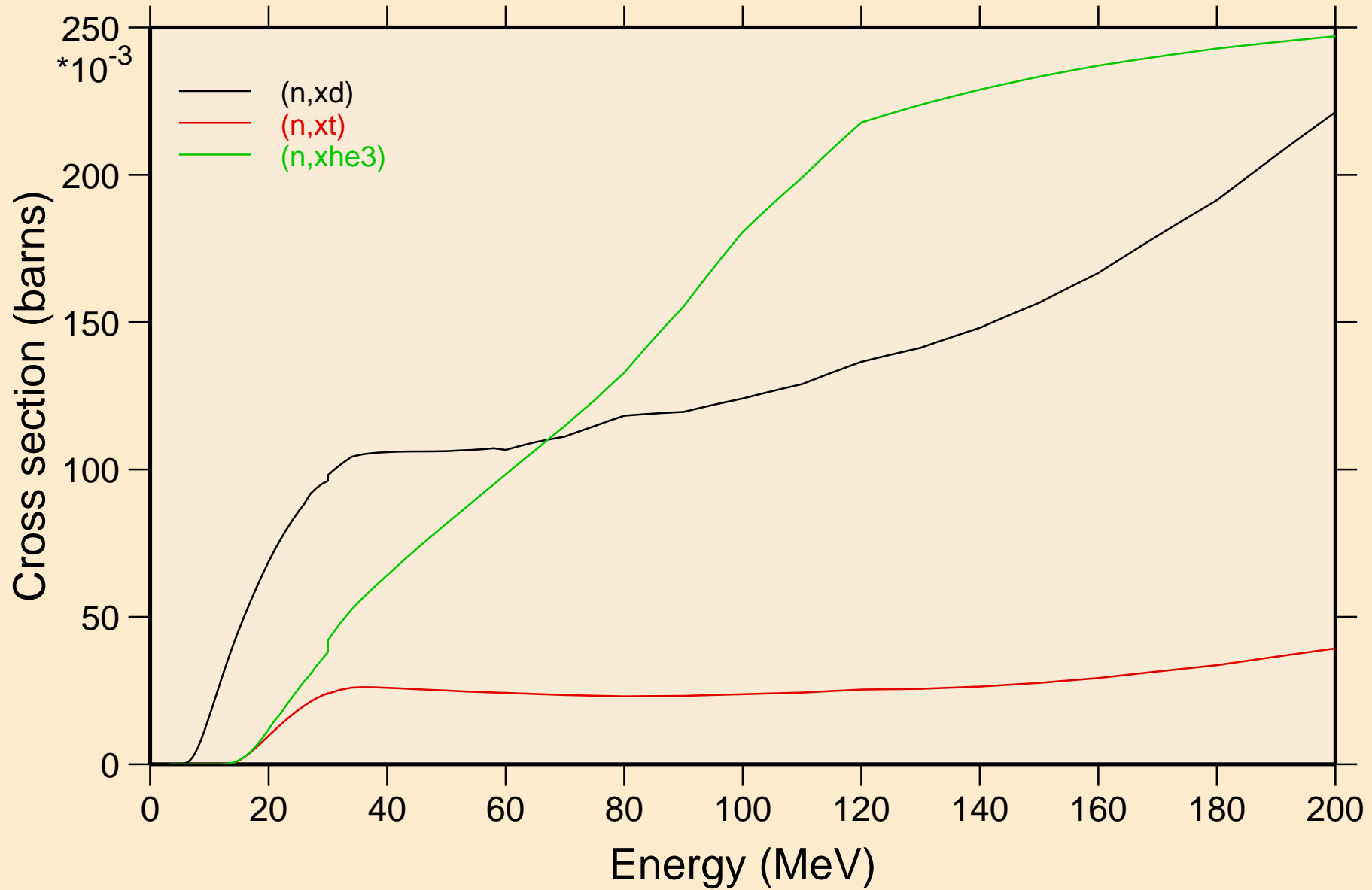

FE053M NEUTRON ACER TENDL-2021 LIBRARY; T=293.6K
angular distribution for elastic

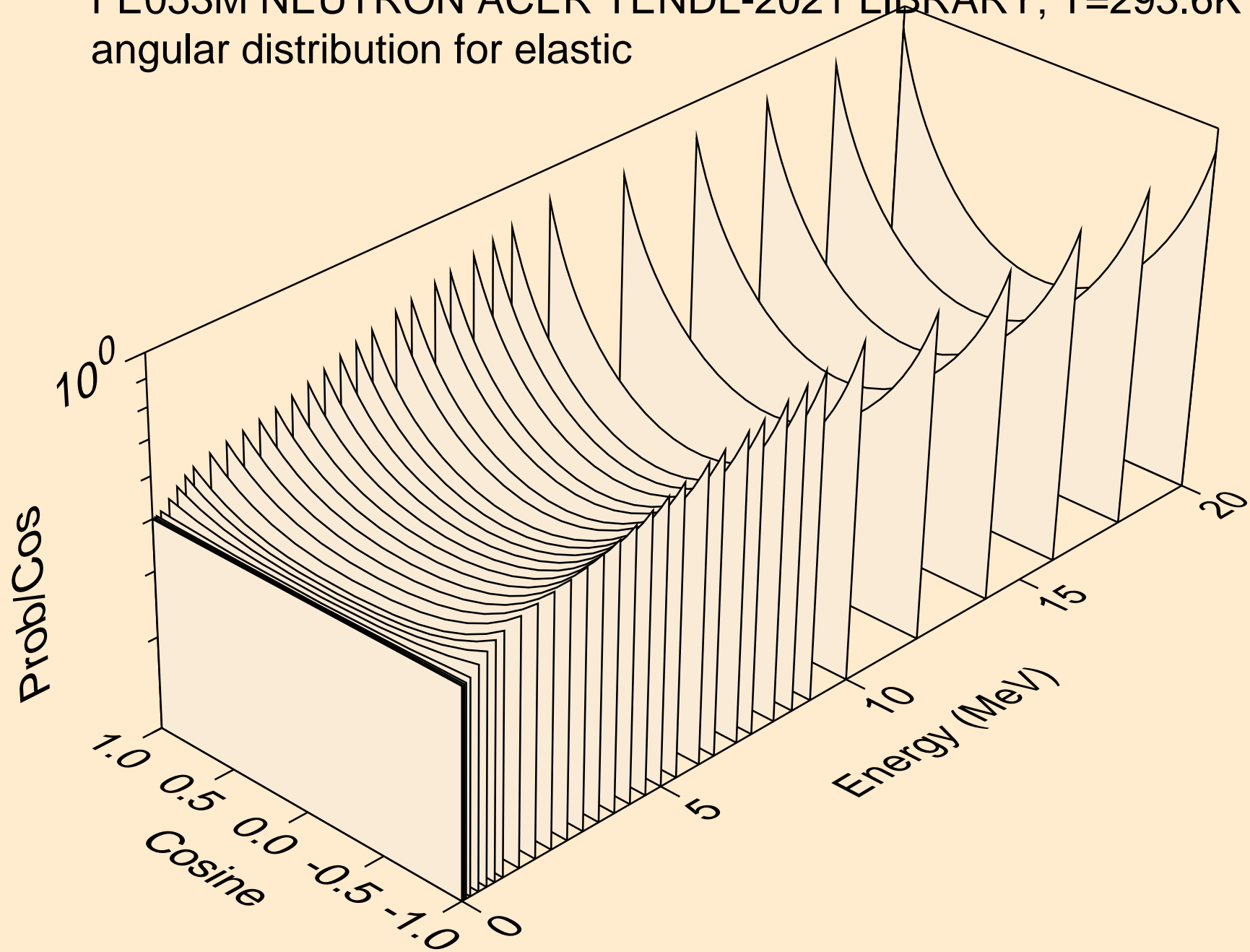

FE053M NEUTRON ACER TENDL-2021 LIBRARY; T=293.6K
angular distribution for elastic

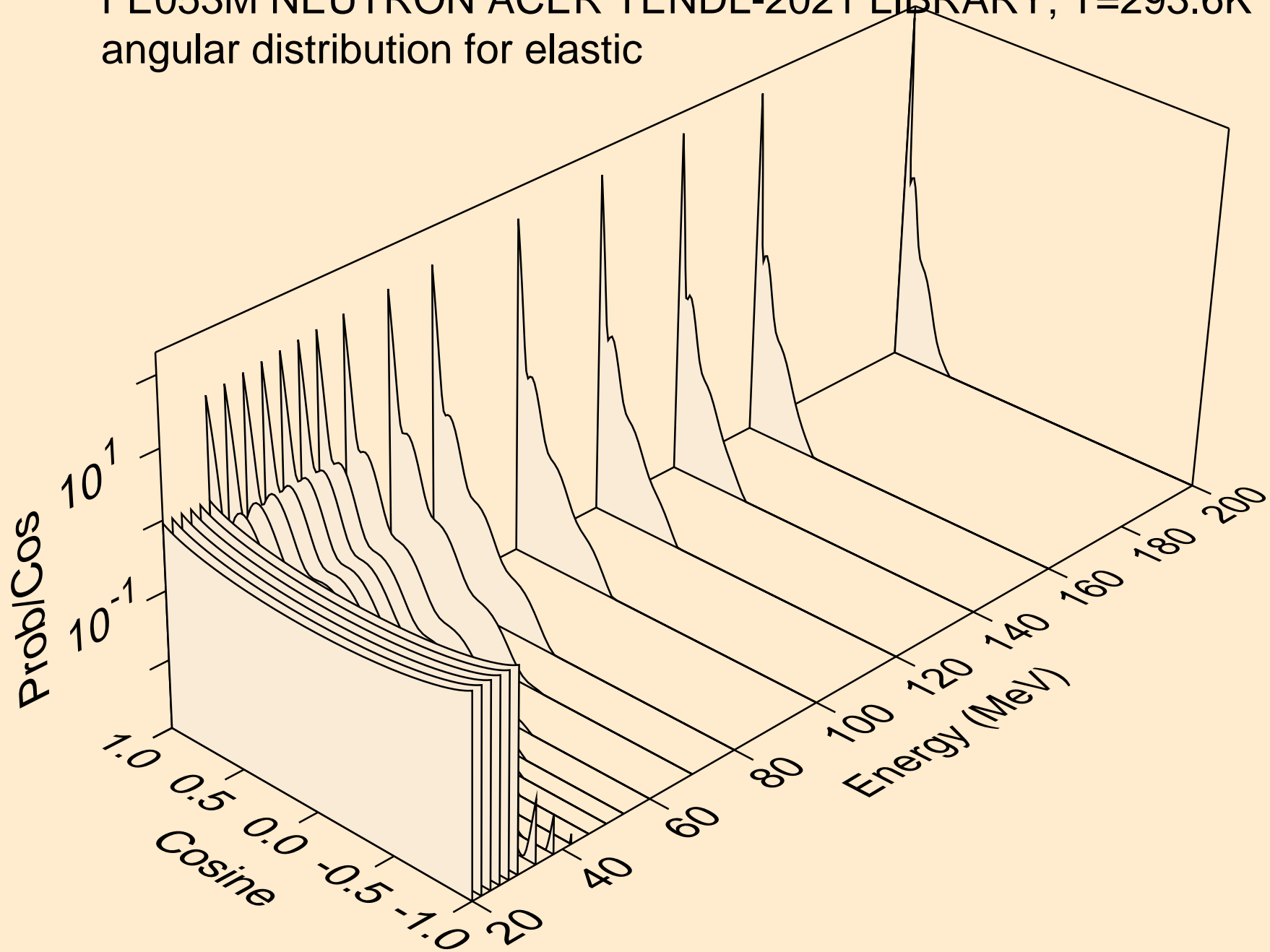

FE053M NEUTRON ACER TENDL-2021 LIBRARY; T=293.6K
angular distribution for (n,n*1)

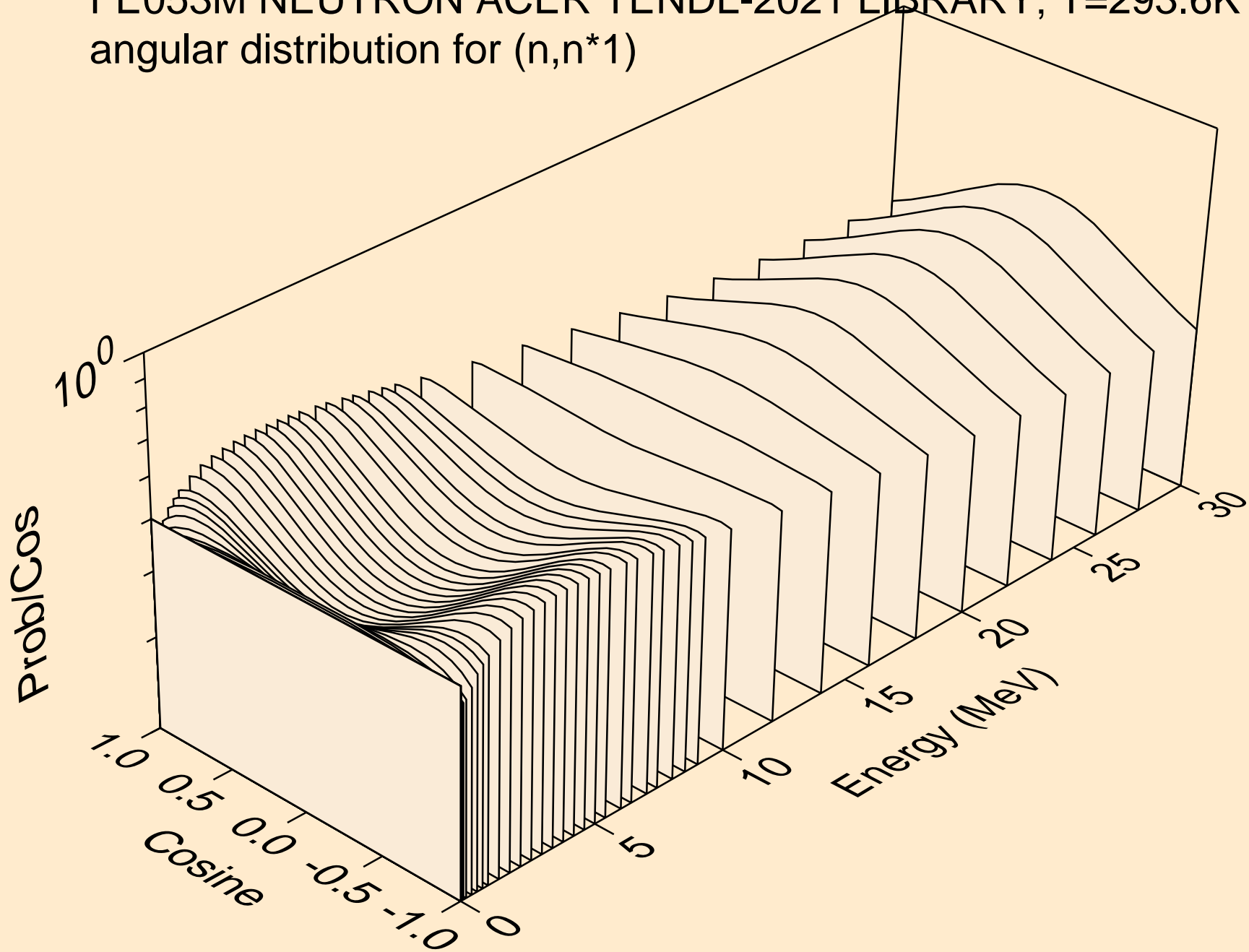

FE053M NEUTRON ACER TENDL-2021 LIBRARY; T=293.6K
angular distribution for (n,n*2)

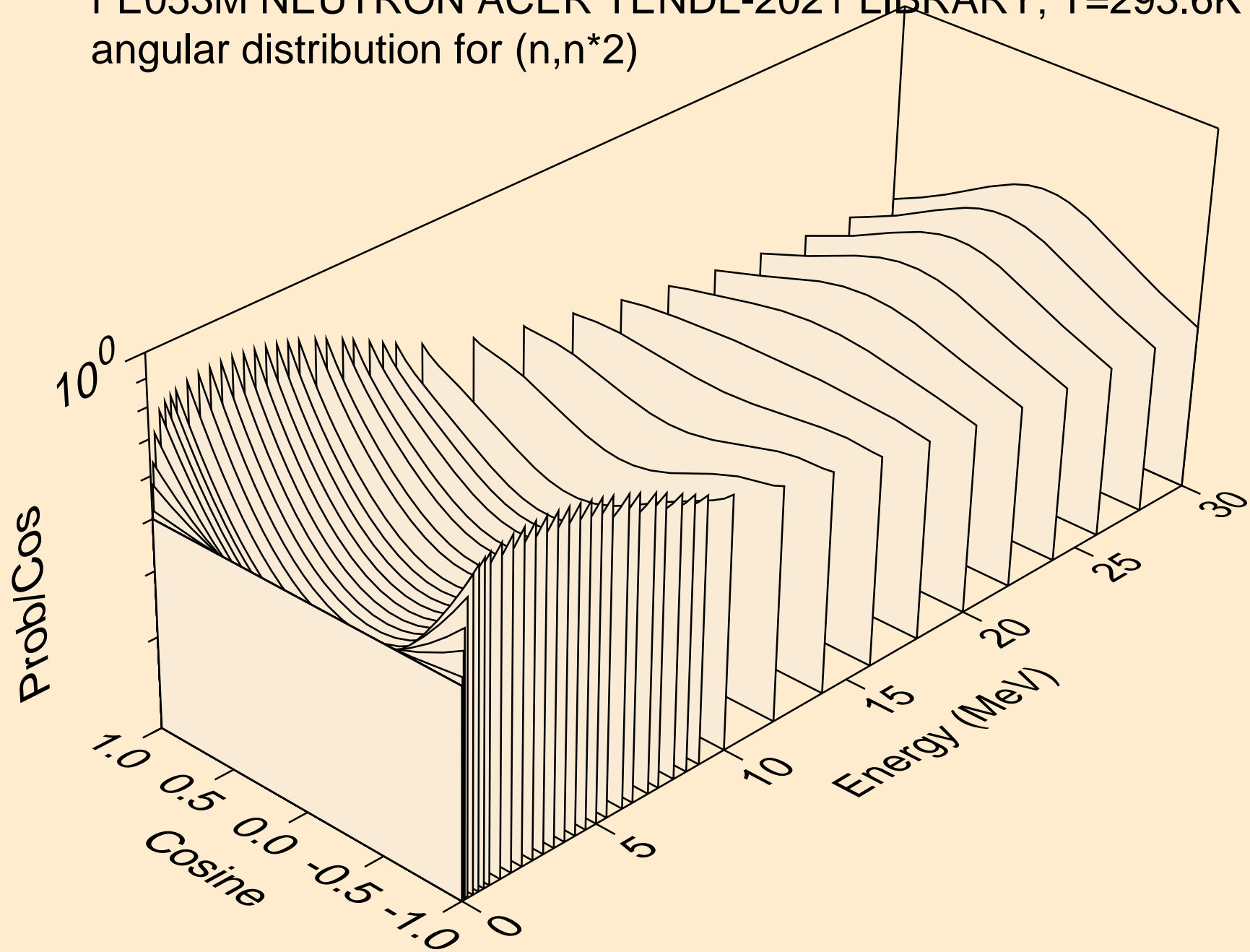

FE053M NEUTRON ACER TENDL-2021 LIBRARY; T=293.6K
angular distribution for (n,n*3)

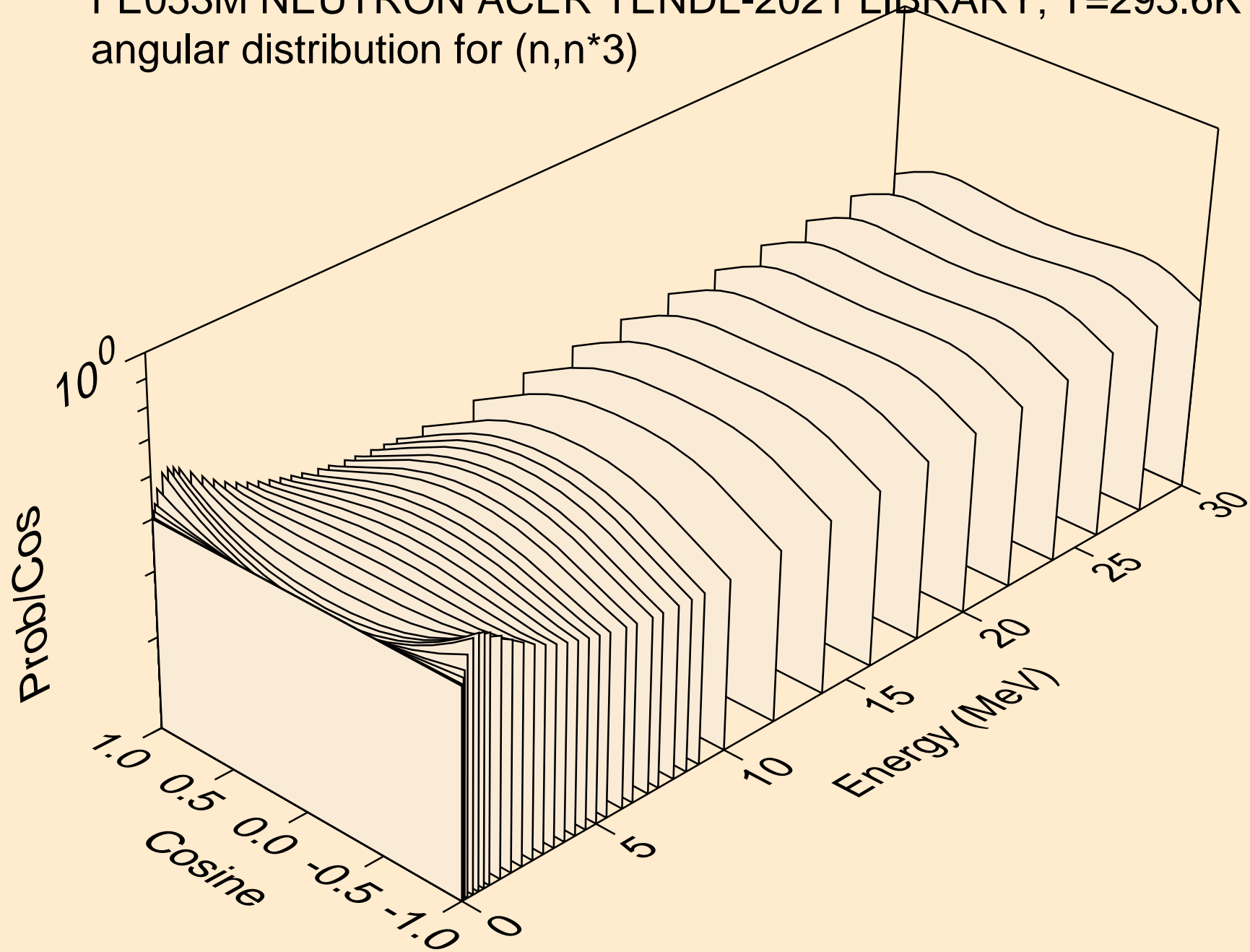

FE053M NEUTRON ACER TENDL-2021 LIBRARY; T=293.6K
angular distribution for (n,n*4)

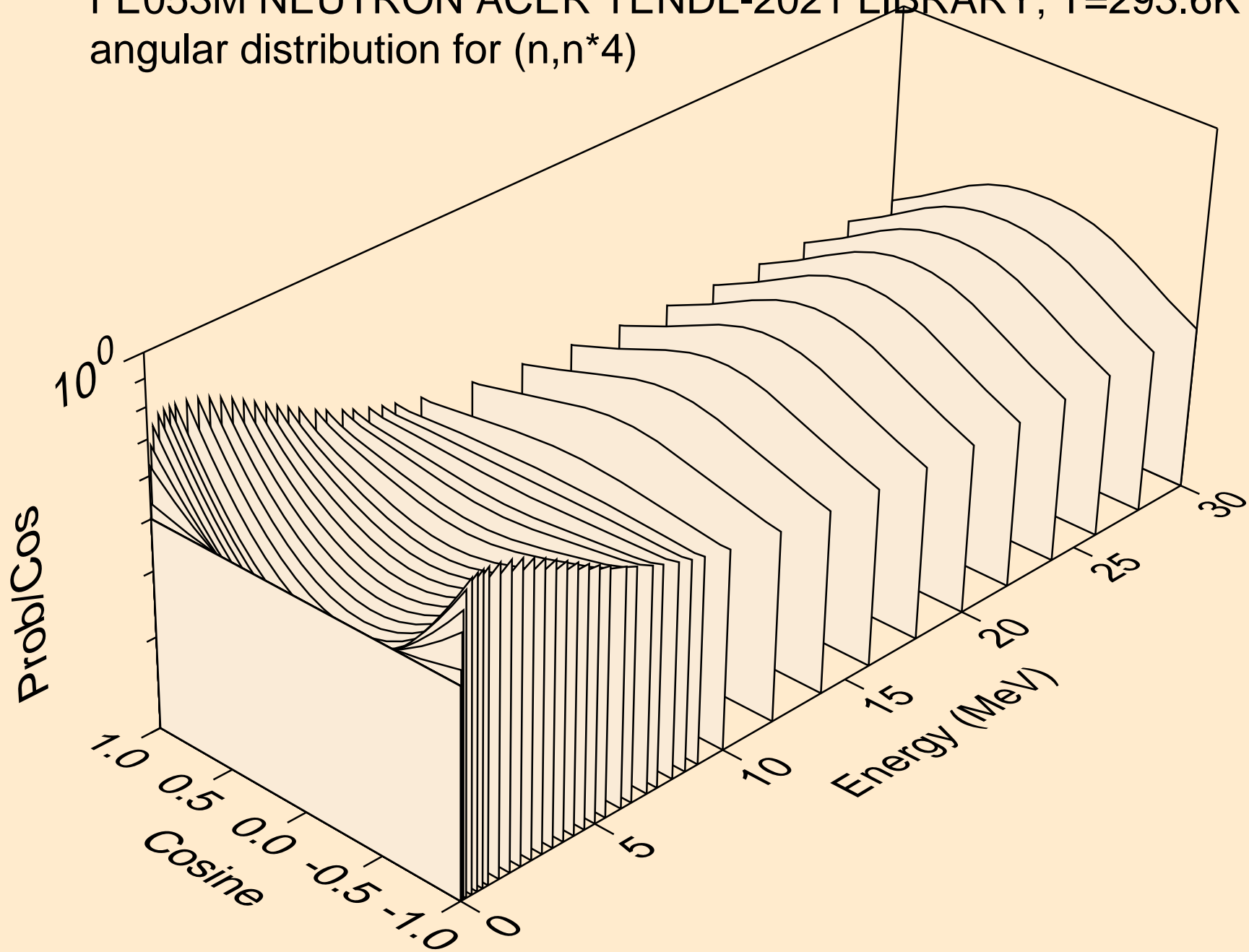

FE053M NEUTRON ACER TENDL-2021 LIBRARY; T=293.6K
angular distribution for (n,n*5)

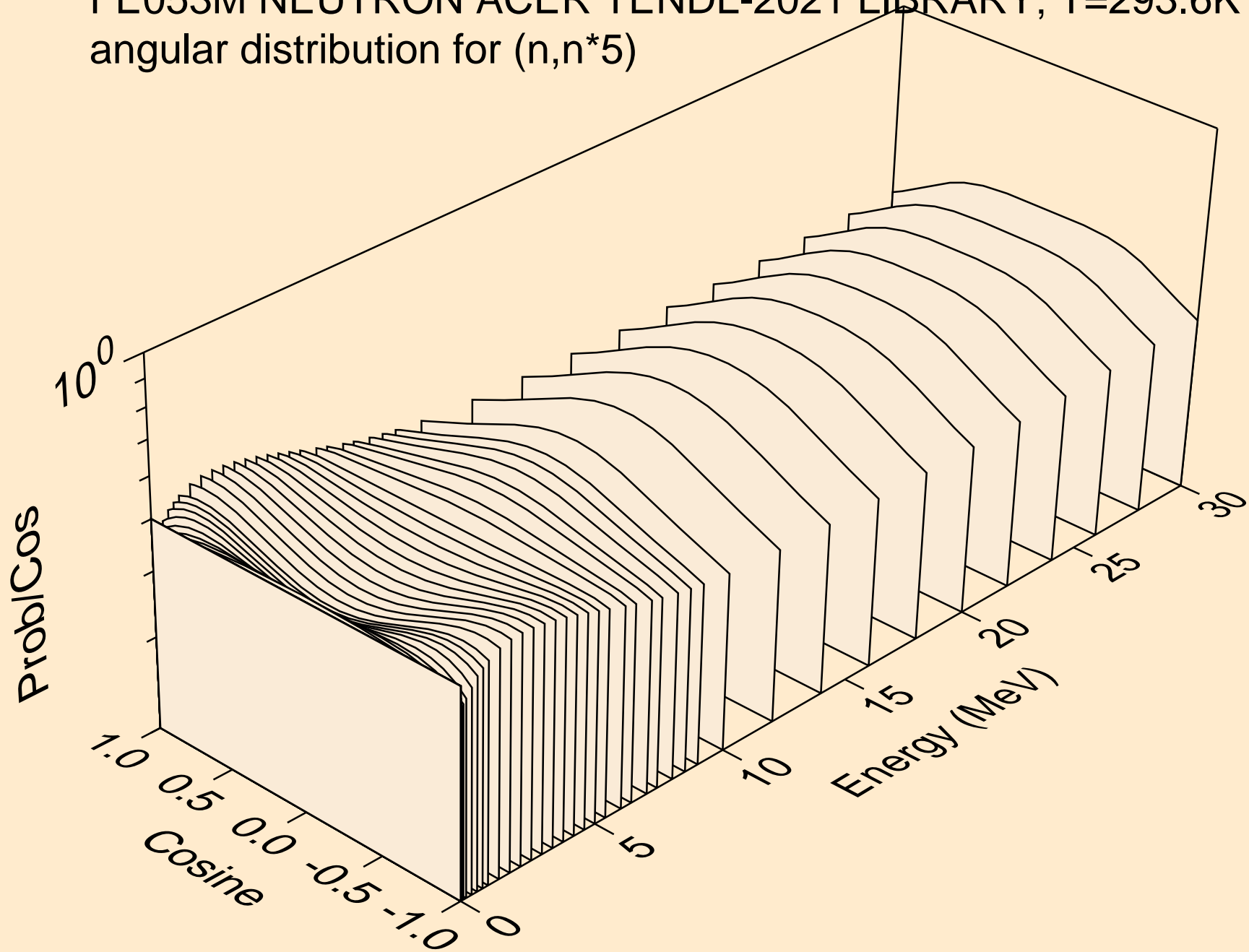

FE053M NEUTRON ACER TENDL-2021 LIBRARY; T=293.6K
angular distribution for (n,n*6)

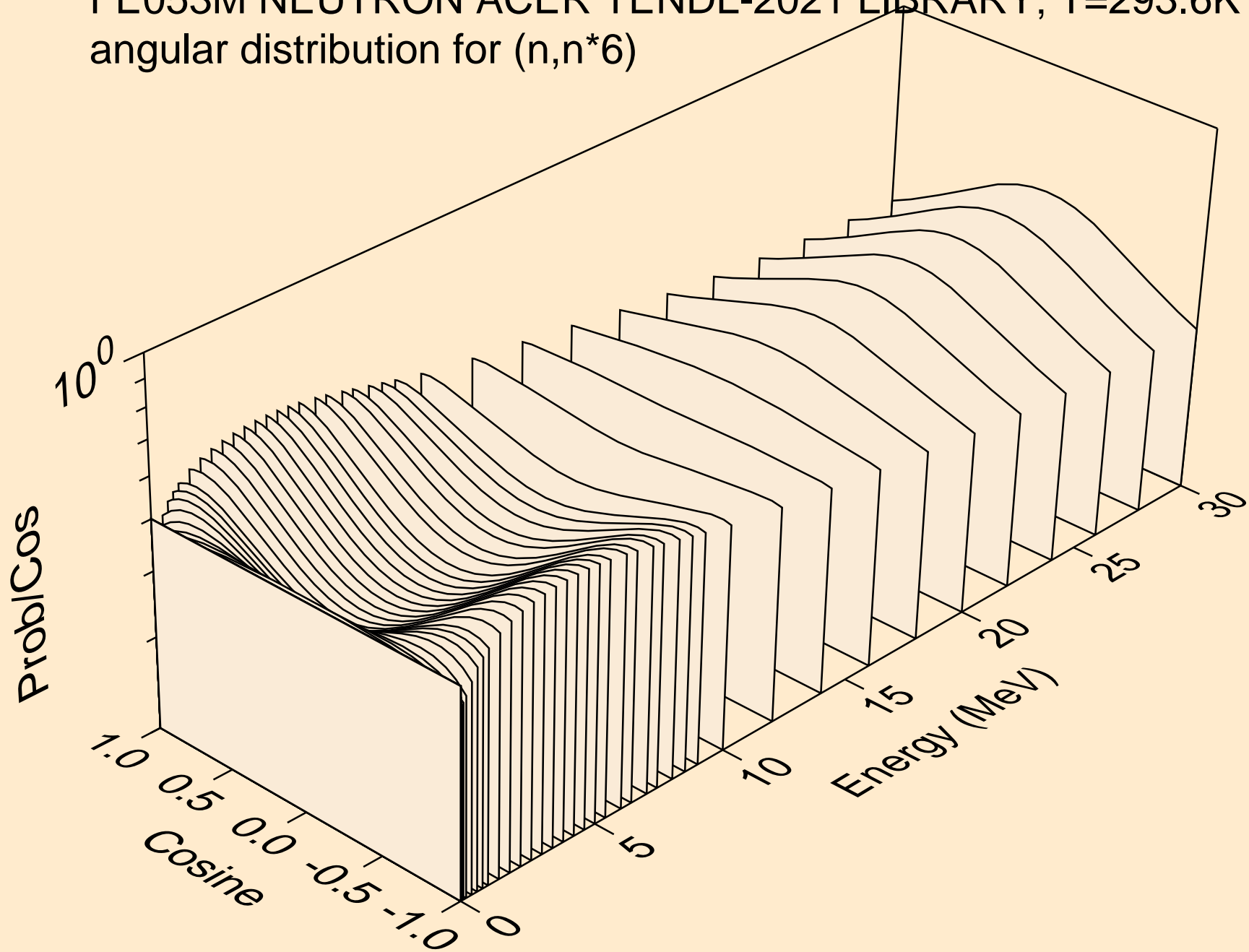

FE053M NEUTRON ACER TENDL-2021 LIBRARY; T=293.6K
angular distribution for (n,n*7)

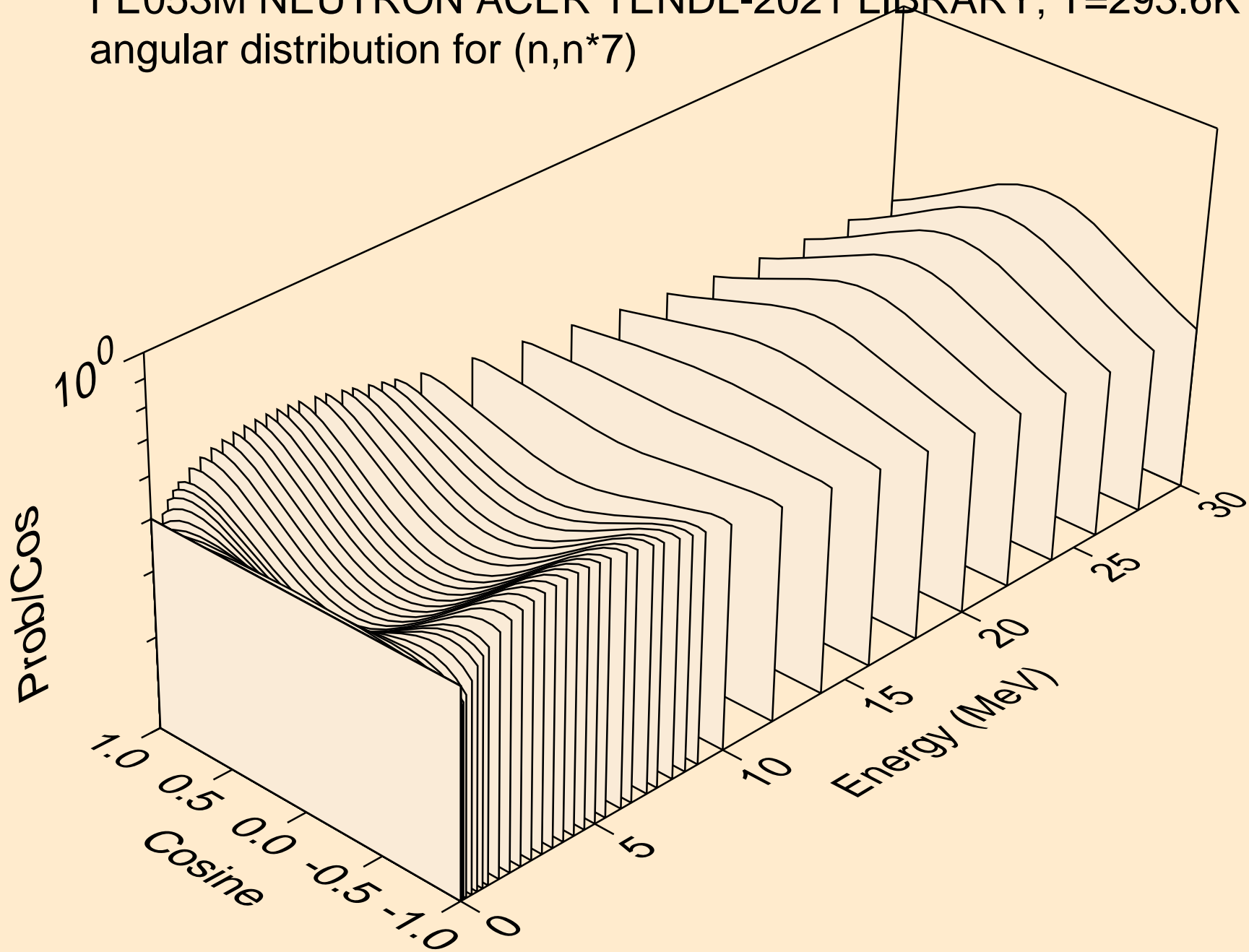

FE053M NEUTRON ACER TENDL-2021 LIBRARY; T=293.6K
angular distribution for (n,n*8)

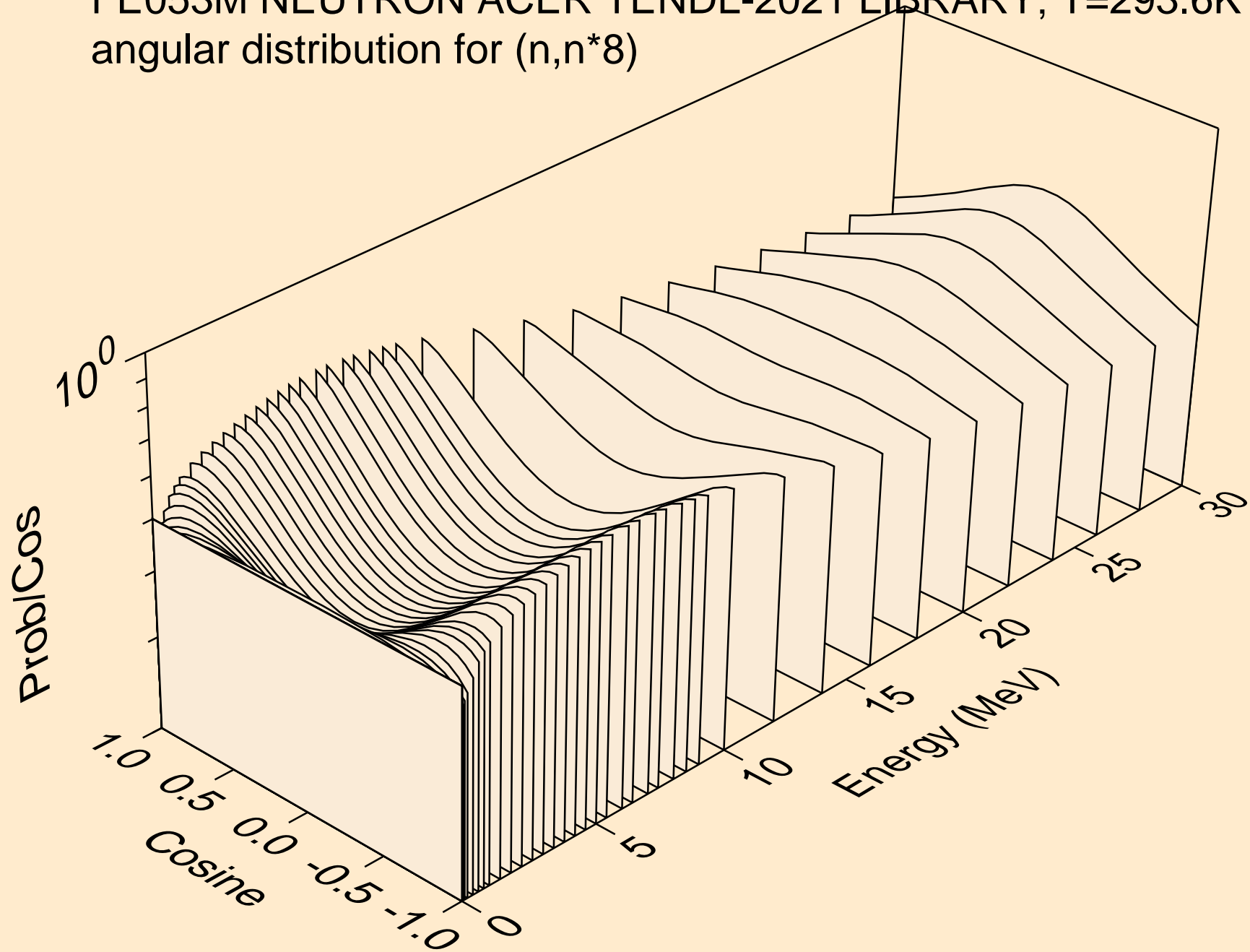

FE053M NEUTRON ACER TENDL-2021 LIBRARY; T=293.6K
angular distribution for (n,n*9)

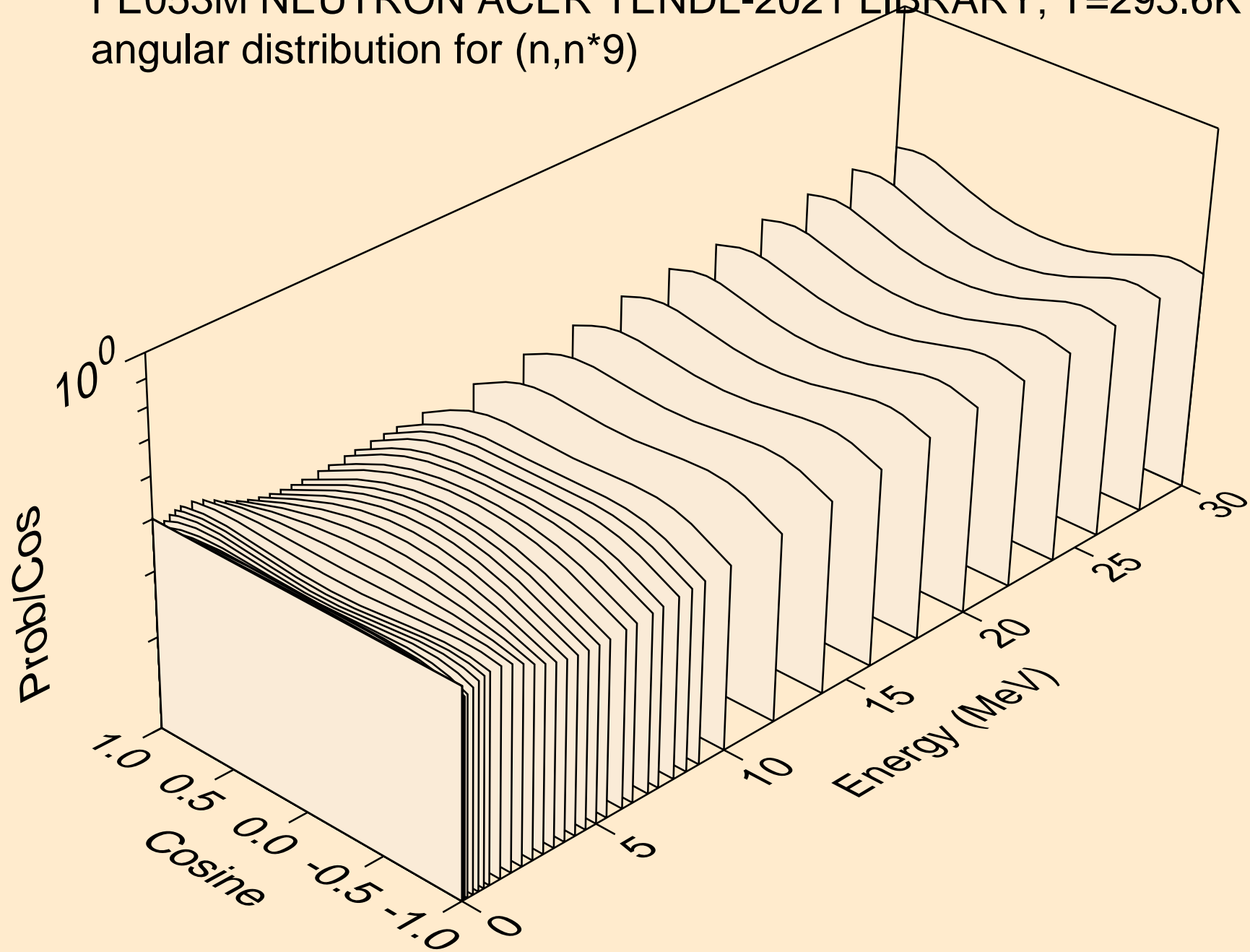

FE053M NEUTRON ACER TENDL-2021 LIBRARY; T=293.6K
angular distribution for (n,n*10)

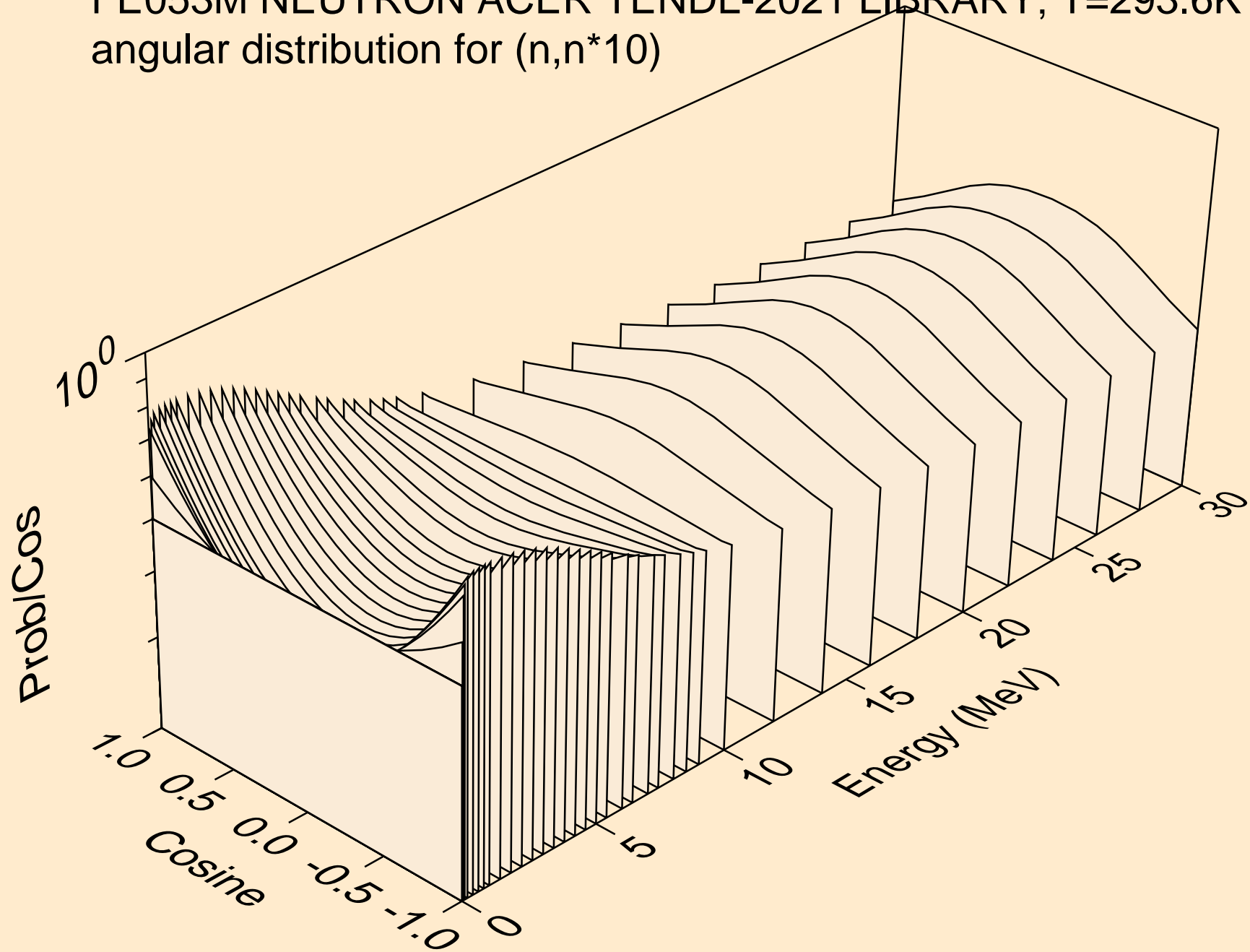

FE053M NEUTRON ACER TENDL-2021 LIBRARY; T=293.6K
angular distribution for (n,n*11)

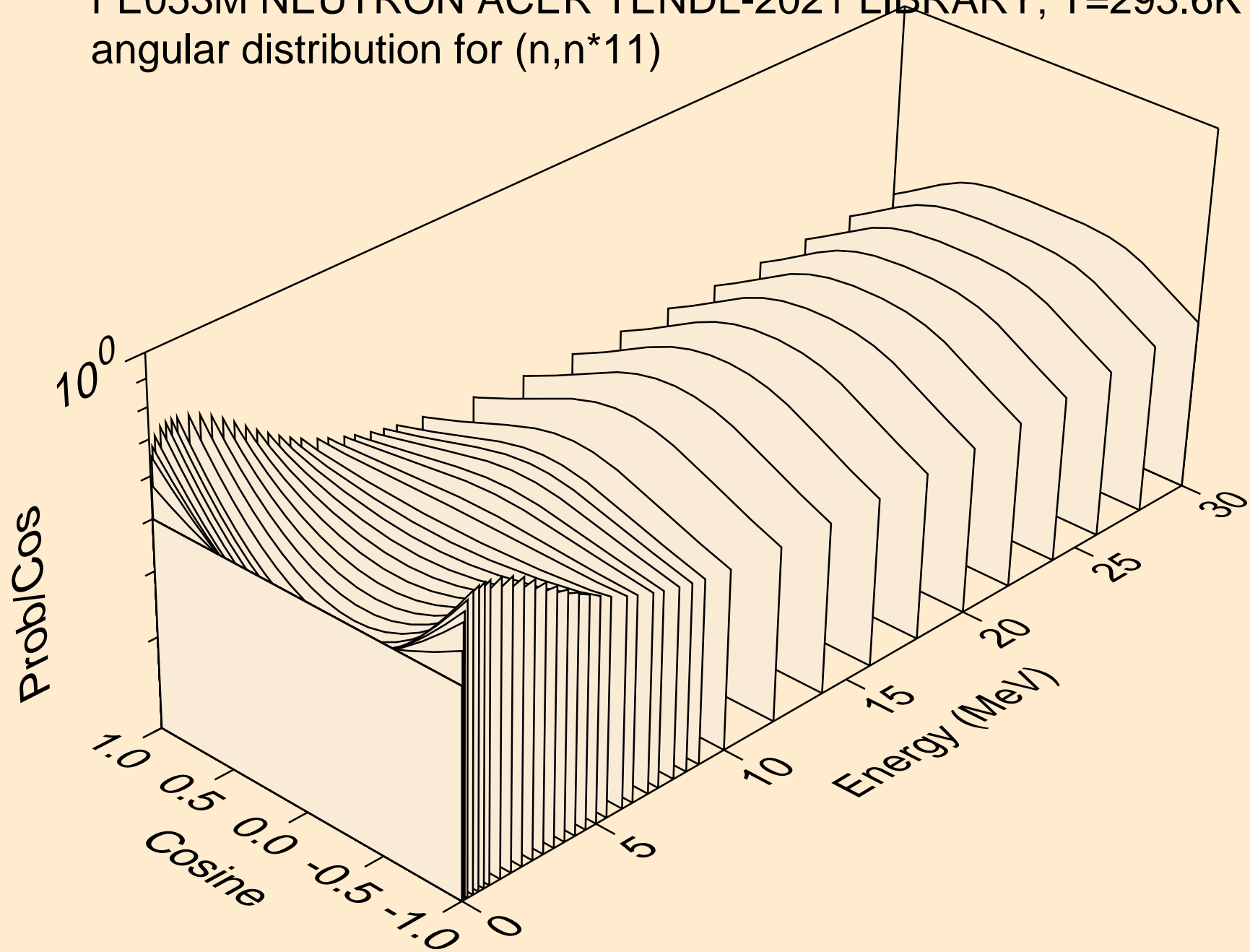

FE053M NEUTRON ACER TENDL-2021 LIBRARY; T=293.6K
angular distribution for (n,n*12)

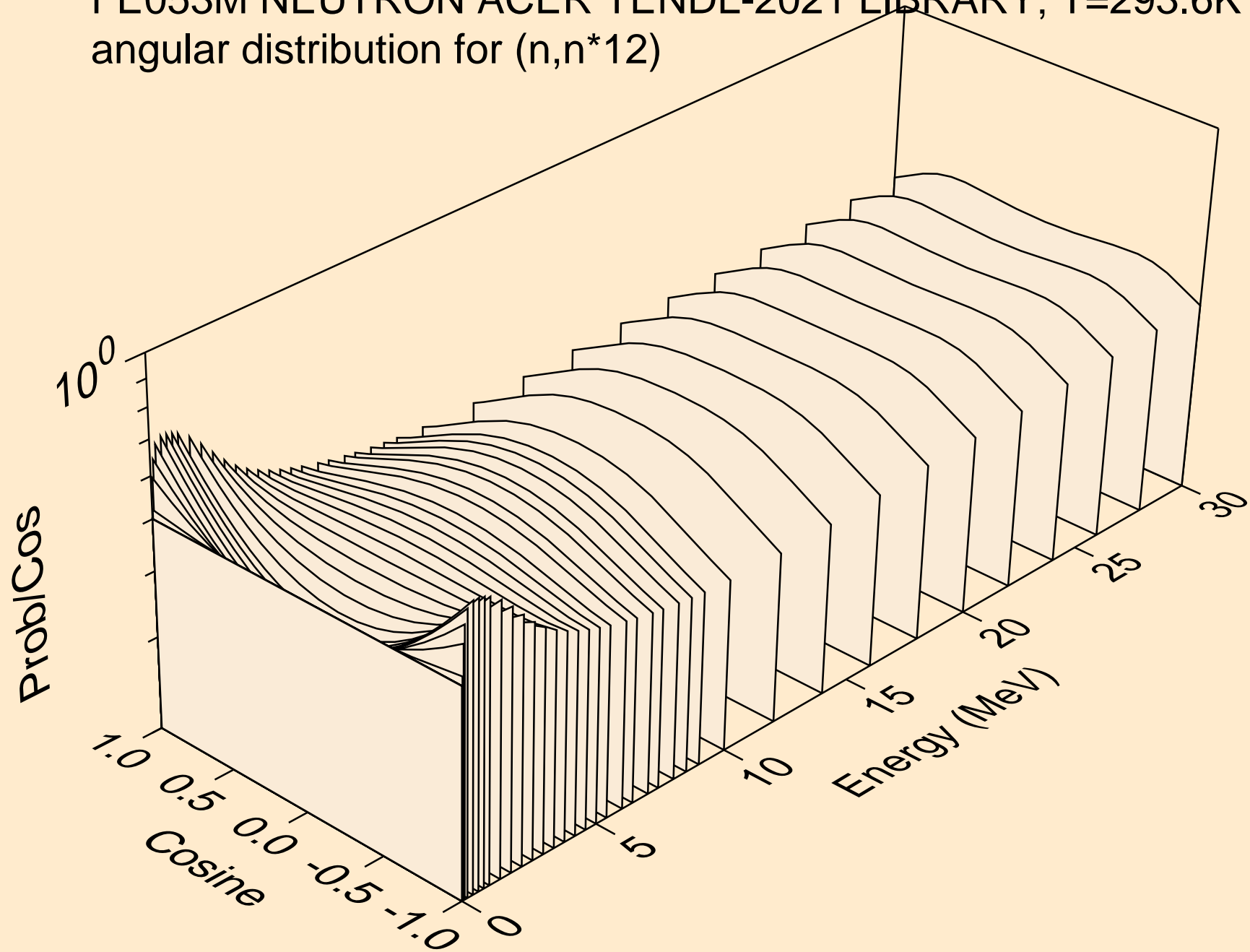

FE053M NEUTRON ACER TENDL-2021 LIBRARY; T=293.6K
angular distribution for (n,n*13)

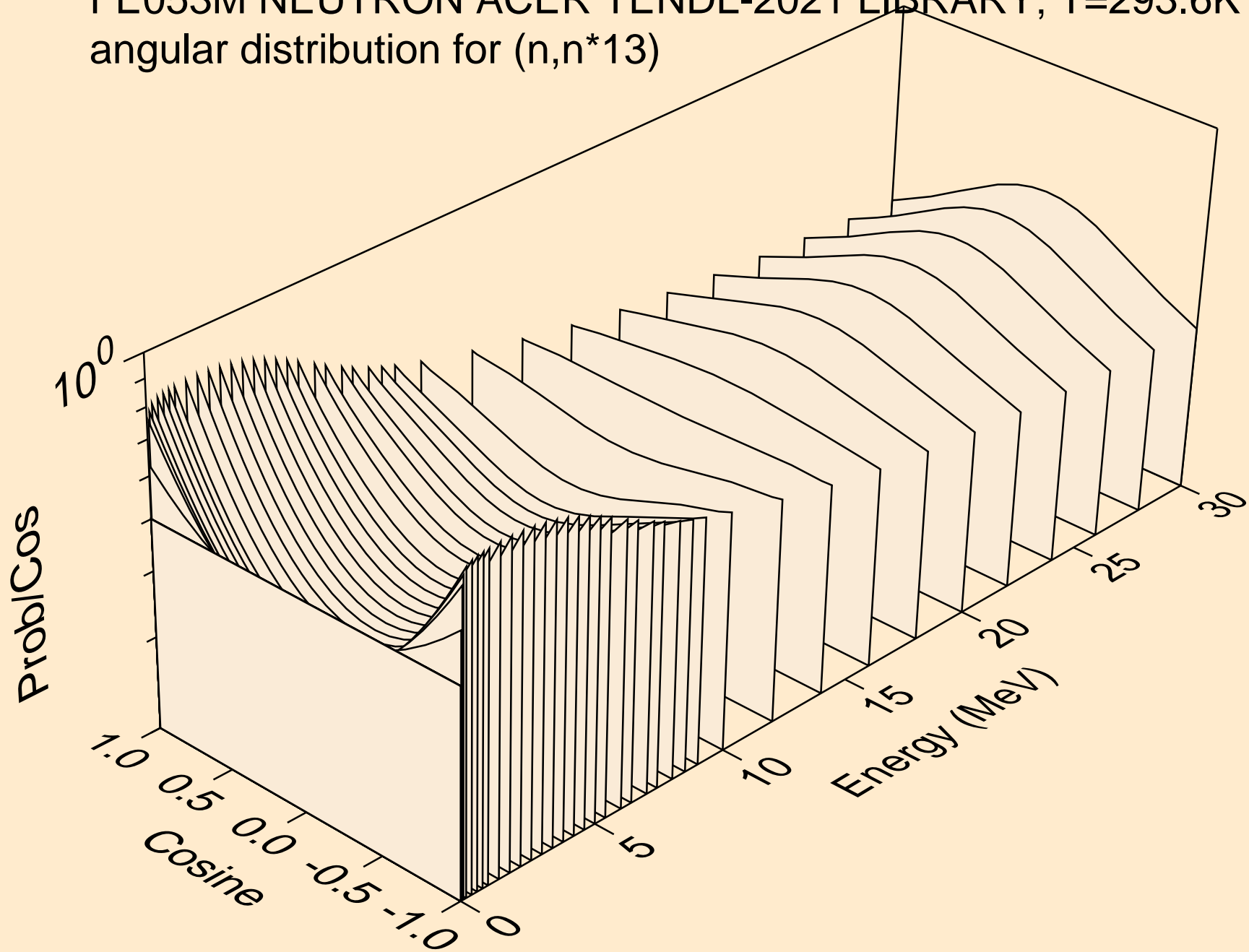

FE053M NEUTRON ACER TENDL-2021 LIBRARY; T=293.6K
angular distribution for (n,n*14)

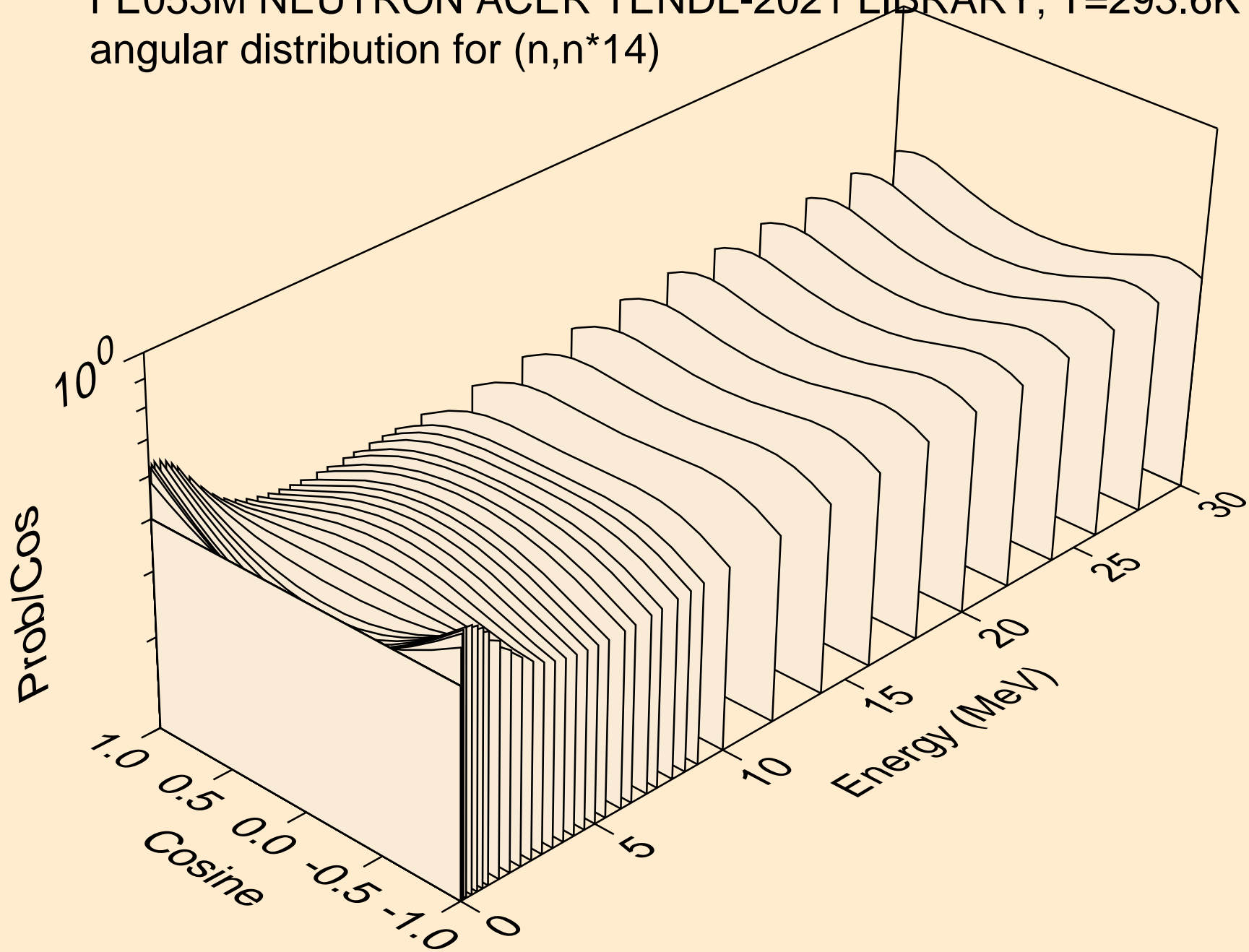

FE053M NEUTRON ACER TENDL-2021 LIBRARY; T=293.6K
angular distribution for (n,n*15)

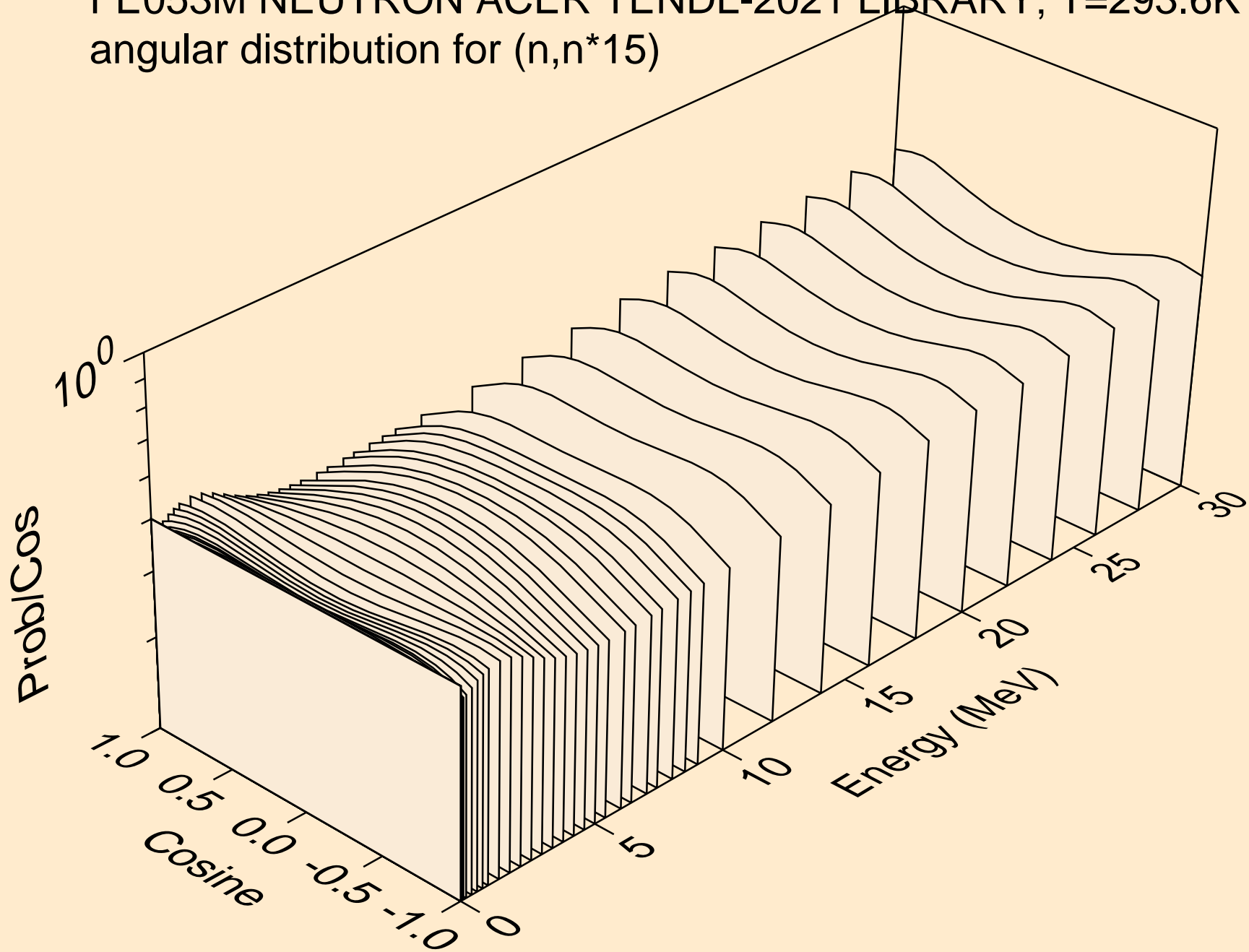

FE053M NEUTRON ACER TENDL-2021 LIBRARY; T=293.6K
angular distribution for (n,n*16)

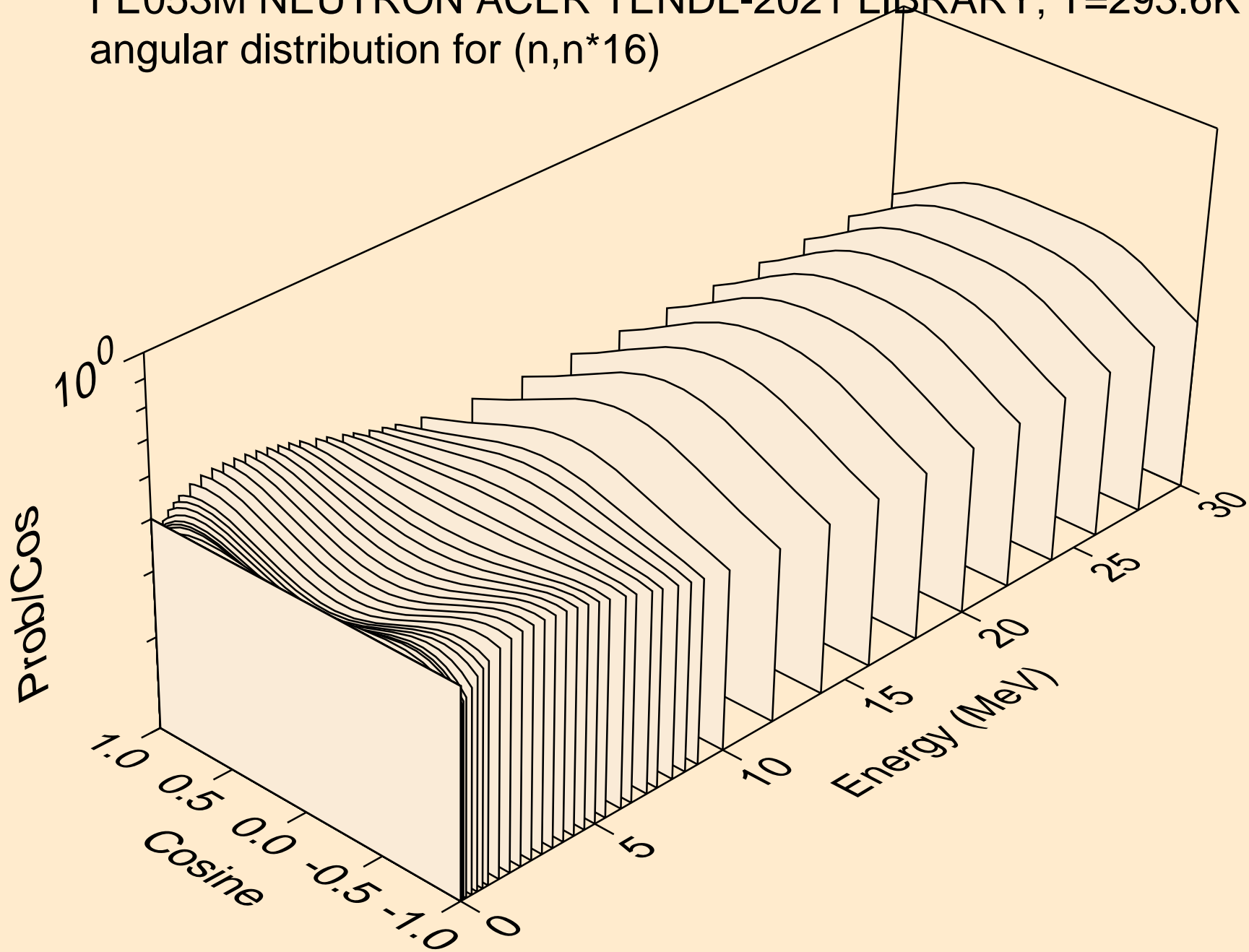

FE053M NEUTRON ACER TENDL-2021 LIBRARY; T=293.6K
angular distribution for (n,n*17)

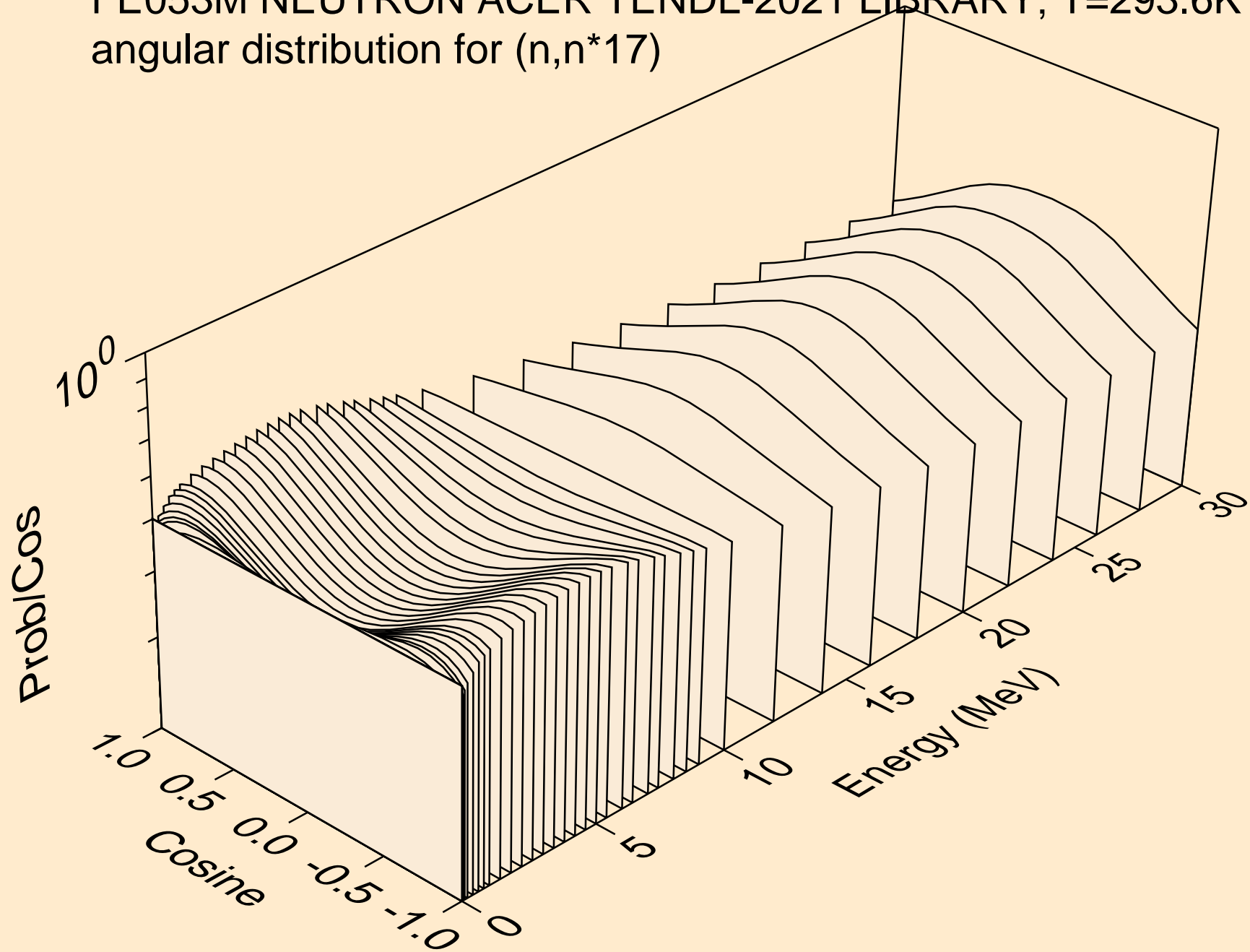

FE053M NEUTRON ACER TENDL-2021 LIBRARY; T=293.6K
angular distribution for (n,n*18)

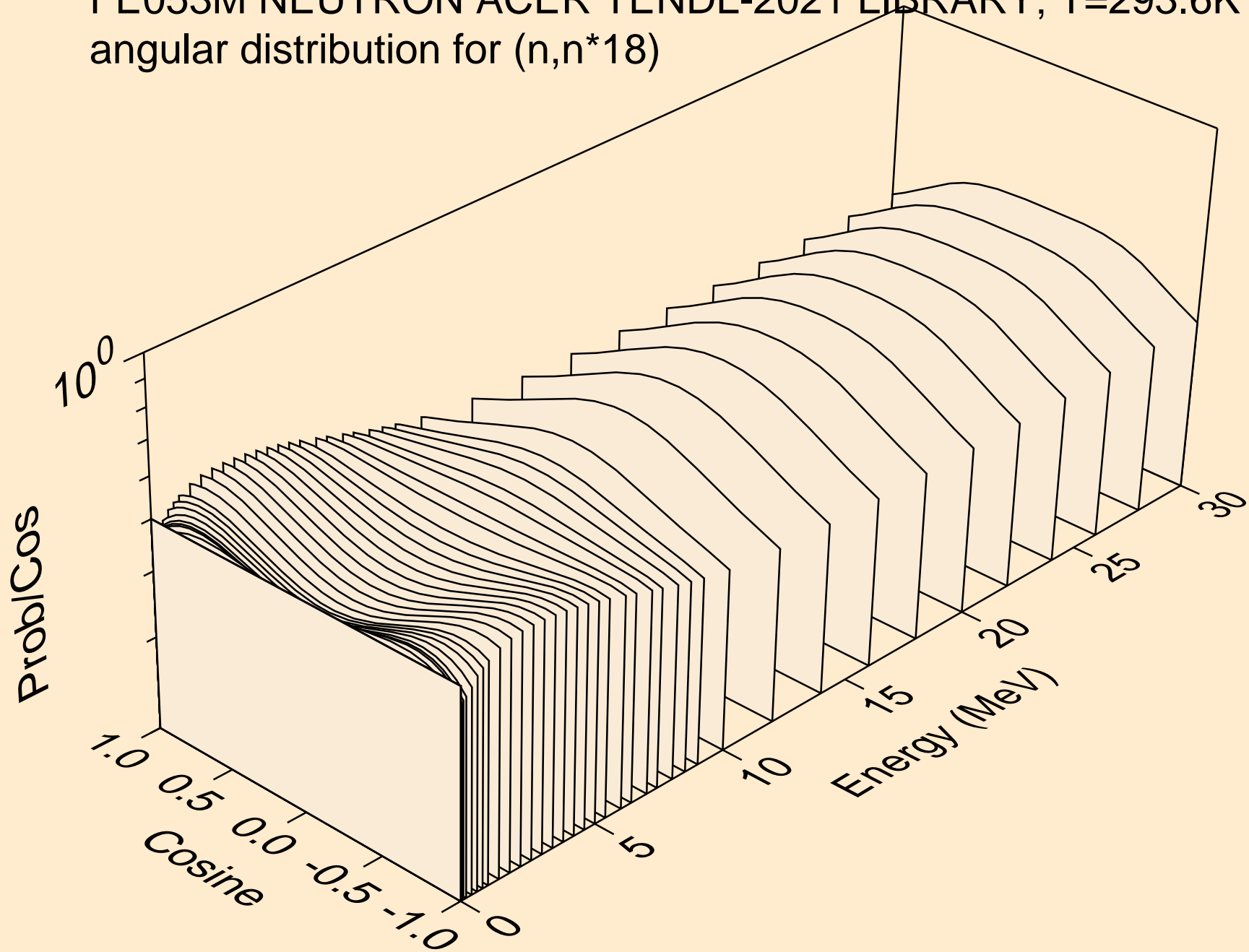

FE053M NEUTRON ACER TENDL-2021 LIBRARY; T=293.6K
angular distribution for (n,n*19)

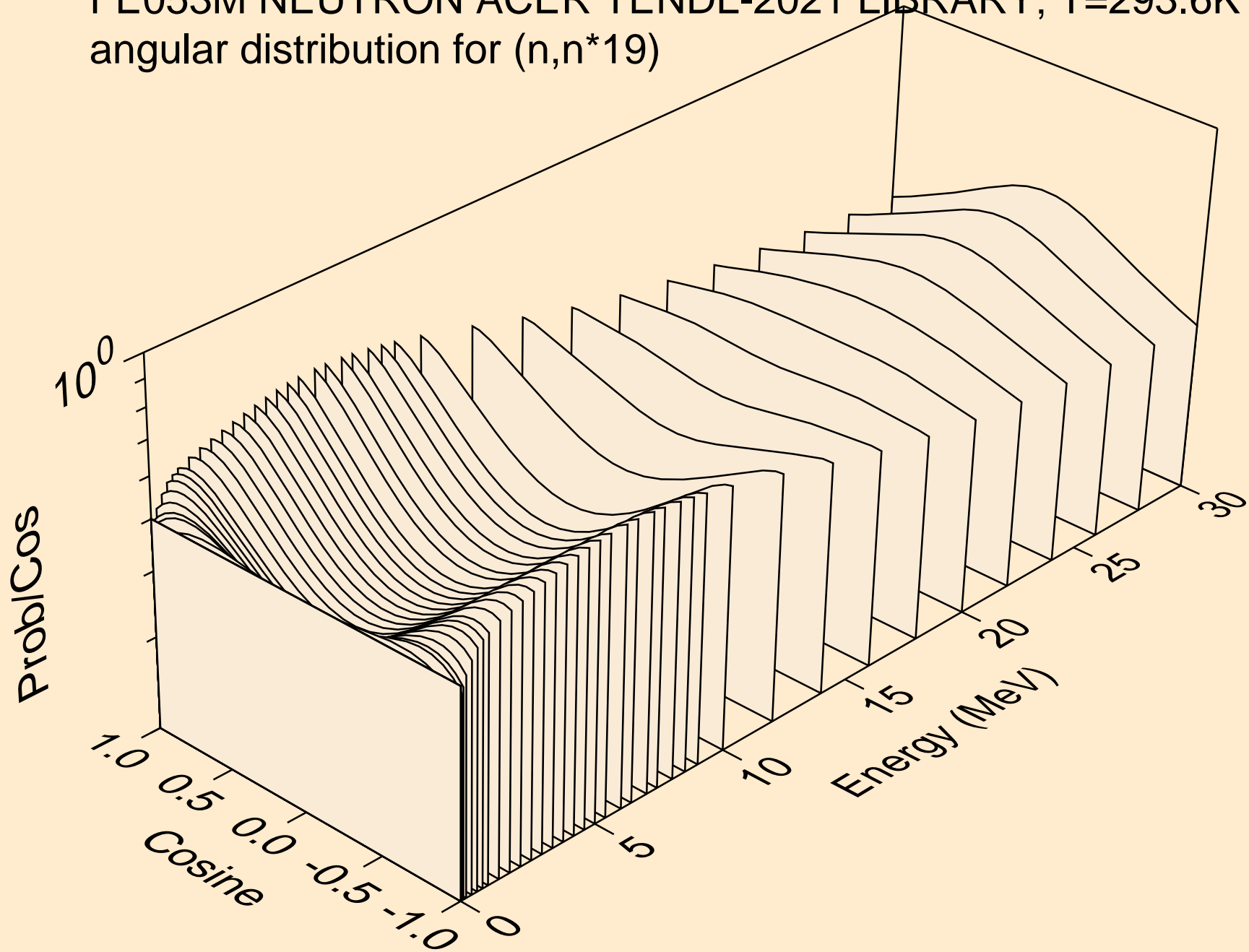

FE053M NEUTRON ACER TENDL-2021 LIBRARY; T=293.6K
angular distribution for (n,n*20)

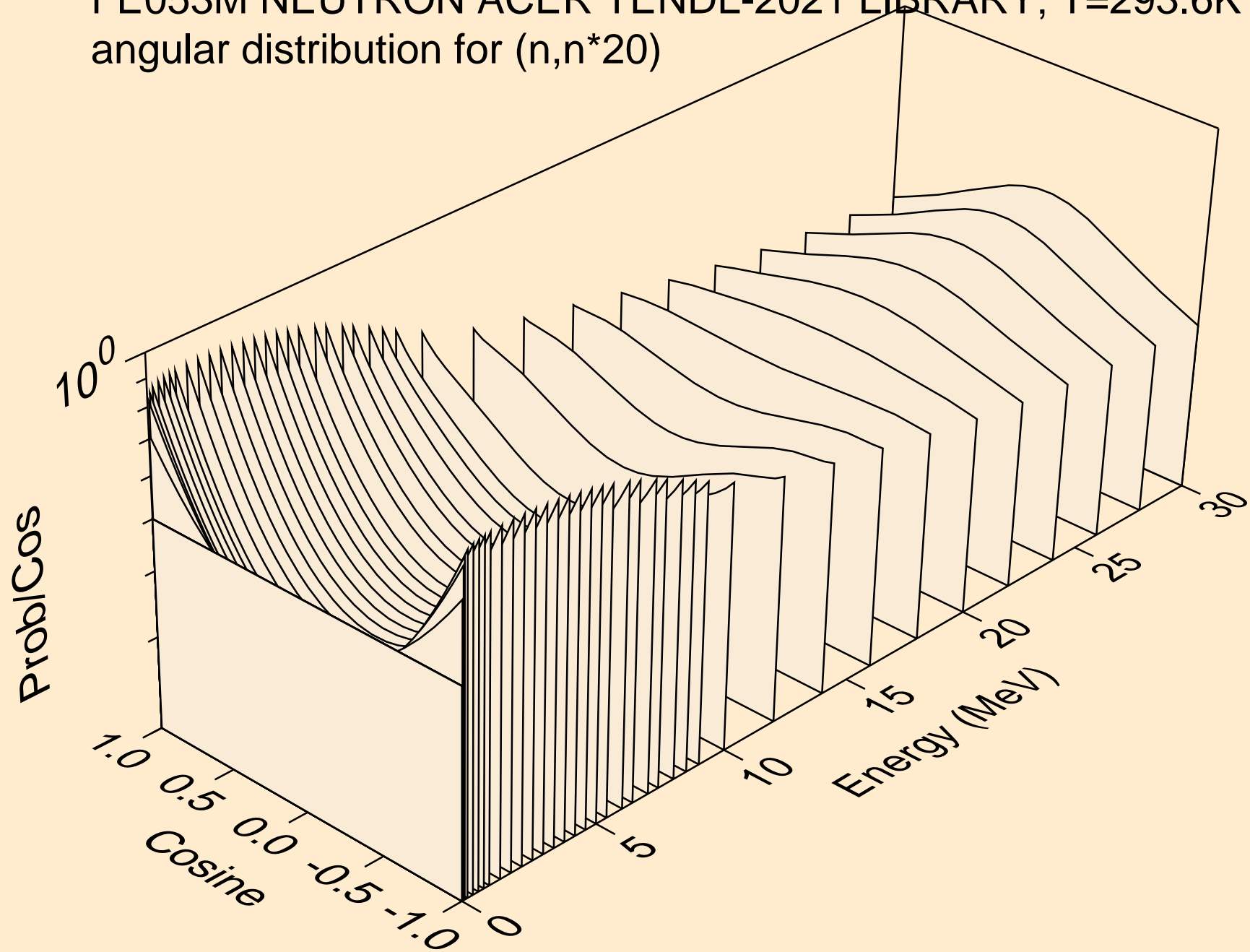

FE053M NEUTRON ACER TENDL-2021 LIBRARY; T=293.6K
angular distribution for (n,n*21)

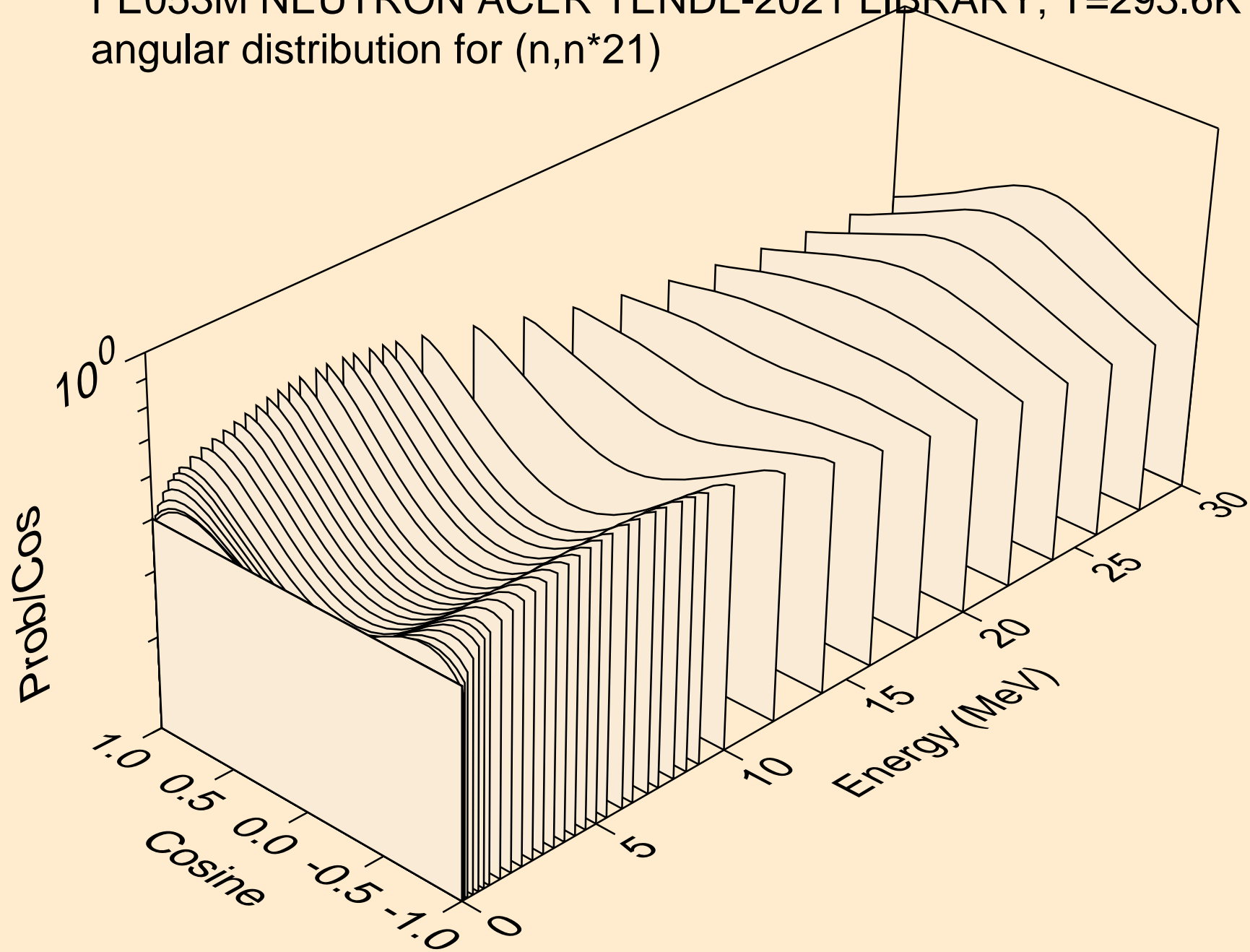

FE053M NEUTRON ACER TENDL-2021 LIBRARY; T=293.6K
angular distribution for (n,n*22)

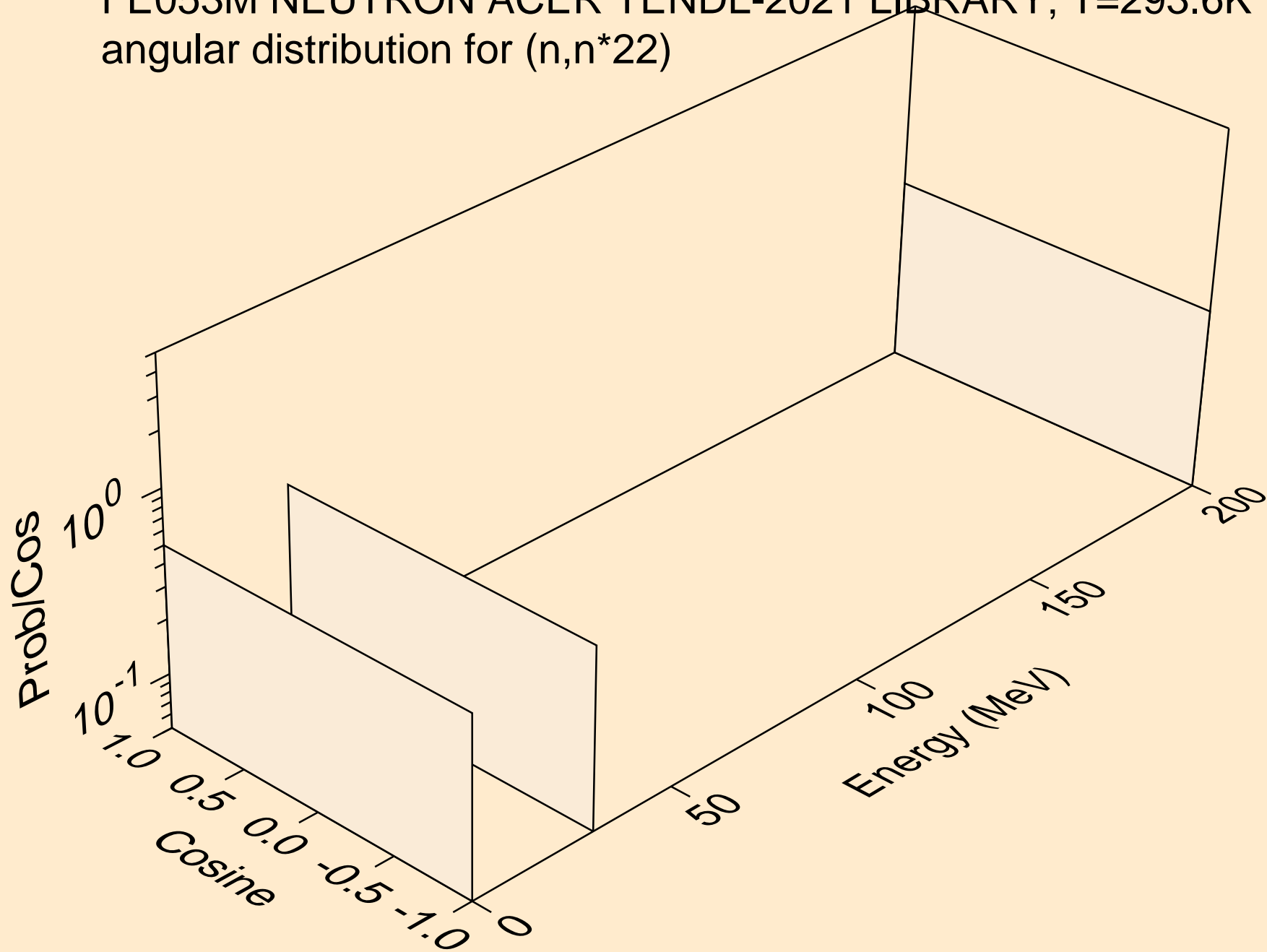

FE053M NEUTRON ACER TENDL-2021 LIBRARY; T=293.6K
angular distribution for (n,n*23)

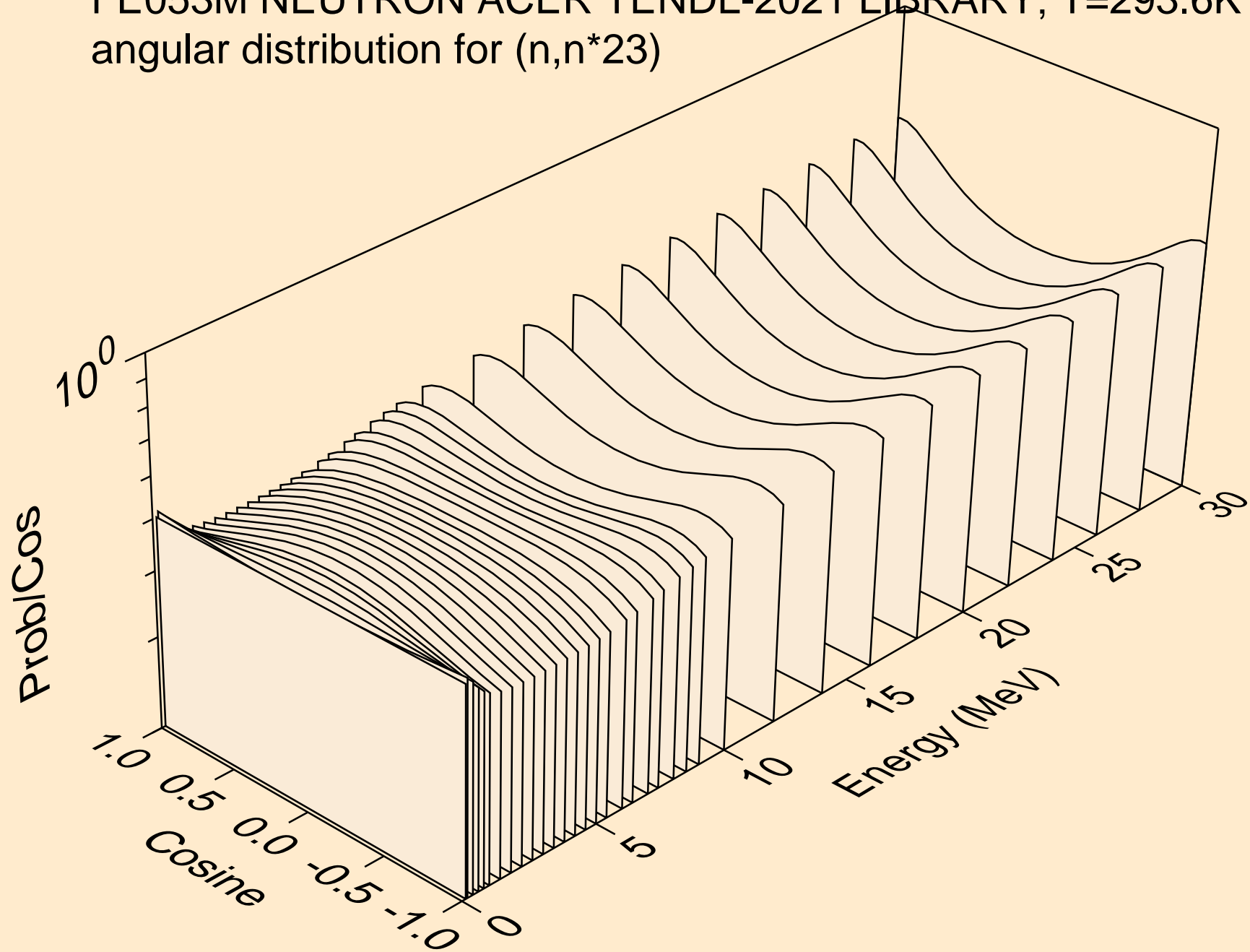

FE053M NEUTRON ACER TENDL-2021 LIBRARY; T=293.6K
angular distribution for (n,n*24)

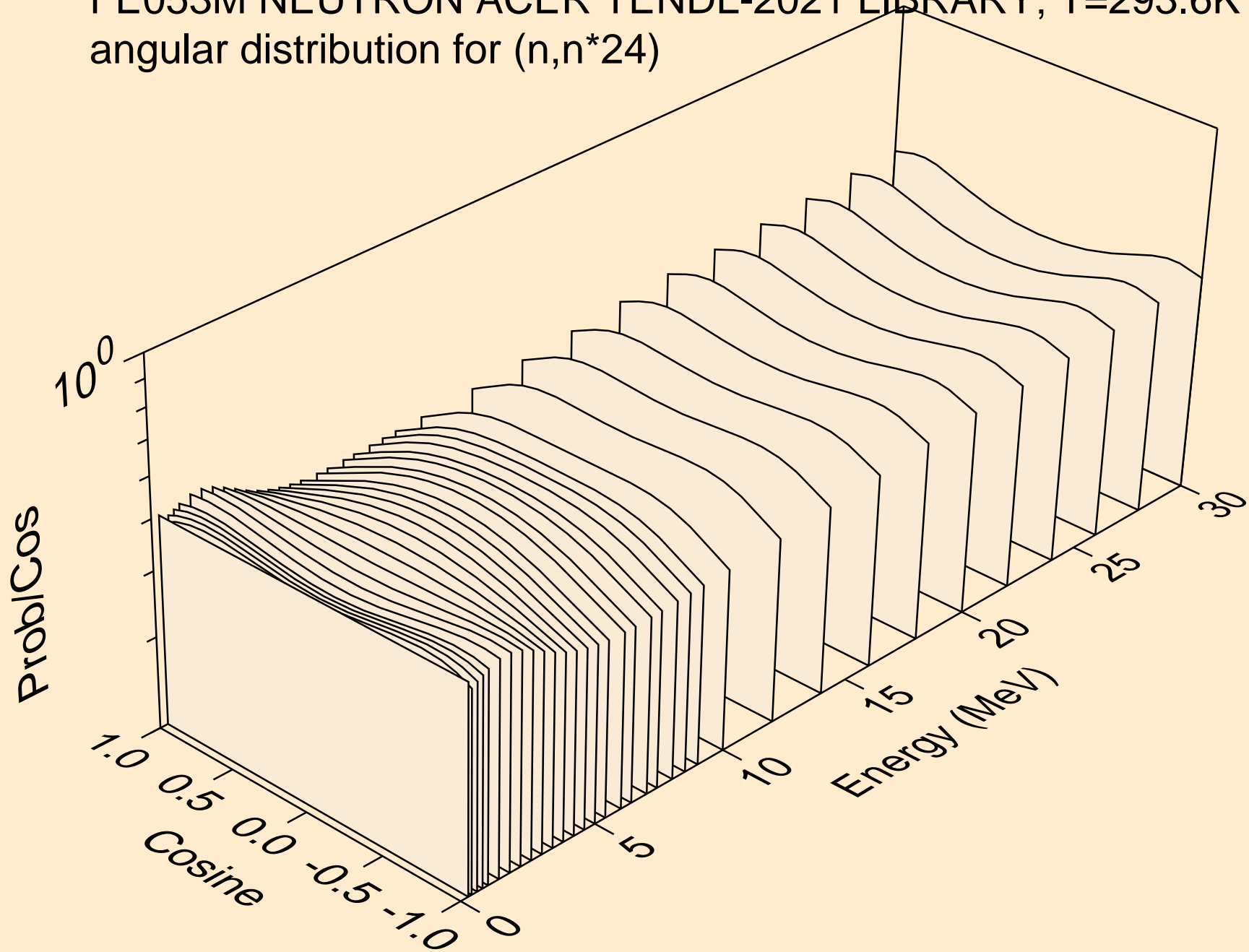

FE053M NEUTRON ACER TENDL-2021 LIBRARY; T=293.6K
angular distribution for (n,n*25)

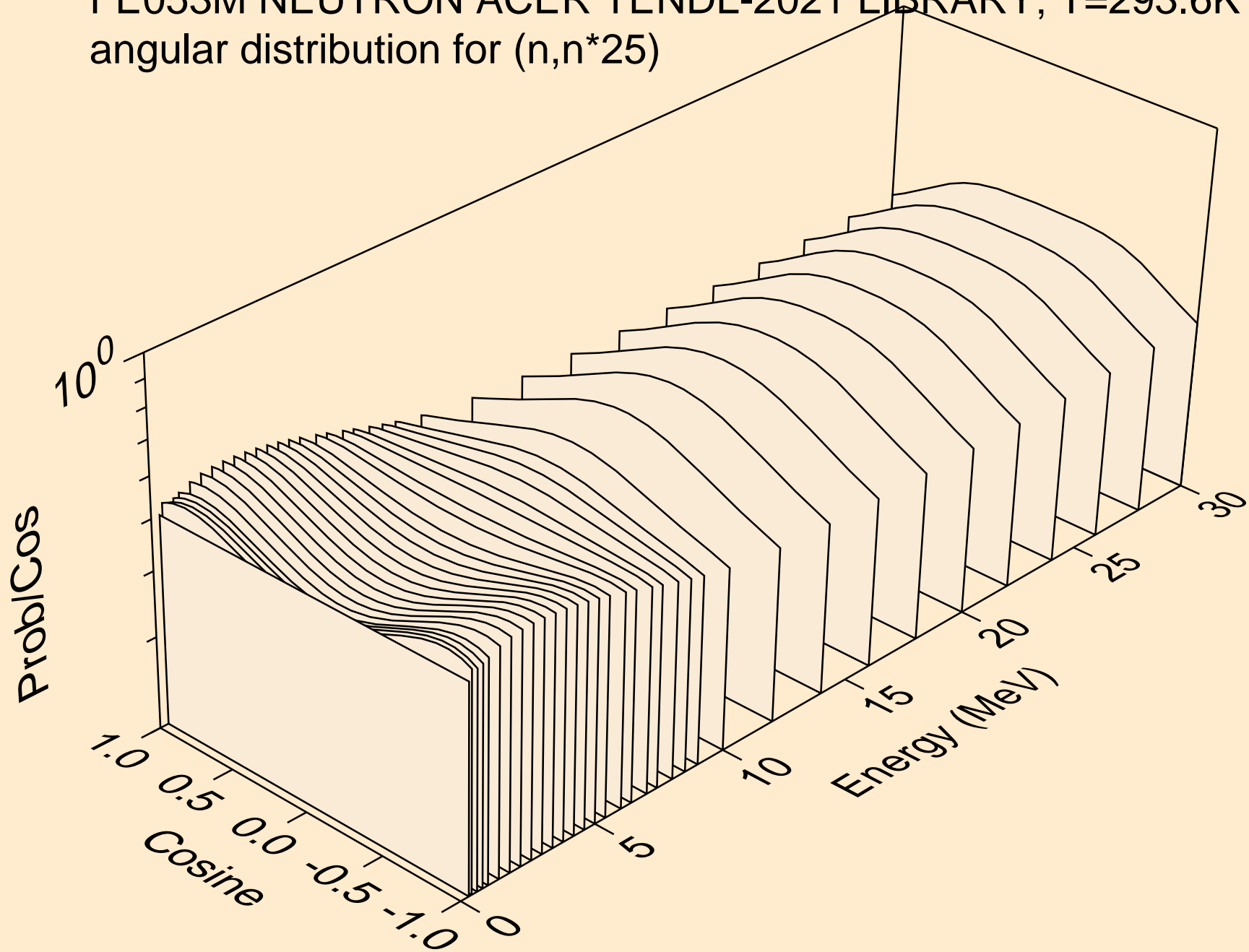

FE053M NEUTRON ACER TENDL-2021 LIBRARY; T=293.6K
angular distribution for (n,n*26)

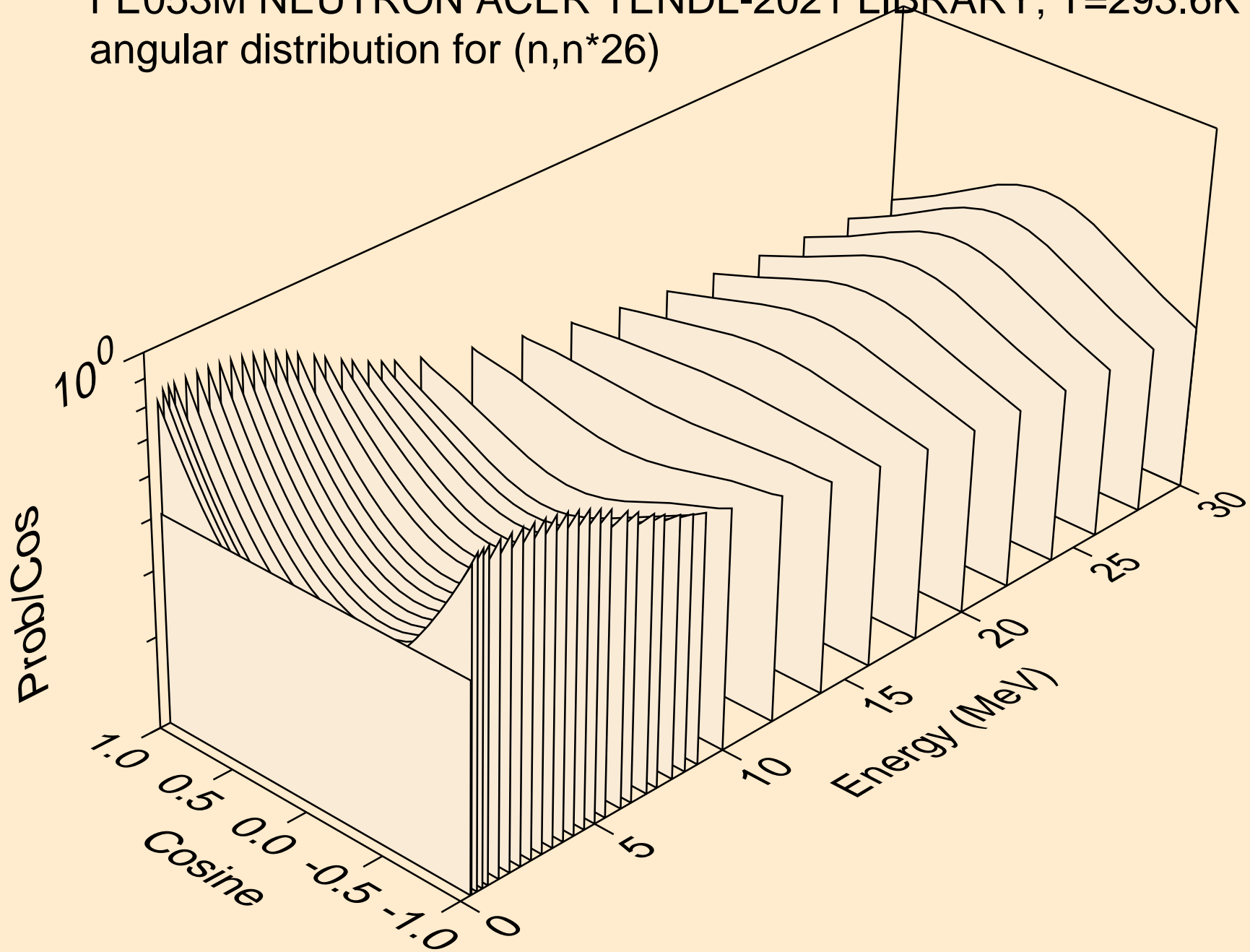

FE053M NEUTRON ACER TENDL-2021 LIBRARY; T=293.6K
angular distribution for (n,n*27)

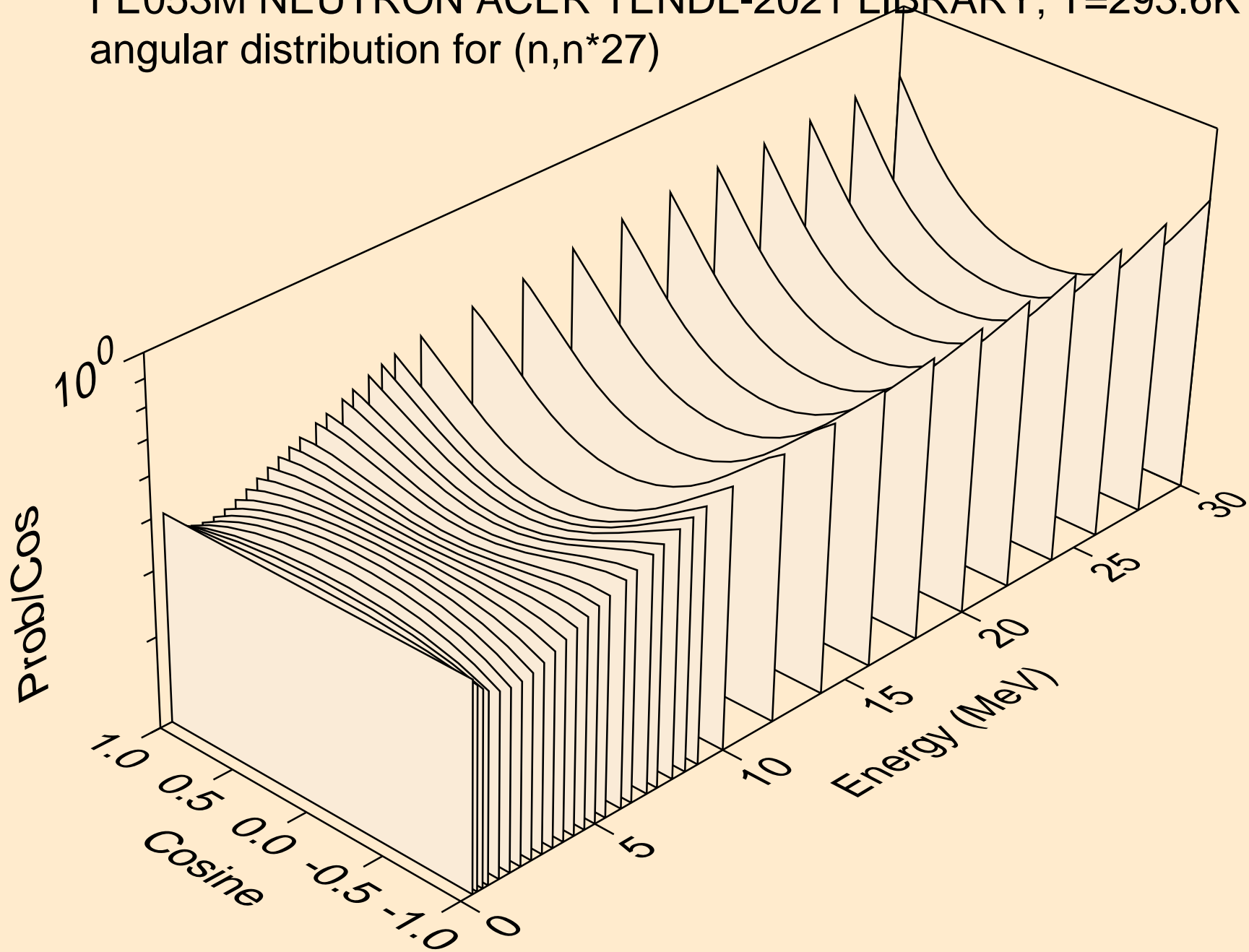

FE053M NEUTRON ACER TENDL-2021 LIBRARY; T=293.6K
angular distribution for (n,n*28)

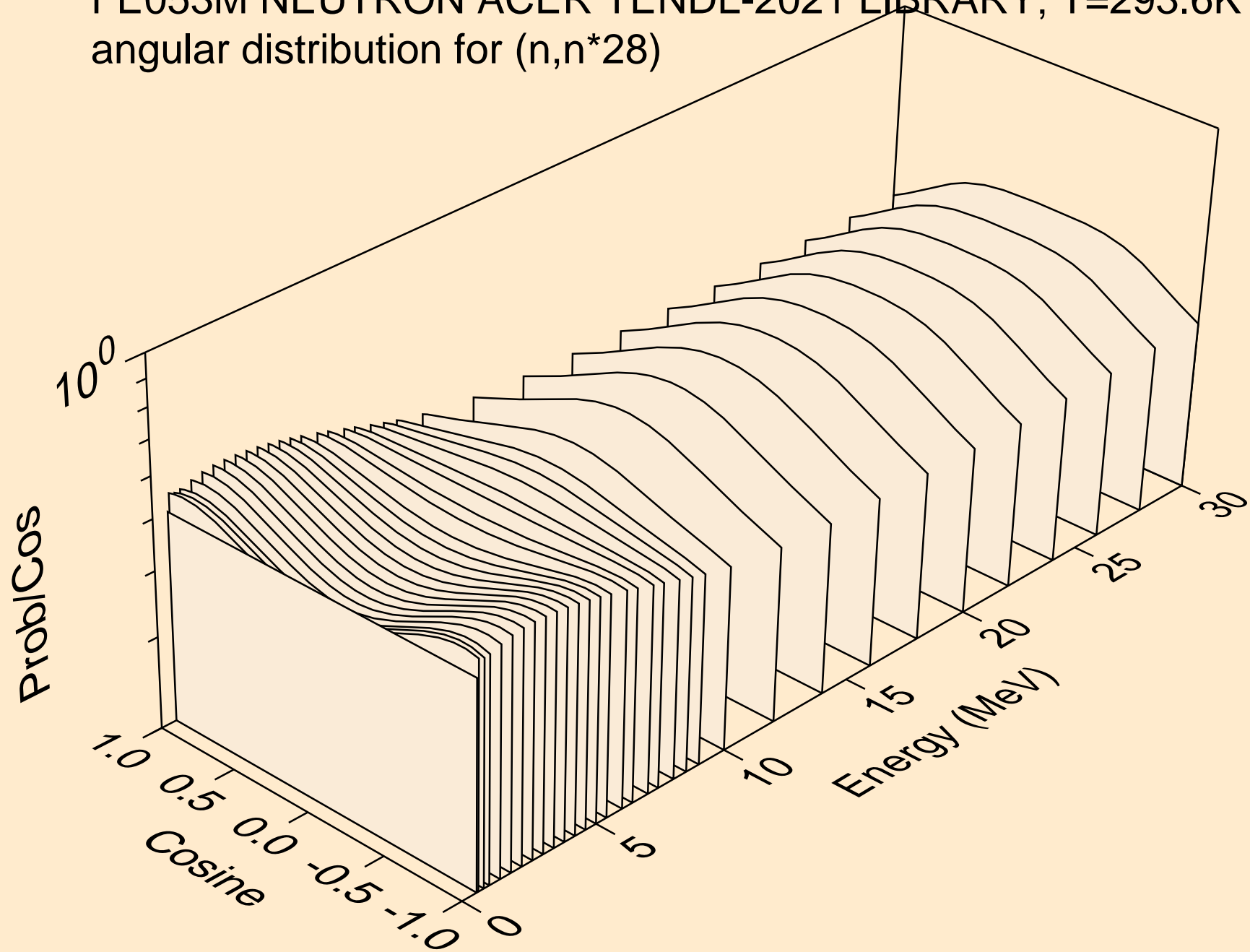

FE053M NEUTRON ACER TENDL-2021 LIBRARY; T=293.6K
angular distribution for (n,n*29)

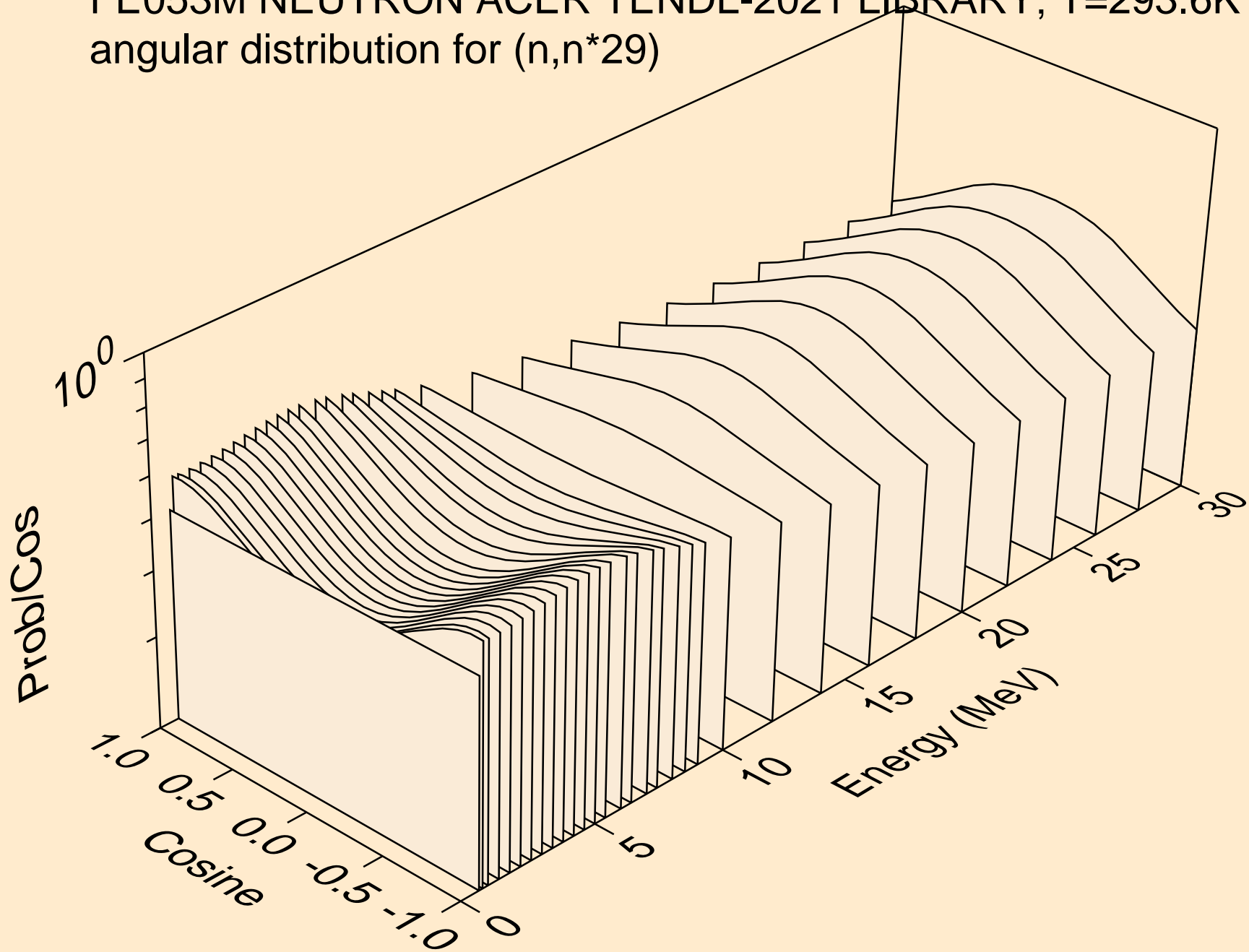

FE053M NEUTRON ACER TENDL-2021 LIBRARY; T=293.6K
angular distribution for (n,n*30)

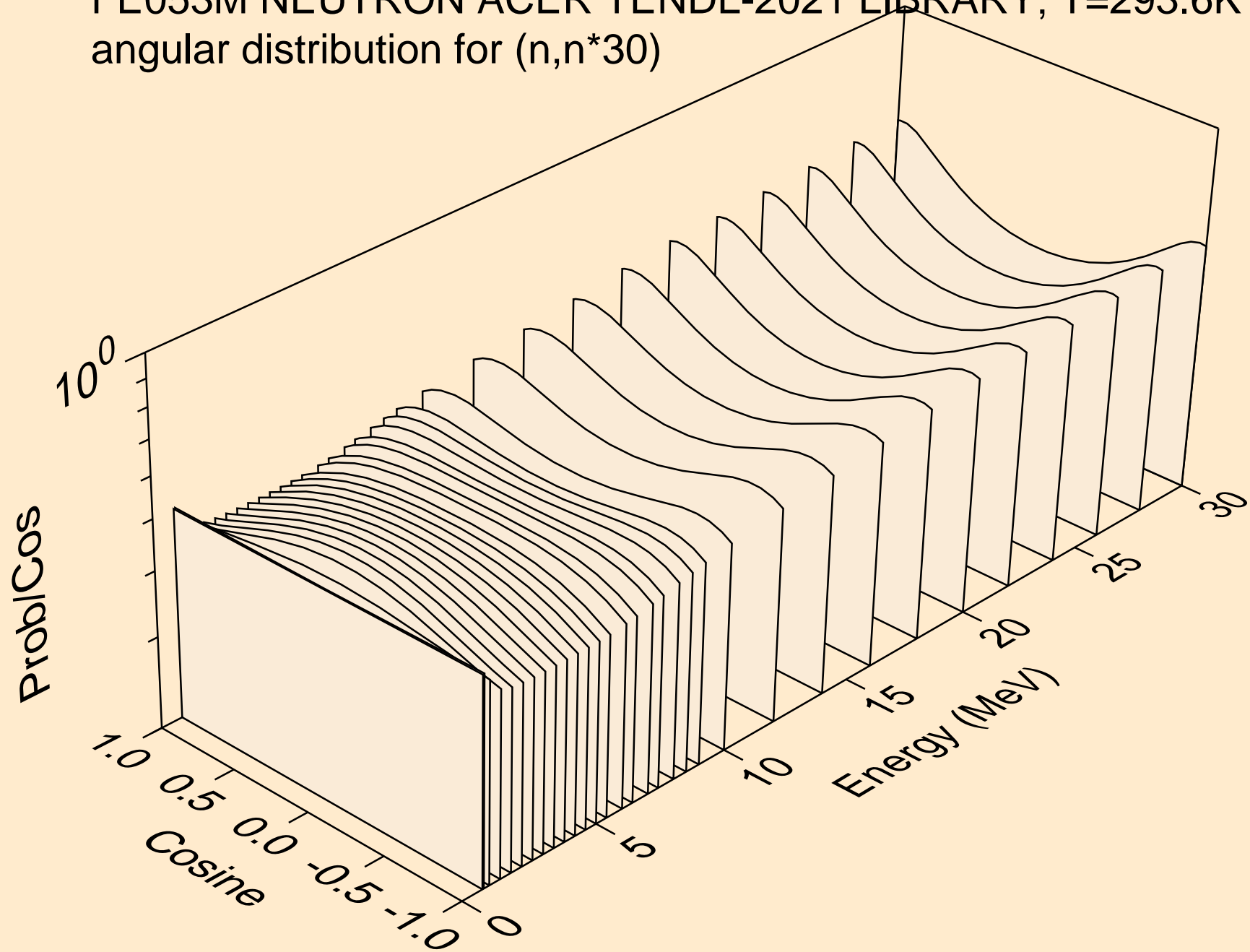

FE053M NEUTRON ACER TENDL-2021 LIBRARY; T=293.6K
Neutron emission for (n,x)

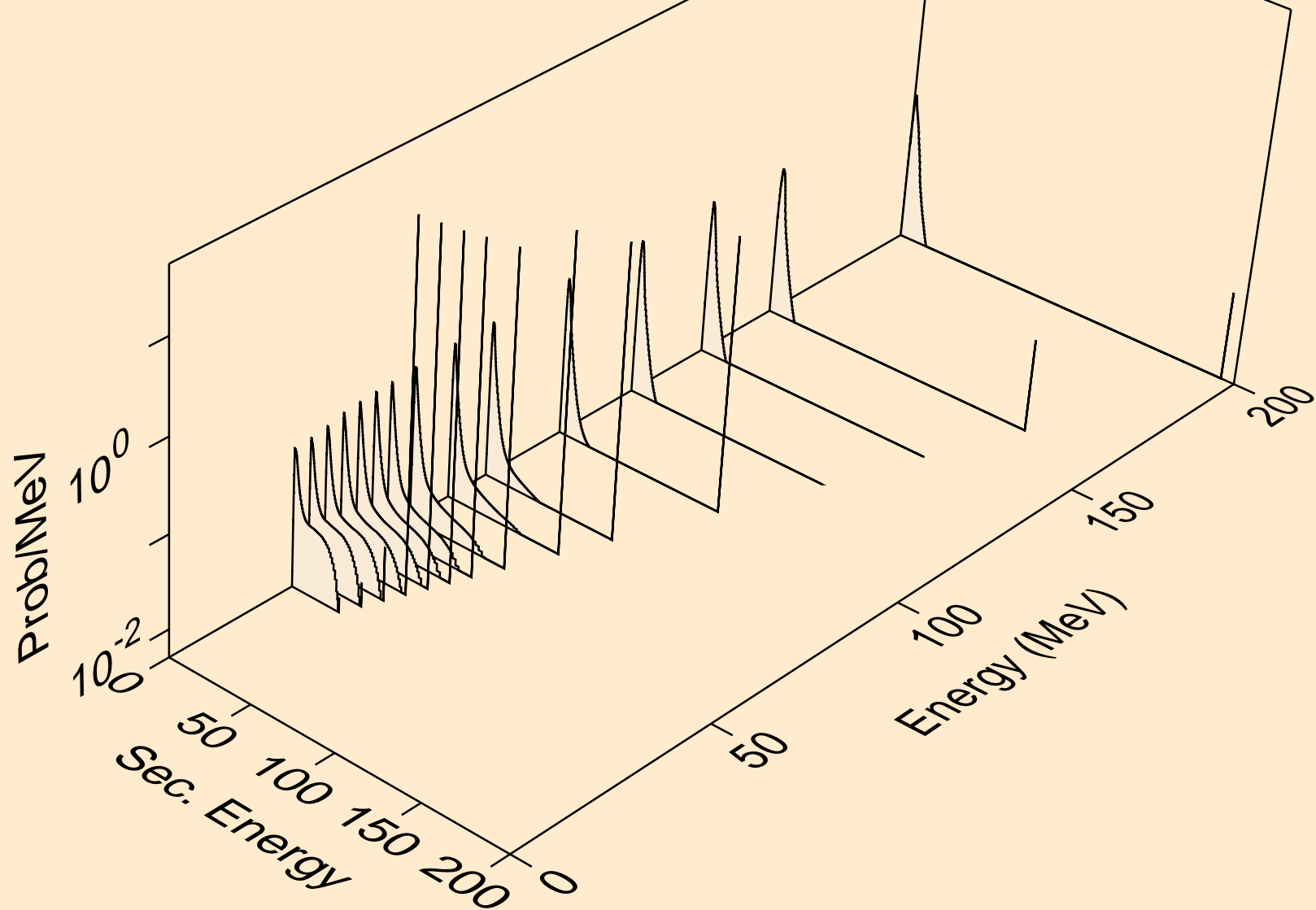

FE053M NEUTRON ACER TENDL-2021 LIBRARY; T=293.6K
Neutron emission for (n,2nd)

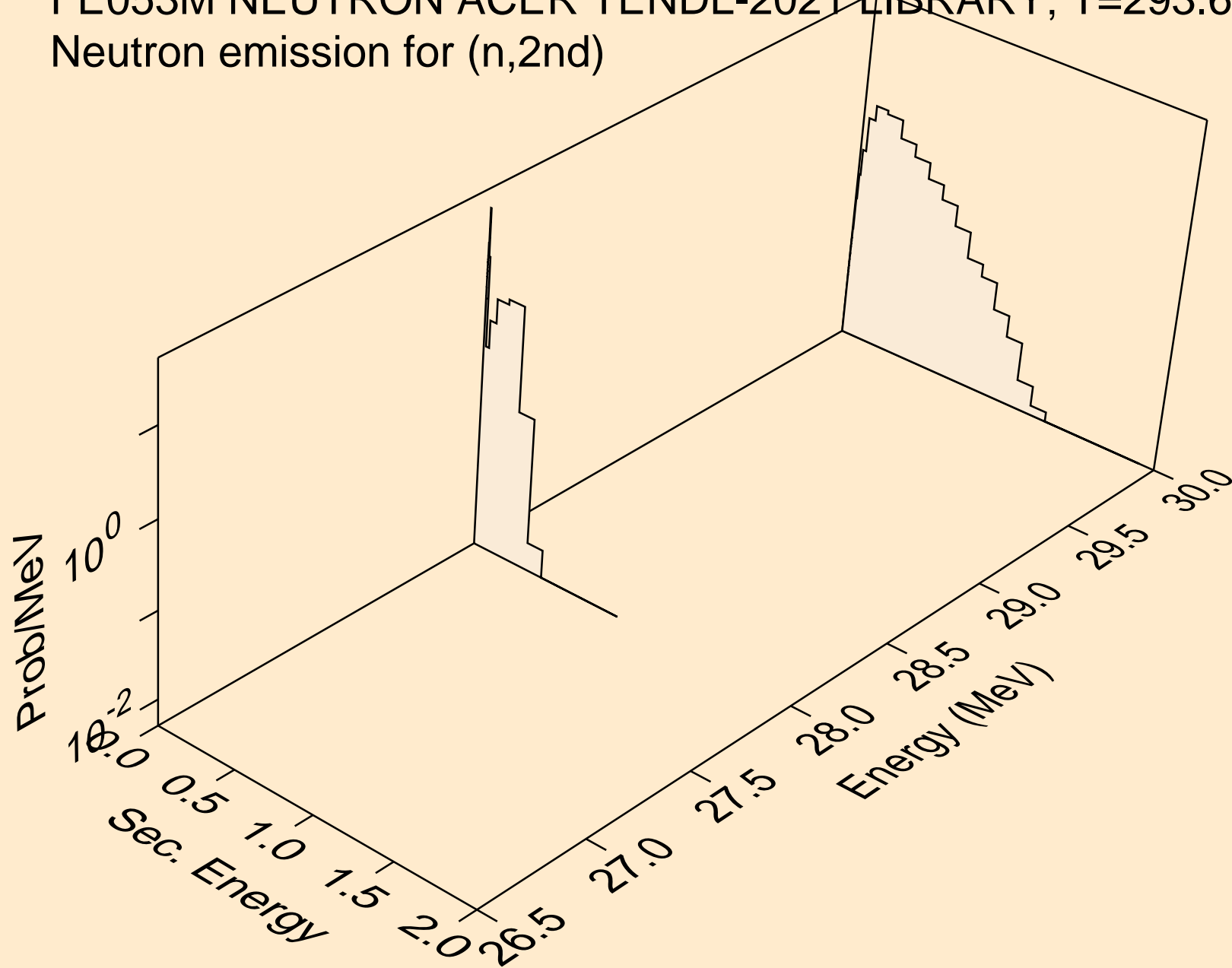

FE053M NEUTRON ACER TENDL-2021 LIBRARY; T=293.6K
Neutron emission for (n,2n)

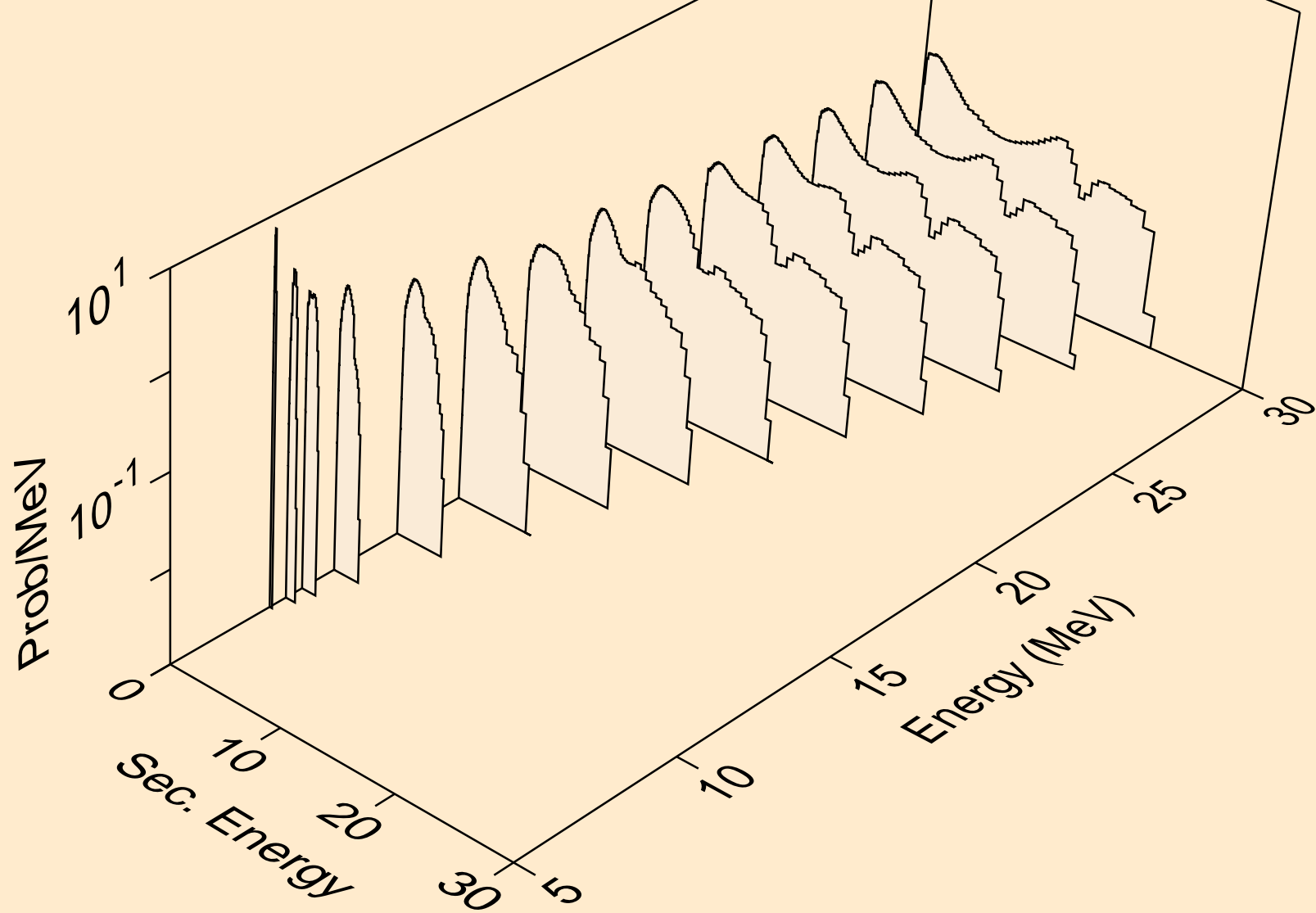

FE053M NEUTRON ACER TENDL-2021 LIBRARY; T=293.6K
Neutron emission for (n,3n)

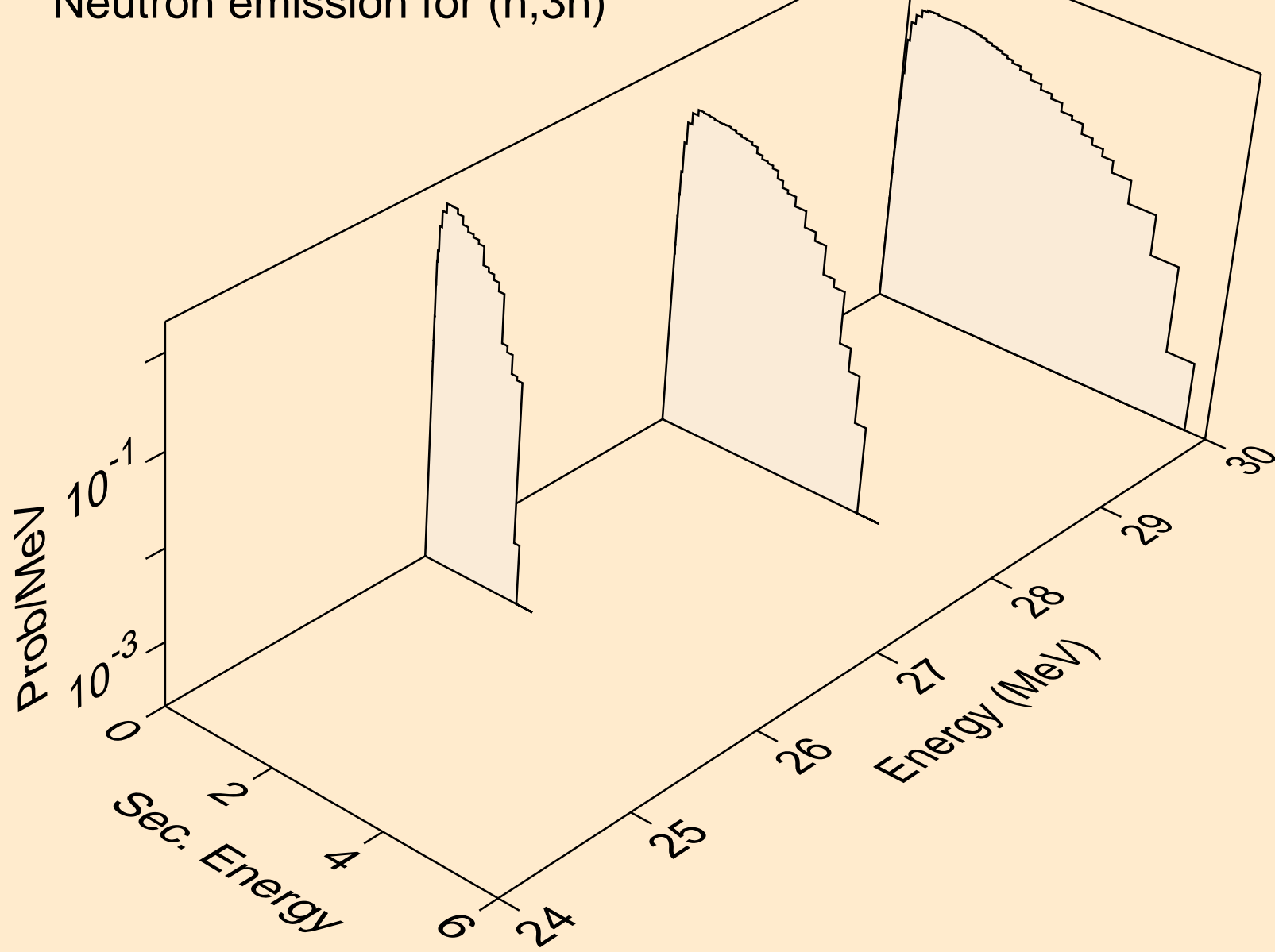

FE053M NEUTRON ACER TENDL-2021 LIBRARY; T=293.6K
Neutron emission for (n,n*)a

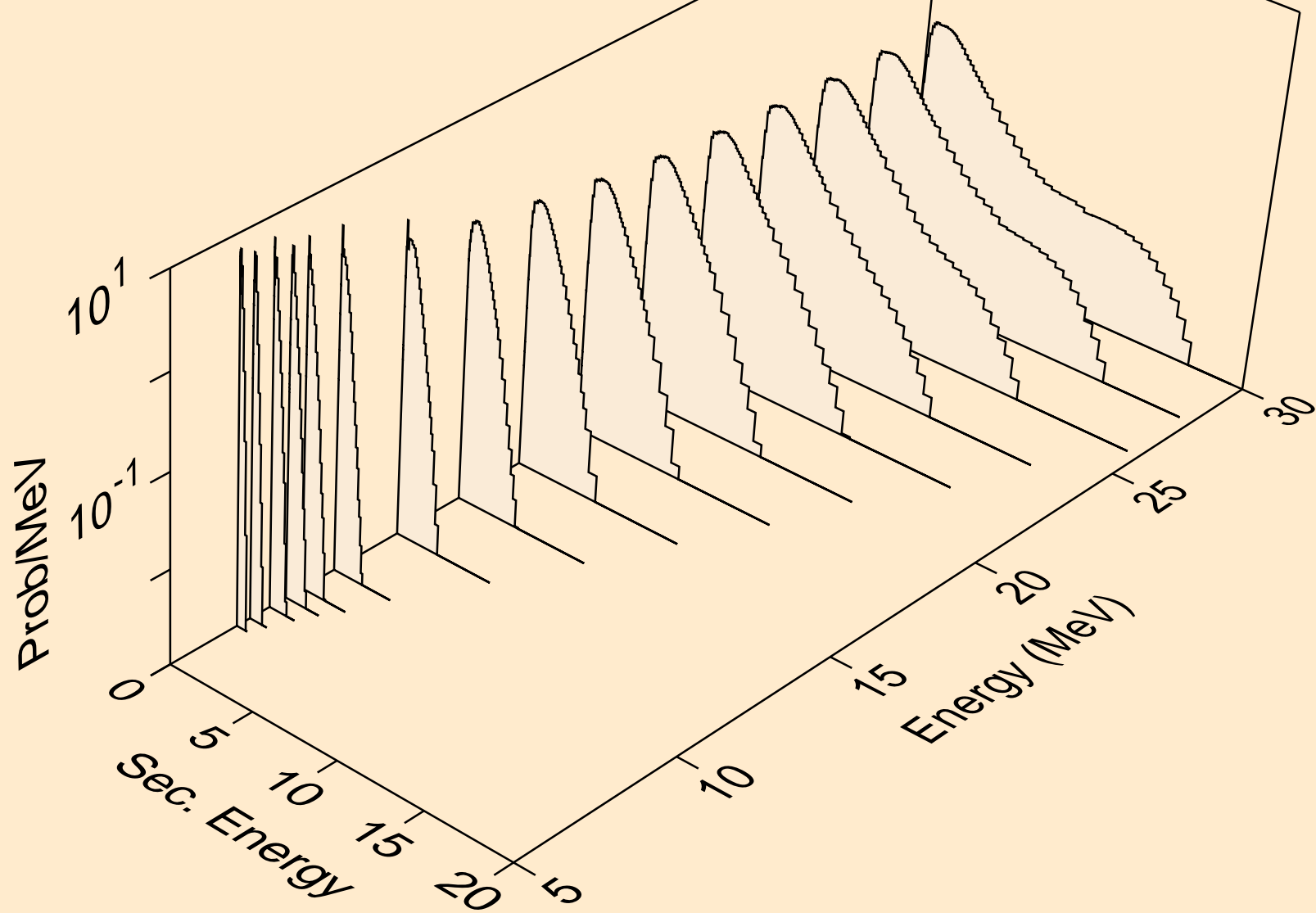

FE053M NEUTRON ACER TENDL-2021 LIBRARY; T=293.6K
Neutron emission for (n,2n)_a

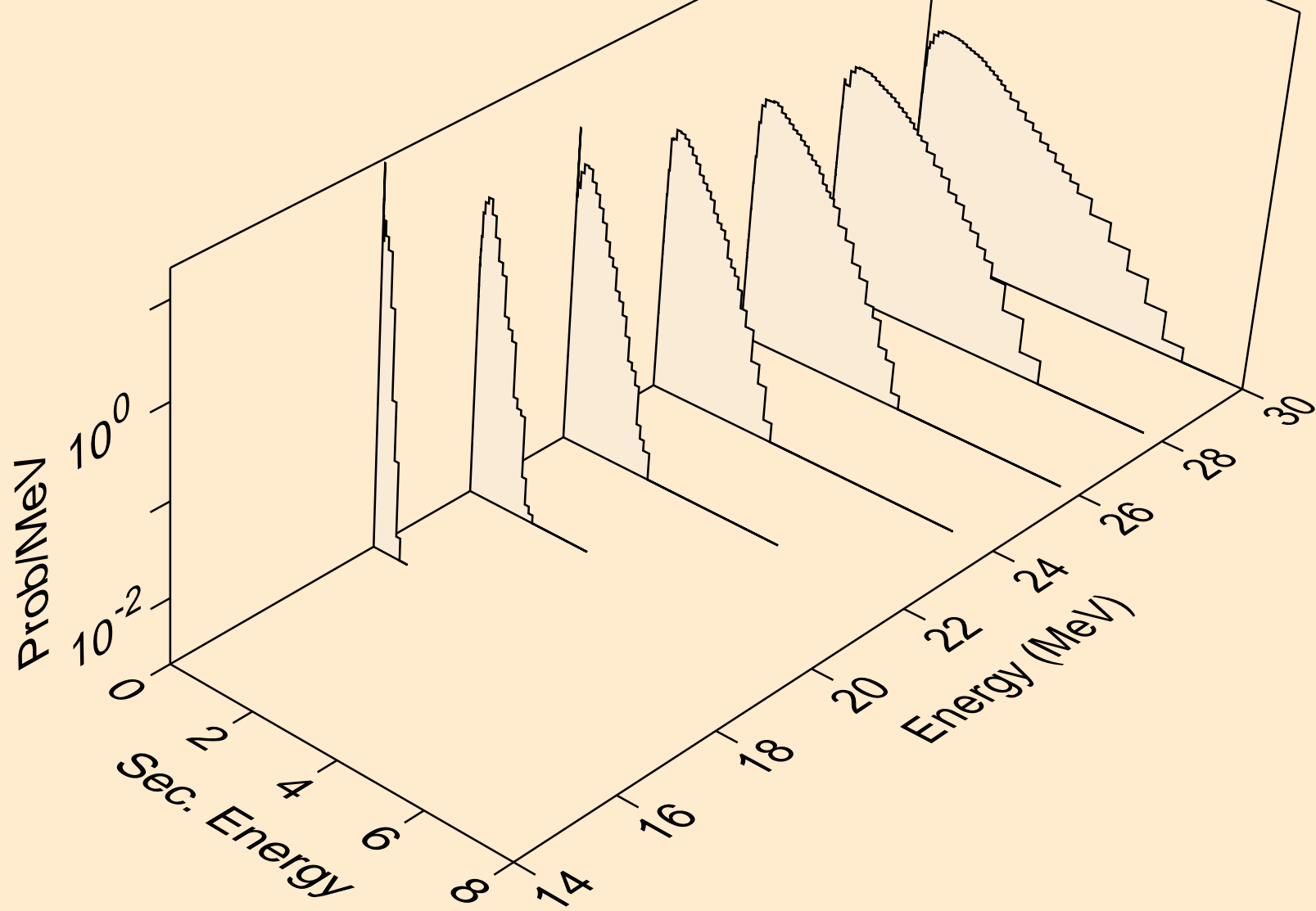

FE053M NEUTRON ACER TENDL-2021 LIBRARY; T=293.6K
Neutron emission for (n,n*)p

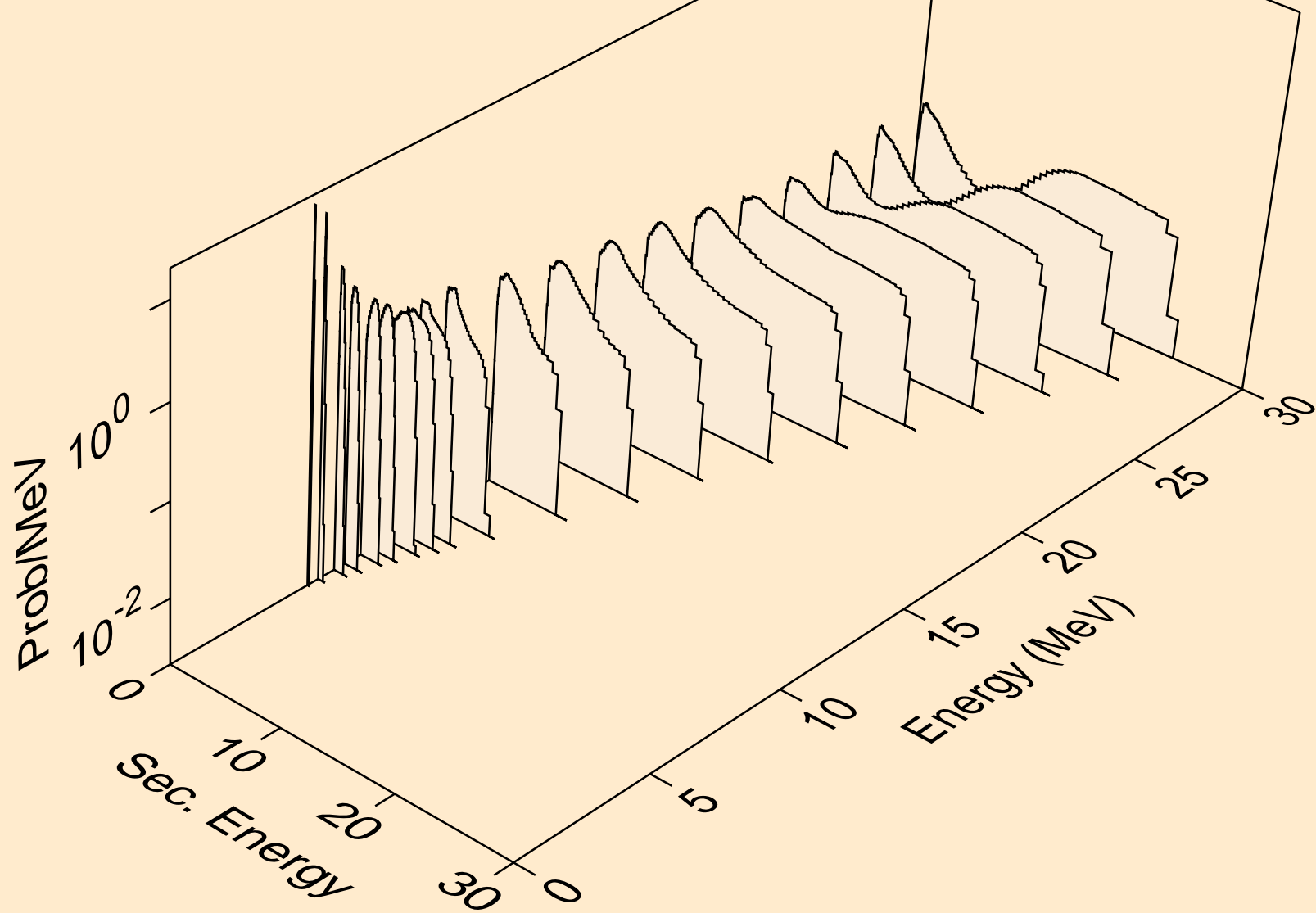

FE053M NEUTRON ACER TENDL-2021 LIBRARY; T=293.6K
Neutron emission for (n,n*)2a

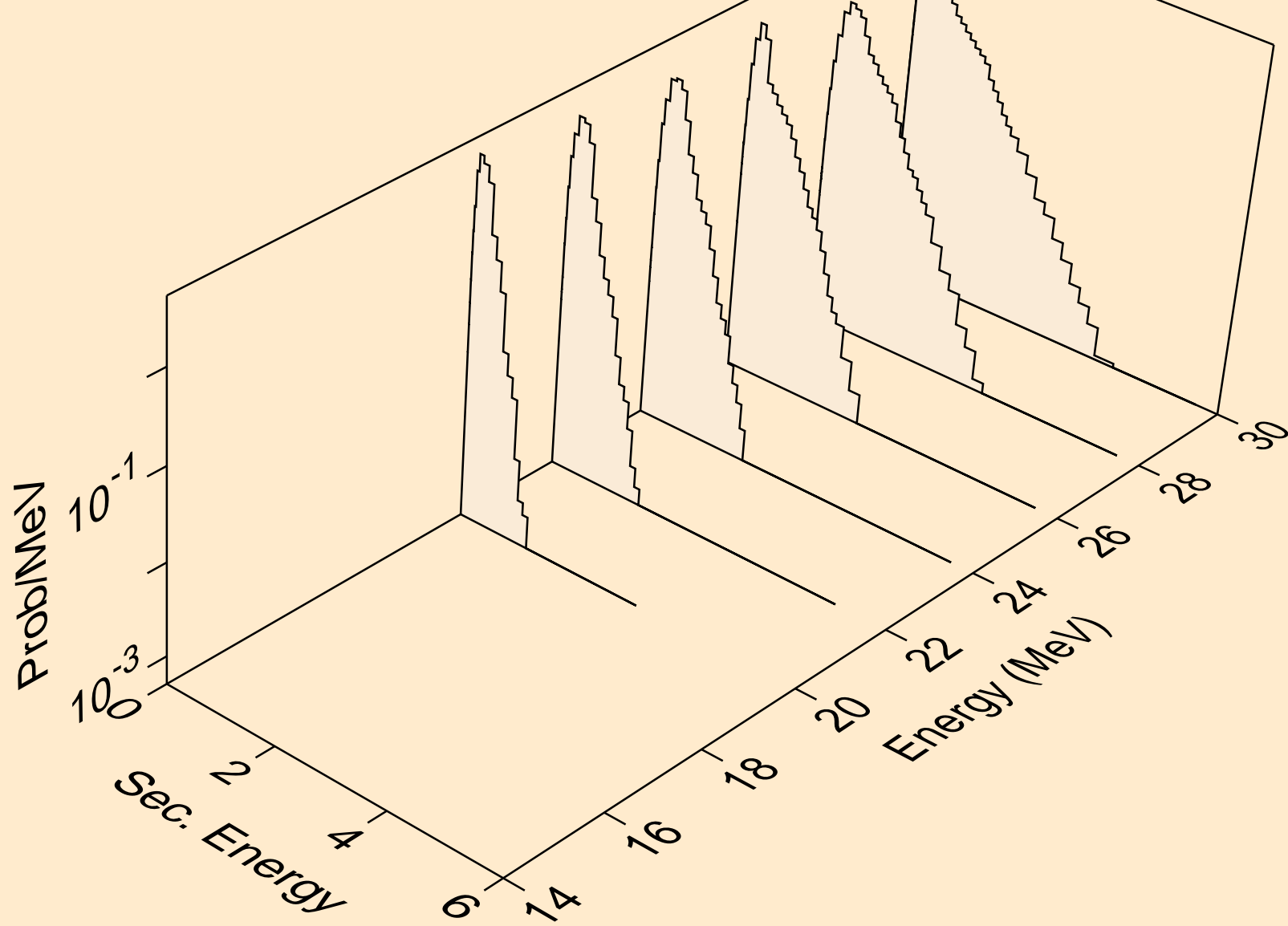

FE053M NEUTRON ACER TENDL-2021 LIBRARY; T=293.6K
Neutron emission for (n,n*)d

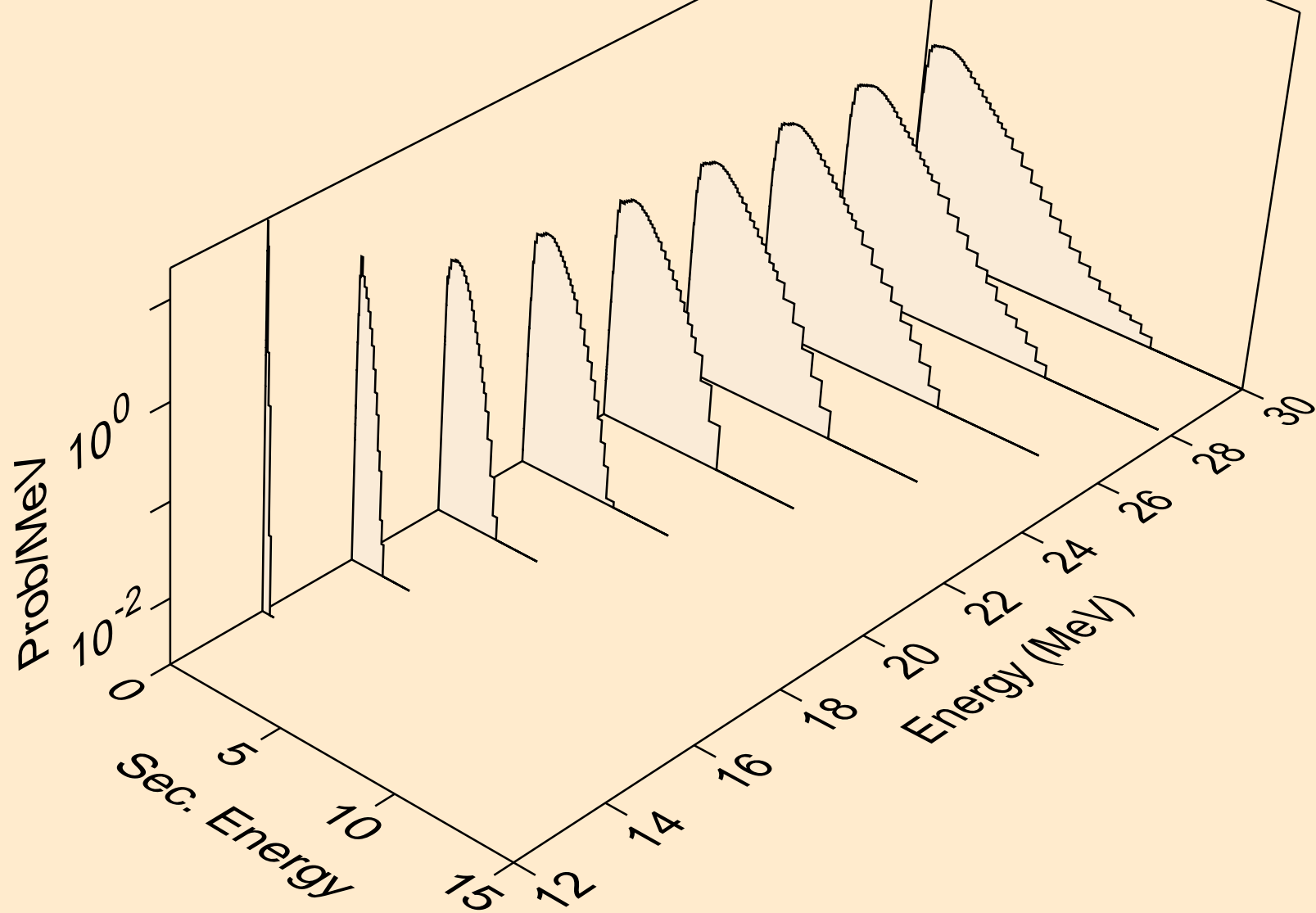

FE053M NEUTRON ACER TENDL-2021 LIBRARY; T=293.6K
Neutron emission for (n,n*)t

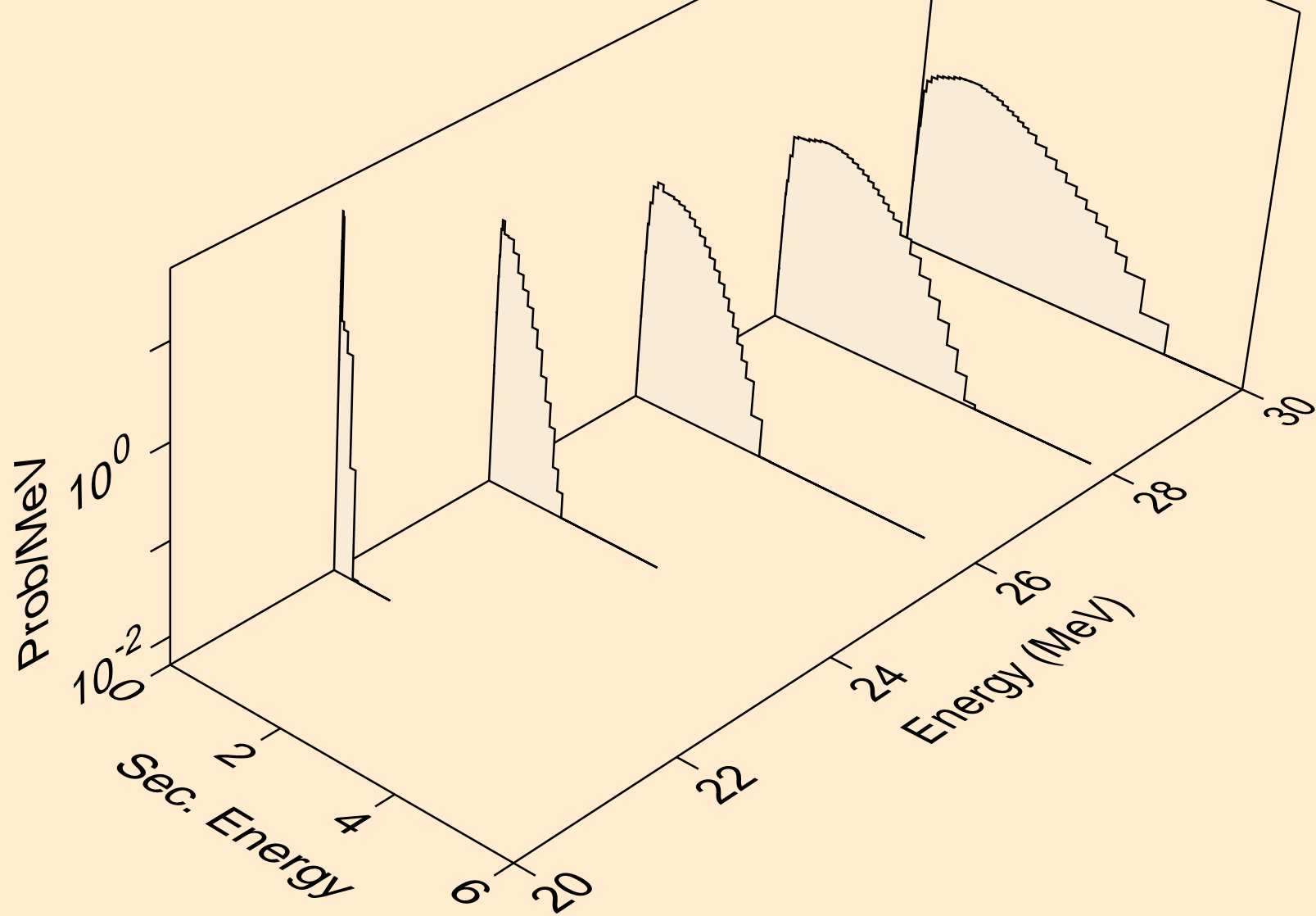

FE053M NEUTRON ACER TENDL-2021 LIBRARY; T=293.6K
Neutron emission for (n,n*)he3

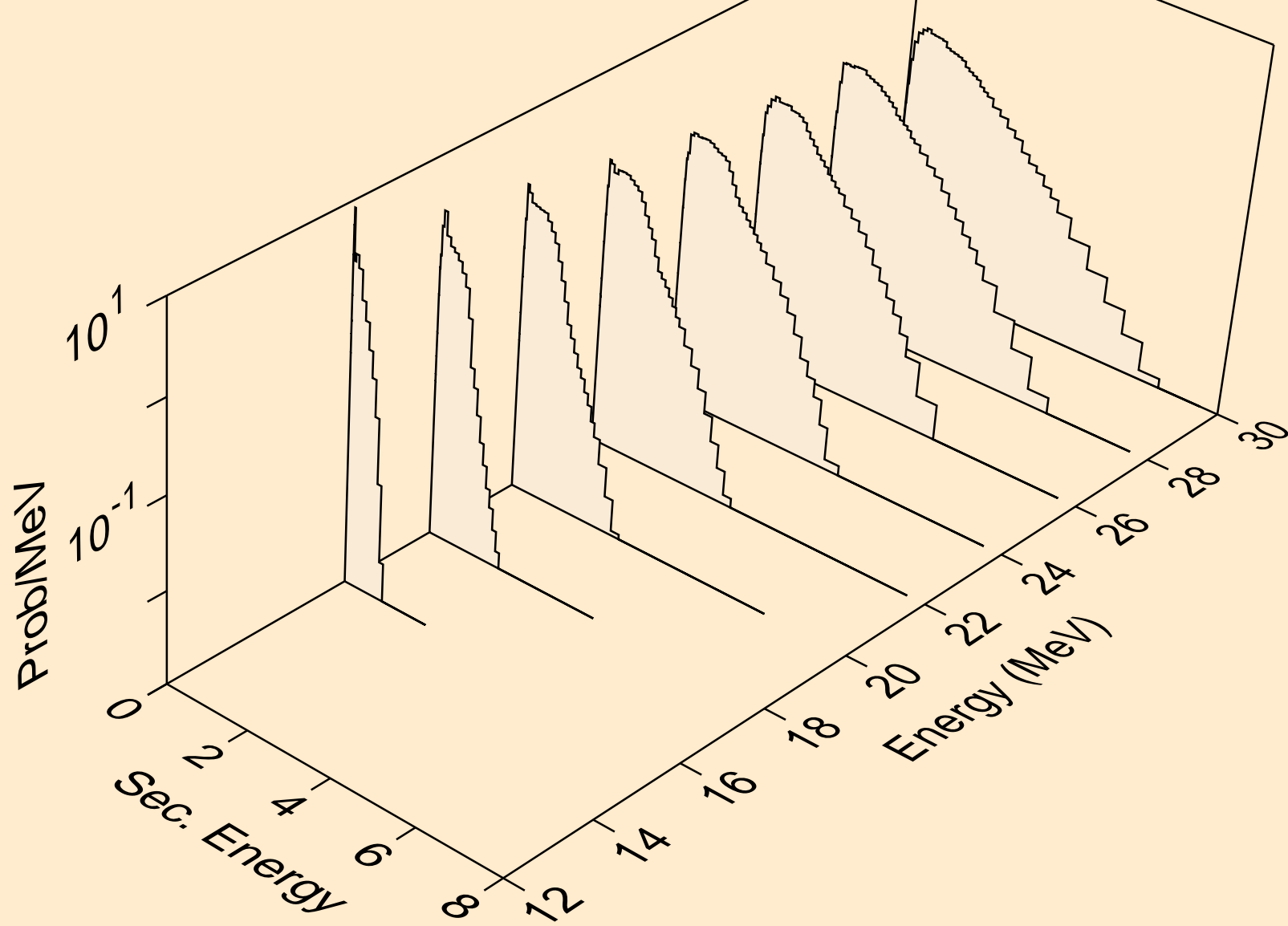

FE053M NEUTRON ACER TENDL-2021 LIBRARY; T=293.6K
Neutron emission for (n,2np)

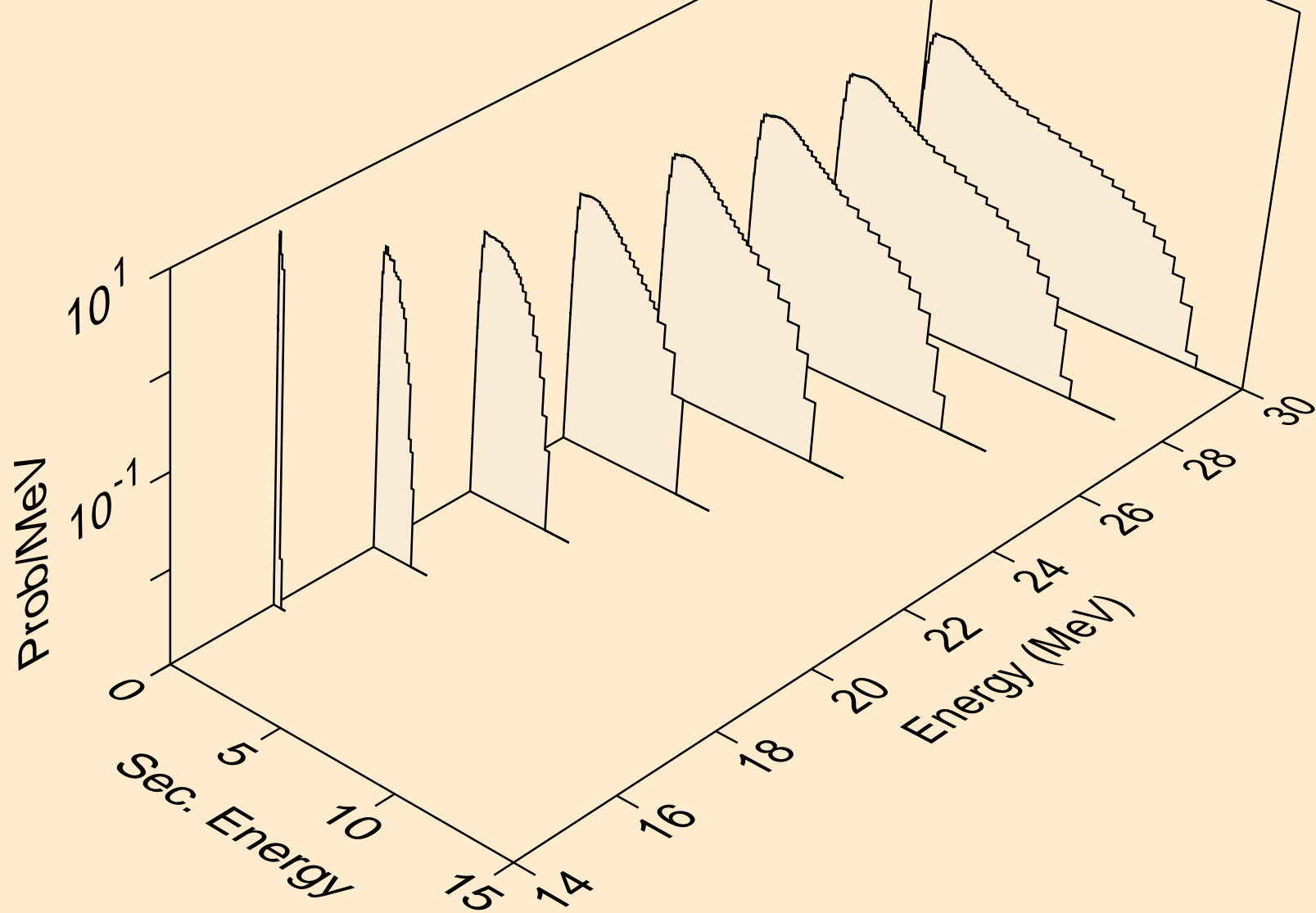

FE053M NEUTRON ACER TENDL-2021 LIBRARY; T=293.6K
Neutron emission for (n,2np)

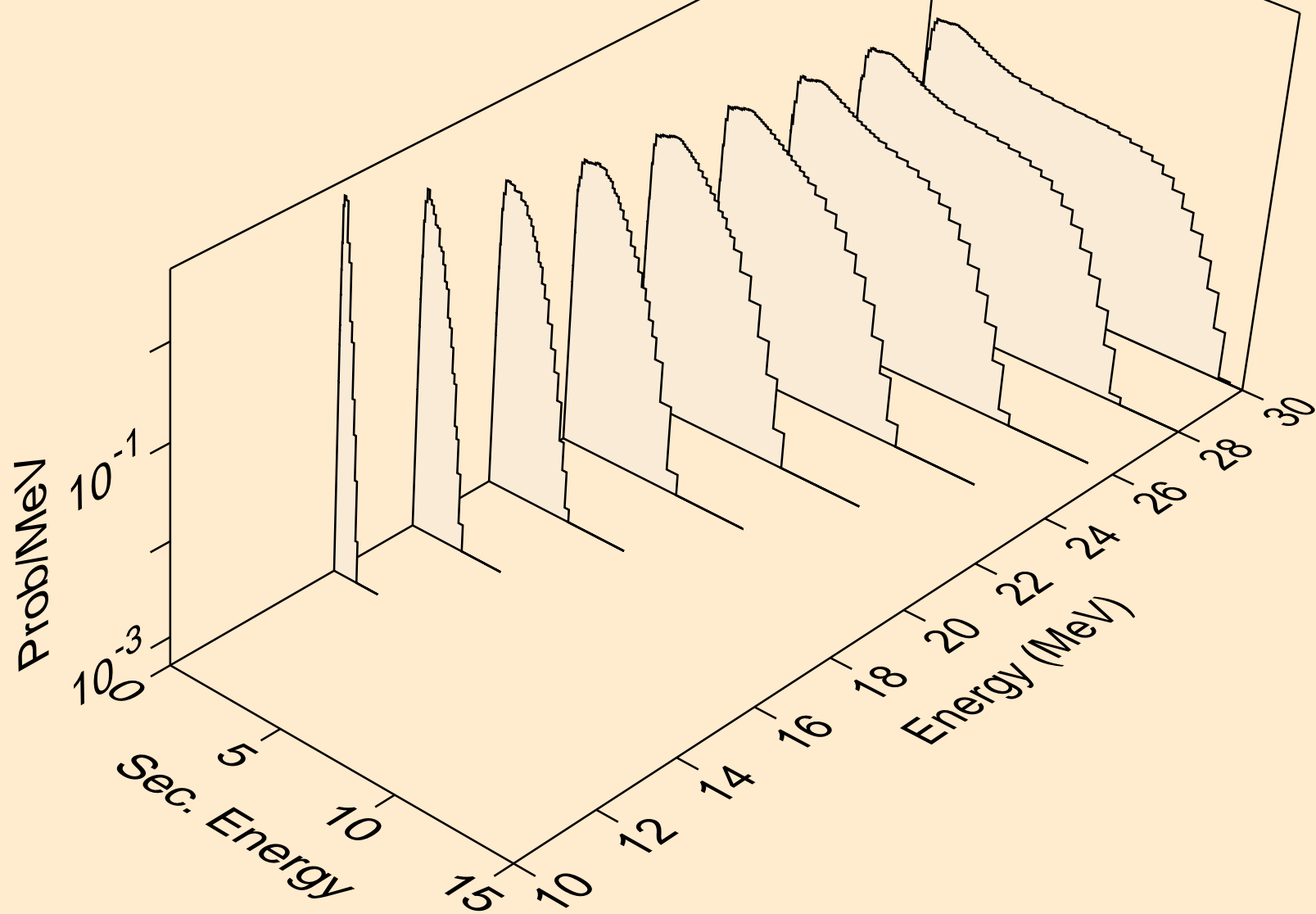

FE053M NEUTRON ACER TENDL-2021 LIBRARY; T=293.6K
Neutron emission for (n,npa)

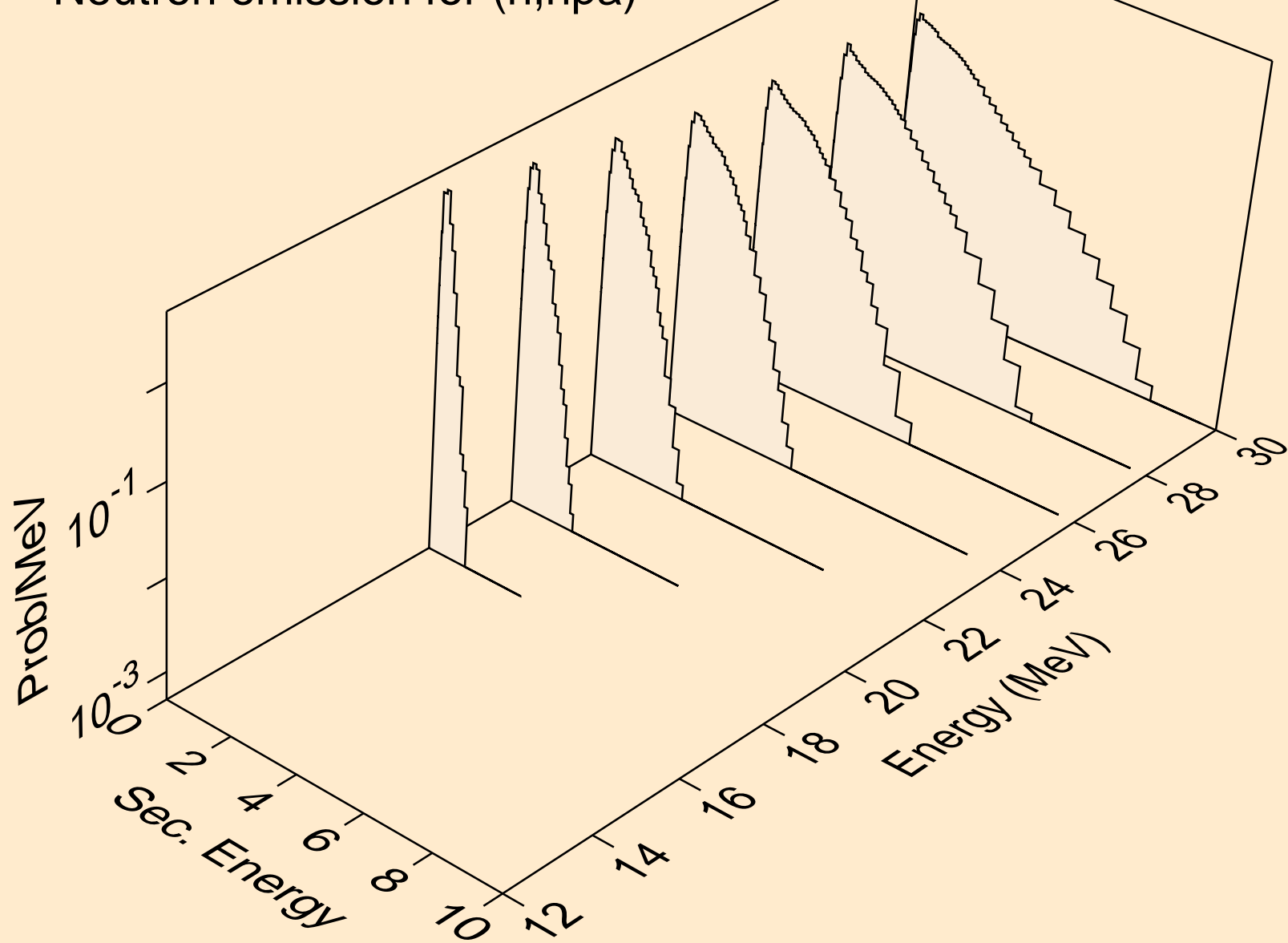

FE053M NEUTRON ACER TENDL-2021 LIBRARY; T=293.6K
Neutron emission for (n,n*c)

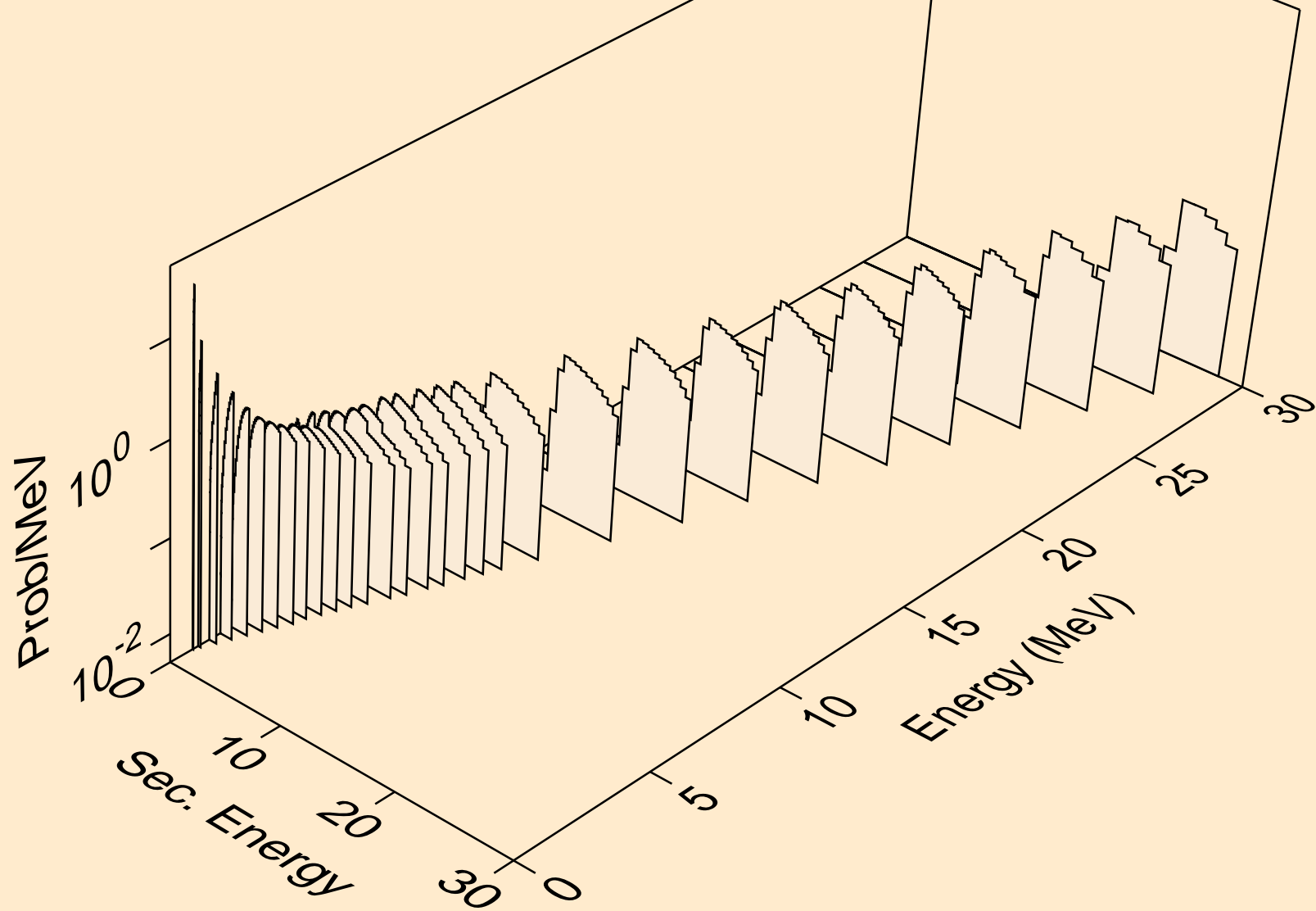

FE053M NEUTRON ACER TENDL-2021 LIBRARY; T=293.6K
Photon emission for (n,x)

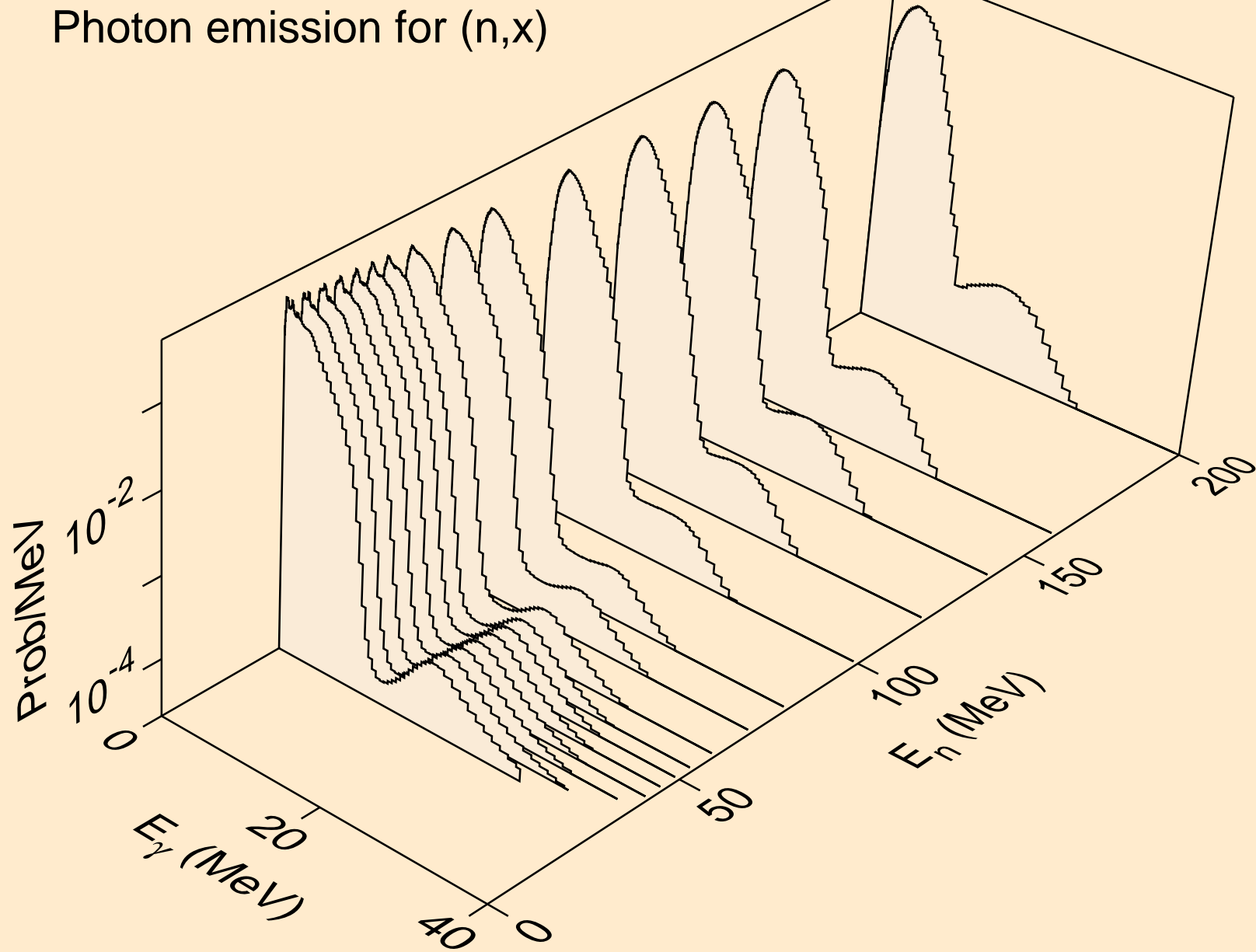

FE053M NEUTRON ACER TENDL-2021 LIBRARY; T=293.6K
Photon emission for (n,2nd)

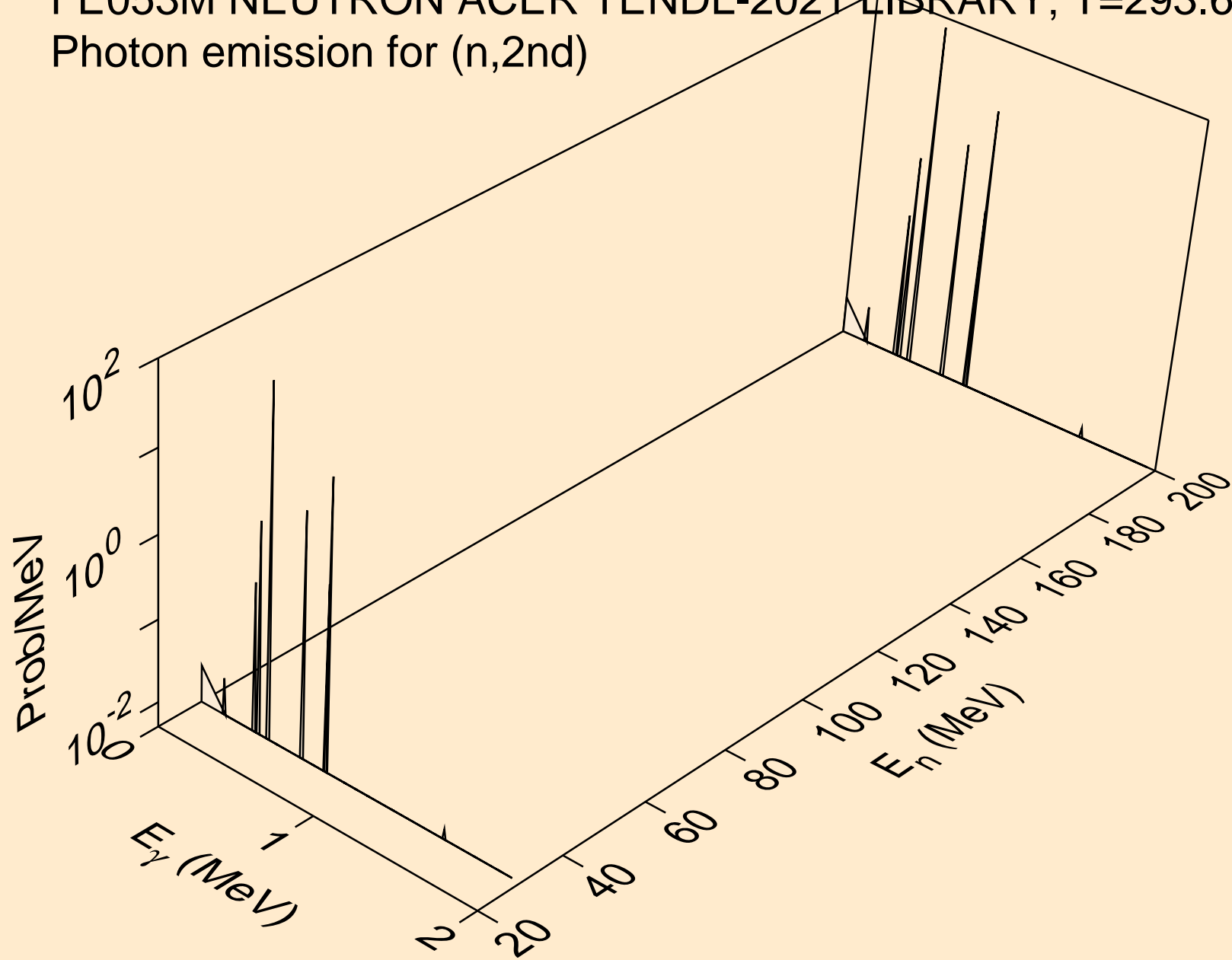

FE053M NEUTRON ACER TENDL-2021 LIBRARY; T=293.6K
Photon emission for (n,2n)

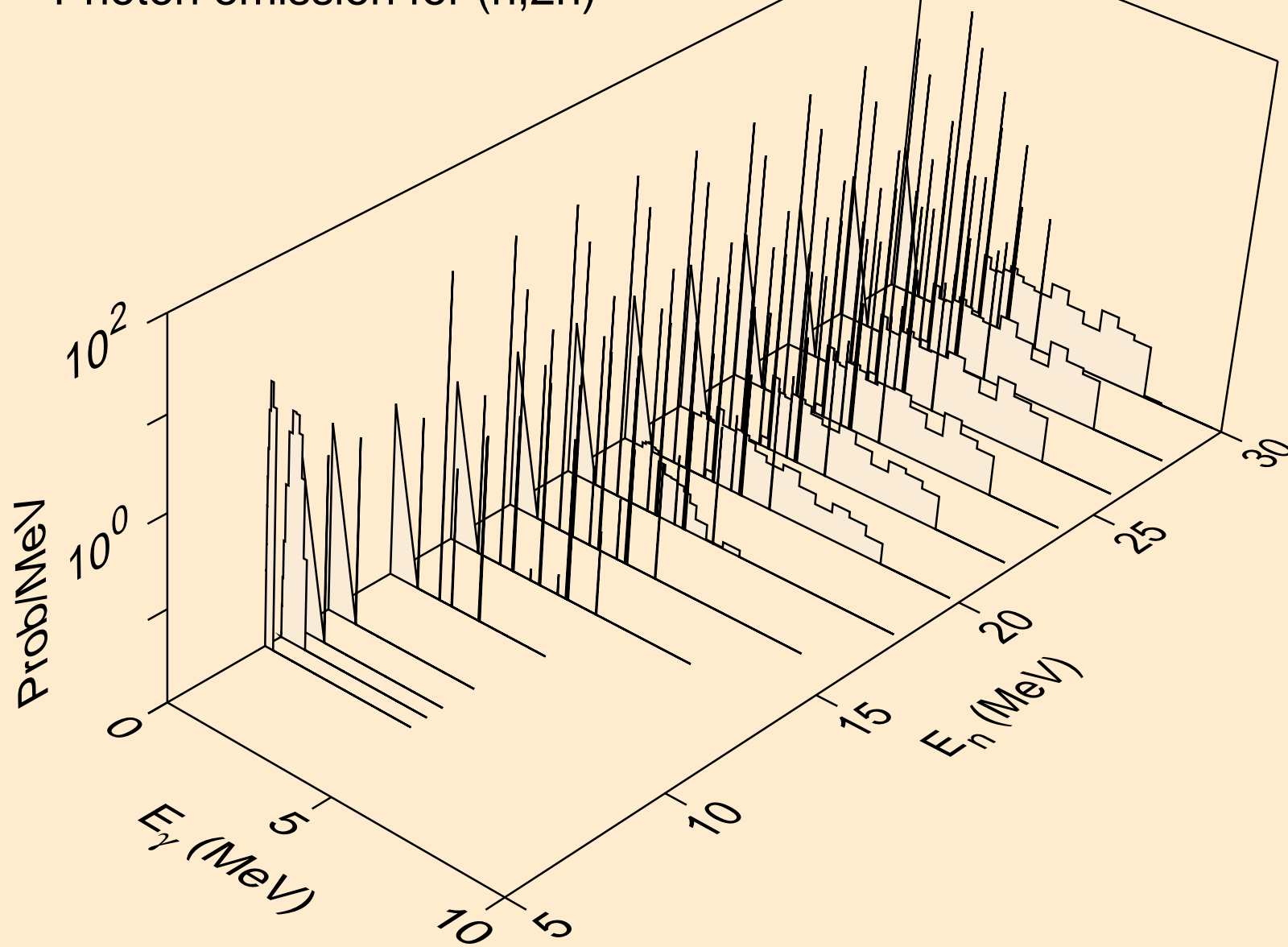

FE053M NEUTRON ACER TENDL-2021 LIBRARY; T=293.6K
Photon emission for (n,3n)

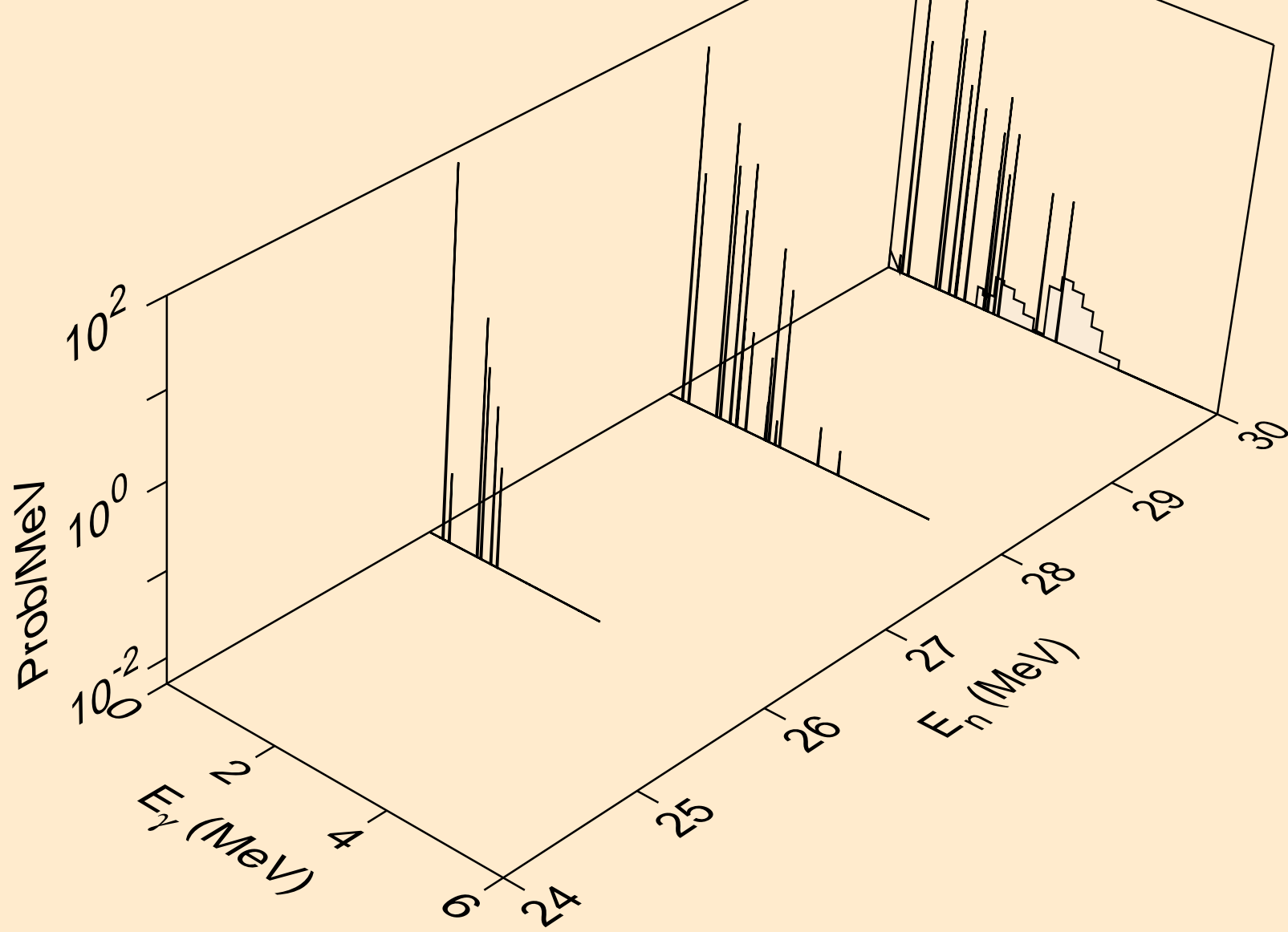

FE053M NEUTRON ACER TENDL-2021 LIBRARY; T=293.6K
Photon emission for (n,n*)a

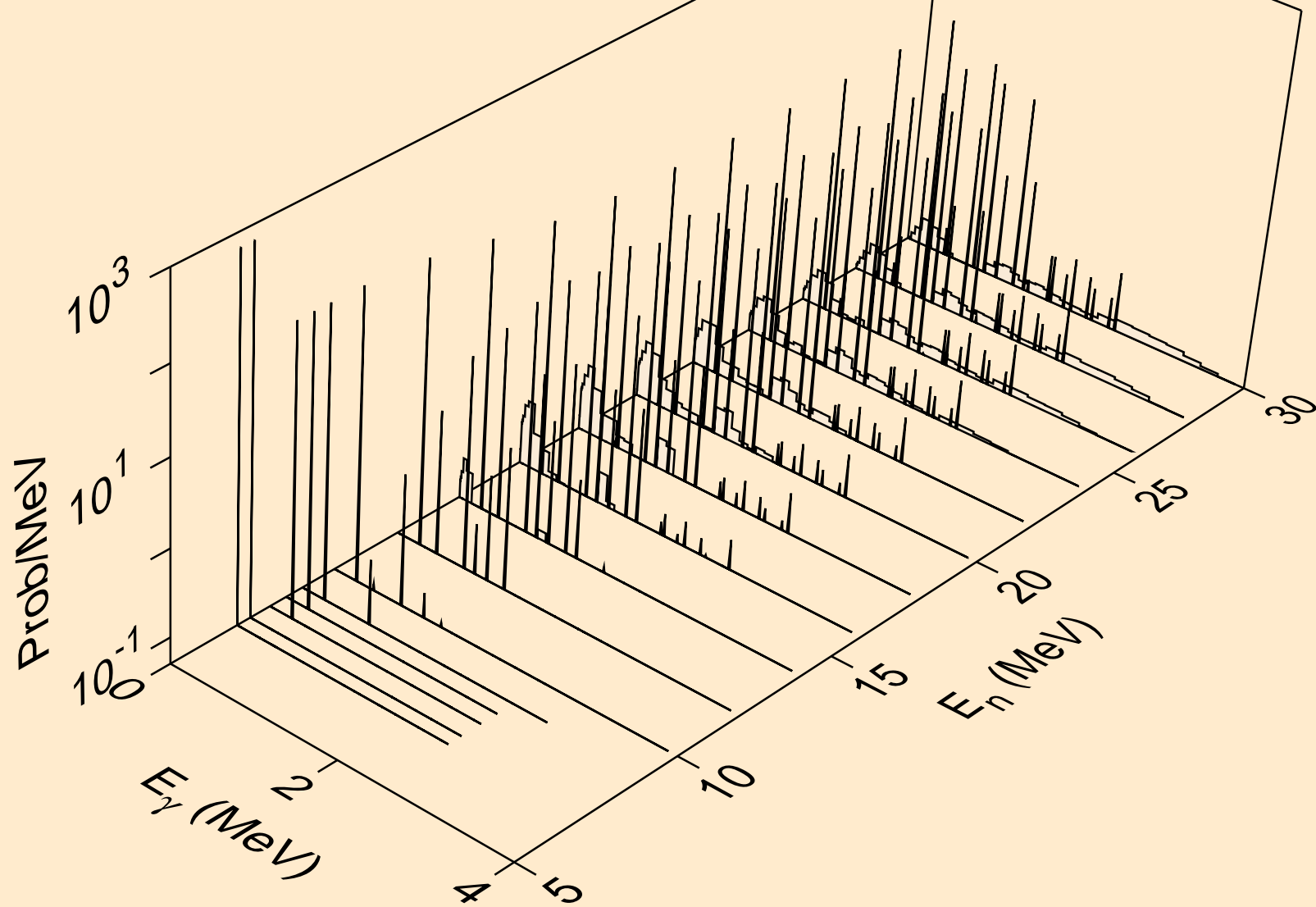

FE053M NEUTRON ACER TENDL-2021 LIBRARY; T=293.6K
Photon emission for (n,2n)a

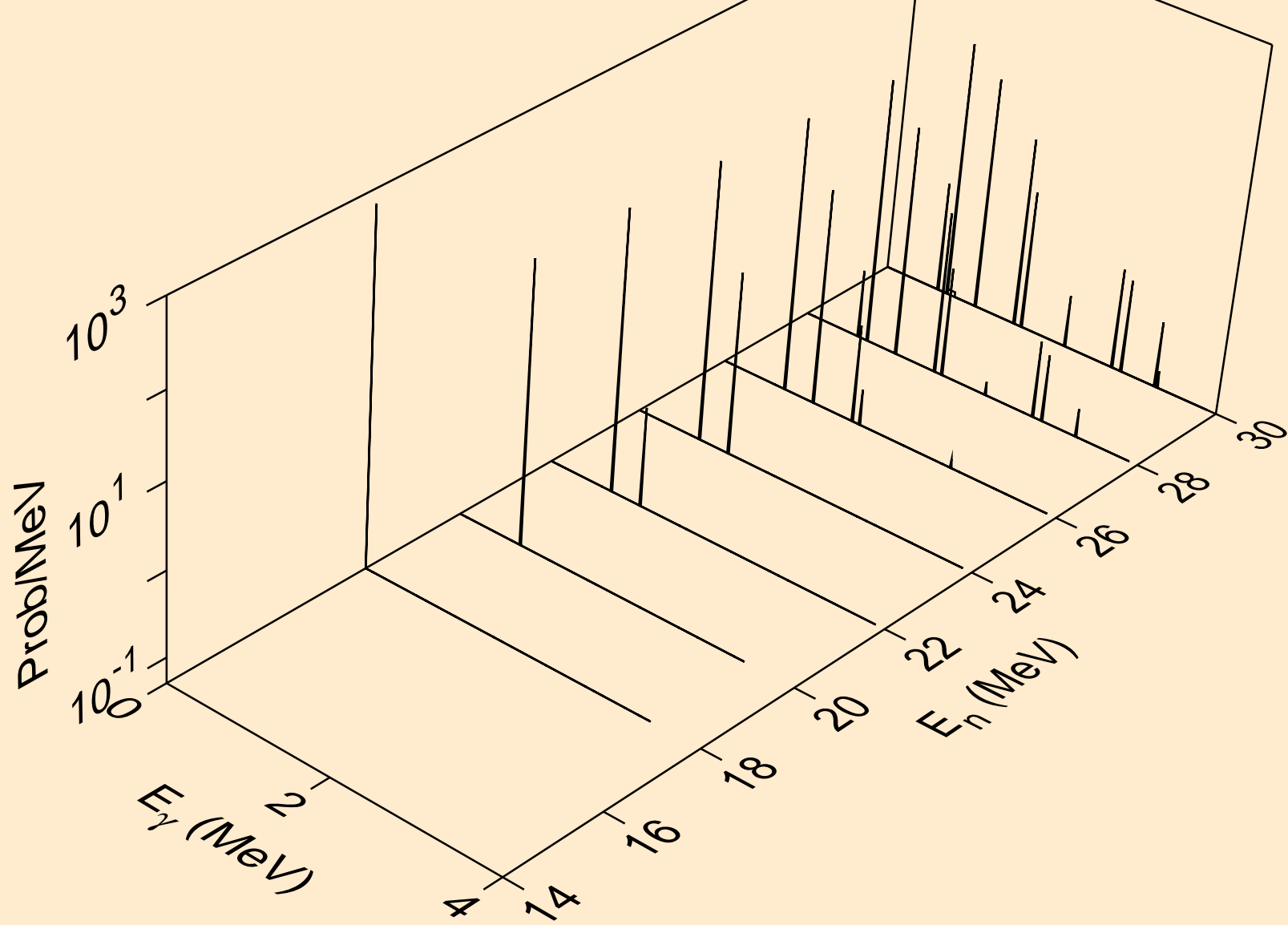

FE053M NEUTRON ACER TENDL-2021 LIBRARY; T=293.6K
Photon emission for (n,n*)p

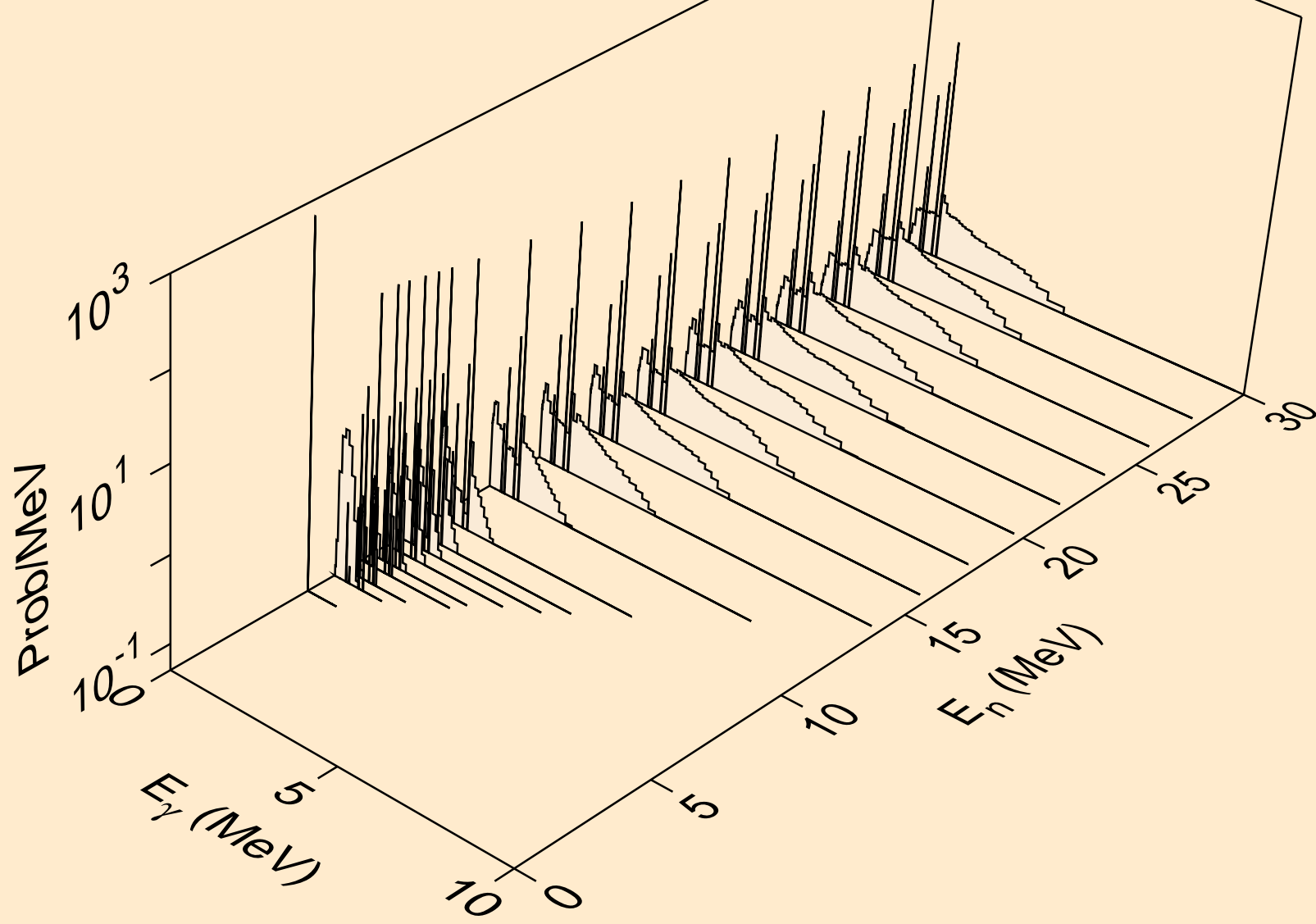

FE053M NEUTRON ACER TENDL-2021 LIBRARY; T=293.6K
Photon emission for (n,n*)2a

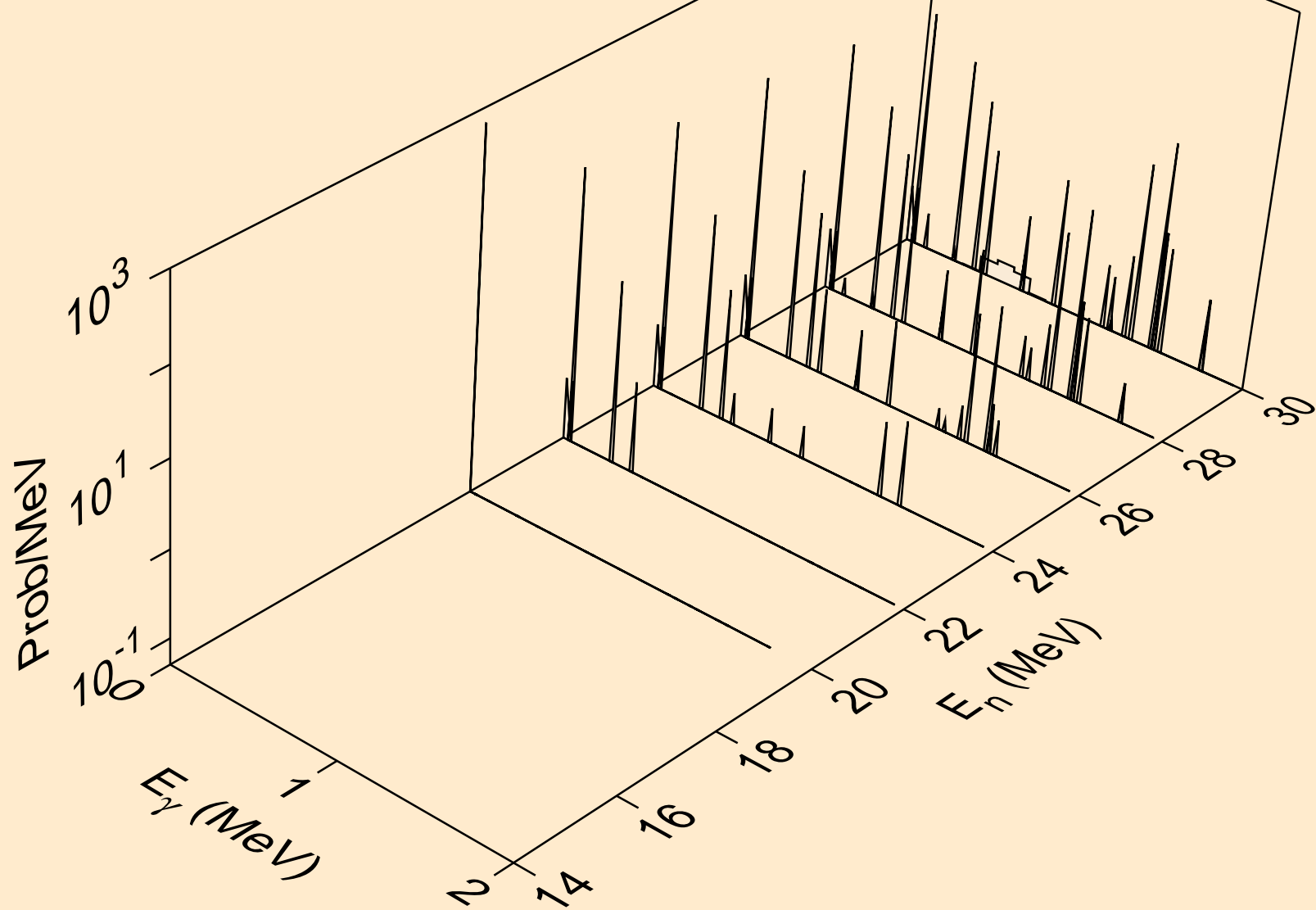

FE053M NEUTRON ACER TENDL-2021 LIBRARY; T=293.6K
Photon emission for (n,n*)d

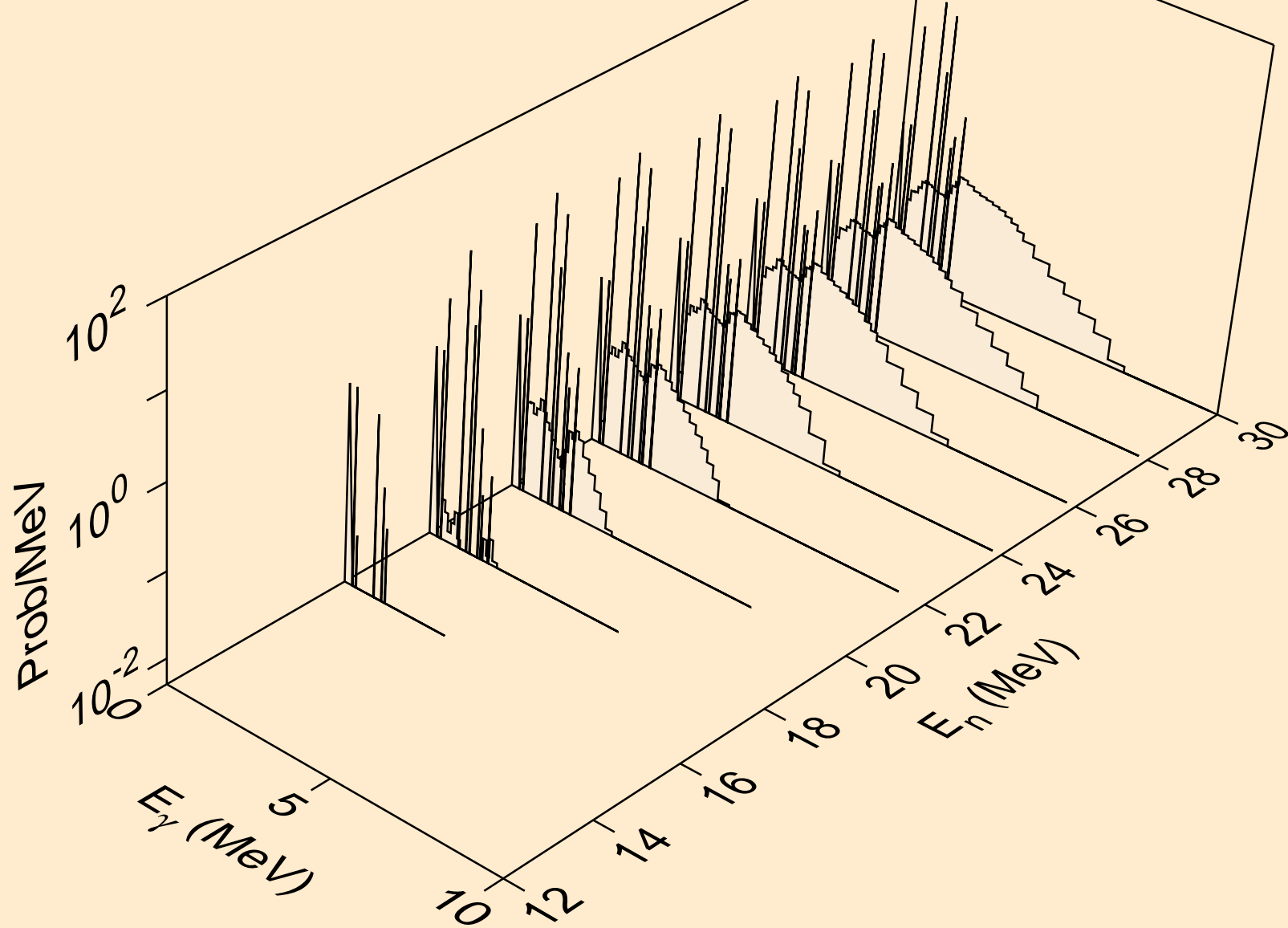

FE053M NEUTRON ACER TENDL-2021 LIBRARY; T=293.6K
Photon emission for (n,n*)t

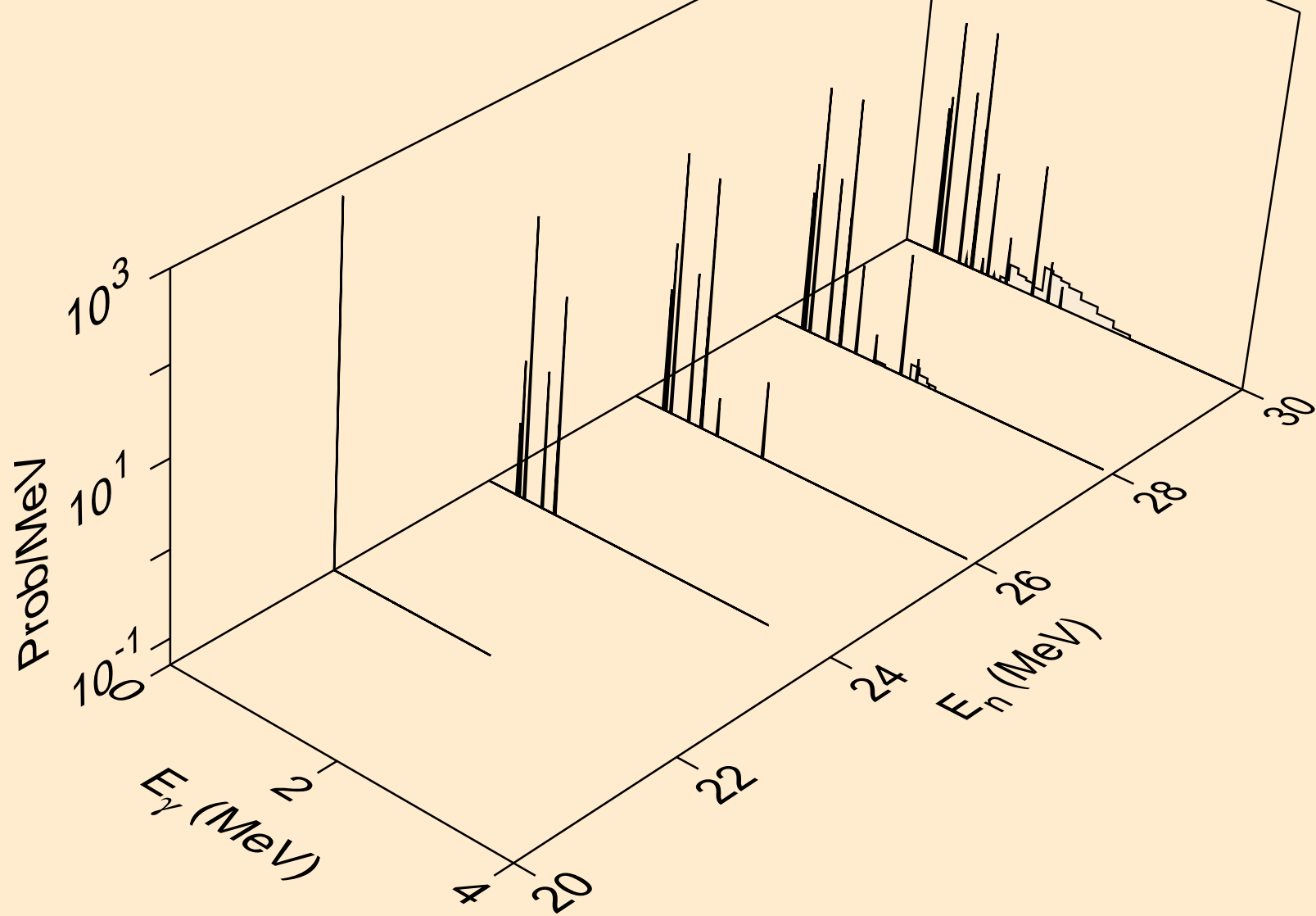

FE053M NEUTRON ACER TENDL-2021 LIBRARY; T=293.6K
Photon emission for (n,n*)he3

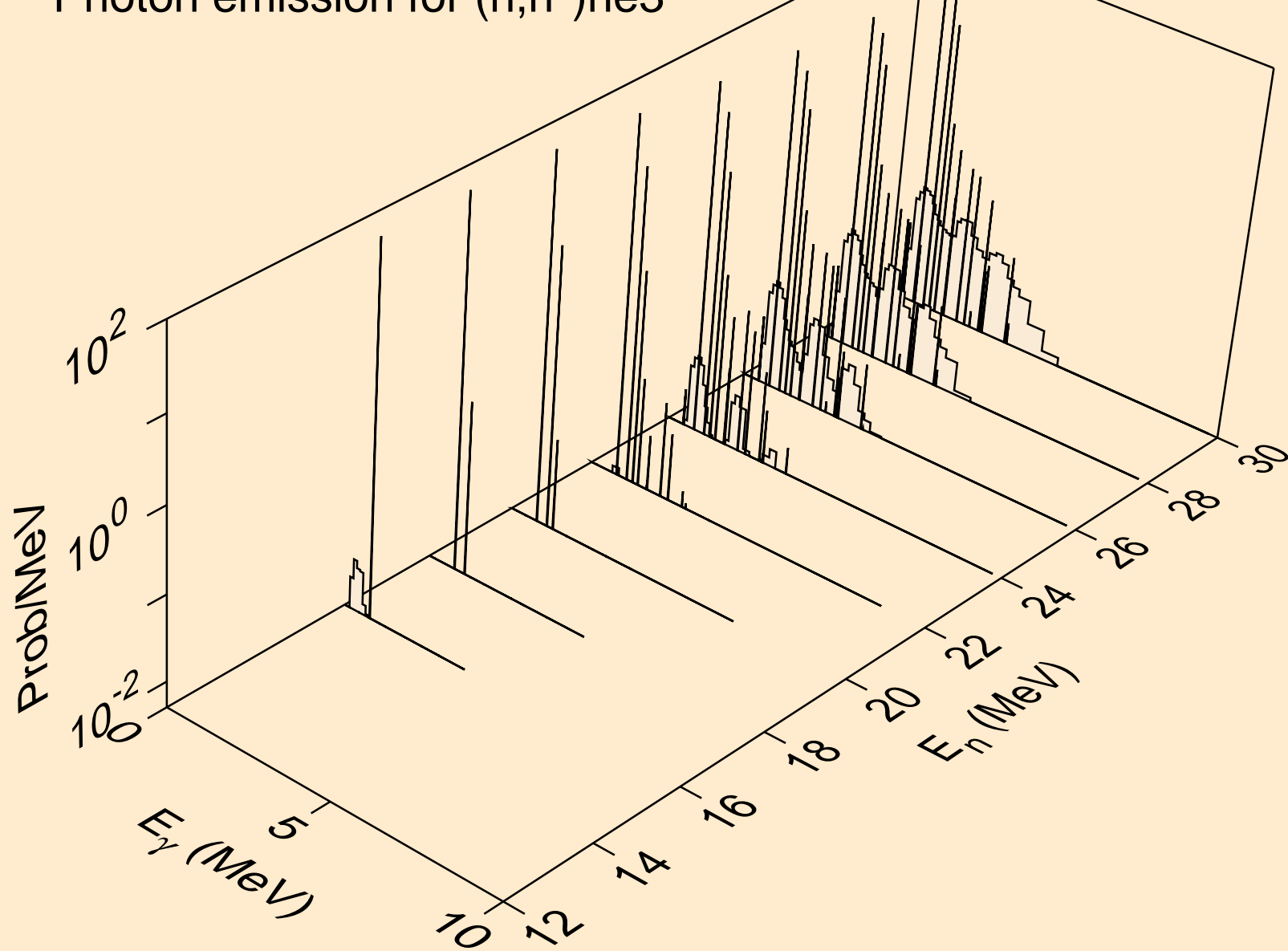

FE053M NEUTRON ACER TENDL-2021 LIBRARY; T=293.6K
Photon emission for (n,2np)

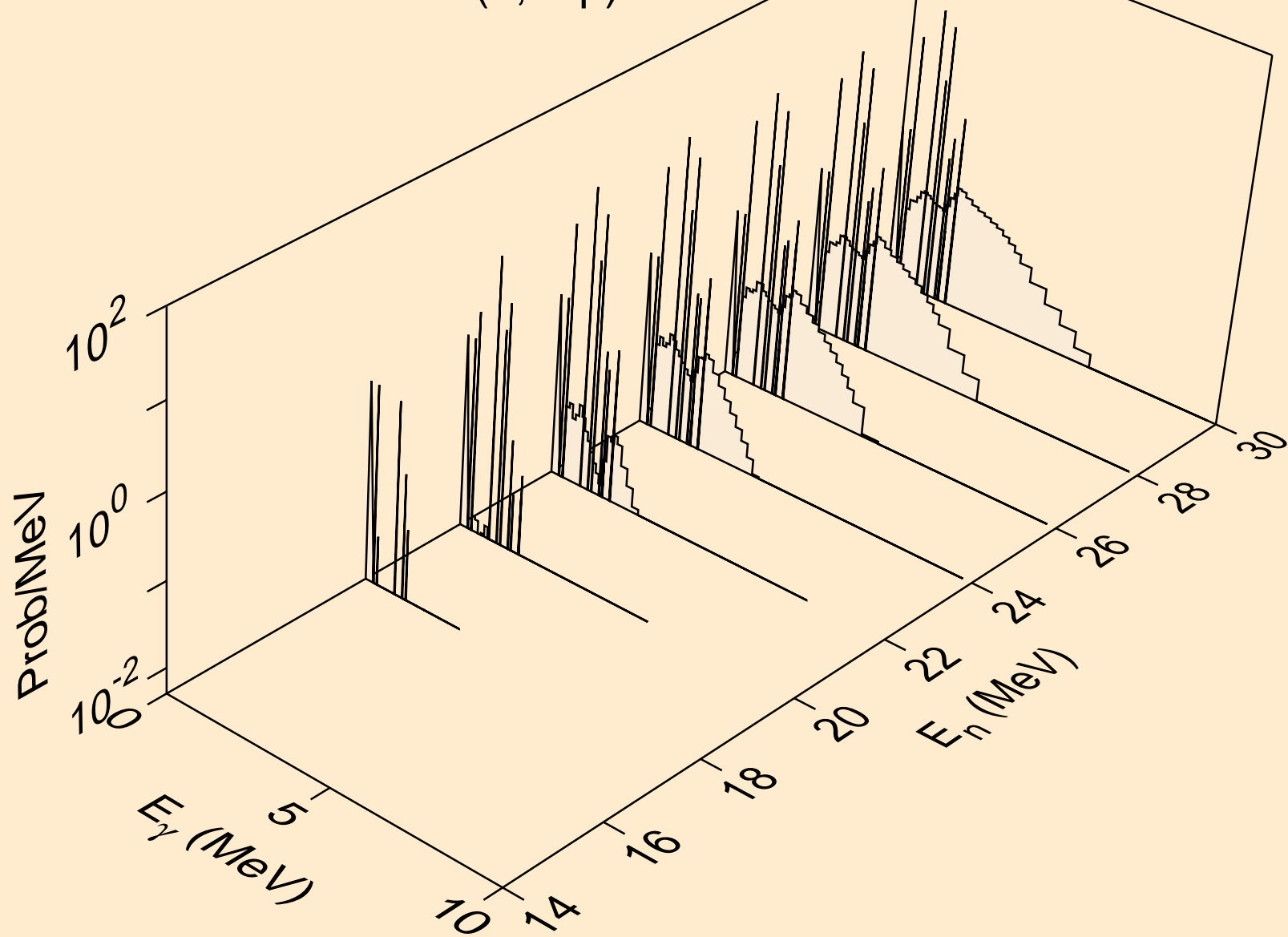

FE053M NEUTRON ACER TENDL-2021 LIBRARY; T=293.6K
Photon emission for (n,2np)

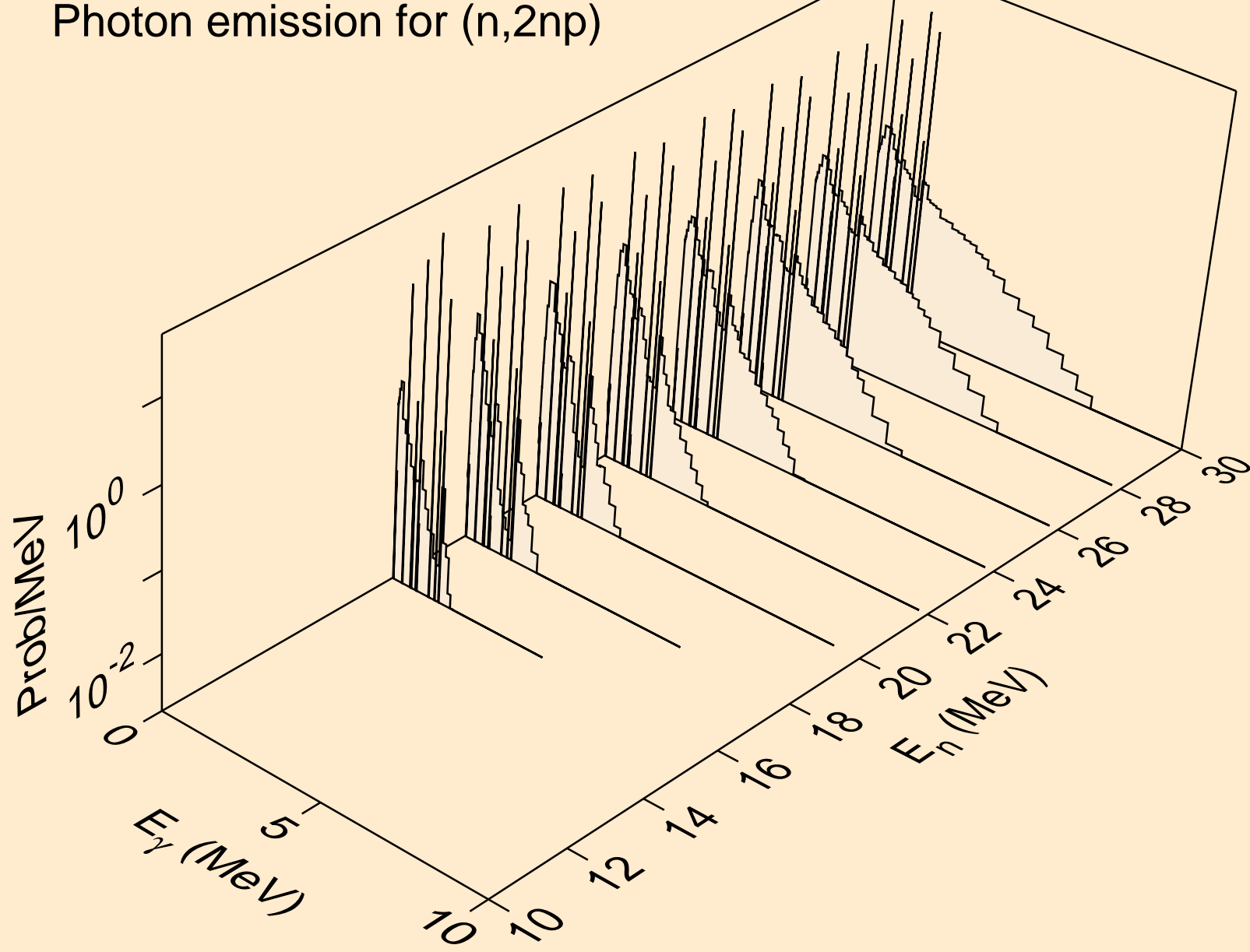

FE053M NEUTRON ACER TENDL-2021 LIBRARY; T=293.6K
Photon emission for (n,npa)

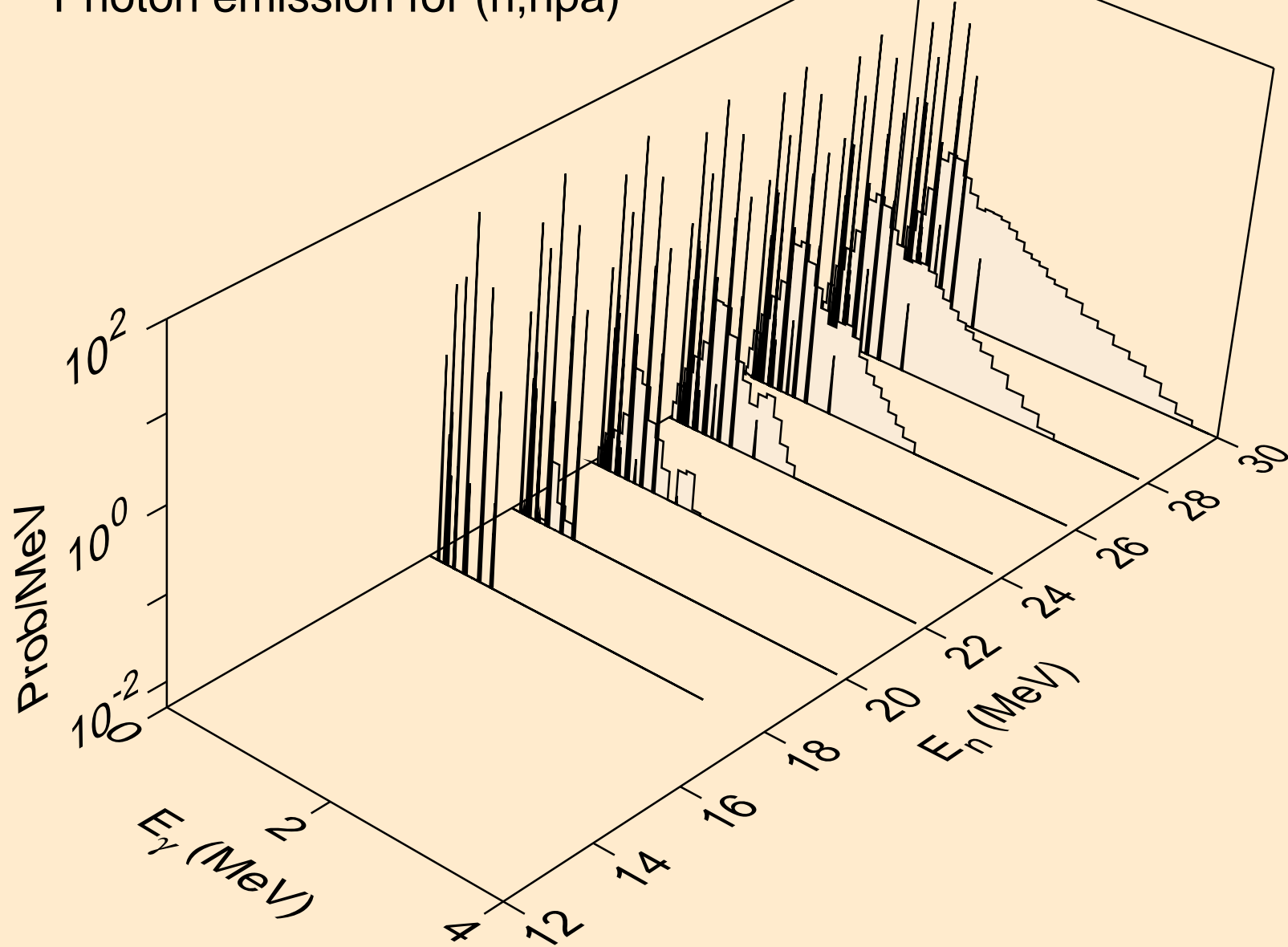

FE053M NEUTRON ACER TENDL-2021 LIBRARY; T=293.6K
Photon emission for (n,n*1)

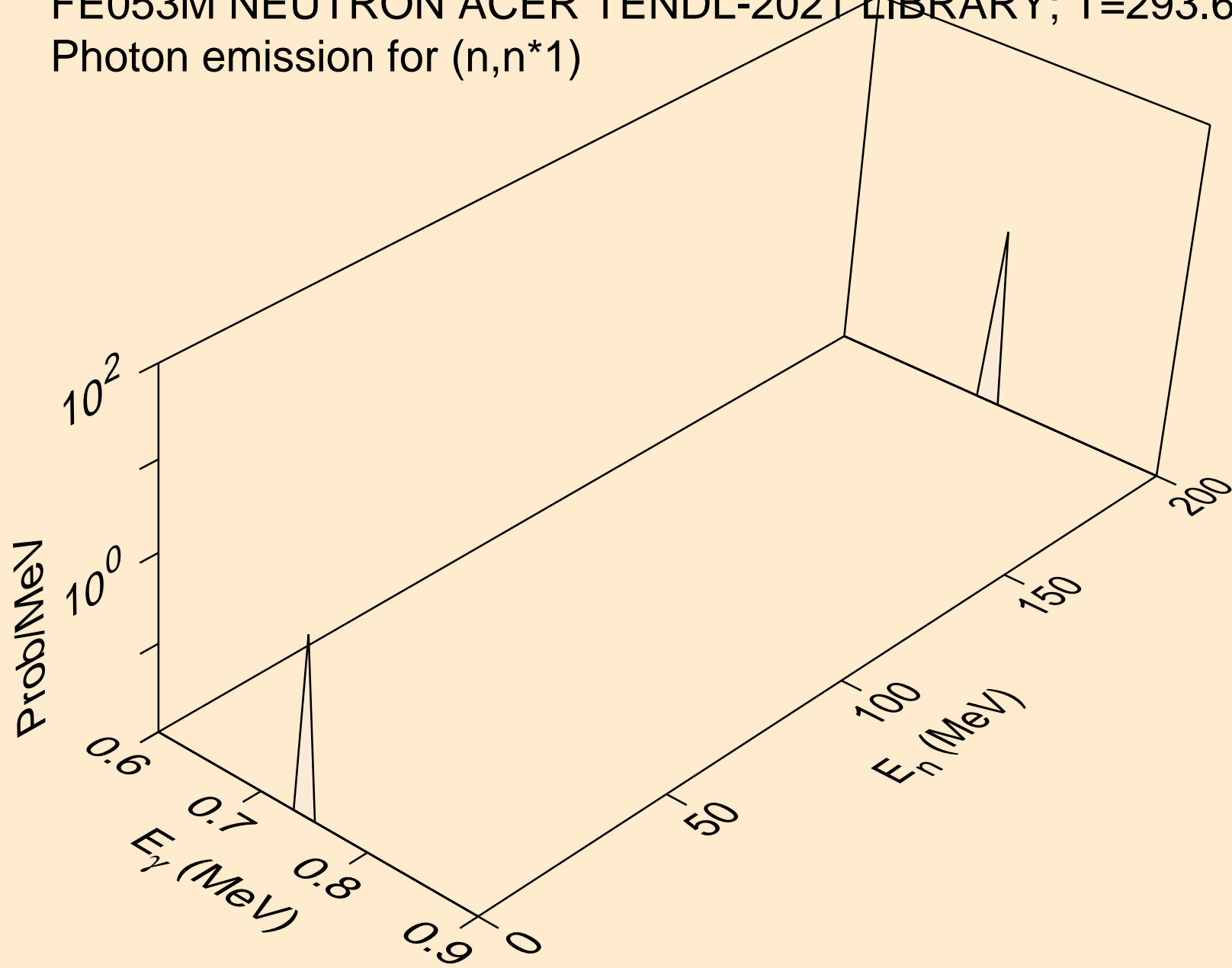

FE053M NEUTRON ACER TENDL-2021 LIBRARY; T=293.6K
Photon emission for (n,n*2)

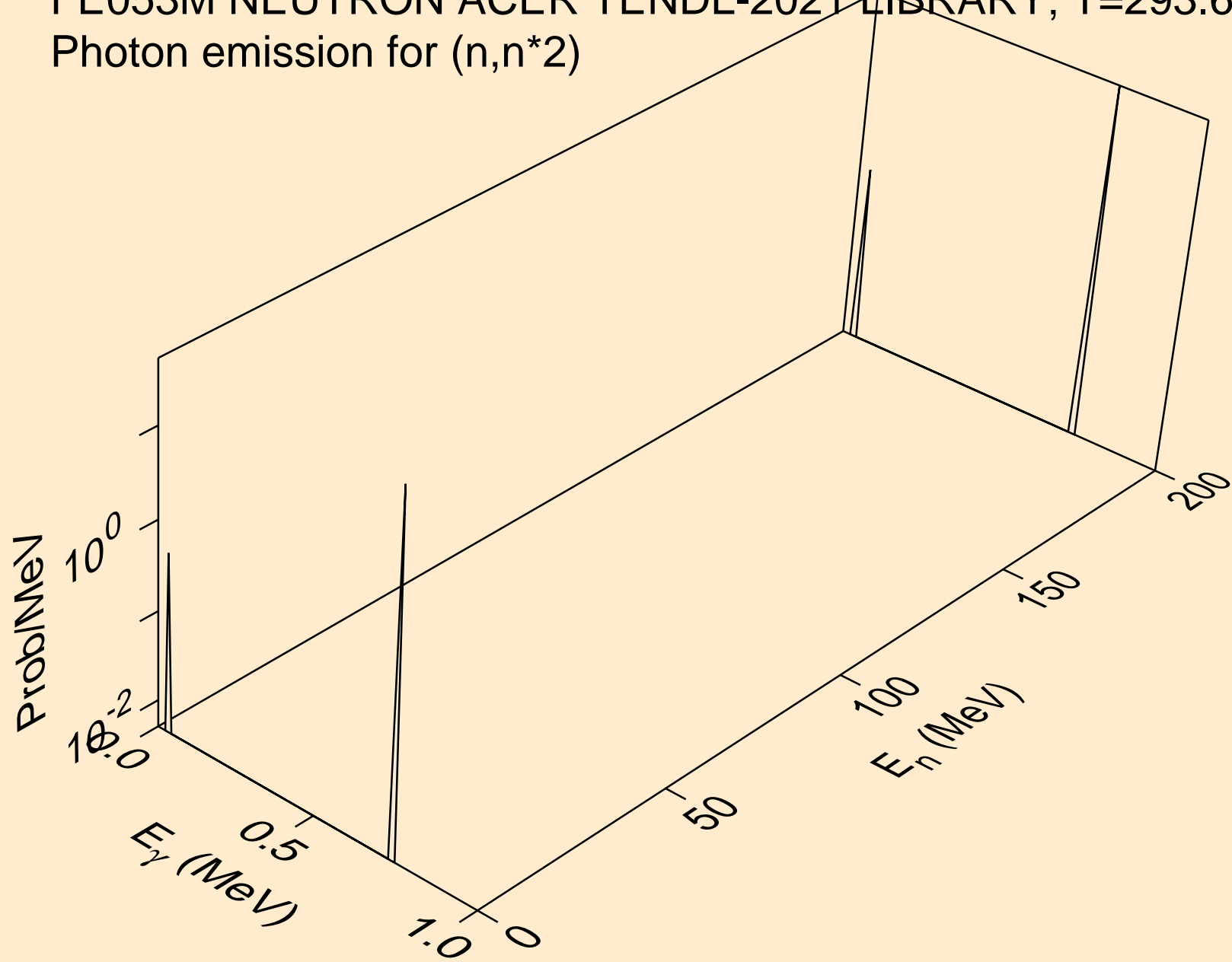

FE053M NEUTRON ACER TENDL-2021 LIBRARY; T=293.6K
Photon emission for (n,n*3)

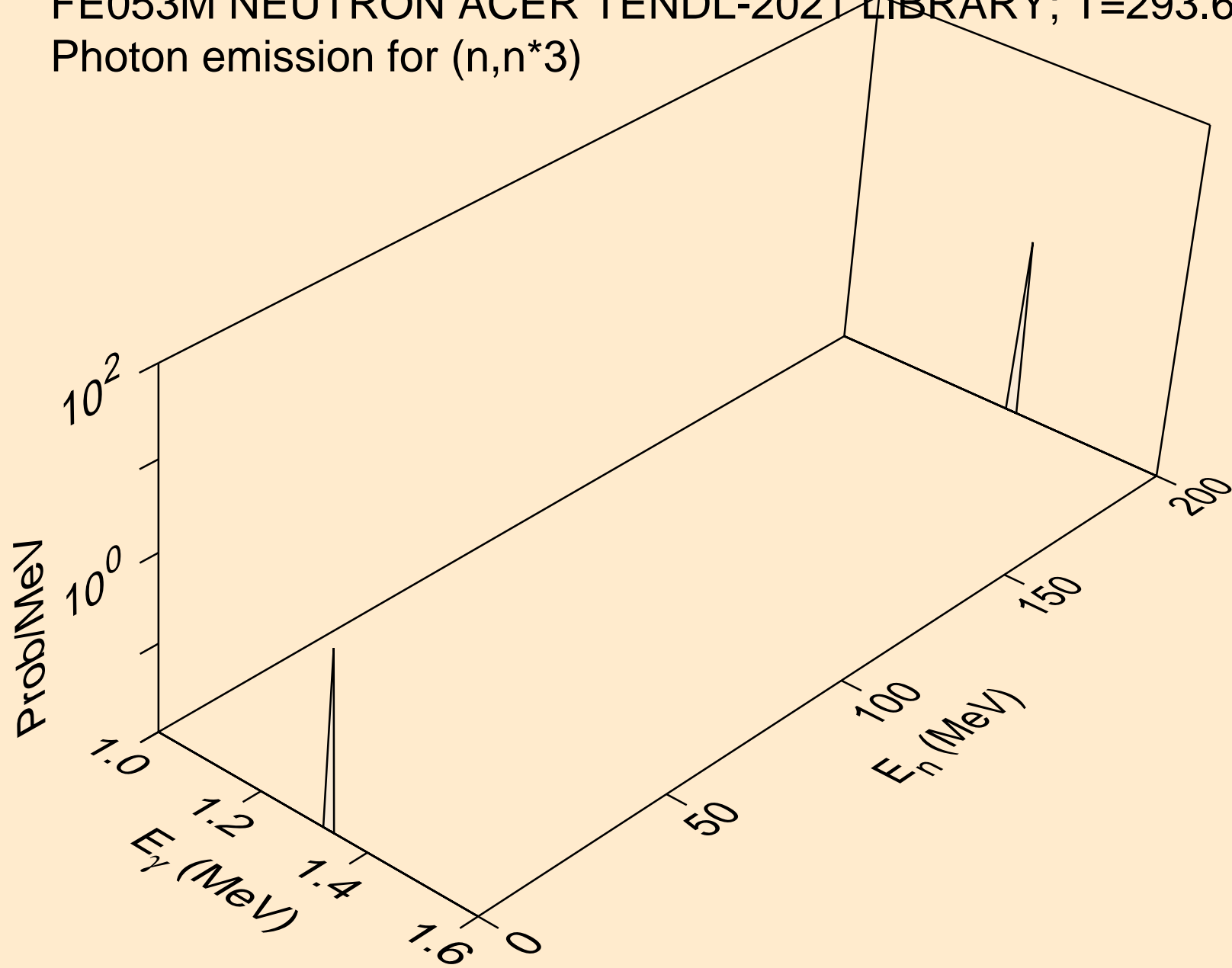

FE053M NEUTRON ACER TENDL-2021 LIBRARY; T=293.6K
Photon emission for (n,n*4)

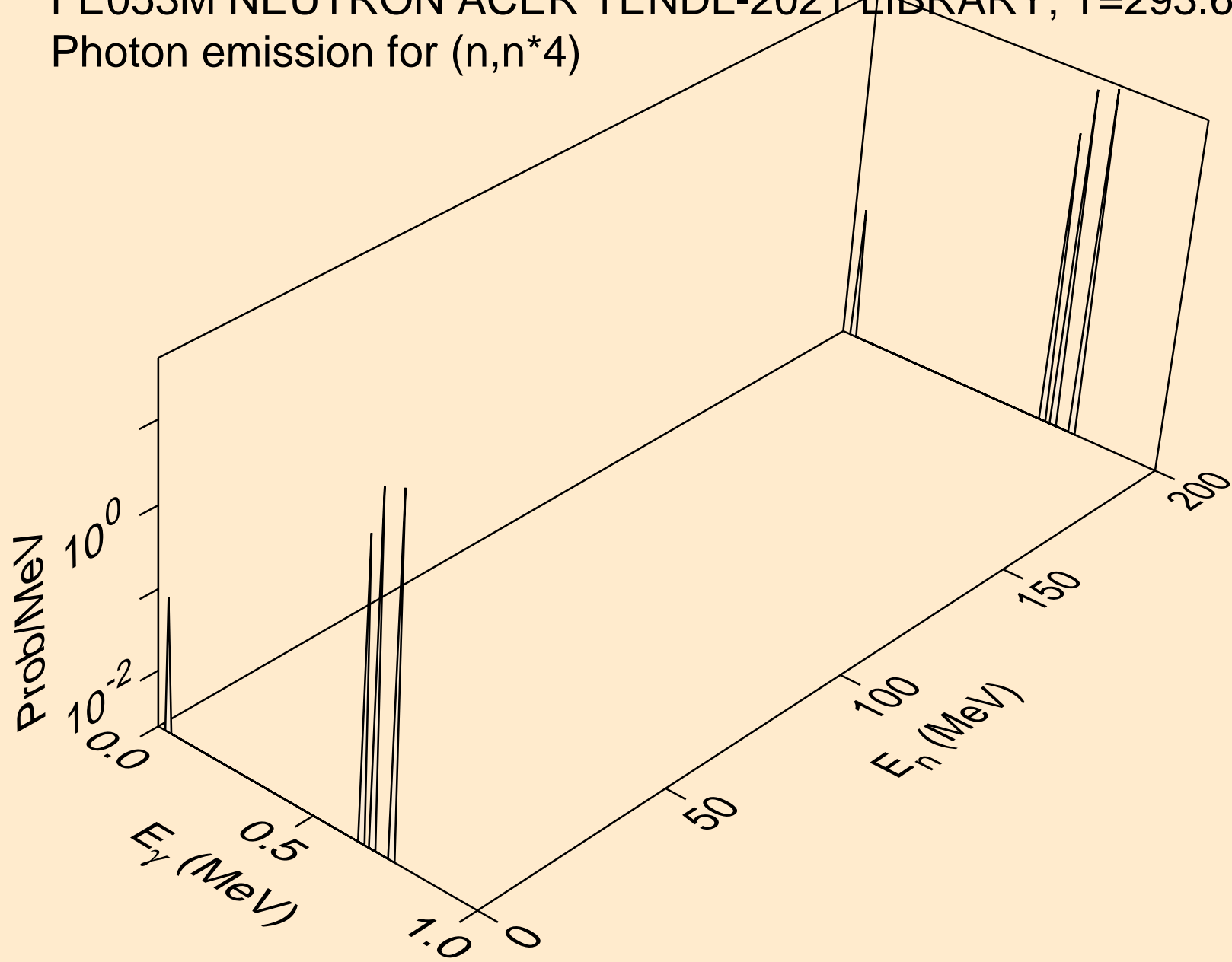

FE053M NEUTRON ACER TENDL-2021 LIBRARY; T=293.6K
Photon emission for (n,n*5)

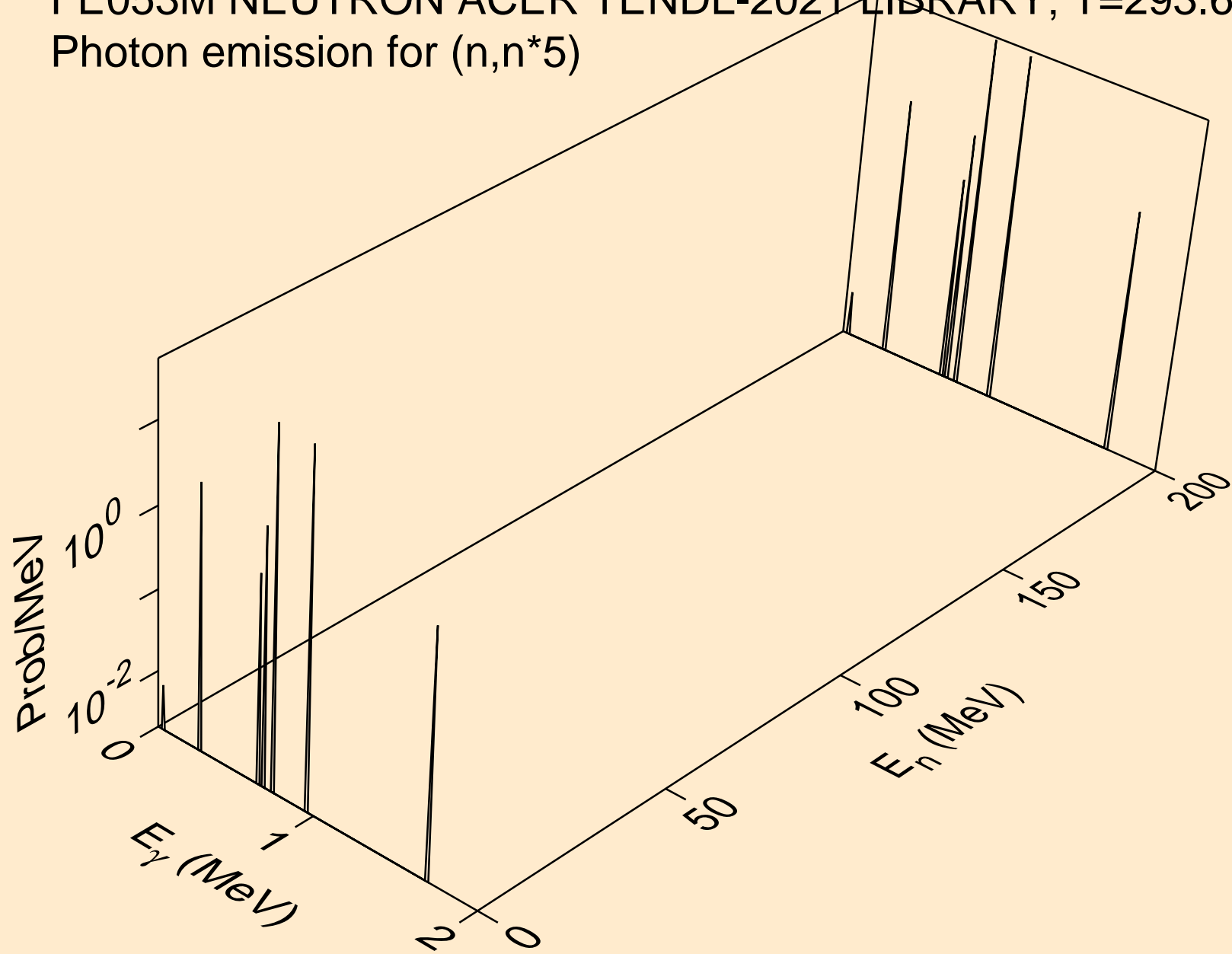

FE053M NEUTRON ACER TENDL-2021 LIBRARY; T=293.6K
Photon emission for (n,n*6)

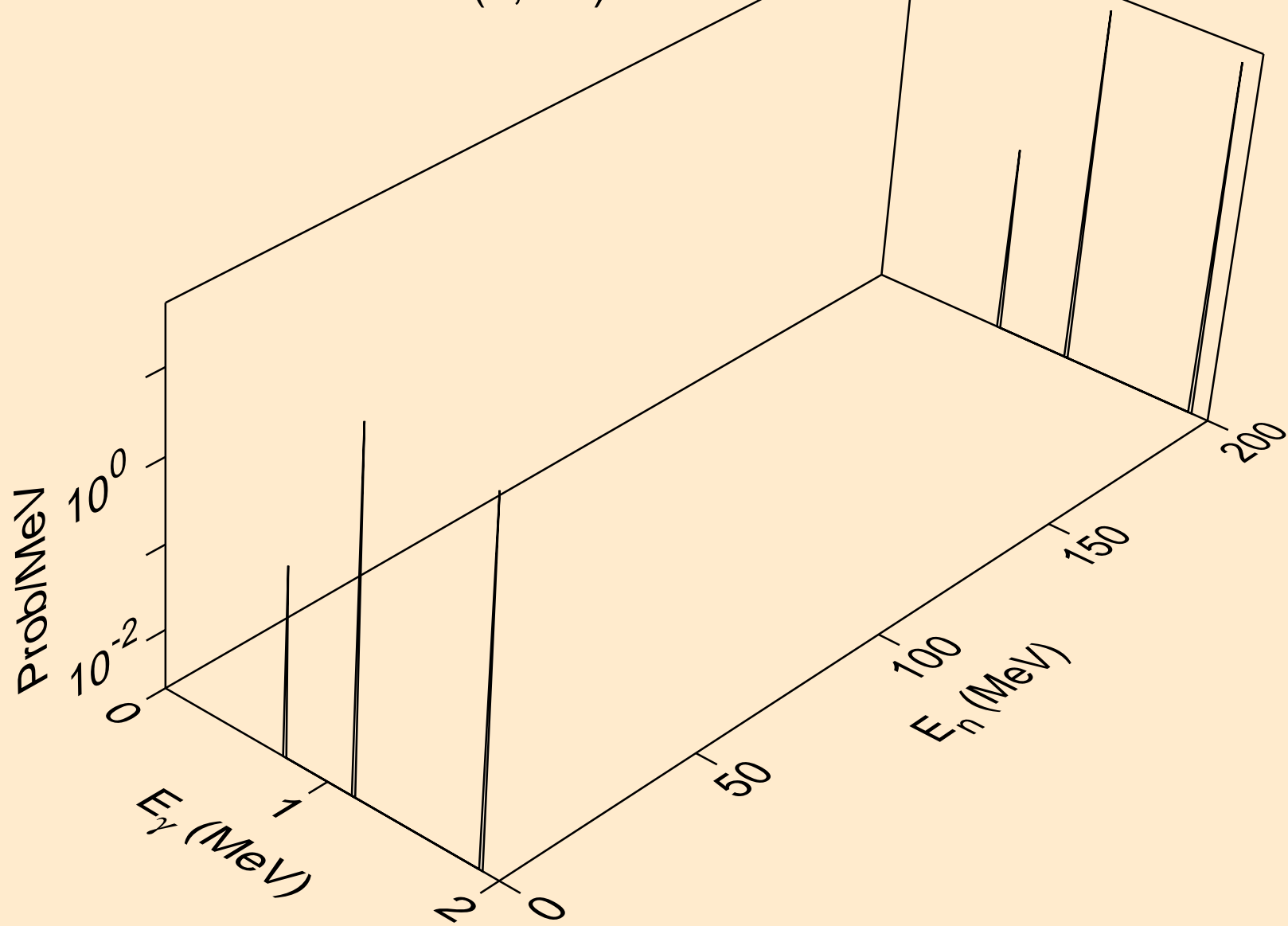

FE053M NEUTRON ACER TENDL-2021 LIBRARY; T=293.6K
Photon emission for (n,n*7)

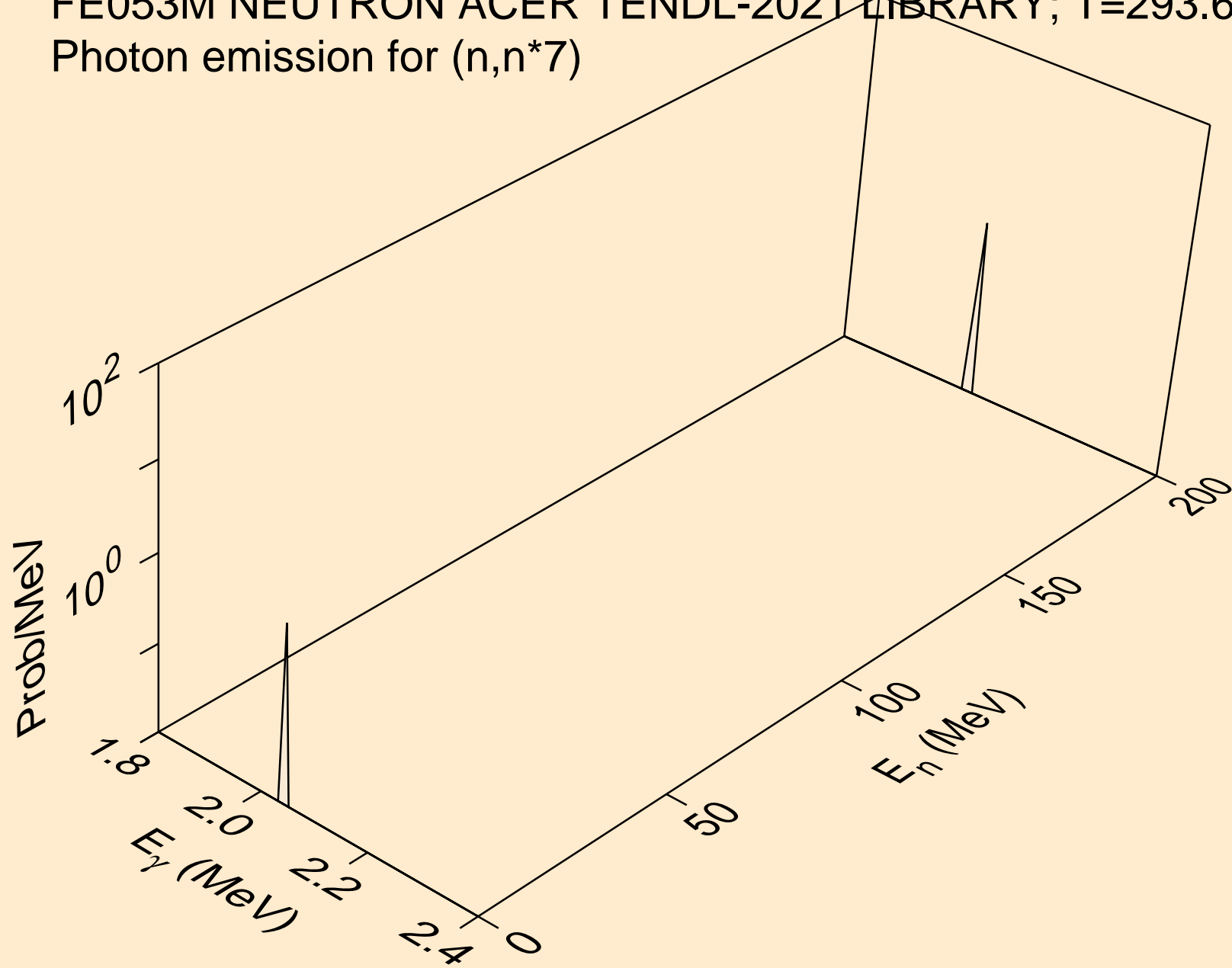

FE053M NEUTRON ACER TENDL-2021 LIBRARY; T=293.6K
Photon emission for (n,n*8)

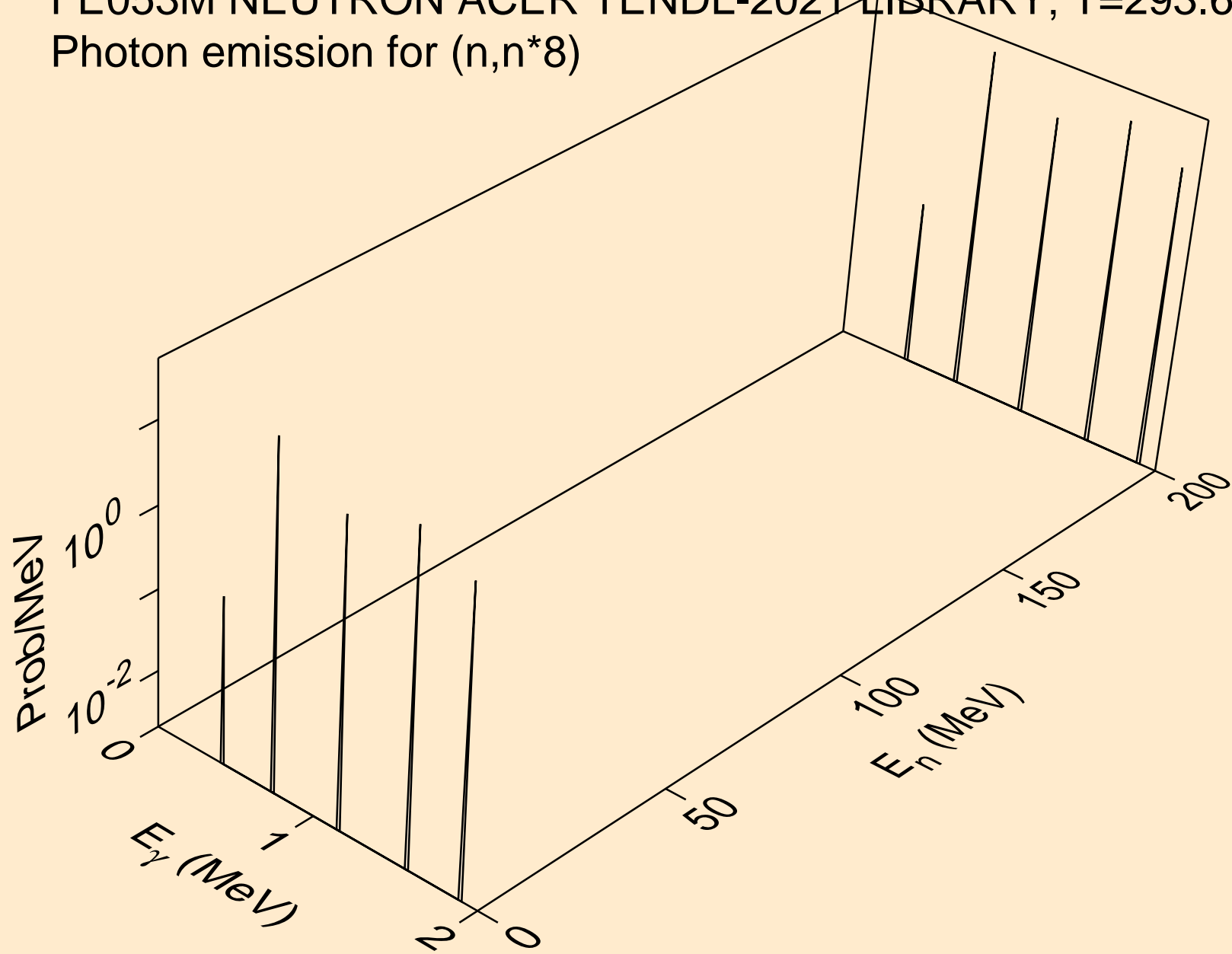

FE053M NEUTRON ACER TENDL-2021 LIBRARY; T=293.6K
Photon emission for (n,n*9)

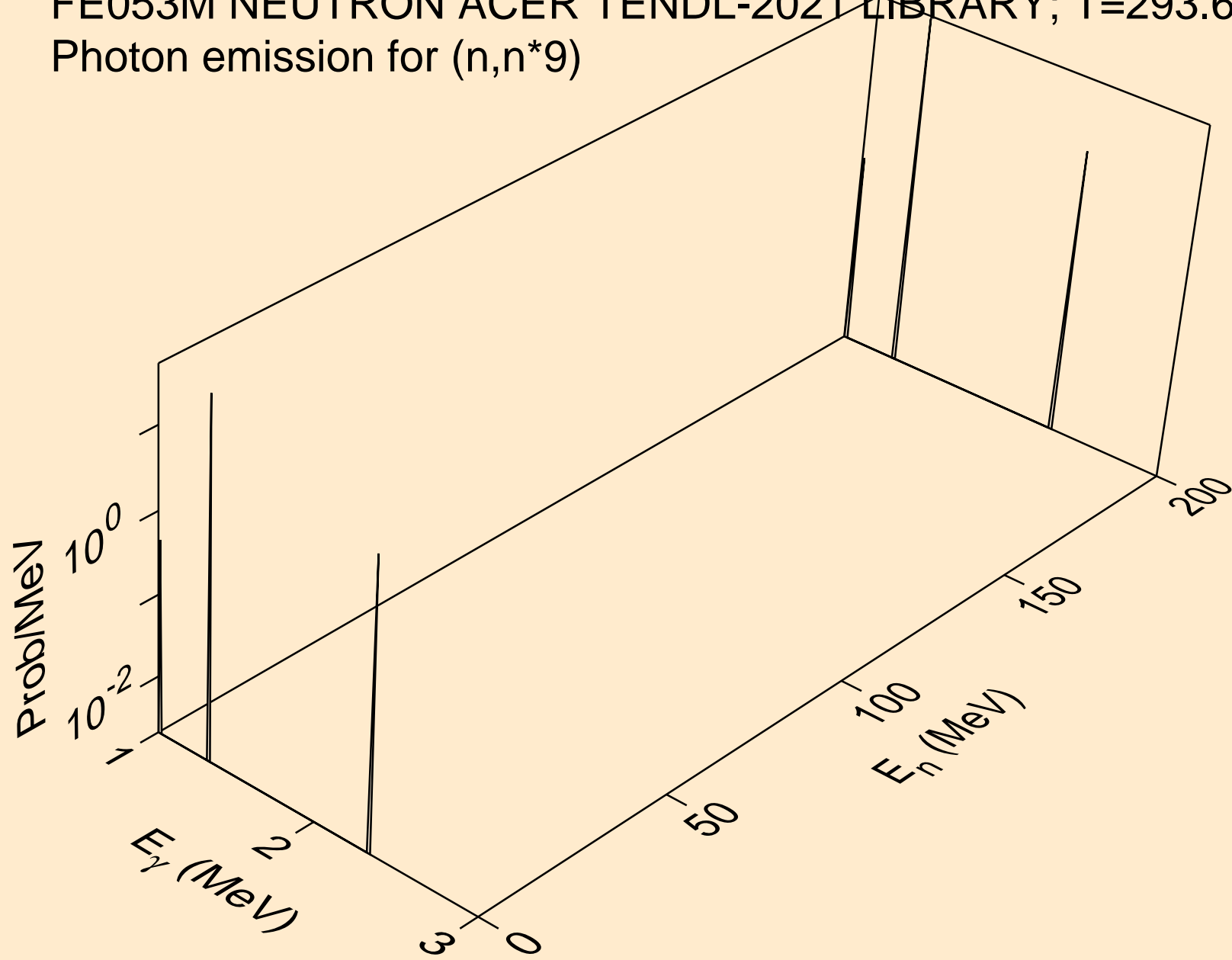

FE053M NEUTRON ACER TENDL-2021 LIBRARY; T=293.6K
Photon emission for (n,n*10)

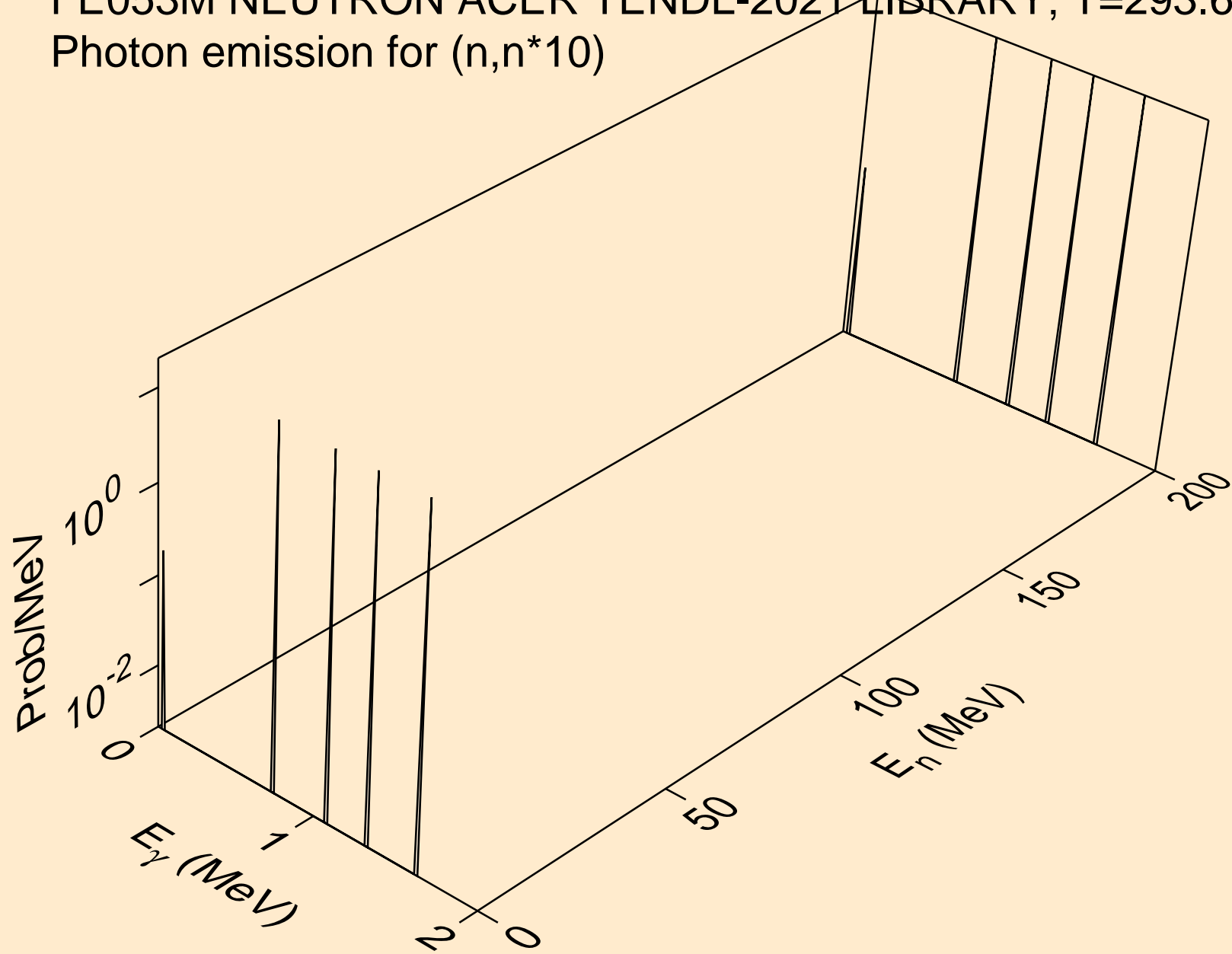

FE053M NEUTRON ACER TENDL-2021 LIBRARY; T=293.6K
Photon emission for (n,n*11)

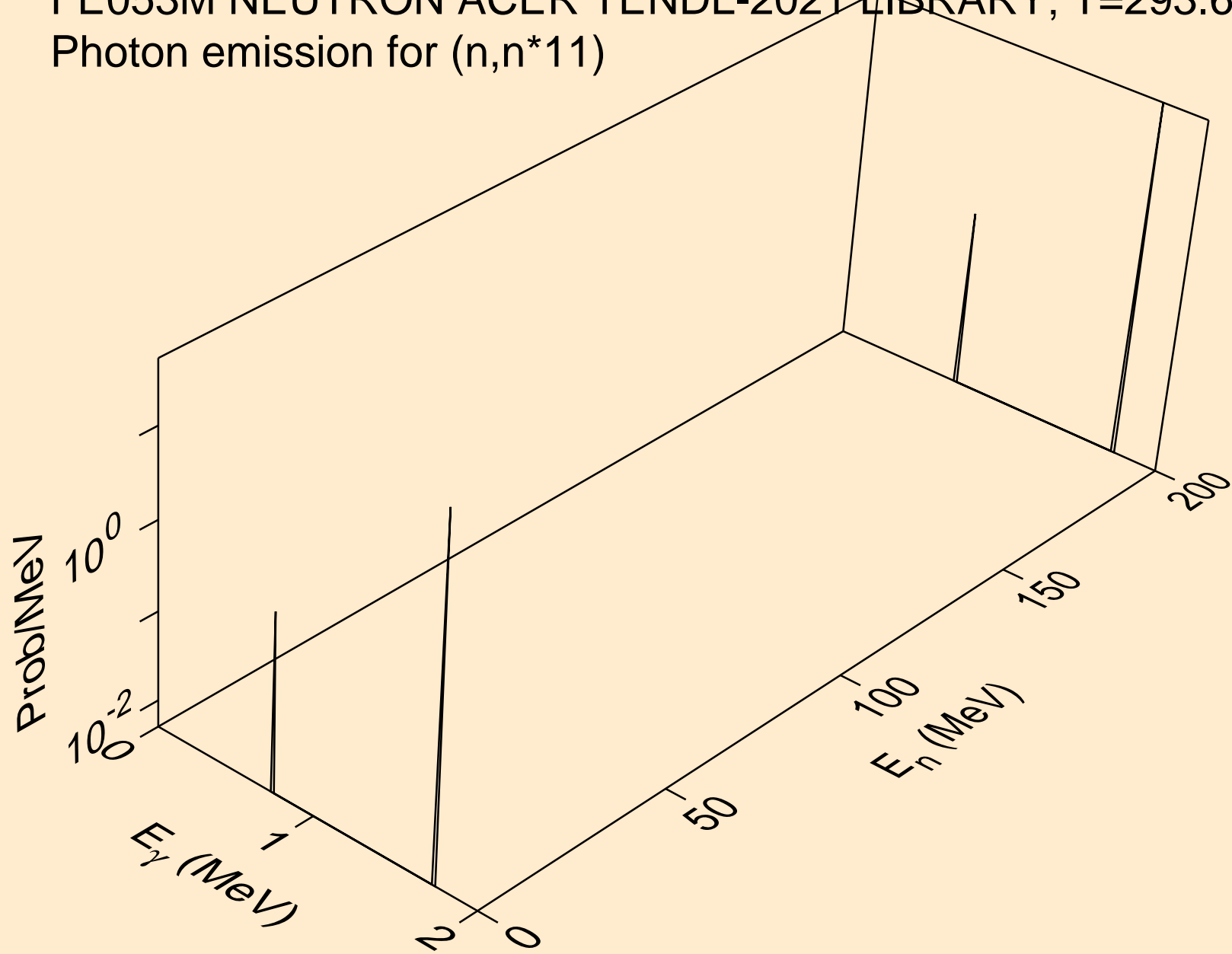

FE053M NEUTRON ACER TENDL-2021 LIBRARY; T=293.6K
Photon emission for (n,n*12)

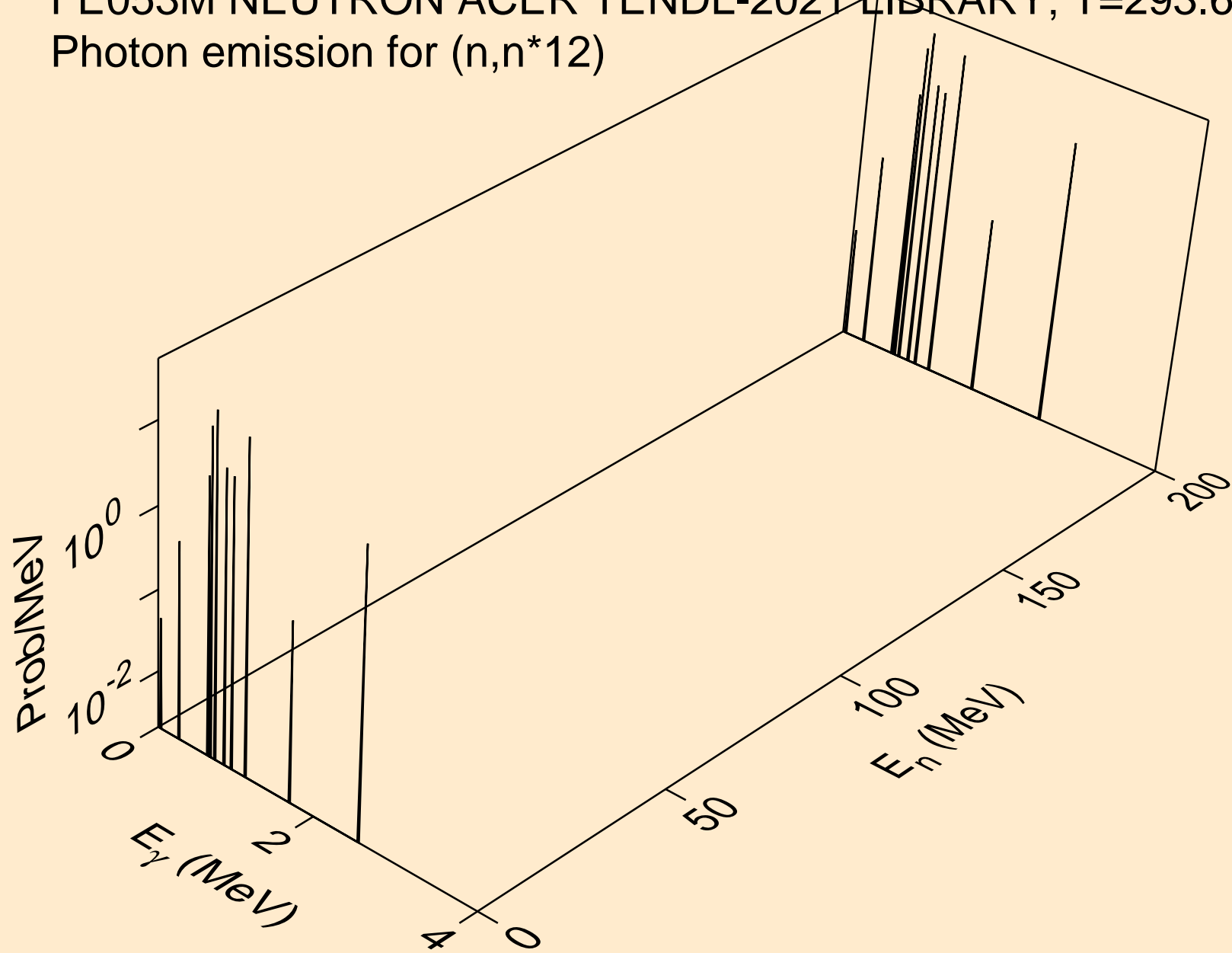

FE053M NEUTRON ACER TENDL-2021 LIBRARY; T=293.6K
Photon emission for (n,n*13)

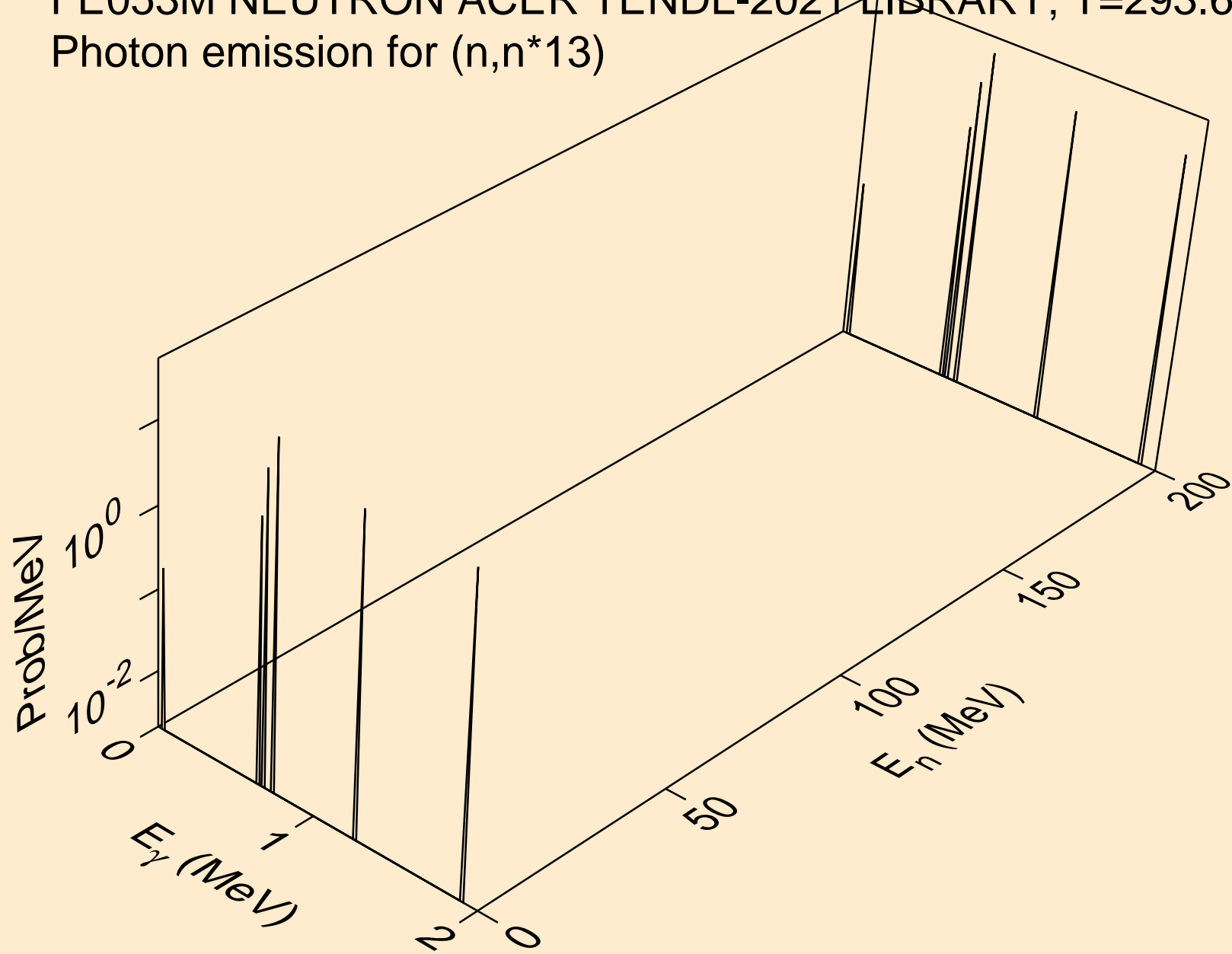

FE053M NEUTRON ACER TENDL-2021 LIBRARY; T=293.6K
Photon emission for (n,n*14)

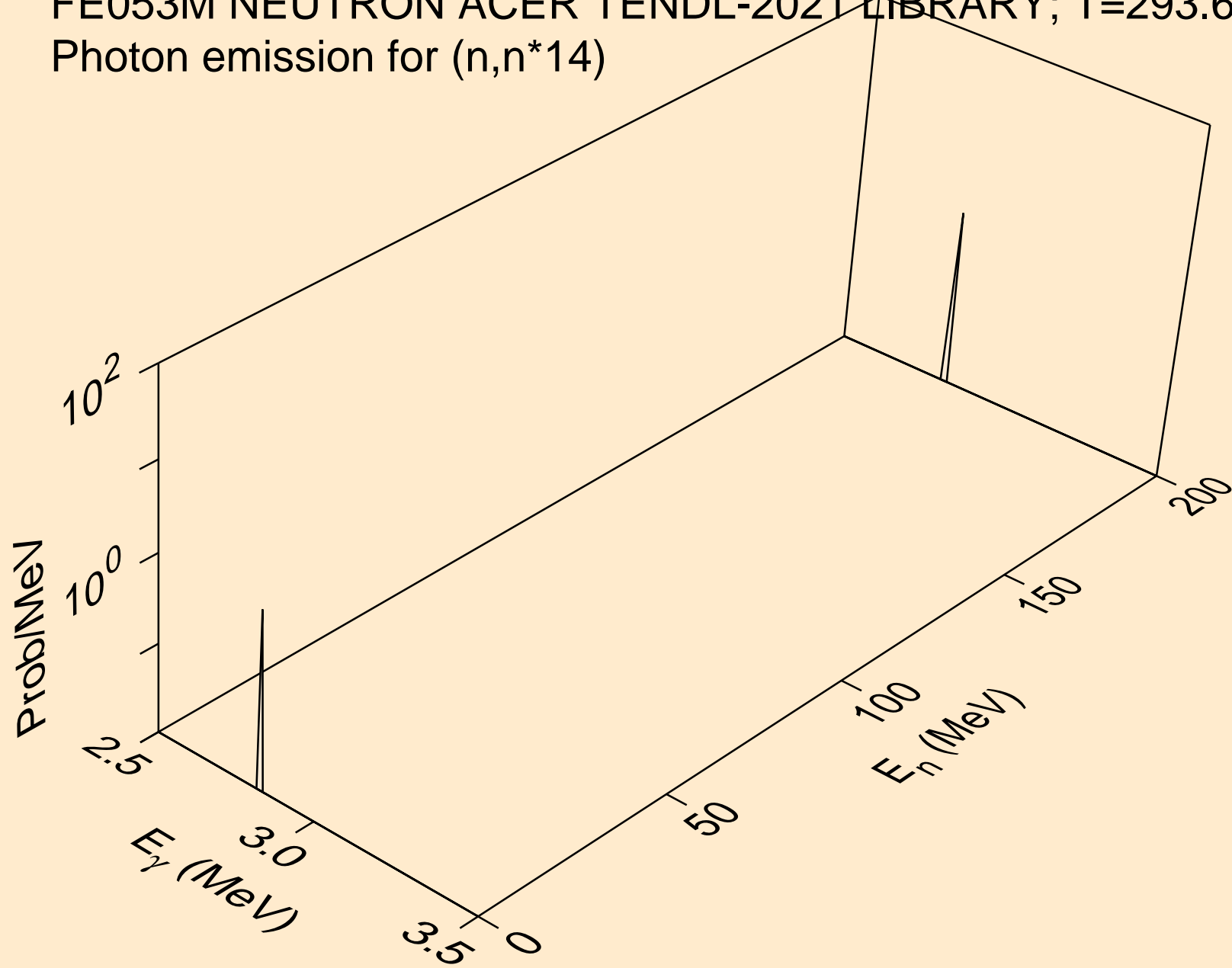

FE053M NEUTRON ACER TENDL-2021 LIBRARY; T=293.6K
Photon emission for (n,n*15)

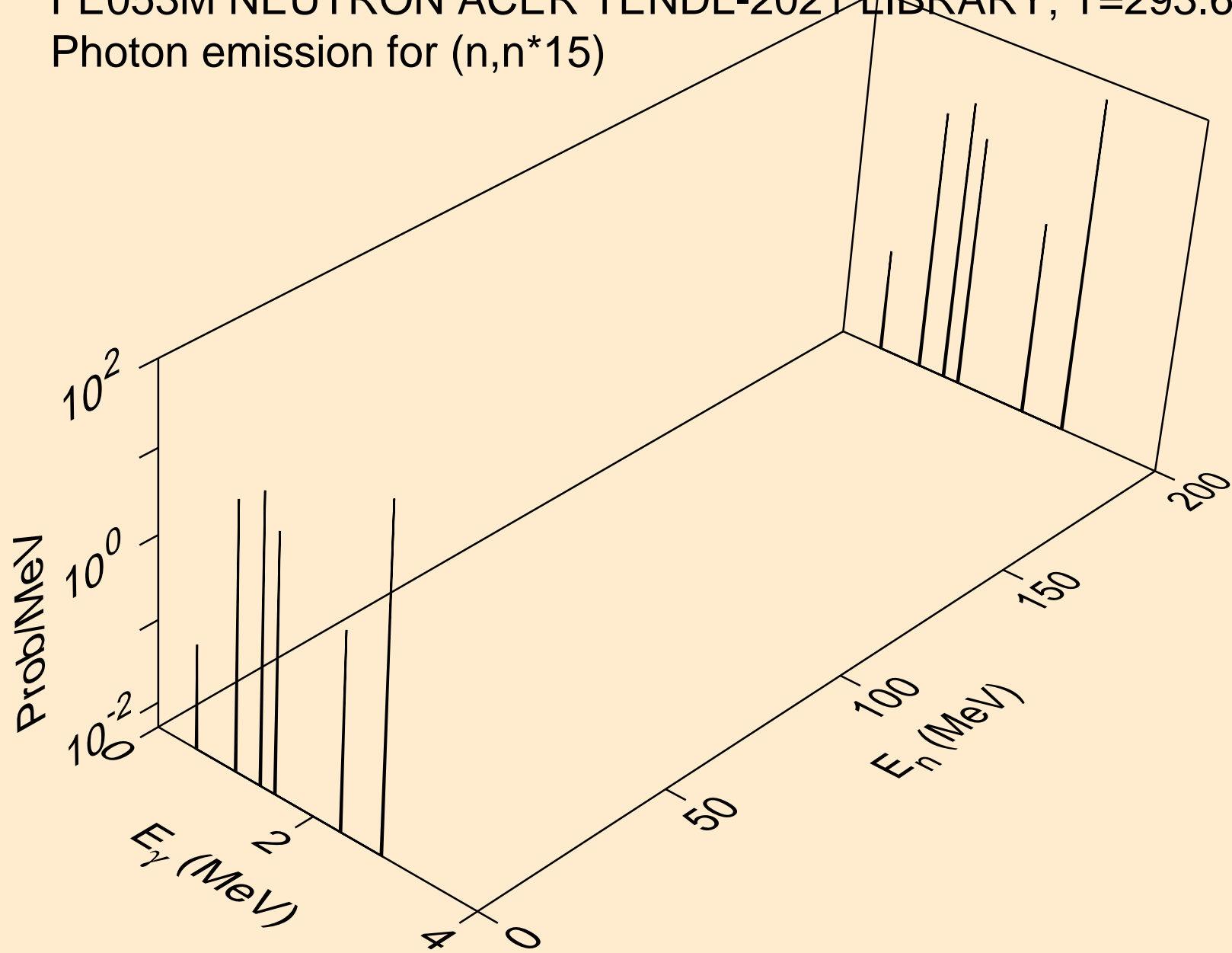

FE053M NEUTRON ACER TENDL-2021 LIBRARY; T=293.6K
Photon emission for (n,n*16)

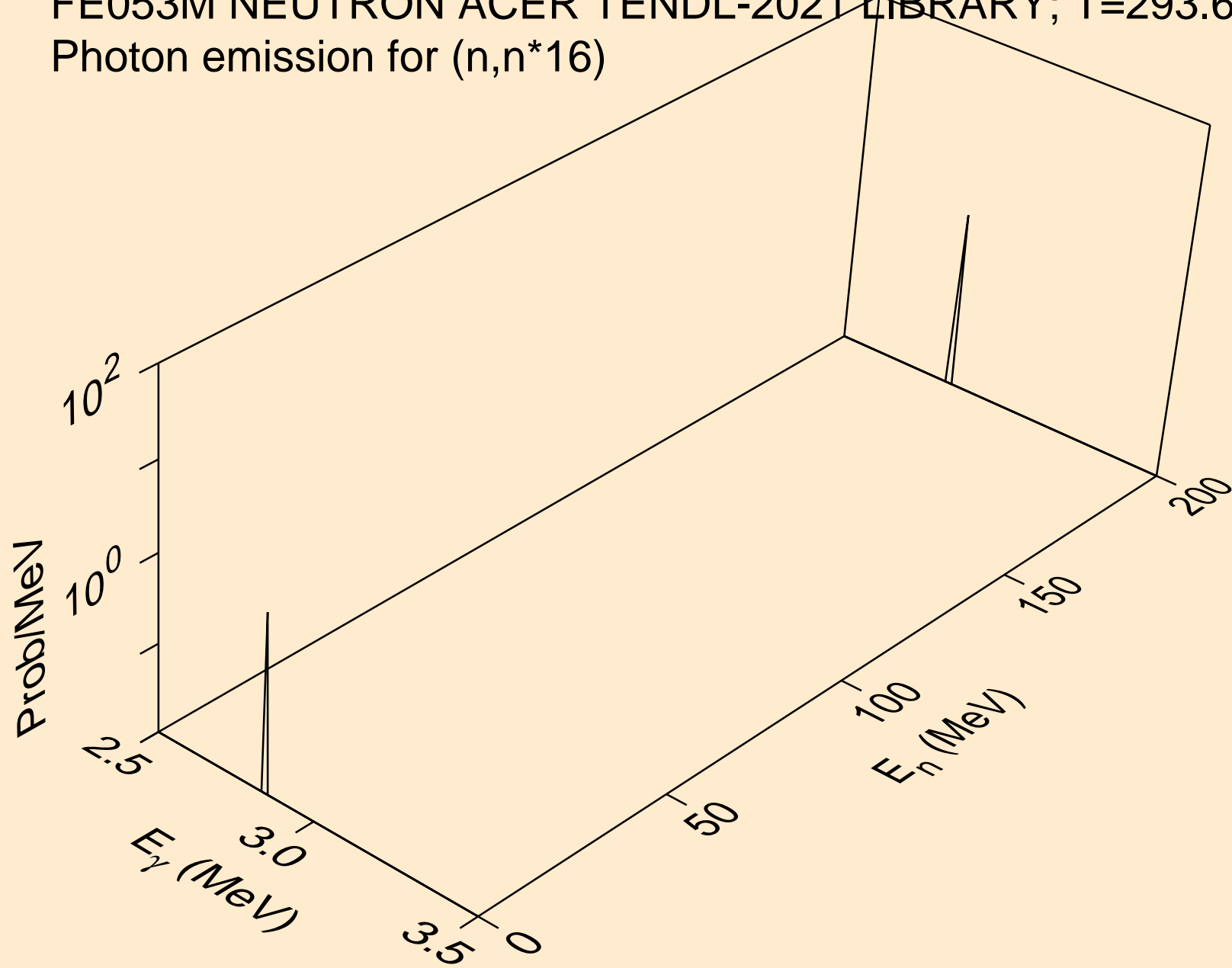

FE053M NEUTRON ACER TENDL-2021 LIBRARY; T=293.6K
Photon emission for (n,n*17)

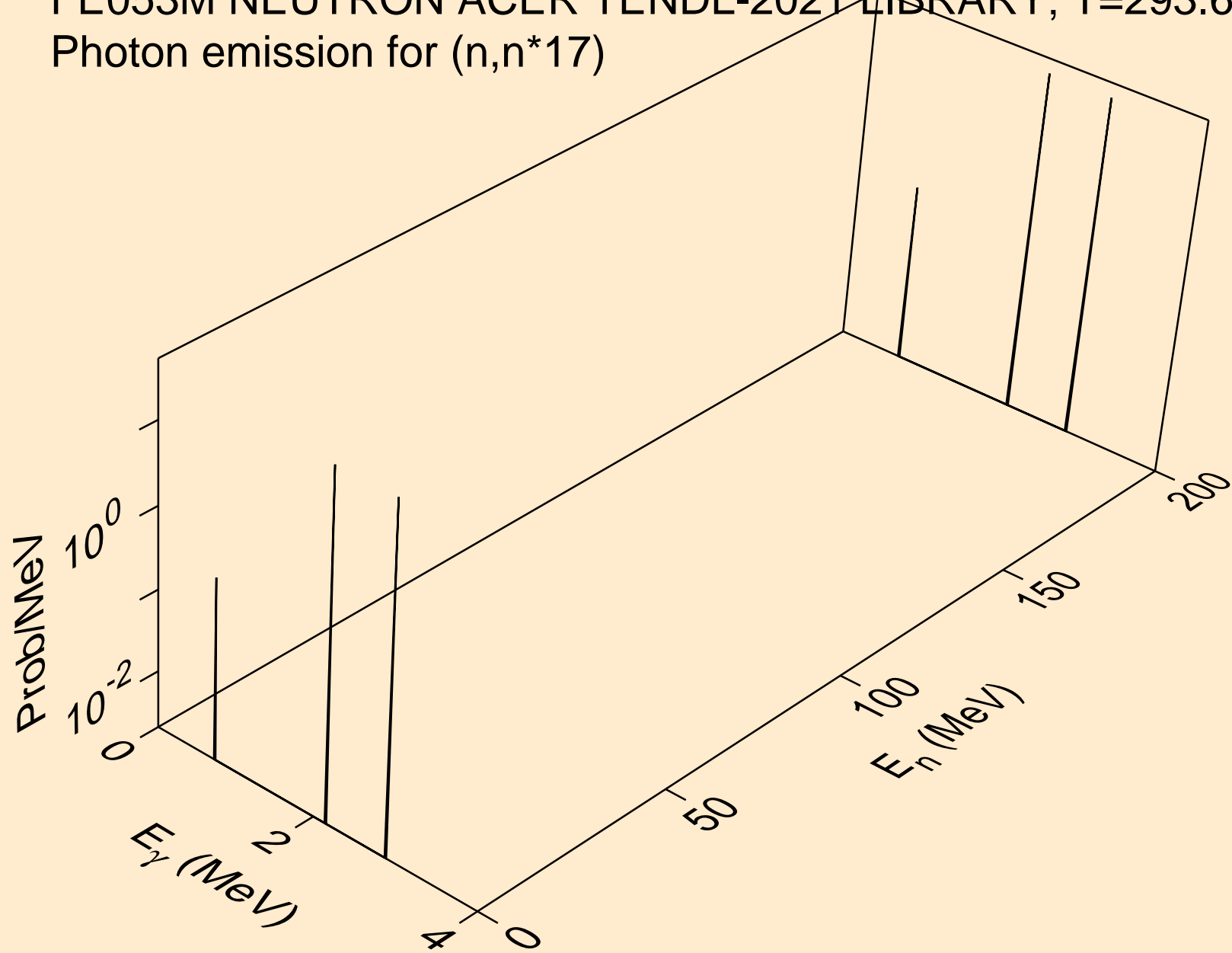

FE053M NEUTRON ACER TENDL-2021 LIBRARY; T=293.6K
Photon emission for (n,n*18)

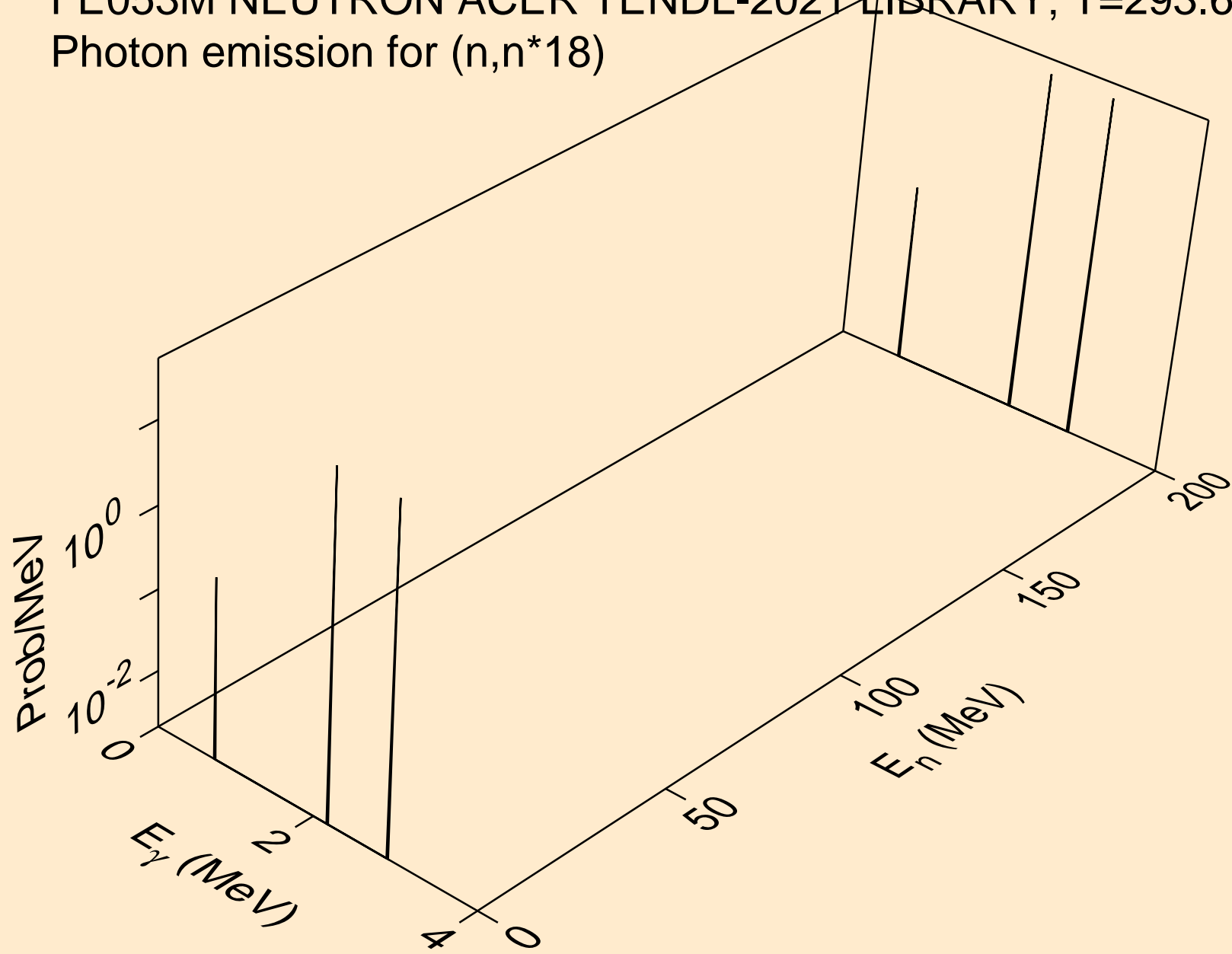

FE053M NEUTRON ACER TENDL-2021 LIBRARY; T=293.6K
Photon emission for (n,n*19)

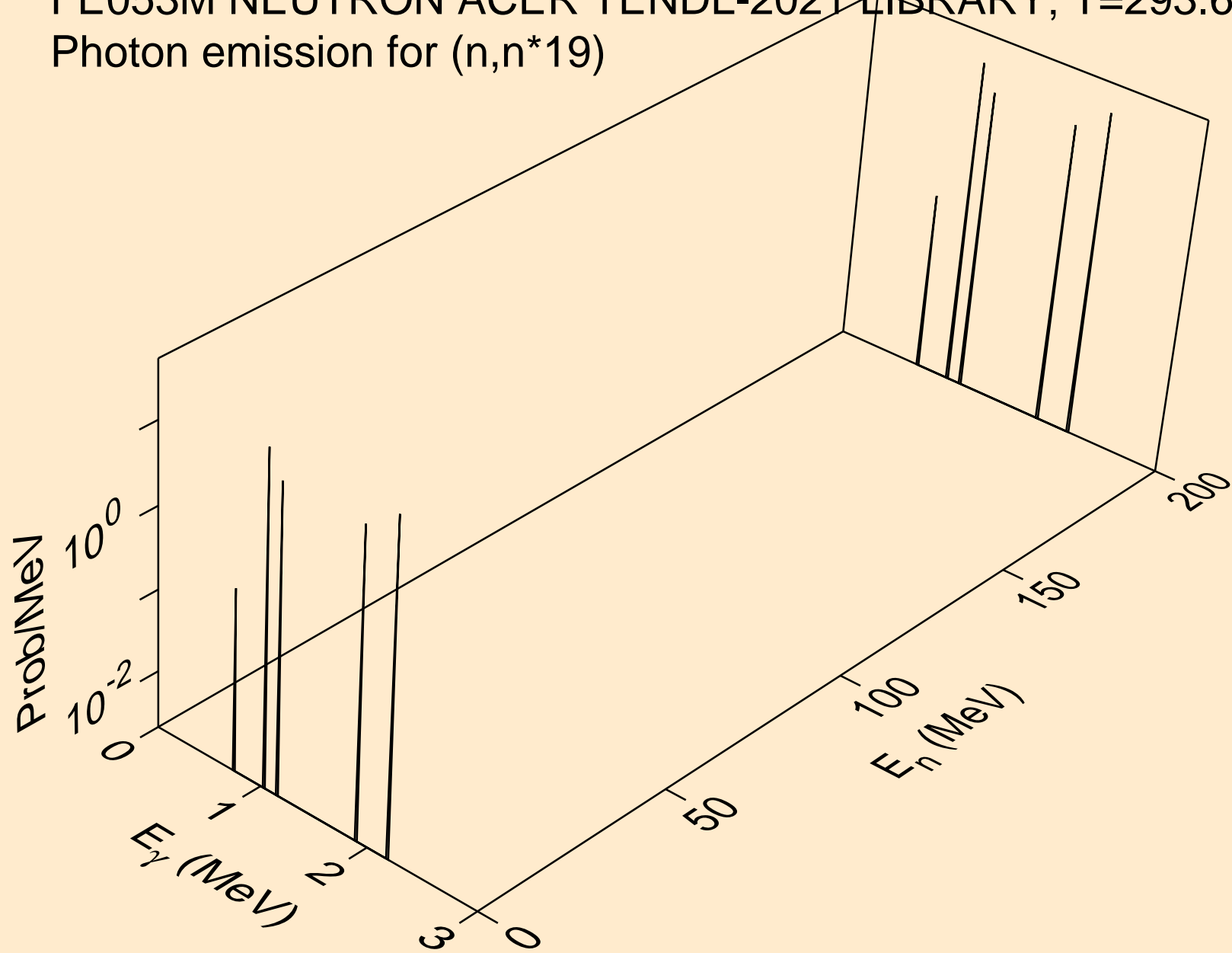

FE053M NEUTRON ACER TENDL-2021 LIBRARY; T=293.6K
Photon emission for (n,n*20)

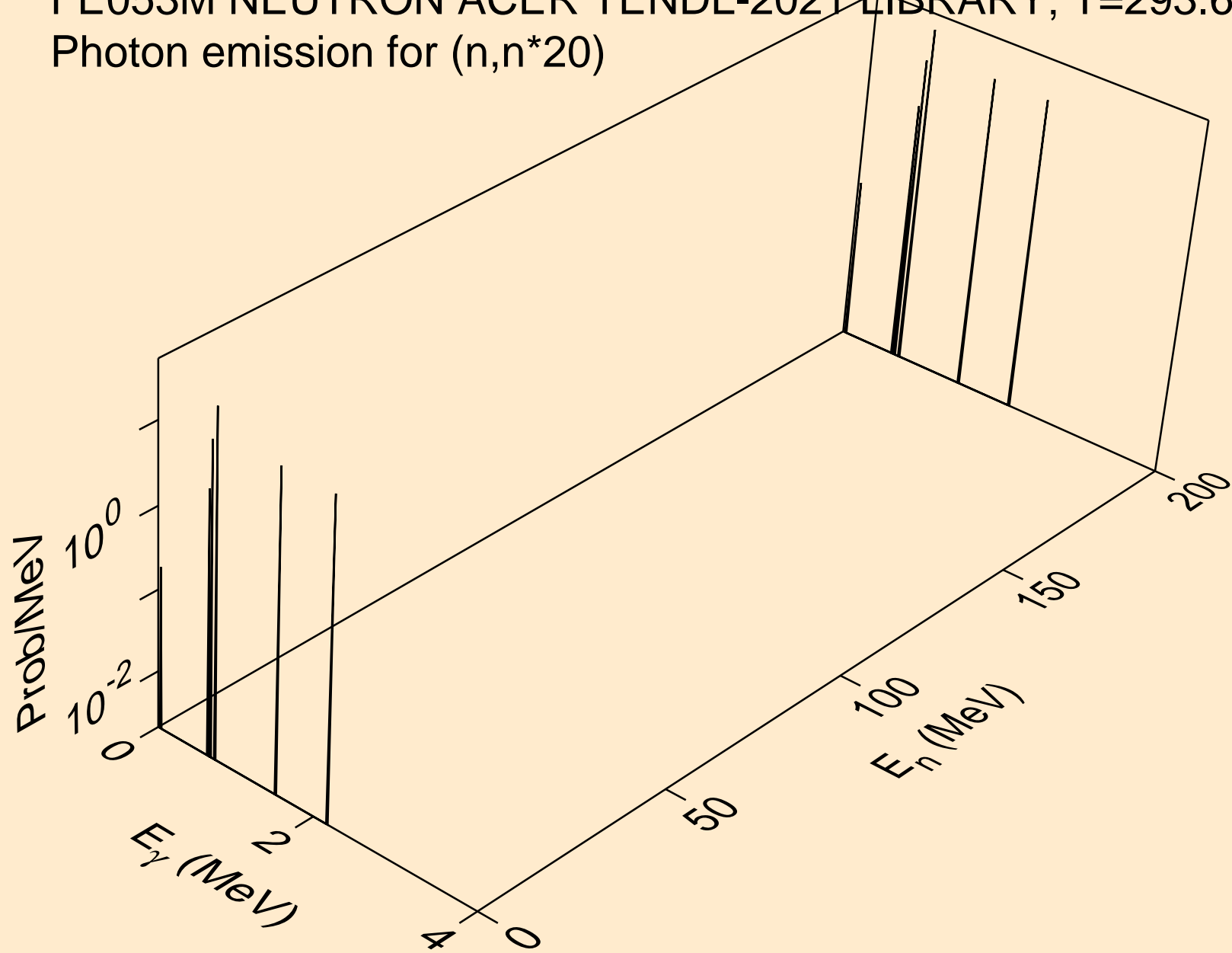

FE053M NEUTRON ACER TENDL-2021 LIBRARY; T=293.6K
Photon emission for (n,n*21)

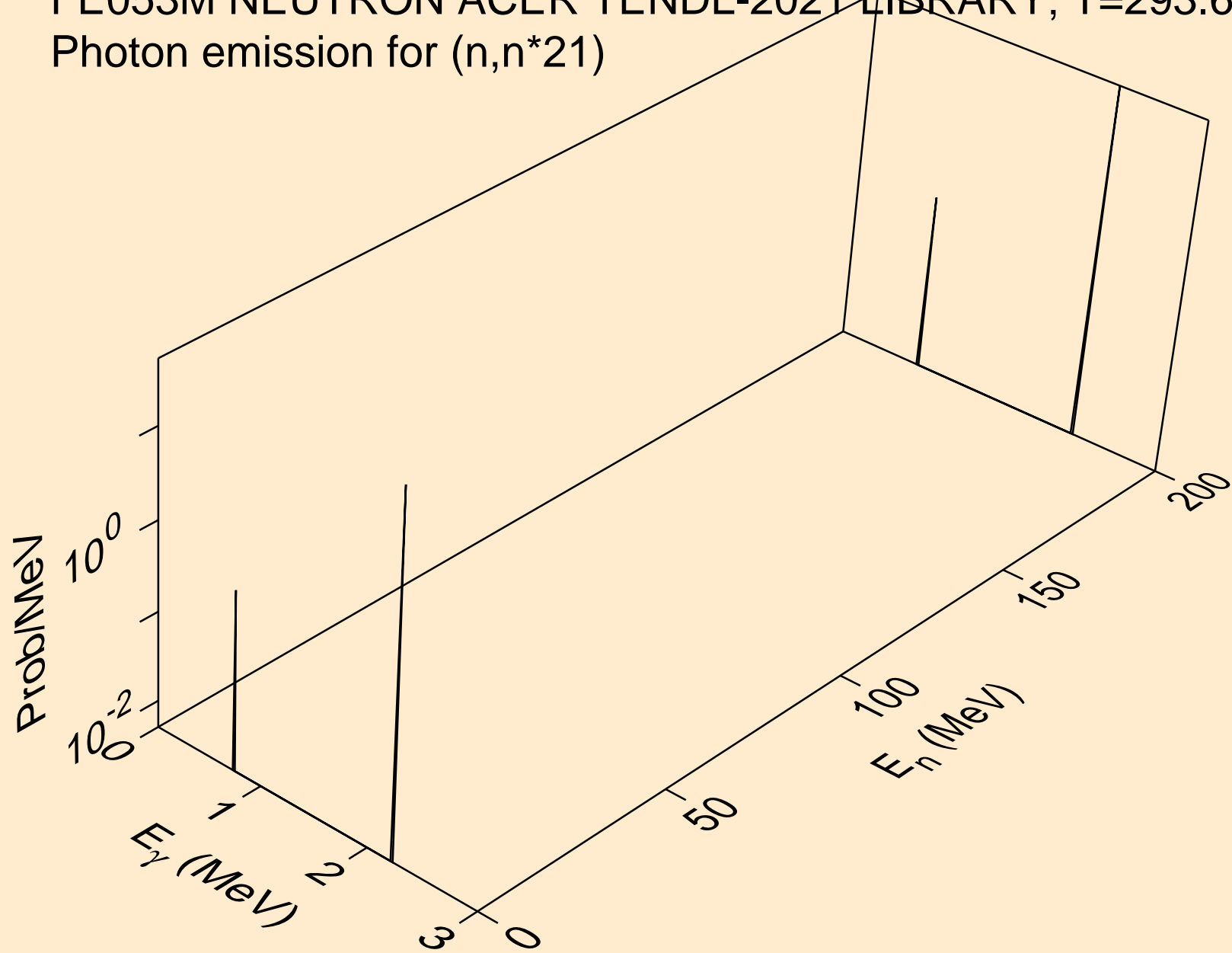

FE053M NEUTRON ACER TENDL-2021 LIBRARY; T=293.6K
Photon emission for (n,n*23)

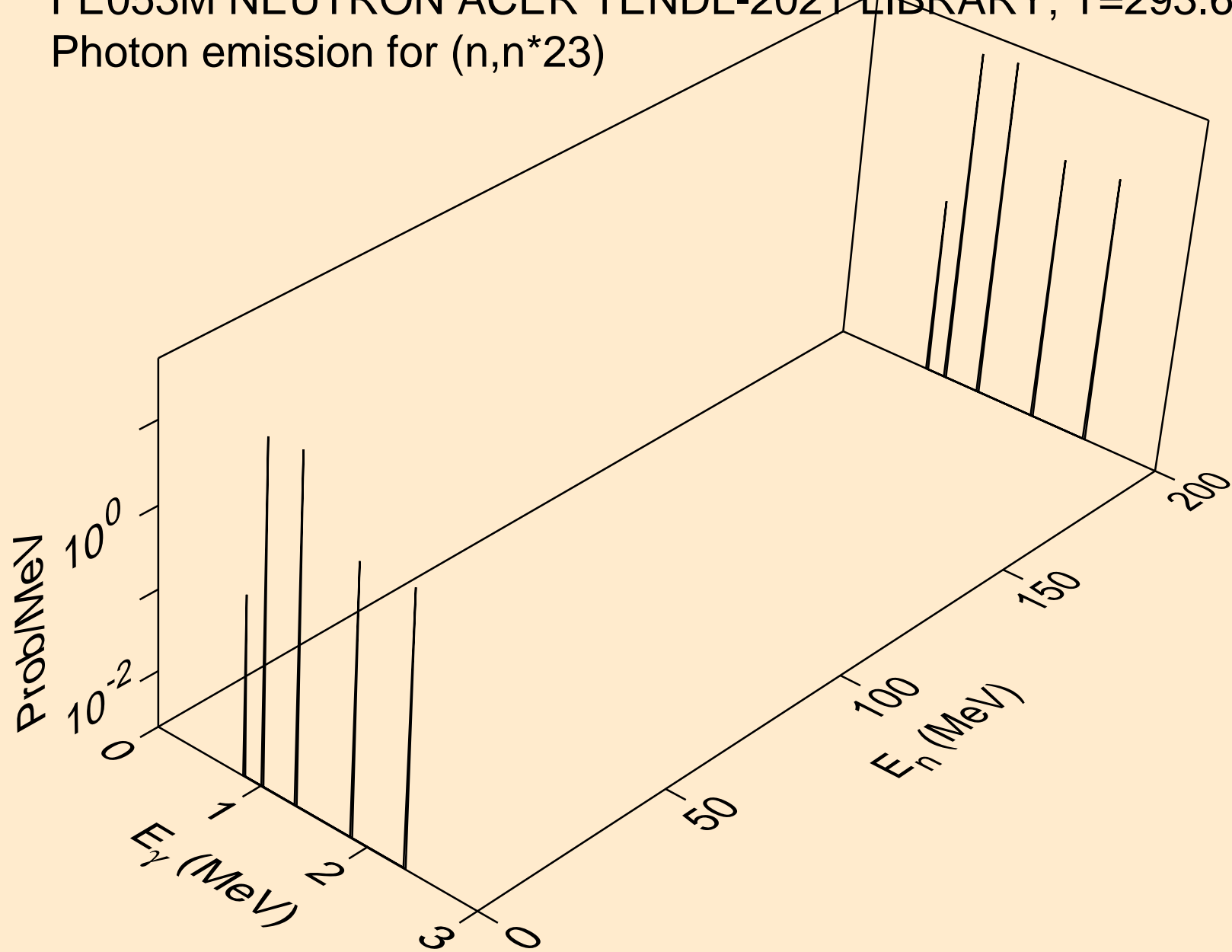

FE053M NEUTRON ACER TENDL-2021 LIBRARY; T=293.6K
Photon emission for (n,n*24)

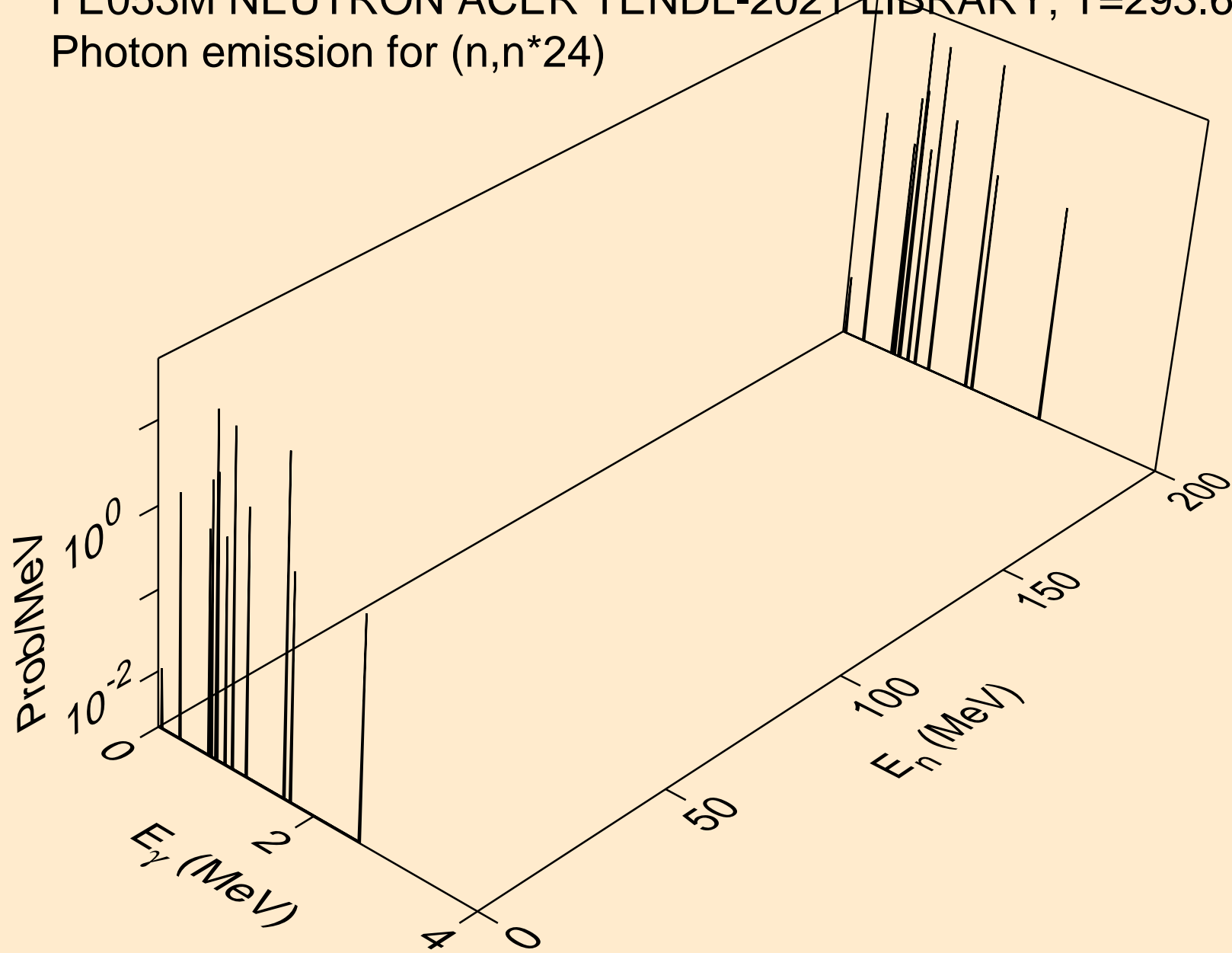

FE053M NEUTRON ACER TENDL-2021 LIBRARY; T=293.6K
Photon emission for (n,n*25)

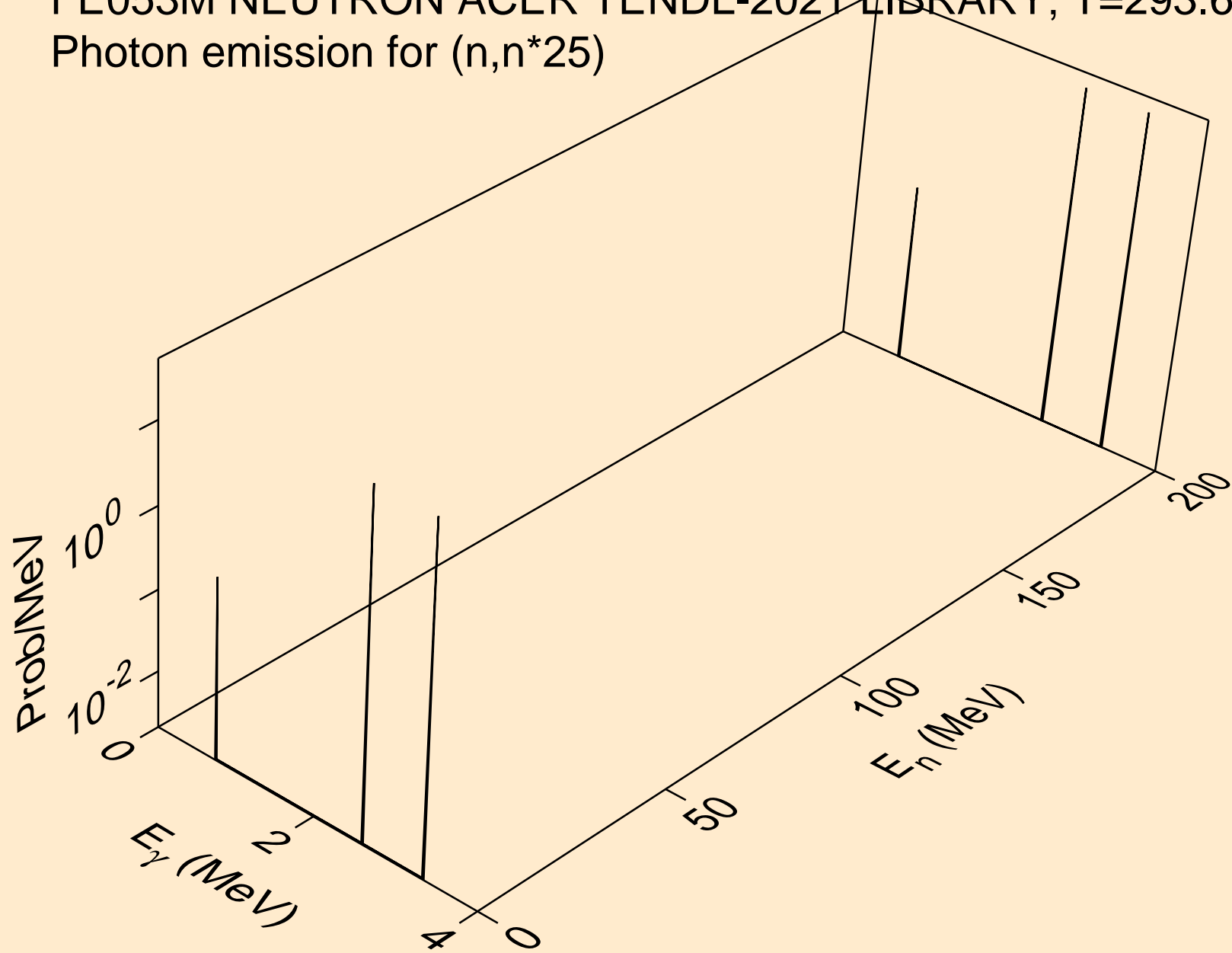

FE053M NEUTRON ACER TENDL-2021 LIBRARY; T=293.6K
Photon emission for (n,n*26)

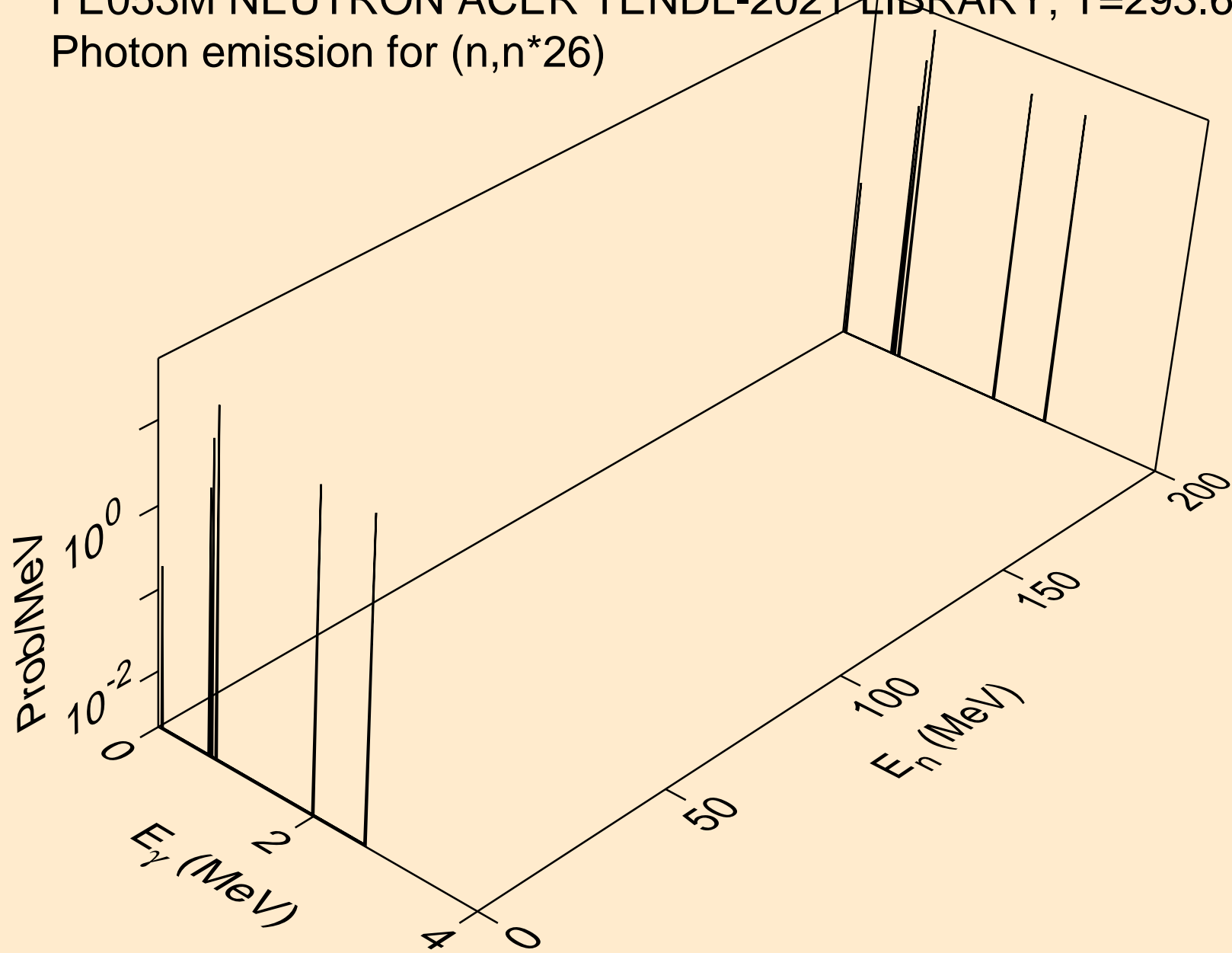

FE053M NEUTRON ACER TENDL-2021 LIBRARY; T=293.6K
Photon emission for (n,n*27)

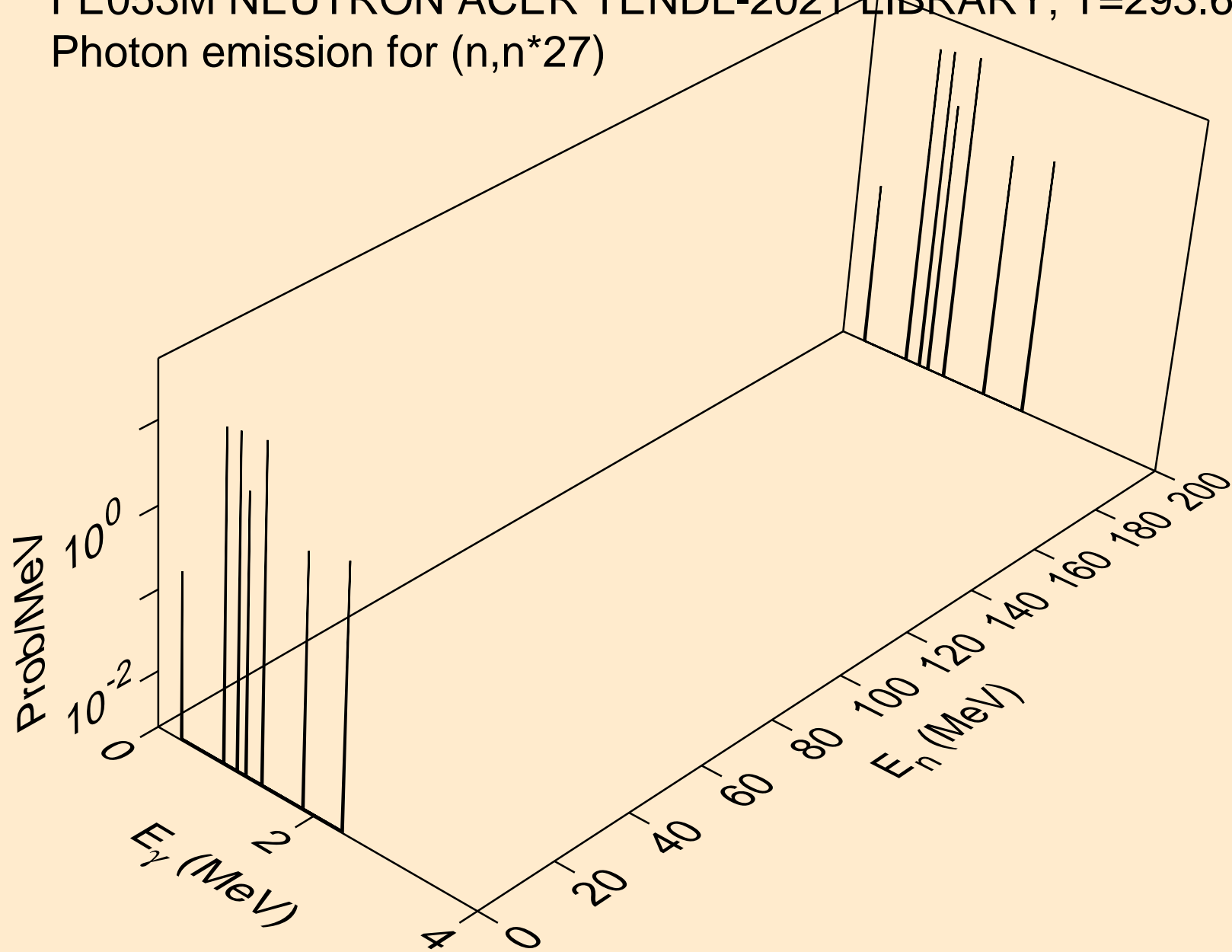

FE053M NEUTRON ACER TENDL-2021 LIBRARY; T=293.6K
Photon emission for (n,n*28)

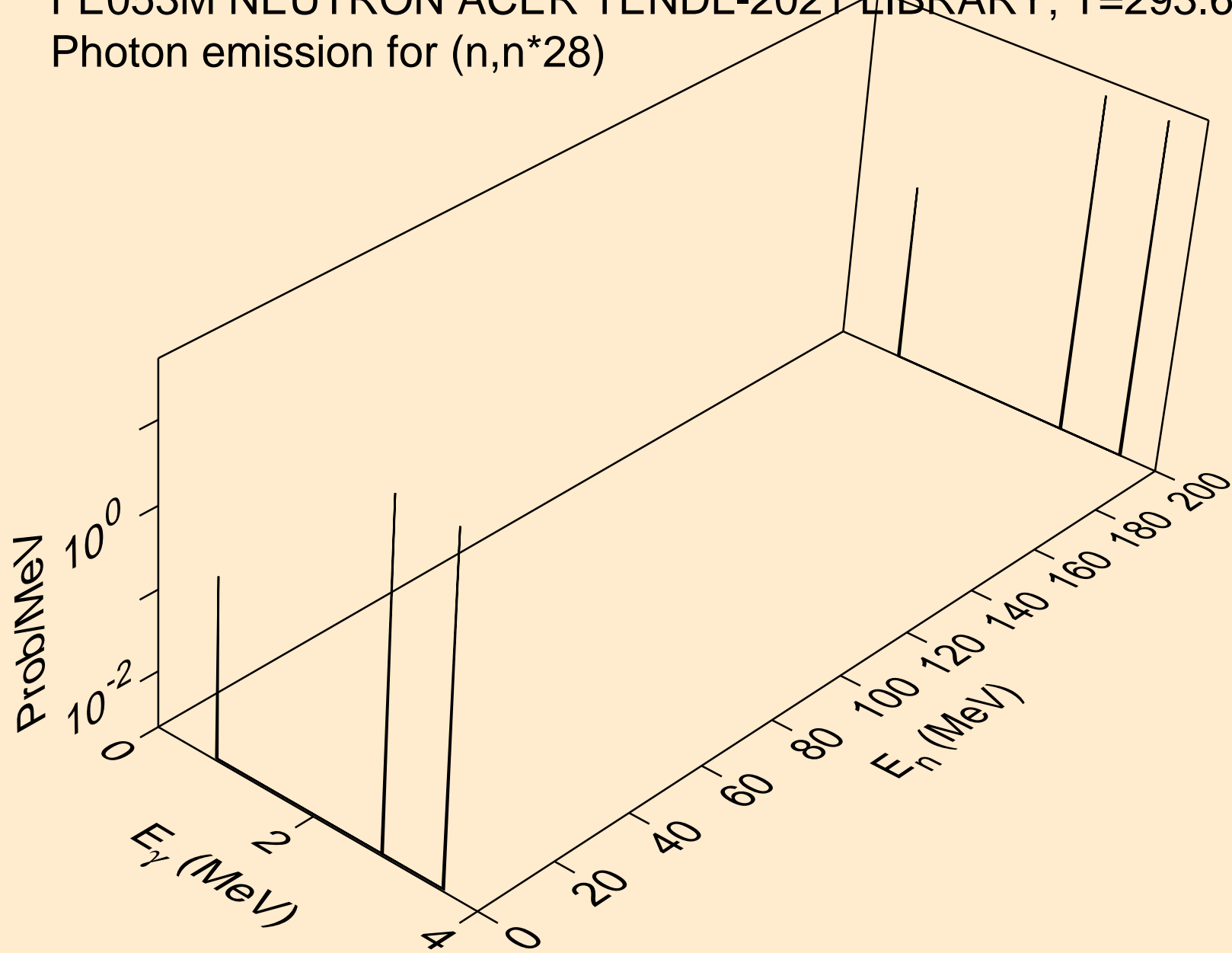

FE053M NEUTRON ACER TENDL-2021 LIBRARY; T=293.6K
Photon emission for (n,n*29)

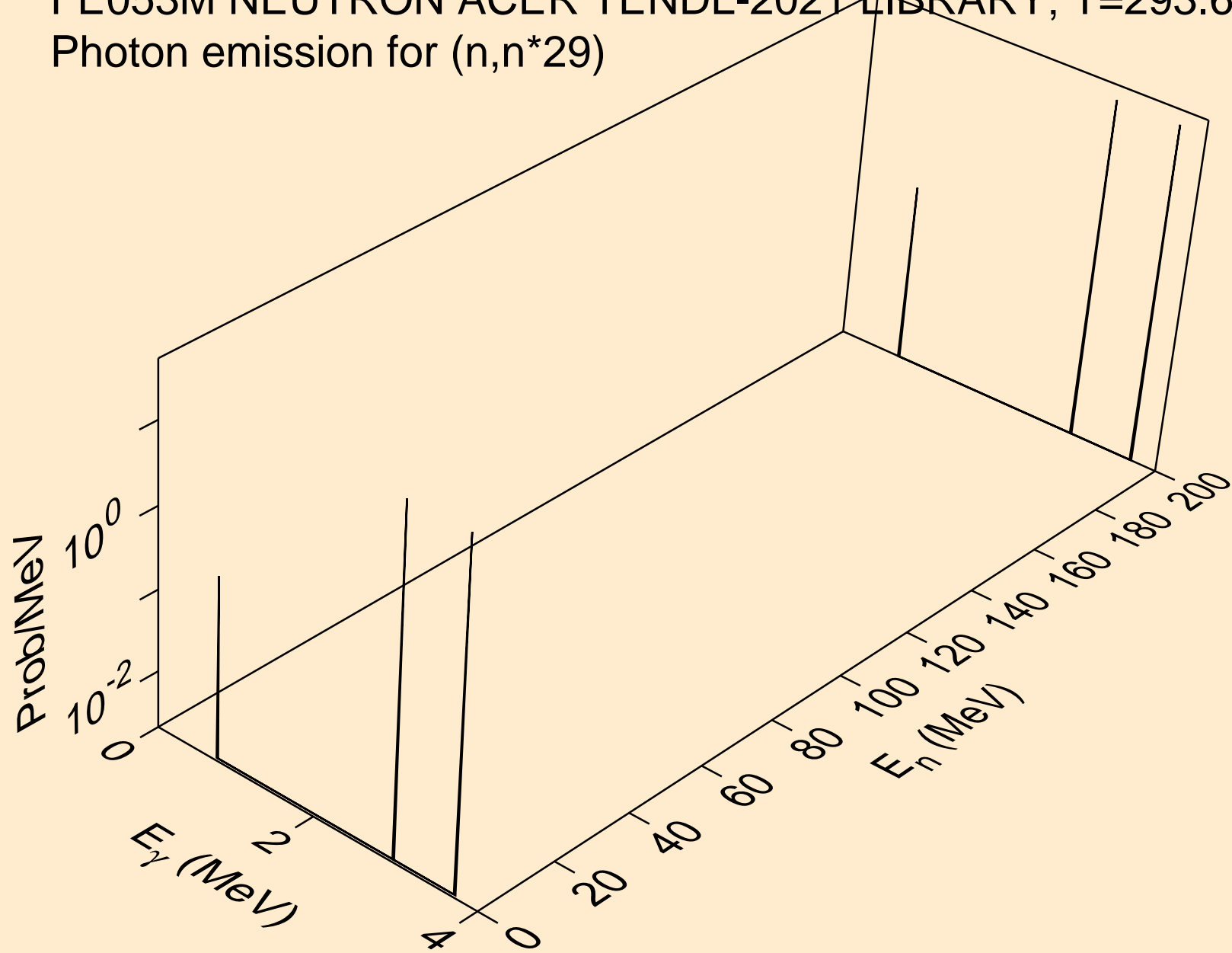

FE053M NEUTRON ACER TENDL-2021 LIBRARY; T=293.6K
Photon emission for (n,n*30)

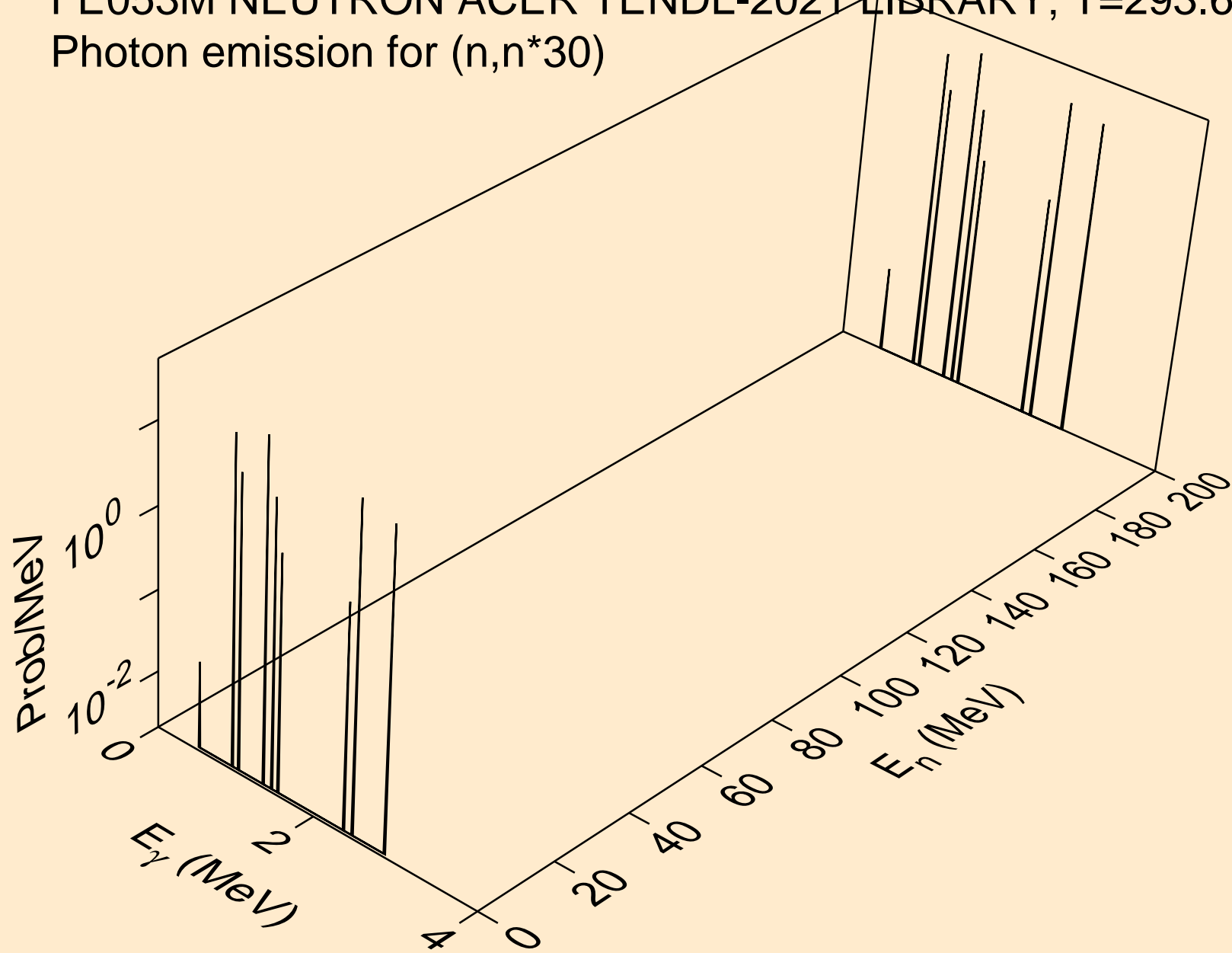

FE053M NEUTRON ACER TENDL-2021 LIBRARY; T=293.6K
Photon emission for (n,n*c)

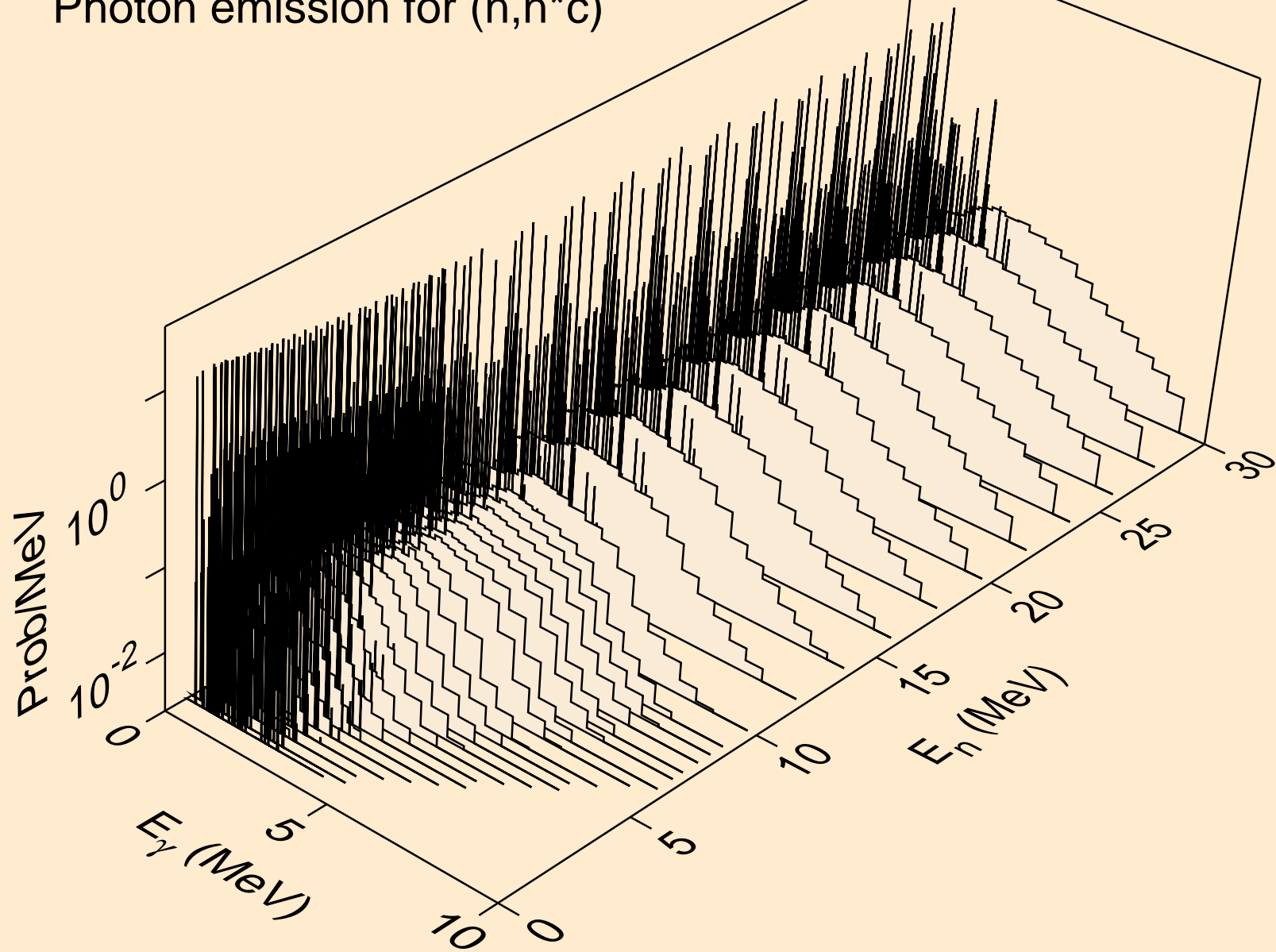

FE053M NEUTRON ACER TENDL-2021 LIBRARY; T=293.6K
Photon emission for (n,gma)

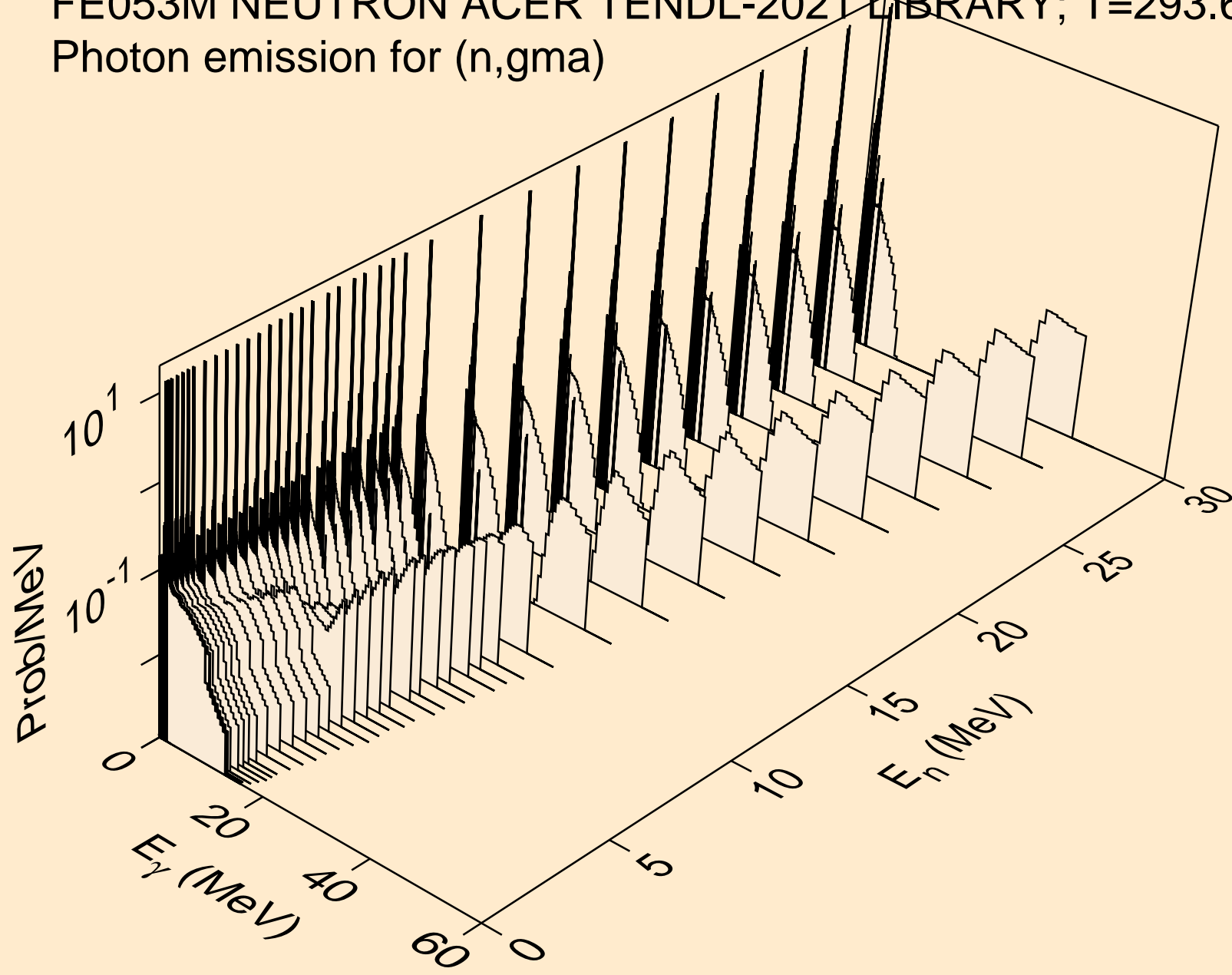

FE053M NEUTRON ACER TENDL-2021 LIBRARY; T=293.6K
Photon emission for (n,p)

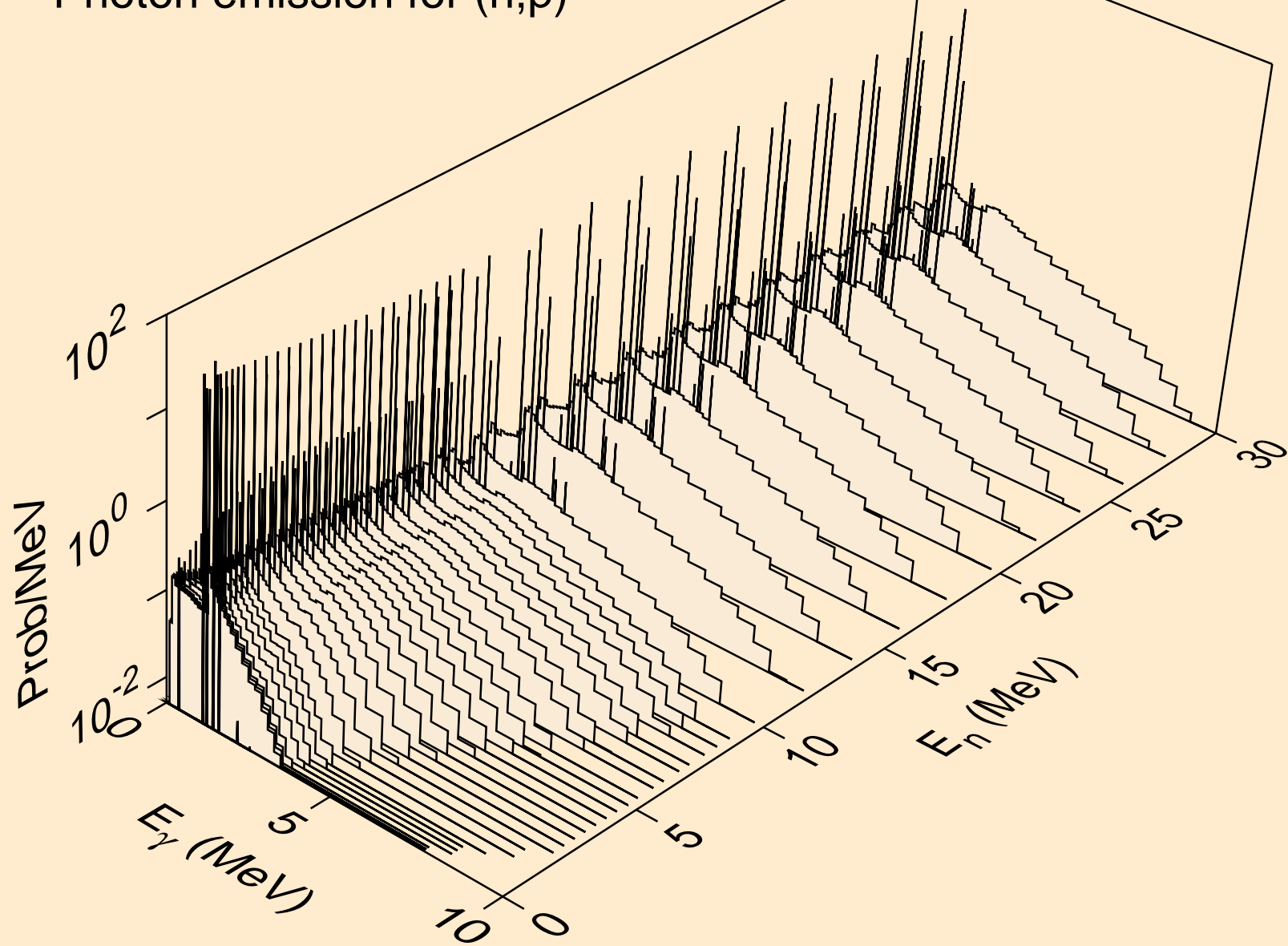

FE053M NEUTRON ACER TENDL-2021 LIBRARY; T=293.6K
Photon emission for (n,d)

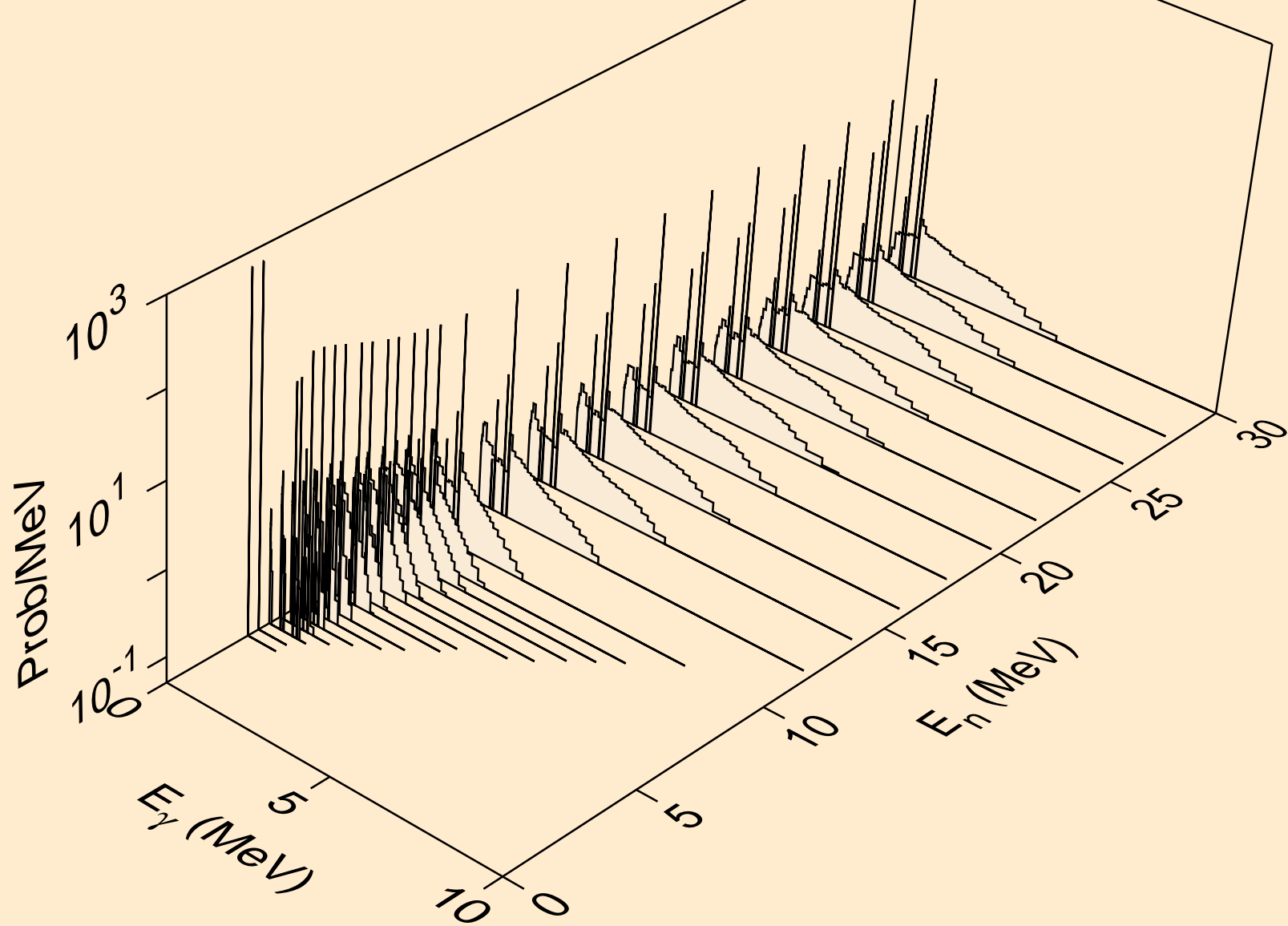

FE053M NEUTRON ACER TENDL-2021 LIBRARY; T=293.6K
Photon emission for (n,t)

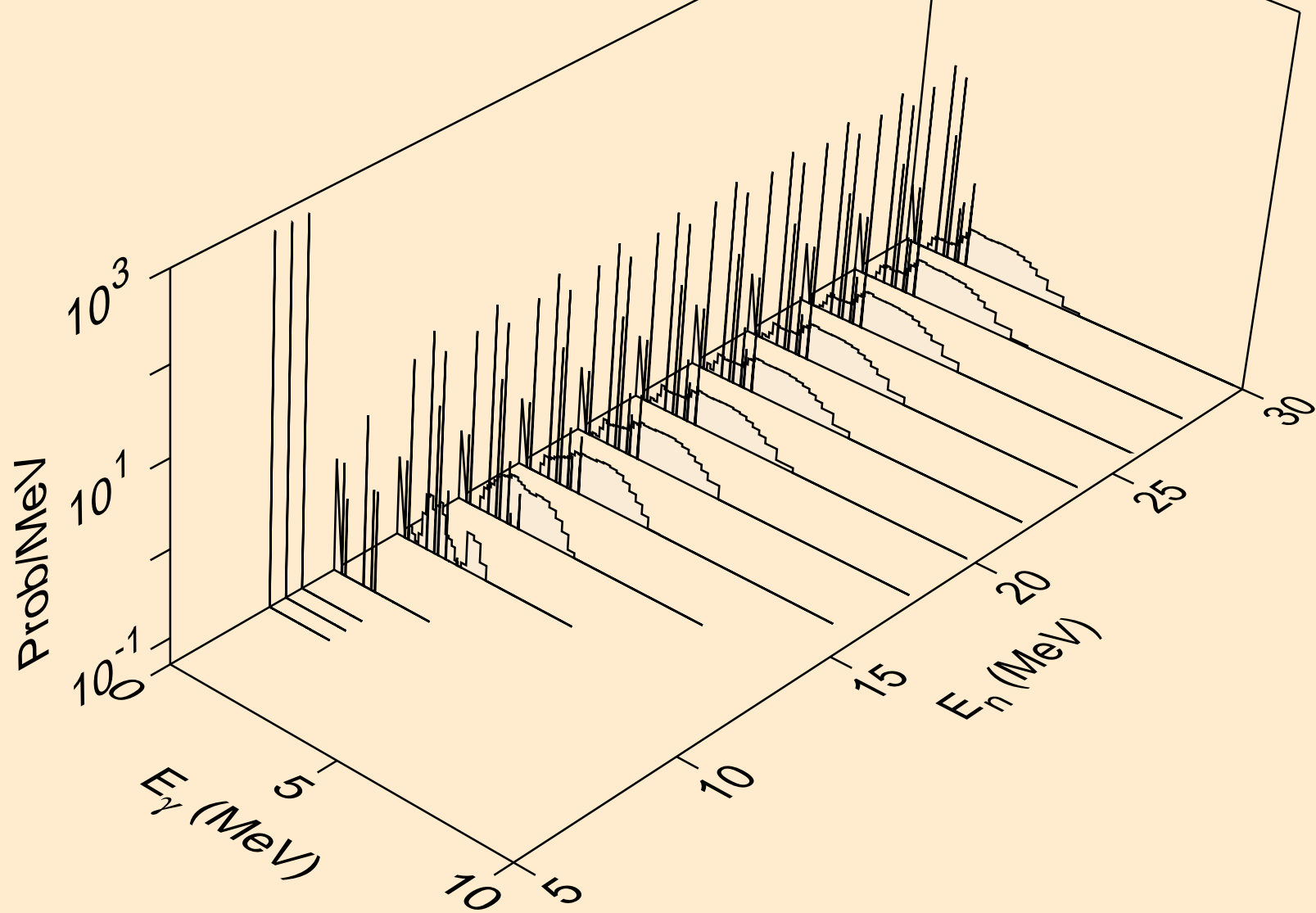

FE053M NEUTRON ACER TENDL-2021 LIBRARY; T=293.6K
Photon emission for (n,he3)

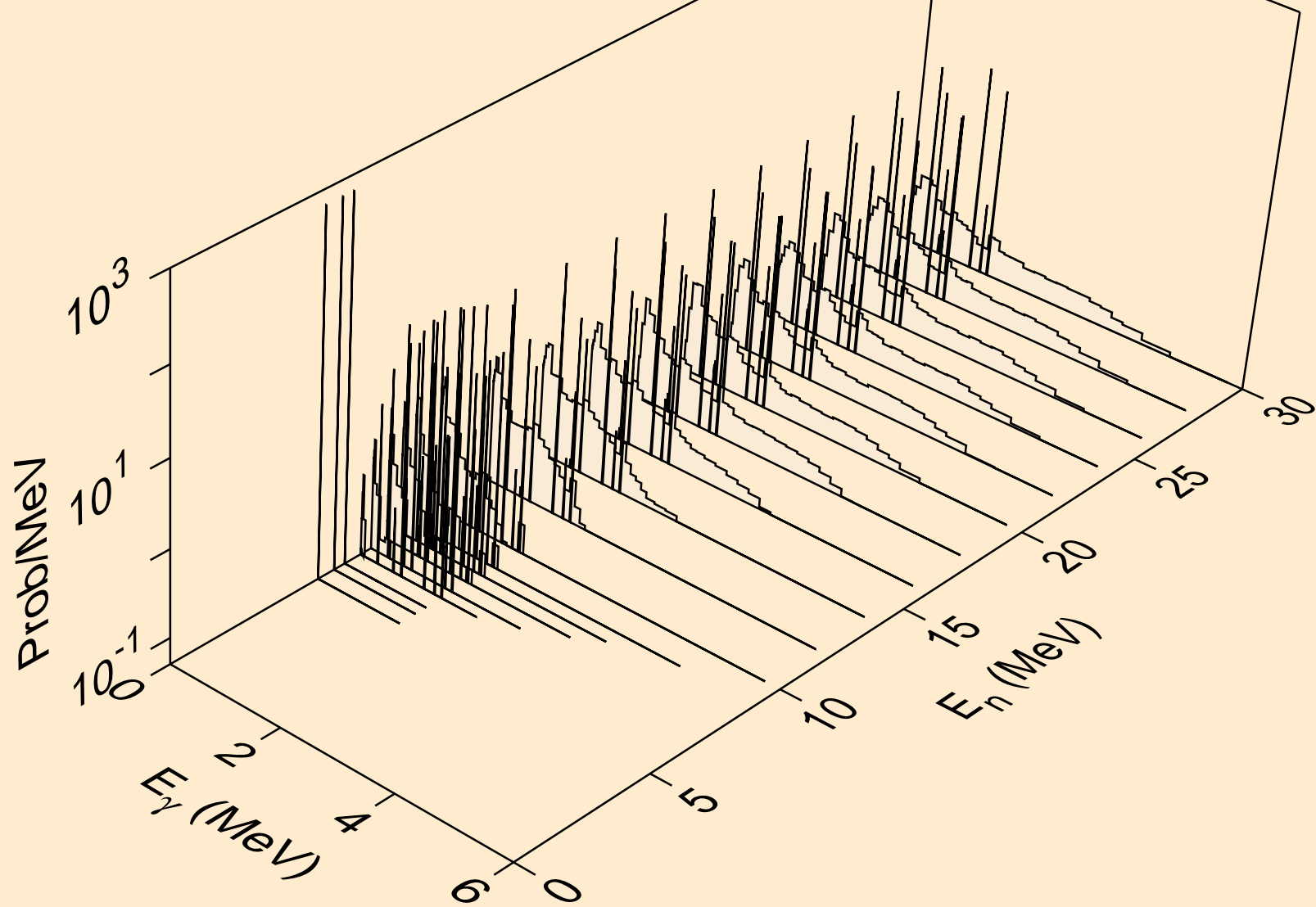

FE053M NEUTRON ACER TENDL-2021 LIBRARY; T=293.6K
Photon emission for (n,a)

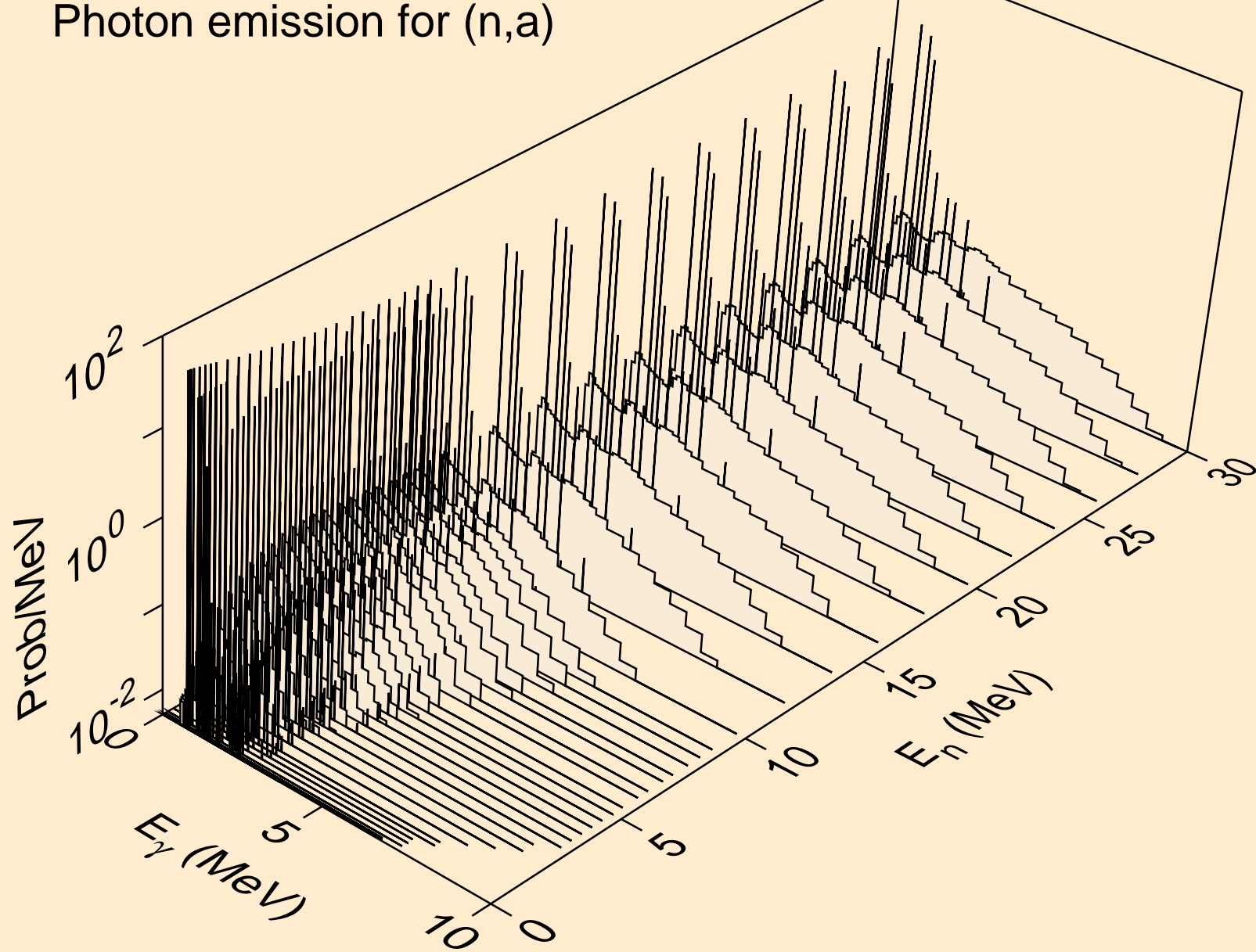

FE053M NEUTRON ACER TENDL-2021 LIBRARY; T=293.6K
Photon emission for (n,2a)

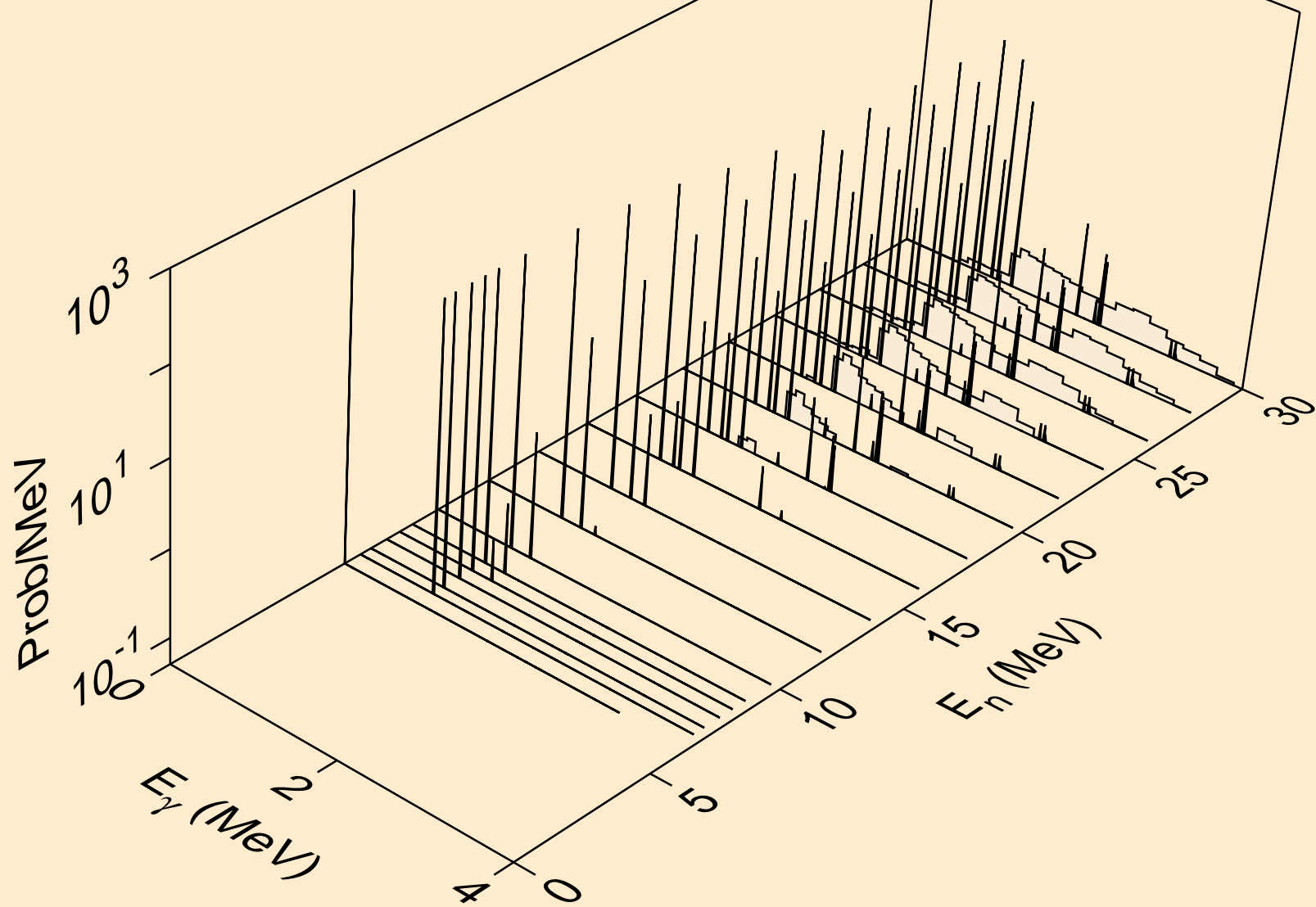

FE053M NEUTRON ACER TENDL-2021 LIBRARY; T=293.6K
Photon emission for (n,3a)

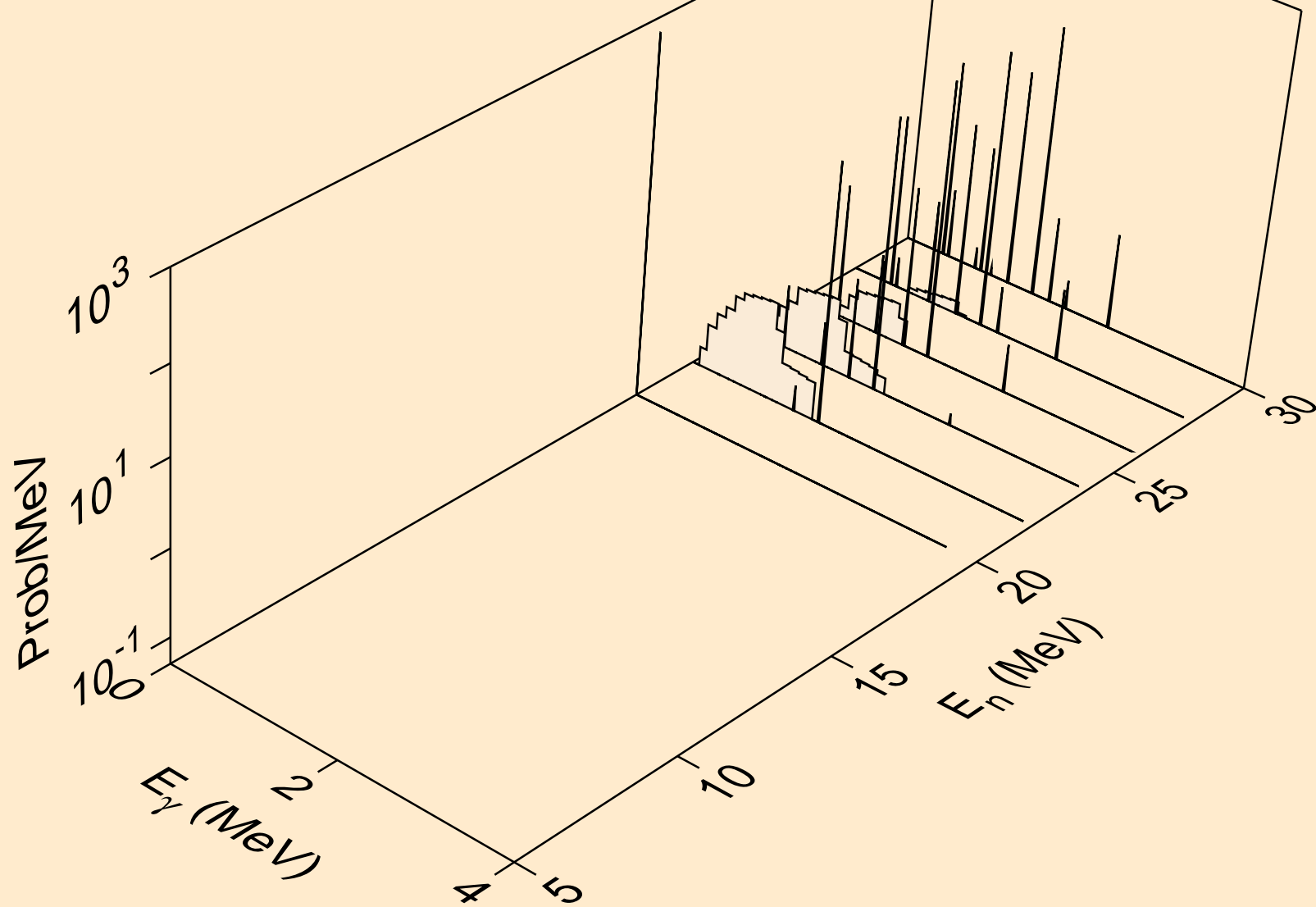

FE053M NEUTRON ACER TENDL-2021 LIBRARY; T=293.6K
Photon emission for (n,2p)

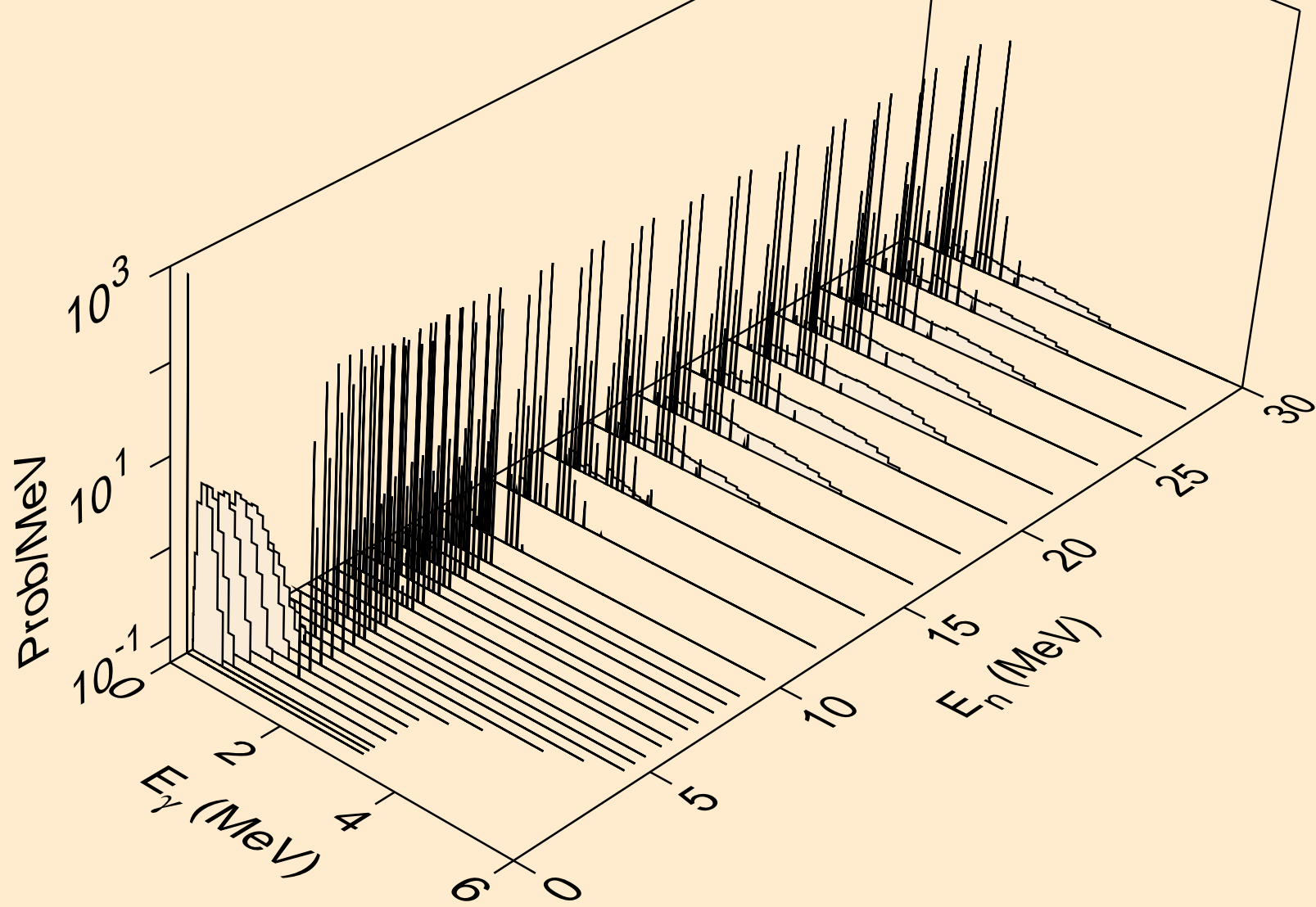

FE053M NEUTRON ACER TENDL-2021 LIBRARY; T=293.6K
Photon emission for (n,p α)

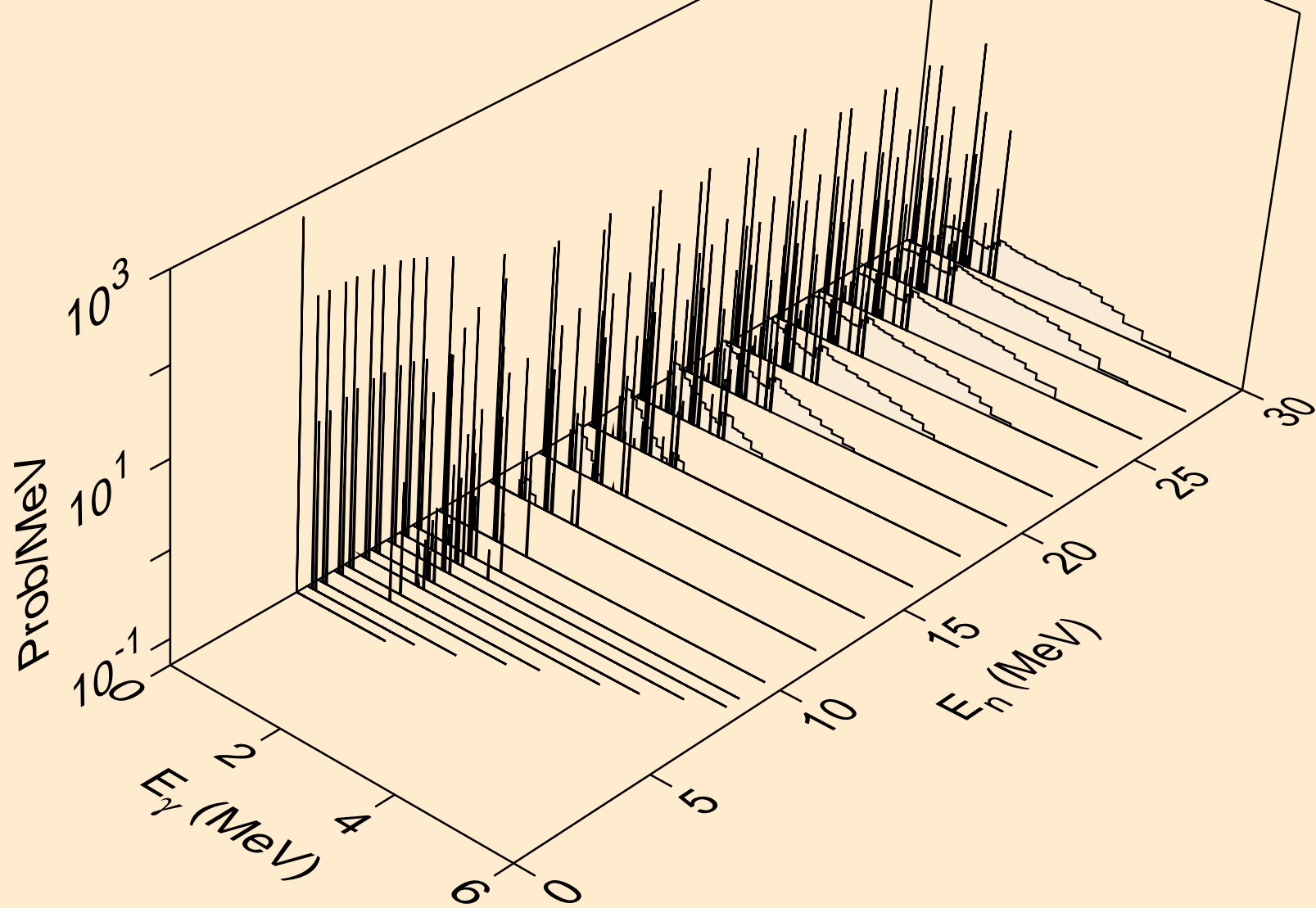

FE053M NEUTRON ACER TENDL-2021 LIBRARY; T=293.6K
Photon emission for (n,pd)

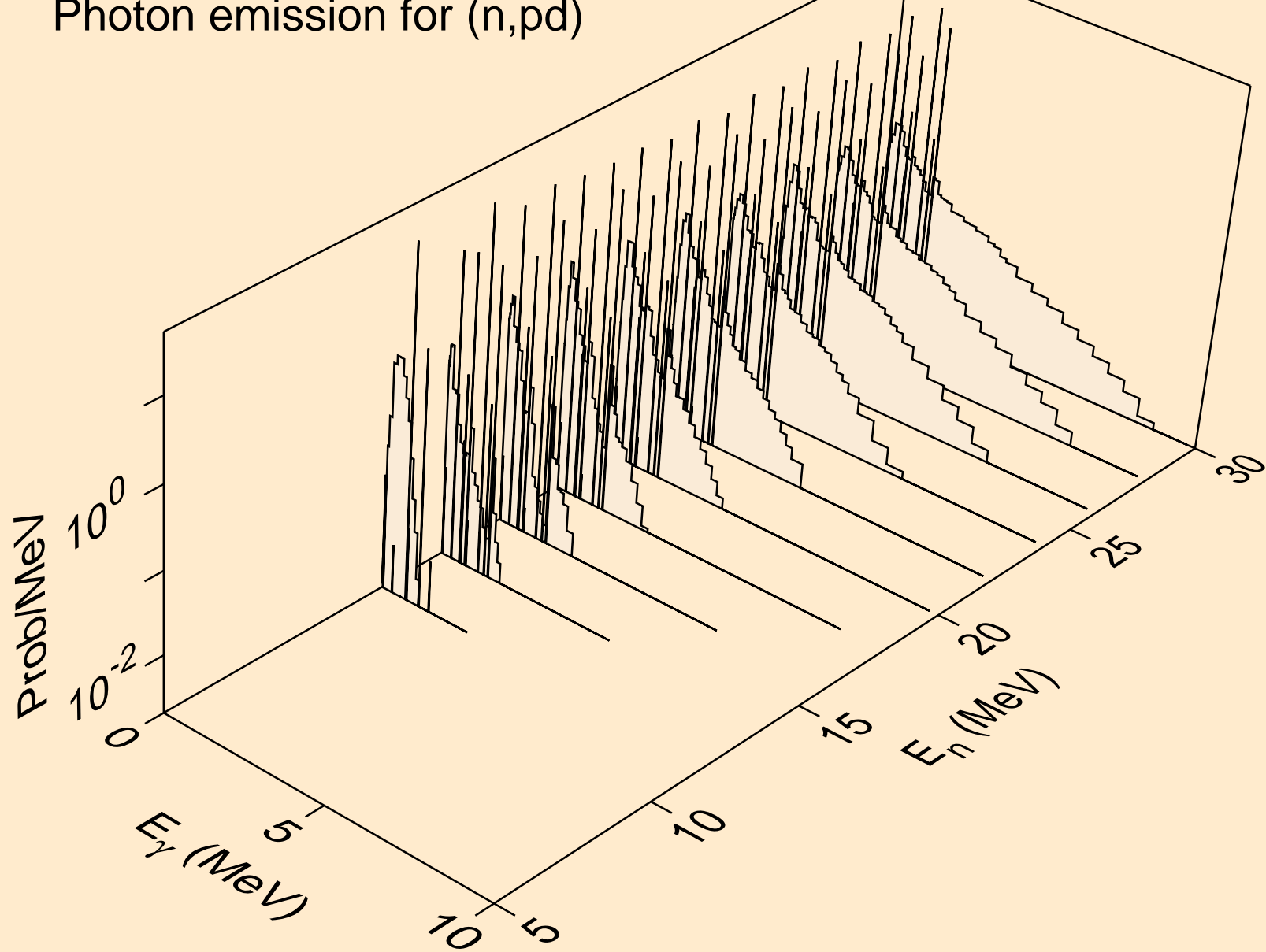

FE053M NEUTRON ACER TENDL-2021 LIBRARY; T=293.6K
Photon emission for (n,pt)

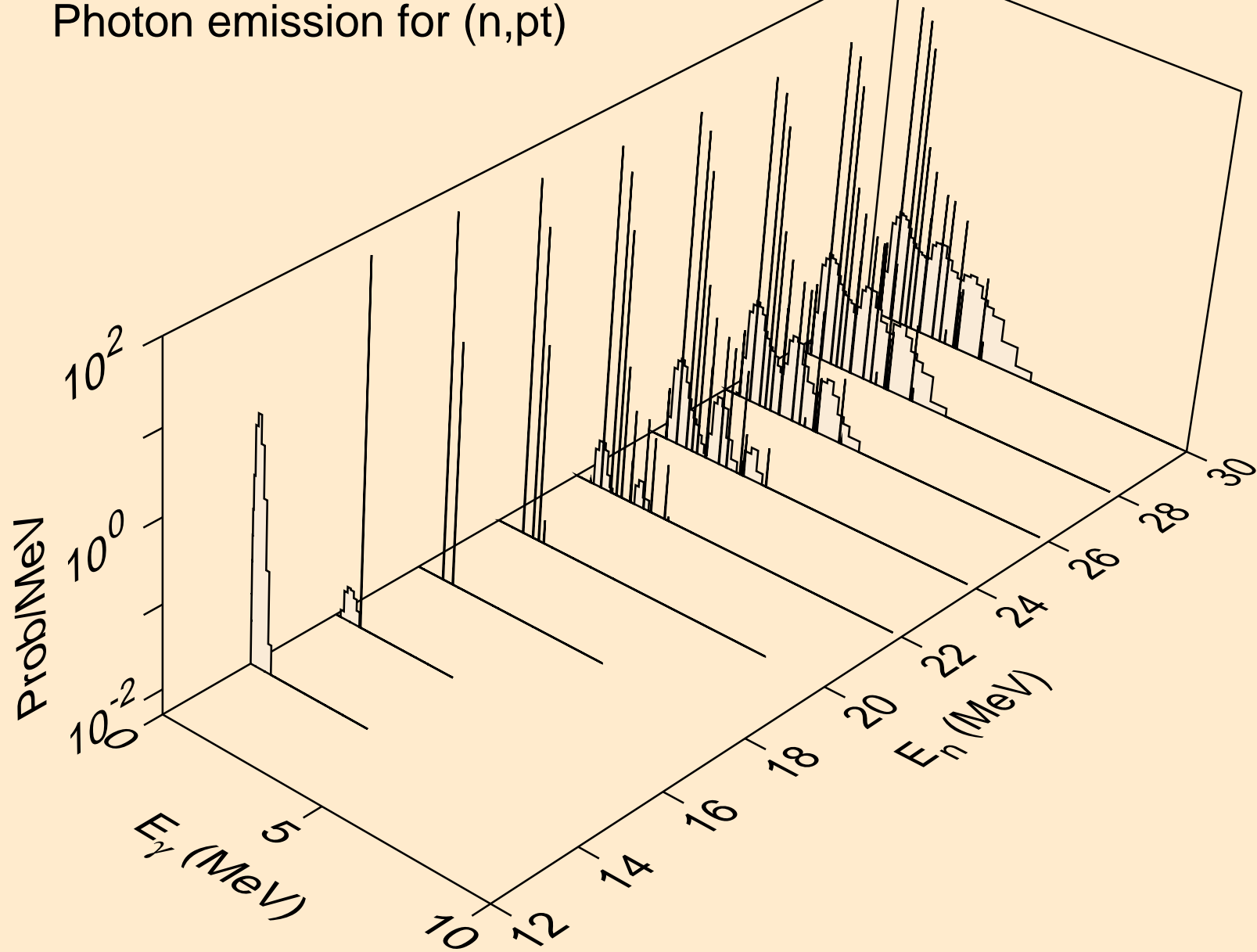

FE053M NEUTRON ACER TENDL-2021 LIBRARY; T=293.6K
Photon emission for (n,da)

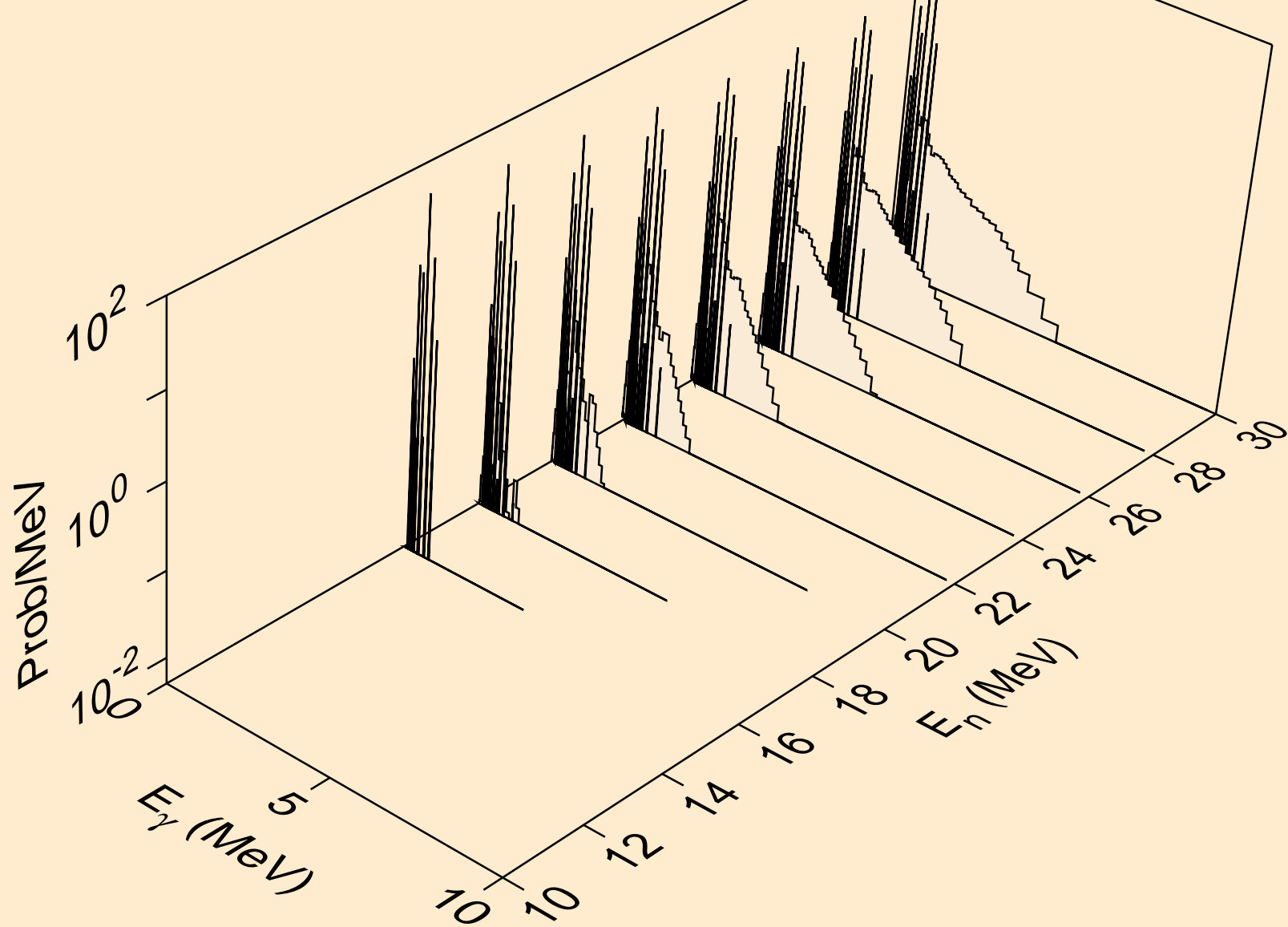

FE053M NEUTRON ACER TENDL-2021 LIBRARY; T=293.6K
thermal capture photon spectrum

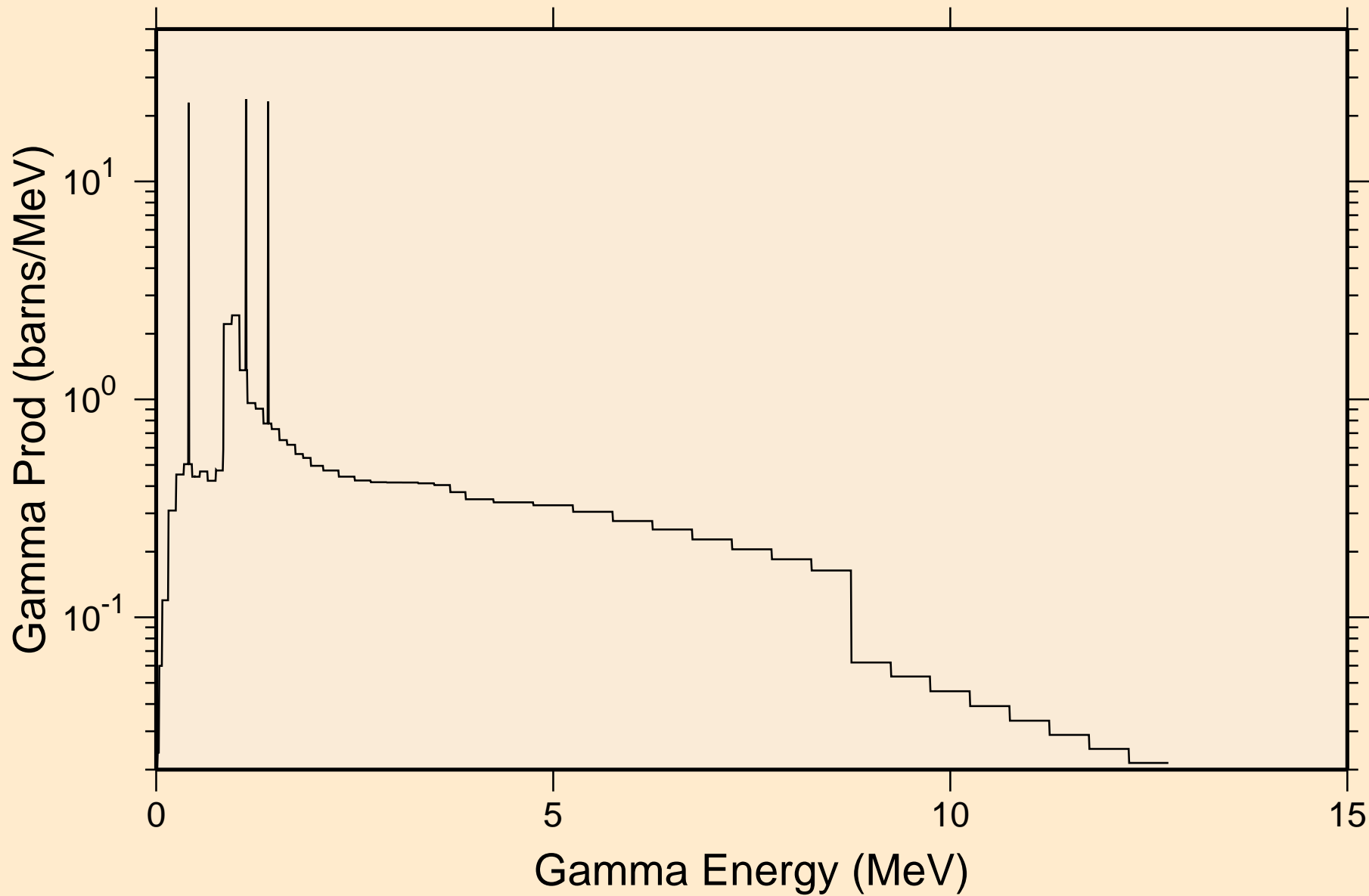

FE053M NEUTRON ACER TENDL-2021 LIBRARY; T=293.6K
14 MeV photon spectrum

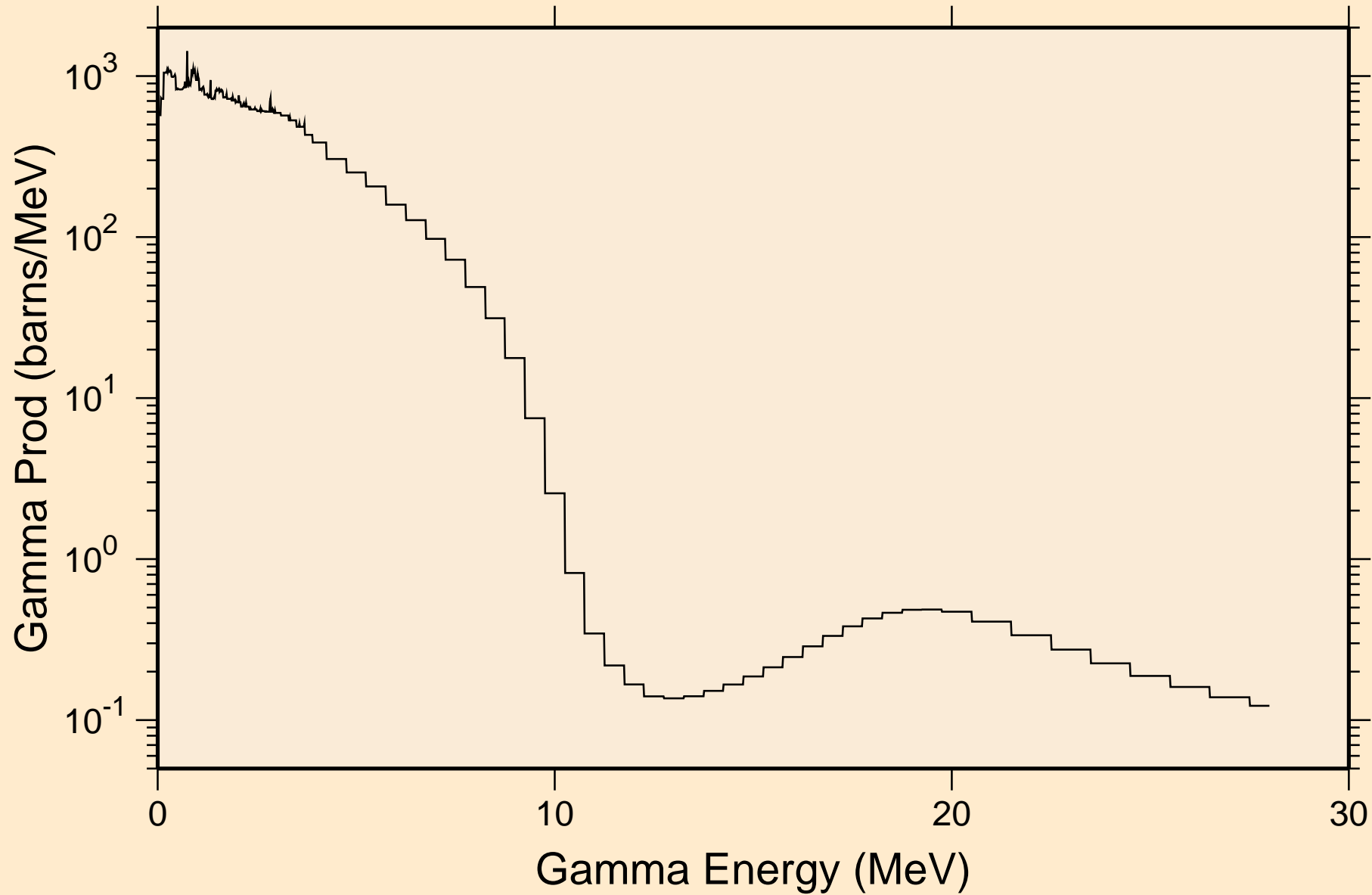

FE053M NEUTRON ACER TENDL-2021 LIBRARY; T=293.6K

Particle heating contributions

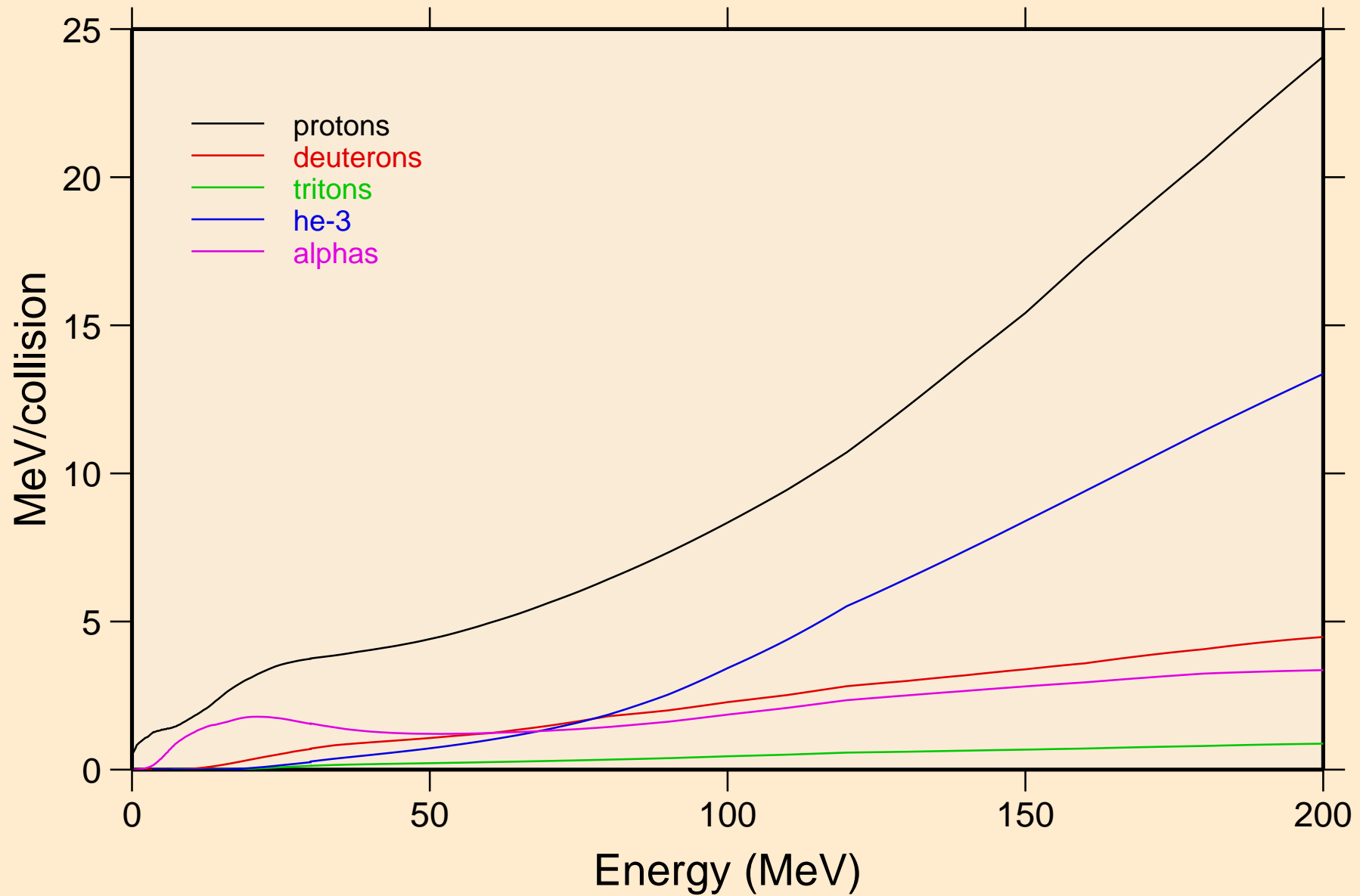

FE053M NEUTRON ACER TENDL-2021 LIBRARY; T=293.6K
Recoil Heating

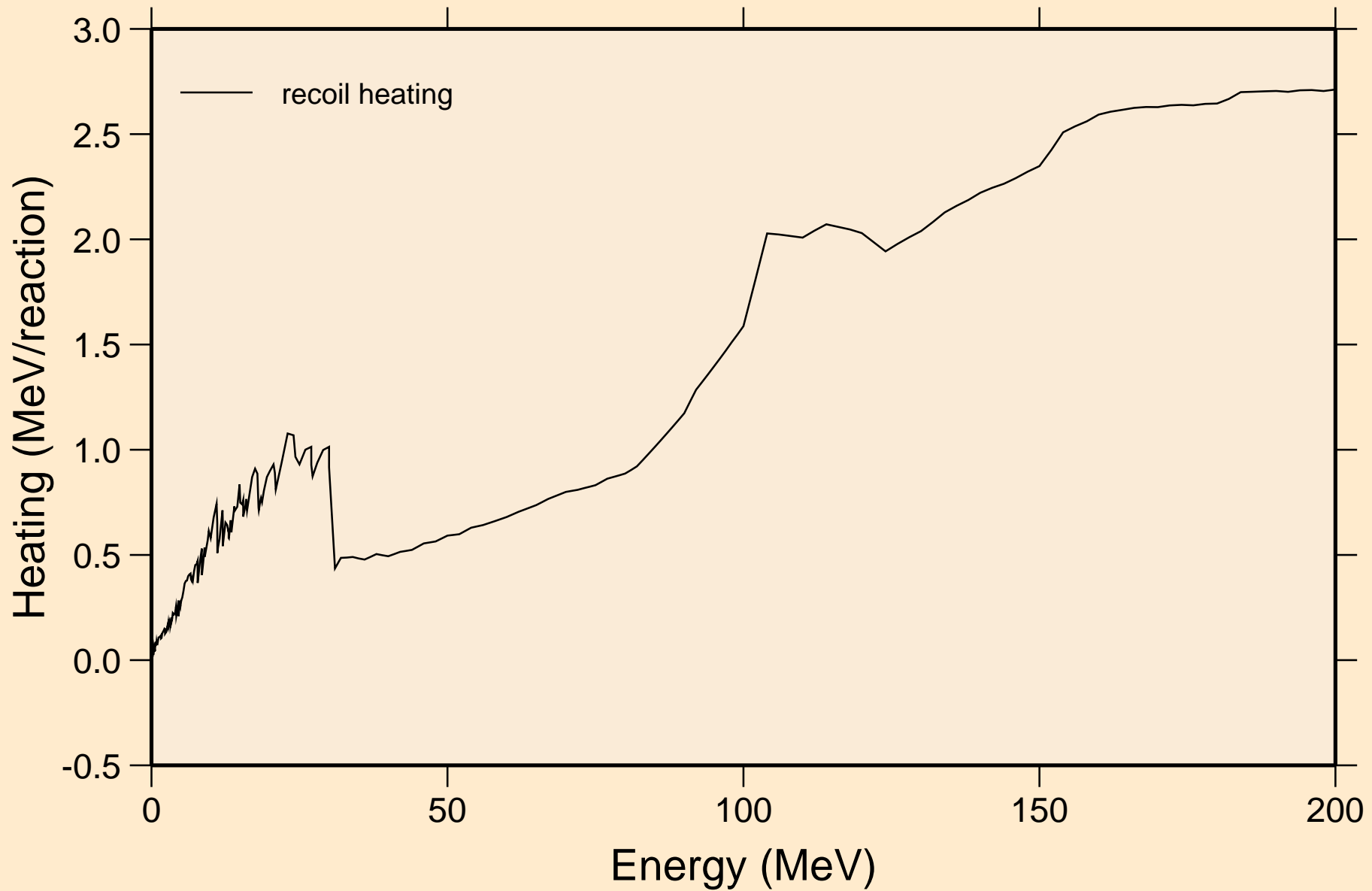

FE053M NEUTRON ACER TENDL-2021 LIBRARY; T=293.6K
Particle production cross sections

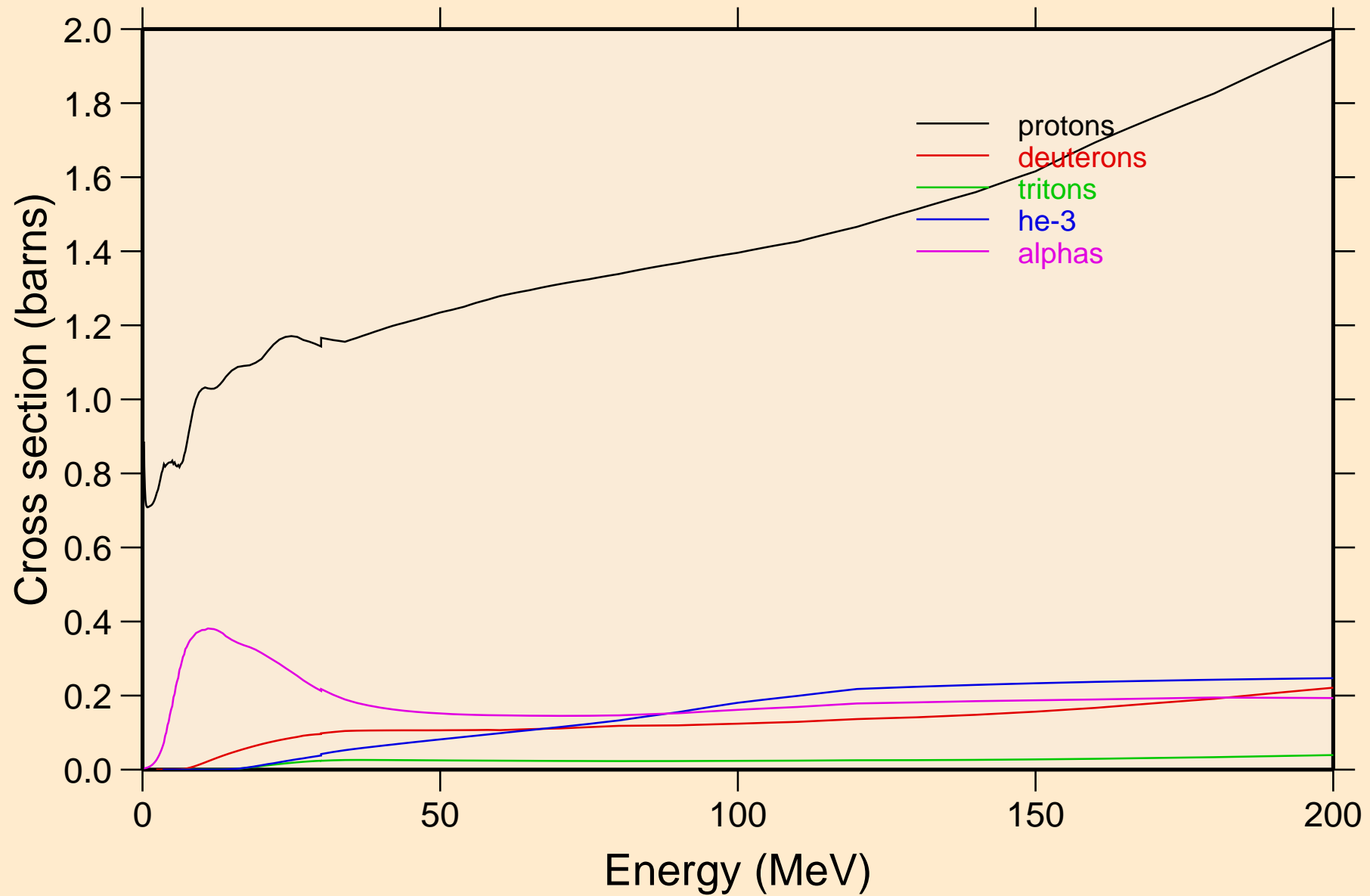

FE053M NEUTRON ACER TENDL-2021 LIBRARY; T=293.6K
protons from (n,x)

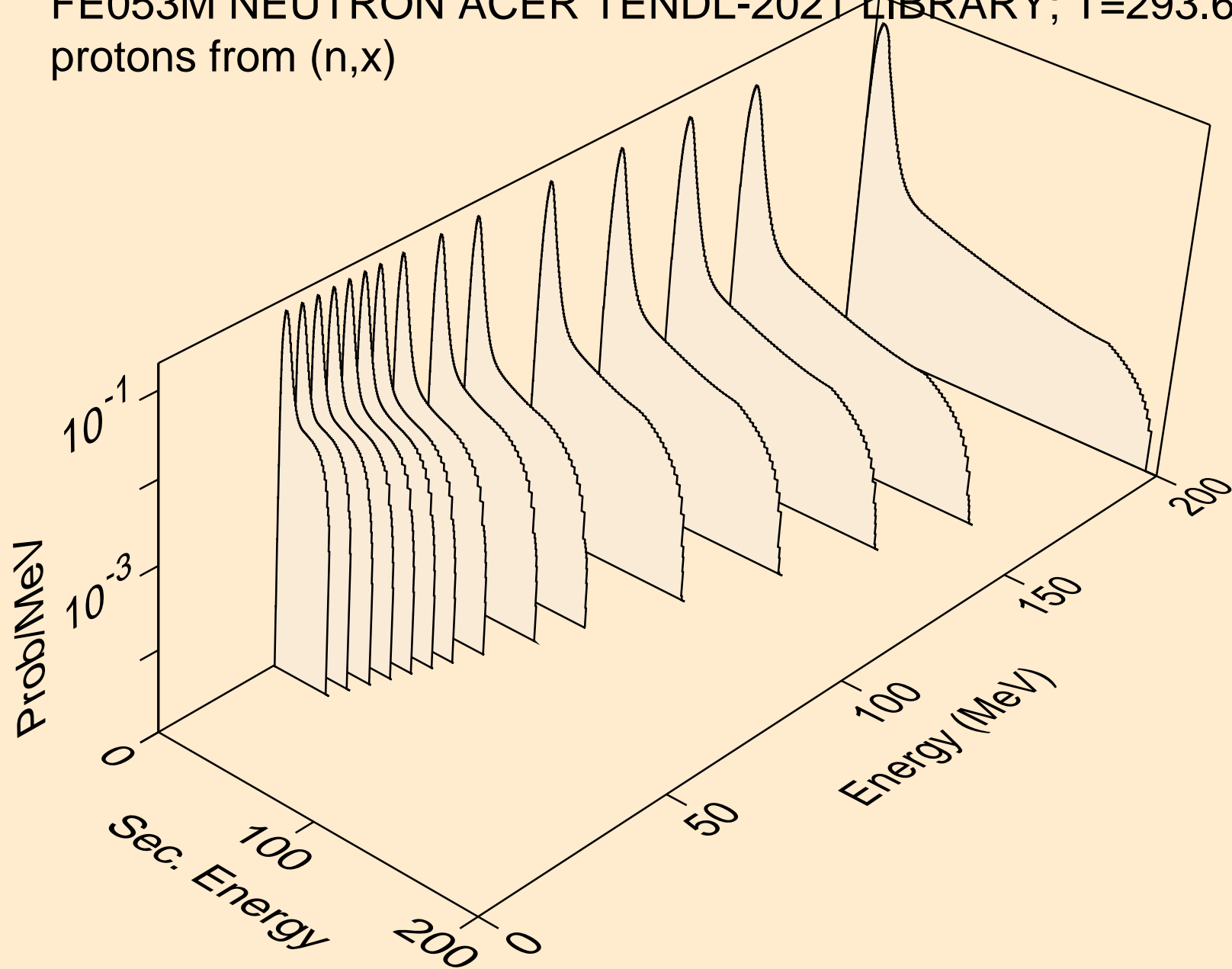

FE053M NEUTRON ACER TENDL-2021 LIBRARY; T=293.6K
protons from (n,n*)p

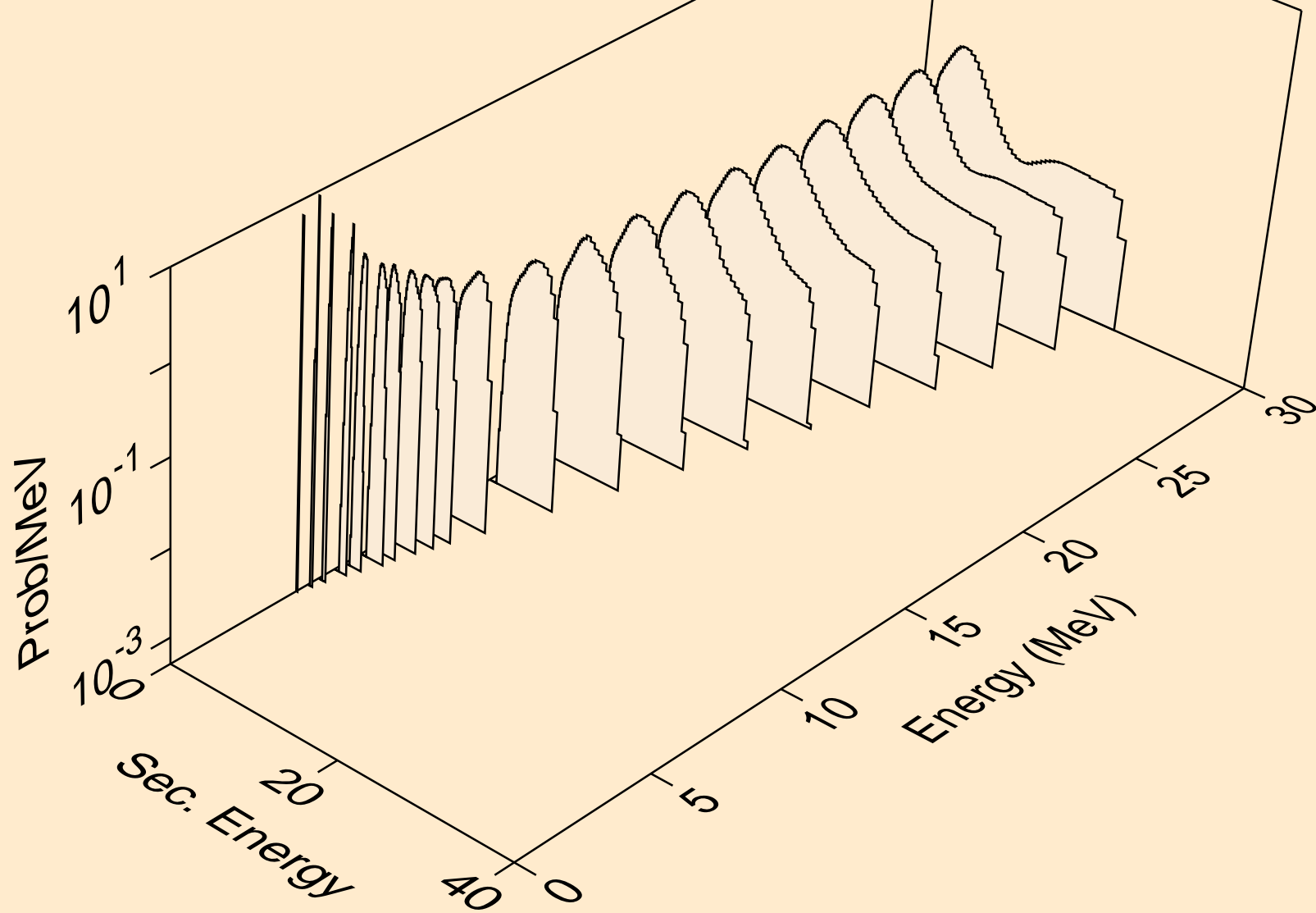

FE053M NEUTRON ACER TENDL-2021 LIBRARY; T=293.6K
protons from (n,2np)

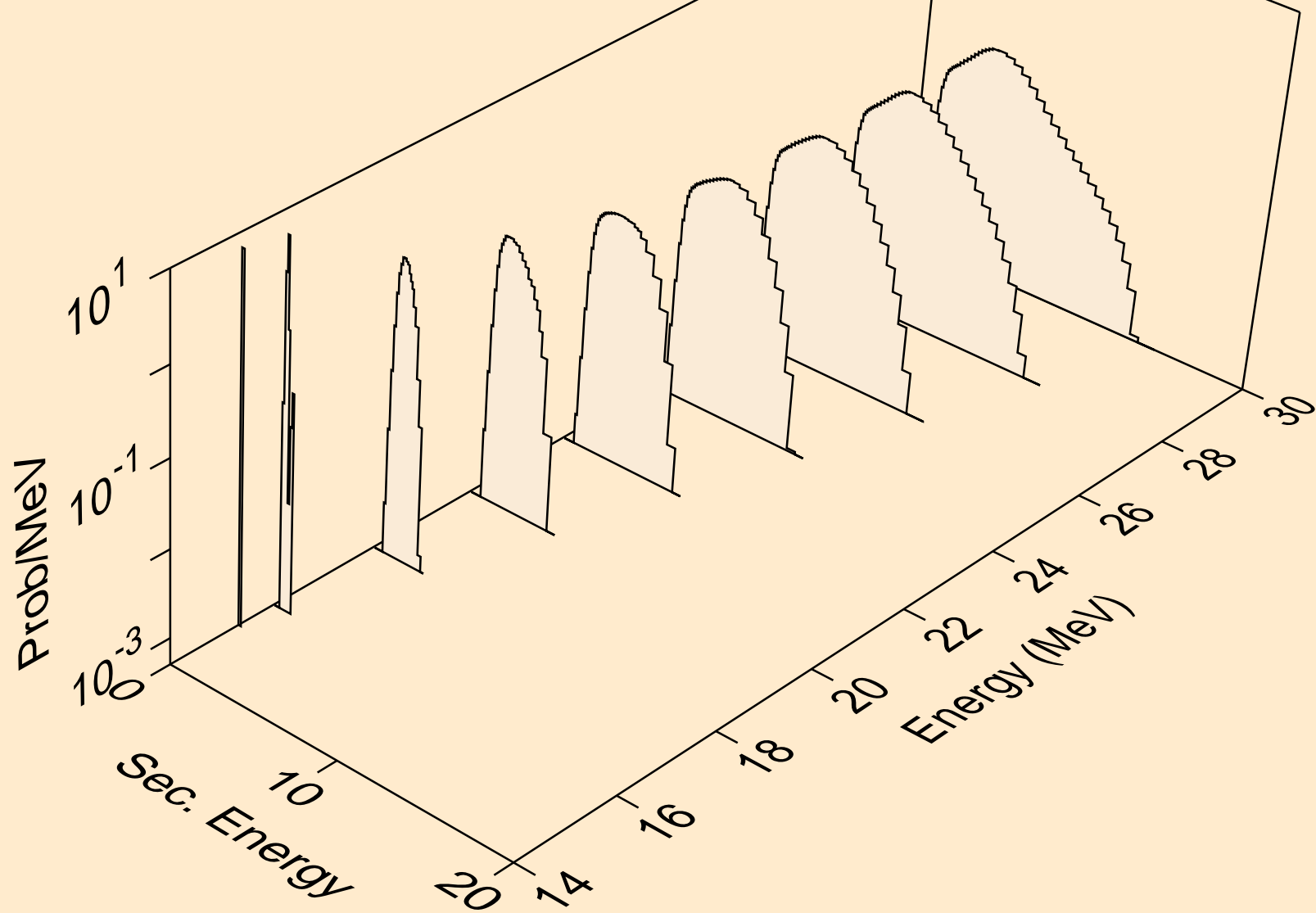

FE053M NEUTRON ACER TENDL-2021 LIBRARY; T=293.6K
protons from (n,2np)

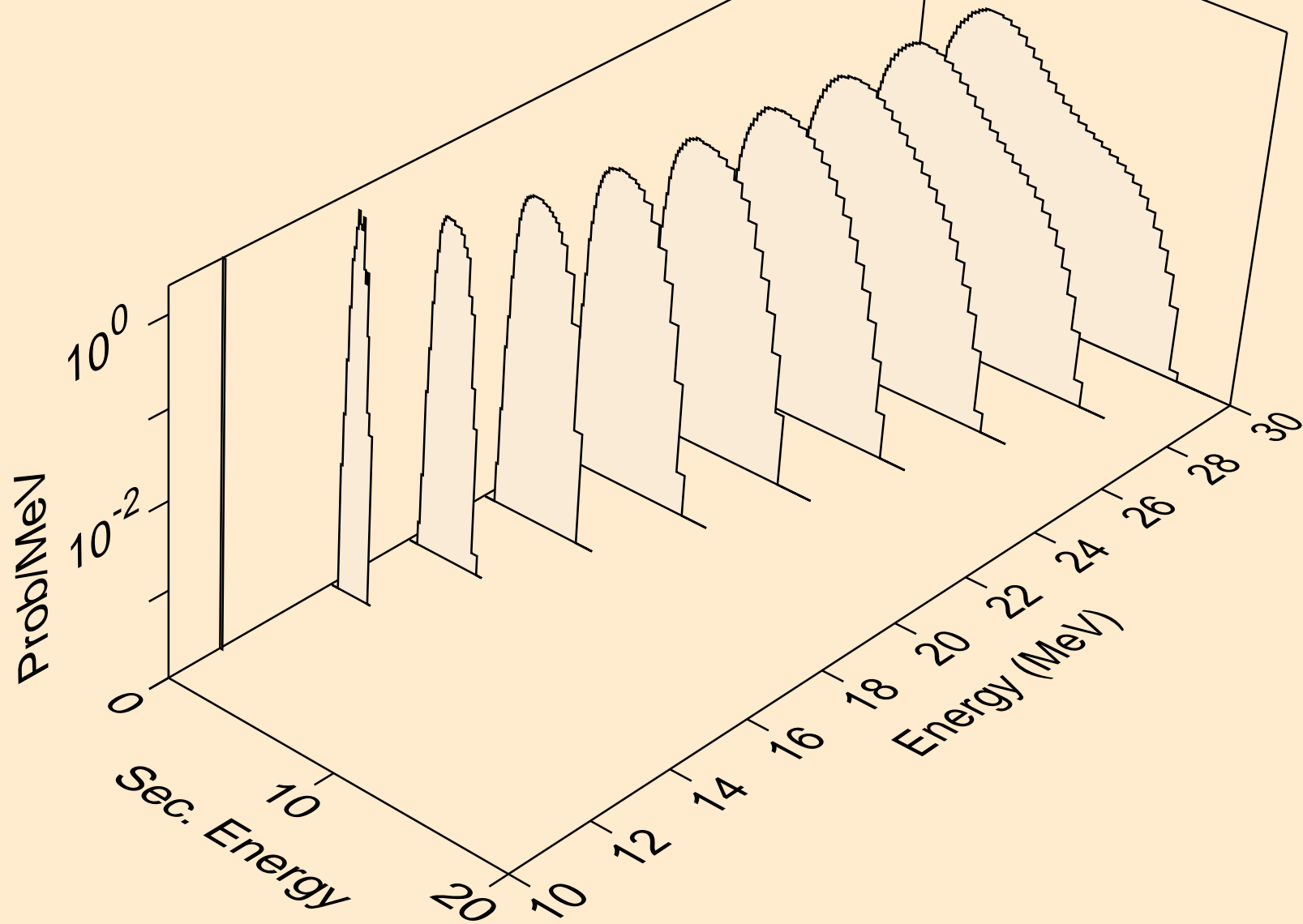

FE053M NEUTRON ACER TENDL-2021 LIBRARY; T=293.6K
protons from (n,npa)

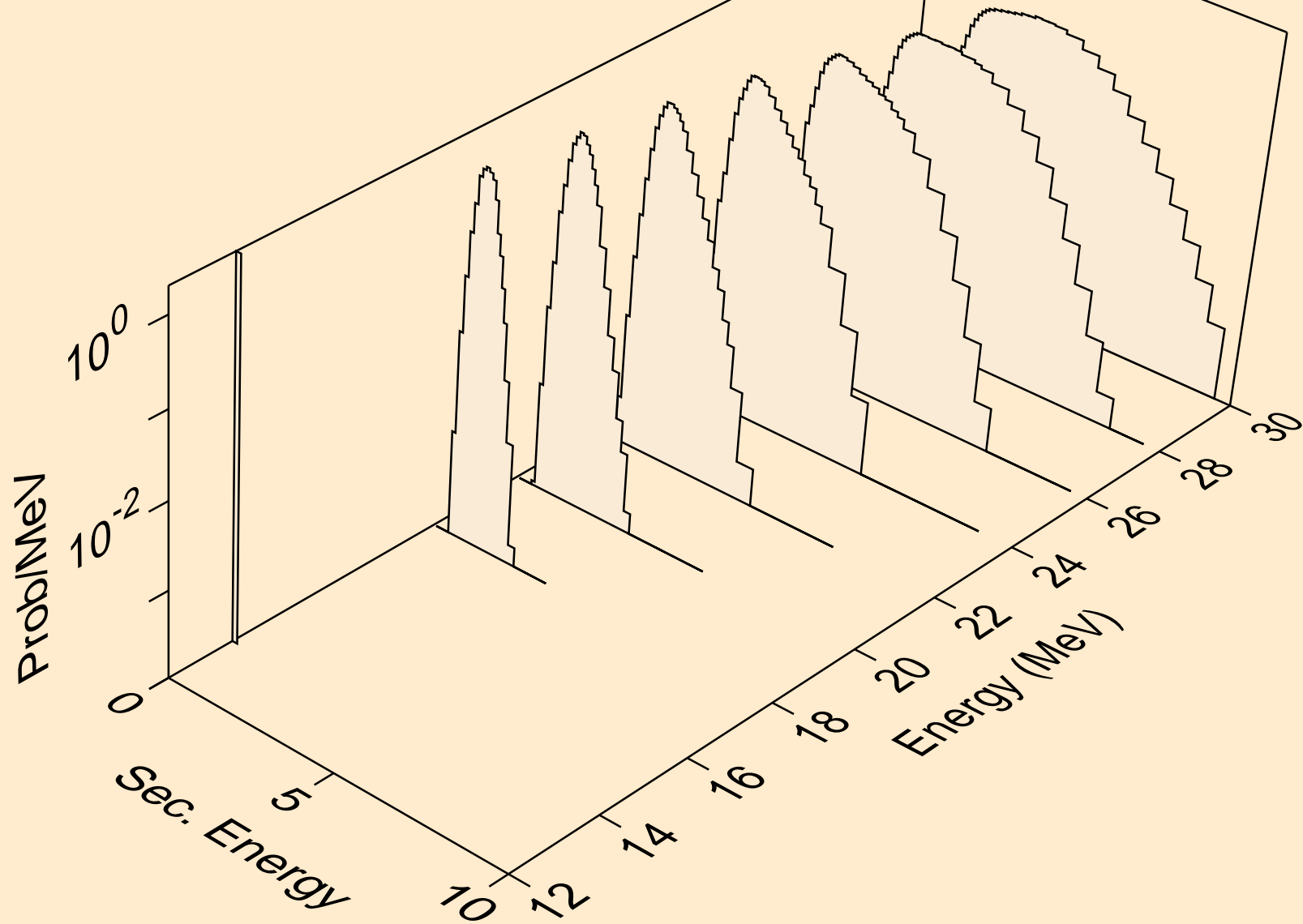

FE053M NEUTRON ACER TENDL-2021 LIBRARY; T=293.6K
protons from (n,p)

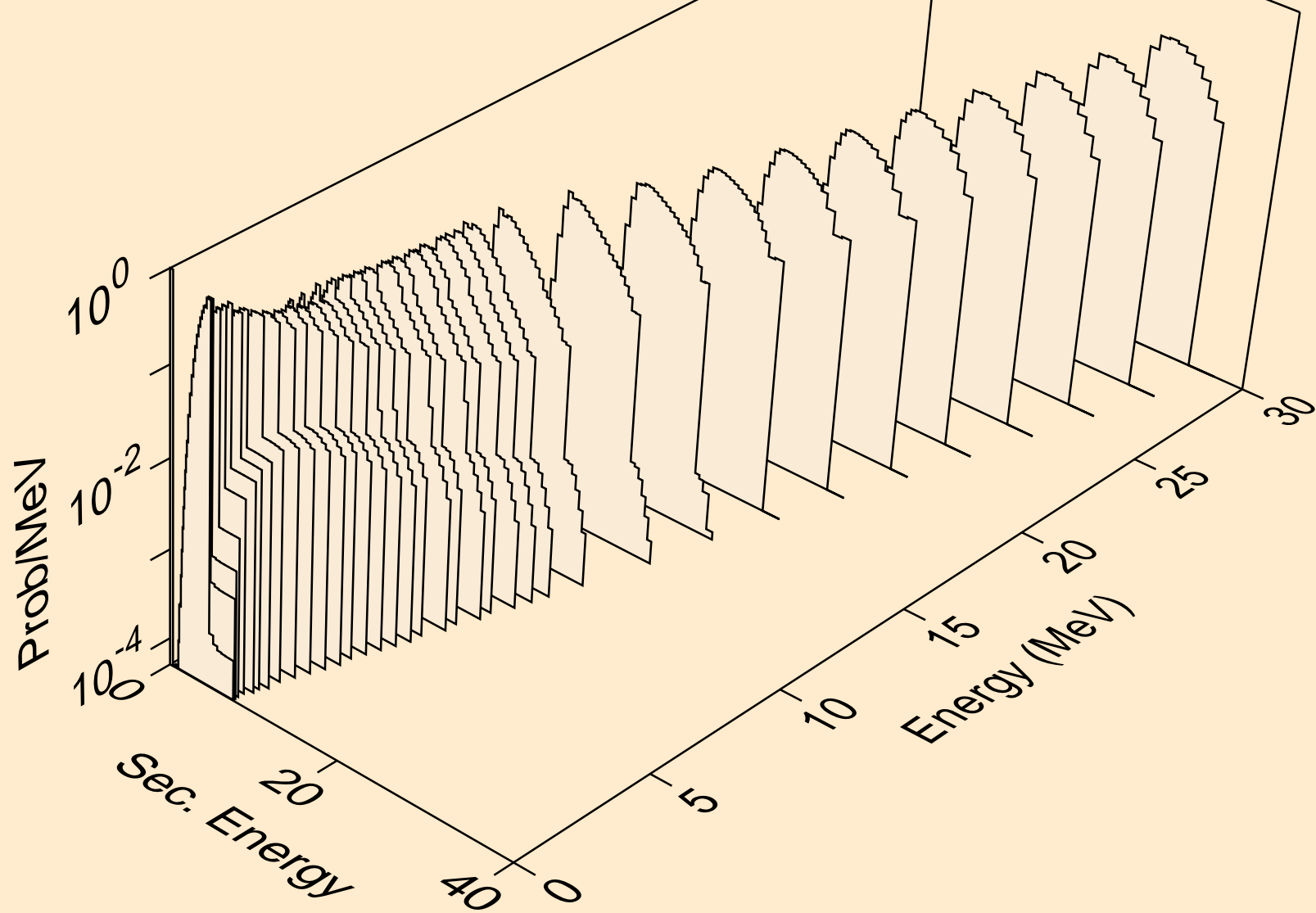

FE053M NEUTRON ACER TENDL-2021 LIBRARY; T=293.6K
protons from (n,2p)

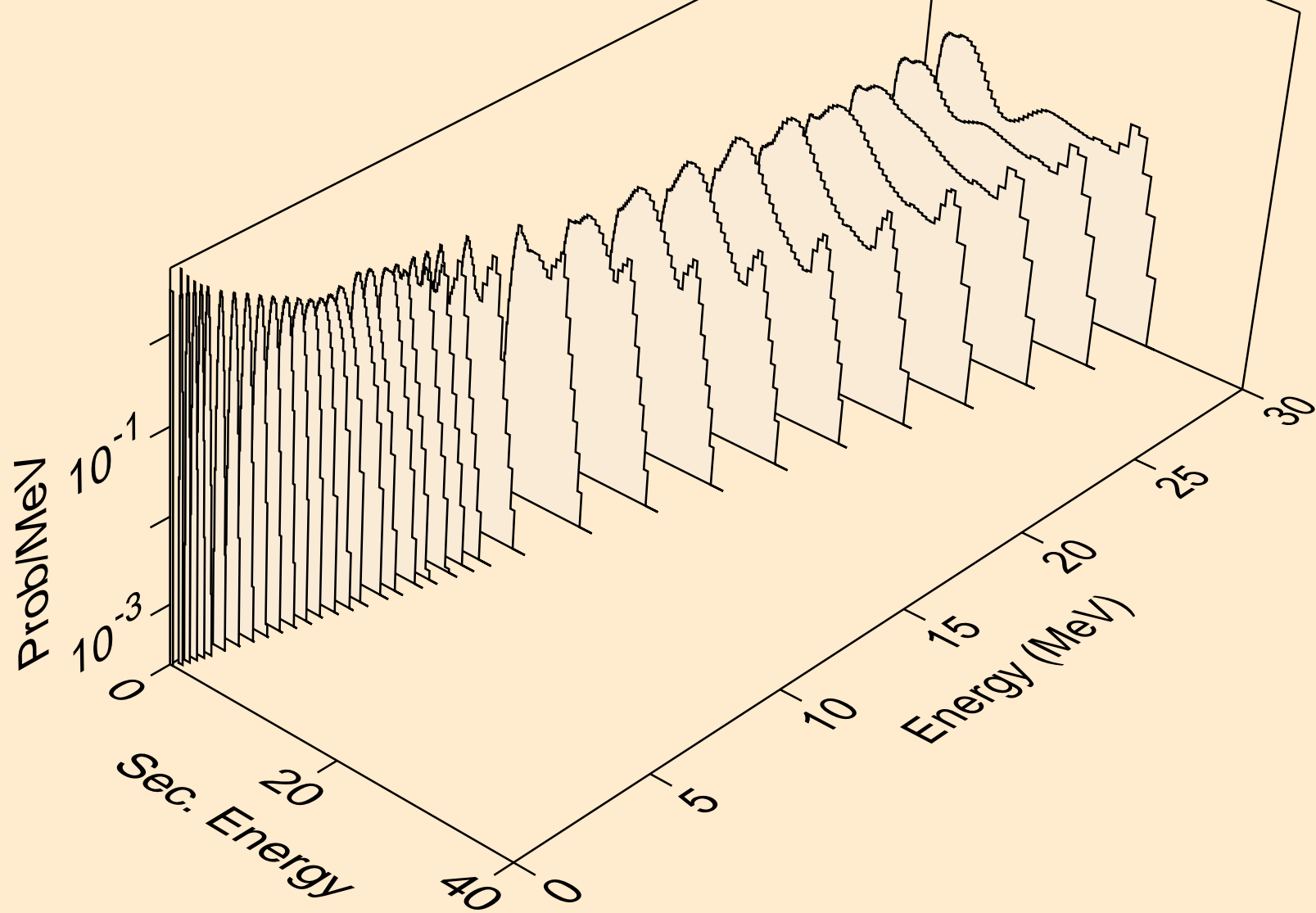

FE053M NEUTRON ACER TENDL-2021 LIBRARY; T=293.6K
protons from (n,p)

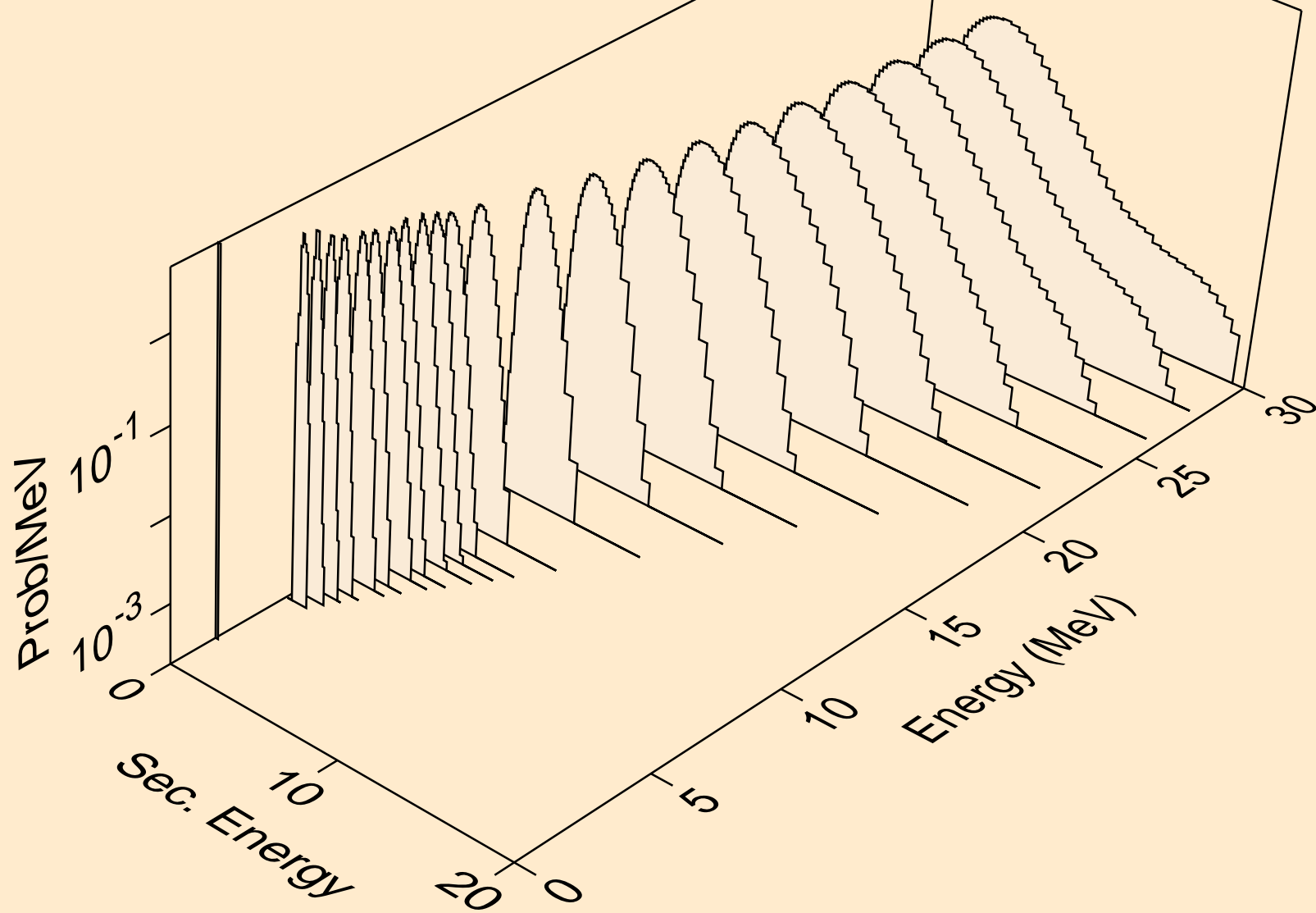

FE053M NEUTRON ACER TENDL-2021 LIBRARY; T=293.6K
protons from (n,pd)

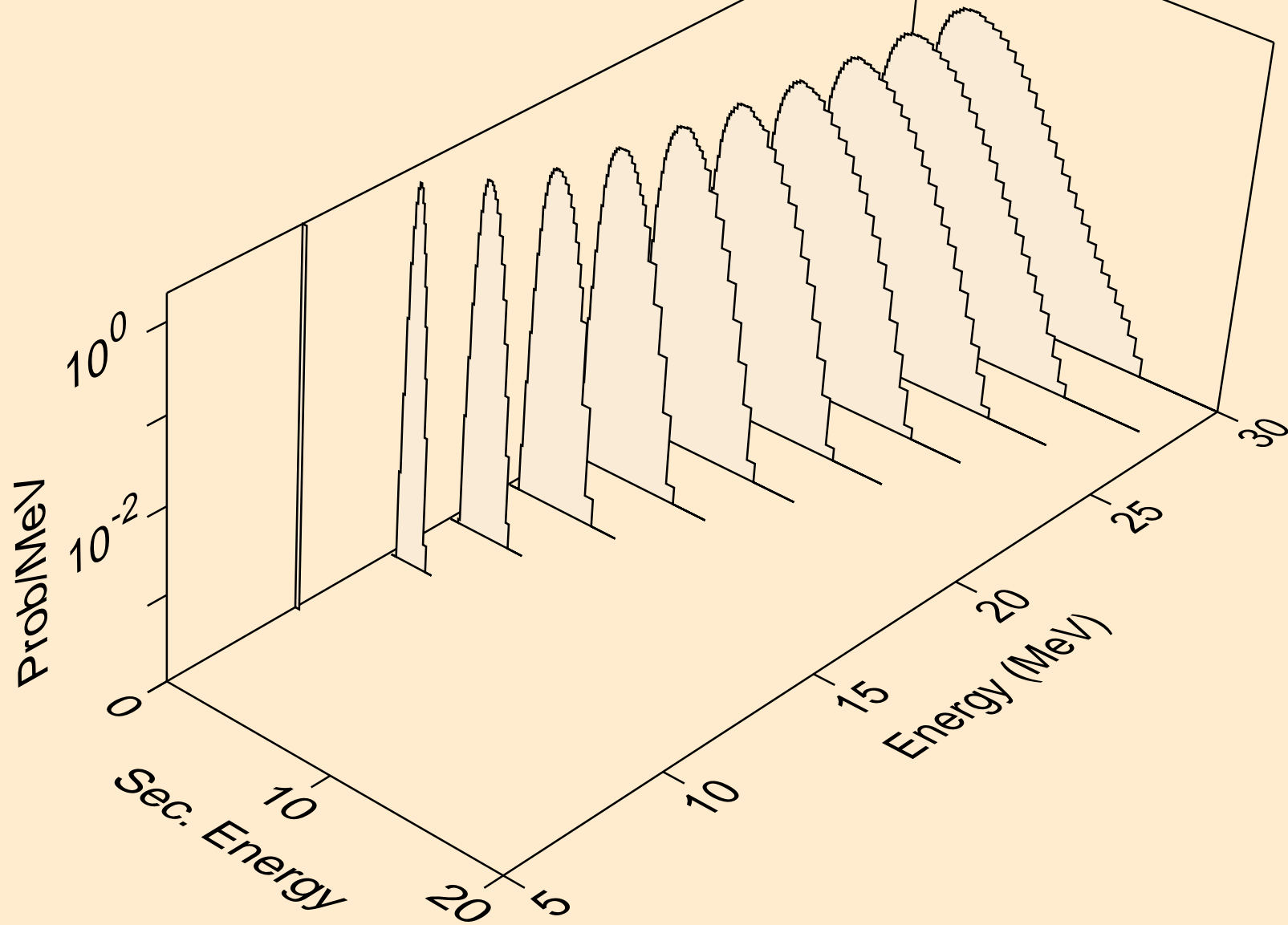

FE053M NEUTRON ACER TENDL-2021 LIBRARY; T=293.6K
protons from (n,pt)

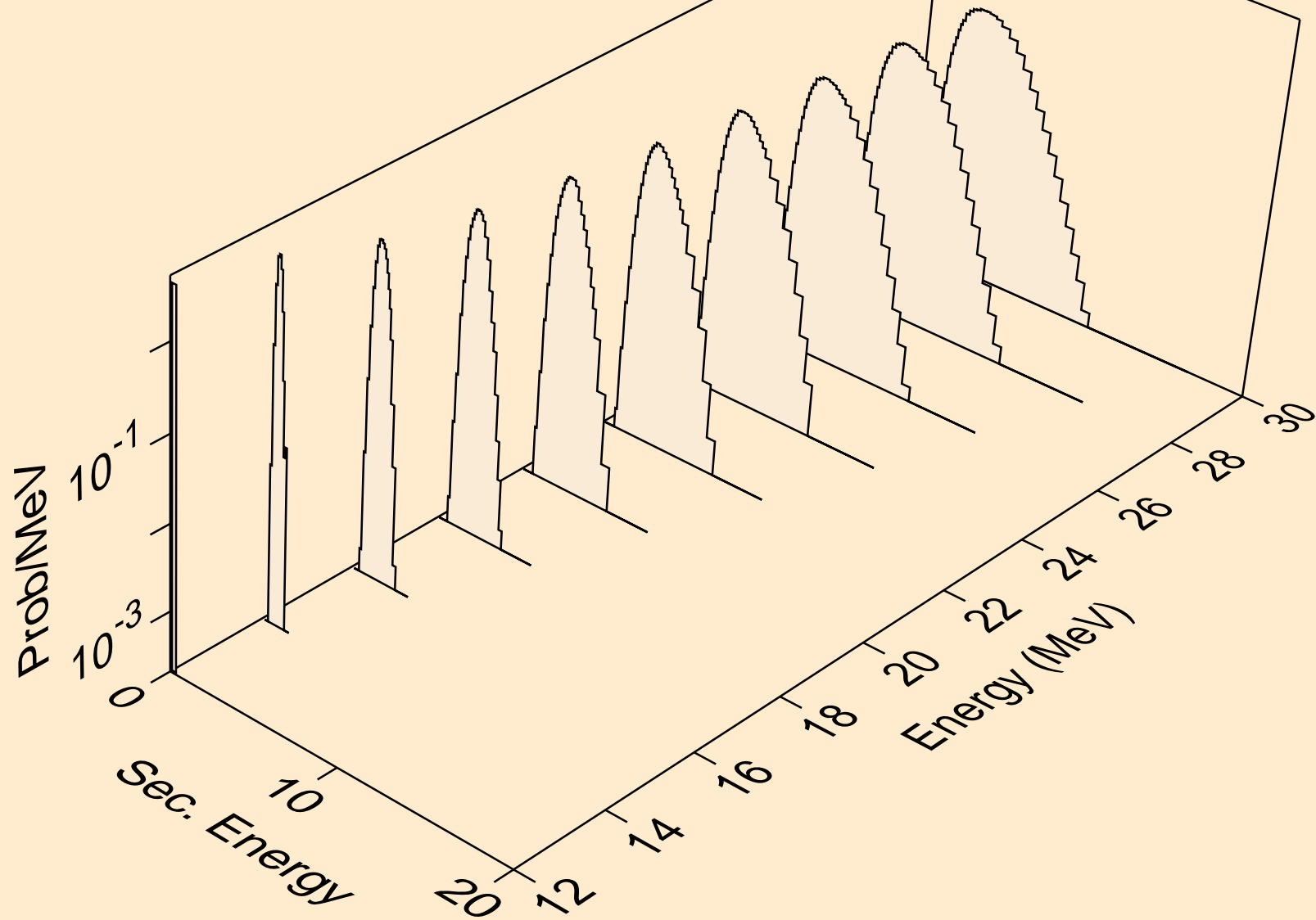

FE053M NEUTRON ACER TENDL-2021 LIBRARY; T=293.6K
deuterons from (n,x)

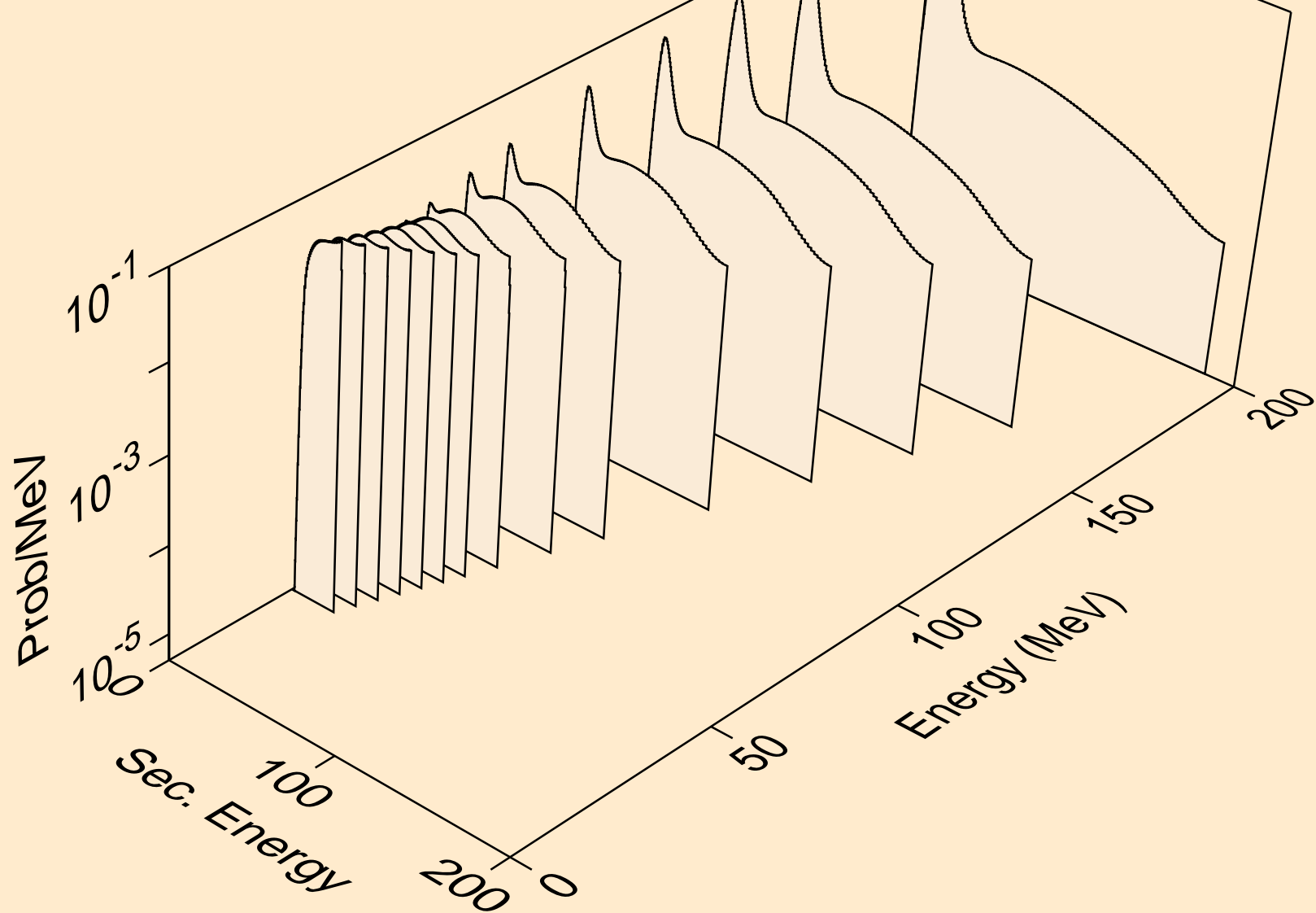

FE053M NEUTRON ACER TENDL-2021 LIBRARY; T=293.6K
deuterons from (n,2nd)

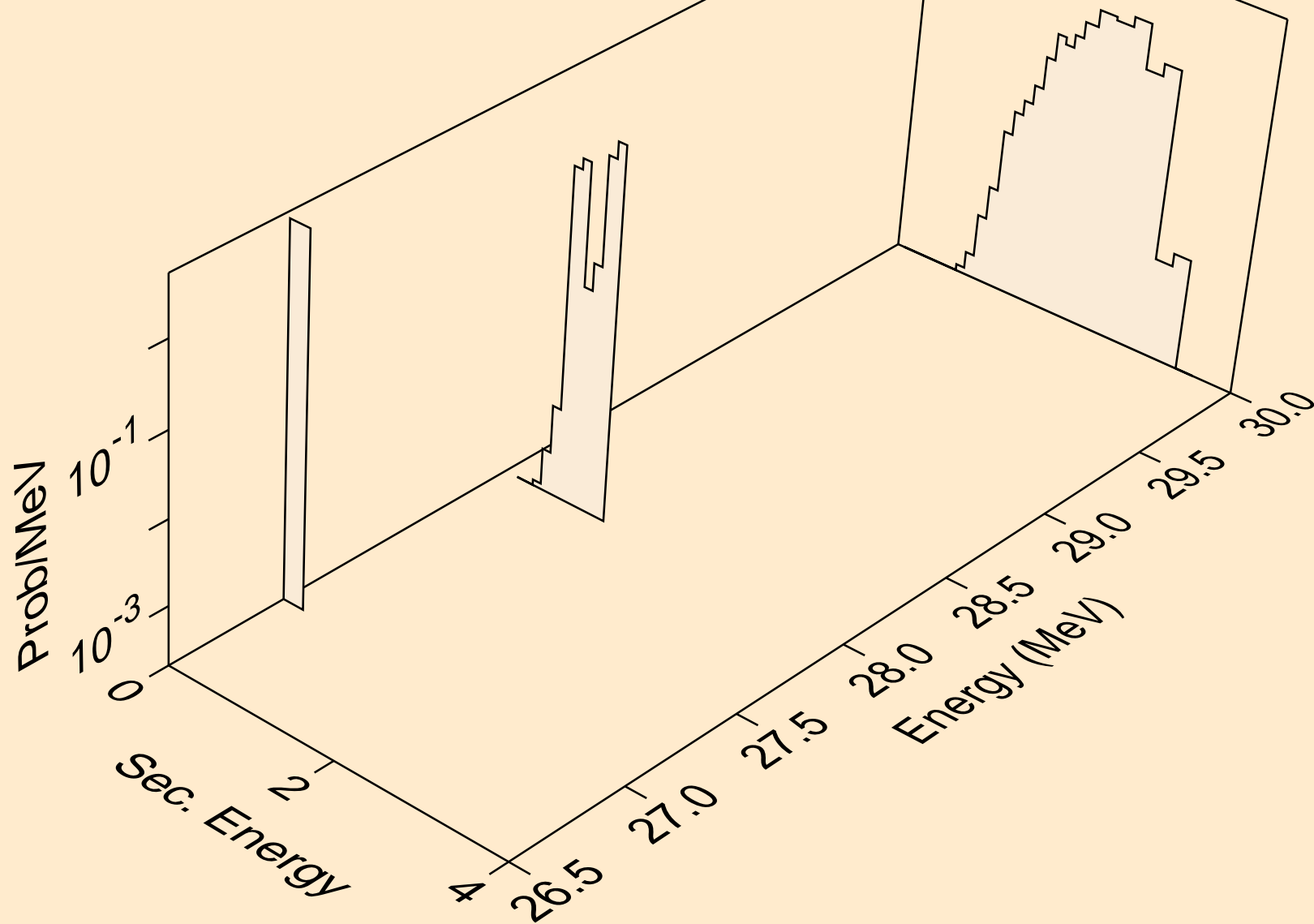

FE053M NEUTRON ACER TENDL-2021 LIBRARY; T=293.6K
deuterons from (n,n*)d

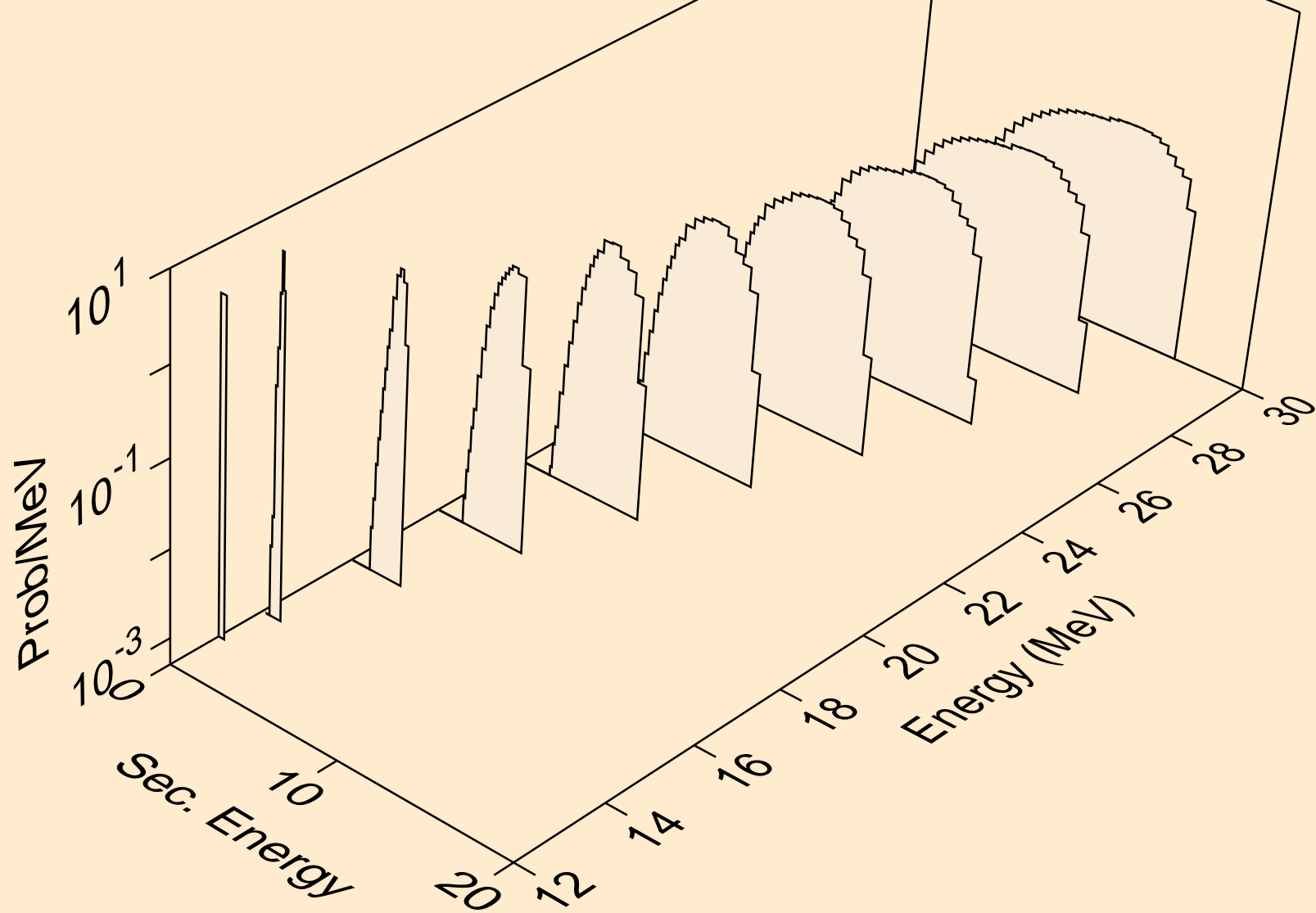

FE053M NEUTRON ACER TENDL-2021 LIBRARY; T=293.6K
deuterons from (n,d)

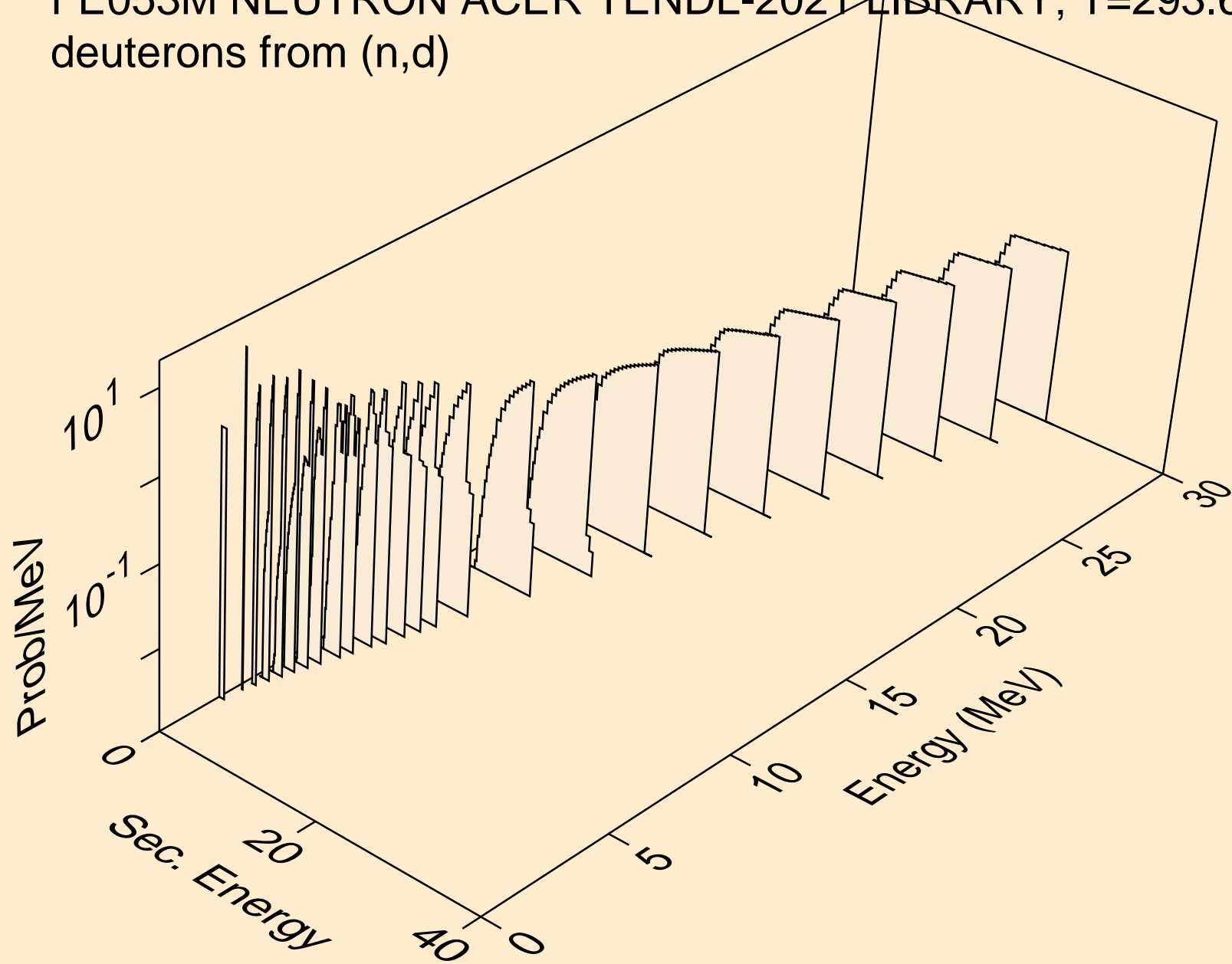

FE053M NEUTRON ACER TENDL-2021 LIBRARY; T=293.6K
deuterons from (n,pd)

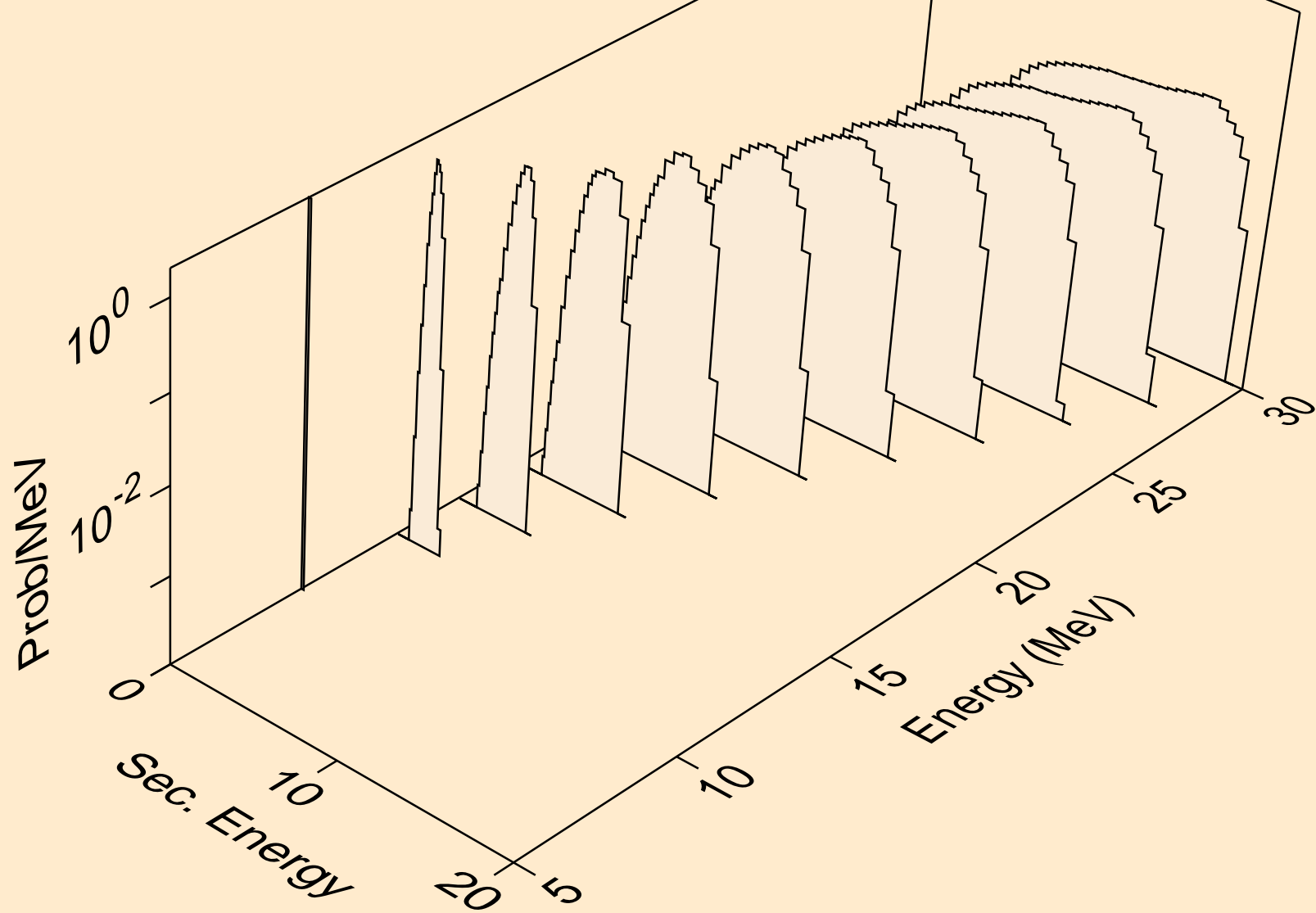

FE053M NEUTRON ACER TENDL-2021 LIBRARY; T=293.6K
deuterons from (n,da)

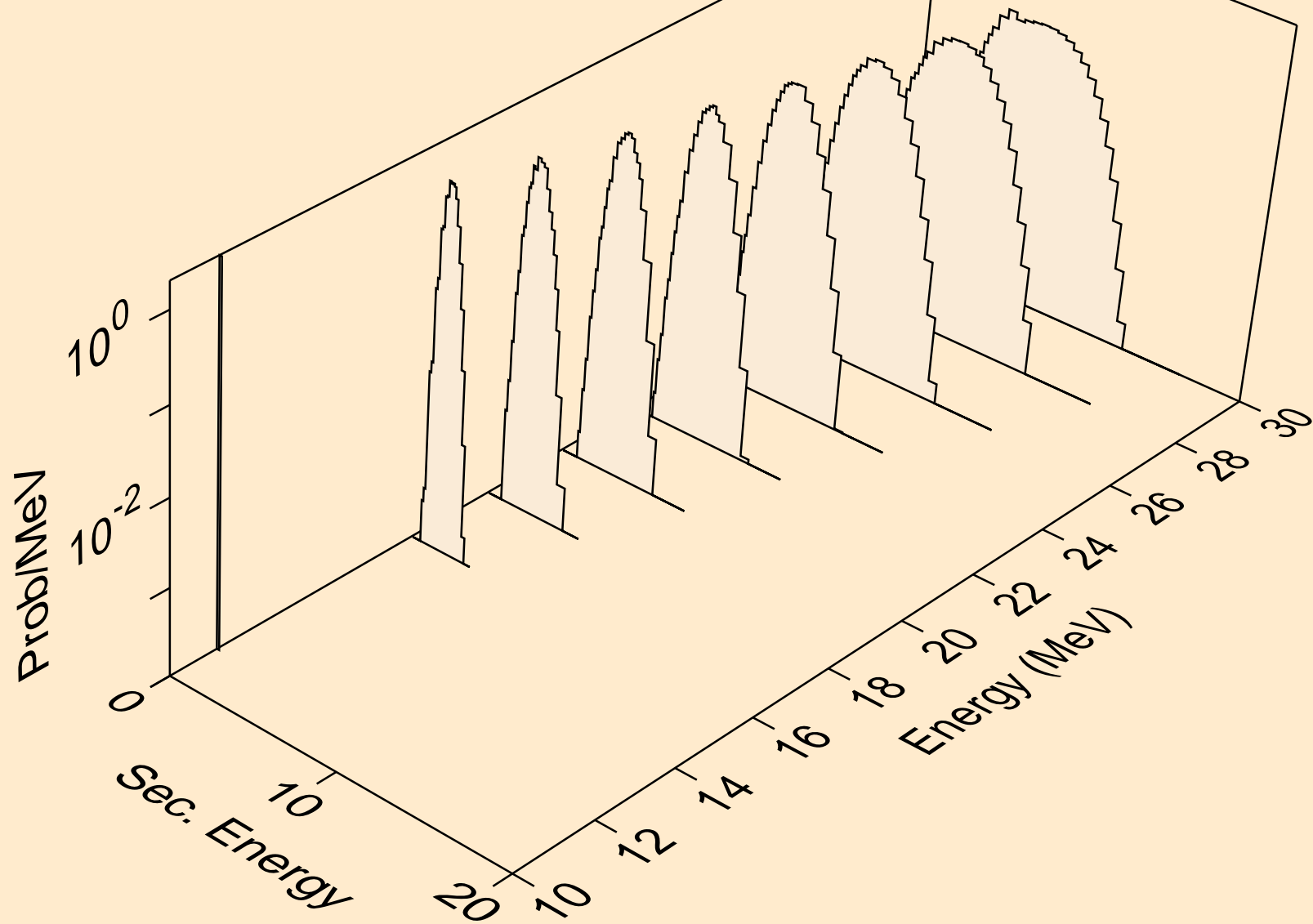

FE053M NEUTRON ACER TENDL-2021 LIBRARY; T=293.6K
tritons from (n,x)

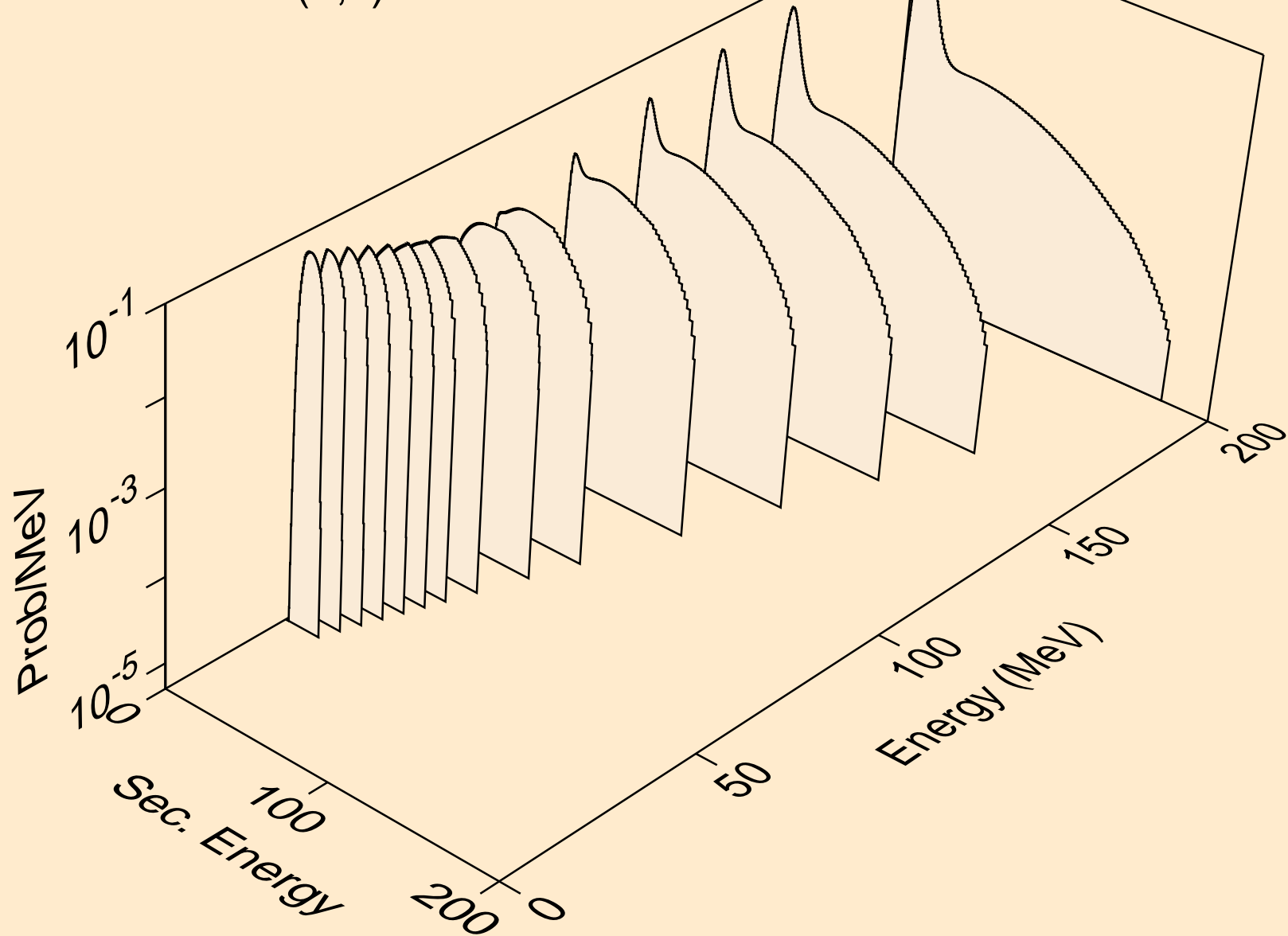

FE053M NEUTRON ACER TENDL-2021 LIBRARY; T=293.6K
tritons from (n,n*)t

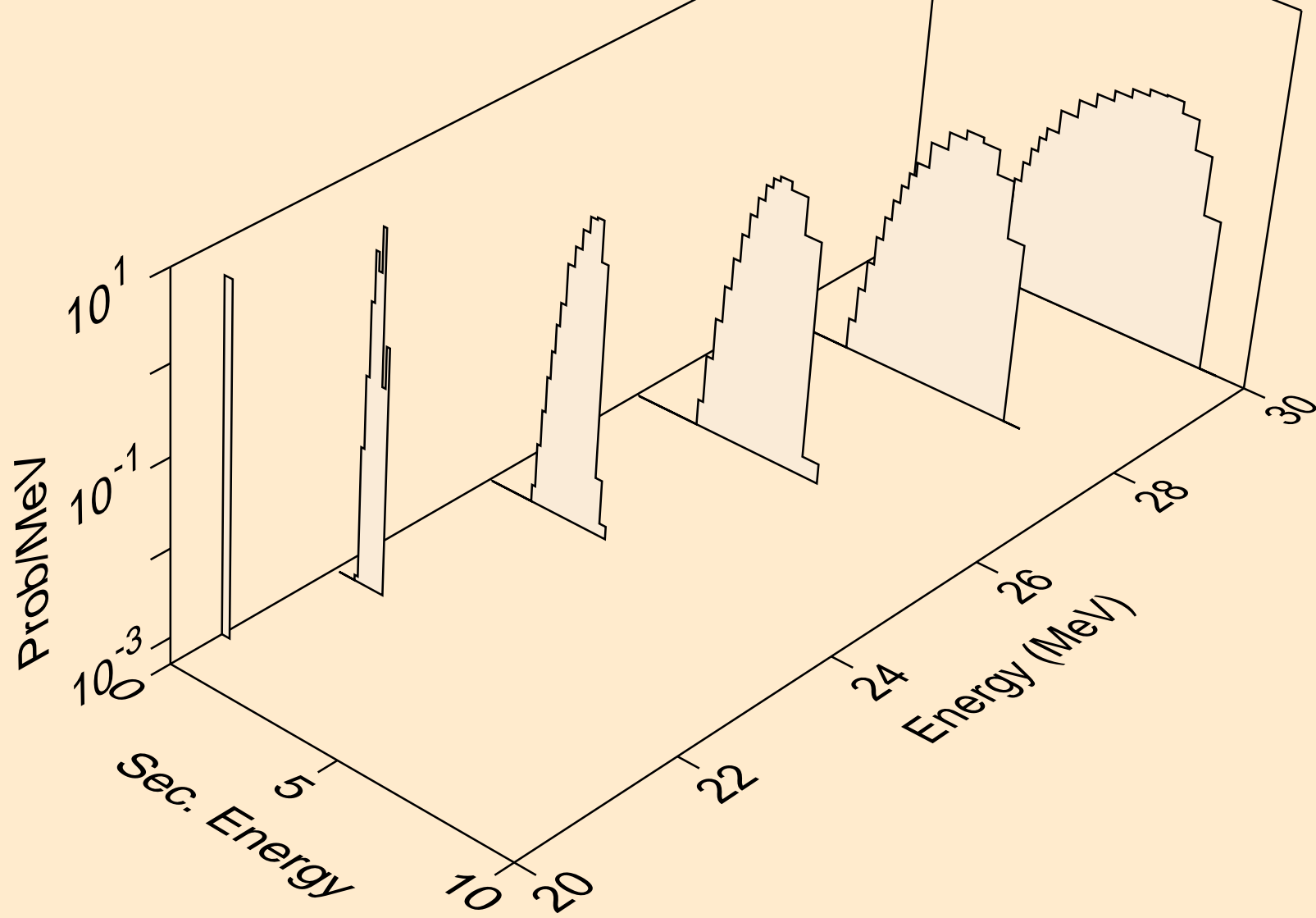

FE053M NEUTRON ACER TENDL-2021 LIBRARY; T=293.6K
tritons from (n,t)

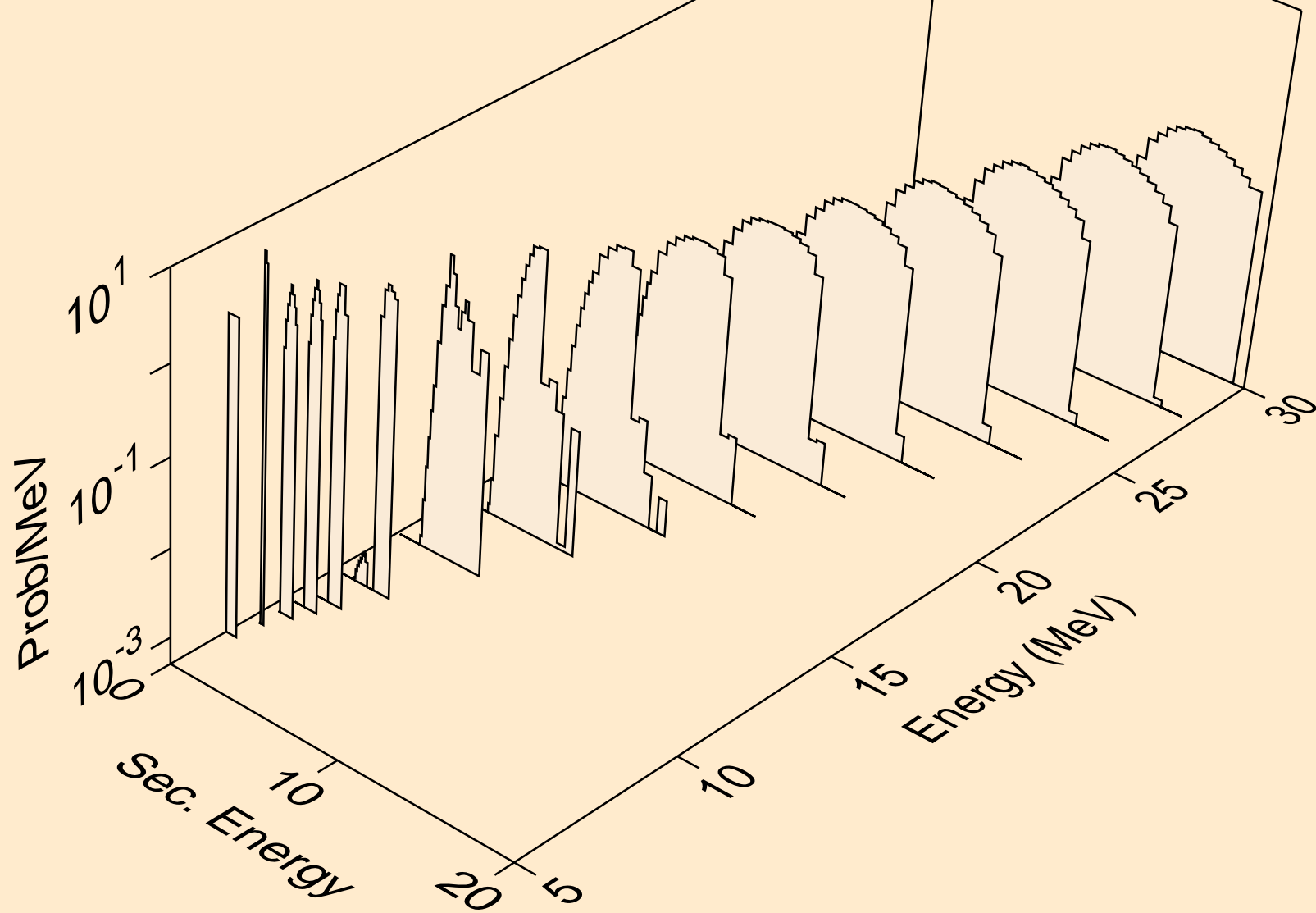

FE053M NEUTRON ACER TENDL-2021 LIBRARY; T=293.6K
tritons from (n,pt)

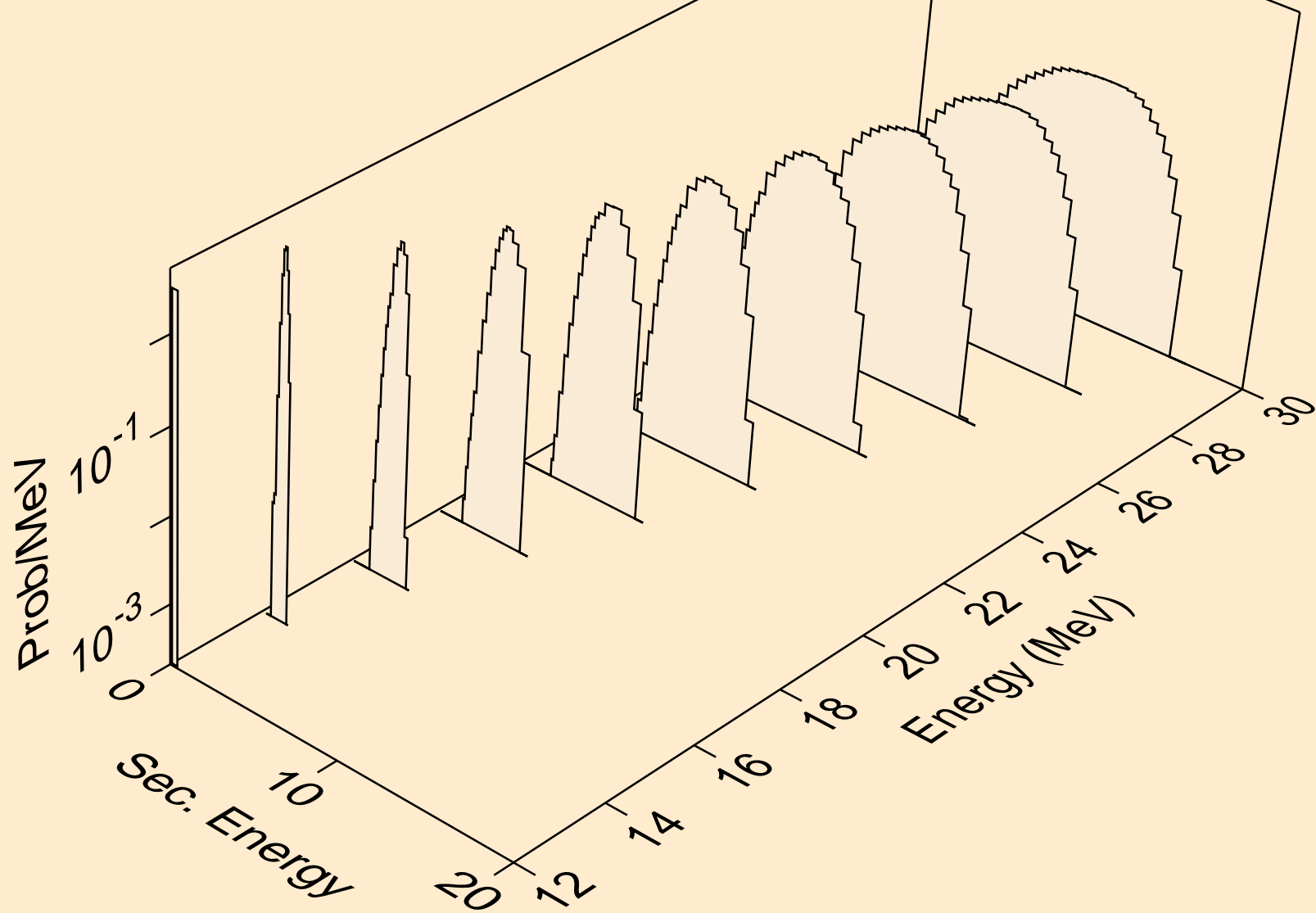

FE053M NEUTRON ACER TENDL-2021 LIBRARY; T=293.6K
he3s from (n,x)

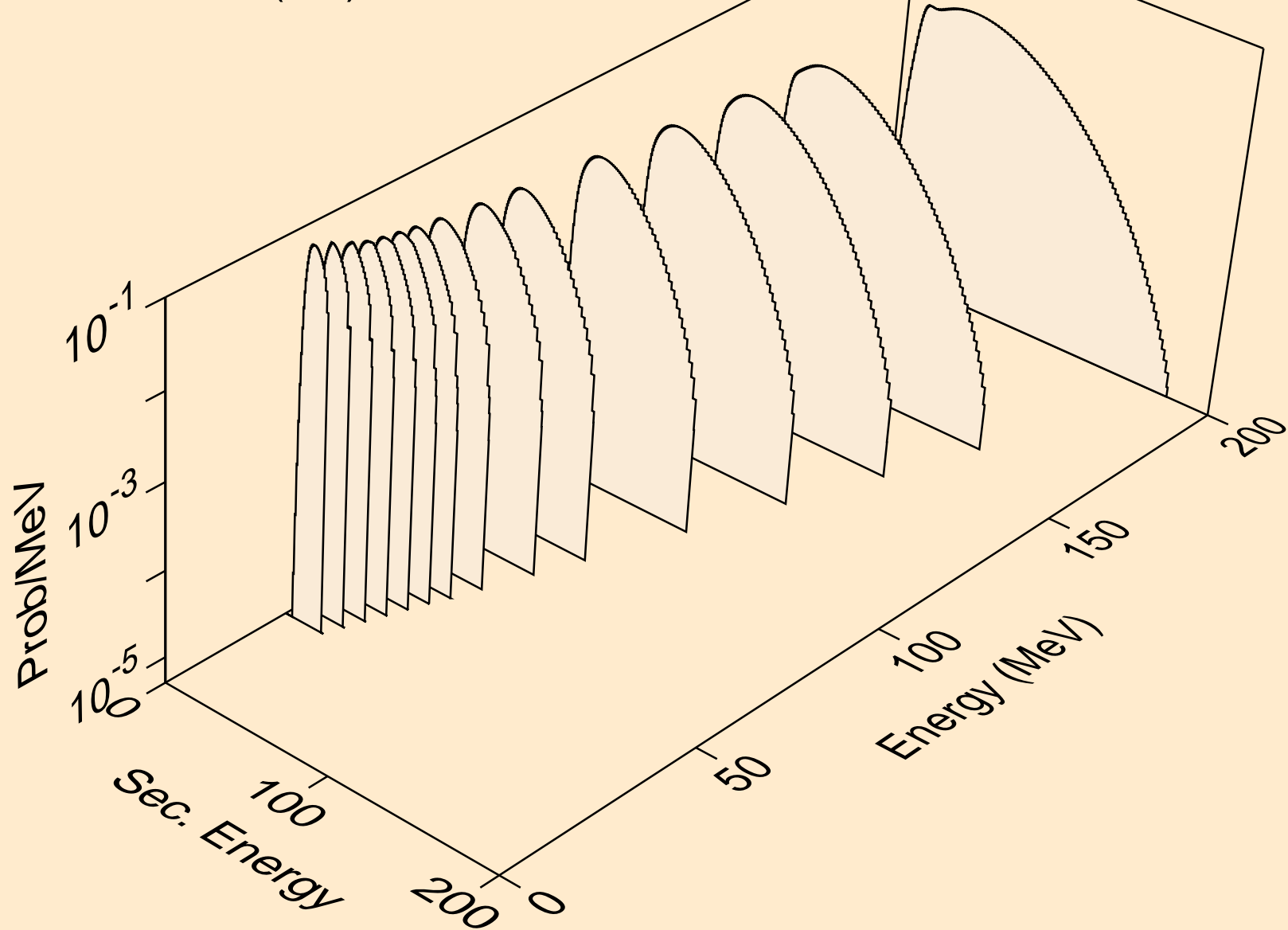

FE053M NEUTRON ACER TENDL-2021 LIBRARY; T=293.6K
he3s from (n,n*)he3

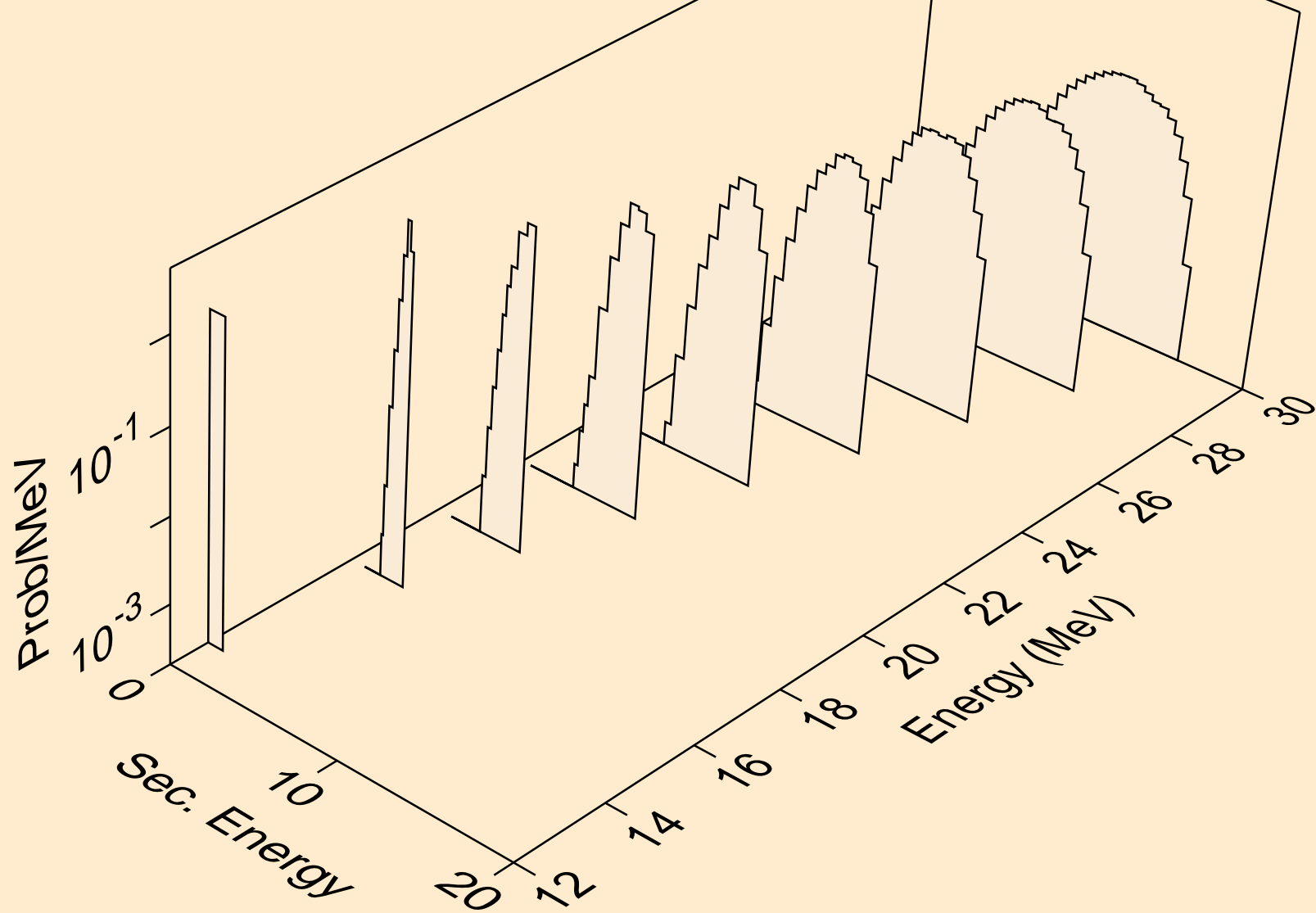

FE053M NEUTRON ACER TENDL-2021 LIBRARY; T=293.6K
he3s from (n,he3)

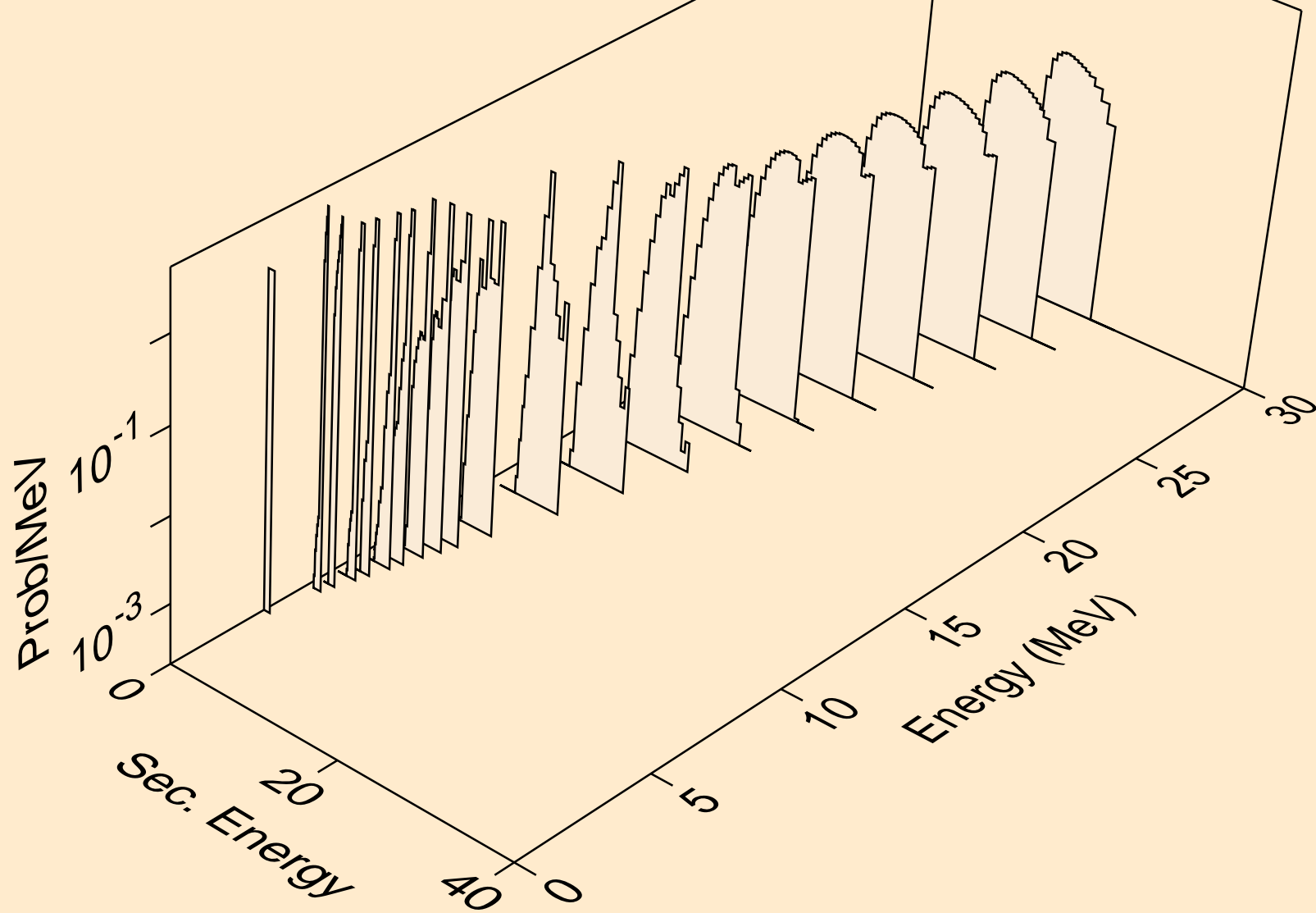

FE053M NEUTRON ACER TENDL-2021 LIBRARY; T=293.6K
alphas from (n,x)

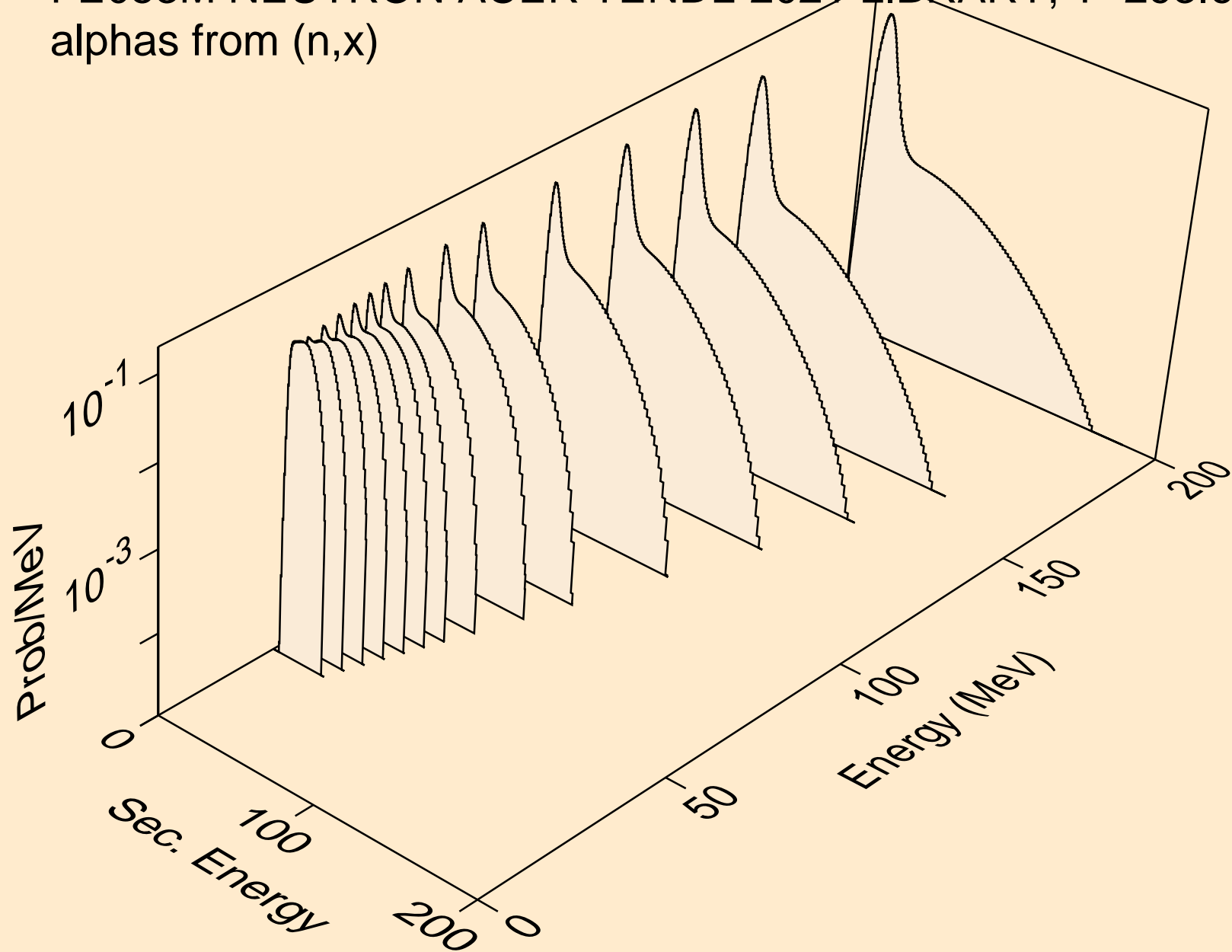

FE053M NEUTRON ACER TENDL-2021 LIBRARY; T=293.6K
alphas from (n,n*)a

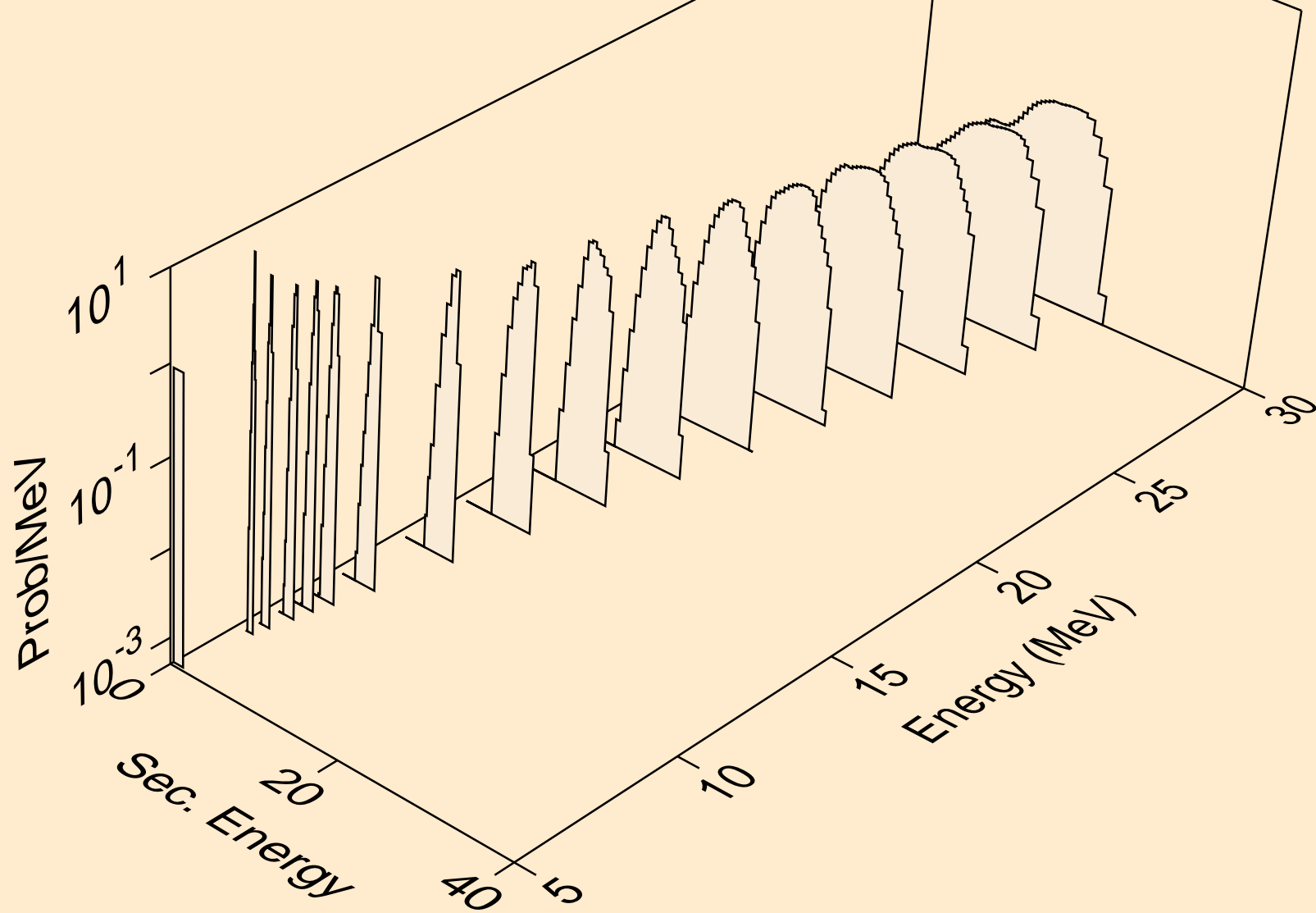

FE053M NEUTRON ACER TENDL-2021 LIBRARY; T=293.6K
alphas from (n,2n)a

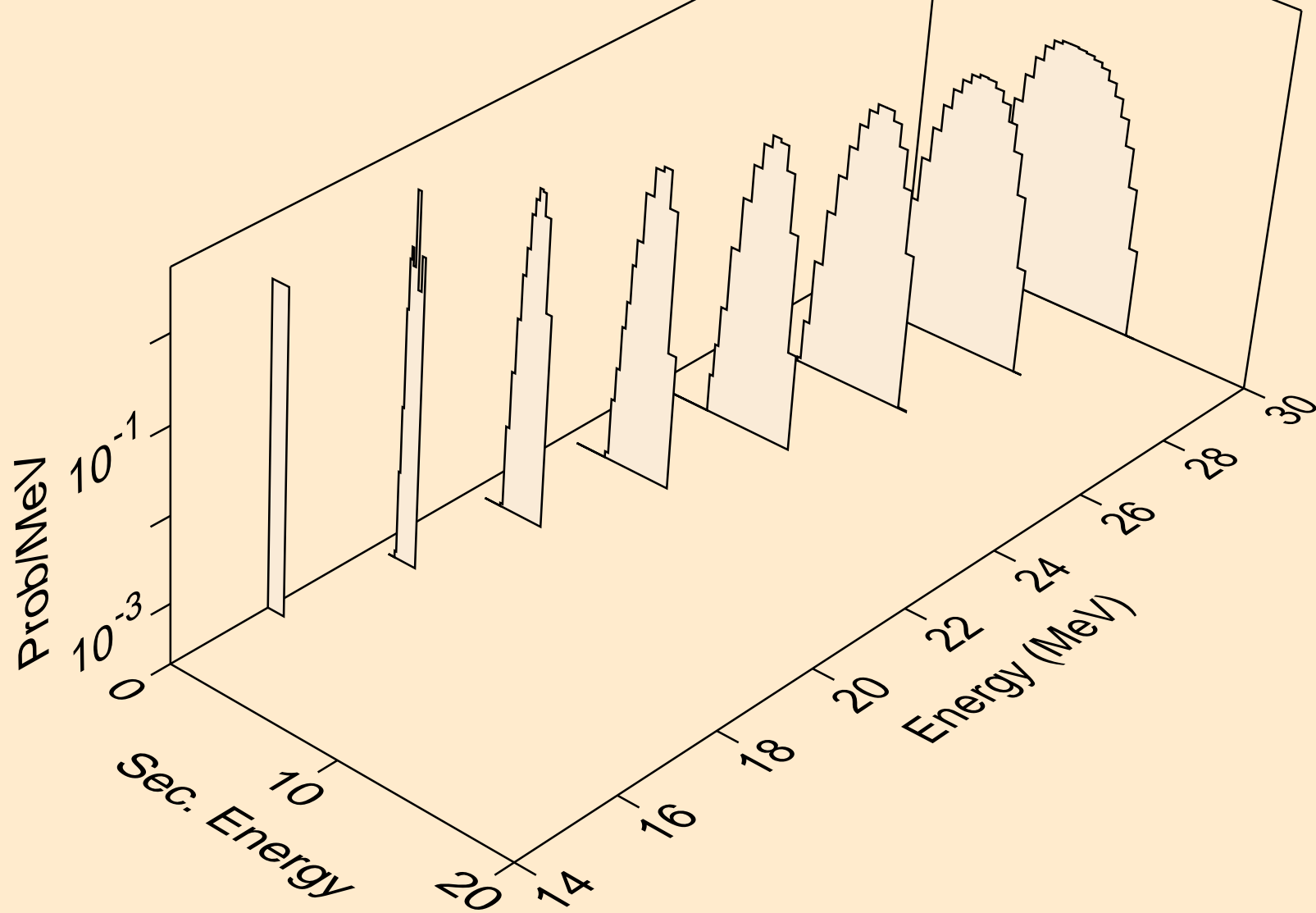

FE053M NEUTRON ACER TENDL-2021 LIBRARY; T=293.6K
alphas from (n,n*)2a

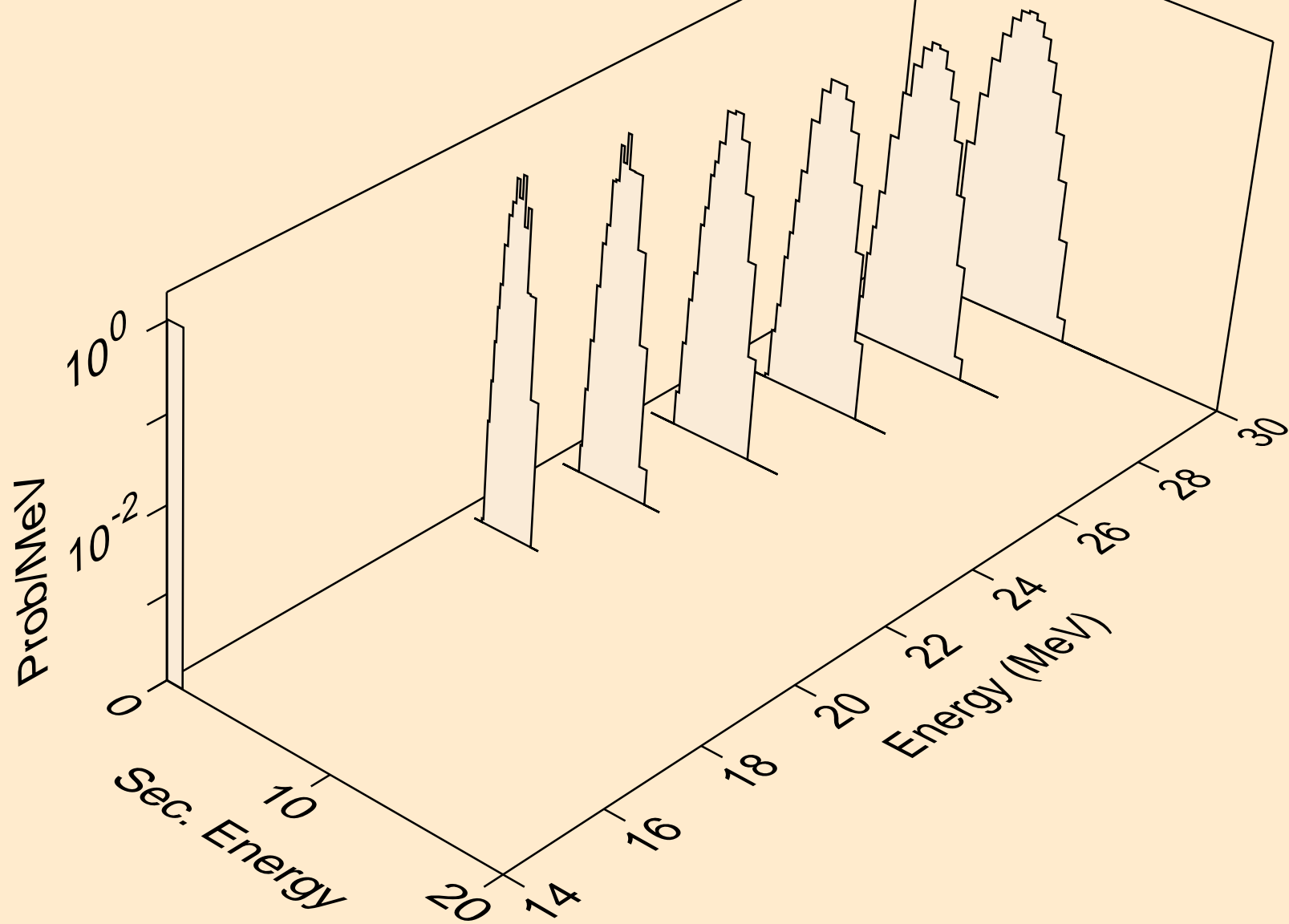

FE053M NEUTRON ACER TENDL-2021 LIBRARY; T=293.6K
alphas from (n,npa)

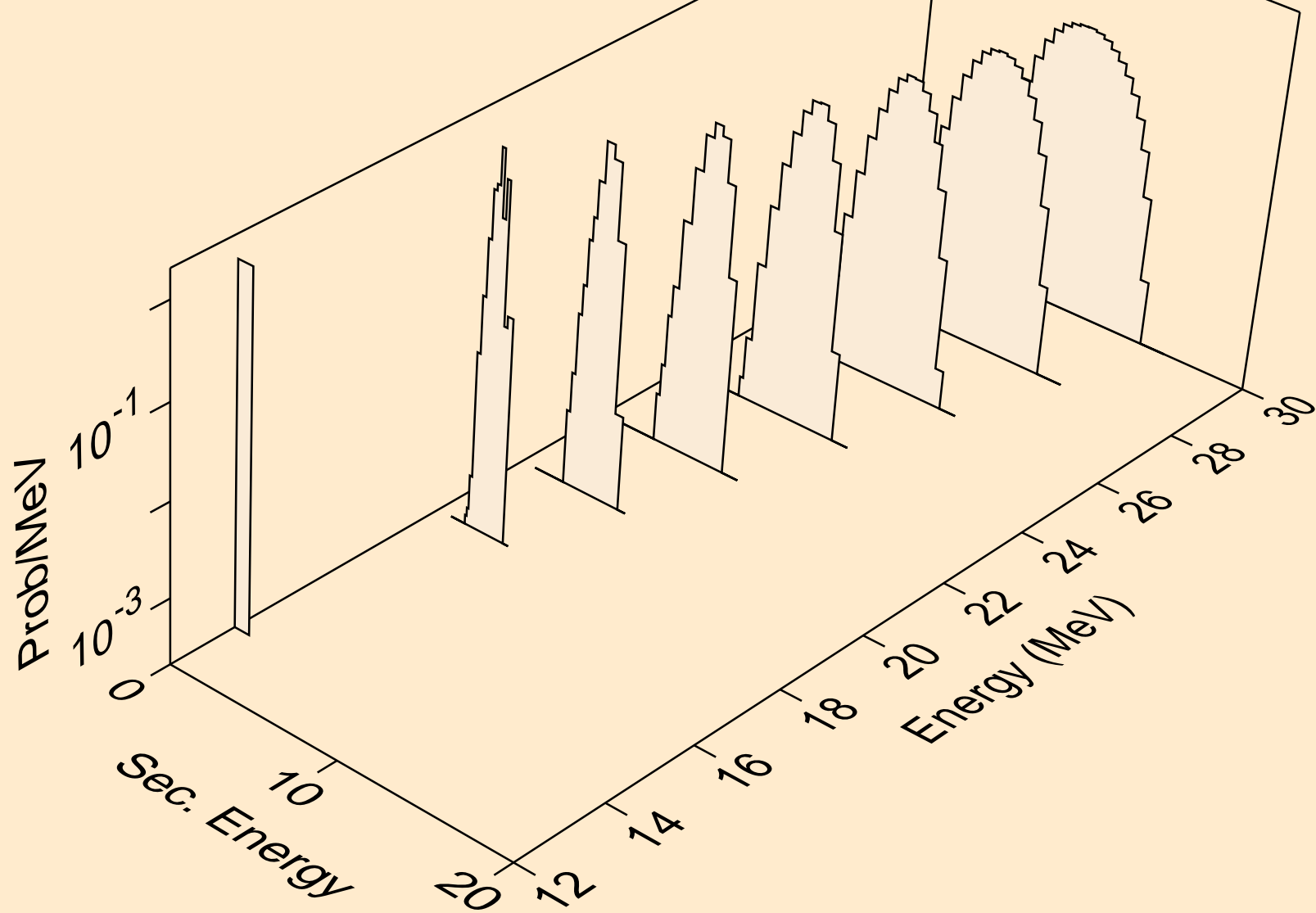

FE053M NEUTRON ACER TENDL-2021 LIBRARY; T=293.6K
alphas from (n,a)

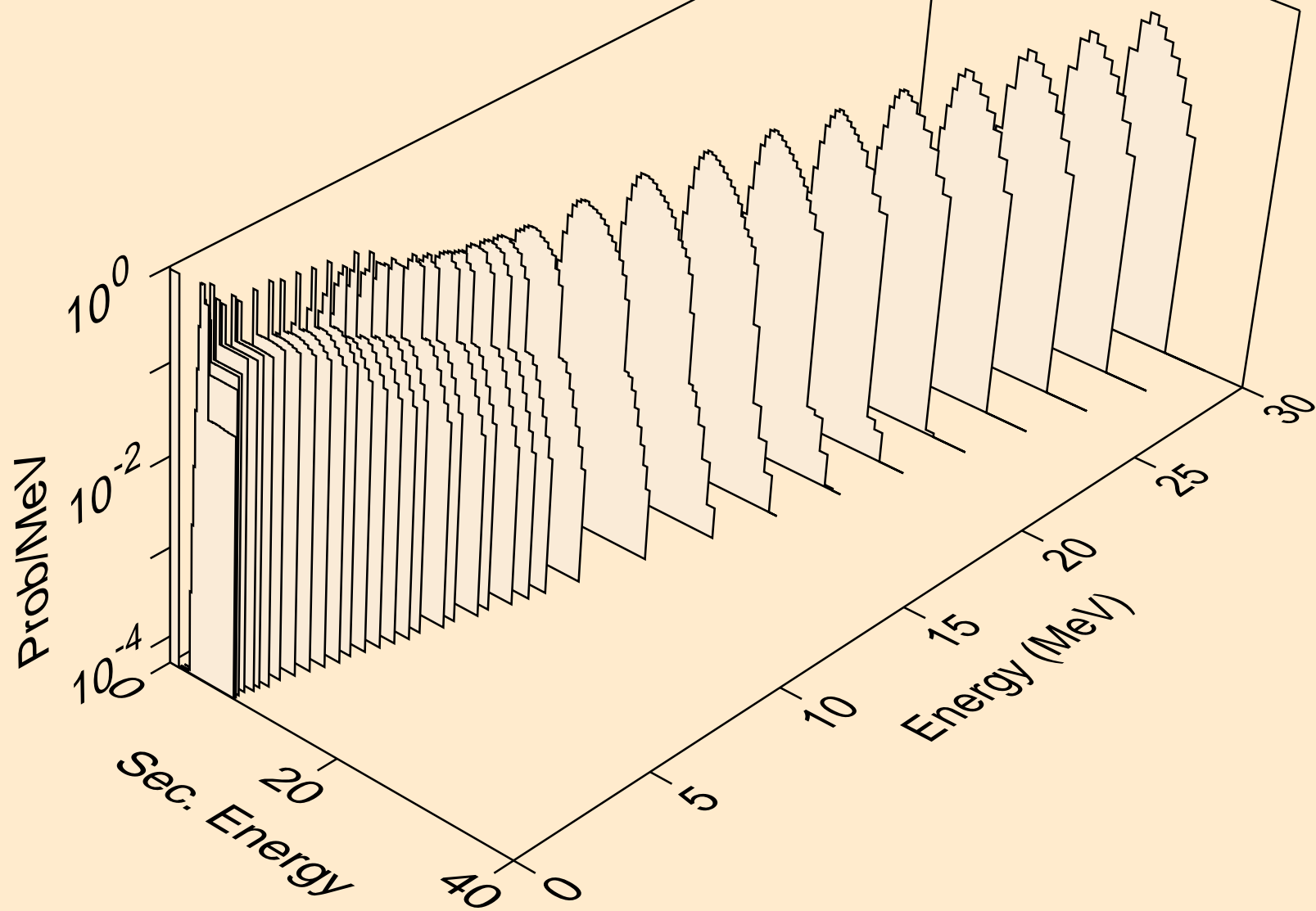

FE053M NEUTRON ACER TENDL-2021 LIBRARY; T=293.6K
alphas from (n,2a)

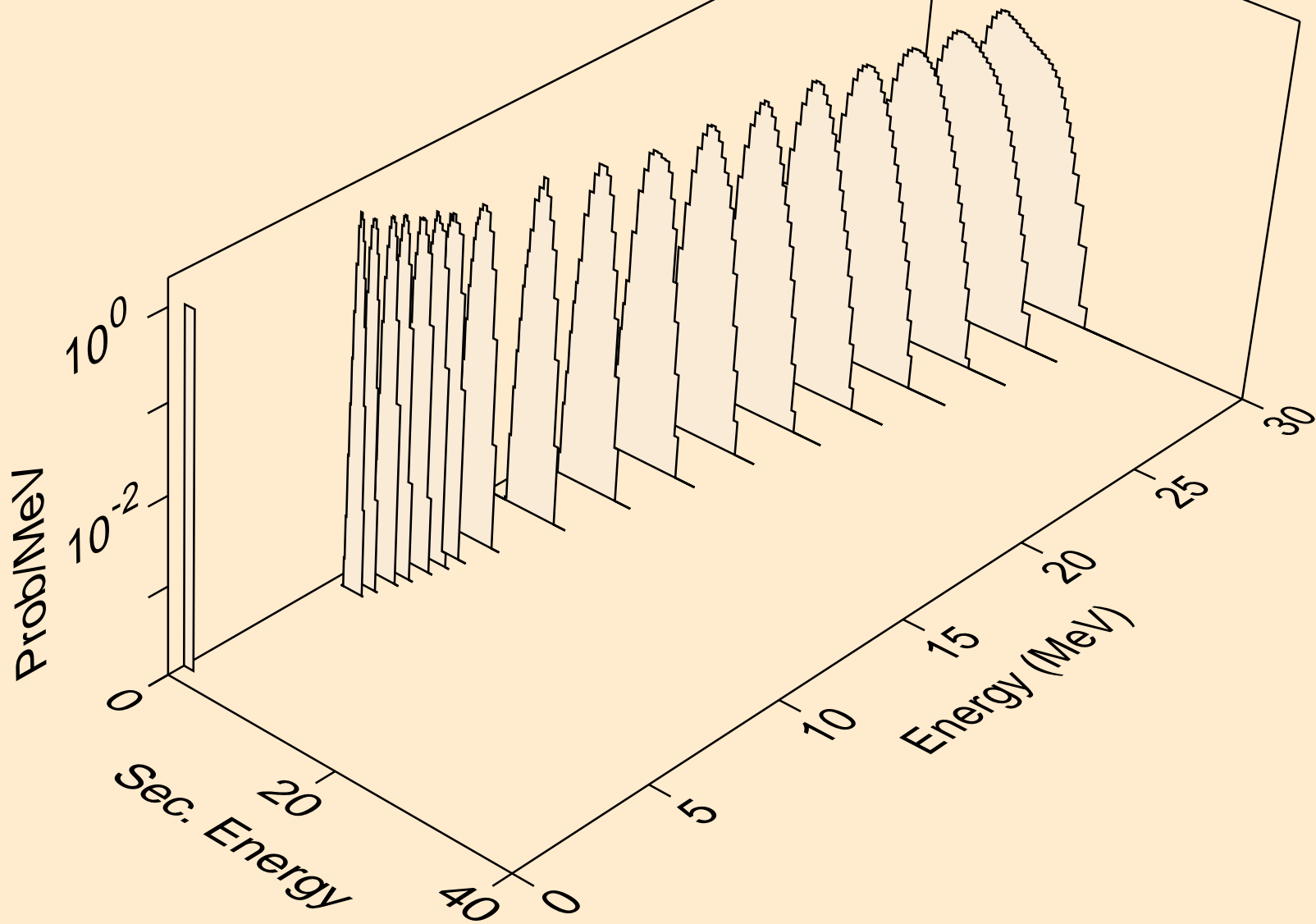

FE053M NEUTRON ACER TENDL-2021 LIBRARY; T=293.6K
alphas from (n,3a)

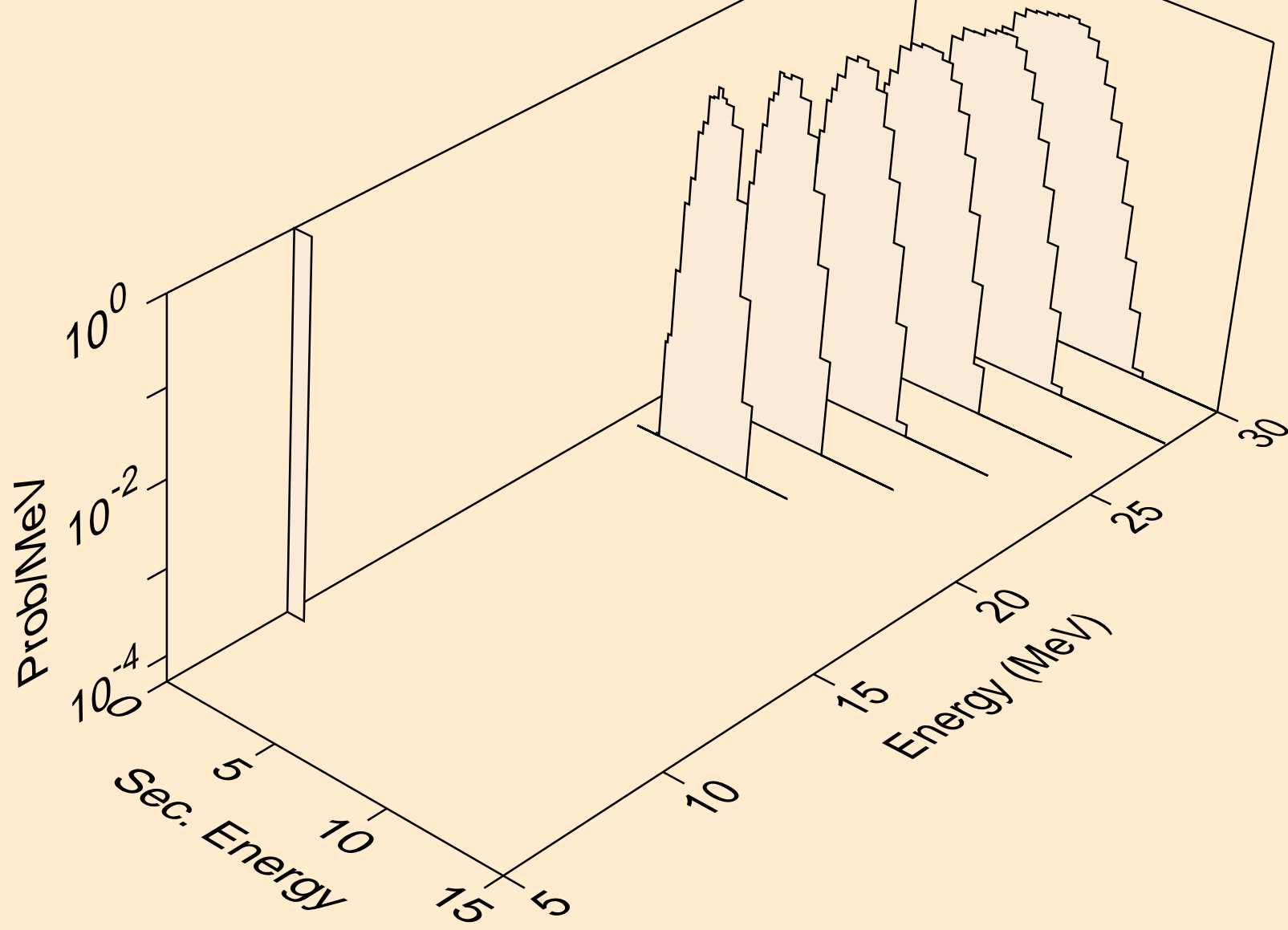

FE053M NEUTRON ACER TENDL-2021 LIBRARY; T=293.6K
alphas from (n,pa)

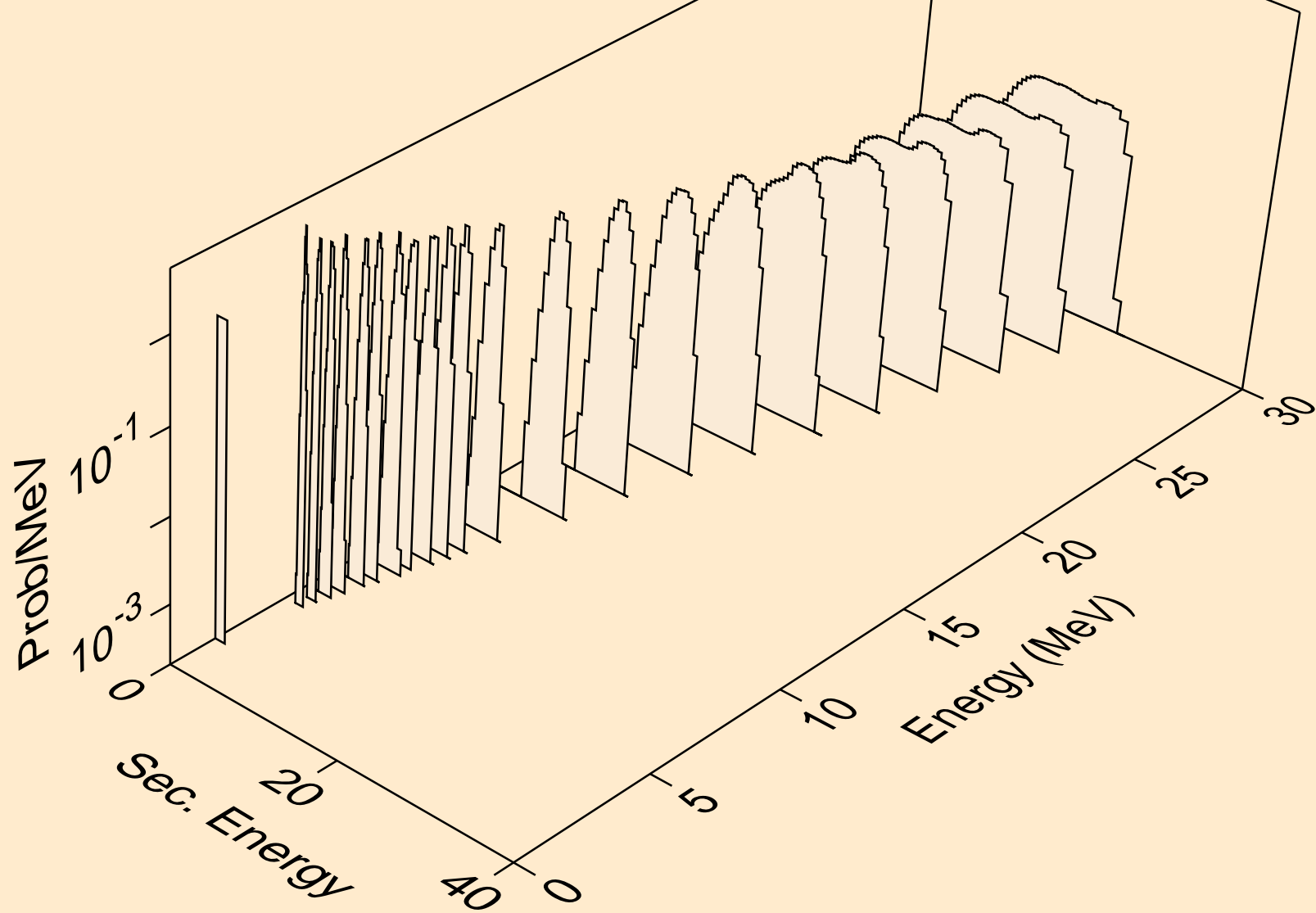

FE053M NEUTRON ACER TENDL-2021 LIBRARY; T=293.6K
alphas from (n,da)

