

FR206 NEUTRON ACER TENDL-2021 LIBRARY; T=293.6K

Principal cross sections

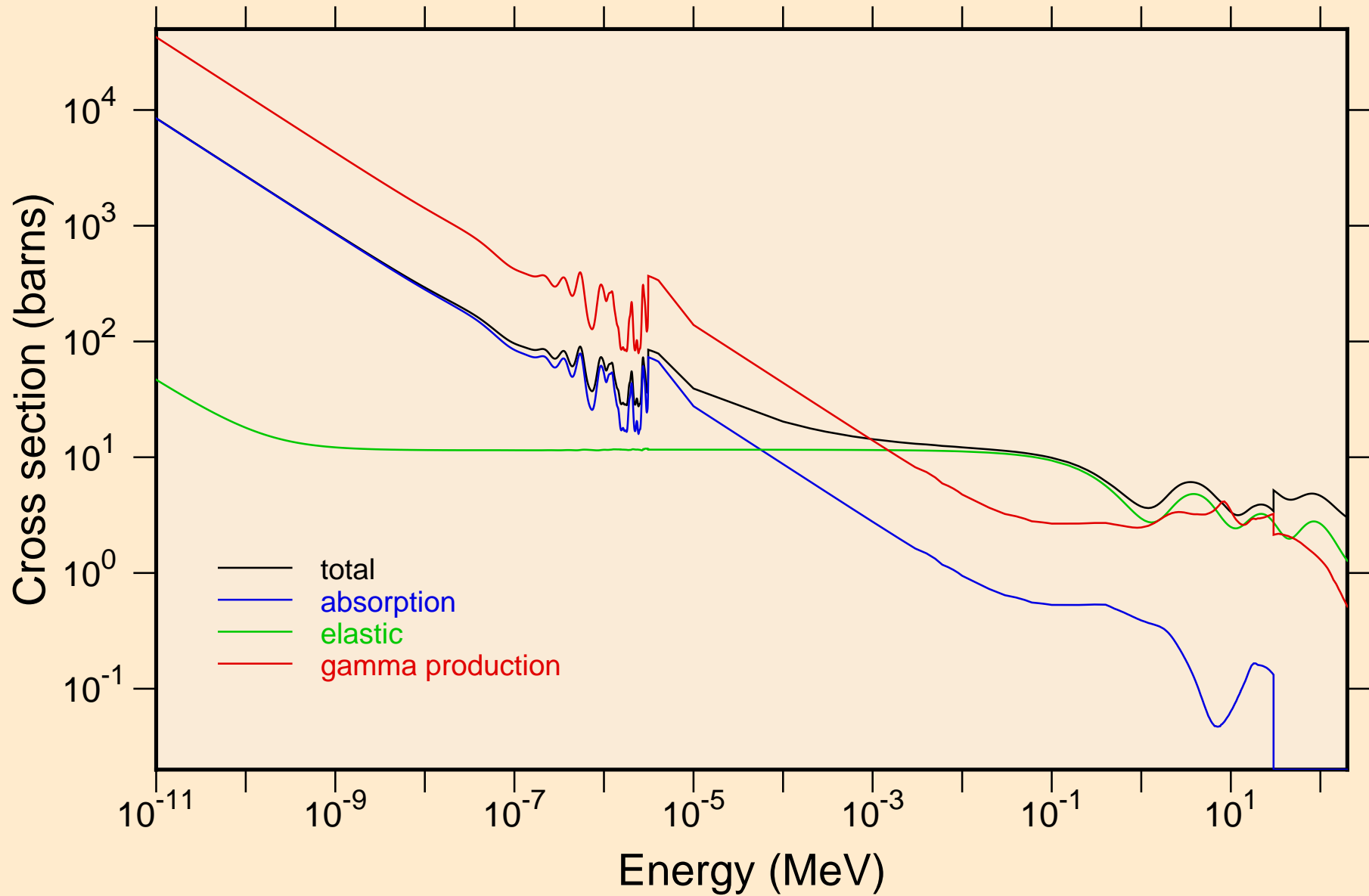

FR206 NEUTRON ACER TENDL-2021 LIBRARY; T=293.6K
Heating

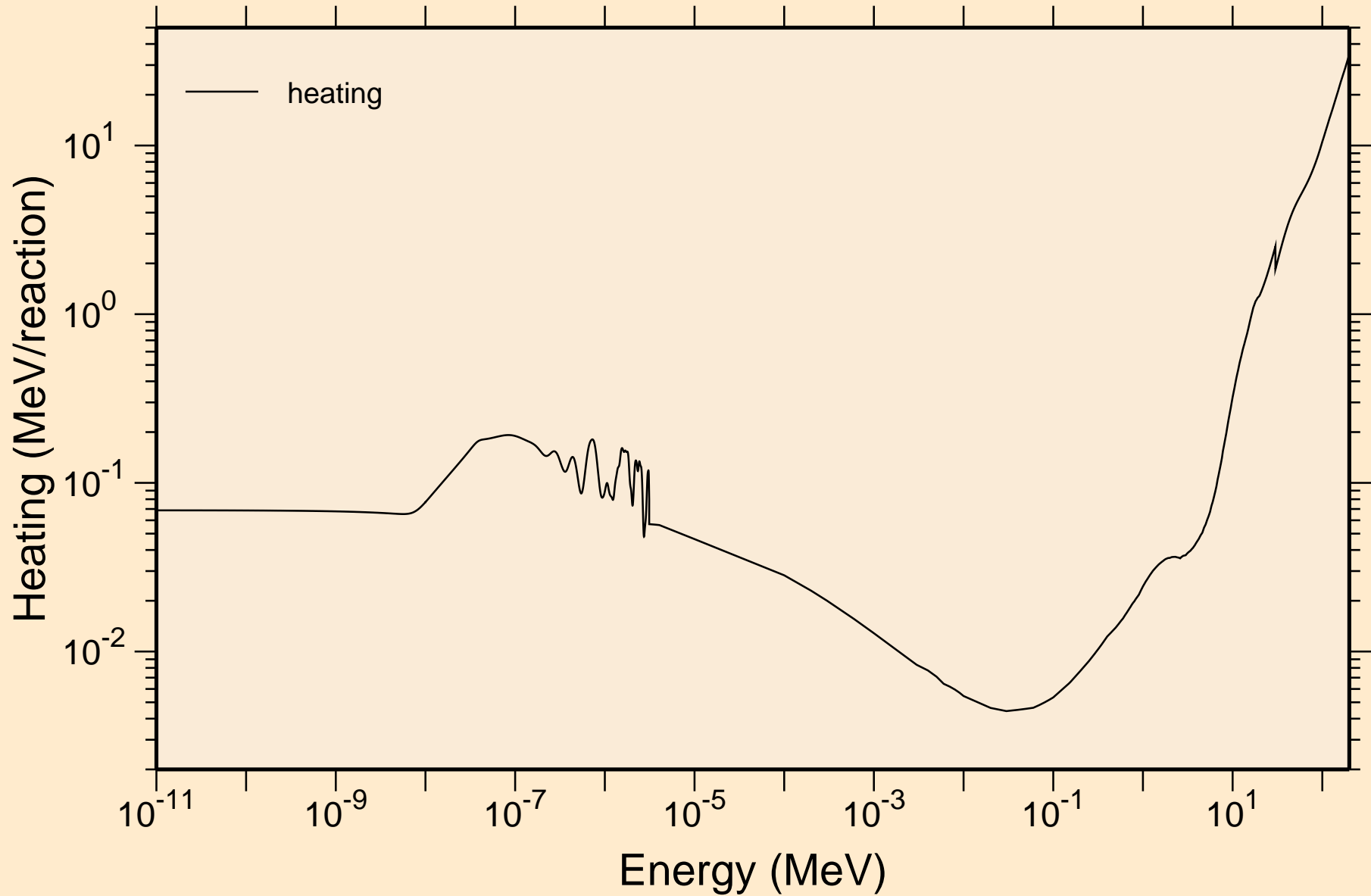

FR206 NEUTRON ACER TENDL-2021 LIBRARY; T=293.6K
Damage

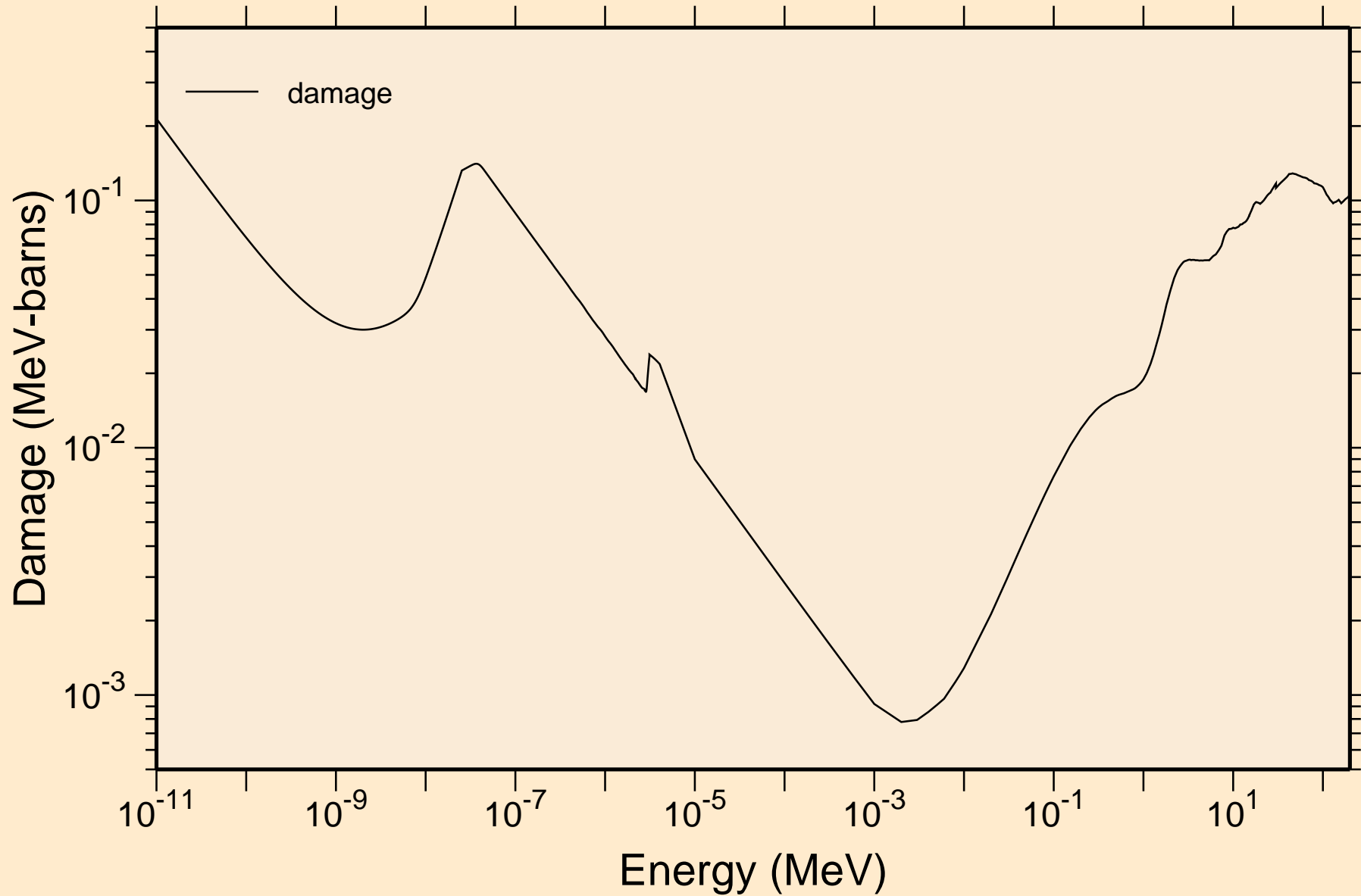

FR206 NEUTRON ACER TENDL-2021 LIBRARY; T=293.6K
Non-threshold reactions

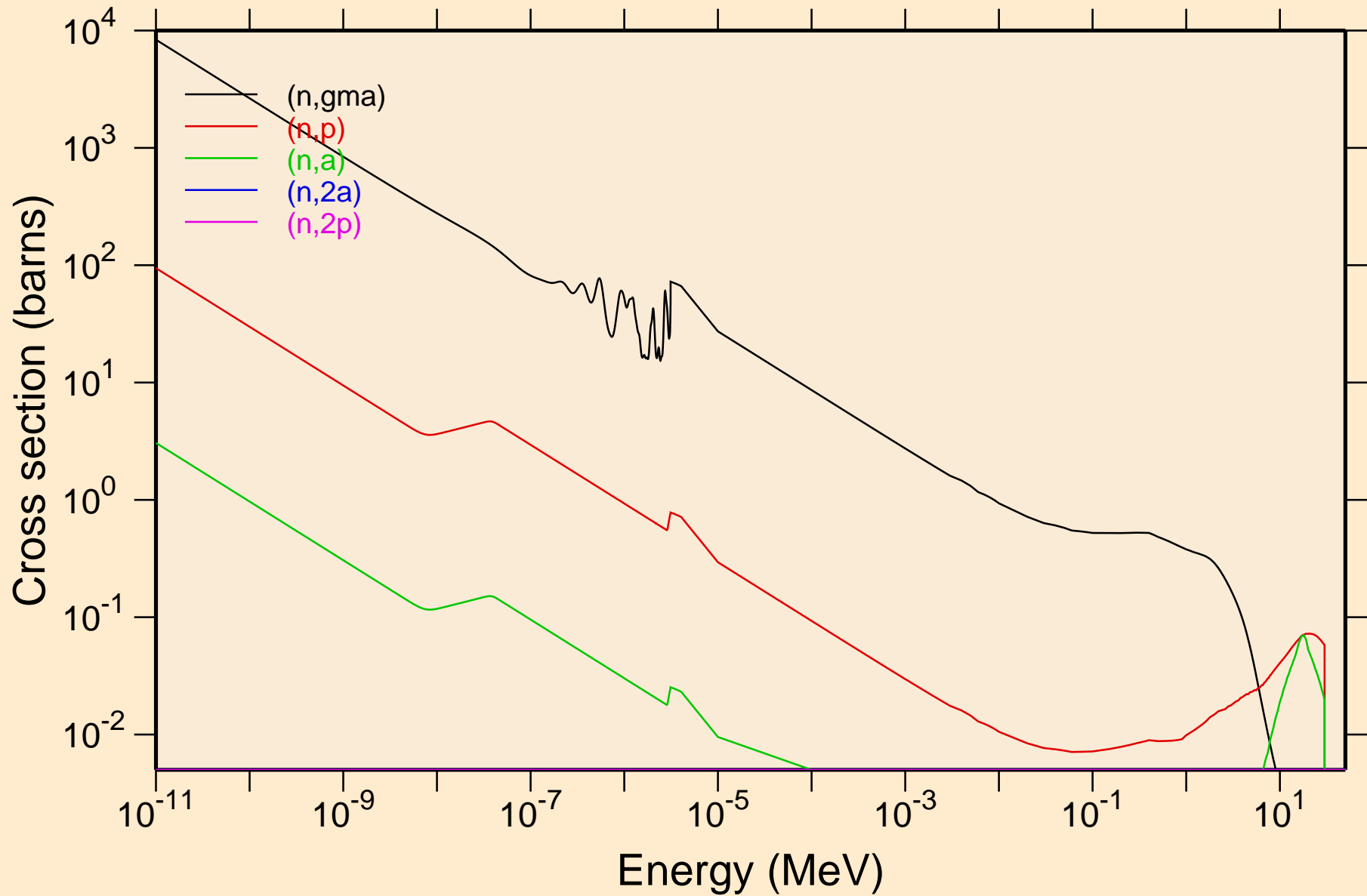

FR206 NEUTRON ACER TENDL-2021 LIBRARY; T=293.6K
Non-threshold reactions

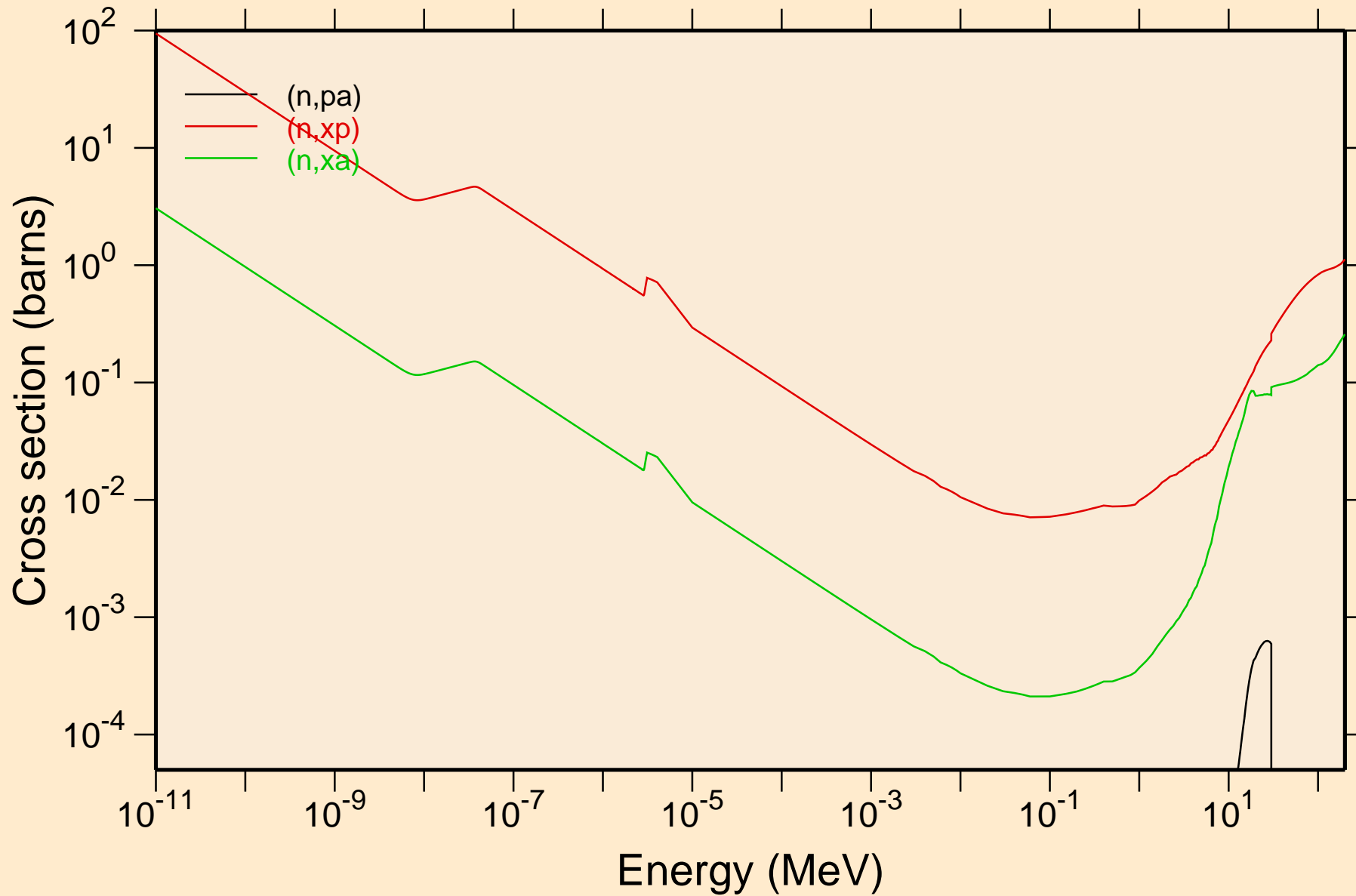

FR206 NEUTRON ACER TENDL-2021 LIBRARY; T=293.6K
Principal cross sections

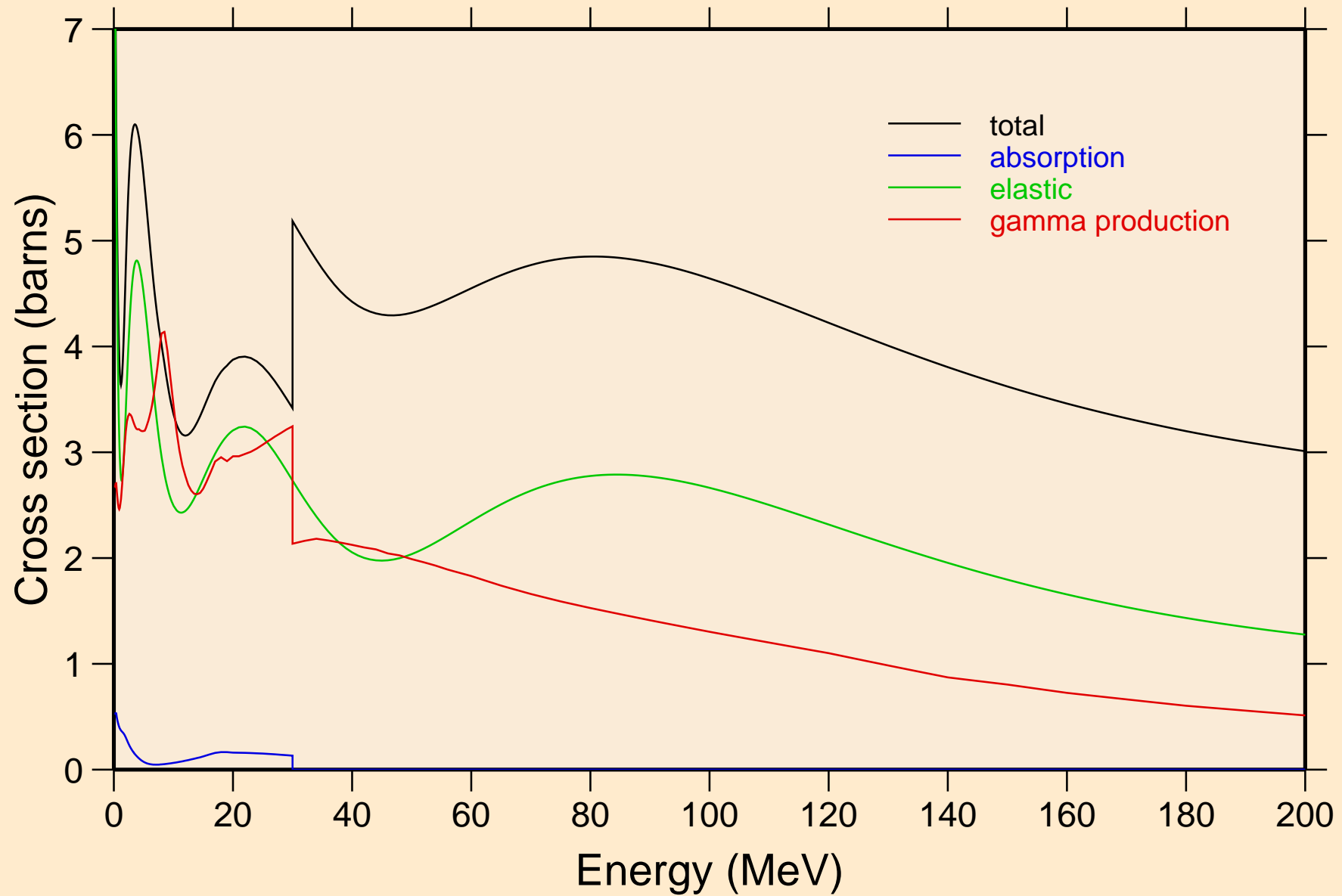

FR206 NEUTRON ACER TENDL-2021 LIBRARY; T=293.6K

Heating

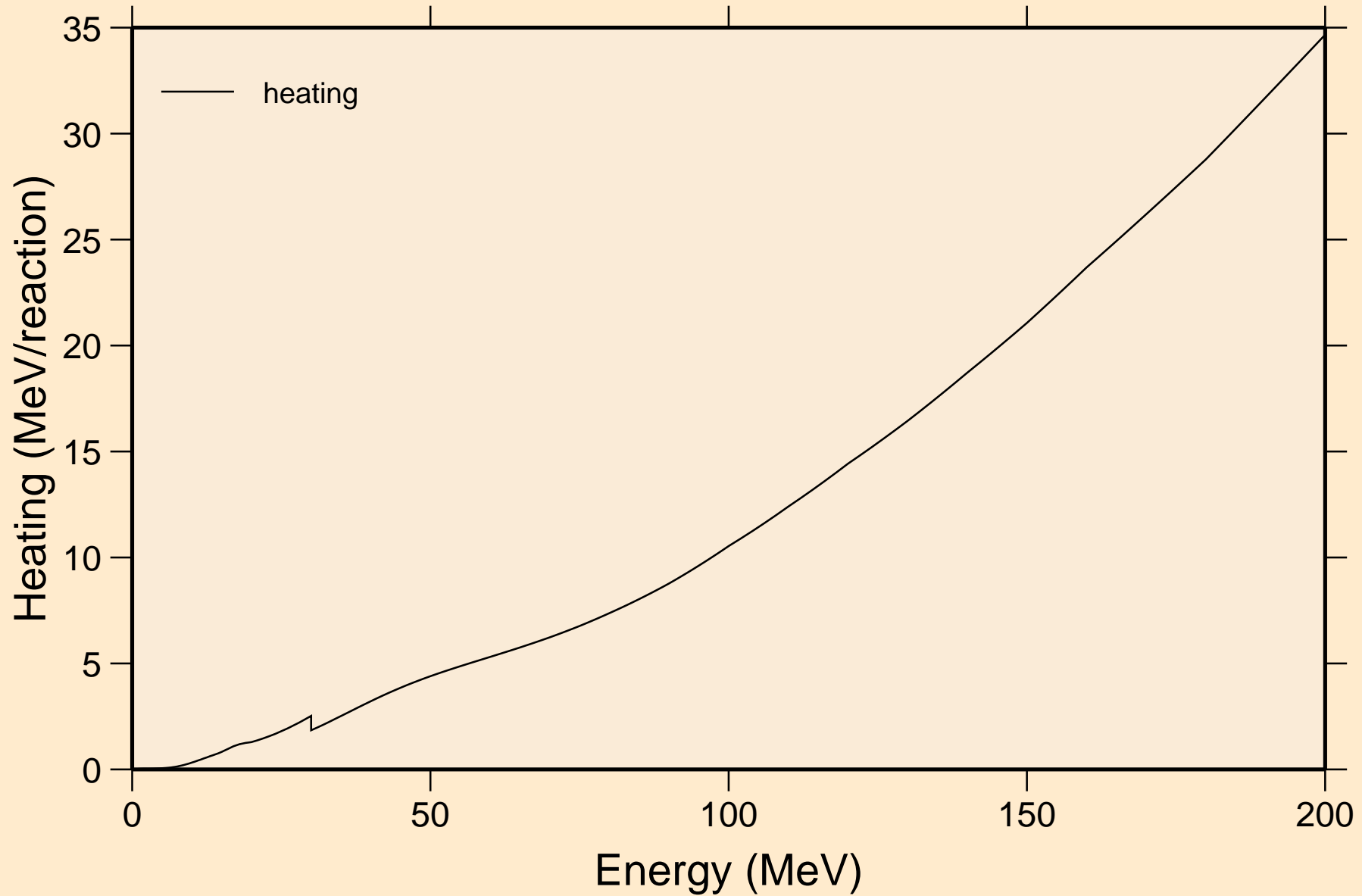

FR206 NEUTRON ACER TENDL-2021 LIBRARY; T=293.6K
Damage

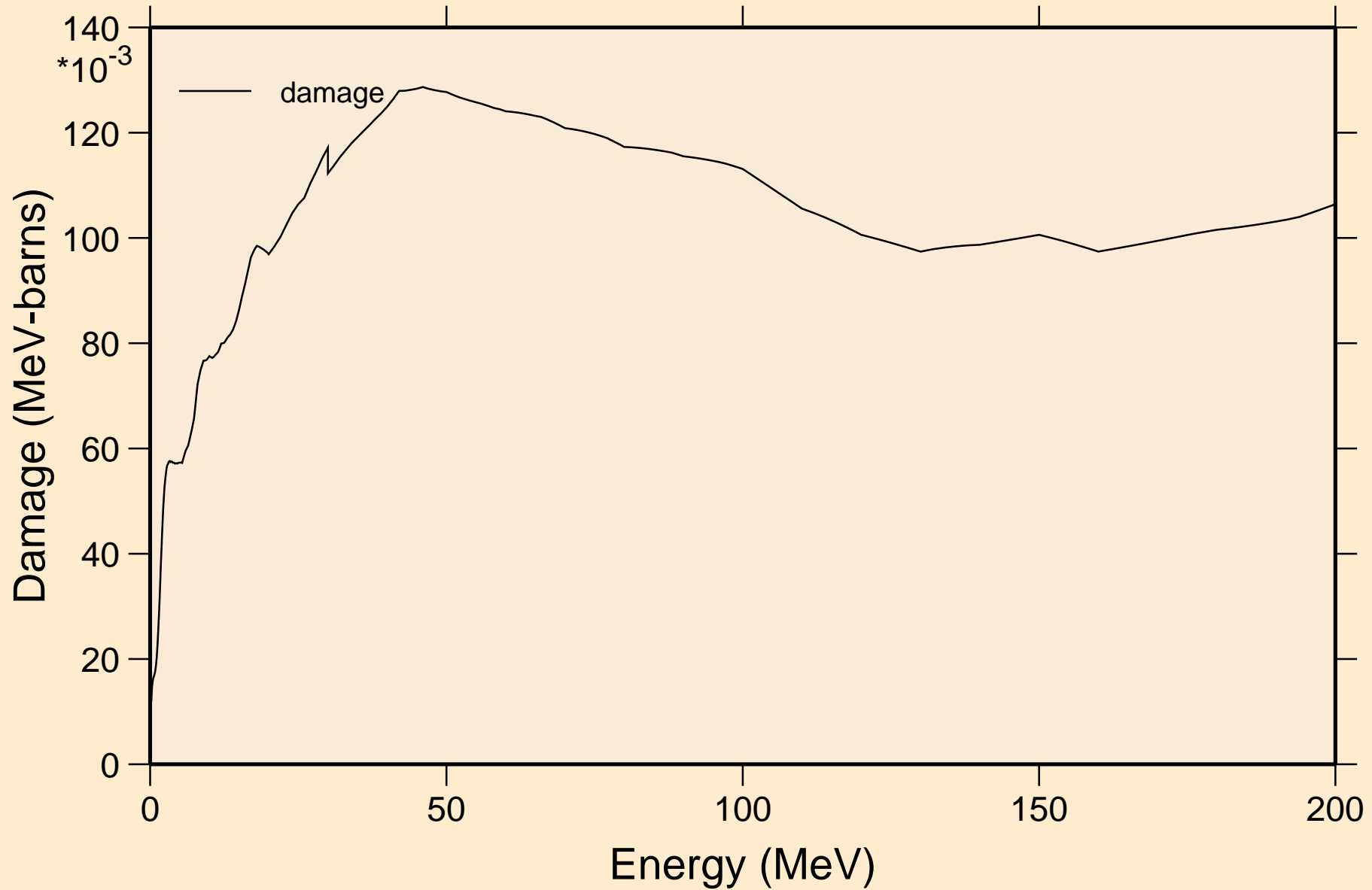

FR206 NEUTRON ACER TENDL-2021 LIBRARY; T=293.6K
Non-threshold reactions

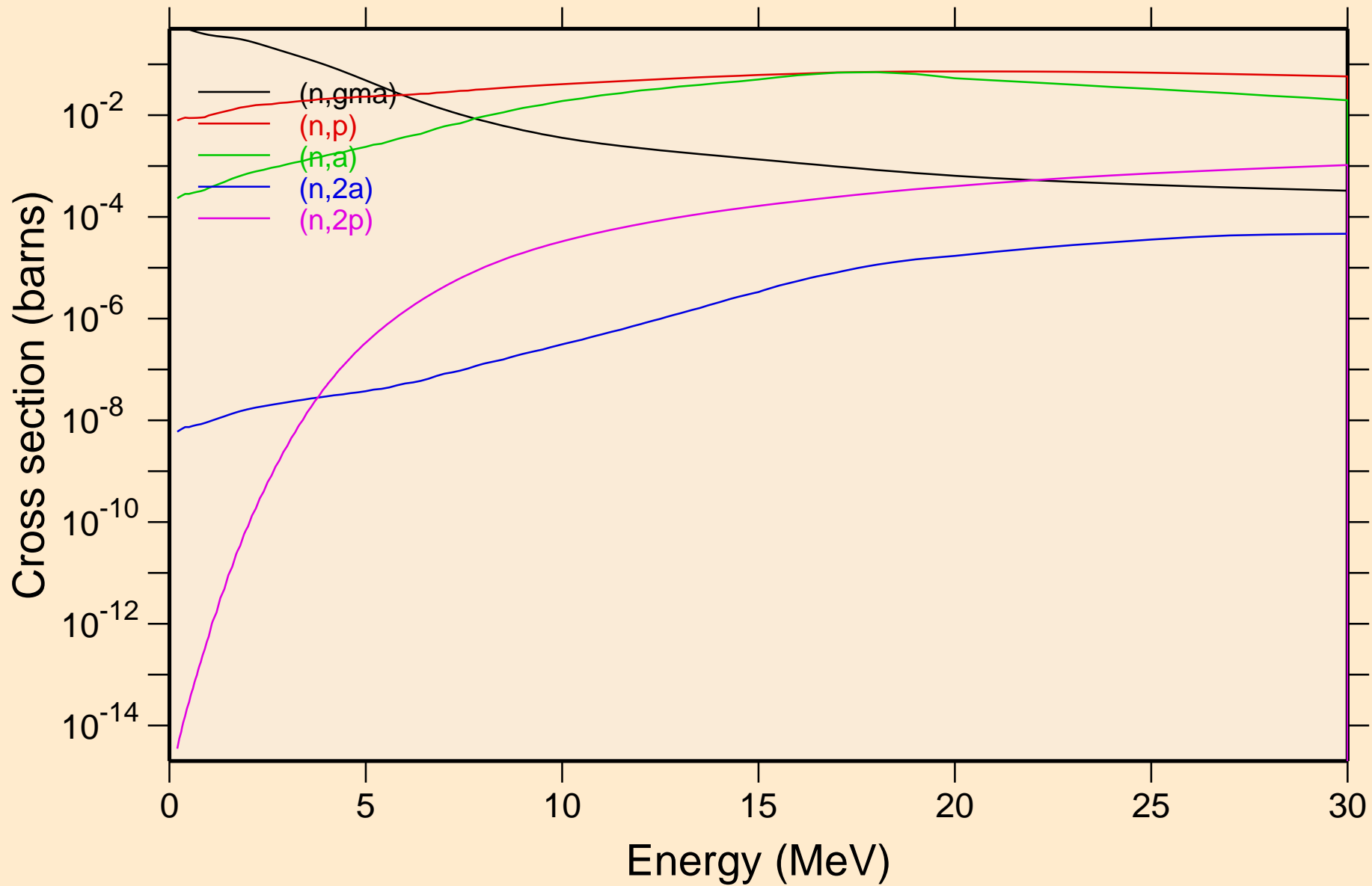

FR206 NEUTRON ACER TENDL-2021 LIBRARY; T=293.6K
Non-threshold reactions

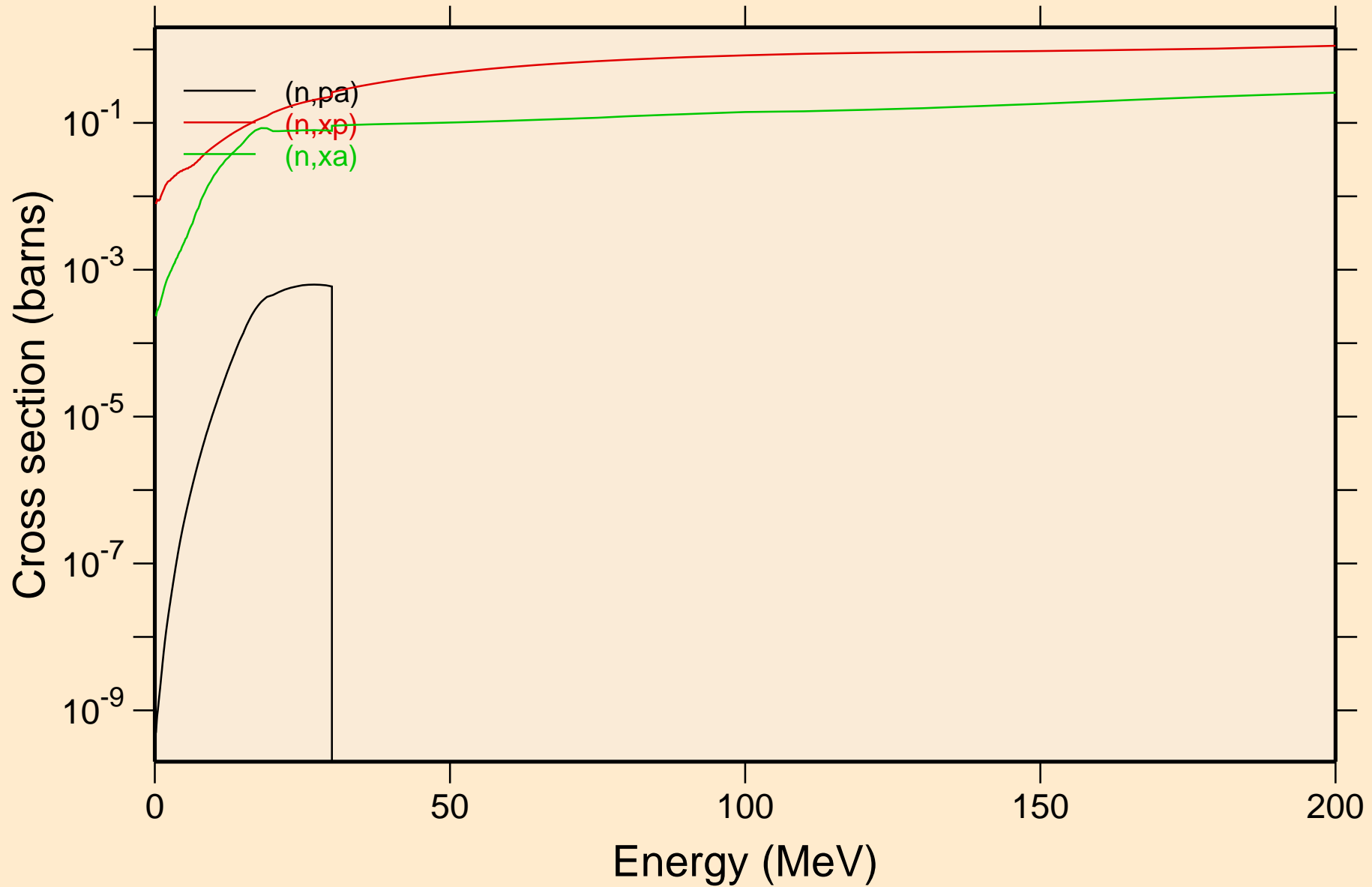

FR206 NEUTRON ACER TENDL-2021 LIBRARY; T=293.6K
Inelastic levels

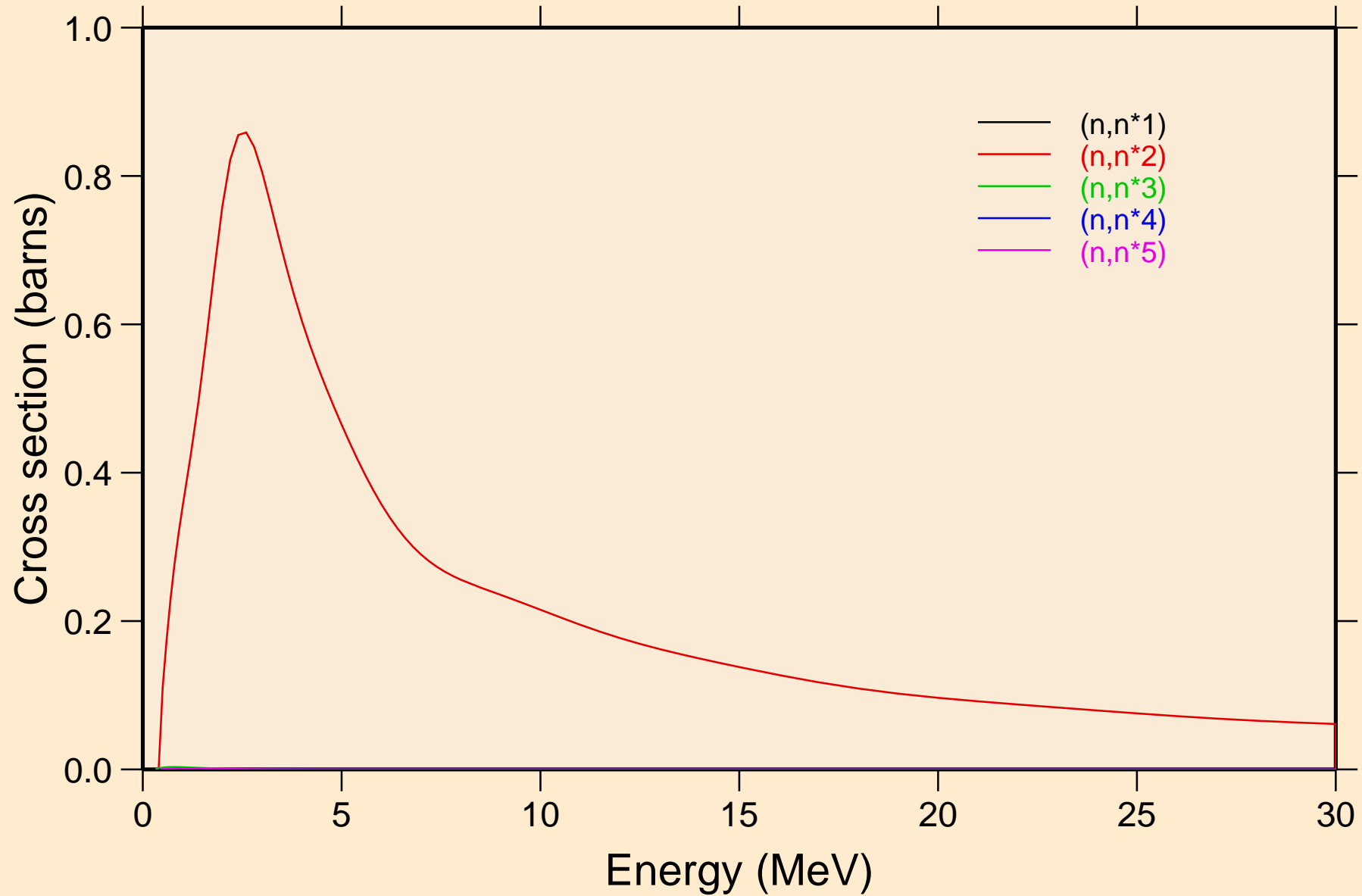

FR206 NEUTRON ACER TENDL-2021 LIBRARY; T=293.6K
Inelastic levels

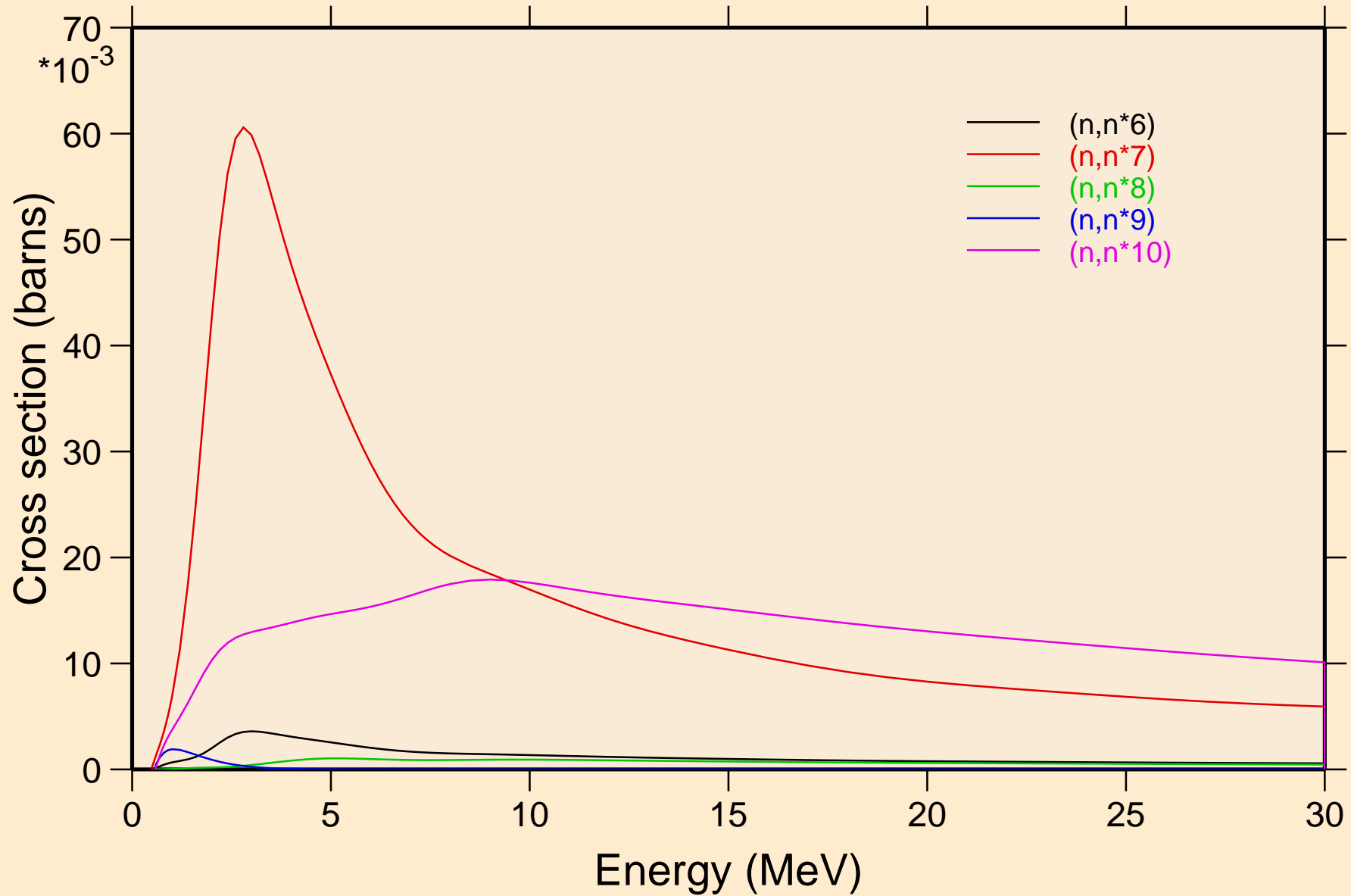

FR206 NEUTRON ACER TENDL-2021 LIBRARY; T=293.6K
Inelastic levels

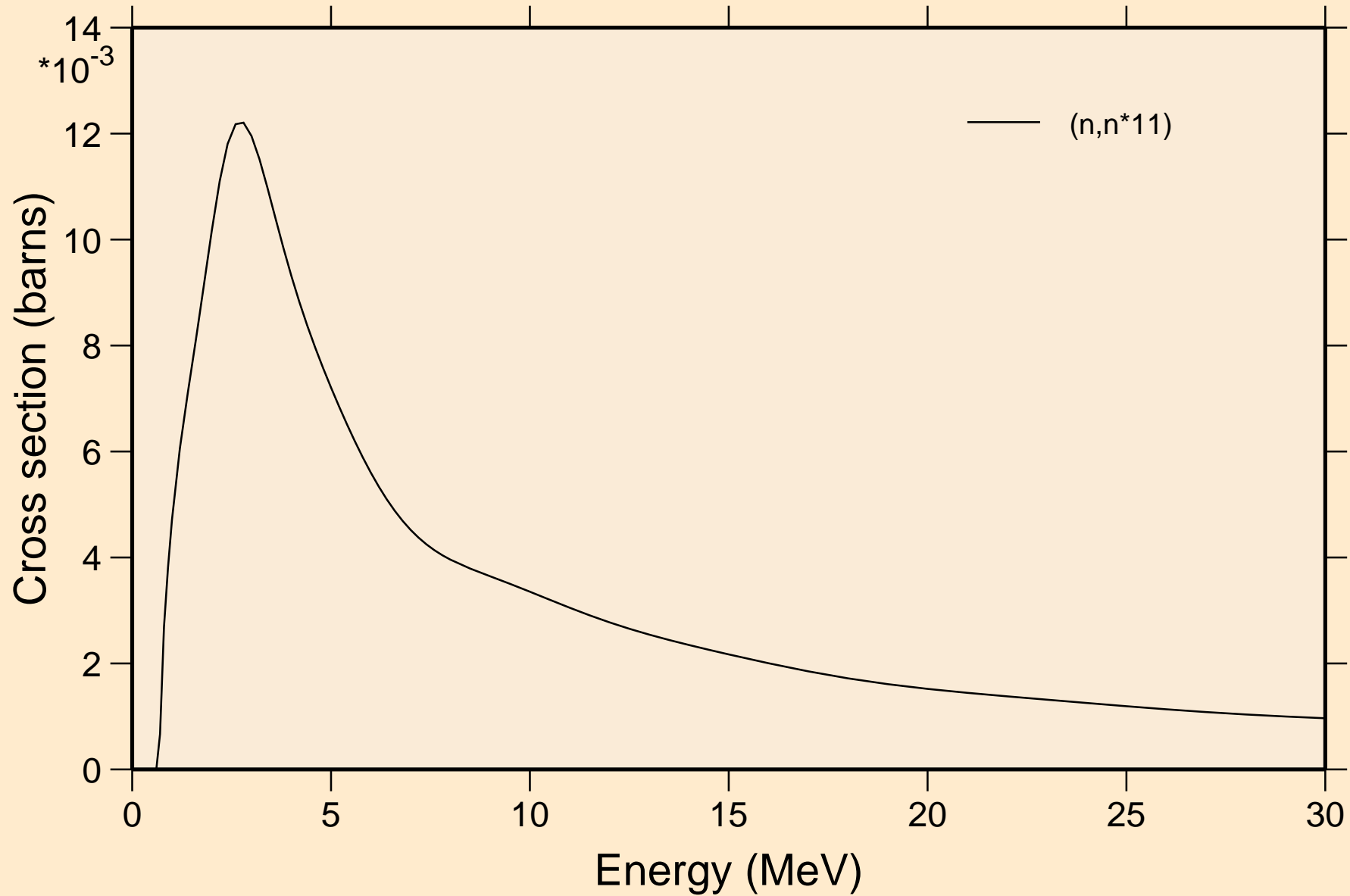

FR206 NEUTRON ACER TENDL-2021 LIBRARY; T=293.6K
Threshold reactions

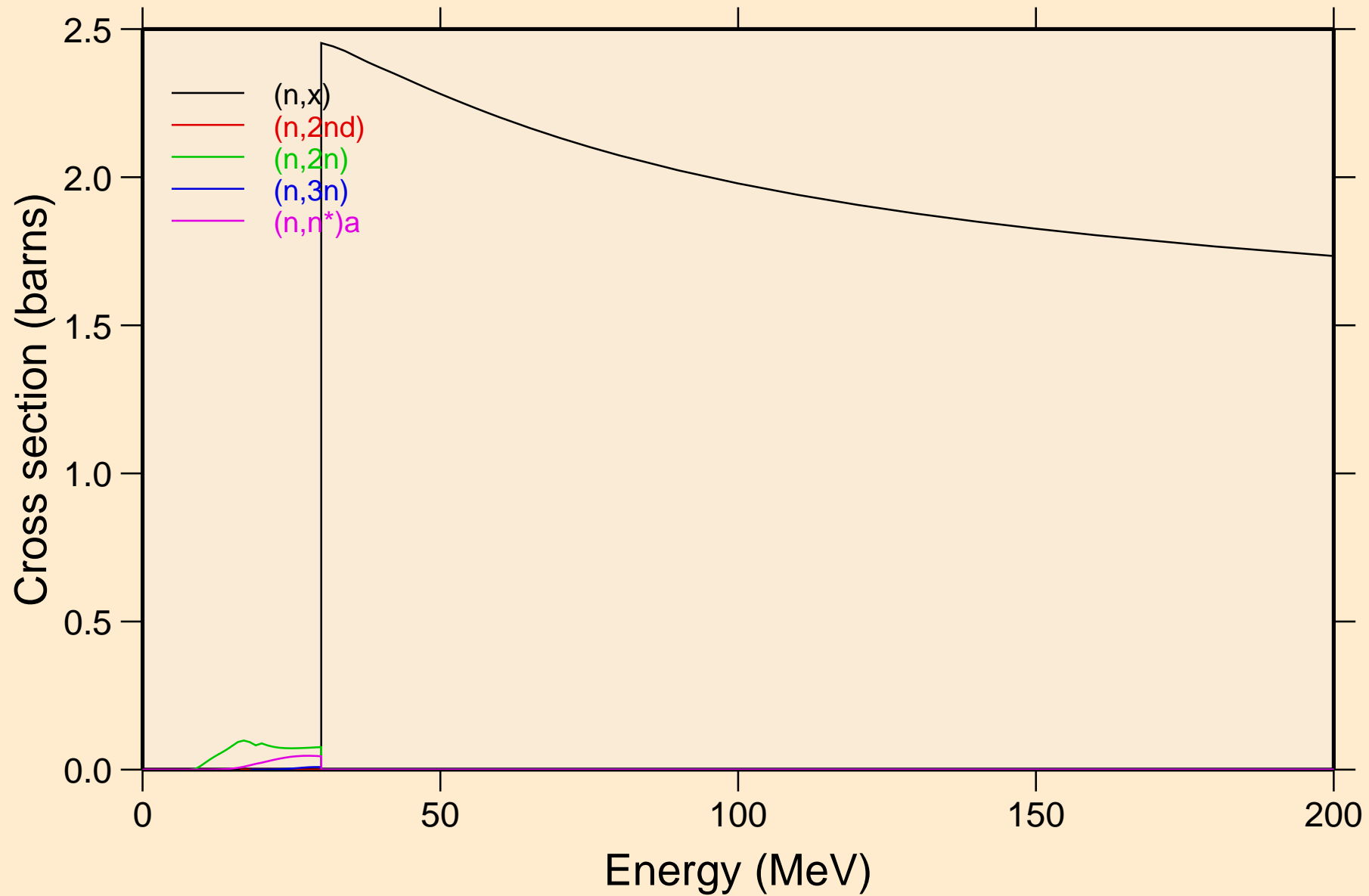

FR206 NEUTRON ACER TENDL-2021 LIBRARY; T=293.6K
Threshold reactions

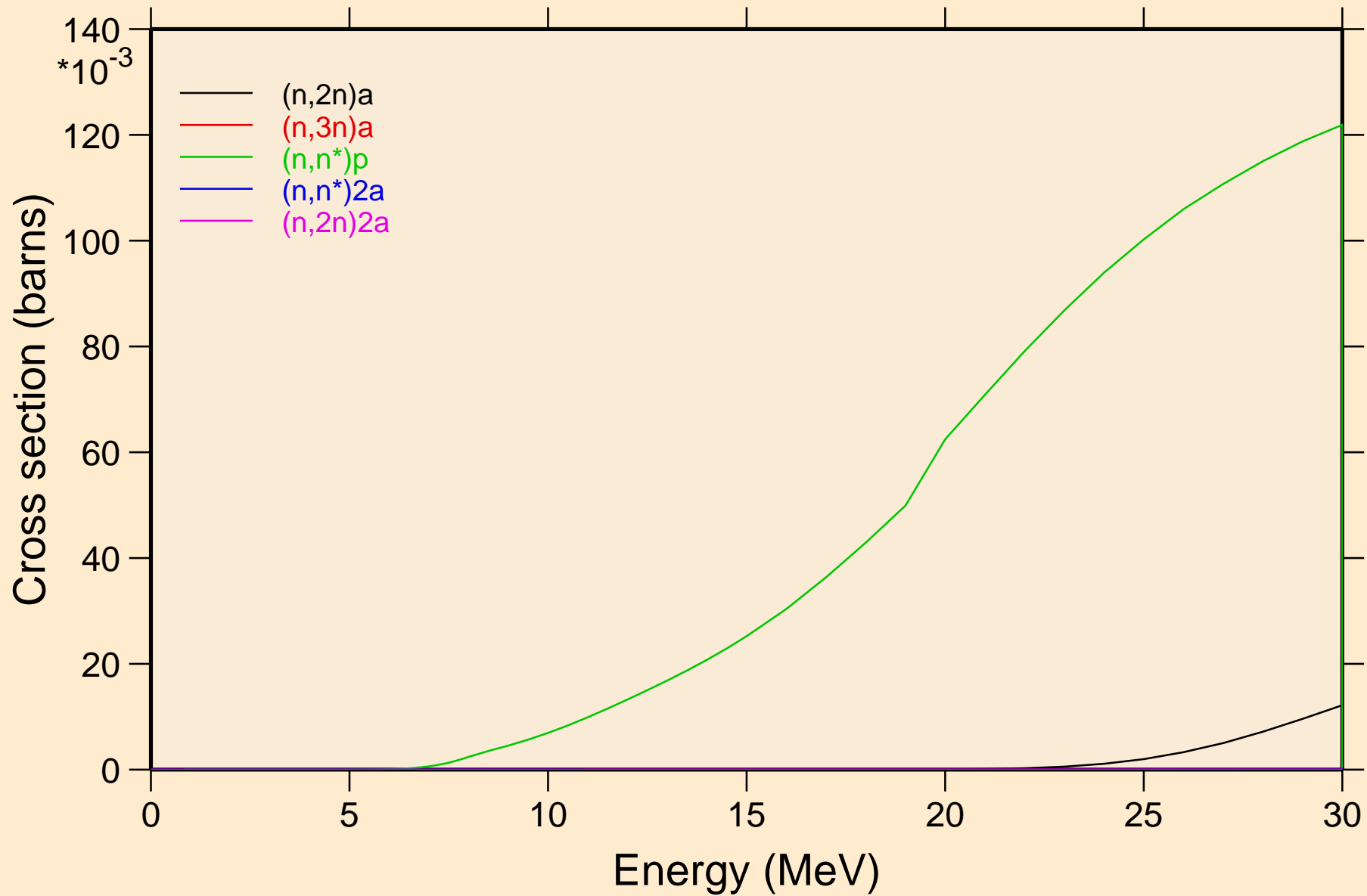

FR206 NEUTRON ACER TENDL-2021 LIBRARY; T=293.6K
Threshold reactions

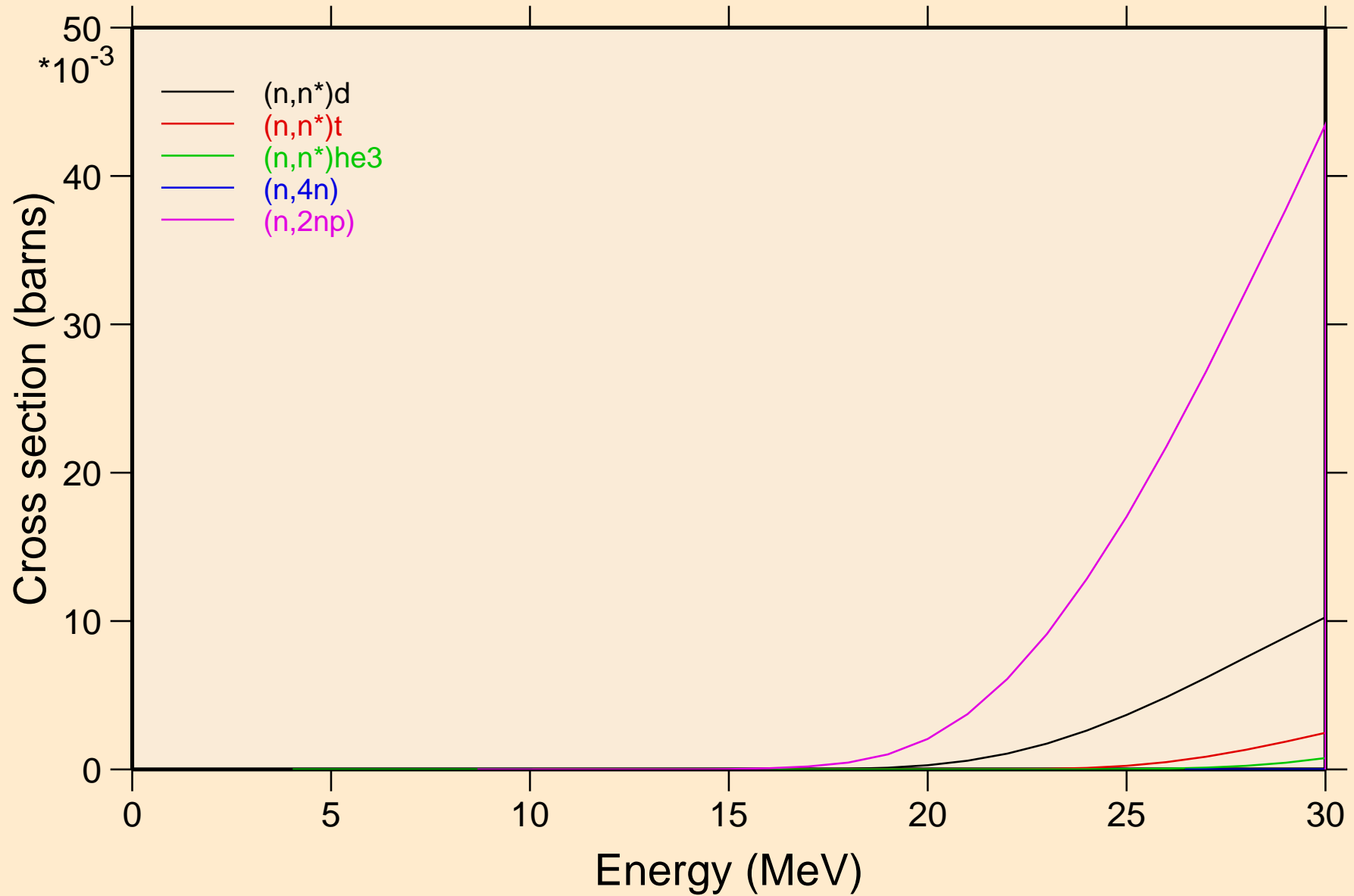

FR206 NEUTRON ACER TENDL-2021 LIBRARY; T=293.6K
Threshold reactions

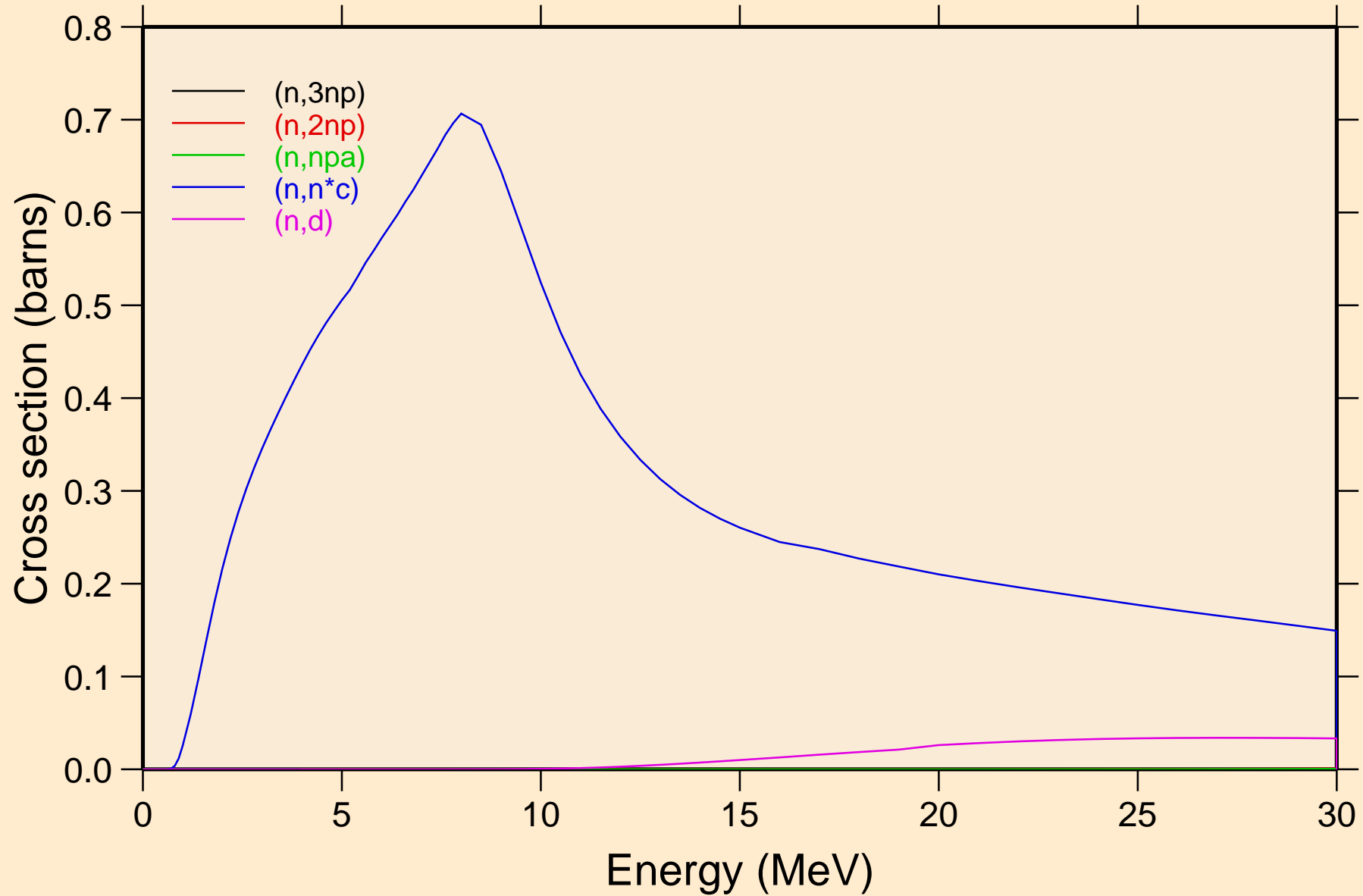

FR206 NEUTRON ACER TENDL-2021 LIBRARY; T=293.6K
Threshold reactions

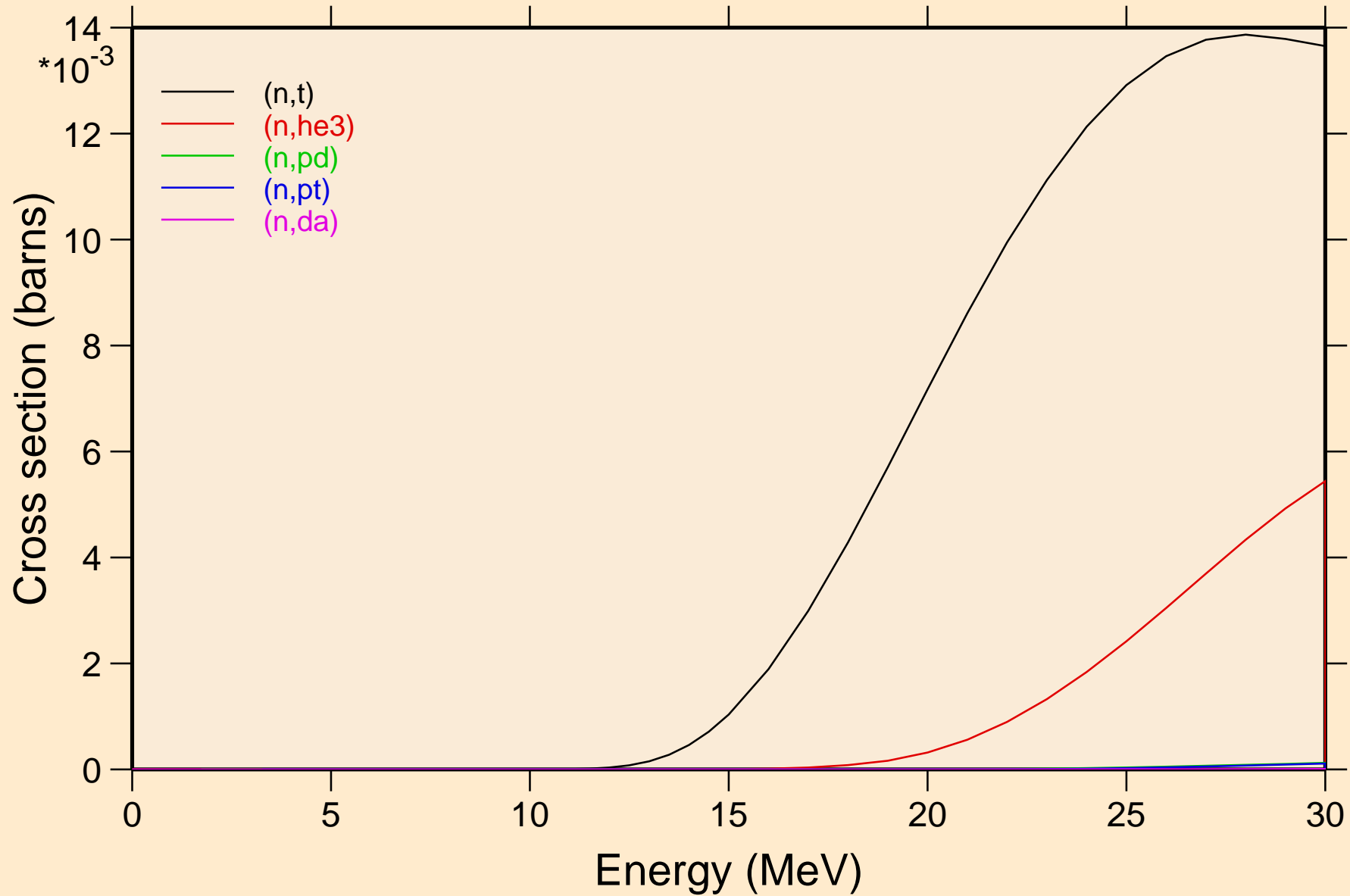

FR206 NEUTRON ACER TENDL-2021 LIBRARY; T=293.6K
Threshold reactions

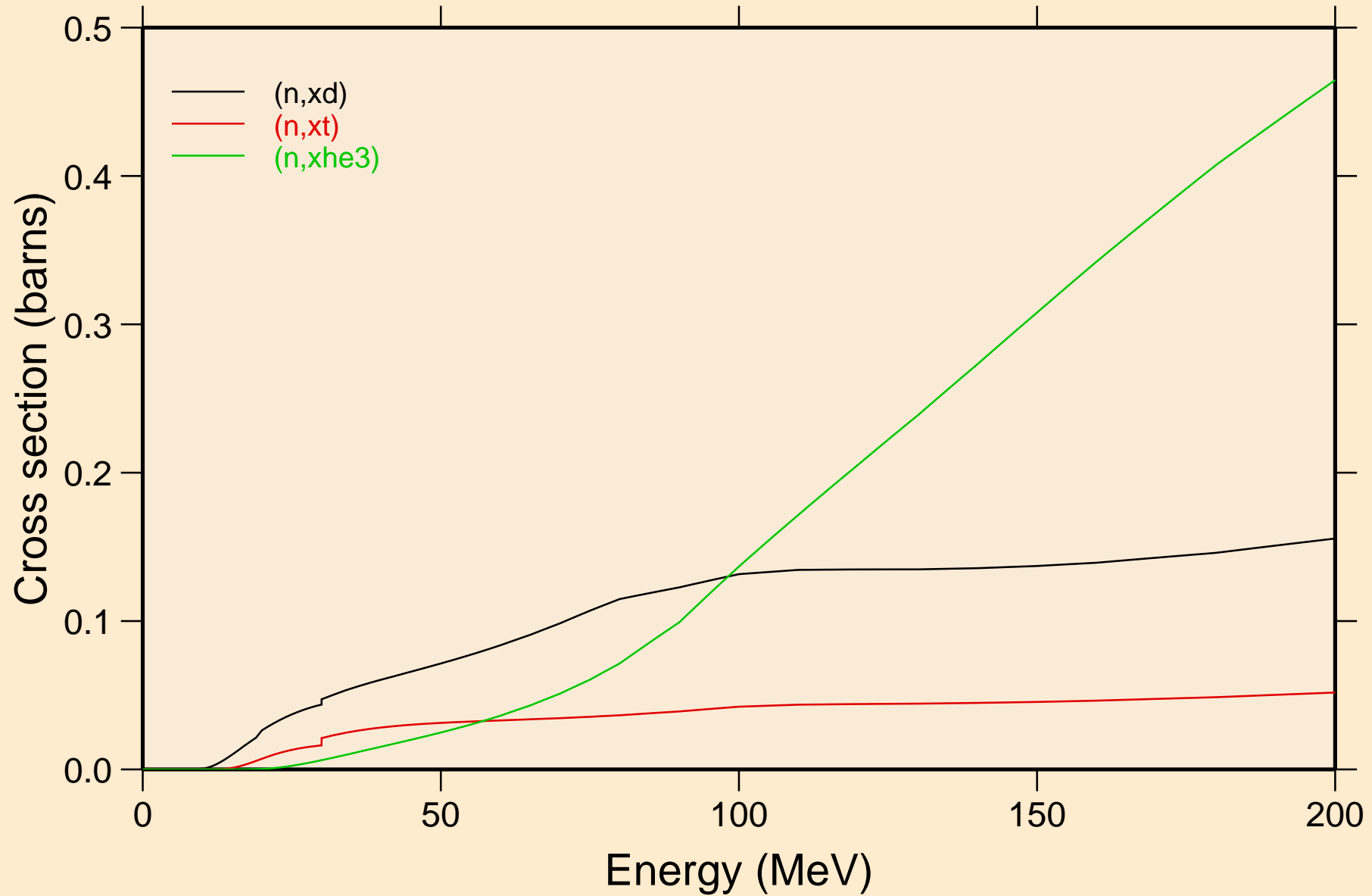

FR206 NEUTRON ACER TENDL-2021 LIBRARY; T=293.6K
angular distribution for elastic

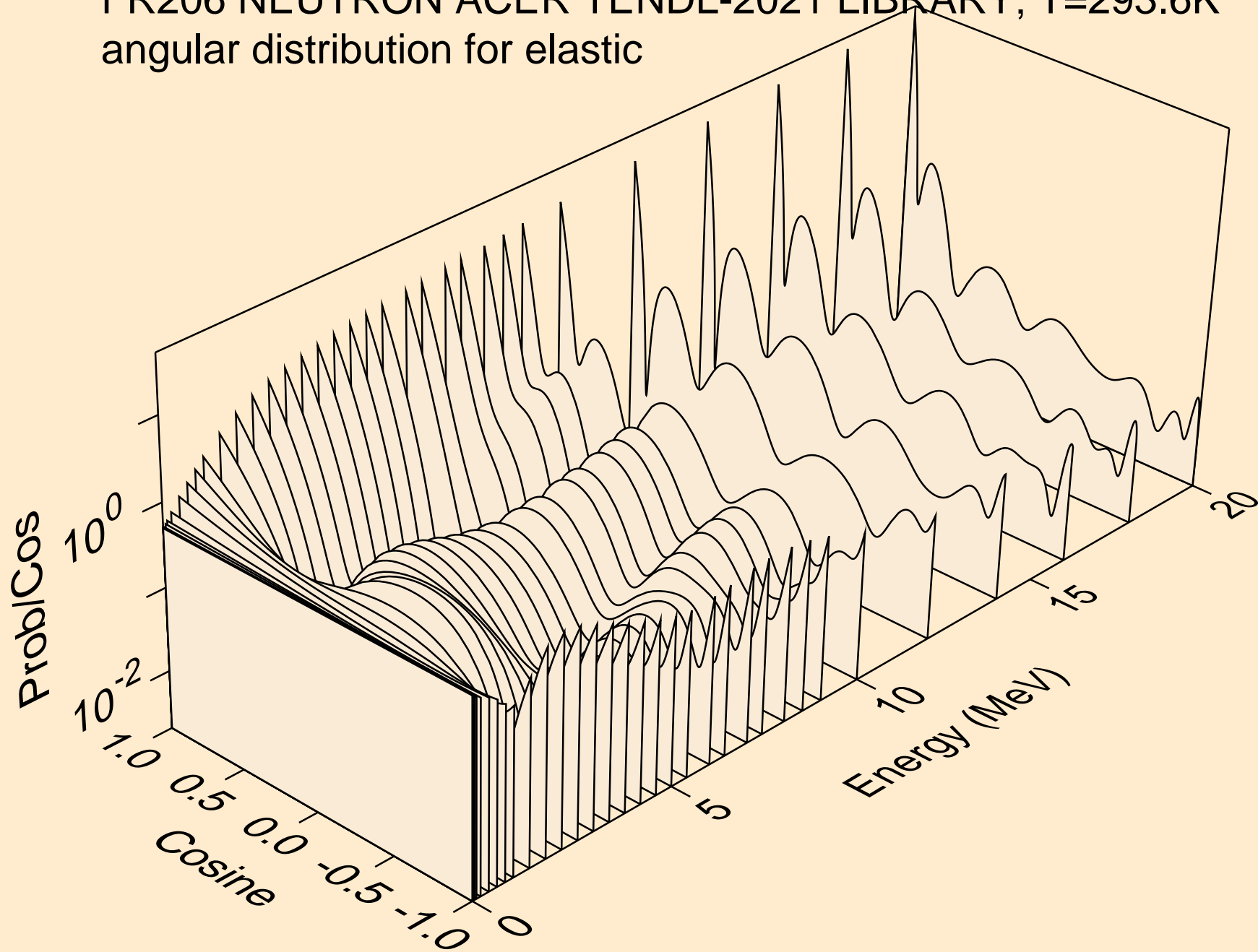

FR206 NEUTRON ACER TENDL-2021 LIBRARY; T=293.6K
angular distribution for elastic

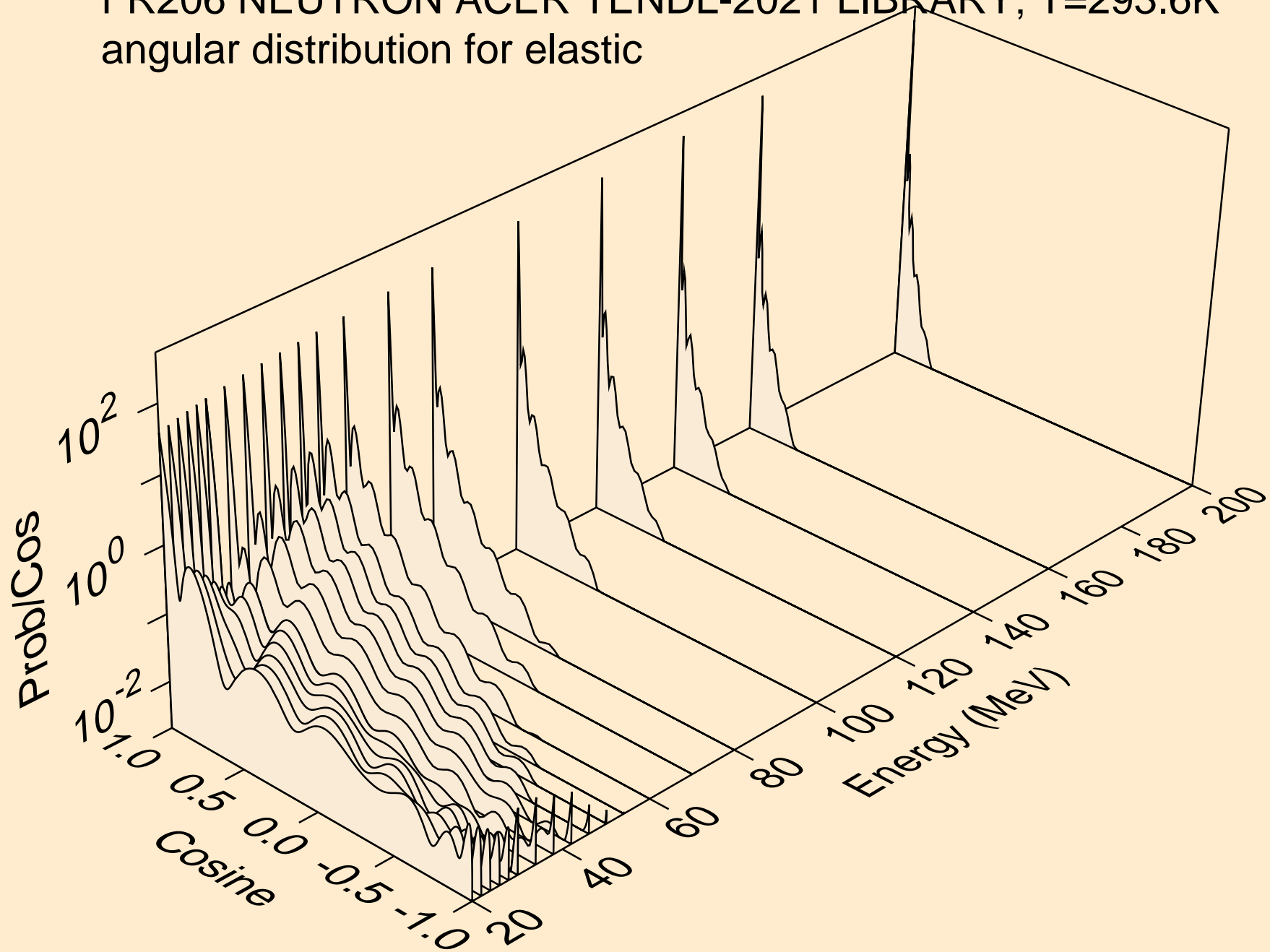

FR206 NEUTRON ACER TENDL-2021 LIBRARY; T=293.6K
angular distribution for (n,n*1)

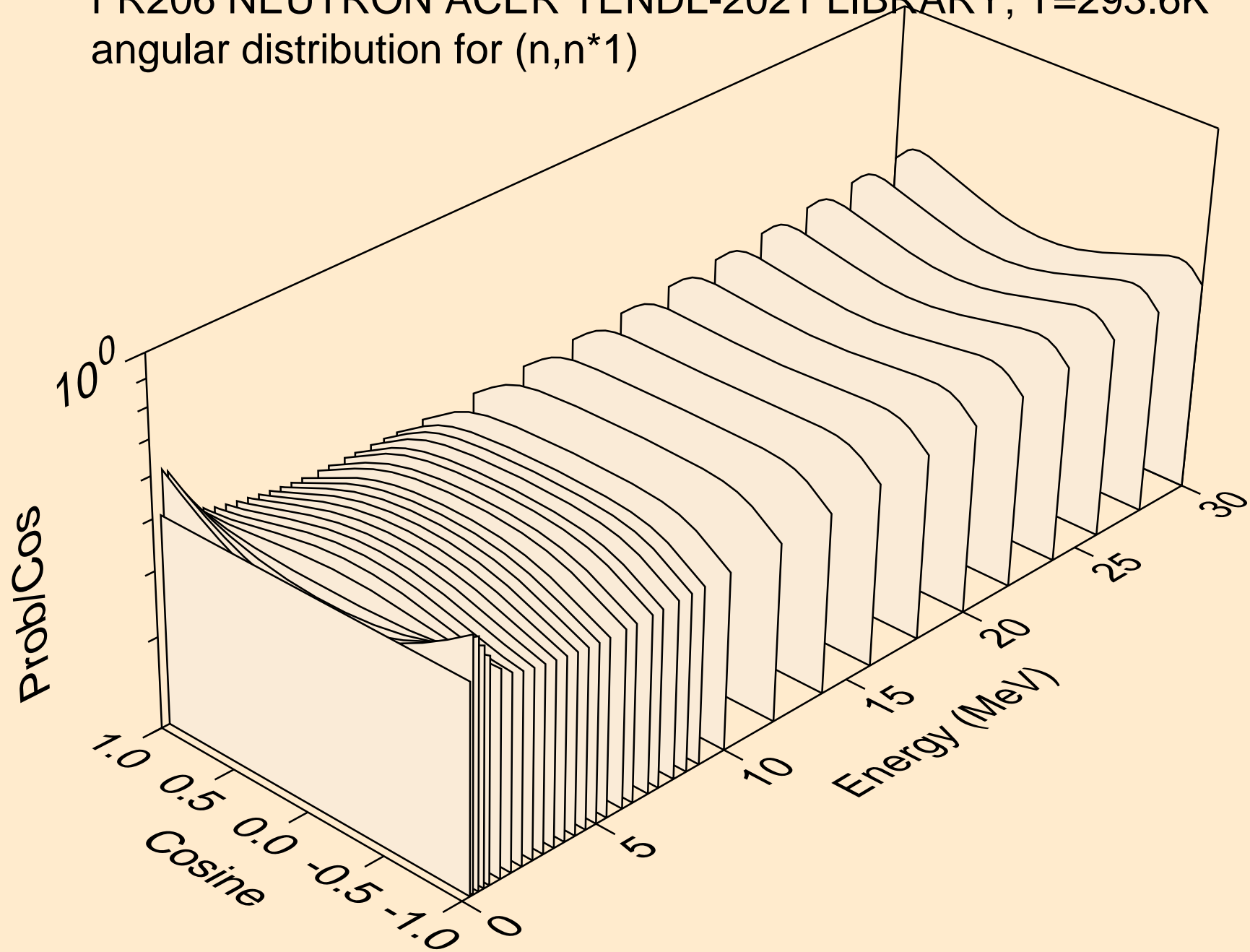

FR206 NEUTRON ACER TENDL-2021 LIBRARY; T=293.6K
angular distribution for (n,n*2)

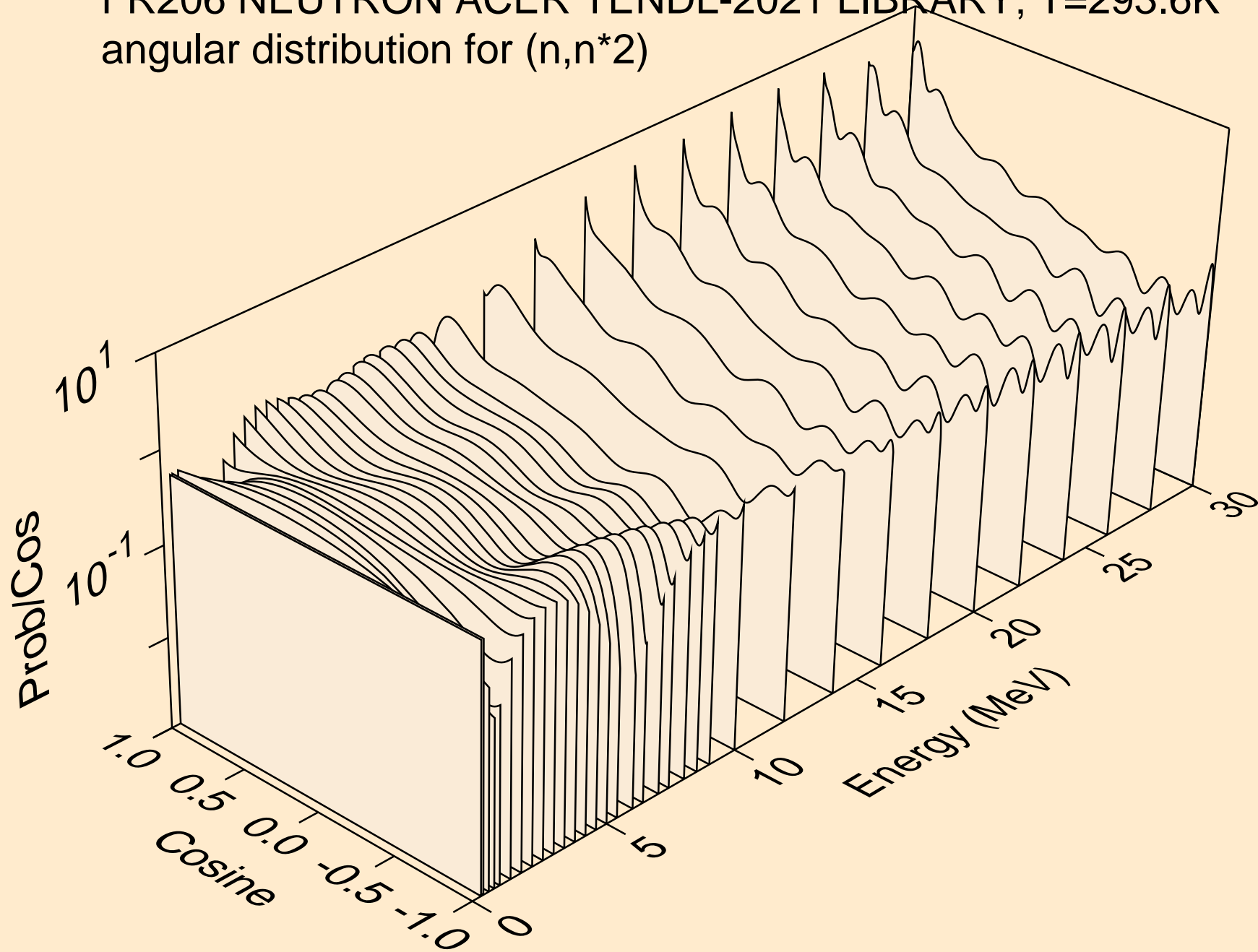

FR206 NEUTRON ACER TENDL-2021 LIBRARY; T=293.6K
angular distribution for (n,n*3)

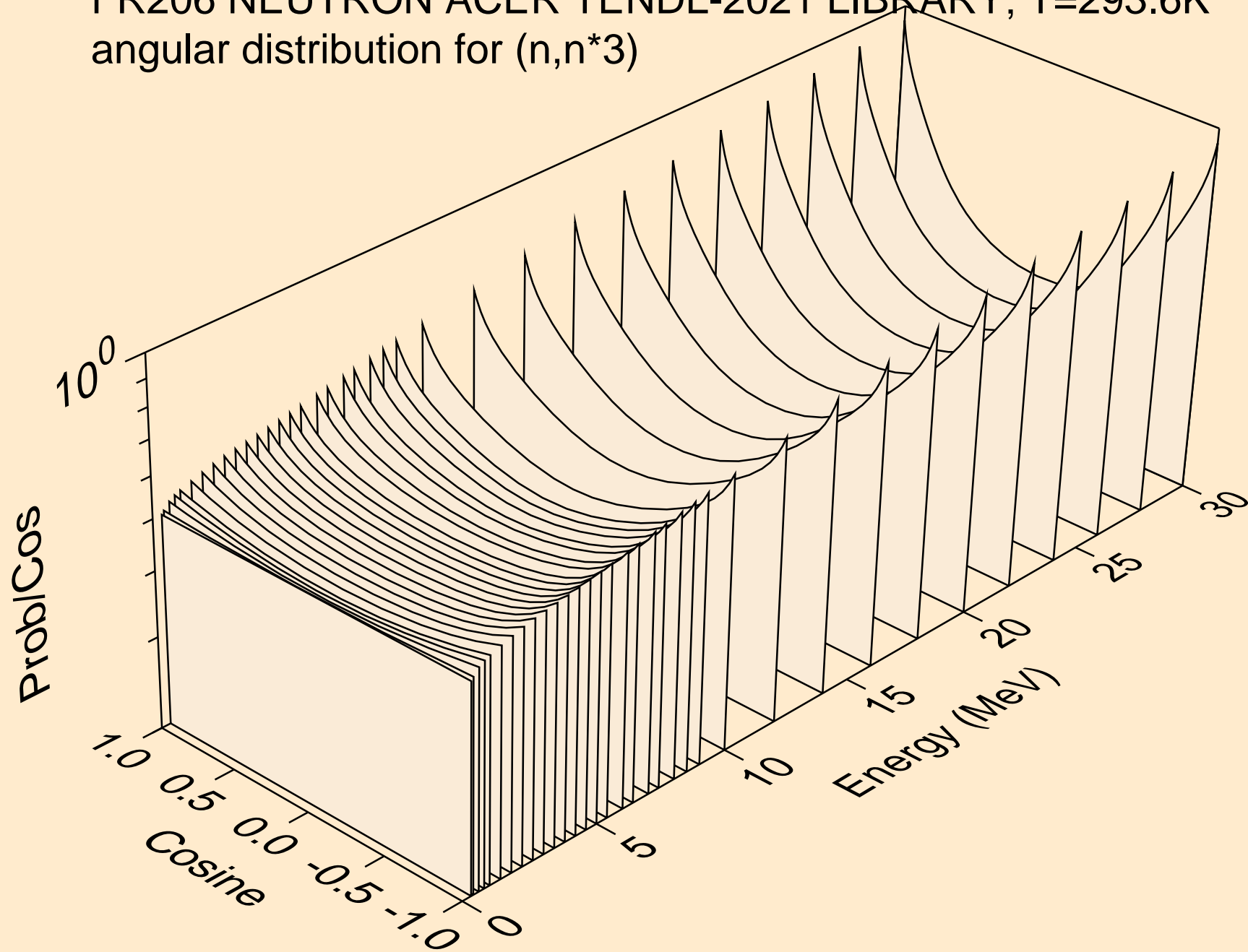

FR206 NEUTRON ACER TENDL-2021 LIBRARY; T=293.6K
angular distribution for (n,n*4)

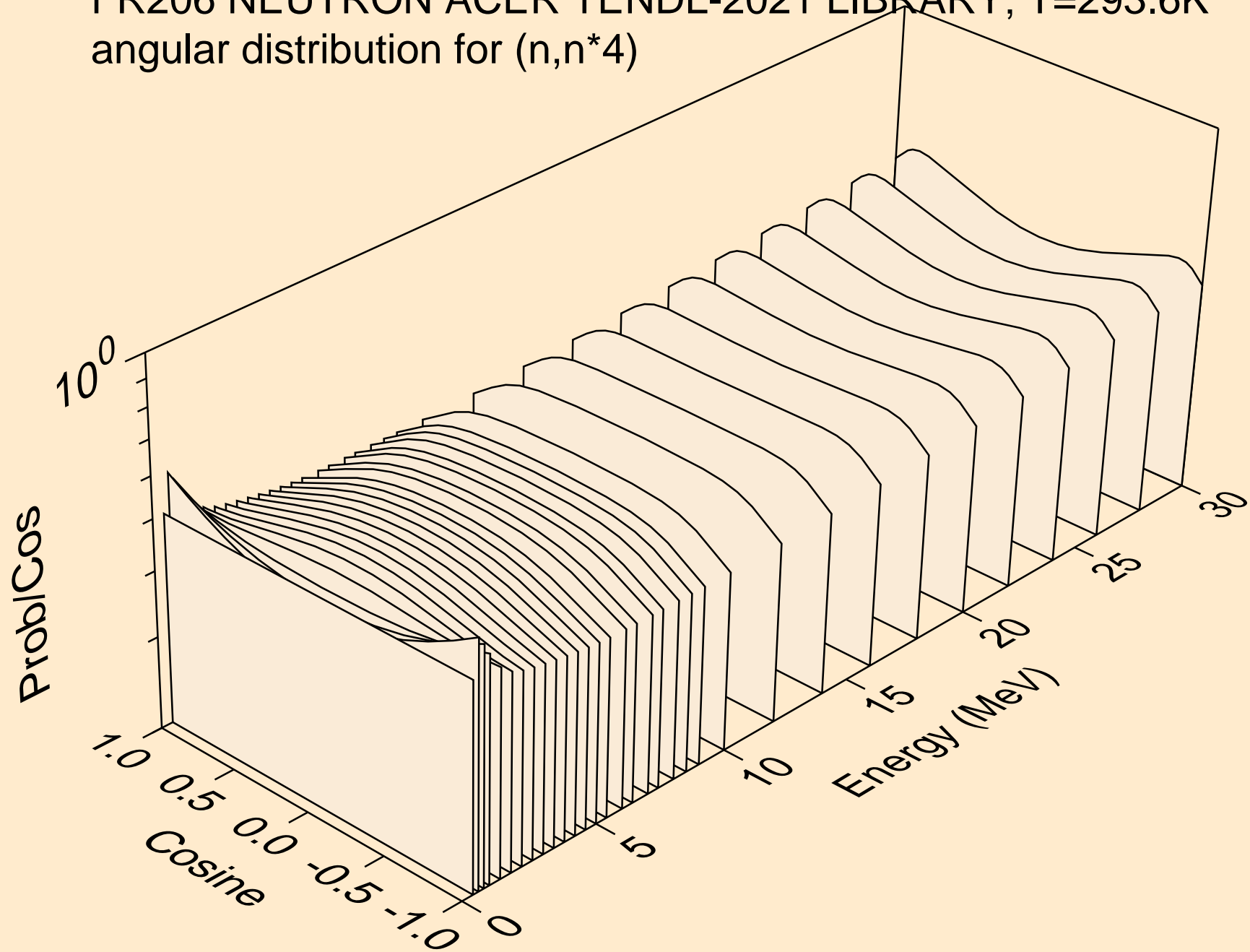

FR206 NEUTRON ACER TENDL-2021 LIBRARY; T=293.6K
angular distribution for (n,n*5)

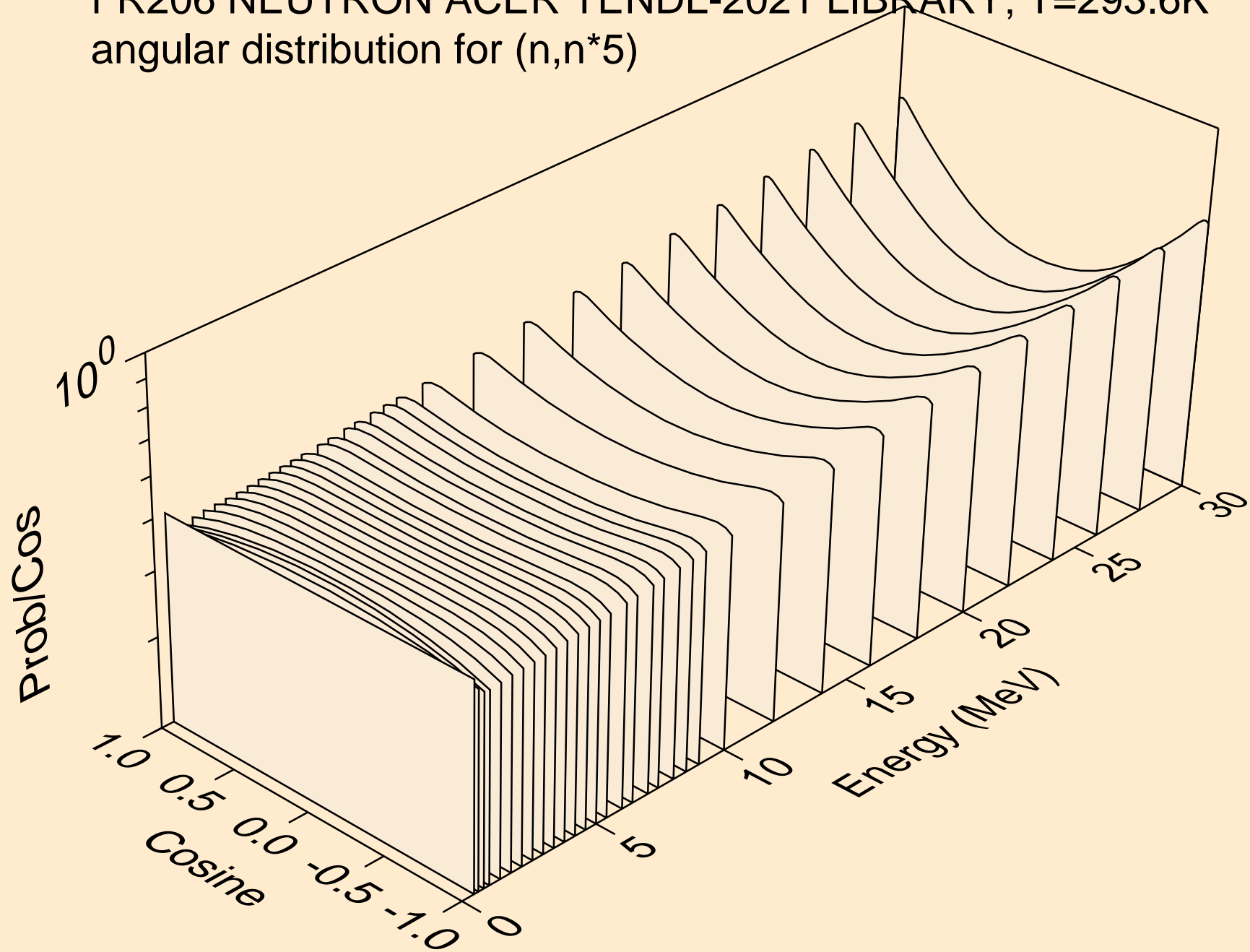

FR206 NEUTRON ACER TENDL-2021 LIBRARY; T=293.6K
angular distribution for (n,n*6)

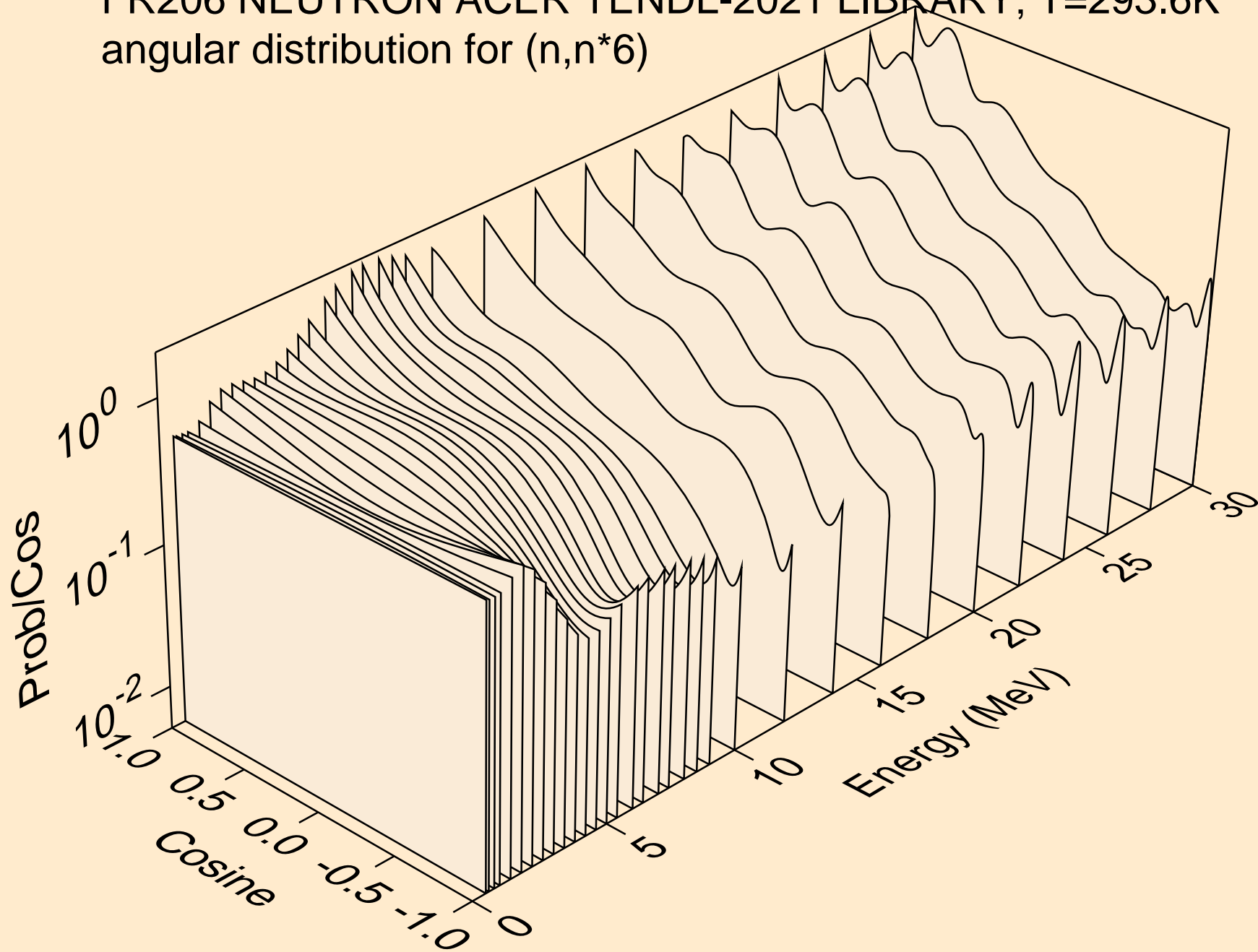

FR206 NEUTRON ACER TENDL-2021 LIBRARY; T=293.6K
angular distribution for (n,n*7)

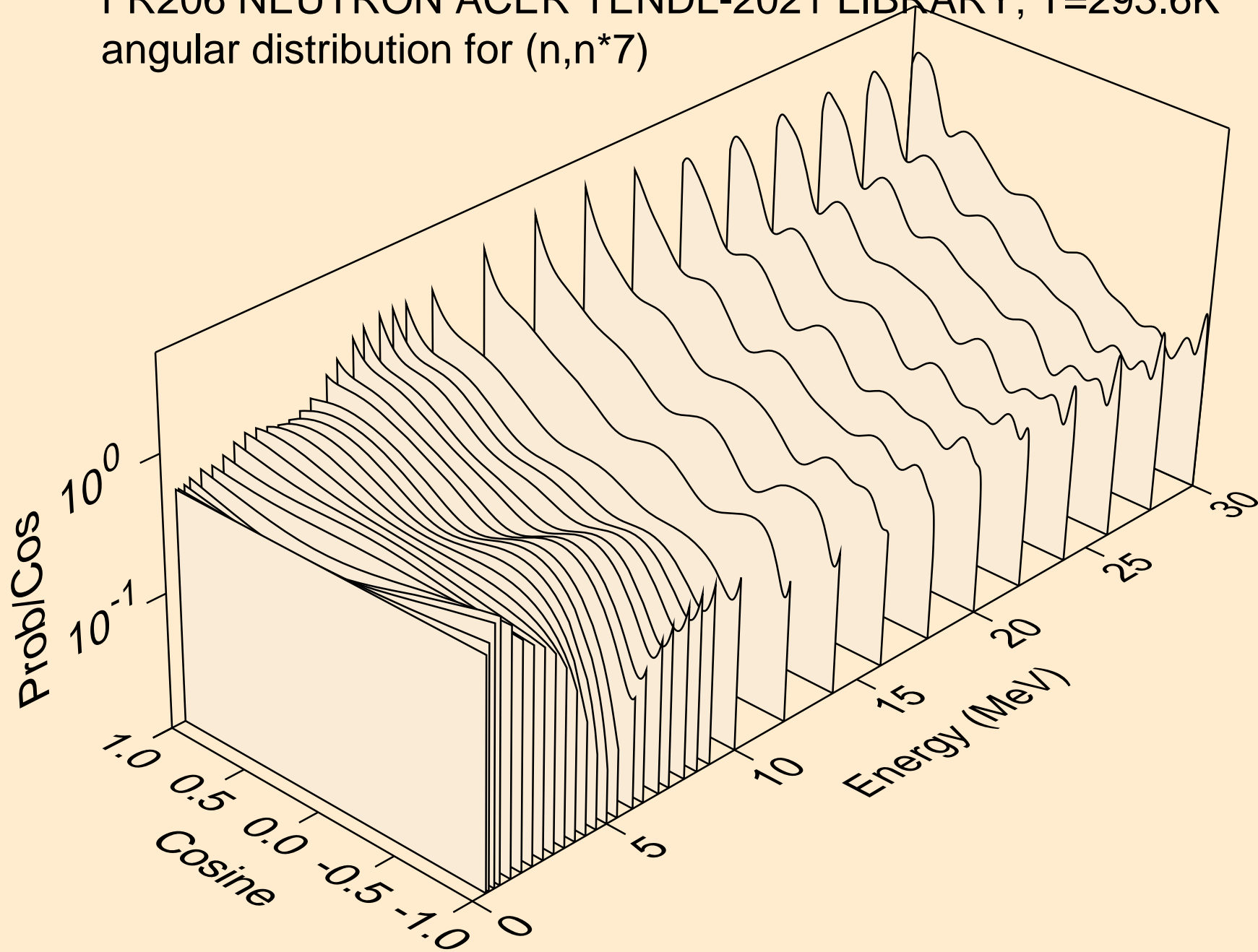

FR206 NEUTRON ACER TENDL-2021 LIBRARY; T=293.6K
angular distribution for (n,n*8)

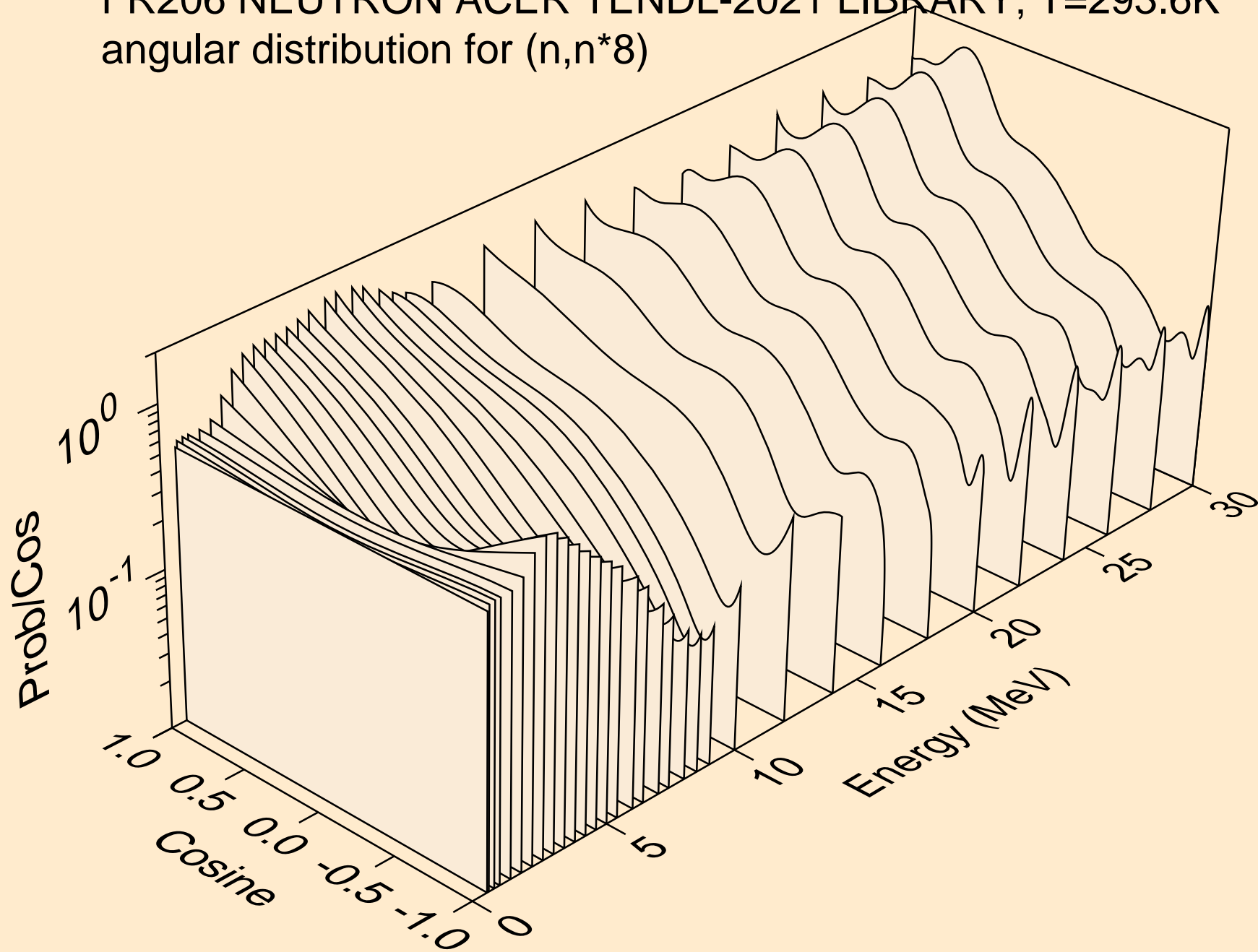

FR206 NEUTRON ACER TENDL-2021 LIBRARY; T=293.6K
angular distribution for (n,n*9)

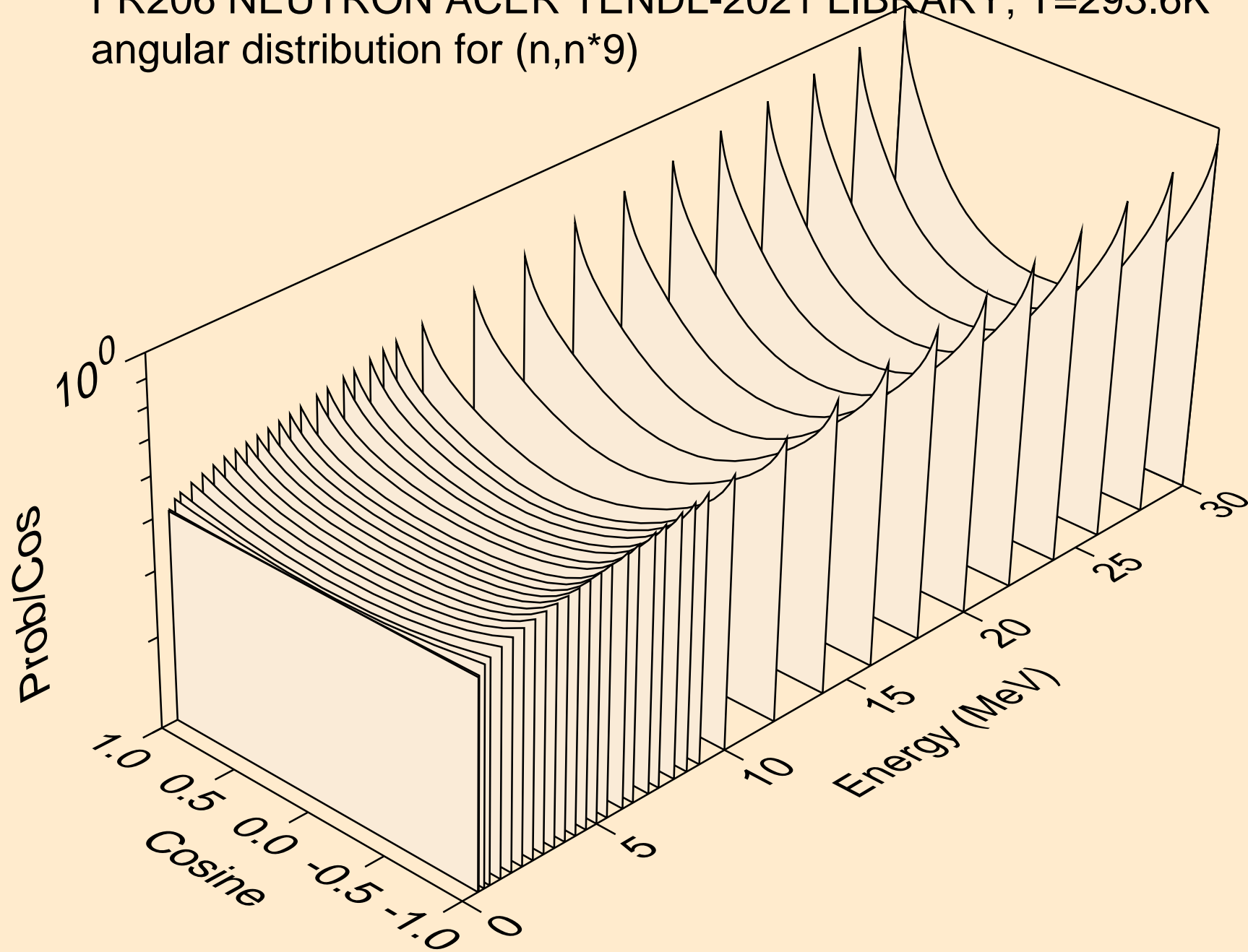

FR206 NEUTRON ACER TENDL-2021 LIBRARY; T=293.6K
angular distribution for (n,n*10)

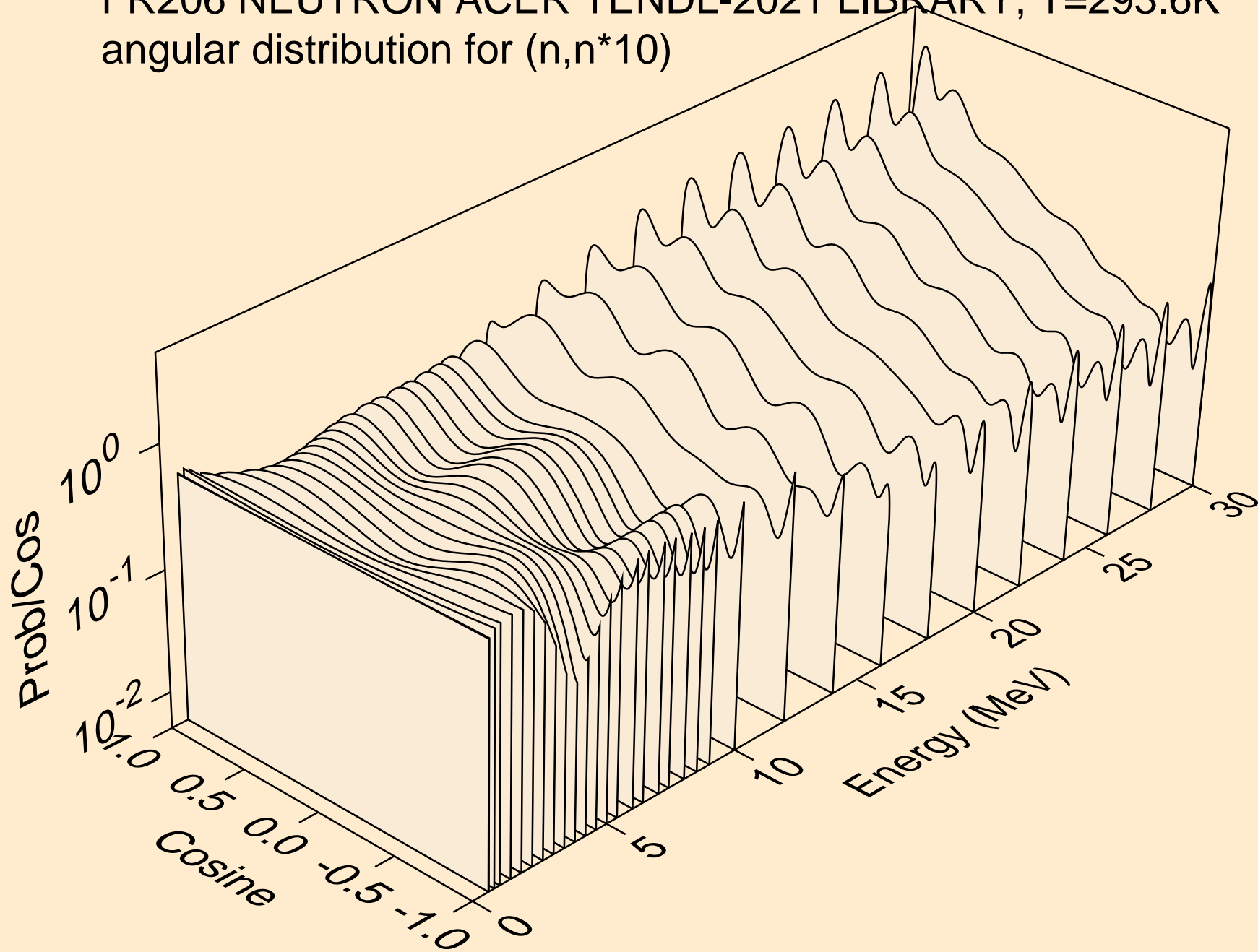

FR206 NEUTRON ACER TENDL-2021 LIBRARY; T=293.6K
angular distribution for (n,n*11)

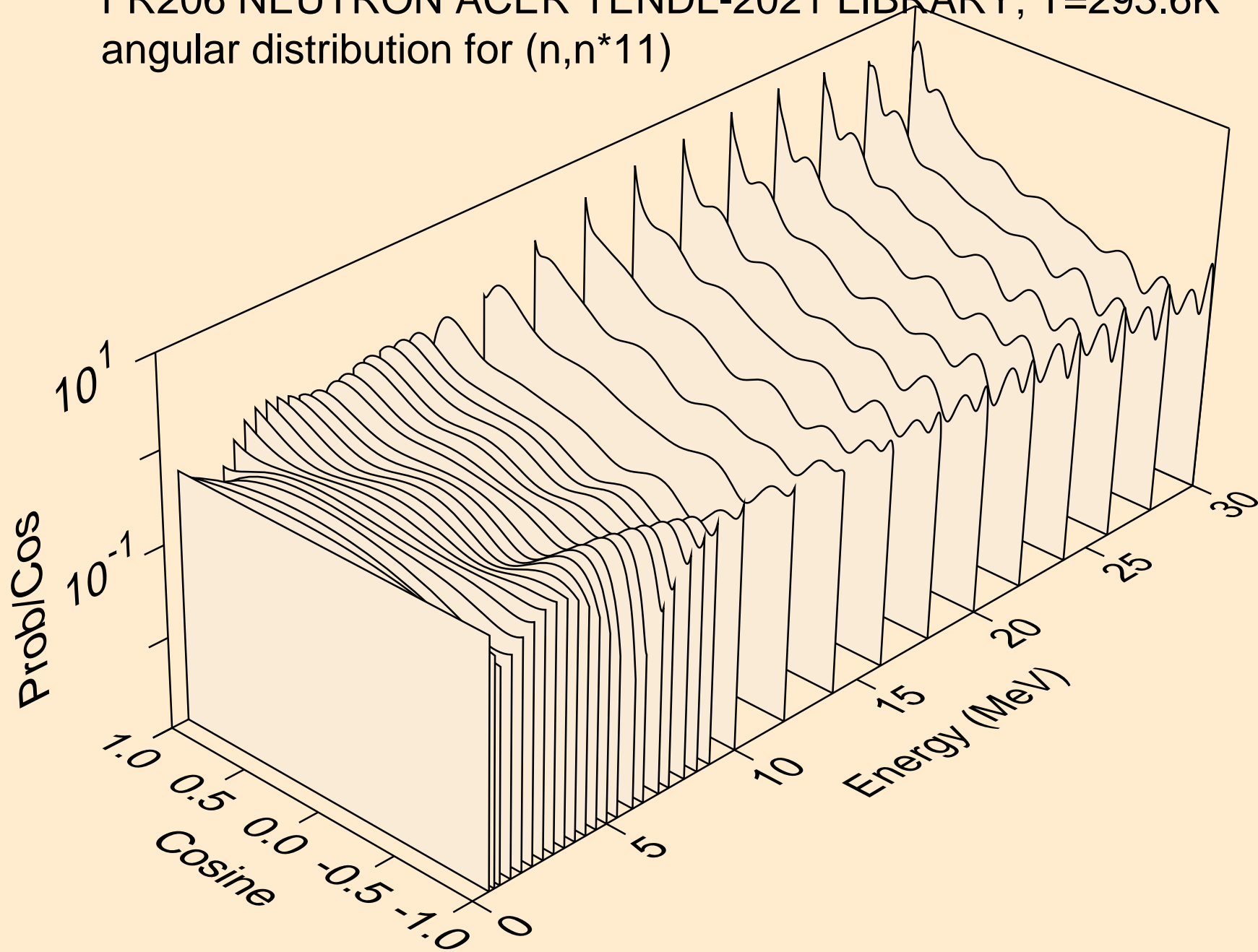

FR206 NEUTRON ACER TENDL-2021 LIBRARY; T=293.6K
Neutron emission for (n,x)

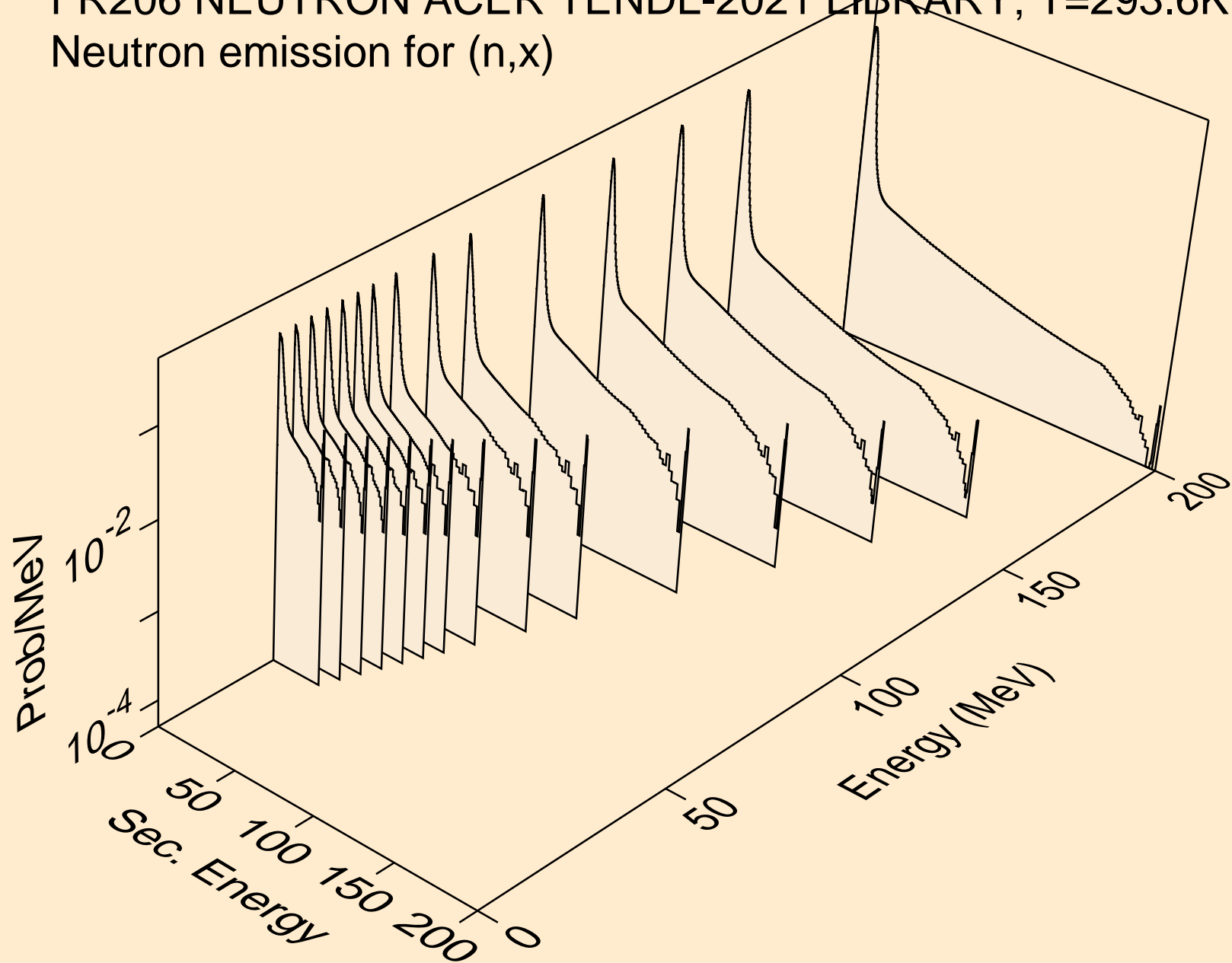

FR206 NEUTRON ACER TENDL-2021 LIBRARY; T=293.6K
Neutron emission for (n,2nd)

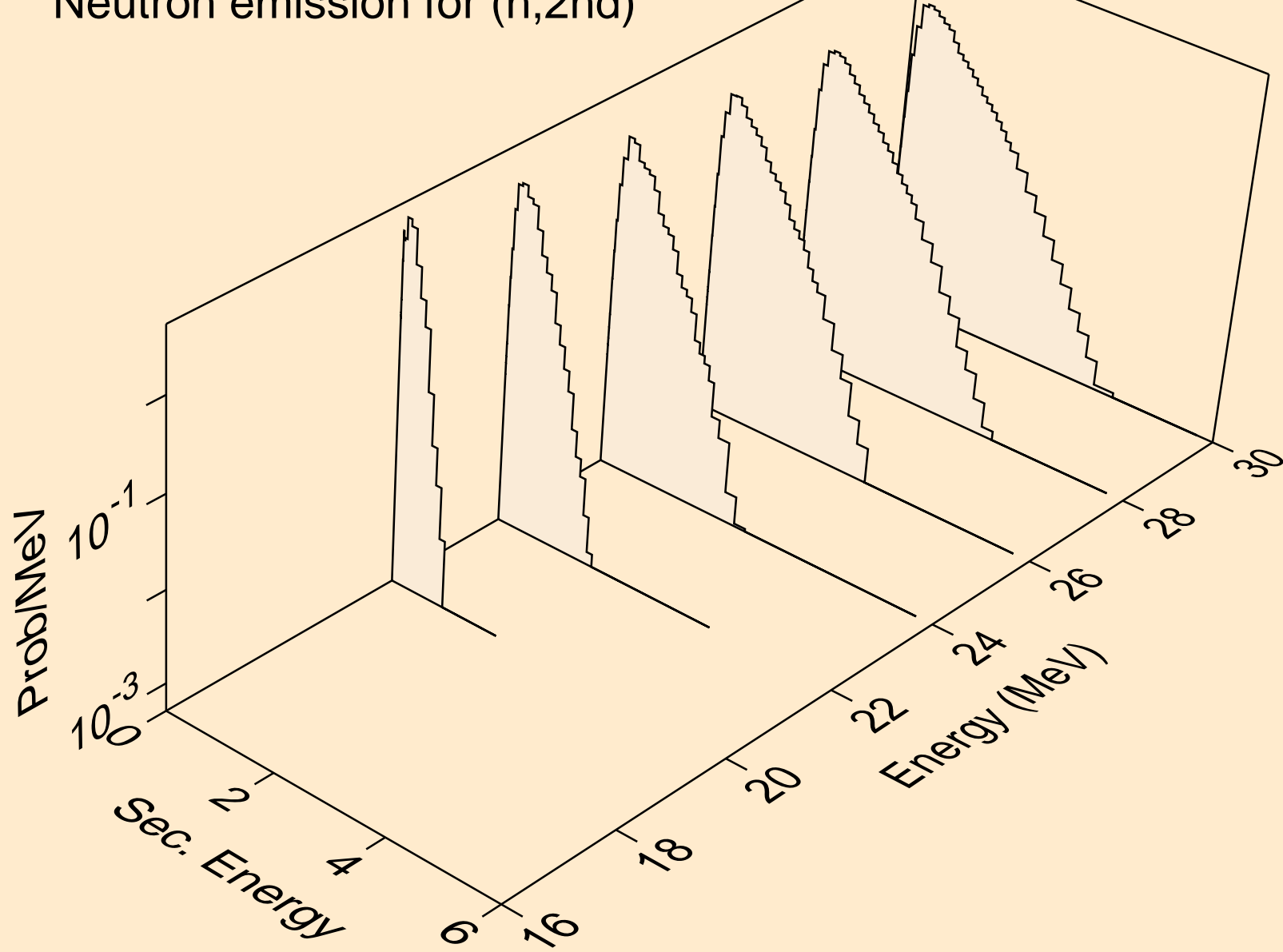

FR206 NEUTRON ACER TENDL-2021 LIBRARY; T=293.6K
Neutron emission for (n,2n)

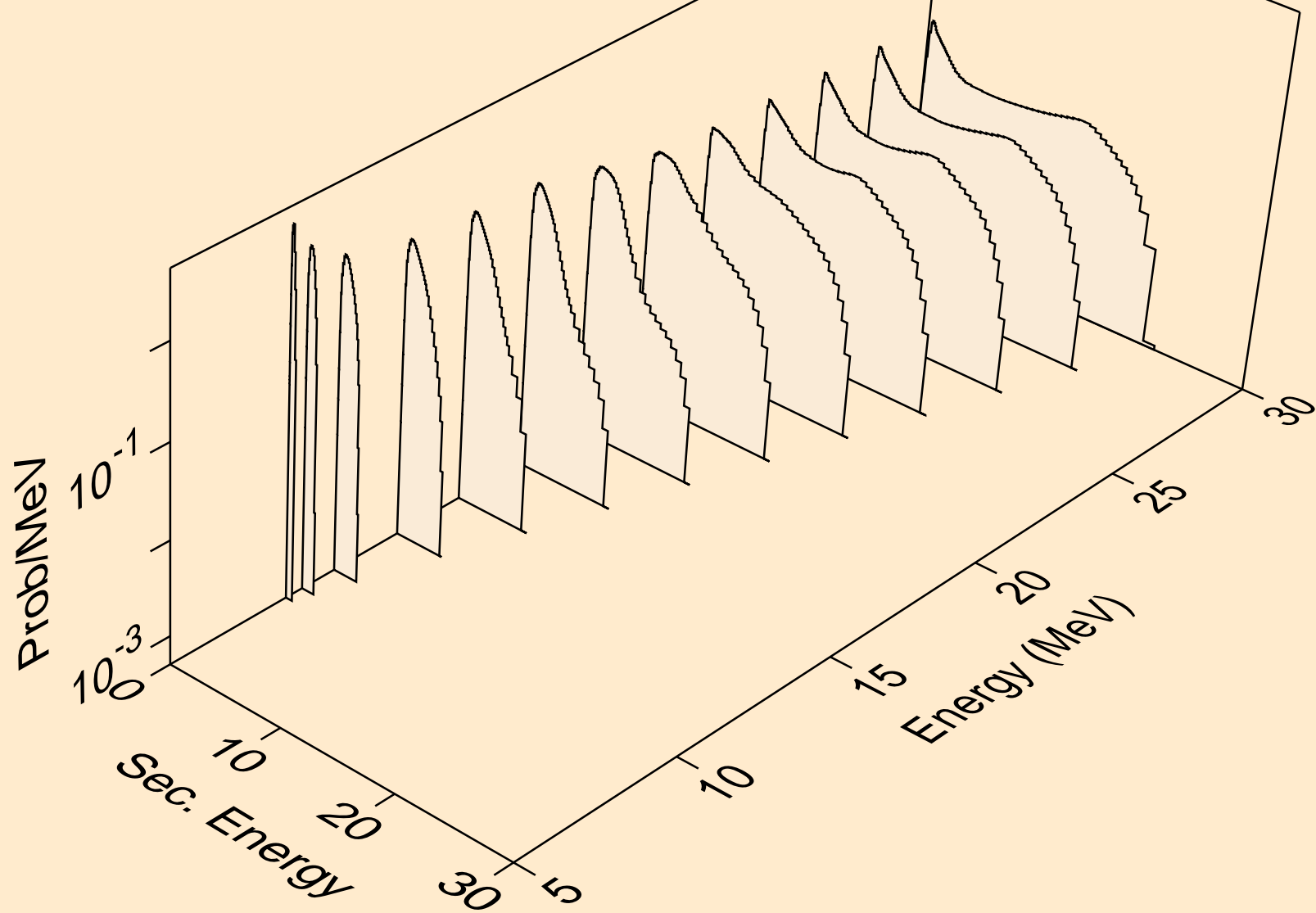

FR206 NEUTRON ACER TENDL-2021 LIBRARY; T=293.6K
Neutron emission for (n,3n)

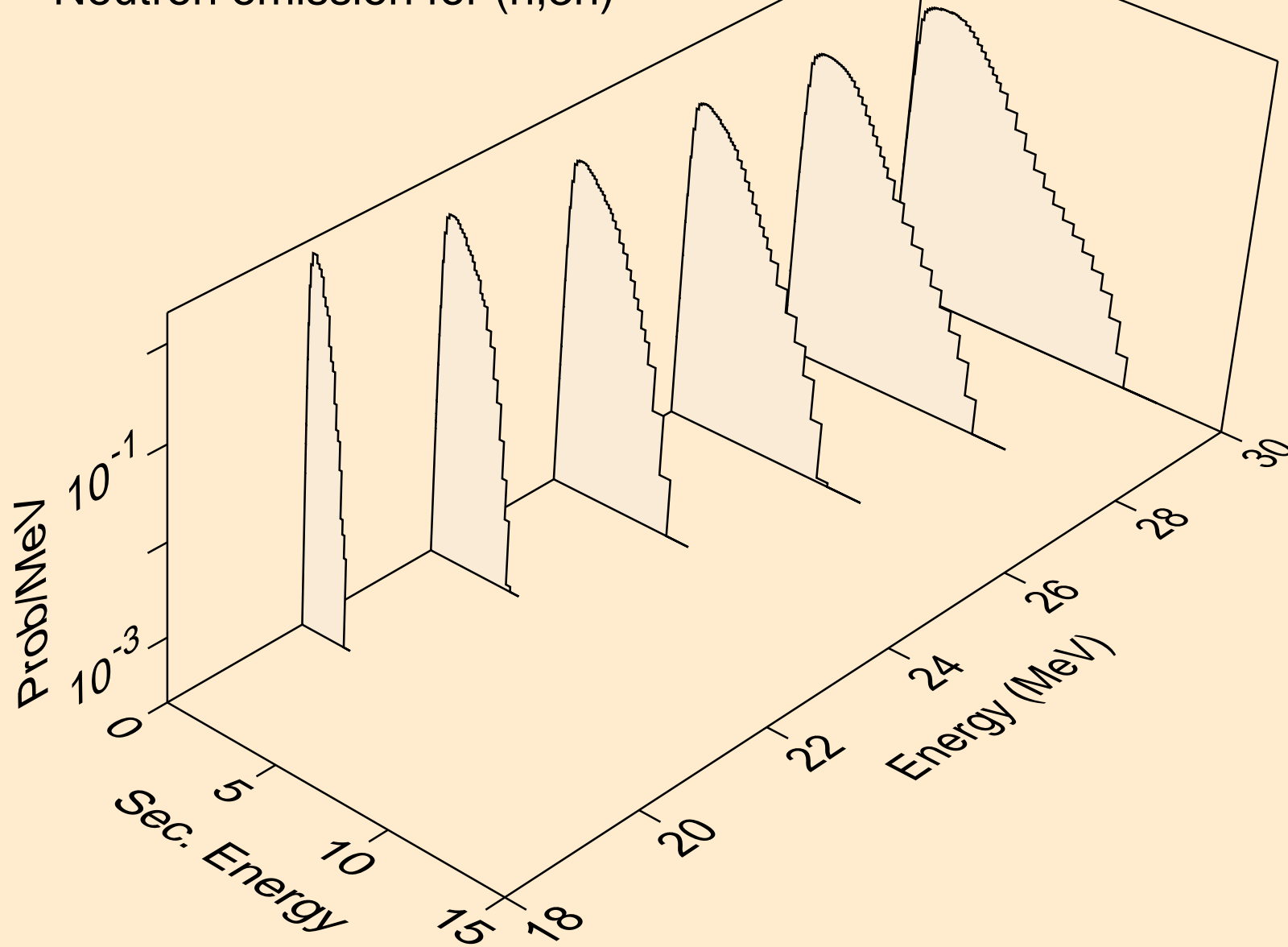

FR206 NEUTRON ACER TENDL-2021 LIBRARY; T=293.6K
Neutron emission for (n,n*)a

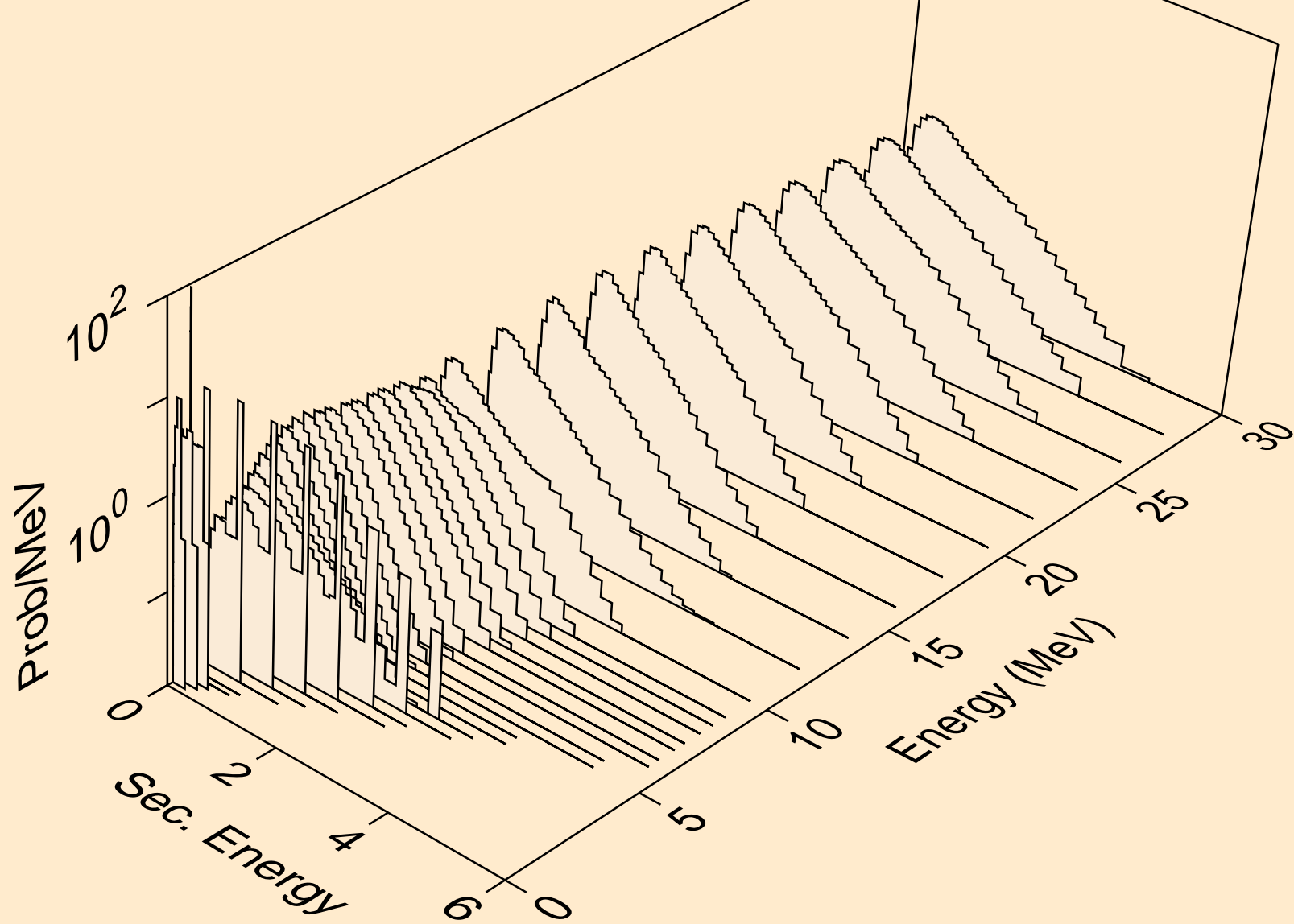

FR206 NEUTRON ACER TENDL-2021 LIBRARY; T=293.6K
Neutron emission for (n,2n)a

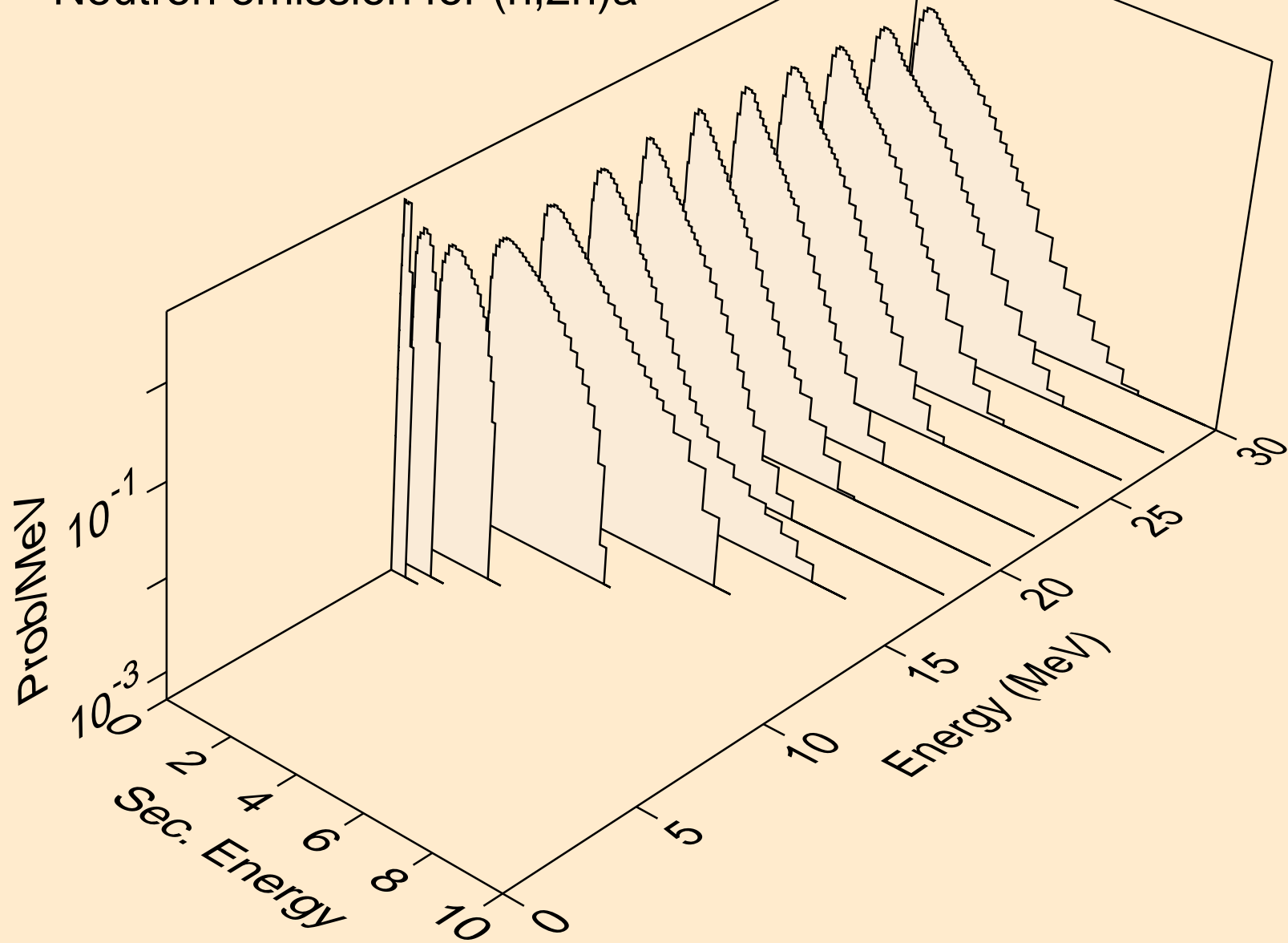

FR206 NEUTRON ACER TENDL-2021 LIBRARY; T=293.6K
Neutron emission for (n,3n)_a

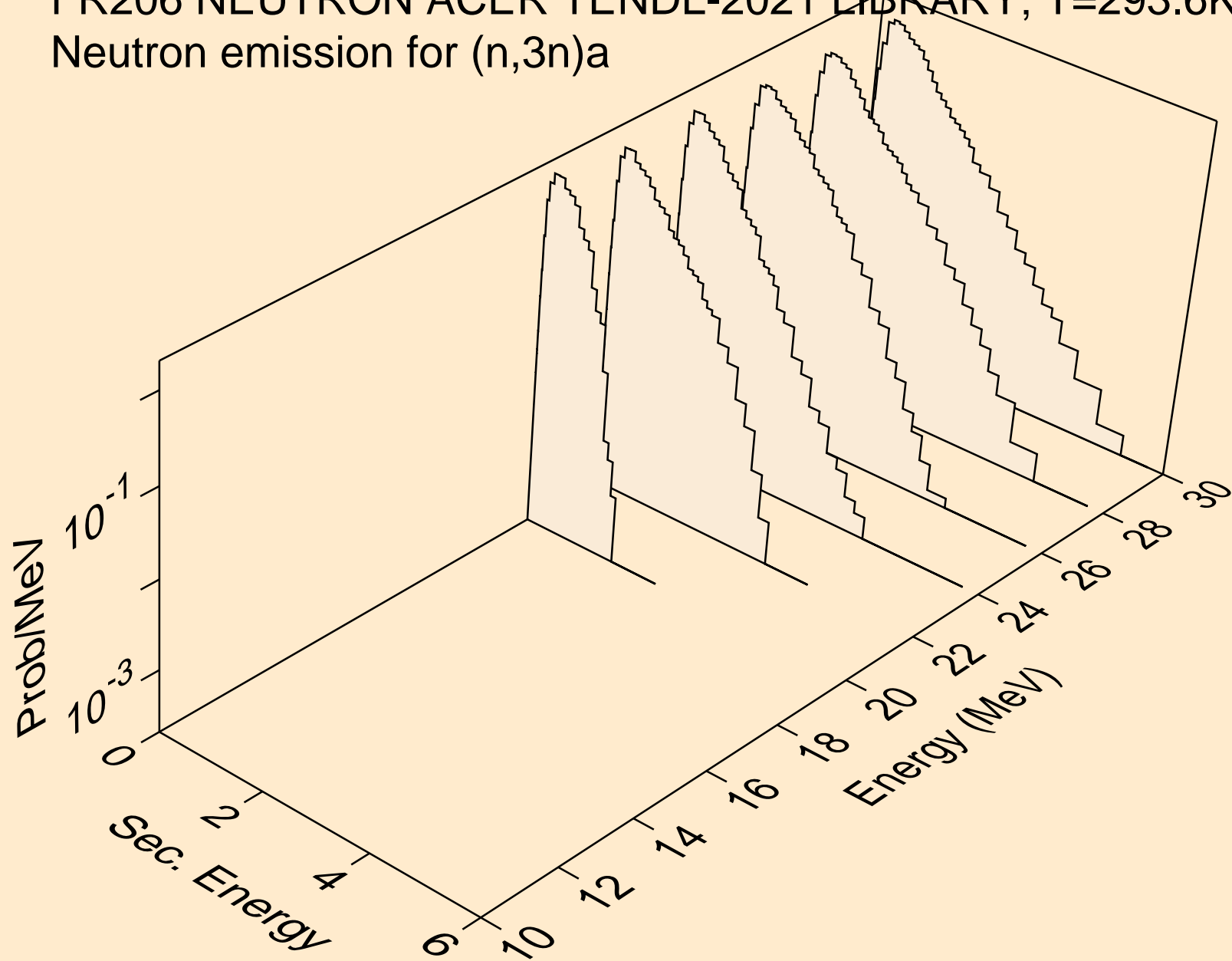

FR206 NEUTRON ACER TENDL-2021 LIBRARY; T=293.6K
Neutron emission for (n,n*)p

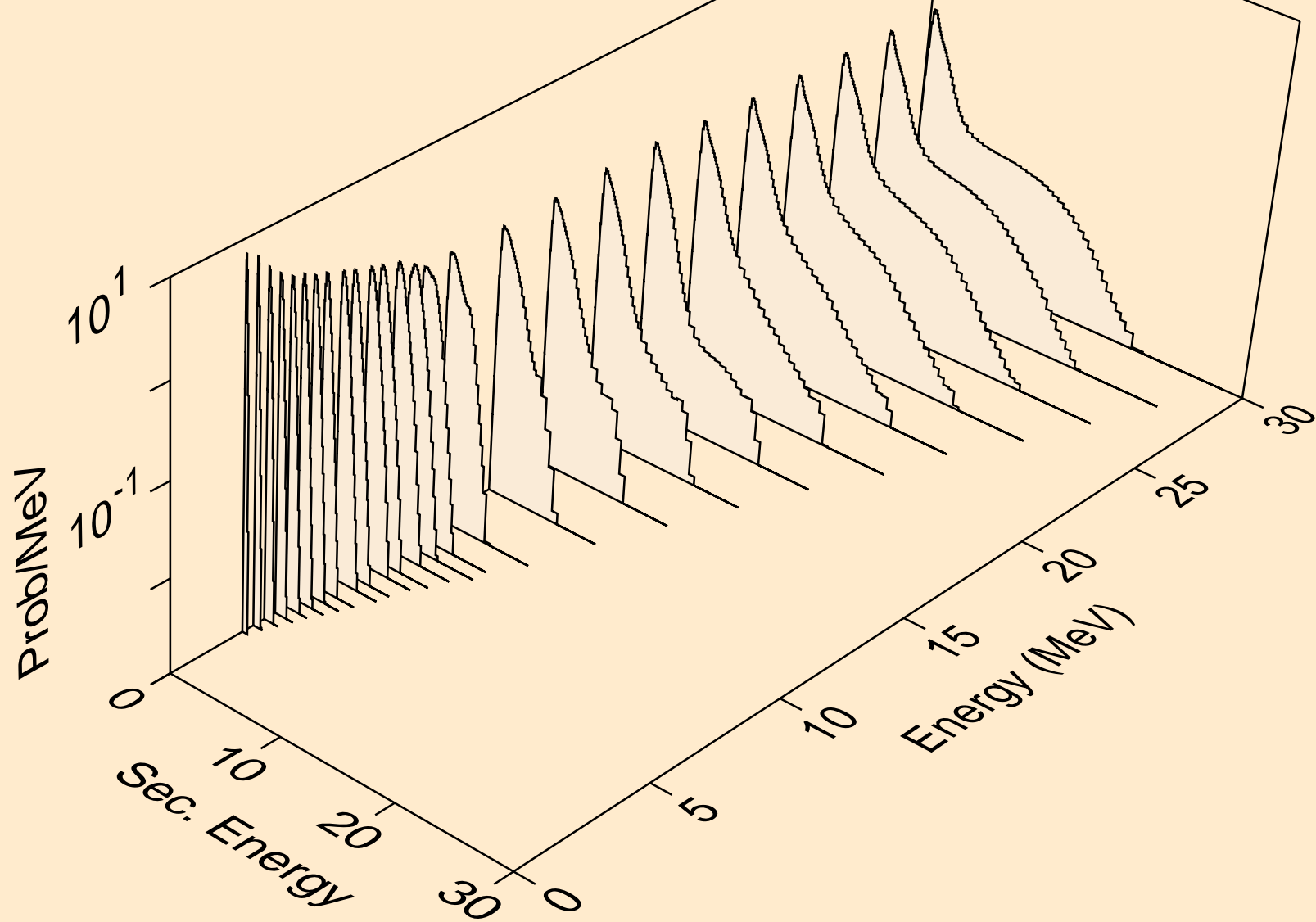

FR206 NEUTRON ACER TENDL-2021 LIBRARY; T=293.6K
Neutron emission for (n,n*)2a

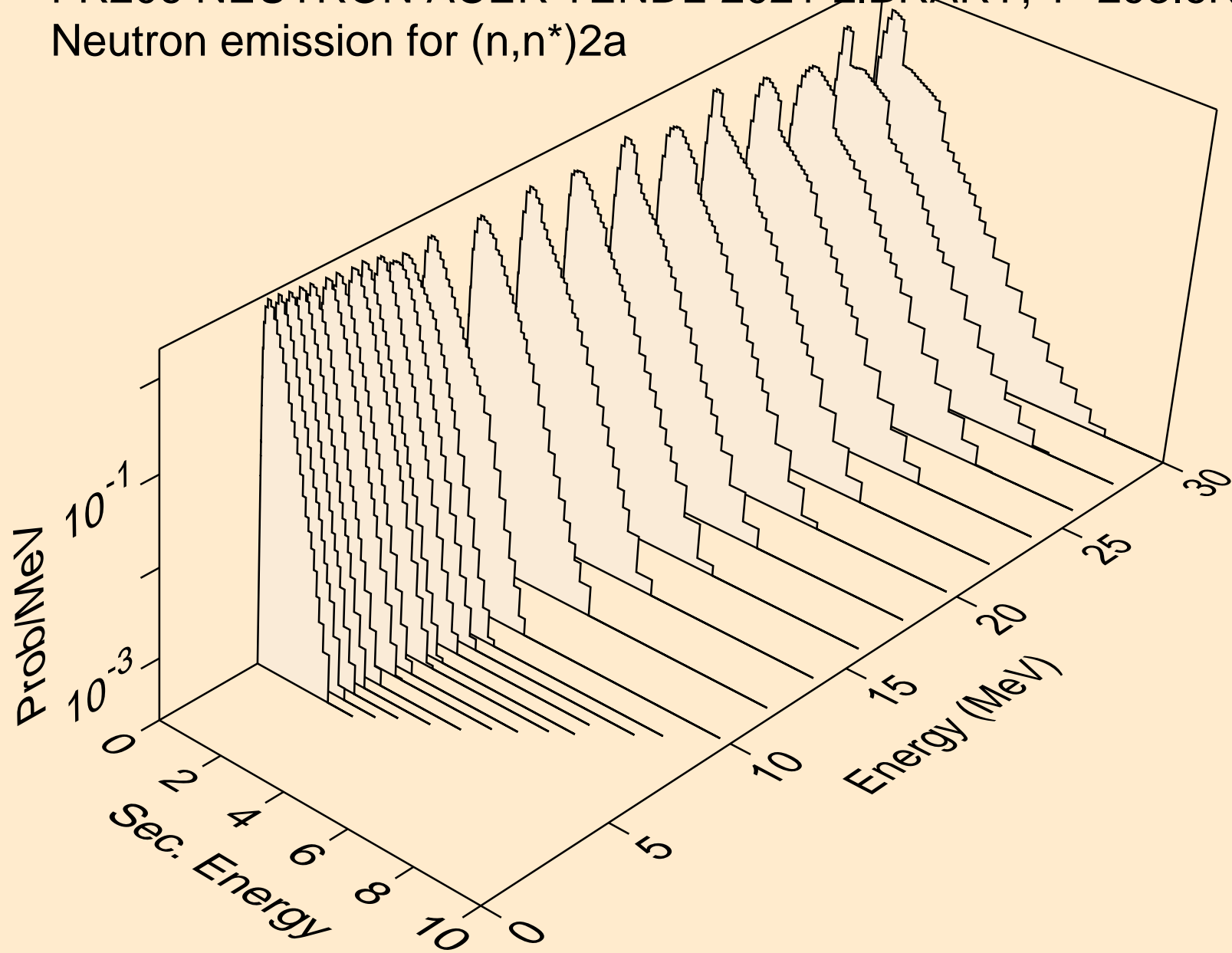

FR206 NEUTRON ACER TENDL-2021 LIBRARY; T=293.6K
Neutron emission for (n,2n)2a

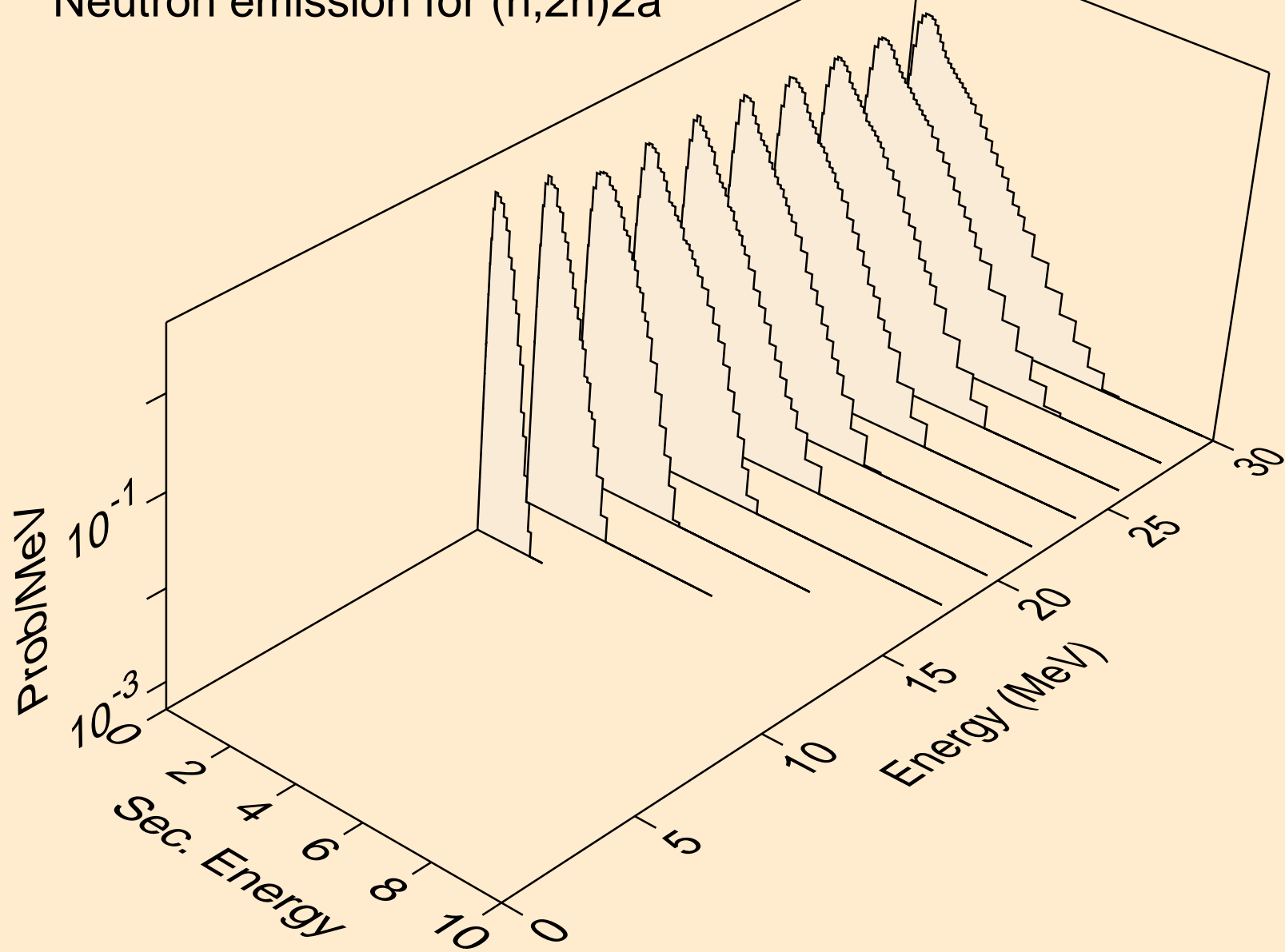

FR206 NEUTRON ACER TENDL-2021 LIBRARY; T=293.6K
Neutron emission for (n,n*)d

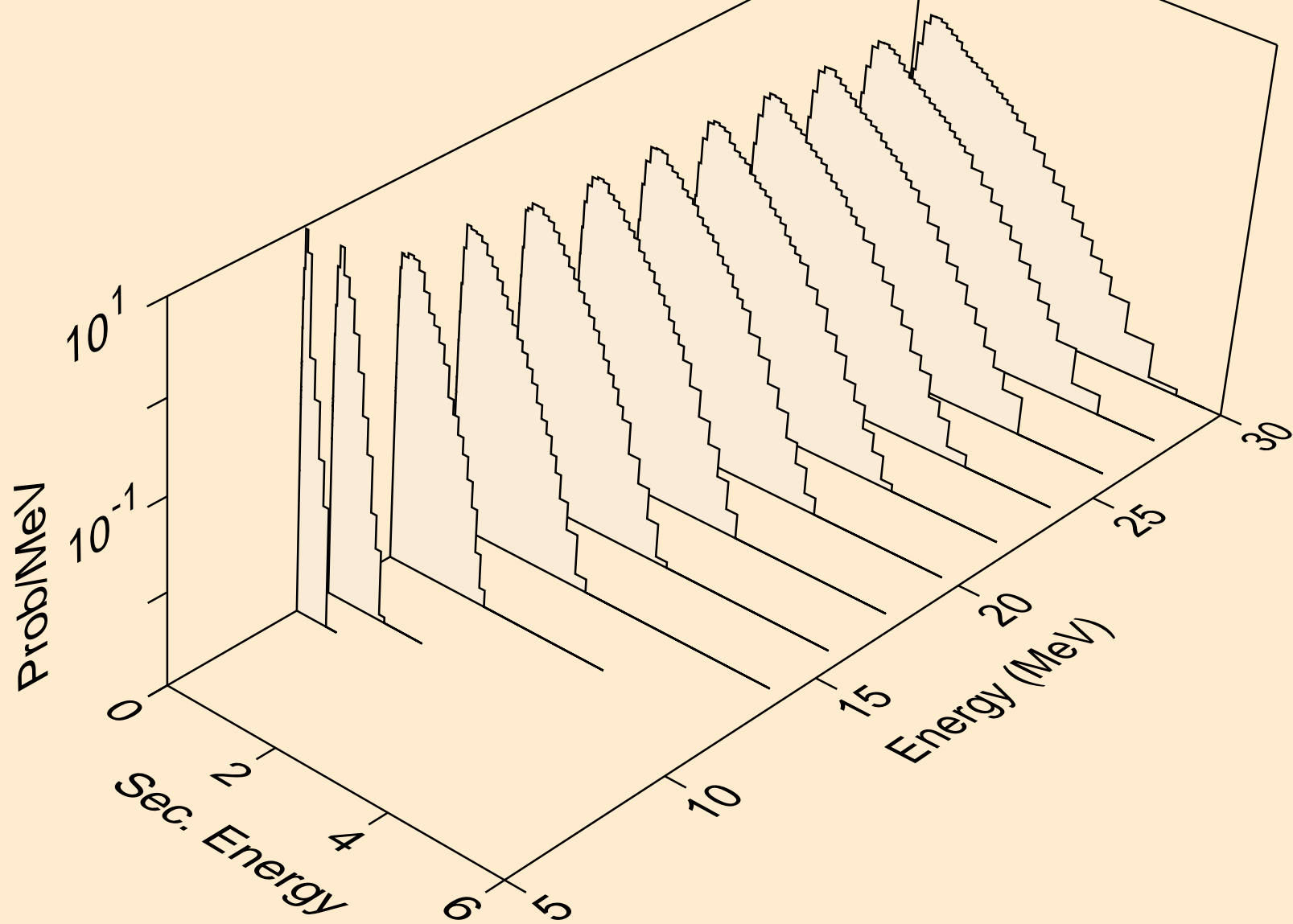

FR206 NEUTRON ACER TENDL-2021 LIBRARY; T=293.6K
Neutron emission for (n,n*)t

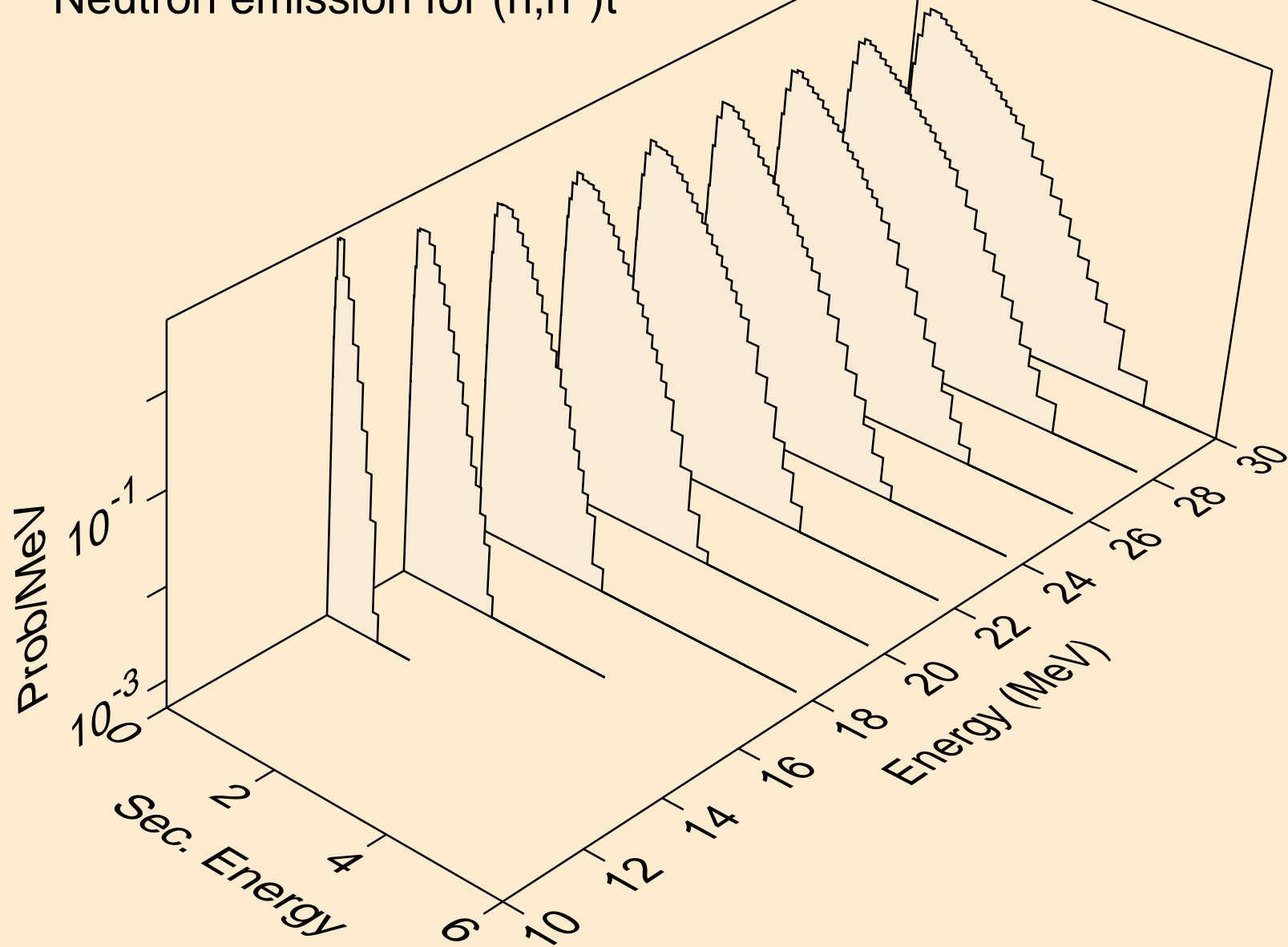

FR206 NEUTRON ACER TENDL-2021 LIBRARY; T=293.6K
Neutron emission for (n,n*)he3

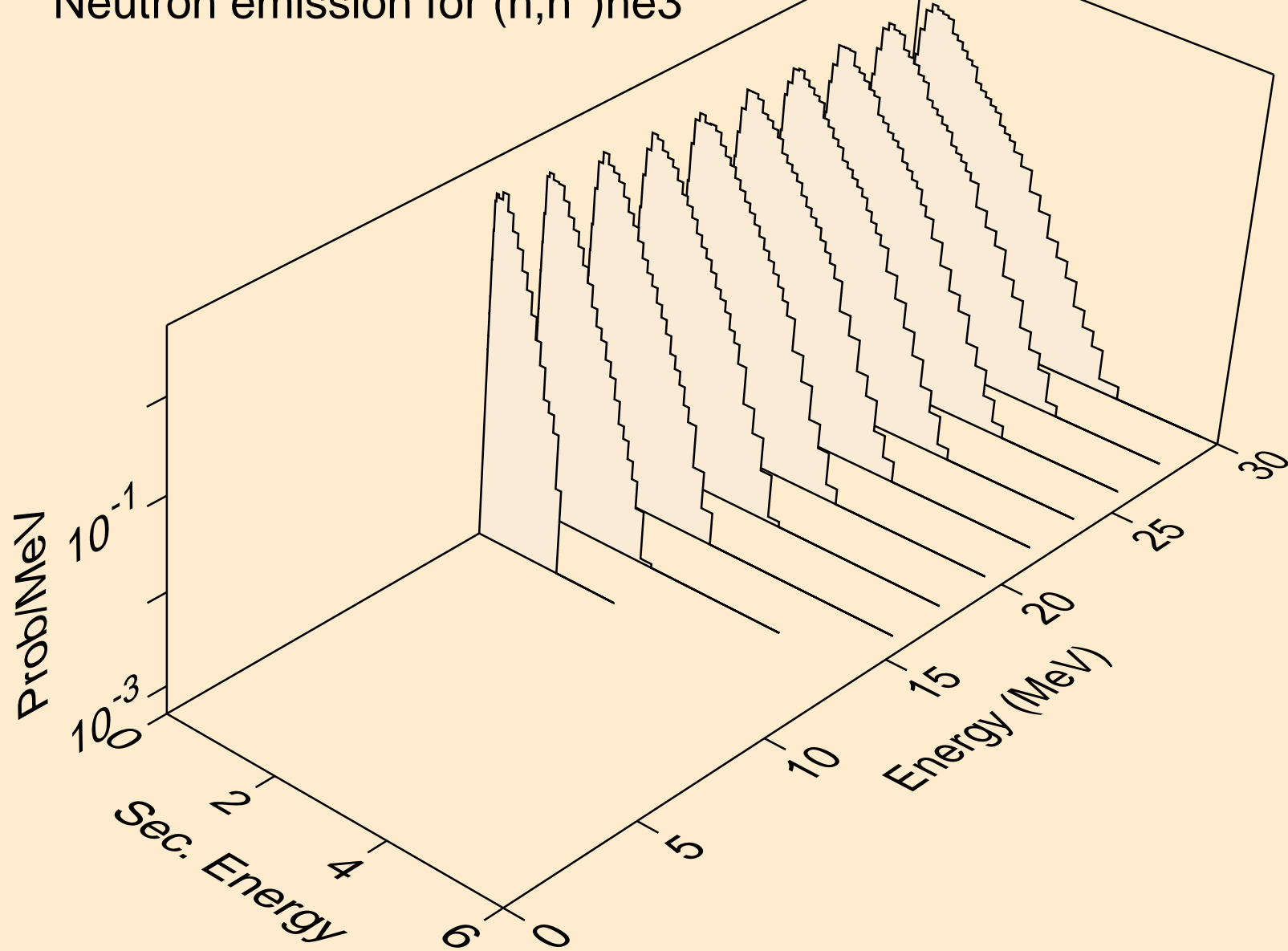

FR206 NEUTRON ACER TENDL-2021 LIBRARY; T=293.6K
Neutron emission for (n,4n)

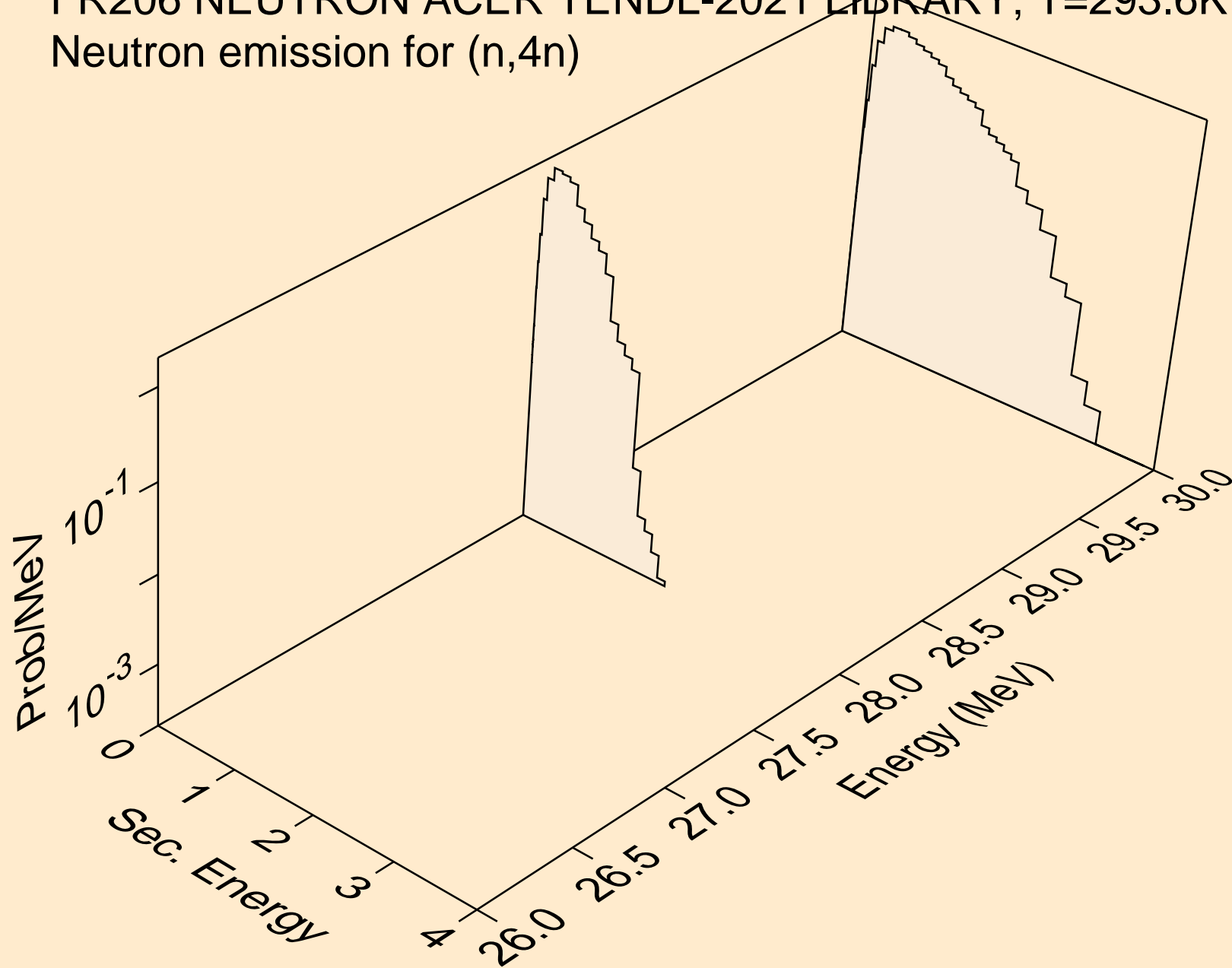

FR206 NEUTRON ACER TENDL-2021 LIBRARY; T=293.6K
Neutron emission for (n,2np)

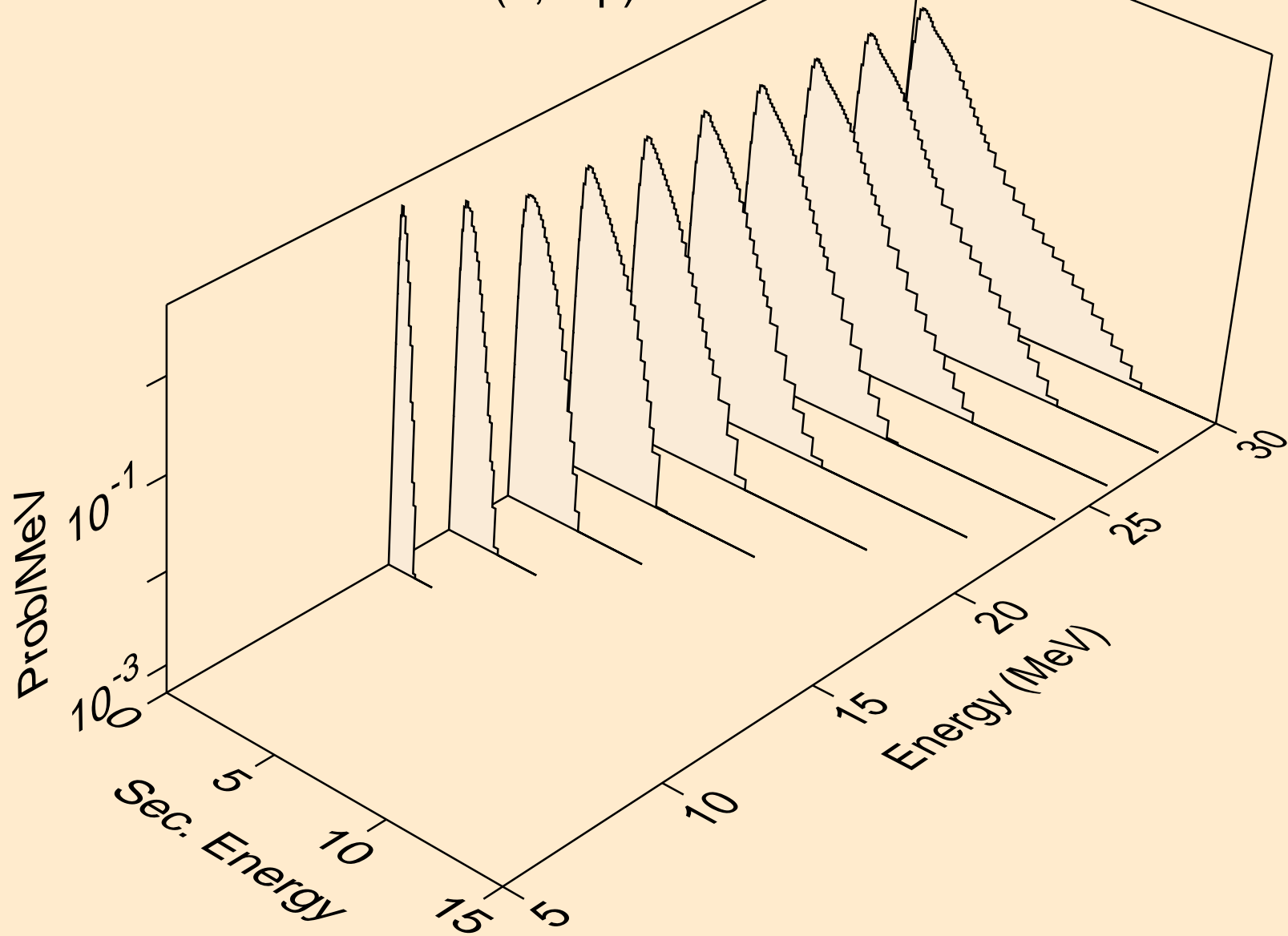

FR206 NEUTRON ACER TENDL-2021 LIBRARY; T=293.6K
Neutron emission for (n,3np)

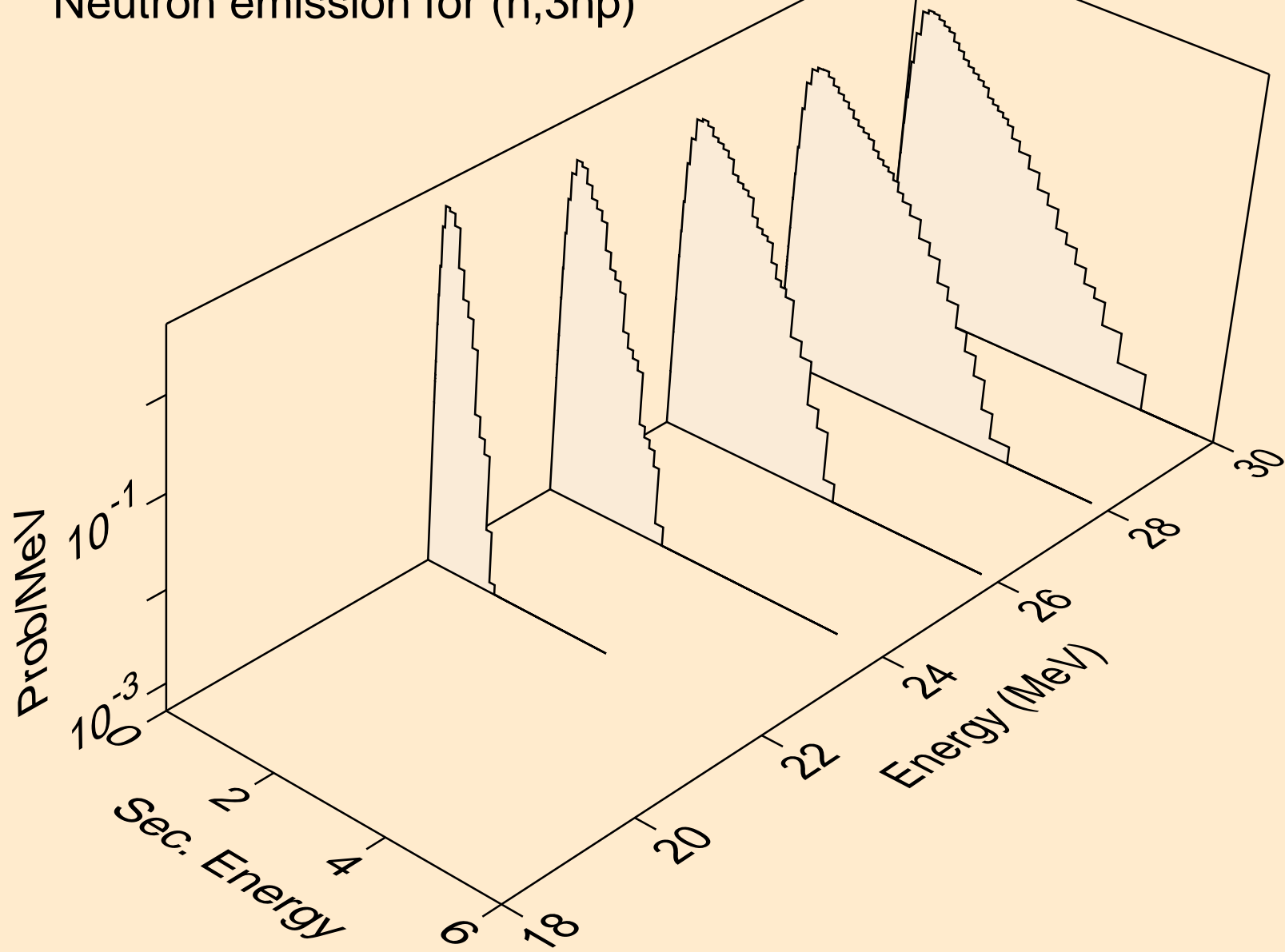

FR206 NEUTRON ACER TENDL-2021 LIBRARY; T=293.6K
Neutron emission for (n,2np)

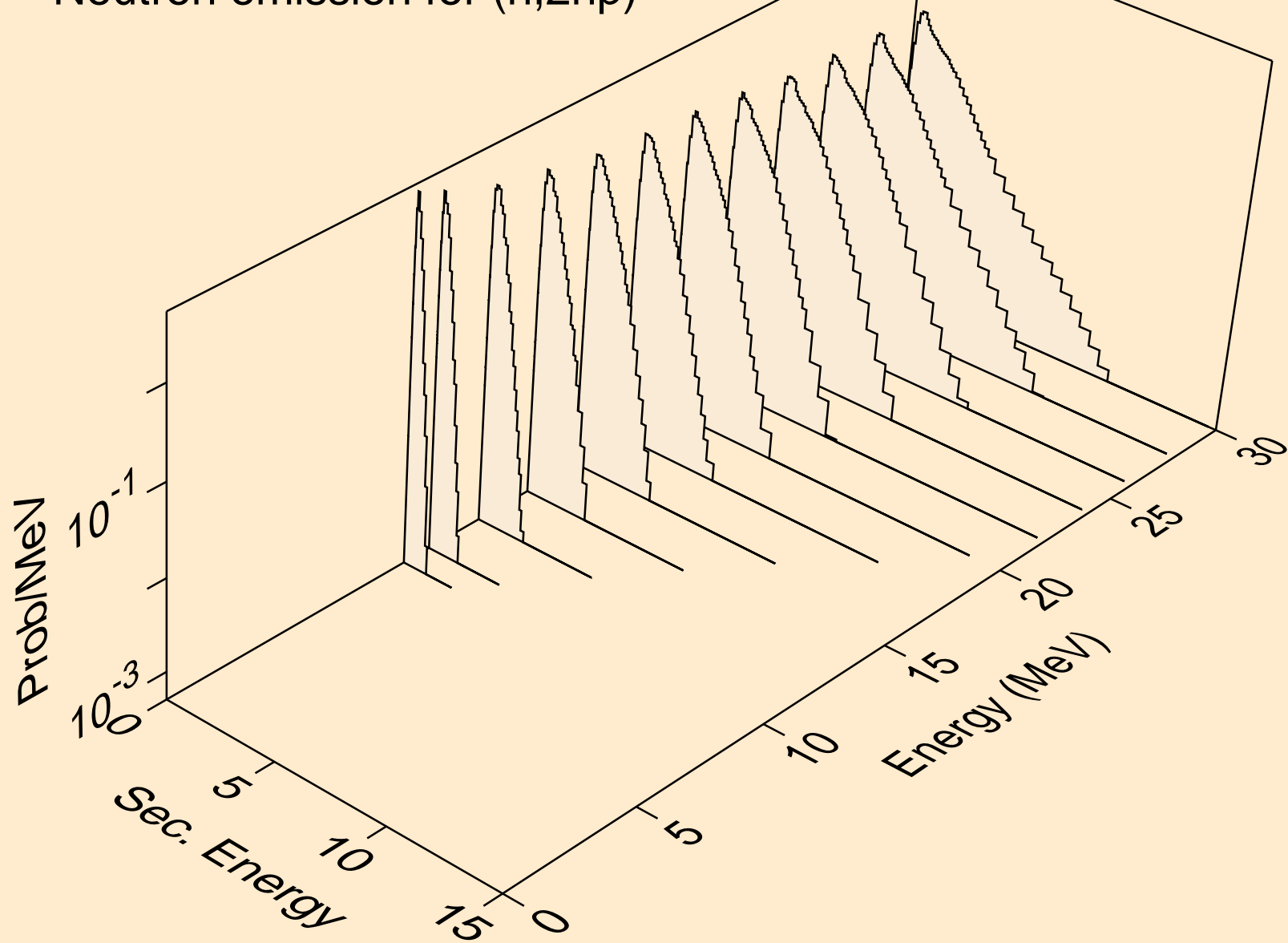

FR206 NEUTRON ACER TENDL-2021 LIBRARY; T=293.6K
Neutron emission for (n,npa)

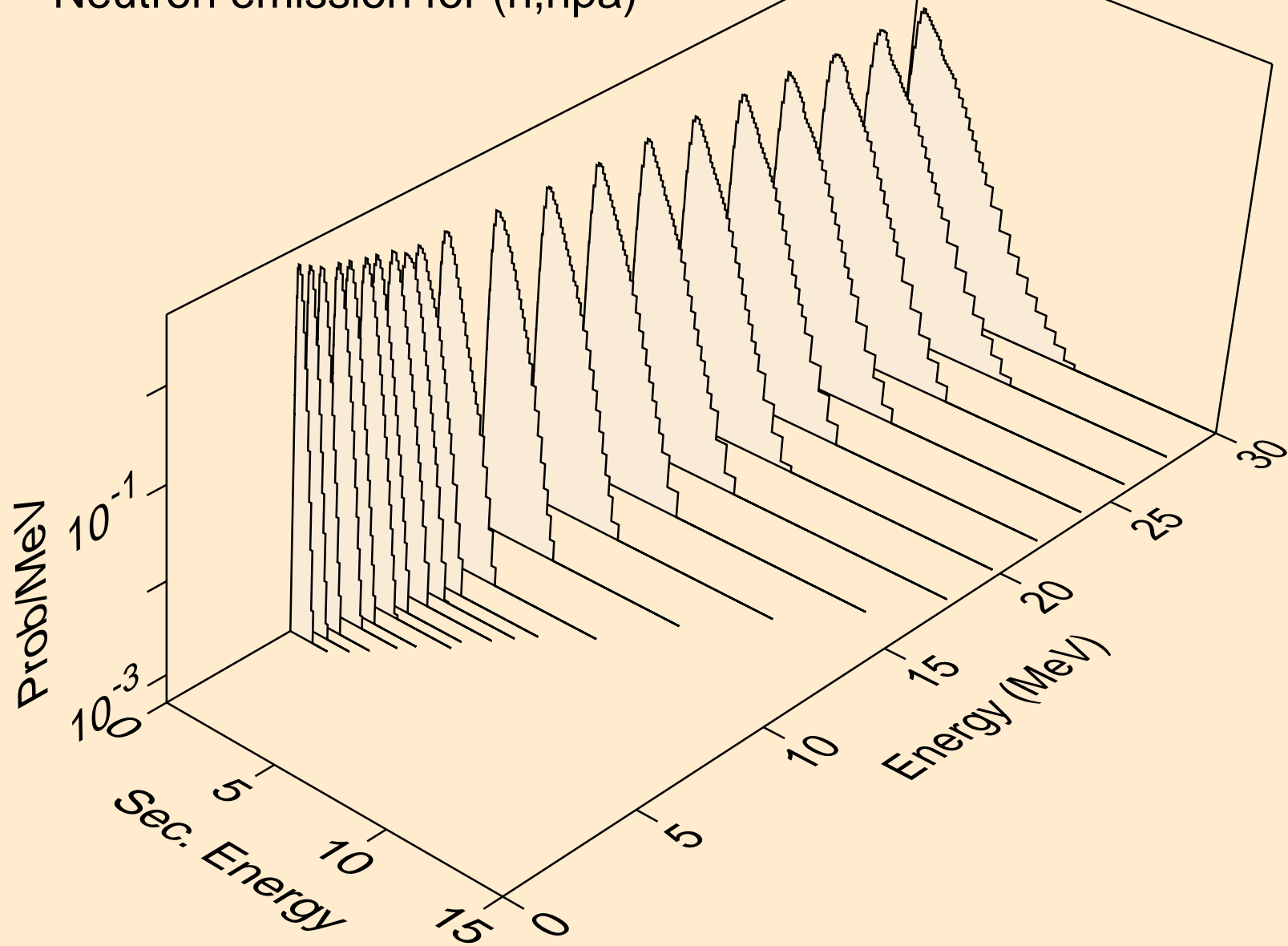

FR206 NEUTRON ACER TENDL-2021 LIBRARY; T=293.6K
Neutron emission for (n,n*c)

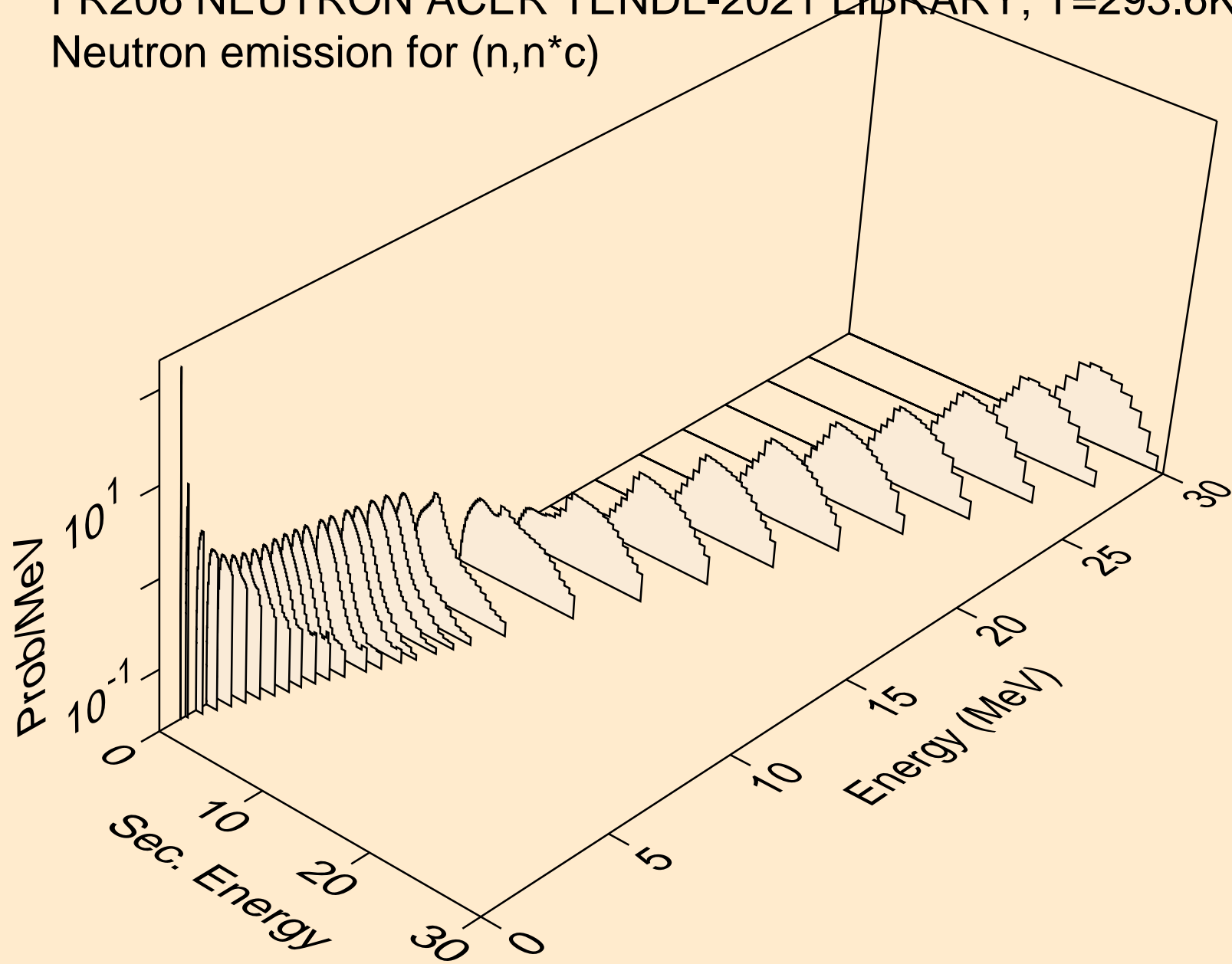

FR206 NEUTRON ACER TENDL-2021 LIBRARY; T=293.6K
Photon emission for (n,x)

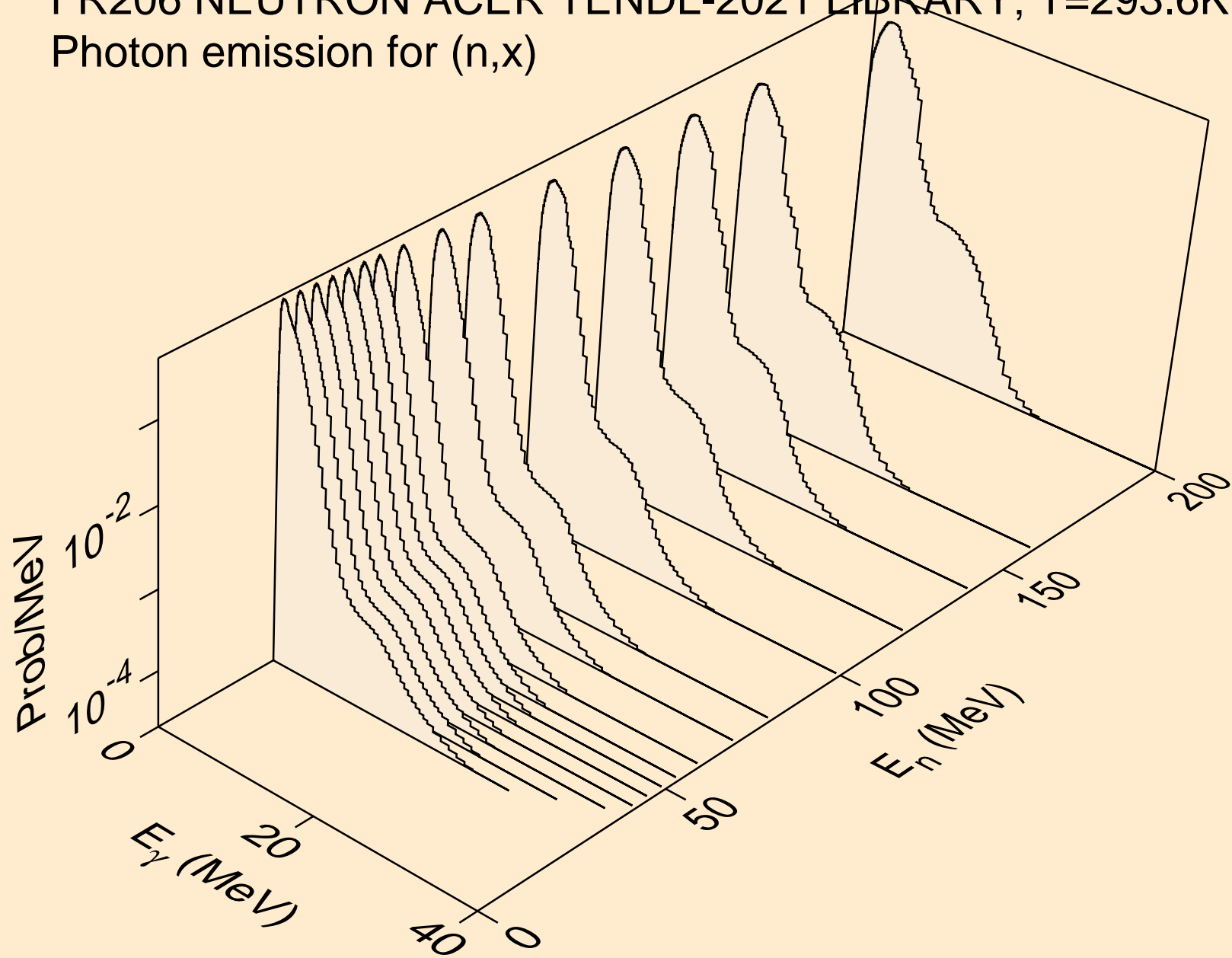

FR206 NEUTRON ACER TENDL-2021 LIBRARY; T=293.6K
Photon emission for (n,2nd)

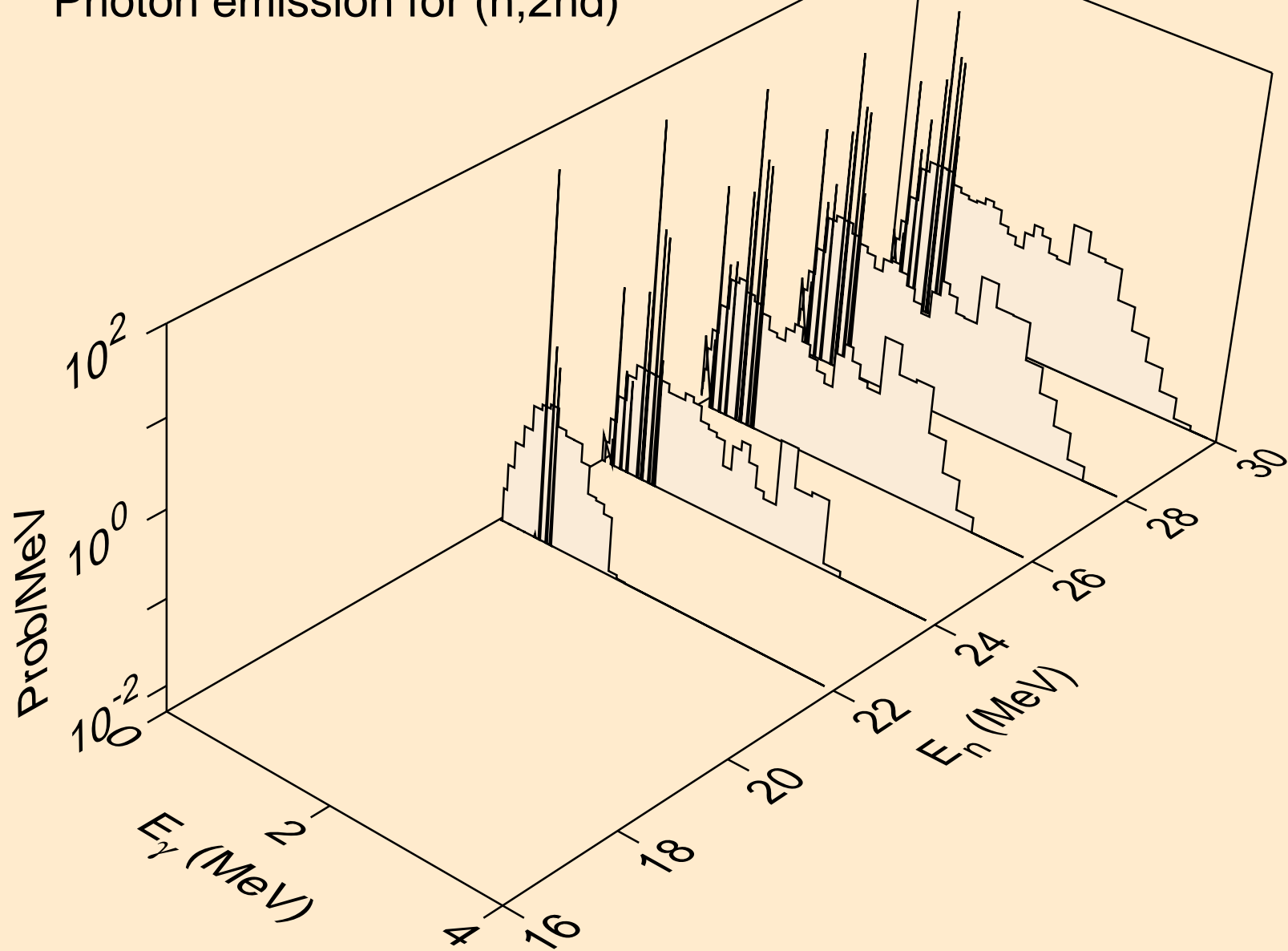

FR206 NEUTRON ACER TENDL-2021 LIBRARY; T=293.6K
Photon emission for (n,2n)

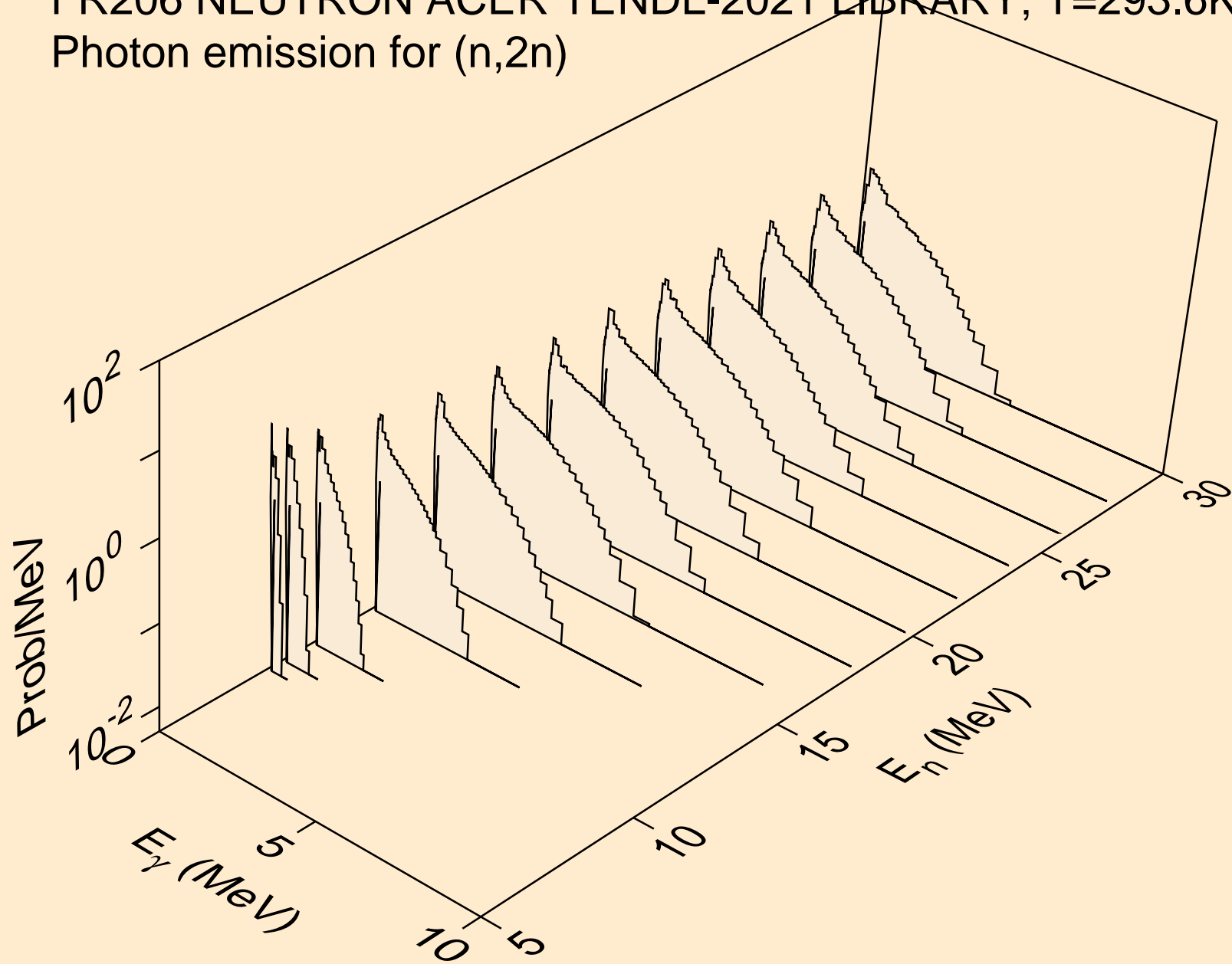

FR206 NEUTRON ACER TENDL-2021 LIBRARY; T=293.6K
Photon emission for (n,3n)

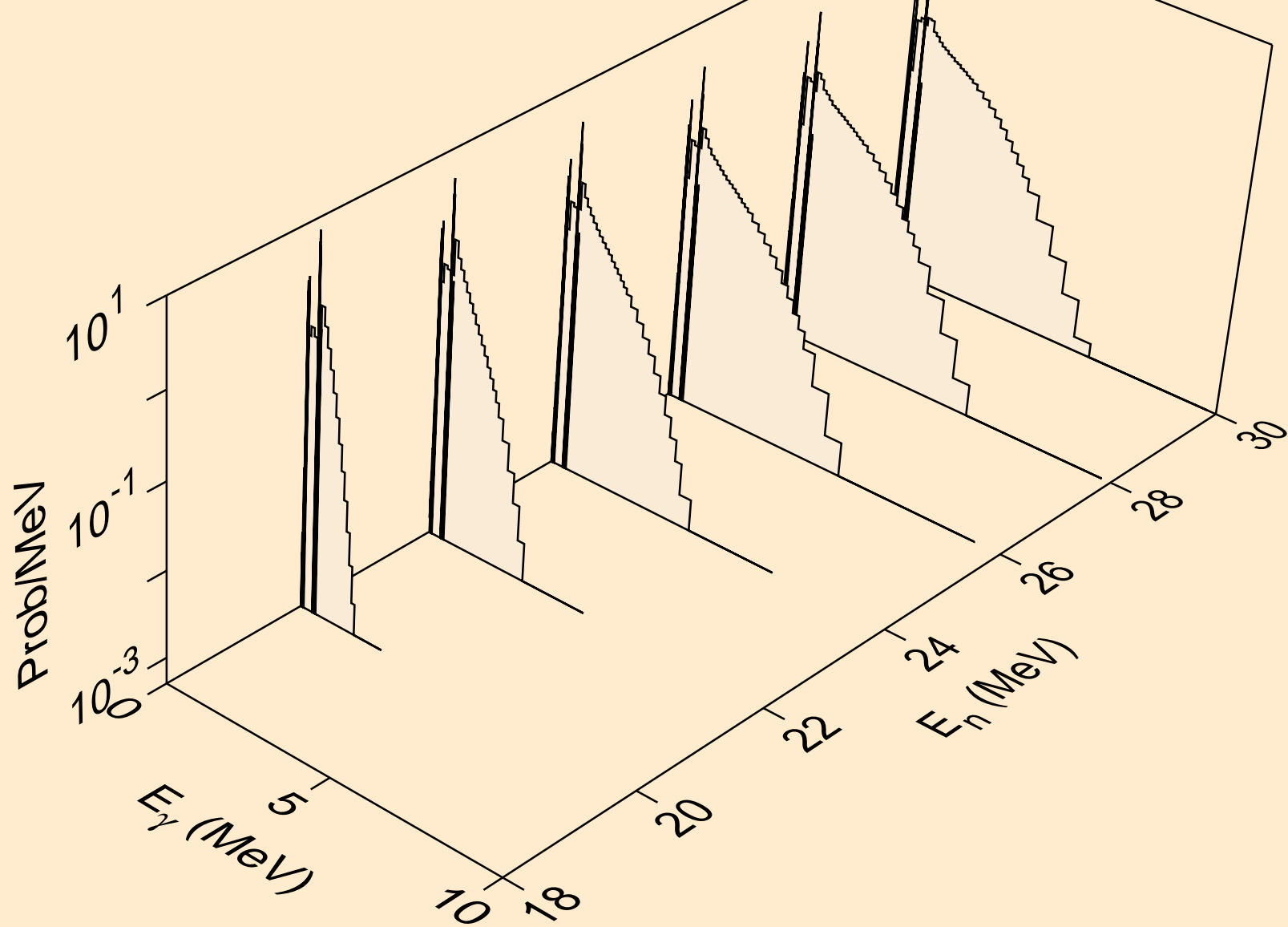

FR206 NEUTRON ACER TENDL-2021 LIBRARY; T=293.6K
Photon emission for (n,n*)a

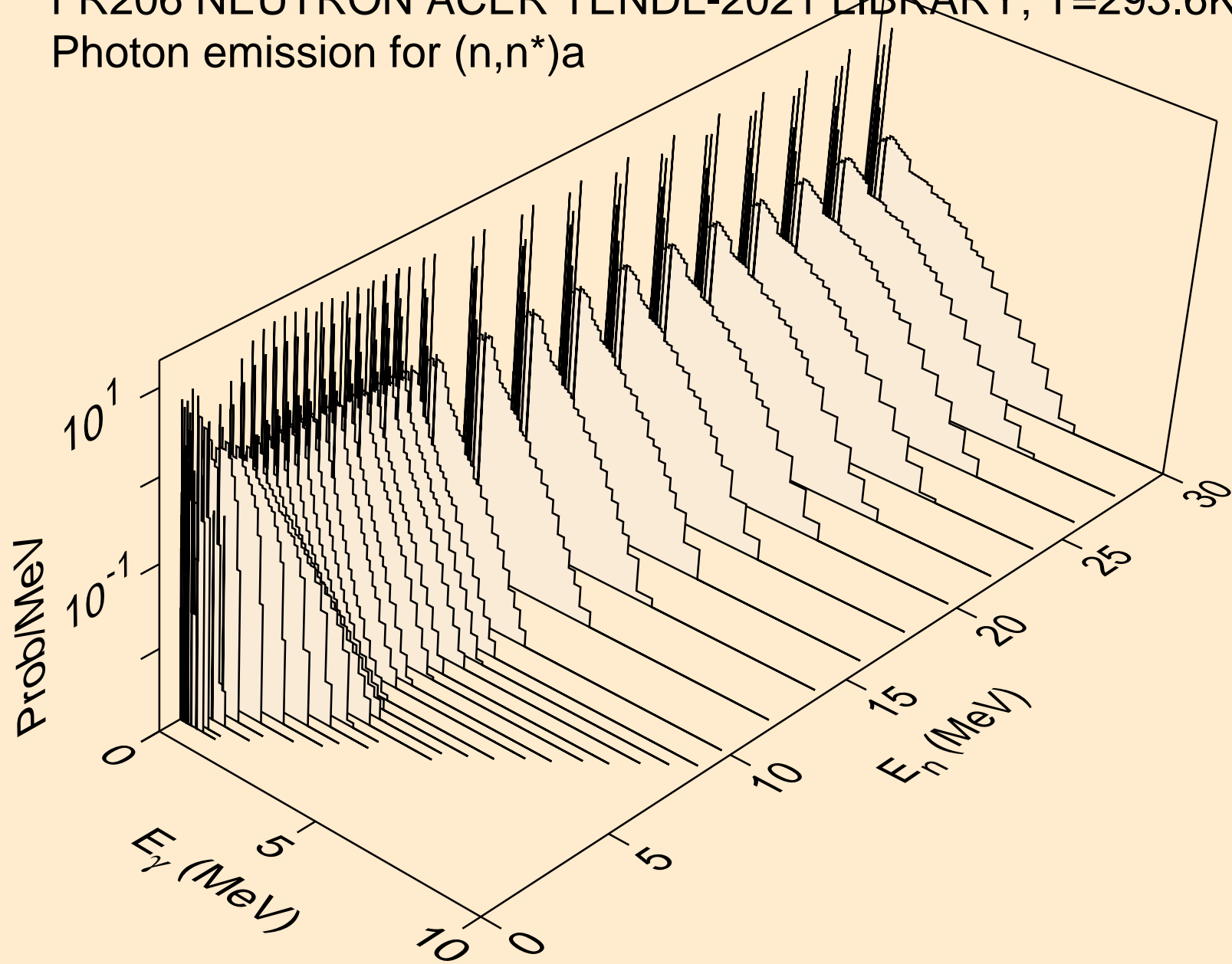

FR206 NEUTRON ACER TENDL-2021 LIBRARY; T=293.6K
Photon emission for (n,2n)a

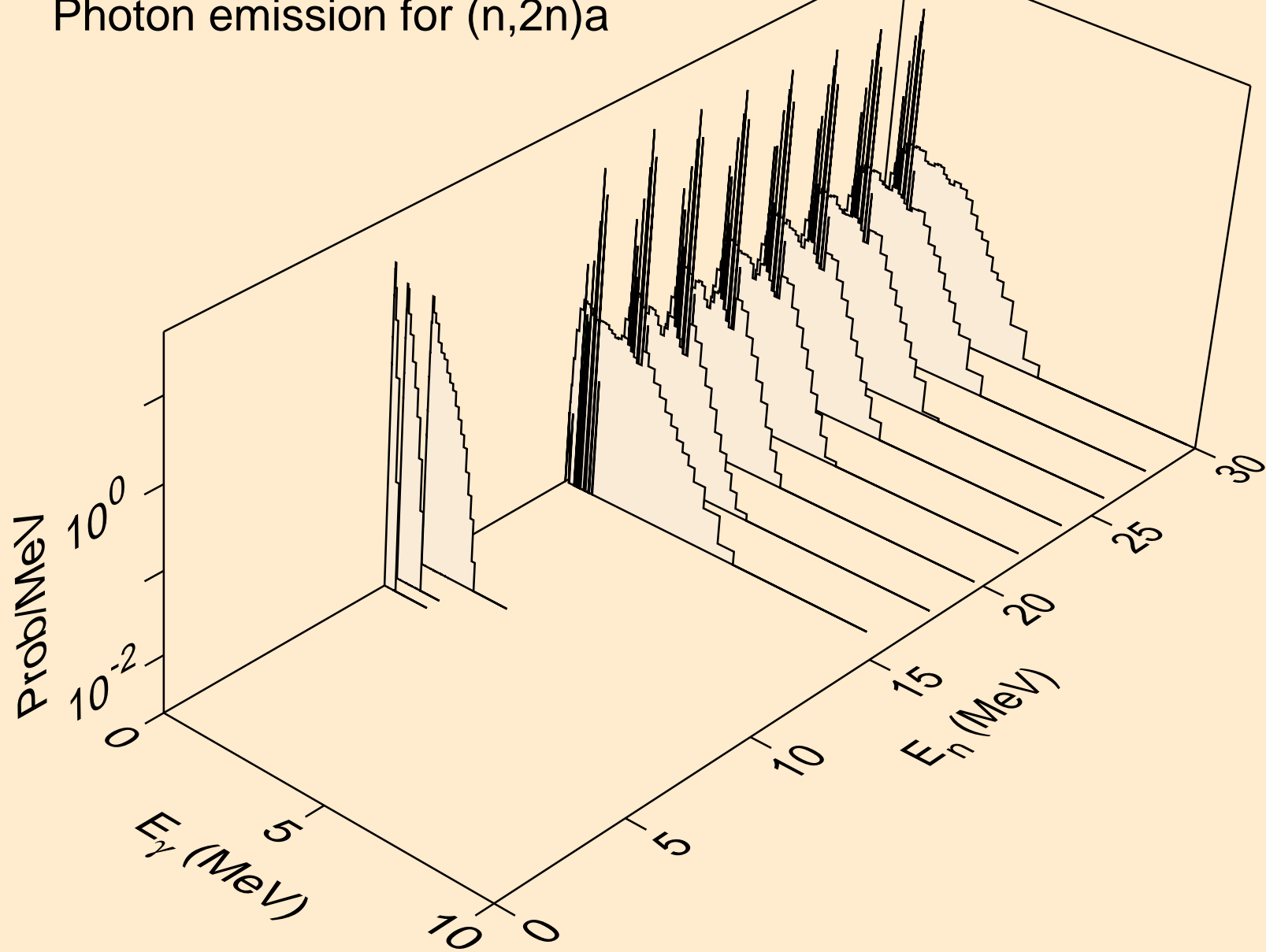

FR206 NEUTRON ACER TENDL-2021 LIBRARY; T=293.6K
Photon emission for (n,3n)a

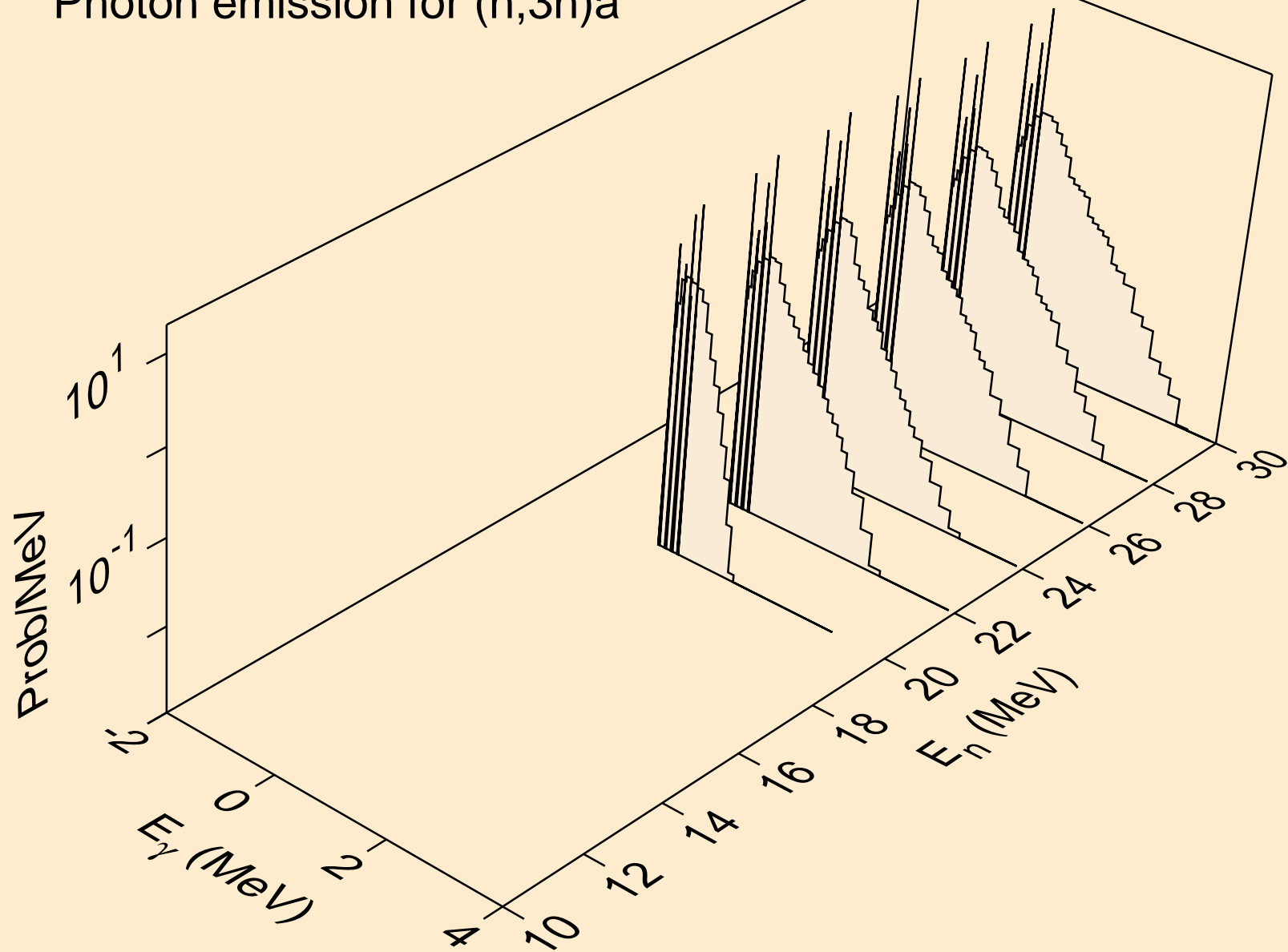

FR206 NEUTRON ACER TENDL-2021 LIBRARY; T=293.6K
Photon emission for (n,n*)p

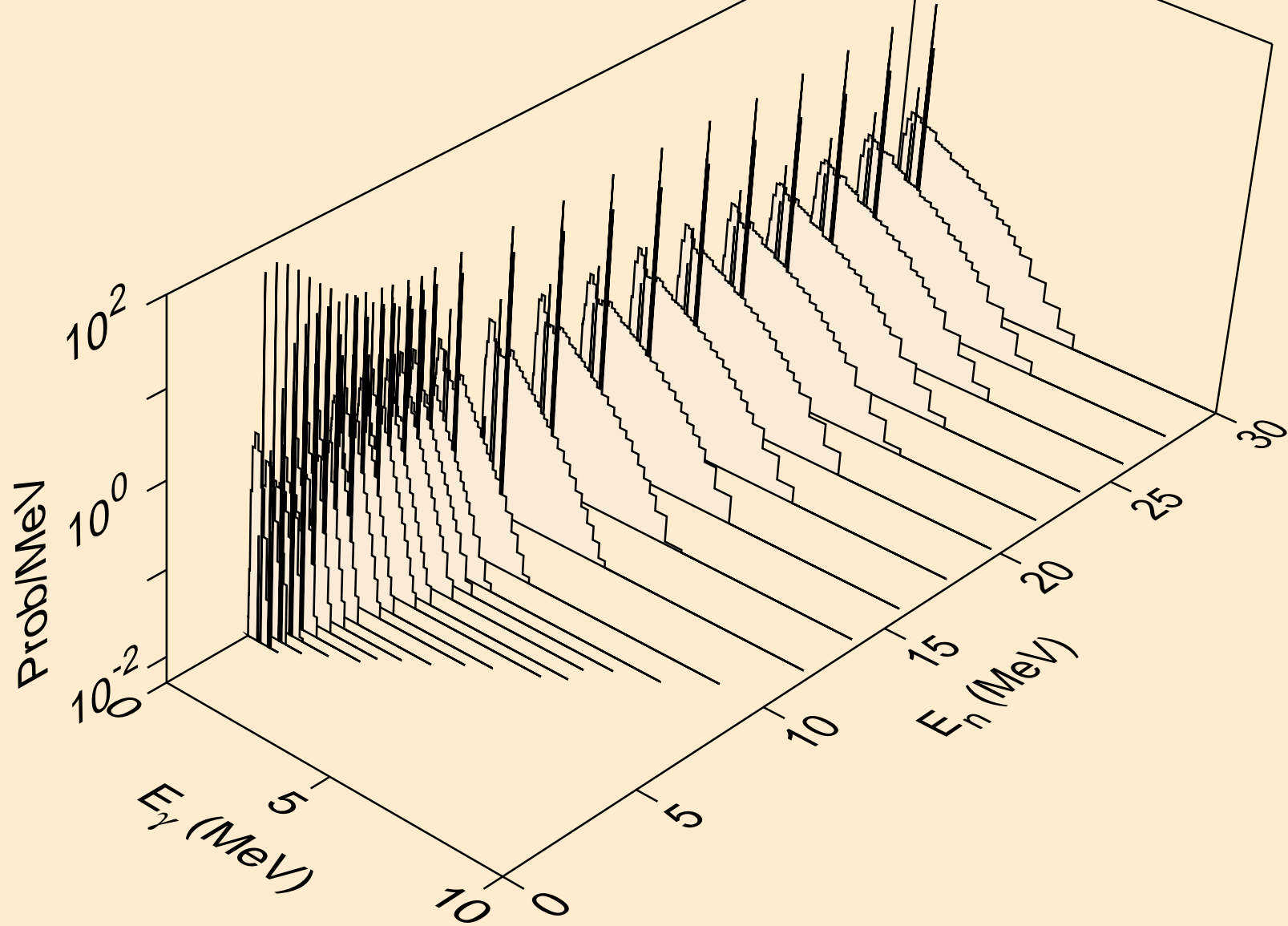

FR206 NEUTRON ACER TENDL-2021 LIBRARY; T=293.6K
Photon emission for (n,n*)2a

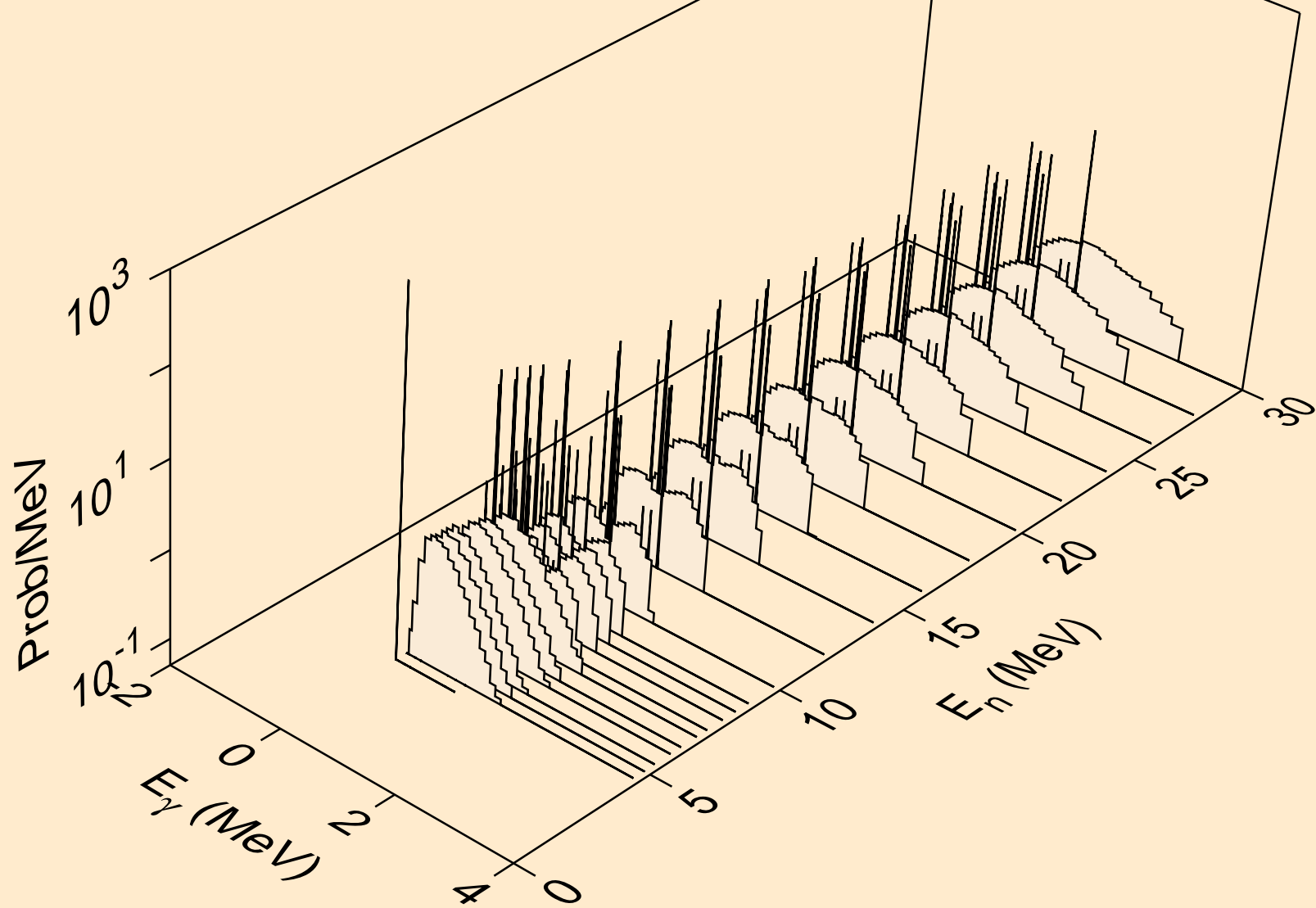

FR206 NEUTRON ACER TENDL-2021 LIBRARY; T=293.6K
Photon emission for (n,2n)2a

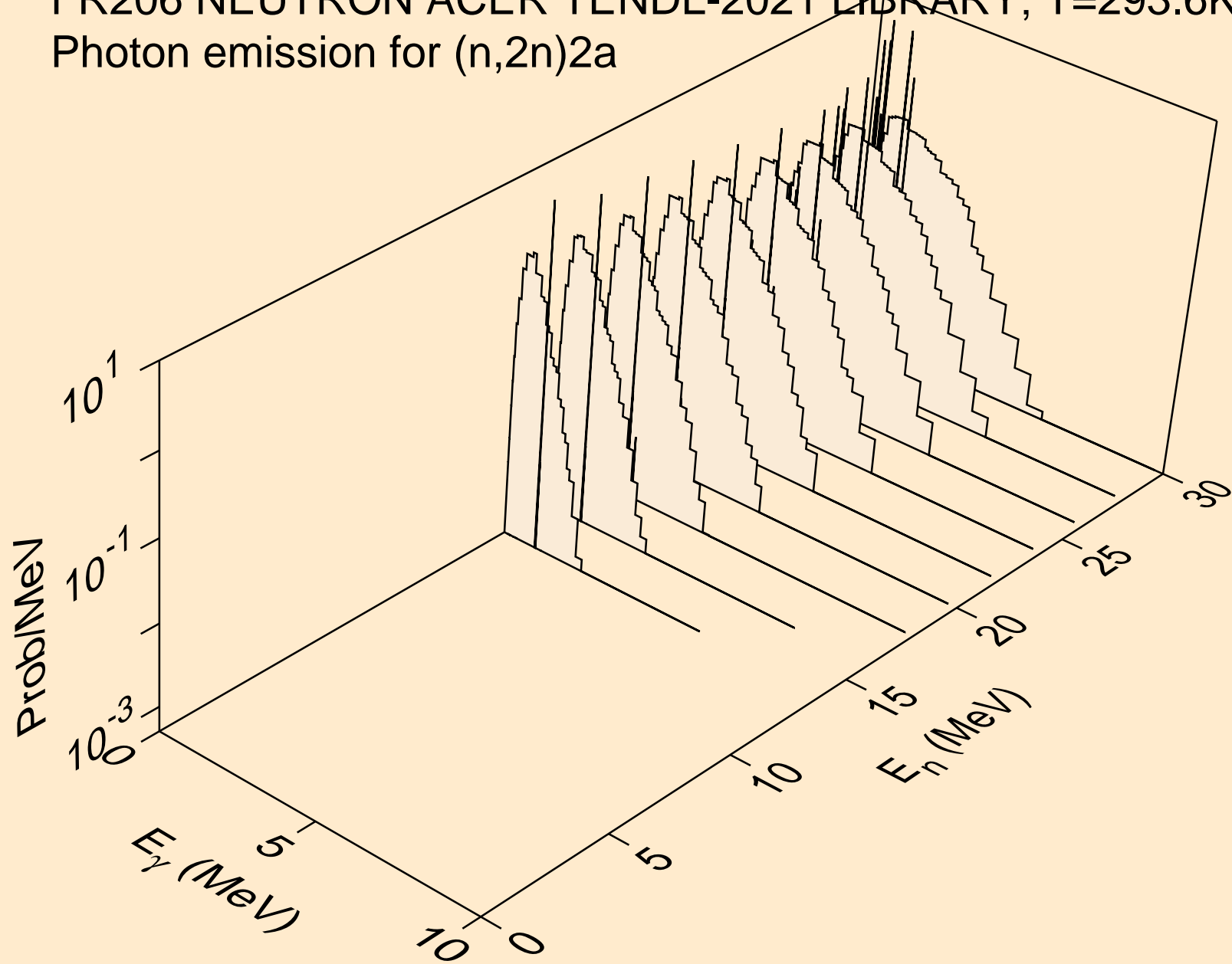

FR206 NEUTRON ACER TENDL-2021 LIBRARY; T=293.6K
Photon emission for (n,n*)d

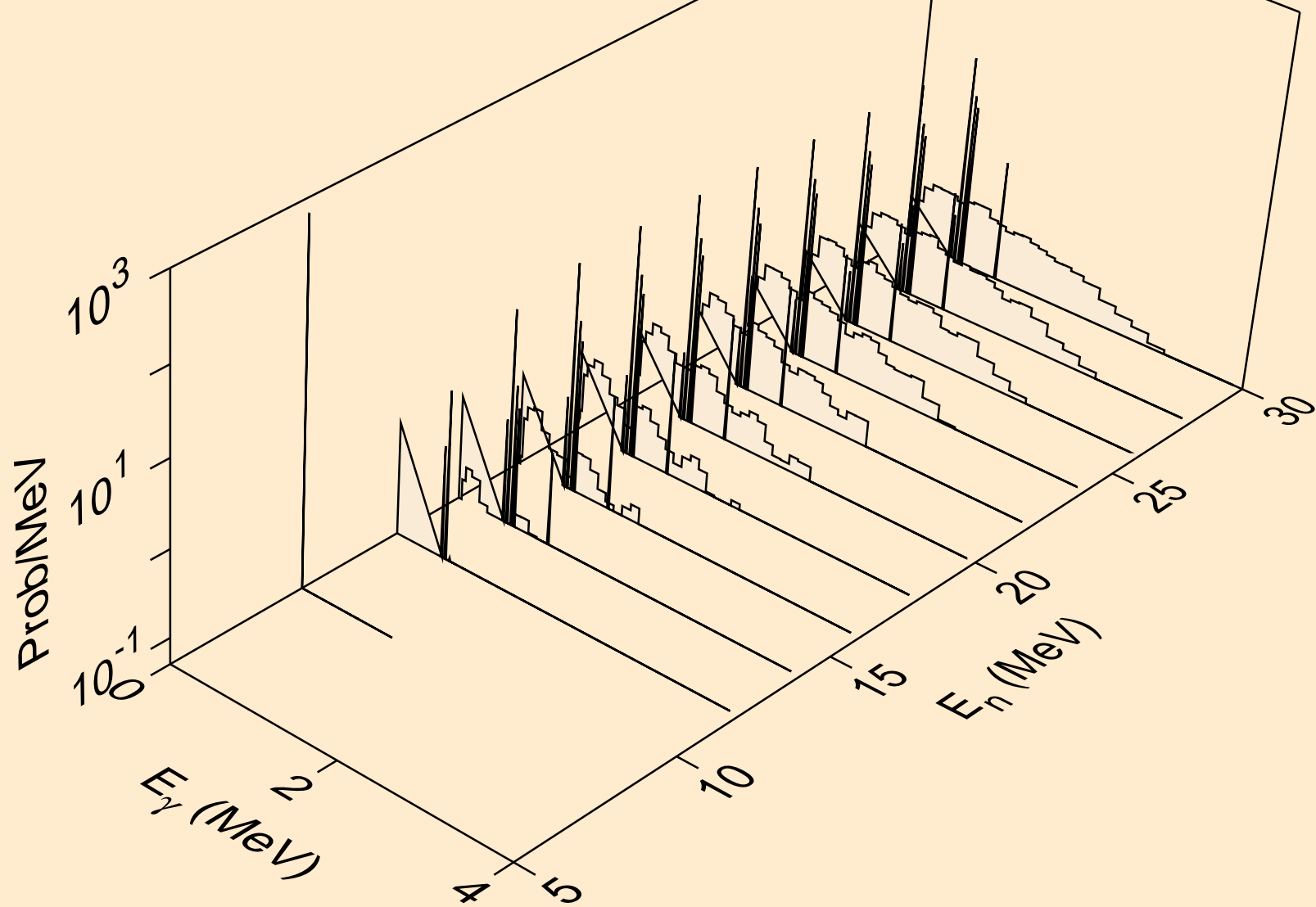

FR206 NEUTRON ACER TENDL-2021 LIBRARY; T=293.6K
Photon emission for (n,n*)t

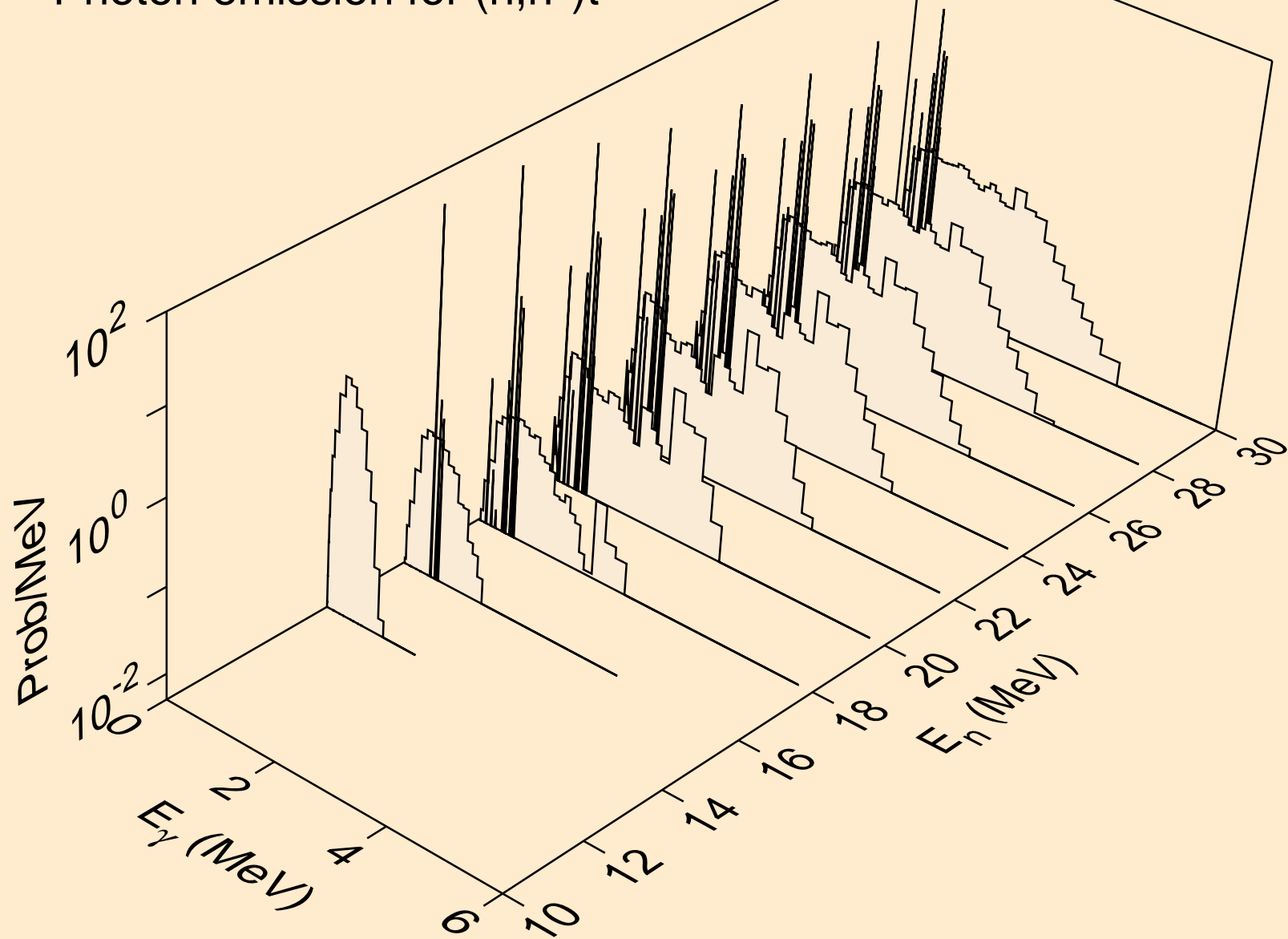

FR206 NEUTRON ACER TENDL-2021 LIBRARY; T=293.6K
Photon emission for (n,n*)he3

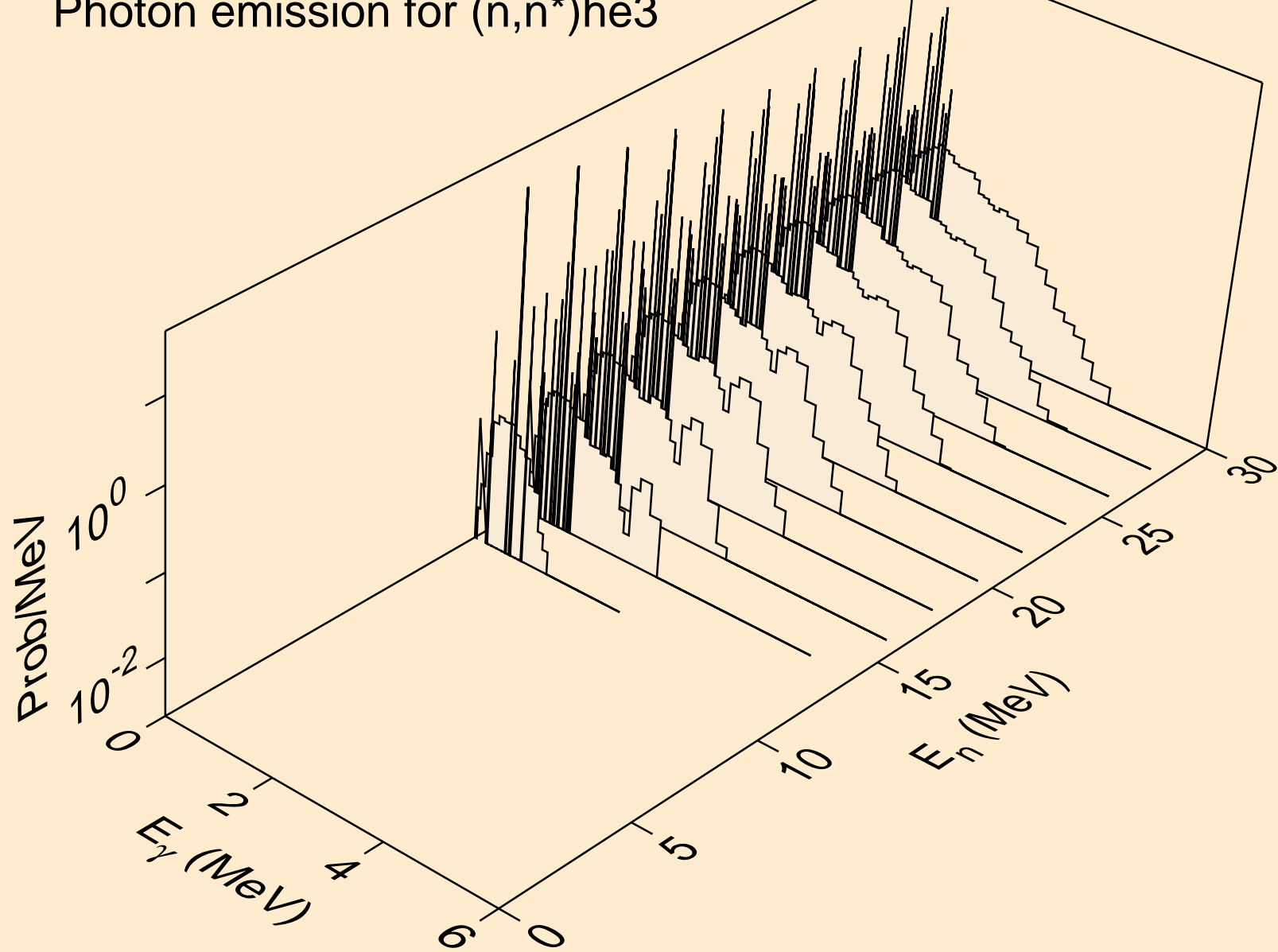

FR206 NEUTRON ACER TENDL-2021 LIBRARY; T=293.6K
Photon emission for (n,4n)

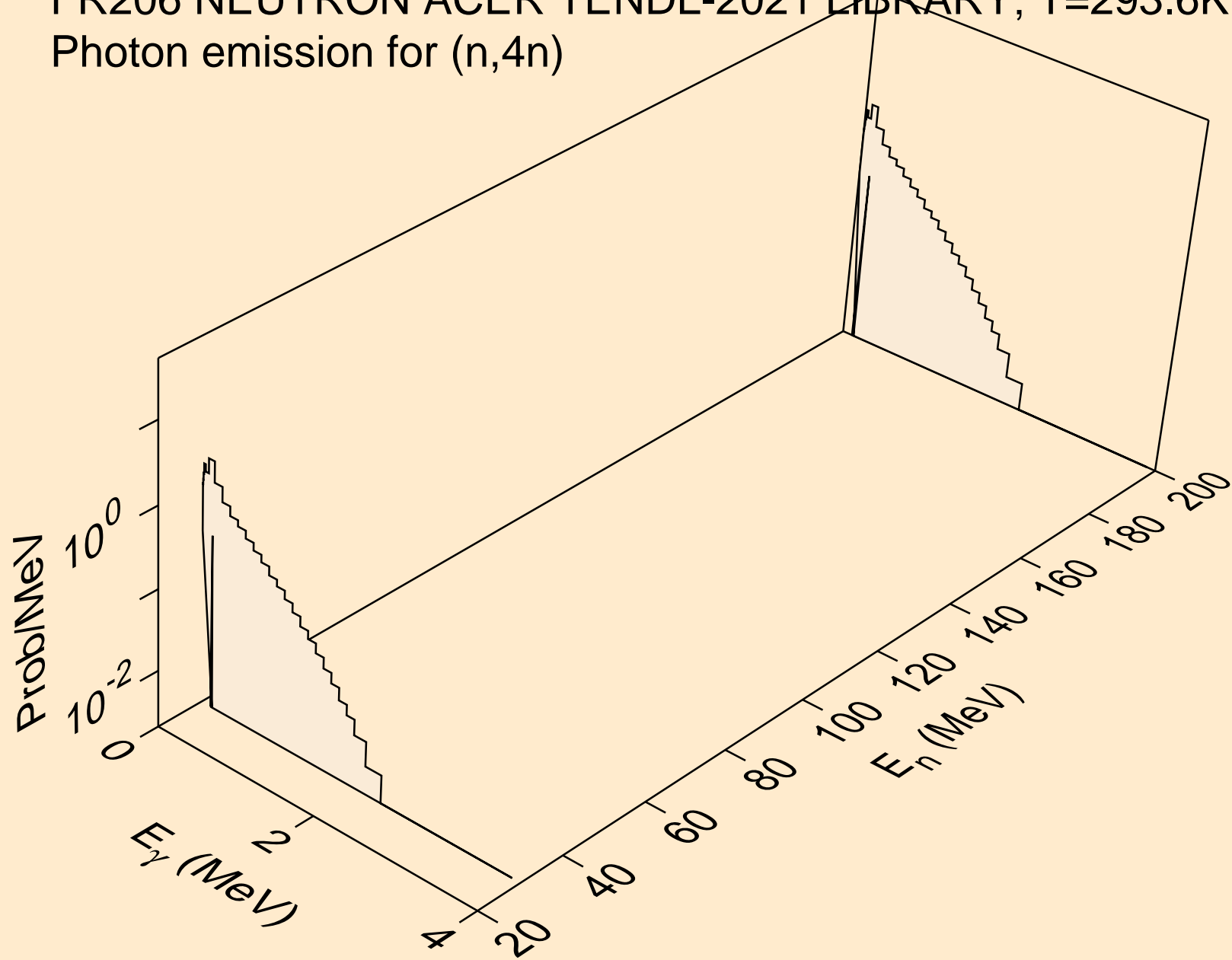

FR206 NEUTRON ACER TENDL-2021 LIBRARY; T=293.6K
Photon emission for (n,2np)

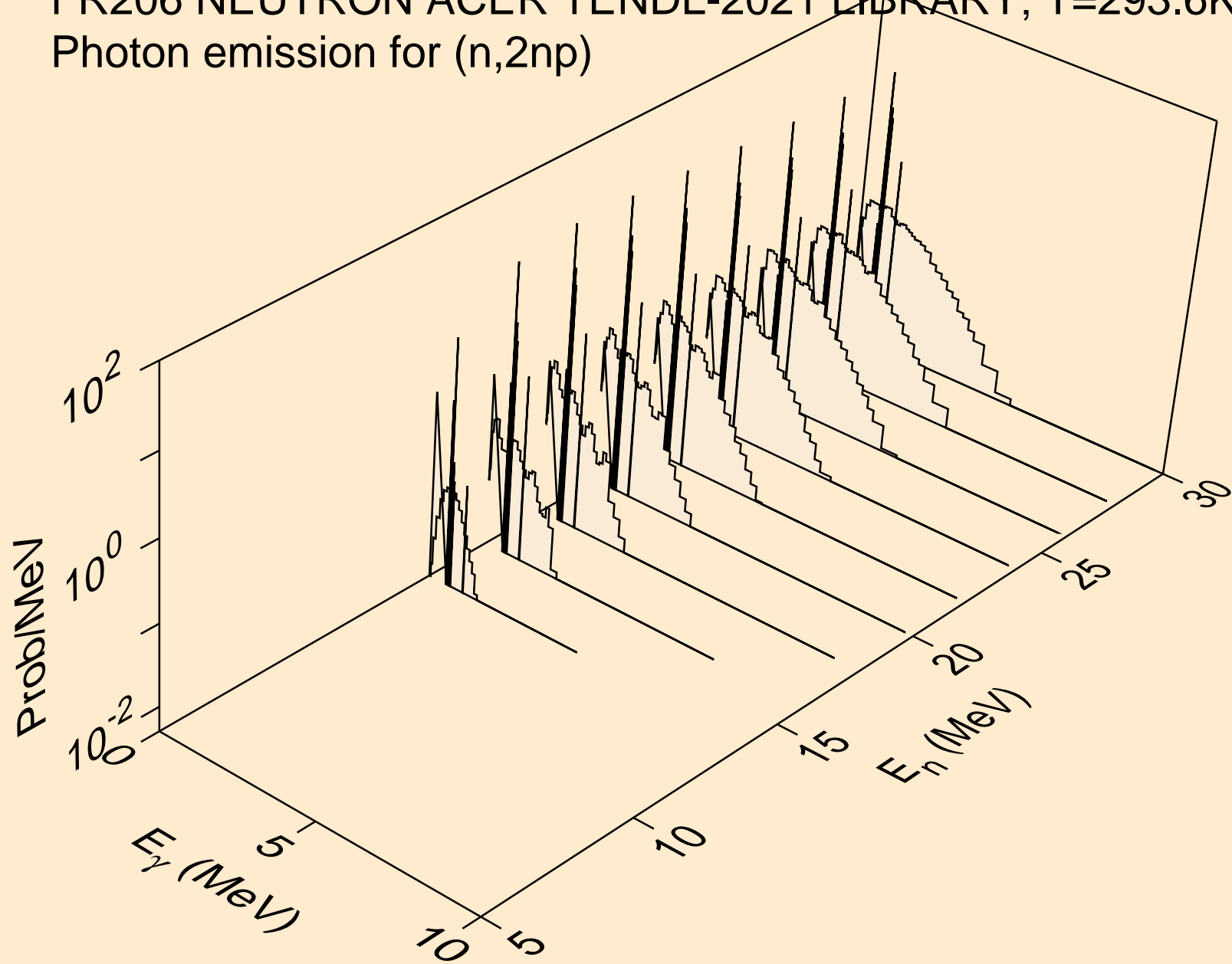

FR206 NEUTRON ACER TENDL-2021 LIBRARY; T=293.6K
Photon emission for (n,3np)

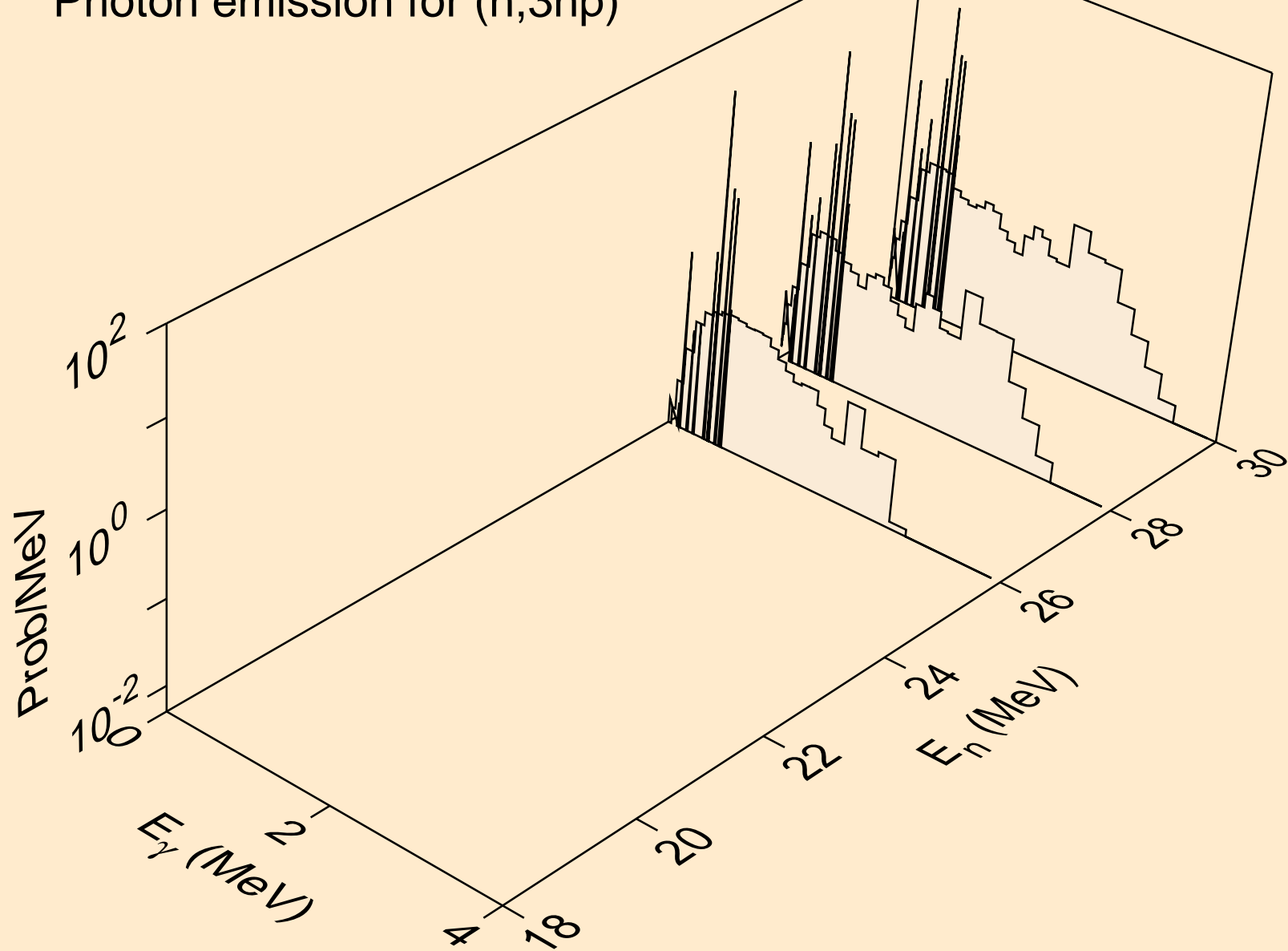

FR206 NEUTRON ACER TENDL-2021 LIBRARY; T=293.6K
Photon emission for (n,2np)

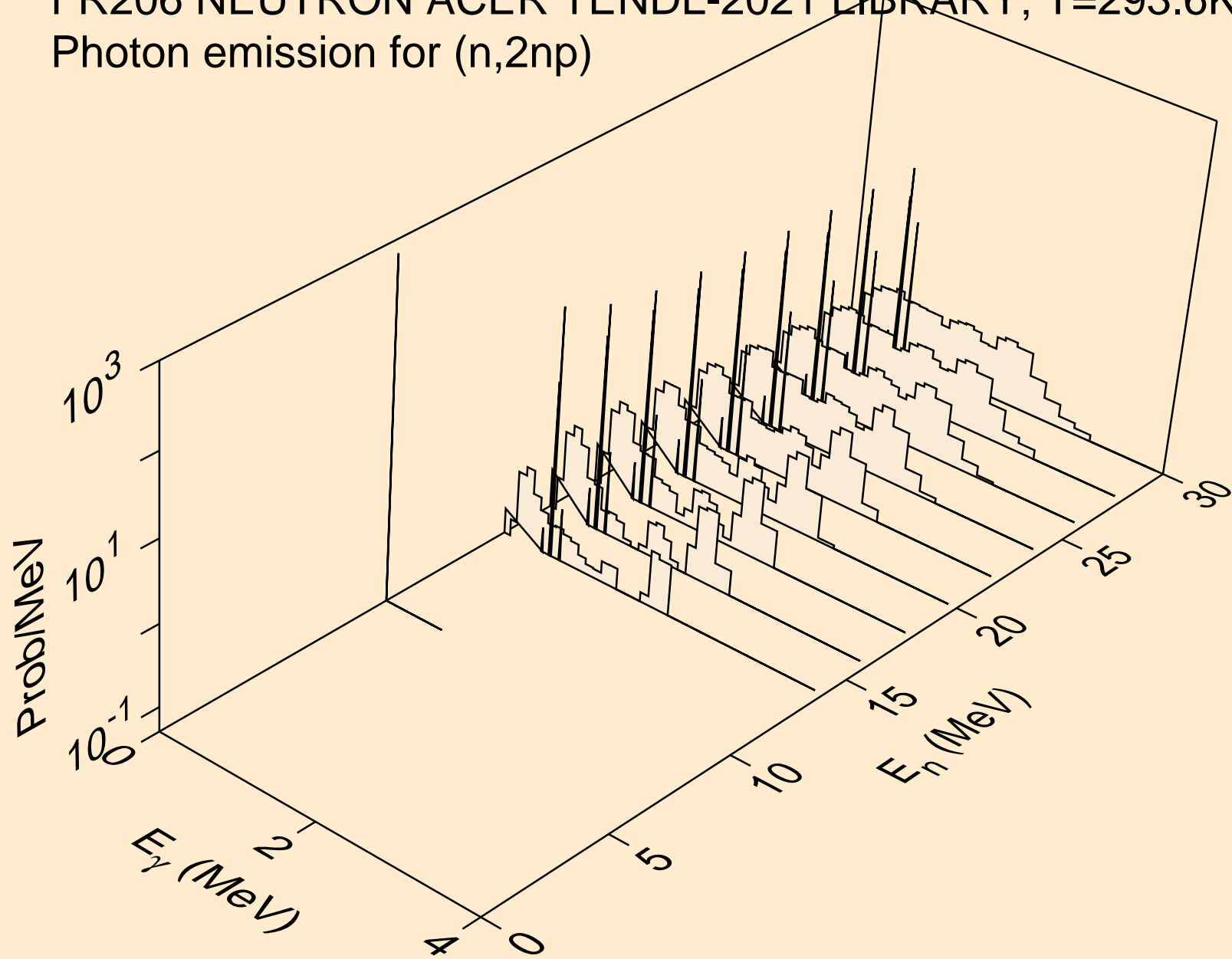

FR206 NEUTRON ACER TENDL-2021 LIBRARY; T=293.6K
Photon emission for (n,npa)

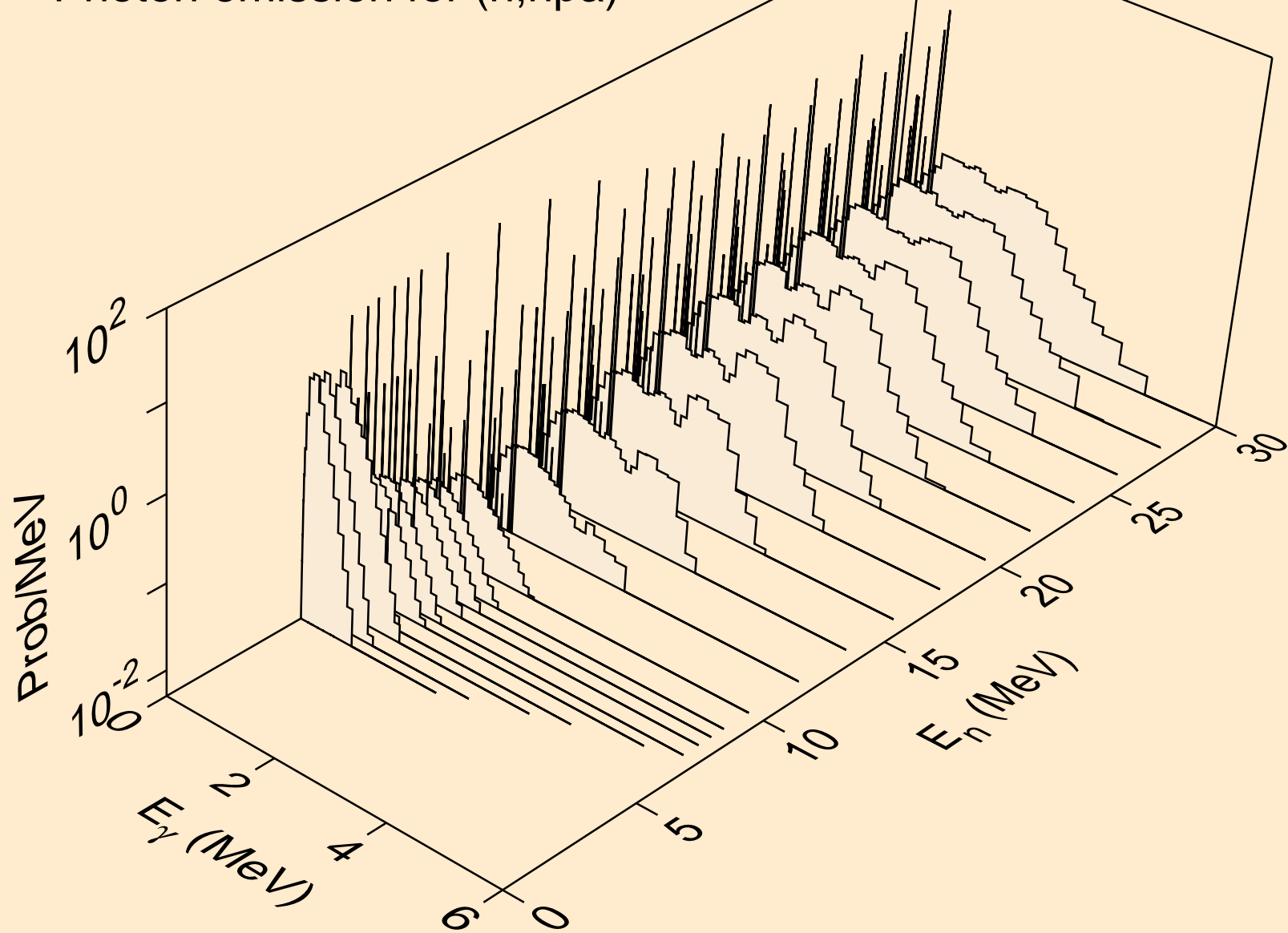

FR206 NEUTRON ACER TENDL-2021 LIBRARY; T=293.6K
Photon emission for (n,n*c)

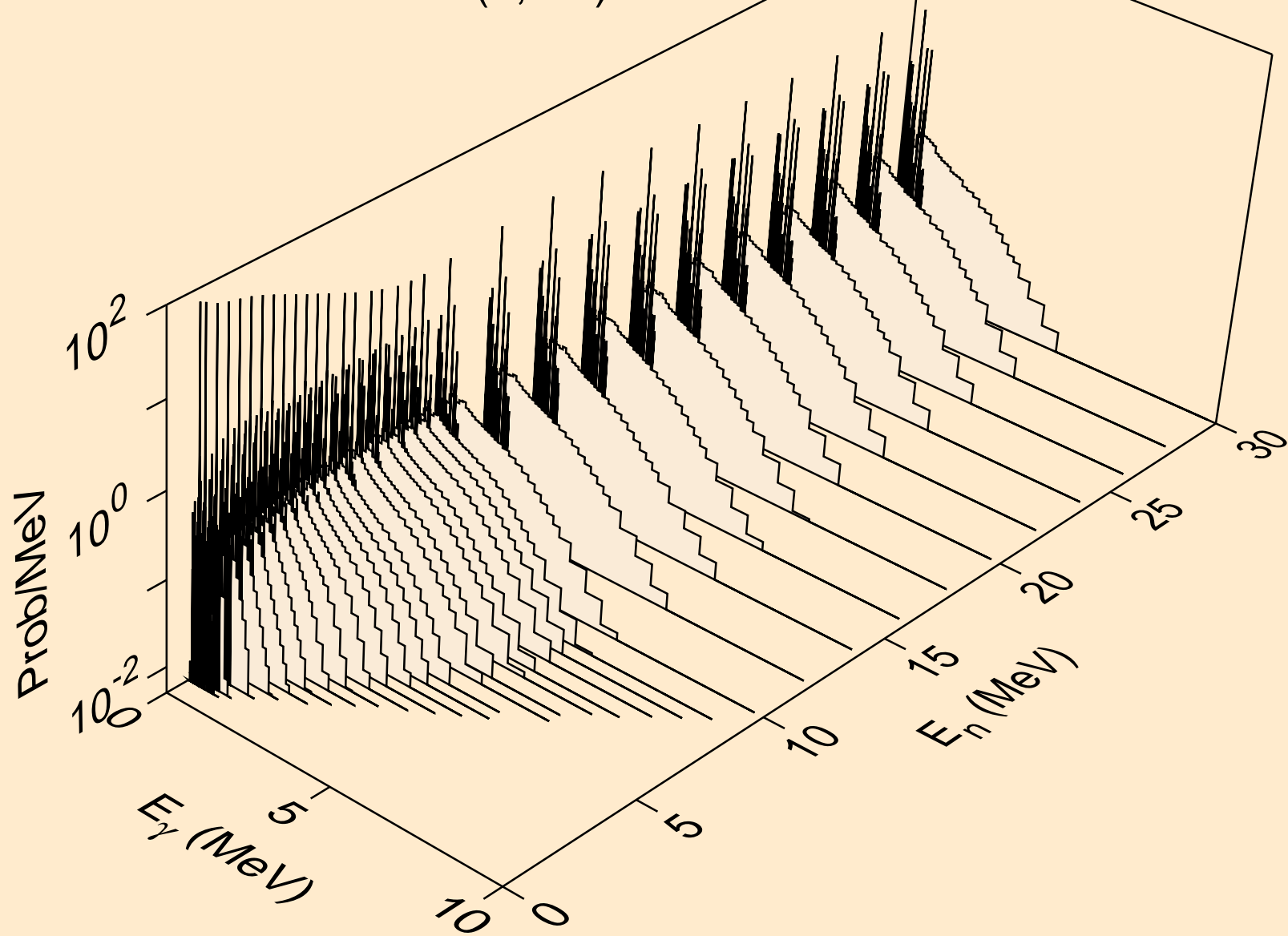

FR206 NEUTRON ACER TENDL-2021 LIBRARY; T=293.6K
Photon emission for (n,gma)

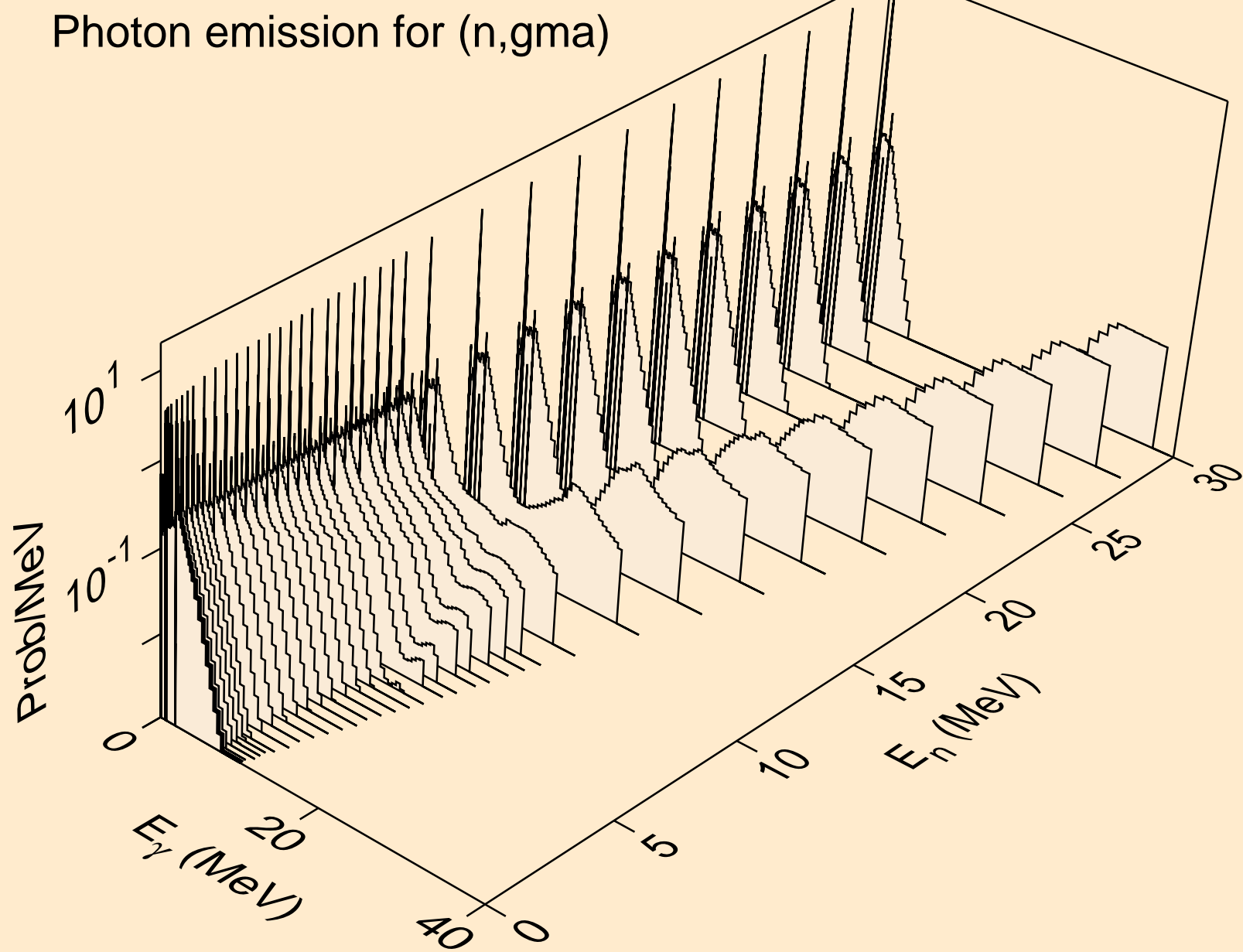

FR206 NEUTRON ACER TENDL-2021 LIBRARY; T=293.6K
Photon emission for (n,p)

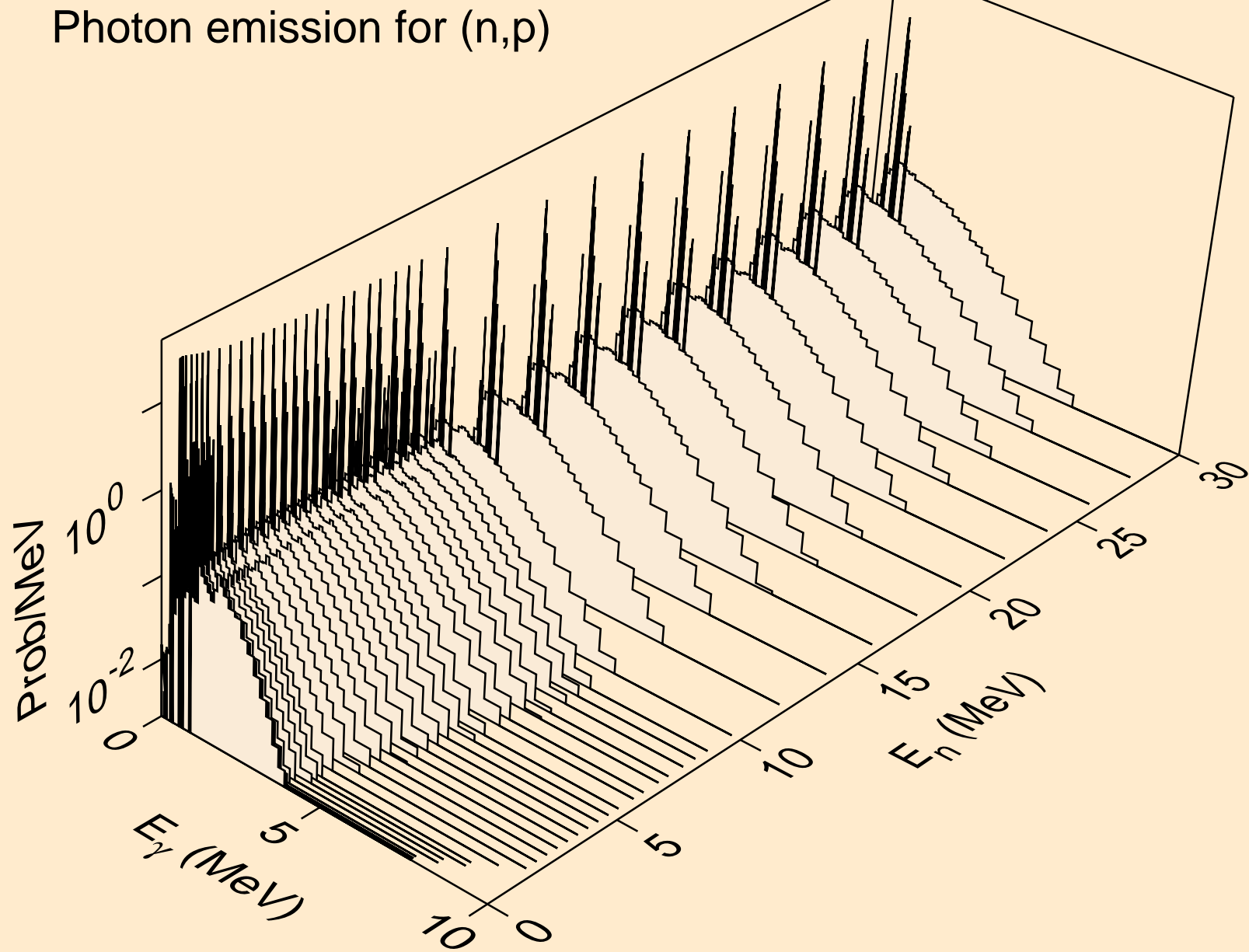

FR206 NEUTRON ACER TENDL-2021 LIBRARY; T=293.6K
Photon emission for (n,d)

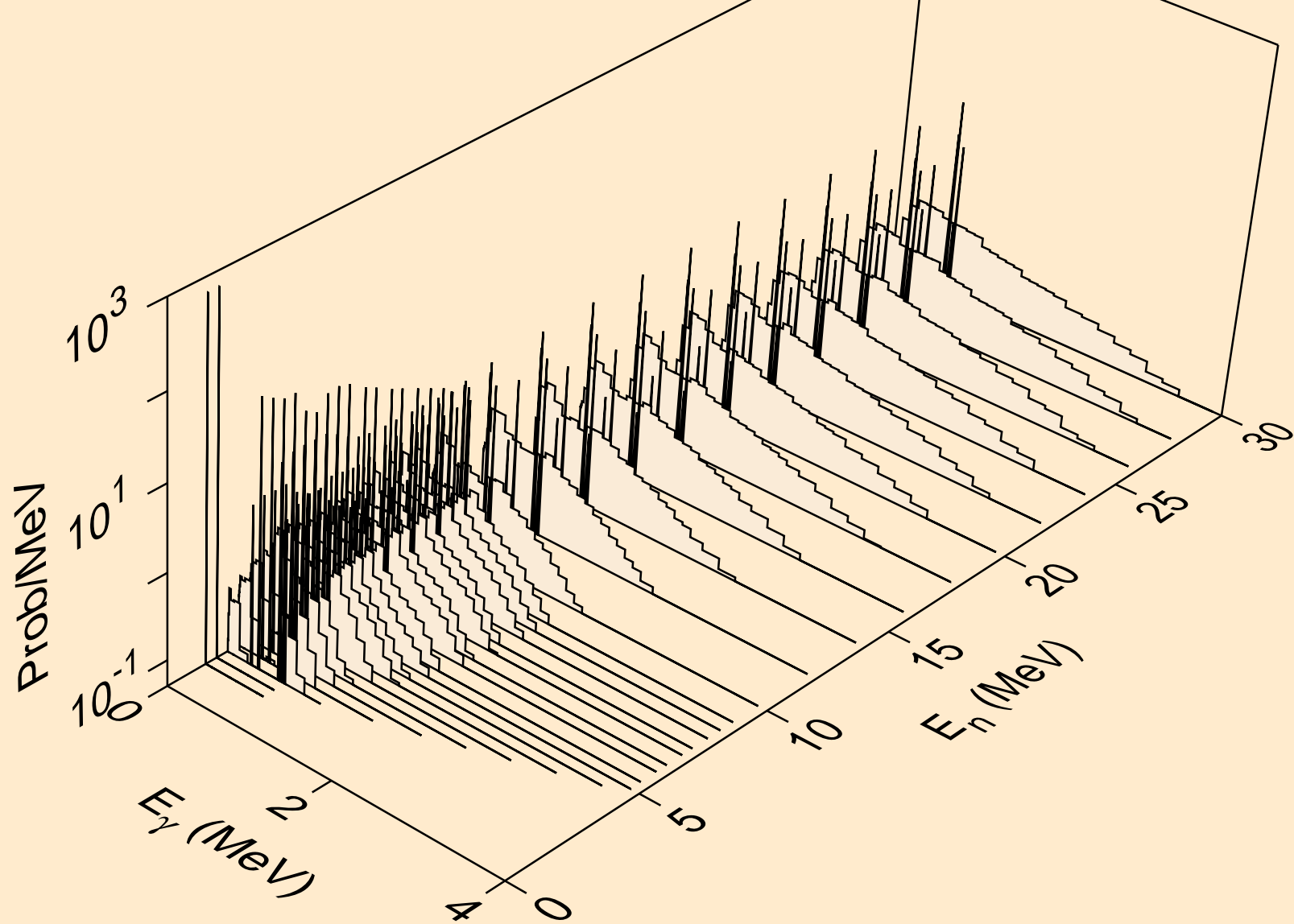

FR206 NEUTRON ACER TENDL-2021 LIBRARY; T=293.6K
Photon emission for (n,t)

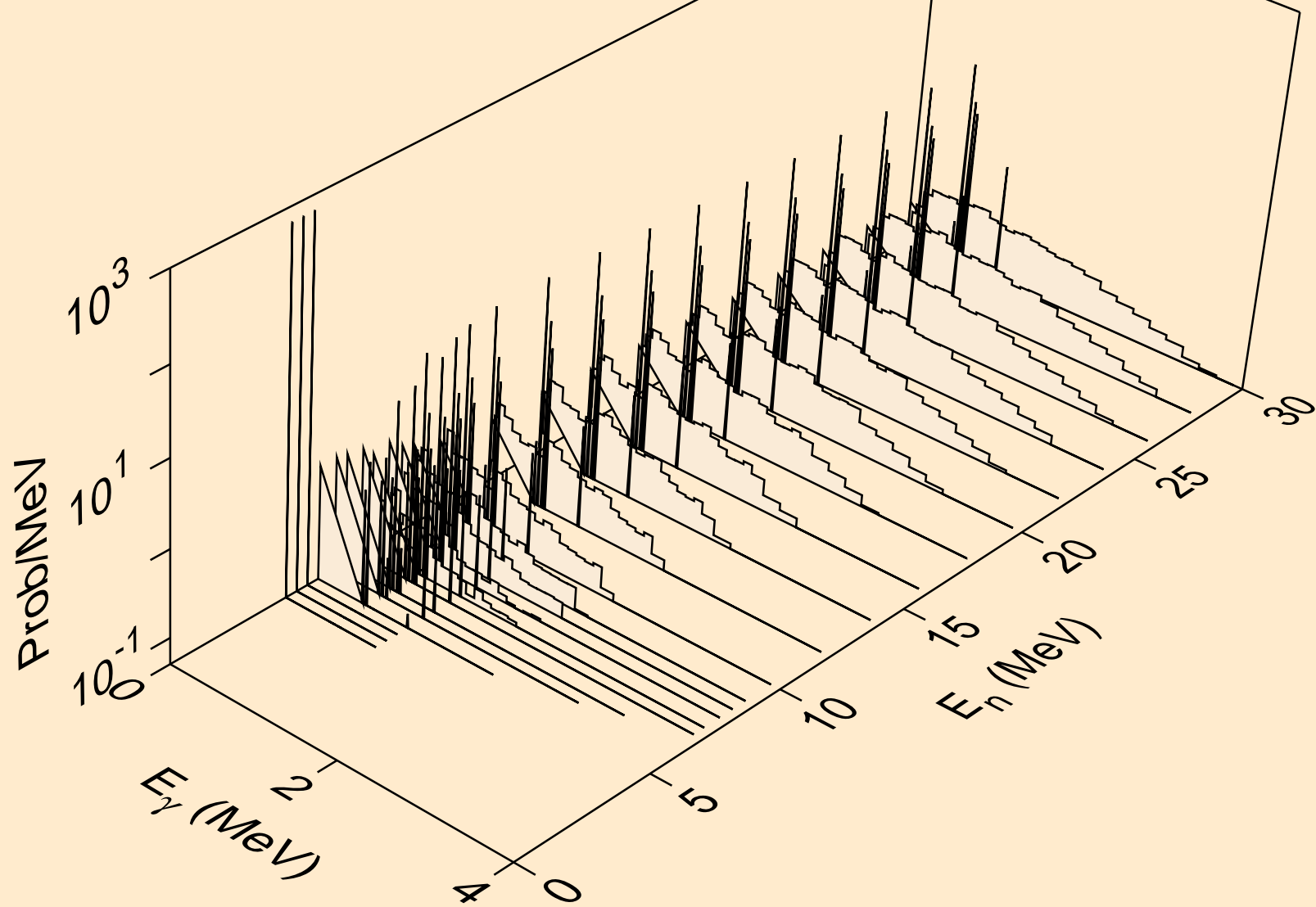

FR206 NEUTRON ACER TENDL-2021 LIBRARY; T=293.6K
Photon emission for (n,he3)

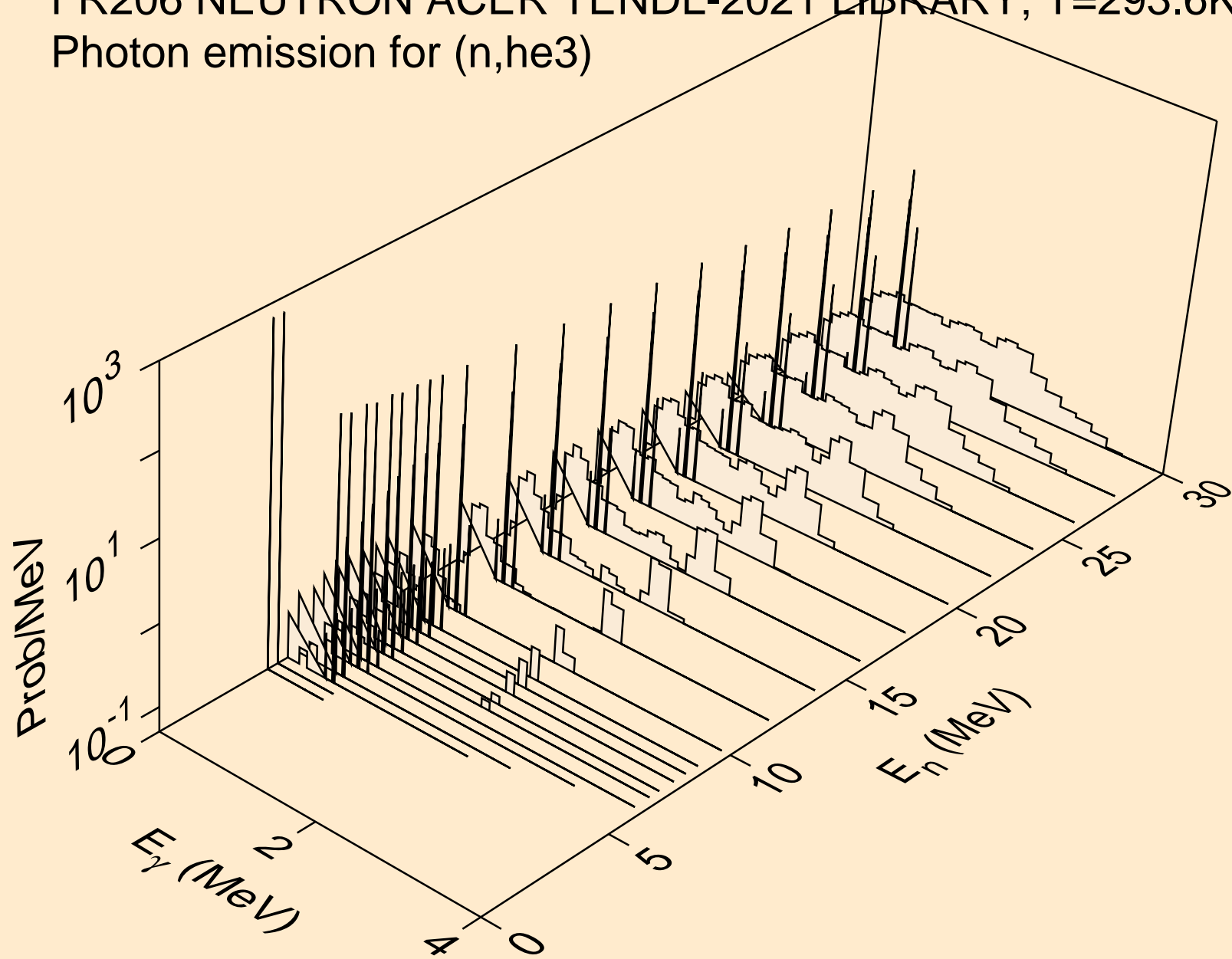

FR206 NEUTRON ACER TENDL-2021 LIBRARY; T=293.6K
Photon emission for (n,a)

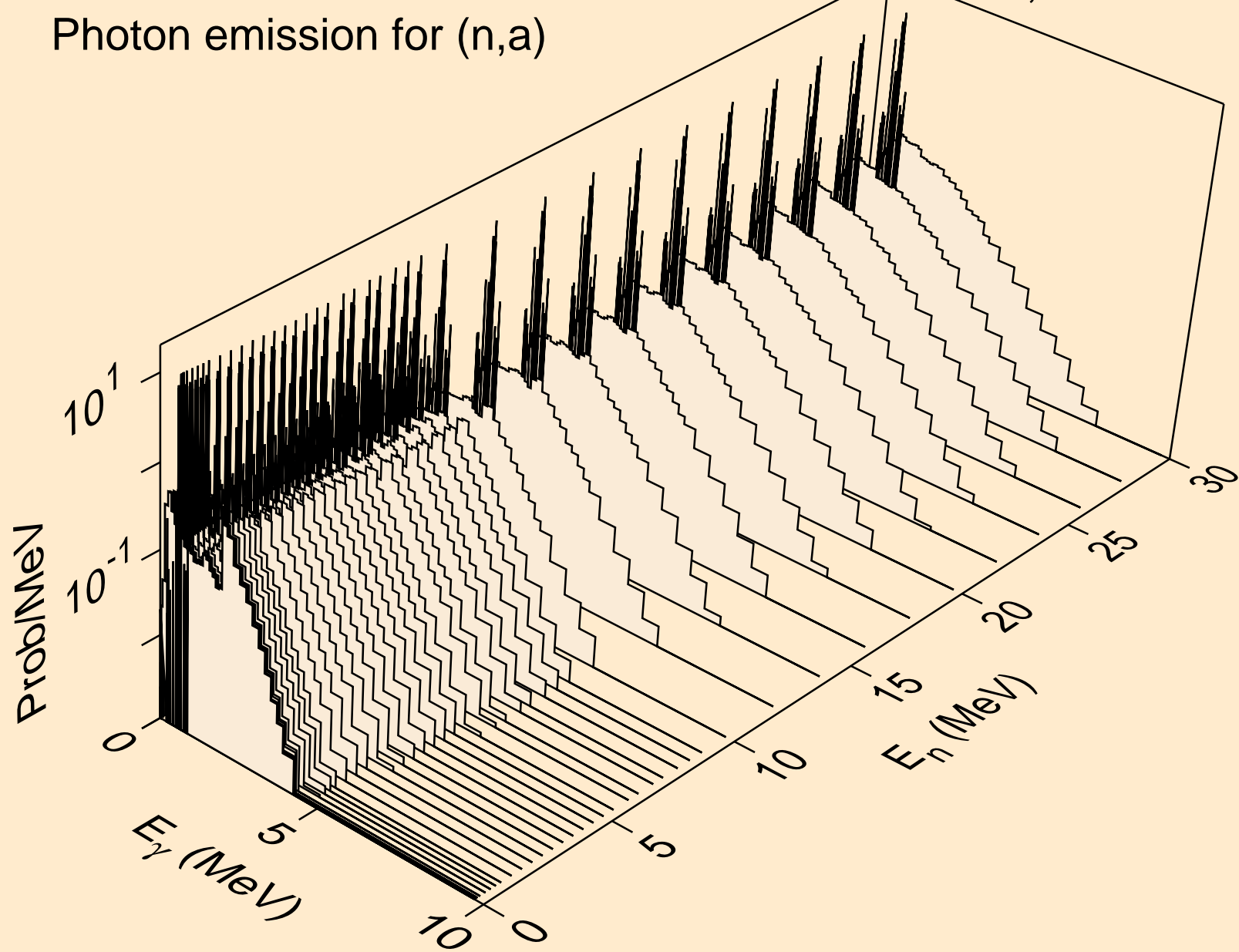

FR206 NEUTRON ACER TENDL-2021 LIBRARY; T=293.6K
Photon emission for (n,2a)

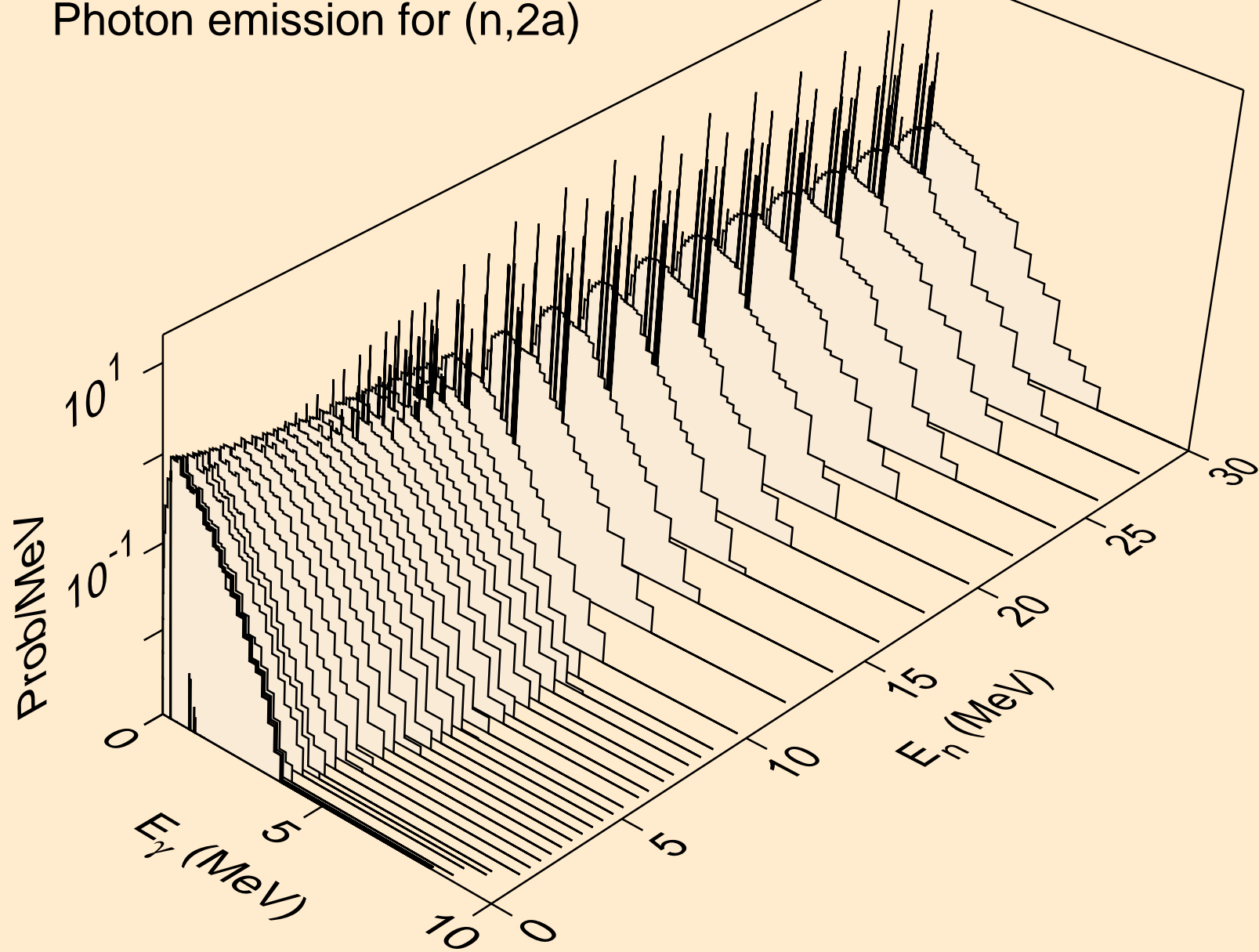

FR206 NEUTRON ACER TENDL-2021 LIBRARY; T=293.6K
Photon emission for (n,2p)

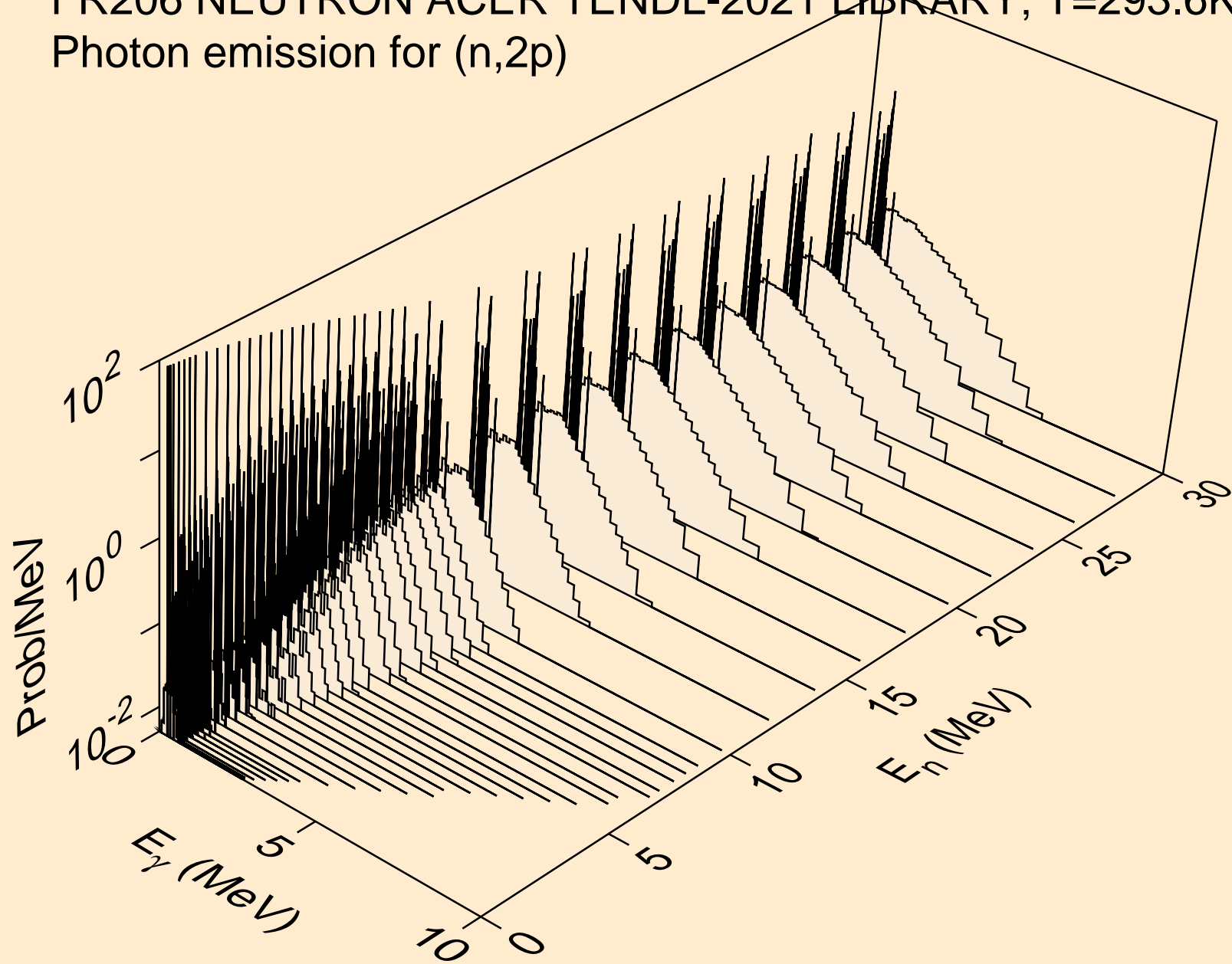

FR206 NEUTRON ACER TENDL-2021 LIBRARY; T=293.6K
Photon emission for (n,p α)

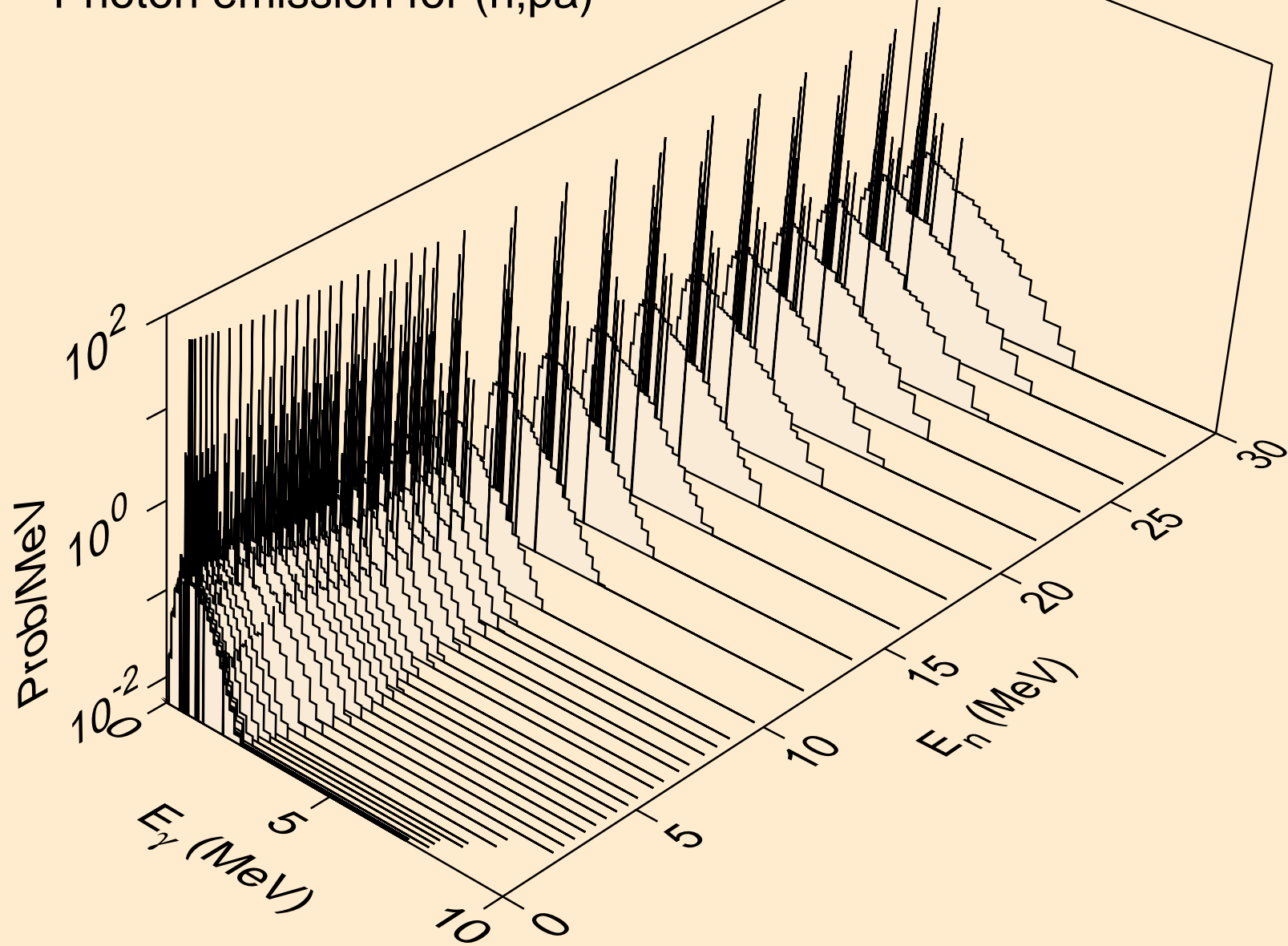

FR206 NEUTRON ACER TENDL-2021 LIBRARY; T=293.6K
Photon emission for (n,pd)

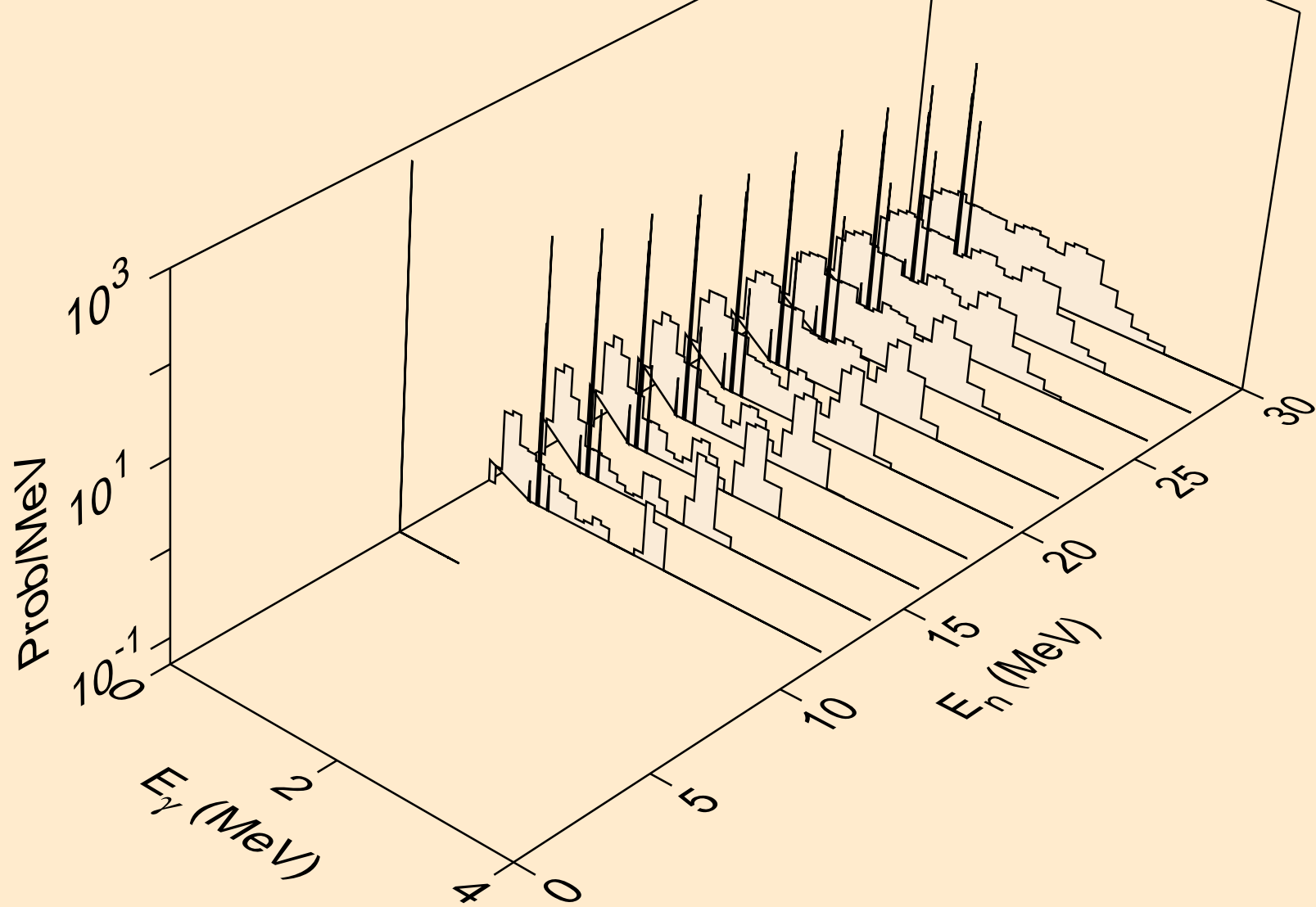

FR206 NEUTRON ACER TENDL-2021 LIBRARY; T=293.6K
Photon emission for (n,pt)

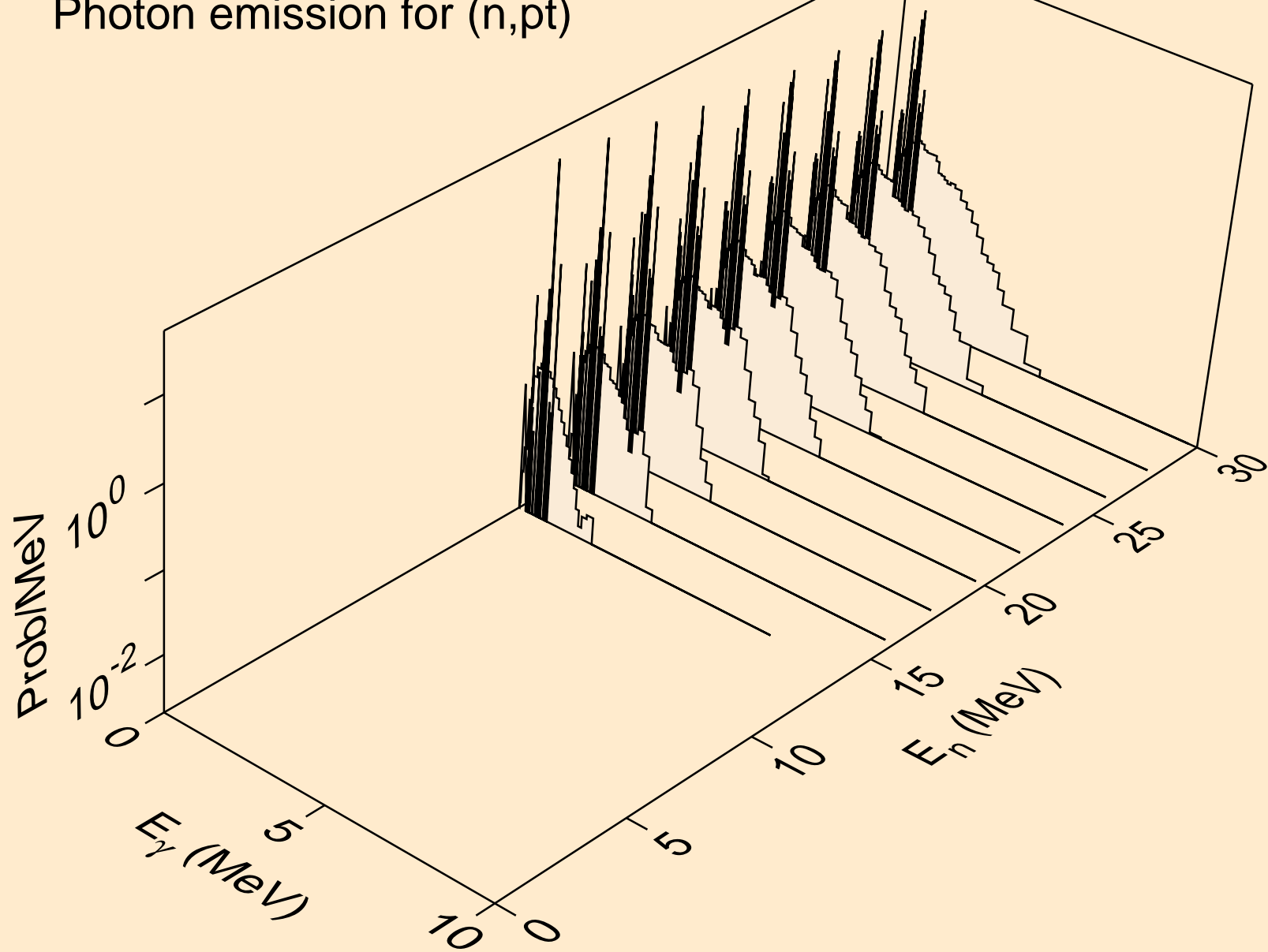

FR206 NEUTRON ACER TENDL-2021 LIBRARY; T=293.6K
Photon emission for (n,da)

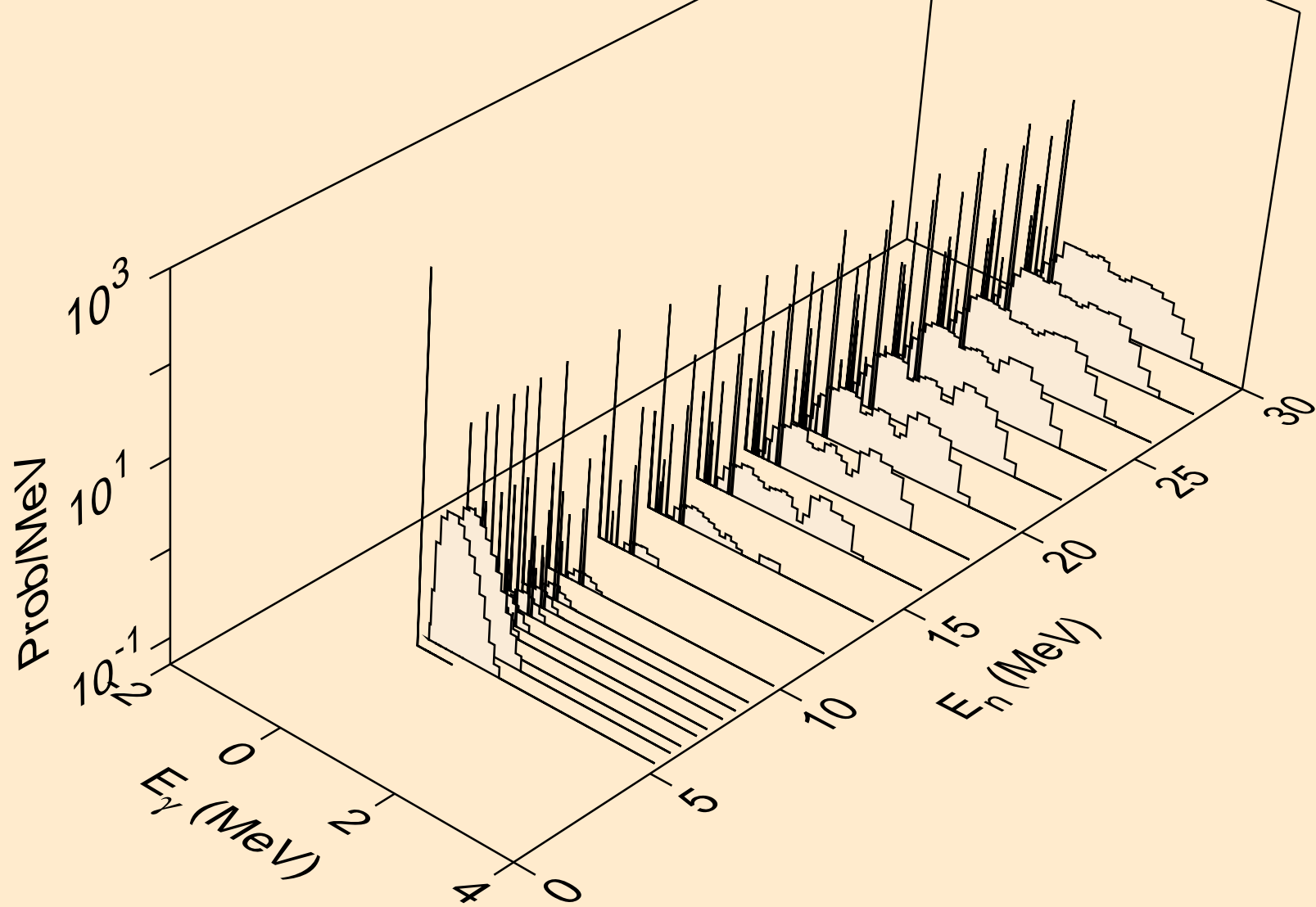

FR206 NEUTRON ACER TENDL-2021 LIBRARY; T=293.6K
thermal capture photon spectrum

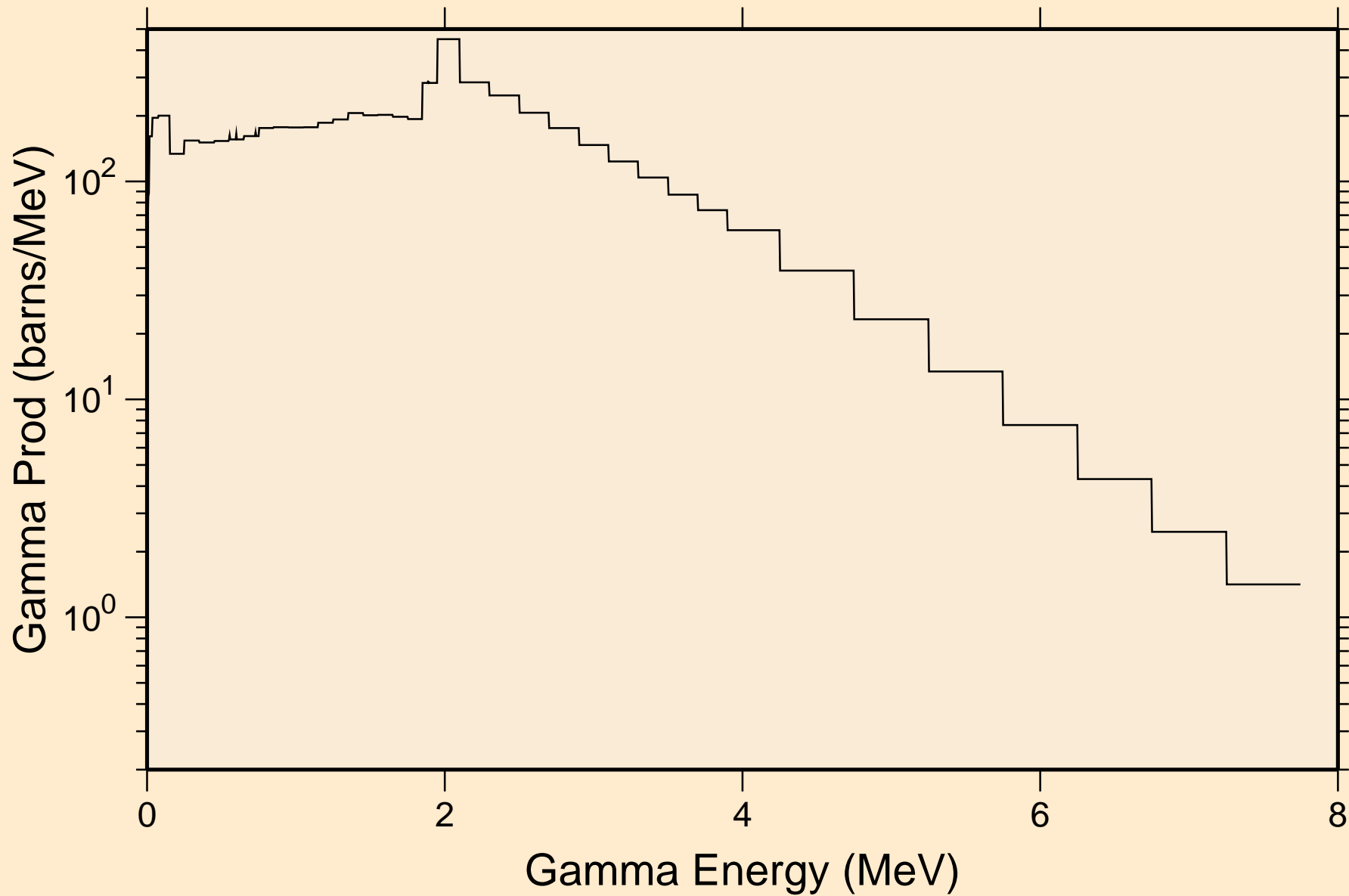

FR206 NEUTRON ACER TENDL-2021 LIBRARY; T=293.6K
14 MeV photon spectrum

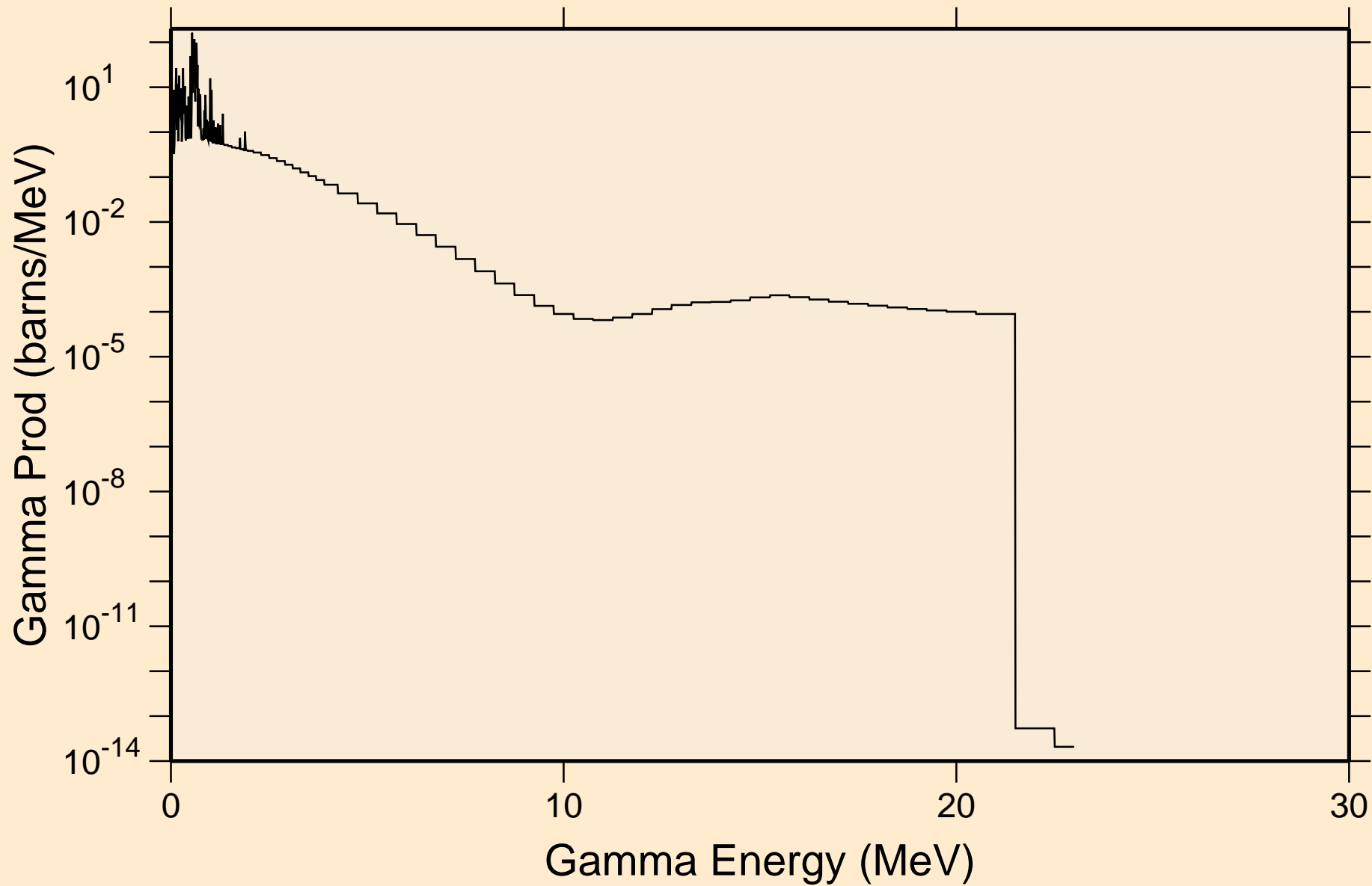

FR206 NEUTRON ACER TENDL-2021 LIBRARY; T=293.6K
Particle heating contributions

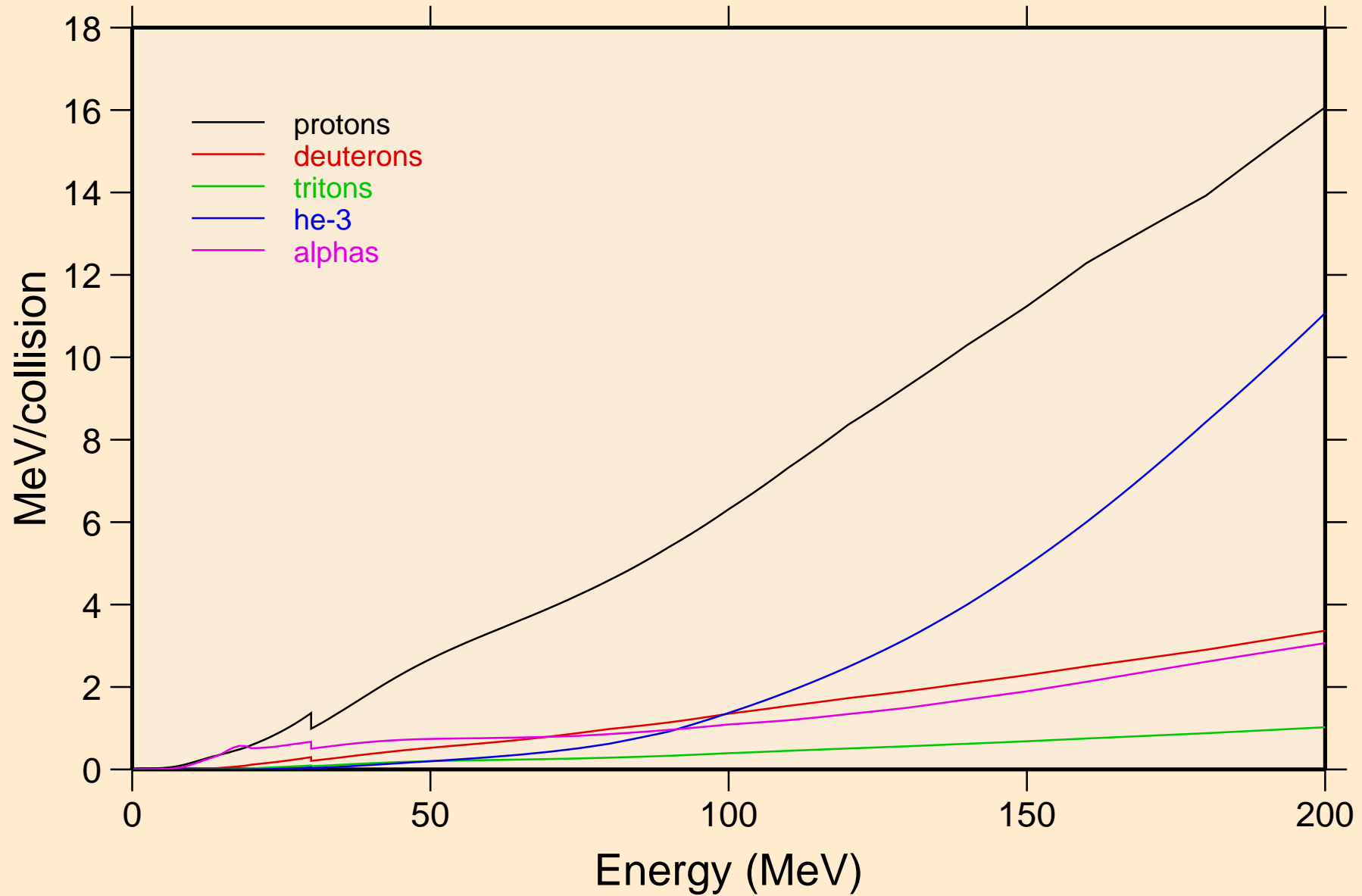

FR206 NEUTRON ACER TENDL-2021 LIBRARY; T=293.6K
Recoil Heating

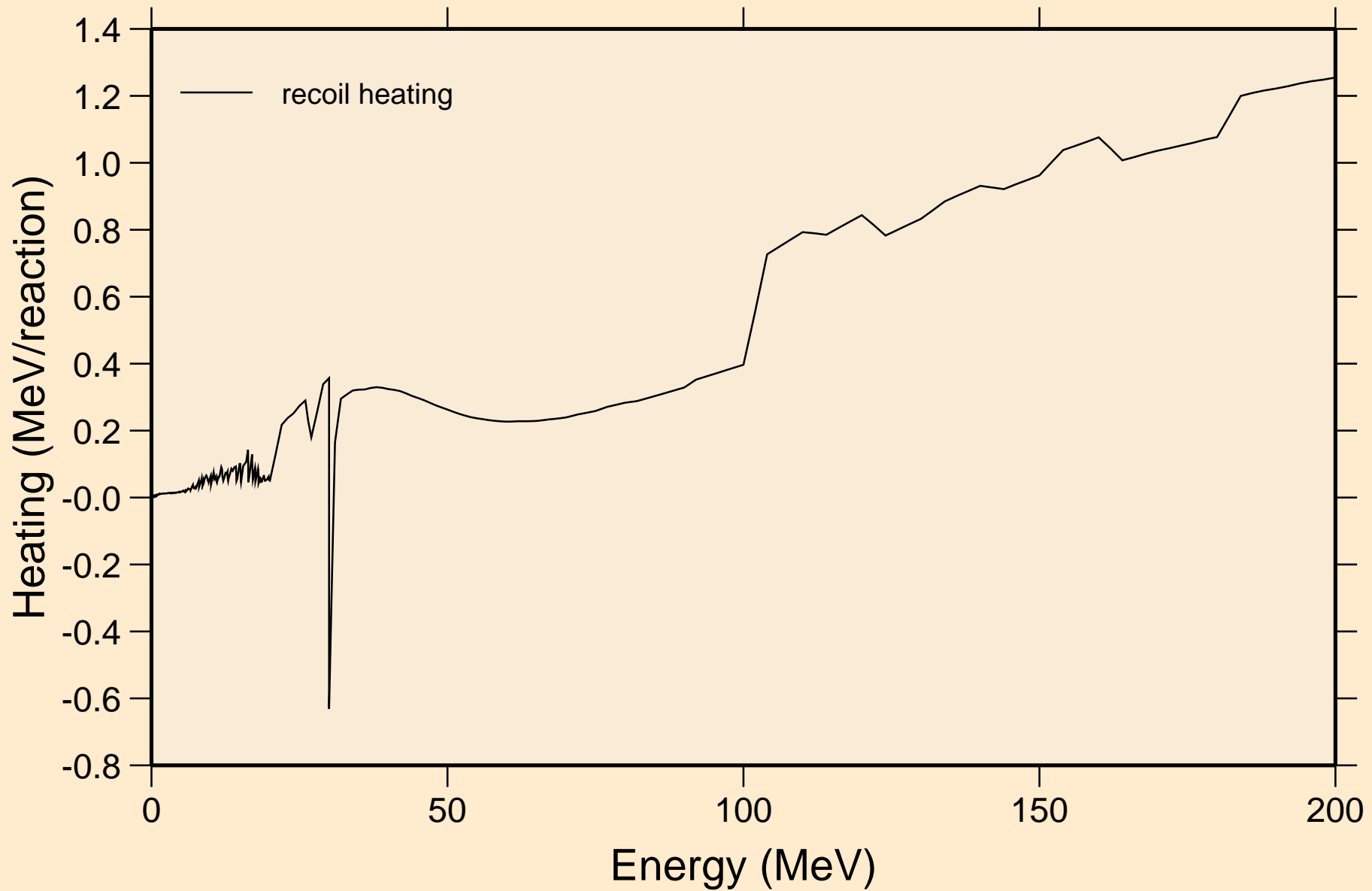

FR206 NEUTRON ACER TENDL-2021 LIBRARY; T=293.6K
Particle production cross sections

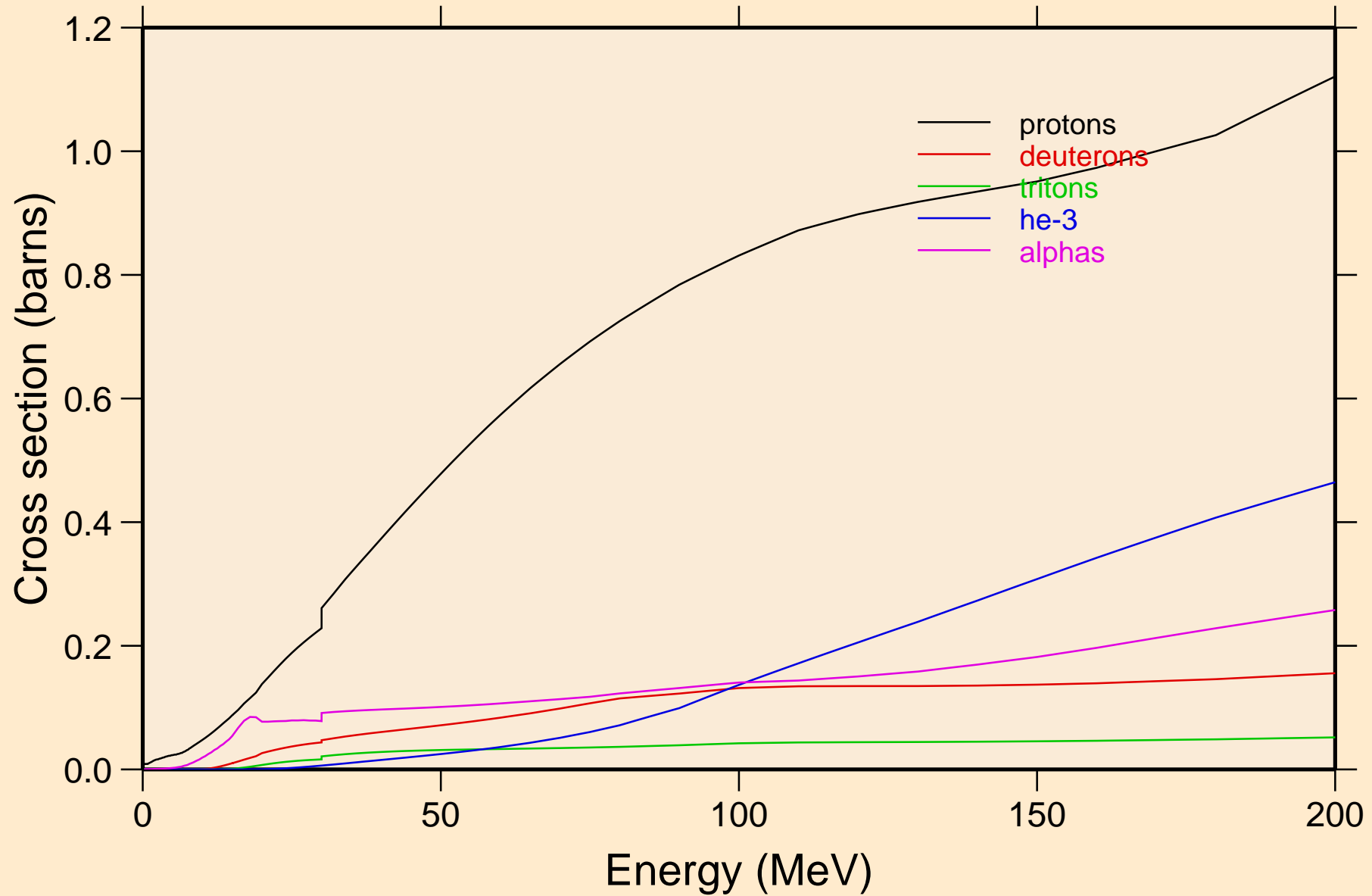

FR206 NEUTRON ACER TENDL-2021 LIBRARY; T=293.6K
protons from (n,x)

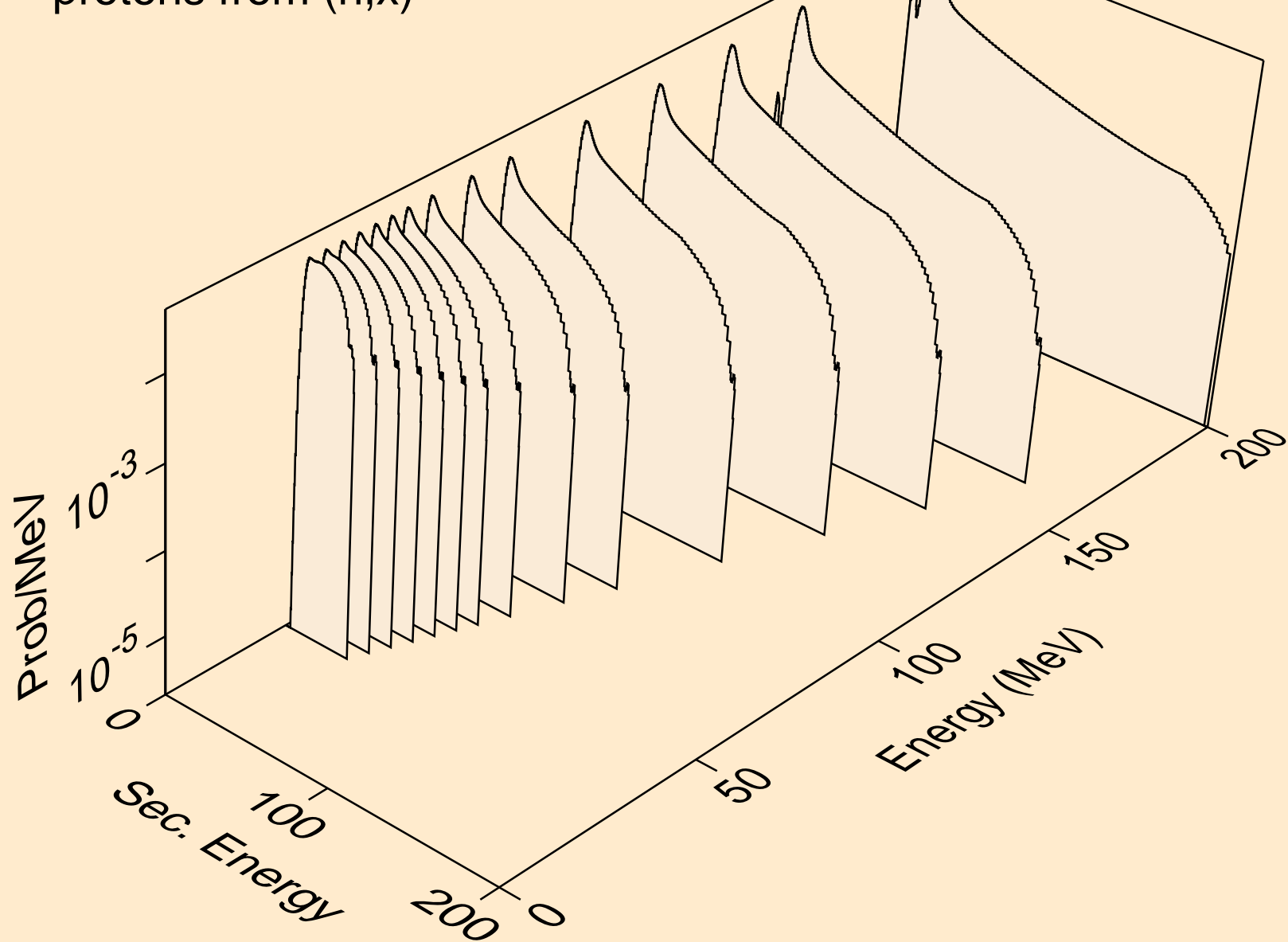

FR206 NEUTRON ACER TENDL-2021 LIBRARY; T=293.6K
protons from (n,n*)p

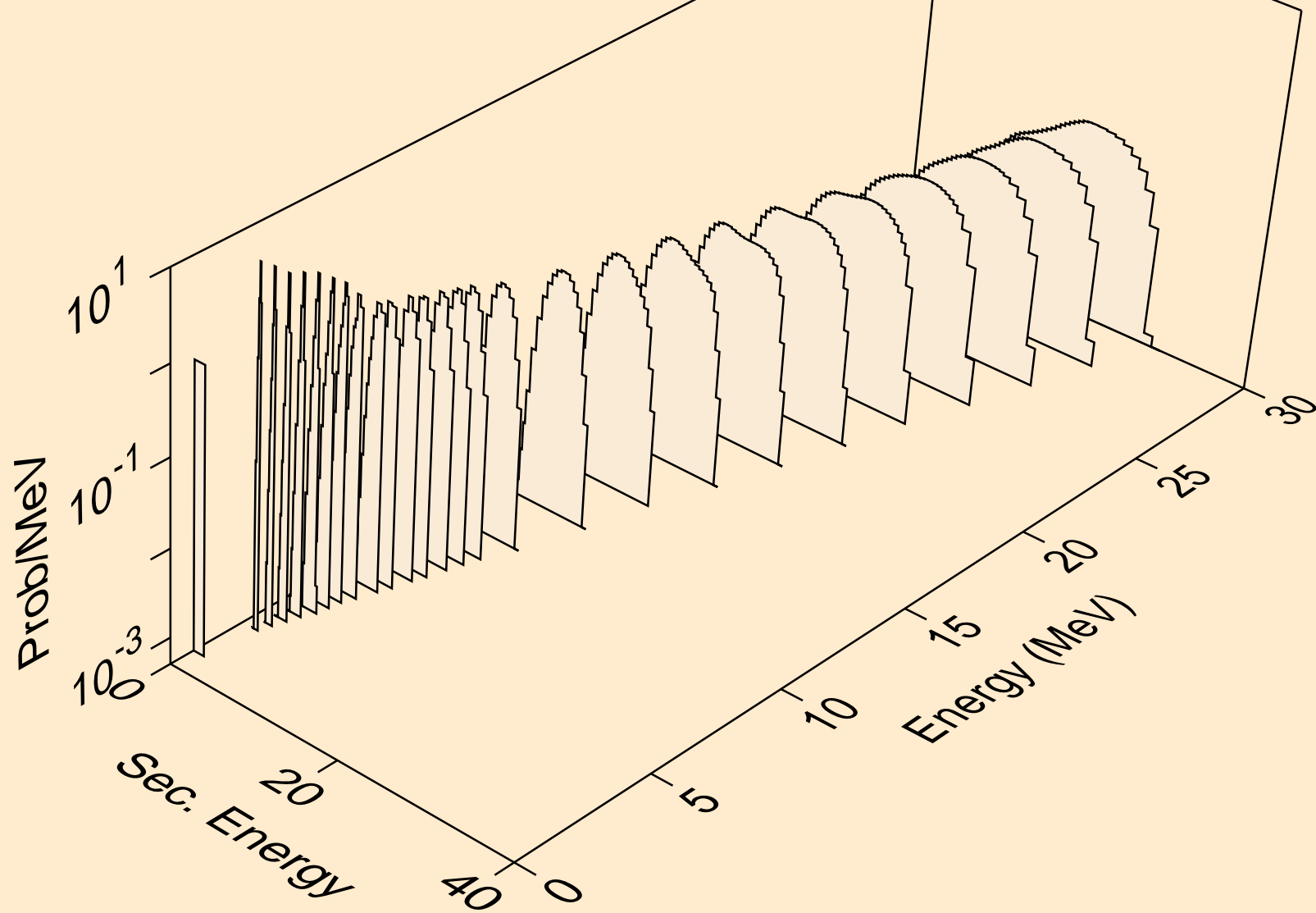

FR206 NEUTRON ACER TENDL-2021 LIBRARY; T=293.6K
protons from (n,2np)

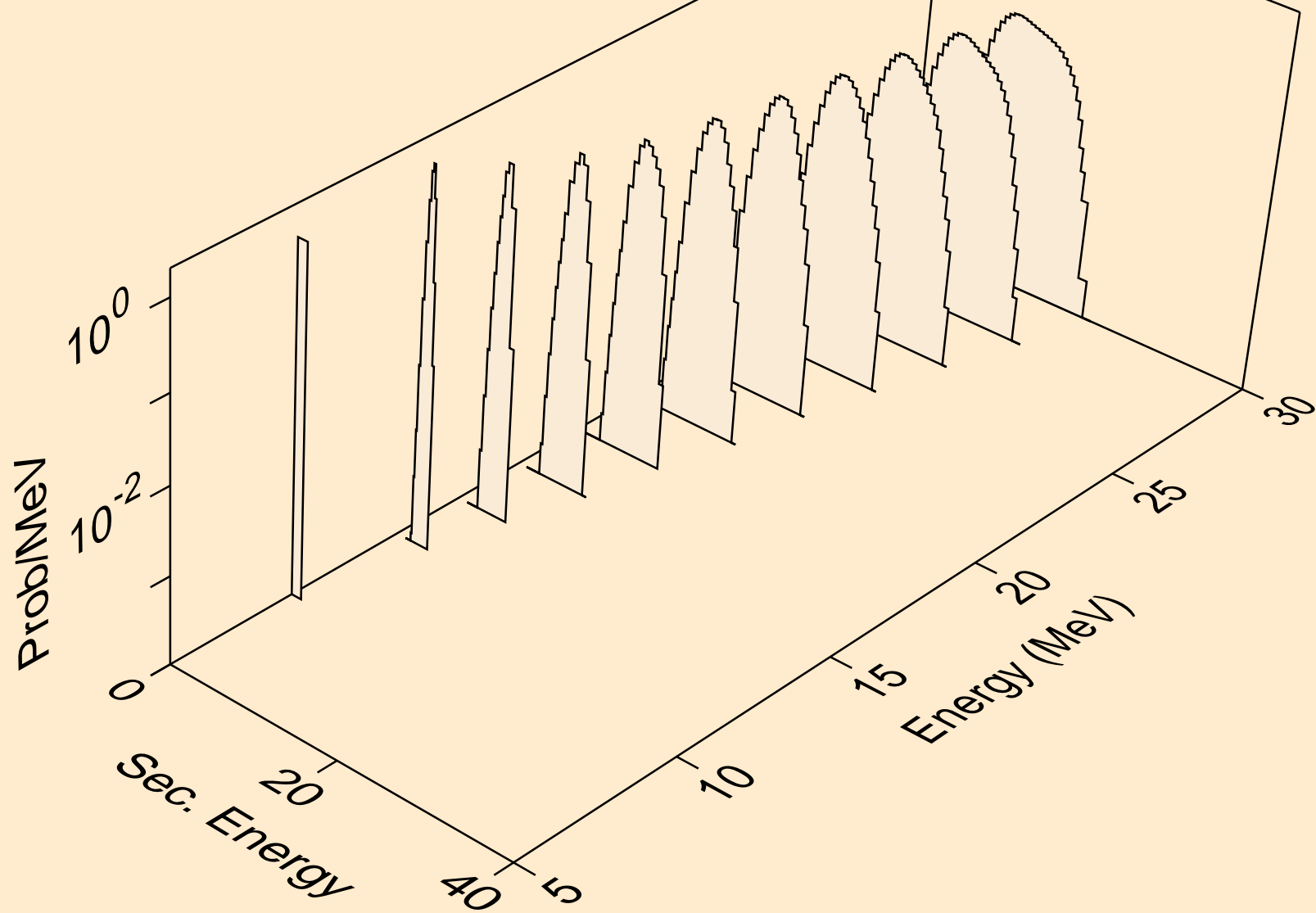

FR206 NEUTRON ACER TENDL-2021 LIBRARY; T=293.6K
protons from (n,3np)

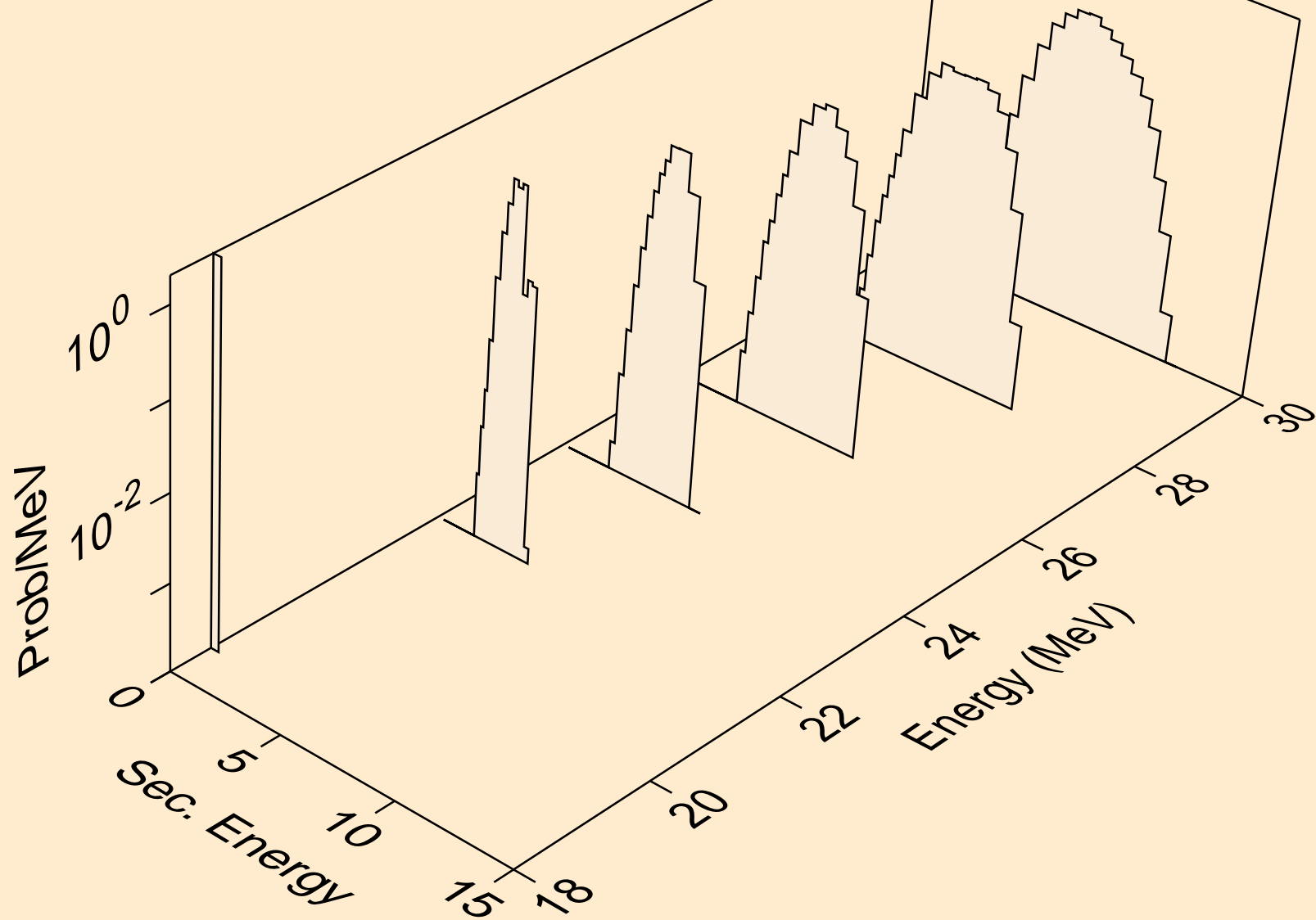

FR206 NEUTRON ACER TENDL-2021 LIBRARY; T=293.6K
protons from (n,2np)

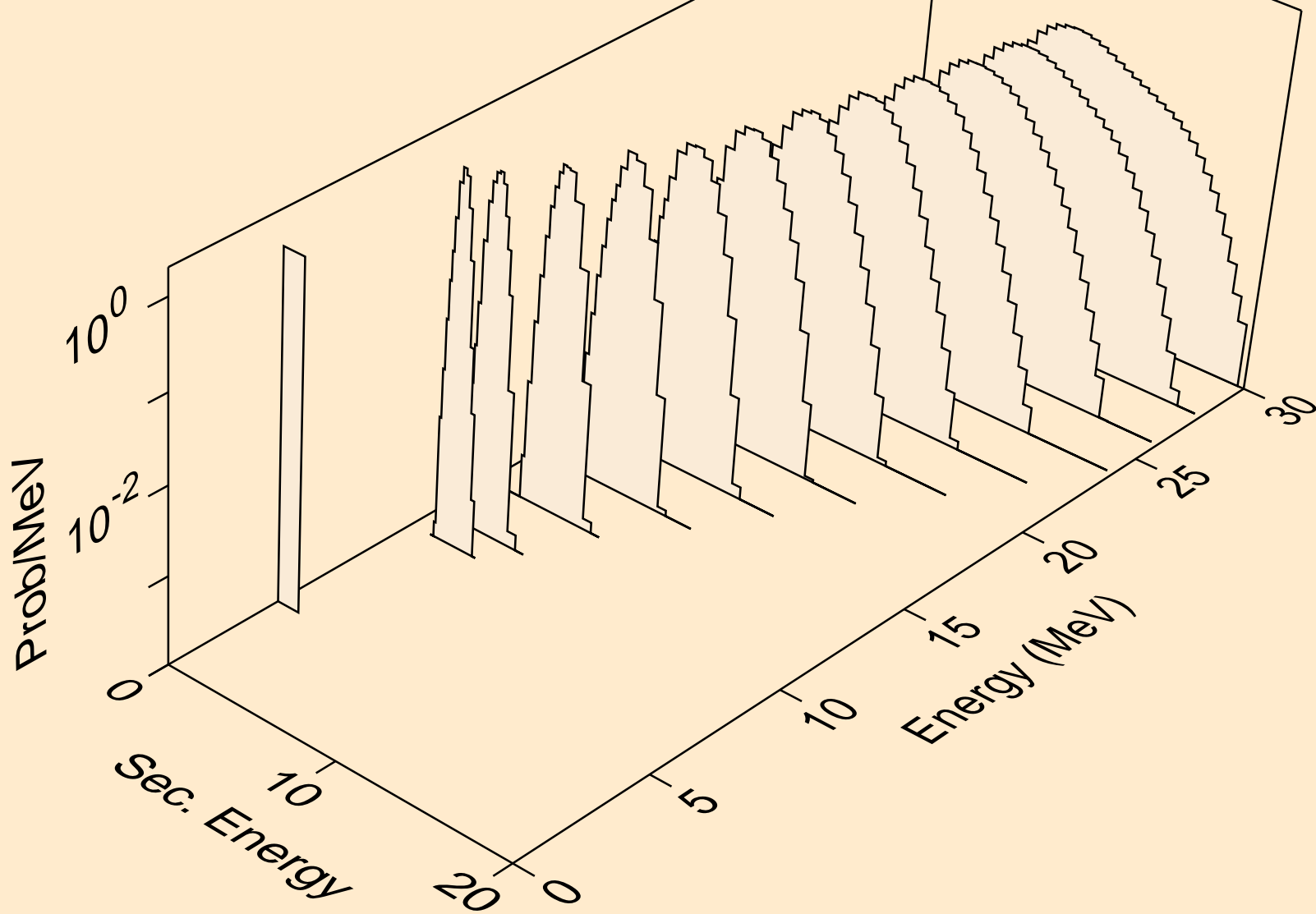

FR206 NEUTRON ACER TENDL-2021 LIBRARY; T=293.6K
protons from (n,npa)

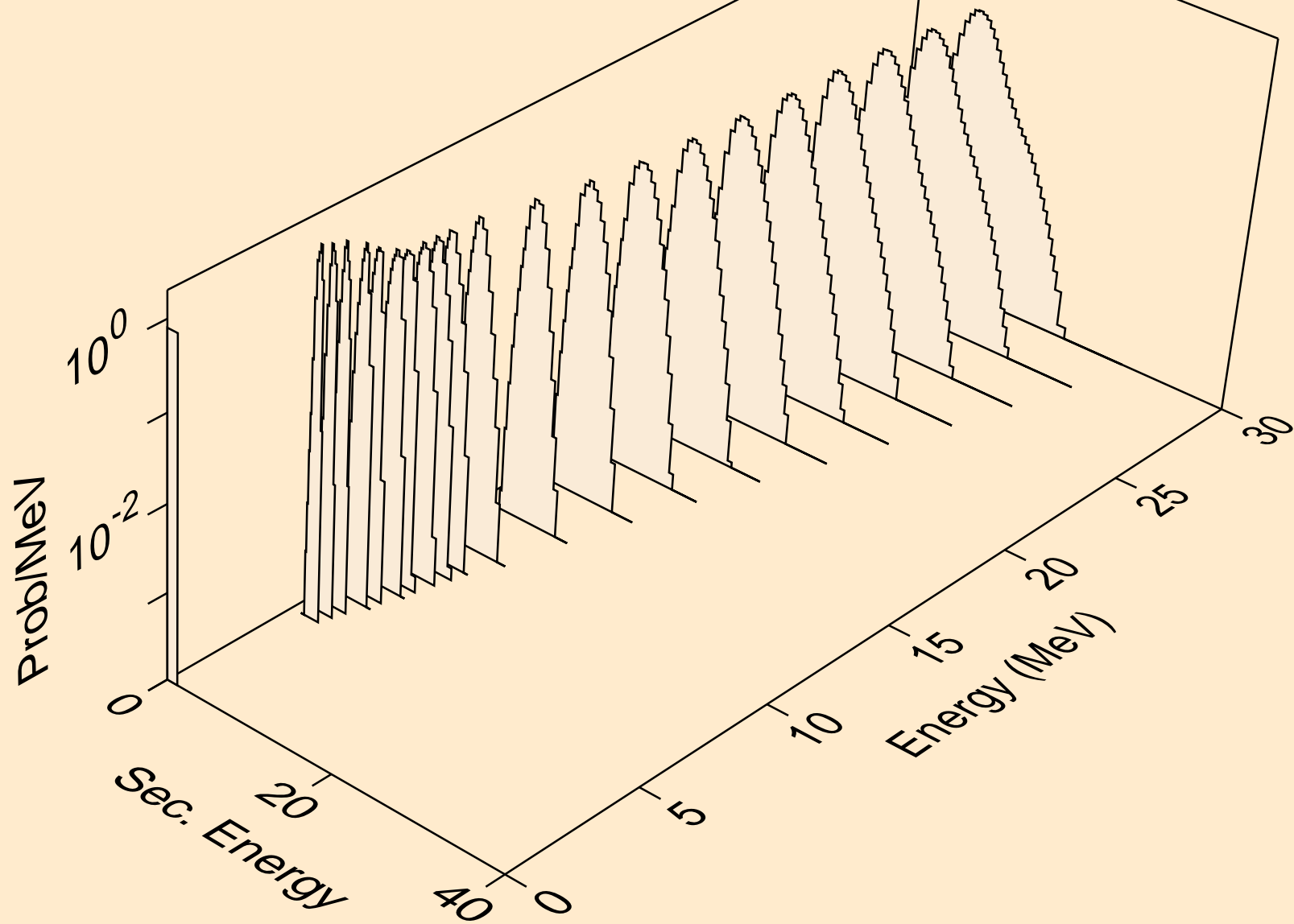

FR206 NEUTRON ACER TENDL-2021 LIBRARY; T=293.6K
protons from (n,p)

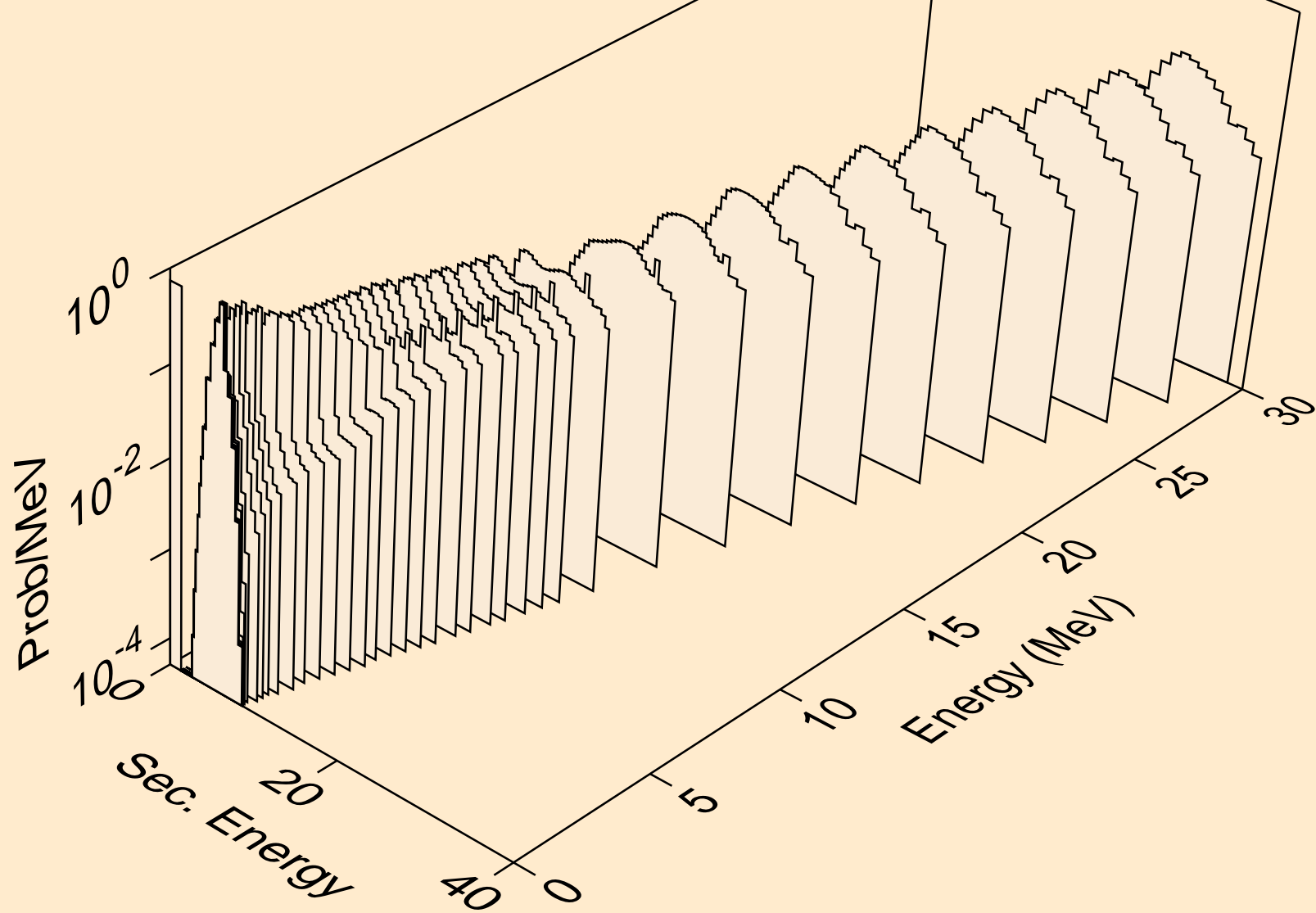

FR206 NEUTRON ACER TENDL-2021 LIBRARY; T=293.6K
protons from (n,2p)

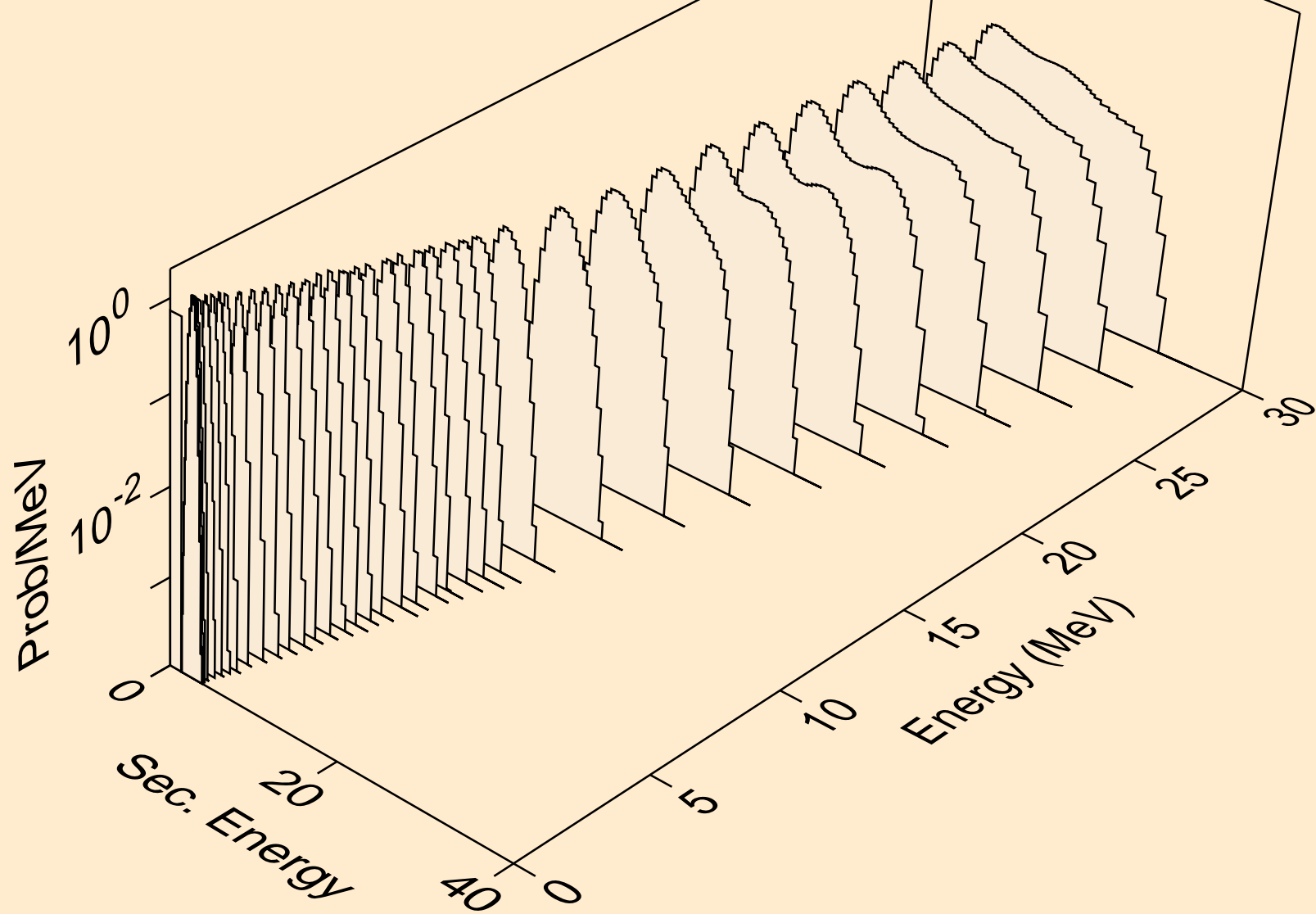

FR206 NEUTRON ACER TENDL-2021 LIBRARY; T=293.6K
protons from (n,p)

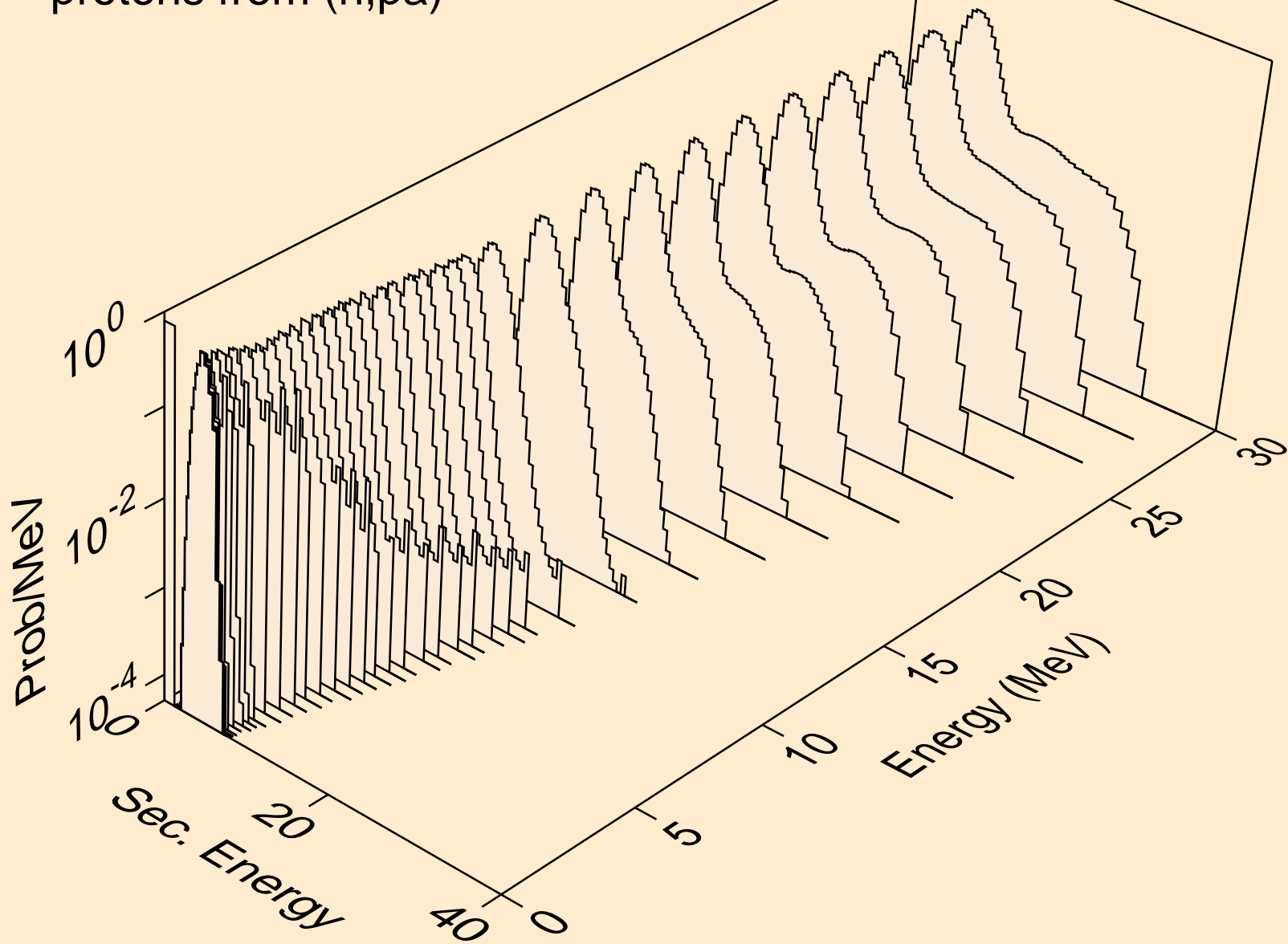

FR206 NEUTRON ACER TENDL-2021 LIBRARY; T=293.6K
protons from (n,pd)

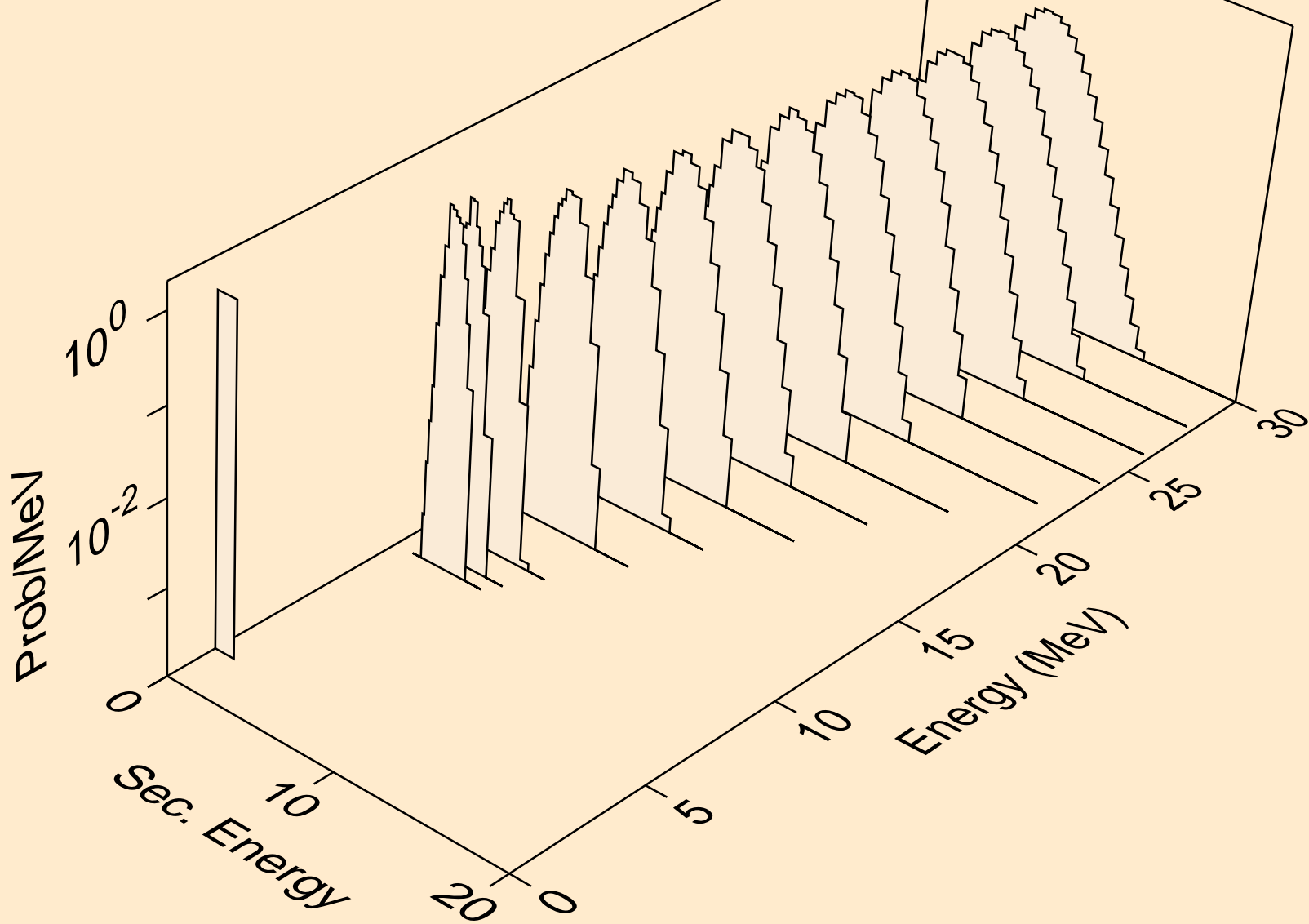

FR206 NEUTRON ACER TENDL-2021 LIBRARY; T=293.6K
protons from (n,pt)

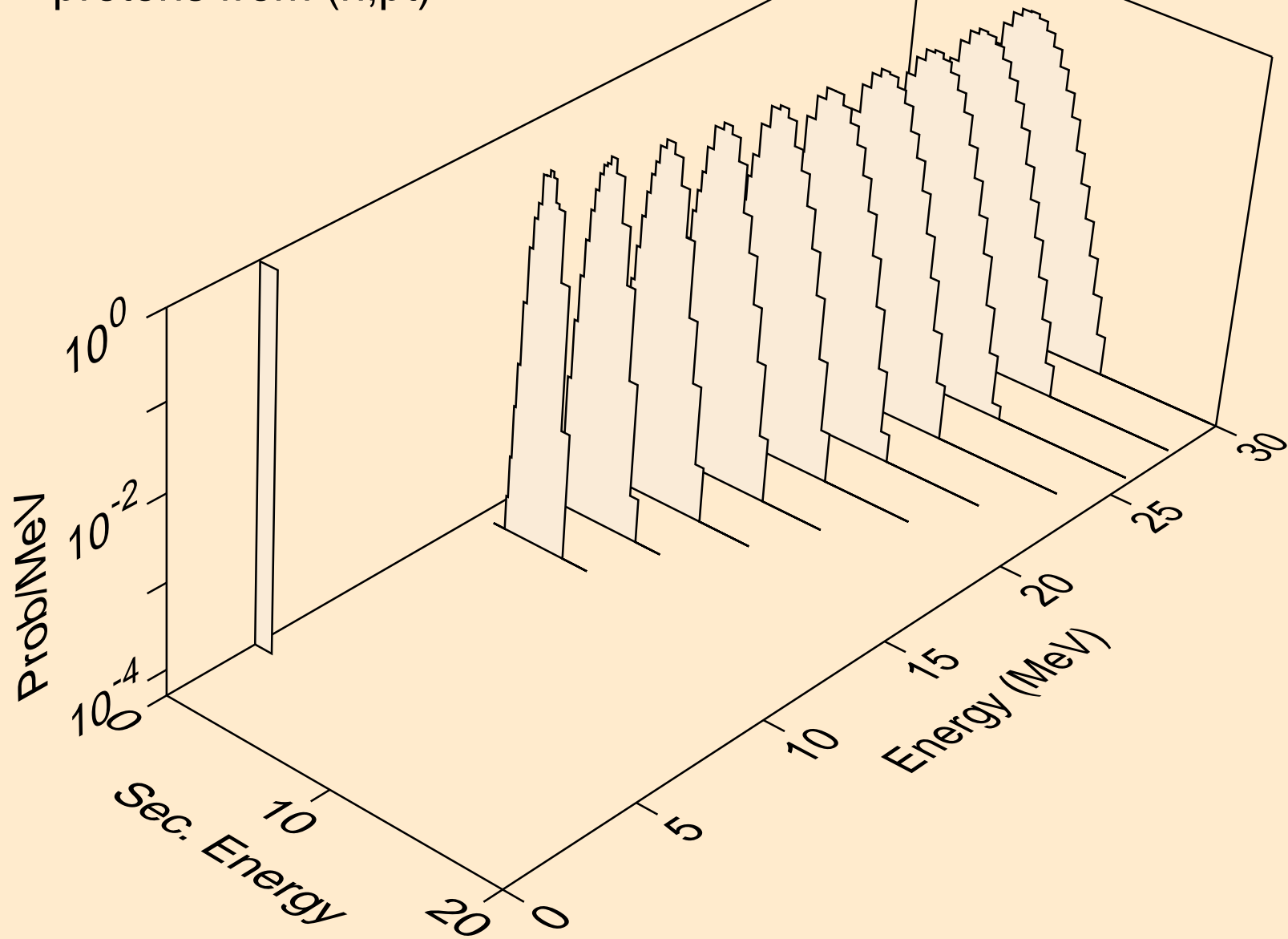

FR206 NEUTRON ACER TENDL-2021 LIBRARY; T=293.6K
deuterons from (n,x)

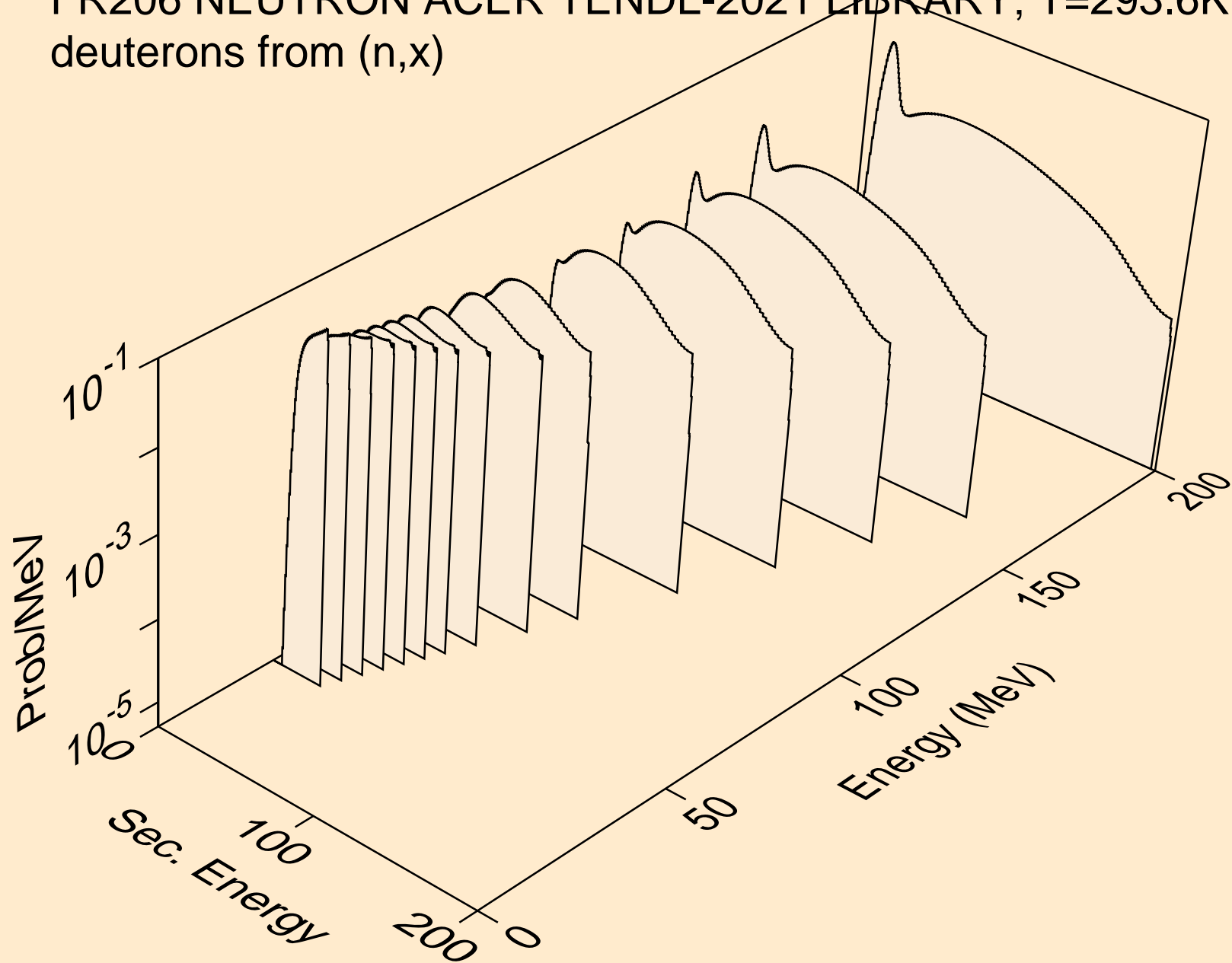

FR206 NEUTRON ACER TENDL-2021 LIBRARY; T=293.6K
deuterons from (n,2nd)

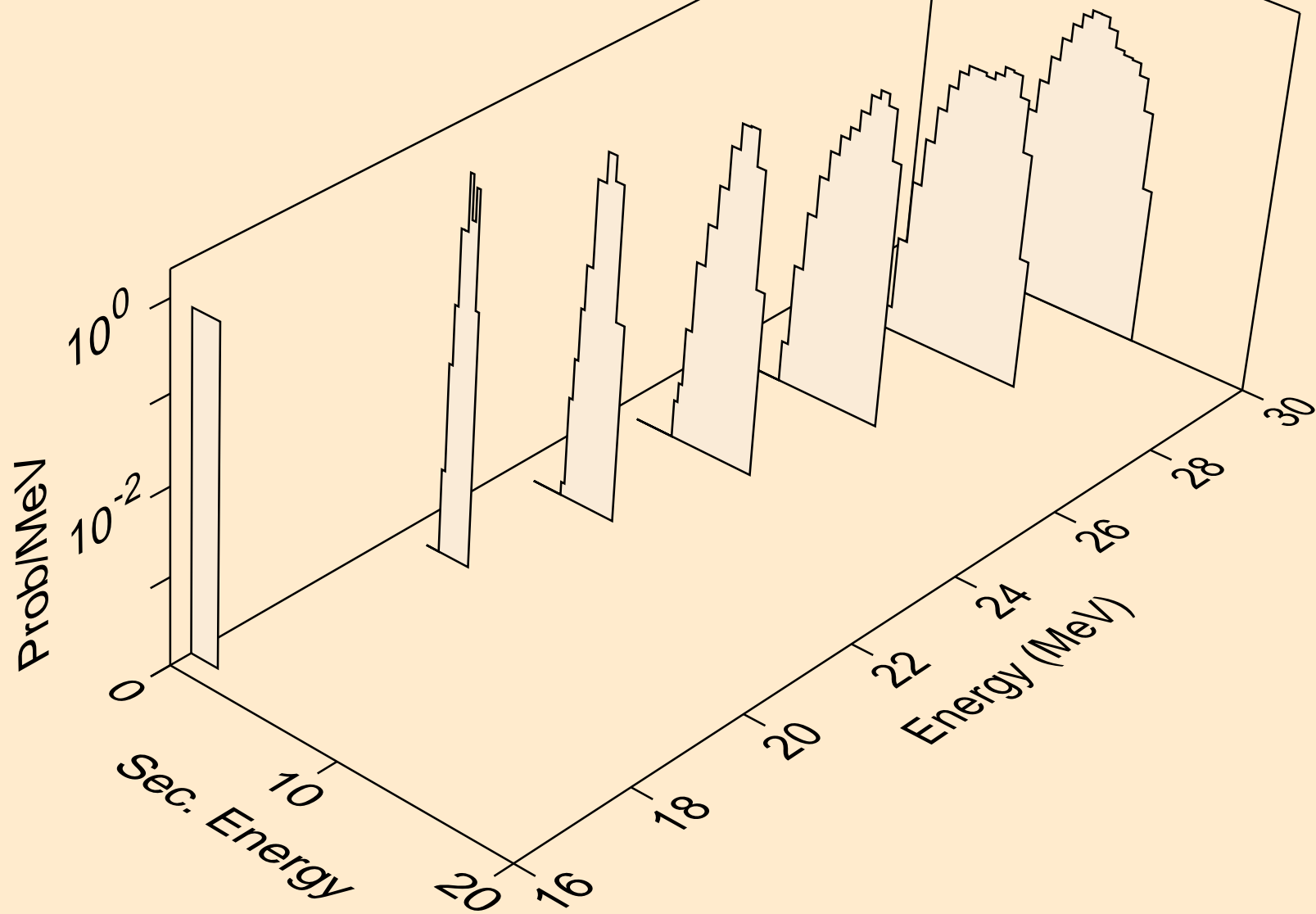

FR206 NEUTRON ACER TENDL-2021 LIBRARY; T=293.6K
deuterons from (n,n*)d

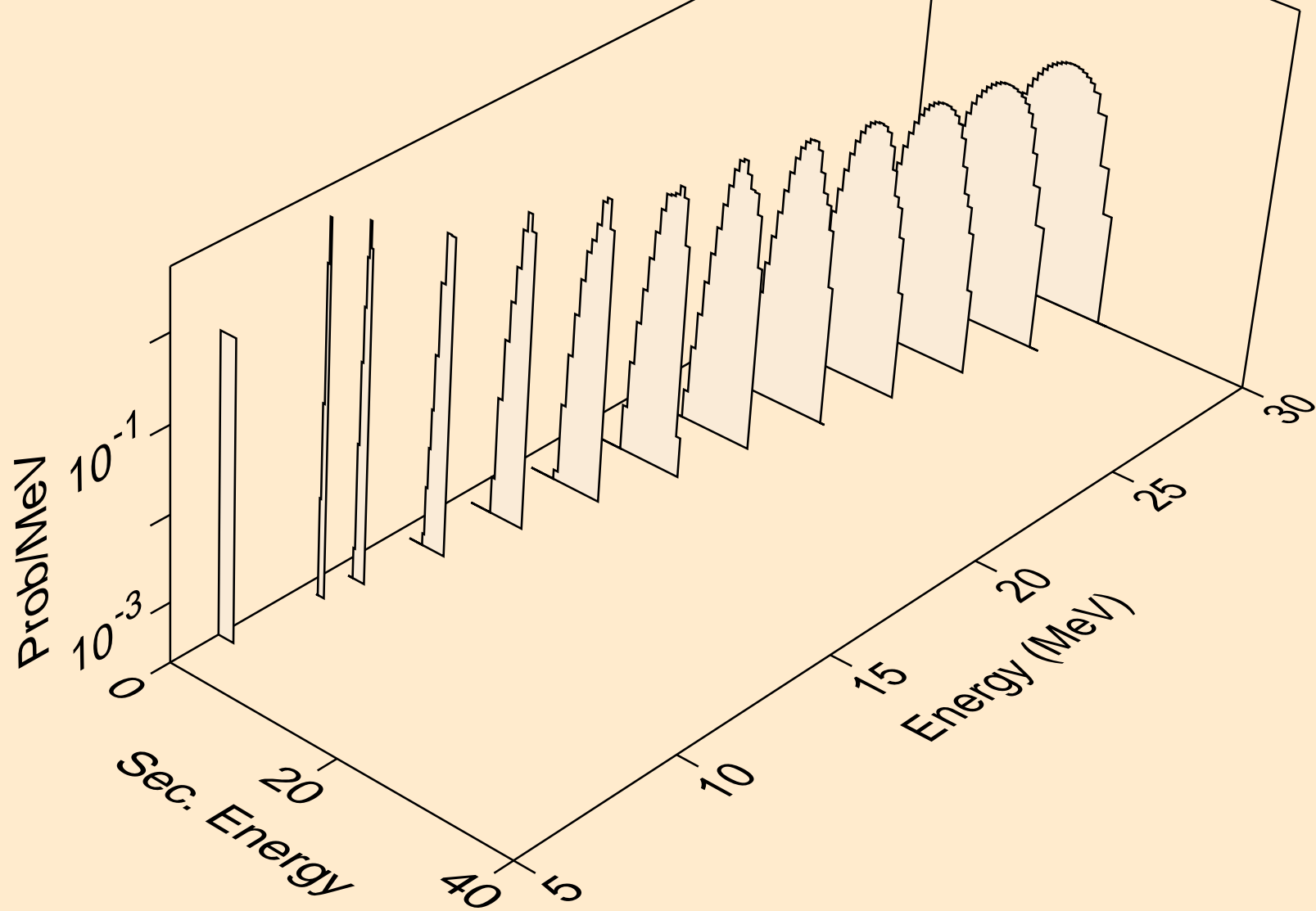

FR206 NEUTRON ACER TENDL-2021 LIBRARY; T=293.6K
deuterons from (n,d)

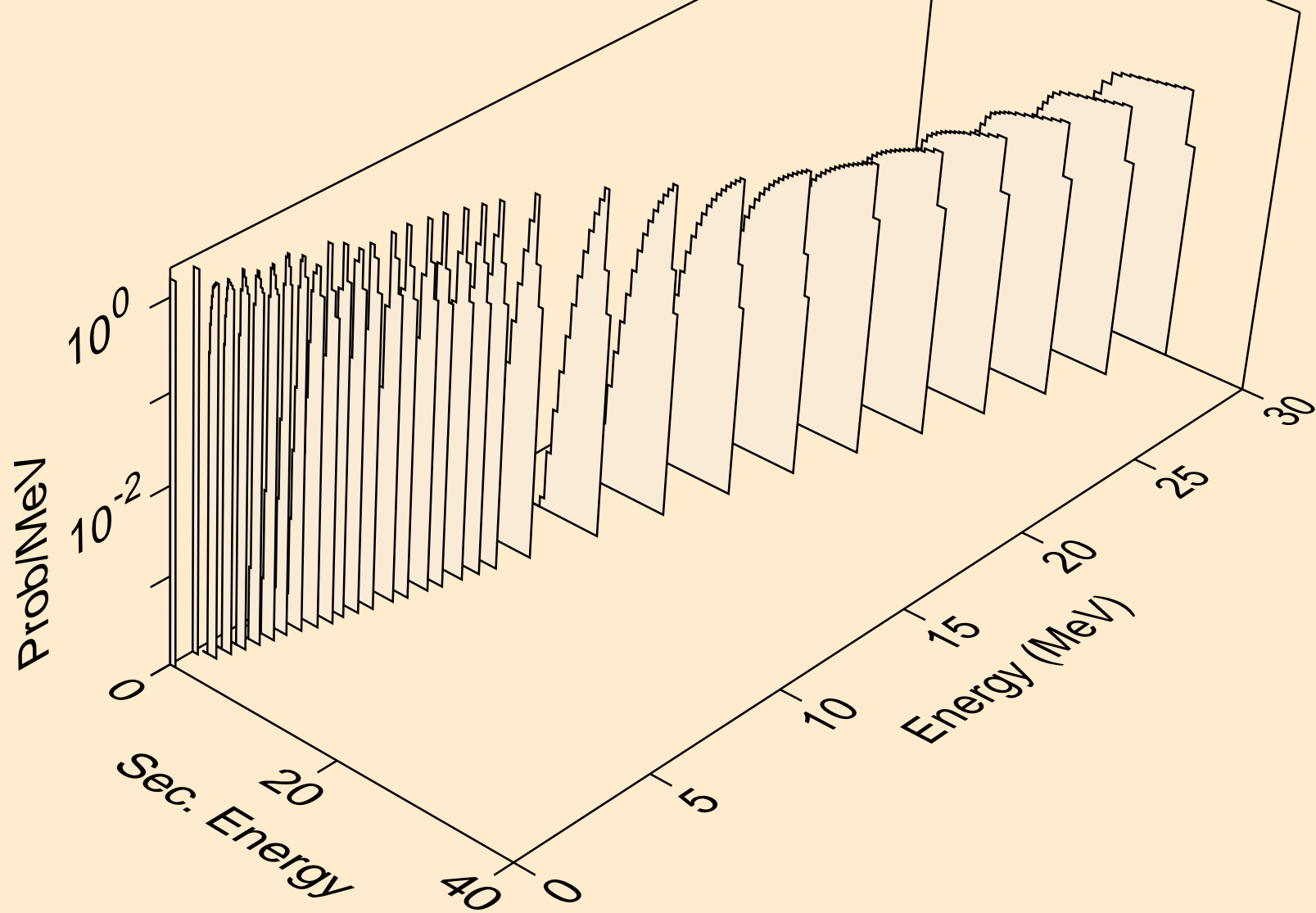

FR206 NEUTRON ACER TENDL-2021 LIBRARY; T=293.6K
deuterons from (n,pd)

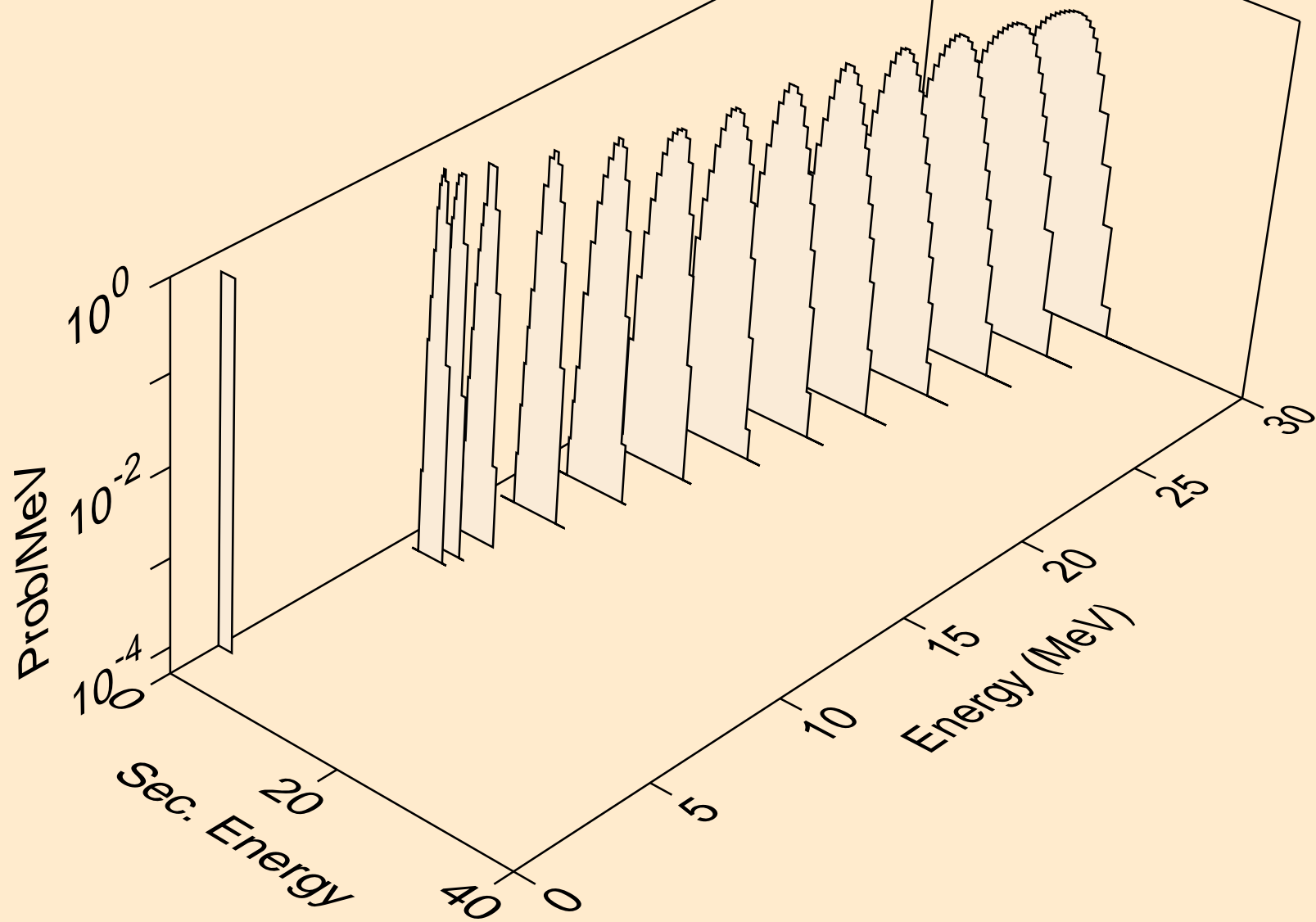

FR206 NEUTRON ACER TENDL-2021 LIBRARY; T=293.6K
deuterons from (n,da)

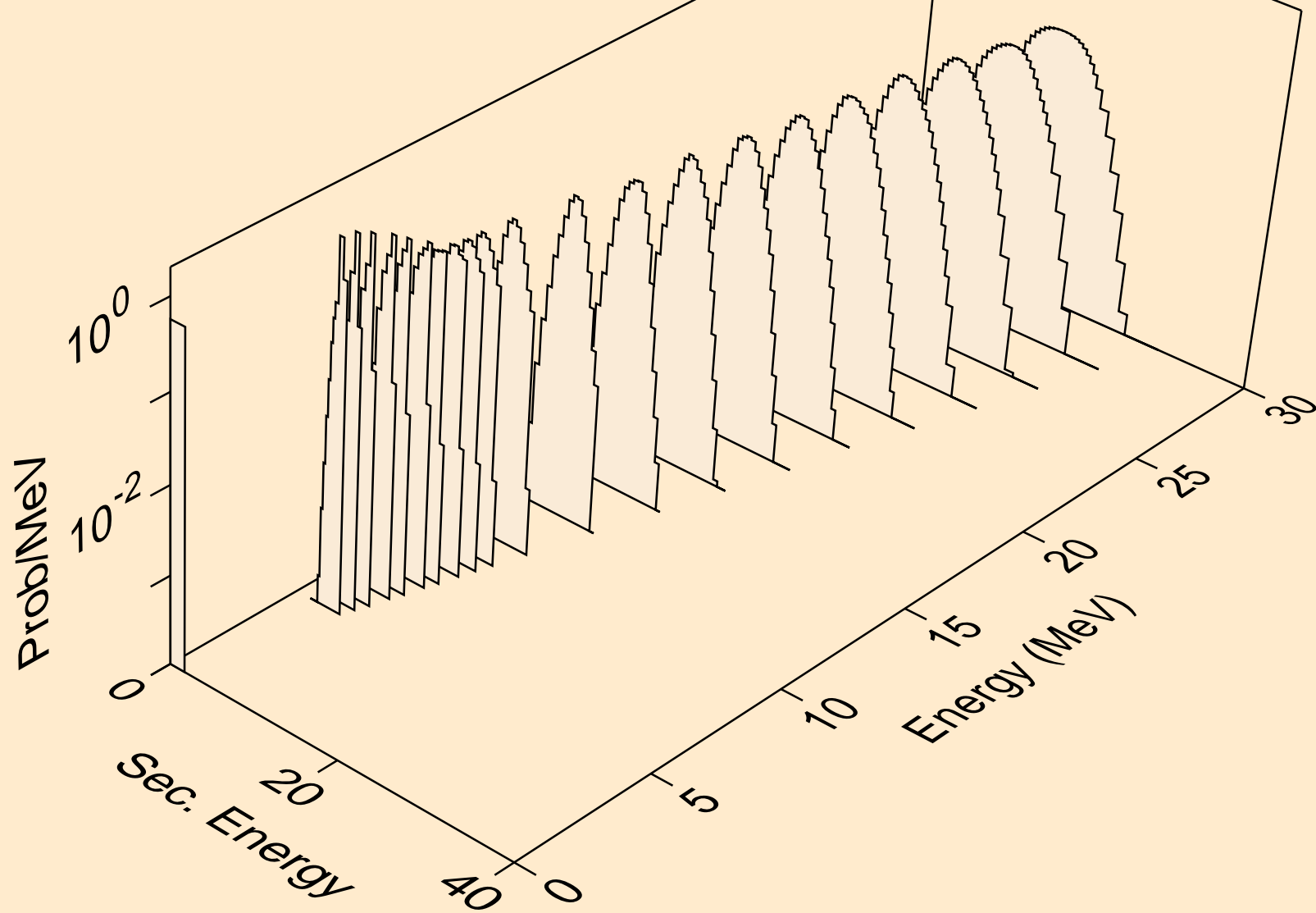

FR206 NEUTRON ACER TENDL-2021 LIBRARY; T=293.6K
tritons from (n,x)

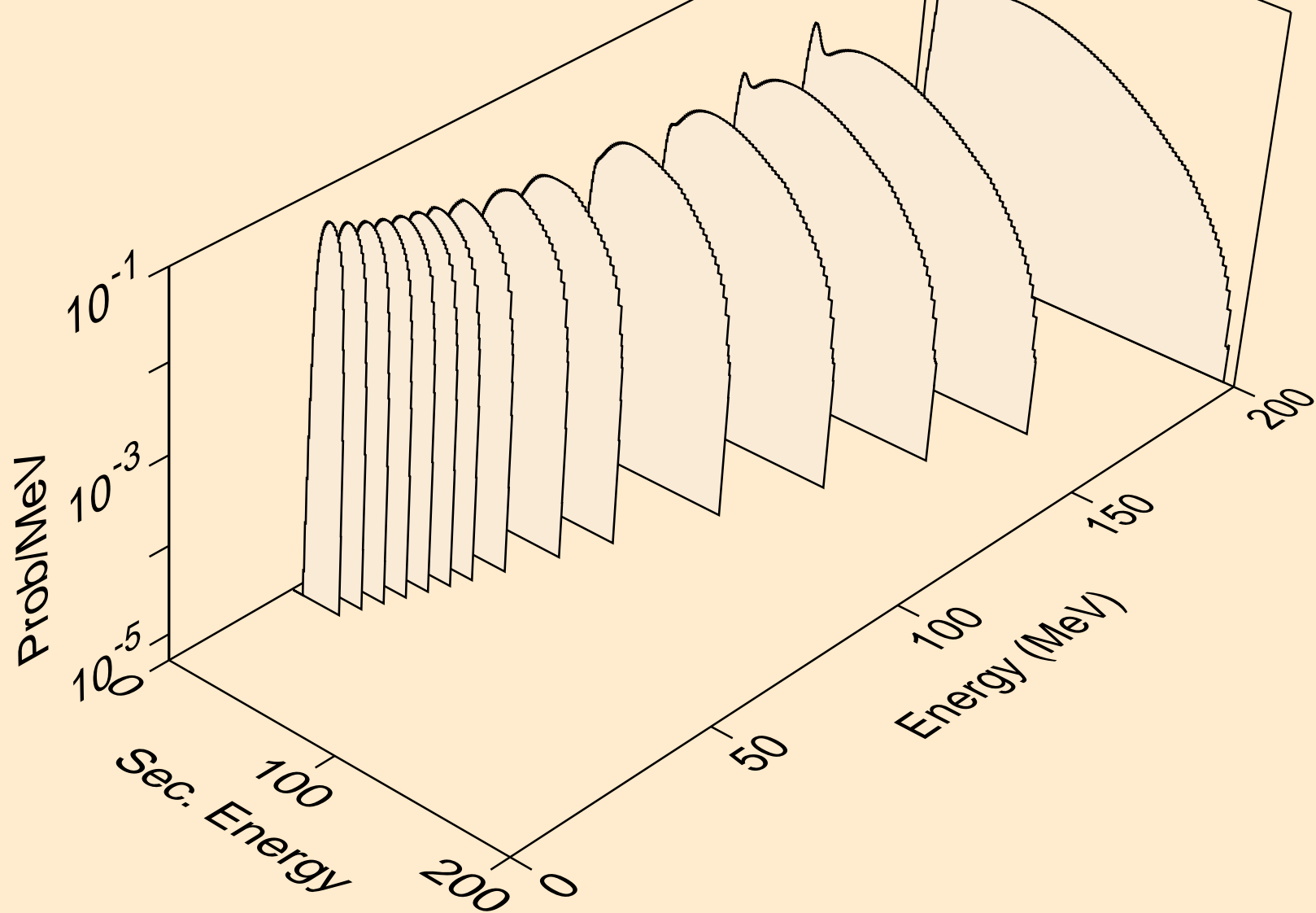

FR206 NEUTRON ACER TENDL-2021 LIBRARY; T=293.6K
tritons from (n,n*)t

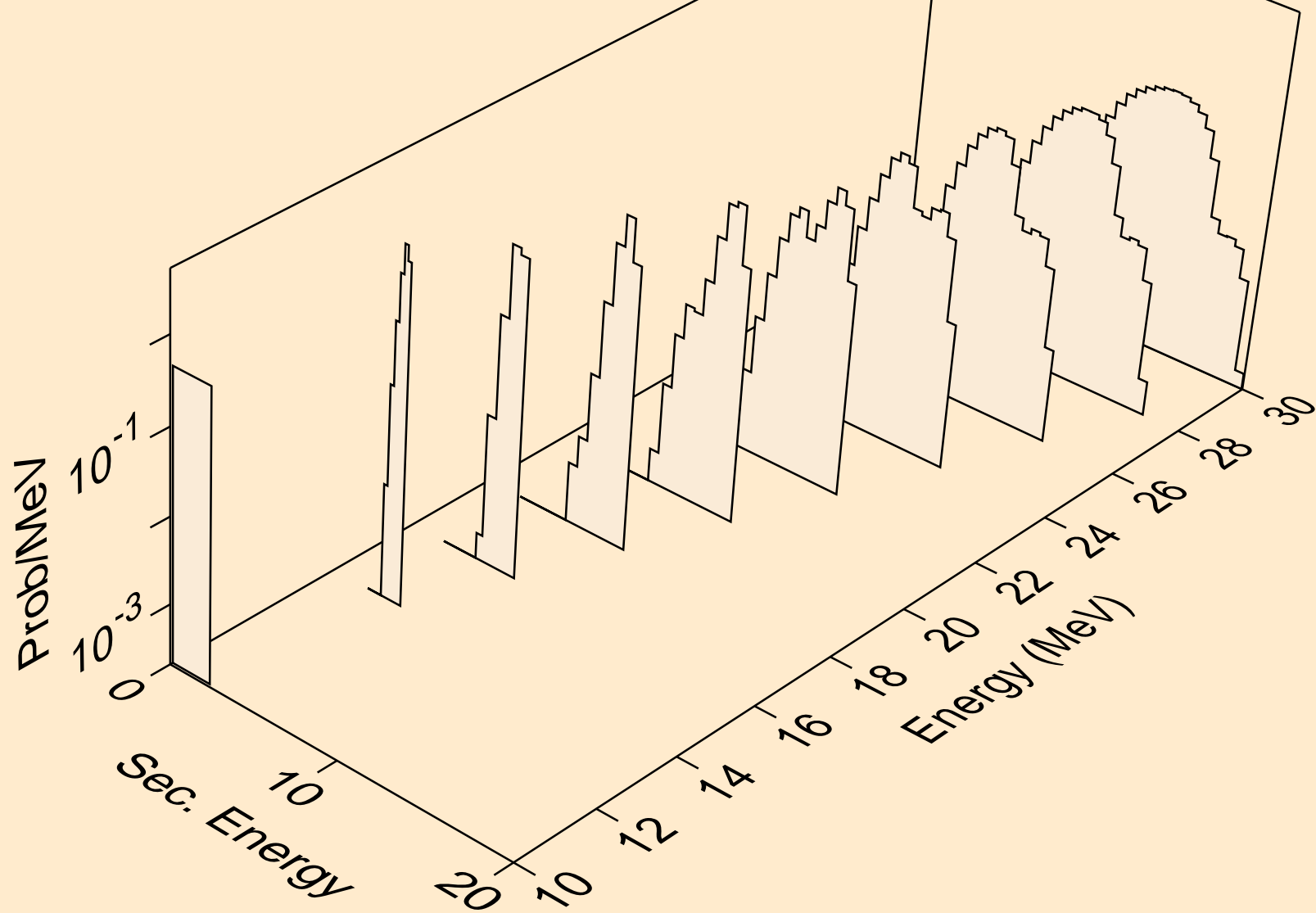

FR206 NEUTRON ACER TENDL-2021 LIBRARY; T=293.6K
tritons from (n,t)

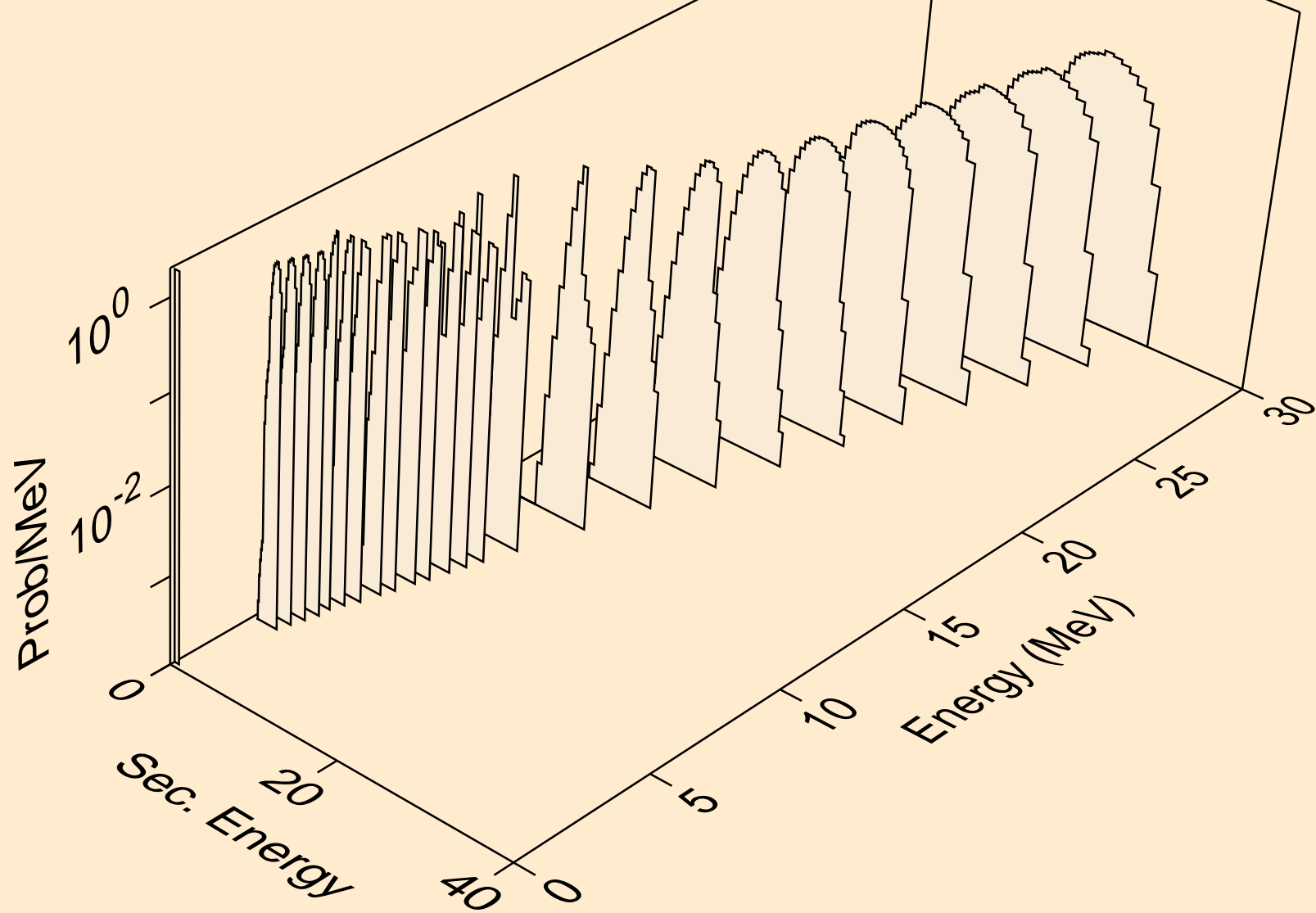

FR206 NEUTRON ACER TENDL-2021 LIBRARY; T=293.6K
tritons from (n,pt)

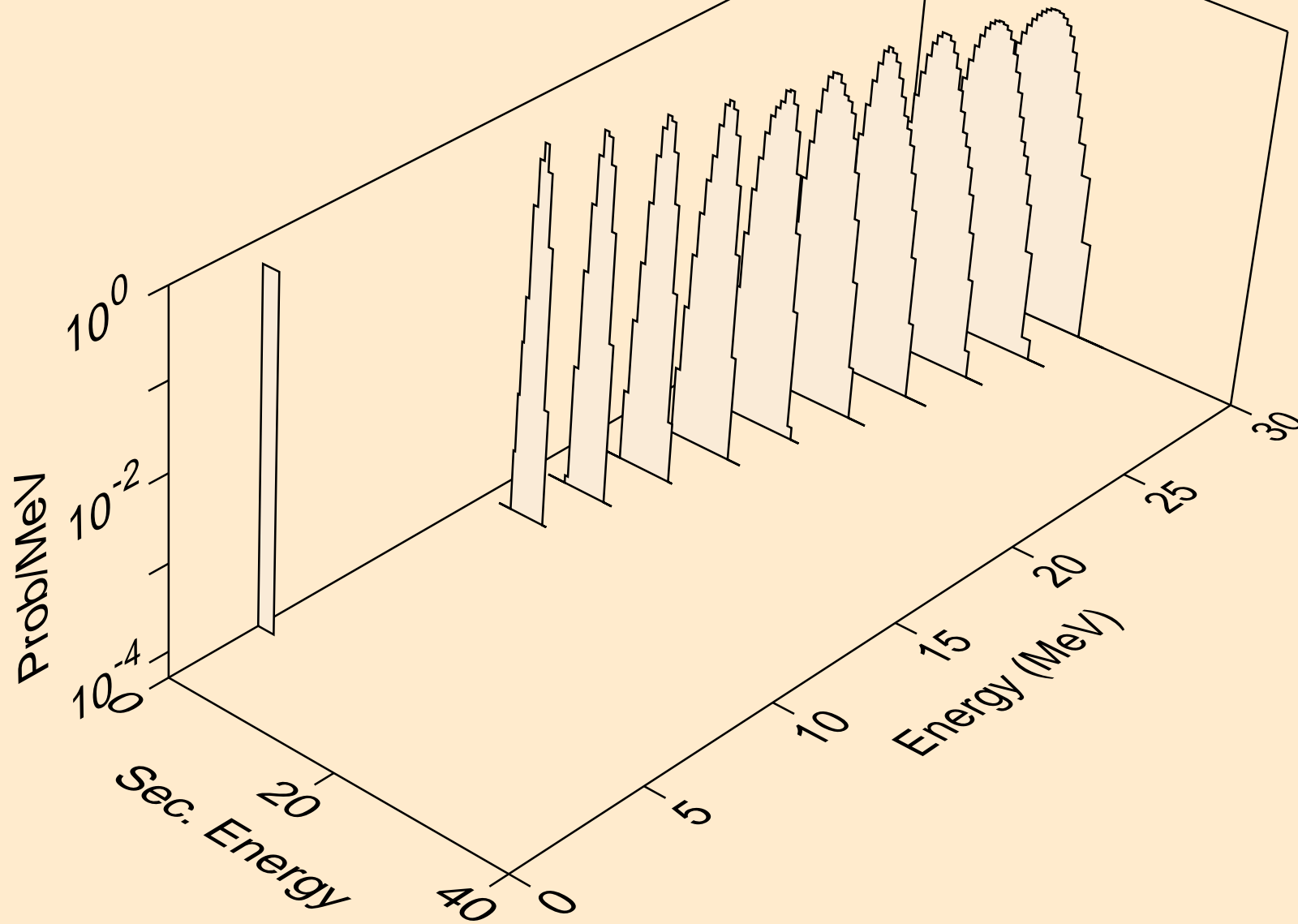

FR206 NEUTRON ACER TENDL-2021 LIBRARY; T=293.6K
he3s from (n,x)

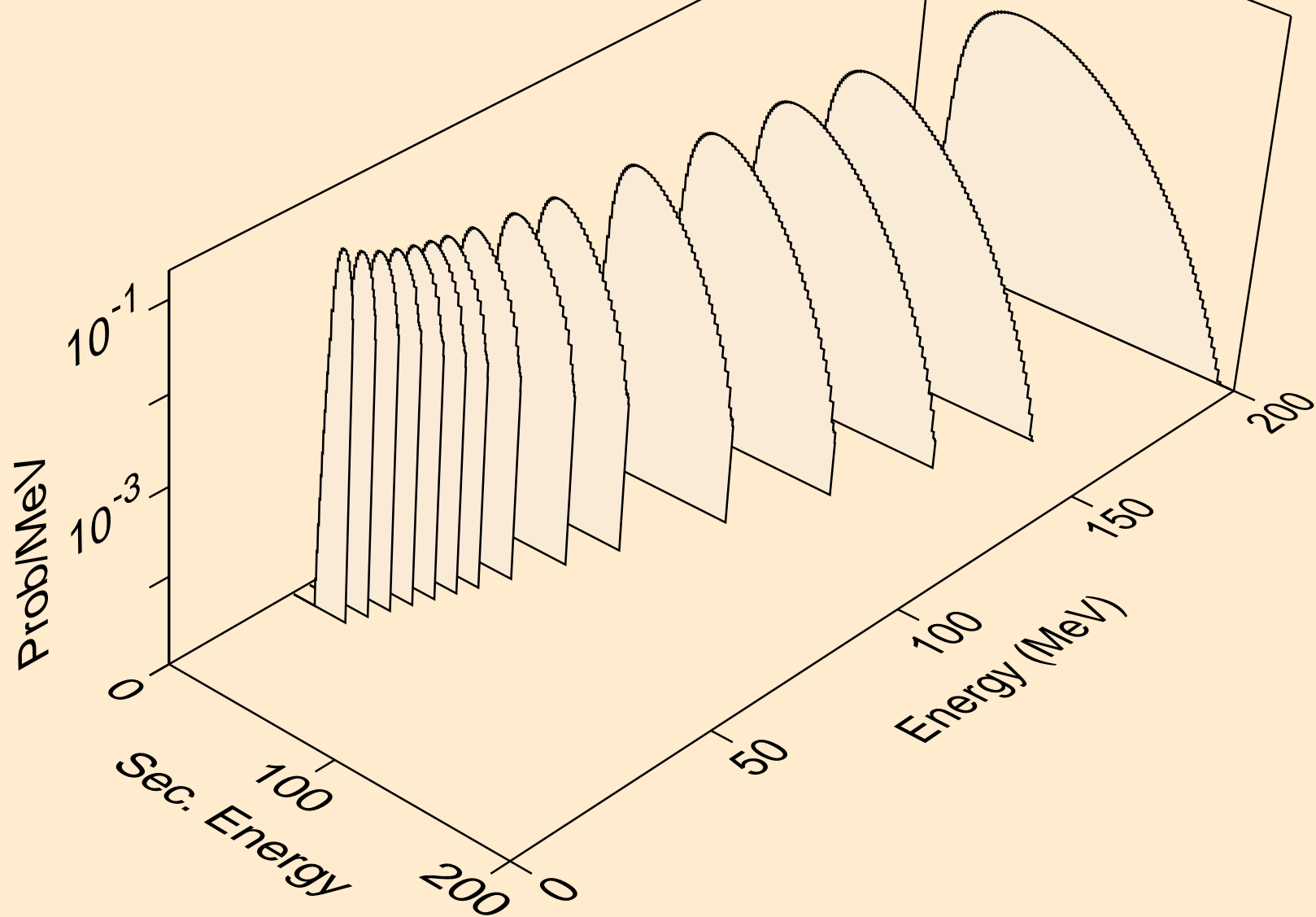

FR206 NEUTRON ACER TENDL-2021 LIBRARY; T=293.6K
he3s from (n,n*)he3

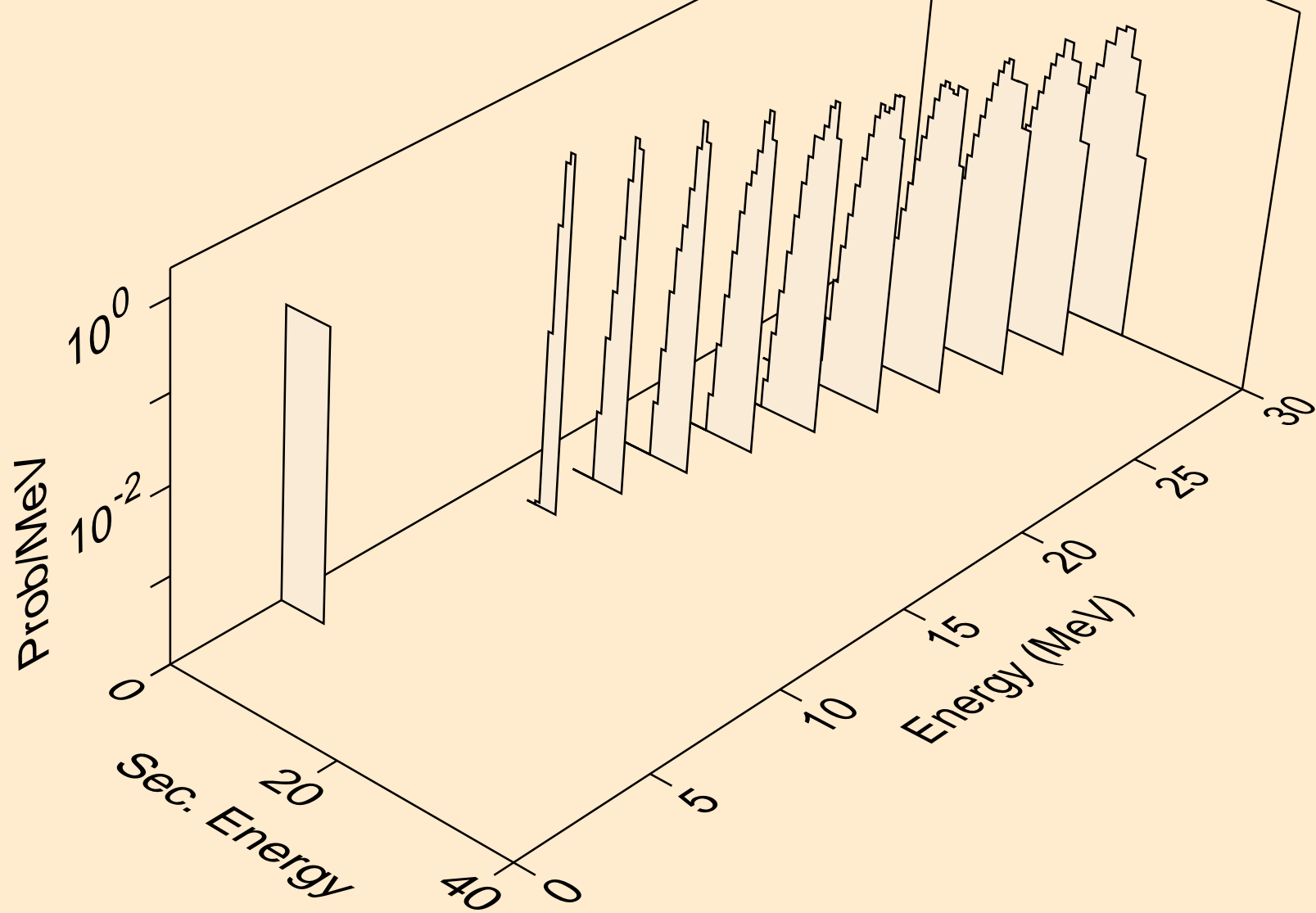

FR206 NEUTRON ACER TENDL-2021 LIBRARY; T=293.6K
he3s from (n,he3)

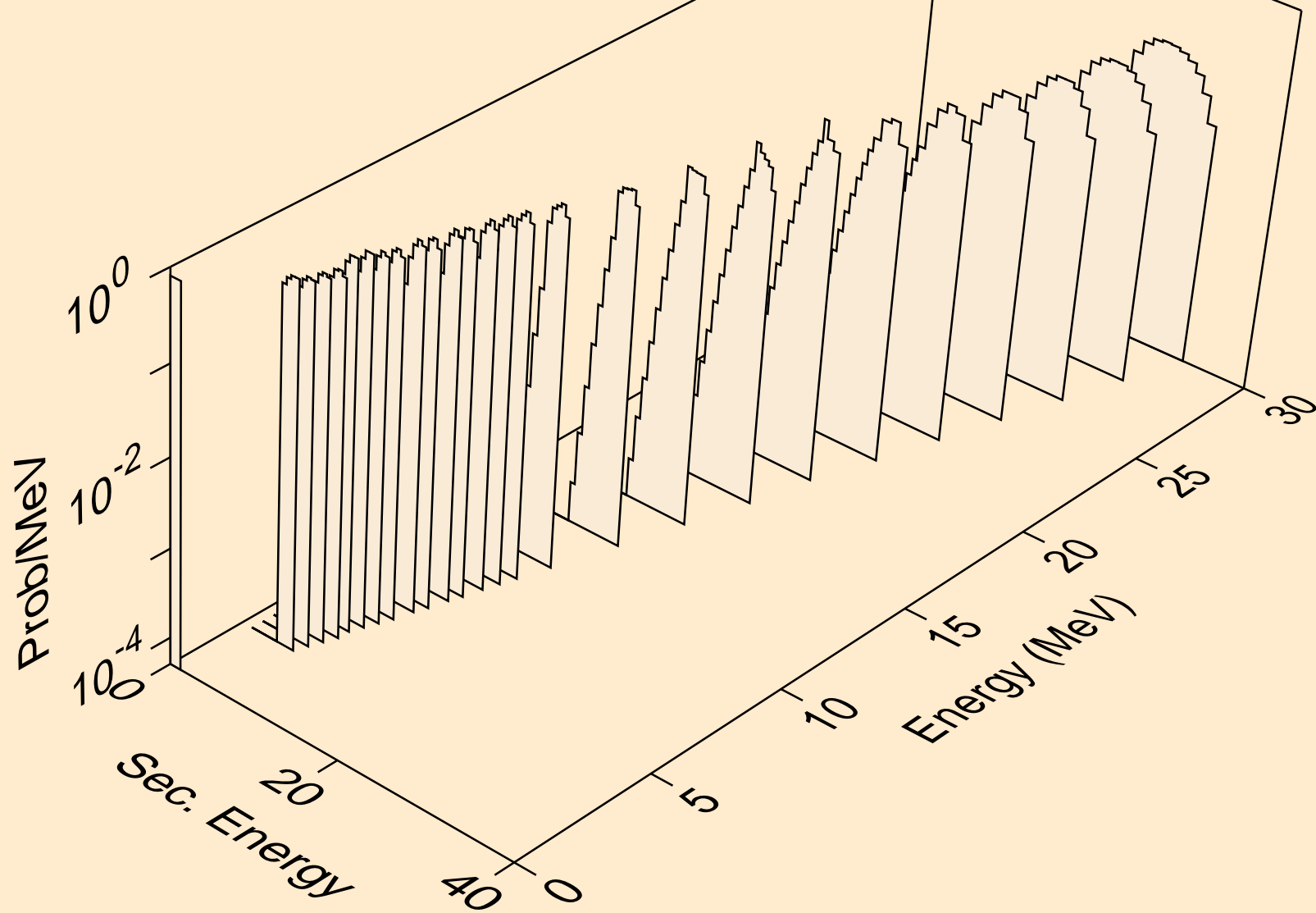

FR206 NEUTRON ACER TENDL-2021 LIBRARY; T=293.6K
alphas from (n,x)

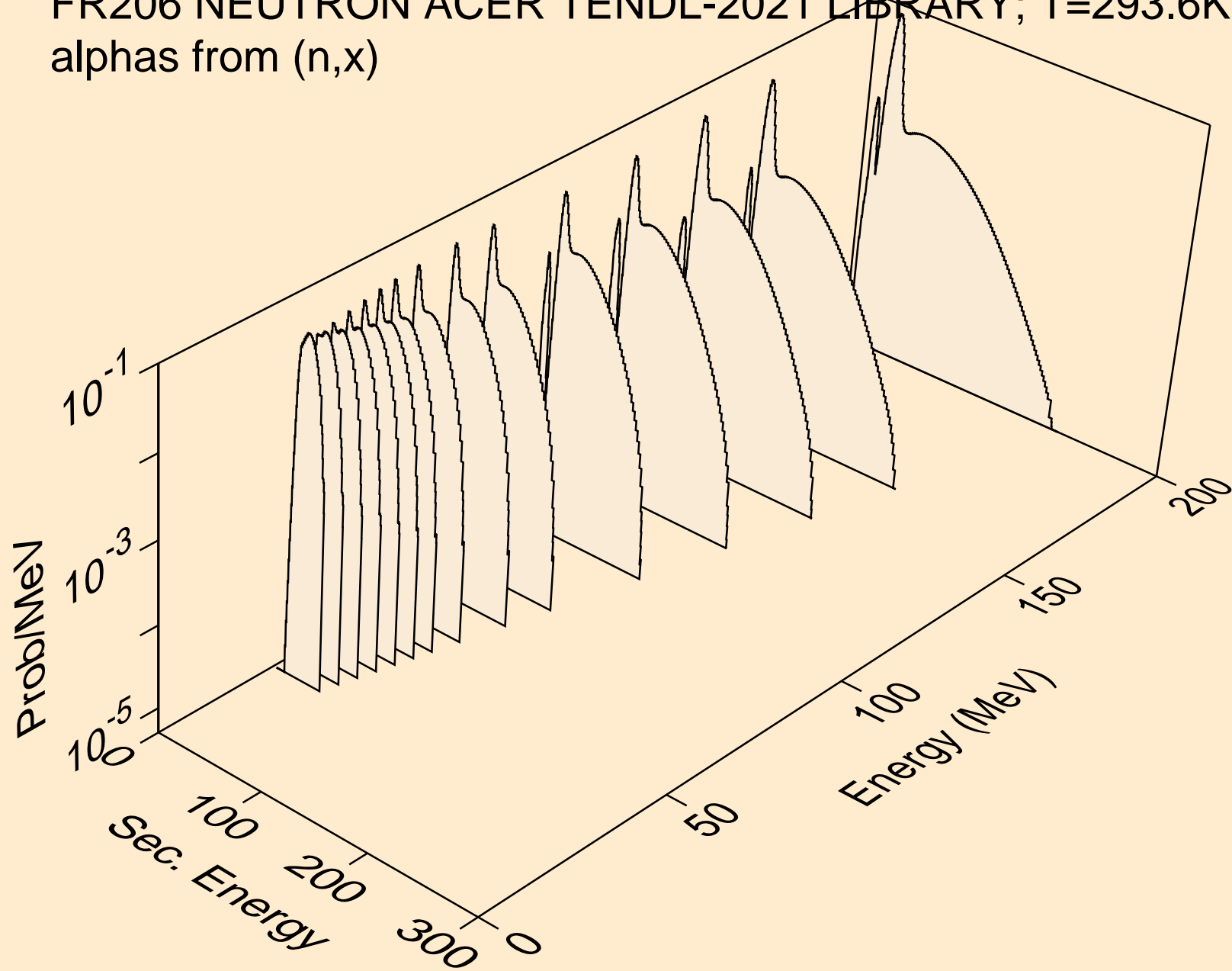

FR206 NEUTRON ACER TENDL-2021 LIBRARY; T=293.6K
alphas from (n,n*)a

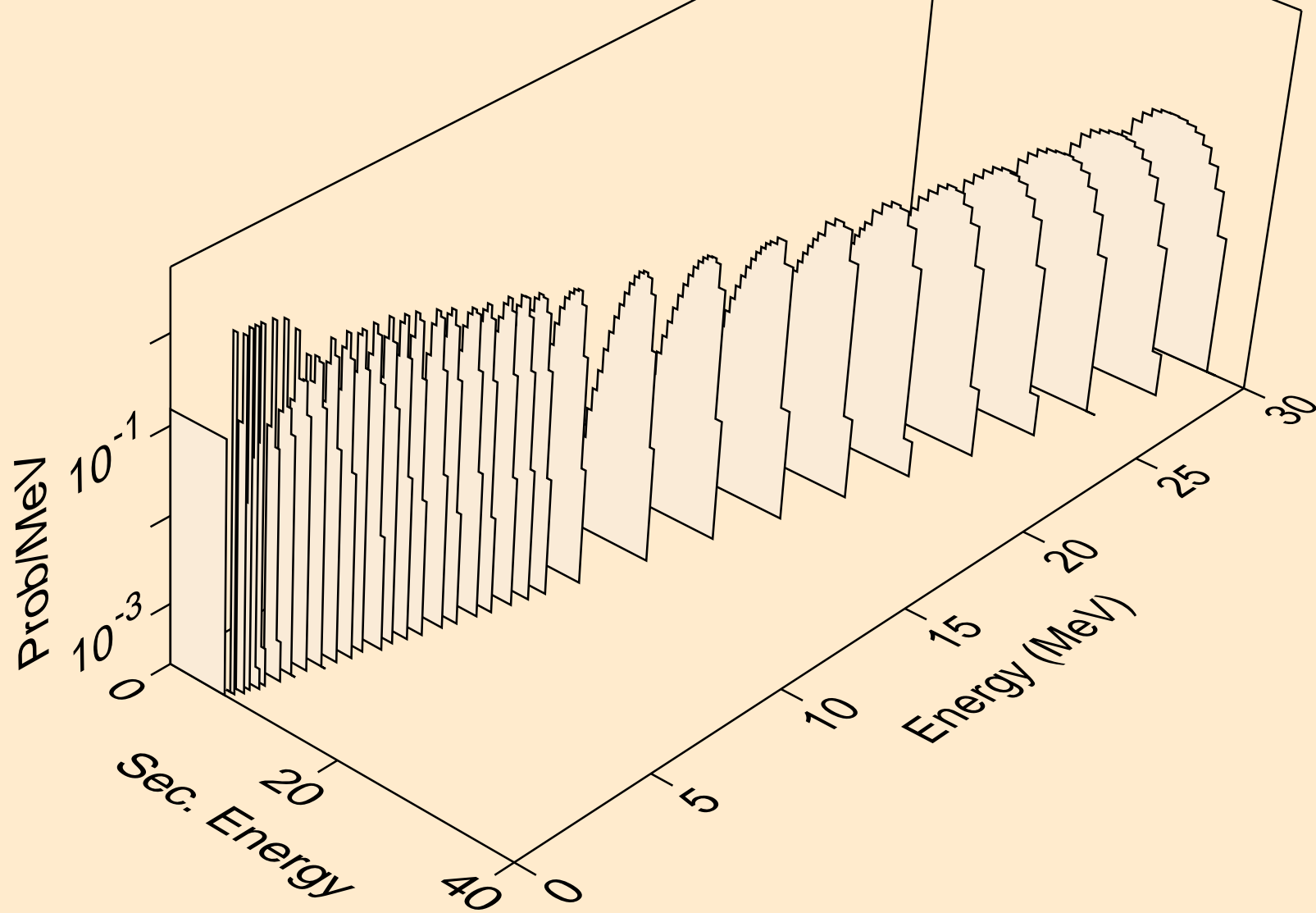

FR206 NEUTRON ACER TENDL-2021 LIBRARY; T=293.6K
alphas from (n,2n)a

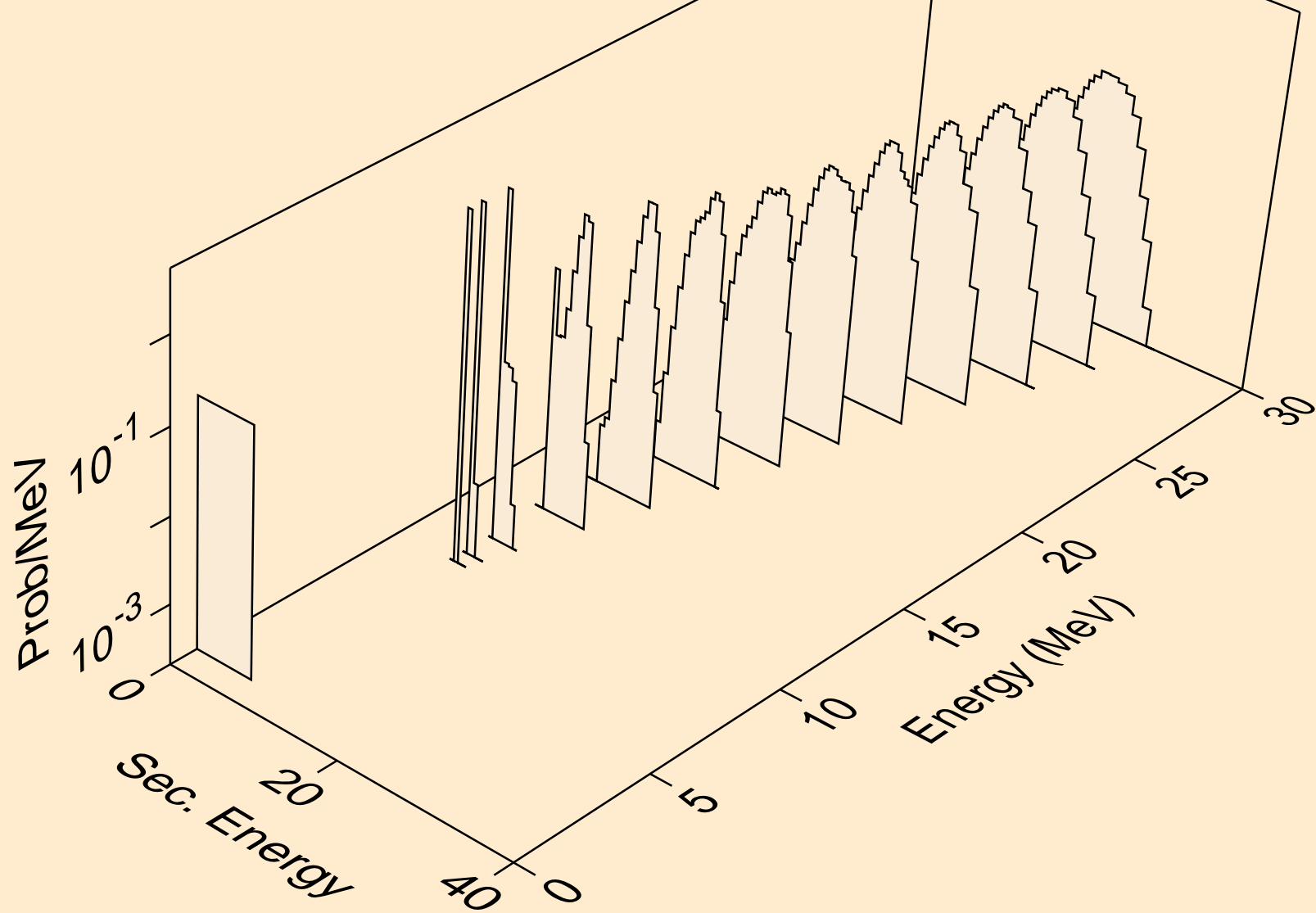

FR206 NEUTRON ACER TENDL-2021 LIBRARY; T=293.6K
alphas from (n,3n)a

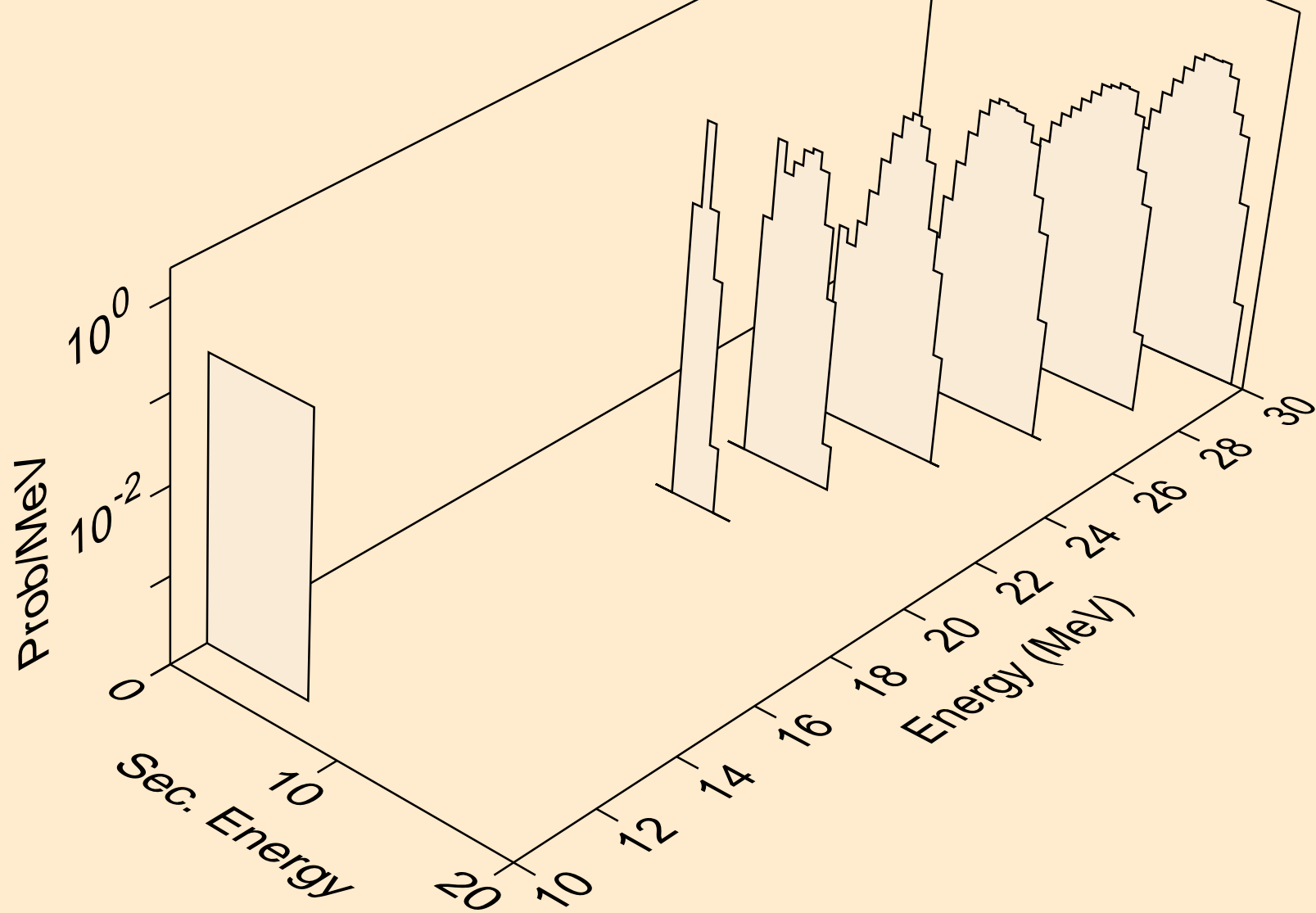

FR206 NEUTRON ACER TENDL-2021 LIBRARY; T=293.6K
alphas from (n,n*)2a

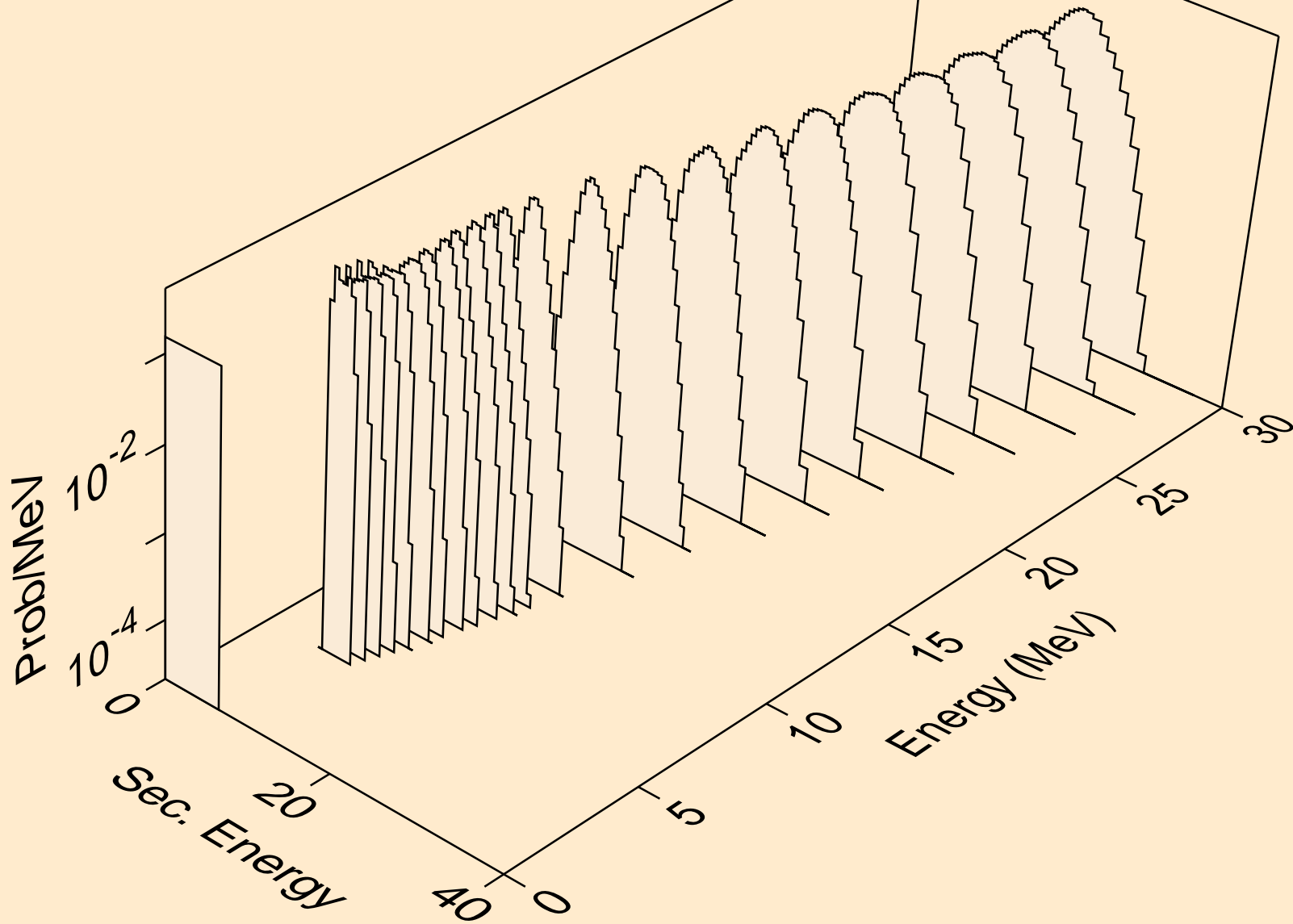

FR206 NEUTRON ACER TENDL-2021 LIBRARY; T=293.6K
alphas from (n,2n)2a

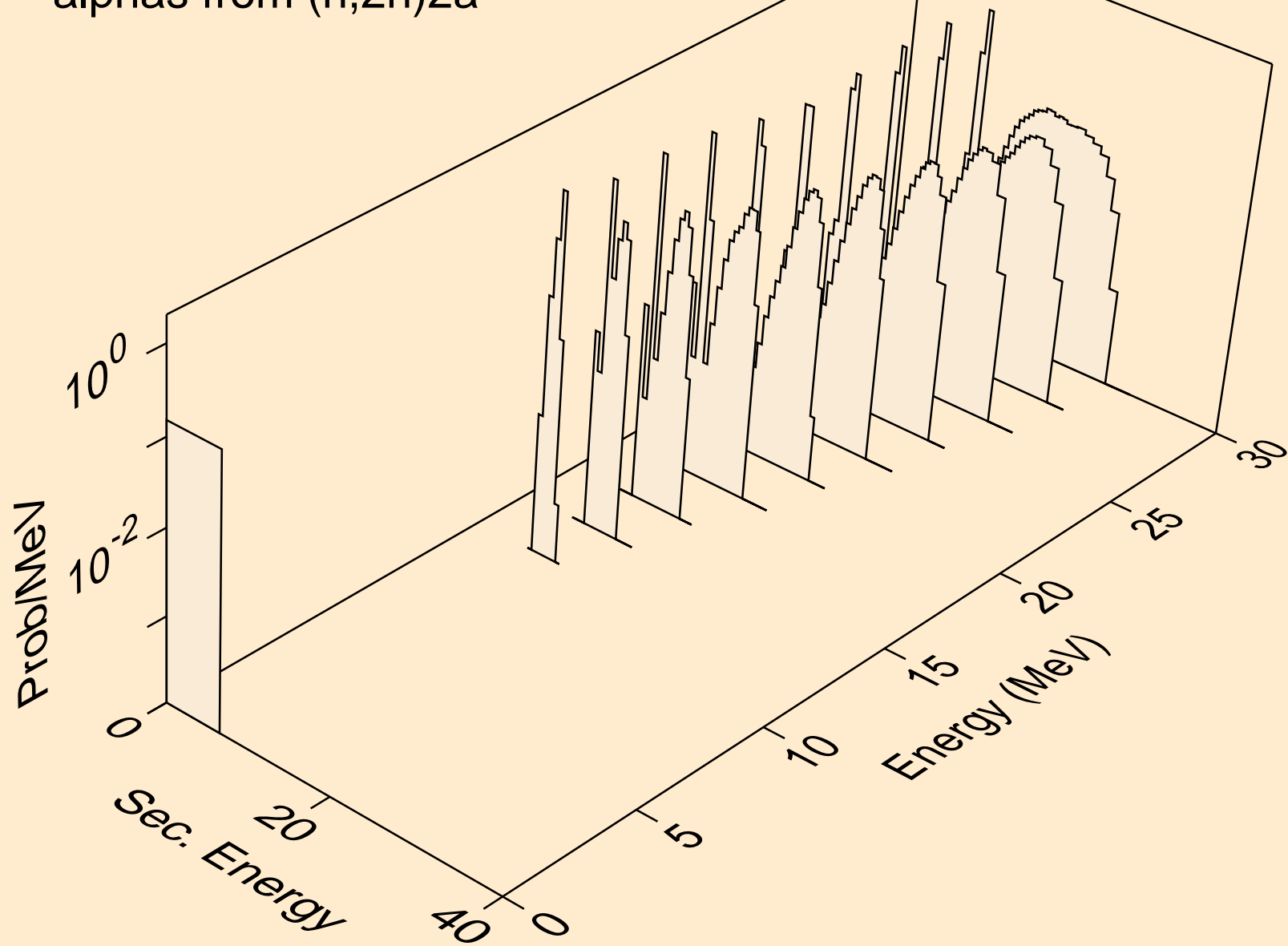

FR206 NEUTRON ACER TENDL-2021 LIBRARY; T=293.6K
alphas from (n,npa)

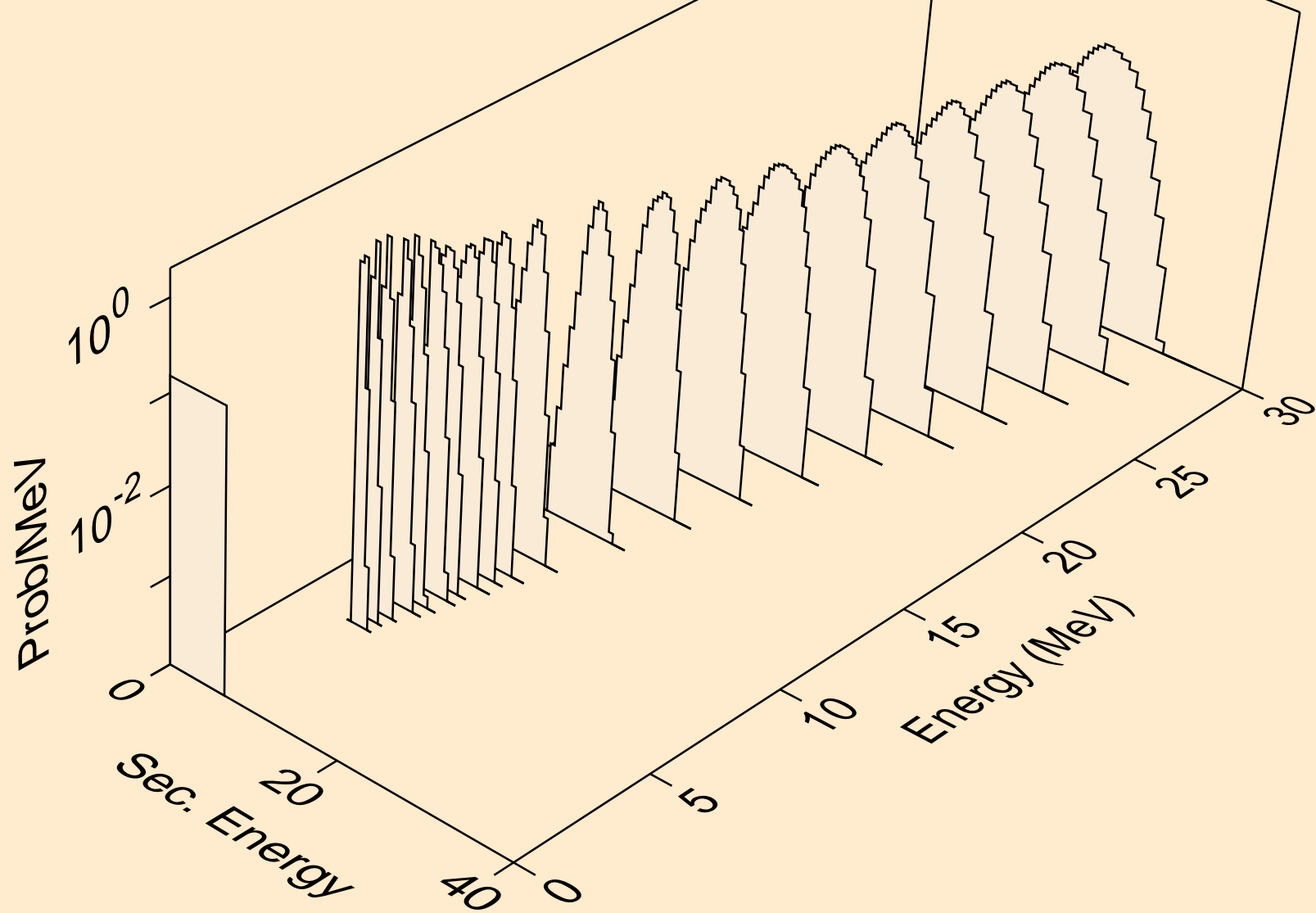

FR206 NEUTRON ACER TENDL-2021 LIBRARY; T=293.6K
alphas from (n,a)

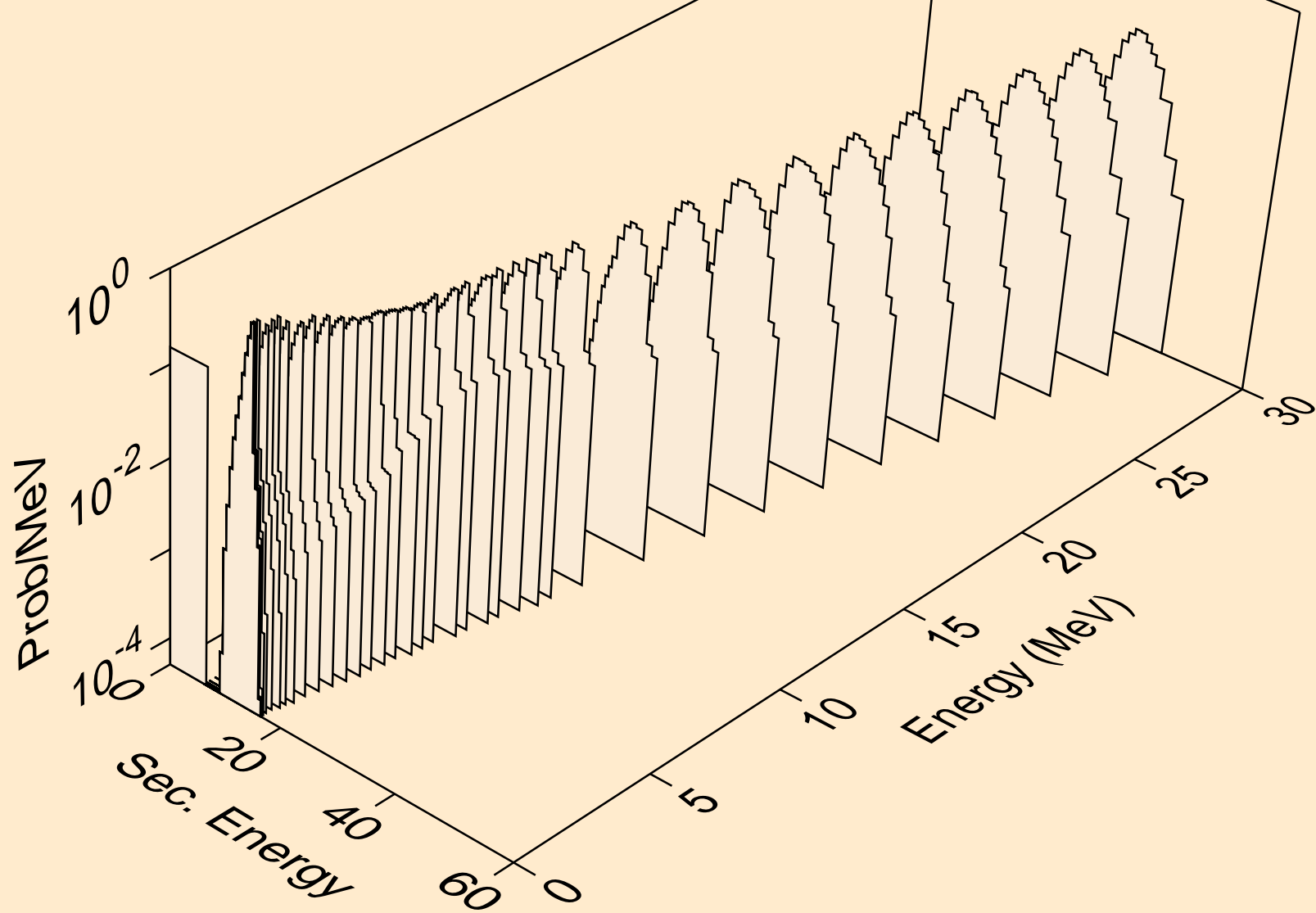

FR206 NEUTRON ACER TENDL-2021 LIBRARY; T=293.6K
alphas from (n,2a)

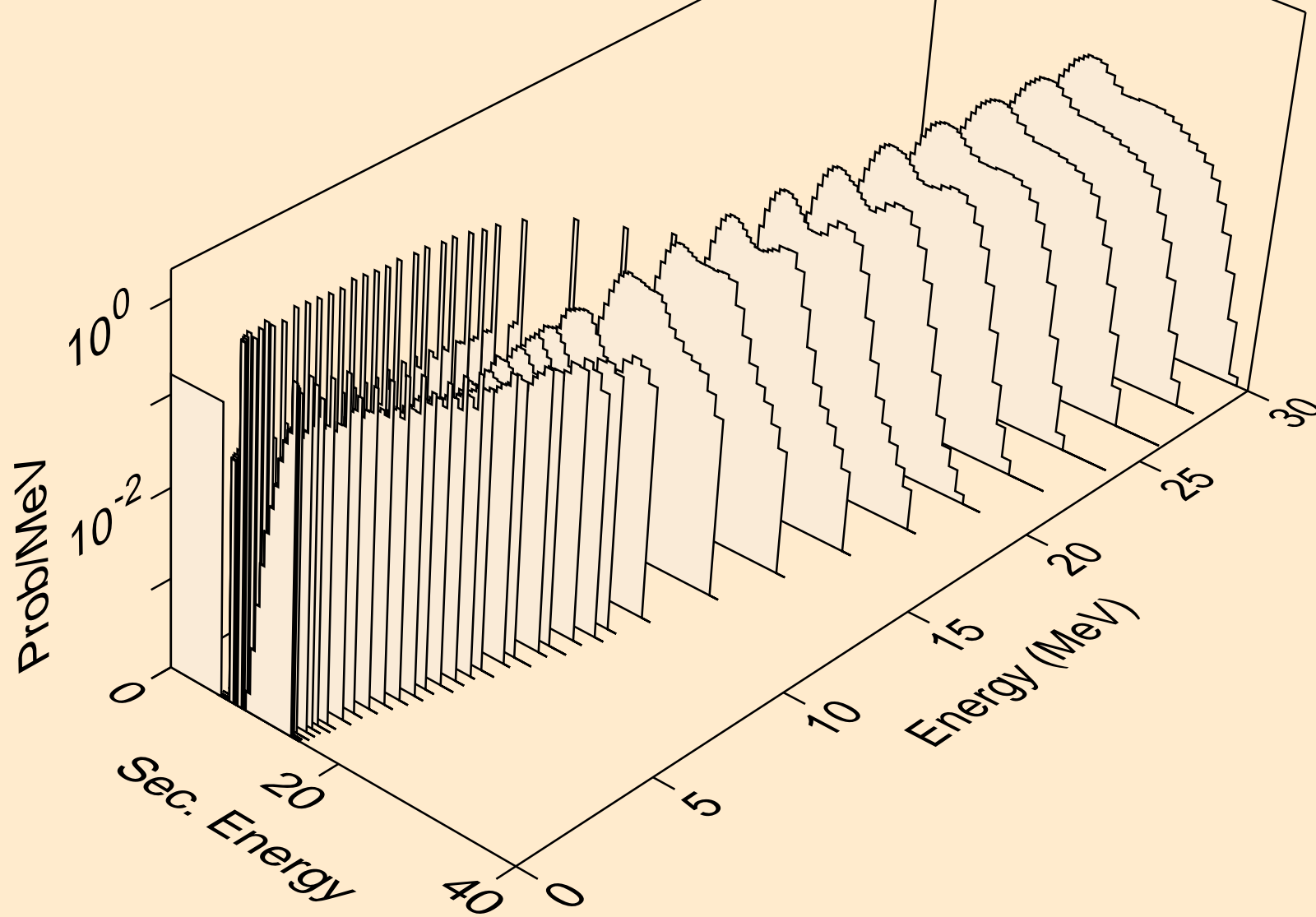

FR206 NEUTRON ACER TENDL-2021 LIBRARY; T=293.6K
alphas from (n,p)

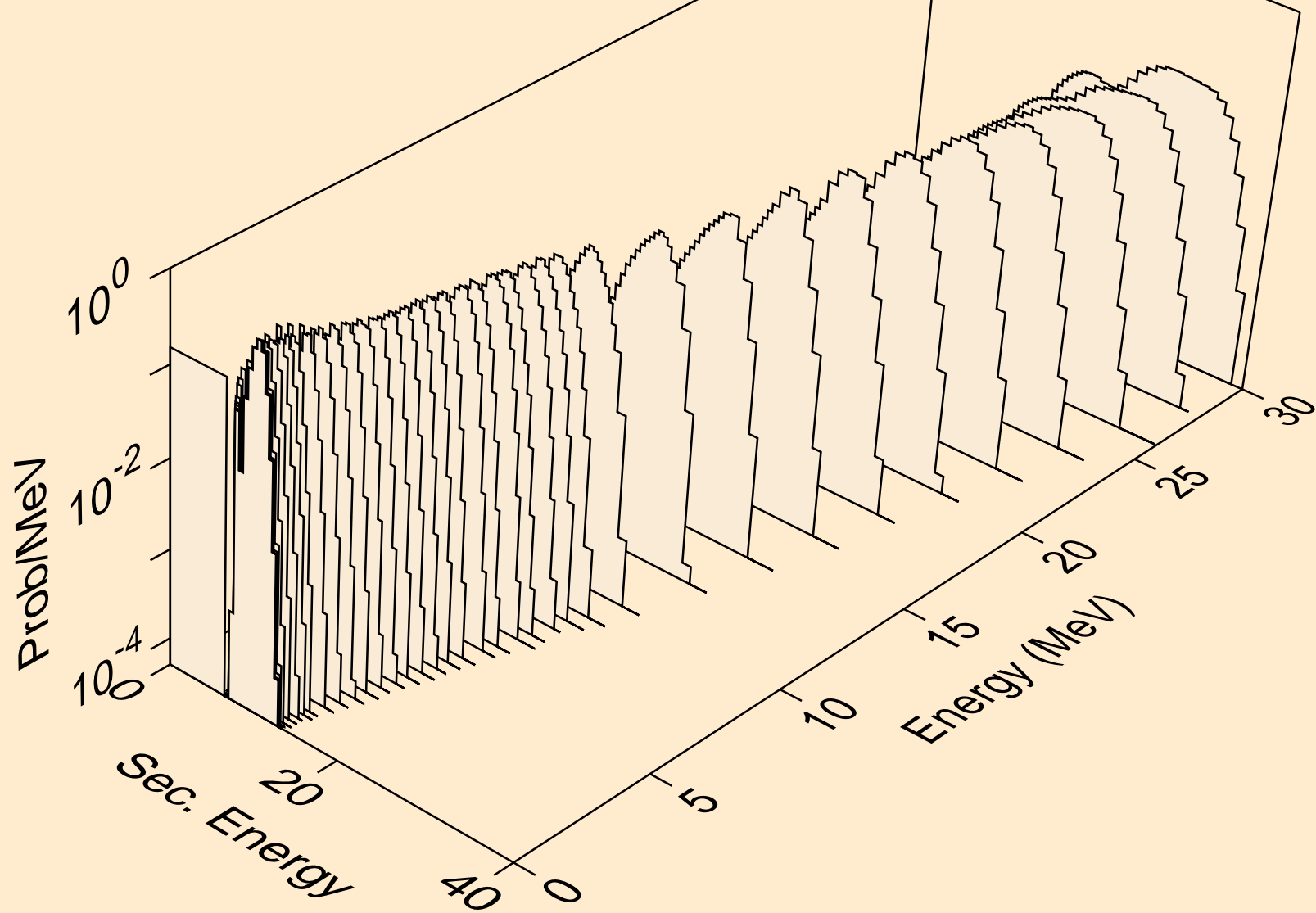

FR206 NEUTRON ACER TENDL-2021 LIBRARY; T=293.6K
alphas from (n,da)

