

GA068 NEUTRON ACER TENDL-2021 LIBRARY; T=293.6K

Principal cross sections

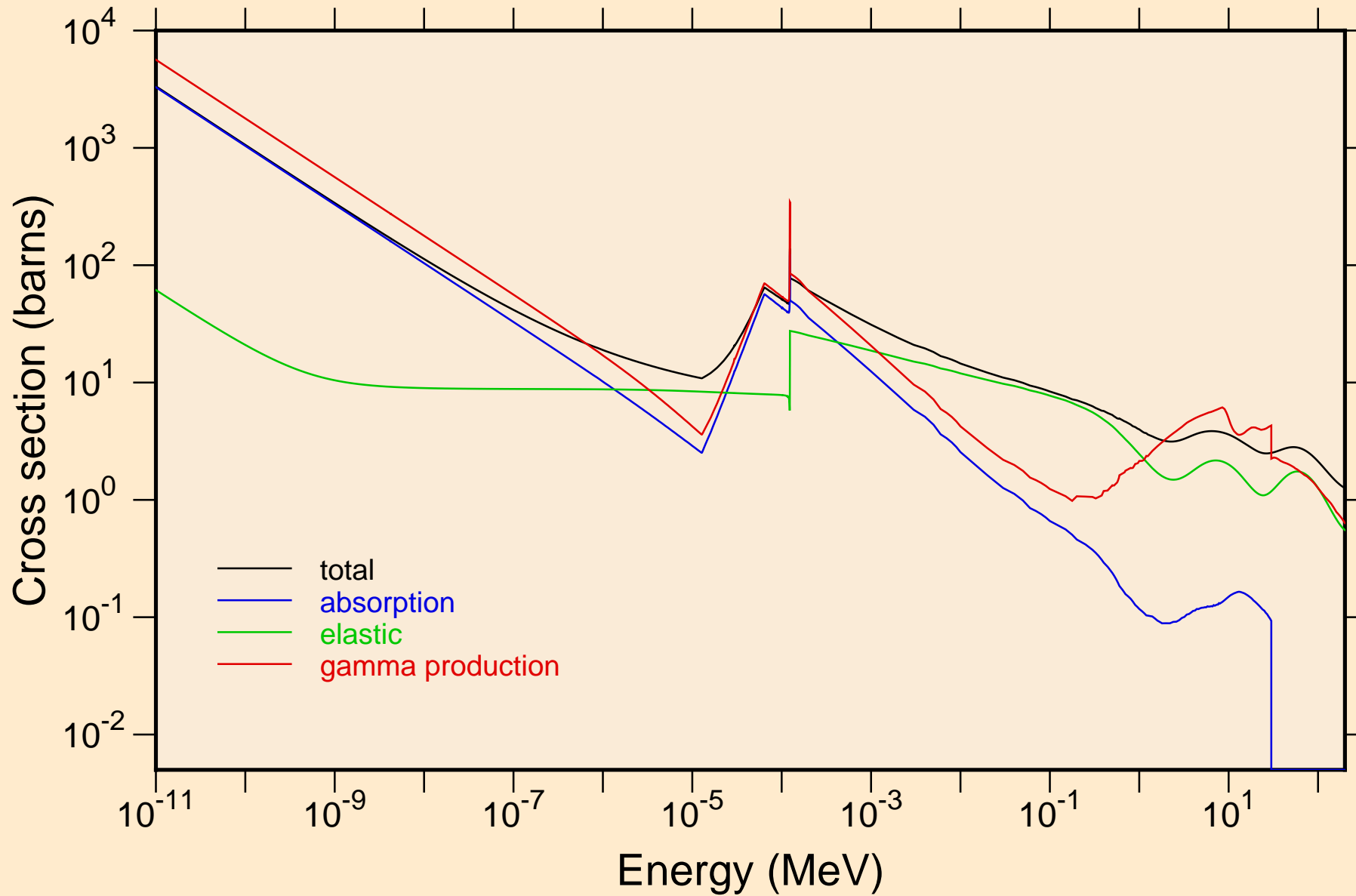

GA068 NEUTRON ACER TENDL-2021 LIBRARY; T=293.6K
Heating

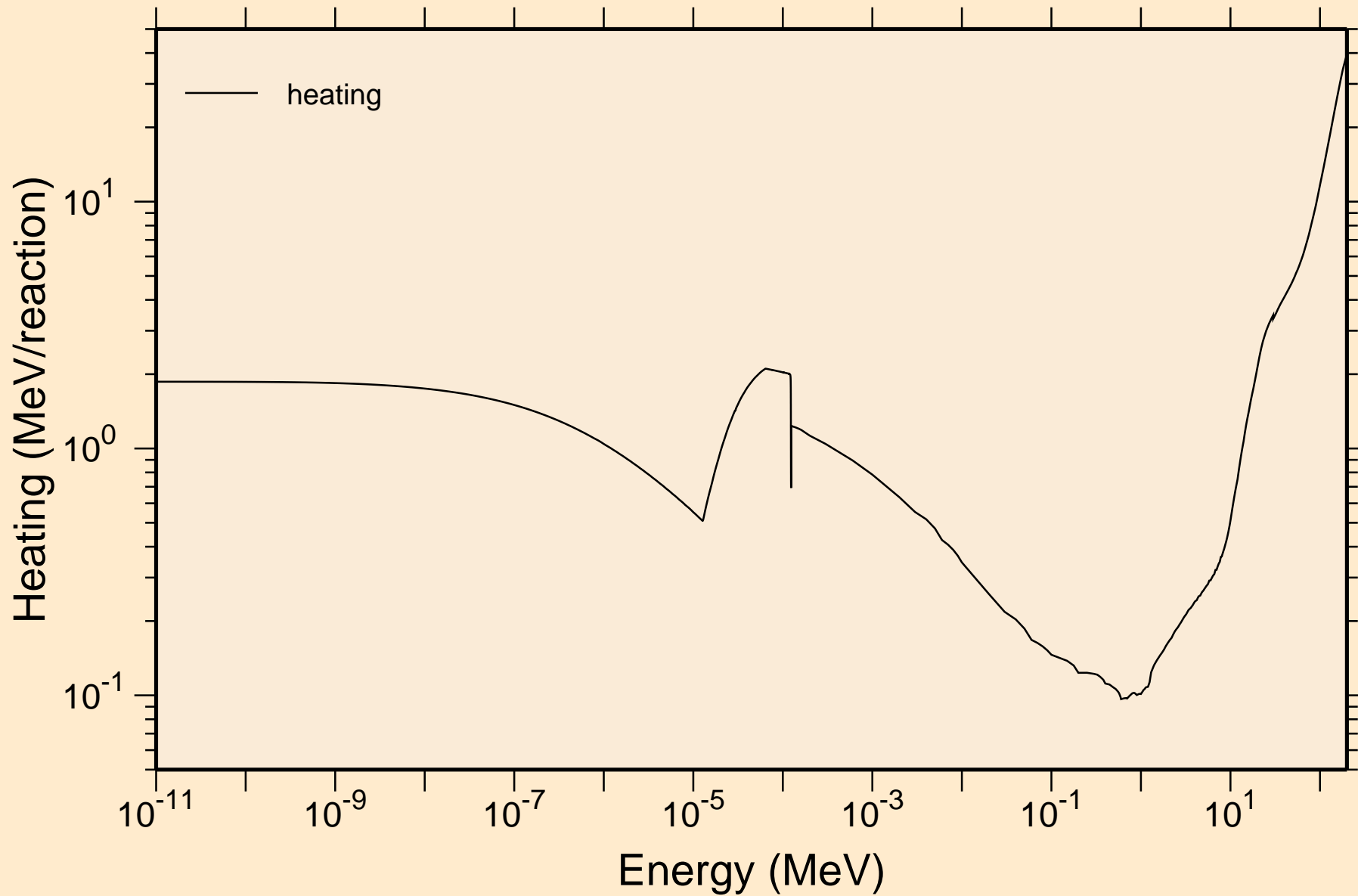

GA068 NEUTRON ACER TENDL-2021 LIBRARY; T=293.6K
Damage

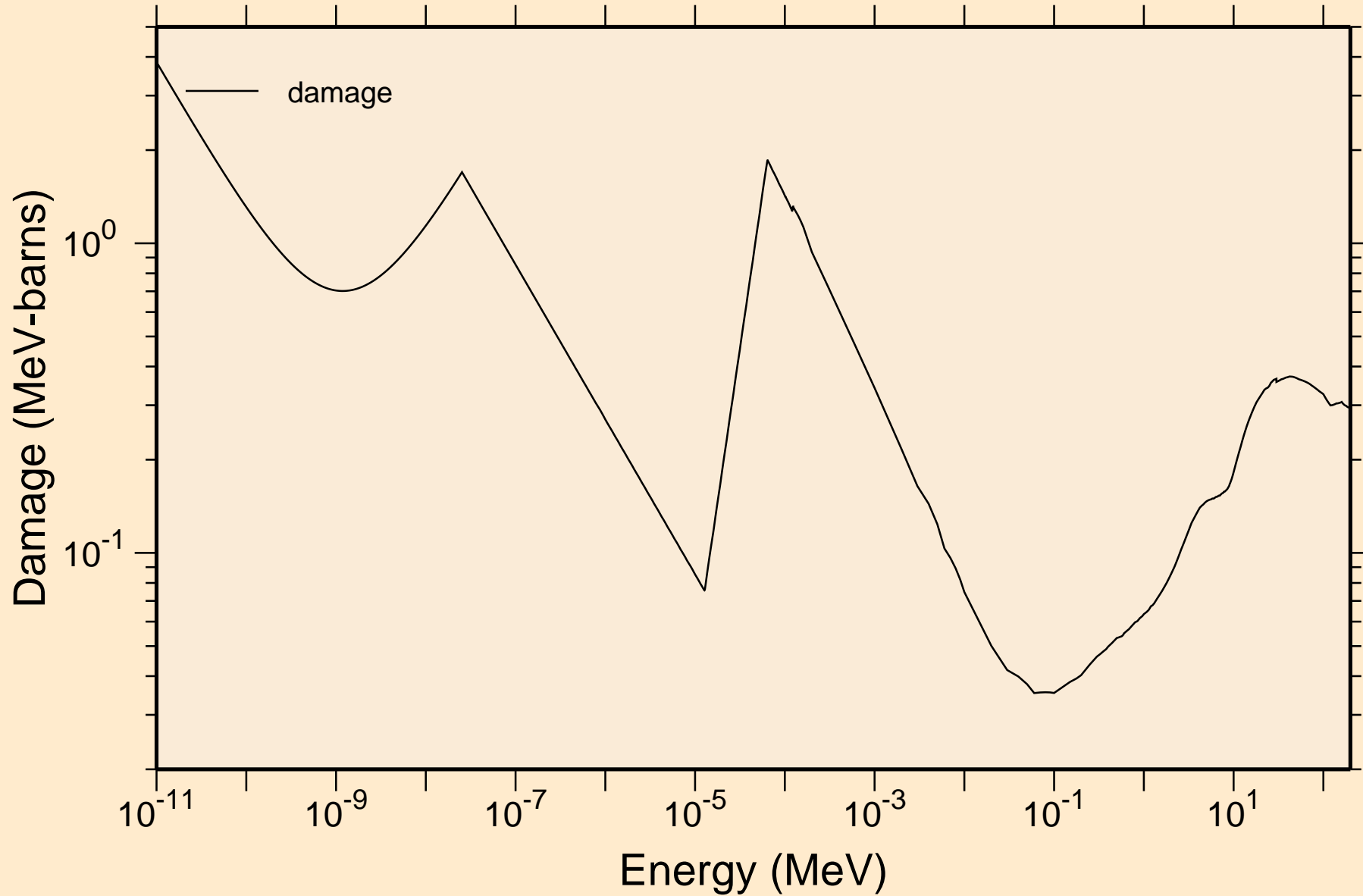

GA068 NEUTRON ACER TENDL-2021 LIBRARY; T=293.6K
Non-threshold reactions

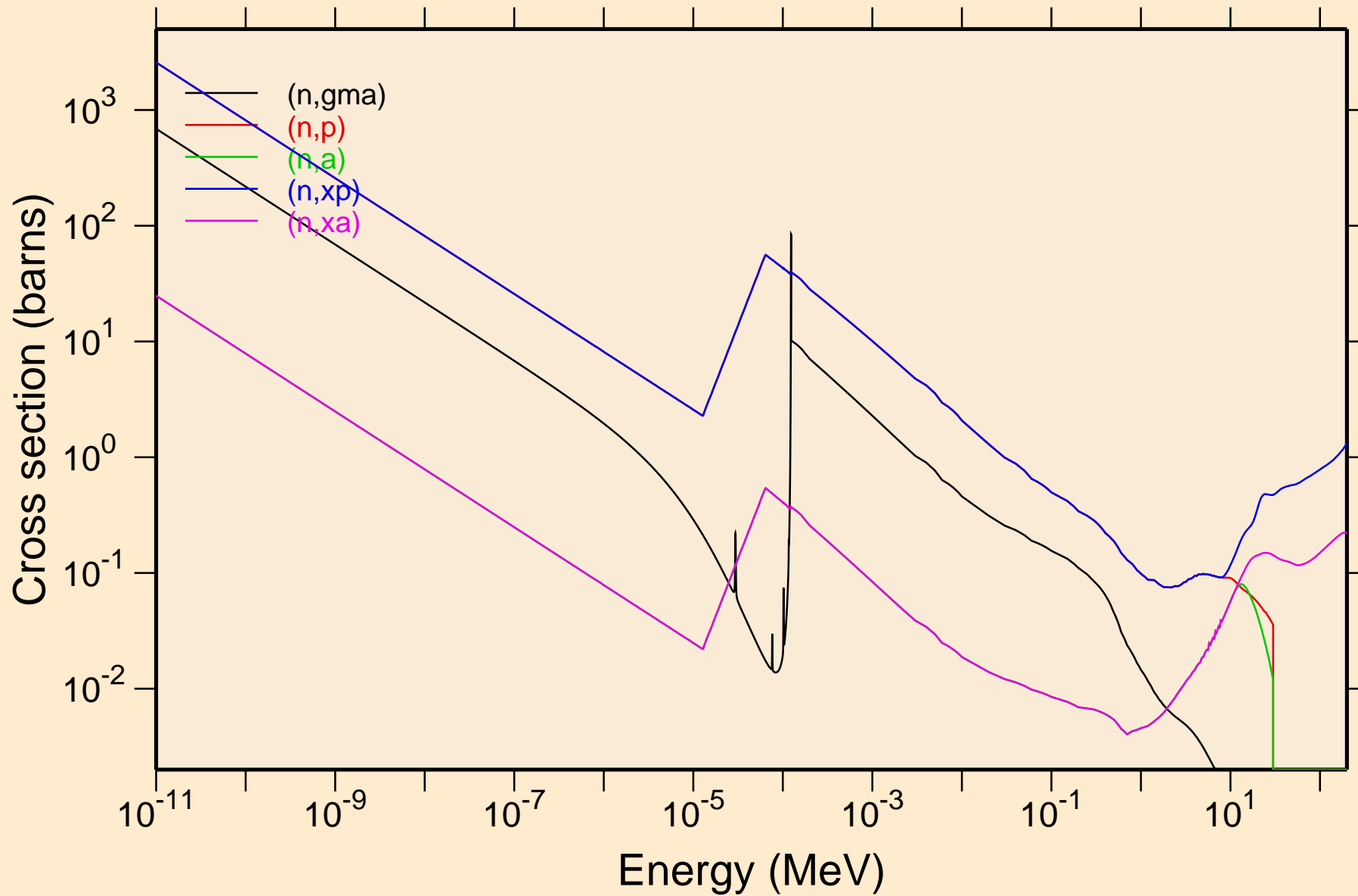

GA068 NEUTRON ACER TENDL-2021 LIBRARY; T=293.6K

Principal cross sections

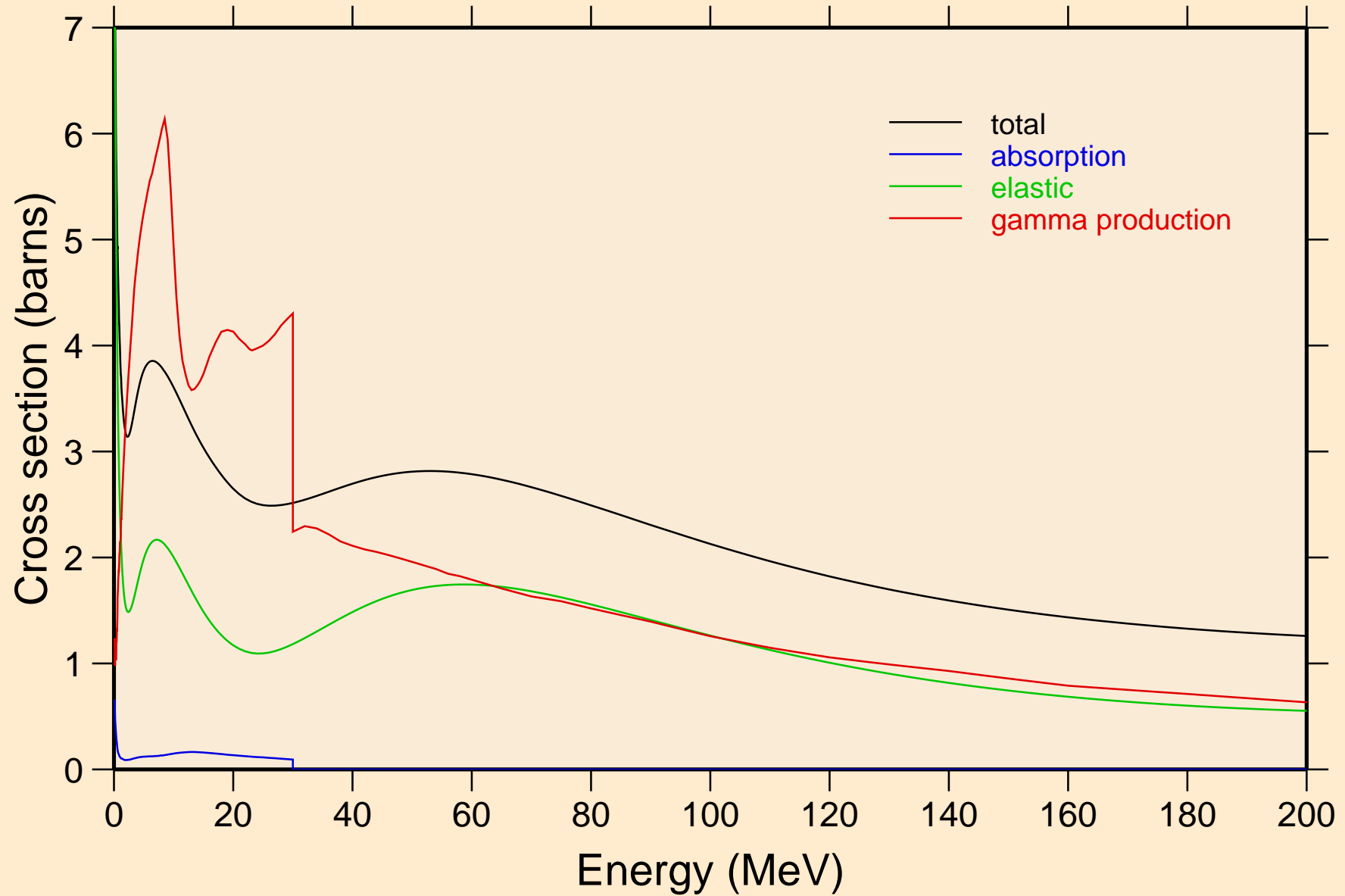

GA068 NEUTRON ACER TENDL-2021 LIBRARY; T=293.6K

Heating

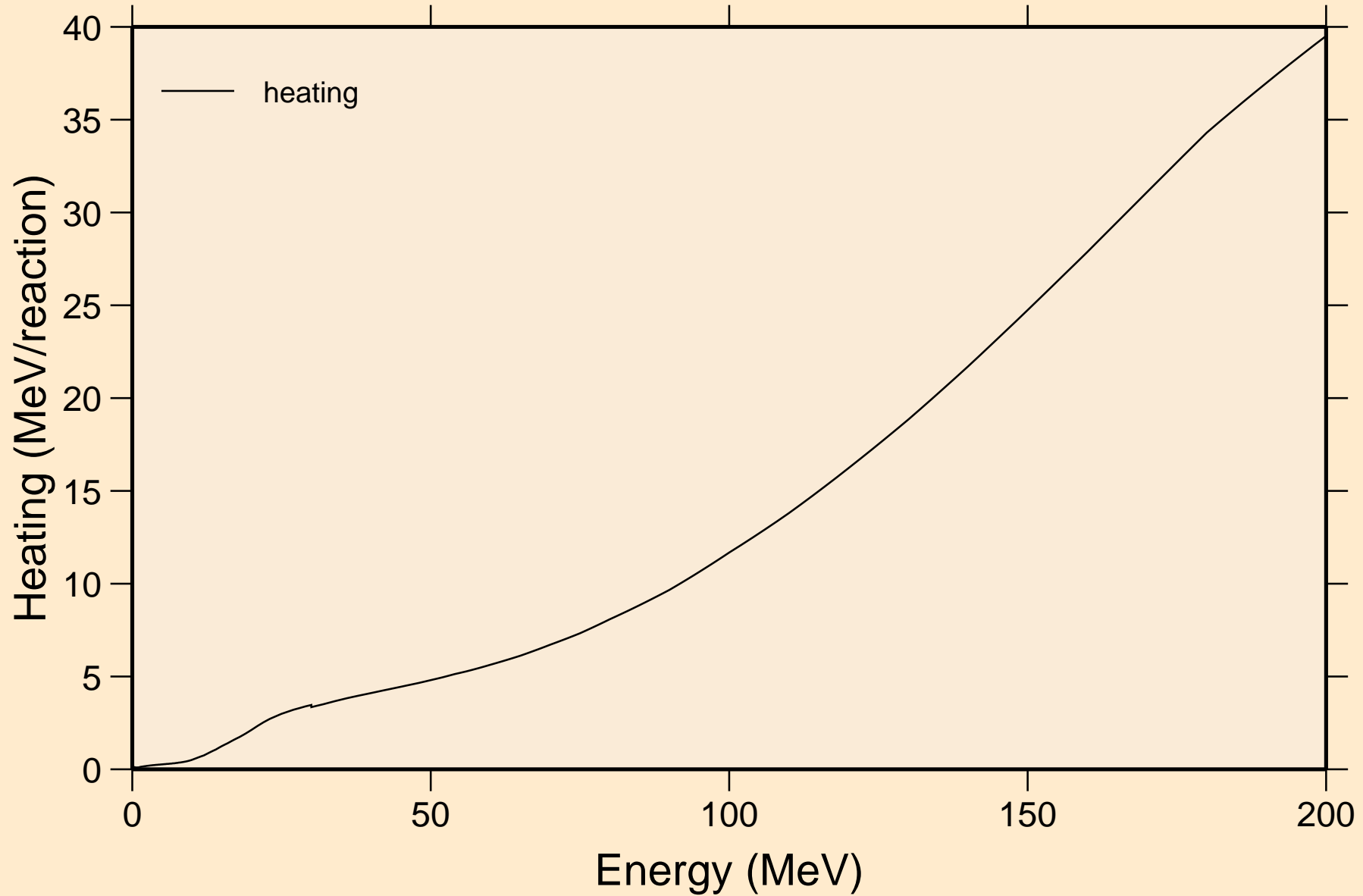

GA068 NEUTRON ACER TENDL-2021 LIBRARY; T=293.6K
Damage

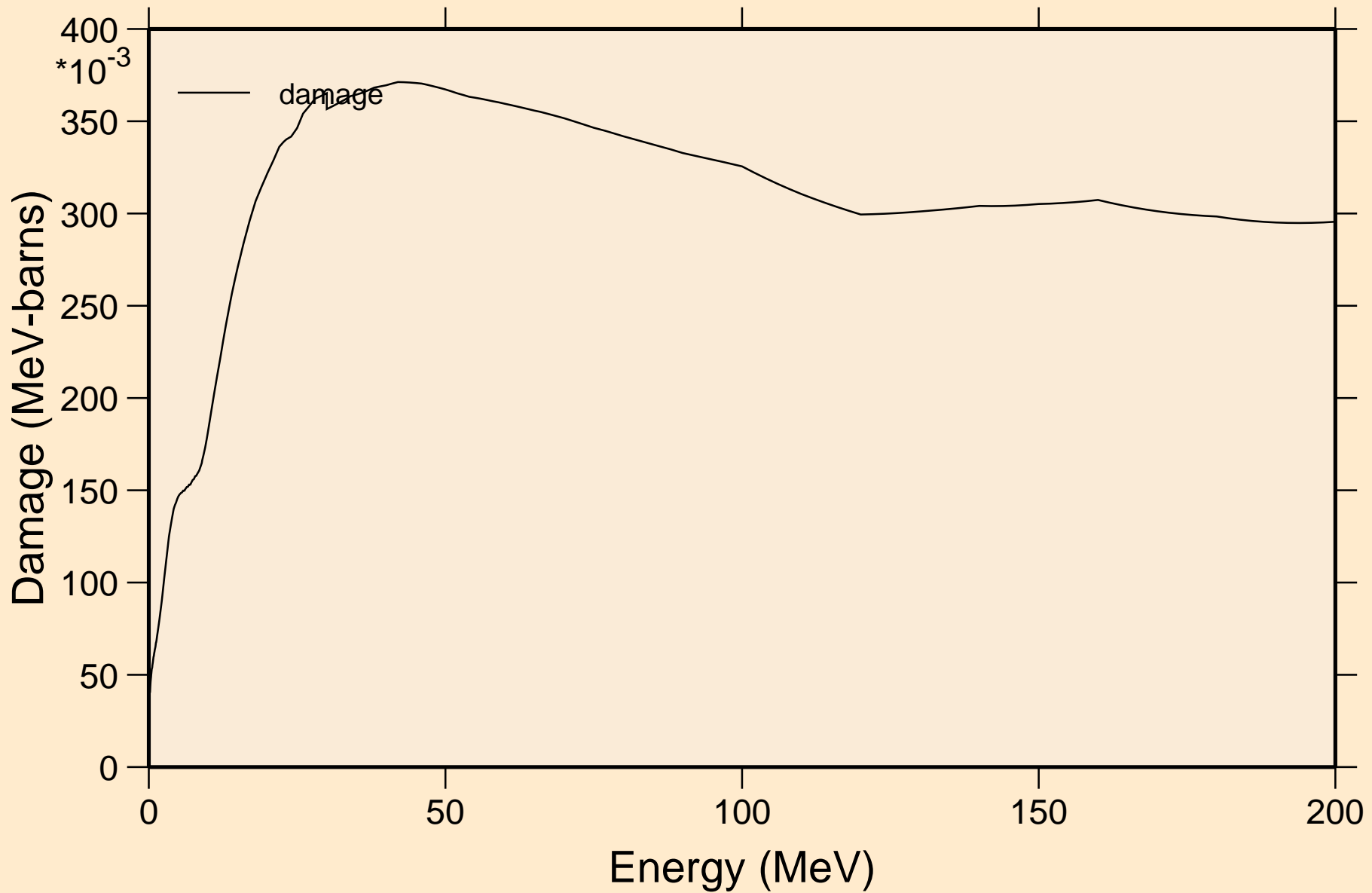

GA068 NEUTRON ACER TENDL-2021 LIBRARY; T=293.6K
Non-threshold reactions

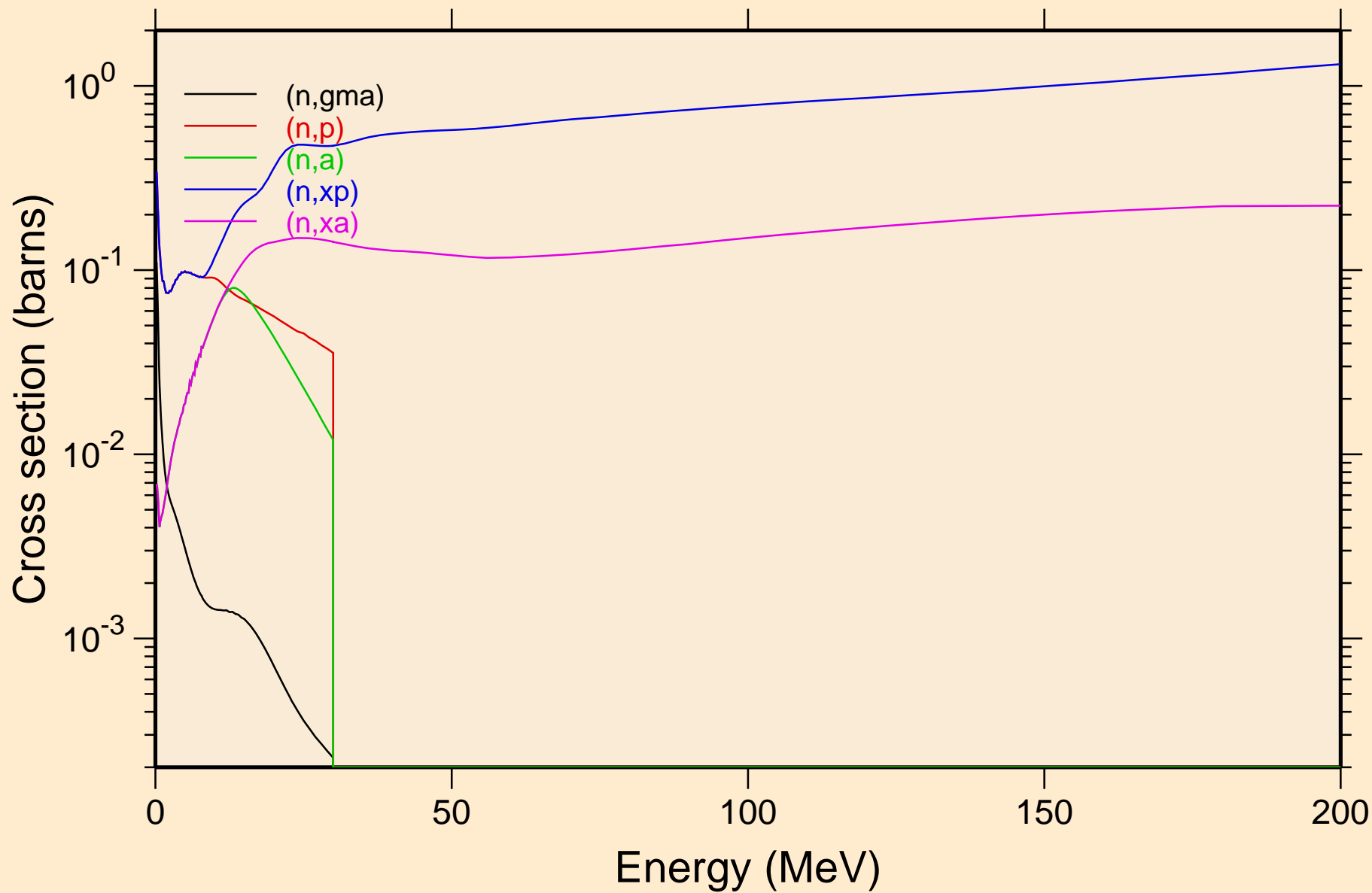

GA068 NEUTRON ACER TENDL-2021 LIBRARY; T=293.6K
Inelastic levels

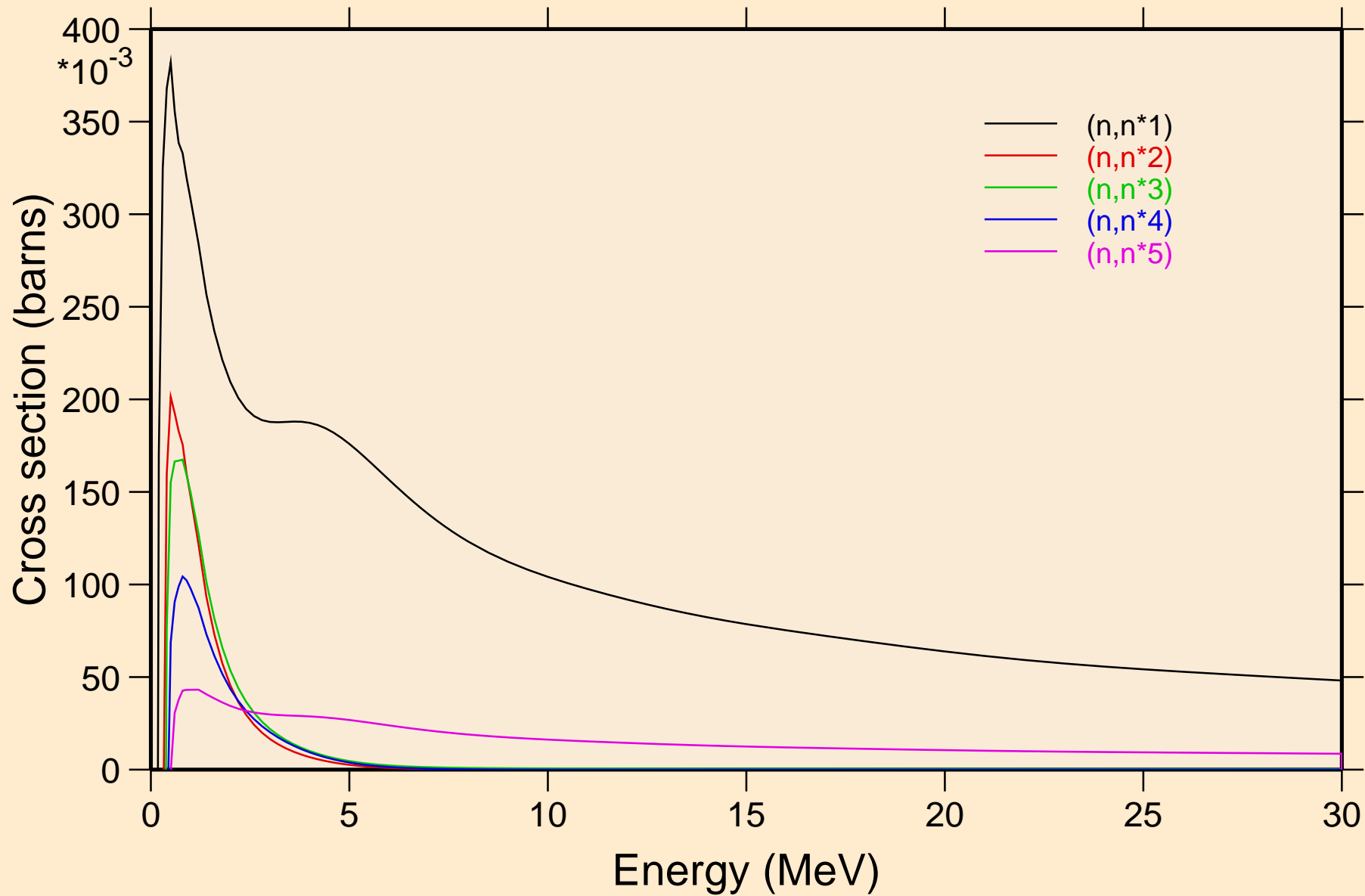

GA068 NEUTRON ACER TENDL-2021 LIBRARY; T=293.6K
Inelastic levels

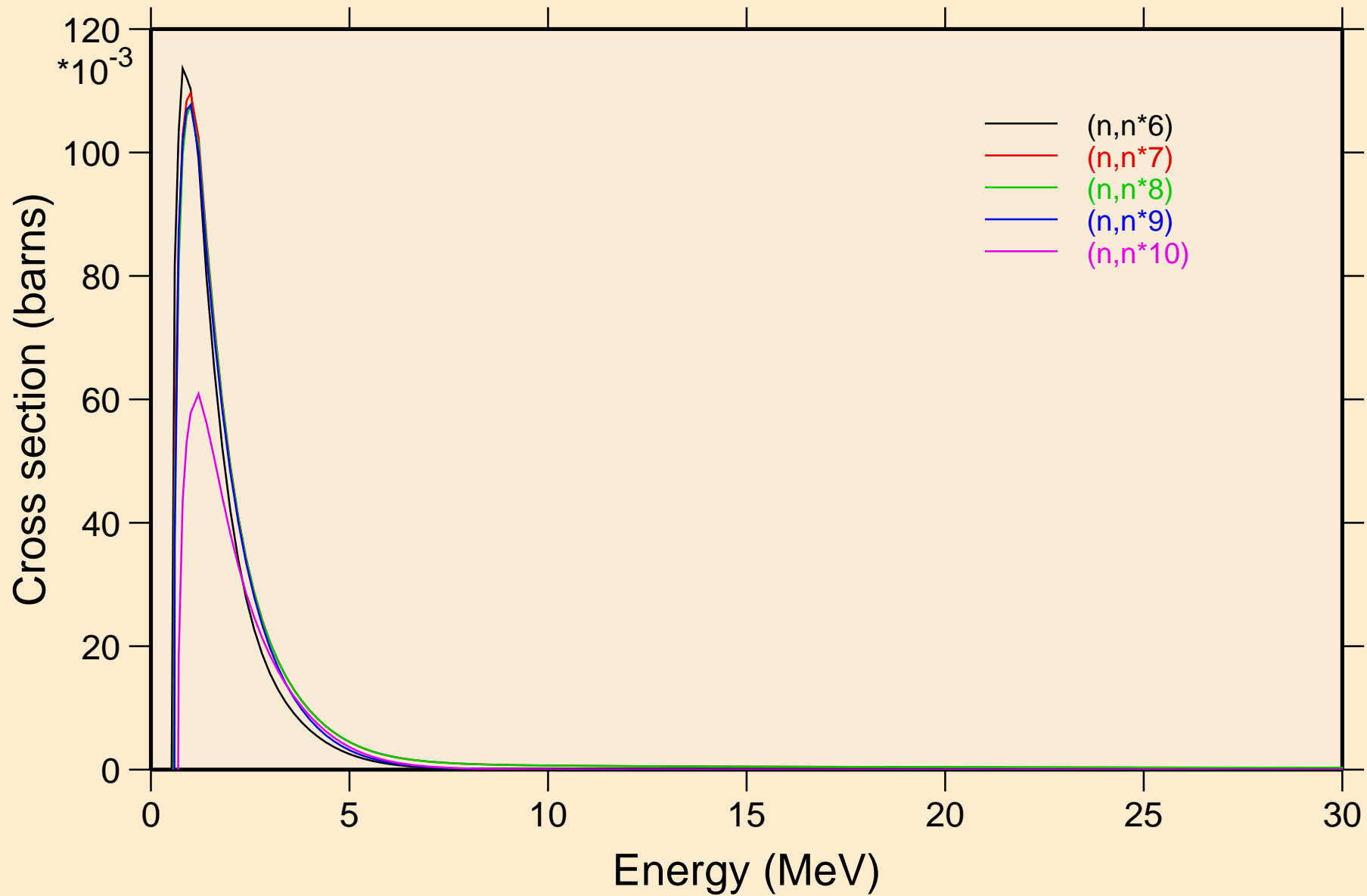

GA068 NEUTRON ACER TENDL-2021 LIBRARY; T=293.6K
Inelastic levels

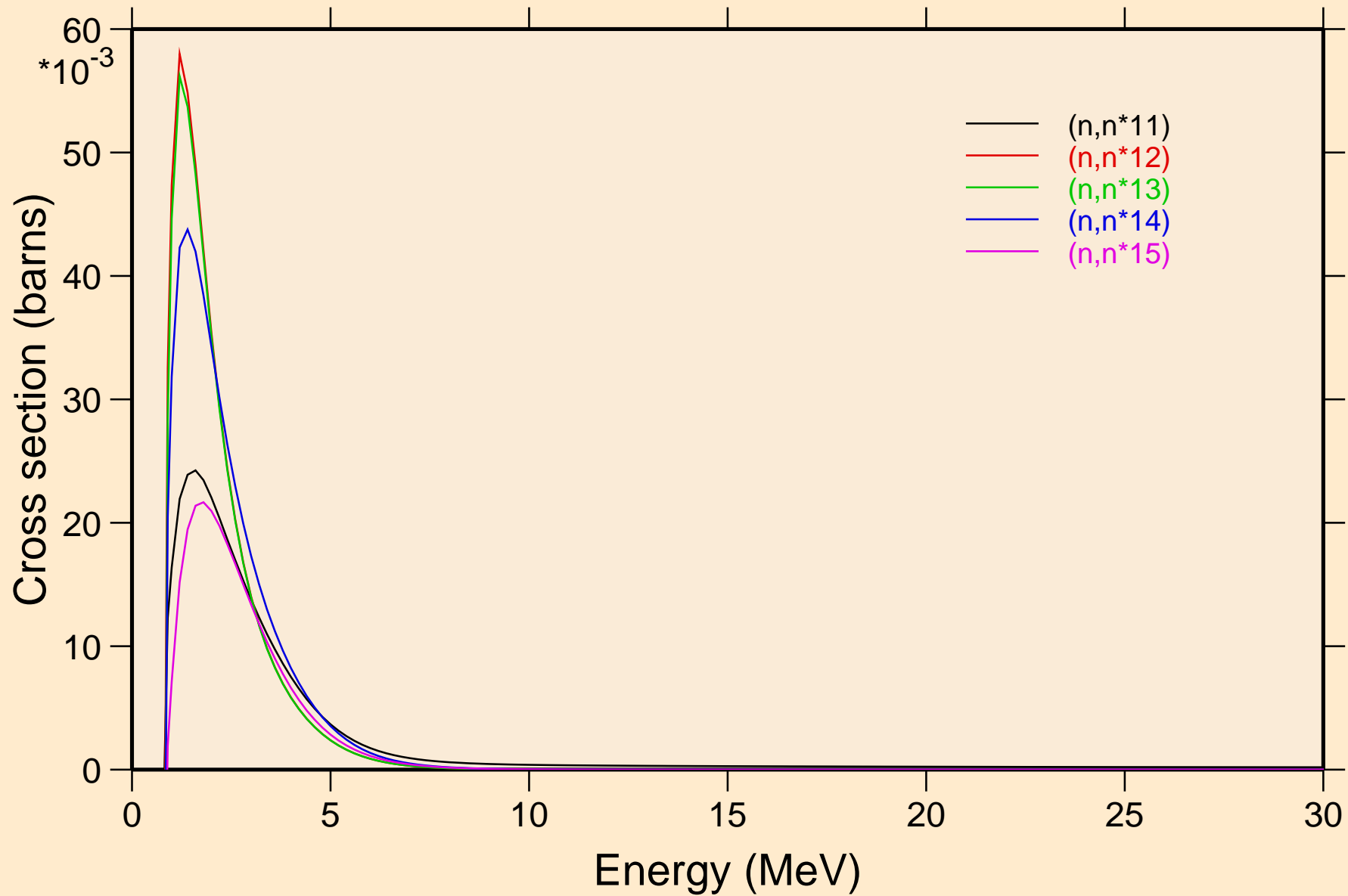

GA068 NEUTRON ACER TENDL-2021 LIBRARY; T=293.6K
Inelastic levels

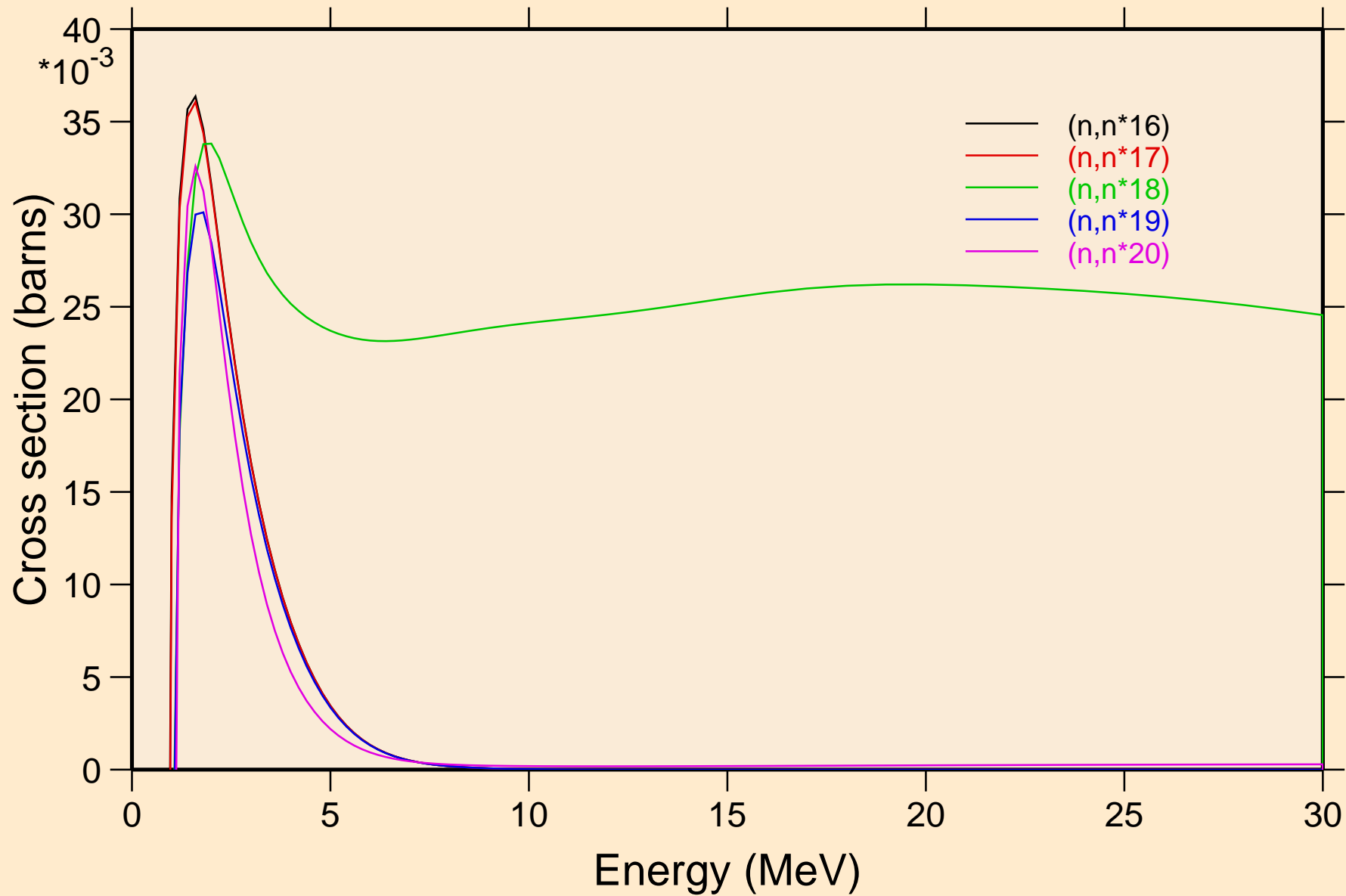

GA068 NEUTRON ACER TENDL-2021 LIBRARY; T=293.6K
Inelastic levels

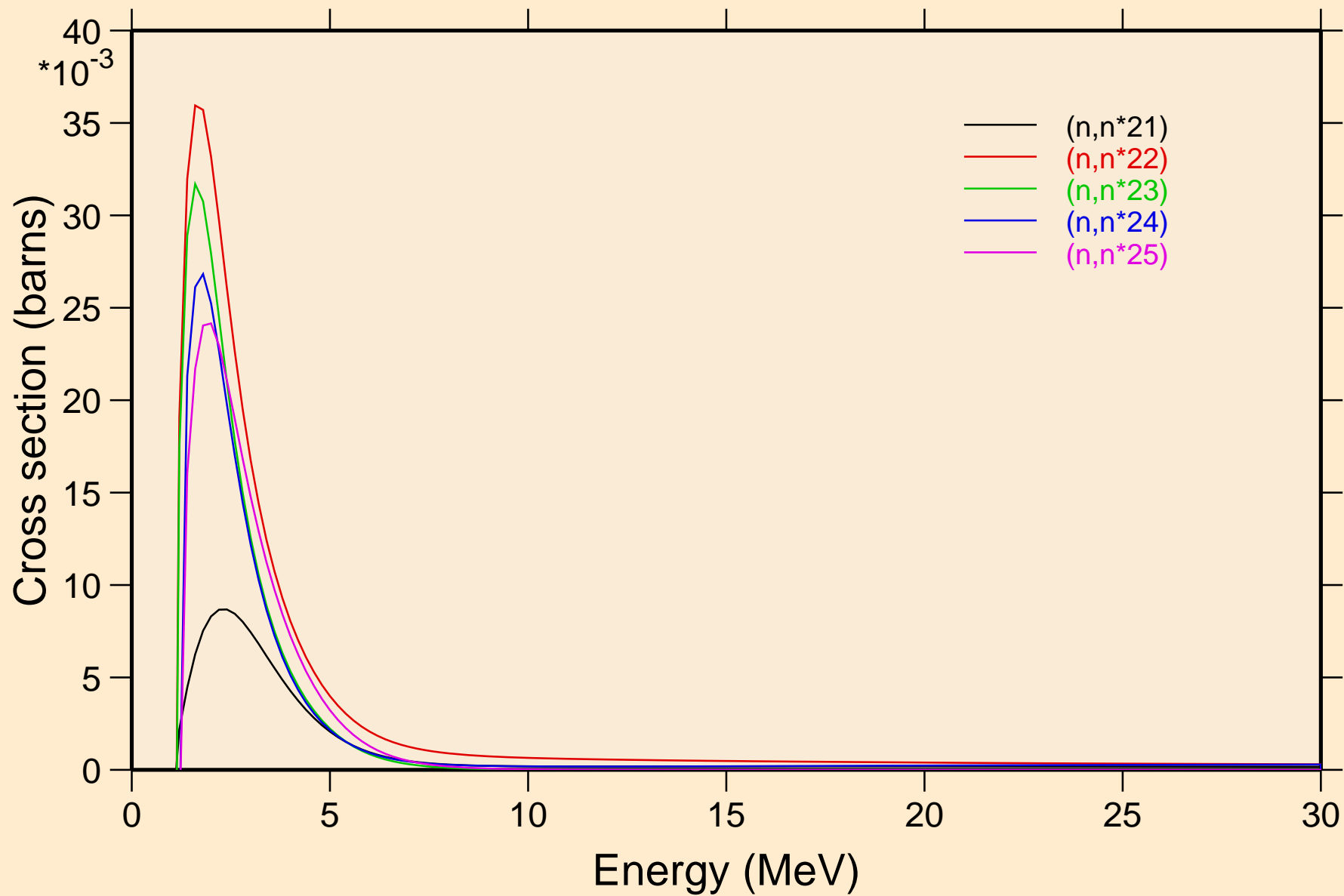

GA068 NEUTRON ACER TENDL-2021 LIBRARY; T=293.6K
Inelastic levels

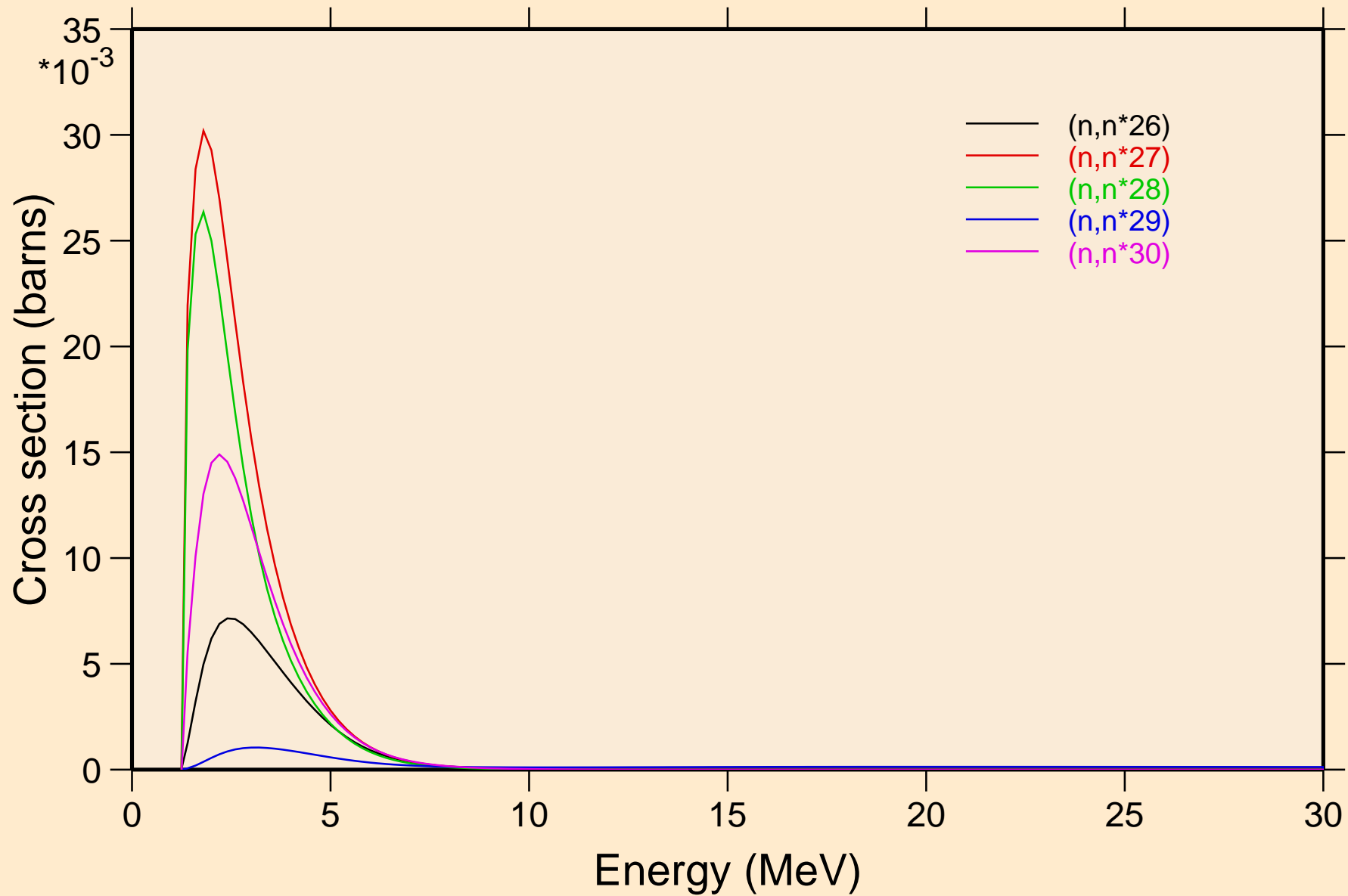

GA068 NEUTRON ACER TENDL-2021 LIBRARY; T=293.6K
Threshold reactions

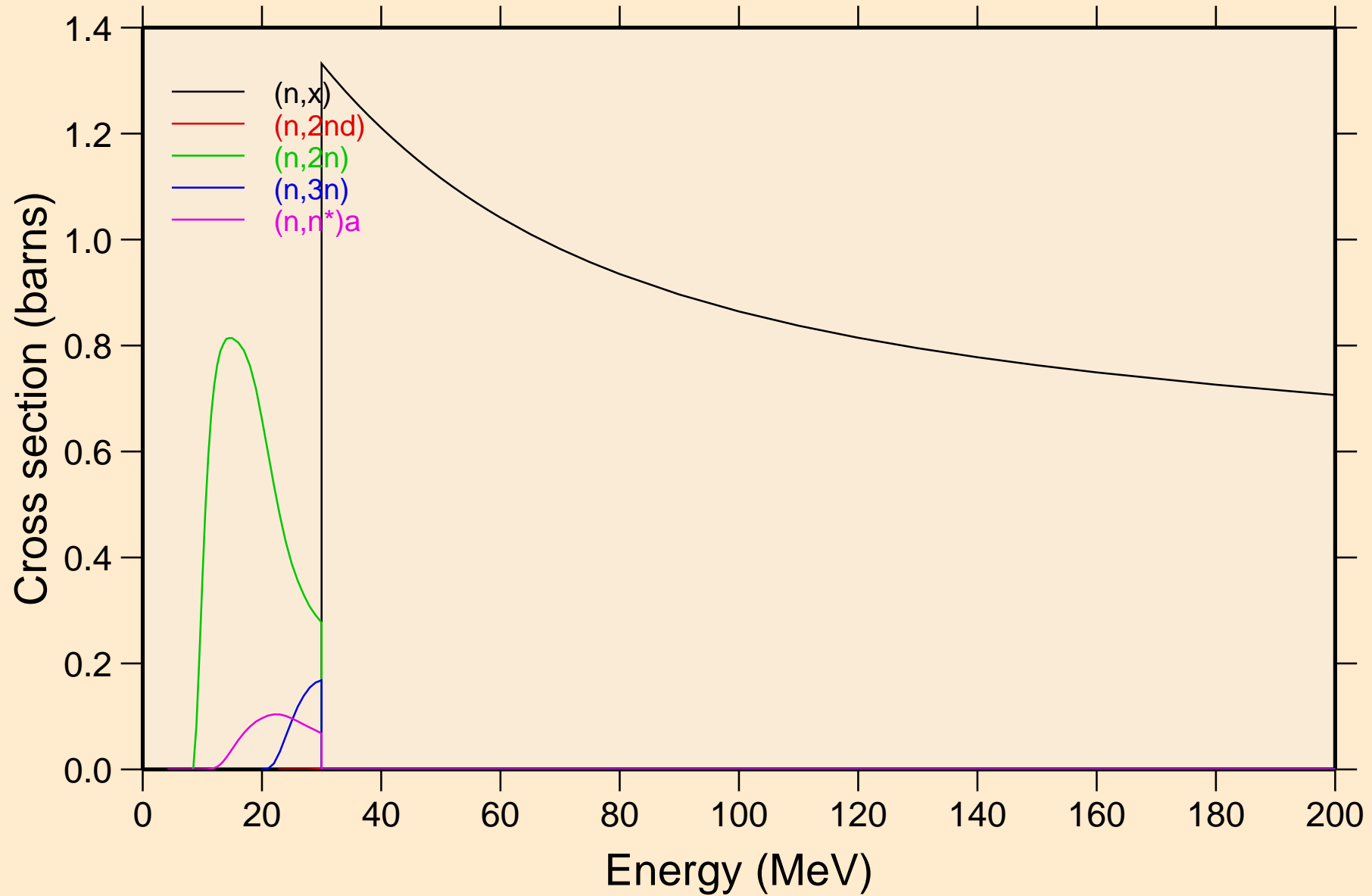

GA068 NEUTRON ACER TENDL-2021 LIBRARY; T=293.6K

Threshold reactions

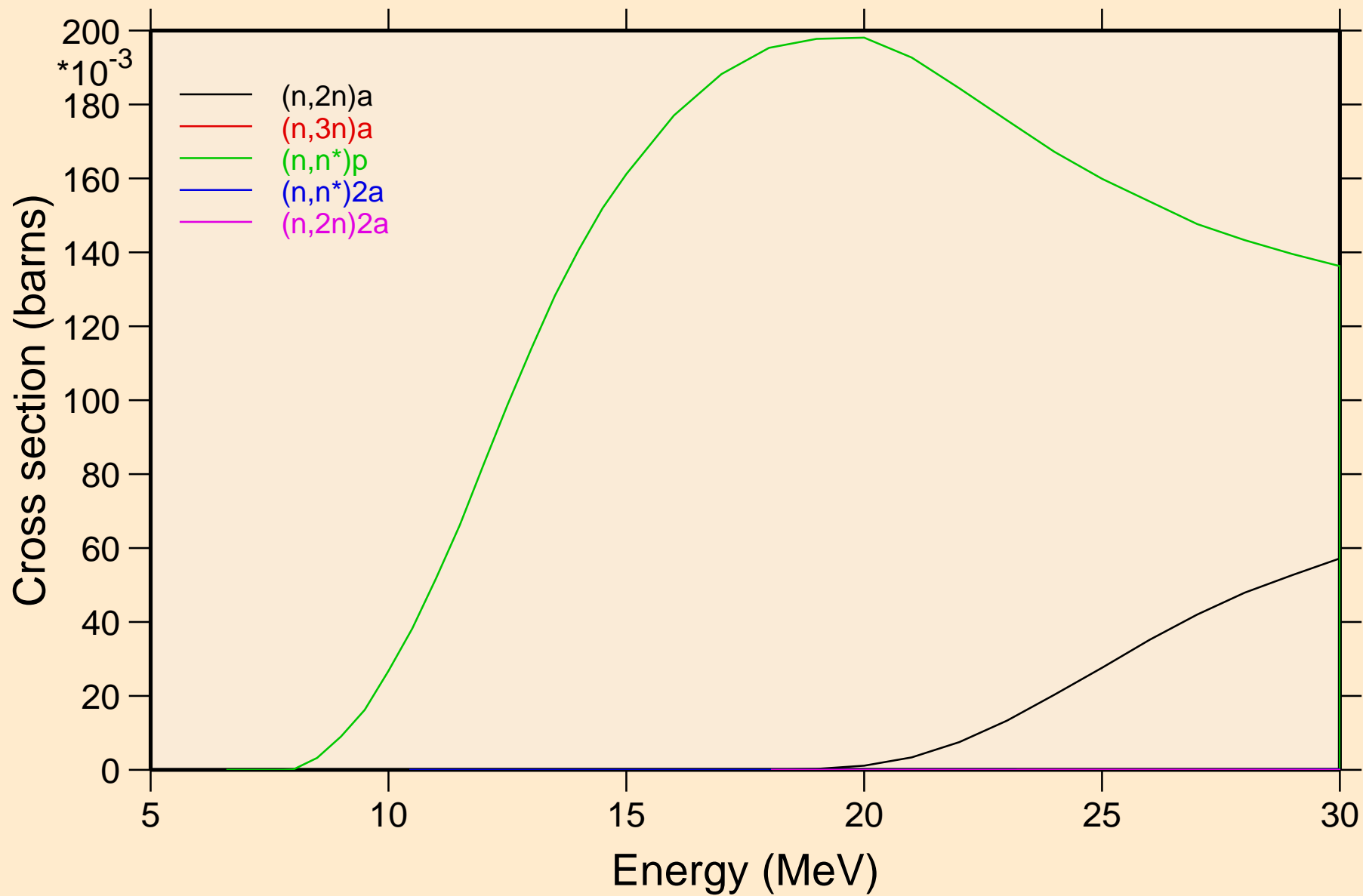

GA068 NEUTRON ACER TENDL-2021 LIBRARY; T=293.6K
Threshold reactions

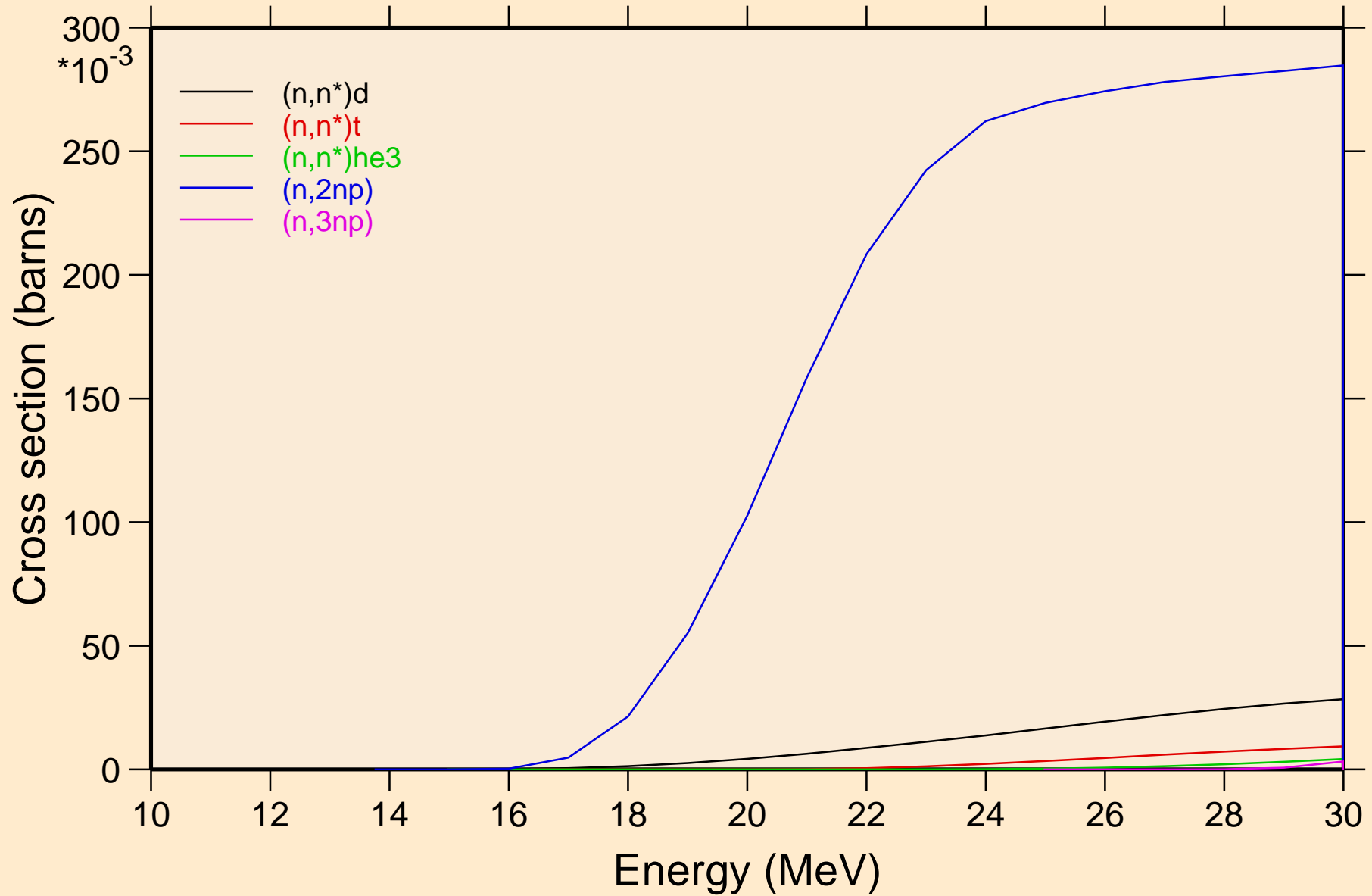

GA068 NEUTRON ACER TENDL-2021 LIBRARY; T=293.6K
Threshold reactions

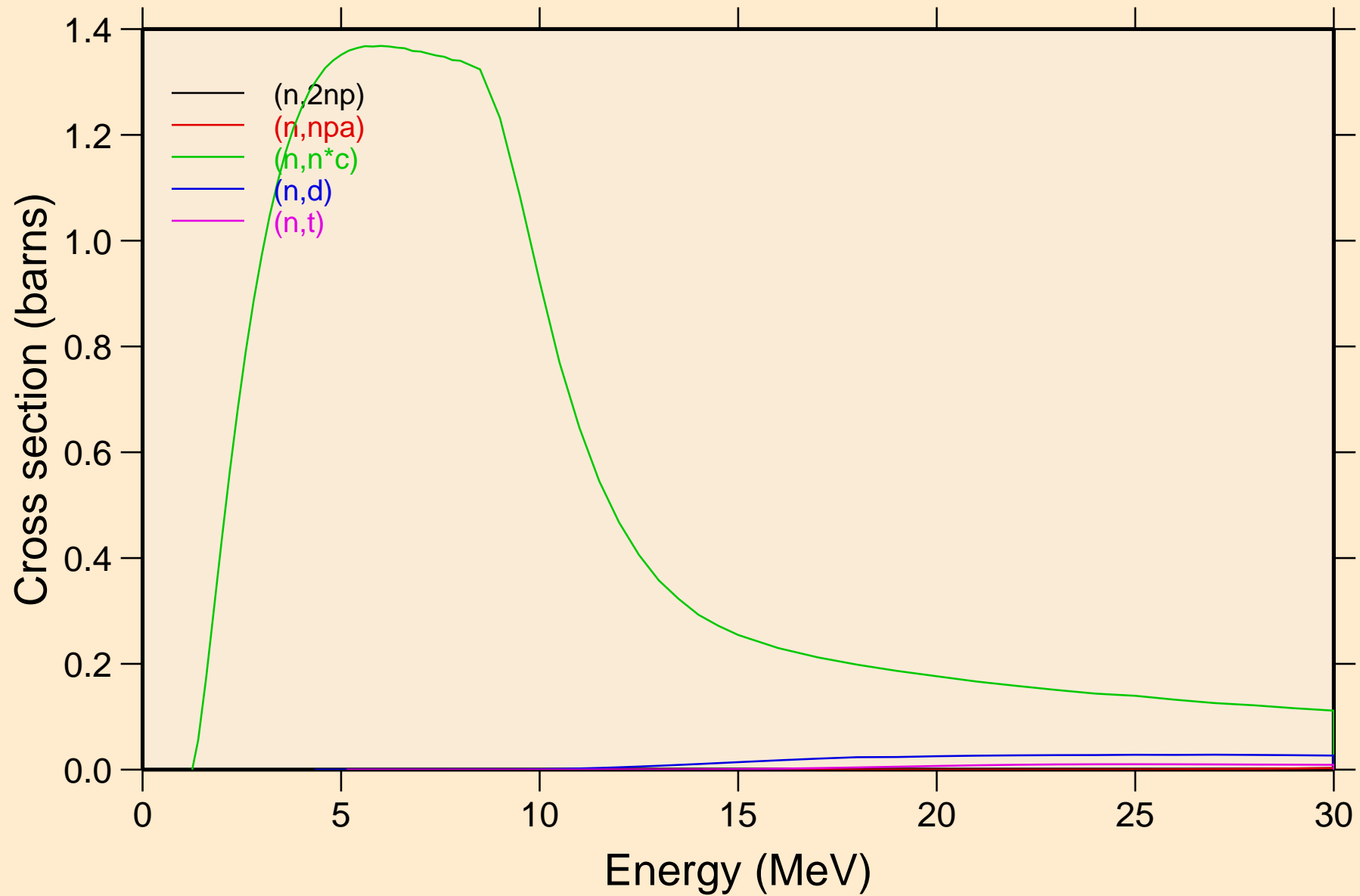

GA068 NEUTRON ACER TENDL-2021 LIBRARY; T=293.6K
Threshold reactions

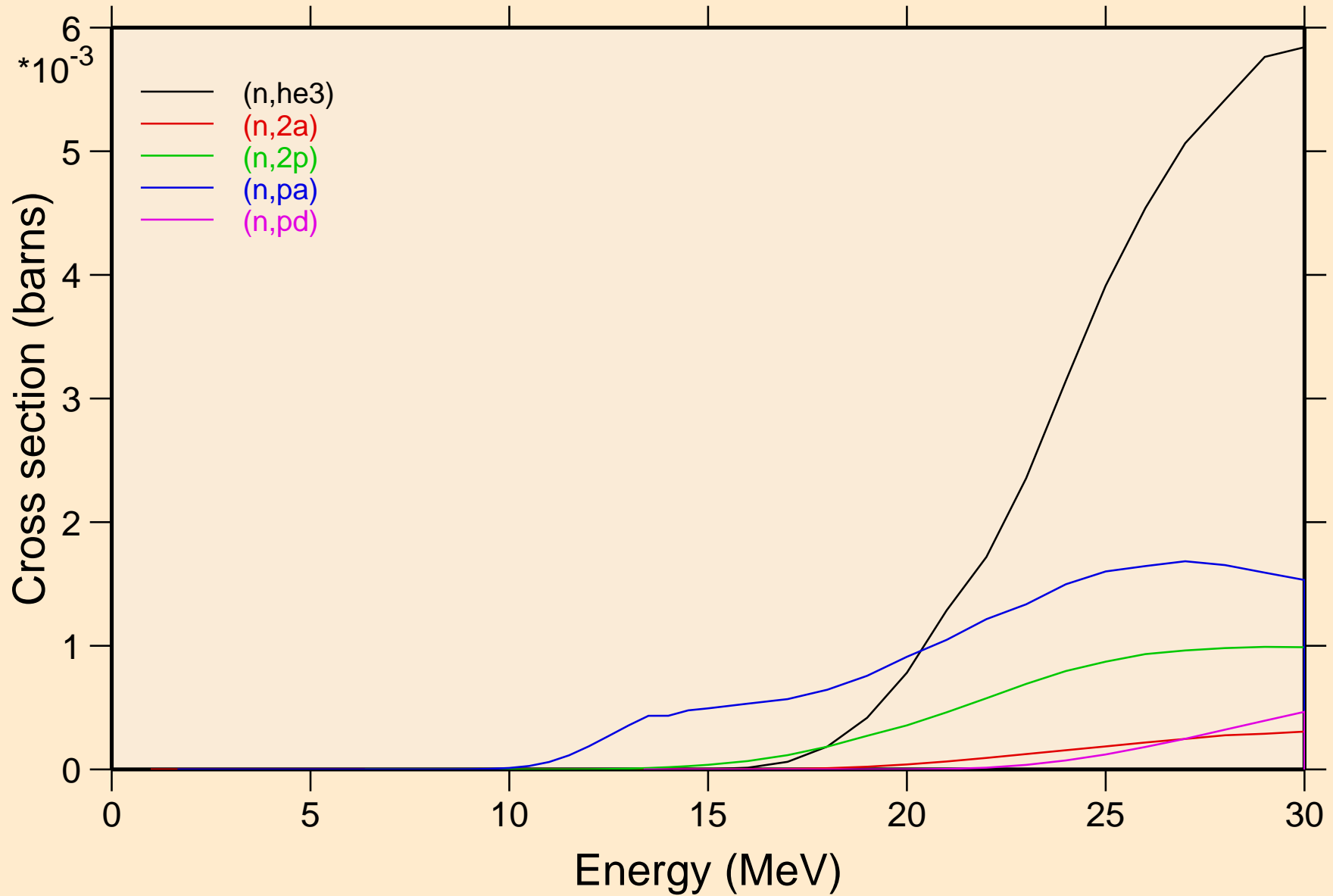

GA068 NEUTRON ACER TENDL-2021 LIBRARY; T=293.6K

Threshold reactions

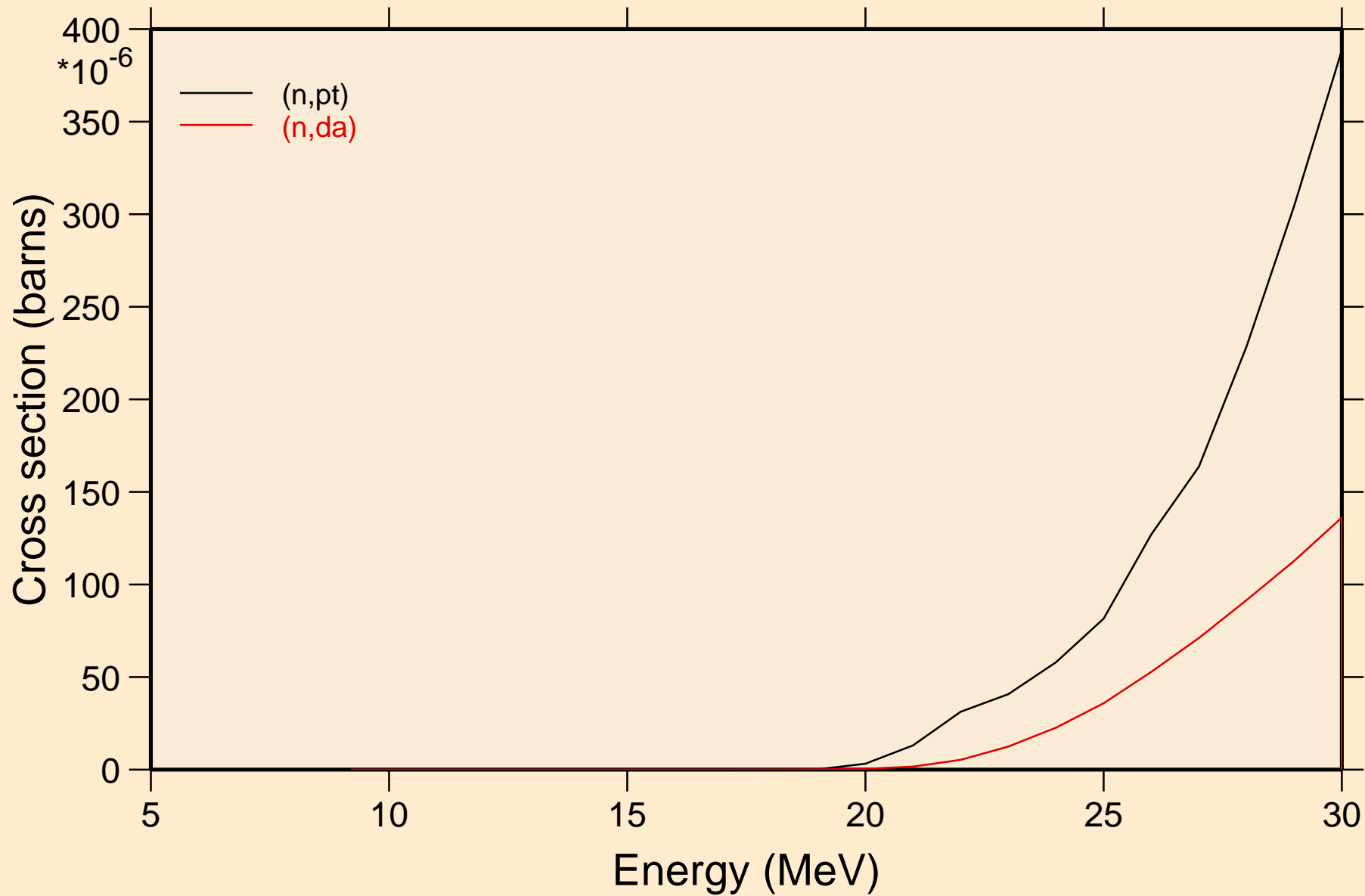

GA068 NEUTRON ACER TENDL-2021 LIBRARY; T=293.6K
Threshold reactions

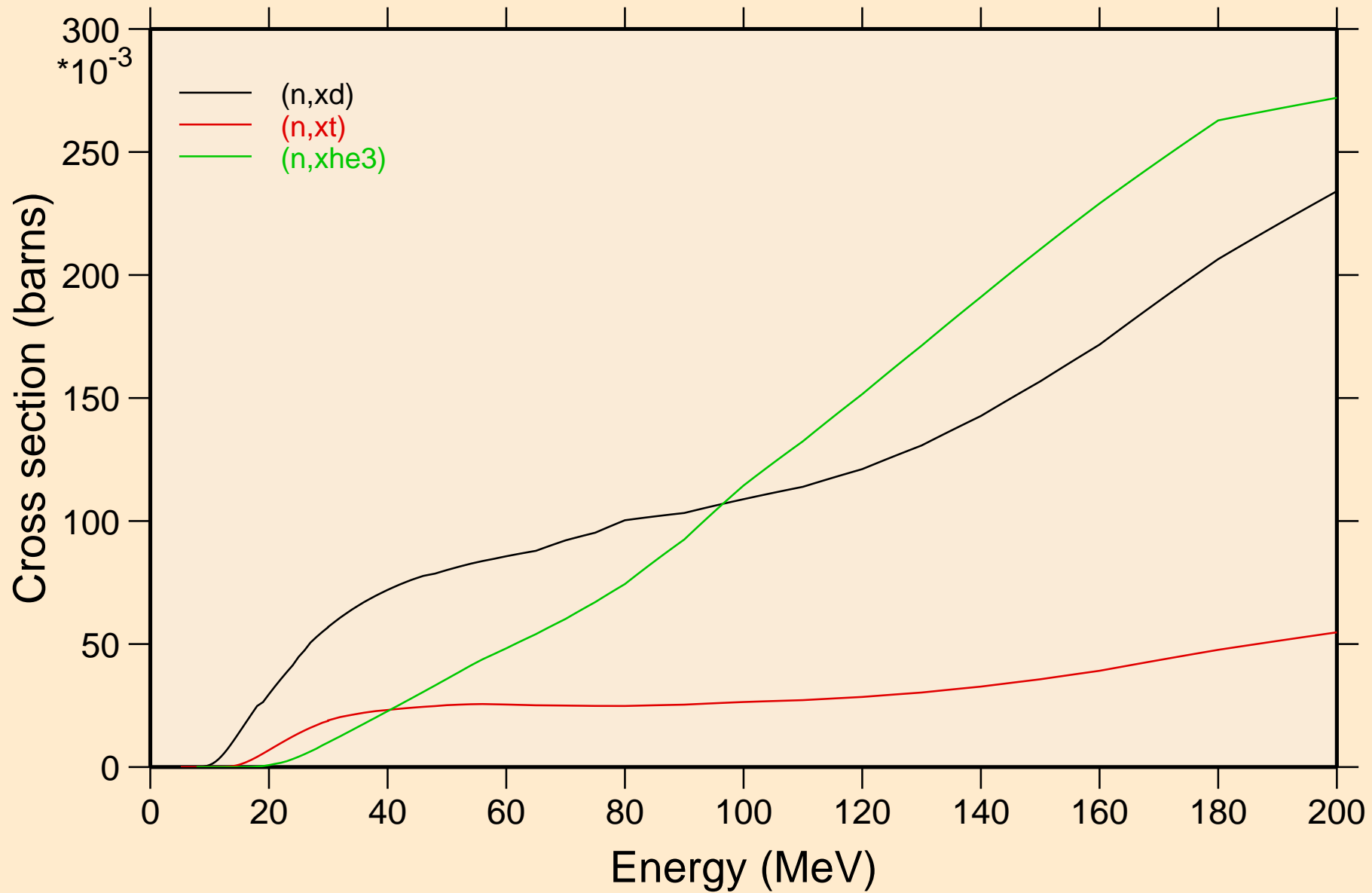

GA068 NEUTRON ACER TENDL-2021 LIBRARY; T=293.6K
angular distribution for elastic

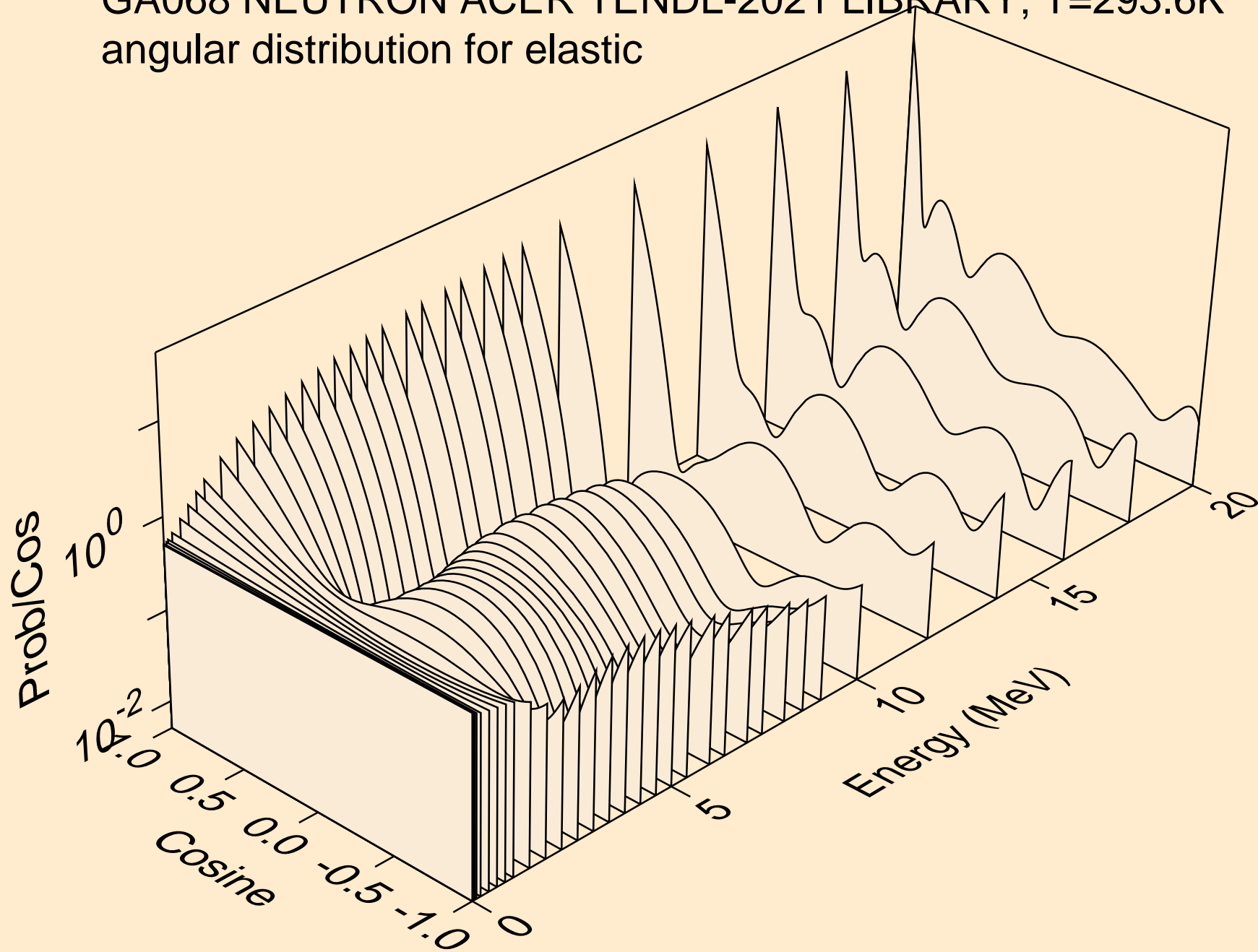

GA068 NEUTRON ACER TENDL-2021 LIBRARY; T=293.6K
angular distribution for elastic

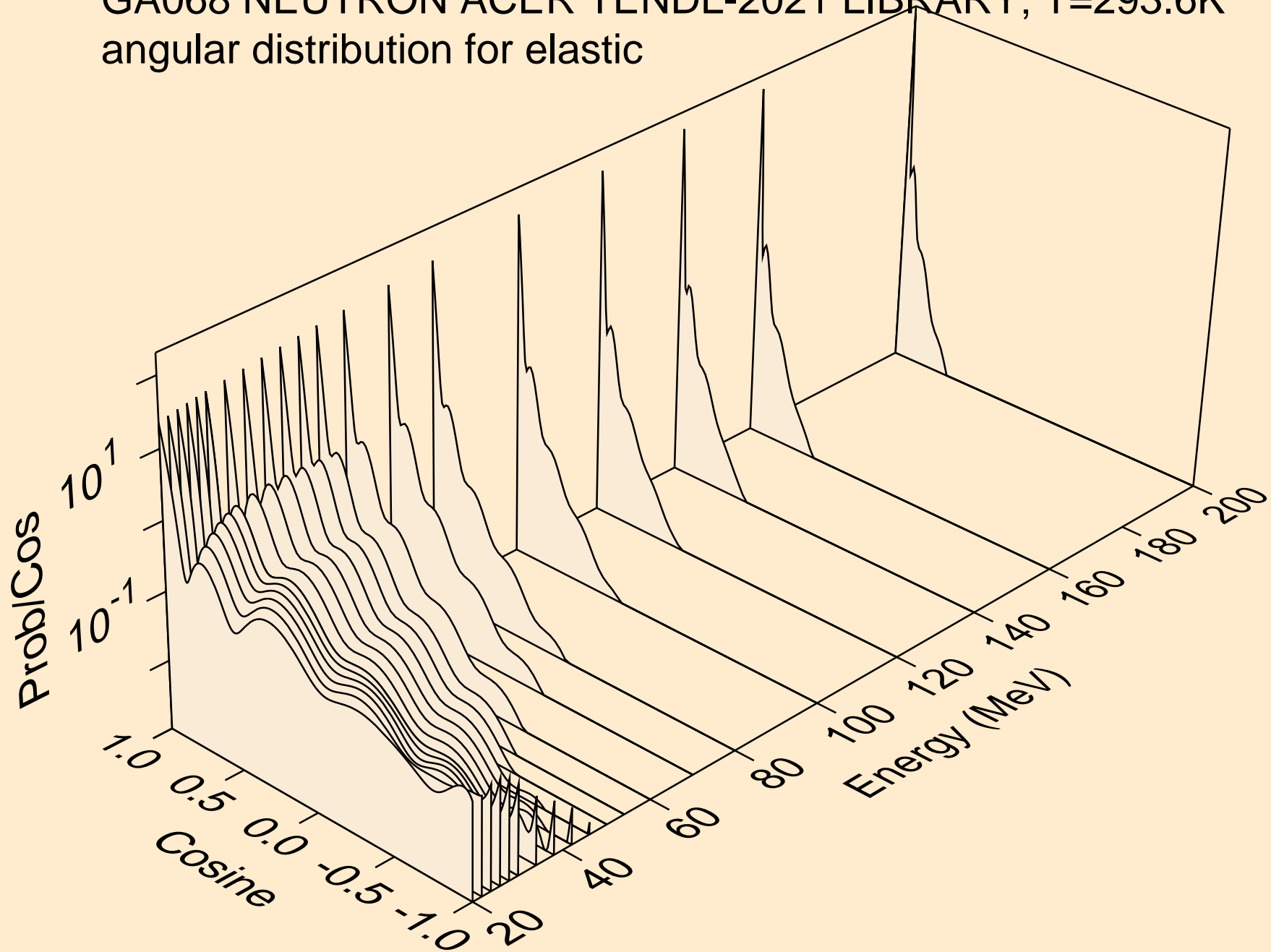

GA068 NEUTRON ACER TENDL-2021 LIBRARY; T=293.6K
angular distribution for (n,n*1)

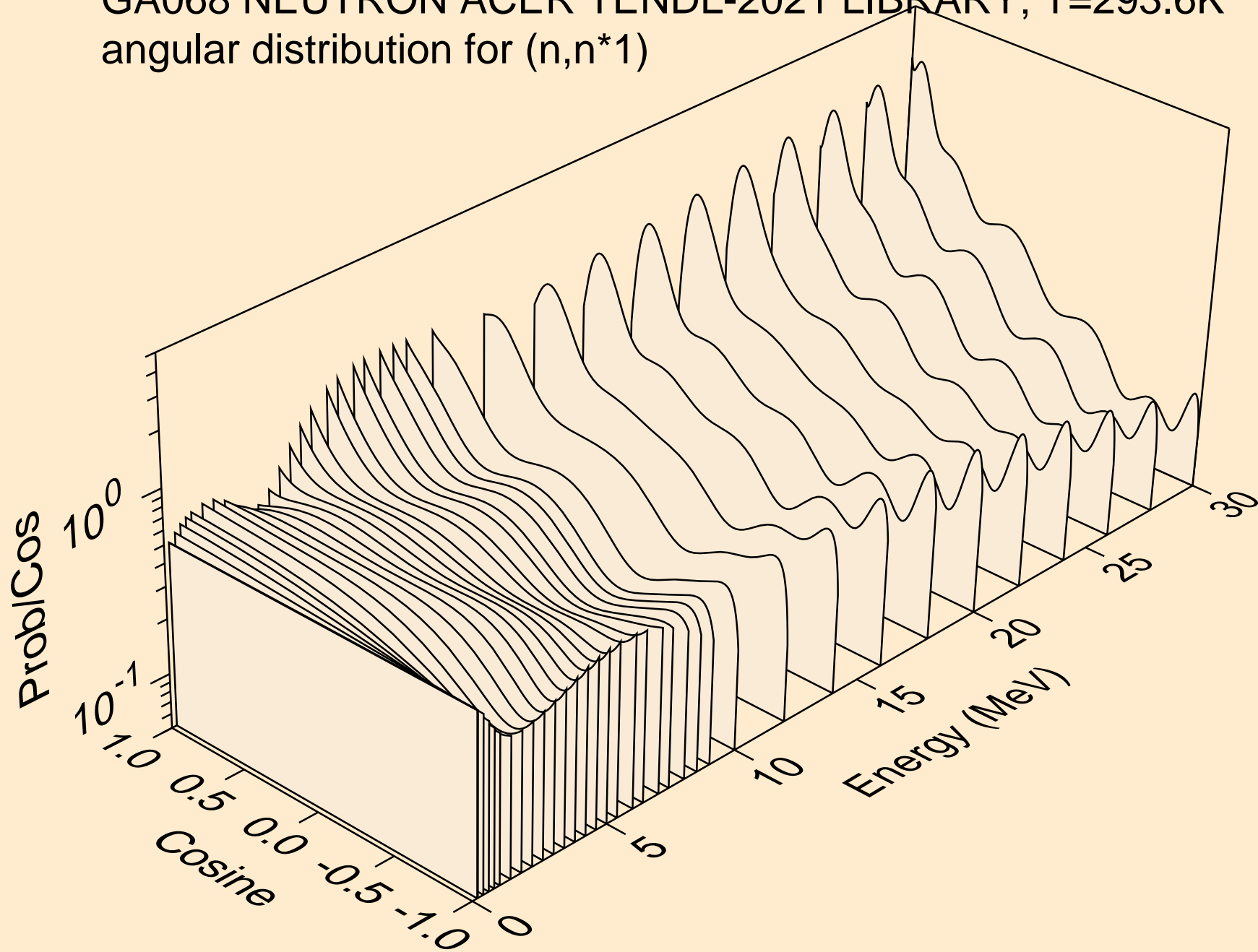

GA068 NEUTRON ACER TENDL-2021 LIBRARY; T=293.6K
angular distribution for (n,n*2)

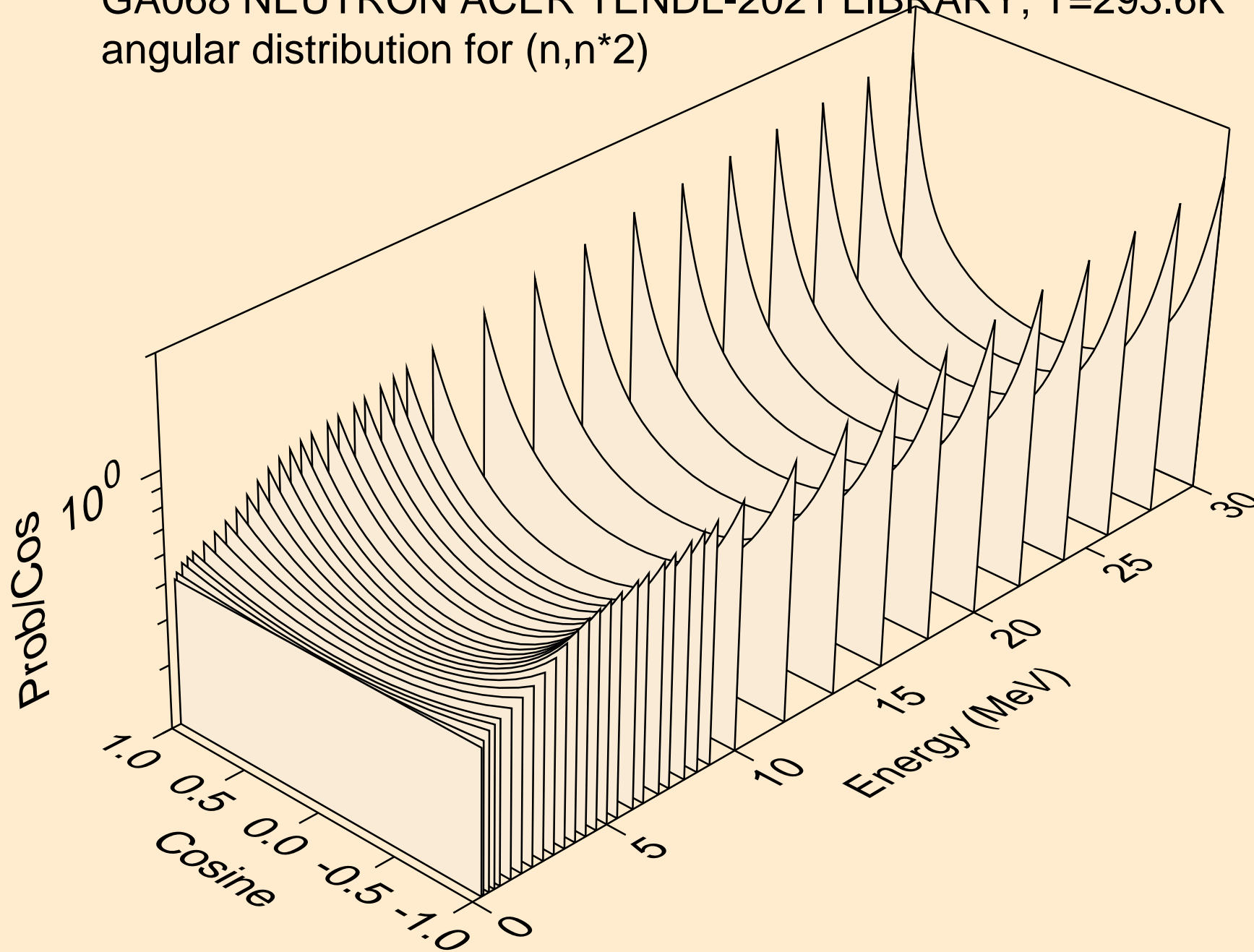

GA068 NEUTRON ACER TENDL-2021 LIBRARY; T=293.6K
angular distribution for (n,n*3)

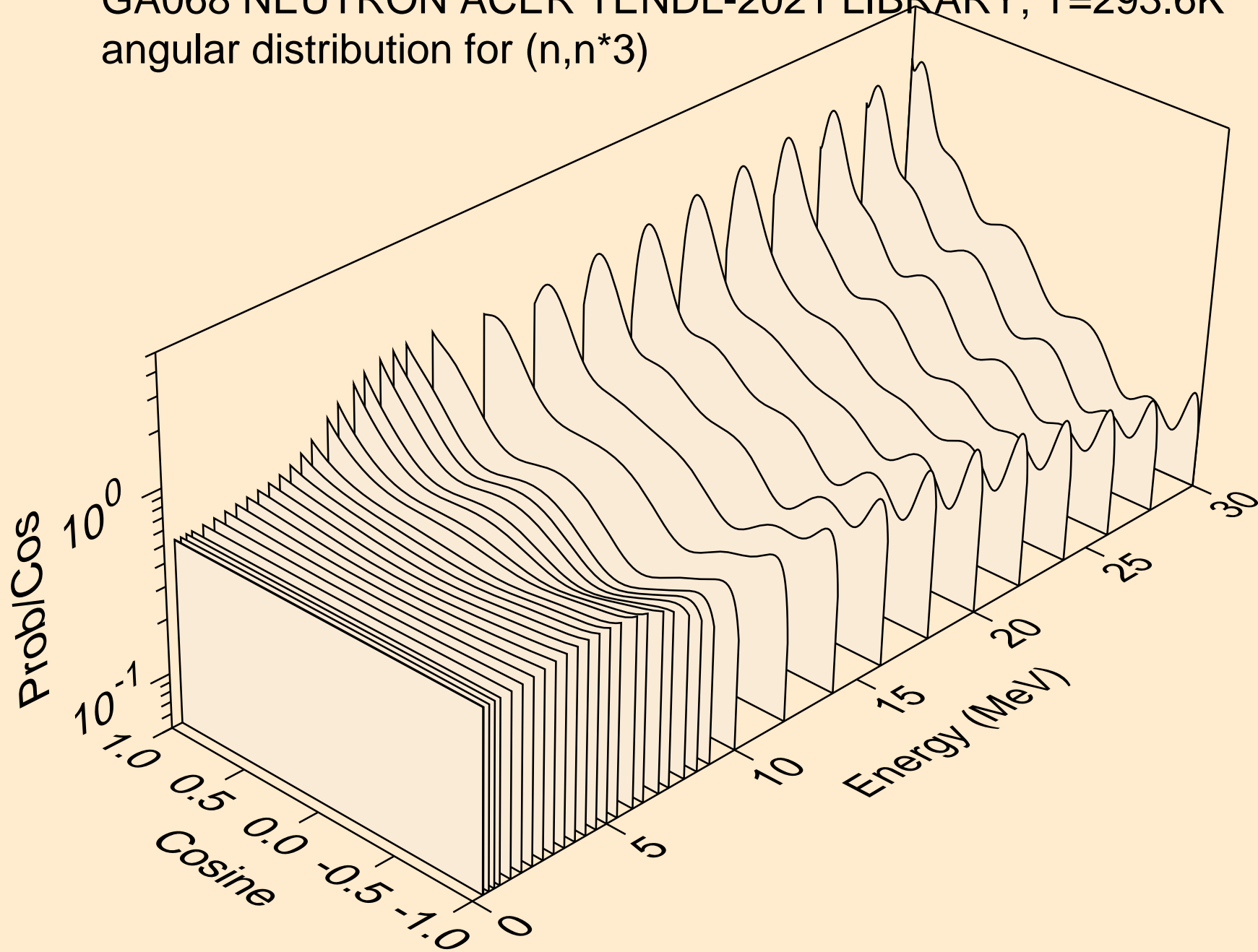

GA068 NEUTRON ACER TENDL-2021 LIBRARY; T=293.6K
angular distribution for (n,n*4)

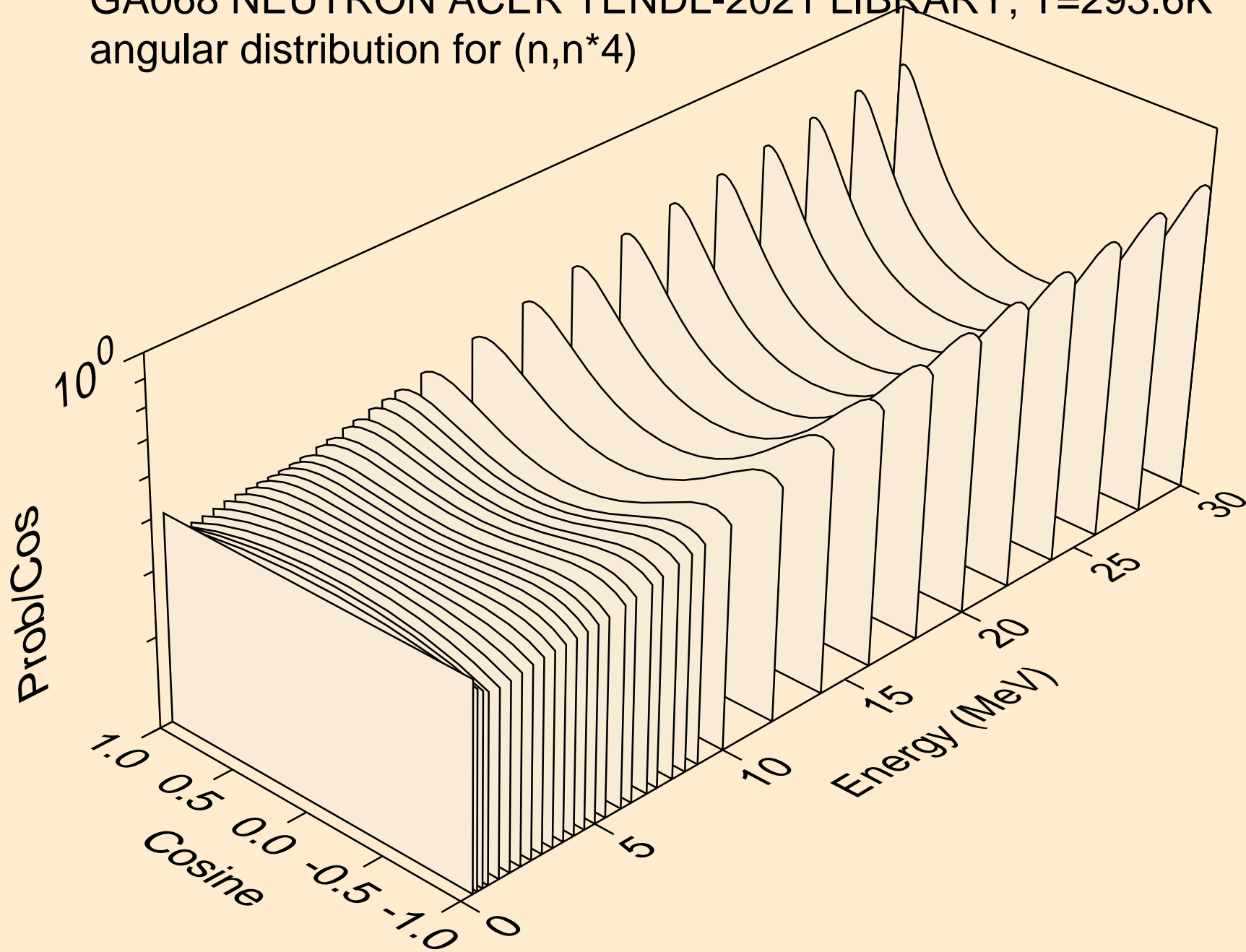

GA068 NEUTRON ACER TENDL-2021 LIBRARY; T=293.6K
angular distribution for (n,n*5)

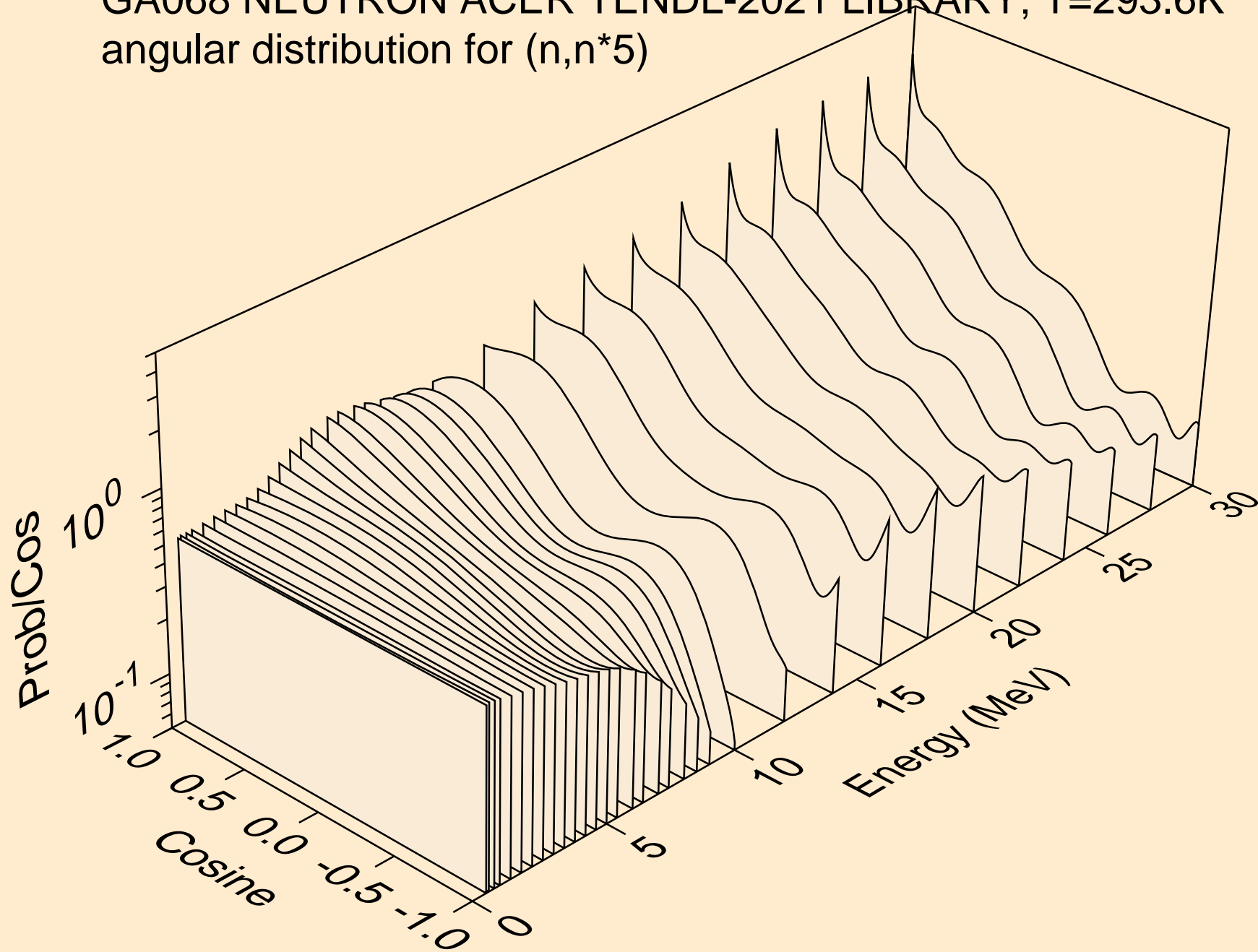

GA068 NEUTRON ACER TENDL-2021 LIBRARY; T=293.6K
angular distribution for (n,n*6)

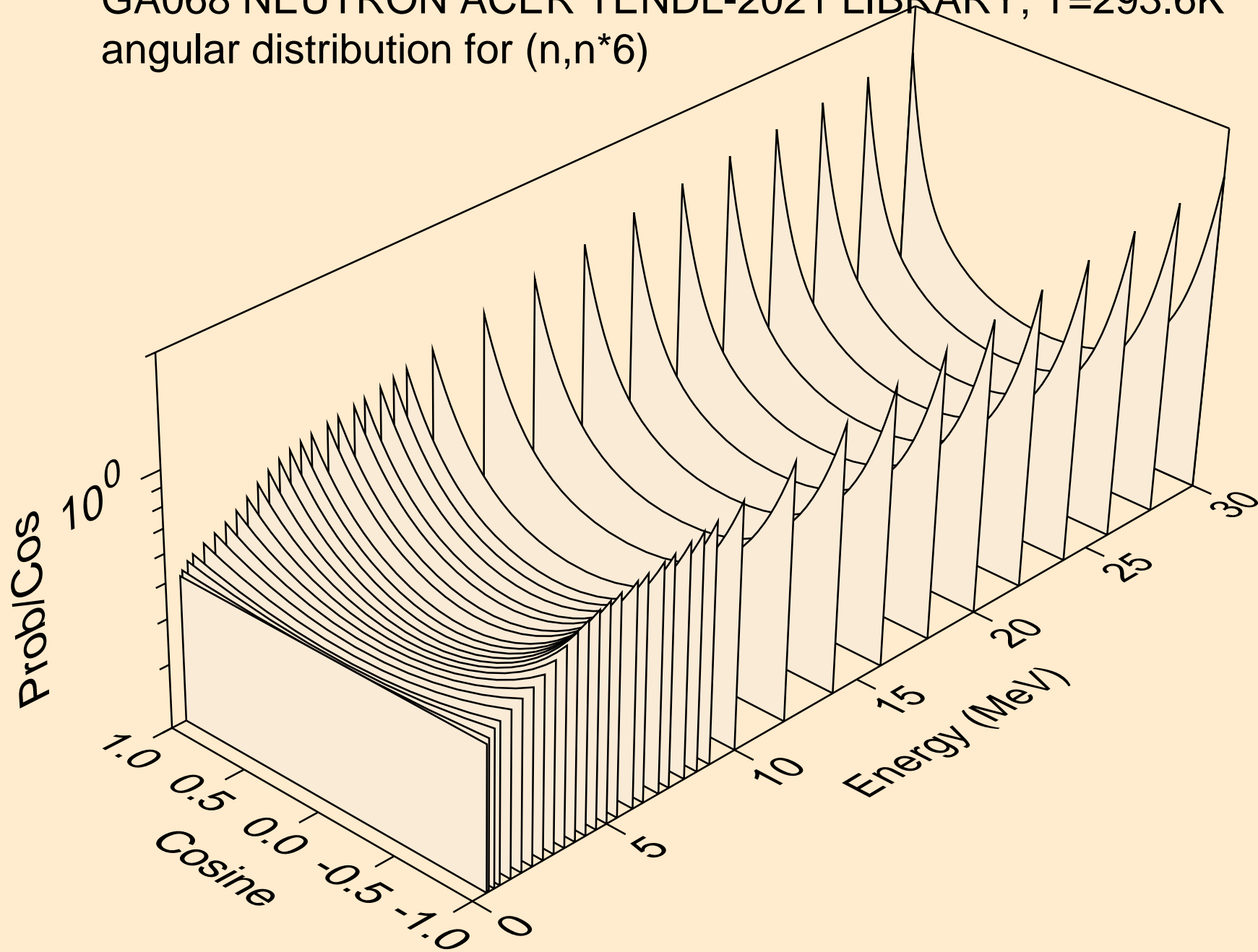

GA068 NEUTRON ACER TENDL-2021 LIBRARY; T=293.6K
angular distribution for (n,n*7)

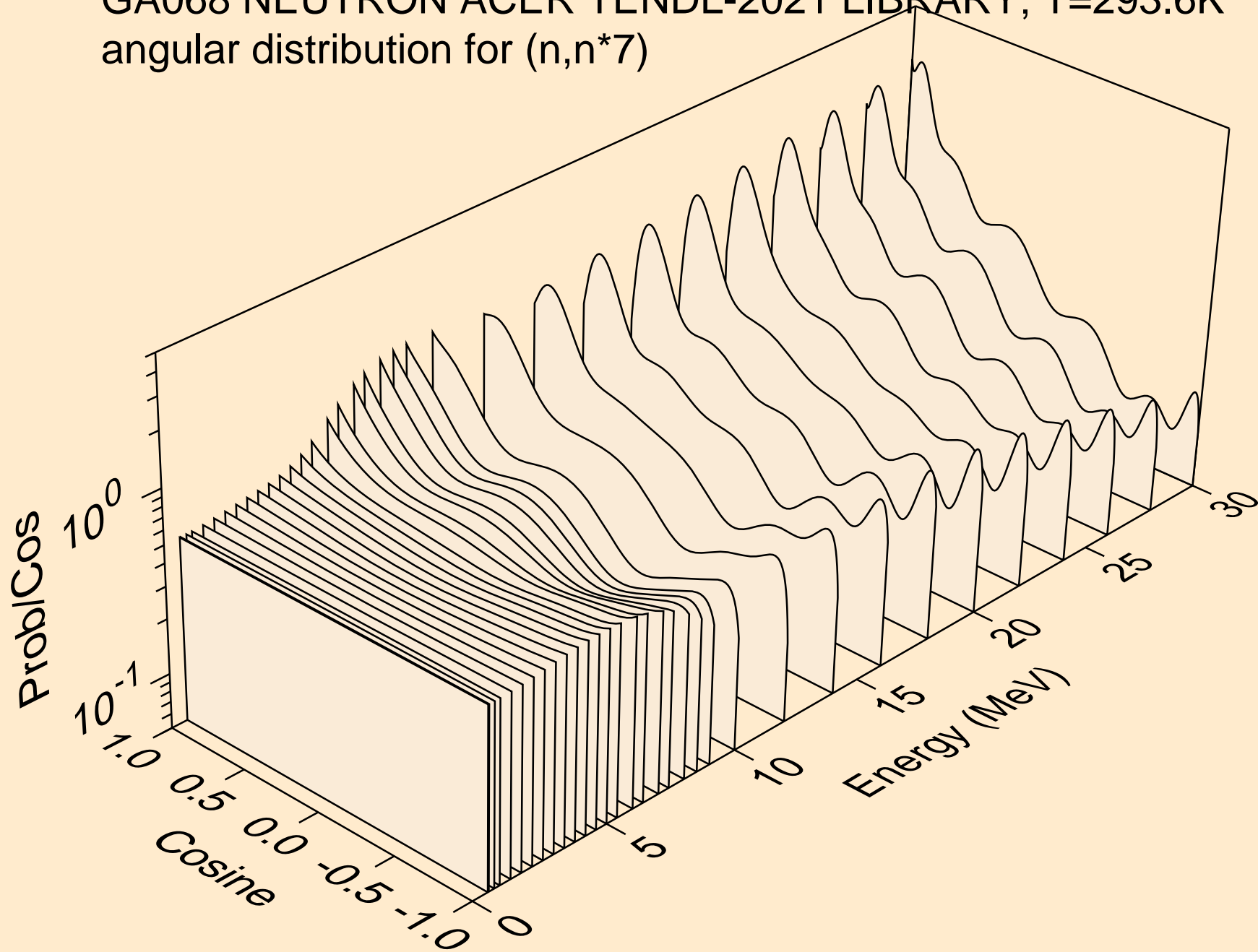

GA068 NEUTRON ACER TENDL-2021 LIBRARY; T=293.6K
angular distribution for (n,n*8)

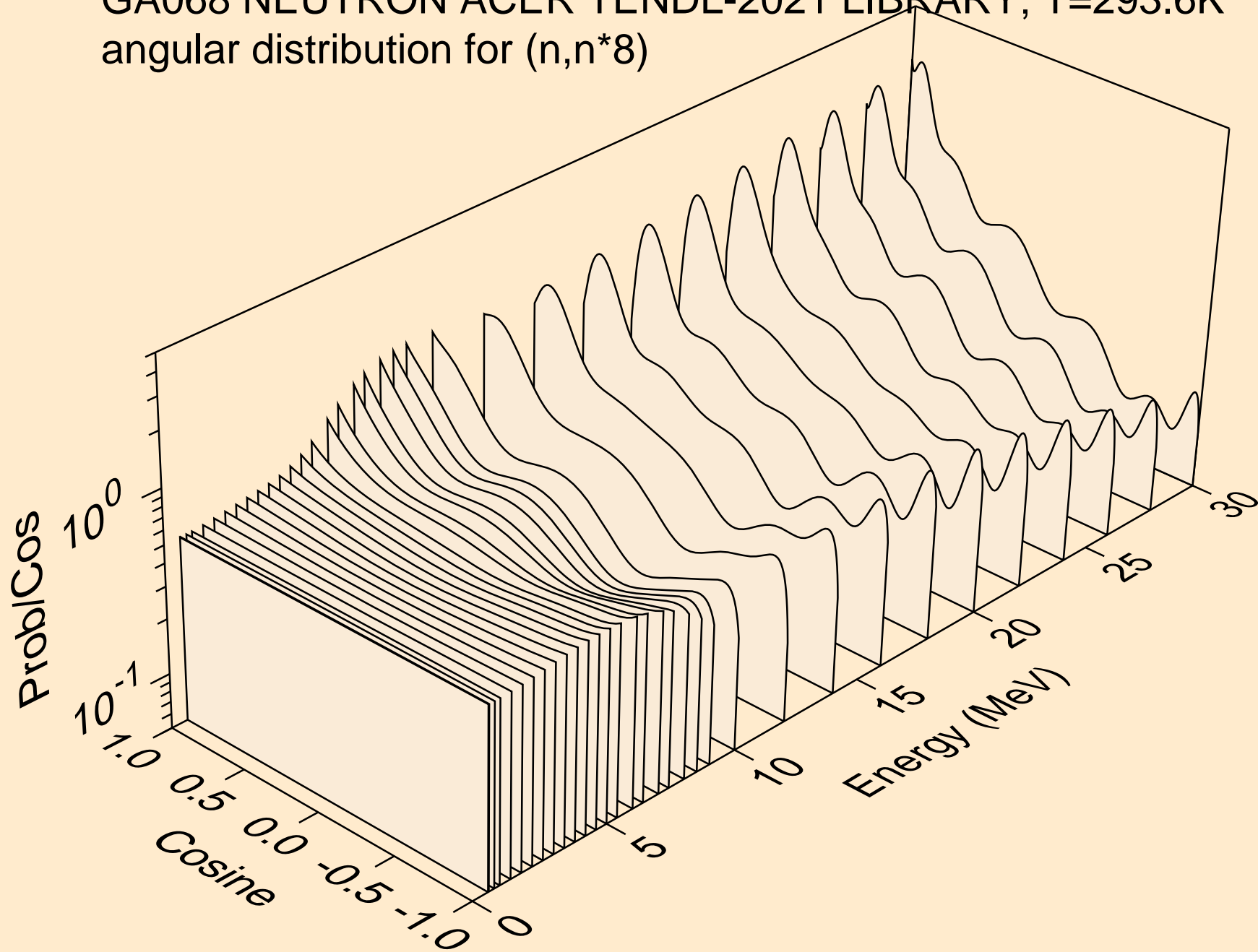

GA068 NEUTRON ACER TENDL-2021 LIBRARY; T=293.6K
angular distribution for (n,n*9)

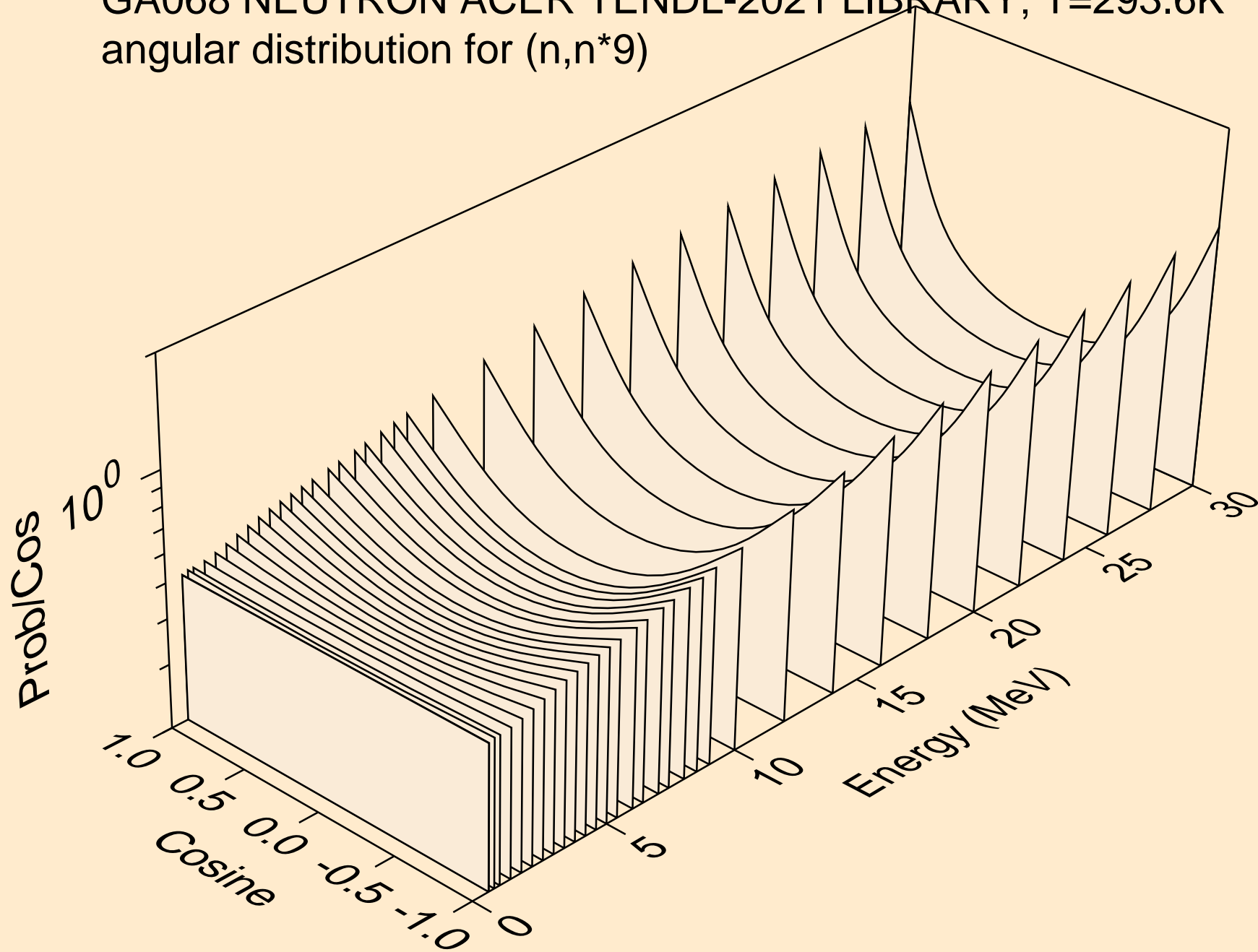

GA068 NEUTRON ACER TENDL-2021 LIBRARY; T=293.6K
angular distribution for (n,n*10)

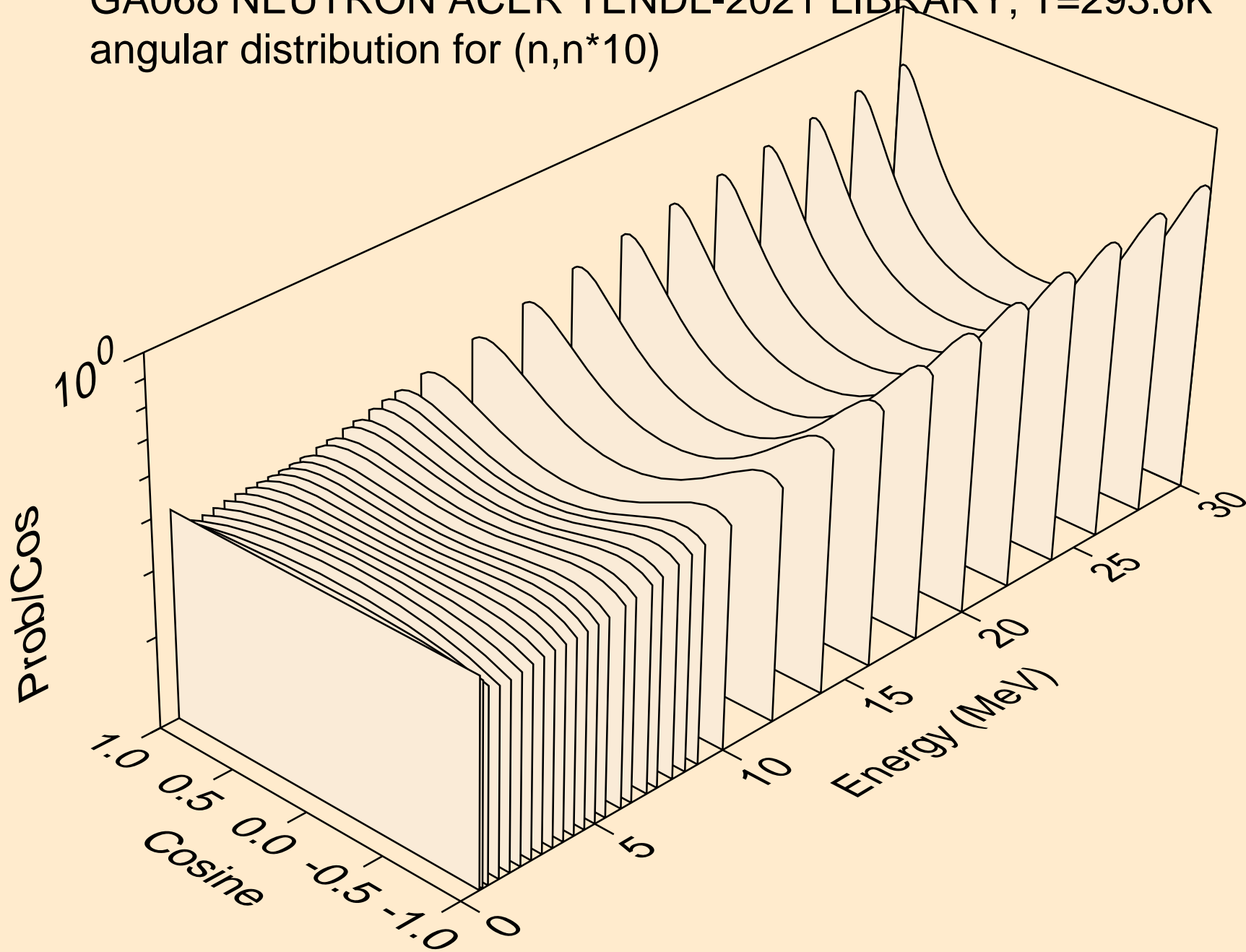

GA068 NEUTRON ACER TENDL-2021 LIBRARY; T=293.6K
angular distribution for (n,n*11)

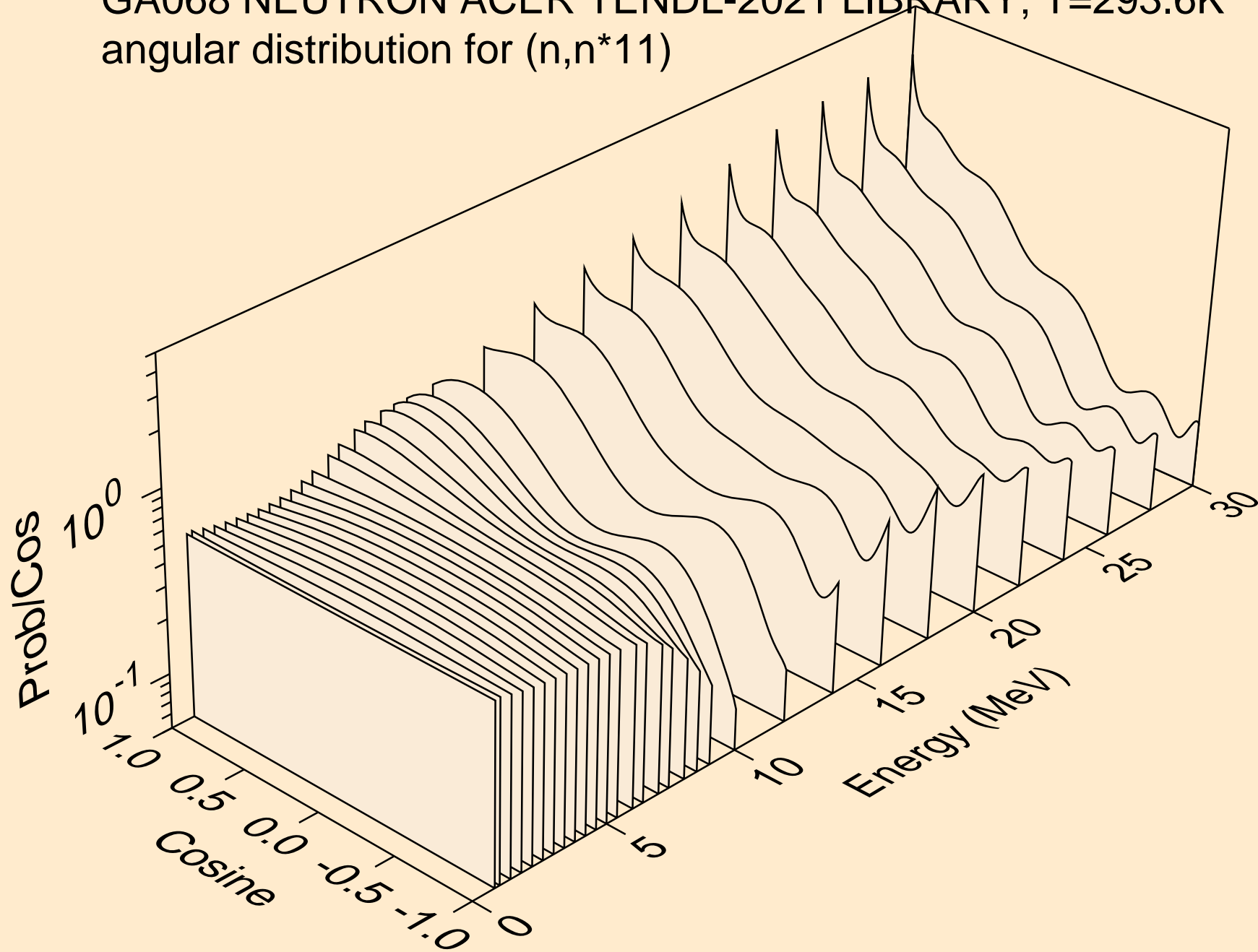

GA068 NEUTRON ACER TENDL-2021 LIBRARY; T=293.6K
angular distribution for (n,n*12)

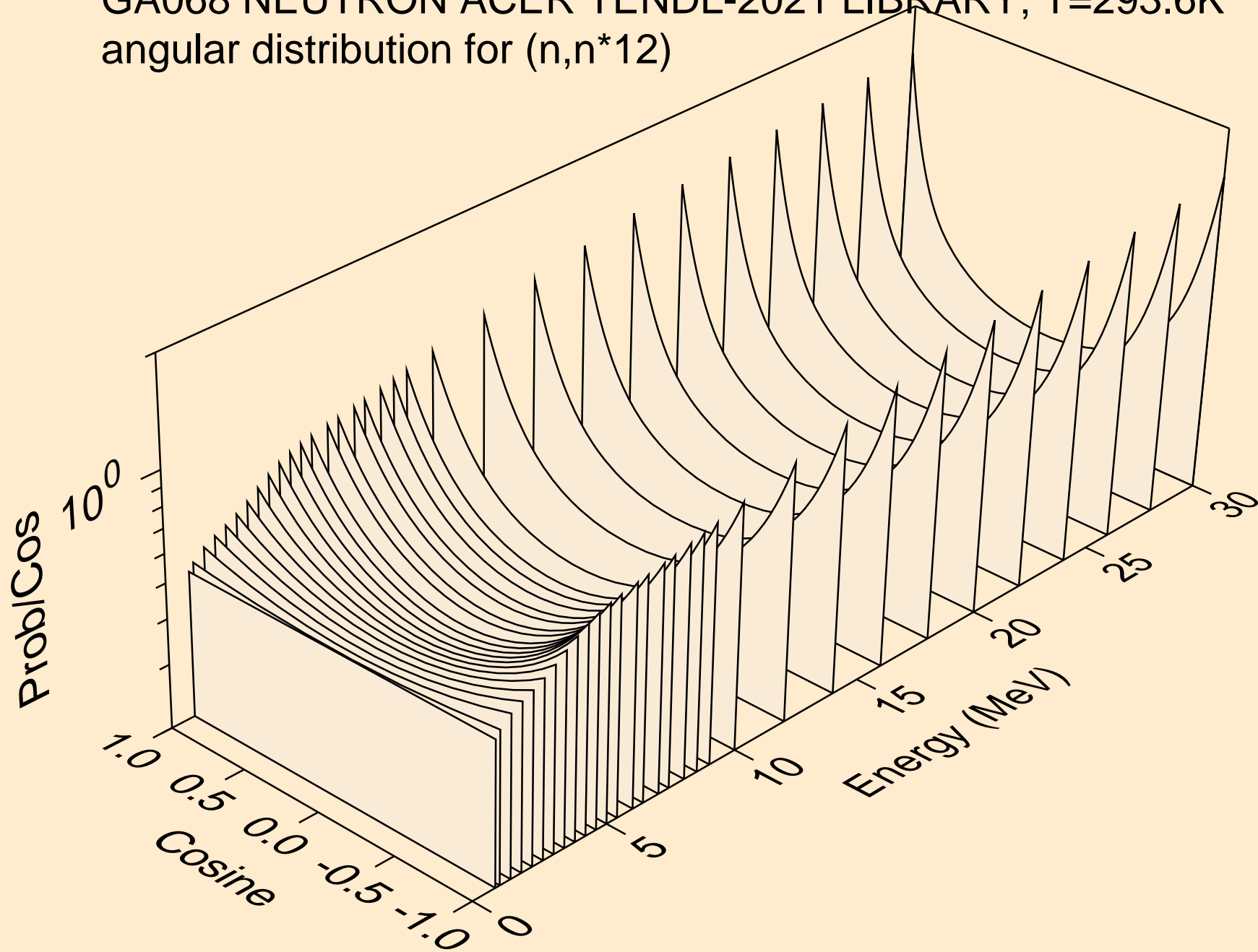

GA068 NEUTRON ACER TENDL-2021 LIBRARY; T=293.6K
angular distribution for (n,n*13)

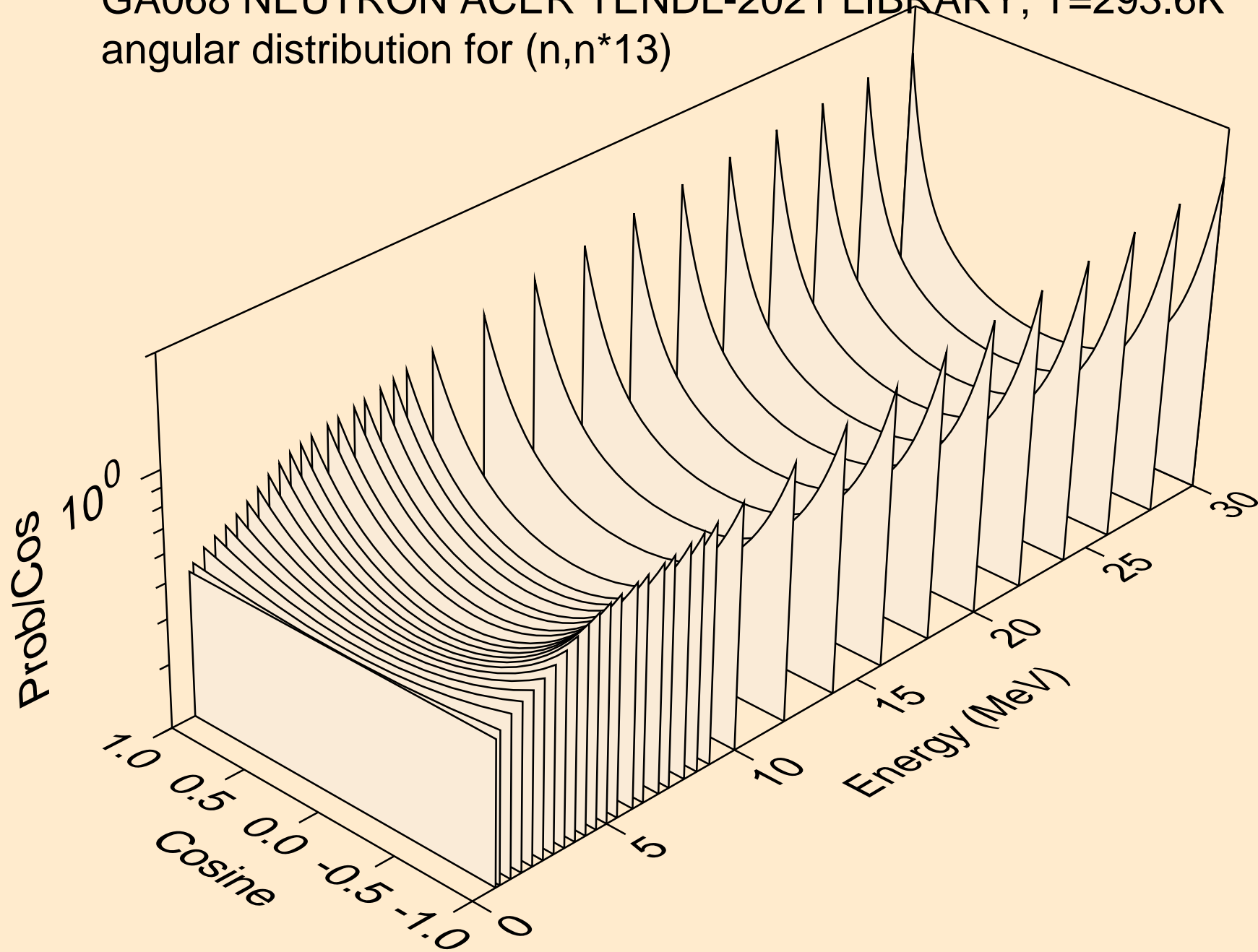

GA068 NEUTRON ACER TENDL-2021 LIBRARY; T=293.6K
angular distribution for (n,n*14)

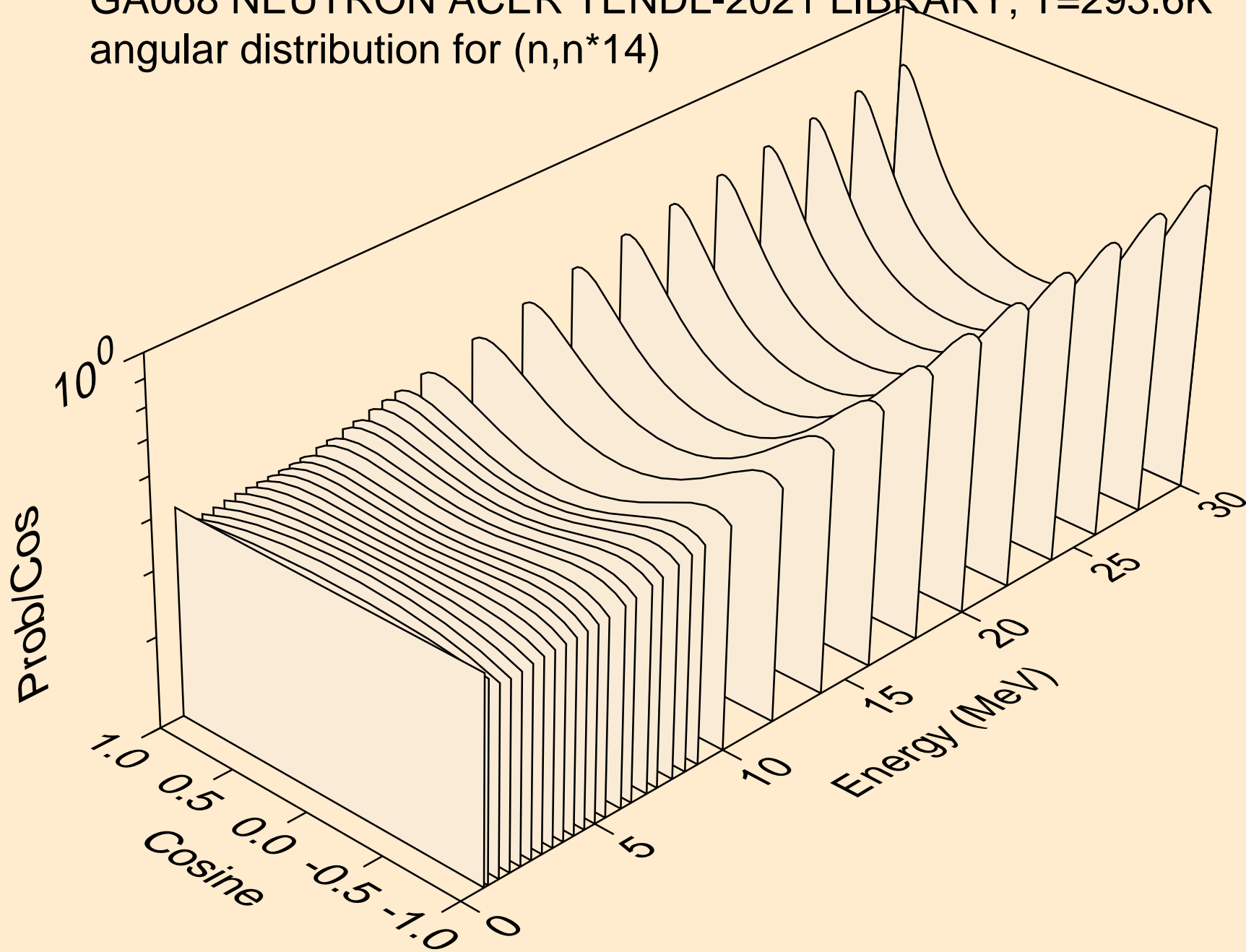

GA068 NEUTRON ACER TENDL-2021 LIBRARY; T=293.6K
angular distribution for (n,n*15)

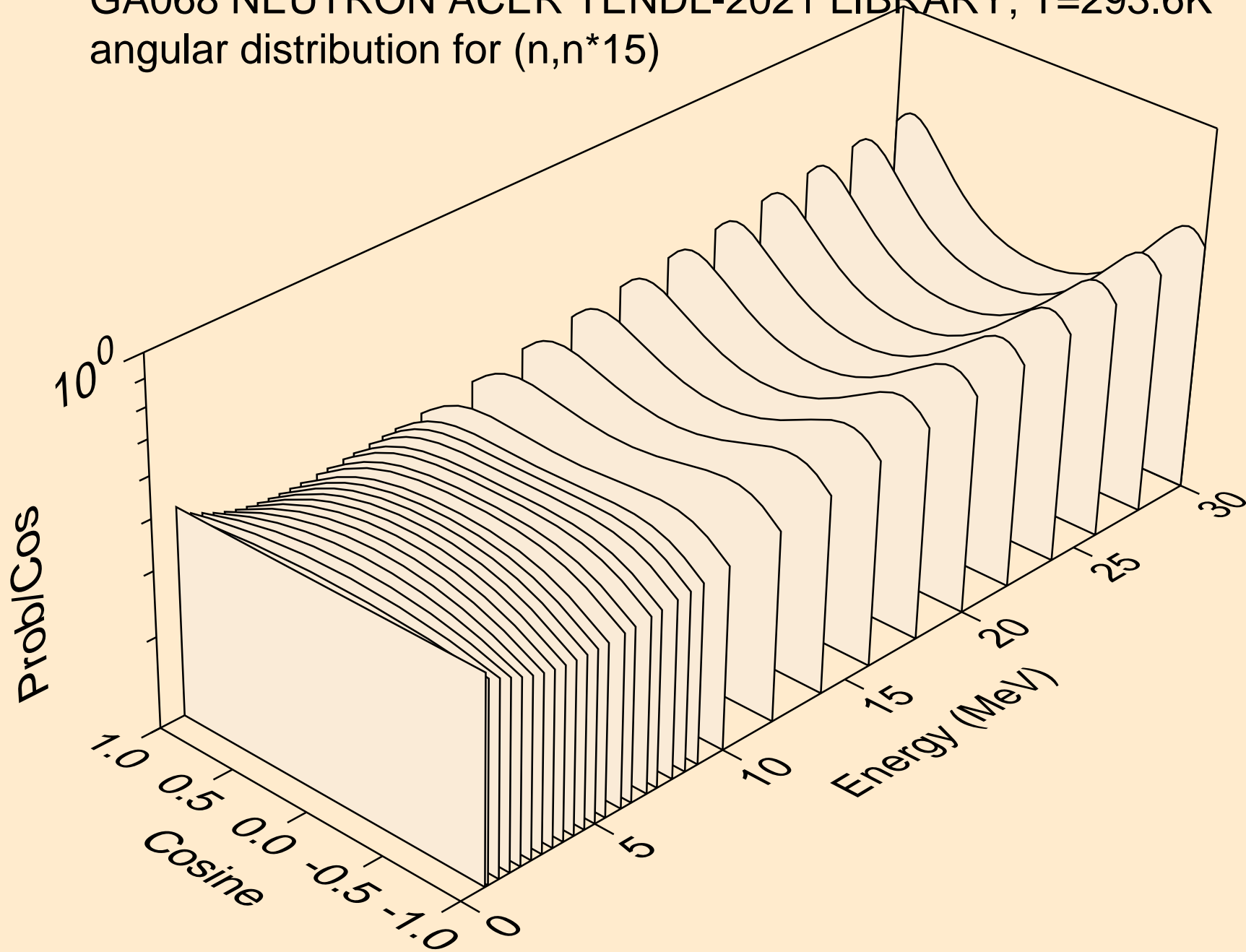

GA068 NEUTRON ACER TENDL-2021 LIBRARY; T=293.6K
angular distribution for (n,n*16)

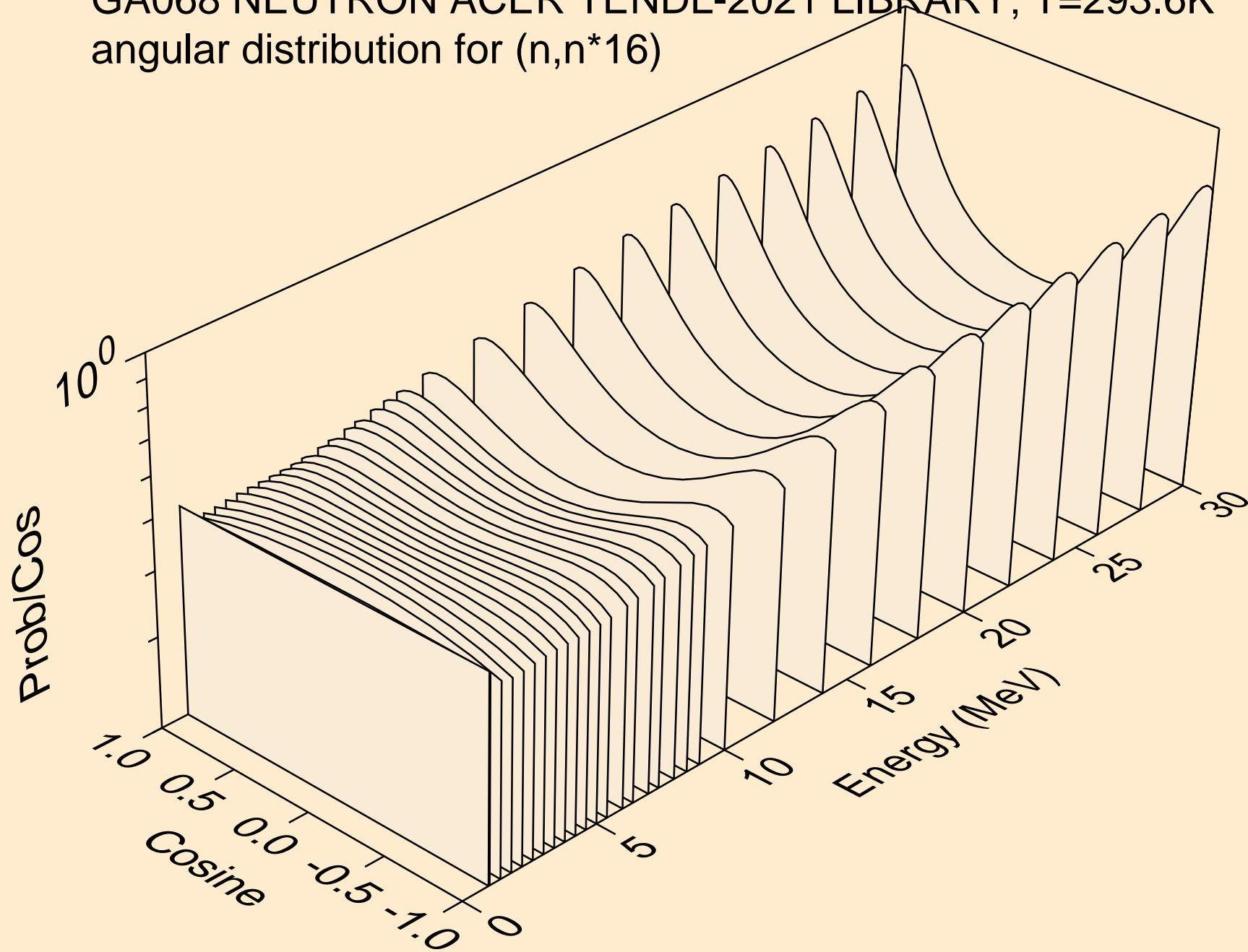

GA068 NEUTRON ACER TENDL-2021 LIBRARY; T=293.6K
angular distribution for (n,n*17)

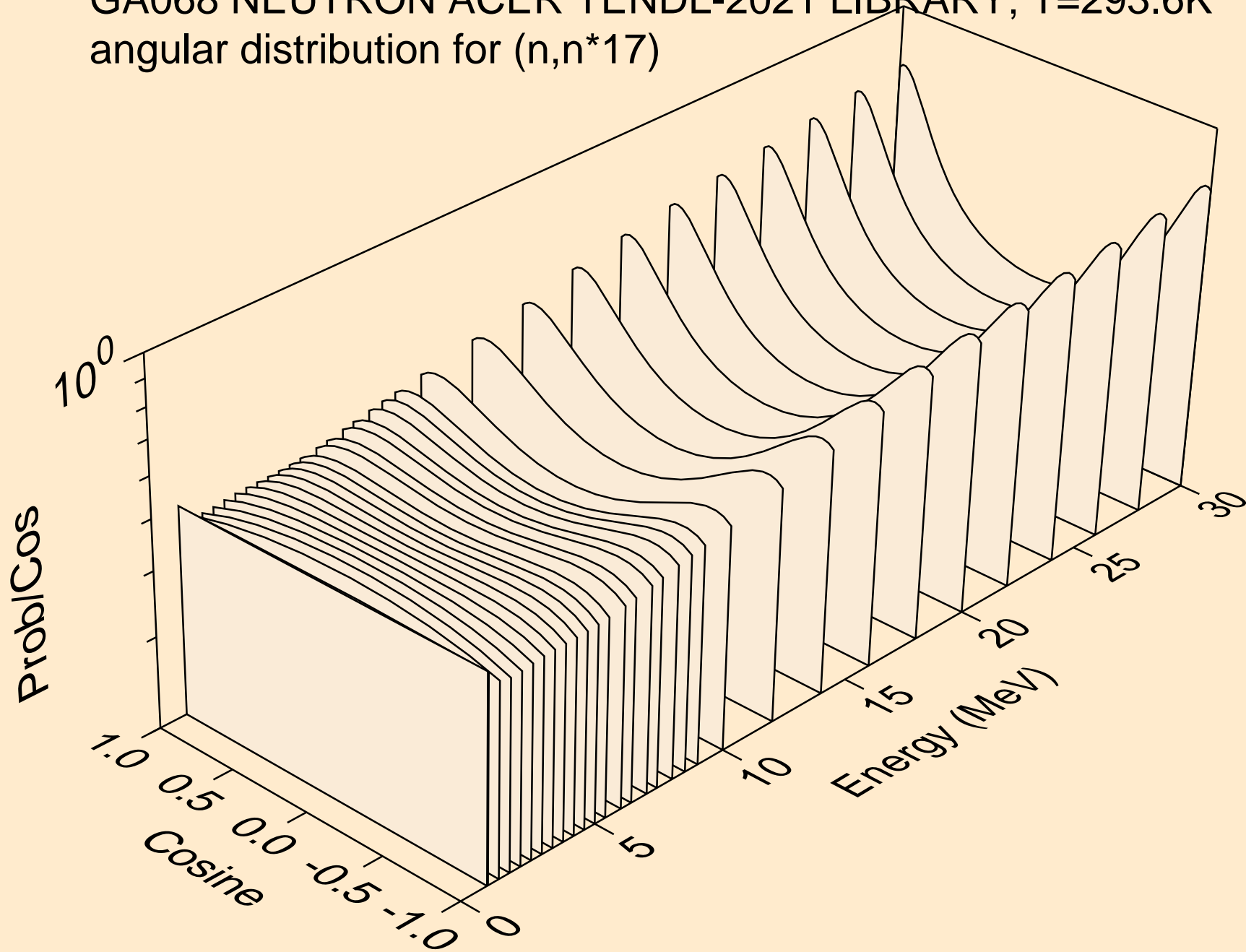

GA068 NEUTRON ACER TENDL-2021 LIBRARY; T=293.6K
angular distribution for (n,n*18)

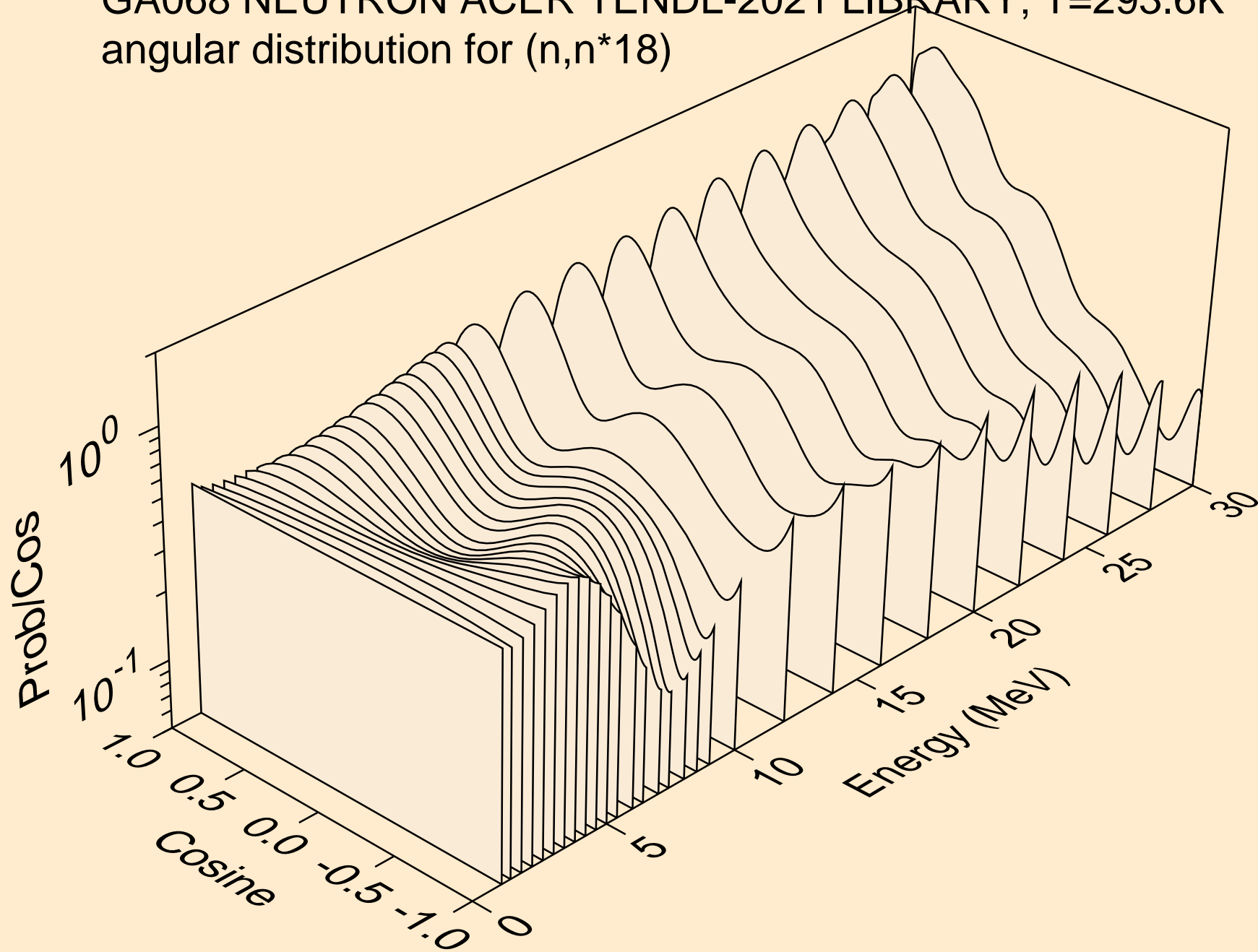

GA068 NEUTRON ACER TENDL-2021 LIBRARY; T=293.6K
angular distribution for (n,n*19)

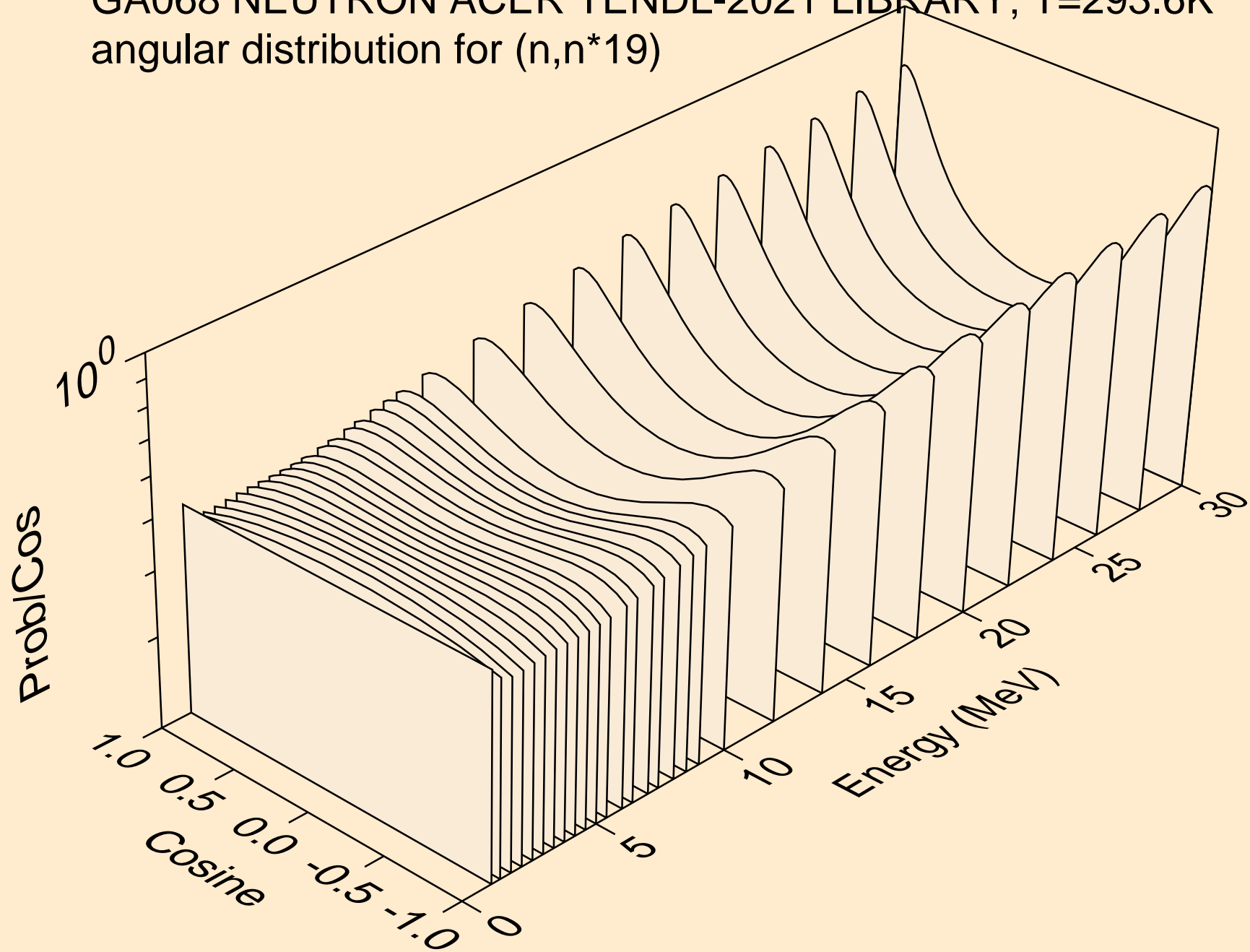

GA068 NEUTRON ACER TENDL-2021 LIBRARY; T=293.6K
angular distribution for (n,n*20)

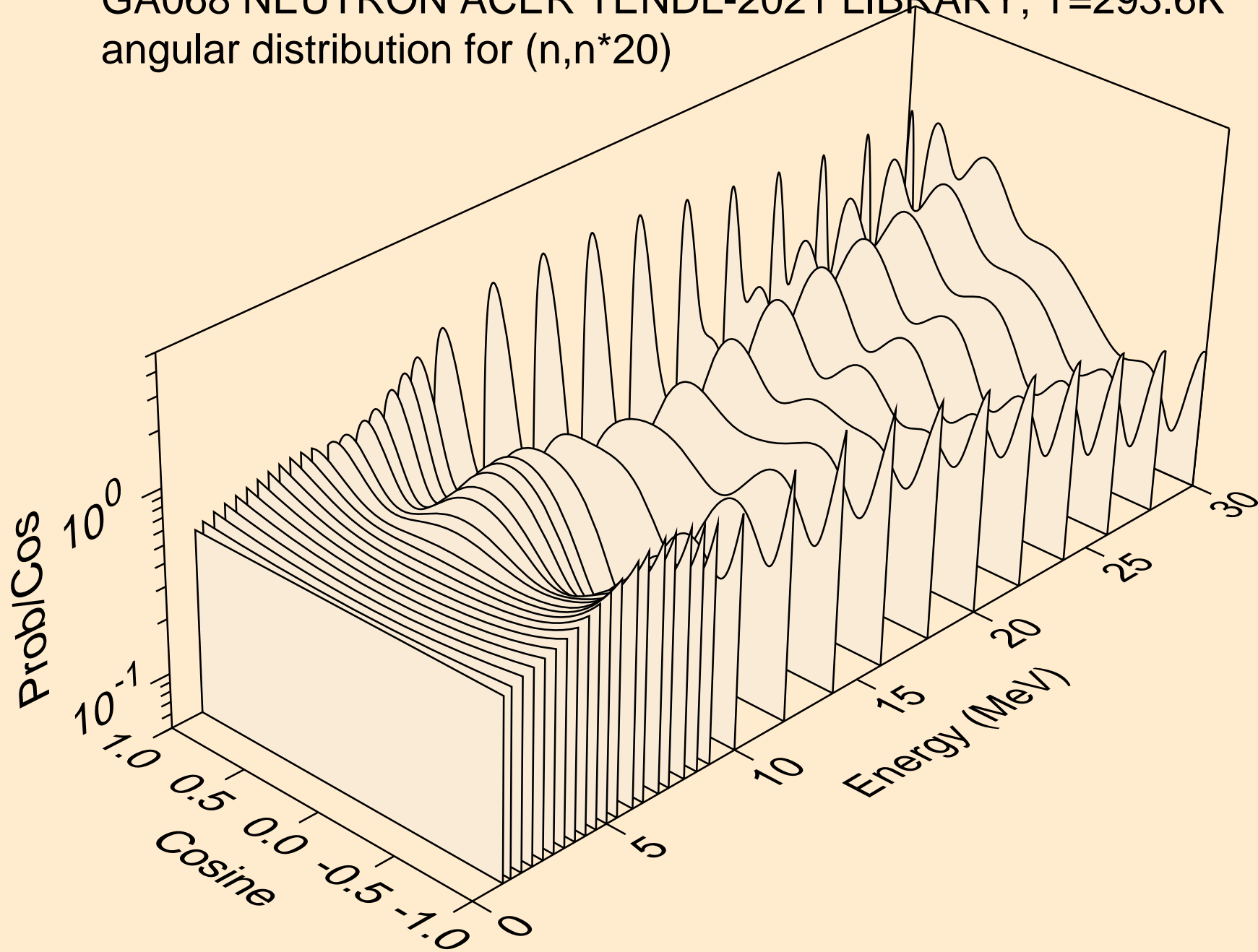

GA068 NEUTRON ACER TENDL-2021 LIBRARY; T=293.6K
angular distribution for (n,n*21)

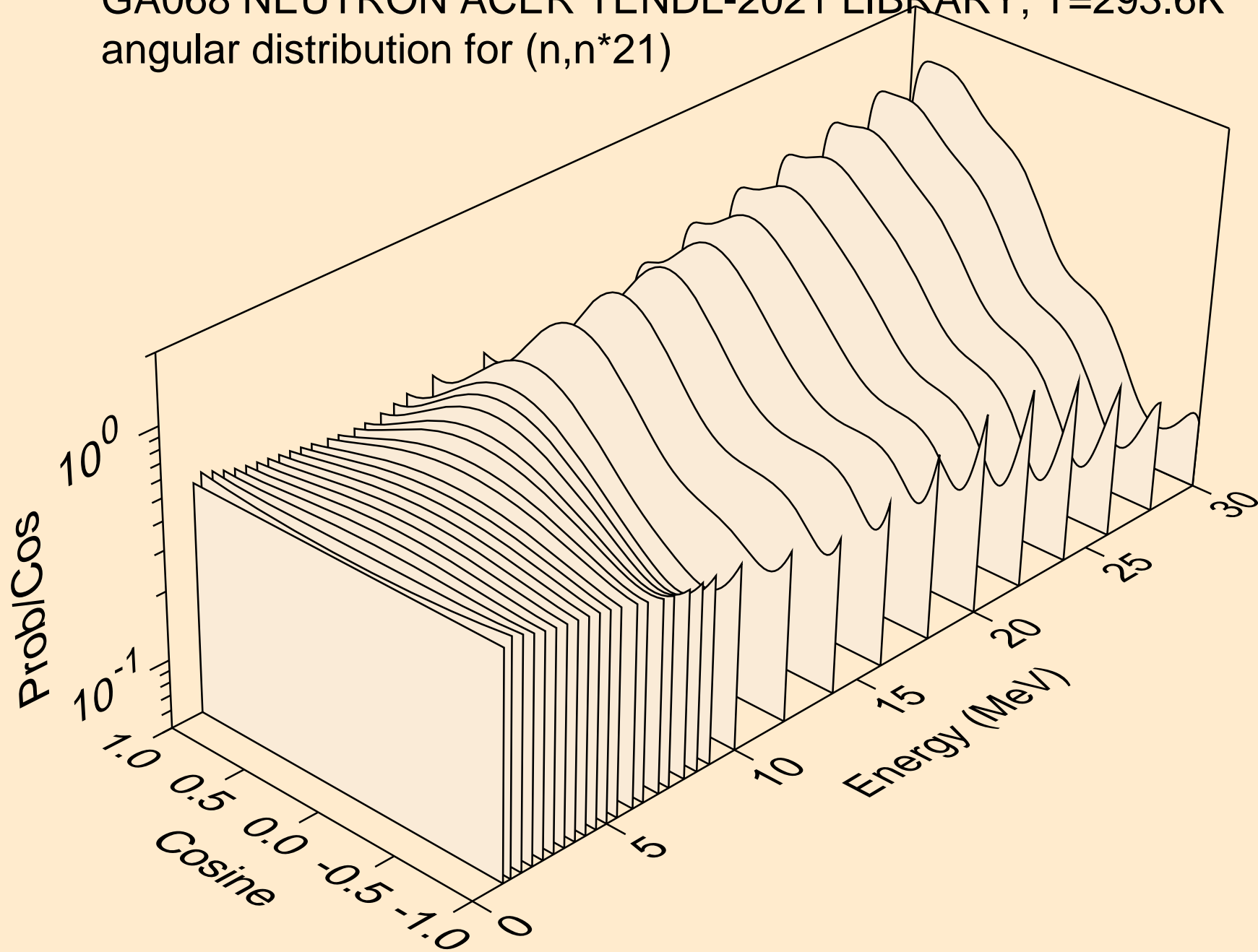

GA068 NEUTRON ACER TENDL-2021 LIBRARY; T=293.6K
angular distribution for (n,n*22)

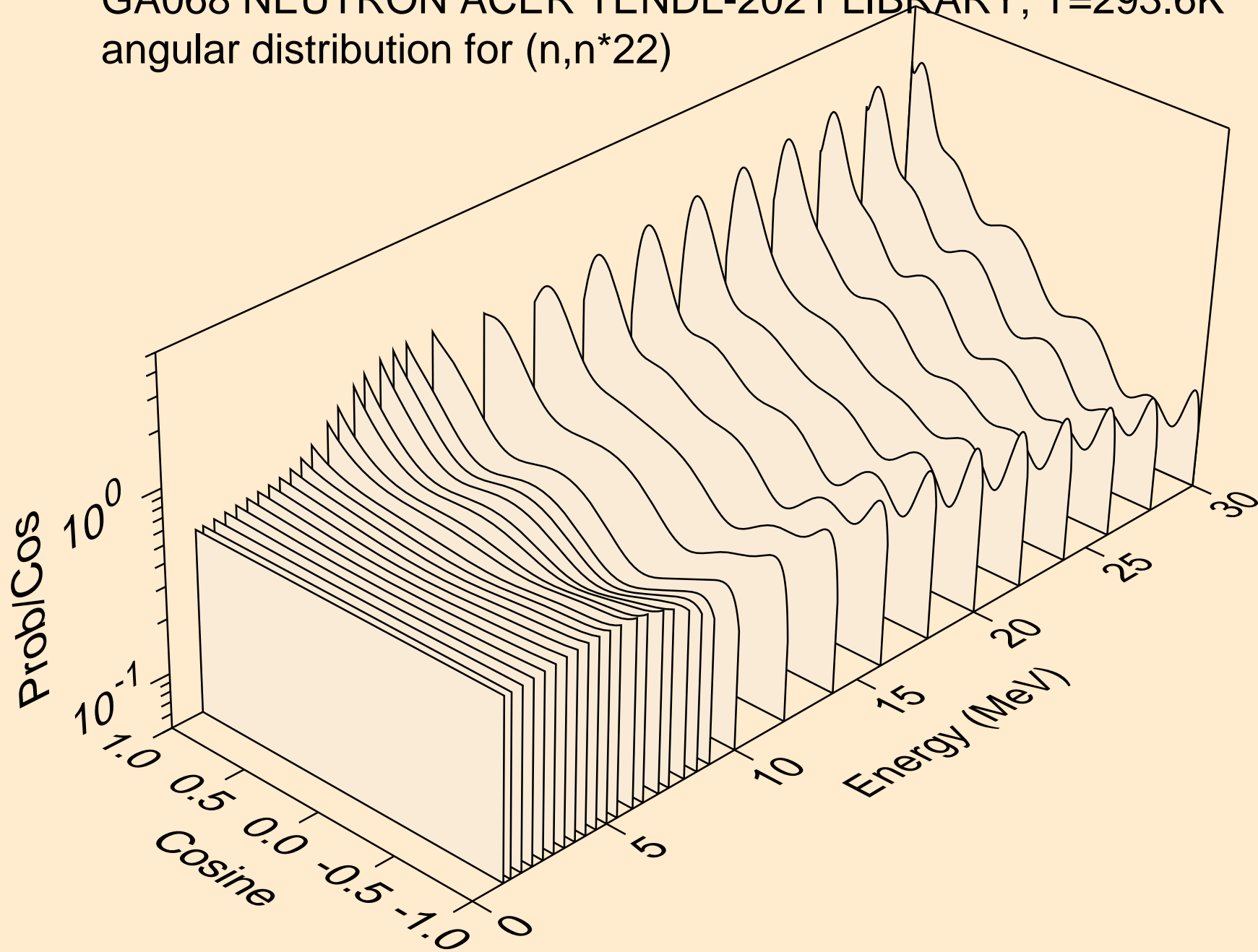

GA068 NEUTRON ACER TENDL-2021 LIBRARY; T=293.6K
angular distribution for (n,n*23)

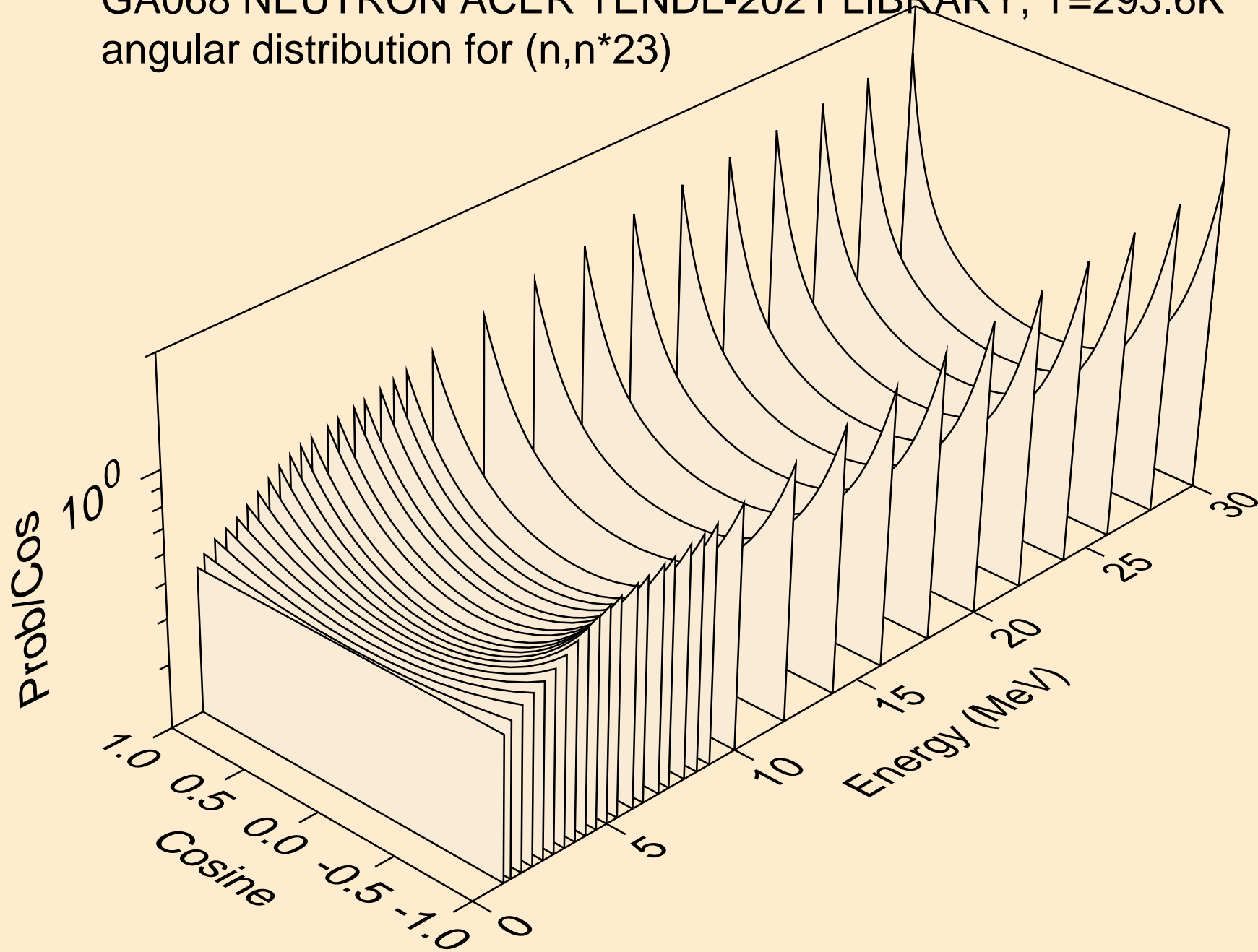

GA068 NEUTRON ACER TENDL-2021 LIBRARY; T=293.6K
angular distribution for (n,n*24)

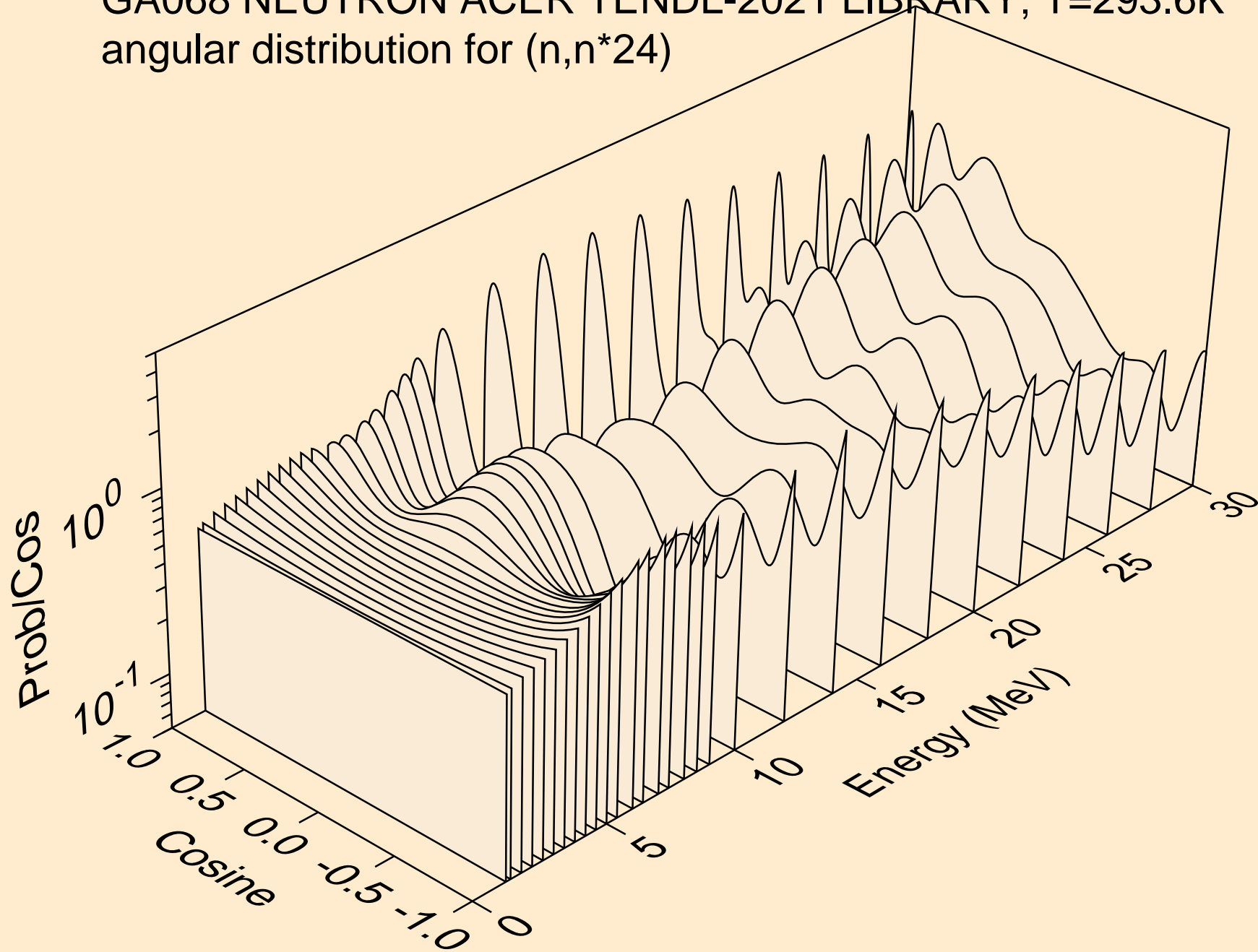

GA068 NEUTRON ACER TENDL-2021 LIBRARY; T=293.6K
angular distribution for (n,n*25)

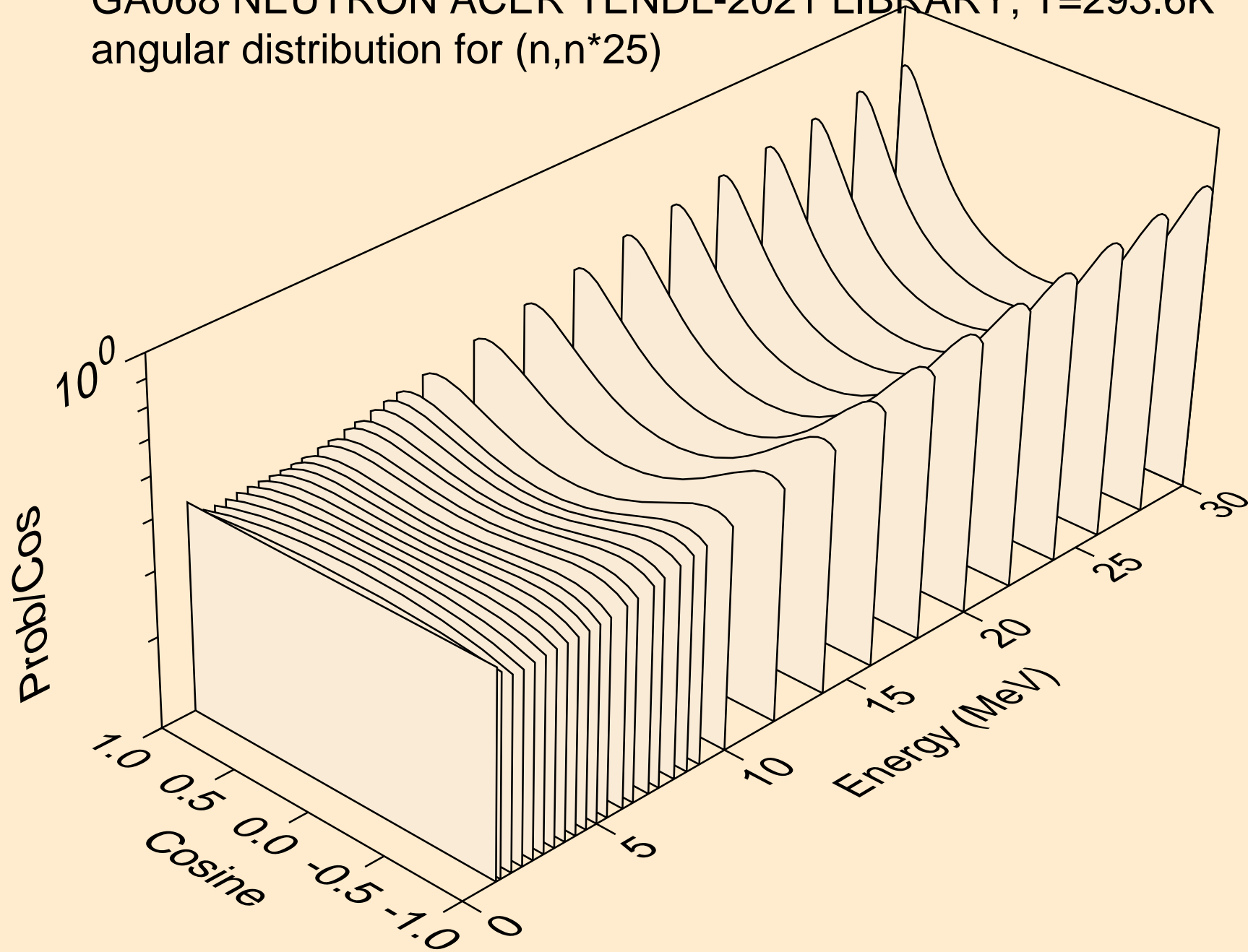

GA068 NEUTRON ACER TENDL-2021 LIBRARY; T=293.6K
angular distribution for (n,n*26)

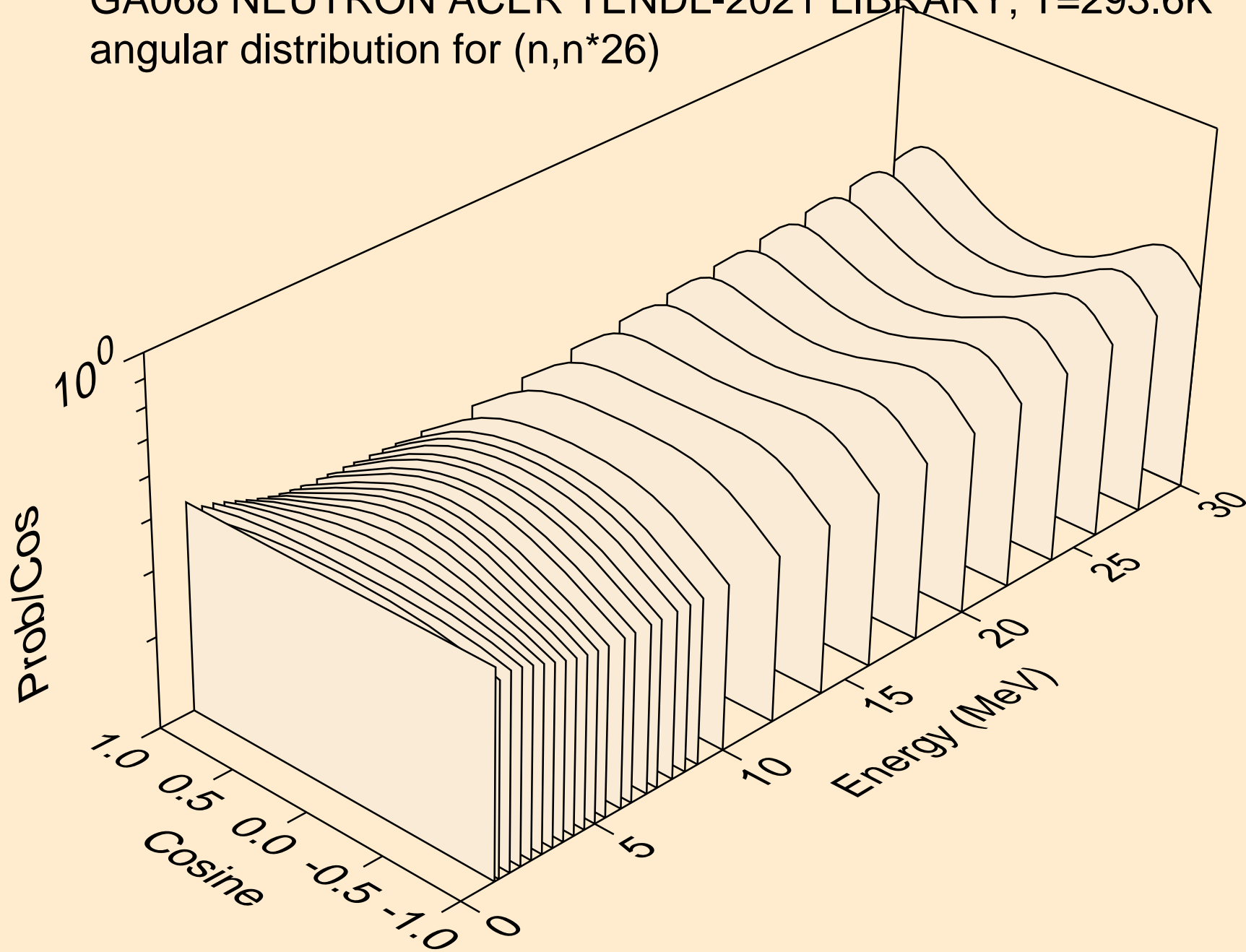

GA068 NEUTRON ACER TENDL-2021 LIBRARY; T=293.6K
angular distribution for (n,n*27)

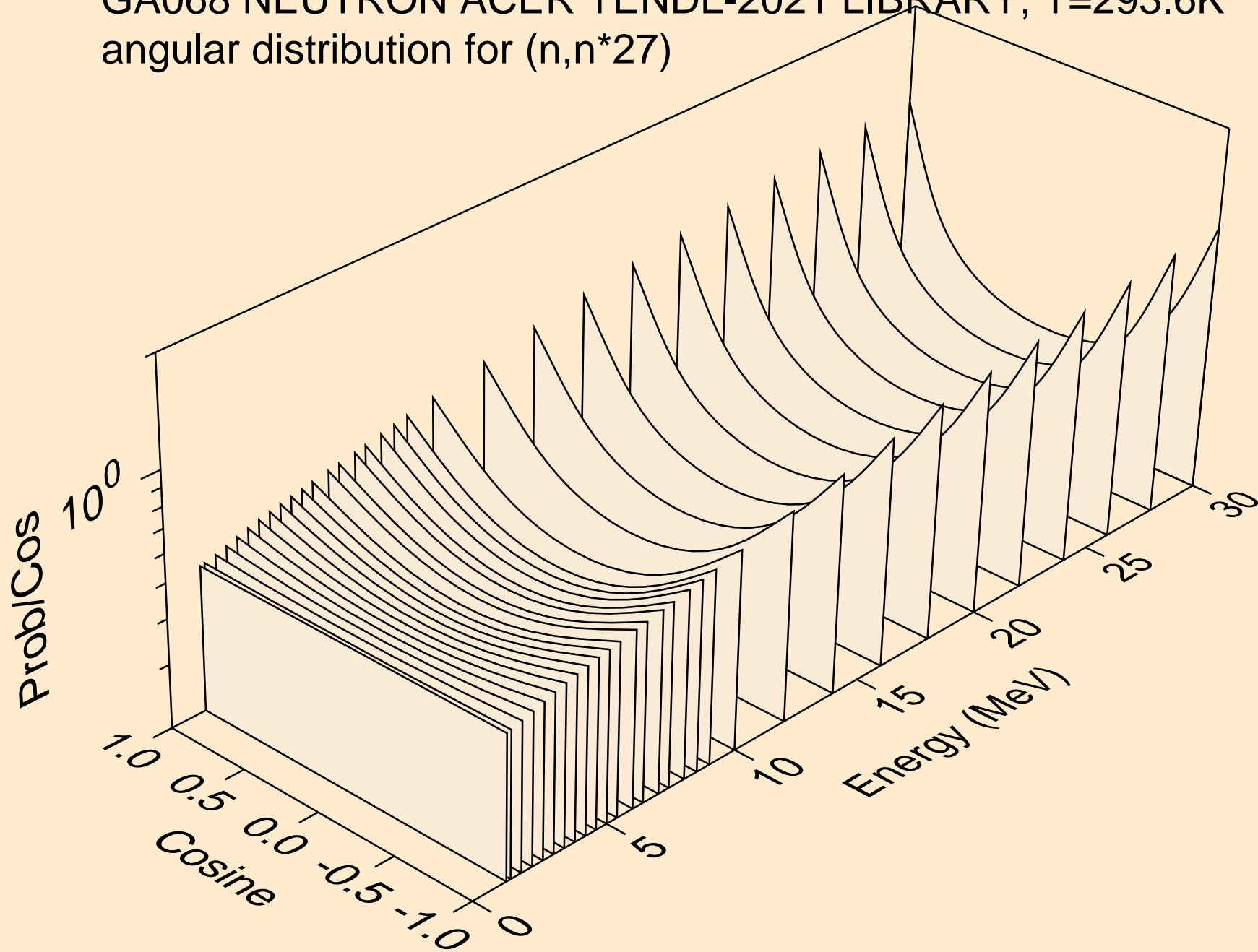

GA068 NEUTRON ACER TENDL-2021 LIBRARY; T=293.6K
angular distribution for (n,n*28)

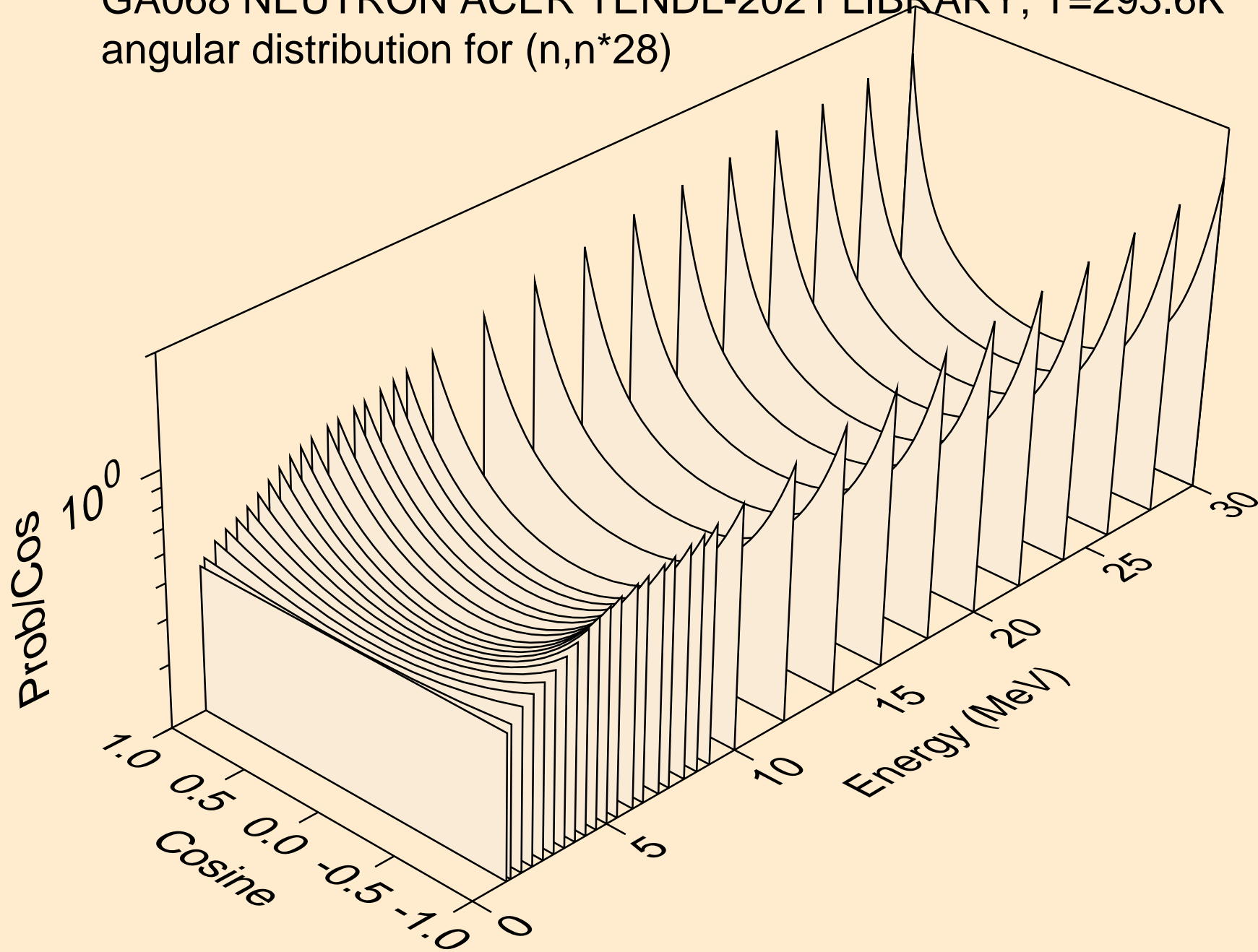

GA068 NEUTRON ACER TENDL-2021 LIBRARY; T=293.6K
angular distribution for (n,n*29)

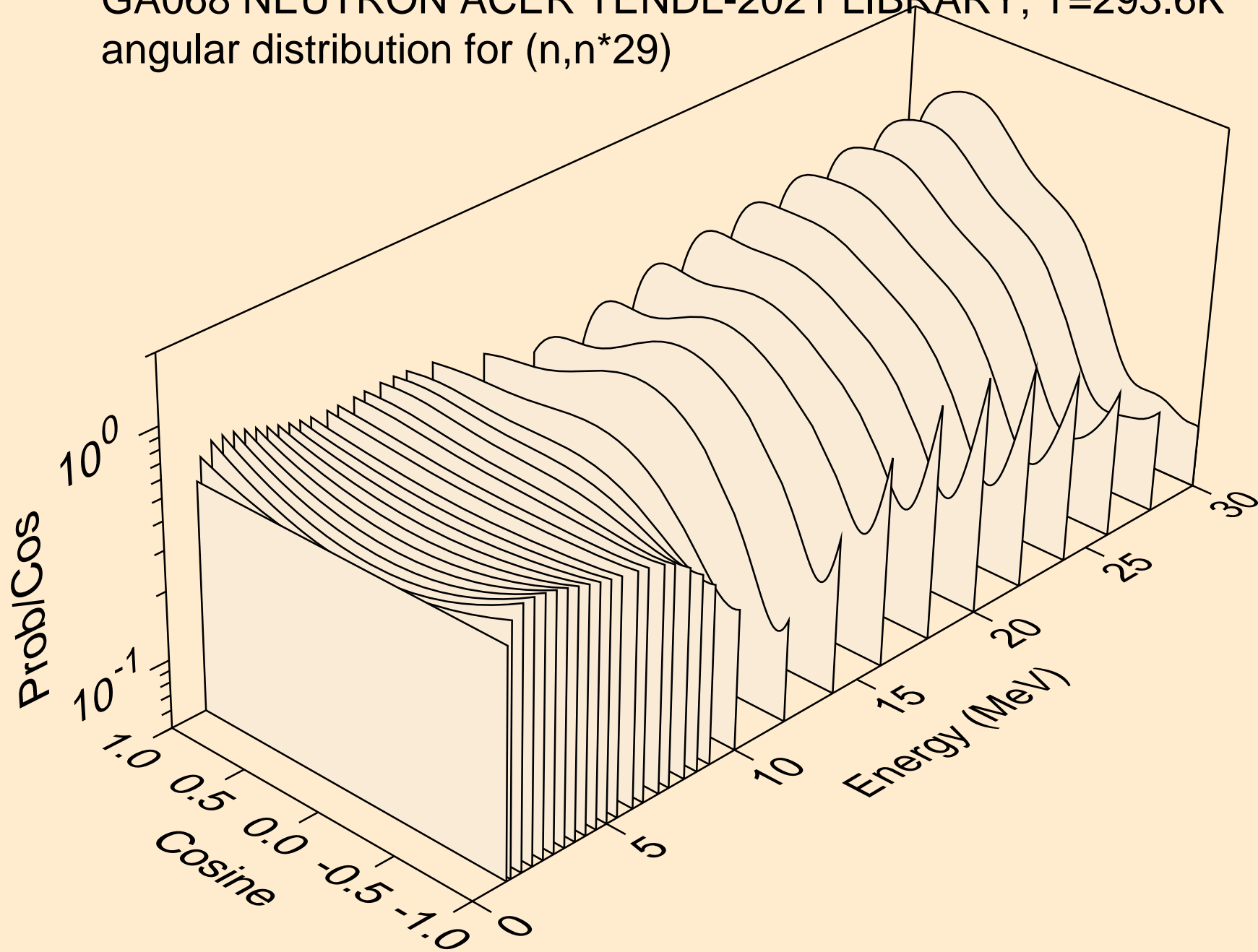

GA068 NEUTRON ACER TENDL-2021 LIBRARY; T=293.6K
angular distribution for (n,n*30)

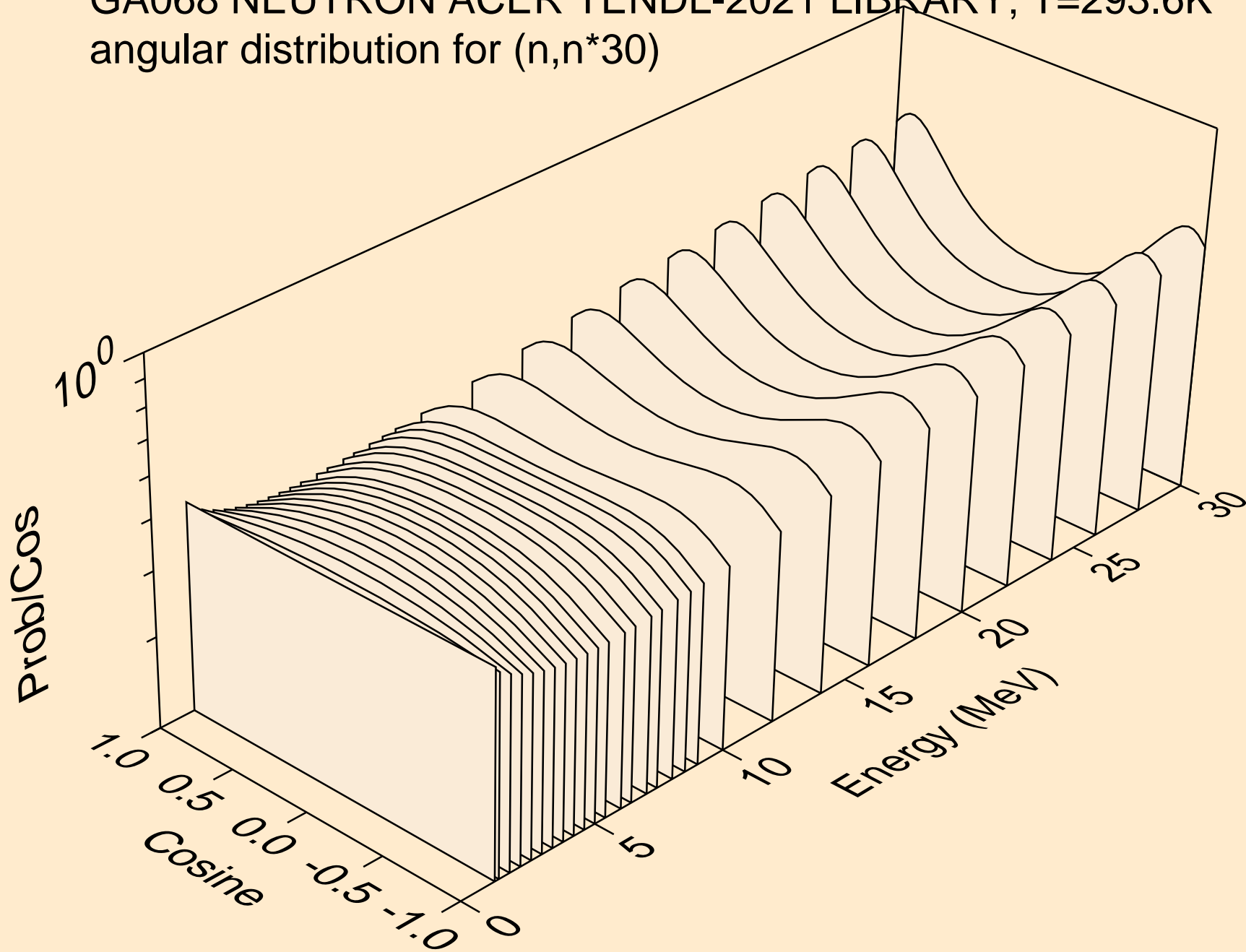

GA068 NEUTRON ACER TENDL-2021 LIBRARY; T=293.6K
Neutron emission for (n,x)

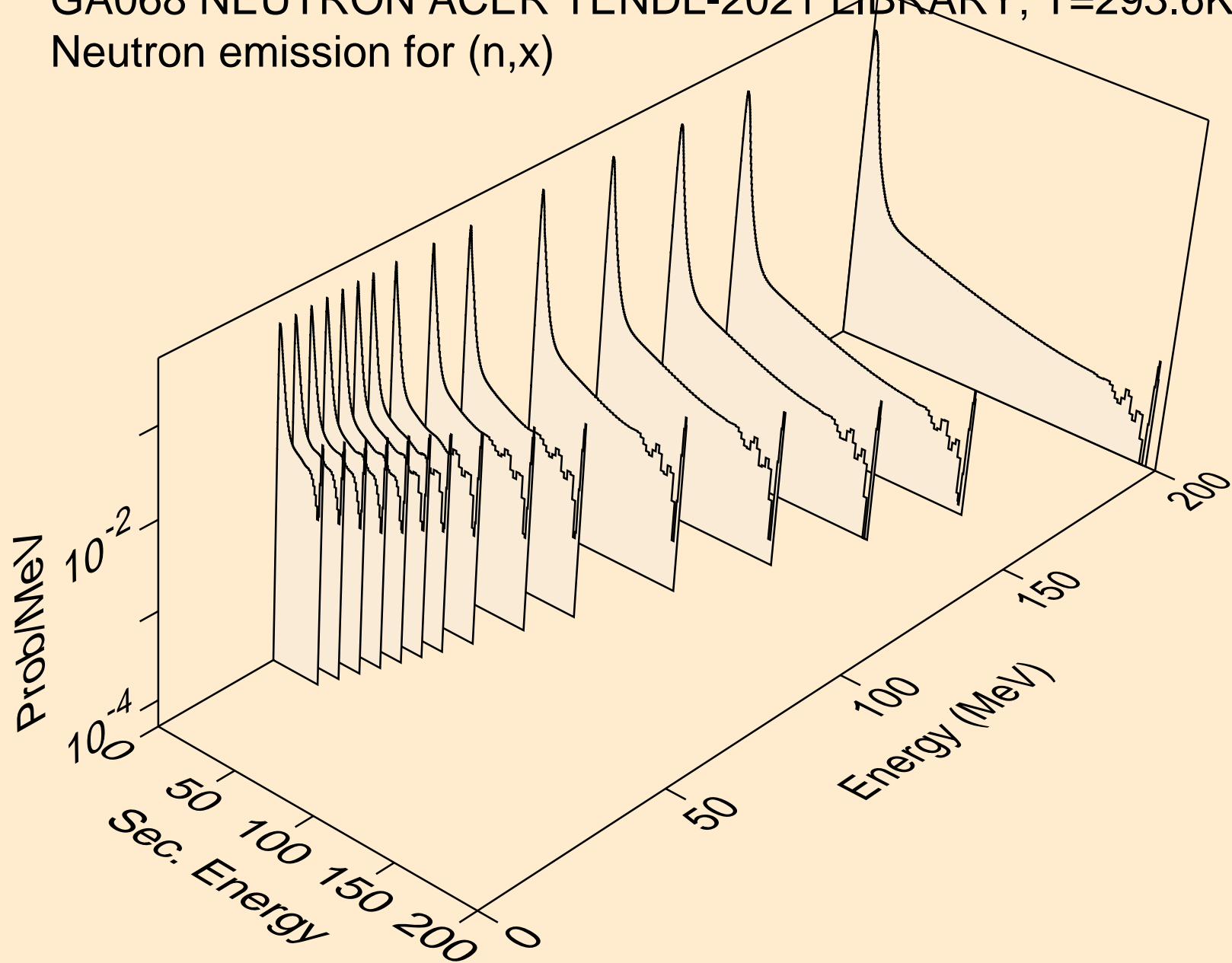

GA068 NEUTRON ACER TENDL-2021 LIBRARY; T=293.6K
Neutron emission for (n,2nd)

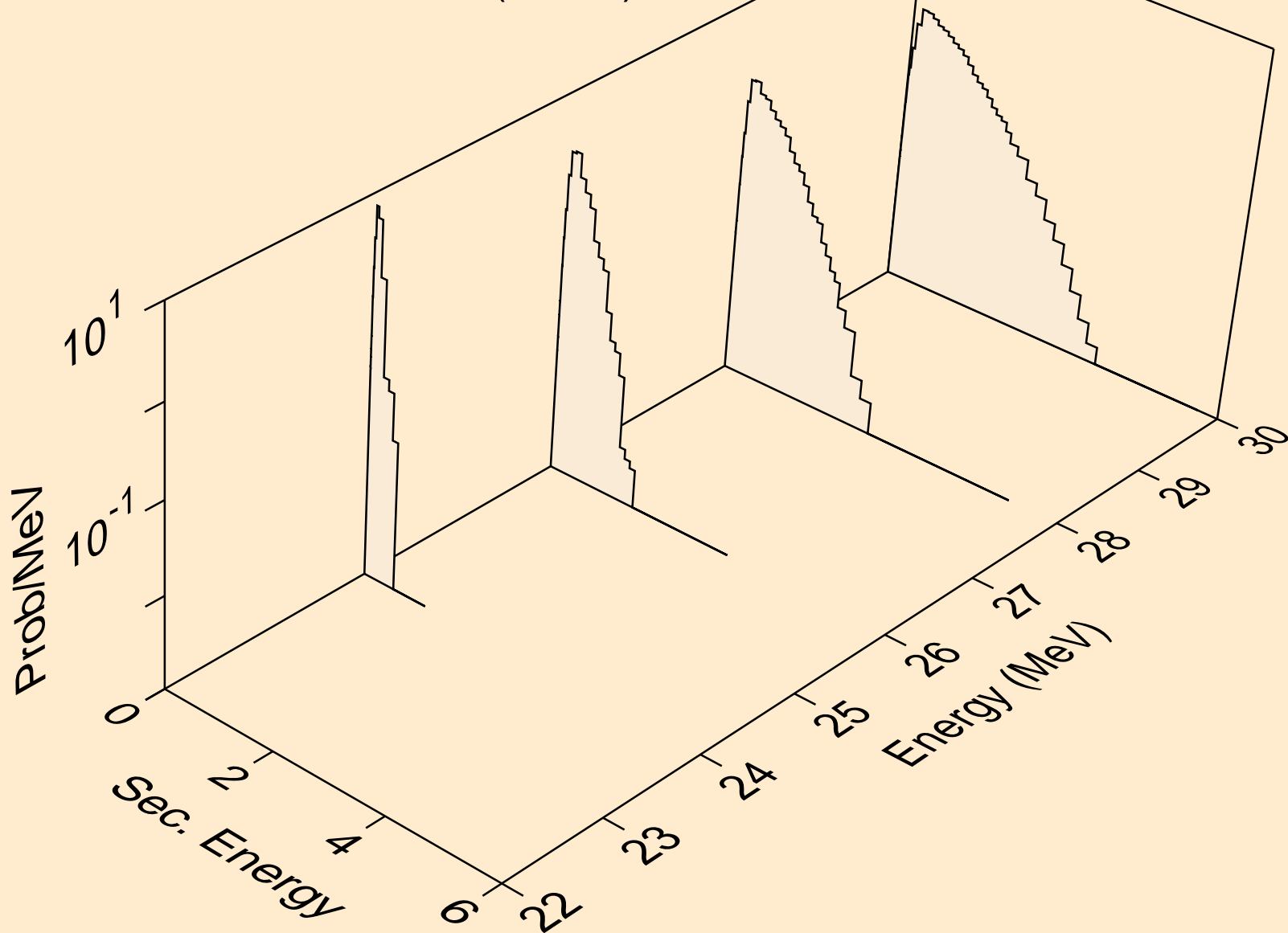

GA068 NEUTRON ACER TENDL-2021 LIBRARY; T=293.6K
Neutron emission for (n,2n)

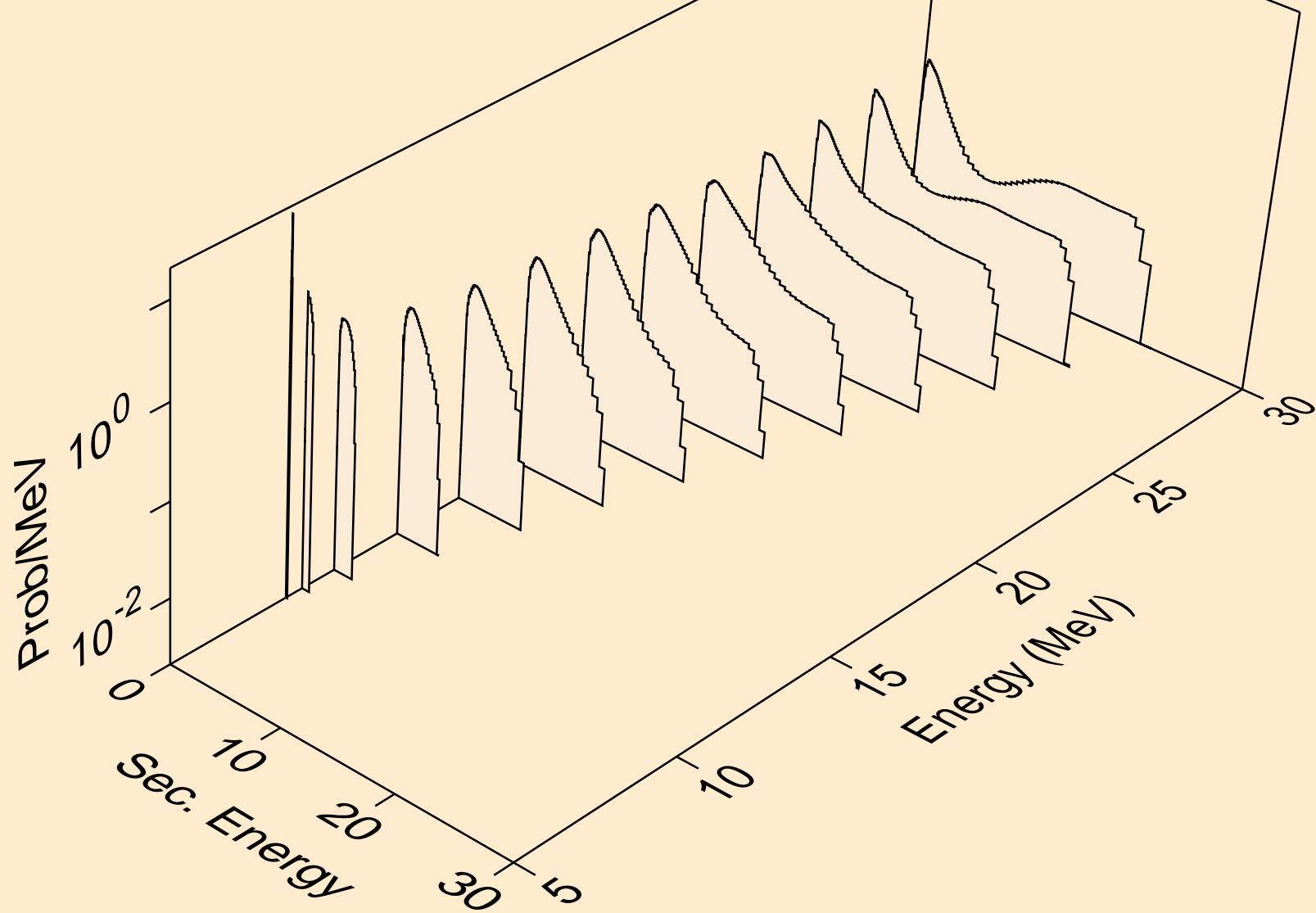

GA068 NEUTRON ACER TENDL-2021 LIBRARY; T=293.6K
Neutron emission for (n,3n)

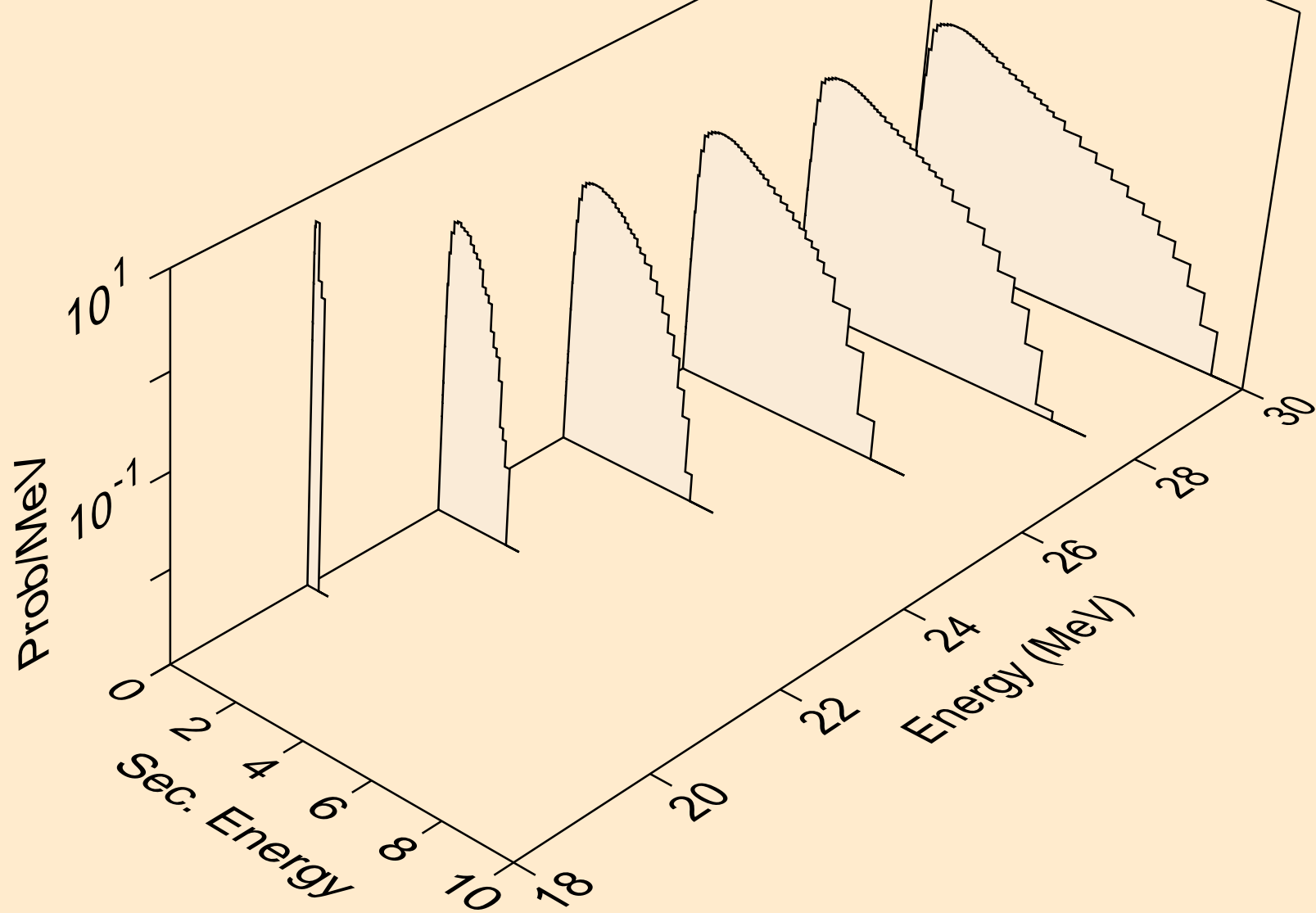

GA068 NEUTRON ACER TENDL-2021 LIBRARY; T=293.6K
Neutron emission for (n,n*)a

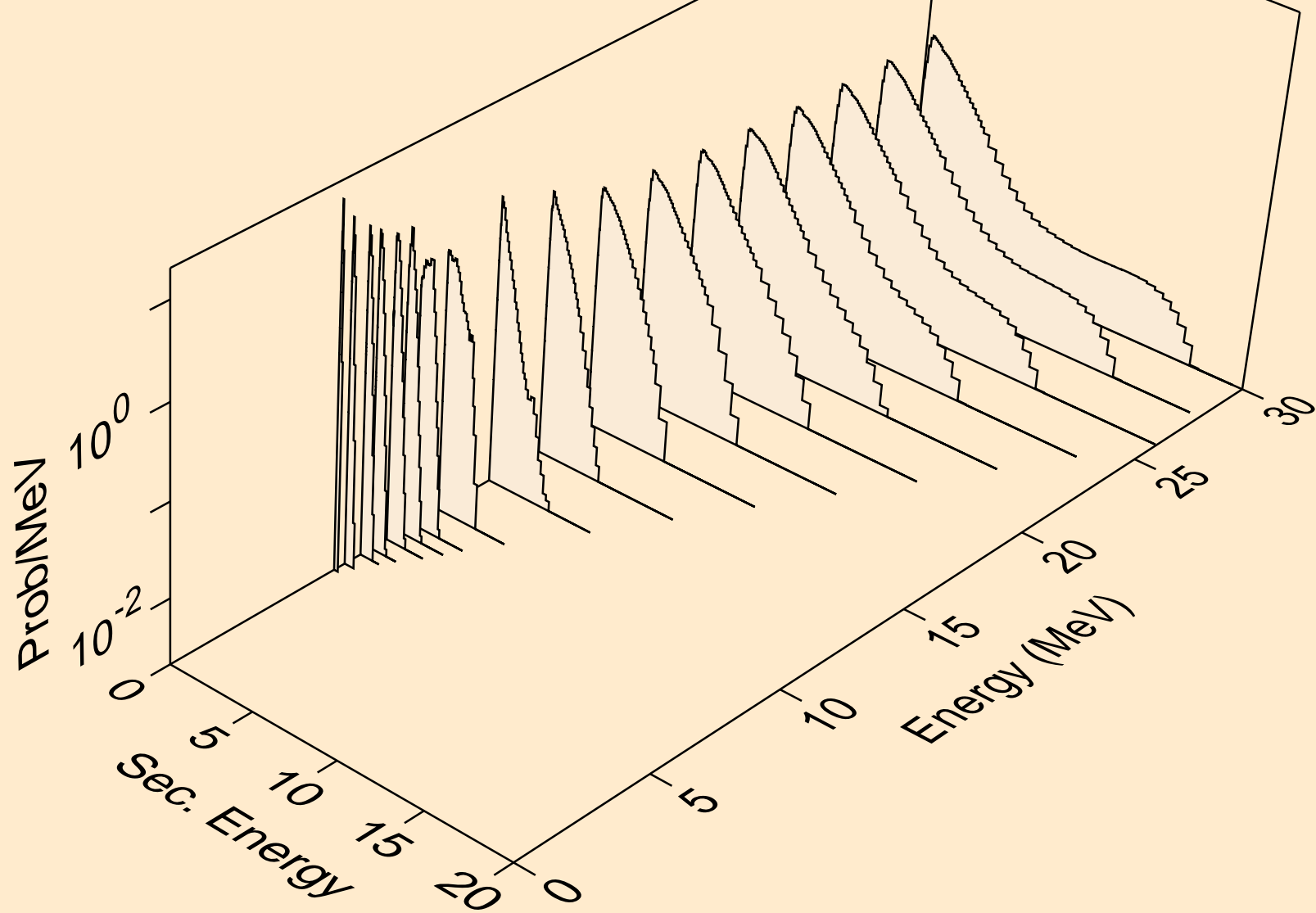

GA068 NEUTRON ACER TENDL-2021 LIBRARY; T=293.6K
Neutron emission for (n,2n)a

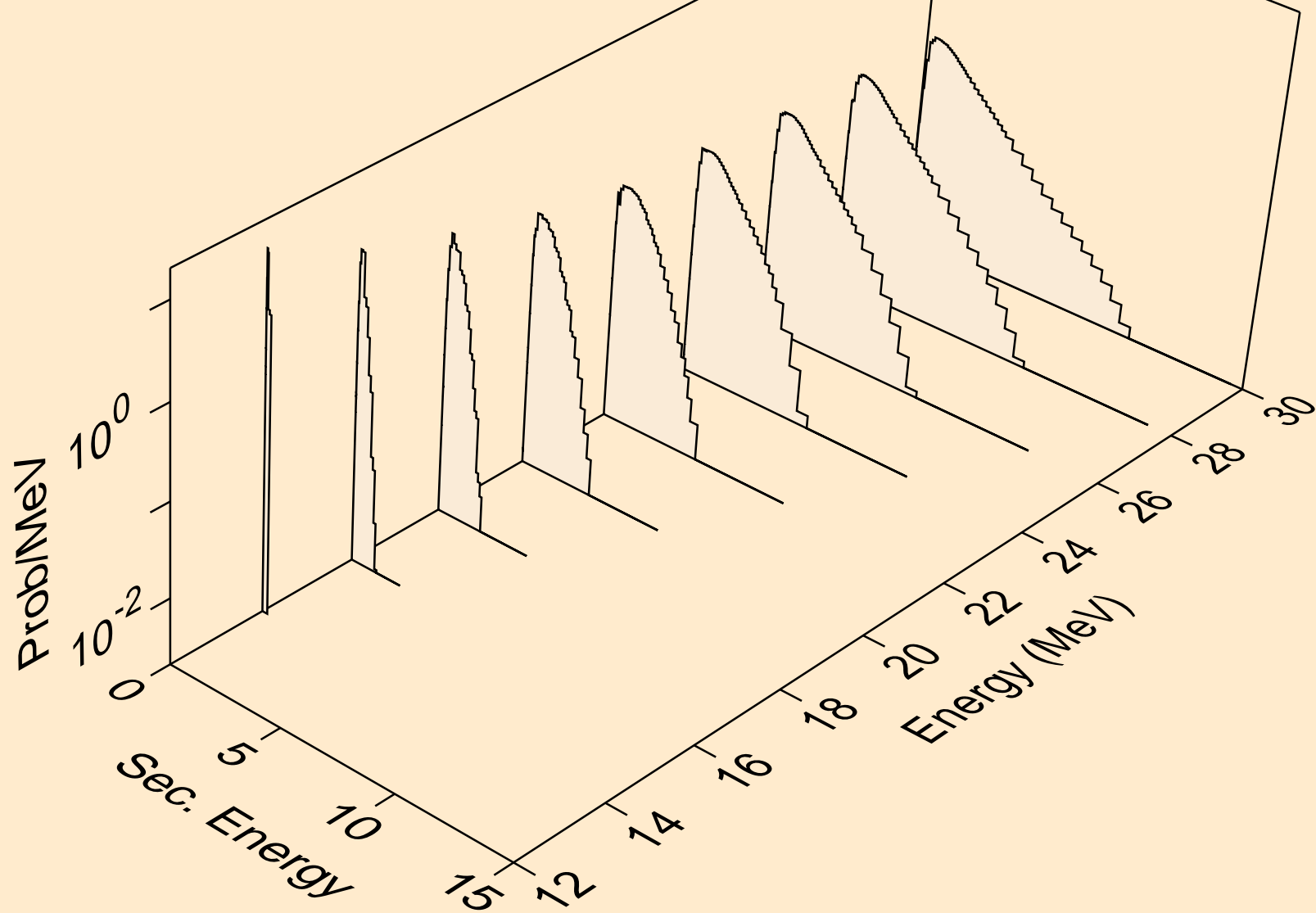

GA068 NEUTRON ACER TENDL-2021 LIBRARY; T=293.6K
Neutron emission for (n,3n)a

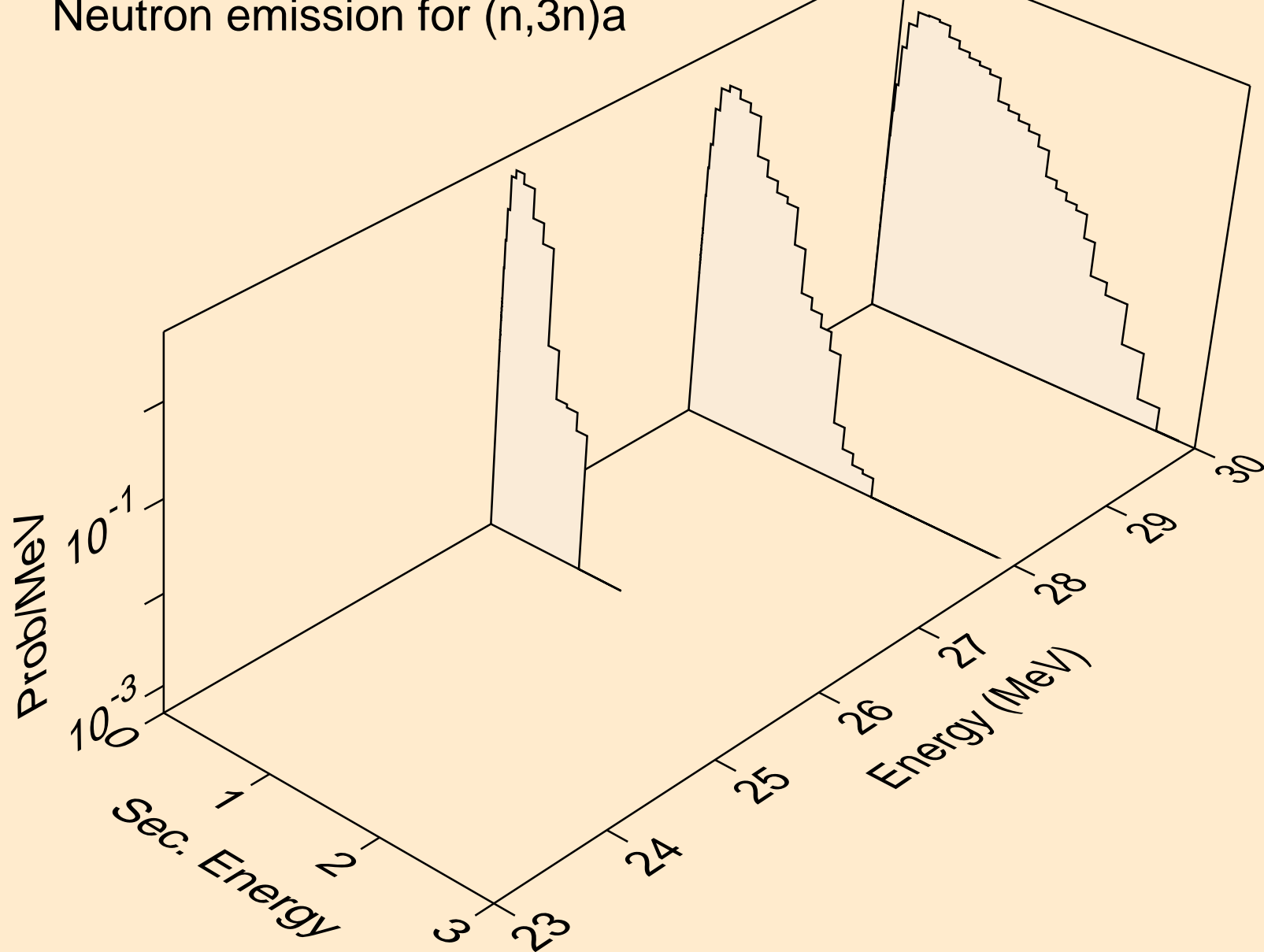

GA068 NEUTRON ACER TENDL-2021 LIBRARY; T=293.6K
Neutron emission for (n,n*)p

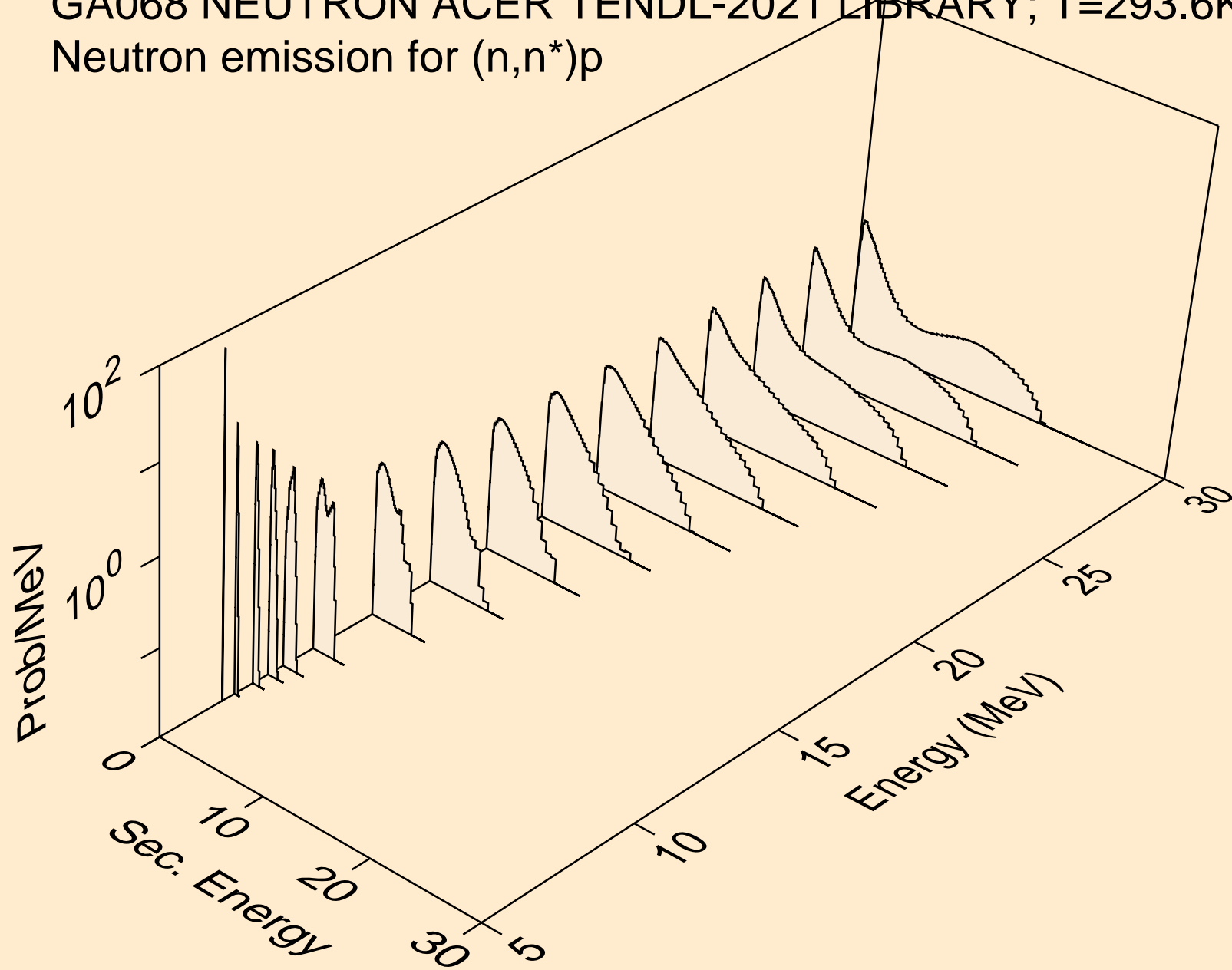

GA068 NEUTRON ACER TENDL-2021 LIBRARY; T=293.6K
Neutron emission for (n,n*)2a

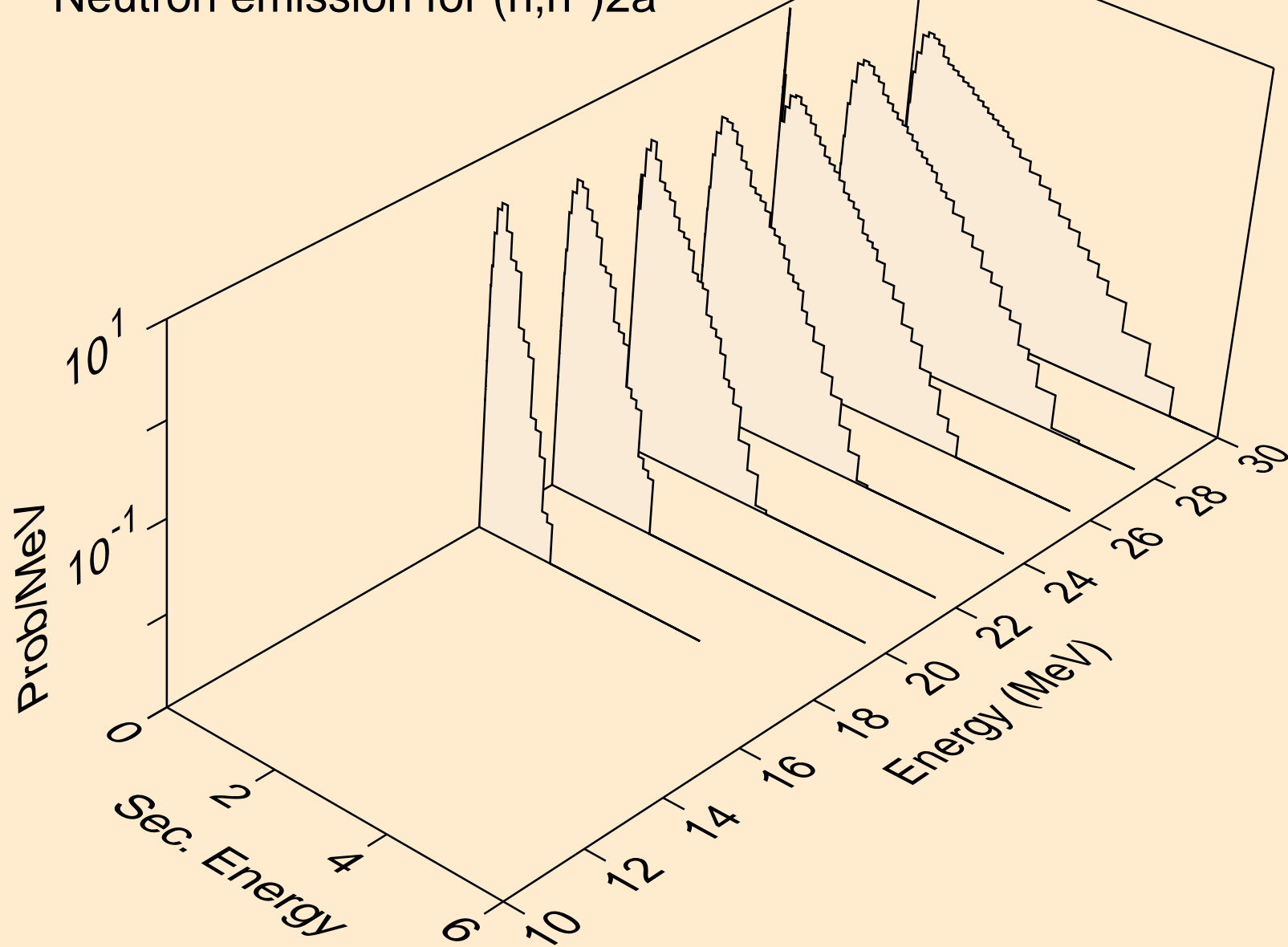

GA068 NEUTRON ACER TENDL-2021 LIBRARY; T=293.6K
Neutron emission for (n,2n)2a

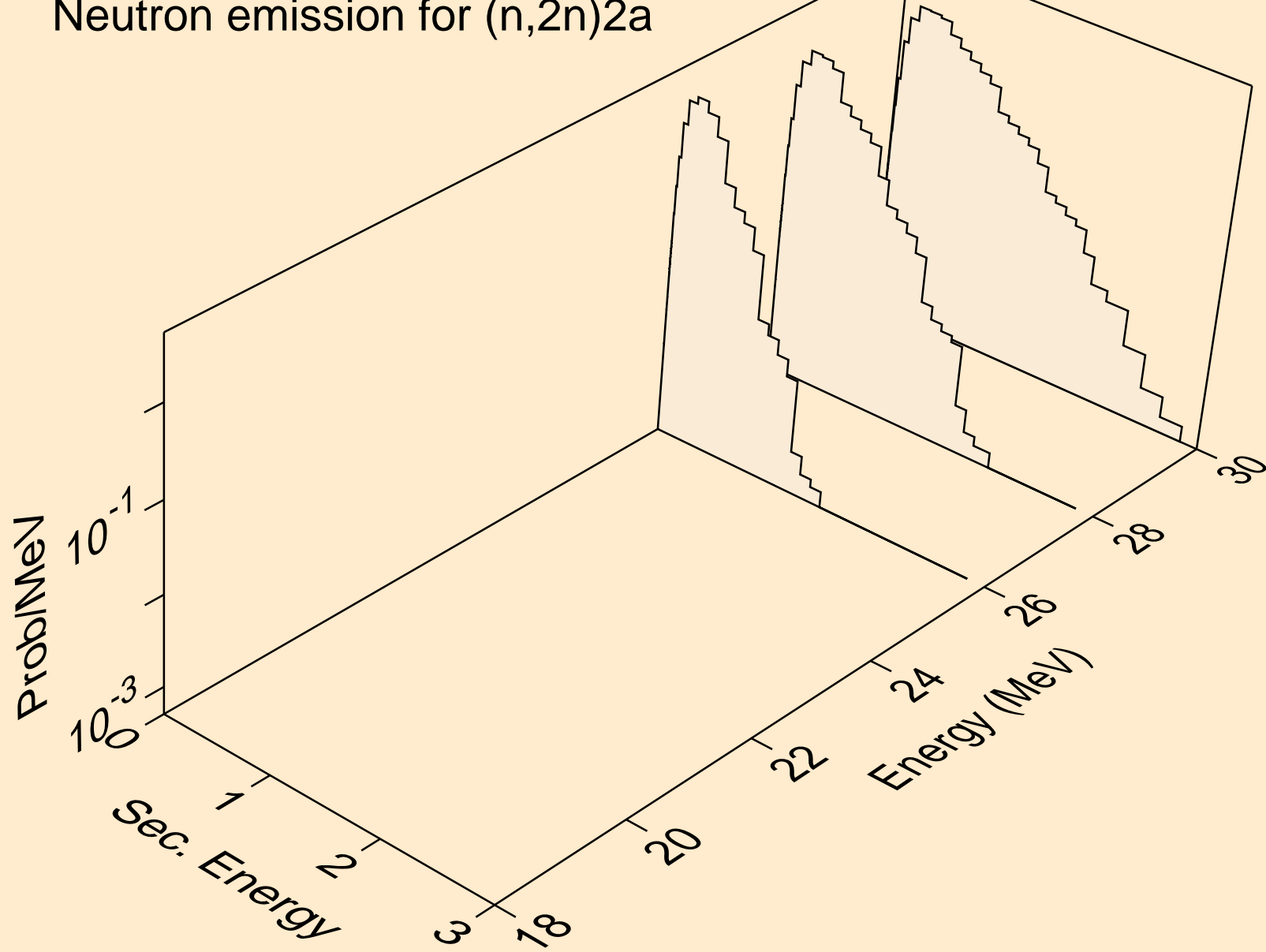

GA068 NEUTRON ACER TENDL-2021 LIBRARY; T=293.6K
Neutron emission for (n,n*)d

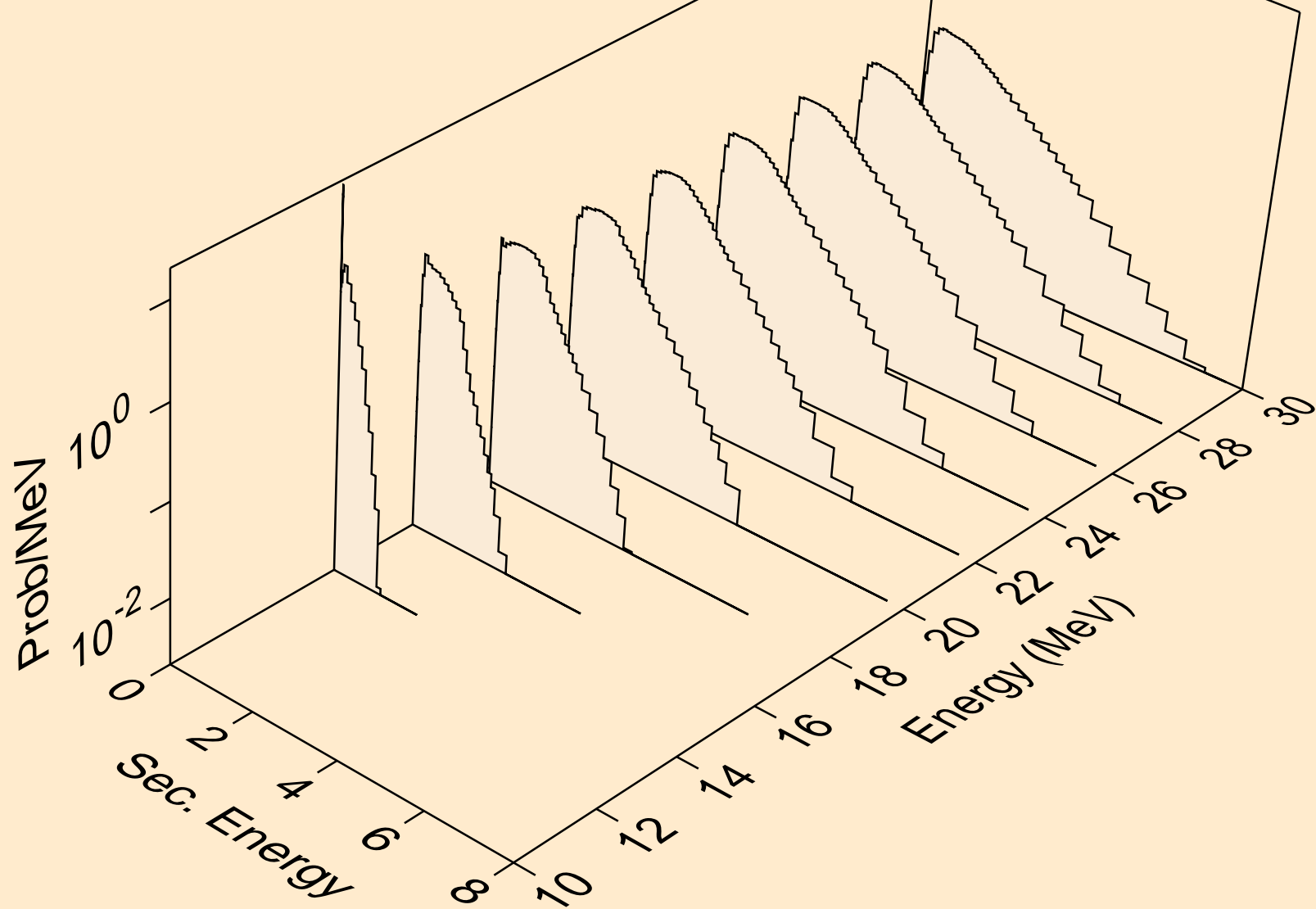

GA068 NEUTRON ACER TENDL-2021 LIBRARY; T=293.6K
Neutron emission for (n,n*)t

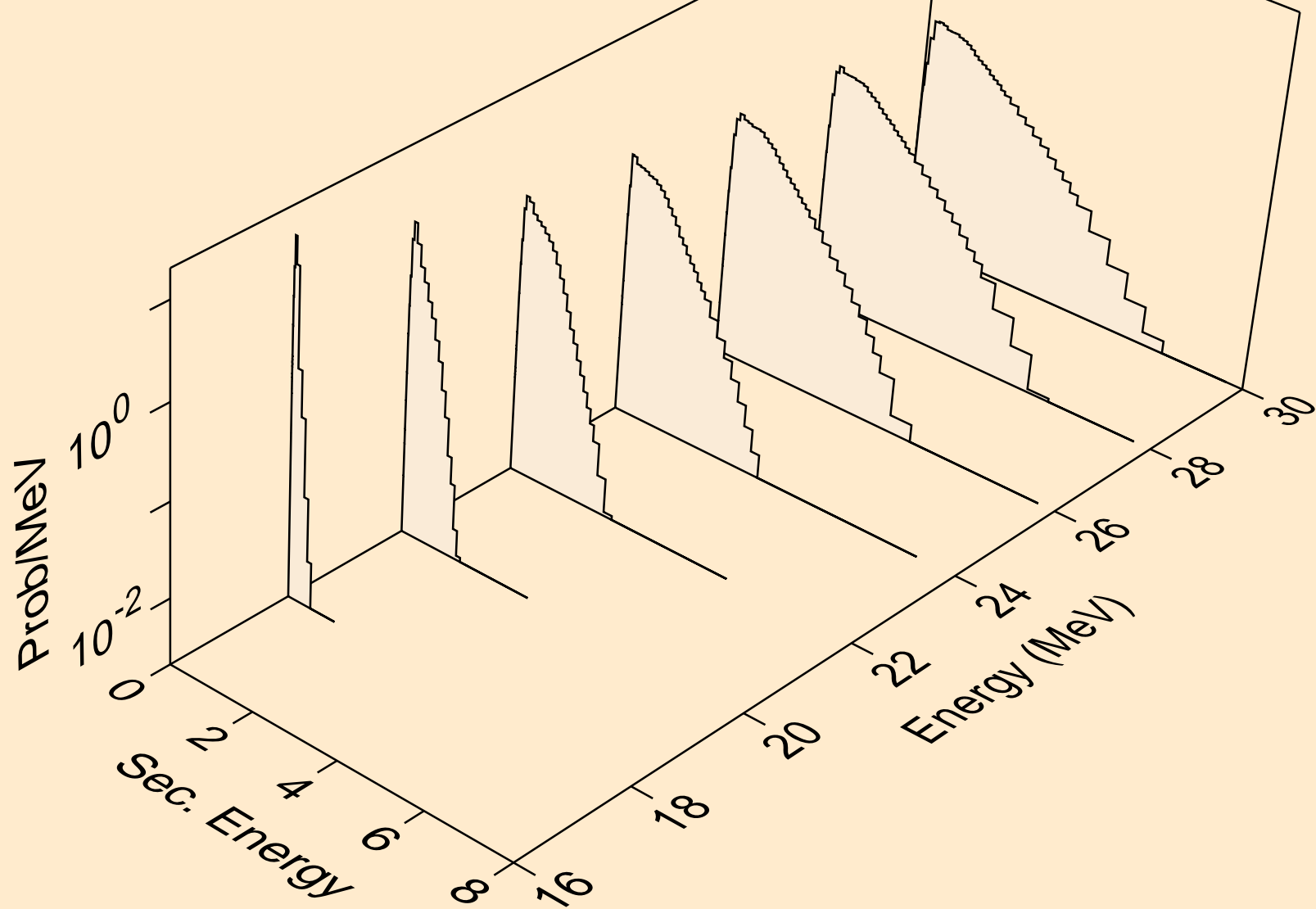

GA068 NEUTRON ACER TENDL-2021 LIBRARY; T=293.6K
Neutron emission for (n,n*)he3

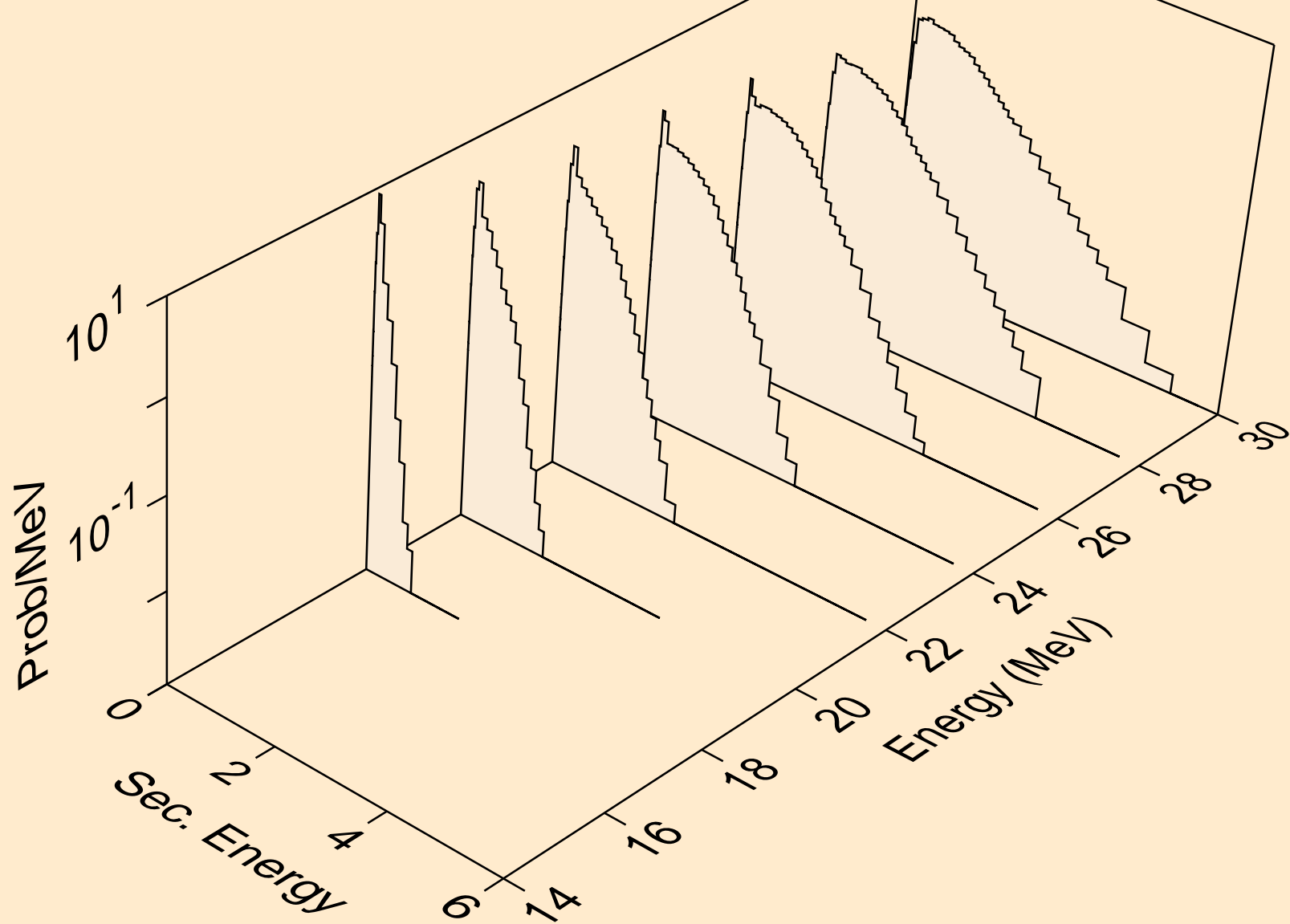

GA068 NEUTRON ACER TENDL-2021 LIBRARY; T=293.6K
Neutron emission for (n,2np)

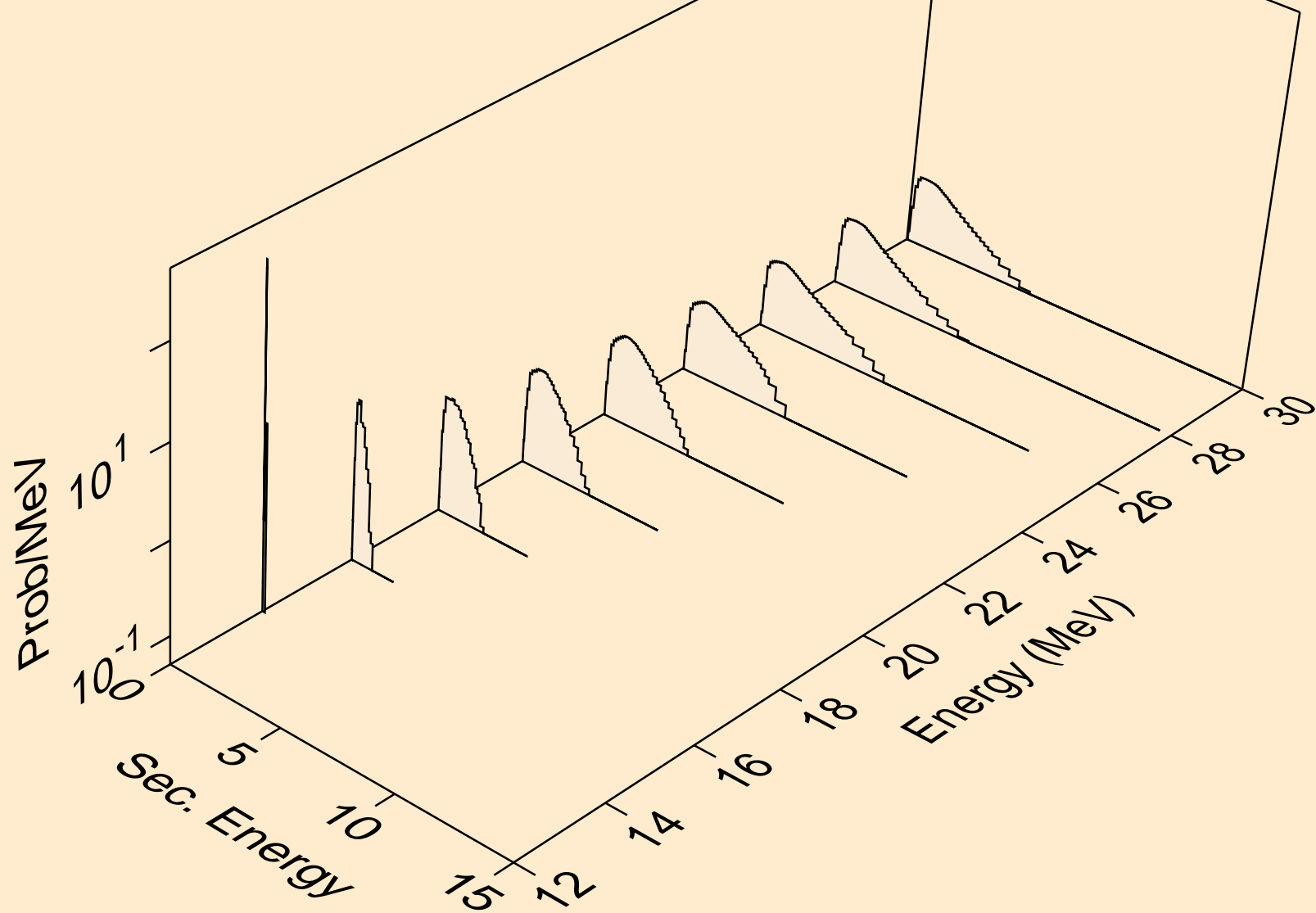

GA068 NEUTRON ACER TENDL-2021 LIBRARY; T=293.6K
Neutron emission for (n,3np)

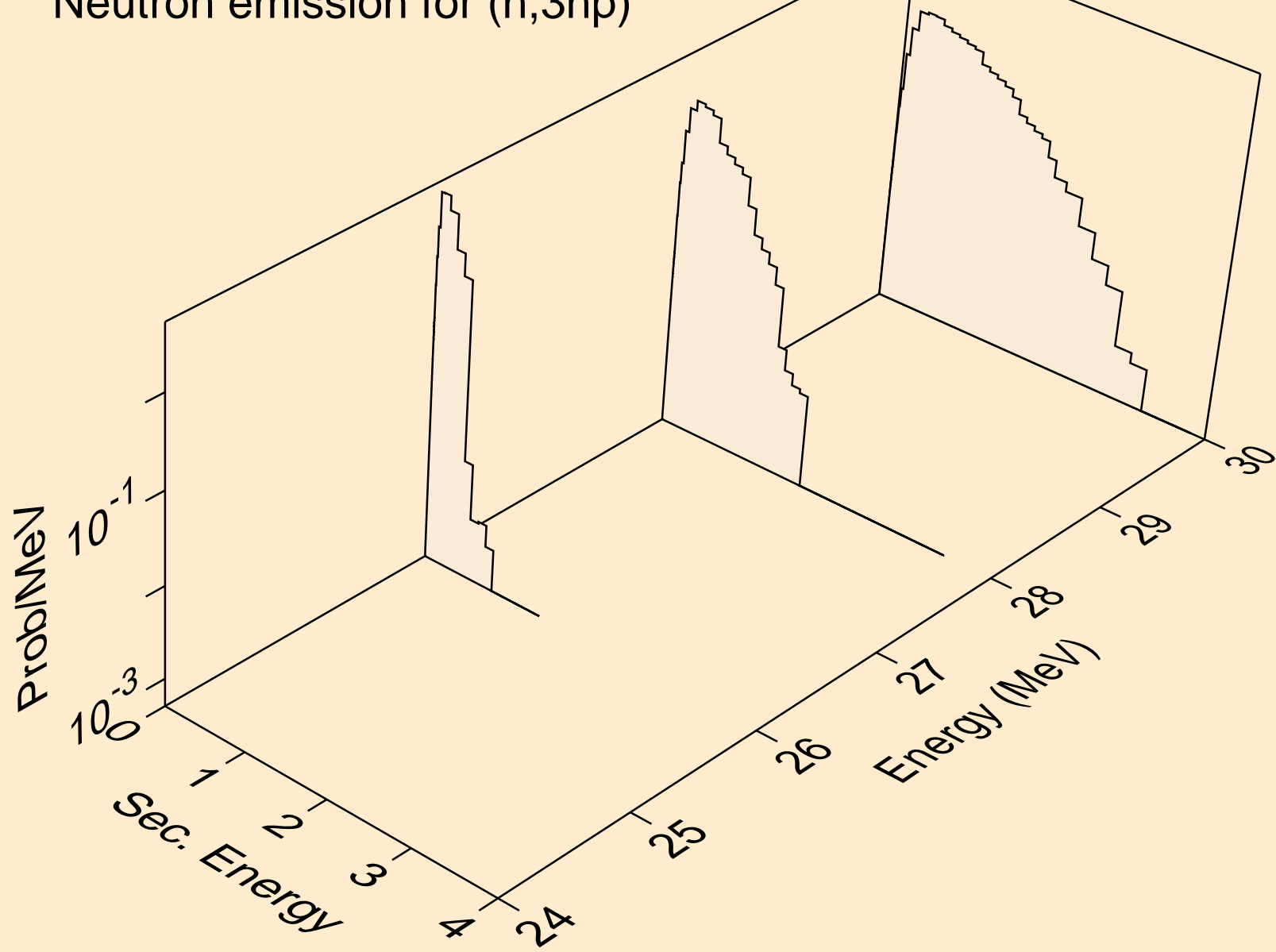

GA068 NEUTRON ACER TENDL-2021 LIBRARY; T=293.6K
Neutron emission for (n,2np)

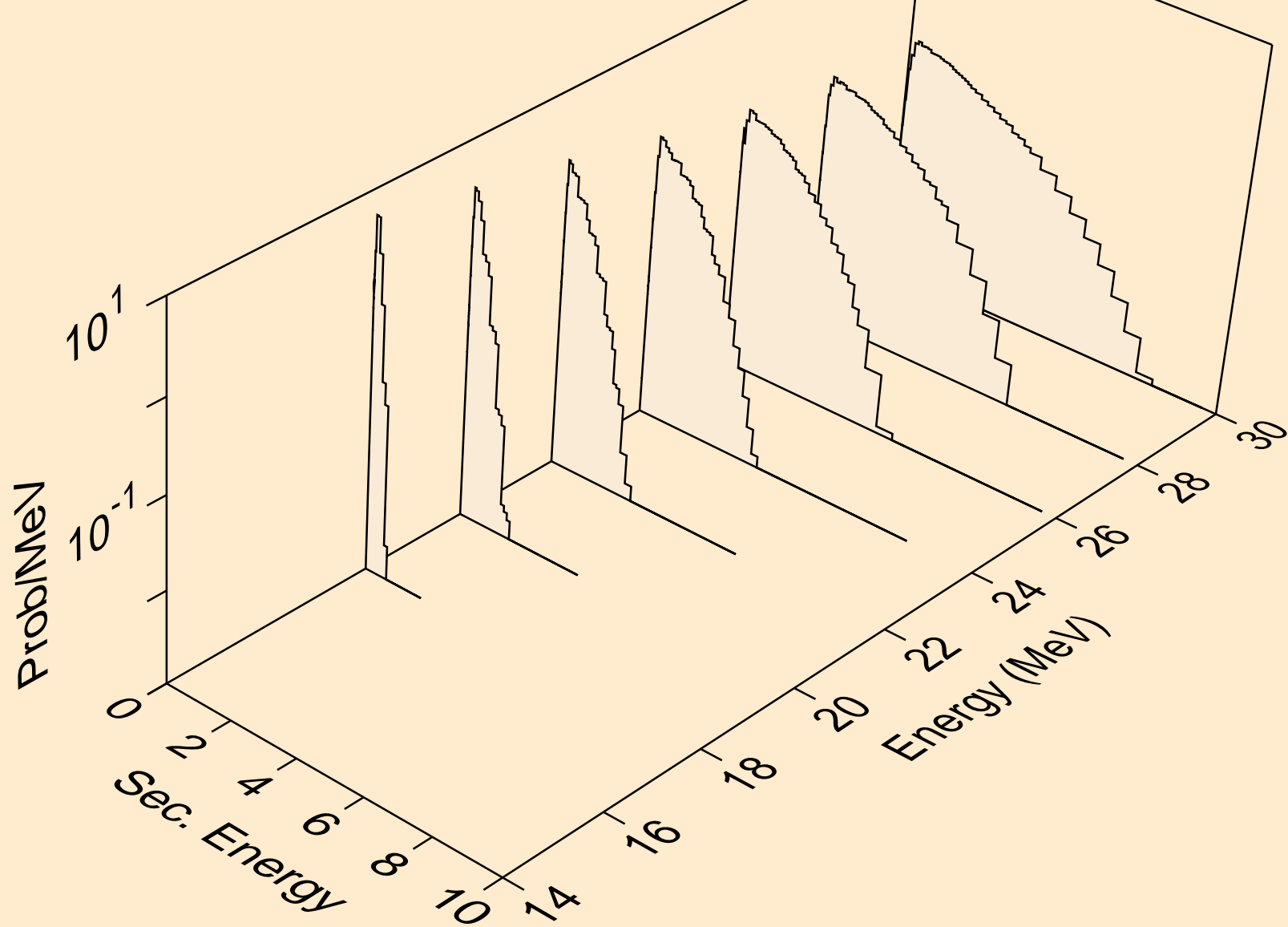

GA068 NEUTRON ACER TENDL-2021 LIBRARY; T=293.6K
Neutron emission for (n,npa)

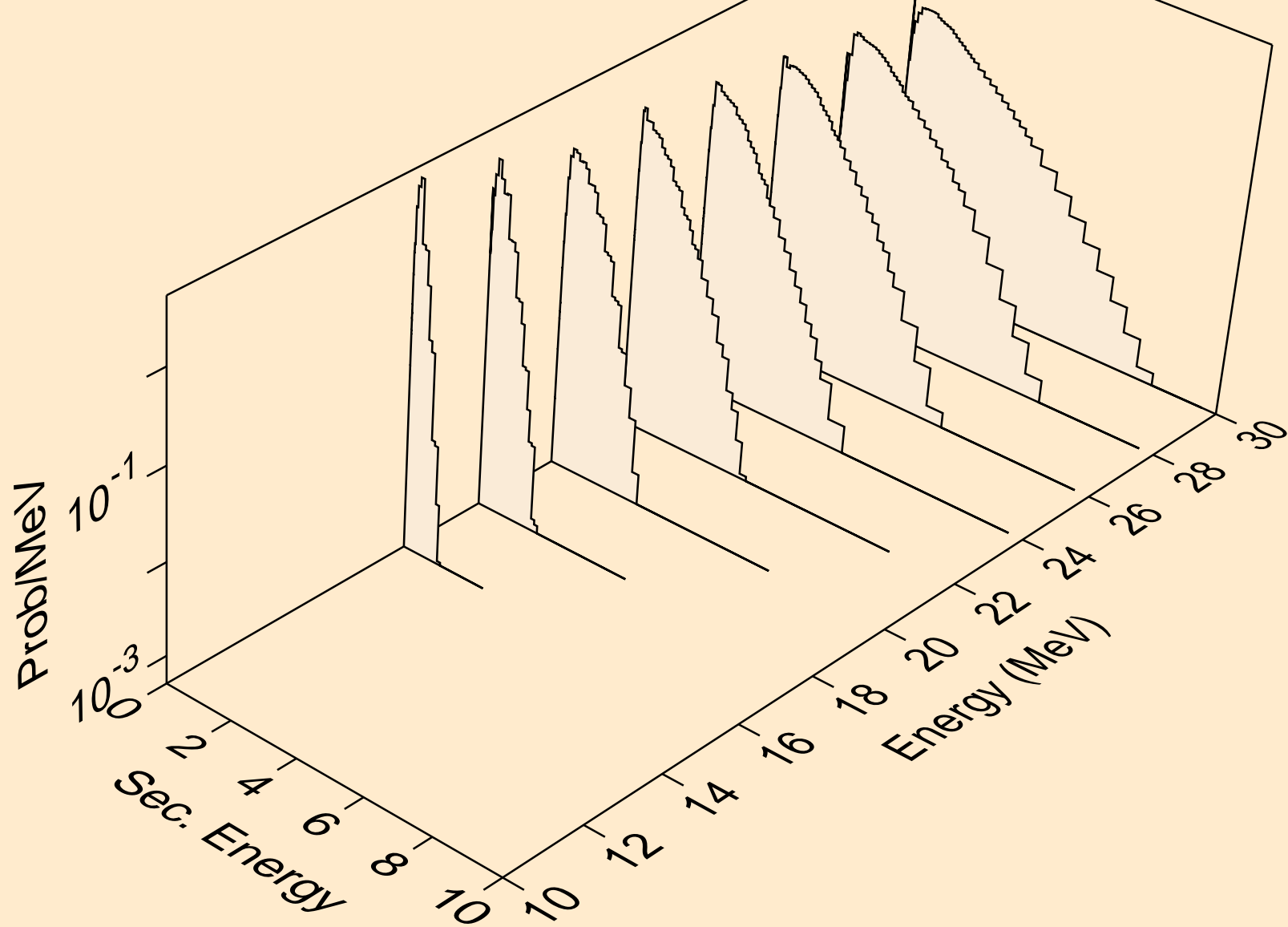

GA068 NEUTRON ACER TENDL-2021 LIBRARY; T=293.6K
Neutron emission for (n,n*c)

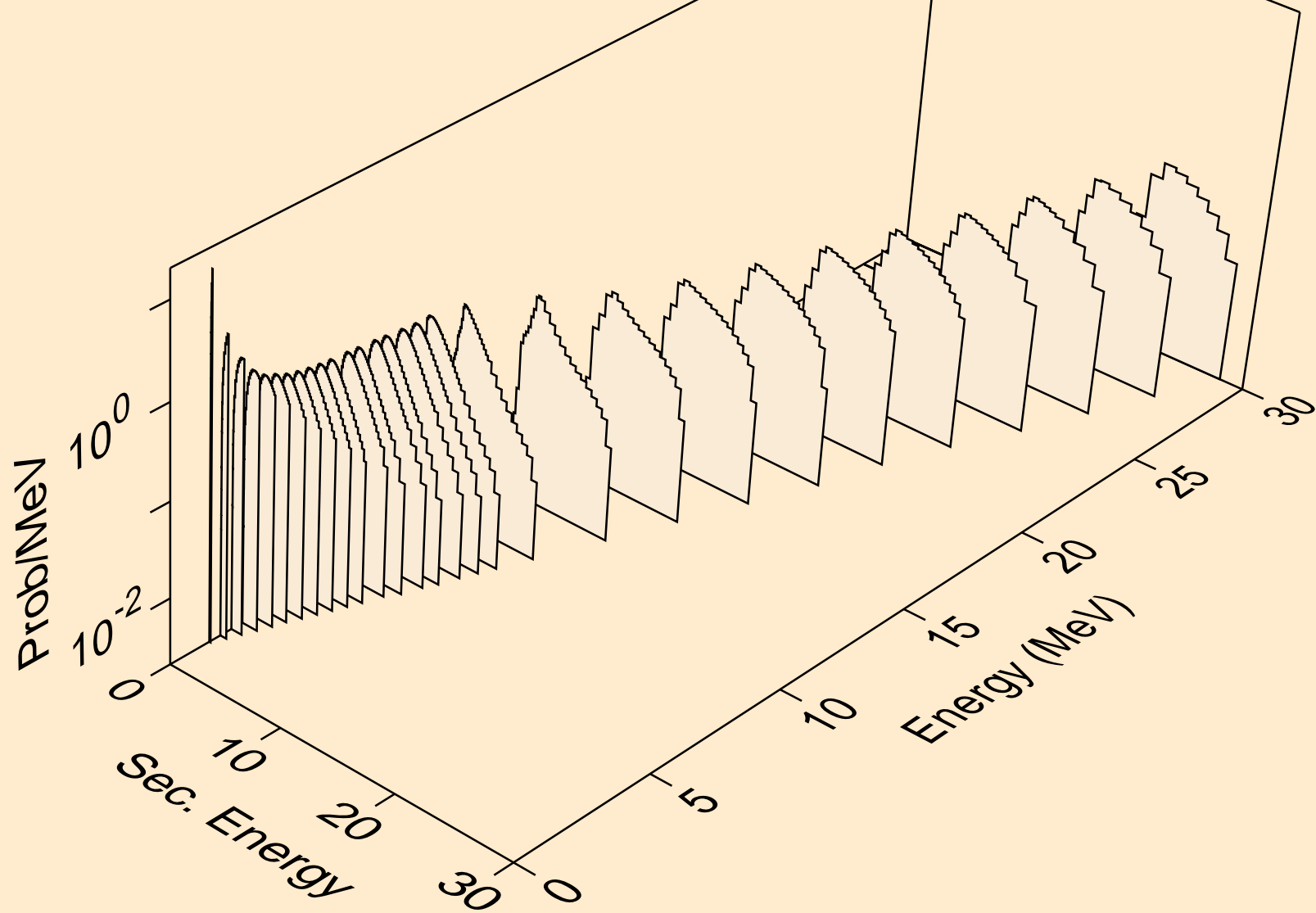

GA068 NEUTRON ACER TENDL-2021 LIBRARY; T=293.6K
Photon emission for (n,x)

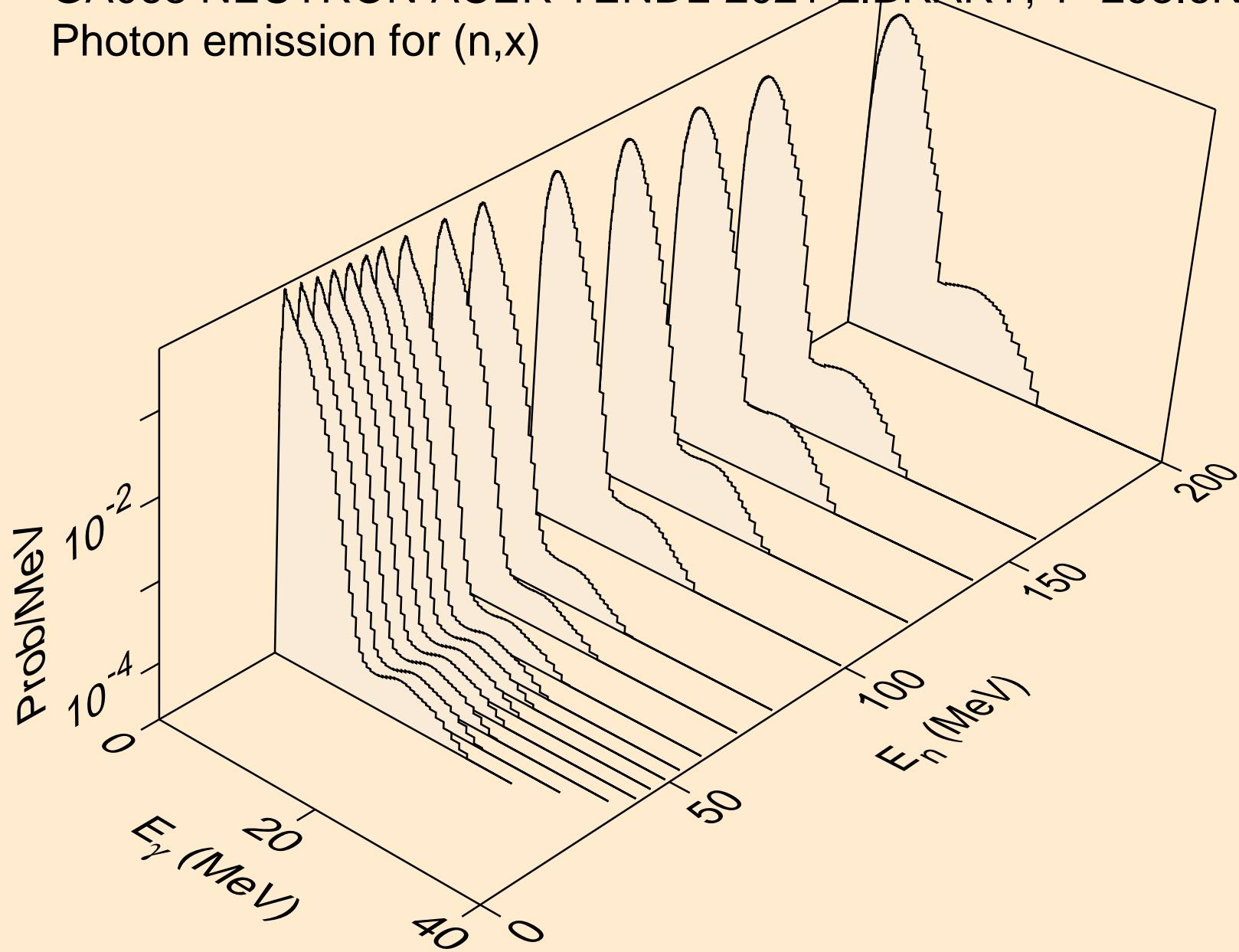

GA068 NEUTRON ACER TENDL-2021 LIBRARY; T=293.6K
Photon emission for (n,2nd)

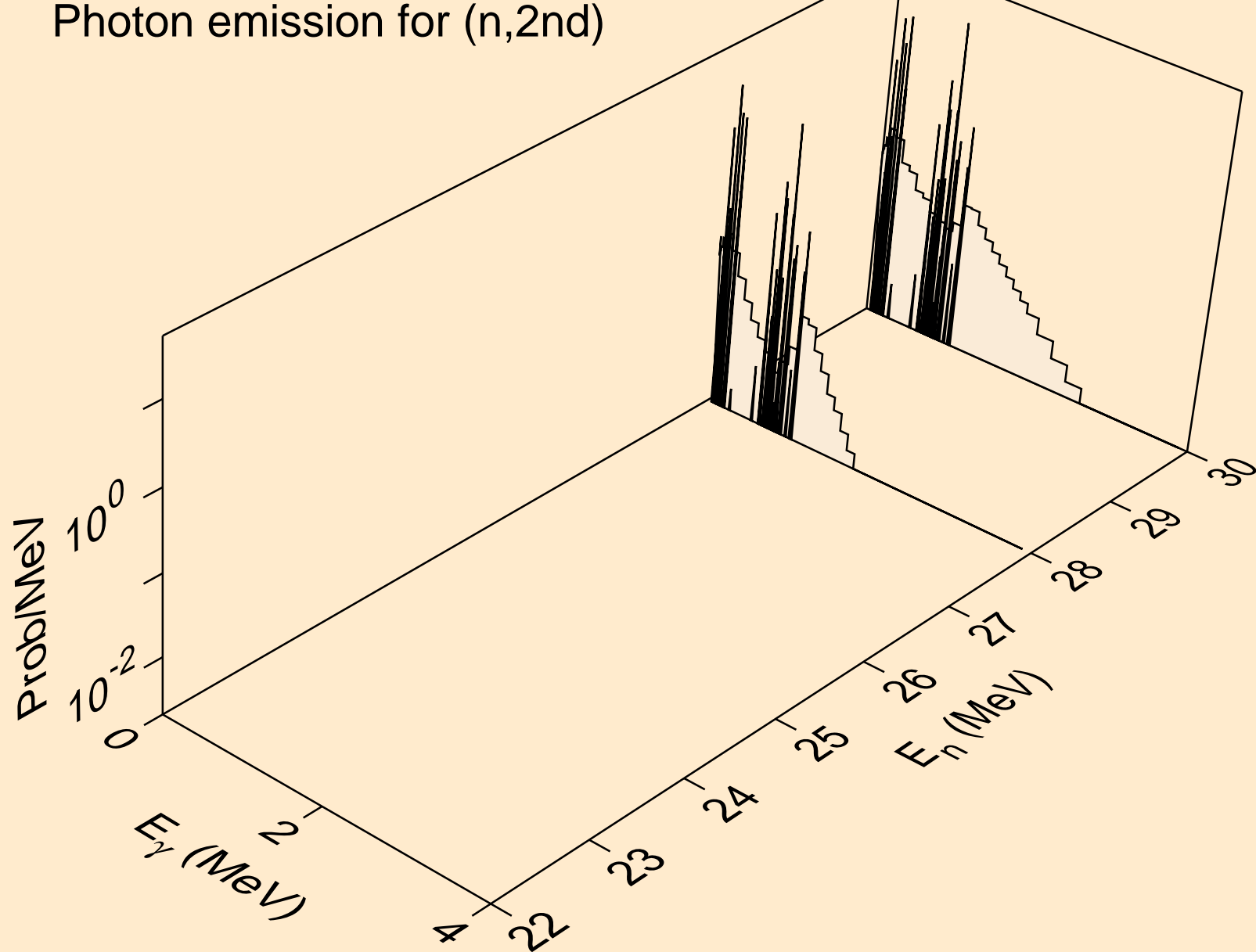

GA068 NEUTRON ACER TENDL-2021 LIBRARY; T=293.6K
Photon emission for (n,2n)

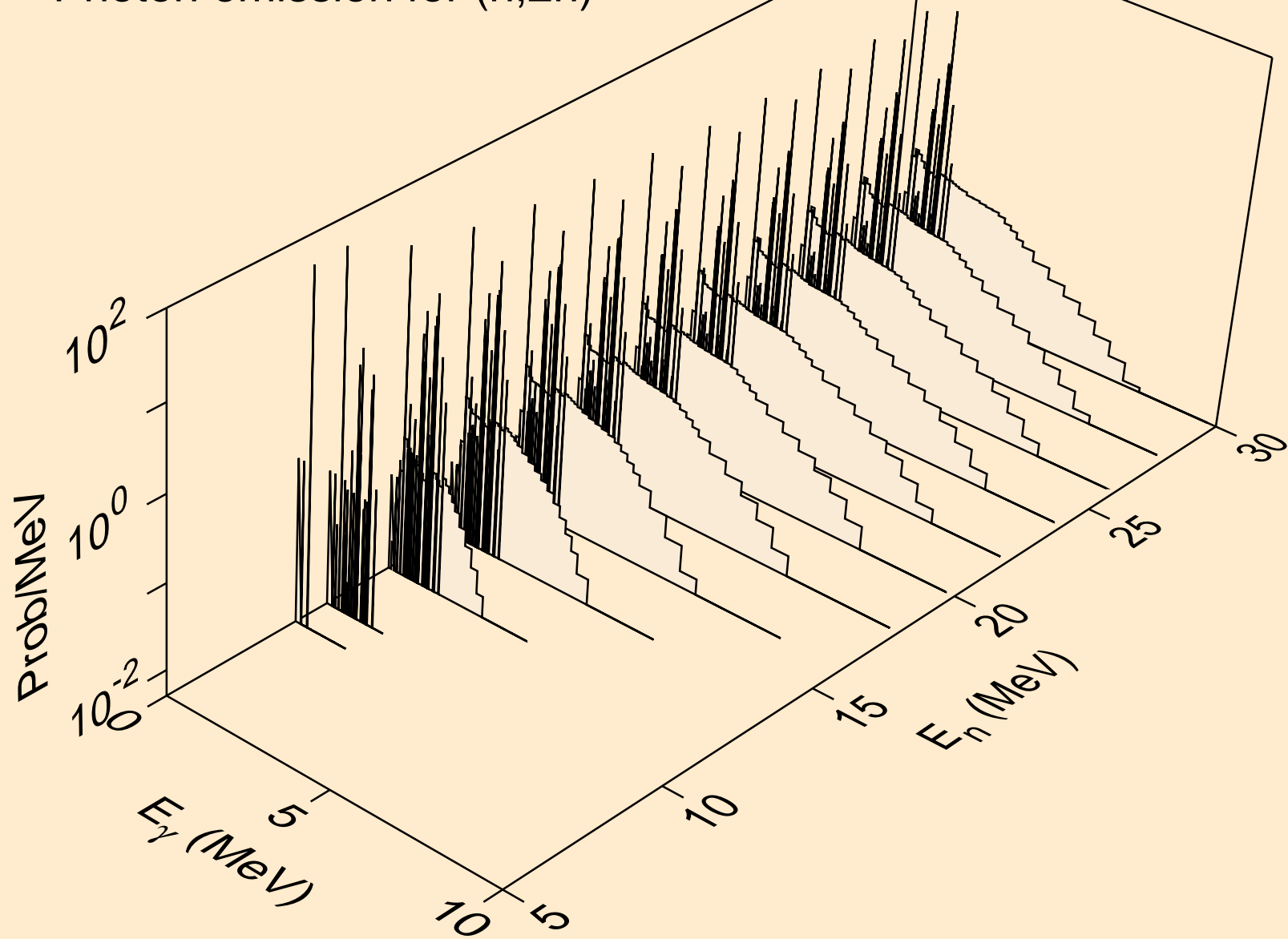

GA068 NEUTRON ACER TENDL-2021 LIBRARY; T=293.6K
Photon emission for (n,3n)

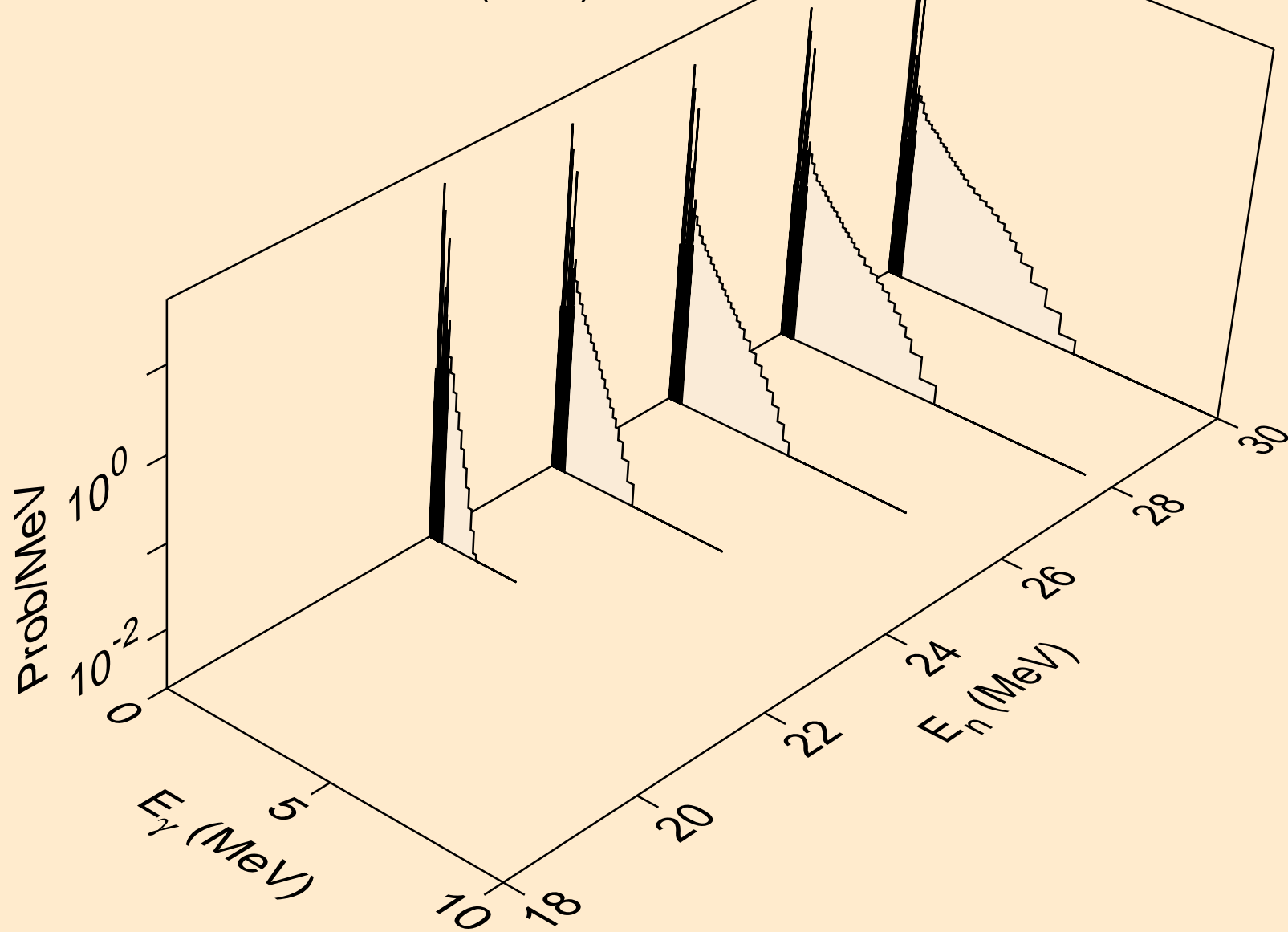

GA068 NEUTRON ACER TENDL-2021 LIBRARY; T=293.6K
Photon emission for (n,n*)a

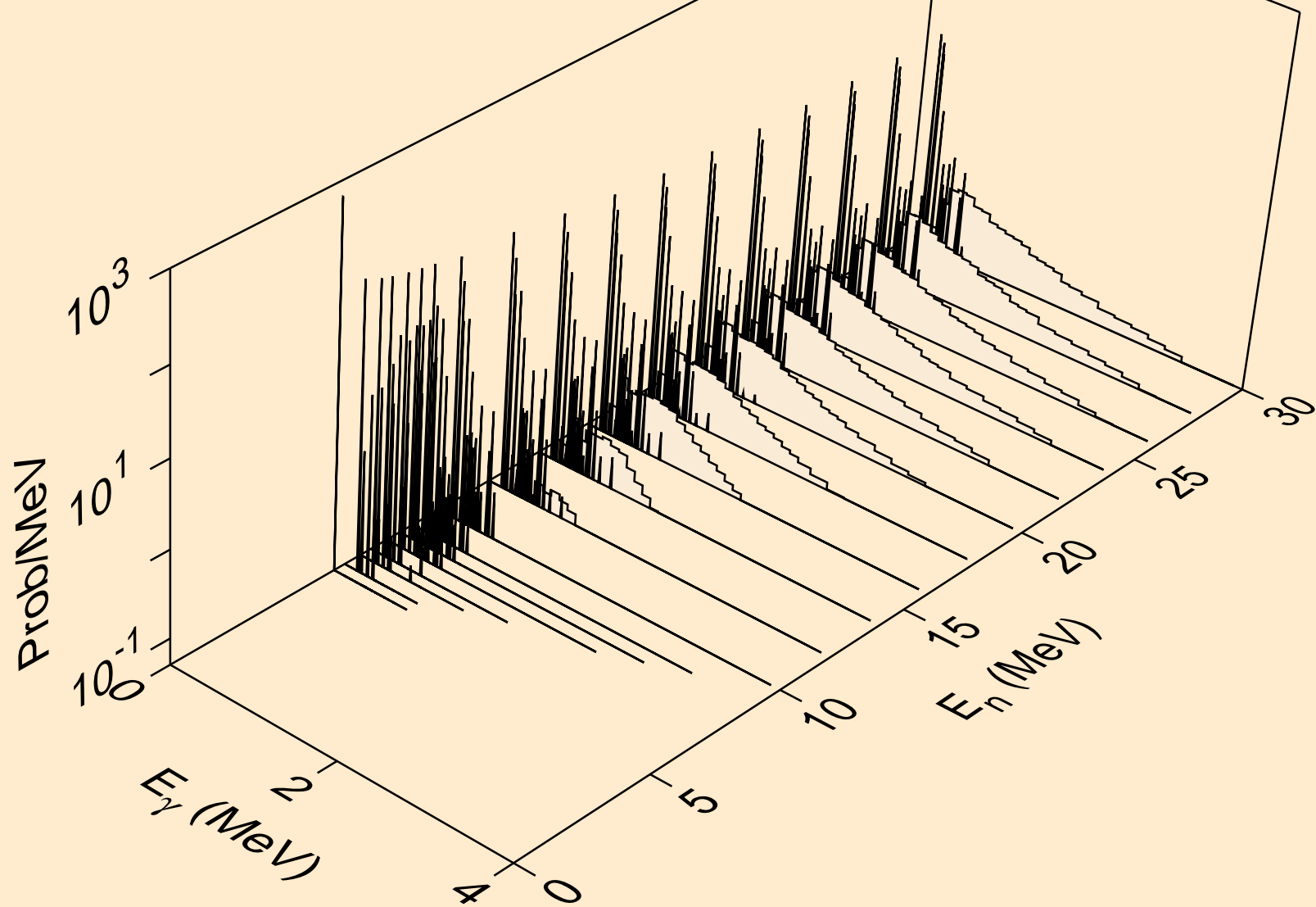

GA068 NEUTRON ACER TENDL-2021 LIBRARY; T=293.6K
Photon emission for (n,2n)a

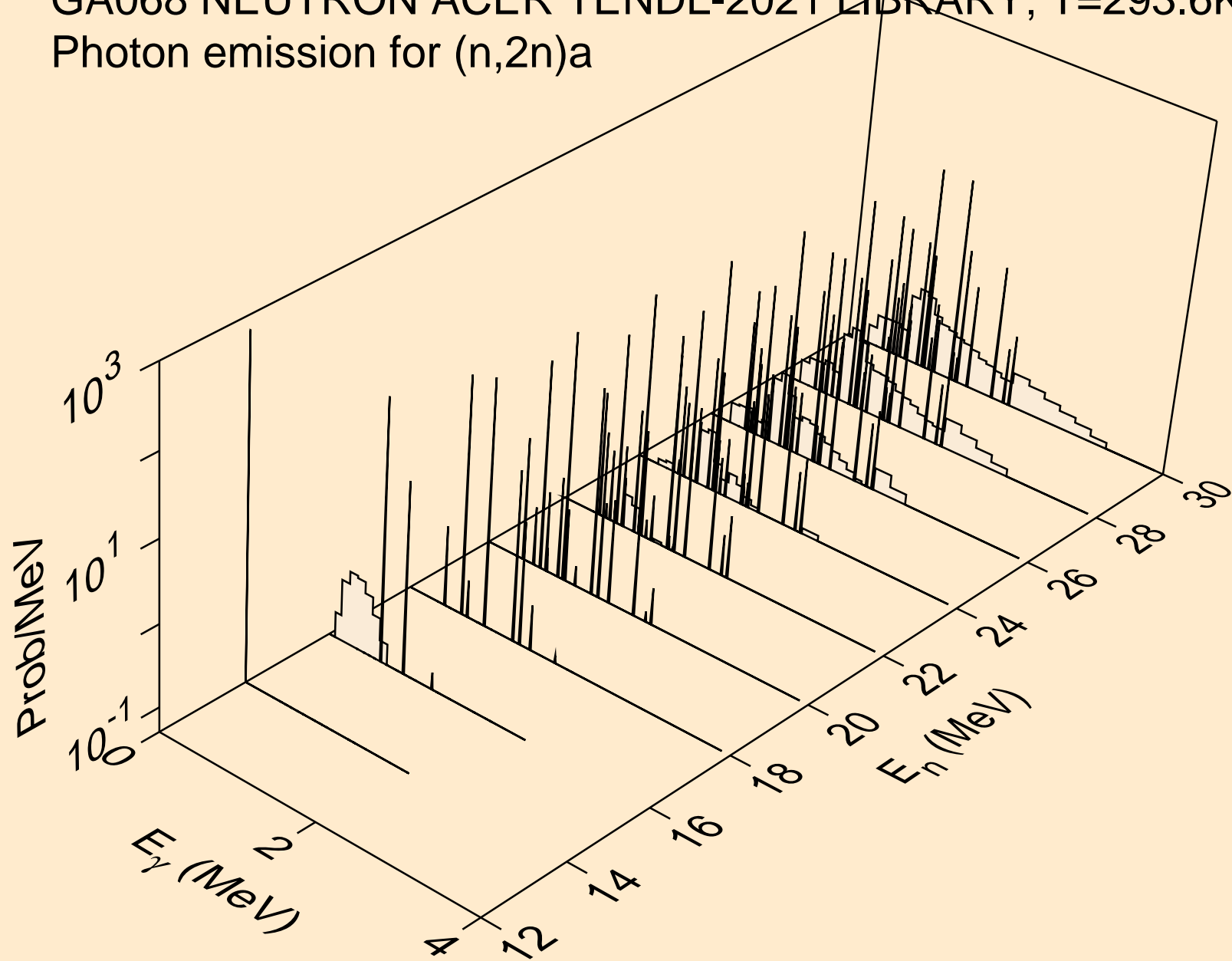

GA068 NEUTRON ACER TENDL-2021 LIBRARY; T=293.6K
Photon emission for (n,3n)a

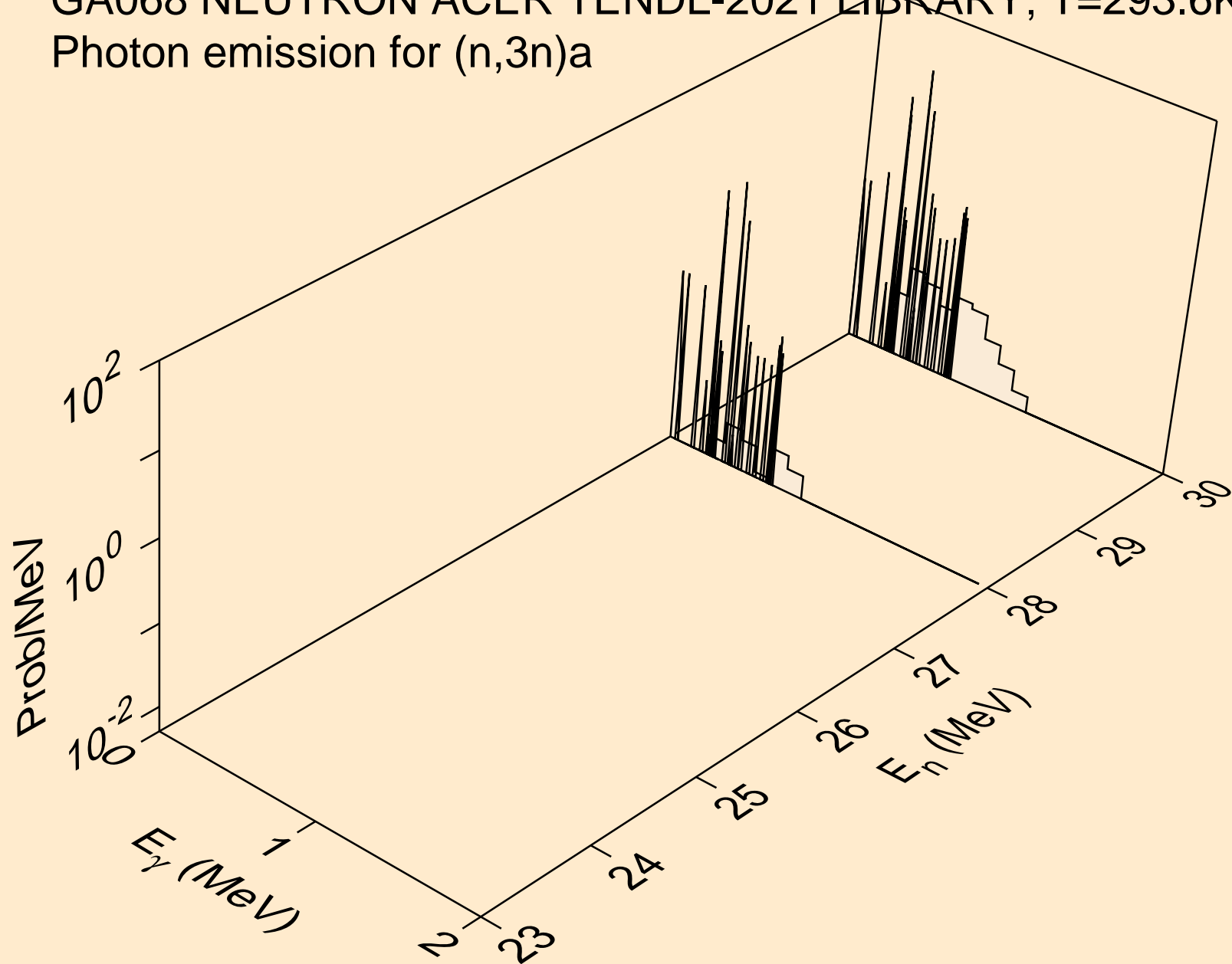

GA068 NEUTRON ACER TENDL-2021 LIBRARY; T=293.6K
Photon emission for (n,n*)p

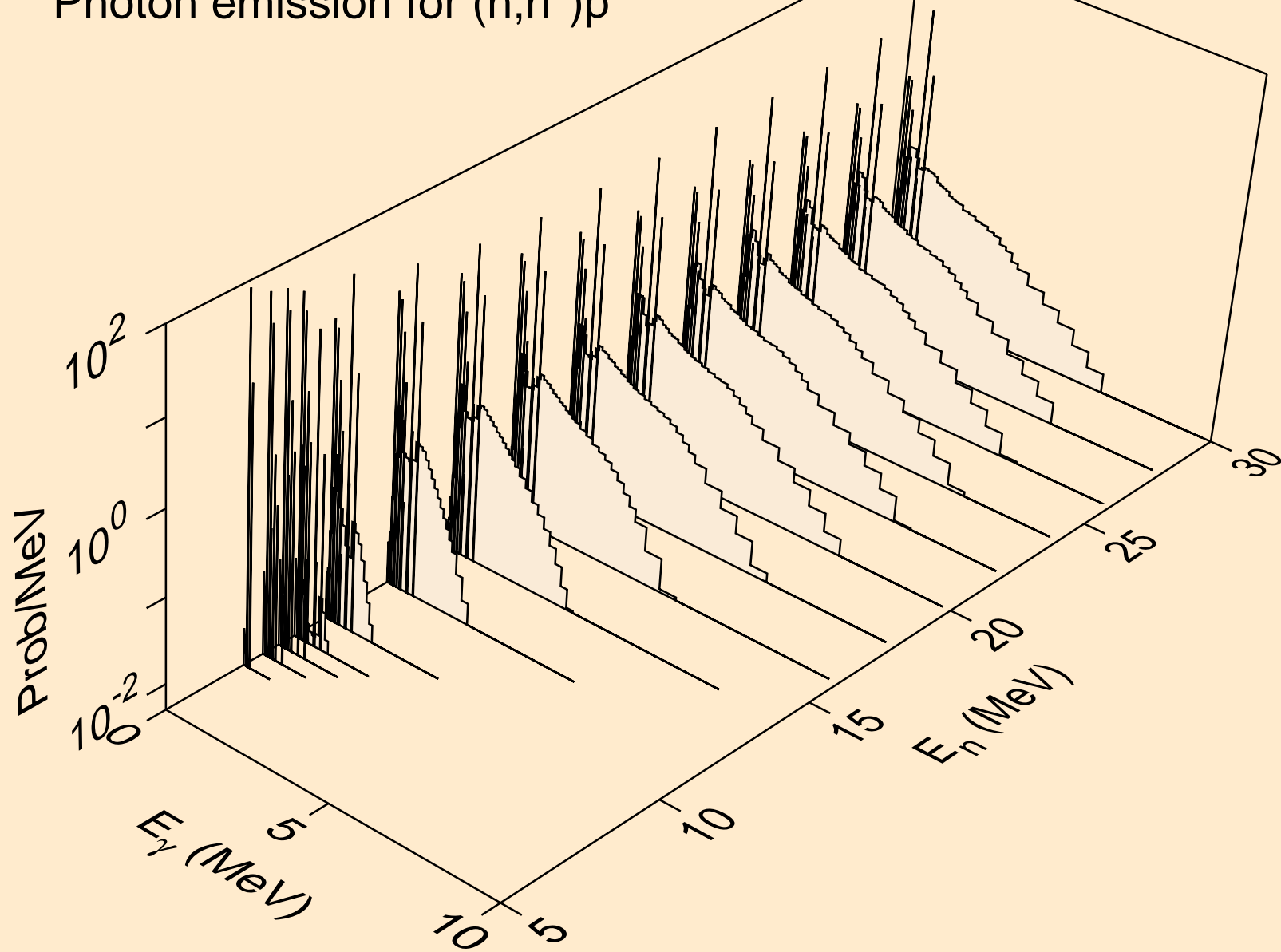

GA068 NEUTRON ACER TENDL-2021 LIBRARY; T=293.6K
Photon emission for (n,n*)2a

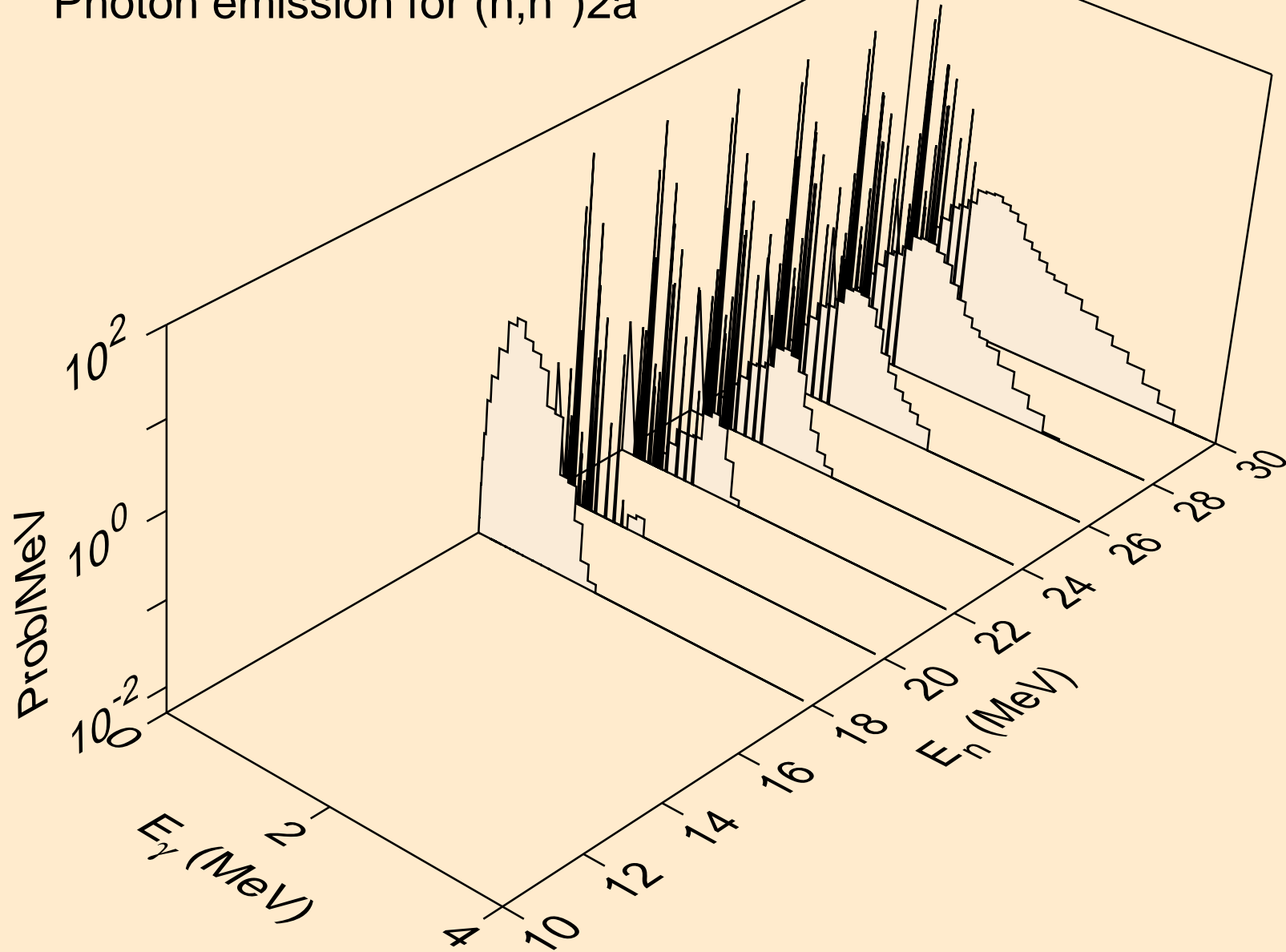

GA068 NEUTRON ACER TENDL-2021 LIBRARY; T=293.6K
Photon emission for (n,2n)2a

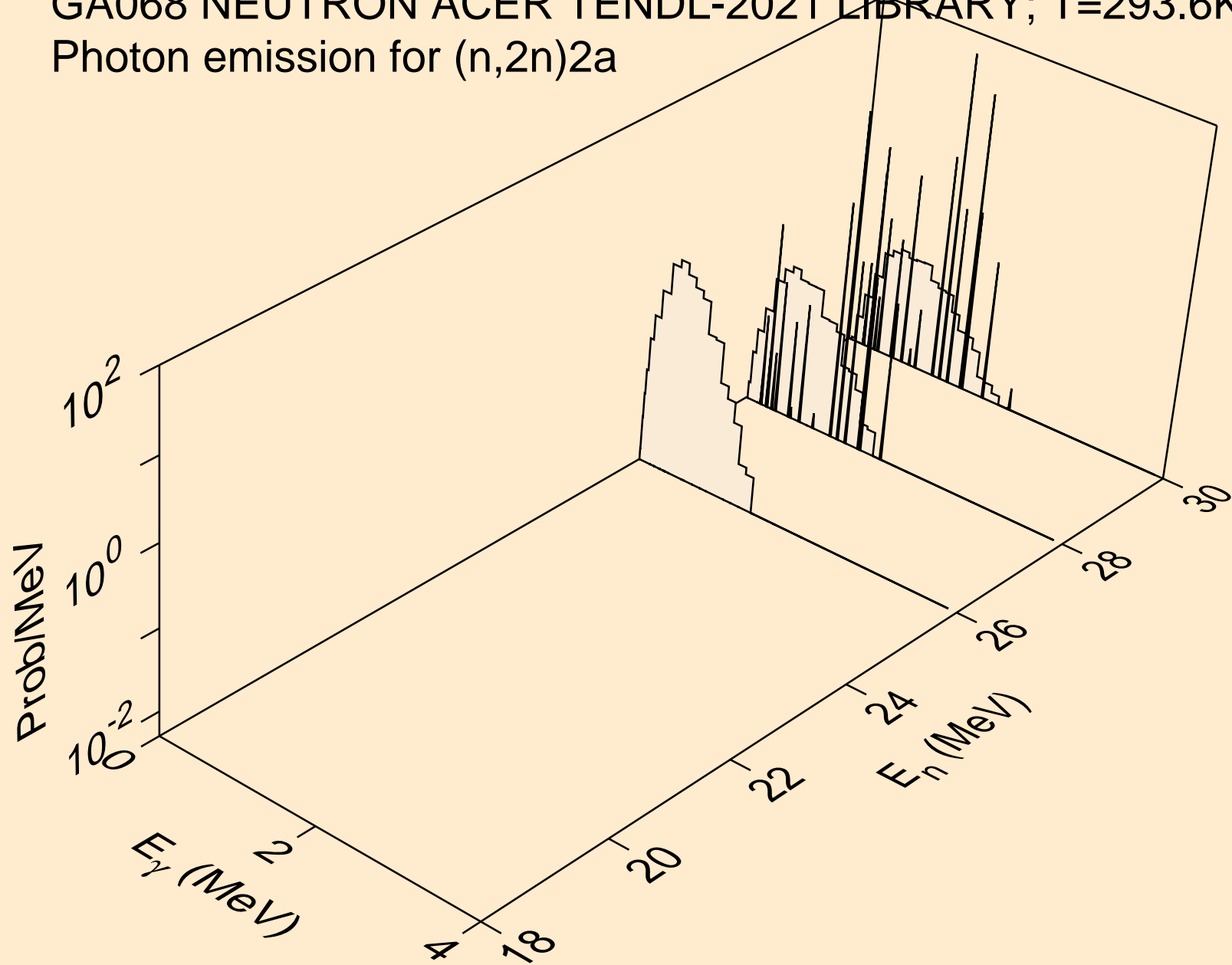

GA068 NEUTRON ACER TENDL-2021 LIBRARY; T=293.6K
Photon emission for (n,n*)d

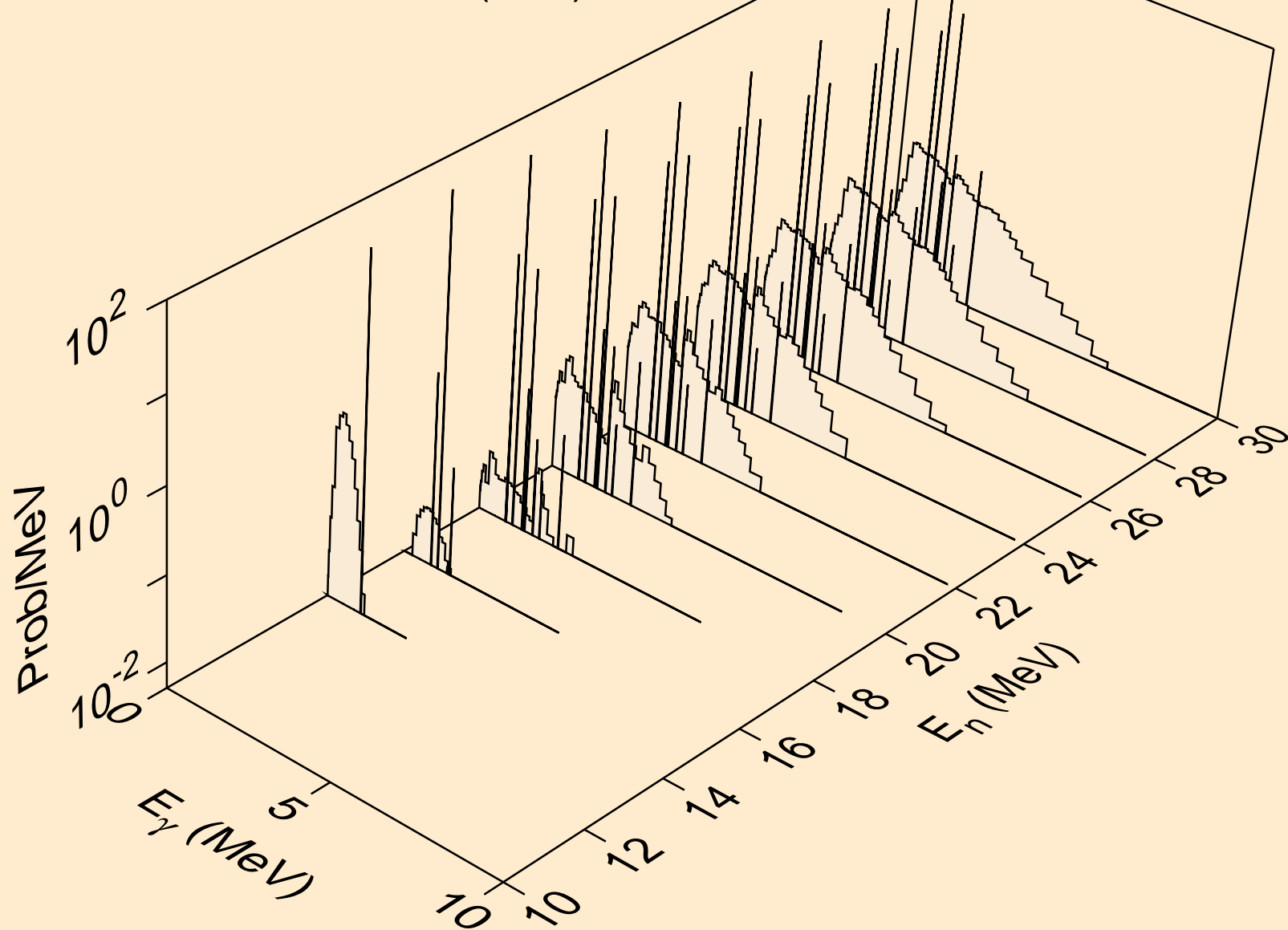

GA068 NEUTRON ACER TENDL-2021 LIBRARY; T=293.6K
Photon emission for (n,n*)t

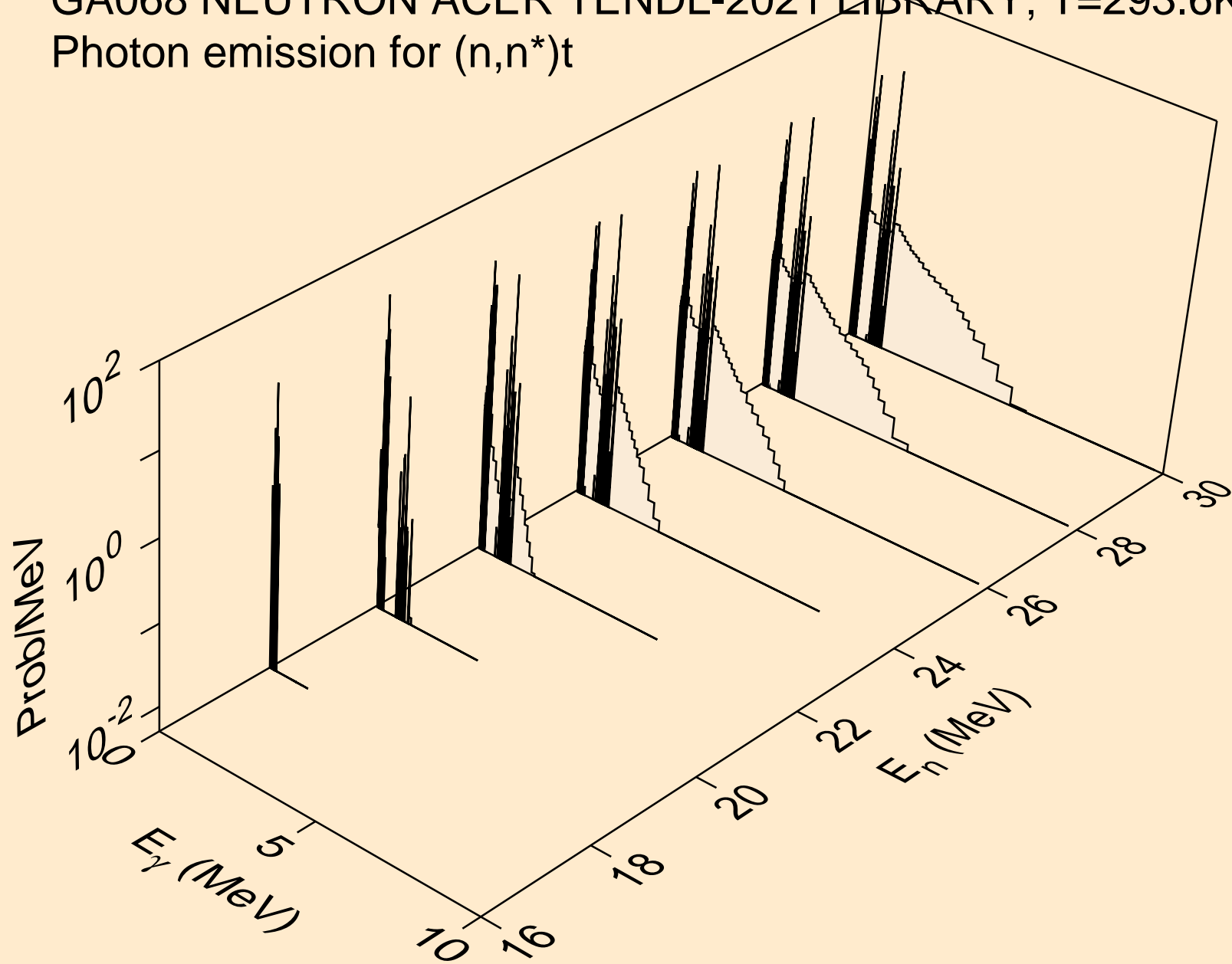

GA068 NEUTRON ACER TENDL-2021 LIBRARY; T=293.6K
Photon emission for (n,n*)he3

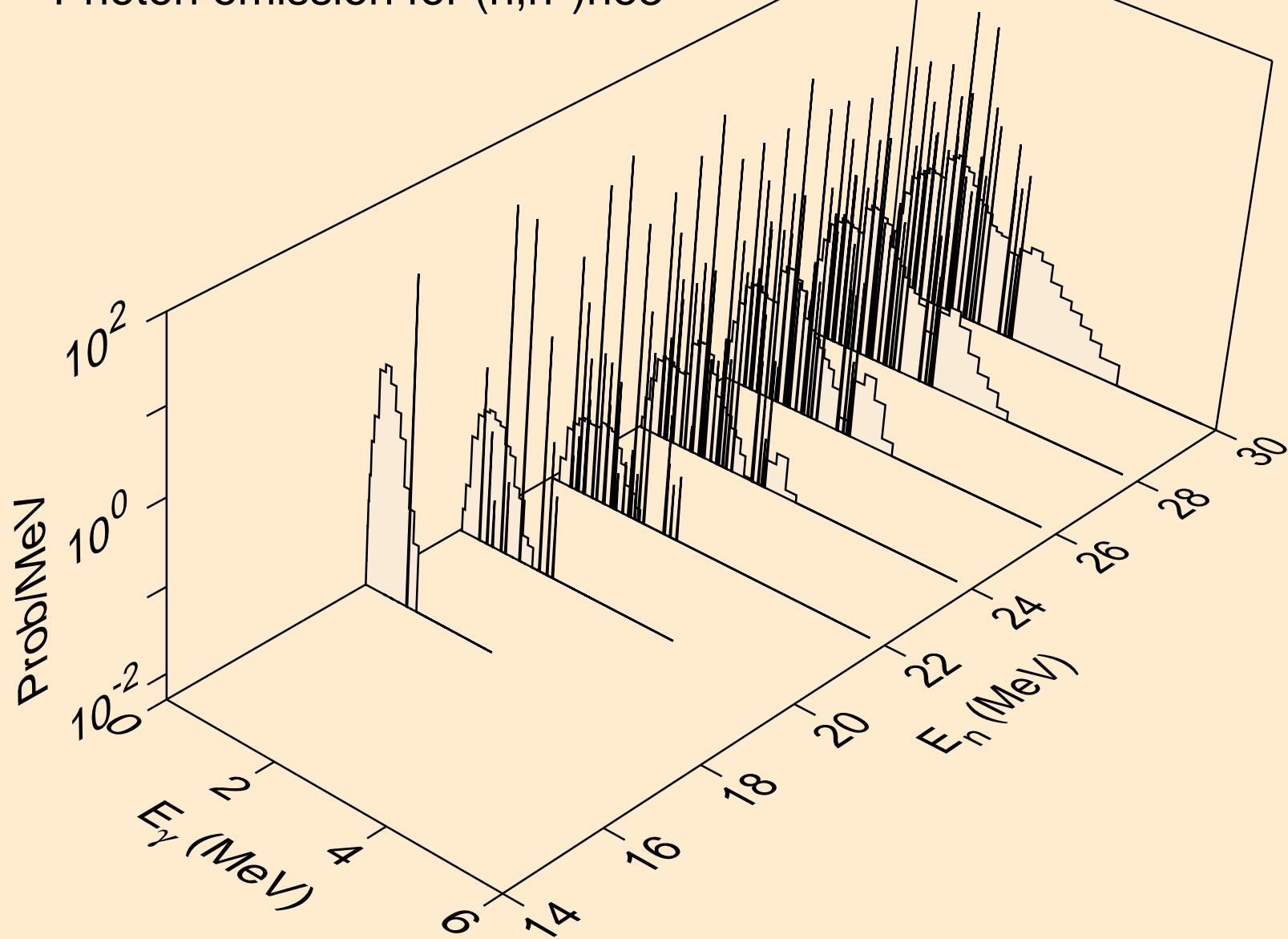

GA068 NEUTRON ACER TENDL-2021 LIBRARY; T=293.6K
Photon emission for (n,2np)

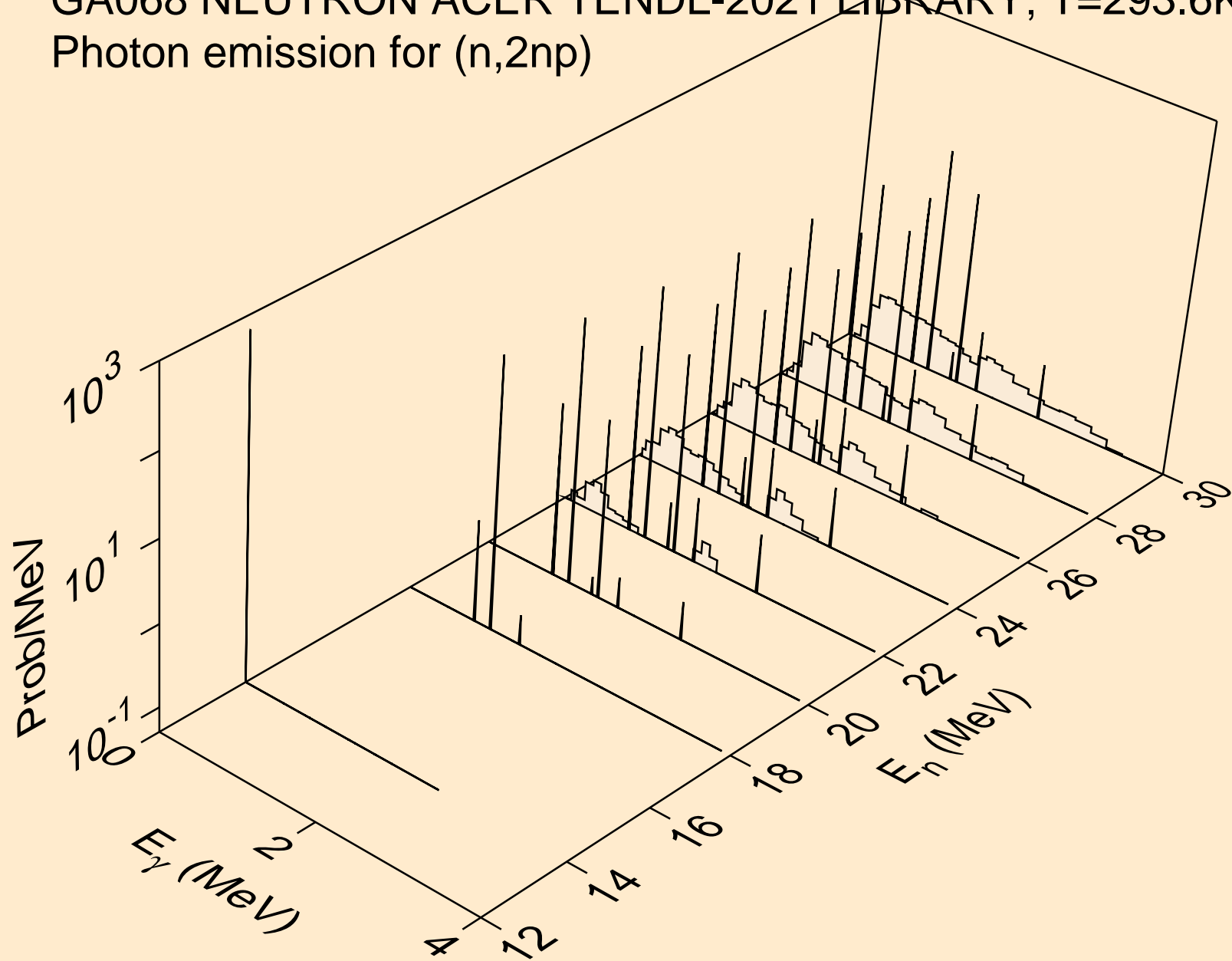

GA068 NEUTRON ACER TENDL-2021 LIBRARY; T=293.6K
Photon emission for (n,3np)

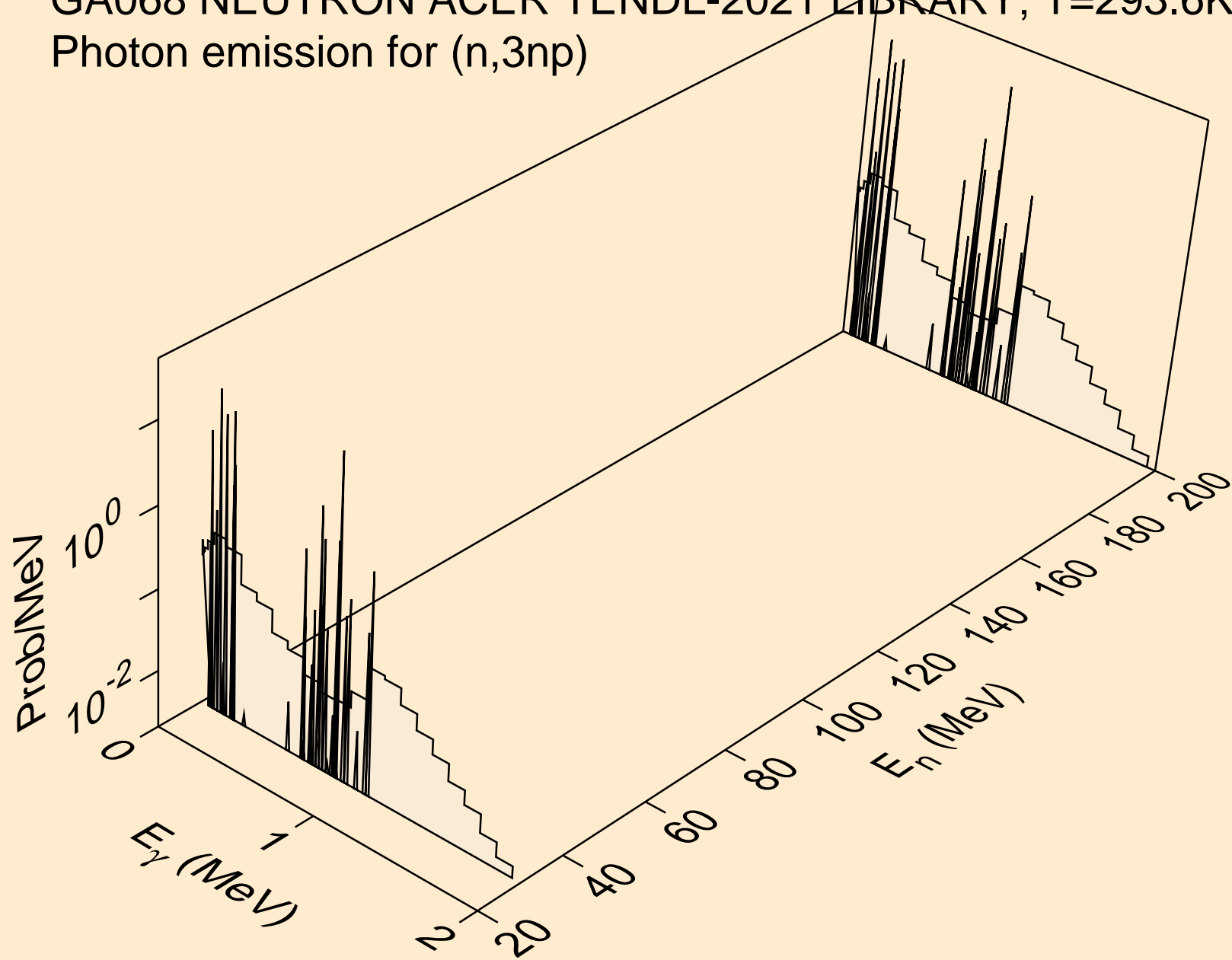

GA068 NEUTRON ACER TENDL-2021 LIBRARY; T=293.6K
Photon emission for (n,2np)

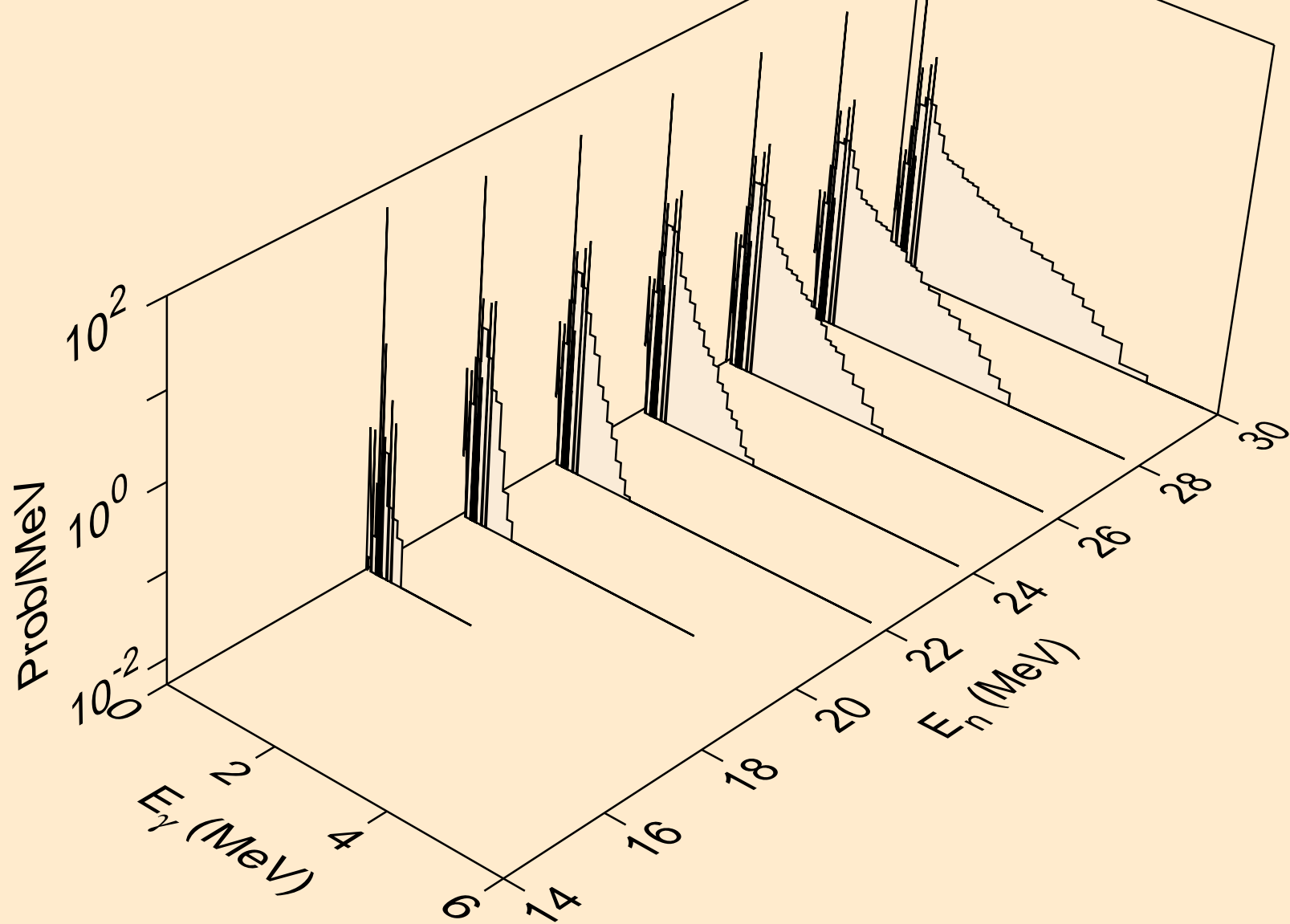

GA068 NEUTRON ACER TENDL-2021 LIBRARY; T=293.6K
Photon emission for (n,npa)

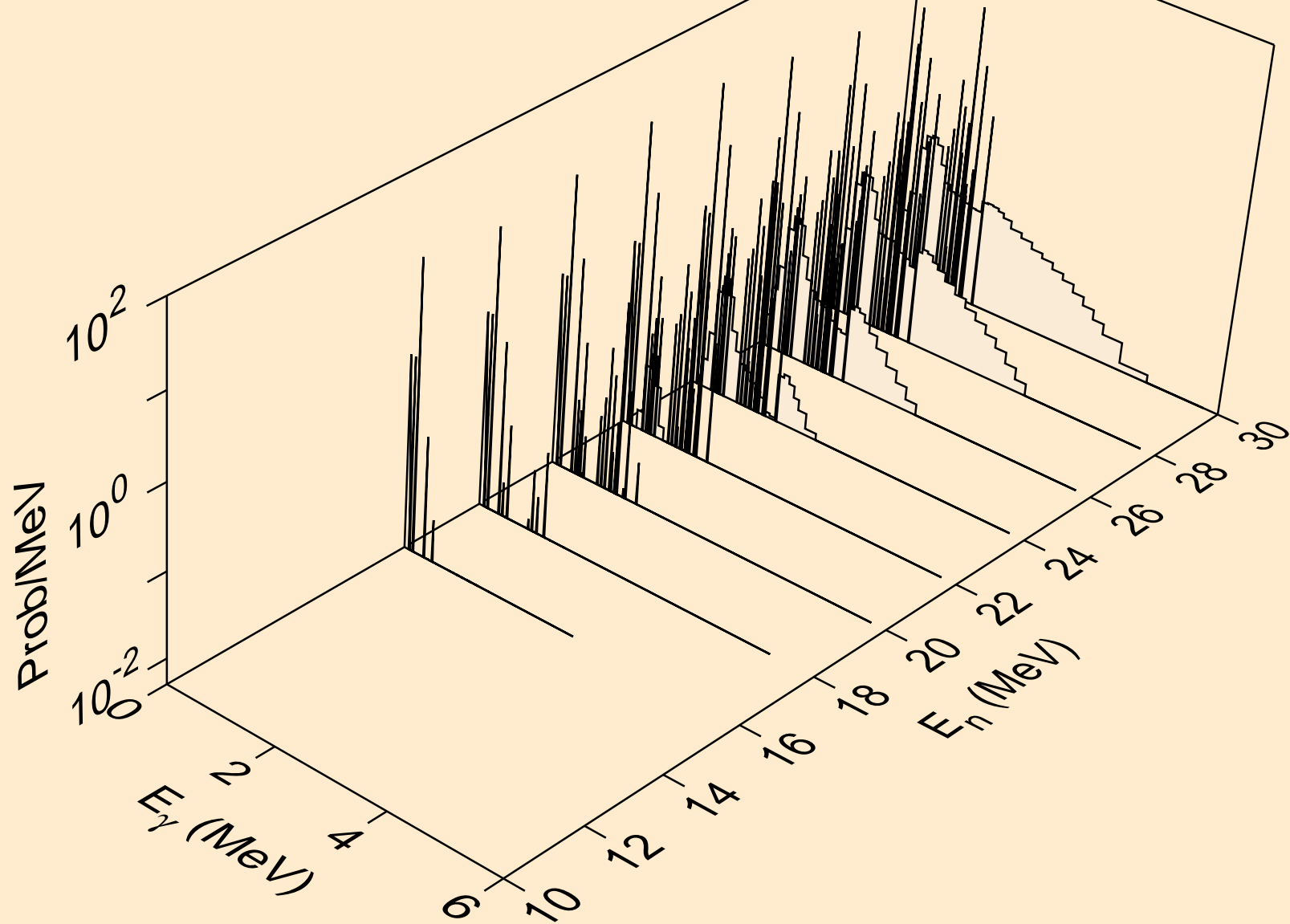

GA068 NEUTRON ACER TENDL-2021 LIBRARY; T=293.6K
Photon emission for (n,n*c)

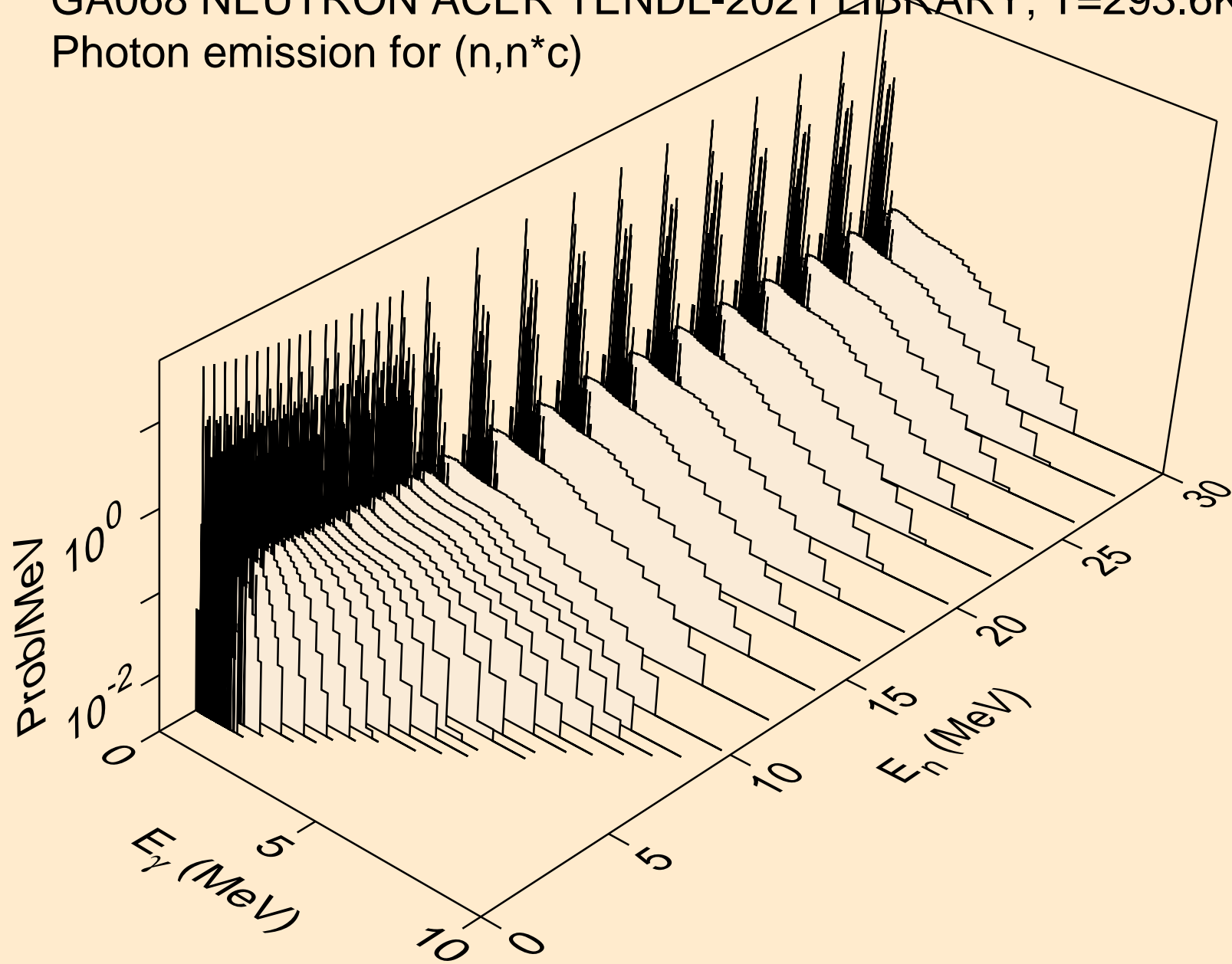

GA068 NEUTRON ACER TENDL-2021 LIBRARY; T=293.6K
Photon emission for (n,gma)

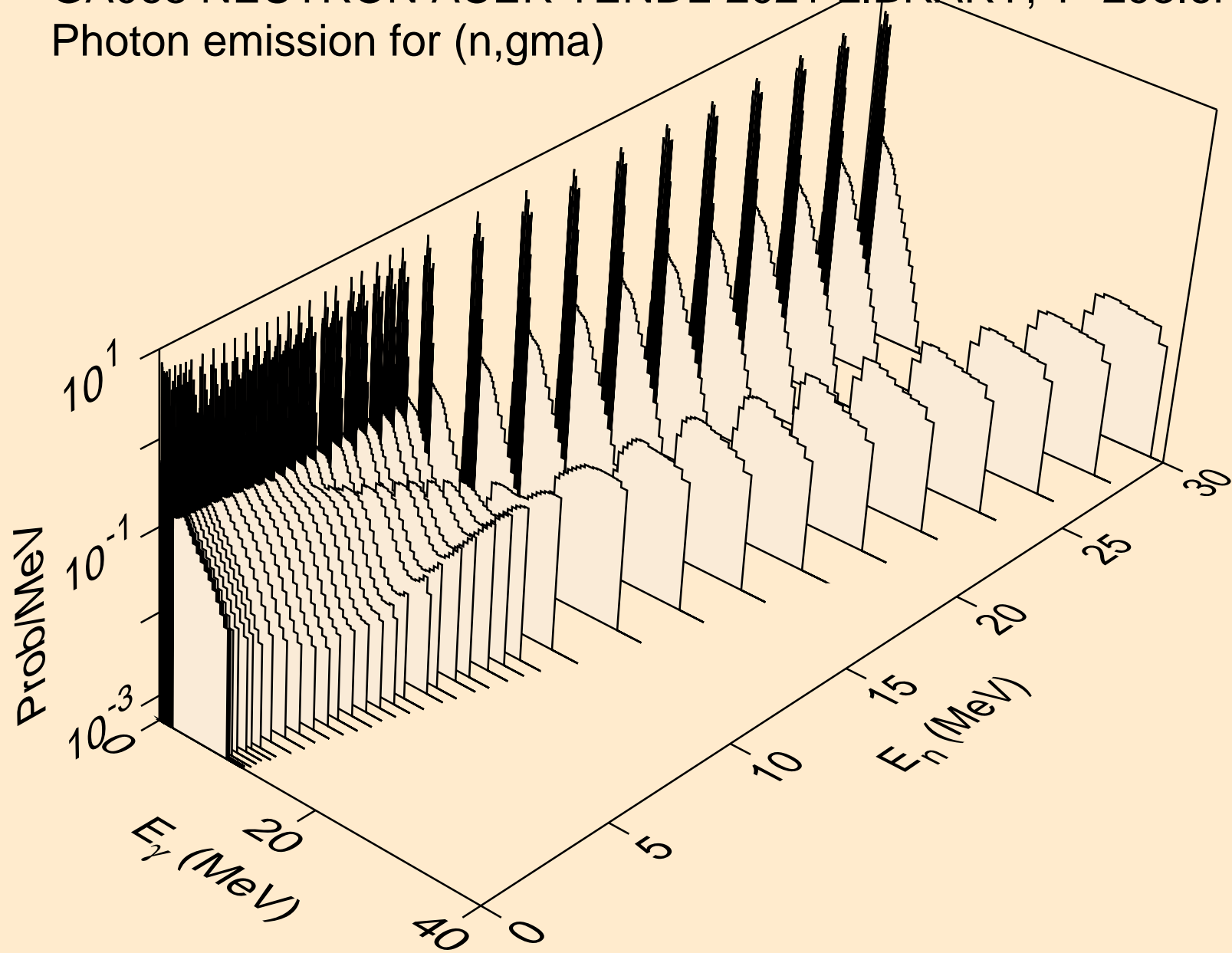

GA068 NEUTRON ACER TENDL-2021 LIBRARY; T=293.6K
Photon emission for (n,p)

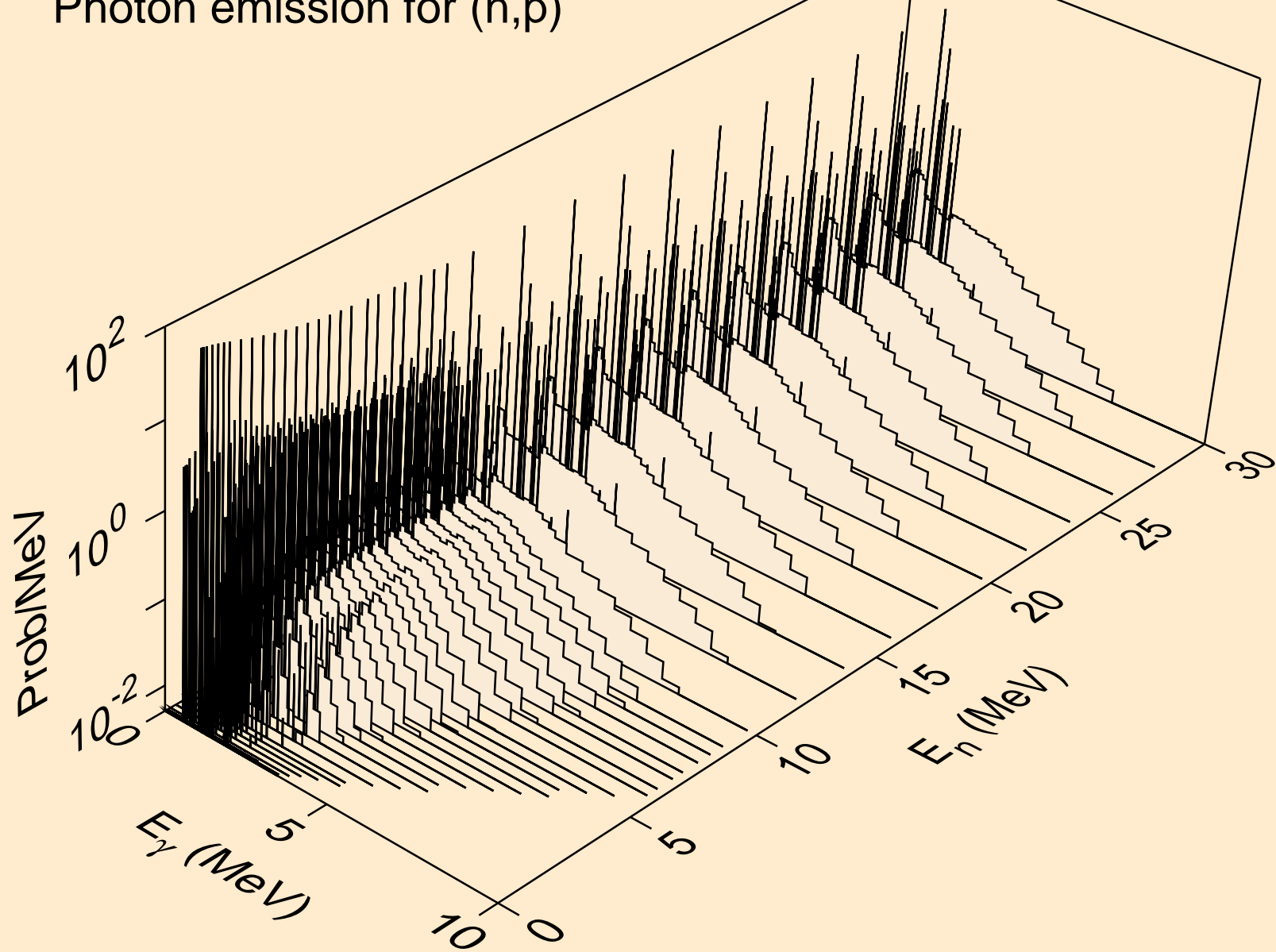

GA068 NEUTRON ACER TENDL-2021 LIBRARY; T=293.6K
Photon emission for (n,d)

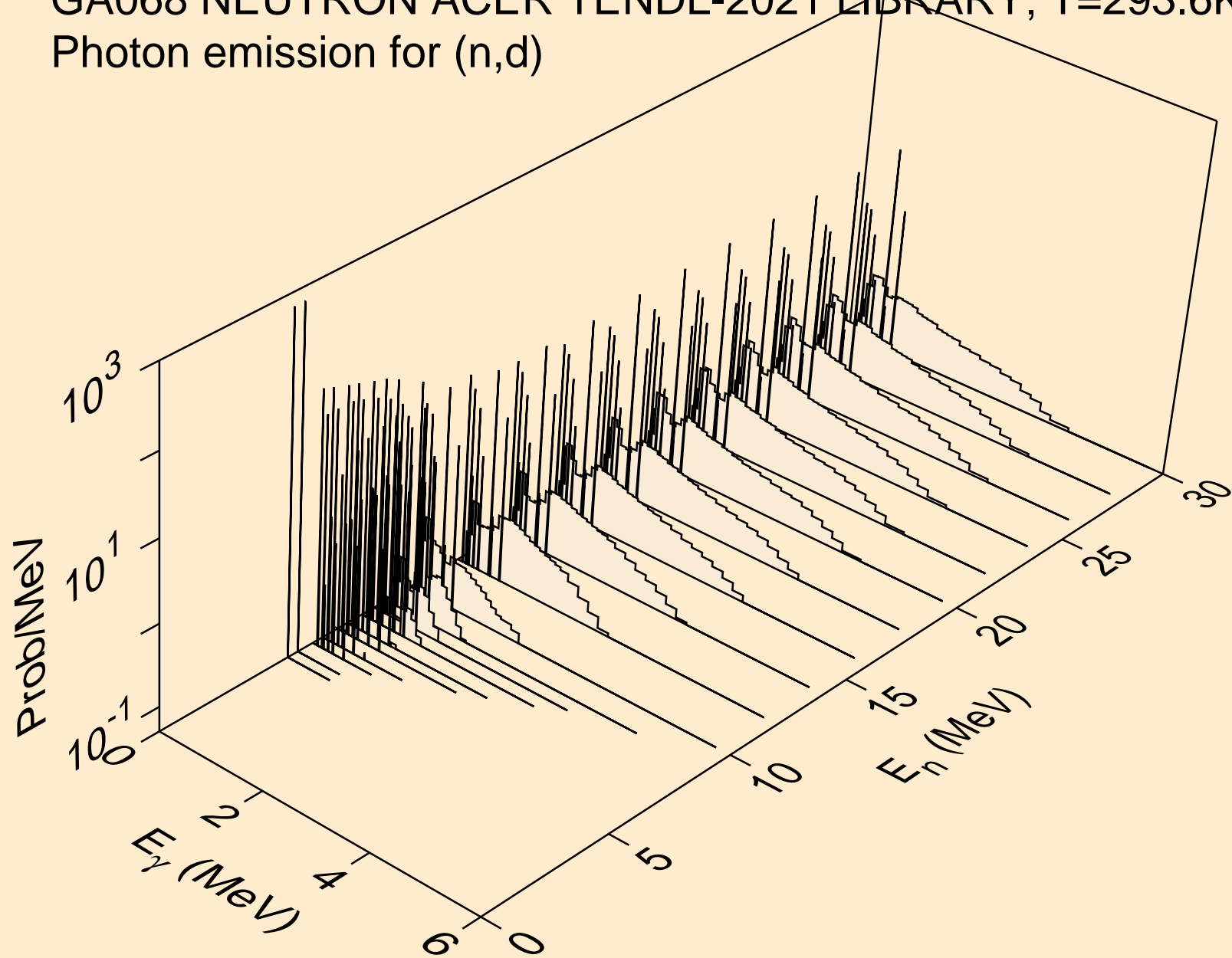

GA068 NEUTRON ACER TENDL-2021 LIBRARY; T=293.6K
Photon emission for (n,t)

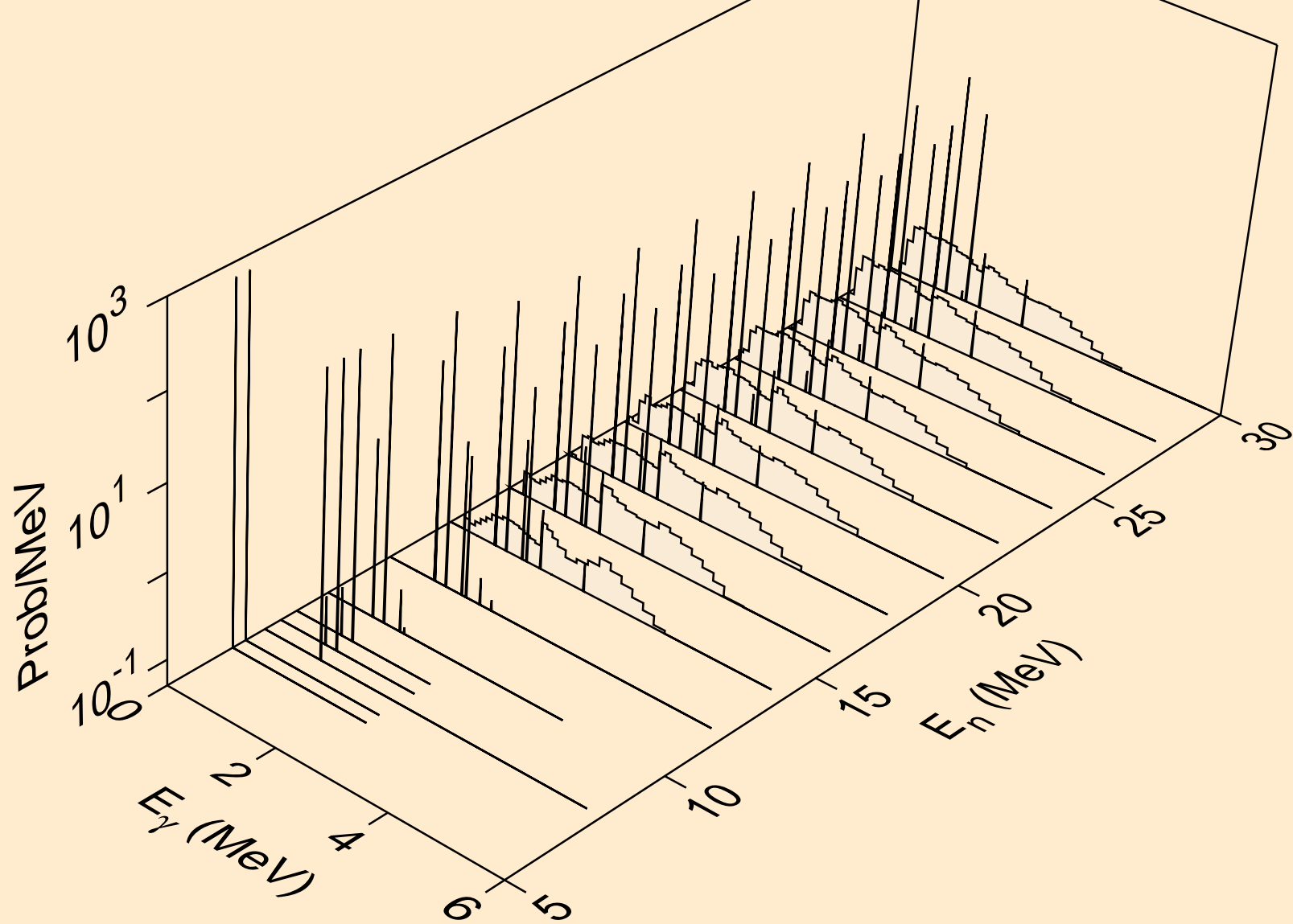

GA068 NEUTRON ACER TENDL-2021 LIBRARY; T=293.6K
Photon emission for (n,he3)

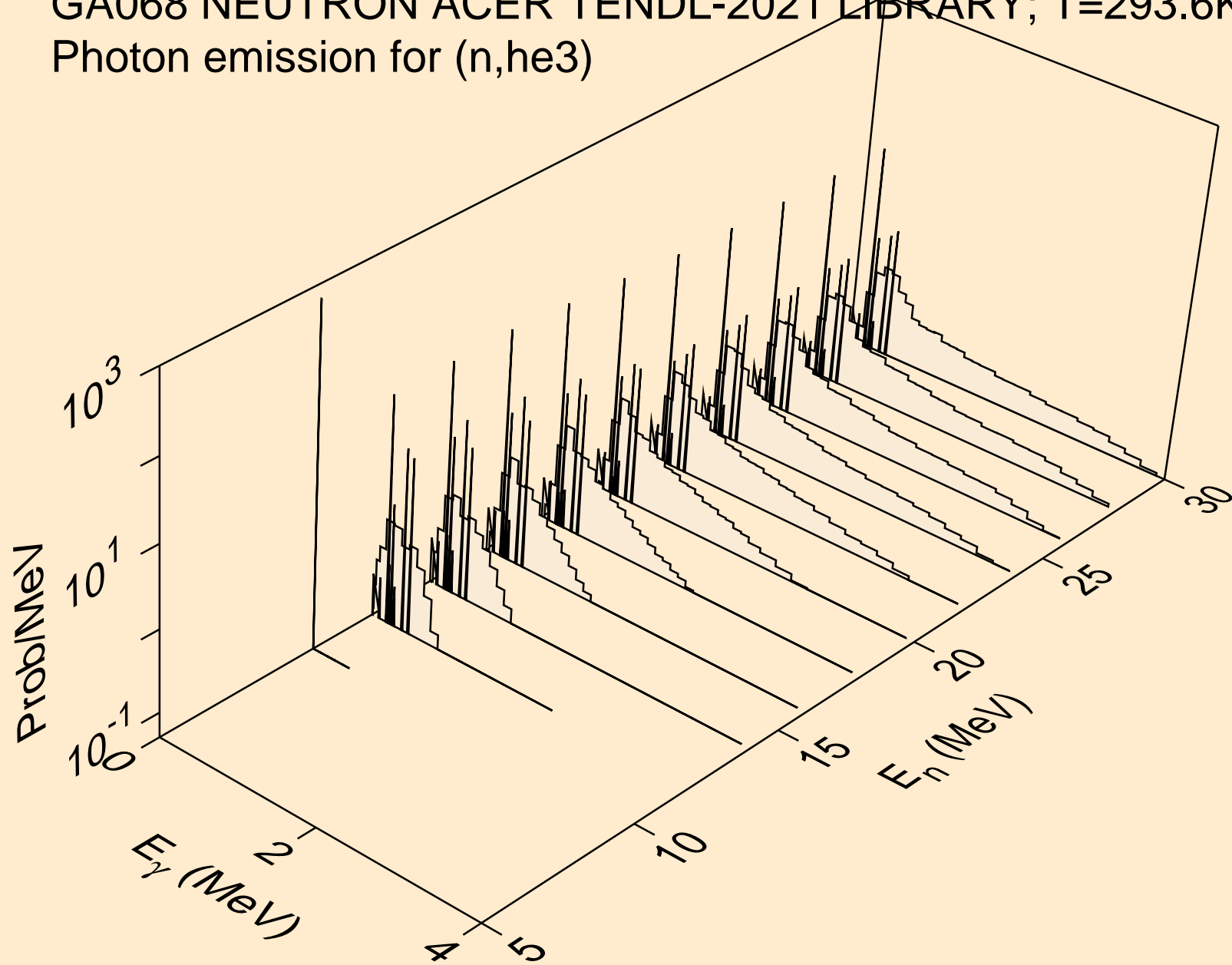

GA068 NEUTRON ACER TENDL-2021 LIBRARY; T=293.6K
Photon emission for (n,a)

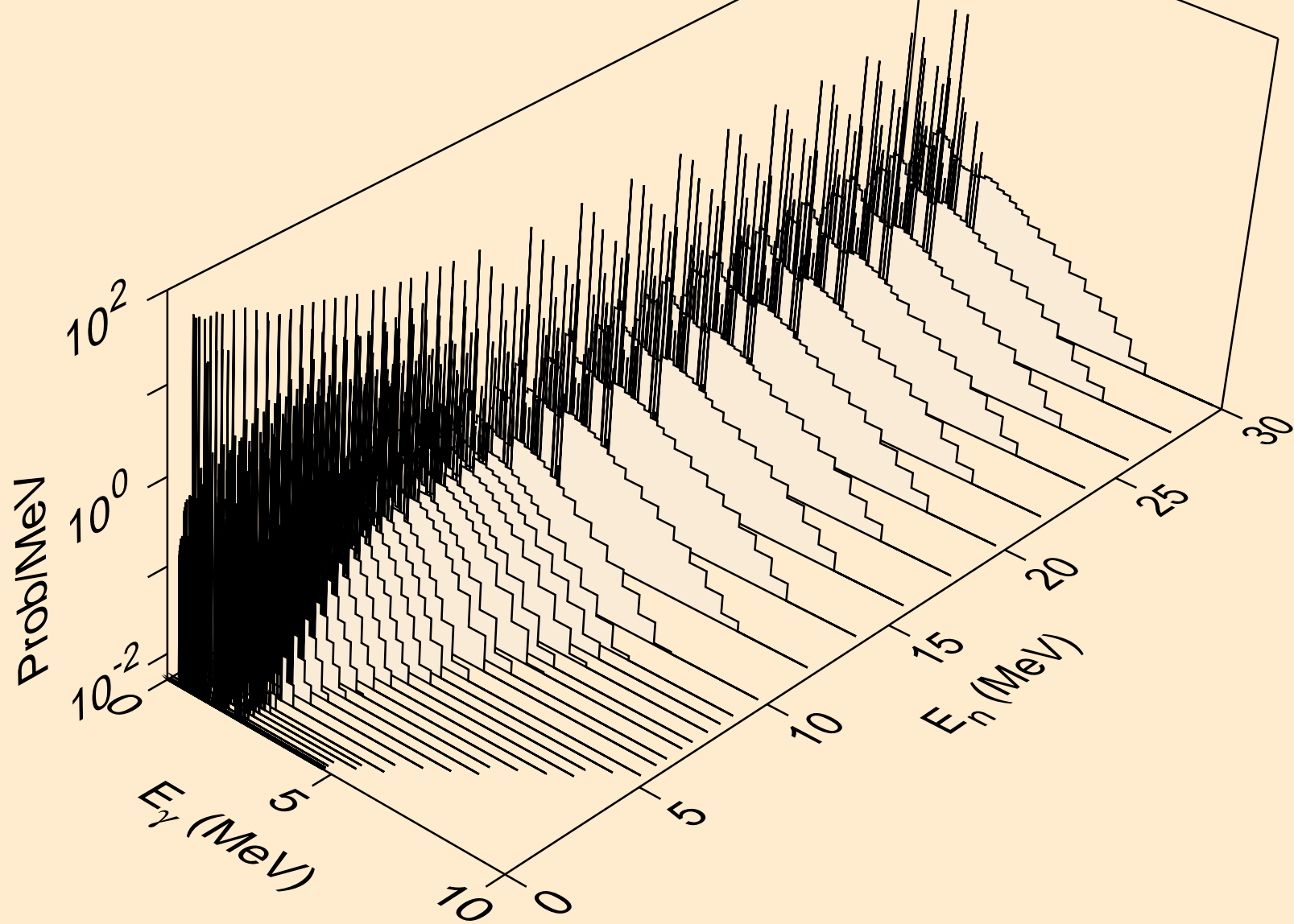

GA068 NEUTRON ACER TENDL-2021 LIBRARY; T=293.6K
Photon emission for (n,2a)

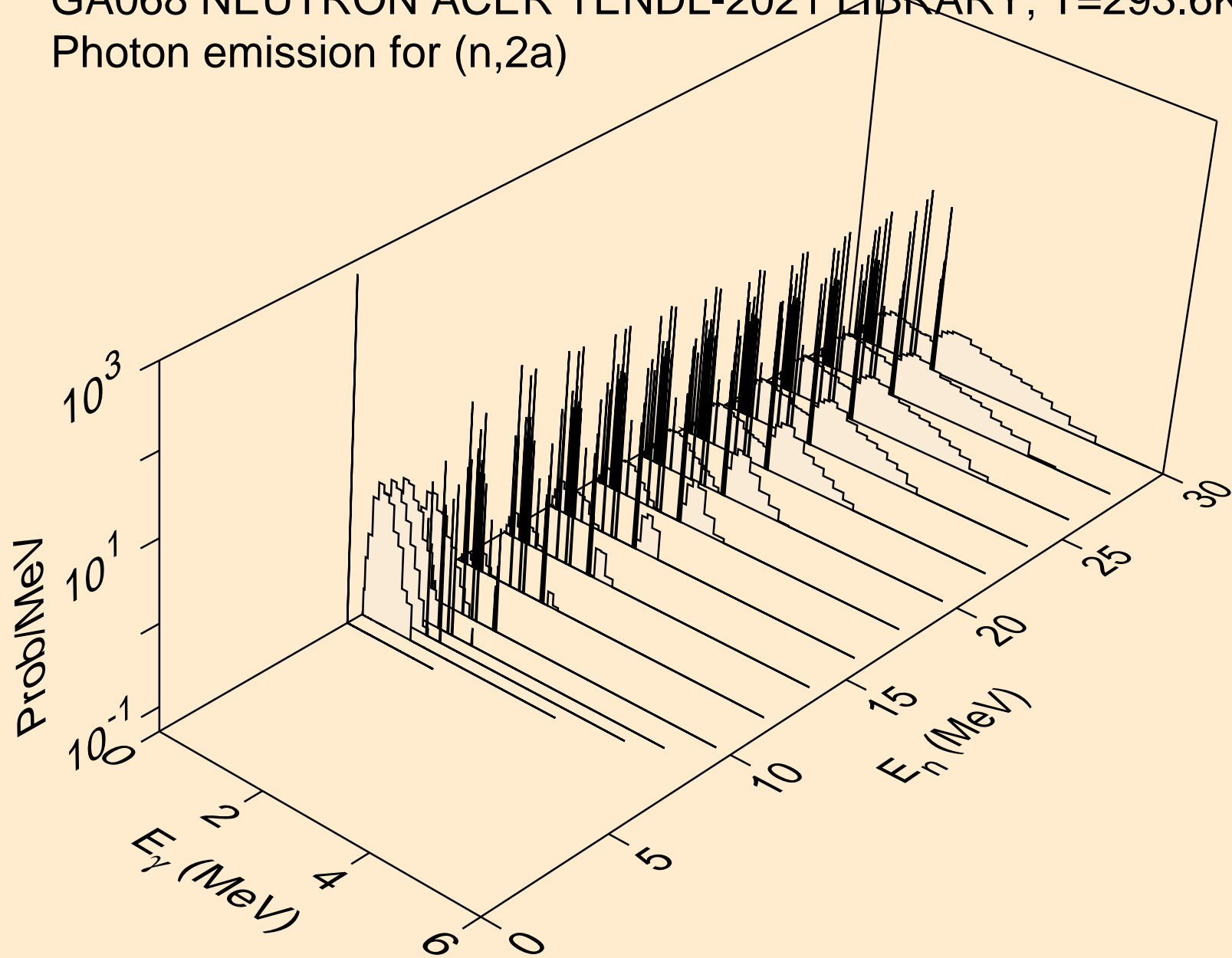

GA068 NEUTRON ACER TENDL-2021 LIBRARY; T=293.6K
Photon emission for (n,2p)

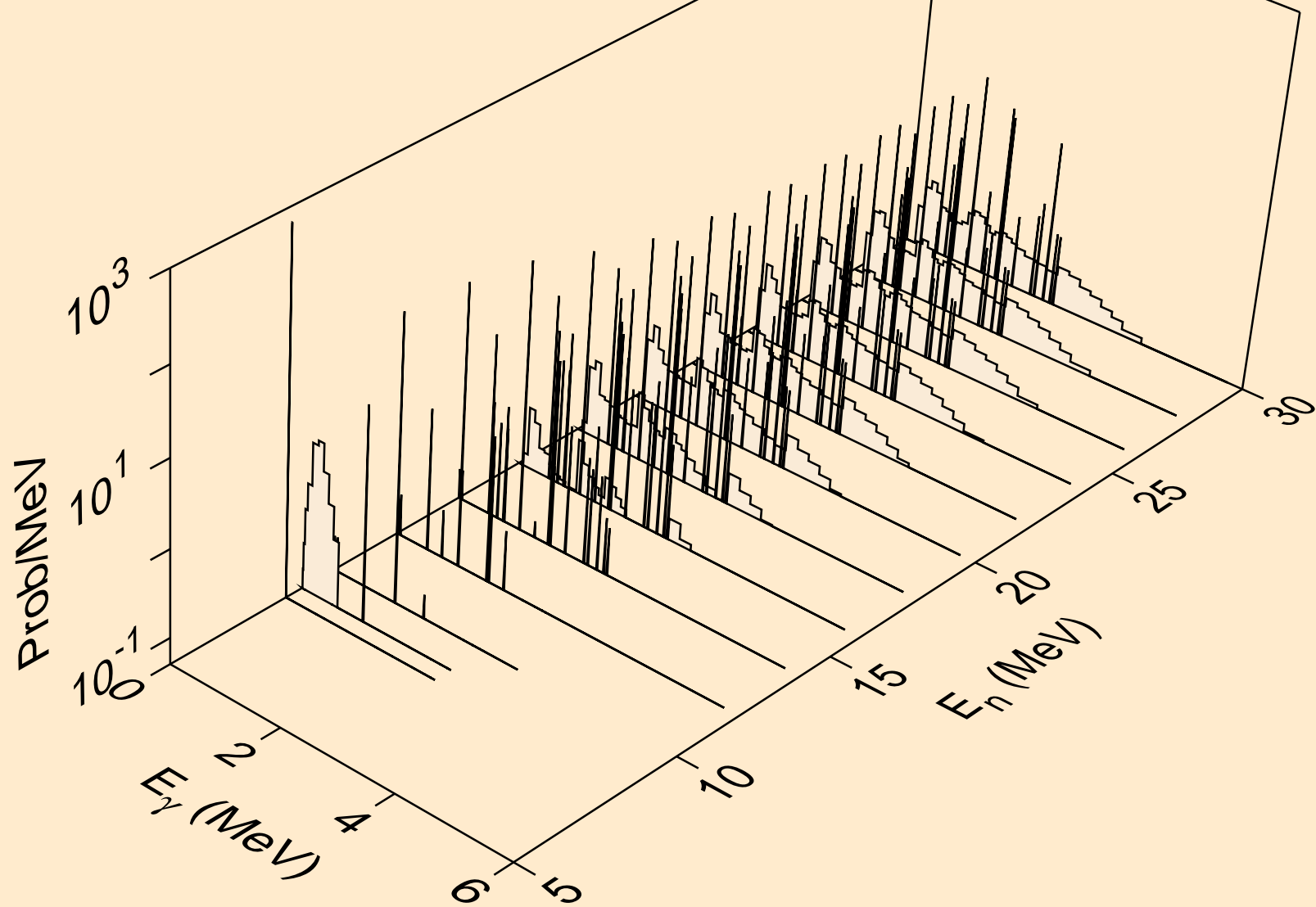

GA068 NEUTRON ACER TENDL-2021 LIBRARY; T=293.6K
Photon emission for (n,p)

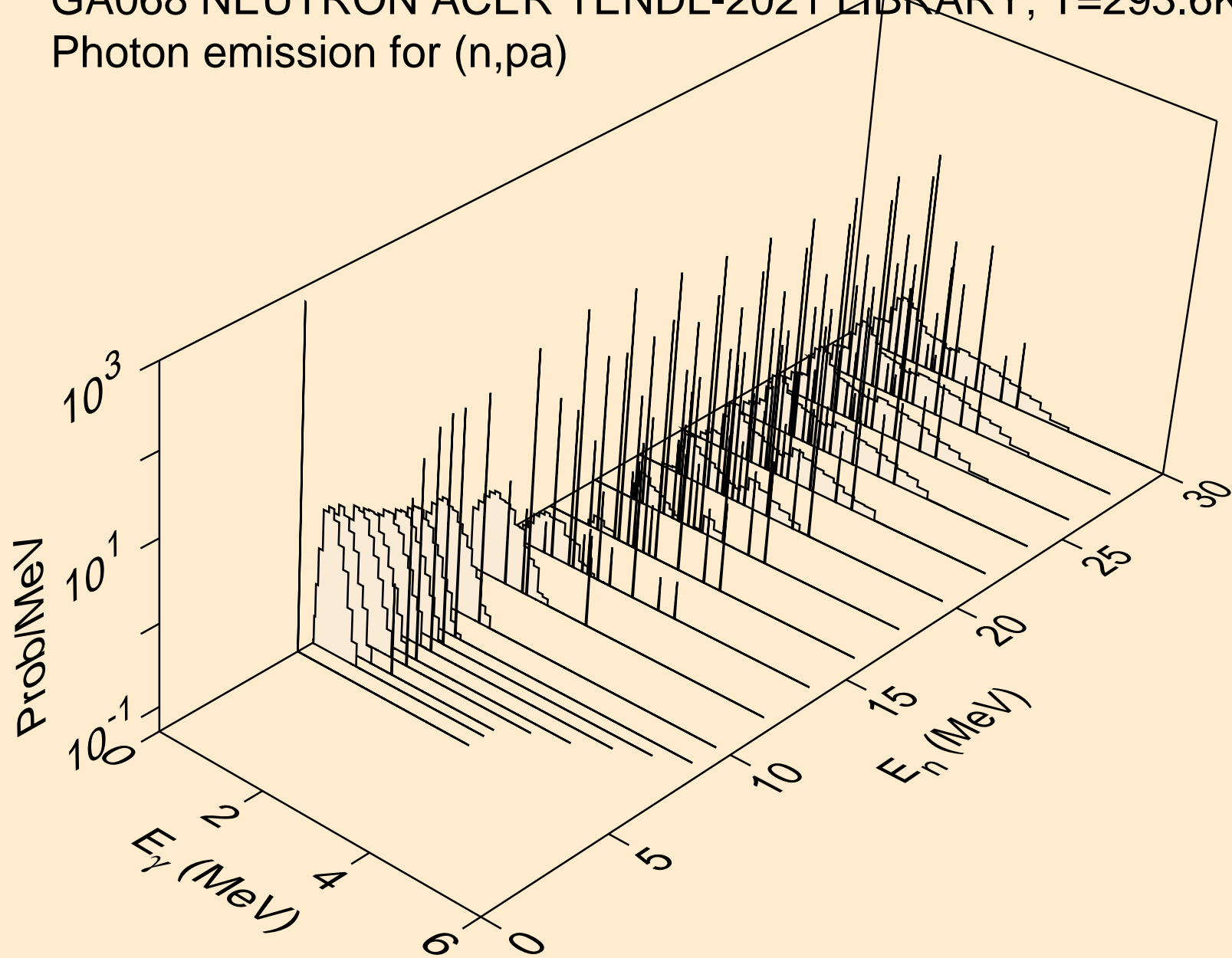

GA068 NEUTRON ACER TENDL-2021 LIBRARY; T=293.6K
Photon emission for (n,pd)

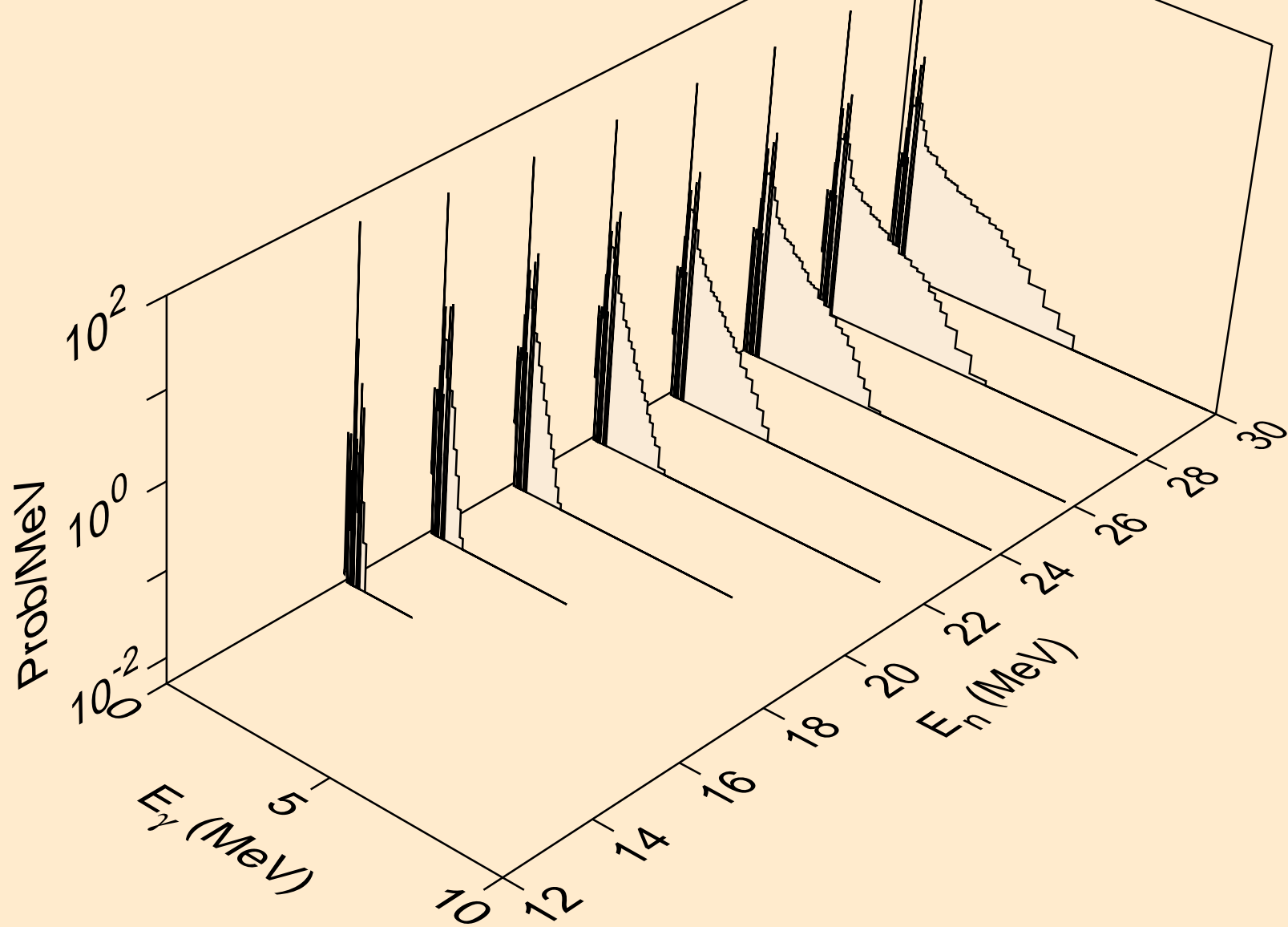

GA068 NEUTRON ACER TENDL-2021 LIBRARY; T=293.6K
Photon emission for (n,pt)

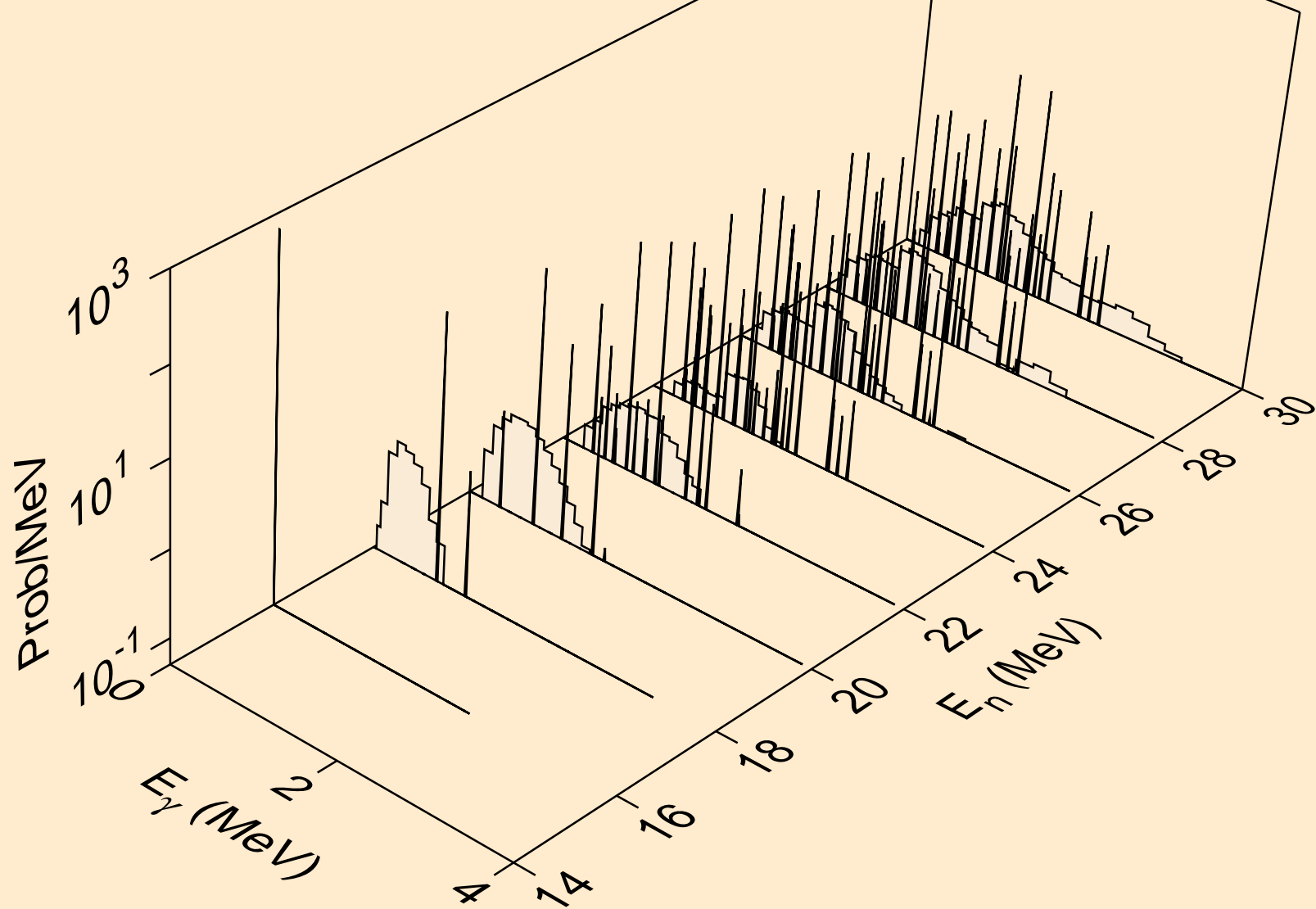

GA068 NEUTRON ACER TENDL-2021 LIBRARY; T=293.6K
Photon emission for (n,da)

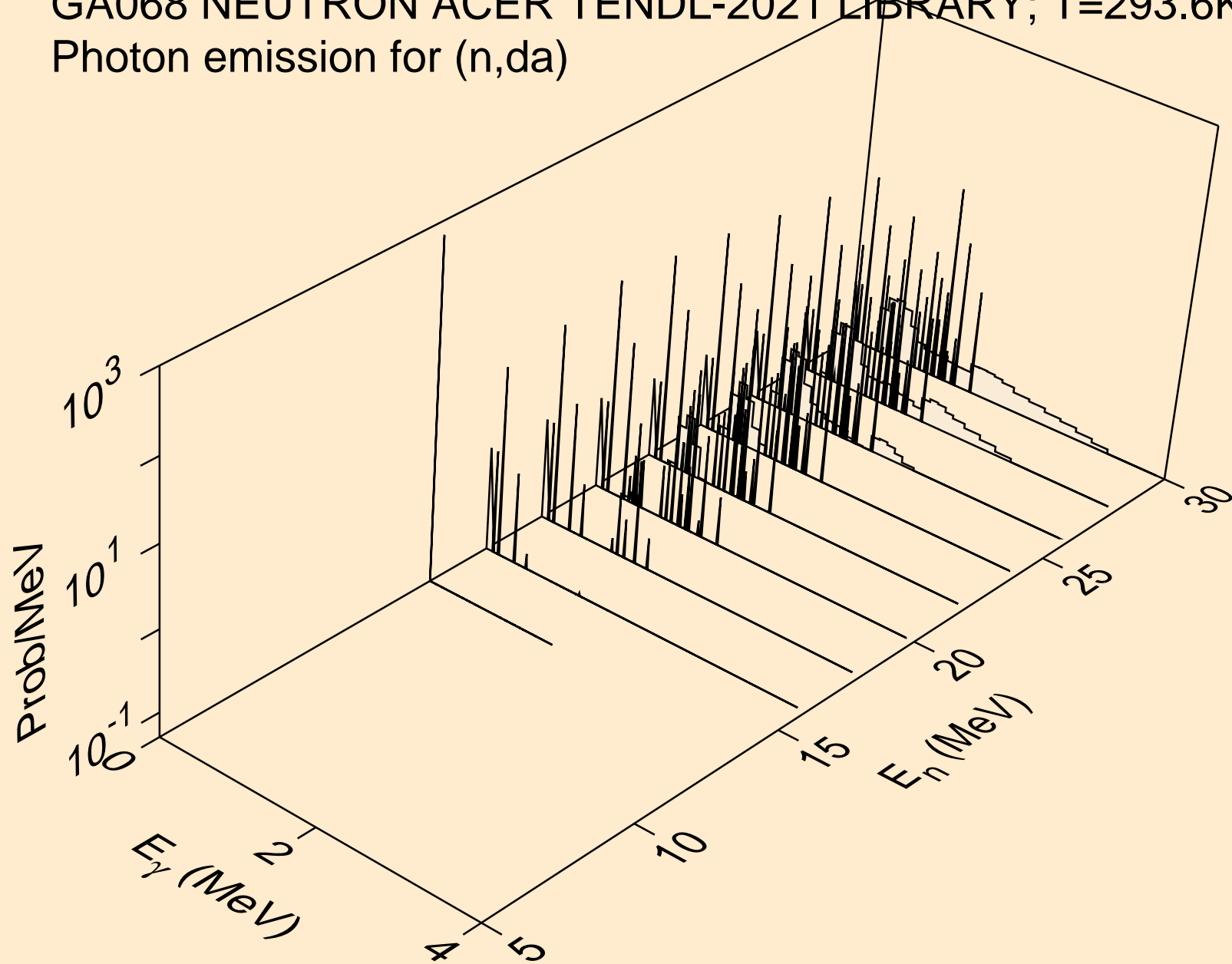

GA068 NEUTRON ACER TENDL-2021 LIBRARY; T=293.6K
thermal capture photon spectrum

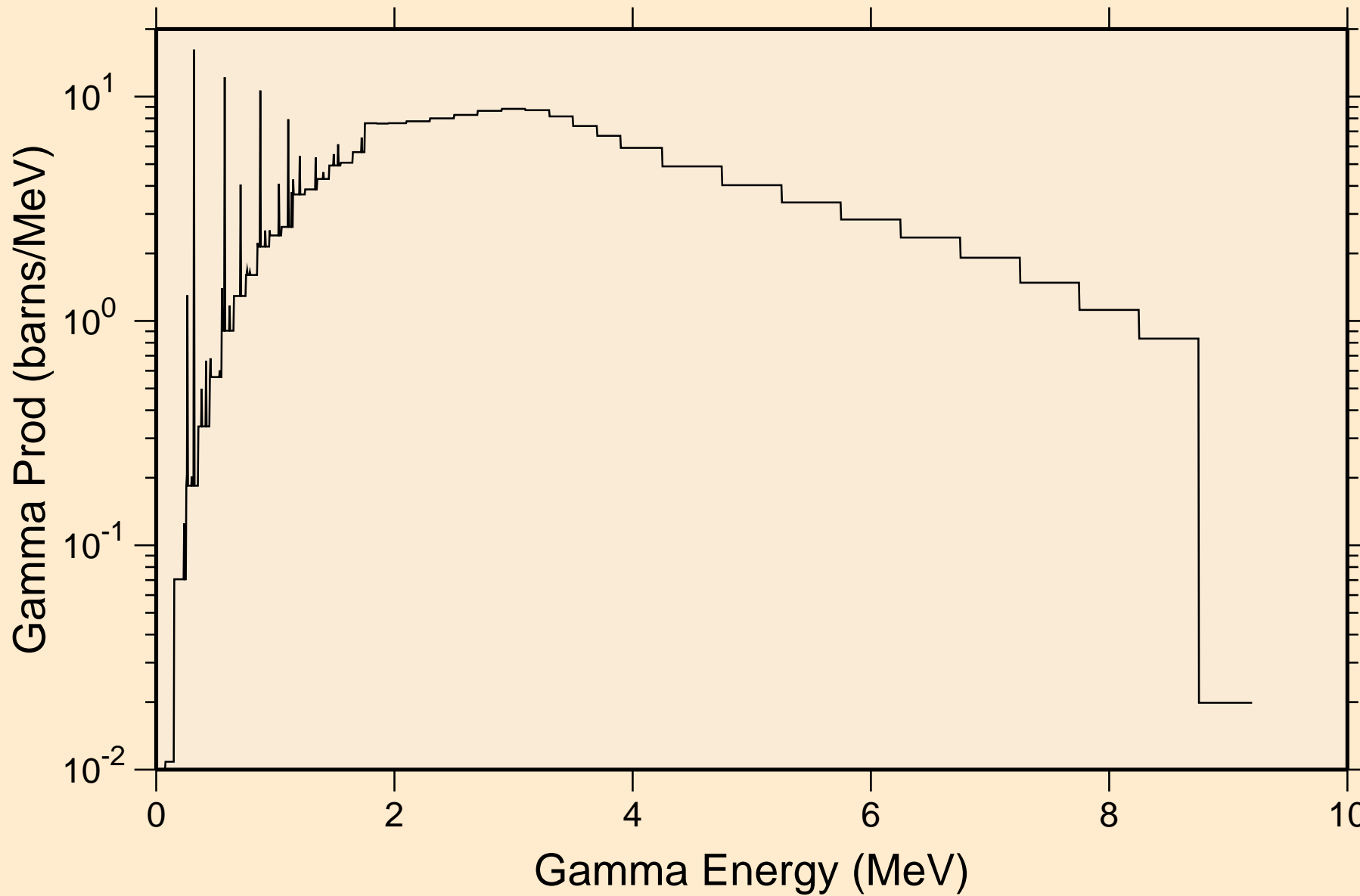

GA068 NEUTRON ACER TENDL-2021 LIBRARY; T=293.6K
14 MeV photon spectrum

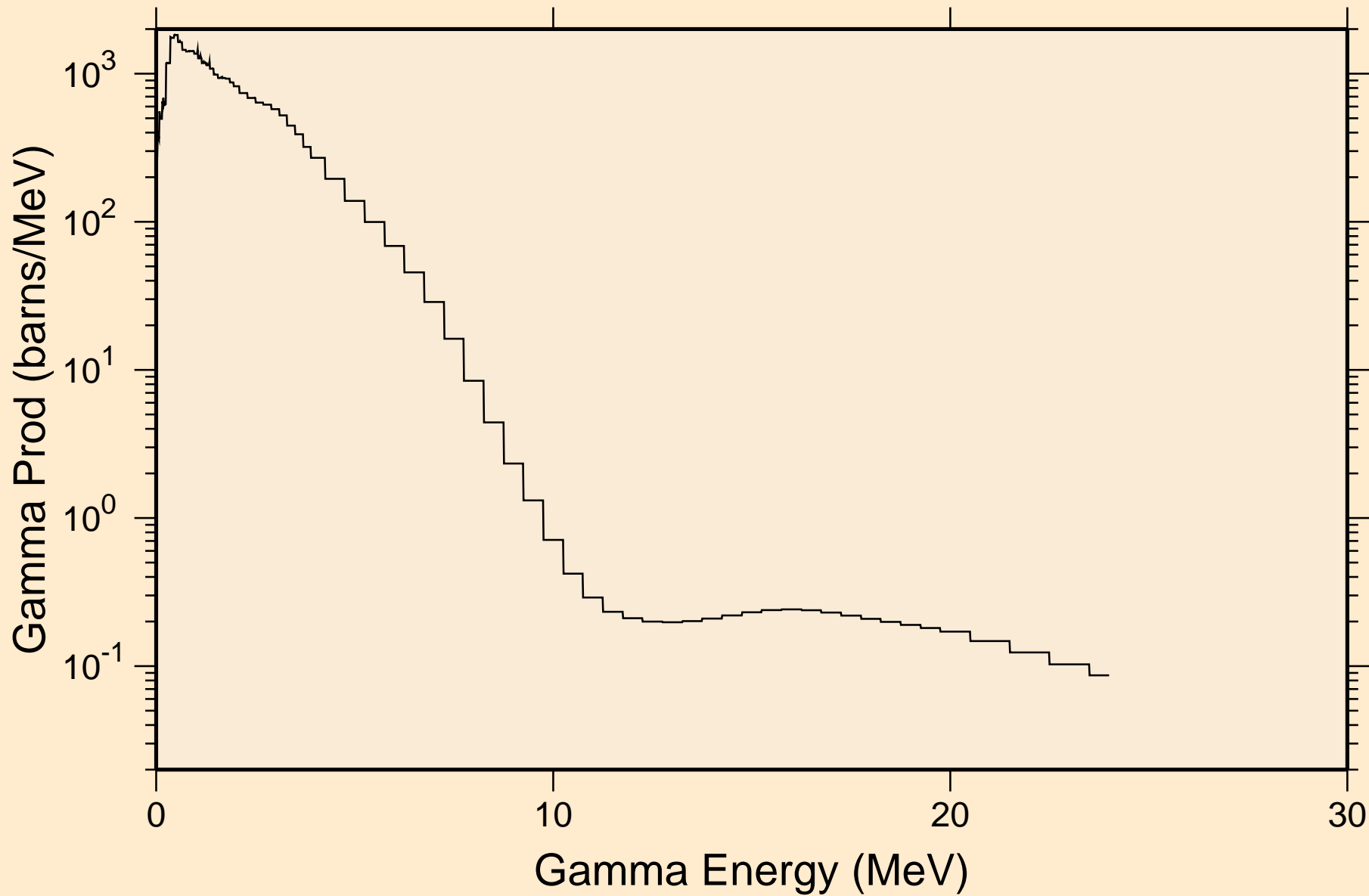

GA068 NEUTRON ACER TENDL-2021 LIBRARY; T=293.6K

Particle heating contributions

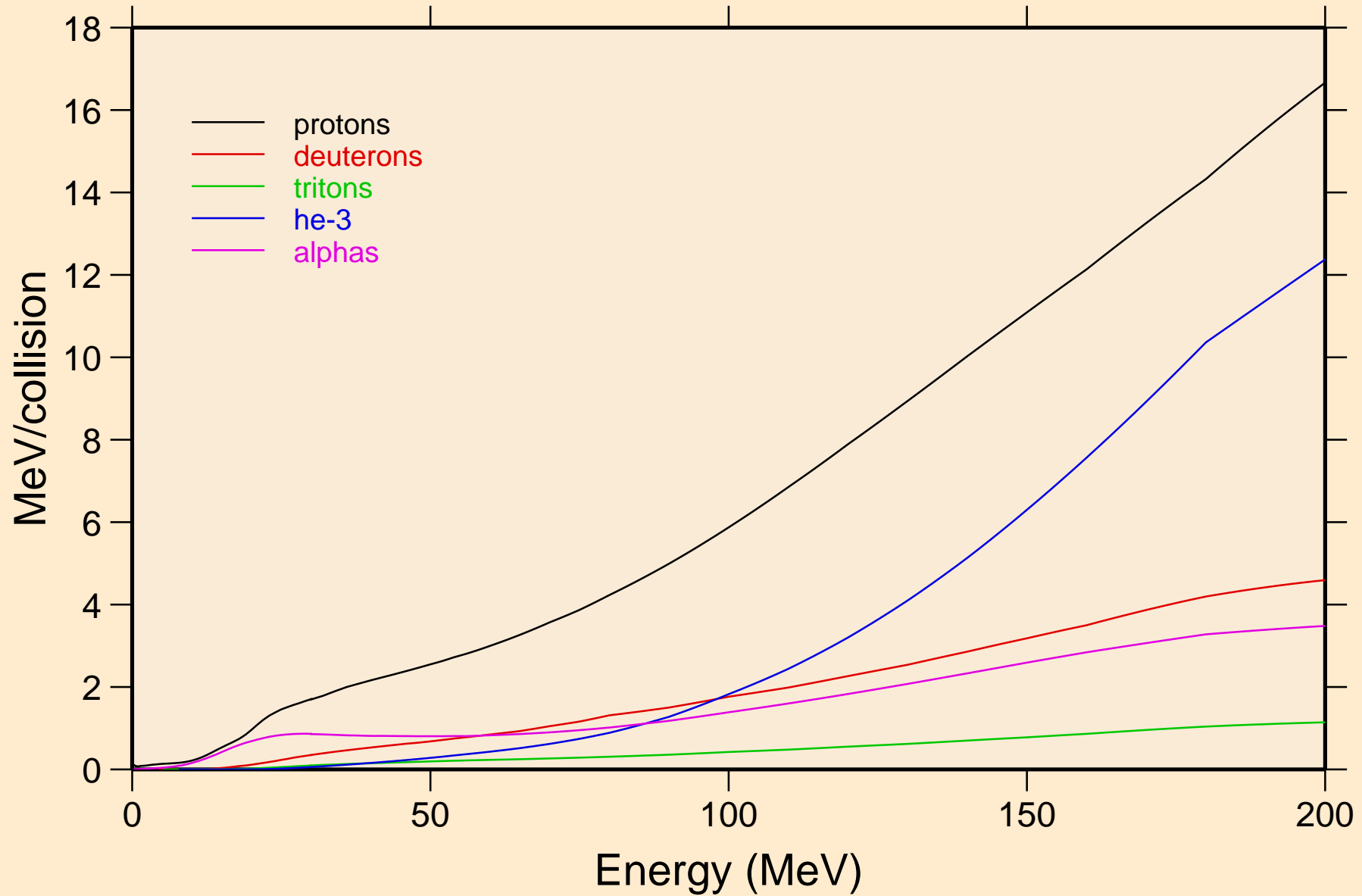

GA068 NEUTRON ACER TENDL-2021 LIBRARY; T=293.6K
Recoil Heating

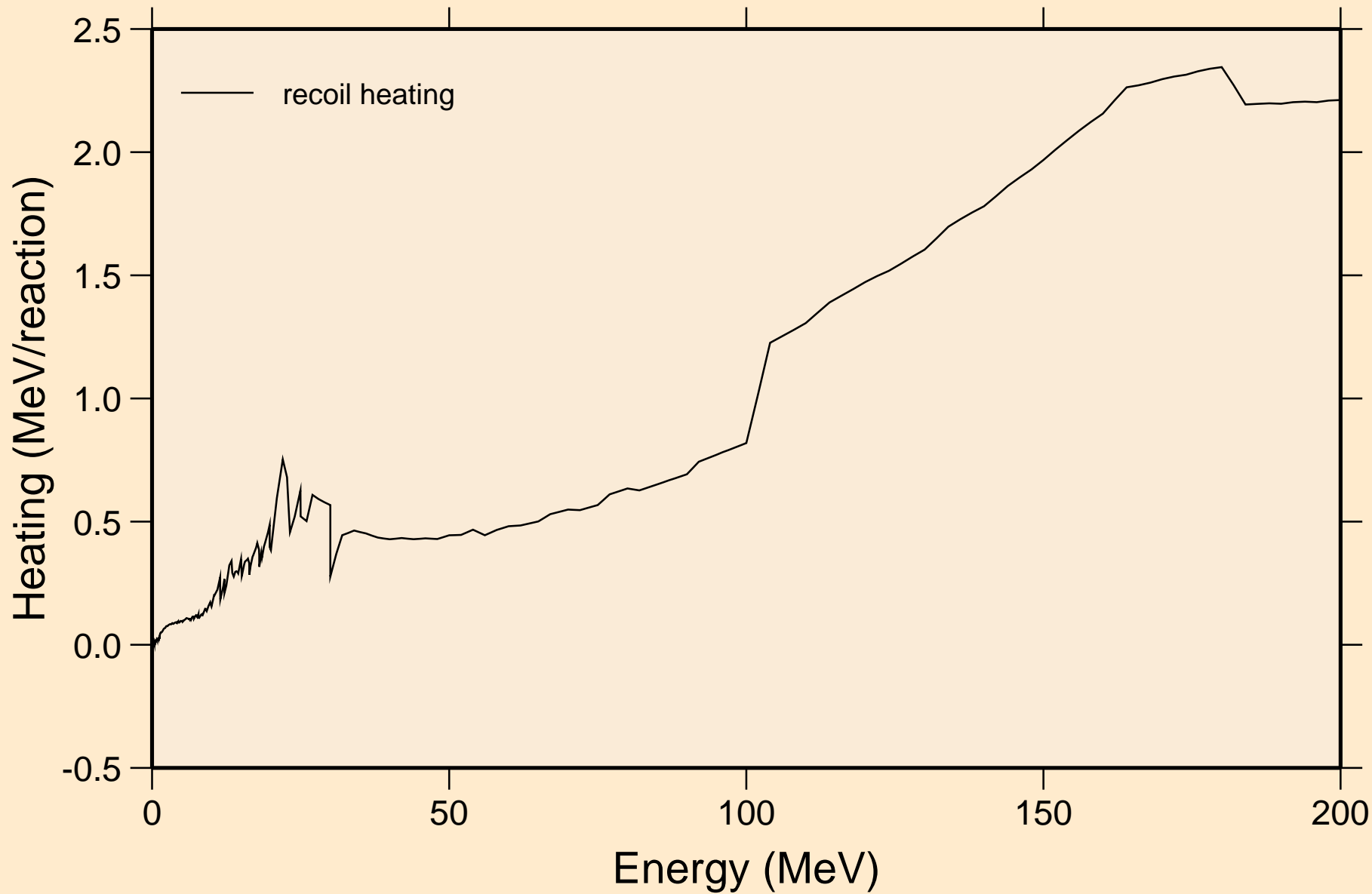

GA068 NEUTRON ACER TENDL-2021 LIBRARY; T=293.6K
Particle production cross sections

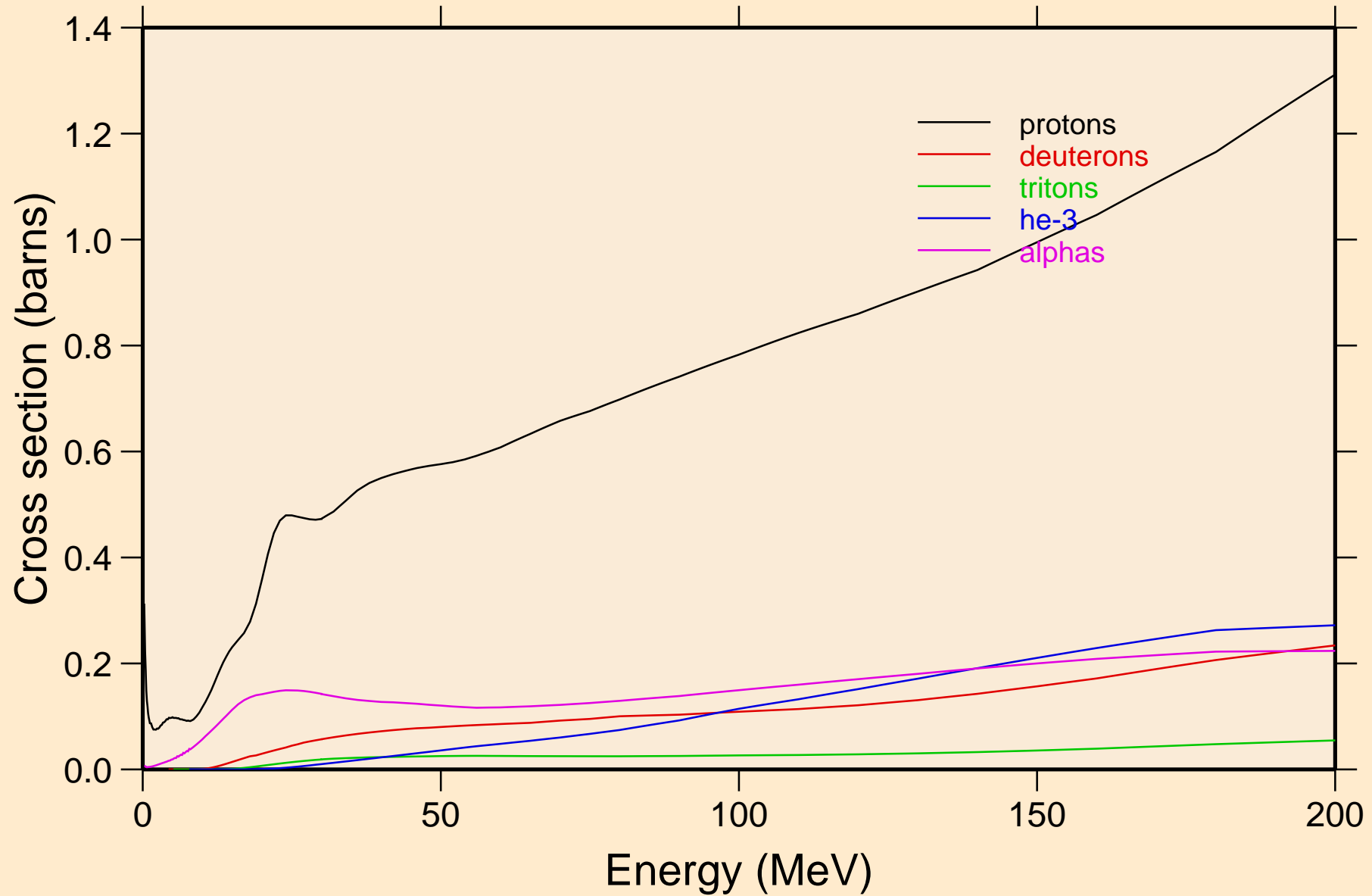

GA068 NEUTRON ACER TENDL-2021 LIBRARY; T=293.6K
protons from (n,x)

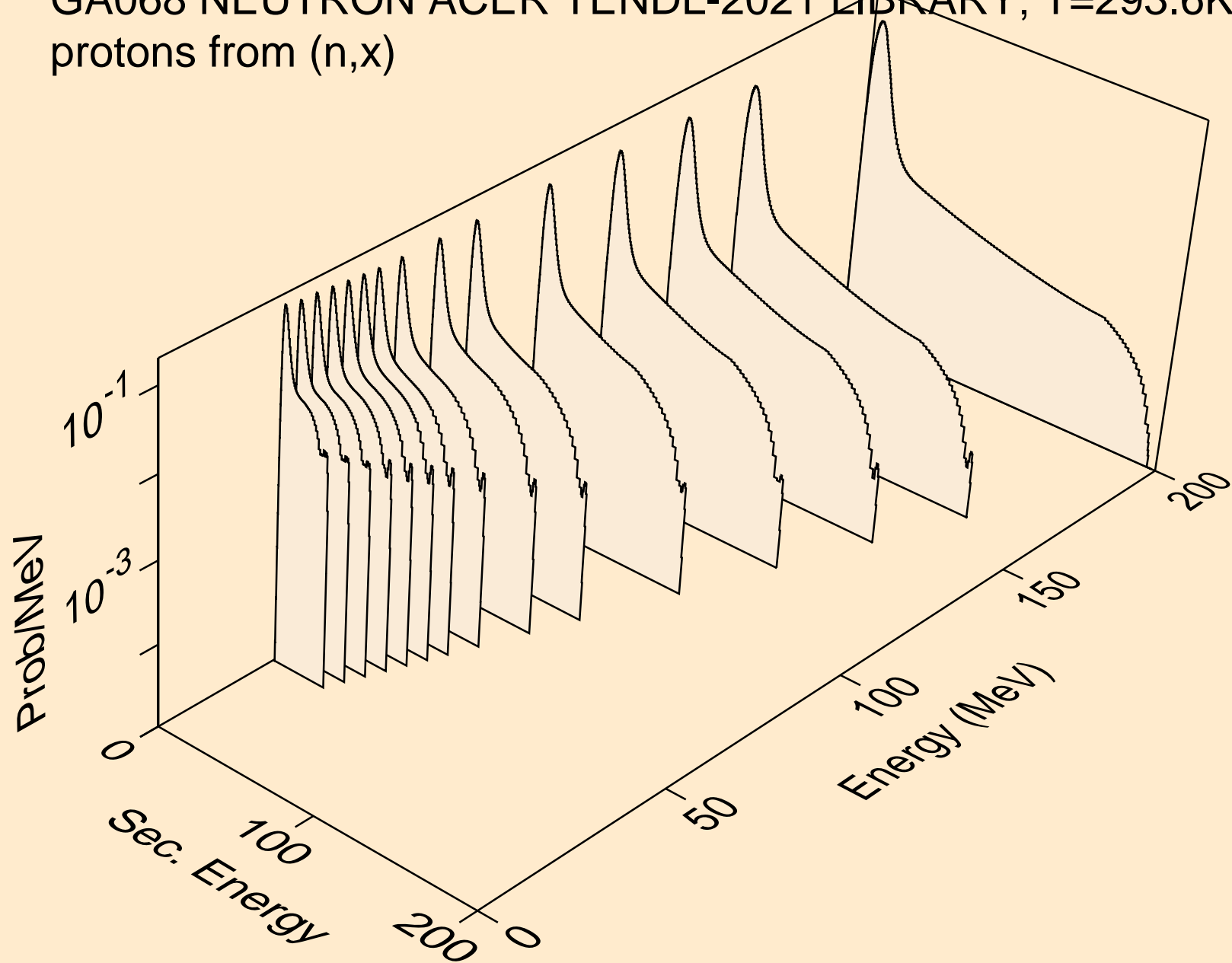

GA068 NEUTRON ACER TENDL-2021 LIBRARY; T=293.6K
protons from (n,n*)p

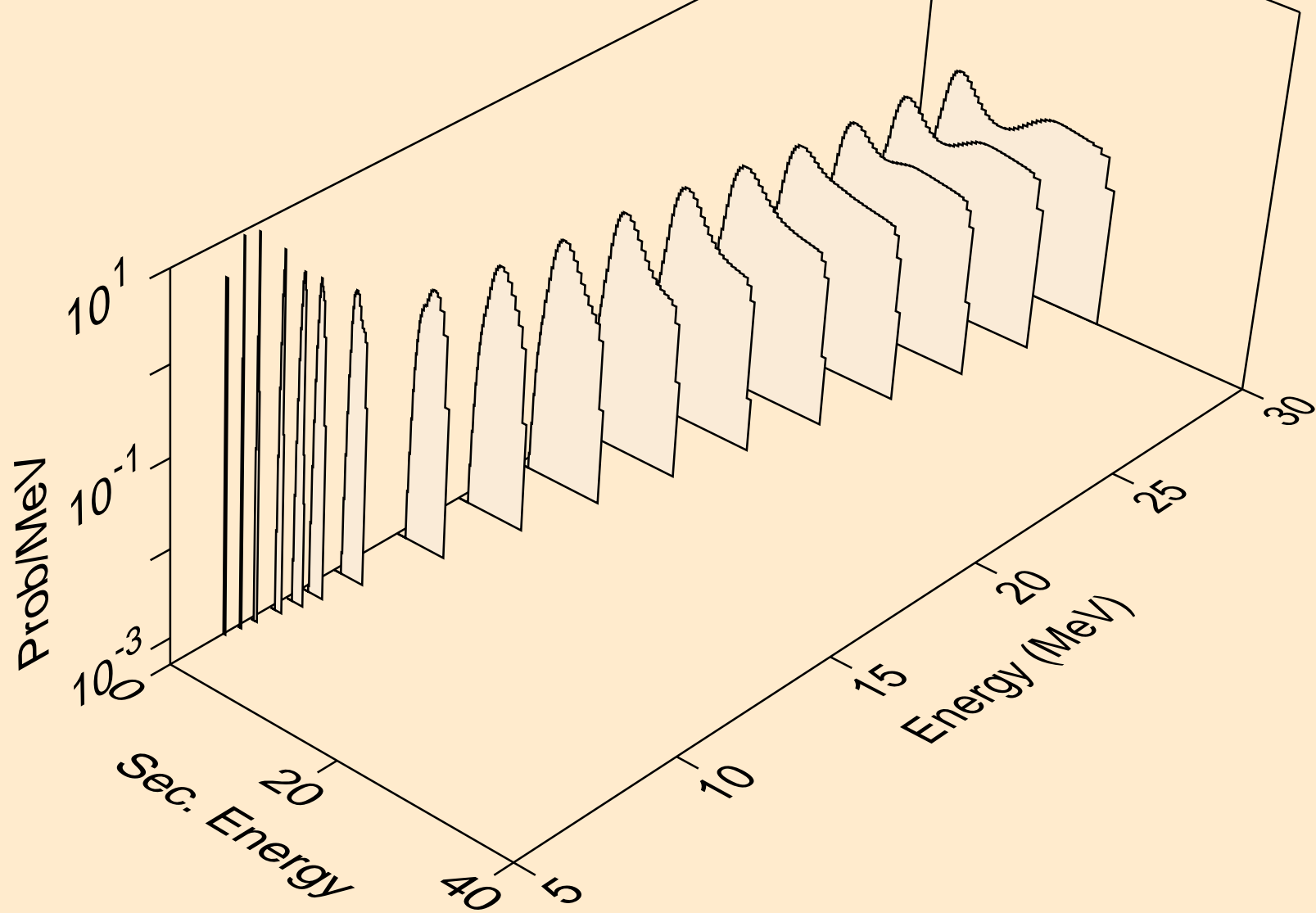

GA068 NEUTRON ACER TENDL-2021 LIBRARY; T=293.6K
protons from (n,2np)

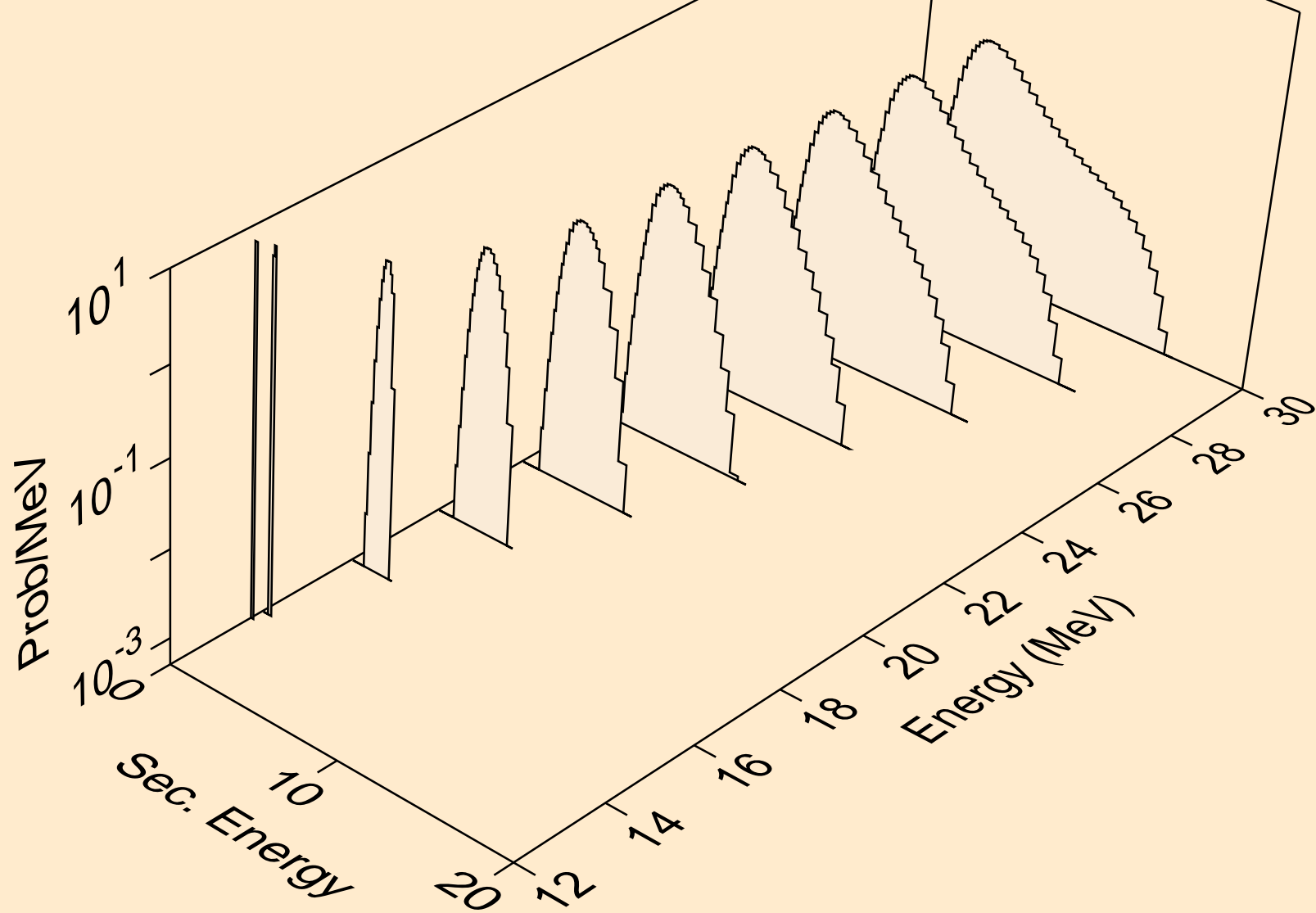

GA068 NEUTRON ACER TENDL-2021 LIBRARY; T=293.6K
protons from (n,3np)

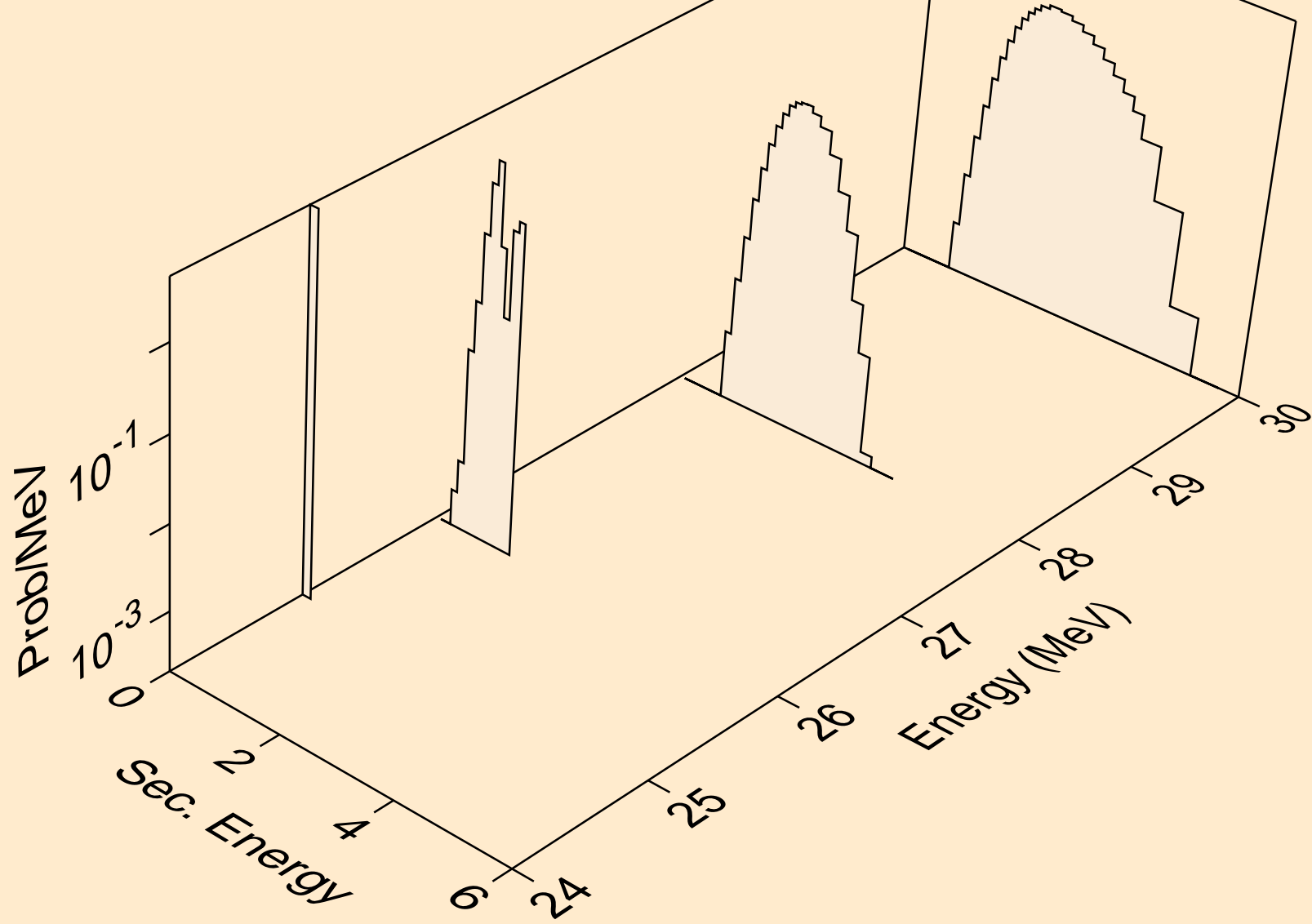

GA068 NEUTRON ACER TENDL-2021 LIBRARY; T=293.6K
protons from (n,2np)

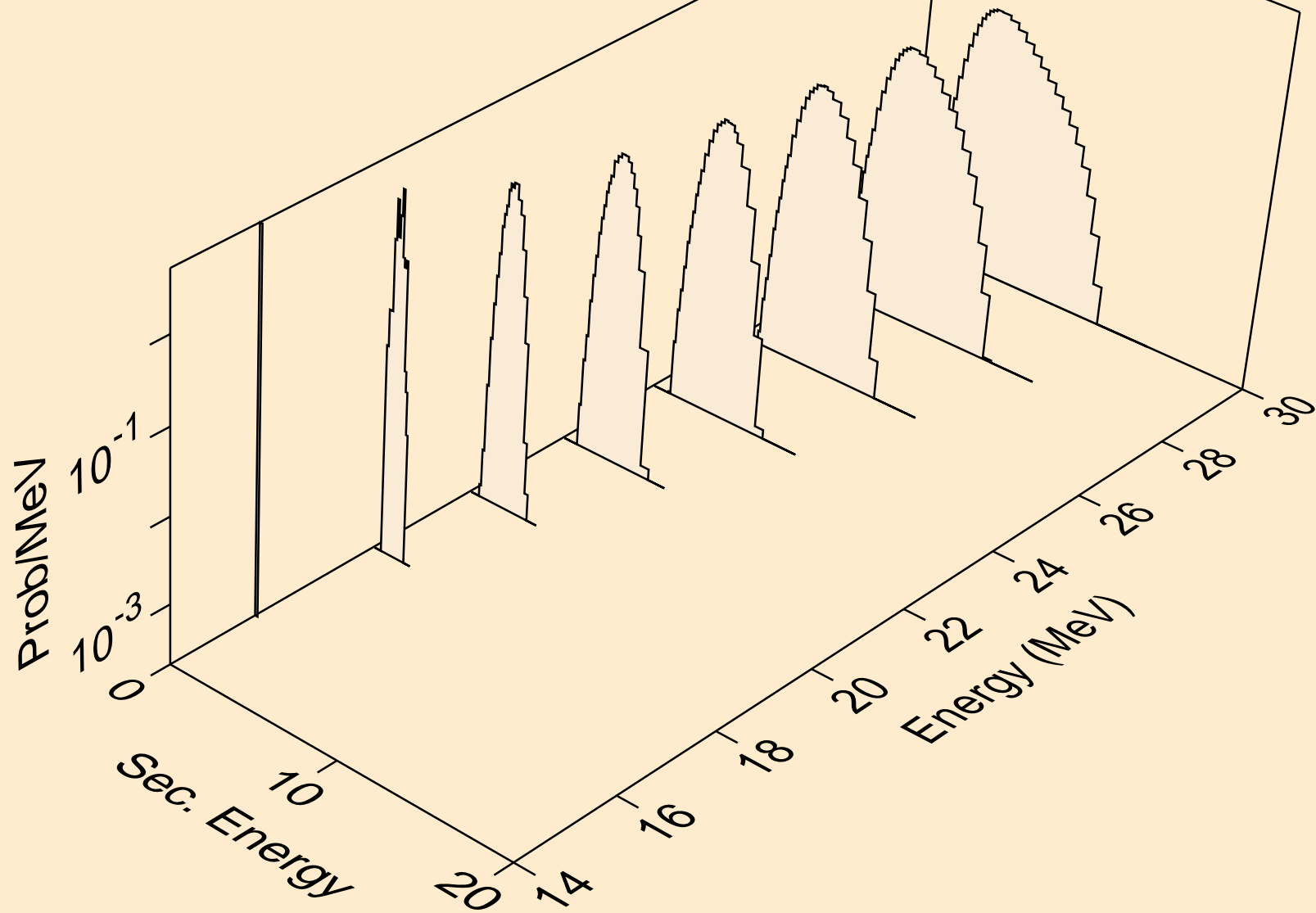

GA068 NEUTRON ACER TENDL-2021 LIBRARY; T=293.6K
protons from (n,npa)

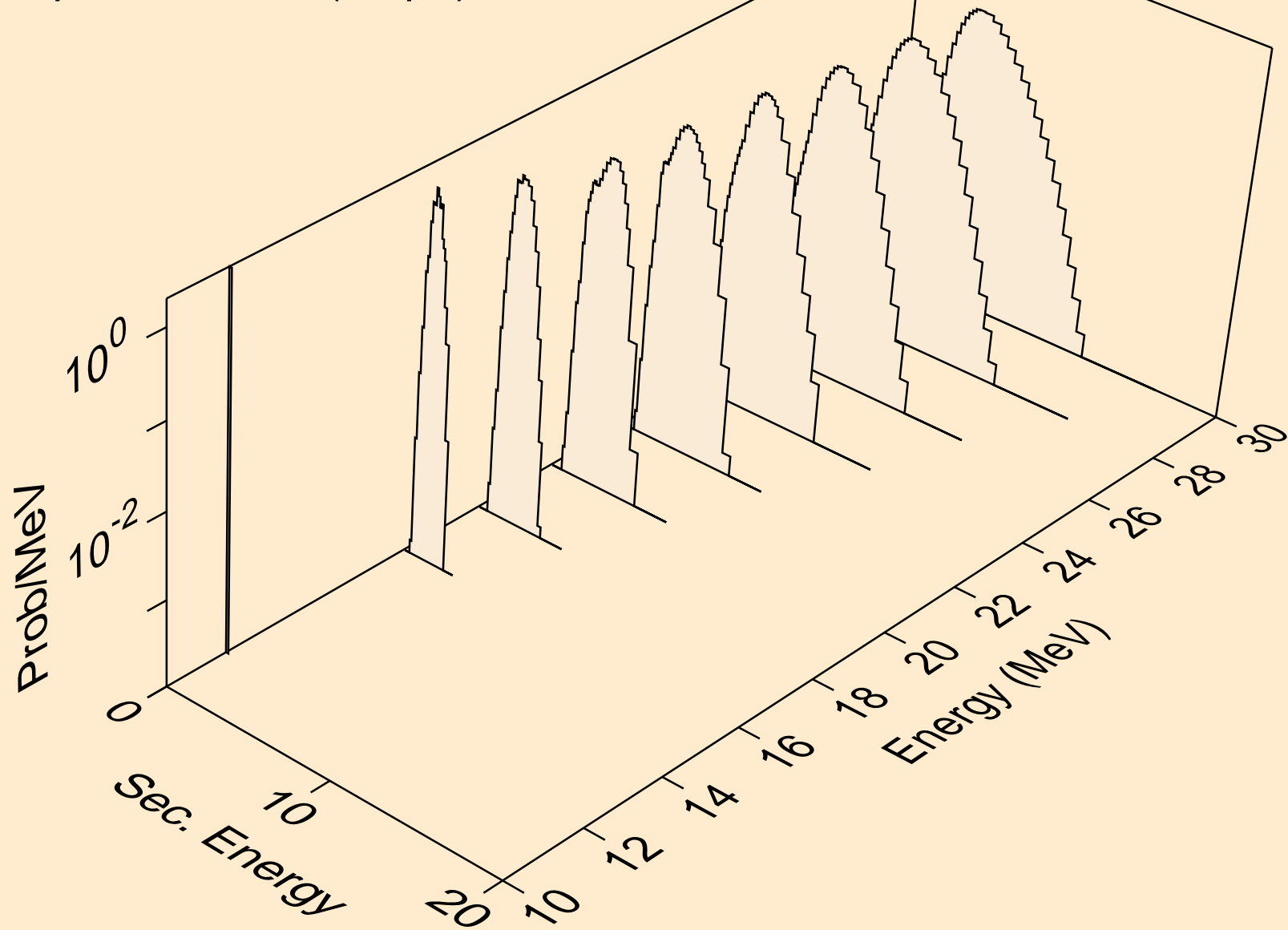

GA068 NEUTRON ACER TENDL-2021 LIBRARY; T=293.6K
protons from (n,p)

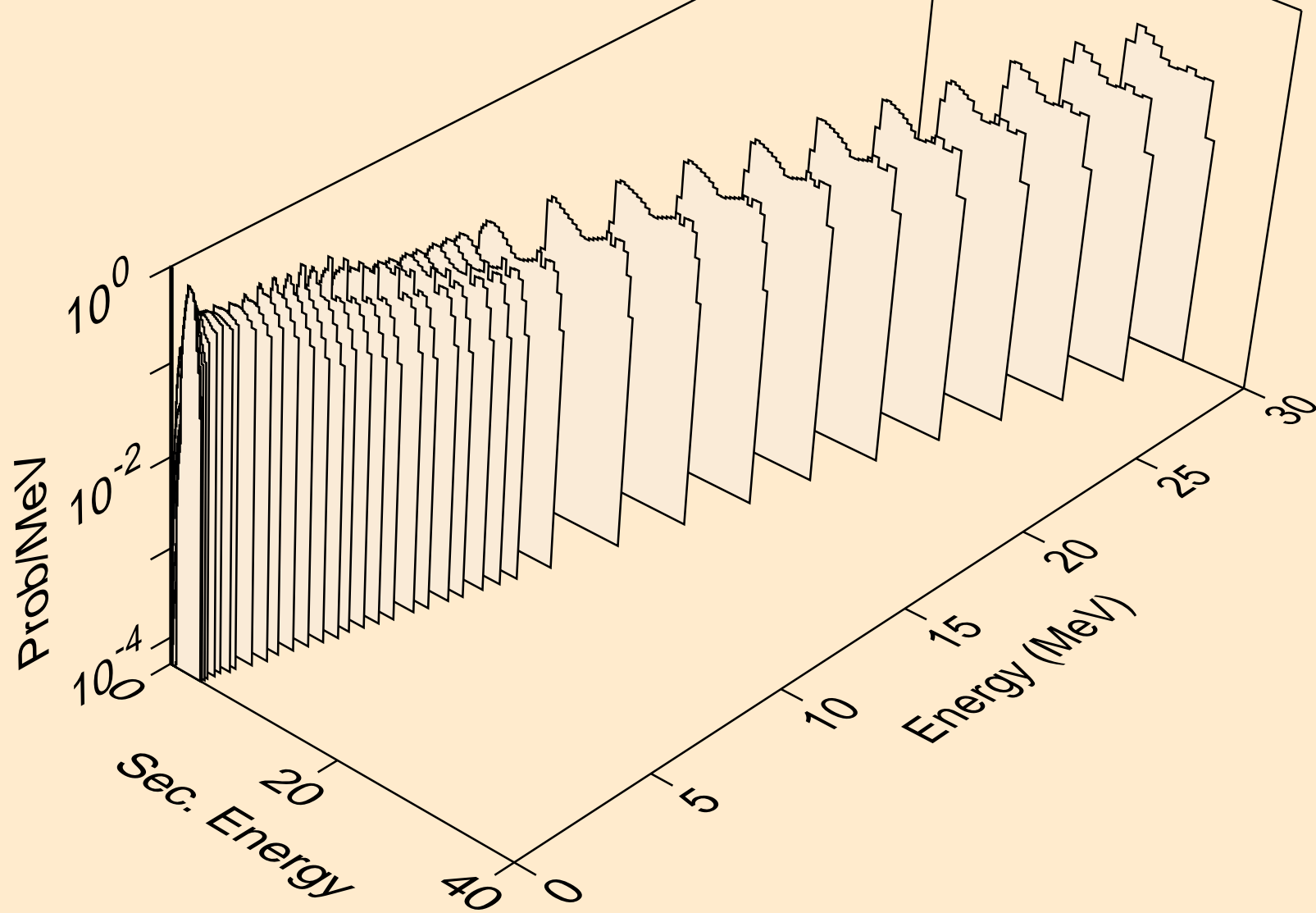

GA068 NEUTRON ACER TENDL-2021 LIBRARY; T=293.6K
protons from (n,2p)

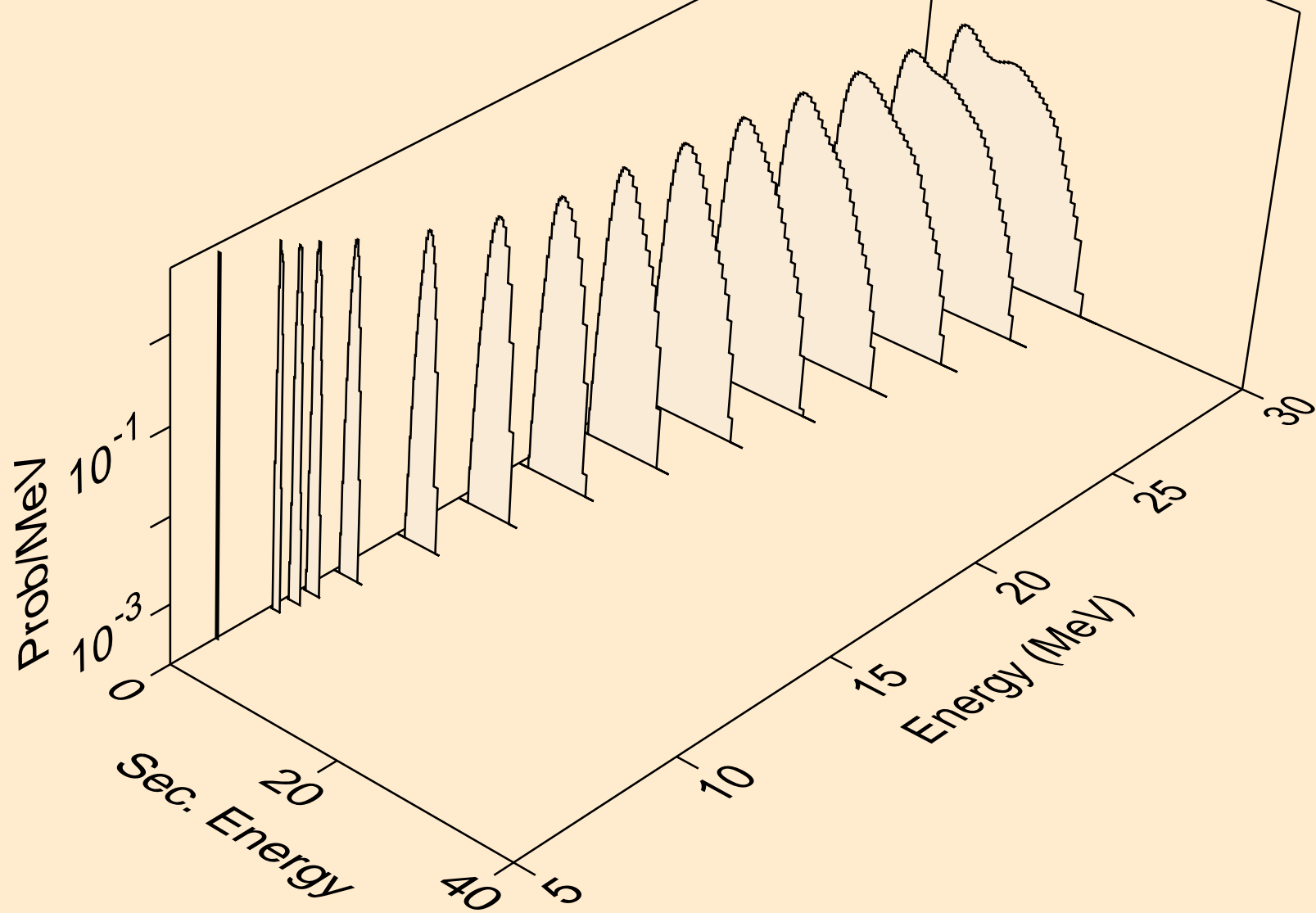

GA068 NEUTRON ACER TENDL-2021 LIBRARY; T=293.6K
protons from (n,p)

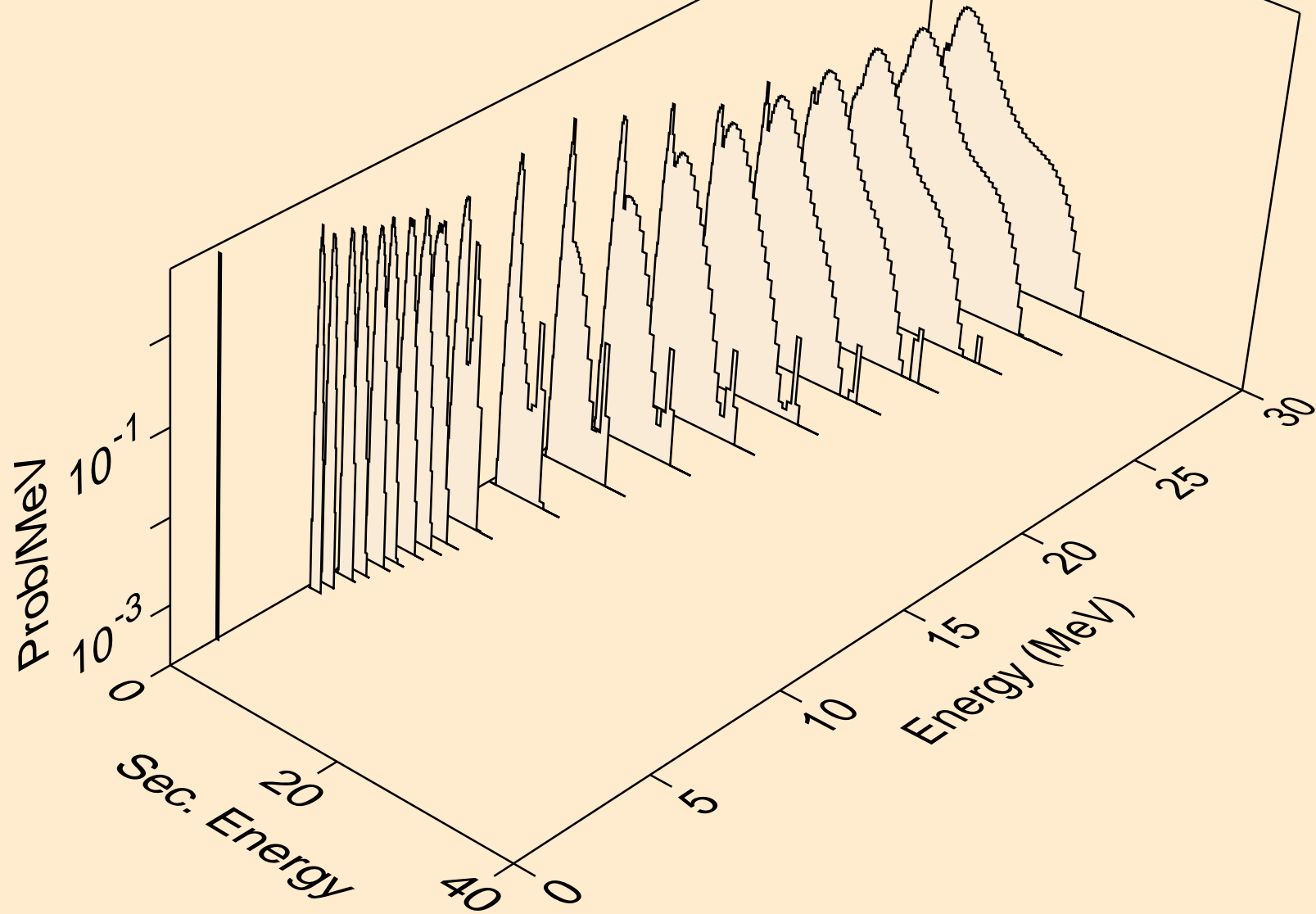

GA068 NEUTRON ACER TENDL-2021 LIBRARY; T=293.6K
protons from (n,pd)

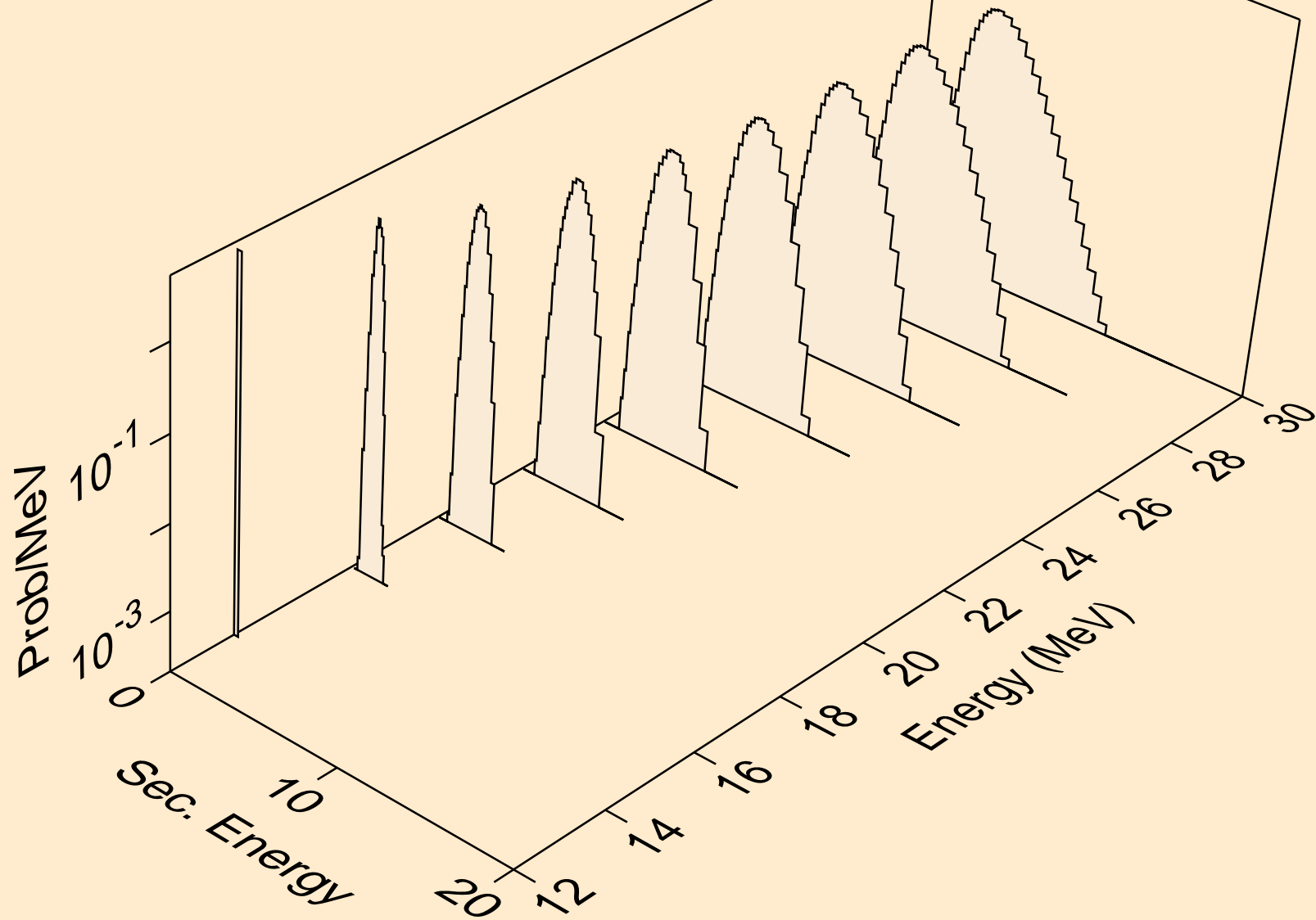

GA068 NEUTRON ACER TENDL-2021 LIBRARY; T=293.6K
protons from (n,pt)

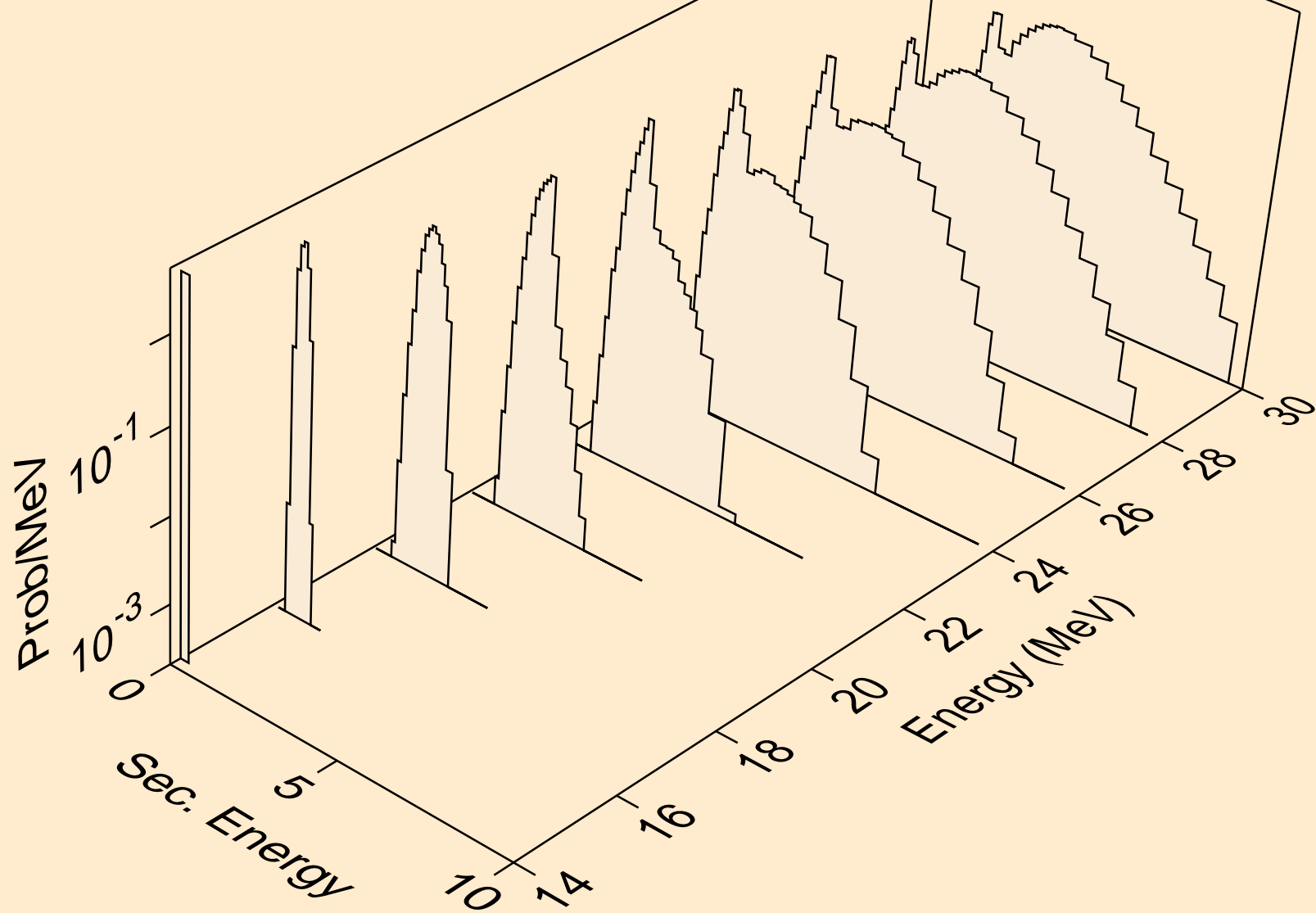

GA068 NEUTRON ACER TENDL-2021 LIBRARY; T=293.6K
deuterons from (n,x)

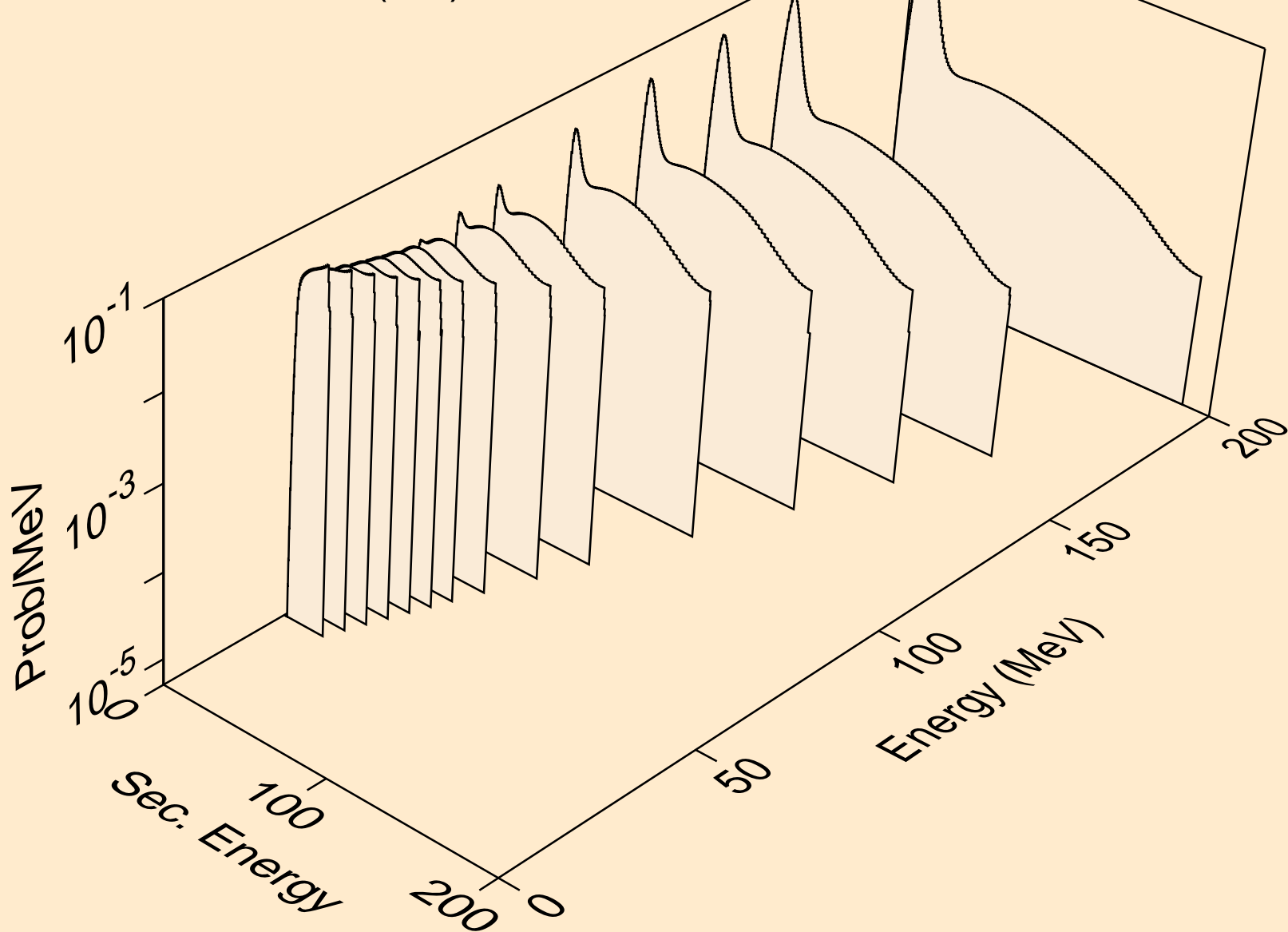

GA068 NEUTRON ACER TENDL-2021 LIBRARY; T=293.6K
deuterons from (n,2nd)

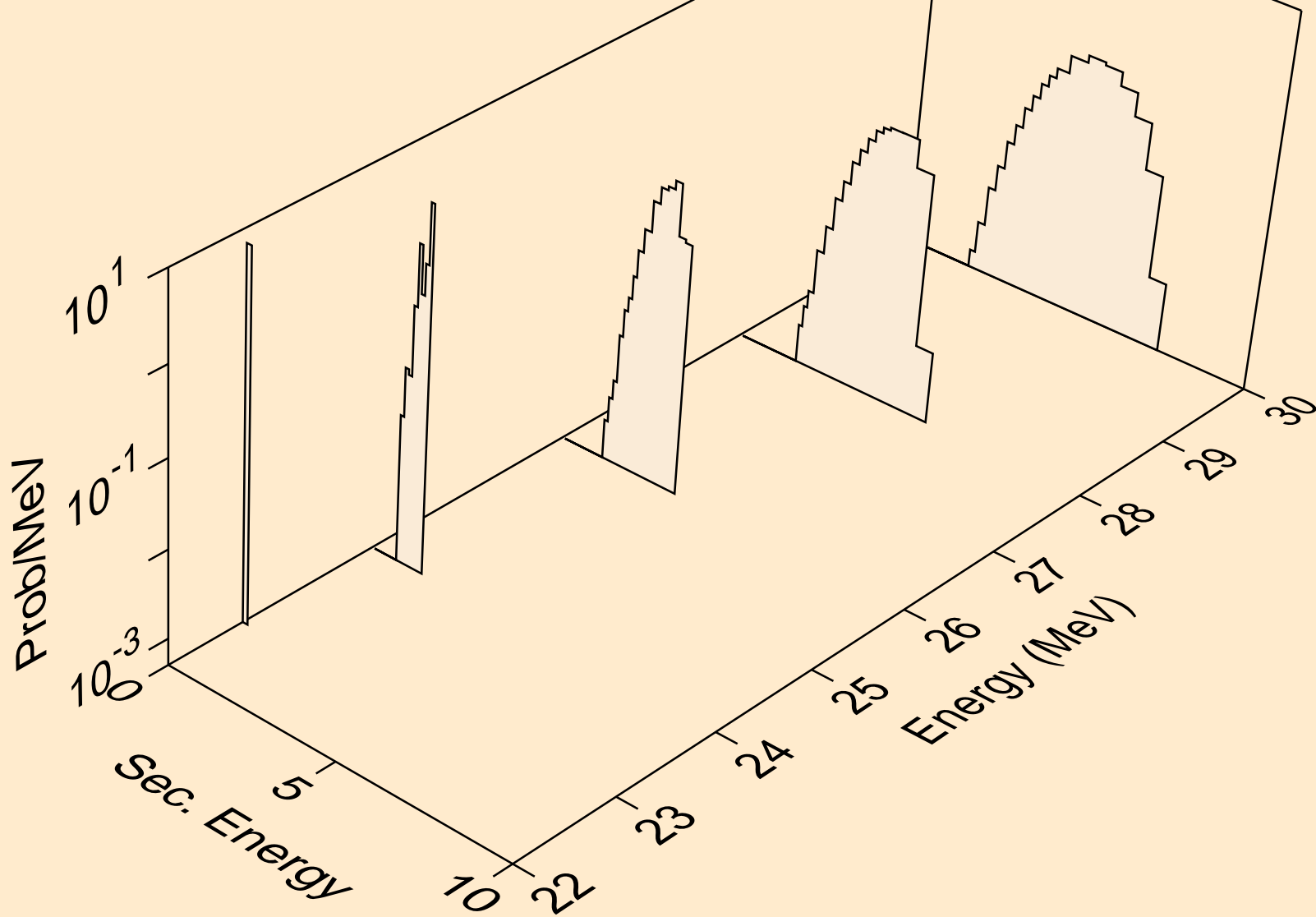

GA068 NEUTRON ACER TENDL-2021 LIBRARY; T=293.6K
deuterons from (n,n*)d

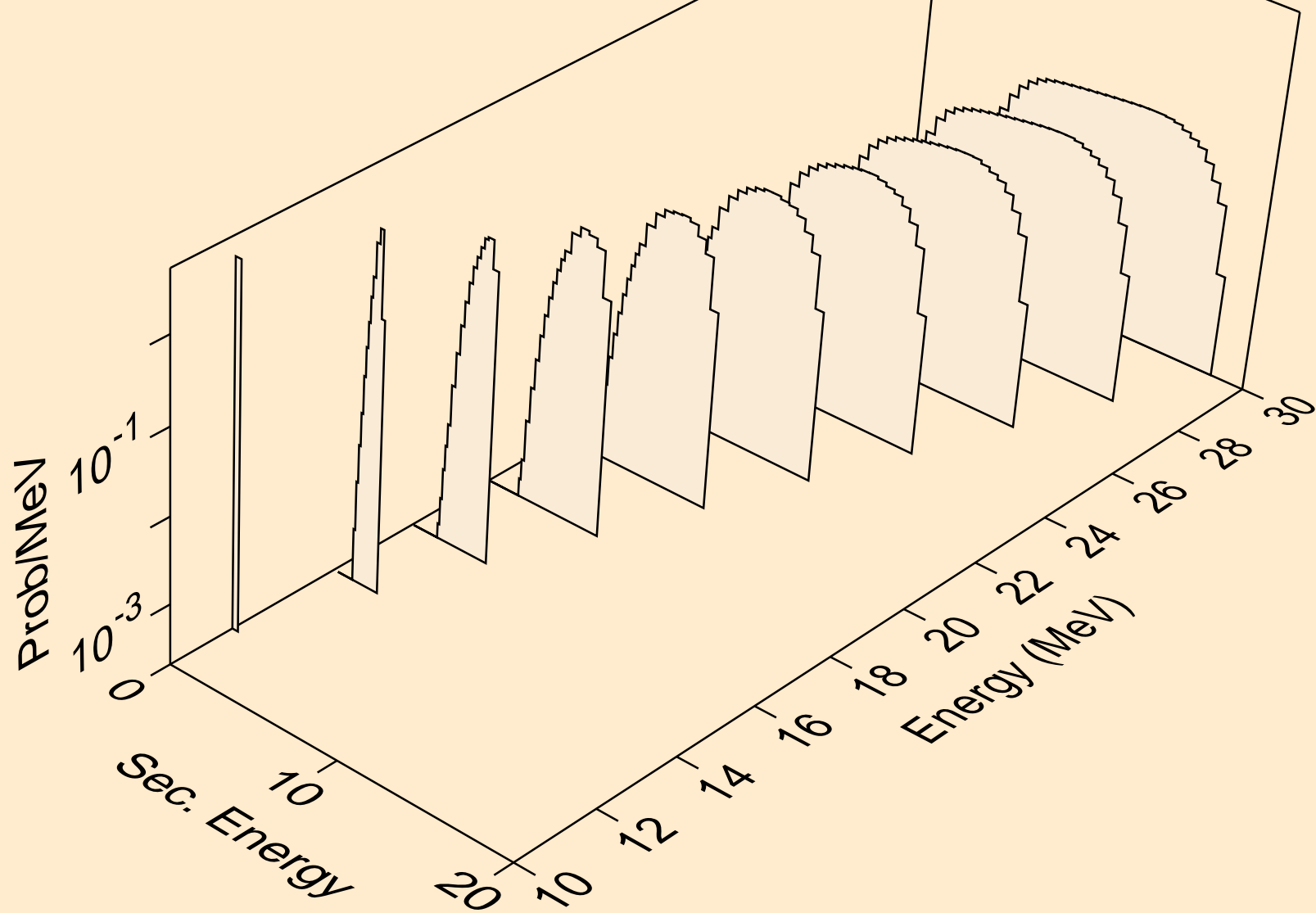

GA068 NEUTRON ACER TENDL-2021 LIBRARY; T=293.6K
deuterons from (n,d)

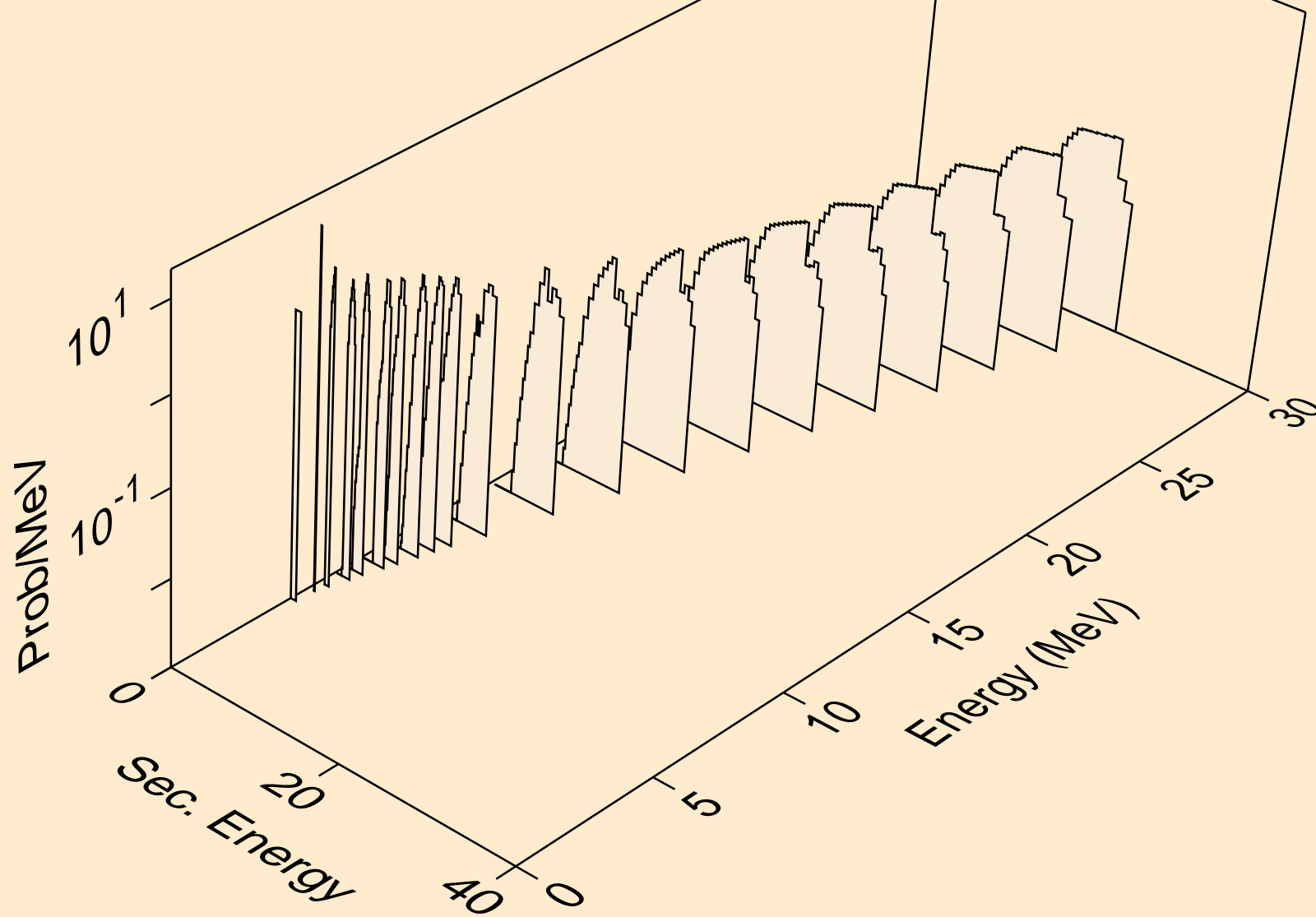

GA068 NEUTRON ACER TENDL-2021 LIBRARY; T=293.6K
deuterons from (n,pd)

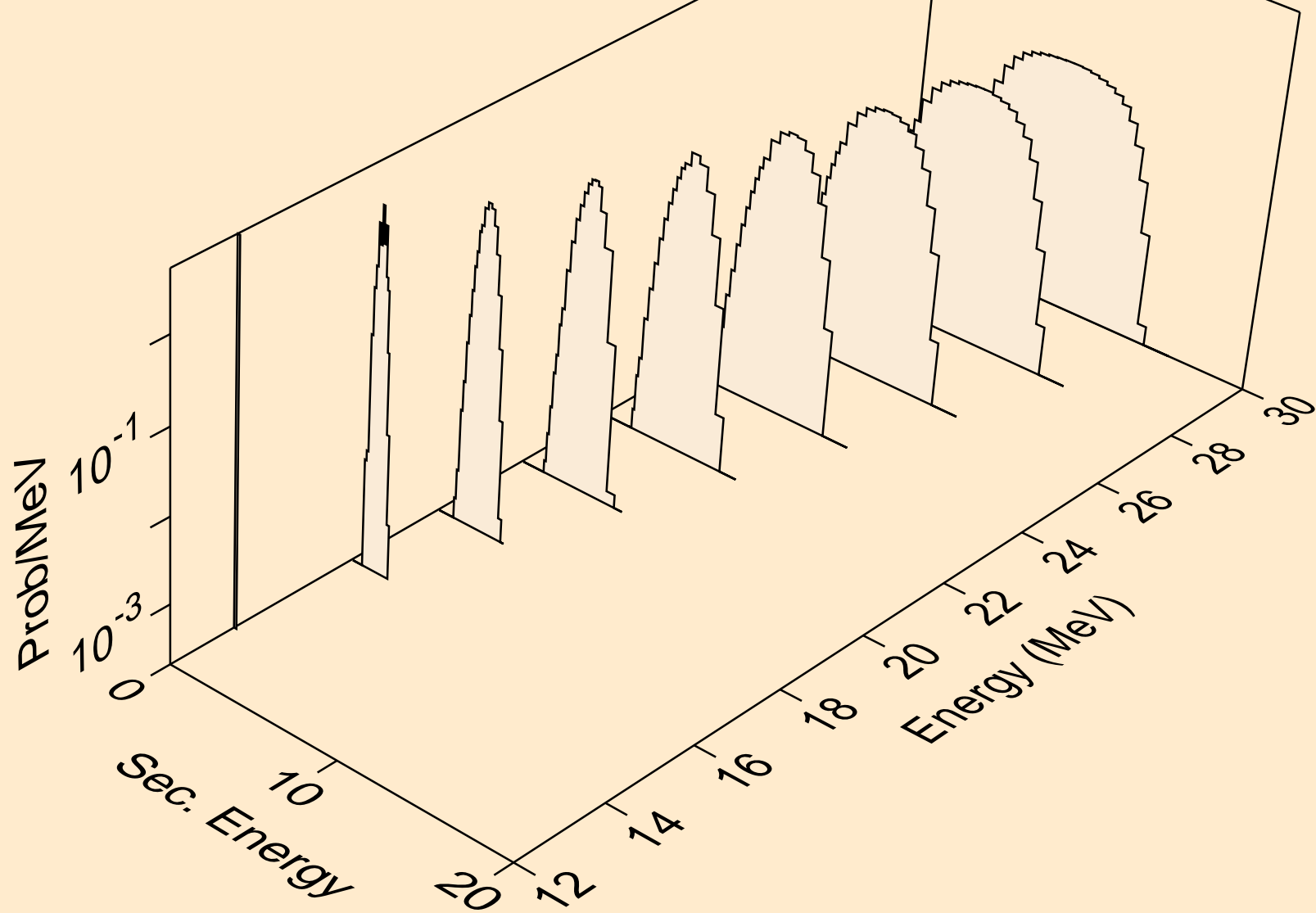

GA068 NEUTRON ACER TENDL-2021 LIBRARY; T=293.6K
deuterons from (n,da)

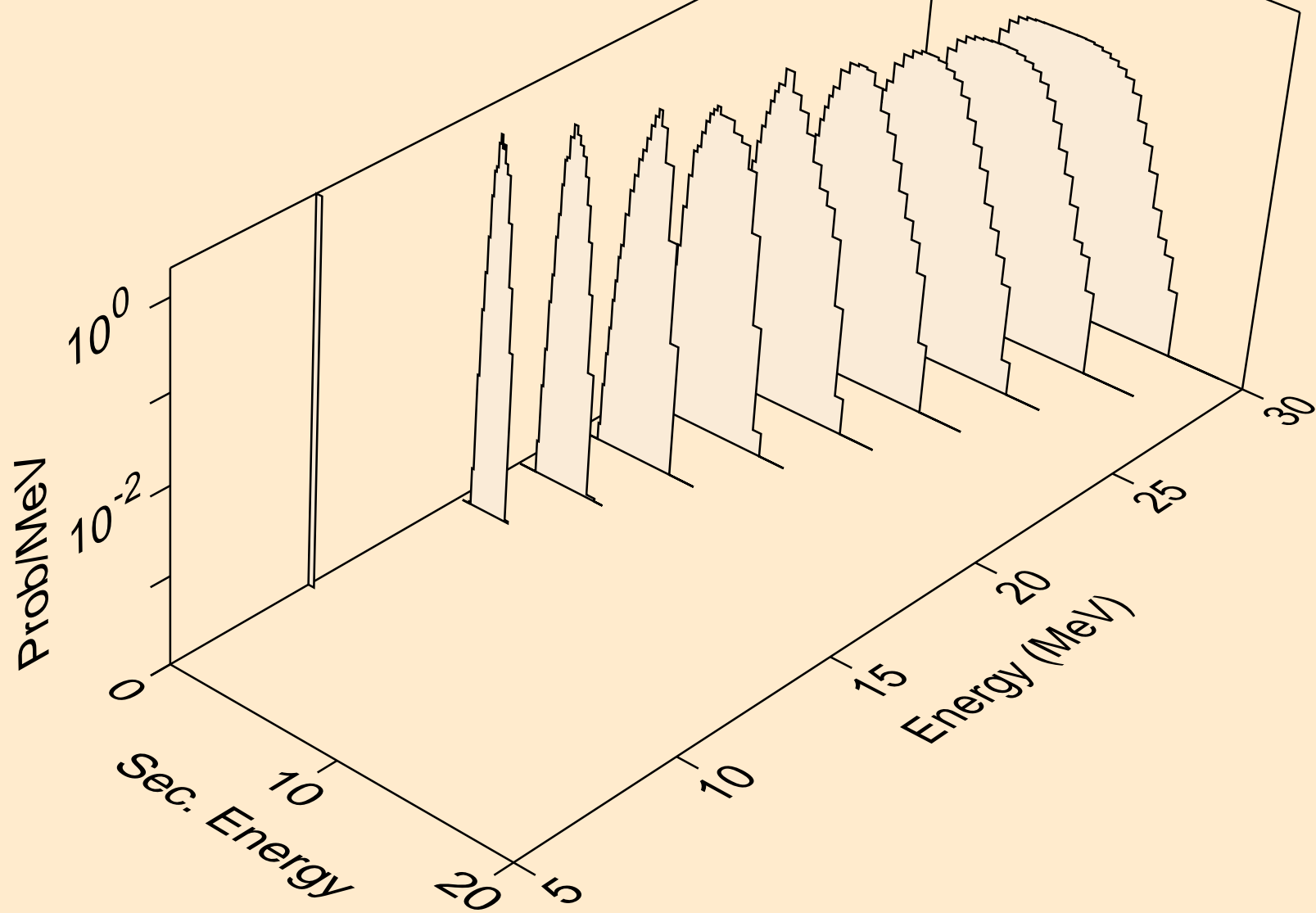

GA068 NEUTRON ACER TENDL-2021 LIBRARY; T=293.6K
tritons from (n,x)

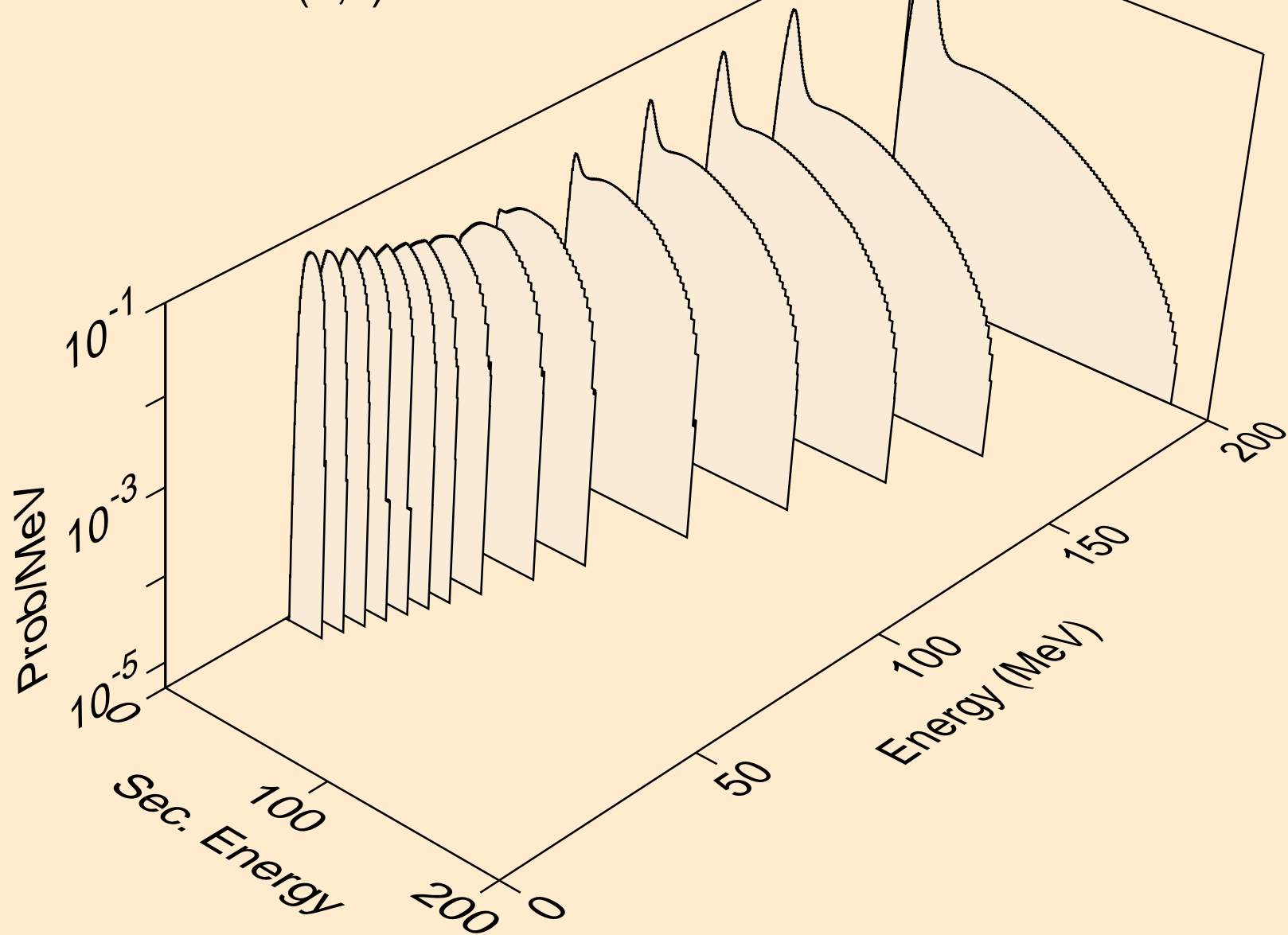

GA068 NEUTRON ACER TENDL-2021 LIBRARY; T=293.6K
tritons from (n,n*)t

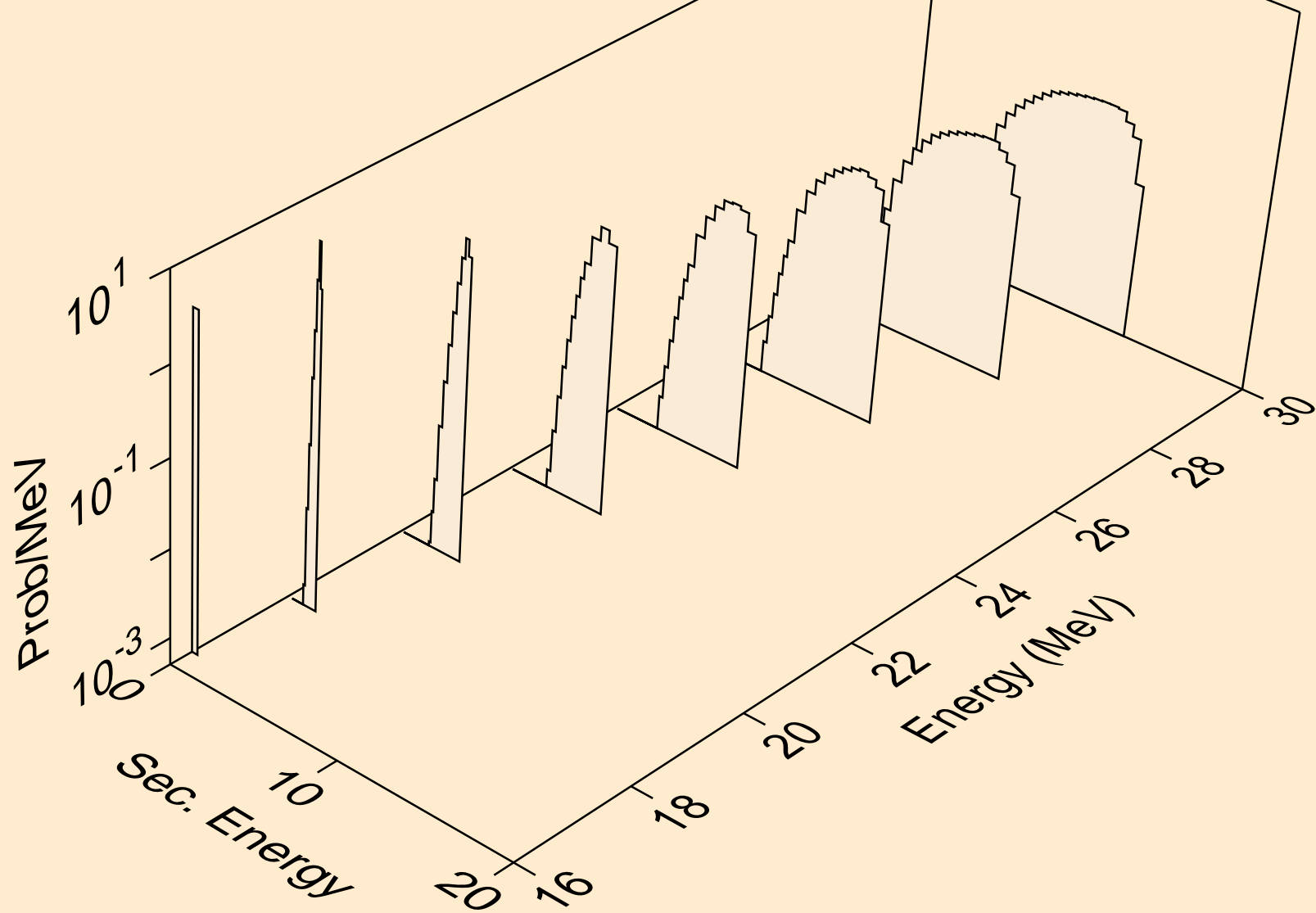

GA068 NEUTRON ACER TENDL-2021 LIBRARY; T=293.6K
tritons from (n,t)

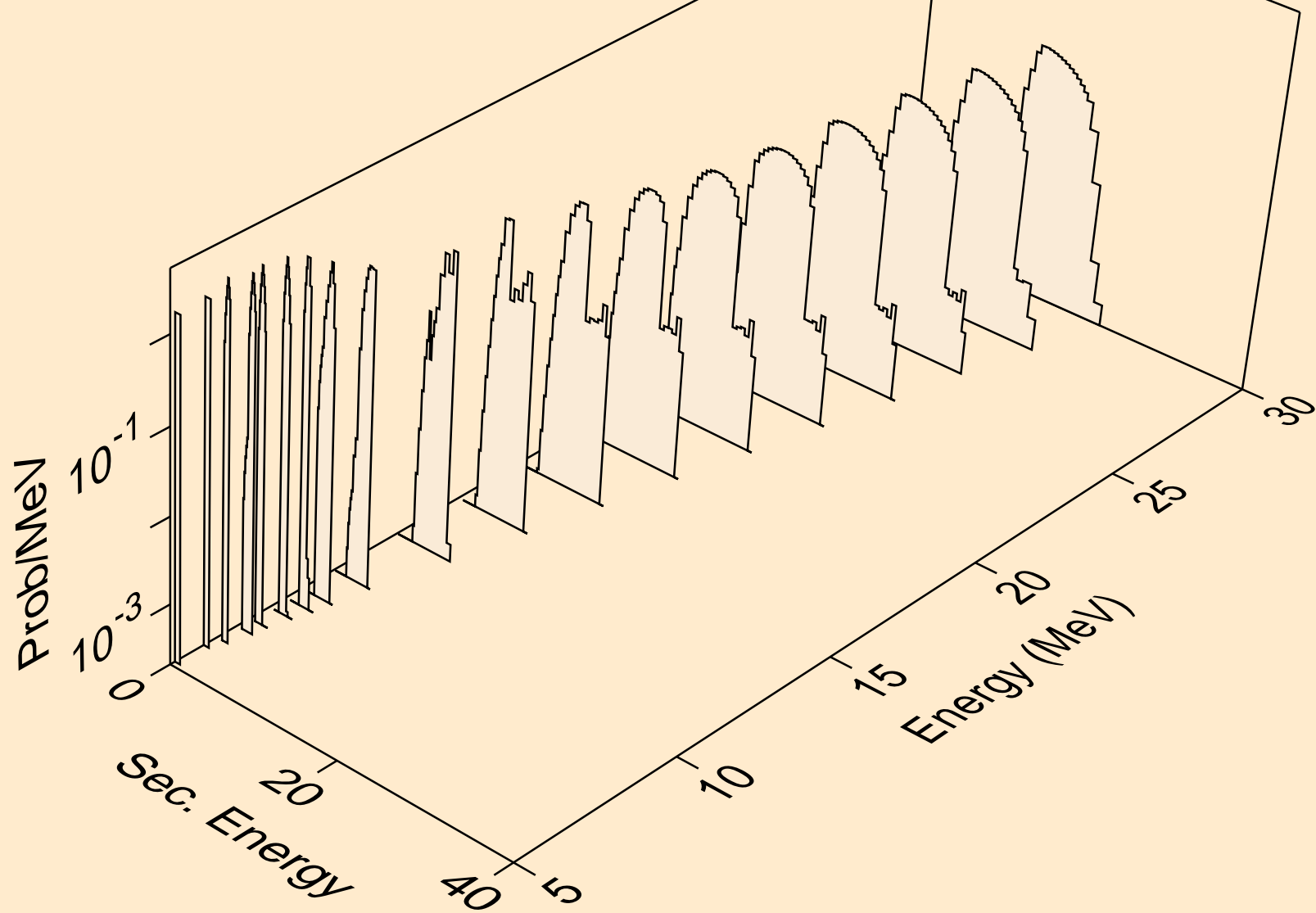

GA068 NEUTRON ACER TENDL-2021 LIBRARY; T=293.6K
tritons from (n,pt)

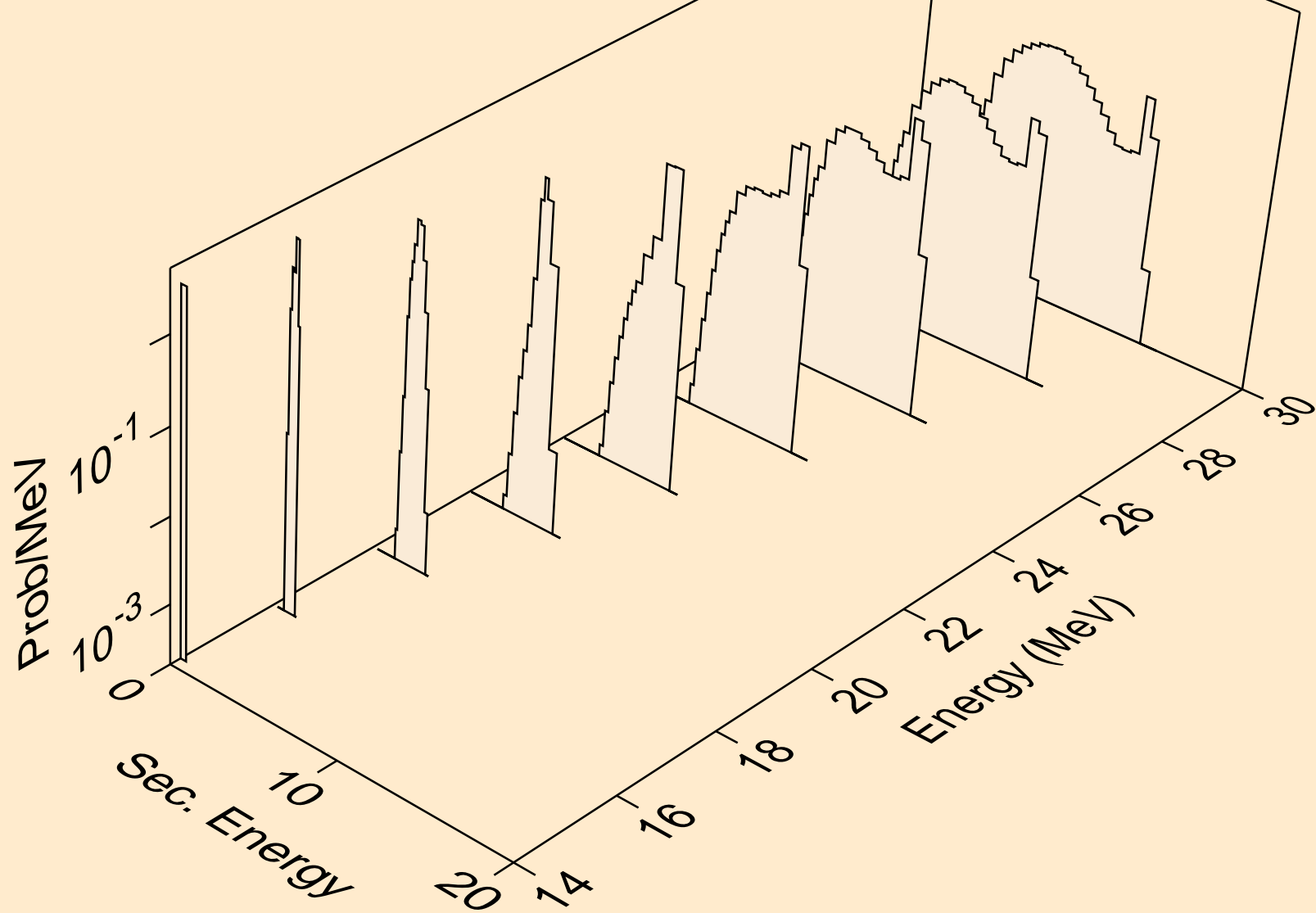

GA068 NEUTRON ACER TENDL-2021 LIBRARY; T=293.6K
he3s from (n,x)

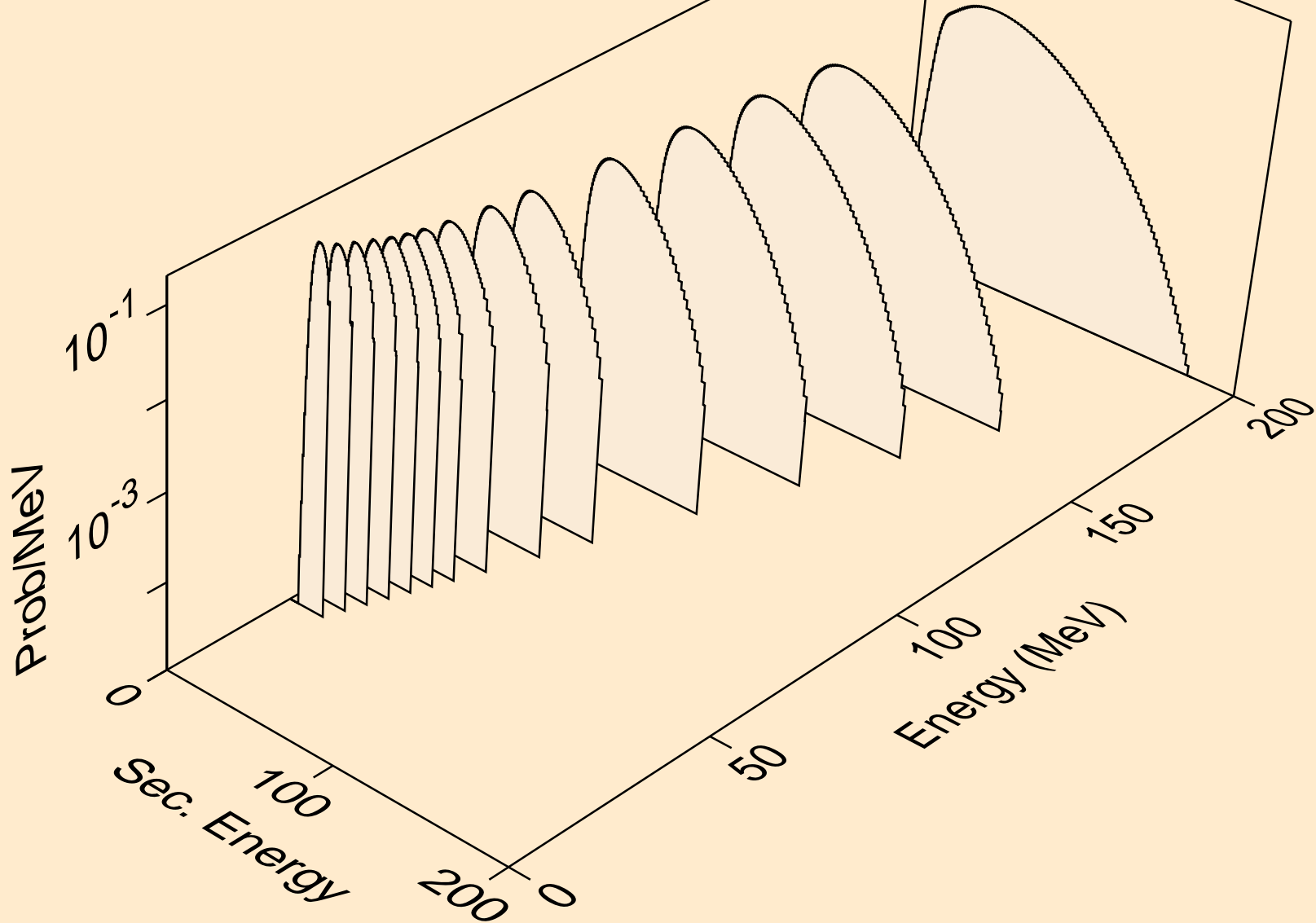

GA068 NEUTRON ACER TENDL-2021 LIBRARY; T=293.6K
he3s from (n,n*)he3

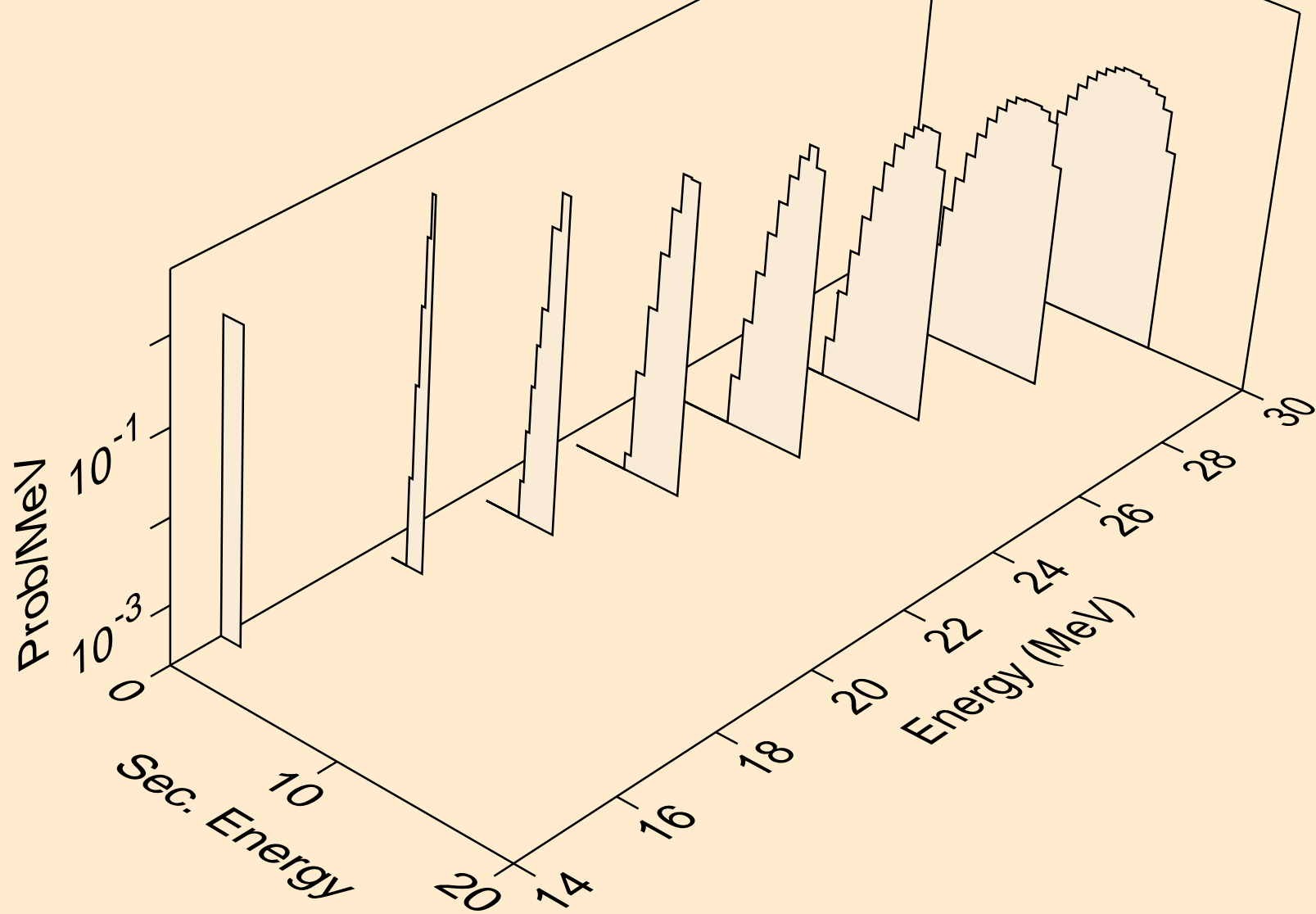

GA068 NEUTRON ACER TENDL-2021 LIBRARY; T=293.6K
he3s from (n,he3)

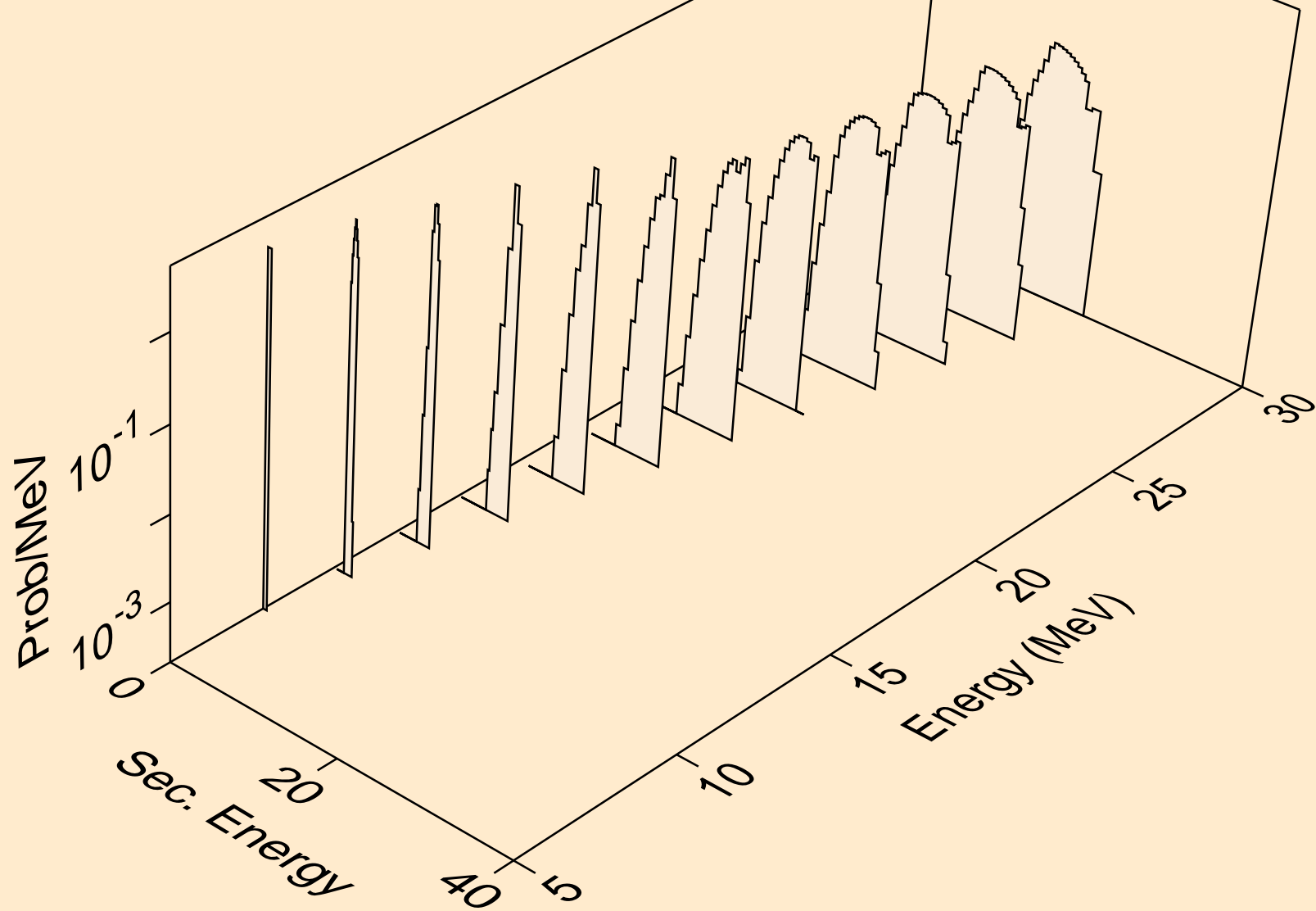

GA068 NEUTRON ACER TENDL-2021 LIBRARY; T=293.6K
alphas from (n,x)

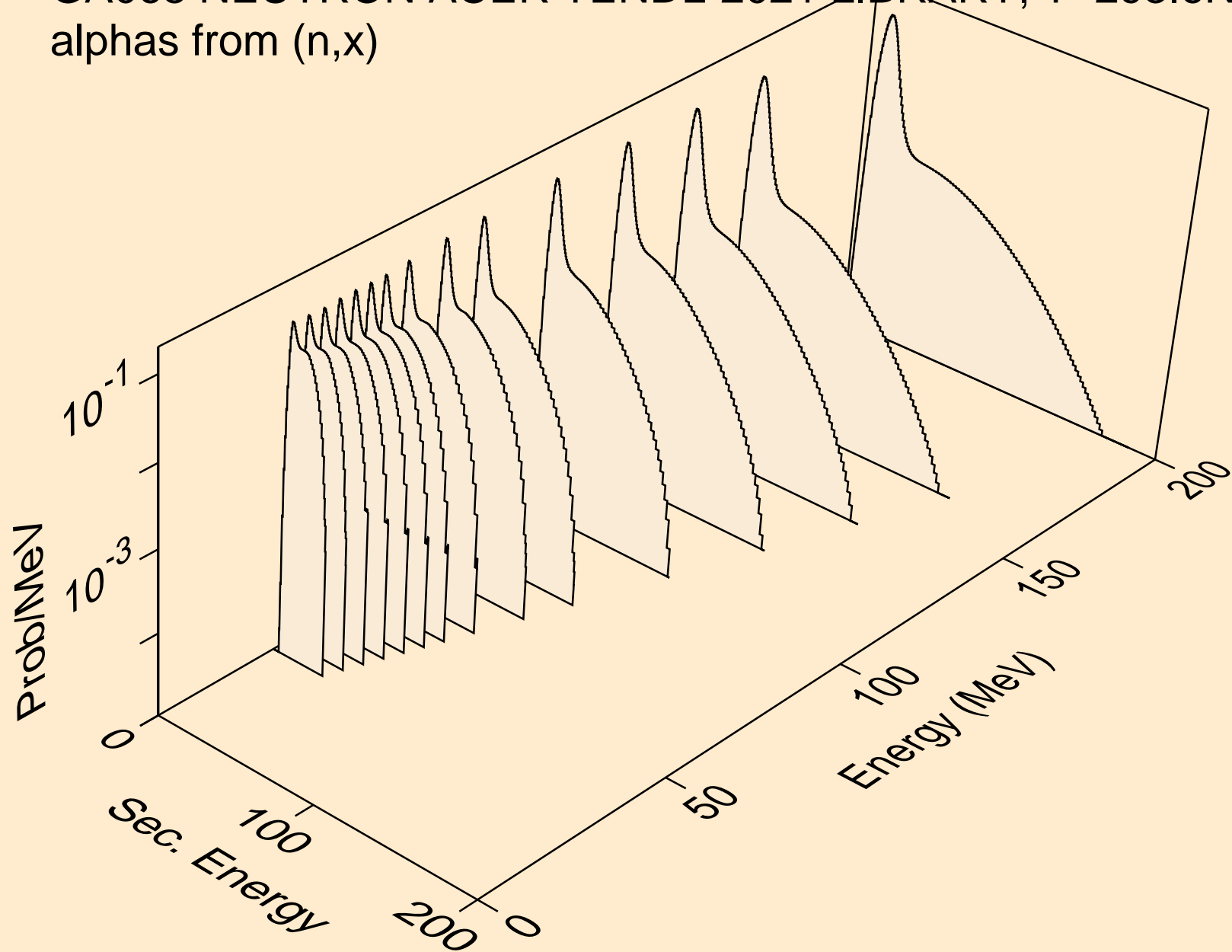

GA068 NEUTRON ACER TENDL-2021 LIBRARY; T=293.6K
alphas from (n,n*)a

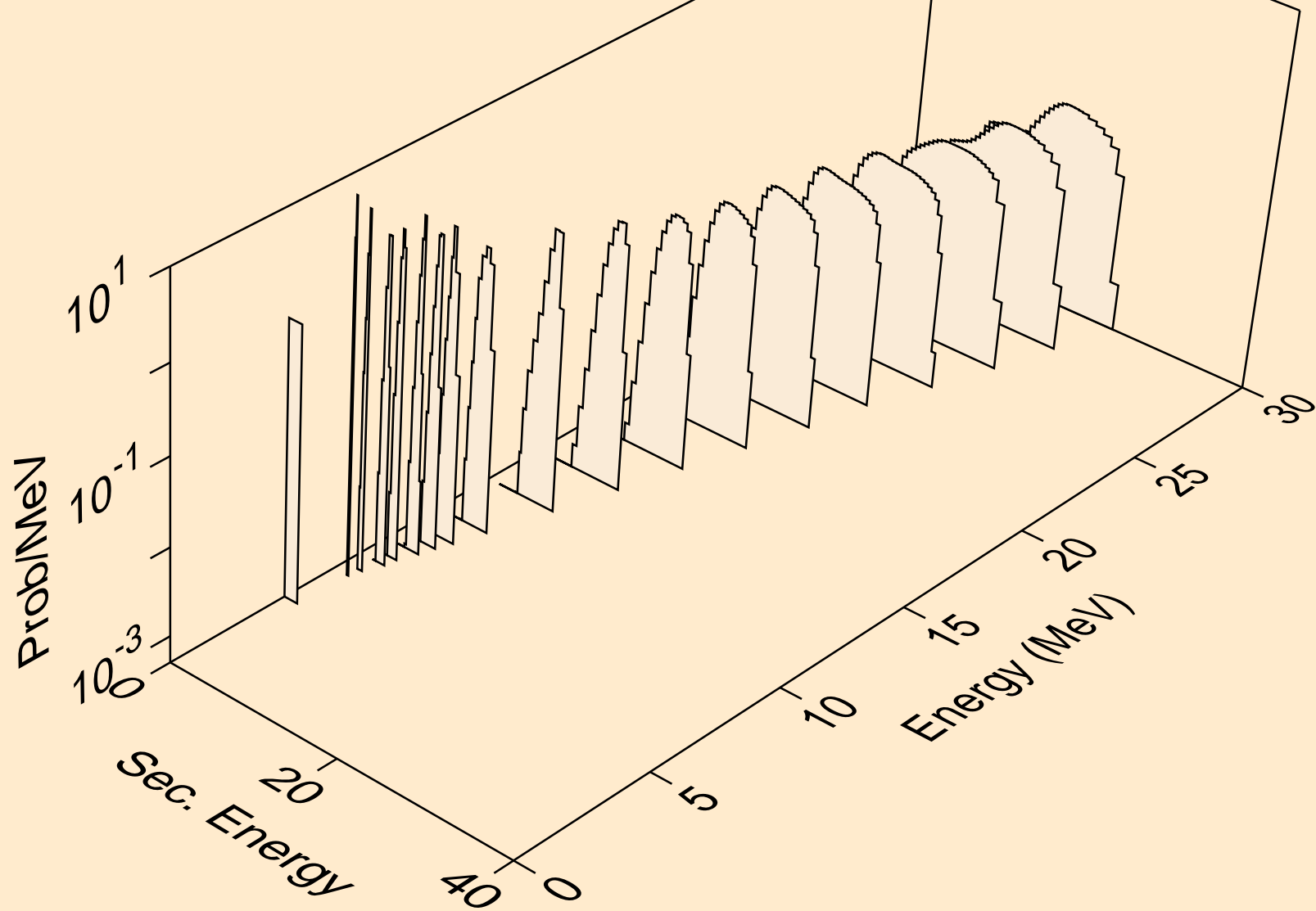

GA068 NEUTRON ACER TENDL-2021 LIBRARY; T=293.6K
alphas from (n,2n)a

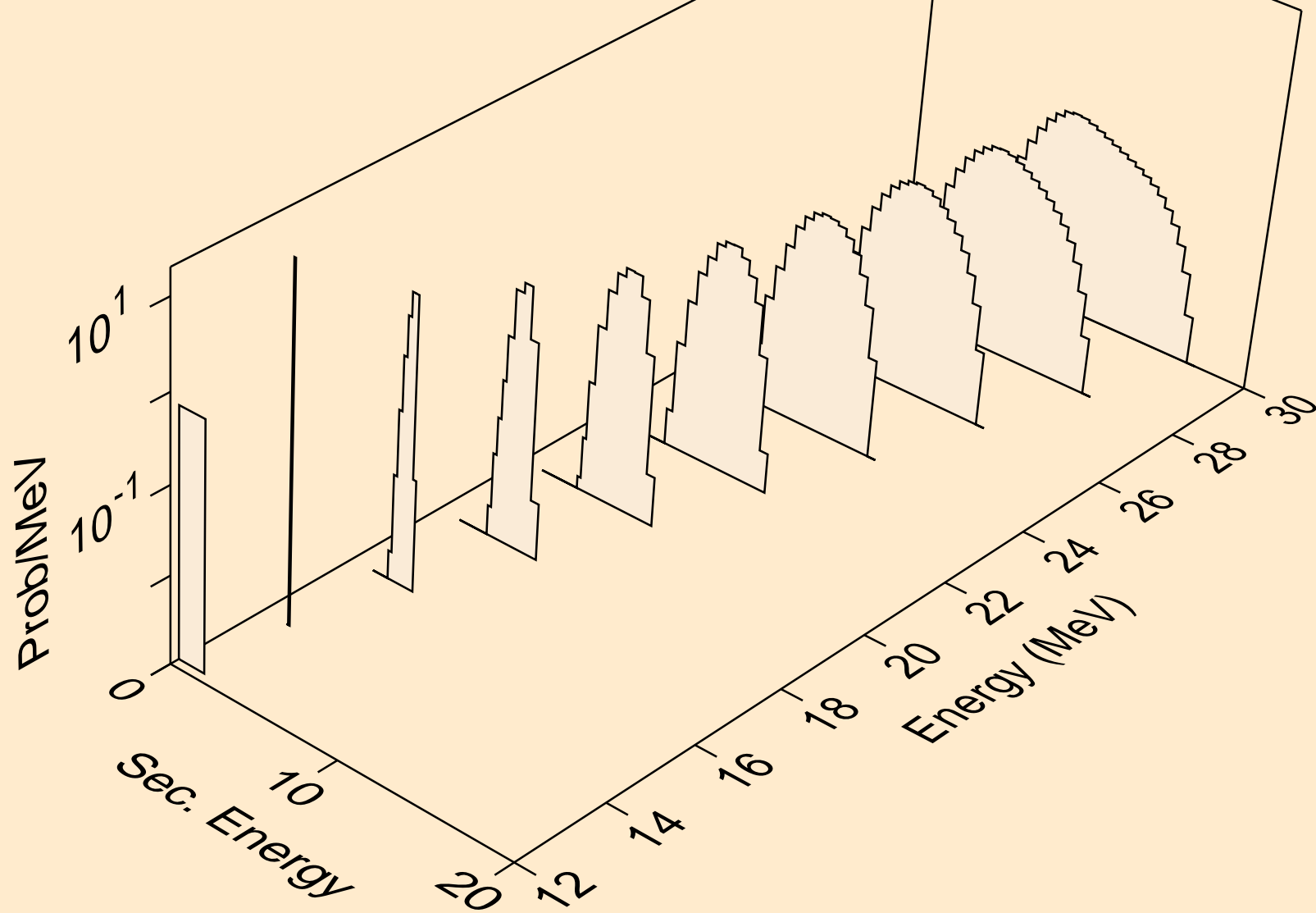

GA068 NEUTRON ACER TENDL-2021 LIBRARY; T=293.6K
alphas from (n,3n)a

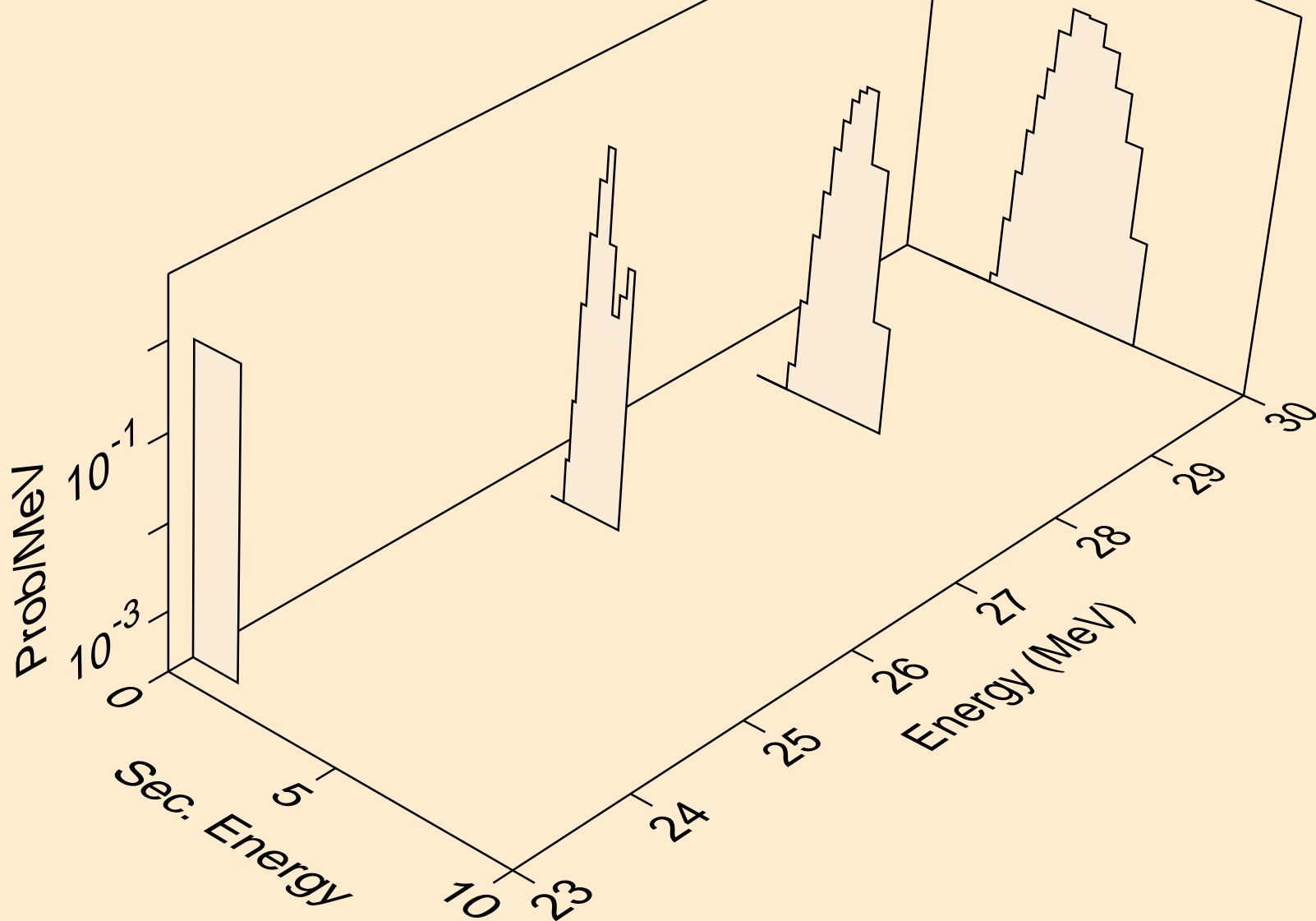

GA068 NEUTRON ACER TENDL-2021 LIBRARY; T=293.6K
alphas from (n,n*)2a

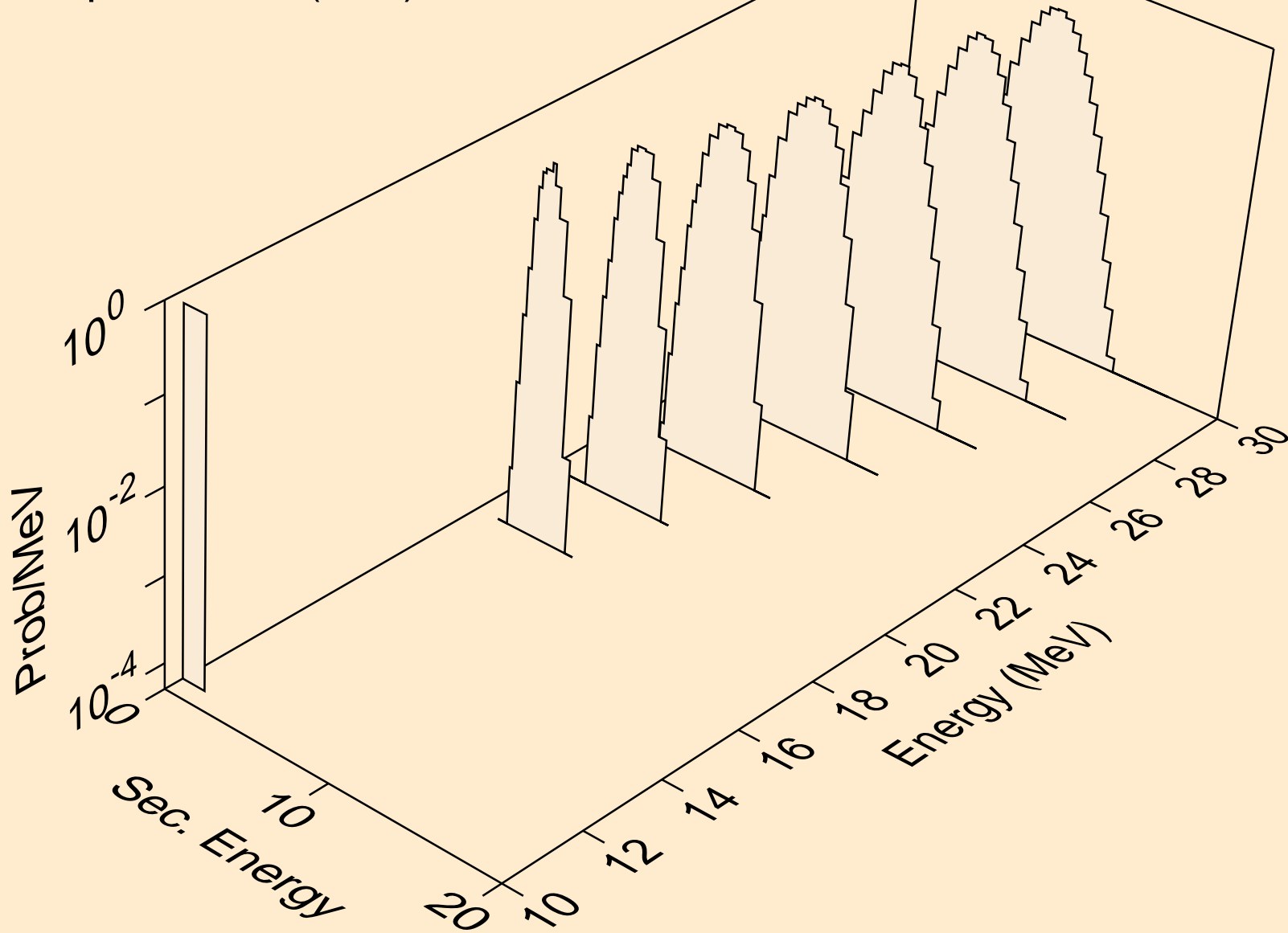

GA068 NEUTRON ACER TENDL-2021 LIBRARY; T=293.6K
alphas from (n,2n)2a

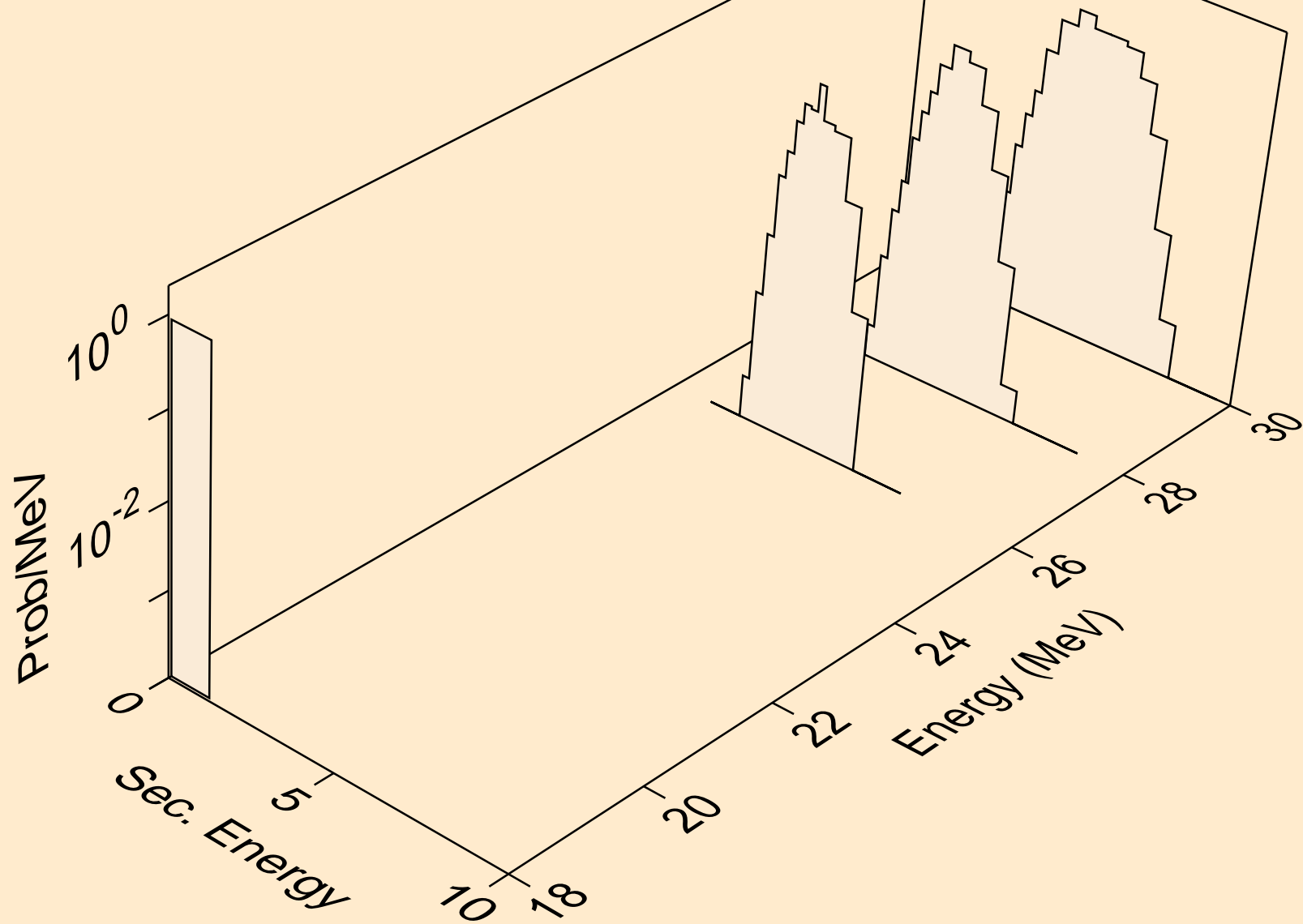

GA068 NEUTRON ACER TENDL-2021 LIBRARY; T=293.6K
alphas from (n,npa)

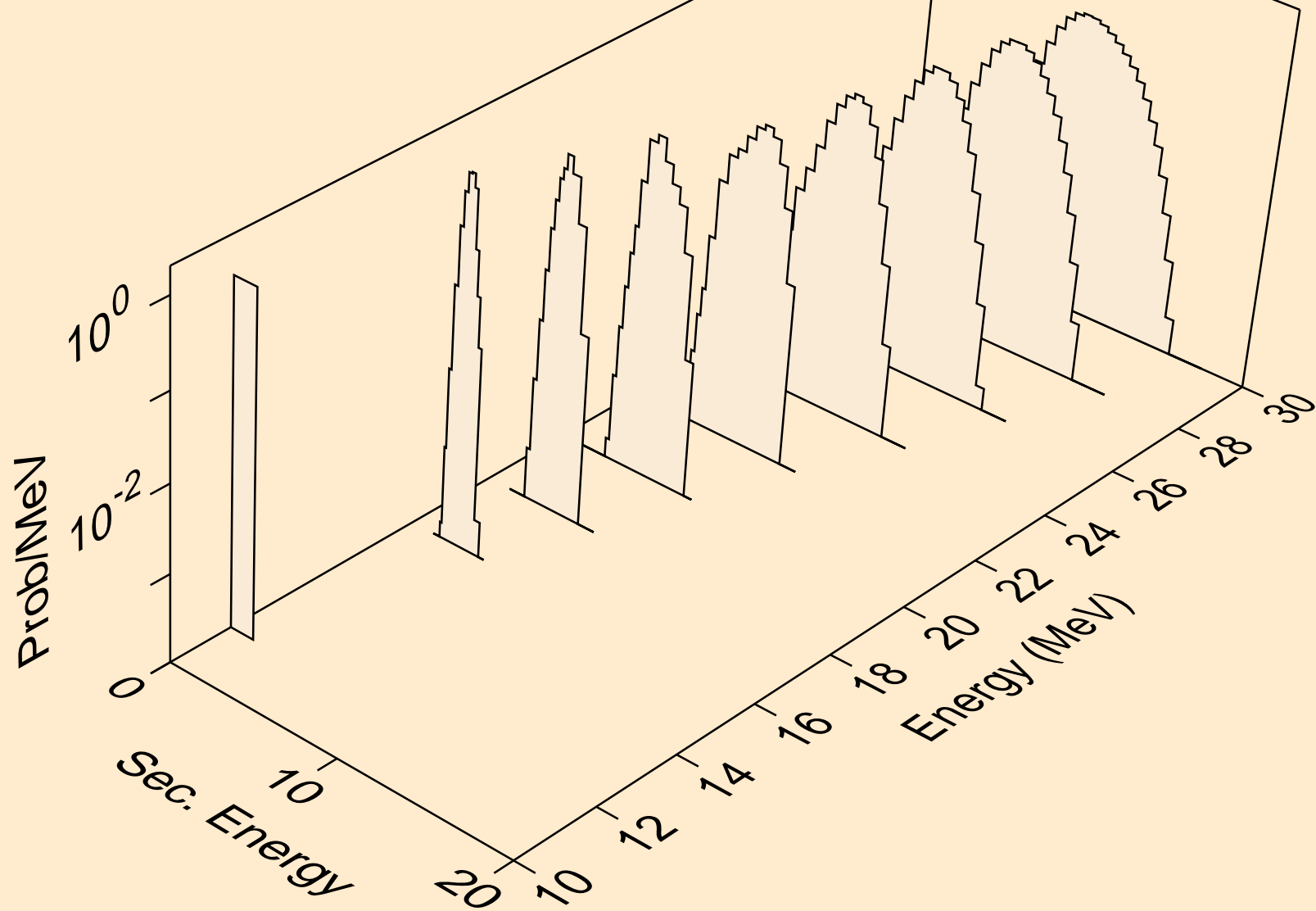

GA068 NEUTRON ACER TENDL-2021 LIBRARY; T=293.6K
alphas from (n,a)

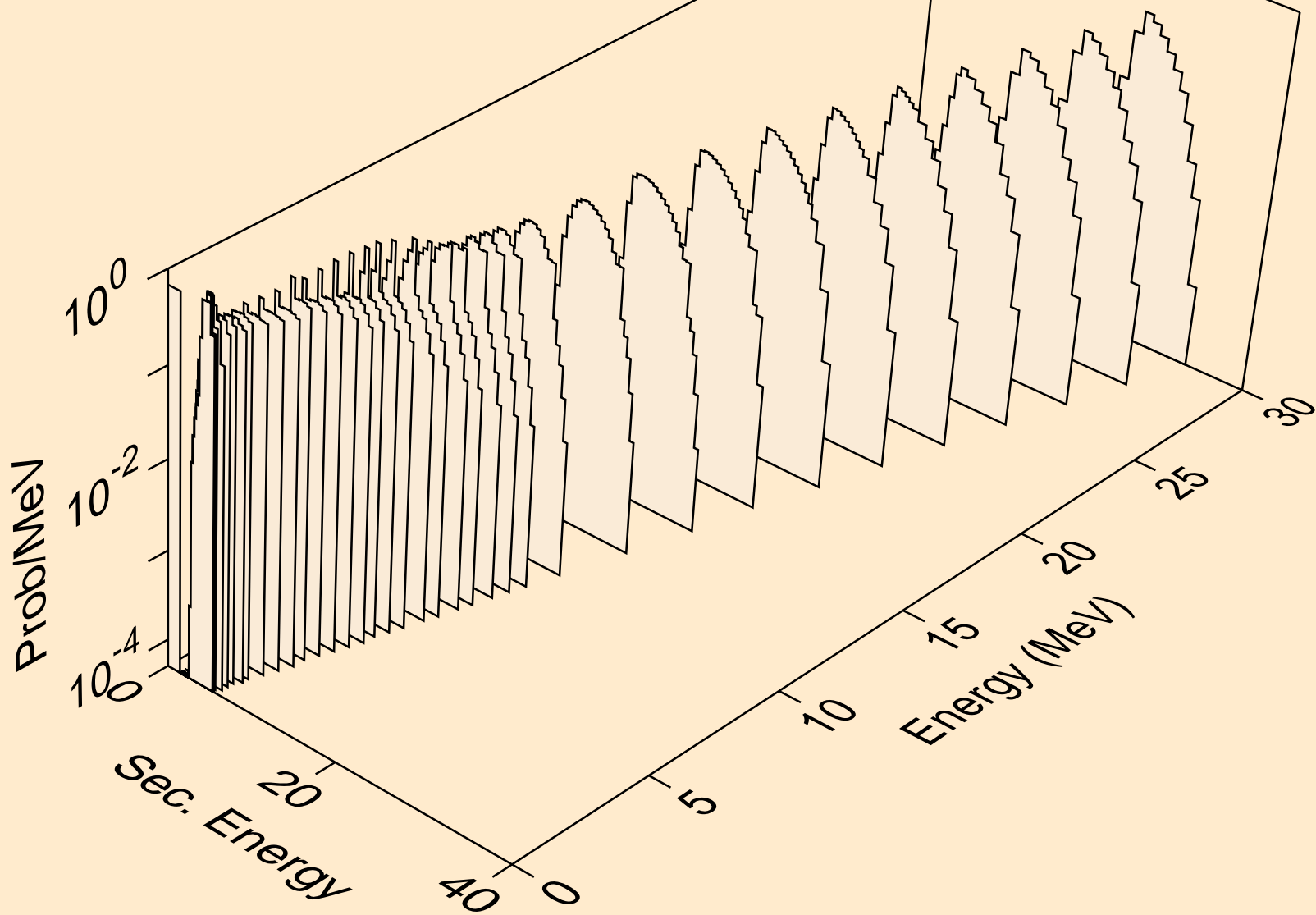

GA068 NEUTRON ACER TENDL-2021 LIBRARY; T=293.6K
alphas from (n,2a)

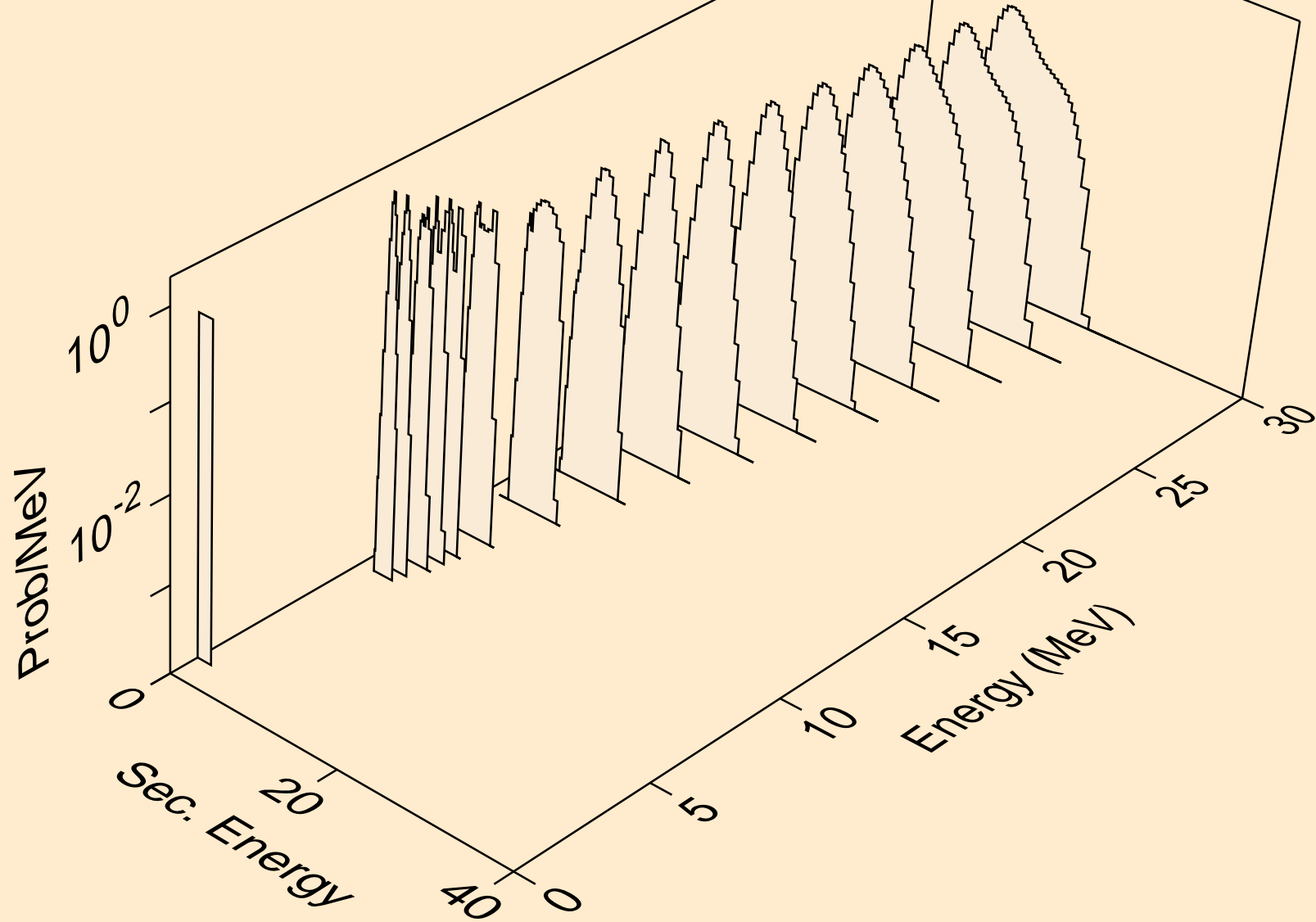

GA068 NEUTRON ACER TENDL-2021 LIBRARY; T=293.6K
alphas from (n,pa)

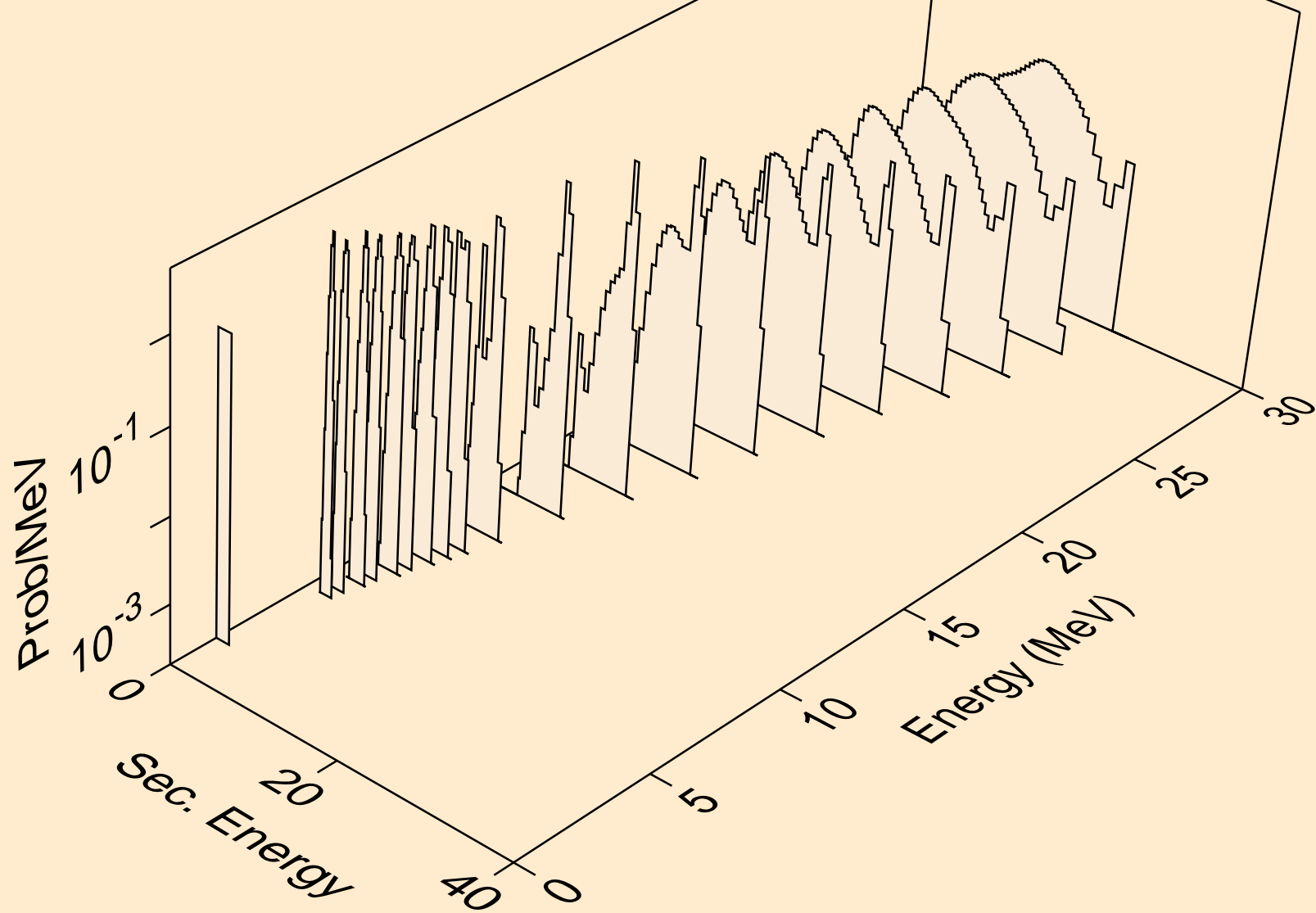

GA068 NEUTRON ACER TENDL-2021 LIBRARY; T=293.6K
alphas from (n,da)

