

GA081 NEUTRON ACER TENDL-2021 LIBRARY; T=293.6K

Principal cross sections

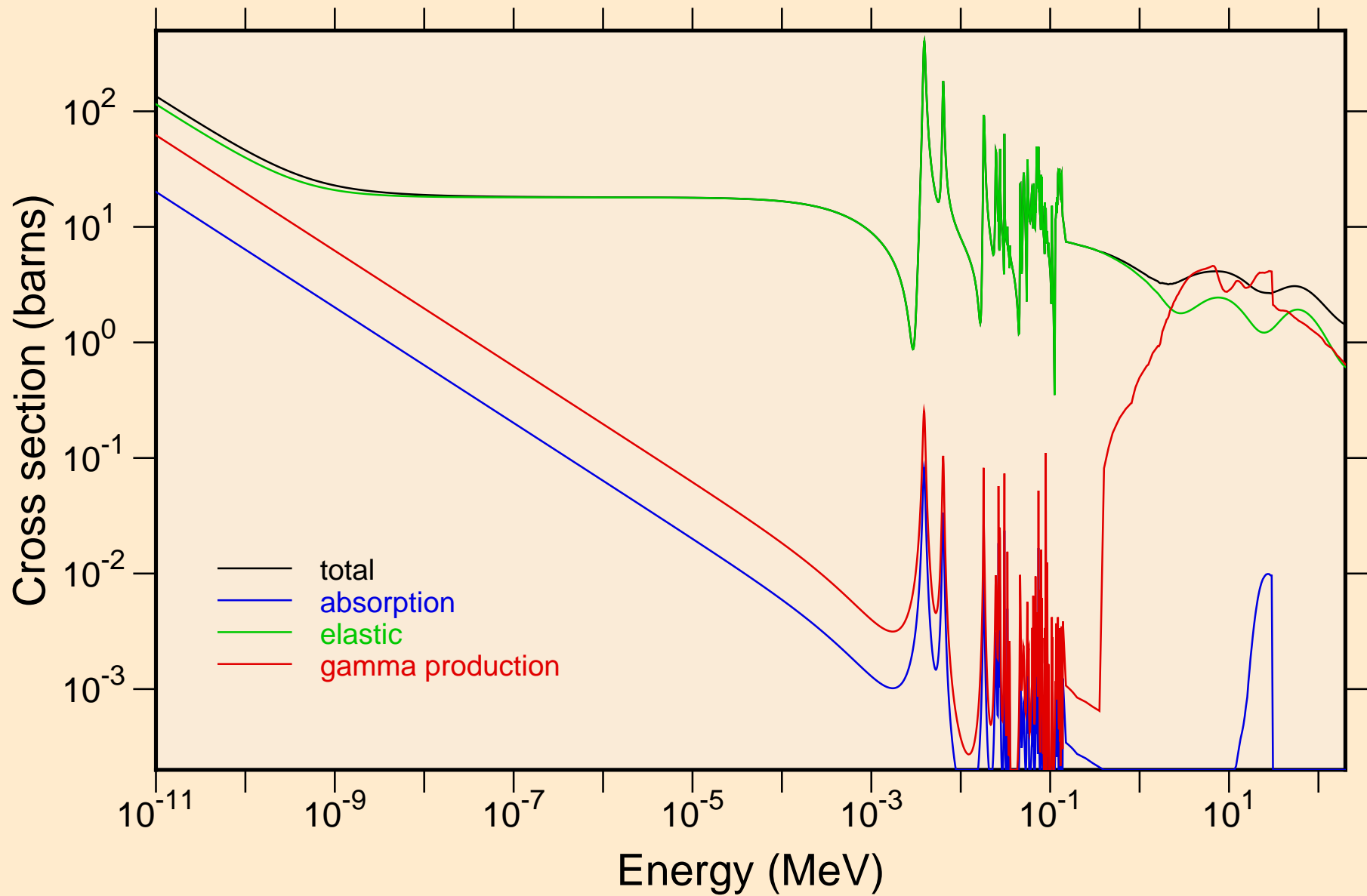

GA081 NEUTRON ACER TENDL-2021 LIBRARY; T=293.6K
resonance total cross section

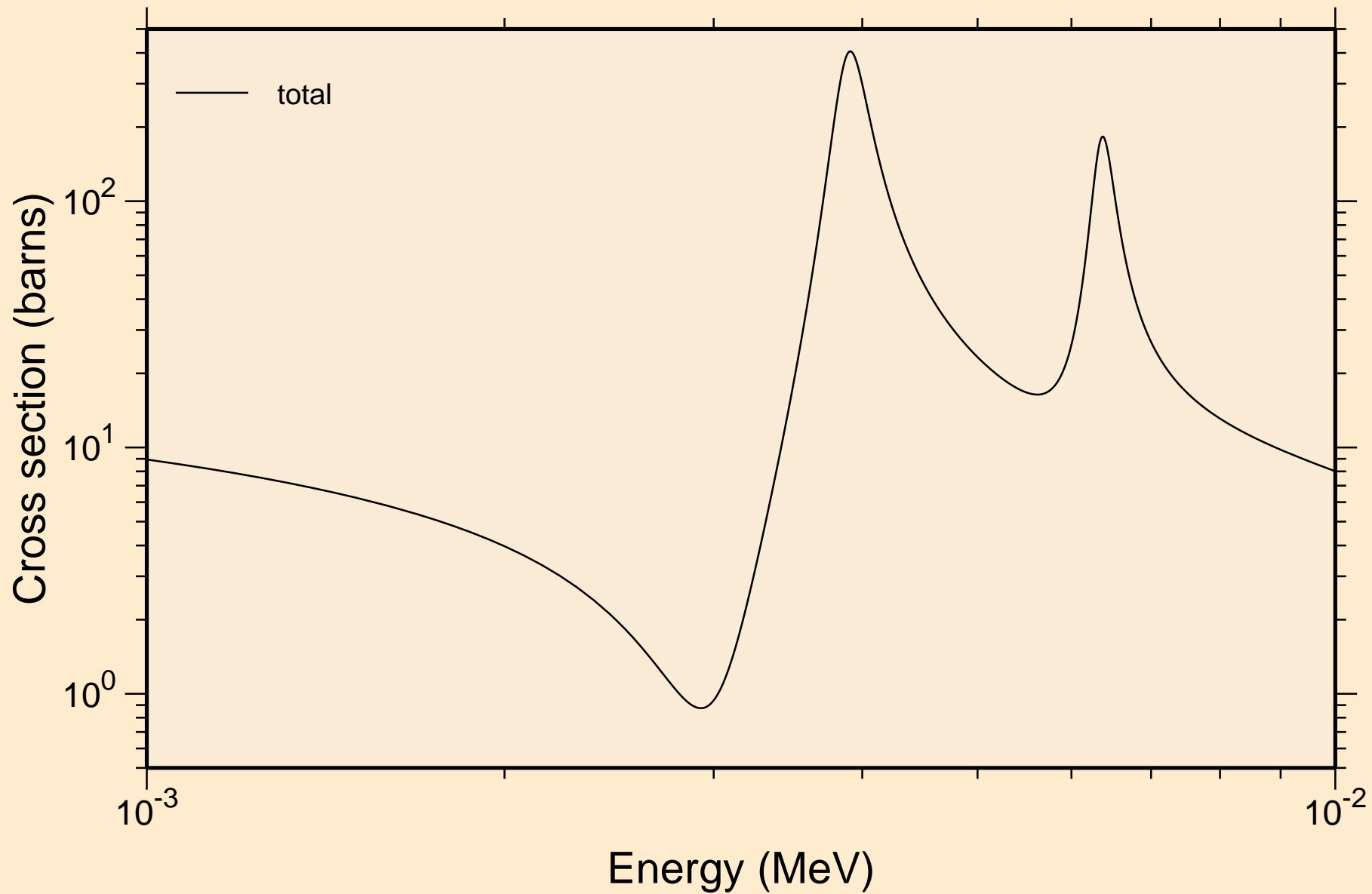

GA081 NEUTRON ACER TENDL-2021 LIBRARY; T=293.6K
resonance total cross section

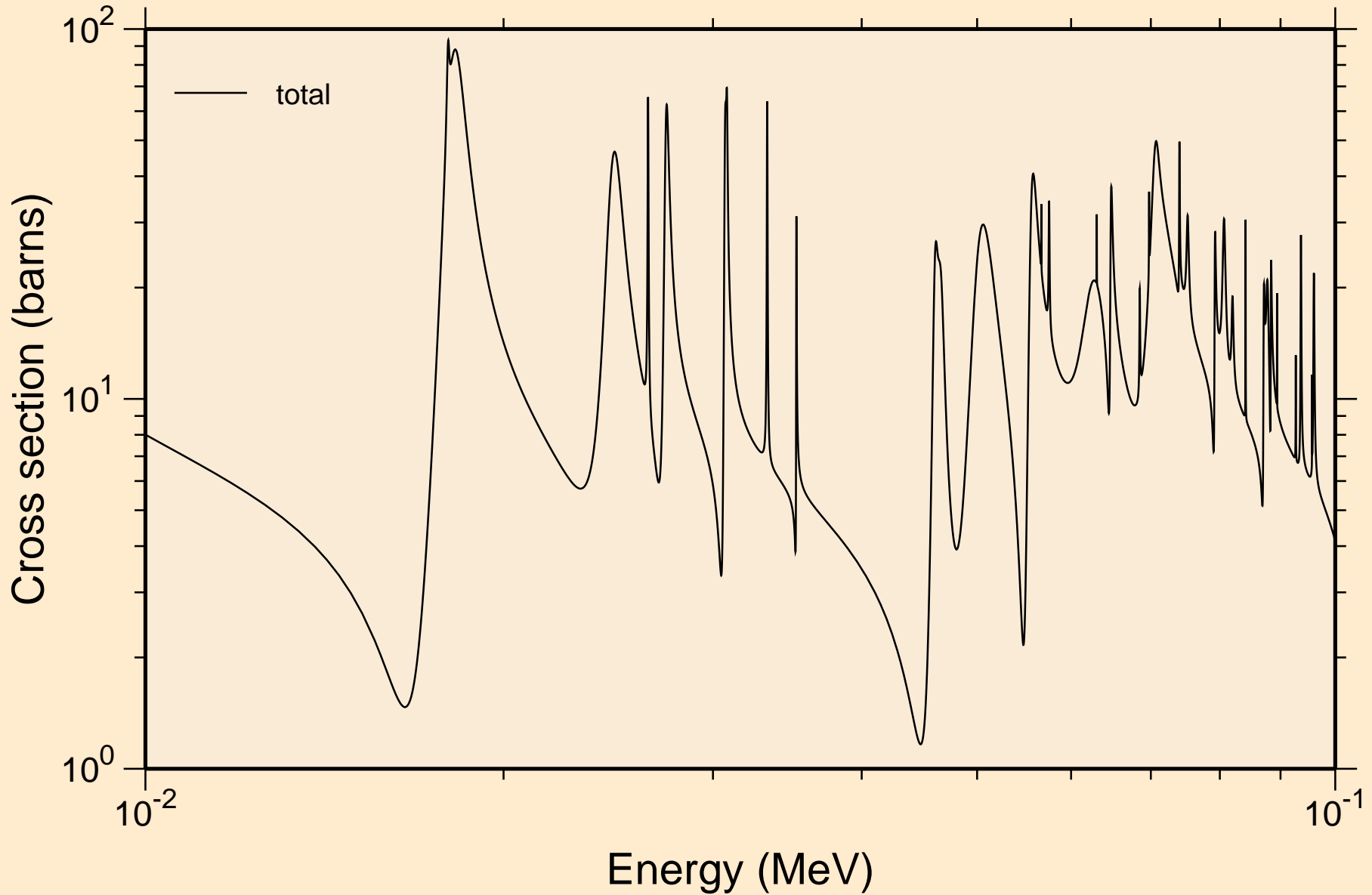

GA081 NEUTRON ACER TENDL-2021 LIBRARY; T=293.6K
resonance total cross section

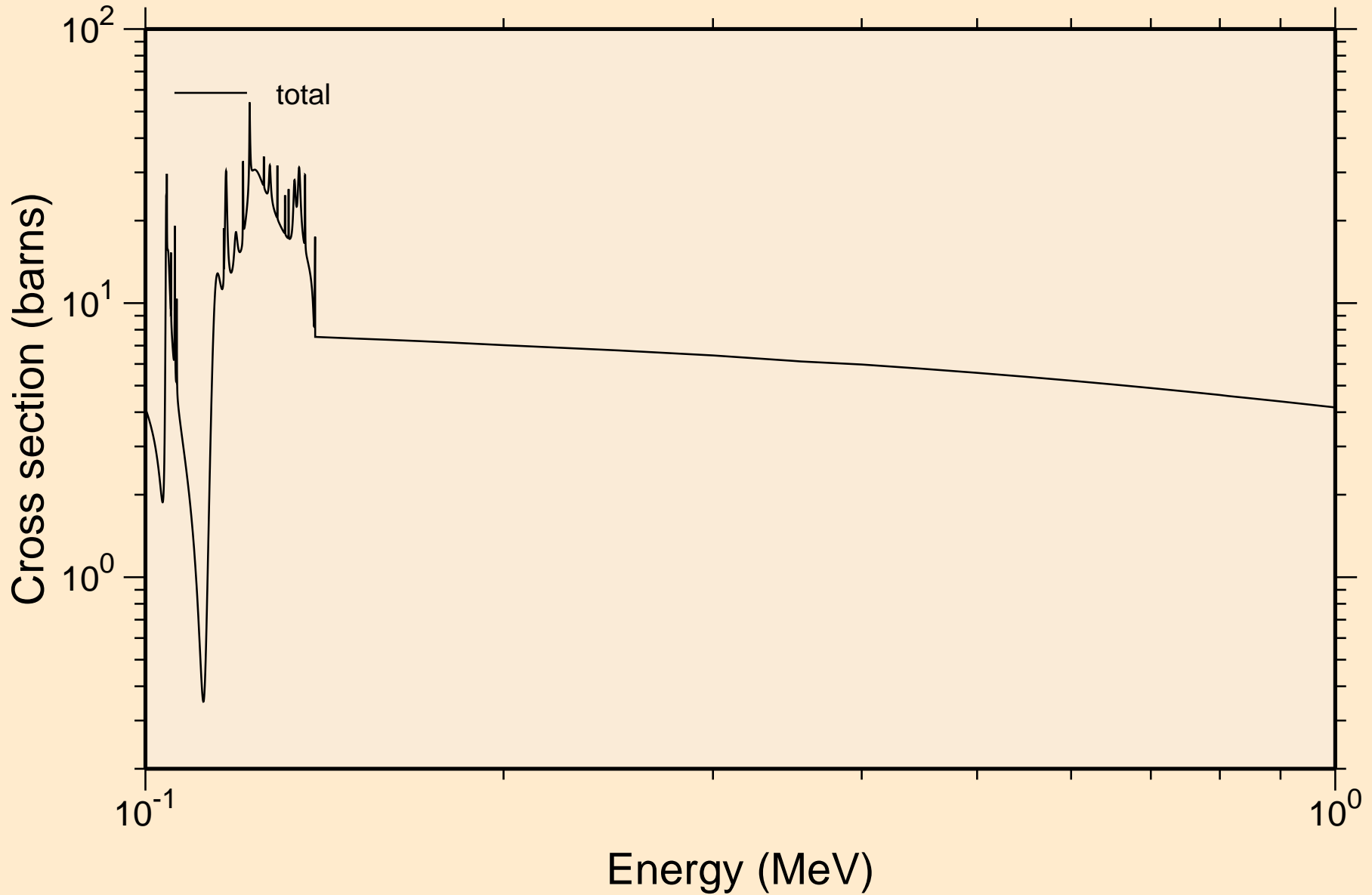

ḠA081 NEUTRON ACER TENDL-2021 LIBRARY; T=293.6K
resonance total cross section

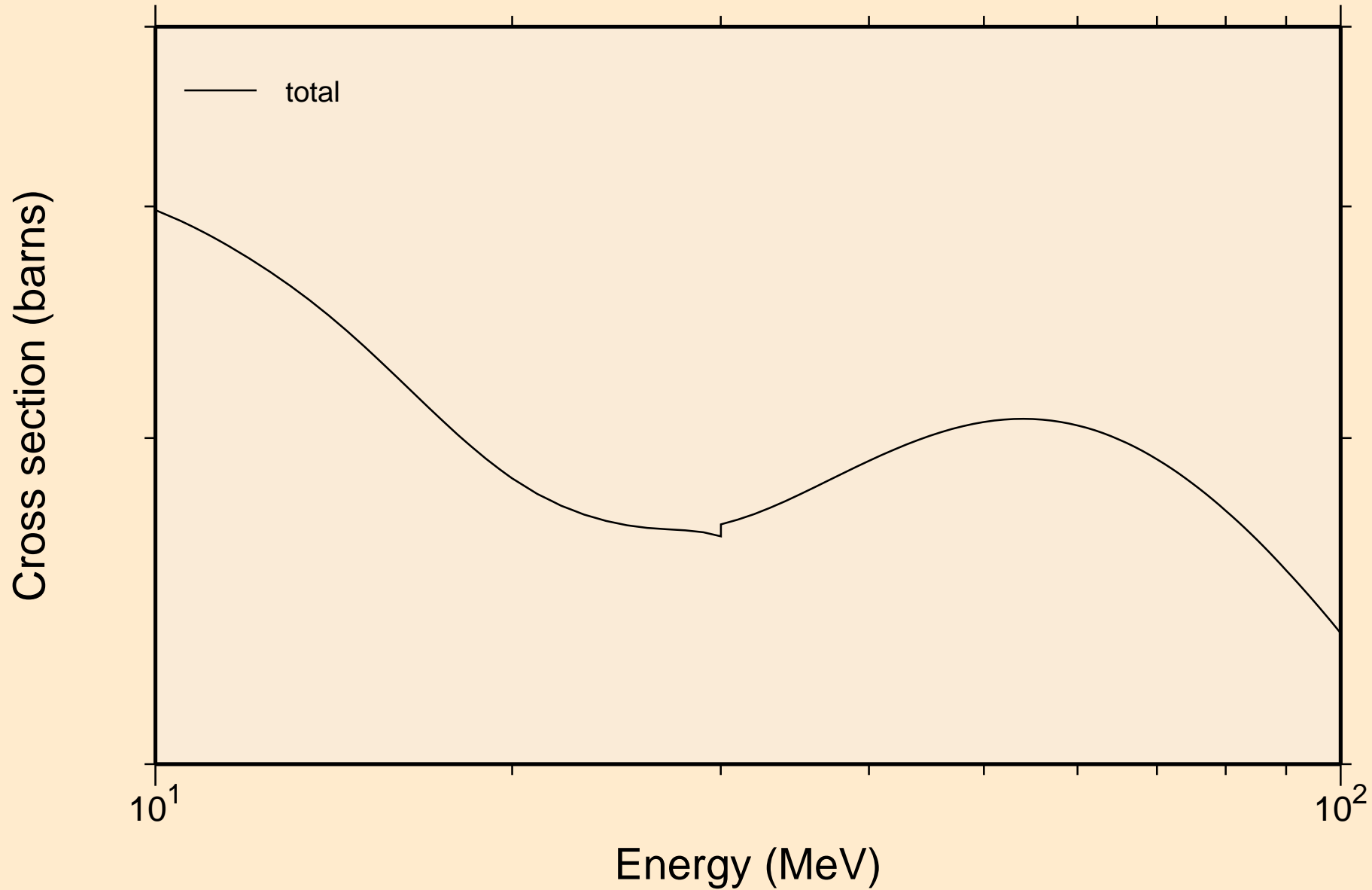

GA081 NEUTRON ACER TENDL-2021 LIBRARY; T=293.6K
resonance absorption cross sections

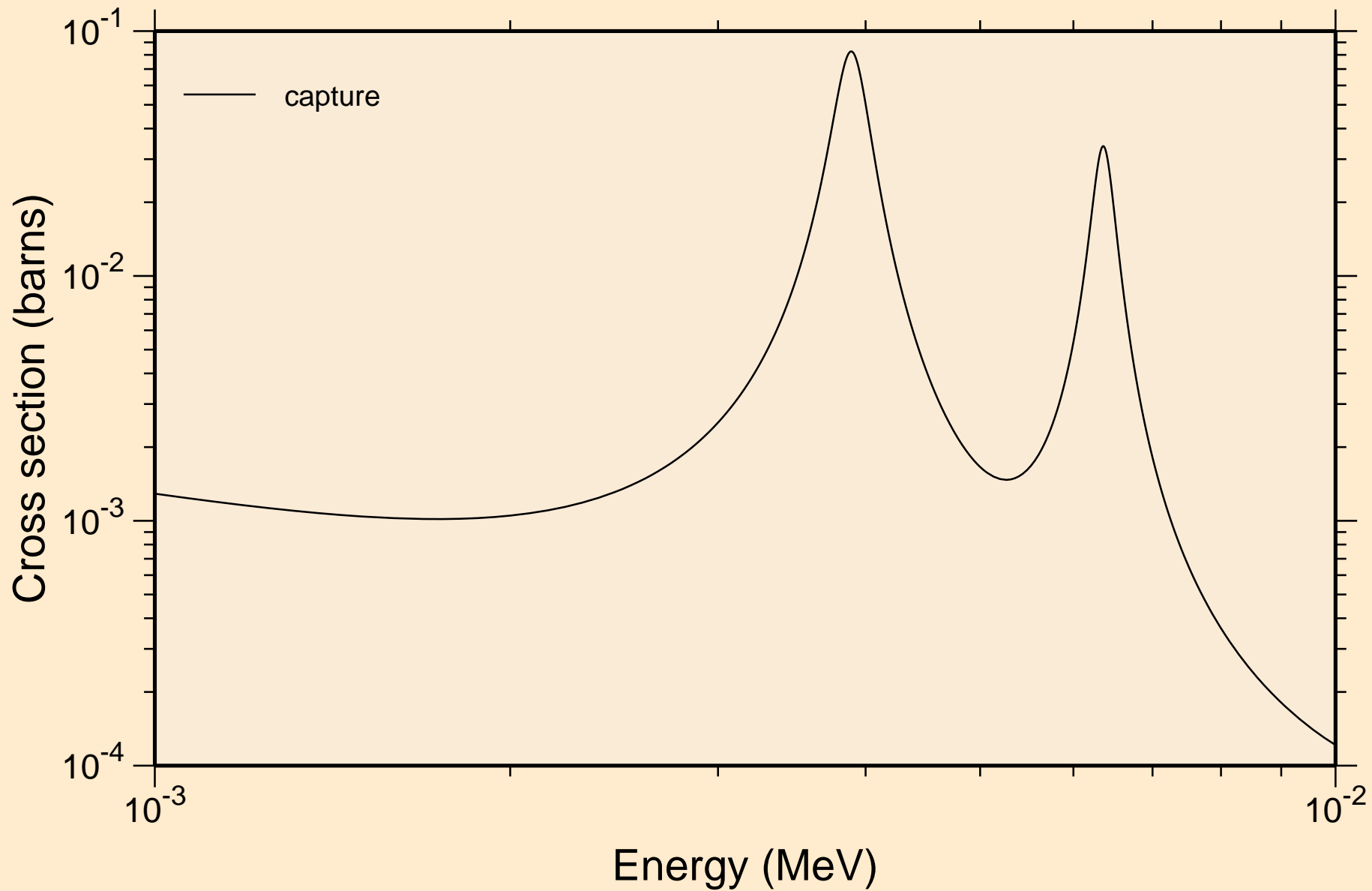

GA081 NEUTRON ACER TENDL-2021 LIBRARY; T=293.6K
resonance absorption cross sections

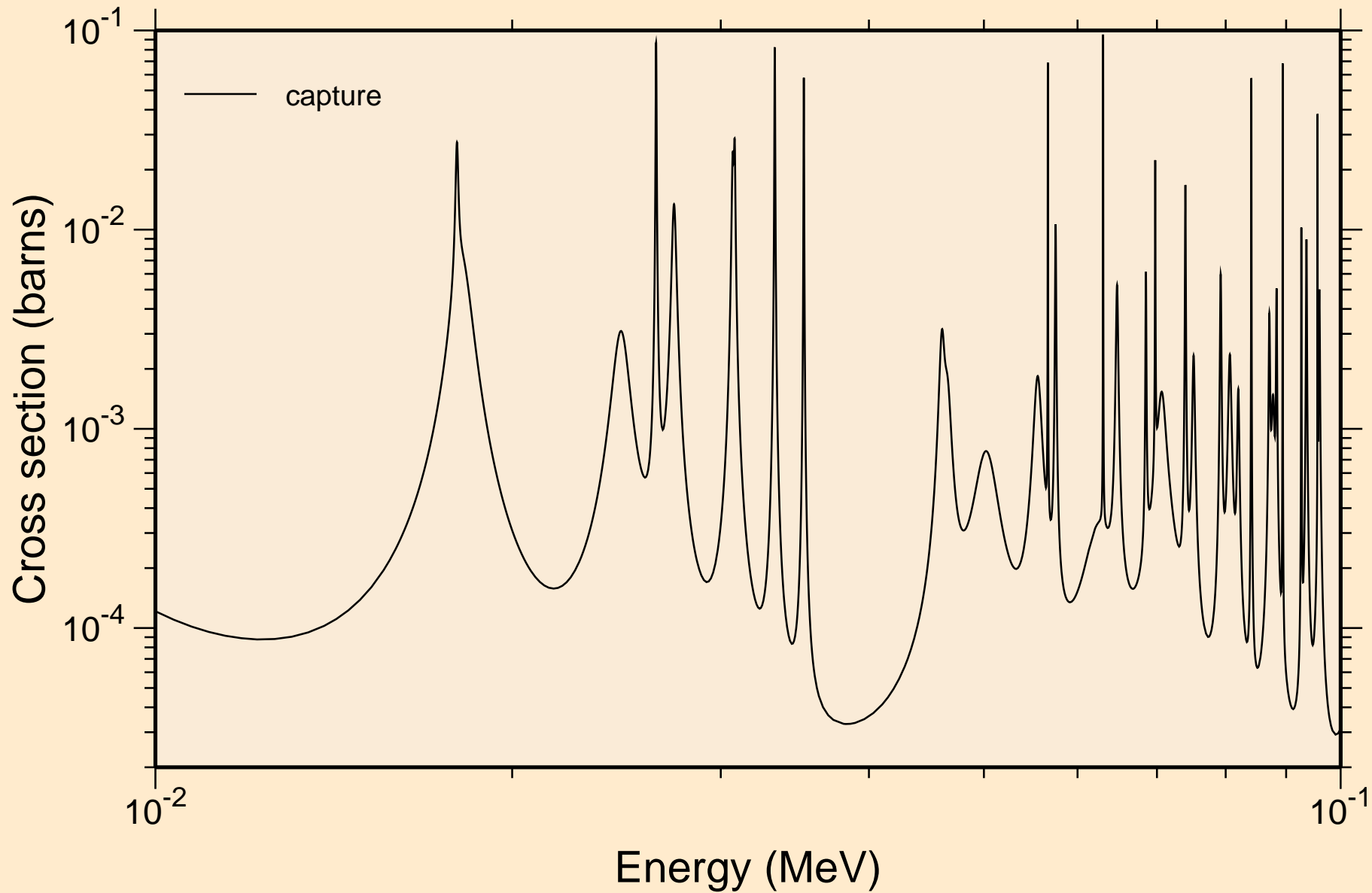

GA081 NEUTRON ACER TENDL-2021 LIBRARY; T=293.6K
resonance absorption cross sections

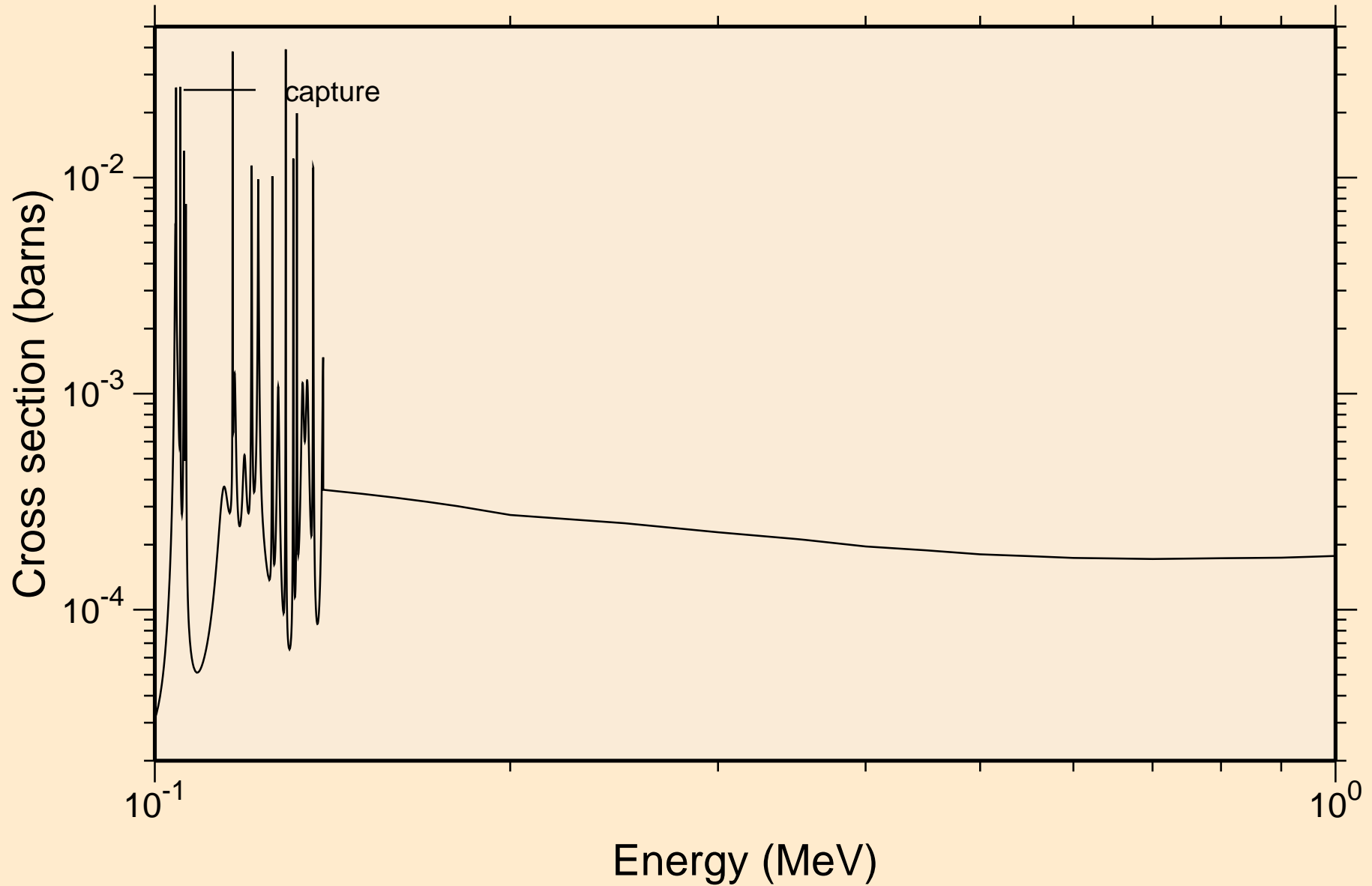

GA081 NEUTRON ACER TENDL-2021 LIBRARY; T=293.6K
resonance absorption cross sections

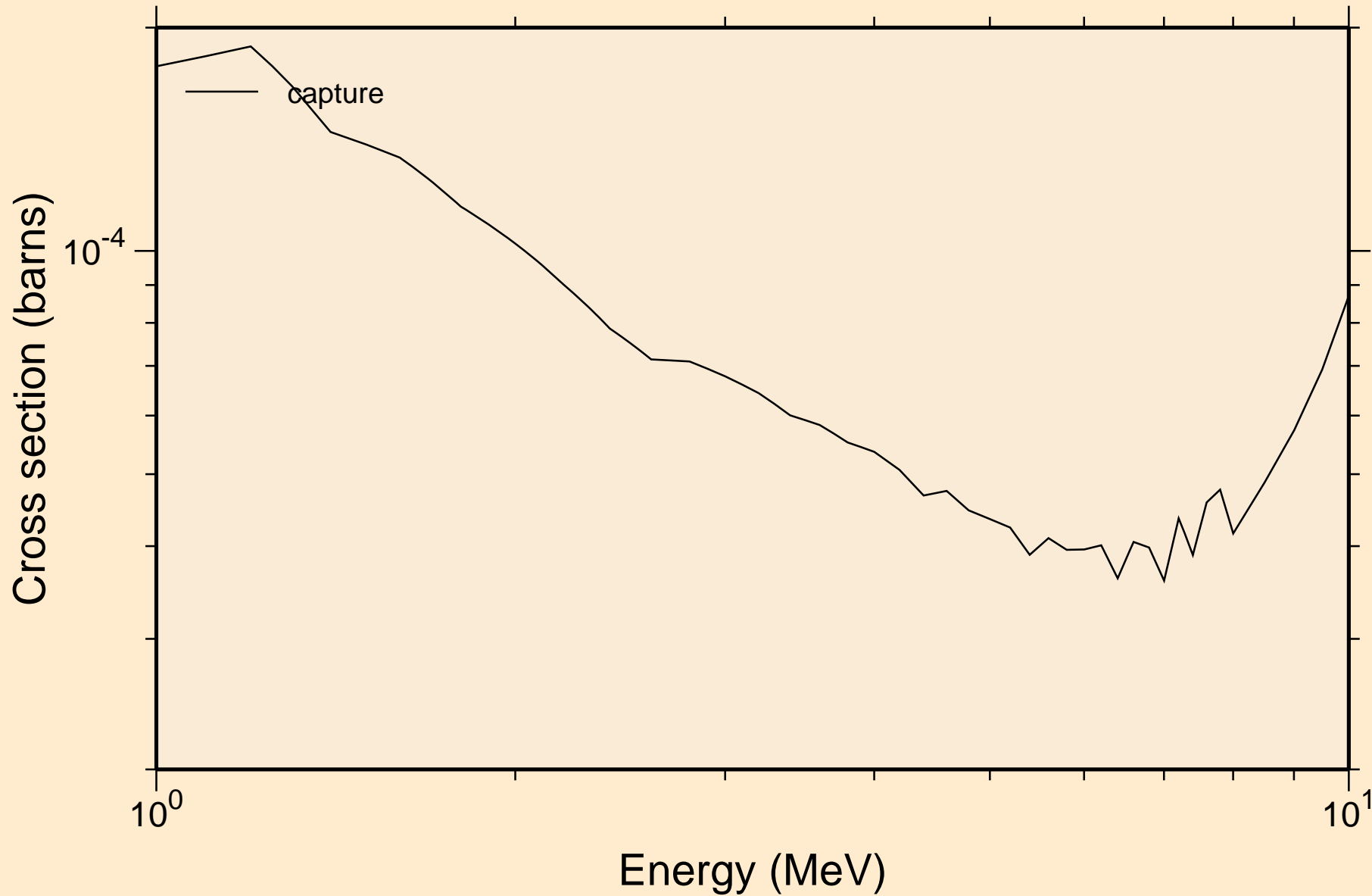

GA081 NEUTRON ACER TENDL-2021 LIBRARY; T=293.6K
Heating

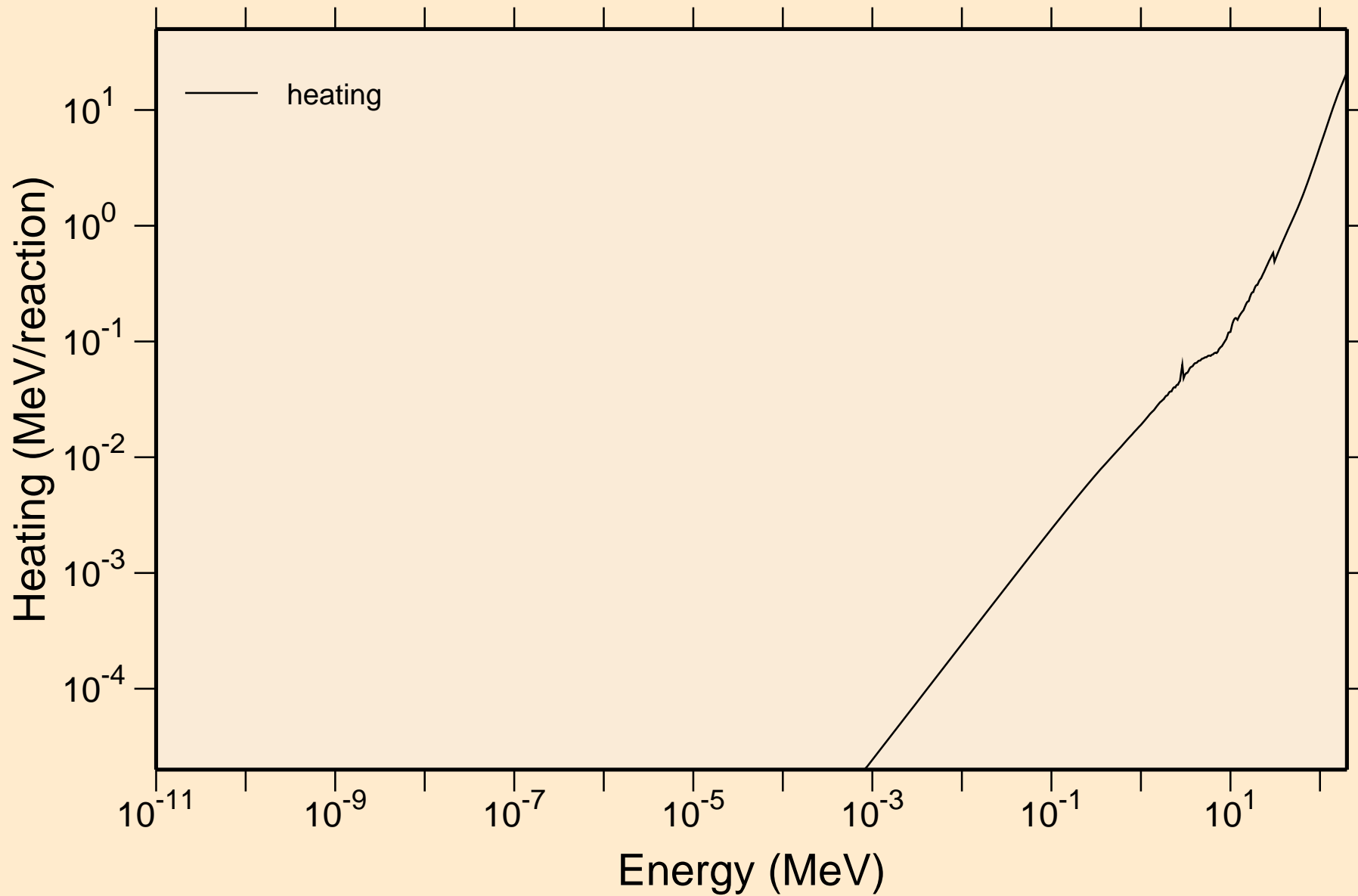

GA081 NEUTRON ACER TENDL-2021 LIBRARY; T=293.6K

Damage

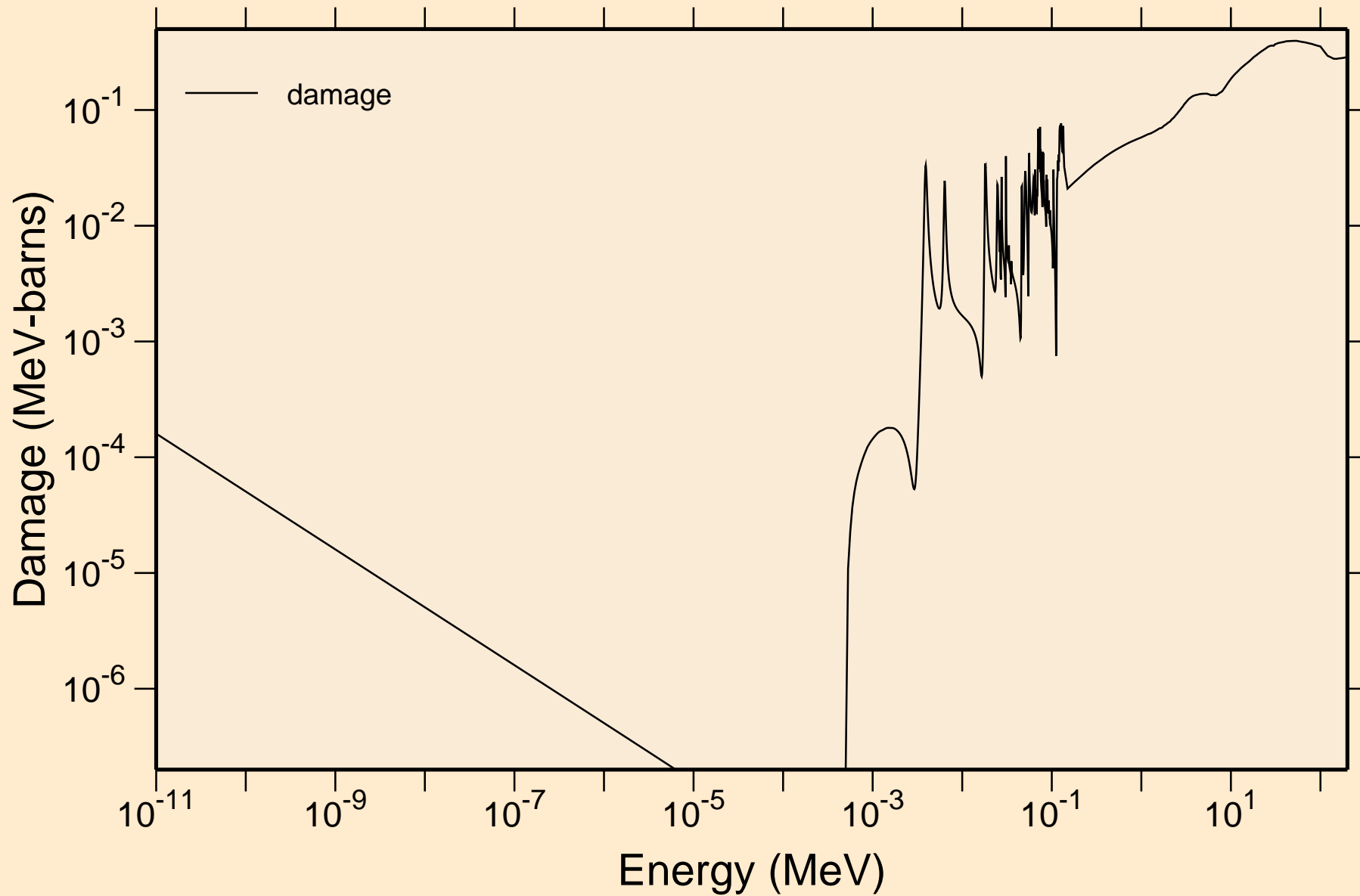

GA081 NEUTRON ACER TENDL-2021 LIBRARY; T=293.6K
Non-threshold reactions

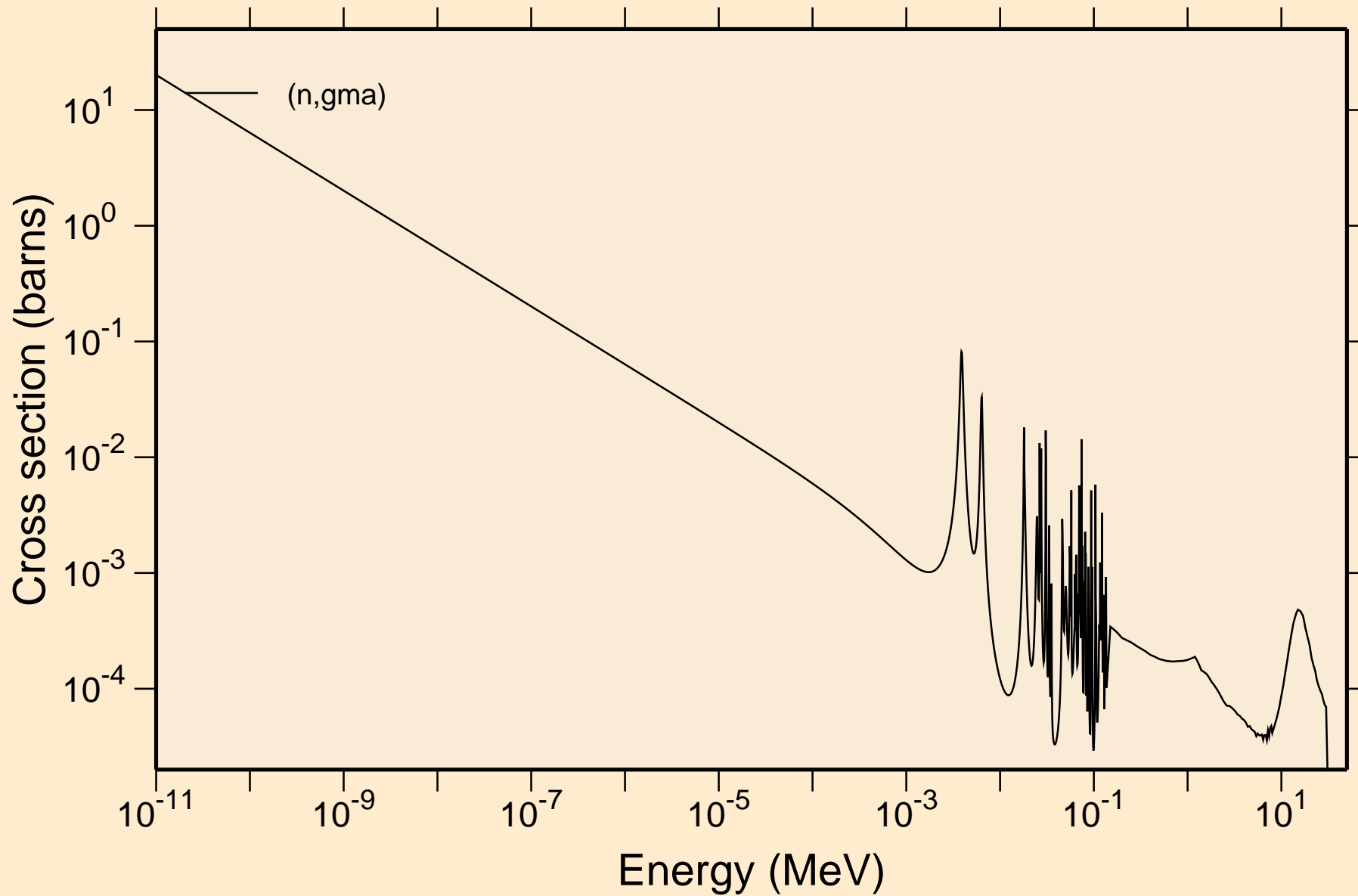

GA081 NEUTRON ACER TENDL-2021 LIBRARY; T=293.6K
Principal cross sections

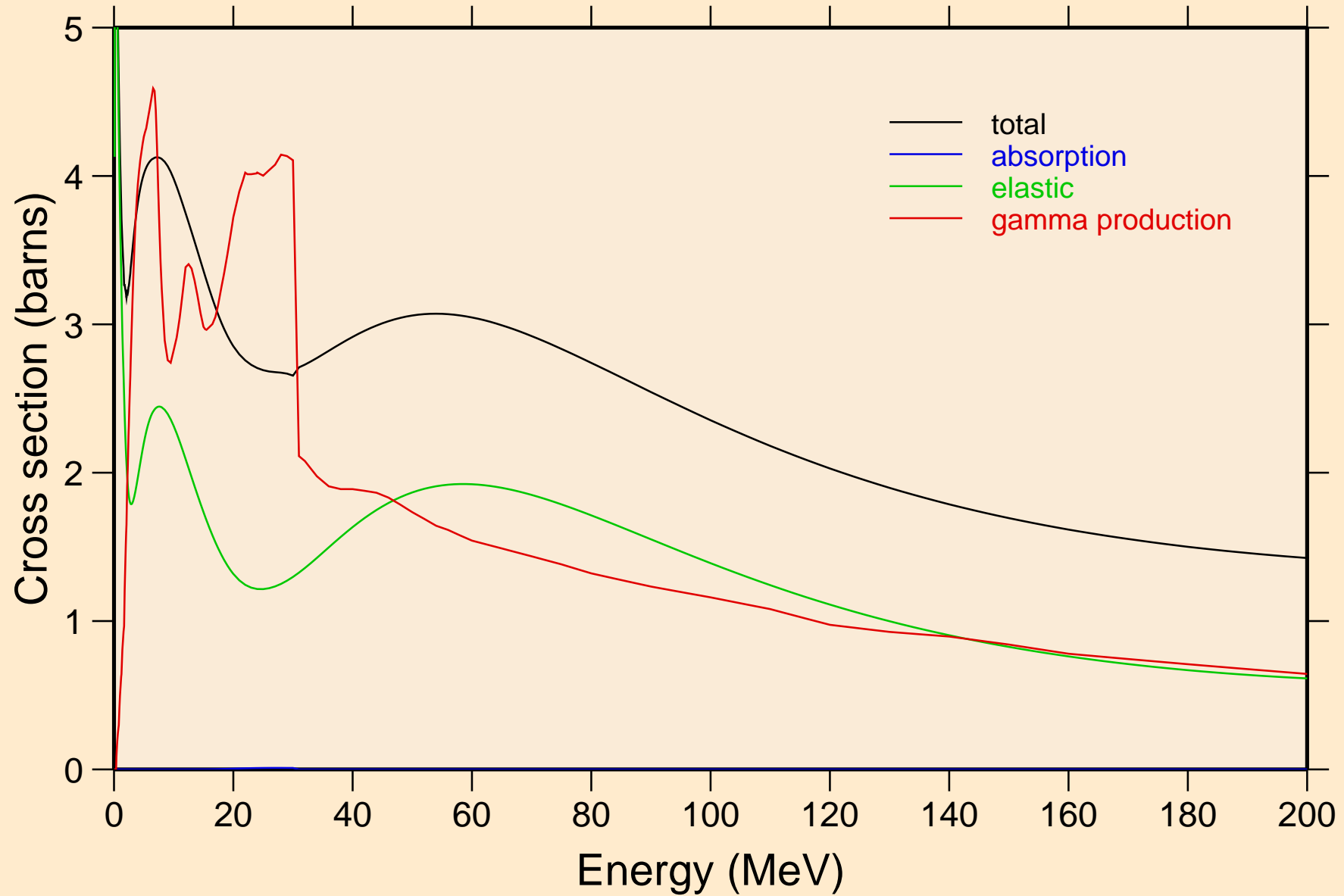

GA081 NEUTRON ACER TENDL-2021 LIBRARY; T=293.6K
Heating

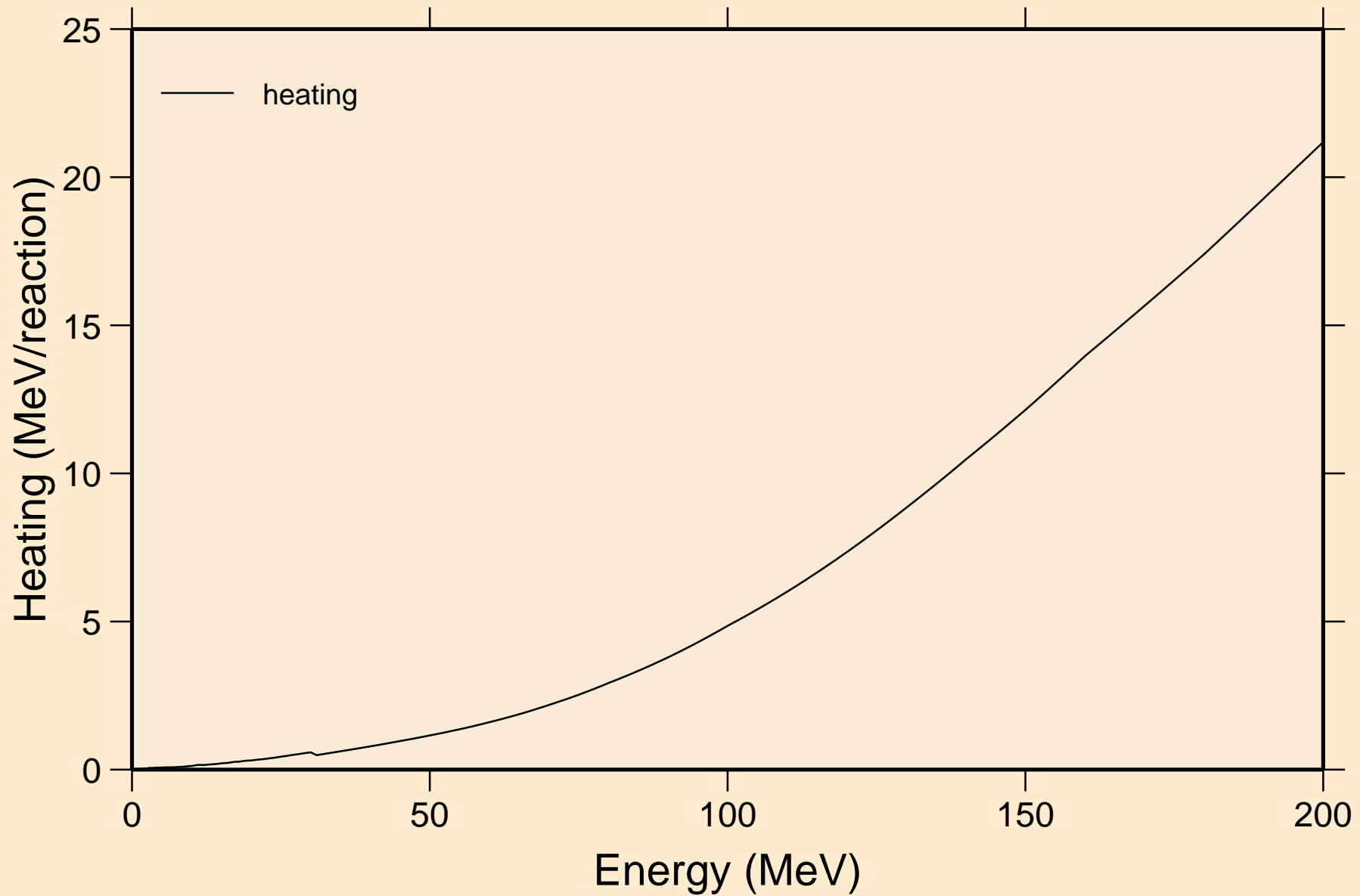

GA081 NEUTRON ACER TENDL-2021 LIBRARY; T=293.6K
Damage

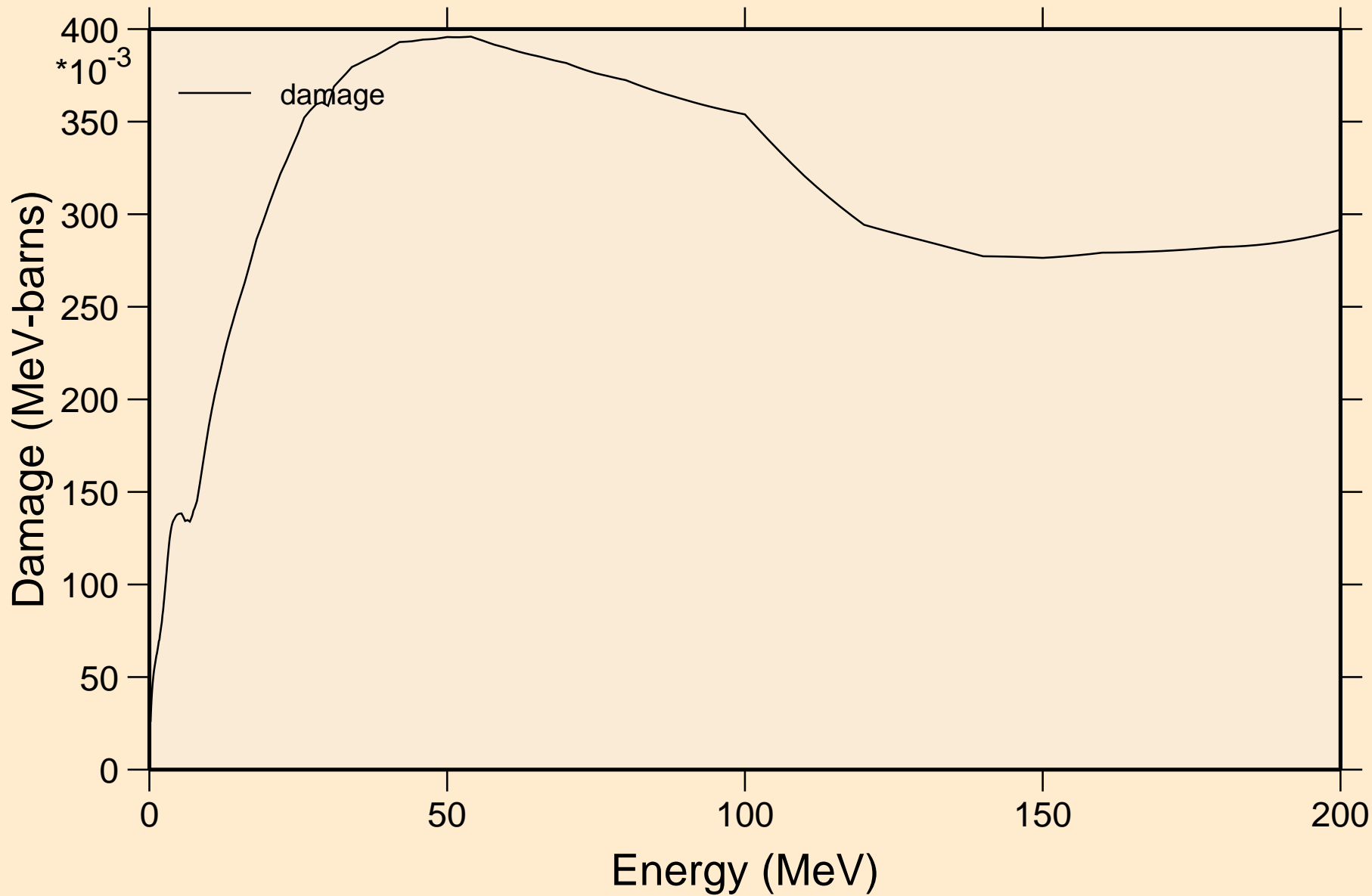

GA081 NEUTRON ACER TENDL-2021 LIBRARY; T=293.6K
Non-threshold reactions

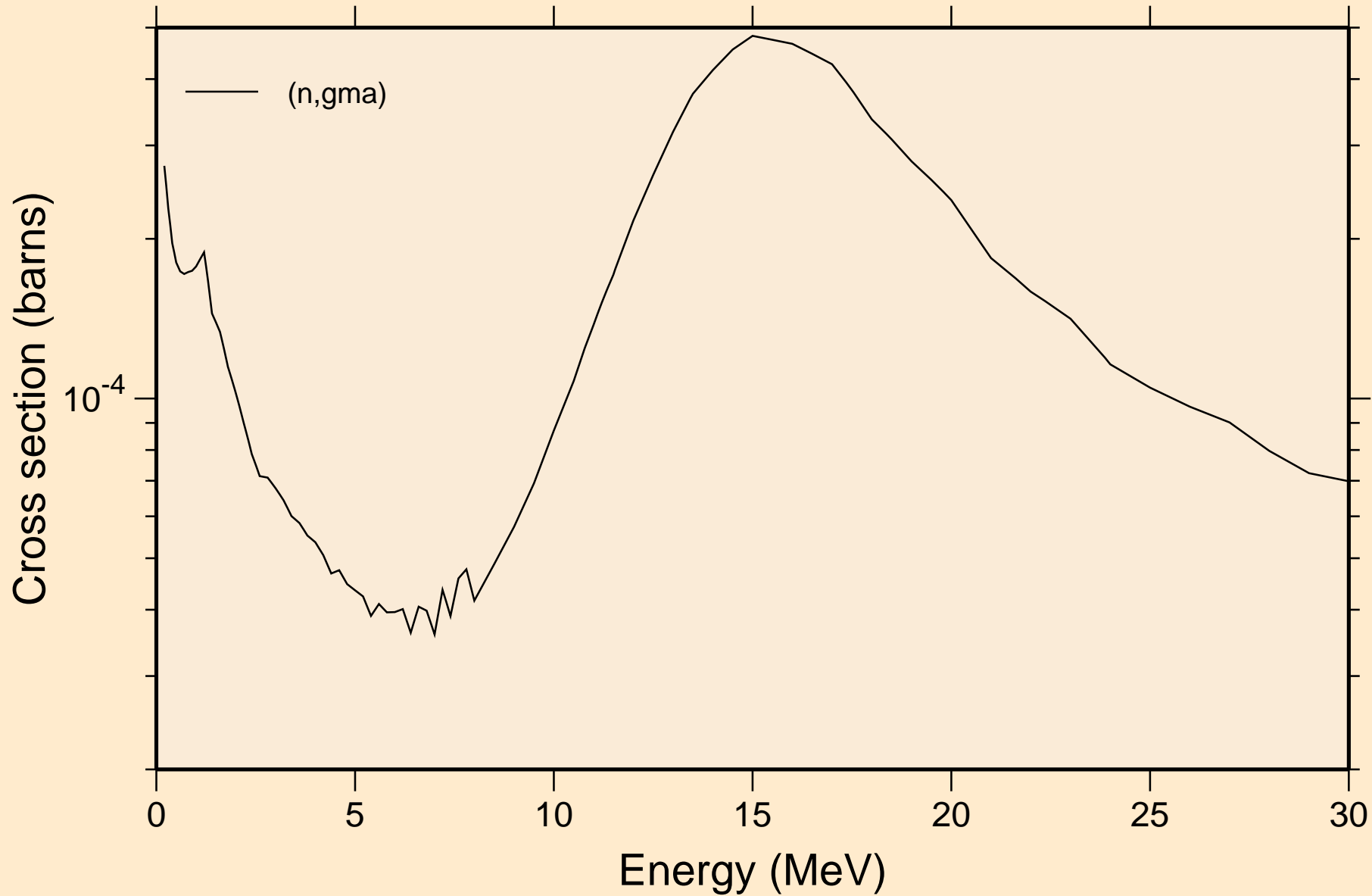

GA081 NEUTRON ACER TENDL-2021 LIBRARY; T=293.6K
Inelastic levels

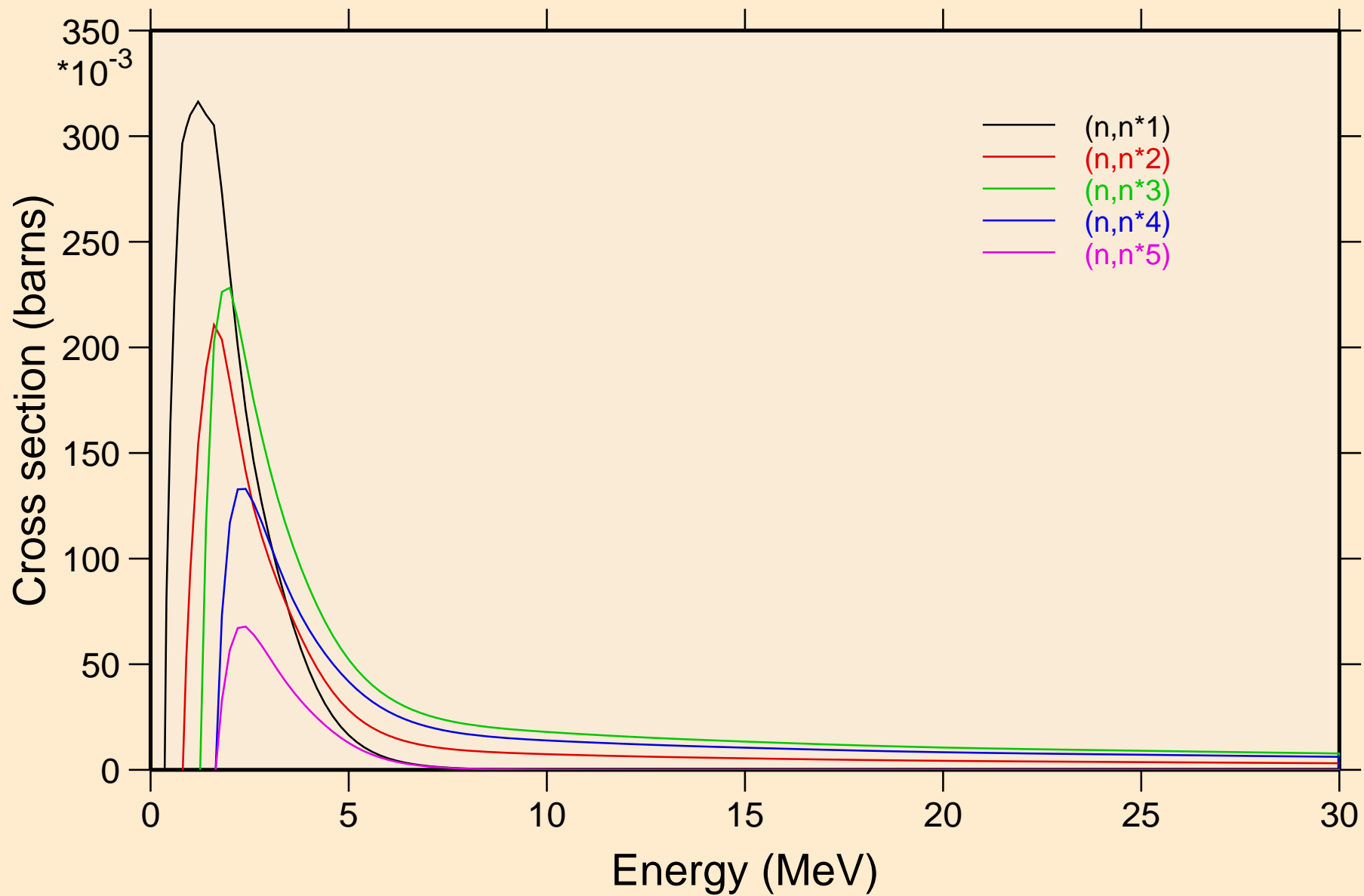

GA081 NEUTRON ACER TENDL-2021 LIBRARY; T=293.6K
Inelastic levels

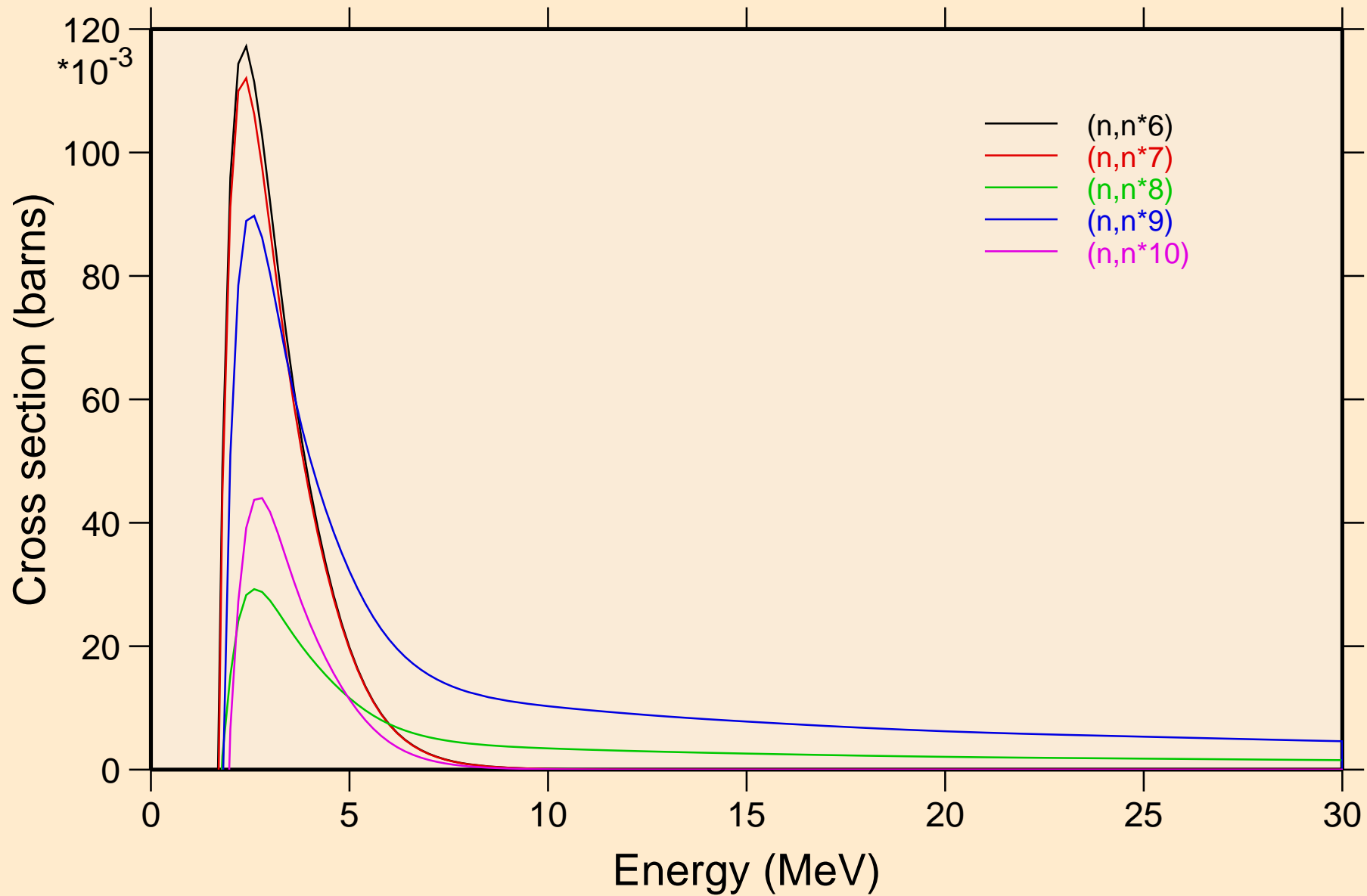

GA081 NEUTRON ACER TENDL-2021 LIBRARY; T=293.6K
Inelastic levels

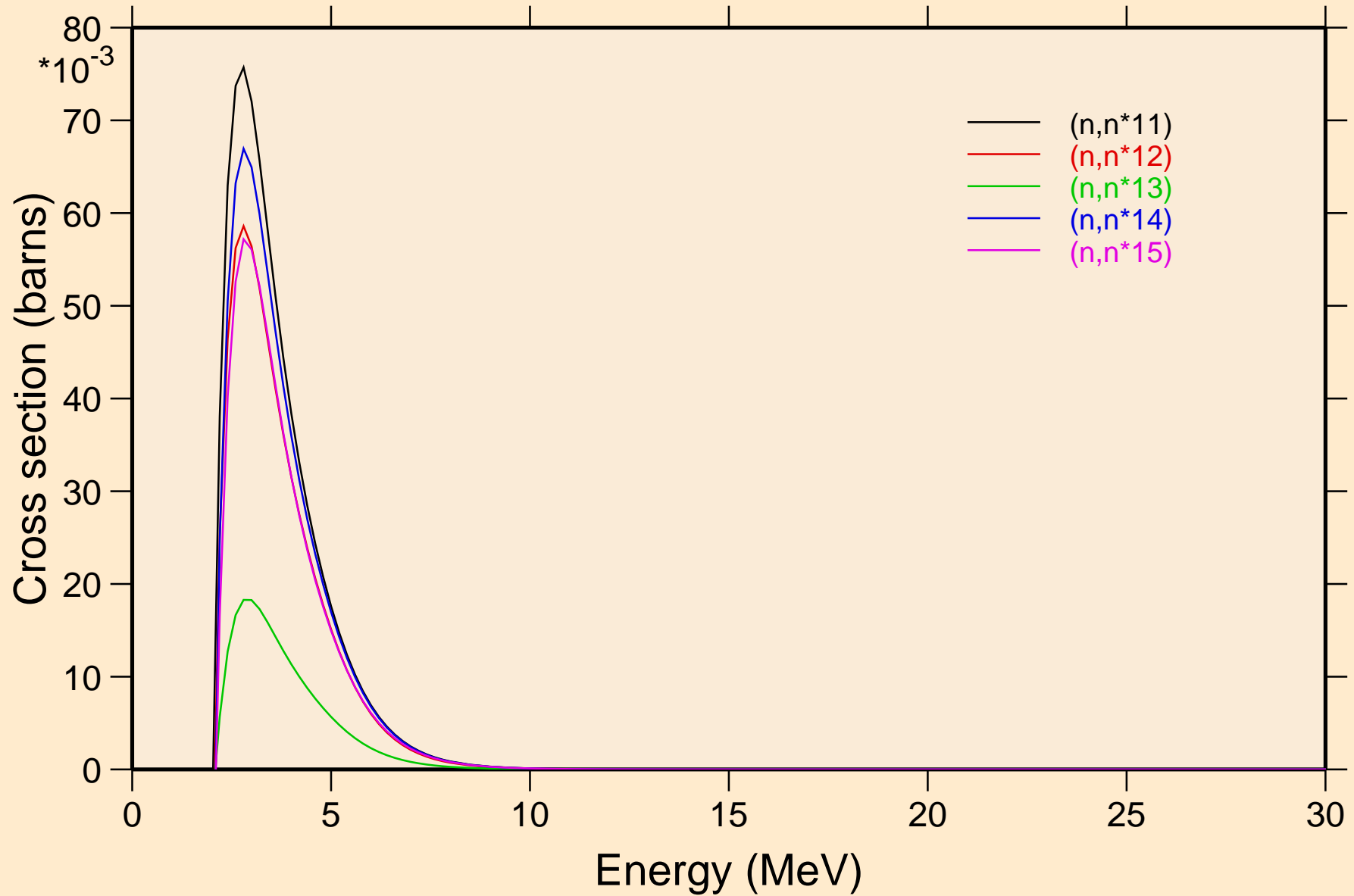

GA081 NEUTRON ACER TENDL-2021 LIBRARY; T=293.6K
Inelastic levels

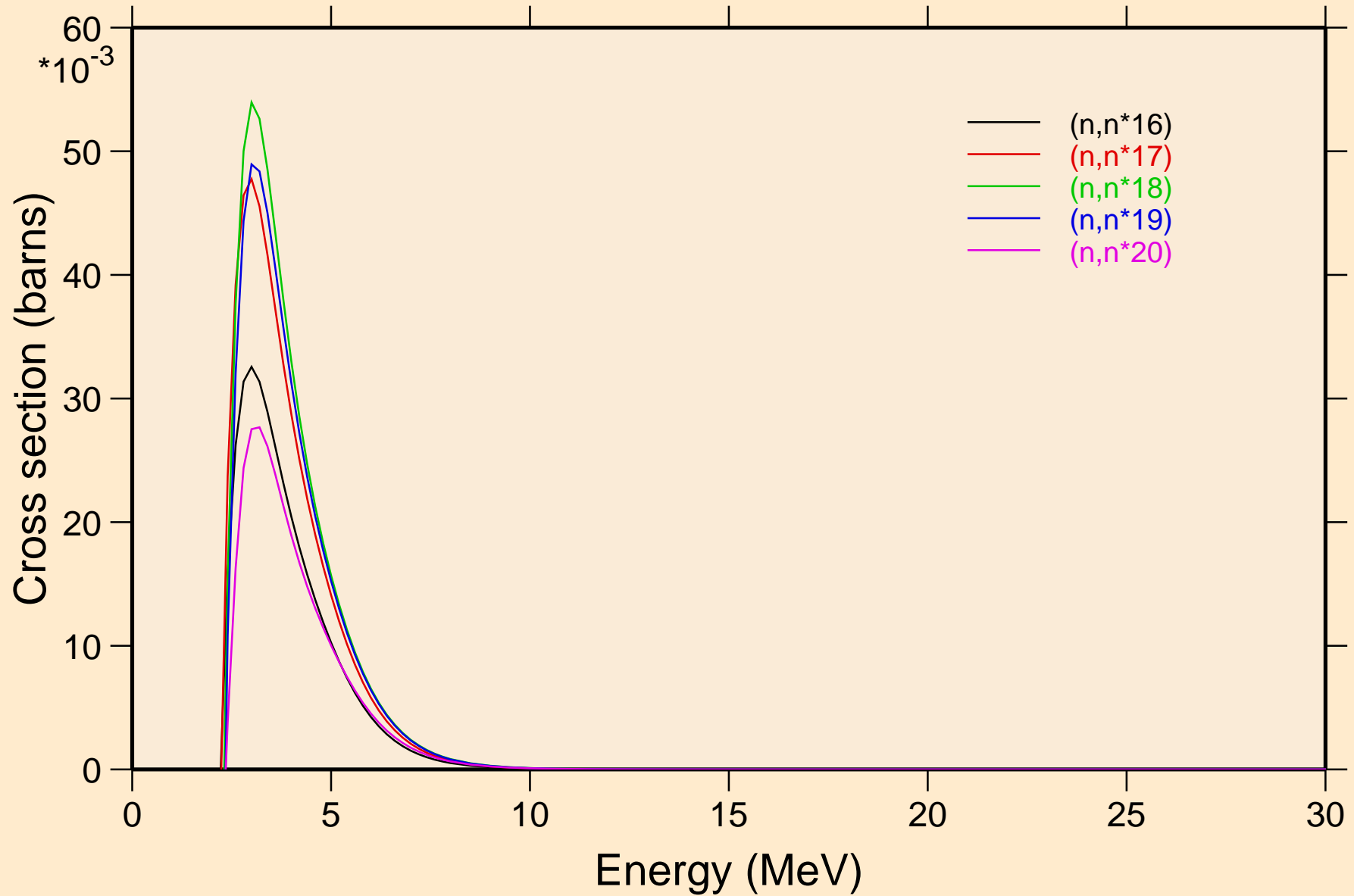

GA081 NEUTRON ACER TENDL-2021 LIBRARY; T=293.6K
Inelastic levels

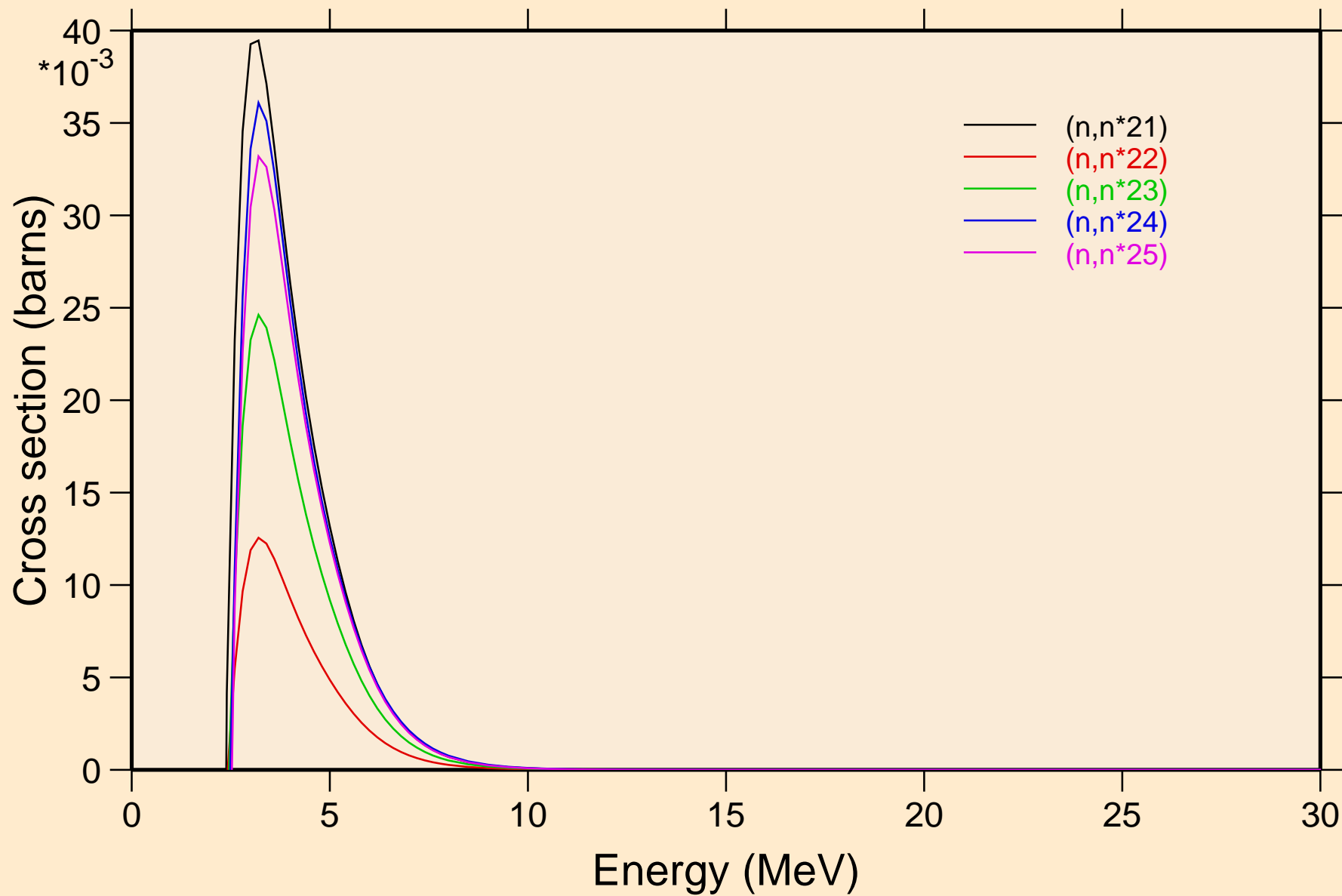

GA081 NEUTRON ACER TENDL-2021 LIBRARY; T=293.6K
Inelastic levels

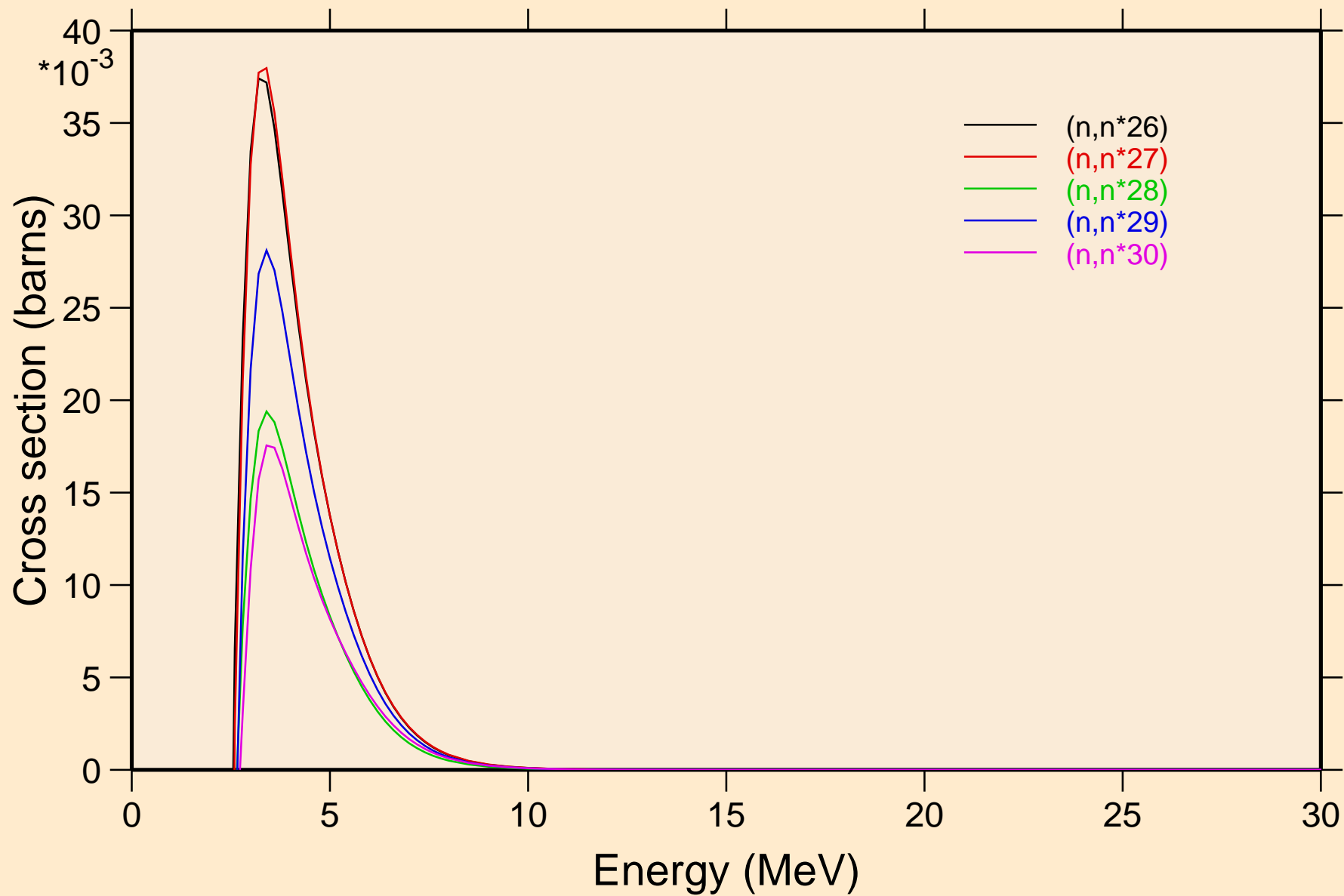

GA081 NEUTRON ACER TENDL-2021 LIBRARY; T=293.6K
Threshold reactions

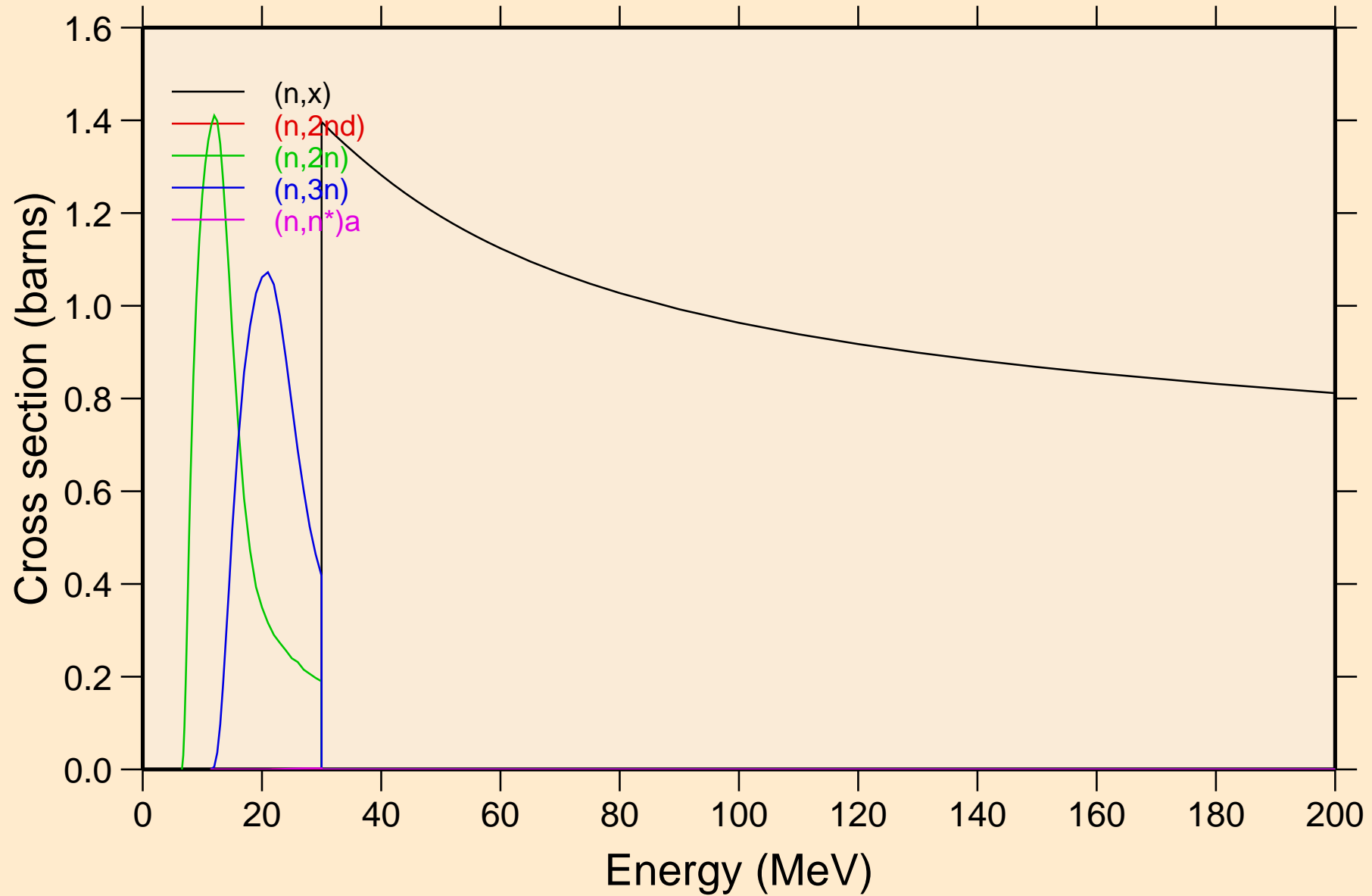

GA081 NEUTRON ACER TENDL-2021 LIBRARY; T=293.6K

Threshold reactions

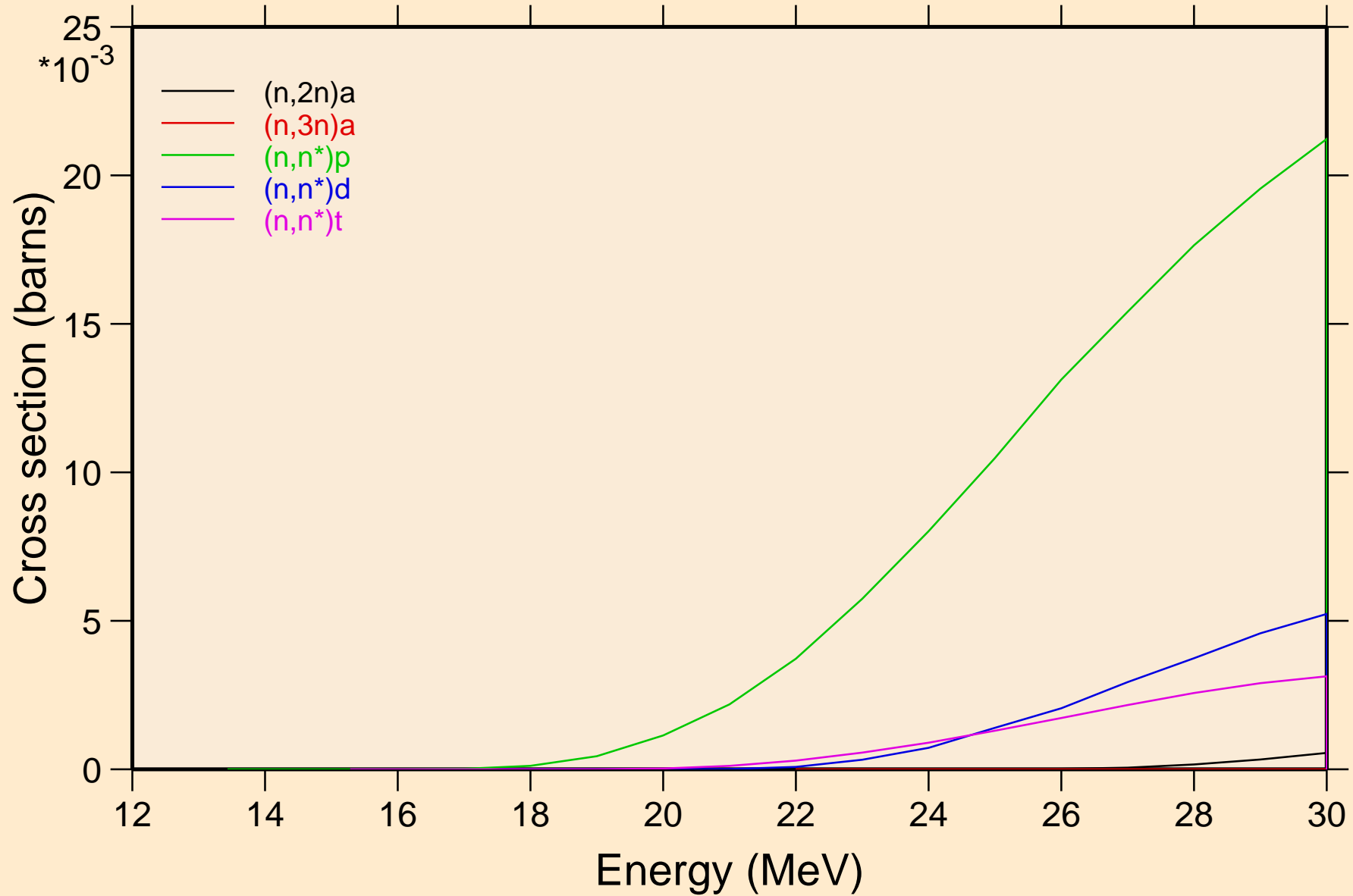

GA081 NEUTRON ACER TENDL-2021 LIBRARY; T=293.6K
Threshold reactions

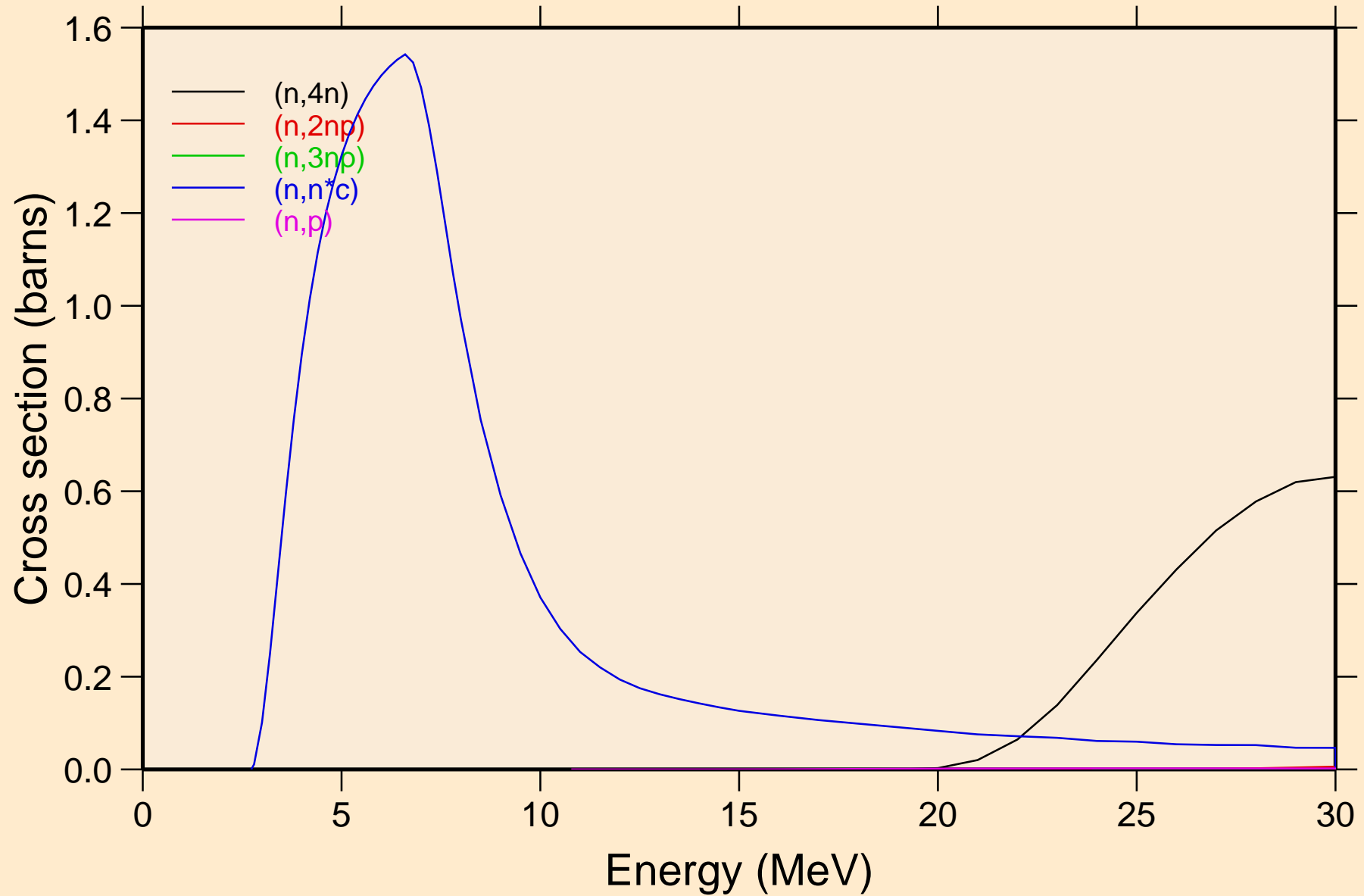

GA081 NEUTRON ACER TENDL-2021 LIBRARY; T=293.6K
Threshold reactions

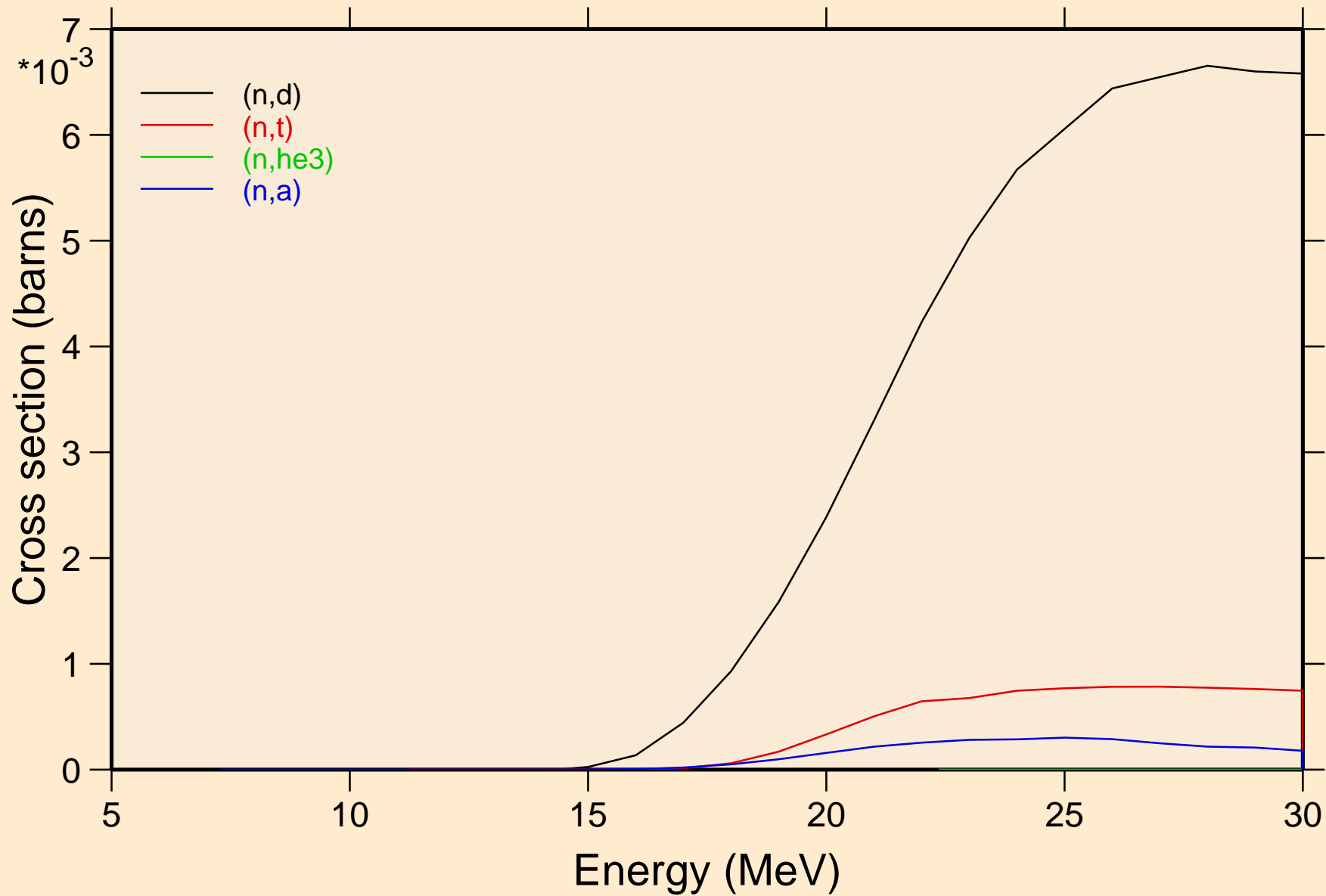

GA081 NEUTRON ACER TENDL-2021 LIBRARY; T=293.6K
Threshold reactions

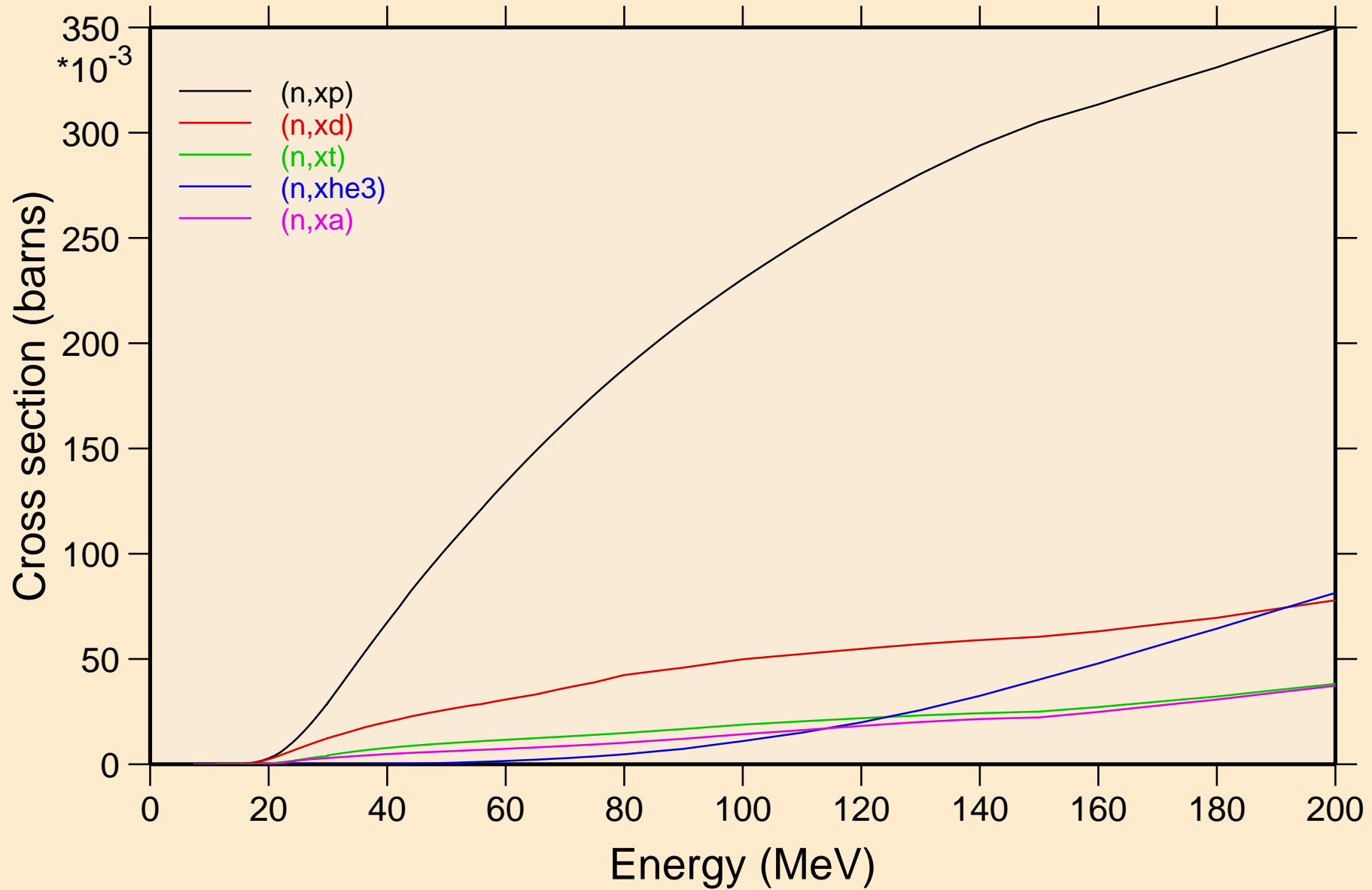

GA081 NEUTRON ACER TENDL-2021 LIBRARY; T=293.6K
angular distribution for elastic

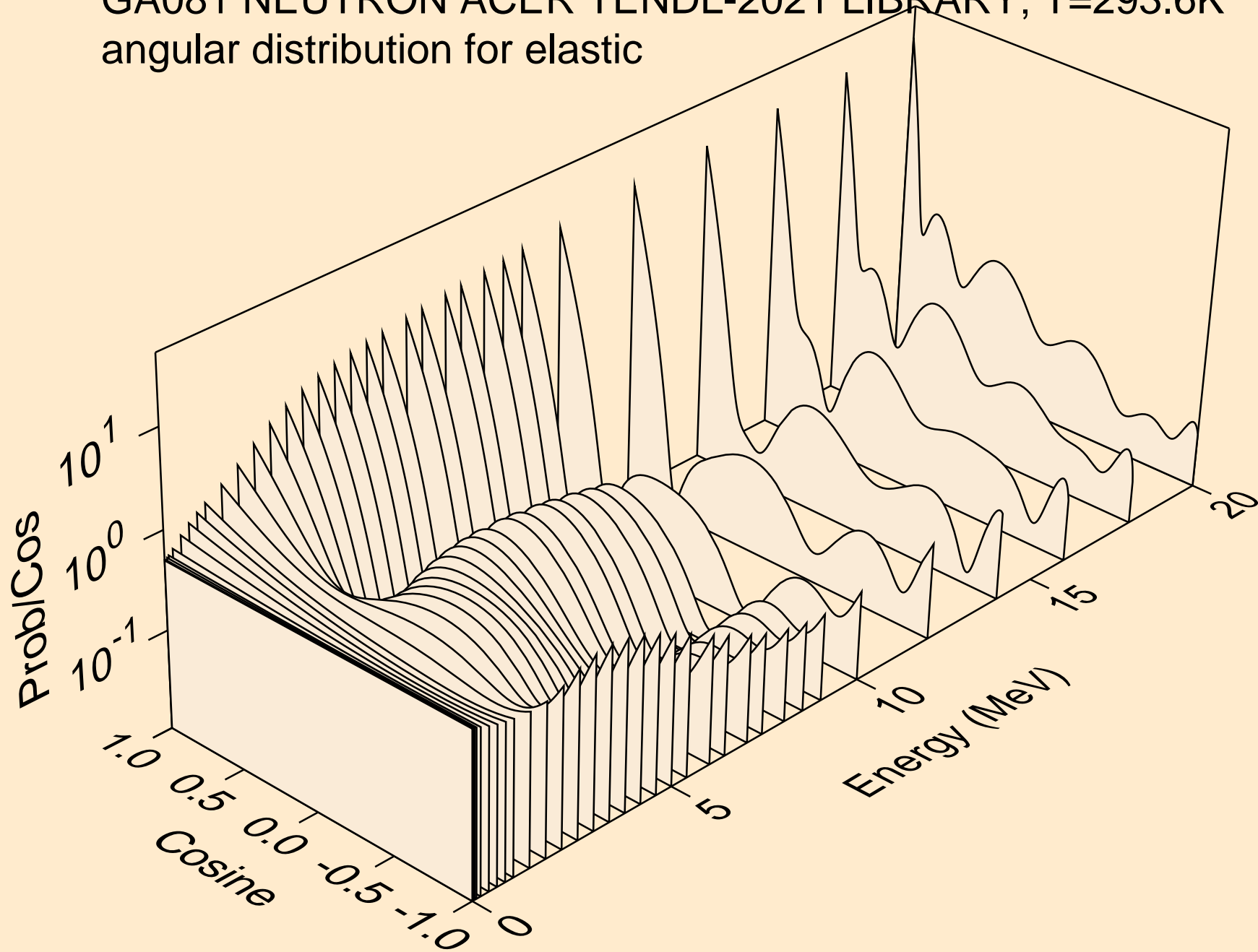

GA081 NEUTRON ACER TENDL-2021 LIBRARY; T=293.6K
angular distribution for elastic

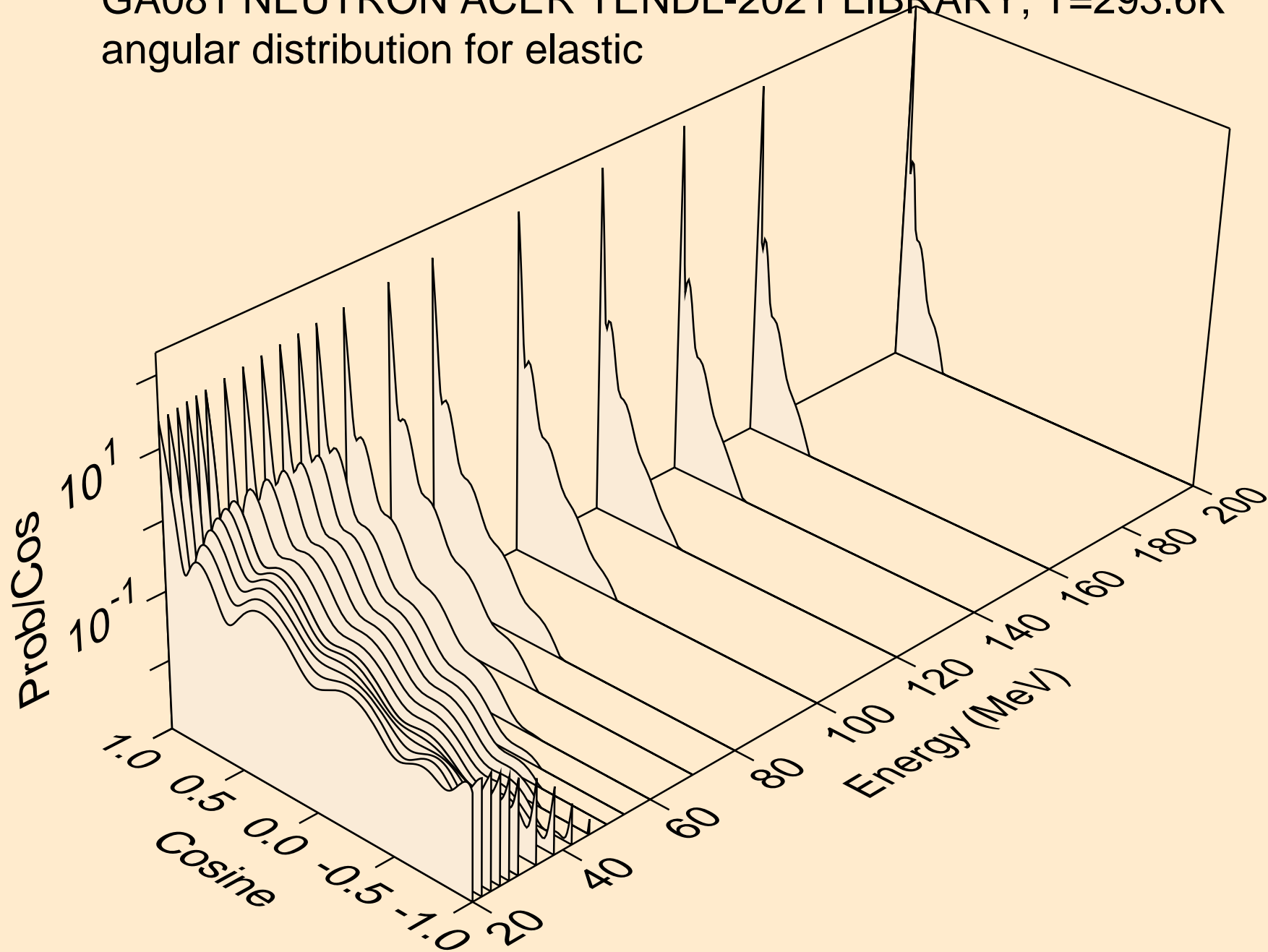

GA081 NEUTRON ACER TENDL-2021 LIBRARY; T=293.6K
angular distribution for (n,n*1)

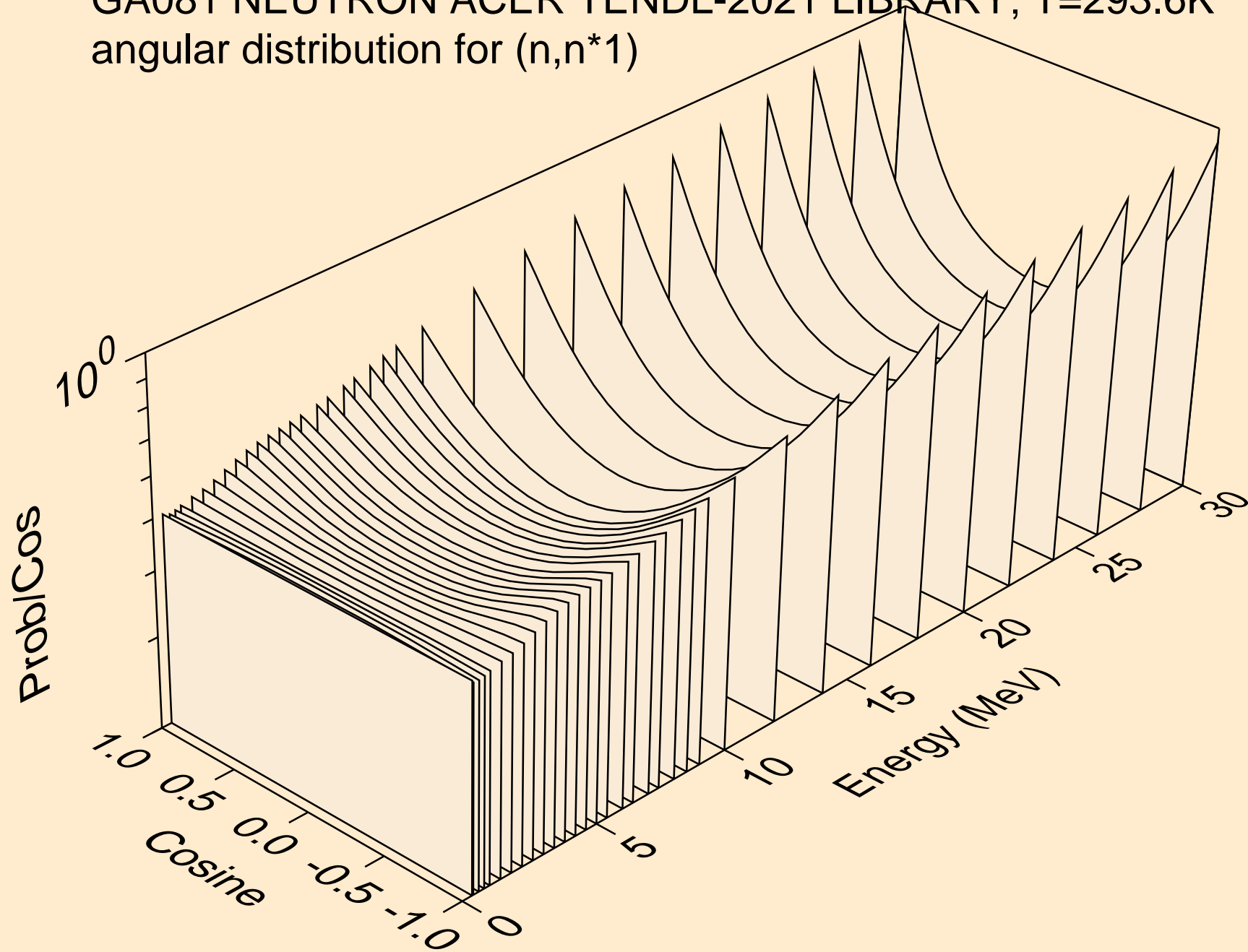

GA081 NEUTRON ACER TENDL-2021 LIBRARY; T=293.6K
angular distribution for (n,n*2)

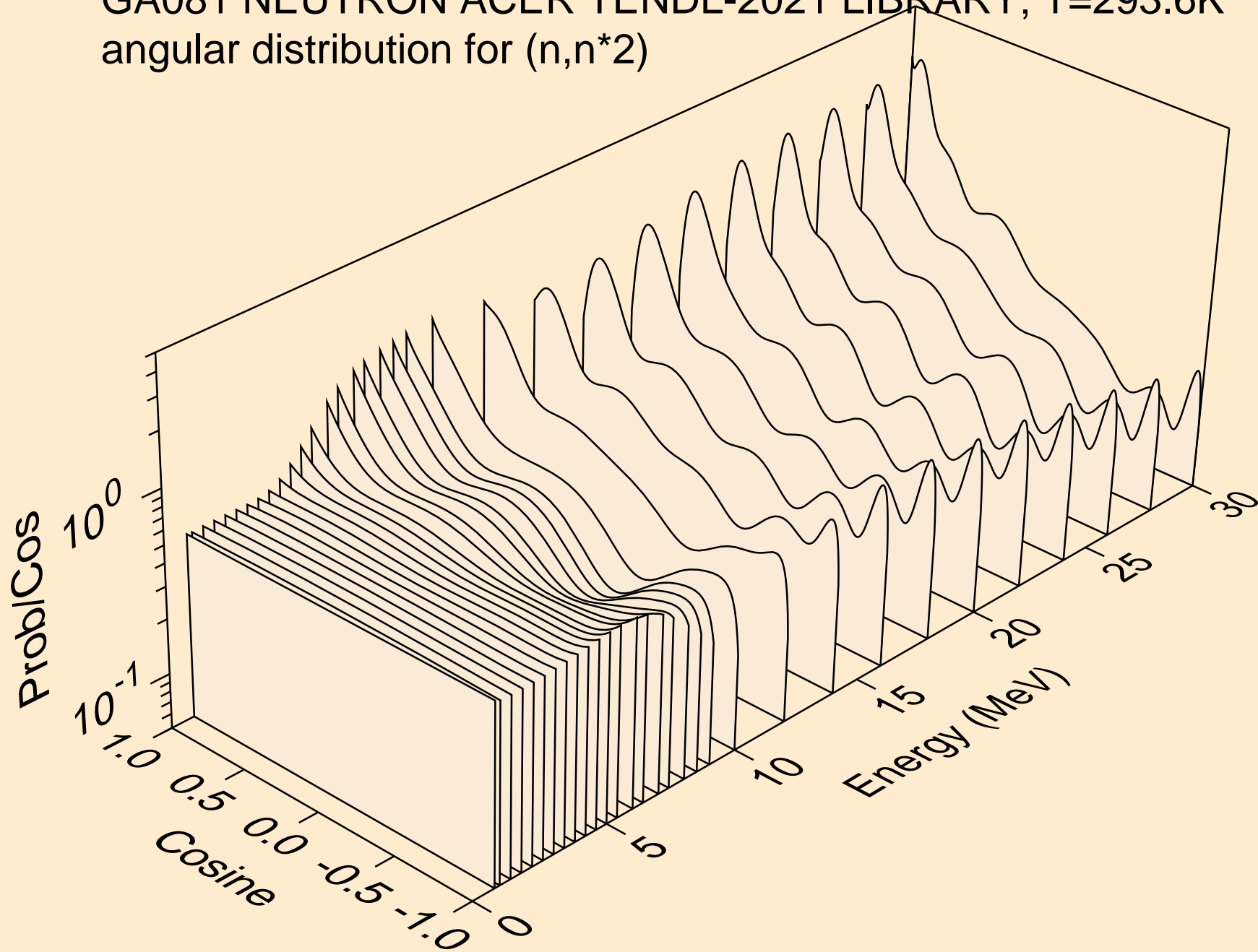

GA081 NEUTRON ACER TENDL-2021 LIBRARY; T=293.6K
angular distribution for (n,n*3)

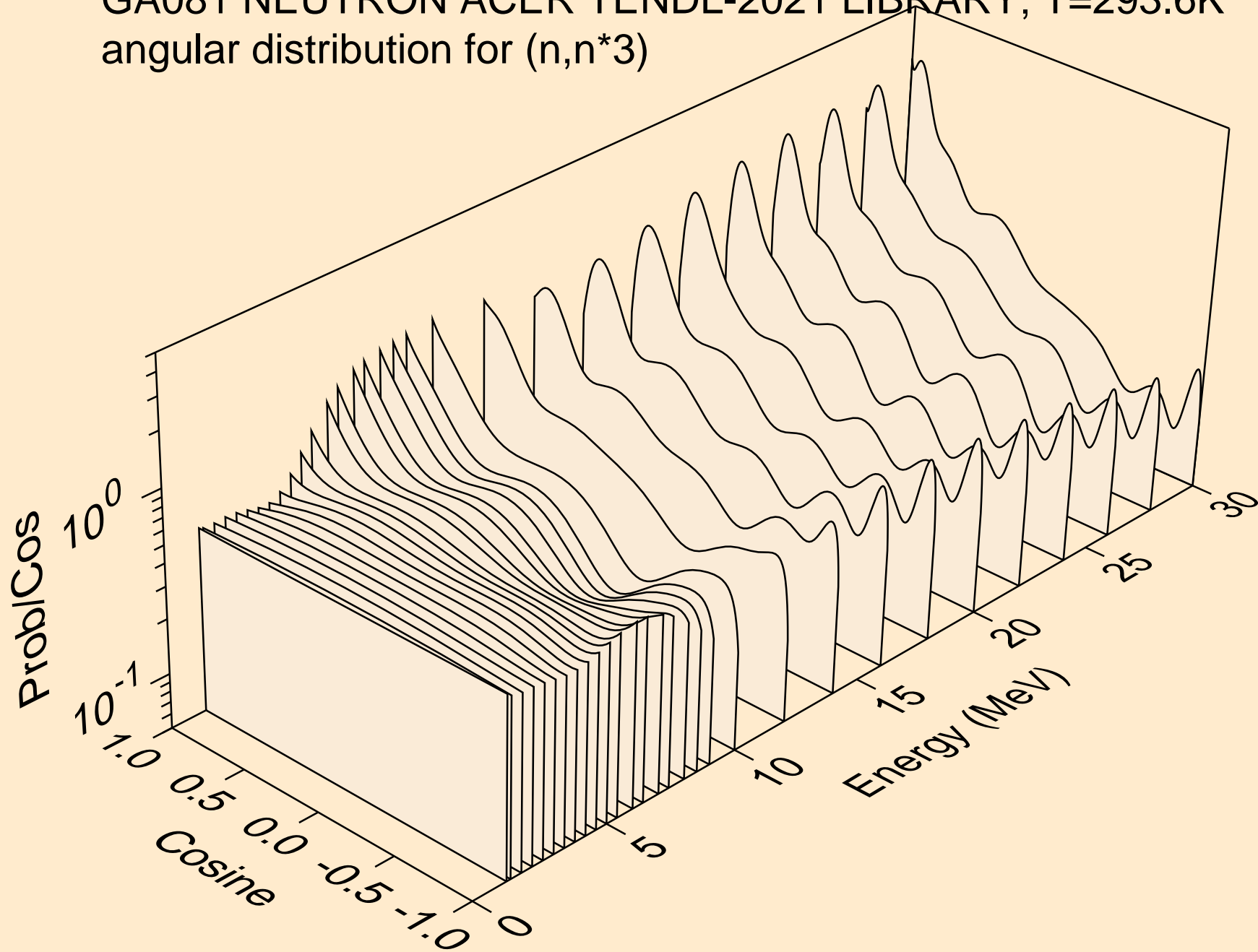

GA081 NEUTRON ACER TENDL-2021 LIBRARY; T=293.6K
angular distribution for (n,n*4)

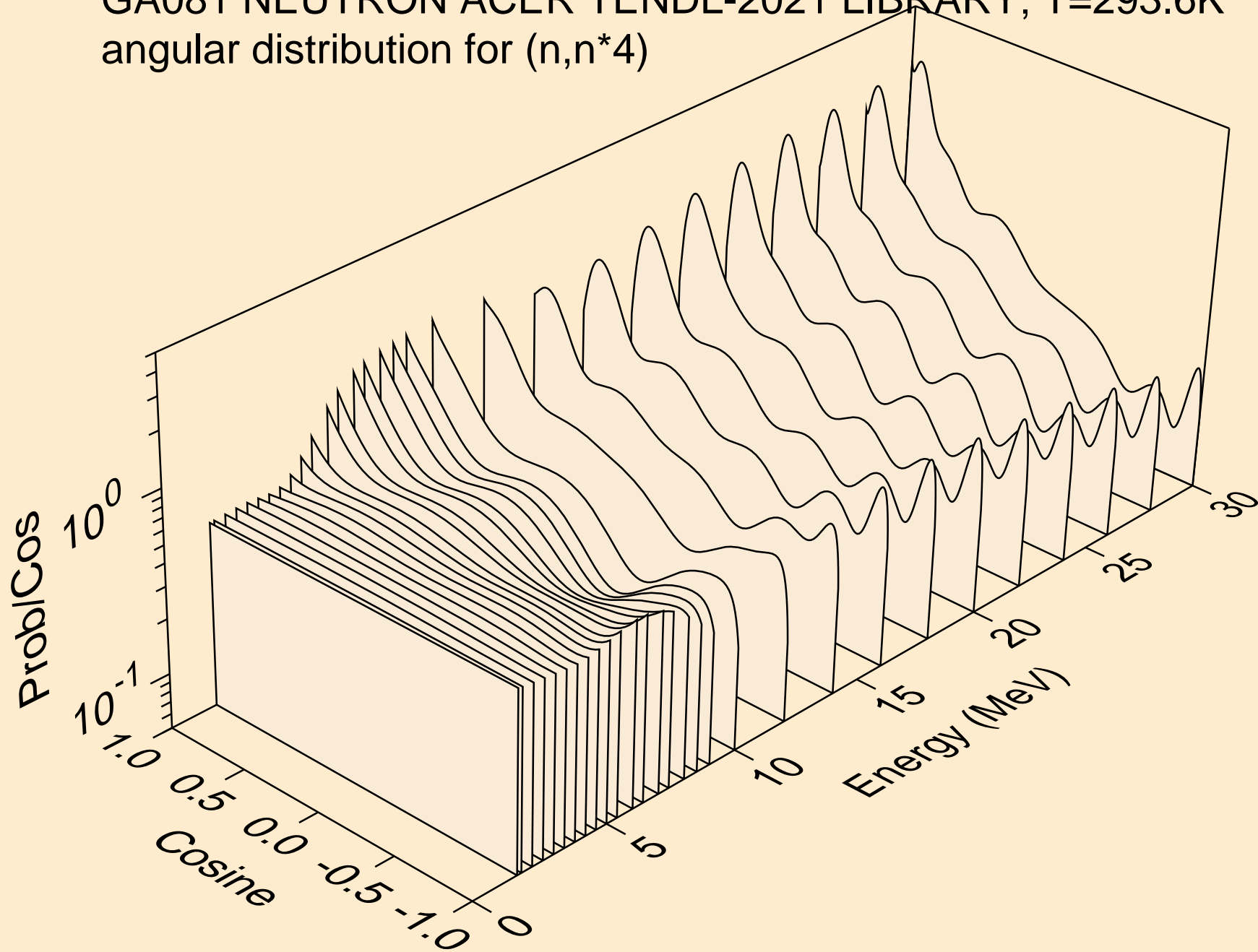

GA081 NEUTRON ACER TENDL-2021 LIBRARY; T=293.6K
angular distribution for (n,n*5)

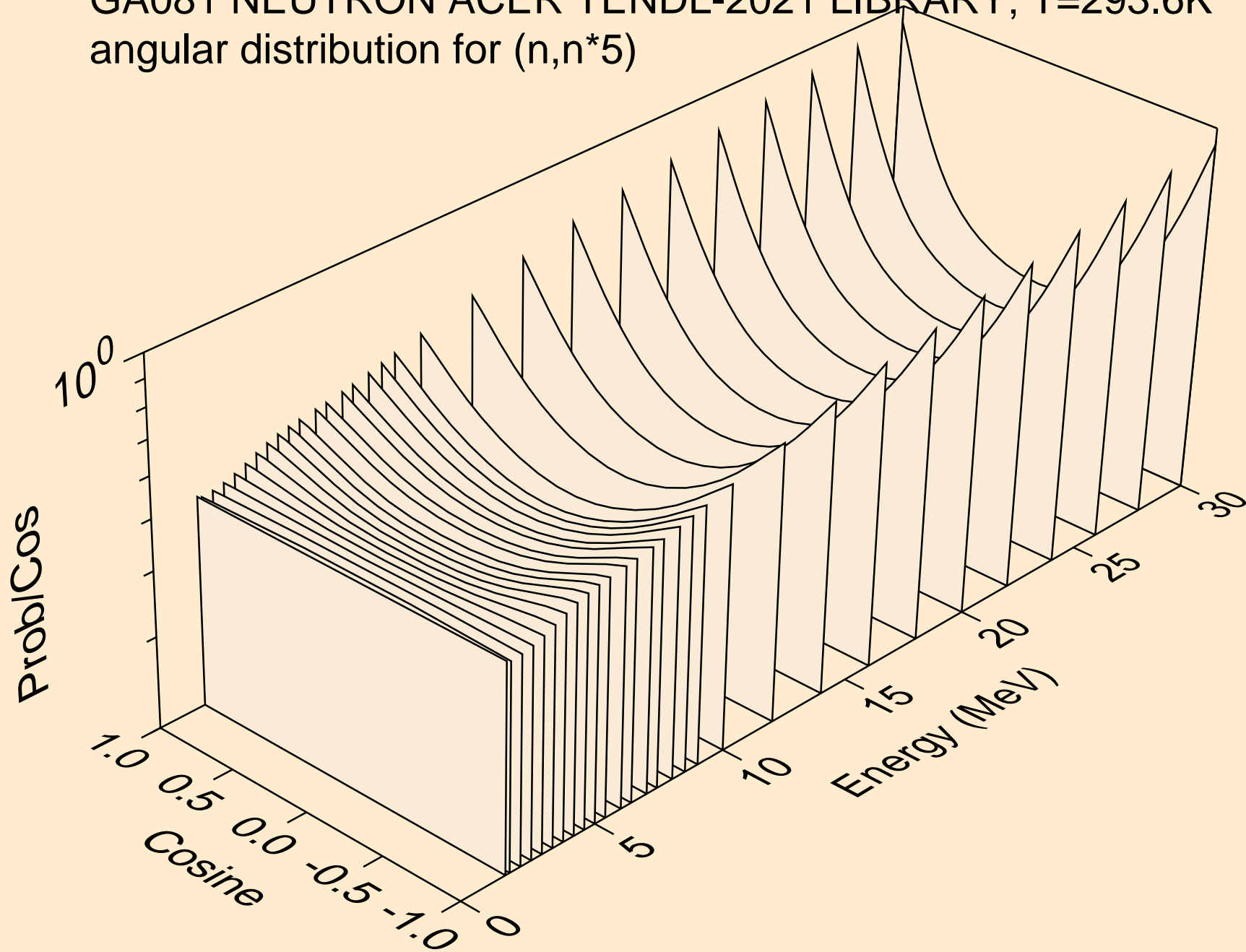

GA081 NEUTRON ACER TENDL-2021 LIBRARY; T=293.6K
angular distribution for (n,n*6)

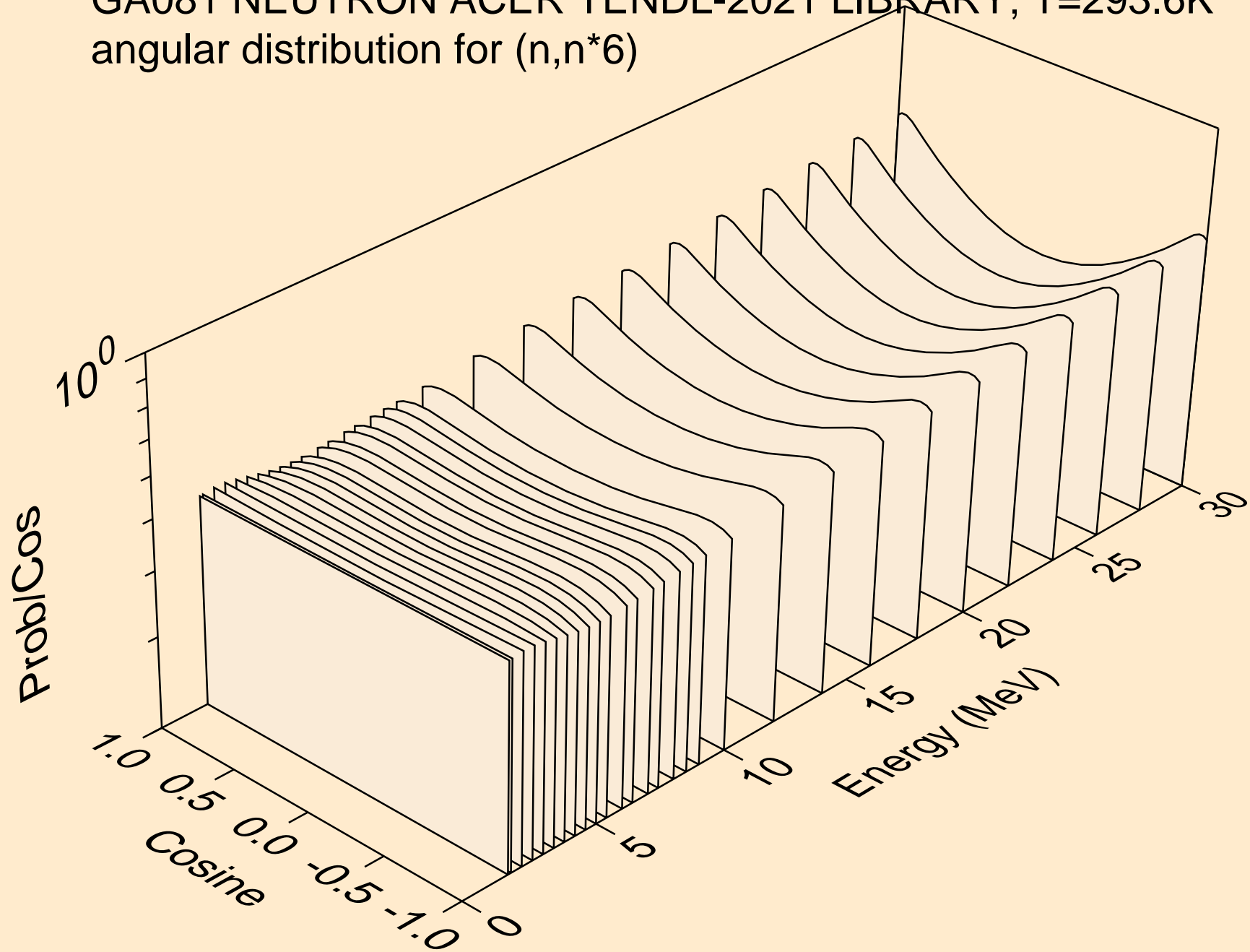

GA081 NEUTRON ACER TENDL-2021 LIBRARY; T=293.6K
angular distribution for (n,n*7)

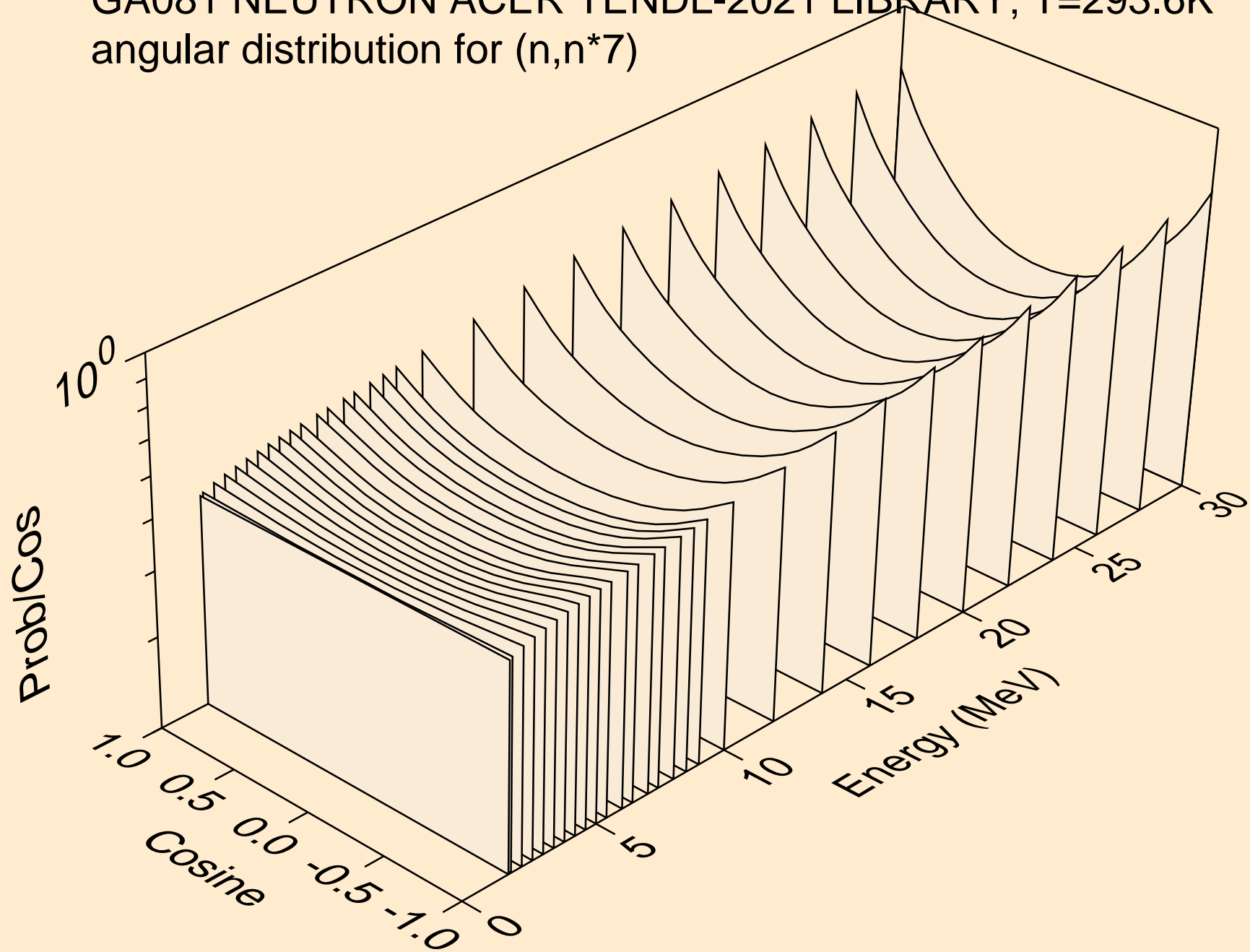

GA081 NEUTRON ACER TENDL-2021 LIBRARY; T=293.6K
angular distribution for (n,n*8)

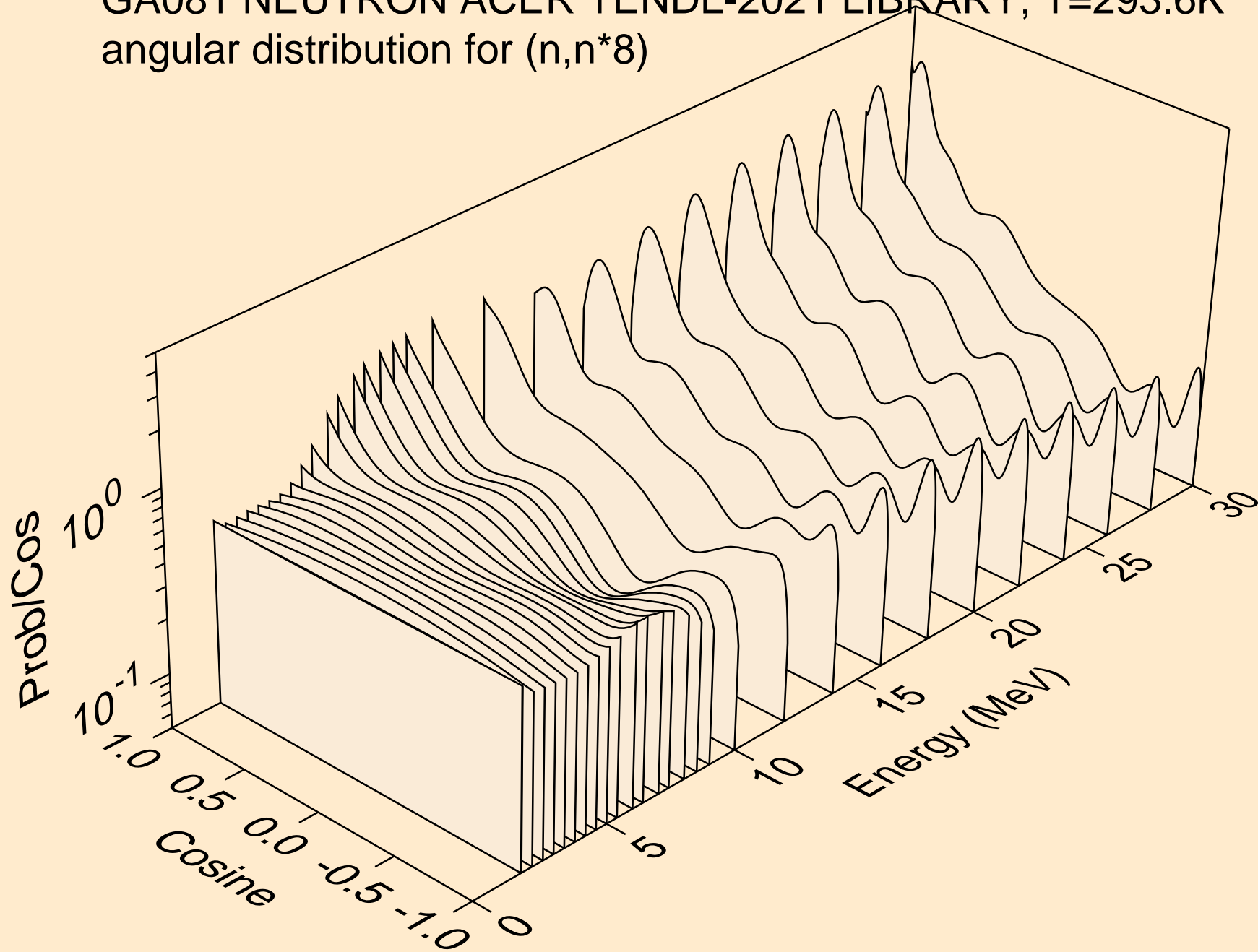

GA081 NEUTRON ACER TENDL-2021 LIBRARY; T=293.6K
angular distribution for (n,n*9)

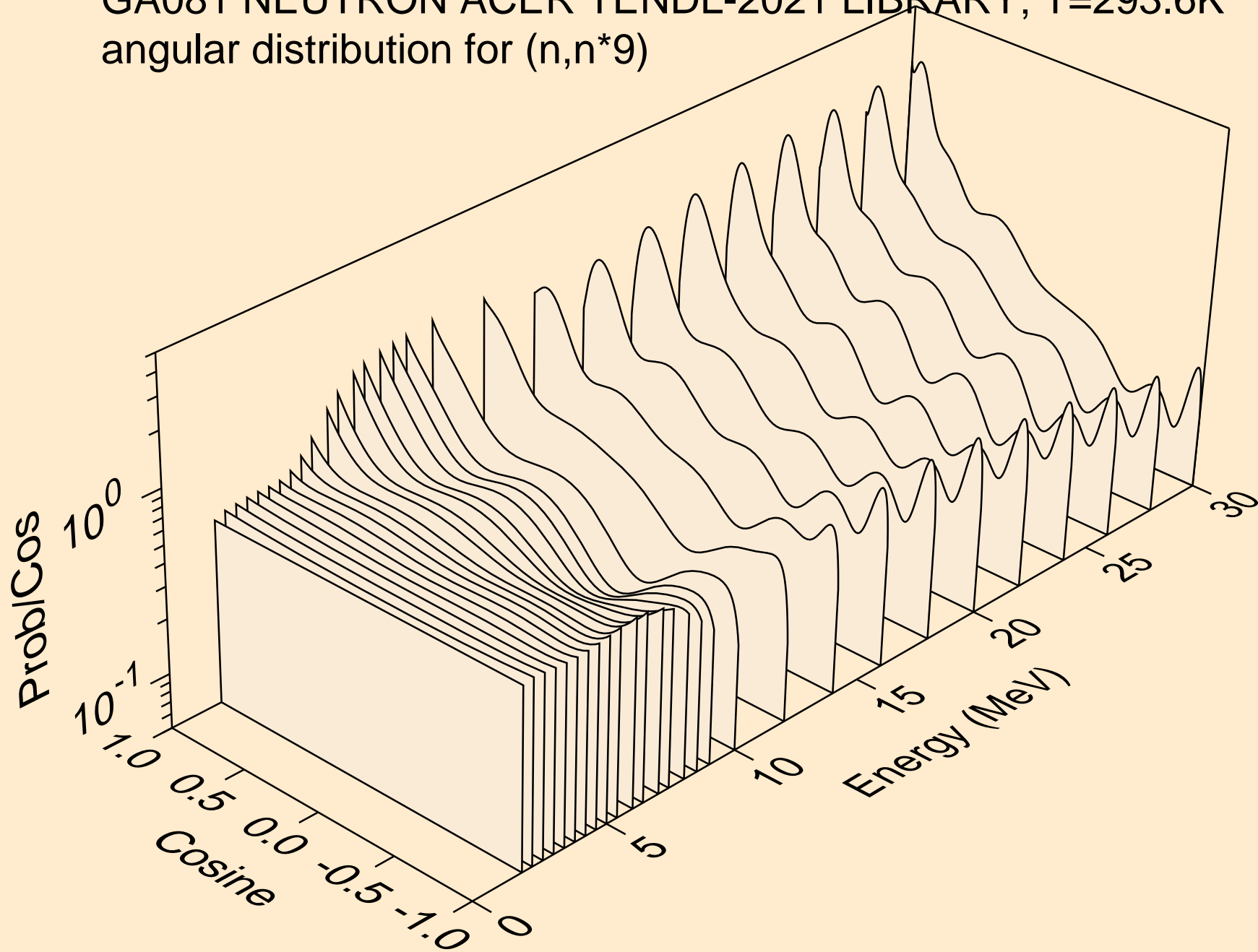

GA081 NEUTRON ACER TENDL-2021 LIBRARY; T=293.6K
angular distribution for (n,n*10)

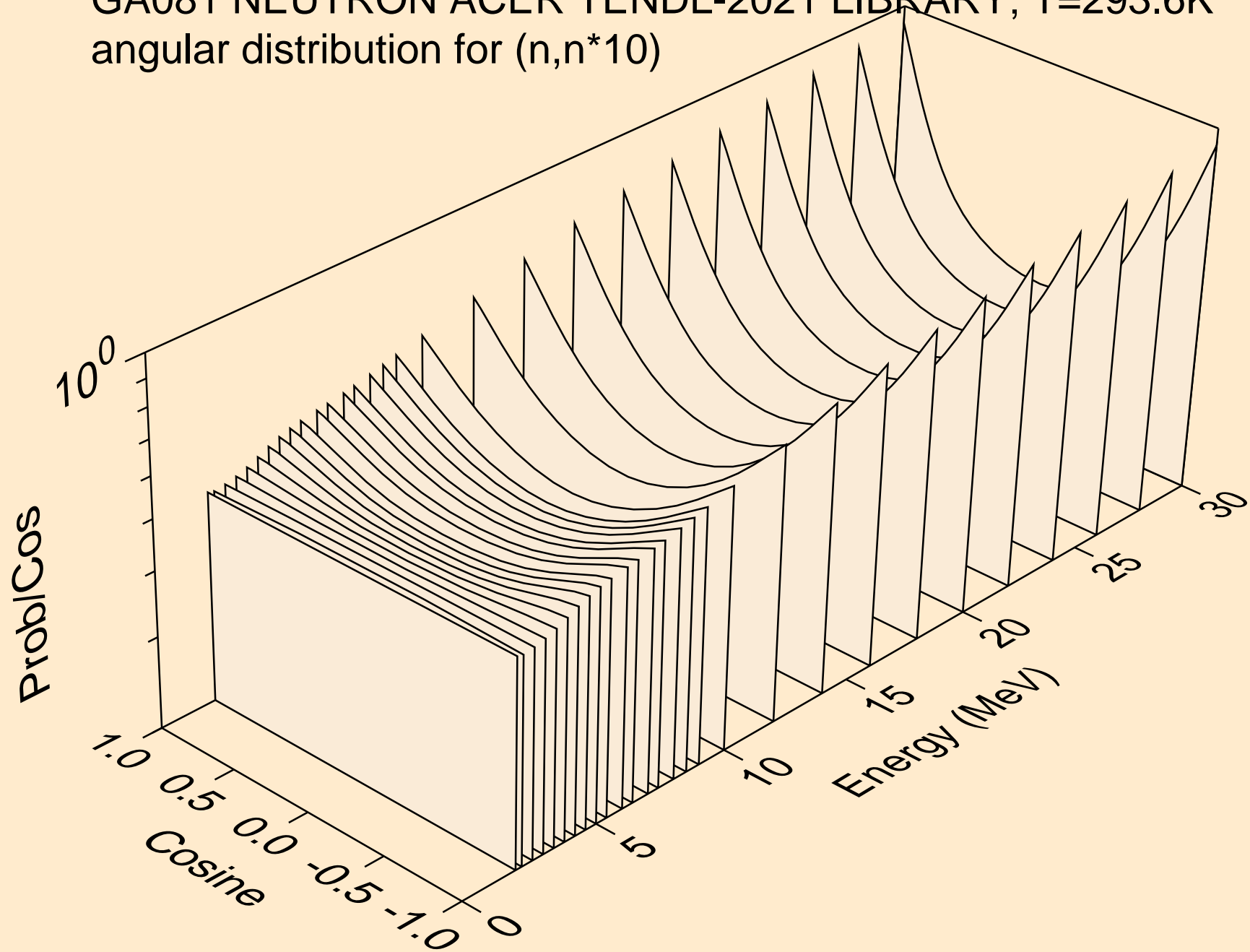

GA081 NEUTRON ACER TENDL-2021 LIBRARY; T=293.6K
angular distribution for (n,n*11)

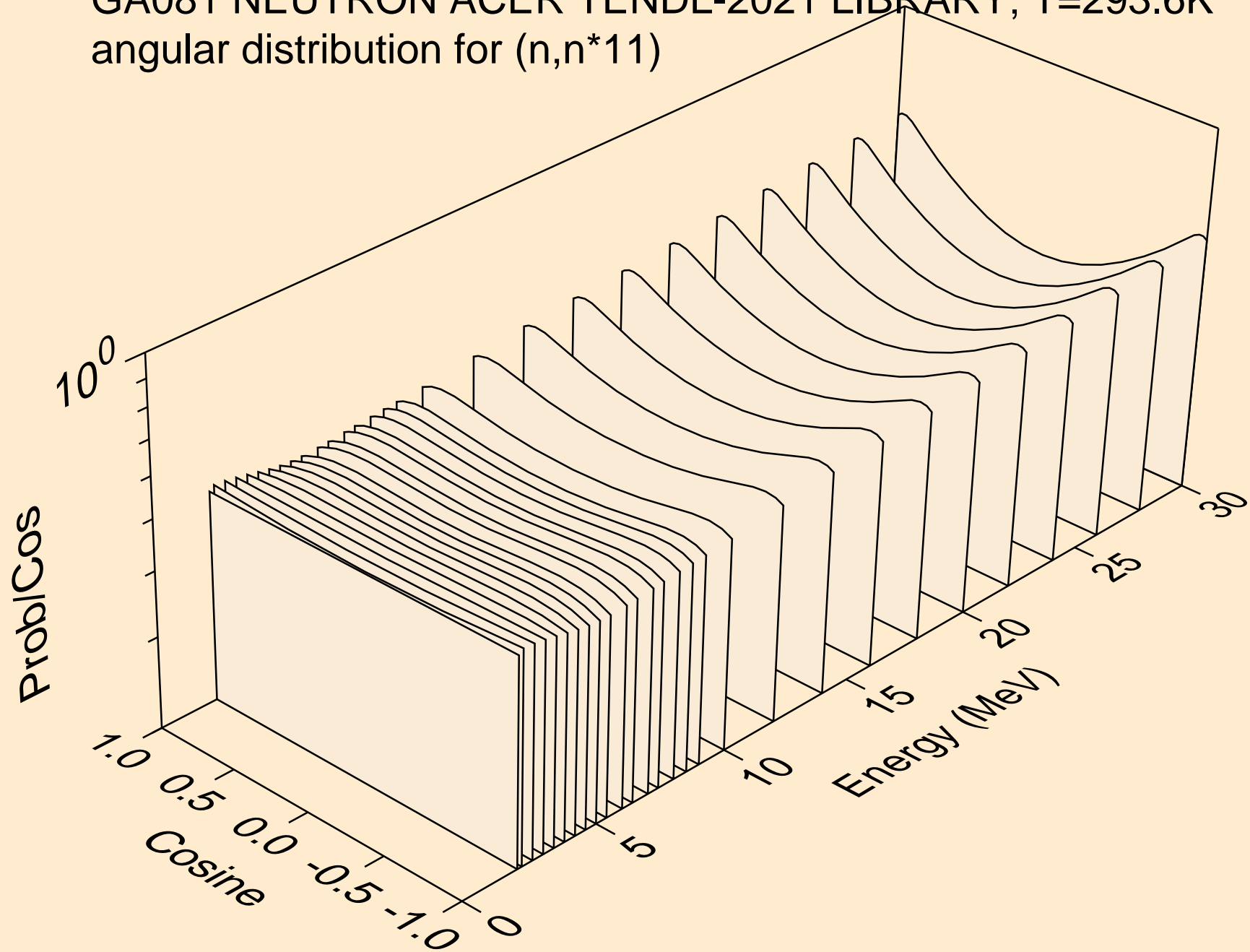

GA081 NEUTRON ACER TENDL-2021 LIBRARY; T=293.6K
angular distribution for (n,n*12)

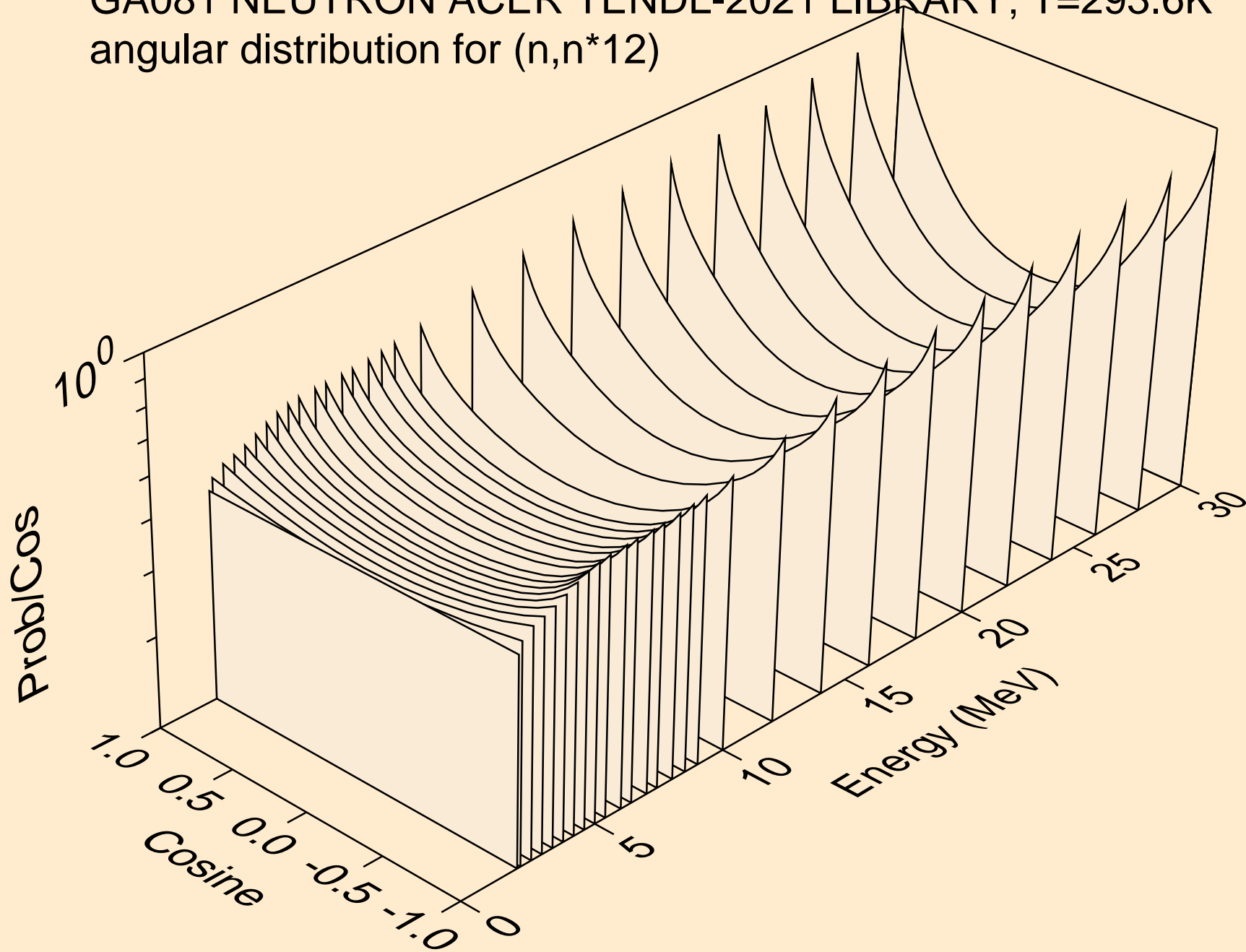

GA081 NEUTRON ACER TENDL-2021 LIBRARY; T=293.6K
angular distribution for (n,n*13)

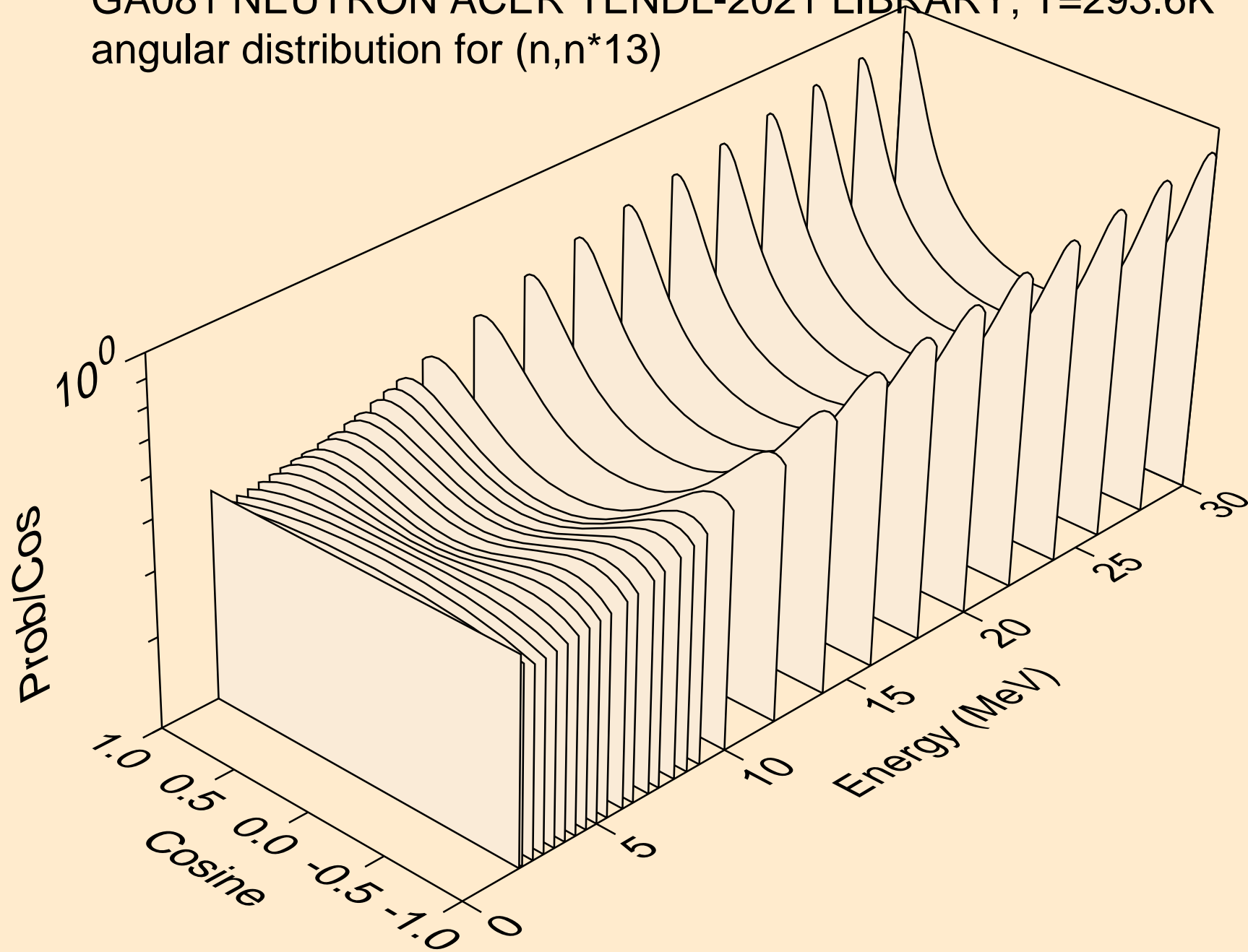

GA081 NEUTRON ACER TENDL-2021 LIBRARY; T=293.6K
angular distribution for (n,n*14)

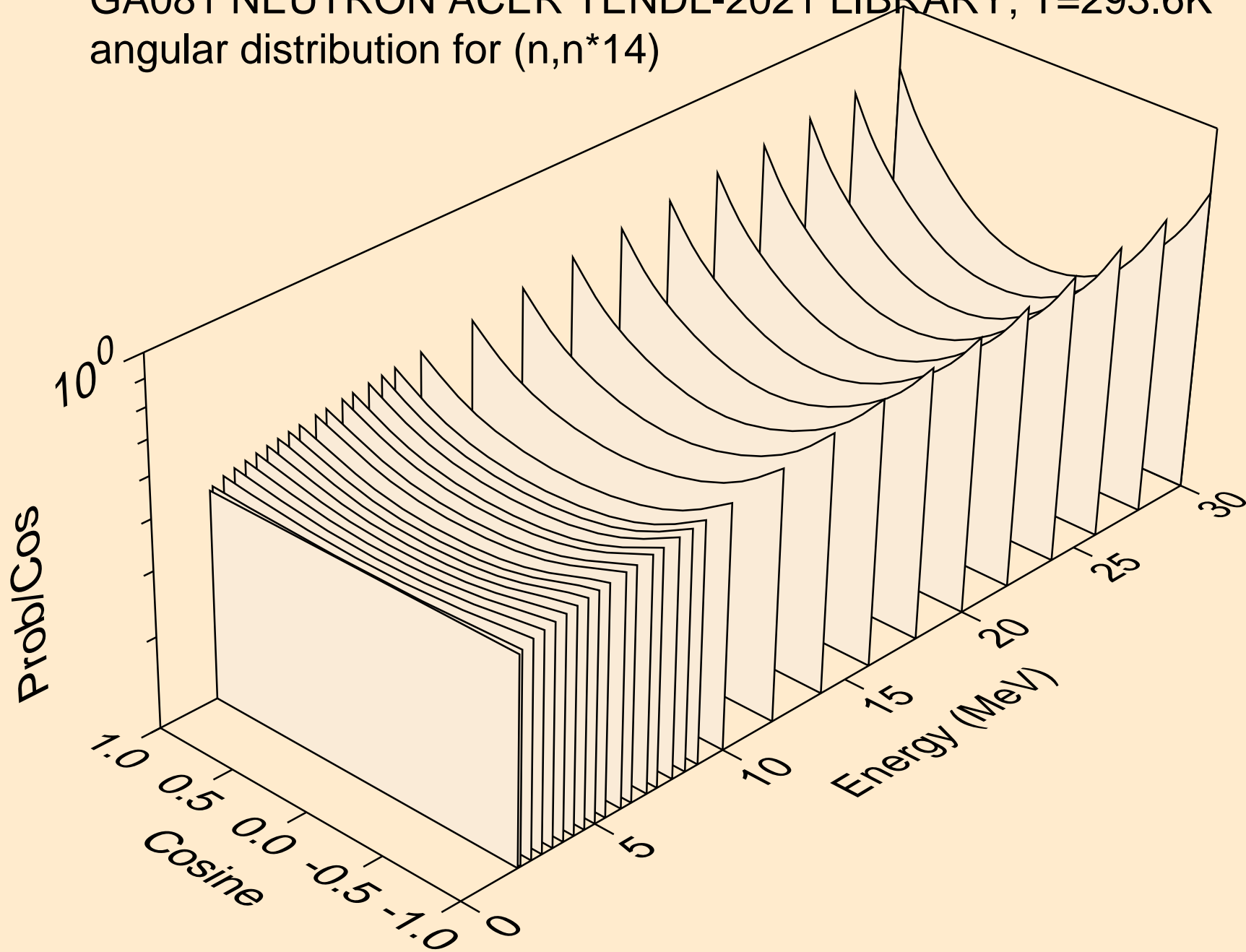

GA081 NEUTRON ACER TENDL-2021 LIBRARY; T=293.6K
angular distribution for (n,n*15)

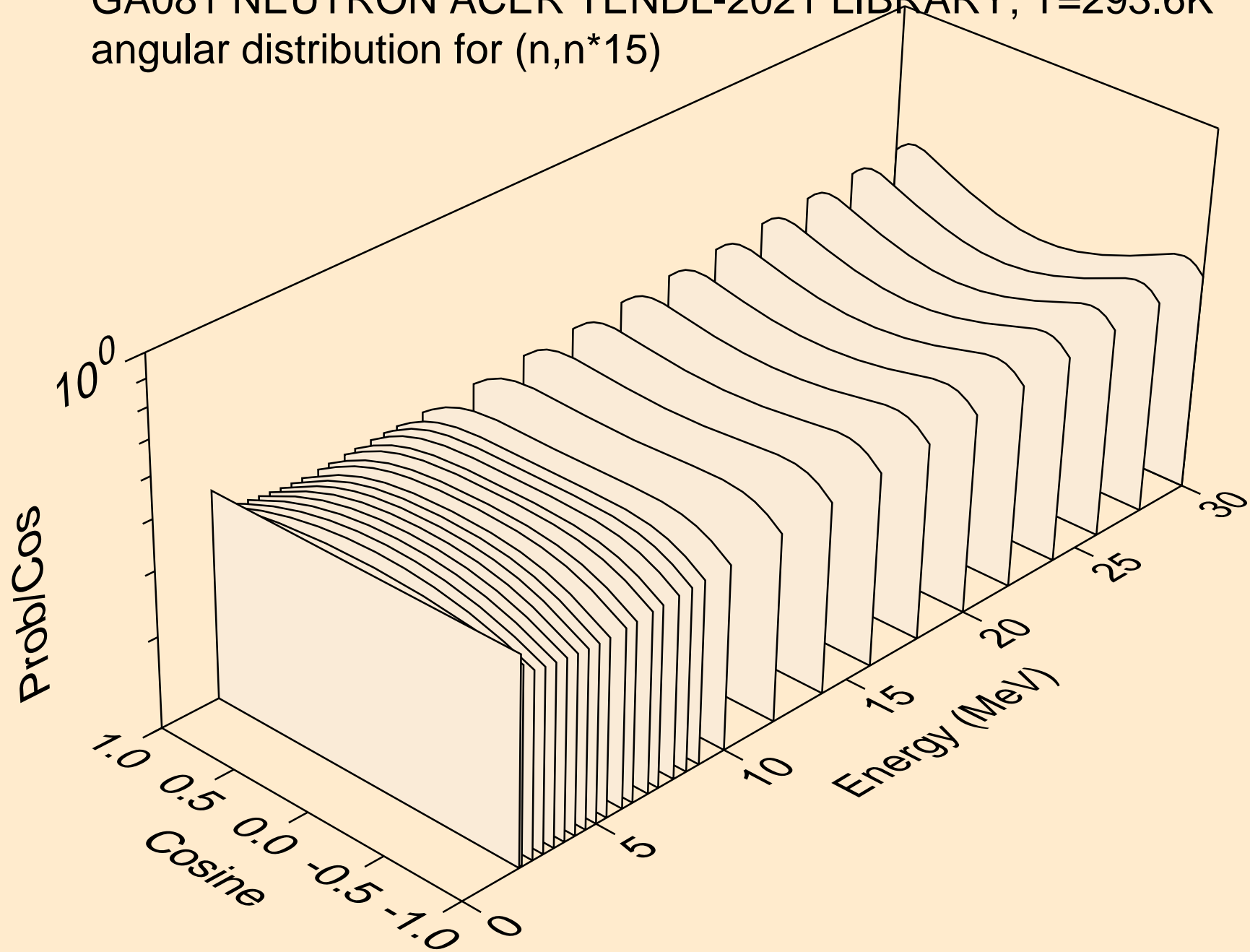

GA081 NEUTRON ACER TENDL-2021 LIBRARY; T=293.6K
angular distribution for (n,n*16)

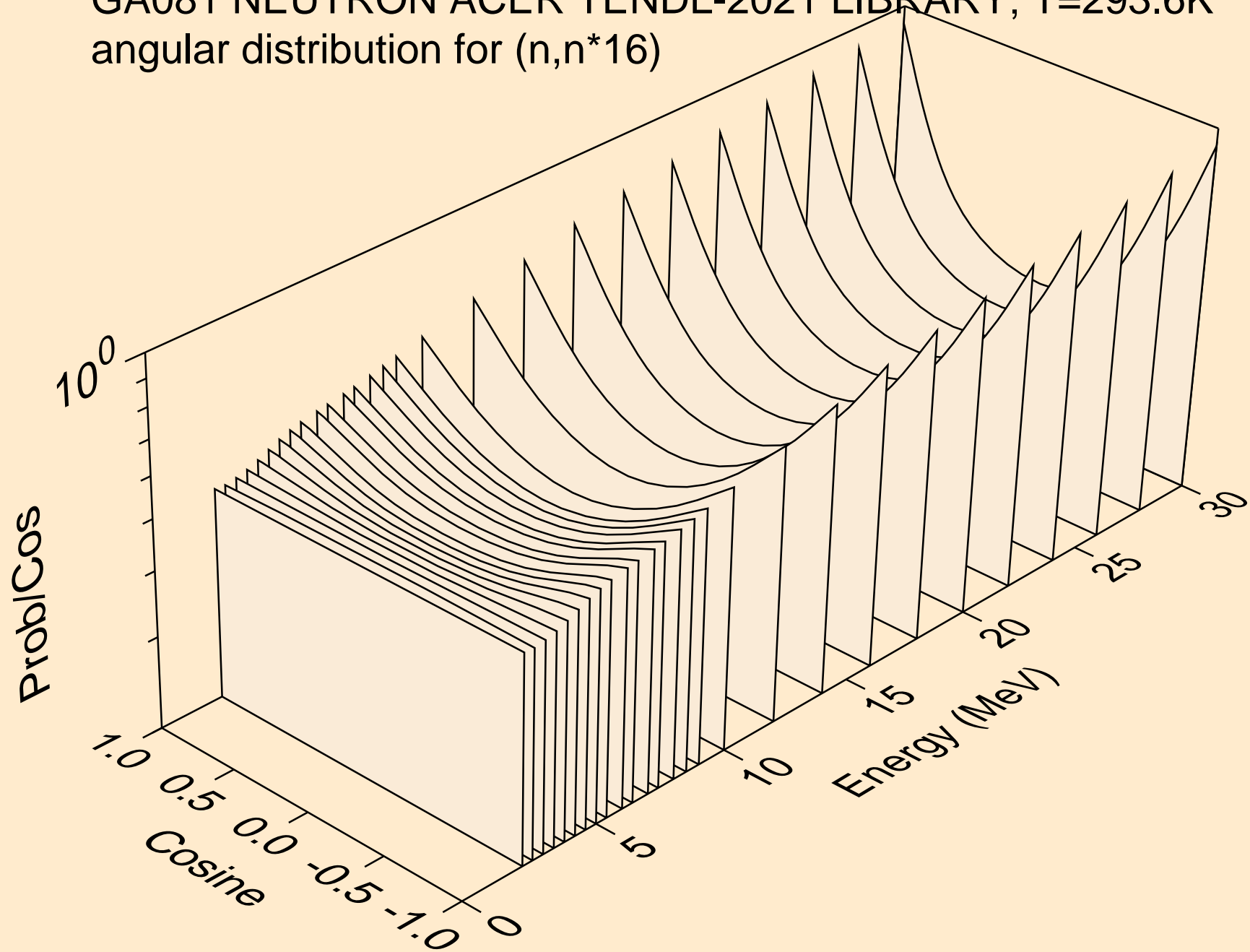

GA081 NEUTRON ACER TENDL-2021 LIBRARY; T=293.6K
angular distribution for (n,n*17)

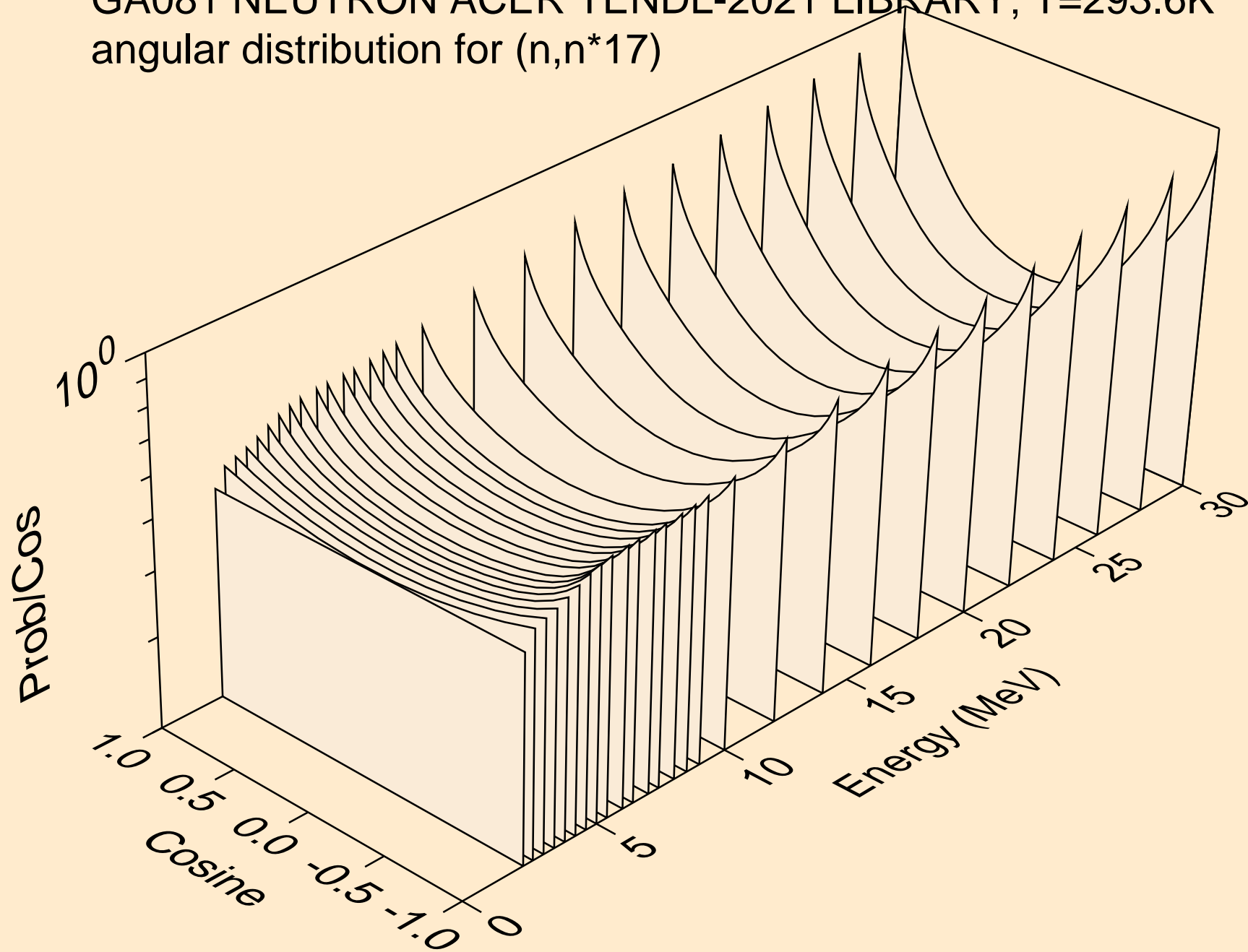

GA081 NEUTRON ACER TENDL-2021 LIBRARY; T=293.6K
angular distribution for (n,n*18)

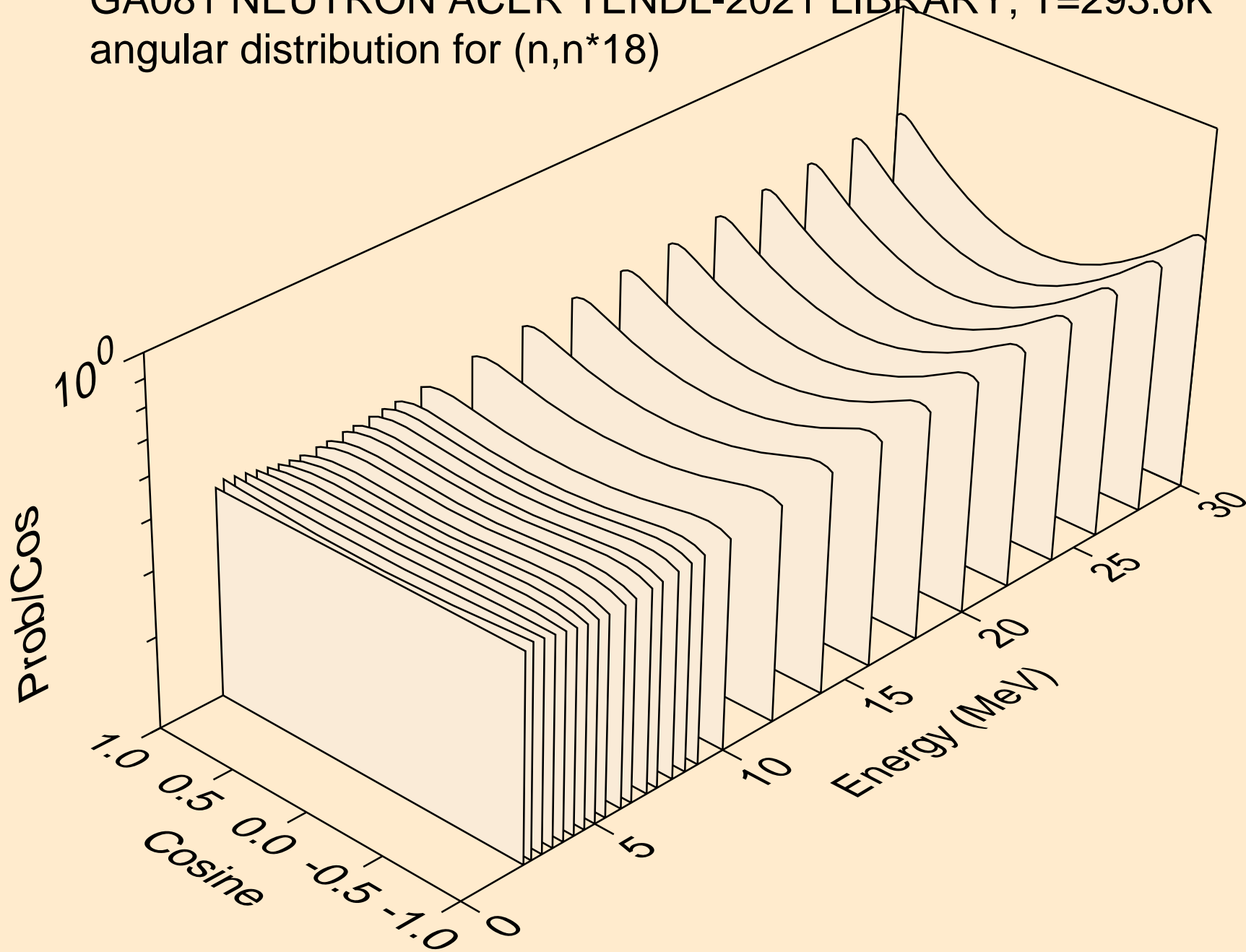

GA081 NEUTRON ACER TENDL-2021 LIBRARY; T=293.6K
angular distribution for (n,n*19)

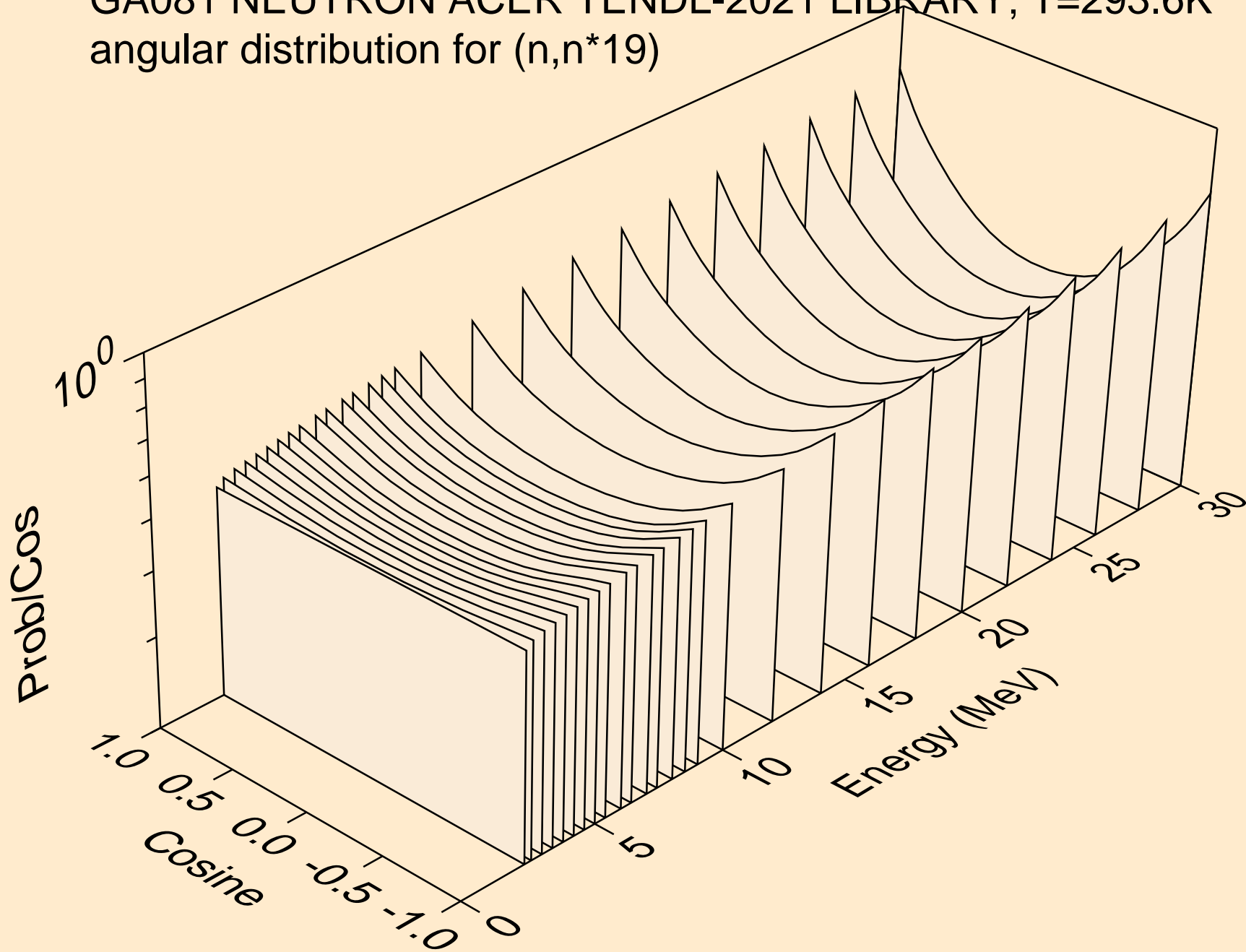

GA081 NEUTRON ACER TENDL-2021 LIBRARY; T=293.6K
angular distribution for (n,n*20)

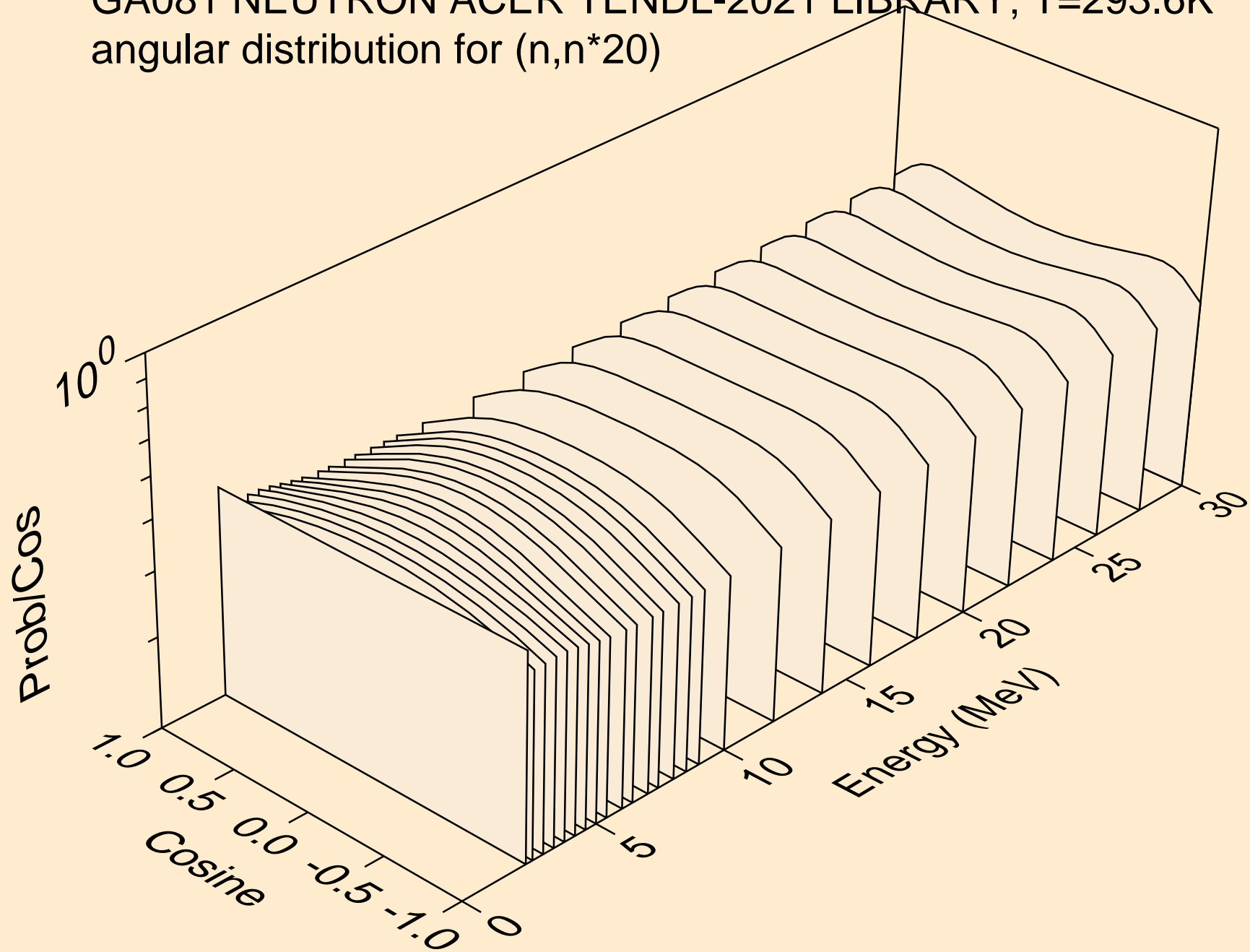

GA081 NEUTRON ACER TENDL-2021 LIBRARY; T=293.6K
angular distribution for (n,n*21)

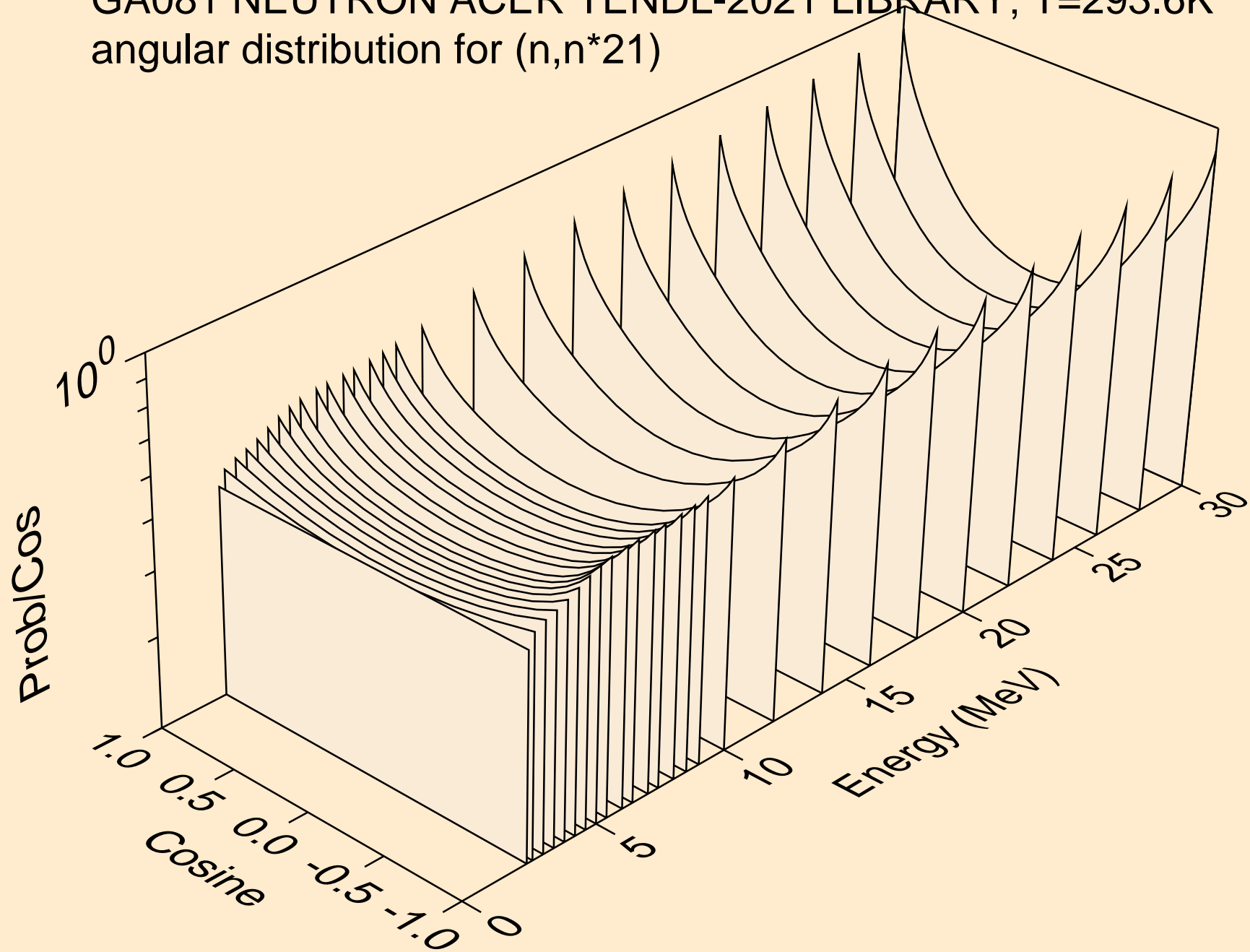

GA081 NEUTRON ACER TENDL-2021 LIBRARY; T=293.6K
angular distribution for (n,n*22)

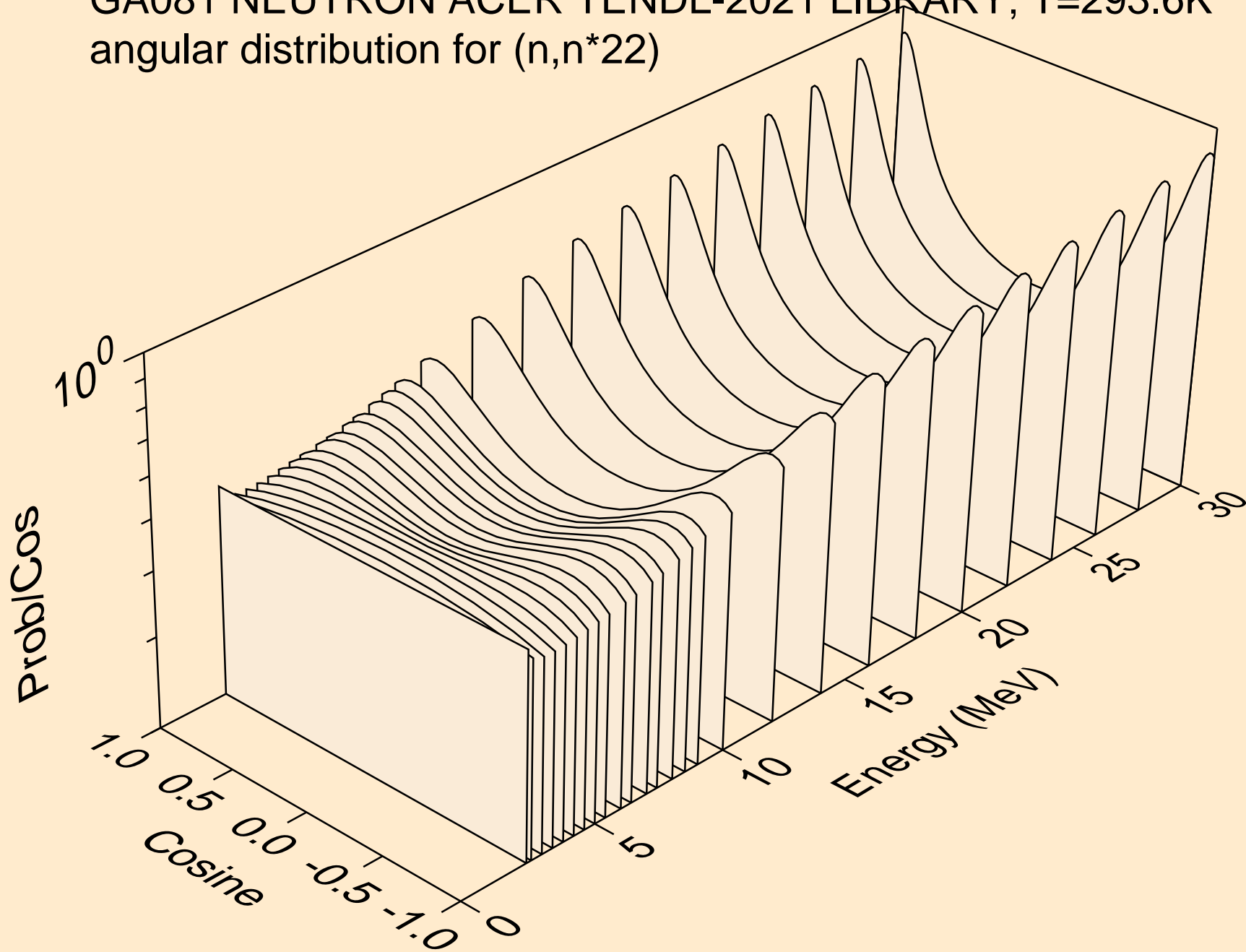

GA081 NEUTRON ACER TENDL-2021 LIBRARY; T=293.6K
angular distribution for (n,n*23)

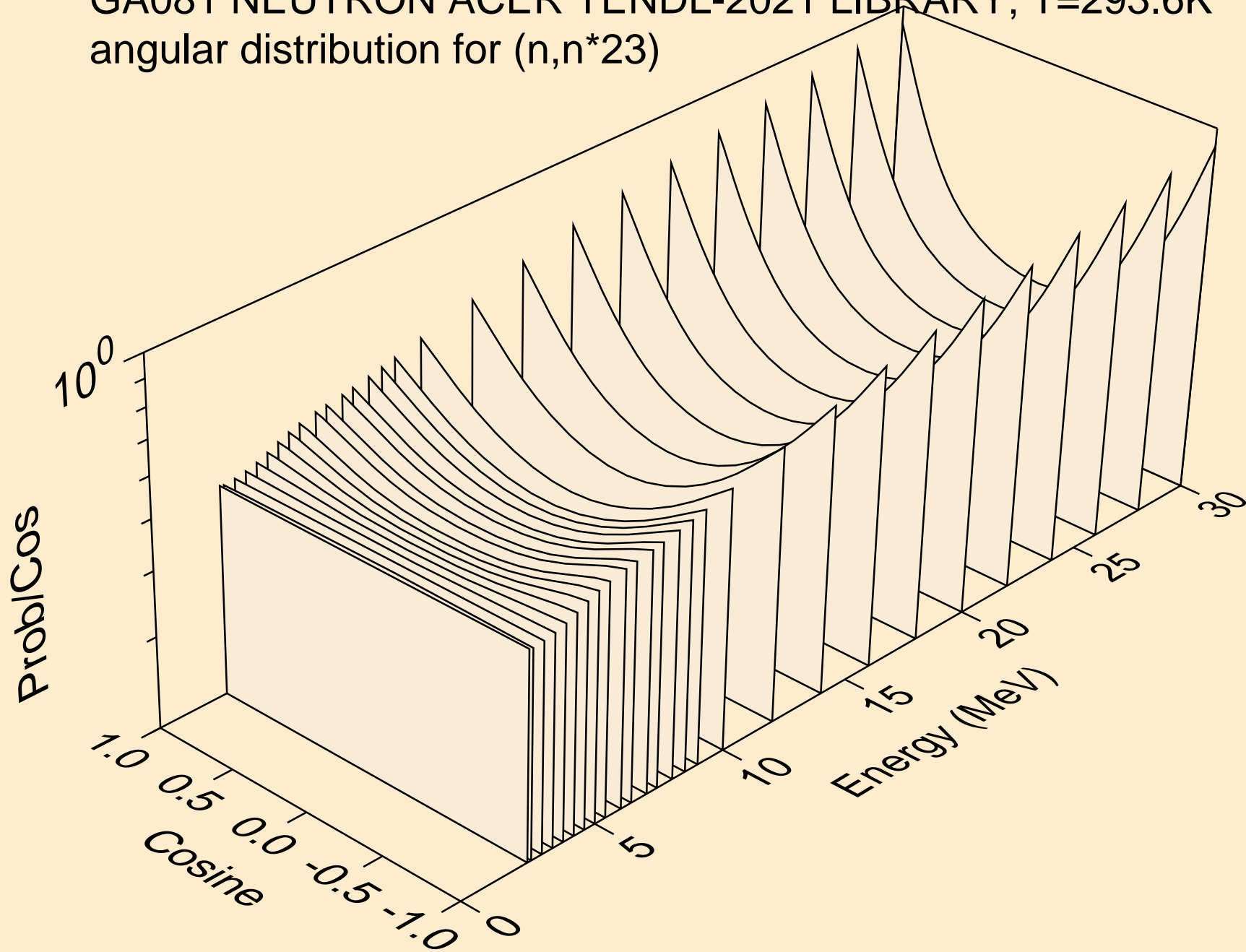

GA081 NEUTRON ACER TENDL-2021 LIBRARY; T=293.6K
angular distribution for (n,n*24)

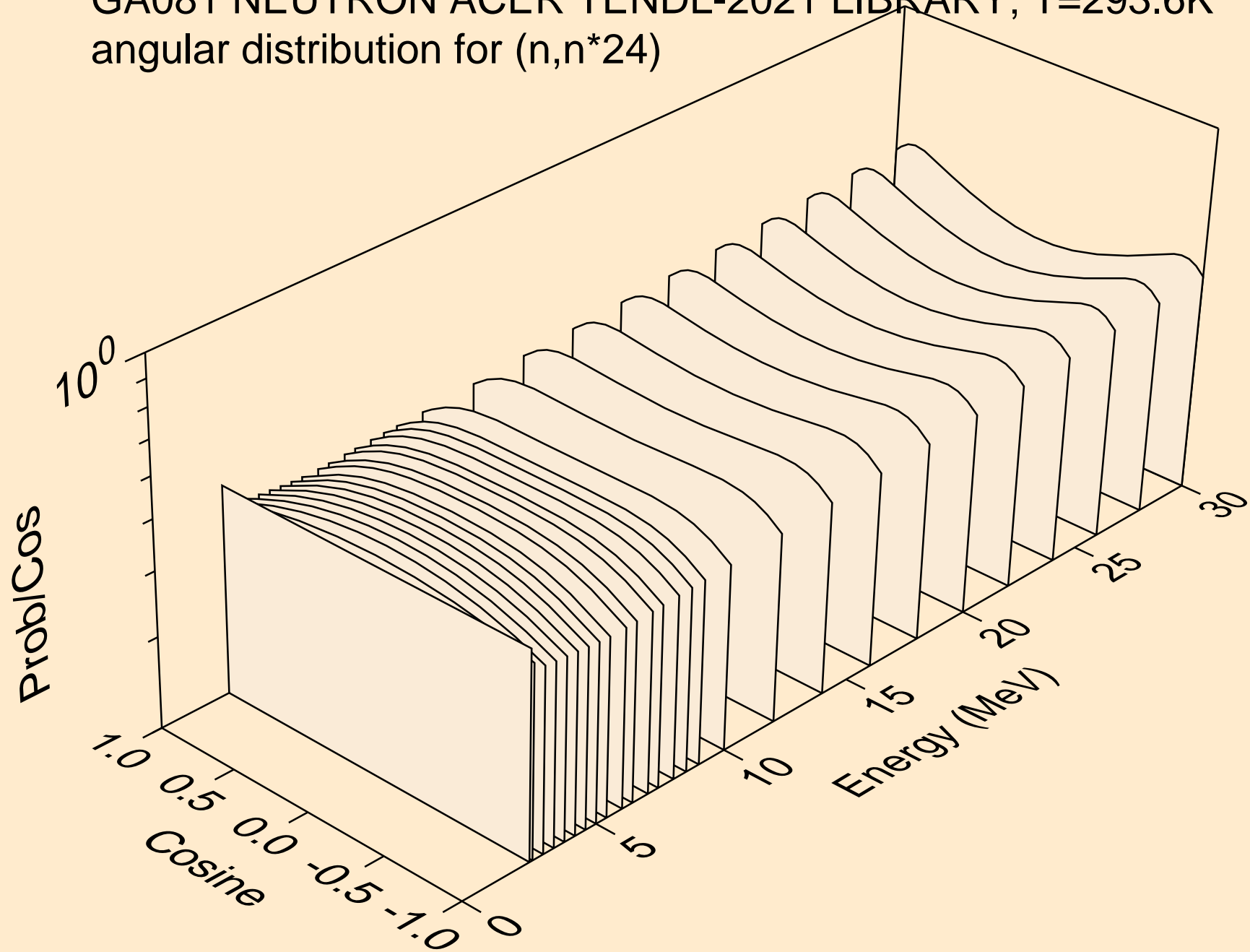

GA081 NEUTRON ACER TENDL-2021 LIBRARY; T=293.6K
angular distribution for (n,n*25)

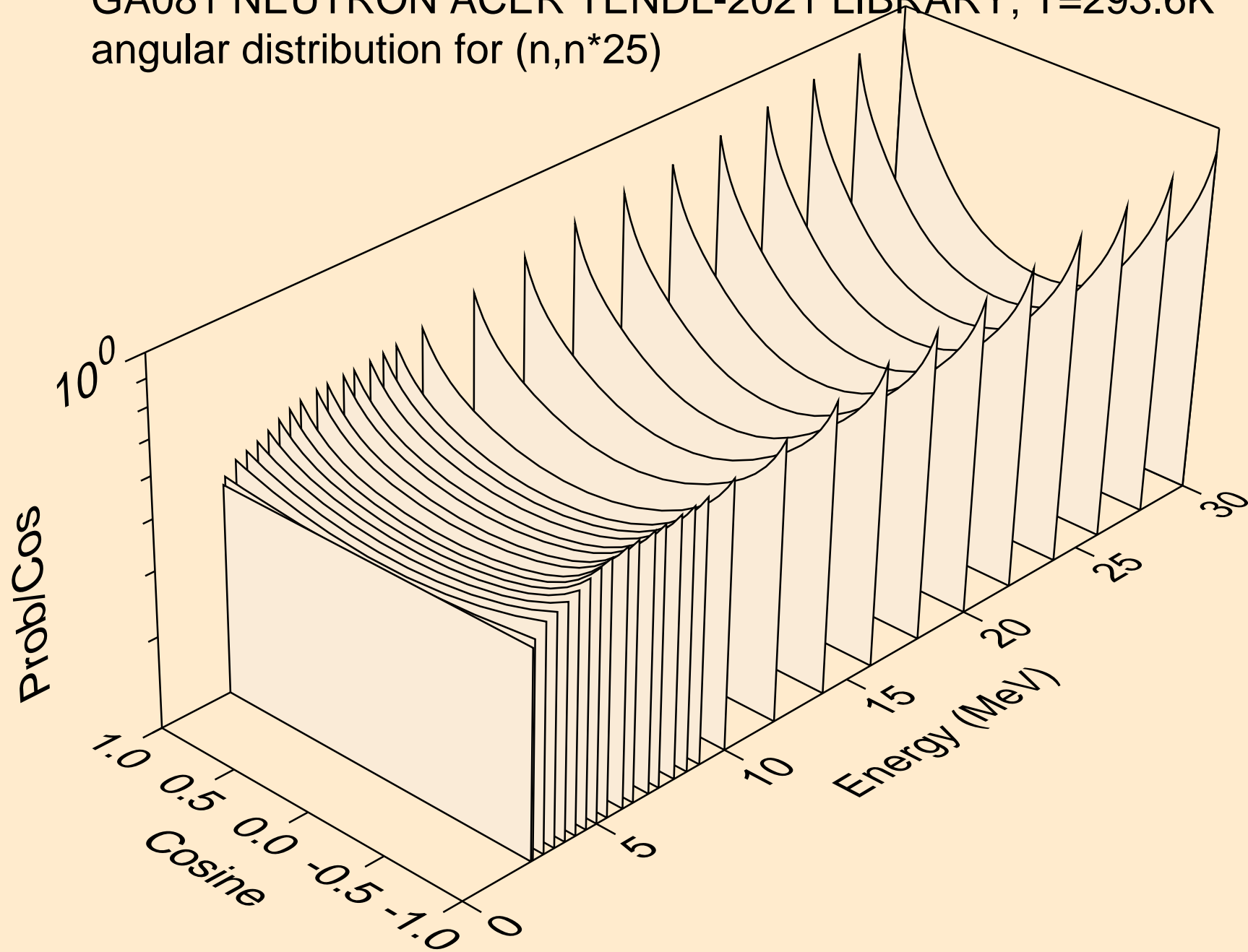

GA081 NEUTRON ACER TENDL-2021 LIBRARY; T=293.6K
angular distribution for (n,n*26)

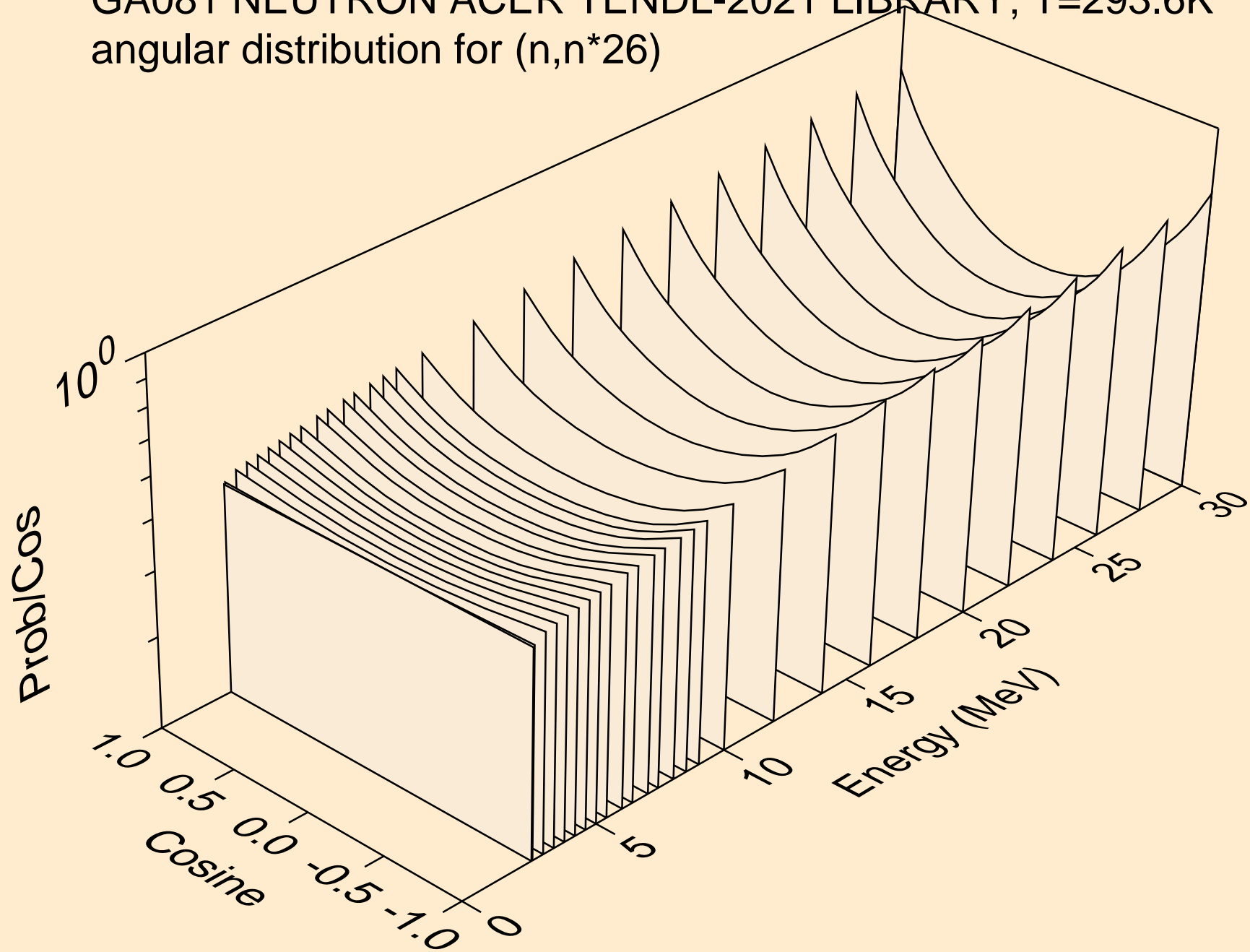

GA081 NEUTRON ACER TENDL-2021 LIBRARY; T=293.6K
angular distribution for (n,n*27)

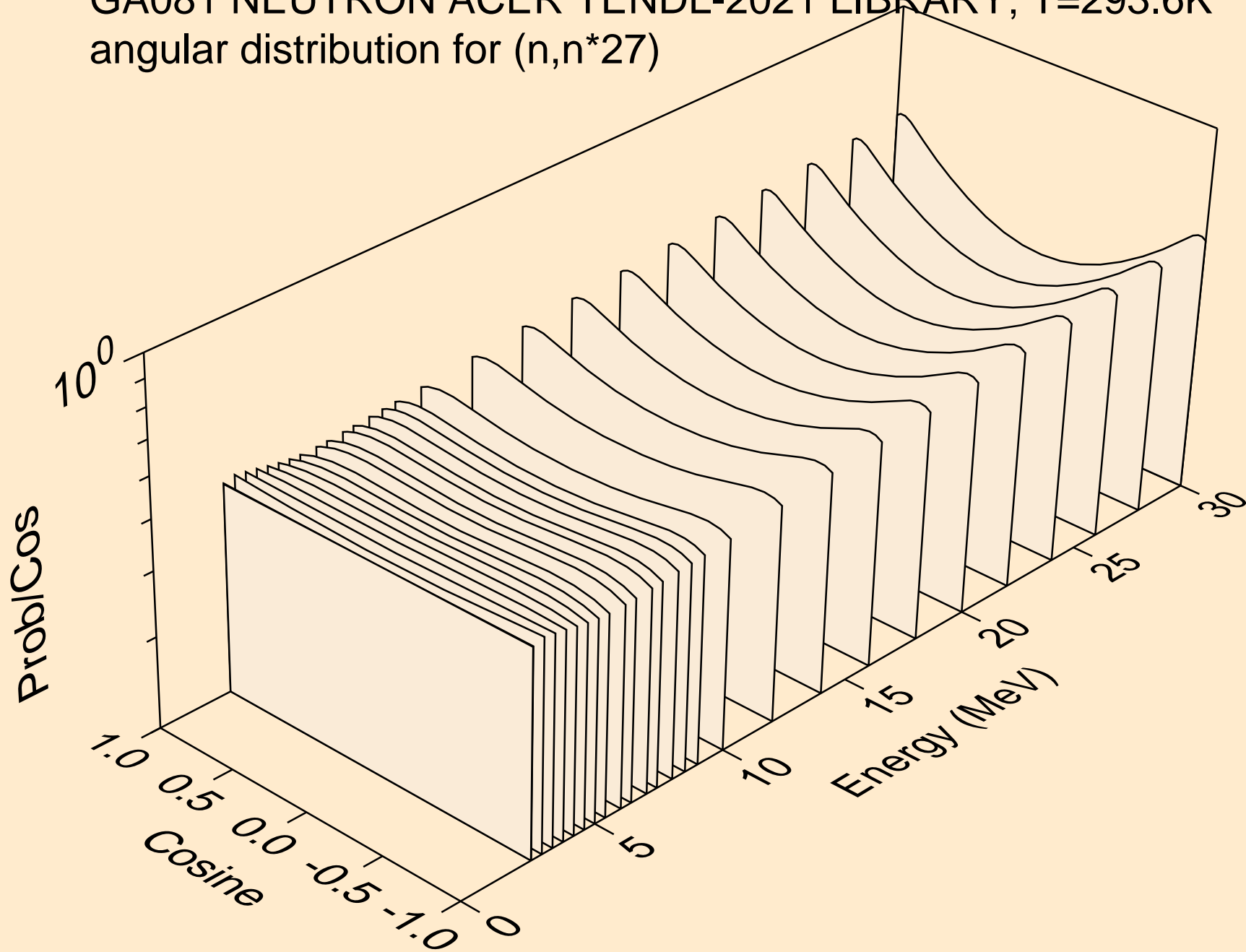

GA081 NEUTRON ACER TENDL-2021 LIBRARY; T=293.6K
angular distribution for (n,n*28)

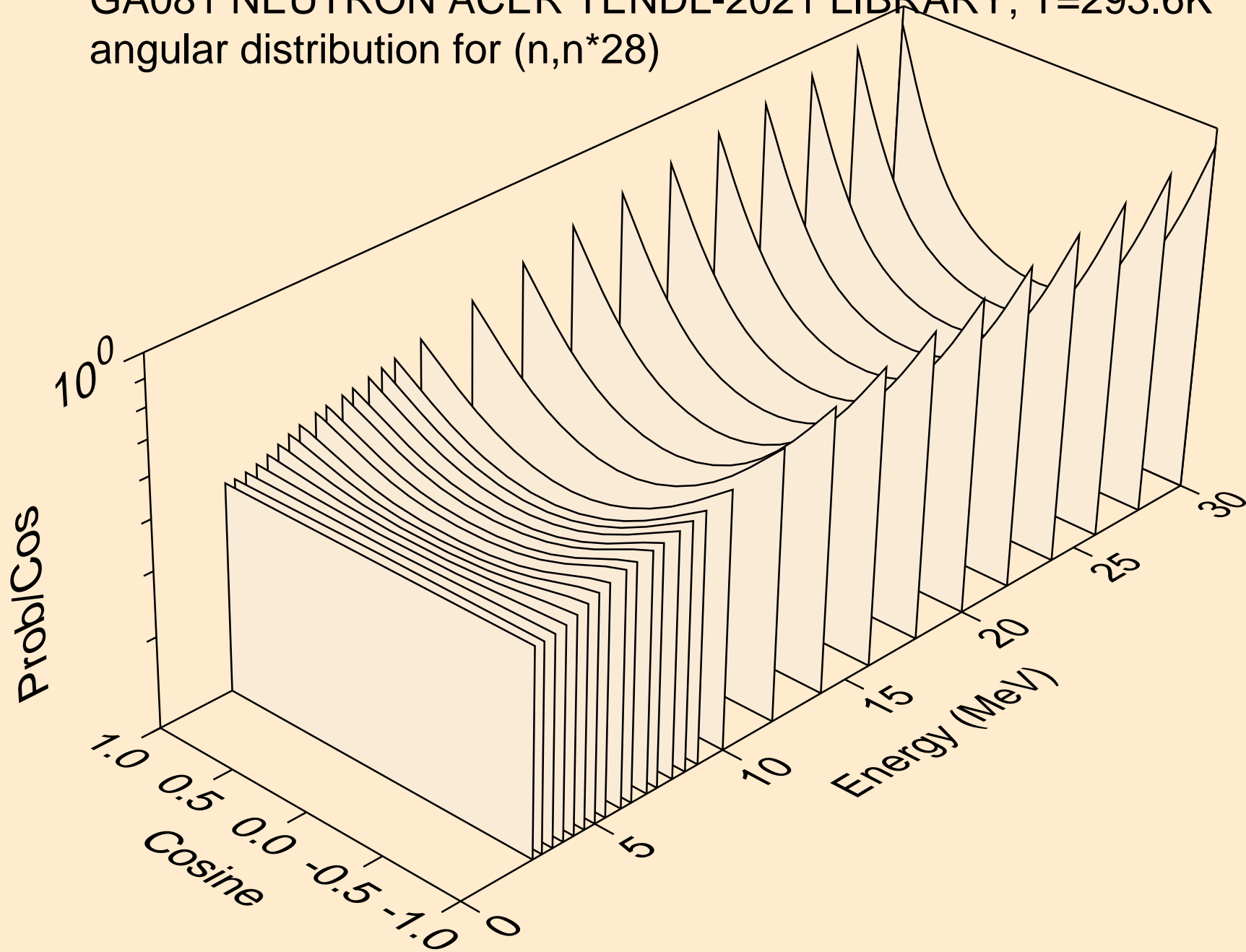

GA081 NEUTRON ACER TENDL-2021 LIBRARY; T=293.6K
angular distribution for (n,n*29)

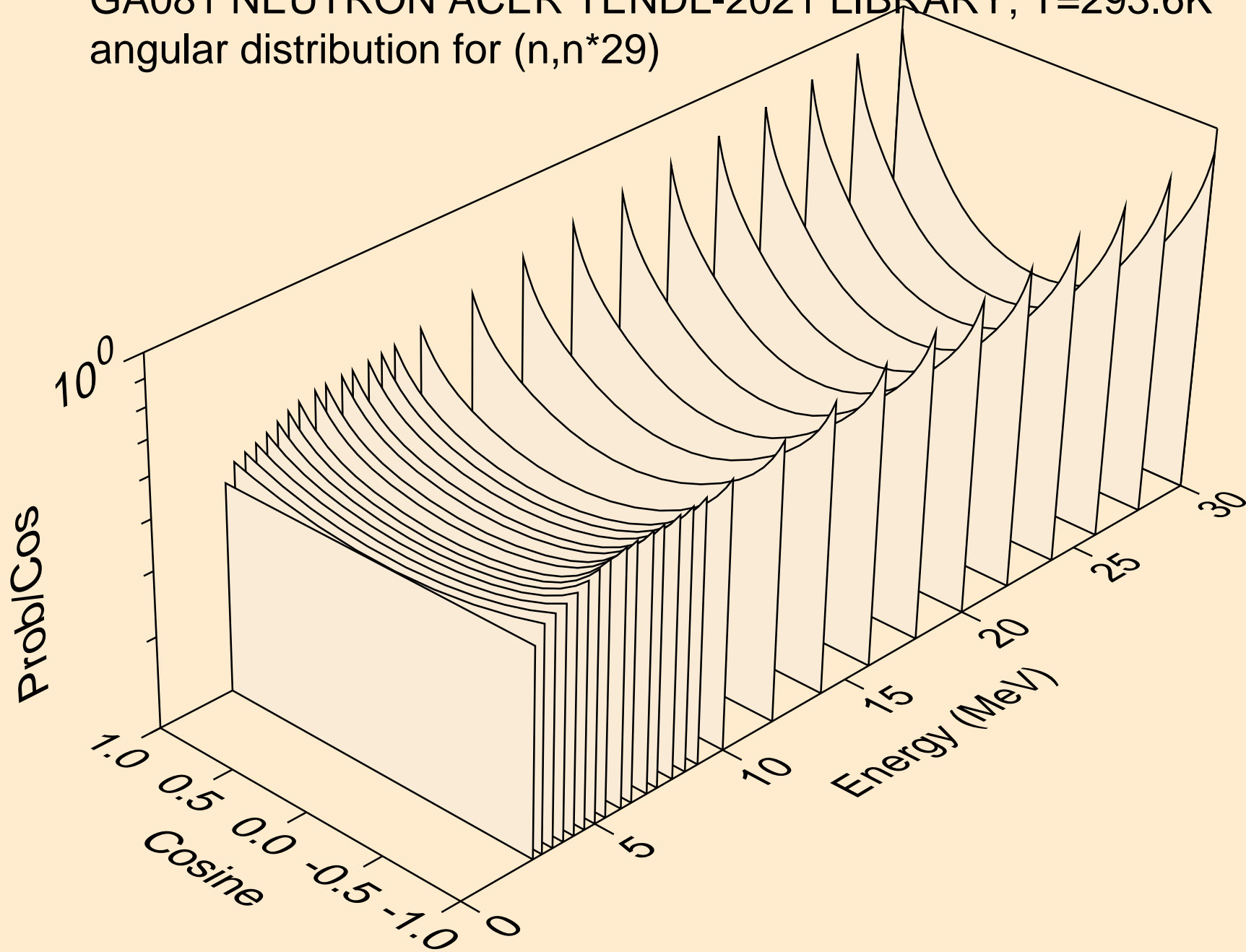

GA081 NEUTRON ACER TENDL-2021 LIBRARY; T=293.6K
angular distribution for (n,n*30)

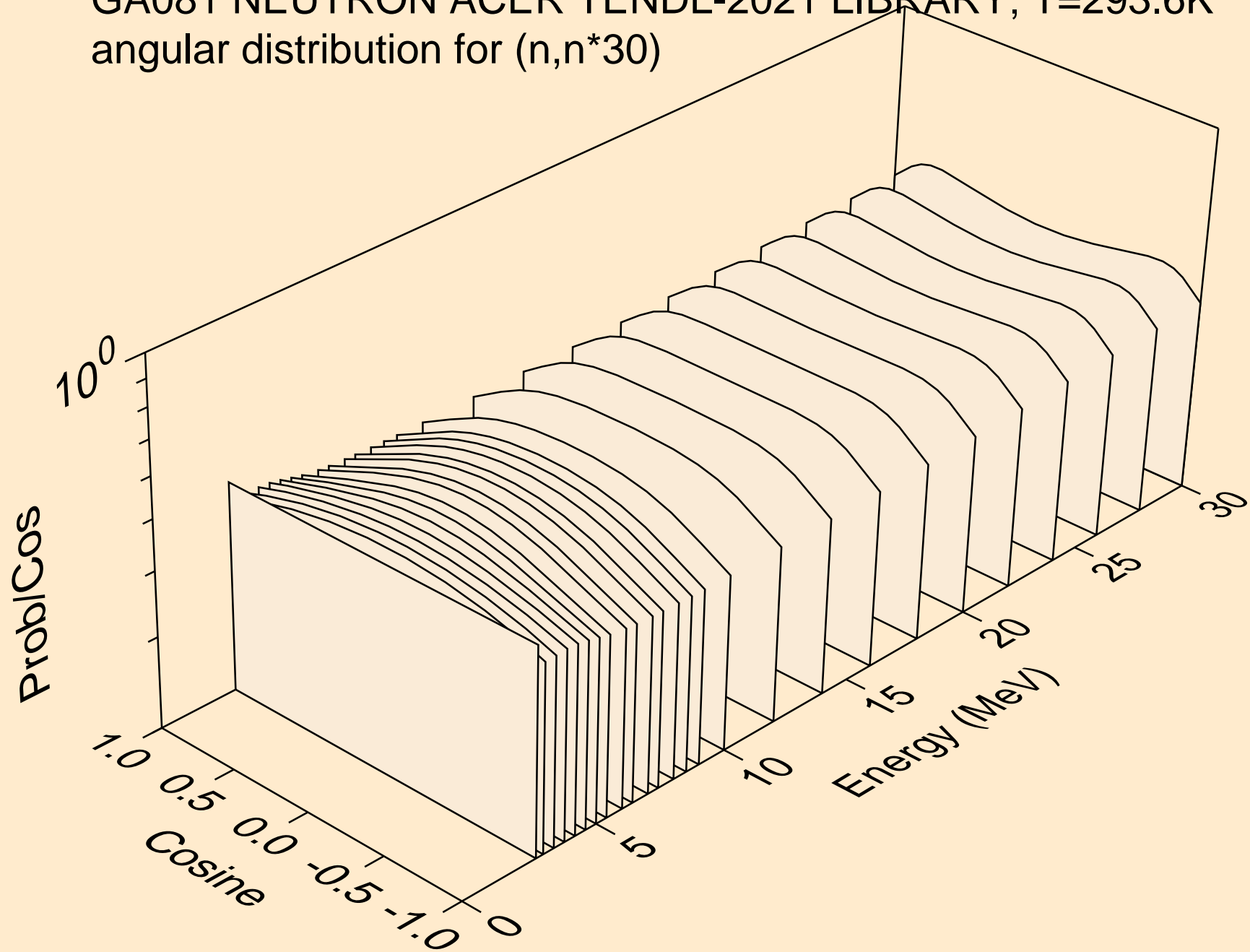

GA081 NEUTRON ACER TENDL-2021 LIBRARY; T=293.6K
Neutron emission for (n,x)

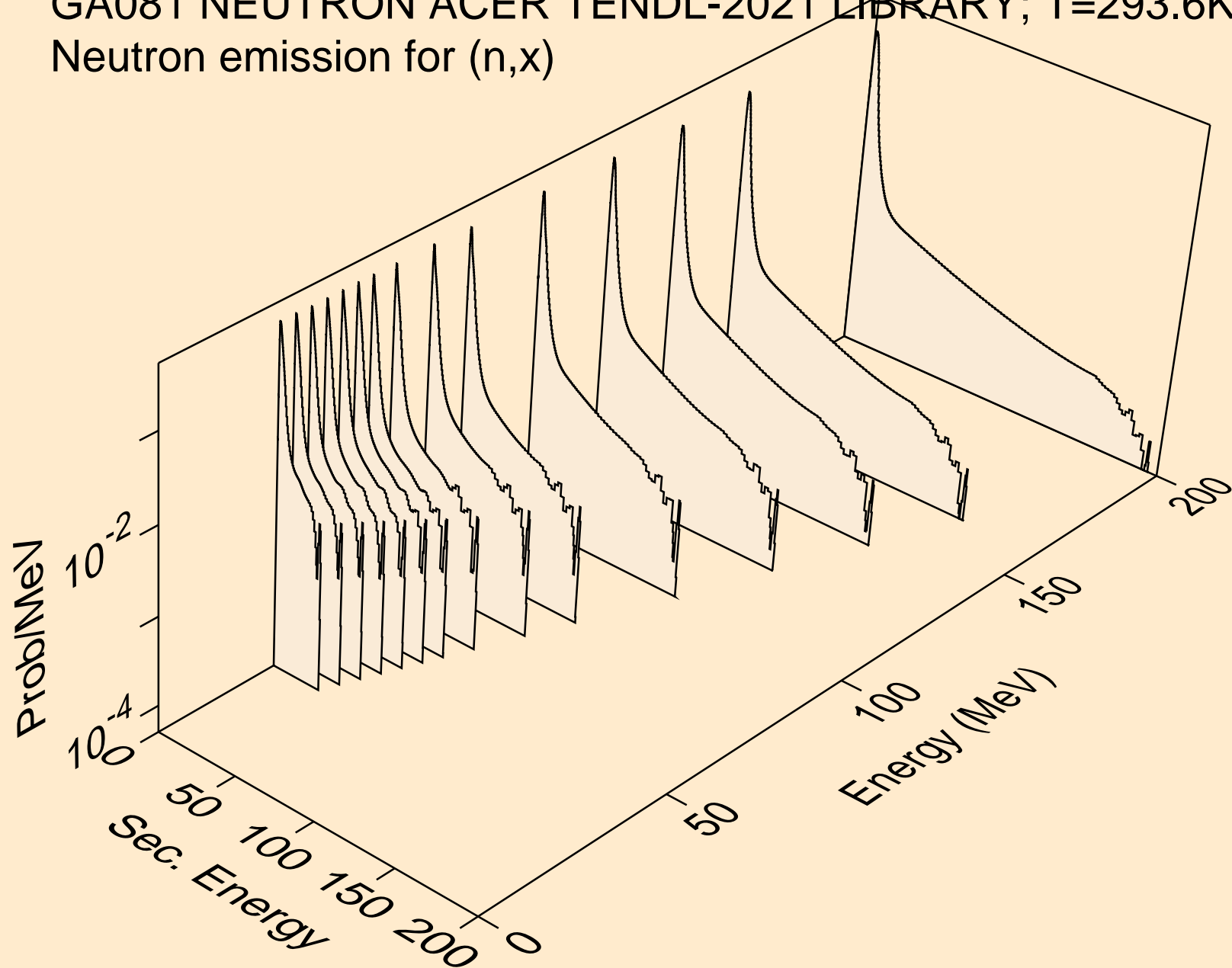

GA081 NEUTRON ACER TENDL-2021 LIBRARY; T=293.6K
Neutron emission for (n,2nd)

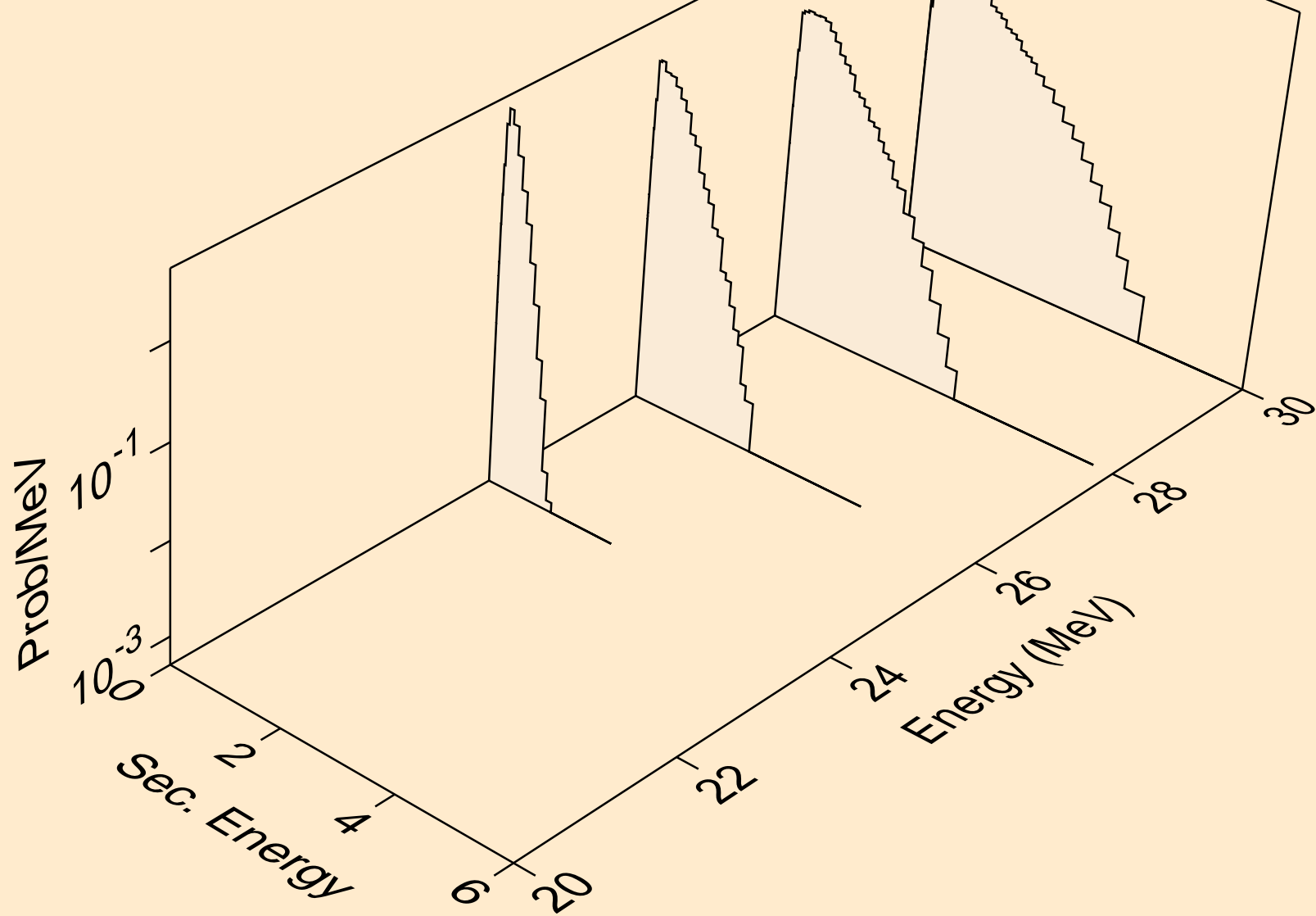

GA081 NEUTRON ACER TENDL-2021 LIBRARY; T=293.6K
Neutron emission for (n,2n)

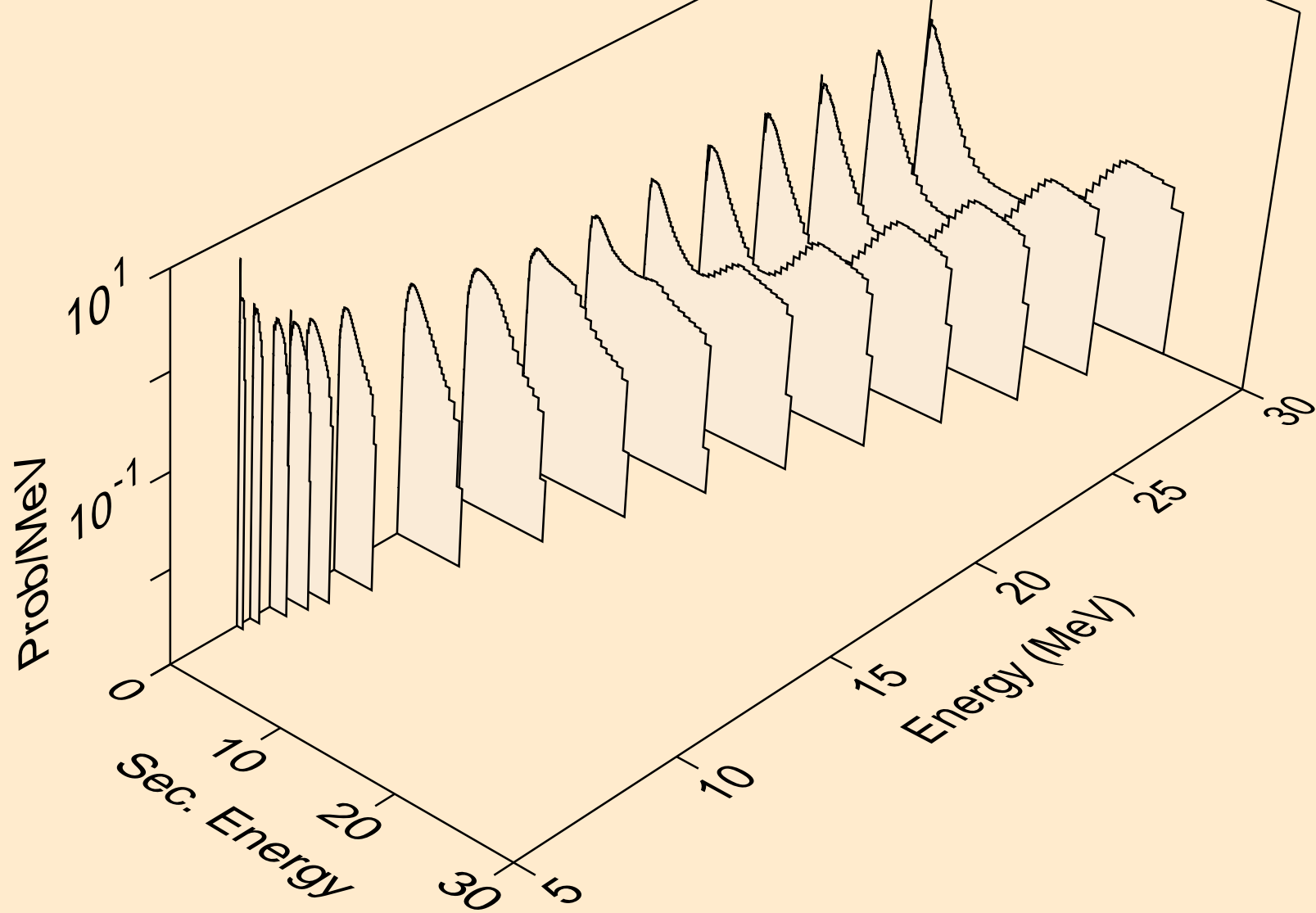

GA081 NEUTRON ACER TENDL-2021 LIBRARY; T=293.6K
Neutron emission for (n,3n)

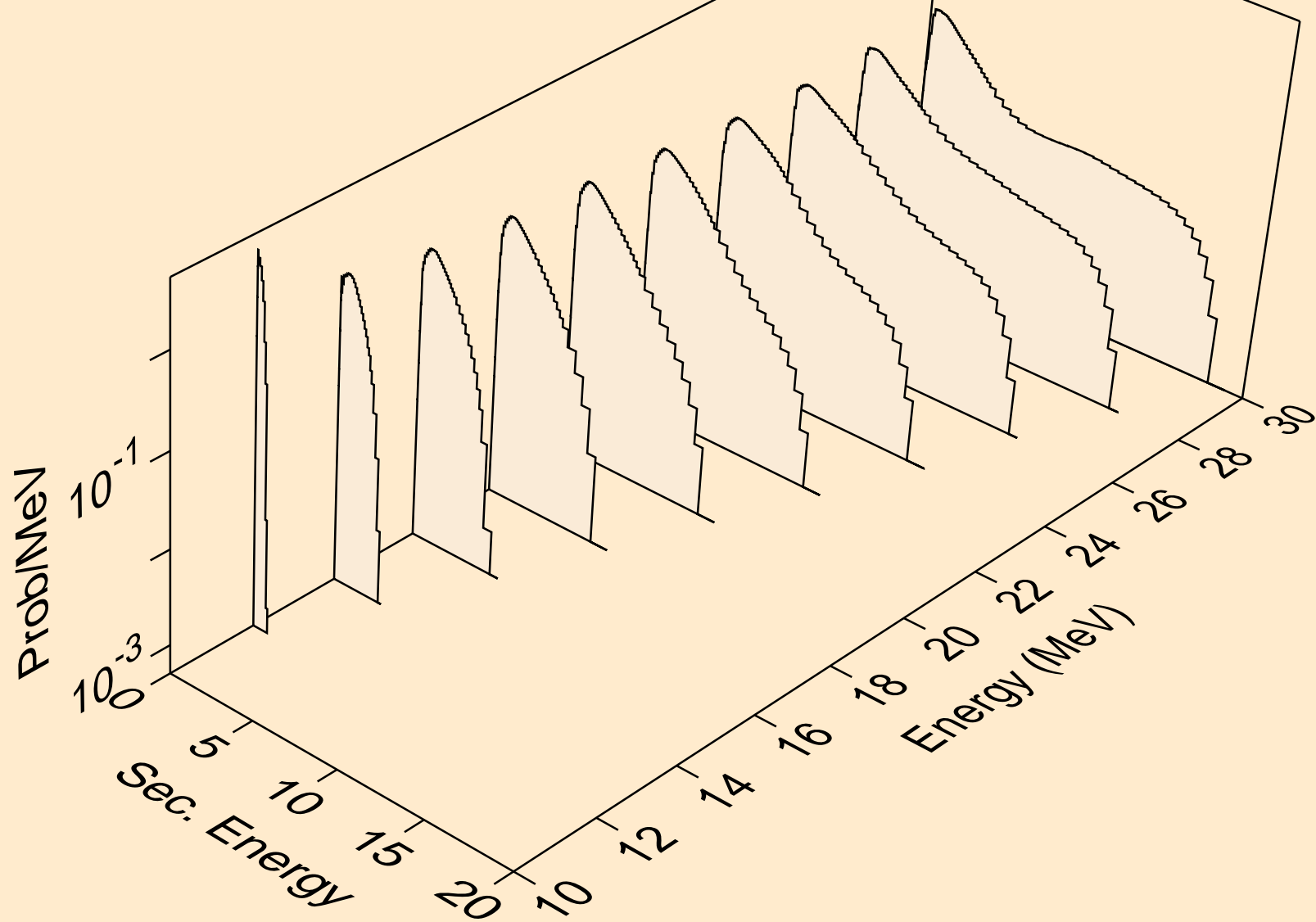

GA081 NEUTRON ACER TENDL-2021 LIBRARY; T=293.6K
Neutron emission for (n,n*)a

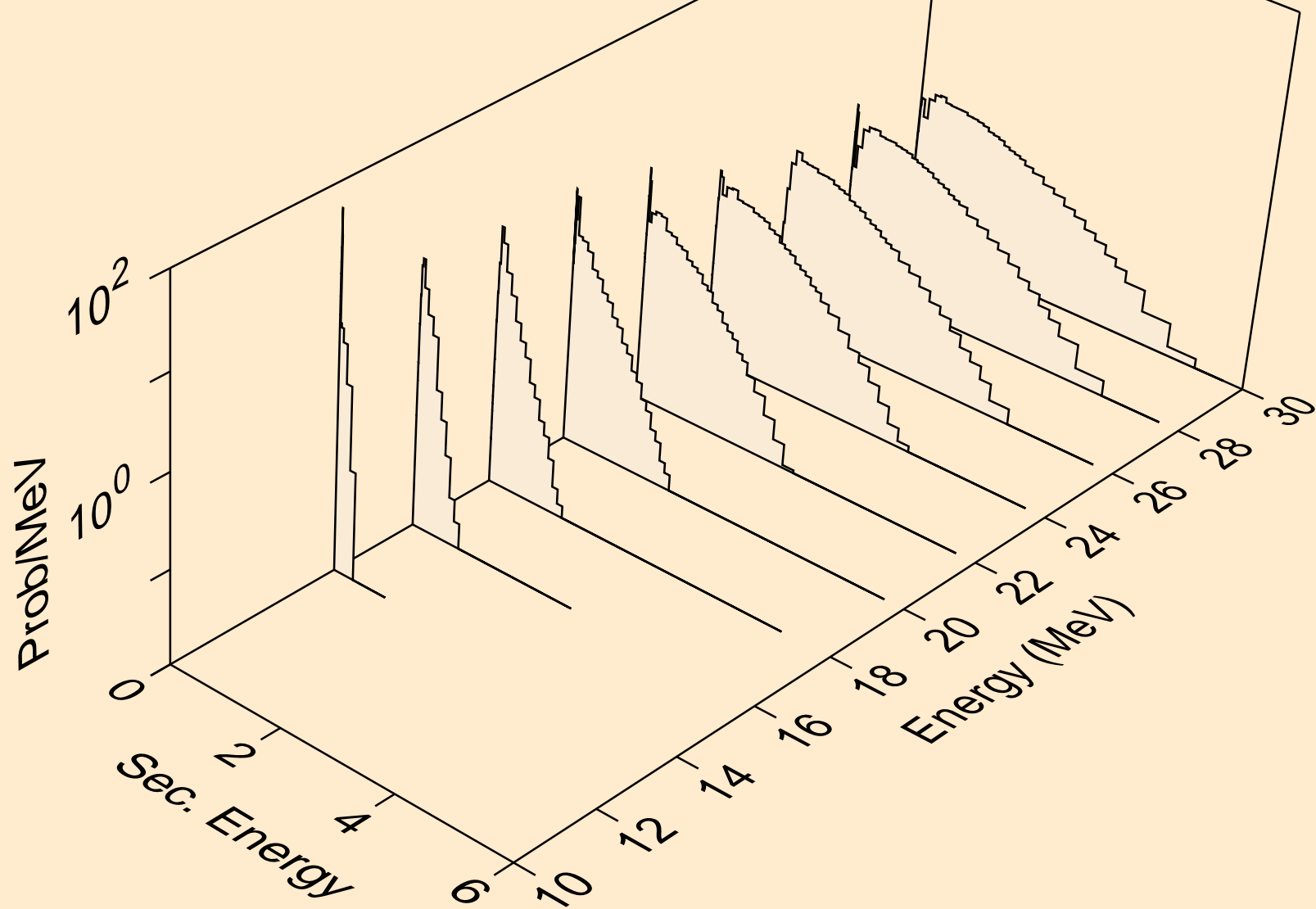

GA081 NEUTRON ACER TENDL-2021 LIBRARY; T=293.6K
Neutron emission for (n,2n)a

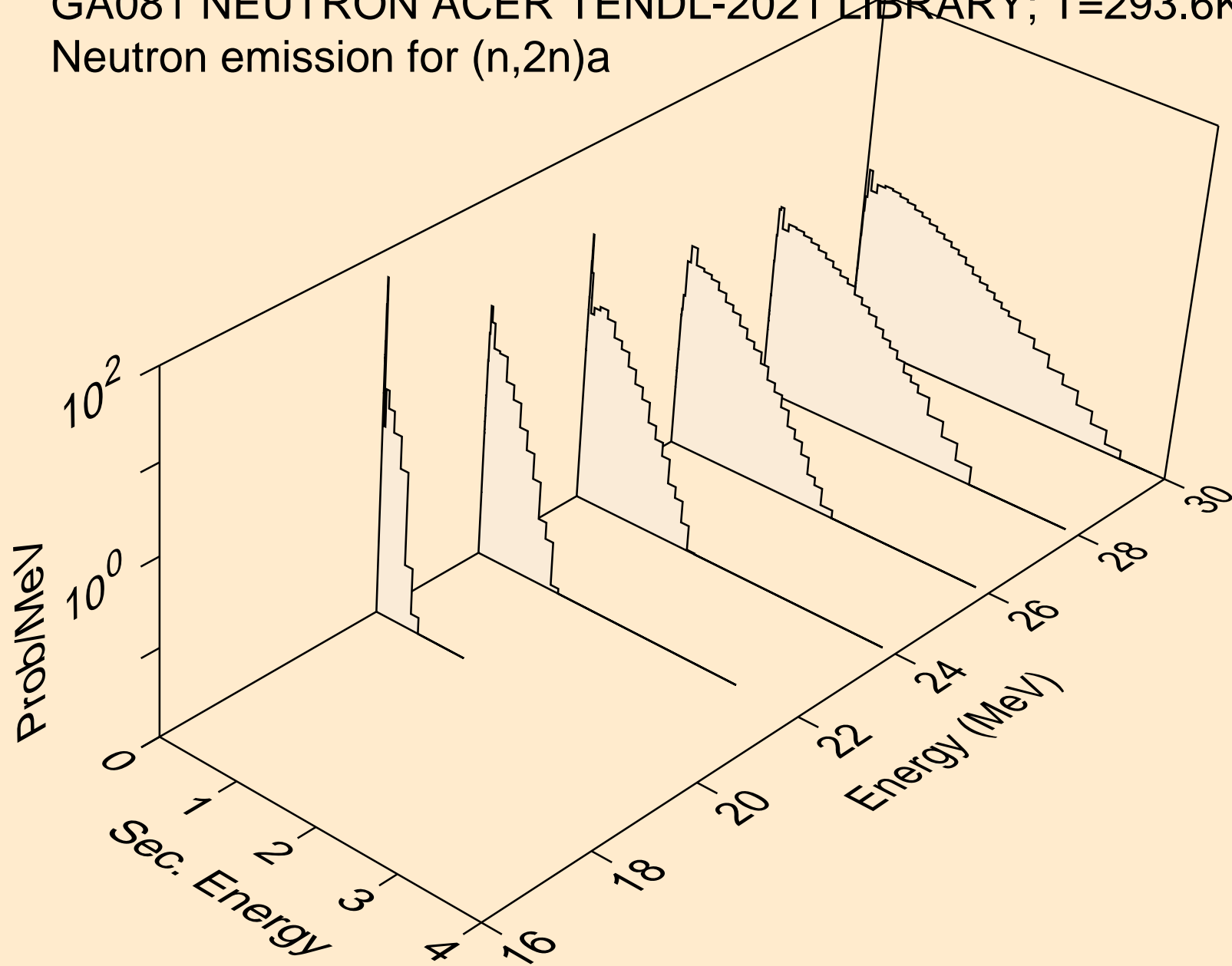

GA081 NEUTRON ACER TENDL-2021 LIBRARY; T=293.6K
Neutron emission for (n,3n)a

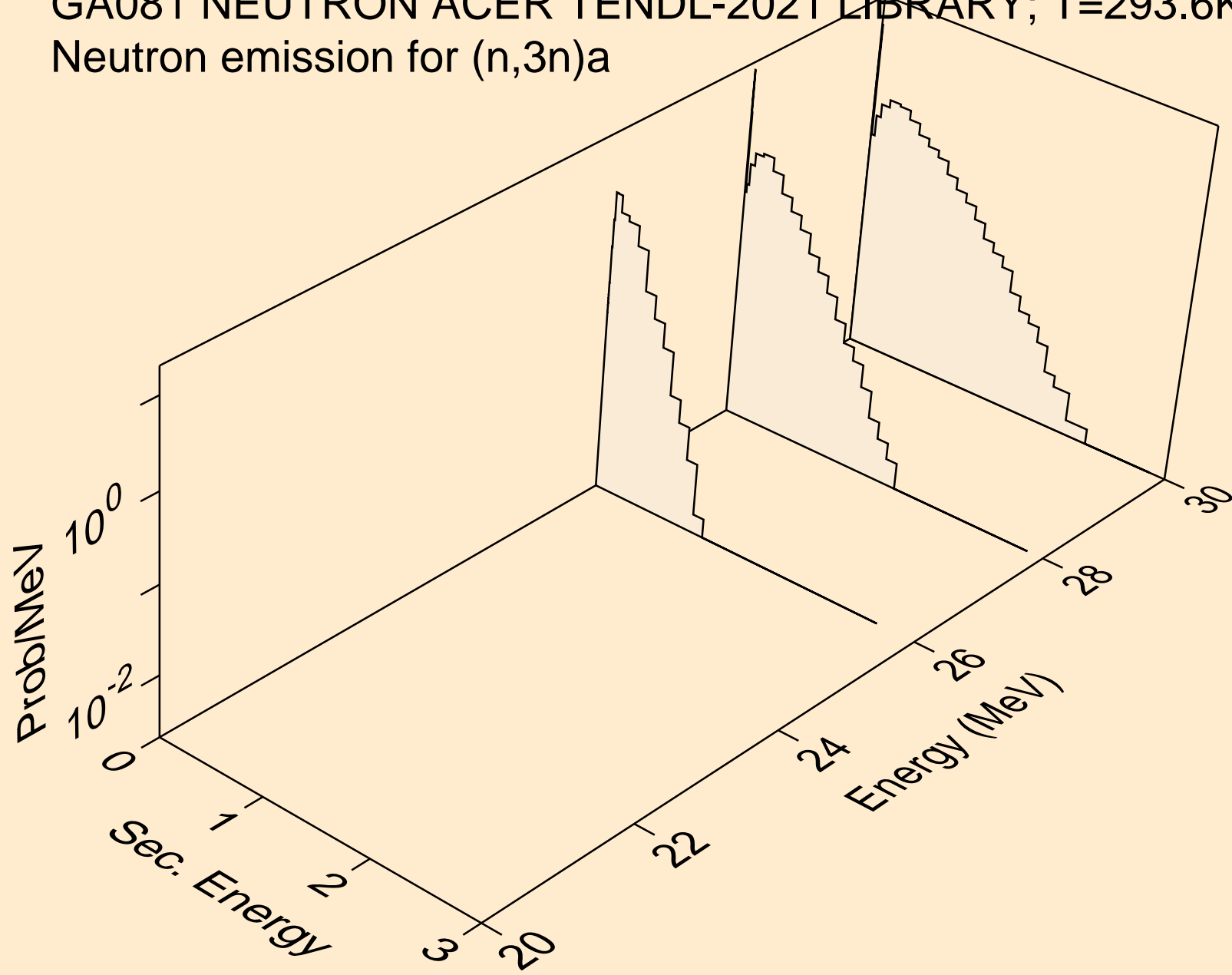

GA081 NEUTRON ACER TENDL-2021 LIBRARY; T=293.6K
Neutron emission for (n,n*)p

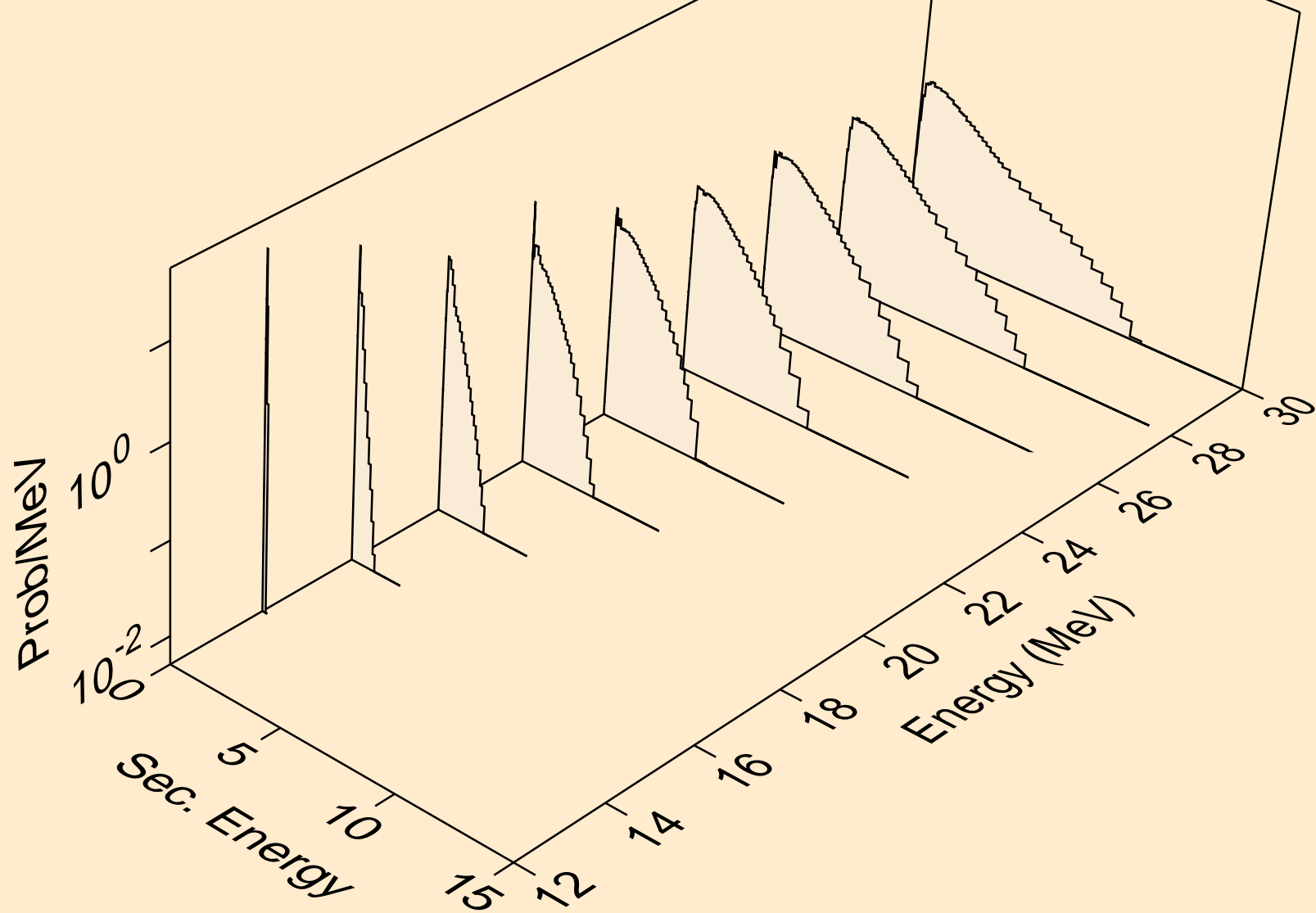

GA081 NEUTRON ACER TENDL-2021 LIBRARY; T=293.6K
Neutron emission for (n,n*)d

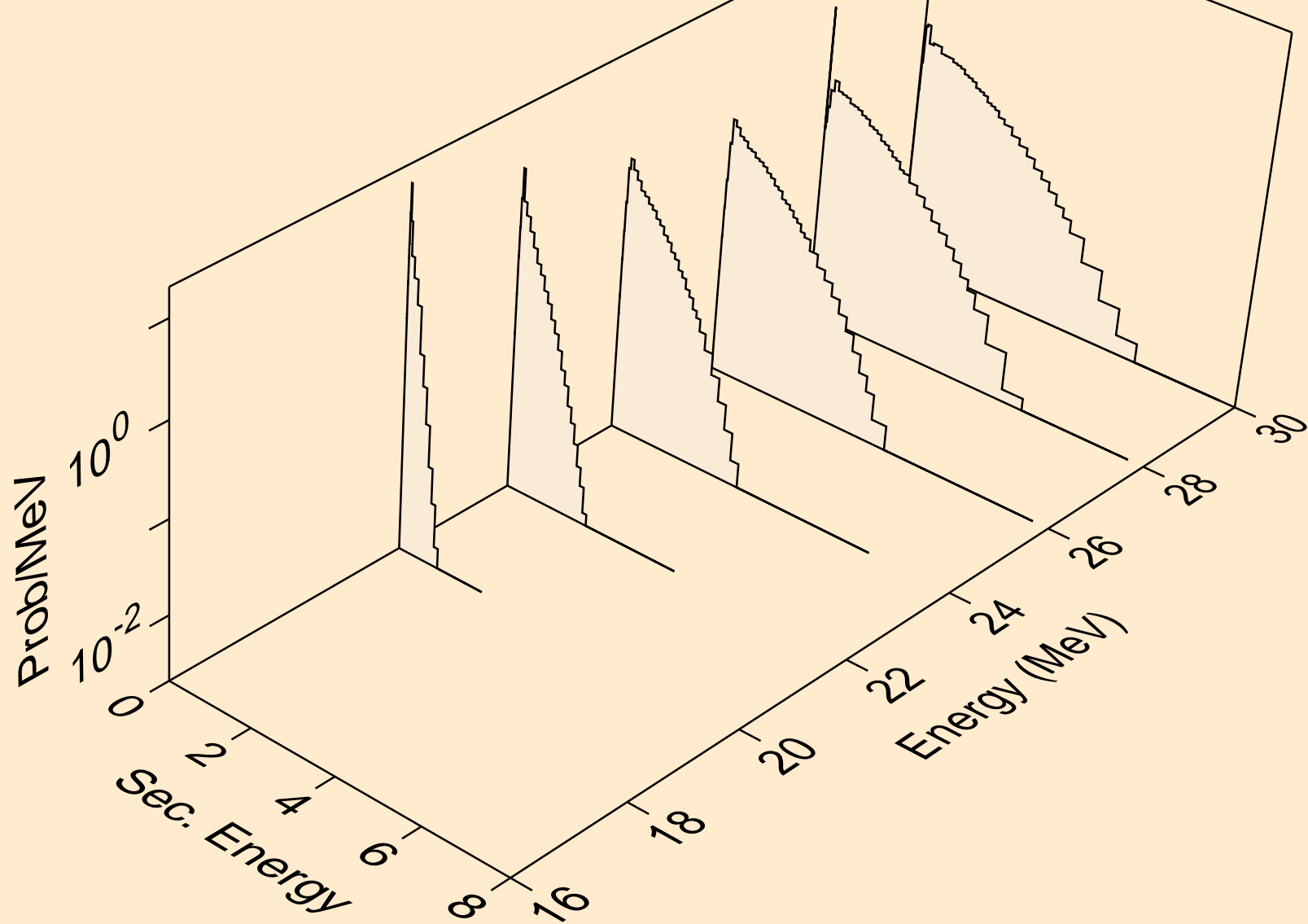

GA081 NEUTRON ACER TENDL-2021 LIBRARY; T=293.6K
Neutron emission for (n,n*)t

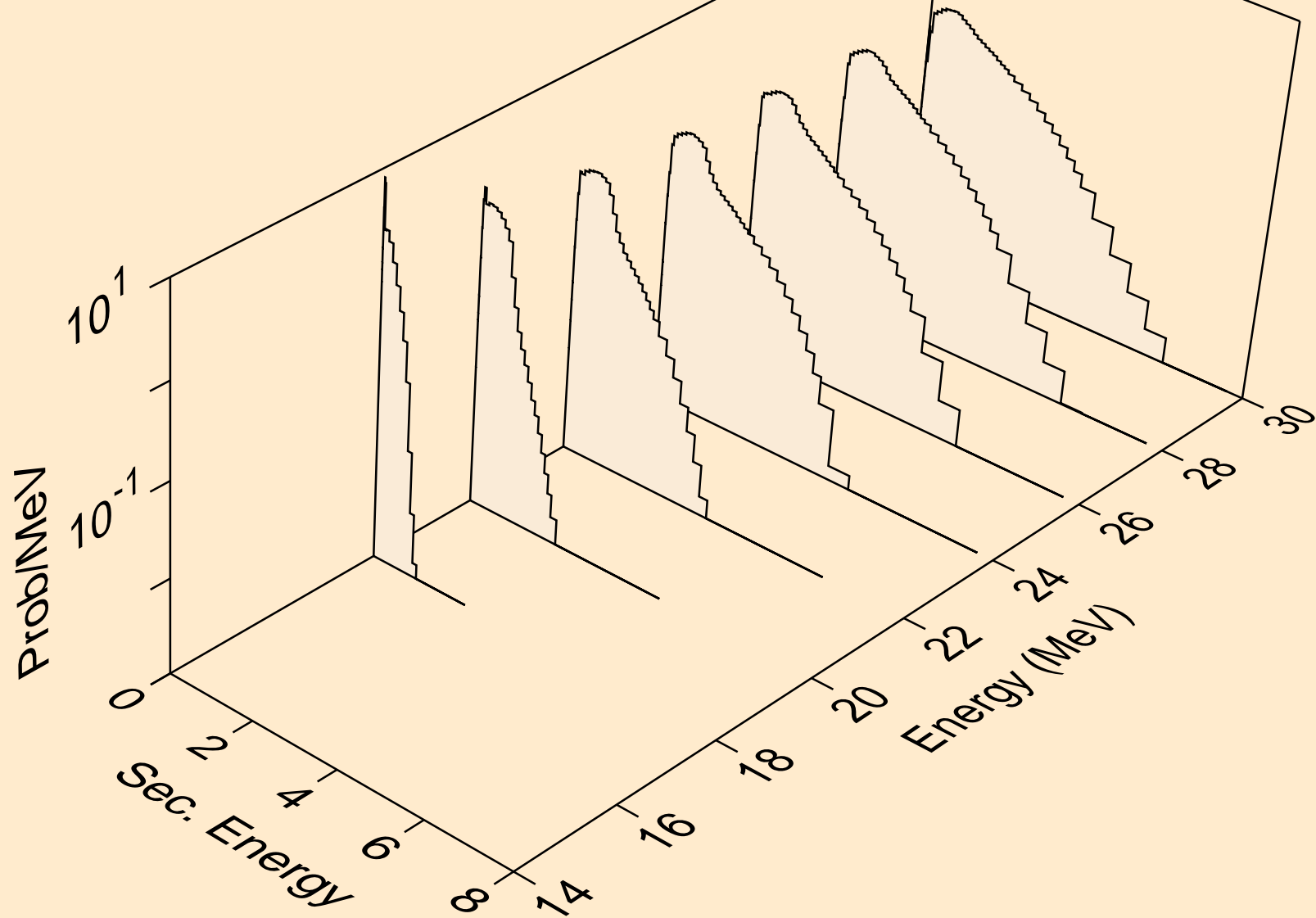

GA081 NEUTRON ACER TENDL-2021 LIBRARY; T=293.6K
Neutron emission for (n,4n)

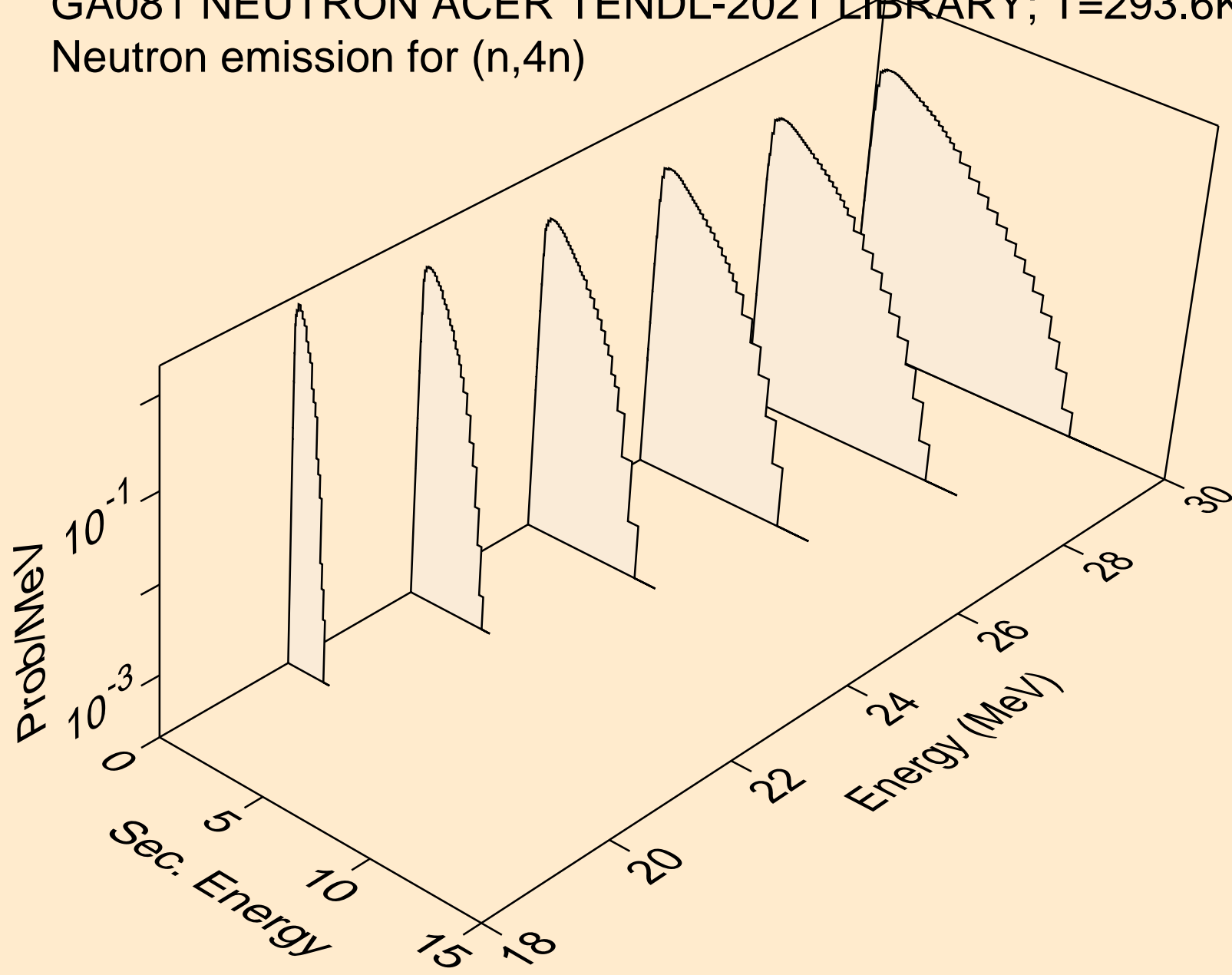

GA081 NEUTRON ACER TENDL-2021 LIBRARY; T=293.6K
Neutron emission for (n,2np)

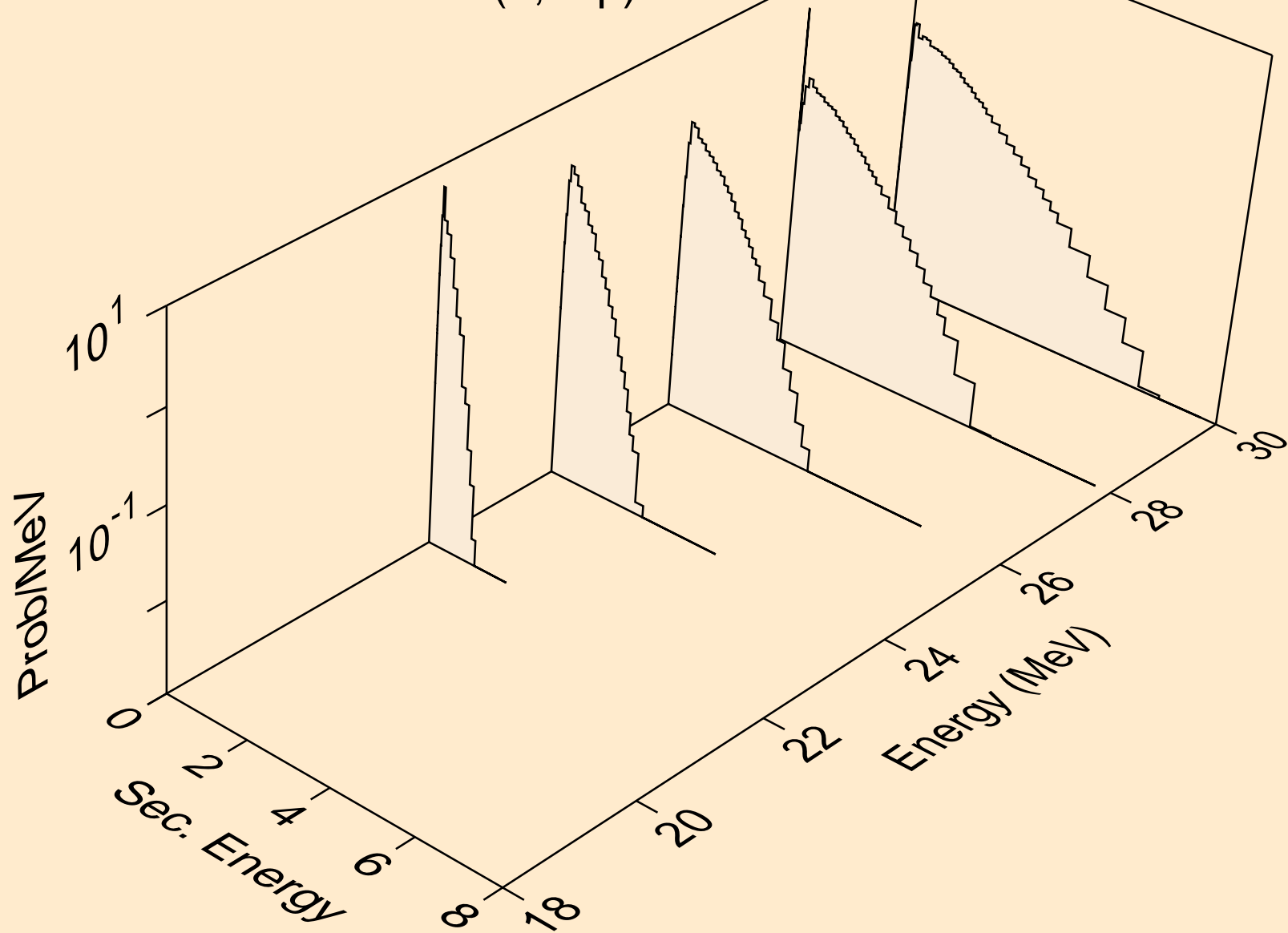

GA081 NEUTRON ACER TENDL-2021 LIBRARY; T=293.6K
Neutron emission for (n,3np)

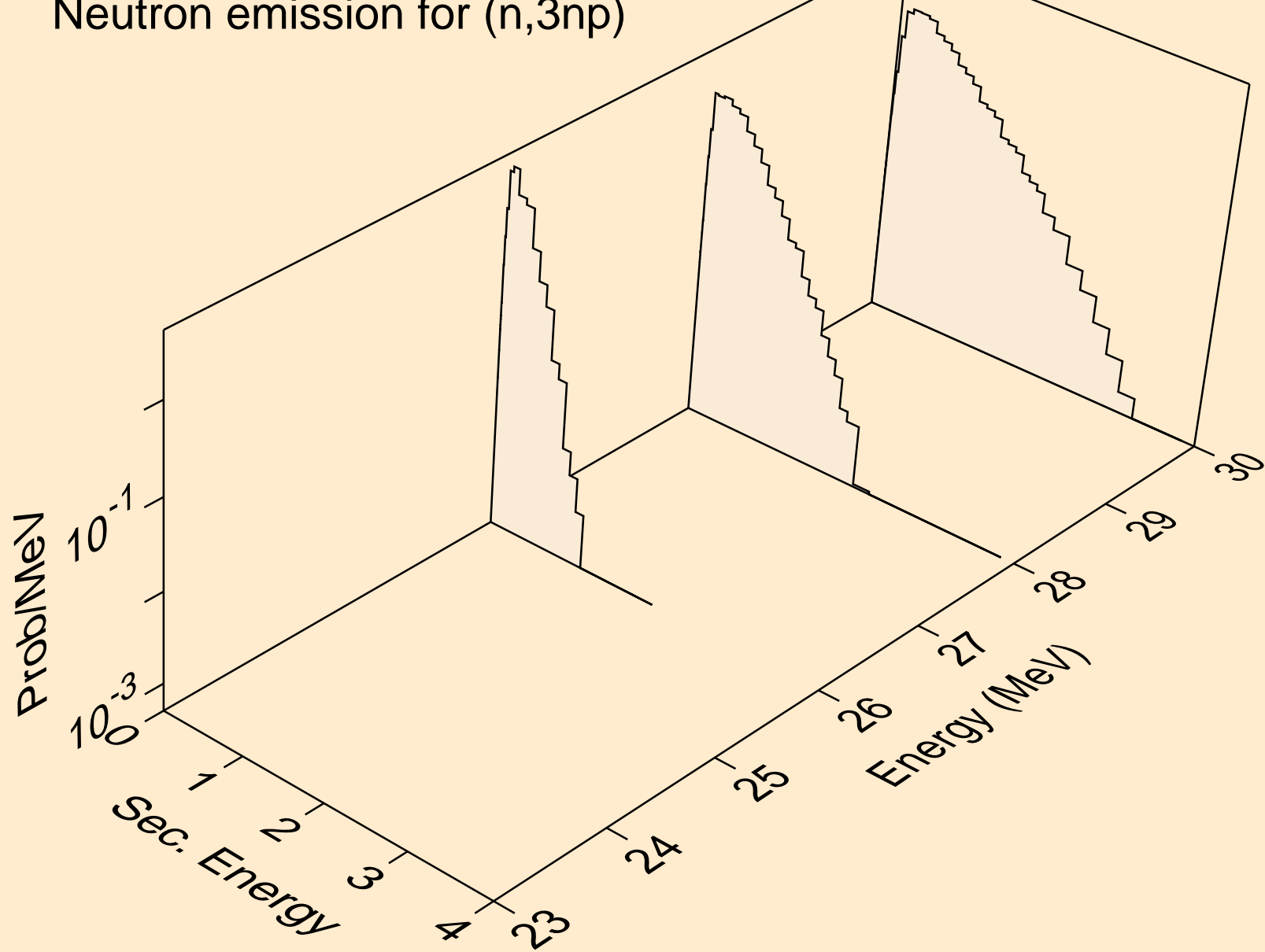

GA081 NEUTRON ACER TENDL-2021 LIBRARY; T=293.6K
Neutron emission for (n,n*c)

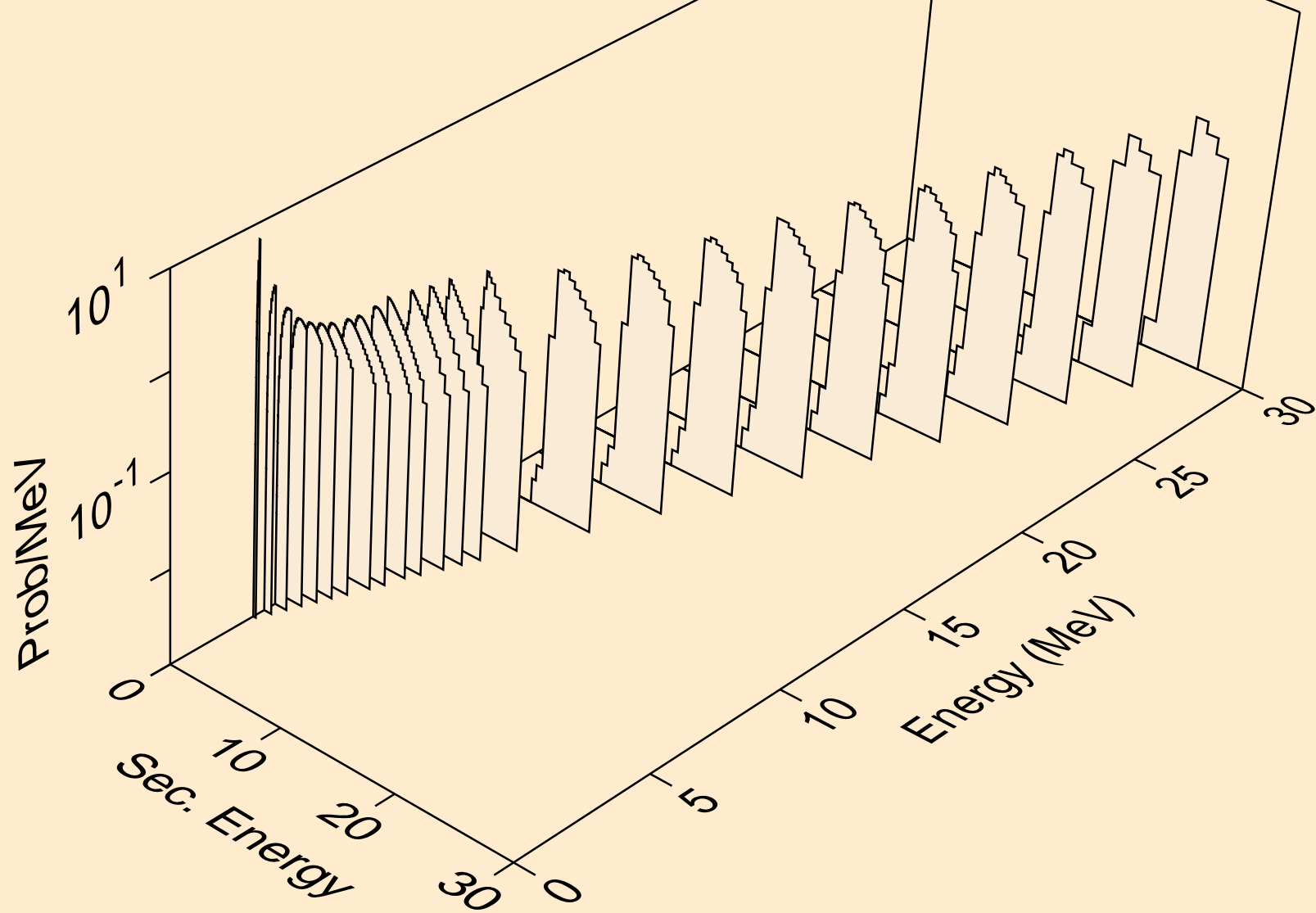

GA081 NEUTRON ACER TENDL-2021 LIBRARY; T=293.6K
Photon emission for (n,x)

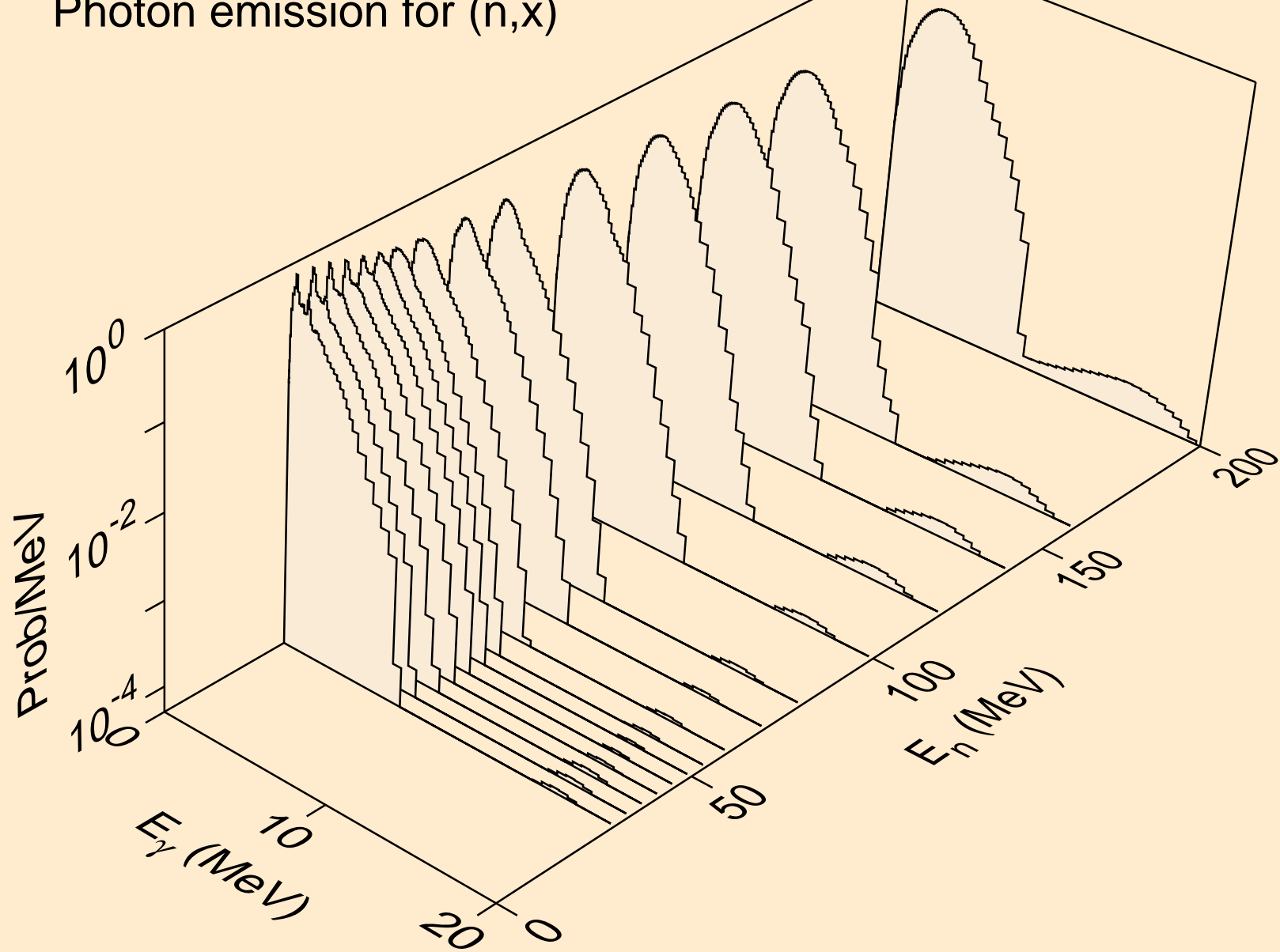

GA081 NEUTRON ACER TENDL-2021 LIBRARY; T=293.6K
Photon emission for (n,2nd)

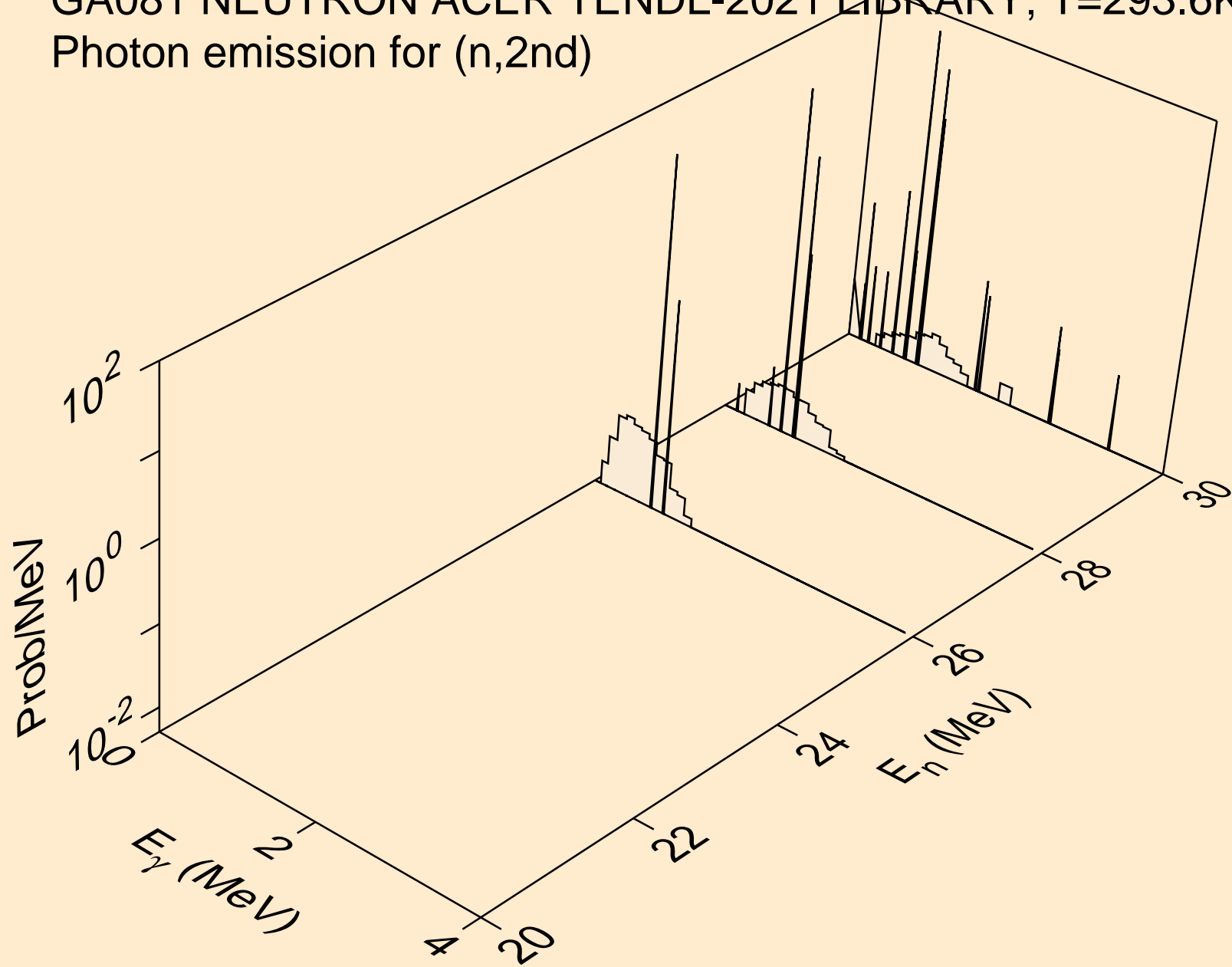

GA081 NEUTRON ACER TENDL-2021 LIBRARY; T=293.6K
Photon emission for (n,2n)

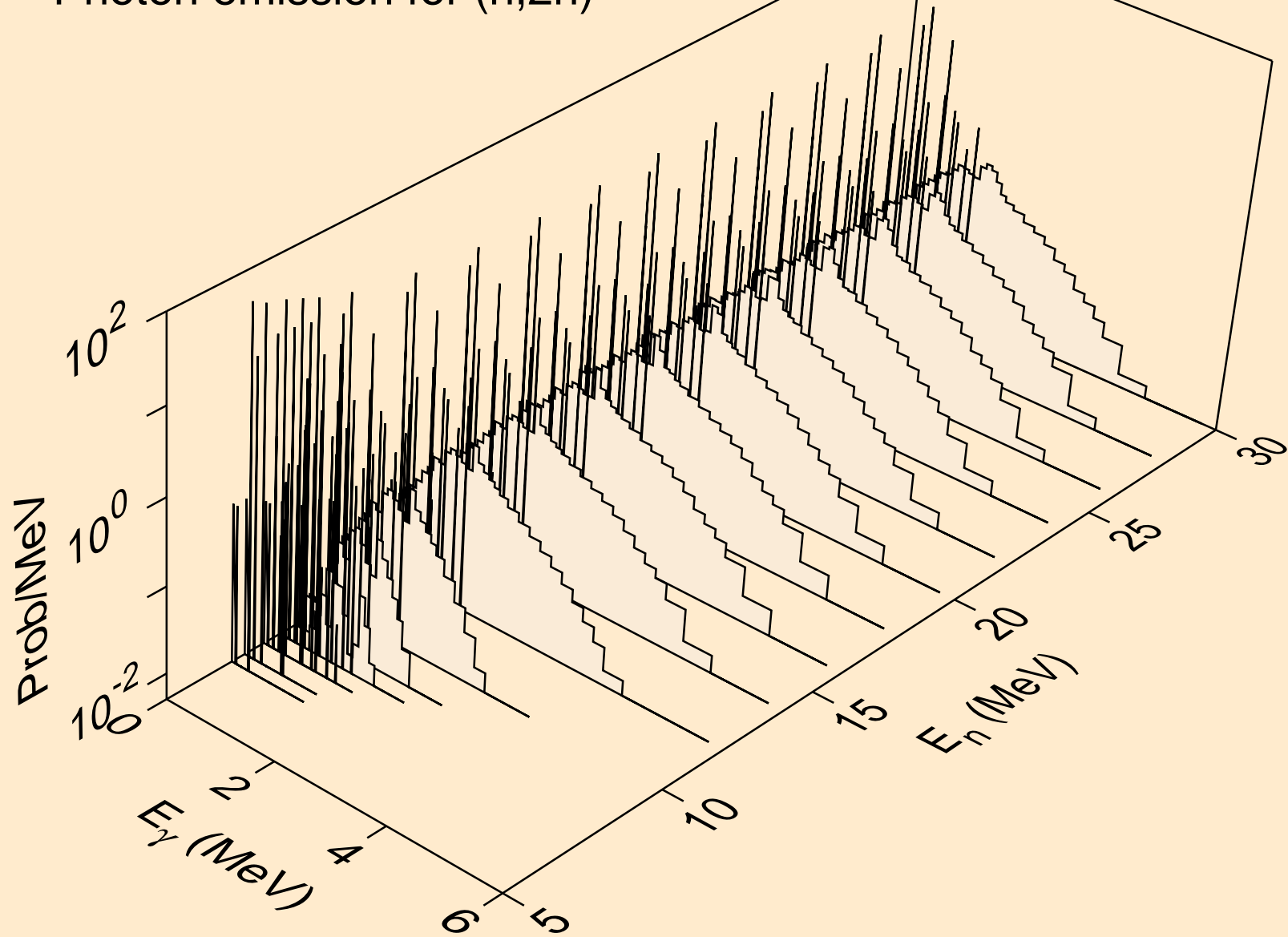

GA081 NEUTRON ACER TENDL-2021 LIBRARY; T=293.6K
Photon emission for (n,3n)

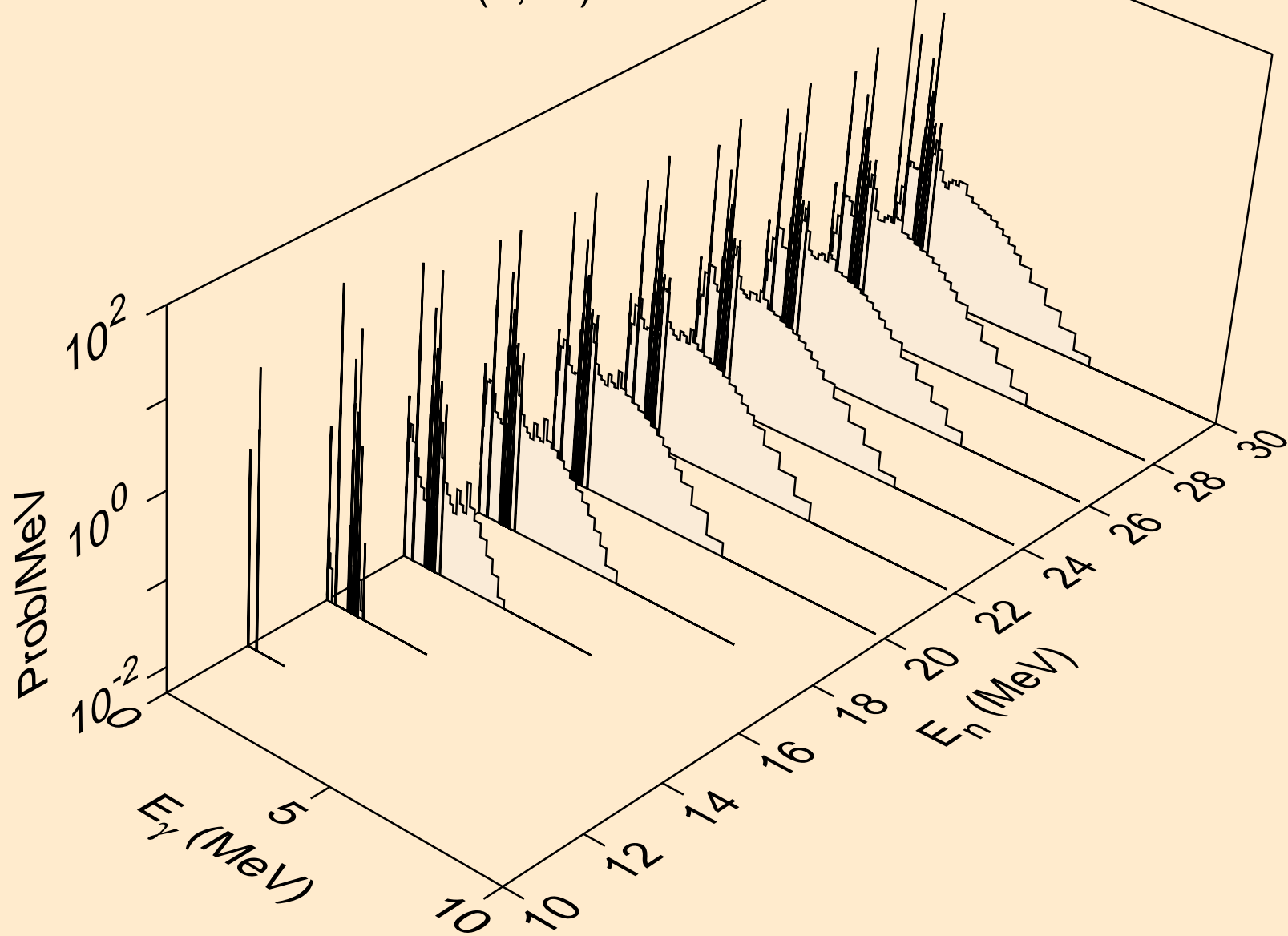

GA081 NEUTRON ACER TENDL-2021 LIBRARY; T=293.6K
Photon emission for (n,n*)a

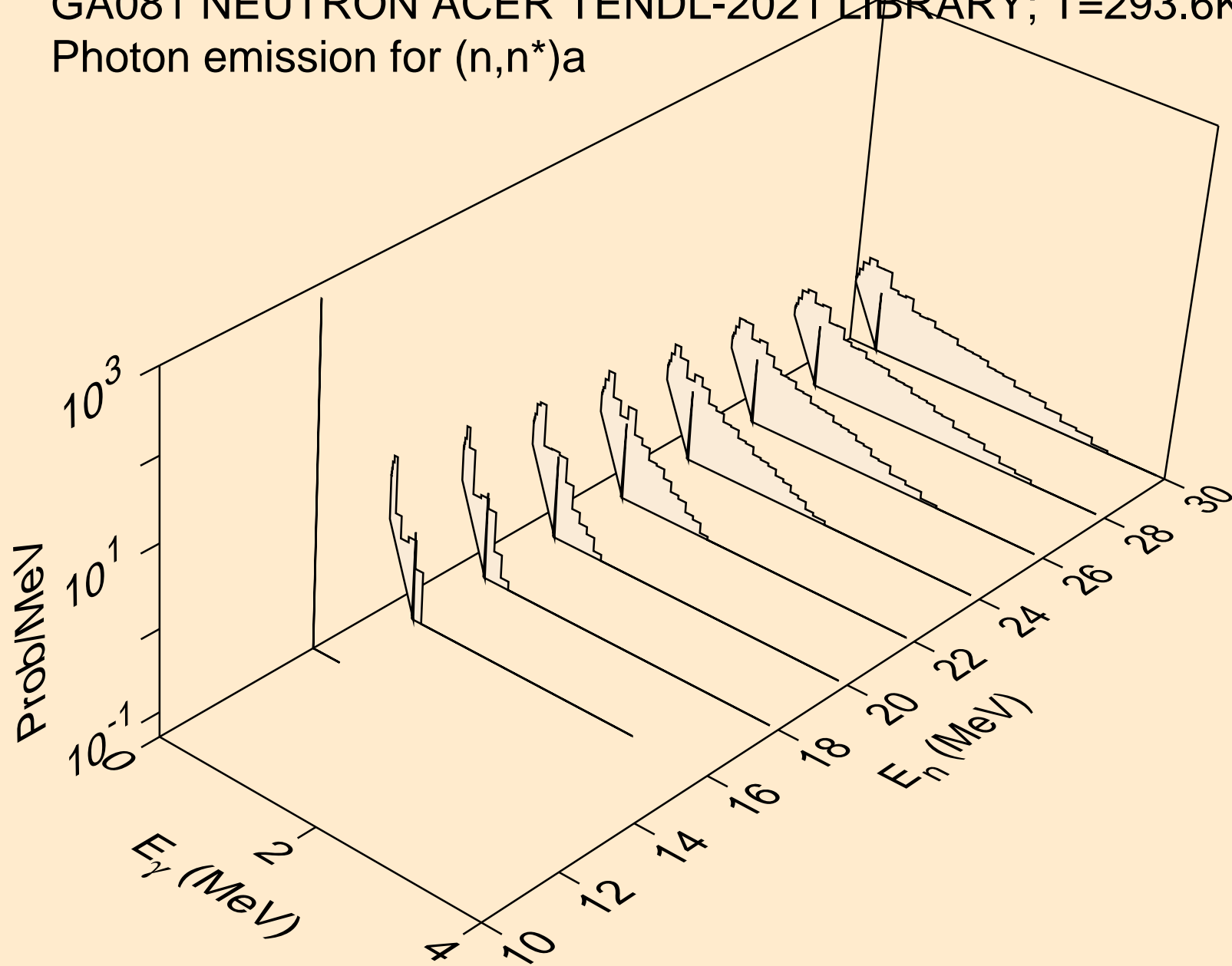

GA081 NEUTRON ACER TENDL-2021 LIBRARY; T=293.6K
Photon emission for (n,2n)a

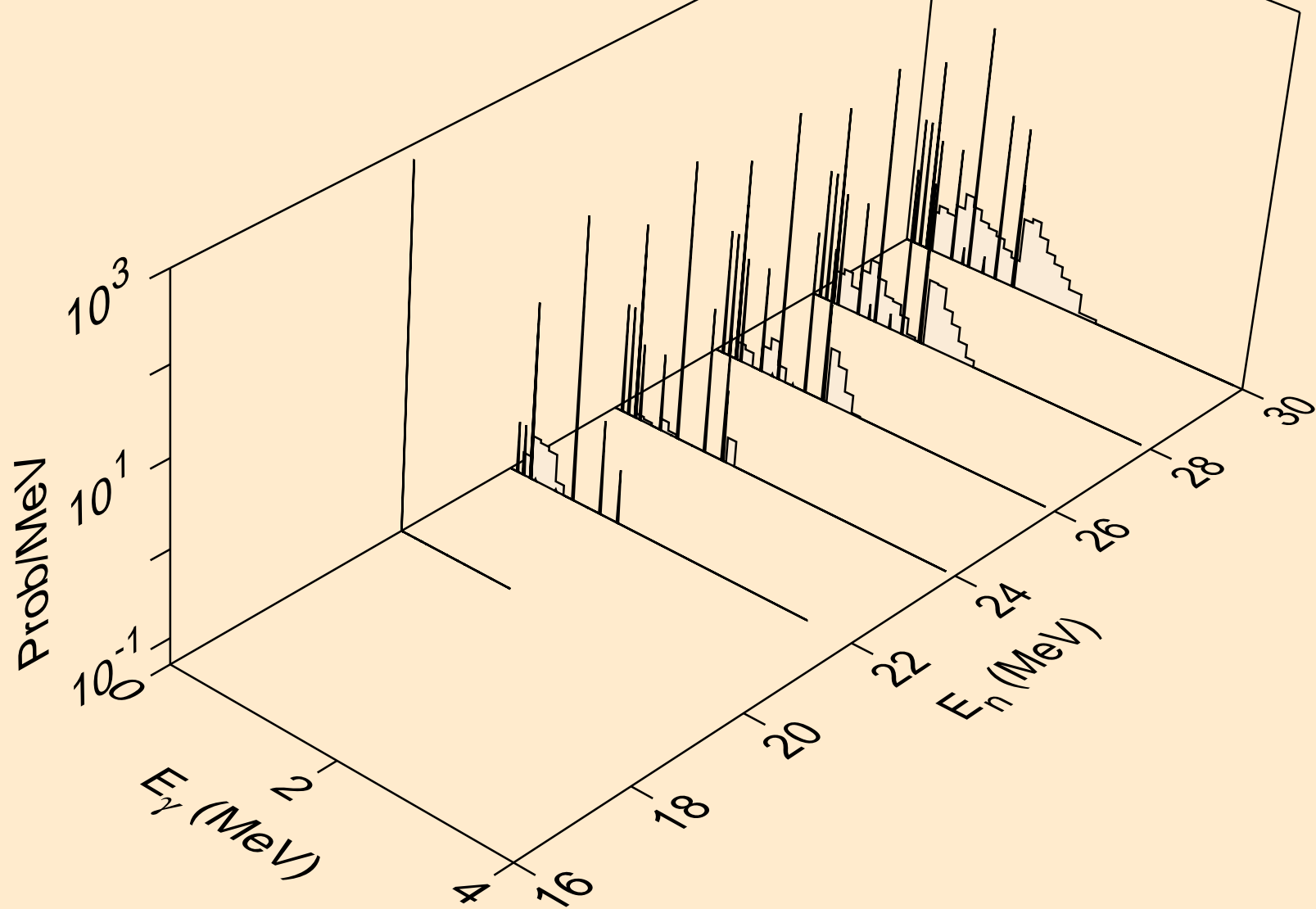

GA081 NEUTRON ACER TENDL-2021 LIBRARY; T=293.6K
Photon emission for (n,3n)a

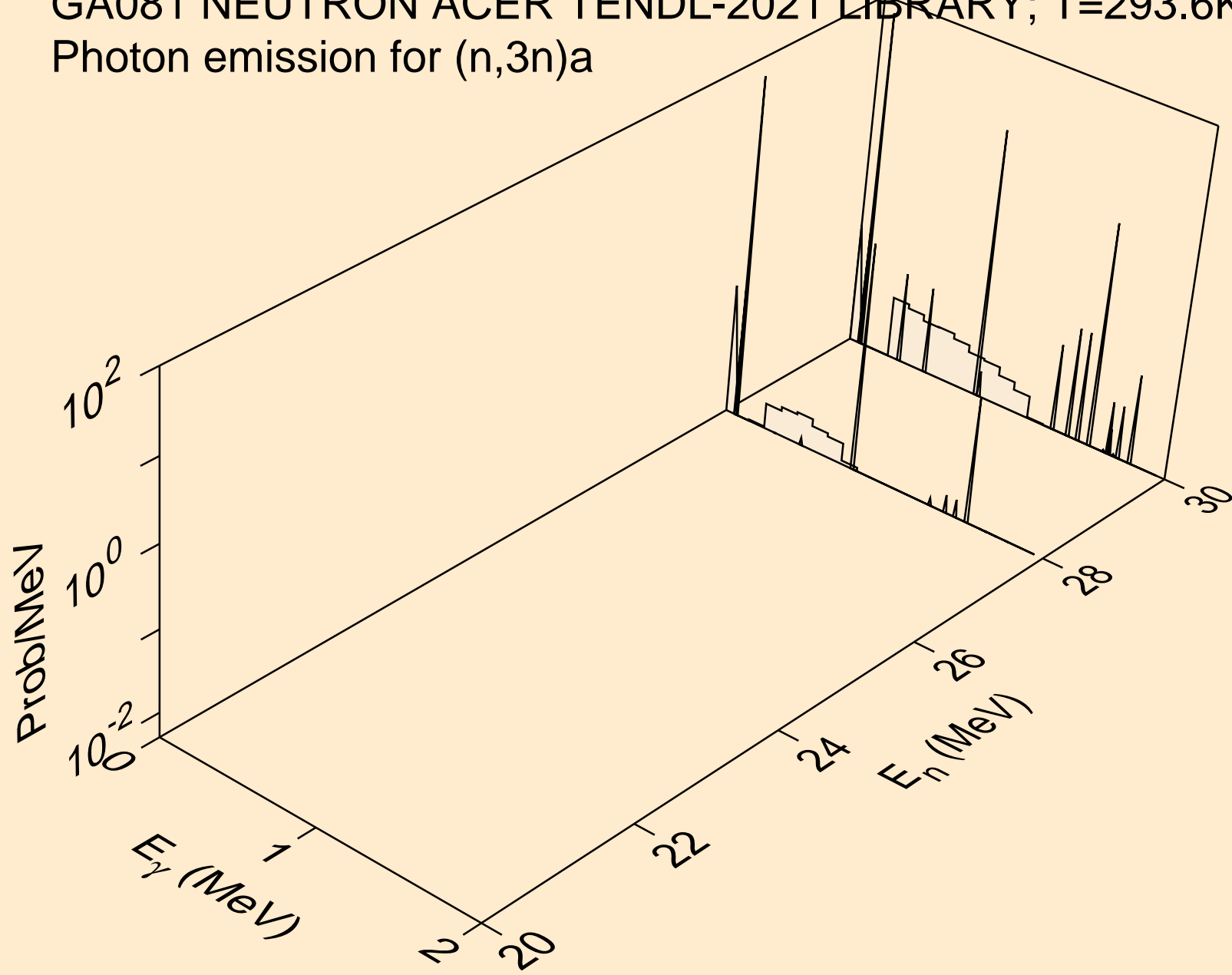

GA081 NEUTRON ACER TENDL-2021 LIBRARY; T=293.6K
Photon emission for (n,n*)p

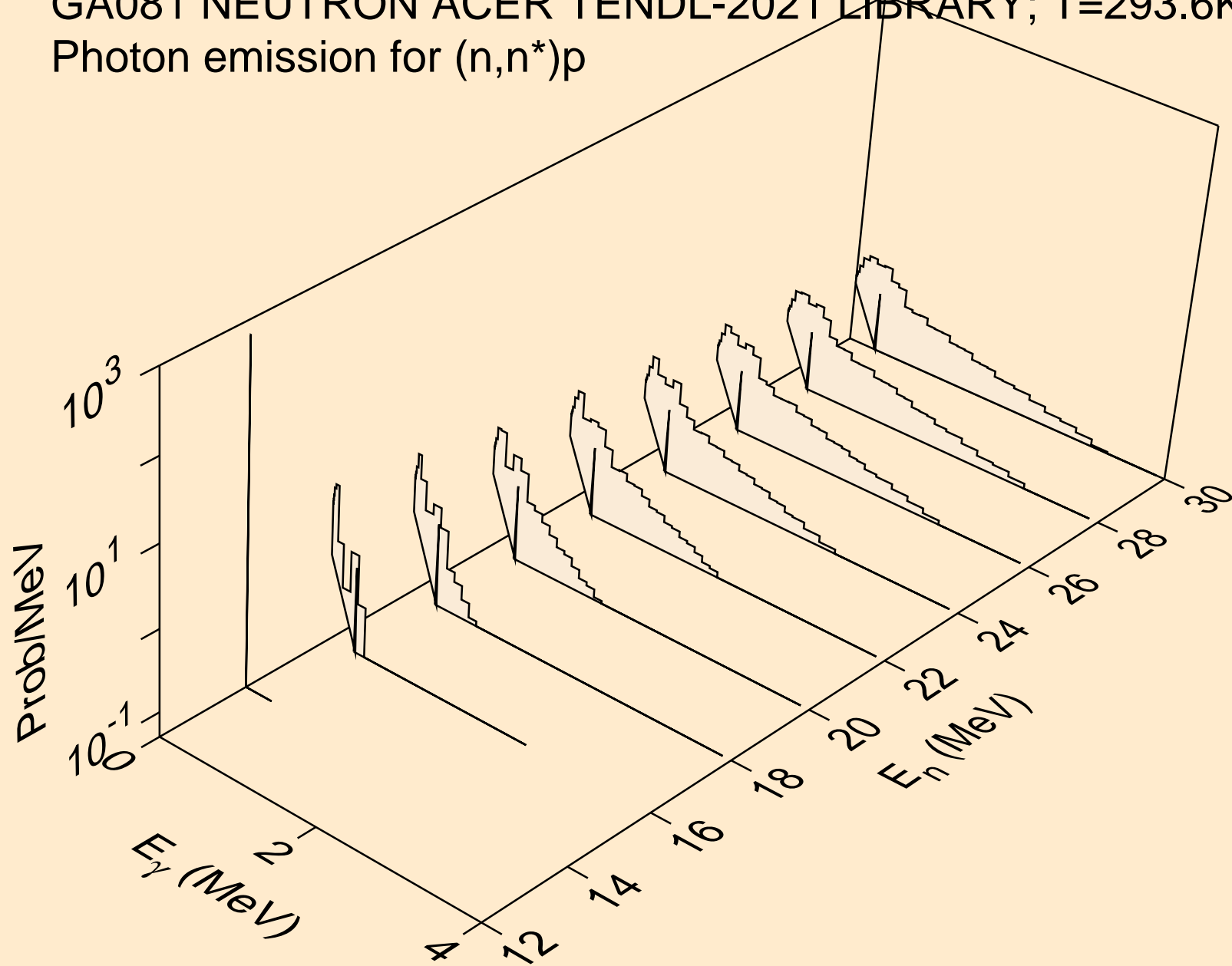

GA081 NEUTRON ACER TENDL-2021 LIBRARY; T=293.6K
Photon emission for (n,n*)d

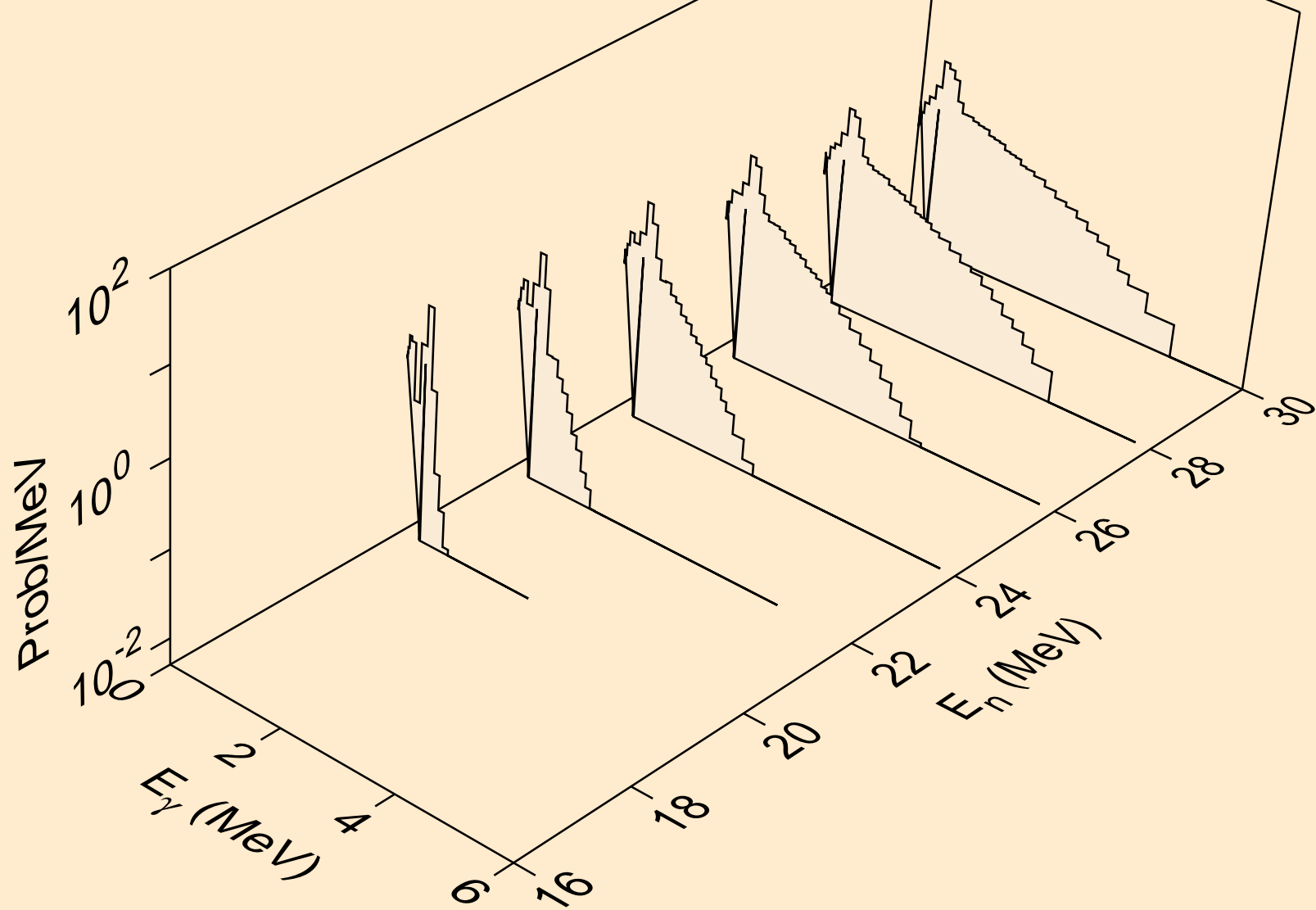

GA081 NEUTRON ACER TENDL-2021 LIBRARY; T=293.6K
Photon emission for (n,n*)t

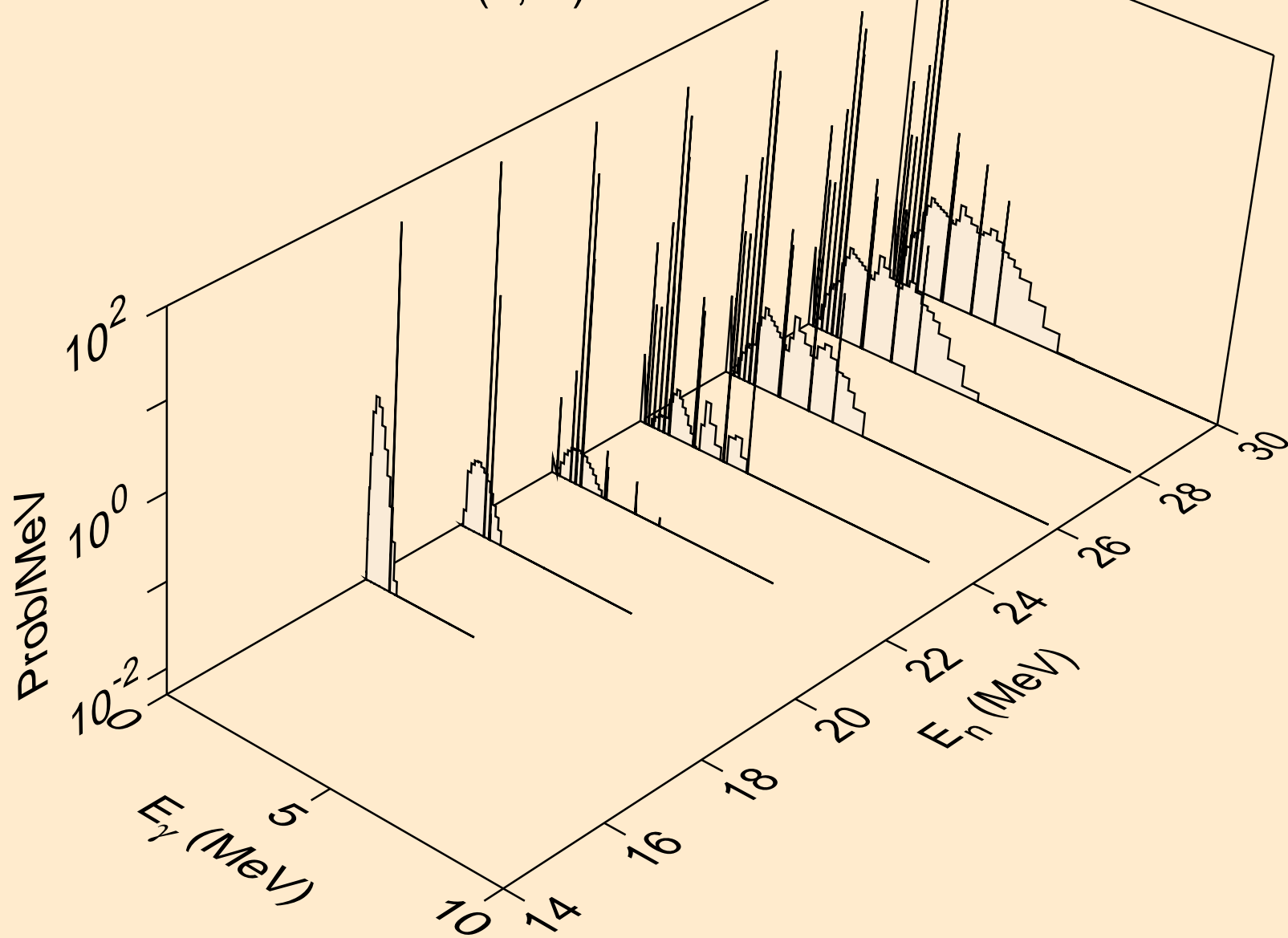

GA081 NEUTRON ACER TENDL-2021 LIBRARY; T=293.6K
Photon emission for (n,4n)

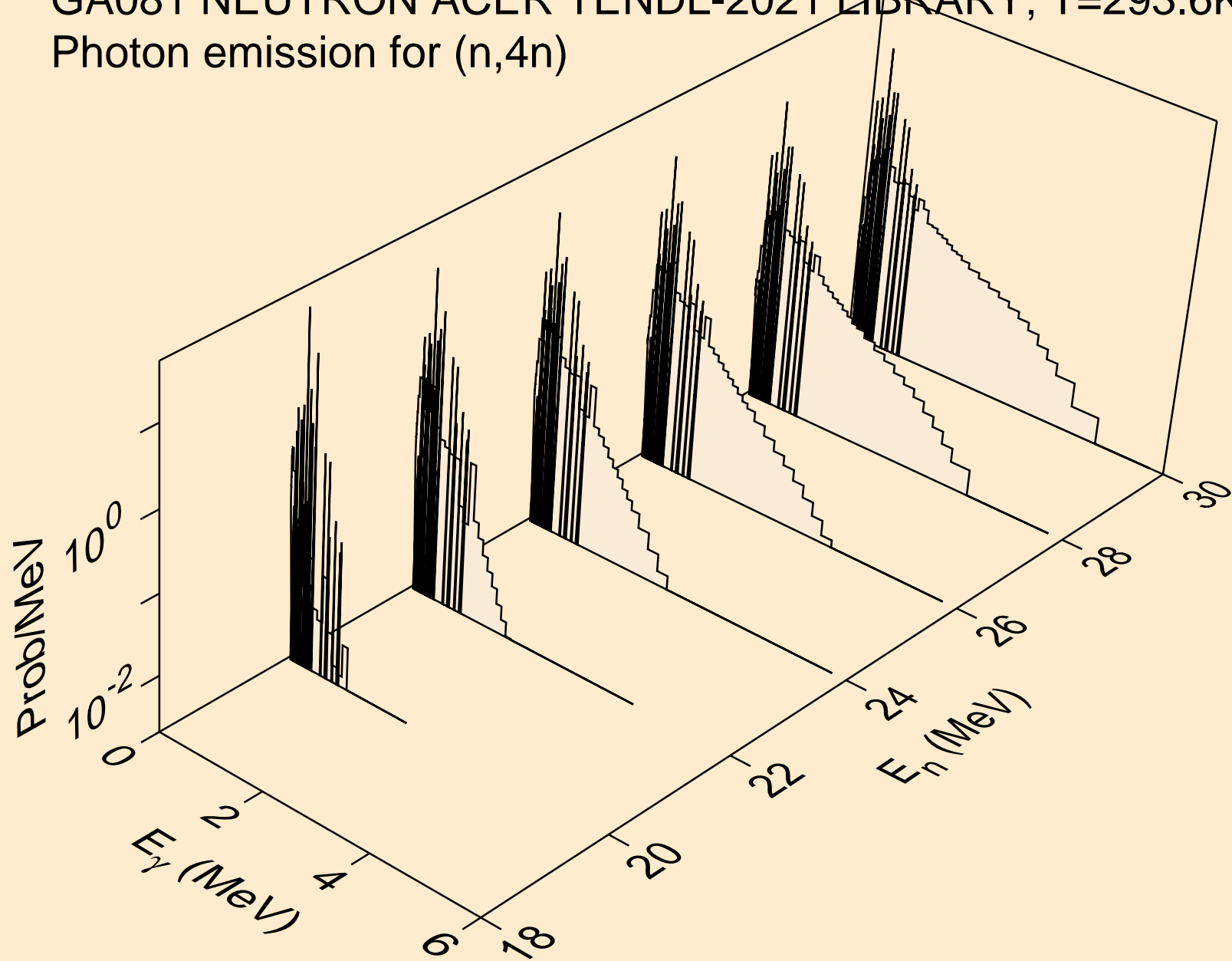

GA081 NEUTRON ACER TENDL-2021 LIBRARY; T=293.6K
Photon emission for (n,2np)

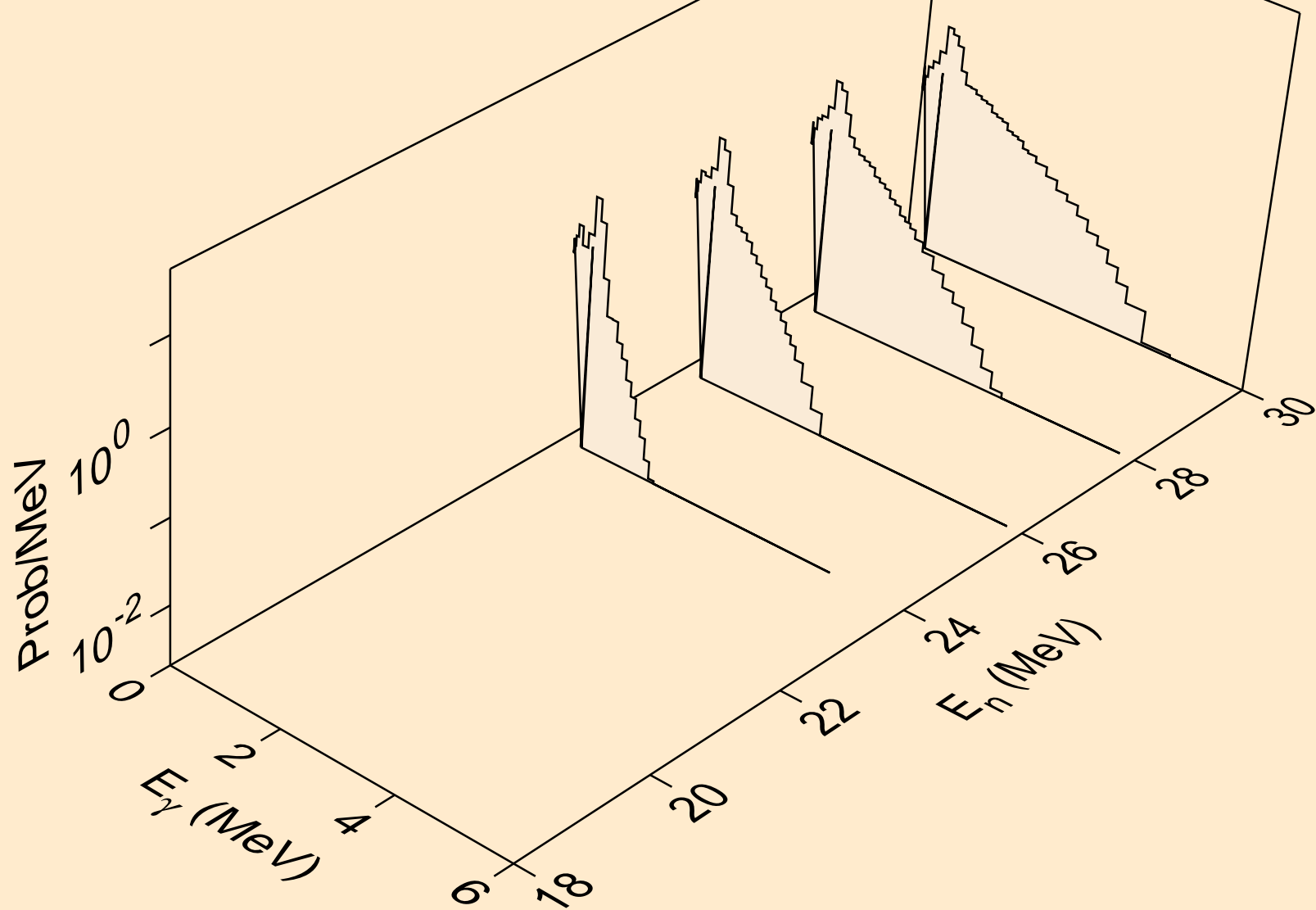

GA081 NEUTRON ACER TENDL-2021 LIBRARY; T=293.6K
Photon emission for (n,3np)

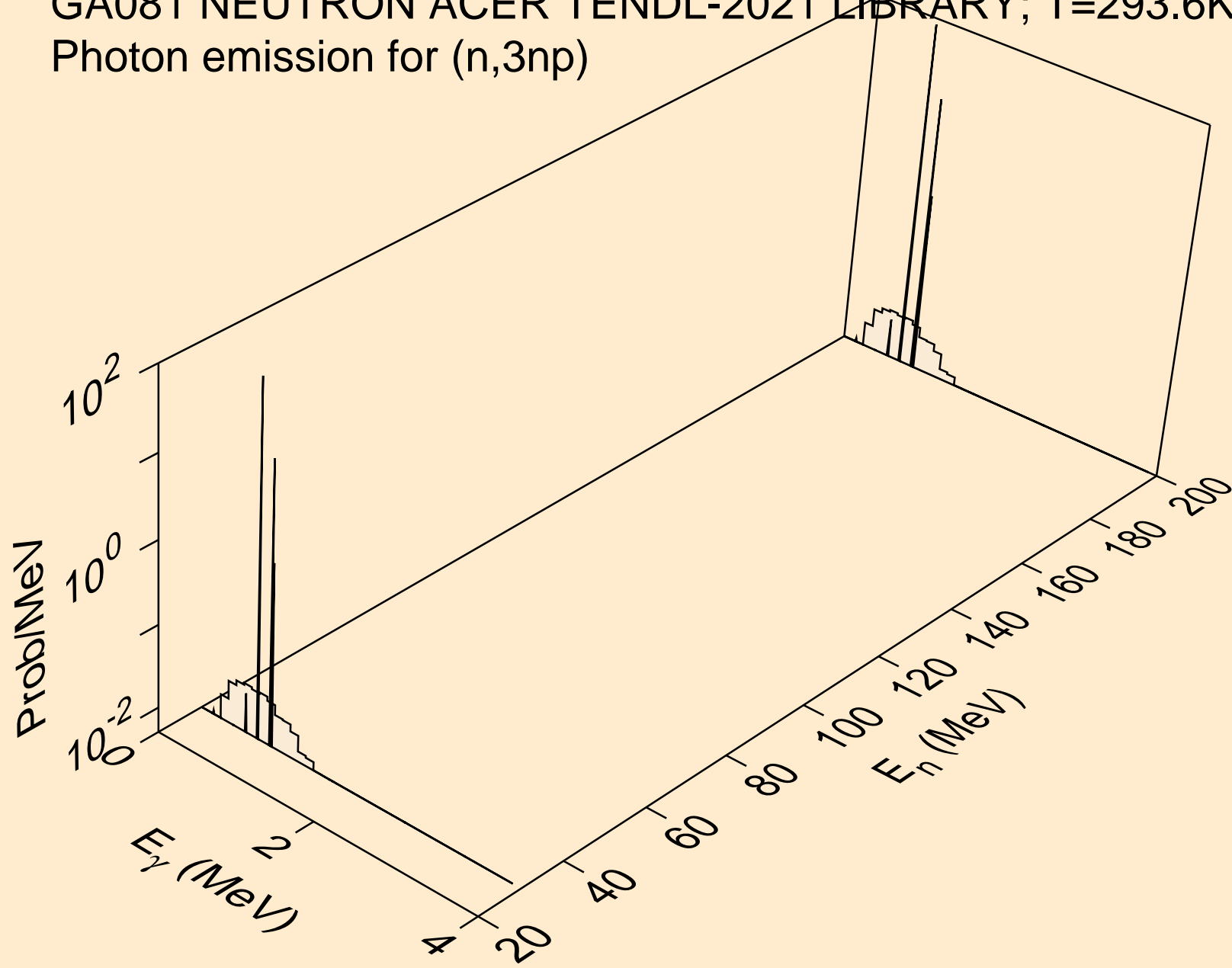

GA081 NEUTRON ACER TENDL-2021 LIBRARY; T=293.6K
Photon emission for (n,n*c)

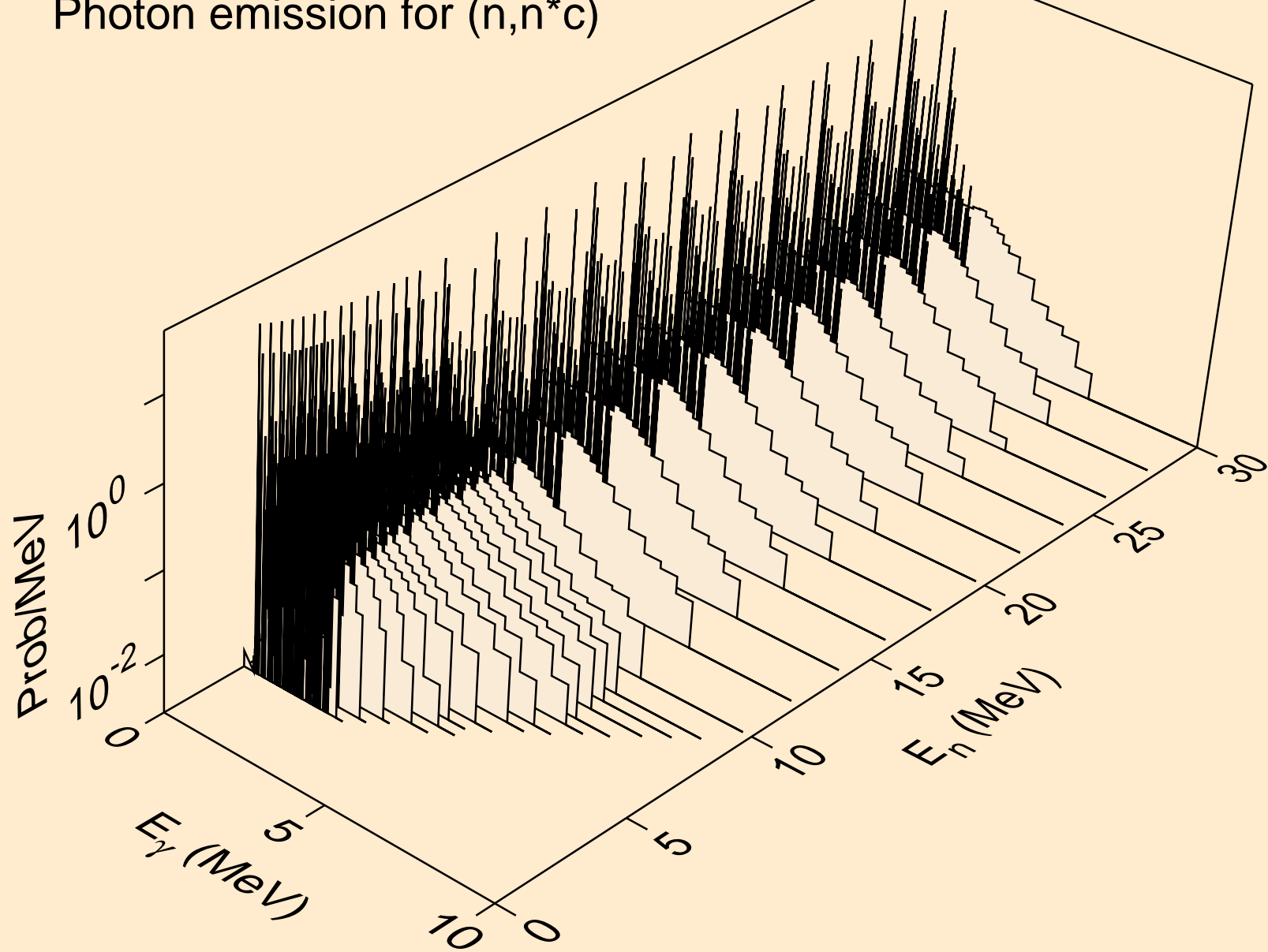

GA081 NEUTRON ACER TENDL-2021 LIBRARY; T=293.6K
Photon emission for (n,gma)

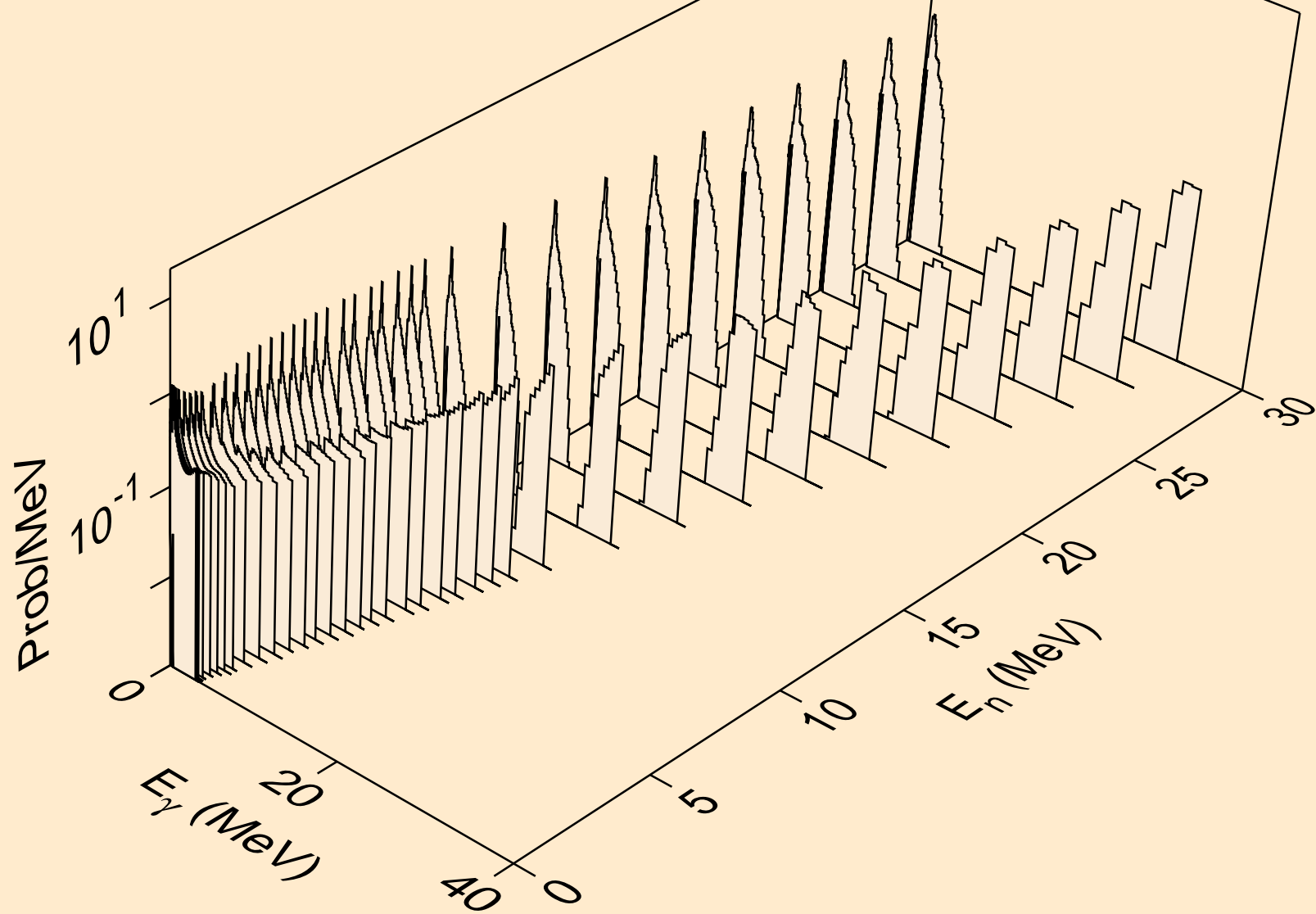

GA081 NEUTRON ACER TENDL-2021 LIBRARY; T=293.6K
Photon emission for (n,p)

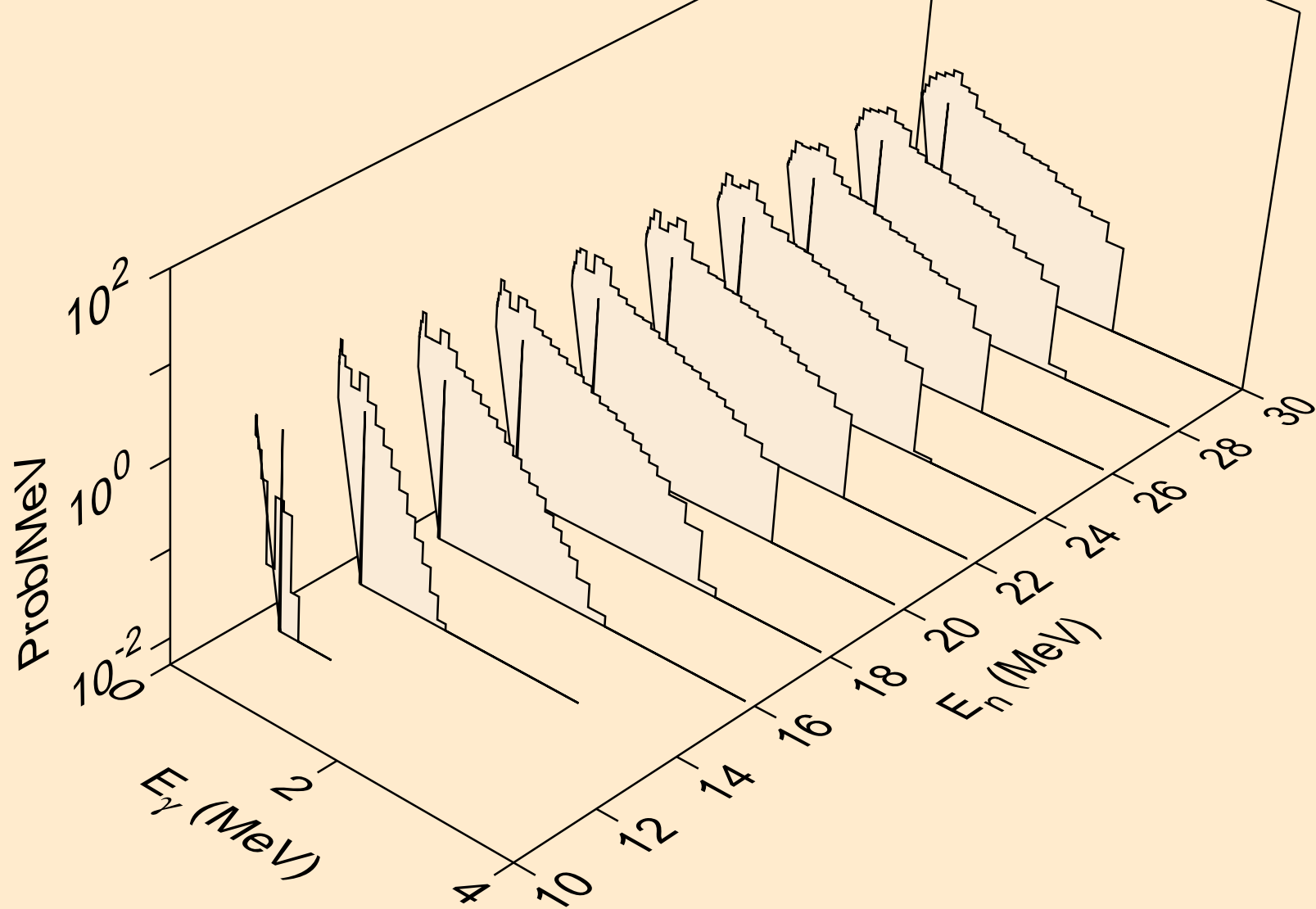

GA081 NEUTRON ACER TENDL-2021 LIBRARY; T=293.6K
Photon emission for (n,d)

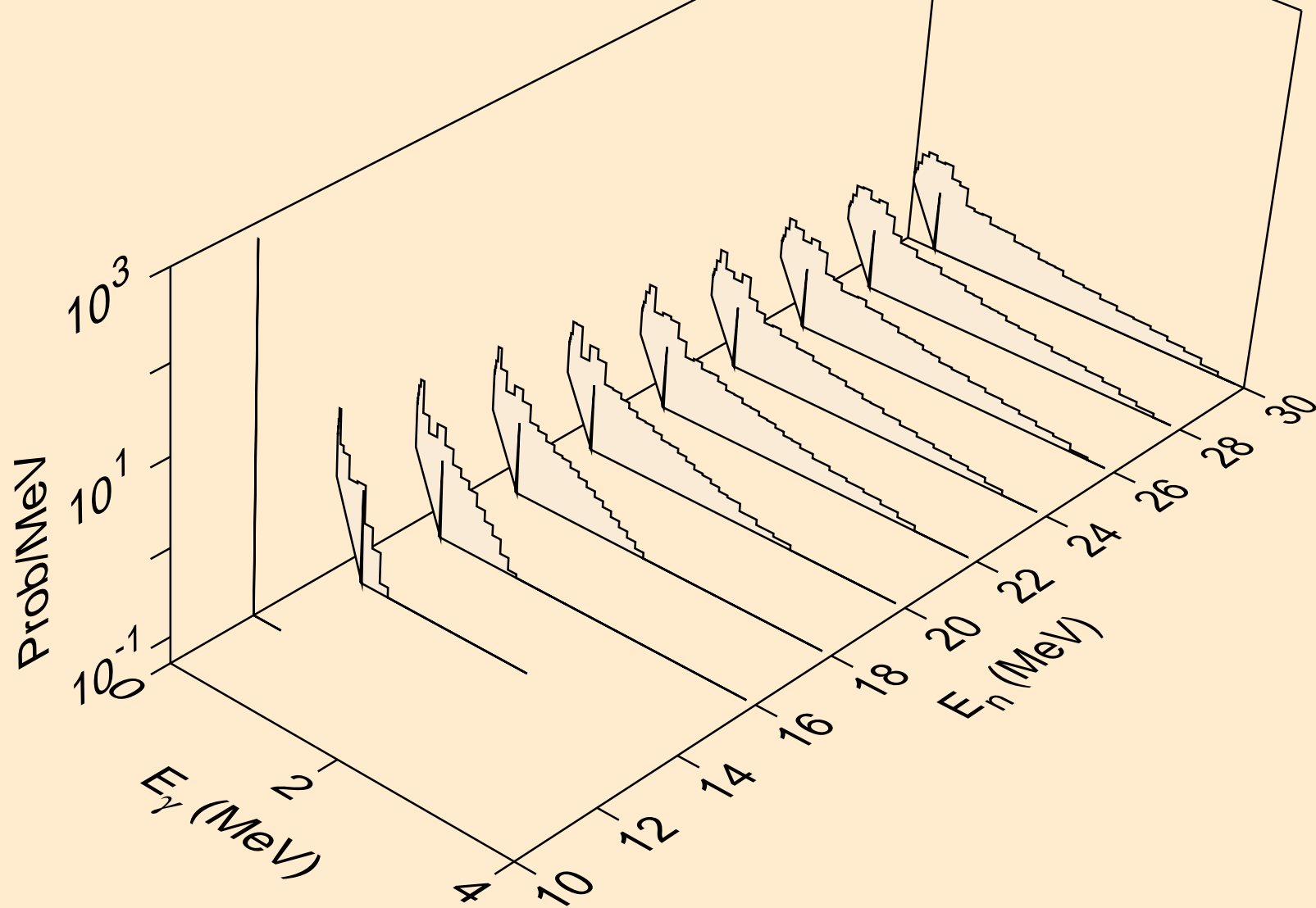

GA081 NEUTRON ACER TENDL-2021 LIBRARY; T=293.6K
Photon emission for (n,t)

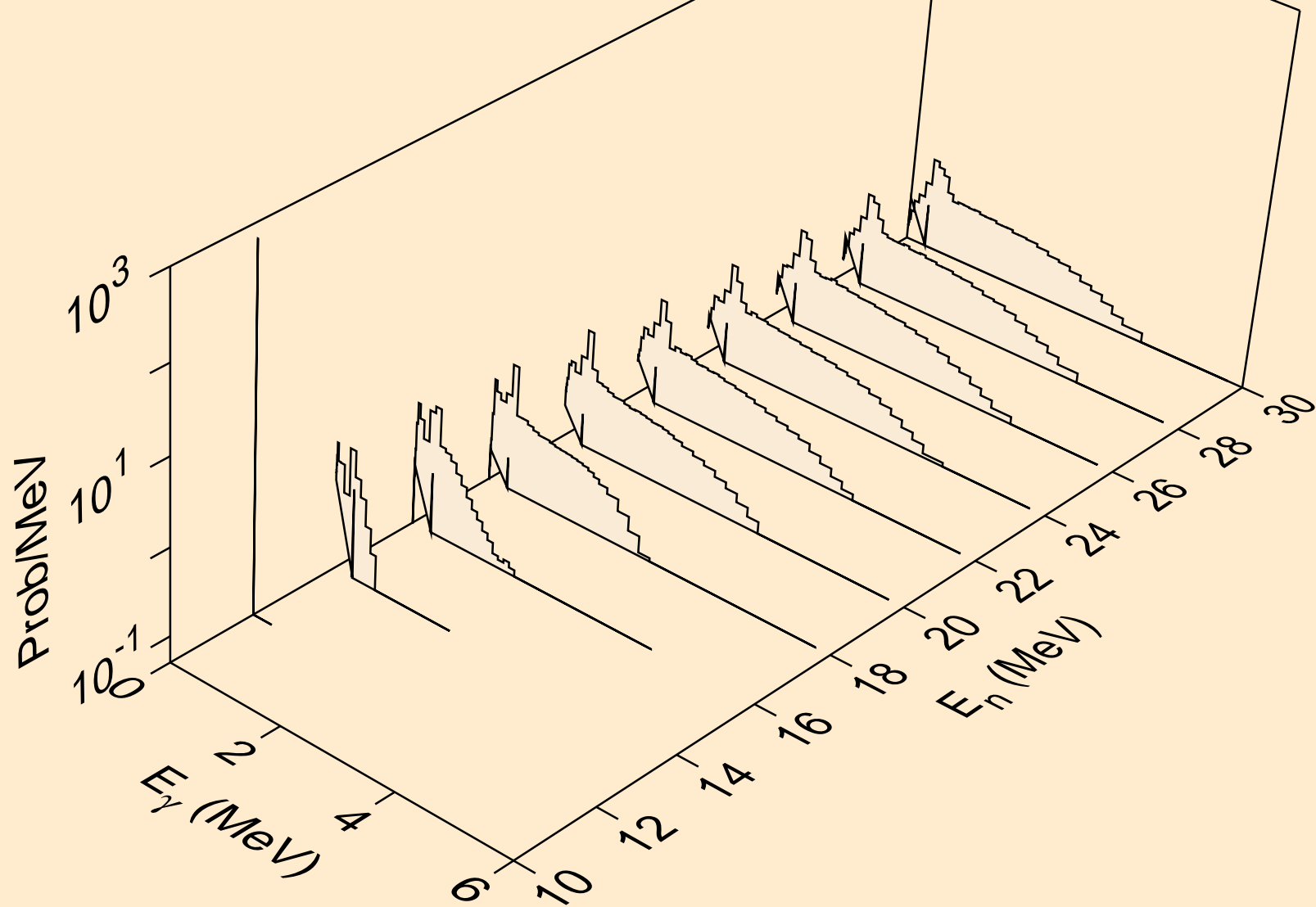

GA081 NEUTRON ACER TENDL-2021 LIBRARY; T=293.6K
Photon emission for (n,he3)

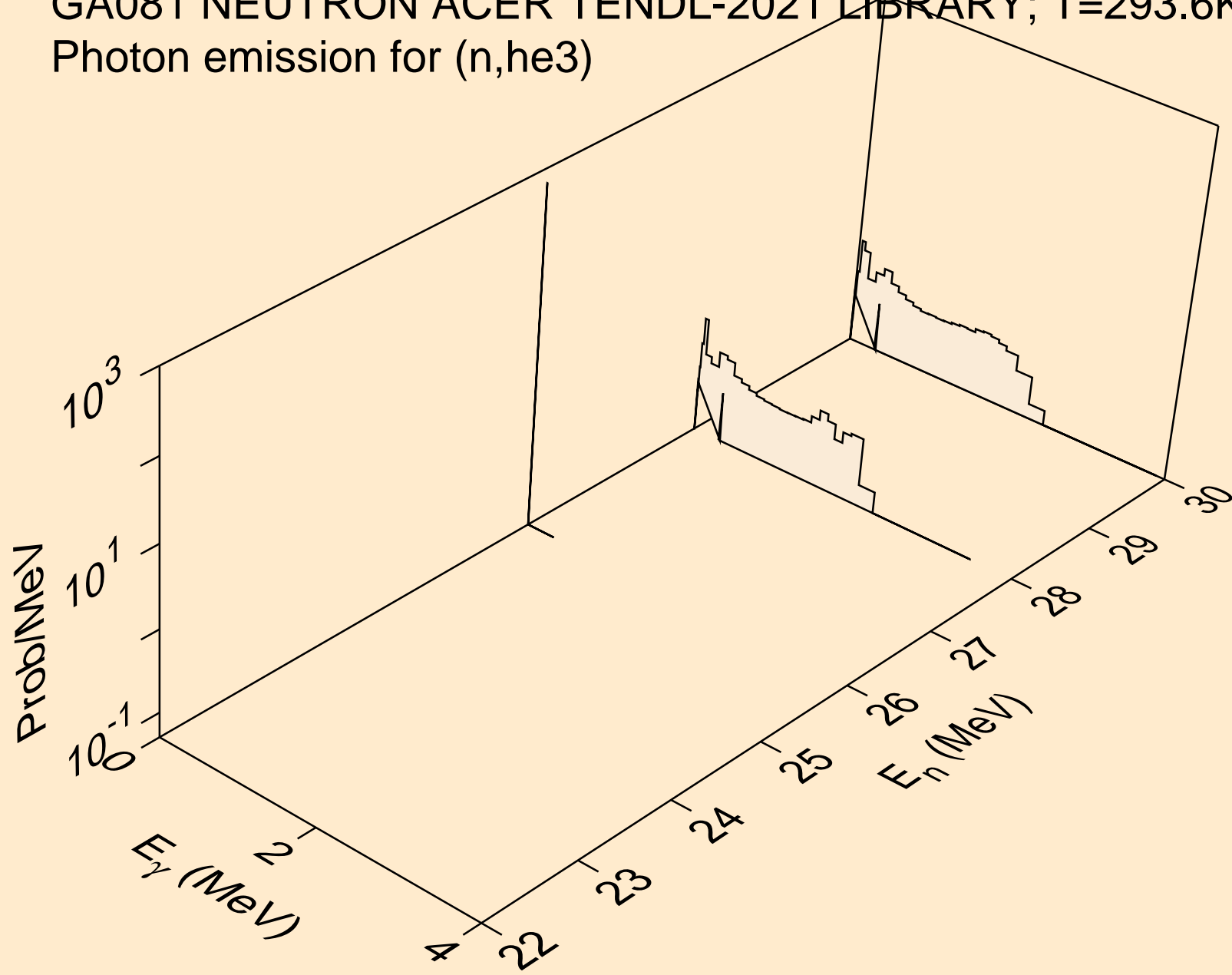

GA081 NEUTRON ACER TENDL-2021 LIBRARY; T=293.6K
Photon emission for (n,a)

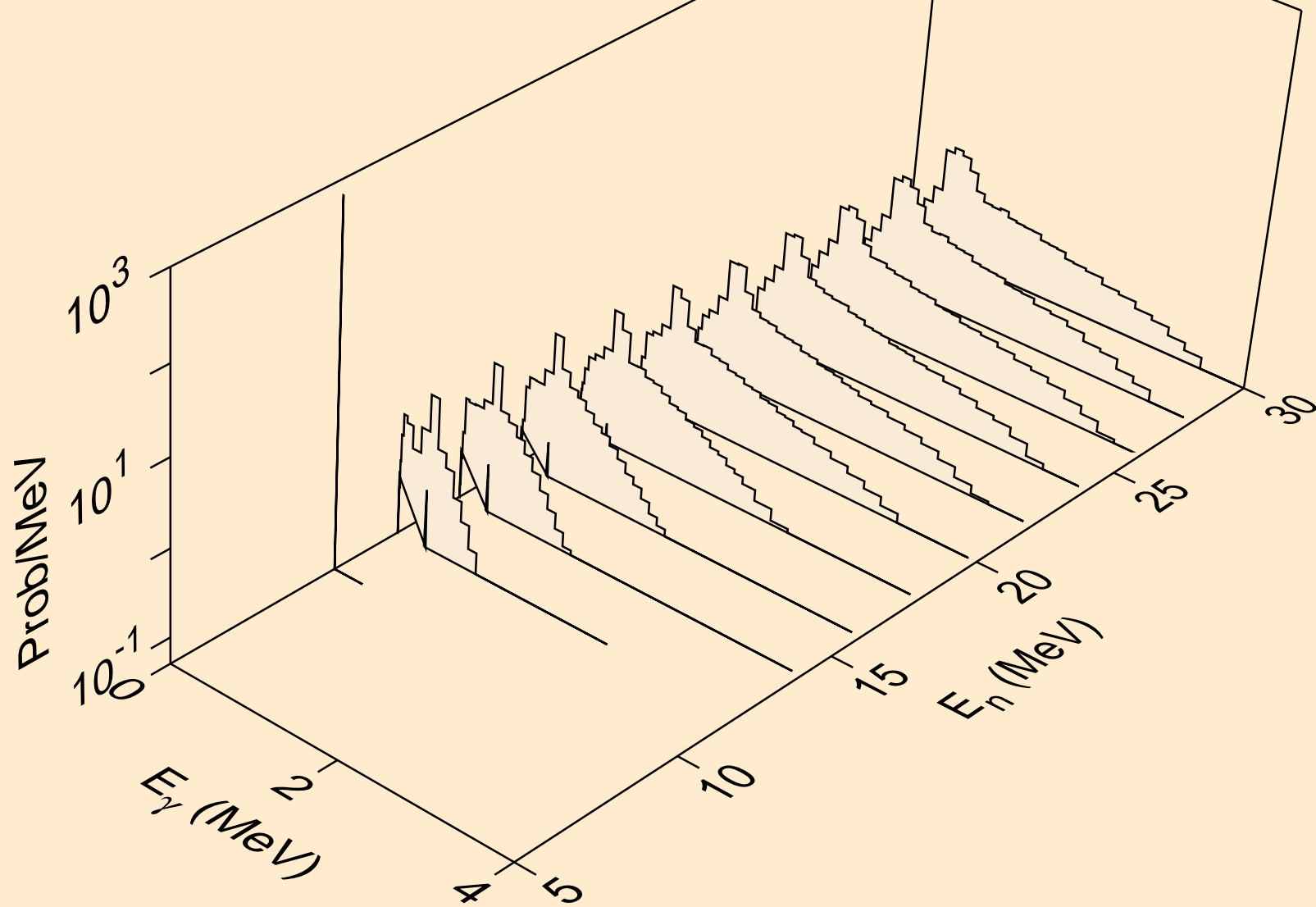

GA081 NEUTRON ACER TENDL-2021 LIBRARY; T=293.6K
thermal capture photon spectrum

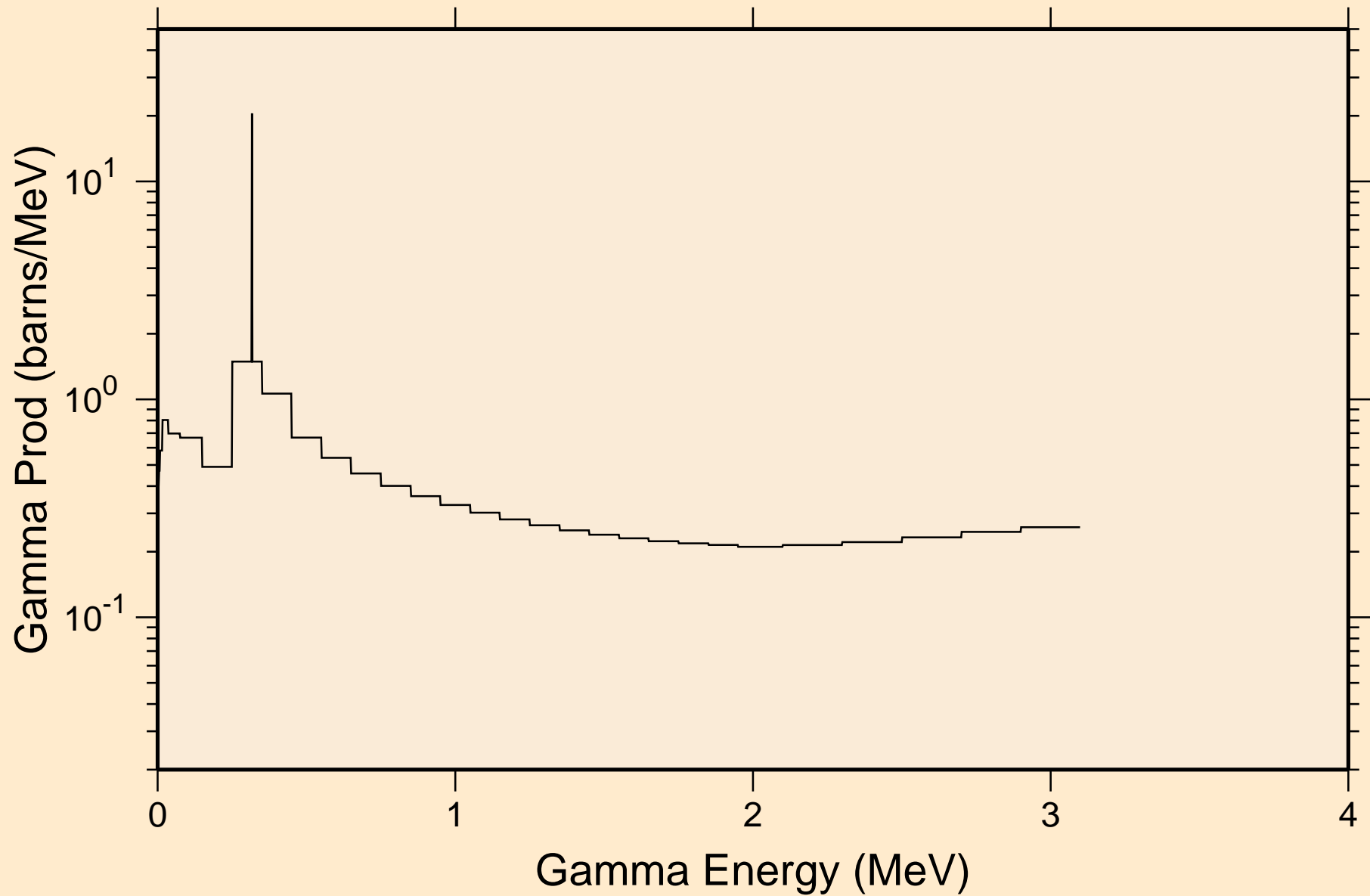

GA081 NEUTRON ACER TENDL-2021 LIBRARY; T=293.6K
14 MeV photon spectrum

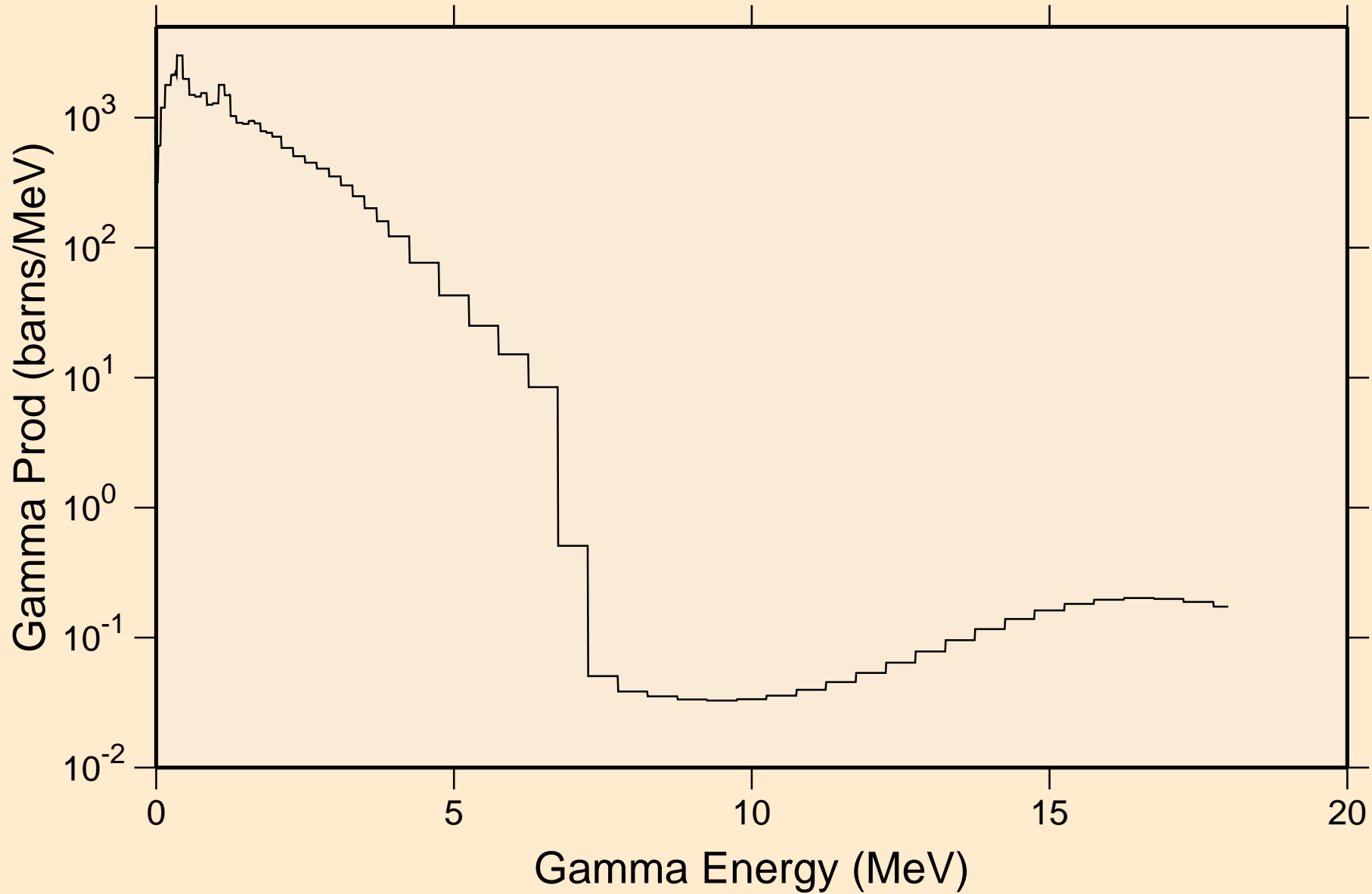

GA081 NEUTRON ACER TENDL-2021 LIBRARY; T=293.6K
Particle heating contributions

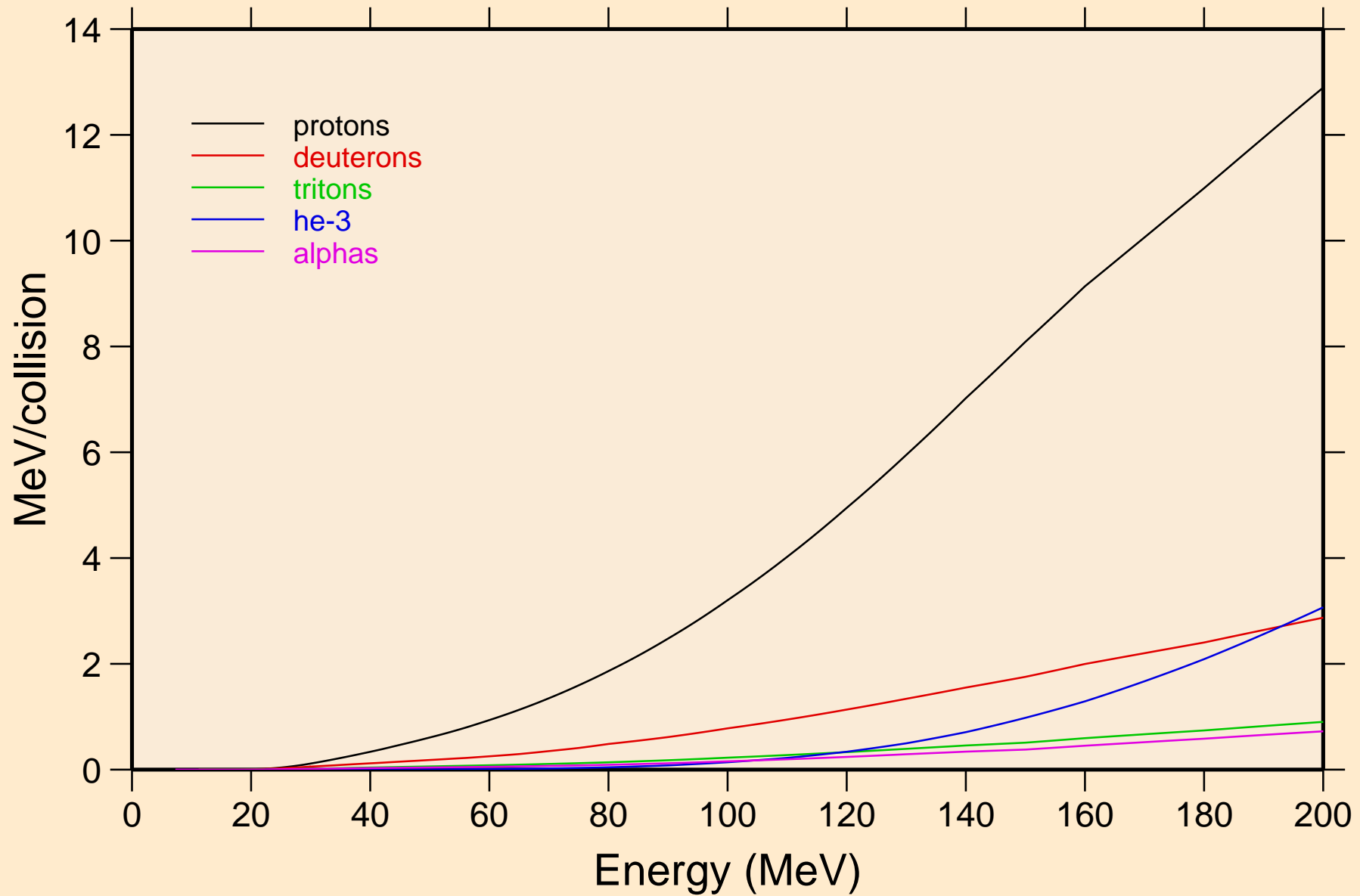

GA081 NEUTRON ACER TENDL-2021 LIBRARY; T=293.6K
Recoil Heating

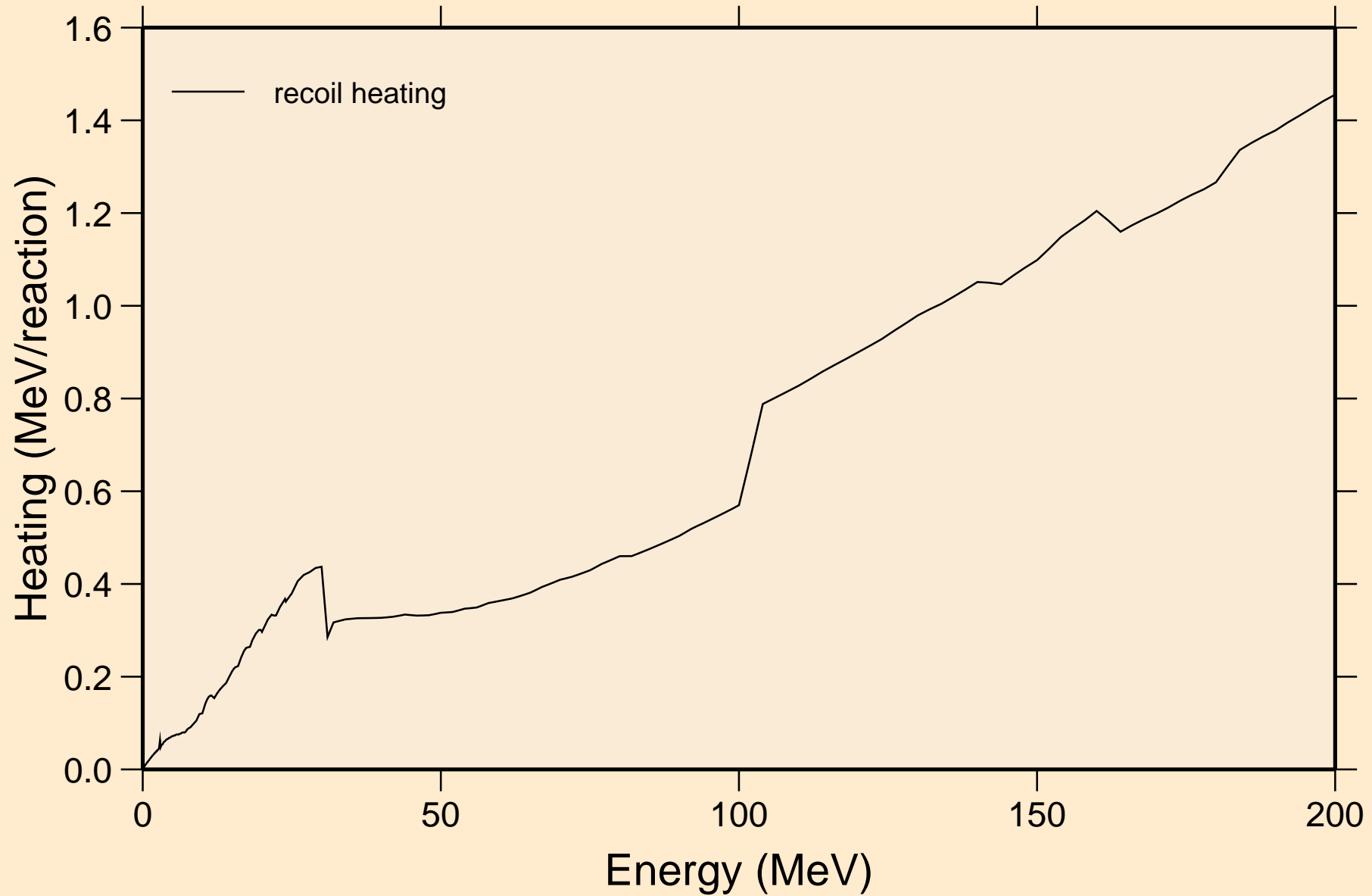

GA081 NEUTRON ACER TENDL-2021 LIBRARY; T=293.6K
Particle production cross sections

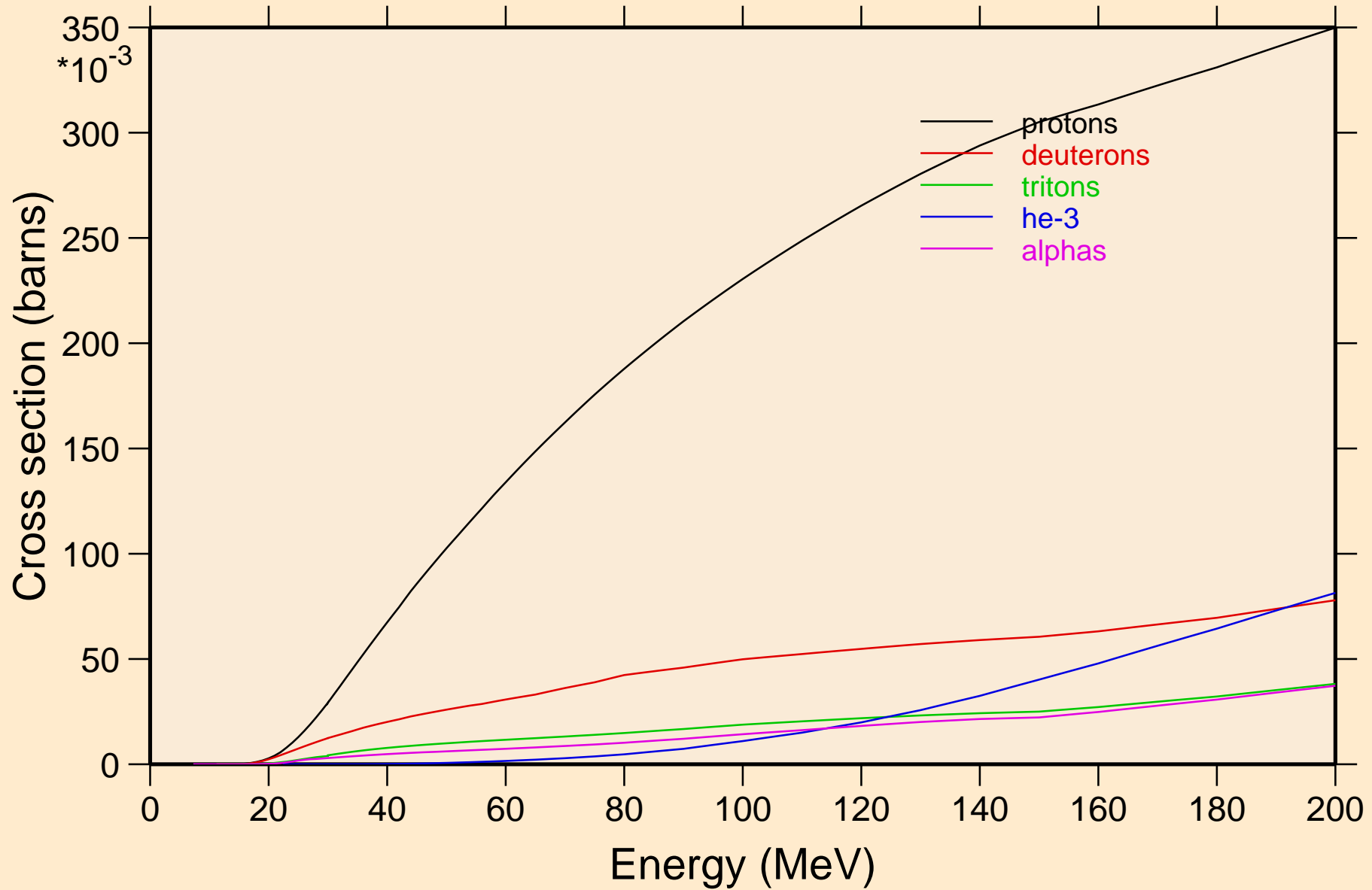

GA081 NEUTRON ACER TENDL-2021 LIBRARY; T=293.6K
protons from (n,x)

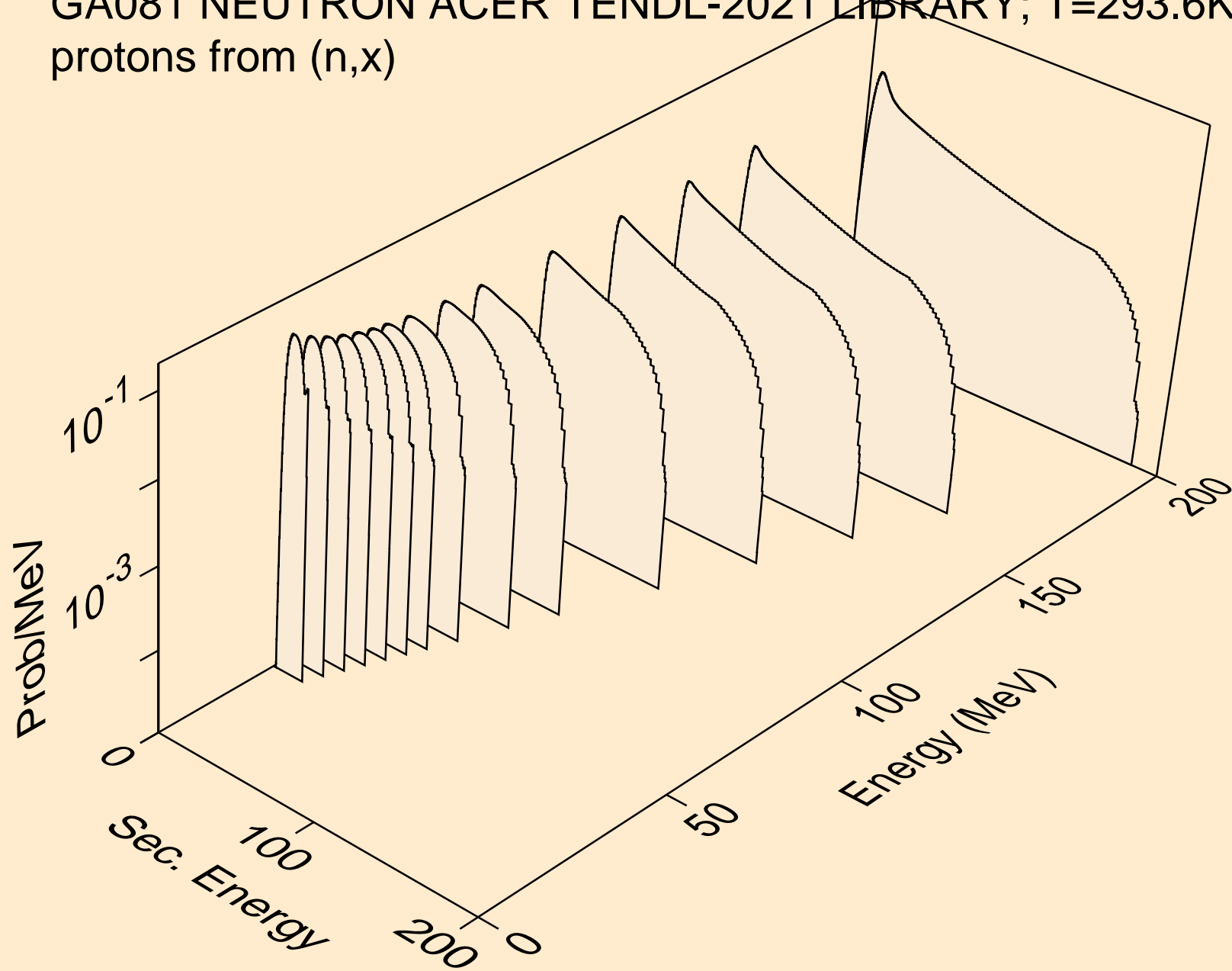

GA081 NEUTRON ACER TENDL-2021 LIBRARY; T=293.6K
protons from (n,n*)p

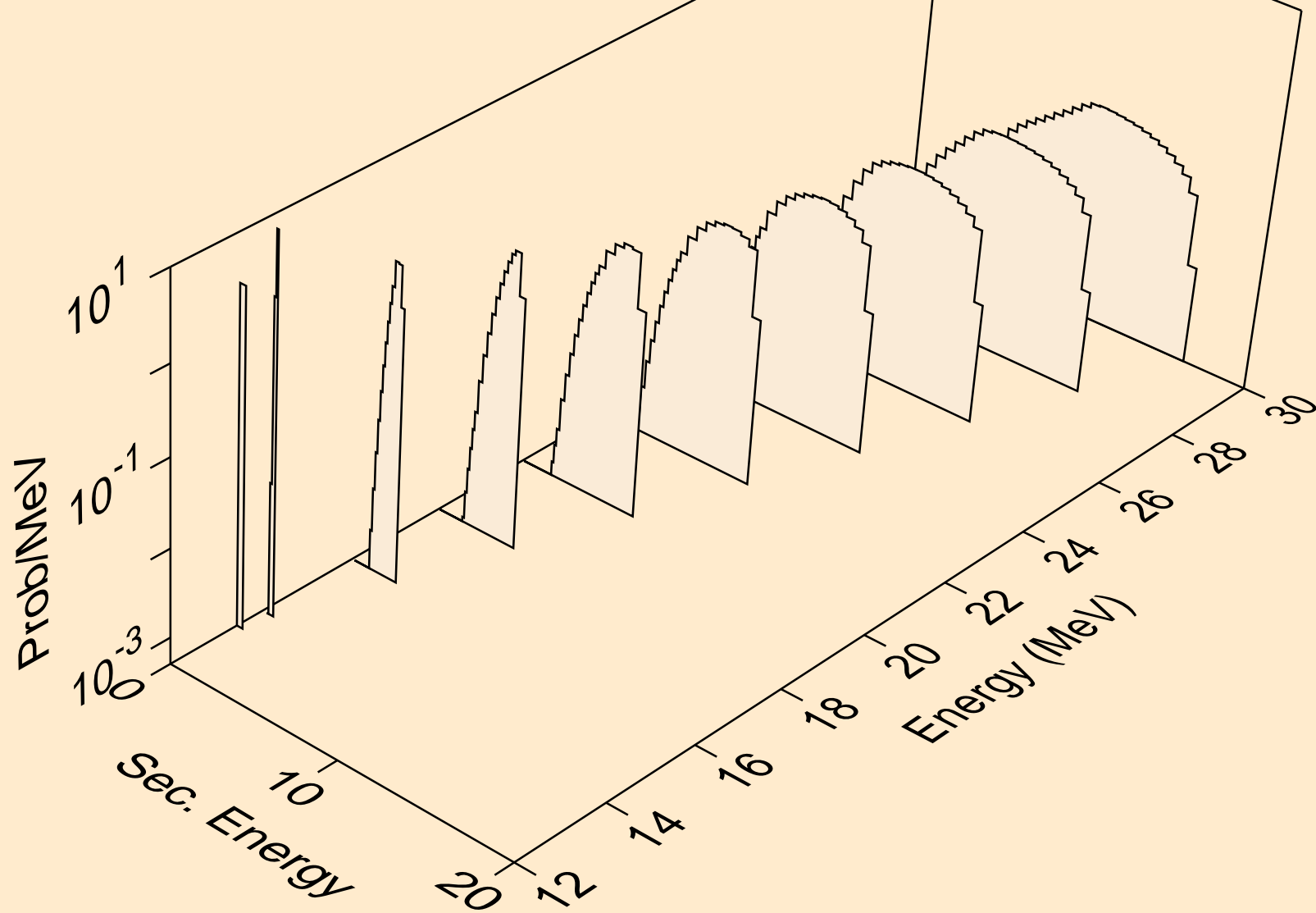

GA081 NEUTRON ACER TENDL-2021 LIBRARY; T=293.6K
protons from (n,2np)

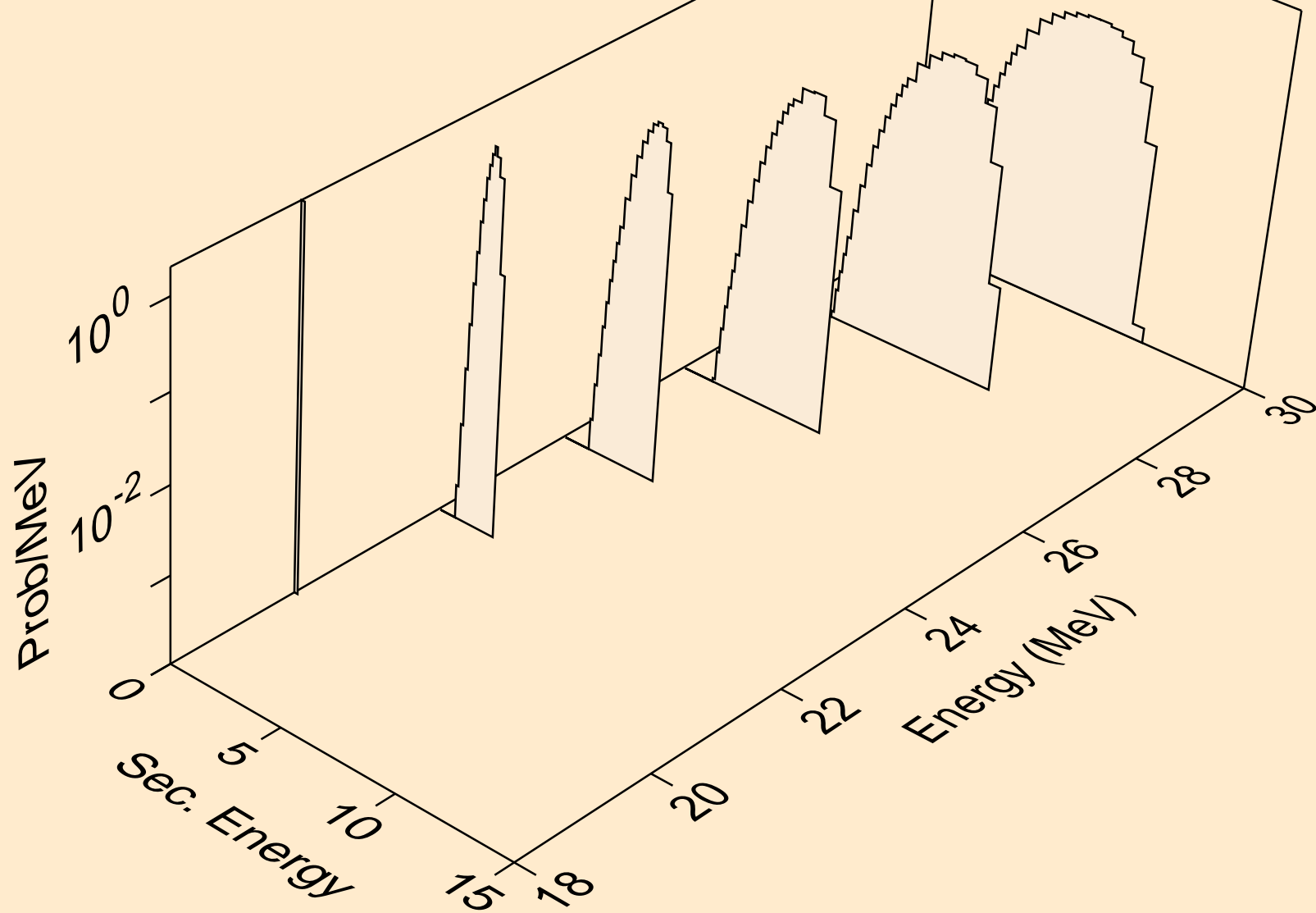

GA081 NEUTRON ACER TENDL-2021 LIBRARY; T=293.6K
protons from (n,3np)

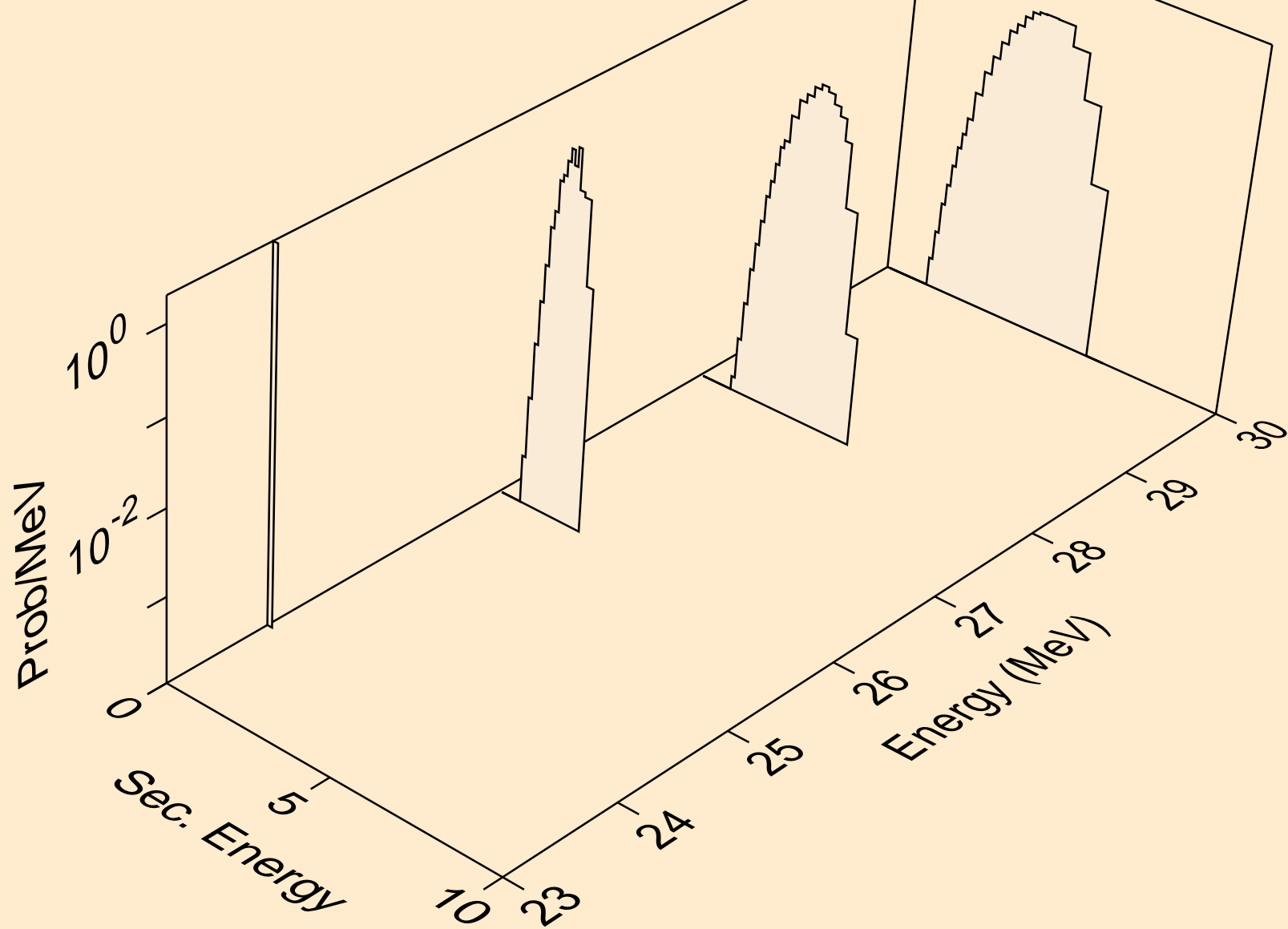

GA081 NEUTRON ACER TENDL-2021 LIBRARY; T=293.6K
protons from (n,p)

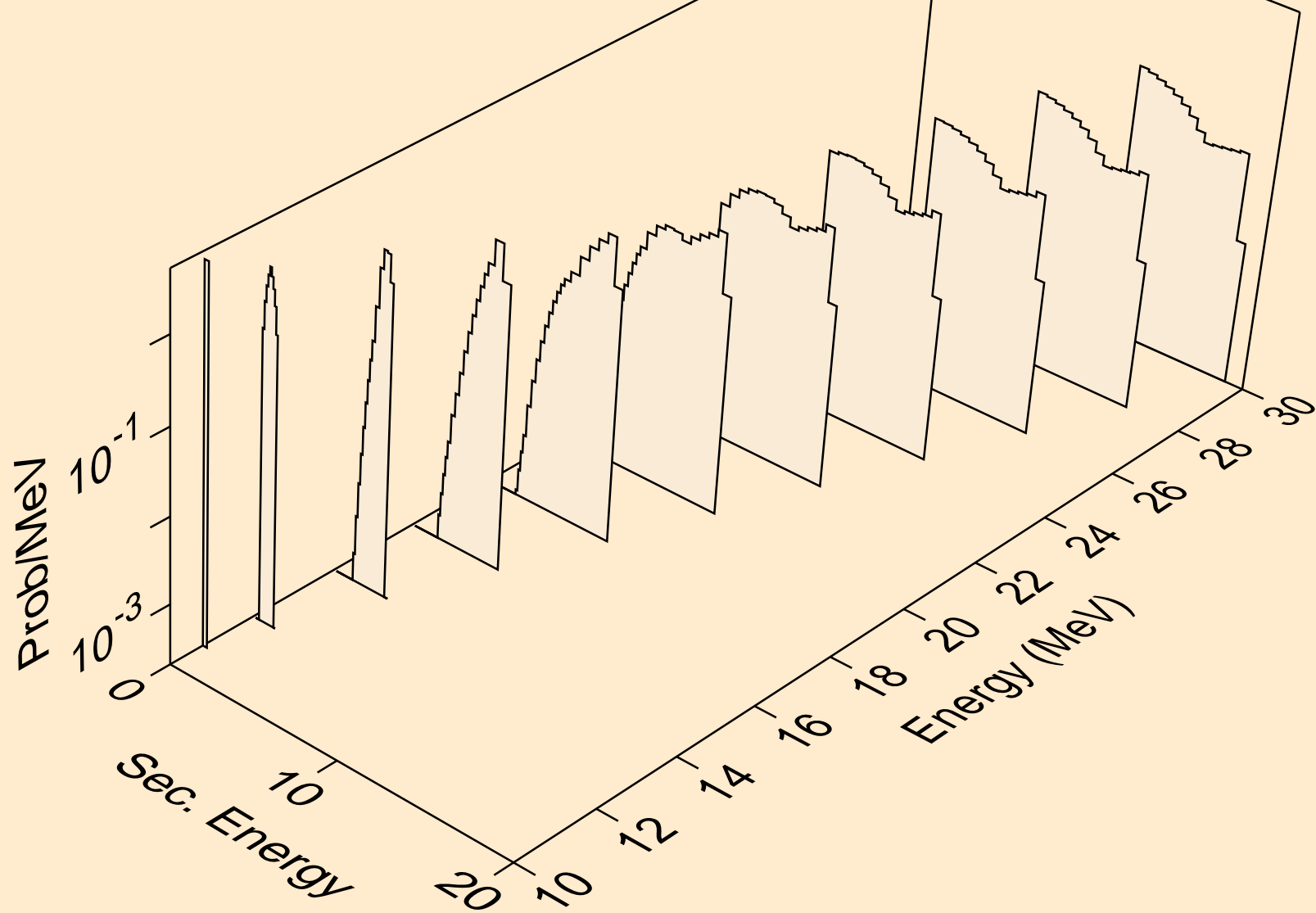

GA081 NEUTRON ACER TENDL-2021 LIBRARY; T=293.6K
deuterons from (n,x)

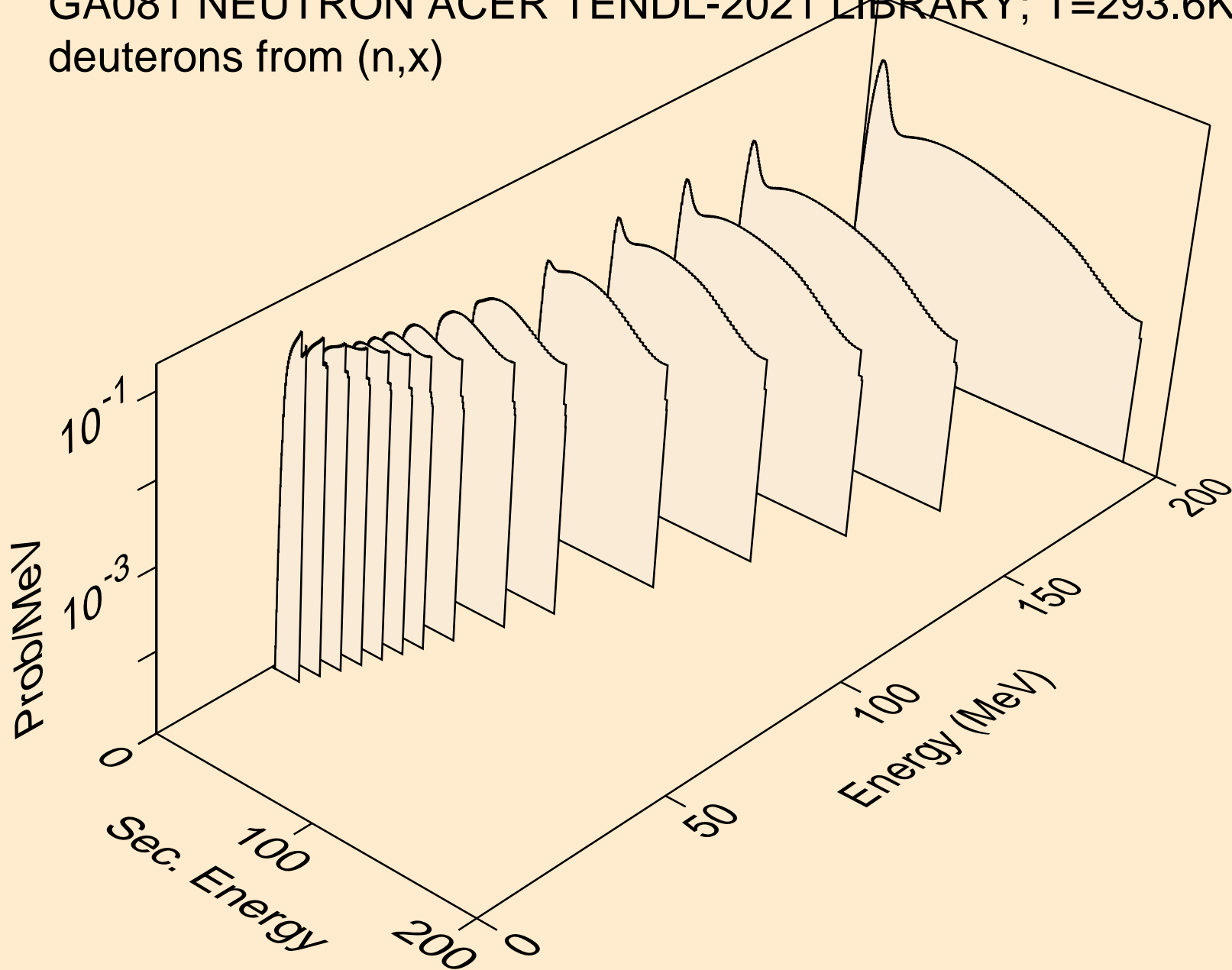

GA081 NEUTRON ACER TENDL-2021 LIBRARY; T=293.6K
deuterons from (n,2nd)

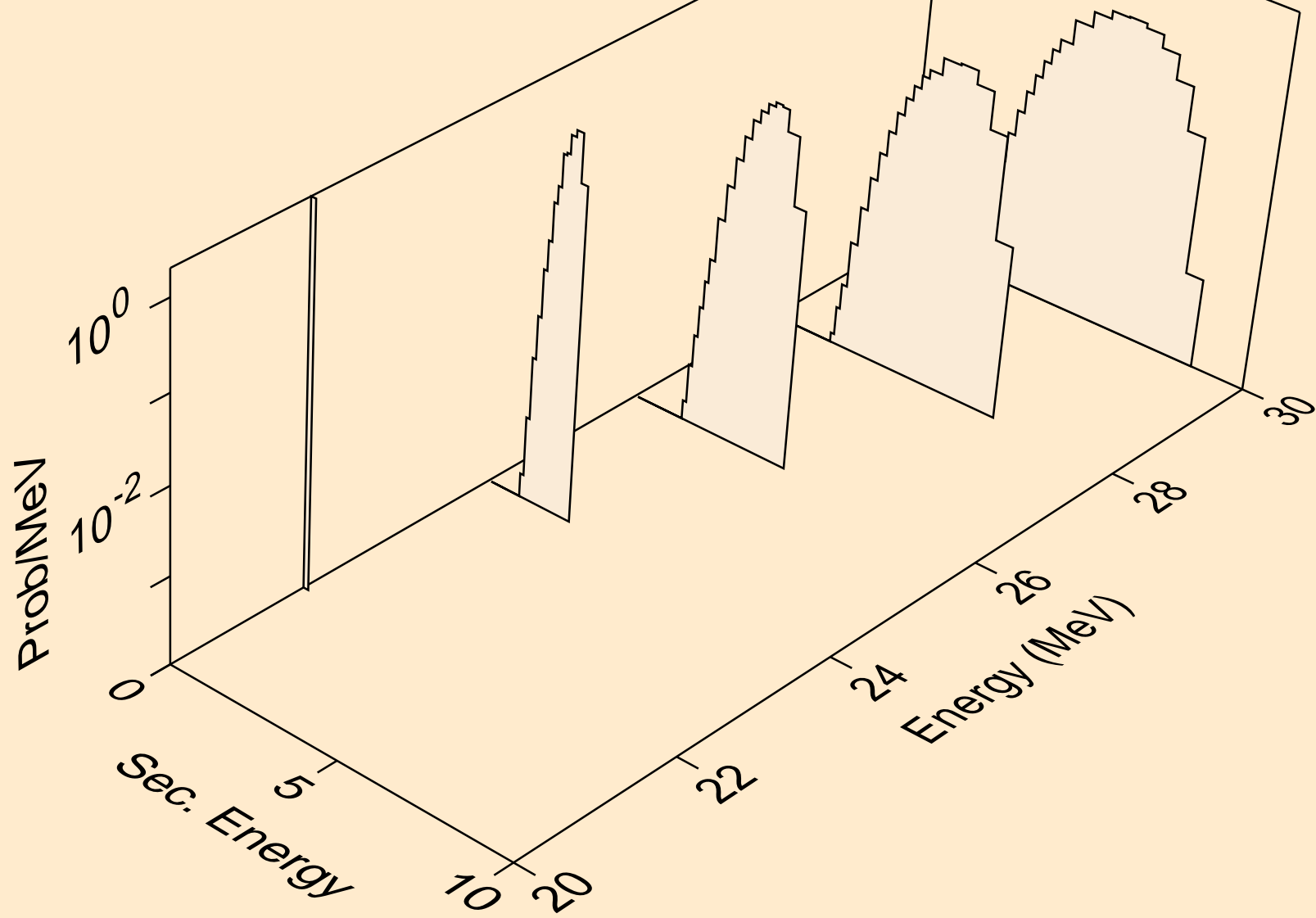

GA081 NEUTRON ACER TENDL-2021 LIBRARY; T=293.6K
deuterons from (n,n*)d

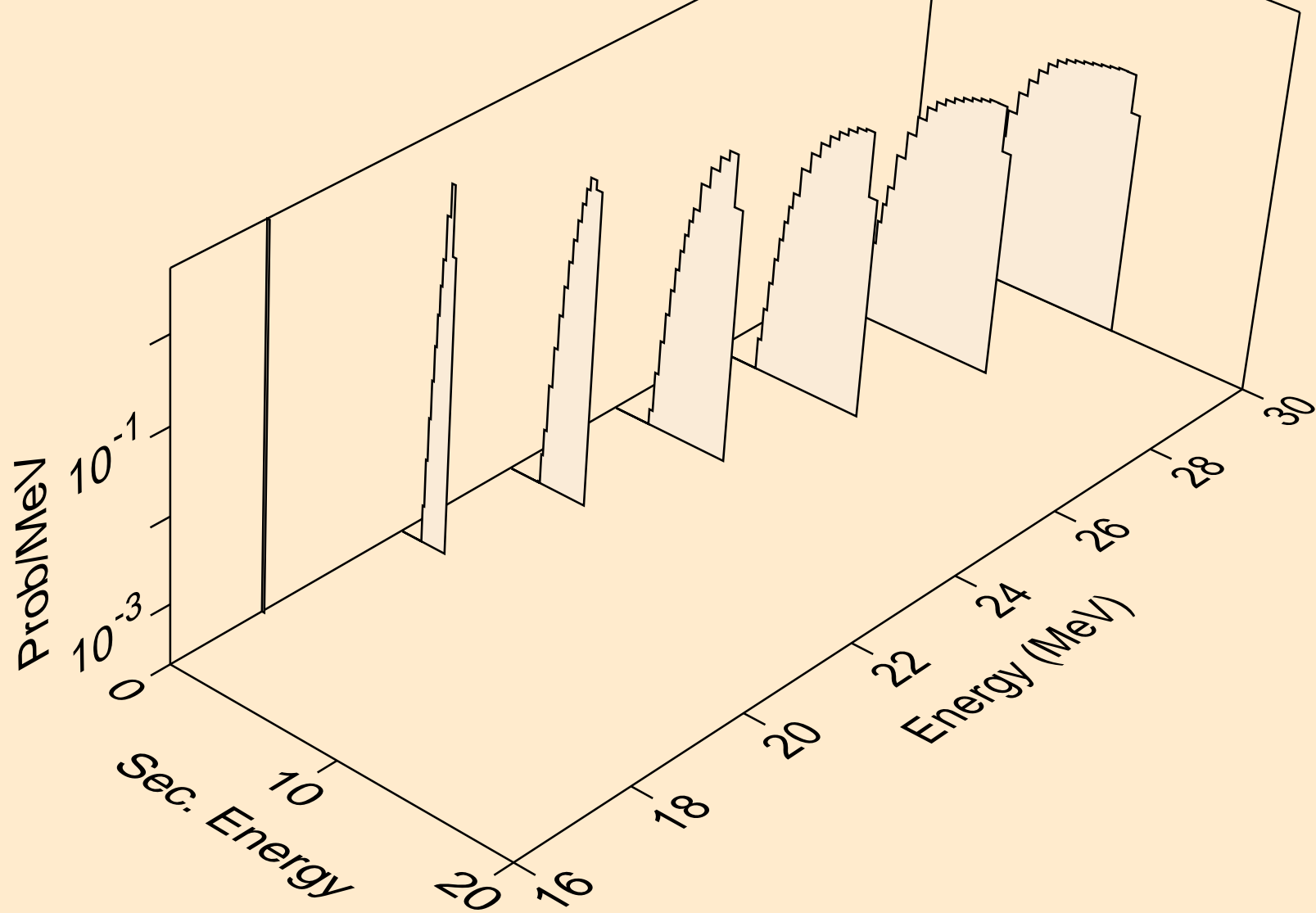

GA081 NEUTRON ACER TENDL-2021 LIBRARY; T=293.6K
deuterons from (n,d)

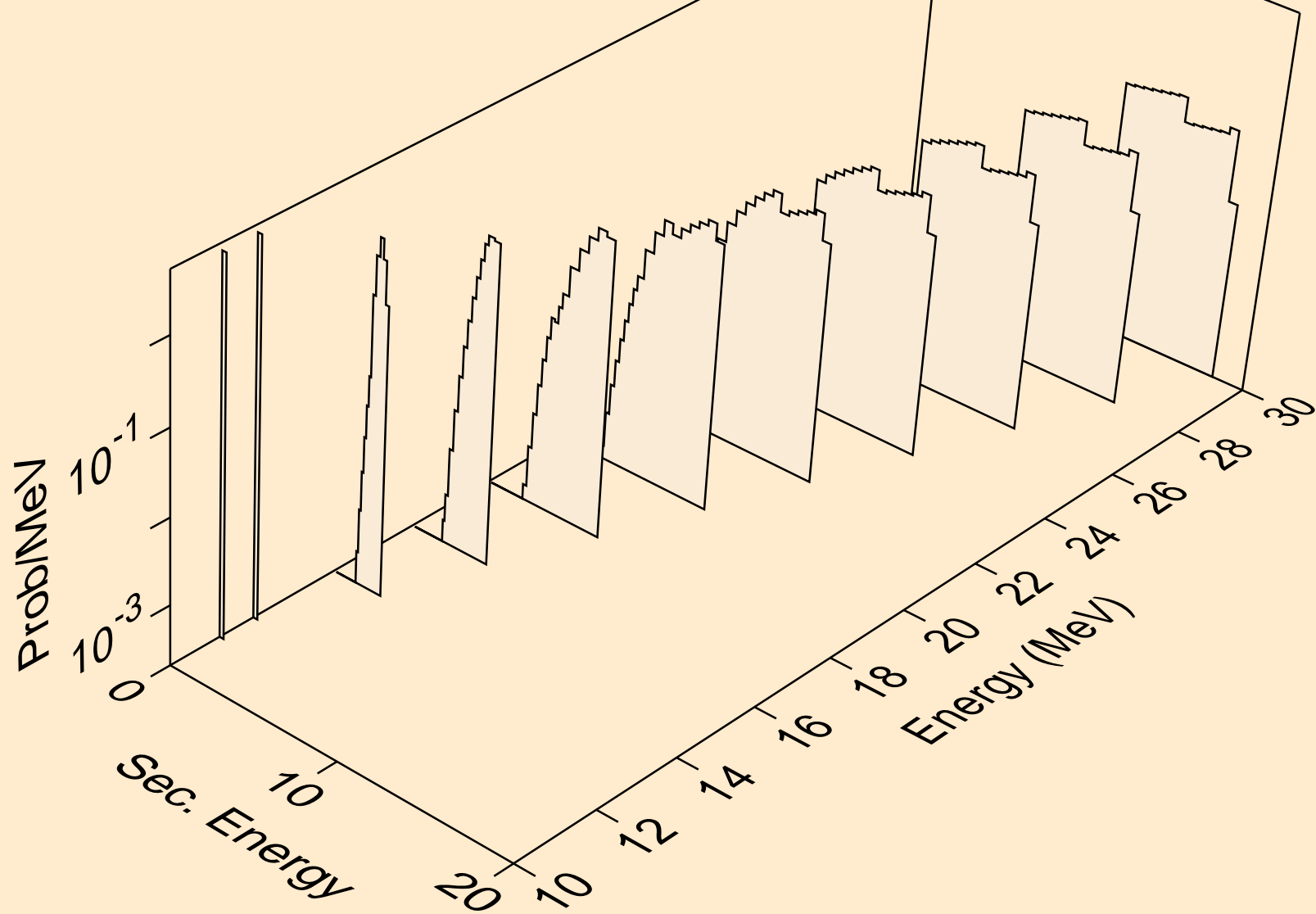

GA081 NEUTRON ACER TENDL-2021 LIBRARY; T=293.6K
tritons from (n,x)

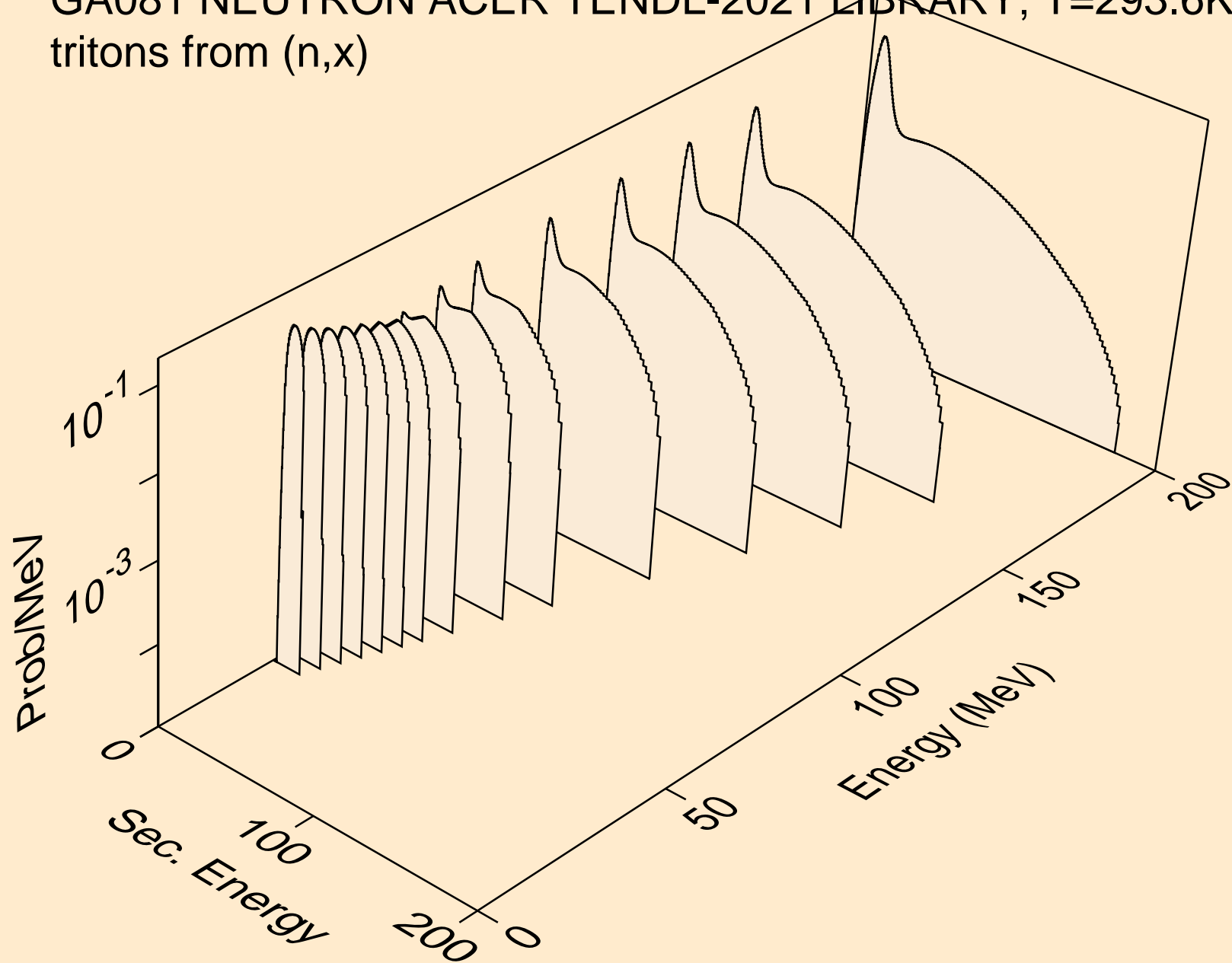

GA081 NEUTRON ACER TENDL-2021 LIBRARY; T=293.6K
tritons from (n,n*)t

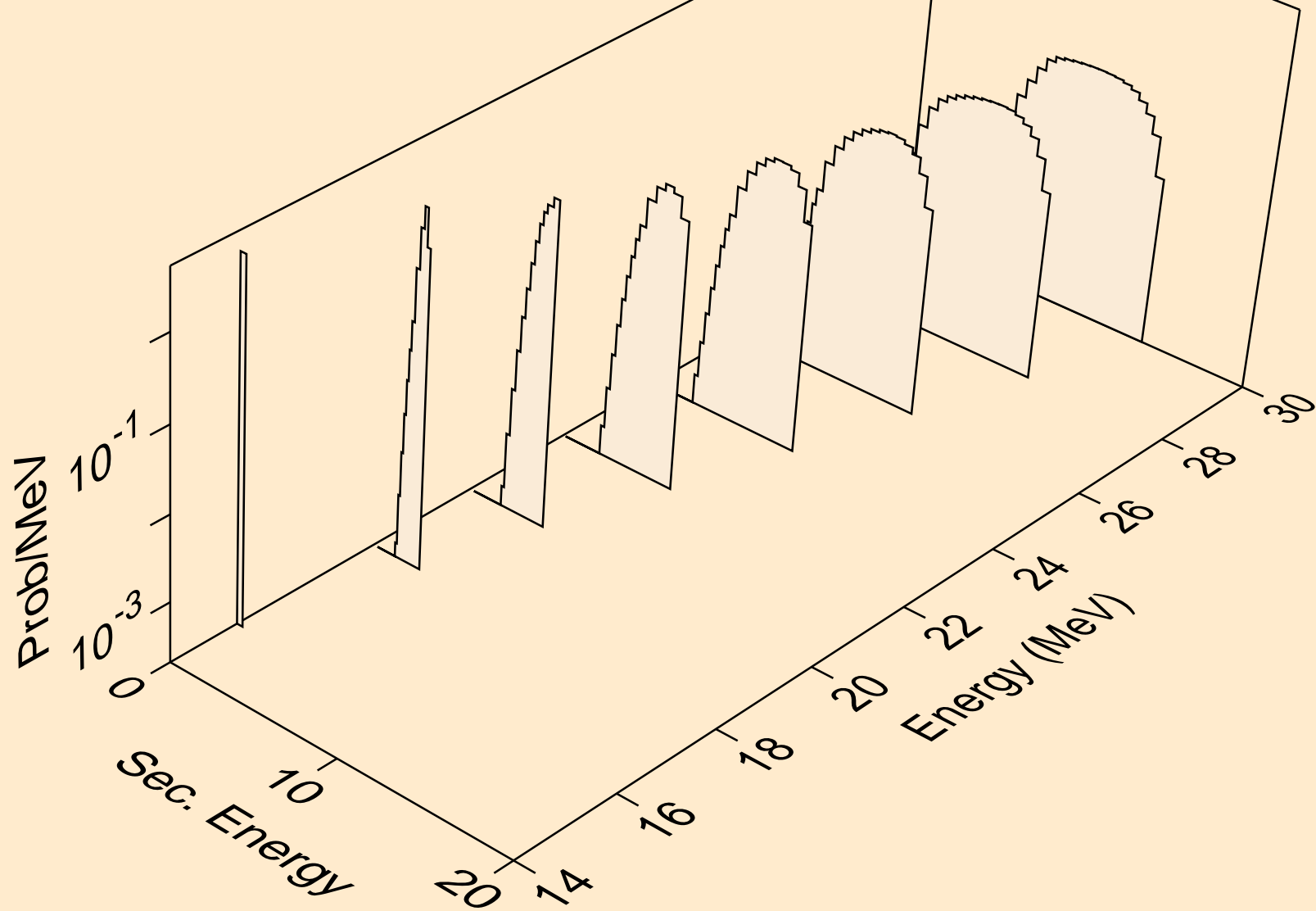

GA081 NEUTRON ACER TENDL-2021 LIBRARY; T=293.6K
tritons from (n,t)

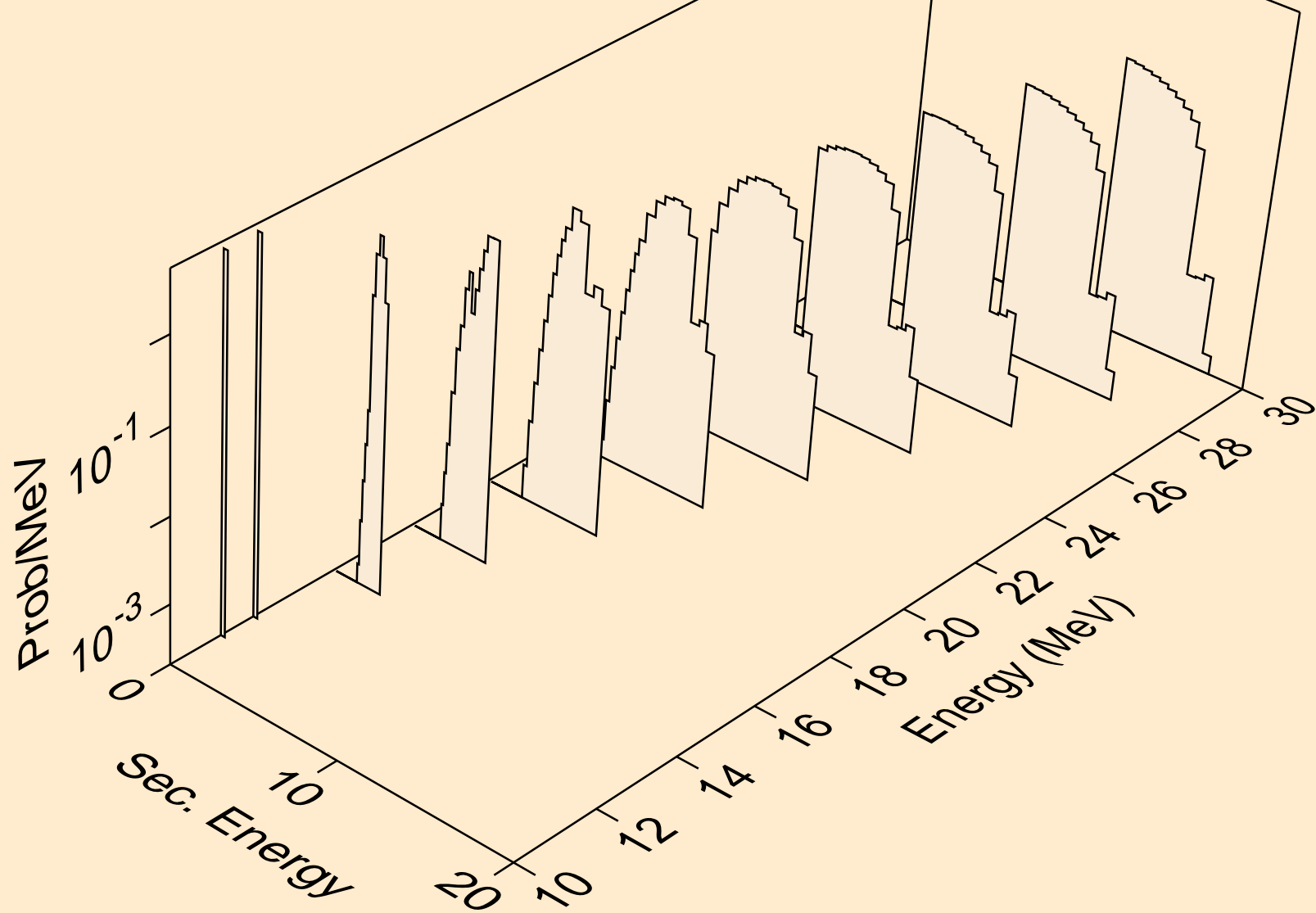

GA081 NEUTRON ACER TENDL-2021 LIBRARY; T=293.6K
he3s from (n,x)

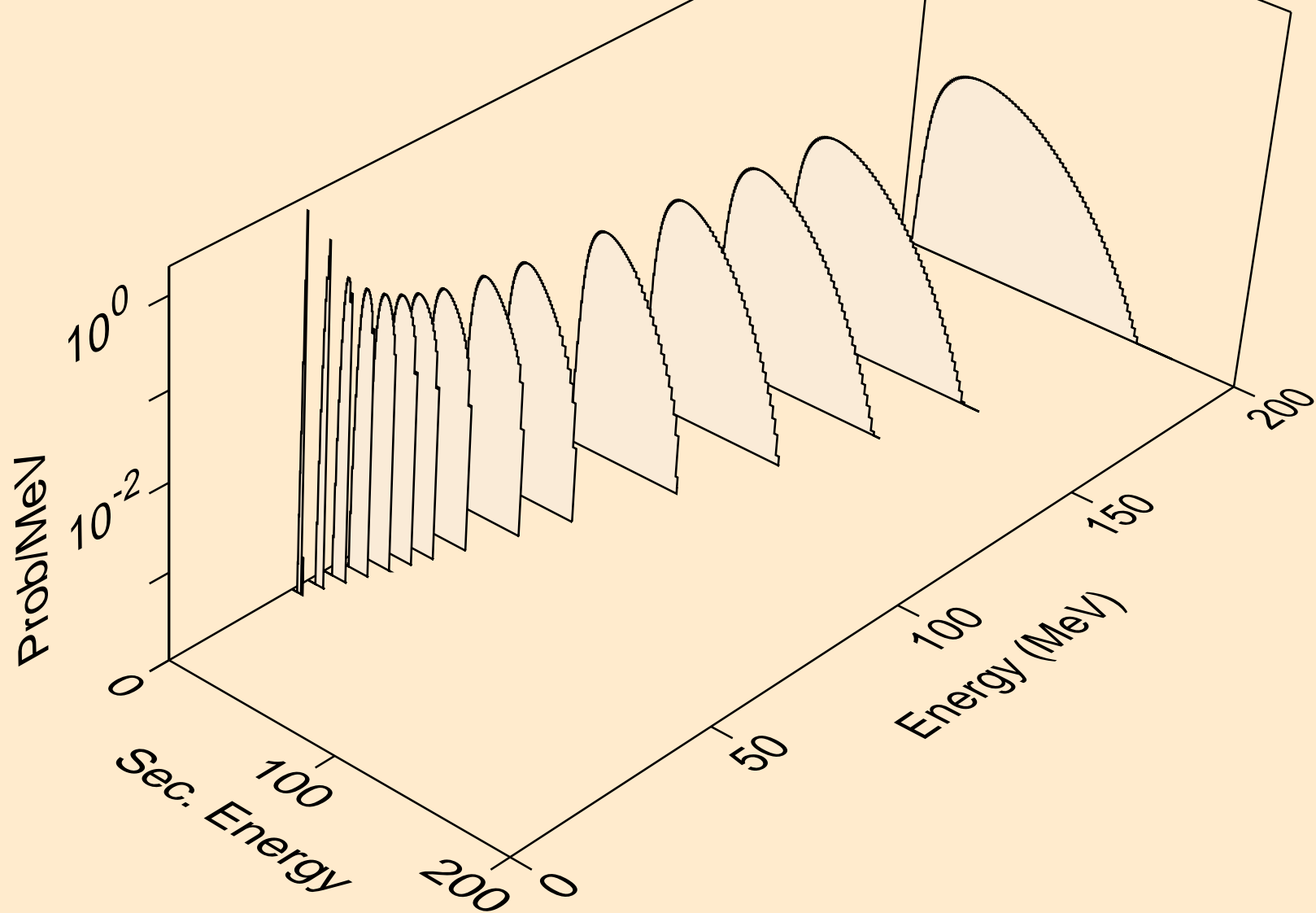

GA081 NEUTRON ACER TENDL-2021 LIBRARY; T=293.6K
he3s from (n,he3)

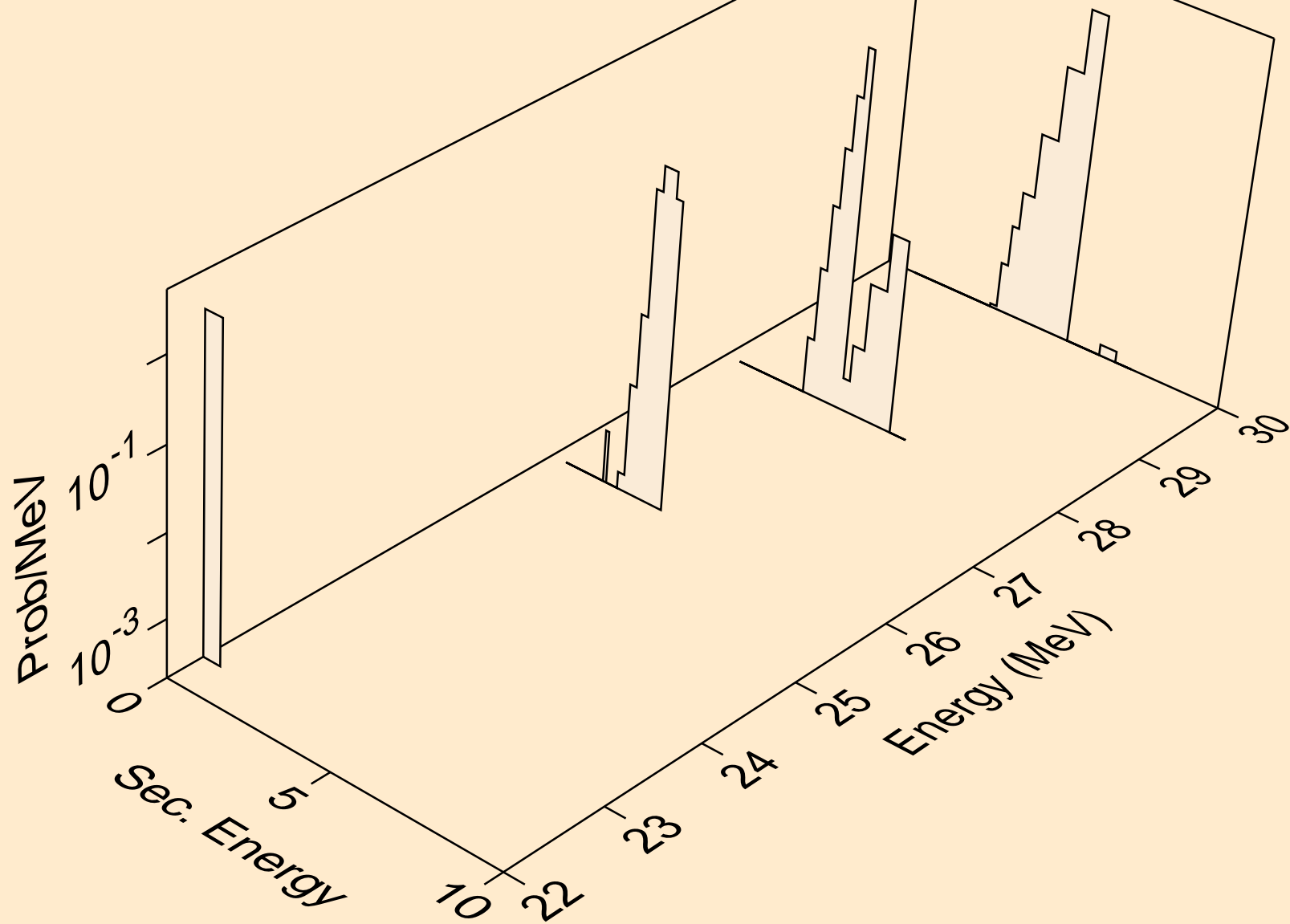

GA081 NEUTRON ACER TENDL-2021 LIBRARY; T=293.6K
alphas from (n,x)

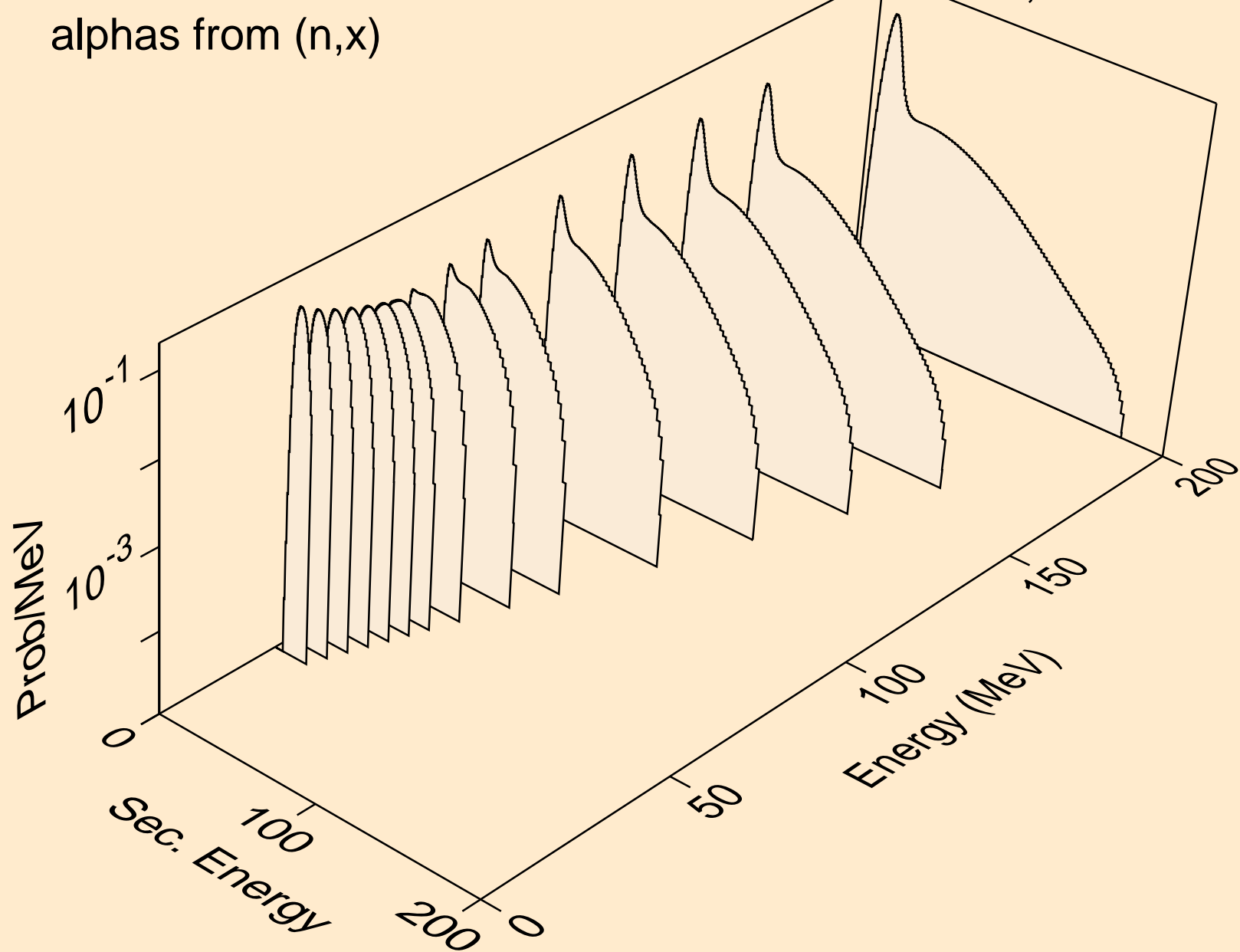

GA081 NEUTRON ACER TENDL-2021 LIBRARY; T=293.6K
alphas from (n,2n)a

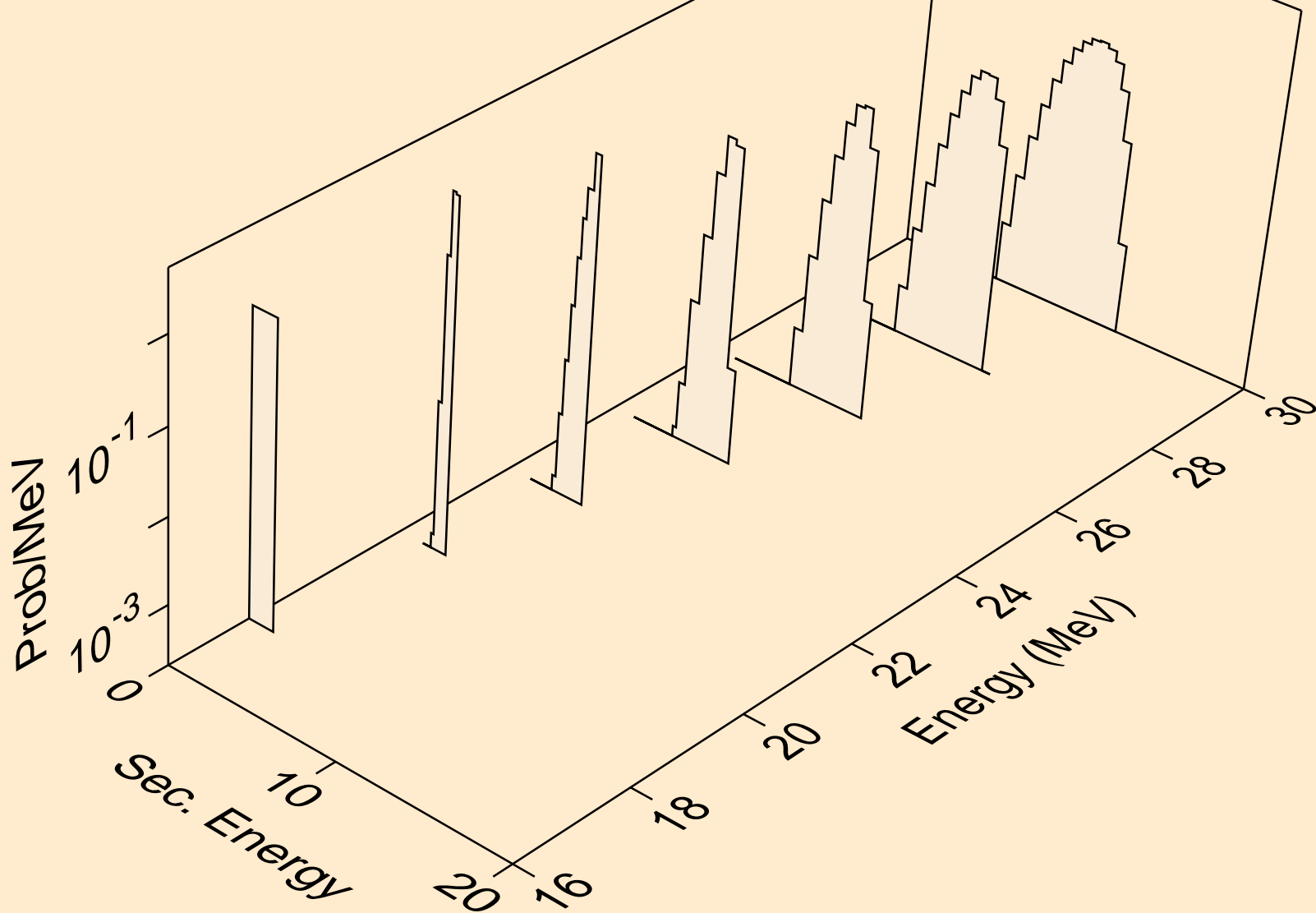

GA081 NEUTRON ACER TENDL-2021 LIBRARY; T=293.6K
alphas from (n,3n)a

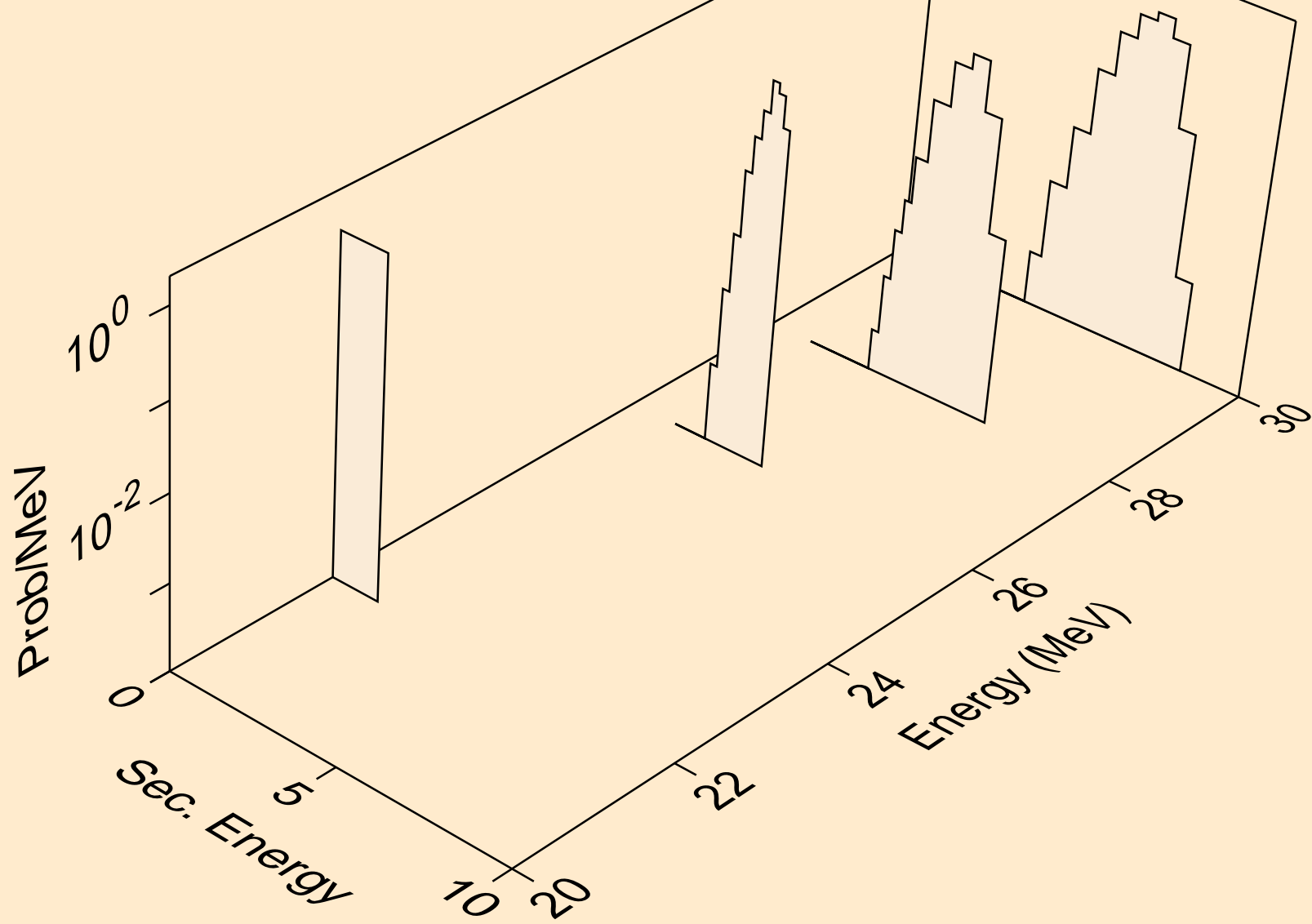

GA081 NEUTRON ACER TENDL-2021 LIBRARY; T=293.6K
alphas from (n,a)

