

GD154 NEUTRON ACER TENDL-2021 LIBRARY; T=293.6K

Principal cross sections

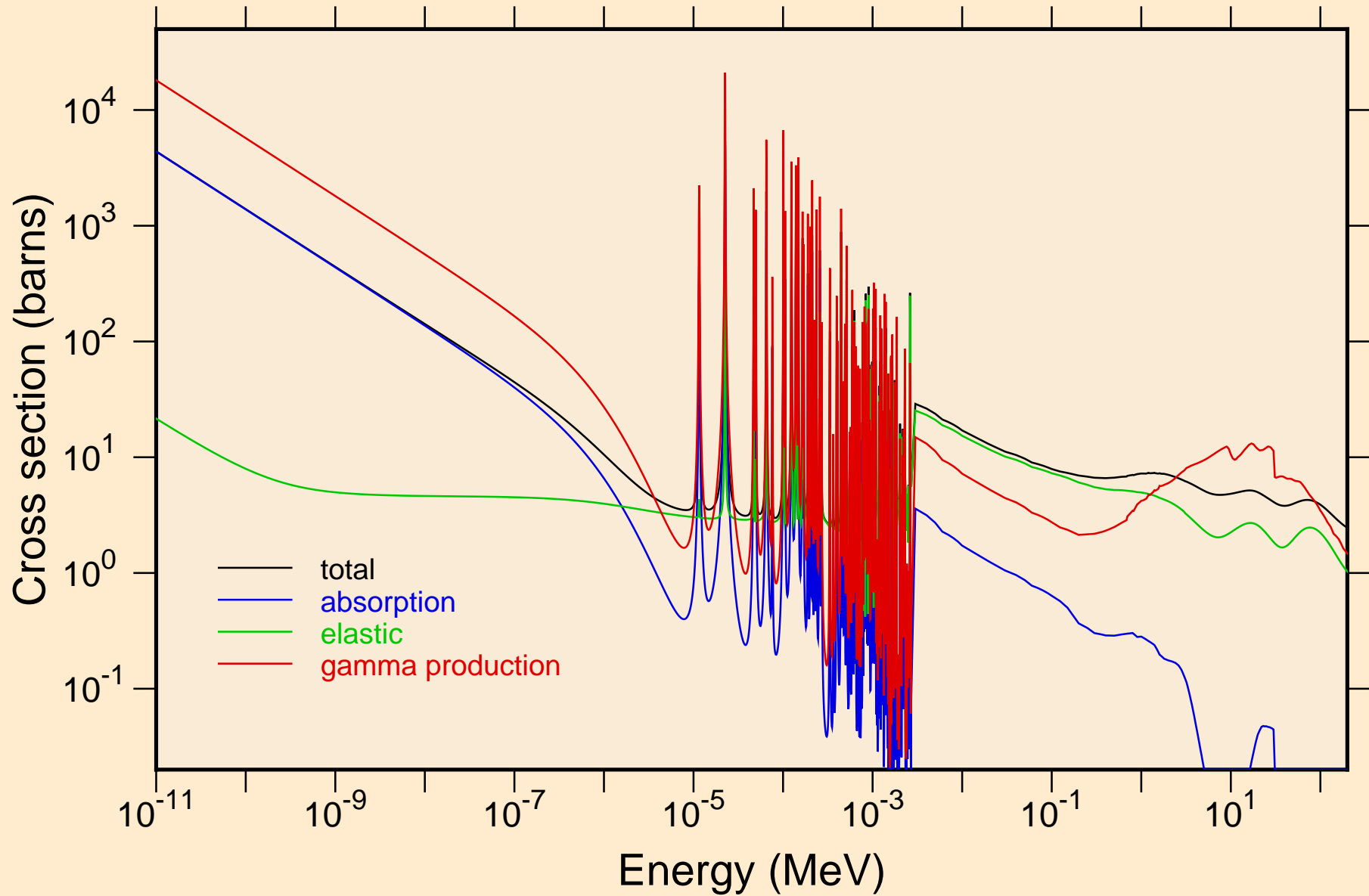

GD154 NEUTRON ACER TENDL-2021 LIBRARY; T=293.6K
resonance total cross section

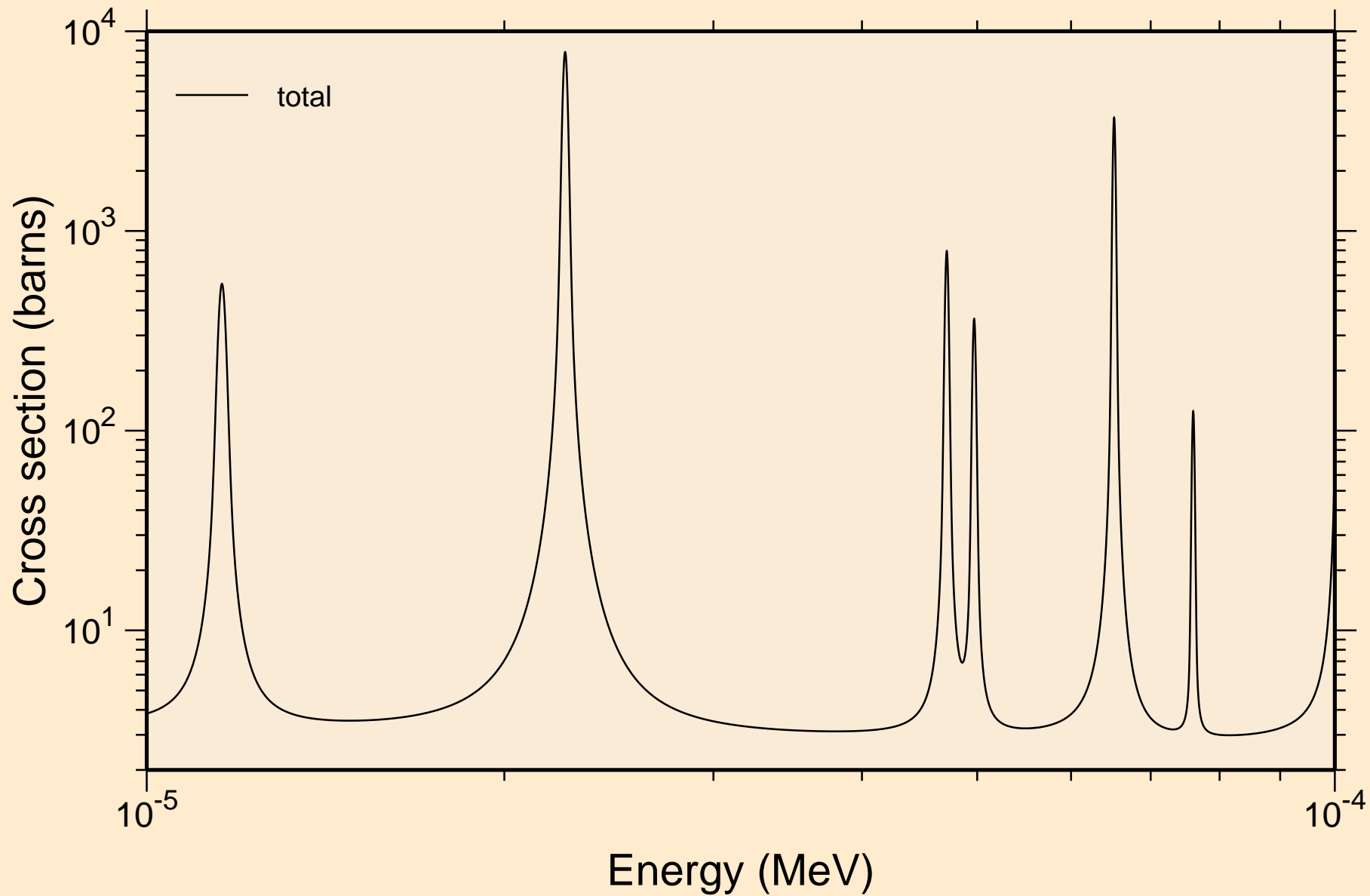

GD154 NEUTRON ACER TENDL-2021 LIBRARY; T=293.6K
resonance total cross section

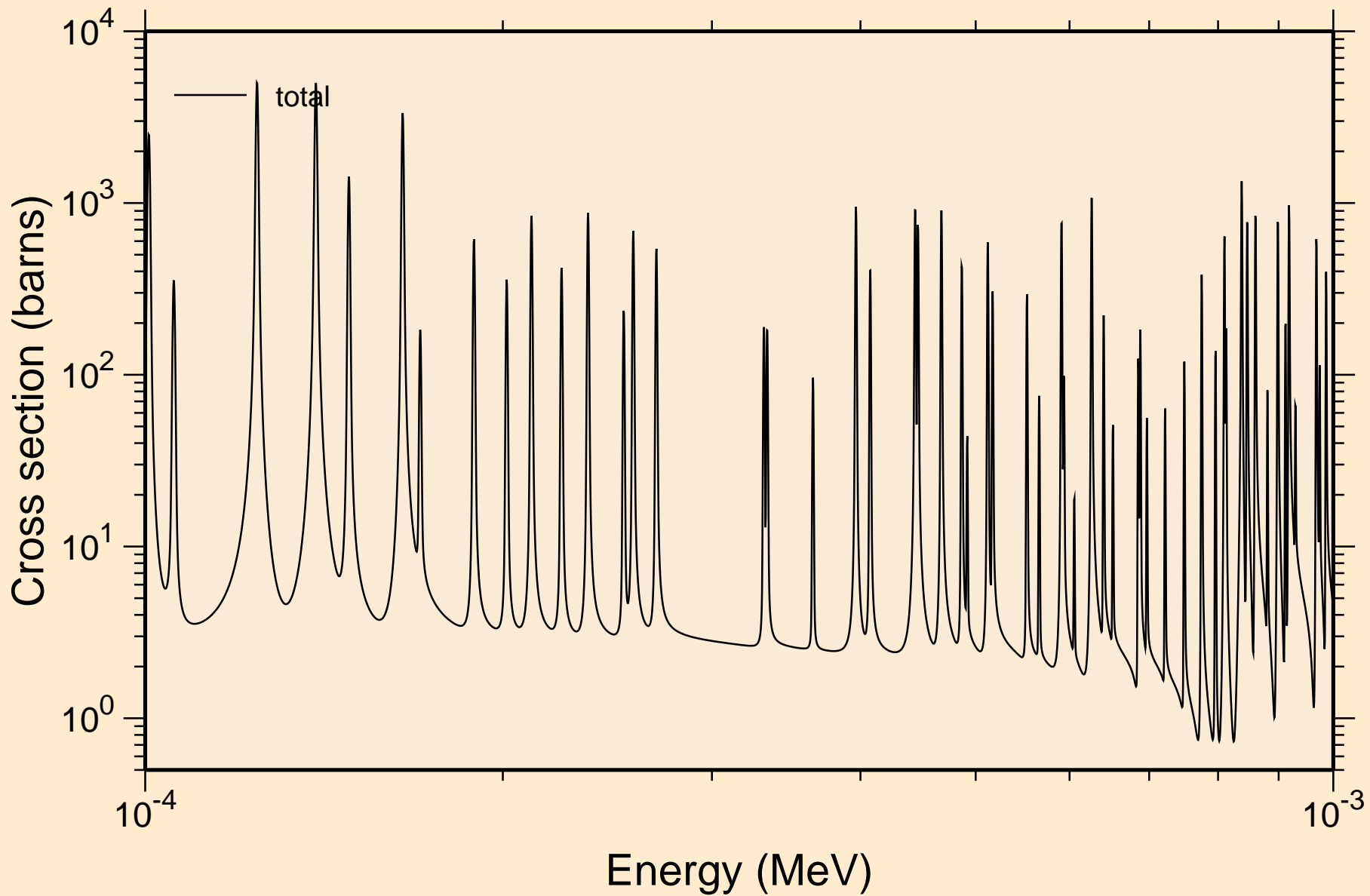

GD154 NEUTRON ACER TENDL-2021 LIBRARY; T=293.6K
resonance total cross section

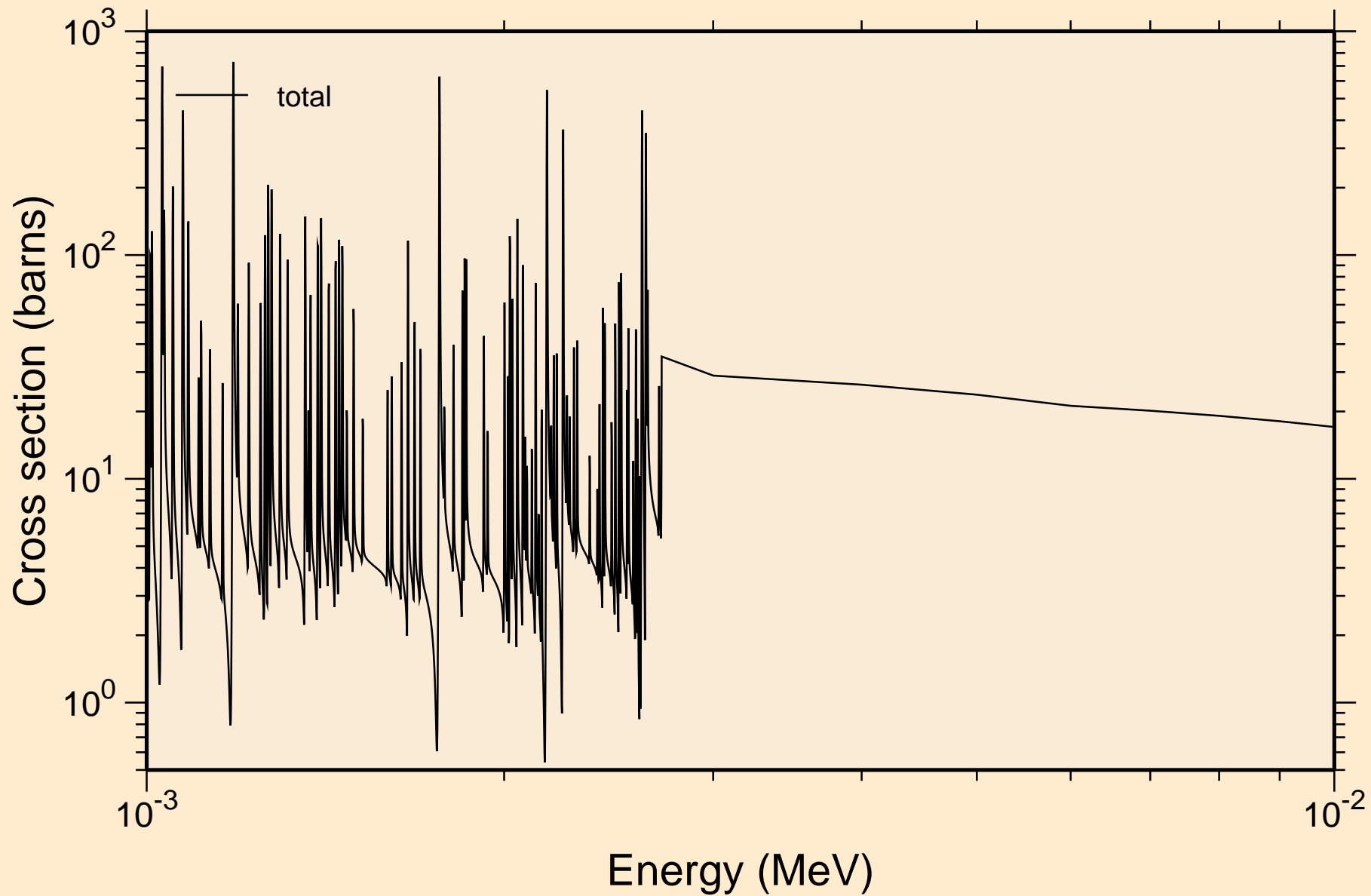

GD154 NEUTRON ACER TENDL-2021 LIBRARY; T=293.6K
resonance total cross section

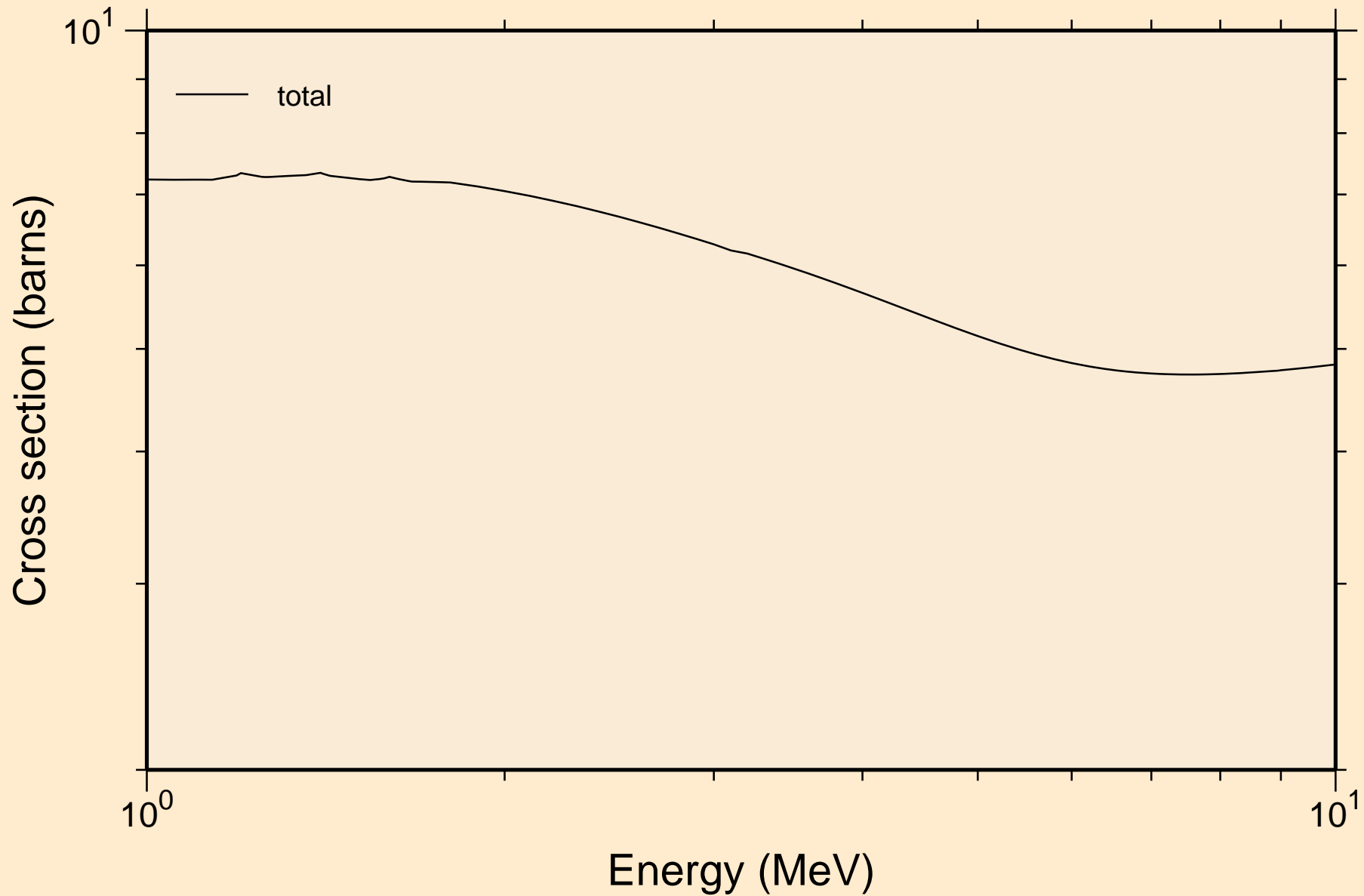

GD154 NEUTRON ACER TENDL-2021 LIBRARY; T=293.6K
resonance absorption cross sections

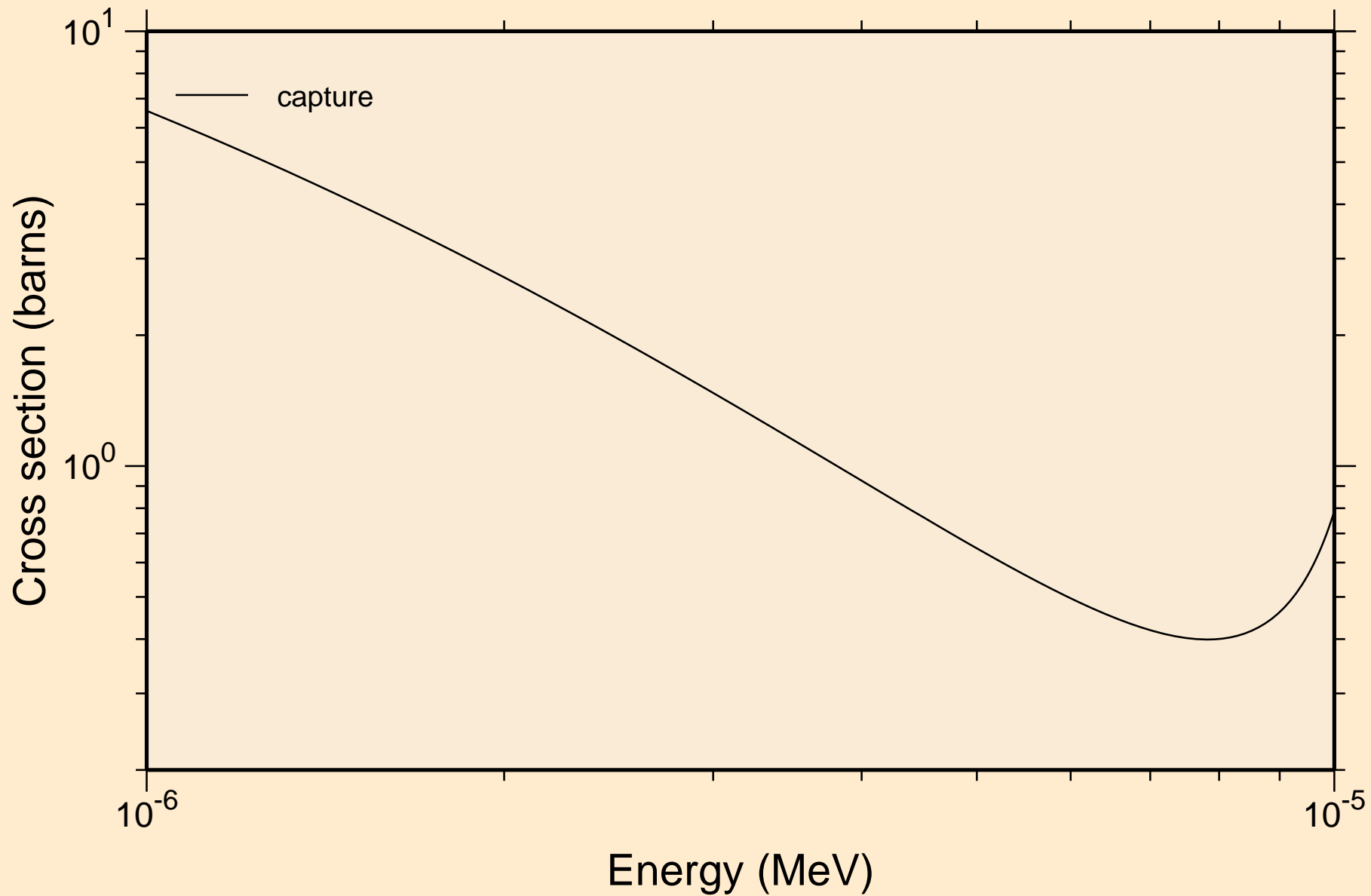

GD154 NEUTRON ACER TENDL-2021 LIBRARY; T=293.6K
resonance absorption cross sections

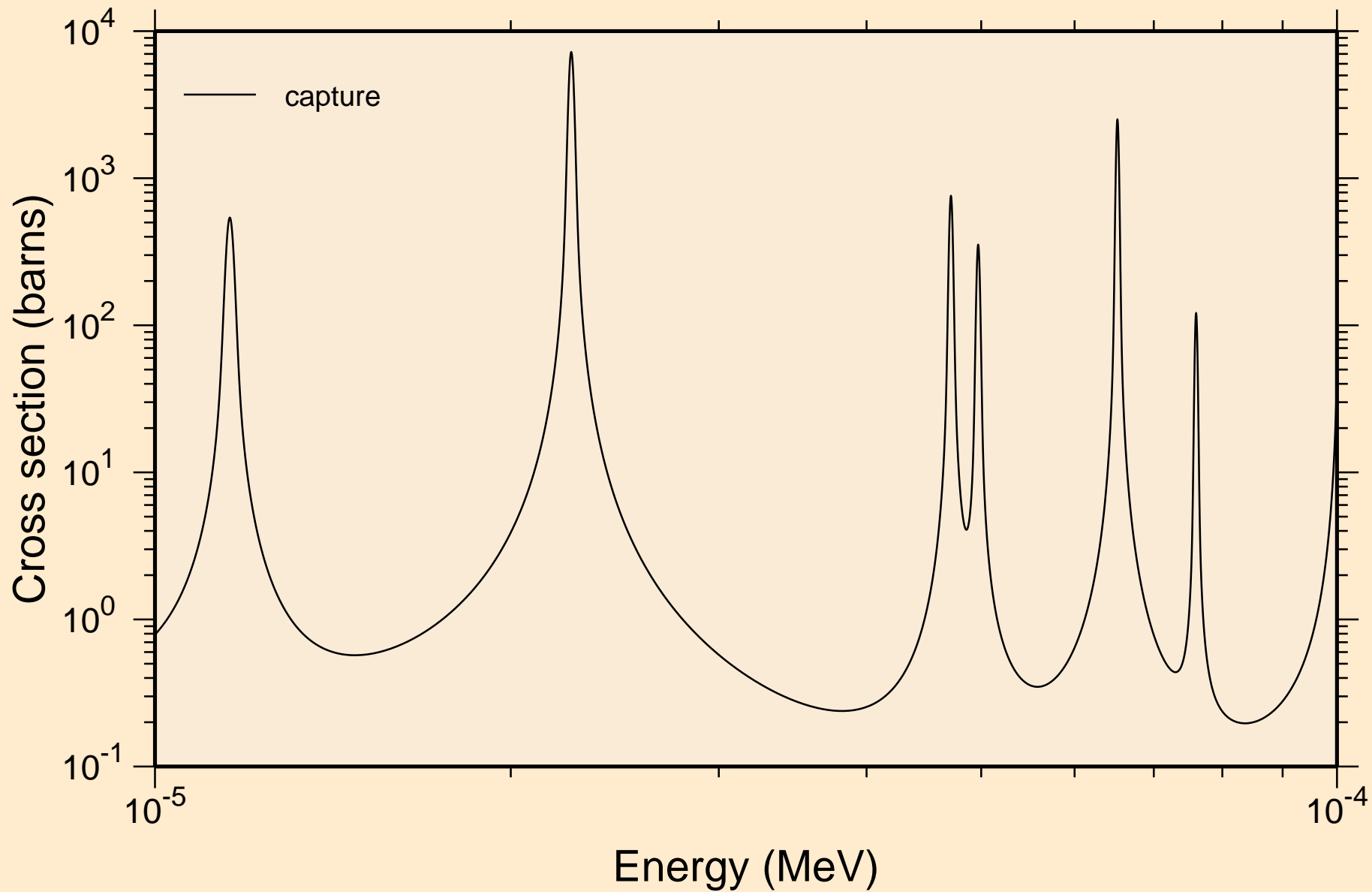

GD154 NEUTRON ACER TENDL-2021 LIBRARY; T=293.6K
resonance absorption cross sections

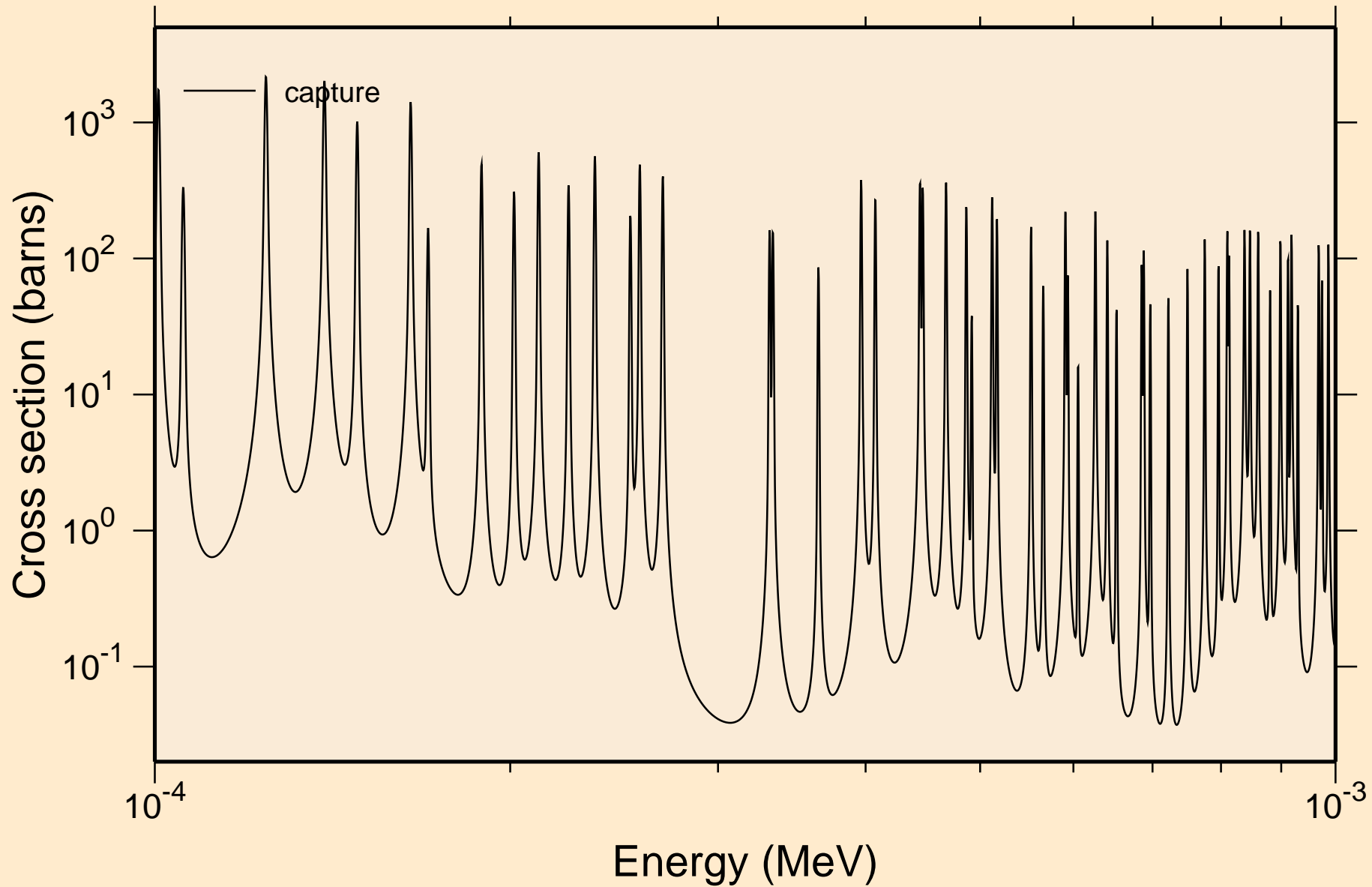

GD154 NEUTRON ACER TENDL-2021 LIBRARY; T=293.6K
resonance absorption cross sections

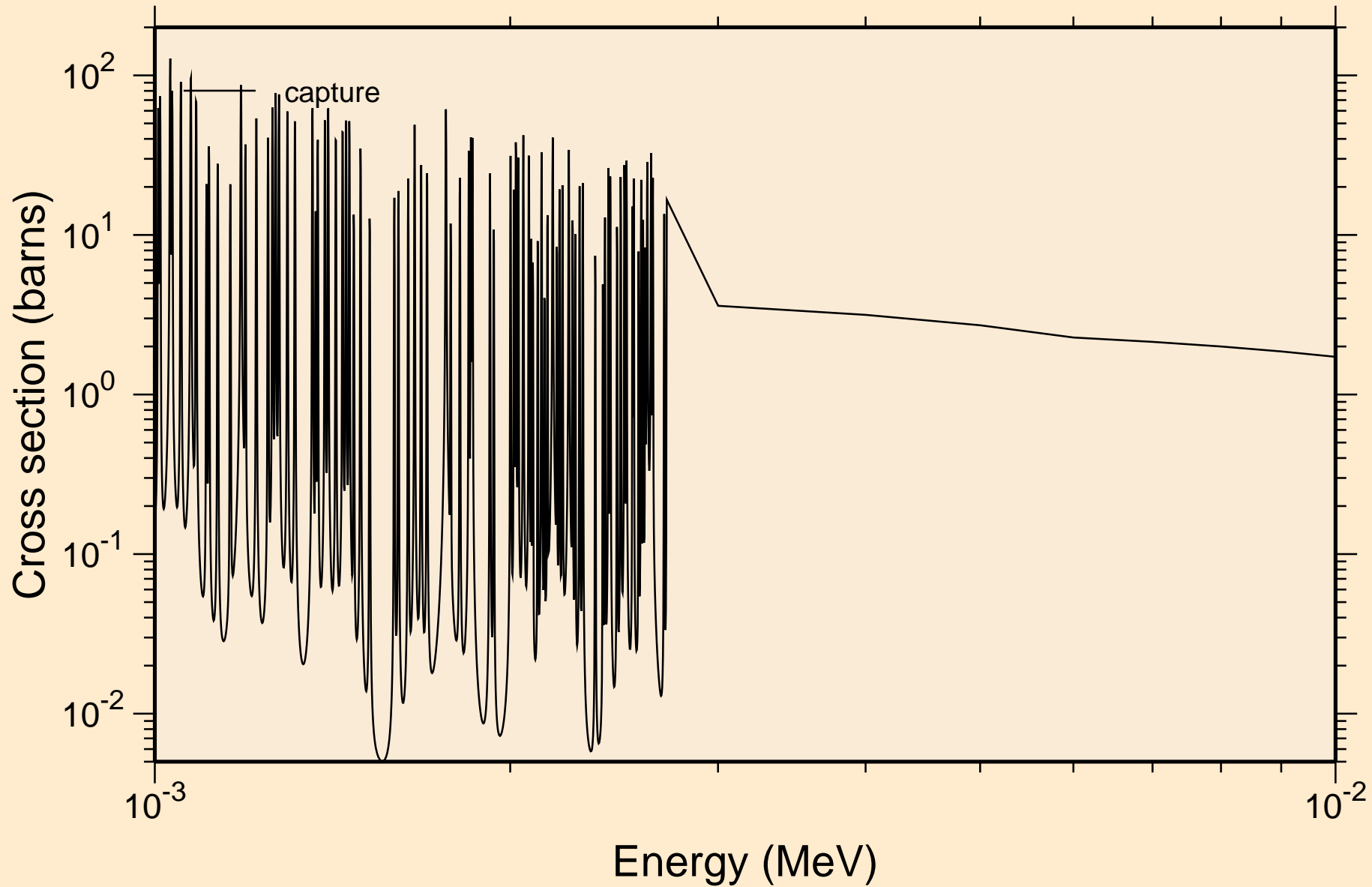

GD154 NEUTRON ACER TENDL-2021 LIBRARY; T=293.6K
resonance absorption cross sections

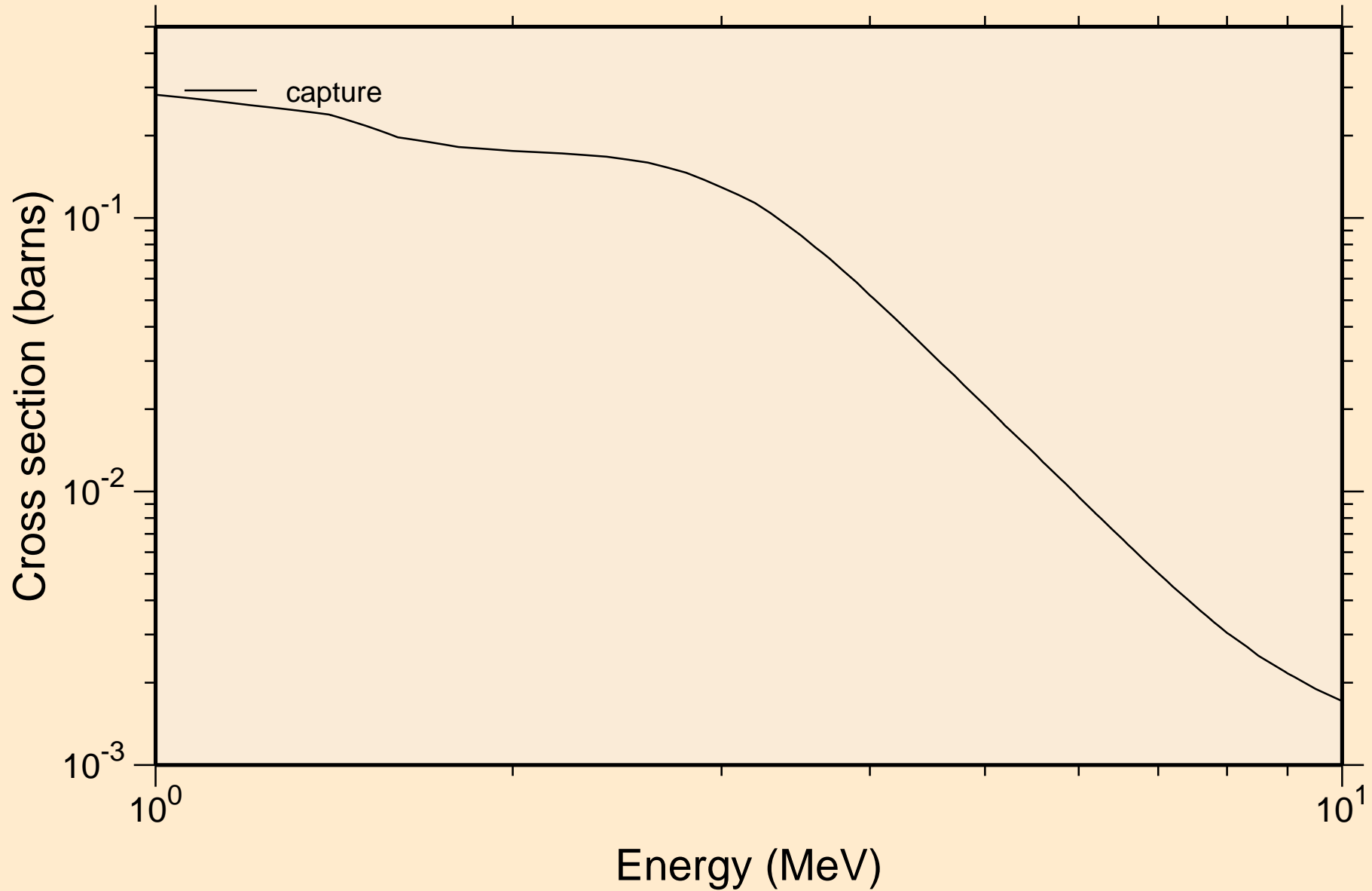

GD154 NEUTRON ACER TENDL-2021 LIBRARY; T=293.6K
Heating

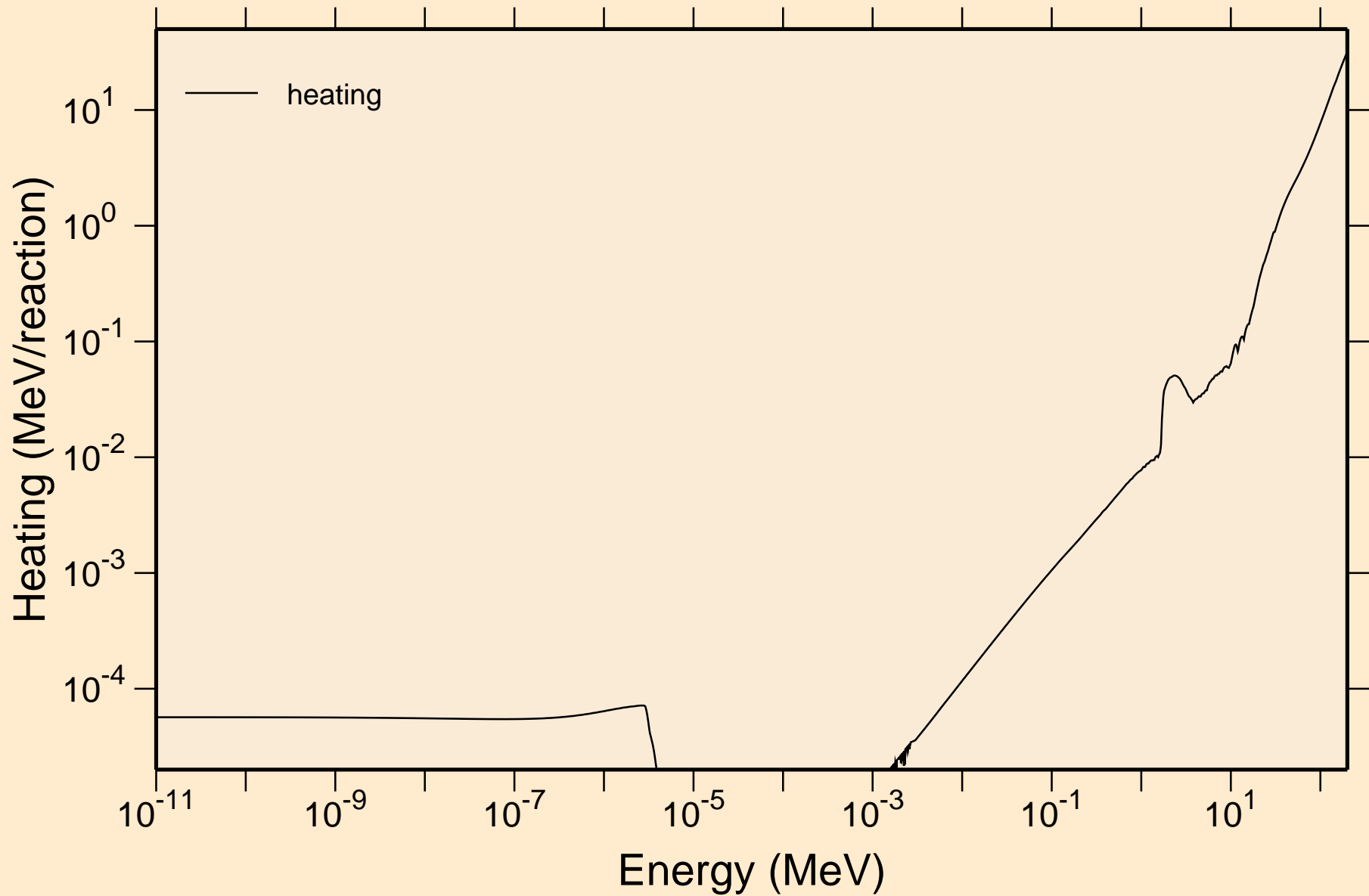

GD154 NEUTRON ACER TENDL-2021 LIBRARY; T=293.6K
Damage

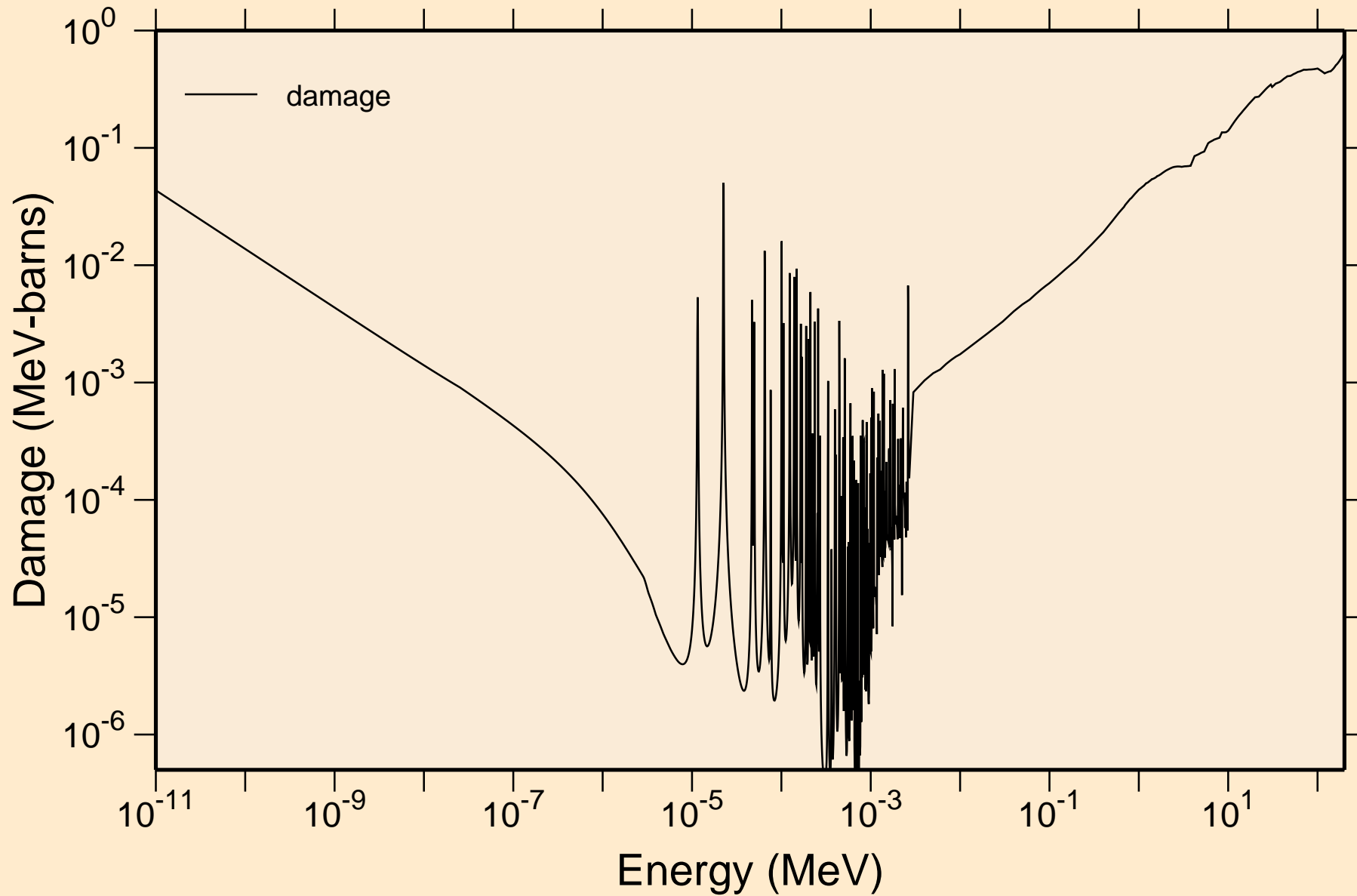

GD154 NEUTRON ACER TENDL-2021 LIBRARY; T=293.6K

Non-threshold reactions

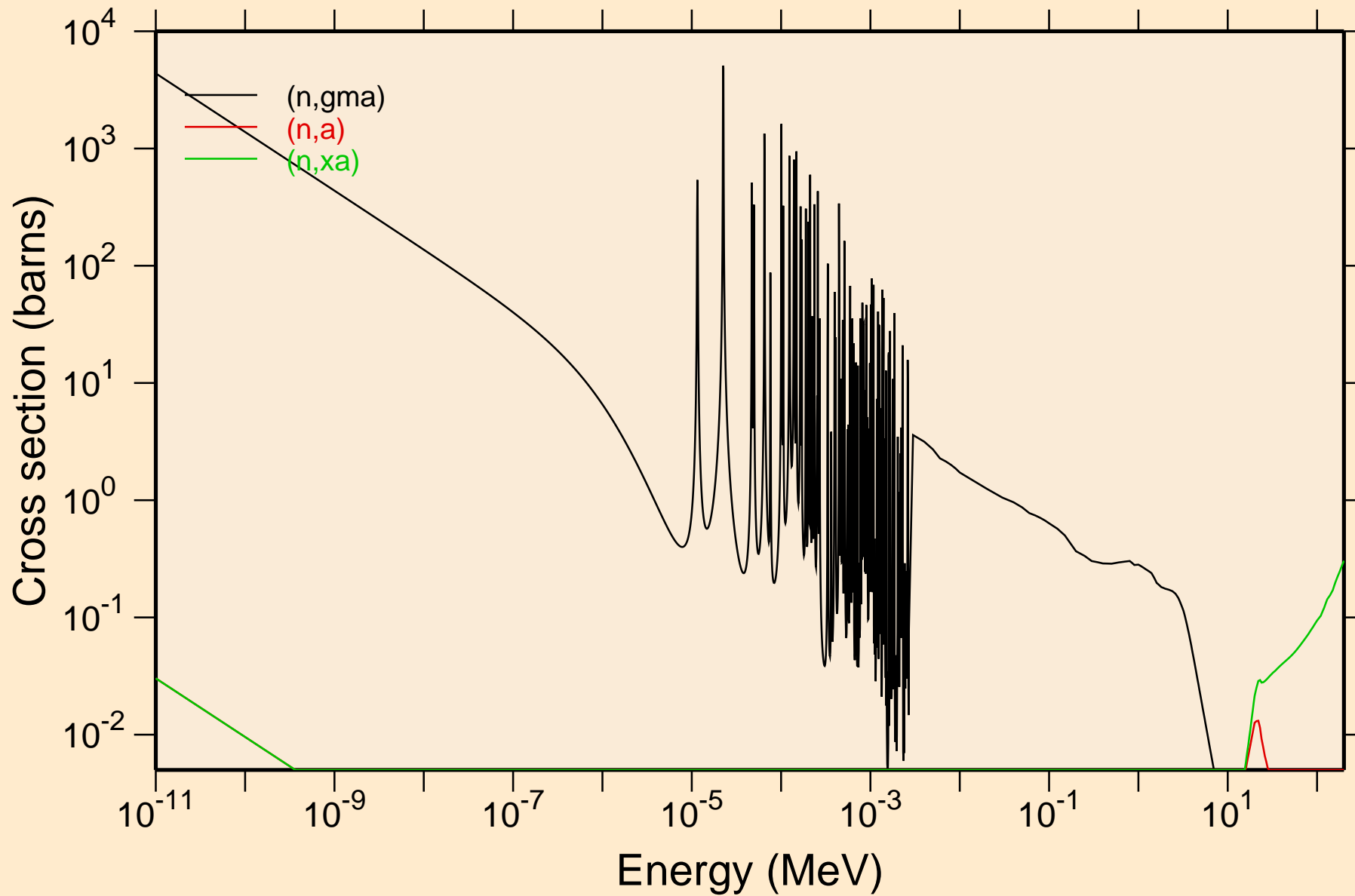

GD154 NEUTRON ACER TENDL-2021 LIBRARY; T=293.6K

Principal cross sections

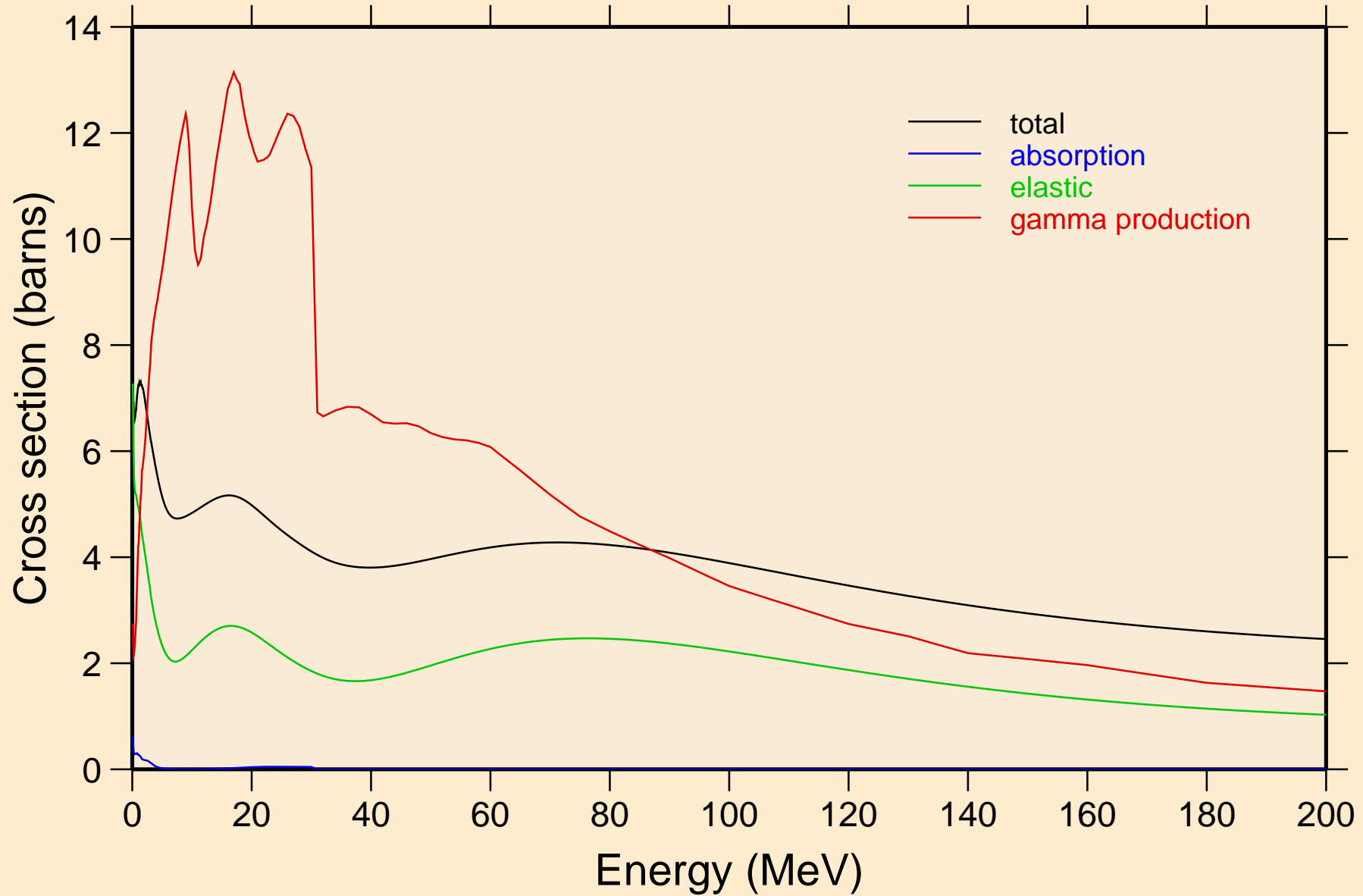

GD154 NEUTRON ACER TENDL-2021 LIBRARY; T=293.6K

Heating

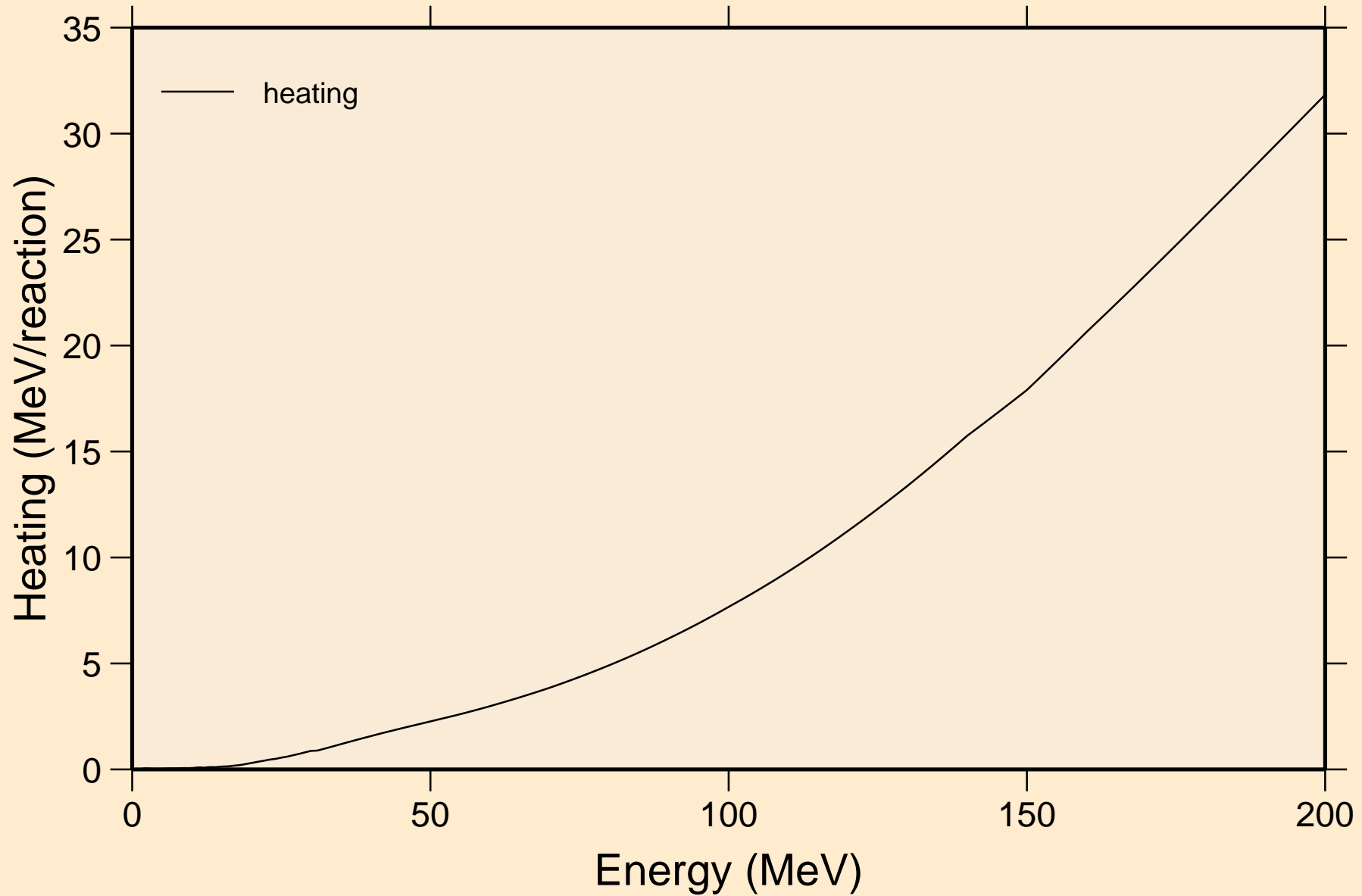

GD154 NEUTRON ACER TENDL-2021 LIBRARY; T=293.6K
Damage

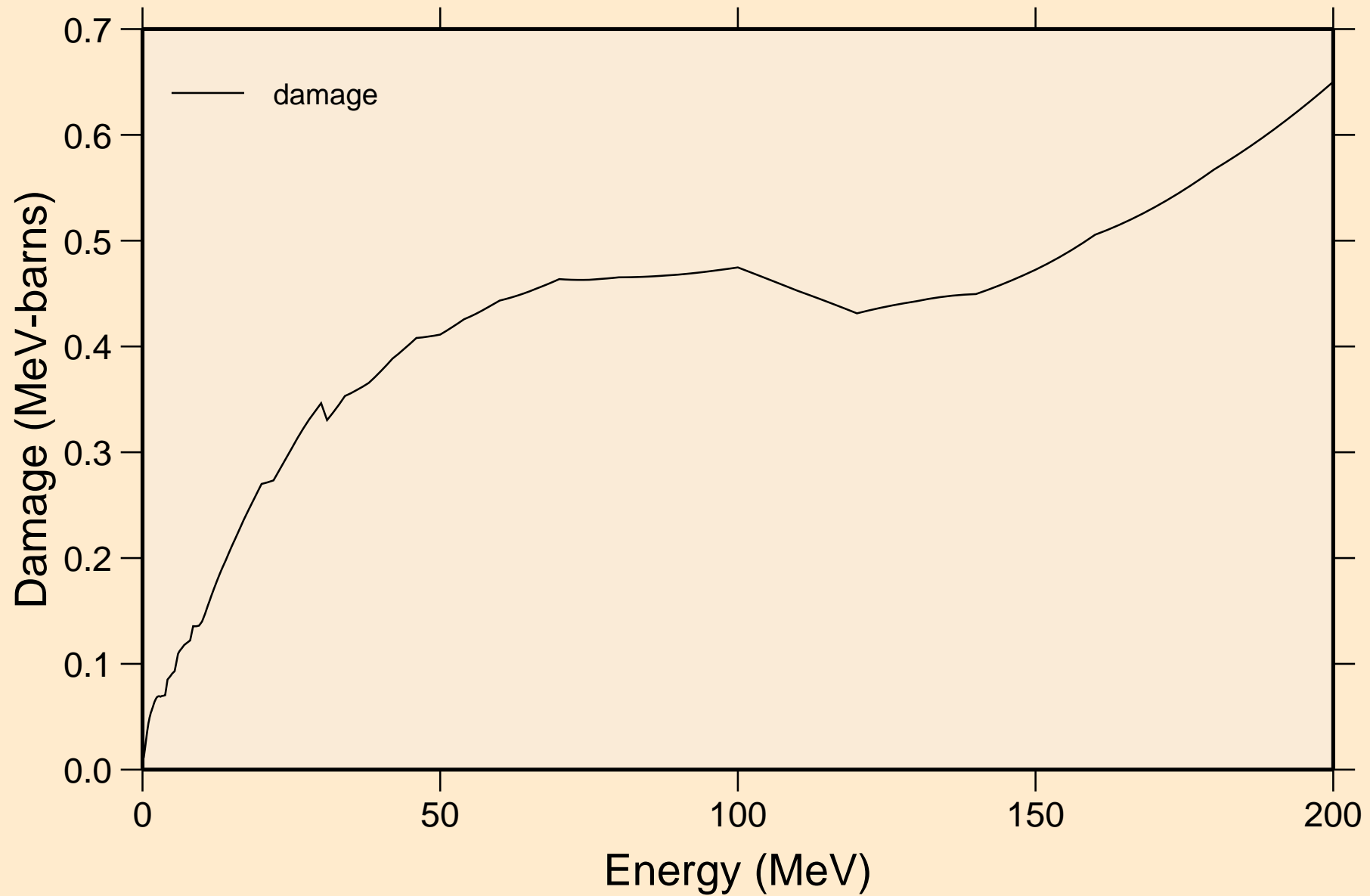

GD154 NEUTRON ACER TENDL-2021 LIBRARY; T=293.6K
Non-threshold reactions

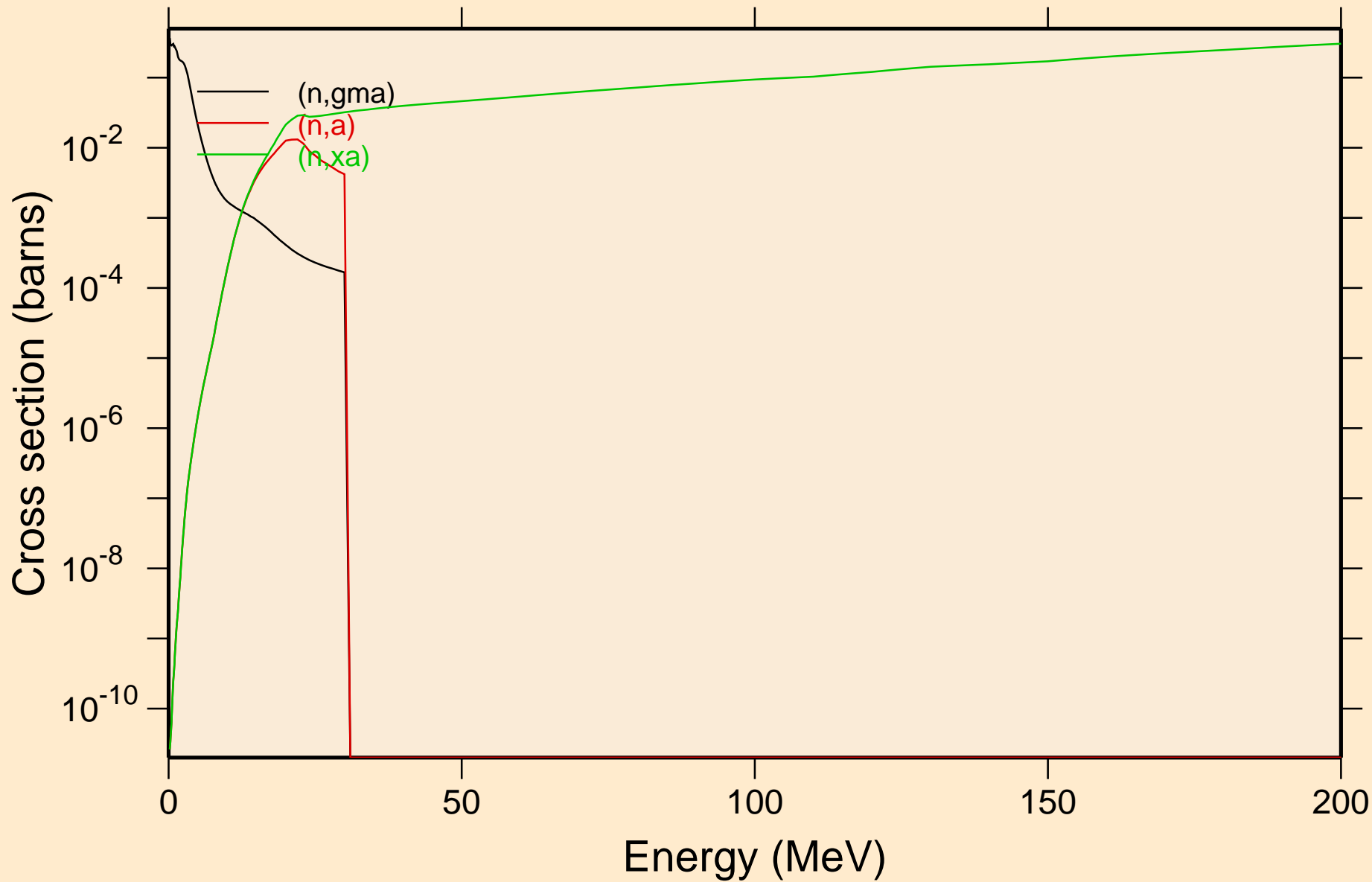

GD154 NEUTRON ACER TENDL-2021 LIBRARY; T=293.6K
Inelastic levels

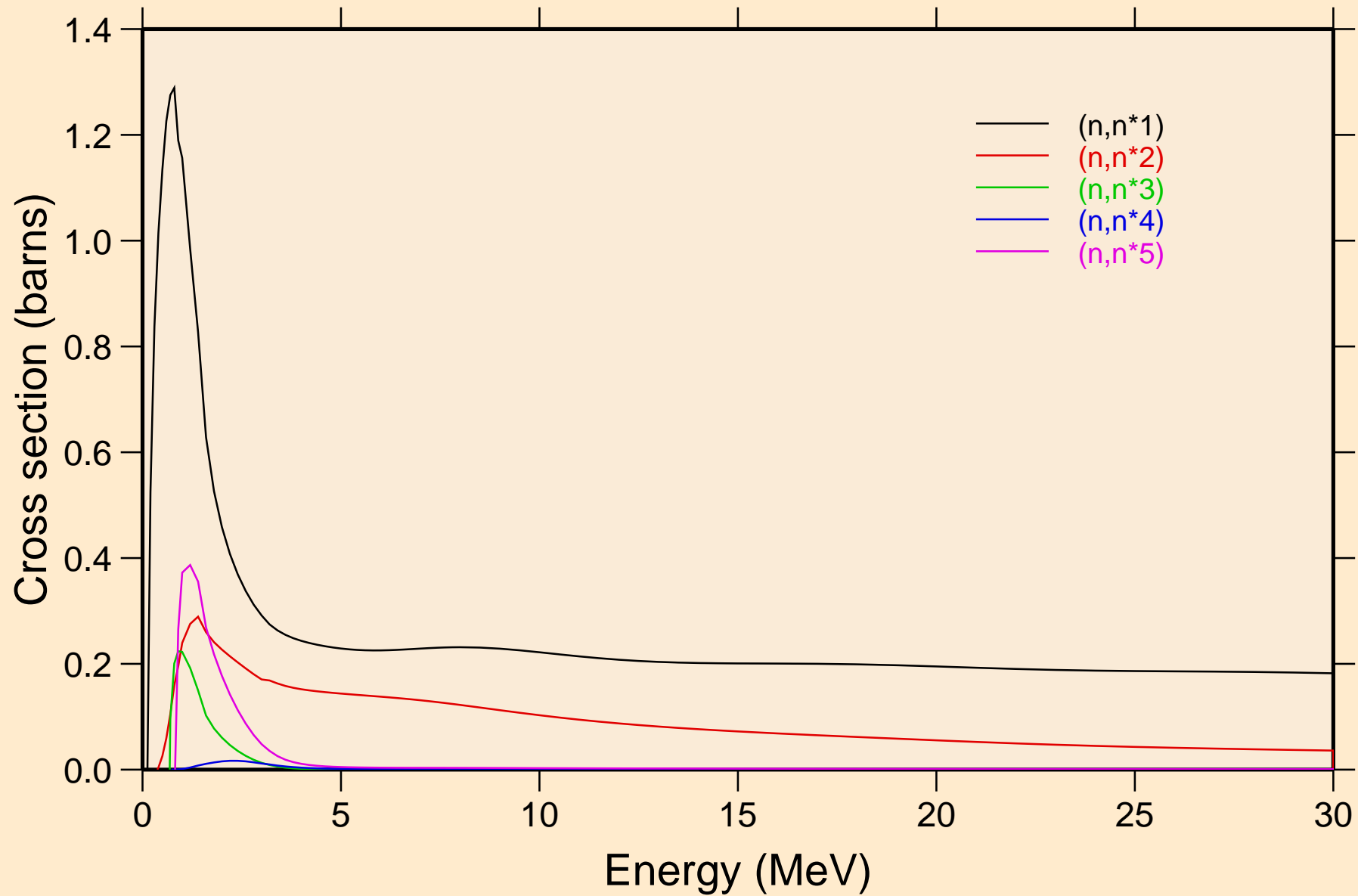

GD154 NEUTRON ACER TENDL-2021 LIBRARY; T=293.6K
Inelastic levels

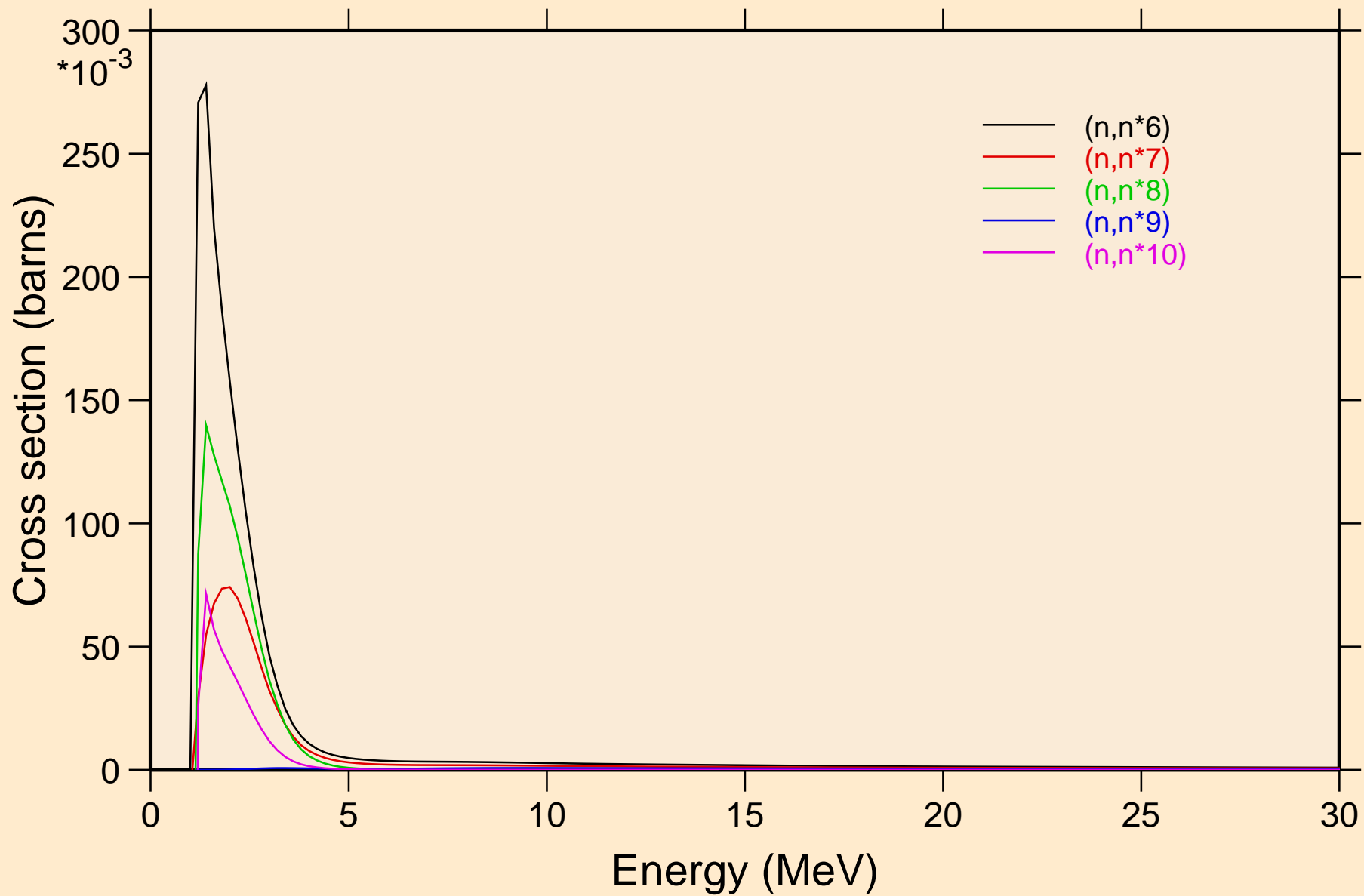

GD154 NEUTRON ACER TENDL-2021 LIBRARY; T=293.6K
Inelastic levels

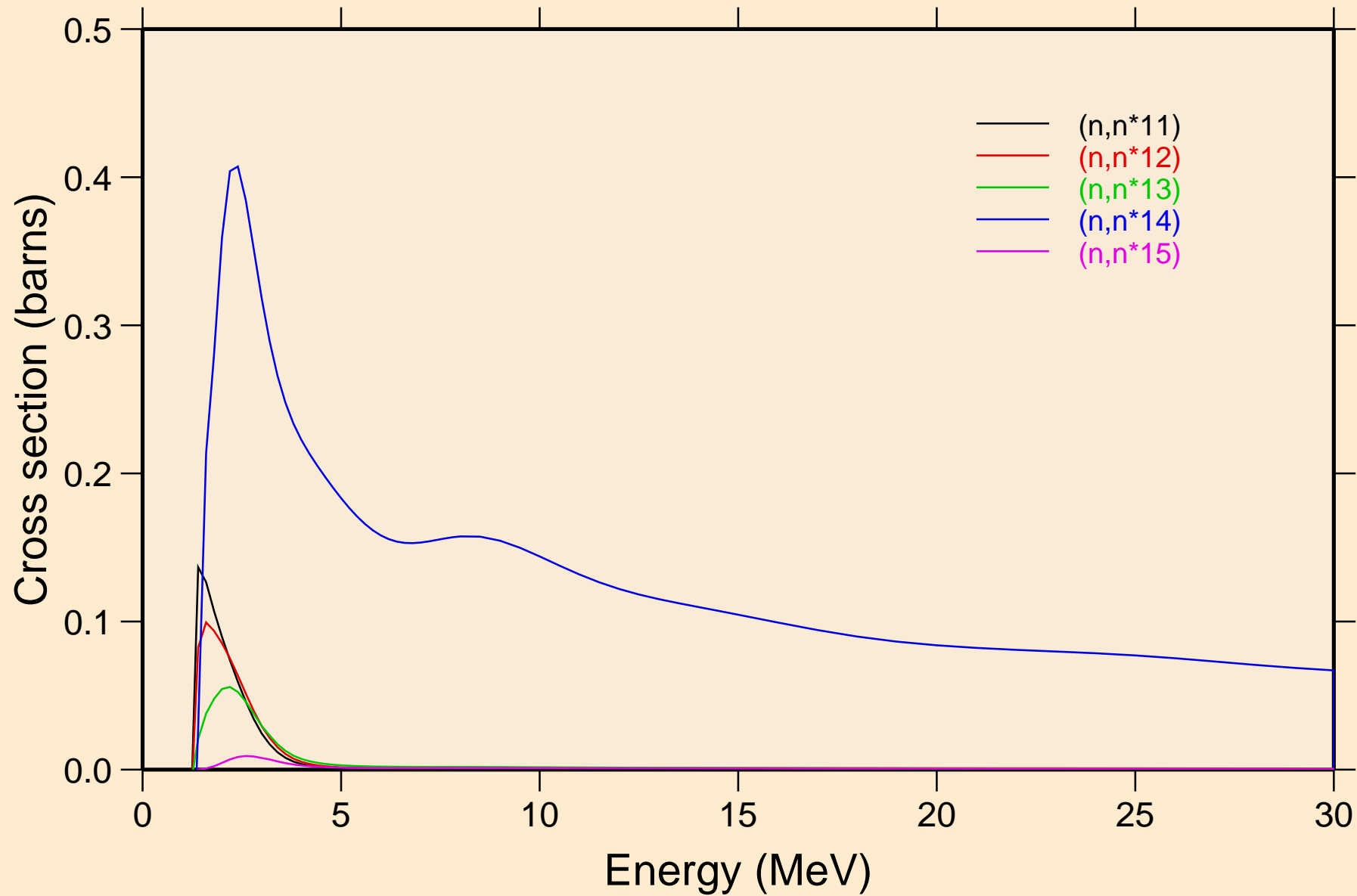

GD154 NEUTRON ACER TENDL-2021 LIBRARY; T=293.6K
Inelastic levels

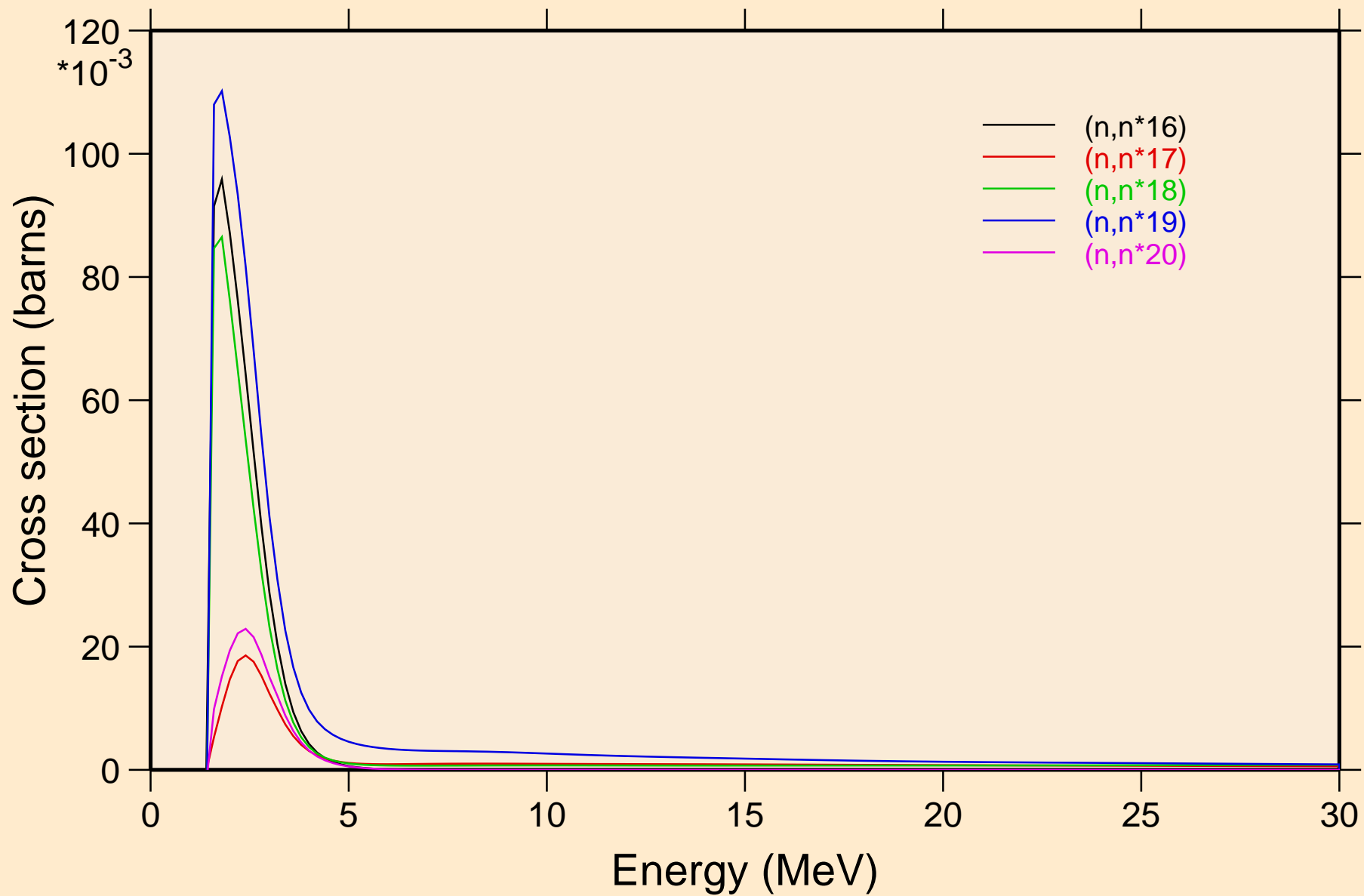

GD154 NEUTRON ACER TENDL-2021 LIBRARY; T=293.6K
Inelastic levels

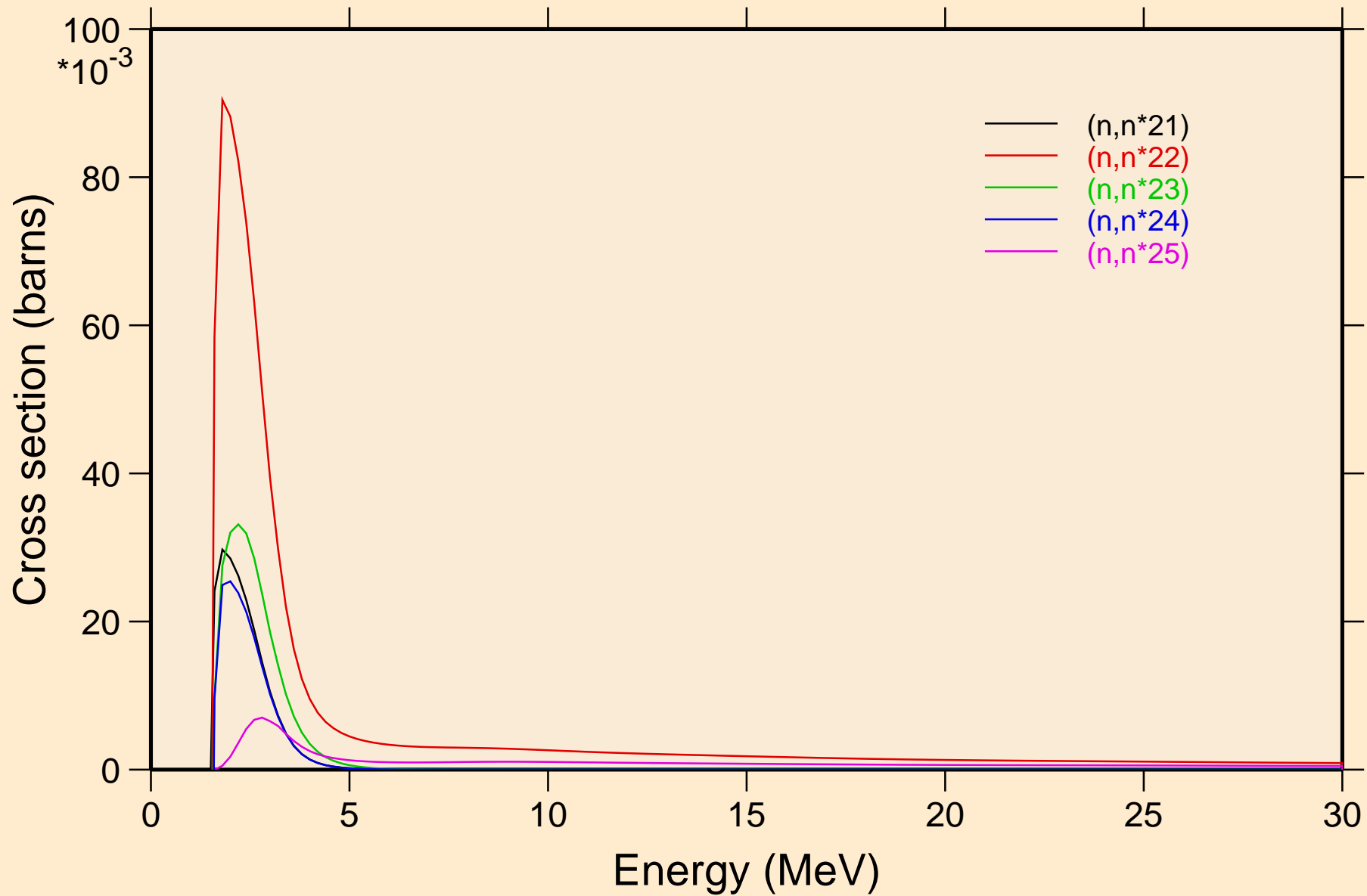

GD154 NEUTRON ACER TENDL-2021 LIBRARY; T=293.6K
Inelastic levels

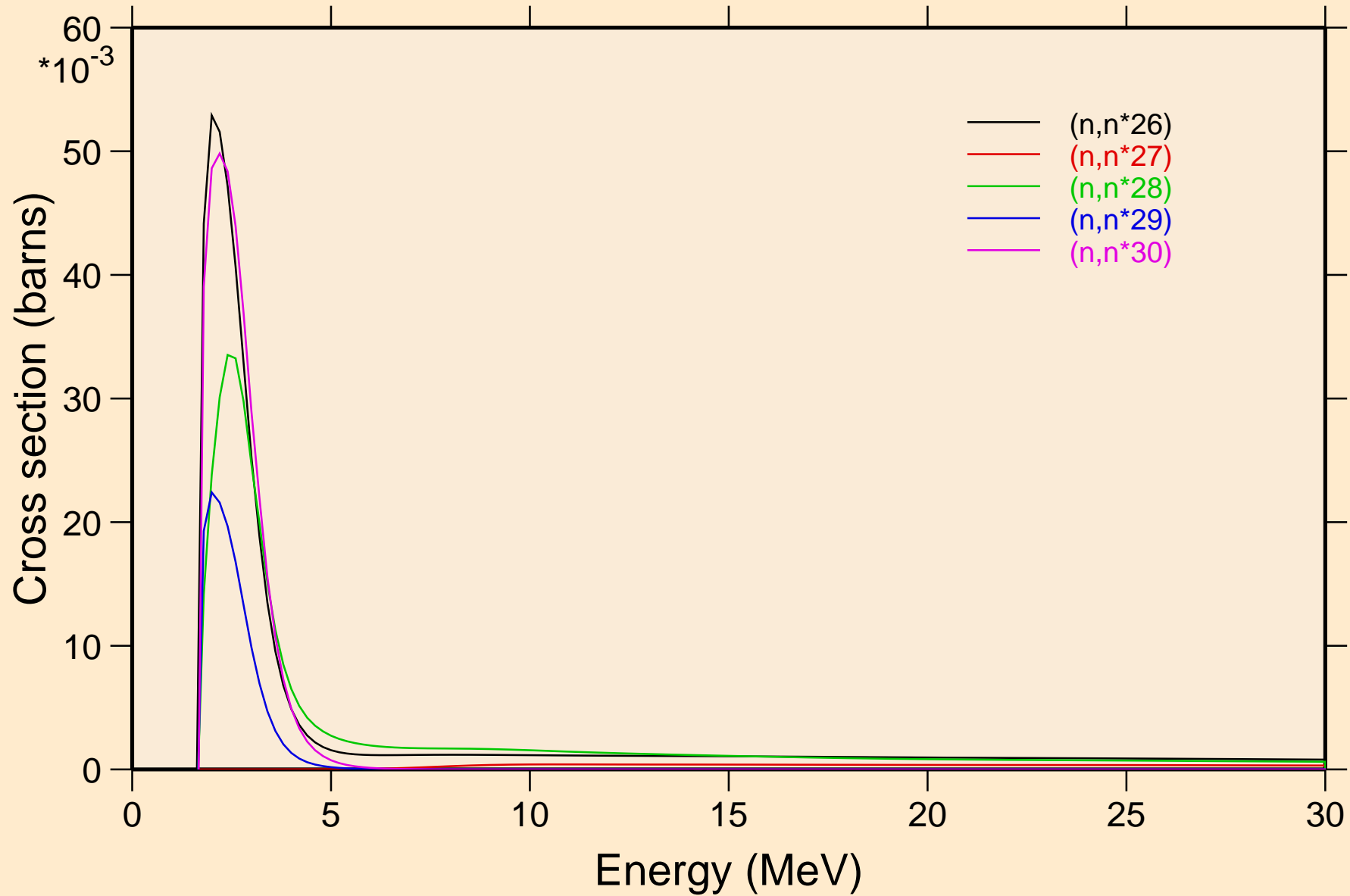

GD154 NEUTRON ACER TENDL-2021 LIBRARY; T=293.6K
Threshold reactions

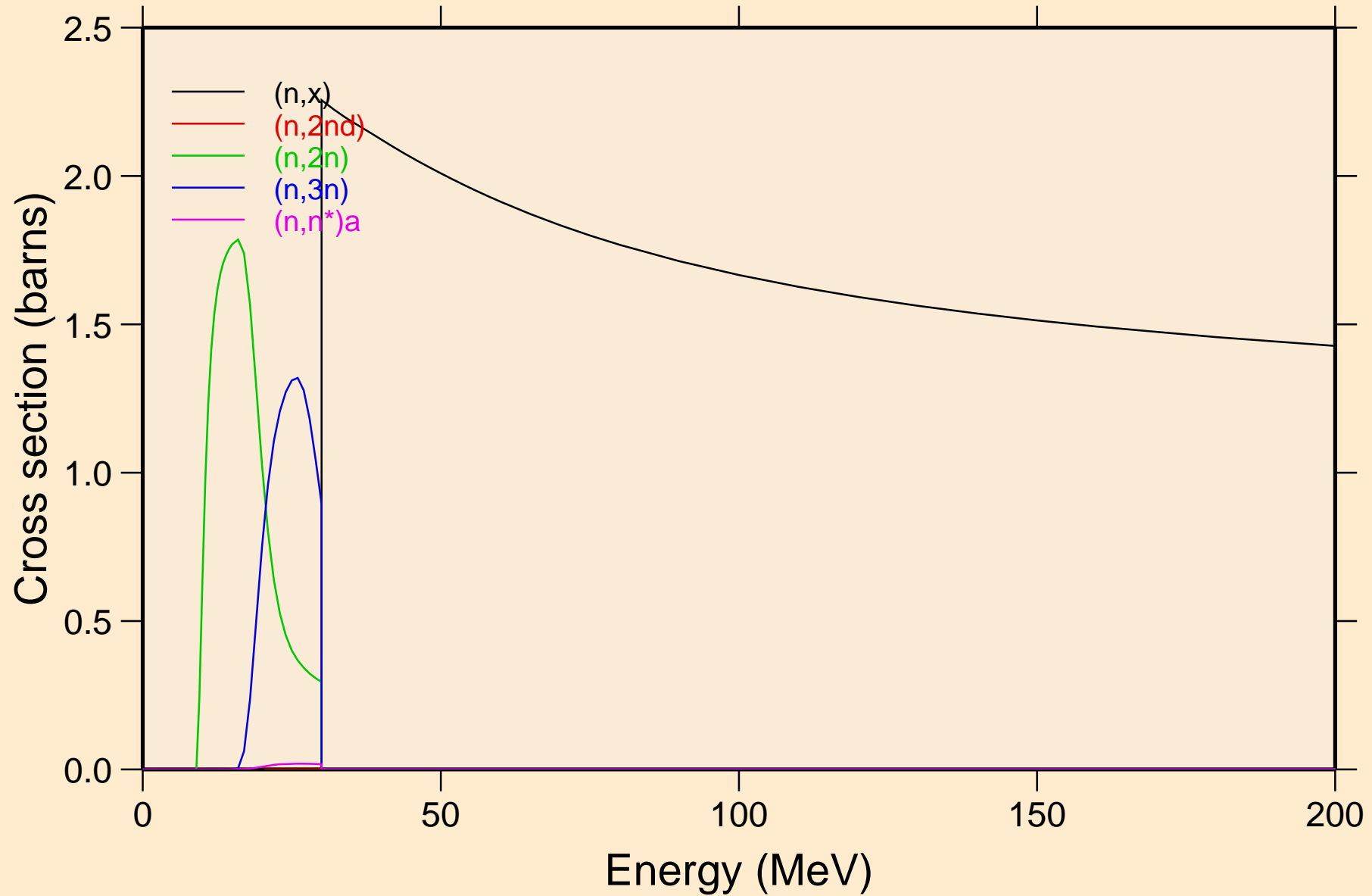

GD154 NEUTRON ACER TENDL-2021 LIBRARY; T=293.6K
Threshold reactions

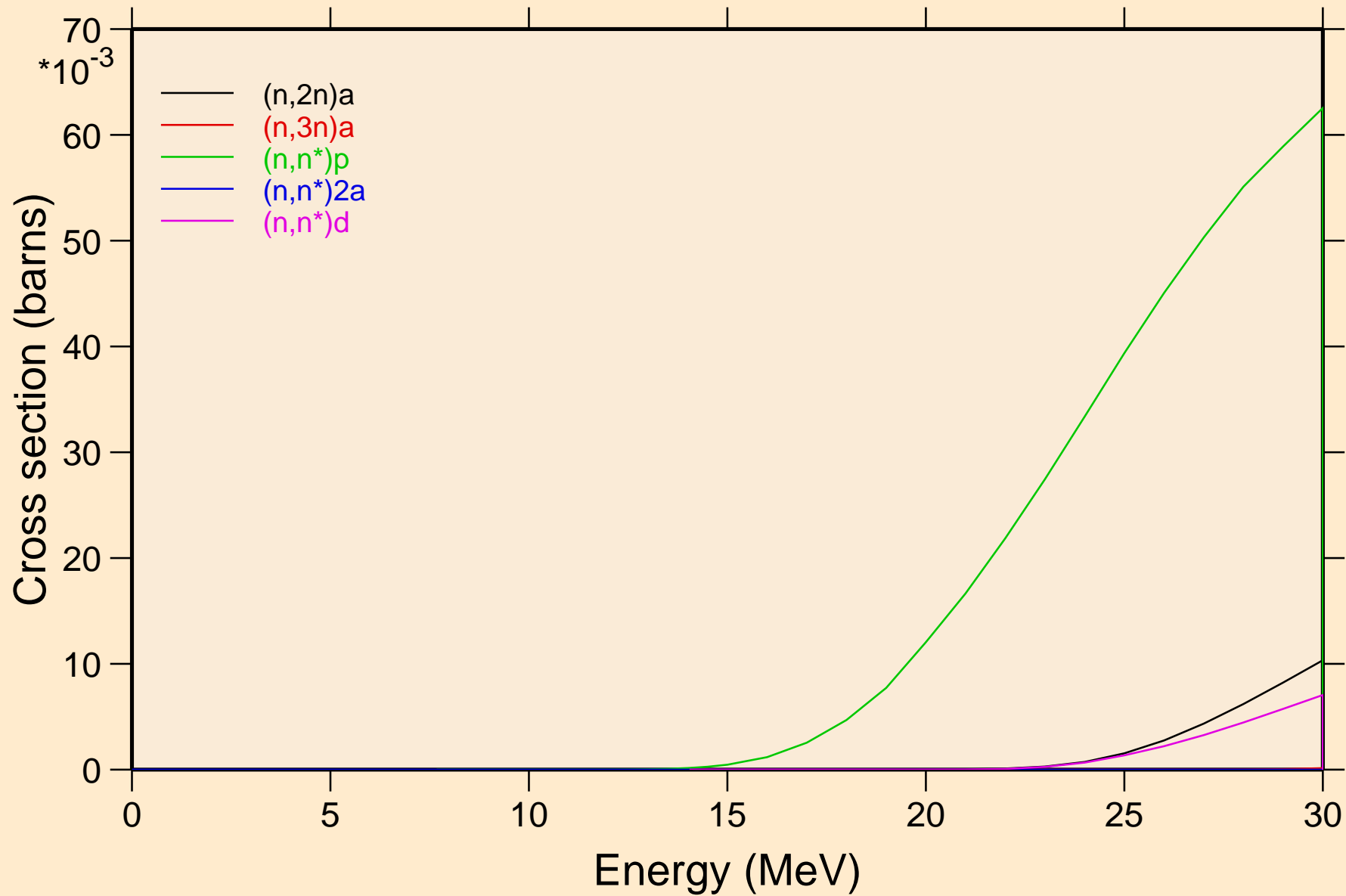

GD154 NEUTRON ACER TENDL-2021 LIBRARY; T=293.6K
Threshold reactions

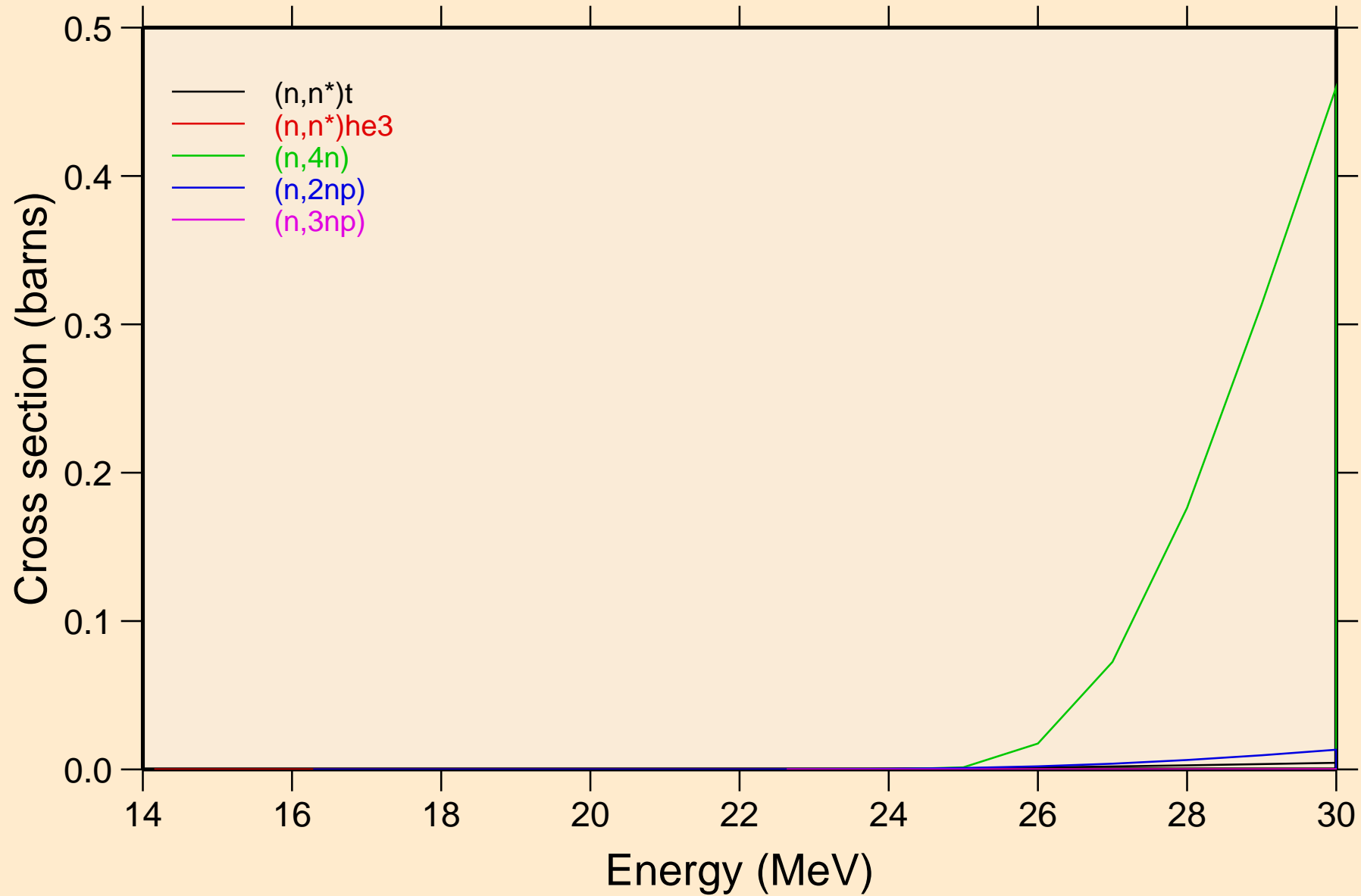

GD154 NEUTRON ACER TENDL-2021 LIBRARY; T=293.6K
Threshold reactions

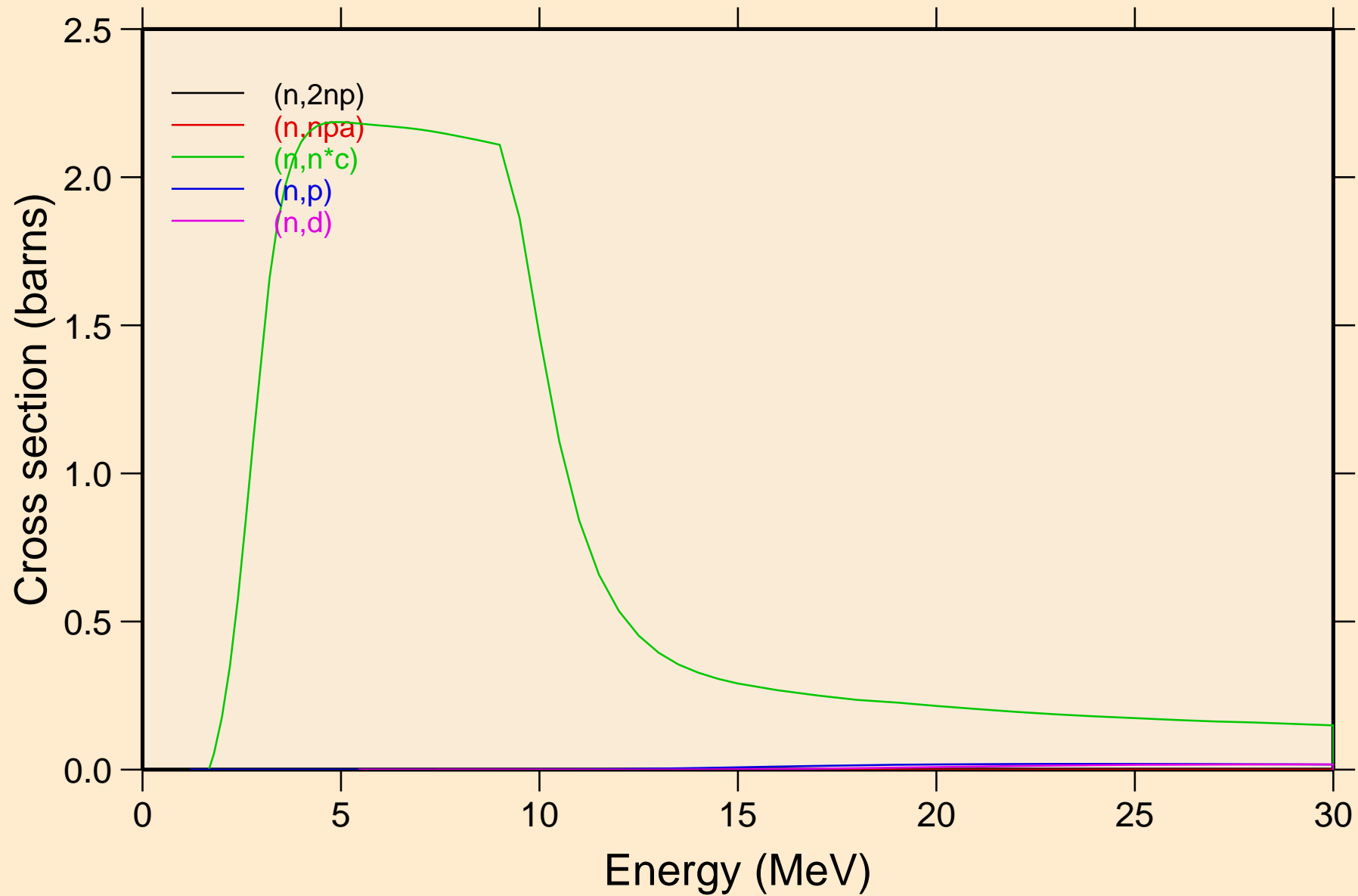

GD154 NEUTRON ACER TENDL-2021 LIBRARY; T=293.6K
Threshold reactions

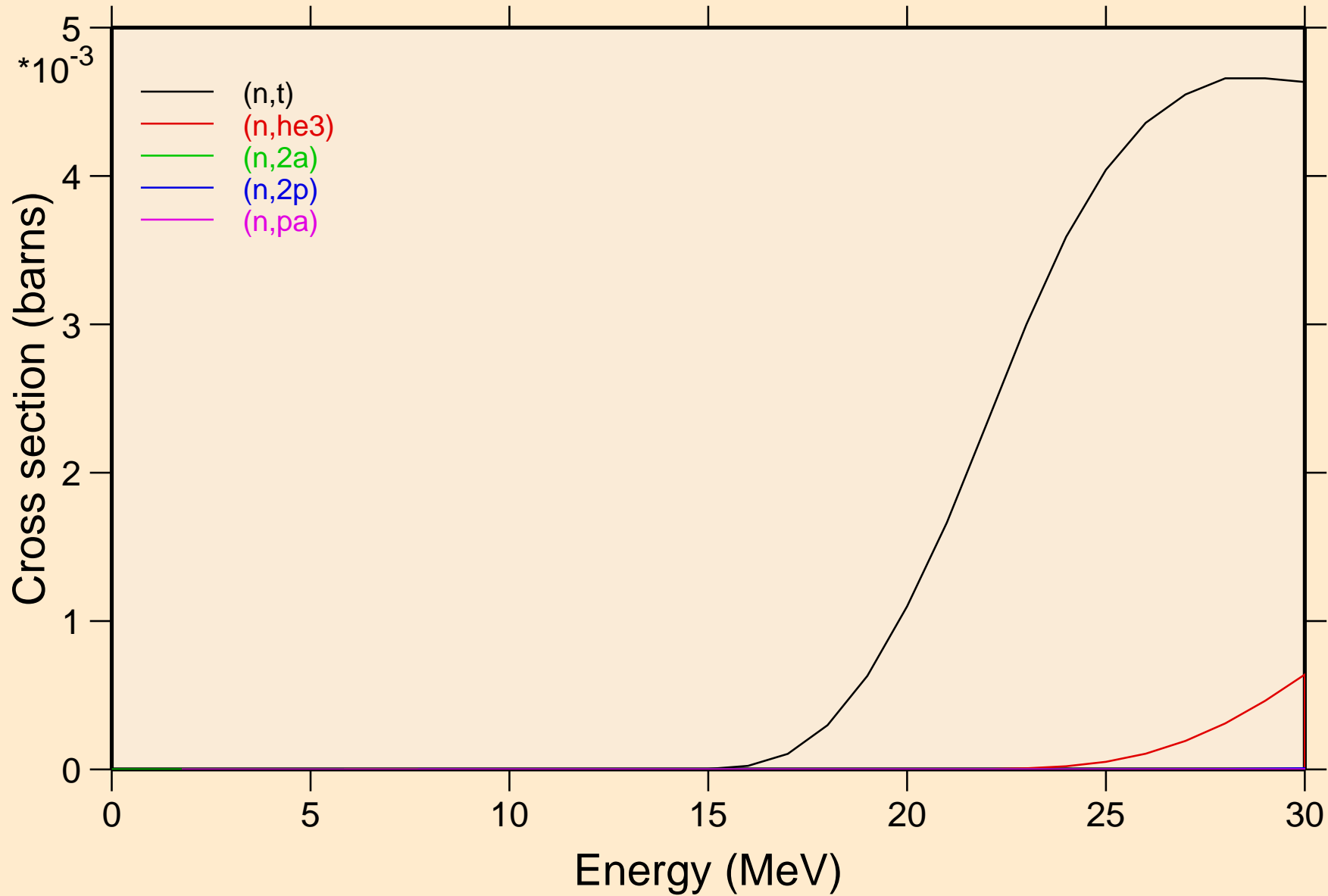

GD154 NEUTRON ACER TENDL-2021 LIBRARY; T=293.6K
Threshold reactions

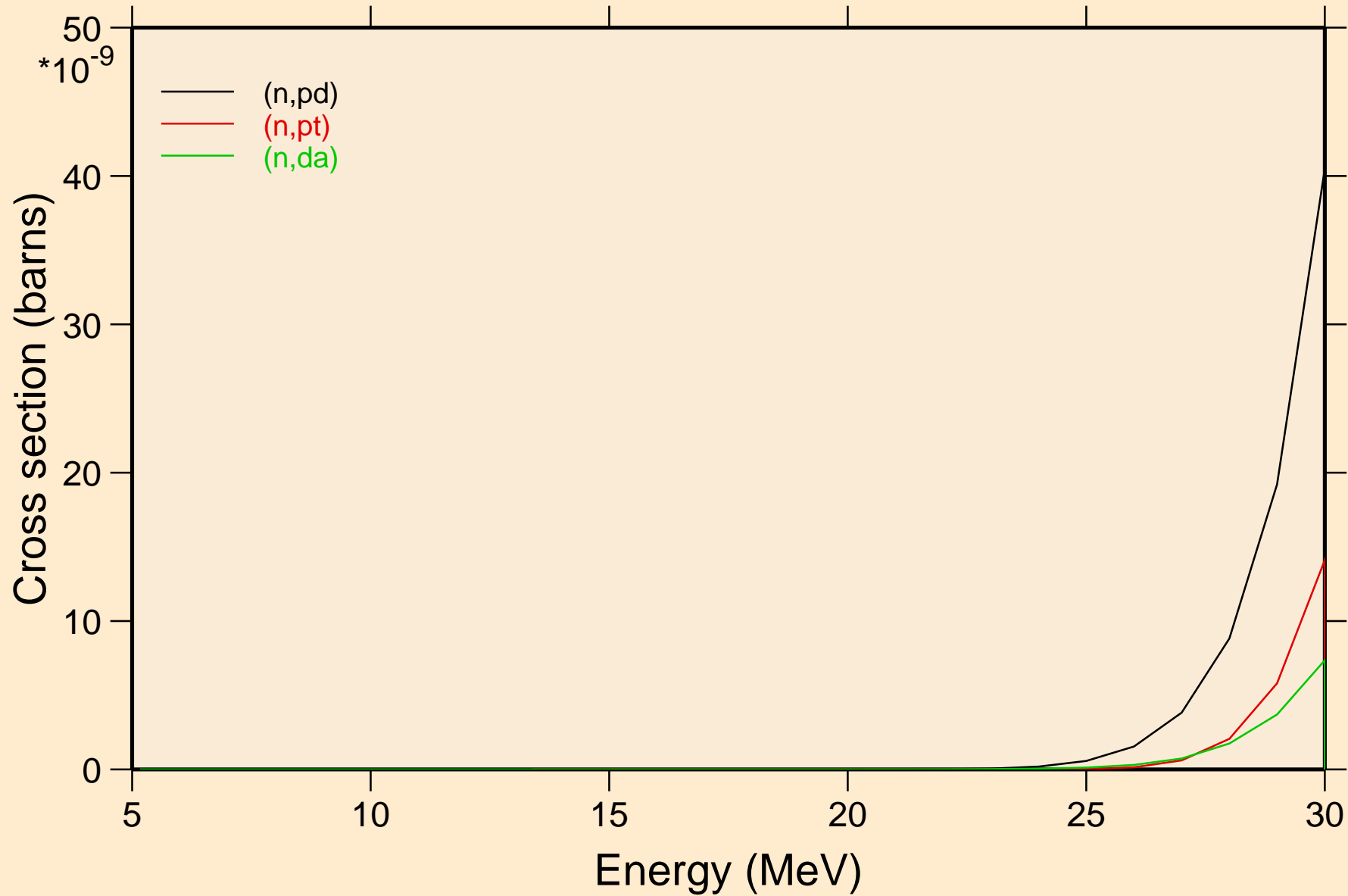

GD154 NEUTRON ACER TENDL-2021 LIBRARY; T=293.6K
Threshold reactions

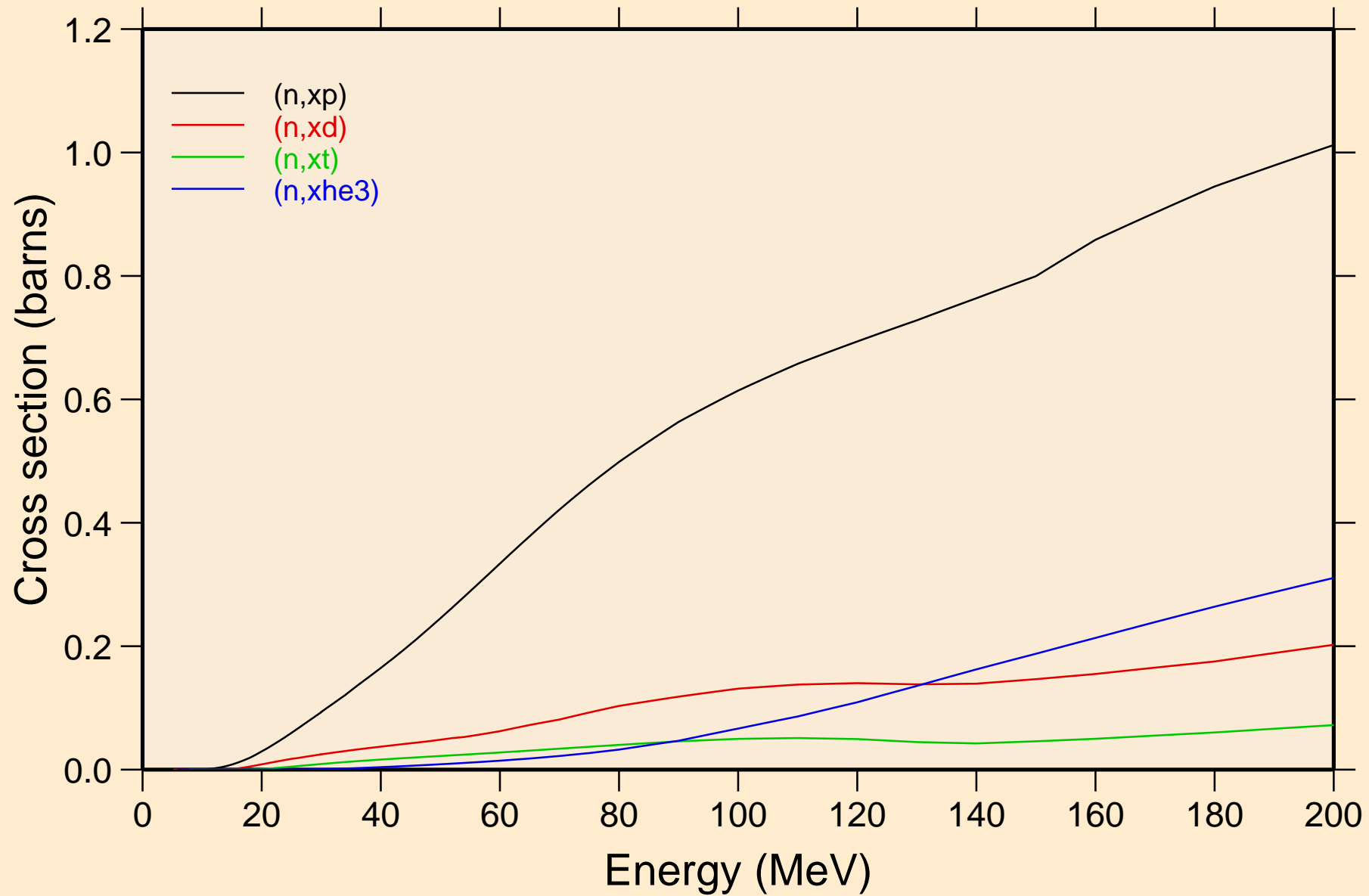

GD154 NEUTRON ACER TENDL-2021 LIBRARY; T=293.6K
angular distribution for elastic

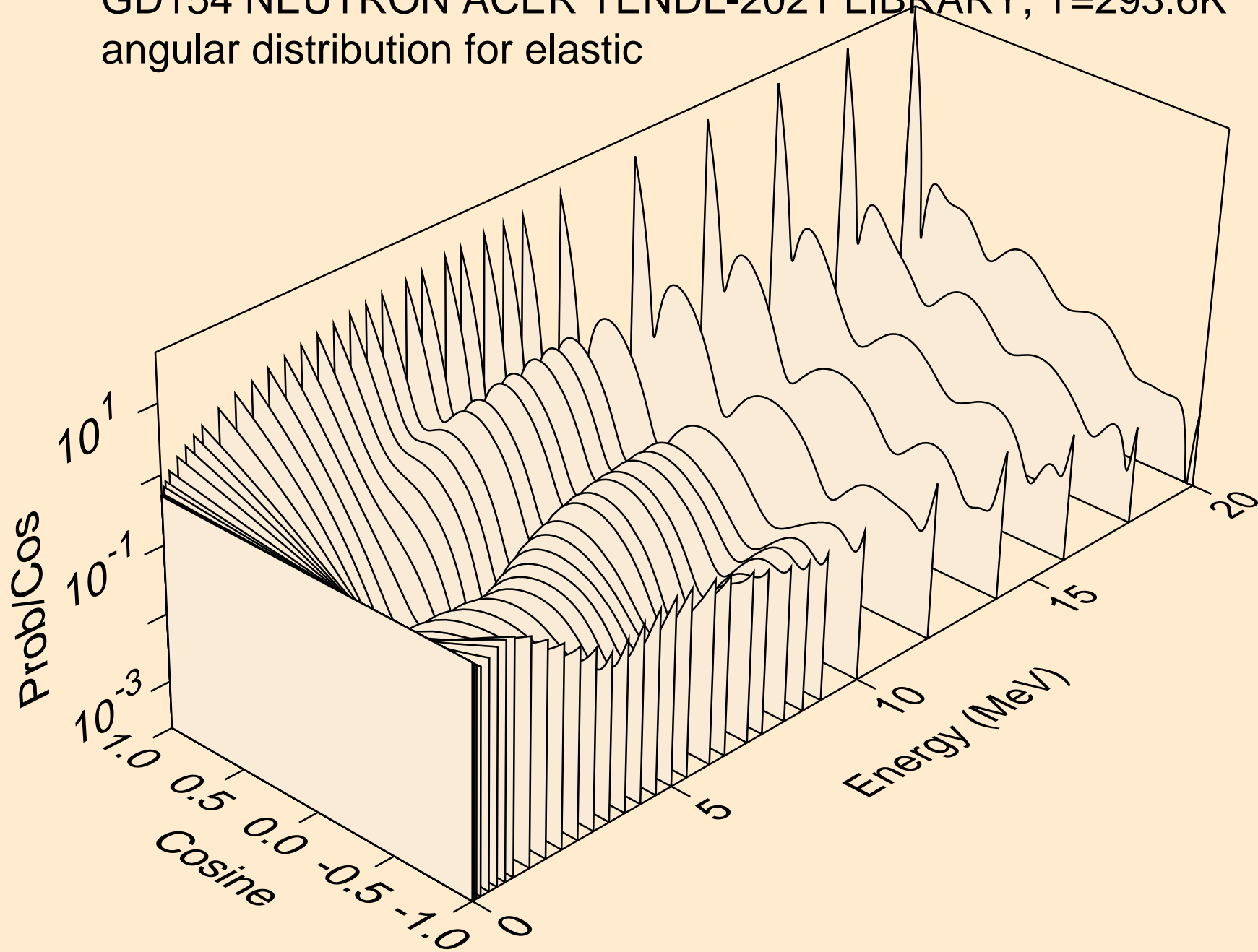

GD154 NEUTRON ACER TENDL-2021 LIBRARY; T=293.6K
angular distribution for elastic

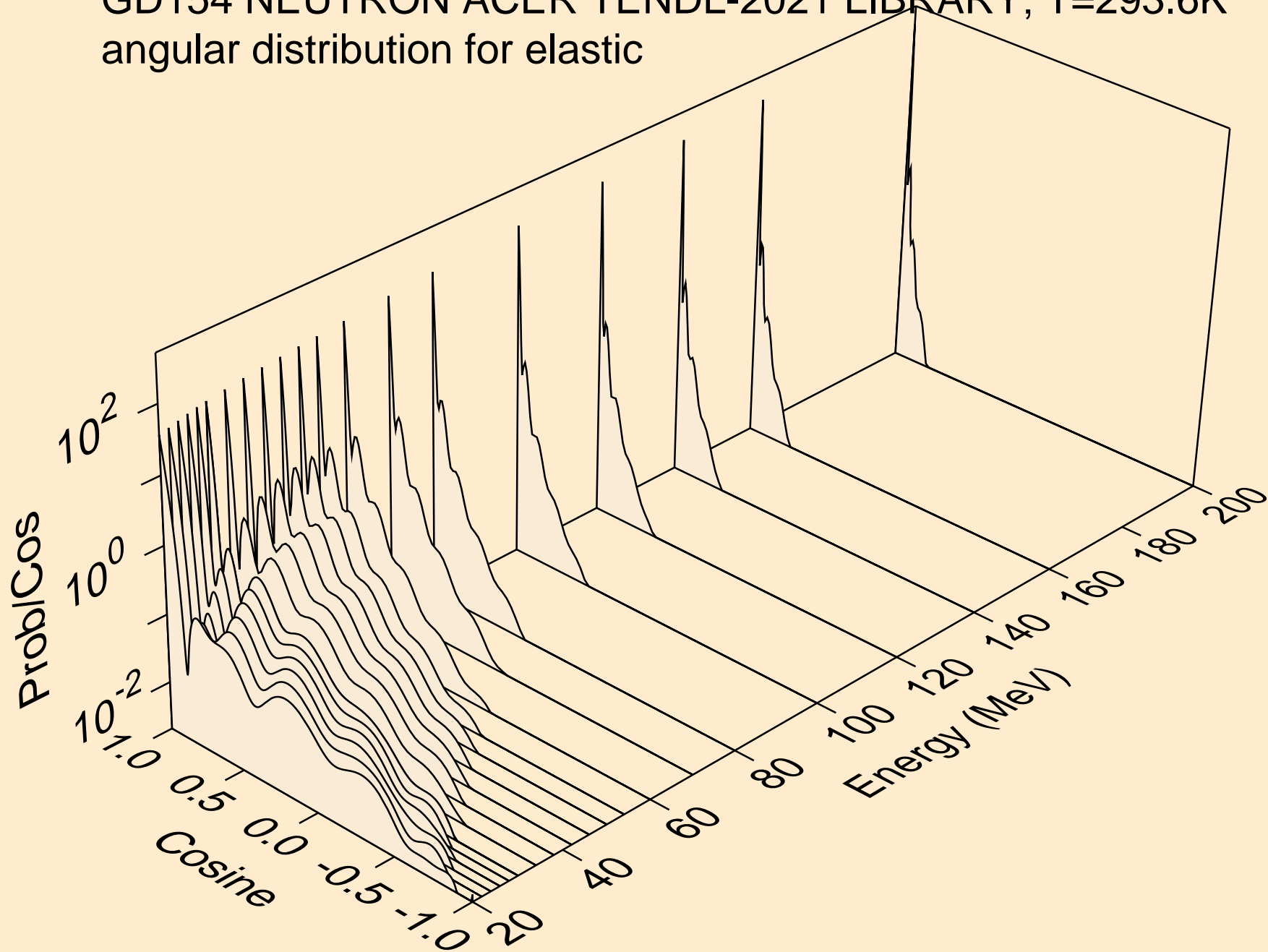

GD154 NEUTRON ACER TENDL-2021 LIBRARY; T=293.6K
angular distribution for (n,n*1)

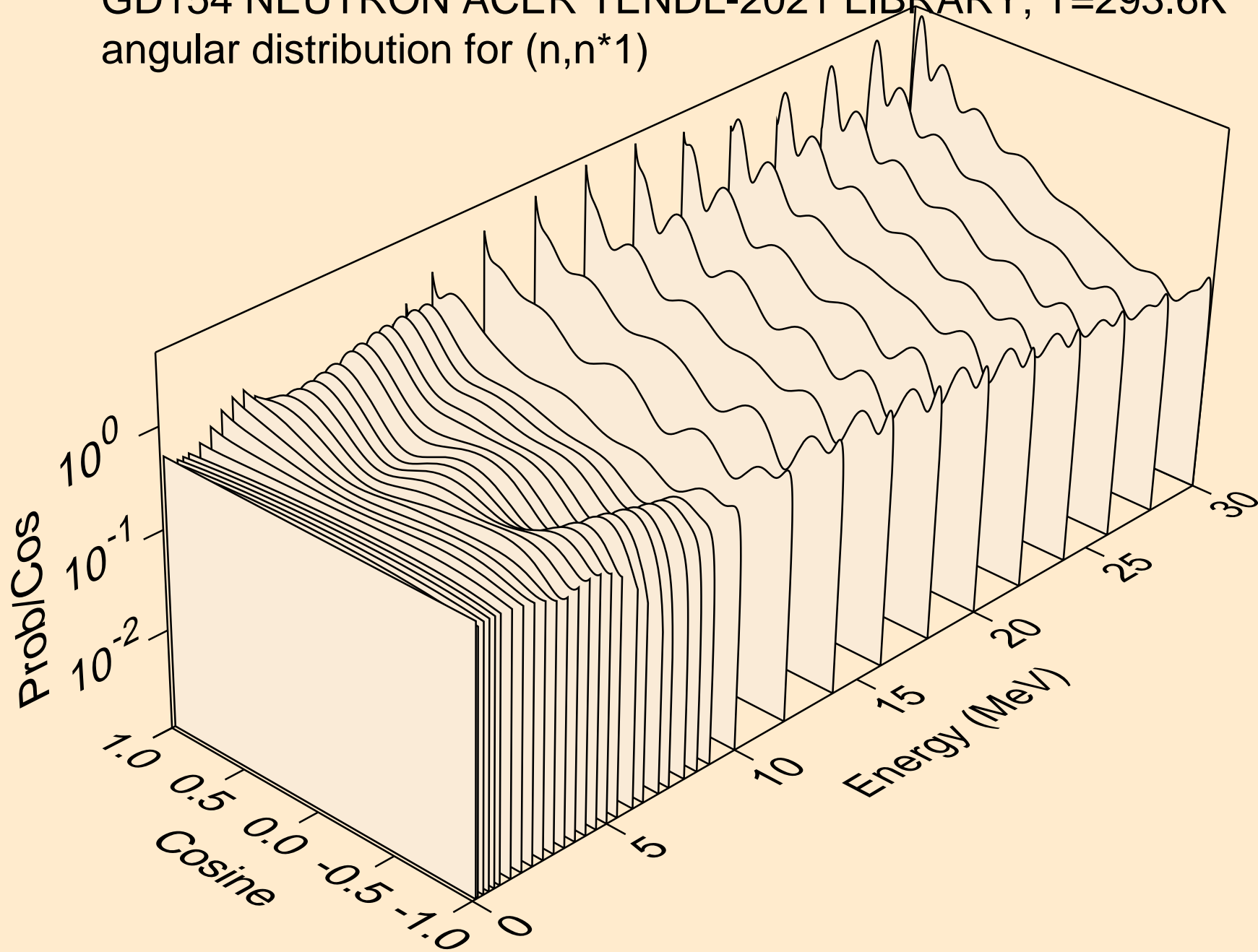

GD154 NEUTRON ACER TENDL-2021 LIBRARY; T=293.6K
angular distribution for (n,n*2)

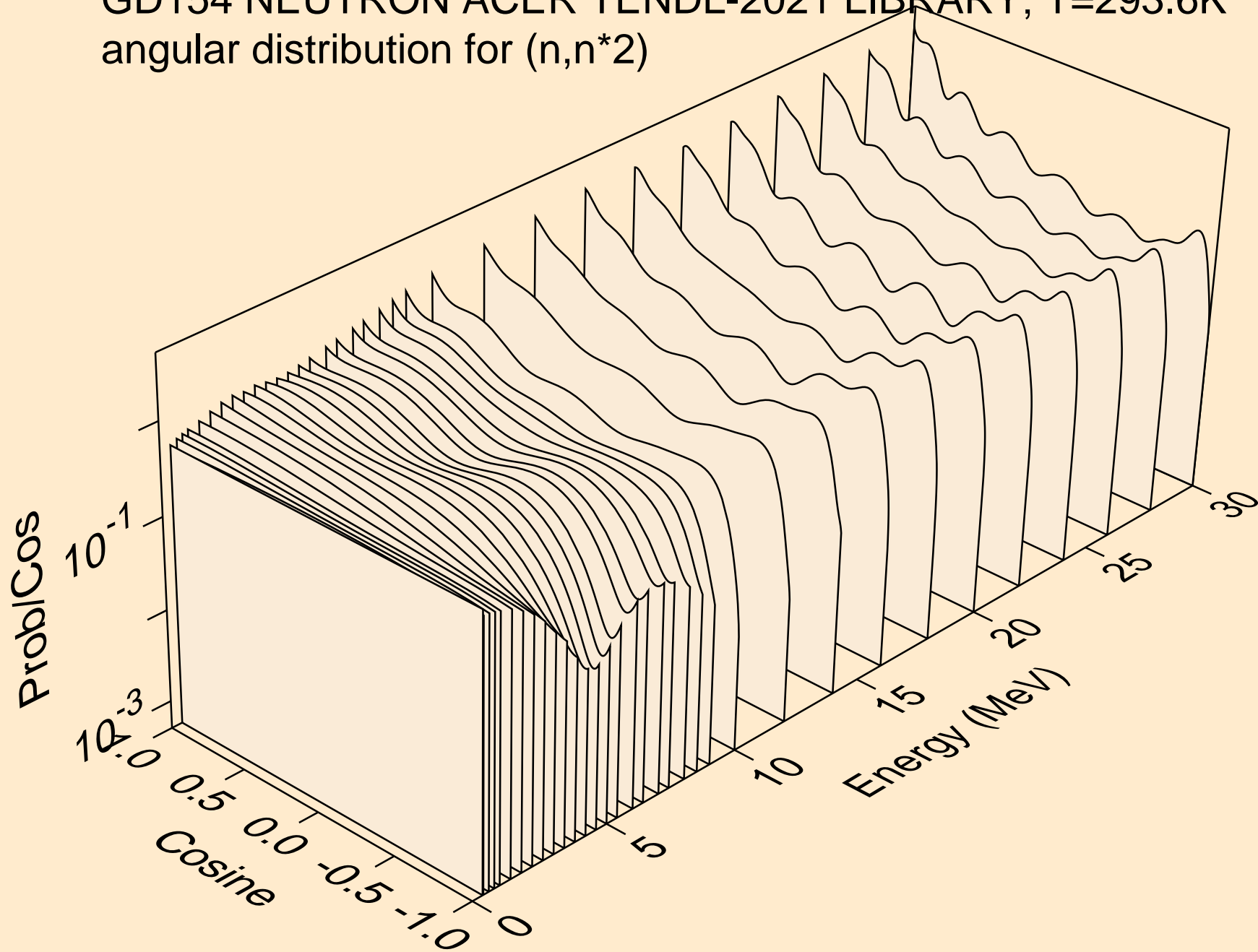

GD154 NEUTRON ACER TENDL-2021 LIBRARY; T=293.6K
angular distribution for (n,n*3)

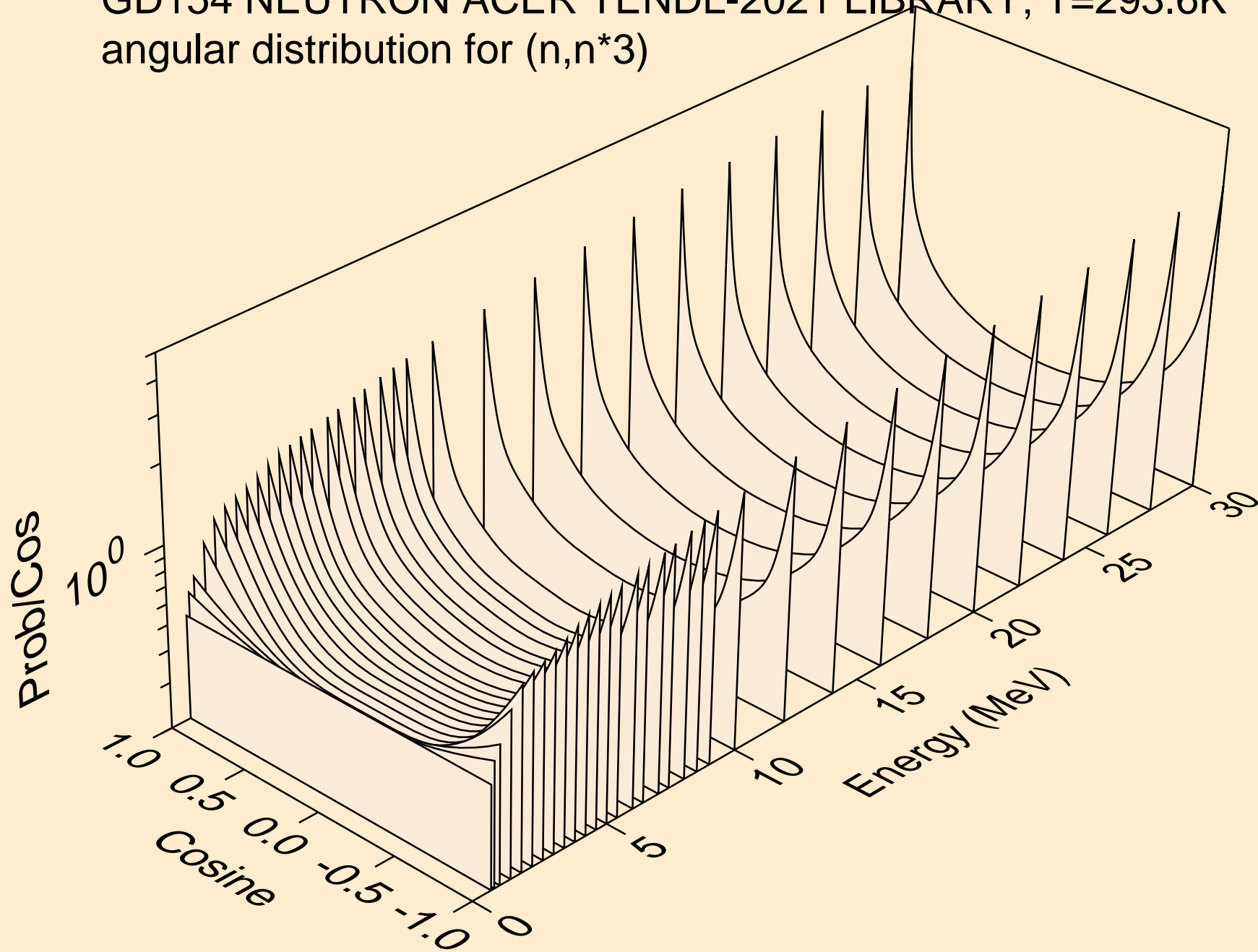

GD154 NEUTRON ACER TENDL-2021 LIBRARY; T=293.6K
angular distribution for (n,n*4)

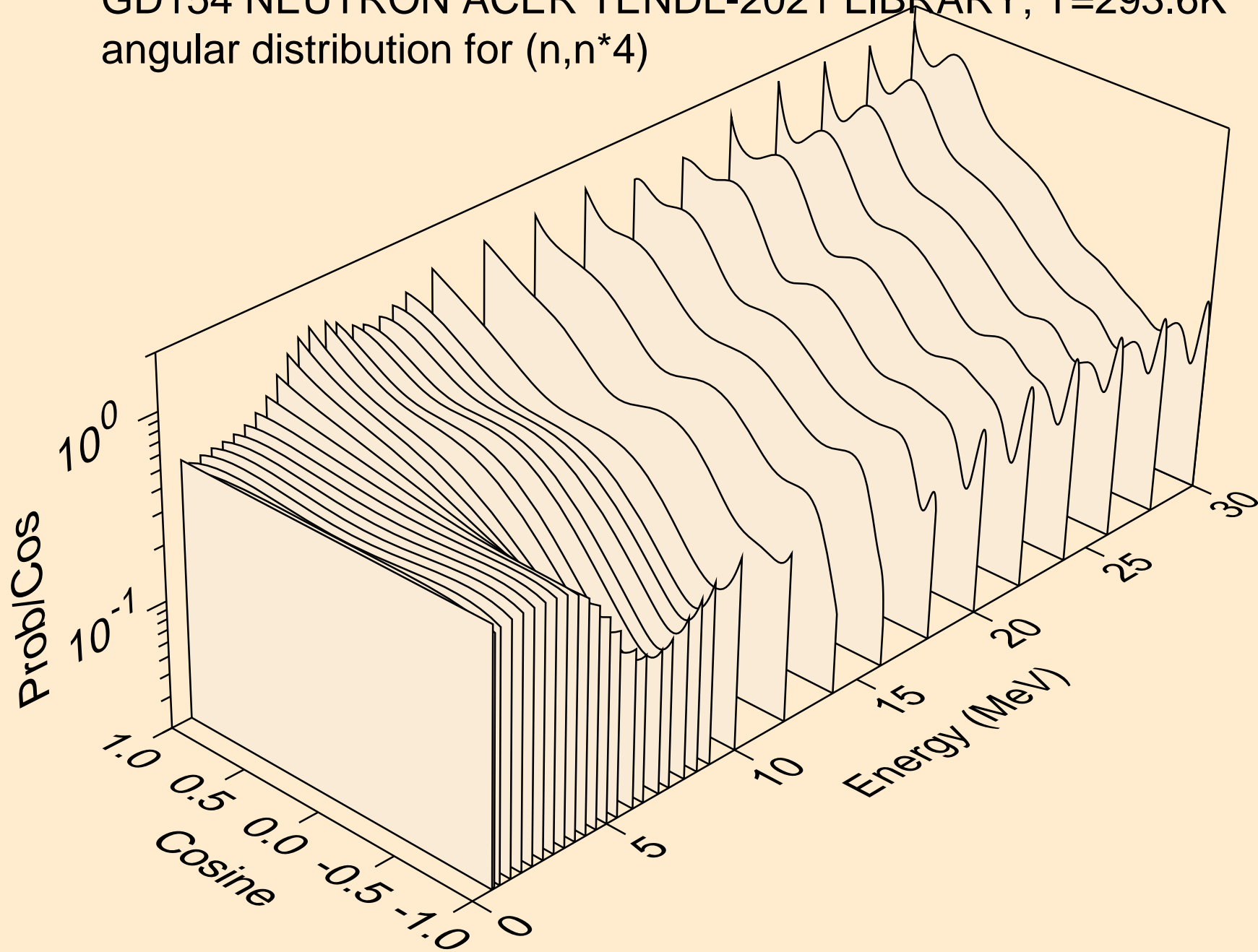

GD154 NEUTRON ACER TENDL-2021 LIBRARY; T=293.6K
angular distribution for (n,n*5)

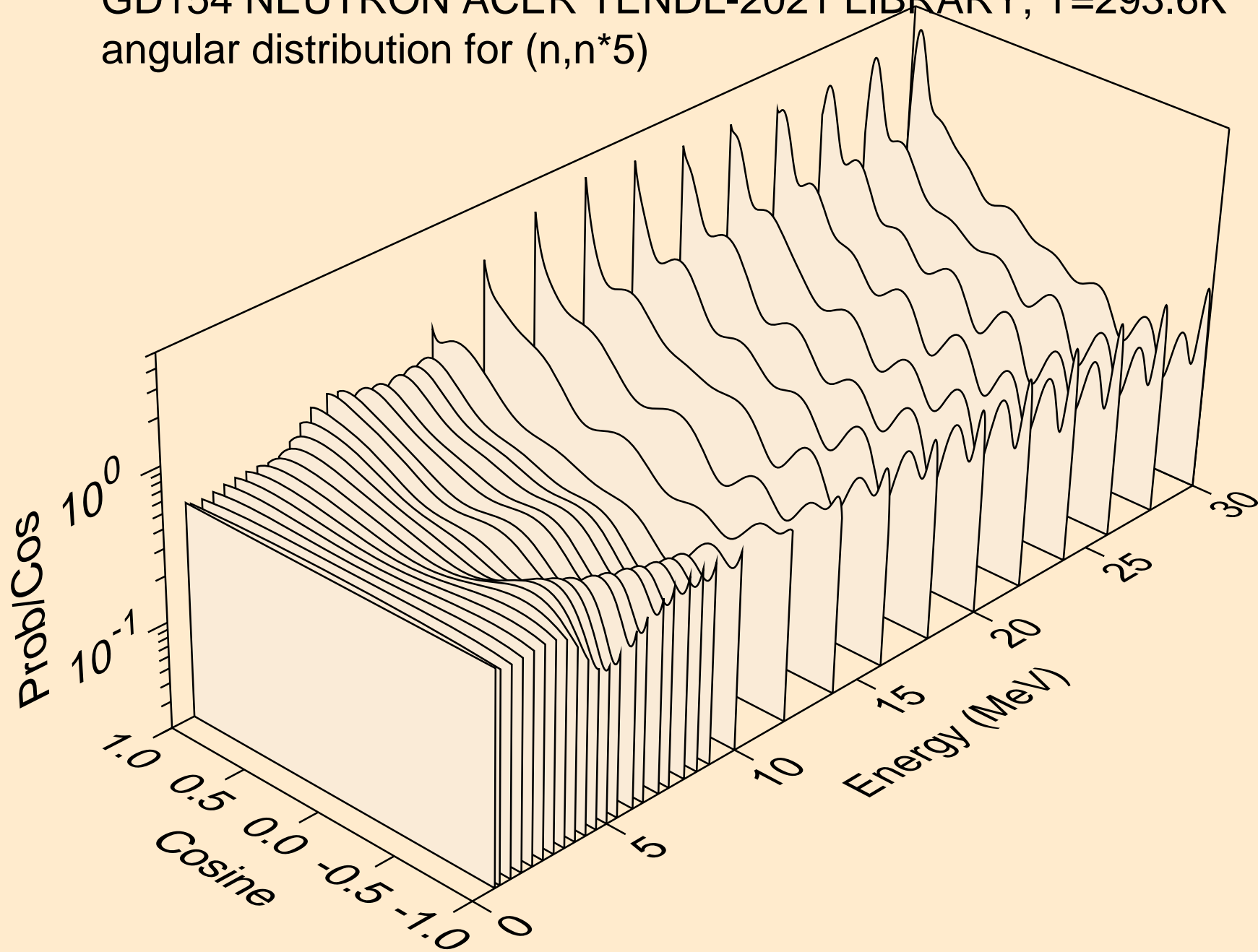

GD154 NEUTRON ACER TENDL-2021 LIBRARY; T=293.6K
angular distribution for (n,n*6)

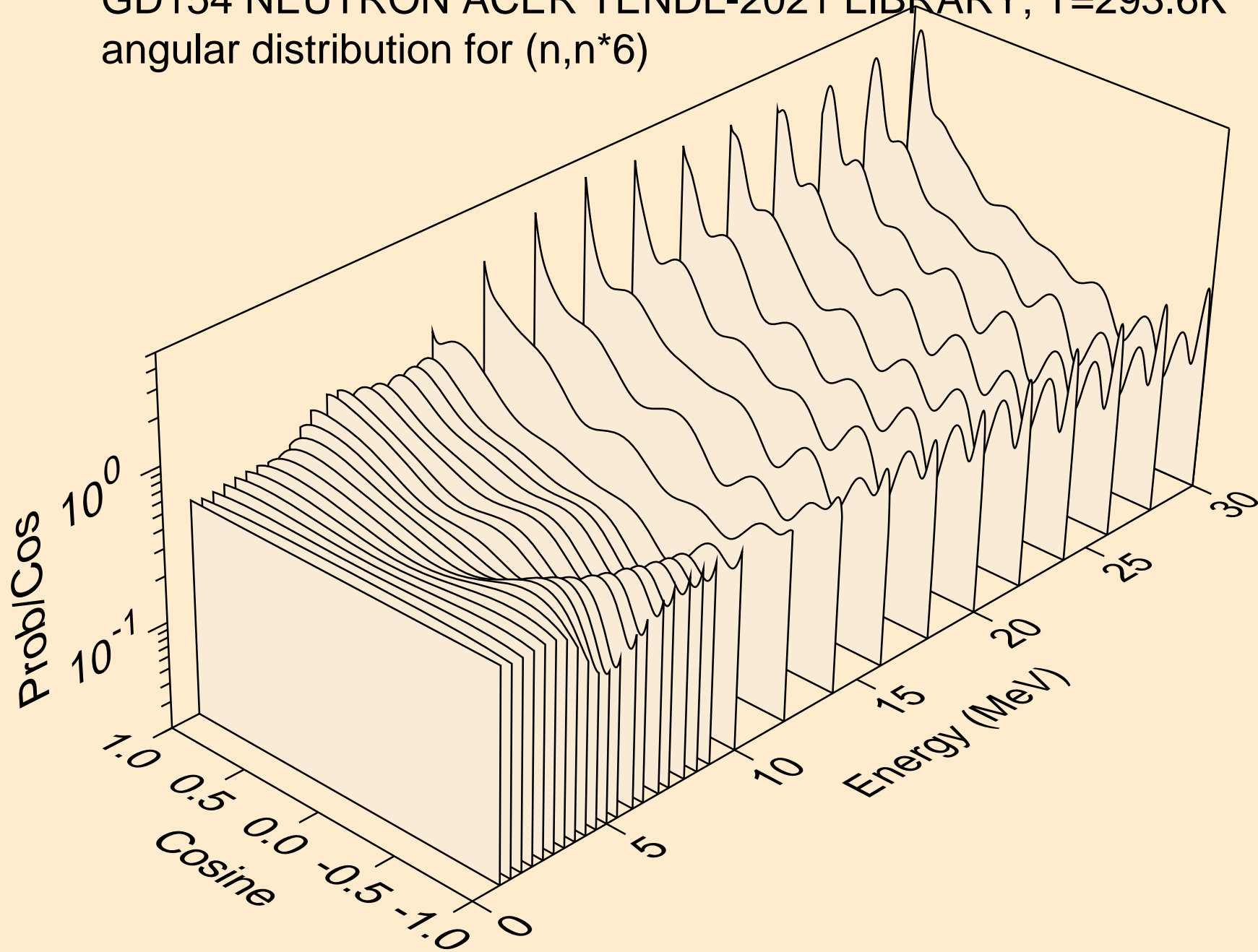

GD154 NEUTRON ACER TENDL-2021 LIBRARY; T=293.6K
angular distribution for (n,n*7)

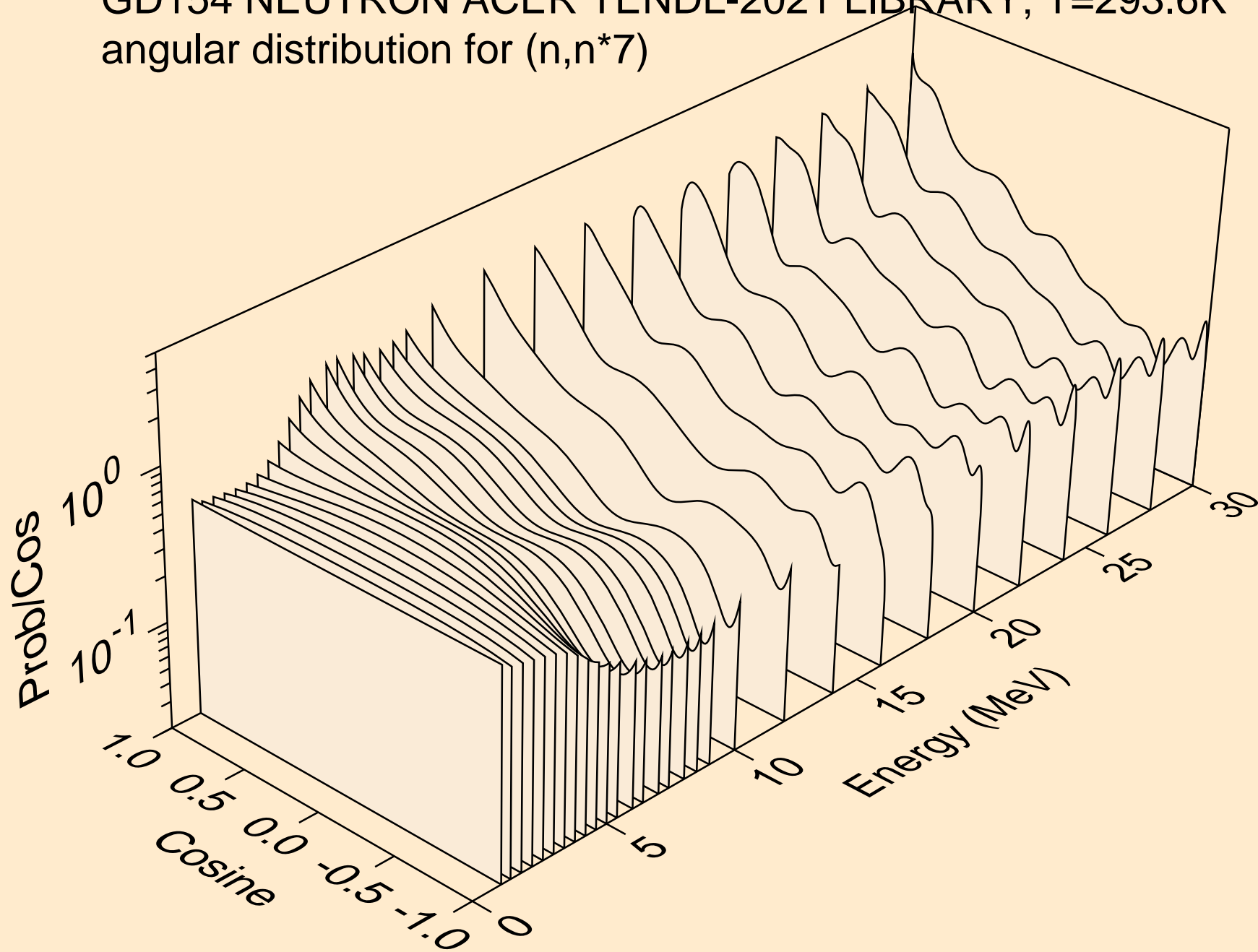

GD154 NEUTRON ACER TENDL-2021 LIBRARY; T=293.6K
angular distribution for (n,n*8)

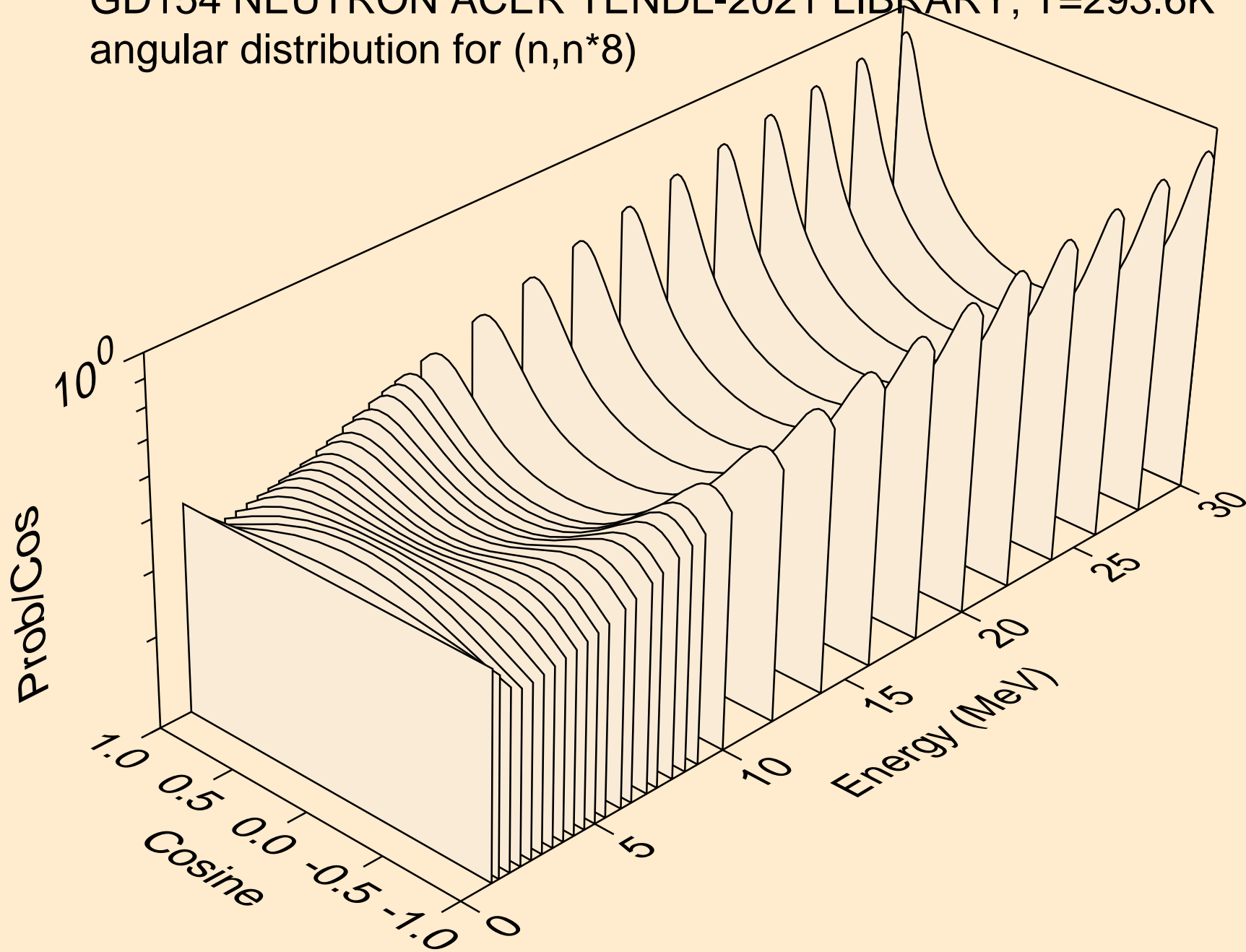

GD154 NEUTRON ACER TENDL-2021 LIBRARY; T=293.6K
angular distribution for (n,n*9)

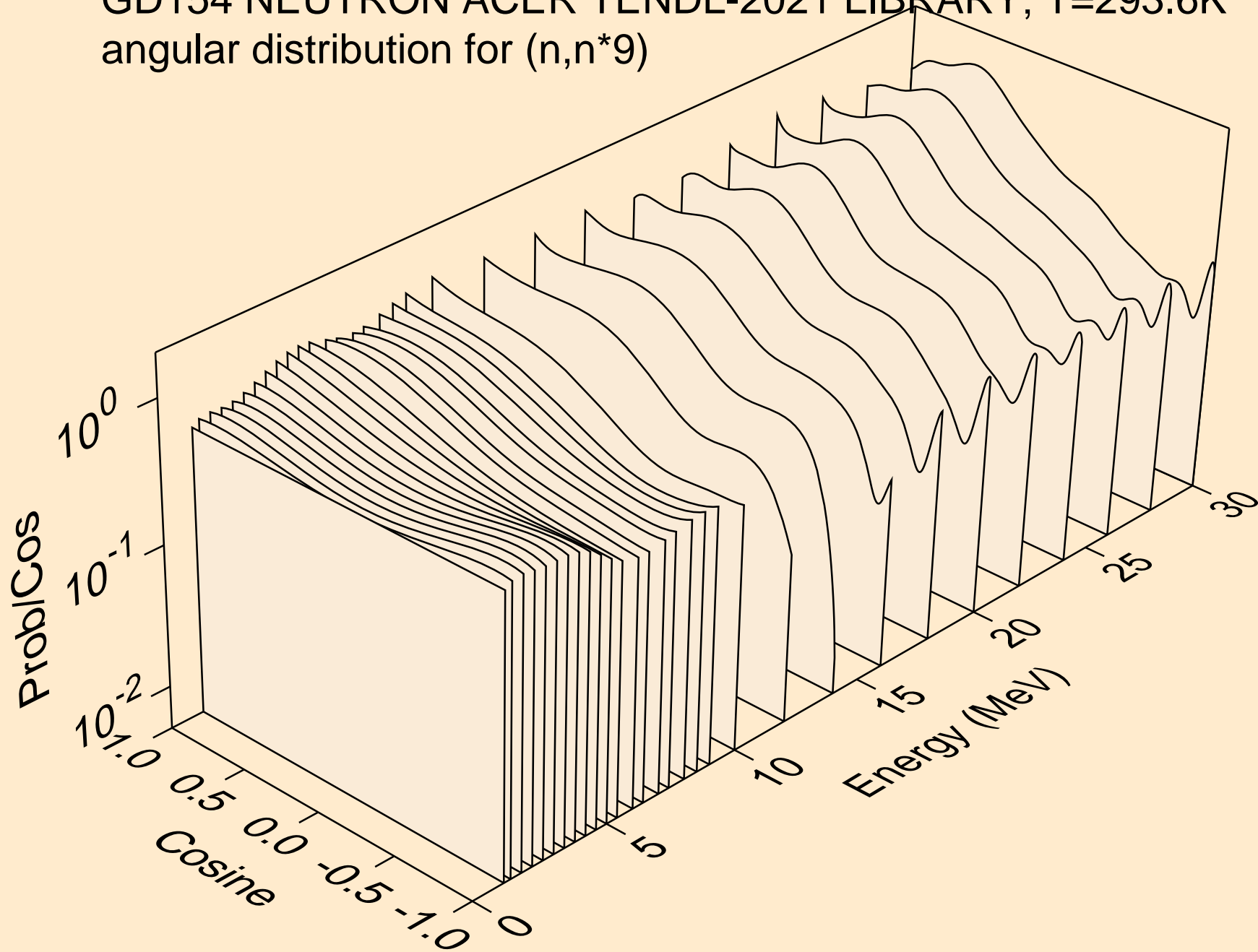

GD154 NEUTRON ACER TENDL-2021 LIBRARY; T=293.6K
angular distribution for (n,n*10)

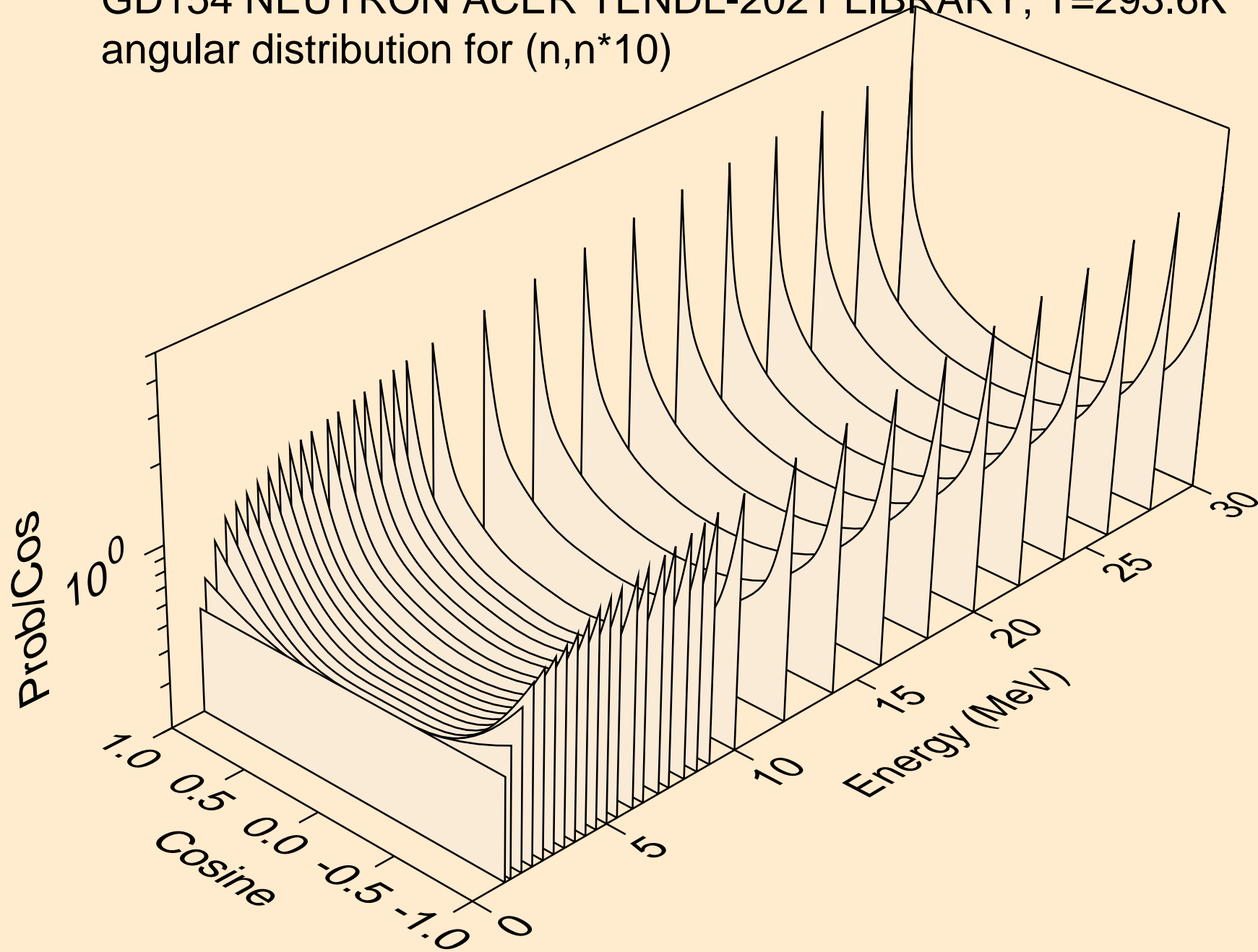

GD154 NEUTRON ACER TENDL-2021 LIBRARY; T=293.6K
angular distribution for (n,n*11)

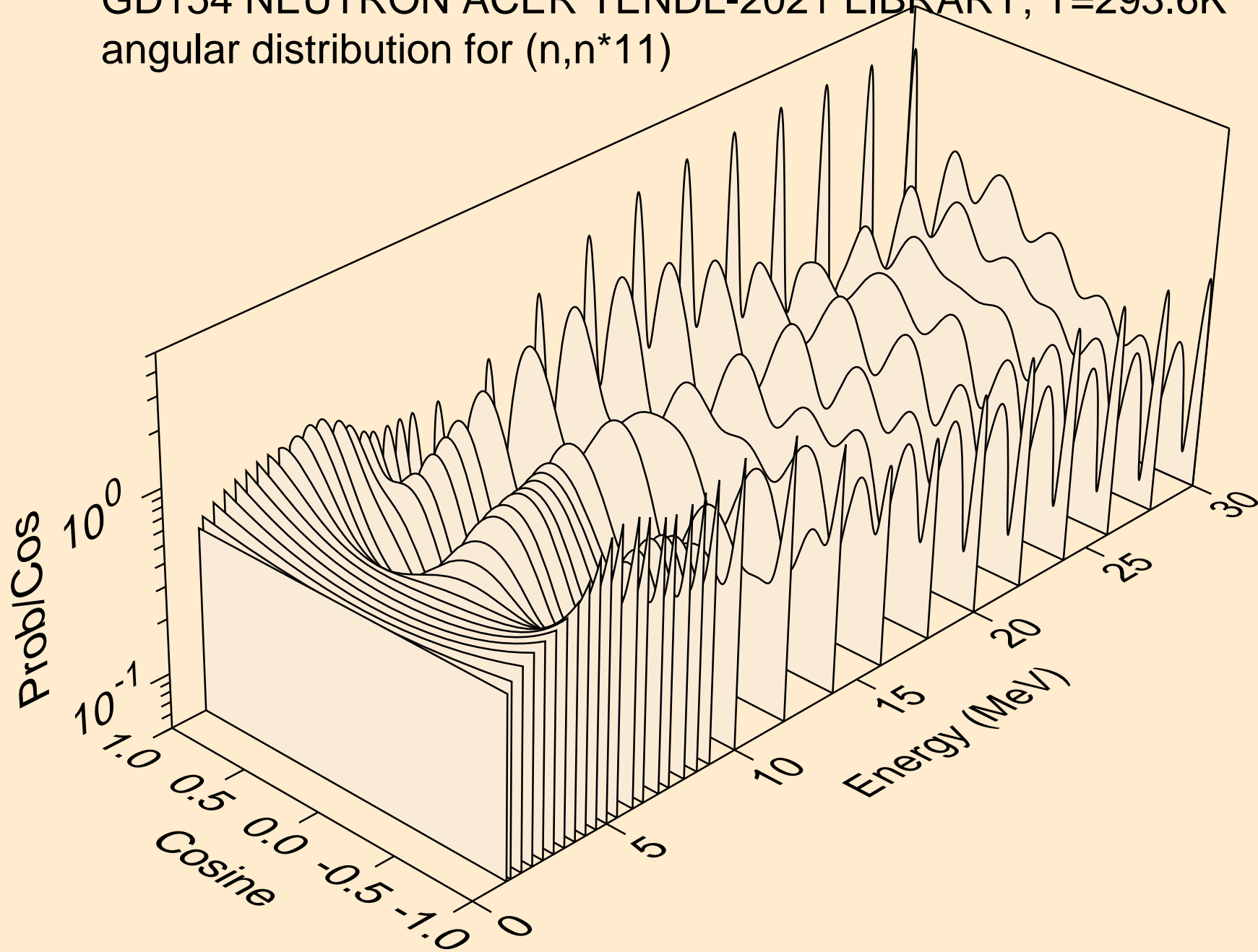

GD154 NEUTRON ACER TENDL-2021 LIBRARY; T=293.6K
angular distribution for (n,n*12)

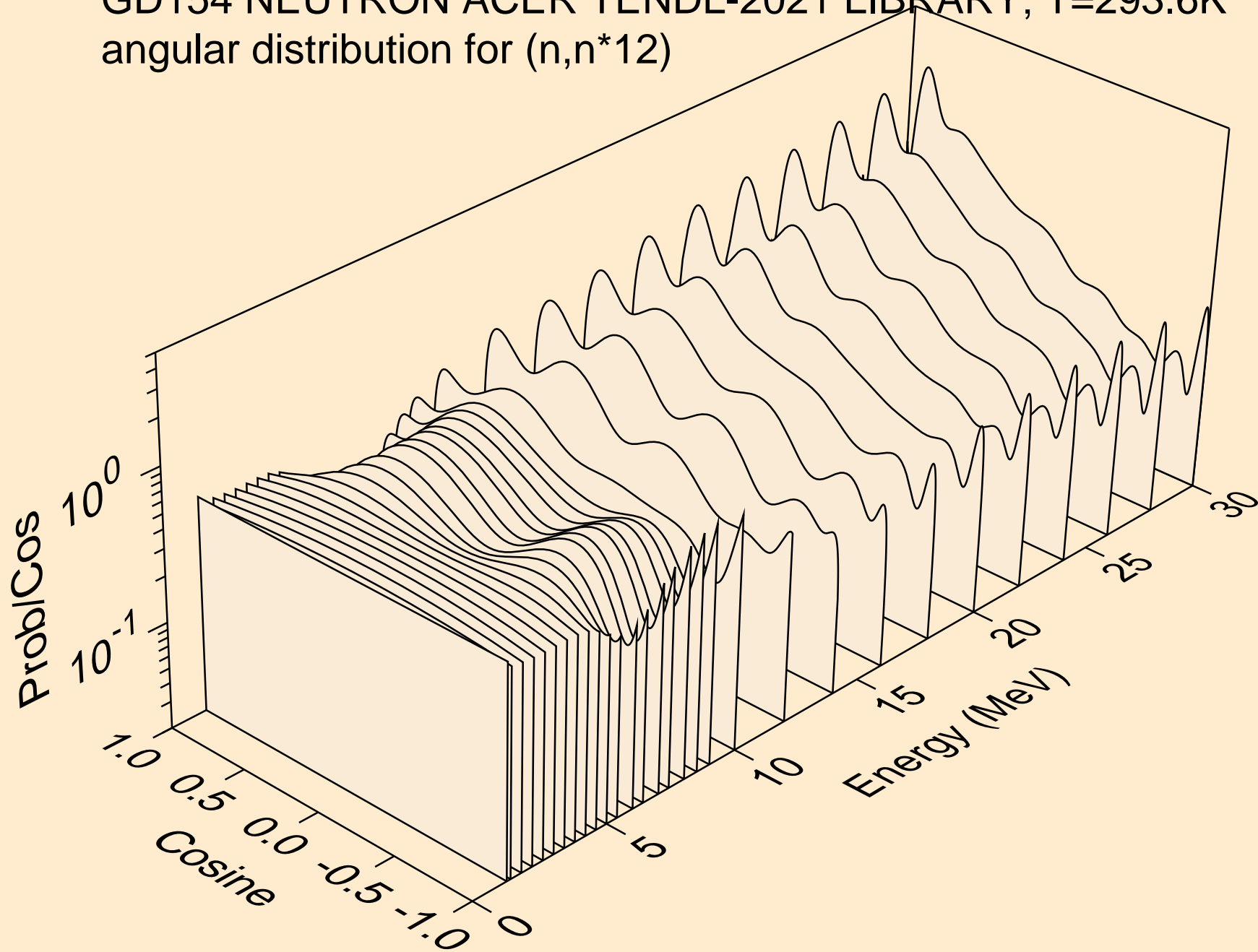

GD154 NEUTRON ACER TENDL-2021 LIBRARY; T=293.6K
angular distribution for (n,n*13)

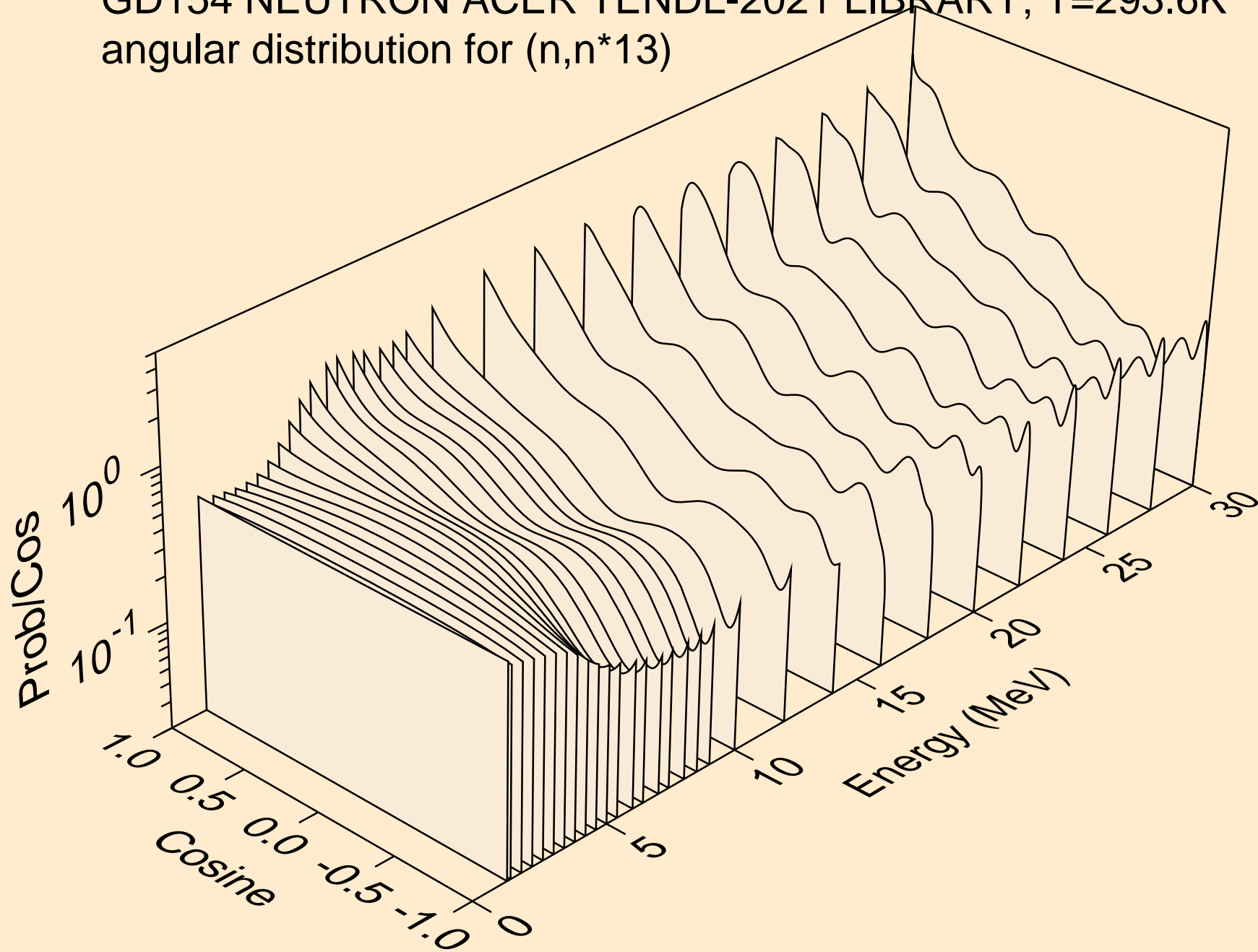

GD154 NEUTRON ACER TENDL-2021 LIBRARY; T=293.6K
angular distribution for (n,n*14)

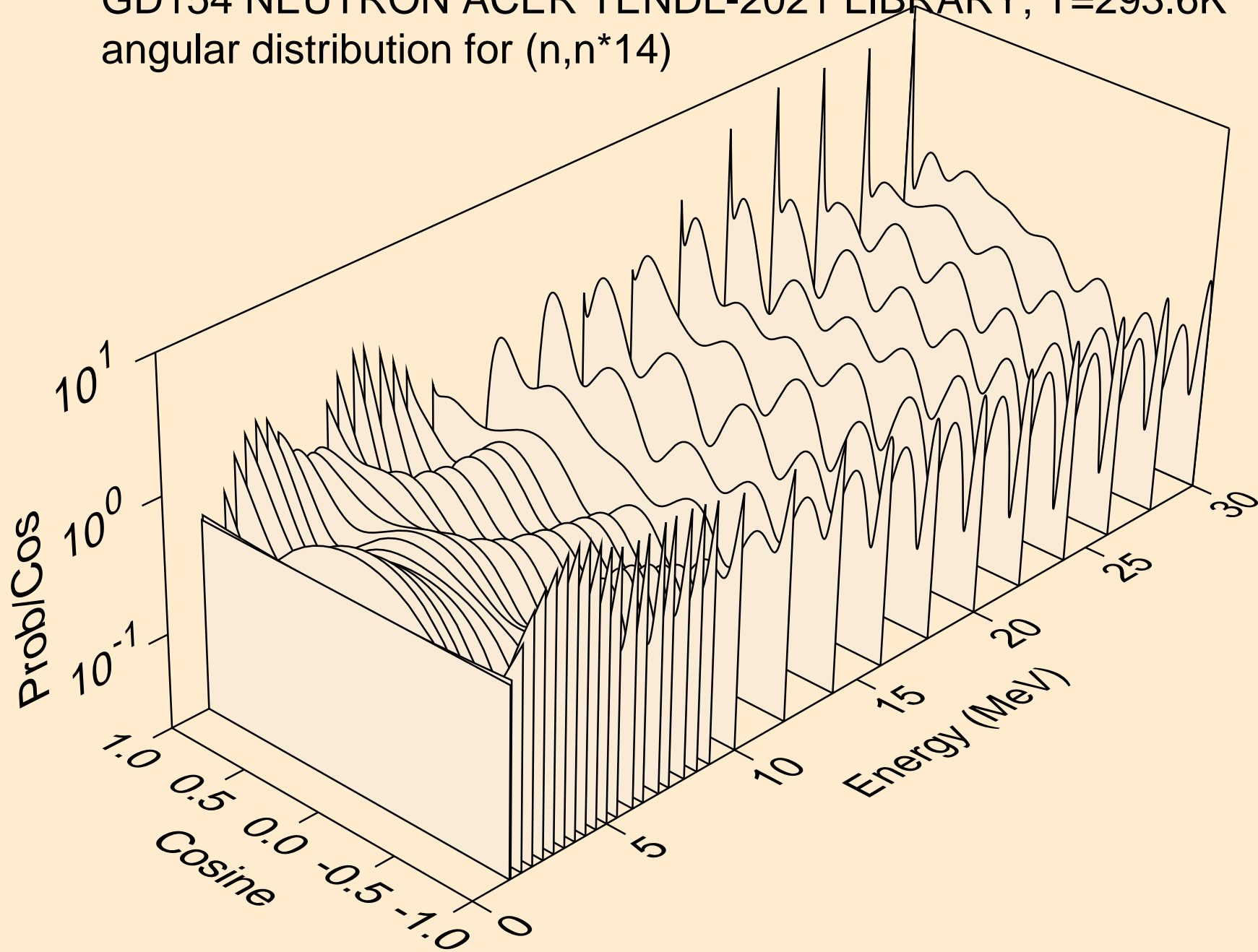

GD154 NEUTRON ACER TENDL-2021 LIBRARY; T=293.6K
angular distribution for (n,n*15)

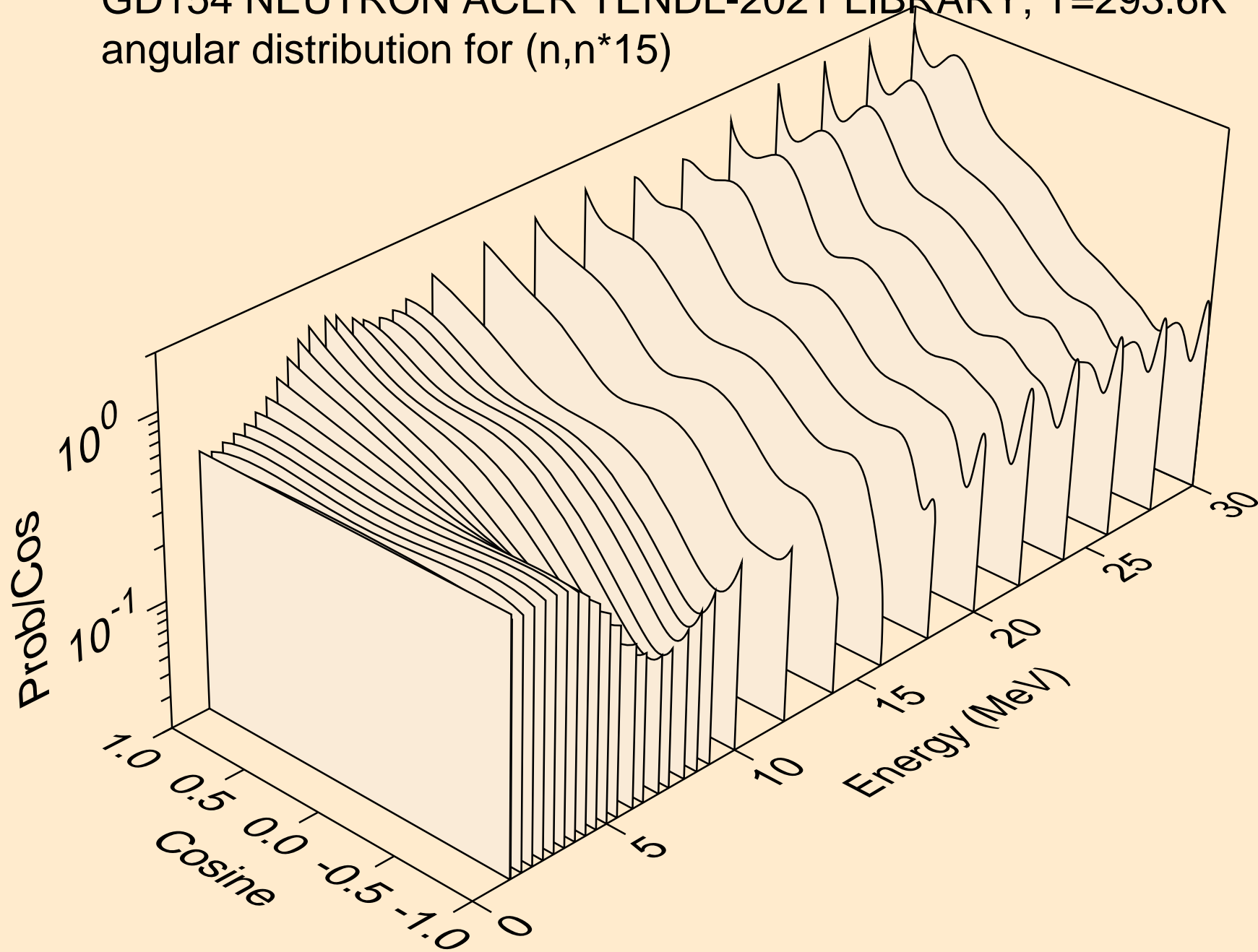

GD154 NEUTRON ACER TENDL-2021 LIBRARY; T=293.6K
angular distribution for (n,n*16)

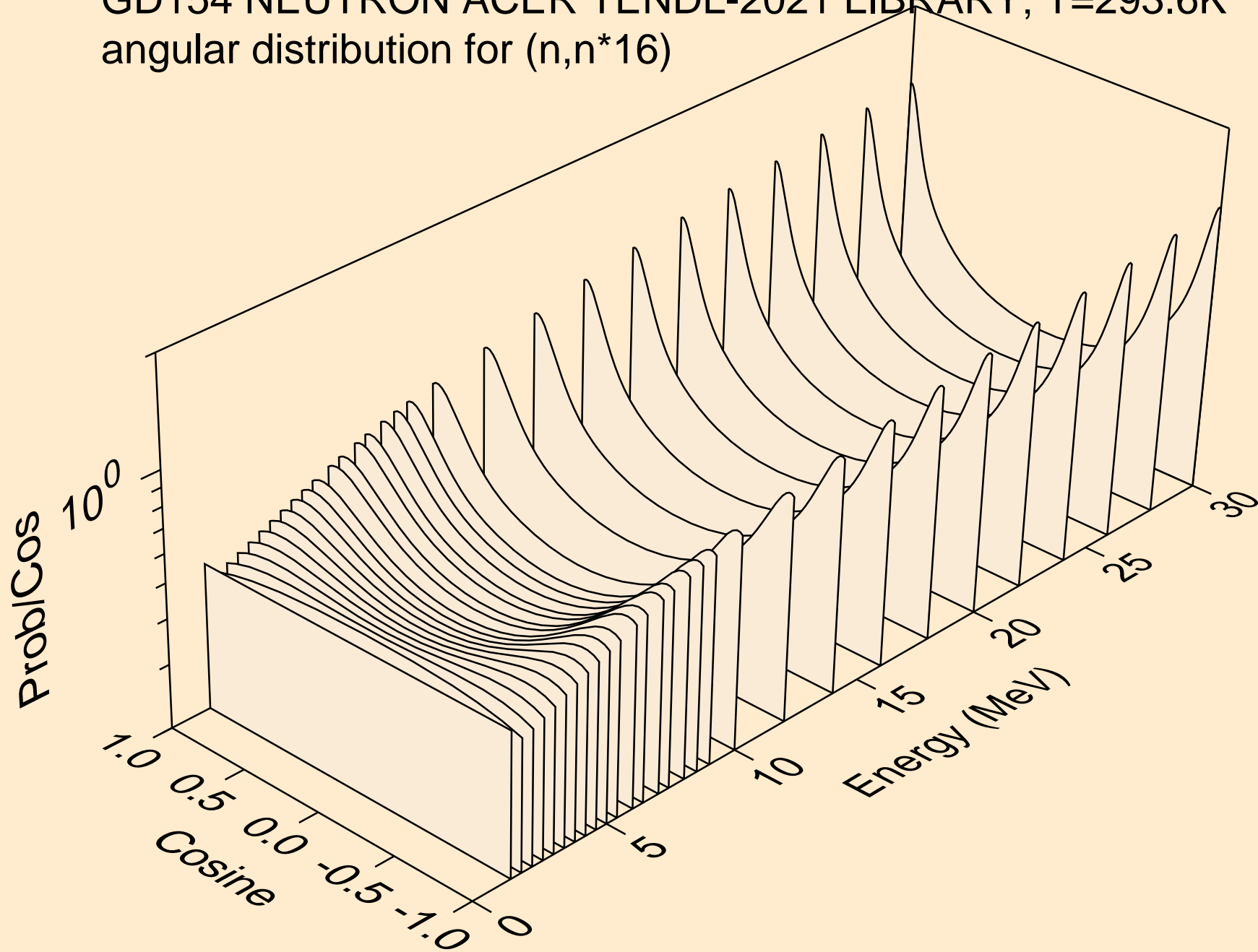

GD154 NEUTRON ACER TENDL-2021 LIBRARY; T=293.6K
angular distribution for (n,n*17)

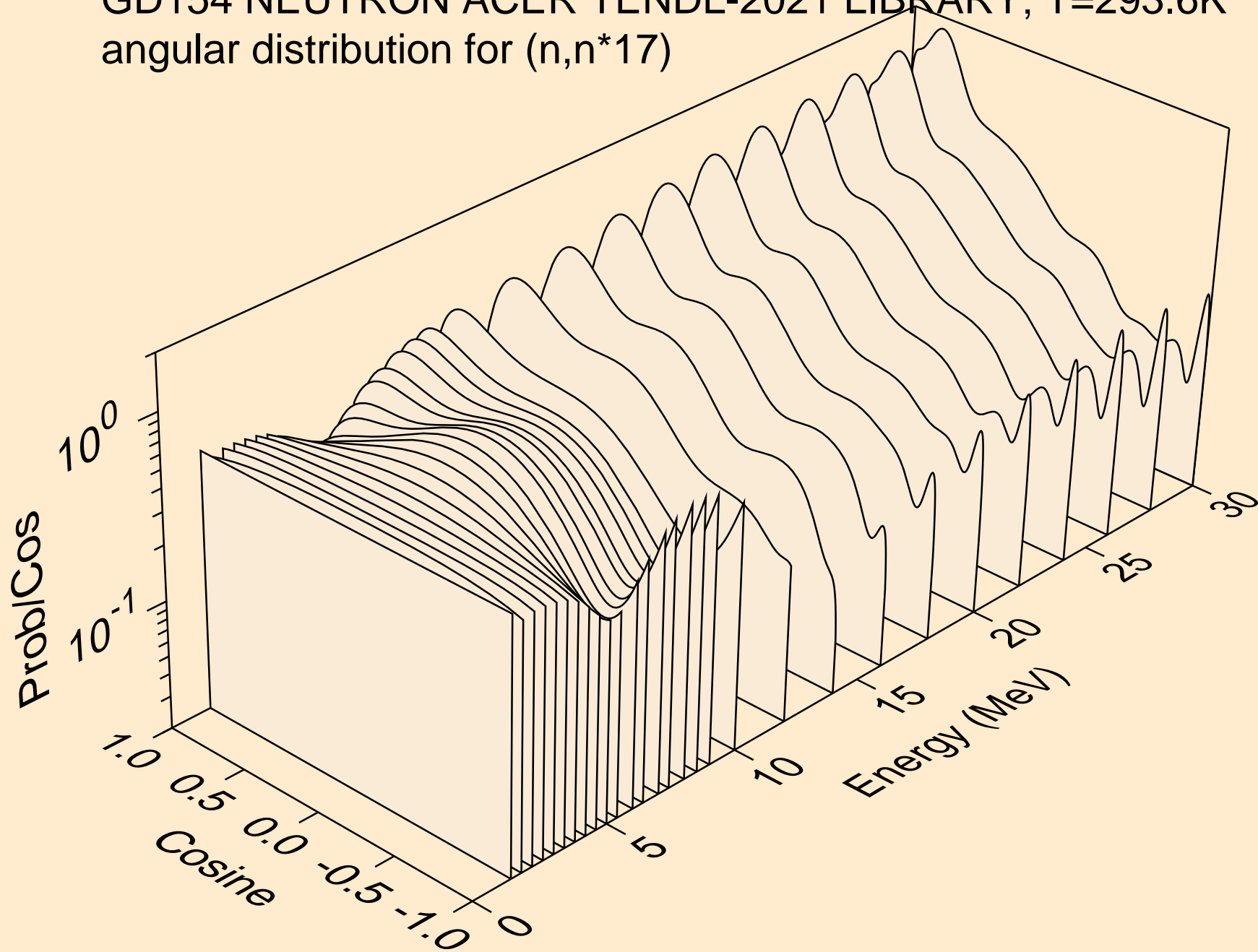

GD154 NEUTRON ACER TENDL-2021 LIBRARY; T=293.6K
angular distribution for (n,n*18)

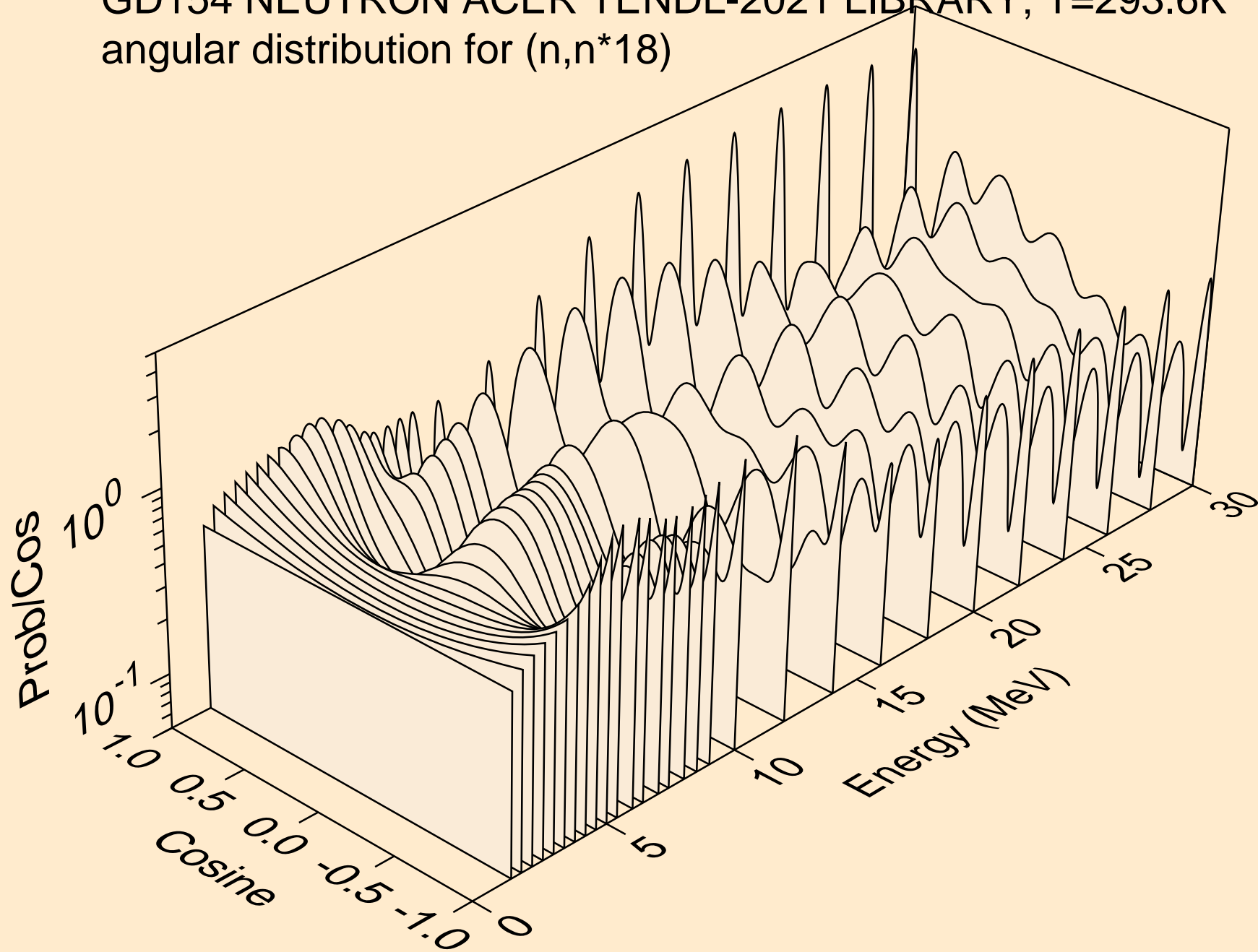

GD154 NEUTRON ACER TENDL-2021 LIBRARY; T=293.6K
angular distribution for (n,n*19)

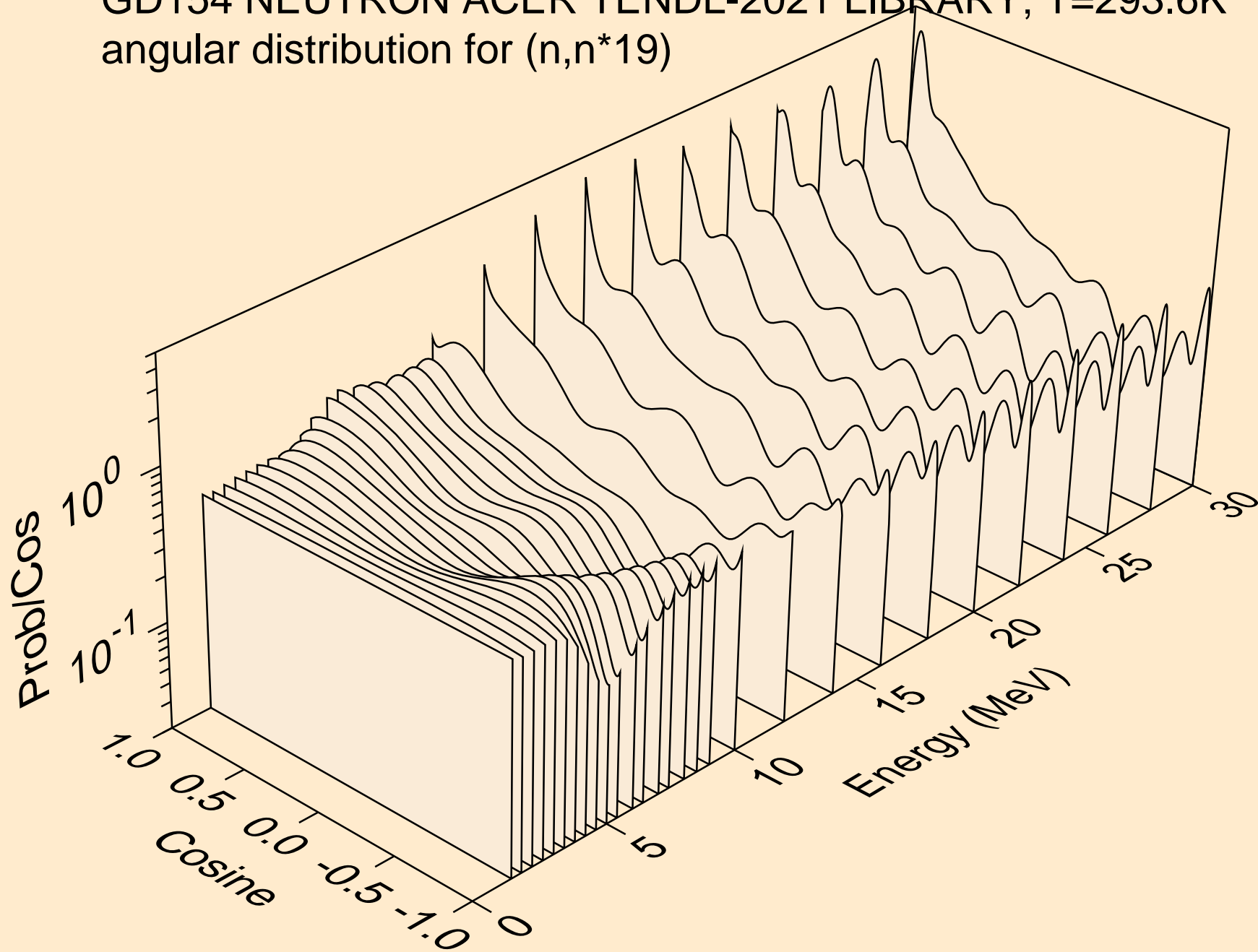

GD154 NEUTRON ACER TENDL-2021 LIBRARY; T=293.6K
angular distribution for (n,n*20)

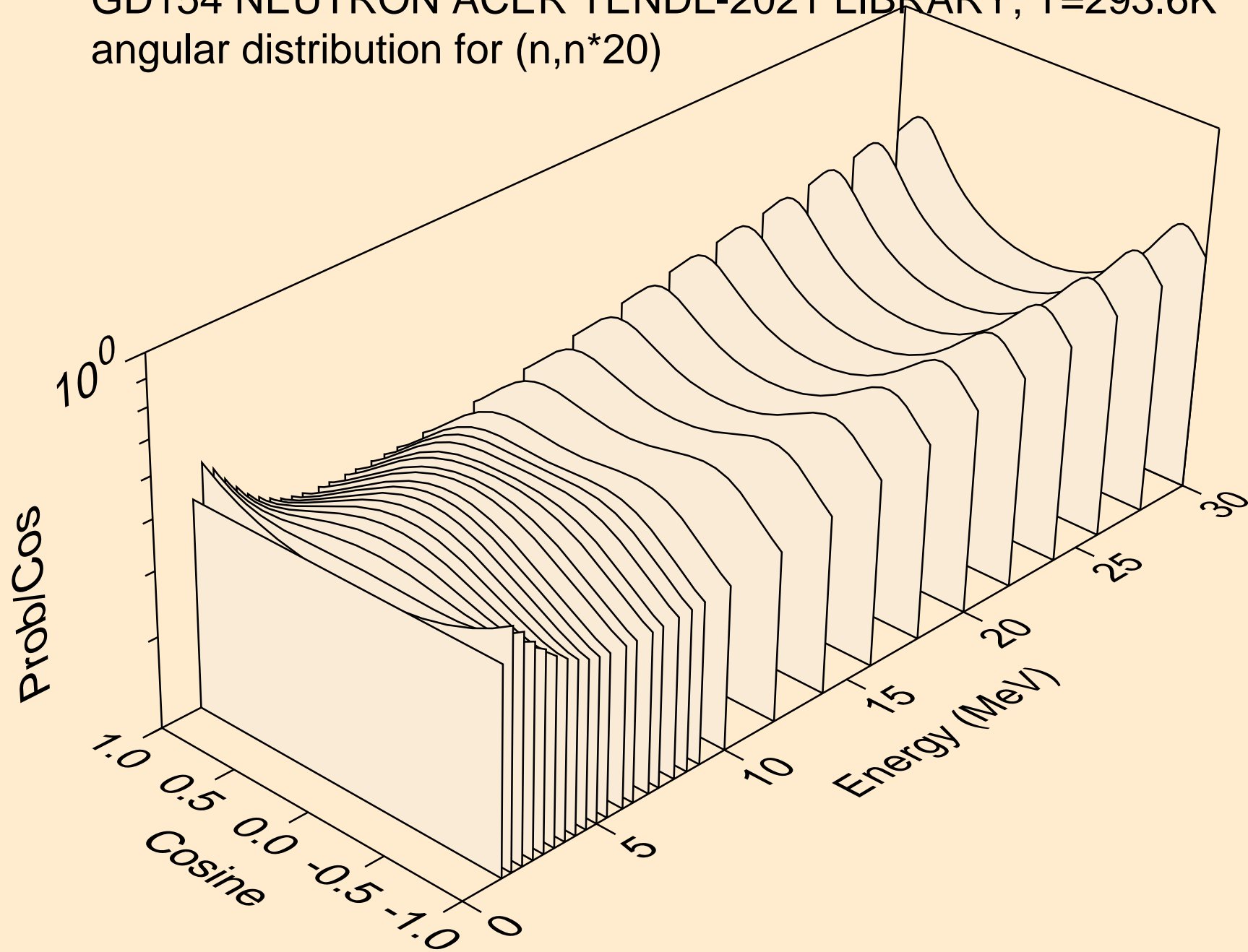

GD154 NEUTRON ACER TENDL-2021 LIBRARY; T=293.6K
angular distribution for (n,n*21)

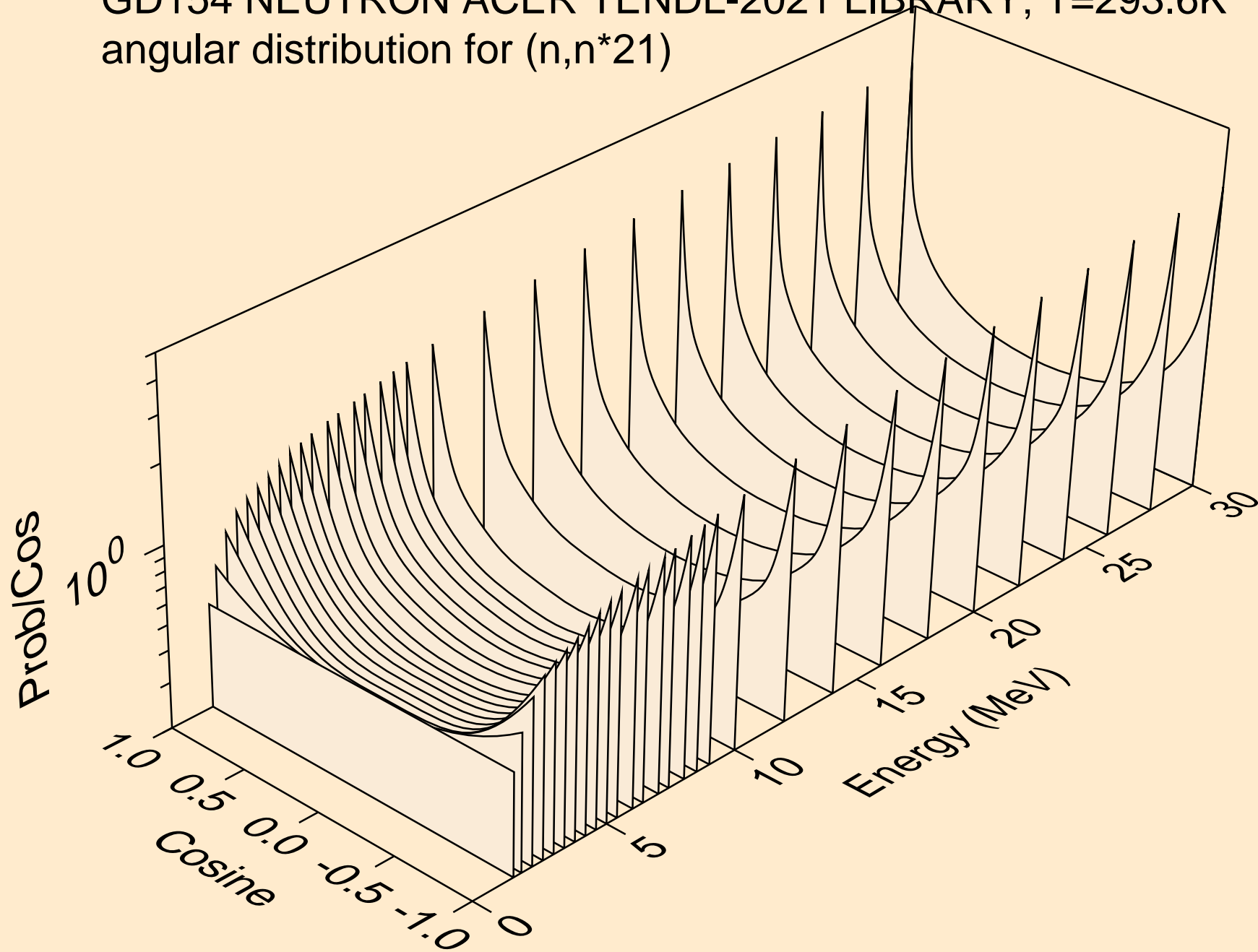

GD154 NEUTRON ACER TENDL-2021 LIBRARY; T=293.6K
angular distribution for (n,n*22)

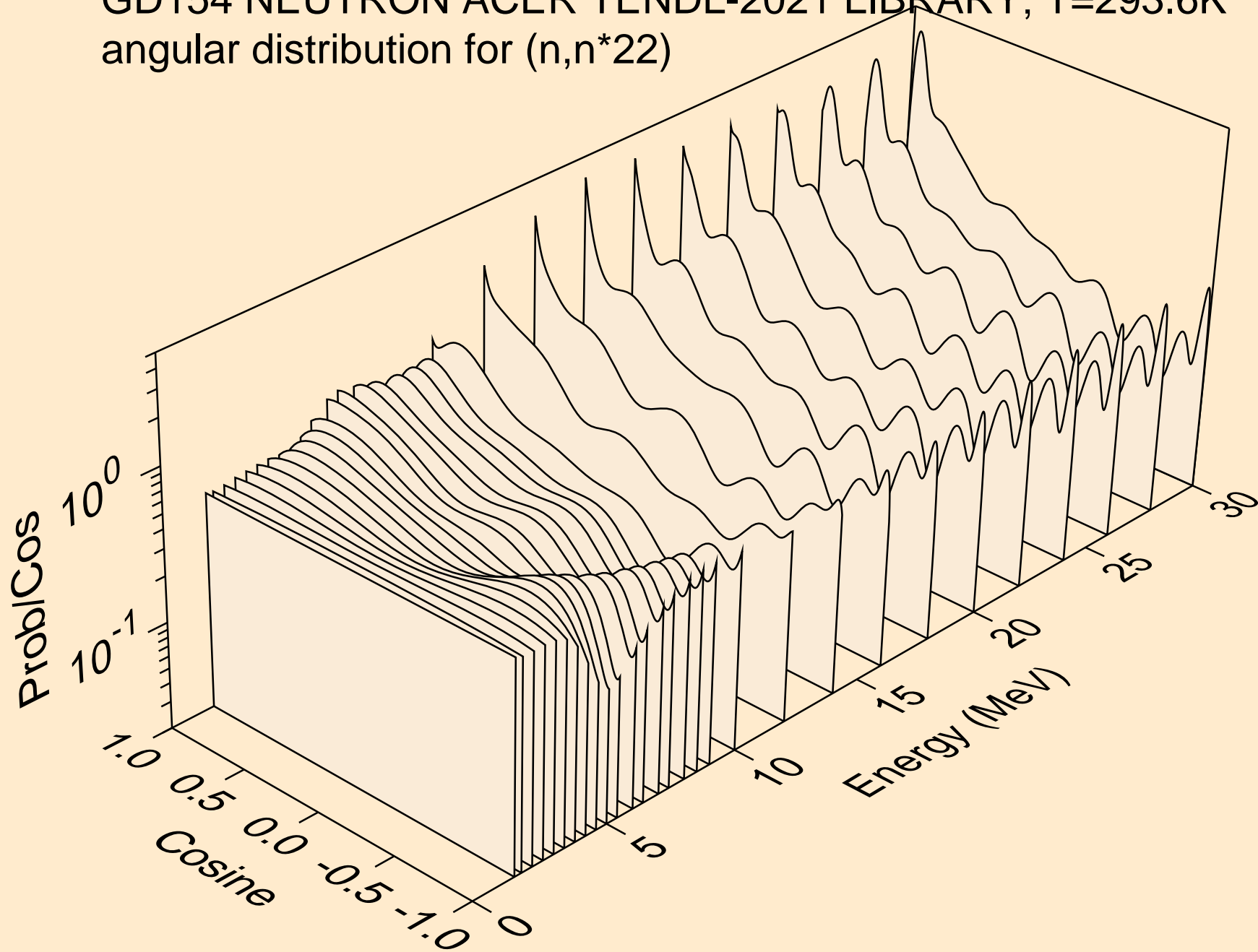

GD154 NEUTRON ACER TENDL-2021 LIBRARY; T=293.6K
angular distribution for (n,n*23)

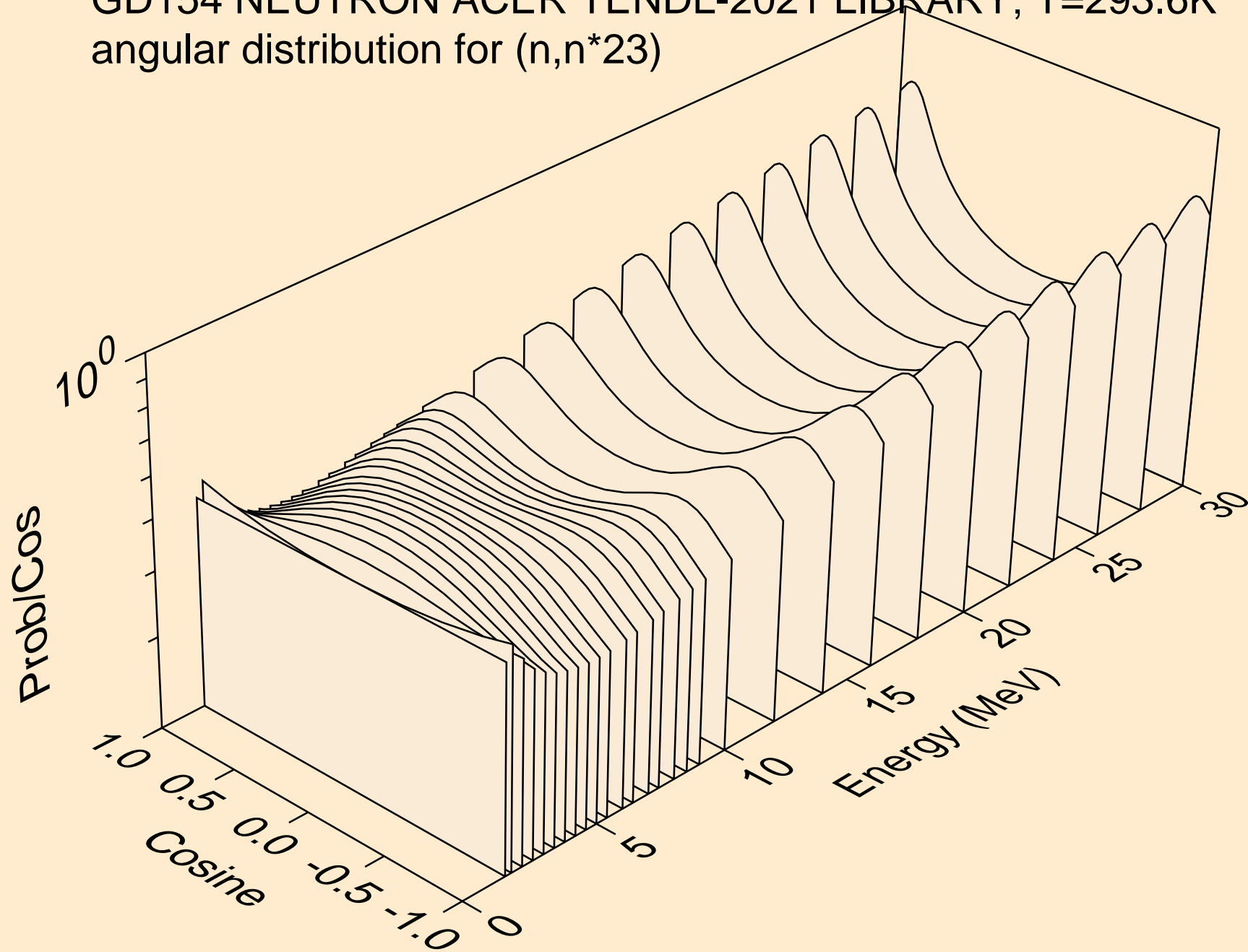

GD154 NEUTRON ACER TENDL-2021 LIBRARY; T=293.6K
angular distribution for (n,n*24)

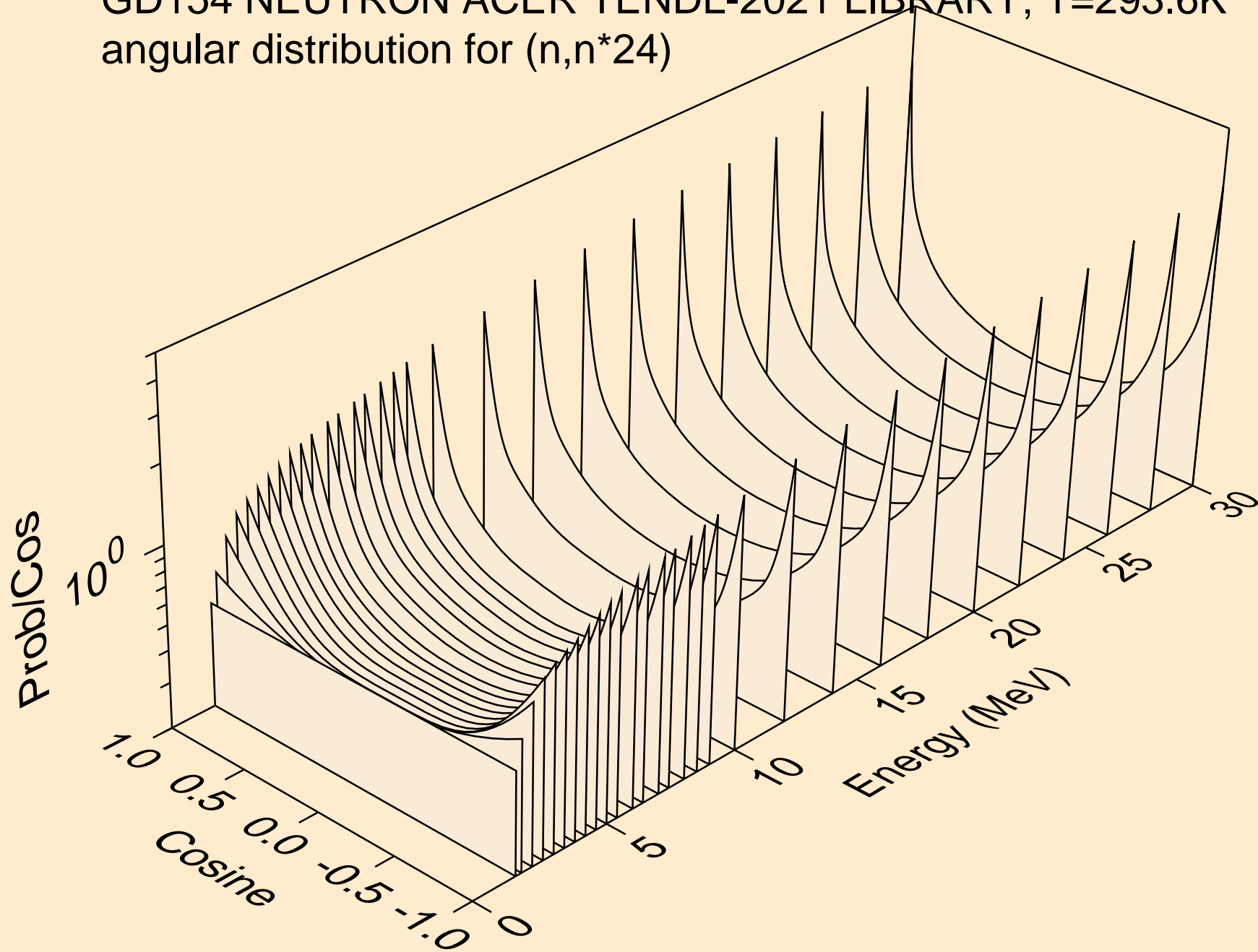

GD154 NEUTRON ACER TENDL-2021 LIBRARY; T=293.6K
angular distribution for (n,n*25)

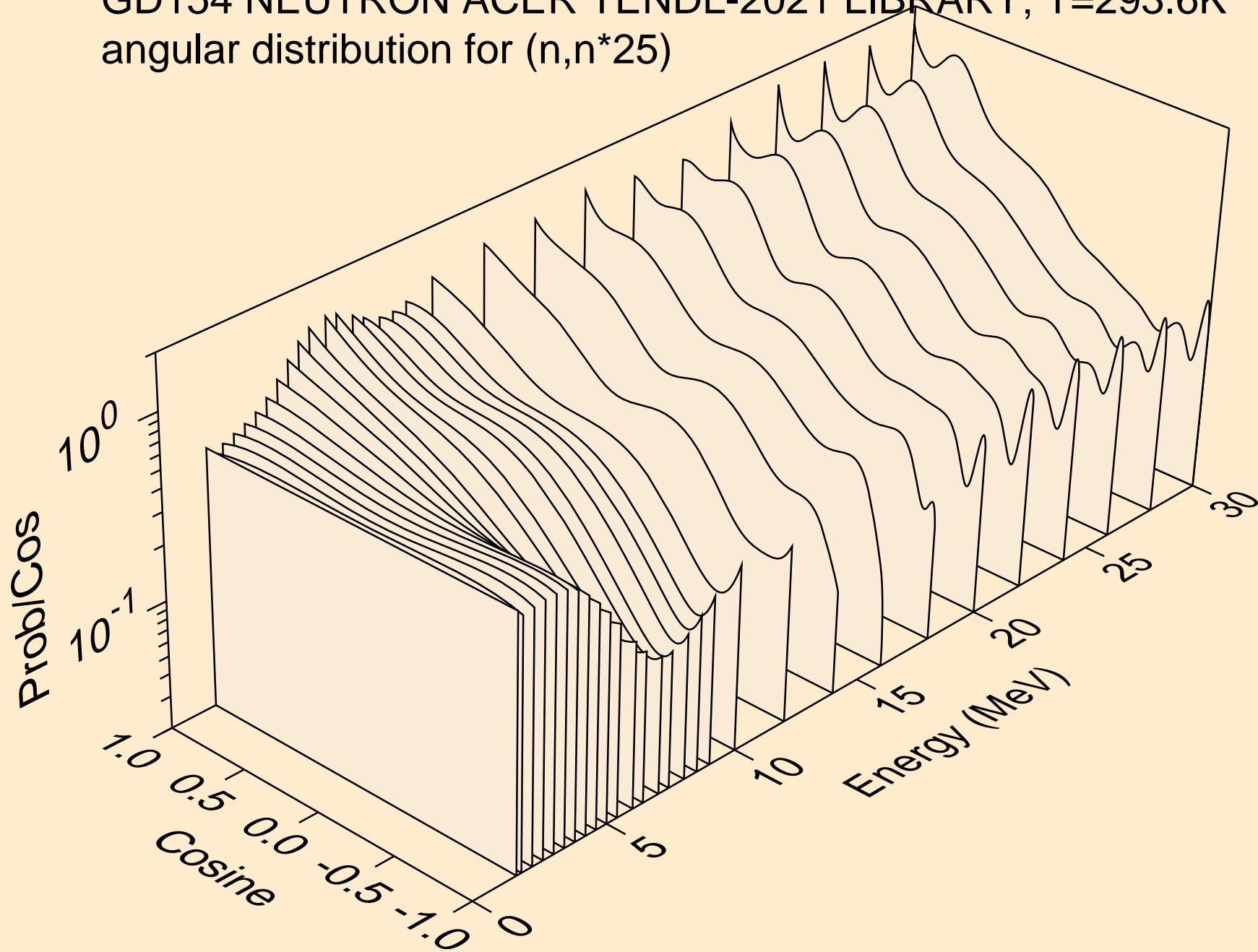

GD154 NEUTRON ACER TENDL-2021 LIBRARY; T=293.6K
angular distribution for (n,n*26)

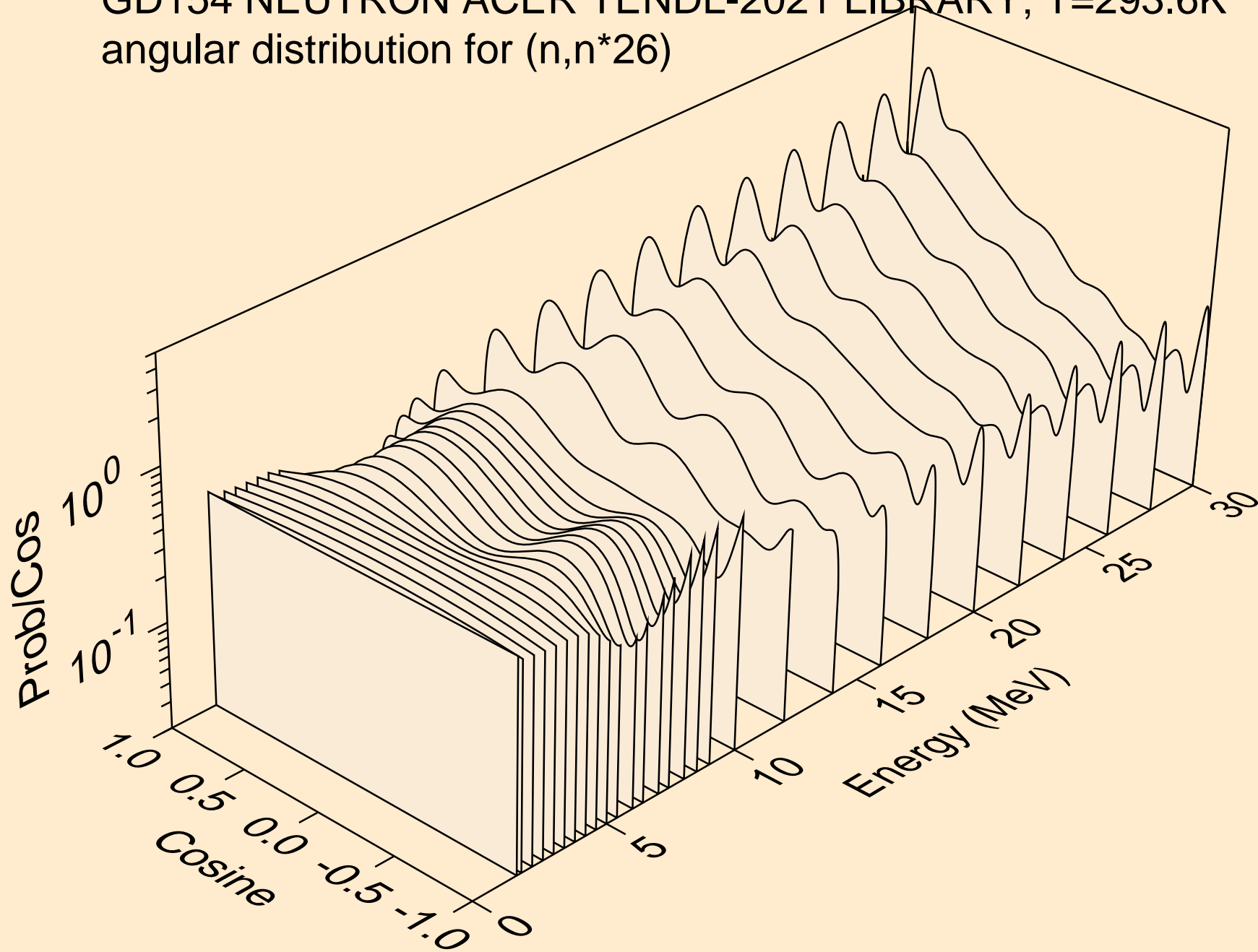

GD154 NEUTRON ACER TENDL-2021 LIBRARY; T=293.6K
angular distribution for (n,n*27)

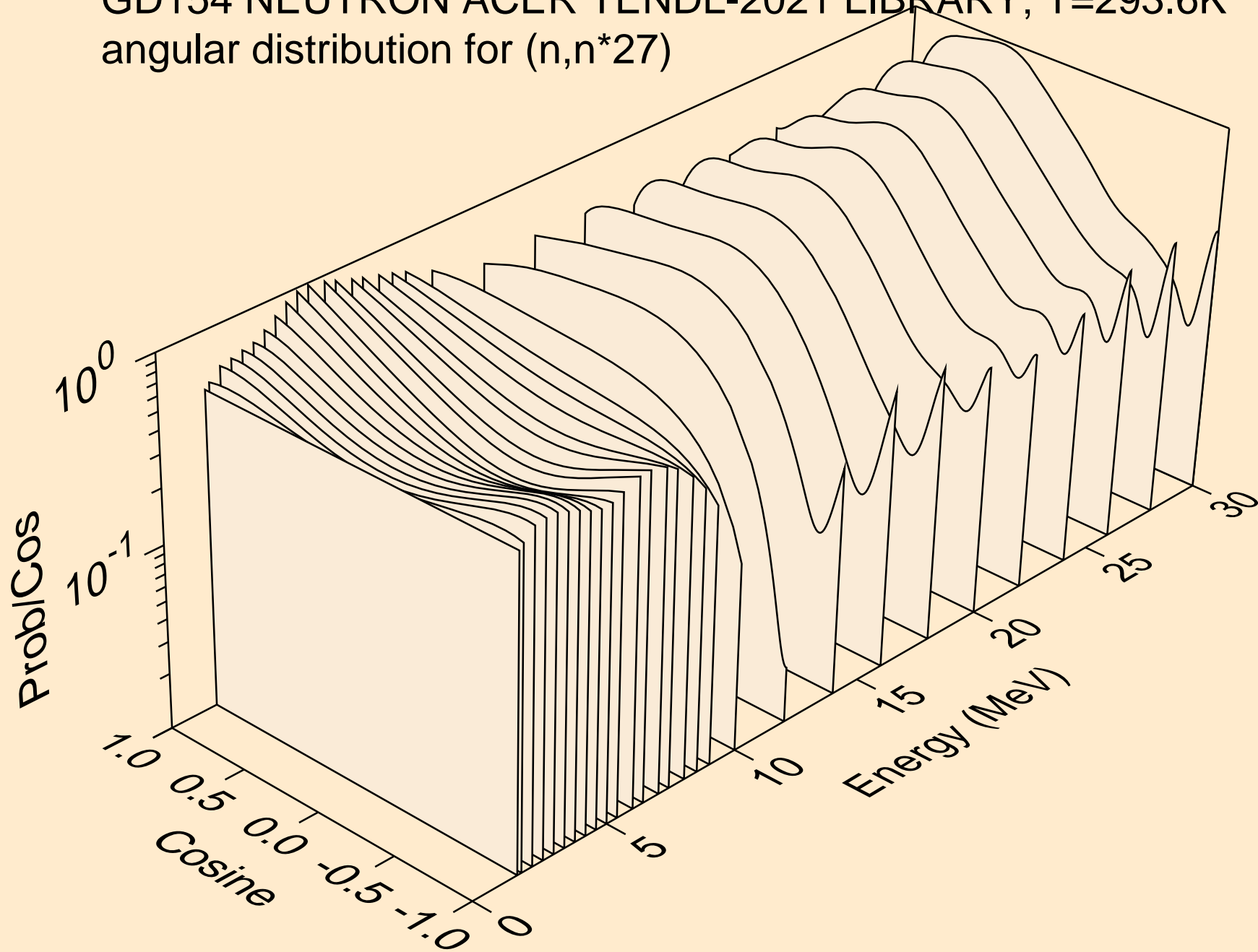

GD154 NEUTRON ACER TENDL-2021 LIBRARY; T=293.6K
angular distribution for (n,n*28)

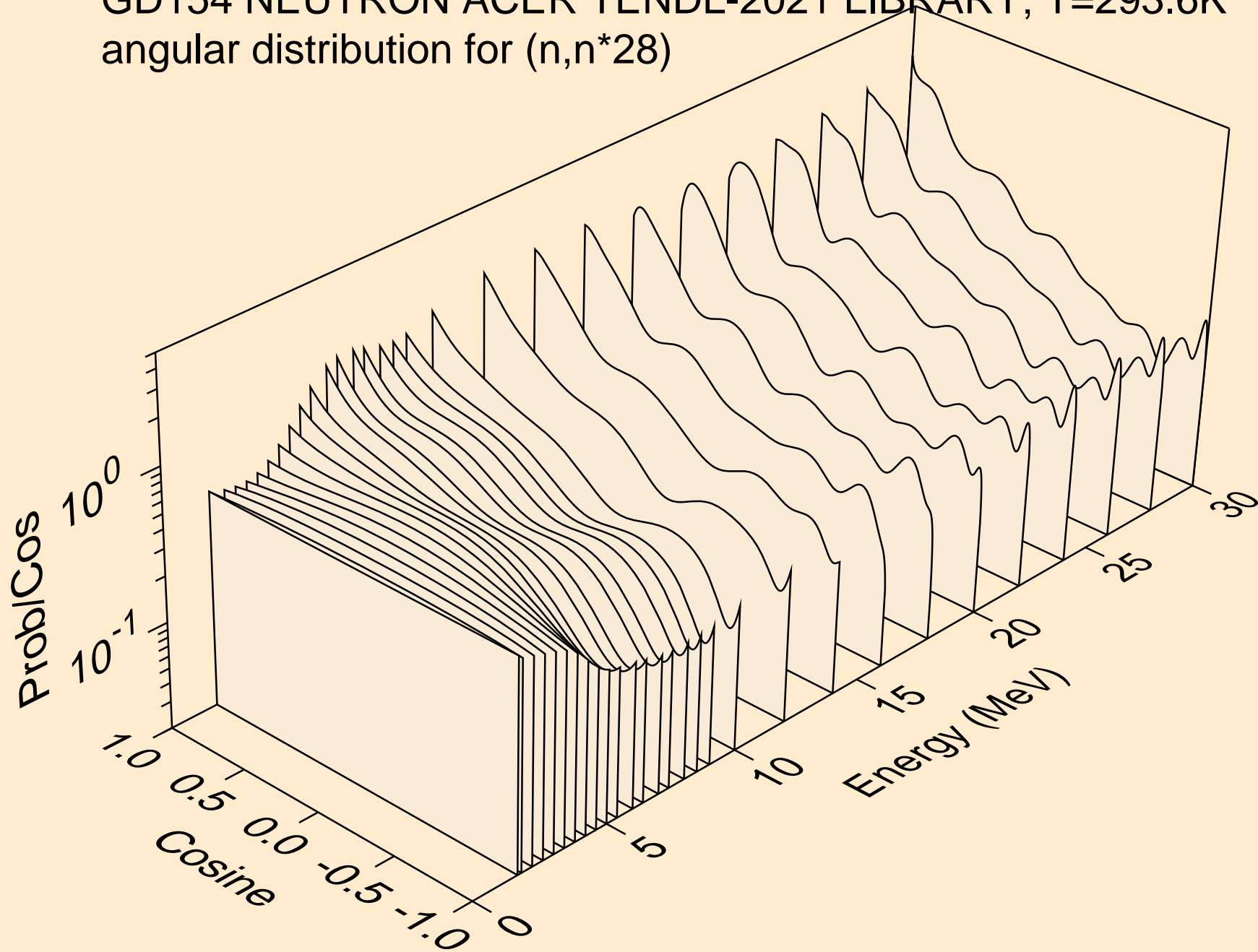

GD154 NEUTRON ACER TENDL-2021 LIBRARY; T=293.6K
angular distribution for (n,n*29)

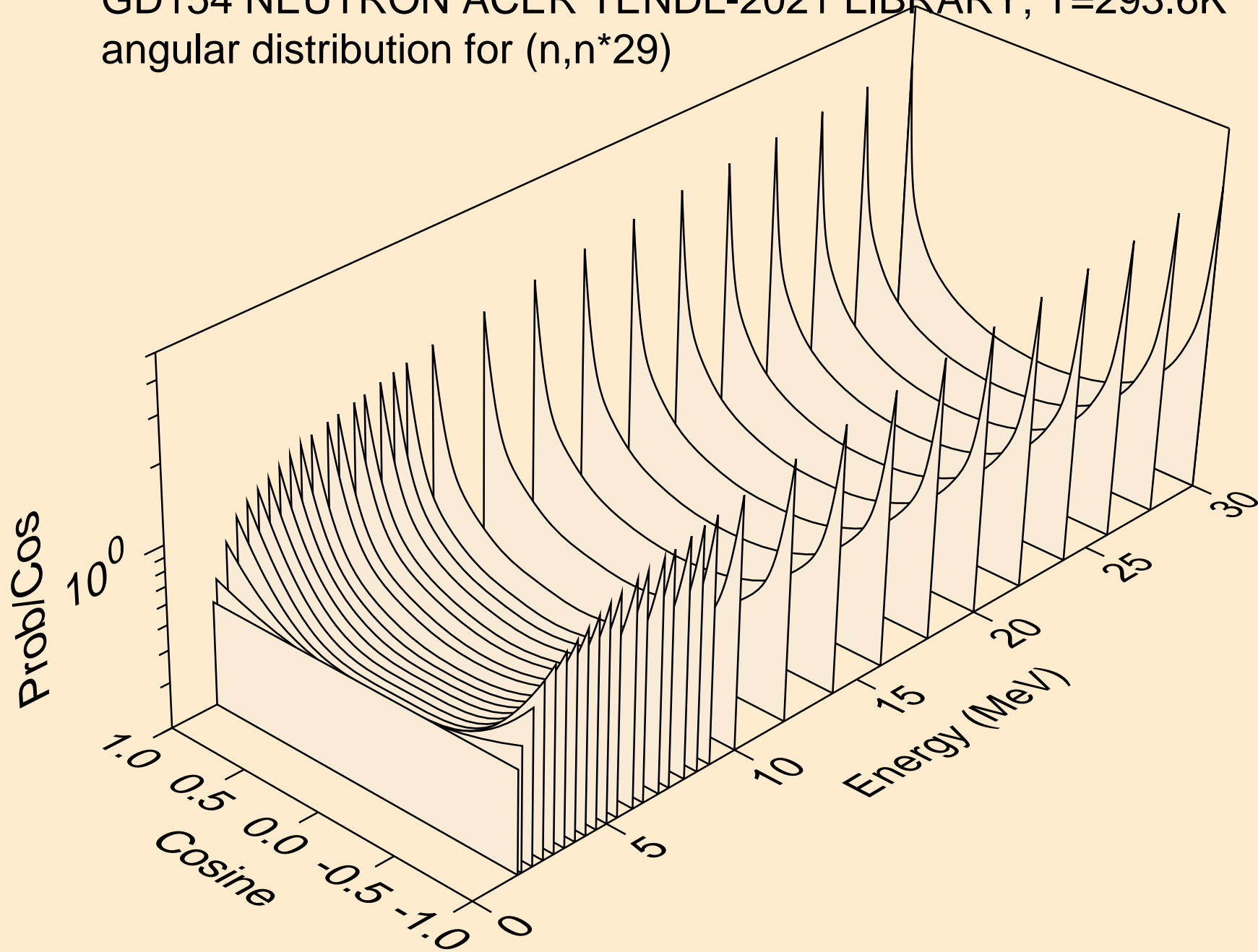

GD154 NEUTRON ACER TENDL-2021 LIBRARY; T=293.6K
angular distribution for (n,n*30)

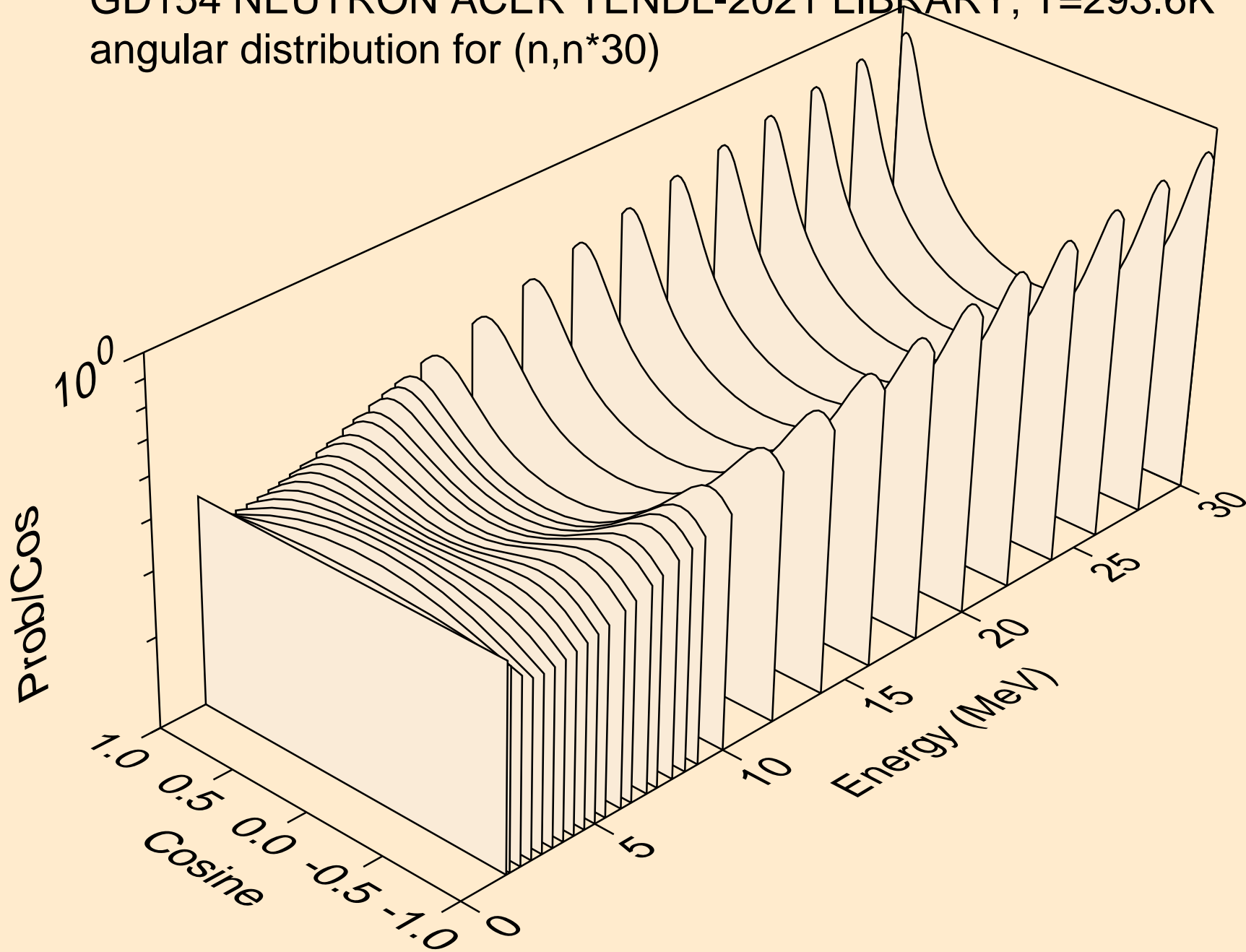

GD154 NEUTRON ACER TENDL-2021 LIBRARY; T=293.6K
Neutron emission for (n,x)

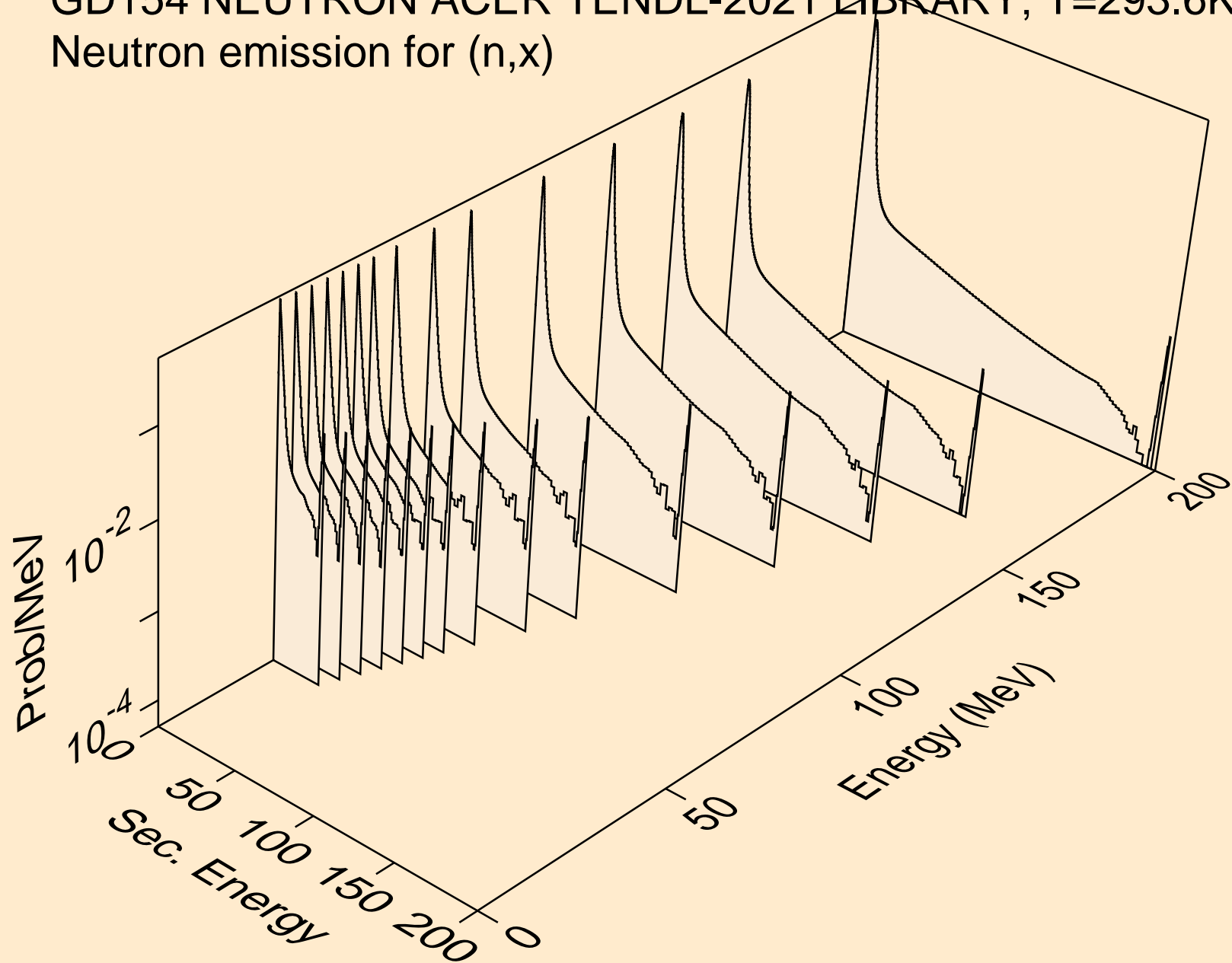

GD154 NEUTRON ACER TENDL-2021 LIBRARY; T=293.6K
Neutron emission for (n,2nd)

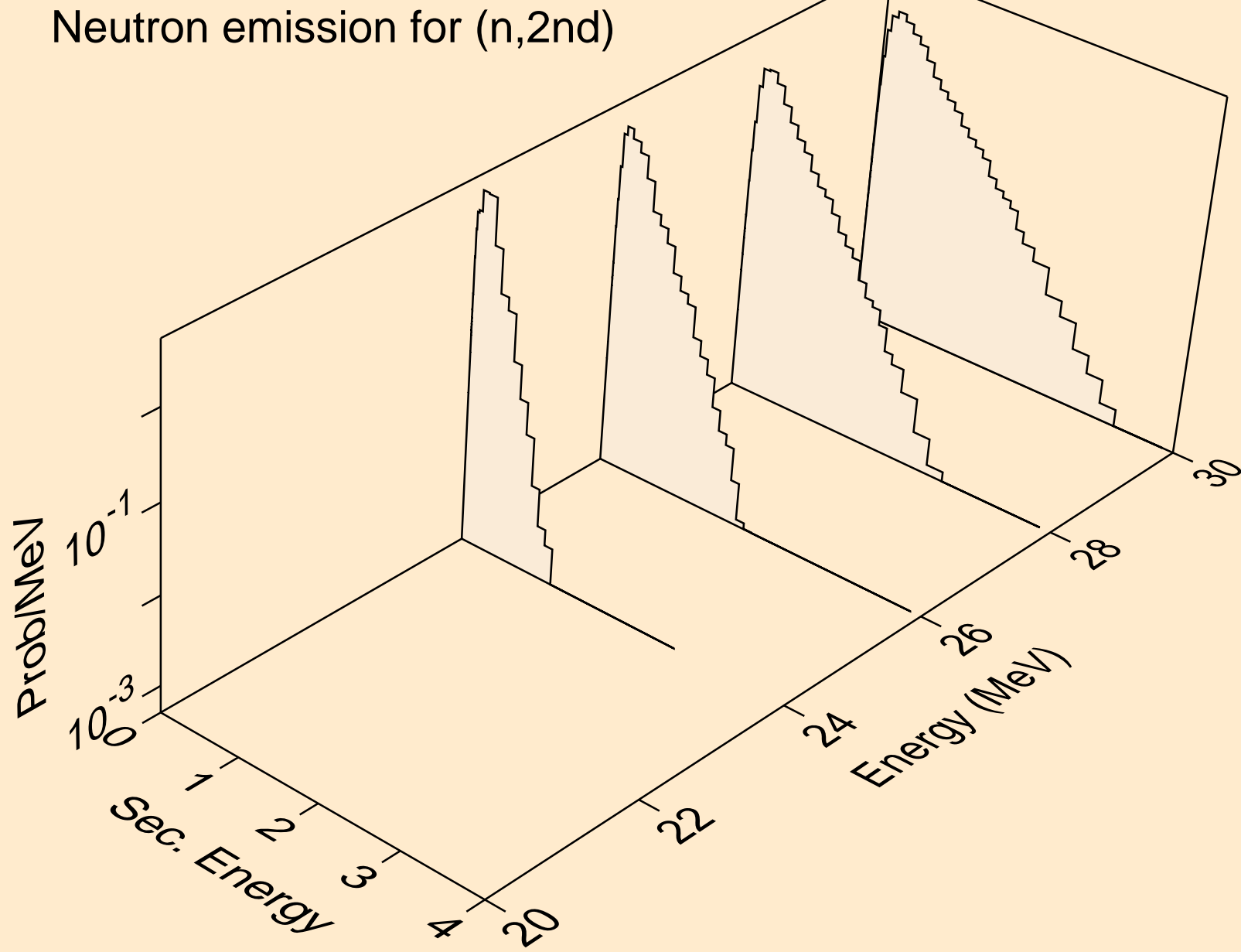

GD154 NEUTRON ACER TENDL-2021 LIBRARY; T=293.6K
Neutron emission for (n,2n)

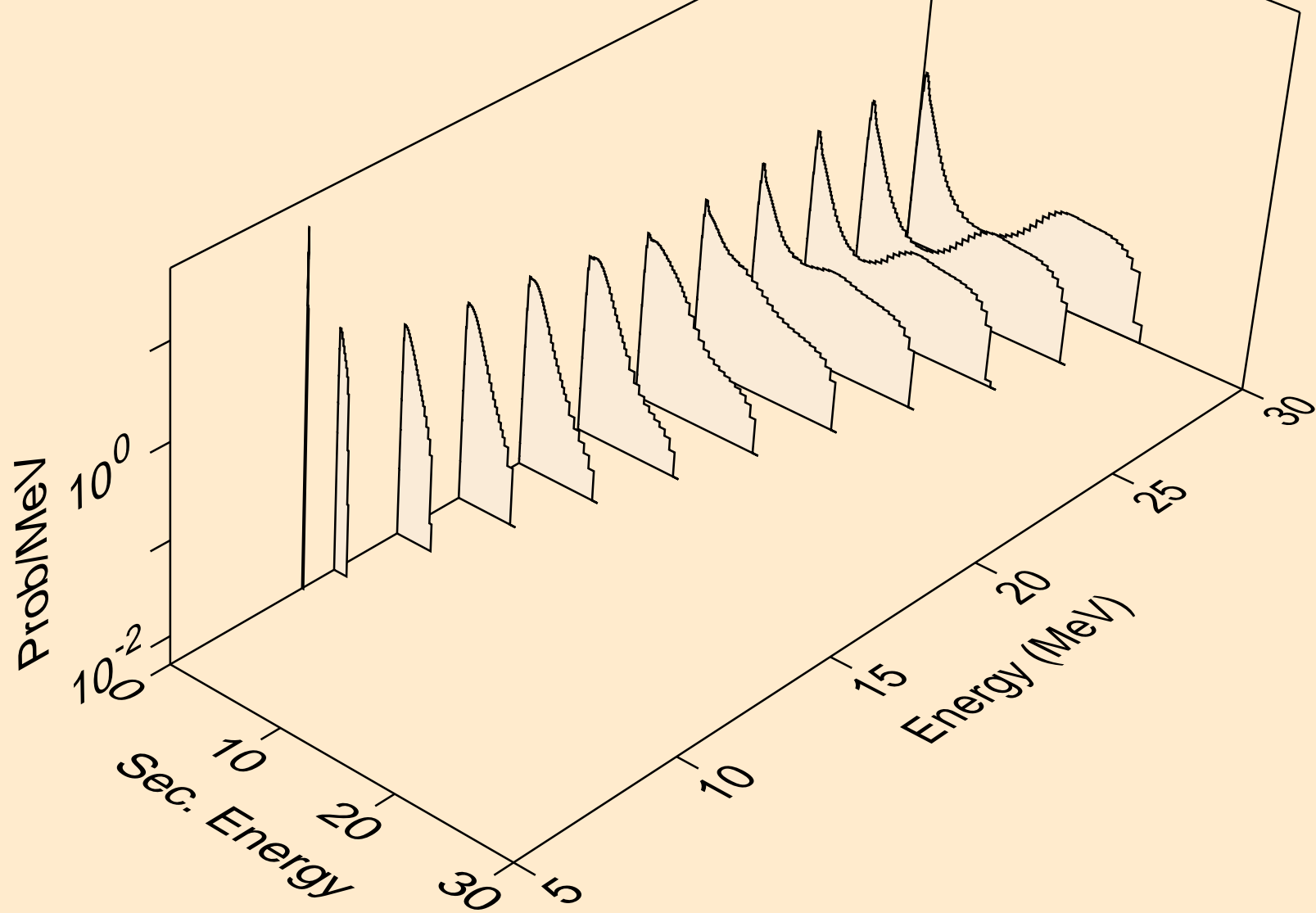

GD154 NEUTRON ACER TENDL-2021 LIBRARY; T=293.6K
Neutron emission for (n,3n)

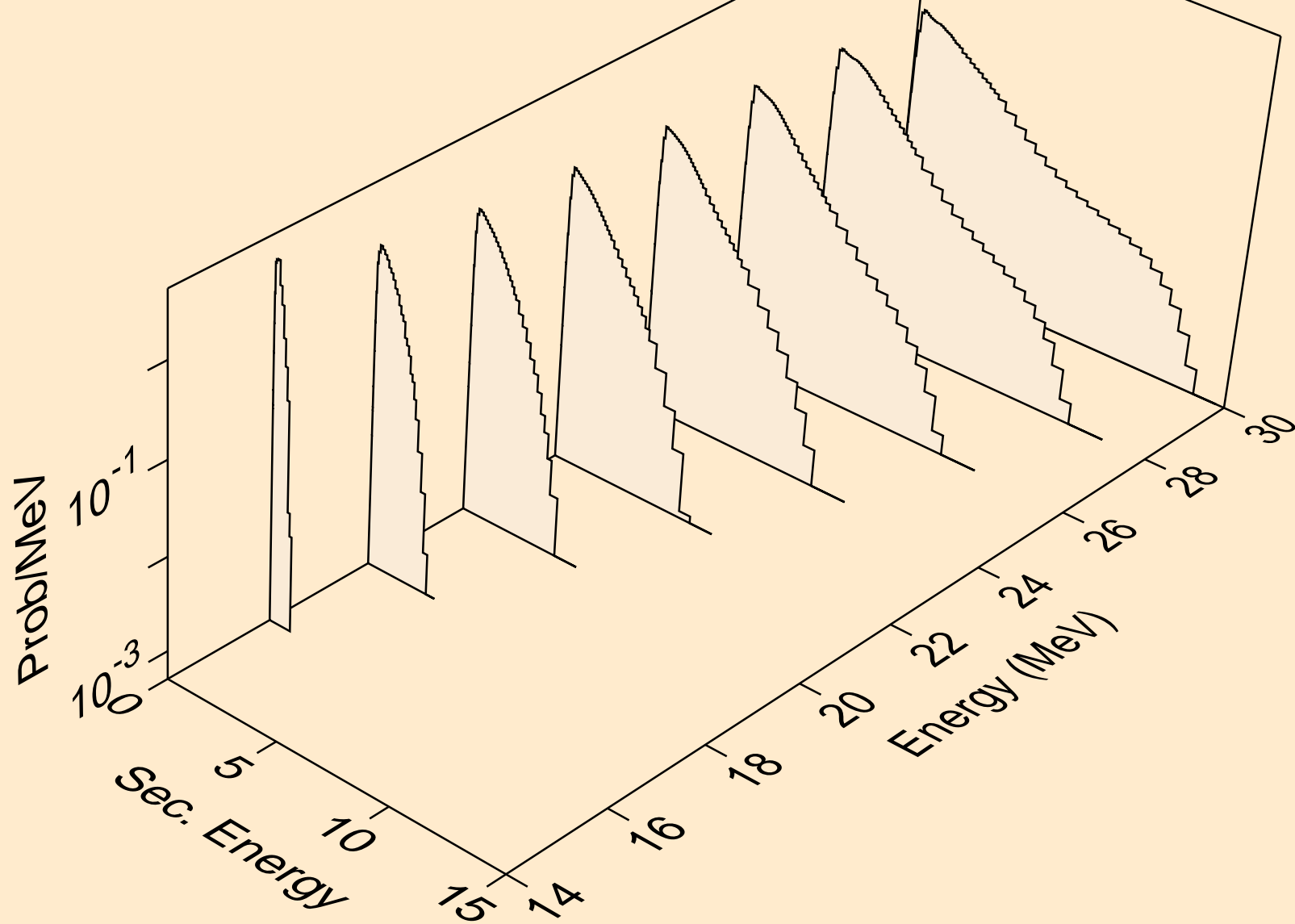

GD154 NEUTRON ACER TENDL-2021 LIBRARY; T=293.6K
Neutron emission for (n,n*)a

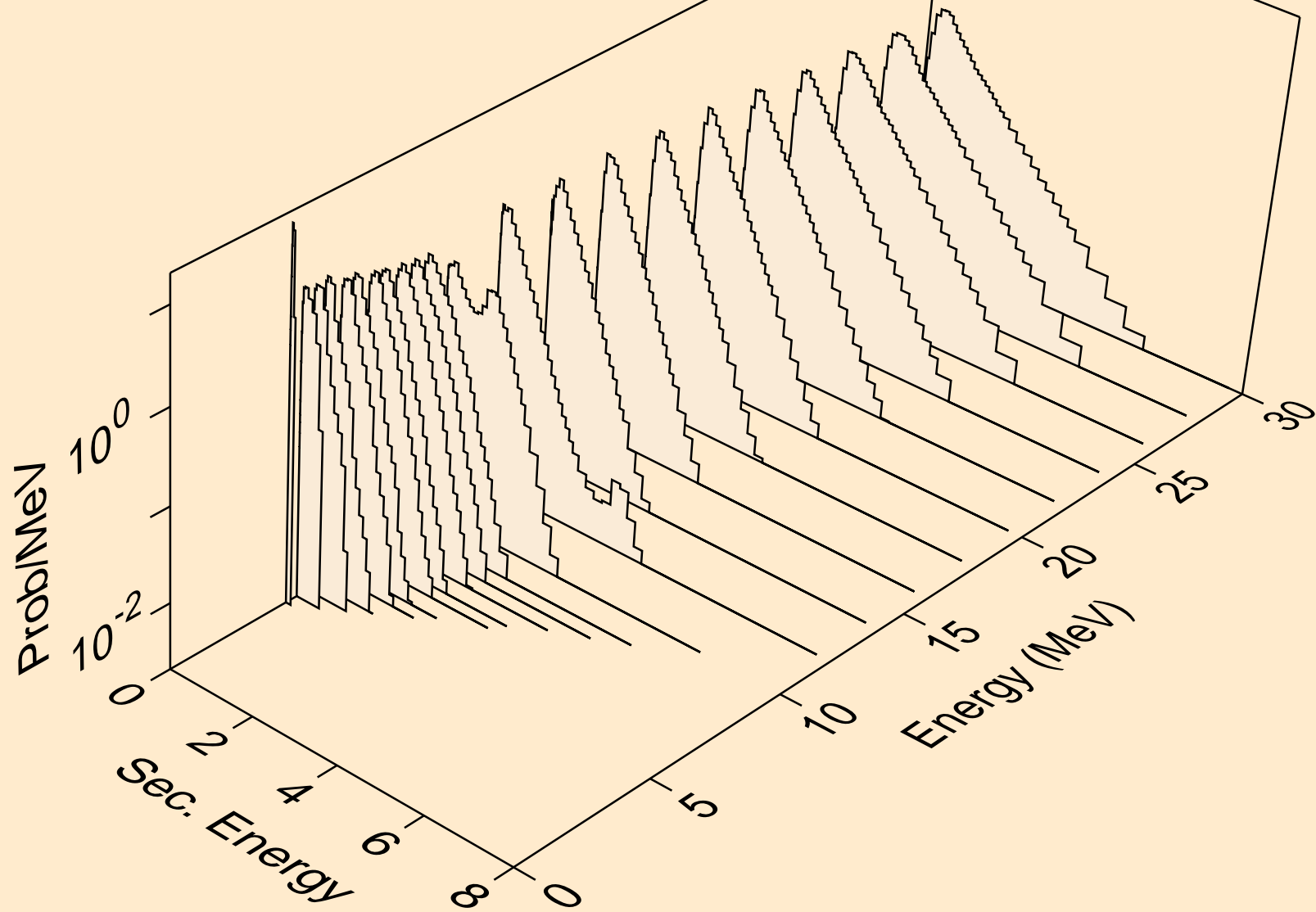

GD154 NEUTRON ACER TENDL-2021 LIBRARY; T=293.6K
Neutron emission for (n,2n)a

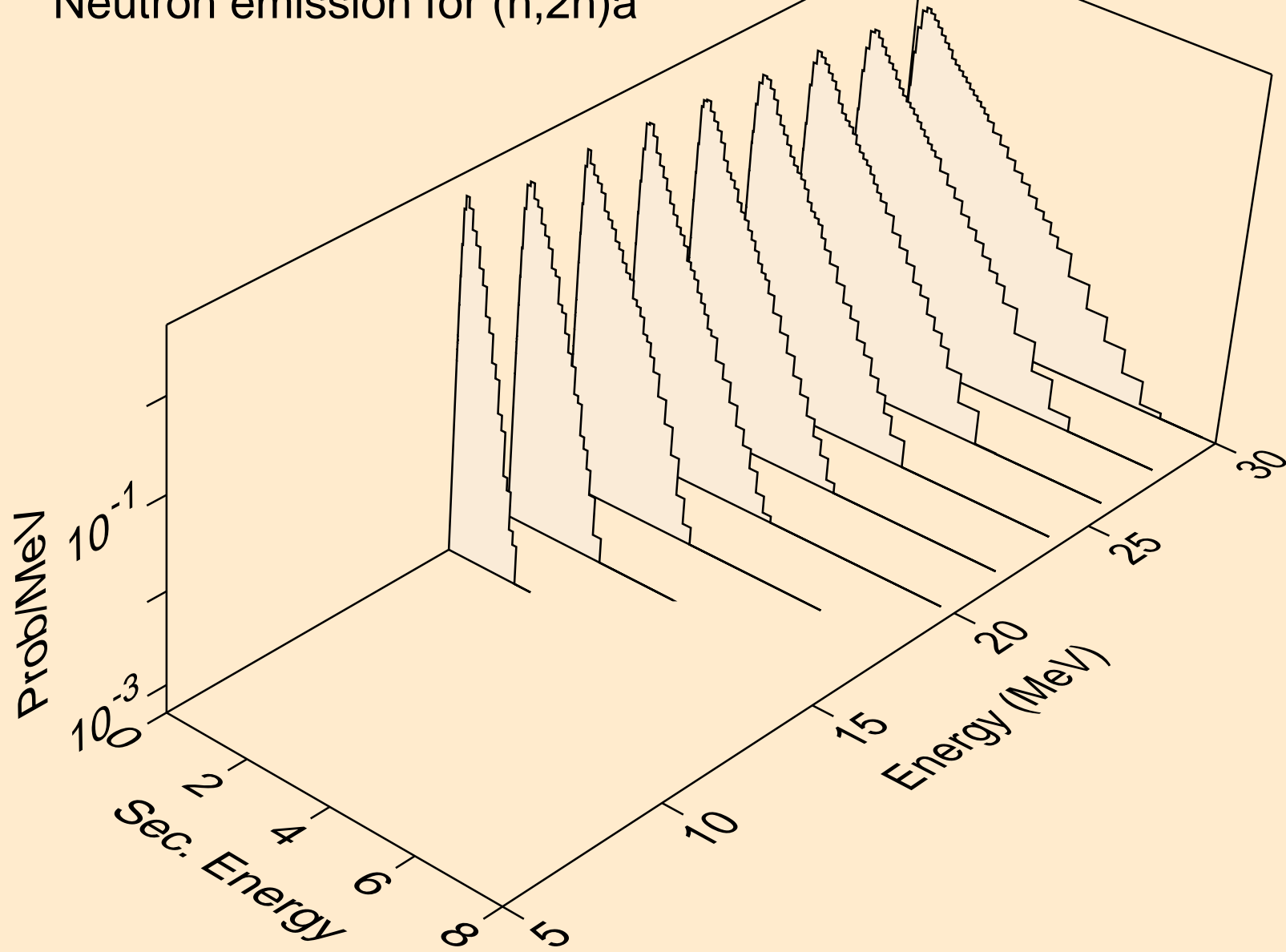

GD154 NEUTRON ACER TENDL-2021 LIBRARY; T=293.6K
Neutron emission for (n,3n)a

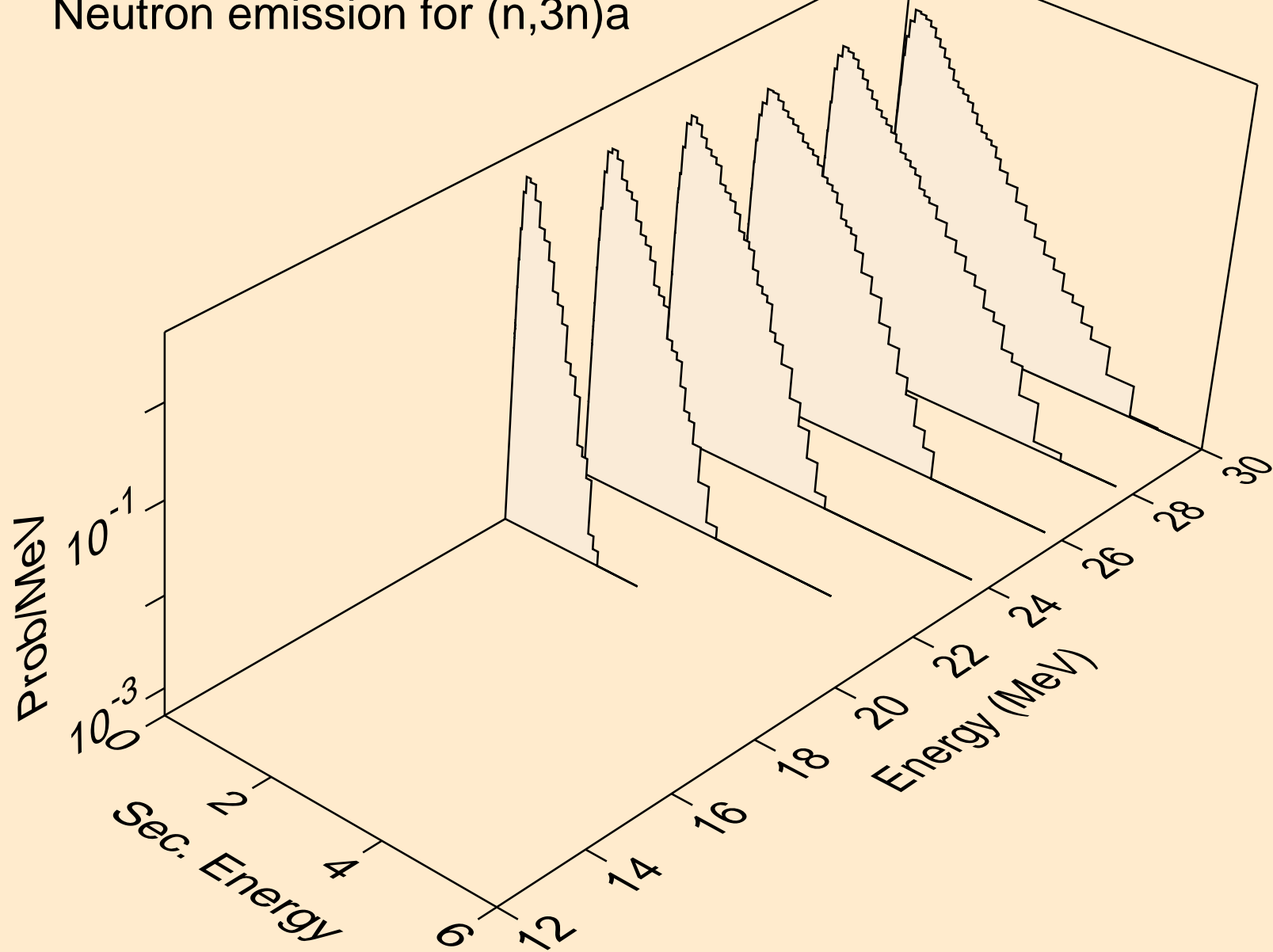

GD154 NEUTRON ACER TENDL-2021 LIBRARY; T=293.6K
Neutron emission for (n,n*)p

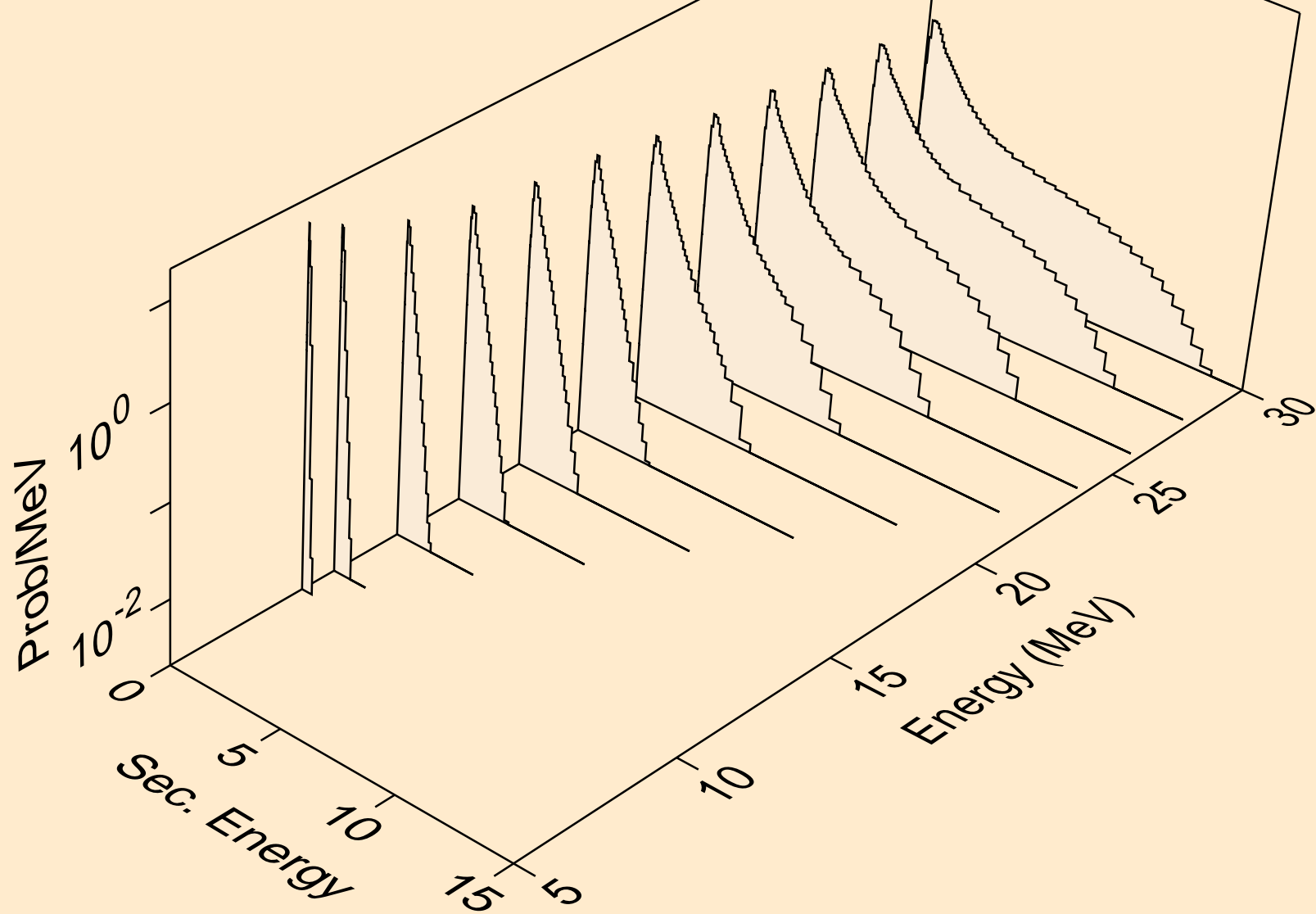

GD154 NEUTRON ACER TENDL-2021 LIBRARY; T=293.6K
Neutron emission for (n,n*)2a

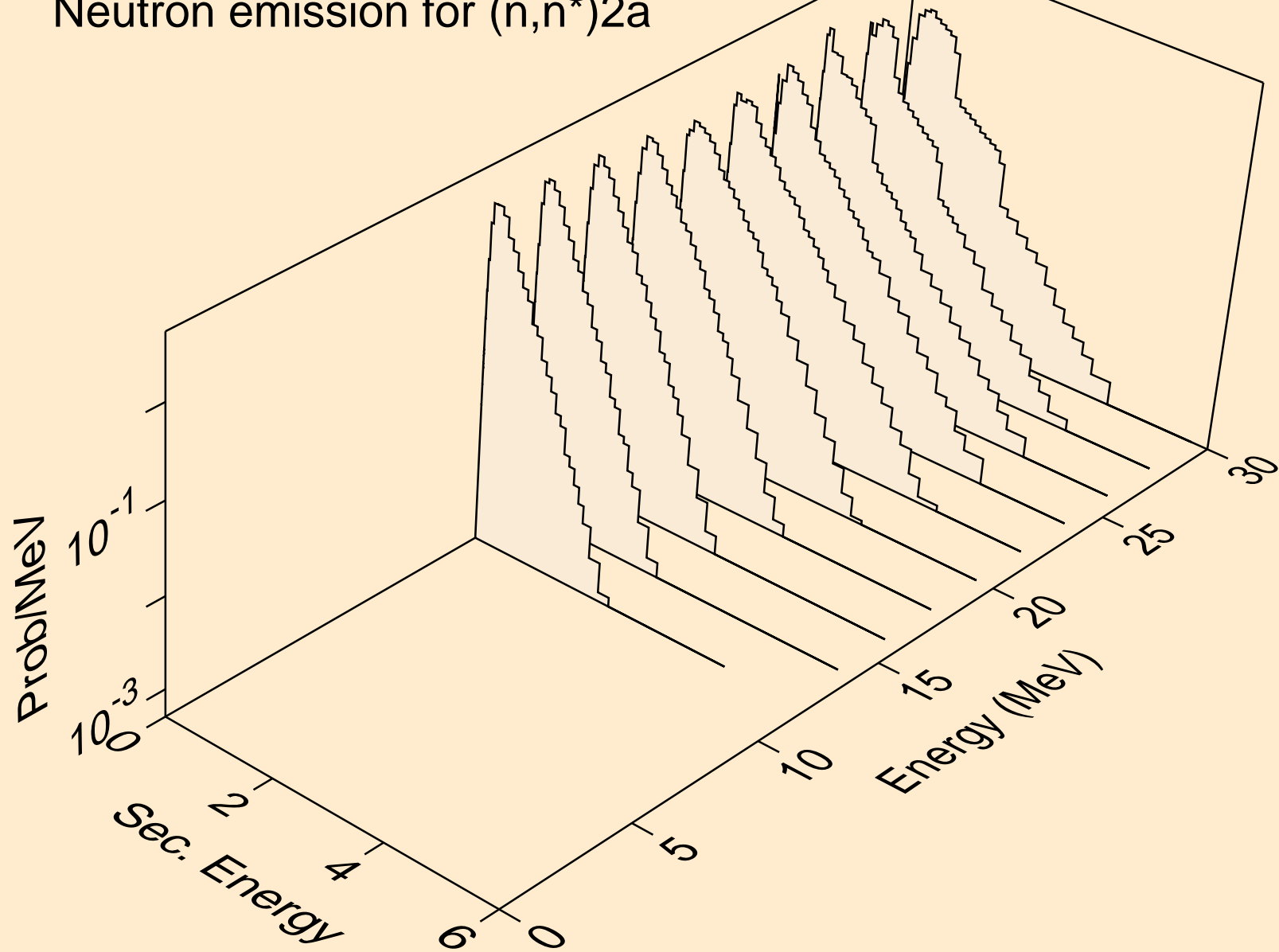

GD154 NEUTRON ACER TENDL-2021 LIBRARY; T=293.6K
Neutron emission for (n,n*)d

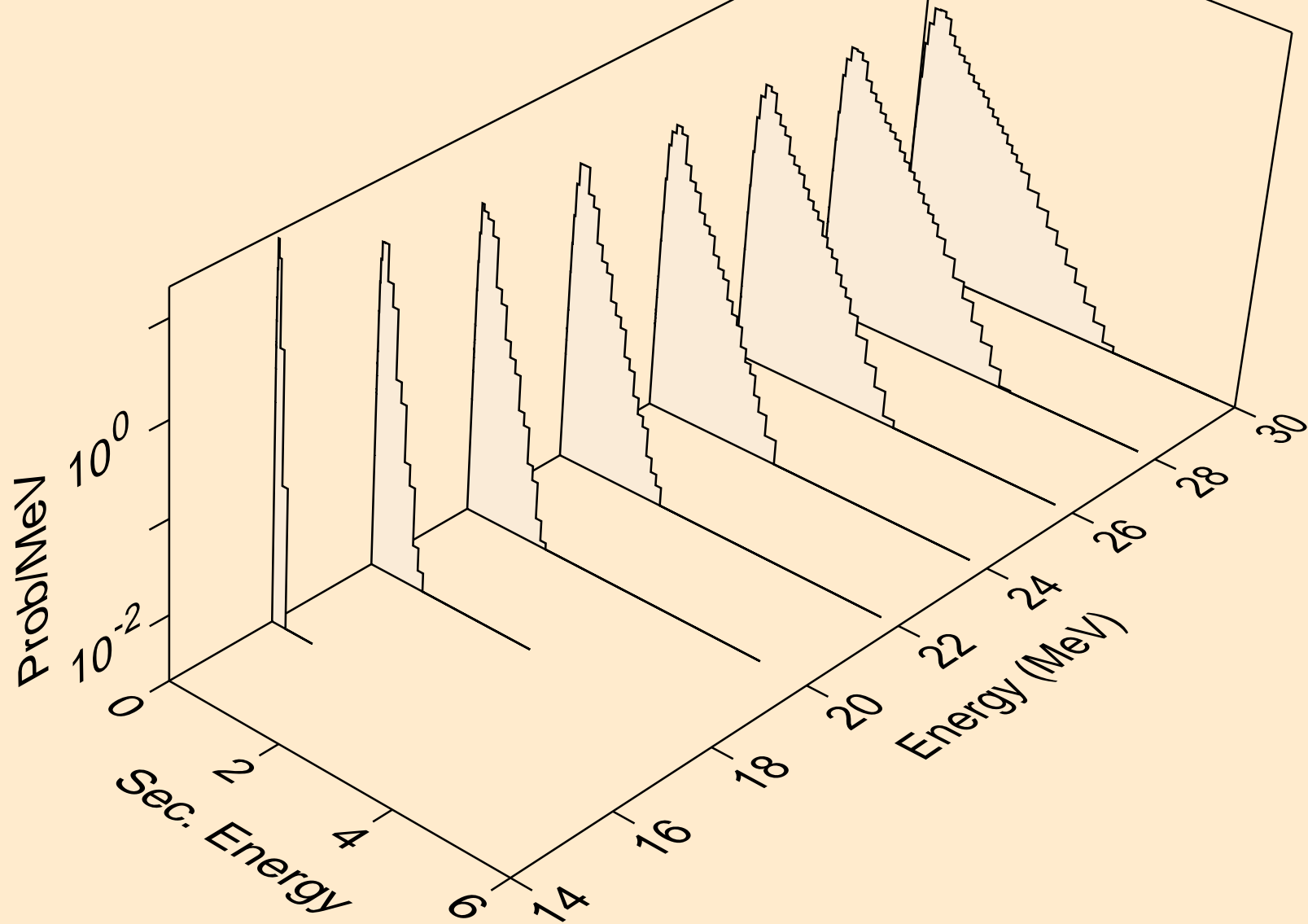

GD154 NEUTRON ACER TENDL-2021 LIBRARY; T=293.6K
Neutron emission for (n,n*)t

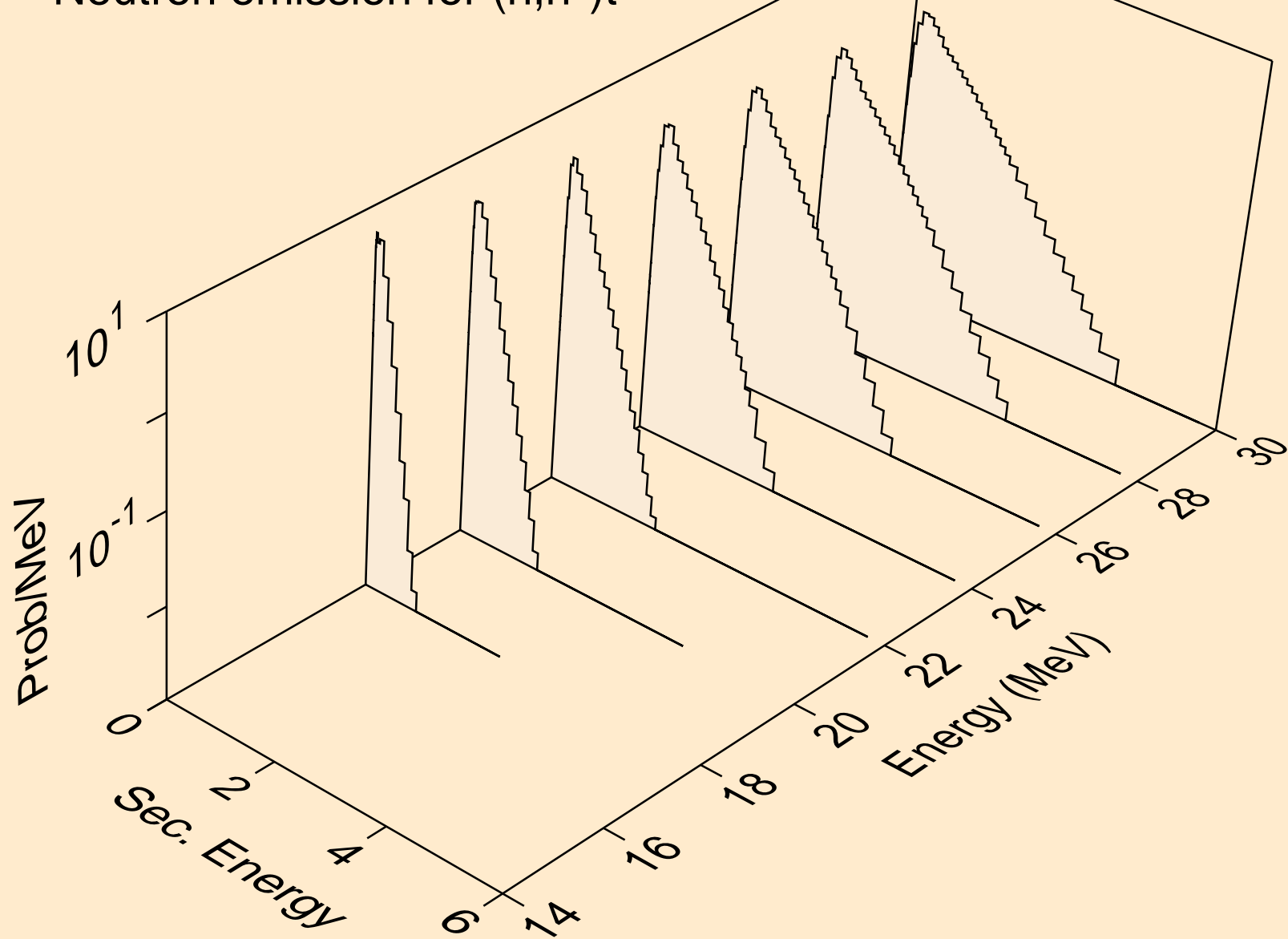

GD154 NEUTRON ACER TENDL-2021 LIBRARY; T=293.6K
Neutron emission for (n,n*)he3

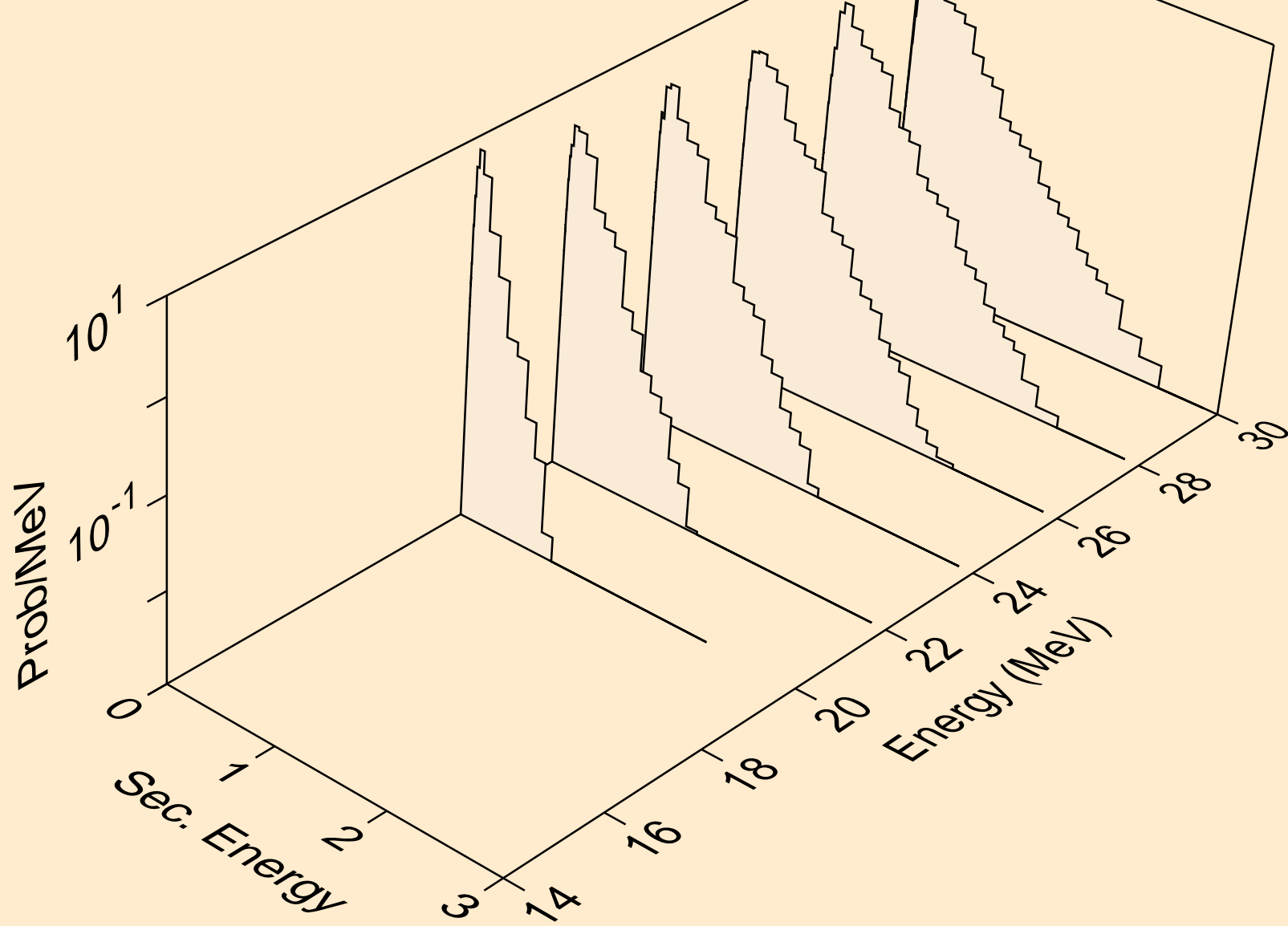

GD154 NEUTRON ACER TENDL-2021 LIBRARY; T=293.6K
Neutron emission for (n,4n)

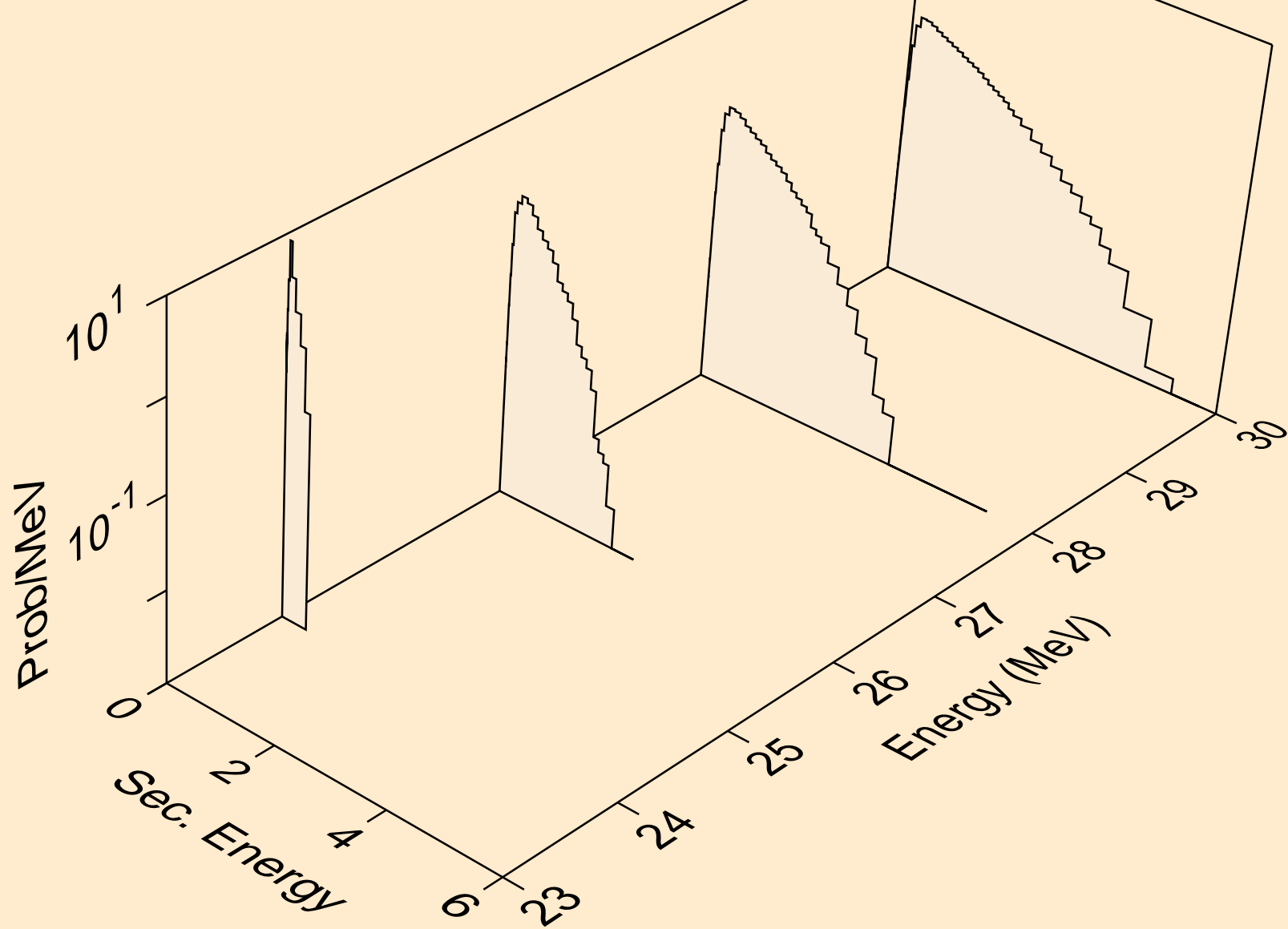

GD154 NEUTRON ACER TENDL-2021 LIBRARY; T=293.6K
Neutron emission for (n,2np)

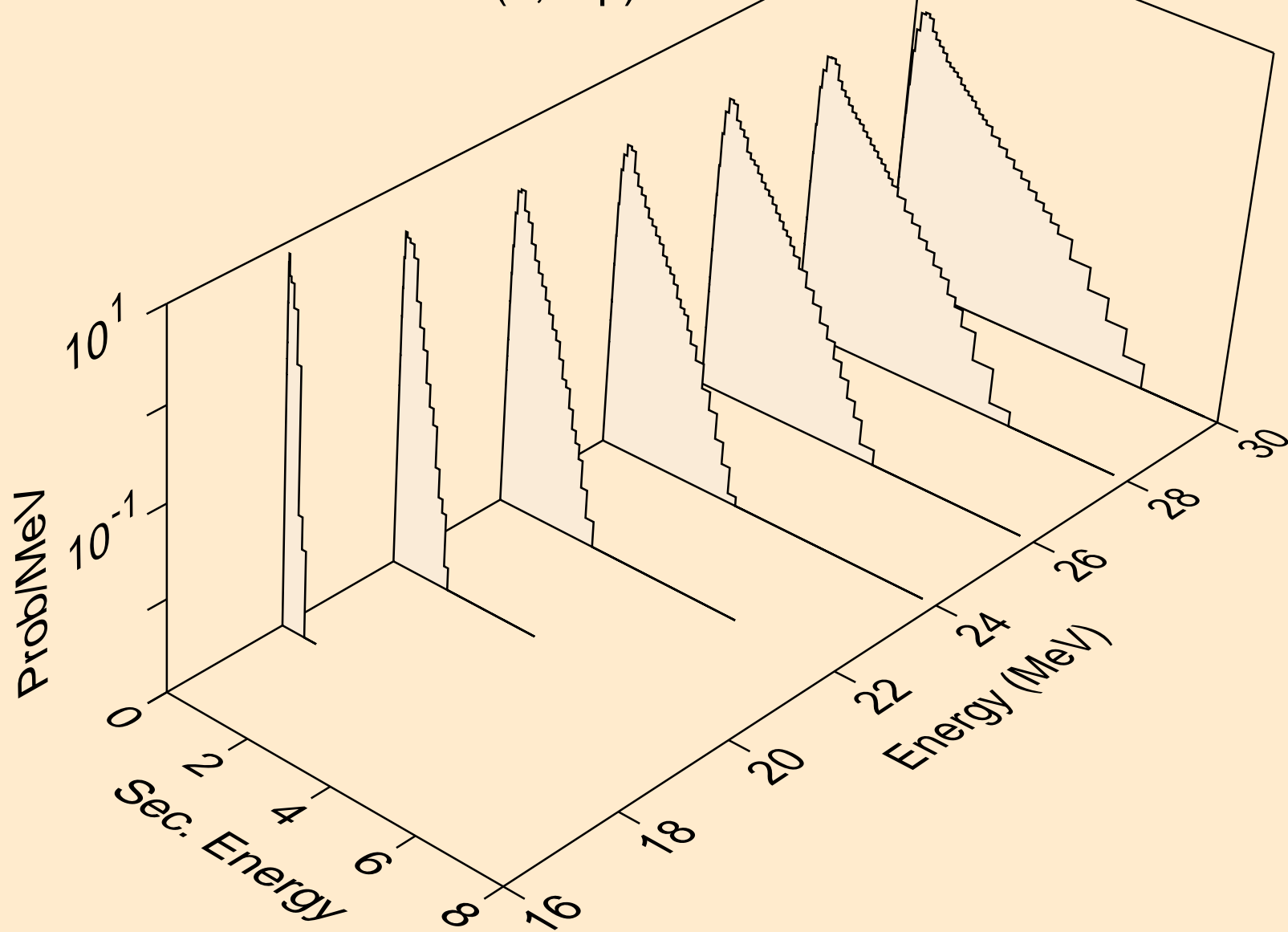

GD154 NEUTRON ACER TENDL-2021 LIBRARY; T=293.6K
Neutron emission for (n,3np)

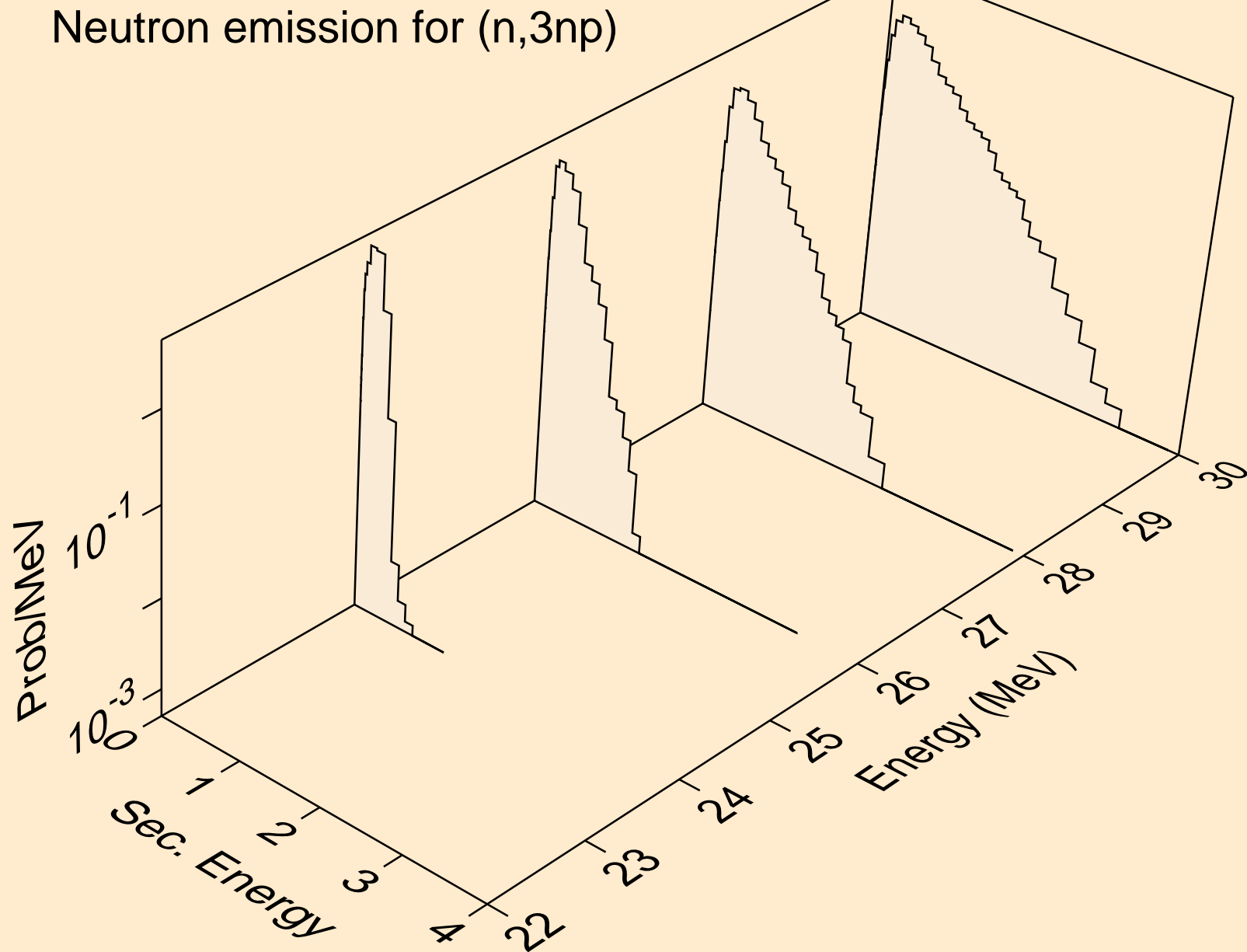

GD154 NEUTRON ACER TENDL-2021 LIBRARY; T=293.6K
Neutron emission for (n,2np)

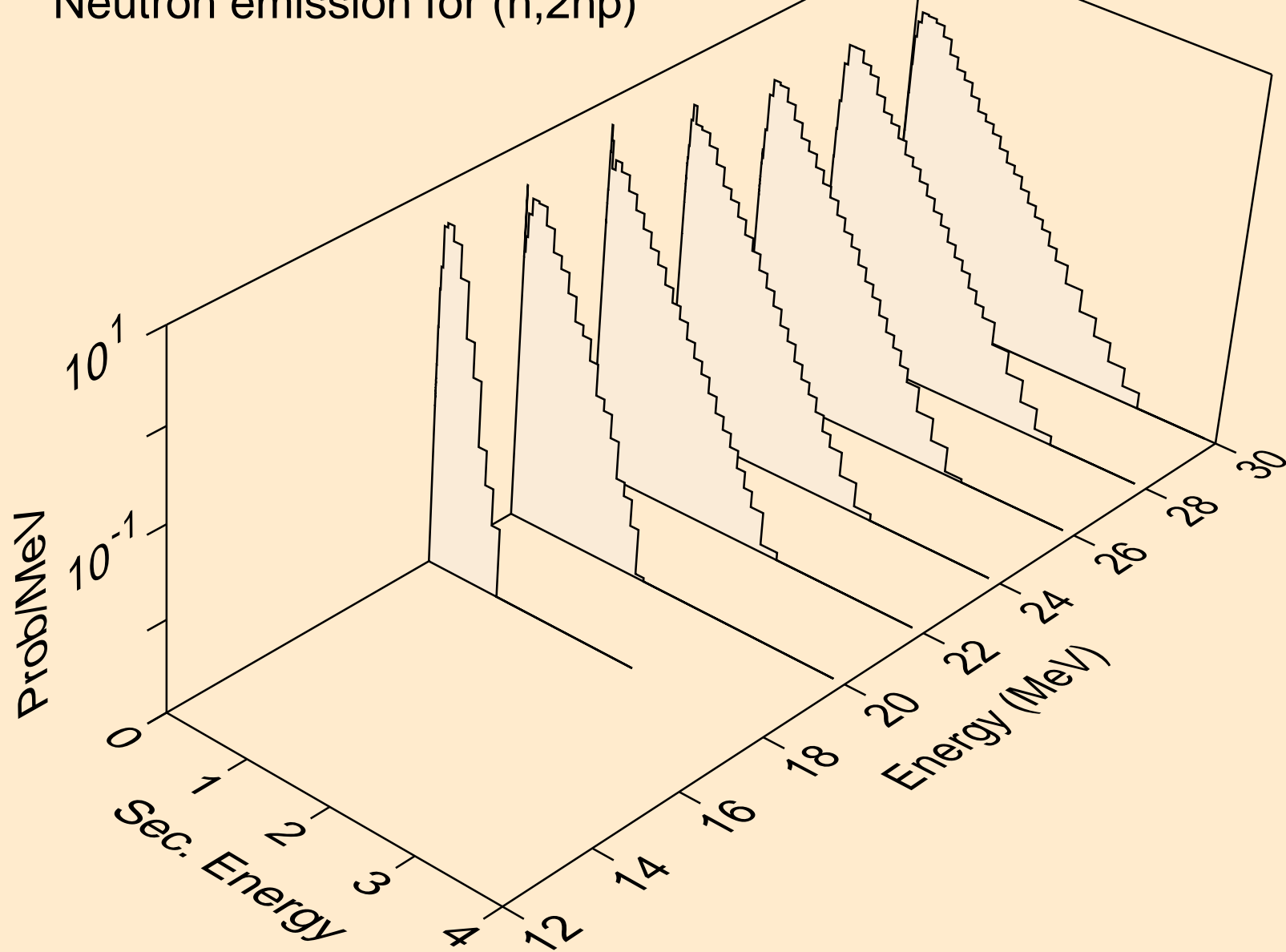

GD154 NEUTRON ACER TENDL-2021 LIBRARY; T=293.6K
Neutron emission for (n,npa)

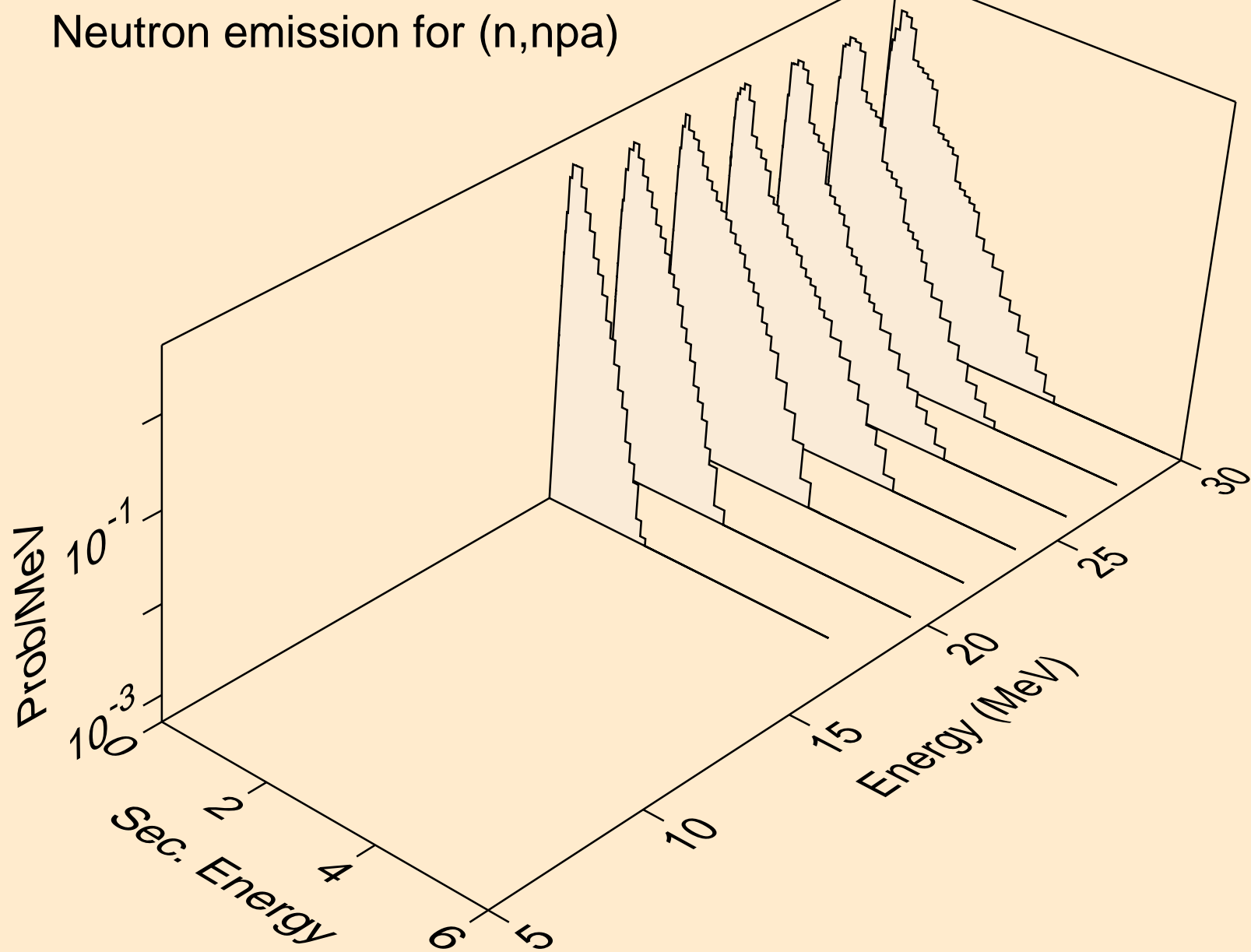

GD154 NEUTRON ACER TENDL-2021 LIBRARY; T=293.6K
Neutron emission for (n,n*c)

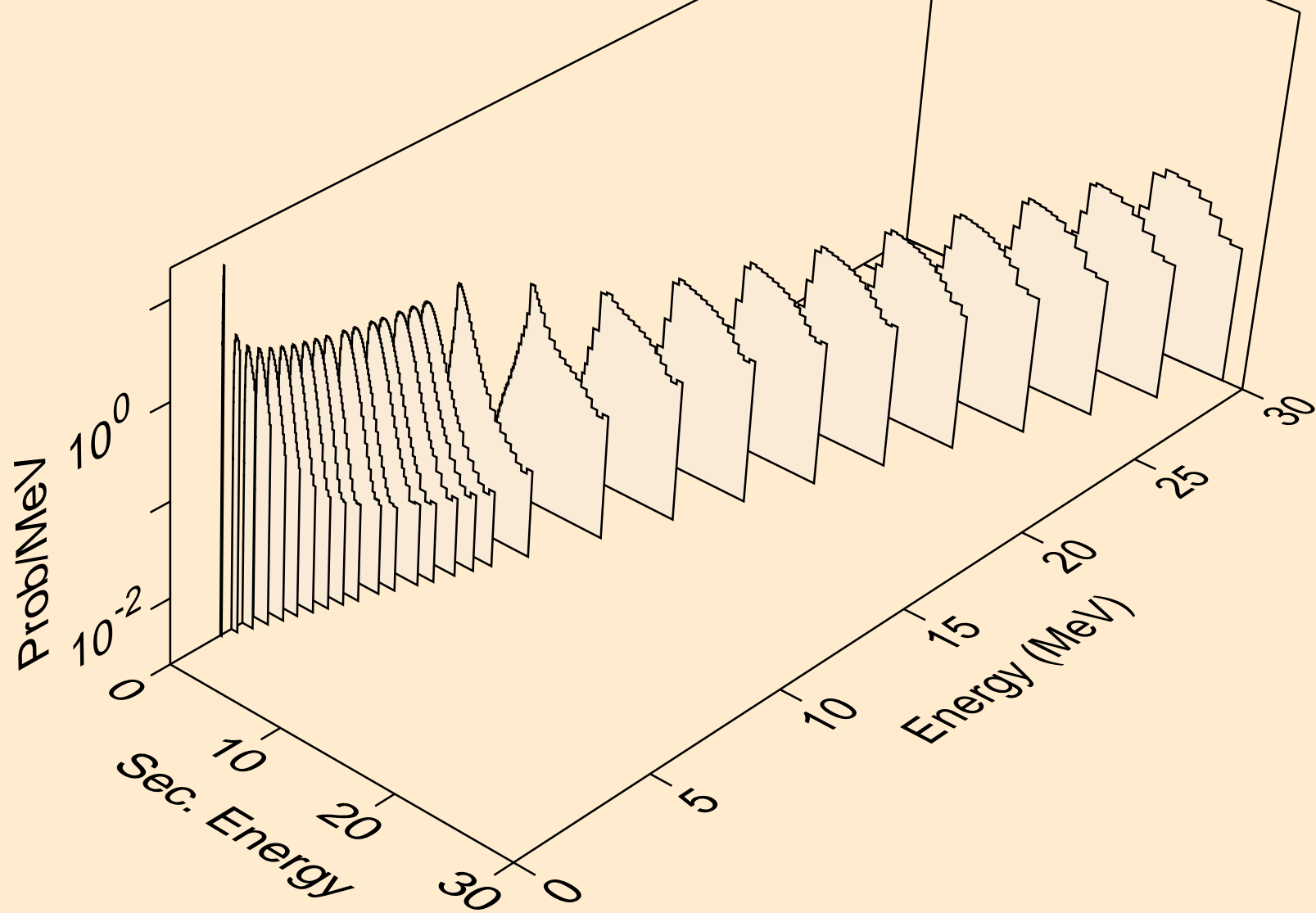

GD154 NEUTRON ACER TENDL-2021 LIBRARY; T=293.6K
Photon emission for (n,x)

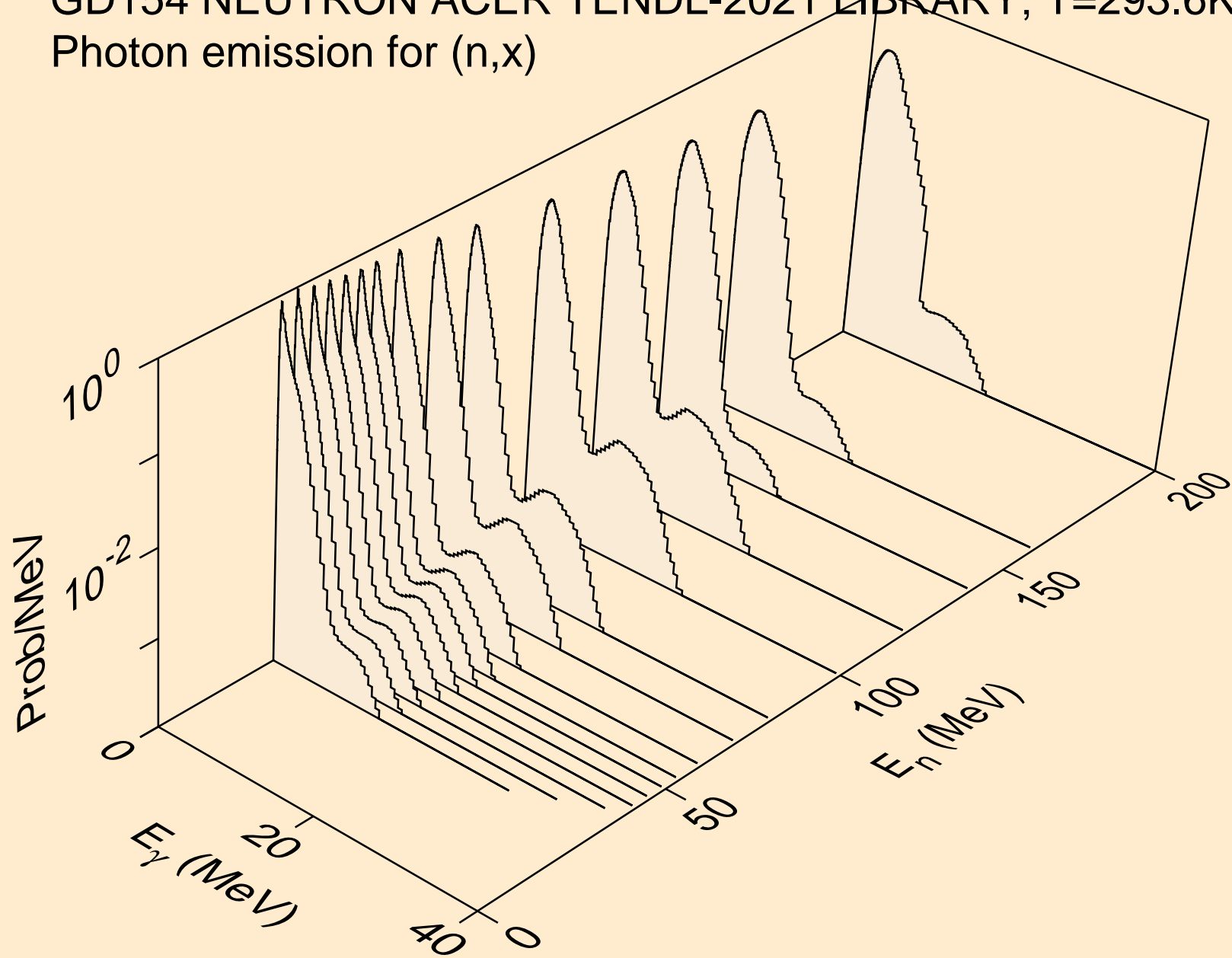

GD154 NEUTRON ACER TENDL-2021 LIBRARY; T=293.6K
Photon emission for (n,2nd)

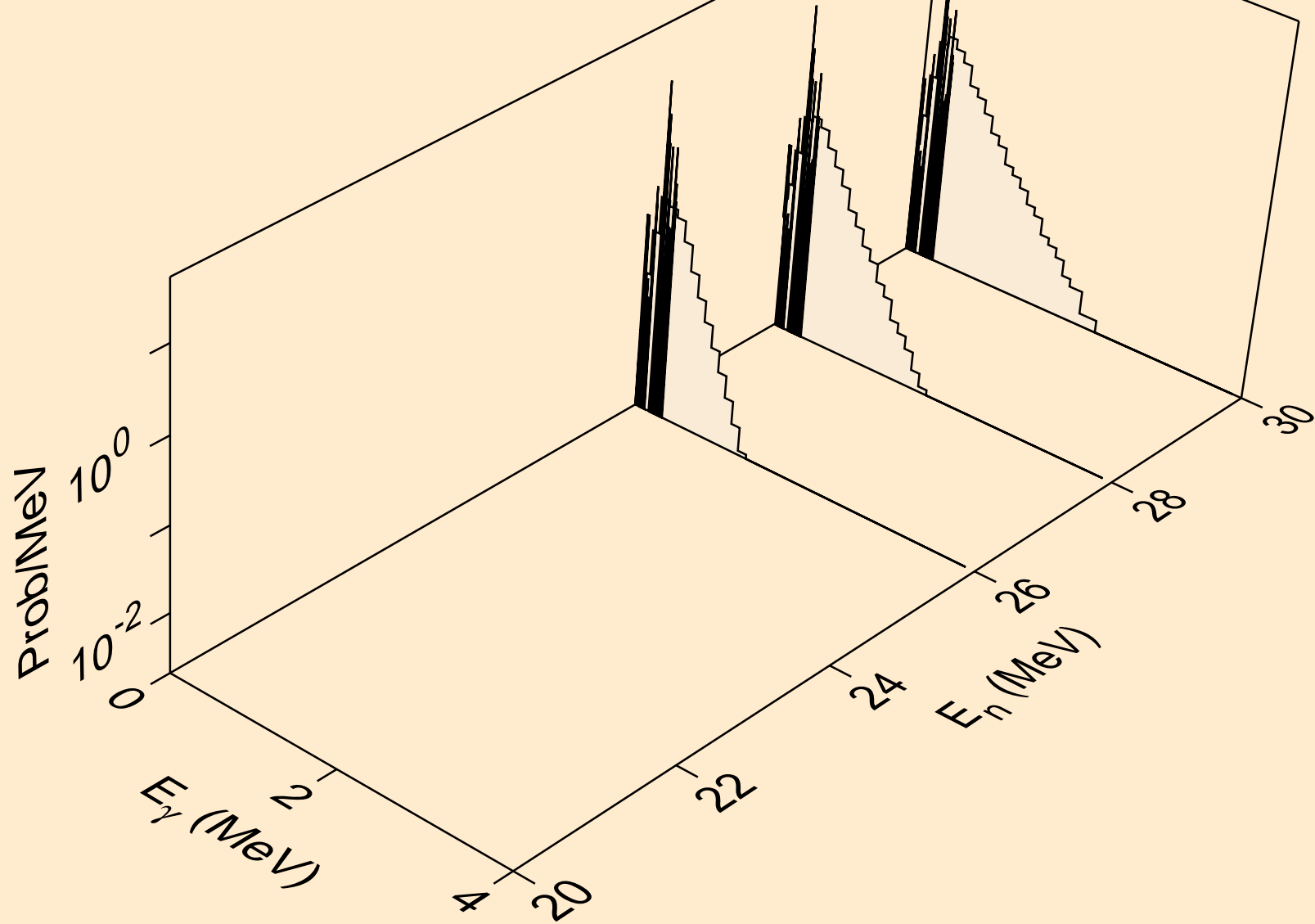

GD154 NEUTRON ACER TENDL-2021 LIBRARY; T=293.6K
Photon emission for (n,2n)

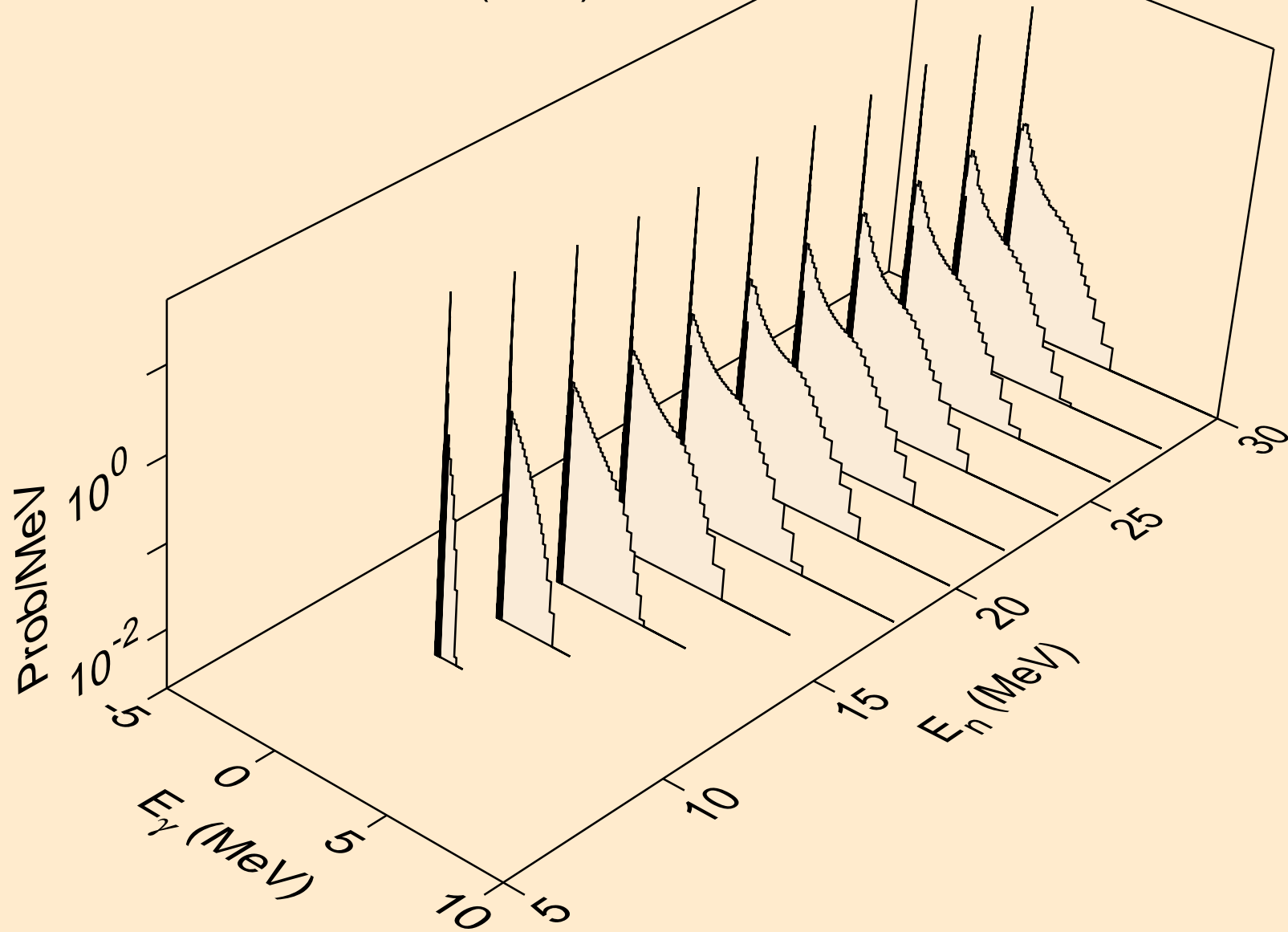

GD154 NEUTRON ACER TENDL-2021 LIBRARY; T=293.6K
Photon emission for (n,3n)

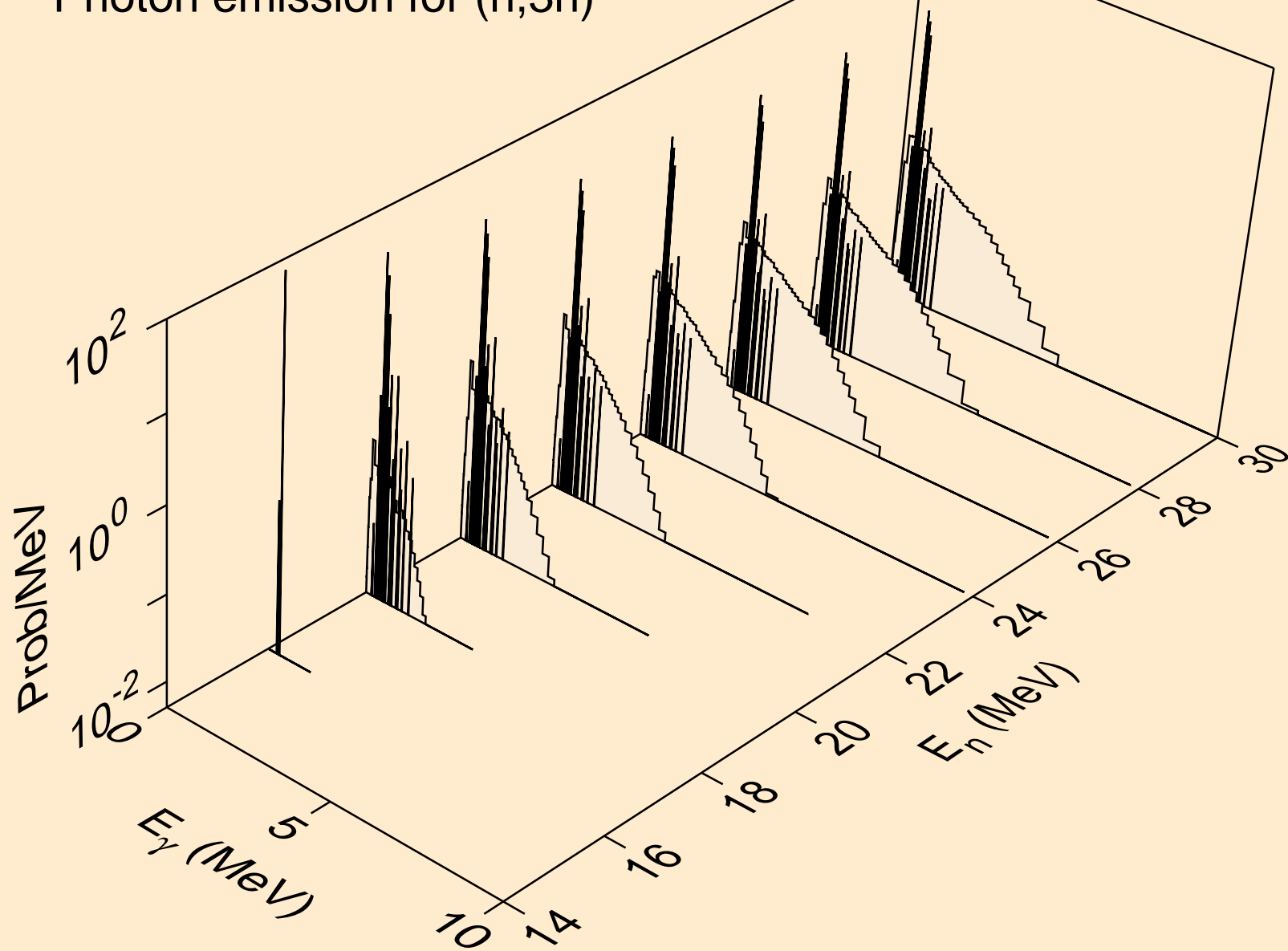

GD154 NEUTRON ACER TENDL-2021 LIBRARY; T=293.6K
Photon emission for (n,n*)a

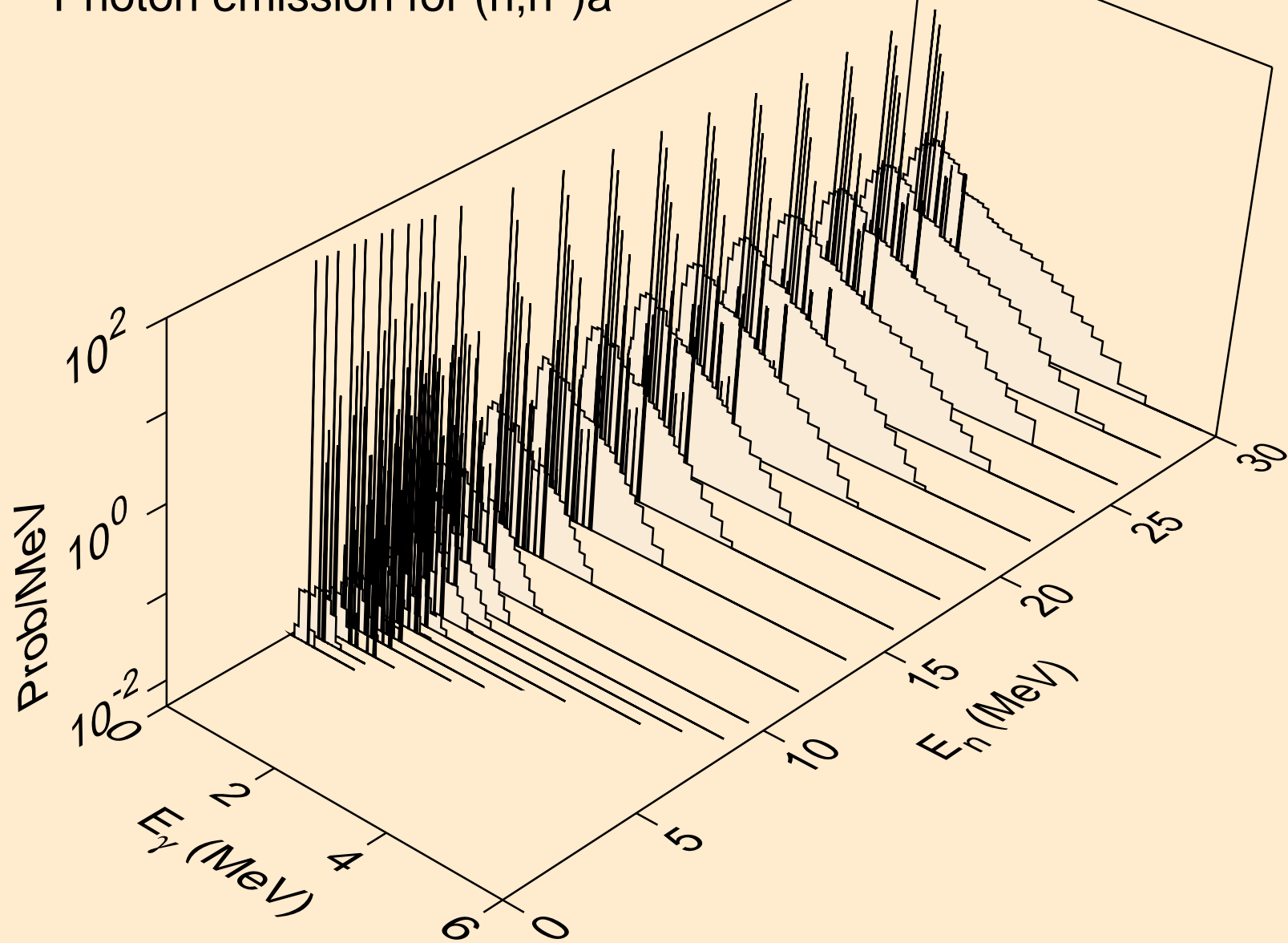

GD154 NEUTRON ACER TENDL-2021 LIBRARY; T=293.6K
Photon emission for (n,2n)a

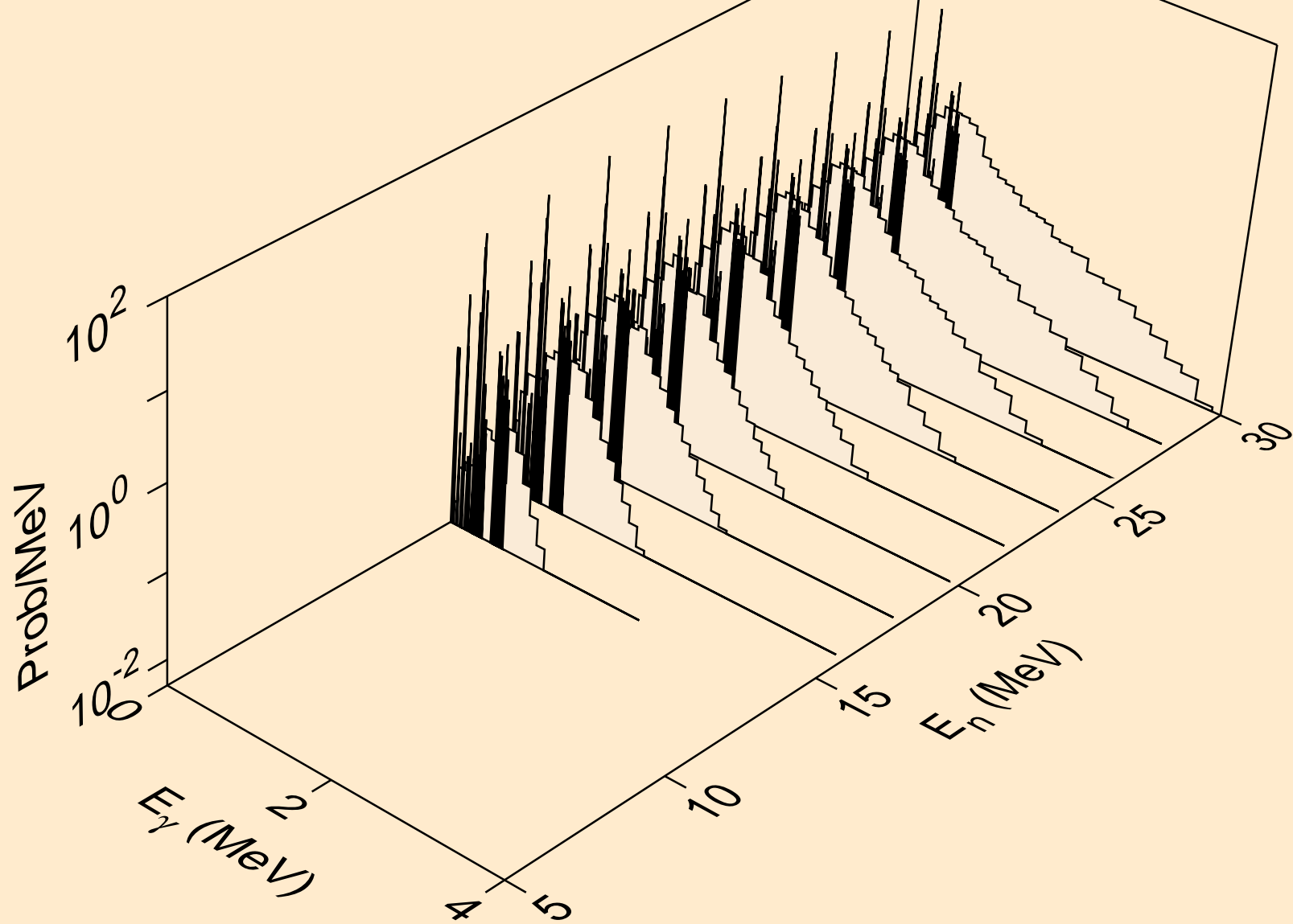

GD154 NEUTRON ACER TENDL-2021 LIBRARY; T=293.6K
Photon emission for (n,3n)a

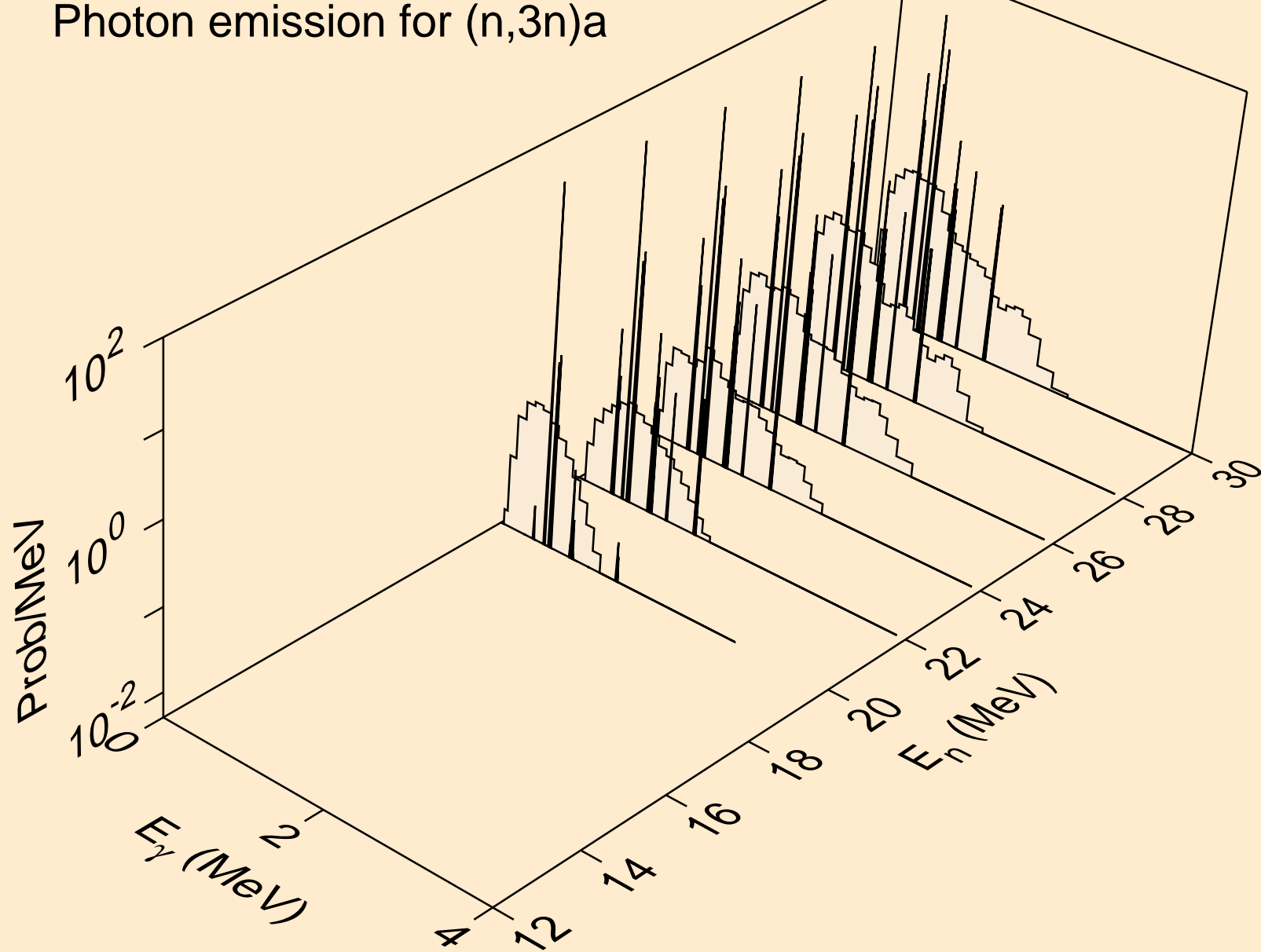

GD154 NEUTRON ACER TENDL-2021 LIBRARY; T=293.6K
Photon emission for (n,n*)p

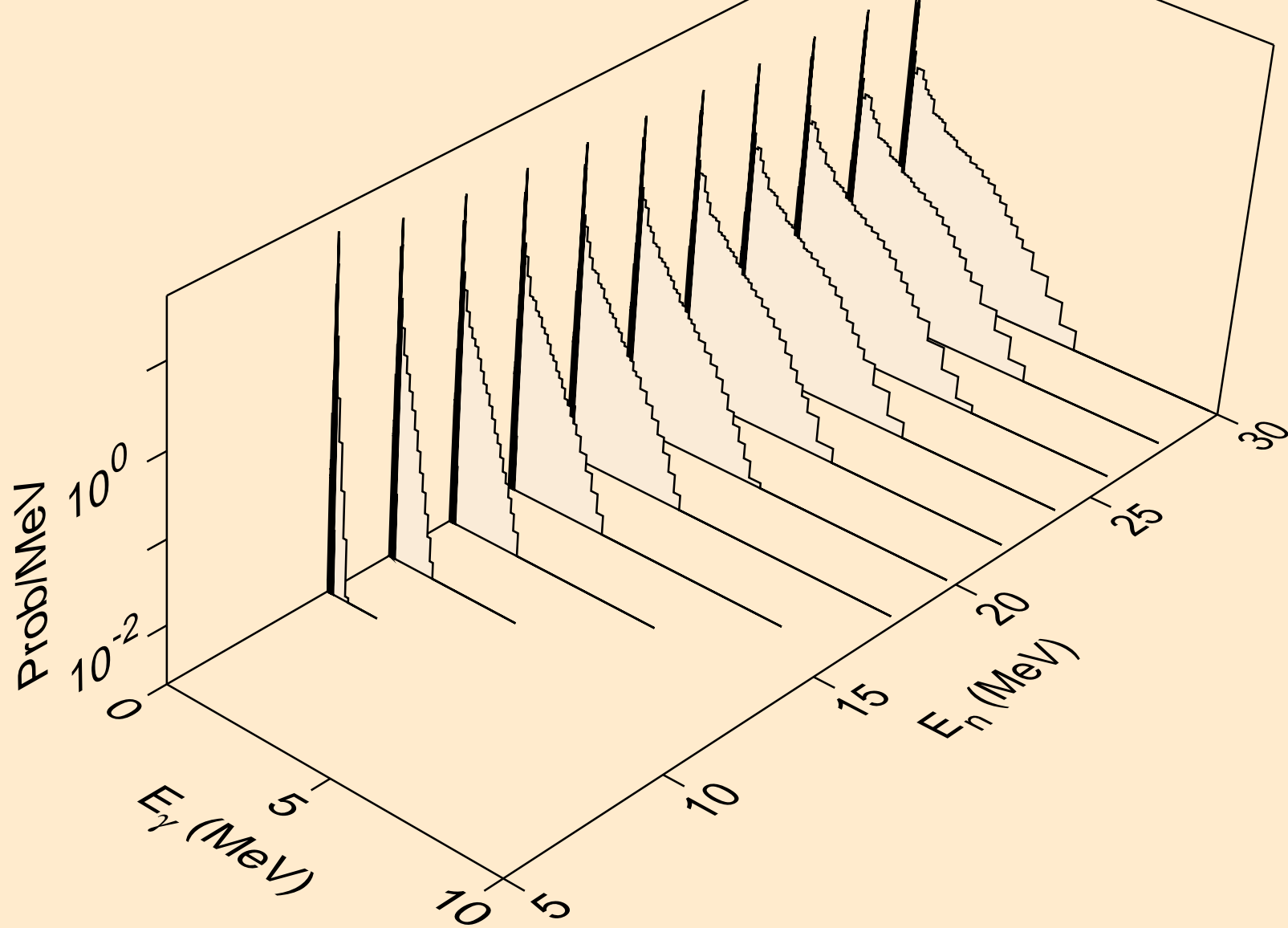

GD154 NEUTRON ACER TENDL-2021 LIBRARY; T=293.6K
Photon emission for (n,n*)2a

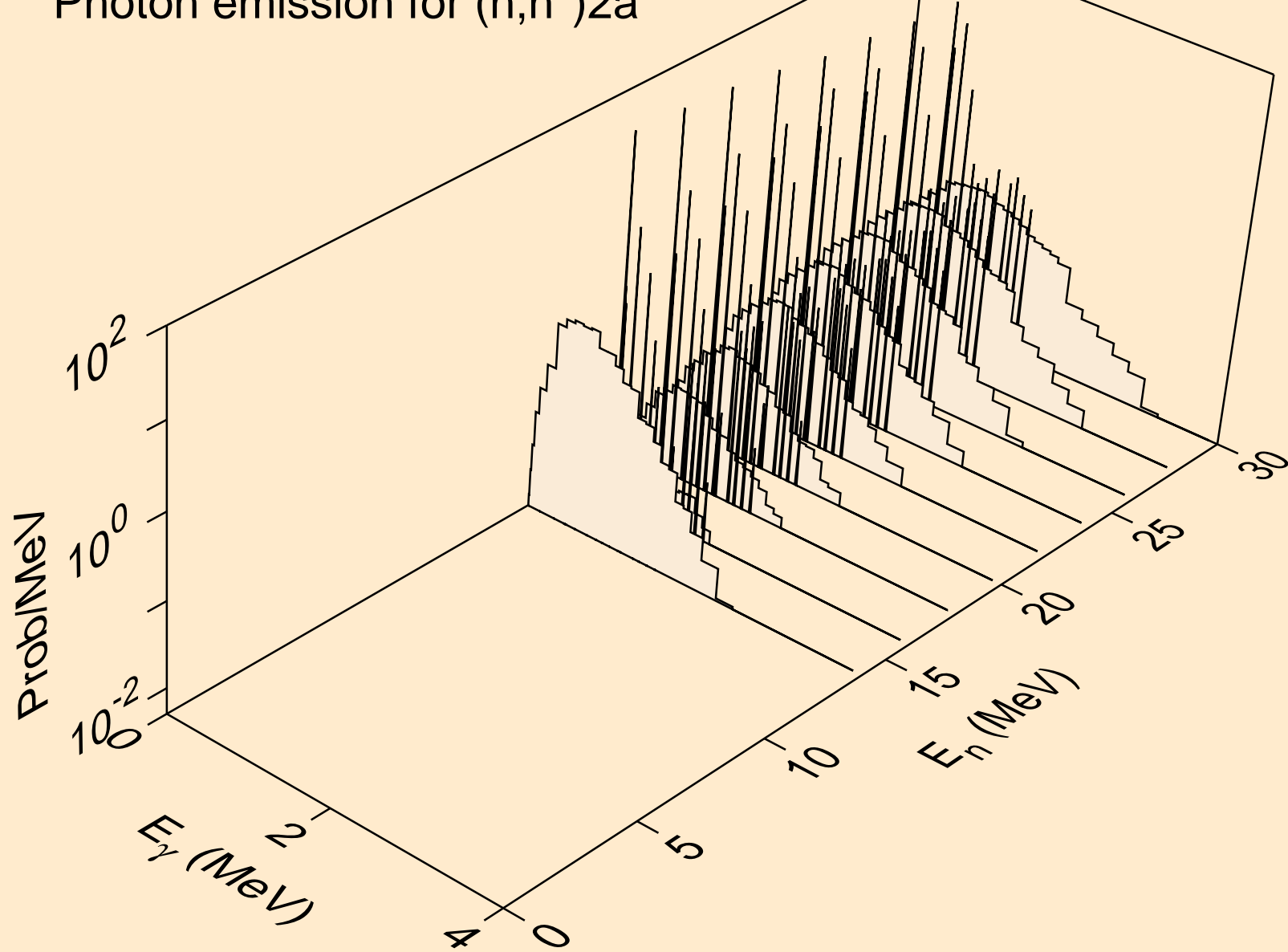

GD154 NEUTRON ACER TENDL-2021 LIBRARY; T=293.6K
Photon emission for (n,n*)d

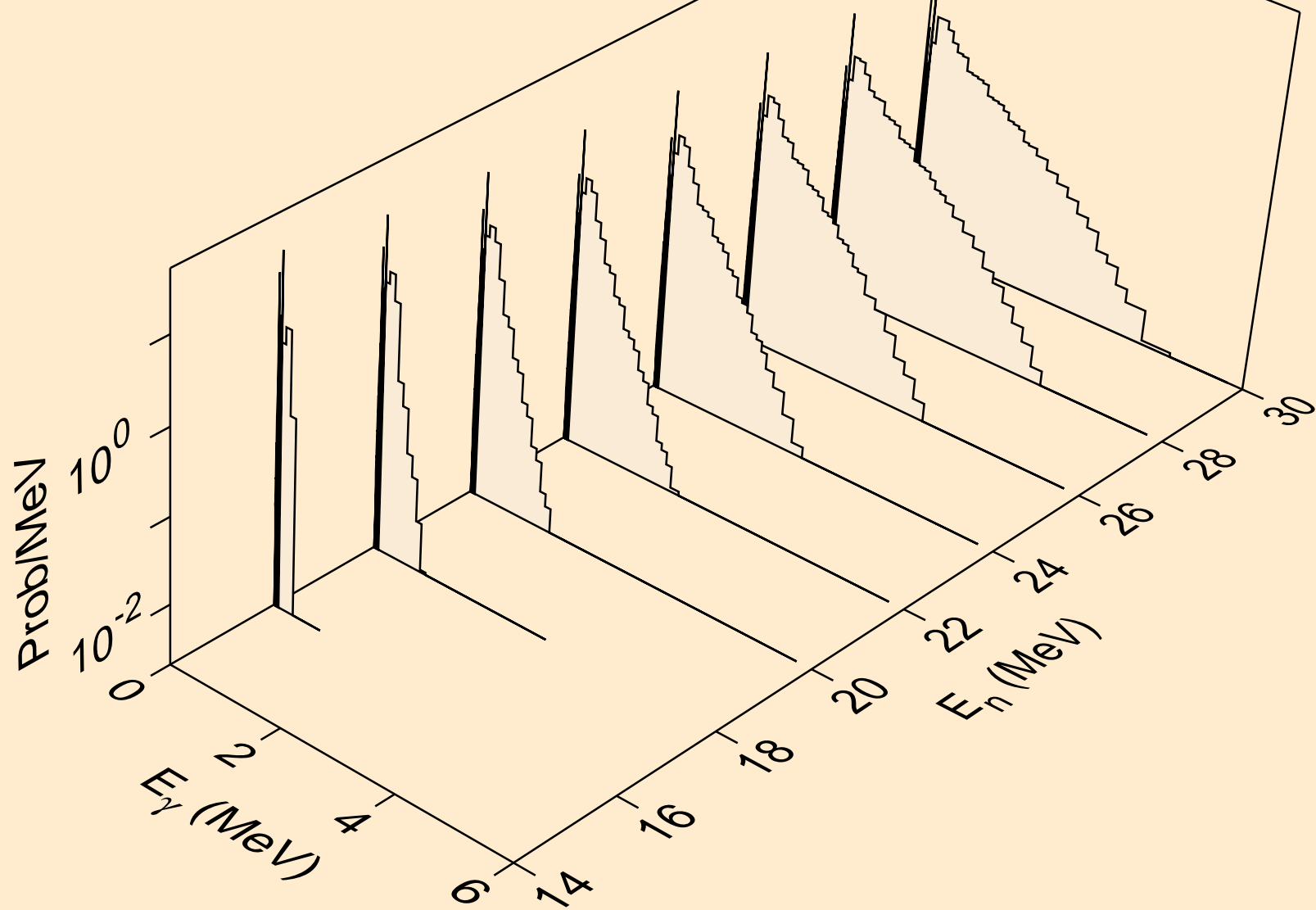

GD154 NEUTRON ACER TENDL-2021 LIBRARY; T=293.6K
Photon emission for (n,n*)t

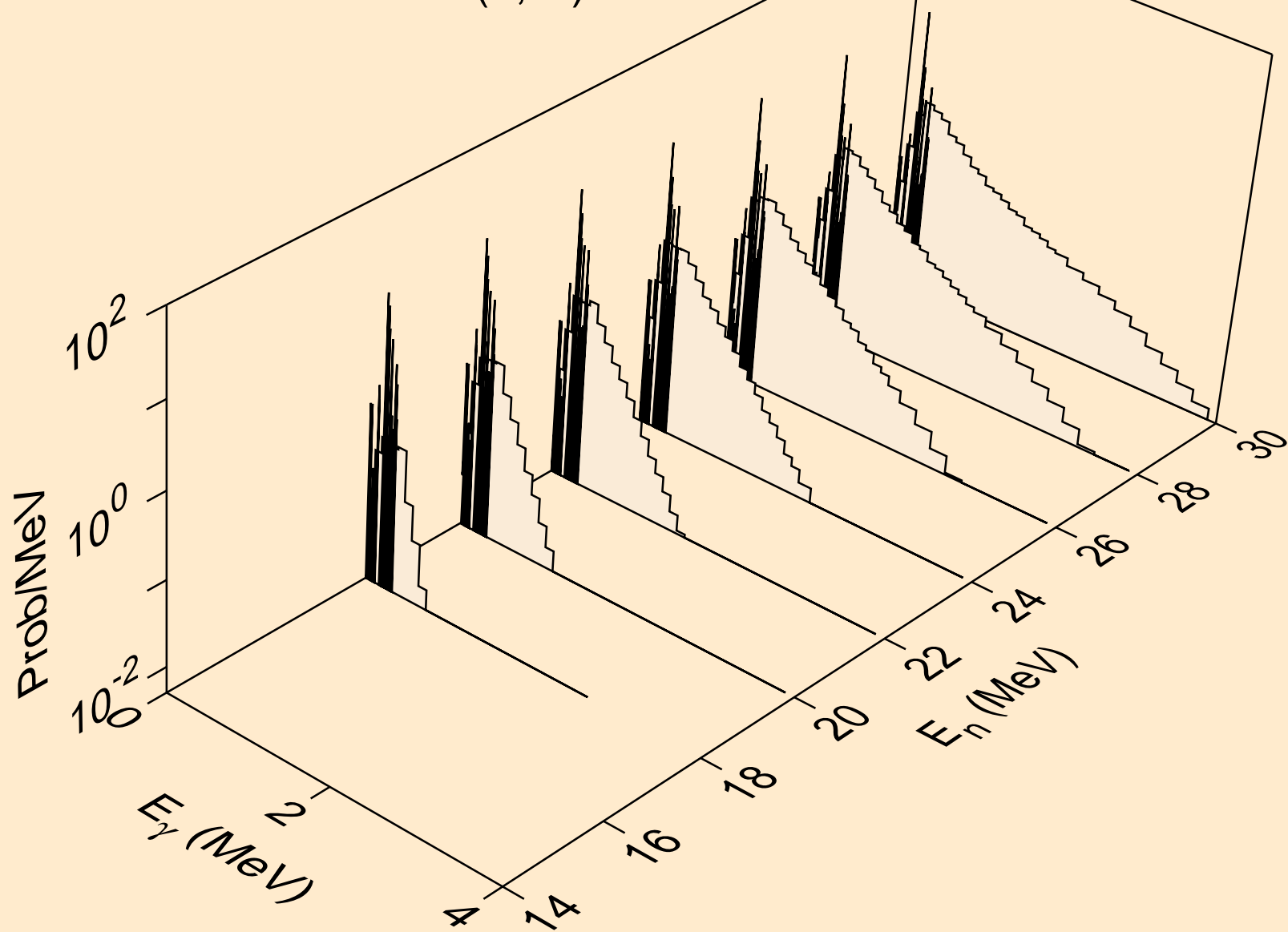

GD154 NEUTRON ACER TENDL-2021 LIBRARY; T=293.6K
Photon emission for (n,n*)he3

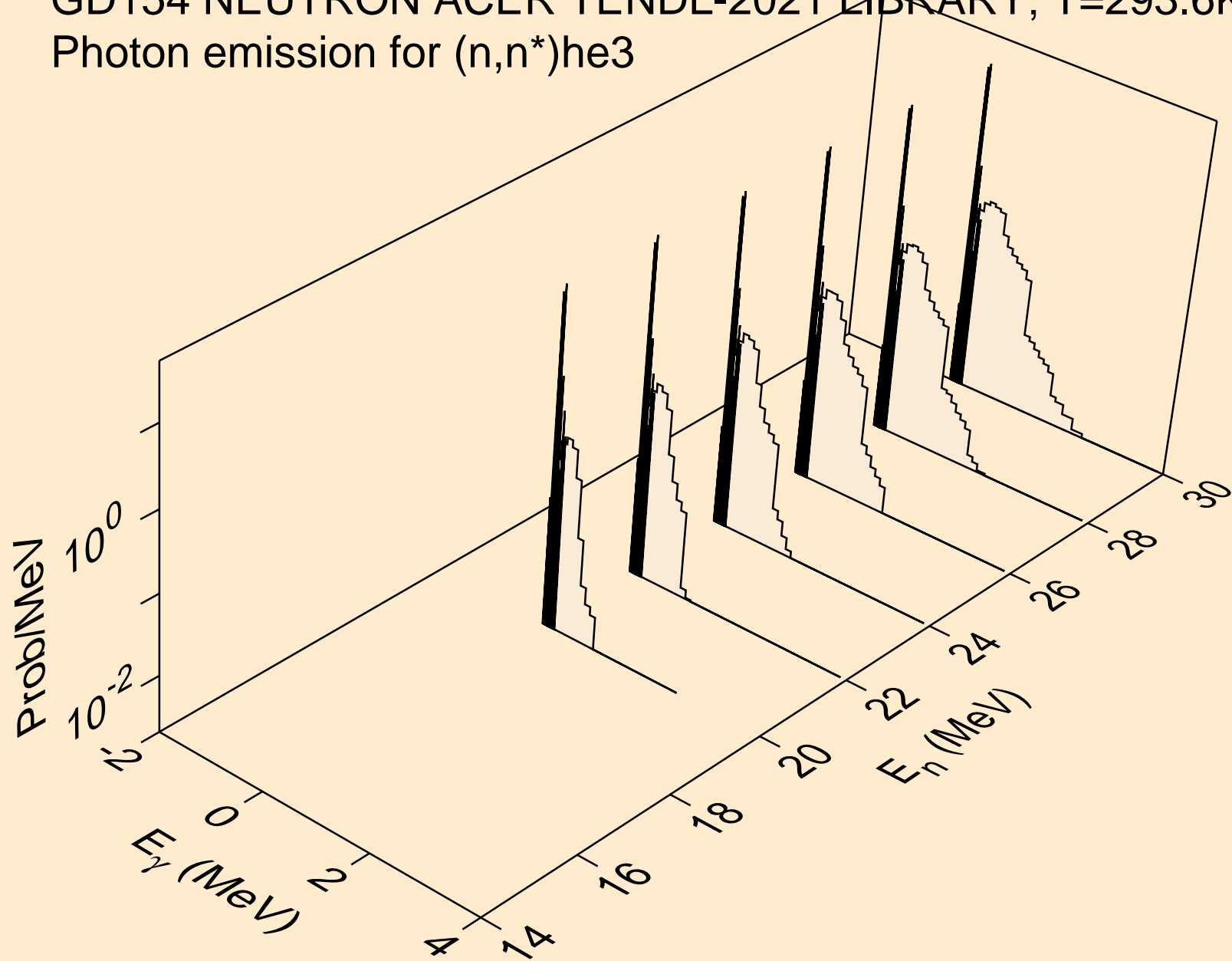

GD154 NEUTRON ACER TENDL-2021 LIBRARY; T=293.6K
Photon emission for (n,4n)

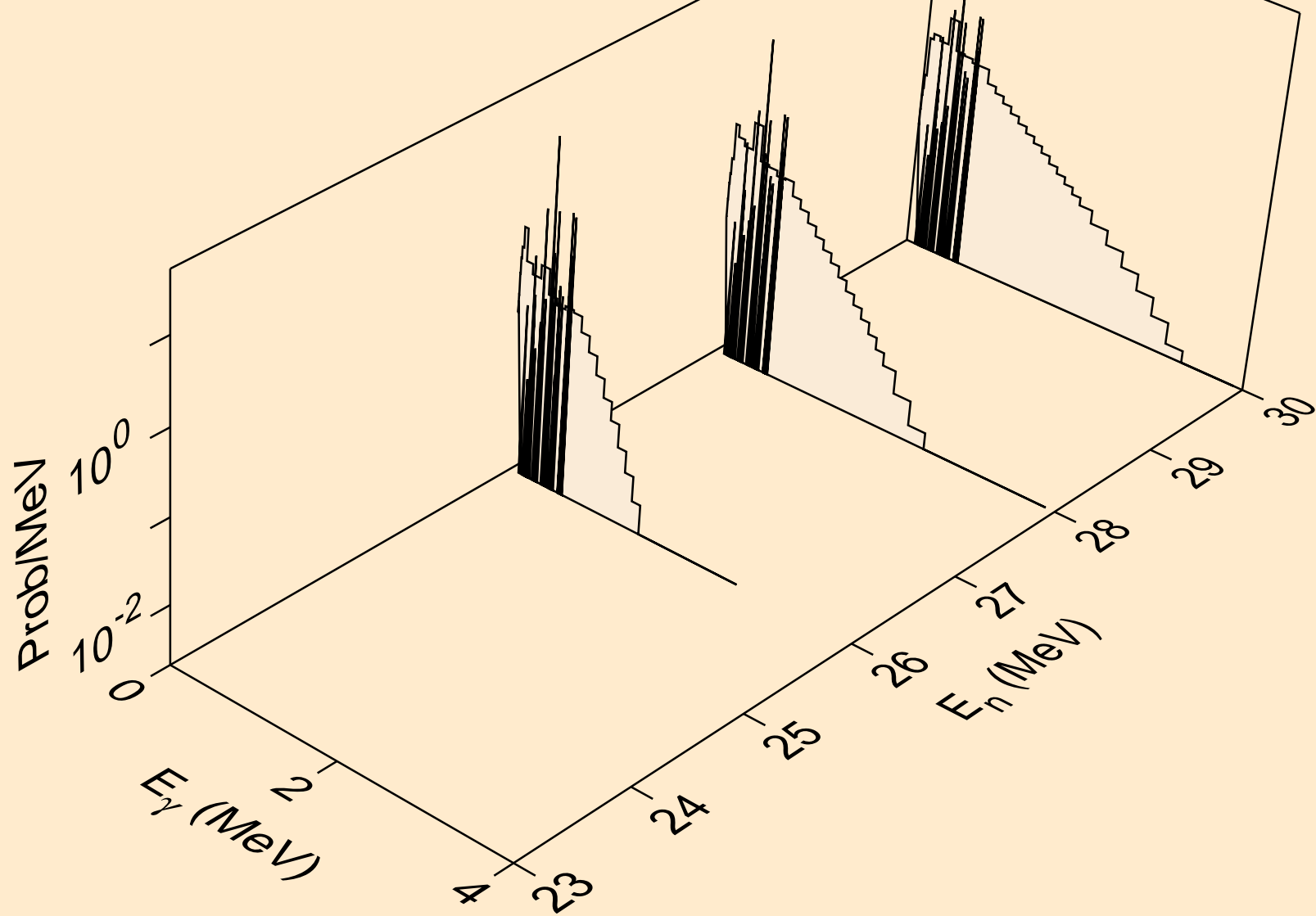

GD154 NEUTRON ACER TENDL-2021 LIBRARY; T=293.6K
Photon emission for (n,2np)

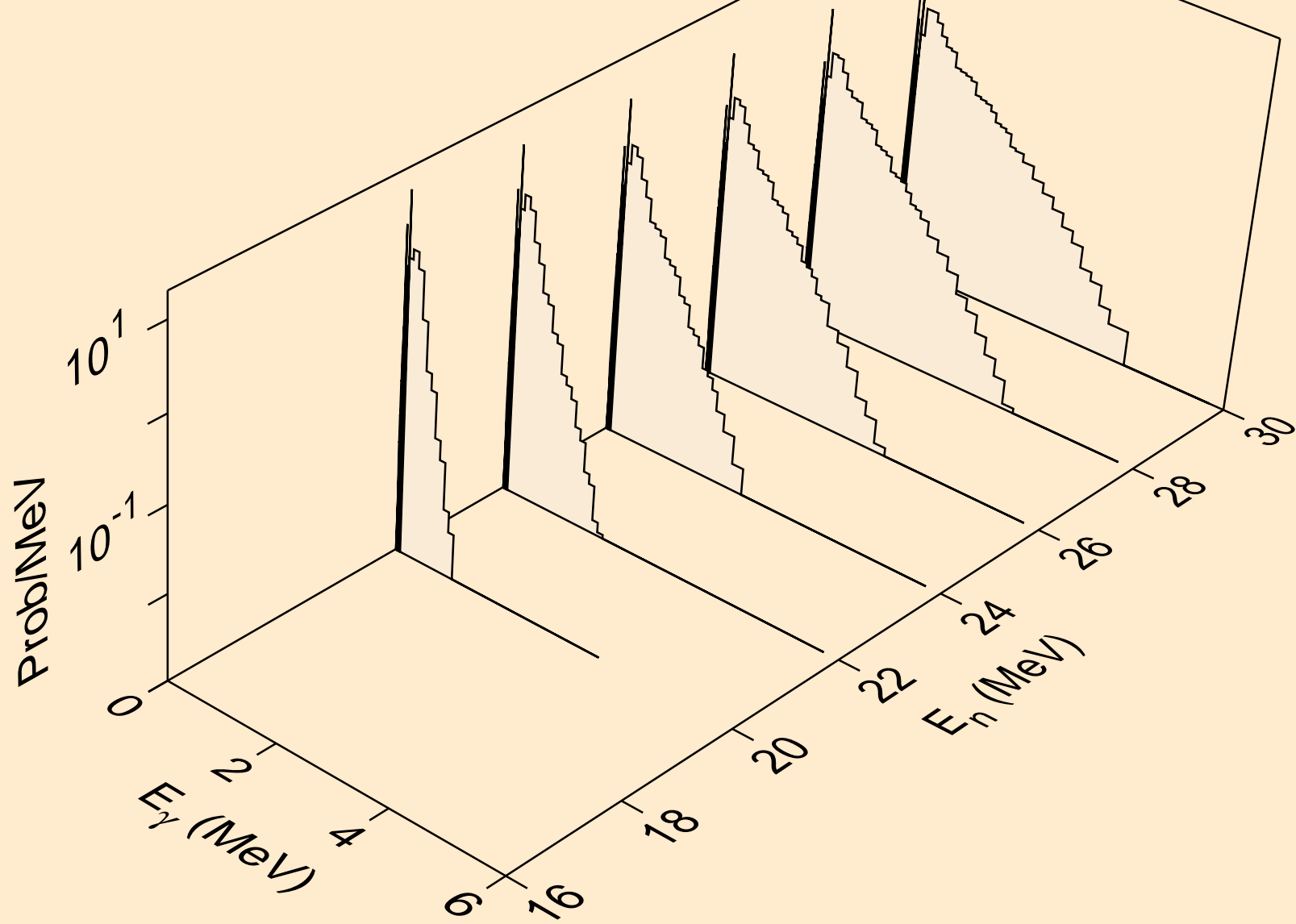

GD154 NEUTRON ACER TENDL-2021 LIBRARY; T=293.6K
Photon emission for (n,3np)

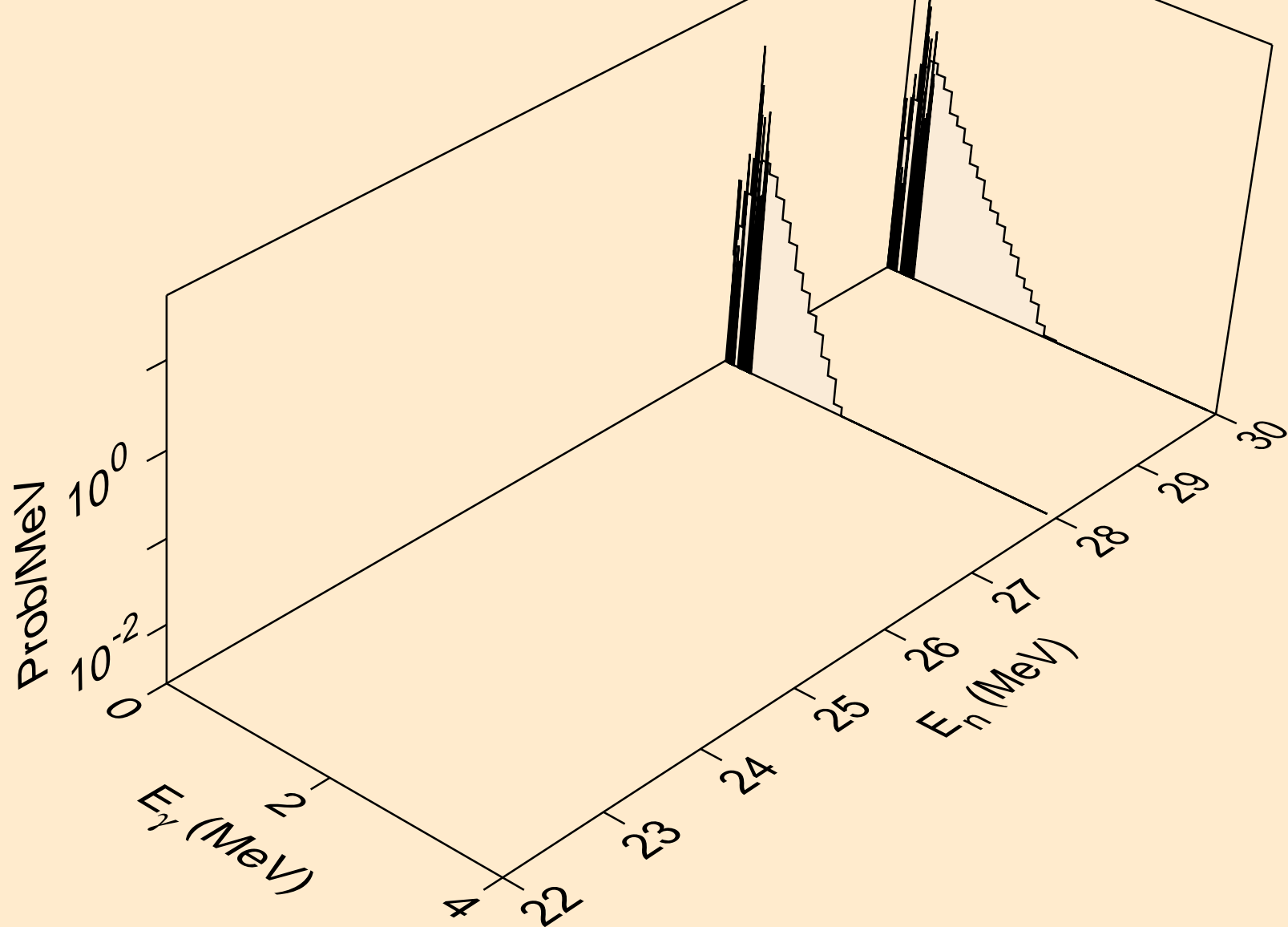

GD154 NEUTRON ACER TENDL-2021 LIBRARY; T=293.6K
Photon emission for (n,2np)

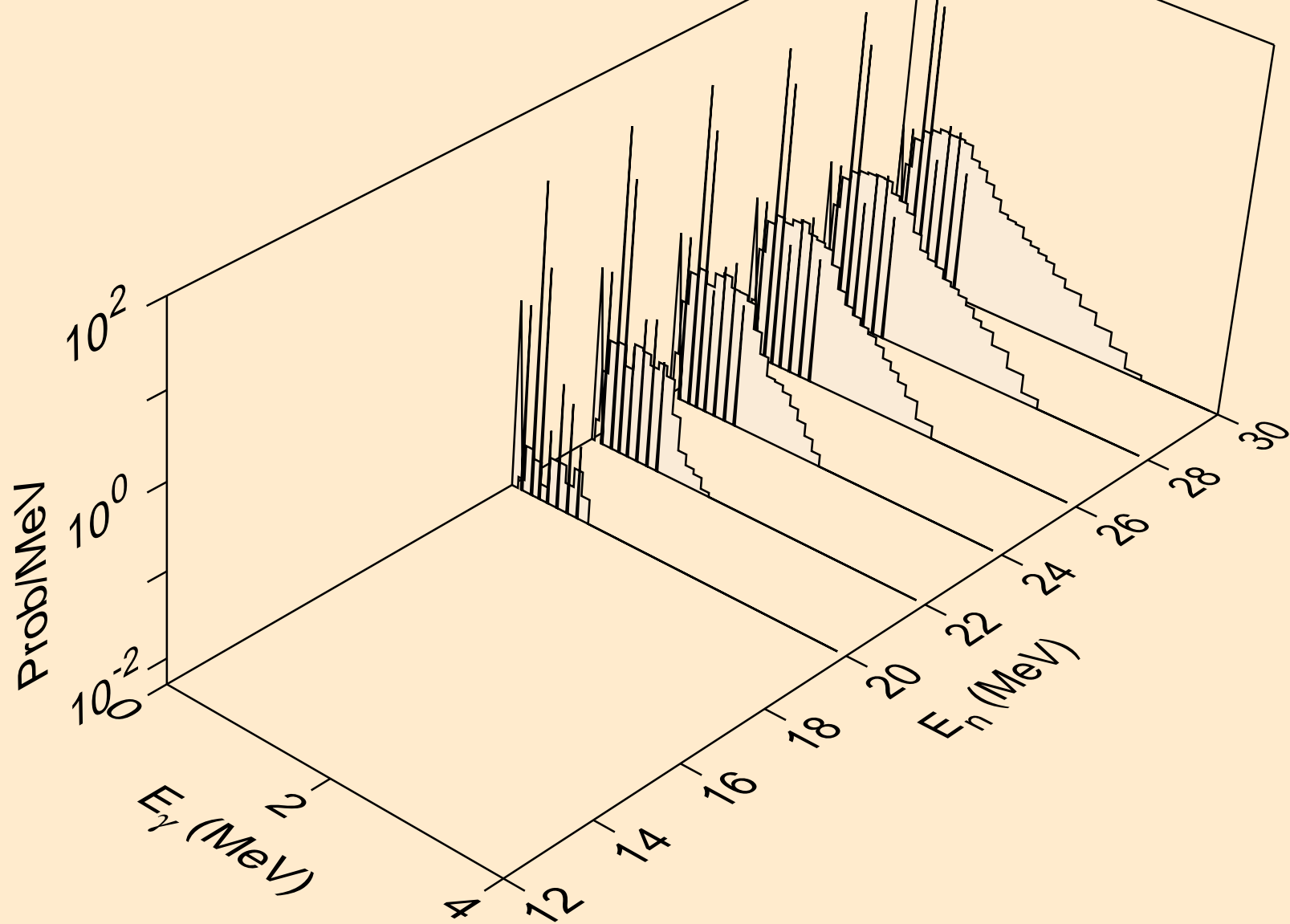

GD154 NEUTRON ACER TENDL-2021 LIBRARY; T=293.6K
Photon emission for (n,npa)

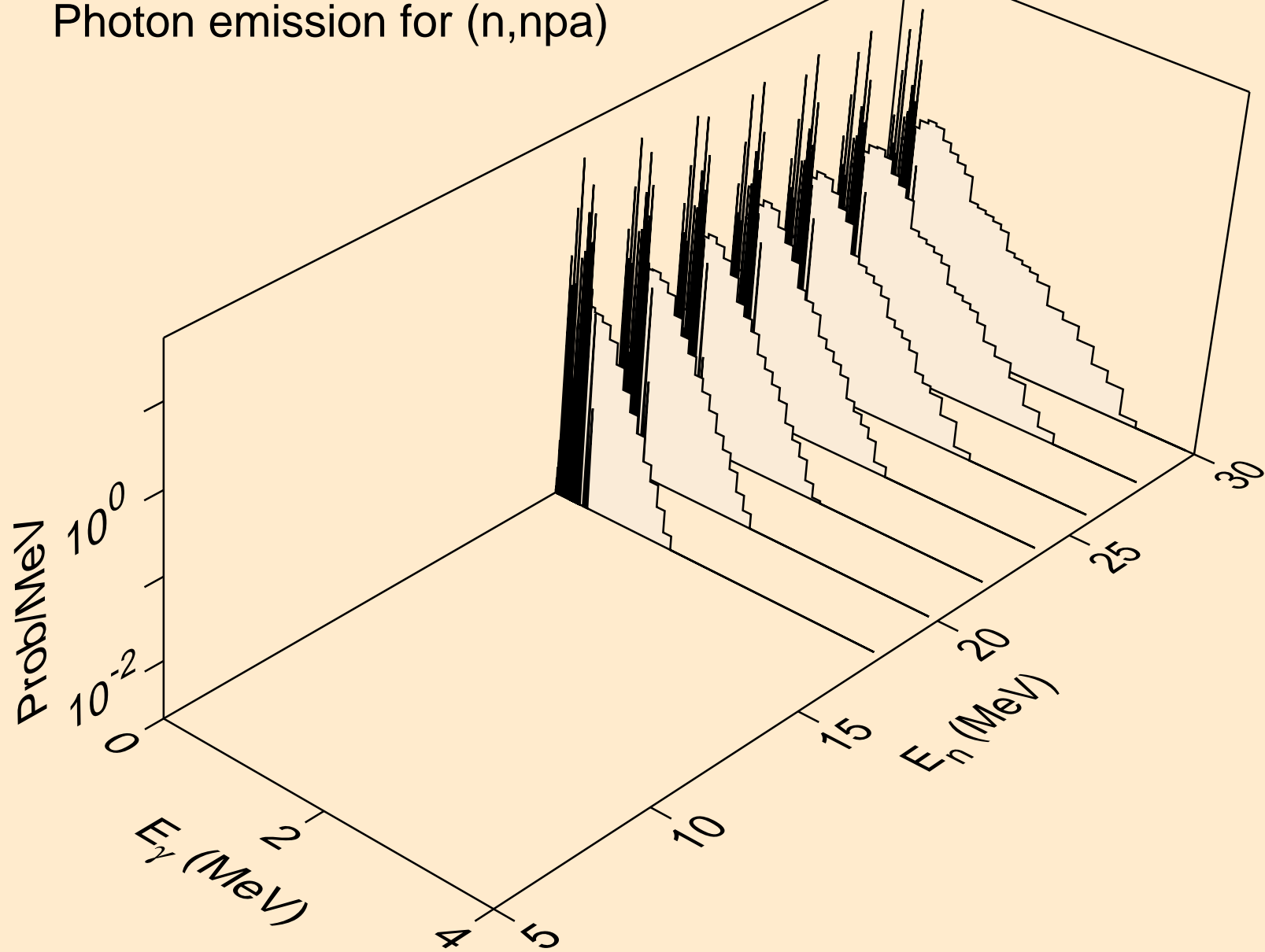

GD154 NEUTRON ACER TENDL-2021 LIBRARY; T=293.6K
Photon emission for (n,n*c)

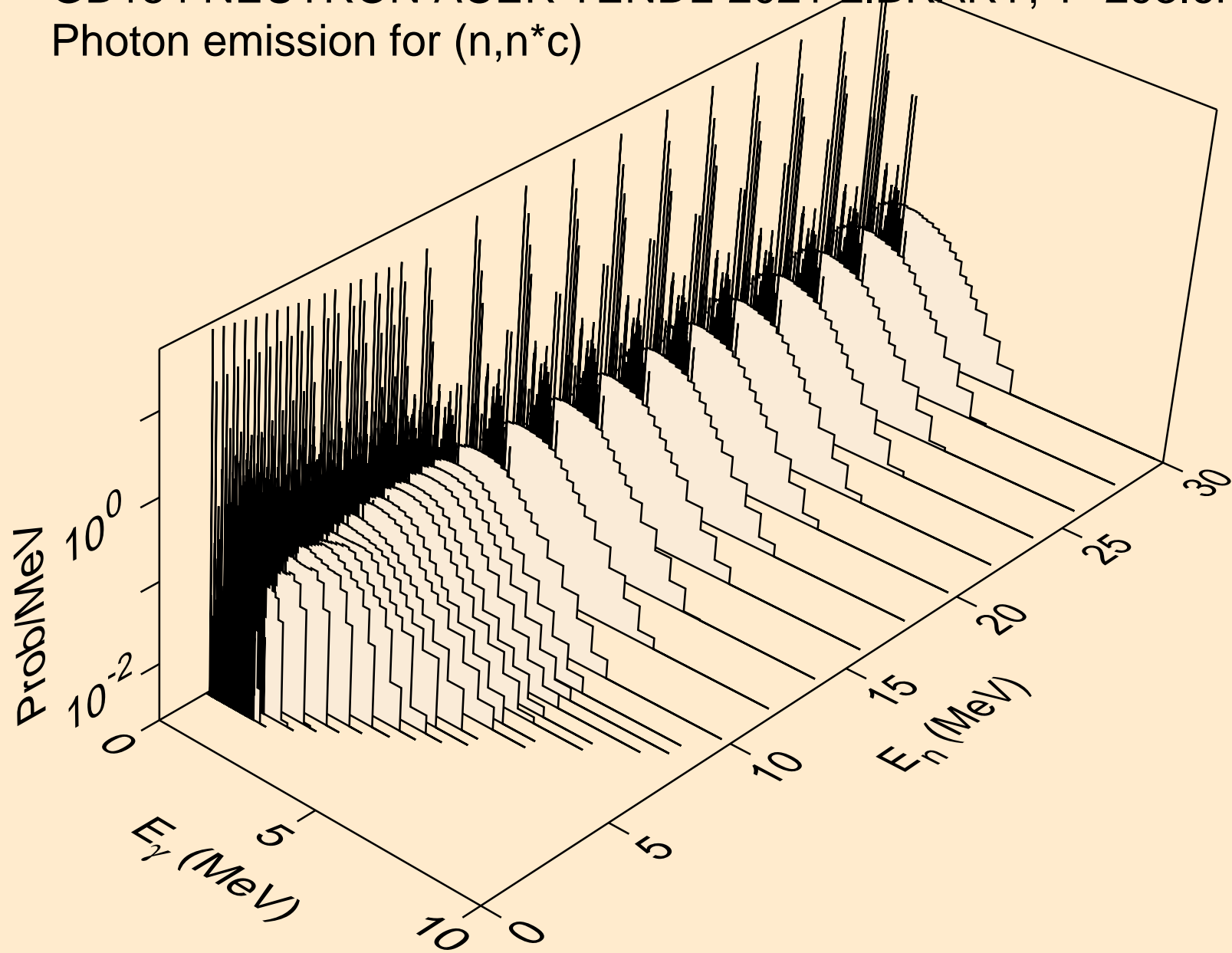

GD154 NEUTRON ACER TENDL-2021 LIBRARY; T=293.6K
Photon emission for (n,gma)

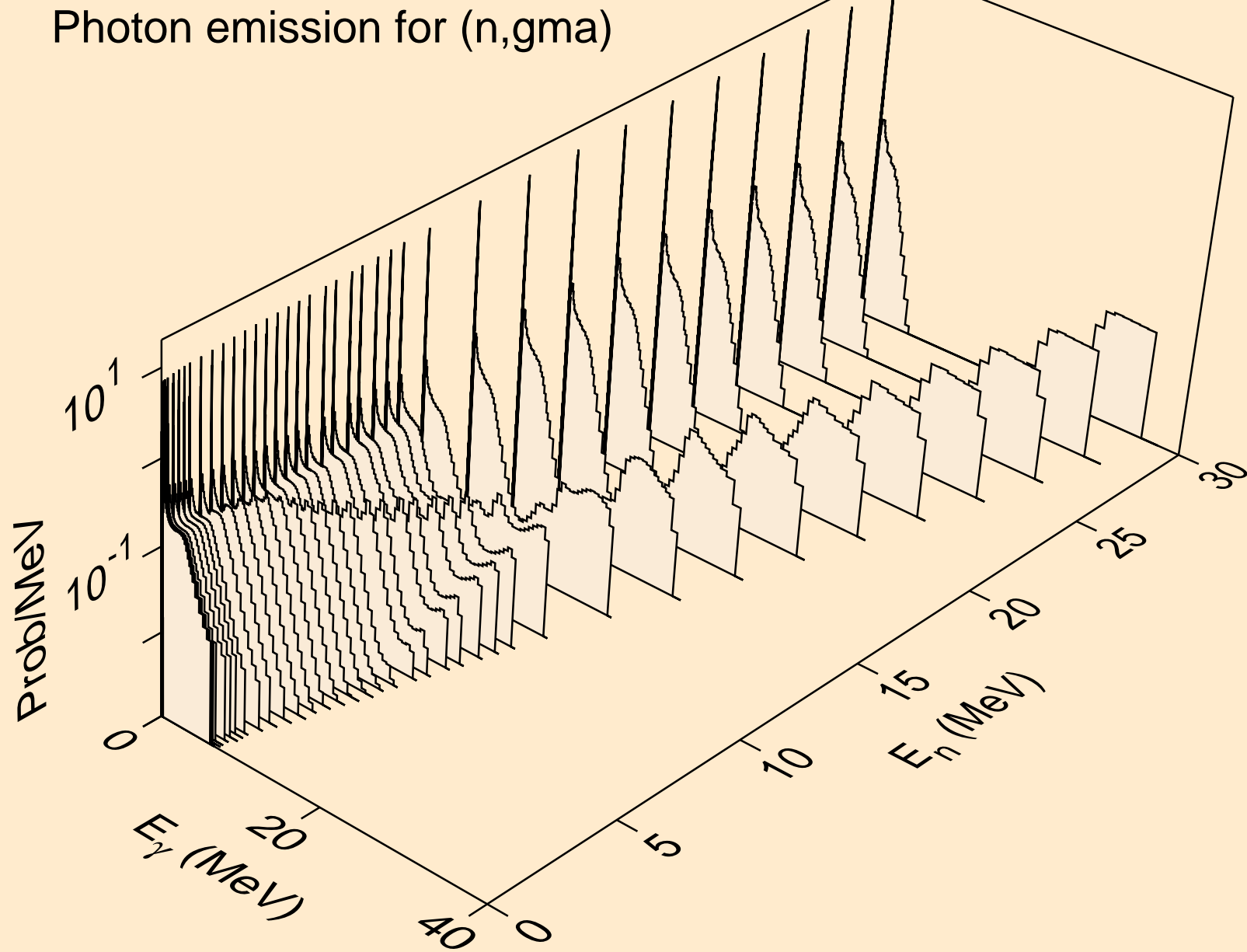

GD154 NEUTRON ACER TENDL-2021 LIBRARY; T=293.6K
Photon emission for (n,p)

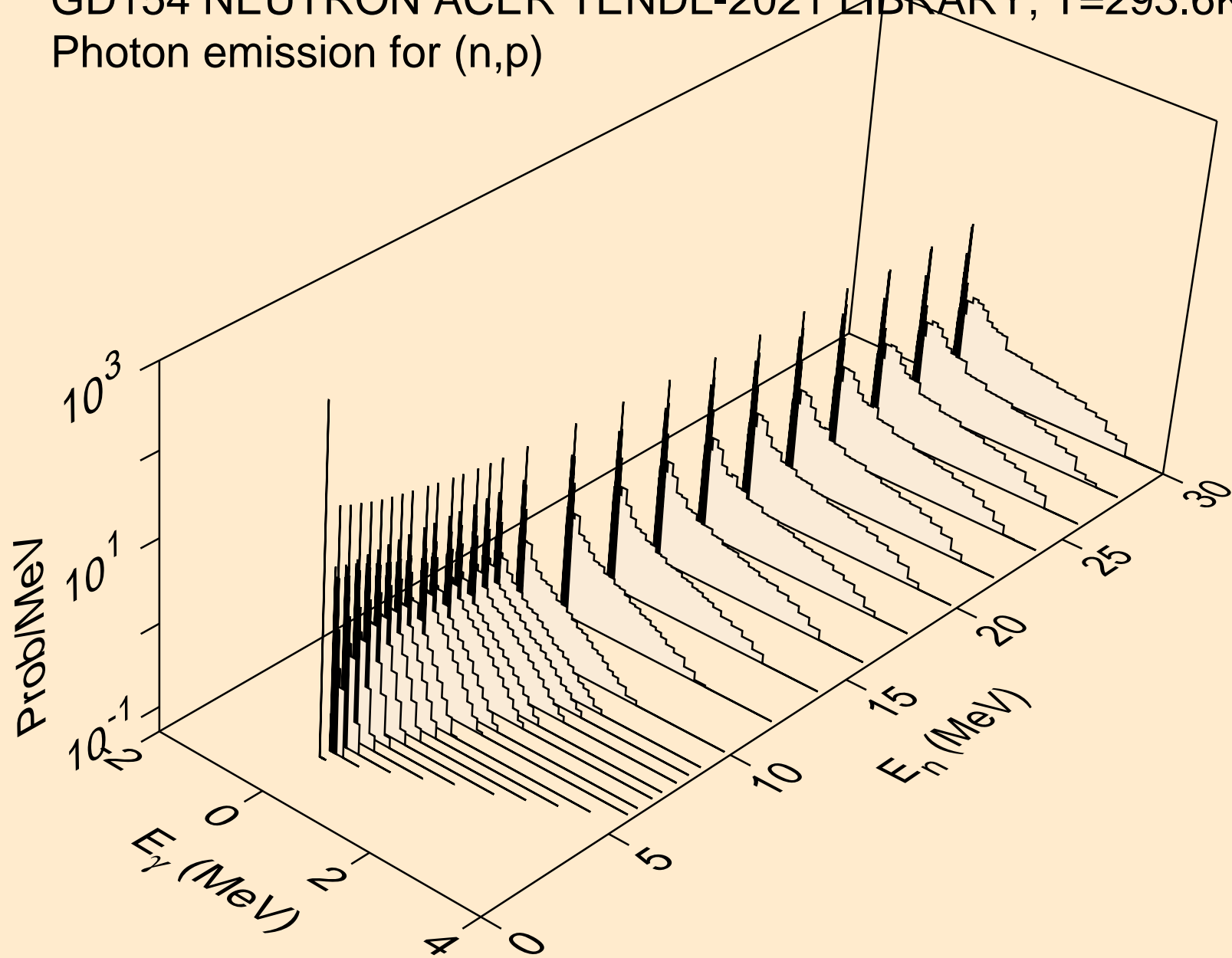

GD154 NEUTRON ACER TENDL-2021 LIBRARY; T=293.6K
Photon emission for (n,d)

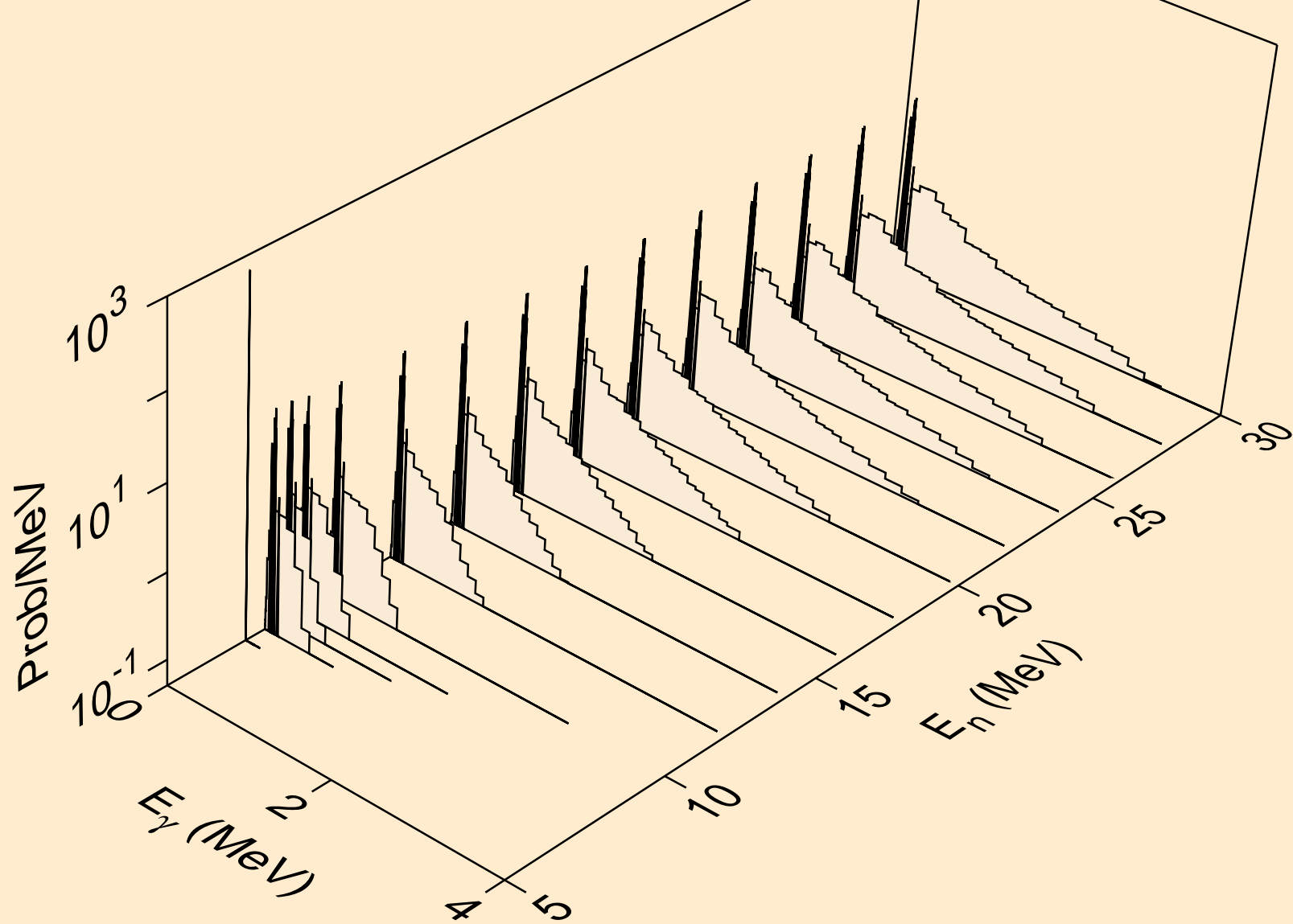

GD154 NEUTRON ACER TENDL-2021 LIBRARY; T=293.6K
Photon emission for (n,t)

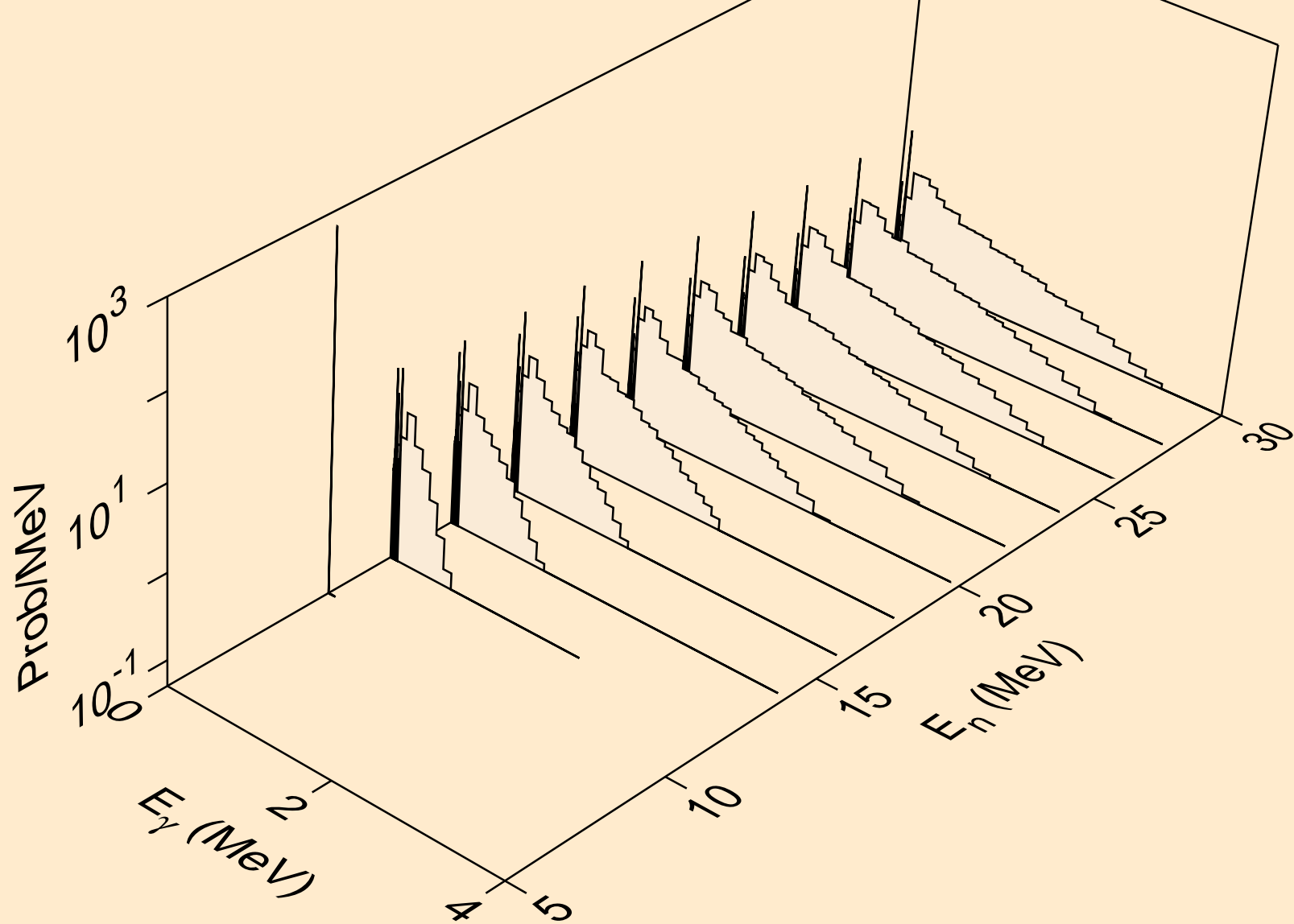

GD154 NEUTRON ACER TENDL-2021 LIBRARY; T=293.6K
Photon emission for (n,he3)

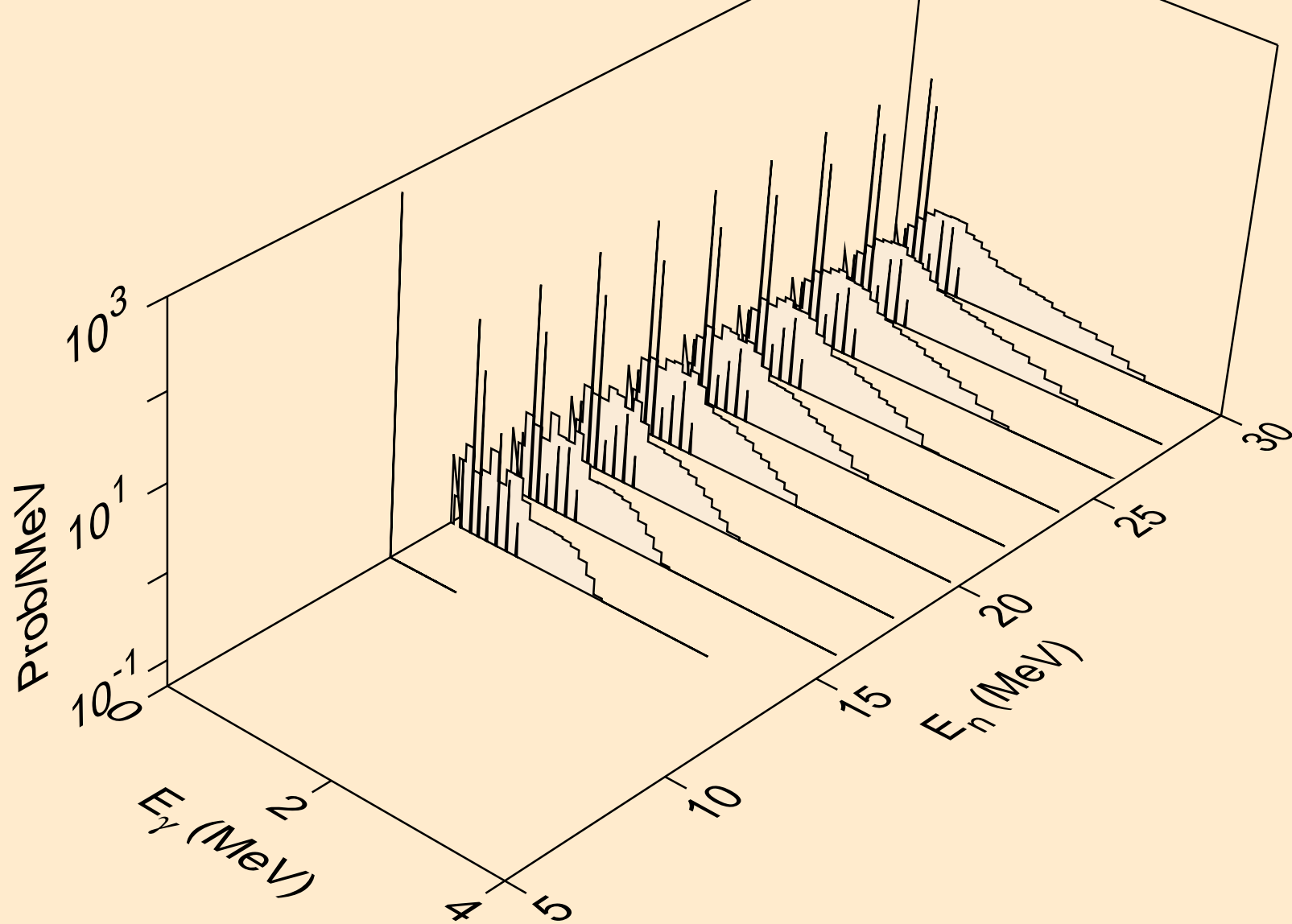

GD154 NEUTRON ACER TENDL-2021 LIBRARY; T=293.6K
Photon emission for (n,a)

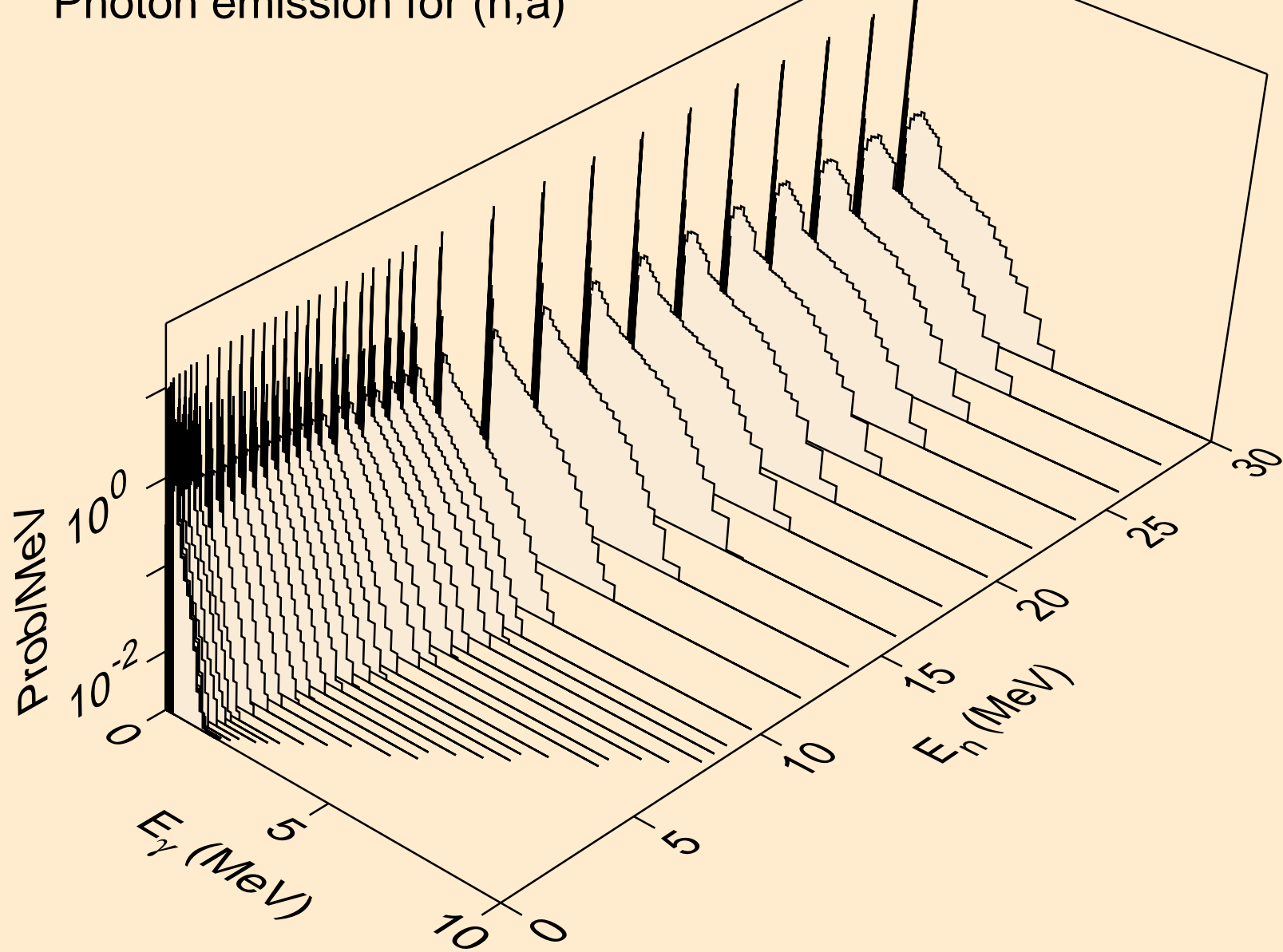

GD154 NEUTRON ACER TENDL-2021 LIBRARY; T=293.6K
Photon emission for (n,2a)

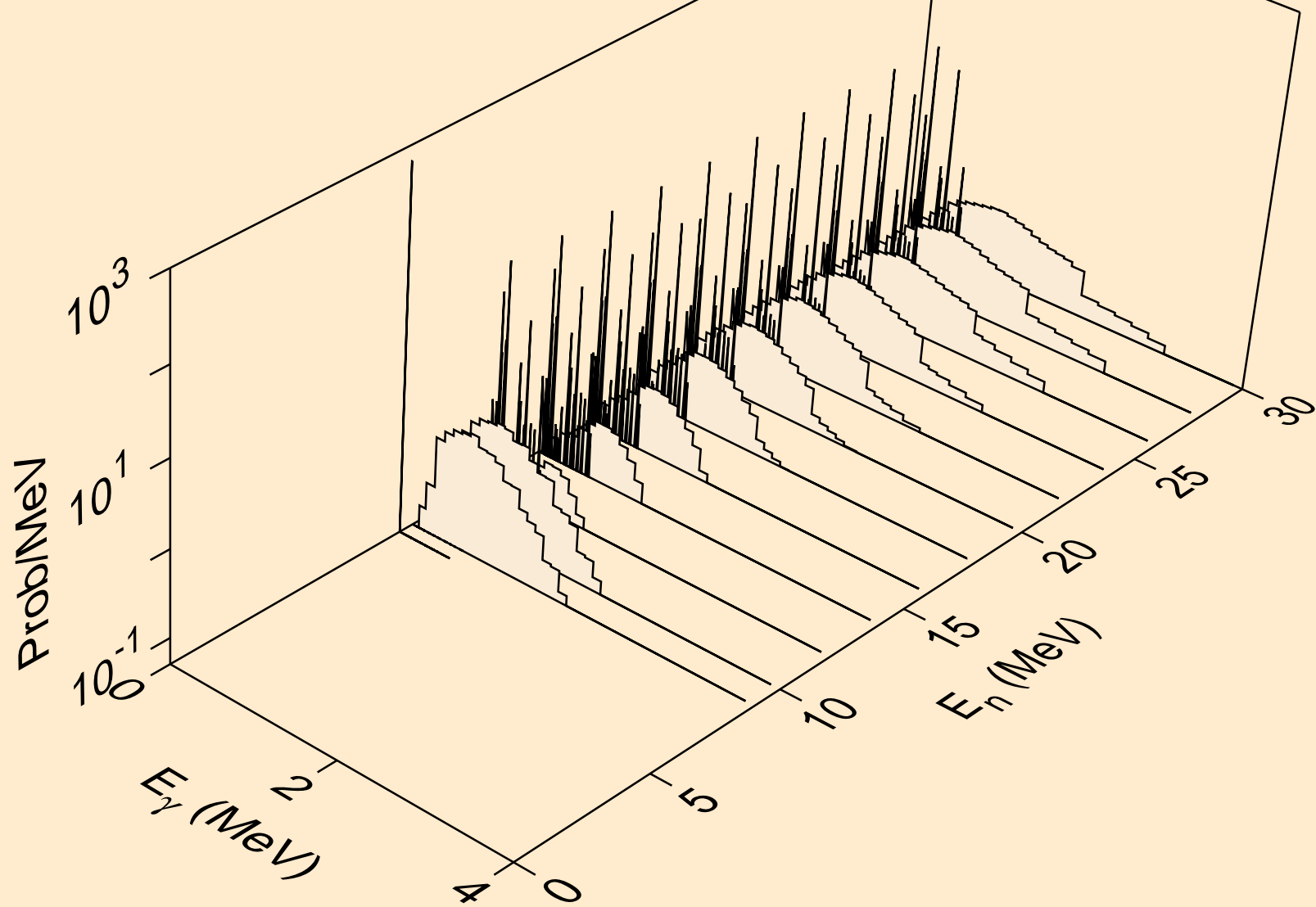

GD154 NEUTRON ACER TENDL-2021 LIBRARY; T=293.6K
Photon emission for (n,2p)

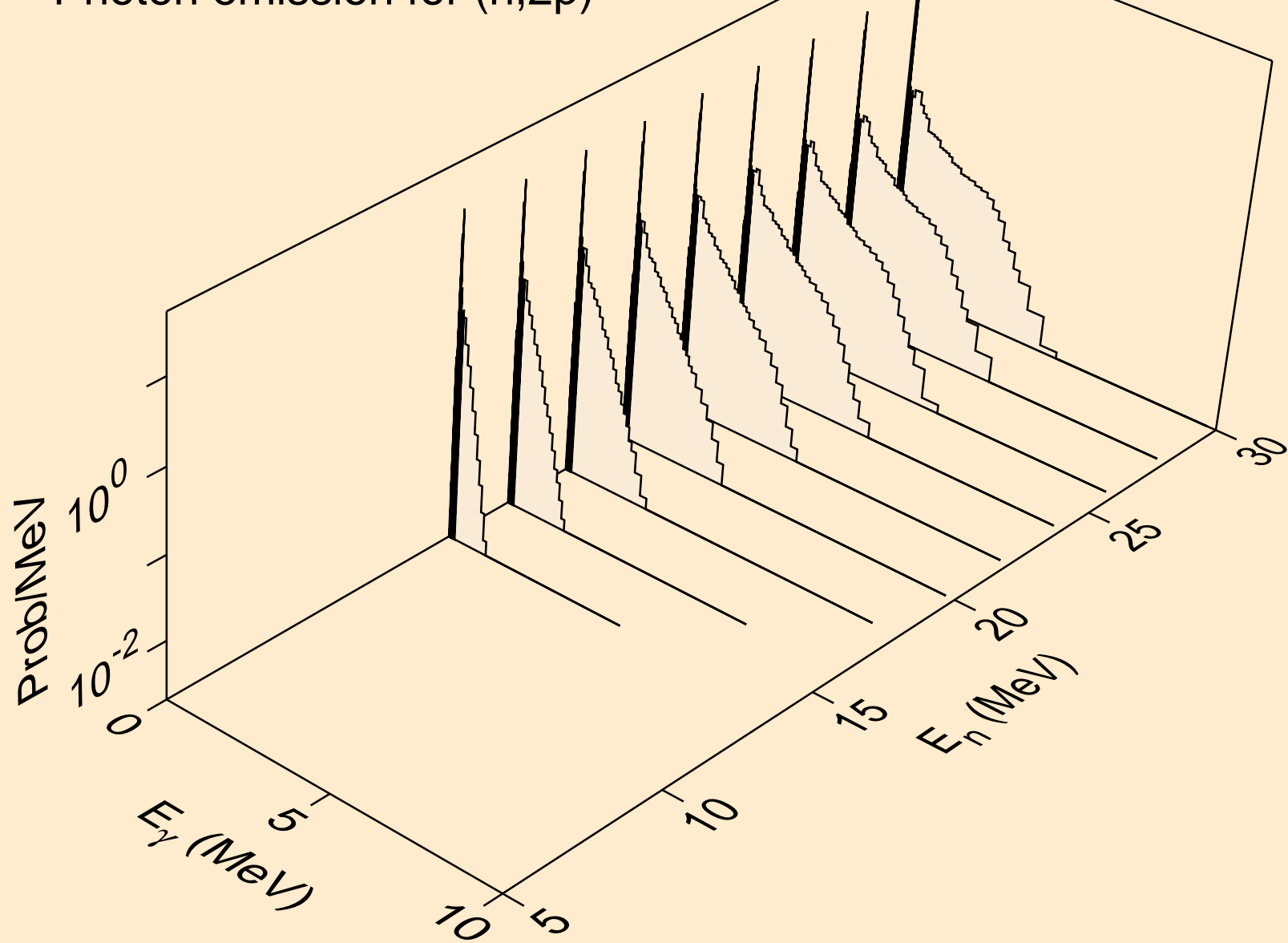

GD154 NEUTRON ACER TENDL-2021 LIBRARY; T=293.6K
Photon emission for (n,p α)

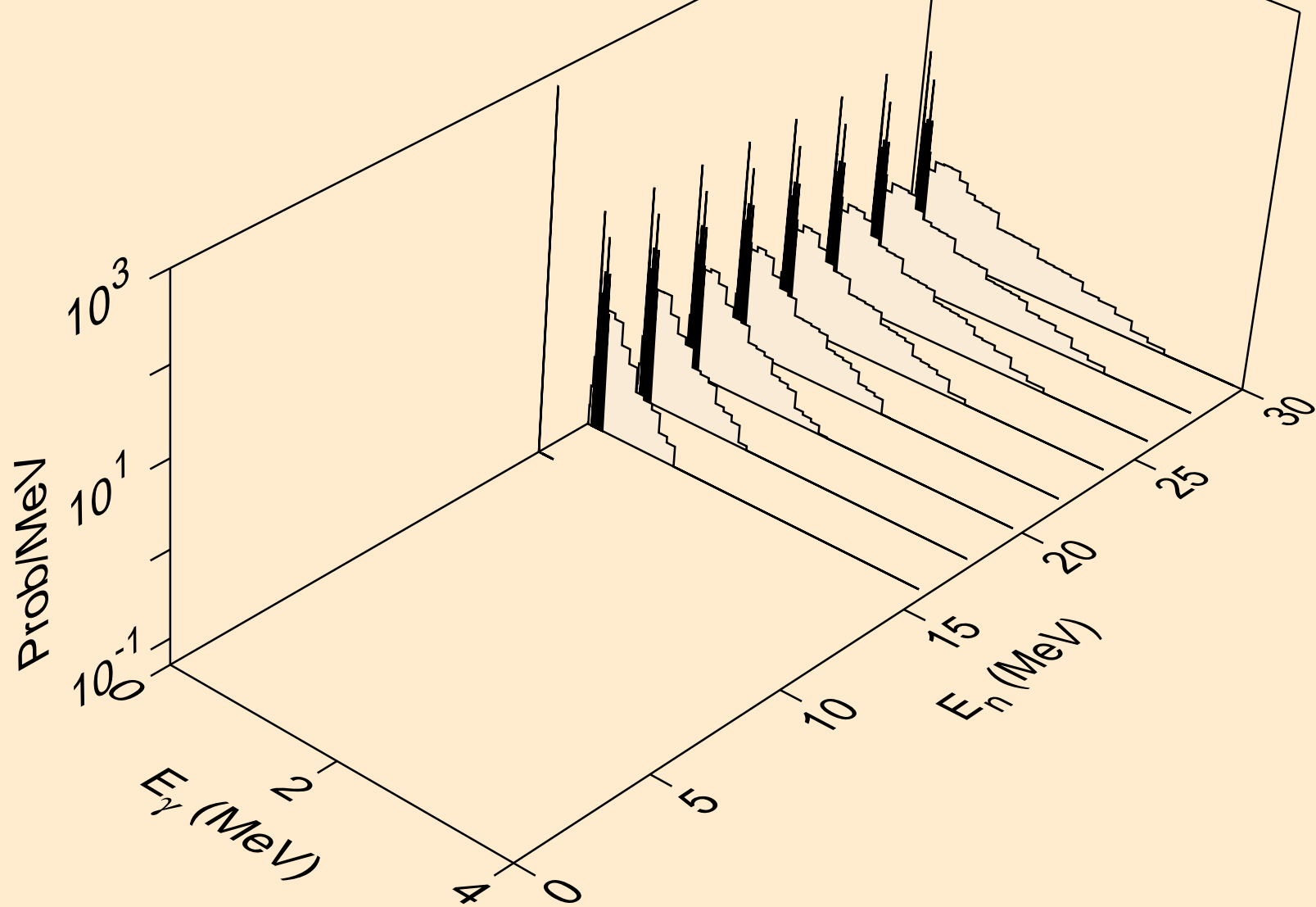

GD154 NEUTRON ACER TENDL-2021 LIBRARY; T=293.6K
Photon emission for (n,pd)

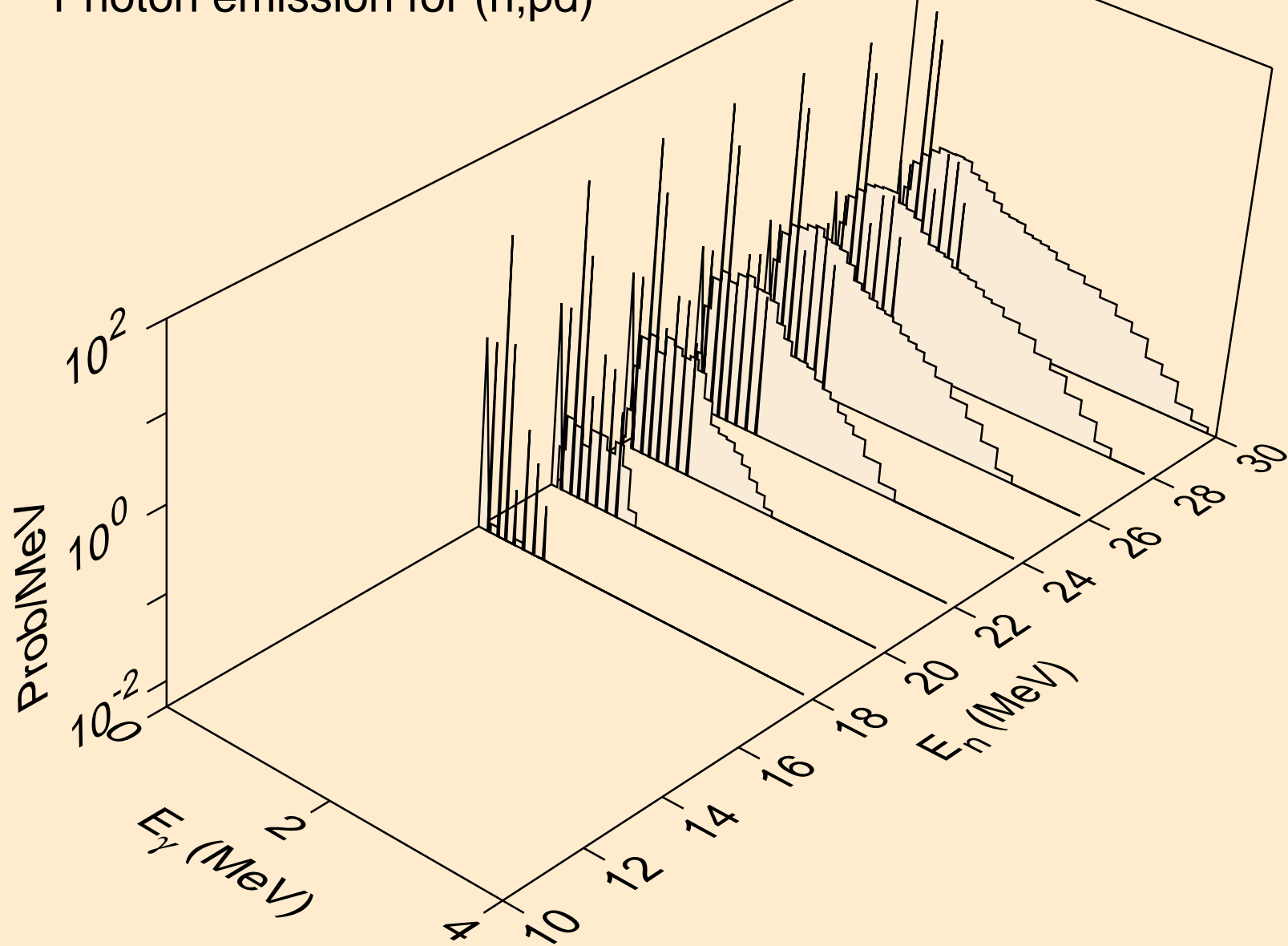

GD154 NEUTRON ACER TENDL-2021 LIBRARY; T=293.6K
Photon emission for (n,pt)

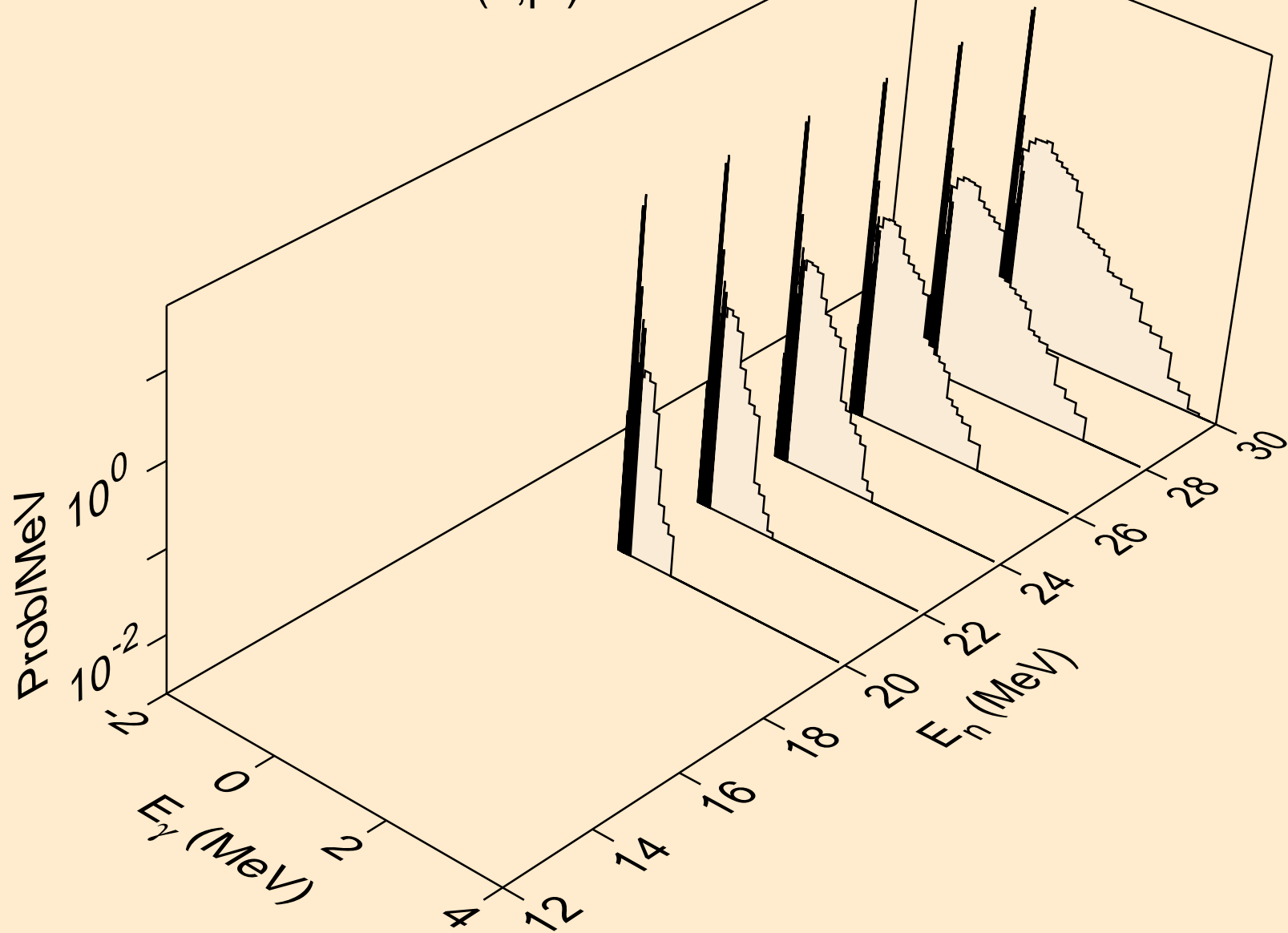

GD154 NEUTRON ACER TENDL-2021 LIBRARY; T=293.6K
Photon emission for (n,da)

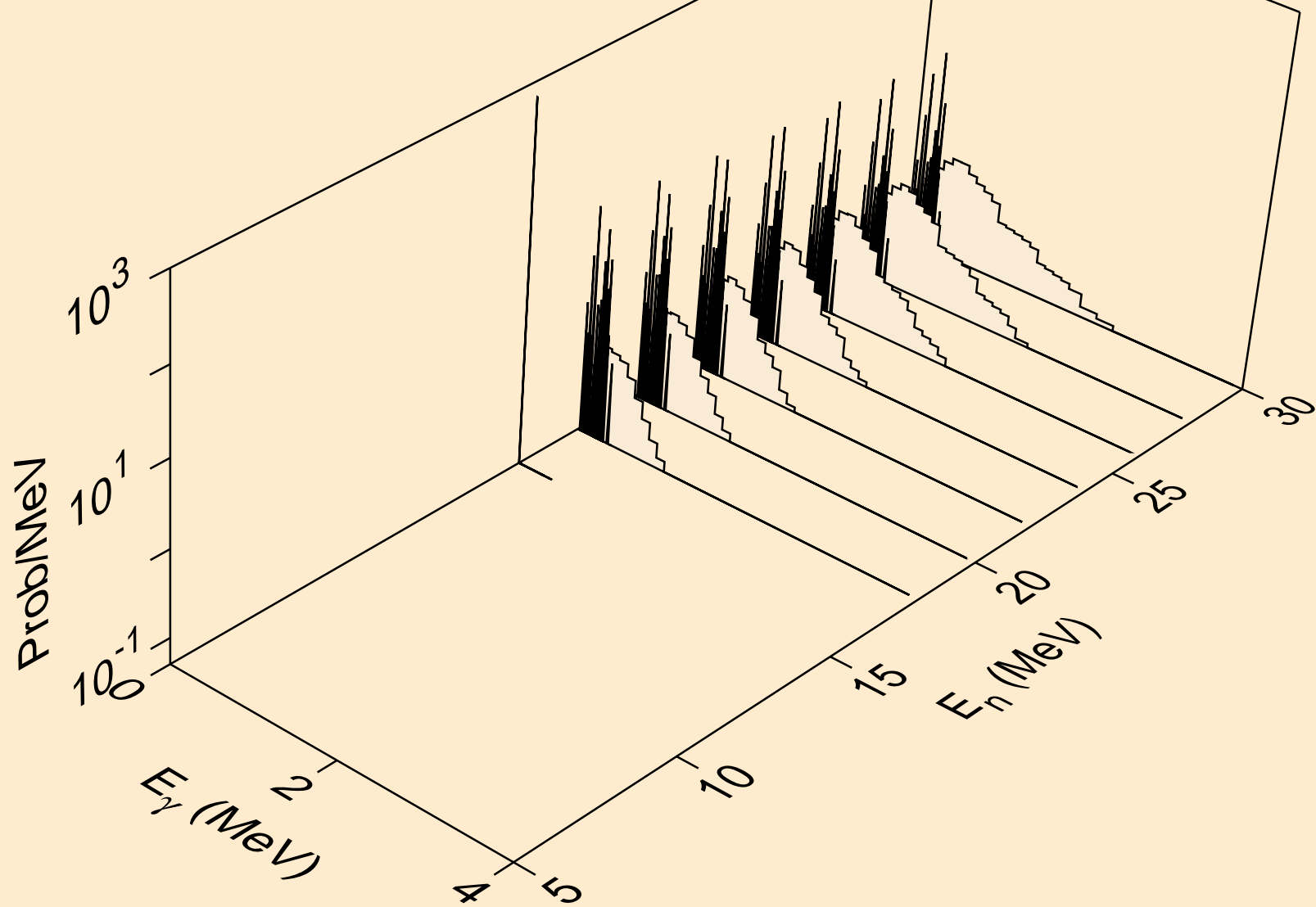

GD154 NEUTRON ACER TENDL-2021 LIBRARY; T=293.6K
thermal capture photon spectrum

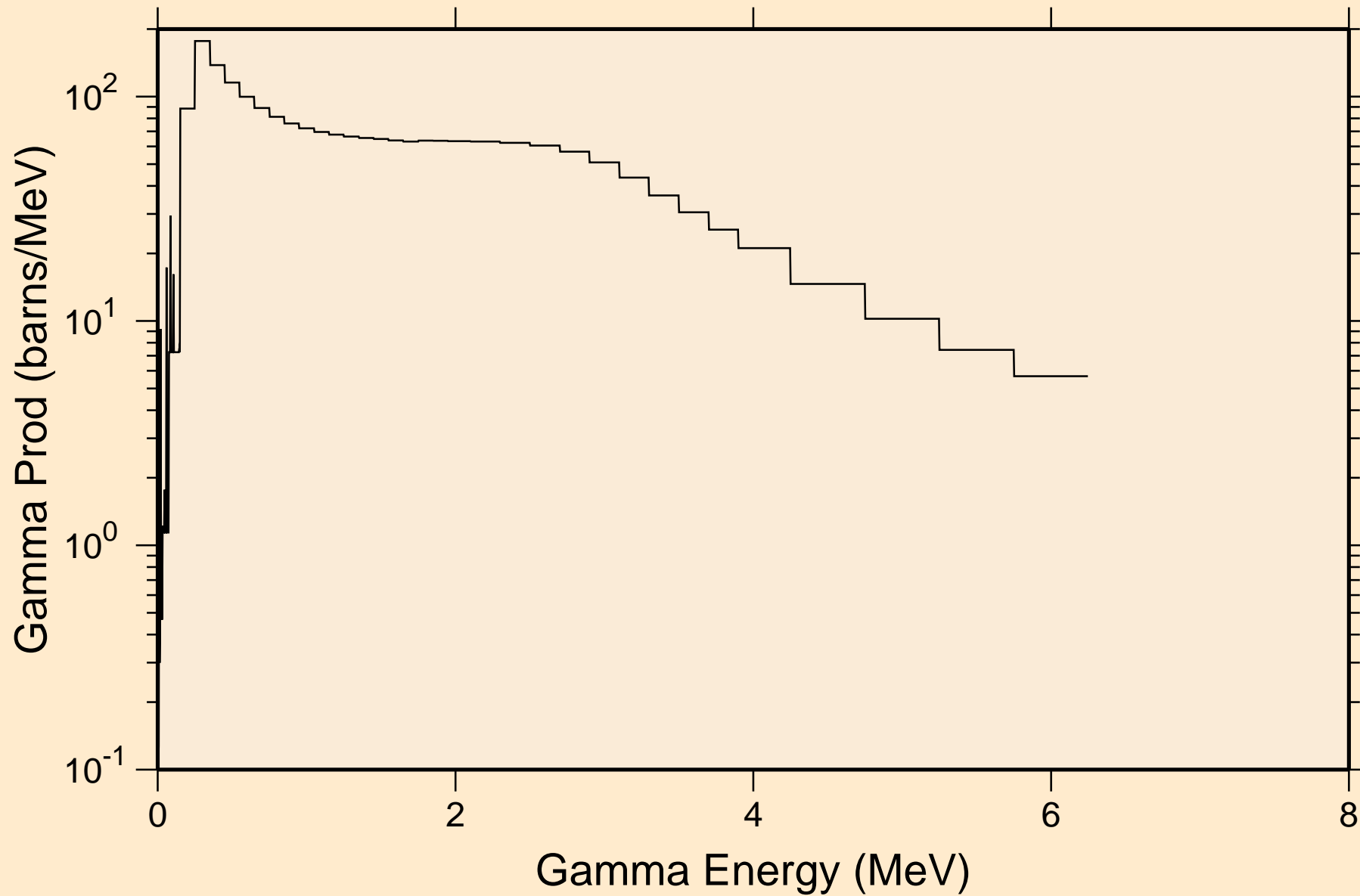

GD154 NEUTRON ACER TENDL-2021 LIBRARY; T=293.6K
14 MeV photon spectrum

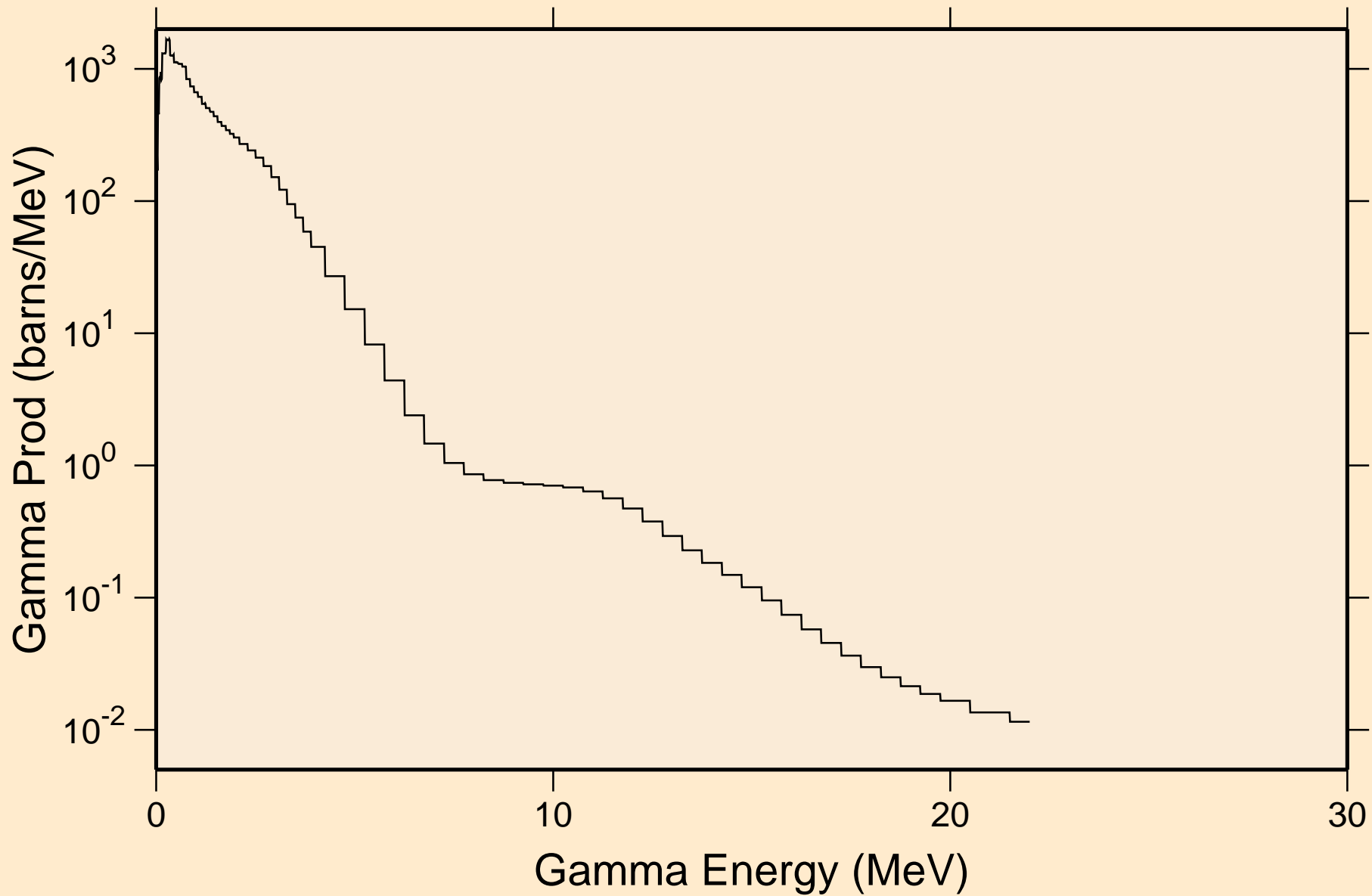

GD154 NEUTRON ACER TENDL-2021 LIBRARY; T=293.6K

Particle heating contributions

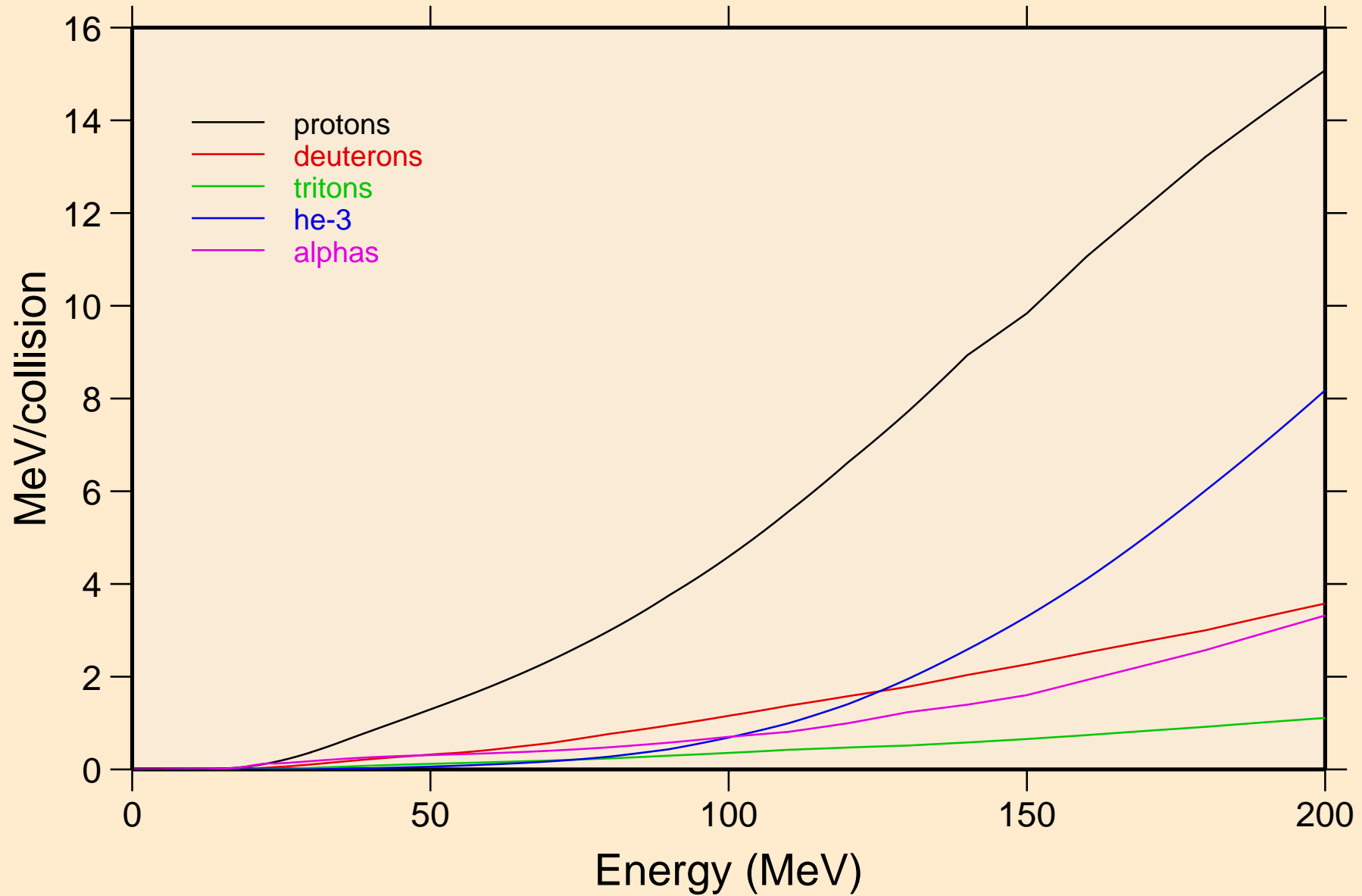

GD154 NEUTRON ACER TENDL-2021 LIBRARY; T=293.6K
Recoil Heating

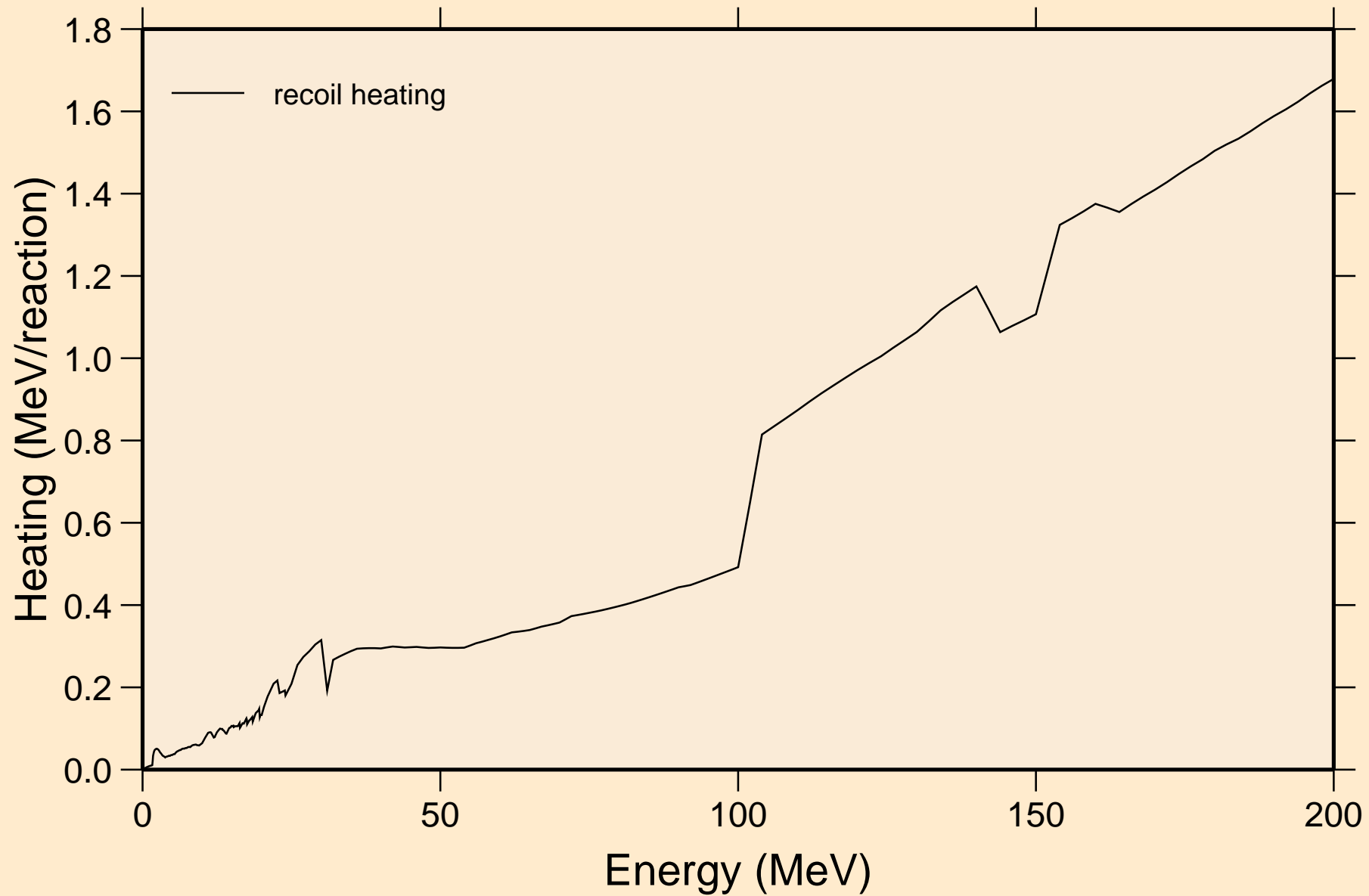

GD154 NEUTRON ACER TENDL-2021 LIBRARY; T=293.6K
Particle production cross sections

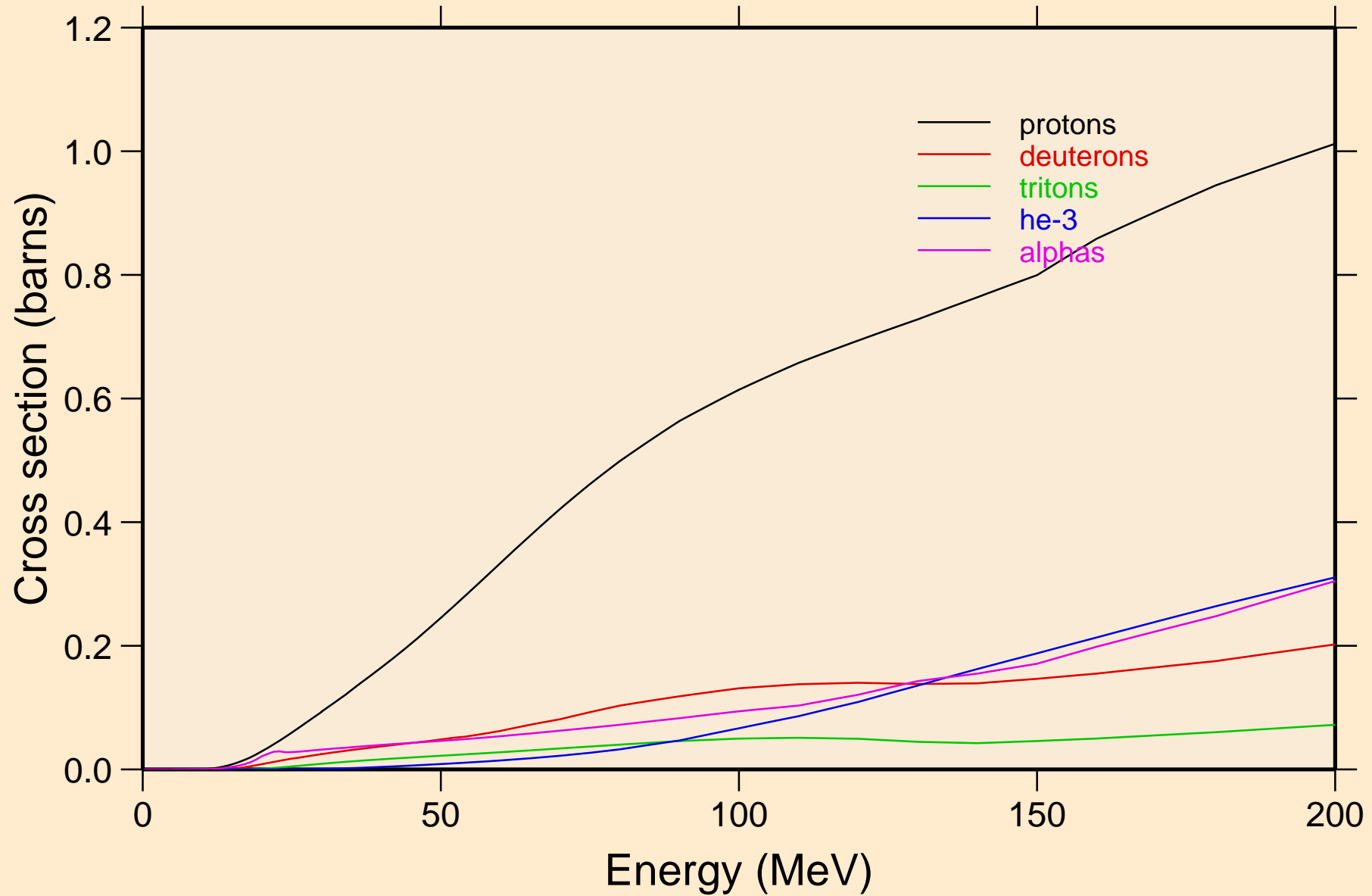

GD154 NEUTRON ACER TENDL-2021 LIBRARY; T=293.6K
protons from (n,x)

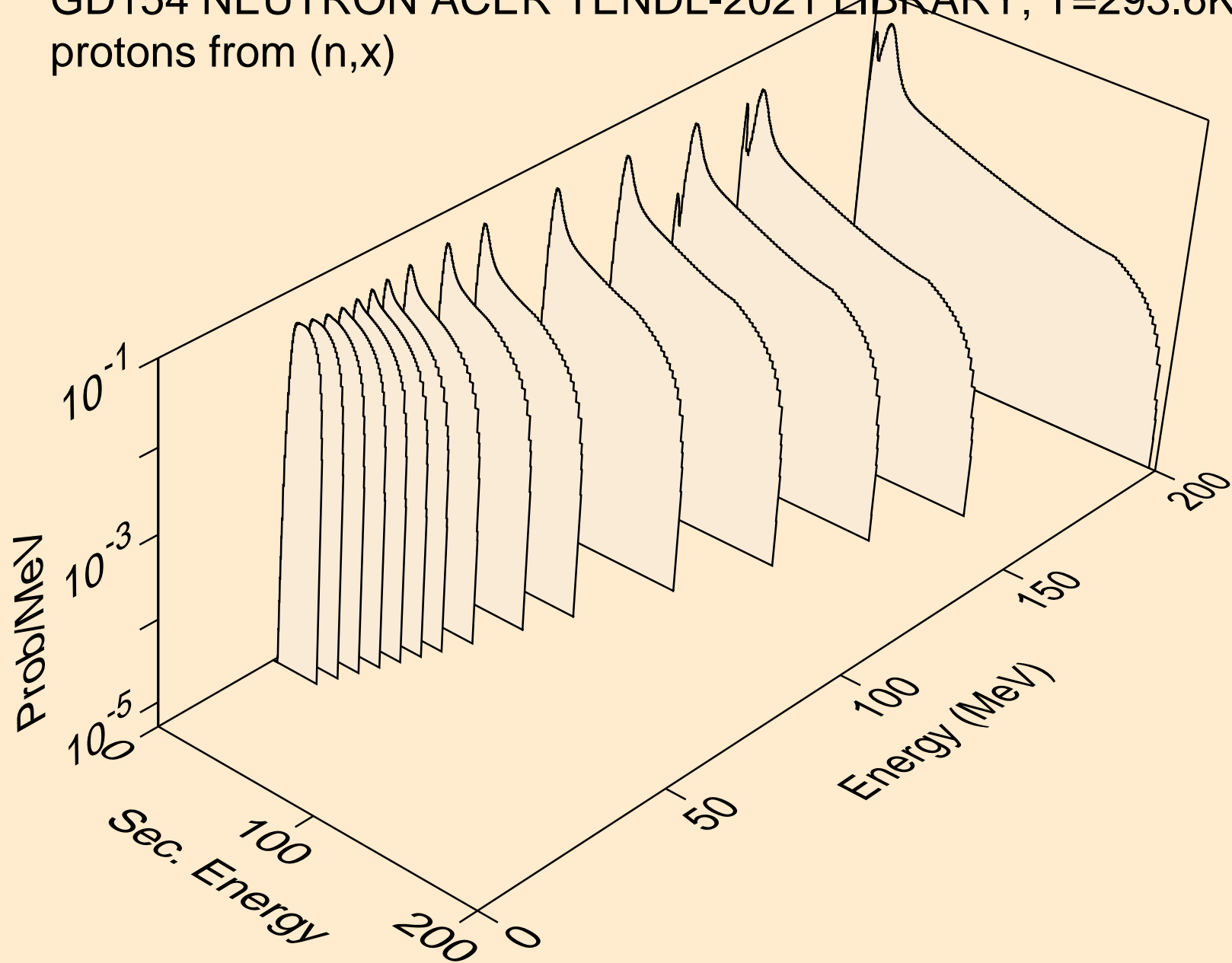

GD154 NEUTRON ACER TENDL-2021 LIBRARY; T=293.6K
protons from (n,n*)p

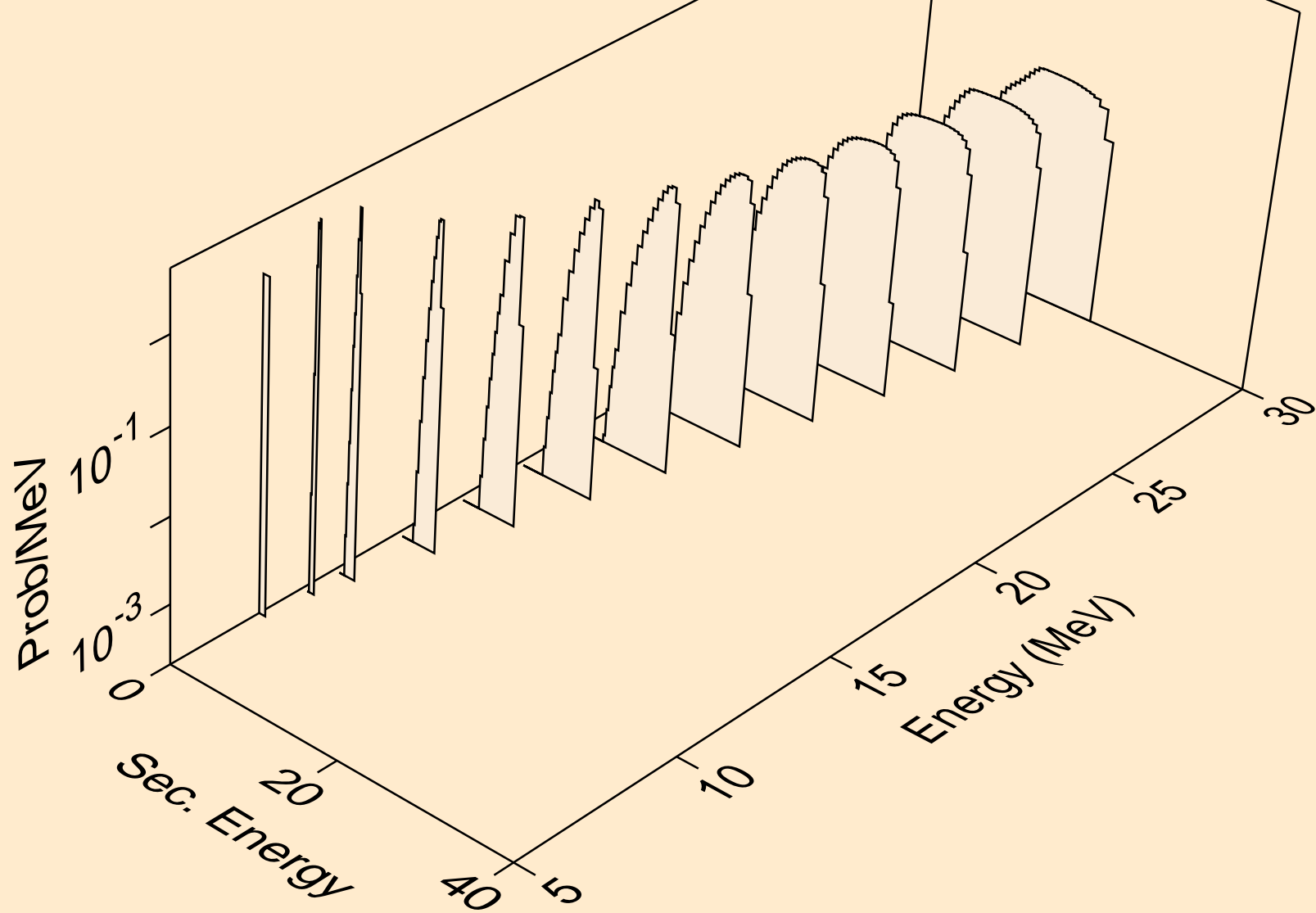

GD154 NEUTRON ACER TENDL-2021 LIBRARY; T=293.6K
protons from (n,2np)

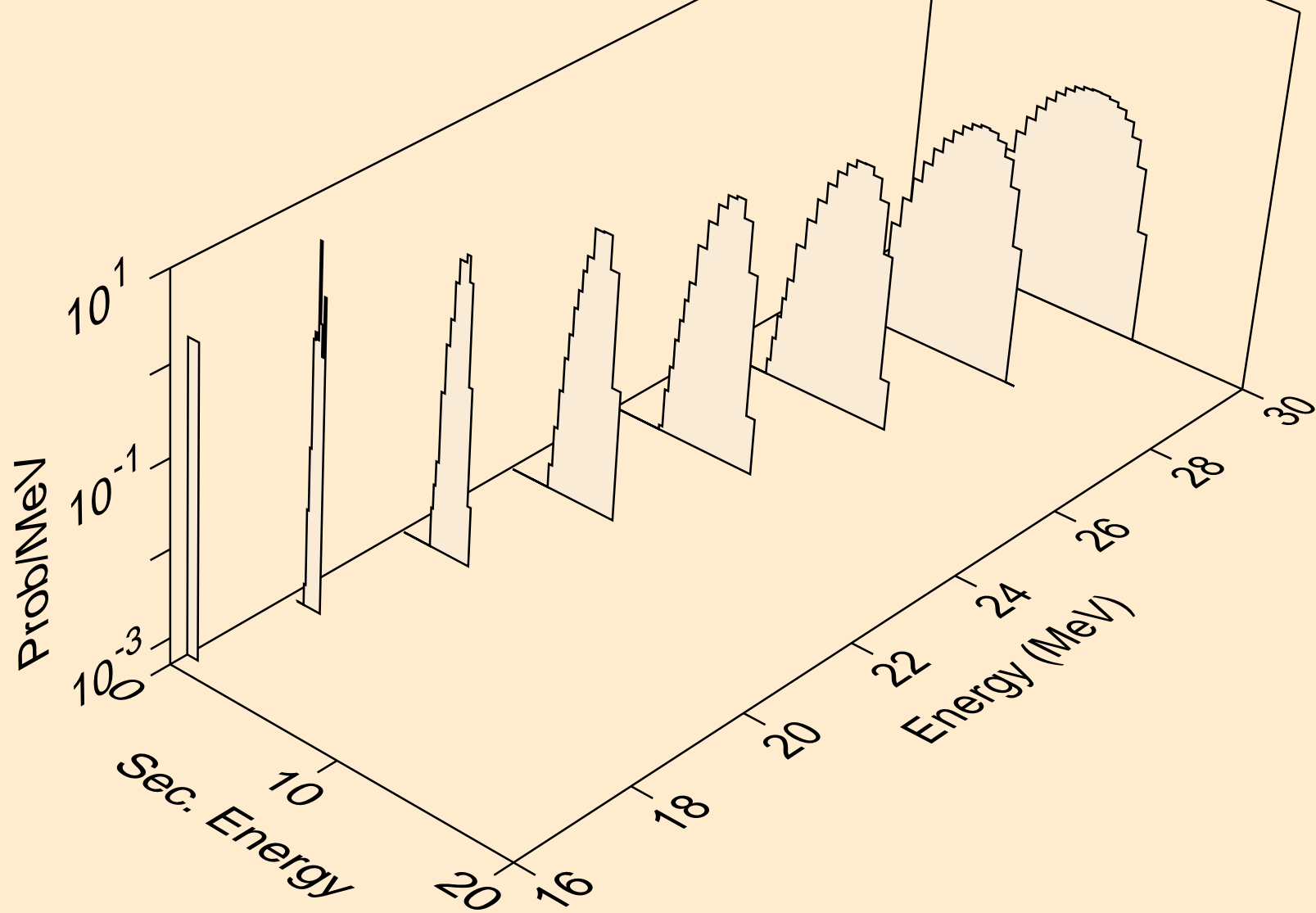

GD154 NEUTRON ACER TENDL-2021 LIBRARY; T=293.6K
protons from (n,3np)

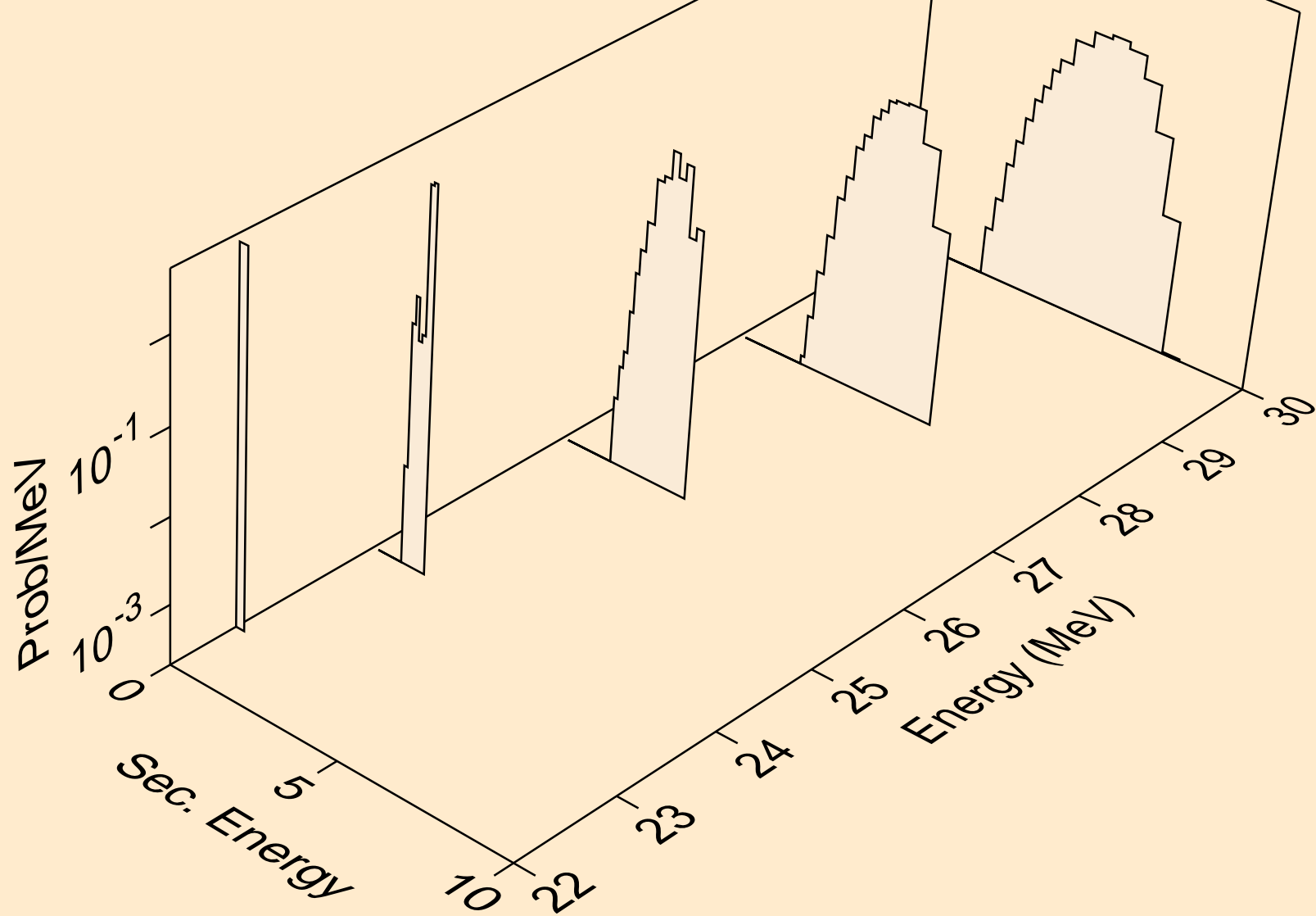

GD154 NEUTRON ACER TENDL-2021 LIBRARY; T=293.6K
protons from (n,2np)

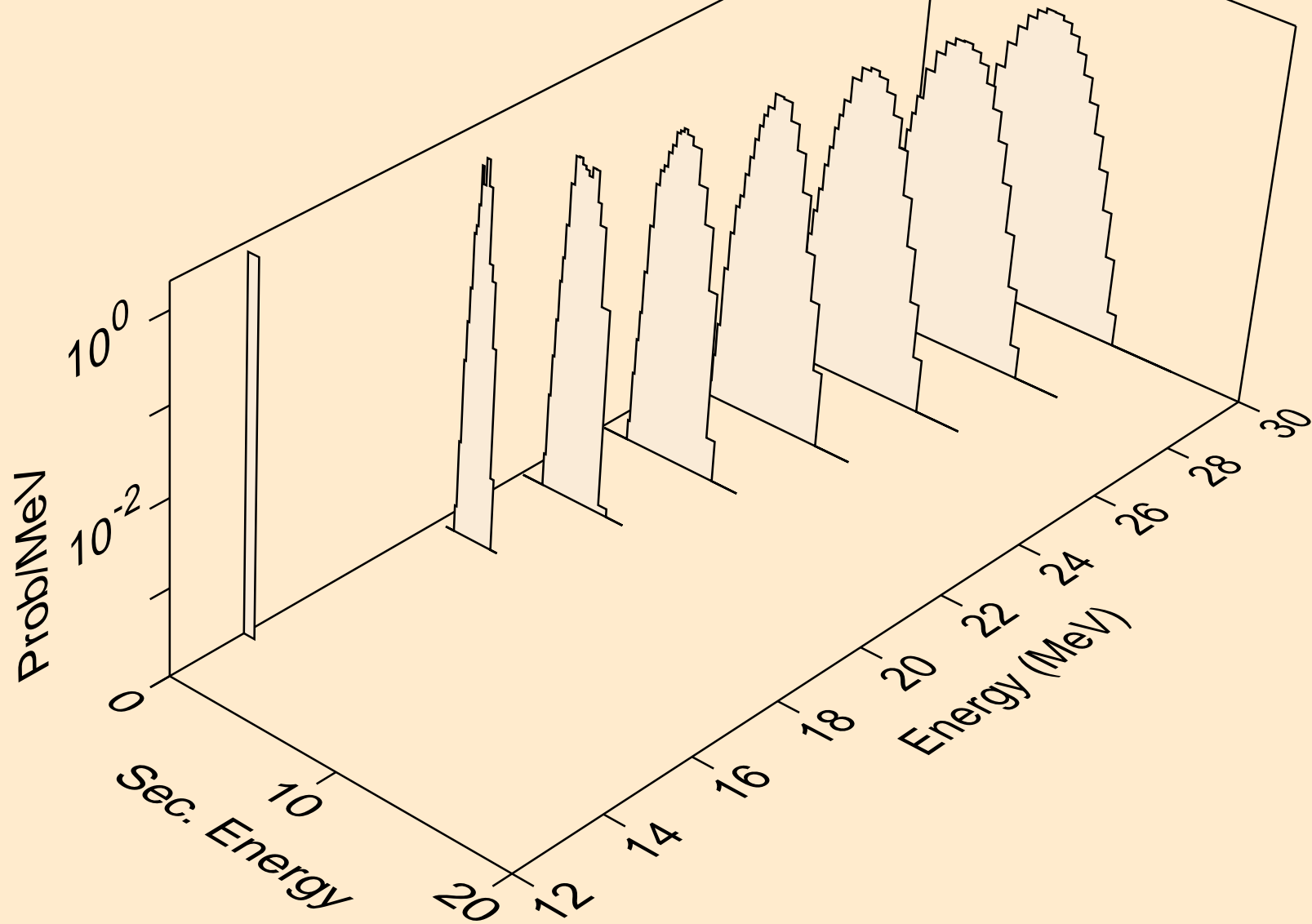

GD154 NEUTRON ACER TENDL-2021 LIBRARY; T=293.6K
protons from (n,npa)

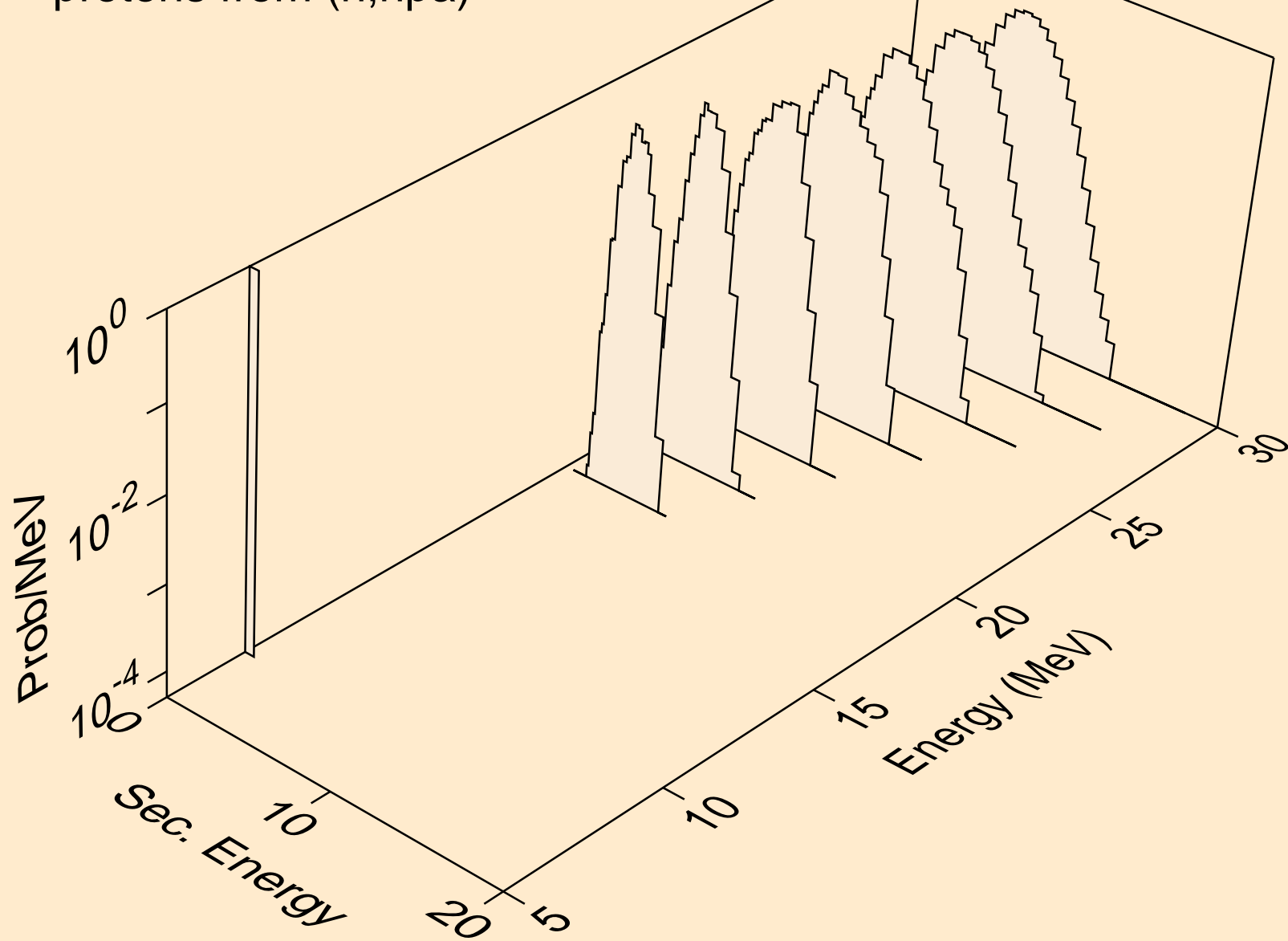

GD154 NEUTRON ACER TENDL-2021 LIBRARY; T=293.6K
protons from (n,p)

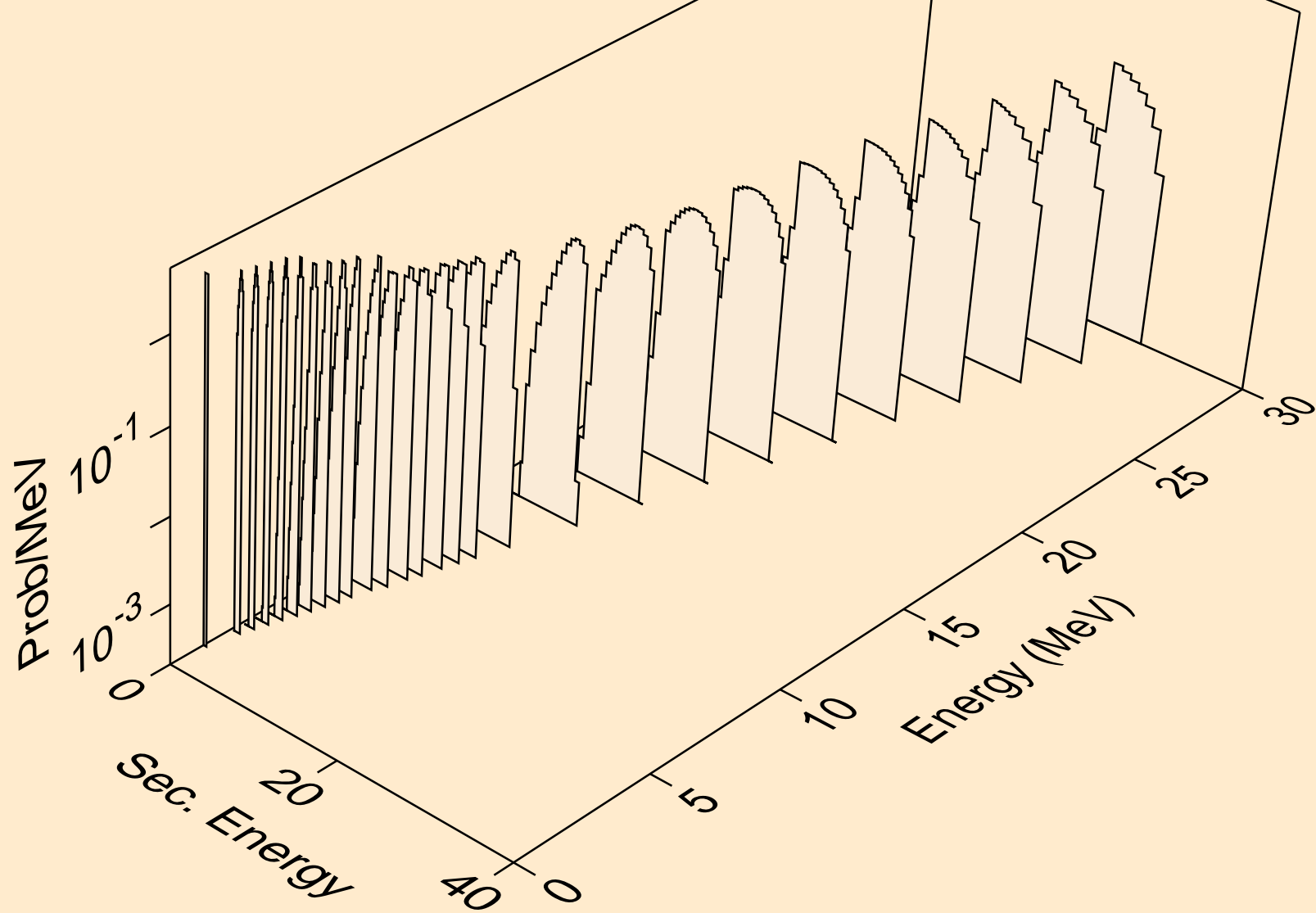

GD154 NEUTRON ACER TENDL-2021 LIBRARY; T=293.6K
protons from (n,2p)

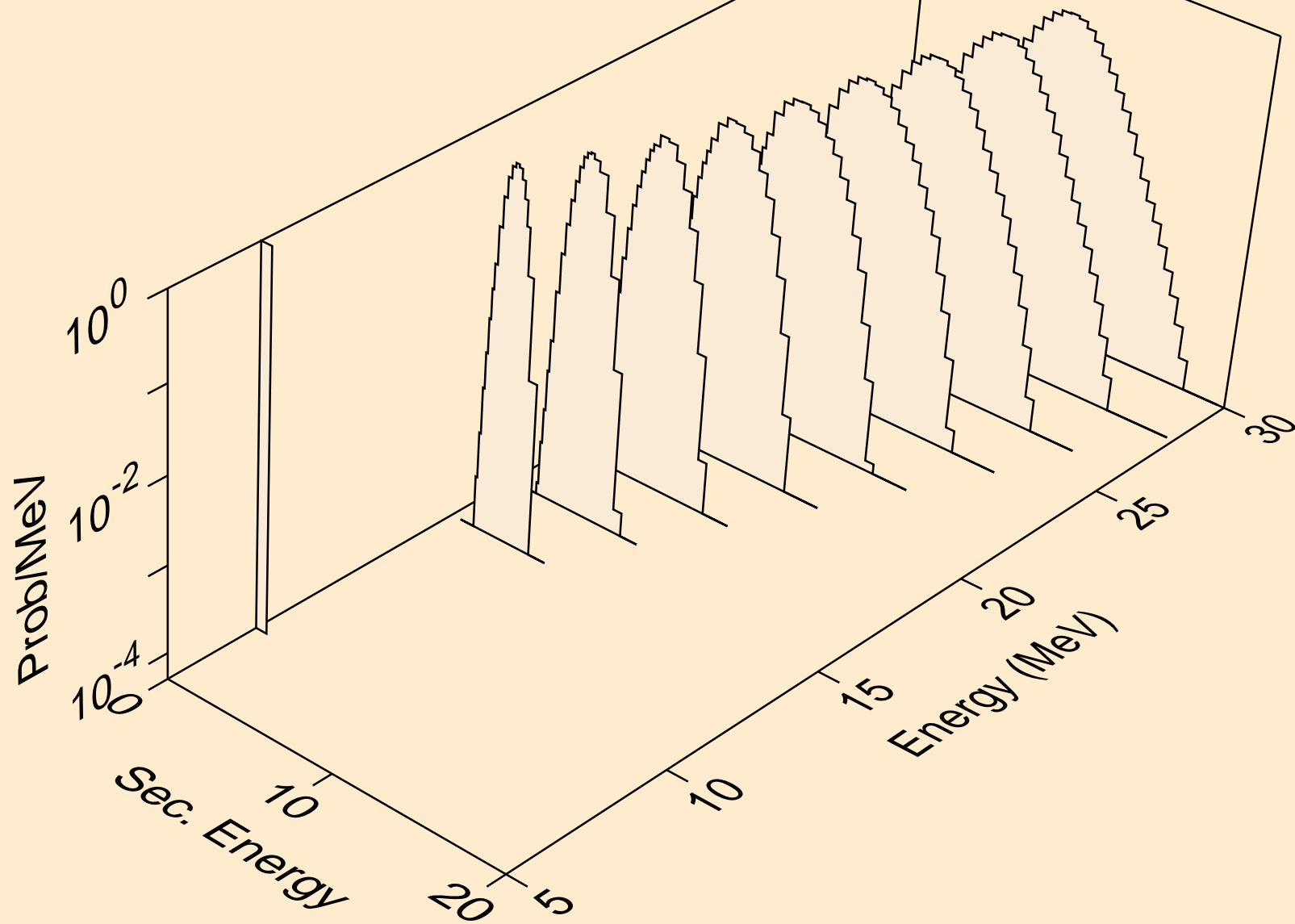

GD154 NEUTRON ACER TENDL-2021 LIBRARY; T=293.6K
protons from (n,p)

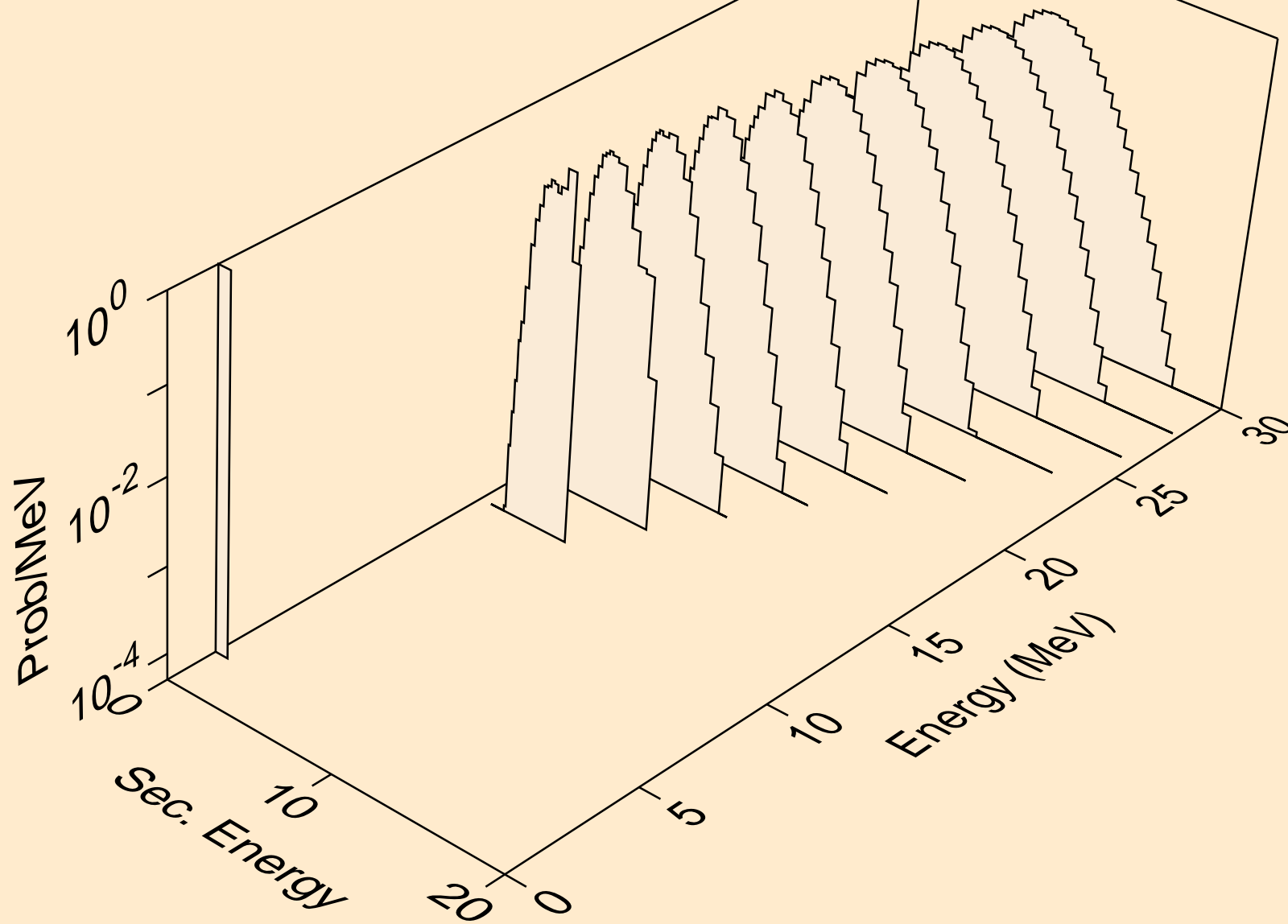

GD154 NEUTRON ACER TENDL-2021 LIBRARY; T=293.6K
protons from (n,pd)

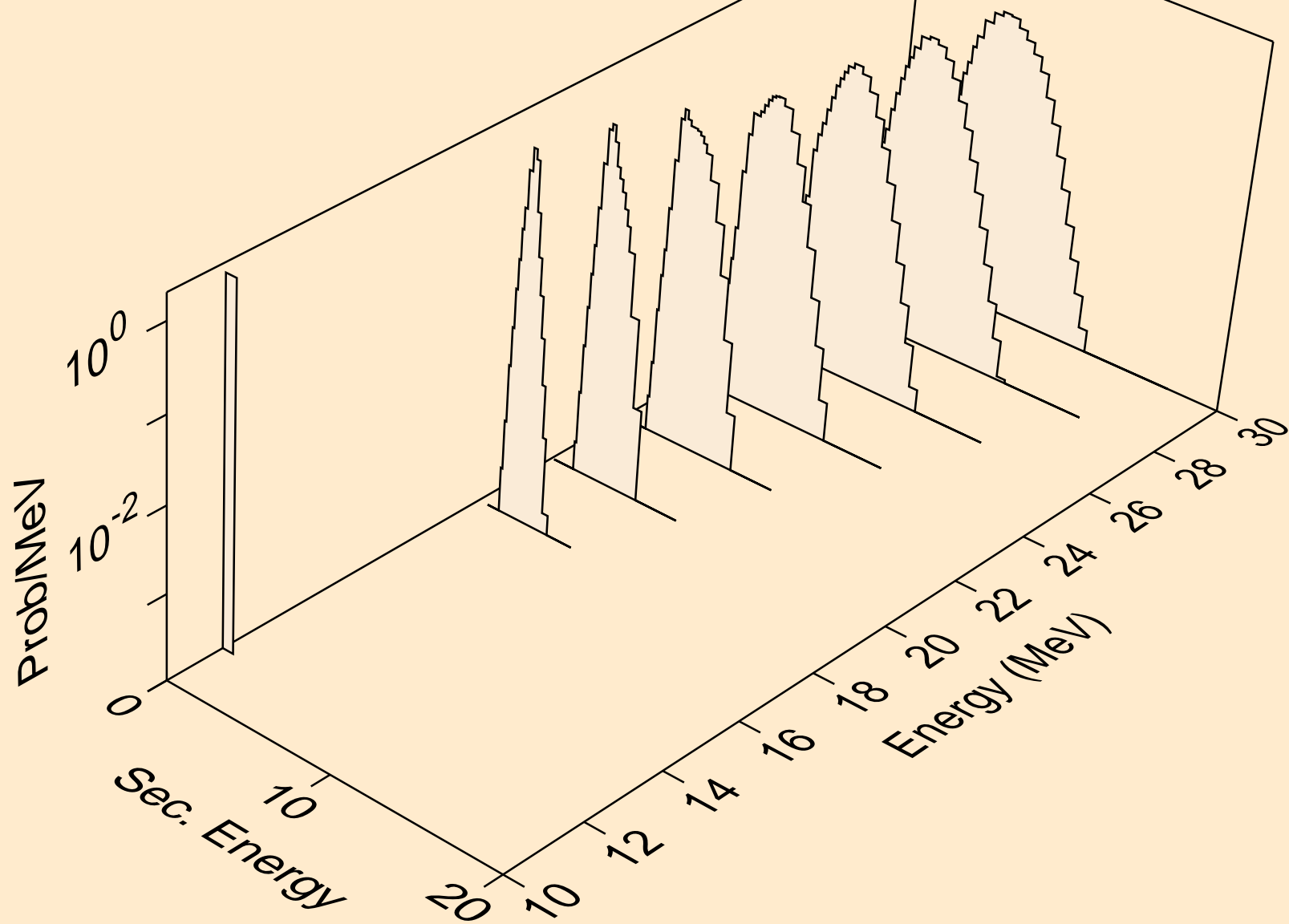

GD154 NEUTRON ACER TENDL-2021 LIBRARY; T=293.6K
protons from (n,pt)

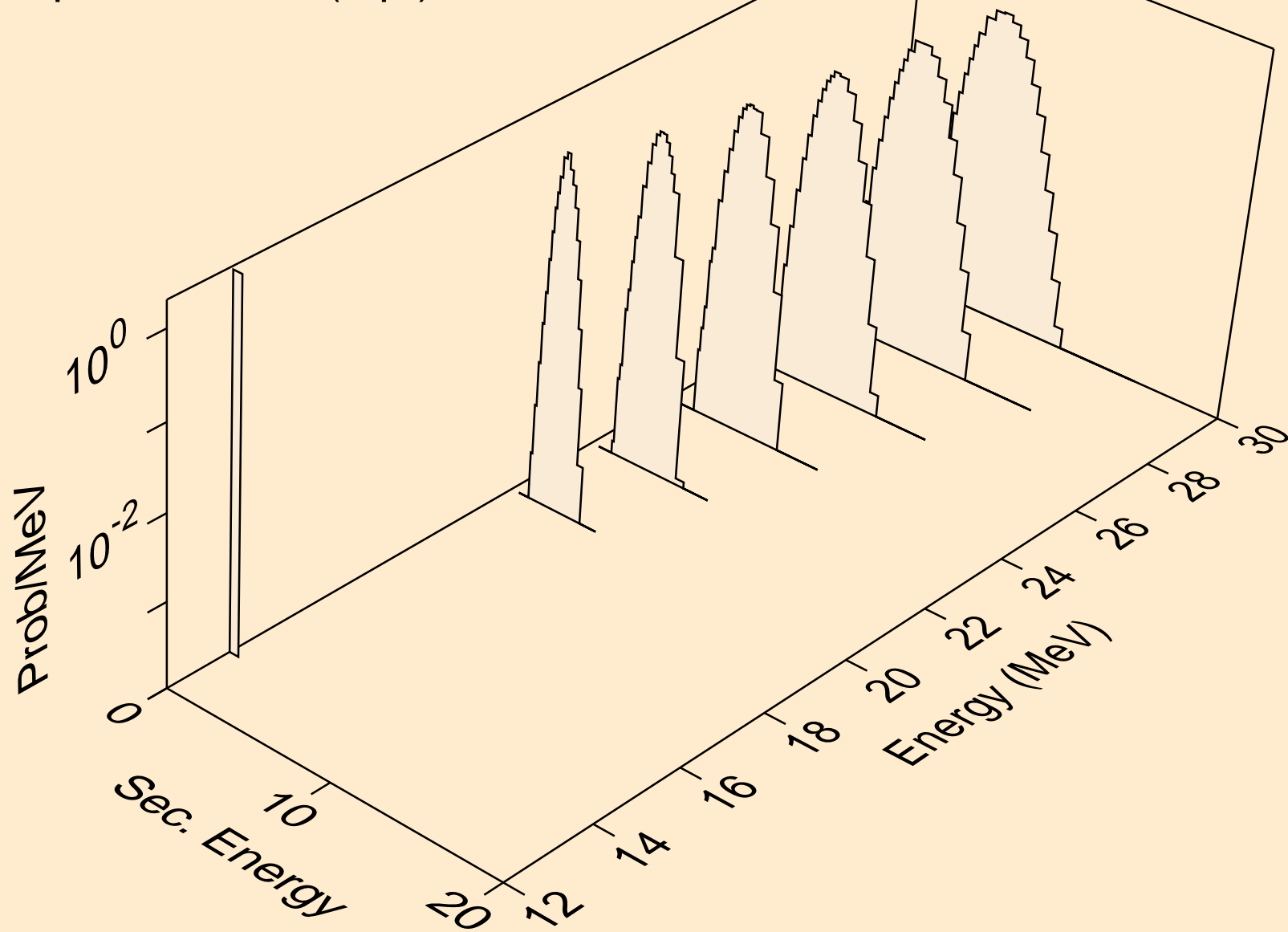

GD154 NEUTRON ACER TENDL-2021 LIBRARY; T=293.6K
deuterons from (n,x)

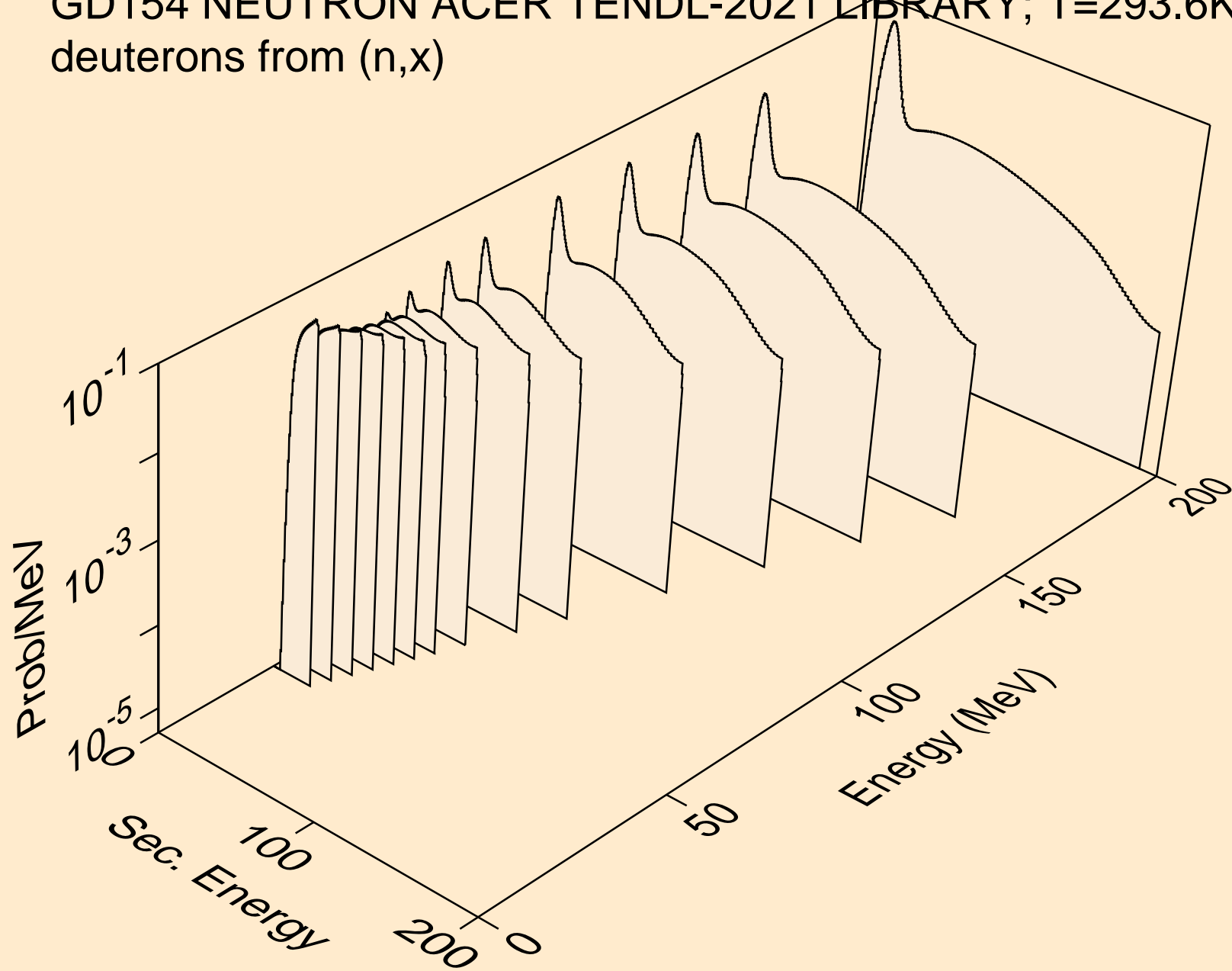

GD154 NEUTRON ACER TENDL-2021 LIBRARY; T=293.6K
deuterons from (n,2nd)

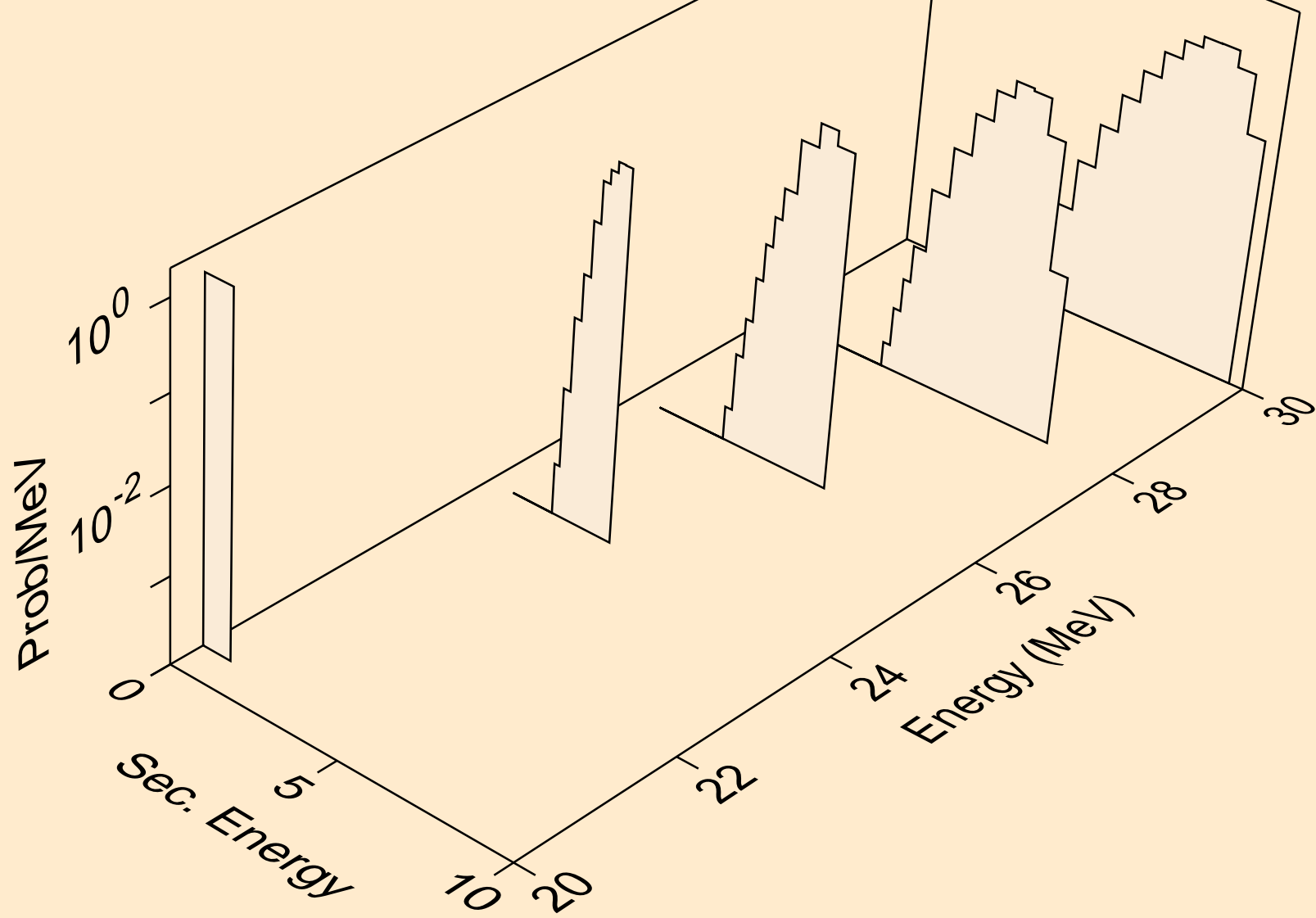

GD154 NEUTRON ACER TENDL-2021 LIBRARY; T=293.6K
deuterons from (n,n*)d

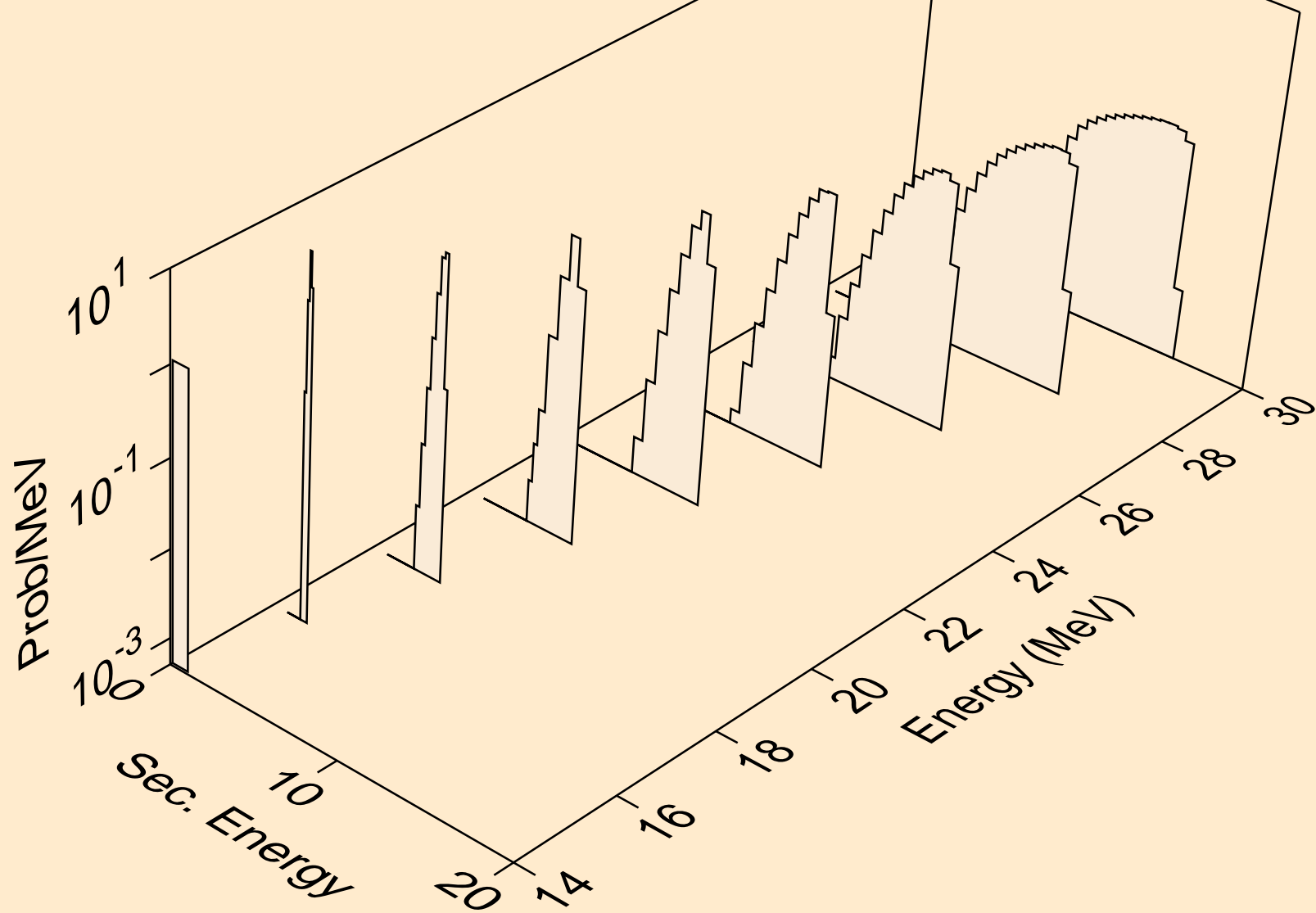

GD154 NEUTRON ACER TENDL-2021 LIBRARY; T=293.6K
deuterons from (n,d)

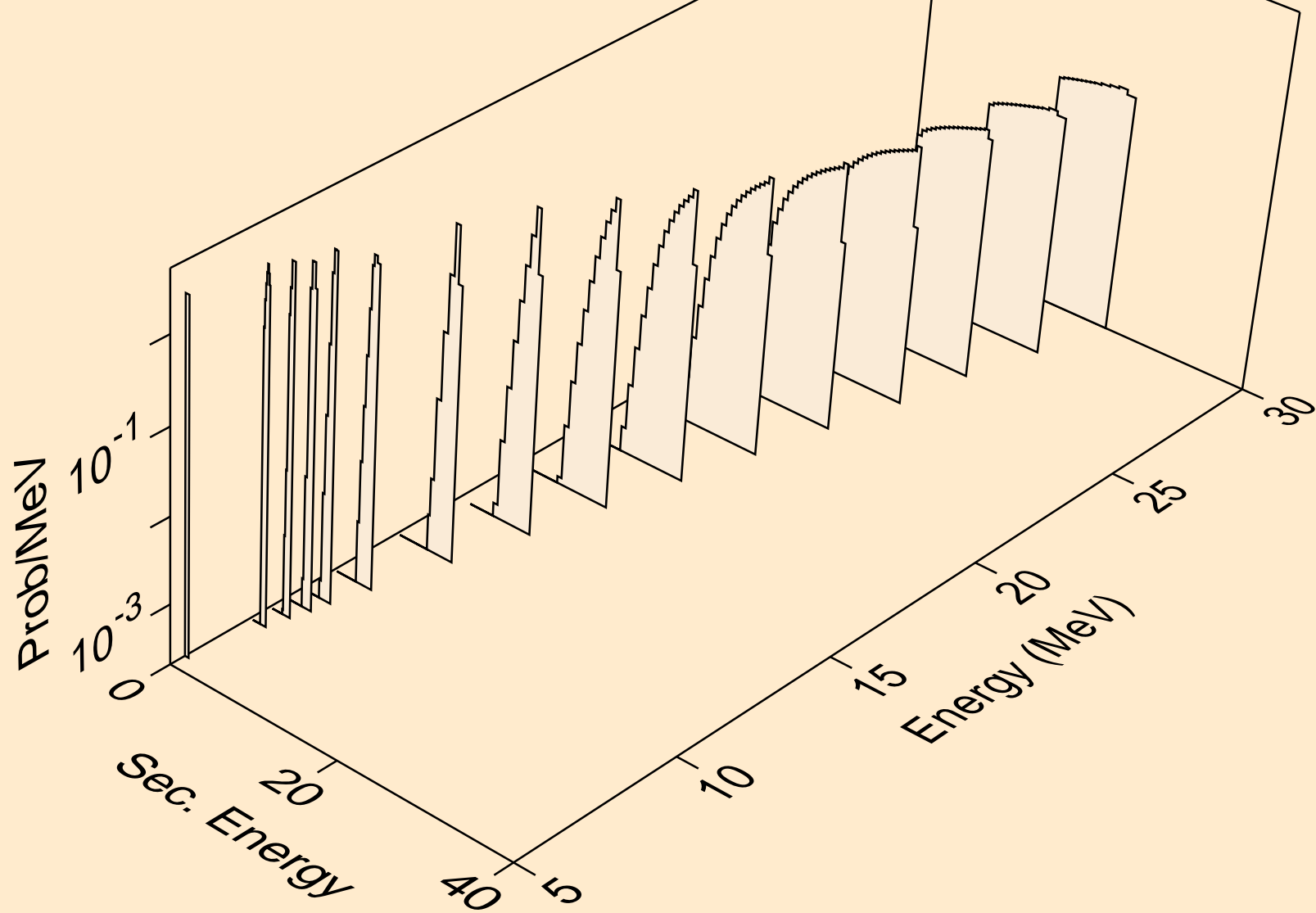

GD154 NEUTRON ACER TENDL-2021 LIBRARY; T=293.6K
deuterons from (n,pd)

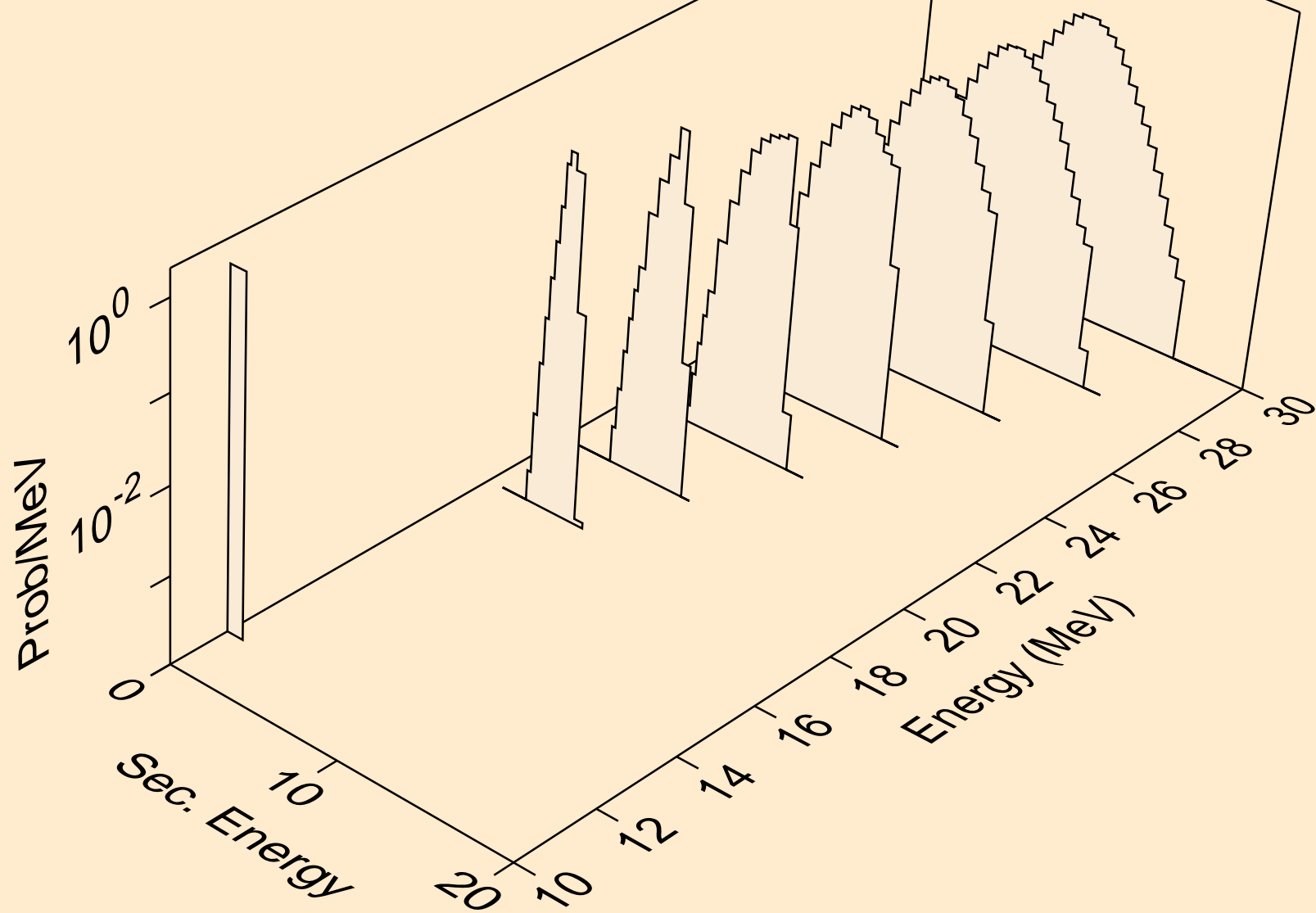

GD154 NEUTRON ACER TENDL-2021 LIBRARY; T=293.6K
deuterons from (n,da)

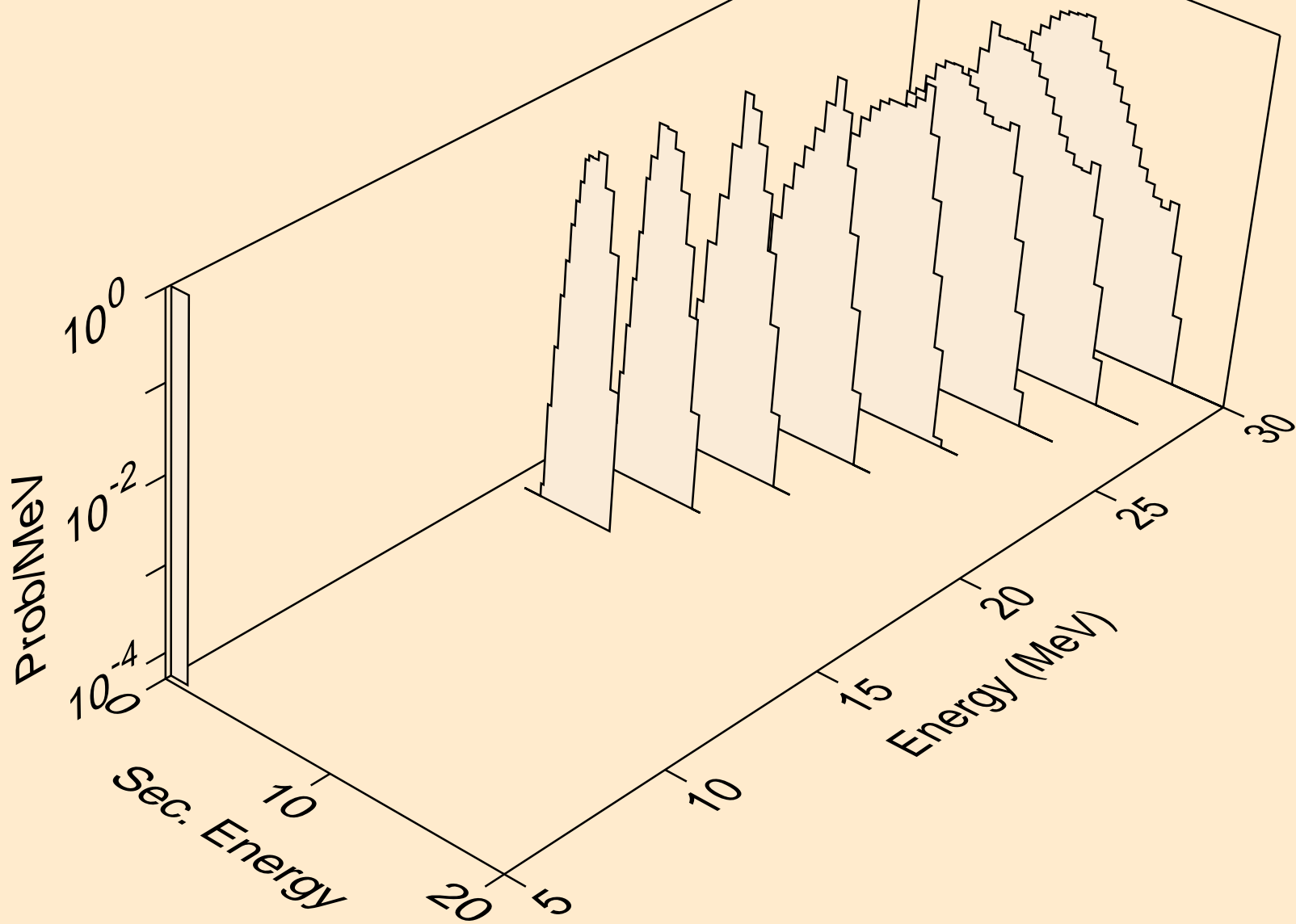

GD154 NEUTRON ACER TENDL-2021 LIBRARY; T=293.6K
tritons from (n,x)

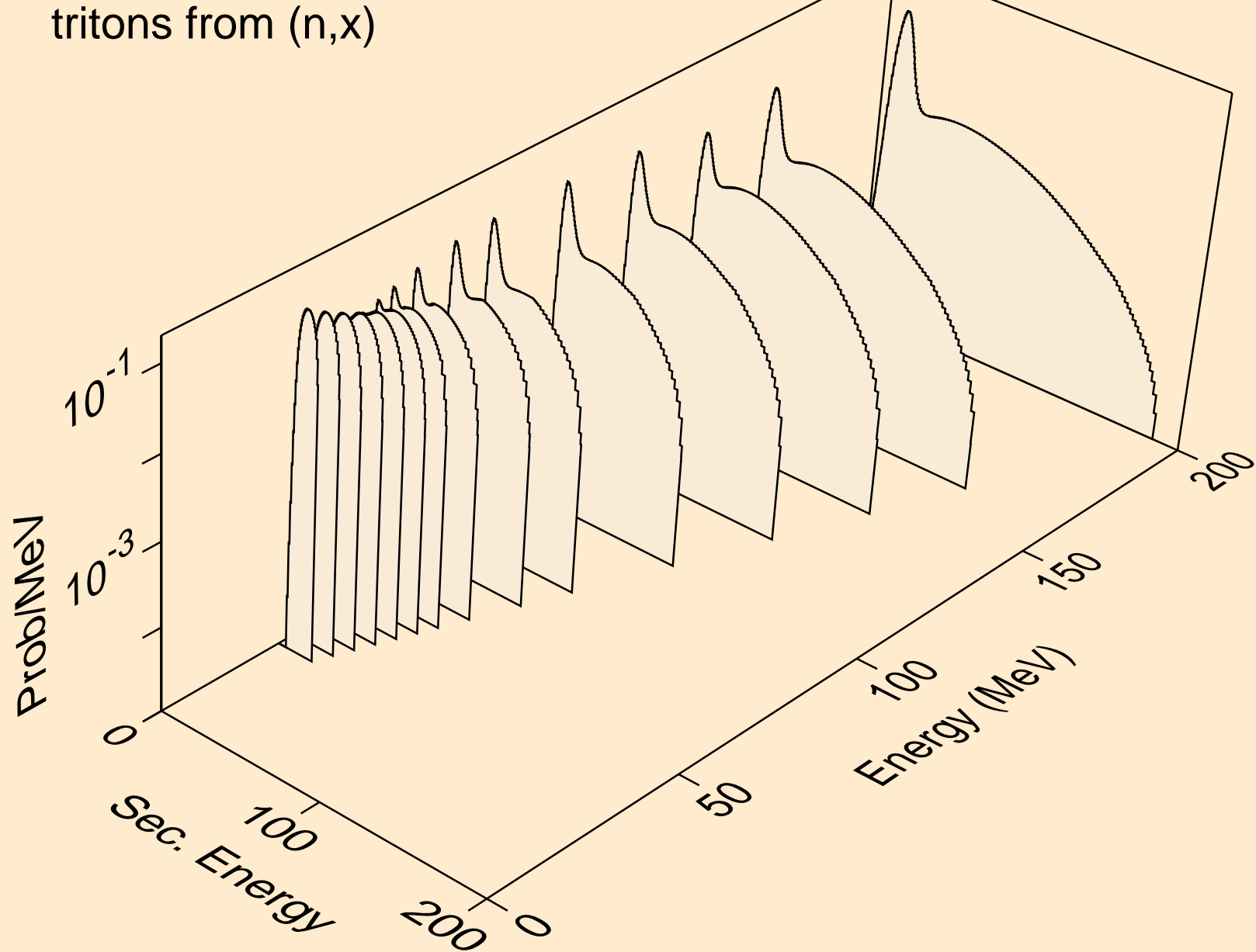

GD154 NEUTRON ACER TENDL-2021 LIBRARY; T=293.6K
tritons from (n,n*)t

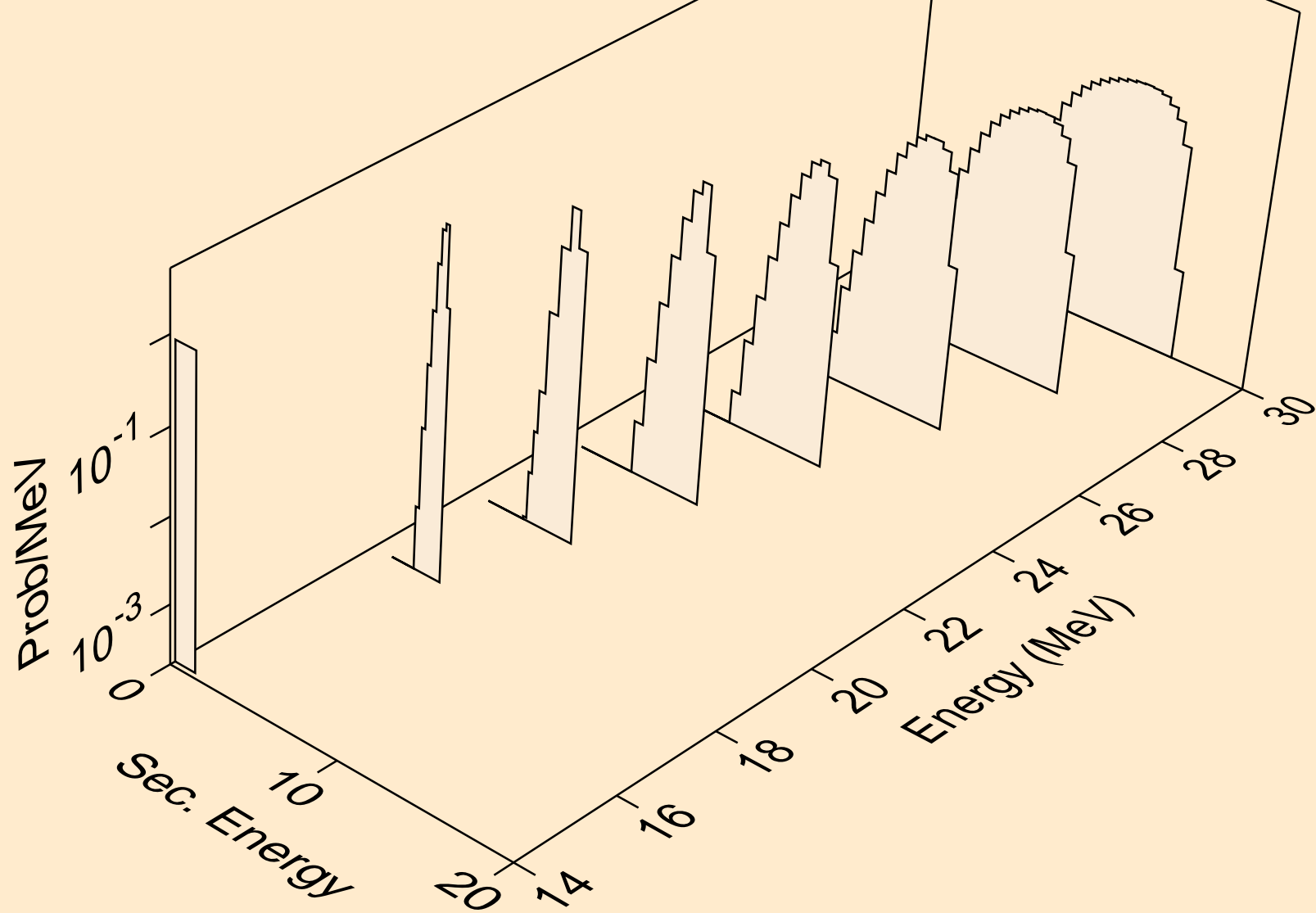

GD154 NEUTRON ACER TENDL-2021 LIBRARY; T=293.6K
tritons from (n,t)

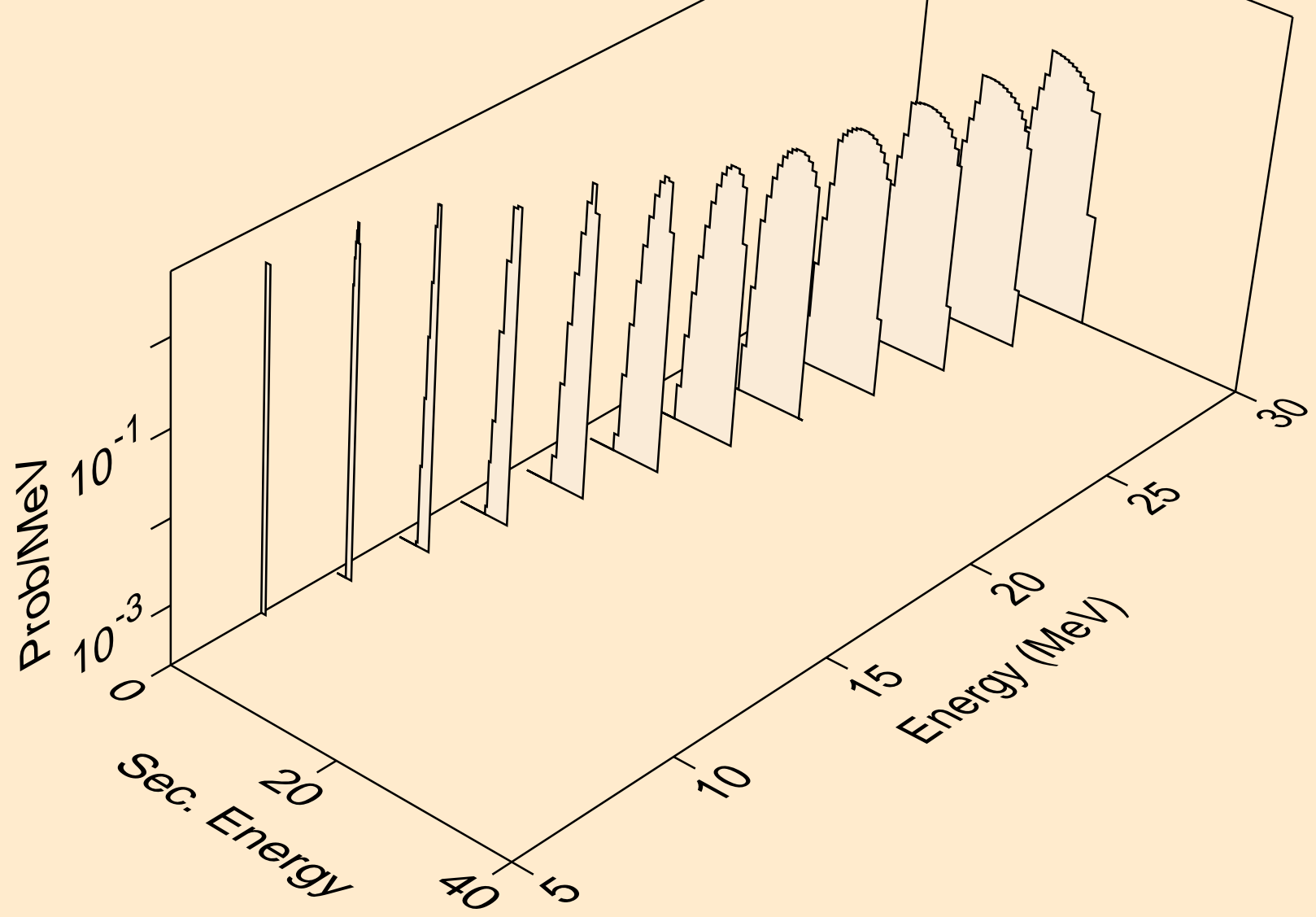

GD154 NEUTRON ACER TENDL-2021 LIBRARY; T=293.6K
tritons from (n,pt)

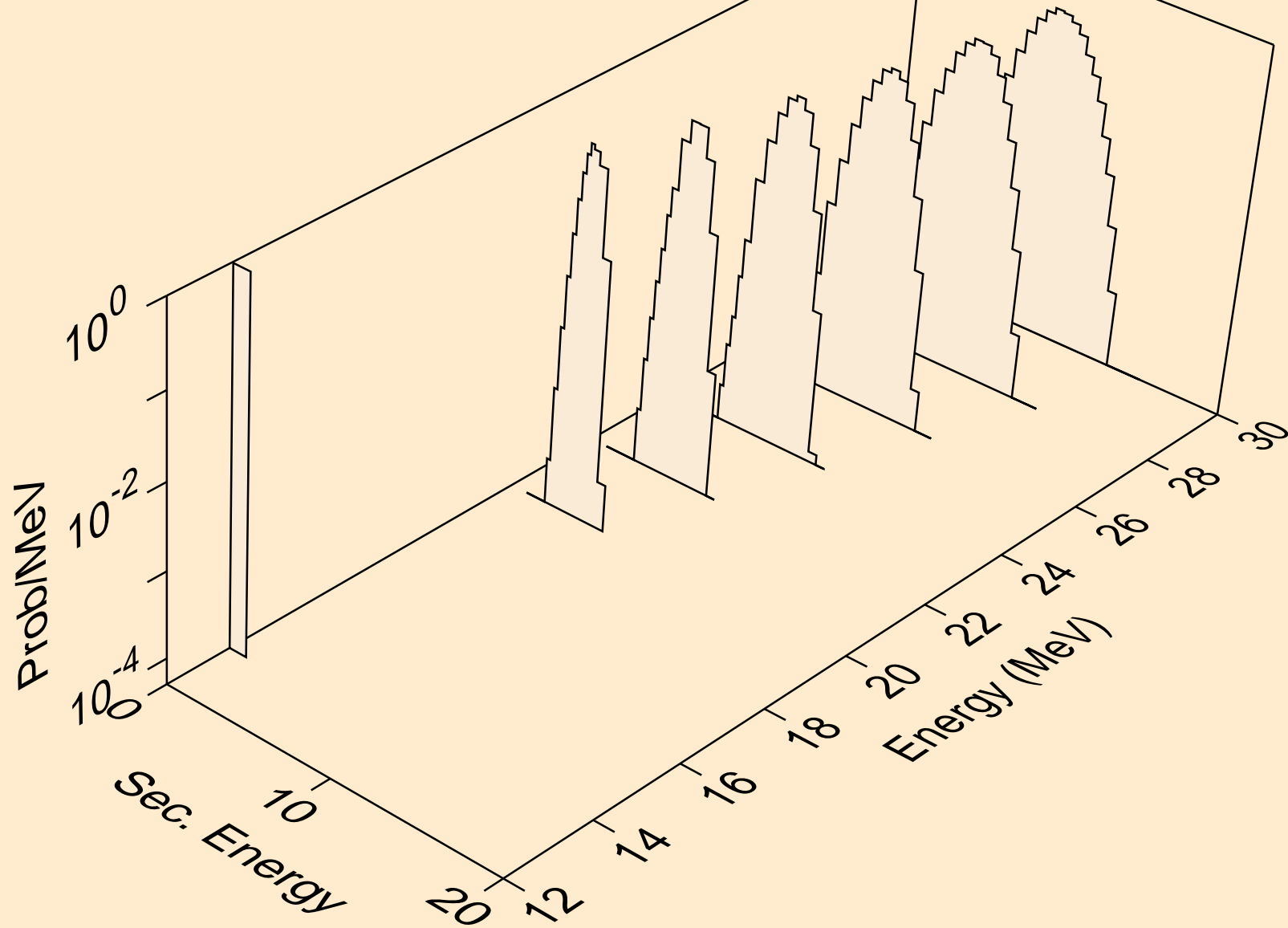

GD154 NEUTRON ACER TENDL-2021 LIBRARY; T=293.6K
he3s from (n,x)

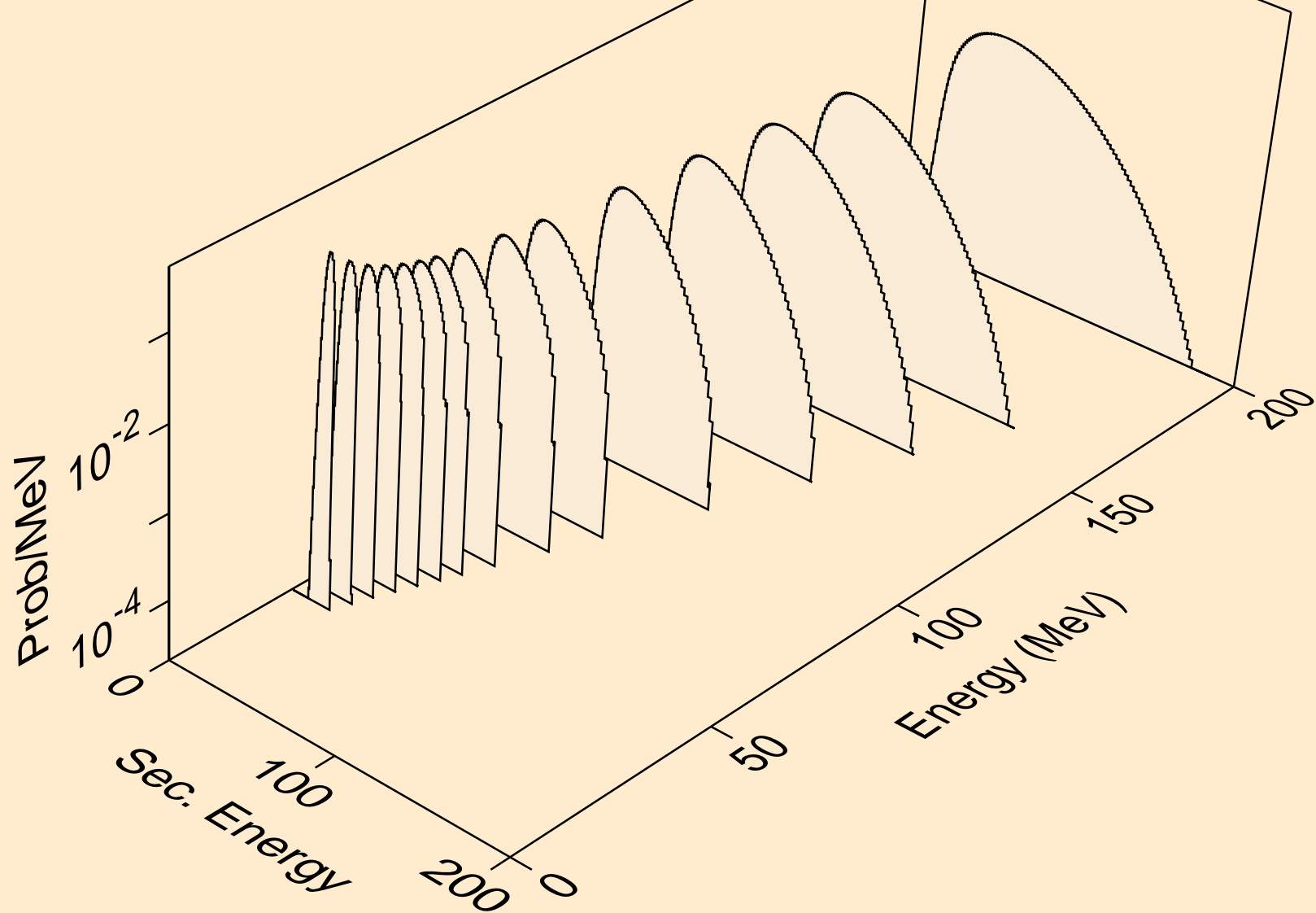

GD154 NEUTRON ACER TENDL-2021 LIBRARY; T=293.6K
he3s from (n,n*)he3

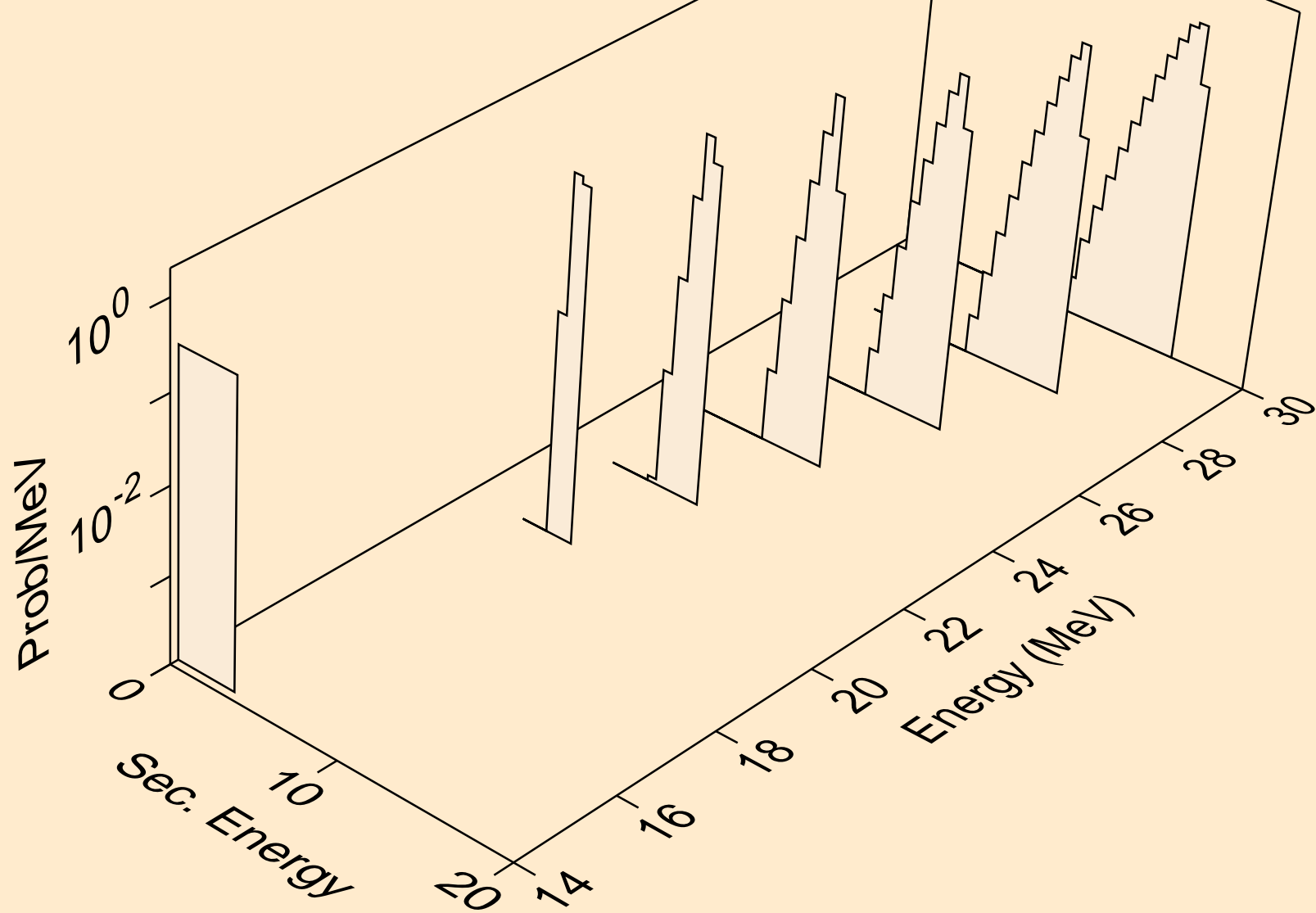

GD154 NEUTRON ACER TENDL-2021 LIBRARY; T=293.6K
he3s from (n,he3)

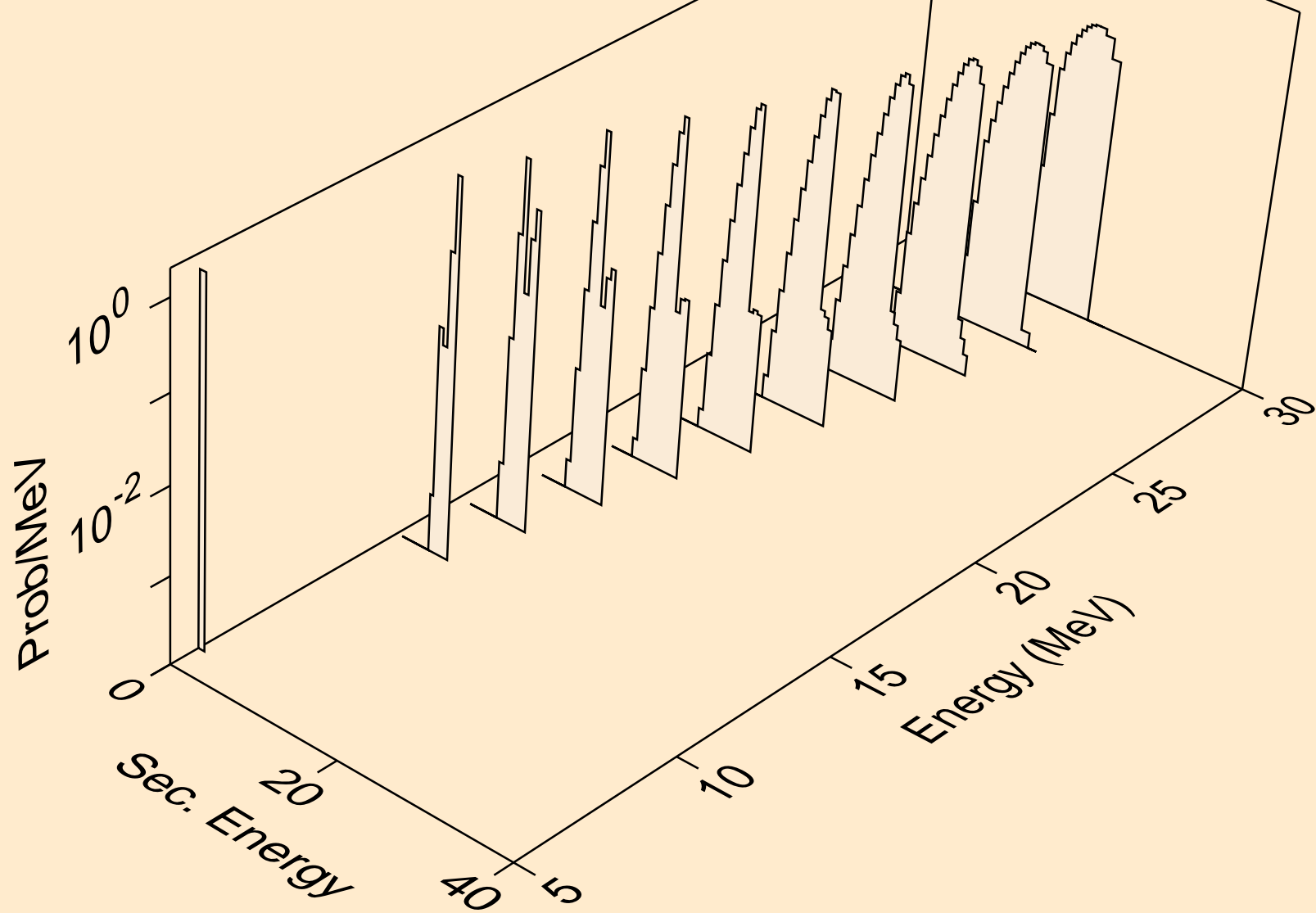

GD154 NEUTRON ACER TENDL-2021 LIBRARY; T=293.6K
alphas from (n,x)

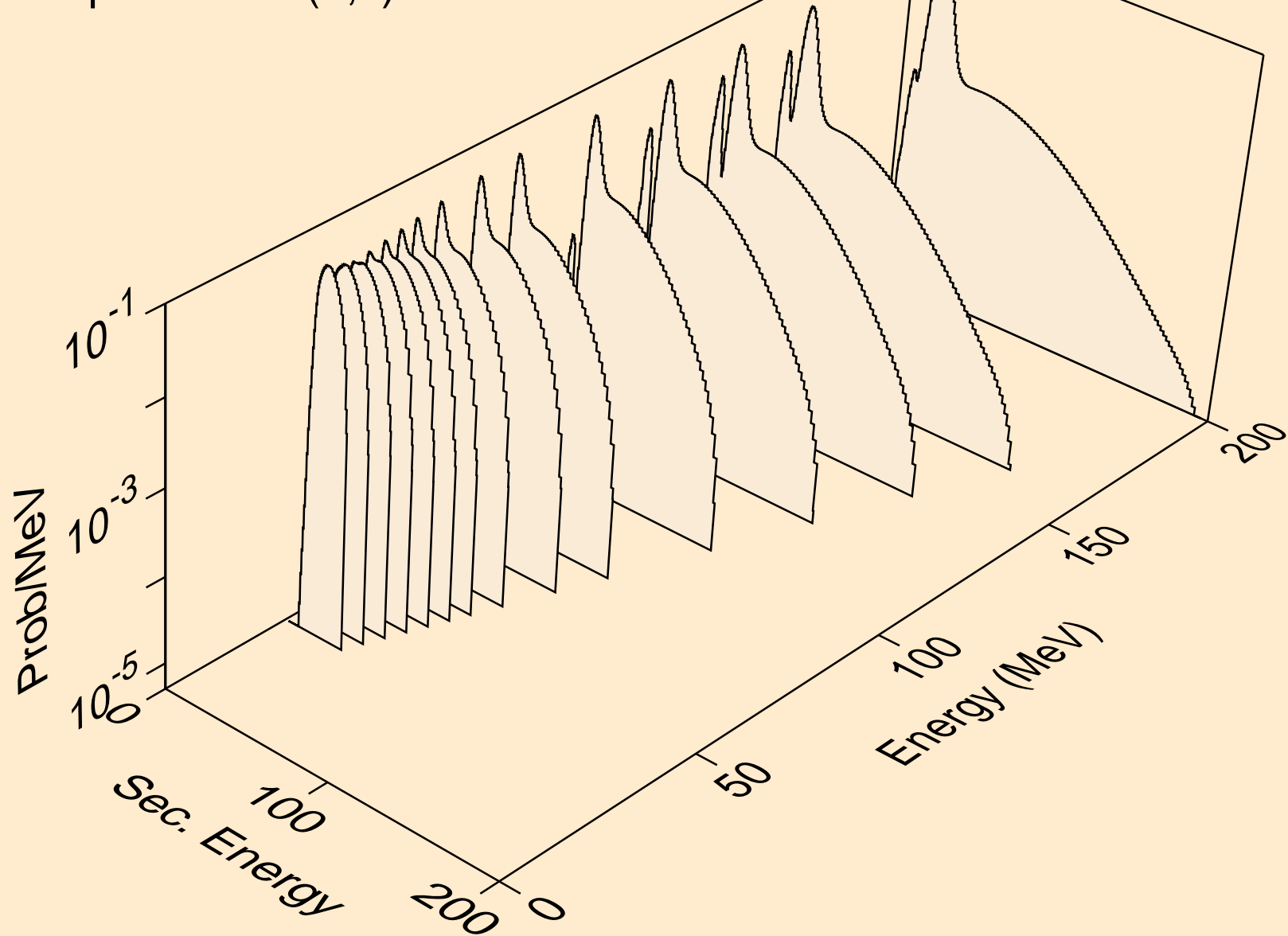

GD154 NEUTRON ACER TENDL-2021 LIBRARY; T=293.6K
alphas from (n,n*)a

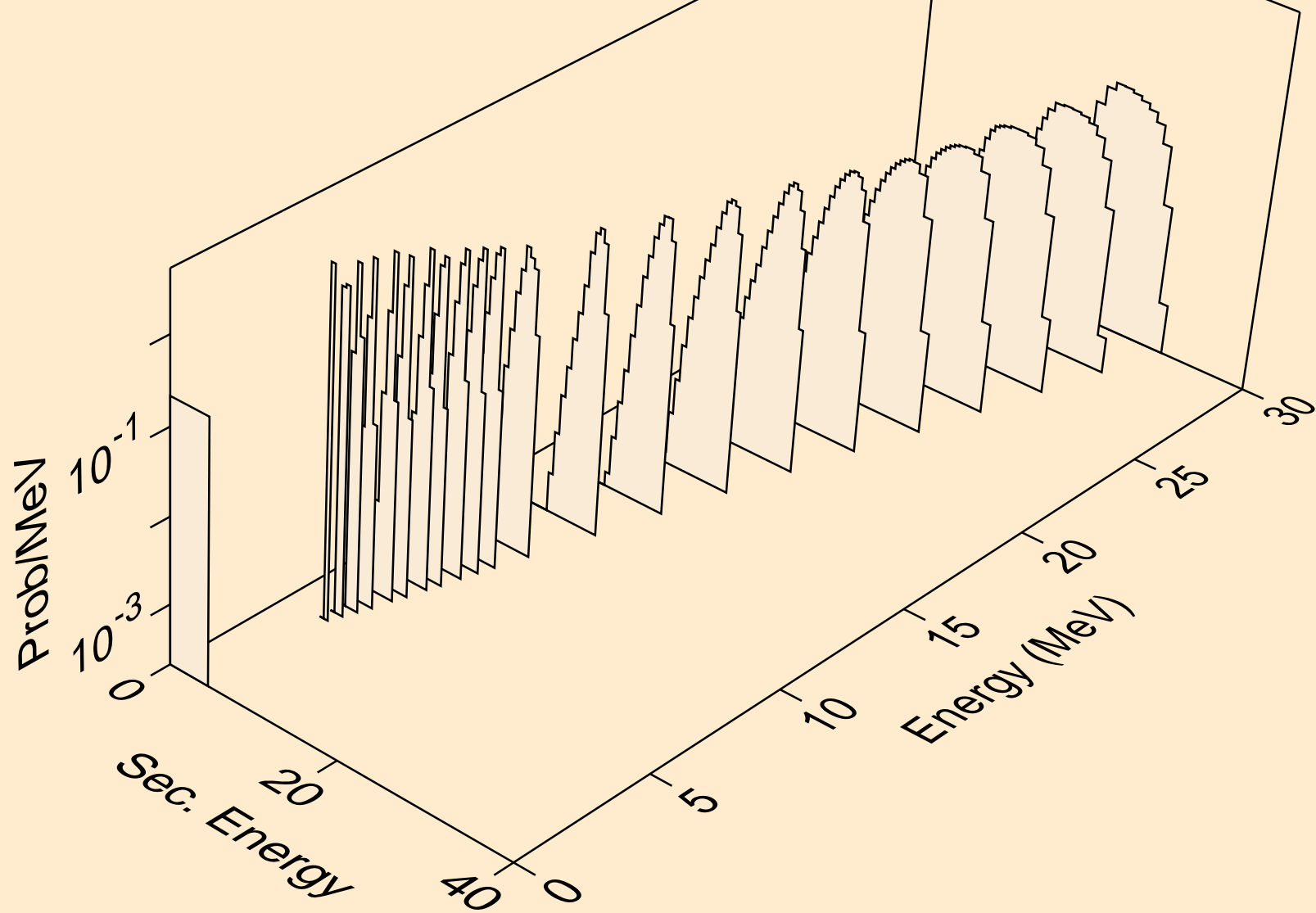

GD154 NEUTRON ACER TENDL-2021 LIBRARY; T=293.6K
alphas from (n,2n)a

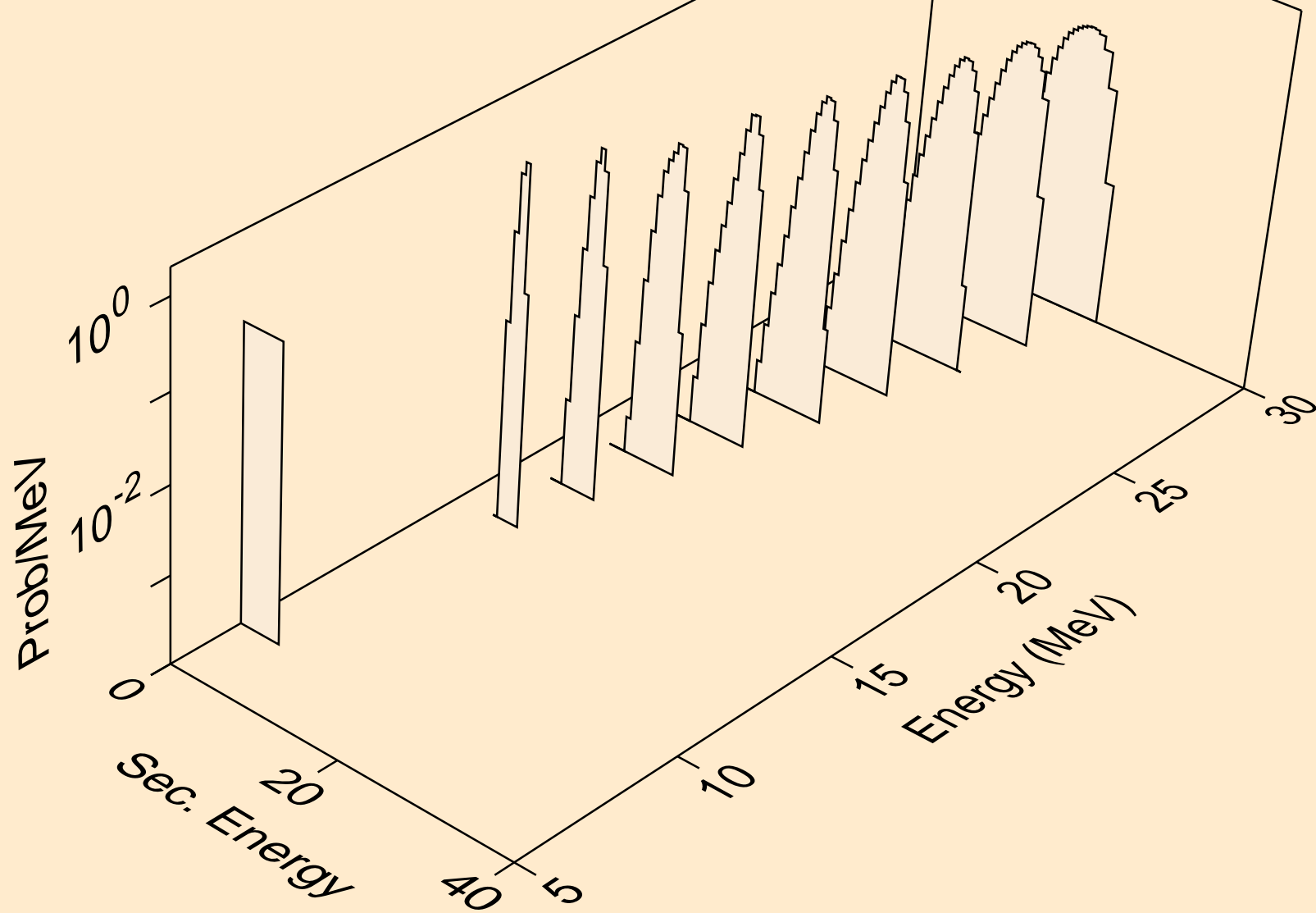

GD154 NEUTRON ACER TENDL-2021 LIBRARY; T=293.6K
alphas from (n,3n)a

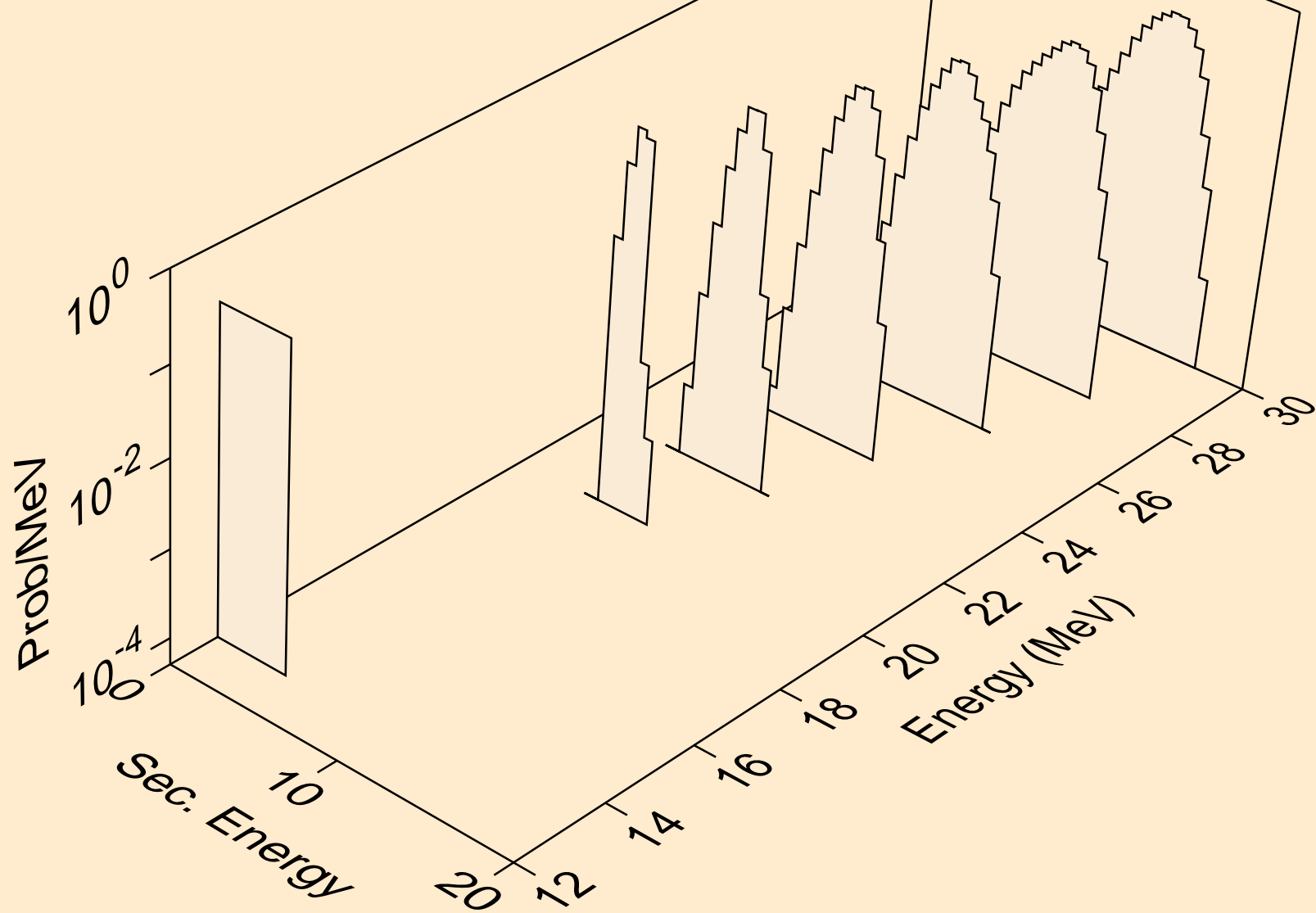

GD154 NEUTRON ACER TENDL-2021 LIBRARY; T=293.6K
alphas from (n,n*)2a

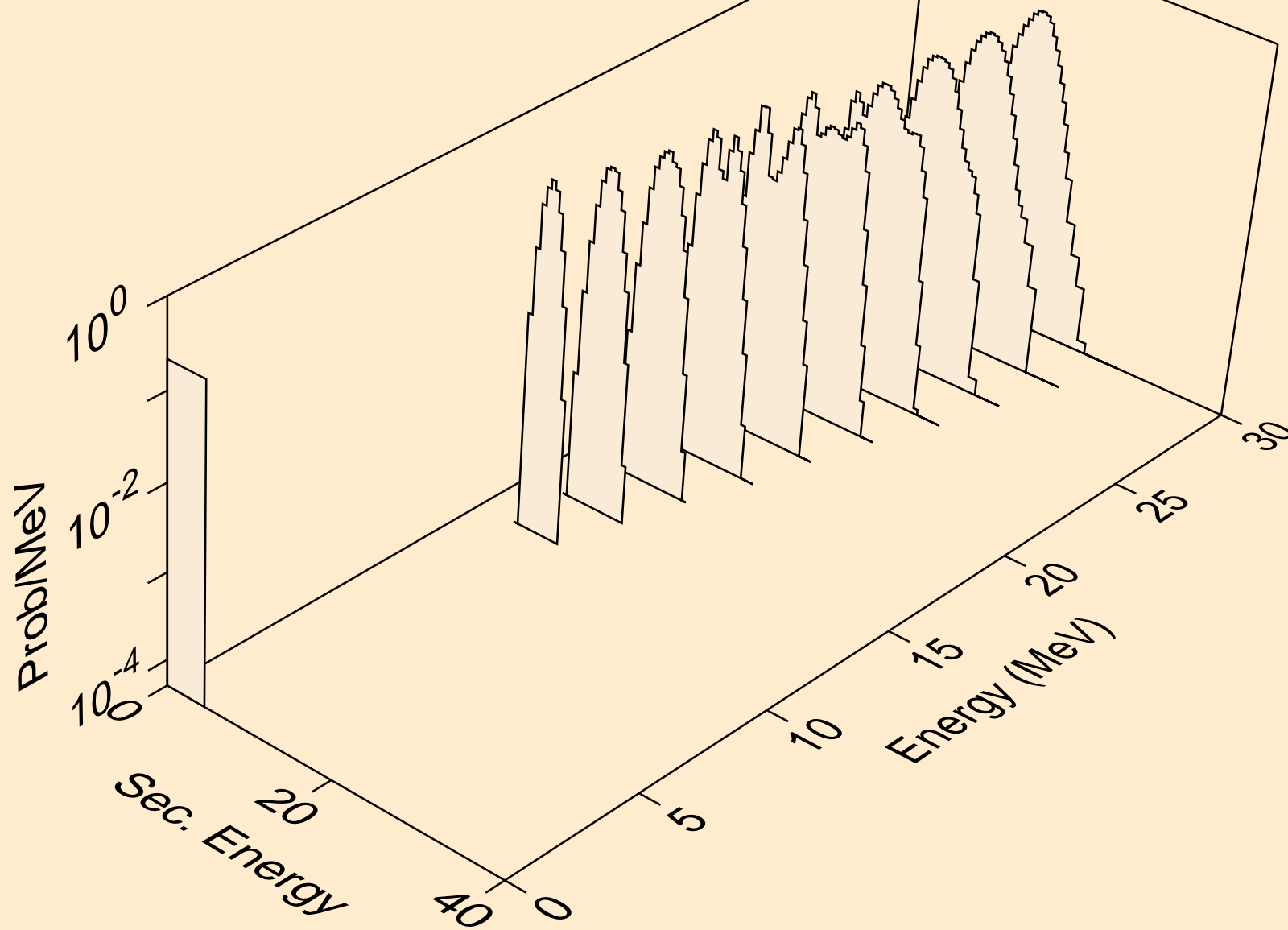

GD154 NEUTRON ACER TENDL-2021 LIBRARY; T=293.6K
alphas from (n,npa)

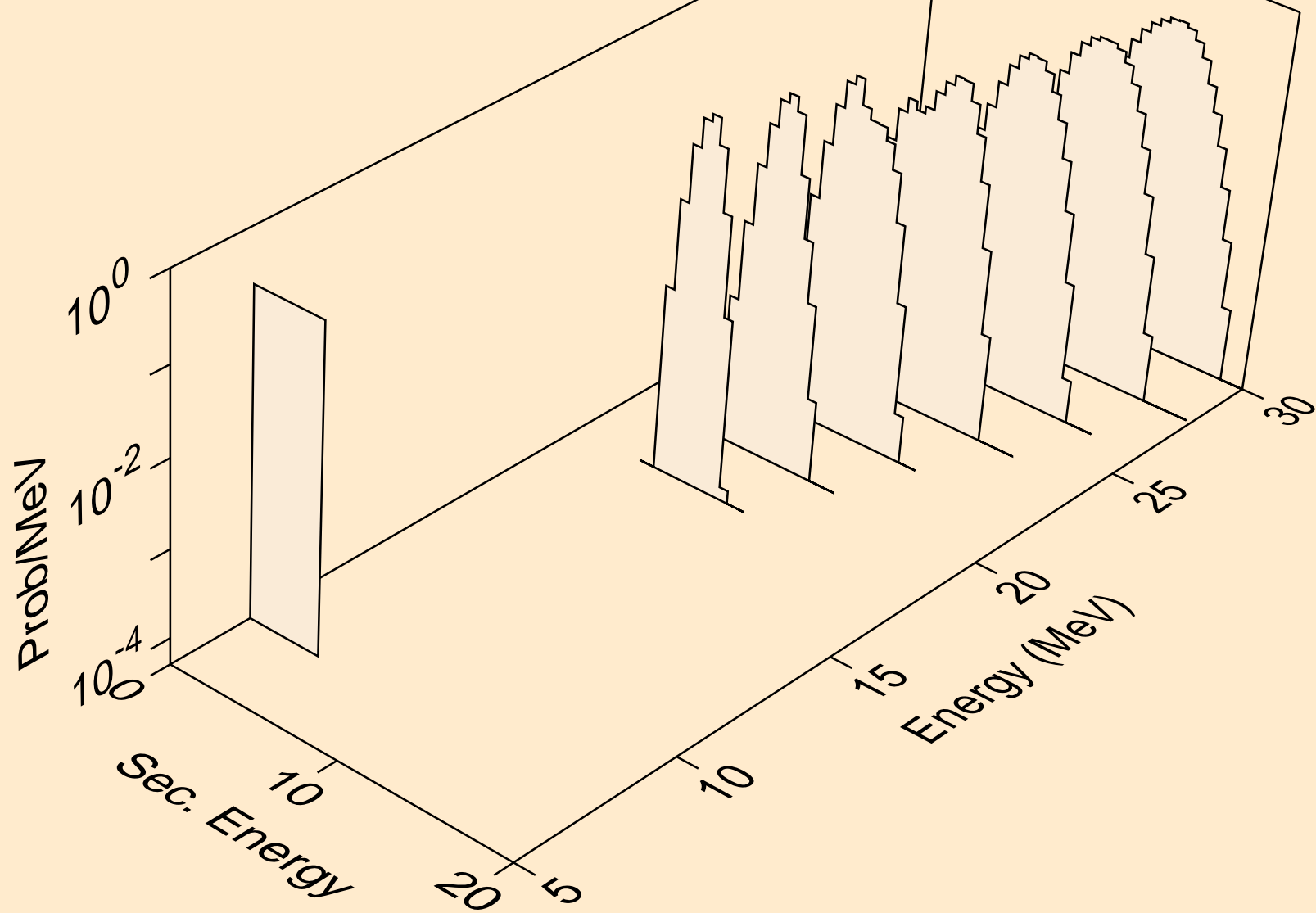

GD154 NEUTRON ACER TENDL-2021 LIBRARY; T=293.6K
alphas from (n,a)

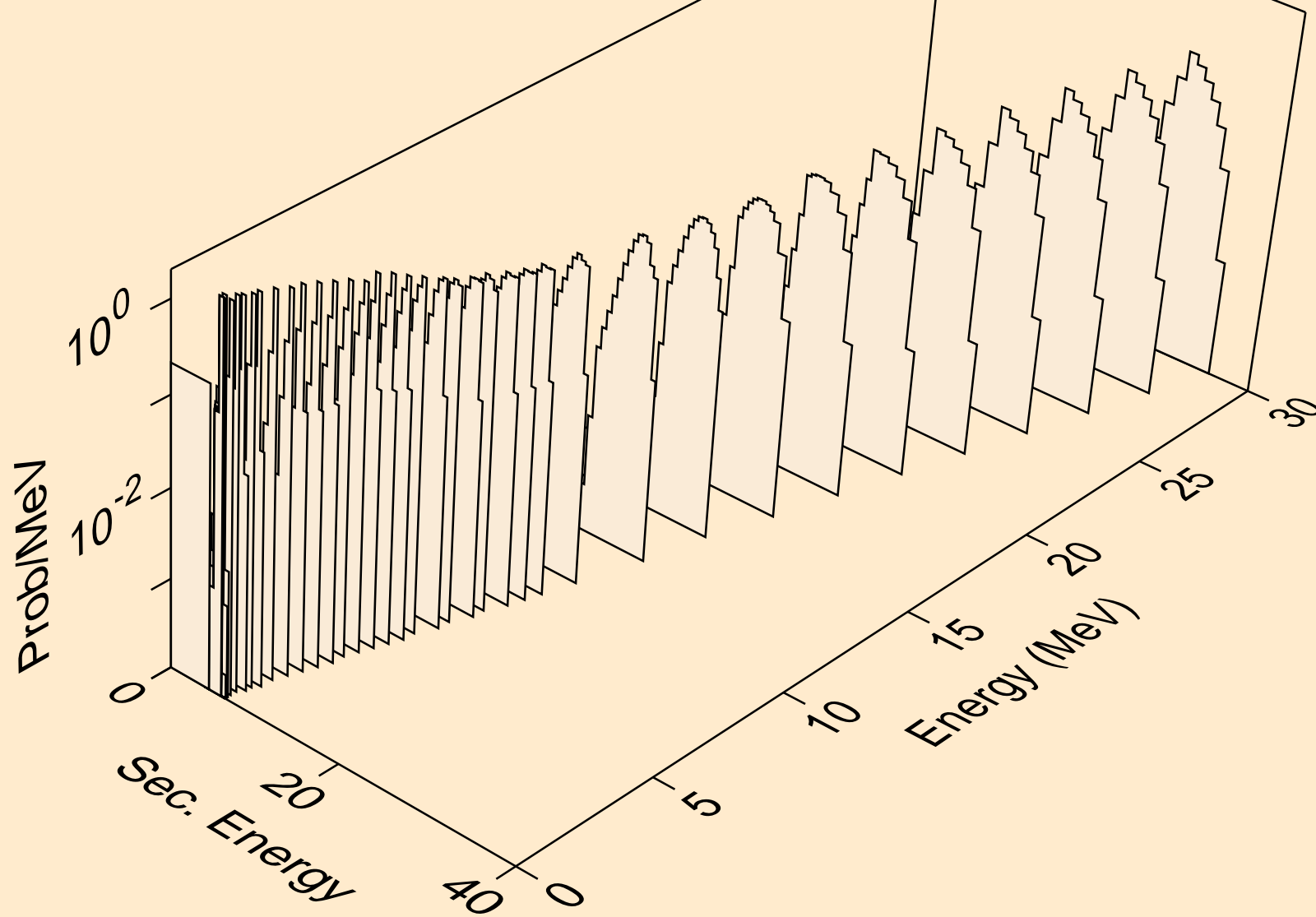

GD154 NEUTRON ACER TENDL-2021 LIBRARY; T=293.6K
alphas from (n,2a)

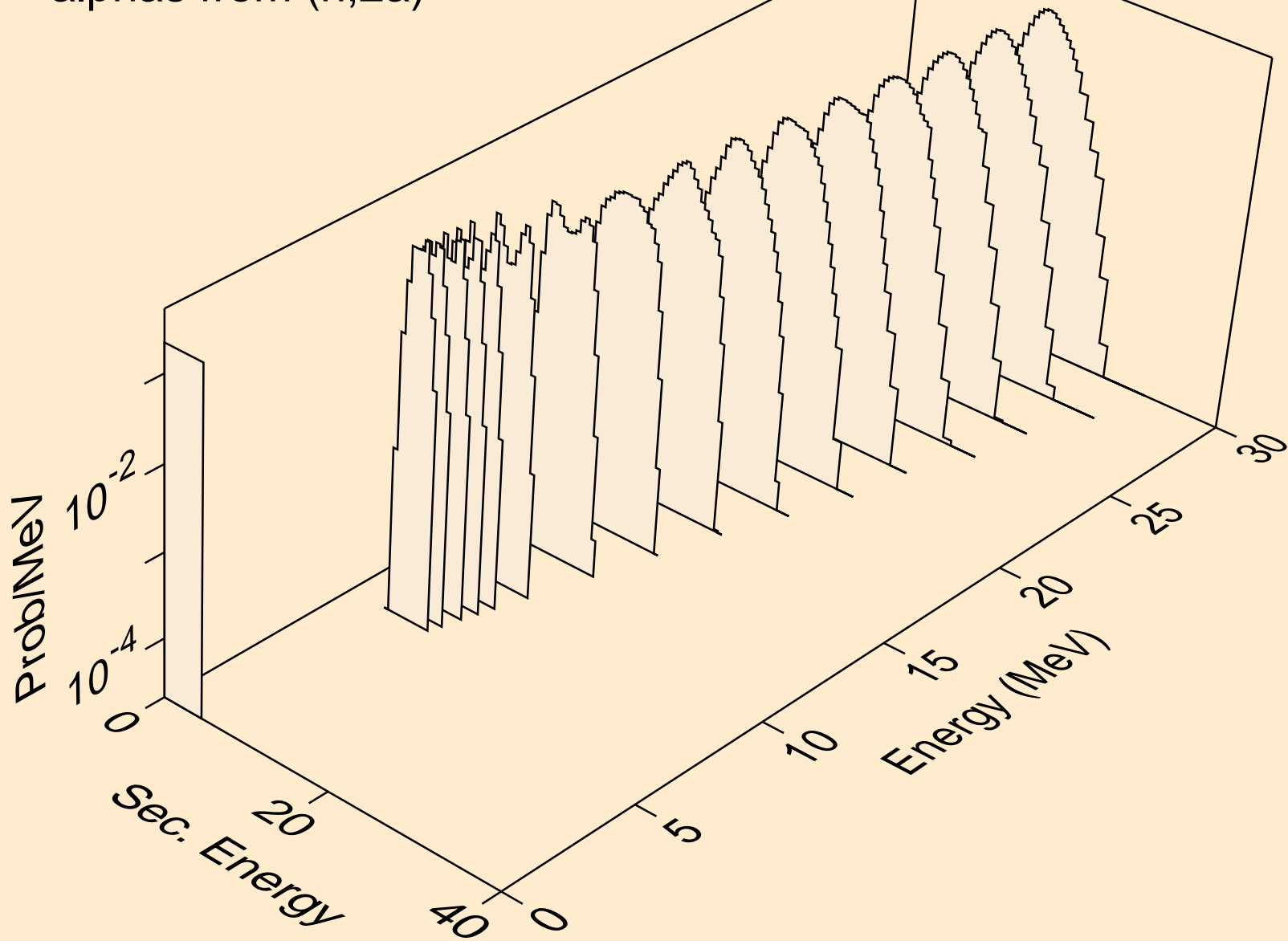

GD154 NEUTRON ACER TENDL-2021 LIBRARY; T=293.6K
alphas from (n,pa)

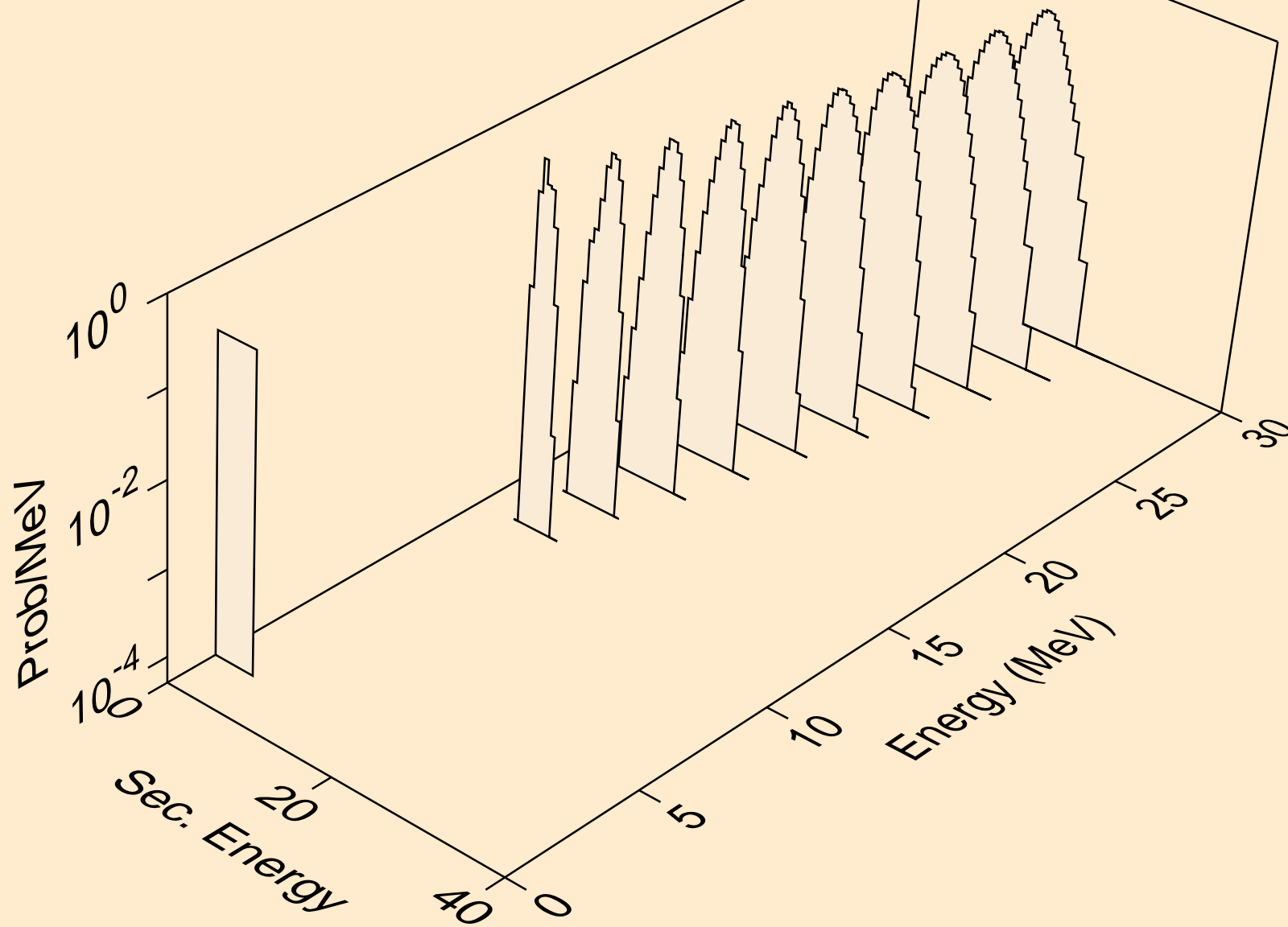

GD154 NEUTRON ACER TENDL-2021 LIBRARY; T=293.6K
alphas from (n,da)

