

GD163 NEUTRON ACER TENDL-2021 LIBRARY; T=293.6K

Principal cross sections

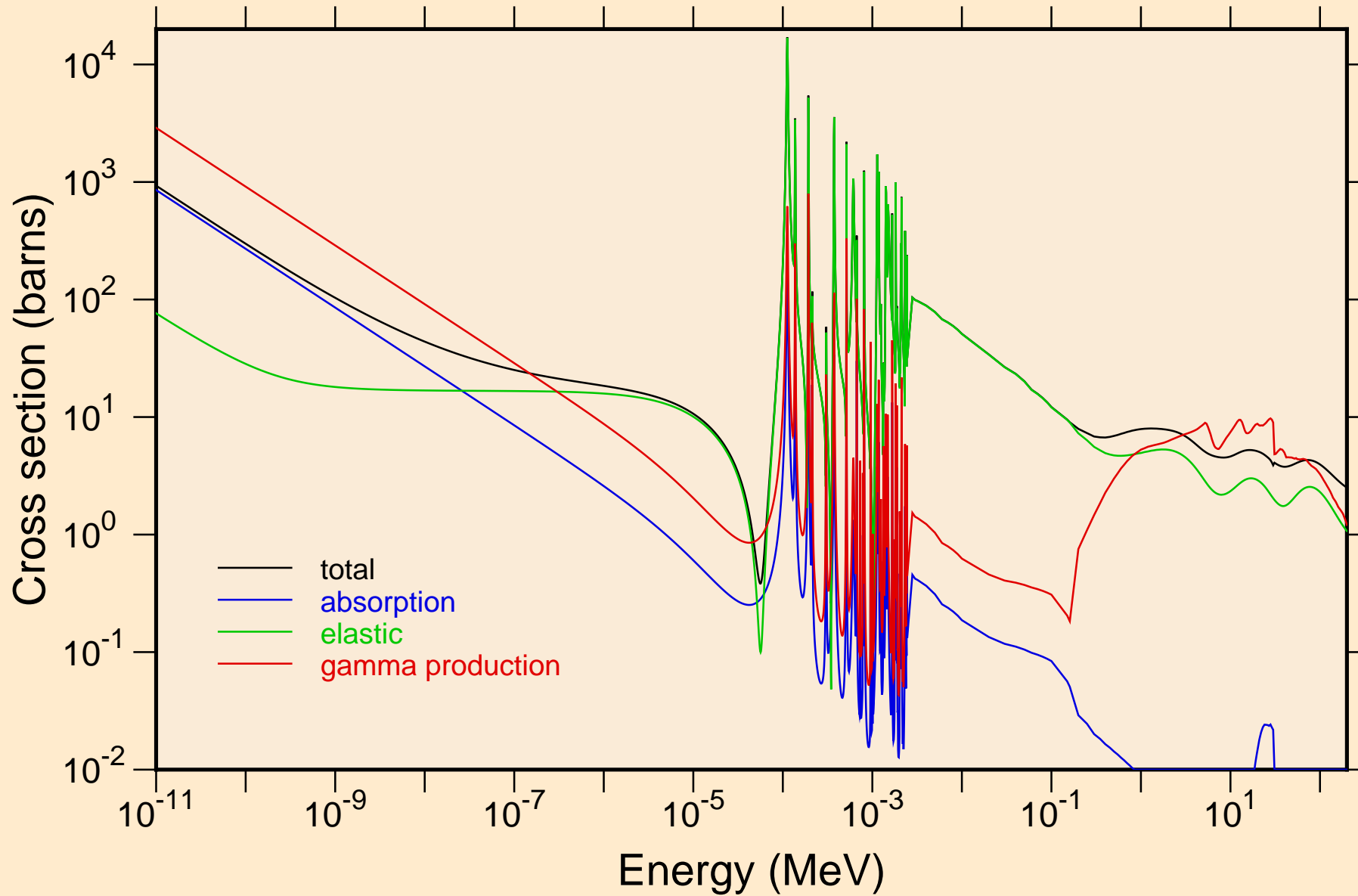

GD163 NEUTRON ACER TENDL-2021 LIBRARY; T=293.6K
resonance total cross section

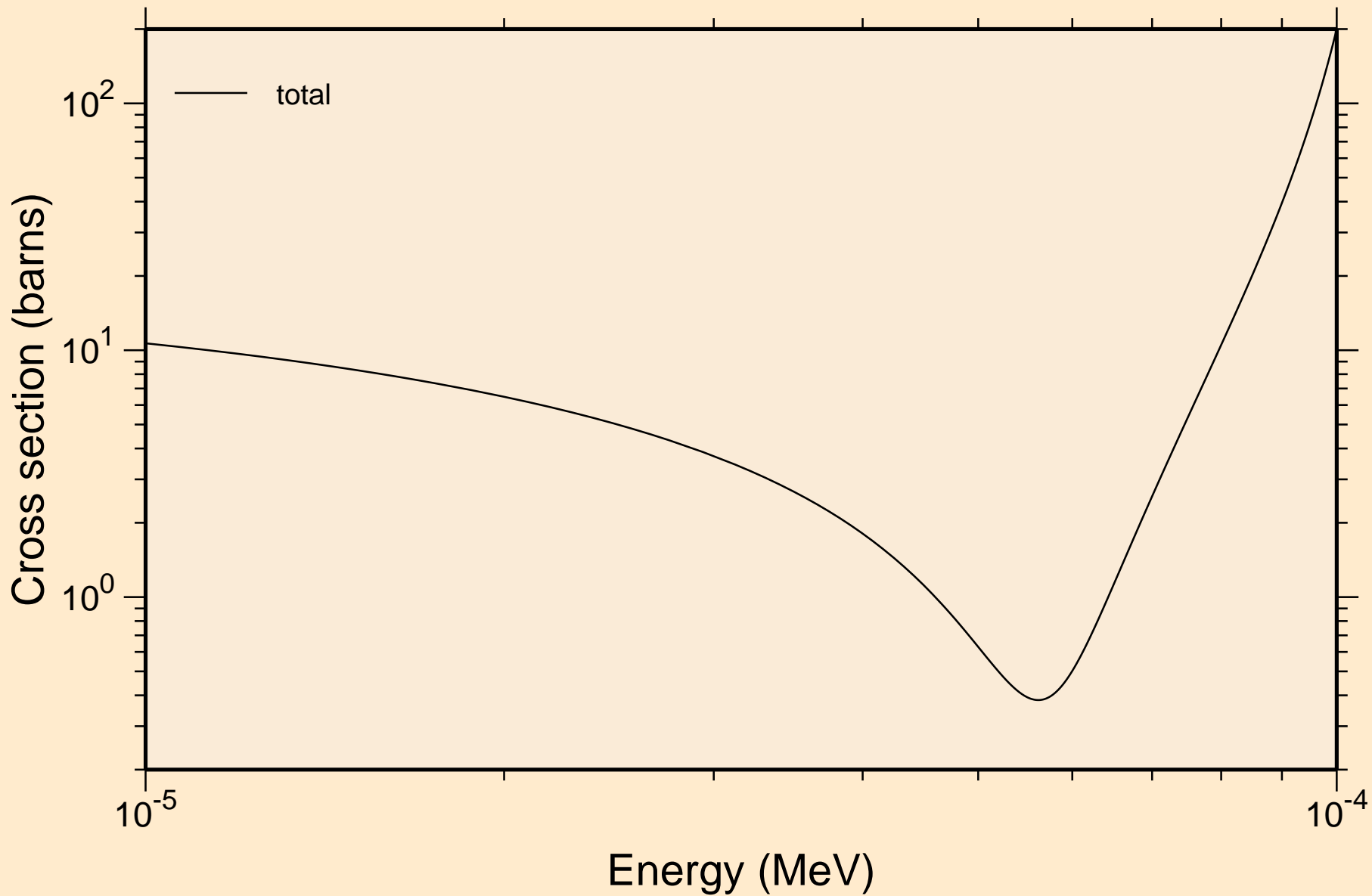

GD163 NEUTRON ACER TENDL-2021 LIBRARY; T=293.6K
resonance total cross section

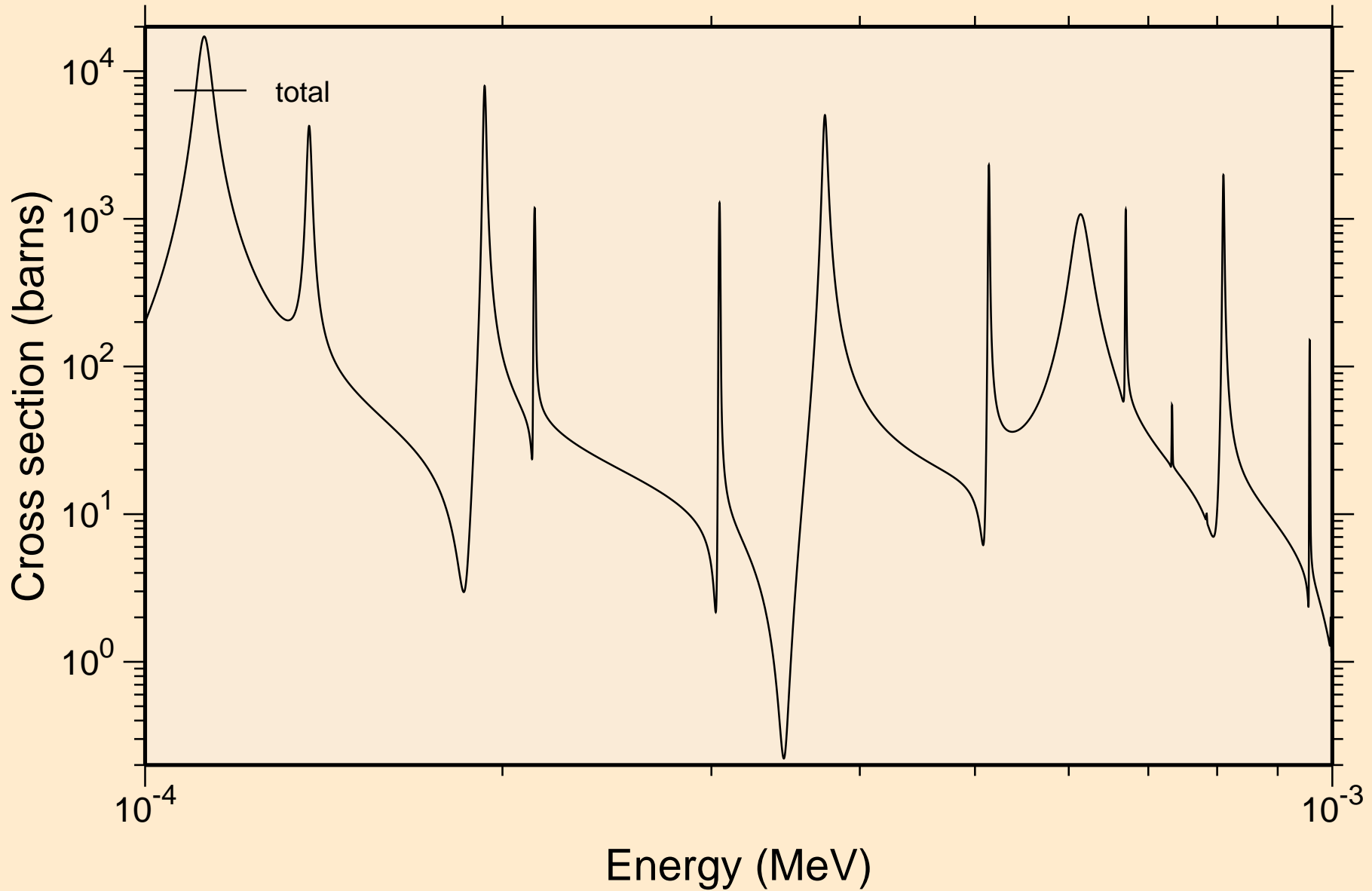

GD163 NEUTRON ACER TENDL-2021 LIBRARY; T=293.6K
resonance total cross section

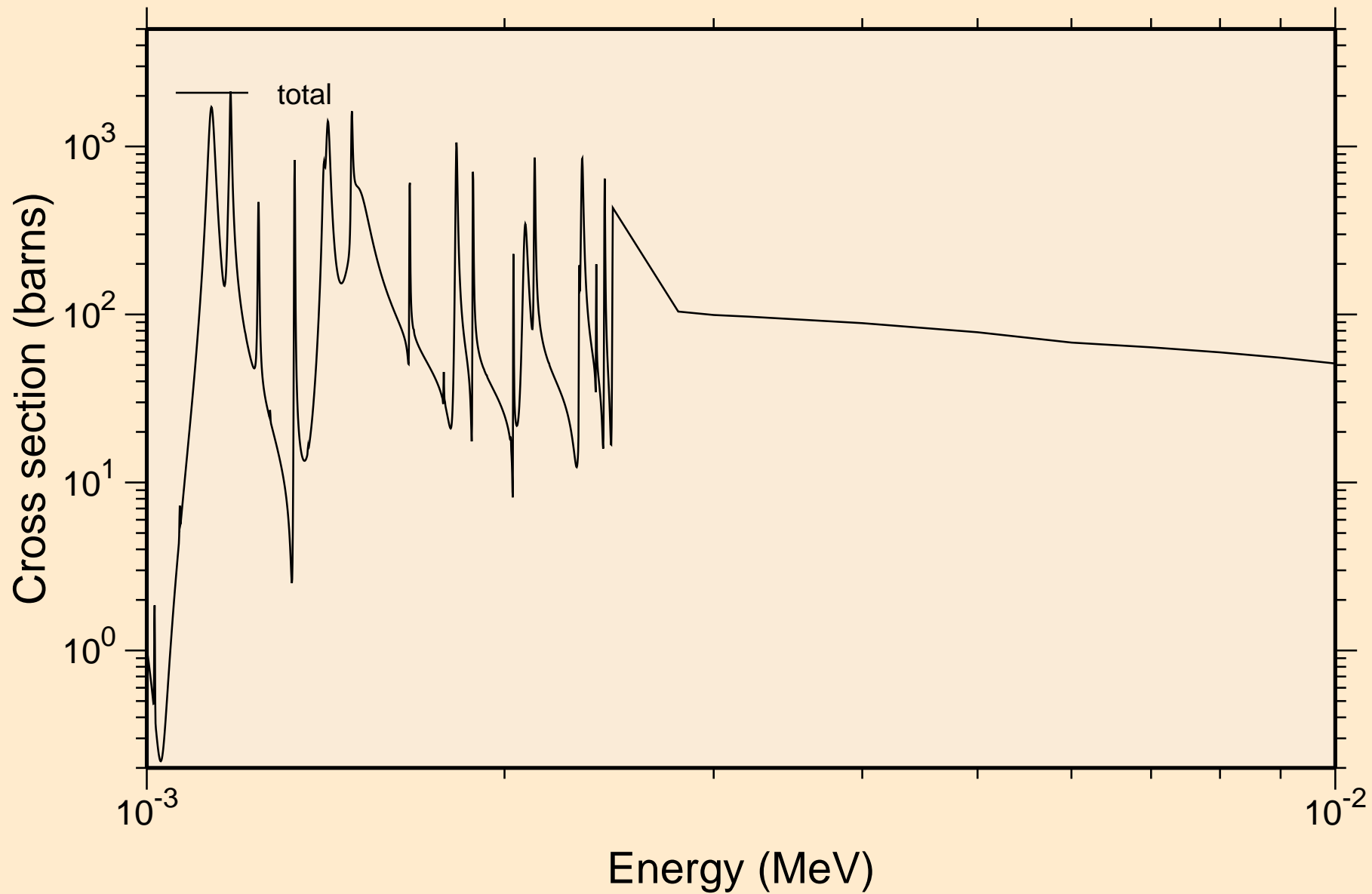

GD163 NEUTRON ACER TENDL-2021 LIBRARY; T=293.6K
resonance total cross section

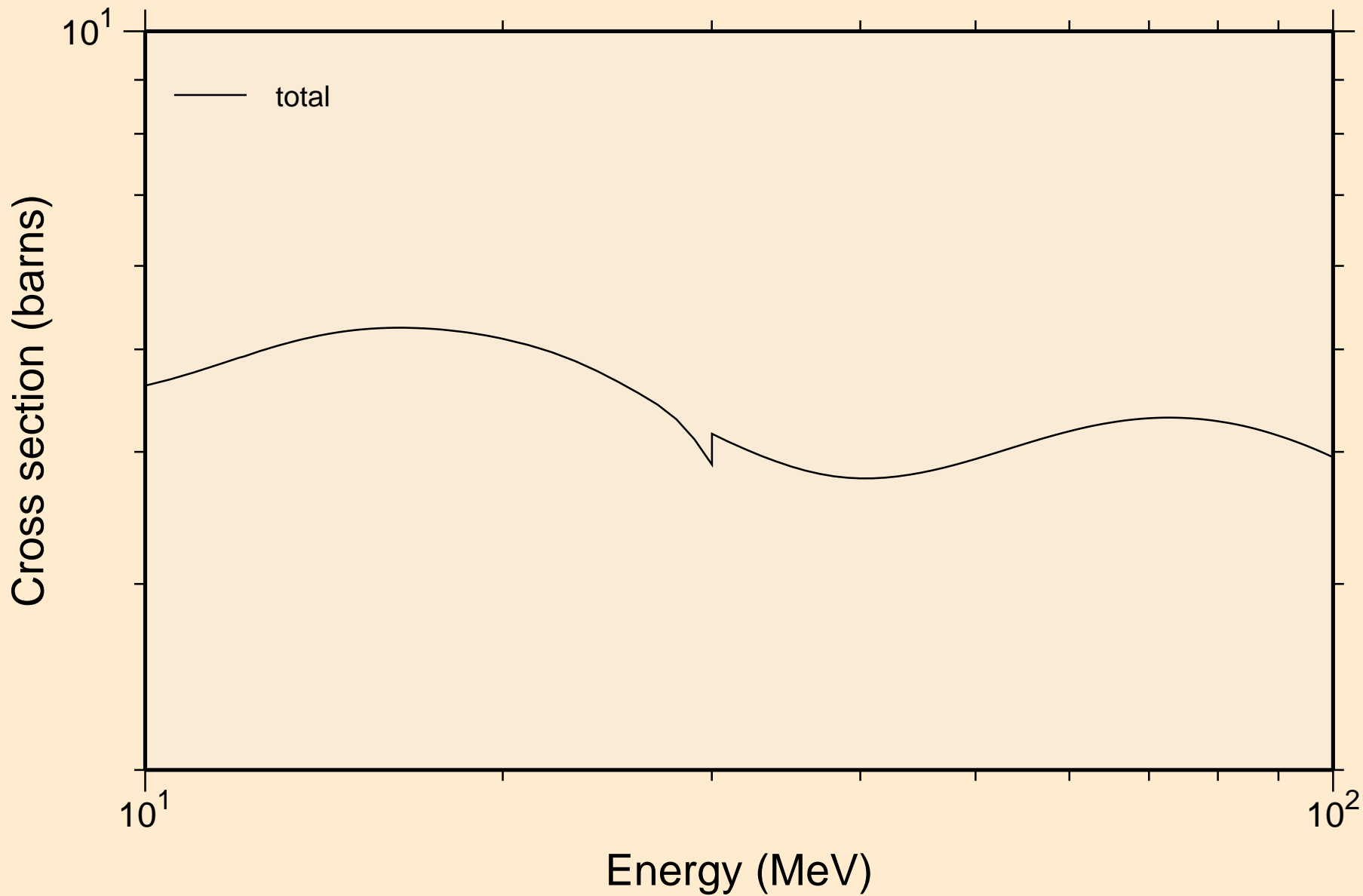

GD163 NEUTRON ACER TENDL-2021 LIBRARY; T=293.6K
resonance absorption cross sections

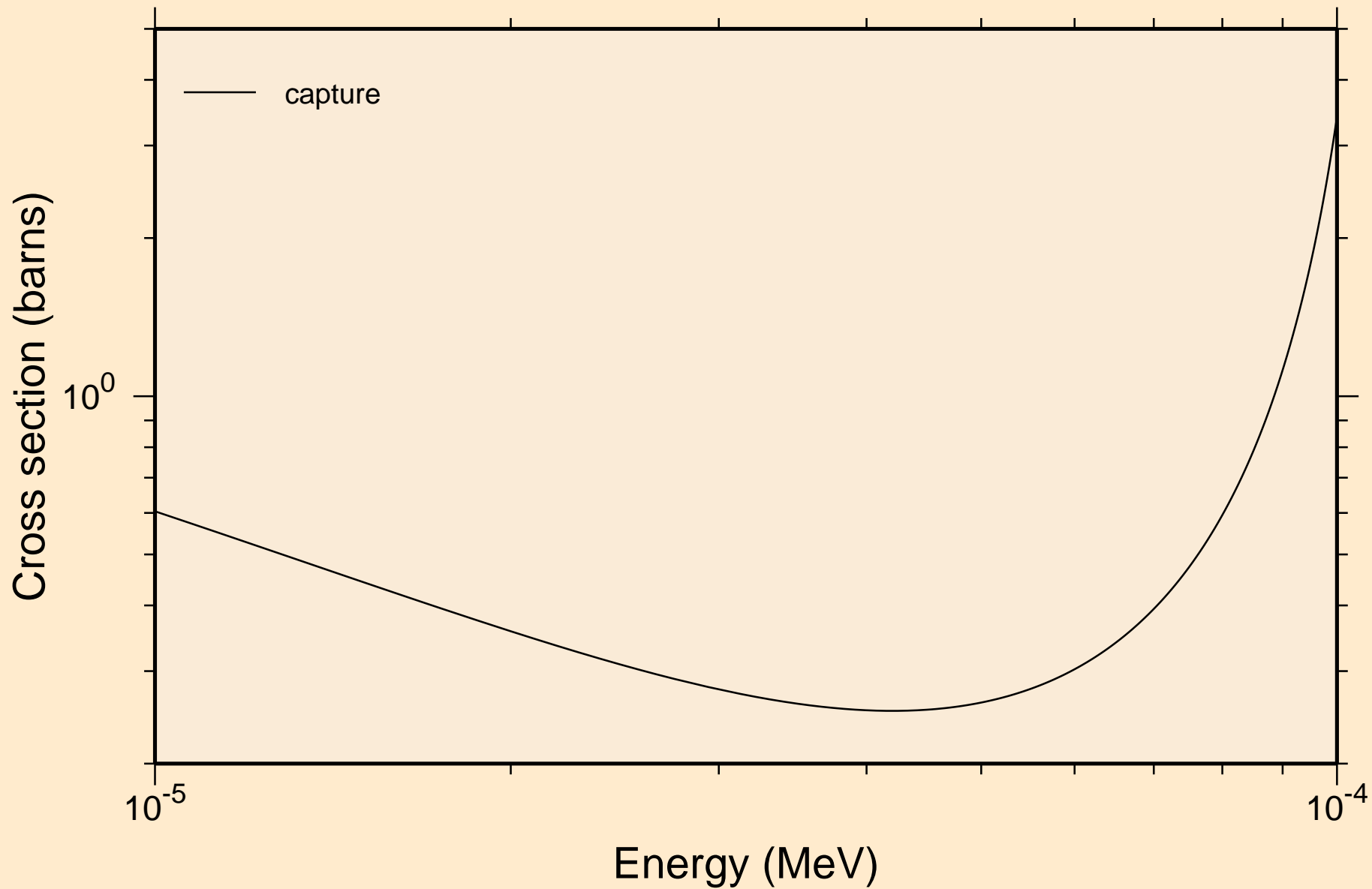

GD163 NEUTRON ACER TENDL-2021 LIBRARY; T=293.6K
resonance absorption cross sections

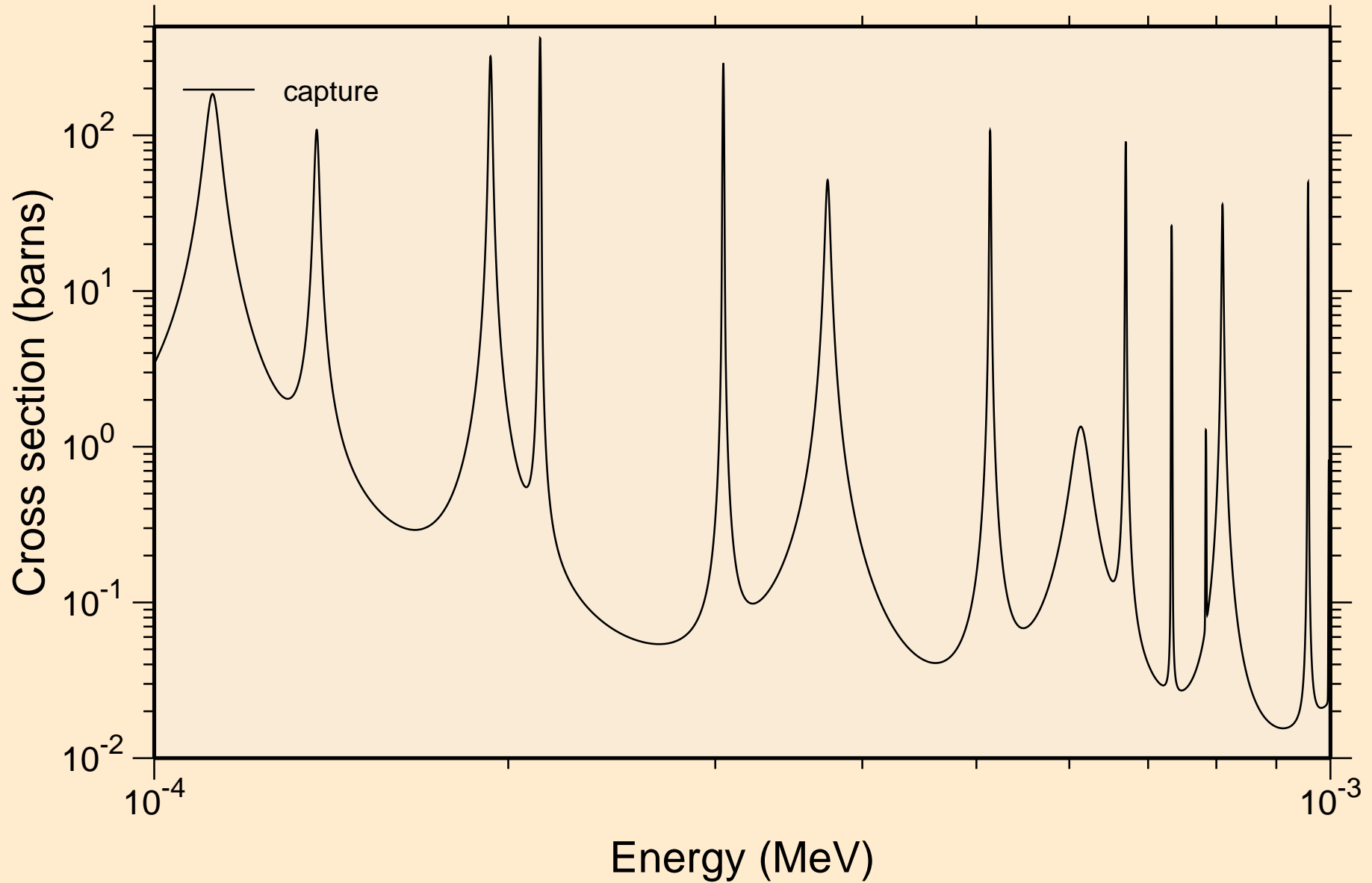

GD163 NEUTRON ACER TENDL-2021 LIBRARY; T=293.6K
resonance absorption cross sections

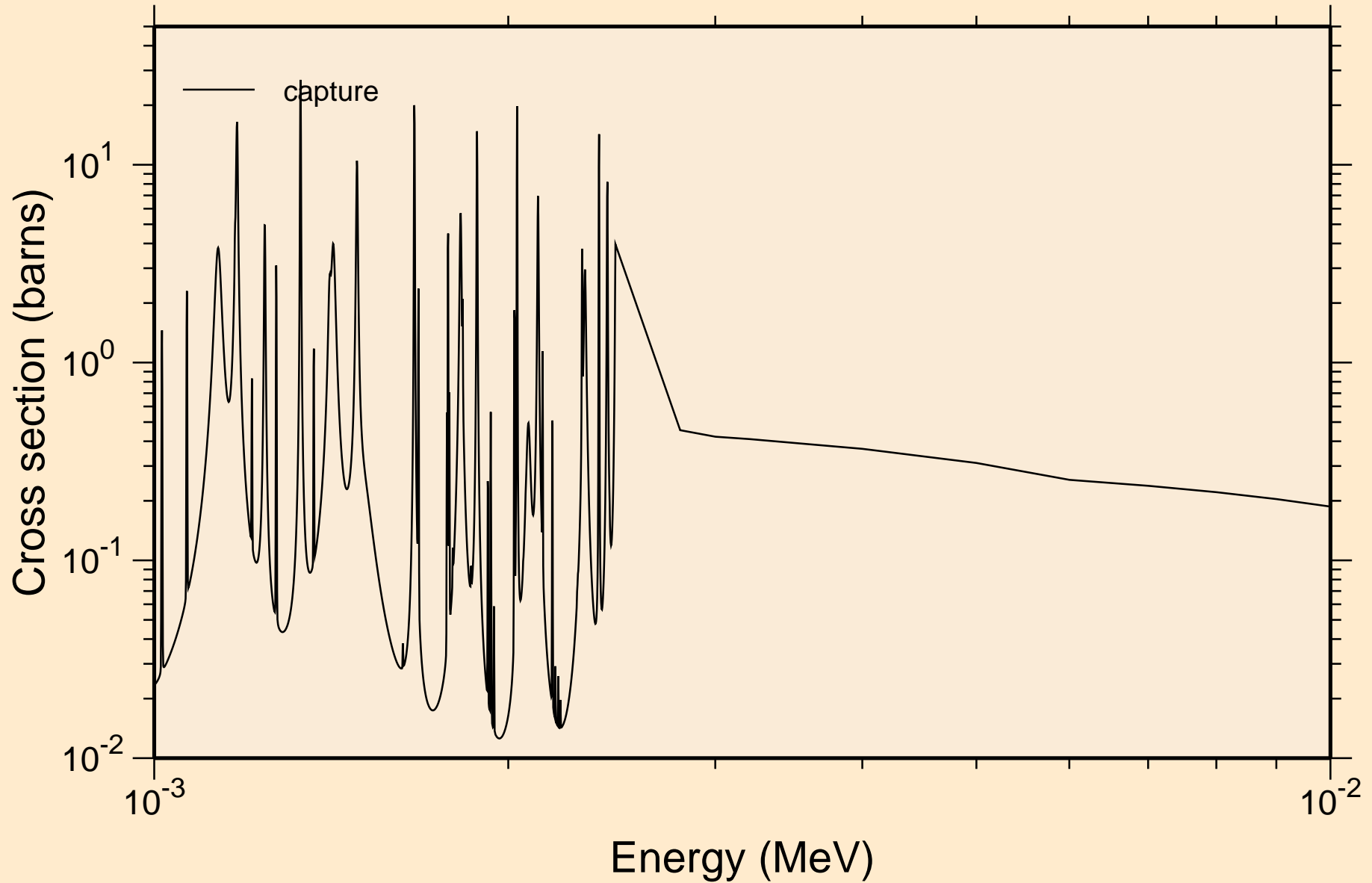

GD163 NEUTRON ACER TENDL-2021 LIBRARY; T=293.6K
resonance absorption cross sections

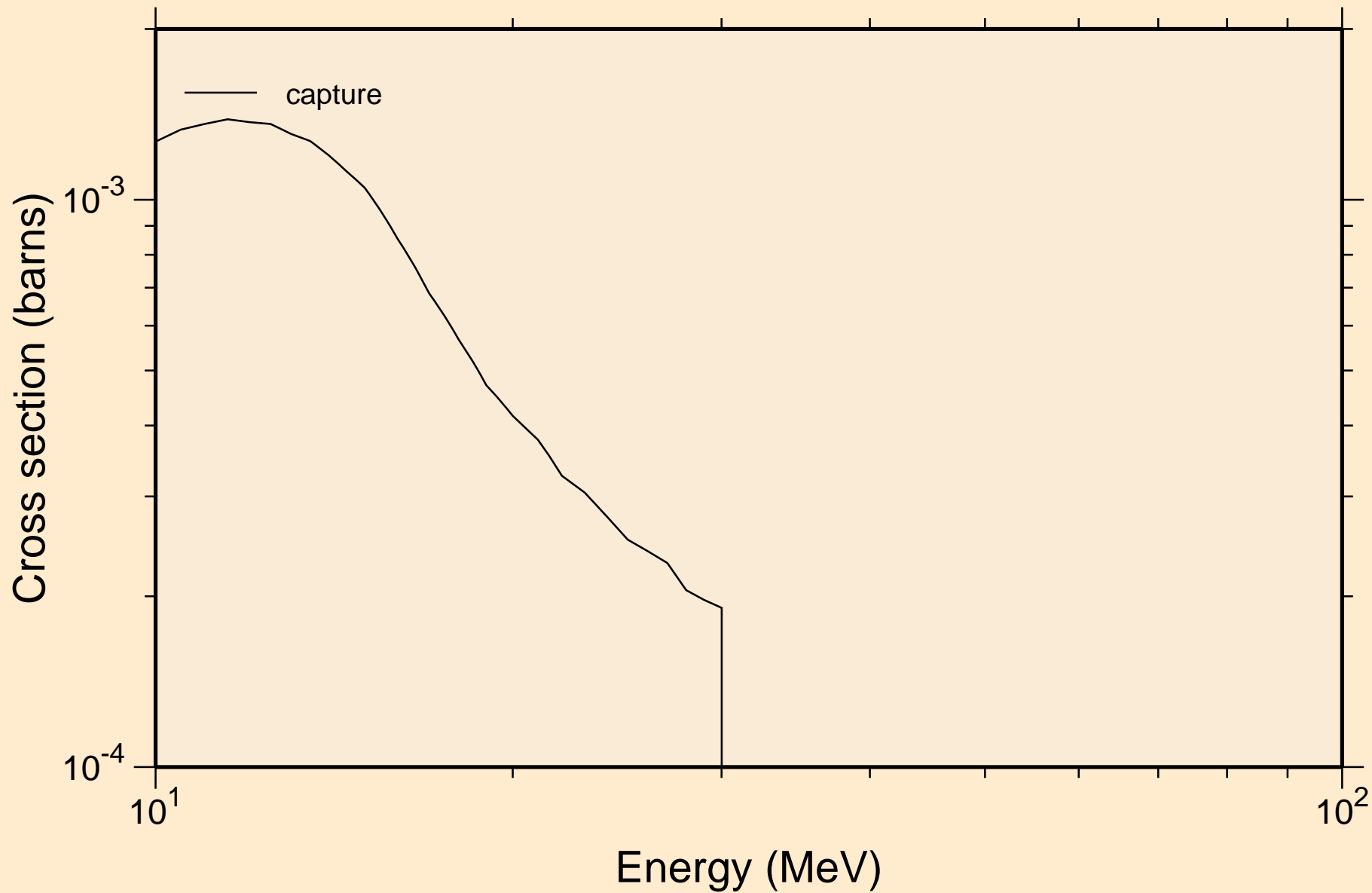

GD163 NEUTRON ACER TENDL-2021 LIBRARY; T=293.6K
Heating

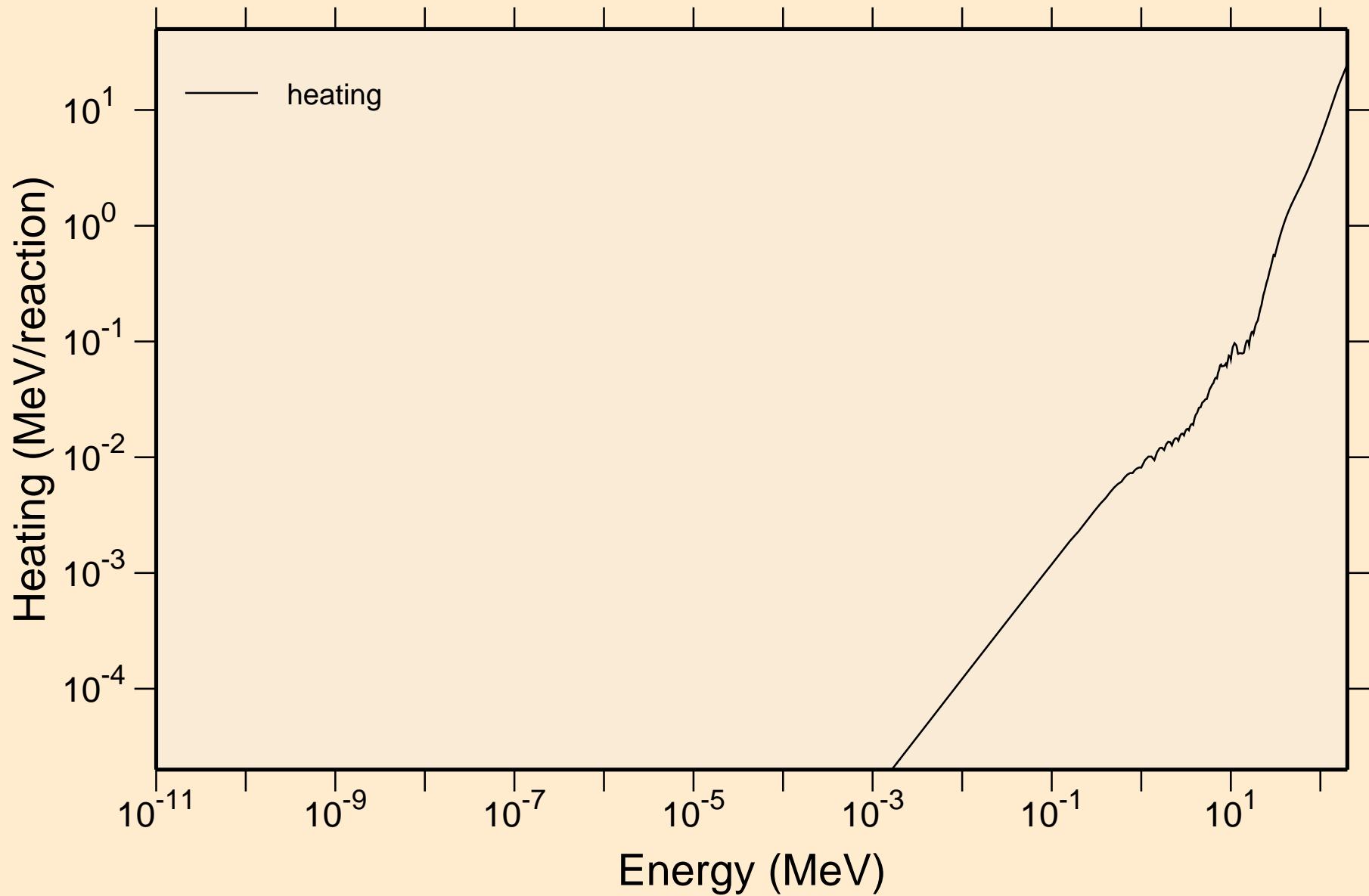

GD163 NEUTRON ACER TENDL-2021 LIBRARY; T=293.6K

Damage

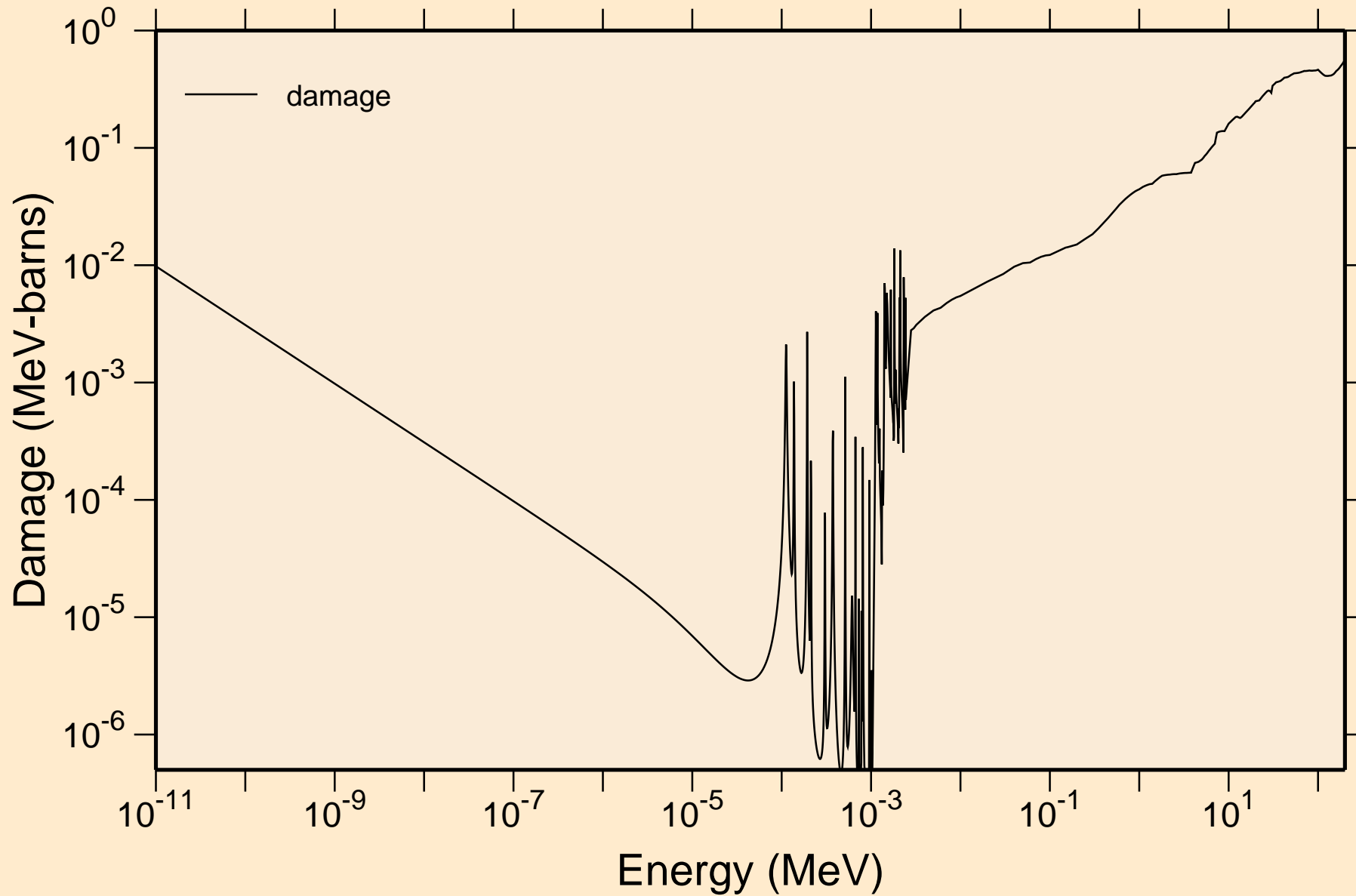

GD163 NEUTRON ACER TENDL-2021 LIBRARY; T=293.6K
Non-threshold reactions

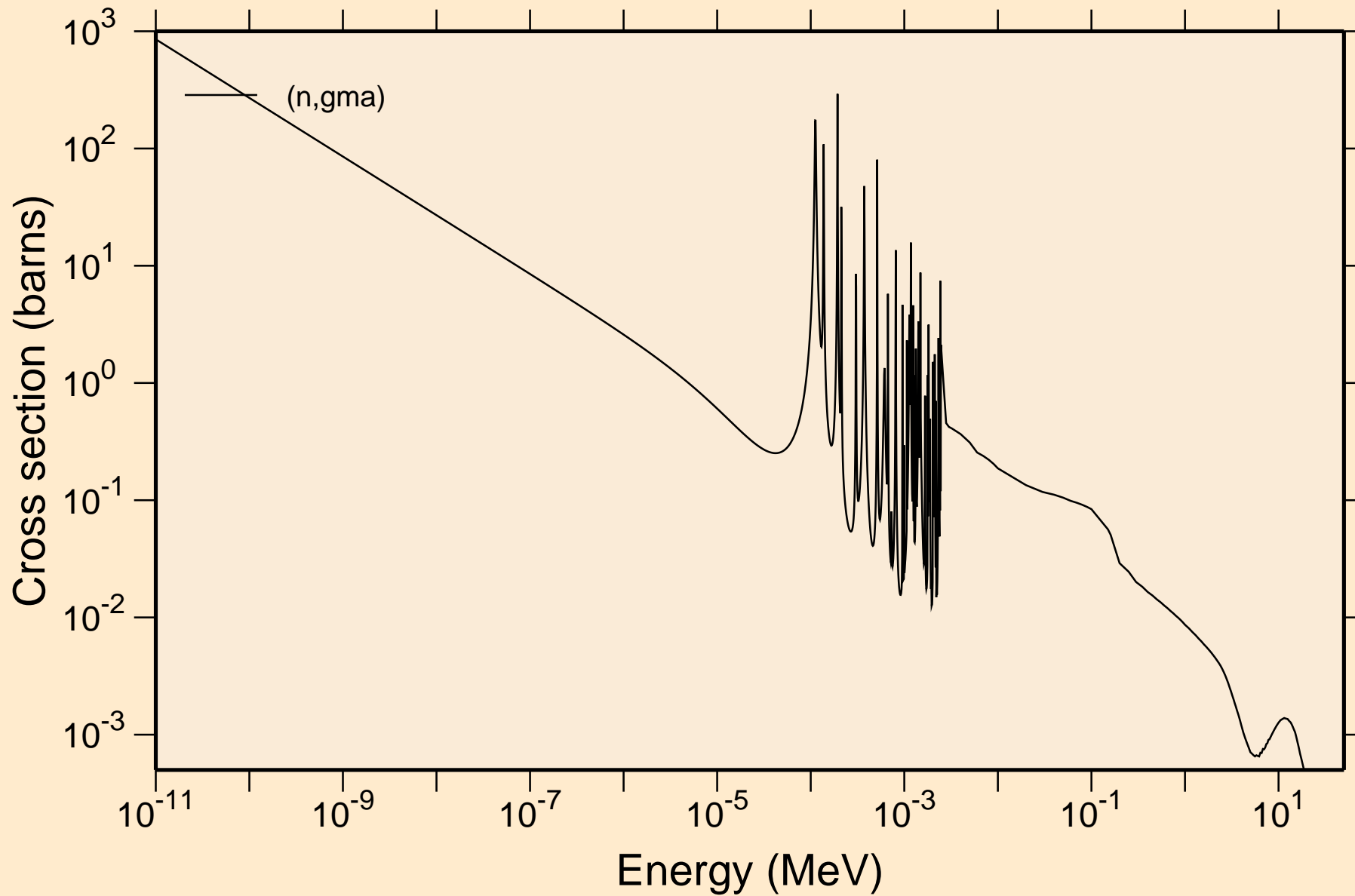

GD163 NEUTRON ACER TENDL-2021 LIBRARY; T=293.6K
Principal cross sections

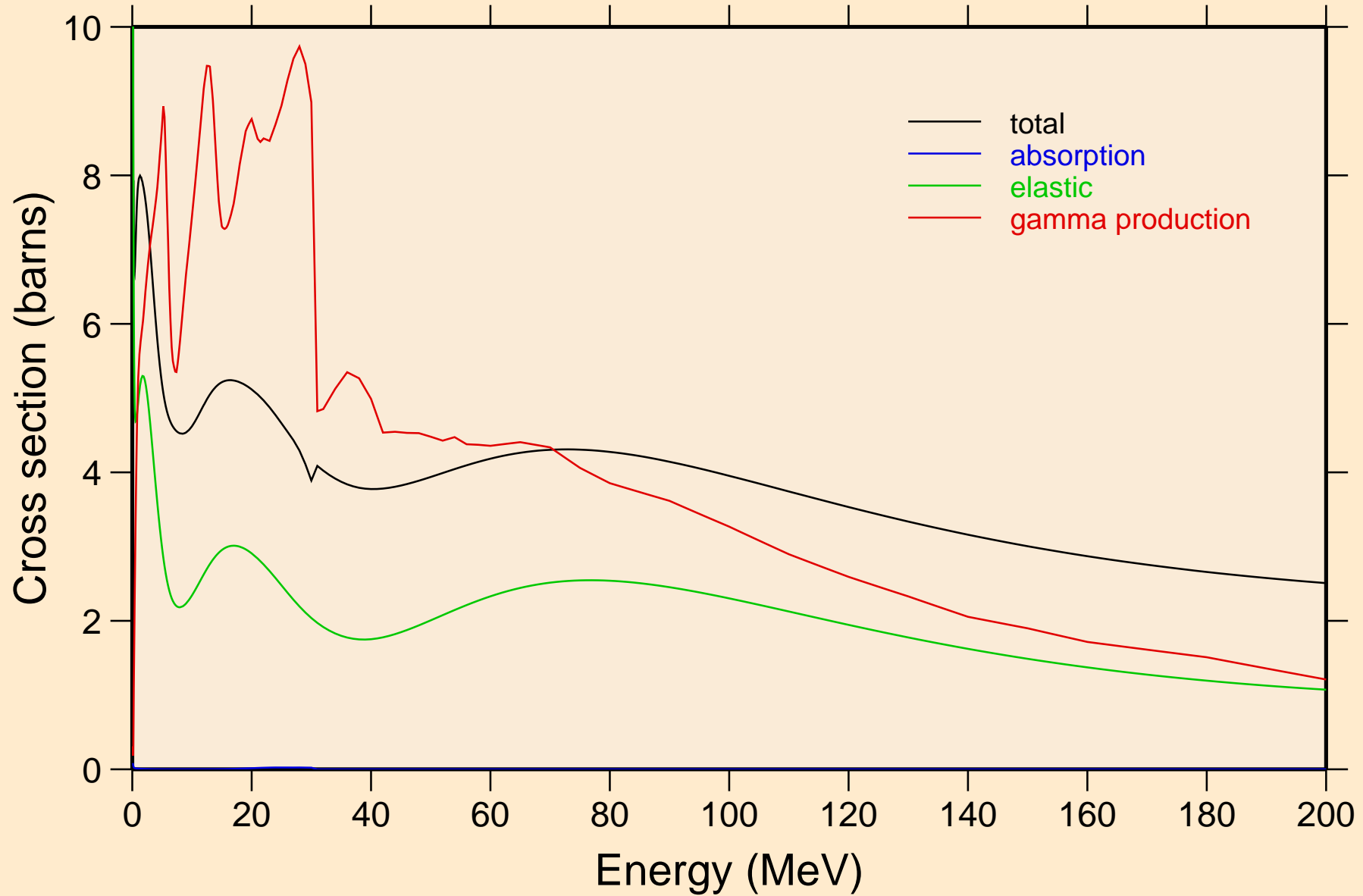

GD163 NEUTRON ACER TENDL-2021 LIBRARY; T=293.6K
Heating

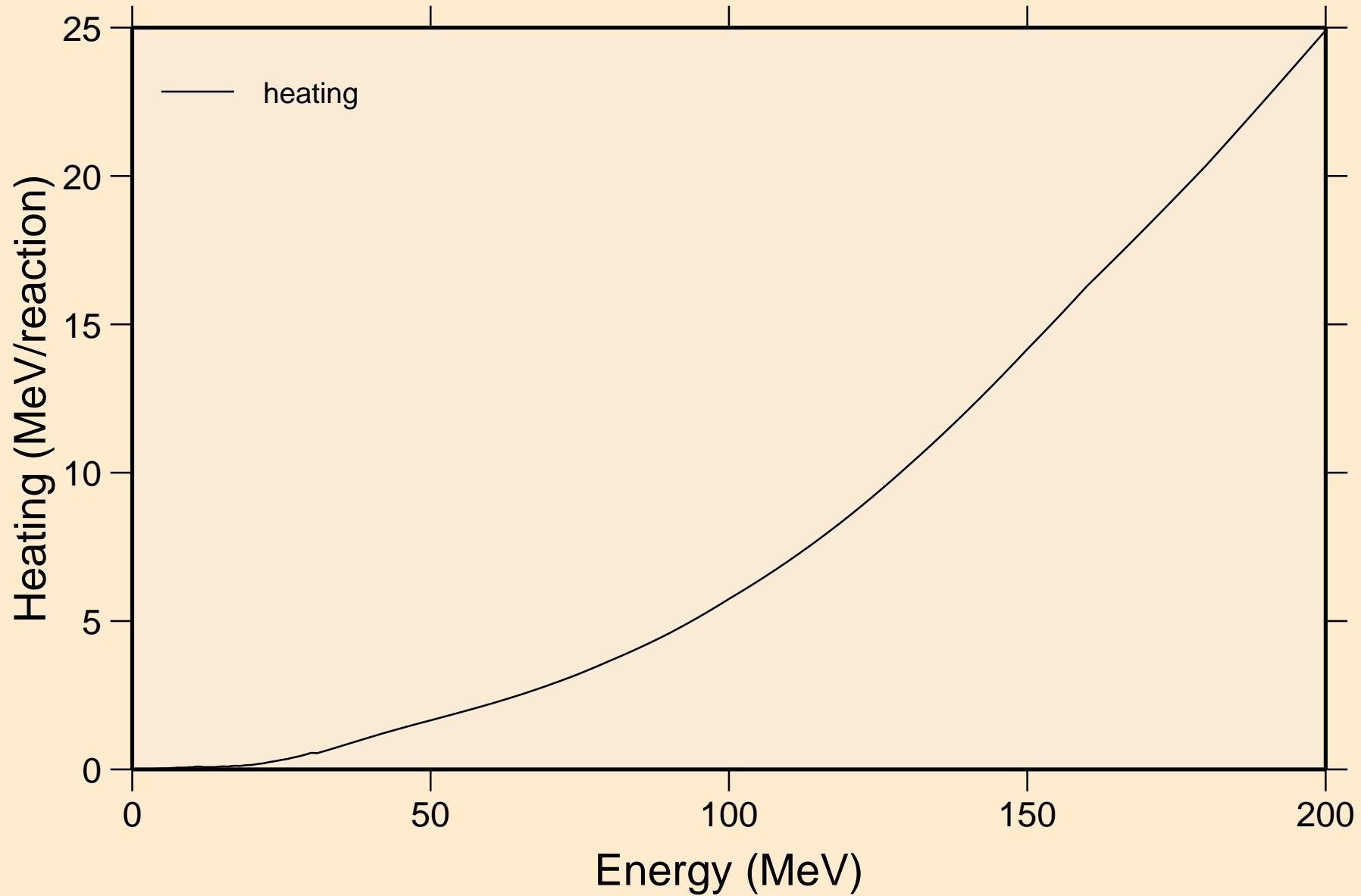

GD163 NEUTRON ACER TENDL-2021 LIBRARY; T=293.6K

Damage

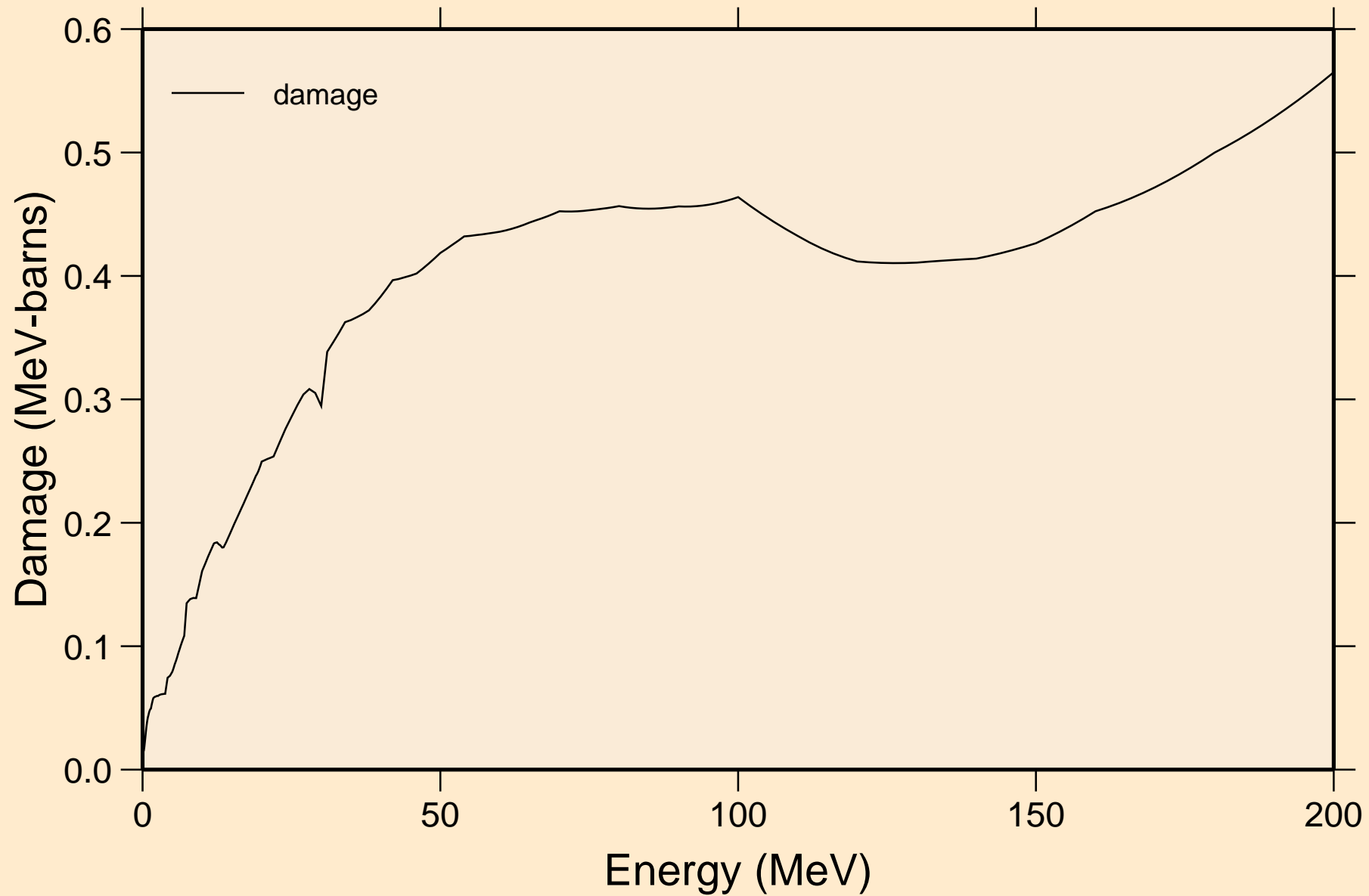

GD163 NEUTRON ACER TENDL-2021 LIBRARY; T=293.6K
Non-threshold reactions

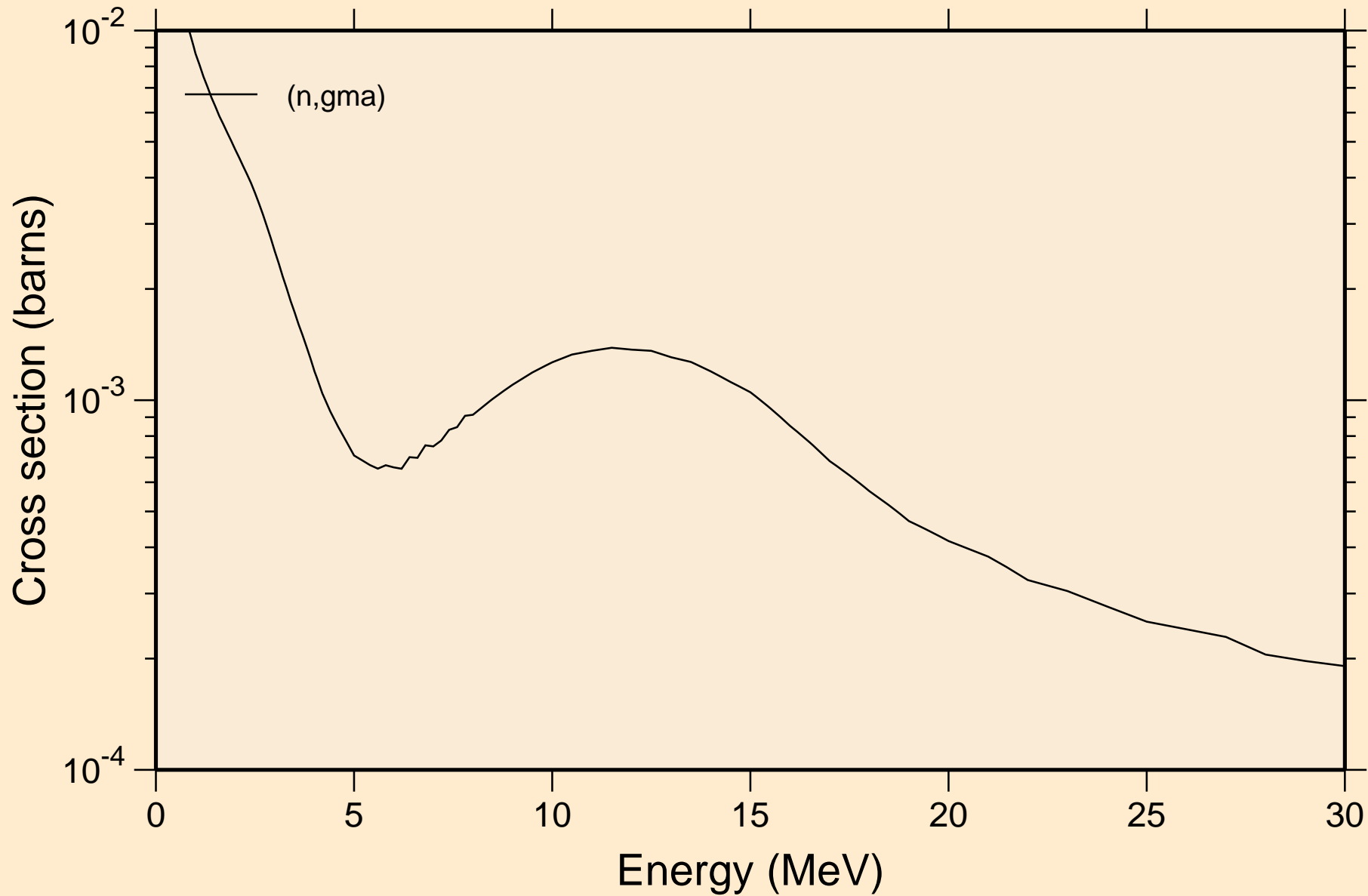

GD163 NEUTRON ACER TENDL-2021 LIBRARY; T=293.6K
Inelastic levels

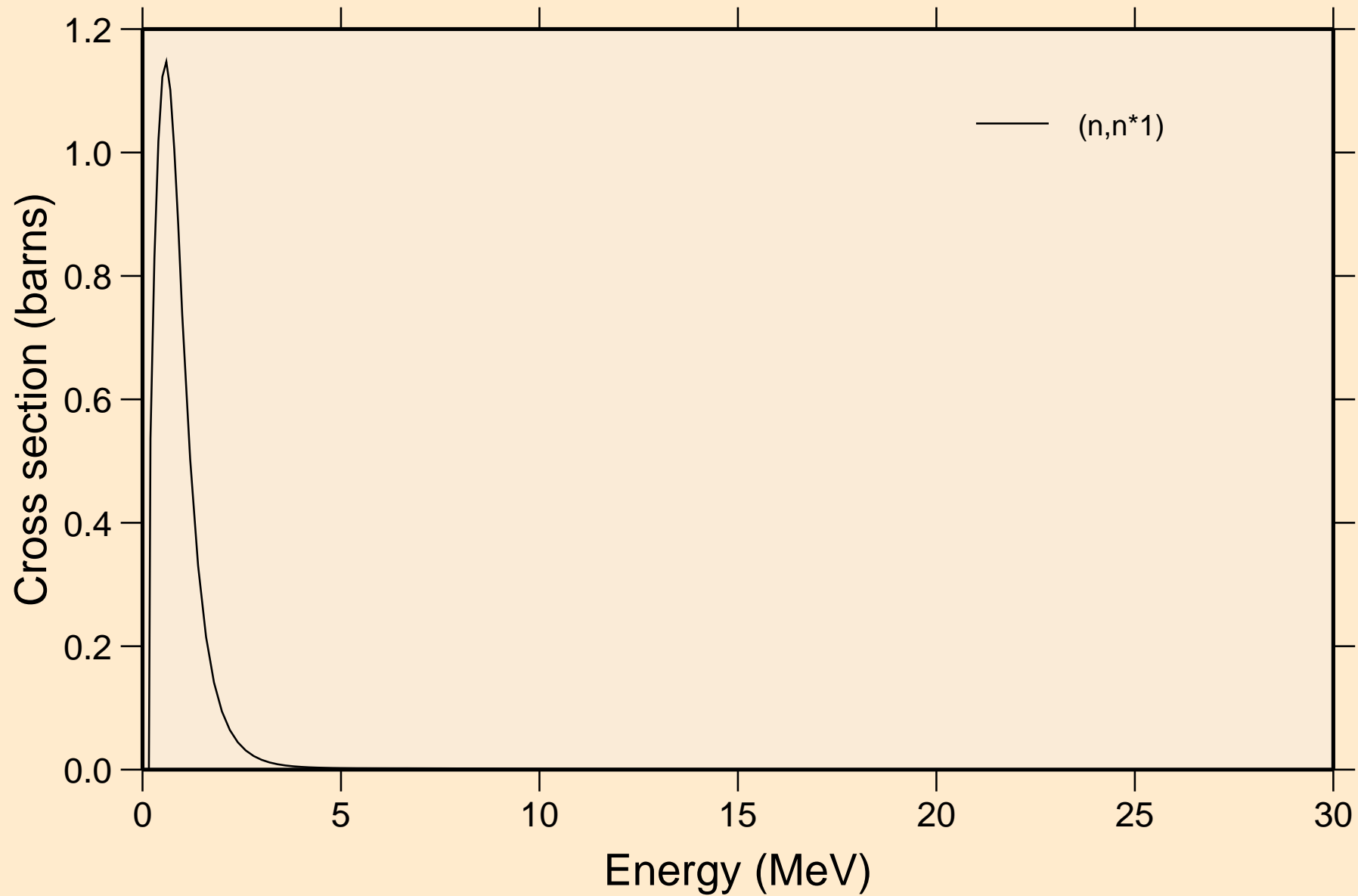

GD163 NEUTRON ACER TENDL-2021 LIBRARY; T=293.6K

Threshold reactions

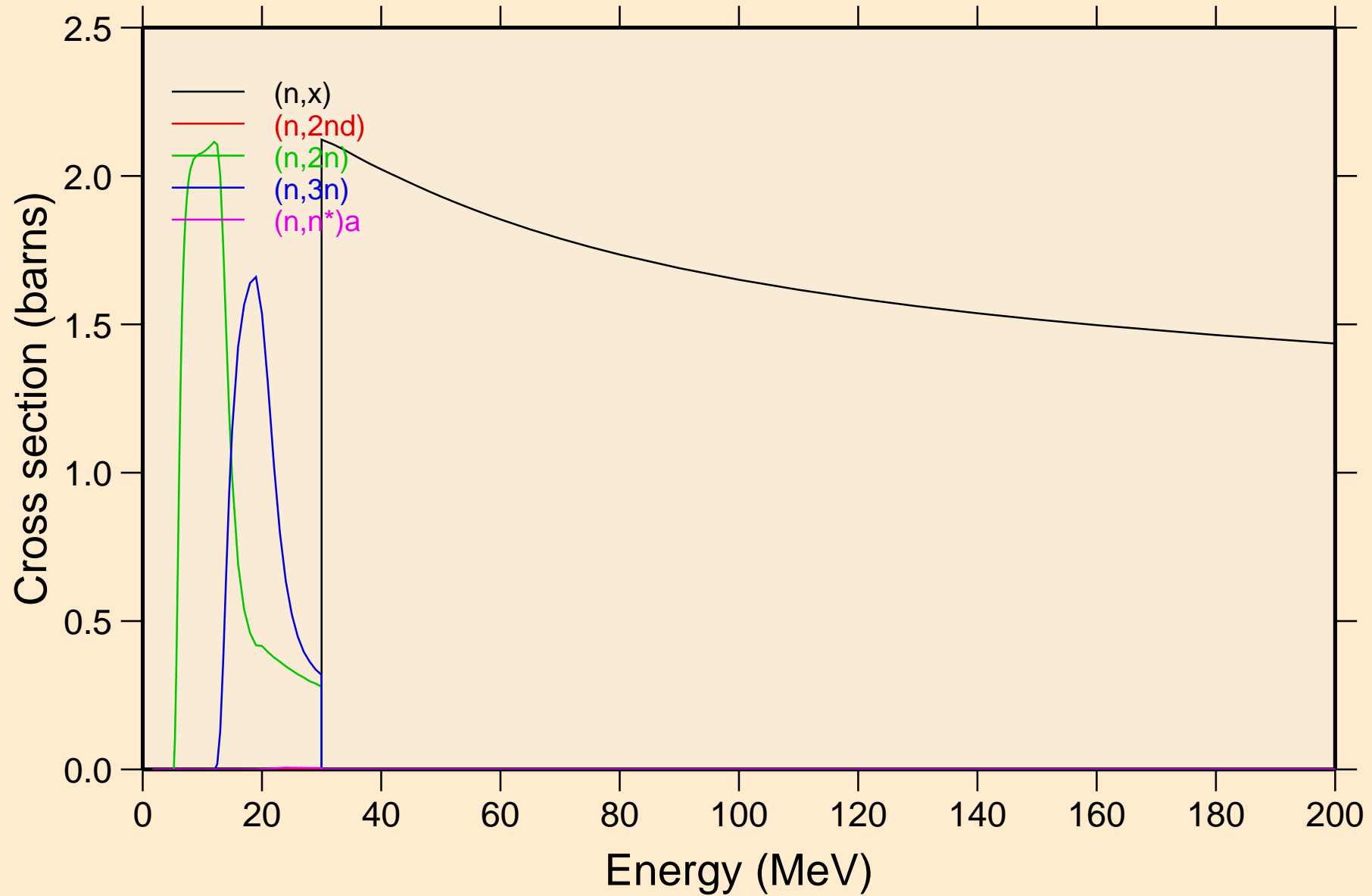

GD163 NEUTRON ACER TENDL-2021 LIBRARY; T=293.6K

Threshold reactions

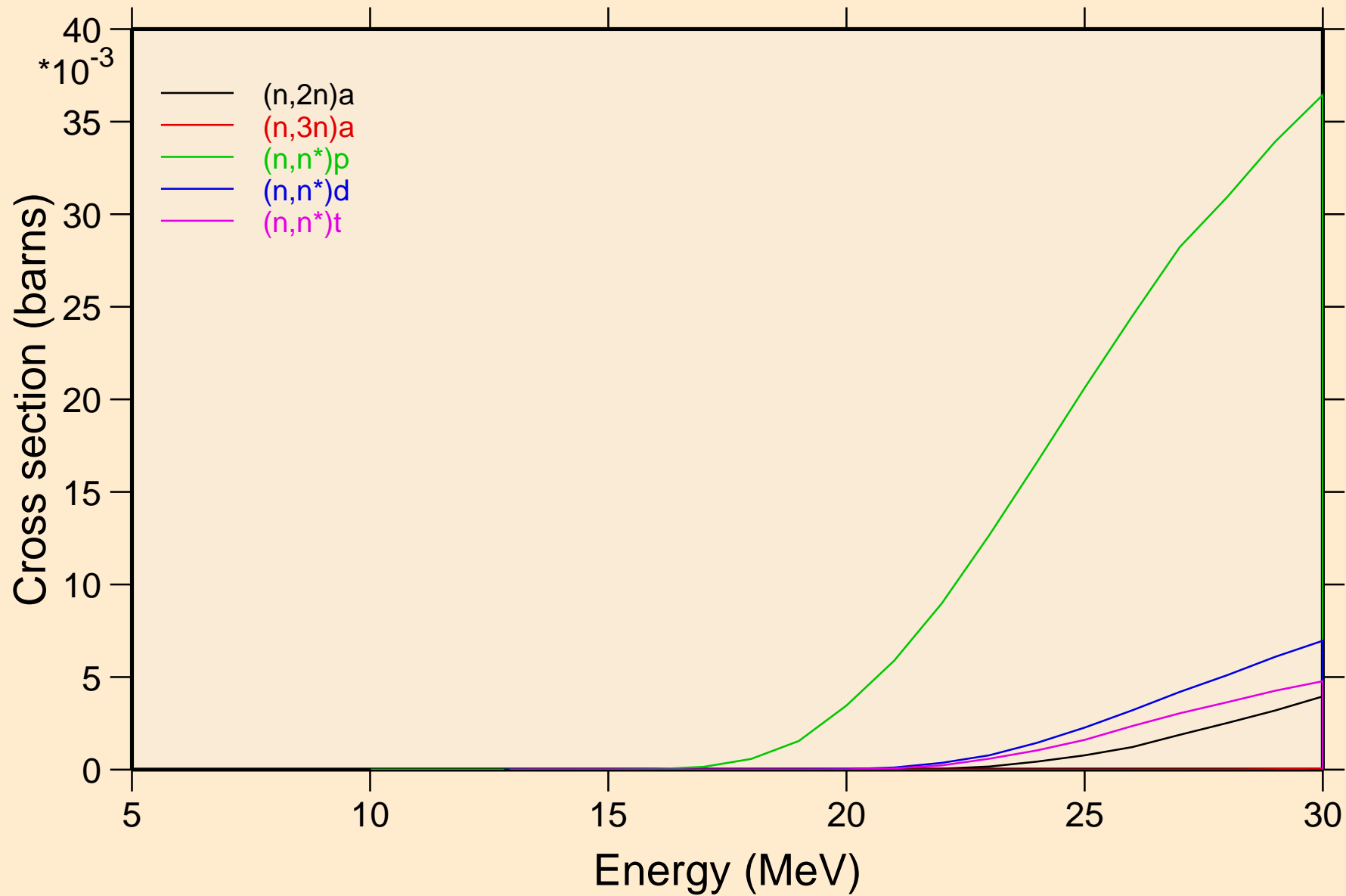

GD163 NEUTRON ACER TENDL-2021 LIBRARY; T=293.6K
Threshold reactions

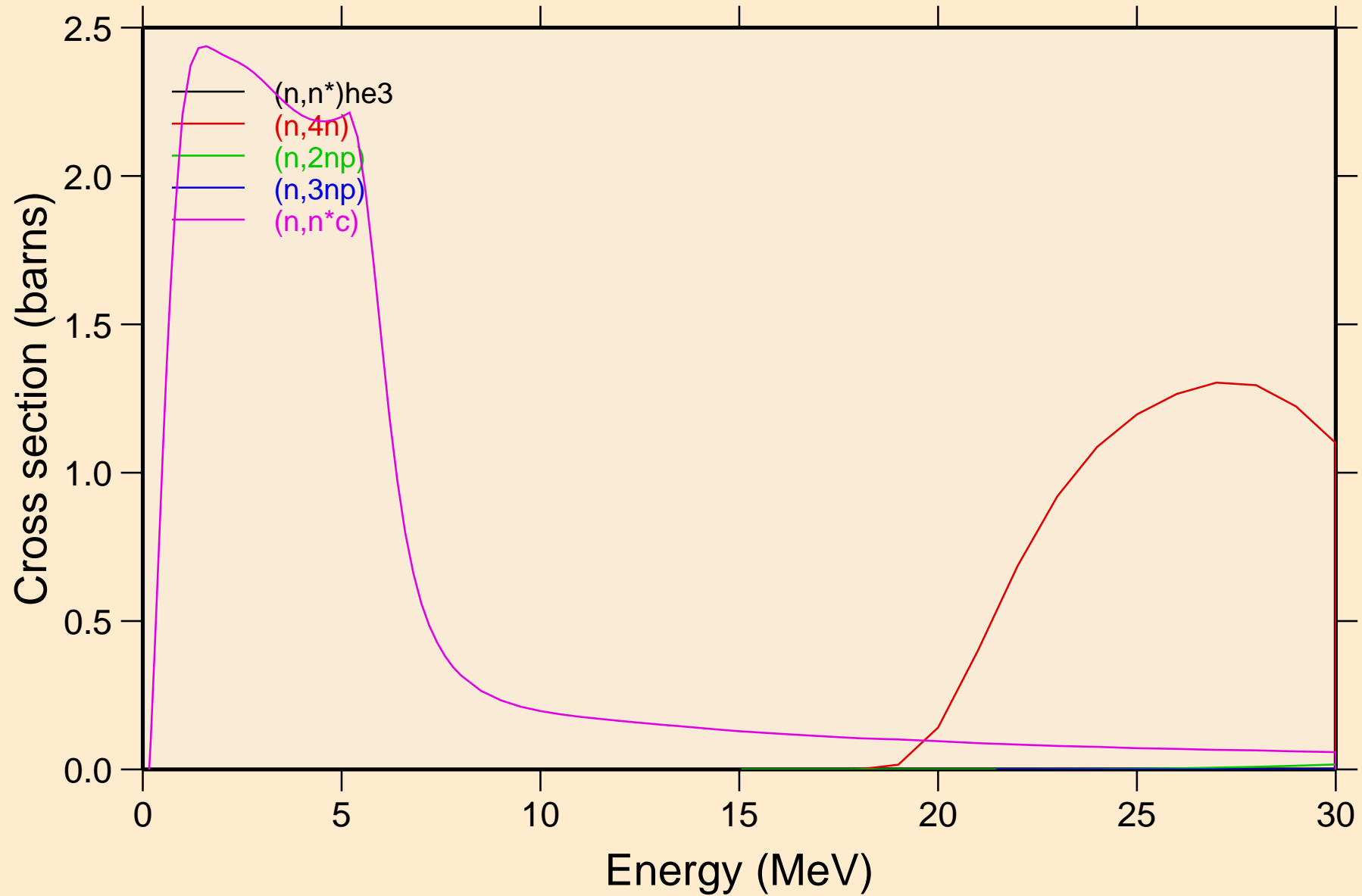

GD163 NEUTRON ACER TENDL-2021 LIBRARY; T=293.6K

Threshold reactions

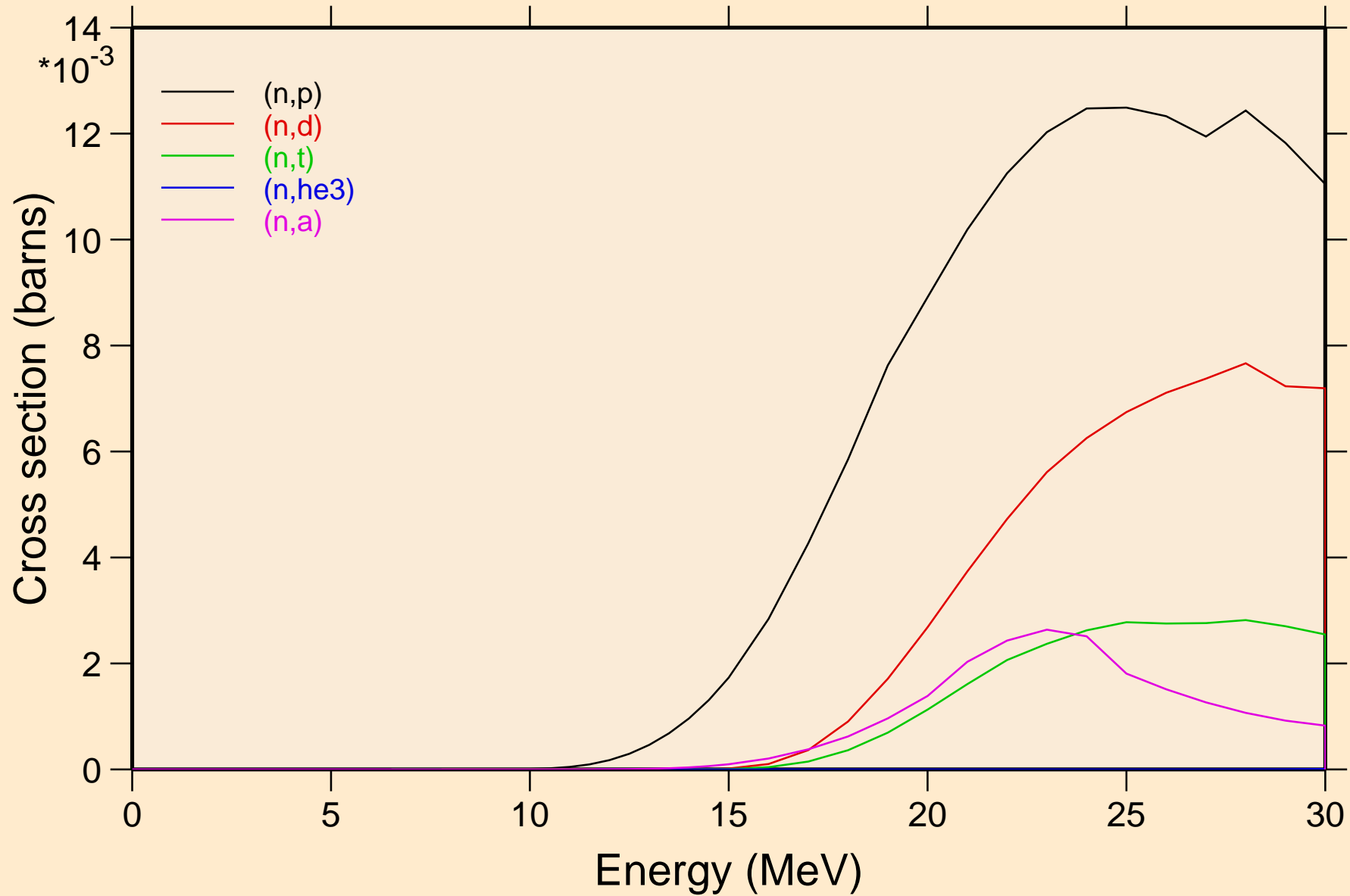

GD163 NEUTRON ACER TENDL-2021 LIBRARY; T=293.6K
Threshold reactions

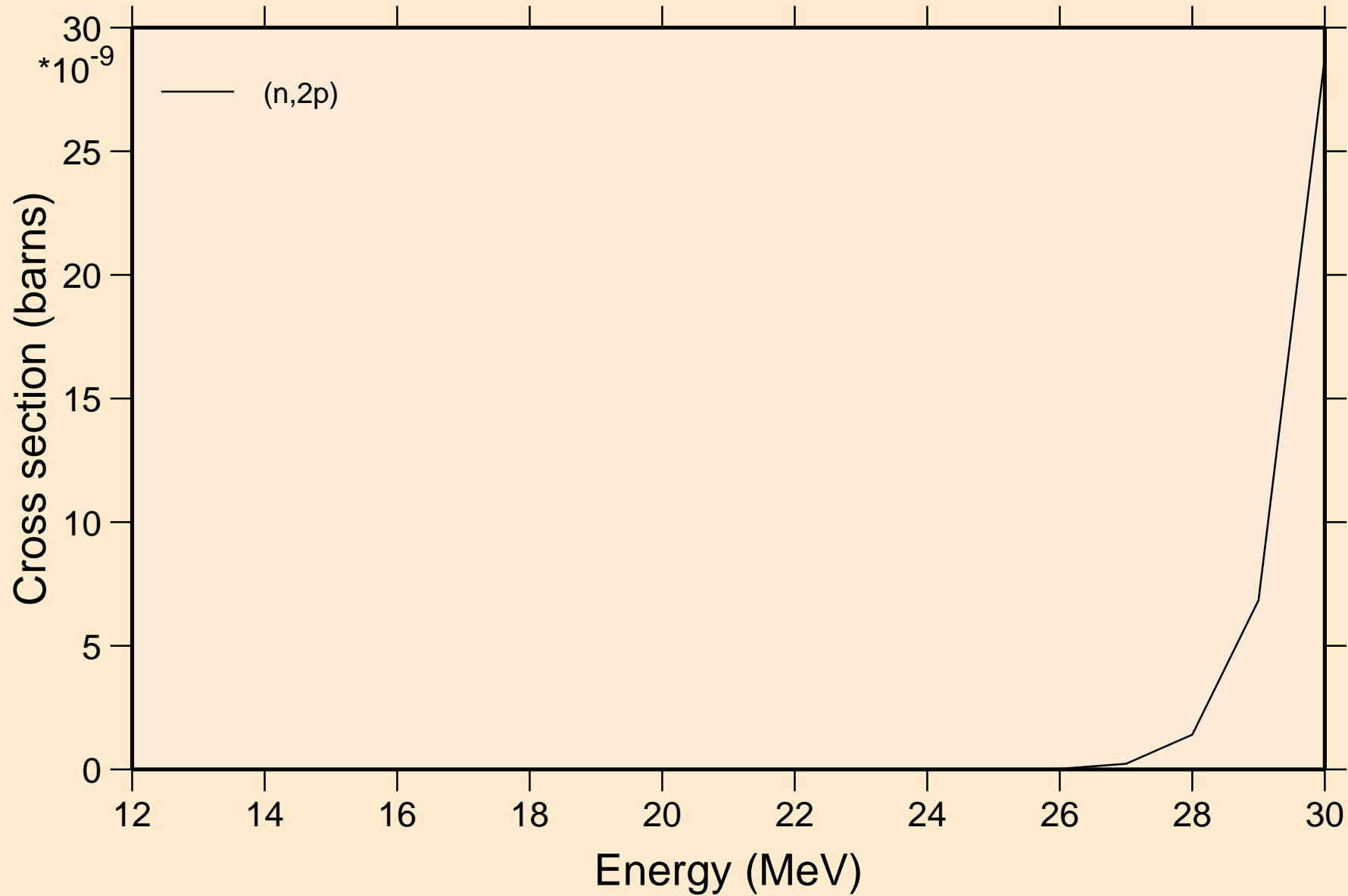

GD163 NEUTRON ACER TENDL-2021 LIBRARY; T=293.6K

Threshold reactions

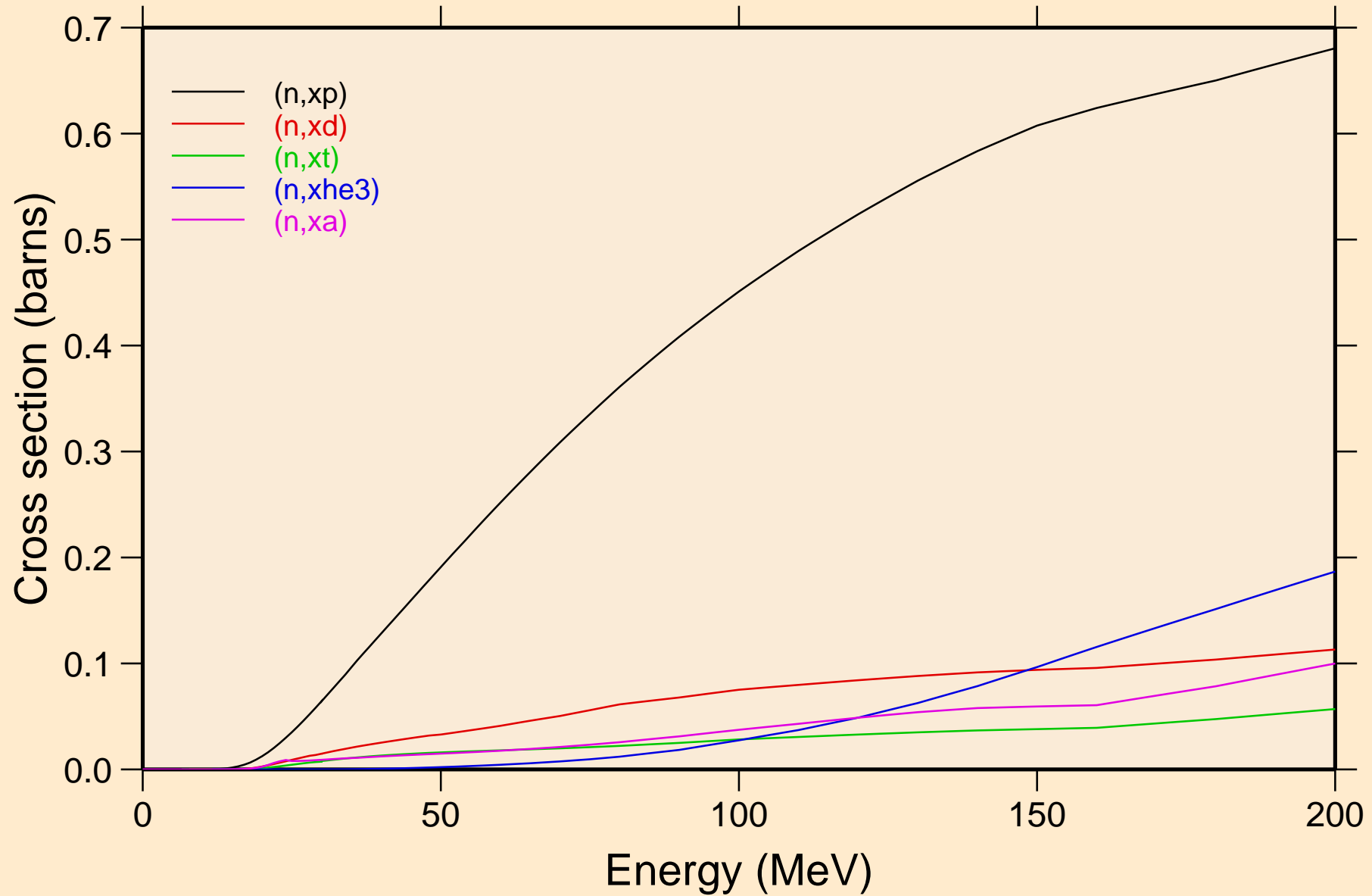

GD163 NEUTRON ACER TENDL-2021 LIBRARY; T=293.6K
angular distribution for elastic

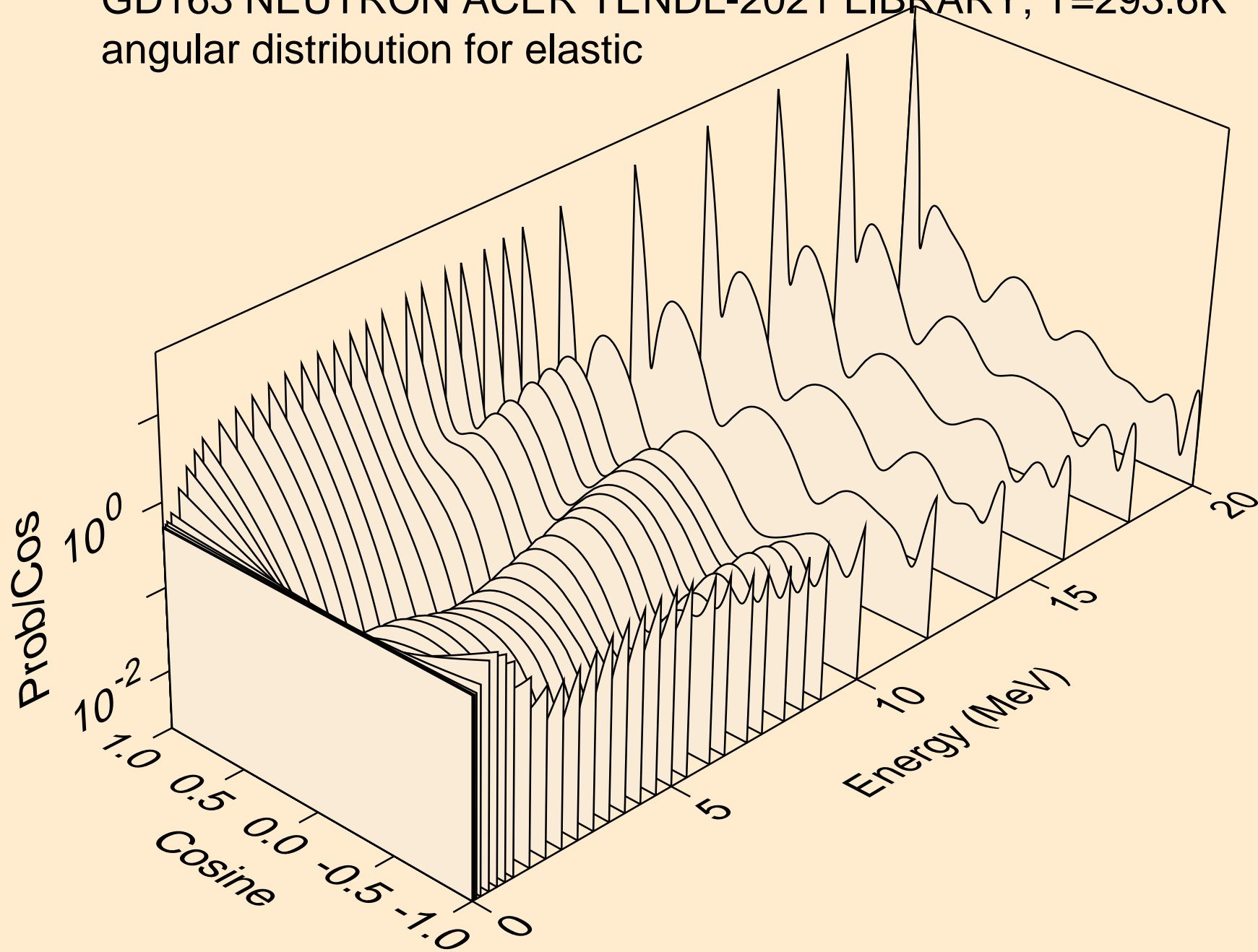

GD163 NEUTRON ACER TENDL-2021 LIBRARY; T=293.6K
angular distribution for elastic

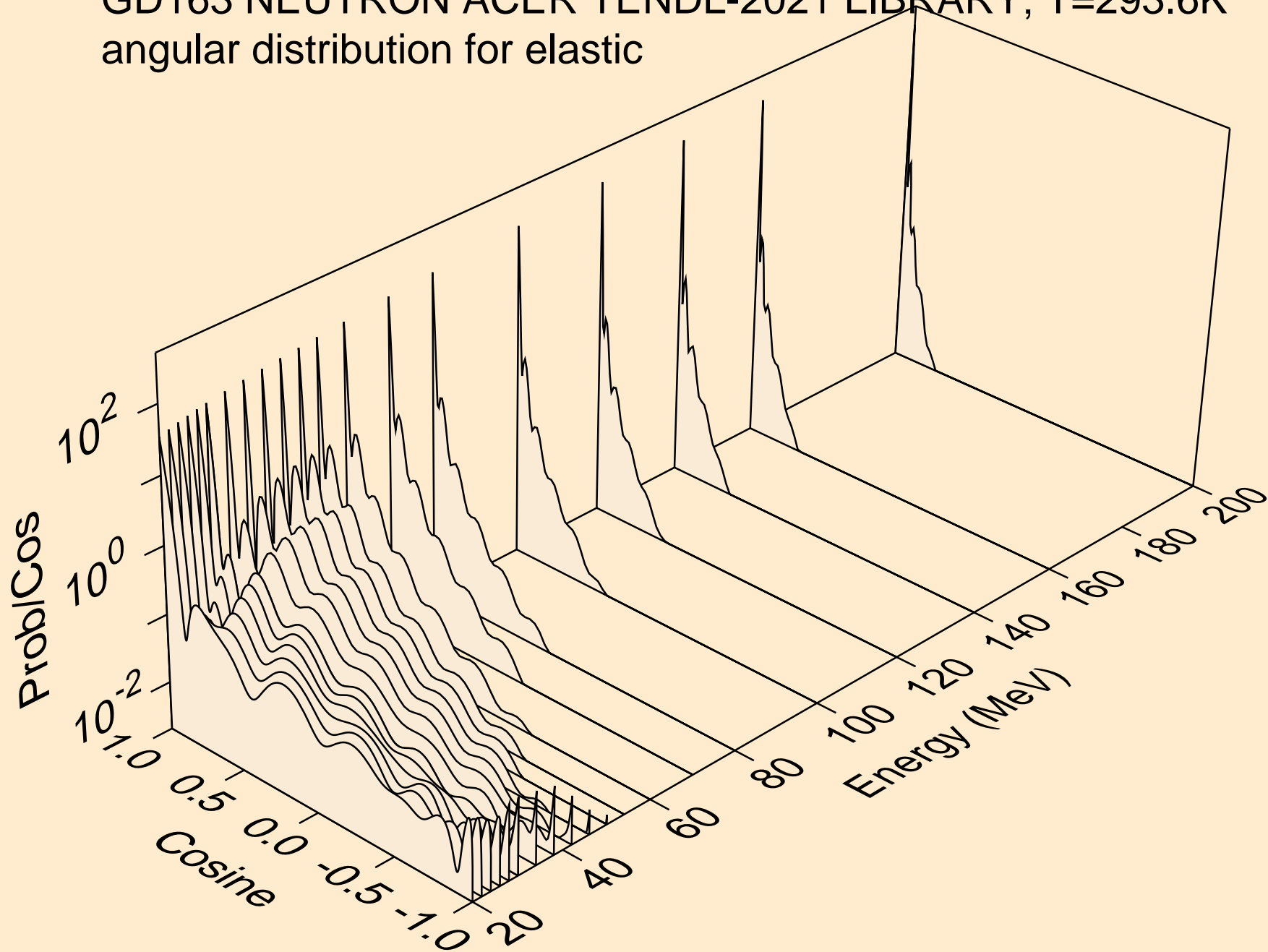

GD163 NEUTRON ACER TENDL-2021 LIBRARY; T=293.6K
angular distribution for (n,n*1)

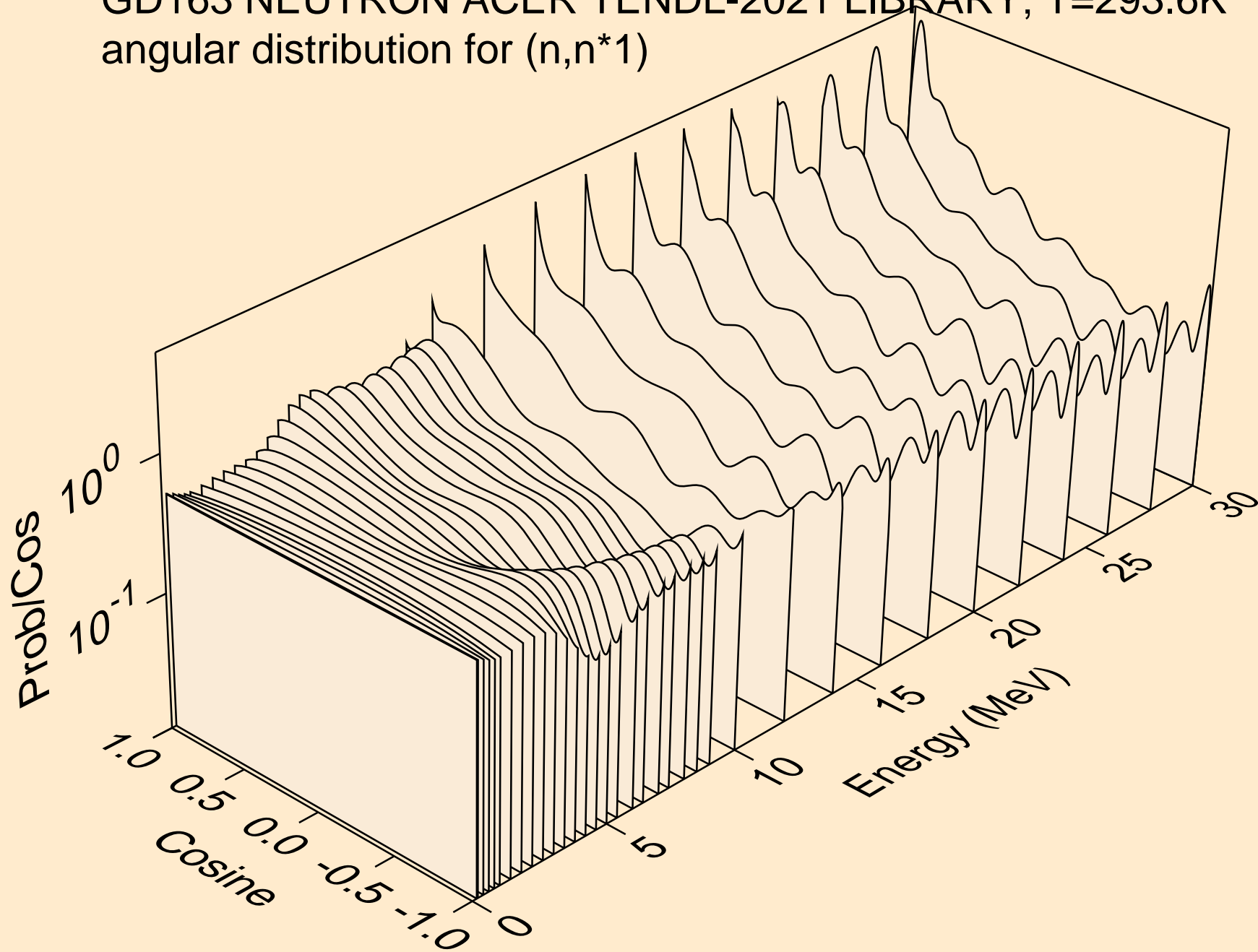

GD163 NEUTRON ACER TENDL-2021 LIBRARY; T=293.6K
Neutron emission for (n,x)

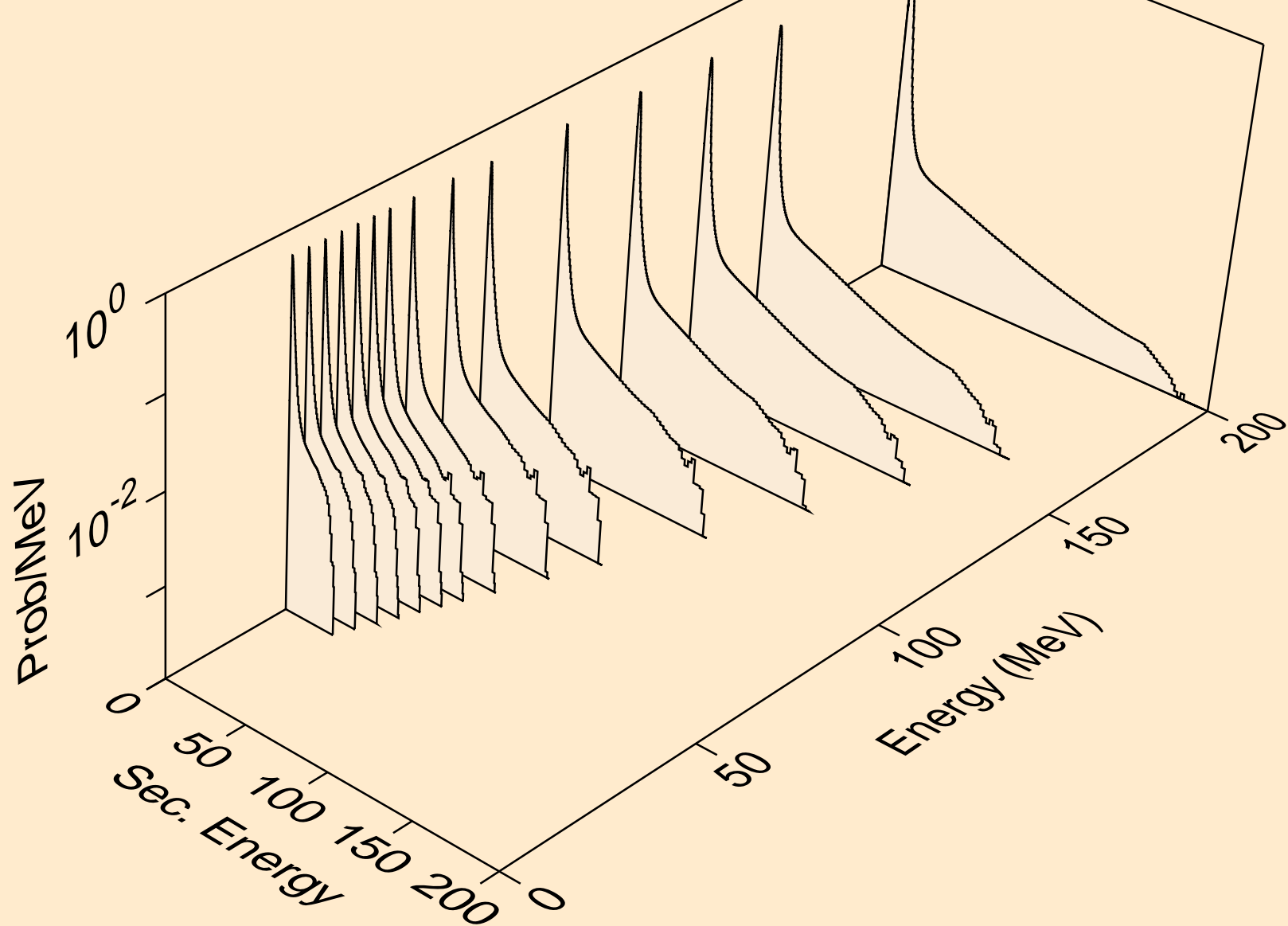

GD163 NEUTRON ACER TENDL-2021 LIBRARY; T=293.6K
Neutron emission for (n,2nd)

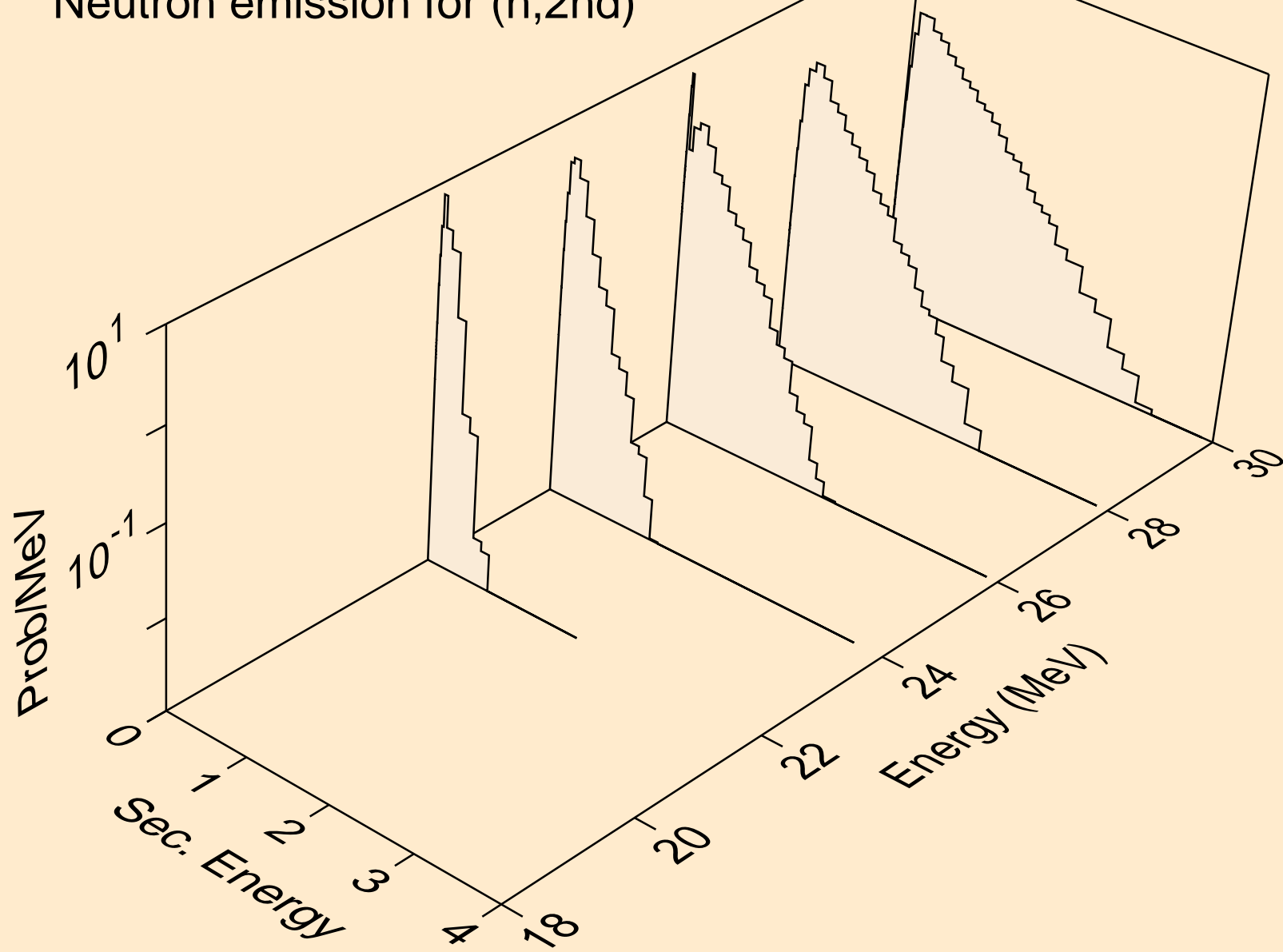

GD163 NEUTRON ACER TENDL-2021 LIBRARY; T=293.6K
Neutron emission for (n,2n)

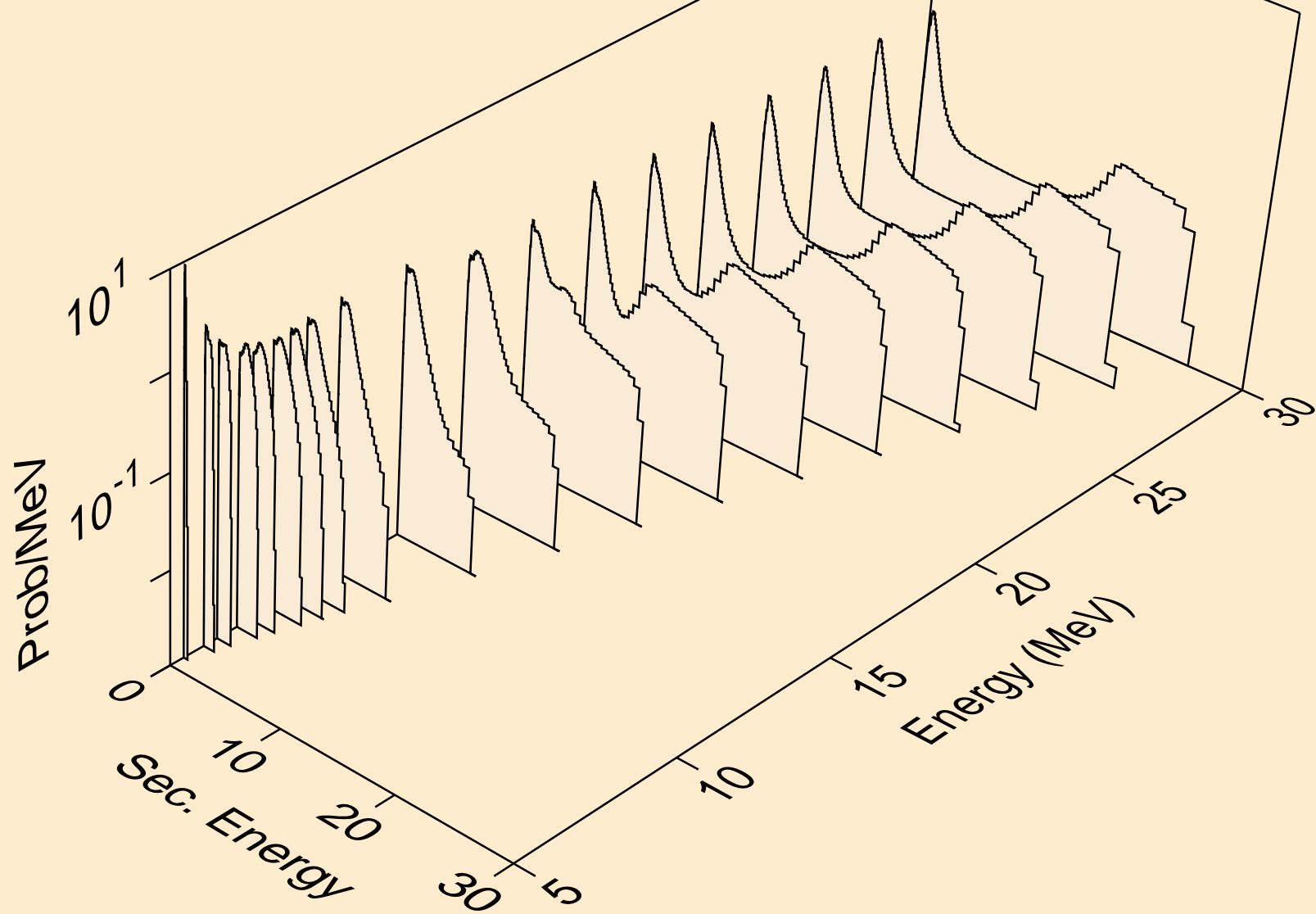

GD163 NEUTRON ACER TENDL-2021 LIBRARY; T=293.6K
Neutron emission for (n,3n)

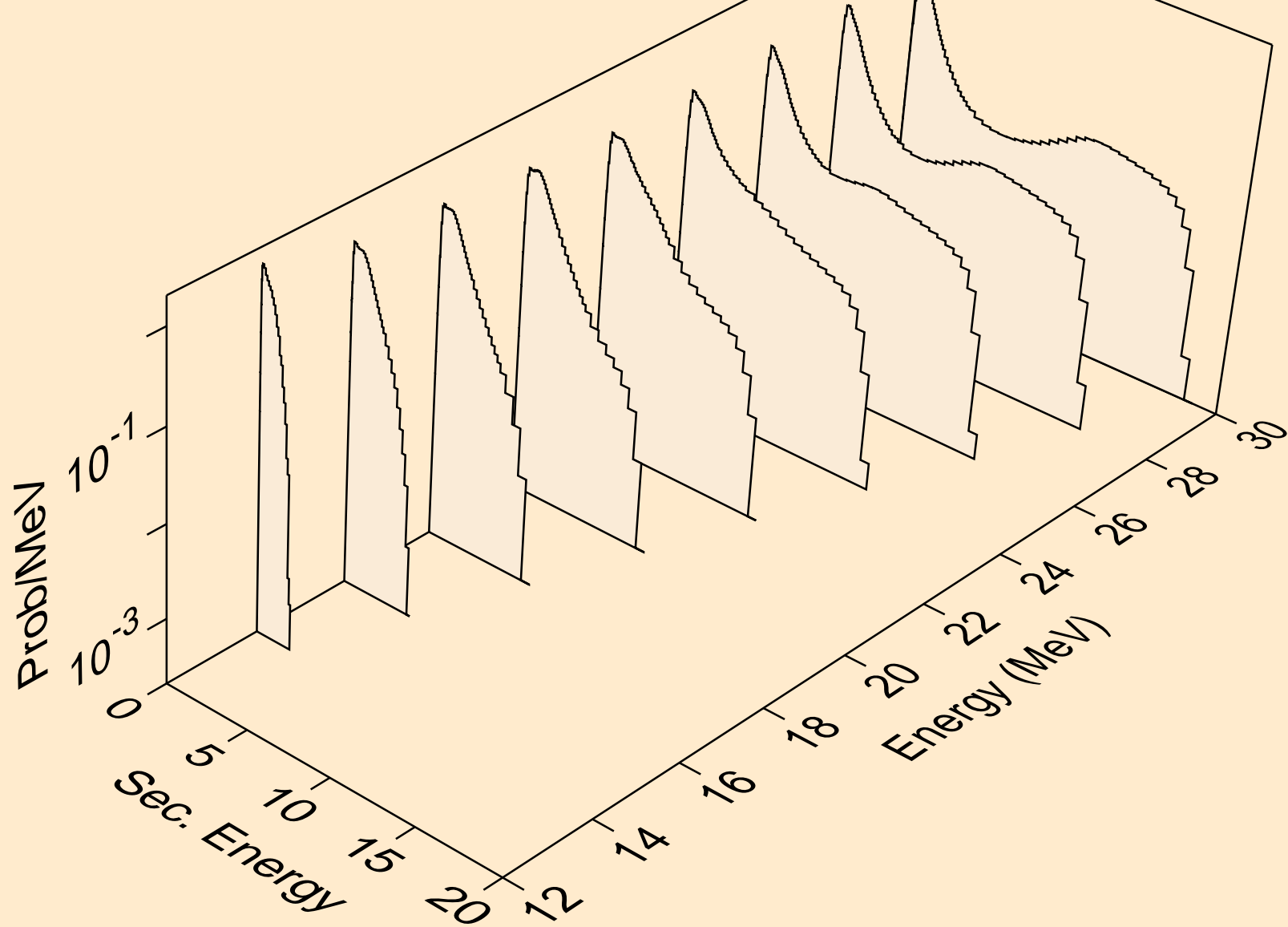

GD163 NEUTRON ACER TENDL-2021 LIBRARY; T=293.6K
Neutron emission for (n,n*)a

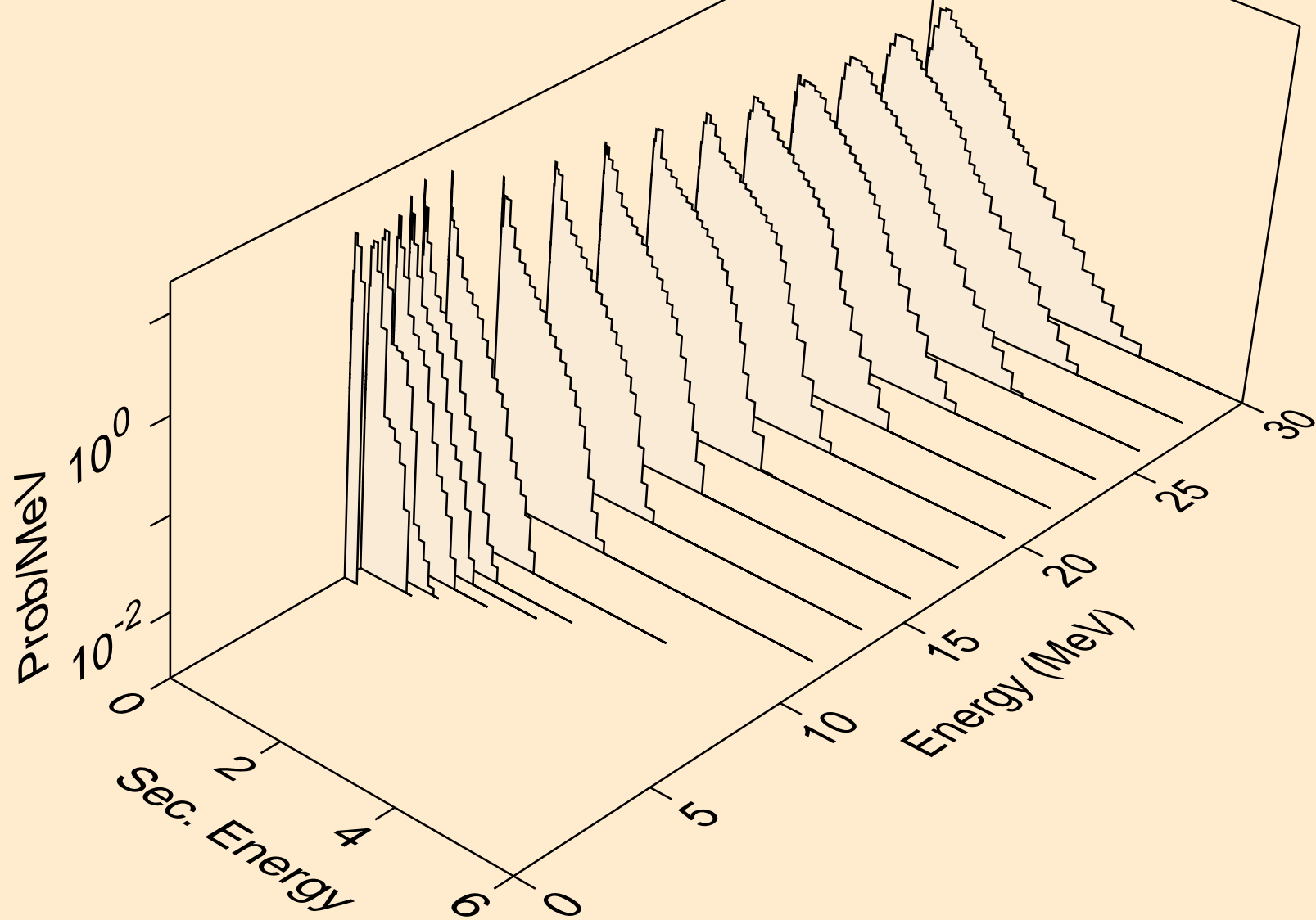

GD163 NEUTRON ACER TENDL-2021 LIBRARY; T=293.6K
Neutron emission for (n,2n)a

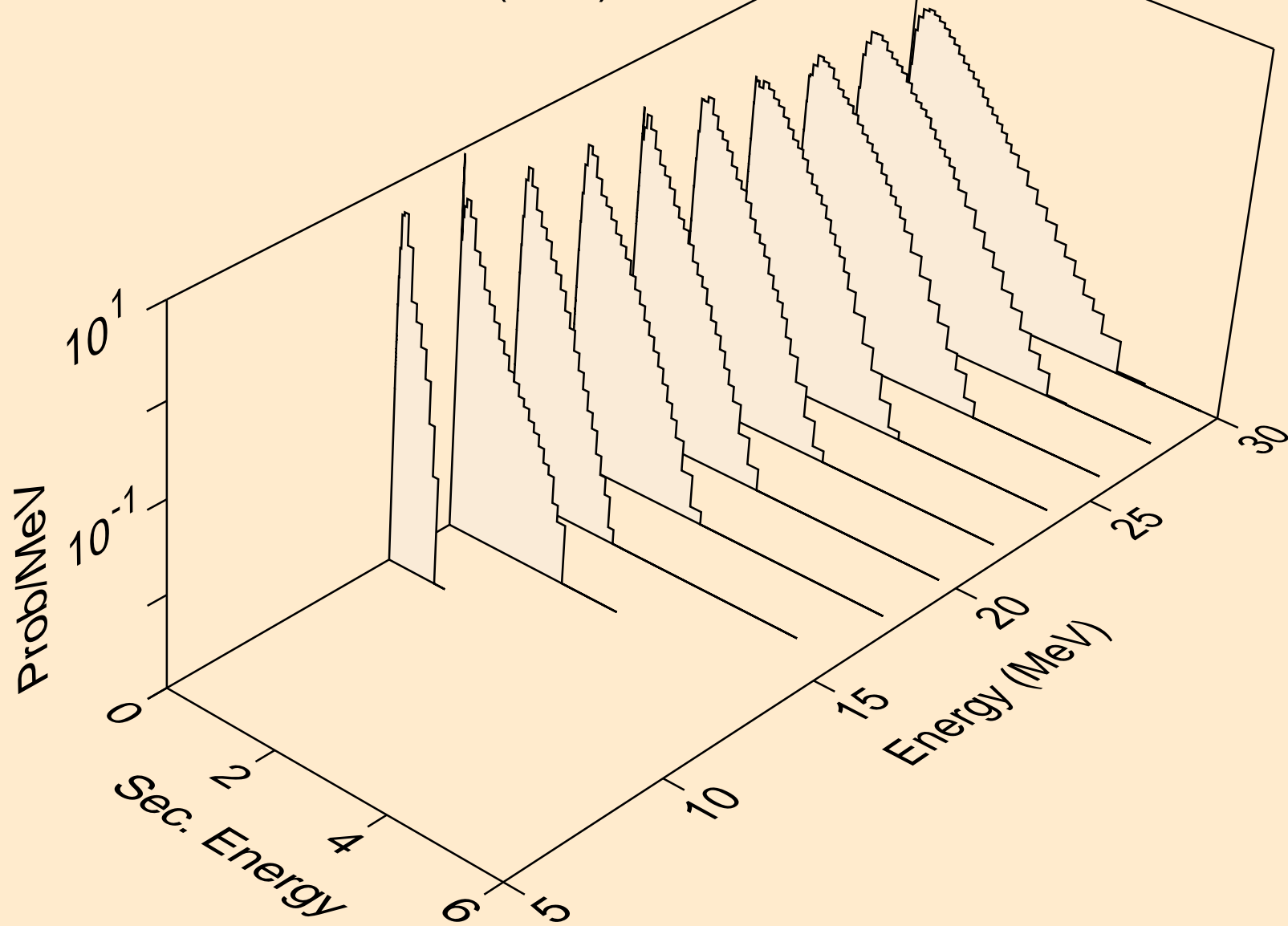

GD163 NEUTRON ACER TENDL-2021 LIBRARY; T=293.6K
Neutron emission for (n,3n)a

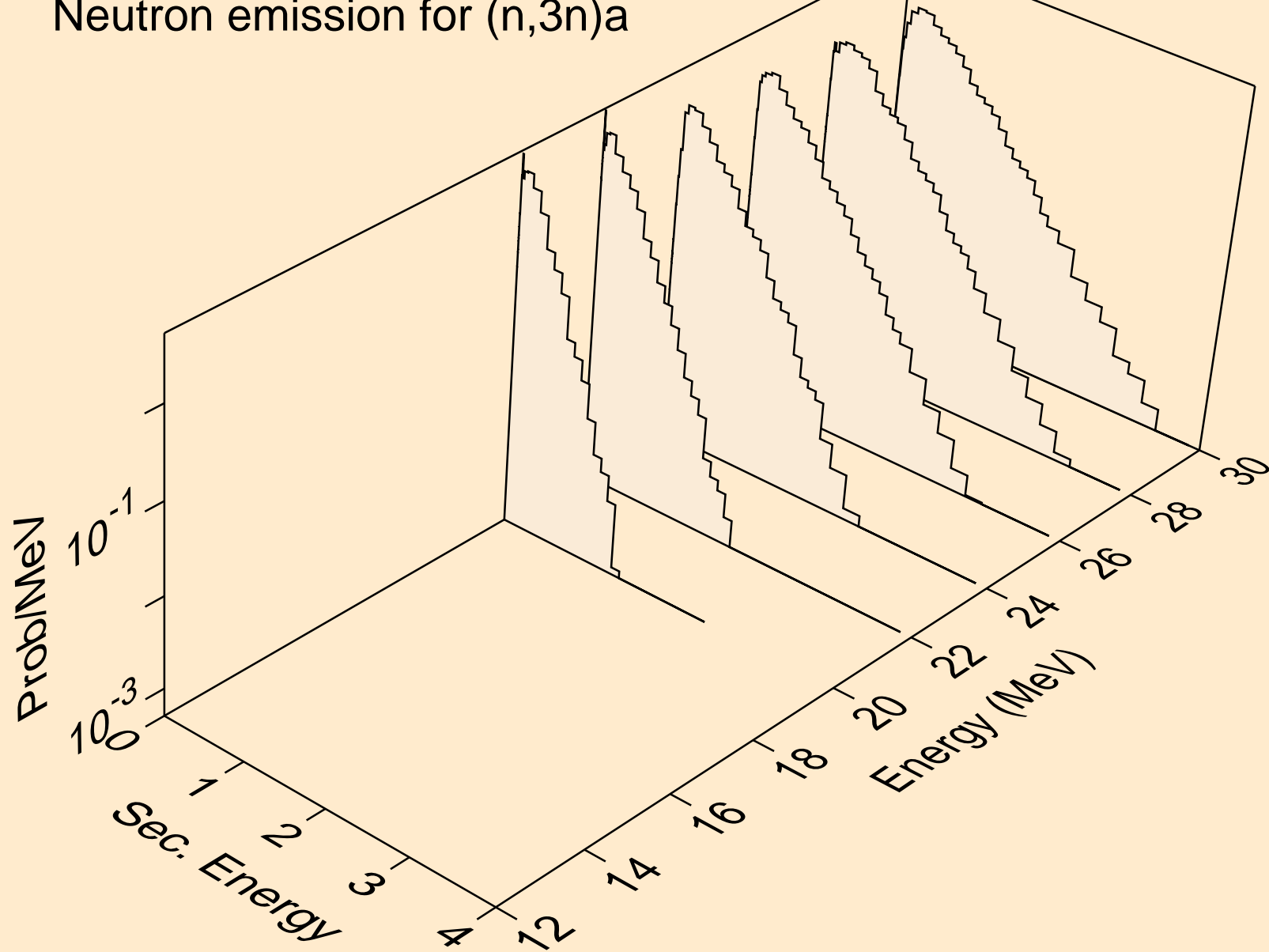

GD163 NEUTRON ACER TENDL-2021 LIBRARY; T=293.6K
Neutron emission for (n,n*)p

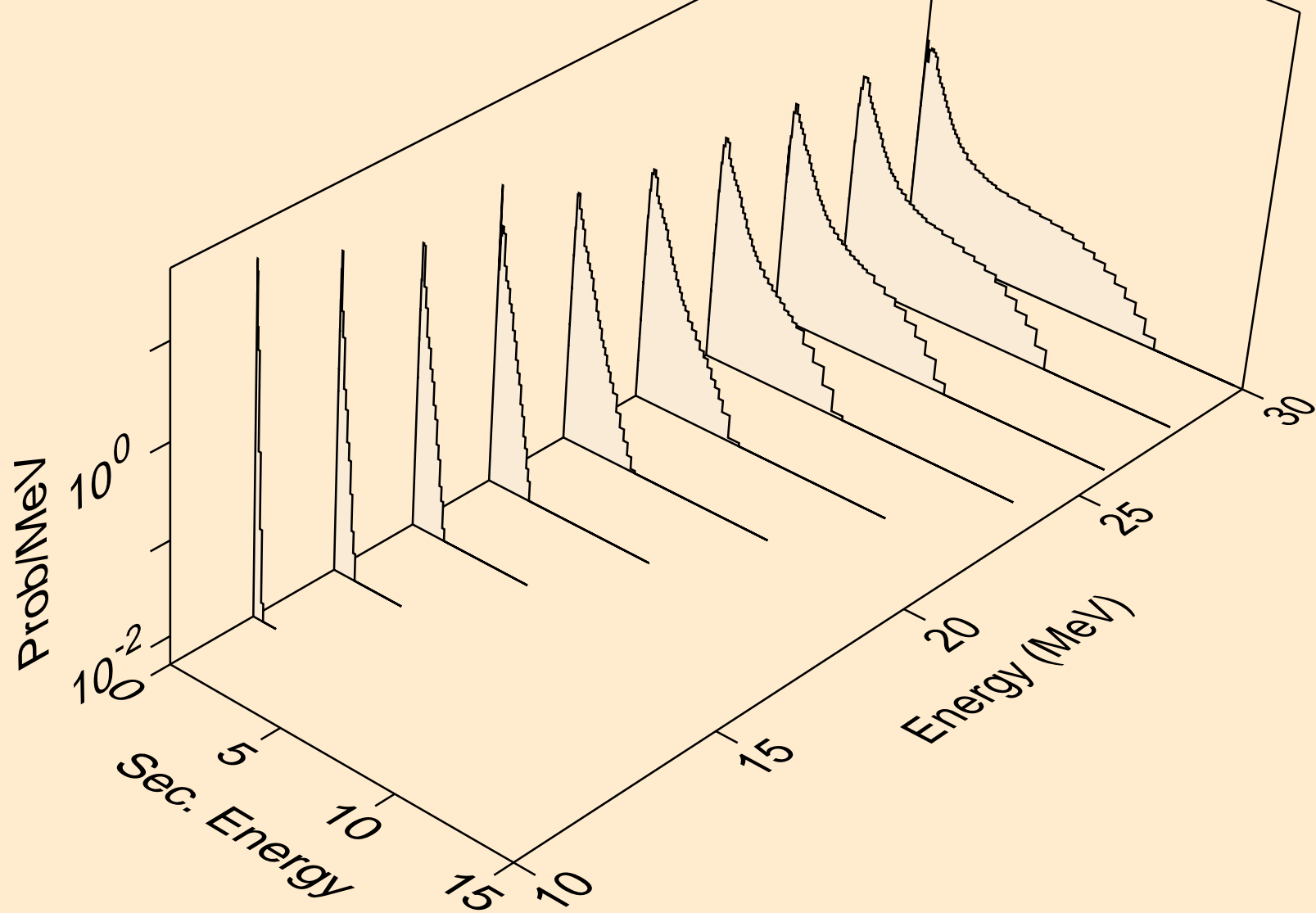

GD163 NEUTRON ACER TENDL-2021 LIBRARY; T=293.6K
Neutron emission for (n,n*)d

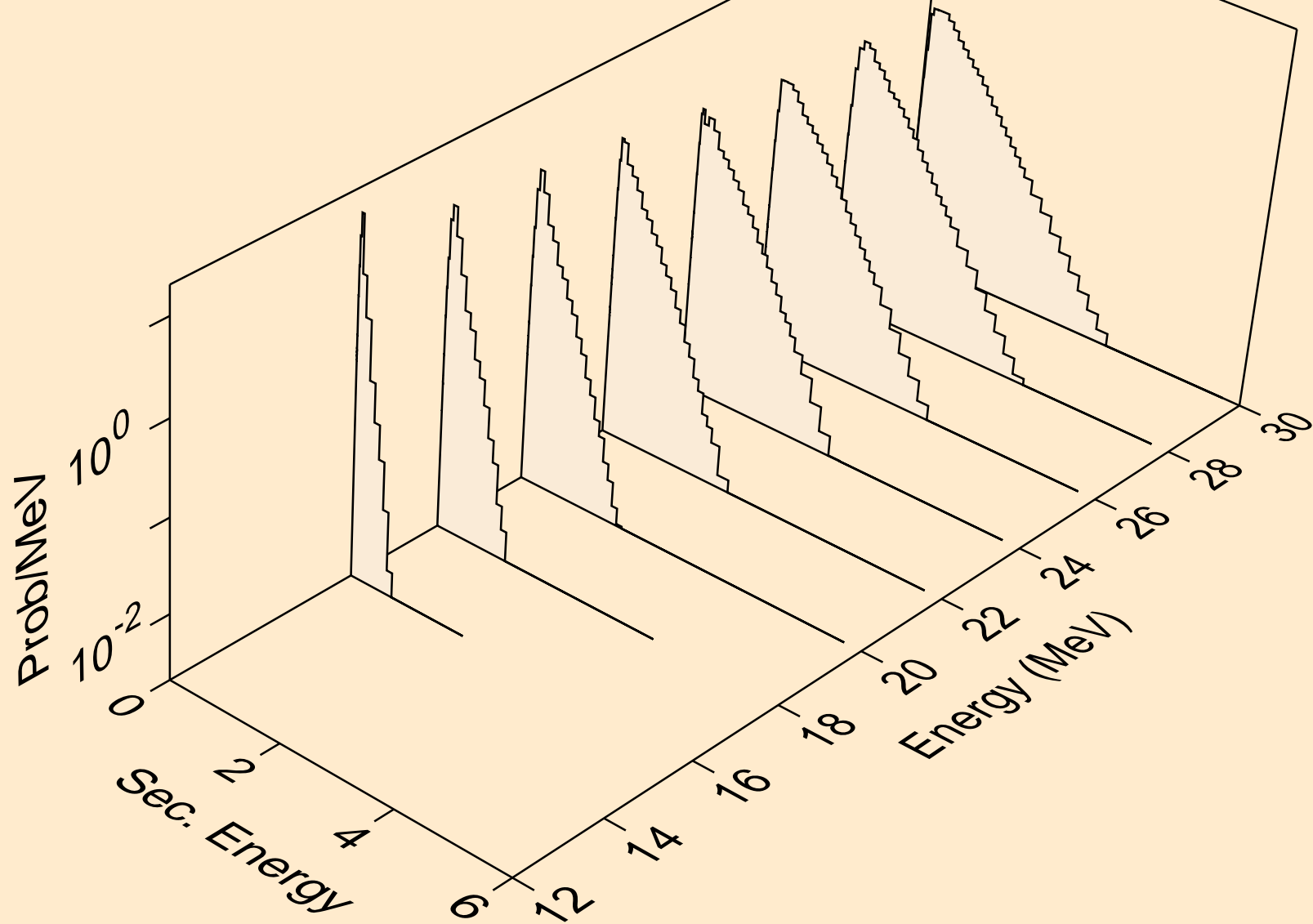

GD163 NEUTRON ACER TENDL-2021 LIBRARY; T=293.6K
Neutron emission for (n,n*)t

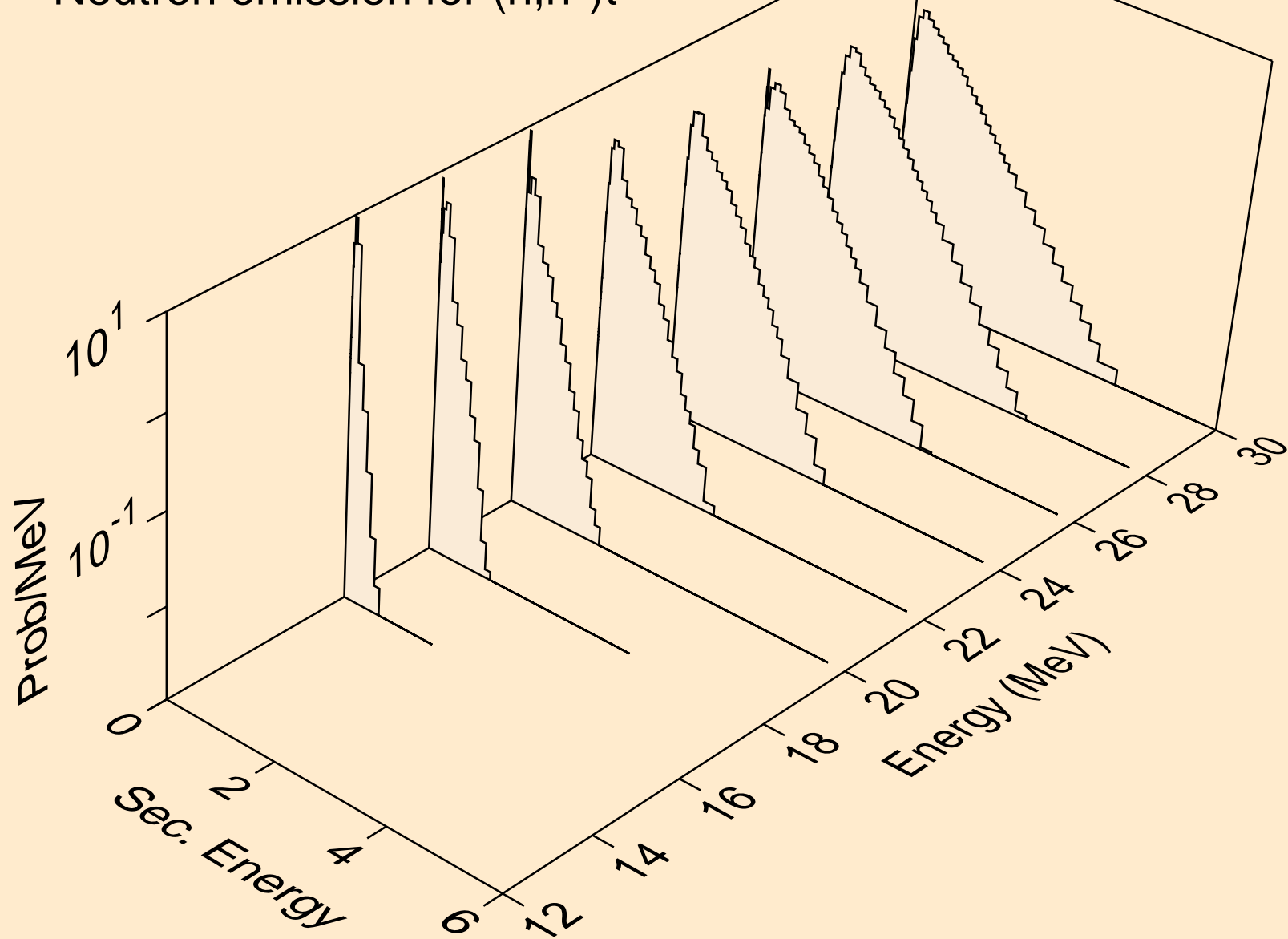

GD163 NEUTRON ACER TENDL-2021 LIBRARY; T=293.6K
Neutron emission for (n,n*)he3

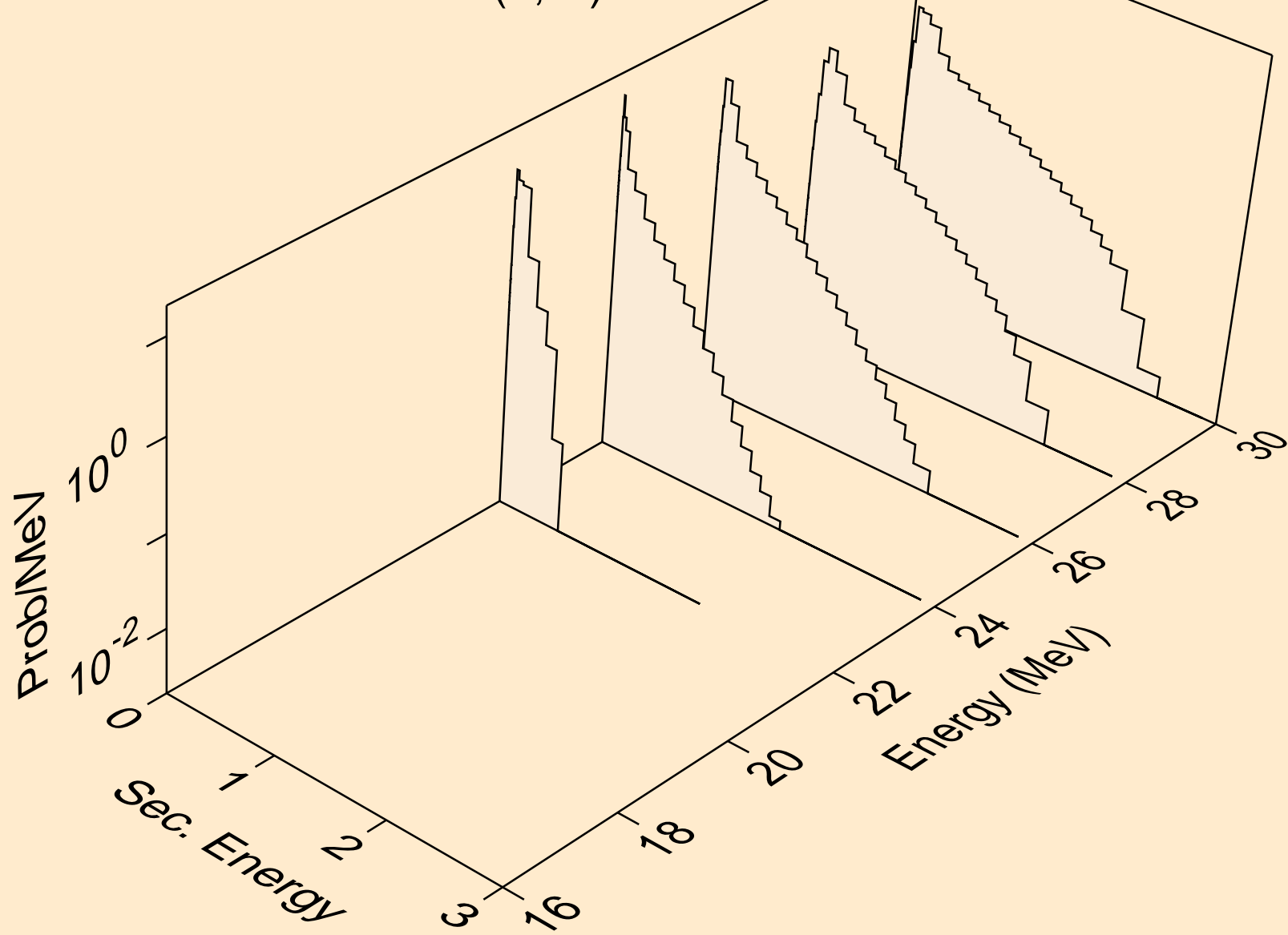

GD163 NEUTRON ACER TENDL-2021 LIBRARY; T=293.6K
Neutron emission for (n,4n)

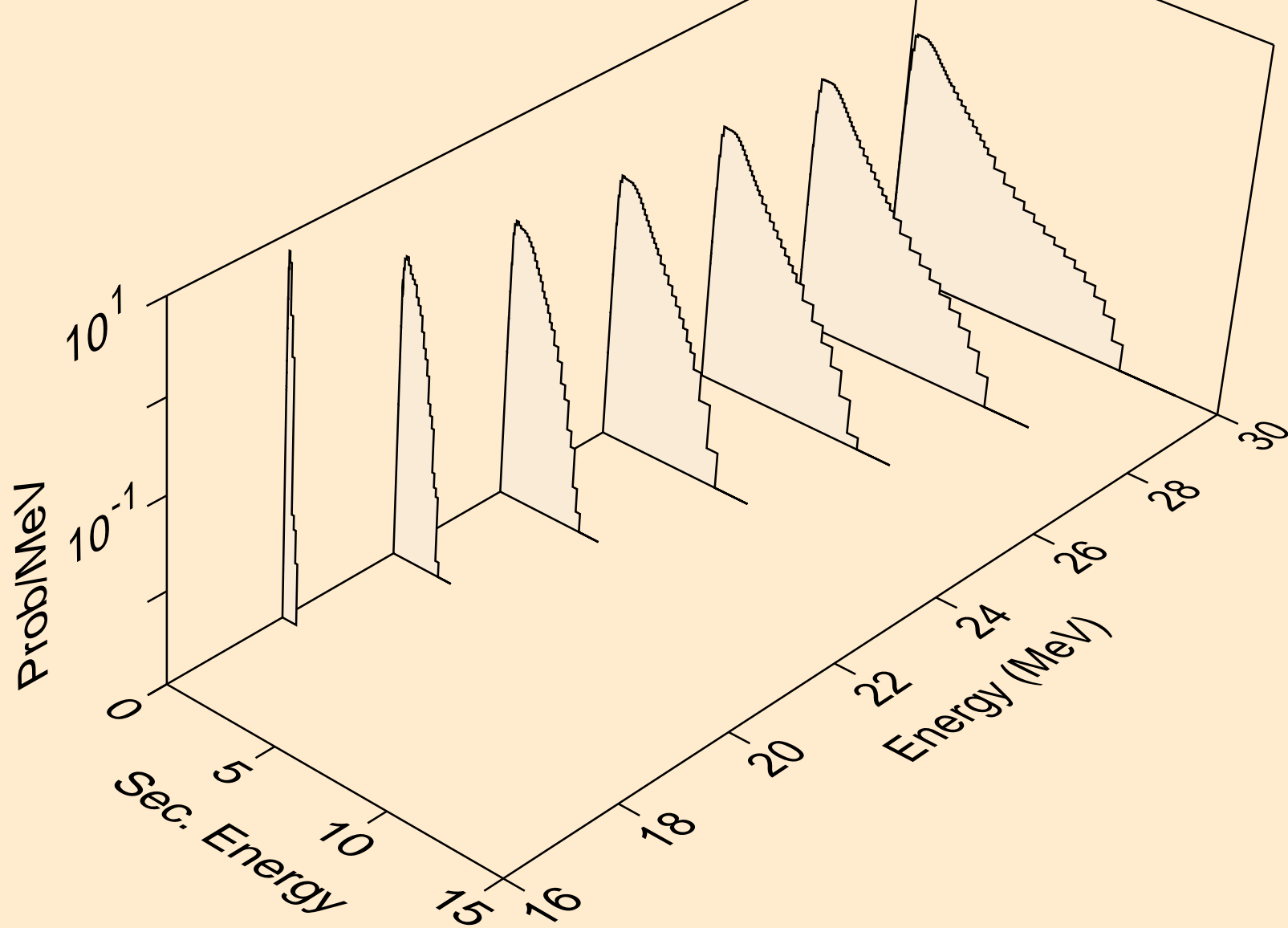

GD163 NEUTRON ACER TENDL-2021 LIBRARY; T=293.6K
Neutron emission for (n,2np)

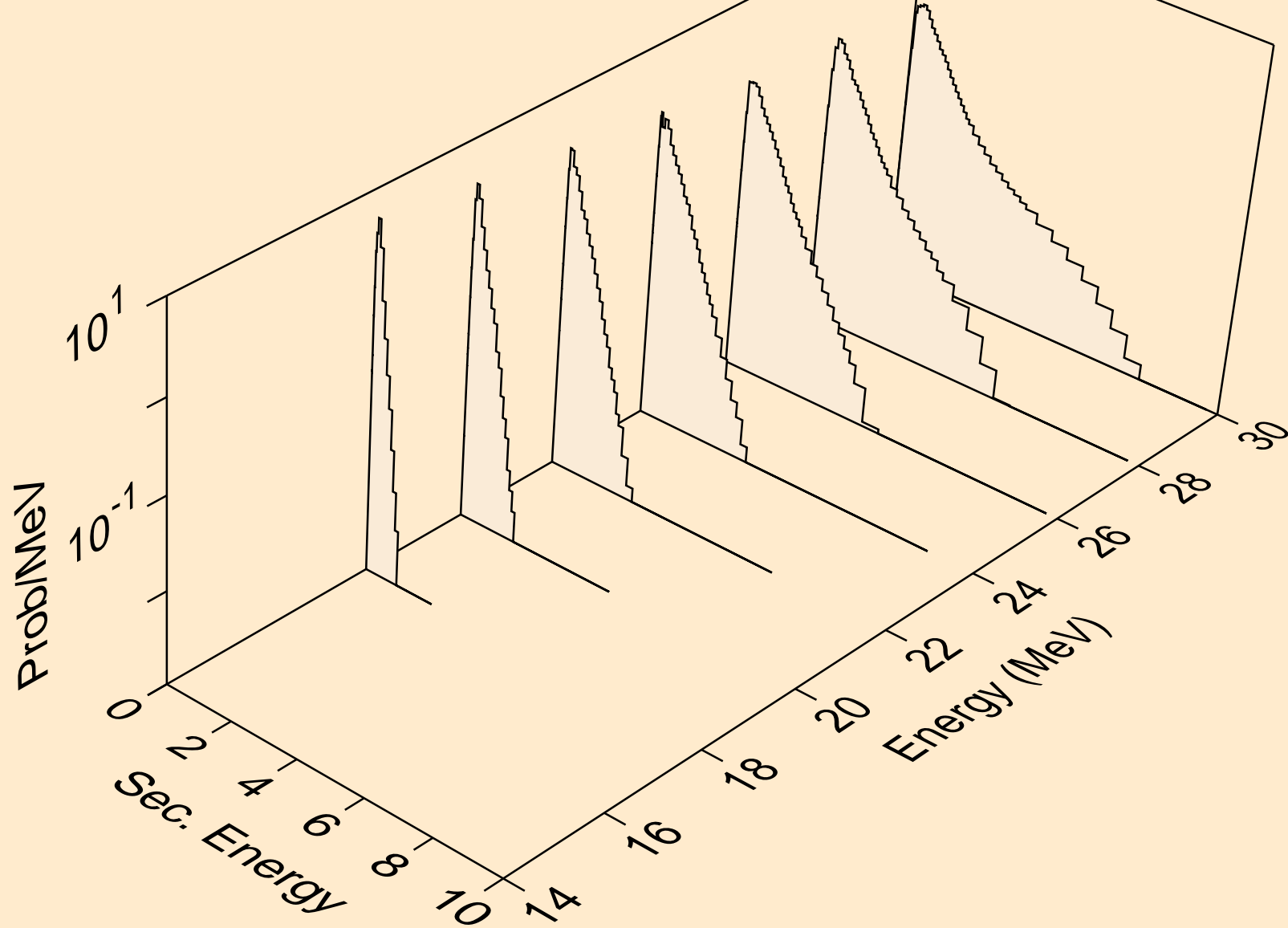

GD163 NEUTRON ACER TENDL-2021 LIBRARY; T=293.6K
Neutron emission for (n,3np)

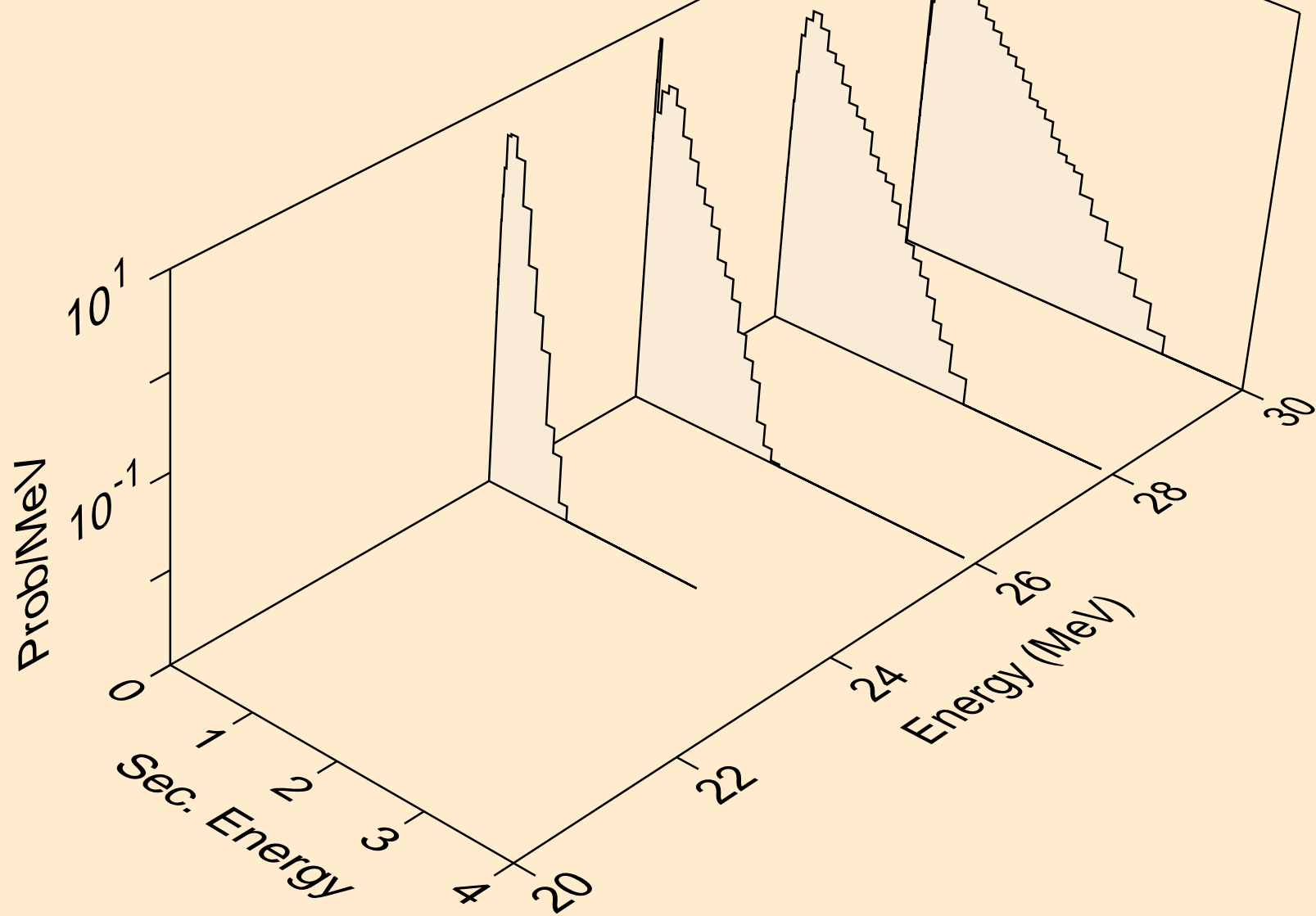

GD163 NEUTRON ACER TENDL-2021 LIBRARY; T=293.6K
Neutron emission for (n,n*c)

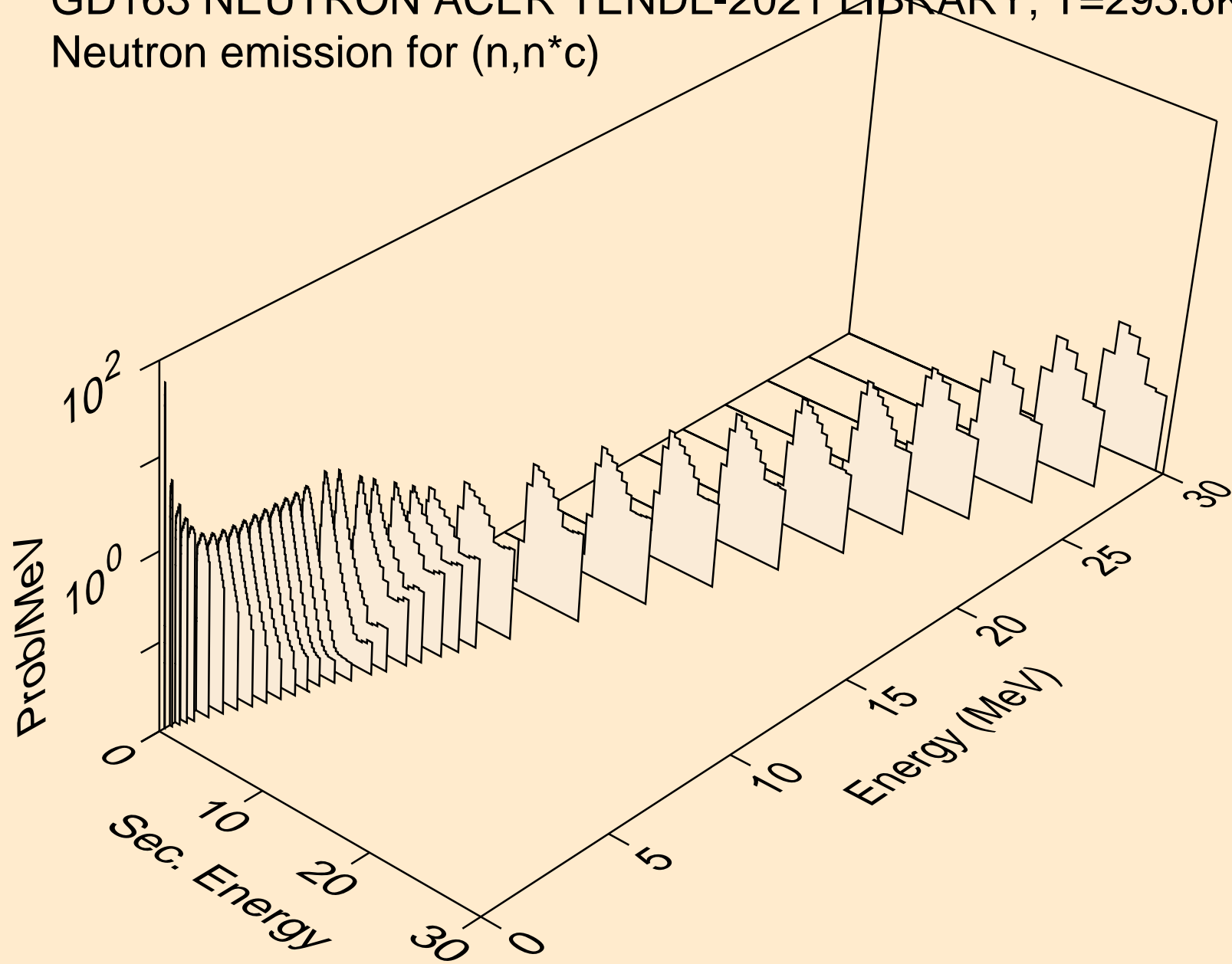

GD163 NEUTRON ACER TENDL-2021 LIBRARY; T=293.6K
Photon emission for (n,x)

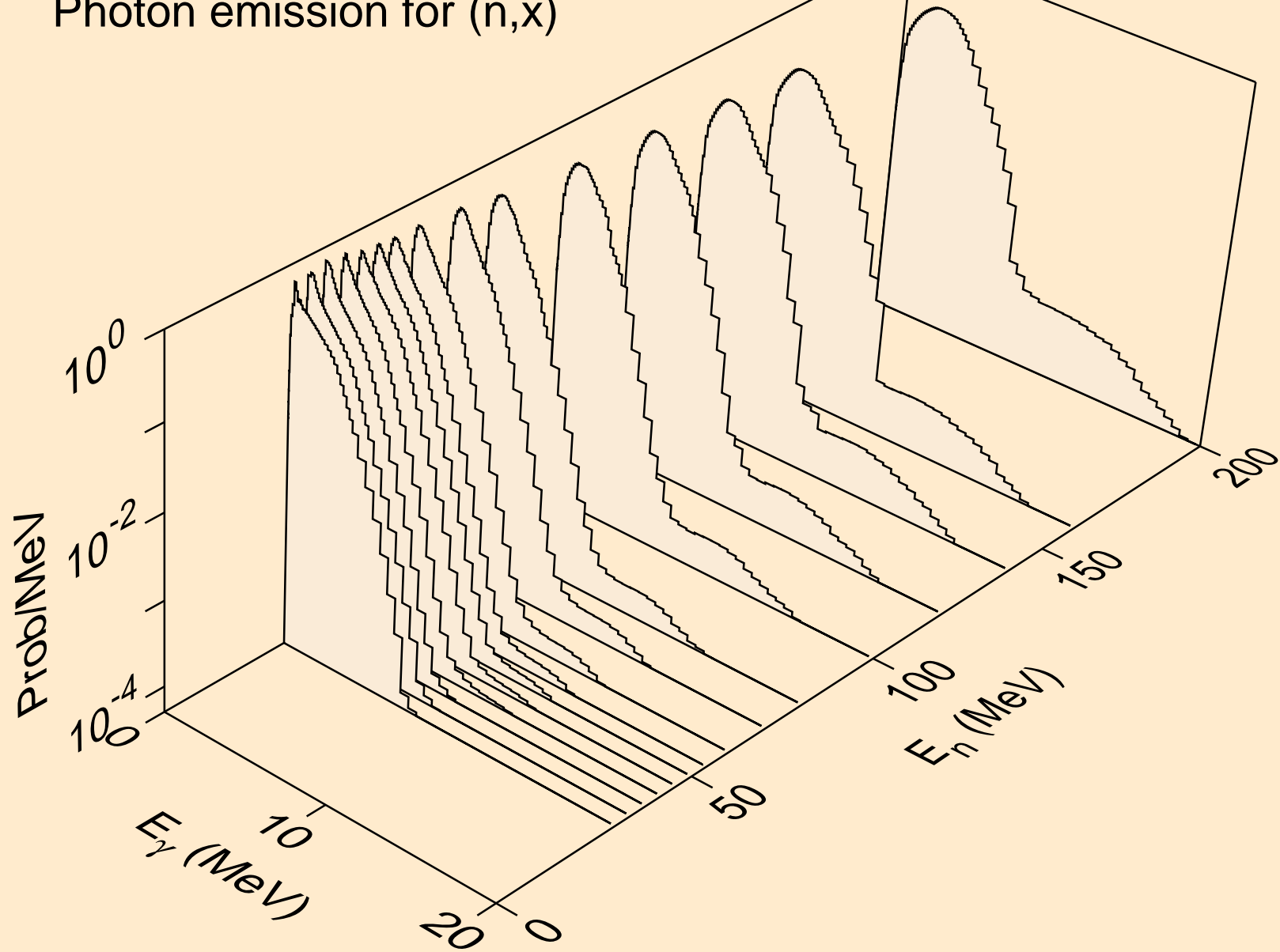

GD163 NEUTRON ACER TENDL-2021 LIBRARY; T=293.6K
Photon emission for (n,2nd)

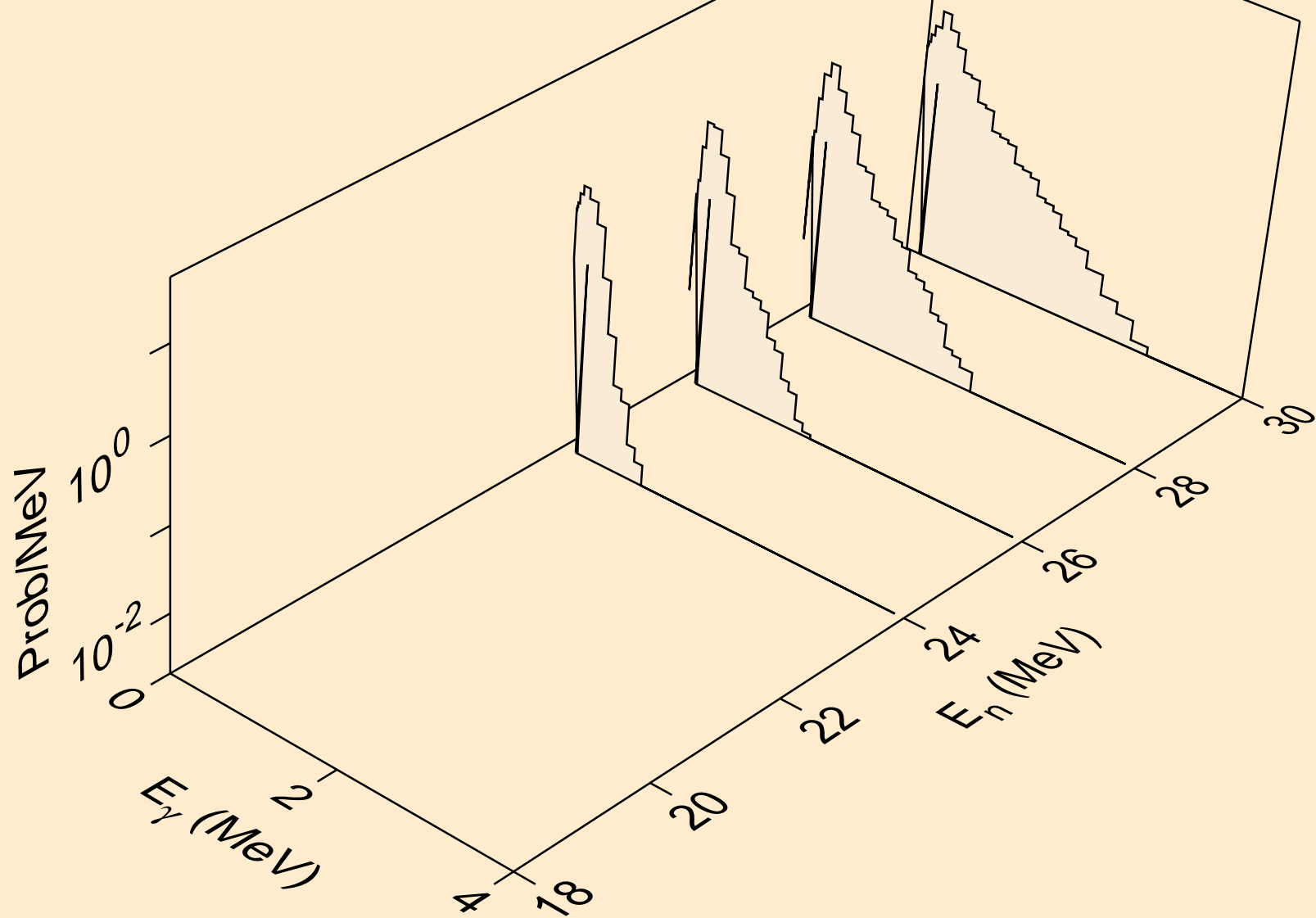

GD163 NEUTRON ACER TENDL-2021 LIBRARY; T=293.6K
Photon emission for (n,2n)

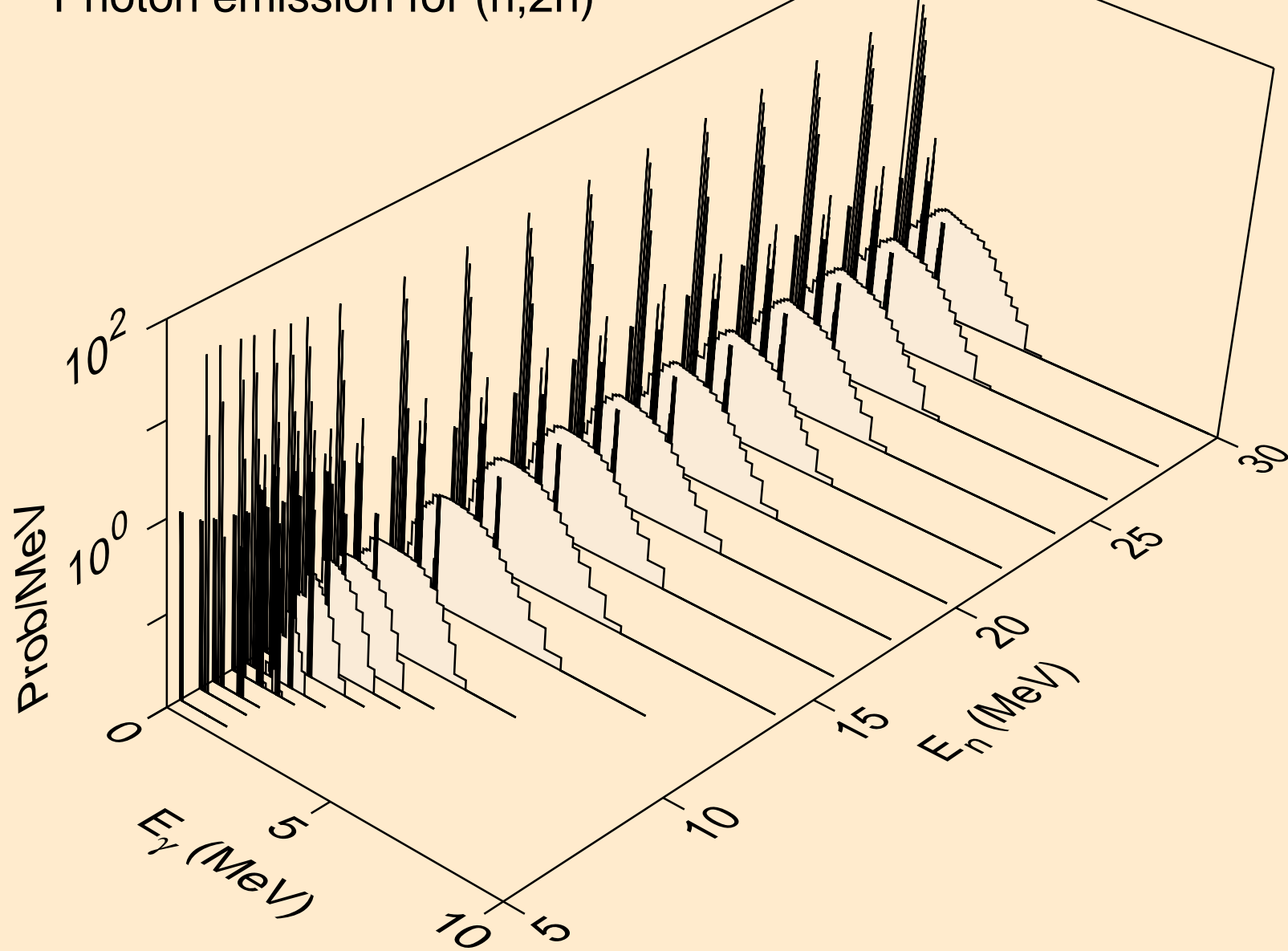

GD163 NEUTRON ACER TENDL-2021 LIBRARY; T=293.6K
Photon emission for (n,3n)

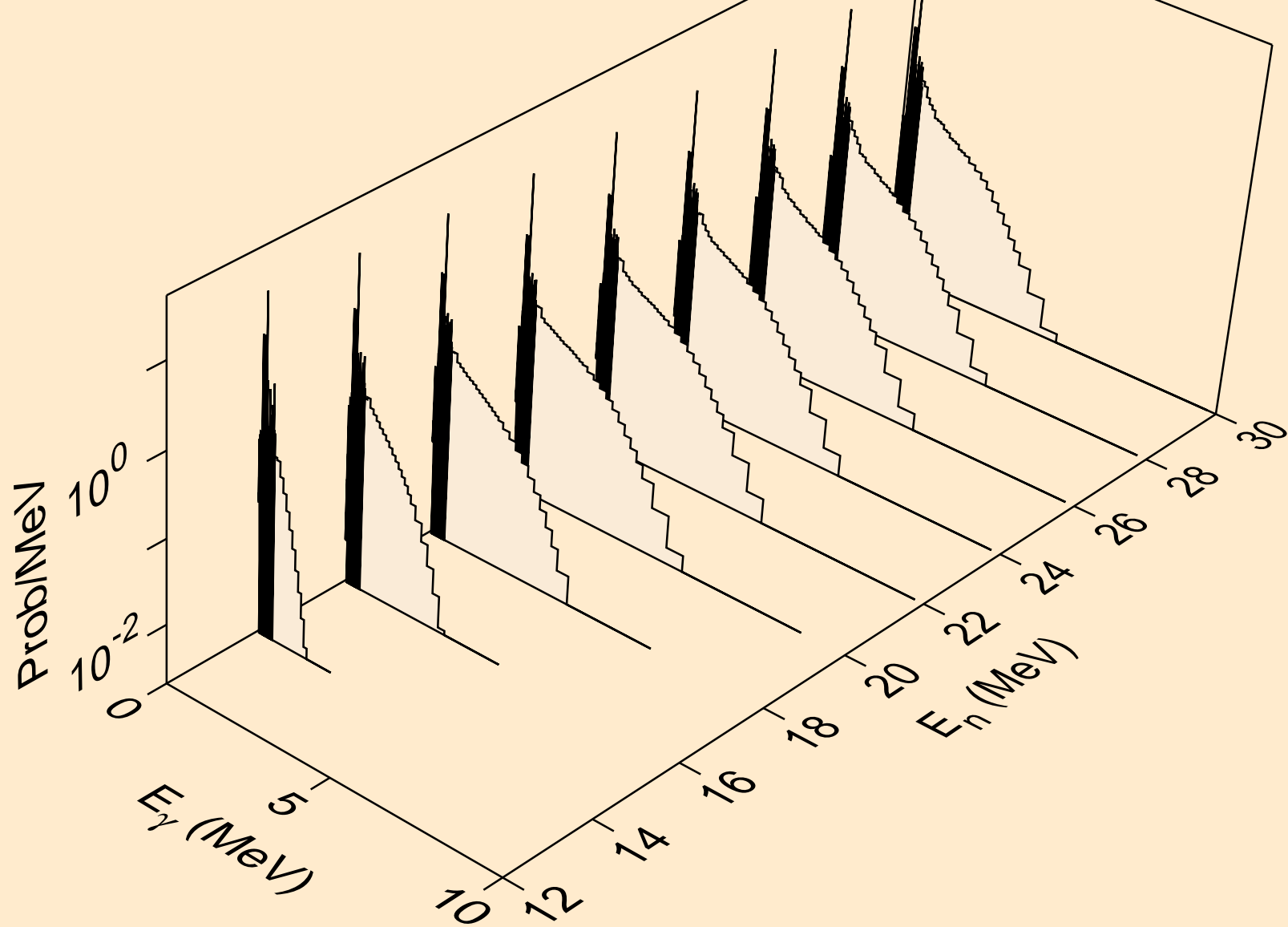

GD163 NEUTRON ACER TENDL-2021 LIBRARY; T=293.6K
Photon emission for (n,n*)a

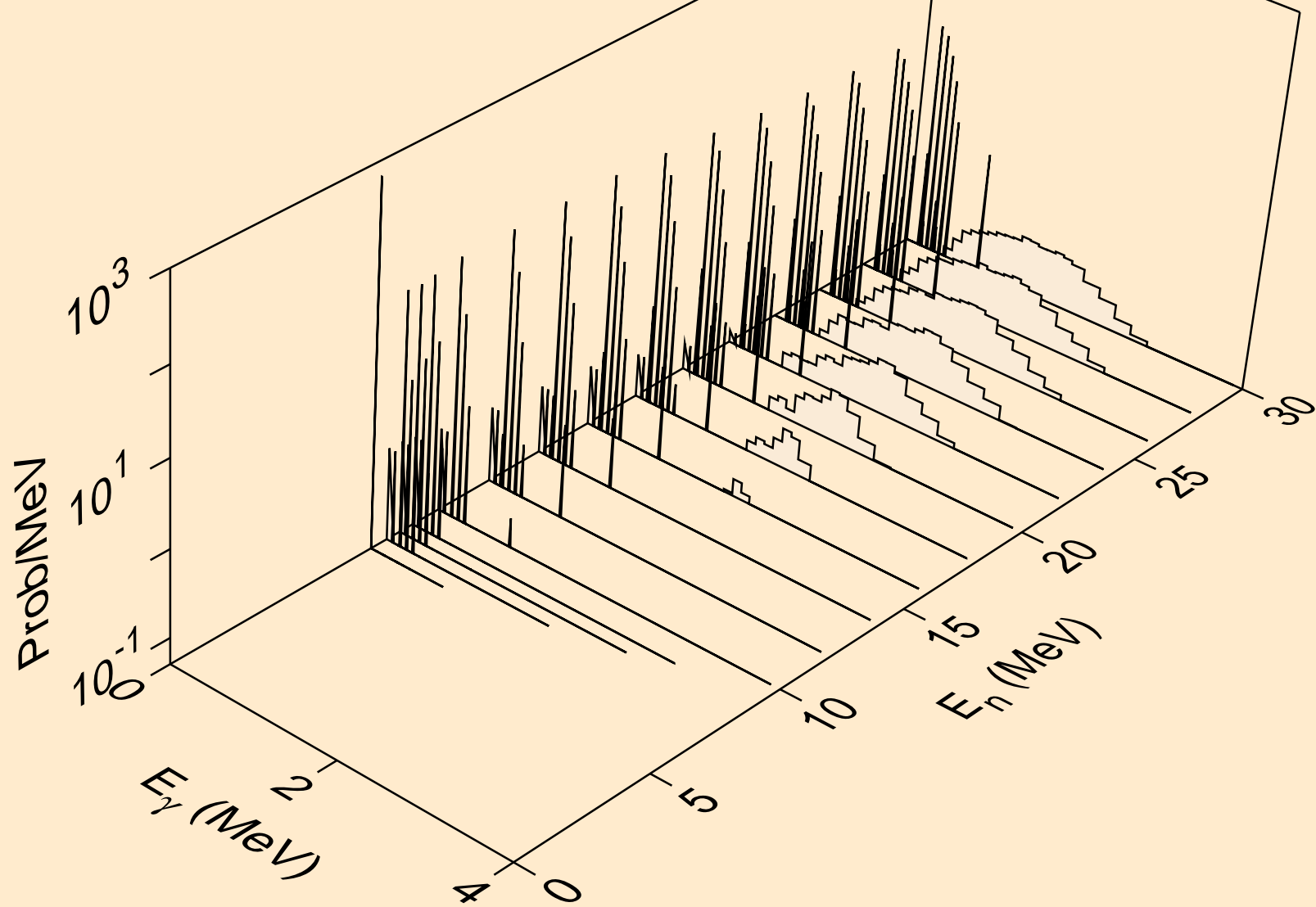

GD163 NEUTRON ACER TENDL-2021 LIBRARY; T=293.6K
Photon emission for (n,2n)a

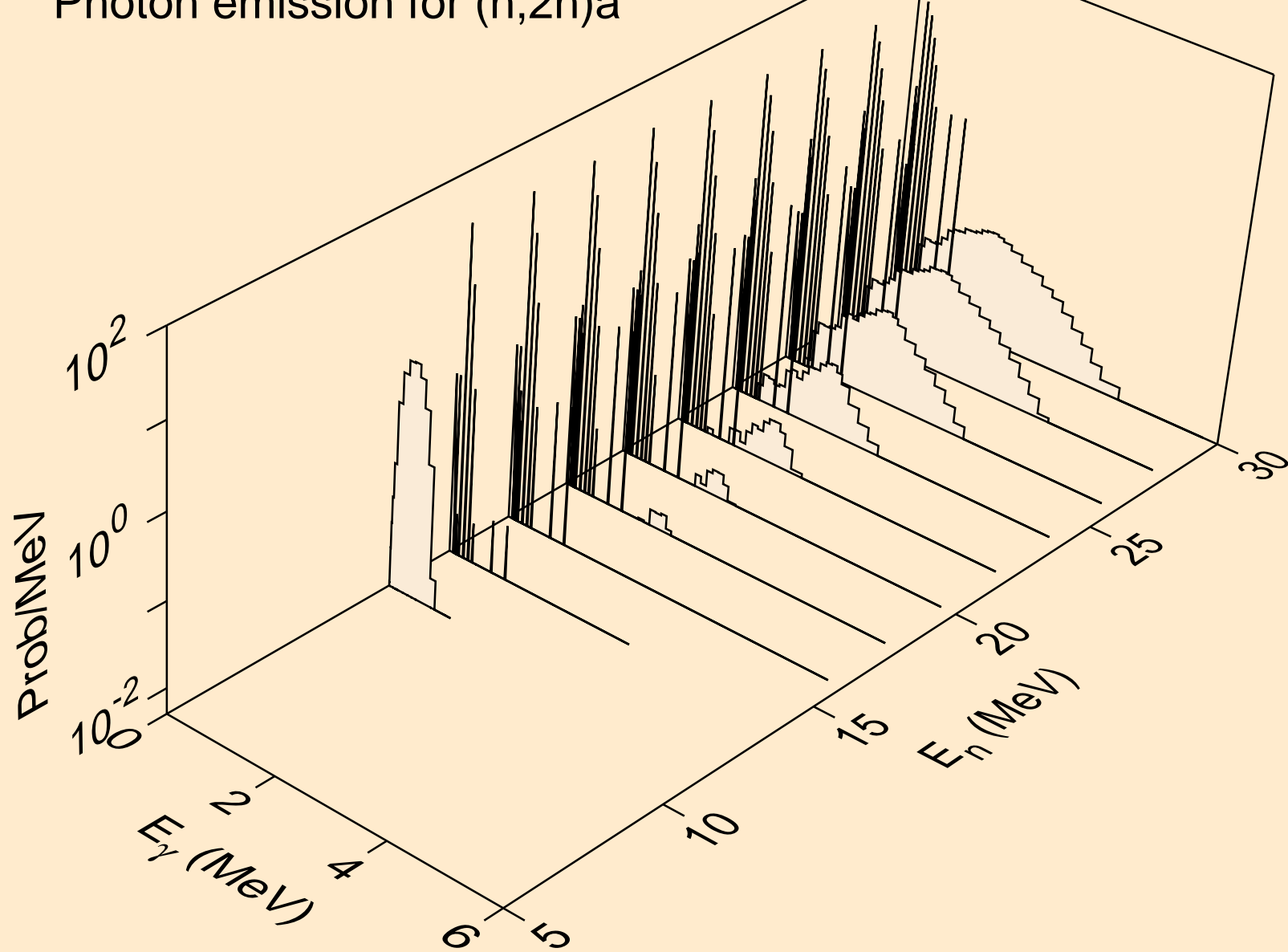

GD163 NEUTRON ACER TENDL-2021 LIBRARY; T=293.6K
Photon emission for (n,3n)a

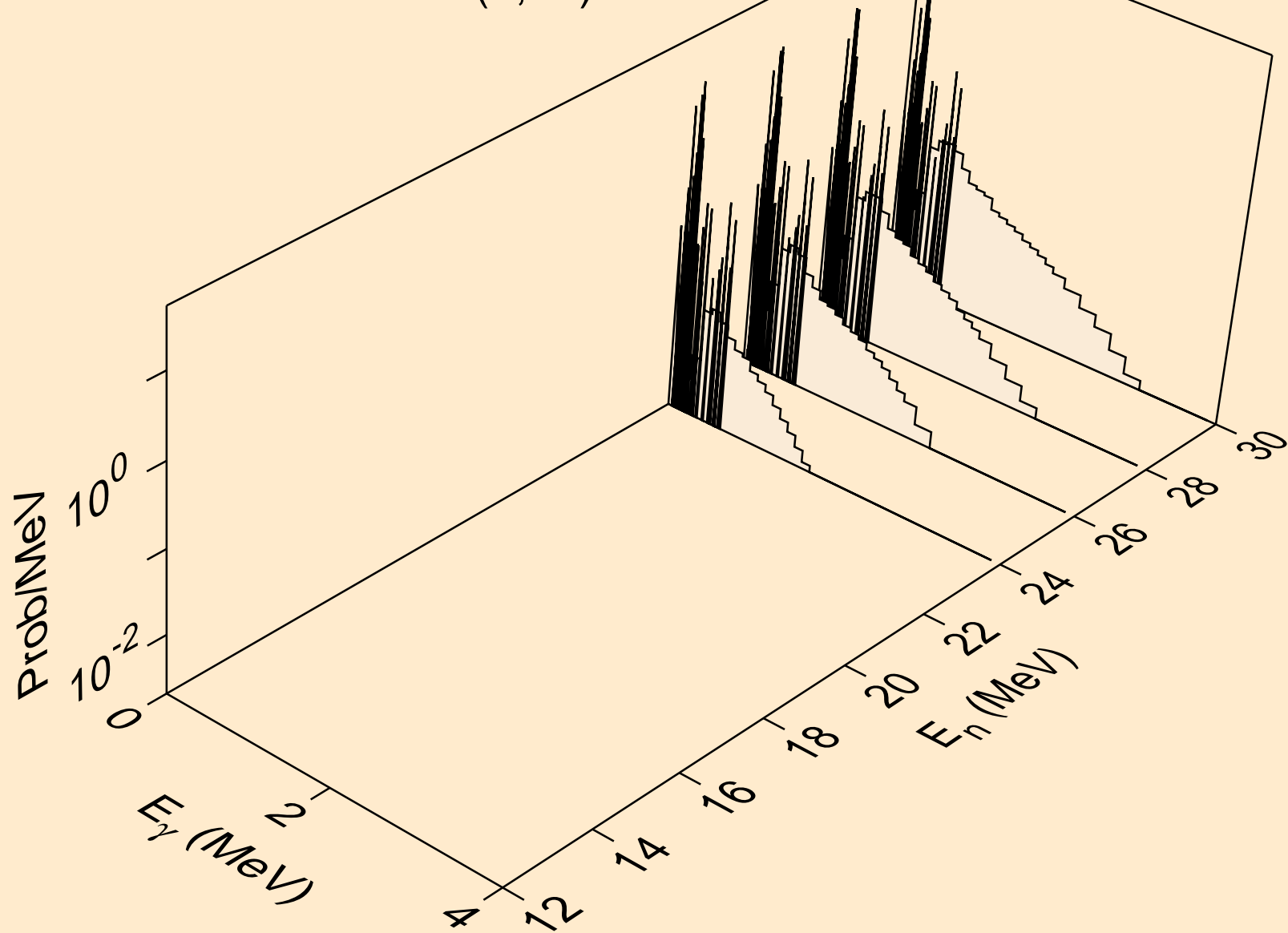

GD163 NEUTRON ACER TENDL-2021 LIBRARY; T=293.6K
Photon emission for (n,n*)p

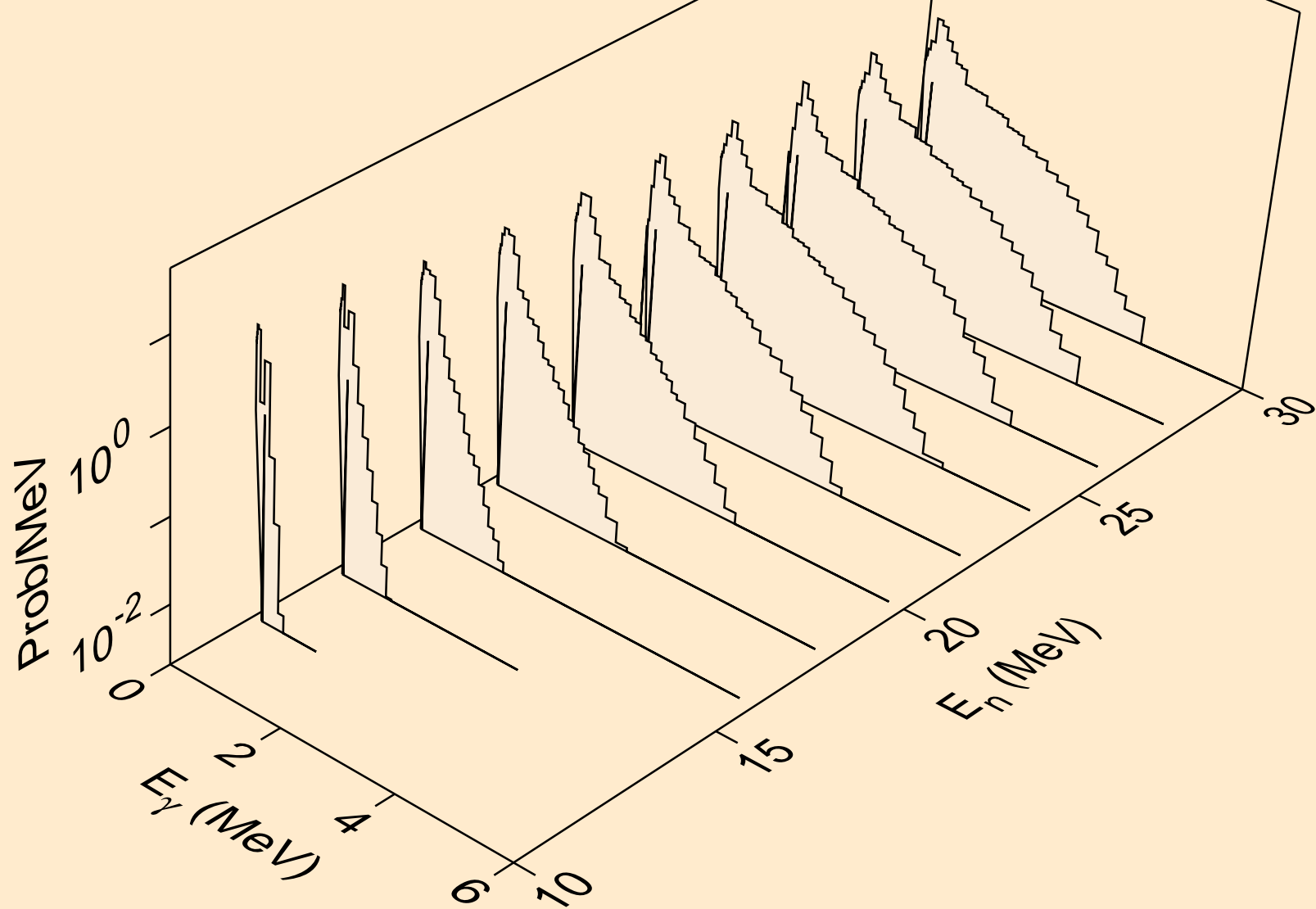

GD163 NEUTRON ACER TENDL-2021 LIBRARY; T=293.6K
Photon emission for (n,n*)d

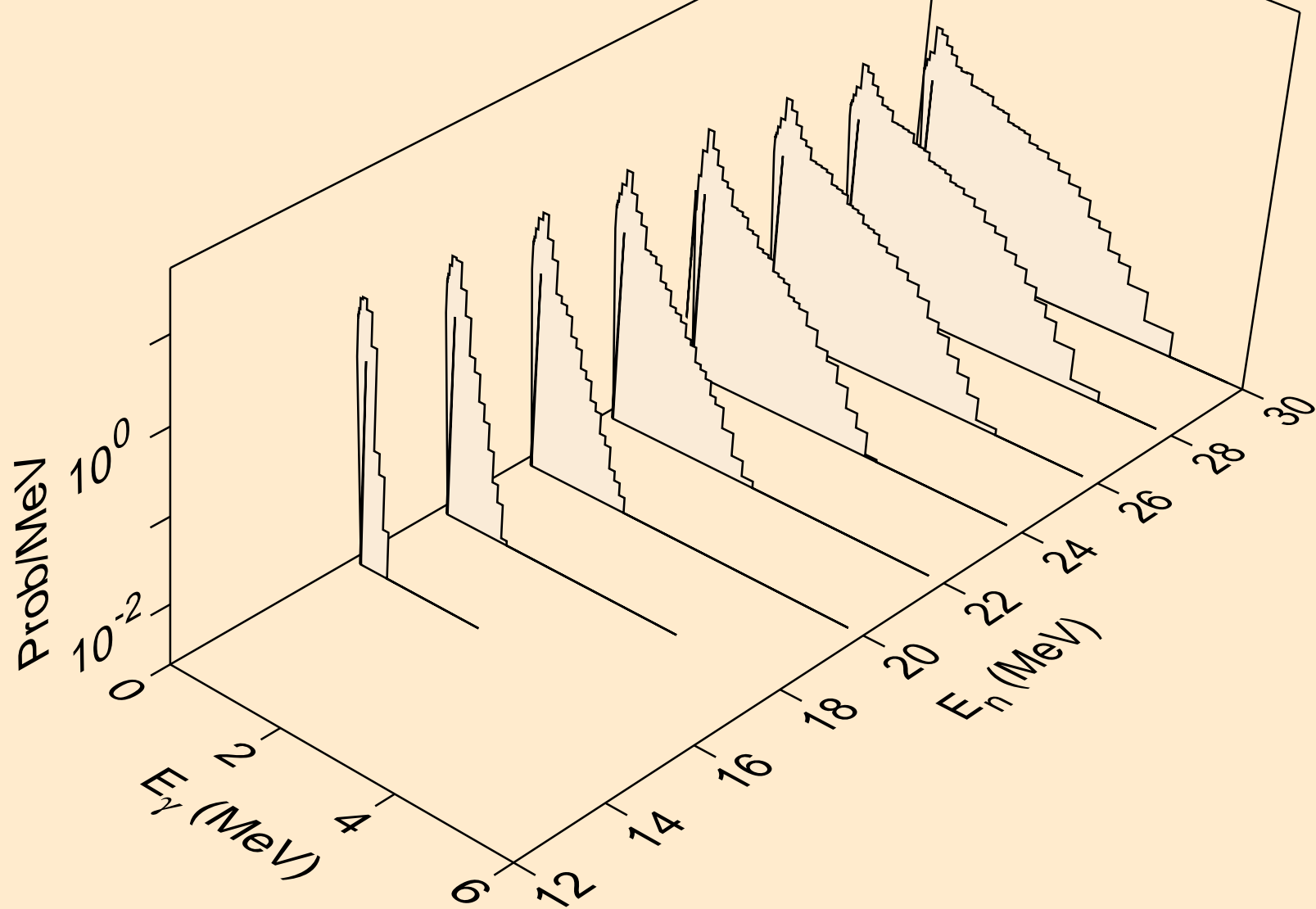

GD163 NEUTRON ACER TENDL-2021 LIBRARY; T=293.6K
Photon emission for (n,n*)t

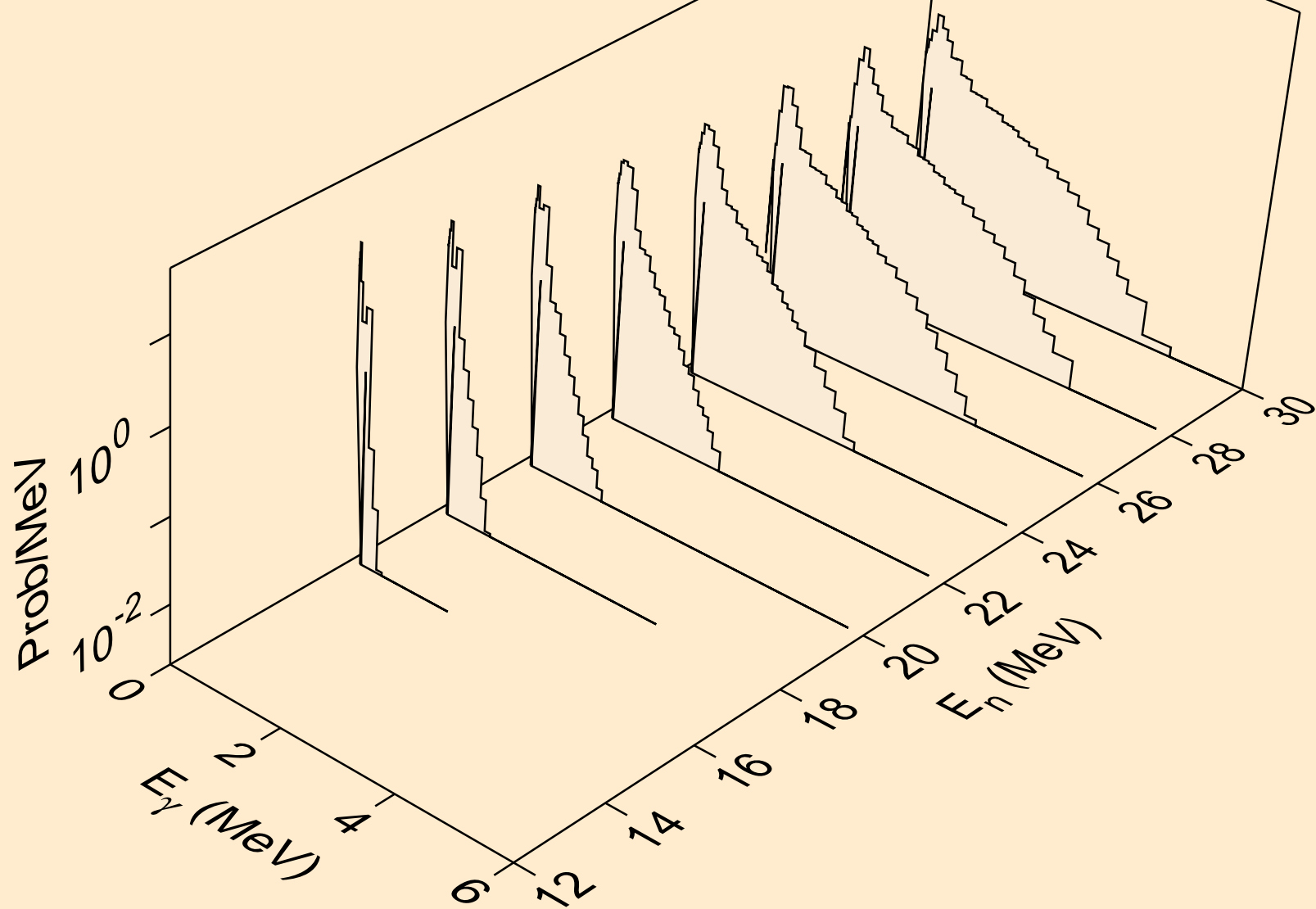

GD163 NEUTRON ACER TENDL-2021 LIBRARY; T=293.6K
Photon emission for (n,n*)he3

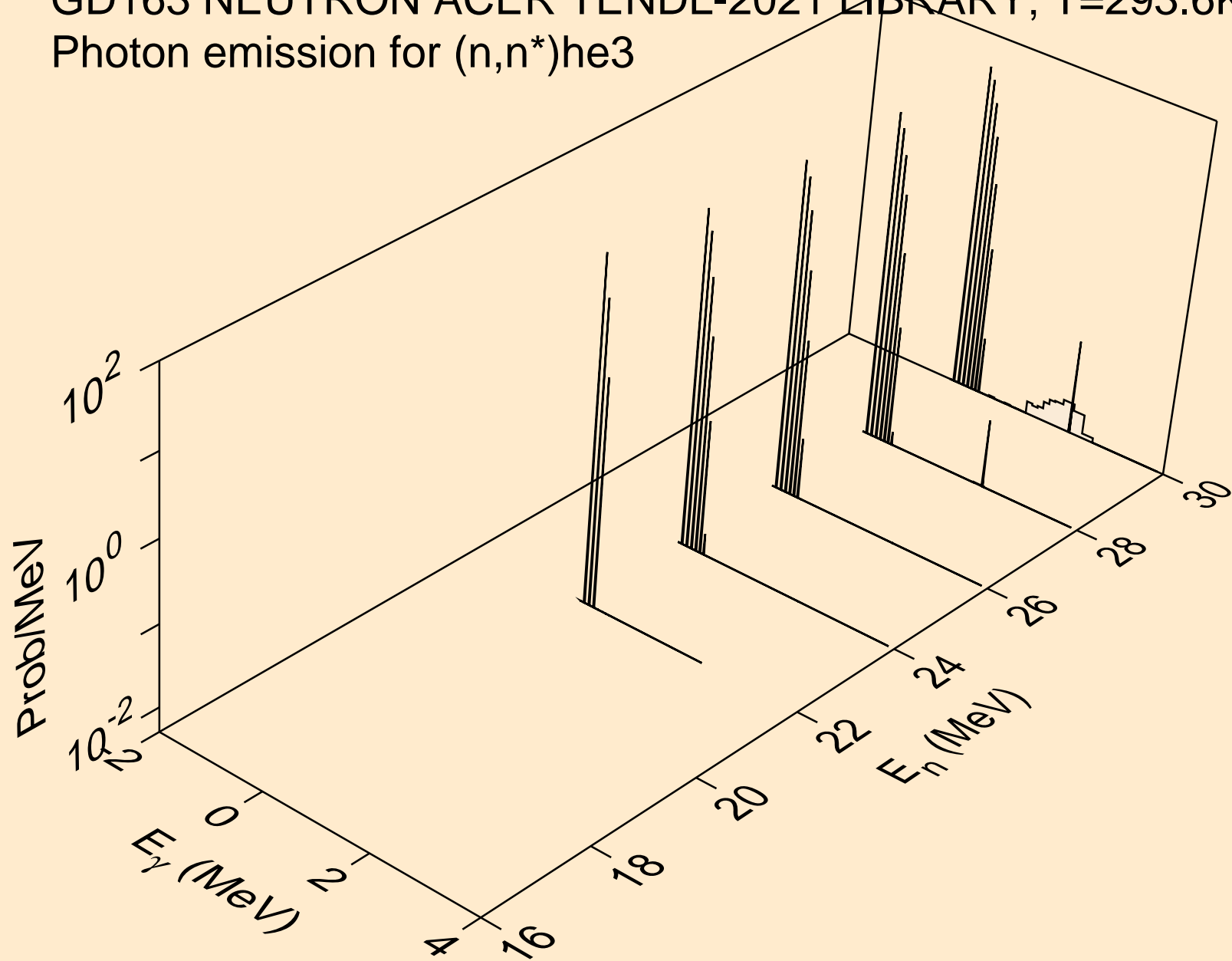

GD163 NEUTRON ACER TENDL-2021 LIBRARY; T=293.6K
Photon emission for (n,4n)

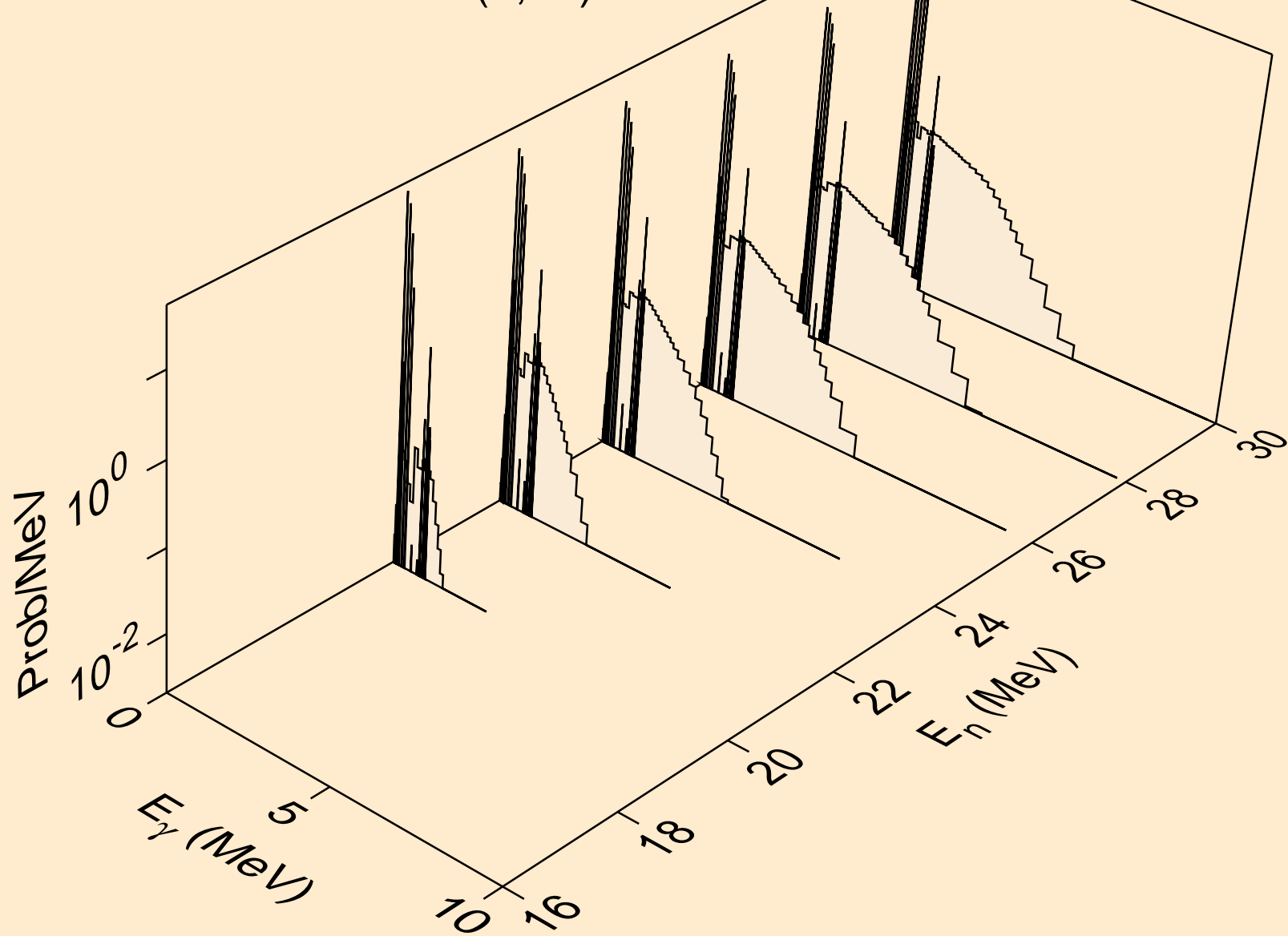

GD163 NEUTRON ACER TENDL-2021 LIBRARY; T=293.6K
Photon emission for (n,2np)

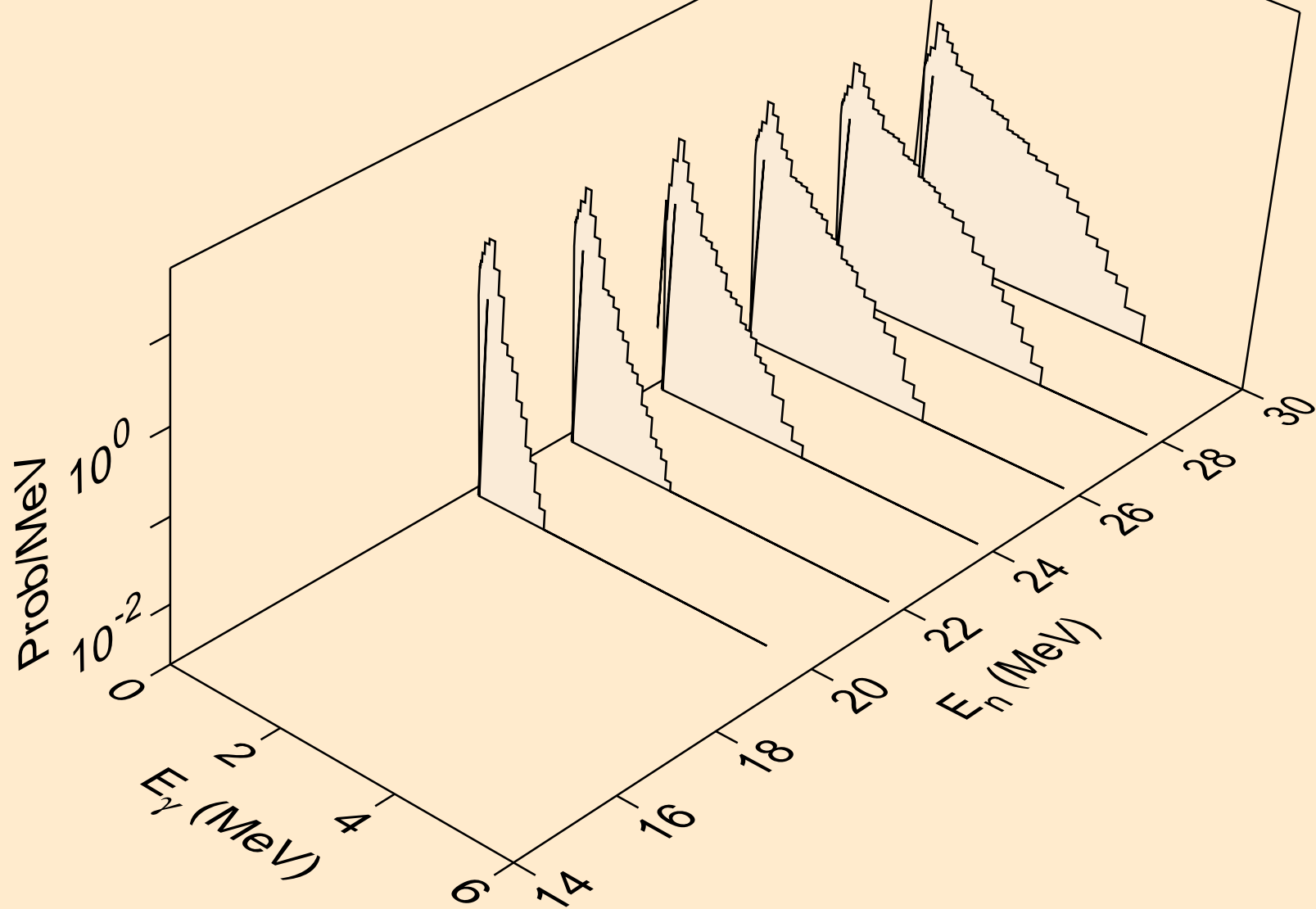

GD163 NEUTRON ACER TENDL-2021 LIBRARY; T=293.6K
Photon emission for (n,3np)

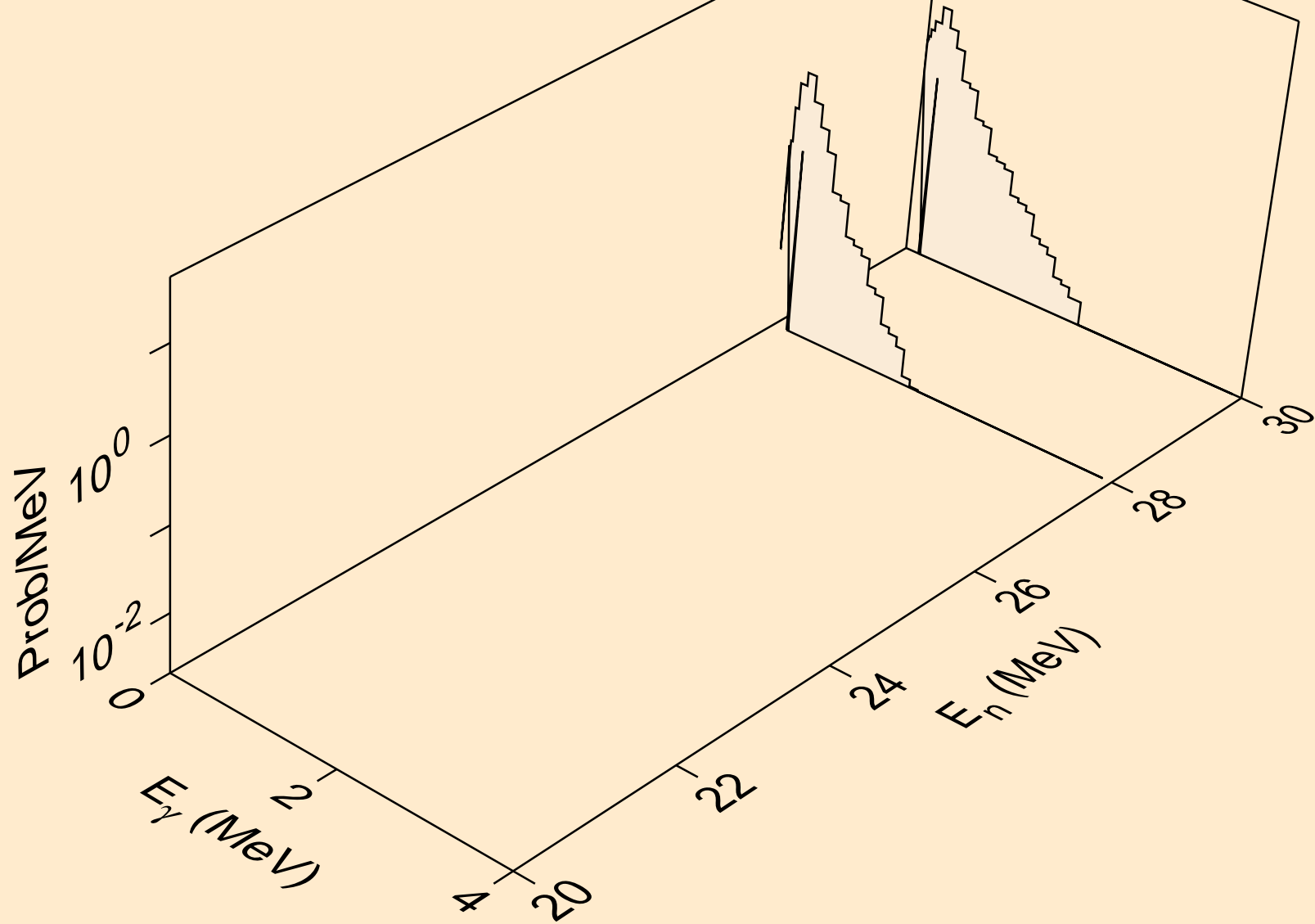

GD163 NEUTRON ACER TENDL-2021 LIBRARY; T=293.6K
Photon emission for (n,n*c)

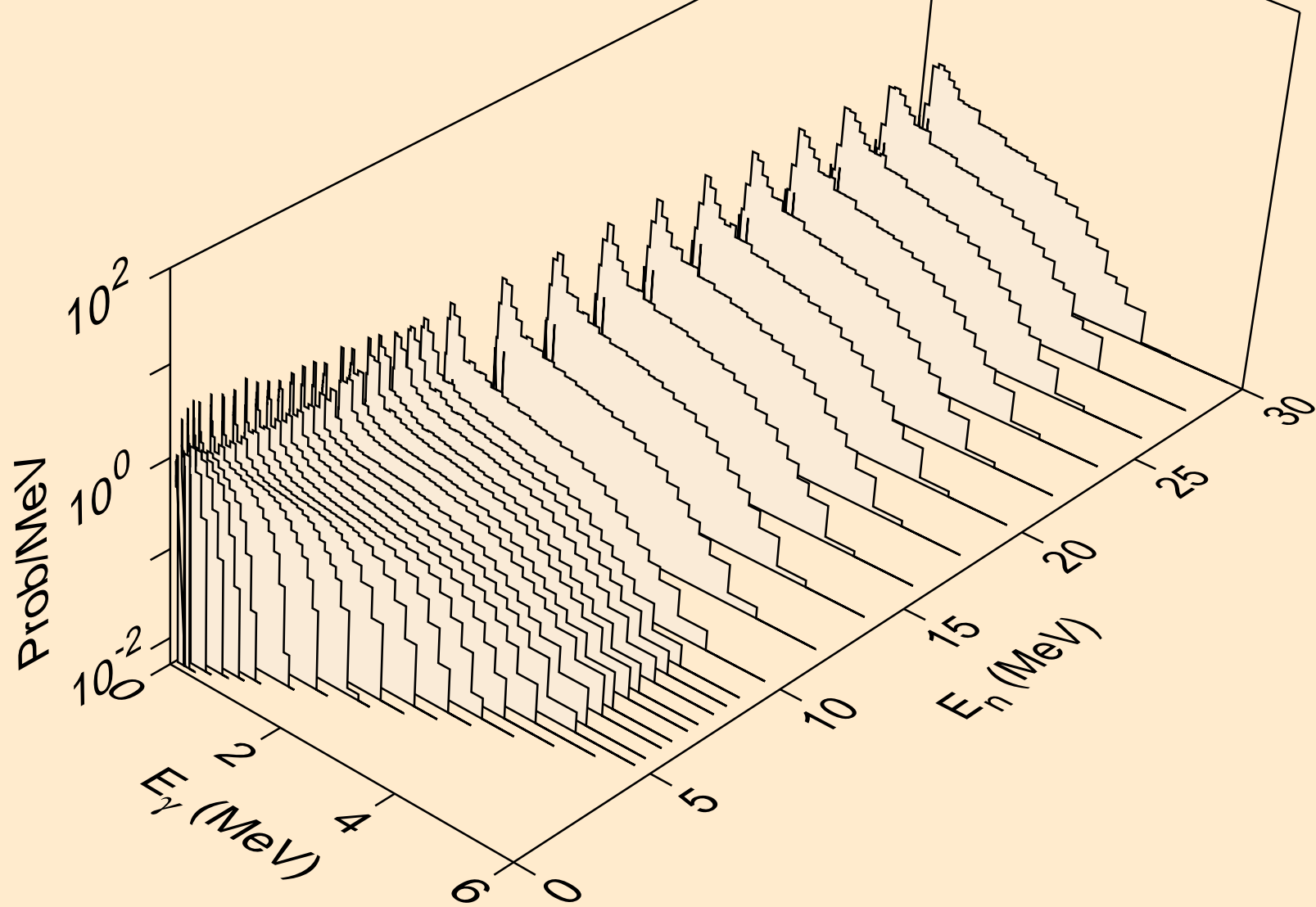

GD163 NEUTRON ACER TENDL-2021 LIBRARY; T=293.6K
Photon emission for (n,gma)

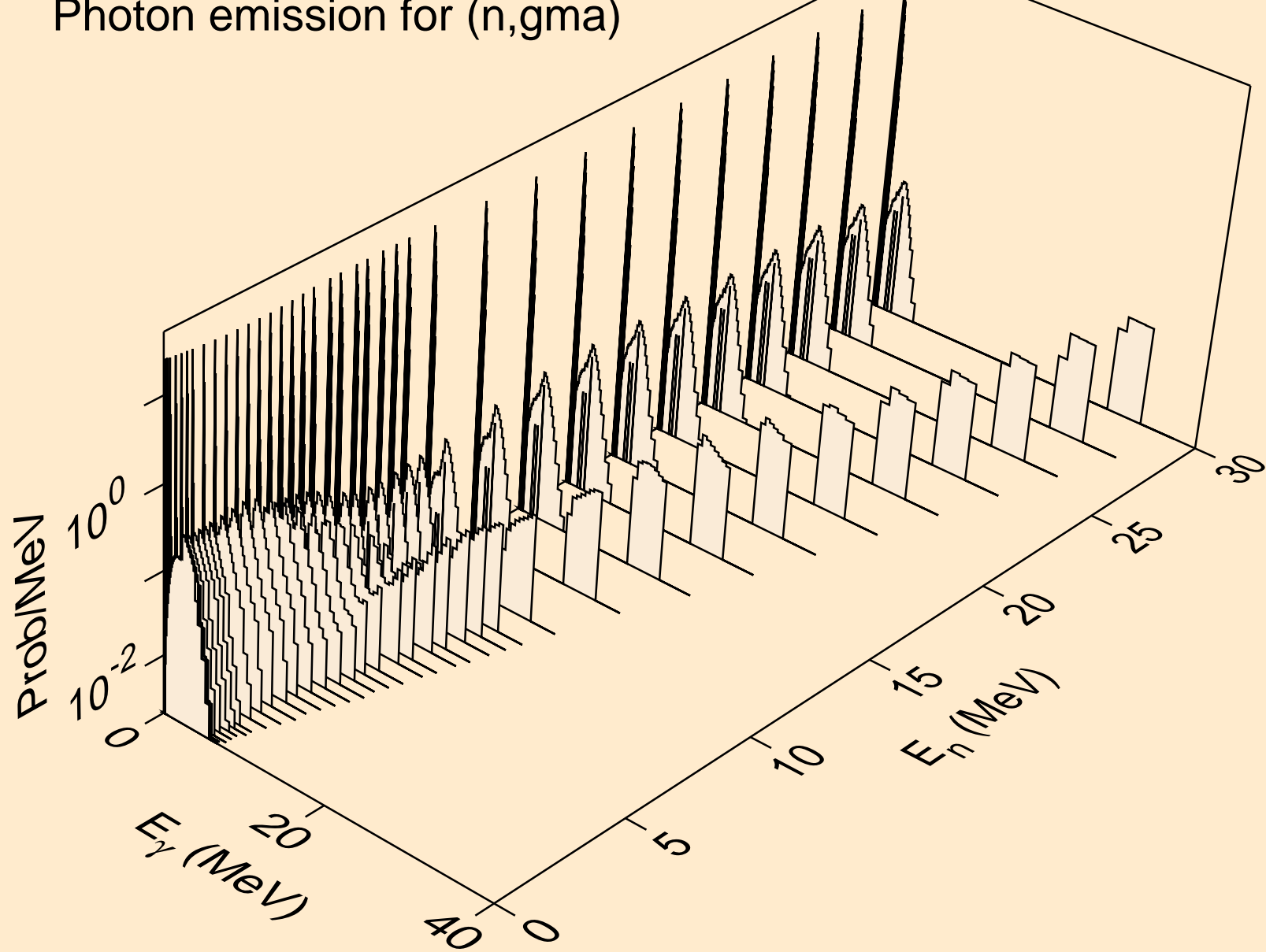

GD163 NEUTRON ACER TENDL-2021 LIBRARY; T=293.6K
Photon emission for (n,p)

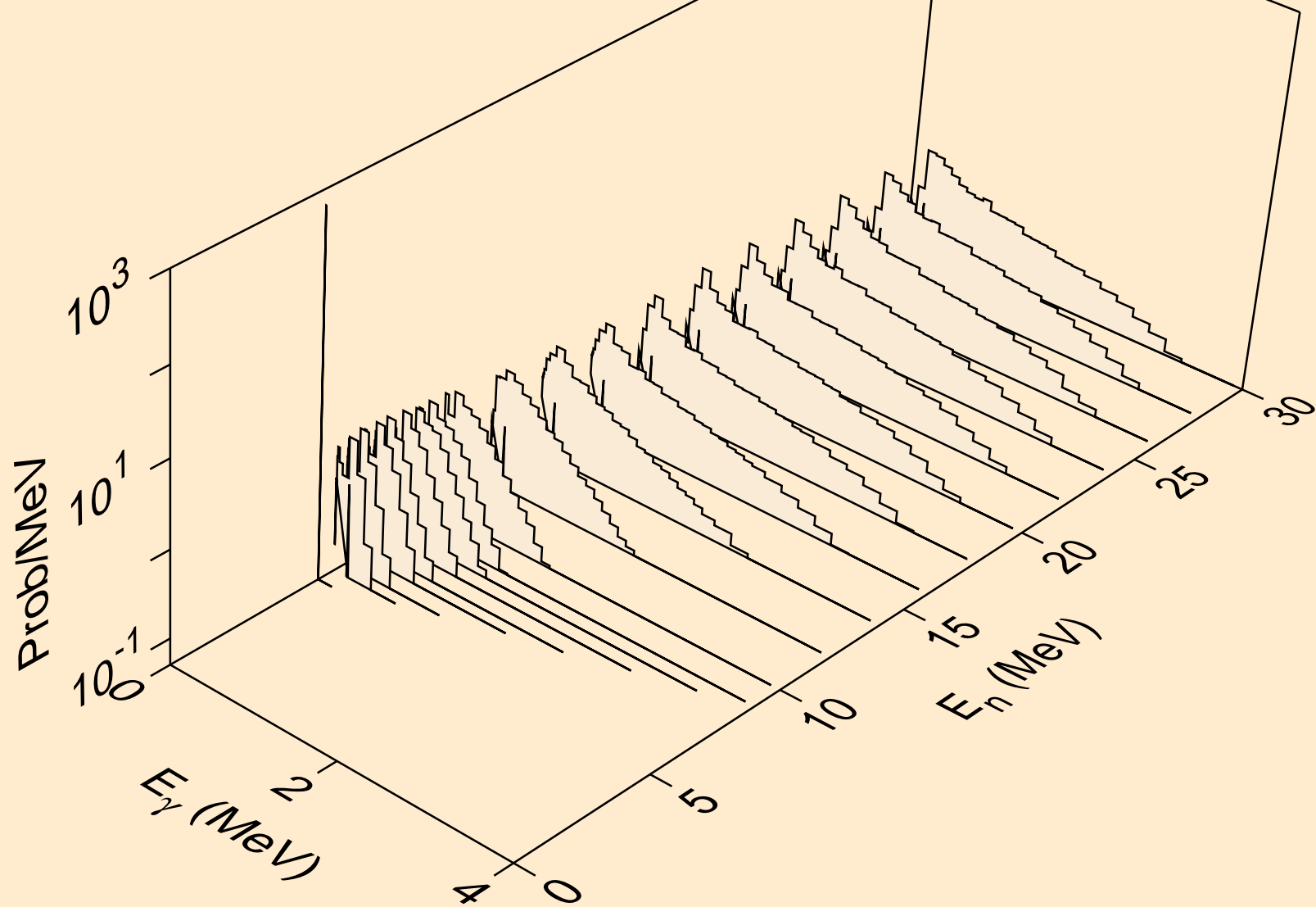

GD163 NEUTRON ACER TENDL-2021 LIBRARY; T=293.6K
Photon emission for (n,d)

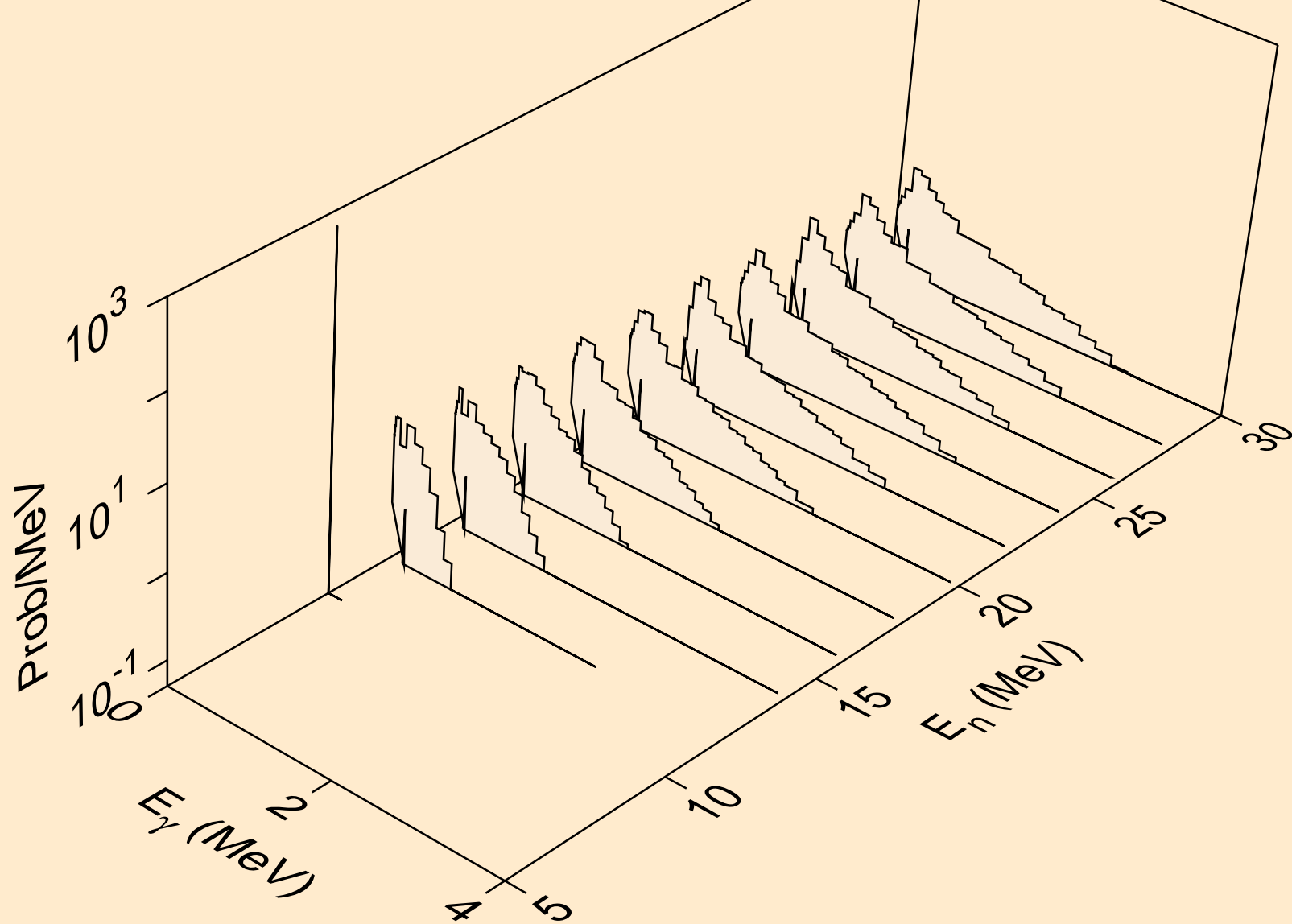

GD163 NEUTRON ACER TENDL-2021 LIBRARY; T=293.6K
Photon emission for (n,t)

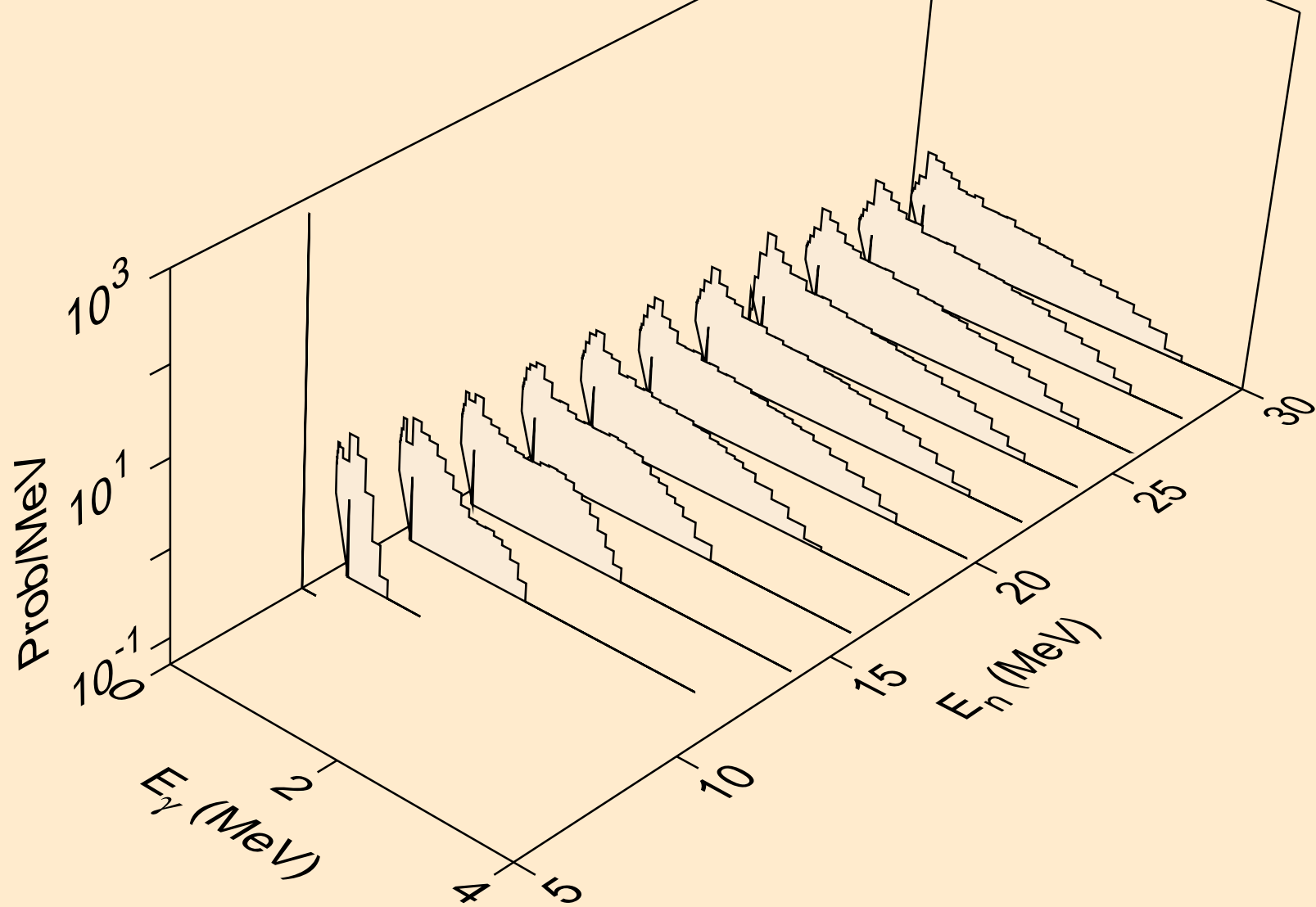

GD163 NEUTRON ACER TENDL-2021 LIBRARY; T=293.6K
Photon emission for (n,he3)

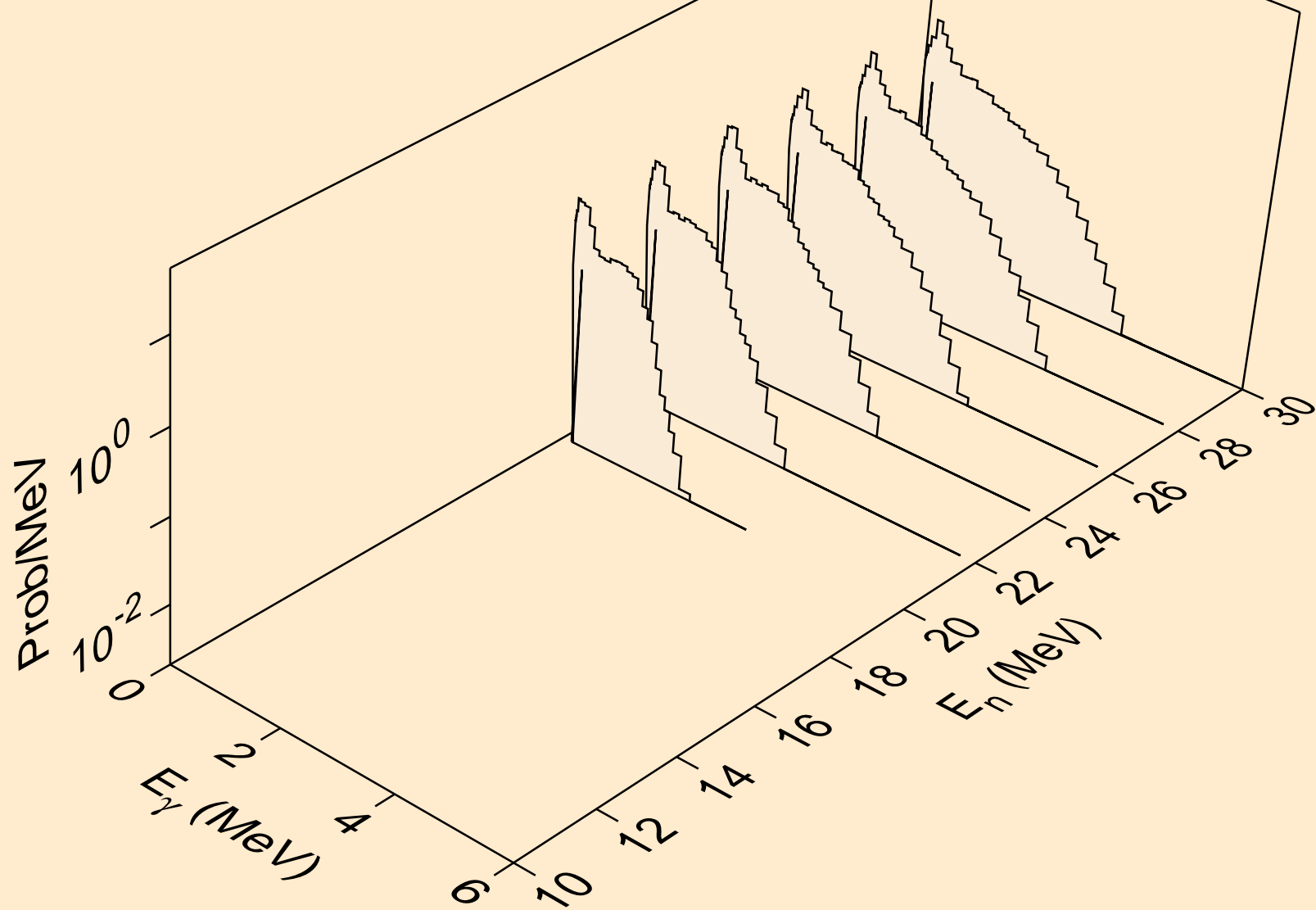

GD163 NEUTRON ACER TENDL-2021 LIBRARY; T=293.6K
Photon emission for (n,a)

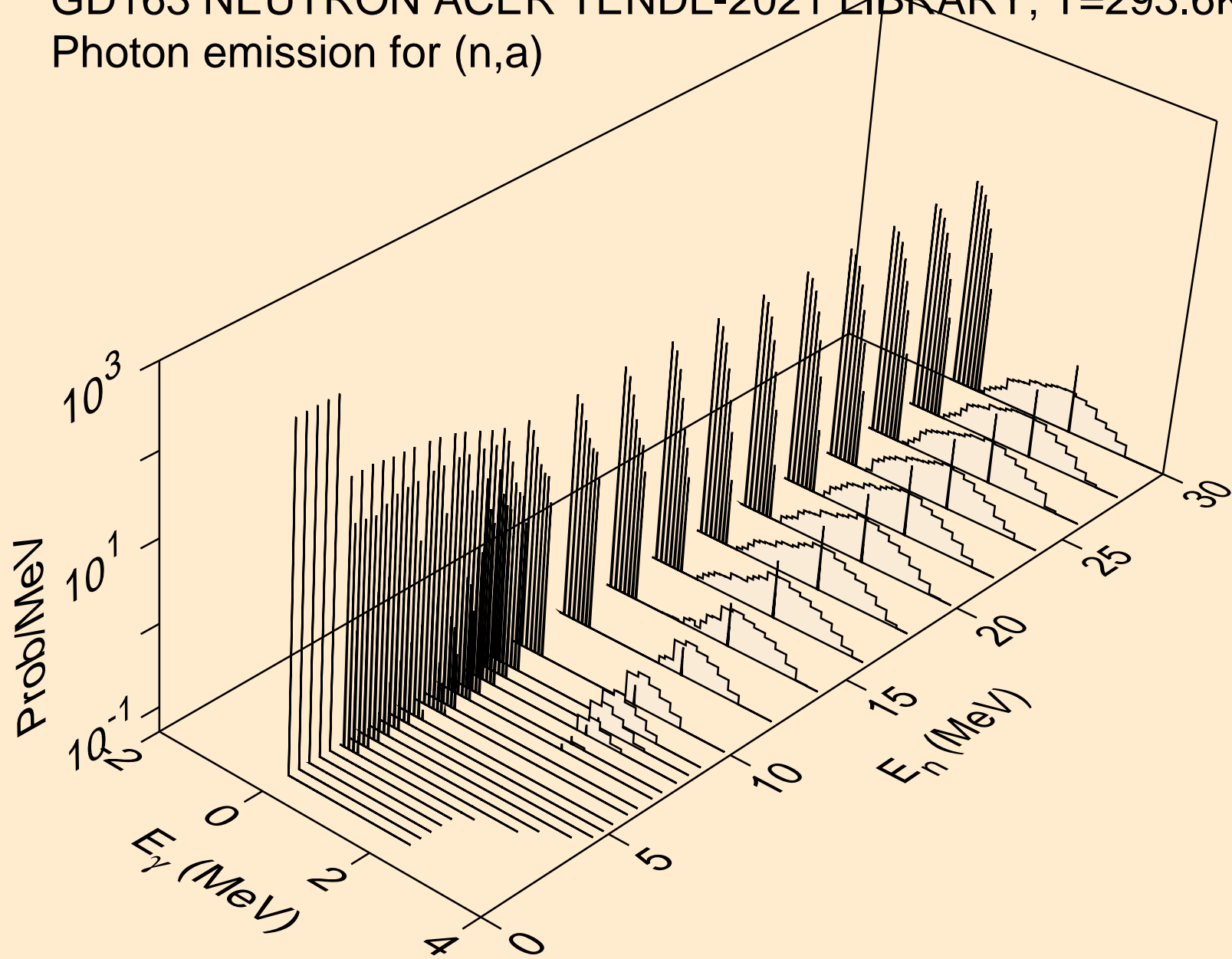

GD163 NEUTRON ACER TENDL-2021 LIBRARY; T=293.6K
Photon emission for (n,2p)

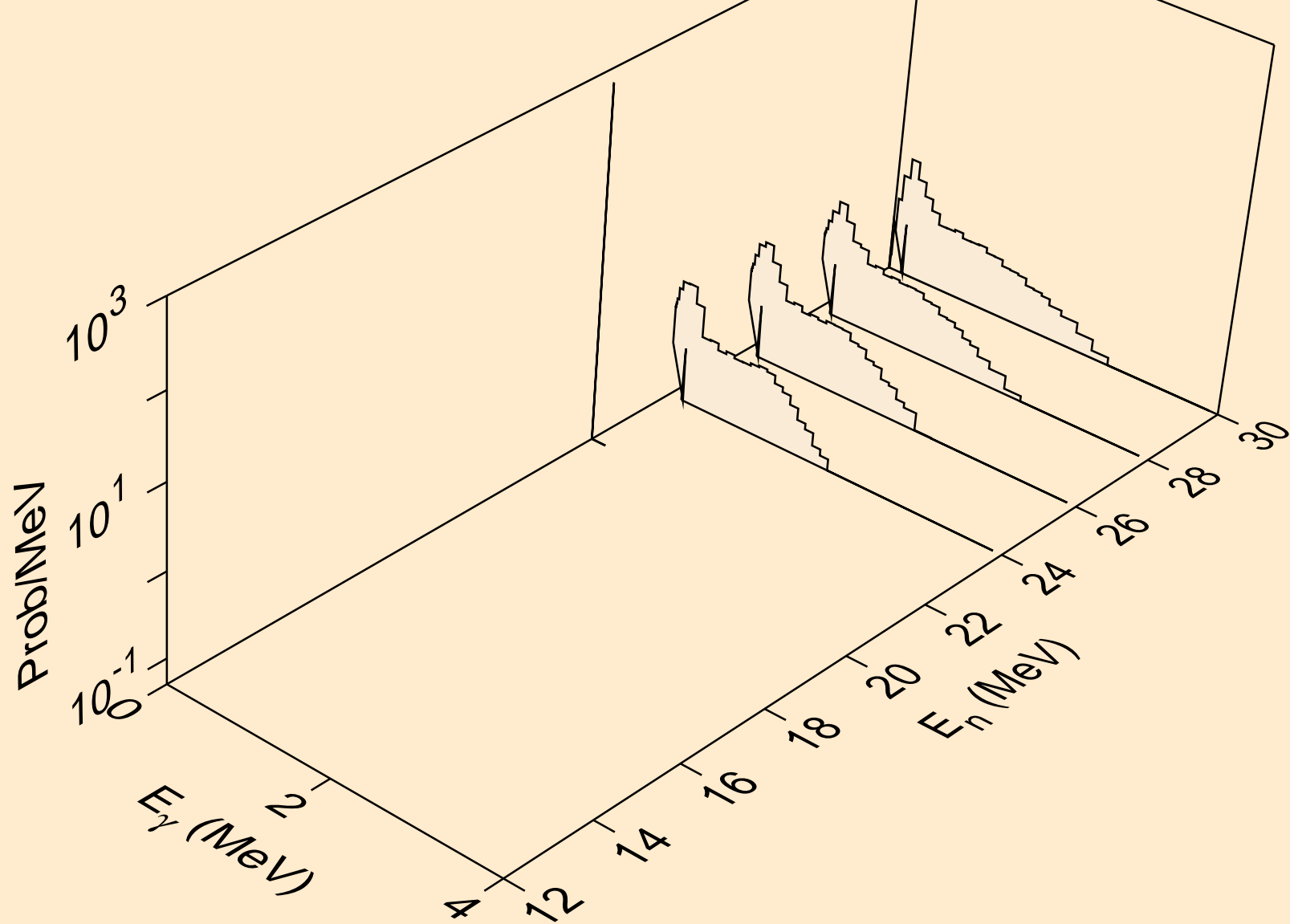

GD163 NEUTRON ACER TENDL-2021 LIBRARY; T=293.6K
thermal capture photon spectrum

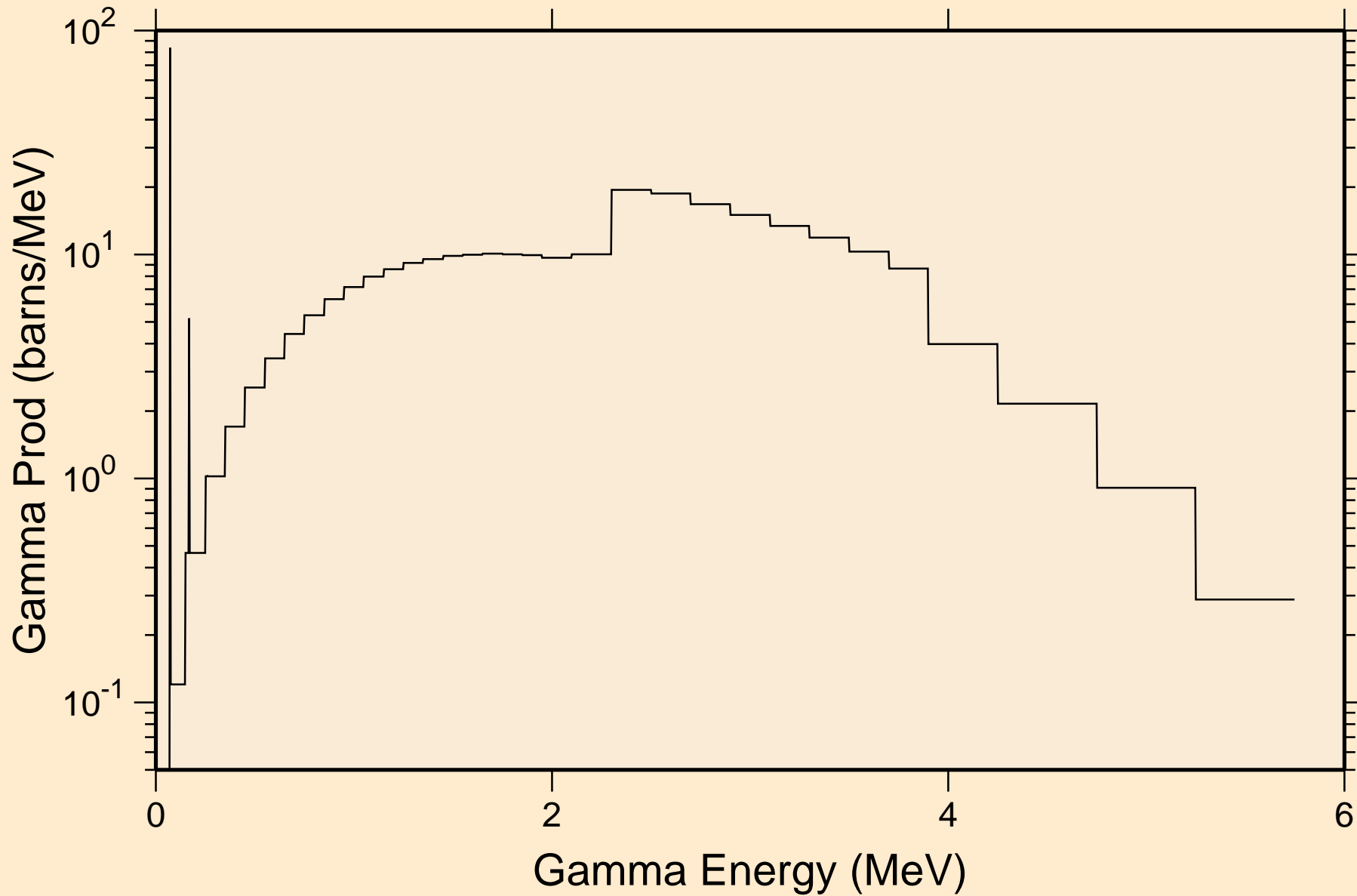

GD163 NEUTRON ACER TENDL-2021 LIBRARY; T=293.6K
14 MeV photon spectrum

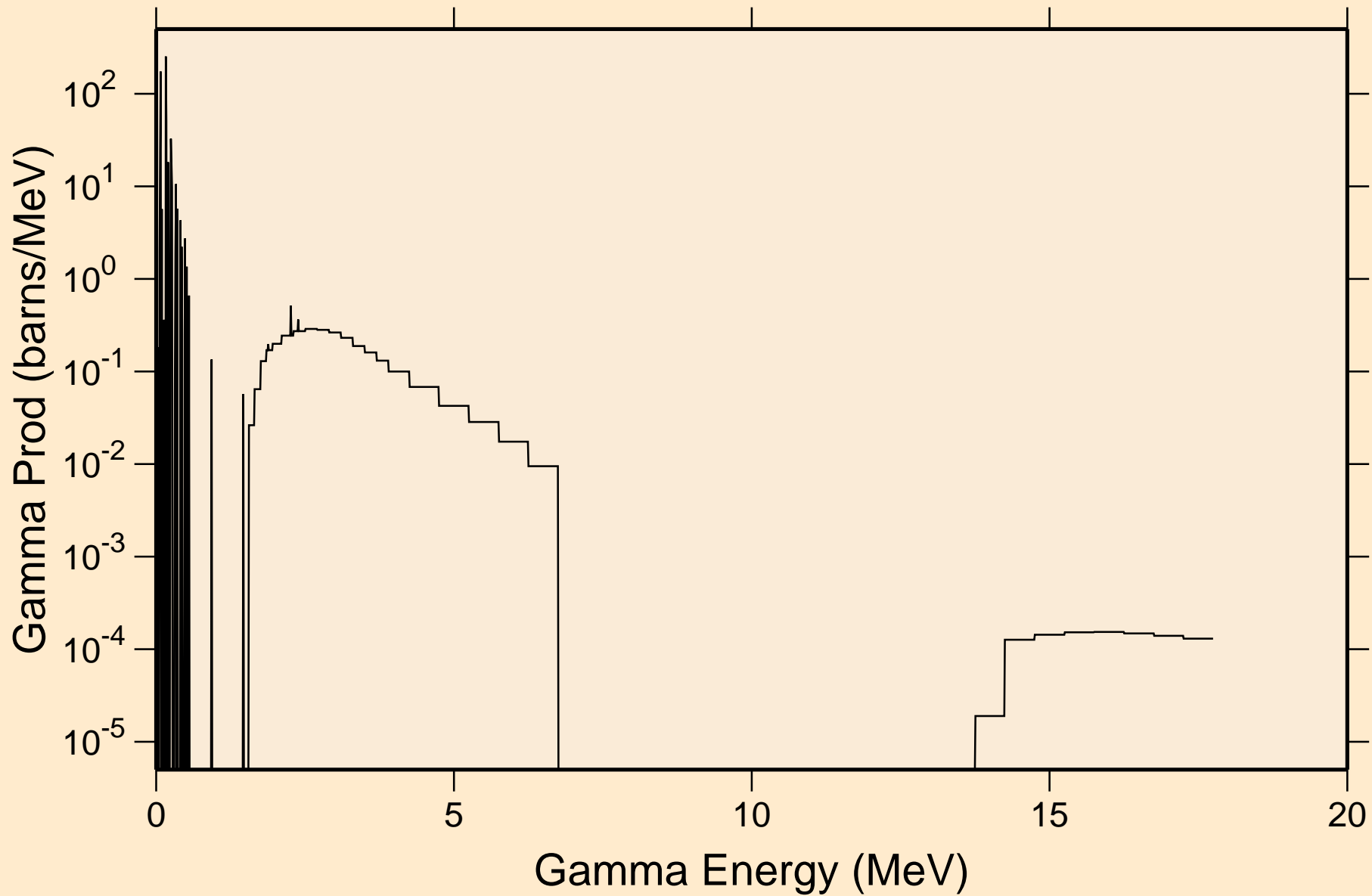

GD163 NEUTRON ACER TENDL-2021 LIBRARY; T=293.6K
Particle heating contributions

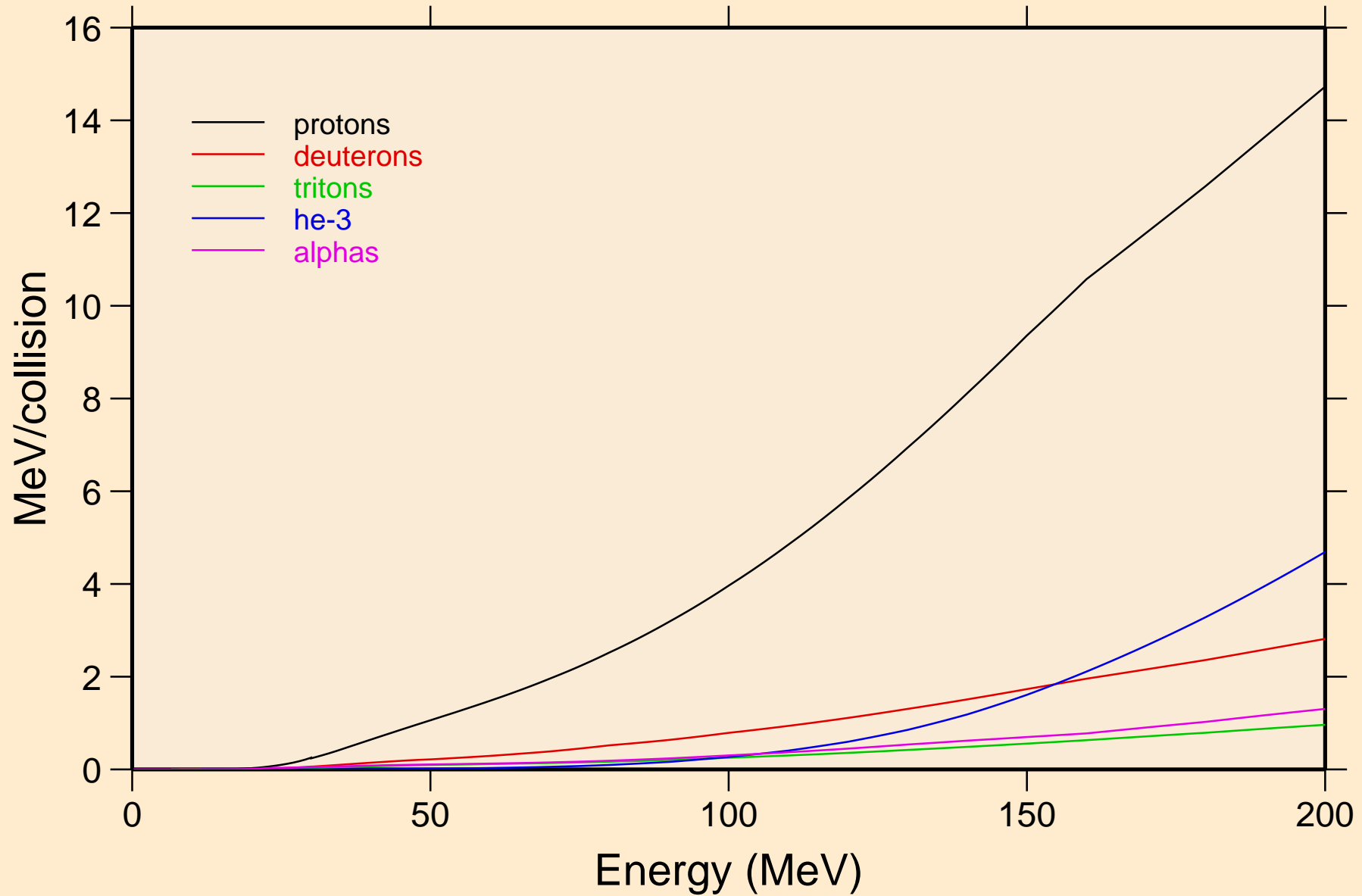

GD163 NEUTRON ACER TENDL-2021 LIBRARY; T=293.6K
Recoil Heating

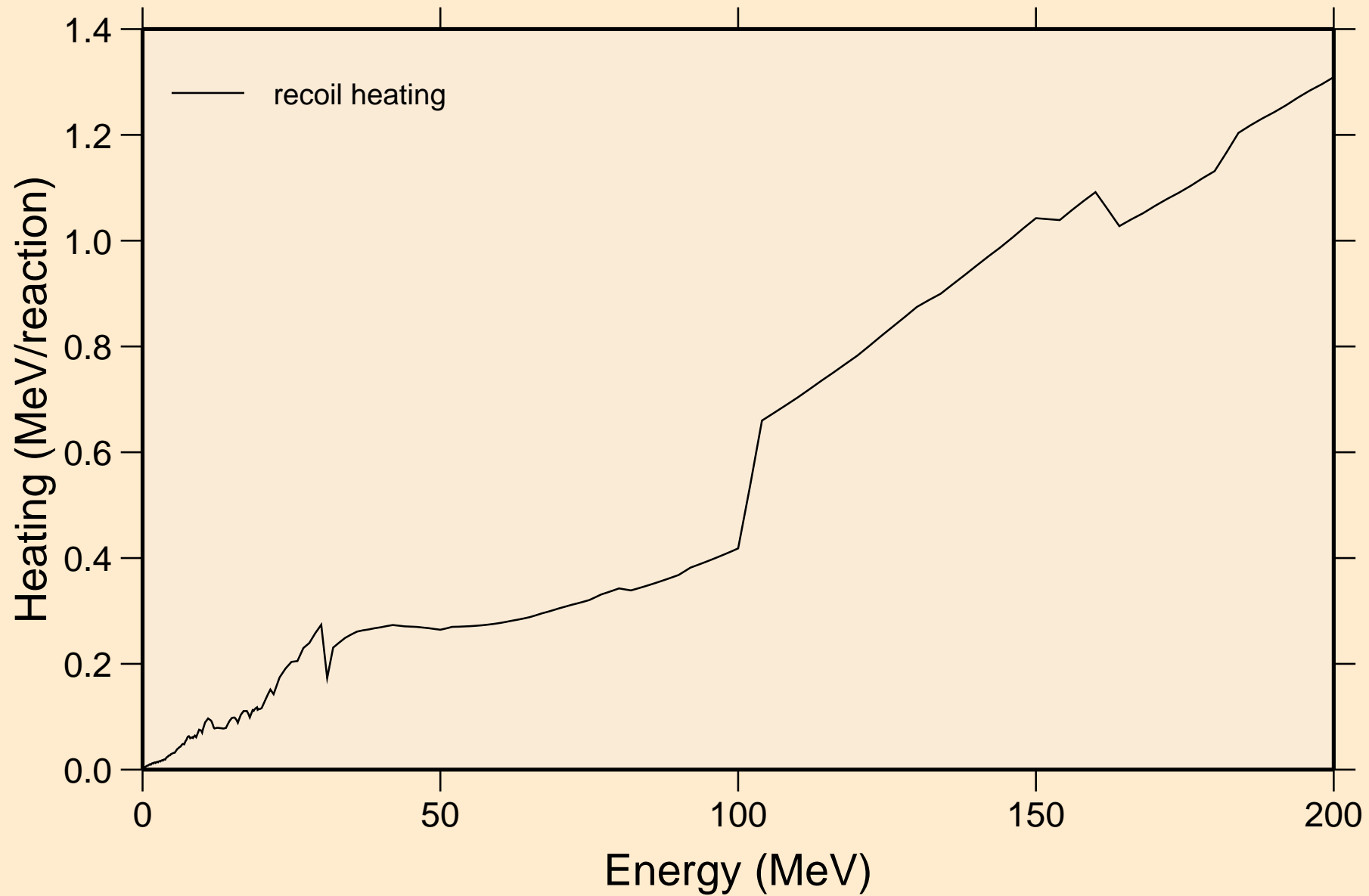

GD163 NEUTRON ACER TENDL-2021 LIBRARY; T=293.6K
Particle production cross sections

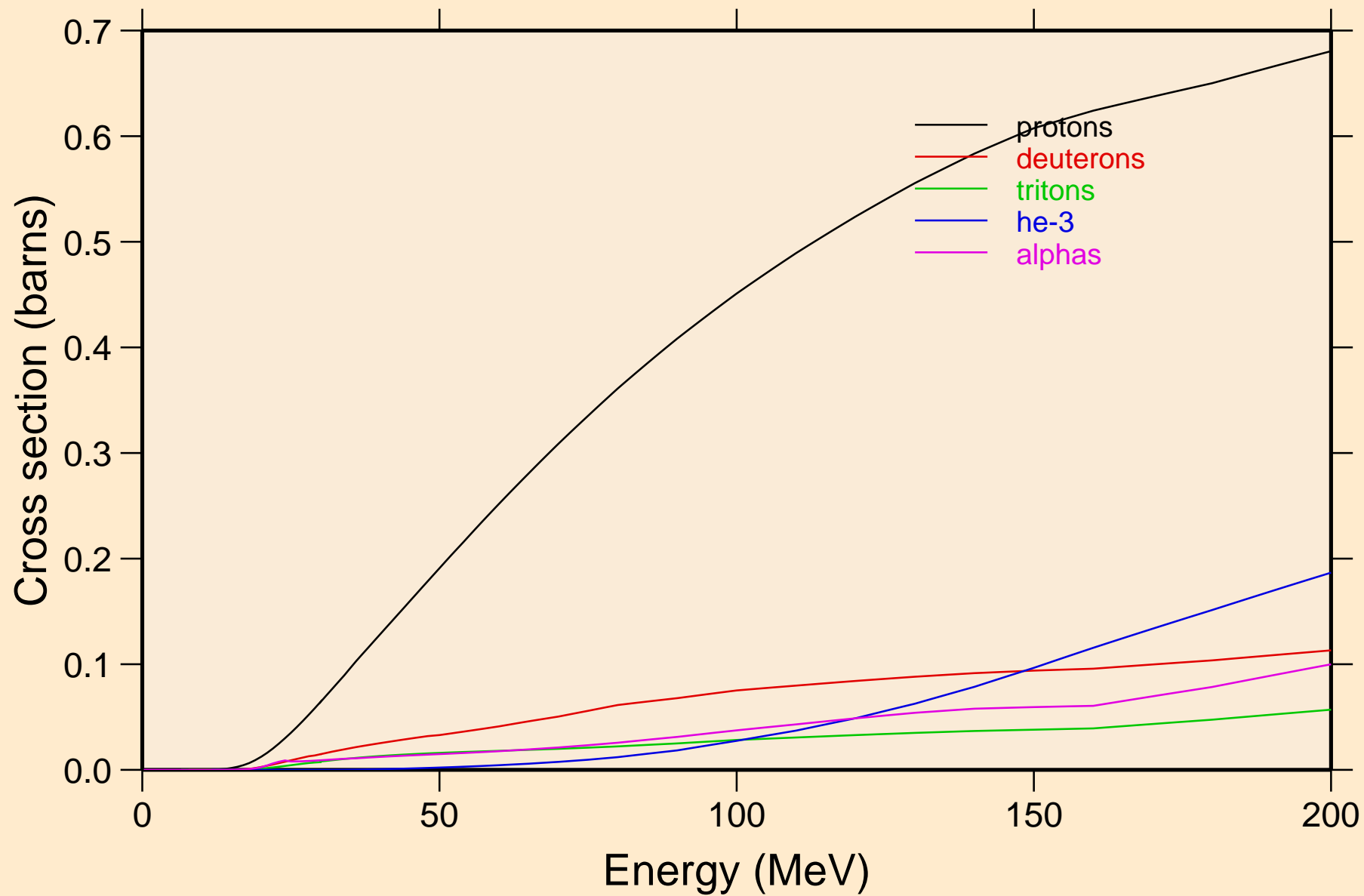

GD163 NEUTRON ACER TENDL-2021 LIBRARY; T=293.6K
protons from (n,x)

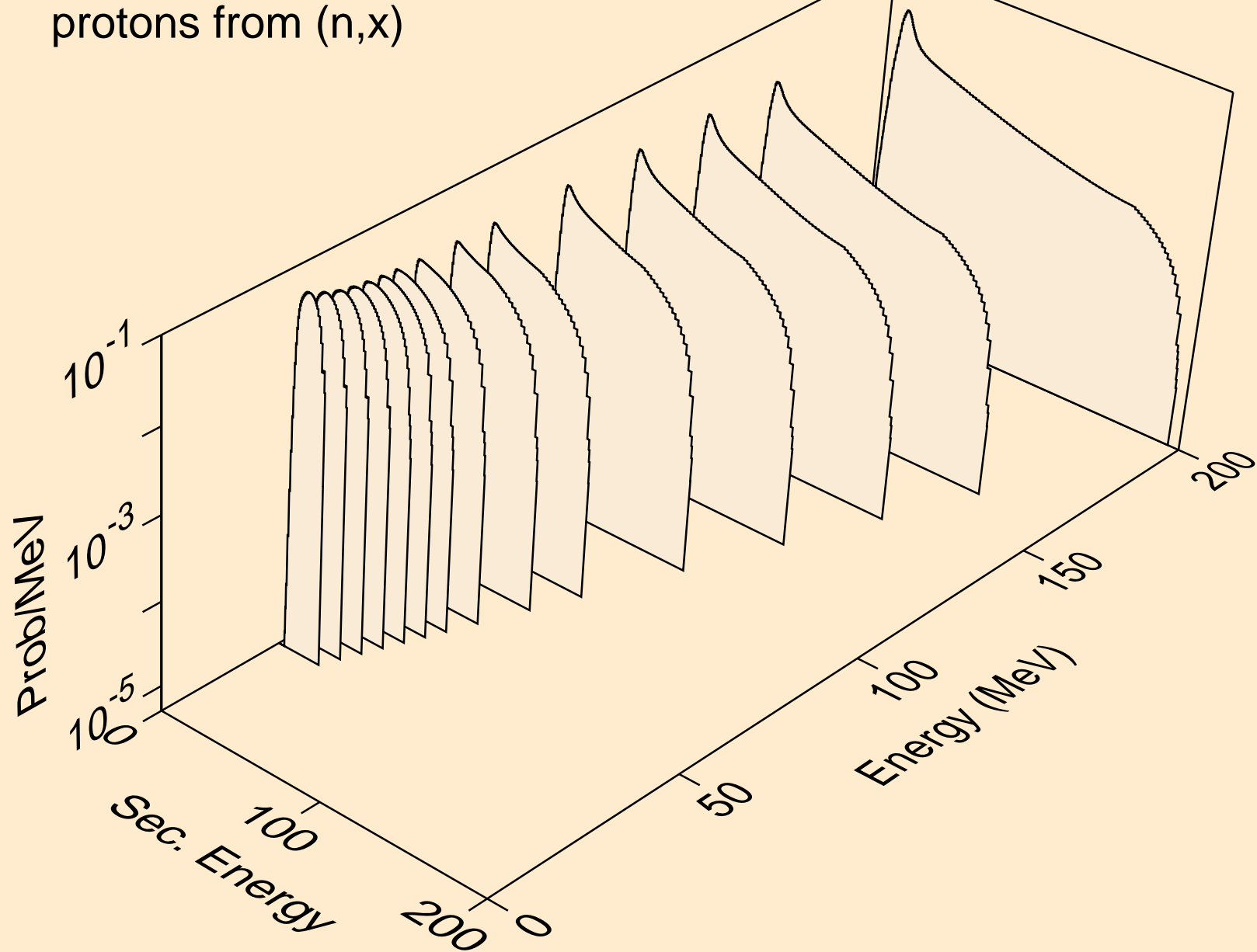

GD163 NEUTRON ACER TENDL-2021 LIBRARY; T=293.6K
protons from (n,n*)p

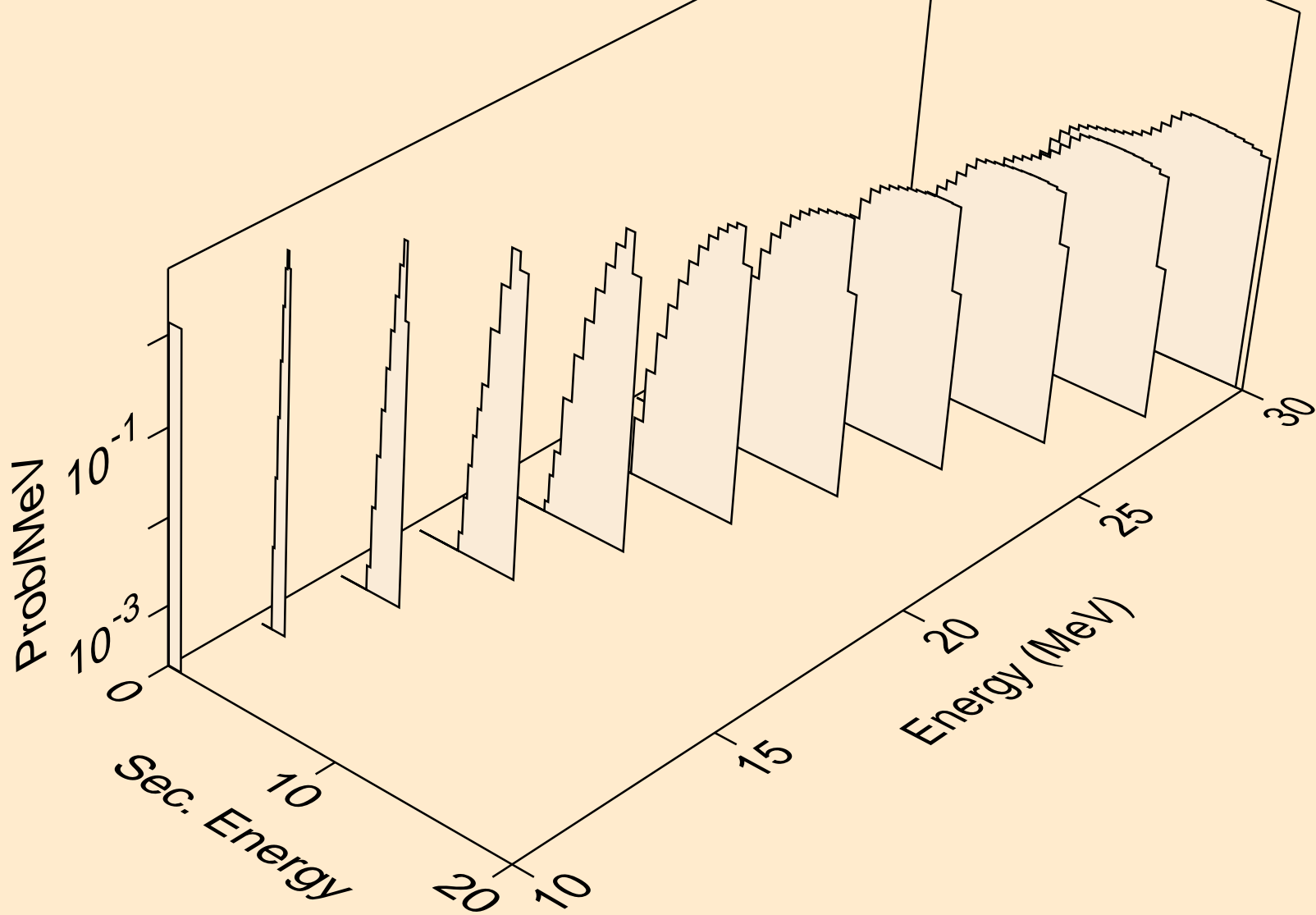

GD163 NEUTRON ACER TENDL-2021 LIBRARY; T=293.6K
protons from (n,2np)

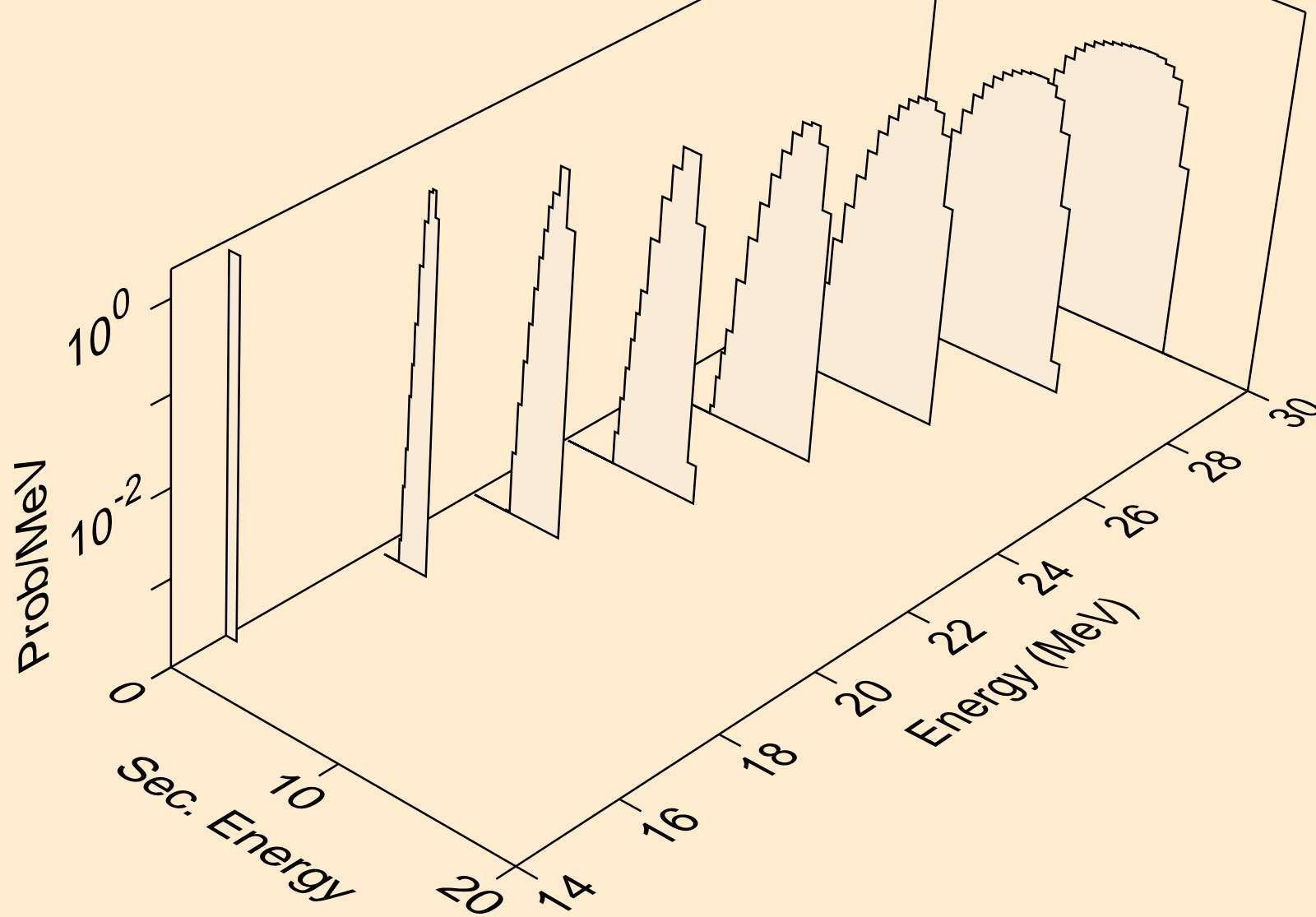

GD163 NEUTRON ACER TENDL-2021 LIBRARY; T=293.6K
protons from (n,3np)

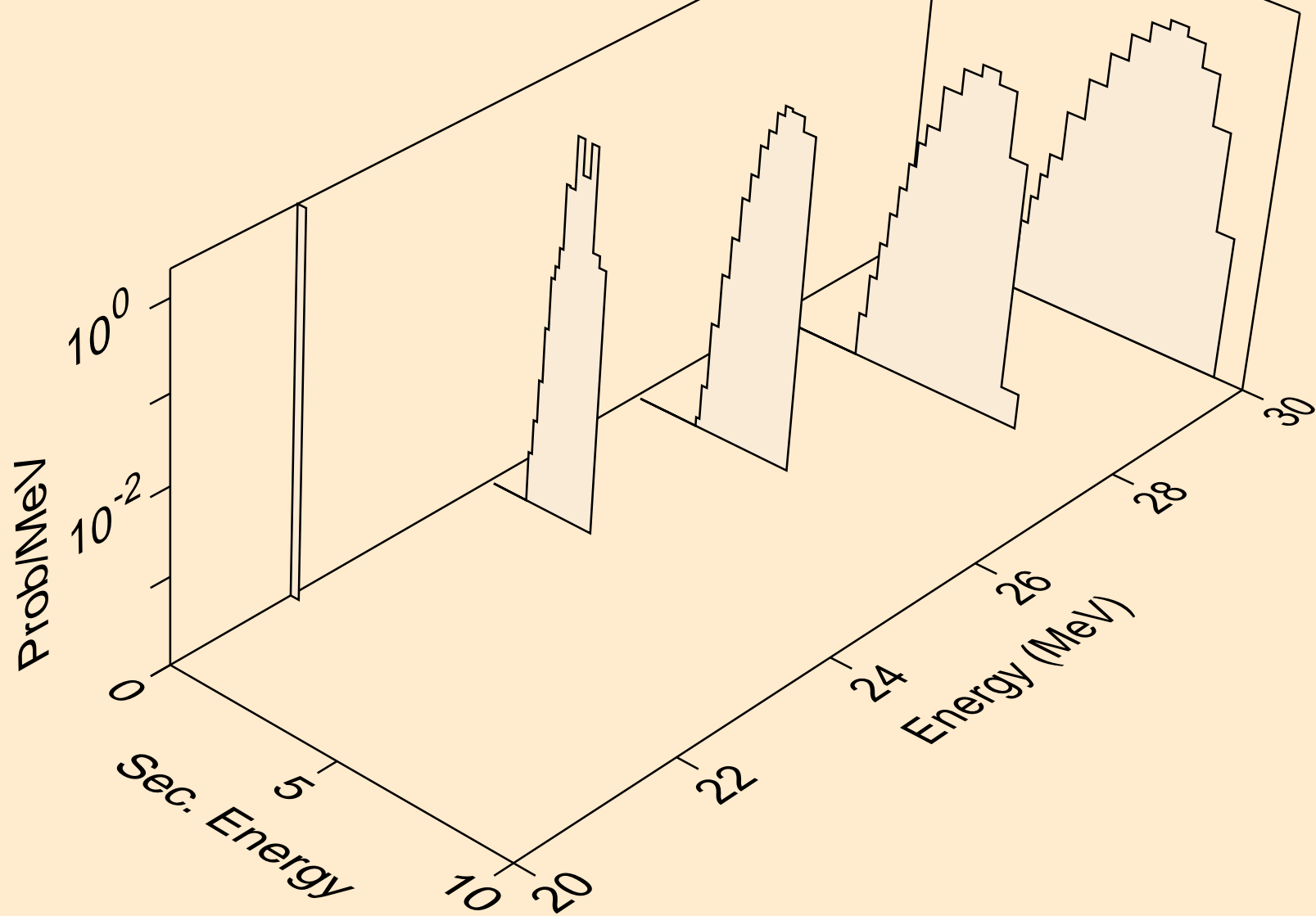

GD163 NEUTRON ACER TENDL-2021 LIBRARY; T=293.6K
protons from (n,p)

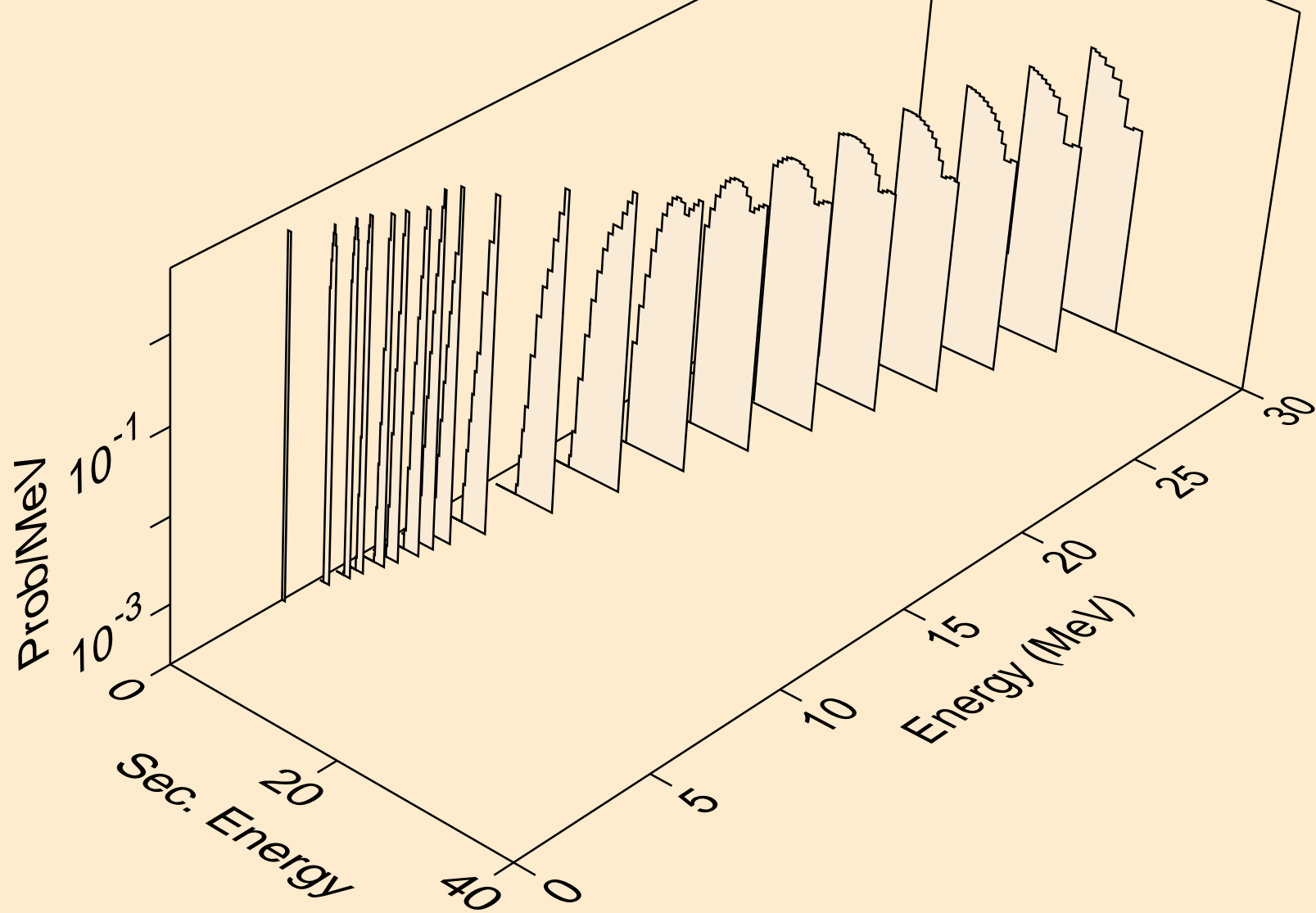

GD163 NEUTRON ACER TENDL-2021 LIBRARY; T=293.6K
protons from (n,2p)

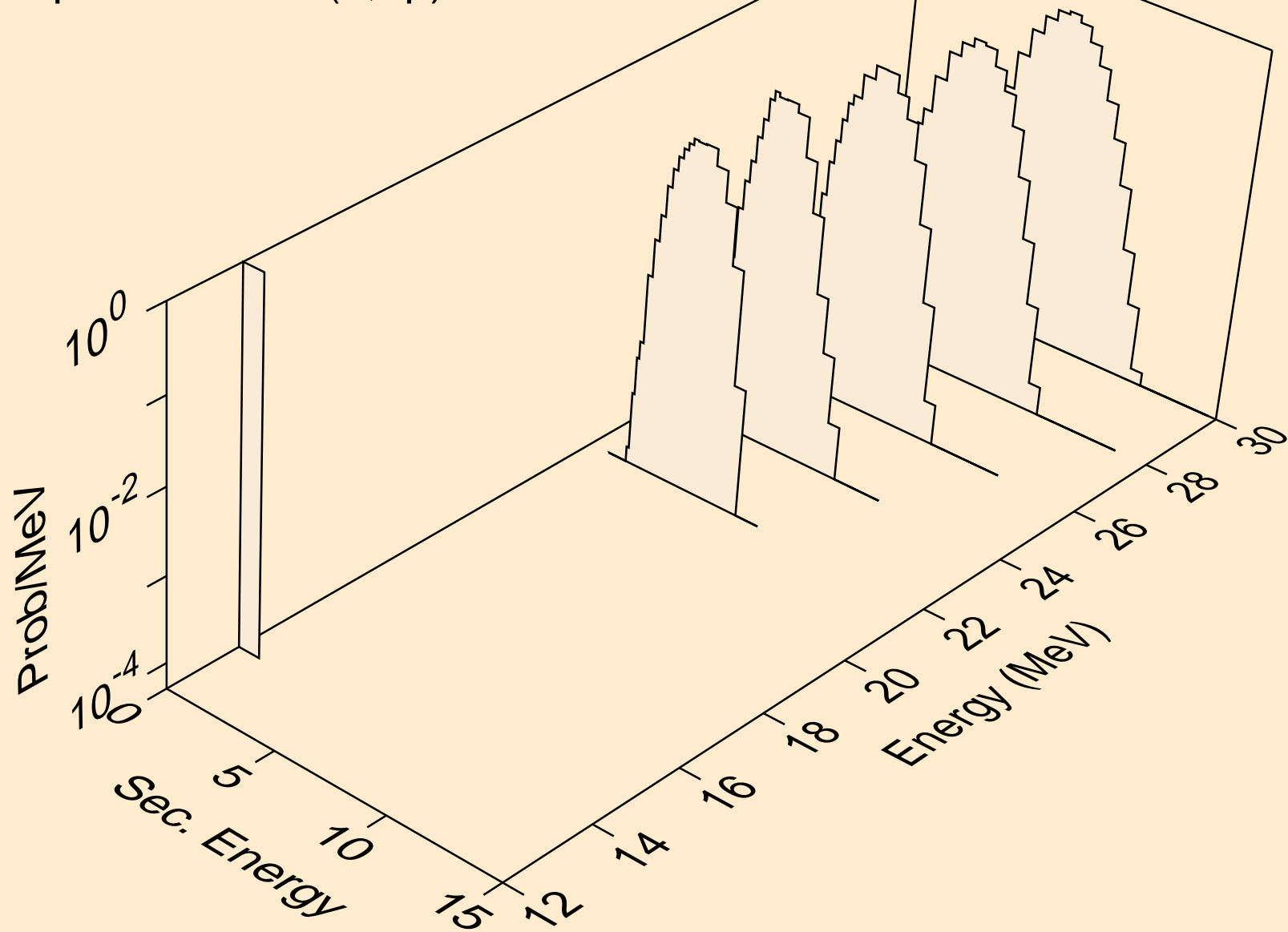

GD163 NEUTRON ACER TENDL-2021 LIBRARY; T=293.6K
deuterons from (n,x)

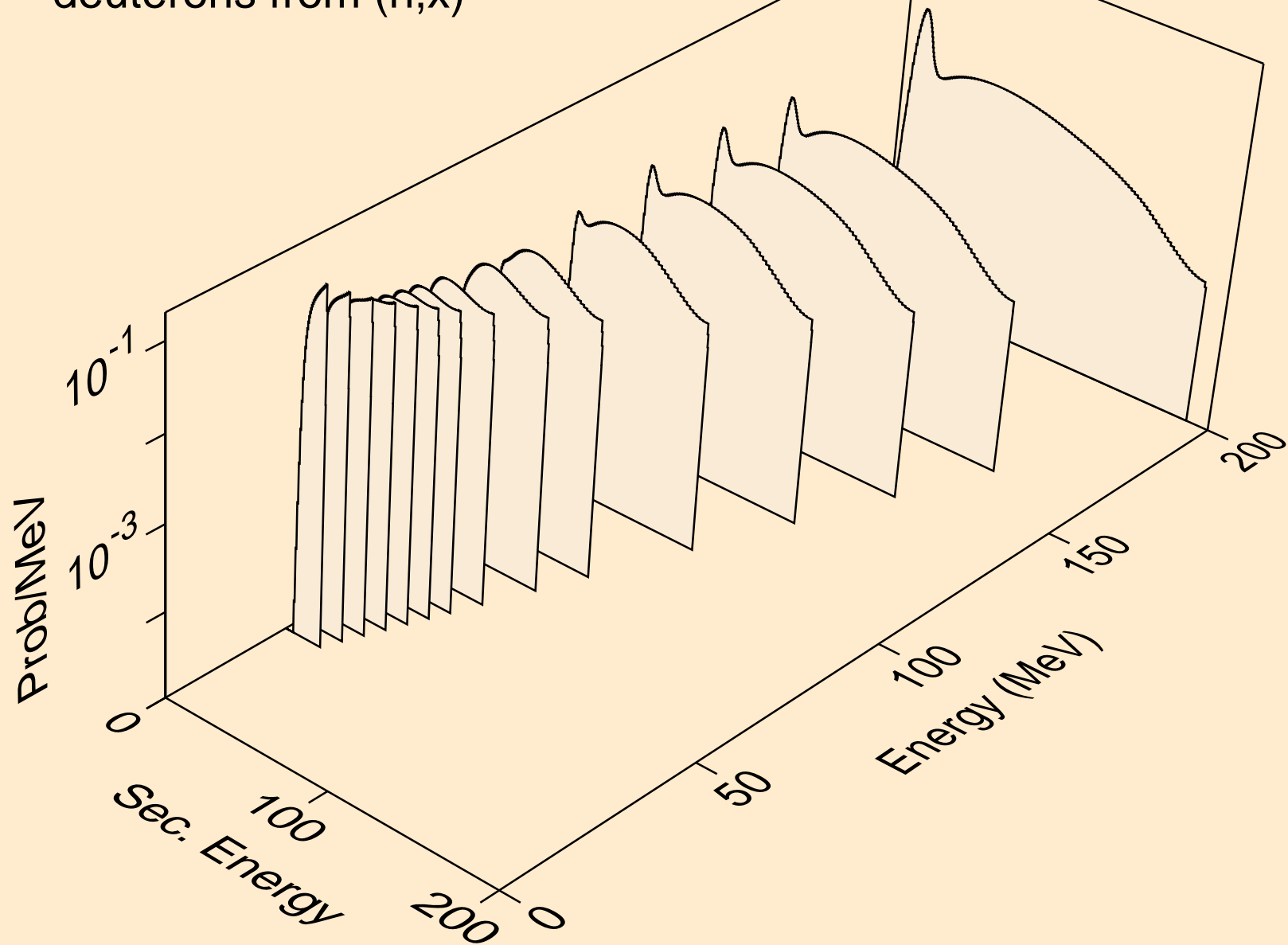

GD163 NEUTRON ACER TENDL-2021 LIBRARY; T=293.6K
deuterons from (n,2nd)

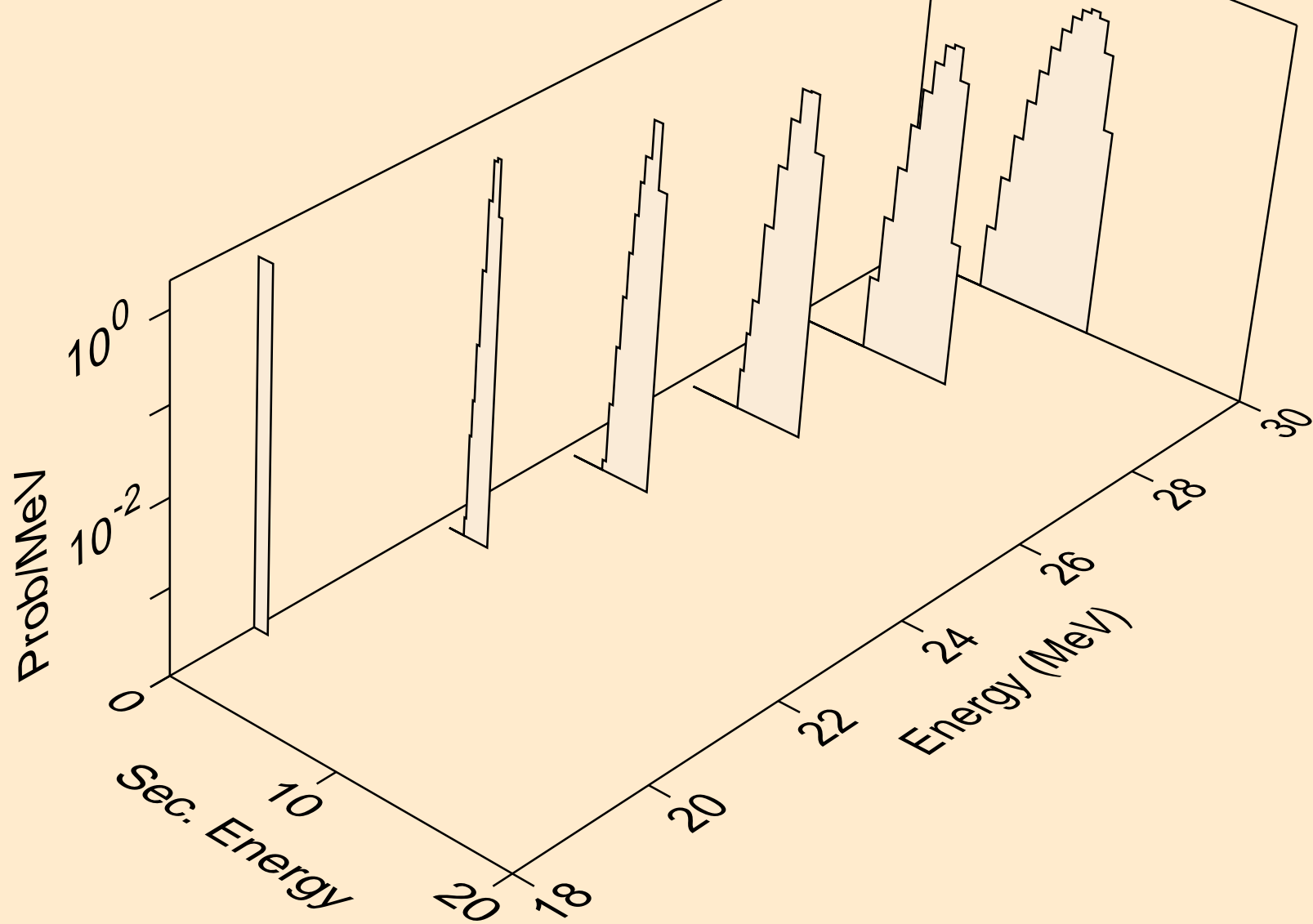

GD163 NEUTRON ACER TENDL-2021 LIBRARY; T=293.6K
deuterons from (n,n*)d

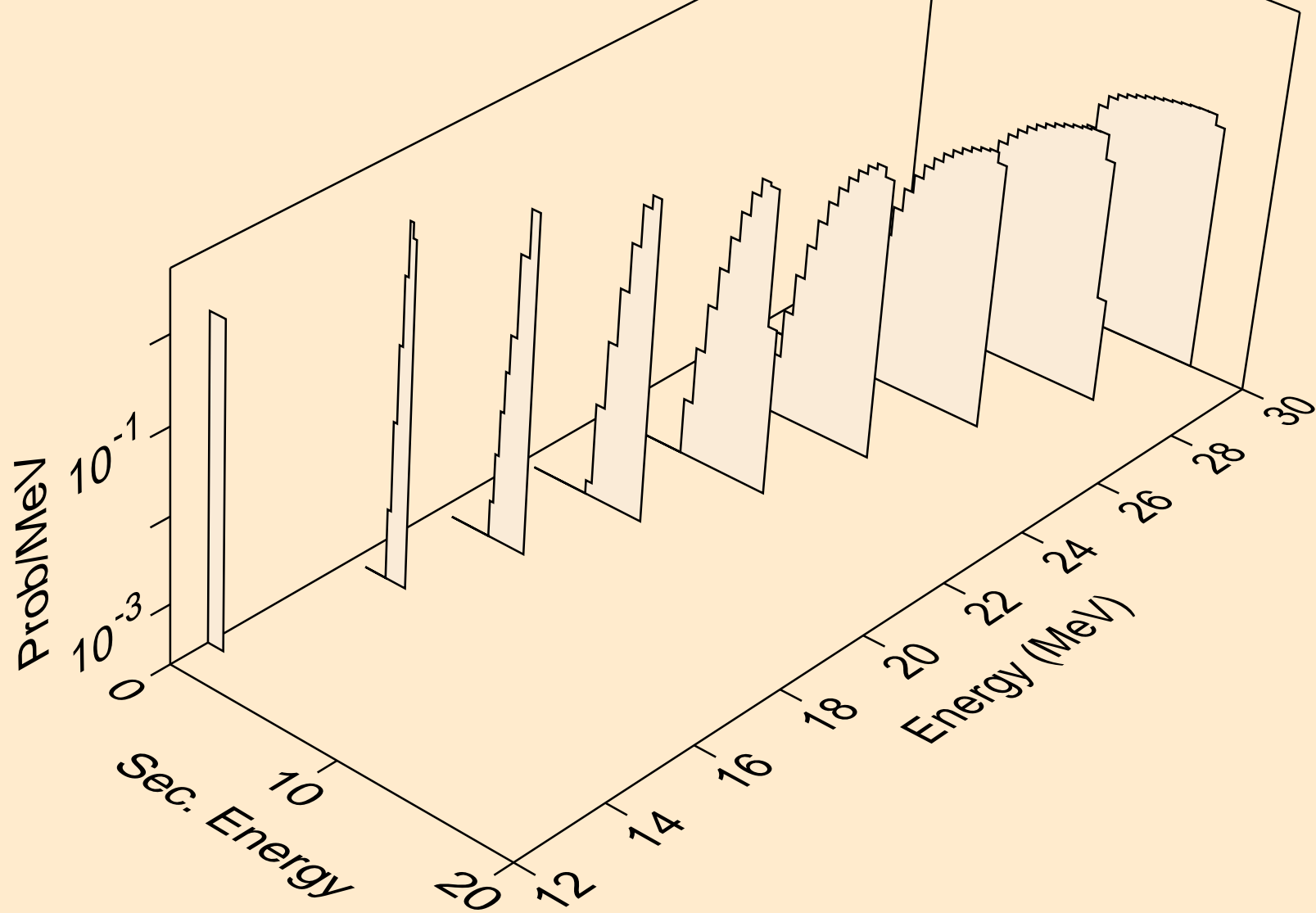

GD163 NEUTRON ACER TENDL-2021 LIBRARY; T=293.6K
deuterons from (n,d)

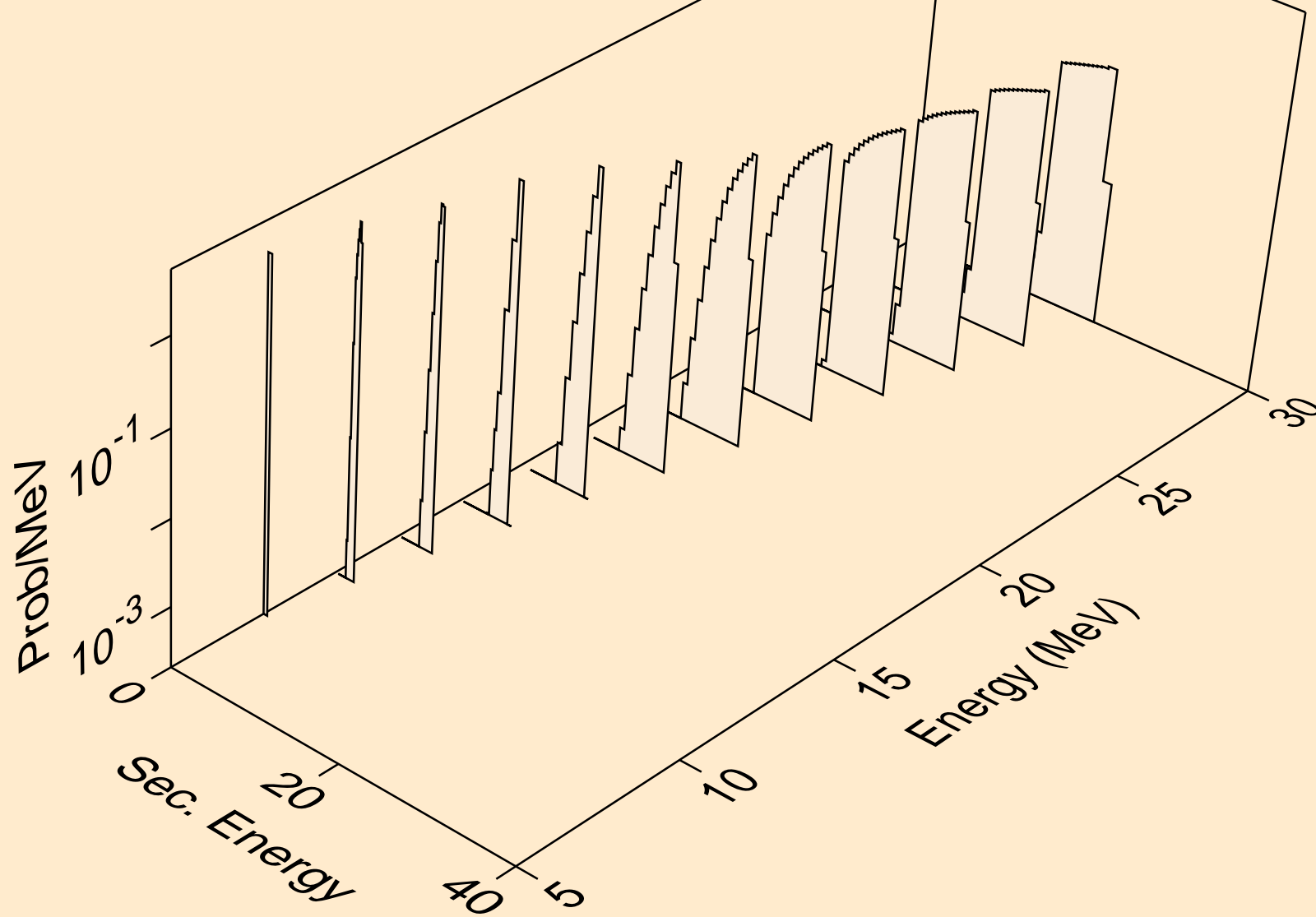

GD163 NEUTRON ACER TENDL-2021 LIBRARY; T=293.6K
tritons from (n,x)

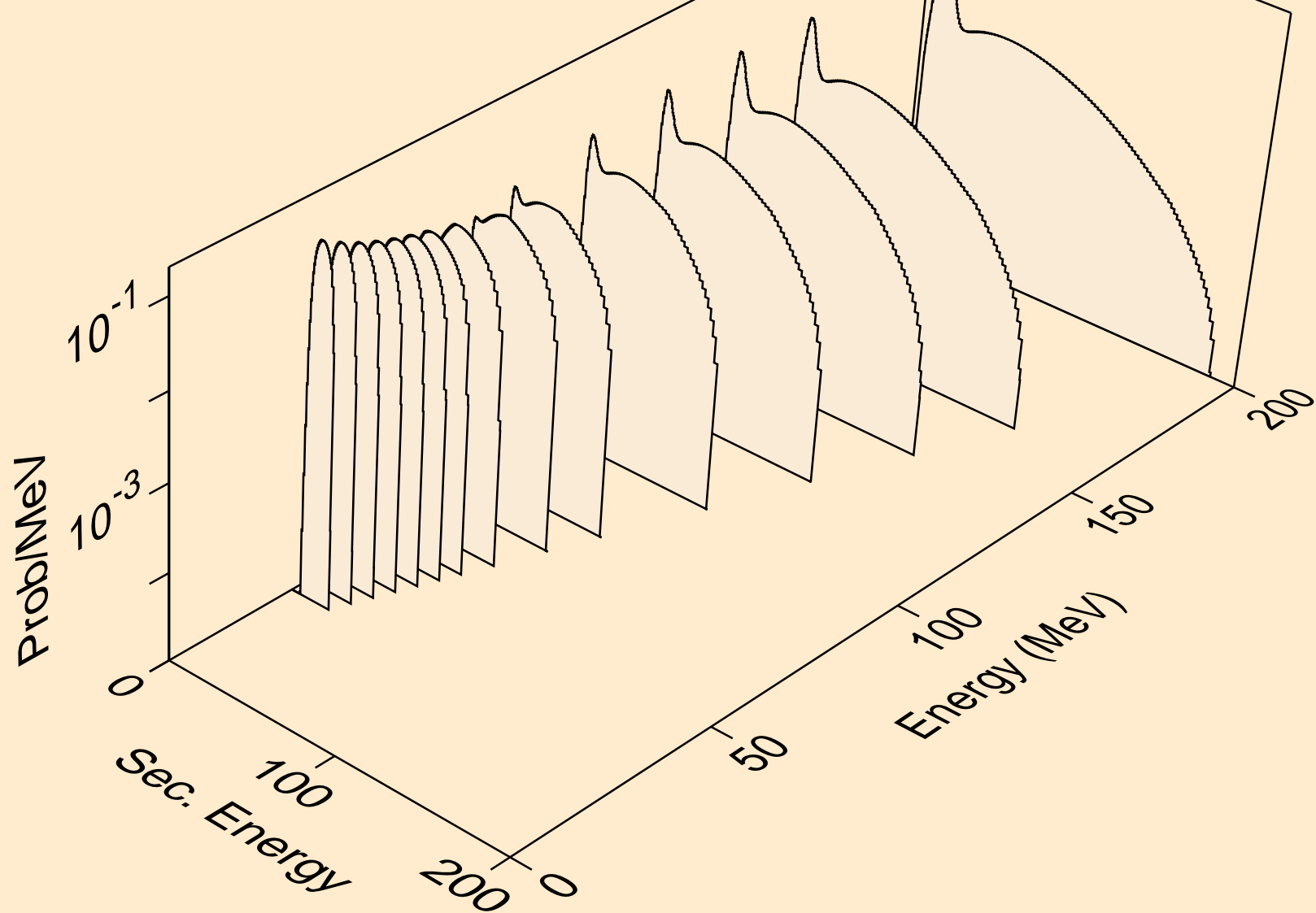

GD163 NEUTRON ACER TENDL-2021 LIBRARY; T=293.6K
tritons from (n,n*)t

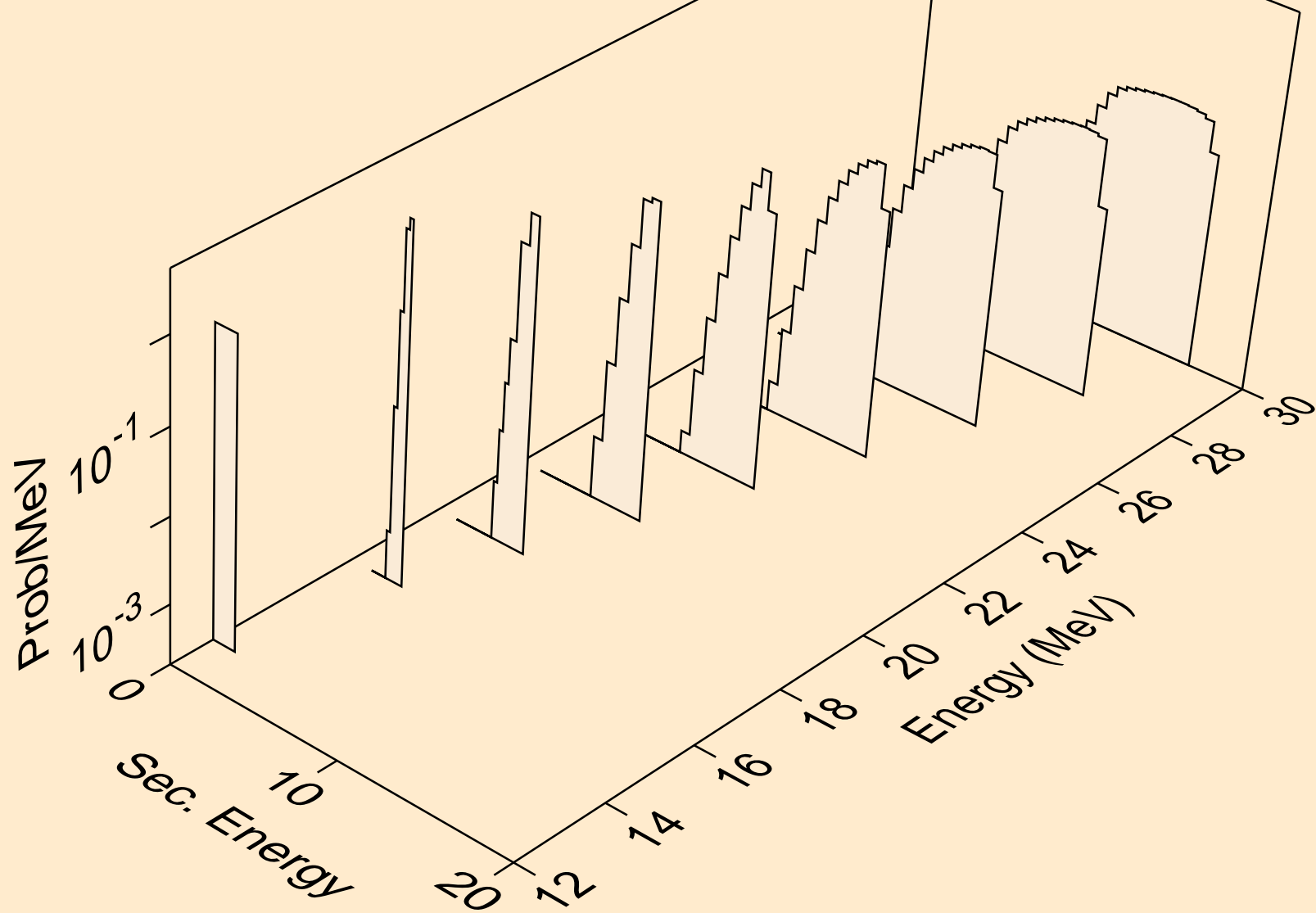

GD163 NEUTRON ACER TENDL-2021 LIBRARY; T=293.6K
tritons from (n,t)

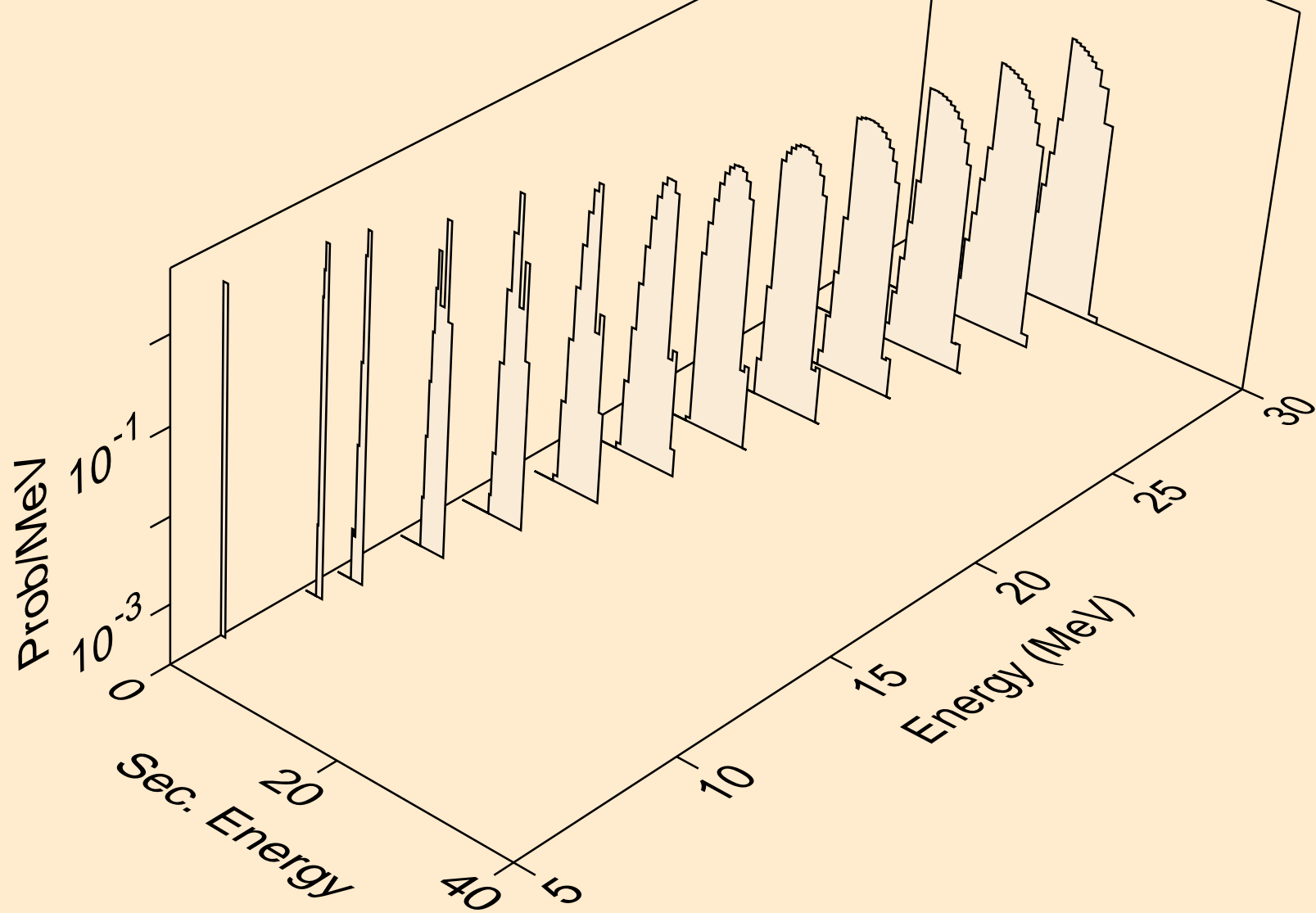

GD163 NEUTRON ACER TENDL-2021 LIBRARY; T=293.6K
he3s from (n,x)

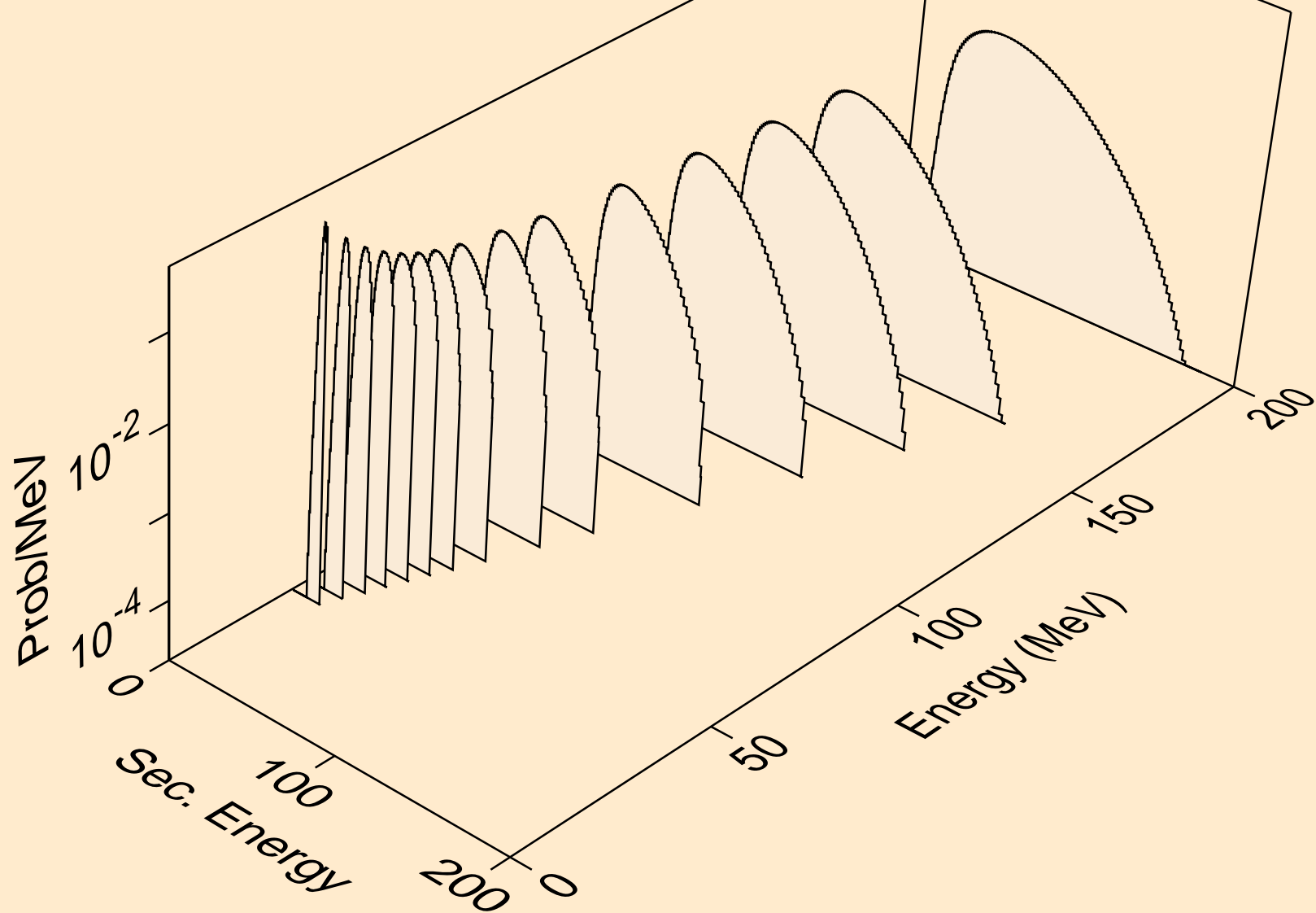

GD163 NEUTRON ACER TENDL-2021 LIBRARY; T=293.6K
he3s from (n,n*)he3

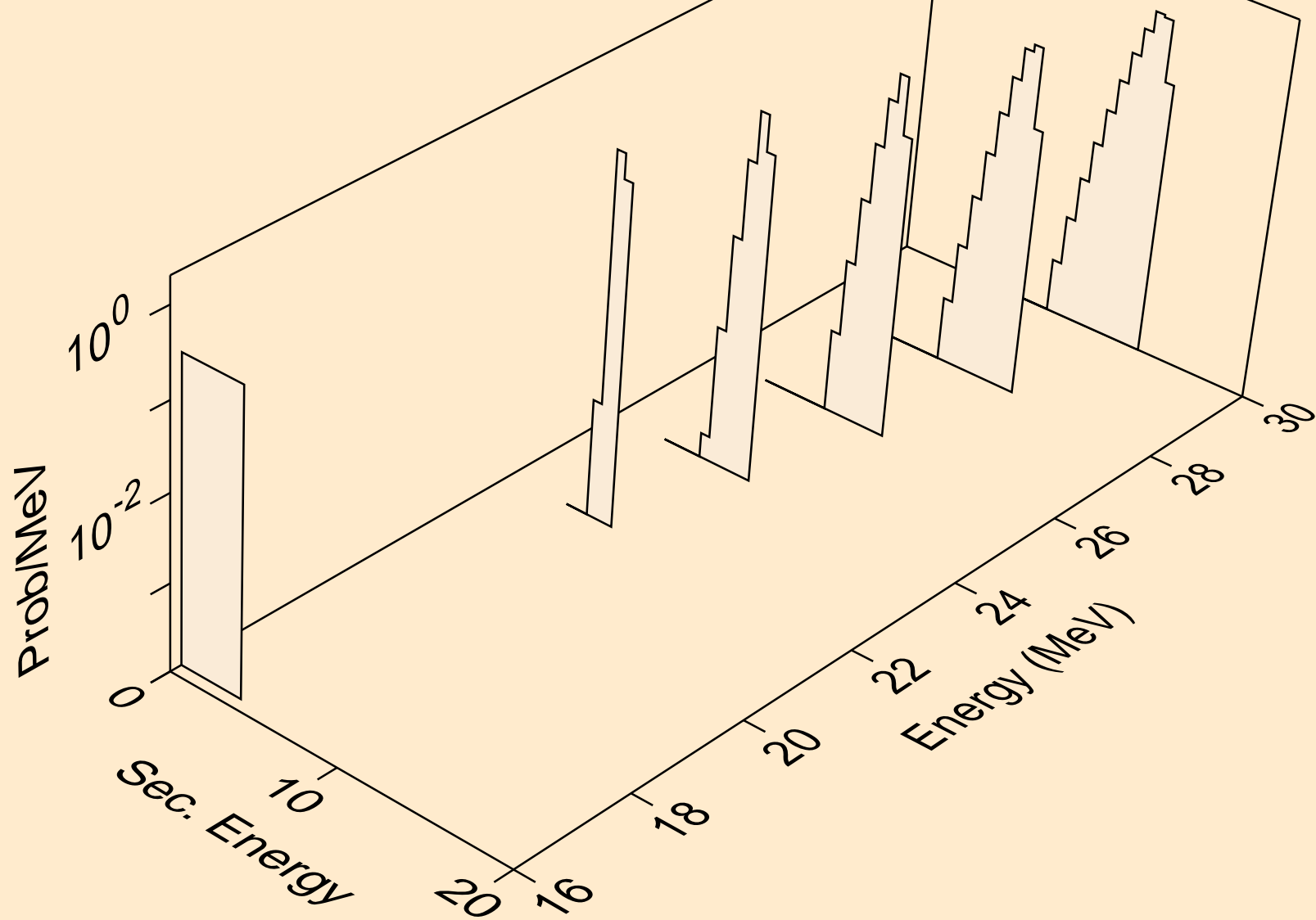

GD163 NEUTRON ACER TENDL-2021 LIBRARY; T=293.6K
he3s from (n,he3)

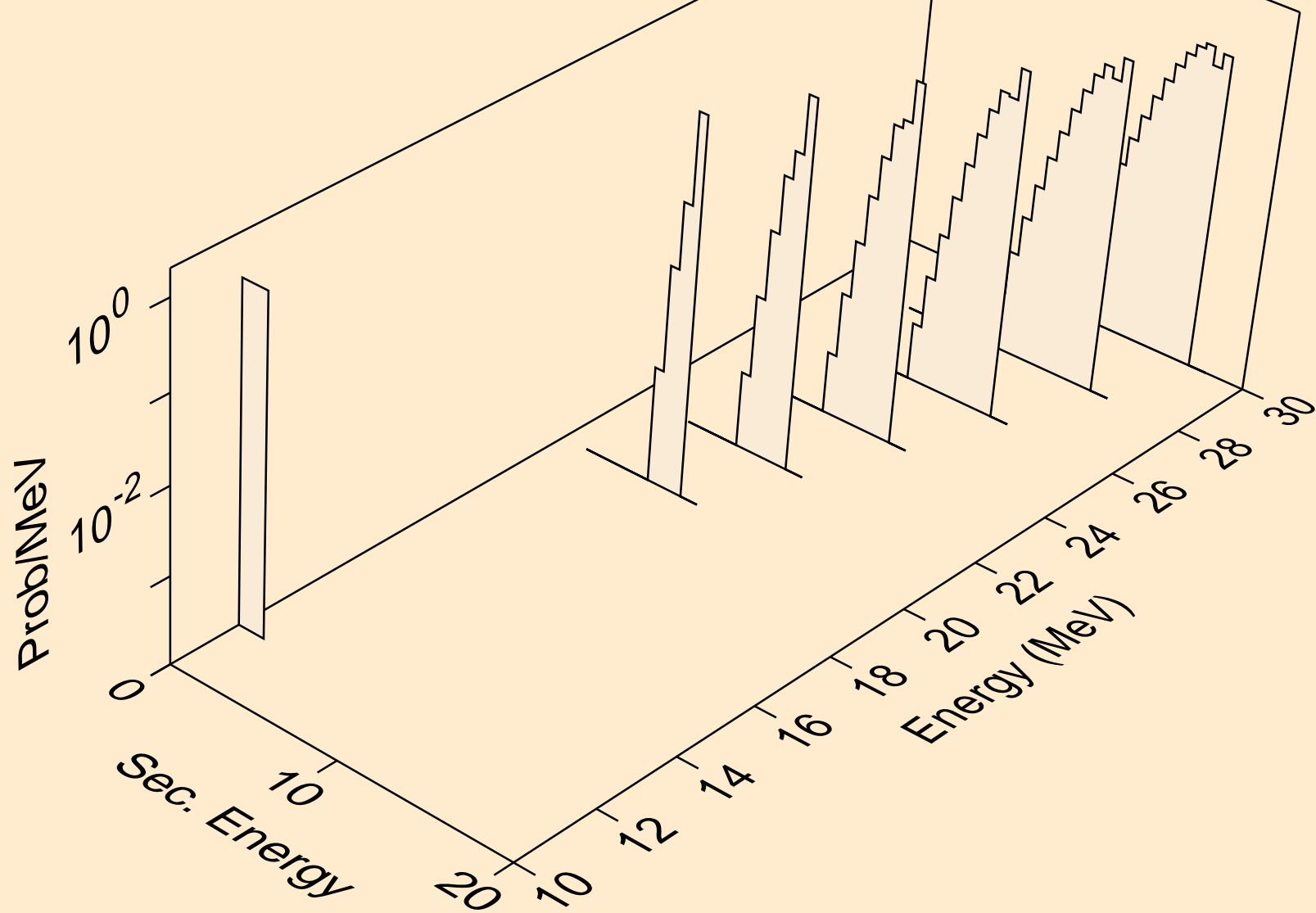

GD163 NEUTRON ACER TENDL-2021 LIBRARY; T=293.6K
alphas from (n,x)

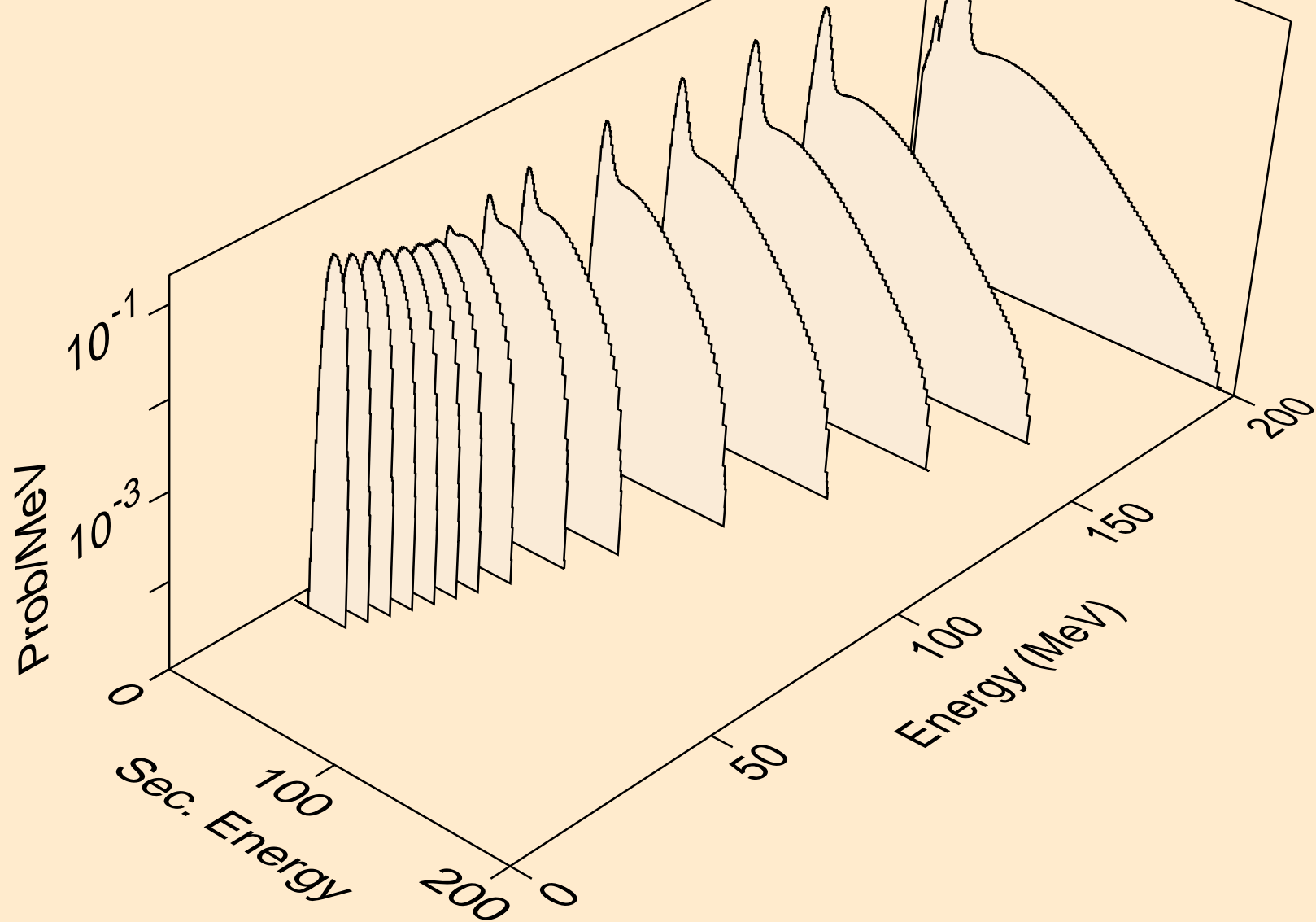

GD163 NEUTRON ACER TENDL-2021 LIBRARY; T=293.6K
alphas from (n,n*)a

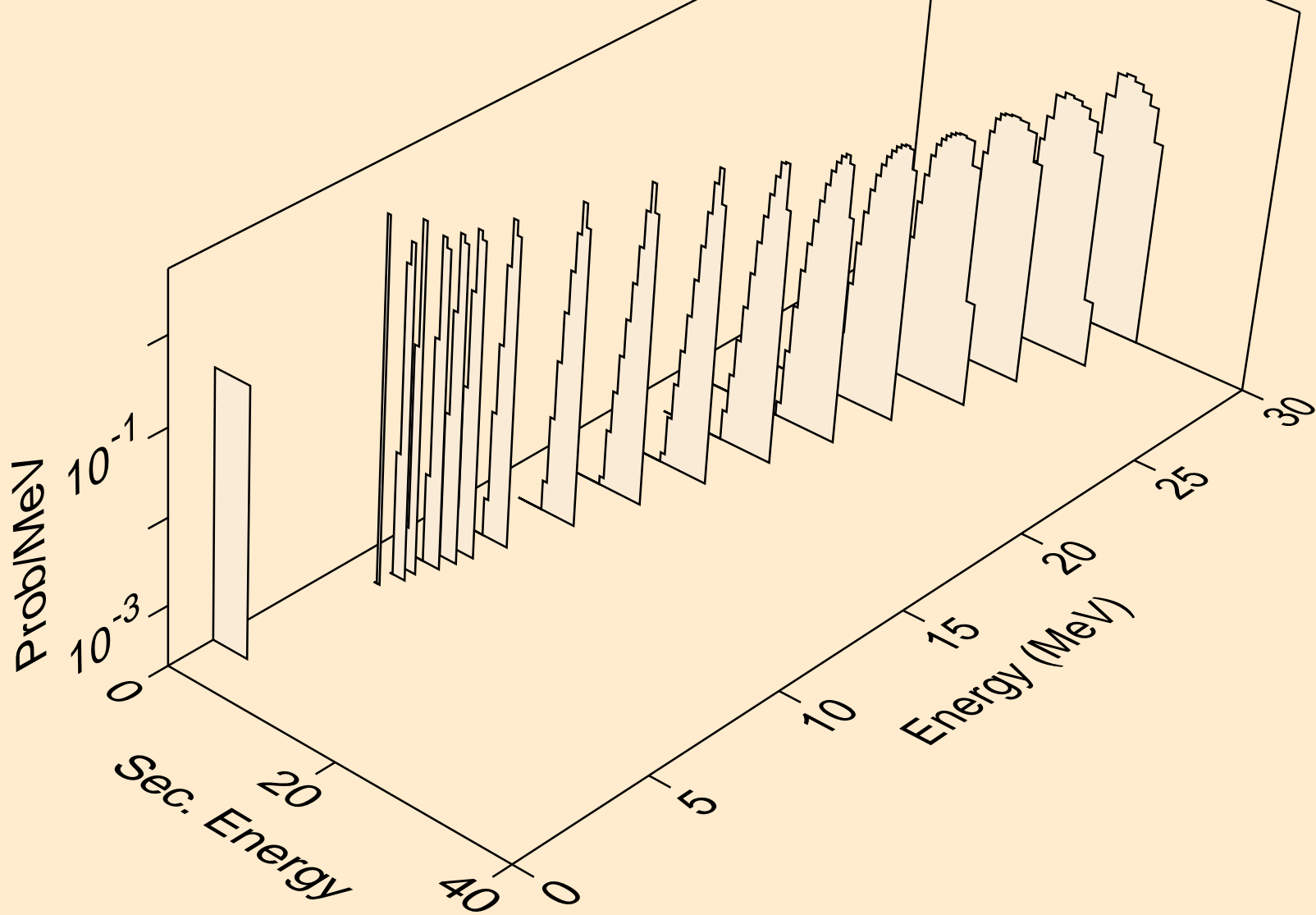

GD163 NEUTRON ACER TENDL-2021 LIBRARY; T=293.6K
alphas from (n,2n)a

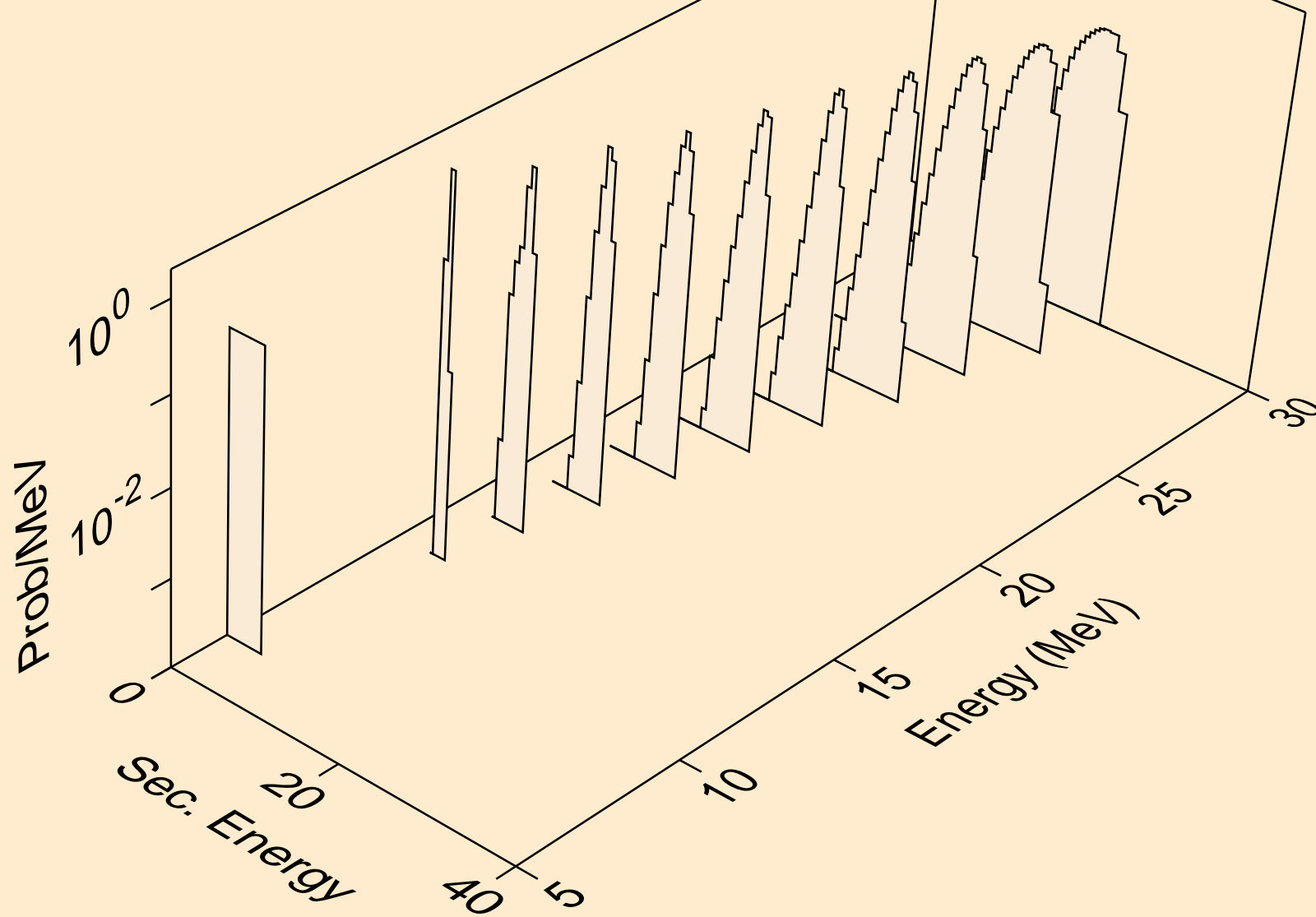

GD163 NEUTRON ACER TENDL-2021 LIBRARY; T=293.6K
alphas from (n,3n)a

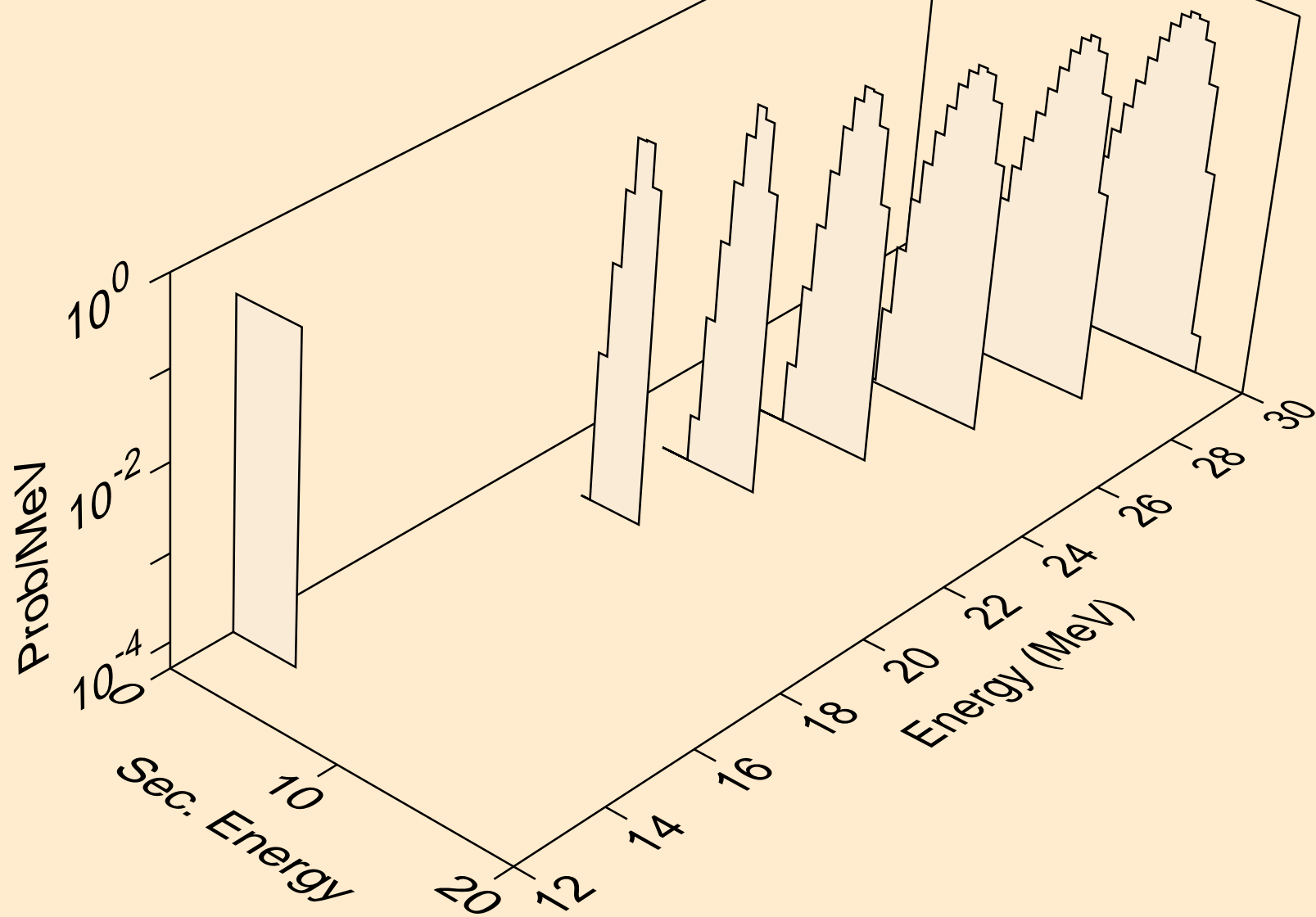

GD163 NEUTRON ACER TENDL-2021 LIBRARY; T=293.6K
alphas from (n,a)

